

ANC

POPULAR MECHANICS

MAGAZINE

WRITTEN SO YOU CAN UNDERSTAND IT

REG. U.S. PAT. OFF.

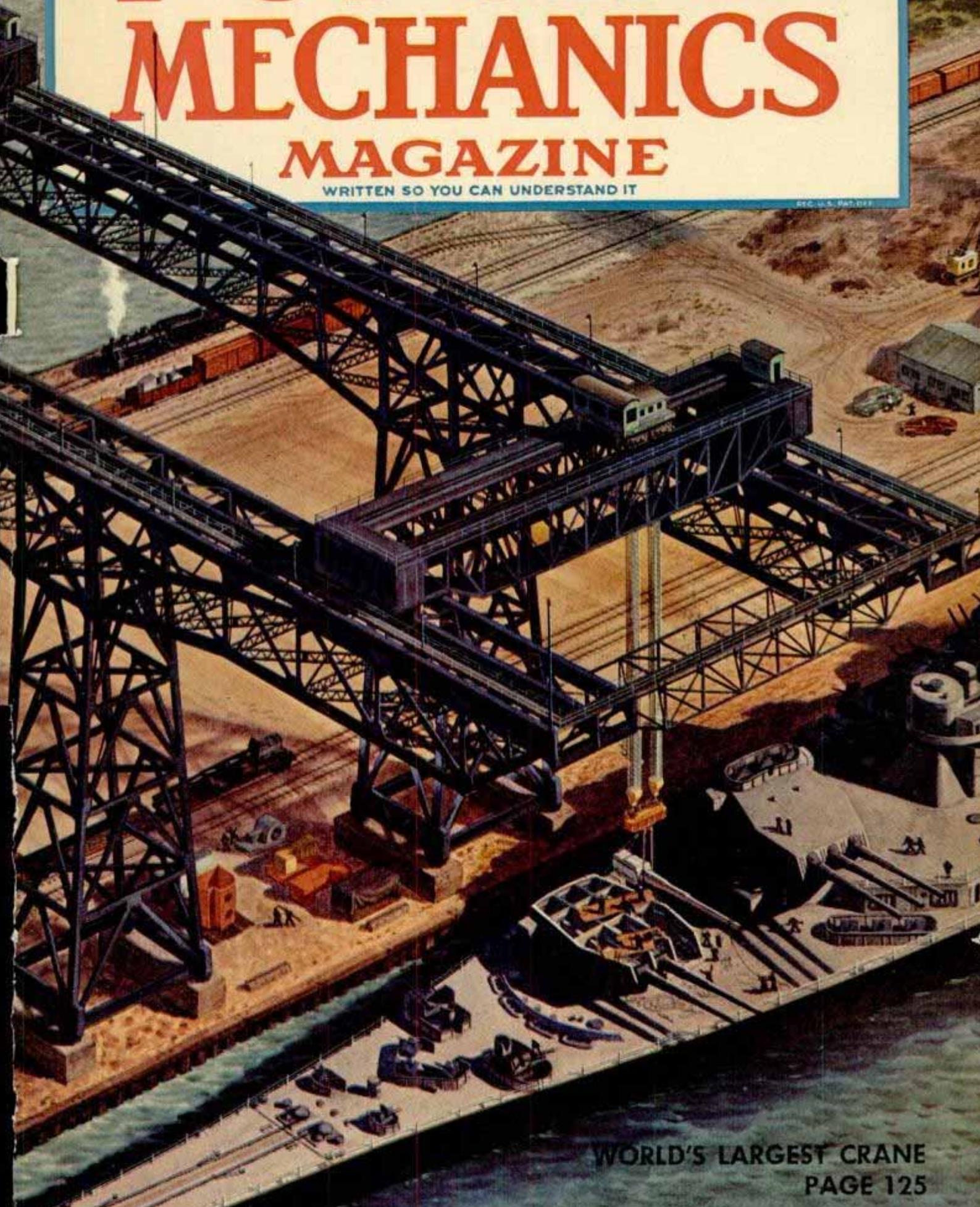

WORLD'S LARGEST CRANE
PAGE 125

Dependable

CHAMPION

AMERICA'S FAVORITE SPARK PLUG



The roaring midgets are in full cry again, dispensing their spine tingling thrills to enormous crowds nightly, on race tracks all over the nation. Tremendous acceleration, and keen driving skill are their stock in trade as they race literally hub to hub. Neither car nor driver can falter for a split second, and that's precisely why dependable spark plugs are of paramount importance. The overwhelming majority of midget car pilots use dependable Champion Spark Plugs. Here is testimony by experts that Champions make every engine a better performing, more dependable engine. Champion Spark Plug Company, Toledo 1, Ohio.

FOLLOW THE EXPERTS

**DEMAND NEW
DEPENDABLE CHAMPIONS
FOR YOUR CAR**

Listen to the CHAMPION ROLL CALL . . . Harry Wismer's fast sportscast every Friday night, over the ABC network



Typical example: the B. F. Goodrich tire that outwears prewar tires

SOUTH of the Mason-Dixon line, scorching highways provide tough testing grounds for any tire. Yet a Georgia automobile dealer writes that B. F. Goodrich tires are still going strong after 40,000 miles.

Pictured above in the light suit is J. A. Wynche of the John Alden Motors Company, Macon—who writes: "According to my speedometer I have gotten 40,742 miles of service out of two B. F. Goodrich Silvertown tires installed in February, 1945, and 33,260 miles from two other B. F. Goodrich tires installed later.

"These tires have been subjected to all types of driving conditions, including rough country

roads. Yet their condition is such that they could be safely driven a few thousand miles more before recapping.

"I have been in the automobile business since 1907, and it is nothing unusual for me to observe and note exceptional performances. This is by far the greatest mileage I have ever secured from any set of tires. I can truthfully say that the new B. F. Goodrich Silvertown tires outwear prewar tires . . . or any other tires I have used."

One reason these tires outwear prewar tires is their wider, flatter tread. This tread puts a greater span of rubber on the highway, takes a firmer grip, spreads car

weight over a larger area, and distributes road impacts more evenly. The extra rubber shares the wear, and as a result gives more mileage with greater safety. Other B. F. Goodrich features include: sturdier top ply, extra breaker strip, 35% stronger cords to resist blowout.

Prices Now Reduced!

Now you can get the tire that outwears prewar tires in all popular sizes at less than prewar prices! And there has been no lowering of quality. *The B. F. Goodrich Company, Akron, Ohio.*

B.F. Goodrich
FIRST IN RUBBER

Ingenious New Technical Methods

To Help You
Simplify Production

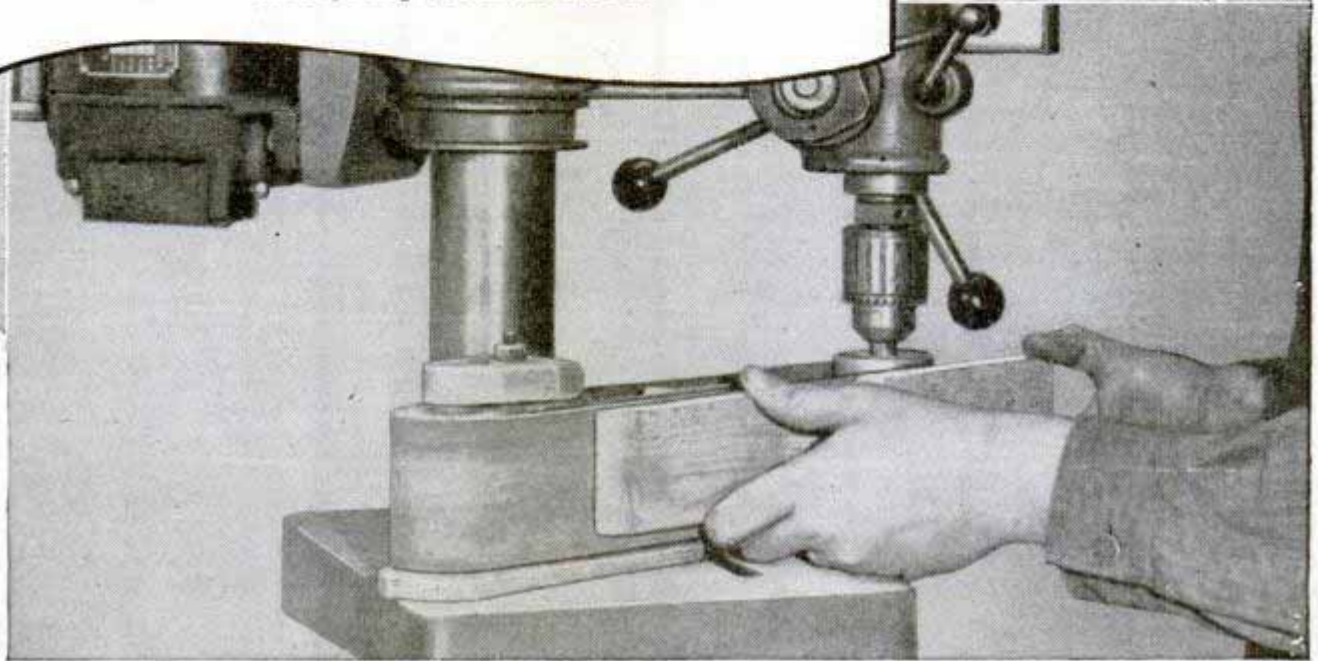

NEW BELT SANDER FOR DRILL PRESS Does Finishing Jobs Faster, Better

A new, simple, faster method for many surface finishing jobs on wood, metal, plastic and other materials has been announced by the OK Specialty Company of Chicago. The new finishing method takes the form of the OK Belt Sander, a drill press attachment.

The new sanding device weighs less than 5 pounds. It is made up of an aluminum base with backing plate or platen, a driven pulley mounted on ground steel shaft and running on precision ground ball bearings, and cast aluminum driver pulley mounted on $\frac{1}{2}$ " ground steel shaft to fit into the drill press chuck.

The base of the sander is bolted to a drill press table. Merely by moving the drill press table, the attachment can be adjusted to handle sanding belts from 26" to 36" in length.

The sander takes belts from $\frac{1}{2}$ " to 3" in width. Two sanding belts, one coarse grit and one fine grit, are furnished with each attachment. The device comes assembled ready for use with any drill press. Most efficient performance is achieved at 3500 to 5000 RPM. The sander stands 5" high, and the base measures $10\frac{1}{2}$ " long by $3\frac{1}{4}$ " wide.

Another time-saver on the job is chewing gum. Chewing gum may be used even when hands are busy; and under dust conditions helps to keep the throat moist—prevents "false thirst." For these reasons many plant owners make Wrigley's Spearmint Gum available to everyone.

*You can get complete information from OK Specialty Company
4655 N. Clark St., Chicago, Ill.*

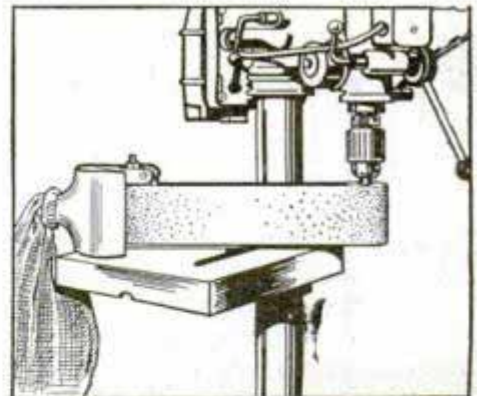

OK Belt Sander
Assembled, Ready for Action



AB-73

Popular Mechanics Magazine

Registered in U. S. Patent Office and Canada

H. H. WINDSOR, Founder

H. H. WINDSOR, Jr., Editor and Publisher



STORMY WEATHER makes a hit with the Army pilots at Wilmington, Ohio. With the latest weather map in his hand, the pilot above will hightail after the darkest clouds he can find, happily exposing their private lives. It's part of a plan to make all-weather flying safer. Editor Jack Kinsey's report on this high-altitude game of tag is on page 117. "Too darn bad," one pilot grumbled. "Looks like a nice sunshiny day today!"

NEXT MONTH "Science HQ of the Navy" will describe a lab where peacetime miracles are born—whistles that disperse fog, and quartz crystals that grow from seeds. A feature for "sidewalk superintendents" takes you aboard the walking dragline, a giant that gobbles a carload of earth in a bite. And movie star Chester Morris explains some tricks for amateur magicians.

SKIERS "waxing up" for the winter season will find complete details on building a ski tow in next month's Craftsman section. An article for hunters looking forward to the bird season is titled "Shotgun Chokes and Gauges." Another feature tips off the prospective buyer of a used motorcycle on points to be checked.

SIGNAL "BOOSTER" described in next month's Radio section increases the sensitivity of short-wave receivers.

Volume 88	SEPTEMBER 1947	Number 3
Managing Editor.....	Roderick M. Grant	
Assistant Managing Editor.....	Wayne Whittaker	
Shop Notes and Crafts Editor.....	James R. Ward	
Radio and Electronics Editor.....	Frank L. Brittin	
Aviation Editor.....	Aubrey O. Cookman, Jr.	
Associate Editor.....	John R. Kinsey	
Associate Editor.....	Clifford B. Hicks	
Eastern Editor.....	Bill Reiche	
Western Editor.....	Thomas E. Stimson, Jr.	
Art Director.....	Frank Beatty	

Assistant Editors			
Donald R. Brooks	Charles D. Emerson	Arthur R. Railton	
Assistant Editors, Shop Notes and Crafts			
W. Clyde Lammey	Wayne C. Leckey	John F. Shrock	A. E. Youngquist

In This Issue

So You've an Invention to Patent	81
These Dogs Count Sheep	88
Flight Plan for London	97
Filming the Waltz of the Flowers	107
Thunder Hunters	117
World's Largest Crane	124
Unveiling the Tucker	136
Task Force Furnace	148
Putting Life in Puppets	156
Hobbyist of the Month	162

For the Craftsman

The Royal Pair	170
Featherweight—An 8-Foot Duckboat	178
Give Your Battery a Break	188
Rifle Conversion	193
How to Take Outdoor Photos	198
Top Performance From Oil Burners	210
Radio and Electronics	221

Table of Contents Continued on Page 8

Published monthly by POPULAR MECHANICS COMPANY, 200 East Ontario Street, Chicago 11, Ill. H. H. Windsor, Jr., president; Paul H. Dunakin, vice president and general manager; D. F. Windsor, vice president and secretary-treasurer; William Harrison Fetridge, vice president and assistant to the publisher; Clover L. Perkins, advertising manager; Alan M. Deyoe, circulation manager. Single copy in the United States and Canada, 25 cents; subscription rates in United States and possessions, Canada, and countries of the Pan-American Postal Union, 1 year, \$2.50; 2 years, \$4.50; 3 years, \$6.00. To all other countries add \$1.00 a year over United States prices for overseas postage. If you plan to move, notify us at least 60 days in advance so you will not miss an issue. Give both old and new addresses. Entered as Second Class Matter, September 15, 1903, at the Post Office at Chicago, Illinois, under Act of March 3, 1879. Entered as Second Class Matter at Post Office Dept., Canada. Copyright 1947 by Popular Mechanics Company. Copyright under International Copyright Union. Copyright in France. All rights reserved under Pan-American Copyright Union. Printed in the United States of America.

Tank blows its top

MEET "Calliope," a medium tank, "souped-up" with a 60-rocket launcher developed for the U. S. Army Ground Forces. "Calliope" can perform like any other tank. Then, at a moment's notice, it can take a fixed position and let fly with a rocket barrage equal to 60 artillery pieces.

"Calliope" is an all-steel model of the enormous strides which the Ground Forces have made in the field of mechanization. At much less danger to itself, one crew can perform missions which would formerly have taken many times the number of men.

Then, too, "Calliope" shows the interesting research and development being carried on by the Army. Any young man with any kind of mechanical bent will find the U. S. Army Ground Forces a fascinating workshop in which to learn skills and trades and give his new-found knowledge the practical application it needs.

There are other advantages, too, to a Ground Forces career. Good pay, steady work, living essentials provided without charge, travel, adventure, and the thrill of doing a worth-while job for your country. Get the facts at your nearest U. S. Army Recruiting Station.

★

Listen to "Warriors of Peace," "Voice of the Army," "Sound Off" and "Proudly We Hail" on your radio.

U. S. ARMY RECRUITING SERVICE

A GOOD JOB FOR YOU
U. S. Army
CHOOSE THIS
FINE PROFESSION NOW!

YOUR REGULAR ARMY SERVES THE NATION AND MANKIND IN WAR AND PEACE



WHEN IT'S AN Exide... YOU START

When you buy a battery, you want to be sure it will start your car . . . today, tomorrow, this winter. You might be tempted to get a cheaper battery, hoping it will last as long as you keep your car. But remember—*just one starting failure* can be far more costly than the little extra you pay for an Exide Battery that you know you can depend upon.

Play safe. Buy starting assurance. When it's an Exide . . . you start!

**Depend on your Exide dealer
for good products, good service**

THE ELECTRIC STORAGE BATTERY COMPANY • Philadelphia 32

Exide Batteries of Canada, Limited, Toronto

In your Mind's Eye

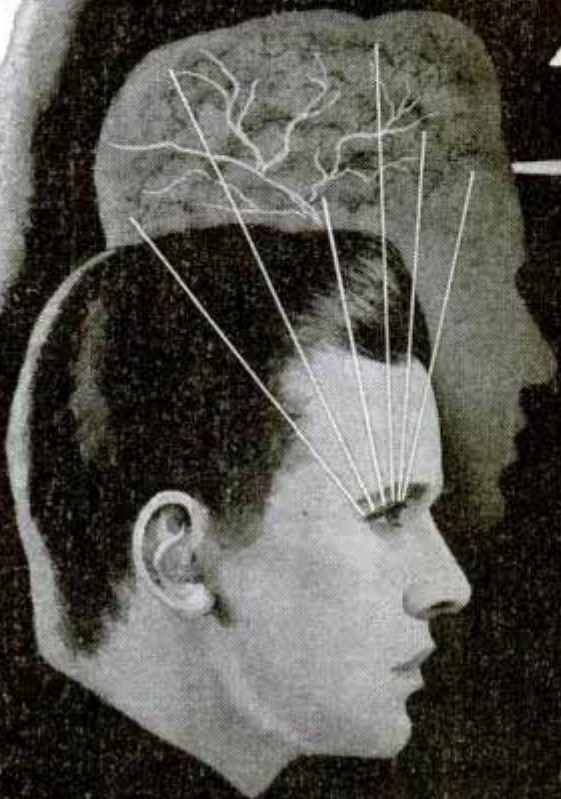

The Secret of MENTAL CREATING

IF you just like to dream, read no further. There comes a time when your fancies *must be* brought into light—and stand the test of every-day, hard realities. Are you one of the thousands—perhaps millions—whose thoughts never get beyond the stage of *wistful wishing*? Do you often come to from a daydream with the sigh, "If only I could bring it about—*make it real*?"

All things begin with thought—it is what follows that may take your life out of the class of those who hope and dream. Thought energy, like anything else, can be dissipated—or it can be made to produce actual effects. *If you know how to place your thoughts* you can stimulate the creative processes within your mind—through them you can assemble things and conditions of your world into a happy life of accomplishment. *Mental creating* does not depend upon a magical process. It consists of *knowing how* to marshal your thoughts into a power that draws, compels and organizes your experiences into a worth-while design of living.

ACCEPT THIS *Free* BOOK

Let the Rosicrucians tell you how you may accomplish these things. The Rosicrucians (not a religious organization), a world-wide philosophical fraternity, have preserved for centuries the ancients' masterful knowledge of the functioning of the inner mind of man. They have taught men and women how to use this knowledge to *recreate their lives*. They offer you a free copy of the fascinating book, "The Mastery of Life." It tells how you may receive this information for study and use. Use coupon opposite.

The ROSICRUCIANS
(AMORC)

SAN JOSE

CALIFORNIA

SCRIBE: F. X. L.
The Rosicrucians (AMORC),
San Jose, California.

Please send free copy of "The Mastery of Life,"
and I shall read it as directed.

Name.....

Address.....

City.....



If YOU were Boss would YOU promote "YOU"?

Be honest now—

suppose that a better job had opened up in your company—carrying with it promotion and more money—could you qualify?

If you were boss, would you select "YOU" for that better job?

Consider before you answer.

First of all, could you *fill* the job? Has your experience fitted you for the step forward—have you been preparing for promotion apart from experience gained on the job?

Or have you just been filling a niche, doing daily tasks well but making no real and intelligent effort to learn and qualify for the job ahead so that if an opening should occur you would be ready to fill it?

The man who gets real promotion makes his own breaks—the man who slaves in the ordinary job at low pay just wishes and dreams of promotion and more money. Which are you?

Business is always willing to pay the man who knows—and pay him well. The man who is ready and willing to take responsibilities—and capable of directing the efforts of other men is a

valuable asset to any business organization. He never wants for a good job and above average earnings. He gets ahead.

We have helped thousands of men achieve promotion and more money—success sometimes beyond their dreams—a success that was started by a coupon similar to the one below.

Get out of that rut—don't be satisfied with a mediocre job at small pay—be a success in business—this coupon may be your first step.

So send it today—right now—tomorrow never comes for the man who consistently puts things off.

*G. I. APPROVED

La Salle Extension University A Correspondence Institution

Dept. 964-R

417 S. Dearborn, Chicago 5

If you can help me get the ability and knowledge for real promotion, I want to know it. Please send me your free 48 page booklet telling how I can succeed in the field I have checked below. I understand you will send this without obligation to me.

- | | |
|--|--|
| * <input type="checkbox"/> Accounting | <input type="checkbox"/> Salesmanship |
| * <input type="checkbox"/> C. P. A. Coaching | * <input type="checkbox"/> Law: LL.B. Degree |
| * <input type="checkbox"/> Bookkeeping | * <input type="checkbox"/> Foremanship |
| * <input type="checkbox"/> Business Management | * <input type="checkbox"/> Industrial Management |
| <input type="checkbox"/> Effective Speaking | * <input type="checkbox"/> Traffic Management |
| <input type="checkbox"/> Stenotypy (Machine Shorthand) | * <input type="checkbox"/> Business English |

Name

Position

Address

City and State

This One



3U24-U3J-14SR

PYROIL SCORES AGAIN

SIX OF THE TEN WINNERS OF 500 MILE RACING CLASSIC USE PYROIL

This year, as in all past years since 1933, the men who know best depend upon Pyroil. Six of the ten winners of the 500 miles Memorial Day Race at Indianapolis kept their racing motors lubricated with the help of Pyroil.

Pyroil gives oil the property of clinging to cylinder walls—removes sludge and carbon. Ask your station attendant to add Pyroil — and add life to your car.

PYROIL for Aircraft Engines

Use Aircraft Pyroil B for lubricating oil, Aircraft Pyroil A for gasoline.

Manufactured and Guaranteed by Pyroil Company, 71 Pyroil Bldg., La Crosse, Wisconsin.

Canadian Distributors:
Central Purchasing Agency, Ltd.
Toronto, Ontario



PYROIL COMPANY

71 Pyroil Bldg., La Crosse, Wisconsin

I want my car to last and run properly. Please tell me more about Pyroil and how it can accomplish this for me.

Name _____

Address _____

City or Town _____ State _____



Jerry, the talking dog, is entertaining hospitalized veterans, by courtesy of the PYROIL Company. Picture of Jerry, sent on request.

TABLE OF CONTENTS (Continued)

AUTOMOTIVE

Electric lock for auto gasoline tanks.....	86
Fold-up auto.....	95
Warning sign for motorists.....	112
Tubless tire.....	129
Cockpit makes truck-sedan.....	155

AVIATION

Porcelain enameled airway marker.....	87
Cessna business plane.....	94
"Silent" plane has five fan-shaped prop blades.....	106
After-burner unit boosts jet thrust.....	106
Plane seat tilts cradle fashion.....	113
Automatic rip cord.....	123
Giant mortar tests aviation equipment.....	134
Supersonic wind tunnel tests models at 2500 m.p.h.....	144
Multiengine dock permits indoor servicing.....	155

BOATS AND BOATING

Trailer lowers boat for launching.....	116
"Greenhouse" for warships.....	129
Floating "hotel".....	146
Spring motor powers baby boat.....	147
Jet-propelled speedboat to attempt record.....	166

FARM

Giant plow.....	94
Converted half-track and trailer hauls wheat.....	135
Folding harrow.....	135
Food value of hay decreased by rain.....	144

HOUSE AND HOME

Robot household "maid".....	112
What's new for your home.....	130
Watertight sink frames.....	166

INDUSTRY

Skyscraper lightning gauge.....	87
Locomotive mover.....	105
Synthetic glycerin to increase supply.....	112
Fewer knocks per gallon.....	116
Vast oil reserve is under water.....	129
Synthetic cloth from antifreeze.....	129
Radiant panels on rail car heat interior by sections.....	140
Natural gas is stored in underground steel tanks.....	141
Mill-a-minute ribbon of steel.....	142
Double-jointed bus.....	160
Two-million-pound test ram checks strength of dome-roof car.....	168

LAWN AND GARDEN

Electric lawn mower.....	94
Grass catcher easy to empty.....	112
Weed sprayer screws on gallon jug.....	113
Rake is adjustable for sweeping.....	134
Chemical poisons quack grass.....	139

OUTDOOR RECREATION

Plastic surf sled.....	86
Whirling globe and "bootstrap lift" provide thrills.....	96
Football sign language.....	114
Automatic fish cleaner handles 10 a minute.....	116
Over-the-belt fishing tackle box opens to form shelf.....	116
Golf course scooter.....	134

PHOTOGRAPHY

Portable copy-printer.....	123
Photo-cell lights second flash bulb.....	144
Portrait camera has automatic film changer.....	145
Sound adapter for silent movie projectors.....	145
Sliding wedge and guide centers small objects and titles on movie film.....	145

RADIO AND ELECTRICAL

"Broadcasting station" for medical treatments.....	96
Color tester for fluorescent tubes.....	113
Balloon targets reflect radar.....	139

TOOLS

Mouth-blown blowtorch.....	123
"Half size" motor for machine tools.....	139
Center punch delivers blow through adjustable spring in handle.....	141
Blind man operates micrometer.....	147
Four-in-one bench tool.....	147
Wheel turns 123,000 r.p.m.....	155
Concrete-block maker.....	161

TOYS AND NOVELTIES

Directional light for bikes.....	105
Blow-dart game.....	106
Flexible cigarette case.....	113
Boy's dump truck serves as scooter.....	135
Ballpoint pencil applies perfume.....	166
The desert blooms in wool.....	167

MISCELLANEOUS

Cables guide trailer dolly.....	86
Hook system eliminates turnbuckles.....	86
Plastic curve plotter used for road layout.....	105
Bank's cement mixer unwraps coins.....	129
Firing speed of guns quadrupled.....	140
Pencil "stretches" three feet.....	147
Piano exerciser.....	151
Fire-fighting tank.....	151
Lightweight utility roller.....	151

(Continued to page 10)

WARNING TO THE CURIOUS!

Don't read another word of this advertisement unless you're interested in a better job, a larger salary, greater responsibility! I. C. S. messages are not addressed to the idly curious—they're for the man who is curious with a purpose.

If you want to know how to start achieving advancement and success, we have important information for you.

We want to tell you that I. C. S. Courses covering more than 400 commercial and technical subjects are available for spare-time study at surprisingly low cost.

We want you to know that pay increases and job betterments are consistently reported to us by I. C. S. students in a volume as high as 600 and more letters a month.

Note, too, that successful I. C. S. graduates are numbered in the thousands and include presidents, board chairmen, production and research heads, superintendents, foremen in almost every branch of industry.

If you're truly curious, you'll want to know the details of what I. C. S. did for these men—and what it can do for you. The coupon brings you this full information. Mark and mail it *right now!*



INTERNATIONAL CORRESPONDENCE SCHOOLS



BOX 5611-K, SCRANTON 9, PENNA.

Without cost or obligation, please send me full particulars about the course BEFORE which I have marked X:

- | | | | |
|--|--|---|---|
| <p>Business and Academic Courses</p> <ul style="list-style-type: none"> <input type="checkbox"/> Accounting <input type="checkbox"/> Arithmetic <input type="checkbox"/> Business Administration <input type="checkbox"/> Business Correspondence <input type="checkbox"/> Certified Public Accounting <input type="checkbox"/> Commercial <input type="checkbox"/> Commercial Art <input type="checkbox"/> Cost Accounting <input type="checkbox"/> Federal Tax <input type="checkbox"/> First Year College <input type="checkbox"/> Foremanship <input type="checkbox"/> Good English <input type="checkbox"/> Higher Mathematics <input type="checkbox"/> Motor Traffic <input type="checkbox"/> Salesmanship <input type="checkbox"/> Sign Lettering <input type="checkbox"/> Spanish <input type="checkbox"/> Traffic Management <p>Air Conditioning and Plumbing Courses</p> <ul style="list-style-type: none"> <input type="checkbox"/> Air Conditioning <input type="checkbox"/> Heating <input type="checkbox"/> Refrigeration | <p>Chemistry Courses</p> <ul style="list-style-type: none"> <input type="checkbox"/> Chemical Engineering <input type="checkbox"/> Chemistry, Analytical <input type="checkbox"/> Chemistry, Industrial <input type="checkbox"/> Chemistry, Mfg. Iron & Steel <input type="checkbox"/> Petroleum Refining <input type="checkbox"/> Pulp and Paper Making <p>Civil Engineering, Architectural and Mining Courses</p> <ul style="list-style-type: none"> <input type="checkbox"/> Architecture <input type="checkbox"/> Architectural Drafting <input type="checkbox"/> Building Estimating <input type="checkbox"/> Civil Engineering <input type="checkbox"/> Contracting and Building <input type="checkbox"/> Highway Engineering <input type="checkbox"/> Lumber Dealer <input type="checkbox"/> Reading Structural Blueprints <input type="checkbox"/> Sanitary Engineering <input type="checkbox"/> Structural Drafting <input type="checkbox"/> Structural Engineering <input type="checkbox"/> Surveying and Mapping <p>Communications Courses</p> <ul style="list-style-type: none"> <input type="checkbox"/> Electronics <input type="checkbox"/> Practical Telephony <input type="checkbox"/> Radio, General <input type="checkbox"/> Radio Operating | <p><input type="checkbox"/> Radio Servicing</p> <p>Electrical Courses</p> <ul style="list-style-type: none"> <input type="checkbox"/> Telegraph Engineering <input type="checkbox"/> Electrical Drafting <input type="checkbox"/> Electrical Engineering <input type="checkbox"/> Electric Light and Power <input type="checkbox"/> Lighting Technician <input type="checkbox"/> Practical Electrician <input type="checkbox"/> Power House Electric <input type="checkbox"/> Ship Electrician <p>Internal Combustion Engines Courses</p> <ul style="list-style-type: none"> <input type="checkbox"/> Auto Technician <input type="checkbox"/> Diesel-Electric <input type="checkbox"/> Diesel Engines <p>Mechanical Courses</p> <ul style="list-style-type: none"> <input type="checkbox"/> Aeronautical Engineer's, Jr. <input type="checkbox"/> Aircraft Drafting <input type="checkbox"/> Flight Engineer <input type="checkbox"/> Forging <input type="checkbox"/> Heat Treatment of Metals <input type="checkbox"/> Industrial Engineering <input type="checkbox"/> Industrial Metallurgy <input type="checkbox"/> Machine Shop <input type="checkbox"/> Machine Shop Inspection | <p><input type="checkbox"/> Mechanical Drafting</p> <p>Electrical Courses</p> <ul style="list-style-type: none"> <input type="checkbox"/> Mechanical Engineering <input type="checkbox"/> Mold-Loft Work <input type="checkbox"/> Pattermaking—Wood, Metal <input type="checkbox"/> Reading Shop Blueprints <input type="checkbox"/> Sheet-Metal Drafting <input type="checkbox"/> Sheet-Metal Worker <input type="checkbox"/> Ship Drafting <input type="checkbox"/> Tool Designing <input type="checkbox"/> Welding—Gas and Electric <p>Railroad Courses</p> <ul style="list-style-type: none"> <input type="checkbox"/> Air Brake <input type="checkbox"/> Diesel Locomotive <input type="checkbox"/> Locomotive Engineer <input type="checkbox"/> Locomotive Fireman <input type="checkbox"/> Railroad Section Foreman <p>Steam Engineering Courses</p> <ul style="list-style-type: none"> <input type="checkbox"/> Boilermaking <input type="checkbox"/> Combustion Engineering <input type="checkbox"/> Engine Running <input type="checkbox"/> Marine Engineering <input type="checkbox"/> Steam Electric <p>Textile Courses</p> <ul style="list-style-type: none"> <input type="checkbox"/> Cotton Manufacturing <input type="checkbox"/> Rayon Weaving <input type="checkbox"/> Woolen Manufacturing |
|--|--|---|---|

Name _____ Home Address _____
 City _____ State _____
 Age _____ Present Position _____ Working Hours _____ A.M. to _____ P.M.

Special tuition rates to members of the Armed Forces. Enrollment under the G.I. Bill of Rights approved for World War II Veterans.
 Canadian residents send coupon to International Correspondence Schools Canadian, Ltd., Montreal, Canada.

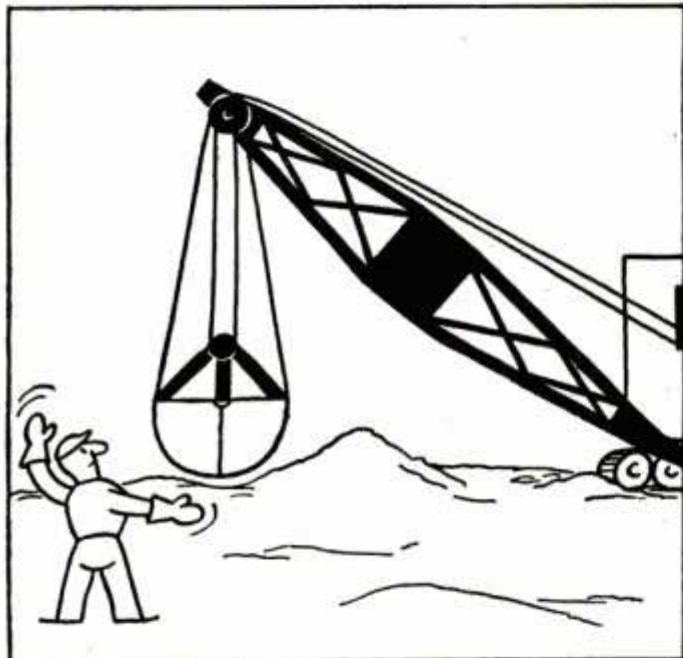
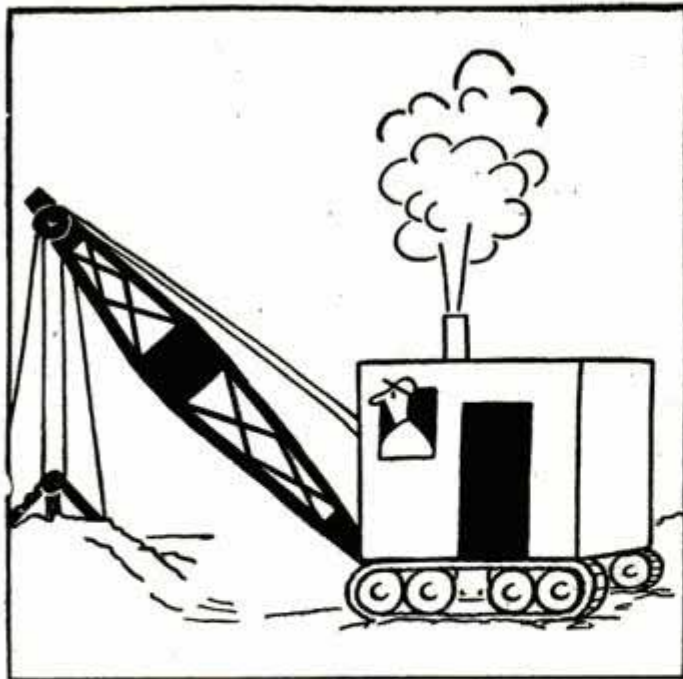

O. SOGLOW

(Continued from page 8)

Antelope roundup.....	152
War-surplus items.....	154
Process duplicates natural growth.....	160
Chemical treatment for boils and ulcers.....	161
Curb climber for crippled persons.....	161
Directory fits beneath telephone.....	168

Craftsman and Shop Notes Index

AUTOMOTIVE

Extension-light outlet for cars.....	176
Padlock fastened to clutch pedal prevents theft of auto.....	206
Glove compartment has envelope to hold miscellaneous papers.....	218

FARM

Power "scoop".....	207
Tractor operates milking units when electric power fails.....	209
Calf feeder kept in position with spring and hinge.....	220

HOUSE AND HOME

Solving home problems.....	174
False front conceals clothes hamper in chest of drawers.....	177
Keyhole guard for door lock.....	186
Spring supports electric-iron cord.....	186
Eliminating window streaks.....	192
Plastic holder for shaving brush mounted in medicine chest.....	192
Guard on electric-light switch prevents accidental use.....	204
Fixing loose furniture casters.....	206

LAWN AND GARDEN

Large wheeled frame is help when hauling leaves.....	176
Sheet-metal collar around stump forms flower box.....	176
King-size "bird cage".....	191

METALWORKING

Hand-wrought log grate has built-in andirons.....	177
Over-size copper fittings soldered to smaller diameter tubing.....	196
Chamfered metal blocks placed face to face form neat V-blocks.....	219

OUTDOOR RECREATION

Double-purpose utility bag.....	183
Hunters cart heavy game on "stretcher" with bicycle wheel.....	183
Boiling water loosens fish scales.....	196

PHOTOGRAPHY

Finger pads keep prints clean.....	201
Extension cord wound on reel.....	201
Metal clip holds cable release to take time exposures.....	201
Dual rack for photoflood lamps.....	201
Synchronized flash for your box camera.....	202

RADIO AND ELECTRONICS

Speaker baffle for public-address system.....	221
Battery-operated amplifier for portable record player or small set.....	222
Simplified volt-ohm-milliammeter test set.....	224

TOOLS

Hand position indicated on hammer.....	176
Converted mill file will serve as cabinet scraper.....	186
Hammer shielded to protect work.....	192
Shop "pincushion" for light tools.....	196
Glue brush made of sash cord.....	196
Toothbrush applies compound to pipe threads.....	204
Vise handle kept from slipping.....	204
Craft quiz.....	205
Slotted bench stops hold handsaw in filing position.....	206
Eye-forming tool for electricians made from old shears.....	217
Metal arrows on control chains aid operation of hoist.....	218
Smooth curve bent in heavy tubing with oxyacetylene torch.....	218
Hanger bolts are set quickly.....	218
Special chisel for concave surfaces.....	218
"Long Tom" extension grinder for internal work.....	219
Short angle improves C-clamp.....	220
Solder holds feeler-gauge screw tight.....	220
Hanger-gauge to apply siding.....	220

TOYS AND NOVELTIES

Multiple-control panel made from radio cabinet.....	173
Inner tube used to inflate balloons.....	182
Tops in tops.....	187
Simulated hull of wrecked ship decorates fish bowl.....	204
Plaster cast of infant's hand.....	206

WOODWORKING

Metal glider conceals screwhead.....	183
Studio-couch "workshop".....	184
Hose clamps hold glued stock.....	186
Auxiliary top increases playing surface of card table.....	187

MISCELLANEOUS

Horizontal strips of molding "frame" display of pictures or photos.....	173
Vacuum bottle kept in pocket with elastic strap.....	176
Tin foil tightens loose screws.....	177
Newspaper sack attached to bike with wire hooks.....	188
Converted oilcan holds gasoline.....	192
Gummed labels stored in fruit jar.....	196
Catches hold stepladder folded.....	204
Safety hook for overhead outlets.....	206
Ruling small squares on paper.....	217
Drawing board has spring clip to hold sketching paper.....	217
Bin set under butcher's block receives meat scraps.....	220

IMPORTANT NOTICE—It is the intention of this magazine to provide its readers with information regarding the latest developments in the mechanical arts. We take no responsibility as to whether the disclosures contained in our articles are covered by patents and advise readers to investigate this subject before making, using, or selling any of the products, machines, or processes described in order to avoid possible liability for patent infringements.

AUDELS REFRIGERATION & AIR CONDITIONING GUIDE.....\$4

New from Cover to Cover—1280 Pages, Fully Illus. Covering basic principles, servicing, operation & repair of household, commercial & industrial refrigeration & air conditioning. A gold mine of essential important facts for engineers, servicemen, users.

AUDELS CARPENTERS & BUILDERS GUIDES—4 Vols.\$6

A practical illustrated trade assistant on modern construction for carpenters, joiners, builders, mechanics and all woodworkers. 4 vols., 1600 pages, 3700 illustrations, flexible covers, Pocket size. Each volume sold separately \$1.50 a vol.

AUDELS AUTOMOBILE GUIDE.....\$4

A practical quick ready reference book for auto mechanics, service men, operators & owners. Explains theory, construction & servicing of modern motor cars, trucks, buses & auto type Diesel engines. 1700 pages, fully illustrated, 55 chapters. Indexed. A standard book for mechanics. New fluid drive covered.

AUDELS DIESEL ENGINE MANUAL..\$2

A practical, concise treatise with questions and answers on the theory, operation and maintenance of modern diesel engines including General Motors 2 cycle Diesel. 384 pages, fully illus., flexible binding, pocket size. All details plainly brought out, this book is of extreme value to engineers, operators & students.

AUDELS WIRING DIAGRAMS.....\$1

210 Pages, Illustrated. Gives practical facts on wiring of electrical apparatus. It shows clearly how to wire apparatus for practically all fields of electricity. Each diagram is complete & self-explanatory. Highly endorsed Pocket Companion.

AUDELS PLUMBERS & STEAMFITTERS GUIDES—4 Vols.\$6

A Practical Trade Assistant & Ready Reference. Explains in plain language & by clear illustrations, diagrams, charts, graphs, pictures principles of modern plumbing practice including Marine Pipe Fitting and Air Conditioning. 4 Vols.—1070 Pages—3642 Diagrams. Pocket size. Each Vol. Sold Separately \$1.50 a Vol.

AUDELS SHEETMETAL WORKERS HANDY BOOK.....\$1

Practical inside information. Fundamentals of Sheet Metal Work. 388 pages, Illustrated. 11 sections. Clearly written. Essential & important facts, figures, pointers in everyday language. Ref. Index.

AUDELS SHEETMETAL PATTERN LAYOUTS.....\$4

Developed by Experts for Sheet Metal Workers, Layout Men & Mechanics. A Practical Encyclopedia in 10 Sections, size 7 x 10 x 2—1125 Pages—350 Layouts—1600 Illustrations. 1001 Key Facts. Fully indexed for ready reference in answering your layout problems. Covers all phases of sheet metal work including Pattern Cutting, Pattern Development & Shop Procedure.

AUDELS ANSWERS ON BLUE PRINT READING.....\$2

For Mechanics & Builders. Covers all types of blue print reading including ship & airplane. 416 pages, fully illustrated.

AUDELS NEW MACHINIST & TOOLMAKERS HANDY BOOK.....\$4

Covers modern machine shop practice in all its branches. 5 practical books in 1. New from cover to cover. Tells how to set up & operate lathes, screw and milling machines, shapers, drill presses and all other machine tools. 1600 pages, fully illustrated, 5 x 6 1/2 x 2. Indexed. 5 sections. 1—Modern Machine Shop Practice. 2—Blue Print Reading & How to Draw. 3—Calculations & Mathematics for Machinists. 4—Shop Physics. 5—How to Use the Slide Rule. 60 chapters. Easy to read and understand. A shop companion that answers your questions.

AUDELS MATHEMATICS & CALCULATIONS FOR MECHANICS \$2

Mathematics for home study or reference. 700 pages, 550 illus. Practical mathematics from beginning. How to figure correctly. Easy, correct methods covering complete review. Illus. & Indexed.

AUDELS HANDY BOOK OF PRACTICAL ELECTRICITY.....\$4

For maintenance engineers, electricians & all electrical workers. 1440 Pages. 2600 Illus. Covers important electrical information in handy form—including Marine Wiring, Radio Principles, Welding. Indexed. A Key to a practical understanding of electricity.

AUDELS RADIOMANS GUIDE.....\$4

A key to the practical understanding of radio including Frequency Modulation, Television, etc., Aircraft & Marine Radio. For radio engineers, servicemen, amateurs. 914 Pages, 633 Illustrations & Diagrams. Photos. Review Questions & Answers, Reference Index. Authentic, clear, concise.

AUDELS ELECTRONIC DEVICES.....\$2

Tells What You Want to Know About Electric Eye. Easily Understood. Covers photo-electric cells & their applications. Amplifiers, illumination, frequencies, voltage, photocell, tubes, Ohm's Law, wiring diagrams, etc.

AUDELS WELDERS GUIDE.....\$1

A concise, practical text on operation & maintenance of all welding machines for all mechanics. Over 400 pages, illustrated. Covers all methods of electric and acetylene welding including airplane work.

AUDEL, Publishers, 49 W. 23 St., N. Y. 10

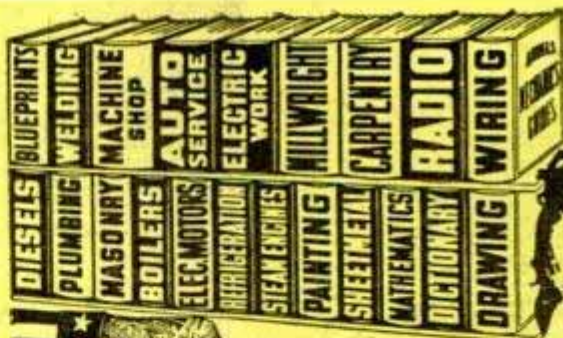

AN AUDEL GUIDE IS A GOOD FRIEND!

Step Up Your Own Skill with the Practical Facts and Figures of Your Trade. Save time and money with right methods, short cuts, labor saving ideas. CHECK NOW! You can look over any Audel Guide in your home. Start the Easy Payments if satisfied.

CUT HERE MAIL ORDER

THEO. AUDEL & CO., 49 W. 23 St., New York 10, N. Y.

Please mail me for 7 days' free examination the books marked (X) below. I agree to mail \$1 in 7 days on each book or set ordered, and to further mail \$1 a month on each book or set ordered until I have paid purchase price.

If I am not satisfied with Guides I will return them.

- | | |
|--|------|
| <input type="checkbox"/> Audels ELECTRIC MOTOR GUIDE | \$4. |
| <input type="checkbox"/> Audels OIL BURNER GUIDE | 1. |
| <input type="checkbox"/> Audels REFRIGERATION & Air Conditioning Guide | 4. |
| <input type="checkbox"/> Audels POWER PLANT ENGINEERS GUIDE | 4. |
| <input type="checkbox"/> Audels PUMPS, HYDRAULICS & AIR COMPRESSORS | 4. |
| <input type="checkbox"/> Audels WELDERS GUIDE | 1. |
| <input type="checkbox"/> Audels BLUE PRINT READING | 2. |
| <input type="checkbox"/> Audels SHEET METAL WORKERS Handy Book | 1. |
| <input type="checkbox"/> Audels SHEET METAL PATTERN LAYOUTS | 4. |
| <input type="checkbox"/> Audels AIRCRAFT WORKER | 1. |
| <input type="checkbox"/> Audels MATHEMATICS and CALCULATIONS | 2. |
| <input type="checkbox"/> Audels MACHINISTS & TOOLMAKERS Handy Book | 4. |
| <input type="checkbox"/> Audels MECHANICAL Dictionary | 4. |
| <input type="checkbox"/> Audels AUTOMOBILE GUIDE | 4. |
| <input type="checkbox"/> Audels DIESEL ENGINE MANUAL | 2. |
| <input type="checkbox"/> Audels MARINE ENGINEERS Handy Book | 4. |
| <input type="checkbox"/> Audels MECHANICAL DRAWING GUIDE | 1. |
| <input type="checkbox"/> Rogers MECHANICAL DRAWING and DESIGN | 2. |
| <input type="checkbox"/> Audels MILLWRIGHTS and Mechanics Guide | 4. |
| <input type="checkbox"/> Audels CARPENTERS and Builders Guides (4 vols.) | 6. |
| <input type="checkbox"/> Audels PLUMBERS and Steamfitters Guides (4 vols.) | 6. |
| <input type="checkbox"/> Audels MASONS and Builders Guides (4 vols.) | 6. |
| <input type="checkbox"/> Master PAINTER and DECORATOR | 2. |
| <input type="checkbox"/> Audels GARDENERS & GROWERS GUIDES (4 vols.) | 6. |
| <input type="checkbox"/> Audels ENGINEERS & FIREMANS EXAMINATIONS | 1. |
| <input type="checkbox"/> Audels ENGINEERS and Mechanics Guides | |
| Nos. 1, 2, 3, 4, 5, 6, 7 and 8 complete | 12. |
| <input type="checkbox"/> Audels Answers on Practical ENGINEERING | 1. |
| <input type="checkbox"/> Audels ELECTRICIANS EXAMINATIONS | 1. |
| <input type="checkbox"/> Audels WIRING DIAGRAMS | 1. |
| <input type="checkbox"/> Audels Handy Book of PRACTICAL ELECTRICITY | 4. |
| <input type="checkbox"/> Audels ELECTRICAL POWER CALCULATIONS | 2. |
| <input type="checkbox"/> Audels ELECTRONIC DEVICES | 2. |
| <input type="checkbox"/> Audels ELECTRIC Dictionary | 2. |
| <input type="checkbox"/> Audels RADIOMANS GUIDE | 4. |
| <input type="checkbox"/> Audels NEW ELECTRIC LIBRARY at \$1.50 a Volume | |
| Vols. I, II, III, IV, V, VI, VII, VIII, IX, X, XI, XII | |

Name.....

Address.....

Occupation.....

Employed by.....

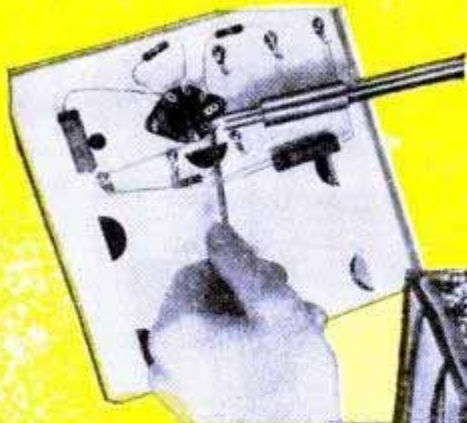

KIT 1 (left)

I send you Soldering Equipment and Radio Parts; show you how to do Radio Soldering; how to mount and connect Radio parts; give you practical experience.

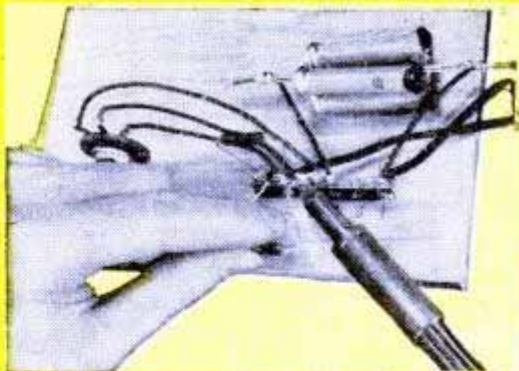

KIT 3 (above)

You get parts to build Radio Circuits; then test them; see how they work, learn how to design special circuits; how to locate and repair circuit defects.

KIT 2 (right)

Early in my course I show how to build this N. R. I. Tester with parts I send. It soon helps you fix neighborhood Radios and earn EXTRA money in spare time.

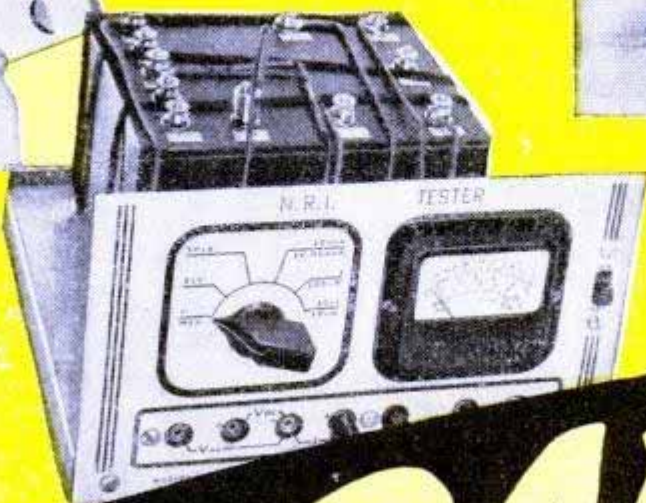

BE A RADIO LEARN BY PRACTICING

KIT 5 (left)

Building this A. M. Signal Generator gives you more valuable experience. It provides amplitude-modulated signals for many tests and experiments.



KIT 4 (below)

You get parts to build this Vacuum Tube Power Pack, make changes which give you experience with packs of many kinds; learn to correct power pack troubles.

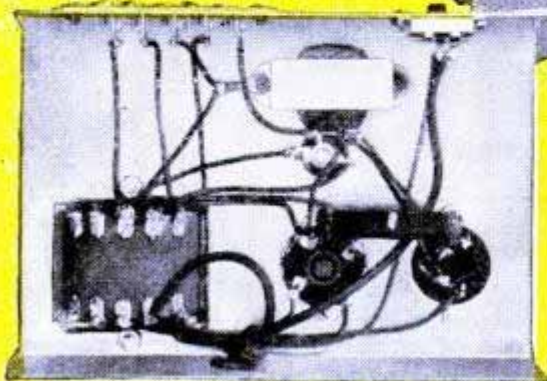

KIT 6 (right)

You build this Superheterodyne Receiver which brings in local and distant stations—and gives you more experience to help you win success in Radio.

RADIO LESSON FREE

I will send you a FREE Lesson, "Getting Acquainted with Receiver Servicing," to show you how practical it is to train for Radio in spare time. It's a valuable lesson. Study it—keep it—use it—without obligation! Tells how "Superhet" Circuits work, gives hints on Receiver Servicing, Locating Defects, Repair of Loud-speaker, I. F. Transformer, Gang Tuning Condenser, etc. 31 illustrations. Get your sample lesson FREE—mail Coupon NOW!

MAIL COUPON BELOW



TECHNICIAN IN SPARE TIME

With **BIG KITS** of PARTS I send you

I TRAINED THESE MEN

MADE \$612, IN 12 MONTHS SPARE TIME

"Soon after I finished my experimental kits lessons I tackled my first Radio Service job. The neighbors were very cooperative. I soon had all the repair jobs I could handle in spare time. I have made \$612 in the past 12 months in spare time."—J. W. CLARK, Wilmington, N. C.



KNEW NOTHING ABOUT RADIO

"I knew nothing about Radio when I enrolled. At present I am doing spare time work. I have more than paid for my Course and I have about \$200 worth of equipment which has paid for itself."—RAYMOND HOLTCAMP, Vandalia, Ill.



VETERANS

You can get this training in your own home under G. I. Bill. Mail coupon for full details.

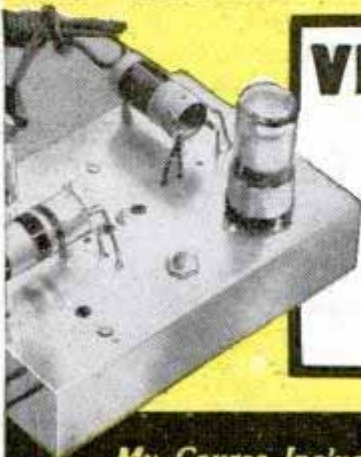

My Course Includes Training in
TELEVISION • ELECTRONICS
FREQUENCY MODULATION

Do you want a good-pay job in the fast-growing Radio Industry—or your own Radio Shop? Mail the Coupon for a Sample Lesson and my 64-page book, "How to Be a Success in RADIO—Television, Electronics," both FREE. See how I will train you at home—how you get practical Radio experience building, testing Radio circuits with **BIG KITS OF PARTS** I send!



J. E. SMITH, President National Radio Institute Our 33rd Year of Training Men for Success in Radio

Many Beginners Soon Make Extra Money in Spare Time While Learning

The day you enroll I start sending **EXTRA MONEY MANUALS** that show you how to make **EXTRA** money fixing neighbors' Radios in spare time while still learning! It's probably easier to get started now than ever before, because the Radio Repair Business is booming. Trained Radio Technicians also find profitable opportunities in Police, Aviation, Marine Radio, Broadcasting, Radio Manufacturing, Public Address work. Think of even greater opportunities as Television, FM, and Electronic devices become available to the public! Send for **FREE** books now!

Find Out What NRI Can Do For You

Mail Coupon for Sample Lesson and my **FREE** 64-page book. Read the details about my Course; letters from men I trained; see how quickly, easily you can get started. No obligation! Just **MAIL COUPON** NOW in envelope or paste on penny postal. J. E. SMITH, President, Dept. 7JP, National Radio Institute, Pioneer Home Study Radio School, Washington 9, D. C.

Good for Both—FREE

Mr. J. E. SMITH, President, Dept. 7JP, National Radio Institute Washington 9, D. C.

Mail me **FREE**, Sample Lesson and 64-page book. (No Salesman will call. Please write plainly.)

Age _____

Name _____

Address _____

City _____ State _____

(Please include Post Office Zone number)



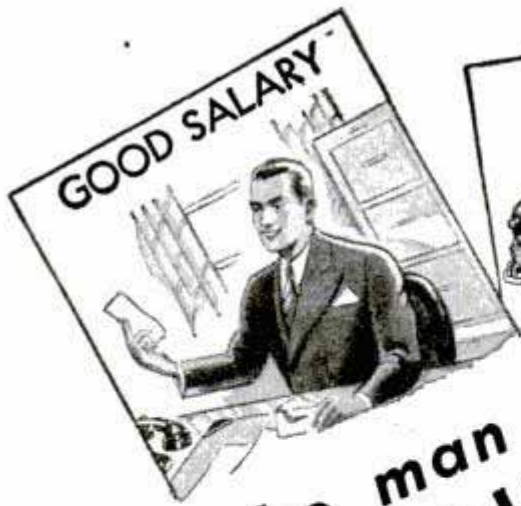

To the man who wants to enjoy
an ACCOUNTANT'S CAREER



IF you're that man, here's something that will interest you.

Not a magic formula—not a get-rich-quick scheme—but something more substantial, more practical.

Of course, you need something more than just the desire to be an accountant. You've got to pay the price—be willing to study earnestly, thoroughly.

Still, wouldn't it be worth your while to sacrifice some of your leisure in favor of interesting home study—over a comparatively brief period in your life? Always provided that the rewards were good—a salary of \$3,000 to \$10,000?

An accountant's duties are interesting, varied and of real worth to his employers. He has *standing!*

Do you feel that such things aren't for you? Well, don't be too sure. Very possibly they *can* be!

Why not, like so many before you, investigate LaSalle's modern Problem Method of training for an accountancy position?

Just suppose you were permitted to work in a large accounting house under the personal supervision of an expert accountant. Suppose, with his aid, you studied accounting principles and solved problems day by day—easy ones at first—then the more difficult ones. If you could do this—and if you could turn to him for advice as the problems became complex—soon you'd master them all.

That's the training you follow in principle under the LaSalle Problem Method.

You cover accountancy from the basic Principles right up through Accountancy Systems and Income Tax Procedure. Then you add C. P. A. Training and prepare for the C. P. A. examinations.

As you go along, you absorb the principles of Auditing, Cost Accounting, Business Law, Statistical Control, Organization, Management and Finance.

Your progress is as speedy as you care to make it—depending on your own eagerness to learn and the time you spend in study.

Will recognition come? The only answer, as you know, is that success *does* come to the man who is really *trained*. It's possible your employers will notice your improvement in a very few weeks or months. Indeed, many LaSalle graduates have paid for their training—with increased earnings—before they have completed it! For accountants, who are trained in organization and management, are the executives of the future.

Write For This Free Book

For your own good, don't put off investigation of *all* the facts. Write for our free 48-page book, "Accountancy, The Profession That Pays." It'll prove that accountancy offers brilliant futures to those who aren't afraid of serious home study. Send us the coupon *now*.

Over 2300 Certified
 Public Accountants among
 LaSalle alumni

G. I. APPROVED

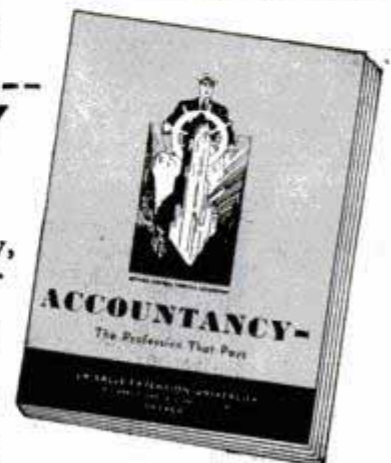

LASALLE EXTENSION UNIVERSITY

A CORRESPONDENCE INSTITUTION

417 South Dearborn Street, Dept. 964-H Chicago 5, Illinois

I want to be an accountant. Send me, without cost or obligation, the 48-page book, "Accountancy, The Profession That Pays," and full information about your accountancy training program.

Name.....
 Address..... City.....
 Position..... Age.....



INVENTORS



Learn how to protect your invention. The U. S. Patent Laws provide that any new and useful art, machine, article of manufacture, or composition of matter, or any new and useful improvement thereof, may be patented if the act of invention is involved. Therefore, every inventor with a valuable invention should take advantage of the Patent Laws and proceed for patent protection in order to safeguard his rights.

A patent gives the inventor the exclusive right to prevent others from making, using, or selling the invention claimed in the patent for a period of seventeen years.

The Patent Laws were enacted for the benefit of the inventor to give him protection for the features of his invention which are patentable. These features must be properly and concisely set forth and claimed in a formal application for patent, in order to comply with the requirements of the U. S. Patent Office. For that reason, the Patent Office advises the inventor, unless he is familiar with such matters, to engage a competent registered patent attorney or agent to represent him. We maintain a staff of registered patent attorneys ready to serve you in the handling of your patent matters.

A specially prepared booklet entitled "Patent Guide for the Inventor", containing detailed information with respect to patent protection and procedure, together with a "Record of Invention" form will be promptly forwarded to you without obligation upon request.

Patents
Trademarks
Copyrights

Registered Patent Attorneys

CLARENCE A. O'BRIEN
& HARVEY B. JACOBSON

71-J District National Building + Washington 5, D. C.

CLARENCE A. O'BRIEN & HARVEY B. JACOBSON
Registered Patent Attorneys
71-J District National Bldg., Washington 5, D. C.

Please send me copy of "Patent Guide for the Inventor" and also "Record of Invention" form. This request does not obligate me.

Name _____

Address _____

City _____ State _____

(Please write or print plainly.)



If you want to
LEARN RADIO
 I offer you the finest,
 most practical training
AT LOWEST COST!

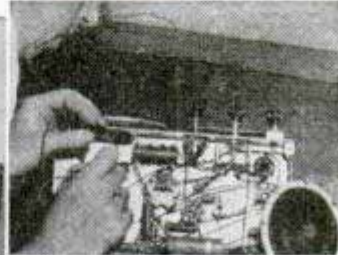
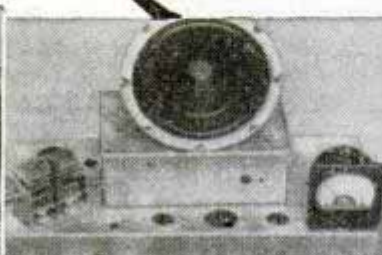

I TRAIN YOUR MIND BY PUTTING YOUR HANDS TO WORK!
You Get 8 Big Kits of Radio Parts and Equipment, Including a Two-band 6 Tube Super Receiver! 16-Range Meter for Testing!



INVESTIGATE
SPRAYBERRY TRAINING
FOR YOUR OWN GOOD!
MAIL COUPON FOR 2 FREE BOOKS!

SPRAYBERRY ACADEMY OF RADIO
 F. L. Sprayberry, President
 Room 1097, Pueblo, Colorado

Please rush my FREE copies of "How to MAKE MONEY in RADIO, ELECTRONICS and TELEVISION" and "How to READ RADIO DIAGRAMS and SYMBOLS."

Name _____ Age _____

Address _____

City _____ State _____

(Mail in envelope or paste on penny postcard)

Read what graduate says: "One job nets about \$26"
 "Since last week I fixed 7 radios, all good-paying jobs, and right now I am working on an amplifier system. This job alone will net me about \$26.00. As long as my work keeps coming in this way, I have only one word to say and that is "Thanks" to my Sprayberry training and I am not afraid to boast about it." **ADRIEN BENJAMIN**, North Grosvenordale, Conn.

15 Minutes a Day!

Give me just this
and I'll prove I can make you
A NEW MAN!

I'M "trading-in" old bodies for new! I'm taking men who know that the condition of their arms, shoulders, chests and legs—their strength, "wind," endurance—is not 100%. And I'm making NEW MEN of them. I'm giving them the kind of powerful, healthy HE-MEN build that spells SUCCESS in life and business.

Only 15 Minutes a Day!

Are you ALL MAN — tough-muscled, on your toes every minute, with all the up-and-at-'em that can lick your weight in wildcats? Or do you need the help I can give you — the help that has already worked such wonders for other fellows, everywhere?

All the world knows I was ONCE a skinny, scrawny 97-lb. weakling. And NOW it knows that I am the holder of the title, "The World's Most Perfectly Developed Man." How did I do it? How do I work miracles with the bodies of other men in only 15 minutes a day? The answer is "Dynamic Tension," the amazing method I discovered and which changed me from a 97-pound weakling into the champion you see here!

In just 15 minutes a day, right in the privacy of your own home, I'm ready to prove that "Dynamic Tension" can lay a new outfit of solid muscle over every inch of your body. Let me put new, smashing power into your arms and shoulders—give you an armor-shield of stomach muscle — strengthen your legs into real columns of surging stamina. If lack of exercise or wrong living has weakened you *inside*, I'll get after that condition, too, and show you how it feels to LIVE!

Charles Atlas

—actual photo of the man who holds the title, "The World's Most Perfectly Developed Man."



Charles Atlas—America's Greatest "Builder of Men"

Among all the physical instructors and "conditioners of men" ONLY ONE NAME STANDS OUT. That name is Charles Atlas!

In every part of the country Charles Atlas is recognized as "America's Greatest Builder of Men." Thousands upon thousands have put their physical development into his capable hands!

Now more than ever, employers are "on the lookout" for vigorous, red-blooded HE-MEN who can be depended on to do a better job. That is why so many men of every age and condition are today asking Charles Atlas to prepare them physically for success.

MAIL THIS COUPON NOW!

FREE!

This Famous Book that Tells You How to Get a Body that Men Respect and Women Admire

My book, "Everlasting Health and Strength," tells you exactly what "Dynamic Tension" can do. And it's packed with pictures that SHOW you what it does. RESULTS it has produced for other men. RESULTS I want to prove it can get for YOU! If you want to learn how you can actually become a NEW MAN, right in the privacy of your own home and in only 15 minutes a day, then man!—get that coupon into the mail to me as fast as your legs can get to the letterbox! CHARLES ATLAS, Dept. 89, 115 East 23rd St., New York 10, N. Y.

CHARLES ATLAS, Dept. 89

115 East 23rd St., New York 10, N. Y.

I want the proof that your system of "Dynamic Tension" will help make a New Man of me—give me a healthy, husky body and big muscular development. Send me your free book, "Everlasting Health and Strength."

Name _____ Age _____
(Please print or write plainly)

Address _____

City _____ Zone No. _____ State _____
(if any)



INVENTORS

Patent Laws Encourage The Development of Inventions

The Rules of Practice of the U. S. Patent Office advises— unless an inventor is familiar with such matters — that he employ a competent registered attorney or registered agent, as the value of patents depends largely upon the skillful preparation of the specifications and claims.

The firm of McMorrow, Berman and Davidson is registered to practice before the U. S. Patent Office. Additionally, it maintains a staff of attorneys able to readily understand inventors' disclosures, to advise concerning patentability, and to prepare appropriate specifications and claims for filing with the Patent Office.

If an inventor believes he has an invention, a search of the most pertinent prior U. S. patents should be made and a report obtained relative to its patentability. Where such report indicates that the invention appears patentable, in order to secure protection, diligence should be exercised in making application for a patent.

McMORROW, BERMAN & DAVIDSON

Registered Patent Attorneys

PATENTS — TRADE-MARKS — COPYRIGHTS

1359 VICTOR BUILDING, WASHINGTON 1, D. C.

McMORROW, BERMAN & DAVIDSON

Registered Patent Attorneys

1359 Victor Building, Washington 1, D. C.

Send me further particulars as to patent protection and procedure and "Invention Record" form at once. I understand that this request does not obligate me.

Name _____

Address _____

City _____ State _____

(WRITE OR PRINT NAME CLEARLY)

NOT BACK HERE!

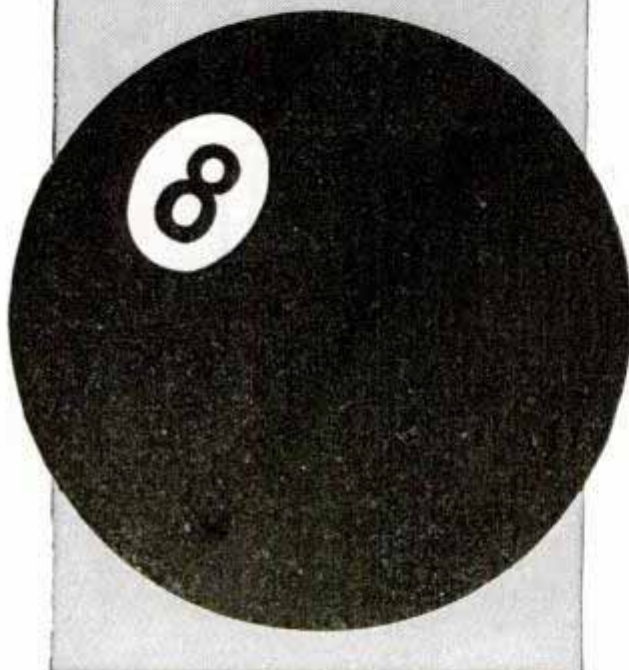

I. C. S. graduates turn up in lots of places — but not “behind the 8-ball.” You’ll find thousands of them in *top* executive posts . . . hundreds of thousands holding good positions and regularly collecting promotions and pay raises.

They realized that the advancements go to the trained men . . . and that practical, authoritative I.C.S. training is just as close to any one as the nearest letter-box. Many of them started drawing the dividends of larger pay checks and increased responsibilities *before* they completed their I.C.S. Courses.

The road they followed to success is open to you. I.C.S. Courses cover more than 400 business and technical subjects. You study in your spare time . . . at low cost . . . in a class by yourself.

If you’re as smart as we think you are, you won’t be caught “behind the 8-ball” with the untrained. You’ll mail the coupon today for full information on how to join the trained men rewarded by this modern world.

INTERNATIONAL CORRESPONDENCE SCHOOLS



BOX 5612-K, SCRANTON 9, PENNA.

Without cost or obligation, please send me full particulars about the course BEFORE which I have marked X:

Air Conditioning and Plumbing Courses

- Air Conditioning
- Heating
- Refrigeration
- Plumbing
- Steam Fitting

Chemistry Courses

- Chemical Engineering
- Chemistry, Analytical
- Chemistry, Industrial
- Chemistry, Mfg. Iron & Steel
- Petroleum Refining
- Plastics
- Pulp and Paper Making

Civil Engineering, Architectural and Mining Courses

- Architecture
- Architectural Drafting
- Bridge and Building Foreman
- Building Estimating
- Civil Engineering
- Coal Mining
- Contracting and Building
- Highway Engineering
- Lumber Dealer
- Reading Structural Blueprints
- Sanitary Engineering
- Structural Drafting

- Structural Engineering
- Surveying and Mapping

Communications Courses

- Electronics
- Practical Telephony
- Radio, General
- Radio Operating
- Radio Servicing
- Telegraph Engineering

Electrical Courses

- Electrical Drafting
- Electrical Engineering
- Electric Light and Power
- Lighting Technician
- Practical Electrician

Internal Combustion Engines Courses

- Auto Technician
- Diesel-Electric
- Diesel Engines
- Aviation
- Gas Engines

Mechanical Courses

- Aeronautical Engineer's, Jr.
- Aircraft Drafting
- Flight Engineer
- Forging
- Heat Treatment of Metals
- Foundry Work

- Industrial Engineering
- Industrial Metallurgy
- Machine Shop
- Mechanical Drafting
- Mechanical Engineering
- Mold-Loft Work
- Patternmaking—Wood, Metal
- Reading Shop Blueprints
- Sheet-Metal Drafting
- Sheet-Metal Worker
- Ship Drafting
- Ship Fitting
- Tool Designing
- Toolmaking
- Welding—Gas and Electric

Railroad Courses

- Air Brake
- Car Inspector
- Diesel Locomotive
- Locomotive Engineer
- Locomotive Fireman
- Railroad Section Foreman

Steam Engineering Courses

- Boilermaking
- Combustion Engineering
- Engine Running
- Marine Engineering
- Steam Electric
- Steam Engines

Textile Courses

- Cotton Manufacturing
- Rayon Weaving
- Textile Designing
- Woolen Manufacturing

Business and Academic Courses

- Accounting
- Advertising
- Arithmetic
- Bookkeeping
- Business Administration
- Business Correspondence
- Certified Public Accounting
- Commercial
- Commercial Art
- Cost Accounting
- Federal Tax
- First Year College
- Foremanship
- Good English
- Higher Mathematics
- Motor Traffic
- Postal Service
- Salesmanship
- Secretarial
- Sign Lettering
- Spanish
- Stenography
- Traffic Management
- French
- High School

Name _____ Home Address _____

City _____ State _____

Age _____ Present Position _____ Working Hours _____ A.M. to _____ P.M.

Special tuition rates to members of the Armed Forces. Enrollment under the G.I. Bill of Rights approved for World War II Veterans.
Canadian residents send coupon to International Correspondence Schools Canadian, Ltd., Montreal, Canada.

PATENT PROTECTION *for* INVENTORS

A PATENT IS A VALUABLE RIGHT

On the basis of a constitutional provision Congress has established a system under which inventors may secure the exclusive right to prevent the unauthorized use, manufacture and sale of their inventions for periods of seventeen years. The inventor secures this protection by obtaining a patent from the United States Patent Office.

The United States Patent Office RECOMMENDS

In its Rules of Practice that "an applicant is advised, unless familiar with such matters, to employ a competent registered patent attorney or registered patent agent, as the value of patents depends largely upon the skillful preparation of the specifications and claims."

We RECOMMEND

that you authorize us to conduct a search through the U. S. Patents pertinent to your invention and submit a report setting forth our opinion regarding its patentability.

VICTOR J. EVANS & CO. has a staff of experienced registered patent attorneys, available to represent inventors in the preparation and prosecution of their cases before the Patent Office. Detailed information and the steps to be taken in obtaining patent protection will be furnished upon request.

FORM BELOW FOR MAILING CONVENIENCE

**VICTOR J.
EVANS & Co.**

Merlin M. Evans

REGISTERED PATENT ATTORNEY

230-K MERLIN BUILDING, WASHINGTON 6, D. C.

Please forward to me detailed information regarding procedure to obtain Patent Protection, together with your convenient "Evidence of Invention" form.

Name

Address

City and State.....

PATENTS • TRADEMARKS • COPYRIGHTS

Get Training *QUICK* in the Great Shops of **COYNE**

Learn

ELECTRICITY

in a few weeks

NOT a "Home-Study" Course!

Practical training pays! Thousands of successful electricians—men earning good money, with steady jobs and a real future—recommend the COYNE Shops in Chicago. We do not teach by mail. All instruction is given in our own big building in the heart of the World's Electrical Center. You make rapid strides here because it's a shop course.

Work on Full-Size Equipment!

In our great shops you actually operate, test, repair the same kinds of electrical apparatus you'll use later on the job. You do REAL house wiring; rewind REAL armatures; run a REAL switchboard. All this plus needed theory makes it easy to learn Electricity in a few short weeks here at COYNE.

No Experience Necessary

Many Coyne students have never had previous electrical experience. Others have had a smattering of it in one or two branches, but realize their need for "All-Around" training. We not only train you for a good job, we help you get it. Lifetime Free Employment Service to Coyne graduates.

SEND FOR FREE BOOK

Yours for the asking—big 40-page book on Coyne Electrical Training. Filled with fascinating pictures of our great shops and our plans to help you. Get your copy free. No cost or obligation; no salesman will call. Mail the coupon today!



B. W. COOKE,
Director,
COYNE ELECTRICAL SCHOOL,
Dept. 67-72,

500 S. Paulina St.,
Chicago 12, Illinois.

Send me your Free Book and tell me about your plans to help me—including Student Finance and added Training in Industrial Electronics and Electric Refrigeration. Mail coupon today.

NAME.....

ADDRESS.....

CITY.....STATE.....

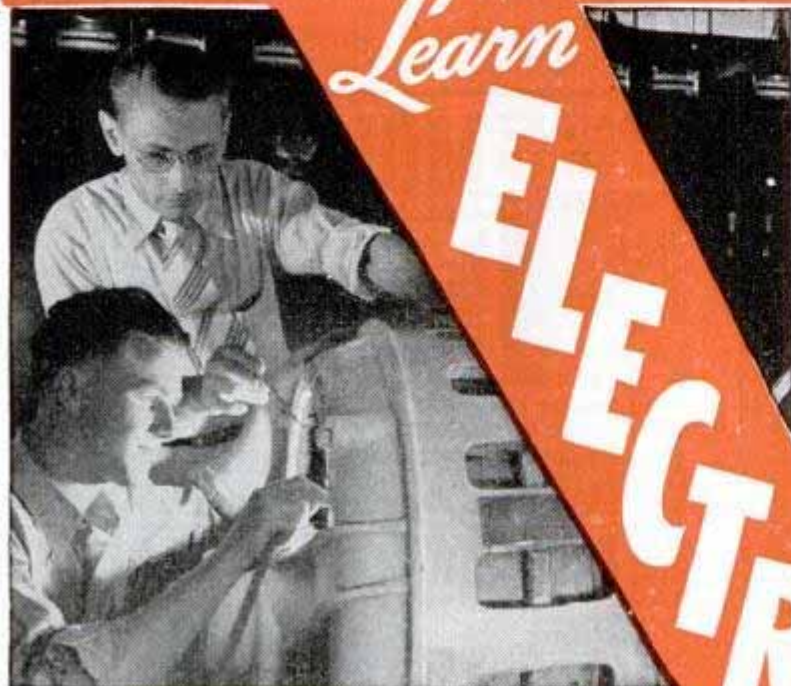

COYNE Shop Training Includes:

Alarm and Signal Work
D.C. Motors, Generators, Controls
A.C. Motors, Generators, Controls
House Wiring
Armature Winding
Stator Winding

Transformers
Switchboards
Home Appliances
—and many other branches including added training in Industrial Electronics and Electric Refrigeration.

NOW IN OUR 49th SUCCESSFUL YEAR



B. W. Cooke

Since 1899, Coyne has been training men and young men for practical, better-paying jobs. Here in our great Chicago Shops you will find the equipment, the friendly expert instructors, to prepare you for a real future in Electricity. Coyne graduates are in demand by many leading electrical firms. Coyne men are trained to make good in their own electrical shops. Come to COYNE!

VETERANS!

Coyne is authorized to accept Veterans for G. I. training. Coupon brings special G. I. Bulletin.

NON-VETERANS

who are short of cash can finance most of their tuition and pay it in easy monthly payments after graduation. Many students earn while learning. We'll help you get part-time work while here if you need it to help defray living expenses.

ANY MAN WITH A PHYSICAL DISABILITY whether a Veteran or not may qualify for Coyne training at no cost to himself for tuition or subsistence. Send coupon for details.

B. W. COOKE, Director

COYNE ELECTRICAL SCHOOL
Dept. 67-72
500 S. Paulina St., Chicago 12, Ill.

The Steady Pay Profession Good Times or Bad!

SCIENTIFIC CRIME DETECTION

FOLLOW
THIS MAN

Operator
No. 38



It Is Easy to Learn!

I will teach you this fascinating science during your spare time at home. It pays to be an expert in Finger Printing, Firearms Identification, Police Photography and Criminal Investigation. I have trained hundreds of men and women now successfully serving in identification bureaus throughout America. You, too, may quickly prepare yourself to become a well-paid valued officer of the law, often sharing in the generous rewards offered for wanted criminals.

FREE! OVER 800

"BLUE BOOK OF CRIME"

This book is full of exciting information on scientific crime detection. It will show how you can get started in a grand career. Now, at amazingly low cost. Clip coupon now... Mail it today.

of all Identification Bureaus in the U. S. employ students and graduates of I. A. S. A majority of these men are heads of Bureaus. Many of them knew nothing about crime detection before training with me. Now they have steady jobs, good salaries and a fine future. Write today for full particulars and free book. Give age.

INSTITUTE OF APPLIED SCIENCE

1920 Sunnyside Ave., Dept. 1356, Chicago 40, Ill.

INSTITUTE OF APPLIED SCIENCE

1920 Sunnyside Ave., Dept. 1356, Chicago 40

Gentlemen: Without any obligation on my part, send me the "Blue Book of Crime," and complete list of Identification Bureaus employing your students or graduates, together with your low prices and Easy Terms Offer. (Literature will be sent ONLY to persons stating their age.)

Name..... Age.....

Address.....

RFD or Zone..... State.....

New BRUSH Electroplater

**ESPECIALLY BUILT FOR
MECHANICS, MODEL MAKERS
HOME CRAFTSMEN**

Easy to Plate GOLD, SILVER, NICKEL, COPPER, etc... For Pleasure and Profit!

If you have a workshop—at home or in business—you need this new Warner Electroplater. At the stroke of an electrified brush, you can electroplate models and projects—you can replate worn articles, faucets, tools, fixtures, silverware, etc. with a durable, sparkling coat of metal... Gold, Silver, Nickel, Copper, Cadmium, and after a bit of practice, even Chromium! Everything furnished—equipment complete, ready for use. By doing a bit of work for others, your machine can soon pay for itself. So make your shop complete by getting a Warner Electroplater right away. Send today for FREE PLATING SAMPLE and illustrated literature. ACT AT ONCE.

WARNER ELECTRIC CO., Inc., Dept. N-31
1512 Jarvis Ave., Chicago 26, Illinois

FREE Details & Sample!

WARNER ELECTRIC CO., Inc., 1512 Jarvis Ave., Chicago 26, Ill., Dept. N-31

Gentlemen: Send Free Sample and Details to:

Name.....

Address.....

City..... State.....

AVIATION

Aeronautical University Approved Training meets exacting standards of aviation industry, prepares for key positions, big opportunities.

Courses in:

AERONAUTICAL ENGINEERING. B.S. degree.
AERONAUTICAL ENGINEERING DRAFTING
CERTIFIED ENGINE MECHANICS
ADMINISTRATION—including sales

PRE-ENGINEERING: Special course for high school graduates and veterans deficient in math and science.

Also refresher courses for Gov't Airplane and Engine Mechanics Licenses for those with aviation experience.

Oldest fully approved aviation school. Outstanding faculty, modern equipment, outside employment, placement service. Day, evening. Approved for Veterans. Send today for FREE catalog "Opportunities in Aviation."

AERONAUTICAL UNIVERSITY

Dept. 77, 116 S. Michigan Ave., Chicago 3, Ill.

**FOUNDED
BY
CURTISS-
WRIGHT**

LEARN AT HOME TO MOUNT BIRDS



Animals, Heads, Fishes, Pets; to TAN. Be a Taxidermist. Profit and FUN.

Hunters, save your valuable TROPHIES. Mount ducks, squirrels, everything. Learn to TAN for leather and furs. Wonderful HOBBY Have a HOME MUSEUM.—BIG PROFITS mounting for others. INVESTIGATE NOW.

FREE BOOK With 100 fine game pictures. NOW absolutely FREE. Write TODAY.

Send Postal TODAY for FREE BOOK. State AGE. N. W. SCHOOL OF TAXIDERMY, Dept. 9376, Omaha, Neb.



LEARN MONEY-MAKING CARTOONING

IN SPARE TIME — by Easy Picture Chart Method

Same Simplified Method that has helped train creators of "Terry & Pirates," "Freckles," "Out Our Way," "Winnie Winkle," "Regular Fellers," "Strange As It Seems," "The Neighbors," and many others. Earn while learning. Send 10c for Picture Chart (to test your ability), and full details. (State age.)

THE LONDON SCHOOL, 4709 Schofield Bldg., Cleveland 15, Ohio



Be A MASTER PLUMBER

Earn \$15 To \$50 A Day

DON'T ENVY THE PLUMBER — BE ONE

Every skilled workman will tell you that Plumbers have the best of it. WINTER and SUMMER the Plumber is busy at top wages. No skilled Plumber is ever out of a job—compare his opportunities with any trade, plus the opportunities of having your own shop.

We teach you Plumbing with TOOLS (not books) under Licensed Master PLUMBERS in one of the finest equipped schools in America. We make you a Plumber, every branch is taught thoroughly—Lead Work—Blueprint for plan reading—all other tricks.

LEARN IN 30 WEEKS WITHOUT PREVIOUS EXPERIENCE

If you like to work with tools you owe it to yourself to investigate. No need to ever work as an apprentice. Get free bulletin. Write now! G.I. APPROVED. Our 24th year.

UNIVERSAL PLUMBING SCHOOL

815 HOLMES STREET

KANSAS CITY, MO.

RADIO ENGINEERING

Broadcasting, Television, FM, Servicing, Electronics, Aviation, Marine & Police Radio taught thoroughly

Engineering course equivalent to 3 years' college radio work. Approved Veteran Training. Catalog free.

VALPARAISO TECHNICAL INSTITUTE, Dept. D, Valparaiso, Ind.

MONEY-MEN ALL FREE

THE PLASTEX Industry needs manufacturers on small scale and for big production of Lamp and Clock Stands, Art Goods and Novelties in Plastex and Marble imitation. Experience unnecessary. 1/2c material makes regular 10c store sellers. Rubber moulds furnished for speed production. Small investment brings good returns. Big chain store orders now being placed. Ambitious men have chance for real prosperity. Our Free booklet will interest and benefit you.

PLASTEX INDUSTRIES, Dept. P,
1085 Washington Ave. New York, N. Y.



WHICH OF THESE *Opportunities* INTERESTS *You* MOST?

Accounting
Air Conditioning
Architecture & Building
Automotive Engineering
Aviation—Practical
Aviation Drafting & Design
Better Foremanship
Bookkeeping
Business Management

Contracting
Diesel Engineering
Drafting & Design
Electrical Engineering
Electricity—Practical
Electronics, Industrial
High School Courses
Machine Shop Operations
Mechanical Engineering

Plastics Engineering
Plumbing—Practical
Private Secretary
Radio Operating & Servicing
Railway Training
Refrigeration
Sheet Metal Pattern Drafting
Shop Management
Tool Making

THINK! LOOK FORWARD!

Business is making big, new plans

Men and Women are preparing for the future

WHAT ARE YOU DOING ABOUT YOUR TOMORROWS?

● *Today*, choose the job you want—and prepare for it. Or if you are already engaged in the work you like best, start training *now* for quicker promotion. Acquire the knowledge that will help you to get ahead faster, make more money and have greater security.

Invest part of your spare time in more rapid progress. Start training now, in spare time in your own home. Be ready to grasp your opportunity and step out ahead of those who lack the ability you have attained.

American School, founded in 1897 as an educational institution *not for profit*, can help you to reach your goal just as it has helped others during the past fifty years. Give serious thought to the list above. Pick one or more subjects that interest you. Then check the coupon at right, add your name and address and mail it at once. The school will send you details on its training plan and outline of study prepared by specialists. There is no charge, no obligation, so send the coupon immediately.

PRACTICAL, EFFECTIVE HOME - STUDY TRAINING SINCE 1897

Take This First Easy Step

CHECK, CLIP AND MAIL COUPON NOW

AMERICAN SCHOOL, Dept. G645, Drexel at 58th, Chicago 37, Ill.
Without obligation, Please send FREE and postpaid, bulletin and details of the Subject checked.

- | | | |
|--|--|--|
| <input type="checkbox"/> PLASTICS ENG'R | <input type="checkbox"/> Accounting | <input type="checkbox"/> Drafting and Design for Men and Women |
| <input type="checkbox"/> Refrigeration | <input type="checkbox"/> Electrical Engr. | <input type="checkbox"/> Radio |
| <input type="checkbox"/> Architecture and Building | <input type="checkbox"/> Electricity-Pract. | <input type="checkbox"/> High School |
| <input type="checkbox"/> Contracting | <input type="checkbox"/> Electronics, Industr. | <input type="checkbox"/> Air Conditioning |
| <input type="checkbox"/> Practical Plumbing | <input type="checkbox"/> Bookkeeping | <input type="checkbox"/> Mechanical Eng. |
| <input type="checkbox"/> Automotive Engineering | <input type="checkbox"/> Private Secretary | <input type="checkbox"/> Shop Management |
| <input type="checkbox"/> Aviation Drafting | <input type="checkbox"/> Diesel Engineering | <input type="checkbox"/> Tool Making |
| <input type="checkbox"/> Aviation | <input type="checkbox"/> Sheet Metal | <input type="checkbox"/> Better Foremanship |
| <input type="checkbox"/> Business Mgmt | <input type="checkbox"/> Pattern Drafting | <input type="checkbox"/> Machine Shop Operations |
| <input type="checkbox"/> Railway Training | | |

Name..... Occupation.....

Address..... Age.....

City..... State.....

AMERICAN SCHOOL

Dept. G645, Drexel at 58th Street, Chicago 37

Learn this Profitable Profession



**IN 90 DAYS
AT HOME**

Money-Making Career Open to Men and Women, 18 to 50

Hundreds of men and women between 18 and 50 make \$10 to \$20 in a single day giving scientific Swedish Massage and Hydro-Therapy treatments. There is big demand from doctors, hospitals, sanatoriums and clubs. Graduates earn large full time incomes from these or in private practice in their own offices. Others make good money from home treatments given in spare time. Learn this interesting, money-making profession in your own home, through our home study course. Same instructors as in our nationally known resident school. You can win independence and prepare for future security by qualifying for your Diploma. Course can be completed in 3 to 4 months. Many earn while they learn. Begin your training at once.



Anatomy Charts & Booklet FREE

Enroll now and we will include, at no extra cost, many needed supplies. Fit yourself to help meet growing demand for Scientific Swedish Massage. Send the coupon at once for complete details. Anatomy Charts and 32-Page Illustrated Booklet, FREE, postpaid.

THE COLLEGE OF SWEDISH MASSAGE

Dept. 764L, 100 East Ohio St., Chicago 11, Illinois

Please send me FREE and postpaid, Anatomy Charts, 32-page Booklet and complete details on Home Training.

Name _____

Address _____

City _____ State _____

Keep that "TICKING" Car



Every operator and mechanic needs AUDELS AUTO GUIDE.

This book saves time, money and worry. Highly endorsed. It presents the whole subject of auto mechanics:

- 1—Basic principles
 - 2—Construction
 - 3—Operation
 - 4—Service
 - 5—Repair
- Handy Size, Easily understood.

588 PAGES
1500 ILLUSTRATIONS



NEW FLUID DRIVE, HYDRAULIC SHIFT AND DIESEL ENGINES FULLY COVERED

Over 1500 pages—1540 illustrations showing inside views of modern cars, trucks and buses with instructions for all service jobs.

4 ASK TO SEE IT!—To Get This Assistance for Yourself Simply Fill in and Mail Coupon Today.

4 COMPLETE • PAY ONLY \$1. A MONTH ←

AUDEL, Publishers, 49 West 23rd St., New York
MAIL AUDELS NEW AUTO GUIDE for free examination, if O. K. I will send you \$1 in 7 days; then remit \$1 monthly until price of \$4 is paid. Otherwise I will return it.

Name _____

Address _____

Occupation _____

Employed by _____ PM

How to Start YOUR OWN BUSINESS

And Reap BIG Profits!

Plastics, one of the most revolutionizing and rapidly expanding industries, offers a great opportunity to all enterprising men and women. This is one of the few industries in which home manufacturers thrive and prosper. You can start even on a spare time basis in your own home, and expand rapidly into a full time business, paying good profits.

LIQUID MARBLE

Make LIQUID MARBLE the amazing Plastic, with a thousand uses. LIQUID MARBLE can be poured into FLEXIBLE MOLDS for casting all kinds of artistic and serviceable articles, such as: ornaments, novelties, desk sets, paper weights, book-ends, souvenirs, statuary, toys, etc.

FLEXIBLE MOLDS

Make your own FLEXIBLE MOLDS. The cost is low—in fact, a large sized mold costs but a few cents. Hundreds of casts can be taken from a single mold.

NO EXPERIENCE NEEDED!

No skill, or previous knowledge is necessary. All you do is follow our easy-to-understand instructions.

UNLIMITED MARKET

The market is literally unlimited. You will find steady year-round demand in your own community. Your problem will not be in selling but in supplying the huge pent-up demand. Moreover, we supply you with names of buyers for your finished products.

WRITE TODAY

Bing Products will show you how to start with a small investment and build a permanent, independent, profitable business! Don't fail to grasp this opportunity! Write today for FREE CATALOG.

BING PRODUCTS

Dept. A-22, 88 Broad Street

Boston 10, Mass.

Enjoy... WORLD'S MOST FASCINATING HOBBY! SEND FOR FULLY ILLUSTRATED BOOK TODAY!



GET THE FACTS on model railroading!

Leading authority shows how easily, inexpensively you can join in the absorbing hobby enjoyed by thousands of mechanics, business and professional men. Scale model railroads look, perform like the real thing!

GET STARTED NOW! Send 10¢, coin or stamps, for fully illustrated booklet, "Model Railroading for You".

MODEL RAILROADER MAGAZINE

Dept. 1509 Milwaukee 3, Wisconsin



Bar Bells

...at Factory Prices

\$8.95 up

WRITE FOR FREE BOOKLET AND PRICE LIST

INDEPENDENT IRON WORKS
2416 East 23rd Street, Dept. P5
Los Angeles 11, Calif.



BUILDING HUMAN STATURE

"I grew 6 inches during a year I followed instructions given in 'BUILDING HUMAN STATURE,'" says the younger man at left. "Now I am a head taller than my father."

If you wonder why you are short send for FREE outline of this remarkable book loaded with practical information.

CARILLON BOOKS

Dept. 129, 3439 S. Michigan Ave., Chicago 16, Ill.

Learn Penmanship

One should learn Rapid Business Writing, both for his own satisfaction and for the convenience of those who must read it. And if Fancy Shaded Writing is learned also, it makes one a still more skillful penman. Good penmanship prevents costly errors and helps to secure and hold good positions, and, like music or elocution naturally attracts persons of refinement and artistic inclinations. If you are dissatisfied with your present handwriting and wish to become a good writer, write for my FREE BOOK, "How to Become an Expert Penman," which contains specimens of penmanship and shows what others have learned by my Simplified Method. If you enclose 10¢, I will send you one of my Favorite Pen Points suitable for plain or shaded writing, and your name with a beautiful flourished bird written on a card. Begin Now. Write for your copy of the Free Book today.

T. M. TEVIS, BOX 25K, CHILLICOTHE, MO.

2 METHODS

Learn RADIO-ELECTRONICS

at HOME... or in our LABORATORIES

TAKE YOUR CHOICE!



LEARN IN CHICAGO IN ONE OF NATION'S FINEST TRAINING LABORATORIES

36 weeks — that's all the time you need to get one of today's finest practical trainings in RADIO and ELECTRONICS. That's all the time required to prepare yourself for America's great opportunity field that offers so many thrilling possibilities for a GOOD JOB with a REAL FUTURE—or a profitable RADIO SERVICE BUSINESS OF YOUR OWN.



MODERN TELEVISION TRAINING calls for ample equipment. In our modern Chicago training laboratories, you will find some of the finest Television equipment available for training purposes.

Now you can enjoy outstanding training advantages in the large, entirely NEW postwar laboratories of DeForest's Training, Inc. in Chicago. You get ALL of your instruction amid a large staff of highly skilled instructors and loads of modern, costly commercial Radio-Electronic and Television equipment.

We secure comfortable living quarters for you. Get complete facts about this remarkably effective way to qualify yourself QUICKLY for a GOOD PAYING FUTURE — and about our EMPLOYMENT SERVICE that helps our graduates GET STARTED. MAIL COUPON BELOW FOR COMPLETE DETAILS.

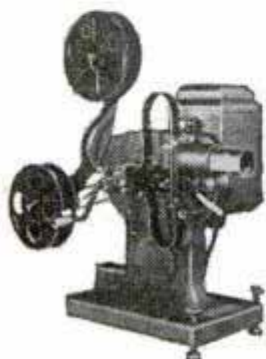

D.T.I.'s Home Study Course Includes the use of a 16 mm. Motion Picture projector and Movie Film to help you learn important fundamentals FAST-ER . . . EASIER. Get vivid — LASTING Impressions by means of the modern MOVIE-WAY method of instruction.



GET "SHOP METHOD" TRAINING AT HOME — IN YOUR SPARE TIME

Look around you! What other field embraces so many exciting, fast-moving activities as F. M. Radio, 2-Way Train Radio, Aviation Radio, Broadcast Radio, Radio Manufacturing, 2-Way Bus, Truck and Cab Radio, Police Radio and other branches?

DeForest's Training, Inc. makes it possible for YOU to train in the privacy of your own home for this bright field of Radio and Electronics — and without interfering with your present job.

You get a long-tested, PROVED combination of home study advantages — plus EMPLOYMENT SERVICE — which helps you get started toward a real future in Radio and Electronics.

3-Way Method Gets Results!

No previous RADIO or ELECTRONIC experience is necessary. Our effective A-B-C Home Study Method includes (A) "Learn-By-Doing" Home Laboratory of many Radio parts enabling you to work out 133 fascinating experiments at home, including 7 different Radio Receiving Circuits; (B) a 16 mm. Movie Projector and 12 reels of "Learn-By-Seeing" Movie Film that speed your progress; and (C) well-illustrated lessons. MAIL COUPON BELOW FOR COMPLETE DETAILS.



ABOVE: You work out 133 intriguing experiments from this equipment to get valuable, practical experience AT HOME.

VETERANS!

Both our (1) Chicago Laboratory and (2) Home Study Courses are accepted under the "G. I. Law." If you qualify, the Government will pay cost of either Course you select.

DEFOREST'S

TRAINING, INC.

Affiliated with the DeVRY CORPORATION
CHICAGO, ILL.

E. B. DeVry, President
DeForest's Training, Inc.
2533 N. Ashland Ave., Dept. PM-D9
Chicago 14, Ill.

Please send me information about the Radio-Electronic Course I have checked:

HOME STUDY CHICAGO LABORATORY BOTH

Name Age.....

Address Apt.....

City Zone State.....

If under 18, check here for special information.

If a discharged Veteran of World War II, check here.

BETTER JOBS BETTER PAY FOR SKILLED MEN! QUICK TRAINING BOOKS SHIPPED for Examination

SEND NO MONEY! Prepare for a better job at bigger pay by sending the coupon NOW for any set of easy-to-understand self-training text books. These great books, prepared by long experienced experts, can help you to acquire the "know how" that wins promotions and puts more money in your pocket. Any set of books sent for 10 days examination.

AUTOMOBILE ENGINEERING



4 Big, Thick Books
20th Edition, 2800 Pages

These wonder books tell how—step by step—to make the repairs and adjustments that keep any make of car at maximum operating efficiency. More than 2000 illustrations, wiring diagrams, data sheets, etc. Total price only \$24.80. Low monthly payments. Sent on trial.

BUILDING, ESTIMATING and CONTRACTING

Up-to-Date Edition
8 Volumes — 3787 Pages

These 8 practical books can help you to make more money by becoming foreman, superintendent, or running your own business. Drawing plans, estimating, building, remodeling, heating, painting and many other subjects included. 3195 illustrations and tables. Total price only \$34.80. Low monthly payments. Sent on trial.

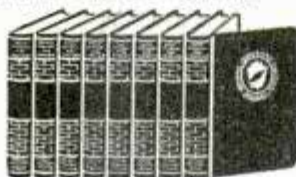

APPLIED ELECTRICITY INCLUDING RADIO AND REFRIGERATION

New 19th Edition
8 Books — 3700 Pages

NEW, up-to-date edition contains many new subjects in detail, including blueprint reading, electronics, P.M. radio, fluorescent lighting and other modern electrical topics as well as full range of standard practices. 2700 illustrations, 134 tables. Total price only \$34.80. Low monthly payments. Sent on trial.



tions, 134 tables. Total price only \$34.80. Low monthly payments. Sent on trial.

Vocational Publishers Since 1898

(A year's consulting privileges with our engineers) (now given with these books at no extra charge.)

AMERICAN TECHNICAL SOCIETY

Dept. X619 Drexel at 58th St. Chicago 37, Ill.

CLIP AND MAIL COUPON TODAY

AMERICAN TECHNICAL SOCIETY, Dept. X619

Drexel at 58th Street, Chicago 37, Ill.

Send for 10 days' free use, the following set of books:

I will pay the delivery charges only, and if fully satisfied, will send you \$2.00 in 10 days and then \$3.00 a month until the total price of \$_____ is paid. If I return the books in 10 days I will owe you nothing. You are to include a Year's Consulting Privileges with your engineers without extra charge.

Name _____

Address _____

City _____ State _____

Please attach letter stating age, occupation and name and address of employer, and at least one business man's name and address as reference. Men in service also please give home address.

HOW to BREAK and TRAIN HORSES

SEND FOR THIS FREE!



Make money with horses. Every farmer, every lover of horseflesh should have a copy of this booklet. If you want to know how to break, train and make money with horses, write today for full information **FREE**, together with my special offer of a course in Animal Breeding. If you are interested in Gaiting and Riding the saddle horse check here. Do it today—now. You'll never regret it.

BEERY SCHOOL OF HORSEMANSHIP
Dept. 1109 Pleasant Hill, Ohio

Have an OFFICE of YOUR OWN!

LEARN NEW PROFITABLE PROFESSION
At Home in 60 Days, Men & Women, 18 to 70!

Be Your Own Boss and the Boss of Others. Be Respected. Meet Interesting People.

Earnings of men and women in this profession run as high as \$5,000-\$15,000 yearly. Others make good money in spare time. Little money needed to start. A business where your earnings begin sooner. Easy to learn. No selling or goods to buy. No experience necessary. A depression-proof business. A course of action to guide you step by step as you earn. All 53 lessons sent at once to use as operating manuals. Easy terms. Diploma. Money-back agreement. Write for **FREE BULLETIN**.



FRANKLIN CREDIT SCHOOL
Dept. 75-J ROANOKE 7, VIRGINIA

BY MAIL in Easy Lessons

SUCCEED IN THE POULTRY BUSINESS!



You can make a good, comfortable living with poultry. For 26 years our course of Home Study training has been helping thousands. With a little study in spare time—you, too, can obtain the "know how" that means extra profits from the start.

Write today for prospectus describing courses, methods, service.

Dept. 50 **NATIONAL POULTRY INSTITUTE**
Adams Center, N. Y.

BE A REAL ESTATE BROKER

PAYS BIG! **EASY TO LEARN**—Start and run your own business quickly. Many graduates report making up to \$1000 a month. Course of study covers Sales, Property Management, Appraising, Loans, Mortgages and hundreds of related subjects. Course offered in home study or residential classrooms.

FREE Big new illustrated catalog from this nationally known school. Send Post Card Today. G. I. Approved.

WEAVER SCHOOL OF REAL ESTATE

Dept. KA-7, 15 E. Pershing Road Kansas City, Mo.

Learn Public Speaking

Learn theory and fundamentals at home—in spare time. Then acquire actual experience and practice. Send for **FREE** booklet "Power of Effective Speech."

North American School, Dept. 1356
1315 S. Michigan Ave., Chicago 5, Illinois

SHINE WITHOUT 'POLISH'



New Invention! • Sells Like Wild

Replaces messy pastes, liquids. Simply glide over shoes—and PRESTO!—you have a lustrous, long-lasting shine. No mess. No fuss. No soiled hands. Clean. Handy. **WORKS LIKE MAGIC!** For Men's, Women's and Children's Shoes. Low priced. Lightning seller!

SAMPLES FOR AGENTS Sample offer sent immediately to all who send name at once. A penny postal will do. **SEND NO MONEY—just your name.** KRISTEE CO., 672 Bar Street, AKRON, OHIO

ELECTRICAL APPLIANCE REPAIRING

OFFERS BIG MONEY — INDEPENDENCE

If now employed start your home appliance repair business NOW in your spare time and be set with a business of your own no matter what happens. Operate from your garage, basement, kitchen, vacant store, etc. Work as many hours as you wish—the home appliance repairman is his own boss. It is a profitable occupation, for on many types of repairs it is not unusual for a repairman to charge on the basis of \$5.00 to \$6.00 per hour! Remember, there are millions of electrical appliances in this country. Appliances such as refrigerators, irons, sewing machines, vacuum cleaners, heaters, toasters, washing machines, motors, etc. To replace any of them is mighty expensive. That is why mechanically inclined men will find the Electrical Appliance Repair Business one that offers the trained man unlimited earning possibilities.

YOU CAN QUALIFY

All you need to become a successful electrical appliance repairman is ambition plus a little training at home in your spare time. If you are mechanically inclined—that is to say—can hold and use tools, our profusely illustrated course written in simple, easy to understand language will prepare you for the years to come. It does not matter if you have not had a great deal of schooling or have had no previous training along these lines. WE WILL TEACH YOU. Age should be no barrier—nor should any minor physical handicap.



WE TEACH YOU

Profusely illustrated with photographs and simple drawings we show you what troubles to look for and how to make each repair on an electrical appliance. We give you a good sound working knowledge of electricity, and how to do welding, nickel plating, etc. Our course shows you how to solicit business and keep it coming to you. Not a theory course but an honest to goodness course written by and used by repairmen the country over. Price of course is so low that the savings on your own household appliance repairs will quickly pay for it. Why work for others at the wages they want to pay you? Learn a good trade and operate your own business and determine just how long you work each day and the amount of money you make. ACT NOW!



MAIL COUPON TODAY

CHRISTY SUPPLY CO.
2835 N. Central Ave., Dept. D-4903
Chicago 34, Illinois

Please send me free illustrated literature about America's Fastest Growing Industry — ELECTRICAL APPLIANCE REPAIRING.

Name _____

Address _____

City _____ State _____

It's YOUR future — Make the most of it!



Start now to earn the bigger pay in electrical repair

WAS there ever such an opportunity to get started in electrical maintenance and repair—and at top-notch wages? Are you ready—with experience and ability—to cash in on it? Others are getting just the sort of background needed—quick! practical!—to handle the great variety of electrical maintenance and repair work TODAY—from this well-known electrical library. You can too!

THE LIBRARY OF ELECTRICAL MAINTENANCE AND REPAIR

5 vols., 1826 pages, 1724 illustrations

Gives you the "know-how" to tackle any wiring or motor job. Five books show you HOW—to install all types of motor and generator units—to inspect and repair motor starters and generators—to diagnose motor and generator troubles—to figure new windings for old cores—DC and AC windings—to test armature windings—test induction motors, etc., etc. One book is full of trouble-shooting charts that show quickly symptoms, causes, specific remedies, etc.

Take the first step toward improving YOUR future—Mail this coupon TODAY

No money down—special price—easy payments—FREE trial

McGraw-Hill Book Co., 330 W. 42 St., New York 18, N. Y.

Send me for ten days' free examination the Electrical Maintenance and Repair Library. If satisfactory I will send you \$1.50 in 10 days and \$3.00 monthly until the price of \$16.50 is paid. If not wanted I will return books postpaid. (To insure prompt shipment write plainly and fill in all lines.)

Name.....
 Home Address.....
 City and State.....
 Company.....
 Position..... PM-9-47

AUDELS Carpenters and Builders Guides 4 vols. \$6



Inside Trade Information for Carpenters, Builders, Joiners, Building Mechanics and all Woodworkers. These Guides give you the short-cut instructions that you want—including new methods, ideas, solutions, plans, systems and money saving suggestions. An easy progressive course for the apprentice and student. A practical daily helper and Quick Reference for the master worker. Carpenters everywhere are using these Guides as a Helping Hand to Easier Work, Better Work and Better Pay. To get this assistance for yourself, simply fill in and mail the FREE COUPON below.

Inside Trade Information On:

How to use the steel square—How to file and set saws—How to build furniture—How to use a mitre box—How to use the chalk line—How to use rules and scales—How to make joints—Carpenters arithmetic—Solving mensuration problems—Estimating strength of timbers—How to set girders and sills—How to frame houses and roofs—How to estimate costs—How to build houses, barns, garages, bungalows, etc.—How to read and draw plans—Drawing up specifications—How to excavate—How to use settings 12, 13 and 17 on the steel square—How to build hoists and scaffolds—skylights—How to build stairs—How to put on interior trim—How to hang doors—How to lath—lay floors—How to paint



THEO. AUDEL & CO., 49 W. 23rd St., New York City

Mail Audels Carpenters and Builders Guides, 4 vols., on 7 days' free trial. If O.K. I will remit \$1 in 7 days, and \$1 monthly until \$6 is paid. Otherwise I will return them. No obligation unless I am satisfied.

Name.....
 Address.....
 Occupation.....
 Reference..... PM



BUILD YOUR OWN MOTOR CAR!

Here's news so thrilling, so sensational, it's almost too good to be true. Imagine. Now, you can build your own auto starter motor car right in your own back yard. A swell deluxe model that travels

over the highways, just like the big cars. A real thrill for anyone who likes to "tinker." Every red blooded boy will want to build one. Cause with this kind of auto, he'll be the "big shot" in his town. This is a real powered auto, not a toy. Rush postcard or letter and let us tell you all about it.

CONSTRUCTIVE ENTERPRISES

BOX 554, RIVERDALE STATION DAYTON 5, OHIO

Learn RADIO TELEVISION ELECTRONICS

Train at home, in spare time, for a good pay job or start a business of your own without capital—under our proven 2-Way method that helps you get into this money-making field of radio quicker. You receive Lessons plus Home Shop Practice including 9 kits of radio parts to make hundreds of tests. Many students earn money in spare time while learning. Write for FREE book "Your Opportunities in Radio" to Hollywood Radio & Television Institute, (Established 1929), Dept. A-8, 810 W. 6th St., Los Angeles 14, Calif.

WANTED DISTRICT PURCHASING AGENTS

No experience or money required. Exceptional opportunity for those who want to establish themselves in a steady, year 'round, well paying business.

For details: Write

PURCHASING MANAGER, DEPT. C
 2719 LAWRENCE AVE. CHICAGO 25, ILL.

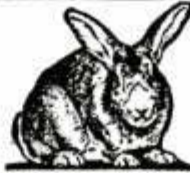

RAISE CHIN-CHINS

No experience needed. Just a few minutes daily and a few feet of backyard, garage or barn space. Several females and a male starts a large, profitable herd. WE FURNISH FREE INSTRUCTIONS. TREMENDOUS DEMAND for breeding and laboratory stock, meat, and world's most beautiful rabbit fur. Brokers, cut off from imported rabbit pelts by world famine, NEED CHIN-CHIN FURS NOW, and for years to come! Write for free illustrated catalog today. WILLOW BROOK FARM • R-36, SELLERSVILLE, PENNA.

Learn LANDSCAPE GARDENING

A thorough, interesting, home study course for those who wish to become LANDSCAPERS, GARDENERS, DESIGNERS, etc., for profit or pleasure. Write today for FREE BOOK to

APPROVED NATIONAL LANDSCAPE INSTITUTE
 FOR VETERANS Dept. P-9, 310 So. Robertson, Los Angeles 36

ARTISTS MAKE MONEY

Do you like to draw? Send name, address, age and occupation for FREE ART TEST, to find out your ability.

ART INSTRUCTION, Inc.
 9137 ART INSTRUCTION BLDG., MINNEAPOLIS 15, MINN.

RUPTURED?

Get Relief This Proven Way

Why try to worry along with trusses that gouge your flesh—press heavily on hips and spine—enlarge opening—fail to hold rupture? You need the Cluthe. No leg-straps or cutting belts. Automatic adjustable pad holds at real opening—follows every body movement with instant increased support in case of strain. Cannot slip whether at work or play. Light. Waterproof. Can be worn in bath. Send for amazing FREE book, "Advice To Ruptured," and details of liberal truthful 60-day trial offer. Also endorsements from grateful users in your neighborhood. Write:

CLUTHE SONS, Dept. 31, Bloomfield, New Jersey

AMERICA'S FOREMOST SCHOOL OF *PRACTICAL TRAINING!*

WILL TRAIN YOU FOR KEY JOB OR BUSINESS OF YOUR OWN

IN

REFRIGERATION AIR CONDITIONING

- SPARE TIME HOME STUDY
- RESIDENCE SHOP TRAINING
- COMBINATION HOME AND RESIDENCE TRAINING

Here is an industry that offers every opportunity you could ask for. Good jobs—security—plenty of chance for advancement—a business of your own.

And here is a school equipped in every way to train you for Refrigeration and Air Conditioning work—one of the largest and most completely equipped schools of its kind in America—a school that already has trained thousands of men for just such opportunities.

GET READY NOW!

Learn Refrigeration and Air Conditioning—now, while the time is ripe. You don't need any advanced schooling or previous experience. If you are at all mechanically inclined and have gone to high school for at least one year or have an equivalent education, we can teach you Refrigeration and Air Conditioning.

LEARN AT HOME OR COME TO OUR SCHOOL

You can take most of your training at home, in your spare time—or you can come to Chicago and take your entire training in our completely equipped shops and laboratories. Either way you quickly acquire the fine points, practical skill, and broad, technical "know how" that makes the expert Refrigeration and Air Conditioning Technician.

Get all the facts about the opportunities in this interesting field of work, and about the I. T. I. system of training that has helped so many men into key jobs in this industry. Fill out the information coupon below and mail it TODAY. You will be under no obligation whatsoever.

AUTHORIZED TO ACCEPT VETERANS FOR G. I. TRAINING

FACTS ABOUT THE INDUSTRIAL TRAINING INSTITUTE

Founded in 1916. Has trained more than 400,000 men for practical work in industrial fields. From 1942 through 1945 trained specialized technicians, exclusively, for the Army, Navy and Marine Corps. Now training thousands of veterans under the G.I. Bill, both in its Residence Schools and by home-study. Occupies five buildings of its own. Has over \$500,000 invested in training facilities, with an instruction staff of more than 100 men. Known everywhere as America's foremost school of practical training for industry.

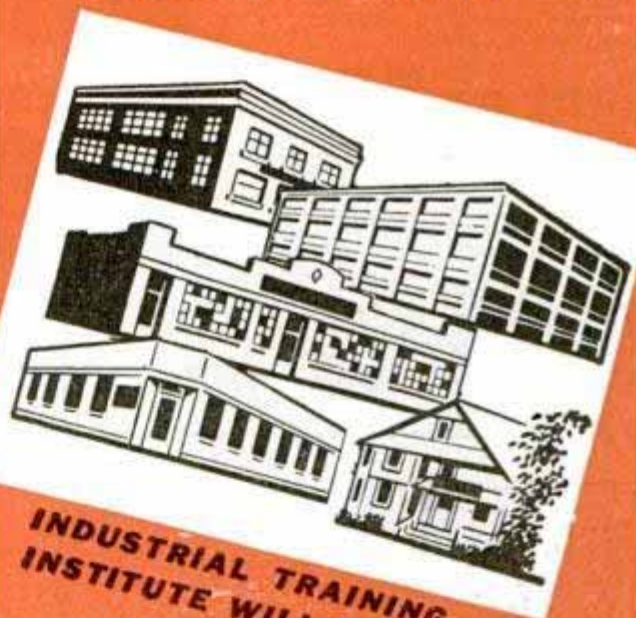

**INDUSTRIAL TRAINING
INSTITUTE WILL TRAIN YOU**

**SEND FOR
THIS
BOOK
FREE**



REGISTRAR P1J INDUSTRIAL TRAINING INSTITUTE

2150 Lawrence Ave. • Chicago, 25, Ill.
Please send me, FREE, your "Camera Visit" booklet and information about the opportunities for trained men in Refrigeration and Air Conditioning. It is understood that I will be under no obligation.

Name.....
Address.....
City.....State.....
Are you a veteran?.....

GET FACTS NOW

NOW! Enjoy Learning to Speak

SPANISH AT HOME

FRENCH-GERMAN-ITALIAN

BIG OPPORTUNITIES and JOBS waiting for those who can speak **SPANISH**. Millions of dollars being invested in Mexico, Central and South America—**BUSINESS and TRAVEL** increasing every day. Now the ability to speak **SPANISH** will mean more to you than ever before.



Only 15 Minutes a Day

The **CORTINA METHOD**, famous for **OVER 60 YEARS**, teaches you to speak **SPANISH LIKE A NATIVE**. Right in your own home, relaxed and at ease, you learn as easily as a child learns—**BY LISTENING** to native instructors on these 30 new, easy-to-understand **CORTINA** recordings. **EVERY WORD CLEAR AS A BELL**.



Sent on 5 Days Approval

THOUSANDS have learned Spanish this quick, easy way for **PLEASURE and BUSINESS**. Why not you? Free, 32-page book, "The Cortina Short-Cut," describes this famous method fully and tells how you can try it in your own home for 5 days. **NO COST IF NOT DELIGHTED**. Mail coupon for free book.



Write Today-NOW!

CORTINA Academy (Established in 1882)
Dept. 649, 105 W. 40th St., New York 18, N. Y.

Please send me — without obligation — your free book. I am interested in (check):

SPANISH French Italian German

Name _____

Address _____

City _____ State _____

WANT \$1,756 to \$3,021 A YEAR?

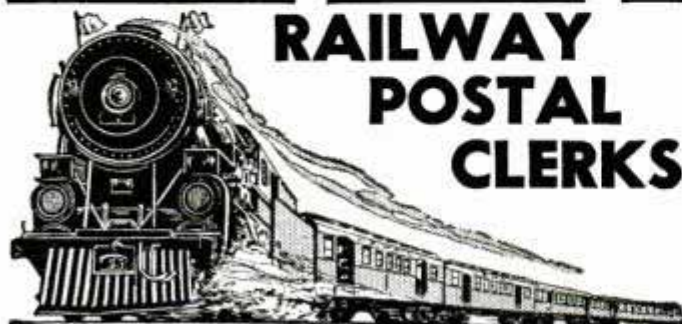

**RAILWAY
POSTAL
CLERKS**

City and Rural Carriers — Postoffice Clerks —
Inspectors—Accountants—Clerks at Washington
—Many other Government Jobs

ANALYZE HANDWRITING

Qualify for Certified Grapho Analyst Degree at home, spare time. Credit, Employment, Personnel Managers, Business, Professional men, women use **grapho-analysis in their work, earn substantial fees in spare time**. Many study solely for personal benefit, no desire to earn money, find it so fascinating they start using it to add to their incomes. Entertainment field pays well, up to \$100 in a week reported. Others establishing profitable practices as Vocational and Family Problem Counselors, Personality Teachers, and lecturers.



GROWING—UNCROWDED PROFESSION

More and more police use grapho analysis handling suspects and criminals. They understand how criminals think. Their handwriting tells. Men like Hugh Dunlap, university student, Harry Allen, retired preacher, use it in court, win cases, earn fees even before graduation. **Only school in world devoted to teaching grapho analysis** offers thorough training to earnest, ambitious men and women regardless of where you live, small town, farm or city. Send for **GRAPHO ANALYST**, illustrated lesson, personal handwriting analysis offer, **ALL FREE**. Must be 21 or over. Address **A. I. G. A. Inc.**, 120, Noel, Missouri.



BOYS-IT'S FREE!

Exciting, new book tells about
"ATOMIC ENERGY"
and **"THE WONDERS OF CHEMISTRY"**

Also shows how to amaze friends with Chemcraft magic and do many exciting home experiments. Free. Send today!



THE PORTER CHEMICAL CO., 22 Prospect Ave., Hagerstown, Md.

FALSE TEETH

KLUTCH holds them tighter

KLUTCH forms a comfort cushion; holds dental plates so much firmer and snugger that one can eat and talk with greater comfort and security; in many cases almost as well as with natural teeth. **Kutch** lessens the constant fear of a dropping, rocking, chafing plate. 25c and 50c at druggists... If your druggist hasn't it, **don't waste money on substitutes**, but send us 10c and we will mail you a generous trial box. © I. P. INC.

KLUTCH CO. Box 4793-I **ELMIRA, N. Y.**



Begin today. Write now for our Free Book, "How to Become a Good Penman." It contains specimens and tells how others learned to write in spare time. Enclose 10c for your name beautifully written and a pen point suitable for shaded writing. Write today.

THE TAMBLYN SCHOOL OF PENMANSHIP
N-441 Ridge Building, Kansas City, Mo.

"How to Make Money With Simple Cartoons"

A book everyone who likes to draw should have. It is free; no obligations. Simply address
CARTOONISTS' EXCHANGE

Dept. 99D Pleasant Hill, Ohio

WANT \$1,756 to \$3,021 A YEAR?

TRAVEL FOR "UNCLE SAM"

Prepare Now for Many Coming Examinations
Veterans Get Special Preference

FRANKLIN INSTITUTE, Dept. M85, Rochester 4, N. Y.

Sirs: Rush to me, without charge, copy of 32-page book, "How to get a U. S. Government Job," list of positions, and full particulars telling how to prepare for them.

Name _____

Address _____ Vet? _____

Learn **RADIO**

IN A FEW SHORT WEEKS

IN THE GREAT SHOPS OF COYNE

48 Years of Successful Training

Work on Actual Radio, Sound, Television Equipment! Expert Instructors Train You by Famous COYNE SHOP METHOD

Get ready quickly for YOUR FUTURE. Big opportunities are waiting for properly trained men in Radio Manufacturing, Radio Sales and Service, Television, Sound, Public Address. With COYNE "All Around" Training, many branches of Radio are open to you.

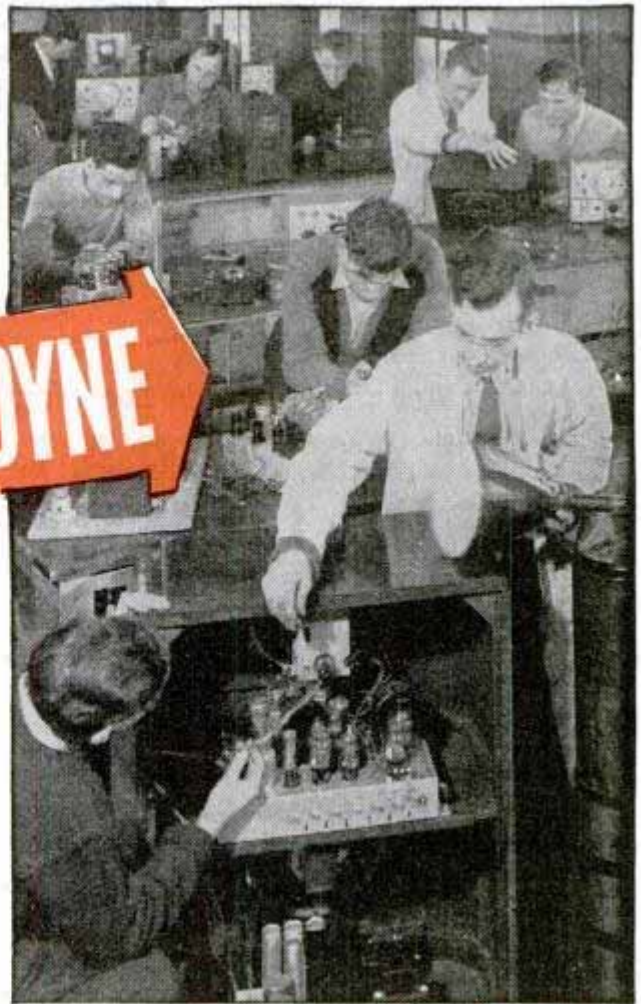

B. W. COOKE

NOT A "HOME-STUDY" COURSE

Learn Radio Fast!

As a Coyne student you work on real equipment in our great shops in Chicago — the Radio Center of the World. We do not teach by mail. All Coyne training is given right here in our big Shops in Chicago. You make rapid progress at Coyne because it's a shop course.

COYNE GRADUATES IN DEMAND

Whether you have had any actual Radio experience or not, we can train you in a few weeks for a better job, steady work and a real future in the Radio field.

First we train you for a good Radio job, then help you get it. Coyne graduates may use our Lifetime Employment Service as often as they wish.

Easy to Start Own Shop

If your ambition is to be your own boss, COYNE makes it easy! We include special training in how to start your own Radio Shop, how to get business, keep records, etc., right along with our course. Then we have Free Merchandising Service for graduates to solve many problems.

SEND FOR BIG FREE BOOK!

Our new, fully illustrated Coyne Radio Book tells all about our great Chicago shops and our plans to help you. Packed with facts and pictures. No salesman will call. No obligation.

We'll Finance Your Training

Non-veterans who are short of cash can finance most of their tuition and pay it in easy monthly payments after graduation. You may earn while learning, to help take care of living expenses while here. COYNE works with you to enable you to get the training you need.

VETERANS!

Coyne is authorized to train those who qualify for training under the G. I. Bill of Rights. Check coupon for special G. I. Bulletin.

Physical Disabilities

Men with physical disabilities may qualify for training at no cost for tuition and subsistence. Check coupon.



ADDED TRAINING

ELECTRIC REFRIGERATION

This valuable training now included with our Radio course.

B. W. COOKE, Director, Radio Division

COYNE

ELECTRICAL SCHOOL
500 S. Paulina Street
Dept. 67-3H
Chicago 12, Ill.
ESTABLISHED 1899



B. W. COOKE, Dir., Radio Div., COYNE ELECTRICAL SCHOOL, 500 S. Paulina St., Dept. 67-3H Chicago 12, Ill.

Dear Mr. Cooke: Send me your Big Free Radio Book and all the facts . . . also full details of your "Student Finance" plan.

Send G. I. Bulletin.

Physical disability details.

NAME.....

ADDRESS.....

CITY..... STATE.....

MAIL FOR BIG Free BOOK

Send for This FREE BOOK



If You Are Interested In Learning ELECTRICAL APPLIANCE Repair & Service

This book gives full information about our low cost HOME TRAINING PLAN. It tells you how to prepare for a good job or a business of your own in this well-paid field. No salesmen. No obligation.

PACIFIC TRAINING SCHOOL—Dept. P-109
7217 So. Broadway
Los Angeles 3, Cal.

NAME _____ AGE _____
ADDRESS _____
CITY _____ STATE _____

Do you want

- .. to go to College?
- .. or to enter a Profession?
- .. or get an Office Position?

(Such as Accounting, Architecture, Nursing, Dentistry; Teaching, Social Work, Osteopathy, Beauty Culture, Optometry, Embalming, Chiropody, Law, Medicine, etc.)

To get anywhere, you practically MUST finish High School FIRST. You can complete our simplified High School Course in SPARE time at home, as FAST as your time and abilities permit. Equivalent to resident school work—prepares you for college, pre-professional examinations, business, industry. Standard texts furnished. Diploma. Credit for H. S. subjects already completed. Single subjects if desired. Low tuition, easy terms. American School, Chicago, est. 1897—endorsed by educators. Finish your high school education NOW, Write TODAY!

High School Course at Home Many Finish in 2 Years

American School, Dept. H645, Drexel Ave. at 58th St., Chicago 37, Ill.

Gentlemen: Send me FREE information covering special training in subjects checked below. No obligation on my part.

- | | |
|--|--|
| <input type="checkbox"/> High School Course | <input type="checkbox"/> Diesel Engineering |
| <input type="checkbox"/> Architecture and Building | <input type="checkbox"/> Drafting and Design for Men & Women |
| <input type="checkbox"/> Automotive Engineering | <input type="checkbox"/> Plastics |
| <input type="checkbox"/> Business Management | <input type="checkbox"/> Private Secretary |
| <input type="checkbox"/> Electrical Engineering | <input type="checkbox"/> Mechanical Engineering |
| <input type="checkbox"/> Elec. and Gas Refrigeration | <input type="checkbox"/> Aviation |
| <input type="checkbox"/> Air Conditioning | <input type="checkbox"/> Salesmanship |
| <input type="checkbox"/> Railway Training | <input type="checkbox"/> Radio |
| <input type="checkbox"/> Electronics, Industrial | |

Name.....
Address.....

Get a



Good Grip

on HIGHER EARNINGS

A powerful vocabulary can bring you a better job—higher income. Scientific tests prove it. We can show you how to build your word power—your EARNING power—in your own home.

Write today for FREE information.

FRANKLIN INSTITUTE

Dept. M118

Rochester 4, N. Y.

LEARN WATCH REPAIRING



AT HOME. By our modern and original system of instruction you can learn every part of the WATCH REPAIRING TRADE AT HOME. Prepare yourself for a well-paying position or start in business after completing our course of instruction. Good watch repairers are in demand and generally earn very good salaries. For particulars apply to the Wisconsin School of Watch Repairing 759 North Milwaukee St., Milwaukee 2, Wis.

What Every Mason Wants



We have important Masonic books for Blue Lodge, Chapter, Commandery, Scottish Rite, and Shrine.

Our Rituals Are Used the World Over. Send for free catalog of books and rituals for Masons, Odd Fellows, Knights of Pythias, Knights of Columbus, etc. EZRA A. COOK, Publisher, P. O. Box 796, PS, Chicago 90, Ill.

WHY DON'T YOU WRITE?

Writing short stories, articles on business, homemaking, travel, gardening, hobbies, shop crafts, local and club activities, etc., will enable you to earn extra money. In your own home, on your own time, the New York Copy Desk Method teaches you how to write the way newspaper men learn—by writing. Our unique "Writing Aptitude Test" tells whether you possess the fundamental qualities essential to successful writing. You'll enjoy this test. Write for it, without cost or obligation.

Veterans: This course approved for Veterans' Training.

NEWSPAPER INSTITUTE OF AMERICA
SUITE 559-P, ONE PARK AVENUE, NEW YORK 16, N. Y.

INVENTING

—FOR PROFIT! If you have an inventive turn of mind, write for free 28-page booklet explaining how the Institute of American Inventors is helping inventors pre-test the profit possibilities of proposed devices to fill today's unprecedented demand for useful new inventions.

INSTITUTE OF AMERICAN INVENTORS

Dept. 4, 1926 Eye St., NW, Washington 6, D. C.

CORRESPONDENCE COURSES IN RADIO and ELECTRICAL ENGINEERING

Tuition \$25

ELECTRICAL ENGINEERING. Get good grasp of wide electrical field. Modern. Very understandable. Theory made easy. RADIO ENGINEERING. Extra fine course in radio, public address, photo-electric work. Trains you to be super-service man, real vacuum tube technician. Tuition ONLY \$25, either course. Deferred payment plan. Servicemen needed badly. Write for free copies of school catalogs, student magazines, etc. FREE LINCOLN ENGINEERING SCHOOL, Box 931-P105, Lincoln, Nebr.

HORSE MASTERY!

A FINE HOBBY—A GREAT VOCATION!

"The EXPERT HORSEMAN"

SUBSCRIBE TODAY 50¢

One Year



FREE BOOK—Tells how you can learn to BREAK COLTS, GAIT SHOW HORSES, TRAIN RODEO, STOCK and RACE HORSES, BREAK BAD HABITS, HANDLE ANY HORSE, TRAIN CIRCUS TRICK HORSES. WRITE TODAY!

ANIMAL LOVERS ASSOCIATION
BOX KA-111 TARZANA, CALIFORNIA

Now Any AUTO REPAIR JOB Can Be a "Push-Over" for You!

**IN LESS TIME—
WITH LESS WORK—
AND MORE PROFITS!**

MoToR's new AUTO REPAIR MANUAL shows you how to service and repair ANY part of ANY car! Now you can lick even the toughest jobs when you have this amazing Manual to make your work easier!

Every job on every car built since 1935 is explained as simply as A-B-C. Clear, illustrated instructions lead you step by step. NOW you can tackle ANY job from carburetor to rear end—and do it quick, easy, right, the FIRST time! Just look up make, model, and the job in the quick index to MoToR's AUTO REPAIR MANUAL—and go to work!

ONLY Manual of Its Kind

No wonder this manual is used by the U. S. Army, Navy, trade and technical schools everywhere, and thousands of successful auto servicemen!

To make this great book possible, the engineer-editors of MoToR Magazine condensed all the meat from 150 official factory manuals for you. They dug out all the information you need; made sure every word is crystal-clear; and put "the whole works" into this one great, handy book!

MoToR's AUTO REPAIR MANUAL is a big book: 856 large pages, 8½ x 11 inches, bound in sturdy covers. Nearly 200,000 serv-

ice, repair, adjustment, replacement, tune-up facts on every car built from 1935 through 1946!

Over 1,000 Pictures!

More than 1,000 cutaway photos, diagrams, drawings, charts, SHOW you what the clear text TELLS you! No wonder thousands of men call this amazing book their Auto Repair "Bible"! No wonder it will save YOU countless hours of work—and help you make MORE MONEY from auto repairs!

See for yourself—without cost!—what a work-saver, time-saver, and "life-saver" MoToR's AUTO REPAIR MANUAL will be for you! TRY it FREE—for 7 days. Learn first-hand how it can pay for itself the first few times you use it!

**FREE
7-DAY OFFER
SEND NO MONEY**

Just mail coupon below—without money! When the postman brings your book, examine it thoroughly. Make it show you what it's got! Unless you agree, this is the greatest time-saver and work-saver you've ever seen—return book in 7 days and pay nothing. Mail coupon today! Address: MoToR Book Department, Desk 1-K, 572 Madison Ave., New York 22, New York.



Clear, Pictured Facts on Every Job on Every Car Built Since 1935!

Nearly 200,000 service and repair facts on all these makes:

American	Crosley	La Salle	Packard
Bantam	De Soto	Lincoln	Pierce
Auburn	Dodge	Lincoln	Arrow
Austin	Ford	Zephyr	Plymouth
Buick	Graham	Mercury	Pontiac
Cadillac	Hudson	Nash	Reo
Chevrolet	Hupmobile	Oldsmobile	Studebaker
Chrysler	Lafayette	Overland	Terraplane
Cord			Willys

856 big pages; including 50 pages of carburetor text, charts, illustrations covering all models. Over 500 charts, tables: Tune-up Chart; Valve Measurements; Compression Pressure; Torque Wrench Reading; Starting Motor; Engine Clearances; Generator; Clutch & Brake Specifications; Front End Measurements, etc.; Engines; Electric, Fuel, Cooling, Lubricating Systems; Transmissions; Universals; Front Ends; Wheels; Rear Ends, etc.



Same FREE 7-Day Offer Applies on MoToR's Truck Repair Manual

For mechanics, truck specialists, service stations, fleet owners. Covers EVERY job on EVERY truck made since 1936! 1400 pictures, 952 pages, 300,000 facts. Used by Armed Forces. Warranted to contain every essential fact you need to know. Strong binding, size 8½x11.

Covers all types Gasoline Engines; Diesels and Hesselmans, Fuel Systems, Governors, Lubrication Systems, Ignition Systems, Starters, Generators, Clutches, Transmissions, Axles, Torque Dividers, Transfer Cases.

Brakes, Steering, etc., etc. Also services buses, farm and industrial tractors, tractor and road building equipment, stationary power machinery, etc. (on all parts described in Manual.)

Offered on same FREE 7-Day examination as Auto Repair Manual. Check box in coupon at right.



Published by MoToR, The Leading Automotive Business Magazine. MoToR's manuals assure high standards of repair work.



MoToR Book Dept., Desk 1-K, 572 Madison Ave., N. Y. 22

Rush to me at once: (Check box opposite book you want)

MoToR's AUTO REPAIR MANUAL. If O.K. I will remit \$1 in 7 days, plus 35c delivery charges; \$2 monthly for 2 months and a final payment of 95c a month later (Price \$5.95). Otherwise I will return book postpaid in 7 days. (Foreign price, remit \$8 cash with order.)

MoToR's TRUCK REPAIR MANUAL. (Described at left.) If O.K. I will remit \$2 in 7 days, and \$2 monthly for 3 months, plus 35c delivery charge with final payment (\$8.35 in all). Otherwise I will return book postpaid in 7 days. (Foreign price, remit \$10 cash with order.)

Print Name.....Age.....

Print Address.....

City.....(if any).....

State.....Occupation.....

SAVE 35c SHIPPING CHARGE! ENCLOSE full payment (check, money order, or postal note) and we pay postage. Same 7-day return-refund privilege.

YOUR OPPORTUNITY IN *Watchmaking*

Here is a career field which offers opportunity at every "tick" of a watch or a clock. Millions of watches and clocks need fixing—millions more will continue to need repairs. Here is an interesting, top-bracket opportunity to start an independent business of your own, or work for good pay in a factory, repair shop or store. AMERICAN SCHOOL OF WATCHMAKING has trained many men who are now making good. At A. S. W. you get proven, practical training under QUALIFIED, patient instructors who delight in the success of their students and graduates. MAIL THE COUPON BELOW for illustrated booklet. It is FREE — and will give you a fine picture of our complete facilities.

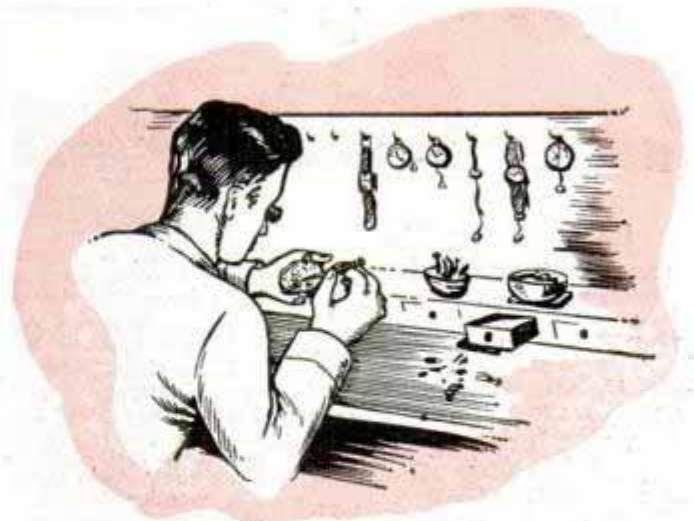

APPROVED FOR VETERANS

American School of Watchmaking
Dept. PM 49-7, 5145 W. San Fernando Rd.
Los Angeles 26, Calif.

Gentlemen: Please send me free booklet and information on your training.

Name (Print) _____

Street _____ Age _____

City _____ Zone _____ State _____

Veteran _____ Non-Veteran _____

STUDY IN LOS ANGELES, CALIFORNIA

Enroll at American School of Watchmaking and study in Southern California, the glamor spot of the country. Beach and mountains, Catalina and Hollywood, the Hollywood Bowl and the Rose Bowl —yes, indeed, here is much to interest the student in off hours and over weekends. DECIDE NOW to investigate the field of Watchmaking for your future.

TECHNICAL



TRAINING

YOUR OPPORTUNITY — — — As An *Aircraft*

Do you like Aviation? Do you like airplanes? Do you like to take things apart and see what makes them tick? THEN YOU WILL LIKE AIRCRAFT INSTRUMENTS. Here is a vital part of the great aviation industry—and necessary part. As long as planes fly there must be trained men to service, repair, and maintain the instruments that make flight possible. AMERICAN SCHOOLS OF AIRCRAFT INSTRUMENTS teaches men to perform this important, interesting and well-paid work.

INSTRUMENT TECHNICIAN

DO YOU WANT A SPECIALIZED CAREER IN AVIATION? Then be an Aircraft Instrument Technician and get your training NOW. 34 Weeks intensive course. Hundreds of A.S.A.I. graduates employed in the industry or have own business. Mail coupon below TODAY for free booklet and complete information.

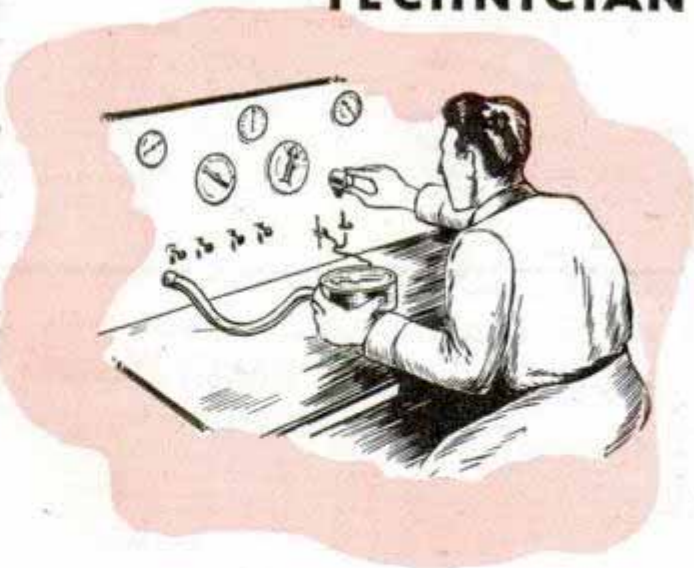

APPROVED FOR VETERANS

American Schools of Aircraft Instruments
Dept. PM 49-7, 5145 W. San Fernando Rd.
Los Angeles 26, Calif.

Gentlemen: Please send me FREE and WITHOUT OBLIGATION, illustrated booklet describing Aircraft Instrument field.

Name (Print) _____

Street _____ Age _____

City _____ Zone _____ State _____

Veteran _____ Non-Veteran _____

INSTRUMENT TRAINING VALUABLE

A sound training in Aircraft Instruments is also applicable to many industrial fields. Many large, important industries use delicate instruments at some point in their operation — and trained instrument men are needed to install, service and maintain them. Here, then is further opportunity for you as an Expert Instrument Technician.

YOUR OPPORTUNITY IN *Plastics*



Consider the growing, important field of Plastics for your future. Many have compared the Plastics Industry with the Radio and the Automobile industries before their great and rapid growth. Today such a comparison seems warranted because more products are being manufactured from various types of plastic materials than ever before—requiring **TRAINED MEN** to develop, design, and fabricate them. Mail the coupon below for complete information and free literature which show, in actual photographs, the many uses of plastics and what trained men must know to get the better paying positions in this field. This literature tells you about Plastics Institute, the oldest and largest exclusively plastics training school in the United States. Read what graduates say about Plastics Institute training and the progress they have made since graduating.

LEARN BY MAIL OR COME TO CALIFORNIA (IMMEDIATE ENROLLMENT)

You can study at home, in your spare time, without interfering with your present employment — or, if you prefer, you can attend Plastics Institute's large, modern school in Los Angeles, the city that "has everything." Please check the coupon to indicate your choice and **MAIL TODAY.**

LEARN BY DOING

You get practical experience making useful, attractive articles from plastic materials which we supply. Many students have earned extra money selling articles of their own manufacture.

APPROVED FOR VETERANS

Plastics Industries Technical Institute
Dept. PM 49-7, 1601 S. Western Ave., Los Angeles 6, Calif.
Gentlemen: Please send me free literature and information on your practical courses. I am interested in Home Training attending school in Los Angeles .

Name (Print) _____
Street _____ Age _____
City _____ Zone _____ State _____
I am a Veteran _____ Non-Veteran _____



FOR

SUCCESS

YOUR OPPORTUNITY AS AN *Aeronautical*

ENGINEER OR MASTER AIRCRAFT (A E) MECHANIC

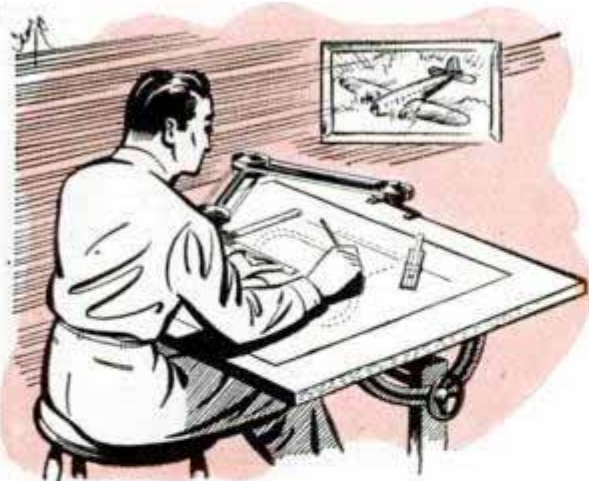

Intensive, practical training courses at AERO TECH have been designed as carefully as a fine airplane . . . with but one thought in mind — **SUCCESSFUL GRADUATES.** Working closely with executives of airlines and large aircraft plants, the training program at Aero Tech is tailored to meet their specific needs. Many important phases of Aero Tech training have been suggested by men who **ARE NOW SUCCESSFUL IN AVIATION**, but who had to first prepare for the road ahead by study and training. **AERO TECH** training prepares you to qualify for your **CAA LICENSE.**

WORK WHILE YOU LEARN

At Aero Tech you can get a full day's training between the hours of 7:00 a.m. and 1:00 p.m., thus allowing ample time for the obtaining of part time employment if desired. Many of our students—Veterans and Non-Veterans—are taking advantage of this plan.

APPROVED FOR VETERANS

Aero Industries Technical Institute
Dept. 49-7, Oakland Municipal Airport
Oakland 14, California
Gentlemen: Please send me complete free information about Aero Tech training.

Name (Print) _____
Street _____ Age _____
City _____ Zone _____ State _____
Veteran _____ Non-Veteran _____

STUDY ON A GREAT METROPOLITAN AIRPORT IN CALIFORNIA

At Aero Industries Technical Institute you get the advantage of being in the center of the great Pacific Coast Aircraft Industry, plus all the chance for recreation and fun which comes with living in California. Room and board are available at reasonable rates — and **YOU CAN OBTAIN IMMEDIATE ENROLLMENT. MAIL THE COUPON TODAY!**

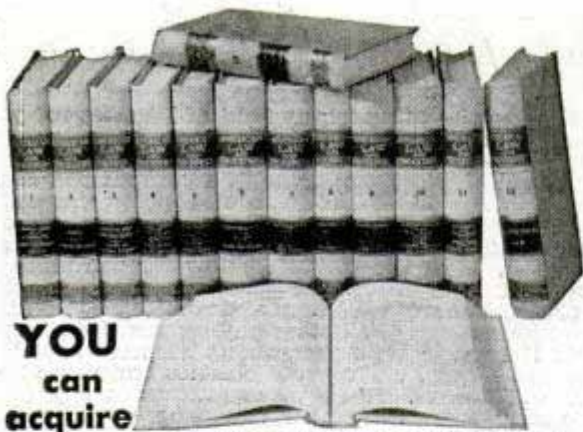

**YOU
can
acquire**

**LAW NIGHTS AT HOME!
L.L.B. DEGREE**

LaSalle's famous Law Library—used as reference in many Law libraries and Law offices—has enabled thousands to master Law surprisingly fast, in spare hours at home, for business and professional advancement.

These 14 remarkable volumes, compiled by leading professors and lawyers, cover the whole basic field of Law in condensed, orderly, simplified manner.

You advance rapidly with this great library, plus special lectures furnished. We guide you step-by-step with personalized Problem Method of instruction . . . you learn by doing—handling legal problems—not by memorizing rules.

Send for two FREE 48-page booklets, "Law Training for Leadership," and "Evidence," answering questions about Law and its value to you, and telling how LaSalle Law graduates are winning rapid advancement in business and public life. Mail coupon below. No obligation.

G. I. Approved

LA SALLE EXTENSION UNIVERSITY

A Correspondence Institution

417 S. Dearborn St. Dept. 964-L Chicago 5, ILL.

Send me your two FREE booklets described above; without obligation.

Name _____ Age _____

Street _____

City, Zone & State _____

PROTECT YOUR HOME

with these **MODERN**
Low Cost **FIRE**
EXTINGUISHERS



A little foresight now may save **LIVES and property later!** Equip your home, your garage, your boat with **AUTOFYRSTOP**, the modern fire extinguisher and alarm that is setting new efficiency records. Write for free literature:

**KILLS
FIRE
BY ITSELF**

AUTOFYRSTOP CO. Dept. PM-947
2035 Washington Av., Philadelphia 46, Pa.

**MONEY MAKING
OPPORTUNITY**

We have openings for high grade salesmen in choice territories. Write for Plan.

WRITERS WANTED!

Business firms now paying writers \$10 to \$100 for writing letters. Wonderful opportunity for people who like to write. Inexpensive new course teaches you all you need to know and where to get the business. Write today.



C. F. ROEHR

936 Van Houten

Clifton, N. J.

FREE Sports BOOK FOLDER

All sports for boys, men and women—from chess to body-building, judo and street fighting. Just send us a postcard with your name and address.



NOTE: If you include 10¢ for postage, we'll also send free an inspiring 3"x5" wallet-size actual photograph of America's Best Developed Athlete. Write to:



CROSS CO., Box 389, Dept. D-1, Kenosha, Wis.

LEARN MOVIE PROJECTION THEATRE MANAGEMENT

The Motion Picture Theatre Business offers big opportunities for trained men. Get into a fascinating field with a post-war future. Train at home in spare time. Free Catalog. Established 18 years.

THEATRE INSTITUTE, 370 Washington St., Elmira, New York

LEARN MEAT CUTTING EASILY-QUICKLY At Home-In Spare Time



The steady, dependable trade of Meat Cutting taught easily, quickly by improved HOME METHOD. National School, established over 25 years, has organized its famous "Learn By Doing" Classroom, Cutting room and Retail Market training system into sound, practical HOME STUDY form.

Now, by the miracle of this EXTENSION TRAINING you can prepare in Your Spare Time At Home, for a better job, bigger responsibilities or success and security in a store of your own. Remember, **PEOPLE MUST EAT!**

Buying, cutting, percentage, pricing, advertising, selling—a complete meat education. For beginner or men with ex-

perience. Thousands of successful graduates. Send coupon for FREE Bulletin NOW!

MAIL THIS COUPON TODAY FOR FREE BULLETIN

National School of Meat Cutting Dept. U85, Toledo 4, Ohio

Send me your FREE Bulletin on Meat Cutting and Meat Merchandising. No obligation. No Salesman will call.

Name _____

Street _____

City _____ State _____

GET INTO RADIO TELEVISION ELECTRONICS NOW!



You build this complete, modern super-heterodyne receiver with the experimental equipment that comes with your National Training. You keep all apparatus sent you.

Practical shop-type training gives you actual experience with Home Radio Equipment — part of

SHOP METHOD HOME TRAINING

By National Schools of Los Angeles a Practical Technical Resident Trade School for over 40 years

FOR YOU—A REAL HOME LABORATORY IN MODERN RADIO

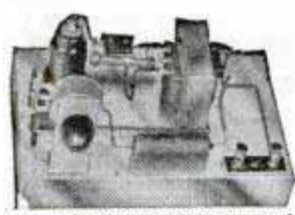

diode oscillator which you get by building it yourself.

Your National Training Kits include equipment for over a hundred practical electronic experiments in your own home. You get standard radio parts for this auto to understand

You learn modulation, beat frequencies, signal generation by a actually building this small radio transmitter with your National shop parts.

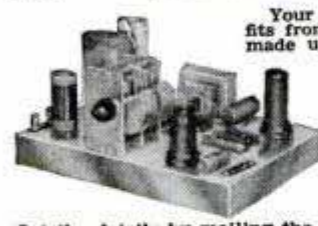
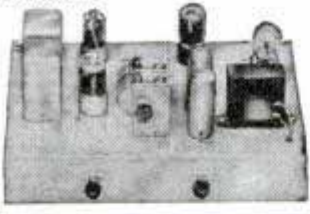

Get the details by mailing the coupon.

Your training outfits from National are made up of the most modern radio equipment—much of it just out of the experimental laboratory. You learn new ways of handling equipment by modern methods.

A permanent faculty of experienced instructors and engineers stands behind all training from National Schools. These men are teaching every day right in our own Television and Broadcasting Studios, Service Shops and Laboratories. From first hand experience with students here at School, our instructors understand the aims and ambitions of men like you. All of our instructors, both home study and resident, have ideal facilities to make your training practical, up-to-the-minute and interesting.

Fine Opportunities Ahead

Learn how National training can fit you in your spare time for the GREAT FIELD OF RADIO—for the NEW AND RAPIDLY EXPANDING BRANCHES — FREQUENCY MODULATION (F.M.), TELEVISION AND ELECTRONICS. You train right in your own home yet have the ADVANTAGE OF REAL SHOP EXPERIENCE behind you. The man who really knows modern Radio is in greater demand today than ever before—not only in Radio proper but in Television

and Electronics—in Aviation, Transportation, Manufacturing, Communications. Good jobs await the trained man, in the production, operation and maintenance of modern Electronic equipment—in Radio stations, in hundreds of industries—in homes, stores, theatres and studios.

Send For Facts Today

You owe it to yourself to investigate how National Schools will prepare you for a CAREER THAT WILL ASSURE YOUR SUCCESS AND SECURITY. Send for the FREE Manual. SEE FOR YOURSELF just how you may readily qualify for opportunities in Radio, Television and Electronics. Read the catalogue we will send you. Then, make up your own mind. For full information, without obligation, send your name and address on the coupon and mail it TODAY!

GET THE DETAILS. USE THE COUPON!



VETERANS

During the War, National trained enlisted men under contract with the War Department. Now, we are training veterans, both resident and home study. If you are a Veteran qualified for training under the G.I. Bill, check the coupon below for special bulletin.

- Here's Just a Few of the Interesting Facts you Learn with the FREE MANUAL
1. Routine for diagnosing Radio Troubles.
 2. Preliminary inspection of Receivers.
 3. How to Test and Measure Voltages.
 4. How to Test Speaker in Audio Stages.
 5. How to Trace the Circuit and Prepare Skeleton Diagram.
 6. Complete Reference Table for Quickly Locating Receiver Troubles.



NATIONAL GRADUATES ARE SUCCESSFUL NOW MANAGER OF SERVICE DEPARTMENT

"I am really proud to be a National Graduate—it has helped me to hold my present position. Now manager of service department for Valley Music Company. Times have changed since I enrolled for National Training I have an amateur Radio station to keep up on experiments in that field. W7HLF. Plus many, many sound installation problems, I have no time to call it 'spare time' anymore—thanks to National Schools." Dwight J. Albright, Medford, Oregon.

COLLEGE PROFESSOR APPRECIATES COURSE

"I want to take this opportunity to tell you how much I appreciate this Course. Since being here at the College I have been able to put the theory to very good use. I have installed a P.A. system in the students' dining hall; today I am purchasing the required equipment to install a similar system in the large assembly hall; and at all of the large meetings held so far I have been assigned the task of setting up the portable P.A. system. I have also repaired several Radios for the boys and the professors, including car Radios. So once again, thanks for a fine Course. I am looking forward to the rest of the training with pleasure. Brother V. Benedict, Saint Mary's College, Calif.

G.I. APPROVED NATIONAL SCHOOLS

LOS ANGELES 37, CALIFORNIA EST. 1905

MAIL OPPORTUNITY COUPON FOR QUICK ACTION

National Schools, Dept. 9-PM
4000 South Figueroa Street
Los Angeles 37, California

Mail me FREE the books mentioned in your ad including a sample lesson of your course. I understand no salesman will call on me.

NAME..... AGE.....

ADDRESS.....

CITY..... ZONE..... STATE.....

Check here if veteran of World War II

(Mail in envelope or paste on penny post card)

SURPLUS BARGAINS

ASSEMBLE YOUR OWN BINOCULARS!

Complete Optics! Complete Metal Parts!
Save More Than 1/2 Regular Cost



GOVERNMENT'S 7X 50 BINOCULARS

Complete Optics, new and ready for assembly. We supply full instructions. Limit—1 Set of Metal Parts and 1 Set of Optics to a customer.

METAL PARTS—Set includes all Metal Parts—completely finished—for assembly of 7X 50 Binoculars. No machining required. Bodies have been factory hinged and covered. A sturdy Binocular Carrying Case is optional with each set of Metal Parts.

Stock #842-H.....\$39.40 Postpaid, plus \$4.80 for Case—Total \$44.20

OPTICS—Set includes all Lenses and Prisms you need for assembling 7X 50 Binoculars. These are in excellent condition—perfect or near-perfect—and have new low reflection coating.

Stock #5102-H.....\$25.00 Postpaid
NOTICE! If you buy both Binocular Optics and Binocular Metal Parts, add 20% Federal Excise Tax to above prices.

ARMY'S 6X 30 BINOCULARS—Complete Optics and Metal Parts for Waterproof Model. Would retail \$102.00 to \$120.00. All Optics coated, perfect or near-perfect. Metal Parts new and perfect. Assembly instructions included.
Stock #830-H.....\$40.00 Postpaid, plus \$8.00 tax—Total—\$48.00

NEVER HAS THERE BEEN SUCH A SENSATIONAL BARGAIN AS THIS!

BUBBLE SEXTANT—TYPE A-10

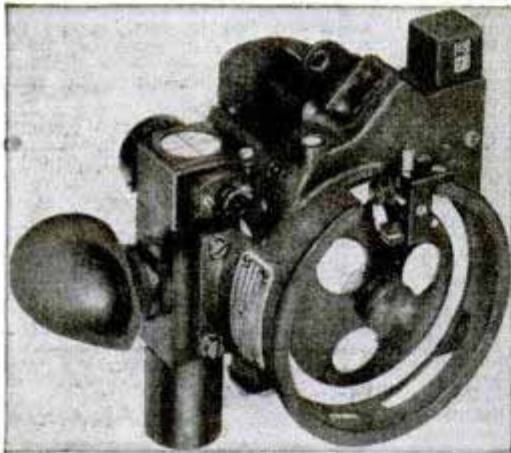

These Army Air Forces Bubble Sextants cost the Govt. about \$200 each. A real bargain at our price of \$125.00! Included with Bubble Sextant shipment is wooden Carrying Case, 3 spare waxed paper discs, flashlight with rheostat for night use (uses ordinary flashlight cells—not furnished) aux. 2-power Galilean Telescope, Allen wrench, 1 spare marking point. Wartime used, but where necessary completely repaired, collimated and put in good working order. If not satisfied that Sextant is exactly as represented, return within 10 days and money will be refunded. Full directions for use accompany each shipment.

Stock #924-H.....\$125.00 Postpaid

BATTERY COMMANDER'S PERISCOPE With Tripod—6 Power Instrument. Excellent condition. Length 27 1/2 inches—diam. 1 1/2 inches. Cost U. S. Govt. approximately \$175.00.
Stock #717-H.....\$20.00 F.O.B. Audubon

MOUNTED KELLNER TELESCOPE EYE PIECE—Perfect coated, in Ordnance sealed boxes. F.L. 1 3/4 inches. Outside dia. of steel mount 40 mm.
Stock #6198-H.....\$3.15 Postpaid

35 MM. KODACHROME PROJECTING LENS SET—Consists of Achromatic Lens for projecting, plus a Condensing Lens and piece of Heat Absorbing Glass with directions.
Stock #4025-H.....\$1.95 Postpaid

CONDENSING LENSES—6 1/2" dia., 9" F.L. Seconds, but suitable for Enlargers and Spotlights.
Stock #1061-H.....\$2.50 Postpaid

We Have a Limited Quantity of Condensing Lenses—seconds—ranging from 4 1/2" to 8 1/2" in dia. with various focal lengths. Send for Free Bulletin titled "MISCELLANEOUS CONDENSING LENSES—H."

MOUNTED PROJECTING LENS SYSTEM. F.L. 91.44 mm. (just right for 35 mm. Projectors). Speed of F 1.9. Outside dia. of mount at one end 60 mm. Length of mount 64 mm.
Stock #4033-H.....\$3.00 Postpaid

We have literally millions of war surplus lenses and prisms for sale at bargain prices. Write for Catalog "H"—Sent Free!

Satisfaction Guaranteed

Order by Stock No.

EDMUND SALVAGE COMPANY
P. O. AUDUBON, NEW JERSEY

SAY YOU SAW IT IN POPULAR MECHANICS

LEARN TO SHOOT!



FREE BOOK, 48 pages, pictures and description. Master shooting INDOORS, learn how to shoot OUTDOORS. Famous training method of "Buckshot" Wilson. Edited by Henry E. Bradshaw. Youngsters become amazingly accurate—"hit pennies in the air!" Experts are fascinated. SAFE for entire family.

FREE!
SHOOT-RITE
MANUAL

STAGNANTLY ILLUSTRATED 48 PAGES

Mighty good reading, the simple but thrilling instructions in Parris-Dunn's INDOOR SHOOTING BOOK! Also describes sensationally accurate Parris-Dunn Trainer Gun and realistic whirling Indoor Ro-Target. SEE YOUR DEALER or write for FREE COPY of this great book, 25 cents for mailing expense appreciated. Address

PARRIS-DUNN • Dept. 65 • CLARINDA, IOWA



"Say, Men, Here's Your Chance of a Lifetime!"

LEARN THE PLUMBING TRADE

Thousands of Skilled Plumbers Are in Increasing Demand in the Building Field!

Our 5-hr., 6-day course requires only 8 months! Includes estimating, blueprint reading, lead work, joint wiping, pipes, fittings, plumbing codes, etc. Trains you thoroughly—to work for others, or open your own business!

VETERANS! Approved by Veterans Administration. We help you get part-time work; assist in obtaining housing while you attend our school.

Write for FREE Information TODAY! (State if Veteran)

NATIONAL TRADE SCHOOL 2610-P Grand Ave.
Kansas City, Mo.



TRAIN

Your VOICE!

Results GUARANTEED

We build, strengthen the vocal organs—not with singing lessons—but by sound, scientifically correct silent and vocal exercises and absolutely guarantee complete satisfaction with results. Write for Voice Book, FREE. Sent to no one under 17 years old unless signed by parent.

Perfect Voice Studios, Studio 1356, Kimball Hall Bldg., Chicago 4, Ill.

SHORTHAND in 6 Weeks at Home

Famous Speedwriting system. No signs or symbols; uses ABC's. Easy to learn; easy to write and transcribe. Fast preparation for a job. Surprisingly low cost. 100,000 taught by mail. Used in leading offices and Civil Service. Write for free booklet.
SPEEDWRITING, Dept. 1509-7, 55 West 42 St., N. Y. 18

Photography for



PLEASURE or PROFIT

Learn at home. Spare time. Practical basic training. Long-established school. Many have earned while learning. Send coupon below for free booklet, "Opportunities in Modern Photography" and full particulars.

AMERICAN SCHOOL OF PHOTOGRAPHY

1315 Michigan Avenue Dept. 1356 Chicago 5, Illinois
Send booklet, "Opportunities in Modern Photography," full particulars and requirements.

Name..... Age.....
Address.....
City..... Zone..... State.....

THOUSANDS NOW PLAY who never thought they could!



Thrilled by Playing

I've had my lessons just a week. I think your course is super. I was more thrilled than words can express when I found I could actually play America, The Merry Widow Waltz and the others.

*J. T., Mancelona, Mich.

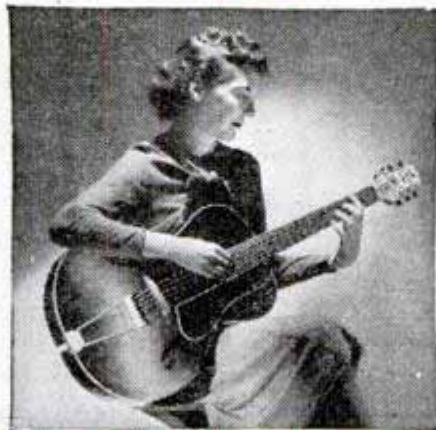

Wouldn't Take \$1000 for Course

The lessons are so simple that anyone can understand them. I have learned to play by note in a little more than a month. I wouldn't take a thousand dollars for my course.

*S. E. A., Kansas City, Mo.



Shares Course With Sister

The teaching is so interesting and the pieces so beautiful I couldn't ask for anything better. I recommend your course highly. My sister shares it with me and feels the same way.

*D. E. G., Wausau, Wisc.



Finding New Joy

I am finding a new joy that I never experienced before, for I have always wanted to play, but had given up hope until I heard of your course.

*C. S., Lucien, Okla.



Plays After 2 Months

I hesitated before sending for your course because of an earlier experience I had with a course by ear from another company. I am playing pieces now I never dreamed I would play after only two months.

*E. T., Prichard, Ala.

*Actual pupils' names on request. Pictures by professional models.

You, too, can play any instrument By this EASY A-B-C Method

YOU think it's difficult to learn music? That's what thousands of others have thought! Just like you, they long to play some instrument—the piano, violin, guitar, saxophone or other favorites. But they denied themselves the pleasure—because they thought it took months and years of tedious study to learn.

Learn in Spare Time at Home

And then they made an amazing discovery! They learned about a wonderful way to learn music at home—without a private teacher—without tedious study—and in a surprisingly short time. They wrote to the U. S. School of Music for the facts about this remarkable short-cut method. And the facts opened their eyes! They were amazed to find how easy it was to learn.

The result? Over 850,000 men and women have studied music at home this simple, A-B-C way. Now, all over the world, enthusiastic music-lovers are enjoying the thrilling satisfaction of creating their own music. They have found the key to good time, popularity and profit.

Costs Only Few Cents a Day

And that's what you can do, right now. Get the proof that you, too, can learn to play your favorite instrument—quickly, easily, in spare

time at home for only a few cents a day. Never mind if you have no musical knowledge, training or talent. Just read the fascinating booklet and Print and Picture sample that fully explain all about the famous U. S. School method. If interested tear out the coupon now, before you turn the page. U. S. School of Music, 79 Brunswick Bldg., New York 10, N. Y. Largest school of its kind in the world. (49th year)

FREE!

Print and Picture
Sample



NOTICE

Please don't confuse our method with any systems claiming to teach "without music" or "by ear." We teach you easily and quickly to play real music, any music, by standard notes . . . not by any trick or number system.

U. S. SCHOOL OF MUSIC,
79 Brunswick Bldg., New York 10, N. Y.

I am interested in music study, particularly in the instrument checked below. Please send me your free illustrated booklet "How to Learn Music at Home," and your free Print and Picture Sample.

Piano	Saxophone	Clarinet	Practical Finger Control Piccolo Mandolin
Guitar	Trumpet, Cornet	Trombone	
Hawaiian Guitar	Reed Organ	Flute	
Violin	Tenor Banjo	Modern Elementary Harmony	
Piano Accordion	Ukulele		

Name _____ Have you
Instrument? _____
(Please print)

Address _____

City _____ State _____

NOTE: If you are under 16 years of age, parent must sign coupon.

SAVE 2c — STICK COUPON ON PENNY POSTCARD

Hunters! Anglers!
You can learn Taxidermy

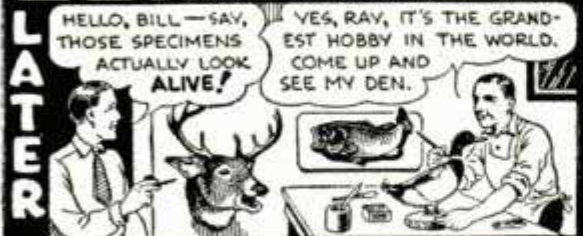

WE CAN TEACH YOU TO MOUNT BIRDS

Great Fun and Profit. Send Coupon for marvelous **Free Book.** It tells All about taxidermy — how you can Make Money and have great fun and fascination mounting Birds and Animals. Save your wild-game trophies — mount for others. Also Mount common specimens, pigeons, squirrels, rabbits, even frogs, into humorous and useful groups — highly interesting and sell at sight. Wild-game NOT necessary. Men, Women, Boys learn quickly by Mail. Marvelous business, send coupon.

BIG PROFITS! Turn your spare time to Cash. Besides Taxidermy learn also to Tan Leather, Tan Fine Furs and make them into scarfs, etc. We teach you Genuine Chrome method—never before revealed. 250,000 students endorse this old reliable school. We offer You our marvelous **Free Book.** Send for Your copy Today. In a few weeks we can teach you a New Trade that earns Cash in depression and good times, too. Then Taxidermy brings great fun and fascination. Investigate! Get the **Free Book.** Sign your name, state your AGE, and the **FREE BOOK** is yours. Send the coupon Today.

FREE BOOK

Northwestern School of Taxidermy,
3376 Elwood Bldg., Omaha, Neb.

Gentlemen:—Please send me your free 48 page booklet explaining Taxidermy.

Name..... Age.....

Address.....

Here's a fascinating, Profitable Hobby

STUDY AT HOME

With An Educational Institution
Men with specialized training win higher positions, insure larger earnings, and are bigger successes in business and public life. Opportunities NOW greater than ever before. Send for our Catalog.

ARTS and SCIENCES
Courses in Philosophy; Education; Letters; Public Health; Medical Jurisprudence; Psychology; Sociology; Physics; Chemistry; Plastics; Geology; Political Science; Theology; Business and Commerce; Accounting; Mathematics; Statistics; Agriculture.

ENGINEERING
Courses in Electrical, Civil, Mechanical, Drafting, Architectural, Steam, Aeronautical, Radio, Structural, Mining, Industrial, Petroleum, Marine, Chemical, Diesel, Automobile, Refrigeration, and Air Conditioning Engineering.

LAW
Complete Professional Law Course includes 18 Hornbook Series college grade textbooks. Courses also in Commercial Law, Patent Law and Medical Jurisprudence.
McKinley-Roosevelt Incorporated, 4610-K, Sheridan Rd., Chicago 40, Ill.

One of America's Leading
Radio and Television Schools
**NEW YORK TECHNICAL INSTITUTE
OF NEW JERSEY**
158 Market Street, Newark, New Jersey

GET FRIENDS, PRESTIGE, SUCCESS
How to Publicize Yourself
New nine-page folio "Personal Publicity" tells how to make friends enthusiastic . . . how to become favorably known in your business, profession . . . make others sit up and take notice of YOU. Easy-to-follow instructions. Articles you can write about yourself for papers, radio. Nine kinds of attention-getting letters. Mechanics of preparing material, photographs. Great help for publicity chairmen of clubs, societies.
ONLY \$1.00
PUBLICITY SYSTEMS
Dept. PM9, Box 322 Jacksonsville, Illinois

TRI-STATE COLLEGE
B. S. Degree in 27 months in Engineering (7 branches); Bus. Admin., Acc't and Sec. Science. Graduates successful. 64th year. Enter Sept., Jan., March, June. Write for catalog.
497 College Ave., Angola, Ind.

NEW HELP FOR RUPTURE
is the amazing Treatise which explains simple, inexpensive, easy, proven way for curbing your rupture, right at home. This proven-way has helped many rupture sufferers quickly. So don't let your rupture get worse. Send for **FREE** details today. Mailed to you in plain, sealed envelope. No obligation.
BRADNER PUBLISHING CO. (Established 1933)
Dept. N. Dixon, Ill.

Now a DYNAMIC Super-WELDER
charged
IDEAL FOR AUTO • HOME APPLIANCE • FARM REPAIRS

DESIGNED TO DO HIGH GRADE WELDING INEXPENSIVELY!
Maintenance Men; Farmers; Mechanics; Machine Shops; Foundries; Auto, General Repair and Job Welding Shops; all using the DYNAMIC find it so indispensable and useful that they cannot afford to be without it. If inexperienced you can easily learn to do a variety of high grade welding jobs by following the practical, simplified operating and welding instructions furnished. Once you see a DYNAMIC in operation, you won't want to be without it. Its simplicity will amaze you. In a year the DYNAMIC only costs you about \$28.50. Helmet, rods, cables, holder and operating instructions, etc., furnished.

SAVES YOU VALUABLE TIME AND MONEY!
This portable industrial transformer type DYNAMIC WELDER easily carried right to the job, can be operated from any convenient, properly wired 110 Volt, 60 Cycle Line — has 8 metallic and carbon arc welding heat stages — does work you would think only possible with a larger more expensive machine. Can also be supplied for 220 volt, 60 cycle operation and other voltages and cycles at slight additional cost. Works on Iron, Steel, Brass, Bronze & other metals.
DYNAMIC WELDER CO., 13 East 23rd St., RH, Chicago 16, Ill.

ONLY \$28.50 COMPLETE Available Now IMMEDIATE DELIVERIES
Write Today for Particulars
GET DETAILS on our 10 day Trial Offer.
Member Chicago Association of Commerce.

FARM IMPLEMENTS
BICYCLE REPAIRS
SHOP WORK
HOME APPLIANCES
AUTOMOBILE REPAIRS

Now

YOU CAN HAVE IMPROVED No-DRIFT FM
in the Sensational New 1948
MIDWEST RADIOS

NEW SERIES
16*
SUPER DELUXE
AM-FM
CHASSIS



14½"
PANASONIC
SPEAKER

5
WAVE
BANDS

Here is the finest radio Midwest has ever produced in its 28 years of manufacturing—a world-ranging, 5-band radio with improved Midwest No-Drift FM . . . plus Standard Broadcast and 3 short wave bands, Television Audio Switch-over, and Color-Ray Tone Selection. The Series 16* Super De Luxe Chassis is a powerful, magnificently-toned radio that challenges comparison for performance, sensitivity, selectivity, and advanced engineering features. Supplied with satin stripe copper finish panel—ready to mount in your present cabinet. Send today for the FREE 1948 Midwest Radio Catalog. Buy your radio direct from the manufacturer on Easy Terms and 30 Days Trial and SAVE!

*SERIES
16 CHASSIS USES ALL
THESE LATEST-TYPE TUBES

30
DAYS
TRIAL

LOW
FACTORY-
TO-YOU
PRICES

EASY
TERMS

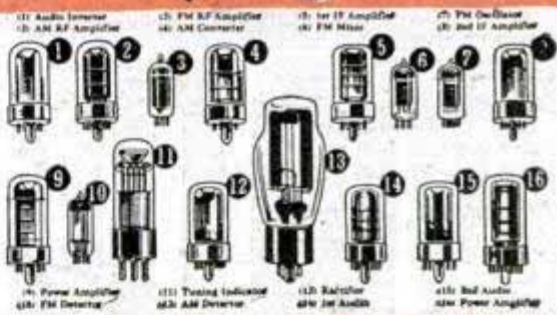

Score of NEW Features such as the Exclusive
MIDWEST TRI-MAGNADYNE COIL SYSTEM
 and **COLOR-RAY TONE SELECTION**

A COMPLETE LINE OF FINE RADIOS AND
 RADIO-PHONOGRAPHS . . . Available in Separate
 Chassis Like the Powerful Series 16* AM-FM Model
 above, or in beautiful Radio-Phonograph Consoles like this:



SYMPHONY GRAND AM-FM
RADIO-PHONOGRAPH CONSOLE
 with **NEW Intermix AUTOMATIC**
RECORD CHANGER

Our Finest! A superbly beautiful musical instrument . . . a masterpiece of furniture design and radio engineering that offers the sensational Midwest NO-DRIFT FM, Automatic Intermix Record-Changer, Exclusive Color-Ray Tone Selection, World-ranging 5-Band Reception, Television Audio Switch-Over, and many more new and exclusive features.

Rush for Free Catalog!
 FILL IN COUPON AND MAIL TODAY OR JUST
 SEND YOUR NAME AND ADDRESS ON 1c POSTCARD

MIDWEST RADIO CORP.
 Dept. 25-K, 909 Broadway
 Cincinnati 2, Ohio

Gentlemen: Please send me your new FREE catalog and details of your liberal 30 Days Trial.

Name _____
 Address _____
 City _____ Zone _____ State _____

MIDWEST RADIO CORP.
 Dept. 25-K • 909 BROADWAY • CINCINNATI 2, OHIO

VETERANS *Learn* WATCHMAKING

A Lifetime Profession

Regardless of Conditions, Age, Sex, or Physical Limitations Veterans—Civilians! Your Opportunity—**LEARN WATCHMAKING**



Lift yourself from a futureless job into a position paying better than your present work. Fit yourself for the job that will permit you to establish your own shop, or be employed in a pleasant environment.

Watch Repairing—Jewelry—Engraving will always be in ever greater demand. Our graduates wanted everywhere. Dignified positions \$50-\$75-\$100 per week. Veterans write today for latest FREE enrollment requirements.

Kansas City School of Watchmaking
Largest Horological School in America
617-621 Wyandotte St. Kansas City 6, Mo.

AVIATION *Career*

MAXIMUM TRAINING IN MINIMUM TIME

CAL-AERO TECH TRAINING will add dollars to your pay check all the rest of your life. Specializing in AERONAUTICAL ENGINEERING and MASTER AVIATION MECHANICS since 1929, Cal-Aero Tech training is carefully designed for just one thing—**TO MAKE MORE MONEY FOR YOU.** An alumni of over 6000 successful graduates proves our career training is unsurpassed.

VETERANS —Write us about Aviation Training, as provided under "G.I. Bill of Rights."



CAL-AERO TECHNICAL INSTITUTE
MAJOR C. C. MOSELEY PRES. SINCE 1929
FORMERLY GUNTESS-WRIGHT TECHNICAL INSTITUTE

GRAND CENTRAL AIR TERMINAL
GLENDALE 1, CALIFORNIA
LOS ANGELES COUNTY

MAIL THIS COUPON TODAY!

Cal-Aero Technical Institute, Grand Central Airport, Glendale 1, California
Please send full information on Aviation Training FREE—without obligation. Dept. 1 PM-1

Name _____ Birth Date _____
Street _____
City _____ State _____

BE A GOVERNMENT LICENSED AIRPLANE AND ENGINE MECHANIC

Train Now at **LINCOLN**

EARN BIG PAY IN AVIATION

Our new enlarged school now offers these courses: **MASTER AVIATION MECHANICS**, CAA Approved 1 Yr. Airplane & Engine Mechanics Course, **REFRESHER AIRPLANE & ENGINE MECHANICS**. Designed for veterans with aviation mechanics experience. Either course is available to veterans under the G. I. Bill of Rights. Write today for complete information.

LINCOLN AVIATION INSTITUTE
UNION AIR TERMINAL DEPT. 9 LINCOLN, NEBRASKA

60 POWER TELESCOPE \$2.95

VARIABLE EYEPIECE 20X-40X-60X

NEW! Three telescopes in one, 3 different magnifications. 20 power for ultra-bright images with 40 and 60 power for extra long range. Guaranteed to bring distant objects, people, sports events, ships, moon, stars, etc., 60 times as close.



Most powerful for anywhere near the money. 5 sections. Closes to 1 ft. long. Contains 4 ground and polished lenses. Also used as a powerful compound microscope. Directions included. Mass production enables us to offer this high-powered instrument at the amazing price of only \$2.95. We pay the postage. Get yours immediately.

BROWSCOPE CO. Dept. 9M 24 West 45 St. New York 19, N. Y.

GARDEN CUTOUTS



Giant Assortment—48 patterns in all. Dutch boys, girls, dogs, birds, chickens, parrot, cats, geese, rabbits, squirrel, frog, bird houses, etc., plus toys, games. Beautiful, entirely new. Easy to make. Big Bargain. Novel method allows you to make project any size you desire. Sell these to your friends—make money. Send only \$1.00 today to **JACKSON, Dept. 25, 5440 N. Shoreland Ave., Milwaukee 11, Wis.**

\$1.00

ELECTRICAL TRAINING

Intensive 32 weeks residence course in fundamentals of industrial electrical engineering, including radio, electronics. Prepares for technician, engineering aides. Approved for veteran training. 54th year. Catalog.

BLISS ELECTRICAL SCHOOL
7640 Takoma Ave., Wash. 12, D. C.

THERE'S MONEY IN CARTOONS!

RAYE BURNS will teach you HOW to CREATE ORIGINAL CARTOONS at home that you may SELL! Course contains 26 lessons and over 600 illustrations. All for Only... **\$2.85**

Send name and address for free details.
RAYE BURNS SCHOOL, Dept. M, Box 3583, CLEVELAND, OHIO

SAY YOU SAW IT IN POPULAR MECHANICS

OLD GOLD JEWELRY WANTED

Dental gold teeth, plates and bridges with metal attached. Any broken pieces of gold jewelry. Immediate payment and free mailing container to you or your friends upon request. **LOWES, DEPT PM** Holland Bldg., St. Louis 1, Mo.

Store Route Plan PAYS BIG MONEY

SELL COUNTER CARD PRODUCTS
Build a good-paying business of your own. Call on dealers of all kinds; show nationally advertised Aspirin, Cosmetics, Razor Blades and 200 other necessities. Big 5c and 10c retail packages, high quality. Attractive counter displays sell goods fast. Free book gives amazing facts. Write! **World's Products Co., Dept. 10-T, Spencer, Ind.**





NOW! ... Build Your Future on

DIESEL OPPORTUNITIES

Compact Diesel Truck Engine

6 cylinders, 5-3/4" bore and 6" stroke, maximum horse power rating 200 H.P. at 2100 RPM.

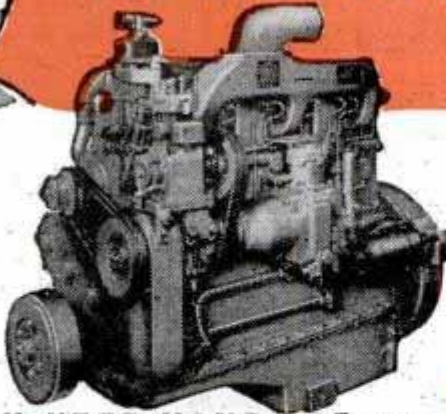

Diesel Power is Going Places

You don't have to look far to see Diesel Power in action these days. Trucks, buses, tractors, railroads, ships, power plants, farm and road equipment—more and more depend on Diesel each day. On the farm, in factories, in communities, large and small—Diesel is growing as it proves to be efficient, economical, dependable, streamlined power.



ON LAND



ON WATER



IN INDUSTRY

Prepare Now

WHILE YOU KEEP YOUR JOB ...

If you are between 17 and 60 and mechanically inclined, you can get thorough, individual instruction at home. With U.E.I. balanced training, you learn first through home study the fundamentals of Diesel in all its phases, in practical, easy to understand lessons. We show you how Diesel Engines operate, how fuel systems work, repairs, latest accessories & auxiliary equipment.

ACTUAL SHOP PRACTICE Then you get valuable practice in our big shop, working on costly equipment under expert Diesel men. This course is new, up to the minute, includes latest techniques. U.E.I. offers placement service for graduates and numerous other features. Now in our 21st year. Coupon brings complete information.

DO IT NOW! It costs you nothing to get all the facts about Diesel opportunities and training. But time is important—send coupon today!

DIESEL KNOWLEDGE is Earning Power

THE NEW AND INCREASING USES OF DIESEL open a broad field for trained men who can install, maintain, operate and repair DIESEL EQUIPMENT. Now is the time to prepare for these opportunities.

Mail Coupon for FREE FACTS

UTILITIES ENGINEERING INSTITUTE, Dept. 197D, Diesel Division, 2521 N. Sheffield Ave., Chicago 14, Ill. Please send me FREE facts about U.E.I. training and opportunities in the field checked below.

- Diesel Refrigeration Welding
 Auto Body & Fender Repair Air Conditioning

NAME _____ Age _____

ADDRESS _____

CITY _____ Zone or County _____ STATE _____

If World War II veteran give length of service _____
[] Check here for special information if you are under 17.



UTILITIES ENGINEERING INSTITUTE

2521 N. Sheffield Ave.
Dept. 197D
Chicago 14, Ill.



WE THINK IN WORDS

LEXIPOWER

THOUGHT IS POWER

Acquiring a superior VOCABULARY is basic training for a top position in any profession, trade or business. To get in the upper brackets financially and socially, develop a masterful VOCABULARY through the fascinating, entertaining and profitable new science of LEXIPOWER. You are judged and rated by every sentence you utter. Executive ability and professional capacity are demonstrated by what you say—not by what your hands do. More POWER to you through LEXIPOWER. Benefit at once! You start using the POWER of LEXIPOWER after the first Lesson. Write NOW for FREE details about LEXIPOWER Dime-a-Day LESSON CLUB.

LEXIPOWER LESSON CLUB

517-H. W. Deming Place Chicago 14, Ill.

BE YOUR OWN BOSS! LEARN ELECTROPLATING HIGHLY PAID FIELD



UNCROWDED, interesting business. Part or full time. Common school education sufficient. Chromium, Nickel, Silver, Gold, etc., money making secrets. Processes. (Approved for Veterans.) Send postcard today, FREE electroplating booklet and proof.

PLATER HYDE

432 F Street Room 520
San Diego 1, California

WANT A GOVERNMENT JOB?



START
\$1,756 to \$3,021 Year
Prepare NOW For Next Examinations

VETERANS GET SPECIAL PREFERENCE

Railway Postal Clerks
City Mail Carriers
City Postoffice Clerks
Ass't Statistical Clerks
Stenographers-Typists
Storekeeper—Gaugers, Etc.

32-Page Civil Service Book FREE

Mail Coupon today—SURE

FRANKLIN INSTITUTE

Dept. M86
Rochester 4, N. Y.

Rush to me, entirely free of charge, 32 page book with:
(1) A full description of U. S. Government jobs; (2) A list of U. S. Government jobs; (3) Tell me how to prepare for a job.

Name.....

Address.....

..... Vet?.....

LEARN A TRADE NOW in Sunny CALIFORNIA

- **REFRIGERATION, RADIO, ELECTRICAL APPLIANCE** Service and Repair ... a Combination Course in three opportunity fields.
- **PLASTERING**—a busy field these days!
- **UPHOLSTERING**—available, Los Angeles or Chicago.

Here are three career fields offering many opportunities to trained men, either in good paying positions or through a business of your own. **GENERAL TRADE SCHOOLS'** courses are **PRACTICAL, INTENSIVE**. Instructors are master craftsmen who know the practical side of each job.

School hours are concentrated so that time is available for taking part-time employment if desired.

Immediate Enrollment. Courses Approved for Veterans Available for Non-Veterans

MAIL THE COUPON NOW FOR COMPLETE INFORMATION

General Trades Schools
1601 S. Western, Dept. PM 9-7, Los Angeles 6, Calif.
Please send me FREE information on your courses as checked below:
Refrig. Radio, Elect. Appl. _____ Plastering _____ Upholstering _____
Name _____ Age _____
Street _____
City _____ Zone _____ State _____
Veteran _____ Non-Veteran _____

PRACTICAL SHOP TRAINING! LEARN A TRADE!

- | | |
|--|---|
| <input type="checkbox"/> AUTO MECHANICS | <input type="checkbox"/> BODY AND FENDER |
| <input type="checkbox"/> DIESEL | <input type="checkbox"/> TOOL AND DIE |
| <input type="checkbox"/> REFRIGERATION | <input type="checkbox"/> MACHINIST |
| <input type="checkbox"/> WELDING | <input type="checkbox"/> MACHINE DRAFTING |
| <input type="checkbox"/> PIANOFORTE TECHNOLOGY | |

America's Leading School
7 Floors of Fully Equipped Shops
Established 1902
Over 45,000 Graduates
Expert Individual Instruction
Learn by Doing

You hear it everywhere:
"GREER SHOP TRAINING IS THE BEST"

MAIL THIS AD TO GREER SHOP TRAINING

(Dept. 297) 460 South State St., Chicago 5, Ill.

Please send without obligation free information regarding trade checked above. (Specify whether you are a Veteran or Civilian)

Name _____ Age _____
Address _____
City _____ State _____

MAKE BIG MONEY IN YOUR OWN YEAR 'ROUND BUSINESS!

**EASY TO START
WITH ONLY A
FEW DOLLARS!**

Here are 3 amazing, new opportunities to get into your own highly-profitable, dignified business—without previous experience—regardless of your age or sex. 1. **LIQUID Synthetic MARBLE**—Easy to make and install beautiful synthetic Marble Slabs—pouring from liquid state. Big Demand for kitchen and bathroom walls, etc. 2. **FIBRE-TITE FLOORING**—Easy to make and install—in any color or color combination. Many years wear. Dustproof. Soundproof. Verminproof. 3. **FLEXIBLE MOLDS**—for Plaster Casting. \$1.00 in raw materials makes up to \$25 worth finished products. F.B. Iowa, writes: "Am on job that will net me \$150 for 4 days work." Get FREE details. No obligation. Write today!

**Write for
FREE
DETAILS
NOW!**

COMPOSITION PRODUCTS CO.
5853 Delmar Blvd. Dept. 91 St. Louis 12, Mo.

HI-SPEED EQUIPMENT

High Compression Heads—Dual Manifolds
Dual Air Cleaners For V8's
Use these simple conversions to increase horsepower, speed acceleration, and increase top speed of your car. Write today for prices and full information.
SANDEE MUFFLER CO. 7523 S. Western Ave. Los Angeles, Calif.

MUFFLERS

STEELS and ALUMINUMS
with a motorboat tone

SINGLES, Chev, V-8, Plymouth, Steels \$5.50, Aluminum \$6.50. Chry., Olds., Buicks, etc., Steels \$7.50, Aluminum \$8.50. V-8 and MERCURY DUALS, Steel \$17.50, Aluminum \$20.00. Aluminums are guaranteed for life of your car.

DEALERS WANTED

SANDEE MUFFLER CO.
7523 S. WESTERN AVE., LOS ANGELES 44, CALIF.

Why spend years learning by hard experience what you can get from a practical book in a few hours.
Write for list of "How-To-Do-It" books on practical subjects. 1000's of pleased customers all over the world.
ADAMS BROWN COMPANY—BOOKS OF APPLIED SCIENCE
Dept. 179 Chestnut Hill 67, Massachusetts, U. S. A.

MAKE UP TO \$5⁰⁰ AN HOUR In Your Own YEAR 'ROUND Business!

**ONLY A FEW
DOLLARS
PUTS YOU IN
BUSINESS!**

Many Clearing as High as \$20 to \$30 a Day NET Renewing Rugs, Carpets, Upholstery. New Method Now Used for Auto Upholstery. Write for Facts About Quick, Easy Way to Get Started

Here is the chance you've been looking for to step into a pleasant, dignified, big-pay business of your own that offers you a steady, year 'round income. Start on "a shoestring," full or spare time, right from your own home. Equal opportunities for men and women, young or old, in small towns or big cities. No experience needed. Many making big money with new Americlean System just cleaning auto upholstery. Easy to learn. We send you complete instructions and quick-cleaning supplies so you can start making money the very first day! Quick method cleans upholstery, rugs and carpets like new without taking off floor! Tremendous demand in homes, apartments, hotels, stores, office and public buildings. Steady repeat business. Territories going fast. Write today for full FREE facts. No cost or obligation. Rush letter or postcard now to **AMERICLEAN CO., Inc.**; Dept. G-9; 211 North 7 St.; St. Louis 1, Mo.

**WRITE
FOR FREE
DETAILS
NOW!**

ON-THE-JOB METHODS

ON-THE-JOB EQUIPMENT...

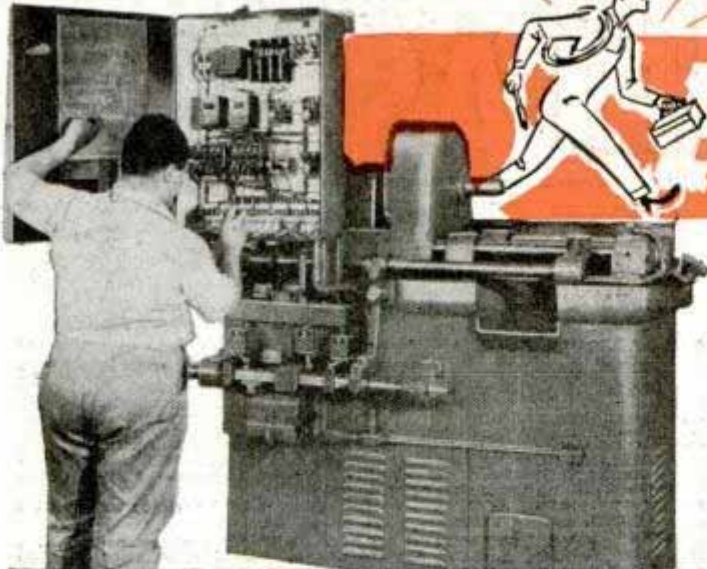

ABOVE: WIRING IN FACING MACHINE

RIGHT: TROUBLE SHOOTING ON LARGE CONTROL PANEL



ELECTRICITY

LEARN THE PRACTICAL WAY

on equipment like this in the large shops of the nation's largest exclusive electrical school!



Electricians are always in demand—make big money... Get "A to Z" experience quickly in our large shops—not "home-study"... **YOU DO ACTUAL WORK** on real equipment. Learn housewiring, armature wiring, motor rebuilding, factory installation, etc. New classes start every few weeks. Living arrangements made.

NO COST TO VETERANS Train at Gov't. expense. Receive \$65 to \$90 month while learning. Coupon brings details.

MICHIGAN TECHNICAL INSTITUTE, Dept. PM9
2281 W. Fort St., Detroit 16, Michigan

- Send me catalog and complete information.
- I am a GI. Send special information.
- Married. Single.

NAME _____

ADDRESS _____

CITY _____ ZONE _____ STATE _____

MICHIGAN TECHNICAL INSTITUTE

Department PM9, 2281 West Fort Street, Detroit 16, Michigan

BUILDING

Millions of homes needed. Nation wide call for builders. Big opportunities. Learn now in spare time.—at home. Practical training with blue prints. No books. Send for **FREE** Trial Lesson and blue print plans.

CHICAGO TECHNICAL COLLEGE
M-151 Tech. Bldg., 2000 S. Mich. Ave.
Chicago 16, Ill.

LEARN

CHEMISTRY

AT HOME

The demand for men trained in chemistry is great. Big pay job opportunities are growing by leaps and bounds. If you want to get into this fast growing, fascinating, high pay field by studying chemistry at home, write today.

INSTITUTE OF PRACTICAL CHEMISTRY
46 PROSPECT AVENUE, HAGERSTOWN, MD.

LAW

STUDY AT HOME for **PERSONAL SUCCESS** and **LARGER EARNINGS**. 39 years expert instruction—over 108,000 students enrolled. LL.B. Degree awarded. All texts furnished. Easy payments. Send for **FREE BOOK**. G. I. approved.
AMERICAN EXTENSION SCHOOL OF LAW
Dept. 81-M, 646 N. Michigan Ave., Chicago 11, Ill.

CHAPMAN CHINCILLAS

The originator of the first Chinchilla Farm in the United States. For information on purchasing the finest, selected breeding stock of these aristocratic animals that were virtually trapped to extinction write or visit—

Established
1919

Chapman Chinchilla Farm
4957 West 104th Street
Inglewood, California

NEW original HOME TRAINING COURSE



Prepares You In
The ART of

**JEWELRY REPAIRING
DESIGNING AND
MANUFACTURING**

EARN AS
YOU LEARN

The First and Only Course of Its Kind By The Largest Approved School of Its Kind

Now—for the first time—a fascinating, 20-lesson, practical Home Training Course in Jewelry Repairing, Designing, Engraving, Enameling, Stone Setting, Plating, Polishing, Casting, Gem Setting, Soldering, and Manufacturing. Prepares you for big earnings as an Expert Jewelry Repairman and a Master of Jewelry Designing and Manufacturing in an uncrowded field.



FREE
DIAMOND
INCLUDED
With Working
Tools as Part
of Our Course.

FREE FOLDER Write today! Get the full facts—then judge. Hurry—enormous need for jewelry repair experts with jewelry in constant need of repairs. Turn your spare time into profit.

ILLINOIS SCHOOL OF WATCH REPAIRING
2870 Elston Ave., Dept. JM-9 Chicago 18, Ill.

**YOUR SKILL
DESERVES
THIS
Engineered Instrument!
NEW
BRUNING**

Refillable Draftsman's Pencil

Designed by engineers for engineers and draftsmen, this new Bruning Draftsman's Refillable Pencil is built on an entirely new principle. No metal grip to nick or score leads—new type rubber clutch provides freedom from lead breakage! Pencil holds full length leads from .073" to .081"—including degrees HB to 9H of any popular drafting lead.

A Fine Tool for Skilled Work
Precision built, this pencil is worthy of a place beside your finest drafting instruments! *Adjustable cap* provides easy identification of degree of leads most commonly used—just turn the cap to indicate degree desired. Knurled grip provides a firm hold, prevents slipping whether pencil is held close to or away from point. The all-plastic barrel is finished in an attractive rust red.

You'll want one or more of these Bruning Refillable Draftsman's Pencils—order now while the supply still lasts at this low price. Just mail the coupon!

List Price Only \$1.00 Postpaid

Charles Bruning Co., Inc.
4722-32 Montrose Ave.
Chicago 41, Illinois

NO
C. O. D.
ORDERS

Gentlemen: Please send me (indicate number of pencils wanted)
Bruning Draftsman's Refillable Pencils at \$1.00 each. Enclosed is (give amount) \$_____ in payment.

Name _____
Address _____
City _____ State _____

**MY DOBE TRAINING
WAS ALL PRACTICAL
EXPERIENCE!**

**I WILL TRAIN YOU
AT HOME UNTIL
YOU GET A
GOOD PAY JOB!**

Get Started NOW in DRAFTING

EXPERIENCE WHILE LEARNING

Your training will be experience because I give you practical jobs to do. And I list your experience and send it to employers as a reference when you are ready. All Dobe trained men start out with experience. You will too, because I will train you until you get a good pay job in drafting.

Take the first step now and step into Drafting—the big opportunity field—as an experienced, well paid draftsman. Act now for a better job, better pay and better working conditions. The field for draftsmen is bigger now than ever before for all new products, machines, construction start with the draftsman. Get into drafting now. I will train you at home in your spare time, and give you actual experience on actual work—the same kind of jobs you will do with the best paying firms. I will train you until you are competent, fully experienced, and holding a position that will bring advancement and pay raises. Write me today.

WORKING TOOLS SENT WHEN YOU START

All drafting instruments and table and other needed equipment sent when you start. Nothing to buy. Act today. Mail coupon to me now and be sure to give age.



MAIL COUPON FOR VITAL FACTS

Engineer Dobe, Div. 1B, Libertyville, Ill.

Send me the Vital Facts on Drafting and Industrial Designing, your Free Book and advertised list of positions for Draftsmen and Designers wanted.

Name _____ Age _____
Address _____
City _____ Zone _____ State _____

**MAGIC LIQUID CASTS
PLASTICS**



THE GREATEST THING IN PLASTICS!

A NEW LIQUID PLASTIC! Just pour PLASTICAST into any kind of mold or container and it hardens in a few minutes to a solid, smooth, clear as glass plastic! No machinery or tools required. **PLASTICAST has UNLIMITED POSSIBILITIES . . .** novelties, toys, jewelry, knick-knacks, fascinating brilliant, sparkling clear or colored plastic articles . . . an endless variety of useful things. Being transparent it is ideal for imbedding flowers, coins, photos, souvenirs, charms, etc. Can also be cast into rods, sheets, blocks, any shape. Make **PLASTICASTING A THRILLING NEW HOBBY OR A PROFITABLE BUSINESS!** No experience required; start casting 10 minutes after you receive your outfit. Full instructions and accessories provided.

COMPLETE MASTER OUTFIT, will make over 200 articles . . . \$3.00 ppd. (C.O.D. orders accepted with \$1.00 deposit).

FREE FIVE ATTRACTIVE MOLDS FREE with every order . . . Scottie, Indian, Airplane, etc. Valuable **Plastics Manual** also sent free for 3c stamp!

PLASTICAST CO., (Dept. C)
5961 Madison St. (Send order to nearest office) P.O. Box 987
Chicago, Ill. Palo Alto, Calif.

SAVE MONEY

HOBBY BOOK DIVIDEND PLAN

Save up to 15% on your craft and hobby books. All the best and latest books from which to choose. Every hobby and craft covered. The more you buy the bigger the savings! Buy 5 or more books and you save 10%, 10 or more books and you save 15%—just like getting a book free. Our big purchases make these savings possible which we pass on to you in the form of a Book Dividend Certificate. Write for your catalog and Dividend Plan today. Send 25c now to

JACKSON STUDIO, Dept. 30
5440 N. Shoreland Ave.
Milwaukee 11, Wis.

Personality Difficulties? Consult our Psychologist

Learn to overcome nervousness, anxiety, fears, physical distress, undesirable habits and personality traits. **Enjoy more Happiness, Health, Success.** Write today for **FREE** Personality Check-Up and details of our Personalized Home-Study Course.

SCHOOL OF MODERN PSYCHOLOGY
Rooms: 2-4-B, 134 E. Second St. Dayton 2, Ohio

Learn BAKING At Home

Baking is one of America's high industries in wages. Nearly depression-proof. Thorough basic home course lays sound foundation. If you have aptitude, write for **FREE BOOKLET**, "Opportunities in Commercial Baking."

National Baking School, 1315 Mich. Ave., Dept. 1356, Chicago 5

NO QUESTION ABOUT THE FUTURE

WHEN YOU'RE TRAINED TO BE A Skilled Electrician!

Jobs in search of men! Our training course (5-hr., 6-day week) trains you in all House Wiring, Appliances, Industrial Electricity. Full course: only 8 months. We help you get part-time work and housing during your training with us.

VETERANS! Approved by Veterans Administration. Gov't.-paid tuition; subsistence pay!

Write for Further Details NOW!
2610-E Grand Ave.
NATIONAL TRADE SCHOOL Kansas City, Mo.



Learn DIESEL

at home... **IN YOUR SPARE TIME!**

HEMPHILL DIESEL TRAINING is available to you at home. Study in your spare time, without interfering with your present employment. This pioneer Diesel educational institution, with thousands of successful graduates throughout the world, offers you the opportunity to learn Diesel at home. **THE DAY OF DIESEL POWER IS HERE!** Railroads, shipping, farming, manufacturing, transportation—almost every great industry is turning more and more to Diesel Power. Think of the opportunities which this presents to the qualified, trained Diesel man.

VETERANS

This comprehensive, practical Home Training course is approved under the G.I. Bill of Rights. You can get started quickly. Just mail the coupon today.

NON-VETERANS

Courses available to you on easy TERMS. Improve your worth on your present job—or future as a Diesel operator or mechanic. Mail the coupon today for complete details.

RESIDENT SCHOOLS LOCATED AT:

NEW YORK 21-24 Queens Blvd., Long Island I. N. Y.
LOS ANGELES 1601 S. Western Ave., Los Angeles 6, Calif.
MEMPHIS 311 S. Main St., Memphis 3, Tenn.

34 weeks practical training. If you would prefer to train at one of these three schools, indicate by check on coupon.

HEMPHILL DIESEL AND AUTOMOTIVE SCHOOLS

Administrative Office: 1601 South Western Ave., Dept. PM-9
 Los Angeles 6, California

Gentlemen: Please send me FREE BOOKLET and information on your Diesel Courses. I am interested in Home Study Resident School at New York Memphis Los Angeles (Check school desired.)

Name..... Age.....
 Street..... Zone.....
 City..... State.....
 Veteran..... Non-Veteran.....



SALES ENGINEER MOLD DESIGNER RESEARCHER FABRICATOR LAMINATOR PARTS INSPECTOR MOLDING TECHNICIAN YOUR OWN BUSINESS

WHICH CAREER IN PLASTICS DO YOU WANT?

Plastics is one of the fastest growing industries—offering you unusual opportunities for an interesting, successful career and security in the years ahead. Trained men, with plastics know-how will fill the important, well-paying positions. YOU can be one of them. Mail the coupon below for a big, colorful, free catalog on Plastics and complete de-



tails about Plastics Institute, America's oldest and largest plastics school. Resident School located in beautiful Southern California. Comprehensive Home Training Courses to prepare you in your spare time at home for a career in plastics. You can enroll immediately! Write Plastics Institute, Dept. PM7-9, 1601 S. Western Ave., Los Angeles 6, California.

APPROVED FOR VETERANS

LEARN BY DOING

To give you practical experience we supply colorful plastics to make useful, attractive creations. You can also make and sell plastics articles to earn while learning.

Plastics INDUSTRIES TECHNICAL INSTITUTE

NEW YORK CHICAGO LOS ANGELES

Plastics Industries Technical Institute
 Dept. PM7-9, 1601 S. Western Ave., Los Angeles 6, Calif. Mail in Envelope or paste on penny postcard
 Gentlemen: Please send me free literature and information on your Resident School Courses Home Training Courses. I understand there is absolutely no obligation.

Name (PRINT)..... Occupation.....
 Street (PRINT)..... Age.....
 City..... Zone..... State.....

Important: Please fill out coupon completely. If non-veteran, please check. If in Armed Services now, please check.



PLASTICS INSTITUTE in the heart of sunny Los Angeles. Here modern laboratories and shops give Resident School students facilities for practice on the finest of industry-type plastics equipment. Also the headquarters for HOME TRAINING.

FREE BOOKLET

FREE

SEND FOR

ALLIED'S Big 164 Page RADIO CATALOG!

WRITE TODAY!



SAVE ON EVERYTHING IN RADIO!



NEW HOME RADIOS



SERVICE SUPPLIES BUILDERS' SUPPLIES



AMATEUR GEAR



SOUND SYSTEMS

164 Value-Packed Pages

Send for your FREE copy of the most complete Buying Guide for Everything in Radio! Here's the Catalog for Servicemen, Dealers, Soundmen, Amateurs, Builders and Experimenters. Features the world's largest and most complete stocks of radio and electronic supplies—quality equipment at lowest prices! Get the speedy service and expert help you want from ALLIED—Radio's Largest Supply House. Depend on ALLIED!

MORE THAN 10,000 ITEMS

Get everything for every radio use: Latest type home radio models, phono-radios, recorders, communications receivers, Ham kits, and gear, code apparatus, radio parts, tubes, tools, test instruments, public address equipment, low-cost easy-to-build radio kits, diagrams and matched parts lists, largest selection of instructive radio books—all at lowest prices!

ALLIED RADIO

ALLIED RADIO CORP.
833 W. Jackson Blvd., Dept. 5-JJ-7
Chicago 7, Illinois



Rush FREE 164-Page Catalog

Name.....

Address.....

City.....Zone.....State.....

1847 A CENTURY OF PUBLISHING 1947
MERRIAM-WEBSTERS

The Merriam-Webster Book of Biographies

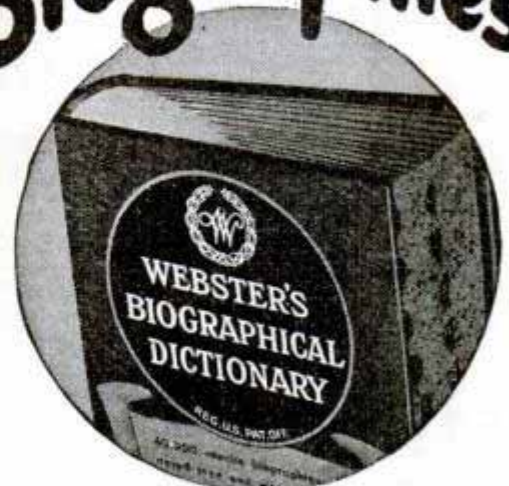

Essential Facts About 40,000 Noted People

WEBSTER'S BIOGRAPHICAL DICTIONARY contains more than 40,000 concise biographies, with pronunciation of names and all essential facts. Includes scientists, statesmen, explorers, writers, painters, actors, eminent figures from every other field. Prepared by the famous Merriam-Webster editorial staff. Valuable to writers, speakers, readers. 1,736 pages, thumb index. \$7.50. At your bookdealer, or from G. & C. MERRIAM Co., 687 Federal St., Springfield 2, Mass.

Learn WATCH REPAIRING

From An Approved School
The Largest of Its Kind



EARN WHILE LEARNING

Spare Time Home Training Prepares You For Big Pay

FREE WATCH working tools and watch included as part of our Watch Repairing Course

The demand for skilled watch repairers—men and women—is increasing with the step-up in the manufacture of watches. Now is the time to prepare yourself in this fascinating profession with the aid of our highly practical HOME TRAINING COURSE—in your spare time-at home. Start your own business or accept a big pay position.

WRITE TODAY FOR FREE DETAILS

Earn while you learn with an "approved" school. Get the facts—then judge.

ILLINOIS SCHOOL OF WATCH REPAIRING
2870 Elston Ave., Dept. PM-9 Chicago 18, Illinois

**WORLD'S
BEST
WANT AD
MEDIUM**

CLASSIFIED Advertisements



Advertisements in this section 60 cents per word, each insertion, minimum 10 words, payable in advance
To be inserted under proper classification, copy must be in our office the 25th of the
second month preceding date of issue

F. W. Johnson, Manager, Classified Advertising
Popular Mechanics Magazine, 200 East Ontario Street, Chicago 11, Illinois

**1314 CLASSIFIED
ADVERTISEMENTS**

**1314 OPPORTUNITIES
FOR YOU**

AUTOMOBILES, MIDGET CARS

"REX May's Racer," 1/16 scale model of 1947 Indianapolis Speedway Classic, six rich colors. Heavy duty motor, long runs from 150 to 175 feet at speeds up to 15 miles per hour, then free-wheeling. Aluminum fin brake drums. Custom built rubber tires. Radiator grill design. Off-set cockpit. Flared headpiece. Steering-wheel that turns. \$3.00 postpaid. (Agents wanted). Moore Mechanical Laboratory, Dept. #1, 1371 Elizabeth St., Pasadena, California.

KAISER-FRAZER. Floyd Clymer's new book (no connection with K-F factory) gives complete uncensored, impartial report 3000-mile Kaiser test run. 100 photographs; describes new Pike's Peak closed car record. Kansas City-Denver record run, economy test. Opinions of 3000 K-F owners. Complete breakdown of equipment units used. Read good and bad about K-F cars. No punches pulled. \$1.50 postpaid. De luxe edition \$2.50. Clymer, Dept. A-91, 2125 W. Pico, Los Angeles 6, Calif.

CUSTOMIZE Your automobile. Over 50 photographs, up-to-minute book intelligently presents numerous restyling ideas, instructions, specific changes, etc., postpaid \$1. Post Publications, Box 723-SE, Arcadia, California.

PHOTOGRAPHS. World's finest automobiles. List 10c. Box 1028, Minneapolis, Minnesota.

HIGH Speed engine tuning for beginners. Manual on heads, rods, shafts, carbs., over fifty questions and answers. Non-technical, instructive. \$1.00 postpaid. \$1.50 c.o.d. George Fawns, A-2552 N. 17th St., Philadelphia 32, Penna.

CUSTOM-STYLING Manual. Easily make car look Hollywoodized. Custom built, ultra-beautiful New, simplified customizing, restyling, streamlining methods. Instructions, illustrations. Plans for accessories, refinishing, mufflers, model changes - Custom, sport, continentals, "town and country," etc. \$3. Almqvist Engineering, Box 660-W, Brooklyn 1.

1947 INDIANAPOLIS "500" Race History Book. Complete details every car, driver competing. 100 photos, charts, drawings. \$1.00 postpaid. Large complete Indianapolis Race History Book. 352 pages, 1100 illustrations, all data 1909 to 1946 inclusive. Postpaid \$3.50; de luxe edition fabrikoid binding, gold lettering, \$5.00. Clymer, Dept. A-90, 2125 W. Pico, Los Angeles 6, Calif.

BUILD Speedy midget track racer from castoff parts! Plans, specifications, construction information. \$1.00. Motor Supply, Box CS-1682, Toledo, Ohio.

AUTOMOBILE Racing book, fifth edition, well illustrated. Instructions on building bodies, frames, engines, Ford A and B conversions. Plans, AAA rules, specifications. Roadster racing, Indianapolis cars. \$1.00 postpaid. \$1.30 C.O.D. Ray Kuns, Dept. 47, Madisonville, Cincinnati 27, Ohio.

BURN Water! Easily convert any automobile (or tractor) to amazing "water injection" (like late war planes) - only \$1.00! Five gallons gasoline saved pays for low cost installation. Many owners save that much fuel in one day's driving. Up to 33 miles per gallon - more power - smoother engine. Including copyrighted installation manual, complete diagrams, instructions, etc. Send dollar today. Newhouse Industries, 5941-K Hereford, Los Angeles 22, Calif.

AUTO Racing magazine subscriptions. Pacific Speedway News, \$6.00 yearly. National Speed Sport, \$4.00. Illustrated Speedway News, \$4.00. All give complete data midget, big car race results. Sample copy each 50c. Specify publication wanted. Clymer, Dept. A-92, 2125 W. Pico, Los Angeles 6, Calif.

AUTOMOBILE Racing, Sixth Edition, 100 illustrations. Working drawings with building instructions for Ford-60 midget, California roadster, Offenhauser racer. Details on racer parts. Sample entrance blank. World's record 158.5 m.p.h. rear engine four-wheel drive car. Interesting information for fans, drivers, mechanics. \$2.00 postpaid; \$2.25 c.o.d. Ray Kuns, Department 63, Cincinnati 27, Ohio.

FORD And Mercury owners. Attention! Give your car that knee-action ride. Restore arch to flat springs. Eliminate side-sway. Free literature. Supertone Mufflers, 2470 E. Slauson, Huntington Park 3, Calif.

SPEED And Mileage Manual - Obtain greater speed, mileage, racing performance from any automobile! Includes simplified methods, speed tuning, gas saving secrets. Instructions on building economizers, speed equipment, duals, mufflers, superchargers, racing fuels, fast conversions, "hot-rods," parts lists. \$1.98. Almqvist Engineering, Box 660-W, Brooklyn 1.

BUILD Automatic clutch, scooters, midget autos, tractors, shop machines. Catalog free. Nichols Equipment Co., Dept. 211, Purvis, Miss.

DUALTONE Chrystalline packed mufflers. Single or twin mufflers for all cars. Duals, priced complete, V8's \$23.00, six cylinders \$33.00, eight cylinders \$36.00. Large chromed tailpipe extensions \$3.30. Small curved \$1.70. Carburetor velocity stacks \$1.30. Chromed station wagon stacks \$15.00. Fender skirts - Torpedo, streamline, teardrop, square \$19.95. Request catalogue. Dualtone Mufflers, 2636C India Street, San Diego 1, California.

TACHOMETERS - 0-5000 or 0-8000 r.p.m., also 130 m.p.h. speedometers, instruments, 4 3/8 diameter, \$10.00 each. Adapters for any motor. Zakarian Engineering, Box 416, East San Diego, Calif.

CLYMERTONE. Twin muffler sets, beautiful sound, complete with necessary welded pipes, E-Z installation. Ford V-8, \$20.00. Chevrolet set with split manifolds, \$37.50. Specify car model. Clymer, Dept. A-94, 2125 W. Pico, Los Angeles 6, Calif.

USED-CAR Handbook, saves you dollars, grief. Photographs, complete comprehensive tests, dealers' tricks exposed. "Judging the Used Car," postpaid \$1. Post Publications, Box 723-TE, Arcadia, California.

TWIN-TONE Mufflers for V-8 and Mercurys 35 to 47 models. Gives more mileage, without back pressure. Mufflers are straight through-type and produce deep mellow tone, \$20.00 a set. Single through-type mufflers for all cars \$6.50 dia. Chrome tall pipe extension 2 1/2" dia. \$3.50 ea. Satisfaction guaranteed. Elmer's Muffler Shop, 139 East Manchester Ave., Los Angeles 3, Calif.

HOLLYWOOD Hot-Rod Manual. Plans, photos, instructions, fast Fords. \$1.50 p.p. Hollywood Hot-Rod, Box 9626P, Los Feliz Sta., Hollywood 27, Calif.

64 NEW Indianapolis 500 mile race pictures. 48 shots 1946 race. Over 500 photos of "500," 1911-1947. Big 9x12 picture book only \$1. Tower Official Photos, Indianapolis 19.

MUFFLER Manual. Convert your own! Hollywood melitone construction details; duals on Vee, straight engines; diagrams, postpaid \$1. Post Publications, Box 723-ME, Arcadia, California.

CLYMER'S Historical Motor Scrapbook No. 4, latest Clymer book old cars and motorcycles. Postpaid \$1.50; de luxe edition, \$2.50. Clymer, Dept. A-98, 2125 W. Pico, Los Angeles 6, Calif.

BELLY Tanks - 75 gallon, new, steel, 6 ft. 4 in. \$7.50. Anzio Boat Co., Box 89, Merced, Calif.

PROFESSIONAL Midget racer, motor-scooter, midget roadster, and midget motorcycle. Plans, specifications for all four contained in illustrated handbook, 25c. Big list bargain priced used motors, motorscooters, servicers, etc., included free! Midwest, 3839 Drummond, Toledo, Ohio.

R & R Mfg. Co., marine and auto division, Anderson, Indiana, Robert M. Roof. \$1.00 for our new 1947 speed and power equipment catalogue with price sheet - showing racing cars, midgets, speed boats with recommendations how to rebuild your motors for racing. Dual ignition racing cylinder heads for V-60-100 and Mercury Ford engines. Dual intake manifolds, racing pistons, camshafts, compound valve springs, Lynite flywheels, quick change gear boxes and numerous other supplies.

MAKE Your Ford fast! Complete details, photographs. How to construct 120 m.p.h. Hotrod. \$1 postpaid. California Bill, Box L-1, Eaglerock, Los Angeles 41, Calif.

AUTO SUPPLIES AND EQUIPMENT

FILLING Station operators. Use your air compressor to make interlocking concrete building block. Good profit possibilities with four hundred dollar investment. Free literature. Delaware Industries, Dept. 10, Muncie, Indiana.

IGNITION: Let it rain; let it pour; starting troubles you have no more with Post Seal (liquid insulation) your car will have new power galore. Adds extra years of life to battery and cables. Prevents corrosion and drain-out. Send \$1.25 M. O. to The Post Seal Co., 731 Palister St., Detroit 2, Mich., for complete protection. Discount prices to dealers on application.

GASOLINE Saving vacuum supercharger, uses gasoline motor's waste, more power, speed, smoother motor, reported savings high as 25%. Price \$12.85. Self addressed stamped envelope for pamphlet showing this great patented invention. McDowell Co., 2000 NE Union, Portland 12, Oregon.

SELL Battery water filters. Make safe battery water. No cost to operate. Nappanee Water Filter Co., Nappanee, Indiana.

MOTORISTS - Emergency brake safety device; prevents accidents, easily installed. \$1 postpaid. Fleming, 14304 Bardwell, East Cleveland, Ohio.

AUTO Sheepswool wash mitts. Sheepswool hoods for polishing machines. Hanson's Chamols, Gloversville, N. Y.

DON'T Swear at your automatic choke. Attach a Redex Hand Choke adapter \$3.00 postpaid. Guaranteed. Redex Machine Co., 1301 Ridgeway, Rochester 13, New York.

SIMPLE Carburetor replacement part, guaranteed to save gas. \$1. postpaid. Albert Daufeldt, Atalissa, Iowa.

INSTALL Surplus jeep motor in Model "A" Ford. Details \$1.00. Thad Huffman, R. 3, Pratt, Kansas.

DAB Wipe-on auto paint color cards 10c. Seventeen colors. Dab Distributors, 1911-N, Lubbock, Texas.

TIRES — Firestone. Retail, wholesale. C. Page, Franklinville, N. Y.

CONVERT Your car or boat engine to burn kerosene. Any model or make. Complete plans and instructions \$1.00. Box 241, Culver City, Calif.

1947 SUPERIGNITIONER \$5.50. Atomic pep, starting, mileage. Burn steam \$1.00. EG Mfg., 355-A East 149th, New York 55.

STOP Leaky windshields with amazing new Plasti-Seal! Only \$1.00 postpaid for 2 lb. can. Easily applied. Marvelous results. Cooper's, 3135 Lawrence, Chicago 25, Illinois.

BODY And fender repairs easy, profitable with new Hobart a.c. welder. Ranges for sheet metal to heavy frame work. Write for free catalog. Hobart Welders, Box M-972, Troy, Ohio.

NEED Auto parts? We have them. New and rebuilt. Prompt shipment. Write requirements. Save money. Buy direct. (See our display advertisement page 242). Factory warehouse. Mechanics Auto Parts, 3807-PM-9 North Ashland, Chicago 13.

RECONDITION Motors without new rings. Instructions 25c. Charles, 12-AU, Norwood, Ohio.

PATENTED Hub cap lock, no keys, lasts for years, \$4 per set postpaid, no c.o.d. State make and year. Law Mfg. Co., Box 628, San Diego 7, Calif.

CONSTRUCT Water injection carburetor yourself. Illustrated plans \$1.00. L. D. Blythe, White City 1, Kans.

AUTO Glass, shock absorbers at factory prices! State requirements for quotations. Shipment immediately with \$1.00 deposit. Cooper Auto Glass, 3135 Lawrence, Chicago 25, Illinois.

AUTO Parts for all autos and trucks. Trans., motors, differentials, fenders, carburetors. Also body parts. Security Auto and Truck Parts, 1923 BJ Grace, Chicago 13.

ATTENTION Chevrolet and GMC owners—If car or truck propeller shaft is worn, save replacing it by having National M-101 or M-102 Drive Shaft Bushing & Seal Assembly installed by your dealer, garage or repair-man. Unnecessary to tear down differential, goes back of U-joint, over old propeller shaft. New heavier bushing on unworn part of shaft saves buying new shaft. New, heavier seal protects transmission and differential by confining lubricant to proper cases. Quick repairs, low cost! Thousands in use throughout nation. If your dealer doesn't have M-101 or M-102, write National Machine Works, Box 4305, Oklahoma City 9, Okla.

MANIFOLD Whistle—Imitates "wolf whistle," siren, etc. Installed on any car manifold in 15 minutes. Send \$6.00 to Protectured Company, 4033 Windsor Rd., Youngstown 7, Ohio.

GRILLES For all cars. Meyers Auto Parts, 820 Dryades, New Orleans, La.

SELL Tires—Make money. Standard makes, first quality. No investment or experience required. Direct Tire Co., 962 E. 129 St., Cleveland, Ohio.

NEW And used automobile and truck parts. Lowest prices. Complete stock. Prompt reply. Babbitt Auto Parts, 2833 W. Chicago Ave., Chicago 22.

HAVING Car trouble? New, used, guaranteed auto, truck parts save money. Transmission specialists. Describe needs; immediate reply. Victory, 2930½ North-western, Chicago 18.

PLATING Outfits for auto parts. Connect to a battery. No tanks used. Free particulars and proofs. Gunmetal Co., Ave. J, Decatur, Ill.

BURN Water in your car. Costs less than gas. More power, cleaner motor. Mail card for data on \$17.50 octa-gane water injecting carburetor. Ralph A. Shade, 563 Lake Road, Webster, N. Y.

GRILLES For all cars. Wagner Grille Co., Route 2, Bernville, Penna.

AUTO TRAILERS

LUXURY Liner. Modern 3 room, has everything. Large manual, drawings, instructions, parts list \$3.00. Nine large blueprints \$5.00. Large 6 view floor plan \$1.00. Circulars 20c. Craftsman Books, Box 1153-P3, Milwaukee 1, Wisconsin.

BUILD Your own trailer! Save money! Have every feature you want! Plans for house, sport, camp and utility trailers. Catalog describing 9 models 10c. 15c in Canada and overseas. Jim Dandy, Box 125-A, Wausau, Wisconsin.

MOTORCYCLES, BICYCLES, MOTOR-SCOOTERS AND SUPPLIES

BICYCLE Supplies — wholesale, retail, metal disc wheels. Universal, 4713 Virginia, St. Louis, Missouri.

BICYCLES, Tricycles for export. Atlas Cycle Co., 3002 Broadway, Chicago 14, Ill.

HARLEY-DAVIDSON Parts, accessories, batteries, and tires, 24 hour service. Authorized factory dealer. Philadelphia Harley-Davidson Company, 857 North Broad Street, Philadelphia 23, Penna.

MOTOR Scooters, bicycle engines. 120 miles gallon. Dime for catalog. Clymer, Dept. A-95, 2125 W. Pico, Los Angeles 6, Calif.

TIRES, Tubes, wheels, 8" to 18" diameter, first-line quality, for power scooters, wheelbarrows, farm equipment, carts, etc. Special offer, August and September only, size 10 by 3.50, 2-ply casing, inner tube, wheel, mounted complete, \$6.90 f.o.b. Akron. Send check or money-order. Write for circular. Jahant Company, 626 East Exchange Street, Akron 6, Ohio.

CUSHMAN Motorscooter \$15. Shaw bicycle motor \$15. Harley-Davidson motorcycle, \$35! Send 25c for bargain catalog #8 packed with money saving buys in motorscooters, motorbikes, midget cars, motors, wheels, tires and parts. Gail and Company, 538 Erie, Toledo, Ohio.

BOYS, Repair your own bike. "Bicycle Repair Manual" teaches brake repairing, rebuilding wheels, etc. 65c. Robert Klausner, Shelbyville, Ill.

WHEELS! Build wagons, scooters, mowers, trailers, wheelbarrows, grocery carts, baby carts, play pens, baby carriages. 4" to 16". Free list. Trulsen Mfg. Co., 811 E. 31, Kansas City, Mo.

BICYCLE Book, how to buy, rebuild, sell used bicycles 50c. John Collett, Handley, Texas.

TIRES And industrial wheels, suitable for scooters, wheelbarrows, farm equipment, etc. All sizes. Bicycles and accessories. Largest assortment in America. Send dime for list. Cycle Transport Company, 1241 So. Michigan Ave., Chicago 5, Illinois.

BUILD America's lowest priced motor-scooter speedster! Complete plans, specifications, \$1.00. Big list bargain priced used motors, etc., included free! Motor Supply, Box 1682-CS, Toledo, Ohio.

LARGE Stock Indian parts. Expert motor rebuilding. New and rebuilt Chief motorcycle, motors only. Indian Motorcycle Sales, Kansas City 1, Mo.

HARLEY-DAVIDSON — New and used 45" motors, service, parts, accessories, tires. Send \$2.25 for army motorcycle manual, 10c for bulletins. Knuth's (Harley-Davidson factory dealer), 2491 Pondulac, Milwaukee, Wis.

CUSHMAN Motorscooter \$20 (includes motor and extra tires). Midget racer \$15! Send 25c for big catalog #938 listing these and scores of other sensational bargains in motors, wheels, motorscooters, motorbikes, servicycles, tires, etc. Associated, Box CS-1764, Toledo, Ohio.

MOTORIZE Your bike. Easy, economical, proven method. No cutting or welding of frame. Plans, instructions, photos and diagrams all for \$1. Dunakin Shops, 819 Golf Lane, Wheaton, Ill.

AVIATION

PROPELLERS — Especially designed 3 blade, 2 blade, for ice-snow sleds, boats. Literature. Standard Aerocraft, Box 387, Ft. Worth, Texas.

NATIONAL Air races, ten photos nearly post card size, described \$1. Souvenir, one dime. Himes Photos, 3341 Superior Ave., Cleveland, Ohio.

BUILD Lightplane, scout wing drawing, circulars 20c. Craftsman Books, Box 1153-P1, Milwaukee 1, Wis.

B-29 COMPUTERS, 400 Cycle dynamometers, 60v.d.c. amplidyne, amplidyne servo-amplifiers, wiring harnesses, inertia starters, starter solenoids, etc. List. Erecoco, 2912 Hewitt, Everett 1, Washington.

VETERANS: Flight training under G.I. bill. Private, commercial and flight instructor ratings. Write for information. Gottschalk School of Aeronautics, Adrian, Michigan.

SENSATIONAL Bargains in used Cubs, Taylorcrafts, etc.! Big, thousand-item catalog, 25c. (Includes listings of "easy to repair" crackups). National, Box 1682-CS, Toledo, Ohio.

GIANT Glider kites. Double, 14x10 ft. Lifts 100 lbs., tows car, etc. Cost government \$108. Yours for \$20. Satisfaction guaranteed. Great Northern Mart, North Adams, Mass.

BATTERIES, GENERATORS

BATTERY Bargain: Exide 24 volt 17 amp. hr. convertible to 12 volt 34 amp. Metal case and cover, non-spillable vents. Hundreds of uses. Orig. \$57.00, now \$7.95 plus freight. Weight 52 lbs. Rush check or money order to Silver Creek Precision Corp., Silver Creek, New York.

BATTERY Bargain: Exide 24 volt 11 amp. hr., convertible to 12 volt, 22 amp. Metal case and cover; non-spillable vents. Orig. \$57.00, now \$6.95 plus freight. Weight 34 lbs. Don't wait. Check or money order. Silver Creek Precision Corp., Silver Creek, New York.

ELECTRICAL SUPPLIES, EQUIPMENT

ALUMINUM Fan blades, correctly balanced, 1/2" bore \$2.25 each. All welded 18" guard \$2.50. Ted Riseman, 207 North Fifth, Springfield, Illinois.

GUN Charger assembly—All new! Contains 27 volt d.c. motor geared for 120 r.p.m. Miniature brass precision-built clutch assembly, 2, type Z, micro switches. Solenoid assembly that contains over 1 pound magnet wire. Many valuable parts. Original cost to government over \$150.00. Now! \$9.95 each. Three for \$25. Real buy! No c.o.d. "Amazing Bachman's," Dept. AU, 23 Herman Street, Rochester 5, N. Y.

TATTOOING Machines, outfits. Free catalogue. Jensen, 120 West 83rd Street, Los Angeles 3.

ELECTRIC Pencil—Writes, engraves all metals. Battery model \$1.00—110 volt model \$3.00. Complete. C.O.D.'s, accepted. Reb Industries, Dept. 265-CC, Elmhurst, Illinois.

ELECTRIC Wire: Single conductor Tires 4/0 flexible 46c foot; 14 conductor #16 18c; twisted pair (used) field telephone wire \$15.00 mile. 1,000,000 feet 200 types stocked. Synthetic, braid, rubber, lead, lead armor, armor coverings. Free list. Erecoco, 2912 Hewitt, Everett 1, Wash.

A.C. Ammeter—5 amp. range, 100 amp. scale, \$1.95. 0-150 a.c. voltmeters \$2.45. 40 watt capsule type thermostat, can be calibrated over 500 degree range, 10 for \$1.00. Close out prices. Send check or postal order. D. E. Kitchen, Logan, Ohio.

SOLENOID Assembly. All new! Contains over 1 pound magnet wire. Over \$30 value. Special \$1.50 each. Four for \$5 No c.o.d. "Amazing Bachman's," Dept. AU, 23 Herman Street, Rochester 5, N. Y.

LAMP Sockets, brass shell. Also Mogul sockets. Three way switches, cord sets, electrical repair parts, lamp parts, wires, etc. Catalog 10c. The Gearon Company, 6405 North Oakley, Chicago.

MICRO Switches! All new! Type Z. \$2.00 value. Special \$1 or 12 for \$10; large micro switch, catalog No. WZE-7RQ9TN, \$4.00 value. Now \$1.50; GE midget precision micro switches, \$1.25 value, 50c each. Combination assortment, variety of 6 micro switches—only \$5. Real buy! No c.o.d. "Amazing Bachman's," Dept. AU, 23 Herman Street, Rochester 5, N. Y.

MANUAL On multispeed three phase induction motors \$2.00. Free literature. Electric Generator Mfg. Co., 1333 N. Dale St., St. Paul 3, Minnesota.

ELECTRIC Fan assemblies. Assemble your own. Ted Riseman, 207 North Fifth, Springfield, Illinois.

OIL Lamps—convert to electric in one-half minute with Gyro converters. Illustrated catalog 10c. All lamp parts. Harps, vase caps, bases, hard-to-get items. Gyro Lamps, 5416M Clark, Chicago 40.

VINYLLITE Plastic tubing. All new! Splendid electrical insulation. Sizes 1/10" up to 5/16" diameter. 1000 feet assortment in coils from 100 to 250 feet. Special \$15. "Amazing Bachman's," Dept. AU, 23 Herman Street, Rochester 5, N. Y.

METER Sockets! Make your own. Source of available materials, plan. \$2.00. Newhouse Electric, Fond du lac, Wis.

BUILD Your own lamps. Save half. Be different. Write for free photos, also lamp parts. Buddy Products Mfg. Co., Dept. 30, 1123 W. Belmont, Chicago, Ill.

ELECTRIC Pencil: Writes, engraves all metals. \$1.00 postpaid. Beyer Mfg., 229-H Dixon Blvd., Uniontown, Penna.

EXPERIMENTERS. Student scientists—Experimental science manuals and kits. Send for list. Queens Experimental Supply Co., 25-12 Steinway Street, Long Island City 3, New York.

MAGNET Wire— $\frac{1}{2}$ lb. coils No. 22. All new! Special 10 rolls for \$3. No c.o.d. "Amazing Bachman's," Dept. AU, 23 Herman Street, Rochester 5, New York.

WELDING, SOLDERING, PLATING

JOHNSON Jiffy-Kit, portable welding and cutting outfit complete with cylinders and carrying case designed especially for hobby shops, small repair shops, refrigeration and electrical service men. You own the cylinders! No rental charges! Free literature! A-A Welding Supply Co., E-9228 S. Ada St., Chicago 20, Illinois.

NEW Model electric welder 110 volt a.c.-d.c.; will weld all metals; easy to use; full directions. Complete with power unit, flame and metallic arc attachments, carbons, fluxes, rods, mask; all for \$19.95. Used by the navy. Magic Welder Mfg. Co., 239 MP9 Canal St., New York City.

SAVE 50% On electric welders, torches, helmets, etc. Holgerson's Service, Canton, Kansas.

NEW Aircraft generators—war surplus—only \$39.50. Original cost \$250.00. Can be converted for use as welder, electric plater, fast battery charger, auxiliary power unit, etc. Model R. 2, volts 25 to 30, 300 amp. d.c., shipping weight 69 lbs. Size 16"x7". Air cooled. Immediate shipment. Original crates. Check with order to save time. Greer, 460 South State Street, Dept. 197, Chicago 5, Illinois.

WELDERS—Govt. surplus tested gasoline driven. Save up to 50%. Iowa Machinery Co., Des Moines.

"BUILD-UR-OWN" Portable arc welder. Save \$300. Easy with Hobart generator plus auto engine. Write for free book. Hobart Welders, Box M-973, Troy, Ohio.

PORTABLE Combination solderer, welder, brazer, 110-a.c., 60 amperes output. Handles all metals including aluminum. Write for free manual. Universals, 2720 Grand Concourse, New York 58, N. Y.

SILVER Solder brazing makes strong unbreakable leak-proof joints all metals. Simplified instructions 50c. Supplies handled. American Products, 830 Lowell Bldg., Chicago 5.

ACETYLENE Welding outfits, new, consisting of 2 gauge regulators, torch, 3 tips, hose, connections, clamps, lighter, \$54.50. Eagle Welding, Dept. PM, 5085 Broadway, Chicago 40, Illinois.

OXY-ACETYLENE Welding outfit including: Full oxygen and acetylene cylinders, \$72.95 complete, f.o.b. Cleveland, Ohio. New, supply limited. Check or deposit with order, balance c.o.d. Cylinders can be refilled anywhere. Ideal for hobbyists, garages, repair shops, etc., includes supply of rod. The Burdett Oxy-Weld Equip. Co., 3399 Lakeside Avenue, Cleveland 14, Ohio.

FULL Information on how I successfully weld, braze, and solder gasoline tanks without explosion. Send \$1.00 to Alfred Schlatter, Francesville, Indiana.

WELD, Cut, braze with gasoline! Amazing discovery shatters costs. Range jewelry to railroad steel. For farm, factory, shop. New opportunities. New wealth. Important! Investigate. Matthews Mfg. Co., Calgary 21, Canada.

ELECTROPLATING Booklet includes full directions for plating jewelry, small parts, metalizing baby shoes. 50c. Hoover & Strong, Inc., 113 W. Tupper Street, Buffalo 1, N. Y.

A.C. Welders, 110 v., welds $\frac{1}{2}$ " steel, \$29. Money back guarantee. Paul Morris, 1850 State St., Schenectady 4, N. Y.

WELDING, Cutting, aircraft welding and soldering equipment. Electric arc welders. Superior Oxy-Acetylene Co., Hamilton, Ohio.

BOOKS—All Kinds—Homecraft, Radio, Plastics, Boat Building, Photography, Model Building. Catalog free. Popular Mechanics Press, 200 E. Ontario St., Chicago 11, Ill.

MACHINERY, TOOLS AND SUPPLIES

MACHINISTS, Hobbyists, Experimentalists. Note! Precision built right angle drives. Excellent for home workshop. Complete with flexible drive cable. Only \$3.50. No c.o.d. "Amazing Bachman's," Dept. AU, 23 Herman Street, Rochester 5, New York.

ASSORTED Scissor screws and saw supplies. List 10c. Overland's Saw Service

GEARS For inventors, experimenters, model makers, schools, work shops, laboratories, etc. Government surplus made of brass, bronze, dural steel and stainless steel. 12 matched pairs; 24 gears, bevel, spur and ratchet. List price \$12.00, our price \$2.50. 25 matched pairs; 50 gears, includes larger gears, also sets of worm gears. List price \$30.00, our price \$5.00. Limited quantity. Order now. Write for our bulletins on ball bearings, rectifiers, relays, selsyns, horns and government surplus materials. Met Exchange, 323 Canal Street, New York.

MECHANICS, Machinists, hobbyists, note! Amazing dual-drive assembly, geared 7 to 1 reduction, is driven by powerful 1/5 h.p. a.c. or d.c. motor. Operates on 6, 27 or 110 volts with transformer. Simple standard attachments convert this amazing unit into a dual-hand or table-drill, polisher, buffer, router, sander, countless other uses. May be used as individual drill, sander, etc., by detaching flexible drive shaft. This wonder machine shop all in one comes set-up as drill equipped with 3 flexible drive cables and mounting bracket. Original cost to government over \$300.00. Now! While they last, \$19.50. No c.o.d. "Amazing Bachman's," Dept. AU, 23 Herman Street, Rochester 5, New York.

FOUNDRY Castings, blueprints, materials for woodworking and metalworking machine tools. Suitable for commercial or home shop production. 23 items, catalog 10c. Lewis Machine Tool Co., 3217 Union Pacific Avenue, Dept. M, Los Angeles 23, California.

WE Offer 60 tons of new war surplus bolts, nuts, washers, screws, etc. All popular sizes. A good mixture for hobby shops, garages, machine shops and farms. A big 40 lb. box for only \$6.85. War Surplus Co., Morris and John Sts., New Brunswick, N. J.

GEAR Reductions! Values ranging from \$500 to \$1100 each. All new! Complete with $\frac{1}{2}$ h.p. motor a.c. or d.c. 110 volt. 25 or 60 cy. Single phase. Variable speeds. Bearing assembly with machined gears. Absolutely the thing for sanders, polishers, winches, hoist conveyors. Adaptable for many uses. Special \$39.50. No c.o.d. "Amazing Bachman's," Dept. AU, 23 Herman Street, Rochester 5, N. Y.

SHEBEL Saw Filer files all saws. Circular. A. P. Shebel, 730B So. 2nd St., Milwaukee 4, Wis.

FLEXIBLE Drive cables. All New! Three sizes. 10", 25", 72". Adaptable for many uses. Over \$5.00 value. Combination offer of all 3 sizes, while they last \$1.75. No c.o.d. "Amazing Bachman's," Dept. AU, 23 Herman Street, Rochester 5, New York.

12" BAND Saw, tilting table, Oilite bearings, all grey iron castings, \$35.00. Backus Machine Co., Boyd, Wisc. Write for circular.

WELDERS, Electric arc. Models and sizes for all requirements. D.c., a.c. 150-600 amp. Portable, stationary. Prompt delivery. Reasonable terms. Write for free catalog. Hobart Welders, Box M-974, Troy, Ohio.

ALUMINUM Compressor tanks. All new! Welded throughout. 3 $\frac{1}{2}$ gallon: just the thing for portable units; at fraction of original cost. Now! \$6 each. 10 gallon size: suitable for storage or marine uses, special only \$7.50. No c.o.d. "Amazing Bachman's," 23 Herman Street, Rochester 5, N. Y.

"ELECTRIC" Hand sander complete \$14.85. Circular. Handy Tools, 255PM Charles, Grand Rapids 6, Michigan.

FOOT Switch—For all power tools. Leaves both hands free. Just plug it in. \$2.00 postpaid. C.O.D.s. accepted. Reb Industries, Dept. 265-CB, Elmhurst, Ill.

MACHINIST Tools, supplies, diamond emery wheel dressers. Precision Tool Service, 55 E. Washington, Chicago 2, Illinois.

ANYONE Can sharpen saws with a Teeho-Tool, 25c. Free details. Teeho, 316 North 2, Maywood, Illinois.

BUSHINGS—Spacers. All new! Made of aluminum and steel. 25-variety assortment. 5 pounds for \$5. No c.o.d. "Amazing Bachman's," 23 Herman Street, Rochester 5, N. Y.

DRILL Grinder for twist drills \$2.95. See ad on page 242.

NEW 12" Bandsaw; anti-friction bearings; tilting table; Write for circular. Sterling, 2310 W. Warren, Detroit 8, Mich.

LONG'S Index head for the lathe, milling-machine, drill-press, etc. Write for folders. Satisfaction guaranteed. Box 537, Torrington, Wyoming.

BUILD Quickchange gear box without castings for \$10.00 Craftsman, Atlas, adaptable other lathes. Complete drawings \$3.75. Stevens, 2604 Military, Los Angeles

BALL Bearings one-fourth list price; gears, switches, rheostats. Free list. Burgess, Box 168, Ferguson, Mo.

BOLT And screw assortment. All new! Guaranteed over 50 varieties. Special! Minimum order, 5 pounds for \$4.95. 10 pounds for \$8.95. No c.o.d. "Amazing Bachman's," 23 Herman Street, Rochester 5, N. Y.

HARDWARE, Tools, drills, taps, dies, reamers, belts, pulleys, pattern, model supplies, saw mandrels, jeweler saws, electrical equipment, brass, steel, drill rod. Catalog 10c. Terek, 6304 Patterson, Chicago 34.

SAFETY Goggles. For your workshop, machine shop, etc. \$2.00 to \$3.00 values. Special! Assortment of 3 for \$2. No c.o.d. "Amazing Bachman's," 23 Herman Street, Rochester 5, N. Y.

ALUMINUM Handles. For socket screw keys. Wittle Manufacturing, 1041 Littit Avenue, Lancaster, Penna.

HOME Shop owners attention—Send for actual photograph and sample of the work our attachments will do. The photograph and sample speak for themselves. Have fun in your home shop. Cut gears, sprockets, ratchets, lay out holes accurately, cut keyways, build complete clocks and other interesting jobs. Build these attachments yourself from our reasonably priced blue prints. Don't limit your lathe to round work only. The Home Shop, 415 Raymond Avenue, Glendale 1, California.

WAR Surplus in small tools for machine shop—Send 15c for bulletin. Travers Tool Company, Dept. P, 5 Court Square, Long Island City, N. Y.

V-BLOCKS At low prices. 10 sizes for all purposes. Free literature. Miles Products, 2532 Wabash, Chicago 16.

DRILL Grinder—Grinds drills to factory accuracy. Callipers with direct reading scales. Circle cutters. New Tool grinder. Lowest prices. Free literature. Factory, 811-B East 31st, Kansas City 3, Mo.

DRILLS-TAPS—Reconditioned high speed, up to seventy-five percent off list. Send for free circulars. Perry Screw and Bolt Corporation, 4250 Grand River, Detroit 8, Michigan.

RIVETS. All new! Made of aluminum, copper, steel. Guaranteed assortment of over 50 varieties. Special. 5 pound assortment \$3.50. 10 pound \$5.95. No c.o.d. "Amazing Bachman's," 23 Herman Street, Rochester 5, N. Y.

ENGINES, MOTORS, DYNAMOS

MOTOR Bargain: New $\frac{1}{2}$ h.p. d.c. or a.c. electric motors. Speed: 9,000 to 10,000 r.p.m. Gear reduction head reduces speed to 135 r.p.m. at sprocket. D.C. operates on 6 to 27 volt battery. A.C. is single phase, 110 volt 50-60 cycles, intermittent duty. Countless uses including lifting devices, garage doors, pumps, etc. Orig. \$42.00, now \$4.95, plus shipping. Rush check or money order. Silver Creek Precision Corp., Silver Creek, N. Y.

RANGER Engine-Aircraft—All new in original case. 570 h.p. 12 cyl. V type. Engine Spec. No. 177. Complete with spark plugs. Original government cost over \$12,000.00 each. Special offer \$200. Crated weight 1200 lbs. No c.o.d. Write for complete description. "Amazing Bachman's," Dept. AU, 23 Herman Street, Rochester 5, N. Y.

GAS Drive arc welders. "Build Your Own." Portable, goes everywhere after profitable jobs. Save \$300 with Hobart generator plus auto engine. Write for free instruction book. Hobart Welders, Box M-975, Troy, Ohio.

SUPERCHARGERS—Aircraft. All new! Contains carburetors, many valuable gears, parts. Can be used as cooling unit with aircraft motors. Original cost over \$5,000.00. Now! \$50 each. No c.o.d. "Amazing Bachman's," 23 Herman Street, Rochester 5, N. Y.

ELECTRIC Pump (de-icer) Black Decker 24 v. a.c./d.c. 1A. Vane 10GPH. Lifts oil 12". New. \$7.25. List. Eresco, 2912 Hewitt, Everett 1, Wash.

MOTORS! $\frac{1}{2}$ H.P.—All new. High speed 110 volt. 25 or 60 cycle, d.c. converted to a.c. ball-bearing motors with forward and reverse switches. Actual cost about \$100.00. Now \$19.50, three for \$50— or—same motor without reverse switch \$15. Three for \$40. Countless uses for home mechanics. Order today! No c.o.d. orders. "Amazing Bachman's," Dept. AU, 23 Herman Street, Rochester 5, N. Y.

WELDING Generator, 150 ampere, \$47.50. Other bargains. Butler, 1885 Milwaukee, Chicago.

AMPLIDYNE Motor - Generators. All packed—new! GE5AM 31N9A. Output 60 v.d.c. input 27 v.d.c. 530 watts. Original cost \$120.00. Now! \$7.95 each. Three for \$20. Order today! No c.o.d. "Amazing Bachman's," Dept. AU, 23 Herman Street, Rochester 5, N. Y.

MOTOR 25c. Flashlight cell operates. Parts complete, plus instructions. Two 45c. Send today! Eitro, Deer Park, N. Y.

WINDING Data, listing 225 motors, single and three phase, \$1.00. Motor Data Co., Box 7631, Kansas City 3, Mo.

MOTOR Winding tester, indicates burned out or partly shorted coils in single or three-phase motors, indispensable for repairmen. Send for bulletin. Motor Industries, Quincy, Illinois.

SELSYNS—All new! Transformers. GE Model 2J1G1. 57.5-57.5V 400 cy.; generators, GE Model 2J1F1. 115-57.5V 400 cy. With gears. Sensational offer! \$1.50 each. Quantity lots \$15 dozen. Order now! No c.o.d. "Amazing Bachman's," Dept. AU, 23 Herman Street, Rochester 5, N. Y.

DYNAMOTORS. All new! 400-cycle. GE5D21N3A. 27 v.d.c. to 110 v.a.c. 485 watts. Sensational offer! \$8.95 each. Three for \$25. Order today! No c.o.d. "Amazing Bachman's," Dept. AU, 23 Herman Street, Rochester 5, N. Y.

BOATS, OUTBOARD MOTORS, ETC.

\$35 SEA SHELL Pre-fabricated 8' plywood rowboat. Free illustrated folder. Hagerty, Cohasset, Massachusetts.

TACHOMETERS 0-5000 And 0-8000 r.p.m. \$10.00, specify rotation. Zakarian Engineering, Box 416, East San Diego, Calif.

PLYWOOD Boat kits! Complete materials for building "Deltacraft," "Junior Dinghy," "Tadpole Skiff," Mahogany marine plywood and oak construction! Send 10c today for illustrated folder featuring these boat kits and other marine materials and supplies. Carmen-Bronson, Marine Department, Mount Vernon, N. Y.

BOATING. Learn at home. Seamanship and piloting. Cruise scientifically. Prepare for a job on the water. Yacht captains earn to \$500 monthly. Write for particulars. Fairway School, Box 811, Old Greenwich, Conn.

MARINE Clearance lights. All new! Gov't surplus. Made for use on landing craft. Operates on all currents. Original value over \$20.00 each. Special! Minimum order 3 for \$5. No c.o.d. "Amazing Bachman's," 23 Herman Street, Rochester 5, N. Y.

BUILD Your boat from full size paper patterns, boats representing forty years careful designing. Send 10c for folders. Up to the minute book on small boat construction. \$1.50 postpaid. Germain Boat Company, Dept. 3, Saginaw, W. S., Mich.

CATALOGUE Over 30 plywood plans—Kyaaks to Cruisers—sent with William Deed's book "Plywood Building," send \$1.00. Marine Mart, Buffalo 7, N. Y.

TWENTY Plywood boat plans \$1.00. Catalog boat building plans 10c. The Rudder, 15 Murray Street, New York.

BUILD Your own boat by the Welch system, with knock-down kits. Save 2/3 cost. All models available. Send 10c for illustrated catalog. Midwest Boat Company, Menomonee Falls, Wisconsin.

AIRPLANE Jettison tanks—Streamlined. 10½ foot, tear drop shaped. 165 gallon. Of light weight lead coated steel, weighs 75 pounds. Floats over 1200 pounds. Ideal for making trim, inexpensive boats, canoes, kayaks, dinghys, duck boats, powered catamarans and runabouts. Prices \$12.50 complete. \$9.75 each for three or more. U. S. freight prepaid. General Sales, 205 Market, Grand Rapids 3, Michigan.

NEPTUNE Outboard motor parts, complete stock. Limited supply new motors, 1½ to 9½ h.p. Citizens Supply Co., P.O. Box 1241 M, Muncie, Indiana.

MARINE Power—Easily convert any Jeep or Ford motor (domestic or foreign) with Convo parts and kits. Complete catalog 25c (coin). Osco Motors Corporation, 2020B East Orleans Street, Philadelphia 34, Penna.

CARTOP Rowboats, Kayaks. Weldwood ready cut kits. Booklet. E. J. Croot Co., #103-D, Basking Ridge, N. J.

P-38 BELLY Tanks, new, steel, 10 ft. 2 in. 165 gallon \$9.95. Anzio Boat Co., Box 89, Merced, California.

OUTBOARD Motor parts, new and used, for all makes. New pistons, standard and oversize. Cylinders rebored. Outboard Motor Mart, Inc., 309 Atlantic Ave., Boston 10, Mass.

MARINE Catalogue, over 5,000 deliverable items, pictured, priced. Send \$1.00. Marine Mart, Buffalo 7, N. Y.

NEW. Used, rebuilt marine motors. Marine conversions, fittings. Free catalog. Stokes Marine Supply, Dept. 24, Coldwater, Michigan.

ALL Copper water jacketed exhaust manifolds for marine conversions of automobile and aviation engines and marine engine replacements; any make, model or age. Joseph Van Blerck & Son, 391 Woodcleft Ave., Freeport, N. Y.

MARINE Conversions for Ford and Jeep engines. Catalog 10c. Lehman Manufacturing Company, Department D, Newark 2, New Jersey.

BOATS And all about them. How to select, build, repair and operate. For 40 years the leading practical boating magazine. Half price trial subscription, 12 issues for \$1.00. Motor Boat, 62 Gold Street, New York 7.

BOAT Designers are highly paid professionals. Complete course by mail. Catalog. Westlawn, Montville, N. J.

ATHLETIC EQUIPMENT, BODY BUILDING COURSES

MUSCLE-BUILDING Equipment—Free big pictured list, Milo barbells, grippers, cables, ropes, etcetera. Nat Berent, 1090 West 43rd, Norfolk 8, Virginia.

BARBELLS \$11.00 up. Stamp for folders. Jackson International Barbells, Springfield, N. J.

HAND Balancing—Acrobatics, easily learned. Write. Power, 923a W. Vine, Kalamazoo, Michigan.

DEADLY Judo—Fiercest fighting technique. Trick knockouts. (200 photographs—plus illustrations). Expert instructions. Three volumes. Complete \$2.25. Variety House, Box 46-BV, Wall Station, New York 5.

MASSIVE Proportions quickly. Personal course and barbells. EG, Elmsford, N. Y.

BARBELLS! Catalog! Bur Barbell Co., 319 Orient Way, Lyndhurst, N. J.

BARBELLS. Exercise equipment. Courses. Free booklet. Good Barbell Co., Reading, Penna.

SPORTING GOODS, GUNS, FISHING TACKLE, ARCHERY, TRAPPING

SPORTSMEN! Storm suits \$10.95. Free literature. Water Master Sales Co., 19463 P5 Ward, Detroit 21, Michigan.

TEAM Uniforms, equipment, trophies, awards. Craig Dare Company, 670 East 42, Brooklyn 3, N. Y.

CATFISH. Carp fishermen. 30 secret formulas \$1.00. C. Strickler, Kleinfeltersville, Penna.

FREE! New and used gun and hunting equipment catalog. 52 exciting pages, fully illustrated. Thousands of fresh new sporting goods items; hundreds of available used and new guns, all types, from America's greatest gun traders. Get the best "sell or swap" deal at Klein's. Satisfaction guaranteed. Mail description or ship your guns! Easy terms available. Klein's Sporting Goods, Dept. TM, 227 W. Washington St., Chicago 6, Ill.

FISHERMAN'S Cast aluminum multiple cavity sinker molds. Hinged and handled. Dealers wanted. E. L. Sweet & Son, Tonawanda, N. Y.

CARTRIDGES: P-38's/9 mm. Lugers 15c each. 8 mm. Mausers/7.7 mm. Jap 25c each. Complete firearms-ammunition list 25c. Frank Parish, Vicksburg, Mississippi.

FLY Tying materials and tools. Professional grade only. We have imported, hooks, Materials catalog 6c. Sierra Tackle Co., 4083 Mission Road, Los Angeles 32, Calif.

FRESH-SALT Water spring steel rod, 12" wood handle, 47" overall, reel, hook, 30 ft. line, sinker, \$1.79 complete, 3 for \$5.00, prepaid anywhere U. S. A. No. c.o.d. Mr. Stuart, 300 Albany Ave., Brooklyn 13, N. Y.

5000 BARGAINS. Firearms, binoculars, war relics. Catalog 40c. Smith Firearms, Runnemed, New Jersey.

HUNTERS, Sportsmen: Here is what you have been looking for. A four piece steel cleaning rod with aluminum handle. Can be dismantled when not in use. Fits all shotguns and large caliber rifles. Only \$1.00 prepaid anywhere in U.S.A. Order now. Don't be disappointed later as supply is limited. Irving Goodman, Box 1998, Fargo, N. D.

LITTLE Library of Useful Information. 102 different books. Catalog free. Popular Mechanics Press, 200 E. Ontario St., Chicago.

BOWS-Arrows. Write headquarters for archery equipment. Quality products. Popular prices. Catalog 10c. Large illustrated hand book instructions, making and shooting, 50c. Archery, 617-B So. State, Chicago 5.

AMMUNITION—New and used shotguns, rifles, handarms, fishing tackle. List 10c. Rudolph's, Atchison, Kansas.

TAXIDERMISTRY

PINEST Glass eyes; taxidermy supplies. Catalog free. Elwood Company, Department 234, Omaha 2, Nebr.

FIELD GLASSES, TELESCOPES, MICROSCOPES, MAGNIFIERS

SEE It closer! 3X field glasses, \$6.60. 3X binoculars, \$5.10. 5X spy glass, \$1.25. 50X microscope kit, \$2.98. Guaranteed. Literature. W. Wardell, 2509-A Clarendon Road, Brooklyn 26, New York.

GUN Sights. All new! A buy for lens value alone. Excellent for spotlights, experimental work, etc. Over \$40.00 value. Special \$5 each. No c.o.d. "Amazing Bachman's," 23 Herman Street, Rochester 5, N. Y.

ULTRA Powerful compound microscope easily made. Perfect lenses and detailed instructions for making microscope that gives 50, 200 and 400 diameters magnification. See the digestive processes of a mosquito. \$3.00. Instructions alone 10c. Suffolk Science Service, Manorville, N. Y.

TELESCOPES. Binoculars, microscopes, big bargain catalog free. Brownson Company, 24 West 45th Street, New York.

POWERFUL Astronomical telescopes easily made. Perfect lenses and instructions. 100 power \$2.50. 100 and 200 power \$3.50. 100, 200 and 400 power \$5.50. Clear vision and full power guaranteed. Instructions alone 10c. Suffolk Science Service, Manorville, N. Y.

TELESCOPES. Microscopes, binoculars, barometers, books; buy, sell, repair. We guarantee. Lists 10c. Rasmussen & Reece, Amsterdam, N. Y.

REFLECTING Telescopes, complete. 3½" diameter, equatorially mounted. View planets, stars. \$19.75. Write Sky-SCOPE Company, 475-P 5th Ave., New York.

BINOCULARS. Telescopes, watches. Buy, sell, trade. Paul Schweer, Donnellson, Iowa.

DOGS, PETS, BIRDS, RABBITS

BEAUTIFUL Pure white police puppies. Ansonia Kennels, Mose, N. Dak.

RAISE Hamsters. New wonder animals from Syria. Delightful pets. Laboratories need thousands. Profitable. Free information. Hamstery, 1519 Basil, Mobile, Ala.

RAISE Diamond Seal rabbits. We pay \$30 to \$60 each. Breeding stock furnished for half cash, balance paid in stock produced. Literature 25c, with hutch plans \$1. Hansen's Rabbit Institute, 1347 Miller Avenue, Salt Lake City 6, Utah.

MONEYMAKING Opportunity raising giant chinchilla rabbits. Waters Rabbit Farm, Glennville, Ga.

ANGORAS. Giant Chinchillas—Finest, pedigree! World's most profitable rabbits. Literature free. Grinsteads, Edwardsville, Illinois.

RAISE Guinea pigs. Make money at home. Big demand. Booklet free. Taylor, Box 426A, Hapeville, Georgia.

\$2000 PER Year raising Angora rabbits. We buy your output. Contract particulars free. Wilsons, 1065 Shryer, St. Paul 8, Minn.

\$50.00 WEEKLY Raising Angoras for us. Free literature. Angorville, 1215-34th Northeast, Cedar Rapids, Iowa.

MONEY In New Zealand Whites and Chinchillas. Increasing demand for breeders, meat, fur. Particulars free. Loughman's, Sandamar Farm, Newark, Ohio.

\$250.00 MONTHLY Raising Angora rabbits. Particulars free. White's Rabbitry, Newark, Ohio.

ST. BERNARD Pups: Champion sired beauties. Franklin Young, R4, Riverhead, Long Island, New York.

BEAUTIFUL. Useful collie-shepherds, pups \$14.00. Paul Schultetus, New Liberty, Illinois.

INCREASE Your income by raising domestic rabbits. Small space needed. Ready market for delicious meat, fur and wool. Largest magazine in the industry tells you how. \$1 per year. Send dime for sample. No stamps. Small Stock Magazine, Lamoni 50, Iowa.

STANDARD Rabbit Journal, Milton, Pa.

70 VARIETIES—Pigeons, rabbits, pheasant, peafowls. Catalogue 10c. Jim Houck, Tiffin, Ohio.

GUARANTEED Chin-Chin giant Chin-chilla rabbits. Greatest amount of delicious meat. Largest, finest, most valuable furs. Tremendous demand for breeding stock. We buy youngsters. Contact world's largest breeder. Willow Brook Farm, R15, Sellersville, Penna.

ZOOLOGICAL And pet animals for sale. Illustrated catalogue, literature, 25c. Trails End Zoo-5, St. Stephen, S. C.

RAISING Rabbits, Cavies, Hamsters, Chinchillas is a growing and profitable industry. Magazine 10c. Descriptive book and magazine 25c. Book and magazine (monthly) one year \$1.00. Address Small Stock Farmer, Pearl River 15, N. Y.

FARMS, FARM LANDS, REAL ESTATE

JUST Out—Strout's new red fall farm catalog! Contains over 2800 outstanding bargains, 34 states—coast to coast. Time-money saver. Write today. Strout Realty, 255-P 4th Ave., New York 10, N. Y.; 20 W. 9th St., Kansas City 6, Mo.; 453 S. Spring, Los Angeles 13, Calif.

NEW Free fall catalog of farm bargains, 20 states, many equipped, many illustrated. Write today! United Farm Agency, 220 S. State St., Chicago 4, Ill.

OZARK Lake resort \$95. 80 acres \$395. Armstrong, Shook, Missouri.

10% TO 20% Income from Avocado groves in the world's finest year 'round climate. Prices from \$20,000 to \$100,000. Write Dale E. Wood, Realtor, P.O. Box 555, Vista, San Diego County, California.

OZARK Magazine, Eureka Springs, Arkansas. For Homeseekers, tourists. Year, \$1.50.

WEST'S Latest catalogue: Over 1000 farm and business bargains, 160 agents, 16 states; free. Write West's Farm Agency, Inc., HE-9, Pittsburgh 17, Penna.

\$5.00 MONTHLY Buys 40 acres near town; price \$200.00. Free list. Box 425-P, Carthage, Mo.

GOVERNMENT Lands \$2.00 acre up. Information all states twenty-five cents. National Tax Service, 834-A Majestic Bldg., Detroit.

HOMESITES \$450—Convenient payments. California's finest garden section. On Morro Bay's scenic shores. Wonderful fishing, hunting, boating, bathing. Fertile soil, softest water, temperate climate, congenial community. Free literature. Richard Motto, 6560 Hollywood Blvd., Hollywood 28, California.

GOOD Farms—Ranches. Washington, Minnesota, Montana, Idaho, Oregon, North Dakota. Dependable crops, favorable climate. Write for literature, lists describing typical postwar farm opportunities. Specify which state. J. W. Haw, 119 Northern Pacific Ry., St. Paul 1, Minn.

OZARK Lands for all purposes. Actual river frontages. 5 acres \$90.00 and upwards. Free list and literature. Hubbard, 424-I, Minnesota Ave., Kansas City 4, Kansas.

POULTRY, FARM SUPPLIES

RAISE Fryers new easy way. One-man home plan earns \$500 monthly. Booklet free. Poultry Guild, 1046-A So. Olive, Los Angeles 15, California.

KNOW How to raise poultry for profit. Read Northeastern Poultryman. Every issue packed with helpful hints and practical suggestions. Latest articles on breeding, feeding and management. Subscribe now. 1 year 65c. 2 years one dollar, foreign subscriptions \$1.00 a year. Northeastern Poultryman, Dept. P.M., 376 Boylston St., Boston 16, Mass.

RAISE Turkeys the new way. Write for free information explaining how to make up to \$3000 in your own backyard. Address National Turkey Institute, Dept. 3, Columbus, Kans.

PROFITABLE OCCUPATIONS

1947-1948 LEATHERCRAFT Supply catalog 10c. Art Craft Supply, 1205 Throckmorton, Fort Worth, Texas.

HOME Manufacturing business—if you have garage or basement write for interesting story on novelty manufacturing. Plastex Products, 711 Laguna, San Francisco.

TYPISTS—Profitable business at home. Complete copyrighted information, 50c. Gaunt, 3521A Broadway, Chicago 13, Ill.

PROFITABLE Exciting advertising profession open to you. Progressive Adver-

FIX Alarm clocks easy, profitable. Jones, 1210X Dudley, Utica 3, N. Y.

ENTER Aviation. U. S. or foreign. I can help you. Free information. Miller, 1333—18th Street, Santa Monica, Calif.

CASH in on television, now! Amazing opportunity to start profitable business. Technical knowledge unnecessary. Write for free details. Marlowe Television, 10 Rockefeller Center, New York City.

SCRAP Metal costing 5c pound brings dollars in finished castings. Lifetime profits. Information. Fritz Foundry, 622 N. Fulton, Allentown, Penna.

"ALASKA—The Last Frontier" offers thousands of opportunities. \$1 brings 1947 official map and copyrighted report with listing of companies now hiring in fishing, construction, mining, aviation and information on business and homestead lands. Alaska Opportunist, 6417 Home-wood, Dept. PM, Hollywood 28, Calif.

START Lamp and shade factory. Profitable, fascinating. Easy to learn. Illustrated course teaches you. Complete instructions and wholesale catalog \$1.00. The Gearon Company, 6405 North Oakley, Chicago.

ATTENTION! Interested in money? Big money? "Dynamic Detroit" service directory lists names, addresses, phone numbers of world's greatest automobile, airplane, auto parts and other factories employing hundreds of thousands of men, women. Contact them direct. Classified, "help wanted section" given free with this issue. Only \$1.00. Service Directory, 2707 S. Telegraph, Dearborn, Michigan.

EARN Good profits from herbs, bees, poultry, rabbits, etc. A few square feet is all you need. New book tells how. Literature free. G. Hopp, 1216-P Park Row Building, New York 7, New York.

"INTERESTED in Latin American and foreign employment?" \$1 brings latest foreign service directory listing oil, mining, aviation, construction and manufacturing concerns with hot tips of companies now hiring. Global Reports, 6417 Home-wood, Dept. PM, Hollywood 28, Calif.

ANNOUNCING Home study course in commercial baking. Practical basic training. Good field for those with aptitude. Nearly depression proof. Send for free booklet, "Opportunities in the Baking Industry," National Baking School, 1315 Michigan Ave., Dept. 3431, Chicago 5, Ill.

YOU Can make real money raising Golden Hamsters, the new amazing tiny animal. Food costs less than 10c month per animal. Breeds in 16 days! Easily raised in basement, attic, garage, barn, or shed. Write for convincing details. Hudson Hamstery, Box 78-P, Palisades Park, N. J.

WOULD You pay 3%—first \$350 made? Color-illustrated book "505 Odd, Successful Enterprises" free! Some offer occasional "day off." Work home. Expect something odd! Pacific, Oceanside, Calif.

EARN More than average. Send card for information about very lucrative trade. Lidemark, 225 Potomac Ave., Buffalo, N.Y.

MAKE Beautiful mirrors from window glass cheaply. Complete instruction folio \$1.00. Metallize baby shoes. Several methods, \$1.00. Learn profitable metal plating, with or without battery, \$1.00. Tes-Co, Box 189-MR, Wilkes-Barre, Penna.

NO Selling, operate vendors, amazing profits, details free. Silver-King, 622 Diversey, Chicago 14, Ill.

"THERE'S Big money in junk," and repairing batteries. Write, Batteryman, Grand Junction 5, Colorado.

HOW To set up and run a mirror shop! Resilver mirrors. For price write, John Sprinkle V50, Marion, Indiana.

MEDICAL Laboratory technicians in great demand. We train you in your spare time, in your own home. You can practice while studying. Write for free catalogue. Imperial Technical Institute, Box 973-T, Austin, Texas.

MUSHROOMS Grown. Boxes. Barrels. Illustrated instructions 50c. Spawn \$1.00. Gordons, 553 William, Winnipeg, Manitoba.

MAKE Beautiful costume jewelry at home for large profits, hobby or therapy. Free illustrated wholesale catalogue of sea shell, metal and plastic parts contains detailed instructions. Florida Supply House, Bradenton, Florida.

LOCKSMITHING—Profitable business or hobby! New course teaches you lock secrets, how to fit keys, de-code, masterkey, etc. Easy self-instruction lessons. Bargain price. Fascinating 100-page illustrated catalog free! Write Nelson Company, Dept. 2-02, Chicago 5.

TYPEWRITER Repairing instructions,

\$40.00 WEEKLY Made growing mushrooms, fresh, dried. Dominion patent 331583. Free spawn. North American, 169P Yonge, Toronto, Canada.

TYPEWRITER Repairmen urgently needed. Earn \$40 to \$50 weekly spare time. Our easy to learn home study course teaches how to repair typewriters. Write for free information. Houston Typewriter Repair Service, P.O. Box 5357A, Houston 12, Texas.

ELECTRIC Clocks are every where you go, buildings, homes, parking lots, factories. Repairs increasing. Our easy to learn course with pictures and drawings teach you how to repair these clocks. Electronic Supply Co., P.O. Box 2350A, Houston 1, Texas.

BOOKS, PERIODICALS, PICTURES, POSTCARDS

BOOKS—Any hard-to-find; out-of-print. Collectors items our specialty. Banker Book Co., Dept. K, 13518 Contour Dr., Sherman Oaks, Calif.

AUTO And truck maintenance manual. Only \$1.00. Redford Developing Laboratory, Box 14, Detroit 19, Mich.

FREE Bargain catalogue. Correspondence courses. All books. Baker, 5509-B Winthrop, Chicago 40.

TRADE Magazines—Business, vocational, diversion. Current single copies. All fields. Free price-list. Commercial Engraving Publishing Co., 34C North Ritter, Indianapolis 19, Indiana.

SEPTIC Tank problems solved. "What to do." A booklet compiled from years of experience. Order now! \$1 per copy. Reuben Selfridge, Septic Tank Engineer, Dept. M-1, Clymer, N. Y.

EARN Extra money handling magazine subscriptions, books, greeting cards. Excellent commissions. Cassell Publishers, Westfield, New Jersey.

ALL Pocket books. Latest reviews, catalogue, free. Gordon's, 2613 Greshaw, Los Angeles 16.

BEAUTIFUL Colored pictures. Lists free. Curtis' Specialties, Box 1916A, Denver 1, Colorado.

WHAT Every Mason wants. We have Masonic books for Blue Lodge, Chapter, Commandery, Scottish Rite and Shrine. Our rituals are used the world over. Send for free catalog of books and rituals for Masons, Odd Fellows, Knights of Columbus, etc. Ezra A. Cook, Publisher, P.O. Box 796-PS, Chicago 90, Ill.

NEW. "The Keys" 10c. Inspirational Books, Box 106, Old Chelsea Station, New York 11, N. Y.

LIFE Of Jesse James 35c. Luhn, Dept. PM, St. Joseph, Mo.

AUTOGRAPHED First edition; ninety page book of "Memory Tuned" Poems, by Olvey, the Postmaster Poet. Send 50c. Cascadden Bros., Lapel, Ind.

BOOK Club supervisors wanted. We train you for fascinating, spare-time secretarial duties. Receive outstanding book benefits and exciting library privileges. Write Library-Builders Guild, 1212 Park Ave., Utica 3, N. Y.

ARCHITECTURAL? Fine art and handicraft books. Catalog 10 cents. Artcraft, Box 6827, Baltimore 4, Maryland.

100 BOOKPLATES (Gummed backs) with your name printed, \$1.00 postpaid. Further information. Write Square Deal Printers, 4640 Prospect Ave., Hollywood 27, California.

KEEP Informed on technical ideas overseas. Practical Mechanics, Britain's No. 1 technical monthly, only journal of its type, brings experts' information on atomic energy, rocket propulsion, television, aeronautics, science, engineering, electronics, models, photography, home workshop, etc. Lavishly illustrated. Many plans, diagrams. Yearly (12 issues) only \$2.00. Subscription Dept. (PM 3), Tower House, Southampton Street, Strand, London, W.C.2, England.

POSTCARDS—New colored, all different. Western states. 90 delivered \$1.00. E. Hall, Box 3660, San Francisco 19.

DOG Owners, attention! Information and instructions that may save your dog's life. First Aid For Your Dog, a booklet by Dr. Dinsmore, prominent veterinarian, \$1.00 (refundable). Copeland House, 46 Park St., Framingham, Massachusetts.

2 BOOKMARKS 10c. Good luck, friendship, birthday cards, 10c each. Figueroa, 25c. Math magic, 25c. Postpaid. Figueroa, Box 222, Chicago 90.

TECHNICAL Books rented. Free list. Rodgers, Box 5286, Chicago.

BOOKS Found free! All subjects. Send wants! Jaher Book Service, 620-P East 178 Street, New York 57.

GOOD "Used" self-instruction educational books on all subjects bought, sold, rented, exchanged. Satisfaction guaranteed. Complete information and 100-page illustrated bargain catalog free! Write—Nelson Company, Chicago 5.

BIG Profits taking subscriptions for all magazines. Agents' confidential catalog listing over 2500 periodicals and complete starting supplies free. Pines Subscription Agency, Flushing, New York.

BOOKFINDERS! (Scarce, out-of-print unusual books.) Quickly supplied. Send wants. Clifton, Box 1377PM, Beverly Hills, Calif.

MAGAZINES (Back dated)—foreign, domestic, arts. Books, booklets, subscriptions, etc. Catalog 10c (refunded). Cicerone's, 863 First Ave., New York 17, N. Y.

MAGIC TRICKS, PUZZLES, JOKER NOVELTIES

NEW Magic monthly, year 25c. Sample copy and new magic catalogue free. Magic Factory, Minneapolis 2, Minn.

FREE Bargain catalogue. Remarkably inexpensive tricks! Postways, Box 5325, Philadelphia 42.

LATEST joke novelties, magic tricks, puzzles. Rush stamp for lists. Magic, Box 35A, Irvington 11, New Jersey.

250 MAGIC Tricks. 25c coin postpaid. Brighton Supply, New Brighton, Penna.

FROZEN Sucker mold. Makes four at a time. \$1.00 postpaid. Descriptive circular free. Freez-Em Molds, Box 2912, Dallas 1, Texas.

ILLUSTRATED "Easy-do" magic catalog. 3c. Lee's, 2231-M McKinley, Berkeley 3, Calif.

COMIC Post cards—Cut out friend's faces from snapshots and paste on cards. Ten cards, 50c in stamps; 25 different \$1.00. Beacon, 4750R York, Philadelphia 41, Penna.

"MAGIC As A Hobby"—Book of 100 magic tricks you can do. Familiar objects used. Make your friendship sparkle with magic. \$1.00. Put your name on our free mailing list. The Baron, Prescott, Arizona.

200 ELECTRIC Stunts. 110 volts. \$1. Kutting Sons, Campbell, Calif.

AMAZE And mystify your friends with highest quality magic. New catalogue 25c coin. Mazda Magic Co., 1135 Westgate Ave., Oak Park, Ill.

GUARANTEED Magic tricks! Amateur, professional. Big 8½x11 illustrated catalog. 10c. Newton's, 121-A Main, Bonham, Texas.

"MAGIC Vanishing card." Throw it into air, it completely disappears. reproduce it later from spectators pocket. Easy to do. Complete, 25c with magic catalog. The Magician, 2463-C Kensington Ave., Philadelphia 25, Penna.

VENTRILOQUISM. Complete course and 36" vent-doll, only \$12.95. Magic catalog 25c. Herbert, P-192 N. Clark, Chicago 1.

500 TRICKS. Send only 10c for Douglas' famous 112-page catalog 500 tricks. New magic for amateur, professional. America's fastest service for 25 years. Douglas Magieland, Dept. 1, Dallas, Texas.

TRUE Secret of ventriloquism. Send for booklet. Quackenbus, Big Flats, N. Y.

MAGICIAN'S Pin, ghost illusion, Houdini escapes, giant catalogue. Everything, complete 25c. Magic Wand-M, 9W Colorado, Pasadena, California.

BE A magician. Large professional magic catalog of latest tricks. 25c. Ireland, C-109 North Dearborn, Chicago 2.

VENTRILOQUISM Taught. 3c stamp bring particulars. Smith, 801 Bigelow, Peoria 5, Ill.

VANISHING Half dollar trick and catalog 25c. Sterling Magic Co., Royal Oak, Mich.

WORLD'S Largest professional magic shop. Keeps you in touch with latest tricks. To receive mailings, send 35c for new catalog. Holden's, M220 West 42nd St., New York.

LARGE illustrated professional catalog 10c. Williams, 900 Plymouth, Ellwood City, Penna.

FREE! Large catalog of magical apparatus if you remit 25c for "Magic Is Fun" magazine. Robbins Co., 152-F West 42nd Street, New York.

EARN Money in any crowd. Call names of strangers, tell unspoken questions. Professional course mind reading, faked spiritualism, etc., \$1. Henderson, Box 341, San Bernardino, Calif.

MAGIC Tricks, puzzles, books, cards, punch boards. Catalog 10c. Specialty, Box 671, St. Louis 1, Mo.

COINS, TOKENS, CURRENCY

OLD Money wanted. Will pay \$100.00 for 1894 dime, S. mint. \$50.00 for 1913 Liberty head nickel (not buffalo). Big premiums paid for all rare coins. Send 4c for large coin folder. May mean much profit to you. Numismatic Co., Dept. 20, Fort Worth, Texas.

LINCOLN Cent collectors: scarce 1922 D 15c. Complete list free. Reynolds, 1118 Mathews, Flint 3, Michigan.

\$10.00 EACH. For certain Lincoln pennies; Indianheads \$50; dimes \$1000.00! Send dime for catalogue of prices paid. Franklin Coin Company, Mishawaka 20, Indiana.

100 FOREIGN Coins \$4.00 postpaid. Parker, 1122 Market, San Francisco 2, Calif.

COINS For collectors, reasonable prices. Free lists. Hutchinson, 3463 "I" Street, Philadelphia 34, Penna.

4 WHITMAN Folders \$1.00. Bargain coin list 5c. Olson, 434 North Menard, Chicago 44.

CASH For old coins and war relics. 48-page coin value guide, 50c. 25 different foreign coins, \$1.00. Royal Coin, 3 School St., Boston.

WORLD Coins—30 different \$1.00. Harry Elsholz, Box 9014, Pittsburgh 24, Penna.

COINS Wanted, will pay up to \$2000 for certain coins, send 25c for catalogue. Burton's, 111 So. Third, Columbus, Ohio.

FOR Sale: 1893 Columbian World's Fair half dollar, 75c; U. S. 2-cent pieces or 3-cent pieces, 25c each; 50 assorted Indian head cents, \$1.25; large 50 page U.S. coin catalog, listing thousands of coins for sale at reasonable prices, 25c; Giant 72 page foreign copper-silver-gold catalog listing over 10,000 coins for sale, 25c. Ben's Coin Company, 72 West Washington, Chicago 2, Illinois.

GET Profit and pleasure in collecting old coins. Send 10c for 56 page illustrated coin catalog. You'll be delighted with it. Send for it now. B. Max Mehl, 370 Mehl Bldg., Fort Worth, Texas. Largest rare coin establishment in U.S. Established 47 years.

FREE! Foreign coin, banknote and coin collectors illustrated catalog to approval service applicants. Send 3c postage. Tatham Coinco, Springfield-125, Mass.

STAMP COLLECTING

HITLER Hidden in stamp design! Like old-fashioned game of finding "hidden faces." Engraver has been jailed. Stamps withdrawn from postoffices. Never again will you find such interesting stamps. Twenty stamps complete. Only \$2.25 to approval applicants. Satisfaction guaranteed. George Wentz, San Marcos, Texas.

SPECIAL! U. S. Centenary imperforate sheet, 5c and 10c 1847 designs, unused, only 15c to applicants for approvals featuring pictorials, commemoratives, unusual stamps, odd countries. Frank P. Nagel, 674 Franklin, Denver 3, Colo.

ERITREA, San Marino, French Morocco, are some countries represented in this select packet of airmails from 18 countries! Send 10c for this superb collection, plus attractive "air-approvals." Airline Stamp Company, 4472 North 39th Street, Milwaukee 9, Wisconsin.

UNEQUALLED Bargain. Stamps from over 25 countries including Fiji, Swaziland, Pitcairn, Tonga, Trinidad, etc., everything 10c to approval applicants. Bennett's, Box 252, Terminal A, Toronto, Canada.

FREE Bermuda 12/6 Shilling George VI, superb, fiscally used (catalogs \$7 postally used) with interesting Hitlers, airmails, Canada, occupation, Finland. This sensational offer 10c only to approval applicants. Criterion Stamp Company, North Hackensack 4, New Jersey.

NEW Roosevelt airmail plus 25 others. 3c to approval applicants. Sanders, 6126 Carpenter, North Hollywood, Calif.

100 DIFFERENT U. S. commemoratives, including Pony Express, \$1.00. St. Louis Stamp Lounge, 713½ Chestnut, St. Louis 1, Mo.

AROUND The world—30 different countries; Basutoland, Nyassaland, Tangier, Cyprus, St. Helena, 10c with approvals. Exeello Stamps, P.O. Box #95, Hacken-

GIBRALTAR Packet free—Nice collection Gibraltar, New Zealand Centennial, British Uganda, French Colonials, early British Colonial, West Indies, South American, war stamps plus Philatopic Monthly Magazine. All for 5c postage. Empire Stamp Company, Dept. PM, Toronto 5, Canada.

GIANT Roosevelt triangle; beautiful set from world's smallest country; catalog value 90c; and 25 different worldwide. Only 10c. Approvals included. Postamps, 1215 Battery, Little Rock, Arkansas.

FREE—United States Columbian set—8 values, retailing \$3—absolutely free to customers for our unusual approvals. Send 3c postage for selection plus full particulars. S. C. Engel, 38 Park Row, New York.

ROOSEVELT Argentina, 25 different Mexico, 25 different Greece, only one dime, with approval requests. Sadlers, 611 Carolina Avenue, Norfolk 8, Virginia.

FREE—Have your stamps from Ionian Islands? Set of four, 45c value, given to approval applicants. Charles Cleaveland, 806 North Humphrey, Oak Park, Illinois.

FREE! 19th Century U. S., commems., Civil War revenues, battleships, a total of 30 stamps to serious approval applicants. Equal value in foreigners given to applicants for foreign approvals. Enclose 5c postage with request. Cosmopolitan Stamp Co., 1457 Broadway, Dept. 9-E, New York.

BEGINNERS' Outfit containing illustrated album, perforation gauge, 300 different stamps (value \$4.00), 1000 hinges. 75c postpaid. Bargain lists free. Alatalo, Maynard 14, Mass.

FREE! 25 Different world stamps. Send 3c postage. Chemcity Stamp Co., 1508 Jackson St., Charleston, W. Va.

FREE Hitler head, French colonial, air mail, Vatican City packet to approval applicants. Nitta Yuma Stamp Co., Harrods Creek, Kentucky.

ABSOLUTELY The finest penny approvals! 10 free from first 500 book. Robert Harris, Box 144, Colorado Springs 1, Colorado.

5000 DIFFERENT \$24.00. Pay \$2.00 weekly. Emil Auer, 16 Duerstein, Buffalo 10, N. Y.

MISSION Mixture. 500 stamps 25c. Garrow, 84M Montevista, Chula Vista, Calif.

300 U. S. Free. Subscribe "Sastco Post" 50c. Sanguinet, 4019 Dunnica, St. Louis 16, Missouri.

FLAG Stamp free with U. S. approvals. Wenigman, 929 Oakdale, Chicago.

SEE Them first! United States approvals plus unique premiums. Jarr, Box 217M, Madison Square, New York 10.

DOLLAR Each: 1,500 foreign; 2,000 British; 750 Australia. Seiden, 1331-M Intervale, New York 59.

PONY Express stamp and 99 different 10c to approval applicants. Tippet, 1118 Clay, Pelham Manor, N. Y.

VALUES! Liquidation of private collection. Over 40,000 stamps. Guaranteed satisfaction. Specify preference. 200—\$1.00. Garon, 3420 W. 18th St., Chicago.

FINLAND Stamp 3c—Approvals, catalogs 20c. Snyder, 11 Washington, South River, New Jersey.

25 DIFFERENT Guatemala, 10c with approvals. Paul Rawden, Box 2920, New Haven 15, Conn.

300 FINE Different worldwide, four dimes. George Rapin, Marlow, N. H.

GERMANY—Illustrated price list, send postage. Fairbrook, Box 180, New York 19.

USED 1938 Presidentials 5c, 10c, 15c, 18c, 19c, 20c, 25c, 50c, \$1. Given to approval applicants. R. B. Rossom, 218 West 59th St., Chicago 21, Ill.

FREE—Airmails, British Colonies, etc. Approvals. O. Burgett, Lima, Ohio.

FREE Gift with low-priced approvals. Russell, 519 Crystal Ave., Findlay, Ohio.

GIFT Packet 5c with approvals. Fred Timme, 110 Milner Hotel, Omaha 2, Nebr.

PHILIPPINES, Japanese occupation 5c with approvals. References. Pomeroy, Minnetonka Beach, Minnesota.

SEE The stamps you buy. 3c stamp brings illustrated bulletin. Robert Paulus, R. E. #6, Iowa City, Iowa.

CHIANG KAI-SHEK! Catalogues \$2.30. (4) mint, victory, commemoratives 49¢-99. 10c to approval applicants. Eliot Stamps, 86-31 Eliot Ave., Rego Park, N. Y.

FREE! Hitler-Heads, Egypt, Persia, Iraq, others with approvals. Baird, Box 1713, Portland 7, Oregon.

FRENCH Colonies: 300 different mint, mostly pictorials, \$1.50 with approvals. James Mace, Arlington, Tamaqua, Penna.

5c PACKETS. Trial packet, lists, ap-

ARMENIA—27 Different 25c with approvals. Jewels "Stamps," Tamaqua, Penna.

SETS—Czechoslovakia, Mexico, Bolivia, Ceylon plus eight others. 25c with approvals. Wirth, Norwichtown, Conn.

U. S. Pricelist 3c. Francis, 3926 South Jefferson, Cincinnati 12, Ohio.

LOOKING For good U. S. approvals? Large selections, fast personal service. Write today. Panther's, Dorchester Center 24, Mass.

20 PORTUGUESE Colonies, 3c. Approvals. Super Stamp Shop, 2 Madison, Greencastle, Indiana.

FREE—33 Trinidad, Haiti, Congo, others. Approvals. Robert Keating, Box 267M, Forest Hills, N. Y.

UNRIVALED Bargain! Includes set Seychelles, set Cyprus, assortment Libia, assortment Uruguay, also Bolivia, Albania, Angola, etc. Everything 10c to approval applicants. Woilastin Stamps, Wollaston 70, Mass.

GENUINE "Goya Nude" set, cataloging \$1.05, complete 35c. Approvals. Royal Stamp Company, Tamaqua, Penna.

EXCHANGE Stamps universe. Particulars free. "Exchangers," Bry 126, Seine, France.

MONACO Roosevelt set, complete \$1.25. Approvals of new issues upon request. Dan Hayden, Box 703, Bloomington, Ill.

USED United States sets: Presidentials \$1.40, famous Americans \$1.95, flags \$1.00, clipper airs 65c. Standard, 3817 Sackett, Cleveland 9, Ohio.

50 DIFFERENT French stamps and our price list, one silver dime. Stampsales, Box 1649P, Oakland 4, California.

BIG Packet 500 stamps only 10c to approval buyers. Sent at once to Wineholt, Woodbine 45, Penna.

WHOOPIE! Wow! 25c worth of U. S. stamps free! No obligations! Write M & N Co., 742A Sheffield Ave., Brooklyn 7, N. Y.

ROOSEVELT Triangle free with approvals. Pelican Stamps, 665 N.E. 120th Street, Miami, Florida.

MINT Roosevelt collection from six countries only 10c. Approvals. Granada, 4891 Southwest 5th Street, Miami 34, Florida.

100 DIFFERENT U. S. and foreign 6c. Approvals. Budwitz, Box 108, Meriden, Connecticut.

FALKLAND Islands map stamps. Three values mint 5c to approval applicants. Middleton Stamp Company, 78-14 Woodside Avenue, Elmhurst, L. I., N. Y.

1000 WELL Mixed U. S. 25c. Monjar, 1750 Fairmount, Cincinnati 14, Ohio.

BRAZIL Diamond shaped set 10c with approvals. Vargo Stamps, 6044 South Fairfield, Chicago 29, Illinois.

FREE! Sudanese, Egyptian, Philippines pictorials! Approvals. Keating, 637 Bergen, Jersey City, N. J.

CANADA Mixture containing hundreds of fine used commemoratives, airmails, specials, blocks, coils, high values, etc. Off paper. 1000 stamps, \$3.00; 2000 stamps, \$5.00; 5000 stamps, \$10.00, postpaid. Money-back guarantee. J. D. Guevremont, Valleyfield, Que., Canada.

ROOSEVELT Collection, 7 issues complete, 3 short sets, 28 stamps altogether, regularly \$2.75. 206 different British Colonies including complete mint peace issues Pitcairn, Solomon Islands, regularly \$1.55. 100 different Greece pictorials, occupation, inflation, regularly \$1.55. Save \$4.85, buy all 3 lots at special price of \$1.00; only to adults applying for foreign approvals. Collectors' Stamp Service, 130M West 42nd Street, New York 18, N. Y.

MINT Pictorials free to approval applicants. Surf Stamp Co., P.O. Box 1016, Wilmington, N. C.

WE Buy old postage stamps. Send 30c for our buying catalogue. 30c refundable. Stamp Market, 356-PM Clinton, Columbus 2, Ohio.

100 DIFFERENT U.S.A. 25c. 1,000 different world \$1.45. Approvals. Hiawatha-stamps, Norway, Michigan.

NUDE Duchess set (two values) 5c to approval applicants. Masters, Box 7027C, Baltimore 16, Maryland.

POWERFUL Magnifying glass! 5c. Approvals. Buchanan, 307 East 23rd, New York 10.

FREE—Beautiful and unusual set of the Italian Social Republic, with introductory foreign approvals. Home Hobby-Craft, 3322 Decatur, Philadelphia 36, Pa.

56 VARIETIES U. S. commemoratives, quarter. Roth, 25 Maple, Bloomfield, N. J.

ROOSEVELT—Three new beautiful large bicolored stamps in packet of 50 different airmails, commemoratives, etc. 5c with approvals. Chesapeake Stamps, 748 Overbrook, Baltimore 12, Maryland.

SPECIAL Packets 5c each all different. 3 Alex'ta and Hatay, 10 Bohemia and Moravia, 5 Br. W. Indies, 10 Croatia, 7 Egypt, 3 Hejaz and Nejd, 5 Iraq, 5 Lebanon, 3 Latakia, 3 Br. Moroccan Agencies, 5 Palestine, 10 San Marino, 5 Syria, 3 Transjordan, 12 Gr. Britain, 3 Vatican City. Stampdean, Box 202, Wilmette, Ill.

FREE Colorful San Marino airmails 3 values to new applicants requesting approvals. Wesken Stamp Co., Box 66M, Queens Village, N. Y.

25 DIFFERENT India—3c with approvals. Customer gifts. Brandwein Stamp Company, Box 92H, Bayonne, N. J.

200 DIFFERENT 25c with approvals. Amity Stamps, Dept. A, Box 867 G.P.O., New York 1, N. Y.

MIXTURES Price per pound. Argentina \$2.50; Denmark \$1.75; France \$1.60; Germany \$2.00; Holland \$1.60; Italy \$1.25; world \$2.00. Longacre Shop, 108K West 42nd, New York City 18.

EXOTIC Pictorial collection: Tahiti spearfishing, Melanesian idol, Ingavi battle, Reunion, Madagascar, St. Pierre Miquelon, Djibouti, Wurttemberg, Dutch Indies, Newfoundland, many others. This outstanding offer only 5c. Imperial, Box 1491, Tampa, Florida.

THREE Hitler heads. Overprinted by Russia. Mint. With approvals. Marvin Green, Box 287, Hollywood 28, Calif.

CANADIAN Collection—From 1870 to date. 80 face different stamps including many pictorial; just about 1/3 of all stamps issued. A \$1 value for only 25c if you request approvals. Fields of Cleveland, 9328 Amesbury Ave., Cleveland, Ohio.

55 DIFFERENT United States, 5c. Approvals. Utechts, 1143-C North Keeler, Chicago 51.

128-PAGE United States catalog—1000 illustrations. 10c. Harris & Co., 202 Transit Bldg., Boston.

\$3.80 CATALOG Value for only 25c. 5 sets from different countries. 37 total varieties. Approval applicants only. Elcerrito, 5611 Meade, San Diego 5, California.

\$27.00 CHINESE Airmail and 50 others 10c to approval applicants. Burmaster, Box 1910-C, Los Angeles 53.

50 STAMPS including triangles, commemoratives, airmails, etc. 10c to approval applicants. Kay Stamps, Box 216, Great Neck, N. Y.

400 FOREIGN 47c. 200 27c. Pacific, P.O. Box 5704, Los Angeles, Calif.

POSITIVELY Greatest free offer—Latest Scott's International \$6.00 stamp album—covering entire world, contains 36,000 illustrated descriptive spaces; Scott's 1948 Standard \$7.00 catalogues "Philately's Encyclopedia"—absolutely free to applicants for foreign approvals becoming customers. Bargain Stamp Service, Santa Ana, California.

25 PICTORIALS—10c With approvals. Stamps, 1267 Tutwiler, Memphis 7, Tenn.

FREE—Worldwide stamps with first approvals. U. S. want lists solicited. Peter Nerger, Palisade, New Jersey.

ATTRACTIVE Approvals! Premiums! Marjay's, Box 14 Station B, Brooklyn 16, New York.

U.S. 1909 Alaska commemorative. This scarce stamp 5c with approvals. Willett Stamp Co., Box 507, Port Chester, N. Y.

SIX San Marino Roosevelts, Estonia 150-2, Hungary 537-50, China 525-8, Italy C106-8, 50c (approvals?), Pem, Box 771-M, Charleston 23, West Virginia.

ARABIAN Stamps for sale. Circular free. Arshak Movsessian B.R.N., Baghdad, Iraq.

BOY! Oh! Boy! Dandy collection of 100 different Hungarian stamps only 10c to serious approval applicants. Modern Stamp Service, Box 12, Wakefield Station, N. Y.

STAMP Racket exposed in "Racket Expose," Newsstands or \$1.00. Falcon Press, Box 779, Newark 1, N. J.

HITLER, Will Rogers, Roosevelt stamps, 99 others, 10c with approvals. Walcott, Box 821M, New Orleans 2, Louisiana.

FREE! Ten mints: Ethiopia Red Cross plus Free French. With approvals. Florida Stamp Company, Box 807, Miami 5, Fla.

GOLDEN Mixture, variety countries. 25c. MacDonald, 30-M Seaman Ave., New York 34.

STAMP Magazine and "Valuable Tips" Book, USA, Box 11, St. Louis 1, Mo.

25 DIFFERENT Hungary! 3c. Approvals. Star Stamp Company, Dept. M, Lakewood, New York.

100 DIFFERENT Including scarce diamond-shaped airmail 3c to approval service applicants. Avalon Stamp Co., Dept. M, Springfield 8, Mass.

ERITREA, Ethiopia and huge Roosevelt stamp, all free with approvals. Logan Stamps, Box 4, New Lots Station, Brooklyn, N. Y.

6 DIFF. San Marino Roosevelts, 10c with 1/4-1/2-1c approvals. Carroll's, 4357A S. Hoover, Los Angeles 37, Calif.

"WORLD'S Best" United States or foreign approvals. America's lowest selling prices. "Stamps," Box Eighty-Seven, Albany 1, New York.

FREE Attractive airmails, commemoratives, pictorials, eight countries, with approvals. Green and Company, Norwood 12, Ohio.

100 U. S. Commemoratives, etc.—10c, 300—25c. Kellermann, Box 457, Newark 1, New Jersey.

ZANZIBAR, Palestine, Manchukuo, Azerbaijan, Haiti, Iraq, Cayman, Siam, Roosevelt, Hitler, 5c. Approvals. Postzegel, Windham, N. Y.

WOW! 10.00 Worth of fun—only 10c! What a treasure hunt! Big package 500 foreign stamps just as received from foreign missions, other sources. Includes stamps from Africa, South America, Free French, Cape Juby, Palestine, etc. Includes airmails, commemoratives and stamps worth up to 50c. This offer sent for 10c to serious approval applicants only—one to a customer. Jamestown Stamp Co., Dept. 22, Jamestown, N. Y.

FREE! Six Greek wind airmails with approvals. El Rey Stamps, 5170 Sunset Blvd., Hollywood, California.

CUBA Roosevelt stamp and 25 different Switzerland only 1c to approval service applicants! Littleton Stamp Company, Littleton 42, New Hampshire.

PERSIA And China packet free to approval applicants. Write "Everglades," Box 3222-M, Atlanta, Georgia.

ARMY Navy set 10c. United States, foreign approvals. Yokums, Box 1327, San Antonio 6, Texas.

FREE! Airmail packet with approvals. Deane Stamps, Box 87, Miami 35, Florida.

FREE—Adults, monthly illustrated price list. Neuendorf, 22-A West Florida, Evansville 11, Ind.

SCARCE U. S. stamps nearly 100 years old, 1893 commemorative, \$5-\$10 stamps, Armed services pictorials complete, Roosevelt set, large allegorical figure of Commerce, old revenues, everything 5c to serious approval applicants. Metropolitan, 140 Nassau, New York 7.

FREE—The Stamp Finder. Big new edition—32 pages profusely illustrated! Tells at a glance the country to which any stamp belongs and so where to place it in your album! Also: 25 different stamps from Vatican City, Palestine, Cyprus, San Marino, etc. All sent to approval applicants enclosing 3c postage. Garcelon Stamp Co., Box 900, Calais, Maine.

50 DIFFERENT Stamps, triangle, airmails, etc., 5c with approvals. Carlton's, 10243 Silverton, Tujunga, California.

UNITED States approvals. Low prices! Gordon Davison, Box 1019X, Manchester, N. H.

FIRST Day covers on approval. Knobel, 1918 S.W. 12th St., Miami, Florida.

ANIMAL, Map and triangle stamps, included in 50 different for 3c to approval buyers. Paul Bauer, 31 Wilkshire, Lancaster, N. Y.

ROOSEVELT, Churchill, Stalin, Hitler, Vatican City stamps free, to approval applicants. Flamingo Stamps, Box 517, Miami Beach, Florida.

EGYPT—15 Different, 5c to approval applicants. Bohemia Stamp Service—1, Bohemia, N. Y.

ILLUSTRATED Stamp Magazine, 26 weeks 25c. Stamp Journal, Kalamazoo, Michigan.

CANADA—75 Diff. 25c. Approvals. Lists. Victoria Stamp Co., London 4, Canada.

FINE Approvals, freshly mounted. Fast, personal service. Tell me what countries you prefer and I'll send them stamps. Skinner, 438 Locust, Long Beach 12, Calif.

WORLDWIDE, Different 200—25c; 500—60c; 1000—\$1.50. Beacon Sales, Maynard 2, Mass.

200 DIFFERENT Stamps, 6c. to approval service applicants. Tatham Stamp Company, Springfield 30, Mass.

BRITISH, Spanish and French Colonies, Vatican, Hitler heads, and airmail packet, free with approvals. Pan-American Stamp-co, Box 145, New York 33, N. Y.

DANDY U. S. approvals; write immediately. Sullivan, Endicott Building, St. Paul, Minnesota.

BERLIN Bears, complete set of eight and 100 different stamps only 10c to approval applicants. Reich Stamp Co., 4647 Kenmore, Chicago 40, Ill. Dept. Mil.

STAMP Collections wanted. Complete collections, duplicate lots, surplus stock, mint and used. Prefer trade for printing or other items, buy outright if priced right. What have you, what's wanted? Vanroy Shirk, Lebanon, Penna.

U. S. Price list. Send postage. State Stamp Service, 1225 Park Building, Pittsburgh 22, Penna.

OLD Scarce U. S. seconds on approval. Slightly defective, nice appearance, bargain prices. Herfield, 551 Clinton, Newark 8, N. J.

ZOWIE-E! A barrel of fun for only a dime. 500 United States stamps—absolutely unpicked and unsorted—just as received from church missions. Many varieties, including large commemoratives, airmails, high denominations up to \$5.00! Stampdom's biggest package of fun—and you might find something really valuable! Price only 10c to serious approval service applicants. Money back if not delighted. Illustrated bargain lists with each order. Mystic Stamp Company, Dept. 80, Camden, New York.

U. S. Price list. Send postage. Stanley Gibbons, 38-P Park Row, New York.

PENNY Approvals, that satisfy. Neil Gronberg, Box 5441-P, Philadelphia 43, Penna.

50 DIFFERENT United States, 10c. Price-list free. Seidenberg, Cassopolis, Mich.

UNITED States approvals complete coverage, fine quality, attractive prices. Seminole Stamps, Box 378, Coconut Grove, Florida.

FREE U. S. price list. Postage 3c. Mark Hanna, 335 - 5th Avenue, Pittsburgh 22, Penna.

WORLD'S Largest diamond and triangle stamps, free stamp magazine, stamps from fighting Free French, 20 stamps from 20 different countries, pictorials, airmails, big bargain 5c with approvals. Capital Stamps, Dept. 2, Little Rock, Ark.

DEALERS—Wholesale list. Postage 3c. Frank, 5031 Queensberry, Baltimore 15, Md.

HOBBIES AND COLLECTIONS

KLONDIKE! For hobby jewelry makers! Novelty jewelry findings swept from tables of large manufacturers—parts for bracelets, pins, earrings, etc.—unfinished chains, rings, pins, stones, clips, beads—many other items. 1 lb. bags—\$3.00 sample bag—\$2.00 per bag in 5 bag lots. Prepaid only. Mdse. Distributing Co., 19 E. 16 St., New York 3. Dept. P.S.

COLLECTORS—Veterans: start collecting U. S. Army and Marine soldier patch insignia. Send \$1.00 for beginning assortment of 10 patches, \$2.00 for 25, to Fox Dept. Store, 593 Third St., San Bernardino, Calif.

FIFTY Unusual bookmatches for collectors. Unused, all different. Not the printed advertising kind. \$1.00. Hall's Iowa City, Iowa.

100 UNUSED Canadian book match covers, all different. \$1.00. Post Office Box No. 8, Toronto, Canada.

MILITARY Insignia, metal regimental crests, campaign ribbons, sample crest 25c. Free catalog. Bon-Lee Company, Dept. N, 5801 15th Ave., Brooklyn 19, N. Y.

50 DIFFERENT Army patches postpaid for only \$1.00 (factory rejects). Catalog free with order. Insignia Mart, 703 Broadway, New York.

FREE Franklin D. Roosevelt memorial set complete. Other choice premiums. Catalogue 10c. Post Card Exchange, Box 116B, Boston 17, Mass.

FIRST Again: United Nations insignia 30c; military emblems 2c up. Send 10c for price lists. Hobbyguild, P-35 West 32nd St., New York.

UNUSED Match book covers. 100 all different \$1.00. 35 Royal Flash covers \$1.00. Free catalog. Charles Edelman, 1311C East 84, Cleveland 3, Ohio.

INVENTING Can be an interesting and profitable hobby. Write for complete particulars. Institute of American Inventors, Dept. 40-E, 1926-Eye St. N. W., Washington 6, D. C.

WANTED: Old cigarette cards. Write Charles Bray, East Bangor, Penna.

CAMPAIGN Ribbons—Beginner's package. Introductory price 50c. Contains 15 assorted ribbons. L.H.G. Company, 19 E. 16 St., New York 3.

ANTIQUES, RELICS, INDIAN GOODS, CURIOS

HITCHING Posts. Beautiful horsehead design. Made of enduring cast iron. Send for free folder. Grafton Metal Products, Grafton, Wisconsin.

6 PERFECT Birdpoints \$1.00, list free. H. L. Talburt, Calico Rock, Ark.

4 FINE Ancient arrowheads \$1.00. Stone tomahawk \$1.00. List free. Lear's, Box 569, Galveston, Texas.

SWORDS, Rapiers, daggers, pistols, armor. Illustrated catalog 50c. Robert Abels, 860-A Lexington Ave., New York.

PRECIOUS STONES, MINERALS

METAL Detectors. The very latest circuit. Free literature. Hedden Metal Detectors, 538 N. Homewood Ave., Pittsburgh 8, Penna.

KING Jade—Not Nephrite or Jadeite, bluish green. Gem quality cutting material available to professionals and amateurs. Send 50c for cut sample. King Gems, Inc., Dept. PM, Box 1579, Colorado Springs, Colorado.

MINERAL Specimens and gem material. Fluorescents. Free list. Plummer's, 5068 Brighton, San Diego 7, Calif.

CAMERAS AND PHOTO SUPPLIES

SPEED-O-COPY; Groundglass focusing attachment for Leica, Contax, Perflex, Argus C-2 & C-3. Send for literature. D. Paul Shull, Dept. PM-9, 240 S. Union Avenue, Los Angeles, Calif.

ANSCO Color roll film: B2, 120, 620, PB20. Rolls \$1.24; 35mm. (20-exp.) \$1.78. Factory fresh, not surplus. Developing \$1.00 per roll. Also color prints. Kolorprince, 373 Floral, Johnson City 7, N. Y.

MAKE Magic Photos—Render photographic image invisible, indefinitely; reappears instantly through (your secret). Stamp brings sample and literature. Invisible specimens with magic slip 25c. Photo Specialties, 812-M No. 18th, Saint Louis, Mo.

THIRD Dimensional pictures possible with new Tri-Vision camera. Inexpensive. Free literature. Wishing Well, 2019 So. 39th, St. Louis 10, Mo.

FAMOUS Army-Navy GSAP electric 16mm. cameras, only \$5.00! Remodel this precision camera yourself, save many dollars. Hundreds of uses; thousands sold at much higher prices. 24 volt drive, magazine load. Less lens: \$5.00 postpaid. With fixed-focus 1 1/2" f3.5 lens: \$20.00 postpaid. Sterling-Howard, 1900 Monterey, New York 57.

PRINT 150 Pictures. Kit 75c. Schmidt, Rt. 14, Box 595A, Milwaukee 14, Wisconsin.

CAMERAS, Enlargers, projectors. Lowest prices. Free catalog. Cavalier Camera, 1822 Center, Pittsburgh 19, Penna.

BASS Says! At the sign of the old "Horse Trader," 37th year. Thousands of satisfied customers everywhere! Finest brands including Kodak, Bell & Howell, Argus, Zeiss, Leitz, etc. Satisfaction always guaranteed, or your money back! Bass buys 'em, sells 'em, trades 'em. Write or wire. Bass Camera Company, Dept. AG, 179 W. Madison St., Chicago 2.

PHOTOGRAPHY For pleasure or profit. Learn at home. Practical basic training. Long established school. Write for booklet. American School of Photography, 1315 Michigan, Dept. 3431, Chicago 5.

HAVE You a camera? Improve your hobby of photography and learn how to make better pictures. Write today for our latest book catalog and sample copy of American Photography, containing articles and pictures by the world's foremost writers and photographers. Camera House, 601, 353 Newbury St., Boston 15, Mass.

OIL Coloring photographs can be a fascinating hobby or profitable sideline for those with artistic talent. Learn at home. Easy simplified method. Send for free booklet. National Photo Coloring School, 1315 Michigan, Dept. 3431, Chicago 5, Ill.

WARPLANE And ship photo slides fits all projectors. 25 for \$1.95, mixed, postpaid. Aero Parts, Municipal Airport, Houston, Texas.

DEVELOP And print your own pictures. Complete, easy-to-follow instructions \$1.00. Folios, Box 341, Frankfurt, Ken-

PHOTO FINISHING

HAVE You photo finishing worries? Forget them. Newly invented camera snaps, develops and prints finished pictures. Write today for our free illustrated folder. Complete details and copy of photo. Pittsburgh Photo Shop, Dept. A-1, 1618 Westmont Avenue, Pittsburgh 10, Penna.

8 HOUR Service. Your 8 exposure roll printed jumbo or regular size, 25c; 12 exposures, 35c; 16 exposures, 50c; 36 exposures, \$1.00. Reprints, jumbo or regular, 3c. Regular prints deckled. Fine grain developing. Send for free mailers. Quality Photo Service, Box 468, San Francisco 1, Calif.

SENSATIONAL Introductory offer! Send snapshot or negative, this ad and 10c. We'll send you a beautiful 7x5" enlargement! Or, Kodak roll developed and printed (with free coupon) only 25c; or 8 giant prints from roll, 30c. Reprints from negatives, any quantity, regular size, 3c; Giant size, 4c. Candid rolls—36 exp. 35mm. developed, vapo-rated, enlarged to 3x4, \$1.00, 18 exp. 50c. Free mailers. Free premium offers sent on request. American Studios, Dept. 364, La Crosse, Wisconsin.

PHOTOS, Documents, etc. photocopied to wallet size and permanently sealed in plastic. \$1.00. Originals returned. Solfis, Box 1942Y, Boston 5, Mass.

FREE! 8x10 enlargement and 11x14 photo album coupons issued with each order. And just to get acquainted, we will develop the first roll of films you send us and from each good negative, make one gorgeous hi-gloss Velox print for only 10c. Prompt Service. Free mailers upon request. Landrum's Photo Service, 6728 Second Ave. South, Birmingham 6, Ala.

25c ROLL Developed with 16 Velox deckledge prints. Quick service. L. Skrudland, Lake Geneva, Wisc.

FASTER, Rolls developed, sixteen sparkling fade-proof prints, professional 4x6 enlargements 25c. Rolls developed eight 4x6 enlargements 30c. Reprints 2c, enlargements 4x6, 4c. Lifetone Photo, 853-39 Fifth, Des Moines, Iowa.

COLOR Prints and Anso color film processing. Prints 2 1/4 x 3 1/4 50c; 3 1/4 x 4 1/4 90c; 4x5 \$1.10; 5x7 \$1.95; 8x10 \$2.85; Film \$1.00 per roll 35mm. Mounted 25c extra. Kolorprince, 373 Floral, Johnson City 7, N. Y.

INDIVIDUAL Fine grain developing. Album size prints. 8 exposure roll thirty cents, 16 exposure fifty cents. Chas. Henderson, R.R. 10, Box 421, Cincinnati 27, Ohio.

FREE 4x6 Enlargement, eight sparkle-tone prints, roll dev. 35c. Reprints 3c. Mail-Box Photos, Dept. E, Box 150, Williamsport, Penna.

FREE 4x6 Enlargement with every ten reprints only 30c. Rolls developed 30c. Globe Photo Service, Dept. 212, La Crosse, Wis.

ENLARGING, Printing, developing. Simplified instructions \$1.00. Fred Carpenter, Hamlin, Texas.

ENLARGEMENTS, Double weight paper 5x7 25c, 5 for \$1.00, 8x10 35c, 3 for \$1.00. Marglo Photos, Emerson, New Jersey.

AMAZING New process. Perfectly toned premium quality prints. Any size roll, any number of exposures developed and printed 19c. Overnight service. 30 day offer. Perfect-Tone Photos, Janesville 24, Wis.

YOUR Favorite photograph reduced to miniature size, 2 1/4 x 3 1/4, and laminated into lifetime plastic. 6 copies \$3.50. Original returned. Plastic Photo Co., 6 Beacon Street, Boston, Mass.

50 VELOX Reprints \$1. Suburban Studio, 1410-M Bond, Rockford, Ill.

FREE Price list on quality developing, printing, enlarging. Write for it today. Bryan's Photo Shop, Dept. M, Panama City, Florida.

100 VELOX Reprints \$2.00. Roll developed 16 prints 25c. Box 5, River Grove, Ill.

PLASTIC Statuettes made by experts \$1.00. Illustrated literature free. Statuette Craft, 8448 Grand River, Detroit 4, Mich.

2c—VELOX Reprints. Roll developed 16 prints 25c. Photographer, Lake Geneva, Wis.

16 FOR 25c—Velox deckled prints with roll developed. Velox reprints 2c. Deckle-tone, Lake Geneva, Wis.

8 PRINTS All enlarged to nearly postcard size from your roll or negatives 25c; 16-50c. (Trial offer). Willard Studios, Box 3535A, Cleveland, Ohio.

THREE Prints each, 8 exposure roll 40c. Two each 35c. One each 25c. Reprints 3c.

EVERY Picture an enlargement. Bigger and better snapshots than you have ever seen before! New electronic developments give you improved lifetime deckled-edge enlargements at our same low prices. Any 8 exposure roll developed and printed enlarge size 25c; reprints 3c each. Fast, accurate service guaranteed! Send for free mailers, today! Enlarge Photo Service, Box 791D, Boston, Mass.

LARGA-PIC—We have only one offer, but it's an outstanding one! Your roll developed and 8 prints made into brilliant Larga-Pic photos for 30c. Reprints from your negatives 4c each. Write for free mailers. Larga-Pic, Box Z2, Brookline 46, Mass.

TWO Beautiful prints from each picture on roll 25c. Twenty-six years of satisfied customers. Quick service. Lens Photos, Dept. J4, Janesville, Wis.

16 VELOX Deckledge prints with roll developed 25c. Studio, River Grove, Ill.

BEAUTIFUL Enlargement from each picture on roll 25c. Cut Rate Photos, Dept. B4, Janesville, Wis.

8 BEAUTIFUL Double size pictures and roll developed 30c. 8 hour service. Free mailers. Pacific Photo Service, Box 666, San Francisco, Calif.

2 BEAUTIFUL Hi-Gloss prints each good negative and enlarging coupon with each 6 or 8 exposure roll developed 28c. Owlphoto Co., Weatherford, Oklahoma.

PHOTOGRAPHY For pleasure or profit. Learn at home. Practical basic training. Long established school. Write for booklet. American School of Photography, 1315 Michigan, Dept. 3452, Chicago 5.

ROLL Developed and 8 prints 30c. Overnight service. Free mailers. Tri-Plex Photo Service, Box 375, San Francisco, Calif.

GLOSS Finish enlargements. 4 5x7 from negative 50c. 3 5x7 from photo 50c. Robert Renshaw, Jr., P.O. Box 478, Chester, Penna.

MOTION PICTURES AND SOUND EQUIPMENT

DISCOUNTS! 8MM., 16mm. films, equipment. Catalogue 3c. Towers, 935 North 40th, Philadelphia 4.

NEW Professional DeVry 16mm. sound projectors \$559.50 complete! Export throughout world! Charlie Poorman, Schuylkill Haven, Penna.

RENT 16MM. sound films 50c reel. Large selection; free catalog. Film Service, 128 Chestnut St., Roselle Park, N. J.

8 AND 16MM. movie films, fast machine processing service, bulk film, free circular, Atlantic Films, 28F N. 4th St., Reading, Penna.

GUARANTEED Fresh Anscocolor for double 8mm. cameras \$7.50! Processing free! Three rolls \$10.00! Postpaid! ESO-S, 828-B West 39th, Kansas City 2, Missouri.

FREE Loan films. Thousands of reels. 138 sources, \$1.00 deposit. Richardson, Wyoming, Penna.

LEARN Movie projection, management. Free catalog. Theatre Institute, Elmira, N. Y.

PROCESS Your own 8mm.-16mm. movie film. Literature. Duro Movie Products, 1519 Eggert, Eggertsville 21, N. Y.

16 AND 35MM. films, projectors (sound). Savarese, Woodcliff Lake, N. J.

"THE CIRCUS," Chaplin's greatest film. Available 16mm. Rice, Haddonfield, New Jersey.

16-35MM. Silent films. List 5c. Bedner, 5300 So. Talman, Chicago.

EXCLUSIVE Home movies. Select films. Write for free list. Home Pix, 1674 Broadway, New York 19, N. Y.

EARN \$8.00 To \$10.00 daily with your movie projector. Details free. Metcalf, 10806 Glenroy, Chicago, Ill.

FILM—Free processing 100 ft. 16mm. Weston 12 \$3.25, Weston 24 \$4.90, Weston 64 \$4.95, 25 ft. double 8mm. Weston 12 \$1.50, Weston 24 \$1.89, Weston 64 \$1.99. Free circulars. Fromader Genera, Davenport 4, Iowa.

QUANTITY Users: Fresh Anso 16mm. 100' movie film, black and white, \$5.25; color, \$7.00. Minimum order, six rolls. Fresh Anso 20 exposure 35mm. color film, 3 rolls for \$4.50. F.O.B. Baltimore. Gartnerman's, 3816-E Eastern Avenue, Baltimore 24, Maryland.

JOIN World's largest cinematographic society. Details free. International Cine Society, Suite 118, 6770 Hollywood Blvd., Hollywood 28, Calif.

SOUND Projectors: Used 16mm., standard brands, from \$195.00. Write for listing. Gartnerman's, 3816-E Eastern Avenue,

16MM. Sound film and equipment rental, sale, exchange. For home, club, church, school, road showmen. Kunz Motion Picture Service, 1319 Vine Street, Philadelphia 7, Penna. 1905 Sanderson Ave., Scranton, Penna. 432 N. Calvert St., Baltimore 2, Md.

JIU Jitsu movies, free list. Stone, Box 171-B Canal Sta., New York 13, N. Y.

EXCHANGES: 8/16mm. silent, \$1.00 per reel. Rentals, sales at money-saving rates. Details for dime. Midland, Box 429, Oak Park 4, Illinois.

400 FT. 16mm. motor projectors \$17.50. Send stamp for 8mm., 16mm. lists. Sterling's, 679 Northampton, Easton, Penna.

8-16MM. Silent-sound films. Complete rental library. All latest subjects. Free catalogue, (sample film 10c). Garden Film, 317 West 50th, New York 19.

COMPLETE Stocks always of Castle, Official, Pictorial films, 8mm., 16mm., sound, Musicals, soundies, free catalogs. We exchange your films and equipment, or buy them for cash. Frank Lane, 5 Little Bldg., Boston, Mass.

PROJECTORS \$16.00 Up. Cameras, film available. Selco Products, Danvers, Mass.

RARE 8-16MM. silent-sound films. International, 2120 Strauss, Brooklyn, N. Y.

FINEST Movie screens, inexpensive, make them yourself. Free literature. Snow White Screen Company, Danville, Illinois.

BASS Says! 37 years of leadership means satisfaction to you! Finest equipment, 8 and 16 mm., sound cameras, sound projectors. Bass buys 'em, sells 'em, trades 'em. Satisfaction always guaranteed, or your money back! Bass Camera Company, Dept. A, 179 W. Madison St., Chicago 2.

BEAUTIFUL Kodachrome slide and lists 25c. Slide Supply Service, 3111 West Tuscarawas, Canton, Ohio.

GUARANTEED Fresh anti-halo outdoor movie film! Weston 12! Daylight loading! Processing free! Three spools double 8mm. \$3.45! Six single 8mm. for Univex, \$4.60! Postpaid! Catalog. ESO-S, 828-B West 39th, Kansas City 2, Missouri.

"THE World's Greatest Passion Play," all sizes sound and silent. Write Hemenway Film, 33-F Melrose St., Boston 16, Mass.

I BUY, Exchange, swap movie films. Harvey Iris, Box 539, Brockton, Mass.

MUSIC AND MUSICAL INSTRUMENTS

ACCORDIONS, Wholesale prices. Request circular. New streamline accordions. All sizes and makes. Metro Accordion Co., 44 N. Albany Ave., Chicago, Ill.

PIANISTS—Popular music chord chart: Shows names; symbols; readings; enharmonics; notation; 648 treble, 180 bass positions. Sensational! Desirable! Practicable! Only \$1.00. Carol Music Chart Co., Box 21 PM-Lefferts, Brooklyn 25, N. Y.

MUSICAL Instruments, hundreds rebuilt like new. 5-day trial. Free bargain list. Meyer's Musical Exchange, 454-A Michigan Avenue, Detroit 26, Michigan.

PIANO—Play without notes or teacher. System sent free, includes chart and directions. Enclose 10c for handling and mailing. Latom Music, 2147B 86th Street, Brooklyn 14, N. Y.

FREE Accordion pickup with each accordion purchased. New or used accordions for sale. Cash or terms, wholesale or retail. Write for bargain list. Del Principe, 307 So. Wabash, Chicago.

JUKE Boxes or record-players. Mend your worn or cracked record centers with the new plastic disc. 3 for 35c coin. E. F. Gattis, 115 West Spring St., West Haven 16, Conn.

SONGWRITERS—Send your song poem at once for immediate examination and free rhyming dictionary. Richard Brothers, 24 Woods Building, Chicago.

SONGWRITERS: Have your song recorded on unbreakable record. Professional singer, piano accompaniment; \$5.00 each, c.o.d. Melodies written for your lyrics or vice versa; \$5.00 each c.o.d. Magnolia Recording Co., 424 Godchaux Bldg., New Orleans 16, La.

PHONOGRAPH Records cheap. Catalogue. Paramount, MH-313 East Market, Wilkes-Barre, Penna.

MUSIC Lovers best offer 6 songs \$1.00. Art Music, 1658 Broadway, New York 19.

SONG-WRITERS Best offer! Art Music, 1658 Broadway, New York 19, N. Y.

PIANIST, Learn piano tuning. Piano Technician, 75 Howard, Keene, N. H.

SONGWRITERS. Catchy lyrics and melodies composed. Piano and orchestral arrangements. Professional work. Leonard Publishing Service, 6227 Justine Street,

PROFESSIONAL Melody to your poem. \$2. Professionals, Mill Valley 339, Calif.

NEW And rebuilt musical instruments. Lower prices. Send for catalog. Give instrument interested in. Harden's Musical Merchandisers, Marion, M. Ohio.

WESTERN Records—Latest numbers 29c. Catalog 3c. F-L Shop, Box 19-L, New York City 35, N. Y.

DUO-FLEX Reeds, for clarinets and saxophones. Eliminate your reed troubles. Circular free. Duo-Flex Reeds, 1204 First Ave., Evansville, Ind.

POEMS Wanted for musical setting! Send poem for immediate consideration. Hamann Service, 614 Manhattan Building, Milwaukee, Wisconsin.

AMPLIFY Your accordion with our new Del Principe pickup, \$22.50. Install it yourself in one minute. Makes any accordion sound like an organ. Works with any amplifier. Special Del Principe amplifier and pickup only \$72.50. Write for details. Del Principe, 307 So. Wabash Ave., Chicago.

MUSIC Arranged. Songs printed. Frank Wildt, Music Publisher, Lancaster, Penna.

POEMS Wanted to be set to music. Free examination. Send poems. McNeil, Master of Music, 510-PM S. Alexandria, Los Angeles, California.

BEFORE Sending your poem to be set to music, know your composer. Free folder. Al. Moquin, 5333 La Cresta Court, Hollywood 38, Calif.

SONGWRITERS! Outstanding ethical offer. Hibbeler, C5, 2157 N. Avers, Chicago.

POEMS Wanted for new songs. Send poem for free examination. Eliot Wright, Master Composer, 207 Rivoli Theater Building, Portland, Oregon.

POEMS Wanted for musical setting. Send poem for immediate consideration. Five Star Music Masters, 630 Beacon Building, Boston.

SONGWRITERS: Send poems for free examination and outstanding offer. United Music Service, 150, Salem, Indiana.

WRITE Songs. Big money and reputation. Write for information. J. Gordon Pub. Co., 201 N. Hoyne Ave., Chicago.

SONG Writer's attention! The amazing demand for phonograph records, accelerated by more than 300,000 juke boxes and the hits popularized warrants your immediate consideration. We are offering song-poem writers the rare opportunity of having established composers collaborate on appealing material received this month. Recola Records, Box 987F, Hollywood 28, Calif.

RADIOS, SUPPLIES, INSTRUCTIONS

FREE New radio catalog is ready! Radionic's catalog lists radios, hard-to-get radio parts, books, amateur, test, and P. A. equipment. All available for immediate delivery. Send today to: Radionic Equipment Co., Dept. 209, 170 Nassau St., New York 7, N. Y.

BUILD "Loudest" crystal radio. Instructions and crystal, 25c. Amorose Radio, Route Four, Richmond, Virginia.

U. S. SIGNAL Corps featherweight earphones \$1.00. Radio service men and experimenters send stamp for our giant radio catalogue. Save dollars. United Radio Co., (100-V) Newark 1, N. J.

FIXED Crystals—latest 1N34, \$1.60; 1N-21, \$1.00. Copy "Crystal Radio Experimenter," 10c. Stanley, 1418 West 50th, Norfolk 8, Virginia.

46 LARGE Crystal, tube set detail prints in binder including catalog, "Radiobuilder"—\$1.25. 3 "Radiobuilders"—25c. Laboratories, Eye-c, San Carlos, Calif.

RETAIL Radio tubes. All types fully guaranteed. No order too small. Postage paid by us. Orders shipped C.O.D. parcel post. American Mail Order Company, 612 Sanford Ave., Newark 6, New Jersey.

BROADCAST Through your radio with the "Tiny-Tone" Little Mike. Complete instructions included, 50c postpaid. Money back guarantee. Tiny-Tone, 1216 Park Row Building, New York 7, N. Y.

ELECTRONIC Surplus. New sample \$20.00 assembly, with descriptive list, \$1.00 postpaid. Engineering Associates, Farhills, Box 26, Dayton 9, Ohio.

TUBES, Parts, wholesale, retail 50 off list. Radio Mail Order Company, 46-13 188th St., Flushing, New York.

TELEVISION Opportunity knocks now. See Marlowe Ad under Profitable Occupations.

HALLICRAFTERS, National, other radios wholesale. Terms. Write. Henry Radio, Butler, Missouri.

"25 YEARS Experience" radio repairing at your fingertips. I've repaired 45,000 radios and have perfected system you can follow step by step. My methods are far simpler than any course published. Requires no calculations. Total price \$1.00 postpaid or c.o.d. Moneyback guarantee. Ross Radio Company, 14615 Grandriver, Detroit 27, Michigan.

RADIOMEN. Servicemen, beginners—make more money, easily, \$250 weekly possible. We show you. Information free. Merit, 216-32A 132nd Avenue, Springfield Gardens 13, New York, N. Y.

AMERICA'S Best buys. Radio tubes 29c up. Free bargain lists. Potter, 1314-P McGee, Kansas City 6, Mo.

MAKE Simple, tubeless, batteryless, distance-getting crystal radios. Crystal and illustrated instructions 25c postpaid. Allen, 427-P, Clinton, Missouri.

RADIO Technician and radio service courses. Training for federal licenses. American Radio Institute, 101 W. 63 St., New York City. Approved under G. I. Bill of Rights.

BUSINESS OPPORTUNITIES

SPLENDID Opportunity to buy established business manufacturing electric lawn mower sharpeners. Good demand. Excellent chance for some aggressive young man. Write for details. Address: Mrs. Charles W. Rhoades, Box 124, Greeneville, Tennessee.

SAVE Postage and time. Your name on our mailing list, one year, 25c. Nate Katz, 4254 N. Kimball, Chicago 18, Ill.

BUILD Your own independent, fascinating and very profitable business at home, spare or full time. \$75.00 and upwards weekly easily possible making beautiful, brilliant, sparkling novelties, religious figures and popular sports souvenirs. Fast sellers through you, salesmen, stores. Quickly learned and few dollars starts you making real money. Successful manufacturer can tell you how and furnish everything. Start small, grow big. Write for full information and "Amazing story of my success" at once. Inghram Company, 2845 Sixth Street, Detroit 1, Michigan.

ELECTRICALLY Inclined men. Amazing illustrated literature free, proving \$100-\$250 weekly possible installing, maintaining fluorescent lighting. Rebuild fixtures for excellent profits. Make beautiful lights for 50c each and less. Free sample materials. Write Willis Fluorescent Service, 101 York Street, Brooklyn 1, New York, Dept. C.

"PLANNED And profitable" mail order selling. New work book of ideas and instructions for beginners, aspirants, established dealers. Send quarter for copy of "Mail Order Business Monitor" magazine and details. Free subscription offer. P. Kaufman Agency, 2629 78th Ave., Chicago 35, Illinois.

MAKE Perfume. Profitable business. Information free. International, 6347 Parnell-X, Chicago 21, Illinois.

GET The job you want or go into business for yourself. We show you how to do either. Details free. Dee Enterprises, 3360 Sims, St. Louis 14, Missouri.

WHAT Do you want to buy? We furnish supply sources for most anything. Formulas of all kinds also supplied. Let us know your wants. Humphrey Re Search, Box 898, Santa Monica, California.

BABY Shoes bronzing supplies, plasticide and onyx bookends, ash trays, frames, pen sets. Hardening solutions. Shoes metalsealed for only \$1.00. Box 2095, Wichita, Kansas.

MAILING List! 10,000 women mailorder buyers, \$45.00, 5000, \$25.00, 1000, \$6.00. Guaranteed accurate. Try them! Woods Remnants, Bedford, Penna.

BUYERS Wanted for plaster novelties. Painted—unpainted. Retail—wholesale. Write today for free information. Bing Products, 88-X4A Broad, Boston 10, Mass.

MEXICAN Feather pictures: fast selling fancy grade. Large selection curios. Wholesale catalogue free; retail 10c. Quivira Specialties, Topeka 1, Kansas.

UNPAINTED Figurines, plaques. List 10c coin. Redeemable. Homemaker, Box 3447, St. Paul 1, Minn.

FOR More business. establish office address, requiring no room, or box number. Rates, \$7.30 and \$14.60 yearly. Co-operative Mail Service, 126 Lexington Avenue, New York 16.

FREE Sample copy national mail order publication. Other opportunities. Write Post-Age, 909 E. 20th, Indianapolis 2, Ind.

OPERATE America's most popular low priced precision penny vending machine. Big profits. Be independent. Write for bulletin and prices. Stock shipments. Fielding Mfg. Co., Desk 947PM, Jackson, Michigan.

PROFITABLE Home sparetime business, making wallets, belts, other fast-selling leather novelties. Simple to make. Tools not necessary. Amazing opportunity. Send for free catalog. Gold Leathercraft, 632 Desplaines, Forest Park, Ill.

BE Your own boss, metallize baby shoes at home, spare time, your own business. H. Schwieger, 804 W. Chestnut, Wauwatosa 13, Wis.

LEARN To metallize baby's first shoes at home. Big profits in spare time. Secrets, free gift. Send card. Schoettie, Friendship, Ohio.

DISTRIBUTORS, Dealers, agents. We have the fastest selling item on the market today. 100% profit. Steady repeater. Rush \$2.98 for complete set-up or write for details. Now! Halco, 804A Anderson Building, Fort Worth, Texas.

CASH In! Local; mail specialties, hobbies, opportunities. Literature 10c. Central, Simpson, Kansas.

MERCHANDISE At half the standard advertised price and catalog 10c, none free. Ken Solomon Company, 813 Broadway, New York 3, N. Y.

WANTED—Able organizer, manager, sales executive to lease, implement and conduct hobby enterprise. Eight cottages, workshop (1200 sq. ft.), and homesites available. Beautiful, high, shady seashore. Bathing, boating, hunting, fishing, golf. Retired executives' paradise. Give personal details, qualifications. Gadgets, Villa Tasso (Niceville), Florida.

MOTHPROOFING And cleaning business pays well. I'll show you how to start on amazingly small capital. Write today for details on eight practical plans. Howard Robinson, Ph.G., Box A, South Ohio Street, Sedalia, Missouri.

GET Into a billion-dollar industry, unlimited possibilities, large demand, small capital. Details free. Beecroft, 15 Park Row, New York 7, New York.

START Your own electroplating business, highly paid, uncrowded field. Learn at home. G.I. approved. Send postcard for free electroplating booklet and proof. Plater-Hyde, Room 521, 432 "P" Street, San Diego 1, California.

IF You'd like your own, high income but easily learned office business, write for free details today. Cole Associates, Syracuse 2, N. Y.

UP To \$1500 yearly selling by mail in spare time interest you? New ideas and plans every month. Details free. Idea of Month Club, Box 118-A, Baltimore 18, Md.

LEARN To metallize baby shoes. Complete instructions \$1.00. Don Brady, 1618 Sage St., Topeka, Kan.

PROFITABLE Letter shop operation. Details free. Wollard, Box 268-E, Newark, Ohio.

PLASTICIZE—Lasting beauty-protection for autos. Used like polish. Entirely new. Opp. excl. distributors earn \$15,000 annually. Plasticize, 2254 N.W. 62nd St., Miami, Fla.

OPERATE Profitable mail order business. Splendid opportunity. Free details. William J. Nott, 2718-F W. Cambridge St., Philadelphia 30, Penna.

PROFITABLE Mail order business. Write—Beier's, 837-A Hoffert, Bethlehem, Penna.

SWAP! Successfully! Instruction book 25c. "Swappers," 2836-PB Slevin, Louisville 12, Kentucky.

BECOME A finance man. Particulars free. George Lenhoff, Lincoln 8, Nebr.

GO In magazine renewal and subscription business. Pays big—repeat orders come automatically. Supplies furnished. Get free catalog and commission list. Write today. McGregor Magazine Agency, Dept. PM-8, Mount Morris, Ill.

MAGAZINE, Mail order plans 25c. Worth dollars! National, Woodbine, Maryland.

METALLIZE Baby shoes, new ideas, particulars free. Krall, Box 8087, Pittsburgh 16, Penna.

"EARN" Dollars daily. Start profitable mail order business. Plans 25c, magazine free. Lane, 548-B 61st Street, West New York, New Jersey.

50 GOLDEN Opportunities for profitable mail order operation. Free literature. Star Publications, Dept. S, 207 Investment Bldg., Pittsburgh 22, Penna.

"FREE Broadside" "Key to Greater"

PROFITABLE Co-publish magazines. \$1.00 up. Details; samples 10c. Thompson, Box 1332, Tonawanda, N. Y.

PROFITABLE Mail business easily started. Free literature. Box 63-E, Station H, Buffalo 14, N. Y.

FLASH, 3 Classic novelties. Large profits. Gold mine for agents, salesmen. Hurry. 25c coin, not stamps. Martin, PM 57 Hart, New Britain, Connecticut.

CAPITAL Raising made easy; millions available; send for Financing Your Business; large 250 page volume; complete details, only \$2.00. Seminole Publishing Company, Room 9, 317 W. Forsyth St., Jacksonville, Florida.

JIFFY-TILL, 1½ H.p. rotary garden tractor, list price \$237.50, wants dealers. Box 394, La Mesa, California.

DOES \$1,500 Yearly in spare time by mail interest you? Free details. Lawson, Box 1302-P9, Detroit 31.

COMPOSITION Flooring—Made in most colors. Lifelong, soundproof, resilient. Flexible molds. Cast novelties, plaques, statuary. Big money—your own business. Catalog free. Write Bing Products, 88-A3M Broad Street, Boston 10, Mass.

\$5 COMMISSION On booked distant moving jobs you recommend. United, 243 West 60th Street, New York, N. Y.

PERFUME Manufacturing business—Little capital. Big profits. Particulars free. Rosa, 907 Adams, Brownsville, Tex.

POPCORN Machines. Potato chip outfits. Long Eakins Co., 4760 Hi St., Springfield, Ohio.

YOUR Own business. Bronze baby shoes. Make bronze castings, novelty castings, liquid marble, flexible molds. New methods, easier, quicker, more profitable. Productive Arts Co., Dept. M-7, Box 221, Seattle 11, Washington.

\$46 FROM Square foot plywood. Jigsaw necessary. Write, Woodarts, X-38, Bridgewater, Mass.

BE Your own boss! Let us show you how to make big money right at home! Free details! Kiktavi, 8620 South Ruthelen, Los Angeles 44, California.

START Profitable mail order business on \$5. Write Duncan, Ortega Station, Jacksonville, Florida.

HOME Workers wanted to hand-spin Angora wool. Either sex. House of Angora, M9, Springfield, Illinois.

OWN A mail-order paper products business. Sell envelopes, tags, bags, boxes, by mail, wholesale. Tremendous demand. Steady profits. No capital necessary. Write Omaha Envelope Service, Dept. 218, 4721 California, Omaha 3, Nebraska.

START Home mail order business. Martin, 2454-SM Wilson, Chicago 25, Illinois.

CHRISTMAS Wreath maker's Lycopodium for 30 wreaths. Fourteen lbs. Red and green \$6.00. Lycopodium Foundation, Owasso, St. Paul (8), Minn.

RUBBER Molds. Make your own. Air-cure liquid. Quart \$2.95. Free model. Plasticwood, concentrated plaster hardener, quart \$2.50. Lusterglaze, quart \$2.50. Directions. "Model-A-Month-Club," membership (25c annually) brings information, free model offer each month. Rubbercoat, 3873-A California Street, San Diego 1, California.

OPERATE Profitable mail order business. Splendid opportunity. For details write Livingston Service, 1308 Staples St. N.E., Washington 2, D. C.

SECURITY, Happiness, independence. Selling by mail. Free details. W. E. Young, Box 1477, Fed. Sta., Portland 7, Oregon.

HOME Business, pleasant surprise. Write Reim, 3931 Bayo, Oakland 2, Calif.

GENUINE Natural Latex for rubber molds. Only two coats necessary for thick mold. Make money reproducing statuary, plaques, novelties. Low cost. Write: Major Chemical Company, 131 Inman St., Cambridge, Mass.

VARIETY Store business, large profits. I tell you how to start. Fred Carpenter, Hamlin, Texas.

CASTERS—Beautiful, flawless models. Write Cooper's, Box 44, Augusta, Maine. Lacquered, introductory special, \$1.00.

BIG Money in auto supplies, parts, radios, ammunition, guns, home supplies. Wholesale catalog for dime. Main Supply, Fairfield, Ill.

300% PROFIT Selling fast-selling item by mail, local. Dade Products, Box 1720H, Cleveland, Ohio.

SUCCESSFUL Business opportunities \$1.00. Wholesale directory \$1.00. Reimer, E-1119 Chestnut, Saginaw, Michigan.

HOW To make profits in mail order 25c. Mail Order Monitor, 356 South Broadway.

OPERATE Profitable postage stamp dispensers. Part or full time. \$19 each. Write J. Budinas, 524 Mahoning, Lehigh, Penna.

INCREASE Your income. Gain wealth! Use our sound business plans. Free literature. Sackett, 92B Waring Ave., Mansfield, Ohio.

SELL By mail. Inexpensive course tells how. Free magazine. McKittrick, Box 58, Mt. Vernon 4, Ill.

IDEA Men! Let's get together and get some money out of our ideas, instead of promises. James Corubia, Lakewood, New Jersey.

AGENT Or exclusive distributor for cigarette lighter mfg. MacGregor, Tahoe Valley 16, Calif.

MOLD Novelties, colored pottery, statuettes, composition flooring — Easily learned. Start in garage or basement. 5c material makes \$1.00 seller. Waterproofing, plastic homes, Particulars free. Marbleizing Service, Edwardsville, Illinois.

BOOKRACK, Adjustable, self-locking, plans \$1.00. Woodcrafters, Box 245, Warrington, Penna.

GET Hundreds money making deals, business ideas, plans and manufacturing. Amazing folio free. Austin Mail Service, Dept. O-5, 5538 Lexington, Chicago, Illinois.

SUCCESS Seekers, a postcard will bring you the means of fulfilling your ambition. Frank Davis, Success Service Associate, 68 N.E. Stanton St., Portland 12, Oregon.

MAKE Big profits installing weatherstrip to save fuel. Double Seal Co., 2725 Ross, Waco, Texas.

GET It for them wholesale. Be community buyer nationally-known merchandise; radios, refrigerators, washers, sweepers, typewriters, etc. Savings up to 50%. This pleasant, easy work can earn up to \$5000 year. Get details today. Kraft, Aurora 8, Missouri.

RECEIVE Information, booklets, samples, etc., from over 40 of the best "Business and Money-making Opportunities" advertised this and other magazines. Send \$1.00. (Satisfaction or refund) to: Box 502-CAA, Elizabeth, New Jersey.

PLASTIC—Intermix makes ordinary casting plaster "shatterproof." Gallon develops 100 pounds quart \$2.00, gallon \$4.50. Plastic Products, 3151-N Southport, Chicago.

PLASTIC—Liquid glass, china glazes, protects plaster, wood, etc. Pint \$1.00, gallon \$4.00. Plastic Products, 3151-N Southport, Chicago.

RUBBER—Airlastex "makes mold overnight." Pint \$1.25, gallon \$7.00 with instructions. Plastic Products, 3151-N Southport, Chicago.

NEED Extra money? Get our offer. Strictly spare time. No selling. No experience. Free particulars. A. Jones, Box 522, Jamaica 1, N. Y.

SAWDUST. Turn it into cash. Instructions 25c. Charles, 12-AR, Norwood, Ohio.

ADDRESSES Hard-to-get items. Mailing lists. Q Service, 422 S. Dearborn, Chicago 5, Ill.

QUIT Wasting dollars trying to start a mail order business. Get and read the truth and save losses. Send quarter for ideal booklet of facts, not promises. Send for "How to Build Your Own Mail Order Business" and get "in right" for profits. Douglass Service, 3231-M 40 Ave., S.W., Seattle 6, Washington.

ASSOCIATE Distributors can make big money distributing new copyrighted manuscript "Telephone Salesmanship as of Today." A repeater. Sound deal. Only spare time needed at start. Plenty co-operation. Write R. L. Mackin, 1512 Roblyn, St. Paul, Minnesota.

FREE Details moneymaking spare time businesses. Experience unnecessary. Write Greene, 1035 East 10th Street, Brooklyn 30, N. Y.

12,000,000 COLLECTORS Your market! Become successful postage stamp dealer. Large profits. Proven method. Write Largentiere Company, 6462 83rd Place, Forest Hills, New York.

WHITE Liquid rubber for making flexible molds! Quick drying! Safe! For home, classroom, or industry! Quart \$2.00, Gallon \$5.95. Full instructions! Beginner's booklet on molding and plaster casting 25c. Free with order! Plastercraft Supply Company, 1406 East 43rd Street, Cleveland 3, Ohio.

MAKE Big money. Start own real estate brokerage business. Our big authoritative manual tells how. Price \$2.00. Money back guarantee, literature free. Realtor, Box 2983, Houston 1, Texas.

SUPER X molding latex for better molds. Liquid sample 25c. Literature and sample free. W. Wooley, 115-B Donald, Peoria, Ill.

METALLIZE Baby shoes. Correct modern method. Information free. Universal, Box 1076-A, Peoria, Ill.

MAKE Rubber stamps! Enormous profits. Resilver mirrors. Brush plating. Universal, Box 1076-A, Peoria, Ill.

INVESTIGATE Mail order or home business. 140 new ideas. Write Marshall, Box 655, Centralia 13, Washington.

DO It with sea shells. Free instruction sheet. Big profits. Werts, 1429-56th Avenue, Oakland 3, Calif.

WHOLESALE Lists, business plans, home profits. Free. Holm Sales, Box 12A, Oaklandon, Indiana.

DOLLARS Daily! Cleared \$1,900 in two months by mail! Write immediately! Loeb, A-9, Silverton, Cincinnati 13.

\$5000. YEARLY Operating your own office. Many more needed nationally. "Hunt," Box 308, Burlingame, Calif.

AMAZE Others. Add faster than adding machine. Free details. Math Institute, Box 633, Mobile 4, Ala.

MAKE Own products, keep all profits! 500 formulas, rush 25c. Wilde, Z-9, Rossmoyne, Ohio.

NUPLAMOLD Molds are permanent, will not shrink or deteriorate. Made to order. Own your own business, start spare time. Make big money duplicating hundreds of decorative ornaments or industrial items. Start now; get our price list. Write the Shop Technician, 314 Westport Road, Kansas City, Mo.

FAMOUS Kruse Vita-Life health and beauty equipment earns chosen operators big money. Proven, effective methods past 34 years assures success, any community 5000 up. Clean, dignified. Your own business. Write immediately for details. Glossbrenner Manufacturing Corporation, 330 West Court Street, Indianapolis, Indiana.

SEA Shells in bulk, and sea sponges. Wholesale only. L. Russell Company, Box 954, Nassau, Bahamas.

A BUSINESS Of your own bronzing baby shoes. Course of instructions \$1.00, refunded with first order of \$6.00 or more of supplies or mountings. Write for free wholesale price list. Western Bronze Supply, 5423 Melrose Ave., Hollywood 38, Calif.

BOOKKEEPING Service-by-mail. Amazing growth. Beginner landed eighty-two \$15 a month contracts in three months. Unique selling methods revealed. Postal brings copy of magazine article. Management Consultants, Box 33, Forest Hills, N. Y.

FOR Best money making plans, ideas etc., write, enclosing stamp, to Gofflot Service, Alhambra, Calif.

LEARN Import — Export! Represent manufacturers! Study at home. Uncrowded fields, unlimited opportunities. ITP trains you in a few weeks. Five years free information service. Folder free! International Trade, 246-P Fifth Ave., New York 1.

OPPORTUNITY Mail 6 months 25c. Roth, 1455B Cornelia, Chicago 13, Ill.

MAILING Postcards selling repeat merchandise is profitable. Everything supplied. Details free. Gordan Publishers, Box 23, Pawtucket, R. I.

START Home business making statuary, plaques, novelties, garden furniture, artificial marble flooring, liquid marble. Make your own flexible molds. Amazing profits. Folder free. Creative Publishers, Box 236-L, Winnetka, Illinois.

GET Plenty of mail steadily, samples, catalogs, seed books, masses of real bargains and opportunities. Every day a big mail day, when your name is listed in our big mail column. Only 25c. 6 months \$1.00, with free gift. Martin's Service, Box 295P, Bassett, Va.

FREE Details of an unusual money making opportunity. Stamp appreciated. T. Flynn, 329 Taylor St., Staten Island 10, N. Y.

WOULD You pay 3%—first \$350 made? Color-illustrated book "505 Odd, Successful Enterprises" free! Some offer occasional "day off." Work home. Expect something odd! Pacific, Oceanside, Calif.

OPERATE Profitable mail order business. Write Gallagher Publications, Box 691C, Kingsport, Tenn.

GOODYEAR—Has natural rubber latex for molds, self-vulcanizing, air-curing. Quart \$3.00, gal. \$10.50. Free sample and instruction. Goodyear, Lake Geneva, Wis.

OPERATE Home mail order business.

\$40 WEEKLY, Spare time, your own home business. Many plans. Literature free. Carroll Service Company, 521-A North Pine St., Little Rock, Ark.

FREE Water and our concentrates, makes flavors, lotions, shampoos, 72 products, labels, bottles furnished. Qualco, E-20030 Russell, Detroit.

TWO Amazing new typing opportunities. Earn up to several dollars hour, right at home. New, exclusive, different. Write Schroder, 221 E. Bush, Covington, Ky.

300 MONEY Making plans, ideas, formulas, success schemes. Folio free. Formico Mart, Box 572, Dayton, Ohio.

TATTOOING And engraving pays big profits. Experience unnecessary. Literature free. William Moore, 412M South Green, Chicago 7, Illinois.

LIQUID Rubber for making flexible molds. Qt. \$2.00, gal. \$5.75. Sample bottle 25c. Chaney, 1130 E. 16th St., Jacksonville 6, Fla.

1000 CONTRACT Bookkeepers needed. Start your own business. Part or full time. Free course of instructions. Write H. T. Bedford, 222 W. Maple Grove Ave., Fort Wayne, Indiana.

BRONZED Baby shoe mountings. All-metal bookends, ash trays, picture frames. Onyx and Italian marble bases. Hardening solution. Lead lined tanks. 30 amp. rectifiers \$75.00. Motors for agitation (8 r.p.m.), \$15.00. Write for list. Hollywood Bronze Supply 1770 N. Vermont Ave., Hollywood 27, Calif.

MAKE Money selling "C-E Automatic Water Heaters," \$7.50 to \$26 on each sale. Write Crane Electric, Eugene 4e, Oregon.

SELL Books by mail. Large profits! Free Literature. Cline-Porter, Box 6346 PB, Pittsburgh 12, Penna.

TRAVEL Anywhere anytime. Earn \$85.00 week up. Be your own boss. No experience necessary. Less than \$5.00 investment required. Literature free. Traveler, La Grange 1, Indiana.

RESILVER Mirrors at home. Formula 25c. Ideal Service, Park Ridge 6, Illinois.

BIG Profits and your own business casting latest 1947 metal toy autos, airplanes, ashtrays, savings banks, etc. Enormous wholesale and chain store demand keeps manufacturers busy. Spare or full time. No experience or special place needed. For full information write Metal Cast Products Co., Dept. A, 1696 Boston Road, New York 60, N. Y.

START Home manufacturing business making Cleaning Compounds, Soaps, Insecticides, Cosmetics, Polishes. No machinery. Literature free. Kemix, Park Ridge, Ill.

COLORGLAZED Concrete pottery made without molds. New, low cost, patented method. Cemetery products, novelties, tiles, floors, etc. Basement leaksealing. Other moneymaking projects. Booklet, details free. Men only. National Potteries Company, Grand Rapids, Minnesota.

FOLLOW The ideas of a successful operator in the mail order business. Learn how to make, not lose money. Information free. Walter Seller, Dauphin, Penna.

MAIL Order businesses bought and sold. All types successfully handled through national brokers. List your business now, or tell us what you want to buy. Write for free facts. Turnipseed, Inc., Box 681, St. Louis, Mo.

MAKE Liquid marble, flexible molds, statuary, art goods, novelties, artificial marble flooring. Literature free. Kemico, Park Ridge 50, Ill.

FOR Greater opportunity write, Leaf Service, Box 998, Ingleside, Texas.

DRAIN Tile and block machinery. Flower pot, love seat, block and brick molds. Aluminum lawn furniture. Data free. Concrete Machinery Company, Hickory 6, N. C.

"IDEAS For Additional Income" copy 25c. MacLaughlin, 415 So. Fourth Ave., Puente, Calif.

BABY Shoes metalized the durable method. Complete instructions \$1.00. St. Albans Plating Industries, 135-17 135 Ave., So. Ozone, L. I., New York.

UNPAINTED Plaques, bookends, ash trays. List. Bava, 3655 E. Canfield, Detroit 7, Michigan.

METALLIZING Baby shoes makes you money! Learn this simple, profitable business from nationally recognized authority. Get professional results with professional "know-how"! Free particulars. Joseph B. Kushner, Metal Finishing Consultant, Stroudsburg 3, Pennsylvania.

COIN Machines earn big money! Machines are now available at \$11.75 that can earn as high as \$7 weekly profit. Place machines in stores, hotels, filling stations, etc., and your income starts immediately. Routes can be operated in spare or full time with no experience needed. We'll tell you how and send you a catalogue describing our nut, candy, gum, and postage vendors, also scales, amusement games, etc. Write immediately to Parkway Machine Corp., Dept. P, 623 W. North Ave., Baltimore 17, Md.

CO-PUBLISH And advertise in The Central Mail Advertiser. Sample copy for stamp. Low rates. Large circulation. Bagby Printing Co., Georgetown, Ohio.

HOW To set up and run a mirror shop! Resilver mirrors. For price write—John Sprinkle V60, Marion, Indiana.

GOT \$24,500 Using "schemes" from "Schemer" magazine, Alliance, Ohio. 49th year, \$1.00. Three samples 25c.

RAISING Canaries pays good profits. Valuable bird book—"Its Care, Breeding and Training." Price \$1.00. American Canary, 2839 N. Halsted, Chicago.

OPERATE Profitable mail order business. Write Walter Service, 4159-A East 112th, Cleveland 5, Ohio.

METALLIZE Baby shoes. Excellent profits. New system insures success. Free details. "Treasures Forever," Metallizers, 89 Henry Ave., Lynn, Mass.

MAKE Strange plastic—1c pound. Makes durable, attractive floors, walls. Build with waste. Save half. Bays Laboratory, Oklahoma City 9.

INCORPORATE Your business. Delaware laws. Many advantages, free details. Tax Research Bureau, Inc., Delaware Trust Building, Wilmington, Delaware.

RECAST Old batteries into new. Latest achievements. Battery Laboratories, Minneapolis.

BIG Mail income. Free particulars. Murray's, 196 Circle, Forestville, Conn.

PARATOL—Amazing new rubber latex moulding compound for perfect detail castings of all kinds tested and approved in long service. No worries—easy to apply, quick drying, maximum strength and long life. Why pay more—buy direct! Quarts—\$1.60. 1 gal.—\$4.90. 5 gals.—\$4.45 gal. 4 oz. samples on request. Send 25c to cover mailing and handling charges. Full instructions sent with each order. Testworth Laboratories, Inc., Manufacturers of coating and adhesive products of all kinds. 407 S. Dearborn Street, Chicago 5, Illinois.

BEST Tested moneymakers—68 page book 25c (coin) postpaid. Business secrets, mail order plans, formulas. Wholesale supply sources. Money back guarantee. Frank R. Carpenter, Boyes Hot Springs, Calif.

OUR Unique service will help sell your idea or invention. Literature free. Ellis Martz, Representative, Muncy, Penna.

GROW Bean sprouts in dark room for market. Pays well. Free information. Mrs. Nickell, Rt. 1, Box 456, Bend, Ore.

START A home business in spare time. Make extra money. Experience unnecessary. Literature free. Ellmar Services, Muncy, Penna.

BIG Money in vending machines. Small-capital start brings immediate profits that build permanent profitable business. Starting instructions free. Becker Vendors, 105-A Dewey, Brillion, Wisconsin.

MAKE Perfumes. Profitable business. Free book tells how. Walter Lawson, 21 Joiner, St. Augustine, Florida.

BELTS! Make 'em and make money. No tools! Sample 50c. Artinc Leather, 411 Joseph Ave., Rochester 5, N. Y.

WINDSHIELD Wiper and fuel pump rebuilding bring big profits. Free particulars. H. & H. Products, P.O. Box 430, East Akron Station, Akron 1, Ohio.

MAIL Order opportunities. Full or spare time. Hundreds of chances. No charge. Postal brings copy. Blackstone Press, Somerville, New Jersey.

GREAT Opportunities and profits in mail order business at home. Free literature. F. Webster, Box 19720, Hollywood, Calif.

MEN—Women—"Everybody likes candy." Learn to manufacture professionally at home. (Our 36th year). Ragsdale Candies, Dept. 4, East Orange, N. J.

MAIL Order business course shows you how to make money, spare or fulltime. Teaches professional mail order technique—not penny-snatching schemes. Fascinating 100-page illustrated success-catalog free! Write, Nelson Company, Dept. 4-02, Chicago 5.

HANDYMEN—Earn money home operating Community "Fix-It" Shop. Write Stafford, 708 Rawlings, Carbondale, Ill.

BOOKKEEPERS—Operate your own simplified "Dollar-A-Week" bookkeeping and tax service. Full or spare time. Details free. Ellis, Box 200, Cedar Grove, North Carolina.

PLASTIC Discs, shapes, metal findings, wholesale, free catalog. "Secors," Bradenton Beach, Florida.

ELITE Collection contains 137 practical money-making plans; local and mail order. New edition. Particulars free. Elite Co., 220 Grand St., New York 13.

QUICK Money! "Repairing car batteries." At home! Easy too! Write. Batteryman, Grand Junction 5, Colorado.

SELL By mail!—Books and novelties! 35 different items! Large profits! Catalog free! Elco, 432 N. Wells, Chicago 10.

OPERATE Profitable home business selling merchandise by mail. Fast sellers. Large profits. Powell Service, 5713 Euclid, Cleveland 3, Ohio.

INTERESTED In immediate mail order cash? Read "Advance"—Voice of mail order. Offers money-making opportunities. Personal guidance and benefits to all. Sample copy 25c. American Mail Trade Association, 313 East 21st Street, Dept. 400, New York 10, N. Y.

COPUBLISH Leading m.o. paper. Latest copy Mail Sale Advertiser and proposition, commemorative stamp. Vanroy Shirk, Lebanon, Penna.

START Profitable mail order business. PMT lists new propositions available; products, sources, accurate methods. Covers ad writing, letter logic, trade information. Send 10c for copy and get free instruction folio offer. Progressive Magazine, Sheboygan, Wisconsin.

START A clock shop. Fascinating, easily learned profitable business requiring little capital. We teach you how to repair all kinds of clocks. Information free. Houston Clock Shop, P.O. Box 5086A, Houston 12, Texas.

HOW And where to obtain capital. Fully explained. Particulars free. Star Service, Wapakoneta, Ohio.

SPECIALTY Manufacturing, the big money business that can be operated anywhere, start on a very small capital; we supply dependable formulas and complete instructions; get interesting free booklet, "Money-making Opportunities in Specialty Manufacturing." Howard Robinson, Ph.G., 1300-A South Ohio Street, Sedalia, Mo.

START Mailorder bookshop—Everything furnished; publisher cooperation. 25c brings booklet, exclusive setup, samples, exciting ideas. General Publications, Ossining, N. Y.

\$25 WEEKLY Working two hours daily. No canvassing. No manufacturing. Lycke, Box 2471, Cleveland 12, Ohio.

137 WAYS To make money, in home or office, business of your own. Full particulars free. Elite Co., 220 Grand St., New York 13.

BRUSH Plating outfits connect to a battery. No tanks necessary. Good paying business at home plating autoparts, bathroom fixtures, bicycles, reflectors, silvering mirrors. No shop or experience required. Outfits furnished. Free booklet. Gunmetal Co., Ave. H, Decatur, Ill.

MONEYMAKING OPPORTUNITIES

SHELL Jewelry kits. All materials furnished with instructions \$2.60 and \$1.00 postpaid. Most distinctive and complete kit ever offered. Order today. Earn while you learn. Catalogue free. Shell-O-Craft Co., Box 365, Station A, St. Petersburg, Fla.

SCHOOL Seniors—Sell classmates America's most beautiful graduation name cards. Largest selection. 40% commission. Outsells all others. Send for free sample kit. Printcraft, 1425 E. Elm St., Scranton 5, Penna.

WOODSCRAFT Is profitable. Beautiful fan with over 40 petals, carved from one piece of wood, shows how. \$3.00 cash or money order. Woodcraft, Lock Box 322, Seattle 11, Wash.

SEWING Machine repairmen make big money lifetime. Start neighborhood shop. Complete repair manual, covering all makes, \$1.98 postpaid. Money back guarantee. Sewing Machine Serviceman, Hamilton 9-E, Ohio.

UNPAINTED Wall plaques. Dime brings sample pair and list. William Grunditz, 12783 Filbert, Detroit 5, Mich.

START Your own business! Big money manufacturing novelties, plaques, statuary. Free catalog. Write Bing Products,

FLOCK Finishing is easy. Supplies, equipment, instructions. Coast Industries, Los Angeles 44.

HOW To set up and run a mirror shop! Resilver mirrors. For price write—John Sprinkle V65, Marion, Indiana.

SPARE Time home work plans. Write Business Plans Company, 1242 Park, San Jose, California.

WHOLESALE Catalog 10c (illustrated). Bargains galore. Stafford, Box 5211-A, Indianapolis 1, Ind.

LEARN To make seashell jewelry, pins, earrings, hair ornaments, novelties. Book of instructions and designs free with \$2.00 and \$5.00 kits, postpaid. Herbert Diamond Co., Box 4619, Miami 31, Florida.

BIG Money. Venetian blinds. Mail \$6.75 sample, instructions. Wally's Blinds, 1022 Rt. 11, Portland, Oregon.

BIG Mail including mail order magazines 10c. Mallo, 767-PM Leith, Flint 5, Mich.

GIGANTIC Mails, trade magazines, opportunities galore 15c. Jackson, Newfoundland, Kentucky.

MONEY Raising sales plan for church groups, P.T.A., auxiliary clubs, direct salesmen. Sell the Magic Wand floor waxer. Write for free facts. Amspeco, Amherst, Ohio.

SAWDUST—Quarter brings list firms buying sawdust. Smith, 375, Williamson, W. Va.

SURPRISINGLY Unusual moneymaking books. Free lists. Ralph Underhill, Beebe, Arkansas.

EARN Up to \$480 month part or full time keeping books for small firms. Simplified system. Write Tax-Saver System, Dept. F, Ft. Worth, Texas.

EARN Money with colorful handmade jewelry. Free circular tells how! Nothing complicated. Dollar starts you! Plastic Works, 712 Kimball, Danville 3, Illinois.

FREE Details, original, profitable business. Willis, Rt. 14, Box 595A, Milwaukee 14, Wisc.

VETERANS! Don't miss your greatest opportunity. For information on the amazing possibilities for income and profit in your loan guaranty, write H. B. Smith, Box 747, Dept. O, Youngstown, Ohio.

RAISE Money easily—For club, school, church, Legion, hospital—with fast-selling Writewell specialties. Plan, samples, free. Writewell, 240 Transit Bldg., Boston.

YOUR Own business distributing free menus. Instructions \$3.00. Reliable Menu Co., Box 124, Champaign, Ill.

ASHES. Turn them into cash. Instructions 25c. Charles, 12-AS, Norwood, Ohio.

315 GOLDEN Opportunities. How to make money, selling by mail. Send for free details. August Warren, P.O. Box 6M, New York 19, N. Y.

EARN While you learn clock repairing. With our method your income can start immediately. Write Akron Clock Clinic, 964 Wye Dr., Akron 3, Ohio.

FREE Booklet! Biggest opportunity quick money! Collection 137 sure-fire plans, secrets, formulas. Stamp. Twin Parks, Box 4696-Z, Dallas 6.

EARN Money evenings, copying and duplicating comic cartoons for advertisers. Adservice, Argyle 1, Wisconsin.

EARN Up to \$2,000 year, inventing simple items. Special cash markets. Hendrickson, Argyle 7, Wisconsin.

I MAKE Big money in the mail-order business. You can do the same at home with my copyrighted system. Write me. I'll tell you how. F. Little, R.D. #1, Glenshaw, Penna.

START Home mail business! Exclusive setups built-to-order for financially responsible beginners, by leading M.O. Association's expert staff. Booklet free! N.M.D.A., 33-B Vassar, Dorchester, Mass.

1947 GIGANTIC Directory of opportunities, advertisers' supplies, sources, trade information, mail order ideas, products, wholesalers, valuable tips—just published! Descriptive literature free. Wilkin & Co., Hillsboro, Ohio.

REVOLUTIONARY Mail order plan! This isn't guess work but a newly-tested practical idea that can help you put extra dollars into your pocket every day. Quick action necessary. Send for convincing details today. Kutz, National Mail Sales Service, P.O. Box 2001, Natural Bridge, St. Louis, Mo.

METALLIZE Baby shoes. Further information free. Metal Crafts, 5501 Suwanee, Tampa, Fla.

WHOLESALE Anything imaginable. New guaranteed list 25c. Refundable. La-

EXTRA Money. Send for new plan. Free. Inspirational Books, Box 106 Old Chelsea Station, New York 11, N. Y.

WOULD You pay 3¢—first \$350 made? Color-illustrated book "505 Odd Successful Enterprises" free! Proven! Work at home, office. Expect something odd! Pacific, Oceanside, Calif.

MAKE Big money. Build your own lamps and sell. Write for free factory photos. Buddy Products Mfg. Co., Dept. 25, 1123 West Belmont, Chicago, Ill.

BEAT Higher costs of living by extra money, spare time, own home, no personal contacts. Provenly successful methods. Write Postway, Box 882, Fort Worth, Texas.

THOUSANDS Articles wholesale. "Supply Source Directory", 10c. Ideal Service, Park Ridge 40, Illinois.

WHY Earn profits for somebody else? Build your own business, spare or full time. Small capital start, grow big! Be your own boss! Start today! Details free! Elliott, 177 Columbia, Edgewood 5, R. I.

METALLIZE Flowers for profit! It's new, easy, sure fire! Free details. Joseph B. Kushner, Metal Finishing Consultant, Stroudsburg 3, Pennsylvania.

EARN Money at home! Thousands dol. Free details. Sizemore, Box 7, 4917 Kostner, Chicago 30.

WIN Money on contests advertised in magazines and on radio. General Contest Bulletin, published monthly, gives hundreds of tips. Lists current contests and rules. Sample 25c. General Contests, 1609 1/2 East 5th, Duluth, Minn.

EXCELLENT Profits raising mink. Details furnished. Franklin Young, Riverhead, New York.

MANUFACTURE Costume jewelry at home for profit, hobby, therapy. Free wholesale supply catalogue. Instructions. Florida Supply House, Bradenton, Florida.

\$25 WEEKLY Working two hours daily. No canvassing or manufacturing. Lycke, Box 2471, Cleveland 12, Ohio.

THERE'S Big money in junk," and repairing batteries. Write, Batteryman, Grand Junction 5, Colorado.

\$246.50 MAKING Unusual secret device without skill, machinery, from former war material costing \$1.50! Simple, baffling invention, unbelievably profitable! Illustrated proofs free. Rolls Enterprises, 115-D West 16th, New York 11.

EARN Money at home—steady income. Write Successful Income Builders, 508-A, Hollywood 28, California.

FORTIFY The future! Start own business; home, office. Booklet describing "Collection of 137 Tested Plans" free. Elite Co., 220-A Grand St., New York 13.

PUBLISH Your own magazine. Hand-some 52 page format, well edited, illustrated. Cost low as \$1.00 month. Brings you prestige, profits. 25c brings sample. Details. National. Ord. Nebr.

AMAZING Possibilities! Greater profits spare or full time. New sensation gives "easy carving" safely-handly refrigerator "storage drawer." Cox Enterprises, 601E S. Vermont, Los Angeles 5.

FORMULAS, PLANS, ETC.

HORSERADISH And beet relish. Delicious, appetizing, make it at home. Send 50c in coin for recipe. John Bock, 1108 East 35th Street, Tacoma 4, Wash.

MARBLEHEAD Fish chowder. Delicious. Economical. Personal recipe 25c. Rosamond C. Hodges, Marblehead, Mass.

PHOTO Kit prints any photo on cloth, paper, etc. \$1.49. Formula \$1.00. Mediant Company, Box 123 Blythebourne Station, Brooklyn 19, N. Y.

NEED Chemists? Formulas? Analyses? Products duplicated? Consulting Scientific Company, Swarthmore, Penna.

THOUSANDS Formulas, plans, trade secrets. Free literature. Kogan, 1032-DF, New York 8.

FORMULAS, 15 Money-makers 25c. Willies, Rt. 14 Box 595A, Milwaukee 14, Wis.

100 SINGLE Ingredient formulas, 25c. Tes-Co., Box 189-MS, Wilkes-Barre, Penna.

ROOFING, 100% Fireproof, low cost, lasts indefinitely; make yourself; formula with instructions. \$1.00. Ray Roofing Co., P.O. Box 255 Petersburg, N. Y.

21 POPCORN, Candy apple, etc. formulas. All money-makers. \$1.00. We can supply equipment. Concession Supply Co., Dept. "A," Box 133 Sta. "B," Toledo, O.

MANUFACTURE Cleaners, soaps, polishes, flavors, cosmetics. Literature free. Kemico Park Ridge 16, Illinois.

10,000 FORMULAS And trade secrets. Free literature. Stillman, 555 Kingston Ave., Brooklyn 3, N. Y.

REAL Manufacturing formulas. Lists free. Cummings, Chemist, Gordon Ave., Syracuse 4, N. Y.

PLASTICS

PLEXIGLAS Masked sheets 12"x12"—1/16" — \$1.00, 1/8" — \$1.25, 3/16" — \$1.55; 1/4" — \$1.85. Include 10% postage. Dyes, rods, cements, shells, buffing compounds, jewelry findings, tools. Free listings. Craft Plastics, Box 129-P, Somerville, New Jersey.

RENEW Leather and leatherette—Make cloth into imitation leather with plastic discovery called Leather-New. Opportunity to make real profits taking care of sales resulting from national advertising. Write for free sample of Leather-New covered material and complete deal. 704 Land Bank, Kansas City, Missouri.

PLASTIC—Sheets, rods, tubes, etc. Free list. Plastic Supply Co., 2618 St. Louis Ave., St. Louis 6, Mo.

TEN Fascinating detailed Plexiglas projects, \$1. Original Plasticplans, Box 181, Cincinnati 1, Ohio.

PLASTIC Costume jewelry, beautiful designs. Free catalogue. Howard Schultz, 115-83 229 St., St. Albans 11, N. Y.

PLASTICS, Supplies, kits. List. Plasmet Sales and Engineering, 4648 Shirley Pl., St. Louis 15, Mo.

CEMENT For Plexiglas, lucite. Red, yellow, blue, clear. 2 oz. each of any three, \$1.00, postpaid. McCormick, 3328 N. Newhall St., Milwaukee 11, Wis.

LEARN Internal carving of plastics for pleasure and profit. It's easy. Exciting. Carve flowers, animals, landscapes of colorful, thrilling beauty in solid Plexiglas plaques and cubes. Send 10c for complete instructions folder, plus jewelry findings catalog and big plastics price list. Plastic Parts, Dept. H-29, 1157 S. Kingshighway, St. Louis 10, Mo.

PLASTICS—Sheets and rods, 8 colors. Stamp brings free list. Hanson Plastics, 7625 South Parkway, Chicago 19, Dept. 90.

WONDERFUL New thermoplastic. Literature free. Sample 25c. Jalco, 161 Dille, Memphis, Tenn.

PLASTICS Trade secrets. Write for free details. Plastics Research, Box 346, Alhambra, Calif.

EDUCATIONAL Offer! Learn by doing! Sample kit containing odorless resin, accelerator, rubber mold, dye, lubricant plus all equipment necessary to make quick castings in lustrous Formalin! Complete with instructions and price lists for quantity orders of these excellent plastics casting materials: \$3.00 f.o.b. Formalin, Romeo, Michigan.

LUCITE —Findings, Tenite rods-tubes, catalog dime, refunded first order. Special offer. Mid-West Plastic Supply, 1717 No. 66th, Omaha 4, Nebr.

PLASTIC Injection machines; toy, industrial, commercial. Jewelry findings, Plexiglas, dyes, Polystyrene rods; tenite; kits, etc. Low prices. Free list. G. Baker Company, River Edge, New Jersey.

METALLIZE Plastics for profit! Free particulars. Joseph B. Kushner, Metal Finishing Consultant, Stroudsburg 3, Pennsylvania.

MAKE Money assembling our pre-fabricated plastic kits. Sample kit 50c. Catalog free. Fabros, Box 156, Station F-1, Buffalo 12, N. Y.

CHEMISTRY

THE House of Winn, home of supplies for amateur chemists. See Winn's New Idea chemical kits and apparatus outfits for home experimenting. Send 10c for retail catalog. Established 1931. John H. Winn, Dept. 509, 124 West 23rd St., New York 11, N. Y.

GET "Planning Your Laboratory," 25c. Catalog, 10c. Pilgrim Chemical, 348C Edith Avenue, Salt Lake City 4, Utah.

CHEMICALS Of all kinds. Special attention to small orders. Write for free catalogue. Lab Chemical Co., Box 206, Oak Park, Ill.

FREE Catalog: Chemistry, mineralogy, biology. Tracey Laboratories, 1907 Harrison, Evanston, Illinois.

SPECTROSCOPE For quick chemical analysis \$3.00. Cutting Co., Box 457, Campbell 1, Calif.

NEW Laboratory supply catalog of chemicals and apparatus, contains over 5000 items with illustrations, 212 pages. Send 50c. Standard Science Supply Co., 1232 No. Paulina Street, Chicago 22, Ill.

CHEMICALS—LAB. Supplies. New catalogue 10c. Mel-Glo Chemical Co., 258 Fourth Avenue, Brooklyn 15, N. Y.

CHEMICALS And apparatus for industrial, analytical, and private laboratories. Complete supply service for correspondence school students. Send 3c for catalog. Dept. M-43, Biological Supply Co., 1176 Mt. Hope Ave., Rochester 7, New York.

APPARATUS, Chemicals, ounce quantities, catalog 5c. Fleischer's Laboratories, Everett 49, Mass.

HELP WANTED

PATTERN Maker, grader, designer, and cutter. Fine Calif. position for a top man experienced in sweaters and knit sportswear. Gantner & Mattern Co., 1453 Mission St., San Francisco 3, Calif.

SELL Christmas Cards, stationery, gift wraps. Gold imprinting free. Samples on approval. Carleton, 25a W. 17th, Bayonne, N. J.

SALES Engineers to place large unit combustion equipment which pays for itself in from 8 to 30 months. An energetic go-getter should make more than \$7000 (per annum) commissions. Give experience. Address—Sales Manager, P.O. Box 1367, Chicago, Ill.

MAKE More money selling individualized buckles, belts, tie holders, cap badges. Choice of 2000 emblems. Quick profits—repeats. Special outfit offer, write Hook-Fast Products, Dept. A, Columbus 6, Ohio.

AGENTS WANTED

GOLDEN Money making opportunity. Sell friends, others new 1947 assortment 21 irresistible Christmas cards and outstanding 50 for \$1.00 personals. Extraordinary gift wrapping, religious, everyday, economy boxes. Up to 100% profit. Tremendous demand, sensational values. Easy sales. Experience unnecessary. Request free samples name imprinted Christmas cards and customer winning 21 box on approval. Holiday Card Co., 463 Congress Street, Dept. C, Portland, Maine.

AMAZING Daily profits. Big repeat business. Sell top-quality, lowest-priced men's dress, work hosiery, full, part-time. Experience unnecessary. Take orders. We deliver. Outfit free. Write Colt Shoe Company, 242-D9 Purchase, Boston 10, Mass.

"27" AGENTS—Salesmen wanted! Liberal territory allotted. Demonstrate amazing "27 Second" eye glass cleaner. Whirlwind seller. Year's supply in compact only 59c. 2 for \$1.00. \$40.00 per gross—110% profit. 27 Second Cleaner Co., Dept. 49-L, 6337 N. Talman, Chicago 45.

MAKE Money easily. Sell 50 for \$1.00 Christmas cards. Cost you as low as 45c. Big line Christmas and everyday assortments. Sell only 50c to \$1.00—your profit 25c to 55c per box. Extra bonus. Write for free samples personal Christmas cards, name imprinted stationery and leader 21 card Christmas, 16 card feature all-occasion assortments on approval. Special offers. Elmira Greeting Card Co., M-71, Elmira, N. Y.

AGENTS—Big line including food products. Fast selling premium and bargain deals. Low prices. Send card for big outfit offer with gift. Ho-Ro-Co, 2725 Dodier, St. Louis 7, Mo.

CHRISTMAS Cards. Earn big money. Take orders galore from friends. 25 exquisite folders with name, \$1.25. Free samples 10 designs. America's fastest selling 21 Christmas folder box, costs 50c. Sells \$1. Request samples today. Sunshine Art, Dept. E-9, 115 Fulton St., New York 8, N. Y.

BUILD Your own local shoe business. No investment. Free outfit starts you. Advance commissions plus bonus. Amazing comfort features. Tanners Shoes, 100, Boston, Mass.

AMAZING New Glow in the dark house numbers, switch plates, decals, pictures, religious articles, etc. Factory representative wanted. Wonderful opportunity. Free samples. Madison Mills, 303 Fourth Avenue, New York, N. Y.

AT Last! Something new and sensational in Christmas cards. Amazing "Oilette" cards. Like costly oil paintings. Designs never before offered. Quick orders. Beautiful 50 for \$1 cards, name imprinted. Big profits. 20 other assortments 60c to \$1. Samples on approval. Puro Co., 2801 Locust, Dept. 740L, St. Louis, Mo.

SELL Ultra blue stock signs to stores, 1000 slogans, comedy, general, religious. 7x11, cost 6c, sells 35c. Make money. Sample free. Lowy, 8 West Broadway, Dept. 333, New York City 7.

YOU Make \$25 for selling fifty \$1.00 boxes. 50 beautiful assorted Christmas cards sell for only \$1.00, your profit 50c. Write today for free samples 50 and 25 for \$1.00 and other boxes on approval. It costs nothing to try. Cheerful Card Co., 157, White Plains, N. Y.

QUICK Money—Profit to 100%, bonus. Sell friends peak value Christmas, everyday cards, gift wrappings, stationery. Free samples 50 and 25 for \$1.00 personals, etching-type Christmas card, initial stationery. 21-card \$1.00 Christmas, 14-card \$1.00 everyday assortments on approval. Special offers. Regal Greeting Card Co., 17394 Mendota Ave., Dept. B, Detroit, Mich.

EVERY Housewife a prospect for Automatic Speede-waxer. Send for details two big profit sales plans. Darby Mfg. Corp., 241 Centre St., New York 13, N. Y.

IMMEDIATE Big profits! Full or part time. Take orders for amazingly beautiful hardwood laminated lifetime plastic reproductions of any picture or negative. Customers everywhere! Write now, Gotham Products, Dept. A, Box 5427, Philadelphia 43, Penna.

CHRISTMAS Cards. Earn \$5.00 with every ten 21 card \$1.00 boxes you sell. Also new plastic cards, wrappings, imprint cards. Write for samples today. Howard P. Ellis, Dept. PM-10, Pitman, New Jersey.

OUR Business booming! Get in on it now. Take orders Water Saver hose nozzles. Car washers, service stations, greenhouses, homes, factories. Water Master Sales Co., 19465 P4 Ward, Detroit 21, Mich.

CHRISTMAS Card moneymakers. Write for descriptive folder. Greenport Art Company, Dept. 928P, Brooklyn 15, New York.

AMERICA'S Finest stainless steel tableware sells on sight. Money back guarantee. Sales kit \$1.00 deposit. Semco, Box 211, Lynwood, Calif.

BE Amazed. Fast profits selling Miracle Cushion Wonder Worker shoes. Also complete line, men, women, children. Advance commission, bonus. Experience unnecessary. Free outfit. Samples supplied. Paragon Shoes, Dept. M1, 716 Columbus, Boston.

QUICK Cash. Sell friends wonder-value 50 for \$1.00, extraordinary 25 for \$1.00 personal Christmas cards. Personal stationery. 32 sensational money makers. Up to 100% profit. Bonus. Write for 6 free self-selling sample portfolios of 50 for \$1.00 to 25 for \$2.50 name imprinted Christmas cards. Special offers. Rainbow Greeting Card Co., 36 East 12th St., Dept. 17-B, New York.

PAST Seller pocket clip cigarette holder. 20 water proof fillers. Cash in now, write for details. A.I.I. Mfg. Co., Hartington, Nebr.

SILVER Plating liquid. Apply with cloth. Renews silverplated ware. Cleans, silverplates, polishes, one rubbing. Genuine silverplate. Also silverplates brass and copper. Female and male selling representatives wanted. Part or full time. Big profits. Exclusive territory. Sells by demonstrating. Retail and wholesale. Nu-Process Products, Aurora, Illinois.

CHRISTMAS Cards. Earn easy money. New 1947 leading, luxurious, box assortments. Sell on sight. 100% profit. Free literature. Torres, St. Francis Place, Brooklyn, N. Y.

\$50 CASH For selling 100 assortments of 21 Christmas cards at \$1.00. Complete line. Free samples 50 for \$1.00 cards. Special offers. Write today. Hedenkamp, 343 Broadway, Dept. S-21, New York 13.

\$1 STARTS You in business. Sell deluxe ties. 100% wool interlining. Costs you only \$7 per dozen, you make \$5.00 dozen. Send \$1.00 for special introductory offer two deluxe ties. Catalog complete line free. Philip's Neckwear, 20 West 22nd St., Dept. K-15, New York 10.

BE Renewal headquarters for all magazines. Christmas gift sales starting now. Big profits. No experience. No capital needed. Free catalog tells how. Write: McGrount Magazine Agency, Dept. PM-2, Mount Morris, Ill.

AGENTS—Make big money from now on, selling the sensational new low priced transparent plastic table cloth cover. Saves on laundry bills. Every woman a prospect. Sample swatches free. Carwell Products, 330D South Wells, Chicago 6.

SELL 10 Boxes of personalized Xmas cards, and we'll pay you \$8.50. Also 7 other beautiful assortments, 50 and 25 for \$1.00 with name. Free samples. Ed-Brite Co., Dept. C, Mount Vernon, N. Y.

FREE — Mexican novelty curiosities. Fast selling. Exceptional profits. "Products," Apartado 9318, Mexico City, Mex.

SCHOOL Seniors—Earn 40% commission selling classmates America's most beautiful graduation name cards. Largest selection. Outsells all others. Send for free sample kit. Printcraft, 1425 E. Elm St., Scranton 5, Penna.

COMIC Greeting cards. Christmas and everyday. Terrific laugh provokers! People love them. Sensational sellers. 100% or more profit. Write now! Novo Products, 922 Diversey, Chicago, Ill., Dept. 105.

STAINLESS Steel, 17 jewel, water and shockproof wrist watches, radium dialed, with flexible bracelet, only \$17—formerly \$42. Wodicka, 339 East 11 St., New York.

PROFITS To 100%, selling Xmas and everyday greeting card assortments. Details and assortment on approval. Glorian, (Dept. 10) 515 East 45th St., Brooklyn 3, N. Y.

WHITE Shirts, pajamas. Sell direct from manufacturer. Free sales kit. Jarod Mfg. Corp., Rockville Centre 4, New York.

SELL Joe Louis's (champion) cosmetics to colored men and Marva Louis's (his wife) cosmetics to colored women. Sells on sight. 100% profit. Joe Louis Products Co., Dept. P, 6 E. Garfield Blvd., Chicago 15, Ill.

SHINE Shoes without "polish." New invention. Lightning seller. Shoes gleam like mirror. Samples sent on trial. Kristee 113, Akron, Ohio.

100% PROFIT For agents to sell Tip-Toe shoe rubbers! Write for details to the Perry Rubber Company, P.O. Box 182, Dept. P, Massillon, Ohio. Send 50c for sample.

PLASTIC Tablecloth covers, curtains, drapes, baby pants, bowl covers and other plastic articles selling like wildfire! Make big money now! Free details. Write Plastics, Dept. 58J, 206 N. Fourth, St. Louis, Mo.

MAKE UP to \$50 a week in spare time selling greatly in demand oil burners for kitchen stoves. Oil Burner Supply, Box 327, Cambridge, Mass.

AMAZING Daily profits, steady repeat business selling Colt's 216 shoe styles. Featuring Whippets—miracle post-war super-flexible, super-durable quality shoes at \$6.95. Exclusive features make selling easy. Experience unnecessary. Free outfit. Colt Shoes, 601-D9 Atlantic, Boston 10, Mass.

SELL Delicious candies, nuts, gum. Immediate delivery. Write Casterline, 2031-R Sunnyside, Chicago 25, Illinois.

UNUSUAL Photographic products, good profits, free sample. Kingston, 3500 Avenue H, Brooklyn, New York.

AGENTS, Dealers, distributors. Handle Porck Glider Head Rest. No competition. Gilrest Co., 145 East Philadelphia Ave., Youngstown 5, Ohio.

JUST Take orders. We deliver. "Gadgets," 210 5th Ave., New York City.

MAKE Money the easy way. Be an agent. Get our giant 1947 Agent's Guide listing hundreds of large companies hunting agents. Free details. Roy Kramer, 329 Gates, Maryville, Tenn.

"SOLVEX" Cleans dirty hands without water. Exclusive territory. Solvex, Monticello, Iowa.

MANUFACTURER Would like to contact shoe, dry goods, and jewelry stores. Profitable proposition. P. O. Box 4967 Florence Branch, Los Angeles, Calif.

300% PROFIT Selling Miracle cleaning powder to homes, taverns, restaurants, garages, etc. Quick sales. Steady repeats. Henry, 2815 Hudson Blvd, Jersey City 6, N. J.

CHRISTMAS Cards — Earn big money selling personals, boxed assortments. Samples. Lincoln Press, X220 Hartwell, Fall River, Mass.

WINDOW Shades, new, side hemmed, sample 39c. Particulars free. Lin-Tex, Box 51, Greenville Sta., Jersey City 5, N. J.

BIG Money selling "Bobby-Jo" baby shoes. Everything furnished. Tested successful mail plan free. No-Co-Ro, Oakland, 6-M, Calif.

EARN Big money selling new line 1947 greeting and Christmas cards. Liberal bonus. Sample on approval. Forest W. Kimball, New London, N. H.

GET Free folio on 200 money making deals. Success plans. Rare formulas. Write Reynard, 108 Maple, Smithfield, Ohio.

SCHOOL Seniors! Your postal will bring our wonder, Kwick-Sell Cardalog of popular graduation name cards. Biggest profits! Only firm giving free souvenir chest and card case. Don't miss out! Hurry that postal! Craftcards, Box 235(L),

PROFITS And fast sales with famous Timex French Dry Wax Polish. A sensation! Different luster for all new and old cars, furniture, etc. Made by a long-established manufacturer. Good looking package that's a proven fast-seller with plenty of rapid repeat business. Quick and easy to apply. Gives hard, glass-like surface that lasts up to 6 months. Every car-owner, garage, service station, housewife, store-owner a live prospect. Good territories open on a money-making basis for aggressive representatives. Write for full details and quantity prices. Send \$1 for regular \$1.50 size. Money refunded on first order. Fully guaranteed. Timex Products Co., 5504-A Virginia, St. Louis, Mo.

THE Most irresistible gift ever created. Economy Distributing Co., 308A West Superior, Cleveland 13, Ohio.

NO Peddling. No capital. Home spare time work. Instructions 25c. Charles, 12-AT, Norwood, Ohio.

AGENTS. Sell finest food products direct to homes. Successfully sold for 25 years. Big profits. Powerful combination sale plans make sales easy. Permanent repeat business. Samples furnished. Live territories open to distributors. Mother Hubbard Products Co., 4139 Grand, Dept. P.M., Chicago.

DECALS—Name plates for imprinting, window letters, pinups, model plane, made to order. Industrial—good sideline. Poster Stamp Press, 4009 Ogden, Chicago 23, Ill.

DISTRIBUTORS. Fast selling item. 100% profit. Repeats. Details free. Morrison's, Box 9312-N, Station 8, Los Angeles 5, Calif.

DISTRIBUTORS. Unusual \$2.98 photograph product. Fine profits. Repeats. Morrison's, Box 9312-N, Station 8, Los Angeles 5, Calif.

NO Money or experience needed. Spare or full time. Steady income writing orders guaranteed men's hose. Variety 20 styles. We deliver and collect. Liberal advance profit. 33% cash bonus. Write today for complete free sales outfit. Kentcraft, Dept. SM, 44 Court St., Brooklyn 2, N. Y.

SCHOOL Seniors: Sell classmates superb Craftcards for super profits. Write Craftcards, Box 235(AK), Pittsburgh 30 Pennsylvania.

\$50 UP, Spare time. Magic money making opportunity. Sell beautiful personalized Xmas cards, 25 and 50 for \$1. Costs nothing to try. Samples free. Victory Studios, Mt. Vernon, N. Y.

ARE You an agent? Free \$1.00 sample. Burns Company, Johnstown, Pennsylvania.

EARN Steady income selling beautiful nylon hosiery. Amazing written guarantee gives free replacement if Kendex hose runs or snags within guarantee period! No money or experience needed. Full or part time. Write orders. We deliver and collect. Write today for complete free money-making sales outfit. Kendex Co., Dept. 105, Babylon, N. Y.

AGENTS-DISTRIBUTORS: \$28.00 daily possible. Flo-Glo Plastic wood-linoleum finishes. Acme, Box 404, Mount Vernon, N. Y. Puerto Rican Distributor, A. R. Torres & Associates, San Juan, Puerto Rico.

AMAZING New rust remover actually "foams" off rust. Works miracles for metal, fabric. 100% profit. Sales guaranteed. Free details. Arch Macdonald, Box 21, Winnetka, Illinois.

\$20 TO \$30 A day easy; sensational new raised letter nameplate, beautifully framed in mahogany; amazing seller to homes, stores, offices, etc. Get our tested plan. Write to Raised Letter Metal Company, Dept. 200, Fox Bldg., Philadelphia 3, Penna.

SMOKE Without fire. Sensational cigarette invention. Quick money. Safe-Gard, Perry-Payne Bldg., Cleveland 13, Ohio.

CHRISTMAS Cards: America's outstanding lines. Free literature tells all! Evers, Elmhurst, N. Y.

AGENTS—Sell nurses, beauticians, doctors and utility uniforms below store prices. 25% commission. Write Medi-Kote Co., Rockville Centre, N. Y.

HUNDREDS Direct selling, local, mail order money-making plans, ideas, etc., in big 32 page 8 1/2 x 11 magazine. Copy free! Opportunities Preferred, 33-P Vassar, Dorchester, Mass.

A NATURAL! Big money, selling new line one piece, lace plastic tablecloths! Sizes to 54x108. Also women's aprons; novel, embroidered cotton pillow cases. Free "interesting" details. Royalty, Box 748-K, Passaic, N. J.

WE Buy old type Singer sewing machines. Your profit up to \$25.00 on each. Write for literature. Essex Shop, 172

VETS. Students, teachers, men, women. Successfully different. Personally desired. \$5.00 business surprise. Write Dysart's Gift Service, 2352 Hawthorne Ave., Louisville 5, Ky.

BIG Commissions. Boost income quickly. Sell stores, restaurants, bars. Plastic tickets, shelf moulding, menu covers, signs. Write today. Pricing Press, 124 White St., Dept. P, New York 13, N. Y.

DISTRIBUTORS. Unusual \$2.98 photographic product. Levine's, 15-X, Boulevard Station, New York 59, N. Y.

BIG Profits! Plastic lace tablecovers. No laundering. Terrific demand. Free swatches. Star, 261 Fifth Ave., New York.

NEW. Extra money plan. Up to 100% profit showing friends unusual personal Christmas cards, box assortments, gift wrappings, humorous, all occasion, religious, social notes, personalized stationery. Extra bonus. Request free 50 for \$1.00, 25 for \$1.00, 25 for \$1.95 name imprinted Christmas cards and personalized stationery folder. Special offer. Thomas Terry Studios, 60 Union Avenue, Westfield, Mass.

100% PROFIT With new electric gas lighter, eliminates matches, pilot. Write Optical Research Products, Fairview, N. J.

SIGNS. Metallic letters for store windows, trucks, etc. Looks like gold leaf. 3 complete alphabets with numerals and catalog \$2.00. Globe, 61 W. Cordova, Vancouver, B. C., Canada.

AGENTS. Big profits, fast selling plastic aprons and accessories. Free details. Texcraft Co., Manchester, N. H.

300 MONEY Making deals. Ideas, formulas, plans, schemes. Folio free. Formico Service, Box 572, Dayton, Ohio.

MAKE Money taking orders for "C-E Automatic Water Heaters." Write Crane Electric, Eugene 4b, Oregon.

LARGE Variety fast selling items from \$1. Manufacturers, 264-5th Ave., New York.

MAGIC Cleaner and laundry soap deal. Hotter than a firecracker. Big profits. Sample free. Bestco, 5007 Irving Park, Chicago.

AMAZING Spare time earnings, sell name imprinted Christmas cards 50 for \$1.00. Leader box pays to 50c profit. 25 big moneymakers. Stationery. No money or experience needed. Approval samples. Empire Card, 155 Fox, Elmira, N. Y.

CHRISTMAS Card agents! New, exclusive, patented children's linenette books. Four books in attractive packet. Retail 50c. Sample on approval. Also cut-out valentine assortment. Elmcraft Card Co., 5928 South Western, Chicago 36, Illinois.

AMBITIOUS. Sell Xmas cards, stationery, big profits, colored catalog free. Beacon Hill Greetings, 115 Chauncey M, Boston, Mass.

FOOT-MASTER Tablets. Amazing seller to those afflicted with foot trouble. Proven seller 45 years. Good profit. Repeats fast. Write Master Products Co., 6 East Oak Avenue, Moorestown, New Jersey.

EXCELLENT Sideline for printing and advertising salesmen. Decalcomania name plates in small quantities. Great demand. Also, make money with our line of automobile initials and sign letters. Free samples. "Ralco" XL-Roxbury, Boston 19, Mass.

SELL Personal Initialed individualized belts, buckles, cap badges, tie holders, 2,000 emblems to choose. Fast profits. Repeats. Write today special outfit offer. Hookfast Specialties, Box 1425, PM, Providence, Rhode Island.

JUST Out! History of World War II. Huge volume. Popular price. Authentic text. Official photographs. Big profits. Riverside Book Company, Iowa Falls, Iowa.

BIG Bargains for big profits. Over 100 sensational values. Men's used suits \$2.00, pants 35c, topcoats \$1.25, overcoats \$2.00, shoes 20c. Experience unnecessary. Free wholesale catalog. Superior, 1250-B Jefferson, Chicago 7.

90c PROFIT Each \$1 sale. Sell positive mothproofing solution to housewives, stores, agents. Experience unnecessary. Postal brings details. Kinford, Wayne 3, Penna.

GREETING Card agents, "line up" with "Pines" for bigger, better, quicker profits. Rush name, address on postcard today. Box 32, Flushing 5, New York.

AGENTS: Stamping names on pocket-key protectors. Sample check with your name, address, 25c. Stamping outfits. Emblem checks, check-fobs, name plates. Hart Mfg. Co., 303 Decatur St., Brooklyn.

137 COMPLETE Plans for starting own business: local—mail order. Particulars free. Elite Co., 220 Grand St., New York 13.

AGENTS—300 % Profit selling genuine gold window letters; stores and offices. Free samples. Metallic Letter Co., 438-B North Clark, Chicago.

\$3 FIRE Extinguisher; quick sales, wholesale or direct; liberal profits. "Fire-Killer," 109 N. Franklin, Syracuse 1, N. Y.

PLATING Outfits for autoparts, reflectors. Connect to a battery. No tanks necessary. Free booklet and particulars. Gunmetal Co., Ave. N. Decatur, Ill.

GOLD Lacquered window sign letters. Large sizes penny each. New foils. Absolutely beautiful. Free samples. Atlas, 544 W. 79th, Chicago 20.

SELL Personalized soap. Name on every cake. Ideal for gifts. Get sample offer. Dunbar Soap, New Brunswick, N. J.

AGENCIES WANTED

SURE Success! Appoint William Pinau Store, Nukualofa, Friendly Island, Oceania, your distributor, annual sales: \$20,000. Bankers: Bank of New Zealand, Auckland. Interesting lists gratis.

HIGH-GRADE SALESMEN

\$221.90 IN One week—Unusual? Not at all! Just look at one week's earnings of these representatives. SWB \$247.84, JRS \$252.80, HMT \$242.75, HC \$252.93, HET \$319.38, OP \$442.40. Direct mail campaign brings hot leads right into your home. Remarkable product does part of 10 men's work—a "natural" during these labor problem days. Has perfect sales story—sells year 'round. As modern as radar! Free equipment offer! We extend credit, deliver and collect. No capital required—no experience necessary. You make big profit on first sale and full credit on repeat business. Every business, store, home, factory, etc. are prospects. Write John Porter, 2433 Indiana, Dept. 300, Chicago 16, Ill.

BIG Commissions—Selling metal burial vaults to funeral directors. Few customers bring steady year 'round income—almost depression proof. Free information. Write Box 101, Gallon, Ohio.

ADVERTISING Book matches—Cash in on political campaigns. Sell union label matches. Cuts for all businesses and political parties. Free powerhouse selling kit. Low prices. Protection guaranteed on repeat orders. Cash commissions. Superior Match Co., Dept. M97, 7530 Greenwood, Chicago.

AMAZING New zipper shoe sells on sight. Big profits for salesmen. Leads line 200 splendid styles. Territories open. Get free sample outfit. Write. Consolidated Shoe, Dept. S-800, Chippewa Falls, Wis.

MAKE Money selling genuine leather jackets. Prospects everywhere. Top quality, full cut, exclusive features. Big cash commissions. Also 250 styles fine shoes. Sample outfit free. Victor Thomas, Dept. V-814, 610 W. Van Buren St., Chicago 7.

MODERNISTIC Plastic combination name plate and see-in-the-dark house numbers—five transparent colors—Mastercraft lettered in silver. Also honor roll plaques for manufacturers, lodges, etc. Real sellers. Details free. Justice Plastic, 2196-M Parkman, Warren, Ohio.

ADVERTISING Book matches—World's largest direct selling manufacturer of advertising book matches offers opportunity for profitable year 'round selling; every business a prospect. No experience needed to start; full or part time. Factory service. Low prices for high quality; repeats; sales kit furnished. Match Corp. of America, 3433-43 West 48th Place, Dept. E-11, Chicago 32, Illinois.

START Your own business on our capital. Always your own boss. Hundreds average \$6,000 to \$25,000 annual sales. We supply stocks, equipment on credit. 200 home necessities. Selling experience unnecessary to start. Wonderful opportunity to own pleasant, profitable business backed by world-wide industry. Write Rawleigh's, Dept. I-U-PPM, Freeport, Ill.

WAGON Salesmen—Fast moving carded goods and 10c line. Long profits. Free facts. Peerless, 2720 Dodier, St. Louis 7, Mo.

SELL—Rubber balls, balloons, toys, specialties; big profits. Halloween noise-maker cat balloons \$5.90 gross wholesale. 150% profit retail. Ellsworth Balloon Hdqtrs., La Junta, Colorado.

SELL Commercial printing. Good profits. No investment. Every business a prospect. Repeat orders. Modern Press, Box 22, A. Crescent Hill, St. Louis 7, Mo.

SALESMEN—We are in touch with mfrs. who are interested in men who are not afraid of an honest day's work. Contact Jay Wico Products, Logansport, Ind.

MAKE Money in spare time. Dealers wanted—Sell high quality line of athletic footwear and top grade of cowboy boots. Build your own business in spare time. For full particulars—write Sport-Pro, 426 East 4th Street, Dept. P-1, Cincinnati, Ohio.

\$140 A Week clear profit. No stock to buy. Write Old Colony Industries, Stoneham, Mass.

CRACK The market. Famous Rotacut gas mower (Maytag engine)—\$99.50; electric model, \$89.50. New 1948 models. Drop shipments. Prepaid. Sample c.o.d. (net). Secures dealership. Catalog free. Act quick. Farm Products Co., M-2005, Excelsior Springs, Mo.

NEW Invention. Opportunity exclusive selling rights. Ingram, 6774 Taft, Detroit 8, Michigan.

AUTOMATIC Fire extinguishers—new and unique plan for distributors. Wall, ceiling and amazing new dwelling units. Two sizes glass balls. 50% to 60% profits. Freight free. Red Ball Co., Box 1552, Salt Lake City, Utah.

SELL Christmas cards! Choice of forty assortments! Earn 60c on dollar sales! Bulletins free! Elfco, 434 North Wells, Chicago 10.

NEW Amazing personal initialed buckles with belts, cap badges, tie holders, emblems, uniforms, shirts, caps, ties, etc. Big profits. Quick repeats. Easy selling outfits—make fast profits. Write, Hookfast Co., Dept. 12, Roanoke, Virginia.

MAKE Money taking orders for "C-E Automatic Water Heaters." Write Crane Electric, Eugene 4a, Oregon.

BONUS Commissions selling photographic creations. Samples. Creative photography, Box 315, Cooper Station, New York 3, N. Y.

FREE! Latest issue Opportunity Magazine. Salesman's Guide. Inspiring, constructive. Shows how to earn money selling for others or in your own business. Hundreds postwar opportunities. Send name and describe what you have sold or are selling. Illustrated copy sent free. Opportunity Magazine, 620 N. Michigan, Dept. 17, Chicago 11, Ill.

EDUCATIONAL AND INSTRUCTION

MASTER Mathematics—Increase inventive ability, improve schoolwork. Learn to use the slide rule. Simple, practical. Complete course, with free slide rule, \$10.00. Engineering Services, Box 35, N. Y. Airport Station, New York.

GOOD Jobs and a sound substantial future await you in hotel and institutional field. Men and women—all ages—needed for well-paid positions that offer color, excitement, ever-new and fascinating duties. Record-breaking travel means even greater opportunities for trained men and women in hotels, clubs and institutions. Lewis School receiving calls for managers, assistant managers, stewards, hostesses, purchasing agents and 55 other types of important positions! From coast to coast there are important positions that offer splendid opportunities for advancement in a business where you are not dropped because you are over 40. Previous experience proved unnecessary! No need to leave your job to qualify. A good grade school education, plus Lewis Training qualifies you at home, in spare time. Our National Placement Bureau helps to place you—and our amazing Certified Job Plan—actually certifies you will "make good" when placed. Write today for Free book! Veterans: This course approved for veteran's training. Lewis Hotel Training School, Room LS-368, Washington 7, D. C. (First and only school of its kind—now in its 31st year.)

LEARN Oil painting—New economical home study course. Write for information. Carlos Art Academy, Correspondence Division, Watertown, N. Y.

NOW You can have an office. Learn credit-collection business by new home study course. Many earn up to \$5000-\$15,000 annually. Free bulletin. Franklin Credit School, Dept. 202J, Roanoke 7, Va.

TRAIN For aviation mechanics high salaries. This famous school approved for veterans. Immediate enrollment. For information write California Flyers, Dept. M-9, Inglewood, California.

PREPARE For Civil Service Examination. Pay for course after securing position. Write Free School, Kokomo, Ind.

GET A government job! \$1756-\$3021 year. Men-women. Prepare for next examinations. Veterans get preference. 32-page book on civil service free. Franklin Institute, Dept. M24, Rochester, New York.

LEARN Add, subtract, divide, multiply decimals. Amazingly simple patented mathematical method. 50c money back guarantee. Rywell, Harriman, Tenn.

UNCOVER Hidden treasure in service station field. "Making Your Service Station Pay" explains. \$1.00 postpaid. Hughes Enterprises, Box 126, Clear Lake, Iowa.

BECOME A Doctor of Psychology or Metaphysics. Teach secret of contentment, happiness. Win degree of Ps.D. or Ms.D. Solve mental worries. Free book. College of Universal Truth, 5153-C North Clark, Chicago.

3800 LATEST Used correspondence courses. Cat. 50c. EG, Elmford, N. Y.

HOME Study courses. Any vocation. Free bulletin. DeVoto Vocational Schools, 35 Vicente, San Francisco 16, Calif.

70 BONE-BREAKING Secrets of Guerilla self-defense, based on simple method of natural, instinctive impulse action. Free particulars. Inspiration House, 3108 Hillside Road, Harrisburg, Penna.

FOOT Correction course—Extension. Degree. Alaska School of Pedopractic, B-2894, Juneau 1, Alaska.

BEST Training U. S. Hobart Welding School. Complete equipment. Non-profit. G. I. Bill. Write for free booklet. Hobart Welding School, Box M-976, Troy, Ohio.

WRITE For profit. It's fun writing short stories at home. Free booklet. Mr. Hardy, Blackstone Sprague, 1100 So. Wabash, Chicago 5.

CLINE School of Photography, Chattanooga, Tenn. 9 months regular, 3 months special. Also color. G. I. approved.

PIANO Tuning learned quickly at home. Big demand! Empire School, Dept. 5C, Champaign, Ill. Established 1935.

RAPID-CALCULATION Course, only \$1.00. It's dynamite. Osborne College, San Bernardino, California.

BE The one who directs the work of others. Learn industrial engineering. Free booklet gives you details of our money-making course. Herbert G. Hecketsweiler, Management Engineer, 3355 North Olcott Avenue, Chicago 34, Illinois.

HOME Study course, drugless therapy. Free literature. Institute of Drugless Therapy, Tama, Iowa.

LEARN Auctioneering by mail. Sample lesson free. Write Nelson School, Renville, Minn.

GOOD "Used" self-instruction educational books on all subjects bought, sold, rented, exchanged. Satisfaction guaranteed. Complete information and 100-page illustrated bargain catalog free! Write—Nelson Company, Chicago 5.

USED Correspondence courses and educational books bought, sold, rented, catalog free. Educational Exchange, Henagar, Ala.

USED Educational books on all subjects sold, rented, also bought and exchanged. Moneyback guarantee. Write today for free catalog and details. Lee Mountain, Pisgah, Alabama.

INVESTIGATOR Training. Phillips Secret Service, 1917B North Kenneth, Chicago 39, Ill.

BIG Money rebuilding shoes. Help needed everywhere or start big-income business of your own. Learn practical, sure, easy way in 3 months. Anyone from 18-60 years can learn easily. Approved for GI training. Rush postcard today. Modern Shoe Rebuilding School, Est. 1927, 2935 Belmont, Chicago 18, Illinois.

29 LANGUAGES By Linguaphone. Russian, Spanish, Portuguese—Direct conversational method for mastering any language quickly, easily, correctly at home. Available under G.I. Bill of Rights. Send for free book. Linguaphone Institute, 83 RCA Bldg., New York 20.

MEDICAL Laboratory technicians in great demand. We train you in your spare time, in your own home. You can practice while studying. Write for free catalog. Imperial Technical Institute, Box 973-E, Austin, Texas.

LEARN Photo-engraving at home or in oldest, largest school in America. Work for newspaper or establish own profitable business. New Tasope' Photo-Engraving equipment available soon. Write for information. Veterans ask about G.I. training. The Aurora School of Photo-Engraving, Tasope' Bldg., Aurora, Mo.

SECRET Investigation. Experience unnecessary. Investigators particulars free. George Wagner, M 126 West 88th, New York.

PLAYS, STORIES, MANUSCRIPTS

NEW Writers needed. Nonfiction material demand is booming. Many magazine editors buy features and "fillers" from new writers. Our earn as you learn lessons prepare you to meet their requirements. Experience unnecessary. Reasonable price, unexcelled service. Details, sample lesson free on request. Use postcard. No obligation. Comfort Writer's Service, 200-PN S. 7th St., St. Louis 2, Mo.

I WANT New writers to cash hundreds of checks for \$1 to \$100, offered each month. The easiest way to write for pay. No previous experience necessary. Send for free details. No obligation. Saunders M. Cummings, 467-M Independence Bldg., Colorado Springs, Colo.

BUSINESS SERVICE

INCOME Tax, bookkeeping record for any business. Postpaid \$3.75. SA Bookkeeping, 10116 St. Charles Rd., St. Louis 14, Mo.

FOR More business, establish office address, requiring no room, or box number. Rates, \$7.30 and \$14.60 yearly. Co-operative Mail Service, 126 Lexington Avenue, New York 16.

TO Whom it may concern. We will represent you in all principal cities of the world. Representatives wanted. Will send you assignments immediately. James W. Farley, Citizens Bldg., Cleveland 14, Ohio.

CHICAGO Mail address. Also branch office service. Resident agents, business assignments. Forwarding, deliveries. Any legitimate service. Faultless, 3439-p Michigan, Chicago 16.

ADDING Machines, \$21.50. New. Write Brown, Box 1412, Wichita, Kansas.

REPRESENTATION—New York, principal cities, business, personal. Copen, 2030 Valentine, New York 57.

CONFIDENTIAL New York mail-address disclosed. Information. Levitt, 330 East 19th, New York City.

SPECIAL SERVICES

WHOLESALE And manufacturers located, any item, 50c in coin or stamps. Reliable Service, Post Office Box 746, Perth Amboy, New Jersey.

POSTMARK Your mail. "Washington, D. C." Letters mailed here, 10c each Complete (receiving, re-forwarding) service, \$2.00 monthly. "Hawkins," 1300-k Taylor.

GOOD "Used" self-instructional books on all subjects bought, sold, rented, exchanged. Satisfaction guaranteed. Complete information and 100-page illustrated bargain catalog free! Write—Nelson Company, Chicago 5.

CARTOONING, COMMERCIAL ART, SHOWCARD WRITING, SIGN PAINTING

OUR Proven courses, including drawing from blueprints, adapted for training by mail. Write for full details. Laincor Commercial Art School, Central Station Box 1445, Toledo 3, Ohio.

MAKE Up to \$100 weekly cartooning and illustrating at home. No experience necessary. Big, new, simplified method shows you how. Rush name for free trial offer. National Artists Bureau, Box 4248-A, Dallas 8, Texas.

FREE Catalog of cartoon markets, cartooning courses, artists' books and materials. Write now. Lawrence Publications, Box 22-AA, New York 23, N. Y.

"HOW To Make Money With Simple Cartoons"—a book everyone who likes to draw should have. It is free; no obligation. Simply address Cartoonists' Exchange, Dept. 99C, Pleasant Hill, Ohio.

COMICS And their creators—Complete story cartooning. \$3.00. Branford Publishers, 6 Beacon Street, Boston, Mass.

LEARN Showcard writing at home in spare time. Fascinating lifetime business of your own. No special skill needed. Free information. Sherwood Publishing Co., Irvington 11-K, N. J.

ARTISTS. Sign men, students! New book contains 130 complete alphabets plus many numerals. New ideas. Saves time. Plastic bound. Only \$1.50 postpaid. Gray & Associates, 1100 Washington, Chicago 7.

PAINT Beautiful pictures quickly, easily, inexpensively. Free literature. Art

ARTISTS—Students: Auto-scale saves half time copying, enlarging, reducing drawings. Guaranteed. \$4. Particulars free. Disco, Box 761, Glendale 5, Calif.

TALENT Test free. American School Commercial Art, Box 8066, Dallas 5, Texas.

MAKE Signs. 9 complete alphabet pattern sets. 3 complete numeral pattern sets and catalog \$1.00. Sign Letter Distributors, P.O. Box 101, Mineola, N. Y.

CHALK Talks. Laugh producing program, \$1.00. Catalog 10c. Balda The Cartoonist, Oshkosh, Wisconsin.

ADVERTISING AGENCIES, LETTER WRITERS, FOR ADVERTISERS

MAILING Lists! Late, guaranteed. Teachers, automobile owners, births, rural, housewives, manufacturers, retailers, etc. Trial 300 \$1.00, 1000 \$7.00. Business Service, 1101 Kings Highway, Shreveport, La.

ADVERTISE: 24 Words, 77 weekly newspapers \$5.00. Write for free rate directory. A. Burton Carnes Advertising Agency, 416 South Michigan Ave., Chicago 5.

ANY Mailing list you want. Mail selling letters, ads, folders—written for you. Print anything. Advertisers, 3439 Michigan, Chicago 16.

INCH Display advertisement Mailorder World, year \$24. Wood's Popular Services, Atlantic City, New Jersey.

MAILING Lists household names, also lists made up of any business, what do you need? 250 for one dollar or \$3 per 1000. Himes Service, 3341 Superior Ave., Cleveland, Ohio.

SPECIALISTS In mail order accounts, large and small. Complete staff artists, copywriters, etc., famous for producing profitable results. No extra costs to dealing with us. Legitimate businesses solicited. Larson Advertising, 315 N. 7th, St. Louis, Mo.

ADVERTISERS! Reach nearly 18,000,000 readers. 25 Sunday national key newspapers, 18 words, \$42.25. "Terrific pullers." 20 popular newspapers, \$8.50. "Free booklet." Special—One inch display 2,821,198 circulation, \$42.00. Newmark's Advertising Agency, (Established 1893) 217-7th Ave., New York 11.

MAIL Order ads, circulars, letters, by leading advertising agency in mail order field. Low prices. Moran Advertising Agency, Box 104, Wilkes-Barre 3, Pennsylvania.

ADVERTISERS: Mail order ad covering United States—2,200,000 circulation—\$28.00 inch. Classified ad, 24 words, 20 metropolitan Sunday newspapers—\$25. Magazine, newspaper, mailing-list ratebook, advertising assistance—free. Chicago Advertising Agency, 20-PM West Jackson, Chicago 4.

ADVERTISE: 24 Words, 40 newspapers \$3.50. Lists free. Advertising Bureau, 229-C Dixon Blvd., Uniontown, Penna.

FREE! 1947 Advertisers Rate and Data Directory. 52 pages! E. H. Brown Advertising Agency, 20 N. Wacker, Chicago 6.

ADS Placed in out of town newspapers and magazines. Low rates. Catalogue free. Ideas that pay. Baker Advertising Agency, Successors Ankrum Agency, 189 W. Madison, Chicago 2.

MAILING Lists, certified, productive, inexpensive, \$5.00 1000. Homeworkers, agents, buyers, etc. Write Dixie Service, King, N. C.

24 WORDS In 64 weeklies \$4.96. H. J. Darnell, 730 Hays, Jackson, Tenn.

TYPEWRITERS, DUPLICATORS, OFFICE DEVICES

"PRINT-O-MATIC" New adjustable model, late model mimeographs, addressographs bought, sold. Write Schubert, 2616 Sunset, Los Angeles 26.

DUPLICATORS \$9.95 Up. (New.) Immediate delivery. "Free circular." Rucker, 2836-PM Slevin, Louisville 12, Ky.

"PRINTOMATIC" Selffeeding post card stencil printing duplicators \$9.50 up. Office size duplicators, Speedoprints, Hilcos, Excellographs \$33.41 up. Literature free. Pittsburgh Typewriter Supply, 336-WK Fourth Avenue, Pittsburgh 22, Penna.

RECONDITIONED Typewriters, mimeograph, multigraph printing devices, appliances, supplies. Catalog. Dixiegraph Service, King, N. Carolina.

RUBBER STAMPS AND OFFICE SUPPLIES

3 LINES 40c; pads 35c; signature \$2.40. Stamp-Right, Wauwatosa, Wis.

SELF-INKING Pocket stamp (with name-address) to print stationery, etc., \$1.50

RUBBER Stamps. Buy direct from manufacturer. Literature free. Lee-Vall Press, Box 1242, Indianapolis 6, Indiana.

PRINTING, MULTIGRAPHING, MIMEOGRAPHING, GUMMED LABELS

PERSONAL Stationery. 50 sheets, 25 envelopes, printed three lines, \$1.00. Sunland, Box 662, Hialeah, Fla.

100-8 $\frac{1}{2}$ x11's MIMEOGRAPHED, \$1.00 Postpaid. Towers, 935 North Fortieth, Philadelphia 4.

100 HAMMERMILL 8 $\frac{1}{2}$ x11 Letterheads or 6 $\frac{3}{4}$ envelopes, \$1.00. Get our quotation first. Free layouts. Beco, 229 Main, Totenville, N. Y.

QUALITY Mimeographing, accurate, reasonable. Riddle, 360 S. Hill, Los Angeles.

MIMEOGRAPHING—Immediate service, 100% accurate, 500 copies \$3.50 postpaid. Booklets, illustrations. Carter Service, 314-39, Latonia, Kentucky.

PERSONALIZED Desk stationery. 125 notes in easel. \$1.00. Petite Notes, Box 149, Hazleton, Penna.

1000 PROCESS Embossed business cards \$4.75 prepaid. Charmick Printing Co., Box 2103, Terminal Annex, Los Angeles 54, Calif.

100 8 $\frac{1}{2}$ x11 HAMMERMILL Letterheads and 100 6 $\frac{3}{4}$ envelopes, \$1.50. W. A. Simons, 1036 Fernwood Ave., Henderson, Ky.

MIMEOGRAPHING — 24 Hour service. Reasonable rates. Free samples. Jay Service, 1028m East 63rd, Chicago 37, Ill.

GET Our printing prices first. Crane, Box 7625, Kansas City 3, Missouri.

250 LETTERHEADS \$1.75. Envelopes same. Mallo, 767 Leith, Flint 5, Mich.

PRINTING? Lowest prices, samples free. Basil Churchill, West Medway, Mass.

500 6 $\frac{3}{4}$ ENVELOPES Printed \$2.35. Mango, 555-A South 20th, Newark 3, N. J.

ENVELOPES Galore, best deal in U.S.A. Letterheads, business cards, same. Send for list. Hyde Park Envelope Printers, 5015 Lake Park, Chicago 15.

MULTIGRAPHING—Samples, including Multigraphic magazine, free. Dougherty, 255 Wash. St., Phillipsburg, N. J.

QUALITY Printing. Reasonable prices. State requirements. Samples. Mero Products, 100 Morrison, Punksutawney, Penna.

OUR Printing satisfies. Complete guaranteed service. Prices and samples free. William Moyer, Alvin, Texas.

125 WATERMARKED 8 $\frac{1}{2}$ x11 Letterheads \$1.00. Envelopes same. Printed. Postpaid. P. Hussey Art and Printing, Abbeville, Mississippi.

MULTIGRAPHING—Printing. Type for multigraph users. Ace Printing, Brentwood, Maryland.

BETTER Grade printing reasonable. Estimates on anything. Economic Press, Leonia, N. J.

MIMEOGRAPHING — Letters, circulars, booklets, pricelists. Lowest prices. Samples free. Martin Mimeo, 3212 Harper, St. Louis 7, Missouri.

QUALITY Printing—Reasonable prices. Fast service on catalogs, folders, publications. Write for prices. Bagby Printing Co., Georgetown, Ohio.

ENVELOPES Printed. Bargain price list free. Michel, Box 76F, New York 16.

100-8 $\frac{1}{2}$ x11 HAMMERMILL Letterheads \$1.00 postpaid. Envelopes same. Race Printing, Hudson, New York.

500 3 $\frac{1}{2}$ x2 $\frac{1}{4}$ FOUR Line gummed stickers, 35c. Moritz Printery, Saginaw, Mich.

1000 BUSINESS Cards \$2.50. prepaid. Reliable Print Shop, 901 E. Jefferson, Louisville 6, Ky.

SEND 10c Now, for our 36-page 1947 pricelist—refunded first order. McCall Press, 1326 South 27th, Omaha, Nebraska.

MIMEOGRAPHING—Letters, pricelists, formulas, instructions. Lowest prices. Lem's Letter Shop, 5710 Stanton, Detroit 8.

PRINTING OUTFITS AND SUPPLIES

PRINT At home—Send 10c for catalogue—presses, type, supplies. Barnhard Co., 6 Columbia St., Newark 5, N. J.

PRINTERS. Make a quick-etch etcher for cuts, halftones. Details. Charles Medlock, Box 256C, Goodland, Indiana.

CUTS—Make real halftones, line cuts yourself! Samples 25c. Particulars free. Rapid Chemical Service, Edwardsville, Ill.

PRINTING Presses, type, supplies. Send dime for complete illustrated printer's supply book, details and press samples. Kelsey, Inc., A-11, Meriden, Connecticut.

HOME Made presses. Write Riegel, 1111 Harrison, Philadelphia 24, Penna.

INEXPENSIVE Home-made printing press. Details free. Novelty Shop, Downsville, Louisiana.

PATENT ATTORNEYS

PATENT Protection—The U. S. Patent Office recommends—"an applicant is advised, unless familiar with such matters, to employ a competent registered Patent Attorney or registered Patent Agent, as the value of patents depends largely upon the skillful preparation of the specification and claims." Preliminary steps to take to obtain patent protection will be sent upon request. Victor J. Evans & Co., 231-K Merlyn Building, Washington 6, D. C.

INVENTORS—Patent laws encourage the development of inventions. The Rules of Practice of the U. S. Patent Office advises—unless an inventor is familiar with such matters—that he employ a competent registered attorney or registered agent, as the value of patents depends largely upon the skillful preparation of the specifications and claims. Write for further particulars as to patent protection and procedure and "Invention Record" form at once. No obligation. McMorro, Berman & Davidson, Registered Patent Attorneys, 134-V Victor Building, Washington 1, D. C.

INVENTORS: Learn how to protect your invention. The United States Patent Office advises the inventor to engage a competent, registered patent attorney or agent to represent him. We maintain a staff of registered patent attorneys ready to serve you in the handling of your patent matters. Special booklet "Patent Guide for the Inventor" containing detailed information concerning patent procedure with "Record of Invention" form will be forwarded upon request—without obligation. Clarence A. O'Brien & Harvey Jacobson, Registered Patent Attorneys, 71B-G District National Building, Washington, D. C.

C. A. SNOW & Co.—M-427, Snow Building, Washington 1, D. C. Registered Patent Attorneys. Write for information.

INVENTORS. For "Record of Invention" form, contact Carl Miller, Registered Patent Attorney, Woolworth Building, New York.

"INVENTOR'S Guide" free on request. Frank Ledermann, Registered Patent Attorney, 154 Nassau St., New York 7, N. Y.

PATENTS. "Proof of Invention" folder mailed without obligation. E. E. Vrooman, Registered Patent Attorney, 871 Woodward Building, Washington 5, D. C.

INVENTORS: Without obligation, write us for information as to what steps an inventor should take to secure a patent. Randolph & Beavers, Registered Patent Attorneys, 21-C Columbian Bldg., Washington 1, D. C.

INVENTORS: Write for free brochure "Evidence of Invention." Labiner, World Building, New York 7.

PATENTS—Trade marks. Irving L. McCathran, 315 McLachlen Bldg., Washington 1, D. C. Registered Patent Attorney.

PATENT And Trade-Mark Practice before U. S. Patent Office. Validity and infringement investigations and opinions. Booklet and form "Evidence of Conception" forwarded upon request. Lancaster, Allwine & Rommel, Registered Patent Attorneys, Suite 411, 815-15th Street, N.W., Washington 5, D. C.

FOR INVENTORS

INVENTORS—Patent laws encourage the development of inventions. The Rules of Practice of the U. S. Patent Office advises—unless an inventor is familiar with such matters—that he employ a competent registered attorney or registered agent, as the value of patents depends largely upon the skillful preparation of the specifications and claims. Write for further particulars as to patent protection and procedure and "Invention Record" form at once. No obligation. McMorro, Berman & Davidson, Registered Patent Attorneys, 134-T Victor Building, Washington 1, D. C.

FREE Pamphlet! How to develop your inventions. Eio Development Company, Department P, Chatham Phoenix Building, Long Island City 1, New York.

SELL Your inventions through "The House of Inventions," 631 3rd Avenue, New York 17.

RELIABLE Patent searches complete with patent copies \$6.00. Protection forms free. Write Raymond L. Smith, Patent Searcher, 703-M Albee Building, Washington 5, D. C.

PATENT Protection—The U. S. Patent Office recommends—"an applicant is advised, unless familiar with such matters, to employ a competent registered Patent Attorney or registered Patent Agent, as the value of patents depends largely upon the skillful preparation of the specification and claims." Preliminary steps to take to obtain patent protection will be sent upon request. Victor J. Evans & Co., 232-K Merlyn Building, Washington 6, D. C.

IDEA Men!—Let's get together and get some money out of our ideas, instead of promises. James Corubia, Lakewood, New Jersey.

UNPATENTED. Patented and patent pending inventions urgently needed. Have hundreds of large manufacturers listed for new inventions. Leslie Buford Stratton, 120-PA South La Salle Street, Chicago 3.

OVER Two thousand needed inventions. 252 pages of ideas, \$2.50 postpaid. Caribooks, Box 56, Fort Hamilton Station, Brooklyn, New York.

HAVE Buyers for practical inventions. Prior patents may kill value of yours. Have patent office search made, cost \$6.00. Unique patent application service includes preparation specifications, claims, drawings, filing and help to sell your invention. Details free. Charles Morton, 11 West 42nd Street, New York.

INVENTIONS Wanted. Patented or pending. Inventors Exchange, Department B, Hartford 1, Connecticut.

INVENTORS: Avoid unnecessary expense. Write for free booklet explaining how our consulting and advisory service can assist you in deriving greatest profit from inventing. Institute of American Inventors, Dept. 40-A, 1926-Eye St. N.W., Washington 6, D. C.

"INVENTOR'S Guide" free on request. Frank Ledermann, Registered Patent Attorney, 154 Nassau St., New York 7, N. Y.

THE Inventor who believes he has a new and useful invention, and needs advice, should consult a competent registered patent attorney. Without obligation, write for full information on how to secure patents and trademarks. Randolph & Beavers, Registered Patent Attorneys, 11-E-Columbian Bldg., Washington 1, D. C.

I SELL Patents. Established in 1900. Charles A. Scott, 773PM Garson Ave., Rochester, N. Y.

INVENTORS: Learn how to protect your invention. The United States Patent Office advises the inventor to engage a competent, registered patent attorney or agent to represent him. We maintain a staff of registered patent attorneys ready to serve you in the handling of your patent matters. Special booklet "Patent Guide for the Inventor" containing detailed information concerning patent procedure with "Record of Invention" form will be forwarded upon request—without obligation. Clarence A. O'Brien & Harvey Jacobson, Registered Patent Attorneys, 71A-G District National Building, Washington, D. C.

HIGHEST Royalties and cash for your inventions when we market them. Free particulars without obligation. Universal Marketing Co., 126 Lexington Ave., New York 16, N. Y.

INVENTIONS WANTED

CASH—Royalty. We manufacture, nationally advertise your ideas, patents. Bonded. Federal Identification Co., Robert Burbridge, Pres., Dept. K1, Burbridge Bldg., Oklahoma City 6, Okla.

INVENTORS — Booklet "Self-Testing Your Patent Or Invention" free on request. Address: Direct Contacts, 11106-A2 Longwood, Chicago 43.

SMALL Inventions wanted by manufacturers. I'll help you sell your invention. Write for circular. Stanley Hull, 7829 Euclid, Cleveland, Ohio.

WANTED — Practical inventions of all kinds. Write John D. & Son, 285 Howard Ave., Box 3213, Dept. PM8, Bridgeport 5, Conn.

MANUFACTURERS Want patented or pending inventions! Send patent copy or complete details. Universal Guaranty Company, Lakewood, New York.

INVENTORS: Hundreds of manufacturers have requested our assistance in locating marketable new products. Complete information, free. Institute of American Inventors, Dept. 40-D, 1926-Eye St. N.W., Washington 6, D. C.

PATENTS FOR SALE

PATS. Pending. Newly designed hammer and tool wedge. Also a new livestock holding tool. National possibilities. Write for further information. Don Christoffer, Spirit Lake, Iowa.

ROACH Trap patent with tooling. Now on market. Sample \$1.00. Wichita Roach Trap Co., 332 S. Holyoke, Wichita, Kansas.

INVENTORS: Test the commercial value of your patented or unpatented inventions, quickly and inexpensively. Write for free information. Institute of American Inventors, Dept. 40-B, 1926-Eye St. N.W., Washington 6, D. C.

MANUFACTURING

MIDWESTERN Manufacturer has facilities for producing new electrical or rubber molded products to your patent specifications. Our production and engineering facilities and nation-wide sales coverage may provide you with the opportunity to have your invention manufactured and marketed by experienced personnel. Write or phone R. L. Long, 322 E. Wayne Street, Maumee, Ohio.

MANUFACTURING. Dies, stampings, tools, special machinery, gear-cutting. Est. 1896. Baums Metal Spec., Kansas City, Mo.

MANUFACTURE Paints, no equipment, capital needed, your garage a factory. Industrial Chemist, 1826 60th, Kenosha, Wis.

ROBBINS Aluminum Foundry, P. O. Box 2446, Denver 1, Colo. Castings made from your patterns.

PERMANENT Moulds for plastics, aluminum castings. Send drawings. Unamit Mould & Machine Company, Bunker Hill, Ill.

EXPERIMENTAL Work, models. Reasonable. Nelson Manufacturing, 948 First, Woodburn, Oregon.

NAME Plates for manufactured products. Etched metal. Ad-Craft, La Crosse, Wis.

MODELS—Small lot manufacturing. Metals, plastics, etc. Milburn, Burlington, Kentucky.

A BRAND New inventor's service. Write for information. J and M Company, Burlington, Kentucky.

MODELS AND MODEL SUPPLIES

AMAZING New book, tells you how to easily build, design, fly gas-propelled model planes. Every kind from cabin job to flying wing. 183 pages, cloth bound. Send only \$2.98 for "Gas Models and Engines." Money back guarantee. Do it now, supply limited. Thomas Y. Crowell Company, 46-P East 29th Street New York 16, N. Y.

BALSA Wood—Generous supply \$1.00. List free. Kaysun, Inc., Dept. PM, Manitowoc, Wis.

PLASTIC Blocks and deadeyes are better. 25c brings samples and lists, refunded. Gullmars, Westhill, Ontario.

CIRCUS Photographs! List and sample 10c. Box 1028, Minneapolis, Minnesota.

DECALS Bargain, plane, P.T. boats insignia, stars, lettering, bomber names, pinups. Set No. 925—worth over \$1.00. Send 50c and 3c stamp. Macha Studio, 4009 Ogden Ave., Chicago 23, Ill.

POWER Models—Steam and gasoline engines, steam traction engine, metals, tools. Catalog 35c. Chas. Cole, Ventura, Calif.

HOBBYCRAFT Lumber, \$1.00, package of 25 pieces cedar or fir, 10 to 24 inches long, 1/8" thick, 2" wide. State size required. Lincoln, Box 172, Baldwin, N. Y.

FREE Estimates on patent models. Wood, metal, plastic. Rogay Industrial Models, 3818 Beecher Street, N.W., Washington 7, D. C.

SHIP Model kits and fittings, most complete stock in New England. Boucher, Fisher, Marine Model and Model Shipways fittings, blueprints and model yacht equipment at standard prices. Send 25c for new illustrated 1947 catalog and price list. Dept. M, James Bliss & Co., Inc., 220 State Street, Boston, Mass.

RAILWAY Models, complete informative catalog HO and O gauge. 128 pages, 35c. Walthers, 247 Erie, Milwaukee, Wisconsin.

LANDLOCKED Sailors! Here's a beautiful, richly illustrated, fully descriptive catalogue of famous model ships—whalers, slavers, corvettes, etc., authentic in every detail. Send for it today. Only 10c. Halesite Yacht Service, Inc., Halesite, Huntington, N. Y.

FUN Building models—Airplanes, trains, ships. Everything furnished. Giant catalog 10c. Ben's Hobby Shop, 72 West Washington, Chicago 2, Illinois.

SHIP Models and yacht supplies complete. Large 64 page catalogue 30c. Bill Wild's, 510 East 11 St., New York City 9.

SHIP and Yacht model fittings; blueprints. Send 25c for illustrated catalog No. 20—listing hundreds of items. A. J. Fisher, 1002-1 Etowah Ave., Royal Oak, Mich.

MINIATURE Steam locomotives, 1/4" 1/8", 3/4" scales. Castings, parts, rail! Thorough drawings with instructions. Catalog 25c. Little Engines, Wilmington, Cal.

HOME CRAFTSMEN

BUILD Your cedar chests, wardrobes, quilt chests from Tennessee cedar. We furnish everything. For anything in cedar, write Craftman Cedar Works, Box 217, Fayetteville, Tenn.

LEATHERWORKER'S Bible. Every leatherworker should own this completely illustrated catalogue combined with valuable instructions and information. Largest in this field. Actual leather samples. \$1.00 postpaid. Satisfaction guaranteed. Artcraft Leather of California, Dept. PM-9, 271 Twelfth St. Oakland 7, Calif.

MAKE Beautiful seashell jewelry! Scores of beautiful things you can make at home. No experience needed. Earn money selling what you make. (Buy wholesale.) Large catalog 10c. Pace's, Box 279-T, Bradenton, Fla.

METAL Workers full size patterns. Giraffe smoking stand 31" high, bird lawn ornament 20", antique drawer pull, ornamental hinge made easy way, small hanging vase holder, sconce candlestick, small shelf. Make of copper, aluminum or iron. Welding unnecessary. Shop tested projects complete with drawings, photographs \$1.00. Reitz and Patzold, Box 3263, Seattle 4, Wash.

MAKE Shell bird pin. Material, instructions, 10c. Oceanshell, Route 1, Box 249A, Rochester, Michigan.

JEWELRY Making simplified. Quality findings, low prices. Large variety pinbacks, earwires, etc. List 10c. Generous assortment \$2. Cameo assortment \$1. Prompt shipments postpaid. Doremby Company, Chisholm 1, Maine.

MAHOGANY—Shipped direct to you from the tropics. Know the pleasure of working with this beautiful wood. Special offer of No. 1 furniture mahogany to home craftsmen. B. Hansbrough, Box 503, Coronado, Calif.

SPECIAL Offer: 80 full size toy, novelty, and lawn ornament patterns only \$1.00. Lynds, Medway, Mass.

LITTLE Husky disc and belt sander for home workshop. Lifetime oilite bearings. Horizontal or vertical. 12" belt and 7" disc. Only \$22.50. Associated Model Mfg., 5 North Sixth St., Philadelphia, Penna.

CELLULOID—New postwar, beautiful assortment, Mottles, opaques, onyx, pearls. Used by ring makers everywhere. One pound assortment—pieces approximately 30 sq. in. each. Price \$1.00. Please add 10c for postage. Craft Service, 337 University Ave., Rochester 7, New York.

OUTDOOR Furniture—Lawn chairs, table and benches, 5 different plans \$1.00. 10—\$2.00. Summercraft Studio, 42 Vernon Street, Newton 58, Mass.

GENUINE Leather scraps for leathercraft items, assorted colors, 6 pounds, \$2.00. Send 10c for sample. International Cushion Co., 515 No. Halsted, Chicago 22, Illinois.

JEWELRY Findings. Lowest prices. George Sassen, 154 Nassau Street, New York 7.

FELT For craftwork, lamp bases, bookends. Felt novelty and catalog one dime. Novelty, 390 Fourth Avenue, New York 16, N. Y.

GUARANTEED: We are America's lowest priced hobby supply house. Write for free price lists. Allcraft Products, Hempstead, New York.

ELECTRIC Pen—Burns: Wood, Plastics, etc. Embosses gold or silver leaf. \$3.00 postpaid. c.o.d.s accepted. Reb Industries, Dept. 265-CD, Elmhurst, Illinois.

WHAT-NOTS Made of wood scraps, 24 inches high, beautiful designs. Full size pattern 30c. 4 assorted patterns \$1. Illustrated folder 10c. Joanness Patterns, P. O. Box 141, Omaha 7, Nebr.

RARE Woods for homecraftsmen. Brazil Rosewood, ebony, cocobolo, beefwood, Goncalo alves, etc. Turnings blocks and dimension. We manufacture every piece ourselves from imported logs. Send for price list. Homecraft Dept. M, The Salisbury Cutlery Handle Co., since 1884, Salisbury, Conn.

NEW 12" Bandsaw; anti-friction bearings; tilting table. Write for circular. Sterling, 2310 W. Warren, Detroit 8, Mich.

SPECIAL—3# Assortment wood screws postpaid in U.S. 79c. Mahogany, walnut, cherry lumber. Veneers. Cedar plywood. Sedlo Company, P.O. Box 7161, New Orleans, La.

DON'T Be Mr. Average man. Be your own boss. Earnings unlimited. Operate from home. \$25.00 adequate investment for immediately earning \$200.00 weekly. Postal brings details. J. T. Van Zile, 79 Mills Street, Morristown, New Jersey.

18" STERLING Silver neck chains, \$4 doz. Pin backs, earwires, gift boxes, supplies. Returnable. M. & P. Mfg. & Supply, 205 University St., Seattle 1, Wash.

LEARN Sea-Shell jewelry and novelty manufacturing. No tools or experience needed. Learn—earn within a week! Complete, beautifully photographed home instruction course, shows you how to make 110 designs of pins, earrings, brooches, hair ornaments, necklaces, bracelets, plaques, ash trays, dolls, animals, miniatures, etc. Explains pearlizing, tinseling, gilding, dyeing, luminous processes. Illustrates 65 species sea shells. Lists 200 raw materials with wholesale prices. Complete course \$1 postpaid. Beginner's kit, \$3 (\$3.50 in Canada). House of Gifts, Box 4550FR, Coral Gables, Fla.

SHELLCRAFT Instruction book and kit for \$6 worth, including 450 Caribbean shells \$1. Satisfaction guaranteed. Shell Company, Miami 36, Florida.

LEATHERCRAFTERS: Ready made leather projects simple to complete are fully illustrated in our 1947 catalog of projects, tools, hides and accessories. Write for free catalog. Ester Leather Company, 145 St. Paul St., Rochester 4, N. Y.

CERAMIC Jewelry supplies, bar pins, ear screws, for ceramic and woodworkers; also glass and seashell assemblers. Free catalog. Philadelphia Badge Co., Dept. B-1, 1007 Filbert St., Philadelphia, Penna.

35 PATTERNS Of action pull toys, trucks, carts, toy furniture, etc. \$1.00. Continental Homecrafters, 907 Birch, Eau Claire 3, Wisconsin.

SHELLCRAFT Beginner's kit with instruction book \$3.00. Price list free. Stelle Shellcraft Industries, 230 Randall Ave., Trenton, N. J.

LEATHERCRAFTERS! Send for free catalog listing leathers, tools, supplies. Kit Kraft, 3203 W. Washington Blvd., Los Angeles 16, Calif.

PLASTIC Jewelry supplies. Free catalog. J & M Novelties, Box 464, Griffith, Indiana.

COPPER Tooling—Material, tools, patterns and instructions \$1.00. Pacific Model Supply, Craft Division, 2509 West Manchester, Inglewood, Calif.

BRASS Rods, tube, sheet for home workshops. Send for catalog 201. Meier Brass, 1155 Bellevue, Detroit 7, Michigan.

WHITTLES'S Supplies, Redicut blanks, special woods, tools. Catalog 10c. Old Whittler, 1402 Charles, La Crosse, Wis.

LEATHERCRAFTERS! Belt kits, projects, leather, supplies. Write for catalog. Art Leather, 411 Joseph Ave., Rochester 5, N. Y.

KNOCKDOWN Cedar chest lumber veneers. Free price list. Giles-Kendall, Huntsville, Ala.

SHELLS, Plastics, findings. Lowest prices. Free catalog. Frances Jones, Box 251, Sarasota, Fla.

EXPERIMENTERS! Interested in electrical, mechanical devices from war surplus? List free. F. Siefke, Box 18, Station E, Buffalo 11, N. Y.

MAKE Shell jewelry—for gifts, as a hobby or start a business. Free catalogue and price list. Complete illustrated book of instructions 75c. Florida Shellcraft Company, Box 1840, Sarasota, Florida.

MAKE IT YOURSELF

BUILD Concrete block machine, motor vibrator or hand. Easy. Inexpensive. Capacity two blocks per minute. Complete plans, photos and instructions \$3.50 postpaid, or write Clyde Lee, Mountain View-8, Oklahoma.

OIL Drum concrete mixer. Details free. Mitkos, 8802 Corwin, Jennings 21, Mo.

BUILD Concrete block machines, portable sawmills, Shop, farm, home machines, 70 plans. Catalog-handbook free. Nichols Equipment Co., Dept. 210, Purvis, Miss.

GRANDFATHER Clock "Spirit of Century" plans with Westminster weight movement pictured. Prices \$1. Kuempel Chime Clocks, Minneapolis 16, Minn.

HOT Water free—from sunlight system. Efficient any locality year 'round. Standard materials, easily built, low cost. Facts free. Solar Water Co., Box 175, Dept. L, Coral Gables, Florida.

PUMACRETE—Most economical method of building. Build own home, other buildings. Build for others at high profits. Inexpensive equipment. Details free. Stamp appreciated. Earl Behling, General Contractor, Box 955, Inglewood, Calif.

COUCHES—Convert boxsprings easily, inexpensively, into space saving Hollywood couches or divans. Free literature. Gutman Company, 1216 Park Row Building, New York 7.

"CONCRETE Block Homes," 24 page booklet: drawings, instructions on how to build. \$1.00. H. C. Lightfoot, Civil Engineer, Richboro 1, Penna.

PLANS AND BLUEPRINTS

YOUR Own home—Rental unit \$990.00 U-Build-It Cottage, 21x24, with plumbing and electricity. Blueprints available. Construction details, diagrams, bill materials. Complete \$1.00 postpaid. U-Build-It, Box 748, Los Angeles 28, California.

FOR THE HOME

VENETIAN Blinds; custom built; samples; Blind Man, Oradell, N. J.

WATCHES, OLD GOLD, JEWELRY

EXPERT Repairing, chronographs a specialty. One week service. All work guaranteed. Send your trial order. Estimates submitted before we proceed. Royal Watch Co., 29 Forsyth St., New York 2, N. Y.

WATCHMAKERS Don't be without B&M hairspring straightening vise. Price \$4.50. Meyer Mfg. Co., 3911 N. Figueroa St., Los Angeles 31, Calif.

WATCHMAKERS' Journal containing helpful hints on watch repairing. Sample copy 15c. Dean Co., 116 Nassau St. New York 7, New York.

SAVE 35-50% Original price, Bulova, Elgin, Waltham, Hamilton rebuilt-like-new pocket or wrist watch; lady's, man's late styles; gift boxed; long service, accuracy, guaranteed. Catalogue free. Brookings, BX-1975B, Little Rock, Ark.

NEW Jewelry for old. Let us put your old jewelry and watches in like new condition. Free estimates. Chicago Jewelry Repair, 3317-A No. Clark, Chicago 13.

WATCHES, Materials, tools, bought, sold. Catalog. Gales, Box 1000, Chicago.

HIGH Class jewelry, payment plan. Fairchild Company, Mt. Vernon, Ohio.

GOLD \$35.00 Ounce—Mail old gold teeth, diamonds, jewelry, watches—receive cash by return mail. Satisfaction guaranteed. Free information. Dr. Weisberg's Gold Refining Company, 1500-Q Hennepin, Minneapolis, Minn.

GEMS, Precious and semi-precious, all genuine, from world wide sources. Deal direct, no overhead, save money. Catalog 10c. Hill Co., Route 7, Salem, Oregon.

CASH For old, broken jewelry. Highest prices paid immediately. Mail gold teeth, watches, rings, silverware, diamonds, spectacles. Satisfaction guaranteed. Information free. Rose Smelting Co., 29-A East Madison, Chicago.

WATCH And clock repairing—Complete practical course in modern horology. 66 illustrated self-instruction lessons. Just out! Low price. Fascinating 100-page illustrated catalog free! Write—Nelson Company, Dept. 3-02, Chicago 5.

WATCH Repairing easy learned by our home study course. Watch repairers are in demand and are among the highest paid craftsmen today. Write for free information. Houston Chronometer & Watch Co., P.O. Box 1140A, Houston 1, Texas.

RAZORS, BLADES, SHARPENING

REJUVENATE Your old safety razor stropper. Amazing improvement in many new stroppers. Complete instructions \$1. (no stamps). Northwest Research and Design Laboratories, P. O. Box 866, Chehalis, Washington.

BARBERS—Look. Magic pencil for ezy shave. Smooth, keen cutting. No honing, always sharp. Guarantee. Price 50c. 211 W. Wilhelminia St., Anaheim, Calif.

TOBACCO, SMOKERS' SUPPLIES

NEW Condenser design pure smoke pipe. Positively no saliva can get into bowl. Condenses and traps tobacco tars while cooling smoke. Imported brier \$7.50 to \$25.00. Pure Smoke Pipe Plant, 220 South 3rd Street, West Newton, Penna.

28" METAL Smoker. Unusual! Attractive! \$1.95 postpaid. Brumar, 2734 New England, Chicago 35, Ill.

CIGARS—Imported. 50 Coronas \$3.60 postpaid. Grebne Distributors, 1410 Ardmore, Grand Rapids 7, Mich.

FOR SALE MISCELLANEOUS

HULL Automobile compass, for accurate road direction, brand new, \$2.50. Prisms for 6x30 or 8x30 binoculars, brand new, \$1.50 each. Offset prisms to be attached to 7x50 B. & L. binoculars, gives double the field of the ordinary 7x50 binocular. Cost \$98.00, special, \$25.00. Green sunshades for binoculars size 6x30 and 7x50 snap on type, value \$7.50, special \$1.25 per pair. Forward money order. No c.o.d. shipments. Send coin \$1.25 for third annual edition of Gun Digest together with our complete catalog or new and used guns, ammunition, rifles, binoculars and powder flasks. Our separate catalog 25c. Public Sport Shops, 13 S. 16th St., Philadelphia, Penna.

SPONGE Rubber boxes. All new! Consists of over 1 pound of $\frac{3}{8}$ " thick rubber. Useful for countless purposes. Such as shock absorbers, upholstering, kneepads. Special! Minimum order, 6 for \$2.50. No c.o.d. "Amazing Bachman's," 23 Herman Street, Rochester 5, N. Y.

GOVERNMENT Surplus wooden tripods with adjustable metal legs. Used by government for engineers' levels and transit, $5\frac{1}{2}$ foot extension. Very strong. Can be used for holding telescopes, cameras, etc. Value \$24.50, special \$4.95, postpaid. Send coin \$1.25 for third annual edition of Gun Digest together with our complete catalog of new and used guns, ammunition, rifles, binoculars and powder flasks. Our separate catalog 25c. Public Sport Shops, 13 S. 16th Street, Philadelphia, Penna.

WANTED—MISCELLANEOUS

MERCURY (Quicksilver). Write for quotation stating quantity. Metallurgical Products Co., 35th and Moore Sts., Philadelphia, Penna.

PERSONAL

EMBOSS Signatures on stationery, invitations, etc., in gold or silver. Sample kit 25c. Tri-color Emboss-em kit \$1.00. Francine, Box 6460, Pittsburgh 12, Pennsylvania.

PARIS, France—Remail service. Personal or business. Letters 2 for \$1.00, monthly rate \$4.00. Cards 3 for \$1.00, you address, return, remail free. Richard Dechant, Dept. H, 28, Ave. D'Iena, Paris (16e), France.

MEXICAN Address. Mail received and forwarded. Free information. Photographic postcards 15c. Remailed free. Leather and silver articles. Questions answered about Mexico 50c each. Tillotson, Apartado 1405, Guadalajara, Jalisco, Mexico.

THICKER, Lovelier hair for men and women. All about latest secrets, discoveries free. Write immediately. Henry Bruns, 3307 Fremont, Madison 4, Wisc.

PRETEND Visiting Detroit, Michigan or Pittsburgh. Instructions with three postcards 25c. Francine, Box 6460, Pittsburgh 12, Pennsylvania.

SWAPPERS! Traders!—Free information. "Swappers' Gazette," 2836-PM Slevin, Louisville 12, Kentucky.

STOP Falling hair. Educational pamphlet entitled "How to Keep Your Hair Till Ninety" free. James Hilton, 4819 Fourth Ave., Brooklyn 20, N. Y.

WHY Worry over bills? Control expenses by scientific budget; new, good. Particulars free. Ludecke Co., 5809A Franklin Ave., Hollywood, California.

MEXICAN Law. General Practice Attorney, 1203 Arizona Street, El Paso, Texas.

RESEARCH—Your personal day! Birthdays, weddings. Do you know on what day you were born? We send exact day by copyrighted method, 25c. six for \$1.00. Any person; family, friends. Send accurate month, date, year, for each person. Research Enterprise, Dept. 3, Box 822, Port Arthur, Texas.

VISIT Juarez, Mexico, by proxy. Three postcards 50c. Write Apartado 79, C. Juarez, Chihuahua, Mexico.

GREETINGS From Switzerland welcomed by your friends. Send dollar bill, for 4 postcards, or letters. Beautiful photographs. You write, return, I mail them. Fontana, P.O. Box 80, Zurich, Switzerland.

RUPTURED? Positive comfort, no undertraps, no steel, no elastic. Write Smith Manufacturing Company, Preston, Ontario.

HAIR Falling? Dandruff? Write Trichologist, 137 Lewis St., Phillipsburg, N. J.

HOW You can find out! Information discreetly developed, any matter, person, problem, anywhere. Personal-business assignments, representations, undertaken. Nation-wide. Officially licensed and bonded service established 1922. Reasonable. All inquiries confidential. William Herman, 170 Broadway, New York.

MISCELLANEOUS

MEN'S Shoes, sizes 11½ to 16, widths AA to EEE. Finest quality, prompt delivery. Free circular. Kingsize, 269, Brockton, Massachusetts.

SHOES—Save 30% for entire family—Buy direct; save the retailer's profit. Send for free catalog. Sutton Shoe Co., Dept. A-3, 32 Sutton St., Baltimore, Md.

EMBOSS Your own. Kit \$1.00. Feole, Box 708, Huntington Park, Calif.

GOVERNMENT Surplus. A thousand bargains. Write for list. A card will do. Army, Navy Surplus Goods, 320 13th St., Richmond, Calif.

SEEK Buried treasure. Methods, mysteries, devices explained. Circulars free. Century Press, Box 151-B, Glen Ellyn, Ill.

BEAUTIFUL Colored 8mm. - 16mm. movies. Over 60 subjects. Catalog, 25c. Projection color sample, "Miss America, 1946," \$1.00. World In Color, Box 392, Elmira, N. Y.

SWISS Musical units \$3.25. Music boxes. Novelties of Distinction, 131 W. 42nd, New York City.

TREASURE Quest. 6289 Lafayette St., Ionia, Michigan. Mexican and Alaskan curios.

FIFTY Assorted Ozark view cards, \$1.00. Rayburn, Eureka Springs, Arkansas.

A THOUSAND Laughs. Unique jackass cigarette dispenser. Holds 10 cigarettes. Simply press donkey's head down, tail rises, presto, out slips cigarette. Satisfaction guaranteed. Sent postpaid for \$1.00 with order or \$1.15 c.o.d. Sanimo Industries, Dept. C-14, Spencer, Ind.

NEW Merchandise catalog 6c. R. E. Reese, Emmaus, Penna.

BEAUTIFUL Gold and silver letters will raise before your eyes when you use our embossing kit \$1.00. Sample 25c. The Village Embossing Shop, Jergins Trust Bldg., 100 E. Ocean Ave., Long Beach, Calif.

BEAUTIFUL Fluorescent table lamp. Mail card for descriptive literature. Harold Ampacker, 307 Electric Ave, Lewiston, Penna.

PANNING Gold—Learn how—160 page instruction book, three large blueprints \$3.00 c.o.d. Free illustrated literature. Old Prospector, B-25, Dutch Flat, Calif.

WANTED 10,000 foot sufferers to test custom made research foot balancers at our risk. Amazing foot relief awaits you. Rush name and address for free trial offer. Kindschi Foot Appliances, Dept. A5, 321 W. Jefferson, Dallas 8, Texas.

"CASE For (Genesis) Creation." 85c. Christian Evidence League, Malverne, Calif. New York.

NOW Ready: New, amazing Classified Advertising Record Book—prepared especially for classified advertisers. Here is a book that tells you instantly whether or not your advertising in any publication is paying you real results. You can tell immediately how many inquiries each publication produced—how much cash received from every ad. Spaces are provided for the name and address of the publication, date of issue, space used, rate, cost of ad, key number, etc. You have a complete record of each publication right before your eyes. Plenty of space to keep accurate record of 28 separate publications. You can have a copy by sending only 10c to cover postage and handling. Send for your copy now. W. F. Johnson, Classified Adv. Mgr., Popular Mechanics Magazine, 200 E. Ontario Street, Chicago 11, Illinois.

PENCILS—Individual or firm name. Dozen 60c, two dozen same imprint \$1.00, gross \$4.80 cash. Delivered. Pencil Market, 611 15th Street, Knoxville 16, Tenn.

UNUSUAL Photo novelties, useful souvenir and list 25c. Photo Novelty Co., Box 238, Trinidad, Colo.

RECEIVE Free samples, magazines, catalogues, moneymaking offers! Mail galore! Your name in all our "surefire" mailing lists two years, \$1.00. Four months, 25c. Stanford, 6220-M 16th, Philadelphia 41.

SQUARE Dance instructions, 25 sets, \$1.00. Rayburn, Eureka Springs, Arkansas.

ATOMIC Laboratory—For few cents, in few hours make and operate remarkable atomic energy devices. All absolutely harmless. Easily made, intensely fascinating. Flash chamber. You actually see vivid, frenzied flashes caused by released atomic energy. Instructions \$1.00. Electro-scope; you test minerals, rocks, earth, etc. for atomic activity. Instructions \$1.00. Wilson chamber; phenomenal display of ionized particles in violent action. Instructions \$1.00. Easily understood scientific explanations. All three above with captivating booklet "Essential Atomic Theory." list of easily obtainable material, much other valuable information, \$2.75 complete. Alpha-Atom, 475 Fifth Ave., New York City 17.

ATTENTION! Prospectors-explorers. Do you seek hidden treasures? Construct a U.S. Army type of metallic mine detector from a U.S. Army mine detector amplifier we are offering at ridiculously low prices. Complete amplifier (less tubes and batteries) with battery case and cables; cables, headphone cord and jack (no phones), complete Army wiring diagram. Amplifier type AN/PRS-1. Only \$2.95. Newark Surplus Materials Co., 58 Market St., Dept. M, Newark, N. J.

LUCKY Coin—Lord's Prayer, Ten Commandments, or Crucifixion on penny. 25c each—50c for all three. Peerless, 2726-C Sturtevant, Detroit 6, Mich.

137 SUCCESSFUL Business plans described in free literature. Profit-Builders, 14 Mellen St., Cambridge, Mass.

LIKENESS Reproduced on beautiful stationery \$4.39. Send photo and money order to Virgil Hill, CA Service, Chambers Ave. Ext., Grapeville, Penna.

HERE'S To good luck, a real horseshoe. Can be used for paper weight or token, or hang above doorway, \$1.00 postpaid. Roy Hain, 449 Franklin St., West Reading, Penna.

ALNICO Magnets, eight, plus 100 experiments, \$2.00. Experiments, 25c. Powerful disc magnets, pair \$2.00. Micro switches, 120V. 10A., \$1.00. Eljay, Box 891, Newark 1, N. J.

ENVELOPES. Any kind-size. Lowest prices. Small or large quantities. Write P.O. Box 6410 North Side, Pittsburgh 12, Penna.

BEAUTIFUL All American mats for bars, counters, bowling pits, entrances and doors. Mats made for every known use. Free circulars. South Bend Fabric Mat Co., 2013 W. Ford St., South Bend, Ind.

SAFEGUARD All cylinder locks. Burglarproof, security guaranteed. Secret, \$1.00. Grand Enterprises, Box 313, New Rochelle, N. Y.

INFORMATION. Any subject. The Rox-bys, 747 S. New Hampshire, Los Angeles 5.

CALENDAR 1753 To 2152. 35c postpaid. Tracy Newton, Decatur, Georgia.

BIG Mails, magazines, catalogs, samples. Name listed, 10c. American Directory, Robstown, Texas.

DO You want a better job? Unique psychological scheme speeds prompt preference to your application by personnel departments big companies. Unusual strategy. \$1 complete. James, Lock Box 1141, Glendale, California.

70 BIBLE Lessons, 25c. Bulletin, Box 87, Cathedral Station, New York 25.

BUILD Your house as a hobby. No rent. No mortgage. Save 50%. Use spare time. No special skill required. Amazing facts sent free. H. C. Lightfoot, Civil Engineer, Richboro 1, Penna.

AMAZING New book "Tattooing World" for amateurs, professionals, and breeders. Successful method of removing tattoos. 250 illustrations. Sent in plain wrapper. Only \$1.00. Zeis Studio, 728 Lesley, Rockford, Ill.

WESTERN Belts \$1.00 up. Free list. Southwestern Import Company, P.O. Box 5052, Beacon Hill Station, San Antonio 1, Texas.

"RECEIVE Mail." Moneymaking offers, opportunities, catalogs. Name listed 10c. Ideal Service, 100, Park Ridge, Ill.

MEXICAN Jumping beans. Dozen 25c; hundred \$1.00; thousand \$5.00. Mexican Products, 126 N. Main, Tulsa 3, Oklahoma.

GOOD "Used" self-instruction educational books on all subjects bought, sold, rented, exchanged. Satisfaction guaranteed. Complete information and 100-page illustrated bargain catalog free! Write—Nelson Company, Chicago 5.

BOOKFINDERS! (Scarce, out-of-print unusual books.) Quickly supplied. Send wants. Clifton, Box 1377PMM, Beverly Hills, Calif.

M-SCOPE Metal, mineral locators latest 1947 electronic type ready for immediate shipment. Fisher Research Laboratory, Inc. manufactured some of the finest metal-locators for the U. S. army. Experience gained is yours in the most efficient metal, mineral locator. Free 16-page booklet upon request. Credit plan available. Fisher Research Laboratory, Inc., Palo Alto, California.

PROFESSIONAL TRAINING IN A MINIMUM OF TIME **RADIO-ELECTRONICS TELEVISION • BROADCAST ENGINEERING**

An Accredited Technical Institute nationally recognized for high calibre training. Prepares high school graduates for technical careers. Classes start every Monday. Comprehensive courses in Radio-Electronics Engineering, Broadcast and Television Engineering, Broadcast and Television Servicing; 2,100 hours classroom and laboratory study. Write today for free informative booklet, "RADIO ENGINEERING AS A CAREER."

CAPITOL RADIO ENGINEERING INSTITUTE
DEPT. P-9, 16th STREET & PARK ROAD, N. W. WASHINGTON 10, D. C.



LEARN THE TRADE WITH THE BIGGEST FUTURE!

Your Future's Assured
In any one of these essential, profitable trades—in the fields where there will be the most activity for years to come!

AUTOMOTIVE & TRACTOR
All-inclusive practical training course on latest models automobiles & tractors, complete overhaul, tune-up & service training with modern testing equipment. Includes complete training in all types Automotive Transmissions, Carburetors, Starters, Generators, Hydraulics, Wheel Balancing, Alignment, Brakes, Etc.

ELECTRICAL
We train in house wiring, industrial electricity, power wiring, power motors. You learn by DOING!

DRAFTING
Complete, college-level courses in architectural & mechanical drafting under instructors with engineering degrees.

PLUMBING
All phases: estimating, blueprint reading, lead work, pipes & fittings, plumbing codes, etc.

SHOE REPAIR
In addition to Building & Automotive Trades. A complete shop course. We show you how to open your own shop—at amazingly little cost!

Get Out of That Rut — and Become a Skilled Tradesman with a Lifetime of Good-Paying Jobs and Probably Your Own Business!

Thousands of skilled tradesmen are in great demand now (and will be for many years to come) in the Building and Automotive Industries. Our practical training courses cover all phases of 5 leading fields! Thoroughly trained instructors; references, credentials. Act NOW!

VETERANS! Approved by Veterans Administration. Government-paid tuition & subsistence pay while attending our school! Our references & credentials are tops. Full information on request.

IN ONLY 8 MONTHS YOU'RE READY FOR A FULL-TIME JOB IN YOUR CHOSEN FIELD! — Thorough, practical training courses require only 8 months! (Shoe Repair, 9 months).

5-HOUR CLASSES, 6 DAYS A WEEK permit ample time for outside jobs. Our Employment Dept. helps you. Get part-time work, FREE. Housing Counselor assists in locating living quarters for you during your training.

NATIONAL TRADE SCHOOL
2610 Grand Ave. Kansas City 8, Mo.

Please send me FREE information about your course checked below:

.....Automotive & Tractor
.....ElectricalDrafting
.....PlumbingShoe Repair

NAME.....
ADDRESS.....
CITY.....STATE.....
.....VETERAN. OCCUPATION.....

HERE'S THE FIRST STEP TO YOUR FUTURE—SEND FOR FREE INFORMATION NOW

Master Watchmaking

The life-long profitable trade of thousands as taught by the Sweazey System.

"FAMED THE WORLD OVER"

CHICAGO SCHOOL OF WATCHMAKING

Founded in 1908 by Thomas B. Sweazey

1608 N. Milwaukee Ave., Dept. 197 Chicago 47, Ill.

GO IN BUSINESS

Before you think!!!

Many fail first 6 months. Avoid pitfalls. Get my guidebook to help you succeed. Auditor, business advisor. Methods used as far as Cal. One pointer may prevent your bankruptcy . . . Only \$1.

GROSNICK, Dept. A, 115 State, Springfield 3, Mass.

MAGIC WONDERS EXPOSED!

Amuse! Confuse! Thrill Everyone! Vanishing light, Ghostly Pellet, Magic Smoke, Mystic Watch, Enchanted Match, Spirit writing, Magic Flea, Wizard's Candle, Etc. 32 Magic Lessons 25c. Free with order Big Catalog.

THE MAGICIAN, 2463 Kensington Ave., Dept. C, Philadelphia 25, Pa.

Thrilling Work COLORING PHOTOS



Fascinating vocation learned at home by those with aptitude. Thrilling pastime. National method brings out life-like colors. Free booklet.

NATIONAL PHOTO COLORING SCHOOL
1315 S. Michigan, Dept. 1356, Chicago 5

EASY WINDOW WASHER



Sensational new invention enables you to clean home windows like a professional. MITY-MIST uses water; no costly preparation necessary. Simply spray on window and wipe clean with blade. One-hand operation.

At all hardware, department, and specialty stores or order direct **\$1.00** post-paid

COLUMBIA INDUSTRIES
19th Ave. & 36th St. Long Island City 5, N. Y.

SAY YOU SAW IT IN POPULAR MECHANICS

Here Is a Way YOU Can Get Ready for the BUILDING BOOM

Learn about Earning Opportunities in BUILDING CONTRACTING

FREE FACTS



Do you want to be on the inside in the building boom—where big money is made? Learn about opportunities for Building Contractors whether or not you have previous experience in this field. Millions of dollars are going to be made in home and farm buildings, in construction of stores, garages, small industrial buildings. The building industry uses men with organizing ability by thousands in construction, supervision, management, sales. Properly trained men needed in production, distribution, finance, installation, and marketing.

Easy to Learn in Nationally Known School

Government estimates housing demand at 40 billion dollars! Others are preparing to get in now! Act immediately—get the facts!

HOME BUILDERS TRAINING INSTITUTE, Dept. D29

DIVISION COMMERCIAL TRADES INSTITUTE

1400 W. Greenleaf, Chicago 26, Ill.

USE OUR TRAINING PLAN TO LEARN AT HOME IN YOUR SPARE TIME

Fill Out, Cut Out, Mail Today

FACTS FREE for Men Who Want to Get Ahead
HOME BUILDERS TRAINING INSTITUTE, Dept. D29
1400 Greenleaf, Chicago 26, Illinois

I am interested in the opportunities in the Building Industry. Please send me free information about getting a start as a building contractor.

Name _____

Address _____

City _____ State _____

TELEVISION IN YOUR HOME NOW FOR \$159.50 ONLY Complete



This easy-to-assemble Transvision kit plus a few hours time gives you a highest quality television set . . . at about half the price you'd pay for the lowest priced set on the market! Designed by television experts, this kit contains everything . . . dipole antenna, 7" picture tube, pre-tuned R.F. unit . . . even solder! Nothing extra to buy. All you need is a screw driver and soldering iron. Assembly

instructions are non-technical and simple to follow. All complex units are pre-assembled at Transvision factory.

EQUALS HIGH-PRICED SETS IN PERFORMANCE

Perfectly focused, clear picture even in brightly lit room. Over 9,000 Transvision sets assembled by novices are in perfect operation today. Cabinet available at low cost. Each set has a factory guarantee. Order one now and see the ball games in the comfort of your living room!

BEACON TELEVISION, Inc.

Distributors for Transvision Television Kits

143 East 49 St.

New York 17, N. Y.

MAIL THIS FOR FREE DETAILS

BEACON TELEVISION, INC., Dept. B
143 East 49 St., New York 17, N. Y.

Gentlemen:

I'm interested in your easy-to-assemble Transvision Television Kit. Please send me more information without obligation.

Name _____

Street _____

City _____ State _____

THE THINGS YOU WANT...



Of course you want a home of your own—perhaps a new car—most certainly, happiness and security for your loved ones! Are you assured of these in your present job? If so, you are indeed fortunate. But, if you cannot see this happy future before you, decide right now to study photography at home.

Our Home Study Courses are planned to make your advancement simple and rapid, even if you have had no previous experience. Students receive constant, helpful criticism and practical ideas for the improvement of their work.

Courses include Commercial, Advertising, News, Fashion, Industrial, Portrait, and Color Photography. Our pay-as-you-learn plan is easy on your budget, and no expensive equipment is necessary. Send the coupon today for full details.

RESIDENT TRAINING

Our nine spacious studios and laboratories are devoted exclusively to resident photographic instruction under the guidance of highly-trained, full-time instructors. Write for details stating if eligible under G.I. Bill.

New York Institute of Photography, Dept. 49
10 West 33rd Street
New York 1, N. Y.

Please send me your beautiful four-color catalog illustrating all the different phases of photography and describing N.Y.I. Home Study Courses.

Name _____

Address _____

City _____ Zone _____ State _____
(LEADERSHIP SINCE 1910)



PAIN'T YOUR CAR WITH "WYPE" for \$3.95

Amazing NEW AUTO ENAMEL

You WIPE ON Instead of Brushing & Spraying

Get Beautiful Mirror-Like Finish That Looks Like Spray Job!

At last! Practically anyone can now paint his car with WYPE and get a beautiful high-gloss job that gives you an expensive finish such as is sprayed on by Professional Auto Painters—at a fraction of regular cost! With WYPE you need NO BRUSH, NO SPRAY, NO MASKING! Just WIPE ON with Powder Puff—which we furnish at no extra charge. You get a brilliant, glossy finish that is truly "factory-like." No streaks, No lap-marks. Guaranteed for TWO years not to crack, peel, chip or fade, if simple directions are followed. Takes about an hour to apply. Dries dust-free in an hour. WYPE comes in eight most popular shades including those on newest model cars. Goes over any other color, lacquer or enamel.

NEW MONEY-MAKING BUSINESS!
WYPE 2 CARS DAILY for \$25.00 each—
Gross Up to \$260.00 Weekly Profit!

Start making BIG MONEY Now! Sell WYPE in cans or go into business painting cars yourself (or hire others to do work). Send for FREE details of powerful money-making plan. Why wait! Start now by ordering one quart or more of WYPE!

Color	Price Per Quart
BLACK	\$3.95
GREEN (Brewster-Dark or Jewel-Light)	3.95
BLUE (Washington-Dark or Monticello-Light)	3.95
GRAY	3.95
RED or MAROON	3.95

Order one quart or more today! SEND NO MONEY! Mail penny postcard. Then pay your mailman for WYPE plus postal charges. Or, if you send money with order, WE pay postage. See your dealer or order direct.

WYPE CORP.

Dept. 49-J, 2214 Dolman St.

ST. LOUIS, MO.

2-YR Guarantee

NO MASKING NEEDED

NO STREAKS or LAP-MARKS looks like SPRAY JOB



ANYONE CAN DO BEAUTIFUL JOB

ONE QUART DOES ENTIRE JOB! DRIES TO GLISTENING PROFESSIONAL FINISH!

WYPE is a new Miracle Enamel for Autos. It is NOT a wax or polish but a hard high lustre ENAMEL finish! With WYPE, ANYONE can do a beautiful job! Order a quart to paint your car or to get started in this BIG-MONEY Business!

YOU Pave The Way To INCREASED PAY!

When facts, figures, faces STICK LIKE BURRS, you better your memory, increase your income. And it's so easy with the new, improved SUPER-MEMORY Course. Est. 1938. Send postcard today for FREE details.

THOR BOOKS, M-9, Box 1210, Chicago, Ill.

LEARN ACCOUNTING SALESMANSHIP SECRETARIAL WORK

Assure Your Future Now!

Hill's, one of America's outstanding Business Schools, offers you the opportunity to enter one of the three fields acknowledged to hold substantial earnings and a secure future. Our FREE book, "Through Hill's to Success," tells how and where the best positions are found and how you can qualify for them by study at home or in our resident school. We have thousands of successful graduates and maintain nationwide employment service. G. I. Approved.

FREE WRITE TODAY

USE THIS HANDY COUPON

HILL'S EXTENSION SCHOOL AND BUSINESS UNIVERSITY, 619 W. Main St., Oklahoma City 2, Okla.

Please send me your Free book, "Through Hill's to Success."

NAME _____

ADDRESS _____

CITY _____ STATE _____

NOW YOU TOO CAN BUILD 15 RADIOS

COMPLETE KIT \$14.75

Absolutely No Knowledge of Radio Necessary

You Need NO Additional Parts

The PROGRESSIVE RADIO KIT

is THE ONLY COMPLETE KIT. Contains everything you need. Instruction Book, Metal Chassis, Tubes, Condensers, Resistors and all Radio parts. The 36-Page Book written by Expert Radio Instructors teaches you to build radios in a Professional Manner. You start with a 1-tube receiver. Before you are done with this kit, you will have built 11 Receivers, 1 Public Address System and 3 Transmitters.

SPECIAL FREE OFFER!

Electrical and Radio Tester sent absolutely FREE with each Progressive Radio Kit. PLUS FREE membership in Progressive Radio Club. Entitles you to free expert advice and consultation service with licensed radio technicians.

Write for further information, or ORDER your KIT \$14.75 NOW! ONLY.

Postage prepaid with check or money order

(Postage not prepaid with C.O.D. orders)

PROGRESSIVE ELECTRONICS CO., Dept. PM-2

22 Havemeyer Street

Brooklyn 11, N. Y.

KNOW HOW TO MIX COLORS AND PAINTS

Profitable Professional Help

Mixing colors is an art—a practical necessity for good results and big-money-making. Get this fine book covering color schemes, color harmony and theory, paint and materials, and how to mix them. Complete—practical—helpful. At your bookseller, or send only \$2.50. C.O.D. if you prefer. Money back if not satisfied.

FREDERICK J. DRAKE & Co., Dept. 16

600 W. Van Buren St., Chicago 7

POPULAR MECHANICS

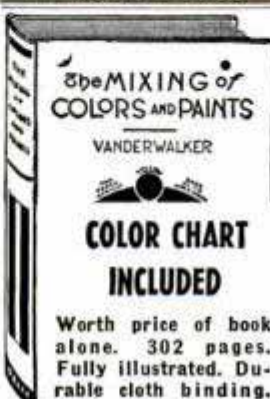

**VETERANS! INCREASE
Your Earning Power!**

**BECOME A SKILLED
AUTOMOTIVE & TRACTOR
CRAFTSMAN in Only 8 Months!**

Growing demand for our Automotive & Tractor Tradesmen! Let us train you for this profitable field. 5-hr., 6-day classes enable you to have a part-time job which our Employment Dept. helps you secure.



Write Now For **FREE** Information About Course Fully Approved by the Veterans Administration

NATIONAL TRADE SCHOOL
2610-A Grand Ave. Kansas City 8, Mo.

**Hollywood
Experts
Help You**

**Make Good in
RADIO-TELEVISION at Home**

Direct from Hollywood, nerve-center of broadcasting, Television, Radio and Sound activities, comes R-T-A's time-proven and tested home training. Here at last—easy to learn, home instruction that quickly qualifies you for steady, good-pay jobs or your own Radio business. Get full details at once! Send postal for **FREE BOOK** "How to Make Good in Radio-Television."

RADIO TRAINING ASS'N OF AMERICA, Dept. PM9
5620 Hollywood Blvd. Hollywood 28, Calif.

Be a NEON Expert



**I'll Show YOU How to
Make \$100 a Week
and UP in NEON**



C. C. Blakely, Executive Director
Acme Neon Institute

★ Today's wide open field for ambitious men who want to make \$100, \$150 and more per week is the colorful, exciting business of Neon. I'll train you for a highly paid place in America's most fascinating industry. At Acme you become a Master Neon Technician. Learn Neon Tube Bending, Color Gassing, Neon Glass Blowing, Cold Cathode Lighting, Bombarding, other important skills.

COAST-TO-COAST OPPORTUNITIES

Demand for Acme Trained Men is greater than we can supply. We're getting calls from coast-to-coast. Today beginners have a once-in-a-lifetime chance to master an art and learn a profession that will pay big dividends for life. Our practical, intensive 500 hour course prepares you for thousands of **BIG MONEY** opportunities. Get a fine job, or go into business. Other Acme Trained Men are succeeding. So can you. Room Assistance for out-of-town students.

Acme Training Approved under the G.I. Bill of Rights. Rush coupon today.

FREE FACTS

Acme Neon Institute
Dept. L-3, 1648 West Van Buren Street
Chicago 12, Illinois

Send me the **FREE FOLDER**, "Your Big Opportunity" plus facts about training me for a highly paid job in Neon.

Name _____
Street _____
City _____



**MAKE MORE MONEY IN
AUTO BODY and
FENDER
REPAIRS**



Get This
Famous
Book Today
**FREE
TRIAL**
in Your
Home
MAIL
COUPON

**QUICK, EASY, LOW COST!
THE HELP YOU NEED!**

Do it now! Get yourself a share of the big money car owners are spending to keep their older cars looking good. Get this famous and practical book that will put you right into this profitable business. No previous experience needed. Get a good job or start a business of your own with little or no capital.

**Covers Methods, Tools, Equipment! Tells How to
Get Business — How to Run a Shop and Make Money**

Thousands of copies in use. A winner everywhere. Written by a man who knows the business thoroughly. Easy to use and easy to understand. Covers the use of tools and equipment, gives approved methods; describes materials and shows you how to actually do a professional job, operate a shop, etc. The very latest information and pictures on all interior and exterior body work and fender repairs—the kind of work people everywhere want and will pay big for when you can do it. Ideal for shop owners and every man who wants to get in on the millions being spent to make old cars look newer. Mail coupon today.

OTHER MONEY-MAKING BOOKS

HOUSE WIRING. New 6th edition. Gives complete, practical instruction. Goes further than most books on subject. Gives National Electric Code. 400 pages. 669 illustrations. Electrical work now at new high. Get this fine book. \$3.00

SHEET METAL LAYOUT. Makes sheet metal layout work so simple that anyone can learn. Get this new instructor and get into the easiest, cleanest and best paying part of all sheet metal work. 143 jobs worked out in drawings and carefully explained. Size of book 8 1/2 x 11 inches. Price \$3.50

GET STARTED NOW

To make money, get into body and fender work now—or one of the other big pay fields covered by these books. Select the book or books you need and order now.

Send No Money • Mail Coupon Today

Goodheart-Willcox Co.

2099 S. Michigan Ave., Dept. 1B, Chicago 16, Ill.

Send books checked C.O.D. including charges. If not satisfactory I will return in 5 days and you will refund money paid. (Outside U.S. remit with order). We will pay all postage charges if remittance accompanies order.

- Body and Fender Repair, \$3.50
- House Wiring, \$3.00
- Sheet Metal Layout, \$3.50

Name _____

Address _____

City _____ Zone _____ State _____

GET INTO DIESEL

AUTOMOTIVE AND ALLIED MECHANICS

GET THIS **FREE** LESSON AND TRY IT. OPPORTUNITY BOOK TOO

Good jobs, interesting and profitable jobs are available for men who really know the new **MOTORS**—Carburetion, Ignition, Fuel-injection and Motor Tune-up. Train NOW to be an **EXPERT** in power and transportation. Send the coupon below for facts packed with opportunity. Learn Diesel, Automotive and Allied Mechanics with—

SHOP METHOD HOME TRAINING

BY A REAL ESTABLISHED RESIDENT SCHOOL

Trained Men are constantly needed to keep this pulsating industry moving ahead. If you are mechanically inclined, you too can find your opportunity by knowing Diesel-electric—Internal Combustion Engines, including Diesel, Gasoline and Butane Types, High-octane fuels—Automotive Drive Systems—developed direct from the Shops and Laboratories of this world-famous training organization. National Schools. Take the first step TODAY! Learn how you may establish yourself successfully in a good job or a business of your own. Get the details. **FREE!**



MAIL OPPORTUNITY COUPON

Paste this on a post card or mail in envelope.

NATIONAL SCHOOLS, Dept. 9-PM
4000 S. Figueroa Street, Los Angeles 37, Calif.

Send me your DIESEL AND MODERN MOTORS book together with a sample lesson **FREE**. I understand I may keep and use this information without obligation.

Name _____ Age _____

Address _____

City _____ State _____

Include zone. Check if Veteran of World War II.

APPROVED FOR TRAINING UNDER GI BILL



GET QUICK STARTS!

Your car will run like a rabbit when you install a set of quick-seating Burd "Graf-Flox" Piston Rings . . . and you'll save on gas and oil too!

Send, today, for free handy booklets for car-owners. Write name and address in margin, clip and mail ad today!



BURD PISTON RING CO., DEPT. PM, ROCKFORD, ILL.



THE OPEN SECRET OF LIFE MASTERY...

Ready to work for you!

Did you know, You do not have to remain as you are? That you can become something better?

Why not wake up and stop being pushed around? Dare to claim good health, the respect of friends and success in your chosen field. Unleash the sleeping powers and energies equal to life's demands. Our Home-Study Self-Discovery-Development Plan may be the very thing you need right now. Money back if you do not get results satisfactory to you. Write for **FREE LECTURE** and full details without obligation, **TODAY.**

School of PERSONAL Psychology

Chartered non-profit correspondence Education
1008-9 Washington Bldg. Louisville 2, Ky.

EARN BIG MONEY! METAL TRADES

Courses offered in:

- Machinist-Toolmaking
- Mechanical Drafting
- Tool and Die Designing & Engineering

Practical training in fully equipped shops and drafting rooms by accredited engineers and instructors. Established two decades.

Approved for Veterans • Day and Evening Classes
Free Employment Service • Dormitory Accommodations
Call or write for Free Bulletin



ALLIED SCHOOL OF MECHANICAL TRADES

42 Allied Bldg., 1338 S. Michigan Ave., Harrison 3915, Chicago 5, Ill.



LEARN To Repair and Service

Electrical Appliances, Sewing machines, motors, bicycles, lawn mowers, saw filing, cutlery grinding, etc.

Postcard Brings Free Details

Start with \$20.00 and a few common tools! Build low cost equipment while earning. Make up to \$6.00 an hour! Complete illustrated course only..... **\$5.50**

5 Days Free Examination C.O.D. 35c Extra
REPAIRMAN'S SERVICE 222-M9 4th Ave.,
Janesville, Wis.

SAY YOU SAW IT IN POPULAR MECHANICS

MEN ARE NEEDED FOR ENGINEERING, RADIO, TELEVISION, ELECTRONICS

Thorough training in radio, including fundamentals, math, repair, sales, broadcasting, communications, with modern laboratory facilities and experienced faculty.

APPROVED FOR VETERANS TRAINING

Moderate tuition and living costs
New Classes Start Each Month

Dept. 3

Albuquerque, New Mexico

EGGERT RADIO INSTITUTE

YOU MAY BE ABLE TO TRIPLE YOUR INCOME IN YOUR SPARE TIME

MAKE BIG MONEY at HOME

FULL OR PART TIME IN A CORNER OF YOUR GARAGE OR BASEMENT

LEARN TO METALIZE BABY SHOES

Heirlooms, Jewelry, Bookends, Novelty Items, Flowers, etc. . . Processing in Bronze, Gold, Silver, Pearl . . . Start a Profitable Business Of Your Own With A Real Future!

No other business gives you such **LARGE RETURNS** for so **LITTLE INVESTED!** Synthetically processed baby shoes retail at approximately \$5.00 per pair. Cost of materials is 5c to 10c per pair. Think—a profit of \$4.90 for your labor!

It's easy to learn (you can learn in your spare time in a few weeks). . . **EASY WORK** (Your equipment does most of the work for you) . . . **EASY TO SELL!** . . .

A NEW FIELD WITH UNLIMITED POSSIBILITIES! Every parent cherishes the first little shoes of their baby and wants them, preserved permanently in this beautiful way. All the "Tricks Of The Trade" and Special Secret Formulas—Now Available To You. **WRITE FOR FREE LITERATURE**

Dept. PM-97, KIKTAVI School of Metallic Arts, 8620 S. Ruthelen Ave., Los Angeles 44, Calif.

COMPLETE KIT OF SUPPLIES INCLUDED





AMBITIOUS MEN! HERE'S YOUR CHANCE TO LEARN ELECTRICITY AT THIS NATIONALLY RECOGNIZED, FAMOUS SCHOOL!

Enrollments Increased! Room For 150 More Who ACT NOW!

Regardless of whether you are a civilian or a "G.I.," it is of vast importance to you, when you invest your money or entitlement, to choose a school like Bailey Technical—a school with a national reputation for highest quality training. Because Bailey Technical Schools are recognized and approved by industry, this increases your possibilities of obtaining the position you want and making rapid, increasingly-profitable progress.

Bailey graduates get the high-paying jobs! Or maybe you want a business of your own. Remember: Bailey Schools teach you basic principles, fundamentals, plus the practical application of theory in actual shop work. You get the "tricks" of the trade which would take years to learn starting at the bottom of the job.

Bailey Technical Schools are approved by the Missouri State Board of Education. G. I. approved. Approved under Public Law 16 (the highest level of acceptance). Approved for State Rehabilitation Training by all states which have a rehabilitation program.

Act now. Send for free catalog. Cut out application at right and mail TODAY!

The BAILEY Technical SCHOOLS
INTERNATIONALLY RECOGNIZED
1651 SO. GRAND BLVD., ST. LOUIS 4, MO.

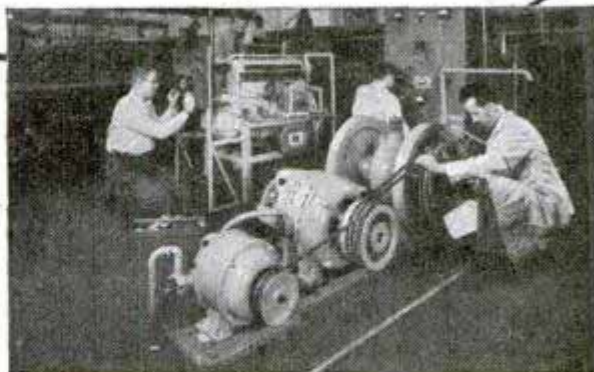

Shop practice at Bailey Electrical School

SEND THIS APPLICATION to:
Bailey Technical Schools, 1651 South Grand Blvd., St. Louis 4, Missouri

Please send me free catalog giving complete information about the Bailey Technical School which I have checked below.

Electricity Diesel Diesel-Electric
 Radio Mechanics Air Conditioning
 Refrigeration

Please send information to:

Name.....
Address.....
..... (2)

LEARN-WATCH REPAIRING AT HOME

FREE information write—American Institute of Specialized Watch Repair—270-276 East Bldg., Grand Rapids, Mich.

CODE SPEED SHORT CUT

Be an expert. Learn to be a Telegraph or Radio Operator. Thousands of men needed. Intensely interesting work—good pay. Learn at home or wherever you are, quickly, easily with the famous Candler Speed System. Book of particulars Free. CANDLER SYSTEM CO., Dept. 5-K, Box 928, Denver 1, Colo., U.S.A.

BIG PAY IN MANAGEMENT

FREE BOOK — Industrial Engineering, The Management Profession — Write for it Today. Top pay for men who get into Factory Management. Booklet contains valuable information for men who want to advance to bigger jobs in business or industry. Learn how you can train for such opportunities as Methods Engineer, Factory Manager, Time study Engineer, Production Engineer, etc. Now is the time to prepare for management positions while industry is rapidly expanding. PLACE-MENT and CONSULTATION services. Learn about Resident and Home Study training programs. APPROVED FOR VETERANS. Write today—request for Booklet and full information does not obligate you.

INDUSTRIAL ENGINEERING COLLEGE, Dept. 19
3309 Washington Blvd. Chicago, Illinois

SAY YOU SAW IT IN POPULAR MECHANICS

BE A BUILDER!
LEARN ESTIMATING AND BLUEPRINT READING AT HOME
Make Money in Building! See This Complete, Simple, Self-Teaching Course in Building, Estimating, Blueprint Reading for 10 Days in Your Own Home!

There is big money to be made in building! New Home and commercial building construction will not equal demand for 5 to 10 years. Contract for building jobs—hire tradesmen to do the work and you take the profits. The Tamblyn System reduces building material and labor costs to simple factors so that you can estimate any job promptly and accurately after you have studied this system. Mail the coupon today and we will send you the complete course, including plans, specifications, estimate sheets, the Building Labor Calculator and complete instructions on a 10-day examination offer. Consultation service free to every student without extra charge.

TAMBLYN SYSTEM, Johnson Bldg., PM4, Denver, Colo.
Send Tamblyn System for 10 days inspection. I enclose \$5.00 deposit and will pay you \$5.00 per month until \$30.00 is paid, if I keep it. I understand my \$5.00 deposit is to be returned to me if I return your course.

NAME.....AGE.....
ADDRESS.....
CITY.....ZONE.....STATE.....

LAW

STUDY AT HOME for PERSONAL SUCCESS and LARGER EARNINGS. 39 years expert instruction—over 108,000 students enrolled. LL.B. Degree awarded. All texts furnished. Easy payments. Send for FREE BOOK. G. I. approved. AMERICAN EXTENSION SCHOOL OF LAW
Dept. 81-M, 646 N. Michigan Ave., Chicago 11, Ill.

DRAW for MONEY... Be an ARTIST!

Trained Artists are Capable of Earning \$50 — \$60 — \$75 OR MORE A WEEK!

You can learn to draw at home in your spare time the well-known WSA way, COMMERCIAL ART, DESIGNING, CARTOONING — all in ONE complete course. No previous art experience necessary—we teach you step-by-step. Prepare now for a fascinating hobby or profitable career. For 33 years WSA graduates have been making good—WHY NOT YOU?

Veterans!
WSA is approved for training under the G.I. Bill

Write today for FREE BOOK, "Art for Pleasure & Profit." It fully describes our up to date course, instruction service, and commercial opportunities for you. TWO ART OUTFITS and other features included with training.

WASHINGTON SCHOOL OF ART, Studio 129H
1115-15th St., N.W., Washington 5, D. C.

Please send me full information and your Free Book, "Art for Pleasure and Profit."

Name.....AGE.....
Street.....
City.....Zone.....State.....
 I am entitled to training under the G. I. Bill.

**Bigger Opportunities
Than Ever in . . .**



**AUTO
BODY
AND
FENDER
REPAIR**

● **THE FIELD IS STILL GROWING** after more than 40 years . . . expanding with the giant auto industry! Millions of new cars are getting to market, millions of old ones are still on the road—**THE NEED for MAN-POWER** in the service field is **INCREASING!**

TRAIN NOW . . . FOR THE OPPORTUNITIES AHEAD!

Don't be stuck in a low-pay job! Opportunity here is big enough for thousands to find big-pay work either in a reliable job or in their own shops. UEI teaches Auto Body & Fender Repairing the *easy* way. No special education or experience needed . . . you can start in your spare time, right at home . . . keep your job while you learn. Then, when home study is finished, you continue at the well-equipped UEI shops getting practical experience. Fix and refinish damage, replace panels and tops. Learn up-to-date methods in use of tools, spray painting, welding, metal work—all under expert supervision.

GET THE FACTS . . . FREE!

UEI HAS TRAINED THOUSANDS for opportunity fields, and students are making good. If you want to get ahead, send coupon today for free facts on **AUTO BODY AND FENDER REPAIRING**. Don't delay!

**AUTOCRAFTS DIVISION
UTILITIES ENGINEERING
INSTITUTE**

2523 Sheffield Ave. Dept. 197-X
Chicago 14, Illinois

Approved for
training under
G. I. Bill

Founded
1927



FILL OUT AND MAIL . . . TODAY!

Autocrafts Division
Utilities Engineering Institute, Dept. 197-X,
2523 Sheffield Ave., Chicago 14, Ill.

Yes, I'm interested! Send me those Free Facts about
Auto Body and Fender Repairing.

NAME _____ Age _____

ADDRESS _____

CITY _____ Zone or
County STATE _____

If veteran of World War II check here
 Check here for Special Information if under 17.

JEWELRY HOBBYISTS

This BEAUTIFULLY ILLUSTRATED **CRAFTS-MASTER'S CATALOG NO. 7** is NEW, DIFFERENT! Contains such items as rosary kits, plastic gems, findings, chains, beads—everything for the serious hobbyist. **SEND 25¢ (REFUNDED ON FIRST ORDER) TODAY!** P. O. BOX 90
PITTSHIRE • PITTSFIELD, MASS.

*The CRAFTSMAN'S
Catalog*

JEWELRY... THE TOUCH OF DISTINCTION

PRICED FOR PLEASURE OR PROFIT!



"LITTLE WONDER" Crystal Radio

NO ELECTRIC—NO BATTERIES—NO TUBES
One of the smallest genuine crystal radio sets in the world. Slider-contact tuning, binding posts for aerial and ground. Extra long range. **SEND NO MONEY.** Just send your name and address and when your "Little Wonder" arrives simply pay the postman \$1.99 plus a few cents postage. Sent prepaid if you inclose check or money order with your order.

MART DISTRIBUTORS

Box 3472 Merchandise Mart, Chicago 54, Illinois, Dept. P15



CARTOON TO SUCCESS!

Learn cartooning from a **PROFESSIONAL!** Let me show you how to create **ORIGINAL** cartoons and **IDEAS**. Send for **FREE** details about course.

Also **CARTOONIST'S MAGAZINE**—lessons, plans and hints. Send 25¢ coin for copy.

CARTOONIST HARTMAN, 2776 California Court, LINCOLN 8, NEB.

BRUSH PLATING OUTFITS

● for re-plating articles in the home and shop. No tanks necessary. Free particulars. ●

GUNMETAL CO., AVE. M, DECATUR, ILLINOIS

STAMMER?

This new 128-page book, "Stammering, Its Cause and Correction," describes the Bogue Unit Method for scientific correction of stammering and stuttering—successful for 46 years. Benj. N. Bogue, Dept. 7802, Circle Tower, Indianapolis 4, Ind.

GET THIS FREE BOOK!

AMAZING INVENTION!

Corrects poor Penmanship in few hours—lots of fun. Details Free. Write,

INVENTOR OZMENT, 34-N, St. Louis, Mo.

PLASTIC SUPPLIES

Plexiglas, Lucite, Sheets, Rods, Tubes, Cement Dyes, Buffs, Equipment, Etc. Lowest prices. Send 3c stamp for catalog.

PLASTICS MFG. & SUPPLY CORP.

Dept. M-9 4707 Euclid Ave. Cleveland 3, Ohio

DRAFTSMEN + MACHINISTS + TOOLMAKERS

ONLY \$2.00 Complete Set. **GUARANTEED.** Price unchanged in 4 yrs.!

"TRIG-EASY"—3 DIAL CHARTS. 144-pg. book—simplifies trig. Accurate. Saves time with compound, spherical and plane angles. Thousands in use. Order postpaid today.
E. H. NEEDHAM, Culver City, Calif.

Learn to MOLD NOVELTIES

Cast plaques, book ends, ash trays, art goods and novelties in Plaster and Imitation Marble. 5c material makes \$1.00 sellers. Composition floors, Tile roofing, Colored Pottery, Plastic Homes, Waterproofing—easily learned. We teach you at home. Start in garage or basement. Particulars free.

RAPID MARBLEIZING SERVICE, Dept. 10-C, Edwardsville, Illinois

**Say You Saw It in
POPULAR MECHANICS**

WHITE SHIRTS First Quality \$2.00 ea.—3 for \$6.00

YES, MEN! White broadcloth shirts—all you want! Collar-attached, full-cut, roomy, comfortable, long wearing, sanforized. Minimum order three shirts, only \$6.00! Worth \$3.50 each. Order NOW. Give collar size, sleeve length. We send COD, you pay postage on arrival. Or send payment now, we pay postage. Write Shirt Hqtrs., Inc., Suite 464F, 122 E. 42nd St., New York 17, New York.



The GLENWOOD MEMORIAL

Freight Paid Anywhere in U.S.A.

In all its beauty and durability is pictured in our free catalog of genuine Marble and Granite. Write for yours today.

U. S. MARBLE & GRANITE CO., A-18, Oneco, Fla.

Raise GOLDEN HAMSTERS

The new wonder animals from Syria. Look like Toy Red Bears. Delightful pets. Everybody wants them. Thousands needed by laboratories. Make money, get started now. Send 10c for illustrated literature, or send \$5 for a pair of hamsters and literature.



GULF HAMSTERY, 1536 BASIL ST., MOBILE 17, ALA.

LEARN WATCH REPAIRING

GET PRACTICAL SELF-TRAINING IN YOUR HOME

through our new and complete book, "Modern Watch Repairing and Adjustment," \$2.75 postpaid. If C.O.D., plus fee. Money back guarantee.—We Supply All Books, Tools, Materials. Complete sets for Students, Watchmakers and Jewelers. Lowest cost. NEW, ALL INCLUSIVE CATALOG, OVER 450 ILLUSTRATIONS, Send 25c. FREE with above book. MODERN TECHNICAL BOOK & TOOL CO., Dept. MMC 55 West 42nd Street New York 18, N. Y.

ELECTRICIANS' SCHOOL

HOUSE AND COMMERCIAL WIRING • MOTOR REPAIR AND REWINDING • ELECTRIC REFRIGERATION

Approved for Veterans Training

PENNSYLVANIA INSTITUTE SCHOOL OF ELECTRICITY
42nd and SPRUCE STS. PHILADELPHIA 4, PENNA.

FREE! FREE! FREE!
For NEW VIGOR—STRENGTH—VITALITY...

Mail this coupon now PM 97

Alan Stephan, Post Office Box 1080, Chicago 90, Ill. Send me, free and without any obligation, your booklet, "Presenting Mr. America . . . Alan Stephan."

NAME _____
ADDRESS _____ CITY _____
STATE _____ DATE OF BIRTH _____

BE A Successful TOOL & DIE DESIGNER

Write TODAY... find out how YOU can earn up to \$10,000 a year as urgently needed Tool & Die Designer. Study under America's outstanding instructors. Day or eve. Courses in MECHANICAL DRAFTING. Free Employ. Service. G.I. approved. MIDWESTERN TECHNICAL INSTITUTE Dept. X, 431 S. Wabash Chicago 5, Ill.

**THESE FACTS
TELL HOW**

Learn MASONRY CARPENTRY



BUILDING TRADES NEED MEN NOW PAY IS BIG — OPPORTUNITY UNLIMITED

The Construction Industry offers unlimited opportunities to men prepared to handle building trade jobs. You can get in on the biggest building boom in history by obtaining actual shop training in Carpentry or Masonry under our expert instructors. If you are a veteran, Midwest School of Building Trades is fully approved for "G.I. Bill of Rights" training. You will receive subsistence allowance while in school. Part time work is also available. Write for free catalog today. MIDWEST SCHOOL OF BUILDING TRADES Dept. A-19, 411 No. Center St., Bloomington, Ill.

Fill Out, Cut Out, Mail Today

MIDWEST SCHOOL OF BUILDING TRADES
Dept. A-19, 411 N. Center St. Date _____
Bloomington, Illinois

Please send me your free catalog telling about the excellent career opportunities in the building industry.
I am interested in MASONRY CARPENTRY
 VETERAN NON VETERAN

NAME _____
ADDRESS _____
CITY _____ STATE _____

This is a STICK-UP!

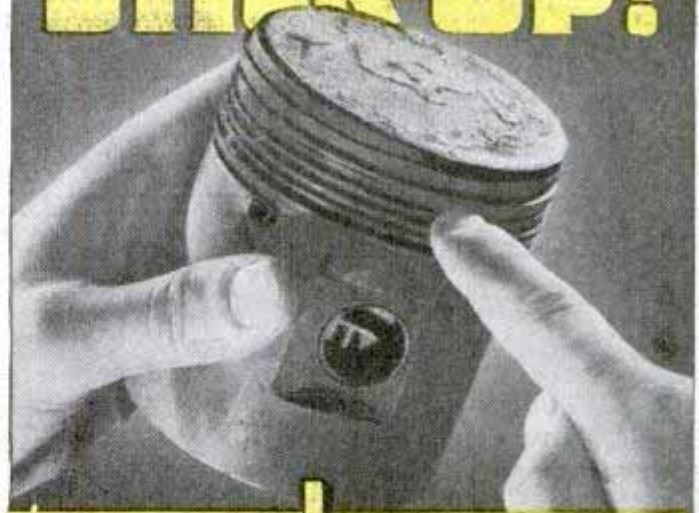

It's a "stick-up"—and you're the loser—when dirty oil circulates through your engine. Have your oil tested—free—by the AC method. If your oil contains grit, dirt or carbon, it stands out clearly on the clean white AC Test Pad. Dirty oil clogs piston rings and slots—makes valves stick—wears out moving parts—wastes fuel and oil—robs engines of power.

You can prevent that "highway robbery" by installing an AC Oil Filter or Element. Why not do it today? Free oil tests with AC Test Pads, as well as AC Oil Filters and Elements, are available at any AC Oil Filter Service Station.



AC SPARK PLUG DIVISION • GENERAL MOTORS CORPORATION

HOW TO Fight! Wrestle! Jiu-Jitsu!

FREE
WITH THIS OFFER!

PLUS WEIGHT LIFTING! STRONG MAN STUNTS!

Be prepared to protect your family, friends, yourself in any emergency! Be admired! George F. Jowett, Champion of Champions, gives you free his "SMASHING CHAMPION SECRETS." Contains many "HOW-TO-DO-IT" pictures that quickly and simply show you how to powerfully deliver a knockout, how to break any hold, how to overpower any opponent plus weight lifting and strong man stunts! Inside professional "Tricks of the Trade" proved successful by police, armed forces, fighters, wrestlers, etc.! Free for a limited time with this sensational offer!



YOU NEED HE MAN FITNESS TO HANDLE ANY TOUGH SITUATION!

NOW! ALL 5 FAMOUS JOWETT COURSES

—1 COMPLETE MUSCLE BUILDING VOLUME! FOR ONLY **25¢**

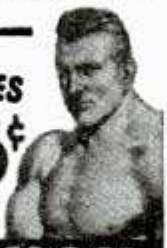

LET ME PROVE I CAN MAKE YOU—

COMMANDO-TOUGH

OR IT WON'T COST YOU A CENT!

says *George F. Jowett* WORLD'S GREATEST BODY BUILDER

Give Me 10 Minutes a Day

LEARN MY TIME TESTED SECRETS OF STRENGTH
I'll teach you the "Progressive Power Method" that rebuilt me from a physical wreck condemned to die at 15, to the holder of more strength records than any other living athlete or teacher! Has proven it builds the strongest, handsomest men in the world. Let me prove on a money back basis—that no matter how flabby or puny you are that I can add inches to your arms, broaden your shoulders, give you a man-sized chest, powerful legs and a Rock-like back—in fact power pack your whole body so quickly it will amaze you—right in your own home! I'll bring to life new power in you inside and out, until YOU are satisfied you are the man you want to be!

Send only 25c for my 5 easy-to-follow, picture-packed courses now in 1 complete volume "How to Become a Muscular He-Man." Try it for one night! Experience the thrilling strength that surges through your muscles.

I am making a drive for thousands of new friends fast—REGARDLESS OF COST!
SO GET NOW MY 5 Muscle Building Courses
(Valued at \$5 each)

All in 1 Great Complete Volume
Packed With How-To-Do-It Pictures!

Now, this "get-acquainted," extremely low price of only 25c is your chance to build a body you'll be proud of! Follow Jowett's easy method of muscle building NOW!
For Only 25c



10 DAY TRIAL!

Think of it—all five of these famous courses now in one picture-packed volume for only 25c. If you're not delighted with this famous muscle-building guide—if you don't actually FEEL results within ONE WEEK, send it back and your money will be promptly refunded!

Photo Book of Famous Strong Men!

FREE!



Photos that inspire you to might and muscle. Free with order.

2 FREE GIFTS!

Jowett Institute of Physical Culture Dept. PM-79
230 Fifth Avenue, New York 1, N. Y.

George F. Jowett
Champion of Champions

George F. Jowett: Please send by return mail, post-paid, FREE "Smashing Champion Secrets" and FREE Jowett's Photo Book of Strong Men, along with all 5 Muscle Building Courses. 1. Molding a Mighty Chest. 2. Molding a Mighty Arm. 3. Molding a Mighty Grip. 4. Molding a Mighty Back. 5. Molding Mighty Legs—Now all in One Volume "How to Become a Muscular He-Man." Enclosed find 25c. NO C.O.D.'S.

NAME _____ AGE _____
(Please Print Plainly, Include Zone Number)
ADDRESS _____

MAKE MONEY CASTING AT HOME

FREE FACTS SENT ..



Cast thousands of perfect Plaques, Book Ends, Ash Trays, Etc. Plaster, Liquid Marble, Etc. ENORMOUS PROFITS. Start in basement or garage. LITTLE CAPITAL NEEDED. QUICK, EASY, NO PREVIOUS EXPERIENCE NEEDED. Rubber molds for speed production. MAKE YOUR OWN. Sample Kit \$1.00. Canadian \$1.50. Plastic Arts Studio, Route 5, Dept. 29, Muncie, Ind.

INDIANA TECHNICAL COLLEGE

Engineering B.S. degree in 27 mos. Aeronautical, Chemical, Civil, Electrical, Mechanical and Radio Engineering, 2-yr. diploma, Air Conditioning and Refrigeration; Drafting, 1-yr. Gov't approved for G.I.'s. Low rate. Earn board. Large industrial center. Demand for graduates. Enter Sept., Dec., March, June. Catalogue. 597 E. Washington Blvd. Ft. Wayne 2, Ind.

NOW READY! Floyd Clymer's Newest and Best Motor Scrapbook of Historical Cars . . . No. 4



Illustrates, describes 200 early cars, motorcycles. Entirely different from books 1, 2, 3 (also available). \$1.50 each postpaid; \$2.50 for De Luxe edition.
CLYMER
Dept. A-9, 2125 W. Pico
Los Angeles 6, Calif.

WANT TO EARN MORE MONEY?

Learn SILK SCREEN PROCESS At Home. FREE big illustrated Book explains how my training enables you to start your own successful business or train for a better job in this well paid, uncrowded Advertising Field. Learn and Earn in your spare time. Complete Kit of Supplies included. Write TODAY.

CALIFORNIA SCHOOL OF SCREEN PROCESS
Dept. PM97 3740 Overland Blvd. Los Angeles 34, California



CARTOONING

HAVE FUN! MAKE MONEY! Cash in on your sense of humor AT HOME—BY MAIL. No experience needed to start. Write today FOR FREE TRIAL LESSON and full particulars.
Moon Gag Cartoon School, Dept. B, Fall Creek, Wis.



WATCH & CLOCK REPAIRING

LEARN AT HOME IN YOUR SPARE TIME! . . . Prepare for a happy future, with security—and qualify for a good job NOW. A fascinating and thorough self-instruction training in American and Swiss watches and clocks. Special section on alarm clock repairs. Fast-growing field. Satisfaction guaranteed. Success-Catalog Free. NELSON CO., 1139 S. Wabash, Dept. J-02, Chicago 5, Ill.

ELECTRICIANS

Get this Great Book **FREE**

Book of 150 Shop Prints, Wiring Diagrams, Full Size 8 1/2 x 11"



For Merely Examining
Coyne's NEW Pay-Raising

7 Volume Set APPLIED ELECTRICITY

Here's a brand new set of electrical books to give you the "know how" on all branches of electricity from appliance repairing to D. C. and A. C. equipment, electrical refrigeration, etc. 3,000 subjects, 10,000 facts, latest methods all explained in easy to follow instructions. In order to prove how valuable and Practical this set of electrical books is I'm willing to give you a FREE copy of my book "150 Shop Prints and How to Read Them" just for looking over this set. Written by the Coyne Technical Staff and backed by 47 years' experience, this set has helped many ambitious electrical workers to bigger pay, better jobs & added opportunity. Here's my offer to you—if you act promptly, I'll send you the 7 volume set Applied Practical Electricity for 7 days FREE examination . . . together with the 150 Shop Print Book. Look the set over 7 days. If you like it send either \$19.75 cash or send \$3.00 after 7 days and \$3.00 per month until \$21 is paid. If you don't want the set, return it and YOU OWE NOTHING. In either event, however, you keep the 150 Shop Print Book absolutely FREE.

SEND NO MONEY!

Compon below is just a request to see the books free and to get my gift book for doing it. ACT—Send coupon Today!
Technical Book Div., COYNE ELECTRICAL SCHOOL,
500 S. Paulina Street, Dept. 67-R6, Chicago 12, Ill.

FREE BOOK COUPON



B.W. Cooke Director
COYNE ELECTRICAL SCHOOL, Dept. 67-R6
500 SOUTH PAULINA STREET, CHICAGO 12, ILLINOIS

Send me that 7 volume set APPLIED PRACTICAL ELECTRICITY and your FREE gift of a copy of "150 Shop Prints and How to Read Them" I'll either return the set in 7 days and owe nothing or send you either \$3 in 7 days and \$3 a month until \$21 is paid or \$19.75 cash. Regardless of whether or not I keep the 7 Volume Set the 150 Shop Prints is mine FREE as a Gift.

NAME _____ AGE _____
ADDRESS _____
TOWN _____ ZONE _____ STATE _____

Now While these Great Industries Go Forward

AIM HIGH—PICK ONE OF THESE BIG FIELDS

- REFRIGERATION AND AIR CONDITIONING
- AUTOMOTIVE MECHANICS
- BODY, FENDER REBUILDING
- ELECTRICITY ● RADIO
- BUILDING
- DIESEL

Make Your Decision

For a Better Job
or a
BUSINESS of YOUR OWN
NOW'S the TIME

INDUSTRY is rapidly making up for lost time. There may never again be such opportunities for men who want better jobs or business of their own to get in on ground floor and go up fast! Yes—FOR MEN WHO ACT FAST, THINGS CAN HAPPEN FAST!

A Few Short Weeks Can Make All the Difference

COMMERCIAL TRADES INSTITUTE was only civilian school selected by Army to train service men for refrigeration. In motive trades our institute gained nation wide fame training Auto Mechanics for U.S. Army. Same quality training available to you now. If over 17 and under 60 learn how you can get started. **CONSULTATION AND PLACEMENT SERVICE WHETHER YOU ARE INTERESTED IN WORTHWHILE JOB OR SETTING UP YOUR OWN BUSINESS.**

TRAIN AT HOME
IN SPARE TIME OR IN OUR
WELL EQUIPPED SHOPS

**YOU CAN'T AFFORD to WAIT
YOUR FUTURE DEPENDS
on WHAT YOU DO TODAY.**



REFRIGERATION *and* AIR CONDITIONING

Trained men paid well to service, install, maintain, repair, rebuild household and commercial refrigerators. Important new developments such as Frozen Foods, and many new industrial uses. Opportunities for full time, spare time earnings. Begin training at home in spare time, finish in our big modern shops, or come directly to shops.

At home you get C.T.I.'s **SHOP PROVED HOME STUDY** instruction—actual shop experience has gone into the practical lesson assignments. That is why it is easy for mechanically inclined men to learn by our Home Study training, and start on actual refrigeration work.

AUTOMOTIVE MECHANICS • BODY & FENDER REBUILDING

Progress rapid by our learn-by-doing **SUPERVISED SHOP TRAINING**. Efficient auto mechanics get excellent pay. Learn to overhaul and repair engines, transmissions, differentials and other assemblies.

Body and Fender Rebuilding offers profitable work. Get good, practical "all-around" training—welding, aligning, mixing and matching colors, spray painting, power and hand tools. Values increased when used cars are made to "look like new."

RADIO SERVICING

Vastly increased number of radio receivers, development of FM broadcasting, installation of public address systems, demand services of trained men who can repair receiving sets, install p.a. equipment. Men who can quickly, efficiently service receiving sets earn good pay, have excellent opportunities to start own business. Get practical training in the big C.T.I. shops. Learn Radio Servicing — pay is good!

ELECTRICITY **ELECTRICAL SERVICING**

Get ready for good job or business of your own. Electricity is the heart of modern industry. Electricians always needed, earn higher pay, work year around. Make rapid progress in step-by-step practical shop training in Electrical Wiring and Circuits; Armature Winding; Electrical Appliance Repairs; Electro Plating and Welding. Rural Electrification, the Building Boom, many new uses of Electricity opening more opportunities in this vast field. Get training under thoroughly experienced instructors, be ready in few short weeks for Job Opportunities in Electricity.

DIESEL

Diesel engines are used to power entire fleets of trucks and buses, to drive tractors and other farm equipment. Diesels have revolutionized the railroads, are employed for passenger and freight trains as well as for switching engines. They are used to power road equipment, and even are being tested for airplanes and passenger cars. A big field that promises even bigger things in the years right ahead. Modern shop training on actual equipment under experienced instructors. Learn Diesel under direction of men who trained Diesel mechanics for U. S. Army.

BUILDING CONSTRUCTION

Do you want to be on the inside in the building boom — where big money is made? Learn about opportunities for building contractors whether or not you have previous experience in this field. Millions of dollars are going to be made in home and farm buildings, in construction of stores, garages, small industrial buildings. Building industry uses men by thousands in construction, supervision, management, sales.

COMMERCIAL TRADES INSTITUTE, Dept. E-29

1400 GREENLEAF AVENUE

CHICAGO 26, ILLINOIS

FILL OUT • CUT OUT • MAIL TODAY!

FACTS FREE FOR MEN WHO WANT TO GET AHEAD

COMMERCIAL TRADES INSTITUTE, Dept. E-29
1400 W. Greenleaf, Chicago 26, Ill.

Send free Illustrated Brochures and other information about the field I have checked below.

- | | |
|---|---|
| <input type="checkbox"/> Refrigeration and Air Conditioning | <input type="checkbox"/> Automotive Mechanics |
| <input type="checkbox"/> Electricity | <input type="checkbox"/> Diesel Mechanics |
| <input type="checkbox"/> Radio Servicing | <input type="checkbox"/> Body & Fender Rebuilding |
| | <input type="checkbox"/> Building Construction |

Name _____

Address _____

City _____ State _____

Veteran Non-Veteran

**HOME OF
C.T.I.**



VETERANS—

Veterans qualifying under "G.I. Bill" have tuition paid by Government plus monthly subsistence allowance while in school. Just mail coupon, we will handle all details. **(LOW TUITION, EASY TERMS if you are not a veteran.)**

A BOOK WITH OVER 2000 DRAWINGS and ILLUSTRATIONS



of DESIGNS, ORNAMENTS and FORMS

There are Ornaments, Designs, Devices, Forms, Shapes, Symbols; wreaths, festoons, silhouettes, borders, monograms, alphabets, frames, columns, crests, patterns, arabesques, zigzags, fringes, garlands, flowers, leaves, tassels, knots, rosettes, bows, feathers, plumes, chains, brooches, finery, gewgaws, spangles, geometric forms, animals, religious symbols, fraternal signs, mythological elements, rules, patriotic symbols, etc., etc. Most of the designs shown are FULL SIZE and Complete, and easy to trace, copy or reproduce. Printed in black and white, they can be enlarged or reduced to fit every size or need. They will prove to be a goldmine of ideas, inspiration and suggestion for developing appropriate, original and unusual designs for CREATING and DECORATING your ART or CRAFT or COMMERCIAL PRODUCTS.

Almost every conceivable kind of adornment and artistic decoration is listed and ILLUSTRATED in this unusually helpful and encyclopedic reference and idea book. This BRAND NEW WORK with 121 Full Pages of illustrations shows the entire range of ornament in all its different styles and manifestations from the dawn of civilization down to the present. Design and form in every phase of art, craft, or trade is included and classified. The multitudinous examples are arrayed and classified according to origin and use.

The book is a most valuable reference source for artists, craftsmen, designers, decorators, printers, painters, sculptors, wood carvers, chasers, modelers, hobbyists, ceramists, jewelers, architects, textile workers, scenic designers, display creators, engravers, metal workers, plastic workers, leather workers, embroidery, rug craftsmen, etc., etc.

If you work with designs of any kind, you need this "2000 DESIGNS, ORNAMENTS and FORMS" by M. Estrin — a beautifully printed and spiral-bound volume. Mailed postpaid if you send order with \$1.98 or sent C.O.D., if preferred, plus postage. Money back guarantee if not exactly as described or if not satisfied.

KNICKERBOCKER PUBLISHING CO., Dept. D-2
120 GREENWICH ST., NEW YORK 6, N. Y.

RADIOMEN! ELECTRICIANS!

Get this Valuable Book **FREE**

Tells How to Start Your Own Shop



for Merely Examining Coyne's NEW Pay-Raising

3 VOLUME SET APPLIED PRACTICAL RADIO

Here's real news for every man interested in Radio. A sensational new PRACTICAL set of radio books, just off the press! Nothing like it ever before. Gives you the "know how" on everything in Radio today. Basic principles to the newest in Television and FM—how to construct, install, service, 600 illustrations, nearly 1000 pages. To prove how valuable these great books can be to you, Coyne will give you a FREE copy of our new 240-page book "Starting & Operating a Profitable Radio or Electrical Business" just for looking over the 3 Volume Set. For home training or field reference, APPLIED PRACTICAL RADIO is backed by Coyne's 48 years of shop experience to help you to bigger pay, better jobs, greater opportunities in Radio.

OFFER LIMITED—ACT NOW! Here's our offer to you—if you act promptly. We will send you the 3 volume set APPLIED PRACTICAL RADIO for 7 days' FREE examination, together with the Business-Starting Book. Look the set over for 7 days. If you like it, you can then pay the low price at easy terms in coupon below. If you don't want the set, return it and you owe NOTHING. In either event, you keep the Business-Starting Book absolutely FREE.

FREE SEND NO MONEY!
BOOK COUPON
Coupon below is just a request to see the books free and get your gift book for doing it. ACT—Send coupon TODAY!



Educational Book Publishing Division,
COYNE ELECTRICAL & RADIO SCHOOL, Dept. 67-R7,
500 South Paulina St., Chicago 12, Illinois
Send me that 3 volume set APPLIED PRACTICAL RADIO and my FREE gift book "Starting & Operating a Profitable Radio or Electrical Business". I'll either return the set in 7 days and owe nothing, or send you \$3 within 7 days after I receive the books and \$3 a month until \$10.75 is paid. Or I'll pay \$9.75 cash. Whether or not I keep the 3 Volume Set, the Business-Starting Book is mine FREE as a Gift.

NAME _____ AGE _____
ADDRESS _____
TOWN _____ ZONE _____ STATE _____



20th EDITION • Auto Library in ONE Book
Leader for 37 Years
WORLD'S GREATEST AUTO BOOK
New Material on Transmissions, Trucks, Tractors, Diesels, Aircraft and Auto Engines

Now, with millions of cars needing repairs and thousands of men needed to do the work, you need the famous DYKE Auto Book more than ever before. 20th Edition covers all principles, construction, repair, adjustments, testing, troubles and remedies. Over a half million copies of 20 editions of Dyke's have been sold. Gives specifications of old and many newer cars. World's biggest book value, \$7.00. This big book, a complete auto library in one volume, has 1483 pages—4600 illustrations and diagrams—weighs 6 lbs.—equal to all books shown above.

MAIL COUPON

Goodheart-Willcox Co., Dept. 11-B, 2009 S. Michigan Ave., Chicago

Send Dyke's Auto Book at once. C.O.D. \$7.00 Enclosed. Payment refunded in 5 days if not pleased.

Name _____
Address _____
City _____ State _____



**AIR
CORP
GUN
SIGHT**

Worth many times this low price. Consists of a polaroid filter, top surfaced prism mirror, actuating motors, compensating adjustments, calibrated dials for air speed, drift, straddling range, etc. Inventors and experimenters will find many valuable parts in this assembly. All brand new in original export packing. Weight 7 lbs. No. 215. Each only..... **\$4.95**

WAR SURPLUS AND HUNDREDS OF OTHER BARGAINS

HUNTING KNIFE



Has 5 inch blade with keen cutting edge, 9 1/2 inches overall. Dressed leather handle with plastic insets and guard. Sheath included. Wgt. 1 1/2 lbs. No. 197. Each..... **\$1.65**

BINOCULAR CASE



Heavy cowhide, hand sewn. Die cut top for compass. Will fit 6x30 Bosch & Lomb or similar binocular. Wgt. 2 lbs. No. A191. Each..... **\$2.95**

**JUNGLE
HAMMOCK**



For back yard, country home and camp use. Has waterproof roof with mosquito-proof nylon netting side. Lets you sleep outdoors safely. Finest construction. Originally designed for U. S. Army use. Shp. wgt. 7 lbs. No. 134. Each..... **\$3.99**

Shatterproof Goggles



All purpose type. Sponge rubber frame. Red shatterproof flexible lens. Adj. head band. With case. New. Wgt. 1 lb. No. 139-Each..... **39c**

STILLS



Distill your own water with one of these fine portable stills. Purchased from the Gov't. Completely self contained. Has 1 gallon capacity; output 1 1/2 gal. per hour. Fitted with genuine Coleman double burner stove. Operates 5 to 7 hrs. on one filling. Heat output 20,000 BTU's. Stove alone is worth this price. All new and guaranteed. Instr. included. Weight 10 1/2 lbs. No. 206. Each..... **\$59.50**

DECORATIVE CHROME STRIPS



For your car, boat, furniture, etc. Highly polished chrome finished strips with clinched edges for flush mounting to any surface. The 3 pound kit provides approx. 15 pieces in lengths from 6 inches to 3 feet and average 3/4 inches wide. Wgt. 4 lbs. No. W224. 3 lb. Assort. only..... **\$2.00**



**TRAINING
RIFLE**

Regulation size and weight. Looks like the real thing. Fitted with adjustable sights and full size leather sling. Bolt action trigger. Has metal barrel and fittings. All brand new and individually packed. Shipping weight 8 pounds. Stock No. 192. Price, Each..... **\$4.50**



**FISHING KIT
18 Pcs. BRAND NEW**

Here is a war surplus special that every fisherman will appreciate. It consists of hundreds of feet of line with lures, hooks, sinkers, etc. Fishing knife and gloves, all packed in a cloth roll up kit that also serves as an apron. Entire assembly of 18 pieces comes packed in a hermetically sealed can. Brand new! A real value. Shp. wgt. 4 lbs. Stock No. 413. Each only..... **\$2.95**

**15 JEWEL STOP WATCH
U. S. AIR CORPS SURPLUS**



Genuine Eigin 15 Jewel movement. Ideal for split second timing in racing, sports, time study, etc. Full sweep hand second hand graduated in 1/10th seconds. Stem wind, start, stop and reset. Used but guaranteed perfect. A splendid value. Shp. wgt. 1 lb. No. 200-Each..... **\$9.95**

BAYONET BLADE

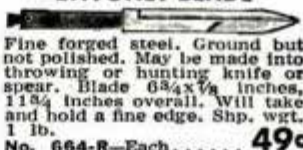

Fine forged steel. Ground but not polished. May be made into throwing or hunting knife or spear. Blade 6 3/4 x 1/2 inches, 11 3/4 inches overall. Will take and hold a fine edge. Shp. wgt. 1 lb. No. 664-R-Each..... **49c**

2 Man Mountain Tent



Regulation Army type two man mountain tent, complete with poles, guy ropes, etc. Of durable nylon with reinforced seams. Ideal for outdoorsmen, campers, etc. Shp. wgt. 10 lbs. A splendid value. Stock No. 202-Each... **\$9.95**



FISHING REEL

Full 100 ft. line capacity. Free acting brass bearings. Ratchet drag. Catalin handles. A real value at this low price. All metal! Shp. wgt. 1 lb. No. F412, Each **98c**



**SHIP
BELL**

Purchased from U. S. Maritime Comm. Measures 10 inches high, 9 3/4 inch flare. Big 6 inch clapper. Weight 15 lbs. Fine for farms, clubs, estates, etc. All new A-541, ONLY **\$9.85**

RUBBER OVERBOARD SUIT



Here is a buy! All rubber suit with parka. Fits over your regular clothes and shoes. Can be cut apart for waist high waders, hip high or knee high boots, also arm length rubber gloves. Heavy gum rubber over fabric. Fine for those who work in the water, commercial fishermen, sewer diggers, etc. Use it as is or cut it up for waders. All brand new! Wgt. 14 lbs. No. 183, Each... **\$4.95**

**7 LB. EXPERIMENTER
PARTS ASSORT. KIT**



A "gold mine" for the radio serviceman. Hundreds of valuable radio parts, new radar and electronic parts and sub-assemblies, coils, resistors, trimming condensers-worth many times this low price. A130R -7 lbs. **\$1.79**

G.I. PISTOL BELTS



Of heavy canvas webbing. Adjustable. Eyeleted all around. Used but perfect. Wgt. 2 lbs. No. 131. Each..... **98c**

U.S. Govt. BOLO KNIFE



Extra heavy. For farm, home or jungle use. Blade of Govt. formula cutlery steel. Walnut riveted handle. 3 1/2 inch bit, 10 1/2 inch blade. You'll find hundreds of uses for a Bolo knife. Blade will take and hold a keen cutting edge. Wt. 2 lbs. A112-with Army Sheath..... **\$4.95**

FLEXIBLE NECK FLASH LIGHT



Ideal trouble shooter's flash light. Flexible neck lets you direct light around corners and inaccessible spots. Brand new! Plastic case with BX type neck. Uses 2 standard flash light batteries (less batteries). Shp. wgt. 2 lbs. No. 205-Each... **\$1.69**

HORSEHIDE JACKET



The leather coat buy of the year! Brand new Army Air Force Type A2 with full length zipper, shoulder straps, knitted waist band and wrists and full satin lining. Finest horsehide - finest tailoring. Order by chest size. Shp. wt. 5 lbs. No. 201-Each... **\$19.95**

MEDICAL STERILIZER



Consists of alcohol burner and sterilizing tray in hinged metal case 1 1/2 x 1 1/2 x 2 1/4 inches. Burner may be used separately. Bright nickel finish. All brand new. A125-Ea. **98c**

Officers Watch Compass



Brand new gov't. surplus. Army-Navy model. Single jewel mounted needle. Silver colored dial. A splendid value. Shp. wgt. 1 lb. A174-Each... **98c**

BERNARD WIRE PLIERS



Parallel acting jaws. Wire cutter at top. Brand new. Wgt. 2 lbs. No. 168. Each..... **\$1.29**

ORDER DIRECT FROM THIS AD

Values galore! Hundreds of hard-to-find items for home, shop and outdoors. Make remittances by money-order, bank draft or personal check. Send 25% deposit on C.O.D. orders. No C.O.D.'s on orders for less than \$5.00. -Include sufficient postage on parcel-post orders-any overage will be promptly refunded. All quotations F.O.B. Chicago. Used items and materials are guaranteed serviceable and as described. Your money back if not more than satisfied.

BIG ILLUSTRATED CATALOG FREE

STARK'S

Dept. PM947
509 So. State St.
CHICAGO 5, ILL.



Our coach forgot a rule!

"YOU GOTTA KNOW ALL THE RULES," I reminded our high school coach the other day, "if you expect your team to win."

"It's the same way with your car," I said, "from the way it looks and runs, you're playing a losing game."

When he asked what I meant, I told him, "You call me your Doctor of Motors and expect me to make sure that your car gives you trouble-free, economical transportation. If you make it a rule to come in regu-

larly, I can spot little troubles before they get big and costly."

Well, I fixed his car—ground the valves, replaced the gaskets, put in Perfect Circle Piston Rings to stop her oil pumping, tuned her up—and from the way he smiled you could tell he felt like he had another winner.

Then, he agreed that it was just plain common sense to bring his car in for regular checkups—that he would make it his No. 1 car rule and never forget it again.

NOTICE TO CAR OWNERS. Perfect Circles are available at any automotive repair shop. Your favorite mechanic—your Doctor of Motors—recommends them. Perfect Circle Corporation, Hagerstown, Indiana, U. S. A. The Perfect Circle Company, Ltd., Toronto, Ontario, Canada.

Your Doctor of Motors
restores power... saves gas
... saves oil with...

**PERFECT
CIRCLE PISTON
RINGS**

POPULAR SEPTEMBER 1947 MECHANICS

WRITTEN SO YOU CAN UNDERSTAND IT
VOL. 88 NO. 3

So You've an Invention to Patent

By John L. Kent

SO YOU THINK you've invented something? Slaved every night and solved the big problem. It's all over now, you say. All you need is a patent and a financial backer to put it on the market.

Well, your troubles are just beginning. It's true that Uncle Sam has a Patent Office, but whether you'll get a patent is another matter. Since you're determined to market your baby, you're not going to stop now when you are so short of your goal. So sit down and look over the obstacles ahead.

First of all, the secrets about your brain child which you've managed to keep to only yourself and a few trusted friends will have to be told to a lot of strangers.

Although inventors are warned to be careful to whom they describe their invention, the patent office must know every detail. Obviously, they cannot tell if a device or method is patentable if you don't give them all the facts. And, it is the details that most often determine patentability. Therefore, you must come clean with Uncle Sam.

The patent office advises that you first seek the advice of a patent attorney. The Commissioner of Patents is not permitted to recommend any attorney, but will furnish a list of those attorneys who are authorized to practice before the Commissioner of Patents. Such attorneys are permitted to include in their advertisements the words "registered patent attorney."

Aviation's birth: Orville Wright clings to one of the world's first planes which overturned during a flight test. The Wright brothers introduced a new field for patents





Included in this composite painting of 19th century inventors are McCormick and Colt (third and fourth from left), Goodyear (seventh from left), Mott (ninth from left), Morse (seventh from right) and Howe (far right)



Copyright by Harris and Ewing

↑ In the public search room attorneys look for similar patents
 ↓ Attorneys can order copies of proceedings upon which previous patents were issued to determine validity of clients' claims

Copyright by Harris and Ewing



Seeking a patent is rather complicated and the expense of a lawyer usually is worth-while. If your invention is unpatentable, the attorney, after making a "preliminary search" will give you the reasons. If, on the other hand, he finds that there is a possibility of getting a patent on your invention, he will send you further papers and have the drawings made in the form required by the patent office.

All this can be done by mail, as patent attorneys gladly will send you the first "disclosure" or "record of invention" forms on which you can draw a sketch and write a description of the invention. Accurate English or exact dimensions are not important on this first form. The idea, however, must be put across. Tell what it is, for what use it is intended, how it works, and if an improvement, why it works better than previous products.

Based on this information, your attorney prepares the patent-office papers and final drawings, which are usually done by specialists who know just what details to include and what to omit. Although at one time the patent office required the submission of a model, this is no longer necessary. It's optional.

Your attorney will file a petition which will describe your in-

vention and list the claims you are making. When it is received at the patent office, it is assigned to a search examiner. All examiners are specialists in some art or science. Thus Jim Jones gets all patent applications for gasoline engines while Tom Brown searches only on patents for sewing-machine mechanisms and attachments. The search is carefully done—it may take the examiner as long as three days to look through all related fields to discover whether or not there is a similar invention already patented.

Each of your claims is investigated and you are permitted to amend your claim according to instructions from the examiner handling your application. You are permitted to resubmit your application until the examiner finds that your remaining claims are not covered by any prior invention and are therefore patentable. The final judgment may result in refusal to grant a patent, for it is possible that all of your claims have been previously patented by others.

If you are issued a patent, you have the sole right to keep others from making, using or selling your invention for a period of 17 years.

A patent may be granted for any new and useful art, machine, manufacture of article, or composition of matter—or for an improvement on these. The three elements considered in determining what is patentable are novelty, invention and utility. The

Below, John Ericsson developed this caloric engine, similar to early steam engines except that hot air actuated the large piston. Below right, "one dog-power engine"—a canine-operated treadmill—is one of the many patented inventions using animal power

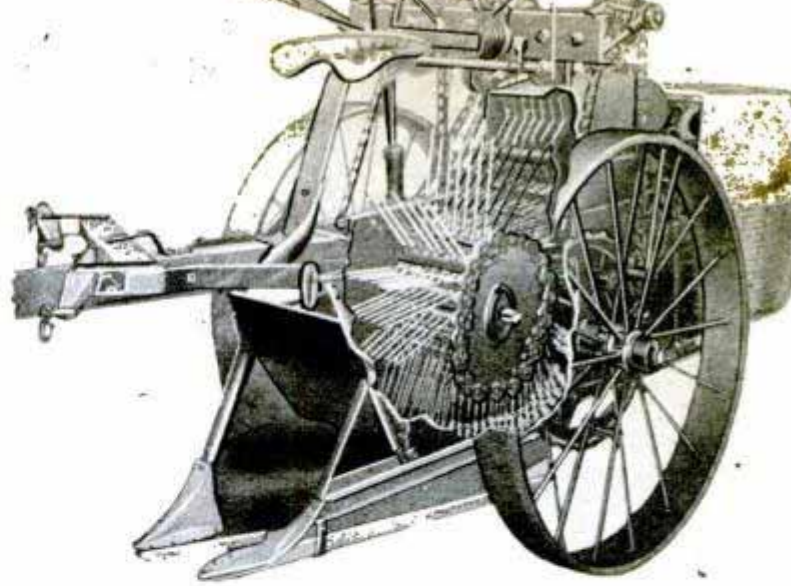

↑ Early model cotton picker, invented about 1910, failed to make the grade. Below, brass working model of a governor for steam engines was submitted in 1858

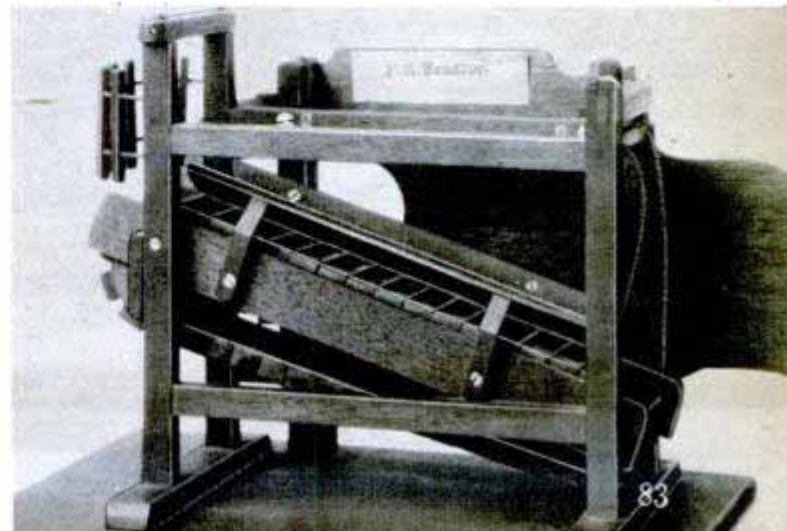
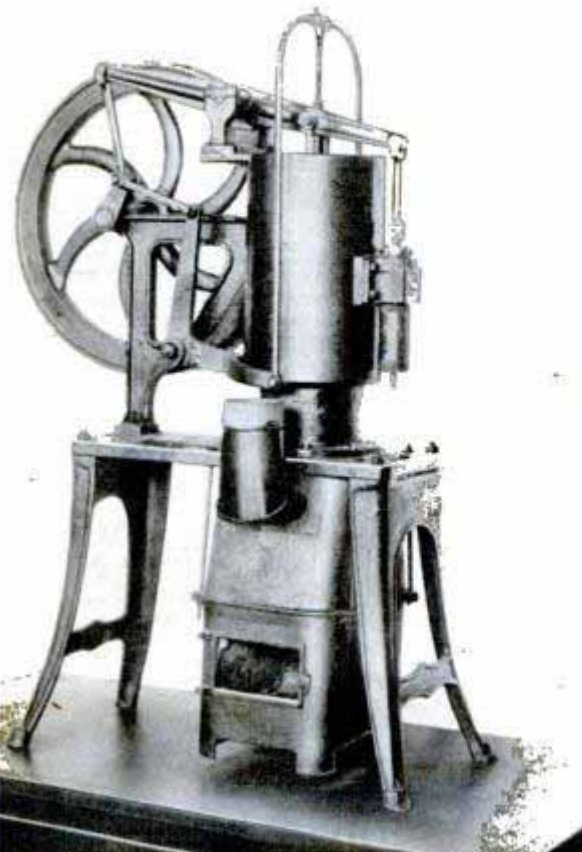
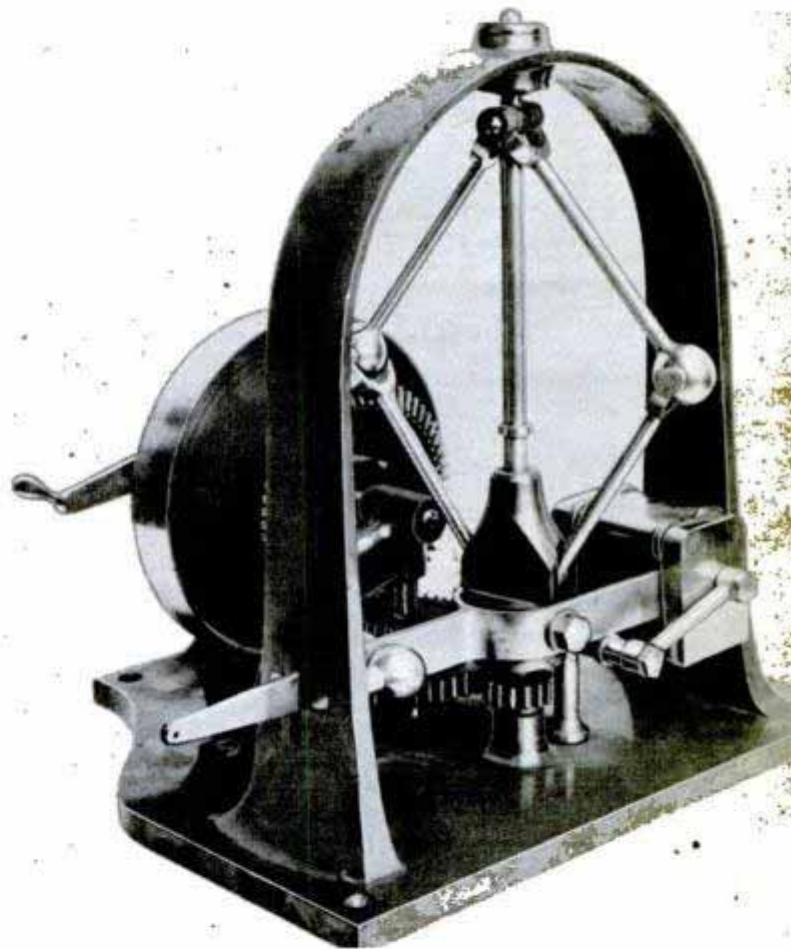

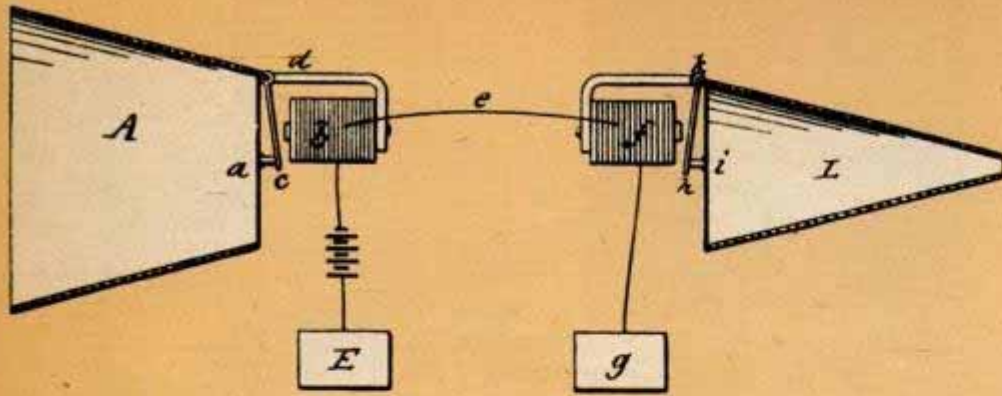

Telephone, as sketched in Bell's patent application, has cone (A) which funnels sounds against membrane (a), causing variations in electromagnet (b). Similar sounds then come through earpiece (L)

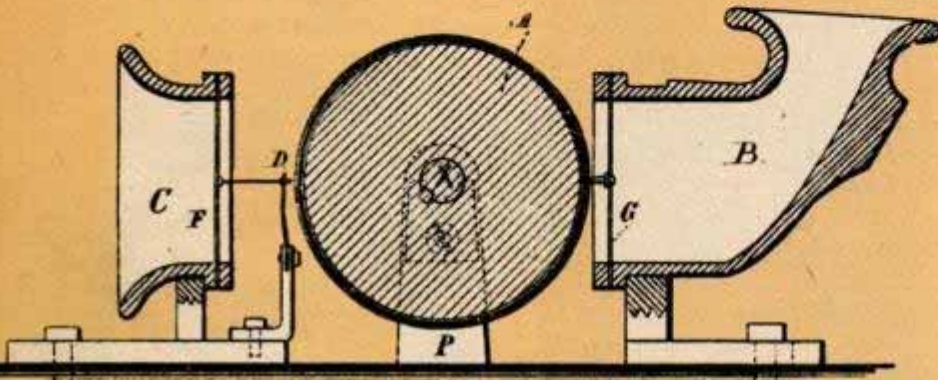

First juke box: Edison, in his patent application for this phonograph, said its purpose was to "record and reproduce the voice"

↓ Sholes-Glidden-Soule typewriter, patented in 1868, was taken over by Remington, arms manufacturer, and produced in quantity

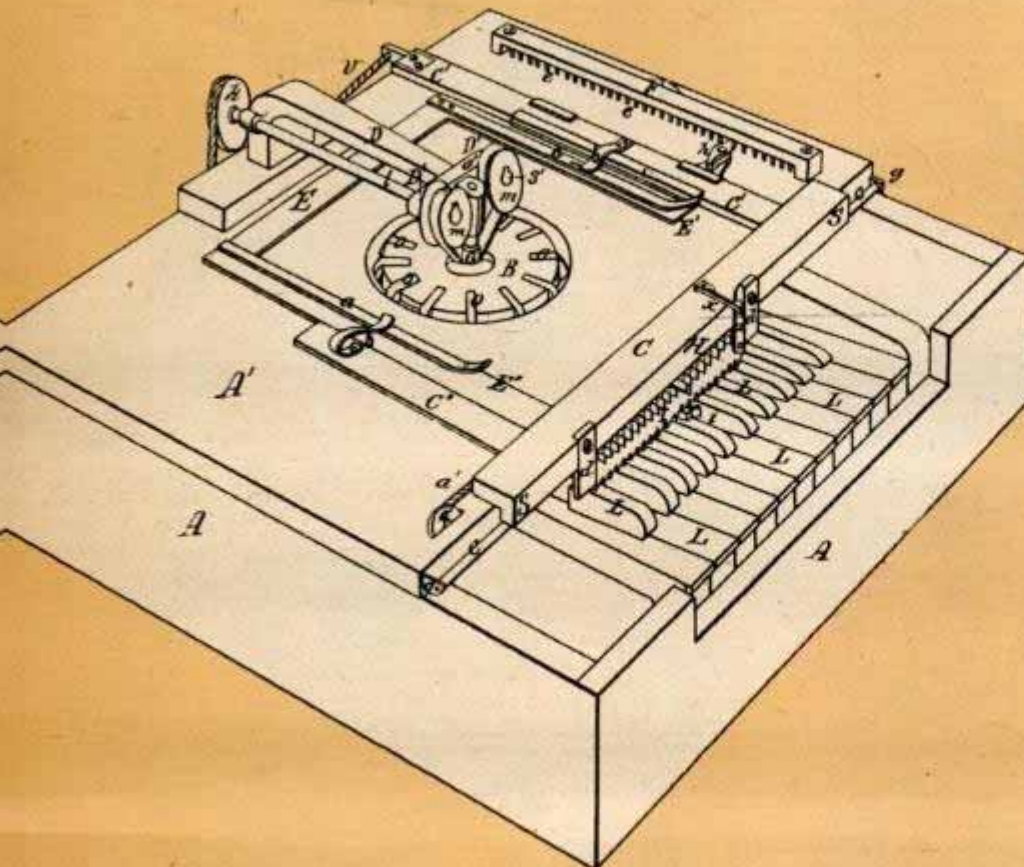

invention must be new, must be a product of inventive ingenuity and discovery and must be capable of being advantageously used for the purpose for which it is created.

No patent will be granted on a useless device, printed matter, a method of doing business, an improvement of a device which is the result of mere mechanical skill, or a machine which will not operate. A mere idea or suggestion is not patentable. The patent office does not recognize that there is such a physical manifestation as perpetual motion.

An inventor often has doubts about his brain child. He wants an opinion and advice from someone other than his friends. If your invention has a military application, contact the National Inventors Council of the Department of Commerce in Washington. Members of the council are 16 outstanding scientists, engineers and industrialists, headed by Dr. Charles F. Kettering, retired research director of General Motors. During the war the council reviewed more than 200,000 inventions and ideas. Those believed to have merit were referred to the Army and Navy.

Veterans of World War II and inventors in general have been asked to continue sending in ideas for new or improved military equipment and devices. Dr. Kettering recently said that many of the best ideas coming to the council are from returning veterans.

Thomas Spooner, head of the Engineering Laboratories of Westinghouse Electric Corporation, made a study of

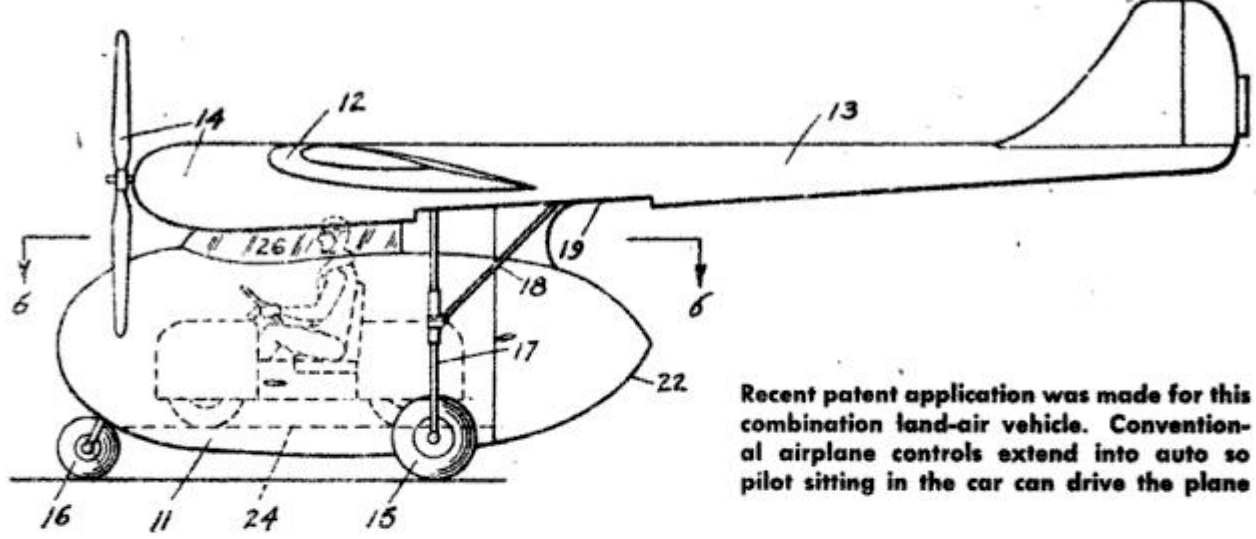

Recent patent application was made for this combination land-air vehicle. Conventional airplane controls extend into auto so pilot sitting in the car can drive the plane

150 scientists' inventive output over a 20-year period and found that although sudden flashes of inventive genius occur among young scientists, most of their contributions were made after they were past 30. Patents on inventions, he declared, take a sudden spurt upward as research men reach the 40-year mark. More than half of 100 outstanding inventions made by Americans were contributed by men past 36, while 35 percent of the total were made by inventors who had passed their 40th birthday.

Since a patent is granted for 17 years only, thousands of patents expire every week. These are available for use by any American citizen. The patent office does not publish a list of expired patents, but a private firm in New York issues a weekly publication which lists them. You may send the numbers of any of these expired patents to the Commissioner of Patents

and obtain copies of the patents themselves.

The early legislators who fixed the term of patent at 17 years wanted to encourage invention by giving the inventor a financial stimulus—the sole control of his invention—but still did not wish to create a monopoly. Eventually all patents are for the public good.

When the Constitution was being debated, a clause to establish a national university was proposed. That clause was dropped in favor of one calling for the promotion of the progress of science and useful arts "by securing to authors and inventors their respective writings and discoveries," on the ground that such an action would benefit more people than would a national university. Our patent system is based on the interpretation of this constitutional provision.

The wealth of inventions bears witness to

(Continued to page 248)

*PUBLIC DOMAIN SCIENTIFIC PUBLISHING CO.
 411 2nd St. N.Y. Out of Business
 New York, N.Y.*

Flying-boat docking setup patented by Glenn L. Martin can be used in rough water. Center winch pulls cable to dock the flying boat, while side winches pay out auxiliary cables to control swing

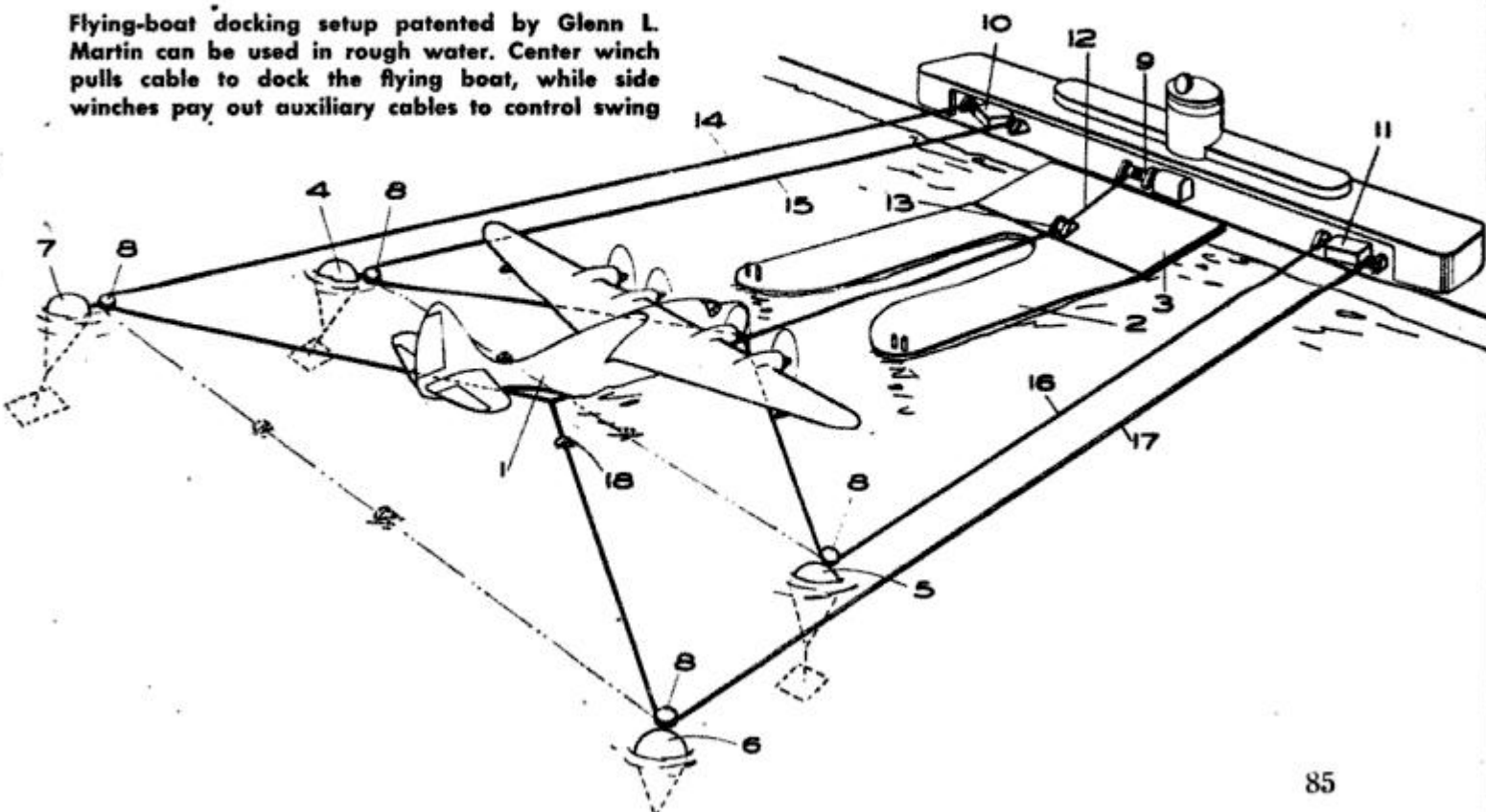

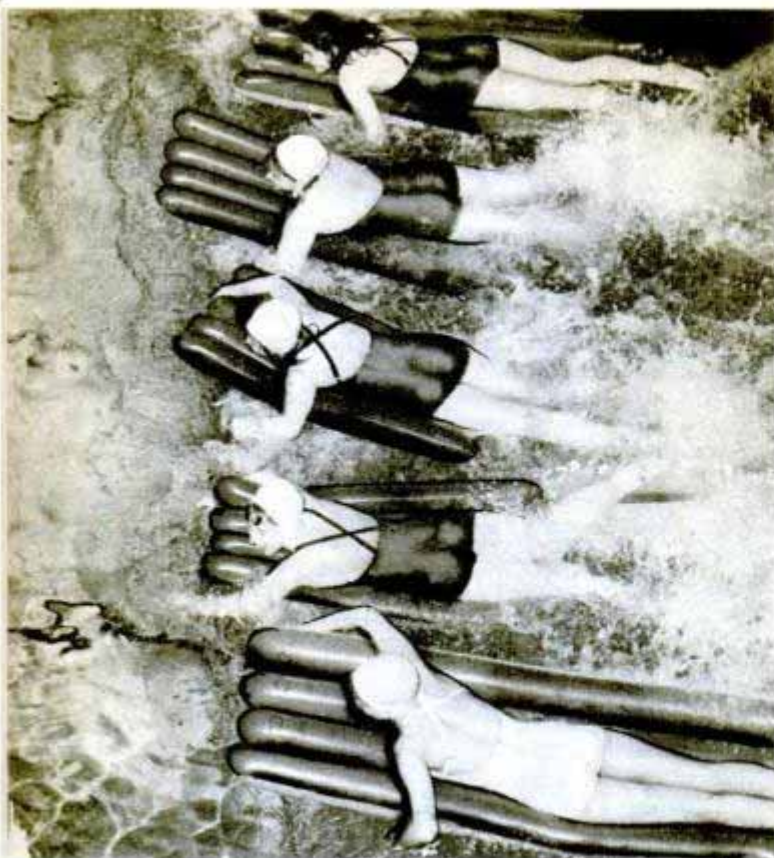

Plastic Surf Sled

Both "belly floppers" and floaters can use a plastic surf sled, two feet wide in sizes four or six feet long. It will support a 200-pound person. The sleds were first put through a practical six-month test by children 6 to 16 years old at a Chicago laboratory school.



Cables Guide Trailer Dolly

Trailers equipped with a combination dolly and jack can be backed into position easily because a cable and pulley system automatically turns the dolly wheels whenever the car is turned. The dolly's guide system permits one man to turn the trailer completely around by hand. No separate jack is needed to level the trailer, as a jack is included as part of the dolly. The two wheels are equipped with airplane-type tires. Two tanks for holding butane fuel can be mounted on the dolly frame for trailers that have stoves. The dolly can be used on almost any size or type of trailer.

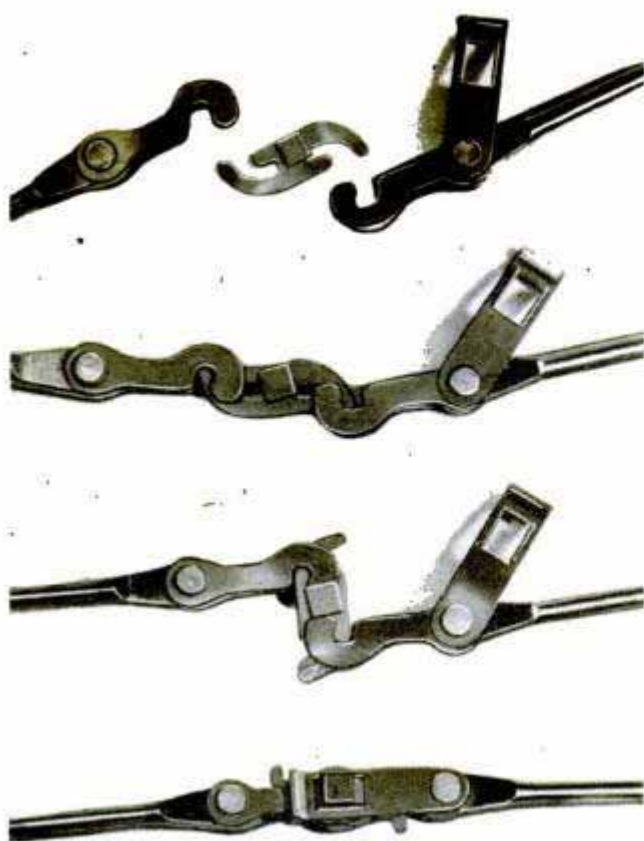

Hook System Eliminates Turnbuckles

Designed primarily for use in aircraft in arctic operations, a hook system provides a quick method for connecting or disconnecting cables under tension. Unscrewing and reassembling a turnbuckle is unnecessary and there is no need to test the tension of the cable every time the parts are re-engaged, as the hook system always returns the cable to the same tension. To disconnect the members, a safety spring is disengaged from a nut and swung aside. The nut is then rotated with a wrench, disconnecting the hooks to free the cable. The procedure is reversed in reassembling the cable. The hooks are available in various sizes, cadmium or chrome plated.

Electric Lock for Auto Gasoline Tanks

Gasoline thieves are thwarted by an electrically operated lock for the metal flap in an automobile fender which provides access to the gas tank. To open the flap, a push button inside the car is pressed. The lock is not connected to the car's gasoline filler pipe.

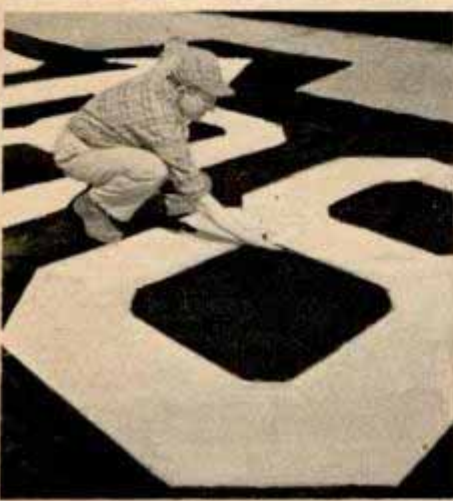

Porcelain Enameled Airway Marker

Porcelain enameled airway markers can be fastened to either flat or curved roofs without puncturing the surface or requiring framework. Identifying legends are formed from combinations of 10 differently shaped basic units. The letters, some of which are 15 feet high, are set in a bed of felt, mopped down with pitch or asphalt and coated with asbestos fiber asphalt plastic cement and portland cement. The glass-like coating increases legibility at a distance.

General Electric photo

Skyscraper Lightning Gauge

Lightning striking a million times faster than sound is recorded by a new device atop the Empire State Building, world's tallest skyscraper. It supplements cameras and oscillographs used in studies from 1935 until war forced their discontinuance in 1941. These studies have provided detailed knowledge of the frequency of lightning strokes, its wave shapes, currents and amplitudes. Much of the information is used to improve production of natural lightning in the laboratory. One common belief disproved by earlier studies conducted by General Electric was that lightning never strikes an object twice—bolts hitting the building 42 times in one year.

☐ Although Boeing's Stratocruiser is much larger than the B-29, its wing is 650 pounds lighter due to a new high-strength alloy.

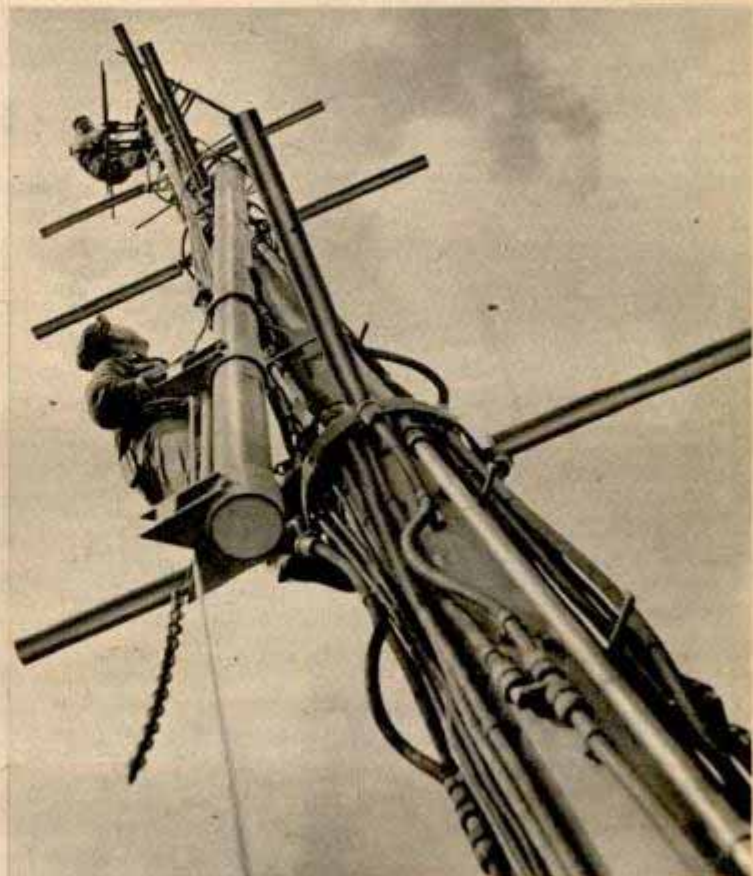



THESE DOGS COUNT SHEEP!

Dewey Jontz' piercing whistle drops Tess instantly no matter what she's doing. He uses spoken commands, too, in ordering his canine "hired hand" to help with the chores



During field test the dog must drive a flock of sheep through three "hurdles." Above, Tess guides them quietly through the narrow opening. Here Jontz signals her around to the left to pick them up after a successful "drive"



TESS IS ONE of Dewey Jontz' Border Collies, a breed with a mission in life. These dogs from the hills of southern Scotland are hard-working farm hands that tend sheep, cattle and poultry.

With a spoken command or a flick of his hand Jontz can send Tess in a great circle, sweeping up a scattered flock of sheep. She'll hold them together or guide them straight through the gate to Jontz. She'll separate one sheep from the rest of the flock and bring it to him.

At the end of a day of hard work there's still the evening chores, and she'll start by driving poultry into the hen house. And regardless of where she is, Jontz' whistle will drop her motionless to the ground.

Sheep men regard Border Collies as the finest working dogs in the world and their ability to handle livestock makes them as valuable as good hired men.

Jontz pays about \$500 to import a prize dog such as Tess, breeds it on his farm near Altoona, Iowa, and sells the pups. After nine years of breeding he has developed a substantial business, as the pups bring about \$50 apiece at weaning time and there are an average of six to a litter, with three litters every two years.

But Jontz has difficulty in buying excellent dogs as the Scottish hill shepherds would rather part with their flocks than sell their favorite Border Collies. A shepherd once turned down an offer of \$1600 for a single pup. And 39-year-old Jontz declares that "\$1000 wouldn't even buy the hairs on Tess' tail."

For centuries the Scottish shepherds have been breeding dogs for only one quality—"workability." The result is a highly specialized dog that instinctively loves commands and is eager to obey.

Most of the dogs you see streaking in great circles around livestock on the nation's farms aren't Border Collies. The breed is comparatively new to this country—the first dogs made their appearance here with shipments of livestock imported from Scotland about 1900. But it's impossible to supply the demand for good Border Collie pups today and likely you'll see a lot of the dogs within 10 years.

The first field trials to test workability were held in this country in the 1920s, although similar trials have been conducted in Scotland for almost a century.

Jontz' dogs—the ones he retains for breeding and trains himself—have won

Jittery sheep sometimes turn in the wrong direction. Here the dog dashes through a hurdle to head them off



SHEDDING



To separate one sheep from the flock, the dog approaches cautiously, then darts through a narrow opening

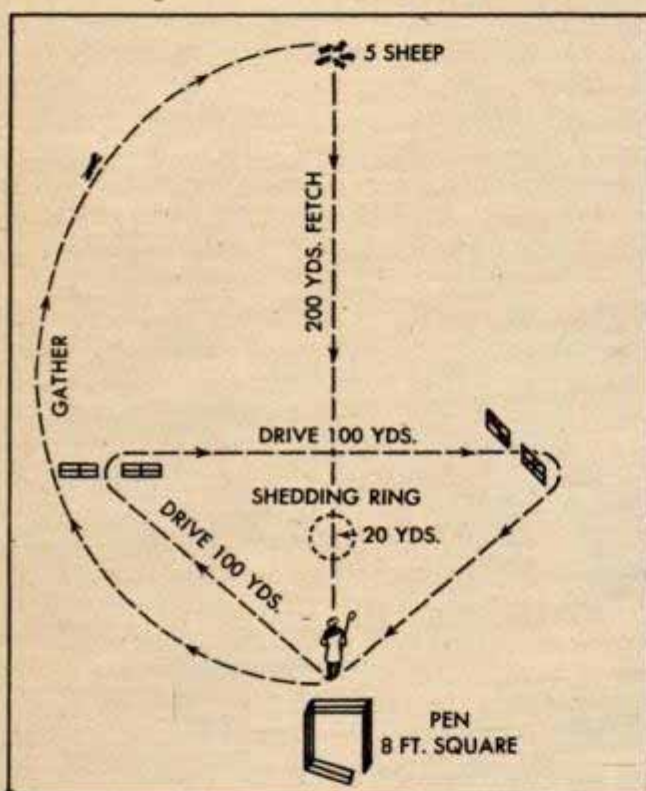

several national field trials including those at Ohio and Rhode Island. His dog Wull won first place in the Virginia trials of 1944 and in 1946 Jontz took second place despite the fact that he was on crutches as a result of an auto accident and had very little opportunity to work with the dogs before the trials.

The feats that the dogs must perform to win a field trial are remarkable, although they are not designed as a set of tricks but as a test of the dog's ability to handle livestock in routine farm work. Jontz runs his dogs through the "qualification course" in his frequent demonstrations before farm groups, fairs and livestock shows.

During such a demonstration Jontz remains in one spot while the dog handles the sheep alone. Upon a signal, five sheep are released 200 yards in front of the man. Jontz then sends his dog in the "outrun" and the dog streaks off in a great semicircle that will bring him up behind the sheep for the "lift." As the dog approaches the

↑ To pass the field trial a dog must cover this course, including shedding and penning, within 15 minutes.
↓ Border Collie guides the flock in a straight fetch to his master—the first step in the penning test

PENNING

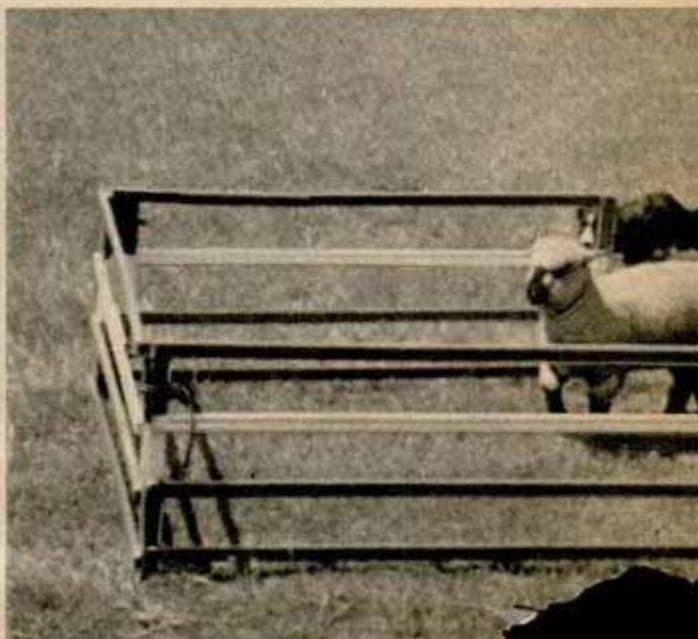
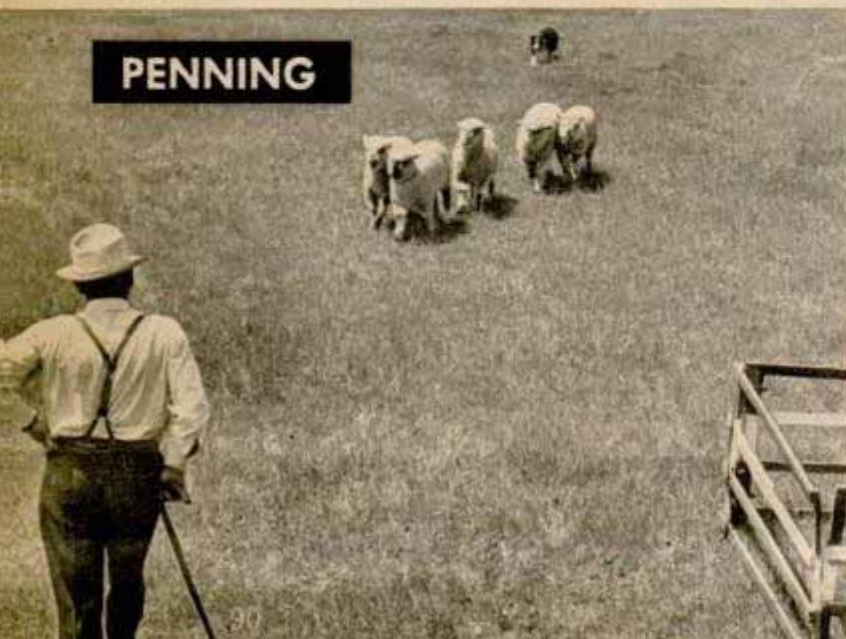



Dog's sudden charge frightens the single sheep away from the flock. The stray is then brought to the "shepherd"

flock, Jontz starts using whistle signals and spoken commands. One sharp whistle means "stop" and the dog immediately drops to the ground. "Come by" means to circle to the right, and "Come away" means to move to the left.

As Jontz says, "Even at 200 yards you can guide the dog as though he had a steering wheel."

In fetching the sheep, the dog first moves in narrowing semicircles to bunch them. He then drives them straight toward Jontz. One hundred yards in front of the man are two 12-foot sections of fence with a narrow space between them representing a gate. The dog must drive all five sheep straight through the gate as part of his "gather."

After negotiating the gate he drives them to Jontz' feet, then guides them 100 yards to the left through another "gate," 100 yards to the right through still another, and then back to Jontz.

After returning the sheep the dog must keep them within a ring 20 yards in di-

ameter while he "sheds" one or two from the remainder of the flock. This is one of the most difficult tests. Jontz watches carefully until a slight opening appears between one of the sheep and the others. Upon his sudden command the dog dashes through the opening and the sheep is frightened away from the rest of the flock. The dog then "wears" this sheep—drives it back and forth until the judges are satisfied he has it under control.

Final requirement is the penning test. The dog reassembles all the sheep and must drive them into a pen only eight feet square, holding them there until Jontz locks the gate.

To pass the trial the dog must complete the entire course including fetching, driving and penning in 15 minutes.

This is only the qualification course and the championship course, used in Scotland, is much more difficult, involving an outrun of 800 yards to gather in two separate groups of 10 sheep which neither the dog

Below, the "shepherd" holds open the gate of the eight-foot-square pen but may not touch the sheep. Right, all sheep must clear the gate before the Border Collie can pull out after successfully penning the flock





↑ Sweeping gesture of the left hand and the words "Come away" start Risp on a wide sweep to the left
 ← Pointing right arm is signal for outrun to right

nor his master can see at the beginning of the trial. The dog also must shed only marked sheep from the rest of the flock.

Such a test requires remarkable canine intelligence and Border Collies have been the only breed able to pass even the qualification course for a number of years. The dogs learn quickly—one of Jontz' dogs won a trial when it was only 7½ months old.

Jontz likes to tell a story about Shep as an example of the reasoning power of Border Collies. One day Jontz was walking across a farm when Shep grabbed a woodchuck by the scruff of the neck. Jontz waited to see what the dog would do with his prey. Shep trotted to a nearby stream with the animal and attempted to drown it by dunking its head under water. But every time the animal went under, so did Shep's nose. Finally Shep trotted back to the bank, placed the animal on the ground between his paws, and surveyed first the water, then his prey. Suddenly he jumped to his feet and grabbed the animal by the tail. This time he dunked the woodchuck without even getting his nose wet.

Although Jontz directs the dogs by command during field trials and demonstrations, the dogs easily can be trained to do farm chores without help. For example, they can drive hundreds of sheep to particular pasture in the morning, fetch them at night, handle the cattle and drive poultry

into a hen house. In one remarkable demonstration Jontz' dog, Risp, stalks chickens, quietly driving them through an opening a foot square.

Border Collies have an instinct to herd livestock and often untrained pups, released in front of a scattered flock, will start to round them up.

Not only can they handle livestock but they protect them as well. Jontz recently received a letter from the owner of one of the pups he sold without training. Topsy had learned to stay a half day in the pasture with the sheep. One day she came streaking toward the house, barking at the farmer's son. The boy ran to the barn, grabbed his rifle, mounted a horse and followed Topsy. He arrived at the pasture just as a wolf was moving in on the flock. The boy's shot missed but the wolf never showed up again.

Another dog, Ring, which Jontz sold to a farmer, was installed in a stable beside the owner's prize horse. One night the farmer was awakened by Ring barking beneath his window. When he went to the stable he found the horse extremely sick. Only a quick visit by the veterinary saved the animal.

Although Border Collies are essentially working dogs, they make fine pets and are especially gentle with children. Wull, one of Jontz' former pups, is the "best outfielder the neighborhood baseball team ever had." Another owner reported that his dog watched the youngsters play football for several hours and then joined the game. To this day, he says, the dog will pick up the football by the laces, run with it a little way, place it on the ground, back



Border Collies, when raised from pups, make fine pets and are exceptionally gentle with children

Canine "fence" suddenly appears around a small flock and the sheep remain motionless. The dogs can be trained to work as a team around the farm. ↓ Three prize dogs roundup the sheep and start them up a loading chute

off, and then kick it with his paw!

Ross, a Border Collie that Jontz imported from Scotland and then sold, was given a role in the movie "Bob, Son of Battle." His dramatic ability was quickly recognized and he's had parts in several movies since.

Jontz prefers to sell untrained pups, as Border Collies are easy to teach and will do better work when trained by their lifetime master from the start. However, he has trained his own dogs and often gives training advice to farmers who buy his pups.

Fifteen minutes a day usually is sufficient time to train the dog, especially in the first stages. Jontz puts a collar on the pup, calls him by name from the start and feeds the dog himself in order to gain his confidence. With a leash on the collar he teaches the pup to lead and heel, merely by giving the command and controlling the pup with the leash. By the same method the pup is taught to stop.

When the pup is six or eight months old, Jontz exposes him to a small flock of quiet sheep. With broad arm motions, the trainer indicates that he wants the pup to circle the sheep. After practice, the dog will learn to circle the flock on either side.

In all phases of training the "stop" com-



mand is most important. With it the trainer can immediately stop a dog when he makes a mistake. The average Border Collie can be a well-trained dog in one year and a completely finished worker in two.

With the shortage of farm help in this country, Jontz feels that dogs can do a man's share of the work on the nation's 3,000,000 livestock farms.

"After all, show me a man who can roundup and bring in 100 sheep from a large pasture in 15 minutes." With a flick of his hand Jontz sends three dogs after his sheep and a moment later the flock is motionless in the middle of a canine triangle. "Best hired hands a farmer ever had."



GIANT PLOW

When Monroe Terrell of White Horse, Colo., purchased five sections of farm land he figured he'd need big implements to cultivate it so he built a disk plow 60 feet long. The plow is made of five 12-foot sections fastened to a frame hinged in the middle to

permit efficient operation over uneven surfaces. Three bomber tires support the forward frame, which is of X-type construction, and other parts from a bomber's landing gear were used in building the plow's carriage. With his 85-horsepower tractor pulling the 22,000-pound giant, Terrell can plow 170 acres in 10 hours.



Cessna Business Plane

One of the biggest 4-5-place business planes is Cessna's Model 195, which cruises over 165 miles an hour and has a range of more than 700 miles. It is over a mile-a-minute faster than its predecessor. The luggage compartment holds 200 pounds and is accessible from the rear seat. With a gross load of 3350 pounds, the plane climbs 1200 feet a minute and operates at a service ceiling of 18,300 feet. It has a fixed landing gear made of spring steel.

Electric Mower

Only one hand is needed to steer and operate a lightweight electric lawn mower. This leaves the other hand free to adjust the 75 feet of extension cord while mowing. The mower is built low for clearance in cutting under shrubs and the depth of cut can be changed by turning one thumbscrew. The two front wheels have rubber tires and the two smaller rear wheels are of metal to assure grounding the machine.

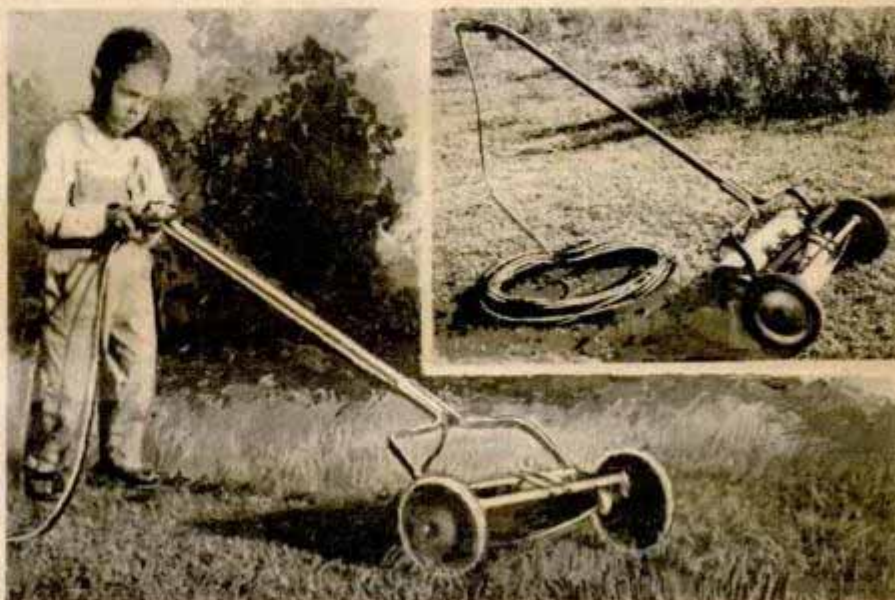

Fold-Up Auto

Right, midget motorcar, designed as transportation for private plane owners from airports, collapses into suitcase-size parcel. Below, seats, wheels and luggage rack unfold



Right, the one-cylinder motor can move the loaded vehicle at a top speed of 25 miles per hour. Below, a few seconds after landing at an airport the owner and his passenger roll off the runway toward home. The midget auto weighs only 72 pounds and is 37 inches long. Built of lightweight tubing, the car will average 60 miles on a gallon of gas, although the tank holds only $\frac{3}{10}$ gallon and can be filled for six cents. The auto supports a 450-pound "pay load"

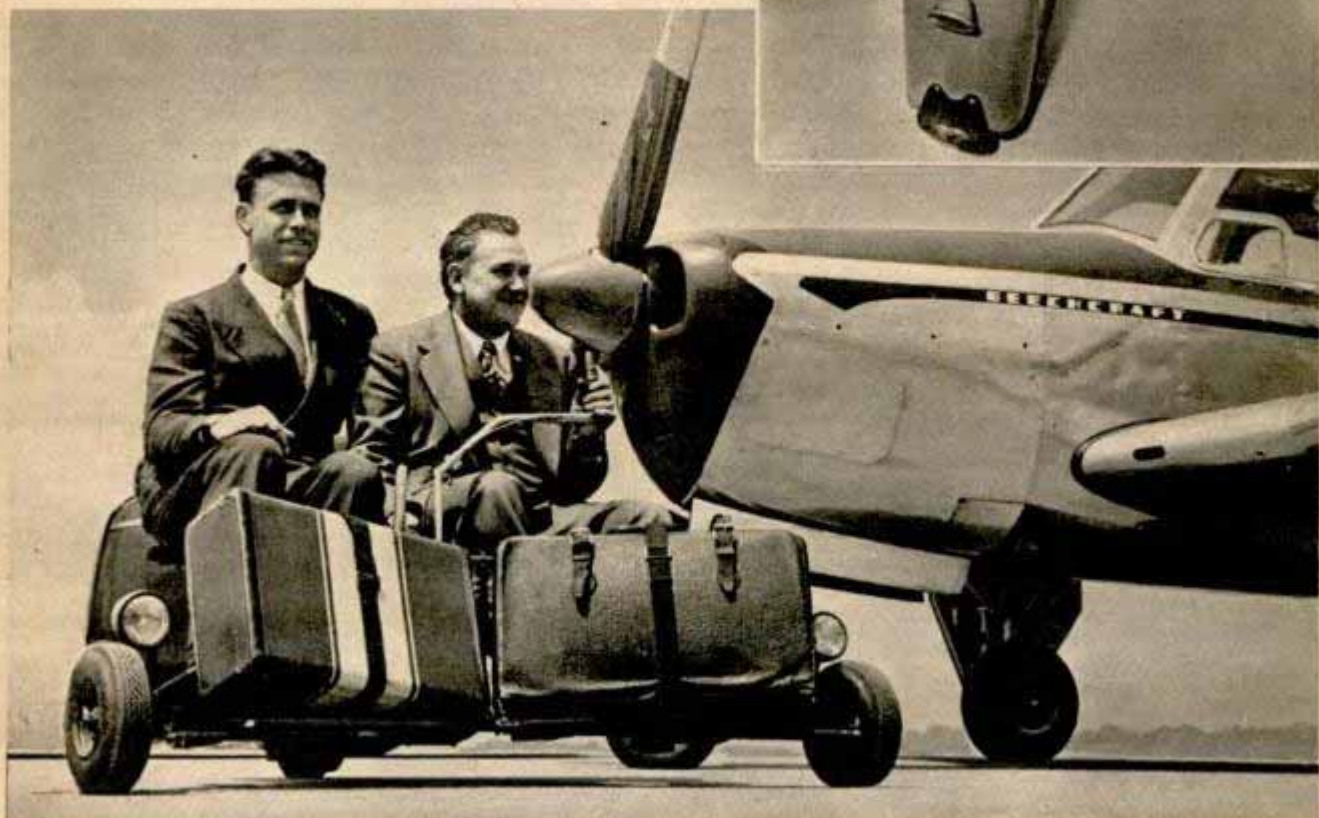

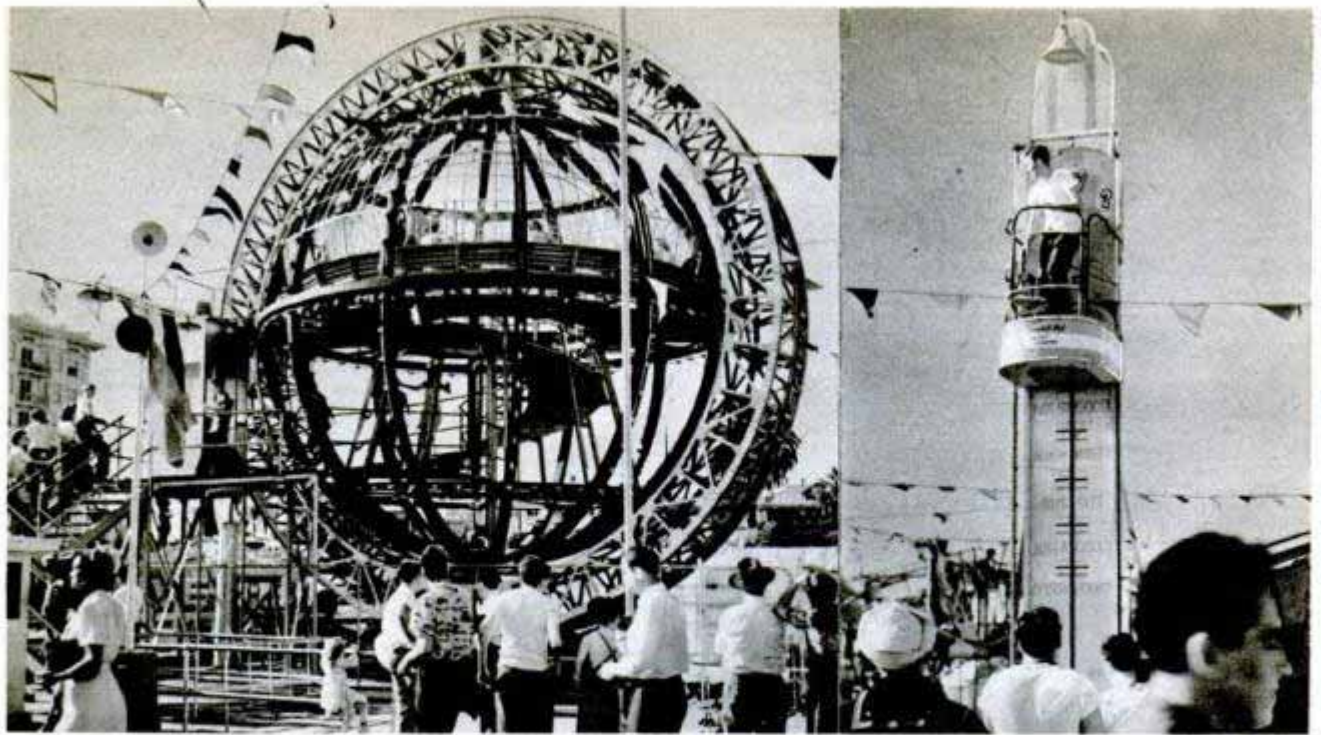

Whirling Globe and "Bootstrap Lift" Provide Thrills

Two unusual "rides" in a southern California amusement park are giving boardwalk strollers a thrill. One is a giant 50-foot globe, built at a cost of \$30,000, that operates like a gyroscope. Heavy steel girders form the framework. Patrons walk up a spiral ramp and are strapped to 75 seats installed at the "equator." When the globe is revolving at maximum speed, it begins to tilt right and left, producing an illusion of still greater speed and the sensation of falling. The other machine is a test

of athletic prowess in which the customer "lifts himself by his bootstraps." A small circular platform is fitted to a track on a 20-foot backboard. Two handles protrude through the floor of the platform. To test his strength the customer stands on the platform and pulls up on the handles. The harder he pulls the higher the platform rises on the backboard, working on the principle of a hydraulic lift. When the operator can lift himself no higher, the platform descends to street level.

"Broadcasting Station" for Medical Treatments

Heat treatments are "broadcast" to medical patients by a portable diathermy machine that radiates microwaves of energy. Equipment emitting short waves at 27,000 kilocycles per second has been used in the past, but the new machine steps up

the frequency into microwaves at 2,450,000 kilocycles per second. The super-high-frequency radiation is quickly absorbed in the body to produce a penetrating heat. Because of the short wave lengths the energy can be directed at any part of the patient's body like a beam of light, eliminating electrodes that formerly had to be strapped to the patient and permitting the doctor to view the area being treated. The diathermy equipment, complete with a director, weighs 35 pounds and can be plugged into any 115-volt 60-cycle a.c. outlet. The Federal Communications Commission has assigned a radio band for medical applications.



Alaska is the "air travelingest" area in the world, with 69 percent of the population as passengers during a year, compared with 10 percent in the United States.

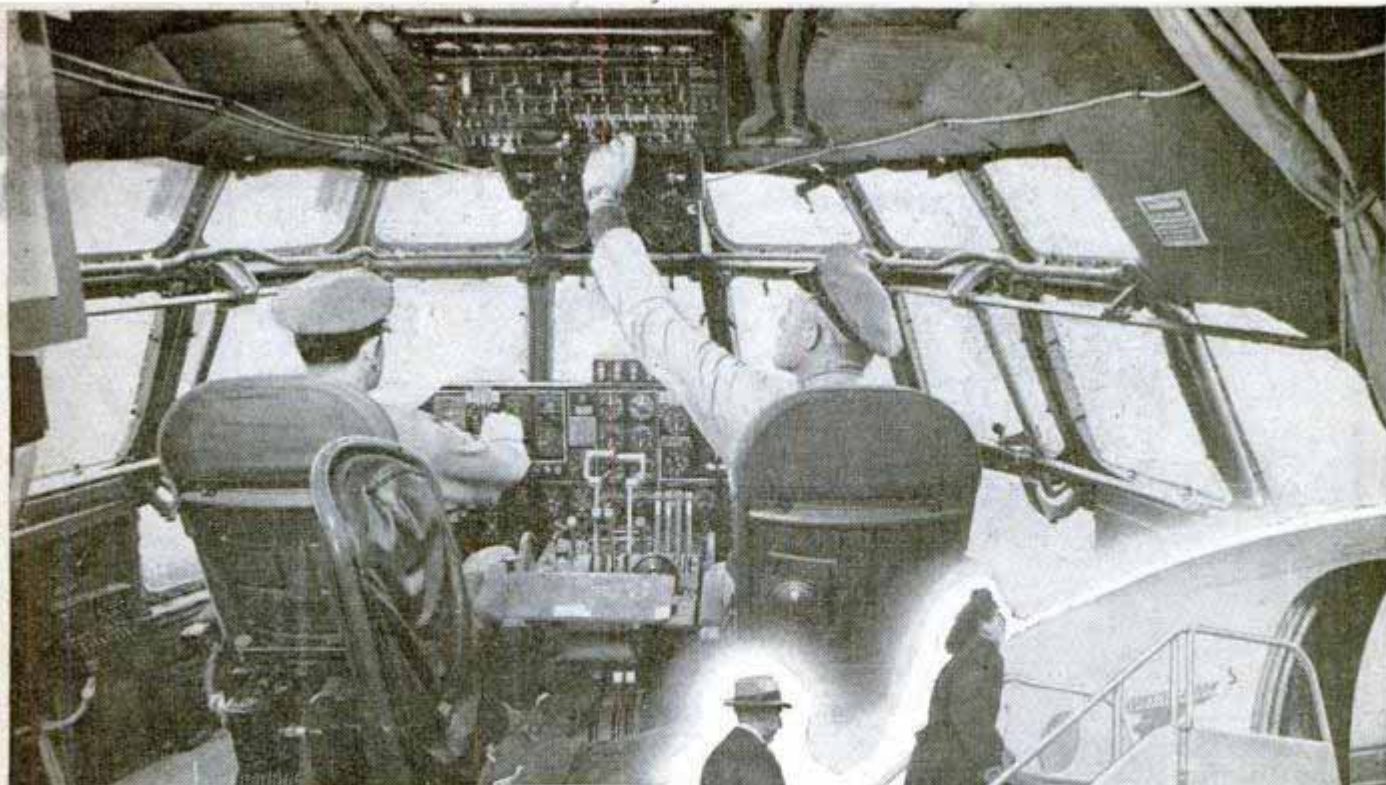

Boeing Aircraft photo

Your captain-pilot has plenty of room for his work. More spacious cockpits, like the Stratocruiser's, greatly aid safety and efficiency



FLIGHT PLAN FOR LONDON

ICEAN FLYING seems disarmingly simple, but probably nothing you've ever done was more painstakingly planned. It is a far cry from 20 years ago—when such a trip was a wild, blind adventure, warranting a ticker-tape reception.

Behind the soft, steady hum of the engines now is a story of countless hours of preparation, accomplished to make your lap on the world's 300,000 miles of air network a safe and speedy one. Knowing what happens behind the scenes will help you understand why crossing an ocean by air is almost

as safe as an auto ride to the corner grocery. Several of the 62 international airlines, for example, have gone from 6 to 17 years without a fatality. With better equipment and more experience, everything points to even greater safety in 1948.

Let's see what makes the operation tick so accurately. For our close-up examination we'll take a typical run of American Overseas Airlines between New York and London. That's not too long, in this age of flight, just over 3000 miles in half a day!

Your first concern is likely to be the kind of

By Aubrey O. Cookman, Jr.



One predeparture "must" is the crew's session with an aerologist. A course is chosen only after careful study of his last-minute weather reports

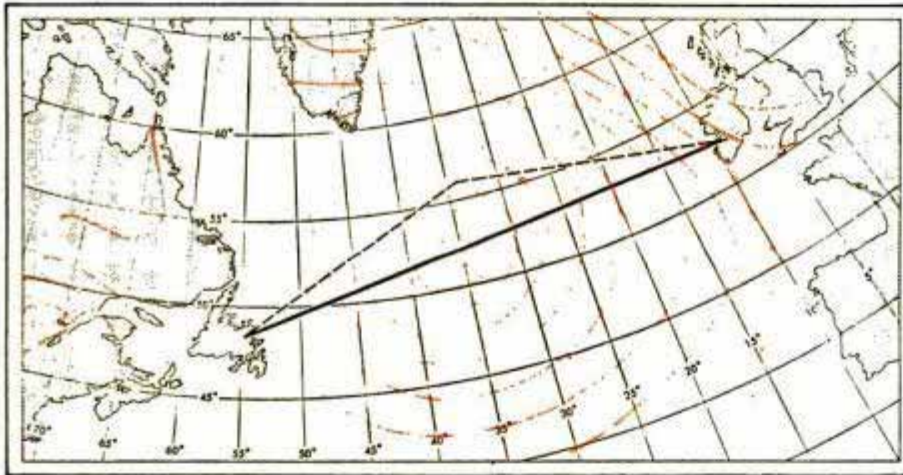

Sometimes the longest way is the quickest. Assisting winds made the broken line Shannon-Gander flight route faster by 33 minutes. Below, checking emergency equipment for one of the plane's three life rafts

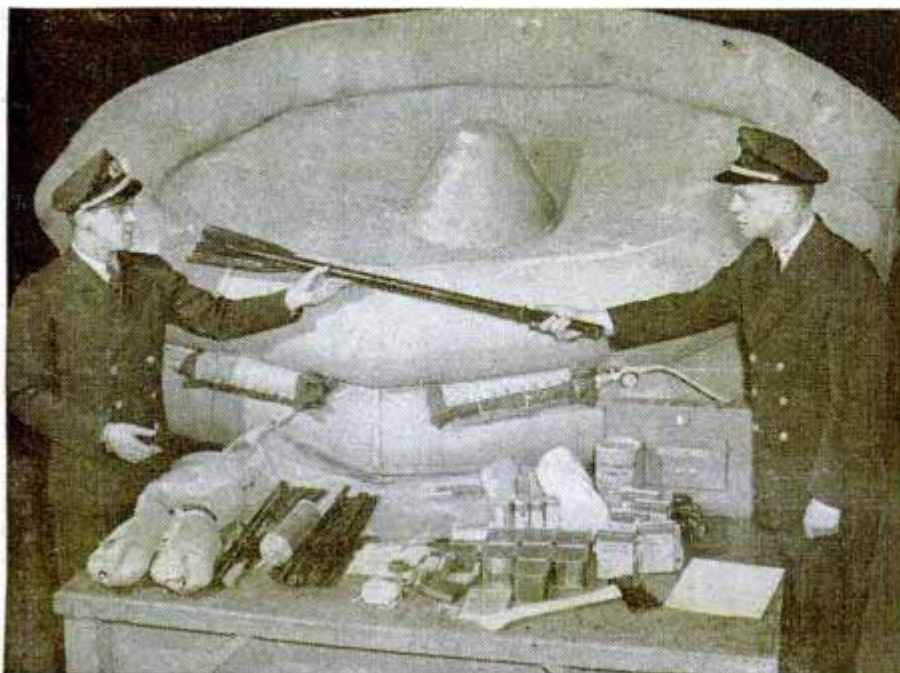

plane you'll fly. AOA uses seven Lockheed Constellations and 10 Douglas DC-4s now for 24 round trips a week, with eight giant Boeing Stratocruisers due to join the fleet in early 1948. All are sound, four-engine craft, cruising between 250 and 300 miles an hour with 60 daytime or 45 sleeper passengers. They've already completed over 14,000 crossings for this line alone, so don't get fidgety about their ocean-hopping ability. The Atlantic has been bridged by air over 91,000 times since Lindbergh's flight.

So you've gotten a U. S. passport and a British visa, and a reservation is set for morning departure. If you're a U. S. citizen, the company's passenger-service representative can check you through in five minutes and no customs visit is necessary.

With all that has been said about the red tape of international travel, it is appropriate to mention that a plan is in motion to combine passport and visas in a world travel card. Nations approving the card would permit their citizens to move freely between their respective countries. The card would be valid for a year and issued only to citizens of countries approving the plan.

An army of maintenance men is already swarming over your air steed for tomorrow's trip, giving her careful attention varying from the 12 to the 24-hour "big check," depending on expert diagnosis of her needs. The propellers had barely stopped whirling from the last crossing before a mechanical "mule" towed the shiny bird into a hangar for checkup. And at about the same time her most recent

flight engineer was in for a talk with maintenance chiefs, giving them a detailed account of her trip behavior.

The treatment runs from cleaning and minor repairs to complete engine changes. Certain parts of the airplane are automatically checked or replaced, even if a fault isn't detected. Five specialist groups go over assigned sections with a fine-tooth comb, looking for trouble or anticipating it. In air-line language this is the turnaround process, your assurance as well as the company's that everything mechanical is working perfectly.

After the maintenance crews finish, the plane is pulled out and gassed for predeparture engine run-up. Cargo, mail and baggage are trundled into position on a chain of small trucks and loaded into the ship's cavernous belly. Your own share is a 66-pound baggage allowance. Beyond that you pay an extra one percent of the one-way fare for each additional 2.21 pounds.

The human element of your trip was set in motion several days earlier, when a flight crew was designated and given the departure time. AOA has 200 pilots split up among its 65 full crews, so there is always a fresh unit available. On the other



Hoisting cargo into the craft's belly. Although there's a 66-pound baggage limit per passenger, additional mail and express quickly swell the total

side they'll get a two-day layover before returning. Pilots are held to a maximum, 85 flying hours a month.

Two hours before airplane boarding time the crew assembles at operations for a general briefing session. They are told of pertinent changes in lighting, field conditions, airway-control procedures, communications and anything else unusual along the route, as well as being brought up to date on new company operational rules.

Afterwards the captain-pilot, first officer and navigator confer with a meteorologist,

Between flights maintenance crews swarm over the plane for checks that take from 12 to 24 hours or more

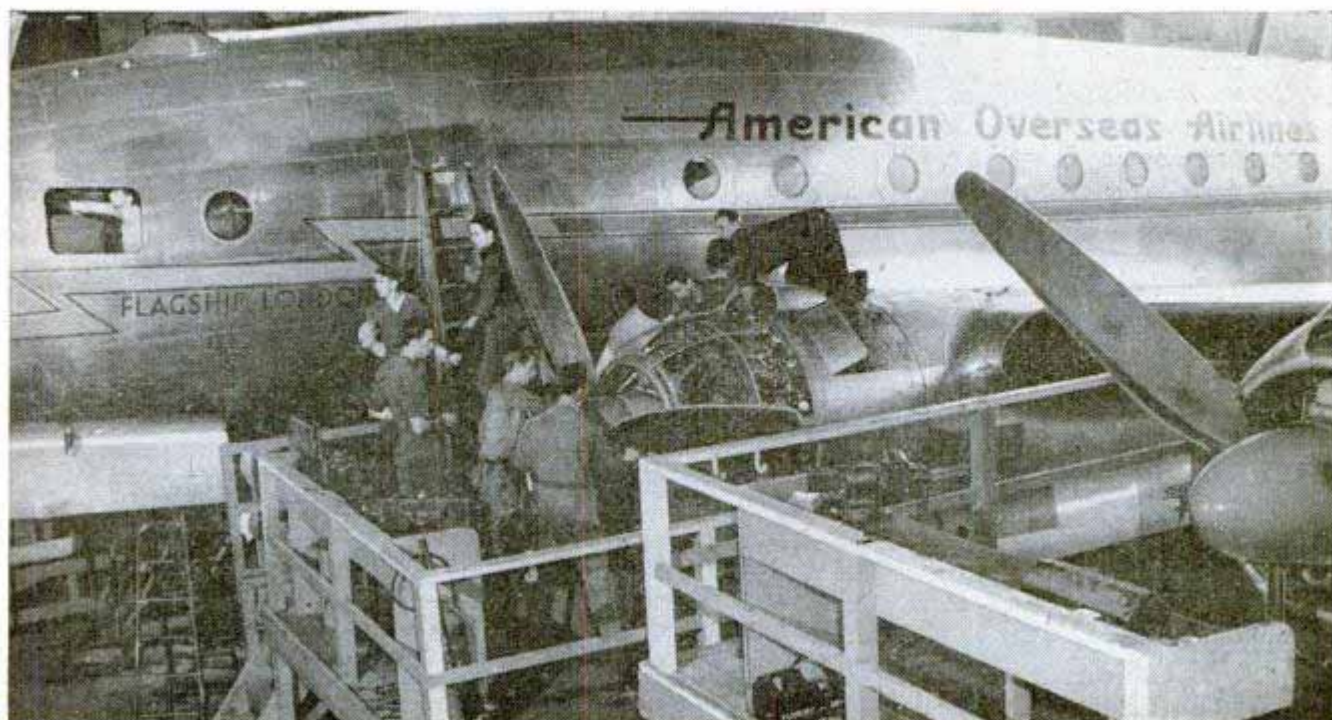



Behind the two pilots sits the flight engineer, keeping a running check on the operating condition of the big bird. Right, all the lines pride themselves on attractive en-route meals. Here a purser prepares dinner salads

who describes the weather en route and forecasts what can be expected later. This is a service of the United States Weather Bureau, augmented by hourly reports from international weather ships, 13 of which will shortly be dotting the North Atlantic, and from radioed messages sent by aircraft en route. From it the captain has to decide how he'll operate as to altitude, speed and course, the time it will take to cover each zone or leg, and the amount of fuel he'll need.

Your London trip, for example, could call for stops at both Gander, Newfoundland, and Shannon, Ireland, instead of going straight through to the latter, then on to London in little more than an hour. Such a flight might carry 2200 gallons for the first leg, though 1700 would presumably be enough, and add 2600 to 2800 gallons at Gander for the Shannon leg, with the alternates protected. Sufficient fuel is always loaded to get to the destination, then to an alternate field,

and still allow for a two-hour hold in case of bad weather. Gander is 1135 statute miles from New York and the next leg to Shannon is just under 2000.

A new method of long-distance flight planning puts schedules and timetables on a precision basis and greatly cuts point-to-

Planes joining the fleet early next year will have a lower-deck lounge. It is connected with the main passenger sections by a circular stairway

Boeing Aircraft photo





American Overseas Airlines photos

Altimeter readings give the navigator, left, a height check on the accuracy of upper-air forecasts. Right, the communications officer takes a hot meal, steak and all the trimmings, without deserting his desk

point air time. Known as Best Time Track Operation, it works on the pressure-pattern flying principle that sometimes the longest way takes the shortest time. Captains and navigators select the fastest path not only on the basis of the best altitude, but by deciding which wind pattern offers

them the greatest push across the ocean.

The North Atlantic's prevailing "lows" are spotted and a route chosen that takes advantage of the airflow circling counter-clockwise around them, giving aircraft passing to the right an added tail wind of many miles an hour. With high-pressure

Though there's scant possibility of using them, once airborne a stewardess tells passengers how to use the life belts. First-timers listen avidly

areas the effect is gained by passing to the left and picking up speed from the clockwise wind currents.

The conventional method has been to compute flight time for two or more altitudes, but over a single route. With Best Time Track, to provide a mathematical basis of comparison, a system of standard routes was worked out so that one or another would normally fit a favorable wind pattern and offer a sizable time saving. The necessary data is extracted directly from weather maps.

While on short flights it isn't practical to make long detours to take advantage of wind currents, it can shorten long trips by more than an hour, considerably shrinking the required fuel load.



FLIGHT PLAN - Long Range

A.O.A. Form 319-A

Aircraft: 906 Cruise: CON. From: EINN To: VOGA Trip: 41-15 Date: 16TH FEB 47

FLIGHT ANALYSIS

Zone	Dist	Eff Wind	TAS	GS	Time	Eff Wind	TAS	GS	Time	Den Alt	Den Alt
GREAT CIRCLE											
4	440	-19	183	164	2:36	-11	182	171	2:38	173	187
3	432	-20	163	163	2:38	-5	167	176	2:27	176	187
2	413	-10	173	173	2:23	-6	176	182	2:17	182	187
1	436	-8	171	171	2:33	-7	175	173	2:31	173	187
TOTALS											
Fuel 12500 Time 10:04 Fuel 11500 Time 9:37											
BEST TIME TRACK											
4	441	-5	183	169	2:42	-6	182	176	2:34	176	198
3	446	+3	186	186	2:28	+7	189	193	2:18	193	198
2	441	+17	200	200	2:12	+19	201	201	2:11	201	211
1	444	+1	184	184	2:25	+2	184	181	2:27	181	211
TOTALS											
Fuel 11800 Time 9:47 Fuel 11550 Time 9:31											

FLIGHT PLAN

Route #2 Via		Initial Heading: T.C. 290° Var. 18°W		M.C. 308 M.C.A. -13° M.H. 255°						
Alt	Zone	Eff Wind	Speed	Zone	Time	Zone	Time	Zone	Time	Howzit Totals
			Air	Dist	Zone	Dist	Zone	Dist	Zone	Fuel-lbs.
8000	4	-6	182	176	441	441	2:34	2:34	2:34	3400
	3	+7	184	184	446	446	2:25	4:55	4:55	6300
	2	+19	201	201	441	441	2:11	7:06	7:06	8850
	1	+2	184	184	444	444	2:23	9:30	9:30	11520
Altn VOGA										
Altn 18 171 153 343 2:15 2470										
Gross Weight										
Take-off	71,800 lb									
Fuel to Destination	11,520 lb									
Landing	60,280 lb									
Howzit Data										
4 Eng. P.N.R.	5:33 Hrs									
3 Eng E.T.P.	6:39 Miles									
Time to E.T.P. 3	3:15 Hrs									
3 Eng time from E.T.P. 3	4:00 Hrs									
3 Eng fuel from E.T.P. 3	560 gal									
Fuel to Deth & Alt.										
Fuel to Deth & Alt. 13990 2033 gal										
Heater Fuel 125 gal										
Hold Fuel 1800 22 gal										
600 10 gal										
Total Fuel Req'd 16515 2753 gal										
Total Fuel Aboard 16650 2775 gal										

Illustrating Best Time Track planning with an actual Ireland-to-Newfoundland flight. While the Great Circle estimates represent shorter mileage at three altitudes, Best Time Track is based on the pressure-pattern flying principle that sometimes the longest way takes the shortest time—when the wind lends a hand. The analysis weighs plus and minus effects of the wind, true air speed and ground speed, and the probable block-by-block time required. Because of anticipated bad weather at lower altitudes, Capt. Toth selected Track #2 at 8000 feet and actually bettered the alternate Great Circle route time by more than half an hour. The mysterious term "Howzit" is actual performance record. Fuel for the chosen path also ran 650 pounds less than for the alternate route.

Dispatcher **R.E. MITCHELL**
 Navigator **H.C. MYERS**
 Captain **S. TOTH**

The technique was tried experimentally over AOA routes for more than six months before its formal adoption. It is expected eventually to lower operating costs and help reduce transatlantic fares.

Meanwhile the flight engineer is learning from maintenance what work was done on the plane since its last trip. Then he goes aboard and checks all the instruments himself, staying to see that the gas load is correct. The radio officer is studying the latest communications instructions and changes in the operations-office file before checking equipment at his station. En-route meals to be put on the plane and expected personal wants of passengers are the main concern of the stewardess and purser. Comfort has a high priority.

As the plane moves into place on the runway, the navigator gives the captain the first compass heading to be flown, while the copilot and radio officer contact the control tower for take-off clearance. The captain handles the throttle and the flight engineer adjusts the propellers, later setting the power controls for climbing when

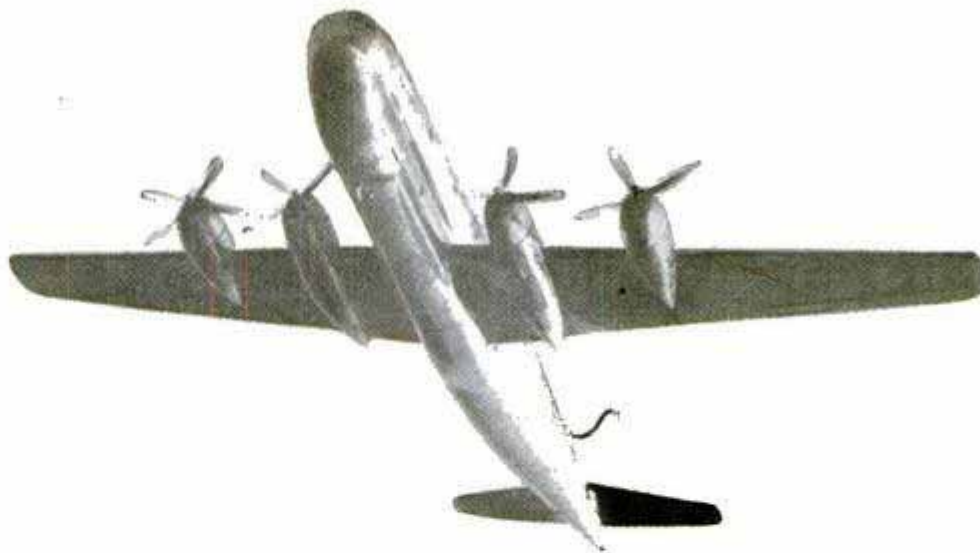

Stratocruisers will look like this to surface ships below. Over 110 feet long, it can cruise around 340 miles an hour

the ship has sufficient speed and altitude. His station is one of the busiest—from now on he'll be constantly working with slide rule and engine calculator, coaxing the best possible performance from the thousands of "horses" at his disposal.

As the plane levels off, the navigator checks his compass for deviation and plots the first position or "fix" on the chart. From then on, working closely with the captain, his primary responsibility is to know the plane's position accurately at all times. Every hour on the hour, a position report is radioed to the ground-control stations, so the plane's progress may be monitored.

Eating, is one of the plushiest items in transoceanic air travel. Breakfast, lunch or

Passengers aboard and four engines roaring, next time this "Connie" comes down she'll be on foreign soil



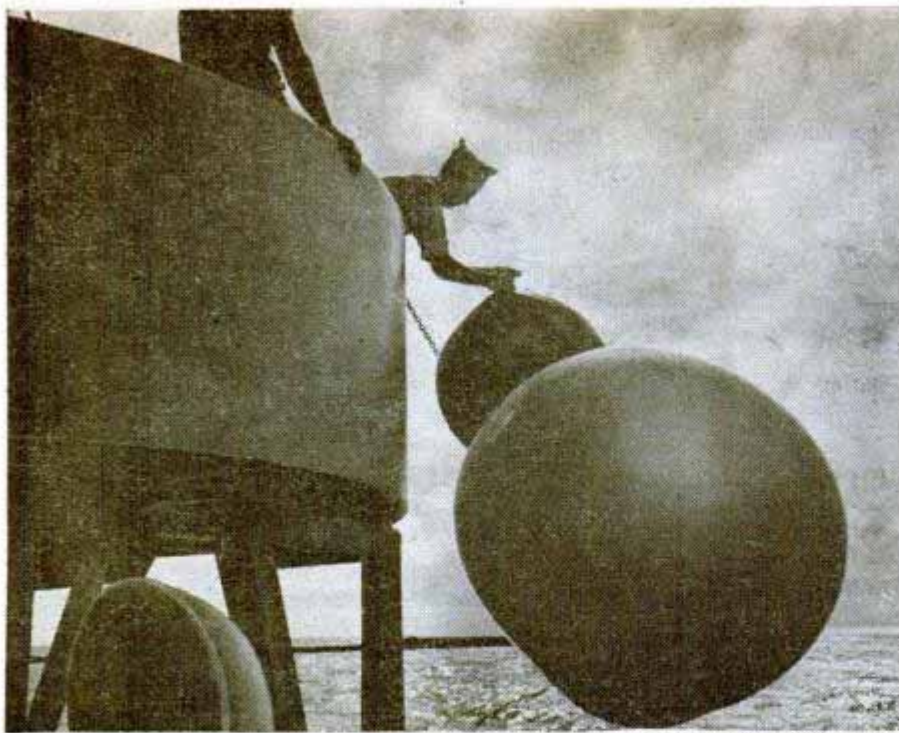

U. S. Coast Guard photo

Launching weather balloons. The larger one lifts equipment to record temperature and humidity, while the smaller checks wind velocity and direction

dinner, depending on your time of travel, are full-course repasts with all the trimmings. Most of the food is prepared in the air line's kitchens at the terminal, then reheated in the plane's galley just before serving. Some meals, like steaks for dinner and good old bacon and eggs for breakfast, are prepared en route.

About an hour out, after you've had time

time it takes radio waves to travel from shore-based stations at known locations to a receiver in the aircraft. Since the signals travel at a constant speed, measurement of the difference in the time it takes the two to arrive becomes a measurement of distance. By taking Loran measurements on a second pair of stations, in the same manner, a

(Continued to page 232)

Maintained by international agreement, weather ships and rescue facilities will cover all air-traffic lanes

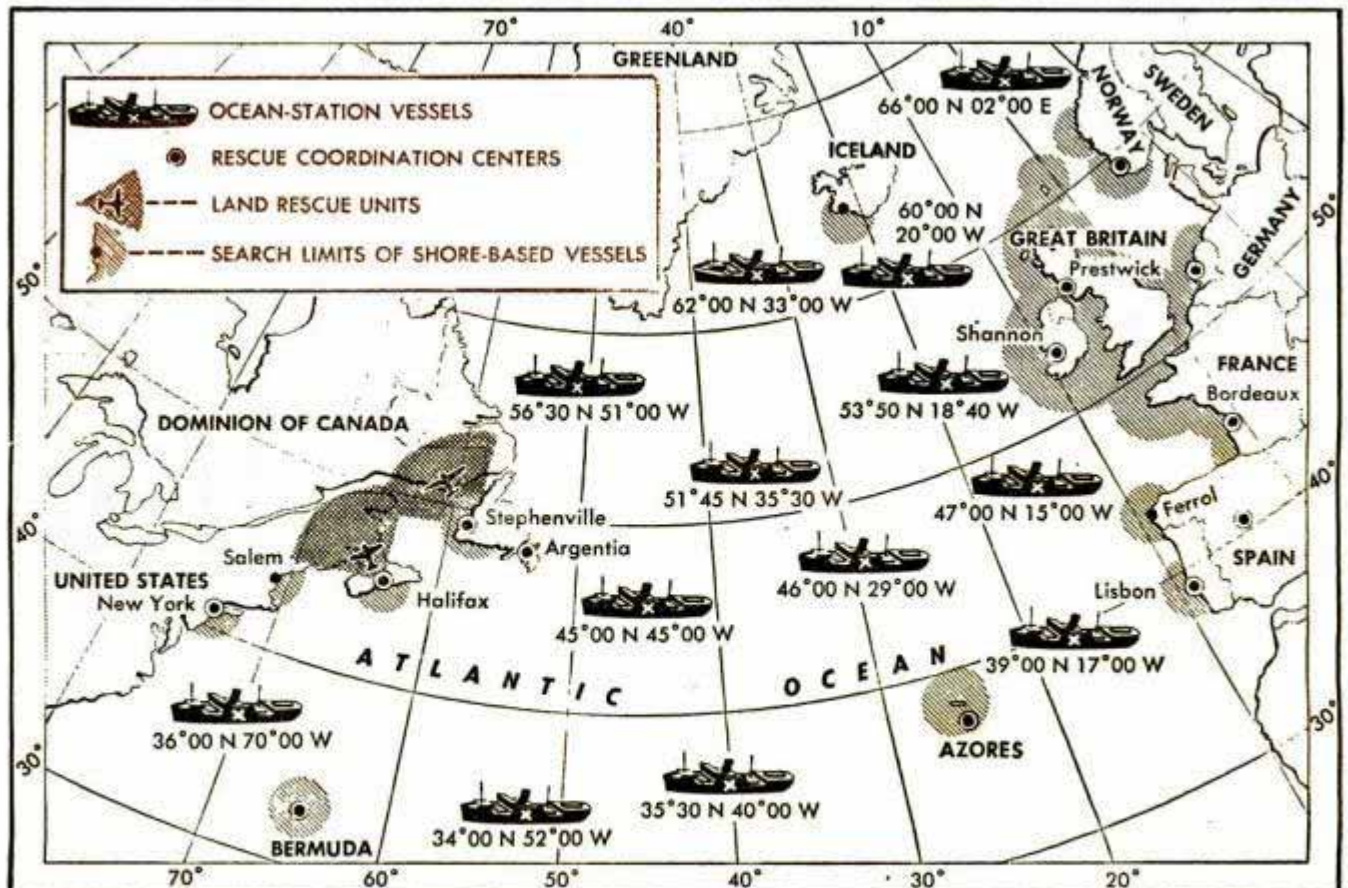

Locomotive Mover

Huge freight locomotives are moved around the Tyler, Tex., roundhouse of the Cotton Belt Railroad by a husky machine less than six feet long. The powerful mid-gut is an air winch mounted on a rubber-tired wagon. After it is anchored to a nearby rail, a cable is run out at right angles to the engine, turned with a pulley and fastened to the locomotive. The winch winds up the cable to move the engine.

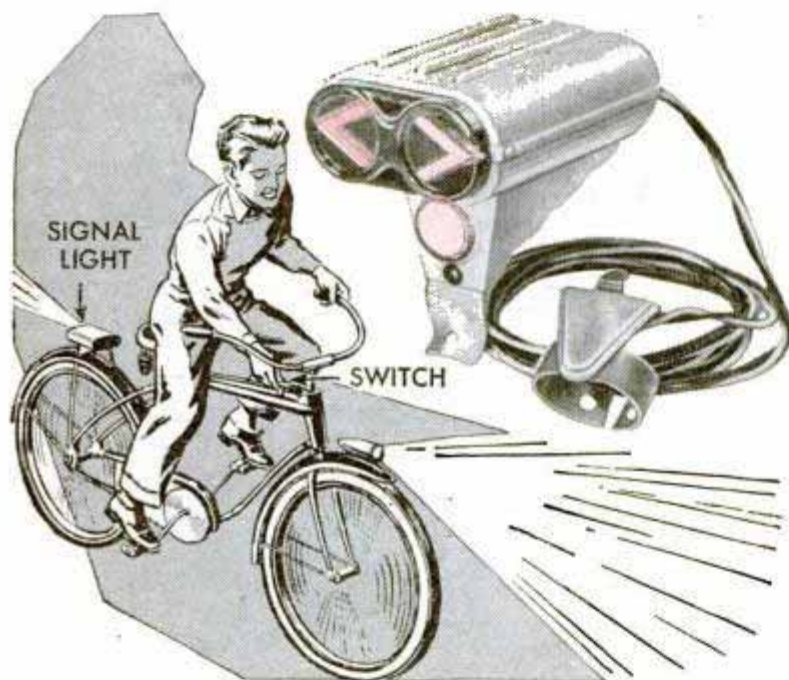
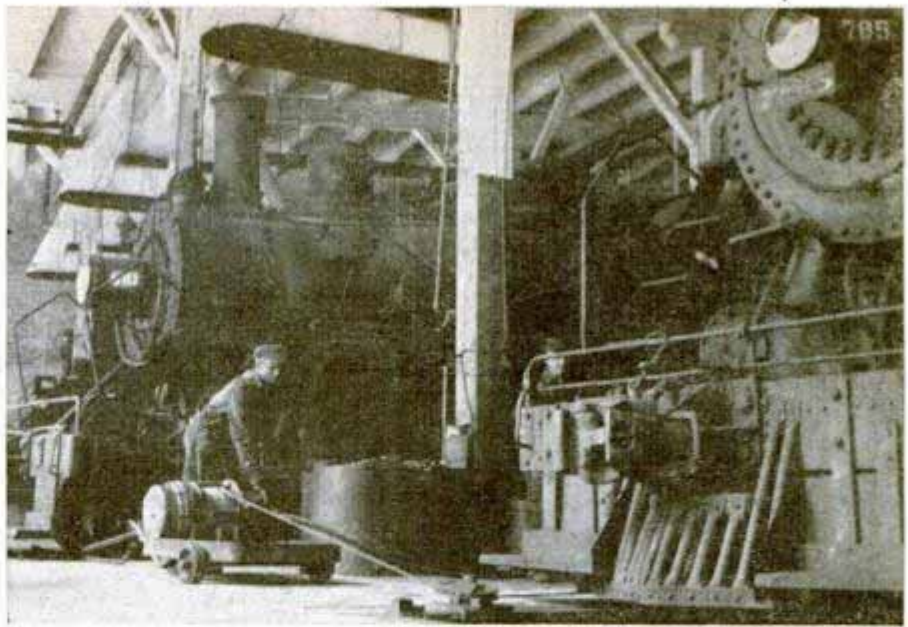

Directional Light for Bikes

Twin-arrow lenses on a rear light for bicycles point out the direction the cyclist intends to turn. The switch for the light is located on the frame of the bicycle in front of the rider. The lamp has a split aluminum case housing two standard flashlight batteries and the arrow lenses. A reflector beneath the lamp serves as a taillight for the bicycle.

Operating a 33-mile run between Belfast and Burnham Junction, Maine, is America's only municipally owned rail line, the Belfast and Moosehead Lake Railroad, which uses two GE Diesel-electric engines to pull the trains.

Plastic Curve Plotter Used for Road Layout

Draftsmen can use a flexible curve-plotting instrument to plan highways and other types of drafting involving long radii. A flexible plastic strip can be adjusted to form various curves. The instrument is available in two sizes. The small one, 1½ feet long, has an adjustment range from 0 to 6 degrees, or infinity to 10 inches actual radius. The larger instrument, 2 feet long, has a range from 0 to 4 degrees, or infinity to 1-foot radius.

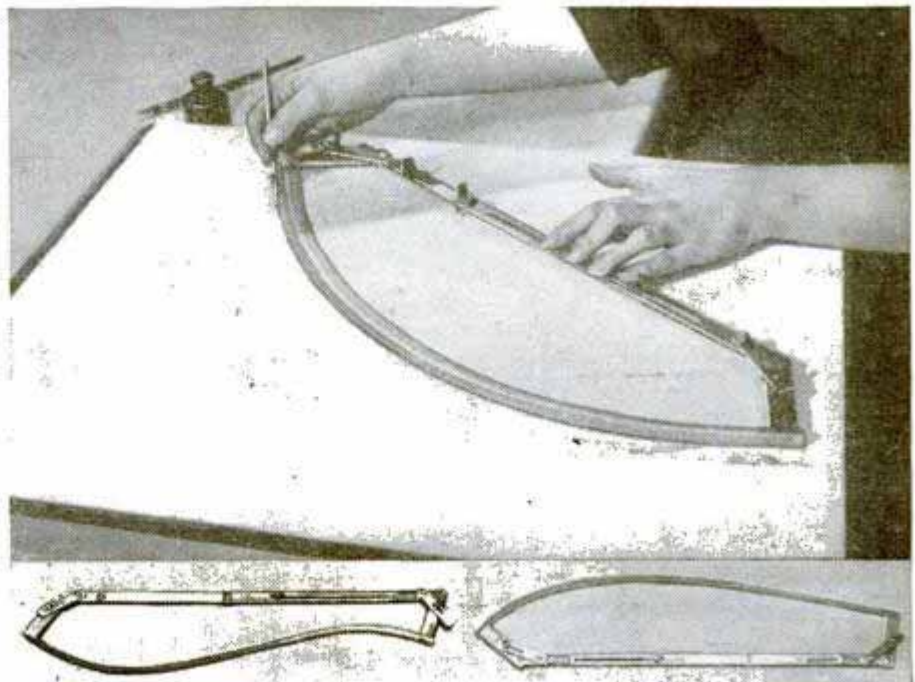



NACA photo

"Silent" Plane Has Five Fan-Shaped Prop Blades

Only a very slight "whish" can be heard at 300 feet from a "silent" plane tested by the National Advisory Committee for Aeronautics. A 90-percent noise reduction

was gained by gearing down the 185-horsepower engine to produce full power at fewer propeller revolutions and fitting the plane with five fan-shaped blades.

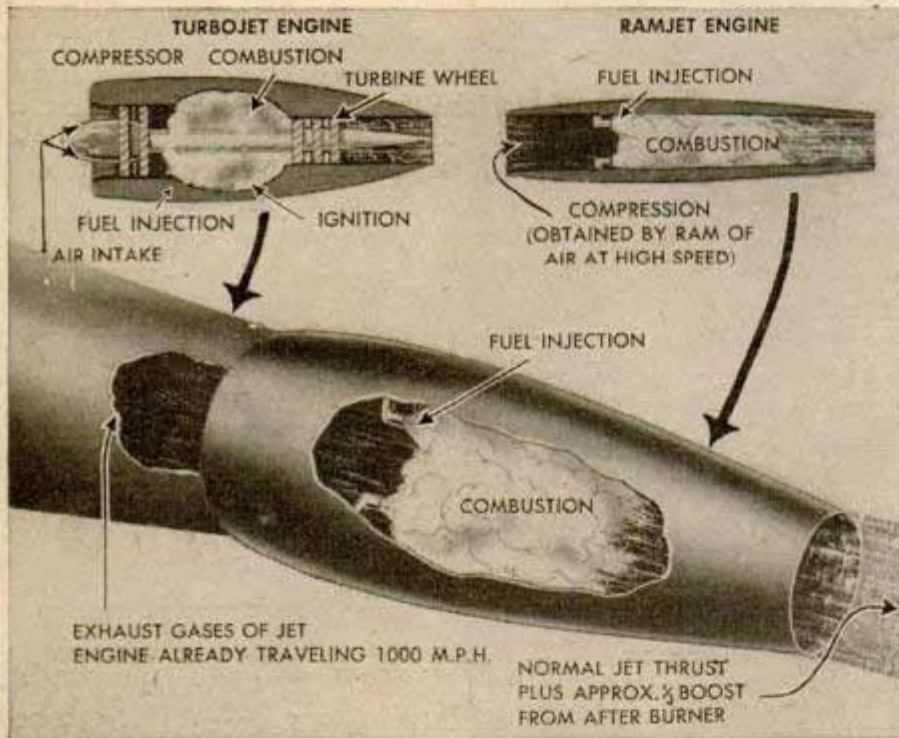

After-Burner Unit Boosts Jet Thrust

Thrust from turbojet airplane engines is boosted one third by an after burner that works like an attached ramjet unit. Fuel sprayed into the tail pipe burns and adds greater mass and velocity to gases already in the turbojet's exhaust stream. Developed for the Navy by Ryan Aeronautical Company, it is intended for use only when emergency bursts of power are needed. Wasteful at low speeds, at high speeds the "ramjet" attachment uses fuel more economically than the turbojet.

Blow-Dart Game

Darts are blown from a 28-inch tube in a new game patterned after the South American Indians' method of killing small game with darts tipped in curare poison. The game equipment consists of the blowgun, $\frac{7}{16}$ inch in diameter; removable plastic mouthpiece; steel-pointed darts—without the poisonous tips; cork target, and carrying case.

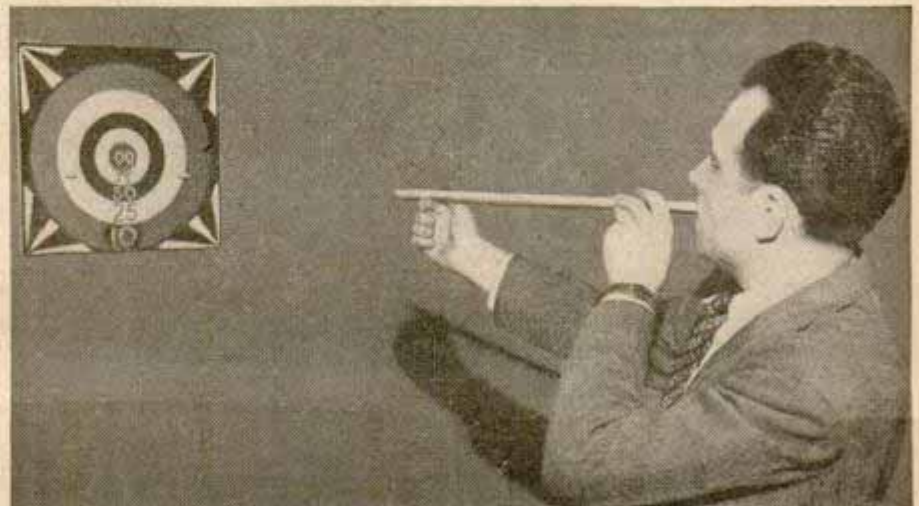



After Ott makes a final adjustment on the lens, the robots will expose a 16-mm. frame every five minutes

By Clifford B. Hicks

TIME SWIRLS through a basement studio in Winnetka, Ill., 10,000 to 50,000 times faster than it passes on the street outside. By harnessing quickened time to his motion-picture cameras, John N. Ott, Jr., makes flowers push through the earth, bud, burst into blossom and wilt—all within a few seconds on the theater screen.

Until just recently Mr. Ott was a banker with a hobby. Now time-lapse photography has usurped his full time; from occasional showings for neighbors and clubs he has graduated to a contract with a Hollywood studio that will buy his films as fast as he can make them. And just ahead are research jobs for

Camera mounted on car patiently "grows up" with the plant. It is elevated by a fine-threaded shaft

The WALTZ of the FLOWERS

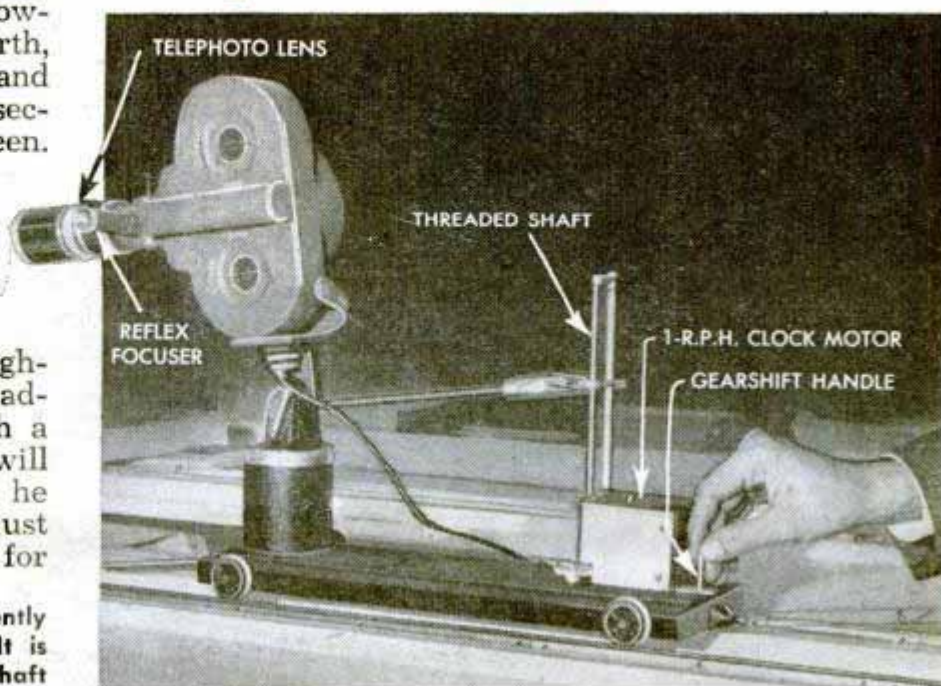

industry, already knocking at his door for time-lapse studies of chemical reactions, medicines, crop fertilizers and weed controls, and food-preservation processes.

Filmed over a period of years, Ott's motion picture, "Flowers in Action," shows rare plants growing from seedlings to maturity within seconds. In the climactic scene, the "Ballet of the Primroses," eleven

botanical dancers swirl, dip, wave their arms and weave in and out to the strains of a Strauss waltz. This single scene took five years to photograph, yet lasts but two minutes on the screen.

Ott's basic idea is to expose single frames of a 16-millimeter film at specified intervals—usually three minutes to an hour. When the film is developed and projected, the rate of growth of the plant is multiplied thousands of times on the screen. It's just the opposite of a slow-motion film.

Time-lapse photography is not new, but Ott has designed his own equipment to regulate automatically the passage of time, and his resulting films are unique. Now Ott wishes he could slow down the passage of his own busy hours, as he hasn't enough time to keep up with the demand to show his motion pictures. He has incorporated

← Timed to the second, this damper closes overhead shutters when exposure is made
 ↓ Sketch shows Ott's elaborate studio including the panel of controls on right wall

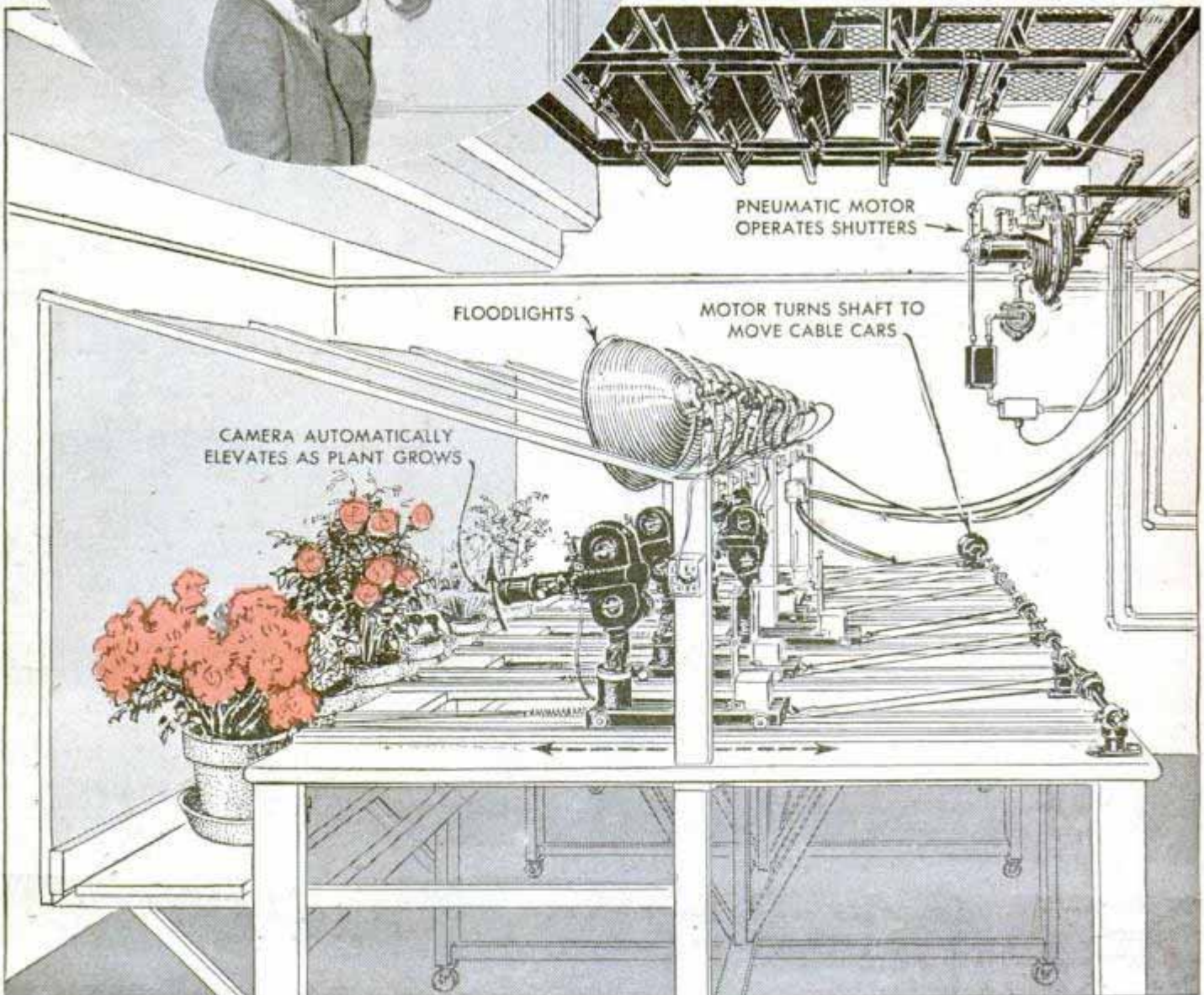
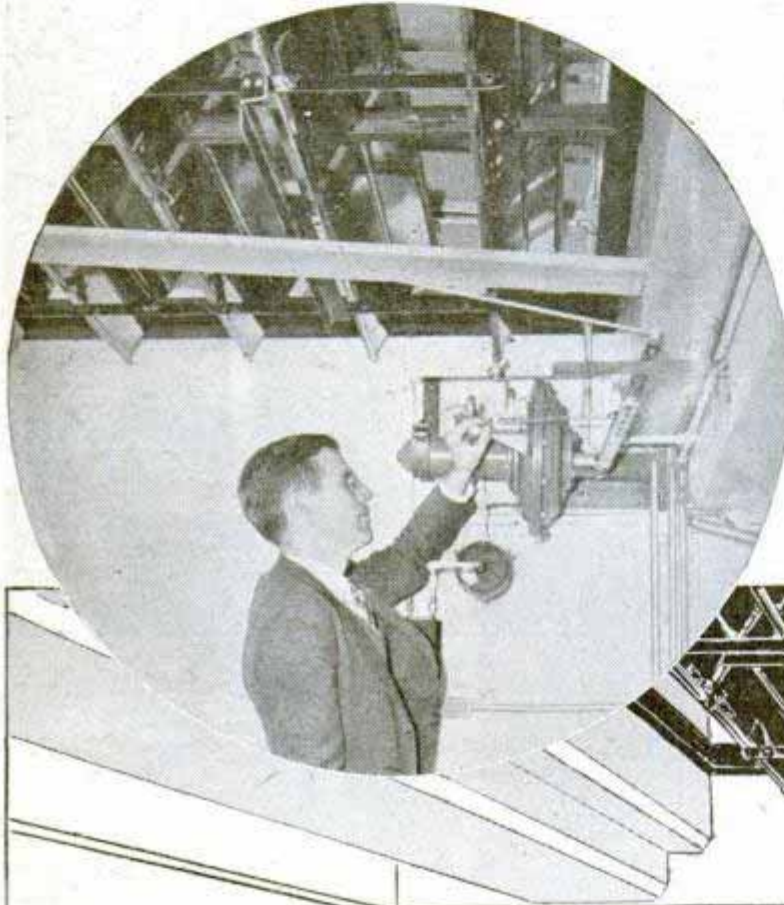



Six robot-operated cameras are lined up on six different subjects. Note variations in lens elevations

his undertaking under the name Phototronics, Inc.

Every few minutes in Ott's basement studio the overhead shutters slam closed, the room lights go off, a bank of photo-floods suddenly springs to life, the camera clicks, the lights go off and the shutters

Ott adjusts a time clock to photograph a new subject. In foreground is original timer he built 20 years ago

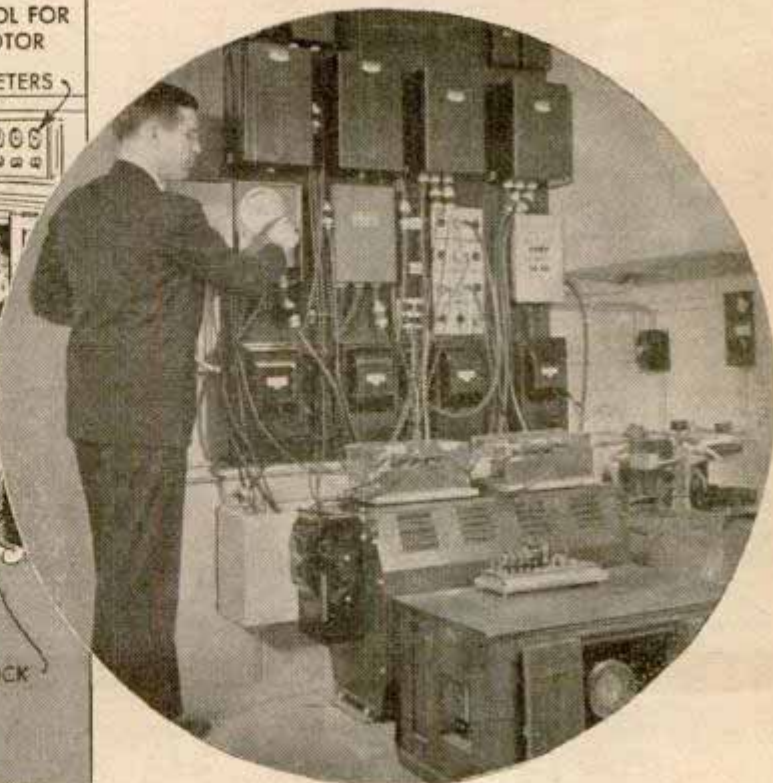
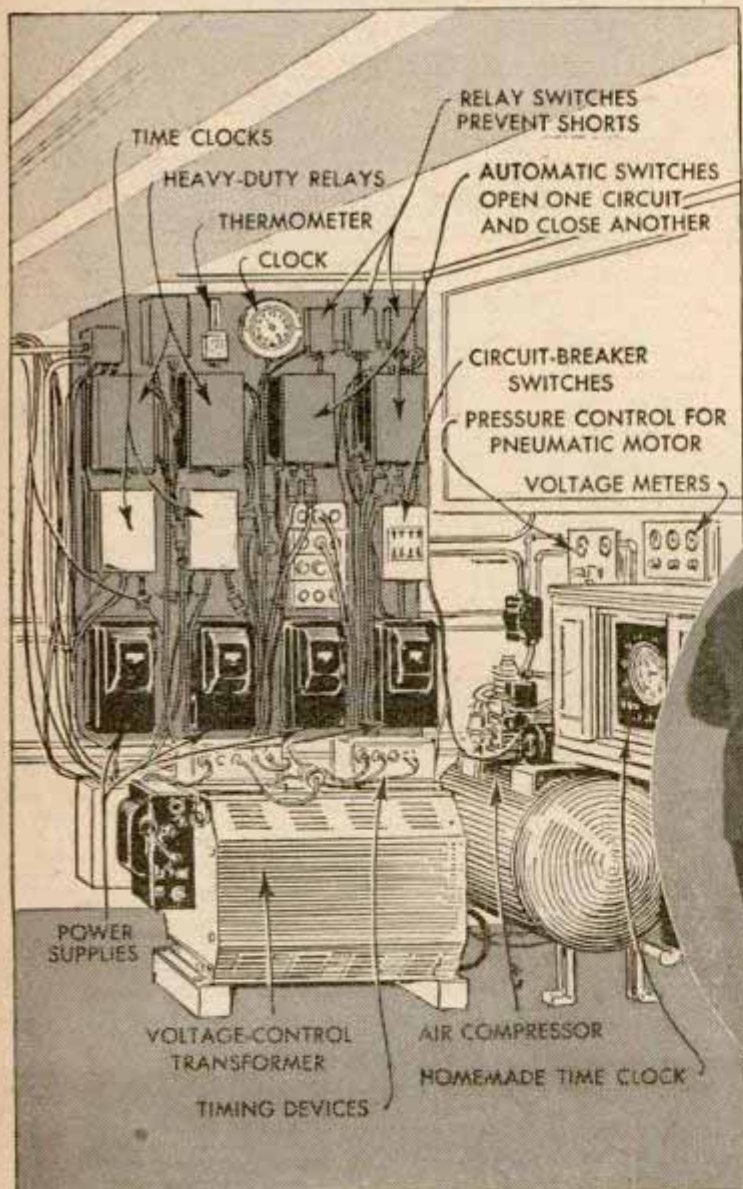

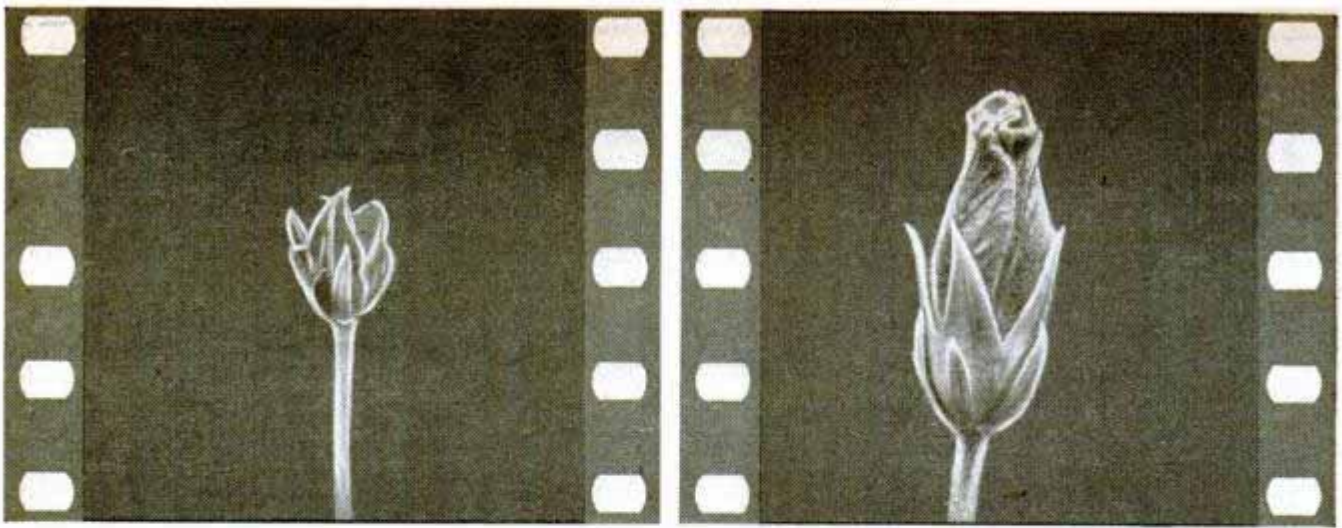

Time-lapse photography—exposing frames at intervals—speeds plant's growth thousands of times on screen.

snap open. It's an extremely complicated and automatic operation to expose one tiny frame of film. His equipment represents 20 years of patient work to overcome the problems of exposing that frame properly.

In order to shoot the sequence titled "Ballet of the Primroses" he built a special stage including a backdrop and a curtain. From wing to wing across the stage ran a track along which the plants were pulled in a cable-car train. Inside each flower pot were a watering pipe and heating element. By alternately watering the flowers and wilting them with heat, Ott made them do realistic dance steps. With two banks of lights opposite each other he made the flowers turn and reach in either direction. The entire sequence was planned in advance to match the musical score. He could determine weeks ahead of time the exact position and condition of each plant in the chorus of floral dancers.

There's only one flaw in the film—a sud-

den movement by all the plants. The unscheduled movement represents Ott's two years in the Navy when he had to postpone his work.

When Ott was 17 years old he bought his first motion-picture camera and decided to combine photography with gardening, his other hobby.

"My first subject was some apple blossoms which I brought into the house," he says. "I knew I had to take a picture at regular intervals. At first I decided to take a picture every hour, but by the time the second night rolled around I thought maybe every two hours would do as well. About dawn of the fourth day I imagine I missed a few frames—I blamed it on the alarm clock. When finally completed, the picture showed blossoms opening so fast that it was impossible to see motion—there was a bud and all of a sudden it was wide open!"

Ott decided that running home every few minutes to take a picture was too much

Attachment permits photographing through a microscope for study of the development of bacteria and molds. The water flask cools the light rays

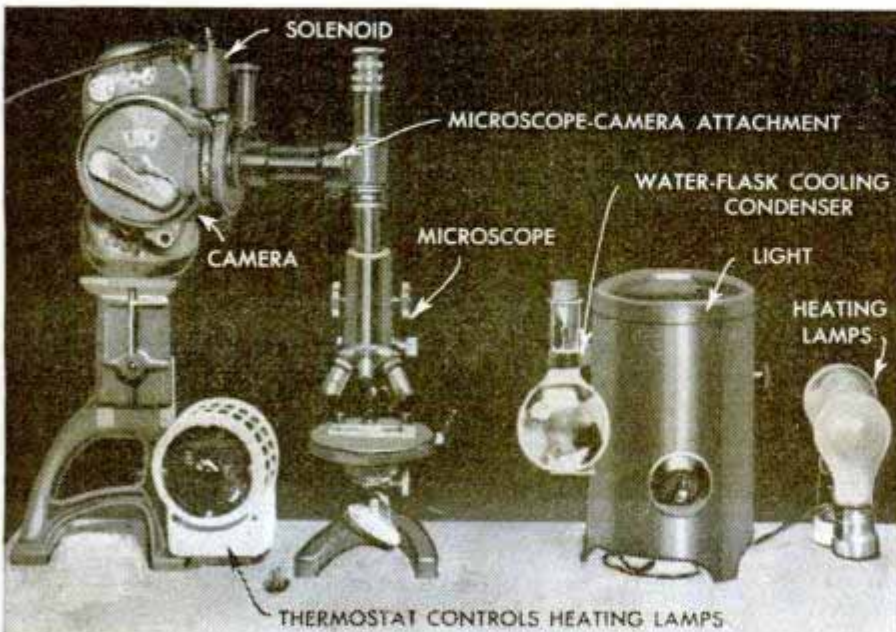

trouble so he built his own timing apparatus from the kitchen clock. He still uses the same clock to regulate part of his equipment. Soon he discovered that he would have to regulate the light, as some of the frames were overexposed and some underexposed. But this brought up still another problem—if he took the pictures in artificial light, how could he give the plants the necessary sunlight?

A more complicated hookup was the answer. He developed his timing mechanism so that it would close a large window shutter whenever a

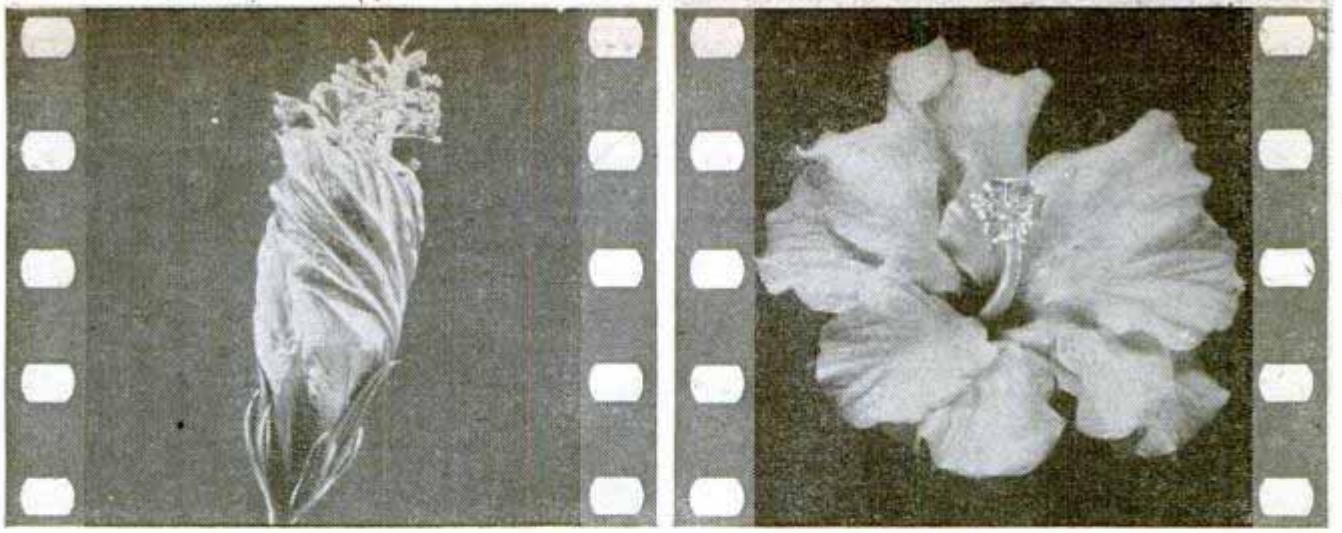

These four frames show development of hibiscus from bud to blossom. Plant in finished film grows up in seconds

picture was taken and open it again immediately afterward. Artificial light filled in the slight interval to give the plants the same illumination for every picture regardless of day or night, bright or cloudy weather.

"I ground out two or three short scenes a year until 1929 when color film became available," he says. "Then I bought a second camera and started again in color. Several years later this first type of color film was so greatly improved that the old movies were outmoded. I really started making today's movies all over again."

But around every corner was a new problem. Every time-lapse movie he tried to make of an orchid was returned by the processor with a new roll of film and a polite letter explaining that something seemed to have gone wrong in developing the exposed roll. Upon investigation, Ott found that the high humidity necessary to grow orchids was spoiling the film. Finally he developed a method of packing the camera with moisture-absorbing chemicals.

Today Ott's studio, projecting out from his basement, is a wonderland of automata. The ceiling is glass-paneled to admit the sunlight necessary for his growing plants, and a bank of shutters operated by pneumatic pressure slams shut for exposures. The complicated robot that performs all split-second tasks is a control panel that covers one wall. The panel includes six time clocks and timing devices, a voltage-control transformer to give exact control over the light, relay switches, circuit breakers, power supplies, an air compressor and a pneumatic damper to operate the shutters. An air conditioner controls temperature and humidity.

Occupying most of the room is a large table mounted on rubber wheels. By moving the table with the passing of the seasons, Ott assures his plants of the greatest possible amount of light. On the table are

six two-rail tracks and on each track is a miniature cable car that holds a camera. Above the cameras is a bank of 14 floodlights with reflectors, and in front of the cameras are plants he is photographing.

But Ott has built into the table refinements so precise the cameras need no attention for weeks at a time. For example, a tiny clock motor on the rear of each cable car turns a fine-threaded shaft so slowly that it makes only one revolution every hour. The shaft in turn elevates the camera. By setting the mechanism at a predetermined speed, Ott literally can make the camera "grow up" with the plant. When

(Continued to page 240)

With miniature time-lapse setup in his back yard, Ott records the development of maple leaves and buds

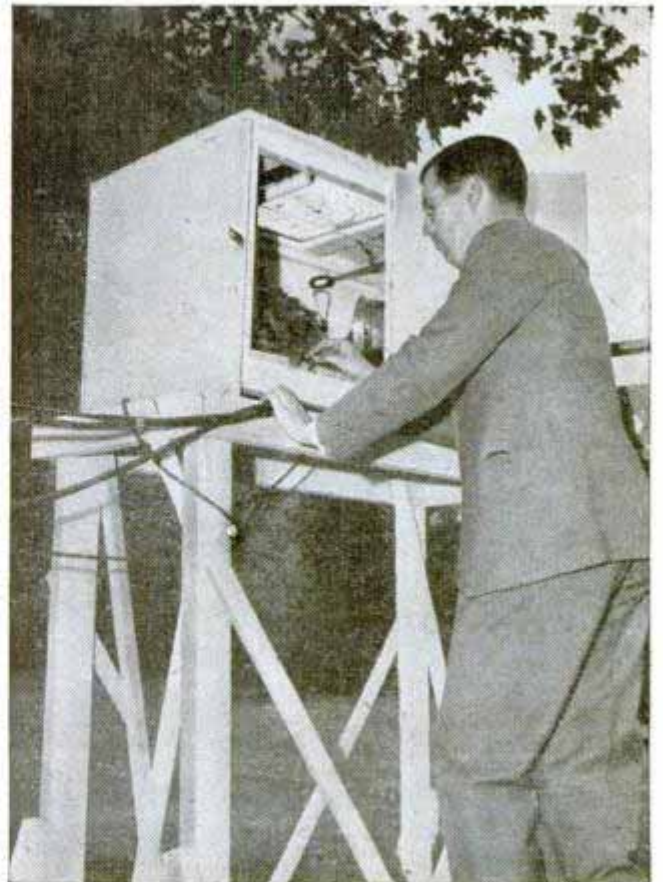



Grass Catcher Easy to Empty

Removing grass from the catcher of a lawn mower just introduced is accomplished without bending and without removing the catcher. A handle raises the catcher a foot off the ground. Then the mower handle is raised and pushed forward so that grass falls into a basket.



Robot Household "Maid"

Several housemaid tasks are performed by a bedside electrical robot invented by A. D. Granger of London. The device turns on a heater at a predetermined time, heats water and siphons it into a teapot or coffee pot. When the tea or coffee is ready, the robot rings an alarm, lights a bedside light and turns on a radio to arouse the sleeper. The automatic "maid" can be regulated to perform as many of the six operations as desired. The device was demonstrated recently at an exhibit in Enfield, England.

Warning Sign for Motorists

Visible 350 yards in either direction, a warning sign helps protect motorists who stop along the highway for any reason. The sign folds up for storage in the rear compartment of the car. Two reflectors on the sign can be seen at night.

Synthetic Glycerin to Increase Supply

Commercial production of synthetic glycerin soon will relieve shortages and add to the supply now being made by soap manufacturers. Glycerin is used in making many articles, including Cellophane, films, toilet articles, drugs, inks, dyes and papers. War demand for glycerin in explosives exhausted the supply available from natural sources and requirements were met by the salvage of kitchen fats in homes. The new synthetic-glycerin plant will be established at Houston, Tex., by the Shell Chemical Corporation and will start operations early in 1948.

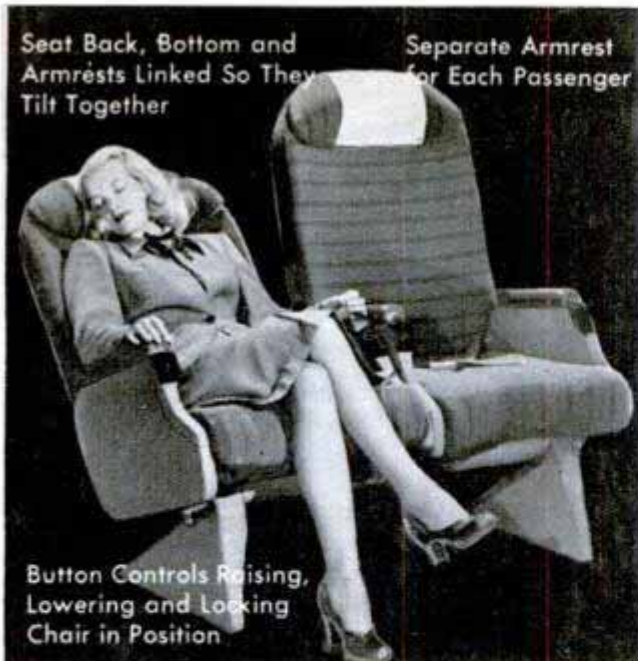

Doak Aircraft photo

Plane Seat Tilts Cradle Fashion

Because some passengers slide down in reclining air-line chairs and bunch their clothing, a seat is being built with back and bottom linked so both tilt together in cradle fashion. The front of the seat curves in to accommodate either the shorter legs of women or the longer legs of men. A button near the right hand operates a hydraulic mechanism that automatically reclines and raises the chair and locks it in any position. Each seat has two individual armrests that tilt with it, maintaining a comfortable elbow height. Both headrest and back are slightly concave to prevent rolling from side to side.

Weed Sprayer

Dandelions, plantains and other lawn weeds are given individual applications of a weed-killing solution by a sprayer that screws to the top of an ordinary gallon jug. The sprayer consists of two tubes and a spray head made of Tenite plastic. The smaller of the two tubes is inserted through the cap until it almost touches the bottom of the jug, serving as an air intake. Attached to the end of the larger tube is the spray head. Tipping the jug shoots a stream of weed eradicator down the tube and out through the sprayer for a direct application to individual weeds. A valve on the cap permits the spray to be shut off at any time.



Attached to the end of the larger tube is the spray head. Tipping the jug shoots a stream of weed eradicator down the tube and out through the sprayer for a direct application to individual weeds. A valve on the cap permits the spray to be shut off at any time.

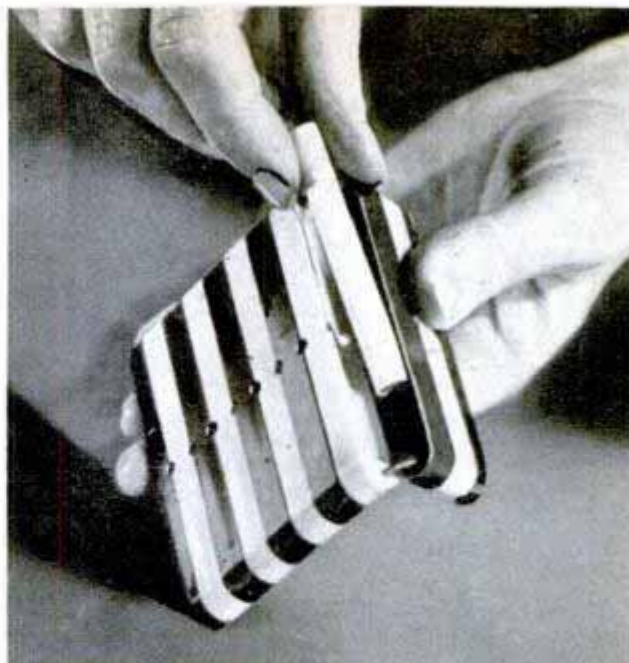

Flexible Cigarette Case

Cigarettes are extracted from a new pocket case by applying slight pressure to open any of 10 plastic compartments held together at top and bottom by coil springs. As soon as a cigarette is removed and pressure released, the case snaps back to its original position. Small holes in each compartment reveal whether a cigarette remains in that section. The case is decorated in contrasting stripes.

Color Tester for Fluorescent Tubes

Fluorescent tubes used in commercial signs are now color-tested by a device which emits ultraviolet rays to make the tubes fluoresce in their true colors. Thus the sign assembler has no difficulty in selecting various shades from "warm white" to "daylight."





1. OFFSIDE



Football's Sign Language

Illustrated by Jay Berwanger, former All-American halfback and present Western Conference official, and members of the Northwestern University squad



2. DELAYING GAME



3. INCOMPLETE PASS
NO PLAY—NO SCORE



1. Offside: Five-yard penalty, called when any part of player's body is ahead of ball when it is put in play

2. Delaying Game: Five-yard penalty resulting from tactics that prevent putting the ball in play promptly

3. Incomplete Forward Pass: Signal shows pass was not successful. It also indicates no score or no play

4. Time Out: Signals team is taking one of four two-minute rest periods to which it is entitled in each half

5. Illegal Motion: Called when man in motion is less than five yards back of line when ball is snapped

6. Holding: Players on offense must keep hands and arms against body when using them against opposition



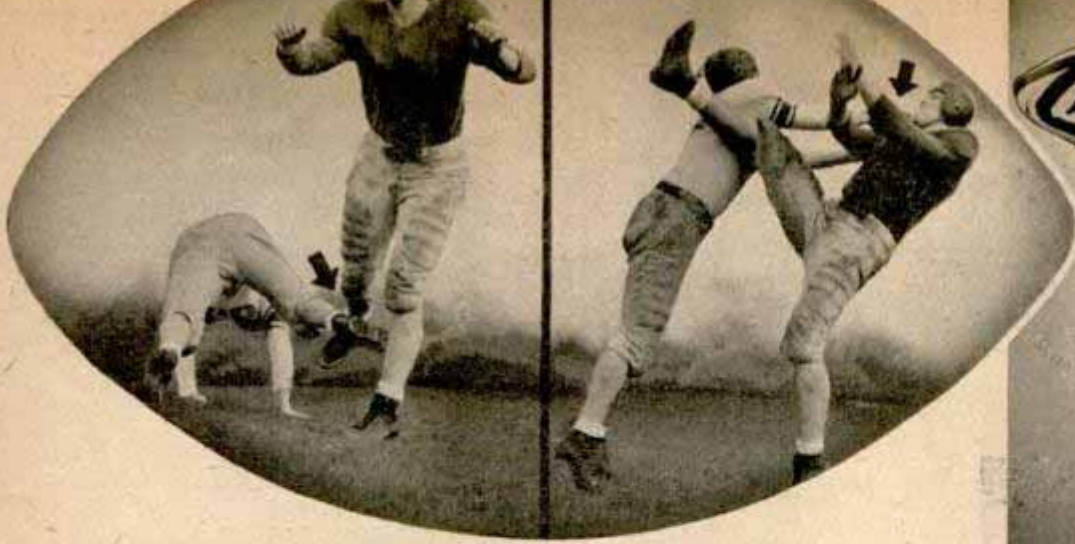

UNDERSTANDING the officials' signals makes football more enjoyable to watch. Besides, if you don't know what they mean you're likely to miss a great deal of what's happening, because their whistles blow an average of 500 times during a game. The rules list more than 70 fouls, with penalties ranging from the loss of a down to forfeiture of the game. Conferences between officials and team captains, often misconstrued from the stands as an "argument," are usually the officials' explanations of the nature of the foul and the options involved for the offended team's captain.



7. Interference: A player cannot interfere with another attempting to receive a pass, except in his own bona fide effort to catch the ball

8. Score: Holding arms overhead indicates touchdown or a field goal

9. First Down: Vigorous pointing motion toward offensive goal means team has made the required 10 yards

10. Illegal Pass: Only one pass forward is permitted during each down

11. Illegal Contact With Ball: Most generally occurs when an ineligible man on offense touches forward pass

12. Roughing, Clipping: Most of the serious bodily contact fouls are signaled this way. For clipping, official also taps back of his leg



12. ROUGHING, CLIPPING



11. ILLEGAL CONTACT WITH BALL

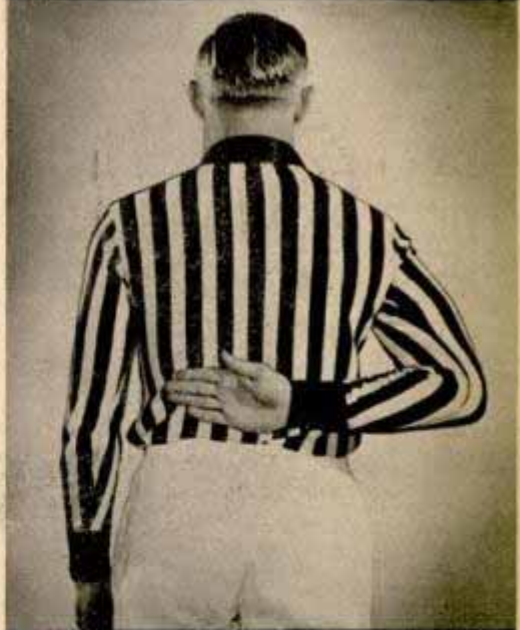

10. ILLEGAL PASS



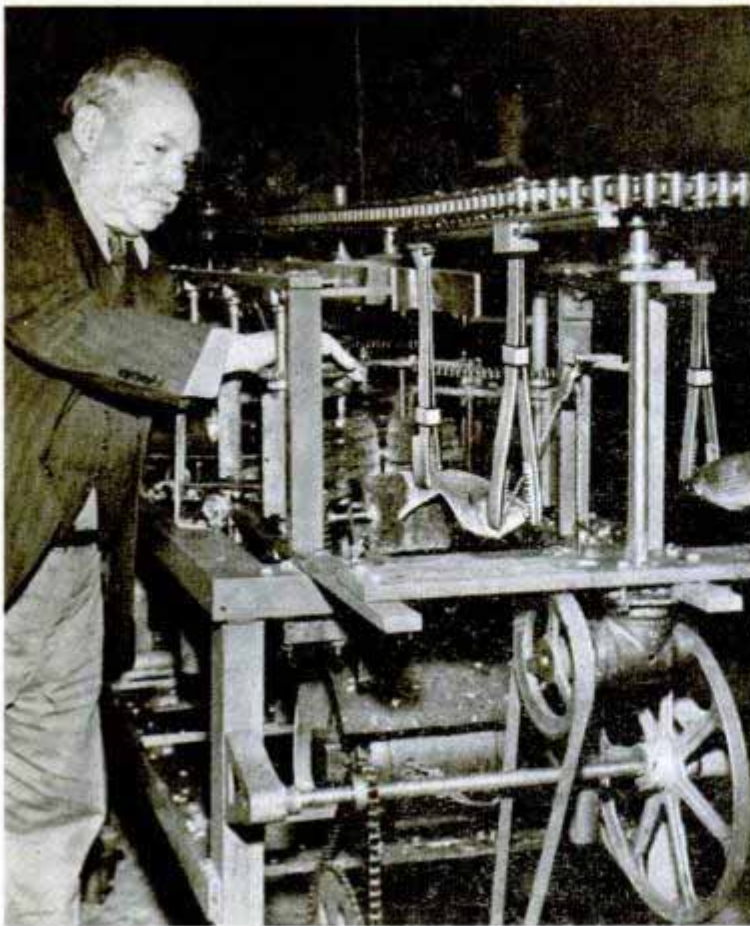

Automatic Fish Cleaner Handles 10 a Minute

As many as 10 fish a minute, untouched by hand, are cleaned and scaled by an electric machine designed for fish markets. Adjustable clamps hold the fish while a conveyor belt carries them through five pairs of rotary brushes which remove the scales. Near the end of the line the fish are split open and cleaned automatically. The machine handles fish ranging in size from half-pounders up to 12 pounds.

Fewer Knocks Per Gallon

Better antiknock gasoline can be produced by vaporizing the gas and straining it through bauxite crystals. The process removes sulphur impurities that cause engine knock. Bauxite is the ore from which most aluminum comes. A single batch treats up to 15,000 gallons at a cost of less than one cent a barrel.

Trailer Lowers Boat For Launching

Boats up to 16 feet in length can be loaded or launched by one man with a boat trailer that has a winch assembly. The stern of the boat rests in a canvas sling and the bow on a cross brace of the trailer. In launching the boat, the owner backs the trailer to the edge of the water, then turns a crank to lower the sling until the boat floats free. To reload the boat he propels it over the sling and

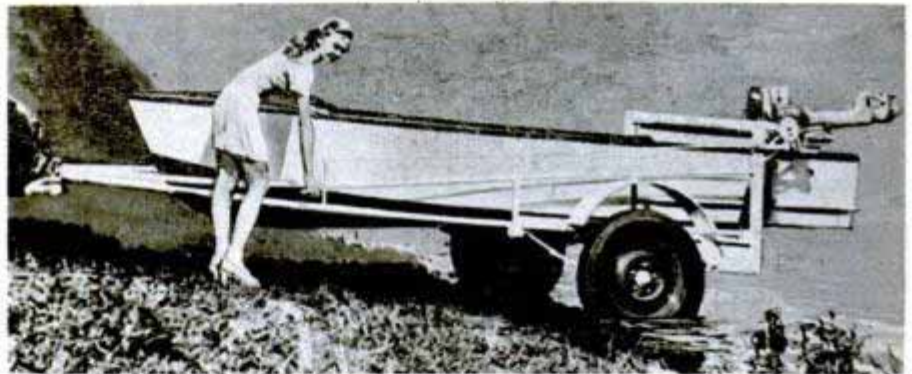

raises it with the winch until he can slide the bow over the cross member. Two models of the trailer are available for boats with beams up to 54 and 64 inches.



Over-the-Belt Fishing Tackle Box Opens to Form Shelf

Anglers are given an "extra hand" with a tackle box that straps to the belt and opens to form a shelf which serves up flies and lures. The fisherman's belt passes through a slot in the outer of two lids. The inner lid swings out into a horizontal position to form a shelf on which tackle can be placed while a change is being made. Made of Tenite plastic, the box is available in two different styles, one compartmented for leaders, large tackle and small bait, and the other for flies and odd hooks. A secure catch on the tongue of the outer lid insures tight closure of the box.



THUNDER HUNTERS

BY FLYING specially instrumented planes through storms and using radar to probe the skies, scientists have discovered new facts about thunderstorms which may lead to safe all-weather flying and effective flood control.

From 38 rocky flights at the Weather Bureau's Thunderstorm Project near Orlando, Fla., it was learned that every thundercloud consists of several cells resembling huge lopsided balloons and containing strong air currents and water.

But between each pair of cells is a layer of calm air, extending from one half to three miles. If a pilot could guide his plane between the stormy cells, the flight would be smooth and safe.

No detection instrument exists today which shows a clear outline of thundercloud cells. Consequently, planes caught in storms are sometimes turned upside down or swept upward several thousand feet.

One of the nation's top weather experts believes that radar sets of the future may be able to distinguish thunderstorm cells from the calm air between them to guide the pilot on a safe course.

By John R. Kinsey

Dr. Horace R. Byers, director of the Thunderstorm Project,

points out that present radar locates thunderstorms by the reflection of its beam from rain-filled clouds. Tests at Orlando also revealed that radar detects the height in a thundercloud where icing begins. The ice level shows up as a bright line on the scope as a warning to pilots.

Tomorrow's radar equipment also may help prevent floods, Dr. Byers predicts. In place of several thousand rain gauges, he visualizes radar sets scanning the skies throughout the country, night and day, to locate thunderclouds and reveal how much water each cloud contains. Radar sweeping through a radius of 50 miles would cover approximately 8000 acres.

The benefits of such a system can readily be seen. In the Tennessee valley, for example, radar forecasts would warn—well in advance—when reservoirs should be opened to let out water to make room for approaching rainfall. The speed of radar in measuring rain before it falls will eventually outmode rain gauges, reports Dr. Byers, on leave from the University of Chicago during the thunderstorm studies.



This is how it looks from a B-29 when approaching a hurricane at an altitude of 30,000 feet. Below, "eye" or center of a hurricane shows up on scope of radar

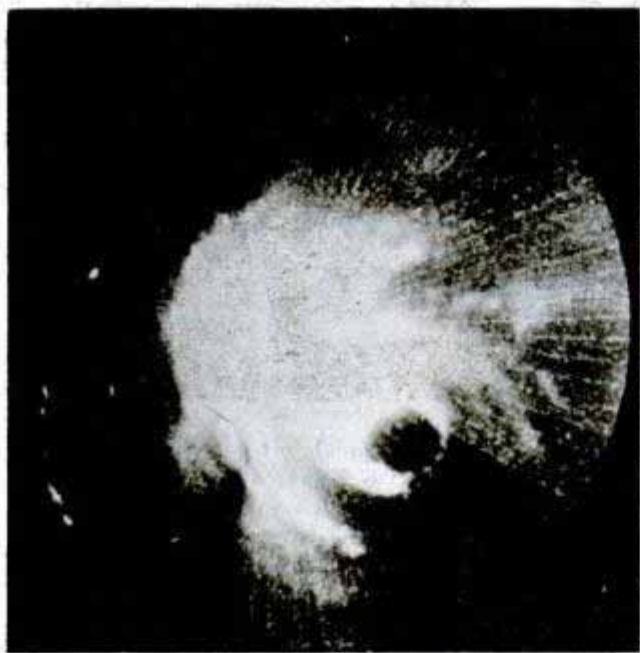

He and his Weather Bureau associates form their conclusions by studying data obtained by a daring group of Army Air Forces pilots and radar observers who fly P-61s through the storms. This summer the flights are being made at the All-Weather Flying Division's Headquarters Field, Clinton County Air Field, Wilmington, Ohio. Actual flying missions began May 12 and will continue until the middle of September, during which approximately 40 frontal-type storms are expected.

Last summer the thunder hunters played tag with storms over the Army Air Base at Orlando, Fla., where 38 tropical-type storms were encountered. In addition to nine P-61s, three sailplanes provided by the Soaring Society of America took part.

The pilots, particularly the glider operators, had some rough times but they and their recording instruments supplied considerable scientific data that may be important to aviation, agriculture, the electrical industry and mankind in general.

Being in a plane hit by lightning has become routine for the pilots, with burn marks leaving their "fingerprints" on the metal skin of the plane. Lightning, despite the belief of many people, presents no great hazard to metal airplanes. The electrical charge, striking the outer surface of a plane, has no effect on the occupants, unless possibly to frighten them.

At Wilmington the pilots and observers are on 24-hour call, waiting for the arrival of a thunderstorm. The moment a ground radar spots an approaching storm (usually at night), five pilots and five radar observers hop in their specially equipped Black Widows.

Other men climb into two F-15s—one outfitted with automatic cameras to take pictures, and the other equipped with an instrument to attract lightning and measure its power and duration.

Guided by radar and radio, the planes enter a storm a minute apart to prevent any possibility of collision. They knife through a thundercloud at various levels—perhaps 6000 feet, 11,000, 16,000, 21,000 and 26,000—to collect data throughout the entire storm.

While rain, snow, wind and lightning bombard the planes, the automatic instruments "take the pulse" of a storm to provide Weather Bureau analysts with measurements to piece together into a complete picture of what takes place inside a thunderstorm.

Accelerometers measure turbulence and drafts; control position indicators differen-

Antenna is maneuvered by man at left to track radio beacon from balloon-borne transmitter. Messages reveal weather conditions at altitudes to 70,000 feet

tiate between air accelerations and accelerations caused by motions of the plane; thermistors take the air temperature; wire recorders preserve comments the sky probers make as they observe the behavior of storms from a "top balcony" seat.

In addition to the airborne instruments, the Weather Bureau studies thunderstorms at ground level by means of 63 surface observation stations located in checkerboard fashion across a 160-square-mile area on the outskirts of Wilmington.

Delicate instruments, operated by clockwork and electricity, give precise readings of wind speed, wind direction, temperature, humidity, atmospheric pressure and the amount of rainfall for each minute of the 24-hour day. Each automatic, self-recording station is visited daily to remove charts containing the data.

Seven radio direction finding units (called SCR-658) are spotted throughout the test area to track balloon-borne radio sets which transmit meteorological data to the ground receiving stations. Wind direction, wind speed, temperature, atmospheric pressure and humidity at air levels up to 70,000 feet are learned from the radio messages.

By plotting and analyzing weather measurements obtained by instruments in planes, balloons and ground stations and by radar, the Weather Bureau now has a more complete understanding of a storm's structure.

As mentioned earlier, a thunderstorm consists of several cells, between which planes may some day chart a smooth, safe course. The height of cells varies from a few thousand feet (at the building stage) to 40,000 feet (at the peak).

Each cell goes through (1) the development or building stage, (2) the peak stage, and (3) the dissipating stage. In the development stage, vertical currents are all upward and continue upward until condensation within the cell reaches such proportions that the rising current no longer is able to carry the increasing amount of water. As water begins to fall through ascending air currents, a downdraft develops.

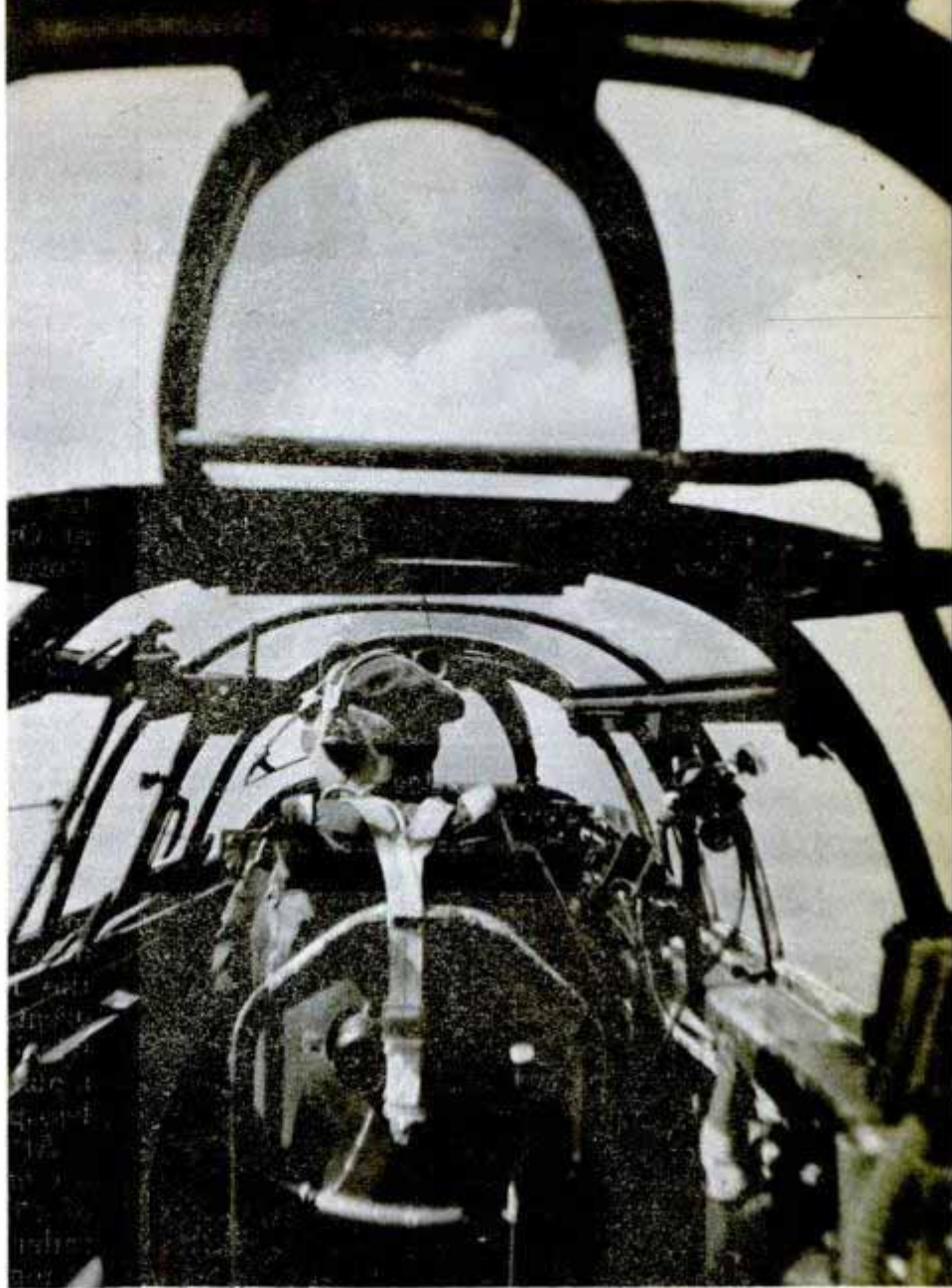

Official AA" photo

When heading into a thunderstorm, this is the view as seen from the radar observer's position in a P-61 Black Widow. This plane is equipped with special automatic instruments to record weather data. Below, model represents the data for weather studies

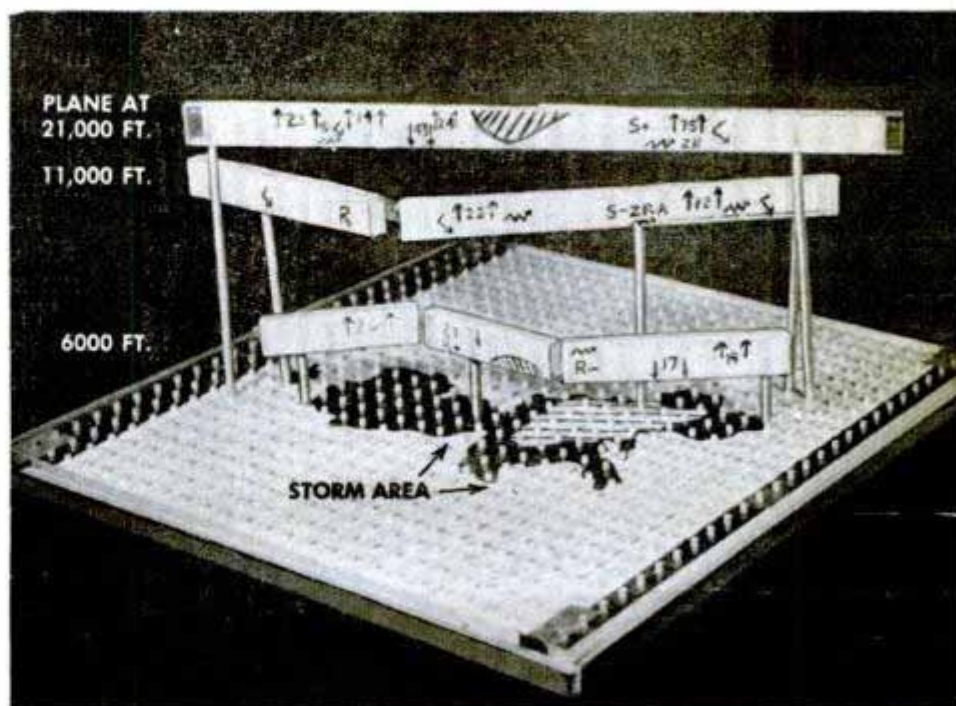

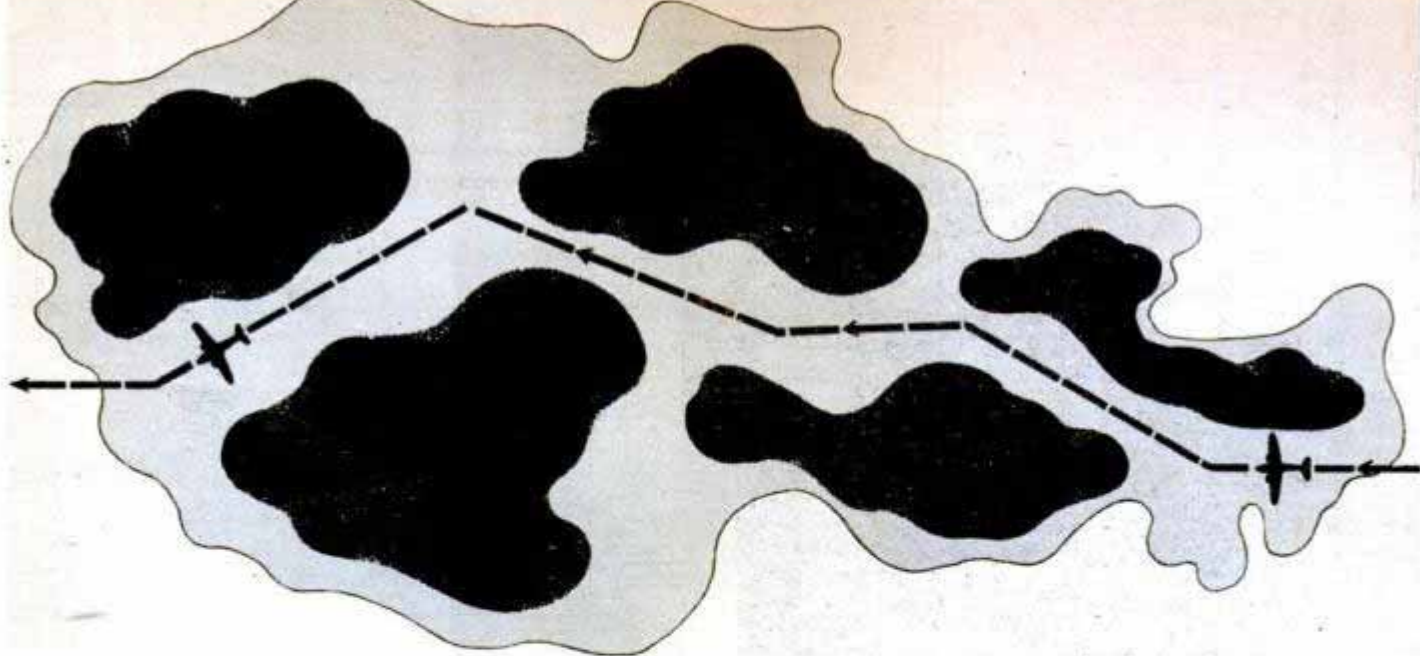

THUNDERSTORM CELL

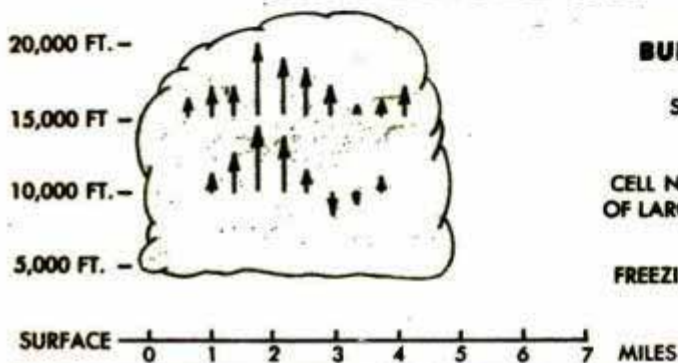

BUILDING STAGE

ST. CLOUD, FLA.

CELL NEAR WESTERN EDGE
OF LARGE MULTICELL STORM

FREEZING LEVEL 15,000 FT.

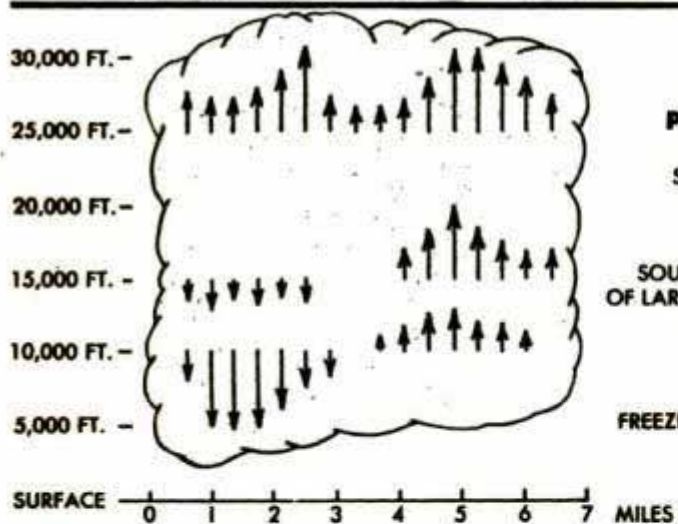

PEAK STAGE

ST. CLOUD, FLA.

CELL NEAR
SOUTHWESTERN EDGE
OF LARGE MULTICELL STORM

FREEZING LEVEL 15,000 FT.

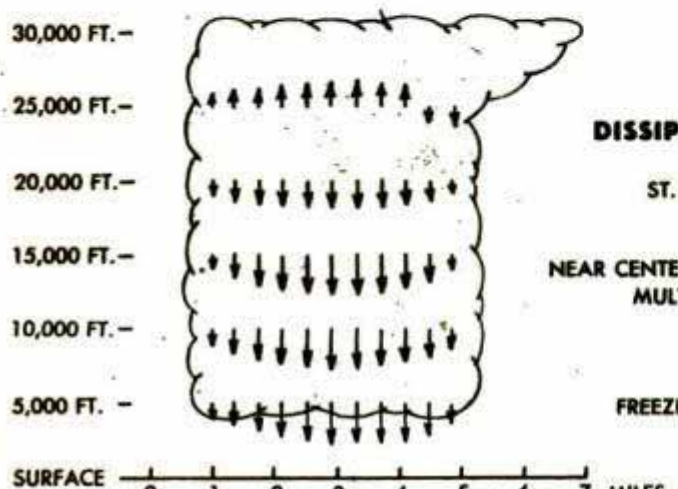

DISSIPATING STAGE

ST. CLOUD, FLA.

NEAR CENTER OF AN ELONGATED
MULTICELL STORM

FREEZING LEVEL 14,000 FT.

Artist's conception of a thunderstorm shows turbulent cells (shaded dark) and calm spaces between them. Radar may be able to locate calm course for planes. Left, thunderstorm cell at three stages

At this point the cell passes into the peak stage.

In the peak stage, the lower portion of the storm contains both updrafts and downdrafts. By the time the downdraft area at the base of the storm exceeds the area of the updraft, the cell passes into the dissipating stage.

In the dissipating stage the downdraft predominates the cell in all but the top section. The speed of the draft is less than it was in the peak stage and the rain under the cell has decreased to light rain.

The downdrafts of the thunderstorm cell are caused and maintained by the rain produced within the cell. Throughout the storm, gusts of wind are concentrated in the cells, with a minimum of gusts between the cells.

While the Weather Bureau and Army Air Forces are exploring thunderclouds, the Navy is spotting and flying through hurricanes in the Guam area. Previously, seven Navy planes flew more than 1000 hours during hurricane patrol flights off the coast of Florida.

Such meteorological studies have increased our knowledge of weather phenomena and techniques of forecasting. For example, it formerly was believed that only about a half dozen typhoons occurred in the Pacific in a single year. Actual investiga-

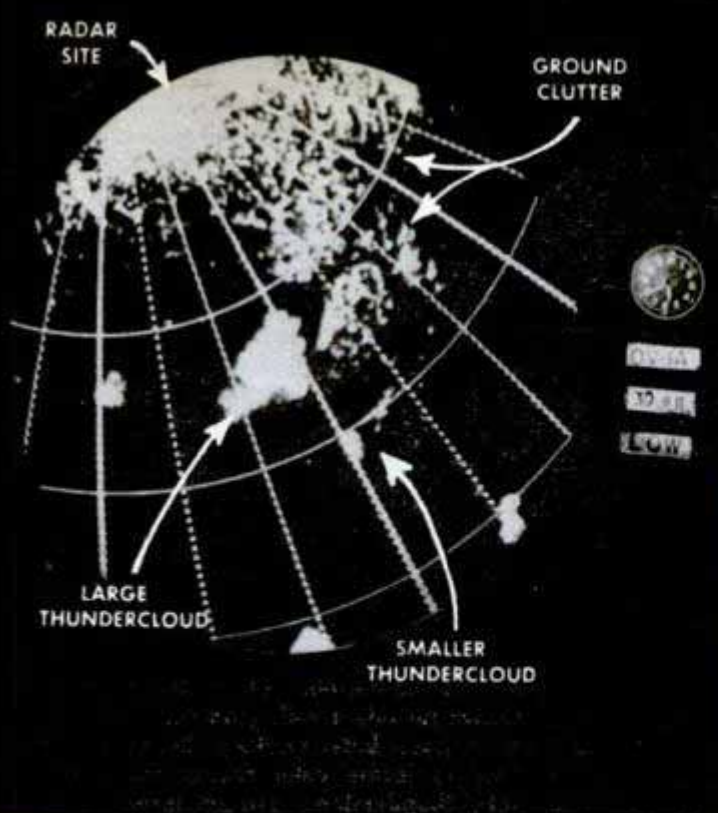

Approaching thunderstorms are detected on radar scope. Below, looking through telescope of a radar tracker

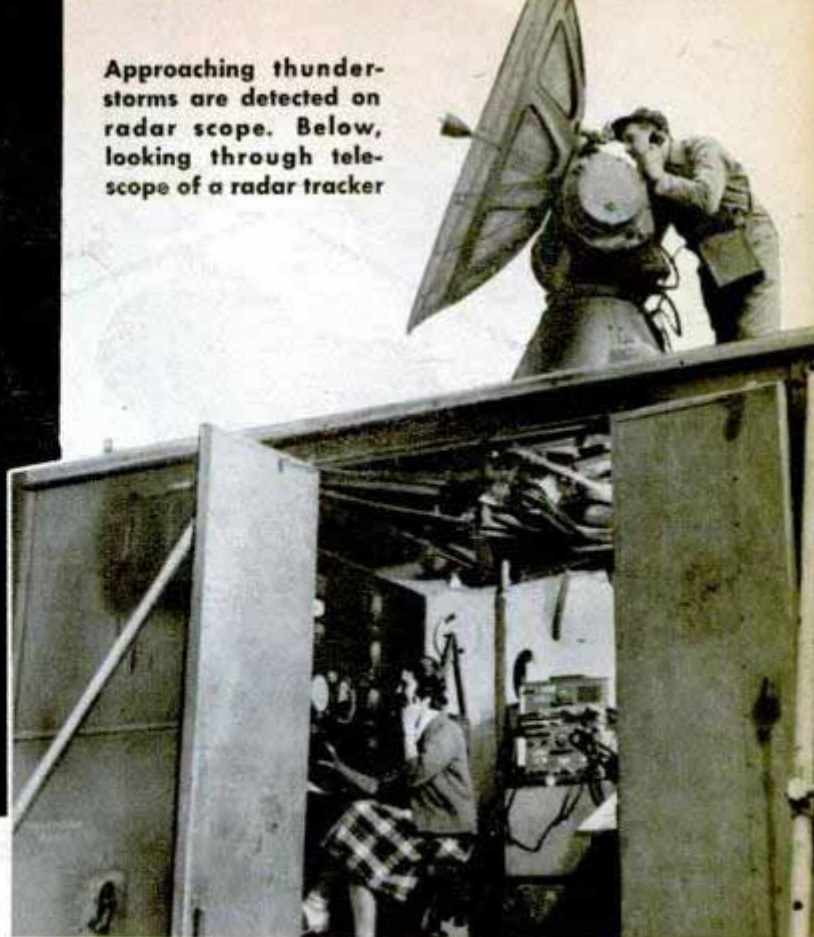

tion, however, showed that at least two dozen such storms could be expected annually in the Pacific area.

With the application of radar to storm detection, Navy flyers are able to spot hurricanes at distances up to 150 miles. Even the structure of a hurricane, with its calm, precipitation-free eye in the center, is distinguishable on the scope. An echo-free circle within the spiral arrangement of a typhoon's storm clouds locates the center.

By spotting the hurricanes 150 miles away by radar—and flashing a warning by radio—forecasters now provide coastal residents with better protection of lives and property.

Another innovation is the use of the wire photograph to deliver weather reports to AAF pilots. Networks of facsimile sets are being installed across the United States for transmitting weather maps.

Use of the facsimile transmitters for relaying weather information was developed by Air Materiel Command Headquarters at Wright Field, Ohio. Present plans call for dividing the nation into four large networks to receive this modern weather-forecast service.

Weather analysts in a centrally located weather station will prepare maps, insert them into the transmitter, and relay copies to stations all over the country.

Shortage of skilled weather analysts has been making it increasingly difficult for AAF pilots to obtain clearances for their aircraft at some fields. Use of the facsimile transmitter will reduce the number of skilled analysts required, and will effect a considerable savings after the initial cost of the installation is met. The system will



Official AAF photo

In this "skiatron," radar operators control air traffic at All-Weather Flying Center and within a radius of approximately 40 miles, preventing aircraft collisions

provide even the smallest airfields with the services of the most skilled weather forecasters assigned to the AAF.

The facsimile set is somewhat similar to the teletype. It operates on impulses which are controlled by the blackness of the picture being transmitted. Now that science has developed improved means to find out and tell the world what kind of weather lies ahead, the only thing needed is some



Another view of an instrumented P-61 in which AAF pilots and radar observers battle through thunderstorms to learn more about rocky weather to make flying safer. Below, analytical chart of a plane's flight through a storm

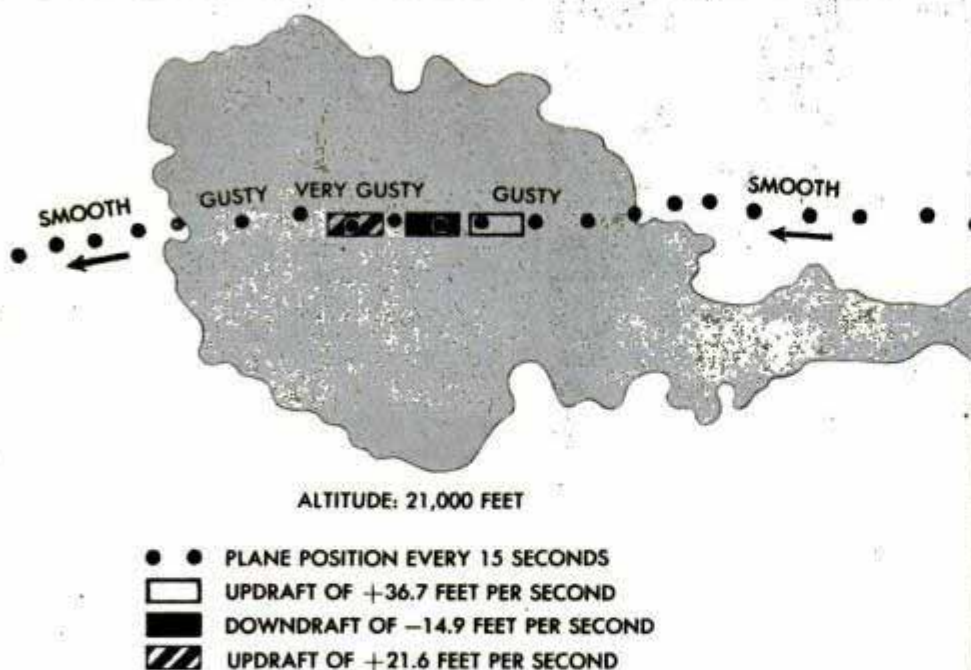

method of changing the weather — in case it doesn't suit us.

Such an idea sounds fantastic, but Dr. Vladimir K. Zworykin of the Radio Corporation of America believes that weather control, within certain limits, is entirely possible.

First, he predicts that electronic devices of the future will make it possible to forecast, in a matter of seconds, the weather outlook for days in advance. With this advance knowledge, two novel methods are suggested by Dr. Zworykin to cause storm centers to alter themselves and dissipate.

In the case of a hurricane developing over an ocean, the RCA engineer recommends spreading a combustible material, such as oil, over a considerable area at the storm center. By igniting the material, energy would be added directly to the building storm. The fire would cause updrafts of surface air, followed by condensation at higher levels. This action would modify the motion of the air masses in the surrounding area.

The second weather control method involves changing the reflection and absorption characteristics of a particular area. In fact, Dr. Zworykin believes radiation from the sun may be used to modify weather. He visualizes the establishment, at strategic points, of "weather control patches," areas of land which eventually would become blackened by deposits of carbon. These highly absorbing areas could be quickly converted to highly reflecting areas by use of fog created artificially.



Fairchild photo

Portable Copy-Printer

Plugged into an electric outlet, a portable photographic printer reproduces any printed material or pictures without the need of a darkroom. It is small enough to be taken to a court or library to copy bulky records or reference material. A sheet of light sensitized paper is placed over the copy and the printer rolled over it. Either negative or positive copies can be made and processed in subdued daylight or ordinary office light.

Mouth-Blown Blowtorch

With the jet supplied by blowing gently into a mouth tube, a lightweight blowtorch uses dry chemical tablets for fuel. A fuel tablet is placed in a holder and lighted to form a flame which is directed against the soldering work by blowing air through the tube. Each tablet burns about 10 minutes and creates heat in excess of 2000 degrees. The tablets may be extinguished and relighted.

You may wish to obtain additional information about the new products described each month in *Popular Mechanics*. If you want to know the name and address of the manufacturer or distributor, just write to Bureau of Information, *Popular Mechanics Magazine*, 200 East Ontario Street, Chicago 11, Illinois. Your letter will be answered promptly.

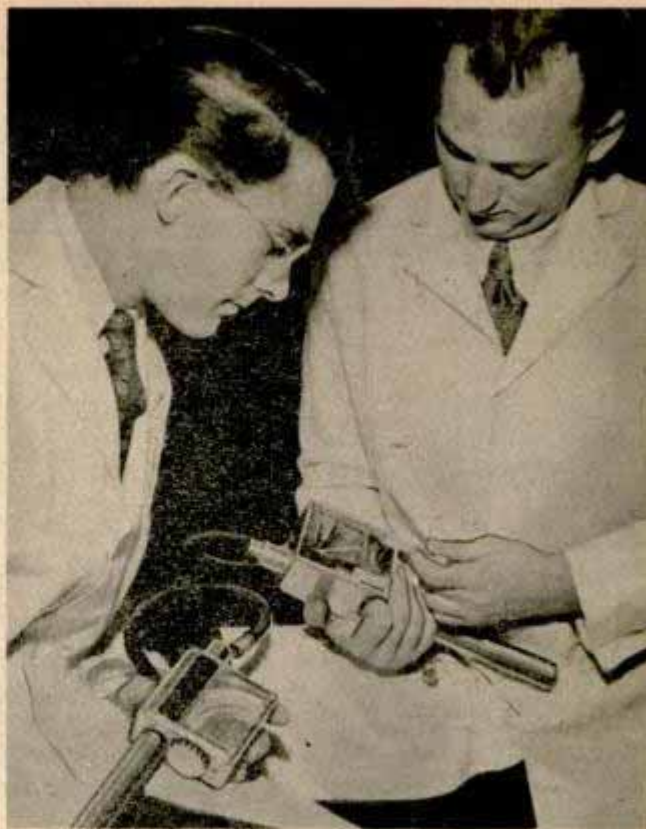

Automatic Rip Cord

Some of the hazards of bailing out at high altitudes are eliminated by an automatic rip cord mechanism "triggered" by atmospheric pressure. Scarcely bigger than a watch, the device has an aneroid barometer that responds to increasing pressure on the downward plunge, opening the chute automatically at a safe altitude.

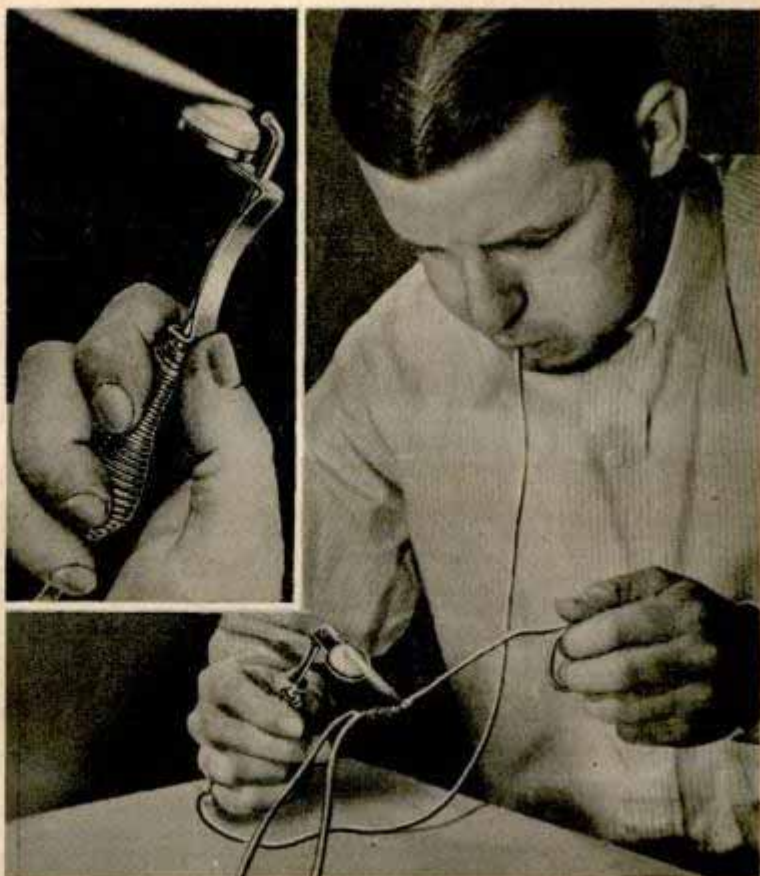

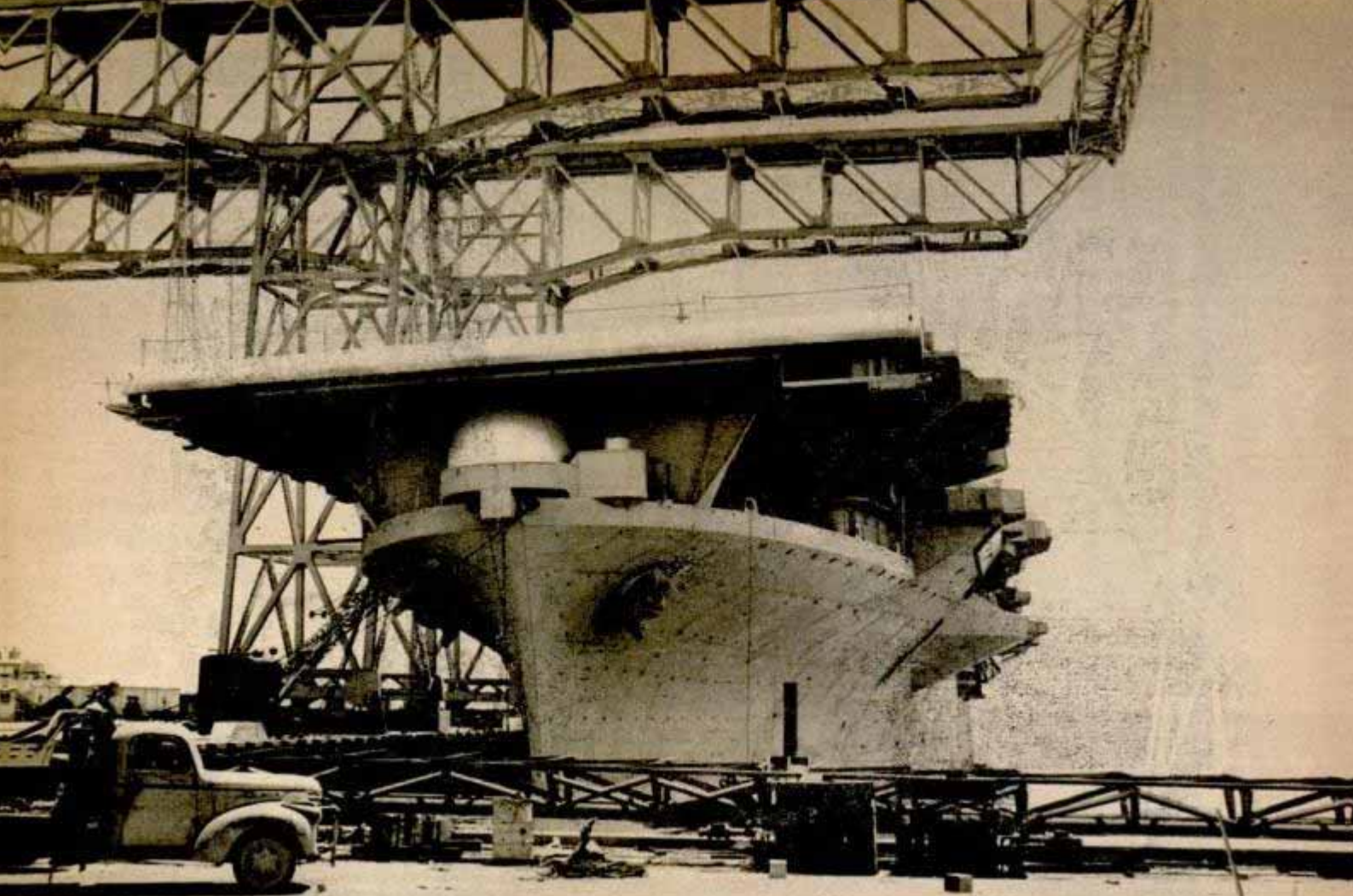

Berthed beneath the world's largest crane is the aircraft carrier Hornet, showing how the structure projects out beyond it. Tops of the trolleys that run on the crane are 207 feet above water. Below, long open slot inside the crane structure, on top of which one of the trolleys will move from side to side, dangling a main and an auxiliary hook downward. Parallel bars at the right will furnish the power



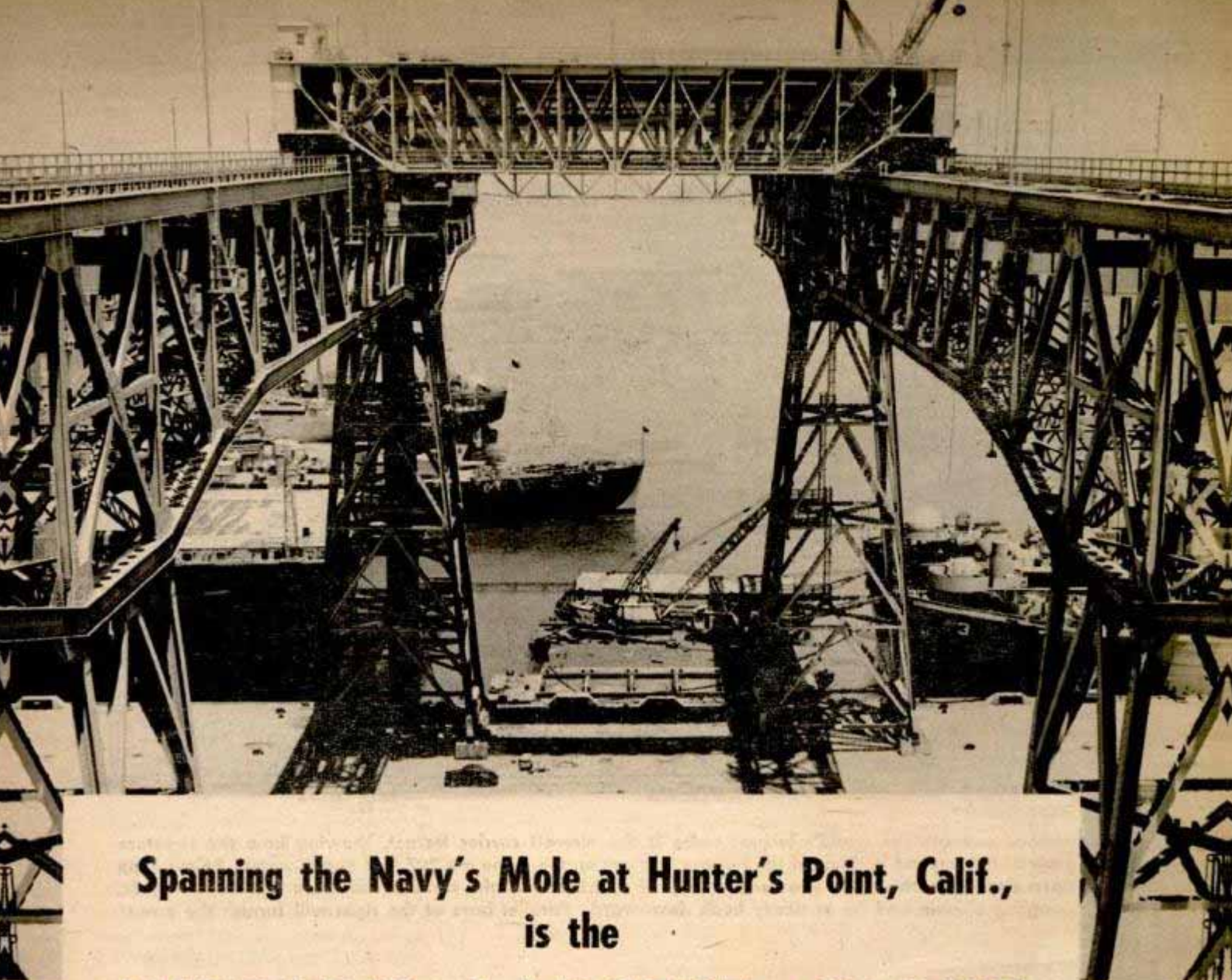

Spanning the Navy's Mole at Hunter's Point, Calif.,
is the
WORLD'S LARGEST CRANE

*Its steel arms can pick up
a 400-ton battleship turret*

THE WORLD'S BIGGEST HOOK, capable of picking up a battleship's turret with ease, will be ready for business this fall at the San Francisco Naval Shipyard at Hunter's Point, Calif.

So huge that its operating crew uses short-wave radio for communication with each other, the great crane has a built-in 15-story passenger elevator, aerial beacons to warn aircraft away and its own electrical substation.

The crane will speed up the regunning of battleships whose big 16-inch rifles, weighing 80 tons each, have worn out. It can regun two ships at the same time or lift an entire turret, minus its guns and weighing 400 tons, in case of battle damage to the turret or a change in design. Formerly it was necessary to cut a turret into pieces for hoist-

ing ashore one at a time, a tedious process.

The crane can lift other miscellaneous heavy loads far beyond the capacity of any other crane in the world. Most of the big cranes used in ship construction have lifting capacities of 50 tons or less.

The biggest hook consists of a pair of overhead traveling cranes mounted side by side on a bridgelike runway that is 182 feet above ground and 730 feet long. This huge runway is built across a special mole or pier and extends 162½ feet out over the water on each side of the mole, towering high above battleships or aircraft carriers berthed below it. The runway rails are 142 feet apart.

Each crane contains a traveling trolley from which is suspended one main and one auxiliary hook. Direct-current motors in the trolleys

By Thomas E. Stimson, Jr.

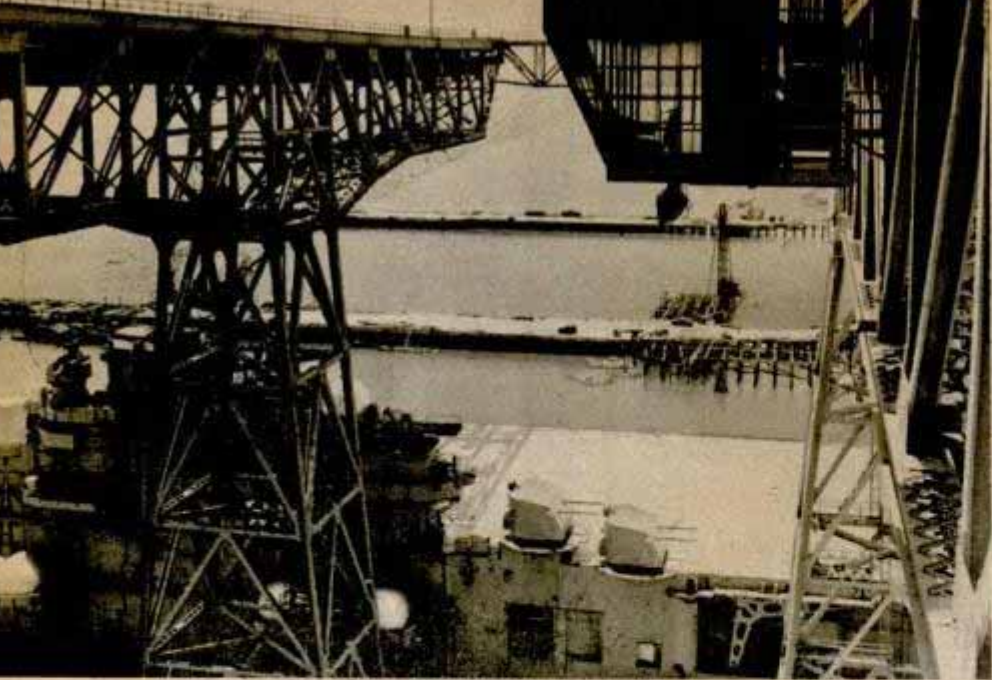

operate the hoisting drums, obtaining their power from parallel rails contained in the crane. The cranes in turn take current from three insulated pieces of railroad trackage that extend the length of the runway.

Each main hook is supported from its drums by 24 parts of $1\frac{3}{8}$ -inch steel rope and has a rated capacity of 245 long tons. Each auxiliary hook has a capacity of 50 long tons. Portions of the trolleys are built of aluminum to conserve weight and their tops are 207 feet above water.

When major loads are to be lifted the two cranes are first brought together and joined by ordinary railroad couplers. Then each main hook is lowered to the ground and attached to its end of a 40-ton steel equalizer beam. Hanging from the middle of this beam is the "biggest hook" itself, a sturdy 5-ton casting with a shank 12 inches square. Cables from this swivel hook will lift approximately 450 long tons.

The hooks can reach 25 feet below the water line and lift loads

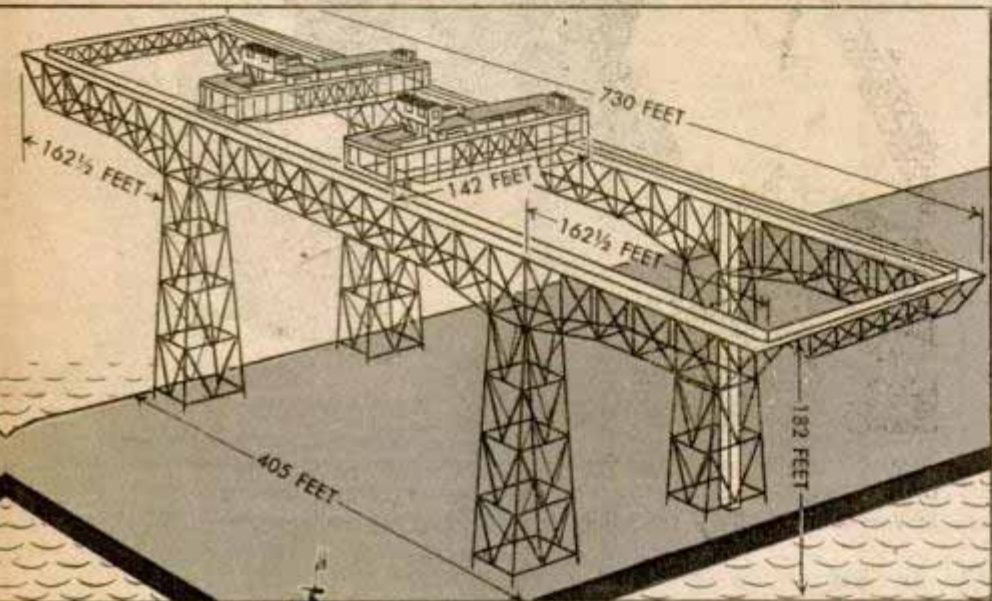

Above, control booth of a traveling crane is in the upper right foreground. Operators use two-way radio to talk with men at the hook. Drawing at left gives crane's dimensions. The whole unit weighs 8400 tons

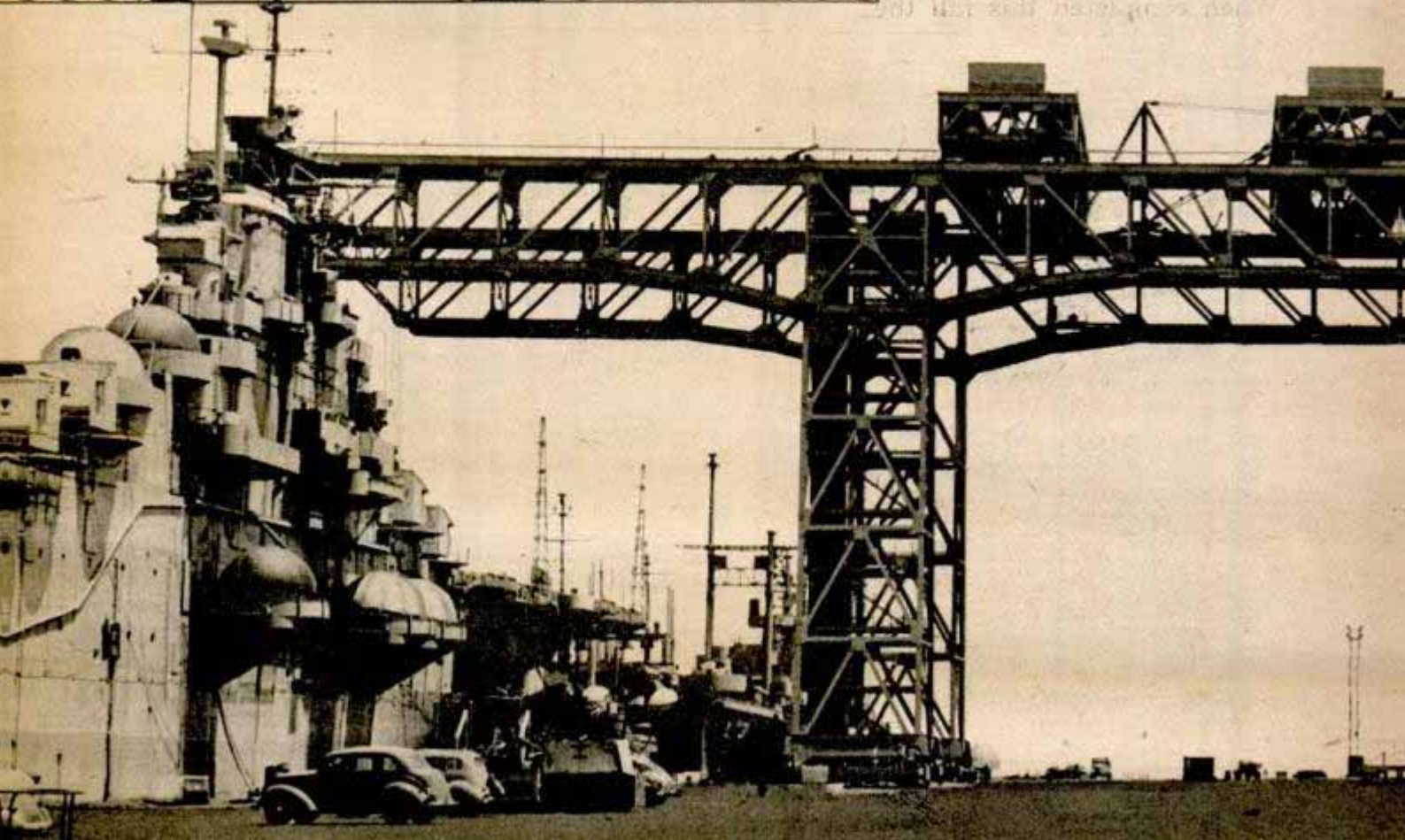

160 feet into the air. To take care of falling tide conditions when a hook is attached to a load that is still secured to a ship, the brakes of the cranes automatically slip when an overload of 150 percent occurs. Depending on the load, hoisting speeds range from 10 to 30 feet per minute.

Green lights on the equalizer beam remain lighted while the beam is horizontal so that the crane operators can tell if they are hoisting in unison. They are replaced by red lights if the beam tilts five degrees or more. Battery powered, the lights are operated by mercury switches.

The two outboard ends of the main runway structure were built with an upward camber of 12 inches. Even under the deflection of a record load they will not sag below the horizontal. There are hydraulic jacks in the bases of each of the four supporting towers for realignment purposes in case the structure settles out of plumb. Complete, the whole unit weighs 8400 tons.

Incoming 11,500-volt power is stepped down to 480 volts at a substation located in one of the towers. Four a.c. motors drive each of the cranes. Hoisting drums in the trolleys use d.c., the conversion being by motor generator sets.

When completed this fall the

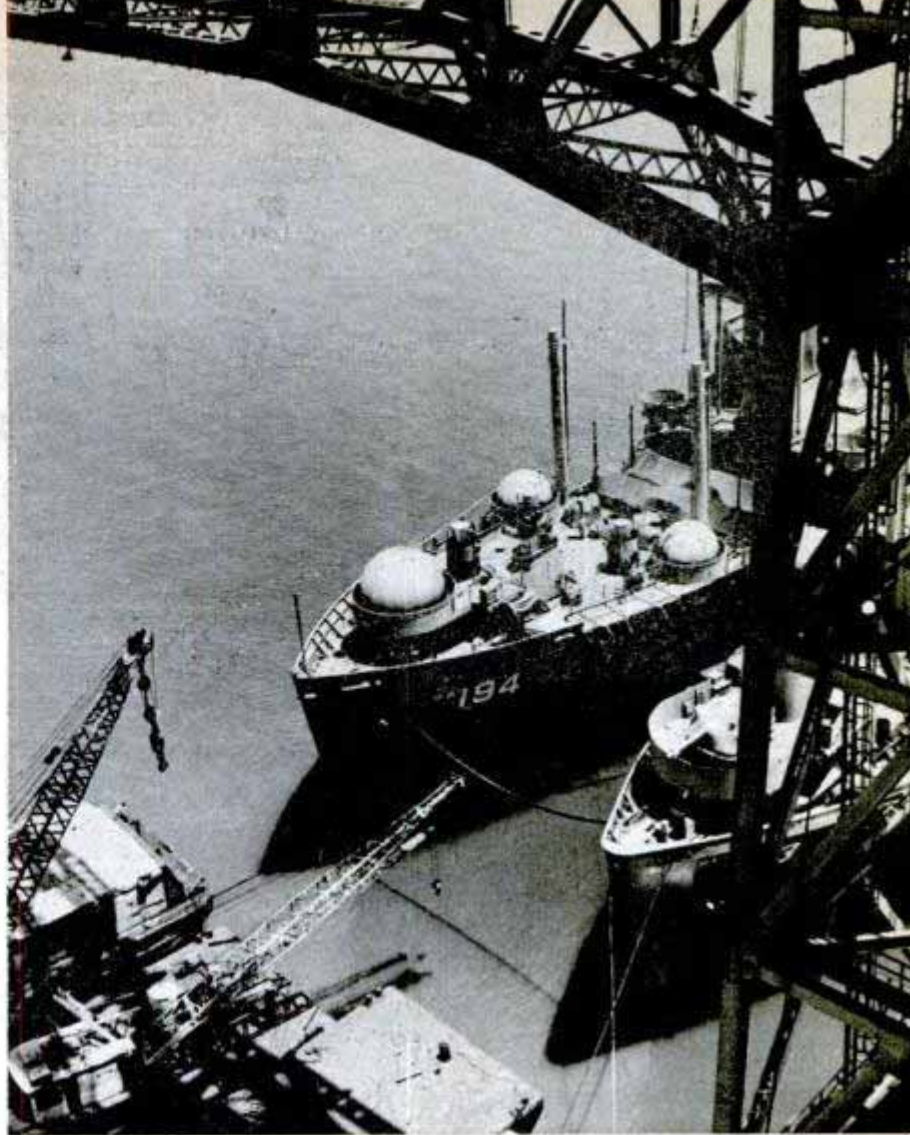

Armed transports are dwarfed by overhanging runway of world's biggest crane. Below, 15-story passenger elevator runs in the tower at left. Two traveling trolleys rest on railway above

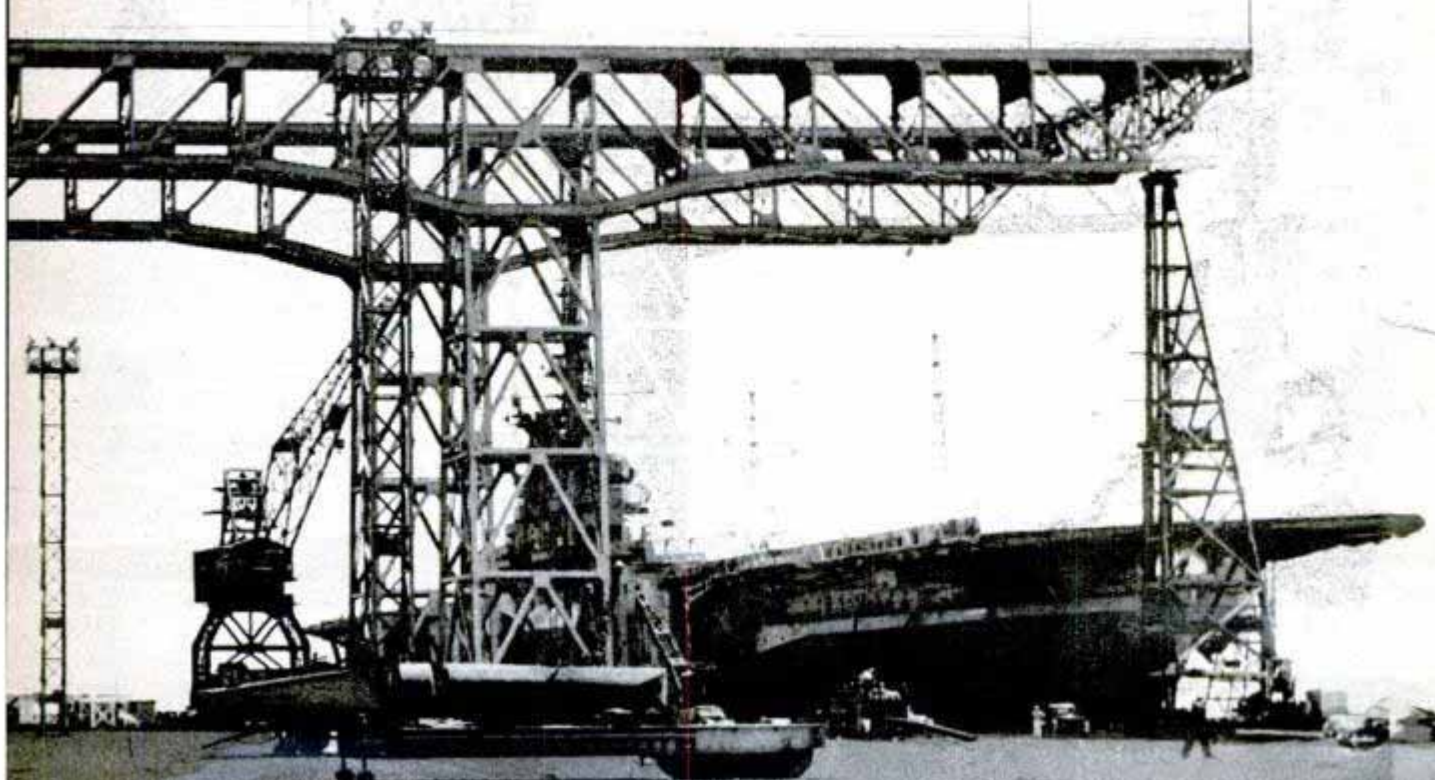

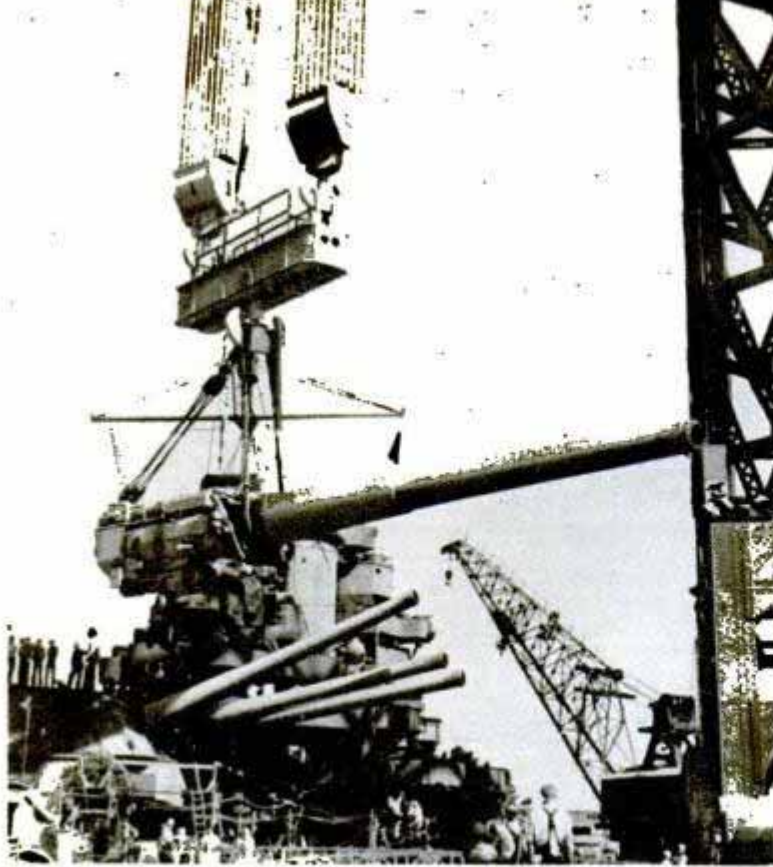

To impress you with the new crane's lifting power, here is one half as large easily hoisting 14-inch guns off a battleship. The Hunter's Point "monster" is designed to lift about 450 tons

entire structure will be subjected to a series of strength tests under the direction of Capt. W. T. Eckberg, officer in charge of construction, before being placed in use. Huge concrete blocks that already have been poured in forms sunk into the mole will be used for the hook tests. Overloads amounting to 125 percent of rated capacity will be applied to the hooks.

The regunning mole was created by driving cellular sheet piling around its dimensions, 1700 feet long and 405 feet wide, and filling in with 3,000,000 cubic yards of sand and rock. Concrete foundations under the towers of the crane structure rest on steel H-piles driven to a depth of 100 feet. In addition the four towers are tied together by huge reinforced concrete beams that are buried in the mole. Including its special mole and appurtenances, the monster crane at Hunter's Point

(Continued to page 256)

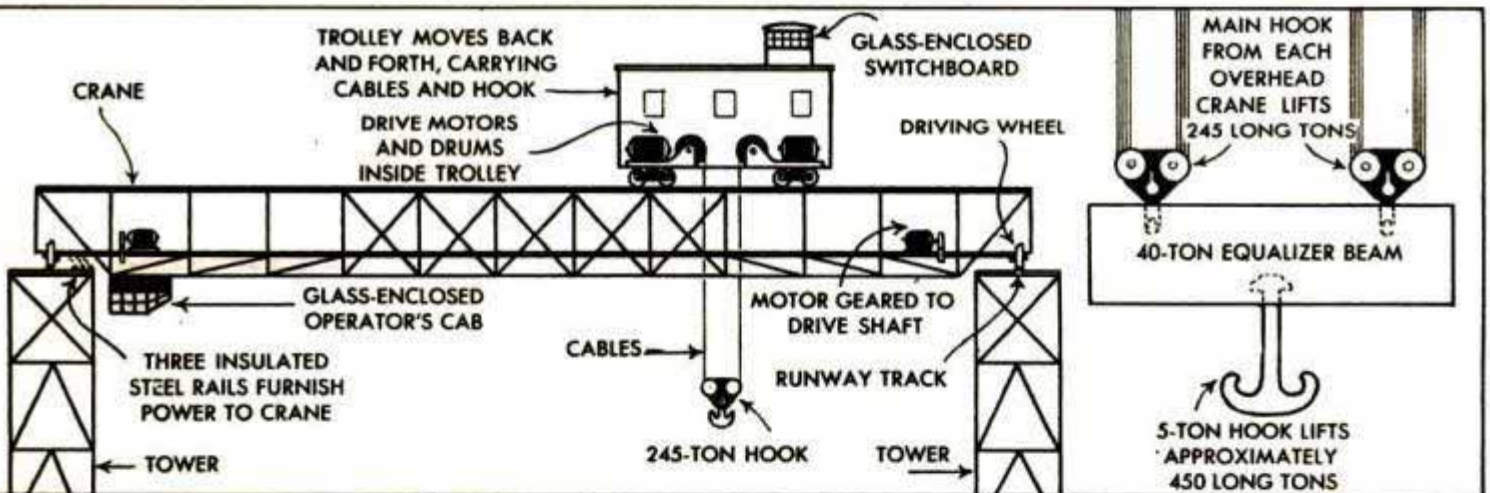

At left is the biggest hook of all, a 5-ton casting that will hang from the equalizer beam when weights near 400 tons are being handled. Right, 245-ton capacity hooks that will be suspended from each of the cranes



Bank's Cement Mixer Unwraps Coins

Standard equipment in one Los Angeles bank is a cement mixer that removes paper wrappers from rolls of coins. The bank deposits its surplus in a Federal reserve bank that accepts coins in cloth bags but not in paper rolls. Removing the wrappers by hand was a time-consuming job so bank teller Bill Ream suggested breaking the rolls in a cement mixer. The mixer now breaks up 200 rolls in four minutes, a job that required 20 minutes by hand. A blower expels wrappers from the machine.

Vast Oil Reserve Is Under Water

If the world's supply of oil runs low, the continental shelf would yield at least 1000 billion barrels of oil, estimates Wallace E. Pratt, petroleum geologist. About one tenth of this vast underwater plain of roughly 10 million square miles borders on U. S. and Alaska. This tremendous oil reserve is approximately 500 times the world's present annual consumption.

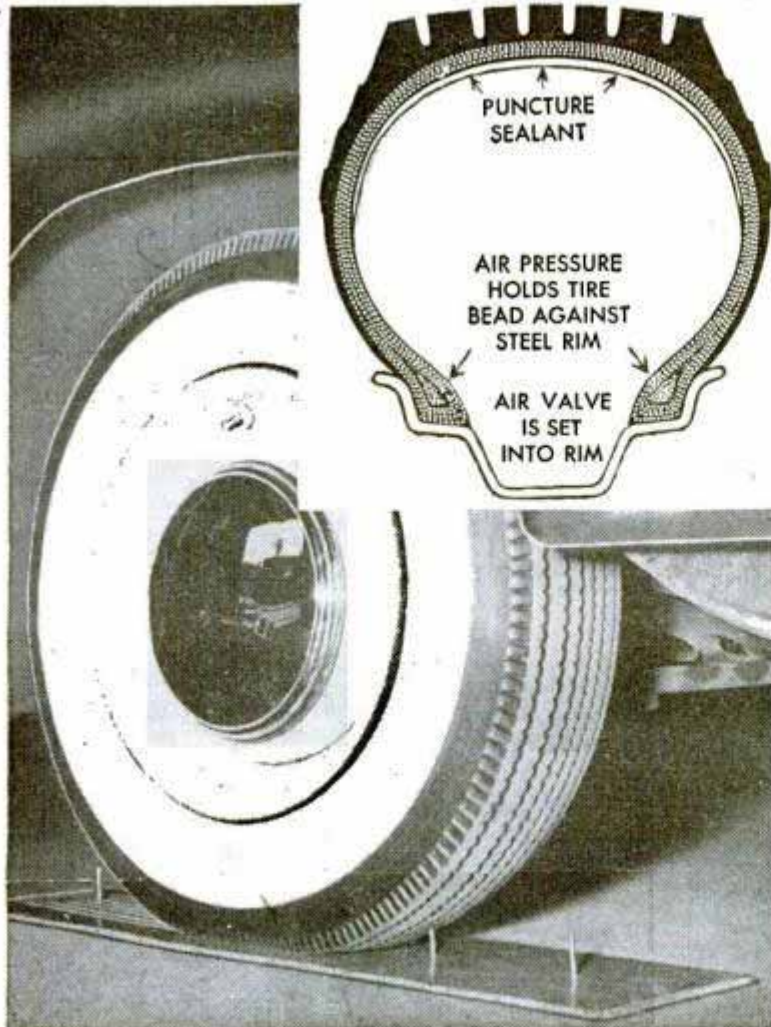

Tubeless Tire

Tubeless tires have undergone high-speed road tests and now are available in limited quantities. The bead of the tire is held against the rim by air pressure and forms an airtight seal, eliminating the need for a tube. The air valve is installed in the rim. A gum-rubber puncture sealant coats the inside of the tire, flowing around the piercing object in the event of a puncture and quickly closing the hole when the object is withdrawn. The tire, which was developed by Goodrich, has a rayon-cord construction.

Synthetic Cloth From Antifreeze

By mixing a synthetic antifreeze liquid with synthetic petroleum products, British chemists have developed an artificial fiber to compete with Nylon and rayon. Called Terylene, it is reported to differ from all other fibers. Textiles made of it are said to resemble silk and can be washed and ironed. Fibers of Terylene can be very fine, or coarse if great strength is desired.

WHAT'S NEW *For Your Home*

A four-page "shopping section"
dedicated to modern homemakers

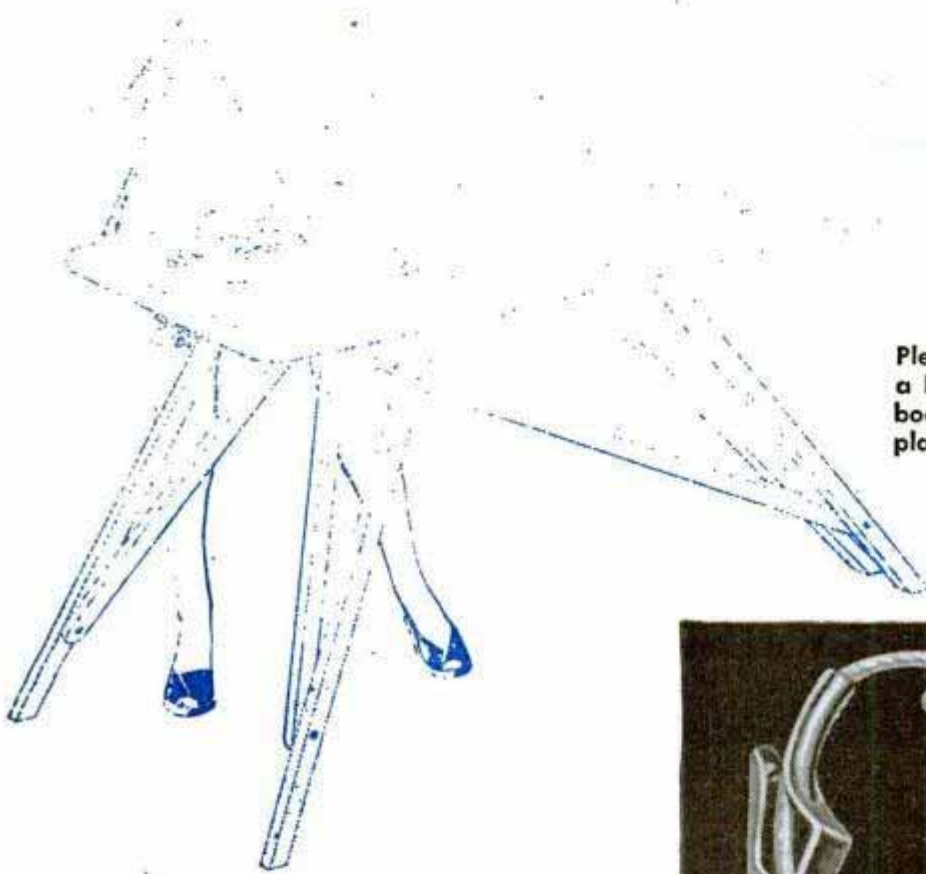

Pleats are pressed more easily with a holder that clamps to an ironing board. The pleats are fastened in place top and bottom by prong clips

Wall plugs with finger grips can be removed easily without jerking, which tends to break the wires. Right, a clothesline holder uses the weight of the hanging clothes to hold the line taut automatically

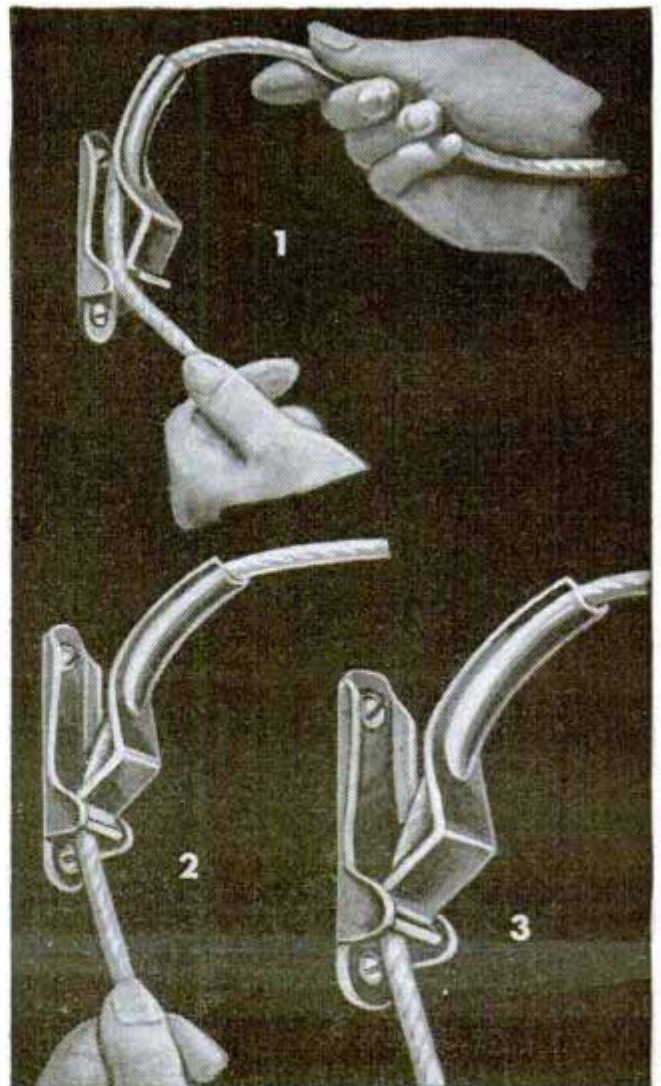



Double-looped wire clips fasten skirts and slacks on hangers so they will not wrinkle, fold or crease. They adjust to any size waistband. Below, roasts carve more easily on holder with spiked base and a spring grip to hold meat in place

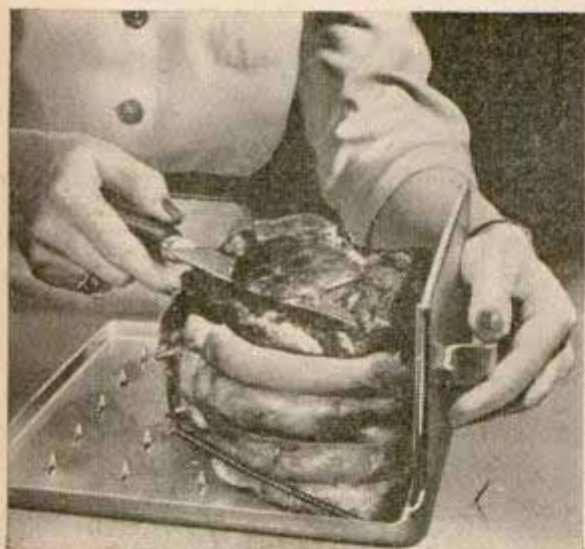

↓ Most hazards arising from hot irons are eliminated by using a small metal shelf that can be attached to any wall corner



Paper draperies that look and feel like fabric can be cleaned with wallpaper cleaner. Below, plastic cuber molds home-colored margarine and freshly churned butter into quarter-pound packs

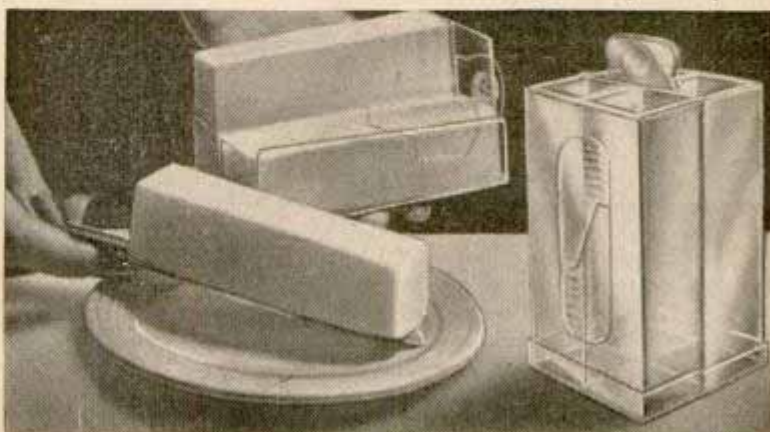
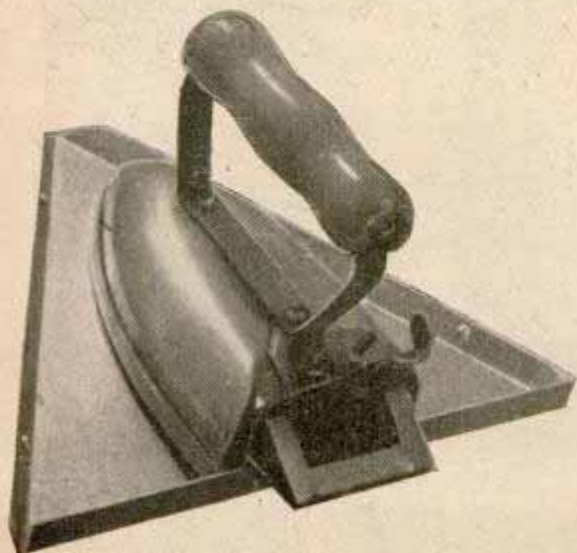

Continued from preceding page



Using a plastic clothes hanger that can hold nine garments in space one usually takes saves both space and pressing bills

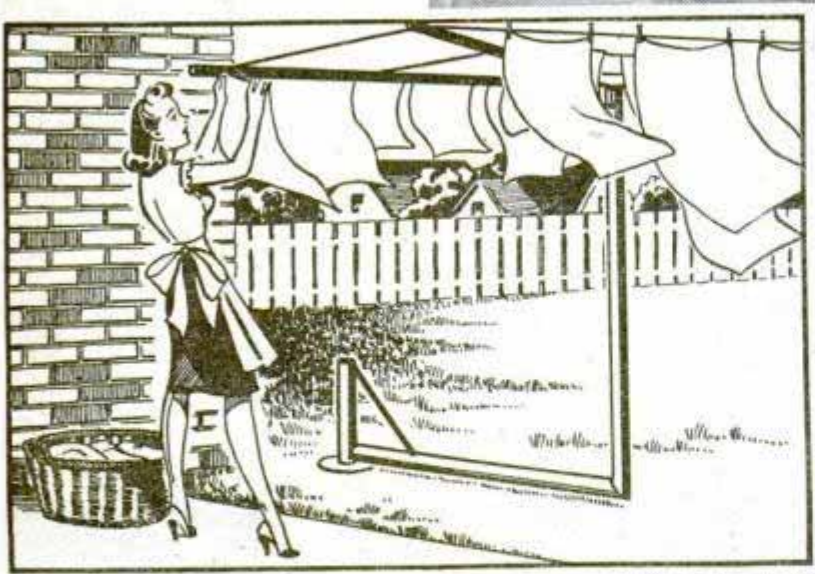

Especially valuable when damp underfoot is a collapsible pivoting clothesline that can be loaded from the walk. When not in use, it folds into a cabinet. For a fast dry, the arms can be allowed to rotate in the wind

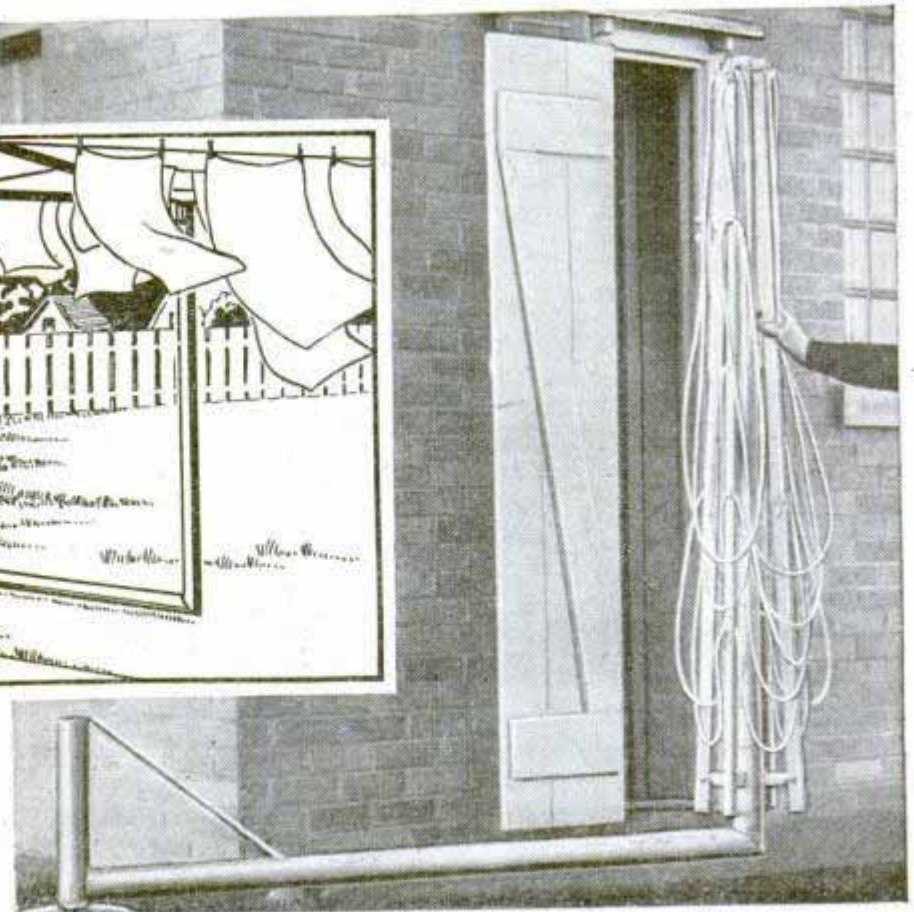

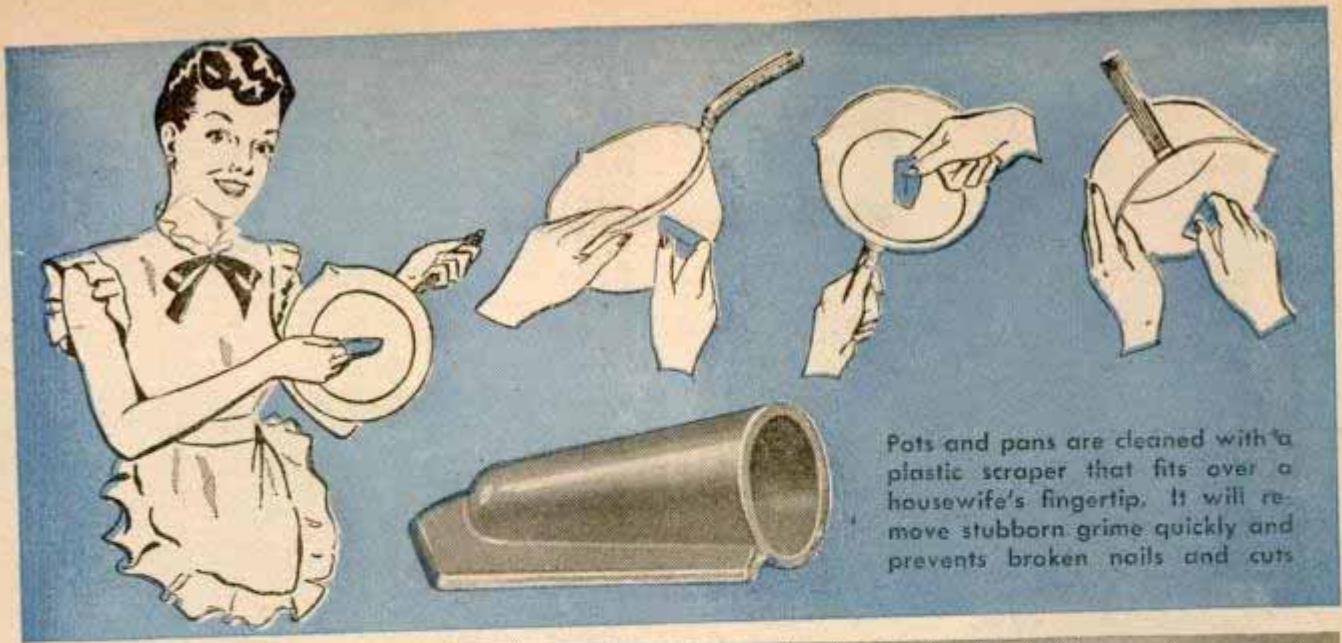

Pots and pans are cleaned with a plastic scraper that fits over a housewife's fingertip. It will remove stubborn grime quickly and prevents broken nails and cuts



By adding four sections to a square bridge table it is speedily converted into a round poker table

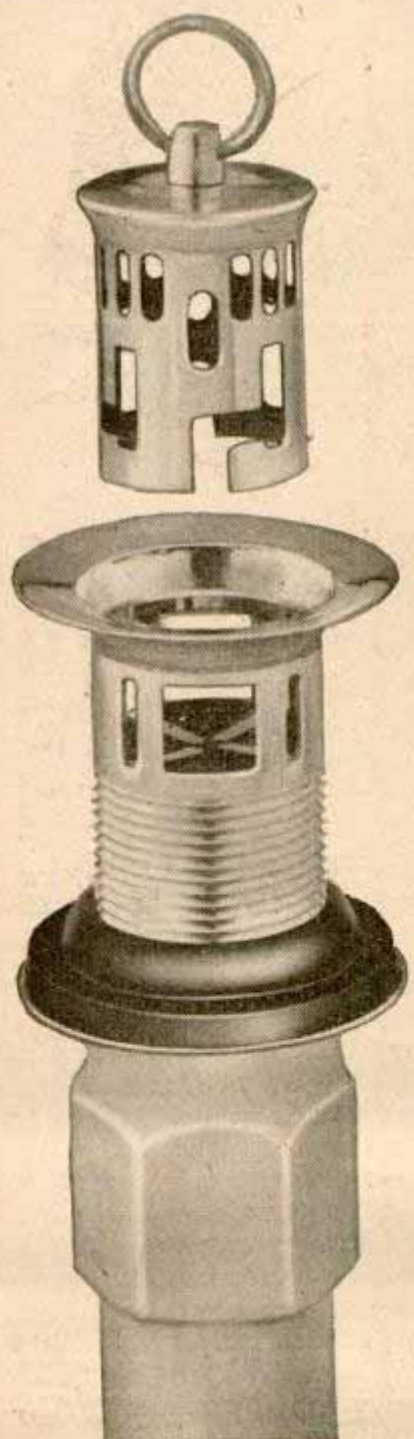

Old washbowls can be modernized with a pop-up drain, left, that takes the place of a rubber stopper. Below, all but one of the 764 possible combinations for this push-button combination door lock ring an alarm

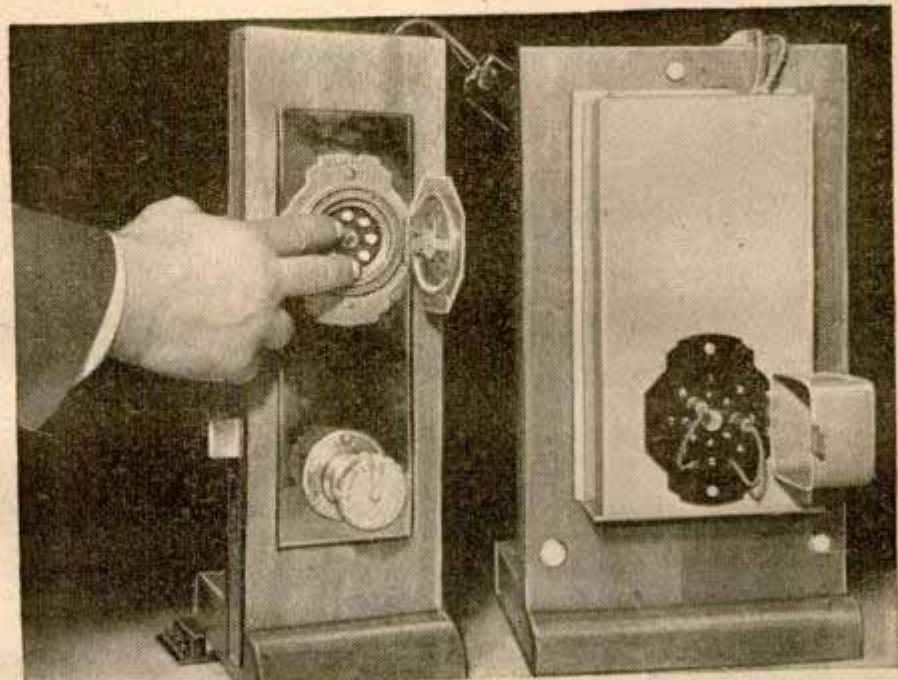



Rake Is Adjustable for Sweeping

For sweeping or raking lawns, a new spring-steel rake is now available. By removing the wing nut and bolt and reversing the position of the rake head, the handle is adjusted to either sweeping or raking position. The 18 raking prongs are welded between two 18-inch crossbars for strength. The extra length handle is 4½ feet long.

Golf Course Scooter →

Arthritis prevents R. J. Jackson, Houston, Tex., auto dealer, from walking long distances, but it doesn't stop him from playing golf. He designed a special motor-driven scooter to carry him, his clubs, and three or four friends. The car is lightweight and equipped with six-inch tires to prevent sinking down in fairways and making ruts.



Mortar Resembling Giant Popgun Tests Equipment at 100-G Loads

Aviation equipment is tested with 100-G loads (100 times the force of gravity) by an air-pressure mortar that operates like a giant toy popgun. Carrying as much as 50 pounds, the cartridge or car reaches top speed of 50 miles an hour in nine inches. It is placed in the lower of two cylinders before firing and held in position by a trigger catch. Then the gates are closed and compressed air fed into the cylinder until sufficient firing pressure develops. As the cartridge shoots into the upper cylinder it is slowed and stopped within 90 to 100 inches by a cushion of air created by its own momentum. It was developed by Boeing Aircraft for guided-missile tests.

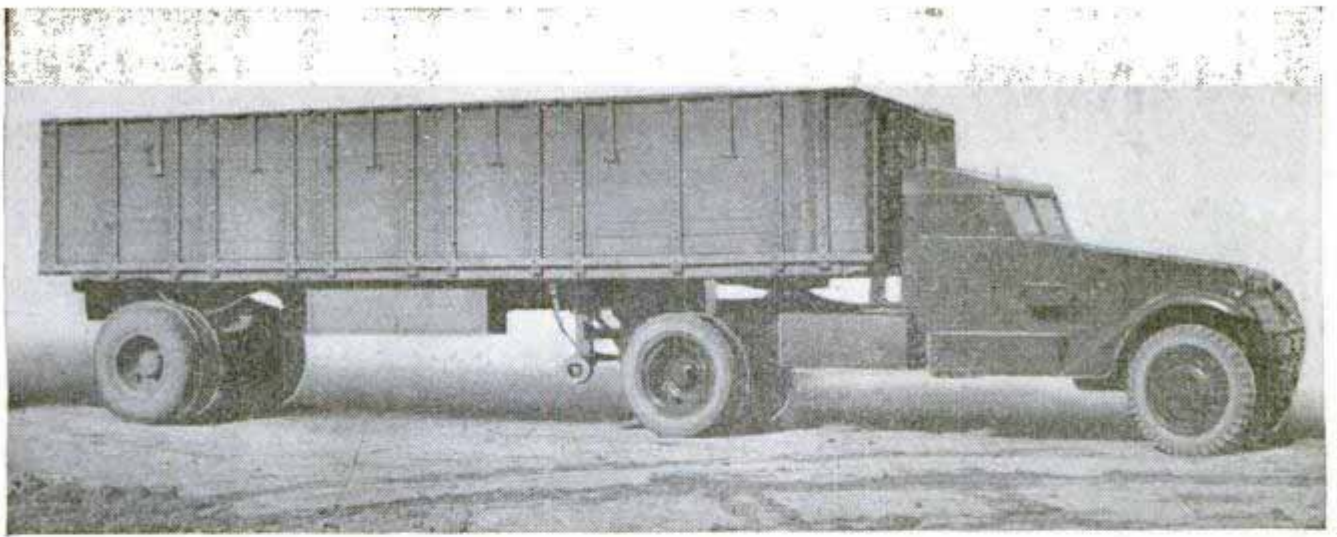

CONVERTED HALF-TRACK AND TRAILER HAULS WHEAT

From an Army half-track and a 10-ton semitrailer, Thomas D. Campbell of Hardin, Mont., has built a huge carrier for wheat. The conversion was simple and the finished unit cost \$2000. Mr. Campbell, op-

erator of a 95,000-acre farm, bought the half-track from the War Assets Administration for \$300 and the semitrailer for \$1100. The conversion was done with a cutting torch, welding torch and electric drill.

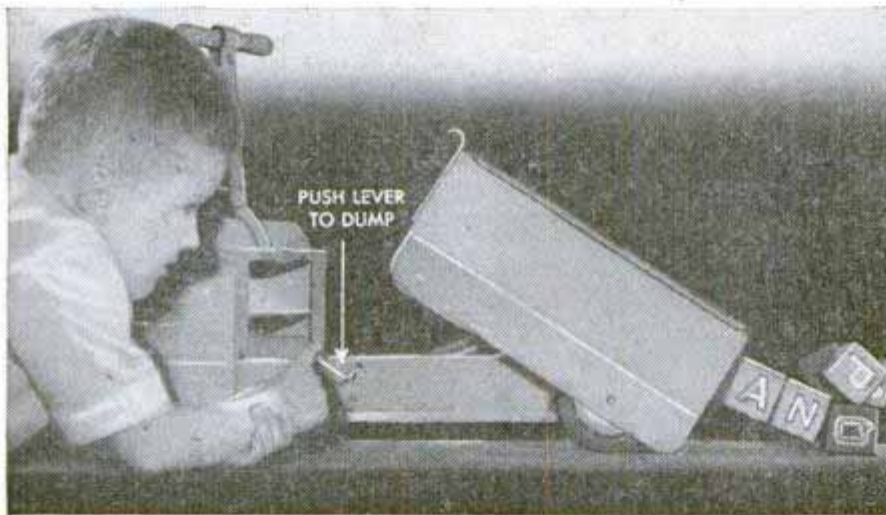

Boy's Dump Truck Serves as Scooter

Three toys are combined into one which serves as a dump truck, pushcart and scooter. A hydraulic steel cylinder dumps sand or other materials and automatically lowers the tail gate. When used as a pushcart or scooter, the backboard is lowered to become a seat or knee rest. The toy weighs 14½ pounds.

Folding Harrow

Time-consuming disassembly work is eliminated with a harrow that folds flat, reducing the width of three, four or more sections to two sections wide. This feature enables a farmer to pull it through the opening of a standard farm gate without taking the harrow apart. To fold, levers are thrown forward and the outer sections are folded inward.

☐ One out of three trucks on the highways today is at least 10 years old.



Unveiling the TUCKER

Only 60 inches high, the Tucker is designed to cruise at 100 miles per hour. Its six-cylinder, 150-horsepower engine is mounted between the rear wheels

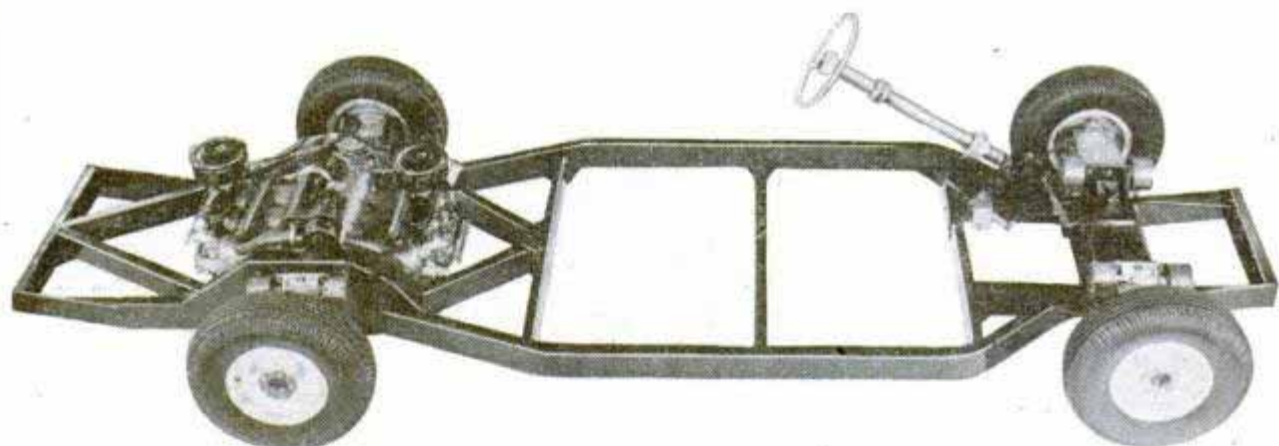

FROM the world's largest factory comes promise of a new automobile incorporating many engineering principles born of Indianapolis Speedway experiments and wartime advances.

It is the Tucker car, a rear-engine sedan with disk-type brakes, luggage compartment under the hood, a windshield that breaks free for safety in impact, and a headlight that "sees" around corners.

Its home is the 500-acre wartime Dodge plant in Chicago, 20 baseball parks bigger than famed Willow Run. Its designer and builder is Preston Tucker, who learned by working for Ford, Cadillac,

Studebaker, Chrysler and Pierce Arrow, and by building racing cars.

In 1926 Tucker and the late Harry Miller became associated in designing and building racing cars. In 15 years, Miller Specials won 11 Indianapolis Speedway classics. The team of Tucker and Miller brought many refinements to the automotive industry, including one of the first conversion heads which changed the shape of the combustion chamber for higher compression and bigger valves.

Now, after 15 years of experimenting and testing, Tucker is building a passenger car that embodies many racing-car ideas. The first Tucker—a hand-built job recently unveiled—is only 60 inches high. It has a third "Cyclops Eye" headlight mounted in the center of the hood. This light is connected to the steering apparatus so that a beam of light turns and illuminates

curves as the front wheels turn right or left.

The Tucker's six-cylinder, 150-horsepower engine is mounted at the rear, directly between the rear wheels. The main parts are aluminum, making the engine 500 pounds lighter than conventional engines of comparable horsepower.

The Tucker is designed to cruise at 100 miles per hour and the speedometer registers up to 140. With fuel injection, high-frequency ignition, light weight and elimination of about 800 parts used in the average auto, the Tucker—its manufacturer predicts—will travel 35 miles per gallon of gasoline at moderate speeds.

With a wheelbase of 128 inches, the new car weighs approximately 2800 pounds, roughly 1000 pounds less than other cars the same length. Door tops extend a few inches into the roof to provide additional headroom for a person entering the car.

Safety is emphasized in the design. A sponge-rubber crash panel, covering the entire dash and front passenger compartment, acts as a cushion in case of accidents. Gauges, instruments and electrical controls are mounted beneath the steering wheel.

The windshield is held in place by channels designed to give way and let the entire piece of safety glass push out, if a crash hurls the driver or a passenger forward. All windows and the windshield are made from case-hardened glass which pulverizes into coarse, gravel-like particles when broken, instead of splintering.

Locating the engine at the rear produces additional safety, according to Tucker. It puts 60 percent

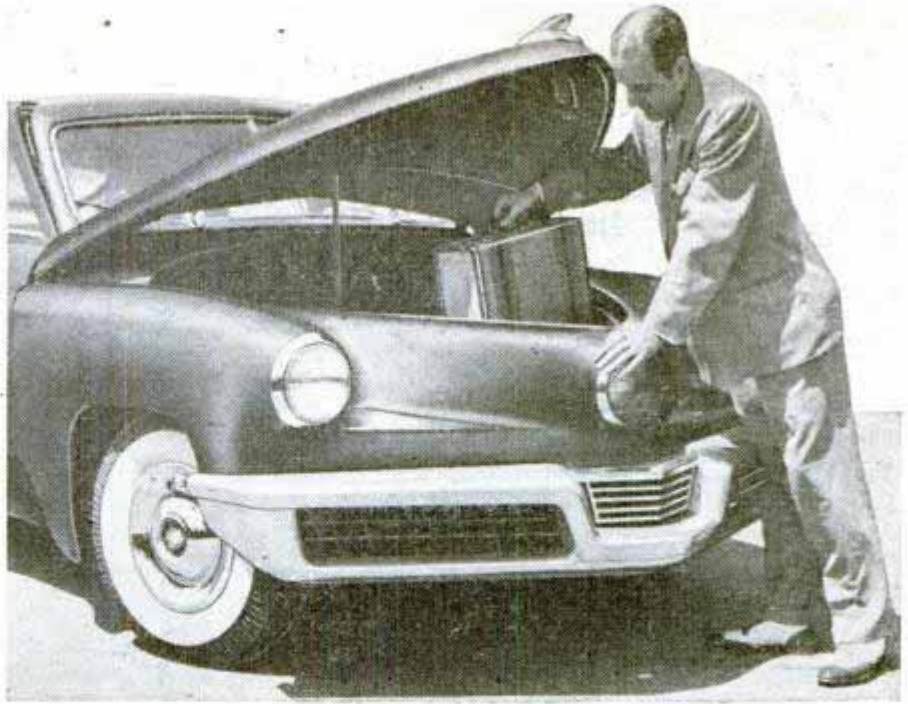

Preston Tucker, designer and builder of the convention-defying car, demonstrates how the space under the hood is utilized as a luggage compartment

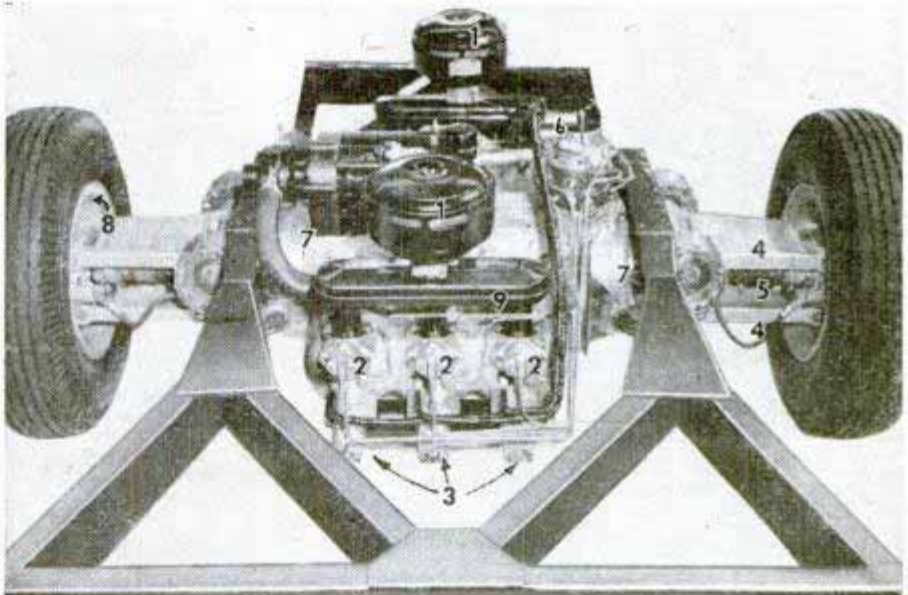

Main engine parts are identified: 1, air filters; 2, intake valves; 3, exhaust valves; 4, wheel-suspension arms; 5, propeller shaft; 6, distributor; 7, torque converters; 8, disk-type brakes; 9, intake manifold. Rear grille releases air that reaches engine through ports at front of back fenders. Six exhaust pipes permit individual gas analysis for each of the six cylinders

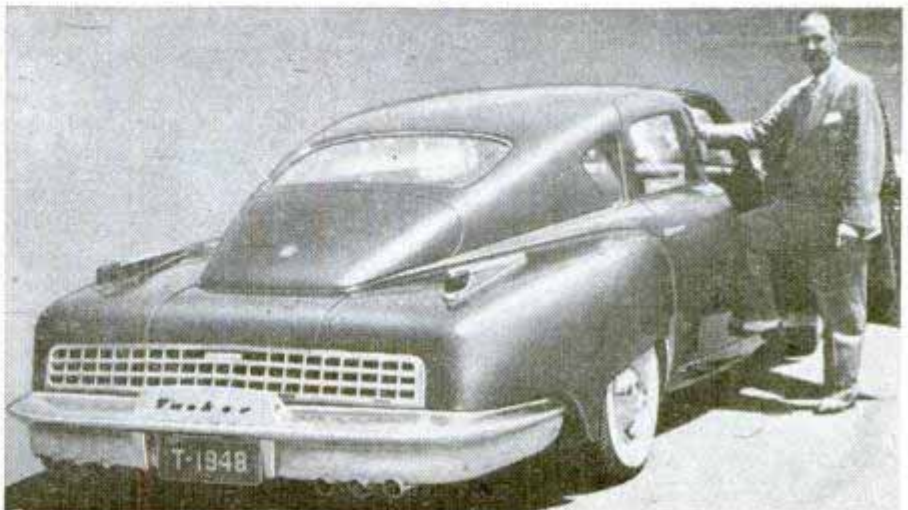

Designers say straight-sided wheel is easier to hold. Instruments are directly below the wheel

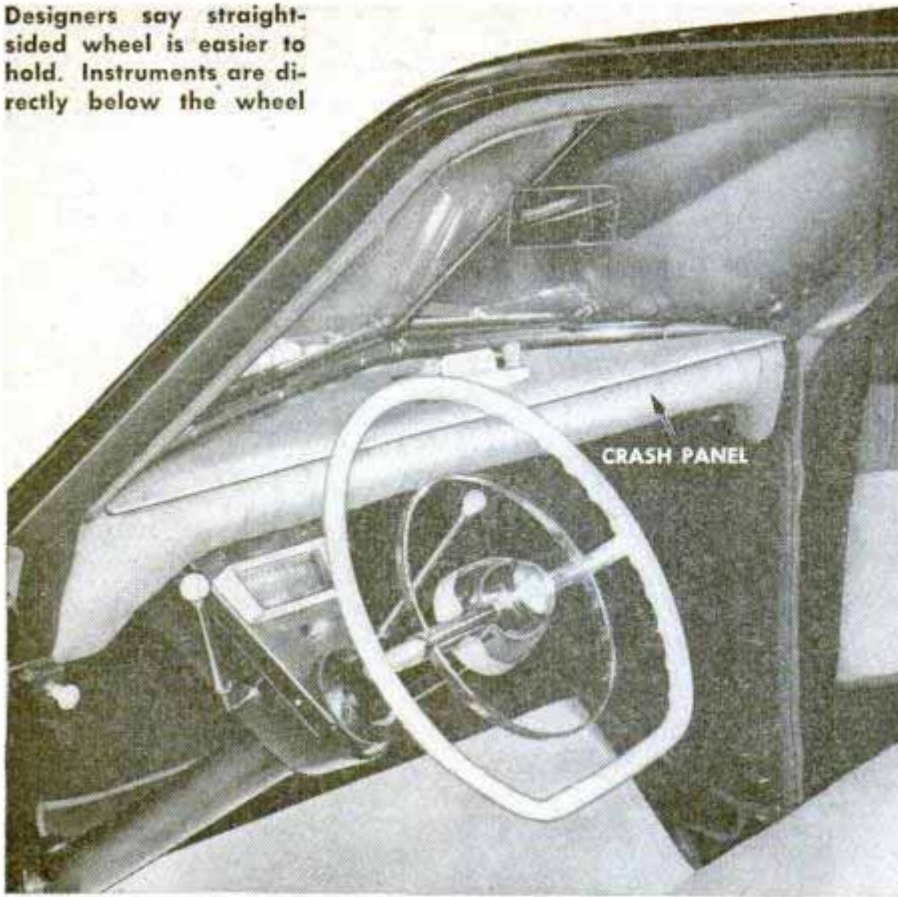

ventional drum brakes, Tucker engineers report. The disk brakes are similar to those used on some airplanes to assure a quick stop after landing.

A single aluminum disk between two friction surfaces provides much greater braking area than drum-type brakes, Tucker explains. Instead of relining disk brakes, the entire brake assembly on the new car can be replaced when necessary.

Advantages of the rear engine listed by the engineer include improved roadability and elimination of engine odors and noises. The block and head are made from a single aluminum casting and since the block and pistons have the same coefficient of expansion, Tucker predicts that his engine will give trouble-

free service three times as long as ordinary engines with a cast-iron or steel-sleeved block. In the conventional engine, Tucker declares, the pistons expand about eight times as much as the piston wall, causing wear and eventual oil pumping.

(Continued to page 236)

Six-throw crankshaft and four main bearings are shown (left) in cutaway view. Center, cross-section drawing of horizontally opposed cylinders. Right, cross-section view of cylinder shows fuel injector and spark plug

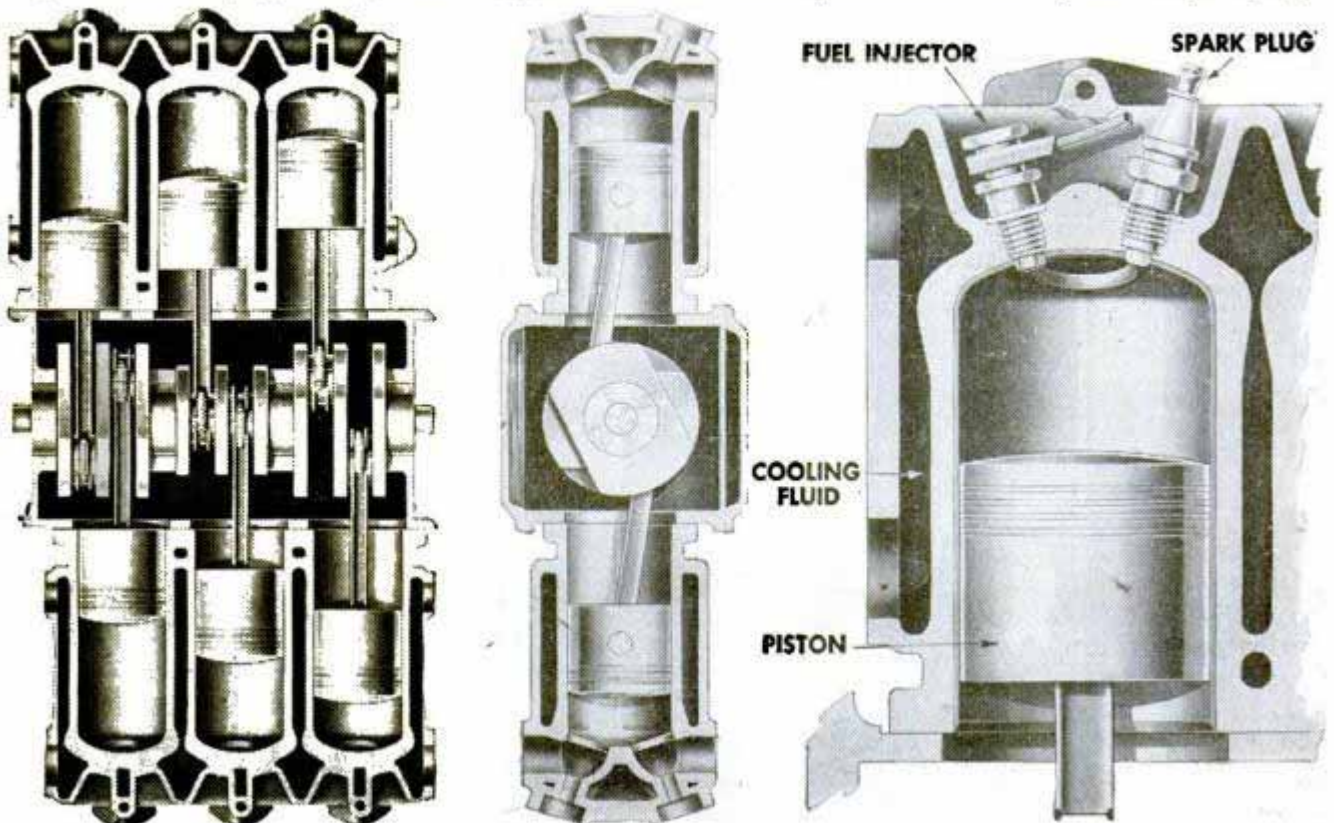

"Greenhouse" for Warships

Plastic panels form a "greenhouse" above the open bridge of the Navy's light cruiser USS Manchester. The transparent enclosure is being tested as a means of providing protection from blast, weather and fumes on the bridge of combat ships. The plastic panels are mounted in a metal framework, forming a hood over the Manchester's bridge. Two types of plastic, Lucite and Plexiglas, were installed in the test unit built by naval personnel.

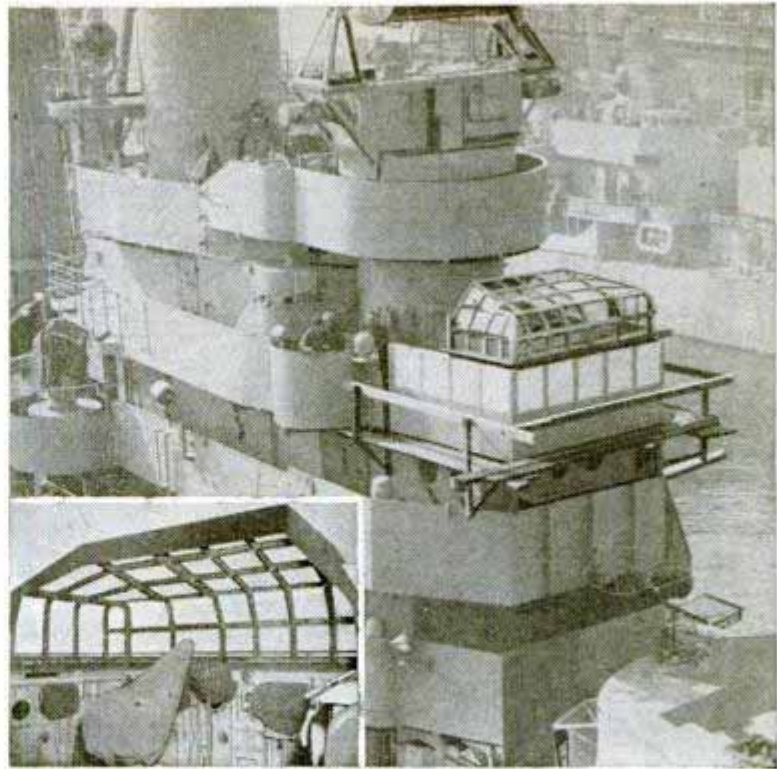

Chemical Poisons Quack Grass

Hard-to-kill quack grass can be eradicated by applying a chemical called IPC which was developed by the British during the war. Recent experiments by the U. S. Department of Agriculture show that the chemical first stops growth of the shoots and then kills them. It is a slow-acting poison. In the experiments the chemical was applied as a dry powder, from 5 to 60 pounds per acre. Sand was used as a carrier. Even in the lowest concentration

quack grass was killed without affecting broad-leaf plants. The chemical is ineffective against some weed grasses including crab grass. It has no toxic effect on experimenters but reasonable precautions are recommended pending further research.

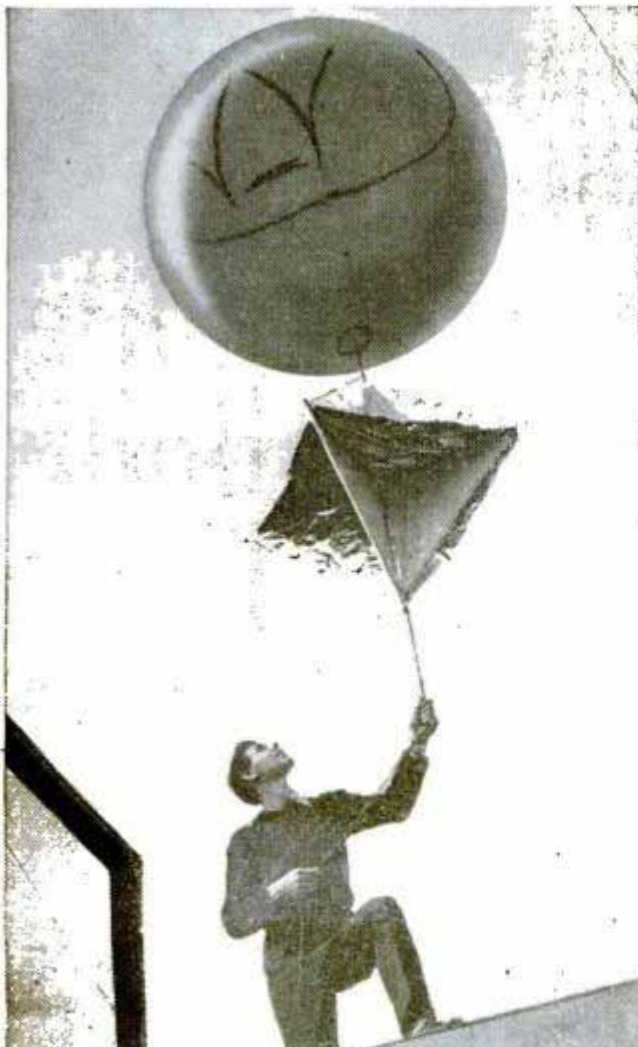

Balloon Targets Reflect Radar

Blasts of ultra-short radio waves are being fired by radar experts at a balloon floating 600 feet in the air in experiments to develop accurate radar-aimed aircraft guns. If the fire-control apparatus is successful it will direct gunfire with the greatest efficiency ever achieved, eliminating the inaccuracies of human gunners. In the experiments carried out by Westinghouse, a five-foot balloon inflated with helium carries aloft a reflector made of balsa wood covered with aluminum foil. Radio waves directed at the reflector bounce off the foil and are beamed back to a receiver. Airplanes will be used in later experiments.

"Half Size" Motor for Machine Tools

Particularly adapted to machine tools, a Fairbanks-Morse electric motor is half the size and a third lighter than conventional types. It ranges in size from $\frac{1}{3}$ to 10 horsepower and can be mounted horizontally as well as vertically, or on an angle base for belt drive.

Information, including manufacturers' names, concerning products described in this issue may be obtained by writing Bureau of Information, Popular Mechanics, 200 E. Ontario St., Chicago 11, Ill.

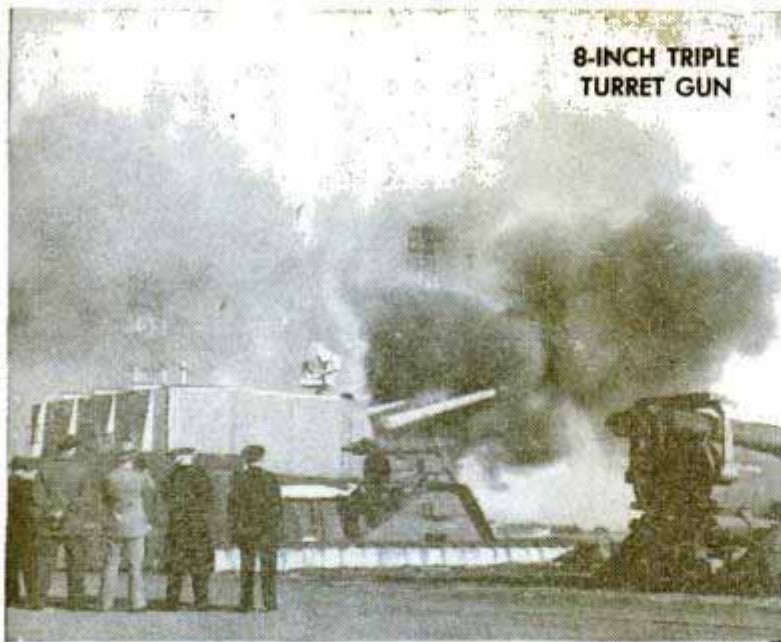

8-INCH TRIPLE
TURRET GUN

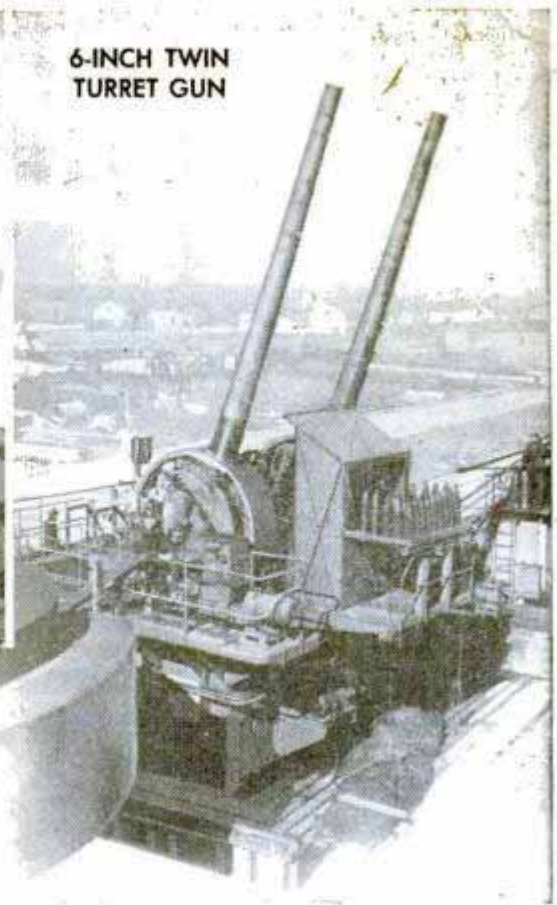

6-INCH TWIN
TURRET GUN

U. S. Navy photos

FIRING SPEED QUADRUPLED

Eight-inch turret guns developed for the U. S. Navy fire nearly four times faster than any gun of the same or larger caliber. Automatic from ammunition handling to muzzles, the batteries eject cartridge cases from the mounts. The cases are used instead of powder bags to speed firing. Fuzes are set automatically in the eight-inch and six-inch mounts. Interference eliminators prevent guns of adjacent mounts from "locking horns" while under the individual control required for following different targets. A control-and-trouble-indicator

panel shows the position of ammunition in the entire loading system and indicates the location of any electrical failure. Similar improvements have been applied to a six-inch dual-purpose gun on light cruisers, and a three-inch antiaircraft weapon.

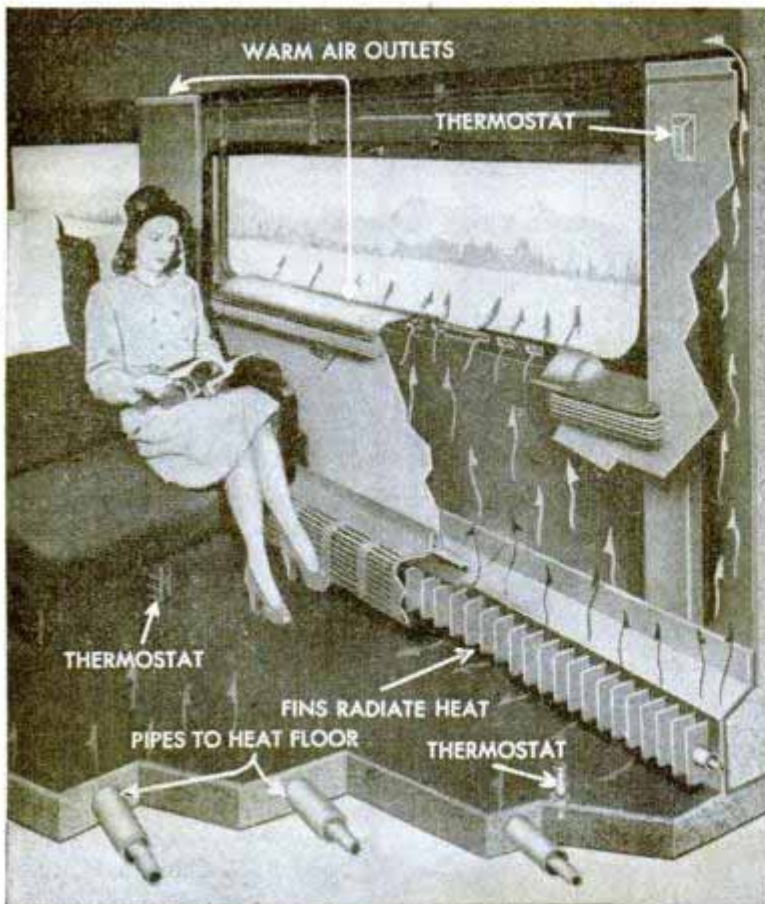

Radiant Panels on Rail Car Heat Interior by Sections

Cold floors and window drafts on railroad cars are eliminated with a semi-radiant heating system being installed on Chesapeake and Ohio cars. The system permits rapid adjustments in the heat of various parts of a car. Thermostats are placed at intervals along the floor and sides of the car, dividing the interior into both vertical and horizontal sections. Each thermostat regulates the admission of heat into its section. Steam from the locomotive's boilers passes through pipes in the car to provide the heat. Part of the heat is released through radiant panels in the side walls, part through an opening just beneath the windows, and the remainder through coils in the floor of the car. Fins on the heating pipes improve the radiation. The design permits temperature variations in parlors and other sections of the car.

NATURAL GAS IS STORED IN UNDERGROUND STEEL TANKS

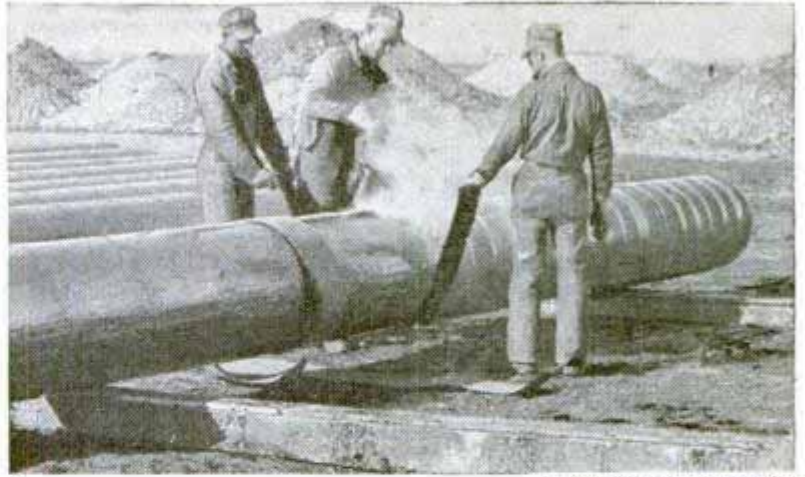

U. S. Steel Corp. photos

Crane lowers pipe into trenches for underground storage of natural gas. The pipes are waterproofed and weatherproofed (above) by a special wrapping which prevents corrosion. Below is a general plan for the subterranean natural-gas storage facilities

Natural gas at Mount Prospect, Ill., will be stored in underground pipe instead of in conventional storage tanks above ground. This innovation may revolutionize the storage of natural gas. The finished project will have a storage capacity of 40,000,000 cubic feet. The gas is to be stored in 40-foot seamless molybdenum-steel pipe sections nosed in at the ends and machined for connection, one to another. The pipe is 24 inches in diameter with walls $\frac{1}{2}$ inch thick. Each pipe will have a capacity of 25,000 cubic feet at 2240 pounds pressure. The company for which the tanks were made reports that underground gas

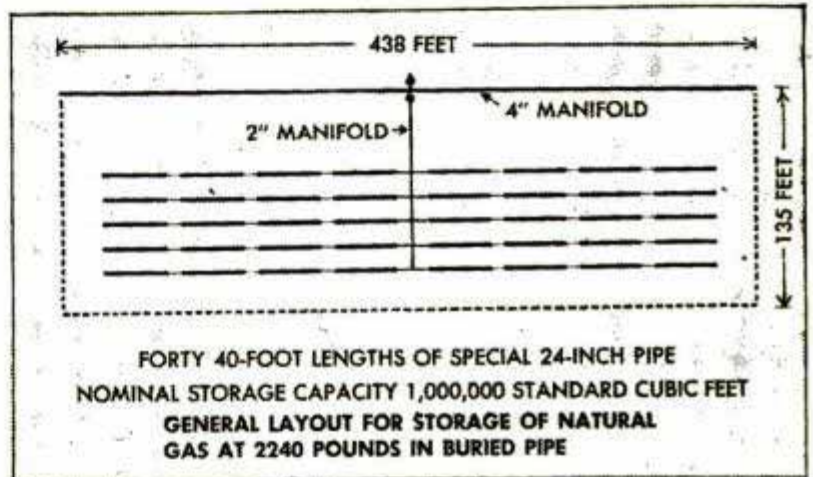

storage costs less for initial installation and maintenance than above-ground tanks. Also, since gas storage is in numerous small pipe sections, it is easy to increase or decrease the capacity. A third advantage is that above-ground hazards are eliminated.

Center Punch Delivers Blow Through Adjustable Spring in Handle

Metal, glass or wood can be center-punched without using a hammer with a punch that delivers an impact through an adjustable spring built into the handle. Only one hand is needed to operate the punch, as the point merely is pressed down to release the spring and mark the surface. A screw adjustment in the handle permits regulation of the spring tension so a blow of 10 to 20 pounds can be delivered. Through a controlled impact the distortion in marking light metals is minimized and the diameter of the impression decreased for greater ac-

curacy. The punch is available in a kit with accessories that include a tungsten-carbide point for marking hard steel, self-centering attachment for countersunk holes, hole-cutting point for punching paper, rivet point for delicate riveting operations and chisel point for tooling soft metals.

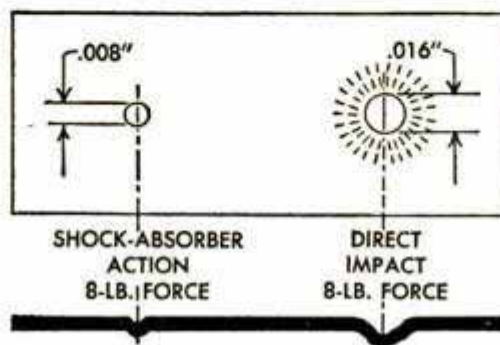

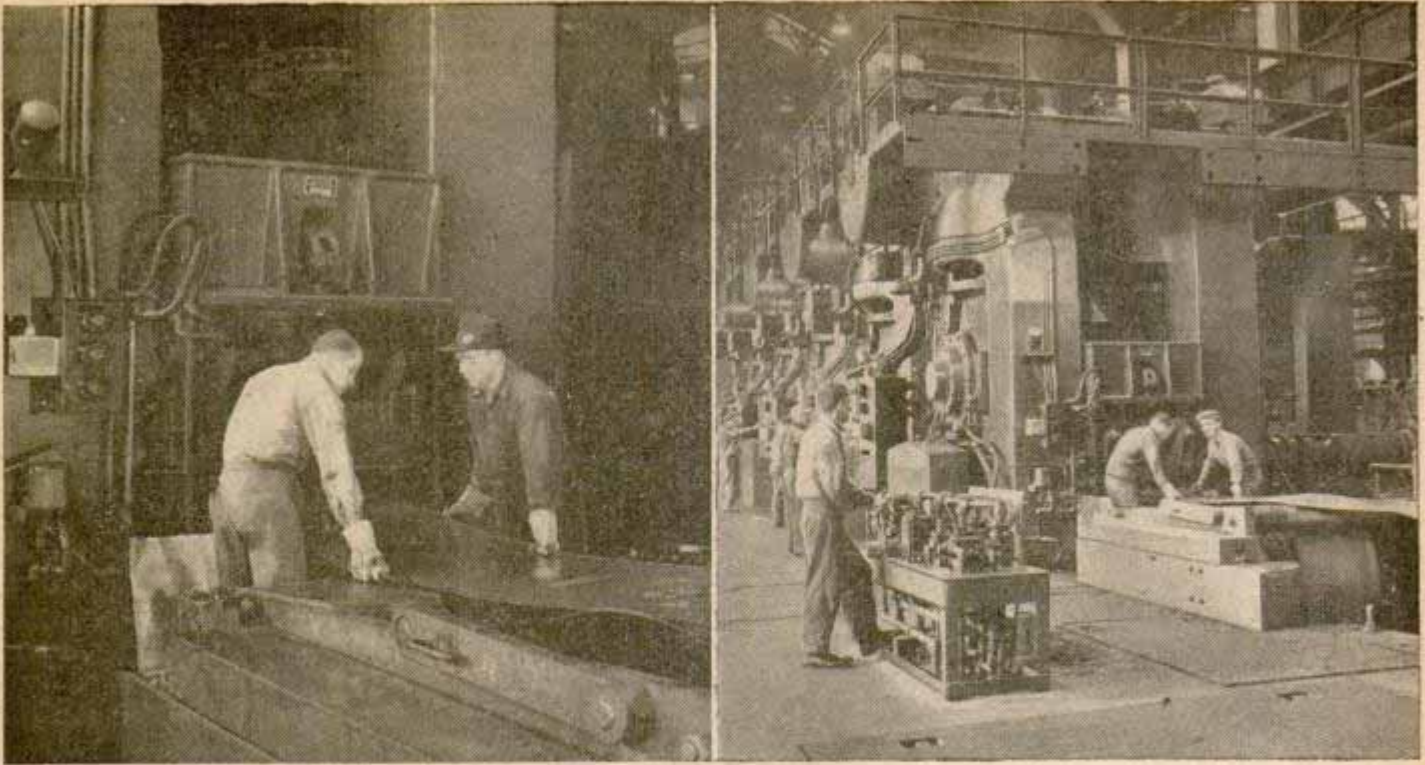

↑ Already reduced to cardboard thickness in previous operations, a steel coil is threaded into the mouth of the mill. It will be secured on the winding reel at the opposite end

Above right, each successive "stand" of the high-speed mill reduces the thickness. Worker at left operates controls governing the speed

↓ Diagram shows layout of the mile-a-minute mill. The prepared coil is mounted on a reel at the right end. Steel rolls out the opposite end at a rate of 1,650,000 square feet an hour

Mile-a-Minute

STRIP STEEL zips through a new rolling mill at a mile-a-minute rate. The mill, installed by the Weirton Steel Company, rolls out strips of "tin can" thickness or heavier, coiling it on a reel at a rate of 1,650,000 square feet an hour—enough for

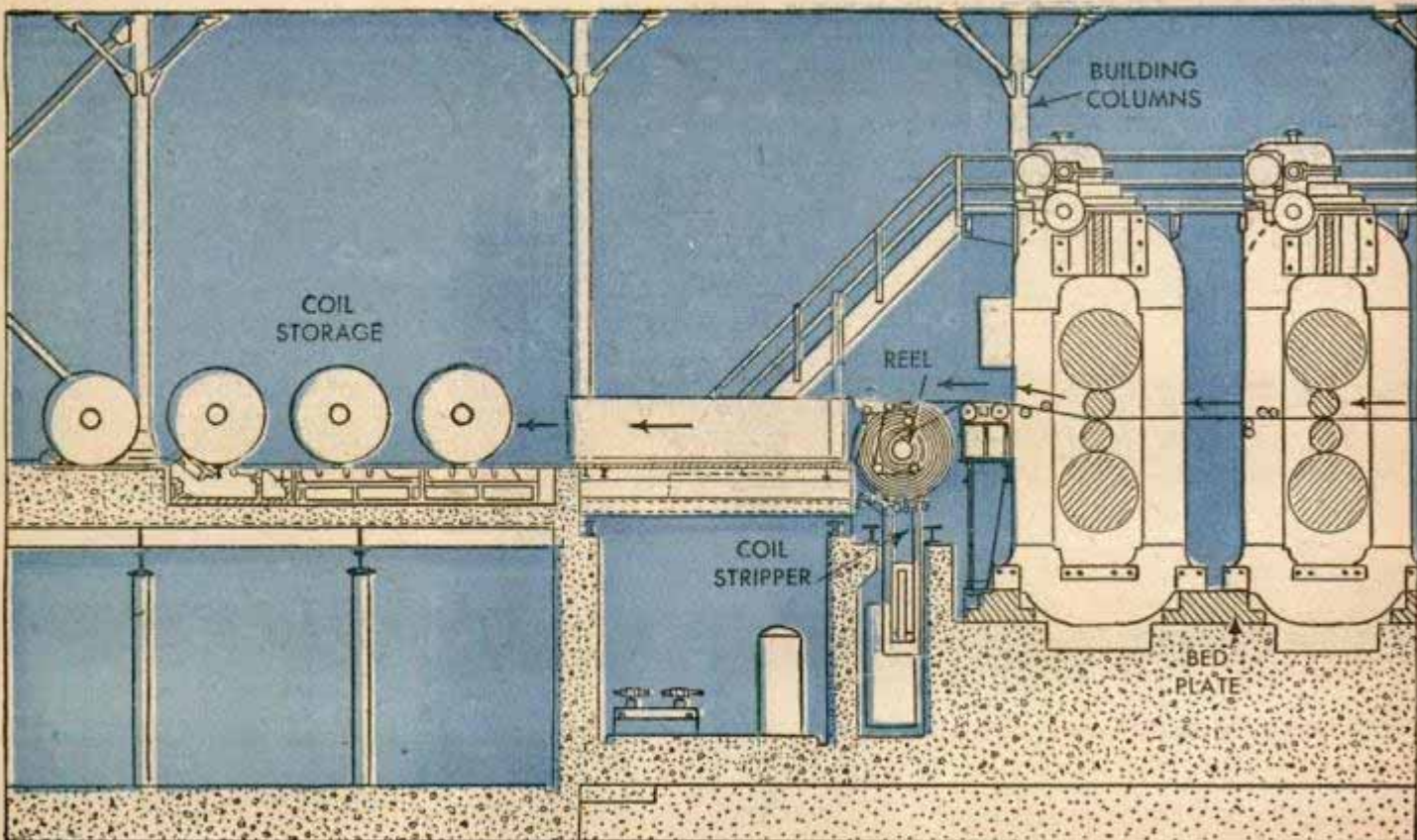

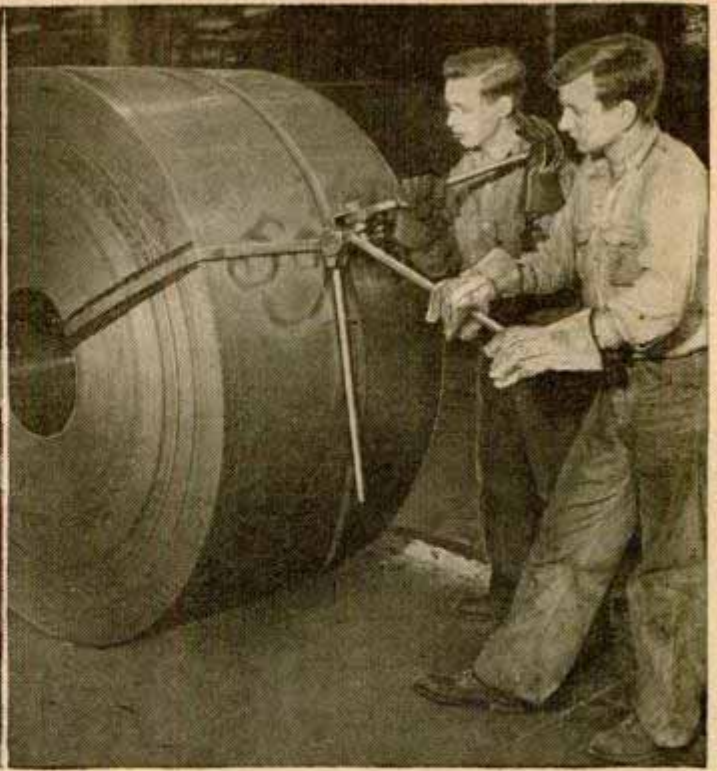
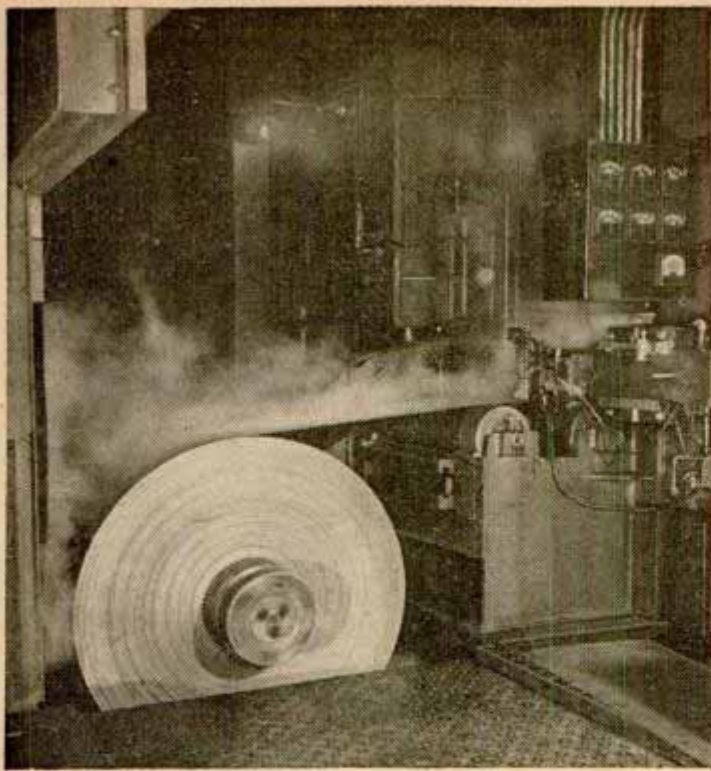

Ribbon of Steel

Left, strip steel flashes out of the rollers and around the winding reel. Above, "bundlers" strap the shining steel coils for shipment

750,000 vegetable cans. A coil of prerolled steel about $\frac{78}{1000}$ inch thick is installed at one end of the mill and threaded through several sets of rollers. The rollers reduce the thickness to $\frac{22}{1000}$ inch or less. In the mill's first stand the ribbon moves 650 feet

a minute, but increases speed in succeeding stands until it flashes out of the mill at more than 5000 feet a minute. The mill is powered by six reel motors of 17,550 horsepower. Tensiometers, designed especially for the mill, control the slack of the steel.

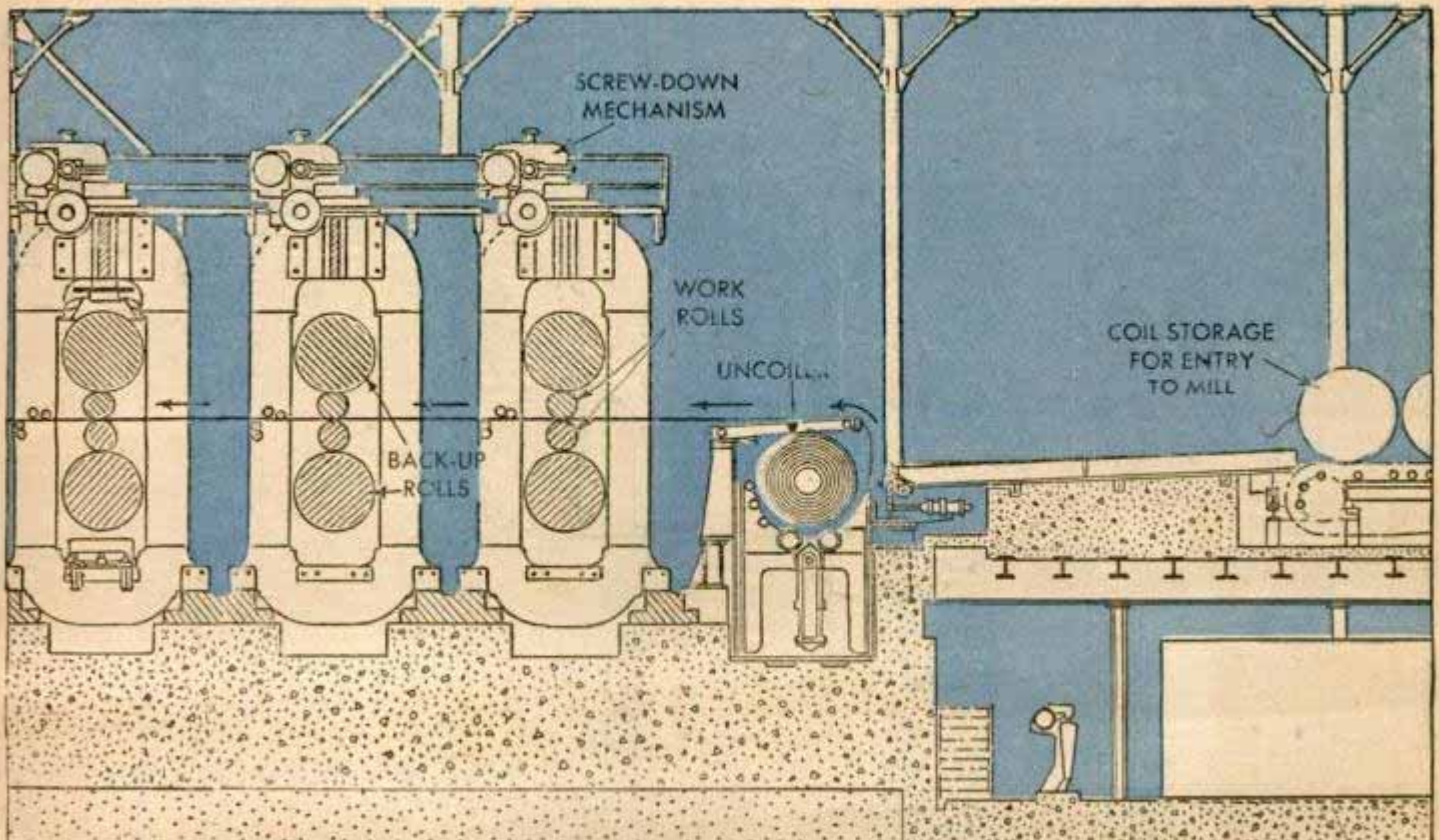

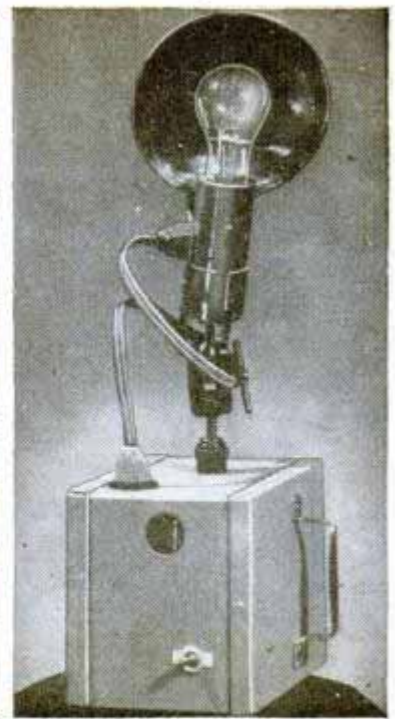

Left photo was taken with an ordinary press flash bulb. Center photo was illuminated by the same equipment plus another bulb fired by a photoelectric cell. Right, light passes through window in the case to fire the bulb

PHOTO-CELL LIGHTS SECOND FLASH BULB

Flash bulbs for side lighting are fired by a photoelectric cell when the bulb on the camera is flashed, eliminating the need for an electrical connection. The electronic circuit, invented by Robert Ritchie, a Los Angeles newspaper photographer, is mounted in a case six inches square. A conventional photo-flash socket and reflector are fastened to the top of the case. In the side is a one-inch hole which admits light to the

photoelectric cell. When the bulb on the camera is fired the sudden change in illumination actuates the cell, which fires the extension bulb. In night tests the unit has fired a bulb a city block away from the flash of the camera bulb. Only a sudden bright light will actuate the cell. Flashlights can be waved in front of it without tripping the light. The small case is fitted with a tripod and weighs only 10 pounds.

Supersonic Wind Tunnel Tests Models at 2500 M.P.H.

Models of projectiles and aircraft that are expected to reach speeds faster than sound are tested in a miniature supersonic wind

tunnel in Los Angeles. Speeds of 950 to 2500 miles an hour are simulated in the tunnel to aid basic research in the design of projectiles. Instruments are attached to tubes around the model to record the pressures.

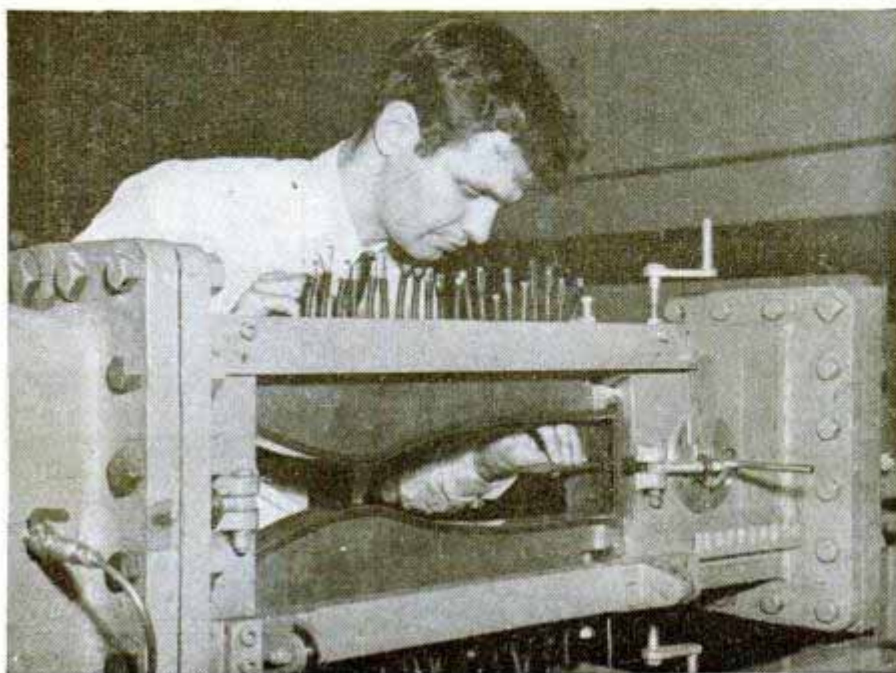

Food Value of Hay Decreased by Rain

It pays to make hay while the sun shines because one rain can cut the feeding value as much as 38 percent. A heavy shower, Cornell University scientists found, reduces sugar, protein and mineral content.

☛ Faucet washers are being made of Nylon to resist heat, cold and acids as well as wear.



↑ **AUTOMATIC FILM-CHANGING** feature of a portrait camera enables a photographer to make exposures every two seconds. Camera is equipped for use with stroboscopic lights. It can be concealed behind wall (dotted line) and operated entirely by remote-control release

SOUND ADAPTER for silent movie projectors uses a radio for amplification. The film is threaded around the sound drum before being wound on take-up reel. A radio-film adapter transmits sound-track impulses to the radio. A separate amplifier can be used, if desired

↓ **EXACT CENTERING** of small objects and titles on movie film is assured by a sliding wedge and centering guide. The wedge is held against the lens and its point aligned with the centering guide by adjusting the camera or titler. If the object to be photographed is beyond the wedge, a short string is used

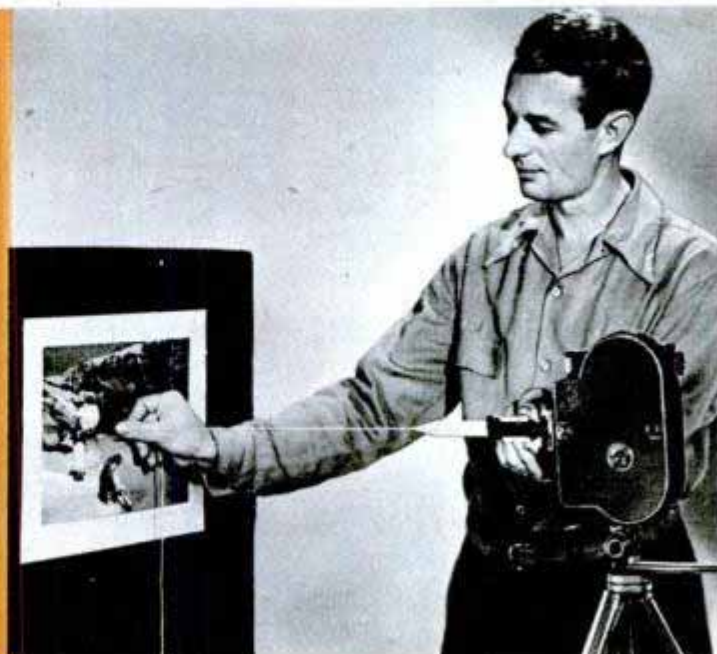
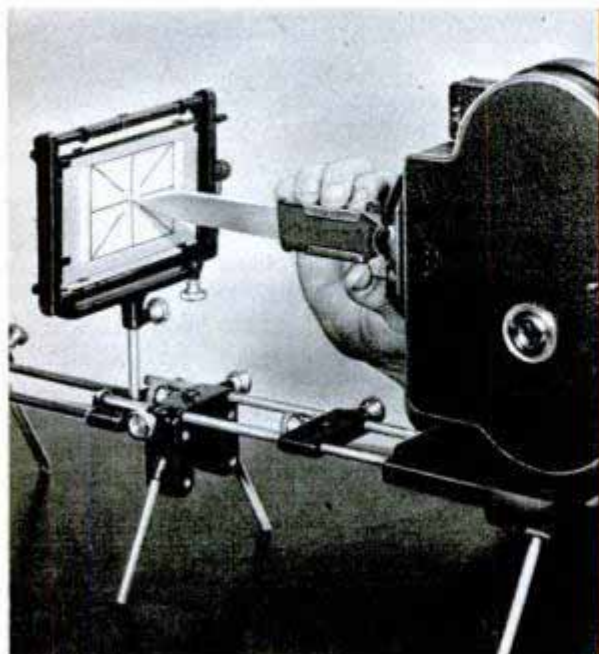



On its trial run the Chinook clipped off better than 18 knots. It has a radar receiving unit (left, in pilot house view). The radar antenna is pictured below

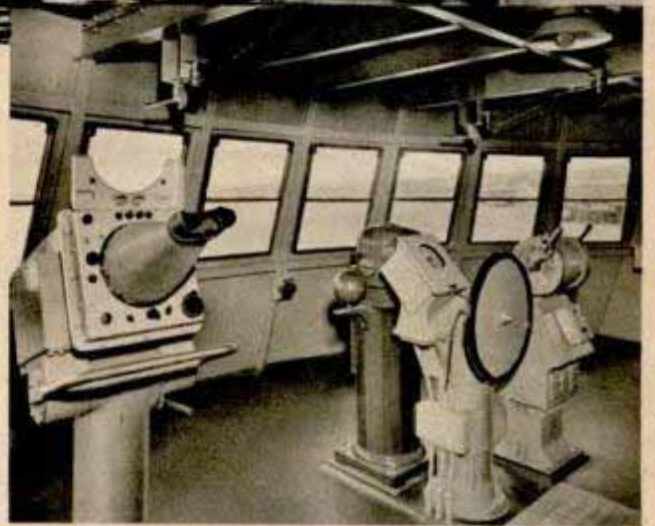
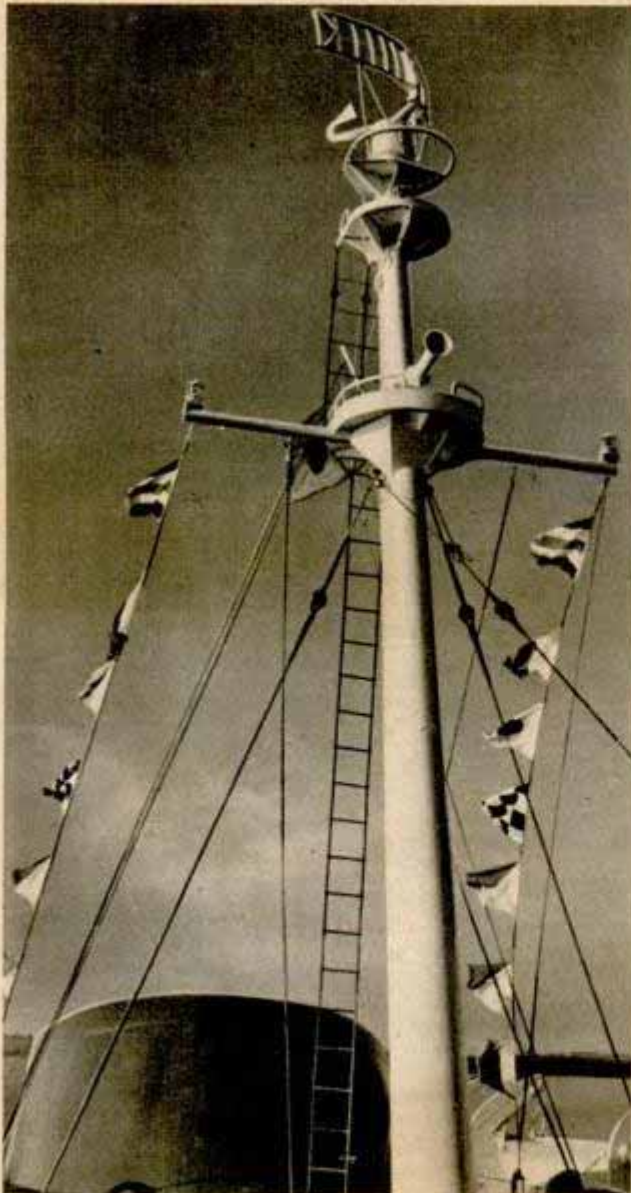

FLOATING "HOTEL"

Costing approximately \$2,000,000, a streamlined ship with the comforts of a deluxe hotel carries passengers on the 92-nautical-mile run between Seattle, Wash., and Victoria, B. C. Owned by the Puget Sound Navigation Company, the ferry has a capacity of 1000 passengers and 100 automobiles. There are sleeping accommodations for 208 persons in 100 air-conditioned staterooms. The M. V. Chinook is an all-steel, twin-screw vessel with a cruising speed of 18.5 knots. Her over-all length is 318.2 feet; over-all beam, 65.8 feet, and mean draft, 13 feet. Four 16-cylinder Diesel engines drive four 490-volt electric generators coupled to four electric propulsion motors. These motors deliver power through reduction gears to two propeller shafts. Electricity is supplied by two Diesel-driven, 200-kilowatt generators. In case of failure of the main power supply, a 100-kilowatt emergency generator automatically goes into action. Lifeboat winches are electrically driven.



Spring Motor Powers Baby Boat

Skipper of her own little boat, five-year-old Sally Worth navigates the canals around a park in St. Petersburg, Fla. The six-foot boat was built by her father, Frank Worth, who installed a spring motor salvaged from an old-fashioned phonograph to power the craft. Mounted on deck, the motor is coupled to a drive shaft by a belt and pulley. Sally winds the motor with a crank between her knees and controls the flow of power with a lever in her right hand. She steers with a lever on her left that is coupled to a bronze rudder. The motor provides $\frac{1}{8}$ horsepower which pushes the boat four miles an hour. One winding carries Sally a quarter of a mile.

Blind Man Operates Micrometer

As part of Great Britain's war rehabilitation program, blind British veterans perform precision measuring jobs by means of special micrometers including one equipped with Braille numbers. In the photographs below, a blind man is operating a micrometer and slip gauge. At right is a Braille micrometer which the operator can "read" by touch.

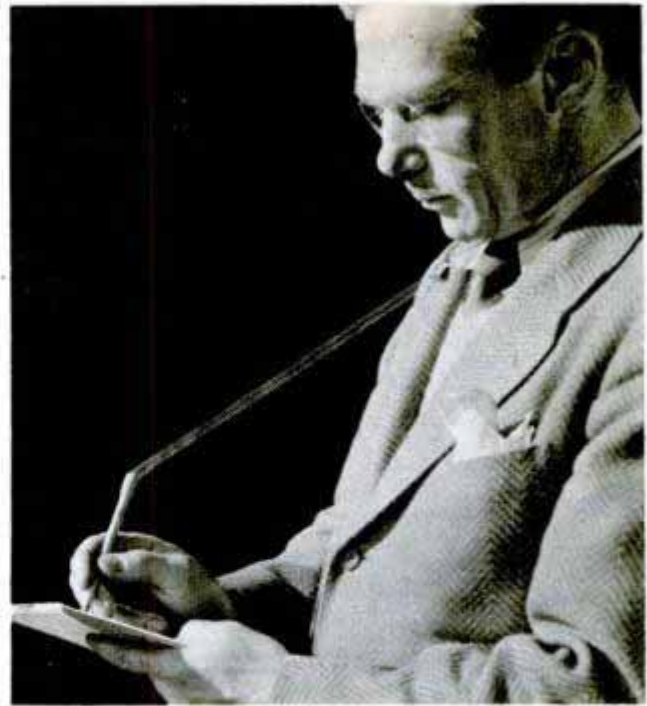
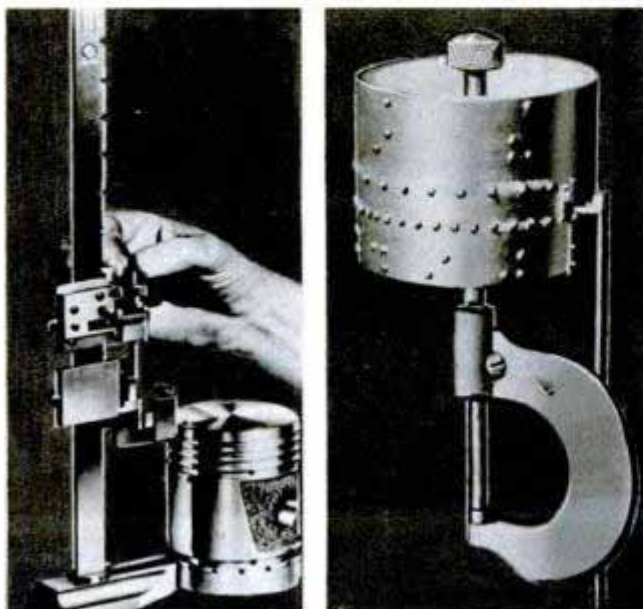

Pencil "Stretches" Three Feet

Always within reach, a pin-on pencil is equipped with a coil spring that stretches more than three feet. Attached to a plastic clamp above the spring is a pin for fastening the pencil to coat or dress so that it can't be lost.

Four-in-One Bench Tool

Metalwork ordinarily performed by four tools is accomplished by one that will punch, form, shear and rivet. Made of hardened steel, it is five inches high, four inches wide and is held to the workbench by four bolts. The punch sizes are $\frac{2}{16}$, $\frac{3}{16}$ and $\frac{4}{16}$ inch and there are sets for solid rivets and eyelets. The punches and rivet sets are interchangeable. All working parts are heat-treated to insure long life.

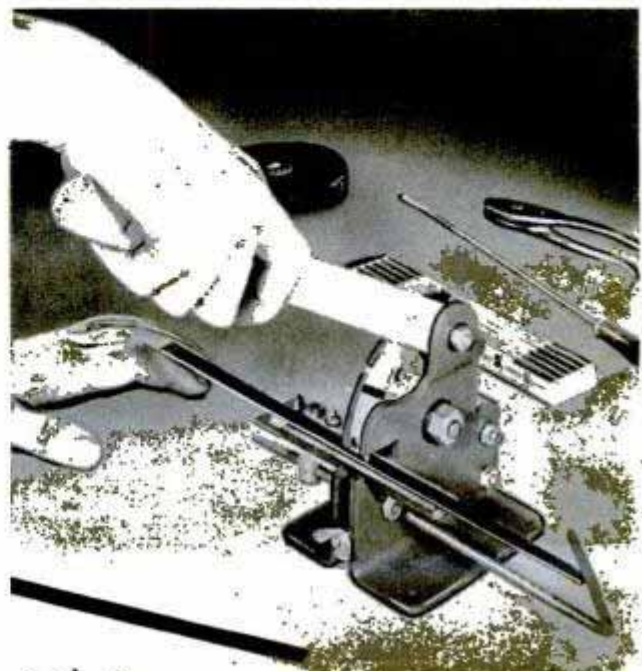

TASK FORCE FURNACE



Sun and dust are the worst tropical enemies. With the temperature at 120 degrees a "cat" roars across the desert

By J. Alvin Kugelmass

UNDER a broiling desert sun in southwestern Arizona the Army is sweating out an ordeal by fire. Military equipment designed for the tropics is checked for efficiency in temperatures that soar up to 122 degrees. Men, too, are being subjected to tests to find out just what happens physiologically and psychologically to a soldier fighting in the desert.

Task Force Furnace, military opposite of Task Force Frigid, the arctic experiment that checked equipment under extremely cold conditions, already has tested many new items designed to make desert warfare less painful and more efficient.

For example, there's a pressed-cork helmet that looks like a cross between a Chinese coolie's hat and an inverted coal scuttle.

"The helmet," explains Lt. Col. Walter D. Richardson, who commands Furnace, "sucks up stray air currents and guides them gently under the brim on the back of the neck where it pours a cooling stream into the shirt."

Many soldiers in the encampment wear glistening, lightweight, Nylon uniforms—with long sleeves. The sleeves are there because the Army wants to test the old bromide that whatever keeps out the cold also keeps out the heat. For the most part, the ex-

After a test "cat" has had a grueling workout under the desert sun, the temperature of the special rubber treads is recorded



periments have proven that the soldier with the most skin covered is the coolest. As a result, the Army will not recommend shorts such as the British wear in Bombay and Palestine. Nylon coverings, perhaps as leggings, perhaps just as trousers, are more effective in keeping the foot soldier cool in the tropics.

Underwear is cut down to a minimum and is made of a net material as thin as gauze. New Army shoes are made with thick cork soles and high canvas uppers. They hook up instead of lacing. "That way," says Col. Richardson, "less sand gets in." For men who handle machines and metals which become too hot to touch under the unrelenting sun, there are gloves with thick canvas palms and backs made of strong netting.

Modern warfare means armored equipment. "And in the desert, the worst sufferers are the men in the tanks," the colonel says. "But we've solved that," he explains, exhibiting a baggy, Nylon suit. This new tank suit envelops a man from neck to ankles. Thick rubber bands are slipped over the wrists, ankles and neck to keep it snug. Then air is piped in, the air valve is sealed, and the body is air-insulated against heat for 8 to 12 hours.

Tanks, too, are being equipped with air-conditioning systems. A stream of water circulates through a container filled with excelsior, and a fan, powered by the engine, blows moist, cool air from the damp excelsior into the tank's interior.

Gasoline feed lines on tanks are insulated with rubber and asbestos to prevent fuel evaporation. Some tanks are equipped with skis mounted on the front end. They've been found effective in traversing soft mounds of sand, and were borrowed for

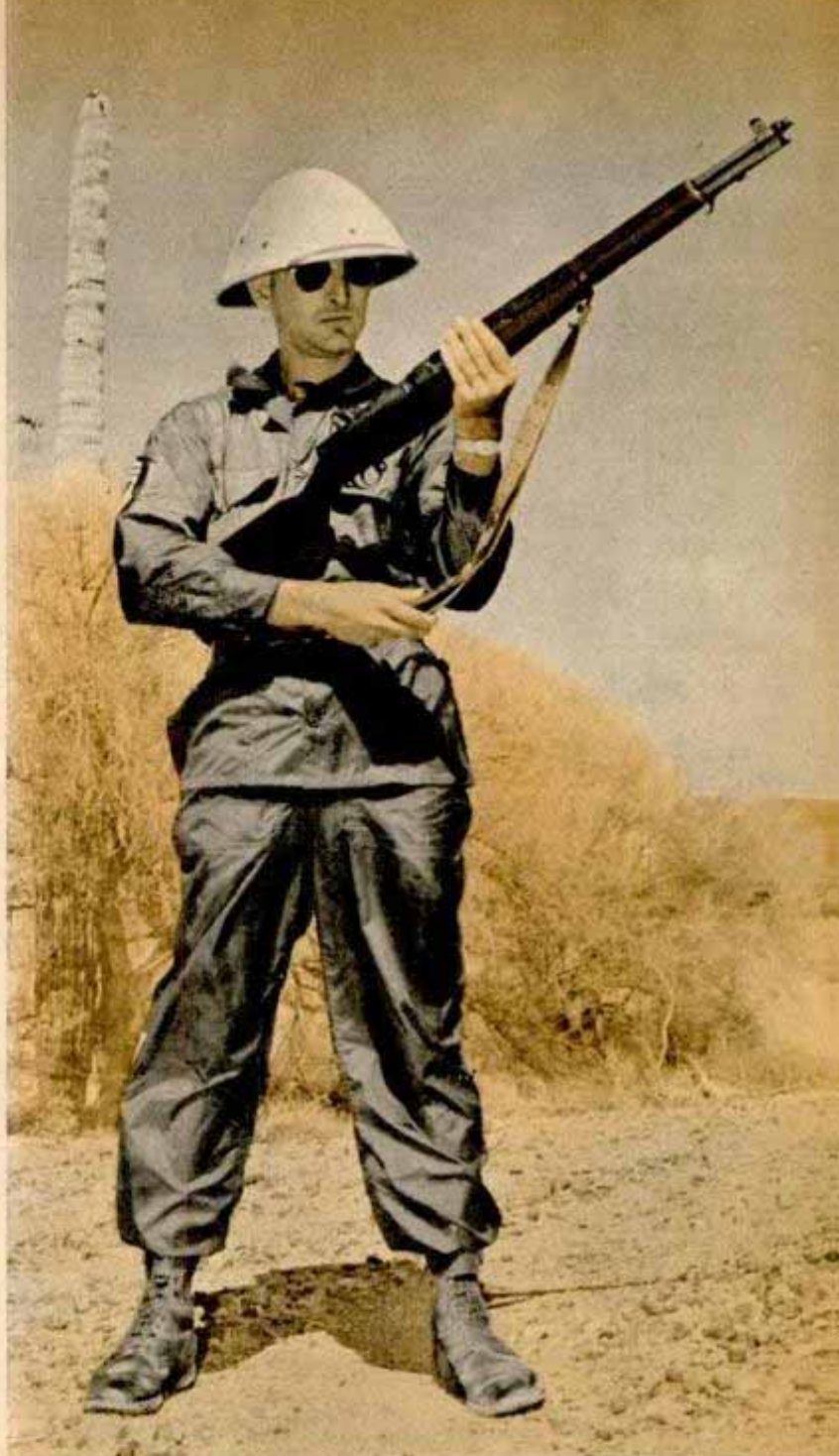

↑ Foot soldier wears Nylon uniform and "coolie" helmet

↓ Experimental plywood and aluminum alloy tent is cool and portable. It can be struck in one minute

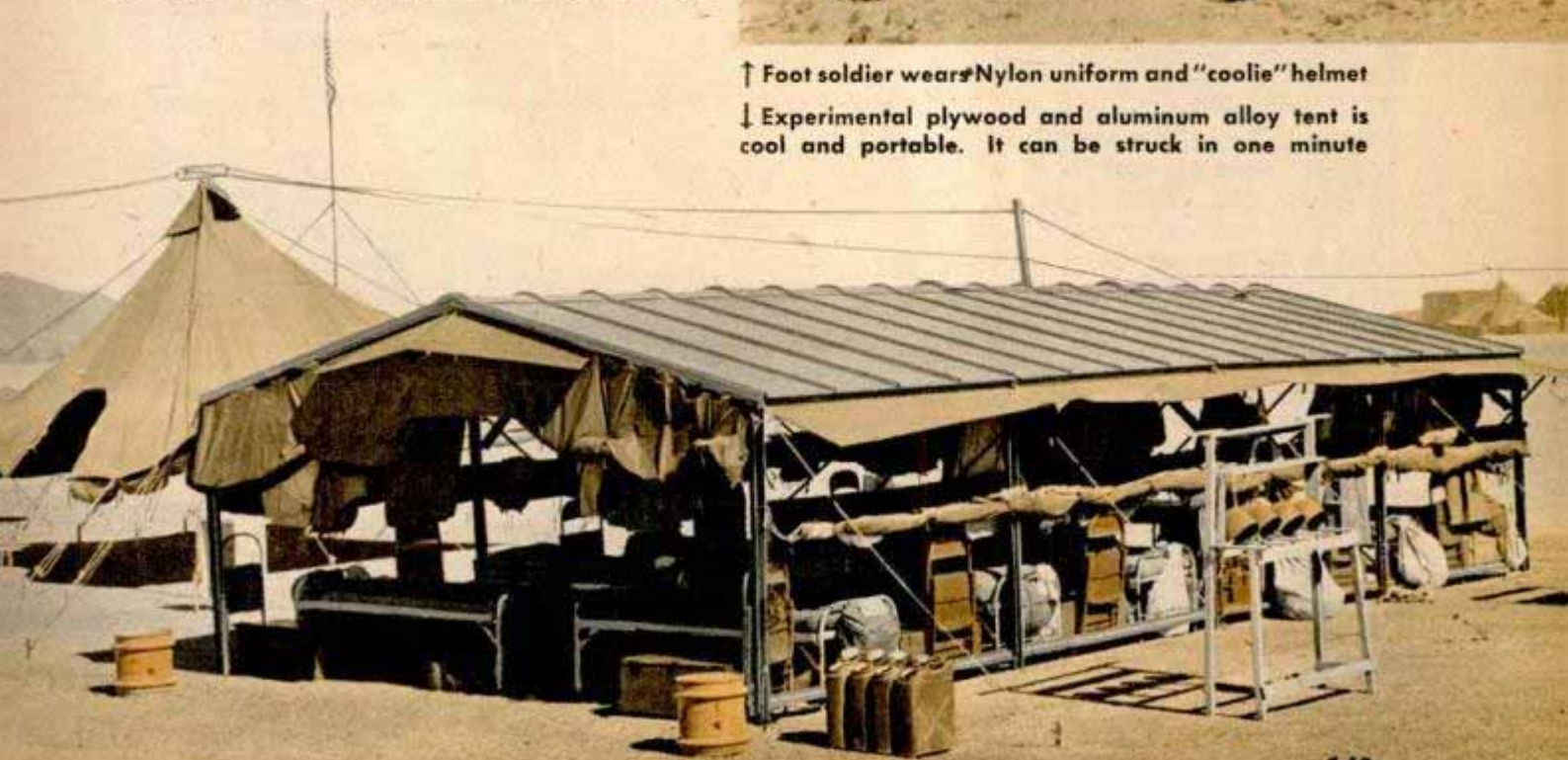



Above, even desert cooks don't swelter. Kitchens have a cooling system and flues carry heat from the stoves. Right, desert well water is filtered and cooled. Without water for two days, a man can be injured for life

the desert tests from Task Force Frigid.

Members of the command live in experimental tents made of pressed plywood, cork and open-weave green canvas. The roof is aluminum painted a pale green. The men like the tents—they say they are cool and comfortable.

Mess equipment made of light plastics has been found to be easier to clean and carry than metal gear. Mobile kitchens have been redesigned with a water-cooling system and flues over the cooking ranges to carry off hot gases. A new field ration similar to the C ration, has eliminated crackers and added bread, which stands up better under desert heat.

Water is carried in a new evaporation bag made of loose-weave canvas to hasten the evaporation process which cools the fluid. Old-style Army water bags were made of rubber. The new ones have three spigots set at the bottom and are so loosely woven that beads of moisture form on the outside.

Other equipment under test includes mobile showers and portable Diesel air-conditioning units for cooling mess halls.

The idea for Furnace had its beginning during the North African campaign

when much equipment was junked or modified in the field to meet extreme heat conditions. Big guns cooled less rapidly and barrels had to be rifled after firing 200 rounds rather than after the usual 400 rounds. Expansion of bullets in the sun was another problem which plagued forces in North Africa.

As a result, extensive field and laboratory tests are being made on guns and ammunition by Furnace with most of the findings classified top secret.

Most tests are made by the men themselves with laboratories double-checking

(Continued to page 256)

Nylon clothes go through a mobile laundry made of heat-resistant alloy

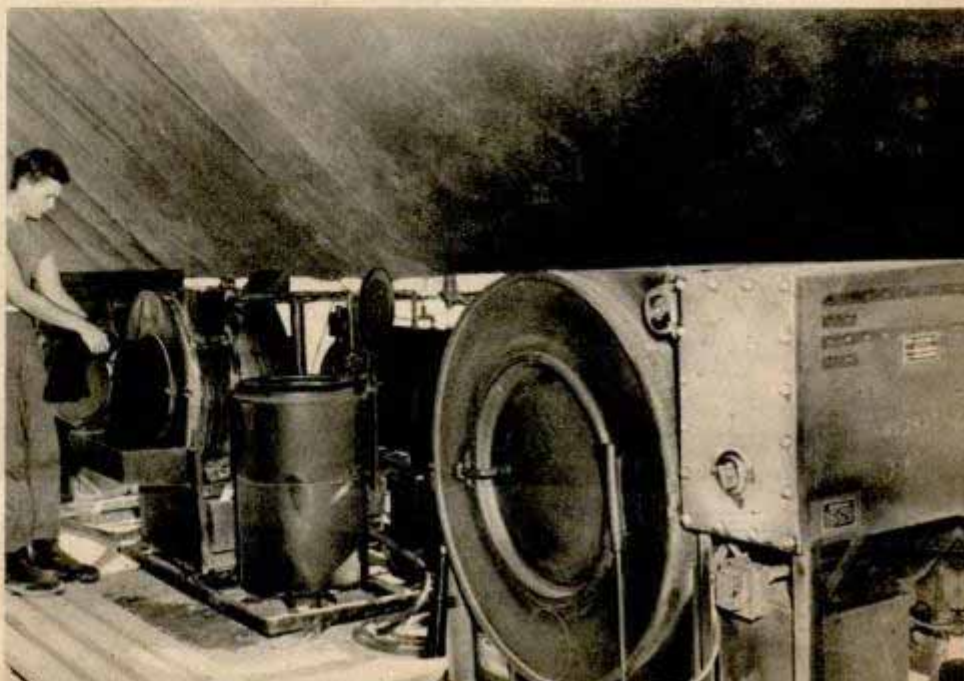

Piano Exerciser

Pianos are transformed into exercise machines by an attachment that retains the music sounds but increases the pressure necessary to strike the keys. The machine was designed for disabled veterans and others who need therapeutic treatment for the hands and wrists. Key pressure can be adjusted by turning a knob on the attachment, with pressures ranging above six pounds. The attachment was developed by Dr. Bruce Armstrong of the Navy and Ben Ross of the Musicians Emergency Fund.

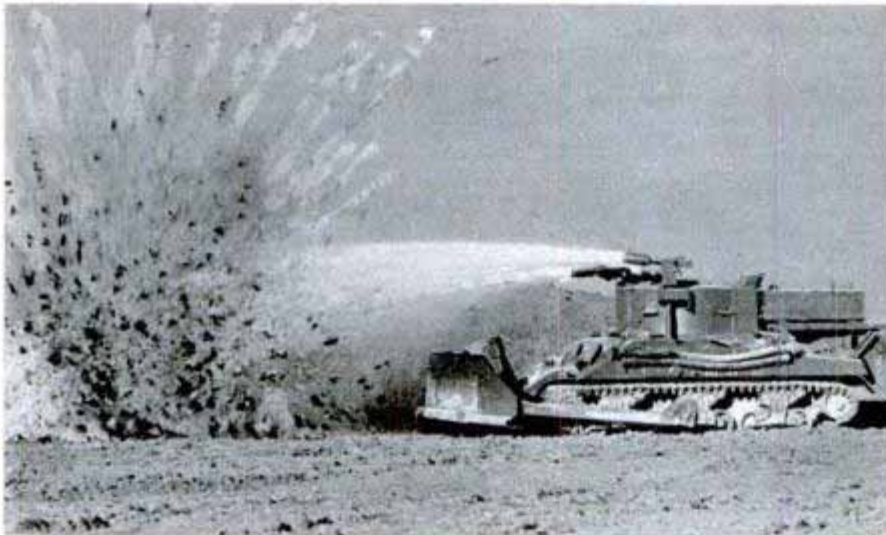

Fire-Fighting Tank

Sherman tanks are being converted into armor-clad fire trucks to fight blazes in ammunition dumps and airfields where explosions threaten firemen. Water nozzles instead of cannon are installed in the tanks. The armored fire trucks are expected to help extinguish fires quickly by permitting fire fighters to ignore explosions when entering a blaze.

Lincoln Electric Company photo

Lightweight Utility Roller

Weighing just a ton, a gasoline-motor roller has been devised for preparing new lawns, driveways, golf courses and for other jobs where full-size rollers are impractical. As rugged as larger models, the machine has a 42-inch body and a 3½-foot wheel base. The watertight welded rollers are filled through an inlet in the side wall. Weight can be increased by placing a 600-pound concrete block in the machine bed.



Information, including manufacturers' names, concerning products described in this issue may be obtained by writing Bureau of Information, Popular Mechanics, 200 E. Ontario St., Chicago 11



With pen's sides forced together, antelope are easy to seize
↓ Portable pen is made of rope netting. Canvas clipped to the bottom dissuades the antelope from charging the sides

ANTELOPE ROUNDUP





"Antelope cowboys" force the herd into the rope corral. The animals shy away from white canvas strip



Tying the animals for easy transportation is more than a one-man job. Sportsmen volunteer for the work

EACH YEAR officers of the Montana Fish and Game Commission, assisted by volunteer sportsmen, ride the range in an antelope roundup, capturing antelope in areas where they have multiplied too rapidly and transplanting them to areas that need restocking. The "antelope cowboys" set up a rope corral with fences angling out from the gate to form a funnel. Then the men take to the range to spot and roundup the antelope herds. When a herd is captured the sides of the corral are forced together to enable ropers to tie the antelope for easy handling. Each animal to be moved is tagged on one ear with the date and location of capture. The roundups have been so successful in spreading Montana's antelope herds that antelope hunting now is a prime sport in the state.

Herd is driven into this capture gate where individual animals are easily seized and hog-tied for tagging



Tag clipped to ear tells date and location of capture. ↓ Antelope are released in areas that need restocking



WAR-SURPLUS ITEMS



Surplus Army flag kit covers are easily transformed into quivers to carry arrows in a bow-and-arrow set

Paperweights, nutcrackers and tack hammers are made from shell casings. Book straps and belts are cut from hand-grenade bandoliers. Cigarette lighters and children's piggy banks emerge from the metal in empty grenades. The list of civilian items created from war-surplus supplies is almost endless. Some of the adaptations are conceived by inventive citizens, but most have been developed by the Products Research Division of the War Assets Administration. This group of experts, organized early in 1946, found countless civilian uses for thousands of specialized war devices which first seemed of no value for peacetime uses. However, there are still many war supplies which defy conversion. What, for example, can be done with millions of jars of black cold cream used as camouflage by Rangers and assault troops? And who wants to buy several thousand cloth labels made up when the Women's Army Corps was still the WAAC?



Civilian defense helmets become ornamental flower-pots. Below, airmen's cushion packs which held medicine and food serve as canoe seats and chest protectors

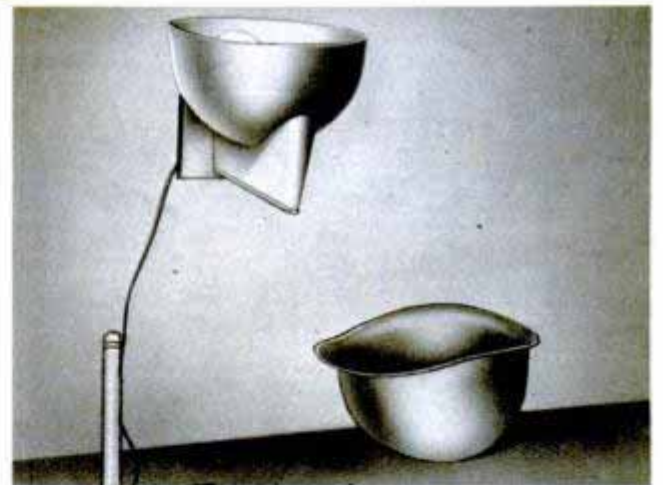

War helmets are converted to wall lamps after rim is cut off. Below, parade periscope made from two tank prisms and a length of plastic tubing





Multiengine Dock Permits Indoor Servicing

Service docks adaptable to all types of multiengine aircraft are part of an international overhaul and maintenance center at Sayville, N. Y. Designed to prevent bad weather from interrupting 'round-the-clock maintenance, they have permanent elevated platforms inside that are expected to prove safer for mechanics than movable

stands and ladders. The most significant variation between engine entry places is that between the outboard niches, for the outboard engines of four-engine craft, and the slots for the inboard engines. Large inner openings are required because the Constellation's engines are closer to the ground than those of other large planes.

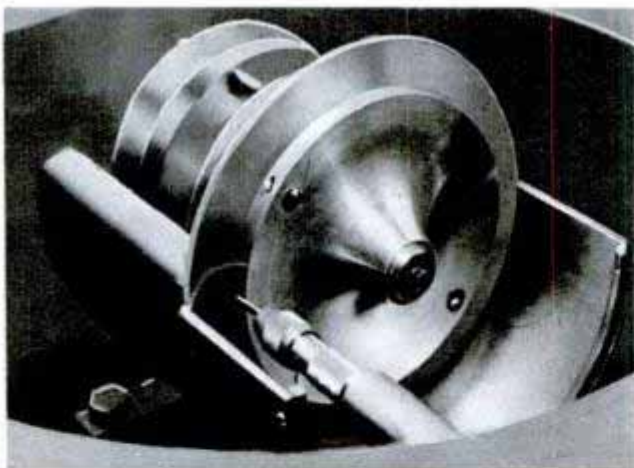

Wheel Turns 123,000 R.P.M.

Spinning at 123,000 revolutions per minute, a small wheel equipped with a razor blade slices ultra-thin specimens of plastic, metal, textile, animal or plant tissue, bacteria and other specimens for examination under an electron microscope. The cutting device, designated by the General Electric Company as a microtome, slices specimens to a "thinness" less than one micron (1/25,400 inch). The speed with which the motor-driven wheel revolves is a new world's record for rotational speed using a rigid shaft, according to GE engineers.

Cockpit Makes Truck-Sedan

By attaching the cockpit of a B-25 plane to the body of a pickup truck, John Page of Kansas City built himself a roomy "sedan." He, his wife and four other persons recently left Kansas City for California in the truck and a house trailer. California law prohibits passengers from riding in a trailer, so Page had to convert his truck into a sedan. He found that the plane cockpit provided plenty of room for all of his passengers.



Music for movie of puppet orchestra is dubbed in by musicians led by director who follows puppet director on screen

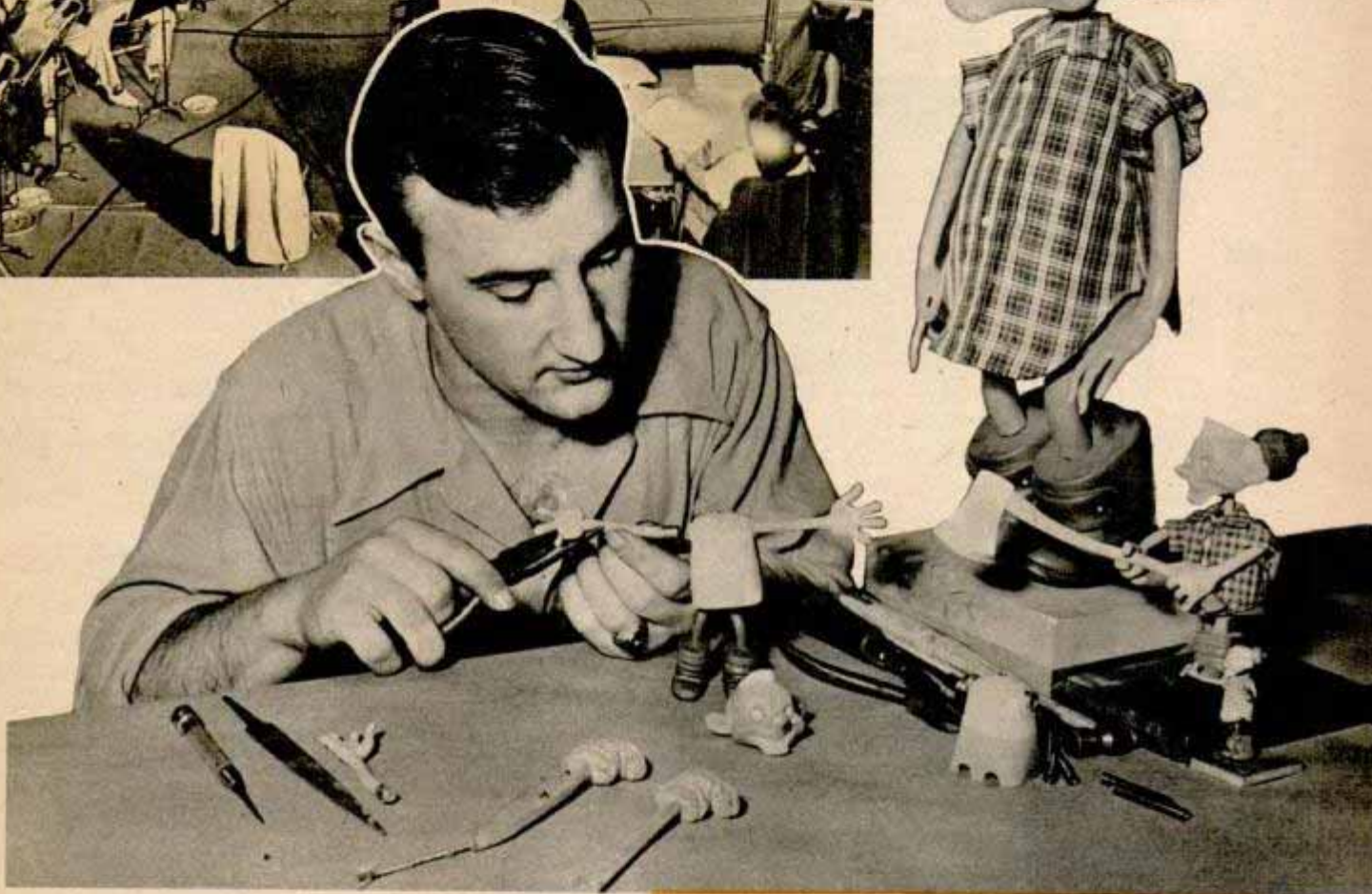

Puppetmaker assembles wood chopper in three sizes. Below, miniature instruments for a tiny orchestra



Putting LIFE in Puppets

POPULAR MECHANICS

HOLLYWOOD'S smallest motion-picture studio produces almost as many movies in its single one-story building as does a major studio which has dozens of huge sound stages.

Pal Productions shoots all its pictures in miniature.

On a visit to the 200 by 300-foot studio you are apt to find a camera crew filming a tiny beach scene on a table top while alongside them another crew makes panorama shots of a miniature oil-well field. Nearby a third crew shoots close-ups of two puppet actors 10 inches tall. All the scenes will appear full size when projected on theater screens.

The Pal puppets are animated by stop motion, a slow and painstaking process by which a single frame of film is exposed in the camera, then a puppet's arms or legs are moved a few millimeters, another frame of film exposed, and so on. When the series of pictures is run through a projector at normal speed, the puppets seem to come to life. They dance, roll their eyes and talk.

George Pal created his animated puppets in Holland, then six years ago Paramount brought him to Hollywood to produce the "Puppetoon" series of short subjects. Since then Pal Productions has pioneered other animation effects and today the studio produces a wide range of entertainment and industrial films.

Animation is an old trick, one example being the movie cartoons. These are a series of drawings, each showing a succeeding step of action, that are filmed one after the other. Pal uses three-dimensional puppets and actual miniature sets to achieve an illusion of perspective and reality such as is suggested by movies of living actors and actual sets. All his pictures are in color.

One picture combines live actors and diminutive lifelike puppets in the same scenes. Part of the picture shows Duke Ellington playing the piano and at the same time watching a genie that dances on the piano top in front of him. Ellington's performance was filmed in a single day, then a month of hard work went into animating the puppet.

When Ellington was being filmed he was told to act in response to off-stage directions and to turn his head from side to side, smile encouragingly, and behave just as if he were actually watching a genie.

After this film was developed and inspected, an imitation piano top was placed in front of the camera to match the position of the real piano in the original picture. Then the genie was filmed in its dance on this stage. Care was taken to move the puppet back and forth to coincide with the direction of Ellington's glances.

Five to 10 frames of film were exposed



Frog and animated musical instrument compare notes in a Pal production. "Water" is glass with salt rings

to show the genie taking a single step. Blinking his eyes or tilting his head took three to five frames. Depending on the number of adjustments to the puppet per shot, from six to eight frames of film were exposed each hour. The Pal technicians figure that on the average an hour's work in front of the camera lasts no longer than a second on the screen. A five-minute

To make a movie showing how an oil well operates, modelmakers build replicas of derricks and other parts

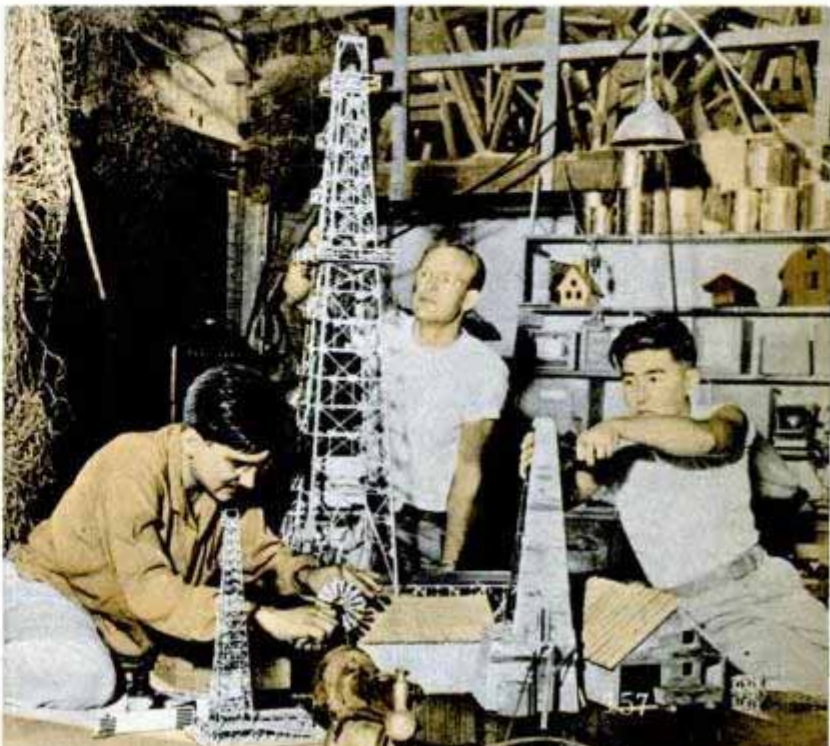



Oil men use the name "horse" to designate one part of an oil-well pump. So, in puppet movies illustrating how a well works, horse heads are used

movie production requires about 300 hours of camera work.

The Ellington film and the genie film were combined into a single composite by a difficult double-printing process. Now that the technique has been perfected for color, other pictures that show live people and puppets performing in the same scenes are planned.

Pal has applied his animation process to all sorts of inanimate objects. He makes submarines appear to dive and surface in an imitation ocean. Tiny aircraft take off from a field and maneuver in front of the camera. An ocean usually consists of ripple glass lighted to show sparkling wave caps. A submarine is made to dive by using a whole series of models in stop motion, each model consisting of a smaller part of the submarine. Aircraft are suspended on threads or wires for animation.

Recently Pal had the problem of making

ground projection screen. From behind the screen you see a clear picture of the movie being projected on its other side.

Behind the screen and placed so that it matched up exactly with the derrick floor on the screen, the technicians built a miniature replica of the derrick floor. Below this they placed a flat wall modeled and painted to represent underground formations. A groove was cut out of the wall, straight down from the derrick floor, and a string of miniature oil-well pipe with a drilling bit at its end was suspended from the derrick so that it fit into the groove.

Then the whole scene, part background movie and part miniature, was filmed by a camera. The audience sees something that would not be possible to film otherwise, an oil-well-drilling rig at work on the surface and with its bit steadily boring into the formations below it.

One close-up in the same picture called

Stagehand changes position of puppet in underwater scene. Ripple glass represents the surface of the water



for a visual explanation of how oil-well mud is circulated down the inside of the drill pipe to the bit and then is forced back up to the surface outside the pipe, carrying with it the chips and debris produced by the bit. Pal's technicians built a separate cutaway of the earth and laid it horizontally on the floor. Then a groove was cut in the model, a cutaway section of drill pipe laid in the groove, and muddy water flowed along the inside of the drill pipe. Escaping through the bit, the water reverses its flow and travels back along the outside of the pipe.

Another stunt for the same picture was to show what happens underground when bullets are fired from a gun perforator device to open up a formation and expedite the flow of oil.

A model of the tubelike gun was placed in position against a cutaway of the earth and a piece of clear glass on which tiny flashes of flame had been painted was placed in front of the gun. The flashes were lined up with the holes in the gun. After a picture had been taken, the glass was removed and a second substituted for it, showing larger flashes of painted flame. Another picture was taken and a third glass was put in position. This kind of animation permits an audience to see the flashes of flame, the bullets plowing into the formation, and the released oil flowing into the well.

Pal's organization consists of 30 technicians and animators under the direction of George Jordan, production supervisor. Virtually every department of a major studio is represented in miniature. Cameras, lights, set construction, make-up, wardrobe, and property departments

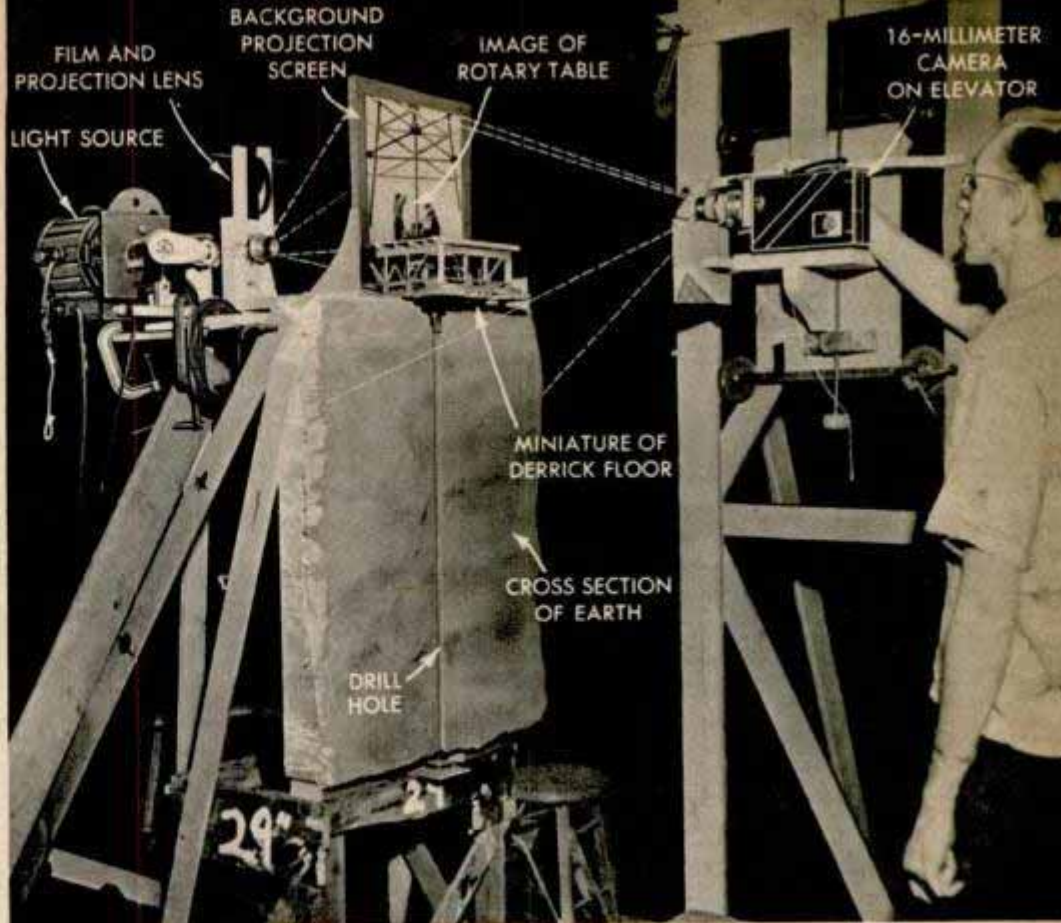

By combining a derrick and drill-hole model with a motion picture projected on a screen one frame at a time, movie is made to show how an oil well works

all play their parts in producing the pictures. Designing and manufacturing the puppet actors requires the work of another department.

After a story idea has been worked out and sketches are made of the puppets, a sculptor creates models of each puppet actor. Most of the puppets are 10 inches tall although important characters may be

(Continued to page 244)

Complex jig is used to animate bare tree trunks in a scene that will show dancing trees. Camera at left will take pictures of trees bowing and swaying

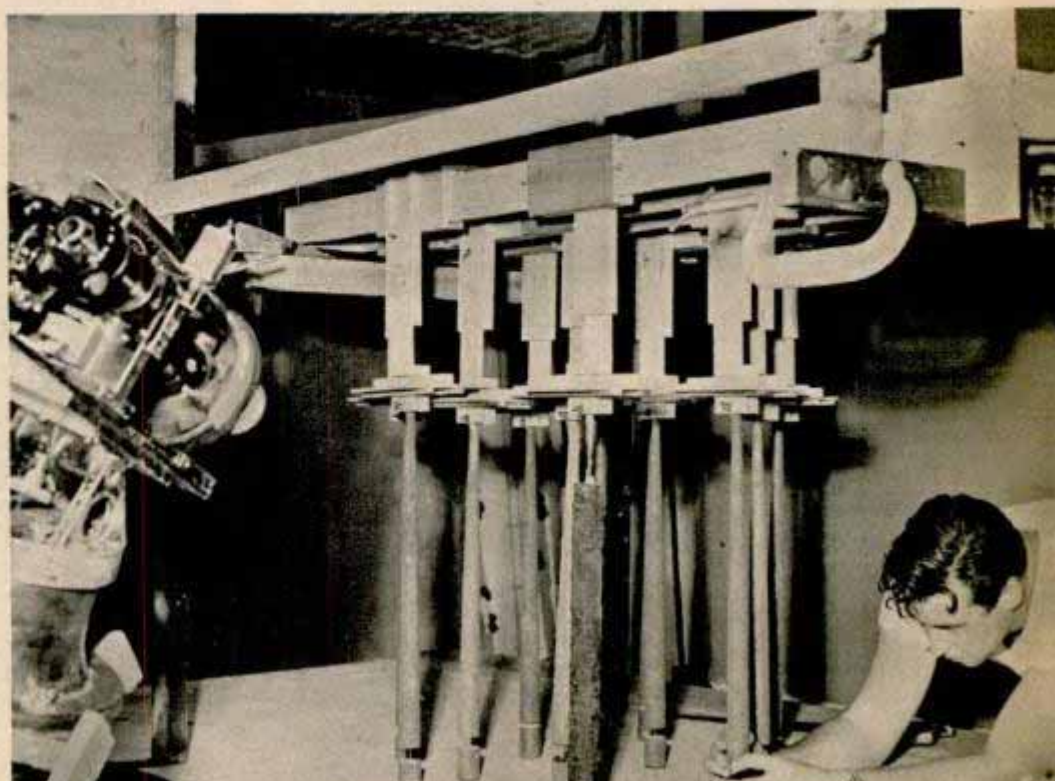

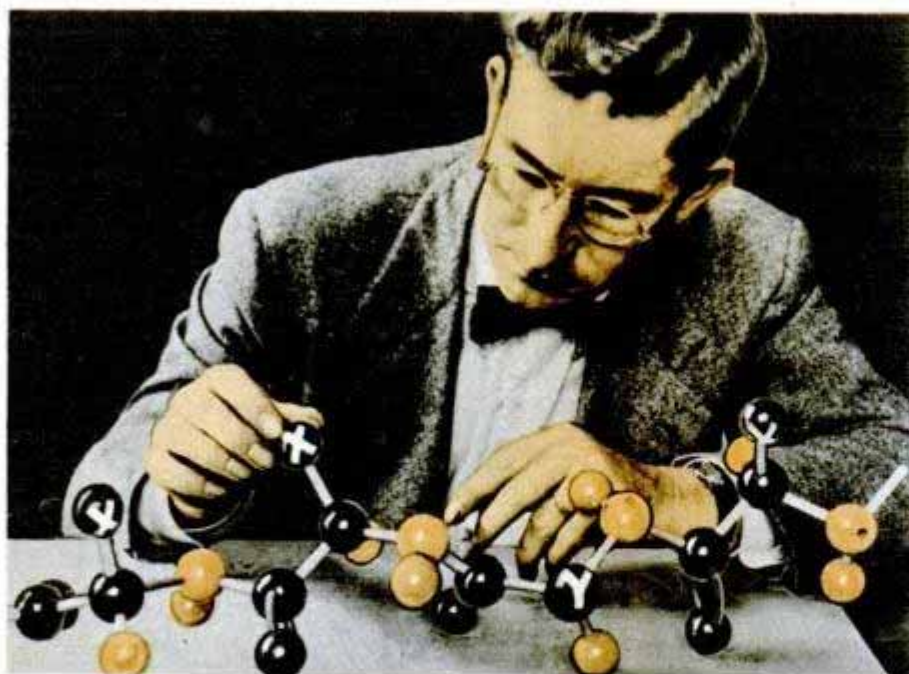

Basic molecular structure of protein shown by Dr. Woodward. Only elements "X" and "Y" are changed in different proteins

ducing these molecules was in the natural growth of plants, animals and human beings. Because it may provide a model for the manner in which the body produces proteins, the new discovery is expected to be especially significant in medicine. Also, by extending the length of natural molecules, the process may be used to modify harmful proteins into harmless substances. The process begins with alpha amino acids which are obtained

PROCESS DUPLICATES NATURAL GROWTH

Wool that doesn't come from sheep, and fur that has never been worn by an animal may result from the discovery by a Harvard University chemist of a process for producing protein-like substances almost identical to those in living cells. Starting with small molecules, Dr. Robert B. Woodward produces complex protein-like molecules comparable to those in hair, muscle, nerves, skin and other forms of living matter. The only previous method of pro-

readily from natural products like meat, or by synthesis from coal, air and water. Synthetic silk-like thread has been produced already. It is the first man-made thread with a molecular structure very similar to that of the natural protein, silk. Although Dr. Woodward declines to forecast the industrial possibilities of the process, it may open the door to synthetic materials that are almost identical in every respect to animal-made products.



DOUBLE-JOINTED BUS

Despite its unusual length, a new double-jointed bus with front and rear-wheel steering maneuvers as easily as smaller vehicles. A rubber hinge connecting the front and rear sections permits the 47-foot bus to pivot on its two middle wheels. This articulation also smooths the ride over bumpy roads. Front and rear wheels are

coupled for steering and the rear wheels automatically "track" the front pair around turns. Powered by two 180-horsepower gasoline engines that are connected to the middle drive wheels by torque converters, the bus needs no differential. Rubber-in-torsion springs and a special "de-gasser" that eliminates engine fumes add to the passengers' comfort. It seats 58 and has been under development since 1938.

Curb Climber for Crippled Persons

To help crippled persons walk and climb curbs, Frank E. Carter of Minneapolis designed a lightweight four-wheeled device equipped with crutches and handles. If the user wants to rest, he flips down a seat which folds out of the way for walking.

Chemical Treatment for Boils and Ulcers

Bacitracin, a new germ-killing chemical, is the medical profession's latest weapon to tame such infections as boils, carbuncles, sties and ulcers. Bacitracin originally was obtained from a germ found in the badly infected wound of a seven-year-old girl who had suffered a compound leg fracture. Dr. Frank L. Meleny and Miss Balbina Johnson of Columbia University tested infectious matter from the wound and discovered that the germs were powerful destroyers of bacteria. Further tests revealed that a filtrate from the germs was effective against boils and carbuncles. Months of research were required to produce small test samples of the new chemical. In subsequent trials, bacitracin was used on 100 patients and 62 were saved from the surgeon's knife. Bacitracin will be of clinical importance, according to its discoverers, only if it can succeed where penicillin or the sulfonamide compounds fail. The chemical is made up in an ointment which melts at body temperature.

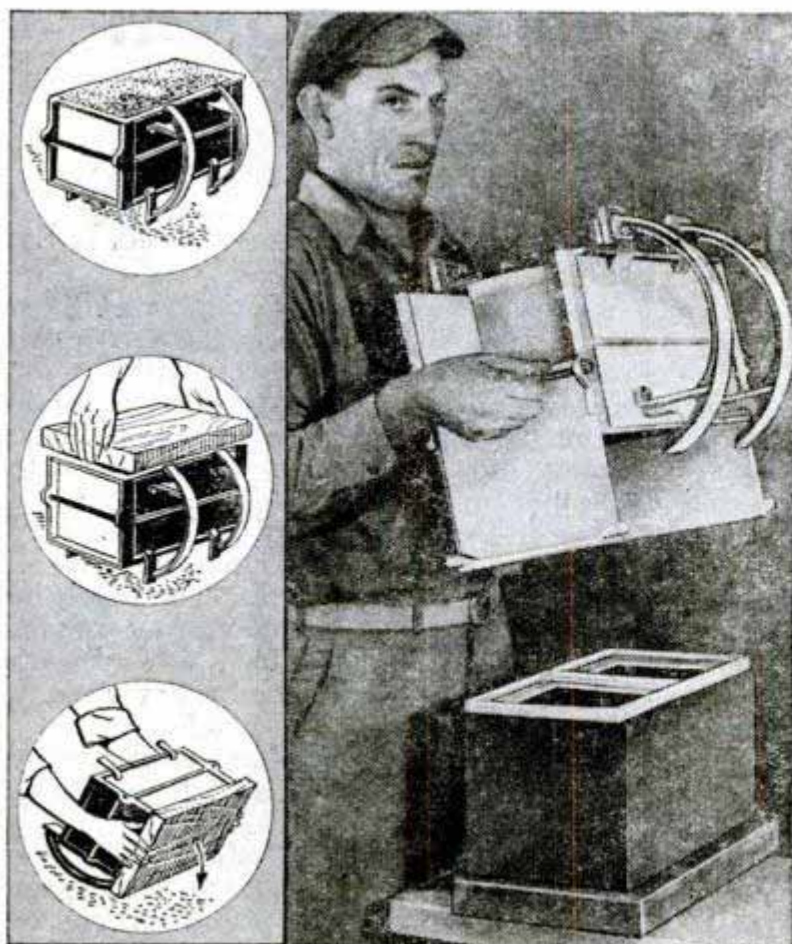

Concrete-Block Maker

Concrete blocks are made quickly and easily with a portable roll-over machine which consists mainly of two rockers attached to a mold box. To form a cement block, the operator fills the mold box with mix, tamps it down with a shovel, levels off the excess, places a smooth board on the mold box and, holding the board against the top, rolls the machine on its rockers over onto the board. Then he lifts the machine straight up, leaving a block 8 inches by 8 inches by 16 inches. Blocks can be produced at the rate of one a minute, according to the manufacturer. The machine weighs less than 30 pounds.

☐ About a million plants now are known and have been named by botanists, according to Prof. Liberty Hyde Bailey of Cornell University, who estimates that at least another million plant species await naming and description.

Brother Joe built this bristling bike to mount part of his gun collection. With a grin, he says it's "a means of transportation for gangsters who can't afford a car"



HOBBYISTS OF THE MONTH

The Bicycling Steinlaufs

EVER SEE a square-wheeled bicycle—or a bike with legs instead of a rear wheel? A family bike that seats five—or a 12-foot "strato-cycle" for looking over the ball-park fence?

These are just a few of the wacky bicycles built from scratch by the Steinlauf clan of Chicago. Four Brothers—Joe, Charley, Maurice and Dave—and their respective families, are happy only when there's a bicycle within reach.

The Steinlaufs will build any kind of a bicycle for a laugh. Take the time Joe's brass bedstead fell apart. He kept the foot, gave Charley the head, and each of them built a bicycle by attaching a sprocket, chain, seat and a couple of wheels. They're still riding the bedstead around the streets of Chicago.

Joe's family takes Sunday-afternoon spins on a custom-built five-seater with Joe guiding from up front while his wife,

two sons and a daughter-in-law pedal from the rear.

When his son Fred was a year old, Joe built him a bike with a sidecar. At two Fred could ride the bicycle without the third wheel, and at 15 he graduated to one wheel. Today he's a unicycle expert, performing atop the 12-foot wheel-and-stem his father built for him.

One of Joe's other hobbies is collecting firearms, but some of his guns have been sacrificed to make a bicycle. The result he laughingly describes as his "two-seater for gangsters who can't afford a car." It's equipped with 10 rifles, three pistols, a searchlight, bayonets and handcuffs.

When his other son Colman couldn't find his ice skates one winter day, Joe whipped together an ice bike. Instead of tires it has four-inch spikes on the wheels that bite into the ice to keep the bike from slipping, and it's equipped with special mittens on

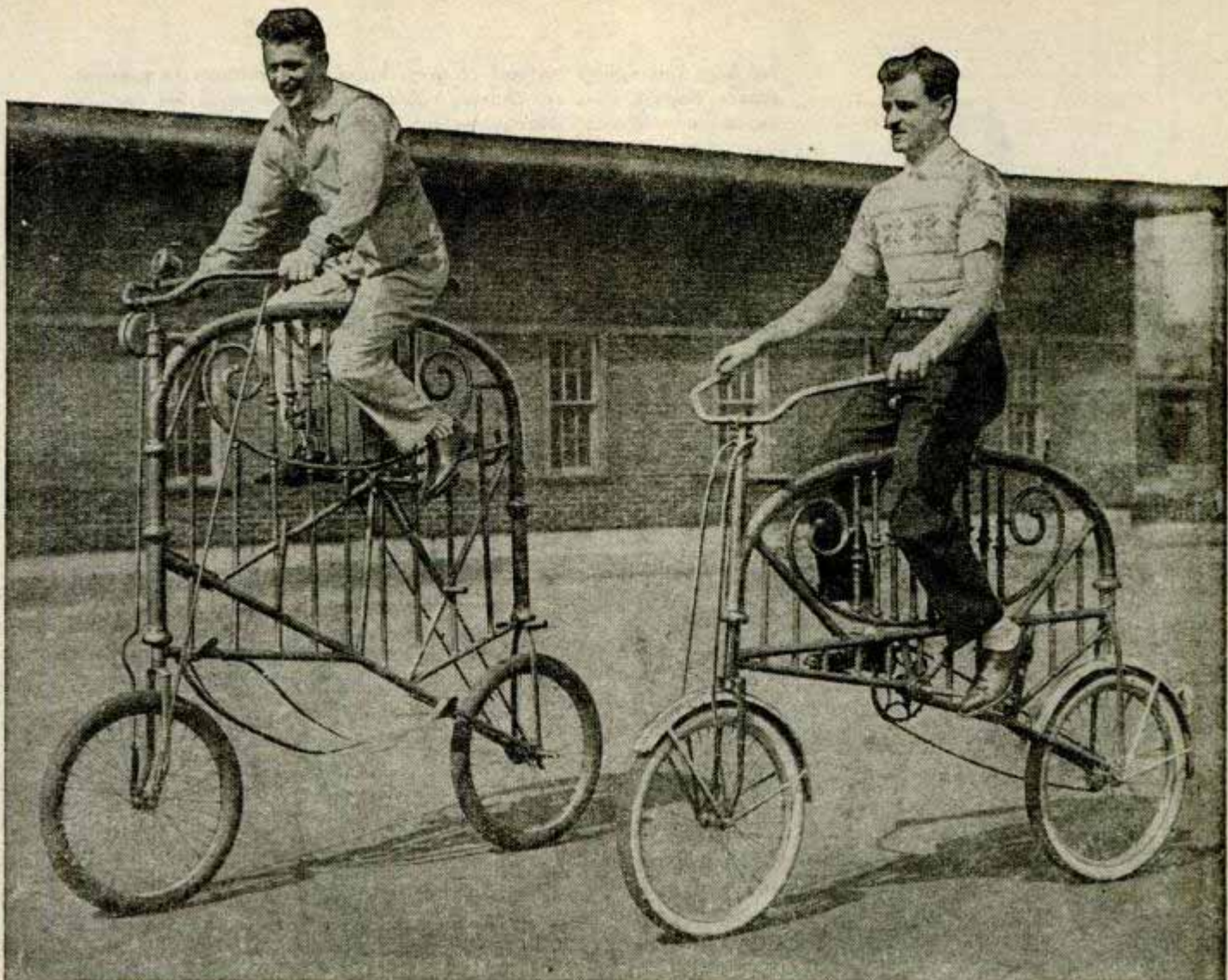

↑ When Joe's brass bedstead broke, two of the bicycling brothers attached wheels and built a couple of bikes
 ↓ Family cycle has five seats, three wheels. Right, when Charley pedals, dummy walks him down the street



Ice bike has spikes instead of tires, handle-bar mittens to prevent frozen fingers. Center, Charley rides the boulevards in his complicated "uno-wheel." He guides by leaning in the proper direction



the handle bars for zero weather.

The brothers are well-equipped to build anything they dream up. All four are mechanics and Joe owns a cycle-and-tire shop, Charley has a garage, Dave runs a service station and Maurice is in the bicycle-toy shop business.

Strung high on the walls of Charley's garage are the queerest bikes of all. To Charley the building of a unique bicycle is an art. He's the man who built the "strato-cycle," the 12-footer that gives him a free seat above the ball-park fence.

The most ingenious of his mechanical marvels is his "uno-wheel." When Charley takes this contraption out for a spin, pedestrians see a giant wheel rolling down the street with Charley inside. The 7½-foot wheel is made of metal tubing. Welded to spokes radiating from the tubing is a

Lower left, the brothers seem proud that the square-wheeled bike is the "roughest riding cycle in existence." Below, Joe's son is an expert atop his 12-foot unicycle

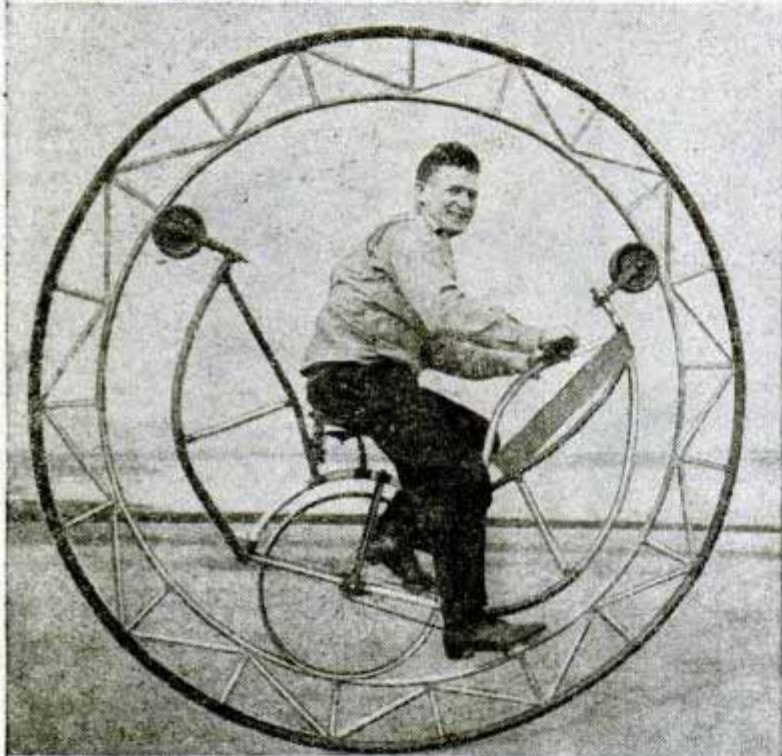

Several days after Charley's wife sent her sewing machine to his garage for repairs he rode it home. Now the whole family goes for a spin when there's mending to be done



slightly smaller wheel. An ordinary bicycle wheel, minus the tire, rolls along the inside wheel. Charley sits on a seat atop a strange assortment of chains, sprockets, frames and wheels. When he pedals, the bicycle wheel turns, rolling the big wheel. He guides by leaning in either direction.

"It's all the application of simple principles of physics," Charley explains, without explaining the principles.

One day Charley's wife sent her sewing machine to his garage for repairs. A few days later he rode the sewing machine home, as he'd built a complicated bicycle frame around the machine. Now the whole family rides the bike when Mrs. Steinlauf has clothing to be mended. Charley guides with a steering wheel, his daughter sits in front operating the brake, his son pedals from the rear and Mrs. Steinlauf sits side-

saddle in the middle doing the mending.

Charley once built a bike with a pair of legs instead of a rear wheel. The legs move alternately, lifting up and stepping forward. But that wasn't complicated enough so he removed the rest of the bike, mounted a seat atop the legs and rode the legs only. This provided laughs for a while, but eventually it, too, seemed tame. So he re-installed the rest of the bike and added to the legs a life-size dummy dressed in street clothes. Now when he pedals the bike, the dummy walks along behind as though it were shoving Charley. With a system of controls, Charley can make the dummy turn its head, wave and smoke a cigarette.

Sons, daughters and in-laws of the brothers have been bitten by the bicycle bug, too. Even the father, 78-year-old Bernard Steinlauf, is an active cyclist.



Ballpoint Pencil Applies Perfume

There's no "underwater" use for a new ballpoint perfume pencil but it's a convenient applicator for perfume or cologne. Slight pressure on the point releases a tiny amount of perfume. The leakproof applicator is about the size of a lipstick tube and holds a half dram of fluid. The case is available in satin silver or gold finish with screw-on caps in ebony or dubonnet.

Jet-Propelled Speedboat → To Attempt Record

Engineers are redesigning Sir Malcolm Campbell's jet-propelled Blue Bird II to give the British speedboat racer another chance to break his own speed record of 141.74 miles per hour. The 27-foot boat failed to perform properly in its first trial. Equipped with a 3000-horsepower De Havilland "Goblin" jet engine which burns a refined kerosene, the boat is a reconstructed model of the original Blue Bird in which Sir Malcolm set the speed record in 1939 on Lake Coniston, England. The potential speed of the new boat is 160 miles per hour. The noise of the engine is so great that the pilot wears sound deadeners in his helmet for protection.

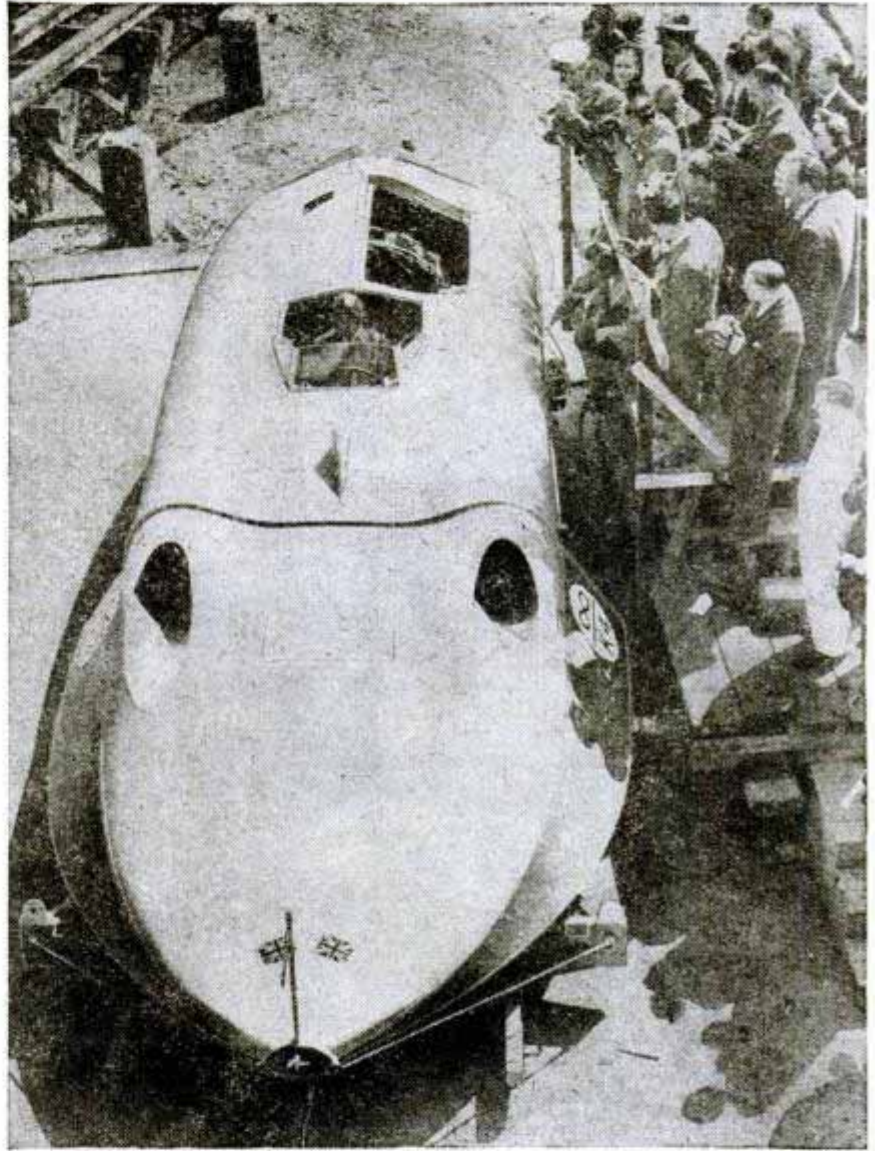

Interlocking lug and frame serve as sink hanger. Tightening screw forces bowl under inside flange of frame and pulls outside flange tightly over sink top covering.

Watertight Sink Frames

"Packaged" sink frames aid in the installation of new sinks and provide a watertight seal between sink and cabinet. The frame is available in 15 sizes to fit most stock sinks and can be installed with only a keyhole saw and a screwdriver. A set of lugs for the cabinet interlocks with the frame to serve as a hanger for the sink. Screws through the lugs force the sink up against the frame to form a seal. The frame can be used with standard plywood tops $\frac{3}{4}$ inch thick plus linoleum or other covering up to $\frac{1}{8}$ inch thick.

The Desert Blooms in Wool

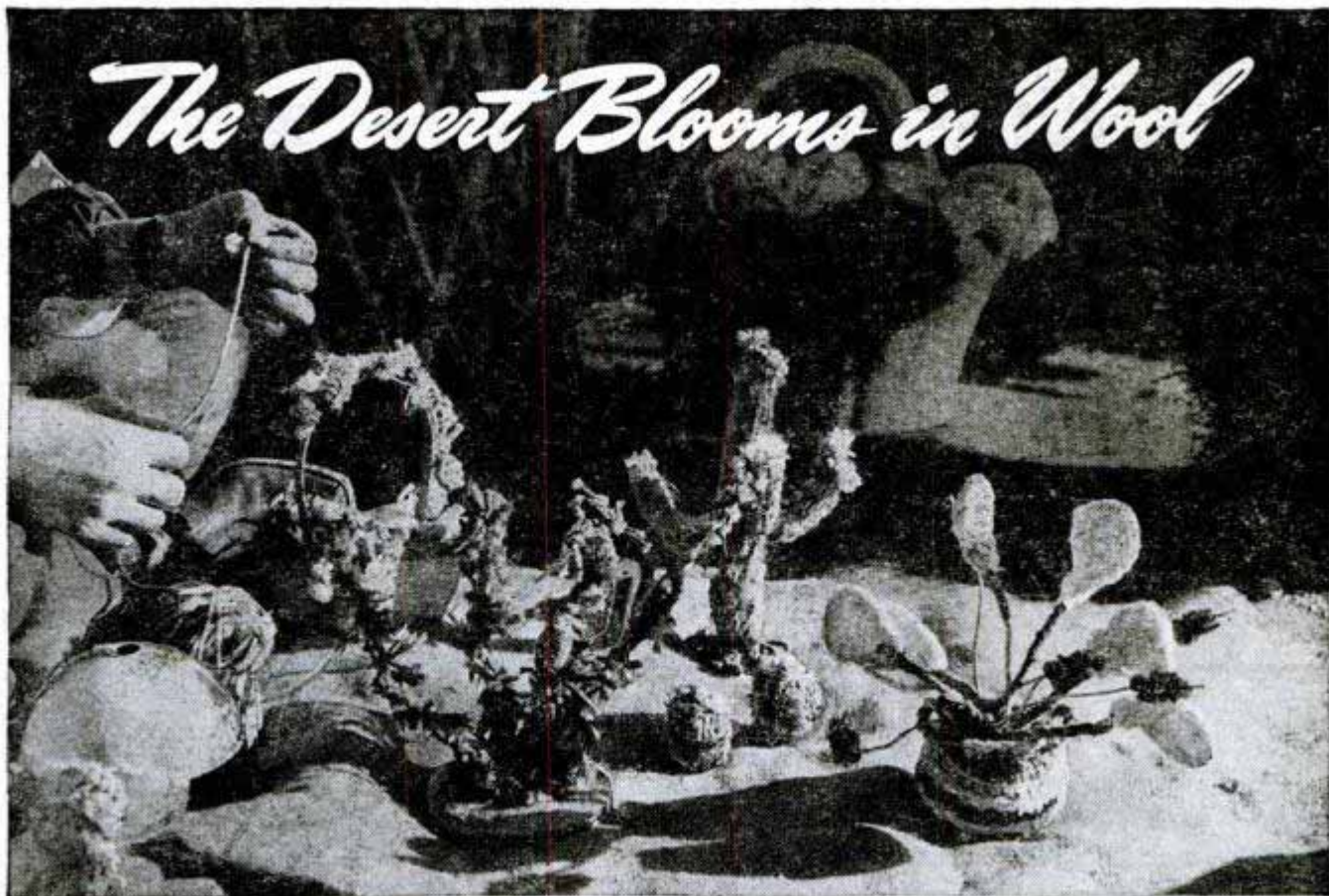

Photos by Dunaway & Haythorne

Lifelike cactus plants and colorful dolls are made by covering wire with bits of wool. Anne Schrank of Tucson, Ariz., trims a wire spine (right)



Photo by Alfred A. Cohn

Miss Schrank started making the decorations as a hobby, but now it's a big business. Above, Indian dolls and wigwam are made into a wall plaque. Right, creating a miniature desert



2,000,000-Pound Test Ram Checks Strength of Dome-Roof Car

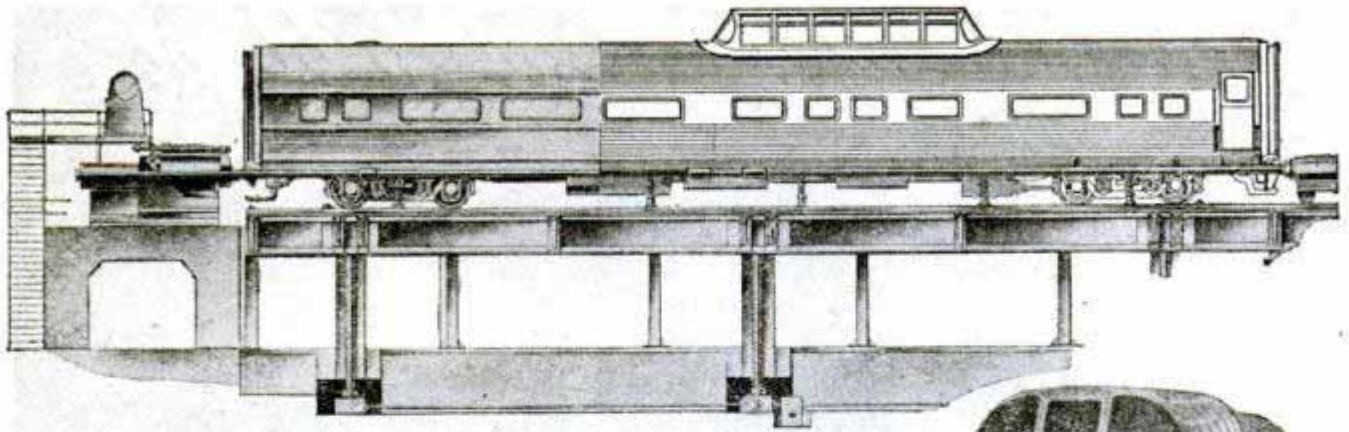
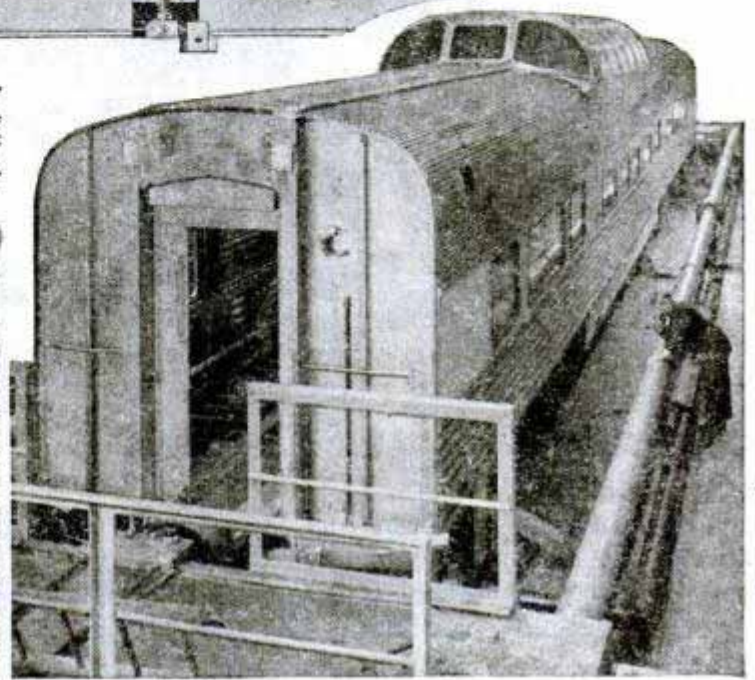
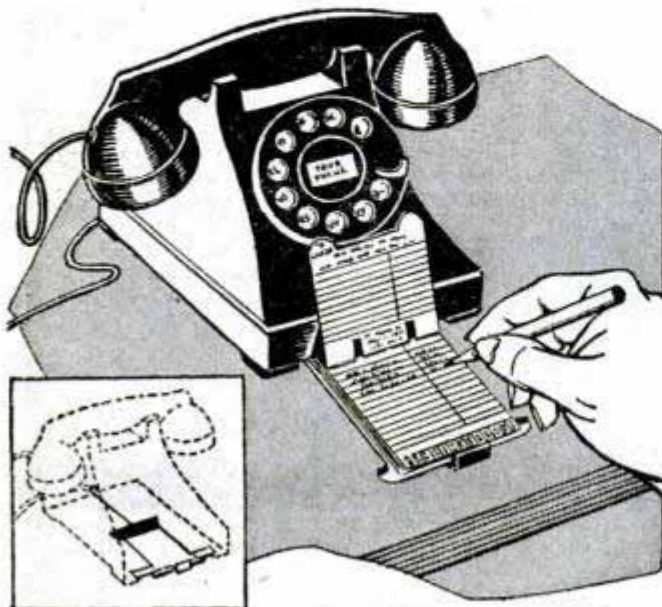

Diagram shows how a car 95 feet long is installed in the ram for a strength test. Below, the ram power unit exerts pressure against end of car. Right, engineer checks car during the test



In the railway structural-test laboratory of the Budd Company huge machines test the strength of new railway cars and provide information for designing cars of the future. One machine tests horizontal strength with a giant ram that exerts 2,000,000 pounds pressure on the ends of cars up to 95 feet in length. A large temperature room recently has been added to the research equipment to determine under

operating conditions the heating and cooling requirements of railway cars. The room is 103 feet long, 20 feet wide and 16 feet high and is insulated with cork. Refrigeration and heating units vary the temperature from minus 20 degrees to plus 130 degrees F. Tests are conducted under changing wind and moisture conditions. The laboratory also tests motor truck trailers and automobile bodies.



Directory Fits Beneath Telephone

Telephone numbers can be found quickly in a directory that fits beneath the base of the phone. The indexed tablet for the numbers is fastened to a metal drawer held in place beneath the phone by a light spring. When the drawer is pulled out the spring automatically lifts the cover of the directory to reveal a page of numbers called most frequently. When the cover is closed the drawer snaps back in place.

Information, including manufacturers' names, concerning products described in this issue may be obtained by writing Bureau of Information, Popular Mechanics, 200 E. Ontario St., Chicago 11, Ill.

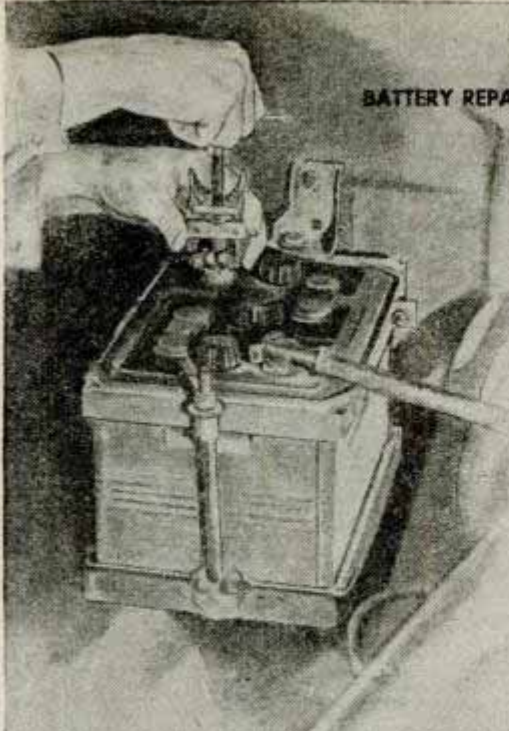

BATTERY REPAIRS



APARTMENT WORKSHOP

The CRAFTSMAN

★ A home shop in a box—that's one way of describing the apartment workshop detailed on page 184. Closed, it makes an attractive studio couch. Open, the underside of the lid forms a handy tool panel. There's a bench with vise, and storage room for additional equipment and partially completed work.

★ A regular maintenance schedule keeps your oil burner working at peak efficiency. Knowing the various parts of common burners, how they work, and how to detect and analyze minor troubles can save both you and your serviceman a lot of time. An article on page 210 goes into this angle.

★ In battery servicing it's the little things that count. Maximum life from your car battery depends on periodic attention to a simple service routine. Each step is pictured clearly in a story on page 188.

★ A duck boat can get you places where you can't go afoot. With the hunting season just ahead, we present plans for building your own boat on page 178.

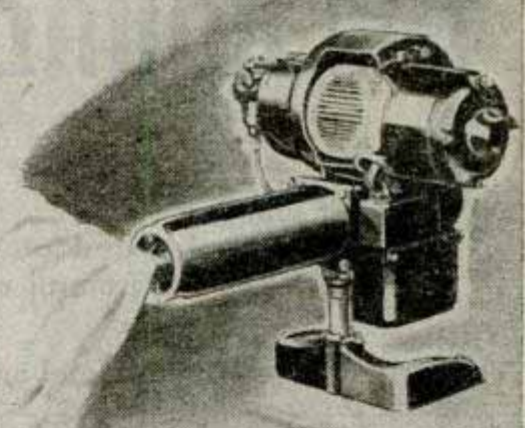

OIL-BURNER
MAINTENANCE

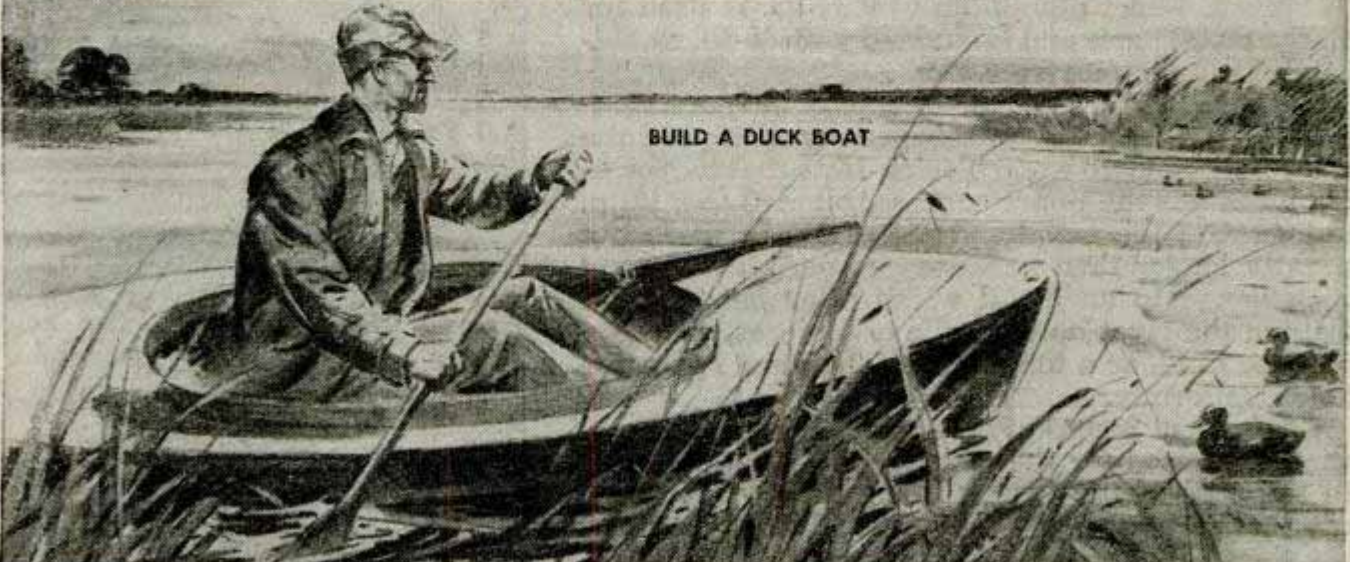

BUILD A DUCK BOAT

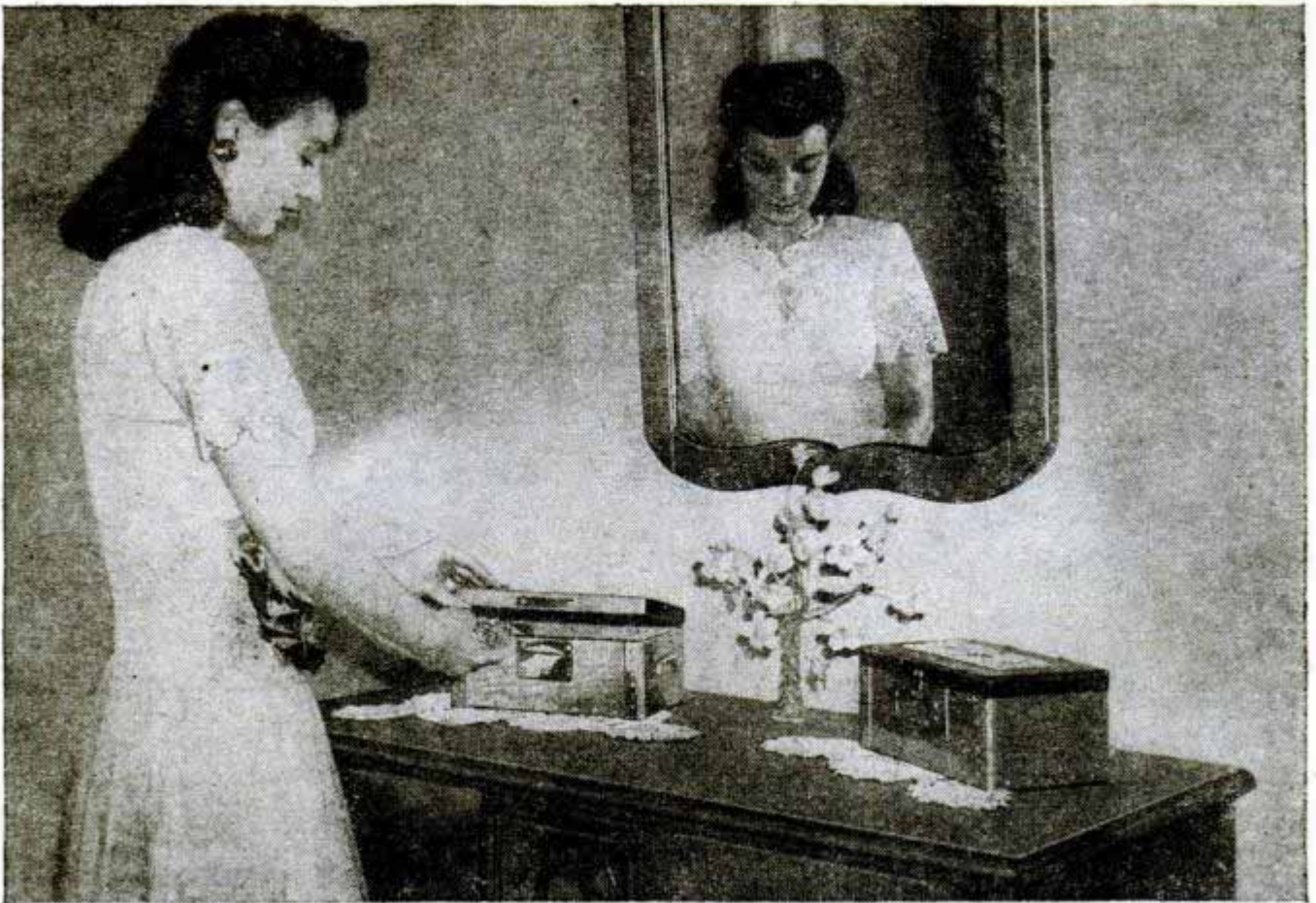

THE ROYAL PAIR

By R. J. DeCristoforo

An attractive "strongbox" dresser set of aluminum and wood safeguards jewelry and other personal items from small children

YOU GET a taste of both metal and woodworking in making these exquisite jewel boxes, and there's just enough hand work involved in making each one to test your skill in duplicating fine craftsmanship. Construction of both boxes is practically the same, the main difference being achieved by the overlay treatment. Sheet aluminum of .064 ga. is used for all the metal parts and is studded with $\frac{1}{8}$ -in. round-headed aluminum rivets.

Fig. 3 shows how the metal ends, which are identical for either box, are shaped by clamping the work between two wood blocks. Note that the forming block has the upper corners rounded to a $\frac{1}{4}$ -in. radius. Cut the metal end pieces $3\frac{1}{2}$ in. wide but slightly longer than necessary to permit trimming each flange to an equal width after bending. In drilling the rivet holes in the end pieces, use a jig of some kind, or a template, to align and space the holes uniformly.

Only select pieces of rare and fancy-grain wood should be used for the wooden parts of the boxes. In the case of the Queen's box, a two-tone effect can be had by making the cover of mahogany and the sides of a lighter wood, such as maple. Select a

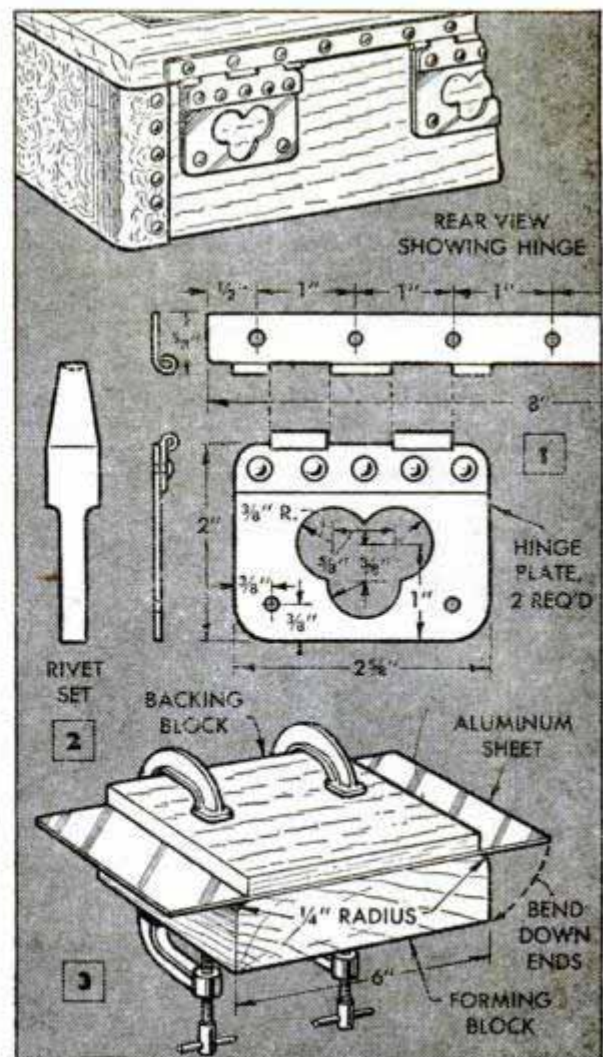

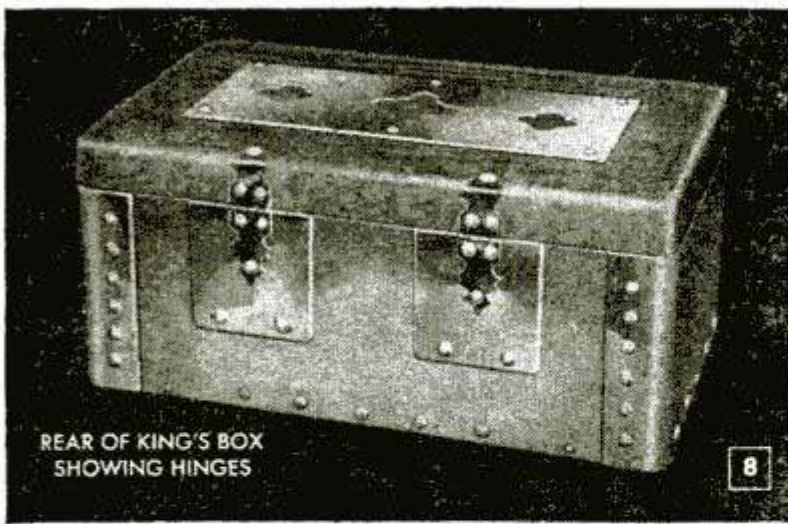

REAR OF KING'S BOX
SHOWING HINGES

8

With the wood parts finished, you can rivet the metal ends to the box. Fig. 5 shows how the rivets are peened flush with the surface on the inside. For this you'll need a rivet set like the one shown in Fig. 3. It can be made from a length of $\frac{1}{2}$ -in. iron rod and shaped accordingly for clamping in a vise. A small depression is formed in the end to seat the rivet head. The hinge plate for the Queen's box is detailed in Fig. 1. The scrollwork in this, as well as that in the cover overlay, Fig. 4, can be cut with a circle cutter in a drill press, or with a coping saw, using a fine jeweler's blade. The part of the hinge which is riveted to

the rear edge of the box cover is fastened by driving the rivets tightly into undersize holes. A piece of extruded aluminum angle is used to make the lock plate, Fig. 7, which is drilled to take a small padlock and then riveted to the box. This leaves the handles which are formed as shown in Fig. 6. The ends are flattened and bent as shown in the side view and finally riveted in place.

Figs. 8 to 12 inclusive detail the King's box, which is entirely of metal except for the cover and bottom. Forming the ends is done as before and these in turn are riveted to sides of metal instead of wood. Figs. 11 and 12 show two methods of peening the rivets; in one, the rivet is simply flattened against the surface, in the other it is expanded in a chamfered hole and then filed off flush. The bottom is attached by drilling undersize holes in the edge of it to take the rivets. Fig. 8 shows how the hinge plates are riveted to the back of the box and how the leaves are bent up over the edge of the cover. Adding the overlay plate and the lock plate and hasp completes the job. Cover the bottom with felt and line the inside with silk or plush.

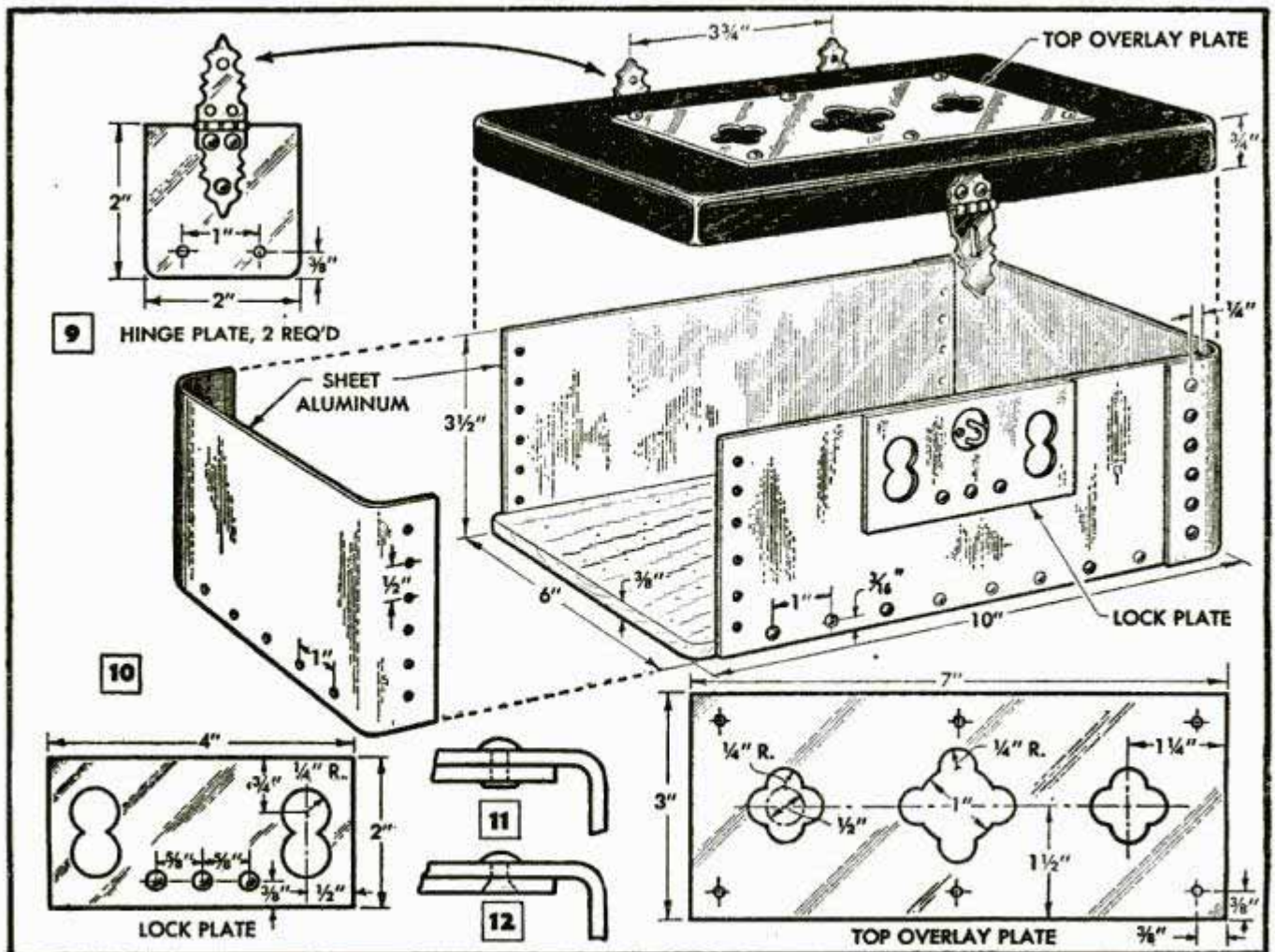

Multiple-Control Panel Made From Radio Cabinet

This is an ideal control panel for electric-train enthusiasts because it has plenty of outlets, a variable-speed transformer, fused power source and, as a safety feature, no exposed wiring. A radio cabinet with an inclined panel provides the housing for the unit. Remove the old panel and substitute one that is drilled for four toggle switches—the number can be varied to suit individual needs—a pilot light and the top of the transformer. The shutoff switch for the power source is mounted on one side of the cabinet. Four receptacles and the fuse block are mounted on the base. For the latter, 3-amp. fuses should be adequate. Extension cords connecting to the outlets pass through the back of the cabinet, which is left partially open to provide ventilation. For a pilot light to indicate that power is on the panel, use a 7-watt bulb with a candelabra base. Cover the light with a red bull's-eye. Binding posts are mounted on the back of the cabinet for quick connection to track wires.

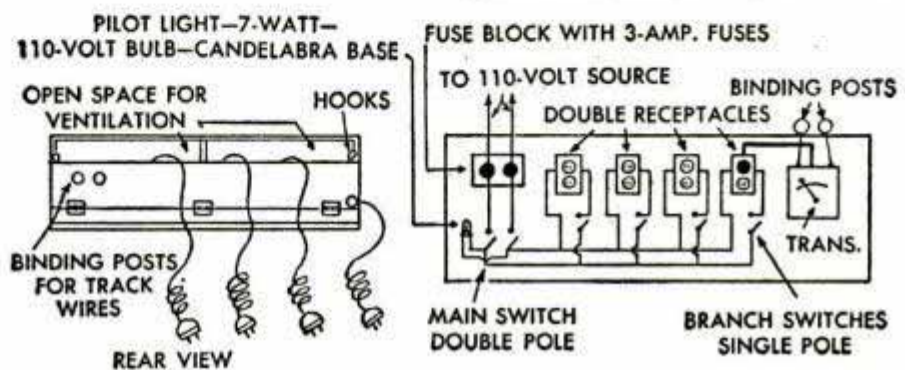
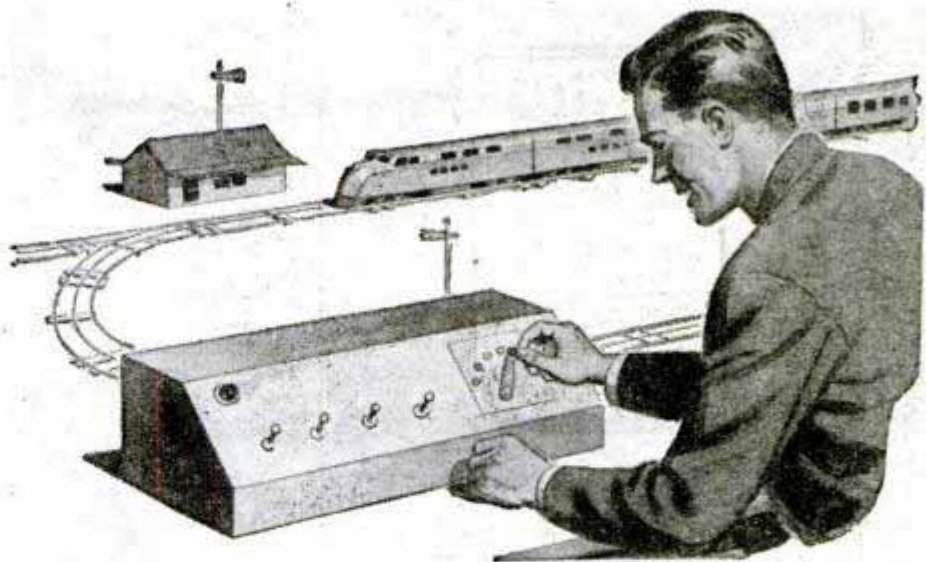

Wm. W. Jacob, Millvale, Pa.

Horizontal Strips of Molding "Frame" Display of Pictures or Photos

One way to display a number of pictures or photographic prints is to mount them in rows, using horizontal strips of molding as

racks. Suggested dimensions for the top and bottom pieces are given in the lower right-hand detail. The distances between the two strips, 19½ in. for 20-in. pictures and 15½ in. for 16-in. pictures are

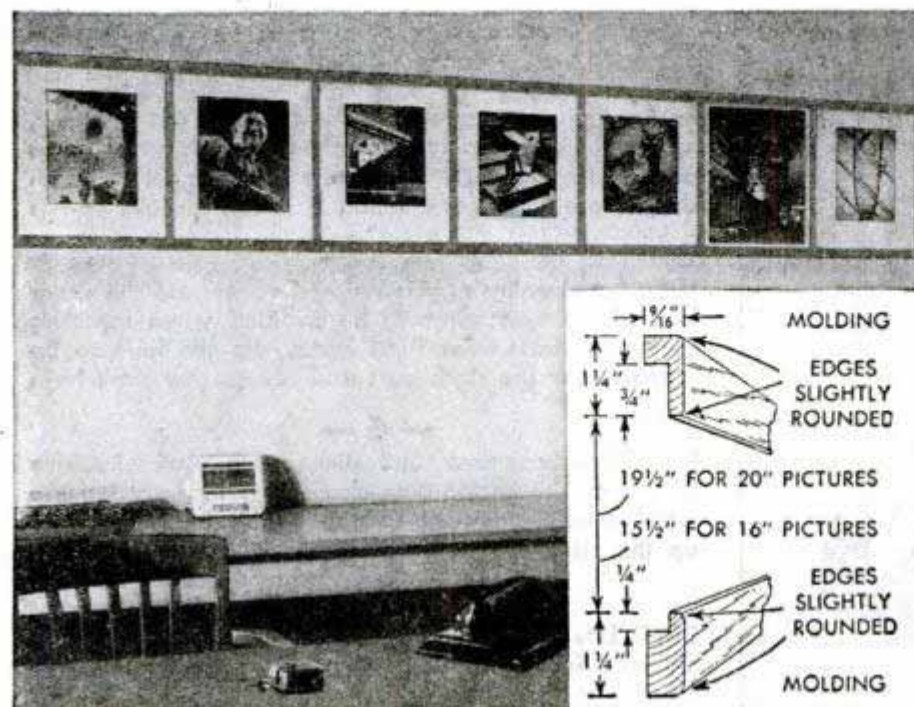

for mounting 16 by 20-in. photographic prints either horizontally or vertically. Prints this size are about right for an ordinary-size room. Smaller pictures are pasted on mats to make them fit. Stock sizes of glass that fit the frame can be purchased. To change a picture, bend the pieces of molding out slightly—not enough to pry them loose—and removal and insertion will be easy. Finish the wood to harmonize with the rest of the room. —Fred G. Korth, Chicago.

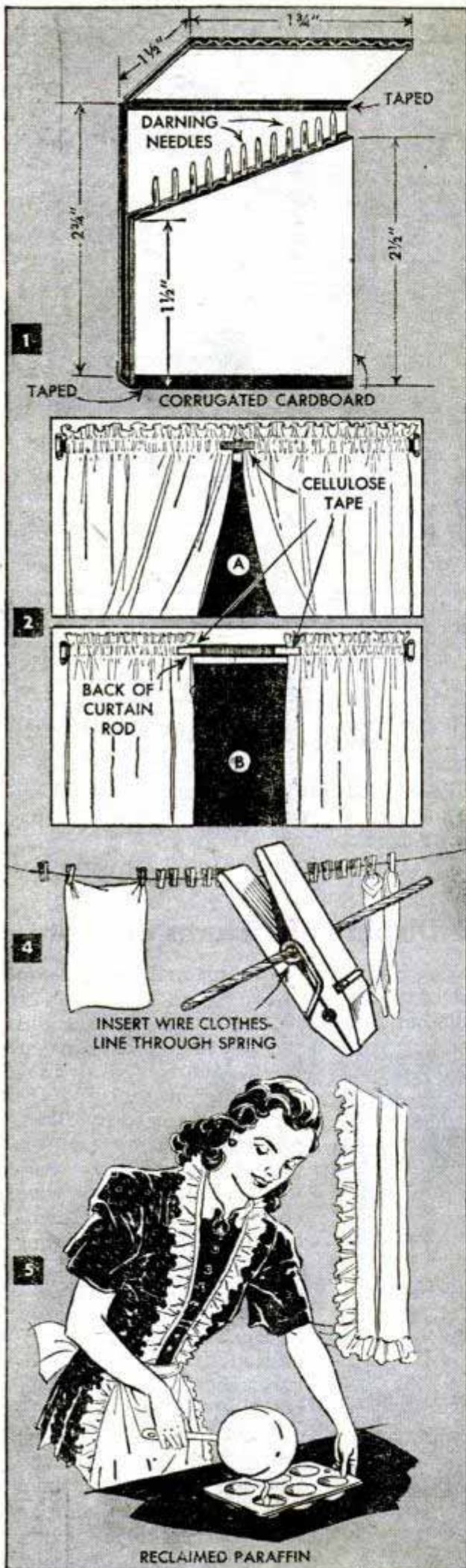

Solving HOME

- 1 -

Made from a piece of medium-weight corrugated cardboard, this needle holder will accommodate a variety of sizes. Cut the cardboard to the dimensions indicated in the drawing and then fasten the holder and cover to the back with lengths of heavy cloth tape

- 2 -

To keep curtains or drapes from sliding out of place, secure them to the back of the rod with small strips of cellulose tape. Detail A shows the manner in which drapes are taped and detail B is for straight panels

- 3 -

If half a darning egg is painted white and the other half black, eyestrain will be avoided when mending socks and hose. For light socks, slip the hole to be darned over the dark part and reverse for dark hose

- 4 -

Permanent basement clotheslines, usually of wire, can be fitted with spring-type clothespins by inserting the wire through the coil of the spring before putting up the line. Then the pins will always be at hand

- 5 -

Small bits of paraffin left over from preserving, or removed from jelly glasses, can be molded into cakes for storage by melting and pouring into muffin tins



PROBLEMS

— 6 —

Marks left by upholsterers' nails when the back of a chair rubs against the wall can be eliminated by coating the nailheads with colorless fingernail polish

— 7 —

Here's an easy way to peel an orange: First, roll it lightly on a flat surface such as a table top. Then cut through the skin to divide it into halves, being careful not to damage the fruit. Finally, using the handle of a table fork, pry the skin completely off

— 8 —

When there are small children around the house, it's difficult to keep them from getting into table drawers and spilling the contents. To prevent this, drill a hole in the side of the drawer near the front and insert a dowel to serve as a stop. Remove the dowel by reaching underneath the table to open the drawer

— 9 —

Knives are kept out of the way safely, yet handy when needed, in this attractive holder. Pressure between the sections holds the blades in place. The cutaway view indicates the manner in which the holder is made

— 10 —

Painting the top of a knife handle shows at a glance which is the sharp and which the dull edge. With this identification, it won't be hard to avoid cut fingers

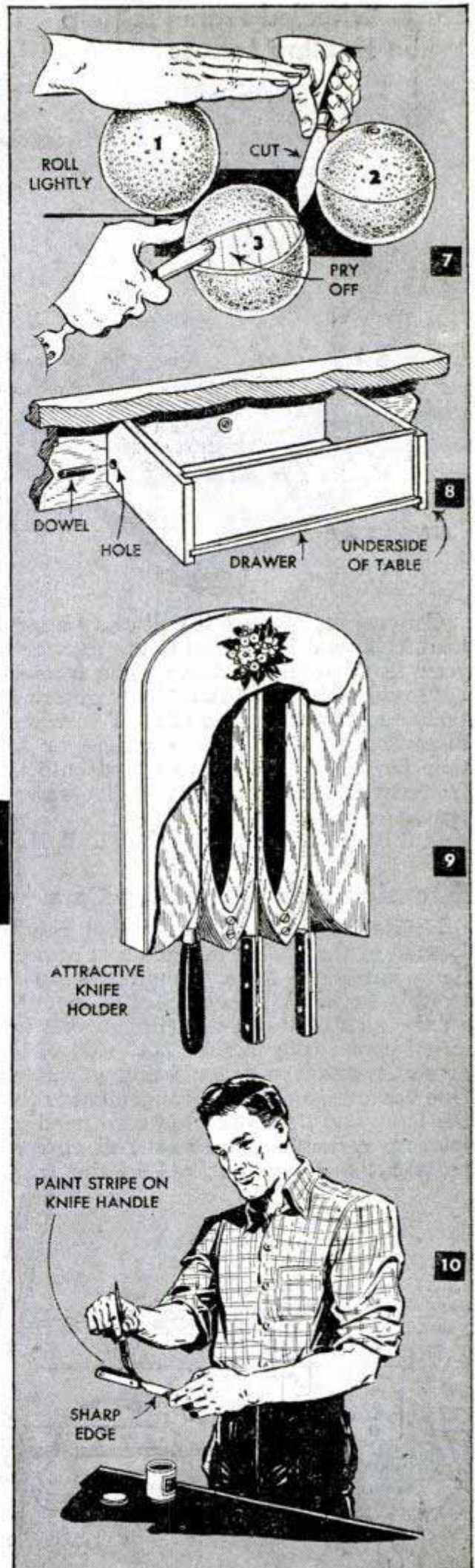

Large Wheeled Frame Is Help When Hauling Leaves



Convenient because it will carry a large load, this wheeled frame is the answer to your leaf hauling problem. The frame is approximately 5 by 7 ft. and has wire mesh tacked to the underside of it. Two wheels discarded from a baby carriage or toy may be used. Leaves are raked onto the frame in the same manner that dirt is swept onto a dust pan.

Elliott McClung, Campbell Hall, N. Y.

Extension-Light Outlet for Cars

Here's an electrical outlet that can be located in the glove compartment of a car for connection to a camping lamp or trouble light. A female plug is mounted on the side of the compartment, one terminal connecting to the "hot" side of the ammeter and the other being grounded. One advantage of this arrangement is that the lamp and its connecting cord need not take up valuable space in the glove compartment but can be kept in the trunk

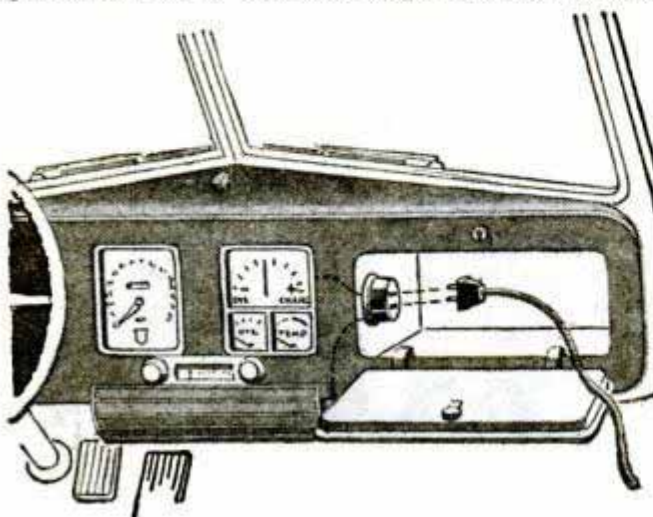

until needed. The trouble light would only require a cord long enough to reach all parts of the car, while the camping-lamp extension should be considerably longer.

Hand Position Indicated on Hammer

After determining by experiment the best way to hold a hammer, mark the spot covered by your thumb. Then, when you pick up the hammer, you will know where to grasp it. A light-colored paint or lacquer should be used to make the marks. If each of your hammers has a different colored "spot," they can be identified in a hurry.

Kenneth Murray, Colon, Mich.



Vacuum Bottle Kept in Pocket With Elastic Strap



When carrying a vacuum bottle in a coat pocket, you can keep it from falling out and breaking by tacking a short length of elastic above the pocket, as in the illustration. The bottle slips under the strap which serves to hold it in place.

Use an elastic band with a good deal of stretch so the bottle will "hug" the coat tightly.—Benj. Nielsen, Aurora, Nebr.

Sheet-Metal Collar Around Stump Forms Flower Box

If you have an unsightly stump in the yard and want to put it to some use, nail a strip of sheet metal 7 or 8 in. wide around the top to make a flower box. Plants that flower profusely are best and will add a quaint and rustic touch to the appearance of the yard. Paint the top of the stump with creosote.—L. Cloutier, Quebec, P. Q., Can.

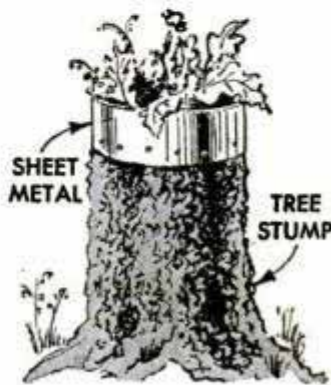

This Hand-Wrought Log Grate Has Built-in Andirons

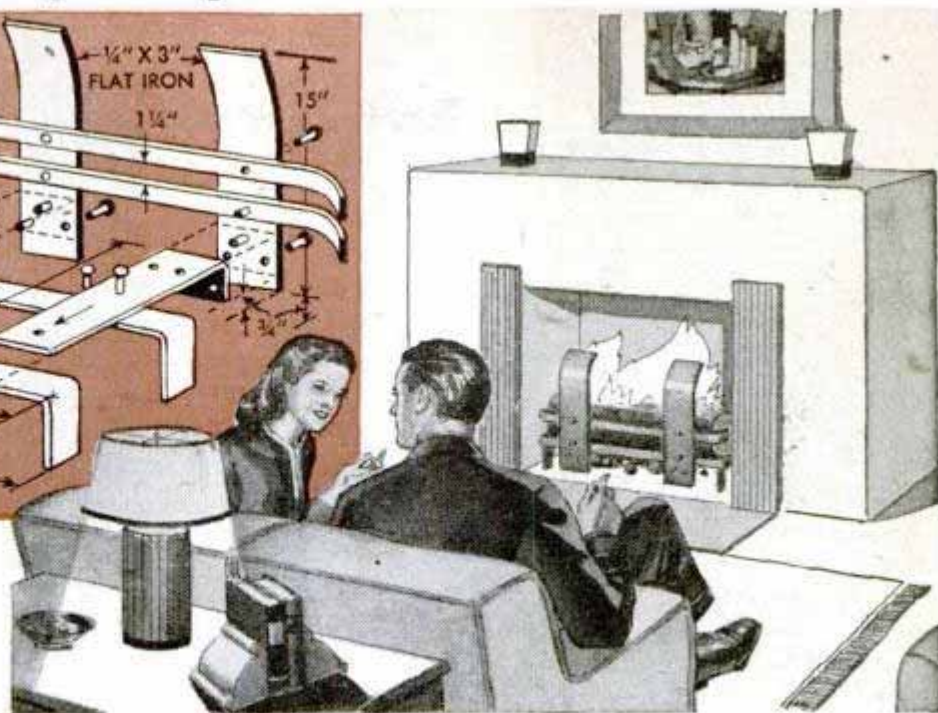
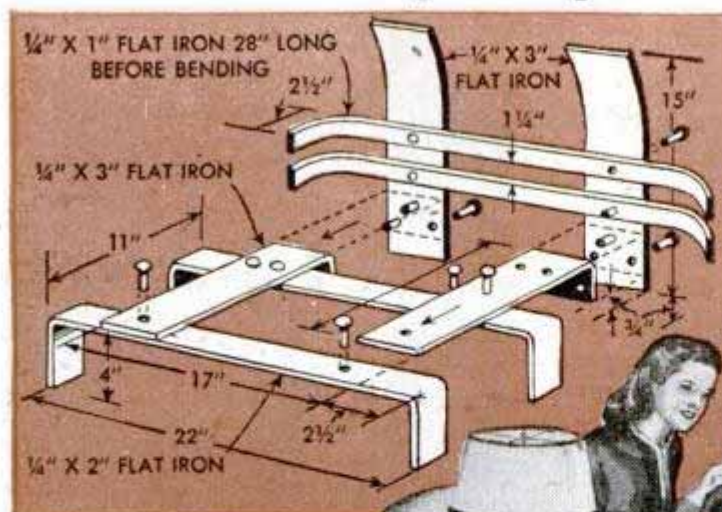

Here's an attractive fireplace grate that differs from the ordinary in that both grate and andirons are all in one. It's primarily for holding logs, although it can be adapted for burning coal by placing a grille, such as a piece of expanded metal lath, over the bottom. All the parts can be hand-wrought cold from stock pieces of $\frac{1}{4}$ -in. flat iron. The dimensions given in the drawing may have to be altered to suit the size of the fire pit. A machinist's vise will aid in making the sharp right-angle bends of the bed pieces, while the curved bends can be formed by working the pieces through the jaws of a monkey wrench. This is done with a slight sideward thrust

as the metal is advanced through the jaws. In the case of the 3-in. pieces, the ends can be curved by clamping the work vertically in the vise, allowing about 4 in. to extend, and then grasping the end with an adjustable wrench. If necessary, a length of pipe slipped over the wrench handle will provide good leverage. All parts are riveted together. The andirons and the connecting horizontal pieces can be given a hammered finish, or the whole unit can be given a coat of flat black paint.

Wayne Snowden, San Francisco, Calif.

False Front Conceals Tilting Clothes Hamper in Chest of Drawers

A built-in clothes hamper in a chest of drawers—that's really novel and is a good reason to bring back that old chest from the attic. The illustration gives the general idea; three or four lower drawers are removed, including the frames, and dismantled. Then a hamper of plywood is made to fit the opening, the front of which is assembled from the original drawer fronts. The sides of the hamper should be rounded at the top to allow it to tilt outward when the unit is hinged across the front at the bottom. A series of holes should be provided in the sides of the hamper for ventilation.

Tin Foil Tightens Loose Screws

Tin foil has been found better than wood plugs to tighten loose screws in hinges. Simply fold the foil into a strip about $\frac{1}{2}$ to 1 in. long and insert it in the enlarged hole. When the screw is replaced the threads will cut into the metal and embed it in the wood, producing a tight connection.



Featherweight

AN EIGHT-FOOT DUCKBOAT

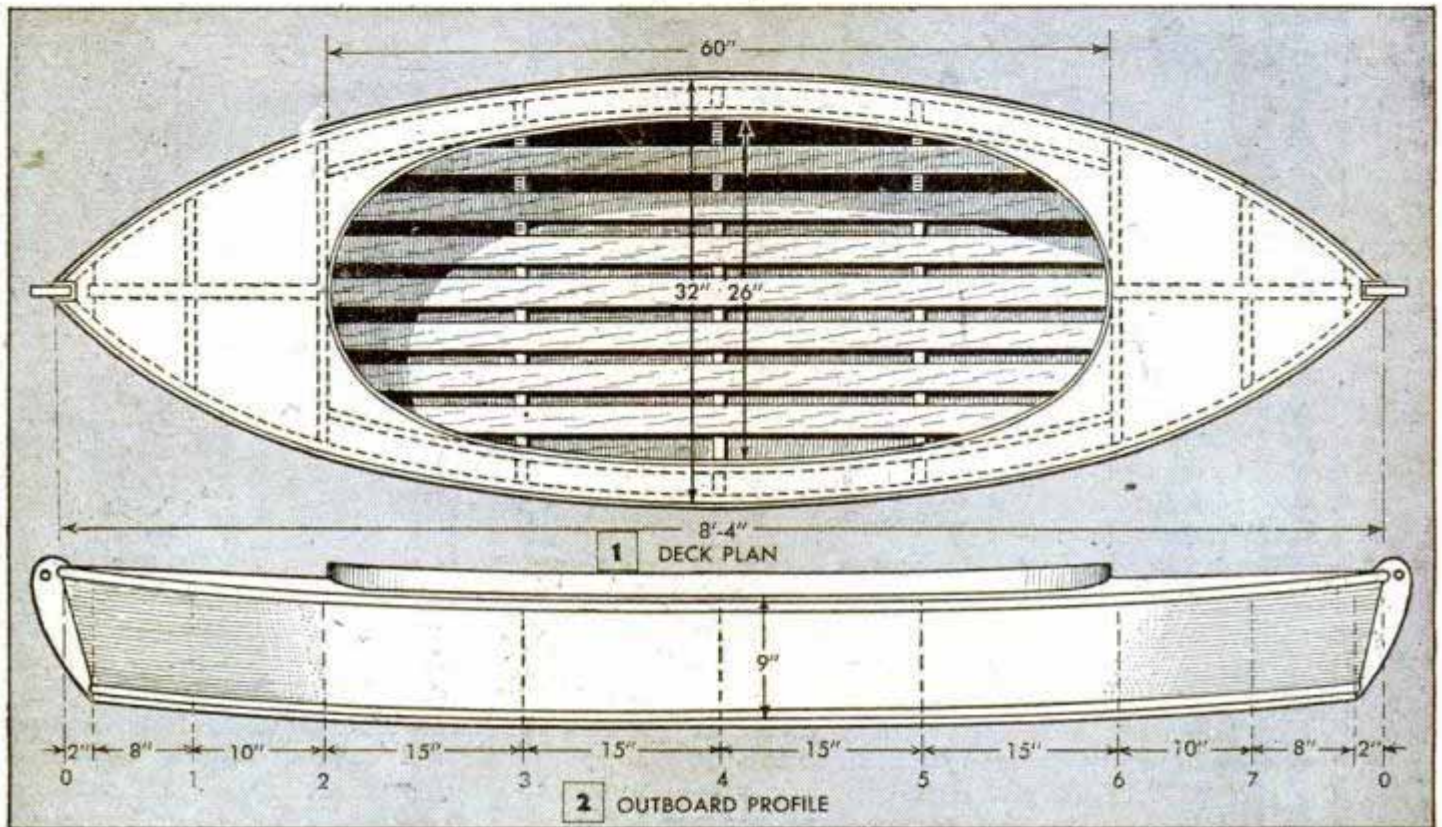

By Hi Sibley

LIGHT ENOUGH to carry on a car or even on your shoulders, this boat will enable you to reach hideaways that are inaccessible with heavier craft. It is sturdy enough to push through dense weed growths and light enough to navigate the shallowest waters. Although only 8 ft. 4 in. long, Featherweight has a capacity of well over 300 pounds. Its construction of $\frac{1}{4}$ -in. waterproof plywood over light pine framing gives it the well-proportioned lines that are shown in Figs. 1 and 2.

Featherweight is built upside down on an erecting frame as shown in Fig. 8. Construction begins with the boat frames, Fig. 4. These are made of $\frac{3}{4}$ -in. (net) pine or other light wood that will not split easily. Full-size patterns drawn on heavy wrapping paper will aid in laying out the pieces to exact size and serve as a guide for assembling them after they are cut. Waterproof glue and No. 8 brass screws are used to join the parts as indicated in Fig. 3. Temporary braces are installed on the open frames 3, 4 and 5.

The strongback of the erecting frame, Fig. 11, is made from a 2 by 8-in. plank. A $\frac{7}{8}$ by $\frac{7}{8}$ -in. batten may be used to mark

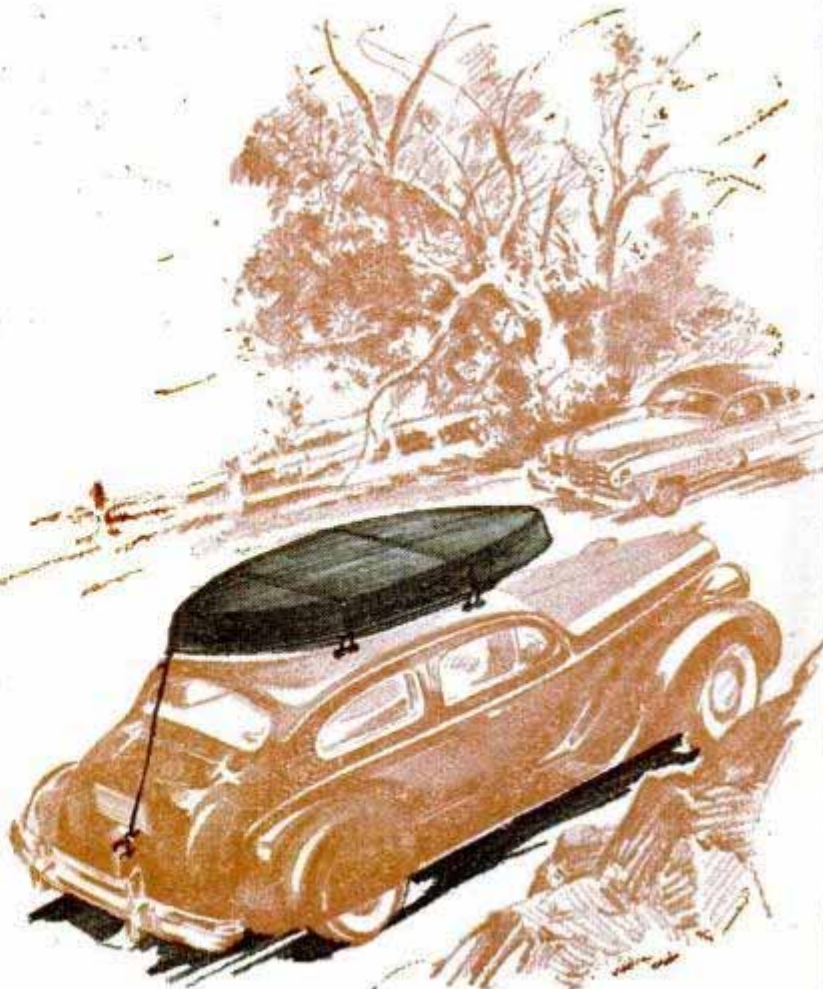

Purpose Bag

Using a twofold purpose, this utility bag will hold ample provisions for a meal and, when the cover is removed, the bottom and ends can be used as a table top. Bottom and ends are made of plywood to fit inside the canvas cover, and these parts are hinged together with strips of canvas. Note that the two ends are fitted with snap fasteners to attach the cover, and the bottom is drilled for a bolt attached to an upright when used as a table. Either canvas or leather reinforcing is used at the places indicated on the drawing. Regular utility-bag handles are riveted on and the addition of a zipper completes the job. When cutting out the bag, be sure to allow the $\frac{1}{2}$ -in. margin required for stitching and, for a neat appearance, make the cover a snug fit over the bottom and ends. Use a

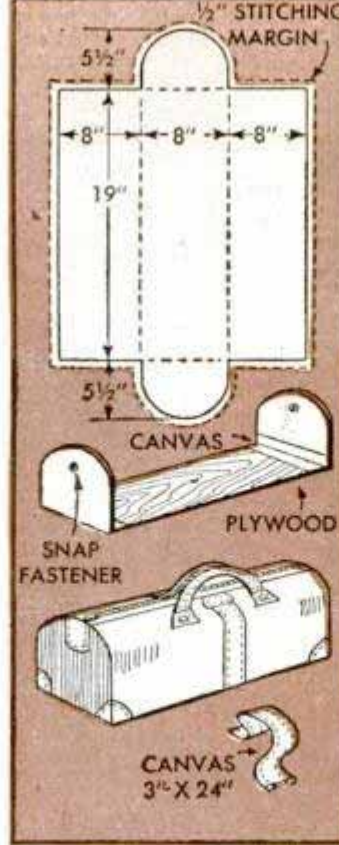

medium or heavy grade of canvas which can be purchased as remnants, either in a solid color or a striped material. Dimensions of the bag can be altered to suit individual requirements.

G. E. Harrington, New York.

Hunters Cart Heavy Game Out of Woods on "Stretcher" With Bicycle Wheel

After the first flush of pride at bagging a fine deer has passed, and you still have to carry the animal to a camp miles away, that's when the deer begins to "take on weight." This wheeled stretcher is designed to take that weight off your shoulders. The longitudinal members of the frame are

angle iron with flat-iron cross members welded to them. Lengths of pipe are bent to shape, slipped over and welded to the angle iron. Dimensions are not given for the stretcher so they can be of a length and width to suit the user. Two bicycle forks, which are connected to a bicycle wheel, are welded to the end cross members. Two additional flat-iron braces are welded to the forks and to the angle iron, one on each side of the frame.

Geo. R. Harrison, Valparaiso, Ind.

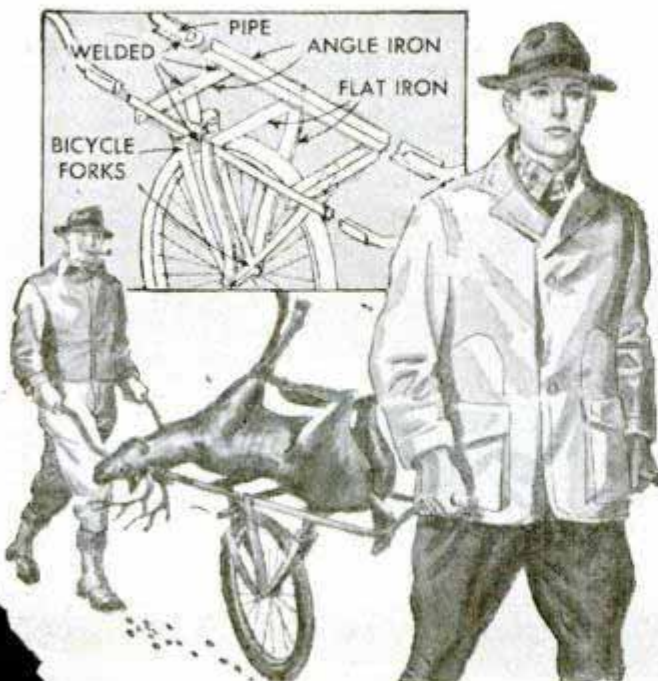

Metal Glider Conceals Screwhead

When a screw-head cannot be countersunk and filled over, it can be covered neatly with a metal glider of the kind used for chair and table legs. Break off the anchor points and attach the glider directly to the head with cellulose cement. If it's ever necessary, this covering can be pried off with a knife to get at the screw to remove it.



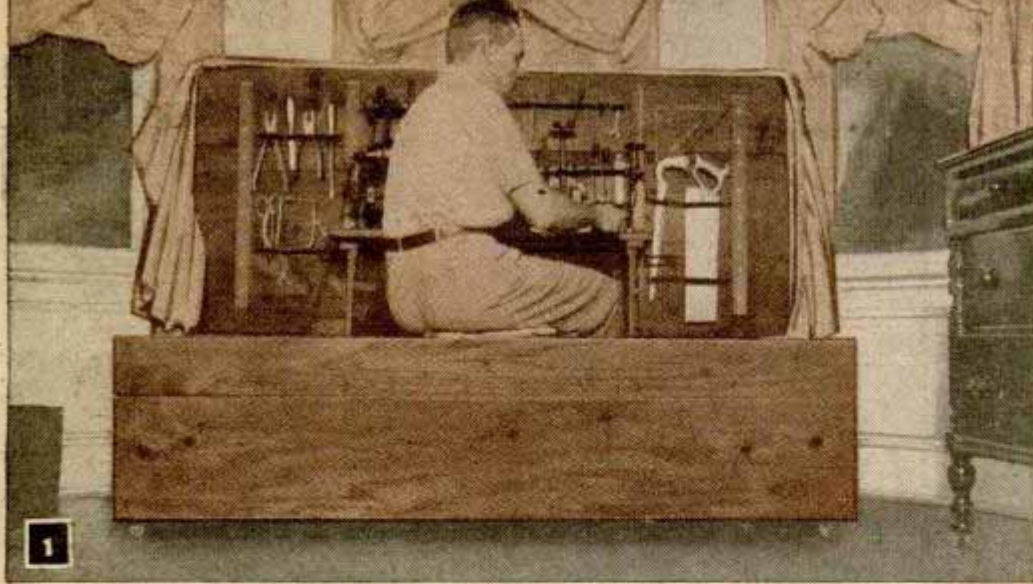

Made to...
ment craft...
portable "w...
disguised as a studio couch, is just the thing for modelmaking, hobby work and tinkering. It keeps everything together and out of sight. Mattress top makes a comfortable couch

By
H. R. Howser

AFTER having had a complete basement workshop for many years, I was like a fish out of water when we moved into an apartment. Trying to carry on by using the kitchen table as a workbench and having to stow away everything each time led me to build the portable, self-contained workshop pictured in Figs. 1 and 3. Not only does it solve the problem of a place to work with everything at finger

tips, but it can be transformed quickly into a comfortable and attractive studio couch by simply closing the cover as shown in Fig. 2. There's really nothing to making it. Fig. 4 will give you a good idea of the construction which amounts to making a large box with a hinged cover and upholstering it with a mattress and slip cover. I used inexpensive, common-grade lumber, although 3/4-in. fir plywood could be used.

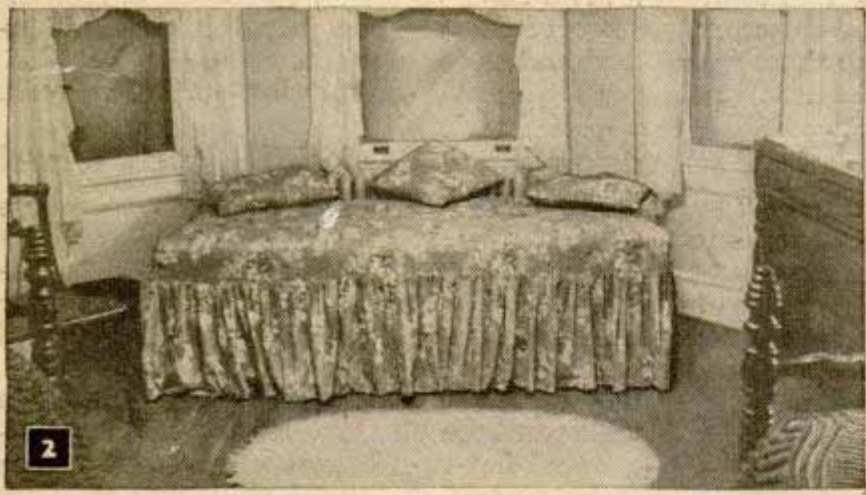

No one would suspect that this studio couch houses a complete "workshop." Just lift the cover and presto!—there it is all before you—everything in readiness to begin work. No time is wasted putting things away

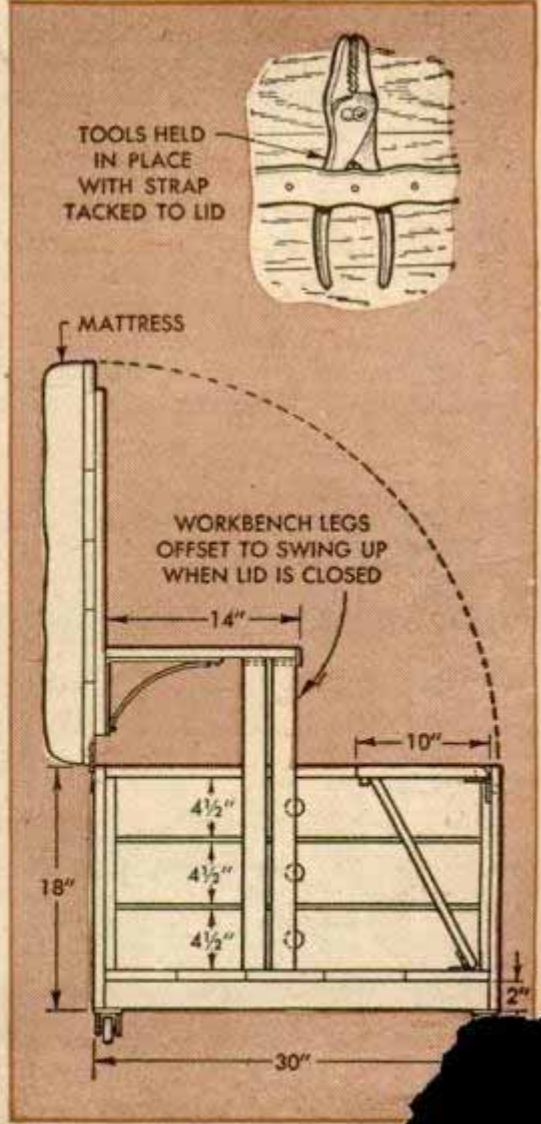
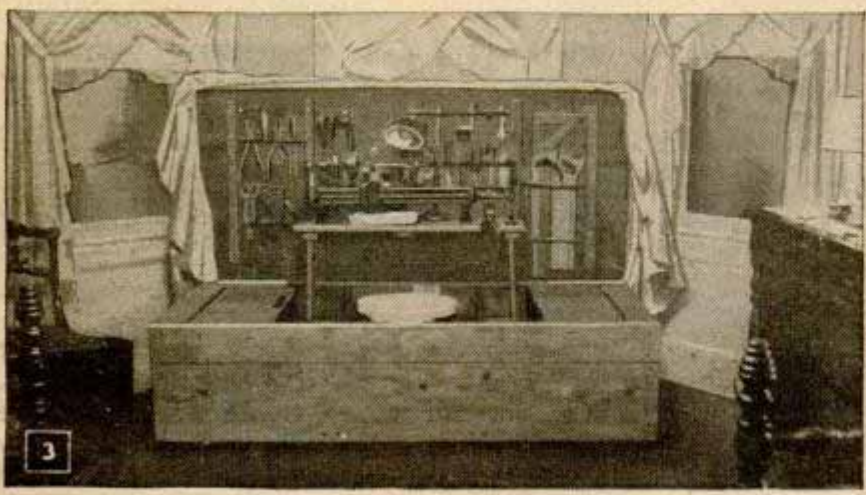

STUDIO-COUCH "WORKSHOP"

This would eliminate the work of building up the sides, top and bottom with battens. Notice that the bottom of the box rests on 2 by 2-in. sills, equally spaced, and that a caster is fastened to each corner.

Each end of the box is fitted with a removable three-drawer cabinet, which is made separately and slipped into place. For these you may be able to purchase a ready-made chest of the unpainted variety, such as is sold in large department stores, and adapt it to fit the box, or the drawer compartment of a discarded piece of furniture might do. It wouldn't be necessary for them to extend the full width of the box either. Regardless, the cabinets should simply set in place so that the whole thing becomes a knockdown affair to facilitate moving. I used flathead screws in assembling the box, and loose-pin hinges in attaching the cover so that it could be dismantled without too much trouble. The side view in Fig. 4 shows how both the workbench and seat are hinged to fold compactly. Regular metal shelf brackets

support the bench top rigidly at right angles to the cover, and the legs are hinged offset to allow them to nest side by side when folded. Midget-type power tools such as a lathe, saw, drill press, etc., are ideal for use in this "shop." Mounting can be such as to allow the machines to be quickly interchanged, and there's ample room to store them in the bottom of the box. A piece of linoleum on the floor of the box will prevent sawdust from seeping through the joints of the boards.

The top is fitted with a standard cotton mattress, 30 by 74 in. This was spot-tacked around the edge to hold it in place and then covered with a slip cover having a pleated flounce. Note the hand holes that are cut in the top edge of the box at the front. This allows you to get a grip under the cover to raise it. Although not shown, a cleanout drawer in the bottom of the box, or a trap door, would facilitate removing shavings and sawdust. This necessitates raising the box higher off the floor to provide access for removal of the sweepings.

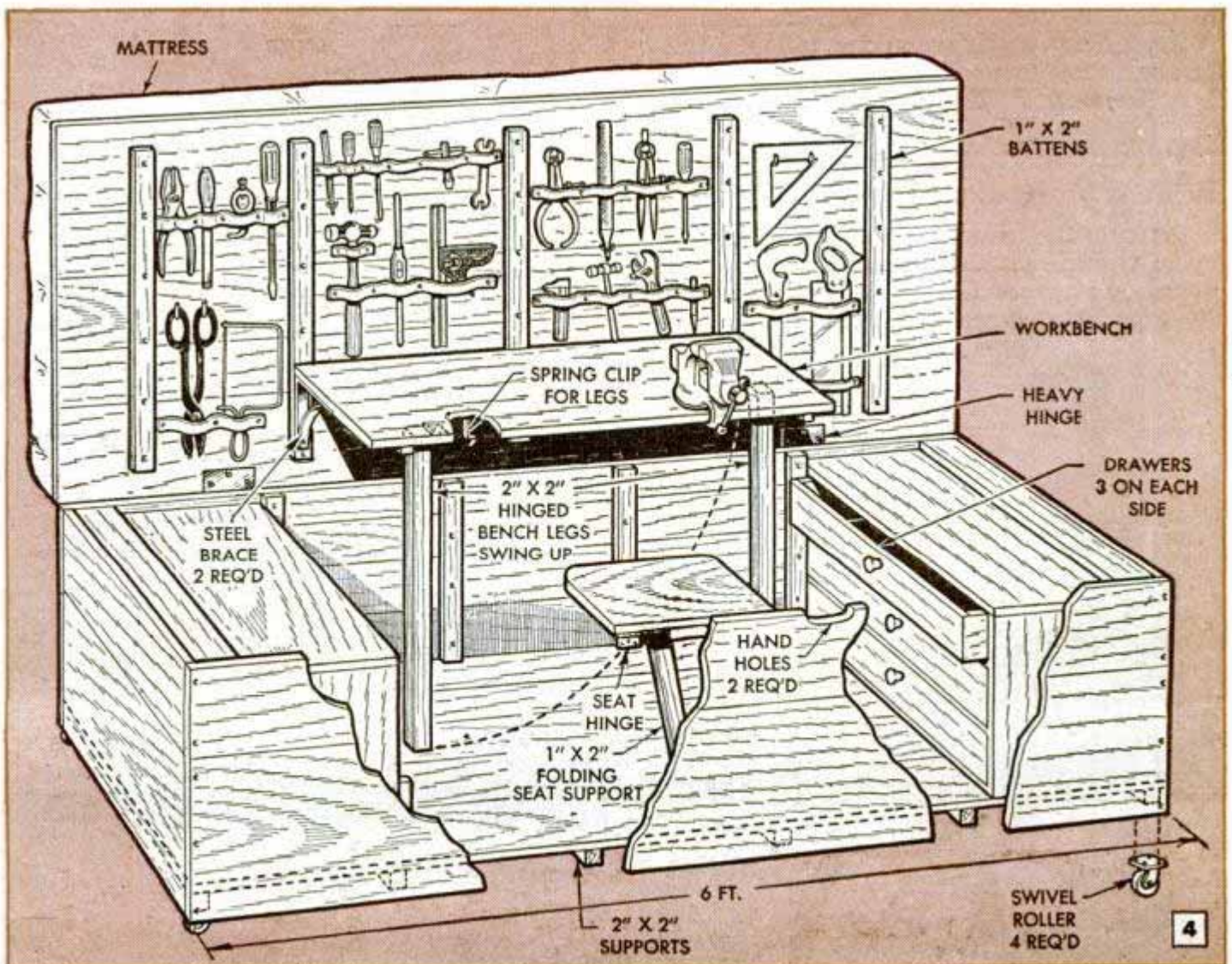

Converted Mill File Will Serve As Cabinet Scraper

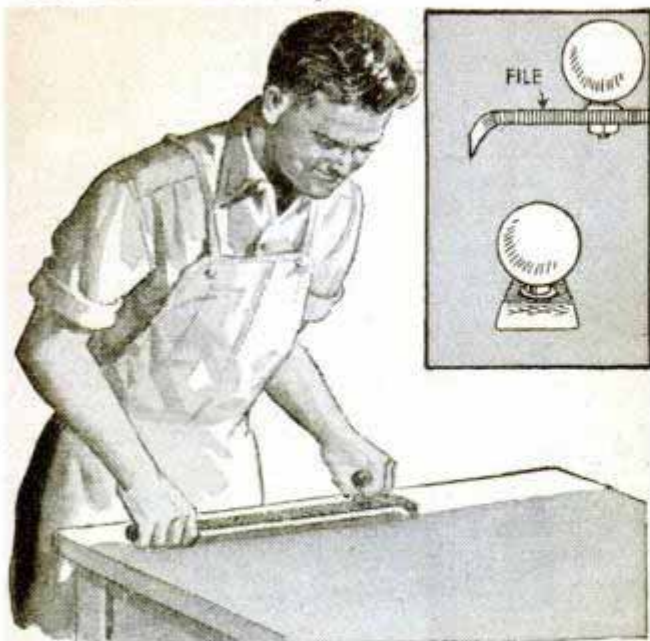

Convenient for heavy-duty work, an old mill file can be converted to serve as a cabinet scraper. Heat the file to a cherry red and shape the end as shown in the detail. Allow the file to cool slowly and do not restore the temper. Treated in this manner, the edge can be sharpened easily. A handle and knob are added to make the scraper easy to use.

Kenneth F. Petersen, Newark, Ohio.

Newspaper Sack Attached to Bike With Wire Hooks

Because the usual wire basket on his bicycle would not hold enough papers, one newsboy attached hooks to the handle bars to support a large bag. The hooks are



formed from $\frac{3}{16}$ -in. rod and threaded to fit drilled and tapped holes in the handle bars. In use, the strap of the bag is looped over the hooks and the bottom rests on the fender.—Wm. Riederich, Elmhurst, Ill.

Keyhole Guard for Door Lock

If you have a lock of the type shown on an outside door, you can make a guard that will prevent a skeleton key from being used to gain entrance. Cut a slot in one side of the keyhole plate so a strip of metal can be inserted to cover the keyhole. This is on the inside of the lock. Then file off the end of the key so that when it is flush against the metal strip—inserted from the outside—the key will engage the lock to open the door.

A. H. Waychoff, Phoenix, Ariz.

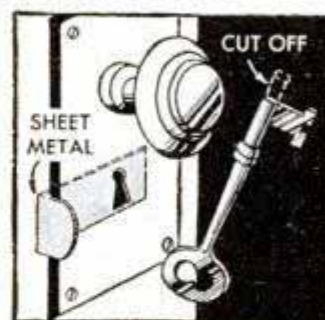

Hose Clamps Hold Glued Stock

When gluing round stock, one craftsman uses several automotive water-hose clamps of the adjustable type. They can be used for work ranging in size from $\frac{3}{4}$ to $3\frac{1}{2}$ in. in dia. Use of these clamps applies an even, over-all pressure to the work, and they are especially useful for pieces such as screwdrivers and file handles.

Wm. Avellino, Philadelphia, Pa.

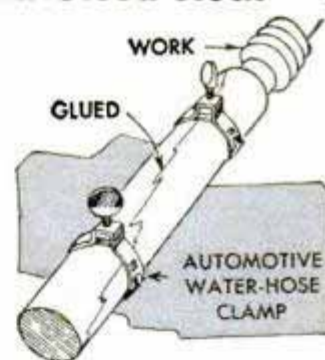

Spring Supports Electric-Iron Cord

Two screen-door springs, one of which will fit inside the other to provide rigidity, will make an inexpensive support for an electric-iron cord. After the smaller spring has been slipped inside the larger, one end is fastened to the board and the other is tied to the cord, allowing enough slack in the cord for free movement of the iron.—C. P. Fitz Patrick, Philadelphia, Pa.

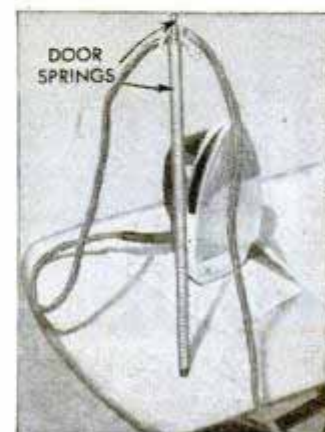

Auxiliary Table Top Increases Playing Surface



Where to play when the gang comes in for an evening of cards is solved in a hurry when you have this auxiliary top, which is designed to set over an ordinary card table. Hinged at the center, it takes up little storage space in a closet, and when open, it forms a large-size playing surface which seats eight persons comfortably. Construction consists of adding trough-like compartments around the edge of an octagon-shape centerpiece. The whole thing can be assembled as one unit and later sawed in half, or each half can be made up separately. Start by laying out and sawing the eight-sided centerpiece. The compartments are

added to the edge of this by first fitting and nailing $\frac{1}{2}$ by 3-in. pieces all around, mitering them where they meet at the corners. Next, the 3-in. pieces forming the bottom of the trough are nailed to the lower edge of the previous piece, mitering it as before. This is followed by fitting the outside piece, and then the trough is divided into compartments by inserting partitions at the eight points. A continuous (piano) hinge makes the neatest job, although two or three butt hinges will do. Complete the job by gluing felt to both top and bottom. Finish with enamel or varnish to match your furniture.—M. A. Zinser, Chicago.

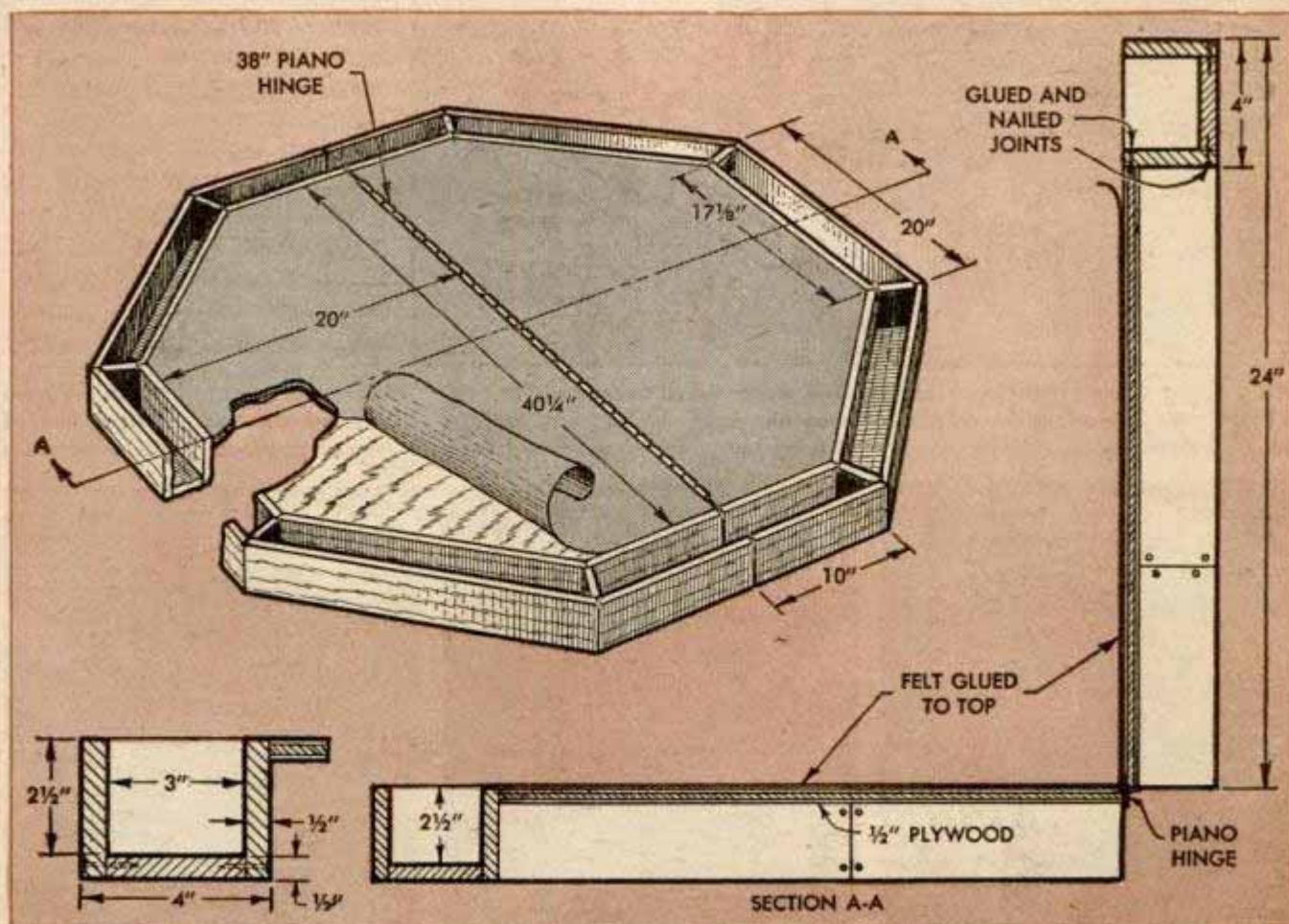

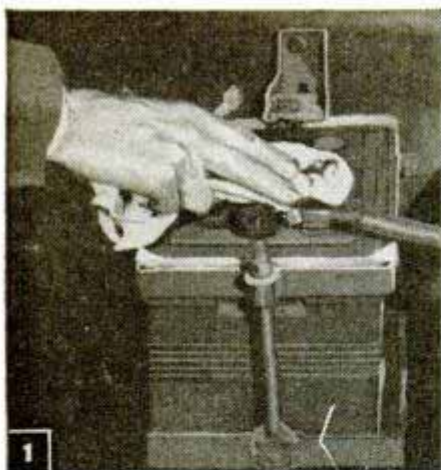

1 Remove white coating from battery terminals with a soda-and-water solution. Wipe dry with clean cloth



2 Check sealing compound for cracks. Repair with compound, using in a tarry consistency that does not run



3 Inspect the battery cradle for acid damage. If the cradle is in poor condition it should be replaced

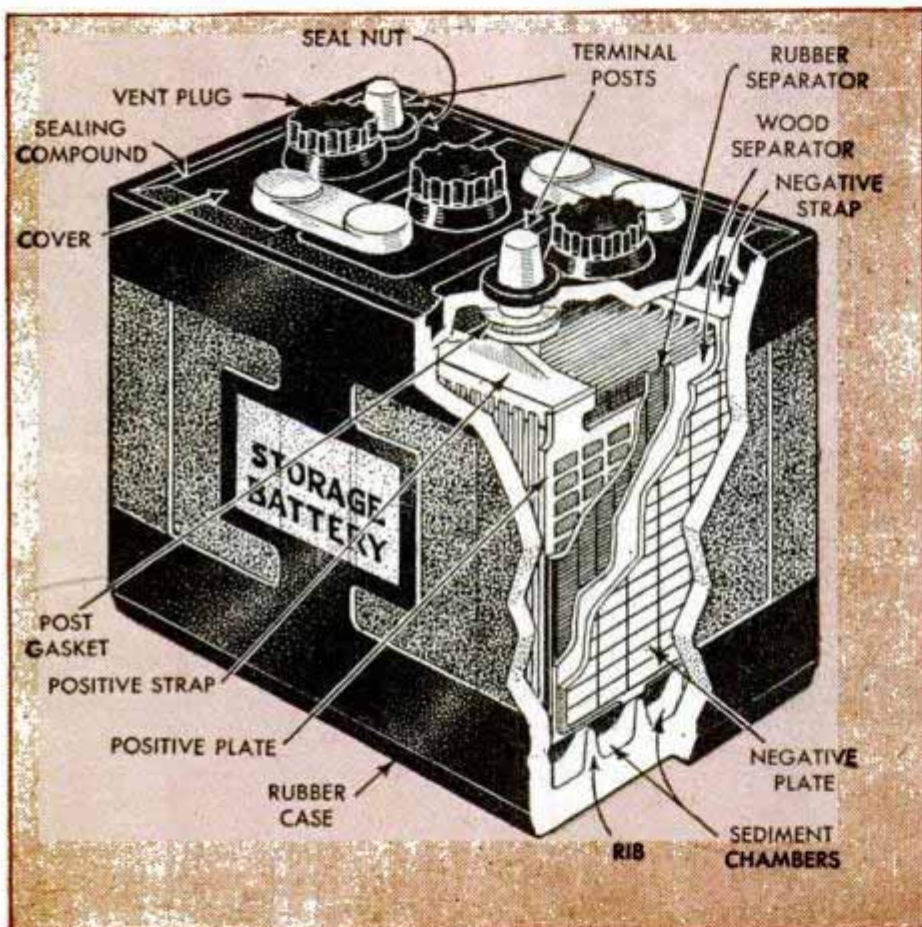

GIVE

By Phil Ruskin

BEFORE one attempts to service any mechanical or electrical device it's a good idea to know how it works. Being well acquainted with your car battery helps you to service it regularly.

A storage battery consists of three identical 2-volt cells connected in series, making a total of 6 volts across the terminals. Each cell has positive plates of lead peroxide and negative plates of lead, the number of plates depending upon the ampere-hour rating of the battery. An electrolyte solution of distilled water and sulphuric acid sur-

State of the charge is checked with a hydrometer. Reading should never go below recommended levels

Add water when necessary. In cold weather add water just before driving car, otherwise it may freeze

Before removing the cables from an old battery, note and, if necessary, mark positive terminal





7 Disconnect ground terminal first. Use a puller and work carefully if clamp is "frozen" to the post



8 When replacing battery, tighten bolts uniformly. Renew rubber washers. Don't draw nuts too tightly



9 Worn or frayed cable should be replaced. Note bends in old cable and install new one in the same way

YOUR BATTERY A BREAK

rounds the plates. In order to keep positive and negative plates from touching each other and shorting the battery, nonconducting separators are placed between each pair of plates. In addition, some batteries have Fiberglas sheets to retard the loss of active material from the plate grids. The case is of hard rubber with a space in the bottom for sludge deposits and the cover is a separate piece held in place by sealing compound.

The plates are not solid, but consist of a framework or grid composed of an alloy of lead and antimony. The mesh of the positive plate is filled with lead peroxide and that of the negative plate with sponge lead. These fillers are porous to allow the electrolyte to penetrate them freely. When the battery is in use, lead peroxide and sponge lead gradually drop off the grids and fall to the bottom of the battery case. The speed with which this happens depends upon how nearly the battery charge is kept normal, how it is charged and how used. To get the

most out of a battery, the active material must be kept on the grid or framework as long as possible, the separators must be kept in good condition and the case protected from damage and leakage.

When the electrical circuit is closed between the positive and negative terminals of the battery, as when the lights are turned on or the car is started, the sulphuric acid in the electrolyte combines with the material on the plates, both negative and positive, to form lead sulphate. Electric current then flows through the electrolyte to the positive terminal and out to the electrical system. As this happens, the amount of acid in the battery solution decreases. This action gives the basis of testing battery strength with a hydrometer, which measures the amount of acid in the solution in proportion to the water present, by the difference in the specific gravity of these two liquids. There is no change in volume of liquid in the battery, as the absorbed acid is replaced by water in the

Clean and brighten terminal posts with a wire brush. Be careful not to get dirt into the cell-cap vents

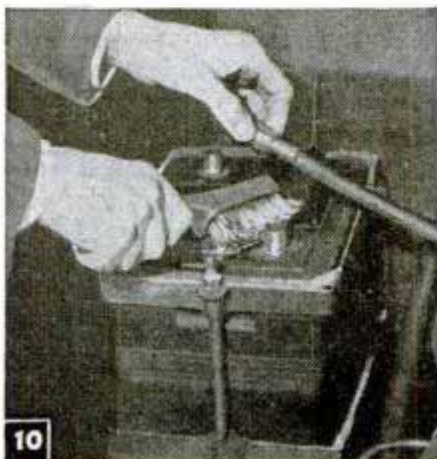

Clean inside of terminal clamps with sandpaper. Grit in the clamp slot will interfere with tightening



Apply mineral grease or white petroleum jelly to battery posts and terminal clamps. Cover thoroughly

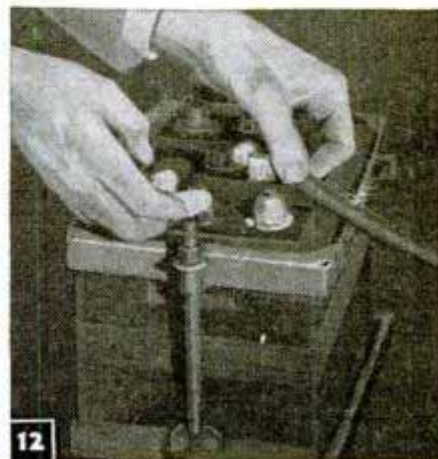

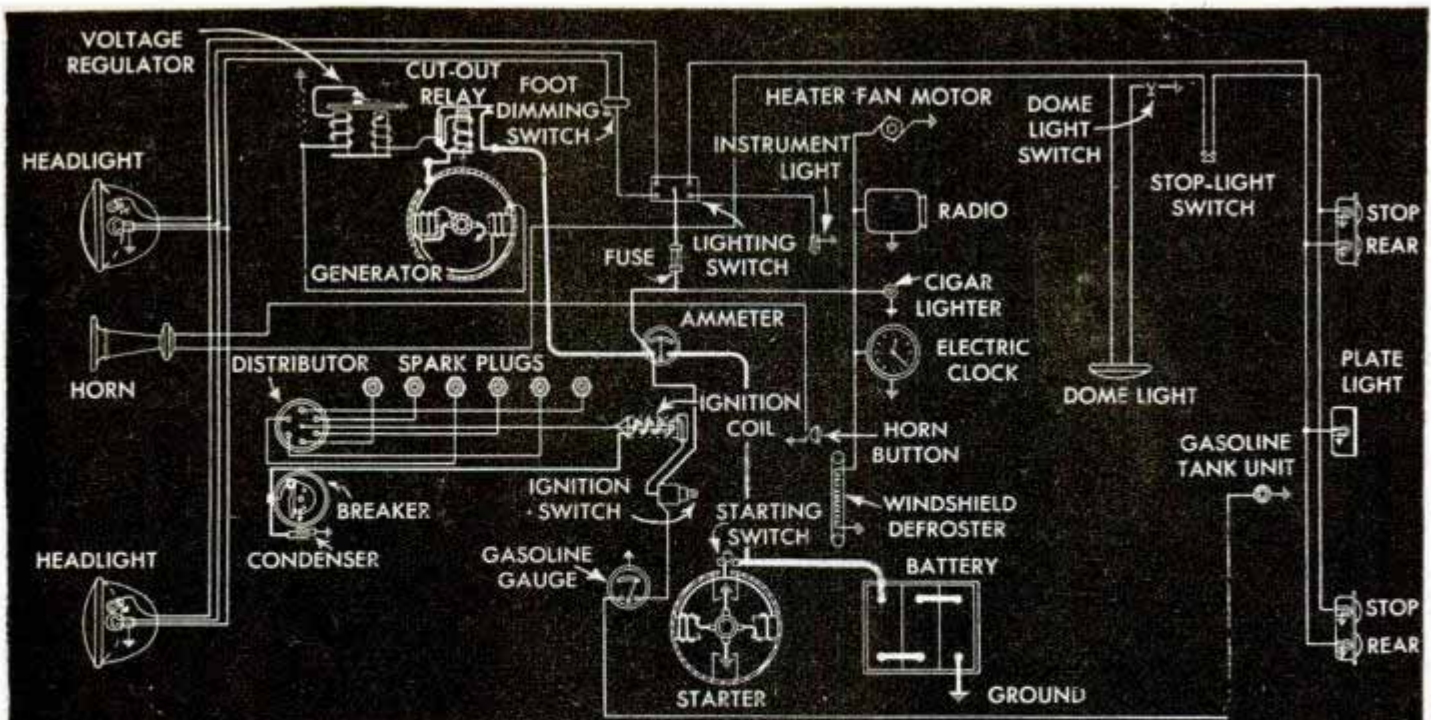

TYPICAL ELECTRICAL CIRCUIT OF AN AUTOMOBILE

Courtesy The Electric Storage Battery Co.

TABLE A
CURRENT LOAD OF A MODERN CAR

HEADLIGHTS.....	14.0 AMPS.
IGNITION.....	1.7 AMPS.
INSTRUMENT LIGHTS.....	0.8 AMPS.
TAILLIGHTS.....	1.2 AMPS.
LICENSE LIGHT.....	0.6 AMPS.
HEATER AND DEFROSTER.....	7.0 AMPS.
RADIO.....	7.5 AMPS.
	32.8 AMPS.

SUMMER STARTING...125 TO 300 AMPS.*
WINTER STARTING...300 TO 700 AMPS.*

*Varies with engine size and oil viscosity

Take a minute to study this typical wiring diagram and you'll have a better idea of the heavy load on your car battery

chemical process. A fully discharged battery contains nothing but water, with the acid completely absorbed in the plates as lead sulphate.

Charging simply reverses this process, and by this means the battery can be restored to full charge, provided the lead sulphate has not been allowed to remain on the plates too long. When it is impossible to recharge a run-down battery, it's usually because the plates have remained sulphated too long, or the active material has dropped off the plates.

When you buy a battery rated at 100 ampere-hours, this theoretical rating means that the battery will deliver 100 amperes of current for one hour, or one ampere for 100 hours. Normally, careful testing and charging of a battery is a job for a fully equipped service station, but a hydrometer to test the strength of the electrolyte is inexpensive to own and easy to use. Make a test only when the battery solution is thoroughly mixed, never immediately after adding water. Hydrometer readings are set for one temperature, usually about 80 deg. F. A temperature correction of "4 points" of gravity must be made for each 10 deg. of variation from 80 deg. F. Add for above 80 deg. and subtract for below 80 deg. For example, the gravity of a fully charged battery, at 80 deg. F., is 1.280. At 100 deg. F., it will be about 1.288. At 10 deg. F., it will be 1.252. These are battery-solution temperatures, not air temperatures.

Figs. 1 to 14 picture the steps necessary in ordinary periodic care of a battery. Table A lists the average current requirements of a modern car with the usual accessories and the detail directly above table A shows a typical wiring diagram.

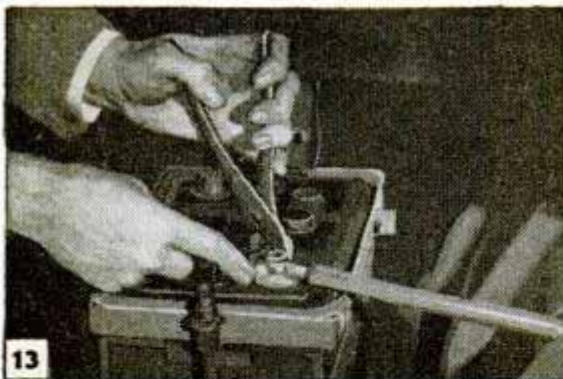

13

Photos Courtesy Auto-Lite Battery Corp.

Above, tighten clamp nuts with battery pliers. Make sure that the clamp is pressed down on the post as far as it will go. Below, ammeter should read discharge when light switch is on

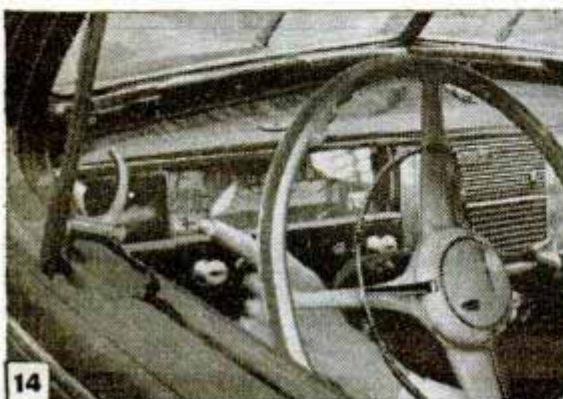

14

King-Size "Bird Cage"



By enclosing this outdoor aviary with glass in winter and providing adequate ventilation through the cupola, it will furnish a home for canaries, lovebirds and other feathered pets the year 'round in sections of the country where the weather is not too severe. By insulating the roof and adding one or two electric "stoves" like the one shown, a satisfactory temperature normally can be maintained. Stock lumber is used for the framing which is erected on a sturdy post, creosoted below ground and anchored with a cross brace at the bottom. It may be set in concrete, if you wish, and should be fitted with a metal baffle to discourage rats from climbing and gnawing their way into the cage. The dry shrub is suspended from the top so that the aviary floor is unobstructed for easy cleaning. Note that in each corner under the roof there is a platform where the birds can take refuge during high summer winds, and that wire nests are installed in the loft. Linoleum is laid on the floor of the cage and covered with clean, sifted sand. Water and seed pans should be placed near the door for convenience in replenishing; never set them under a perch or the shrub

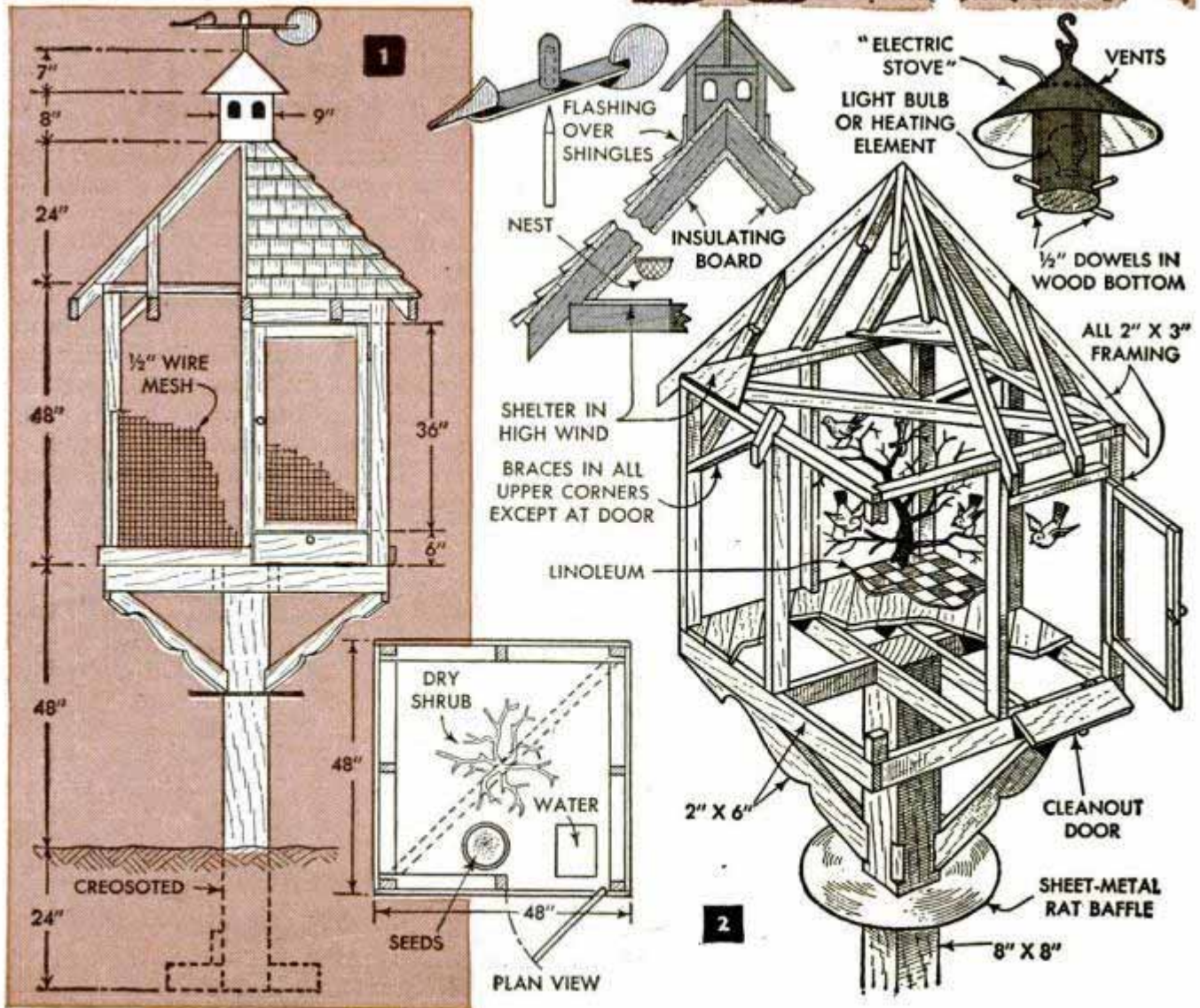

Inner Tube Used to Inflate Balloons With Lighter-Than-Air Gas



To inflate toy balloons, use an automobile inner tube with the valve core removed. Fill the tube by connecting it to a tank of gas, using rubber tubing. Then slip the opening of the balloon over the valve stem and inflate by rolling up the tube, as shown, to obtain sufficient pressure. After some practice, it will be easy to fill the balloons without losing gas. Because of the fire and explosion hazard, flammable gases should be avoided. As a further safety precaution, always fill the balloons outdoors. To save unused gas, screw a valve cap over the inner-tube stem when not filling balloons; otherwise use your thumb as a cap.

A. O. Kriegel, Austin, Tex.

Converted Oilcan Holds Gasoline



An empty 2½-gal. oilcan can be converted to make a handy container with an attached funnel, for extra gasoline. A ring is soldered to the cap of the can and a short length of chain is fastened to this ring. The other end is soldered to the handle. A suitable funnel or spout can be made by obtaining a cap that fits the can and drilling a 7/16-in. hole in it. Solder a 1-ft. length of flexible tubing to

this and fasten a metal ring to the other end of the tubing to make a smooth job. The spout is held on the can with metal brackets. Finally, paint the can a bright red.

D. E. Horn, River Forest, Ill.

Hammer Shielded to Protect Work

If working in close quarters, the exposed claw or top of a hammer head may mar adjoining woodwork accidentally. This can be avoided by cutting a strip of auto inner-tube rubber and making holes at the ends so that it can be slipped over the head as indicated.



Eliminating Window Streaks

When washing windows, it's a good idea to dry them on the outside with vertical strokes and on the inside with horizontal strokes. Or just the reverse, as long as the direction differs for each side. Then you can tell at a glance whether any remaining streaks are on the outside or inside and remove them.

Plastic Holder for Shaving Brush Mounted in Medicine Chest

Useful as well as attractive, this shaving-brush holder is mounted on the inside of a medicine chest. It is especially designed for shaving brushes having fairly large plastic handles. The brush fits inside a composition harness ring that is held between the jaws of a strip of transparent plastic bent to an oval shape. The ring should have an inside diameter slightly less than that of the brush handle so that the brush is easy to insert or remove but will not slip through. A sheet-metal clip secures the holder to the medicine chest.

Robert Scott, Saltsburg, Pa.

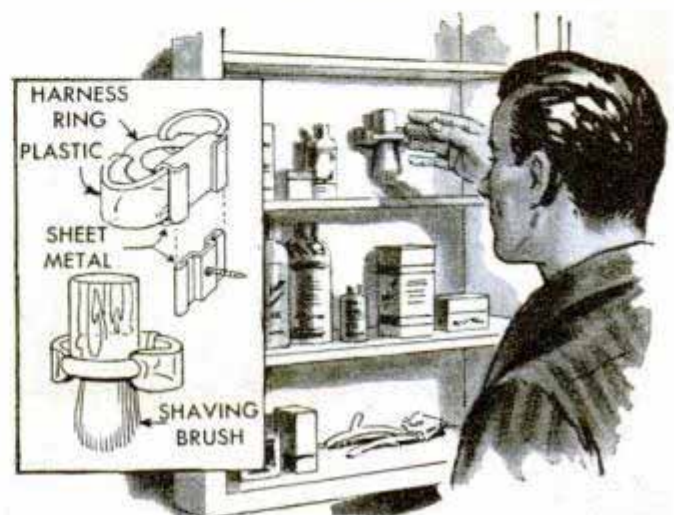

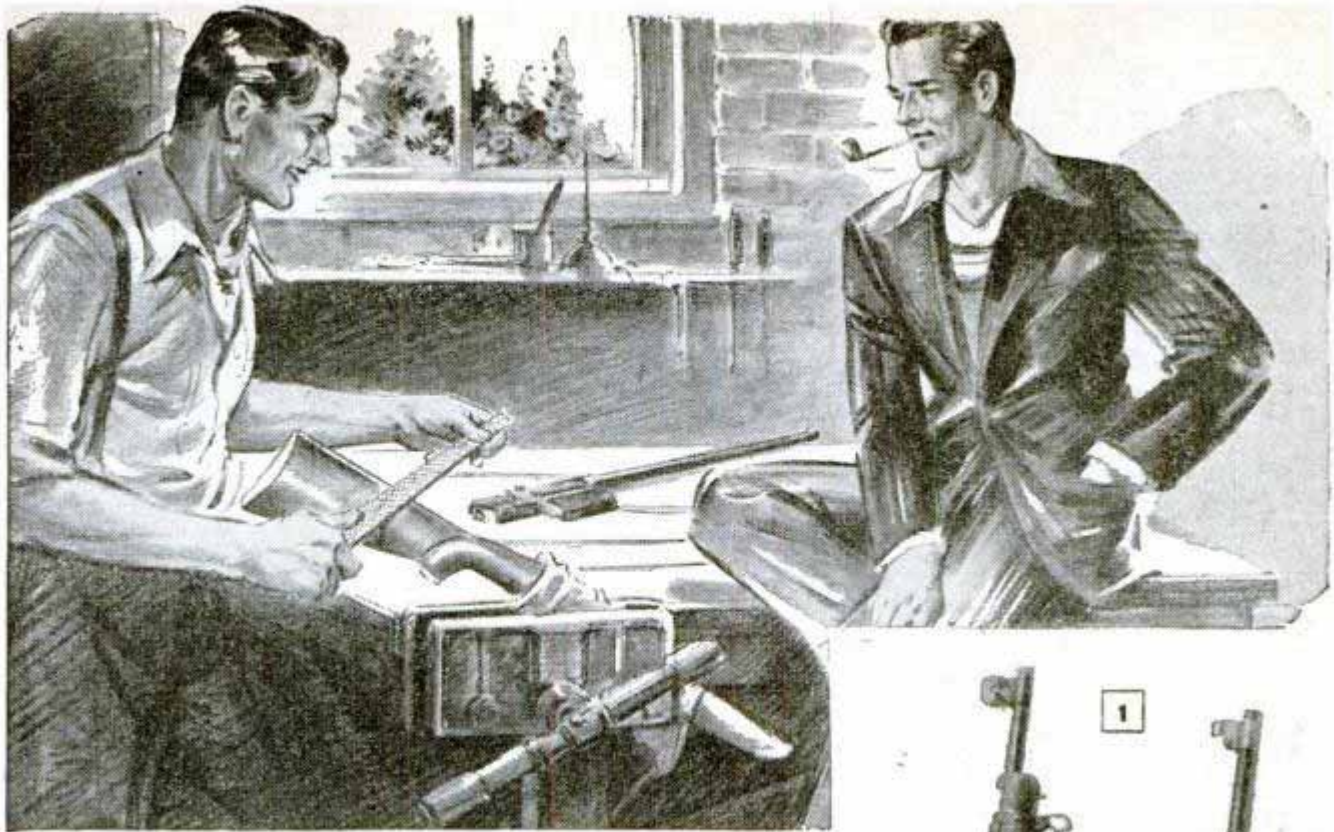

RIFLE CONVERSION

By reshaping the stock and making other minor changes you can make a fine sporting rifle from the Model 1917 Enfield

By Edward R. Lucas

THERE'S A GOOD, high-power sporter just underneath the rough, military exterior of the Enfield rifle. Briefly, all you have to do to convert it to a sporting rifle is remove the barrel cover, cut away a portion of the stock, and take off an eighth of an inch or so of wood here and there. This will provide a neat and serviceable rifle on which can be mounted almost any sighting equipment suitable for big-game hunting.

Before doing any work, there are several points to consider. The pull length or the drop of the original stock can't be altered easily except by the use of leather comb and butt pads, but you can determine the fore-end length quite easily. Some riflemen have a longer reach than others and they grasp the fore end well forward, especially when taking quick, off-hand shots at running game. One should take this point into account before cutting the fore end to length. Ordinarily a fore end one half the length of the barrel, Fig. 2, will be about right. Also, if you want to install a barrel band for a forward sling swivel you should consider the position of the band with relation to the fore-end length. Another thing is the height of the comb at section B-B in Fig. 2. Although the Enfield stock is quite straight the comb height at this point may be a little low for some shooters. You can either build it up by flattening the stock from the grip back to the heel and gluing on matching wood, or shape it as indicated and then raise the comb to desired height

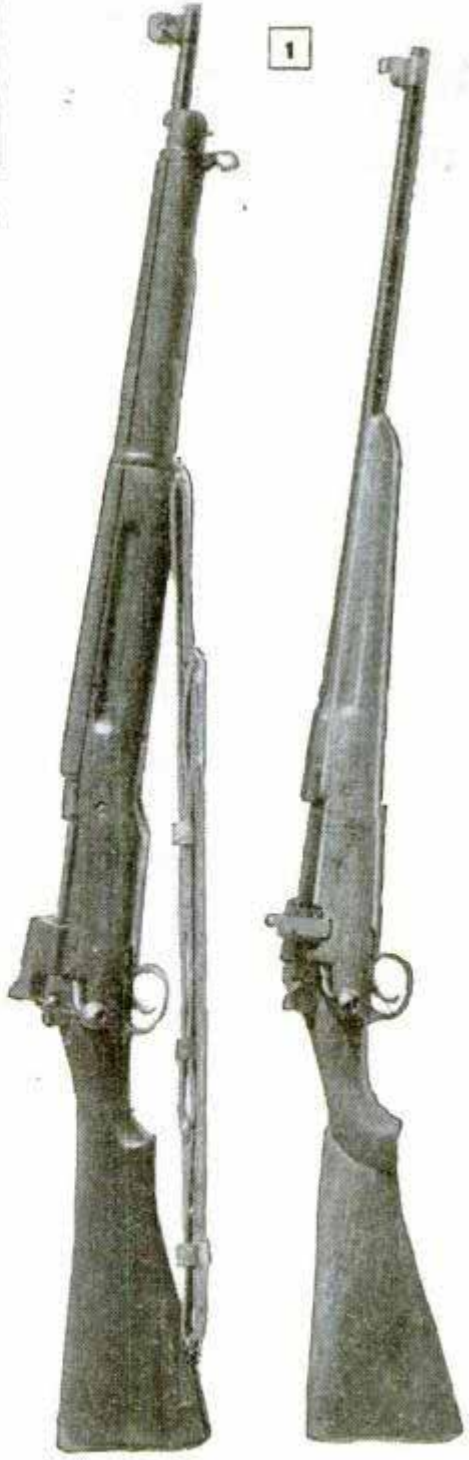

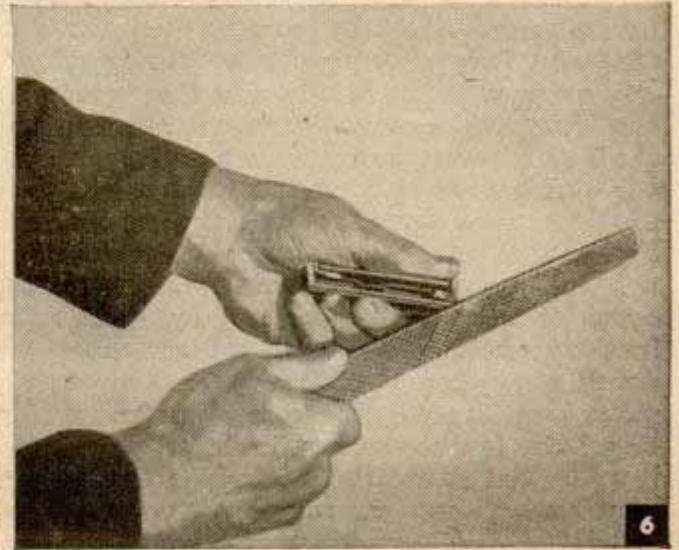
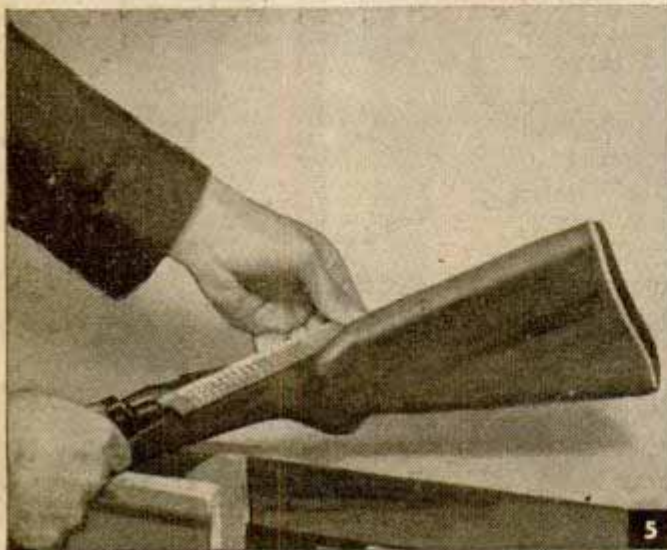
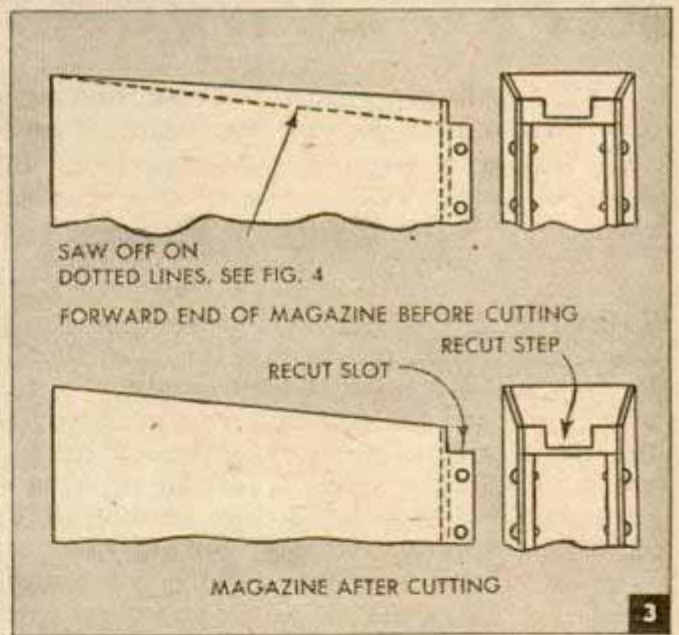
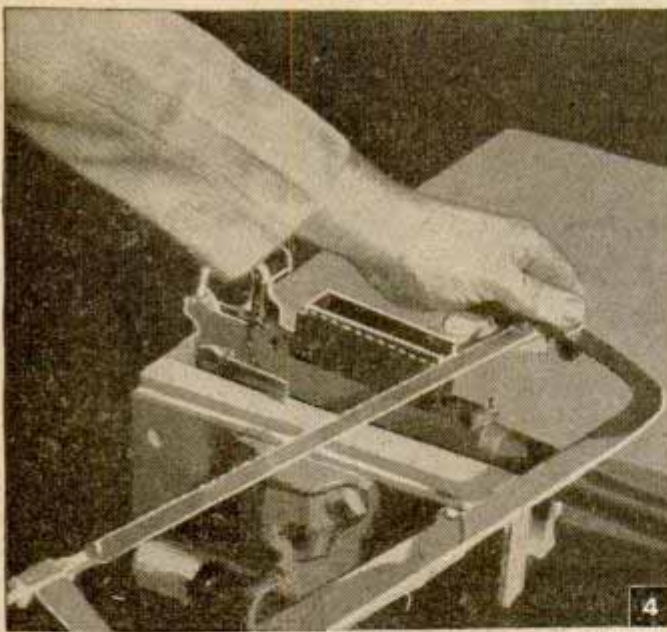
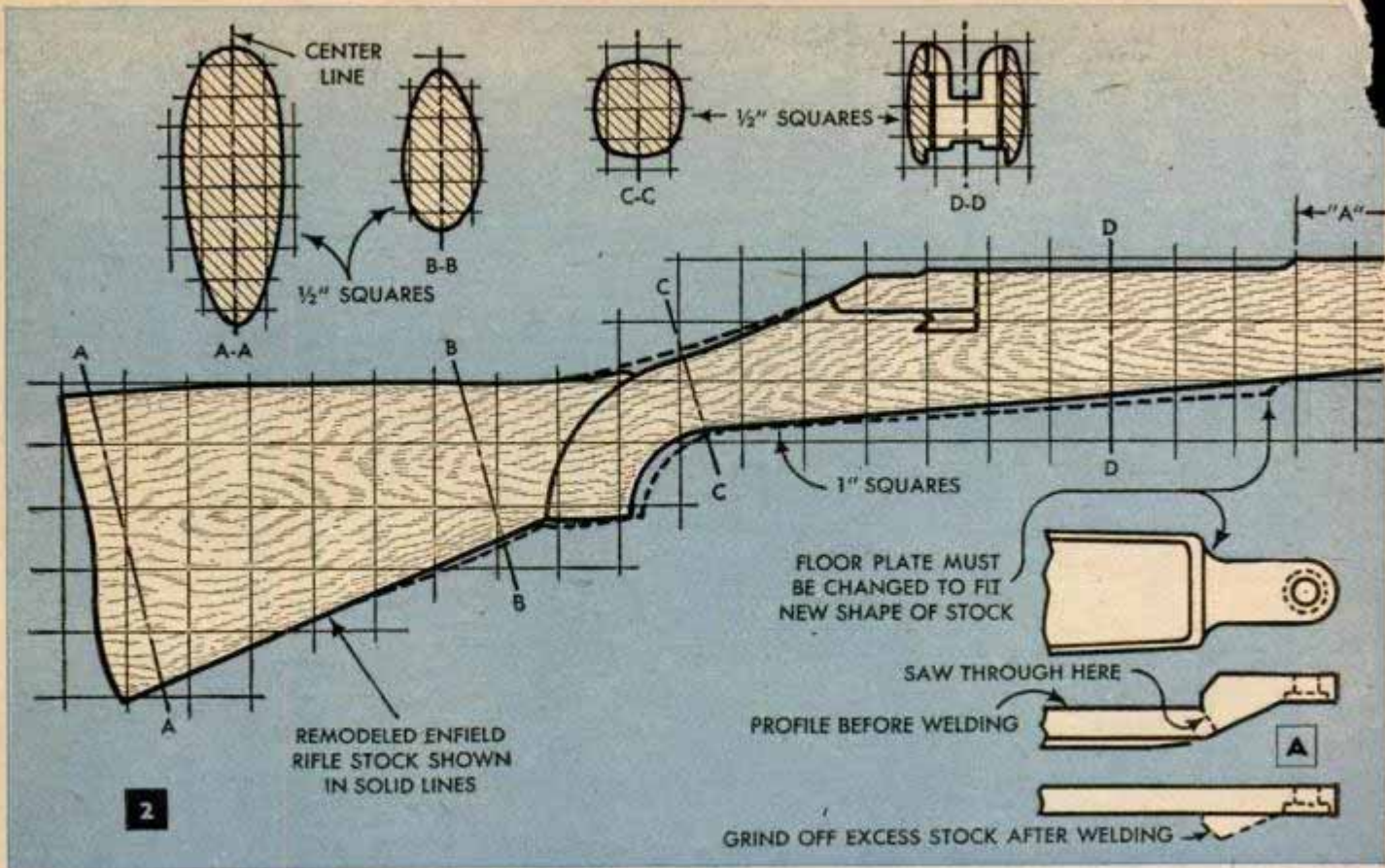

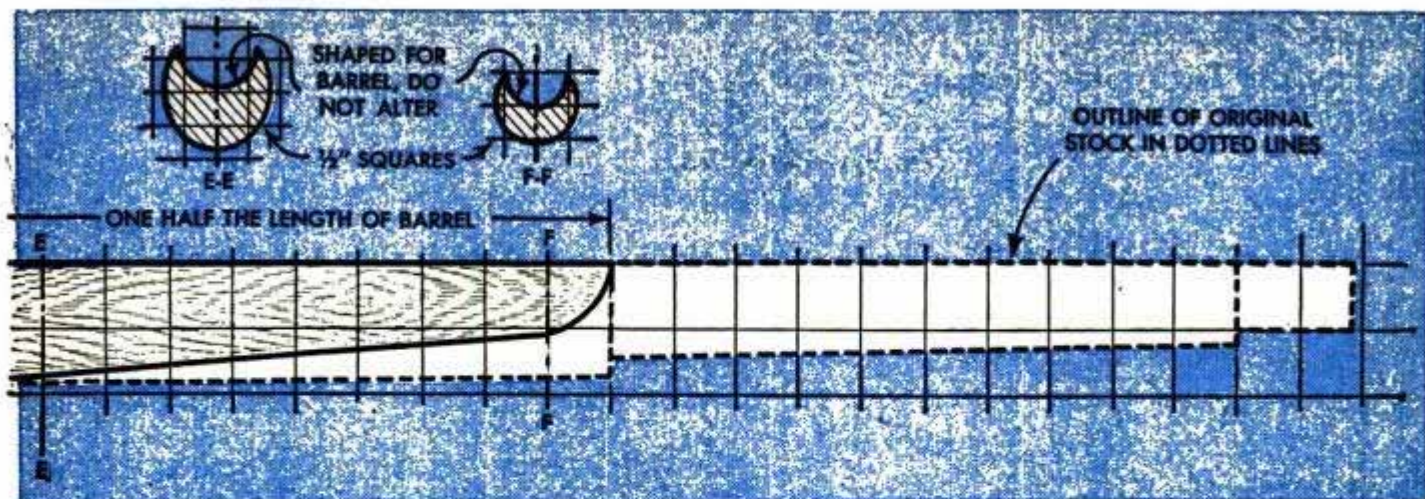

with a cheek pad of the lace-on type. Of course, using the former method would make it necessary to fit a new butt plate of the type used on sporting rifles.

First disassemble the rifle, removing stock, barrel cover and sights. Then make a full-size template of the stock profile, following the solid lines in Fig. 2. Also make templates of one half of the sections A-A, B-B, C-C and D-D. Saw off the fore end square at the point determined. At some points where considerable wood is to be removed a sharp spokeshave can be used. This is faster than a wood rasp. Check frequently with the sectional templates to be sure that you do not cut below the curves. Don't try to finish to exact dimensions with a spokeshave. Come down only part way to remove most of the excess wood, then finish up with a fine rasp and sandpaper. You can't remove all of the finger groove on each side of the fore end without getting the wood too thin at the breech ring. There will be a little of the finger groove left as shown in the right-hand view of Fig. 1. Notice in Fig. 2 that the underside of the grip and the top of the tang are cut down considerably from the original profile. Here care is required because you are working directly across the grain and at an angle with it in a comparatively small area. A

strip of fine-grit abrasive cloth 1 in. wide is ideal for finishing the rounded surfaces.

The magazine floor plate is altered as in Fig. 2, details A, so that it will fit flush with the new profile of the stock. A gunsmith or expert welder can do this job. Before sawing, transfer the location of the two holes to a piece of flat steel. Later, after sawing, this will serve as a welding jig. Both parts can be bolted to it. The floor plate must be reblued. Next, the magazine is altered as in Figs. 3 and 4. The final alteration is chamfering the step at the rear end of the magazine follower so that the bolt can be closed easily when the magazine is empty. Do this with a file as in Fig. 6.

Leaving the barrel its original length generally is recommended, but some riflemen prefer a shorter barrel for hunting. Some cut it back to 22 in. It's recommended that this be done by a gunsmith but you can cut the barrel with a hacksaw and then countersink and crown the muzzle as in Figs. 7 and 8. Use the greatest care not to damage the rifling in this operation. Before you use the rifle have a competent gunsmith check the head spacing. This is important, not only as an aid to accuracy, but is a safety precaution as well. A rifle with excessive head space may be dangerous to fire with standard ammunition.



Oversize Copper Fittings Soldered To Smaller Diameter Tubing



Once in a while, when soldering copper fittings to pipe or tubing, the right sizes aren't at hand. However, if it's the former that is too large, the tube can be made to fit by wrapping it with copper wire and soldering in place. As an example, to fit a 1/2-in. pipe into a 3/4-in. ell, first tin the end of the pipe and solder one end of the wire to it at point No. 1. Then wind the wire around the pipe until it will fit snugly into the fitting. Tuck the loose end of the wire, No 3, under one of the coils, No. 2. Finally, heat and solder as you would if both tube and fitting were of the same size. The wire will keep the solder from flowing out of the joint.

John A. Lerch, Cleveland, Ohio.

Shop "Pincushion" for Light Tools

For those craftsmen who are particular about the care of small tools, the "pincushion" shown here can be made in short order and is an ideal holder for files, punches, scribers, drills and other items

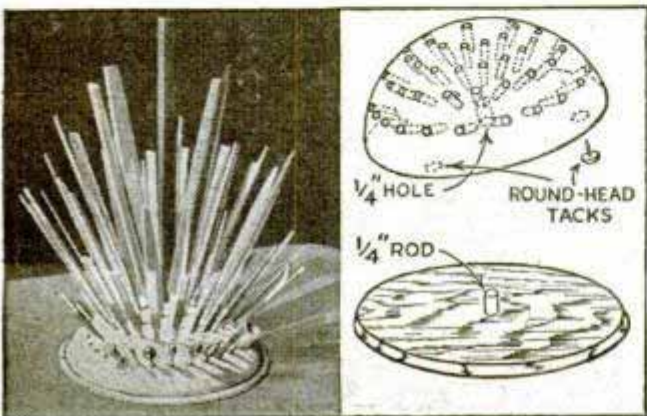

that often are scrambled together in a drawer. A wood block about 4 to 6 in. high is turned to a semicircular shape about 10 in. in diameter. Then mark concentric circles 1 in. apart and drill 1/8-in. holes 2 in. deep at 1-in. intervals along the circumference of each circle. These holes are the holders and can be enlarged as needed. Drill the holes at an angle so the tools will "fan" out. Fasten the holder to its base with a length of 1/4-in. rod and nail round-headed tacks to the latter to serve as coasters.—John Mracek, Oak Park, Ill.

Glue Brush Made of Sash Cord

Here's a useful glue brush that you don't have to clean after use. Instead, just cut off the used end and form a new end. It's made from a 6-in. length of 1/4-in. tubing and a short piece of sash cord.

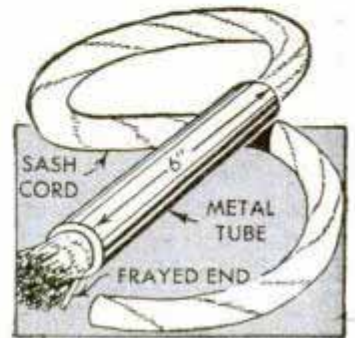

The cord is inserted in the tube with one end projecting slightly. This end is frayed, and when dipped into the glue, it acts as a brush. Whenever a new one is desired, pull the frayed end out a little, cut it off and fray the new end.

Gummed Labels Stored in Fruit Jar

Gummed labels, such as are used to mark canned fruit and preserves, can be stored in sealed glass jars to keep them from sticking together. When the stickers are kept in a drawer or box between canning seasons, moist air will dampen the glue enough to cause the paper to stick. A chemical dehydrating agent, such as lime or silica gel, should be placed in the jar along with the gummed labels.



Boiling Water Loosens Fish Scales

When bluegills, bass or any similar fish are kept out of water for any length of time, the scales set and are hard to remove. This may occur also when fish are shipped or kept on ice. Should this happen, dip the fish quickly in boiling water and the scales can be removed more easily.

R. A. Jenkins, Los Angeles, Calif.

Tops in TOPS

"Handle" tops you can call these for they're spun by holding them with a handle. The top is placed in a wood handle, a strong cord is threaded through the "eye" of the shaft and wound around it like a bobbin. With the top resting on a flat surface and held with the left hand, the cord is given a quick pull, the handle is lifted off and whizz—it's spinning. Making these tops is a lathe job even to the handle, although two other types of handles are given which do not require turning. The tops themselves are finish-turned right on their shafts by first driving 1/4-in. drill rod through an undersize hole in the center of a rough-turned block and then chucking the whole thing in a lathe. Maple or any other hardwood from your scrap box will do. Draw a full-size half pattern of each top and cut a contour template of stiff cardboard to follow in turning. Paint them with bright colors and finish by varnishing.—Michael F. Frieders, Aurora, Ill.

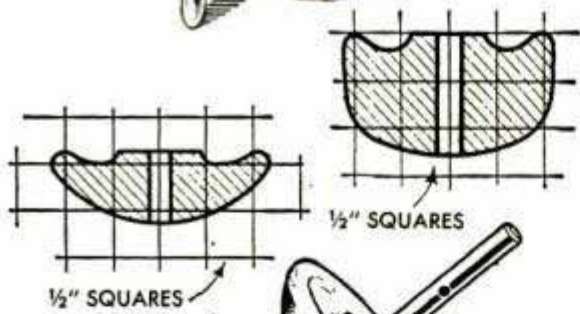
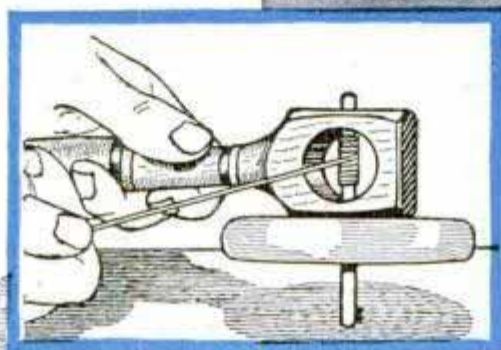
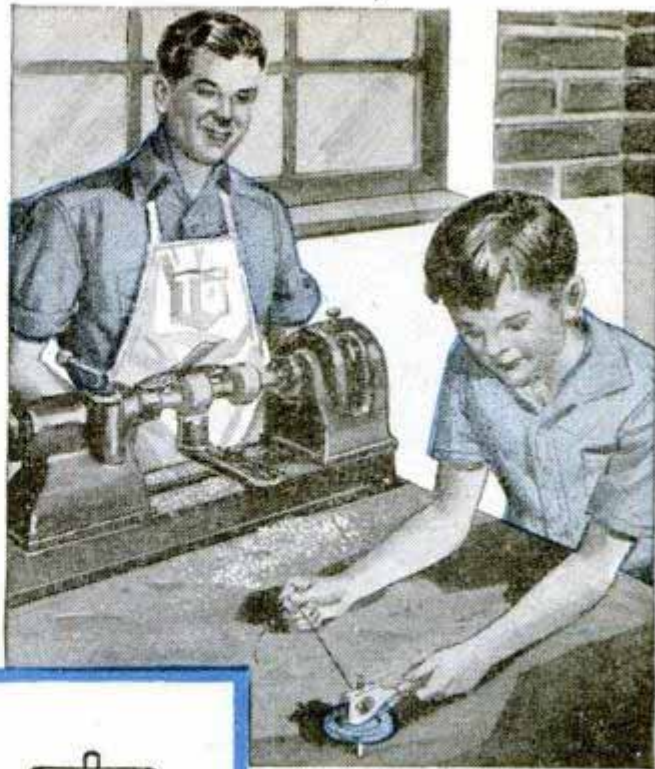

1/2" SQUARES

1/2" SQUARES

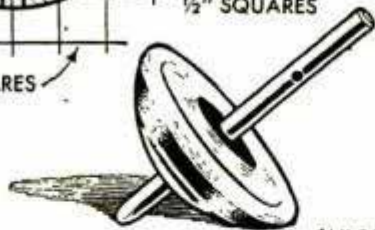

1/2" SQUARES

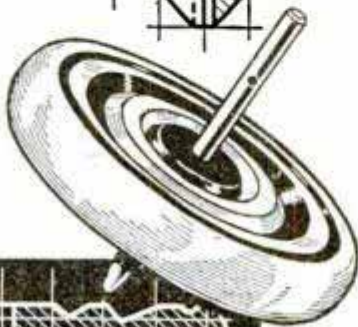
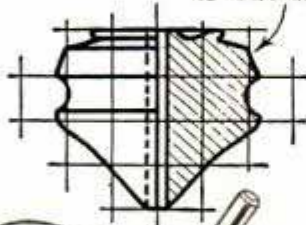

1/2" SQUARES

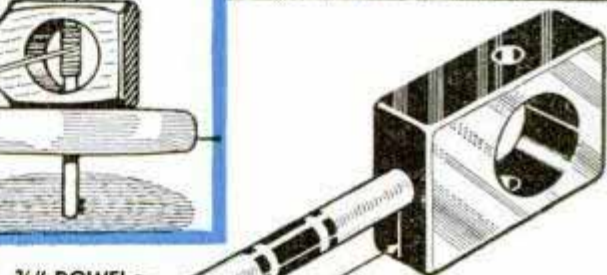

3/8" DOWEL

5"

3/8" HOLE

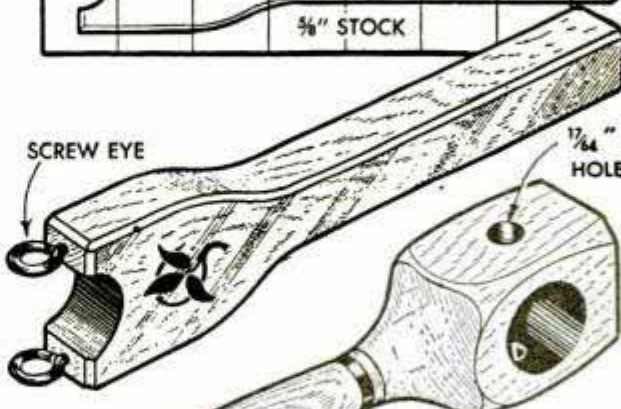
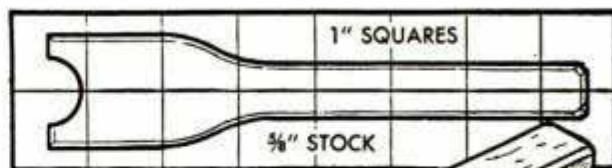
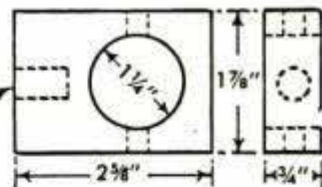

SCREW EYE

17/64" HOLE



1" SQUARES



Above: Bracing elbows against body and holding breath as picture is snapped helps minimize camera movement. Right: For a close-up like this, sharp focusing and accurate framing are a must



It's easy to "scalp" your subjects, especially at close range, if you are careless in aiming the camera. Make sure that you frame all of the subject

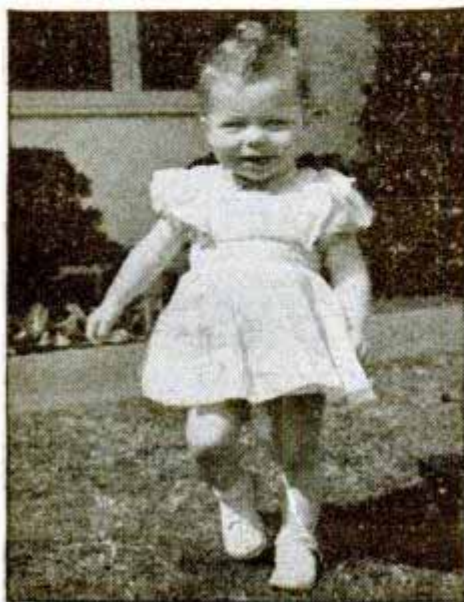

Photos by
Ray Chapin

Five Steps

GETTING OFF to the right start with a new camera is just a matter of remembering five simple, yet important steps—little things that mean the difference between taking a poor picture and a good one.

Step one is to aim the camera accurately. Sharpness and clarity mean little if the subject has been "scalped" by careless sighting. Getting all of the subject within the camera's field is easy if you proportion the subject to fit the film, so to speak. For example, in taking a full-length picture of a person the camera should be held so that the long way of the film is up and down, or vertical. Thus, you'll be able to get closer and the subject will fill the frame without waste area along each side. If you are taking a group picture, where the subject is wider than it is high, then the camera should be held

so that the long way of the film is horizontal. Of course, with reflex-type cameras, which take a square picture, proportioning the subject as to the long and short way is disregarded. The closer you are to the subject the more exacting you must be in aiming. Make it a practice to always check the top, sides and bottom of the sight picture and see that a margin exists all around the subject. Many small cameras are equipped with view finders which are sighted by holding them close to the eye as you would in sight-

Here's the result of "freezing" action with a slow shutter speed





Reflex-type cameras (above) employ a ground glass for focusing, while cameras with coupled range finders are focused by super-imposing split image

to Better Outdoor Photos

ing through a telescope or a gun sight.

Step two to consider is focusing. Here, a camera works similar to field glasses, the lens must be adjusted back and forth to bring the subject within sharp focus. As with sighting, focusing becomes more critical as you approach nearer to the subject. At a distance of 16 ft. you can be off in focusing as much as 6 in. without it being perceptible in the sharpness of the picture. On the other hand, a 6-in. discrepancy at a distance of 4 ft. will result in a very blurred image. Cameras with coupled range finders and ground-glass viewers take the guesswork out

of focusing. Without these a tape measure should be used to determine the lens-to-subject distance. Keep your position once the camera is in focus, as a step forward or backward, especially at close range, will change the distance and throw the subject out of focus. To take a picture of a fast-moving train, auto, etc., select a spot where the subject is to be "stopped," focus on this point and then shoot when the action reaches that particular spot. It's wise to avoid such shots directly broadside.

Step three is getting the right exposure. When the aperture (shutter opening) is small, a camera

By R. W. Emery

Increasing the shutter speed to 1/100th still isn't fast enough

At 1/200th and a larger aperture opening the blur is disappearing

While better, even 1/400th has failed to "stop" action completely





"sees" sharply for a greater distance in front of and behind the point of focus than it does when the opening is large. Thus by stopping down the opening you increase the depth of focus and overcome, to a certain degree, loss of detail through error in focusing. However, in reducing the size of the aperture it must be remembered that the amount of light that can enter the shutter is being reduced, also. This means that the picture must be taken at a slower shutter speed to compensate for this. Other factors that enter in determining shutter speed are the degree of action to be stopped and the speed rating of the film used.

Shutter speed and aperture are determined most easily with a photo-electric exposure meter, although any of the printed exposure guides available will give good results. With a fairly fast film, a camera setting of $\frac{1}{100}$ th (shutter speed) at f:16 (aperture) is an average setting for bright sun. Where the action dictates use of a faster speed, say $\frac{1}{200}$ th, then the aperture is opened to about f:8 to make up for the loss of light at the greater speed. For future reference it's a good practice to keep a record of each shot as to shutter speed, aperture, film speed, lighting and subject, whether it is light, medium or dark.

←
Best way to stop camera movement is to support camera on a tripod



Bright sunshine adds good contrast and sparkle to pictures of children. If care is used to get the exposure correct, you will capture detail in the shadows. Avoid having subject face directly into the bright sun
←

Best time to take pictures is in the forenoon or afternoon. Strong sunshine at midday casts shadows under eyes and nose
←



→
This shot was made in strong sunlight with the subject backlit. This is done by shooting into the sun but not directly. Use a small aperture to obtain detail in the shadows



Step four calls for lighting the subject. A good rule to follow here is to shoot with the sun at your back. With an early or late sun watch to see that your own shadow does not fall into the foreground of the picture. In photographing a person or a group of people do not have them face directly into the sun. Forenoon and afternoon are the best periods during the day to "shoot" people. Noonday sun is objectionable in that it casts long shadows under eyes and nose. A bright but overcast day eliminates the shadow

problem and is considered the best type of lighting for average shooting.

Step five—hold the camera steady. All of the other steps are wasted if you allow the camera to move at the time the picture is snapped. A tripod is the best means for supporting a camera, but if this is not always feasible, you should adopt the practice of bracing the elbows against the body and holding your breath momentarily as the picture is taken. A chair, table or whatever might be handy for support can be used. If it's a car door, be sure that the engine is not running; vibration will spoil the shot, too. In operating the shutter either by a cable release or by the tripper itself, learn to "squeeze off" the shots. A lot of camera movement is caused by snapping the picture jerkily. It should be remembered, too, the slower the shutter speed, the more chance there is for camera movement when held by hand.

Finger Pads Keep Prints Clean



Frequently a great deal of time and effort is spent on an enlargement, only to find that when the darkroom light is turned on there are finger marks that ruin the print. Usually this is caused by handling the paper with fingers that are damp with perspiration or chemicals. To prevent this, wear

rubber finger pads when handling dry paper. Not only will this prevent marking the paper, but it also will assure a firmer grip when the sheet is pushed against the margin stops on the easel.

Extension Cord Wound on Reel



If you have some empty 8 or 16-mm. film spools on hand, they can be used as reels on which to wind extension cords. They will fit nicely into your camera case and when

setting up lights, it won't be necessary to waste time untangling the cords.

H. Klein, Pittsburgh, Pa.

Metal Clip Holds Cable Release To Take Time Exposures



The shutters on many cameras are equipped with only a bulb setting to make time exposures, and in many cases, while the cable release is being held, the camera is jarred and a poor negative results. The metal clip shown in the upper right-hand detail is designed to hold the plunger down and the shutter open for time exposures. A notch is filed in one end to slip over the base of the plunger. To use, press the plunger down and slip the clip in place. After the correct exposure has been made, remove the clip.—Bob Hurst, Chicago.

Dual Rack for Photoflood Lamps

Often the crossarm provided with photoflood-reflector stands is too small to allow the clamp to grip without slipping. However, this condition can be prevented by substituting a wide, flat piece of wood for the metal crossarm. The wood should be as long as the original bar and just a little wider than the narrow dimension of the clamp.—R. F. Donovan, Jersey City, N. J.

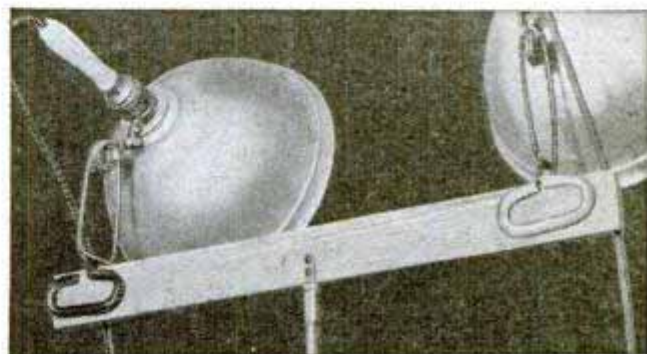

SYNCHRONIZED

Shows how you can synchronize the shutter of any box camera to fire a homemade flash gun. Conversion is simple and does not affect regular use of camera for ordinary outdoor shots

By M. C. Anderson



SHOOTING flash pictures with a box camera is something hard to believe and yet it can be done with remarkable results as shown in Fig. 1. Furthermore, the conversion involves only a minor shutter alteration which anyone can do, and the flash gun is assembled for practically nothing, from a couple of discarded flashlights and a small aluminum pie plate.

To convert the camera, first remove the front cover from the shutter mechanism. Most box cameras have a time-exposure setting, Fig. 5, consisting of a metal slide which, when pulled out, serves as a stop to hold the shutter open. However, if the camera is not equipped for time shots, a suitable slide can be installed easily as shown in Fig. 3. Make it L-shape and slot it to slide back and forth on two small nails. Where the time slide is already built-in, it must be insulated from the rest of the mechanism with a piece of adhesive tape, applied to the slide between it and the shutter plate. This will necessitate removing the plate to get at it.

The slide serves as one pole of the synchronous switch and is wired to one of two phone jacks which are installed in the side of the front cover as shown in Fig. 2. The other phone jack is wired to the shutter plate. Thus when the slide is set for "time" and the shutter is tripped, the little tip on the shutter leaf makes contact with the slide and completes the circuit, causing the bulb to flash. After the bulb is fired, a second movement of the shutter lever is required to close the shutter. In this respect it should be noted that when the camera is not supported by a tripod the subject should be in subdued light so that the interval between the flash and the second tripping of the shutter will not allow movement to be recorded on the film. With the time slide pushed all the way in, the shutter is restored to normal operation.

While you can sight by the regular view finder on the camera, an eye-level one will be found more convenient, especially in framing the subject in poor light. Such a finder can be formed of wire to fold flat in the manner shown in Fig. 6. Both front and rear parts of this can be aligned fairly



Sample shot shows what can be done with box camera using supplementary portrait lens to get close-up

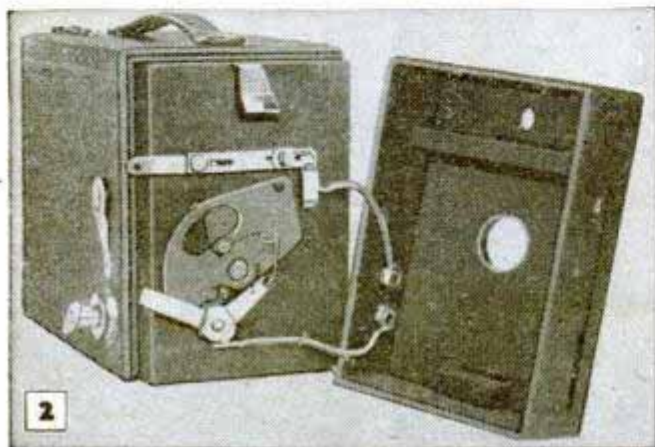

FLASH for your BOX CAMERA

accurately by placing the camera on a firm support, sighting an object through the regular built-in finder and then adjusting the wire finders to coincide. A portrait-lens attachment for taking close-ups can be provided, too, by cementing a ring cut from a cardboard pillbox over the shutter opening. You may have to experiment some with the lens in determining the minimum and maximum lens-to-subject distance. This can be done with the portrait lens in place, the camera set for "time," the back of the camera removed and then focusing on a ground glass of tissue paper. The point where the image is sharp on the paper is where you set the camera for distance.

The flash gun is improvised from the metal case of a flashlight. The side switch is removed and the lens is replaced with a reflector from a second flashlight as in Fig. 6. The socket part of this is cut off and an auto-headlight socket of the bayonet type is soldered in its place to take the so-called "peanut" flash bulbs. Next, a flashlight bulb is taken apart, a burned-out one will do, and the tiny wire attached to the brass shell is removed. Then a length of wire is

soldered to the center contact and the base of the bulb is filled with cellulose cement. The base in turn is screwed into the flashlight reflector and the attached wire is run inside the case and out through a hole just above the screw cap. A second wire is soldered to the center contact of the bayonet socket, after which both wires are fitted with phone-plug tips. An extension cord with phone jacks at one end and plugs at the other should be provided for times when the flash gun is used remotely from the camera, as when taking close-ups.

The bracket which supports the flash gun on the side of the camera is designed to allow the gun to be removed quickly by simply pressing downward. A metal arm is screwed to the bottom of the camera and pins in the end of the arm engage holes in the screw cap of the battery case. Two other L-shape brackets, one screwed to the camera and the other soldered to the gun slightly below, engage each other as shown in Fig. 6. Finally, the lens cap is screwed down against the inverted reflector, and the pie-plate reflector is added. This can be soldered permanently to the gun.

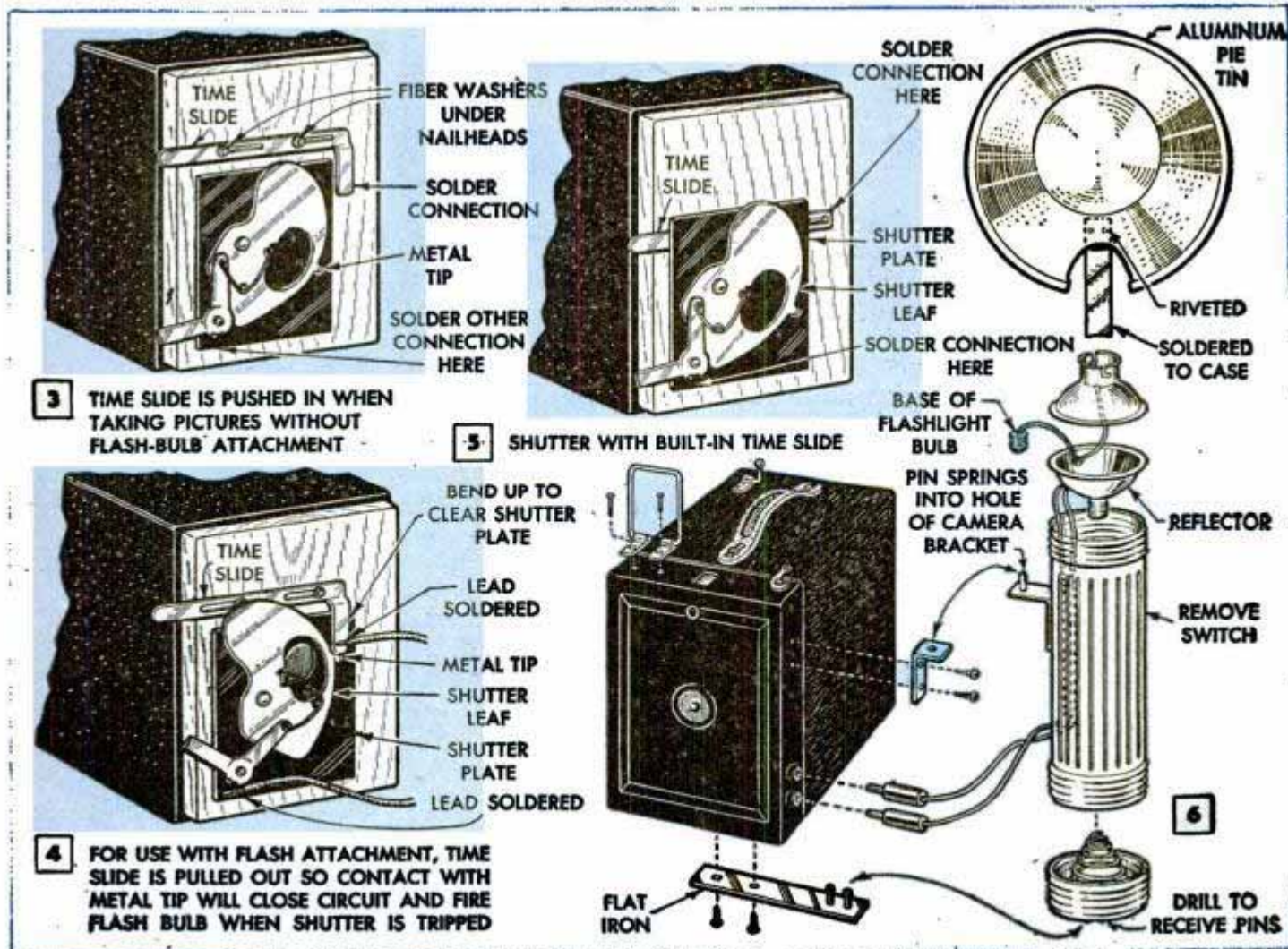

Toothbrush Applies Compound To Pipe Threads



Compound will be spread uniformly over pipe threads if a discarded toothbrush is used. Another toothbrush can be used to clean the threads after they have been cut but before the compound is applied. A thread that is not clean will result in a poor joint.

Clarence Klumb, Rockfield, Wis.

Simulated Hull of Wrecked Ship Decorates Fish Bowl

An unusual bit of decoration for a fish bowl, the model of the hull of a wrecked ship, will add a novel touch. Either copper metal or redwood is satisfactory material, but if the latter is used, it must be weighted to keep it from floating. Ends of the ribs and keel should be cut to look like broken



timbers. If the model is placed in a spherical-shaped bowl, it can be fairly small because of the magnifying effect of the curved surface of the glass.

Charles H. Hardy, Los Angeles, Calif.

Catches Hold Stepladder Folded

Neat and practical clamps for holding legs of a stepladder so it may be carried are made from the catches of a discarded trunk or suitcase. Unlike hooks, the catches will not tear clothing and they are easily fastened and unfastened.

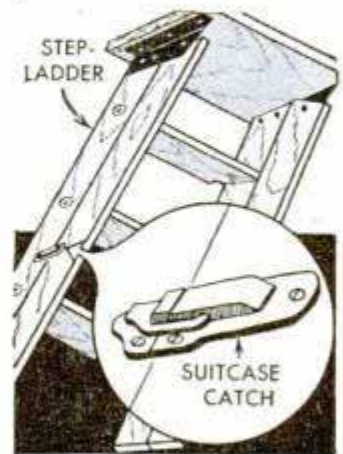

Guard on Electric-Light Switch Prevents Accidental Use

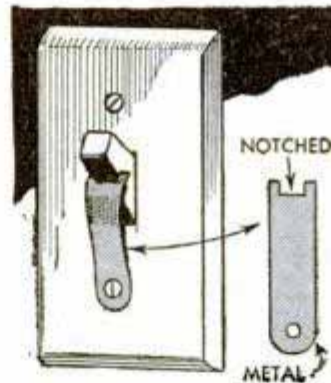

To prevent turning on an electric-light switch accidentally, and also to keep children from playing with the switch, use this spring-metal guard. A short length of flat spring is notched at one end and the other end is

rounded and punched. Then it is bent so that when bolted to the switch plate the notch will engage the toggle but still lift over it easily.—Dr. B. Matzen, Napa, Calif.

Vise Handle Kept From Slipping

You won't pinch your fingers in the handle of a vise if spring tension is applied in such a manner that the handle will not slip. First drill a hole in the handle at right angles to the ball and tap it for a $\frac{3}{8}$ -in. screw. The latter has a coil and washer soldered to the end so that when the screw is in the ball of the vise, the spring exerts sufficient pressure on the handle to keep it from slipping.



What's WRONG?

CIRCULAR-SAW OPERATIONS



1 CUTTING A MITER

- Miter gauge in wrong slot
- Saw too high
- Table tilted wrong way



2 CUTTING DUPLICATE PARTS

- Poor hand position
- Method is not accurate
- Fence used as stop



3 SAWING A RABBET

- Wrong kind of saw
- Piece cut out is trapped
- Splitter should be used



4 STANDARD RIPPING

- Work is too thin
- Wrong hand used for feed
- Blade is too high



5 RIPPING A THICK BOARD

- Splitter should not be used
- Hold-in in wrong position
- Push stick is too short



6 FREEHANDING A TENON

- Cheek cuts made last
- Saw is too high
- Poor hand position



7 DADO SETUP FOR 1/4 INCH

- Wrong kind of saw
- Saws not placed right
- Wrong combination



8 RABBETING WITH DADO HEAD

- Wrong kind of fence
- Work is not supported
- Hold-in should be used



9 CUTTING A BLIND GROOVE

- No splitter
- No stop
- Poor hand position

Answers:

1—Miter gauge in wrong slot—it will strike saw in this position. 2—Fence used as stop will cause work to bind—right way requires clearance.

3—Piece cut out is trapped and may be kicked back like an arrow—better way is to cut rabbet on outer edge. 4—Wrong hand. 5—Hold-in in wrong position—too far forward. 6—Cheek cuts made last—this reduces even more the scant area of contact. 7—Saws not placed right—teeth should point to same side to allow set clearance.

8—Work not supported over table. 9—No stop slot. 9—work will be kicked back. 10—Cut is too deep.



10 RESAWING (1ST CUT)

- Cut is too deep
- Hold-down poorly placed
- Wrong kind of saw

Slotted Bench Stops Hold Handsaw In Filing Position

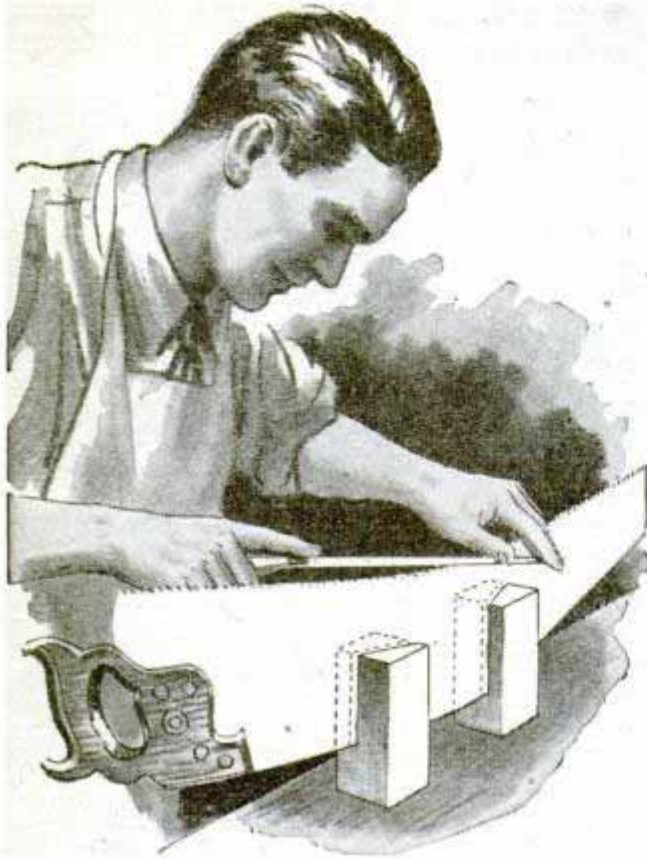

For those who do not have a saw vise, a handy substitute can be made from a pair of bench stops. Slot each stop at an angle and insert the saw by bowing it slightly. This "pinching" action will hold the blade in place, yet its position can be changed easily by bending and sliding it.

Safety Hook for Overhead Outlets

Cut from heavy cardboard, this safety hook will hold two cords together where an extension and overhead outlet are being used. If the outlet is used mainly for extension cords and not for lights, the hook can be left in place permanently so that it will always be there when needed. If you have a piece of fiber or insulating board on hand, it will serve better than cardboard because it is more durable.

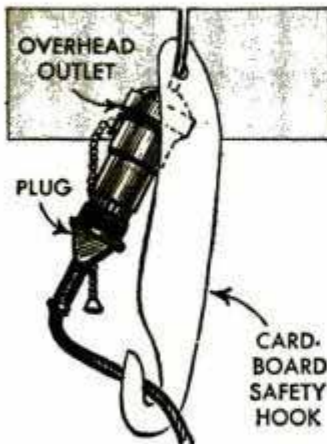

Fixing Loose Furniture Casters

When the casters in furniture work loose, they can be made to fit tightly again by filling the caster hole and reboring it. Select a dowel or whittle a plug that is a

tight fit in the worn hole. Coat the plug well with glue and drive it home, then saw it off flush with the bottom of the leg. When reboring the hole, use a bit of slightly less diameter than the caster pin. The latter is coated with soap before it is driven into place.—Francis W. Henry, Pottsville, Pa.

Plaster Cast of Infant's Hand

Cast in plaster, an impression of a baby's hand or foot will be a pleasant keepsake for years to come. Use ordinary modeling clay that has been warmed until it is soft. Then place an embroidery hoop around it to form the side of the mold. Make an impression of the infant's hand or foot and pour a mixture of plaster of paris into the mold. After the plaster has set, remove the hoop and lift the disk from the clay. The plaque should be painted in decorative colors.

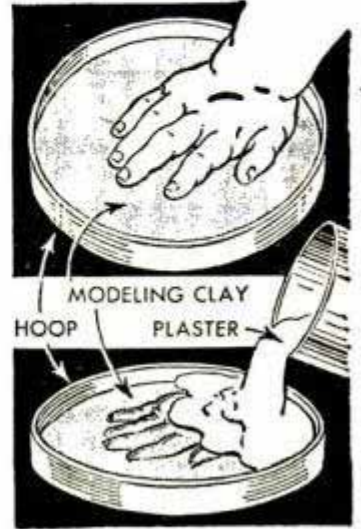

G. E. Hendrickson, Argyle, Wis.

Padlock Fastened to Clutch Pedal Prevents Theft of Auto

If a hole is drilled in the arm of a clutch pedal as indicated and a padlock is fastened through it so the clutch cannot be depressed, it will not be easy to drive the car away. It's a good idea to leave the car in reverse gear also, should anyone succeed in starting the motor or attempt to tow it away.

Herbert E. Fey, New Braunfels, Tex.

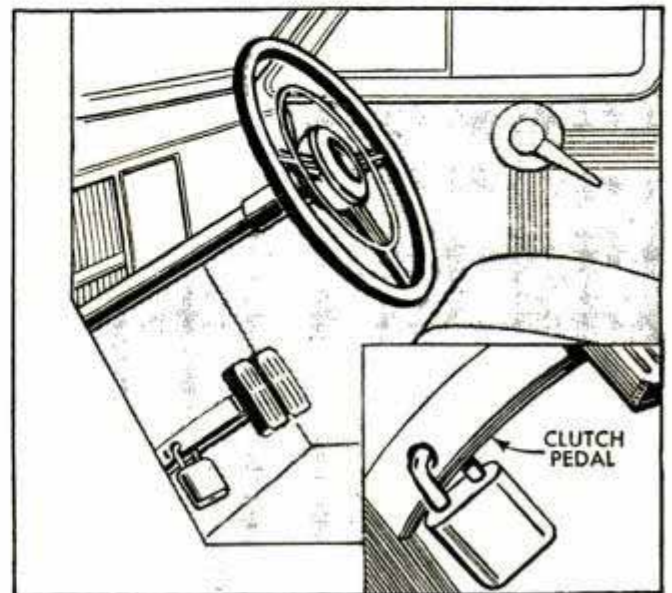

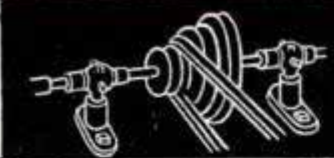

Shop Notes



POWER "SCOOP"

By A. E. Holden

An old grain binder contributed some of the principal parts used to build this speedy unloader and Charles and Max Stevens, Indiana farmers who built the original for their own use, say that it will unload ear corn faster than a two-row picker can gather it from the field. That's counting in the time traveling from the field to the crib, too. Of course, most farmers will want to

equip at least two farm trailers as two or more usually are necessary when handling corn, chopped hay or ensilage from machines working in distant fields.

One look at Figs. 1, 2 and 5 and you will have in mind the general idea of how the unloader works. When in position for loading, the follower, Fig. 2, acts as the front endgate. After unloading it is pulled to the front of the bed by hand. It must be a fairly loose fit to prevent binding between the sides of the trailer bed when it is pulled to the rear by the windlass mechanism. Usually only intermittent operation of the unloader is necessary when unloading ear

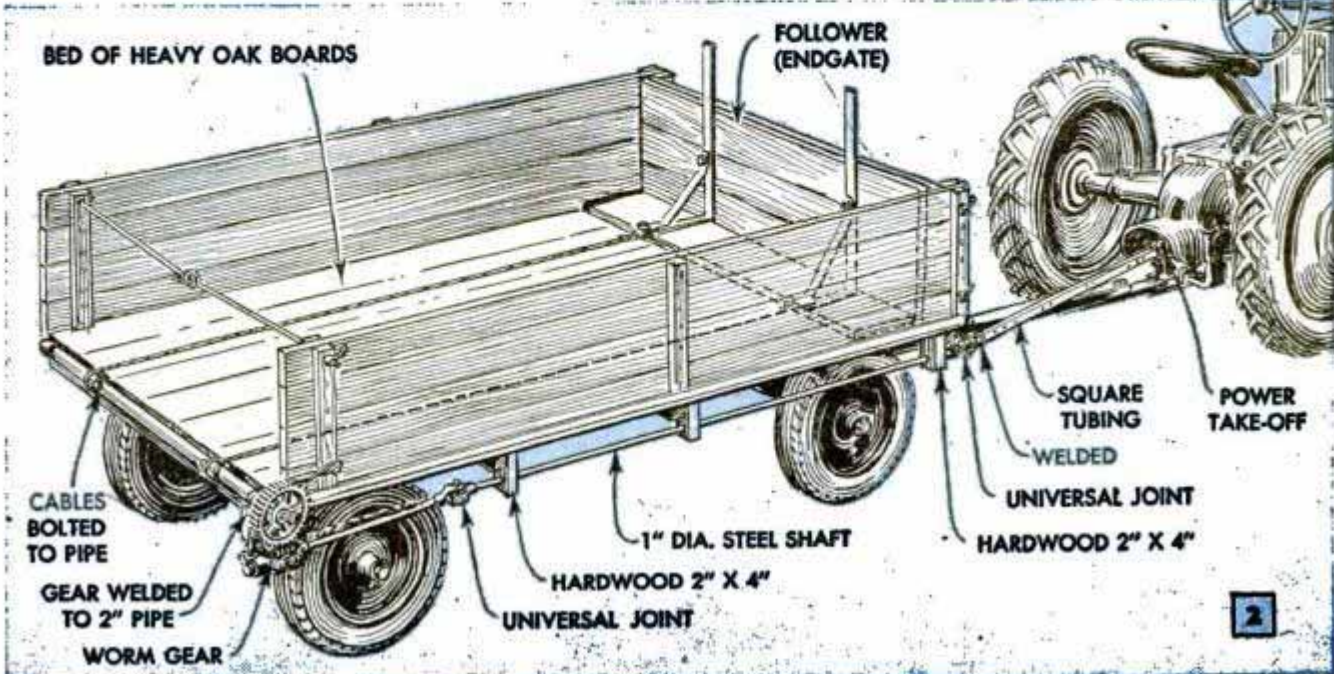

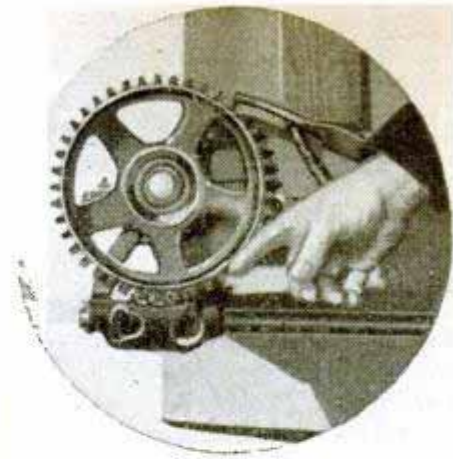
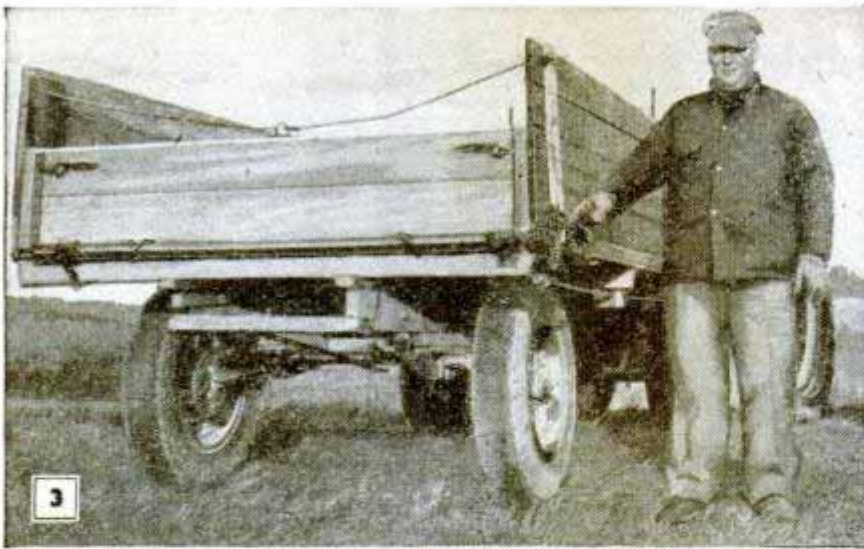

It's not necessary to remove the gear when trailer is used for other work

corn into an elevator, or dumping chopped hay or ensilage into a blower hopper. This requirement is taken care of in the manner shown in Figs. 1 and 5. The worm is driven from the tractor power take-off. One end of a steel bar is inserted in a loop or stirrup made from flat iron, as in Fig. 5. Lifting on the bar, as the operator is doing in Fig. 1, engages the worm with the gear. Dropping the bar slightly disengages the worm and

stops movement of the load. The pawl, Fig. 5, prevents slack in the cables attached to the endgate. As the worm is turning slowly, with the tractor engine throttled to idling speed, it engages and disengages quite smoothly. The load can be moved only a few inches at a time with this arrangement.

The gear and worm are taken from the device provided for raising and lowering the drive wheel of a grain binder. Of

course, any similar gear can be used. For example, the worm gear which drives the apron on some older types of manure spreaders can be adapted to this purpose. Just how the gear is mounted will depend largely on the type used. In any case, the gear is welded to a 2-in. pipe which is mounted in bearings and extends the full width of the bed, Figs. 2 and 3. Steel cables bolted to the pipe and to the front endgate, or follower, finish this part of the assembly. In Fig. 3 the rear endgate is shown in position. The worm is connected to the power take-off through two lengths of round steel shafting, two universals and a length of square tubing, Fig. 4. Hardwood bearings attached to the bed supports carry the long length of drive shaft. Some provision must be made for supporting the worm in the idling position, Fig. 5, and it probably will be necessary to fit washers and shaft collars at one of the bearings to take the end thrust when the worm is engaged with the gear.

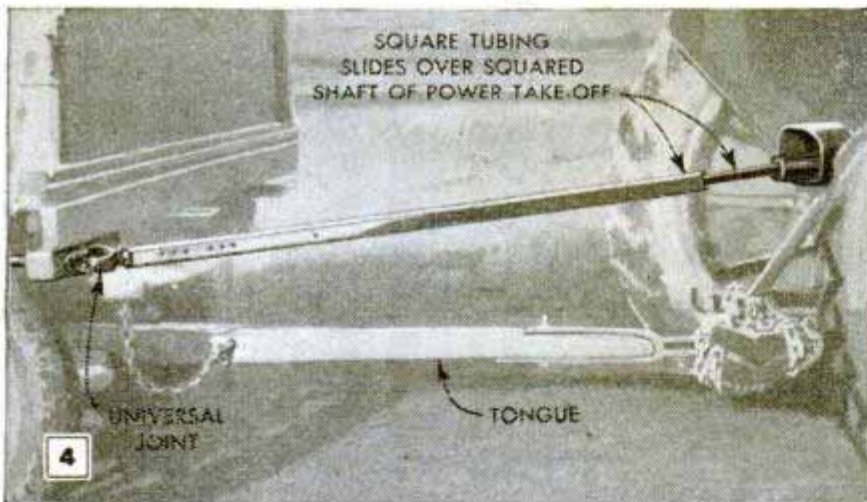

Above, unloader is driven from tractor power take-off through square tubing. Below, slow speed of worm makes it easy to engage it smoothly

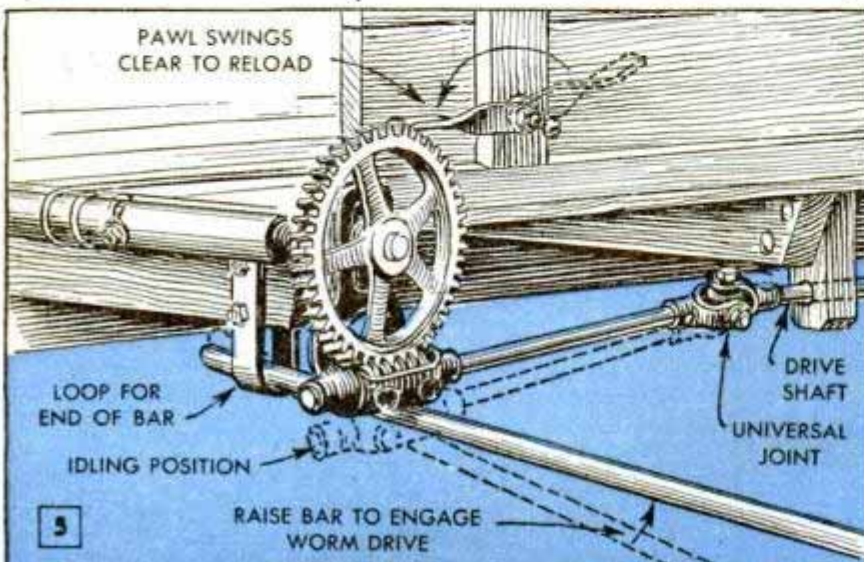

TRACTOR OPERATES MILKING UNITS WHEN ELECTRIC POWER FAILS

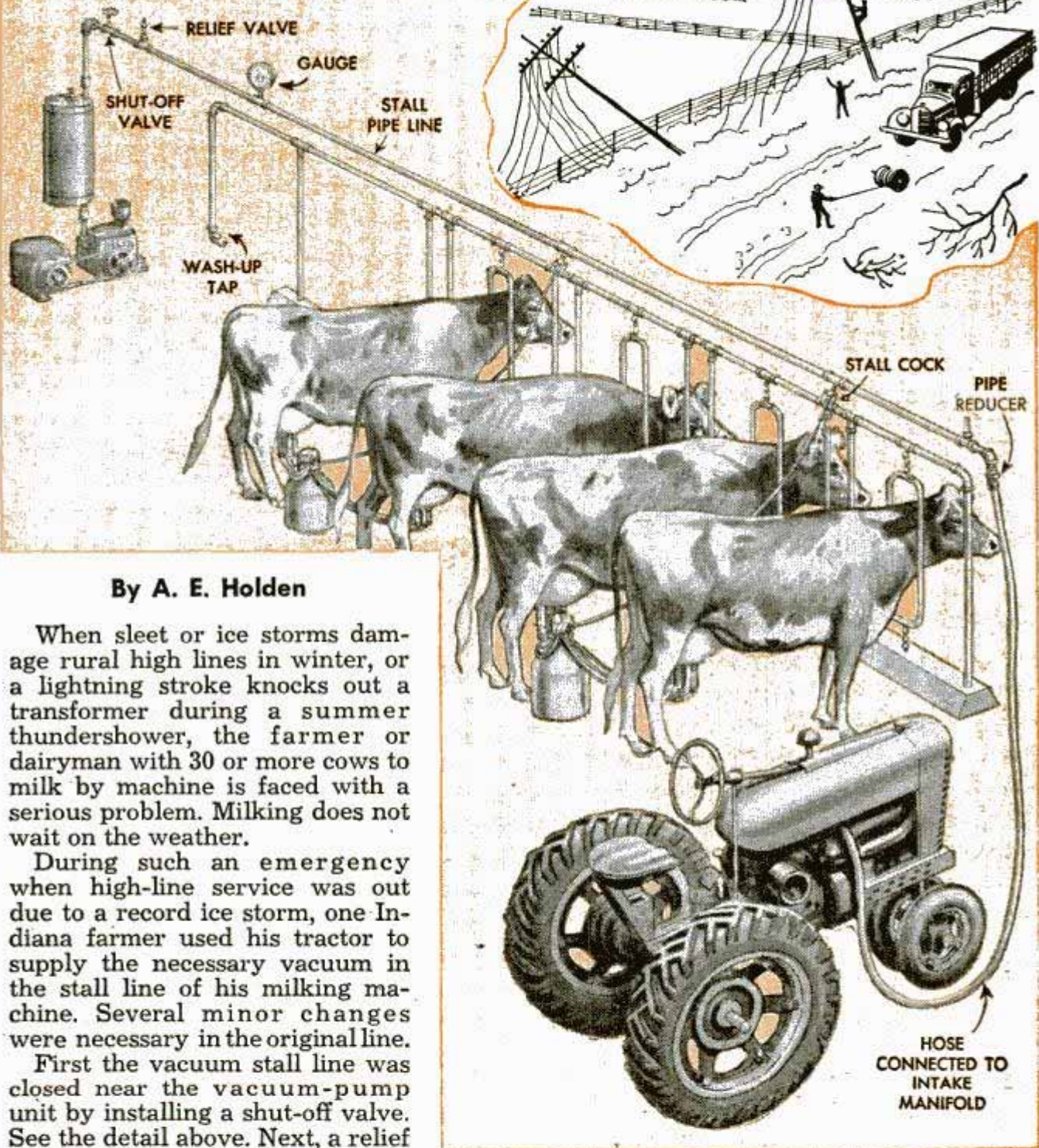

By A. E. Holden

When sleet or ice storms damage rural high lines in winter, or a lightning stroke knocks out a transformer during a summer thundershower, the farmer or dairyman with 30 or more cows to milk by machine is faced with a serious problem. Milking does not wait on the weather.

During such an emergency when high-line service was out due to a record ice storm, one Indiana farmer used his tractor to supply the necessary vacuum in the stall line of his milking machine. Several minor changes were necessary in the original line.

First the vacuum stall line was closed near the vacuum-pump unit by installing a shut-off valve. See the detail above. Next, a relief valve of the ball-cock type was installed in the line to prevent the possibility of building up too high a vacuum at any time during the milking operation. Many tractor, truck and auto engines have an opening into the intake manifold which is tapped and closed with a 1/8-in. pipe plug. This simplifies hooking up the manifold to the vacuum line by the use of standard pipe fittings and a length of heavy hose. That's all there is to it. All connections must, of course, be vacuum tight. Although the family car will do, a large truck or trac-

tor performs best for this purpose because of the greater displacement of the engine. It should be kept in mind, too, that this hookup will work only with those milking units fitted with pulsating-type heads. This method of hooking up a tractor or truck engine to operate the milking units is recommended only as an emergency measure. Make sure that the plug closing the threaded opening in the intake manifold is screwed in tightly when the engine is removed from this emergency service.

TOP PERFORMANCE

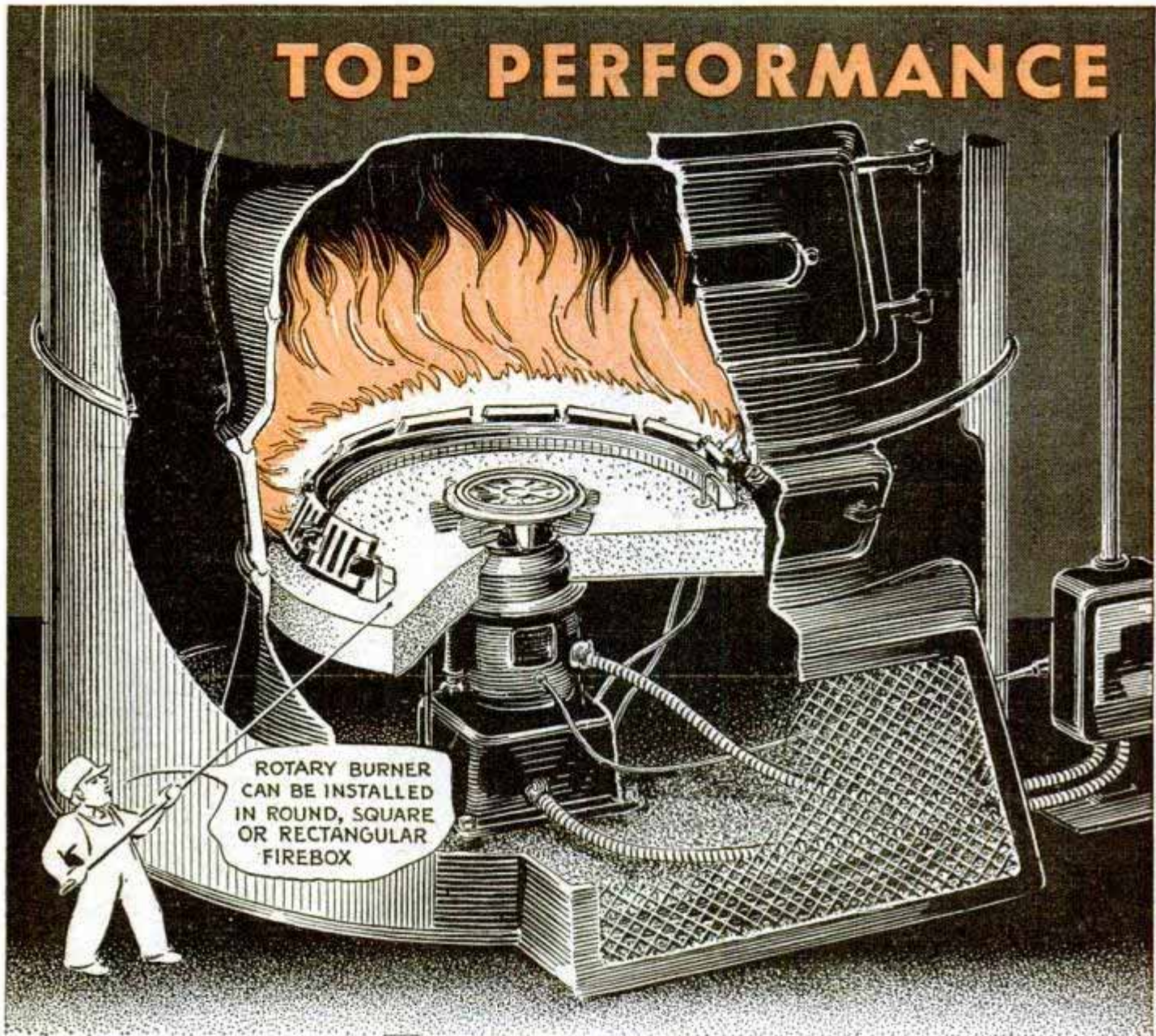

1 VERTICAL ROTARY BURNER

OWNERS of household oil burners have come to expect uninterrupted performance as a matter of course. This is due largely to the cooperative research and ingenuity of manufacturers, dealers and servicemen in an effort to produce ever-better burners and more efficient installations.

Because of its ease of handling and its own peculiar burning characteristics, oil is one of the comparatively few fuels which lend themselves readily to fully automatic control. To the average user, efficiency of the burner is measured by the amount of useful heat delivered per dollar expended for fuel and maintenance. Owners can do much toward maintaining a high efficiency by proper selection and care of a burner.

Figs. 1 and 2 show two types of oil burners commonly installed in home-heating plants. There are variations of these types. All are good, and the problem in selection of a burner is not so dependent on any spe-

cial merit of the burner unit as on its suitability for the

heating system, the average seasonal heating load in your locality, and the peculiarities of the individual centrally fired plant, the building and its immediate surroundings. In addition to the two burners shown in Figs. 1 and 2, one of which operates by mechanical draft, the other by a combination of natural and mechanical draft, there is the natural-draft pot burner, sometimes called the vaporizing bowl burner. This burner usually is supplied in oil-burning space heaters, but also is furnished in oil-fired furnaces as in Fig. 10. This latter type of burner operates with a forced or mechanical draft. When installed in correctly designed furnaces and supplied with uniformly high-grade fuel it is very efficient. With mechanical draft, the burner is somewhat less sensitive to fuel characteristics than the natural-draft pot burner. It is especially suitable in small homes where

FROM YOUR OIL BURNER

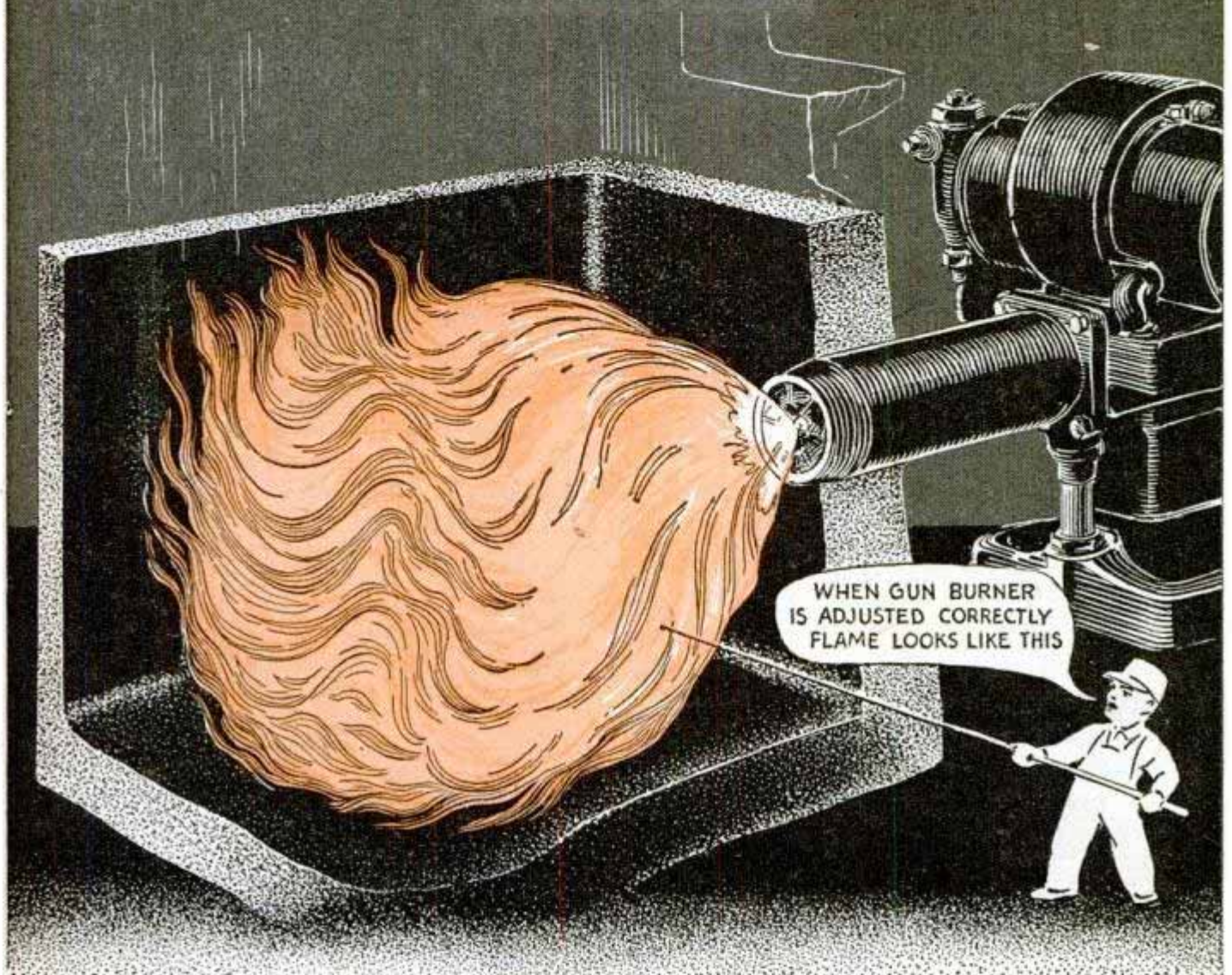

2 GUN-TYPE BURNER

the fuel required runs less than $1\frac{1}{2}$ gallons per hour. The vertical rotary burner, Fig. 1, also made in the horizontal type, is simple in design and construction and is noted for its quiet operation. Oil is fed either by pump or by gravity to a rapidly rotating distributor which combines a fan and oil "slinger." The distributor projects the oil against a hot flame ring, which may be made of metal or refractory material. Heat from the ring vaporizes the fuel and the air-oil mixture burns with a yellow-tipped blue flame that sweeps or "wipes" the walls of the firebox. Because of this characteristic it is often called the wall-flame burner. The flame ring can be installed in a round, square or rectangular firebox. Fig. 3 shows the principle of operation more clearly. Burners of this type often are recommended for installation in older-type heating plants and in small homes where fuel requirement in gallons per hour is quite low. The so-called gun burner, Fig. 2, is per-

haps the most common type installed in centrally fired home-heating plants. These burners operate on two principles, atomization by oil pressure and atomization or emulsification of the fuel by low-pressure air. Low-pressure burners of this type, Fig. 8, can provide the low flame necessary in heating small homes, and because of the large openings through which oil and air flow together, the nozzle does not clog so readily when lower-grade fuel oils are used. Fig. 9 details the nozzle of a burner of the high-pressure type. Here oil is fed from a pump through an oil line to an atomizing nozzle under high pressure, as much as 100 lbs. per sq. in. in some burners. This burner is more sensitive to the quality of the oil but is a highly efficient unit when supplied with high-grade fuel. Although both high and low-pressure burners are similar in design and installation requirements, the low-pressure type differs from the former in that a portion of the combus-



Courtesy Timken Silent Automatic Div., Timken-Detroit Axle Co

Because fuel oil is so easy to handle and requires comparatively small space for storage of a season's supply, oil-fired heating plants are among the first requirements of present-day homeowners. Clean-burning characteristics of oil make it easy to have fully automatic heat in any home

4 HEAT LOSSES:

Walls and Roof.....	44.4
Glass and Doors.....	26.0
Cracks.....	20.8
Floors.....	8.8
Total	100.0



tion air is drawn in with the oil by an atomizing pump. Expansion of the air causes the oil to froth or emulsify and thus enables the burner to deliver an oil-air mixture to the combustion chamber under low pressure through a comparatively large orifice. For this reason the low-pressure burner will operate satisfactorily on a wide range of fuels.

With the exception of the pot burners, in which the fuel is ignited manually and thereafter burns continuously, all late-type burners have some means of automatic ignition. There are several methods, the most common employing a pair of electrodes with high-voltage current supplied by a transformer built into the burner unit. Some burners are fitted with a resistance coil which is heated to incandescence to ignite the air-oil mixture. A few burners use a gas-pilot ignition which burns continuously; others a gas-electric system.

A control unit for an oil burner is designed to maintain automatically the desired room temperature with very little variation from the manual setting. It consists of a room thermostat, a primary control and a limit control. The ordinary room thermostat is the most used. Several types are available for special conditions. Some are clock controlled to give variable

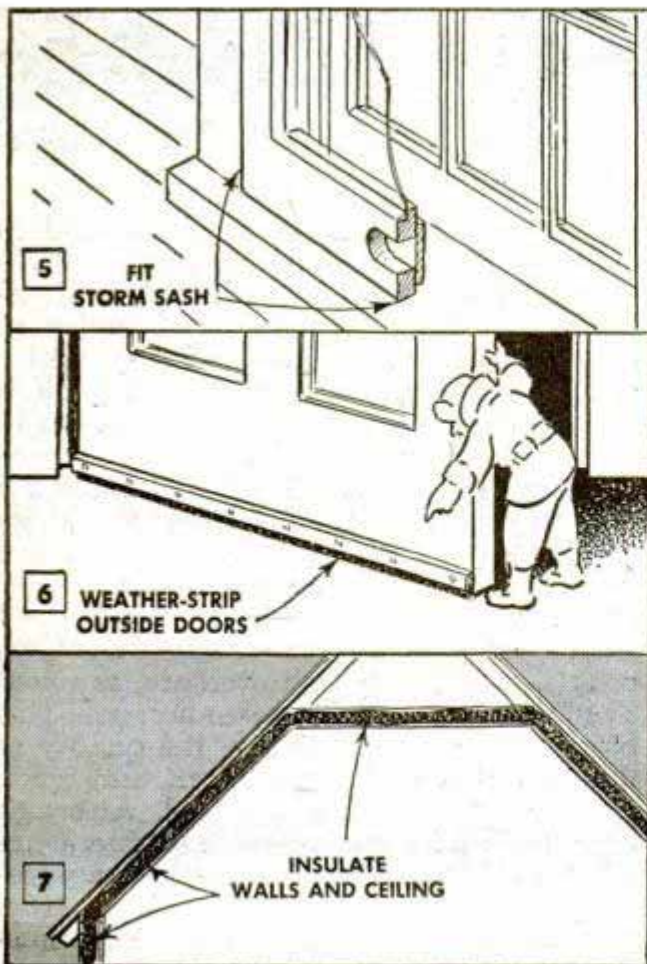

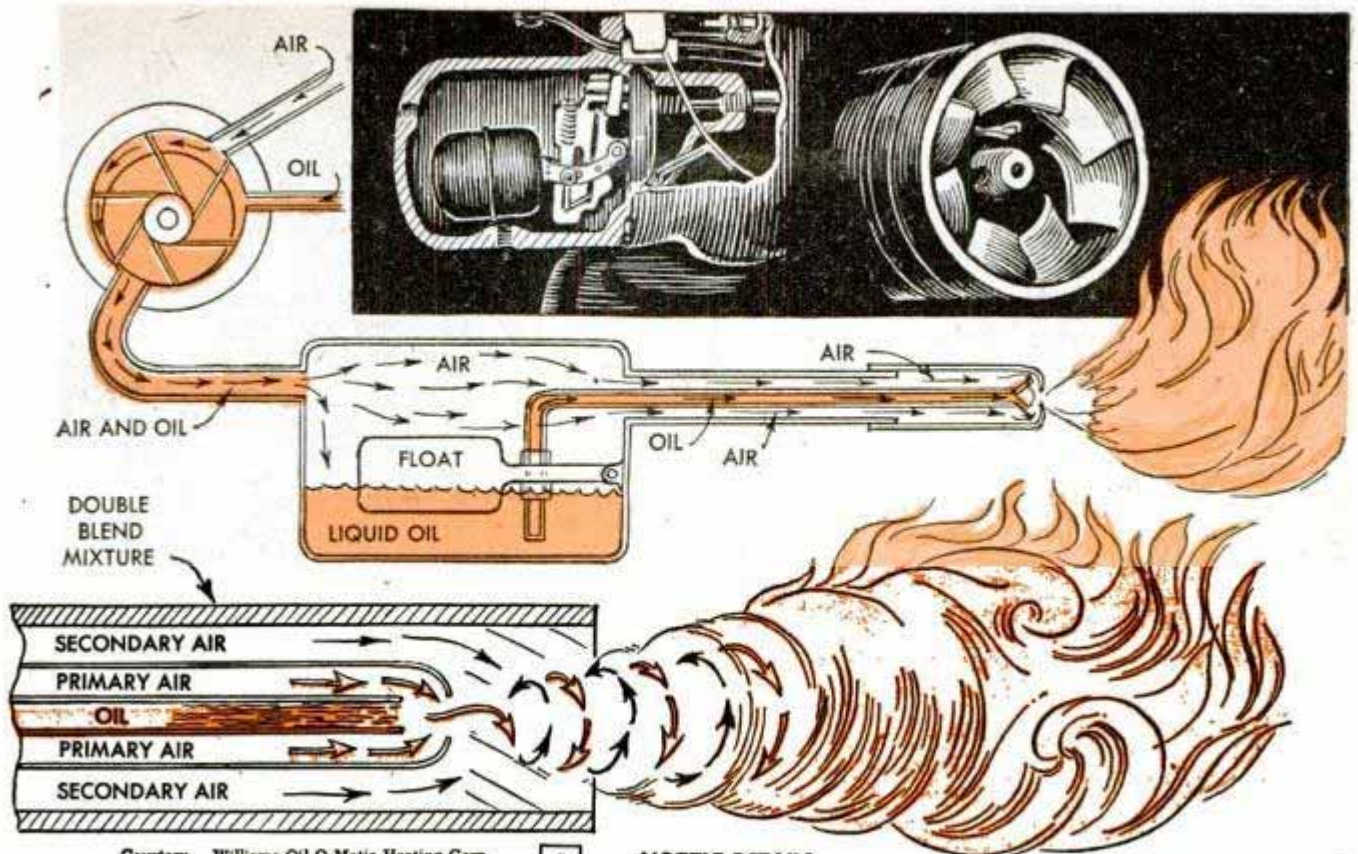

Courtesy Williams Oil-O-Matic Heating Corp.

8 NOZZLE DETAILS
LOW-PRESSURE GUN TYPE

day and night temperatures, and automatically change the settings according to a predetermined schedule. Others are special double-contact types for controlling mechanical-draft pot burners that operate continuously with several stages of fire. When the room temperature is in the range between the two sets of contacts the flame is at "medium fire"; when below, "high fire," and when above, at "pilot fire." In the event of power failure this type of thermostat automatically places the burner at pilot fire with natural draft. Some thermostats are more sensitive than others but usually adjustments are provided for varying the range, or differential, between the "cut-in" and "cut-out" points. This makes it possible to adjust performance to the needs of the individual installation.

Most primary controls are merely safety devices. This control usually is installed between the thermostat and burner and, in addition to closing motor and ignition circuits when the thermostat calls for heat, it will cut out the motor if the fuel oil fails to ignite on starting and also will stop the burner in case of flame failure at any time during the running

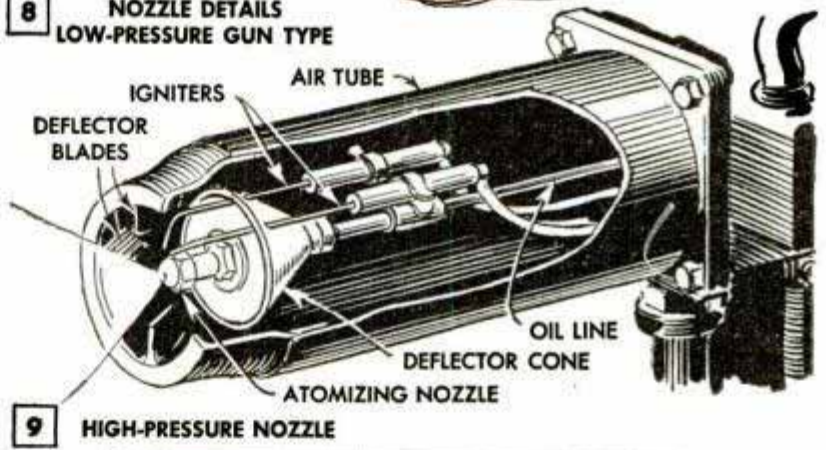

9 HIGH-PRESSURE NOZZLE

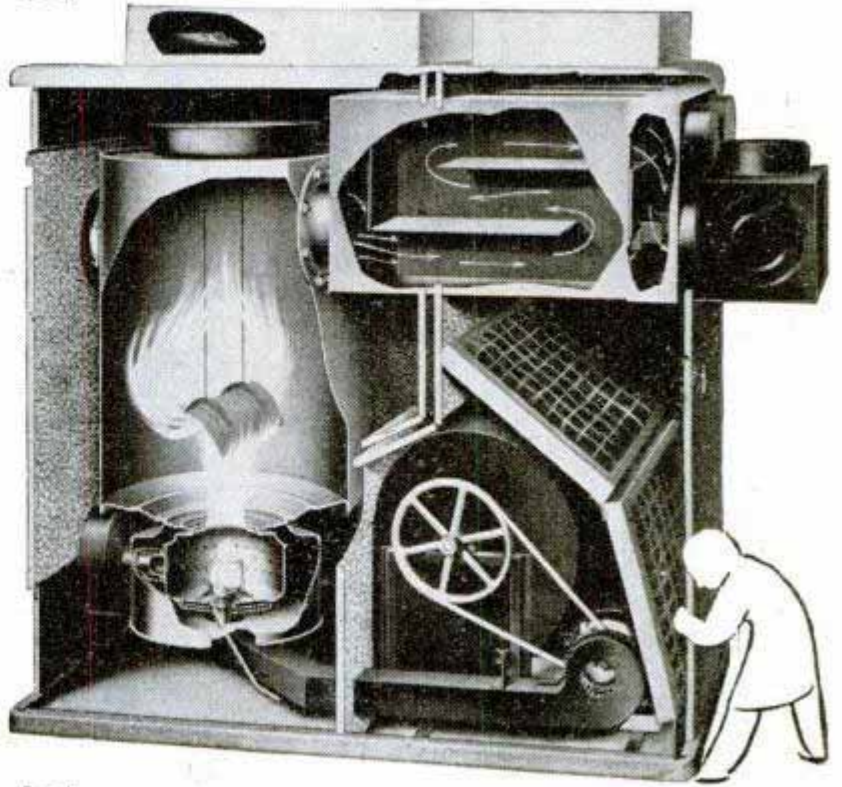

10 POT-TYPE BURNER, FORCED DRAFT

Courtesy Perfection Stove Co



11 BE SURE THESE JOINTS ARE PRESSURE-TIGHT



12 SEAL DOORS WITH FURNACE CEMENT

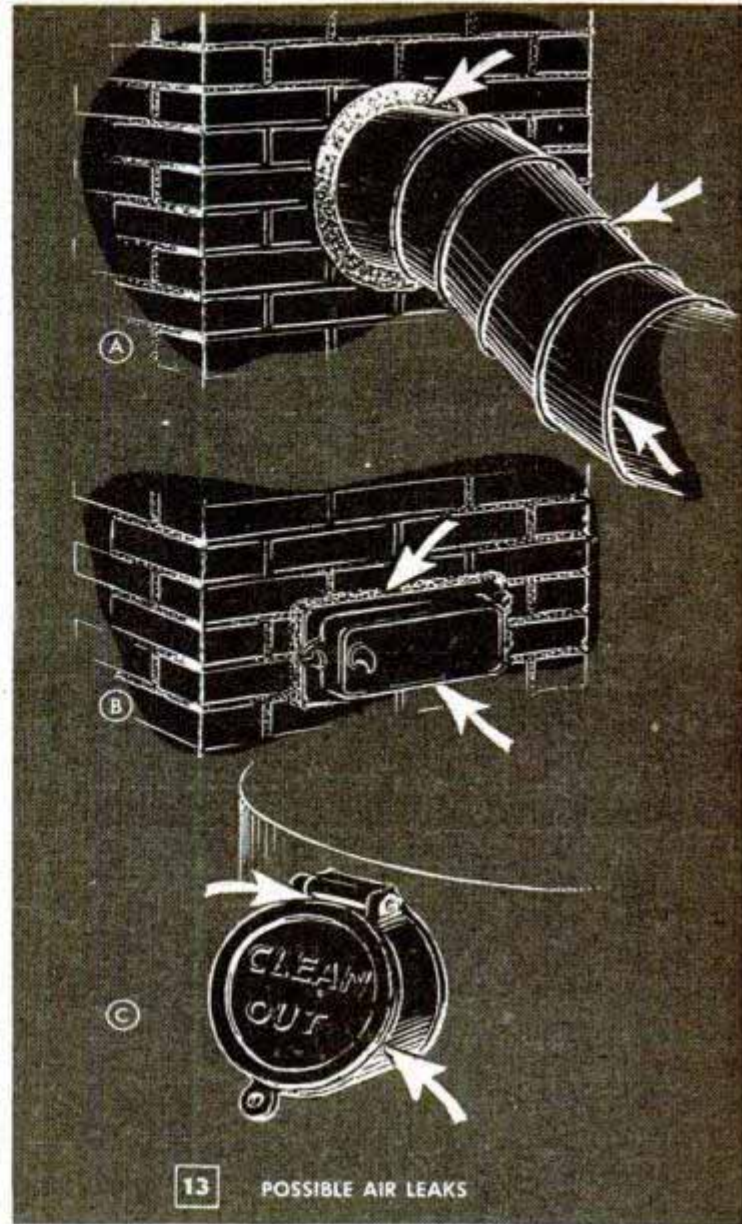
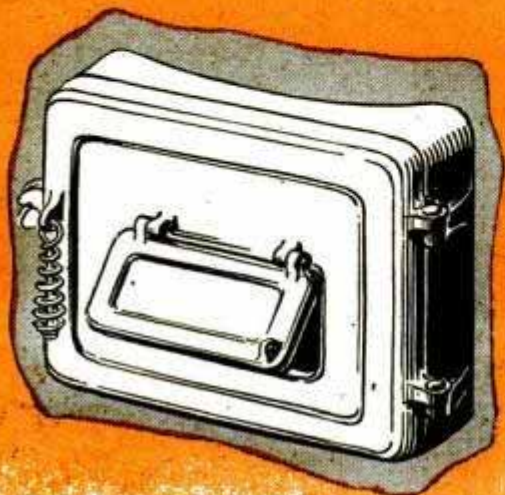

13 POSSIBLE AIR LEAKS

period. At a time of current interruption it prevents starting of the burner until all safety devices are in starting position. Primary controls are designed to meet various conditions and should always be installed in accordance with the directions of the manufacturer. Purpose of the limit controls is to prevent the generation of excessive temperatures or pressures in the furnace or boiler. When, for any reason, the room thermostat is still calling for heat after the safety limits of pressure or temperature have been reached, the limit control "takes over" and shuts off the burner. When pressure or temperature returns to the predetermined "cut-in" point, the control again closes the burner circuit and the burner resumes operation. A pressure limit control is installed on a steam boiler, while a temperature limit control is required for a warm-air furnace or hot-water boiler. In addition, other controls are often furnished. The burner manufacturer's directions and recommendations should always be followed when making the installation.

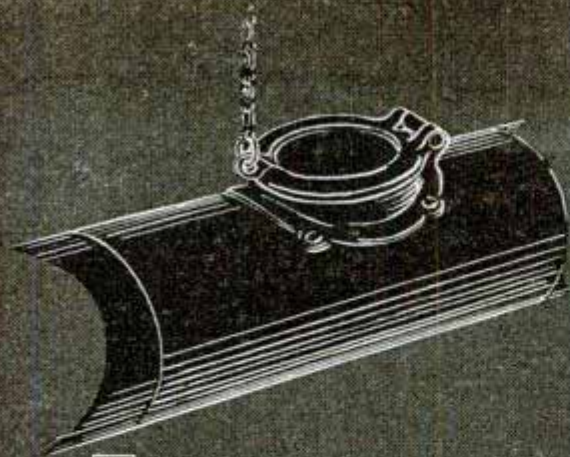

14 SEAL CHECK DAMPER OR REMOVE IT



16 SWINGING HOOD

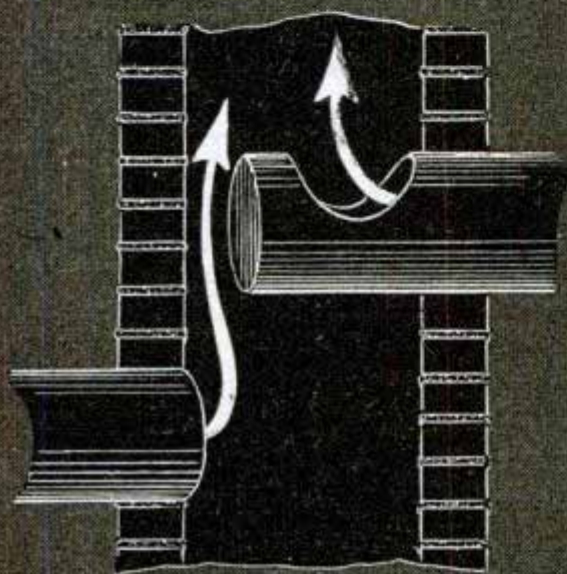

15 FLUE CONNECTIONS

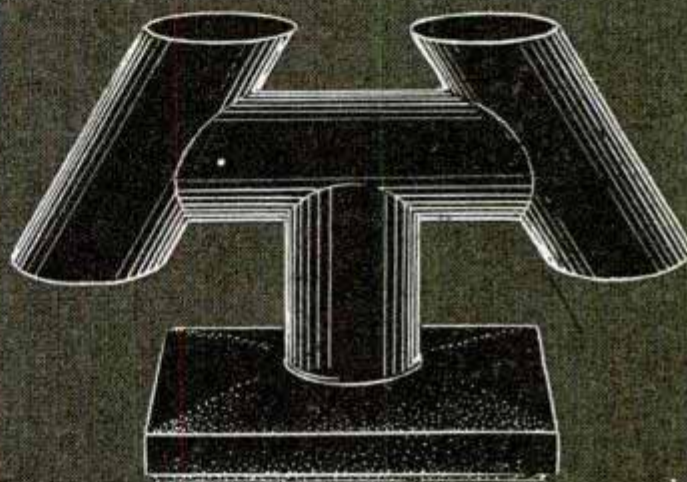

17 T-TYPE HOOD

Courtesy Standard Oil Co. (Indiana)

When installing the fuel-storage tank either inside or outside the building, the requirements of the local codes should be carefully followed. General requirements are that unenclosed tanks inside the building should be not less than 7 ft. from any fire or flame and should not exceed 275 gallons capacity. Certain universal requirements that govern the installation of underground tanks outside buildings also are subject to the installation codes in your locality. Specifications usually cover size and spacing of the tank or tanks, depth, footings, fill and suction lines, venting, location with respect to property boundaries, swing joints in the fill and vent pipes if these are of iron, distance of tank from foundation wall, etc.

Although many experienced servicemen can set a burner

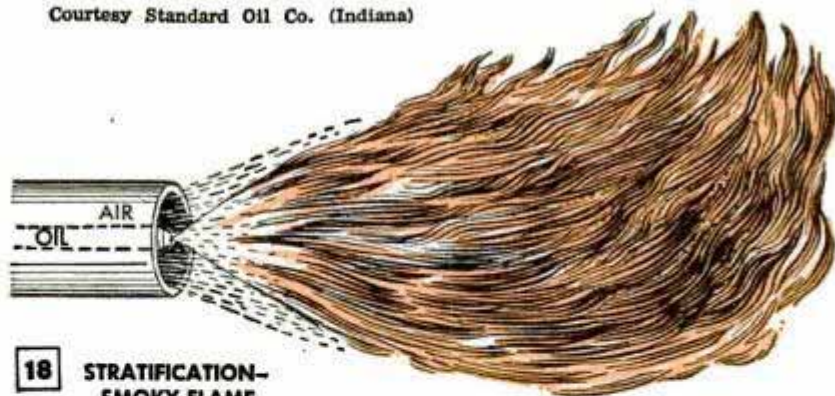

18 STRATIFICATION-SMOKY FLAME

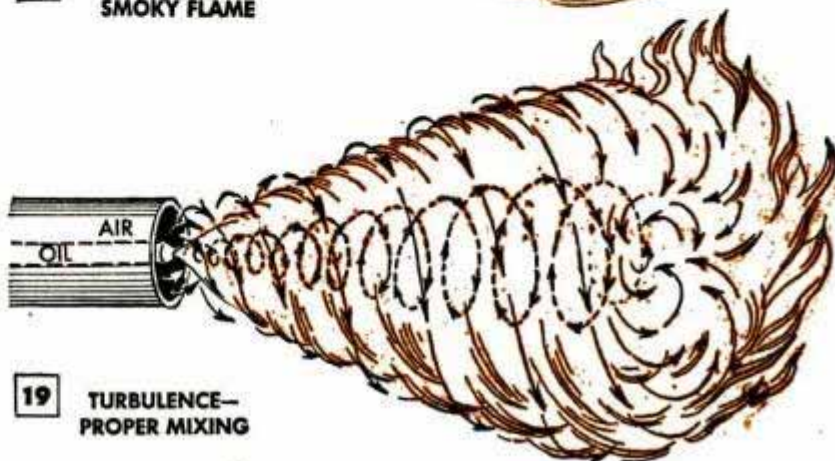

19 TURBULENCE-PROPER MIXING

What's Wrong??

A. High oil consumption.

1. Excessive air infiltration.
2. Boiler too small—insufficient radiation.
3. Boiler controls improperly set.
4. Dirty heat-absorbing surfaces.
5. Incorrect firing rate.
6. Excessive temperatures carried.

B. Burner starts and burns satisfactorily but fails after one minute of operation.

1. Air in suction lines.
2. Excess draft.
3. Strainers clogged.
4. Oil-tank vent obstructed.
5. Dirt or water in oil.
6. Controls out of order.
7. Insufficient fire.

C. Burner puffs when first started.

1. Poor or delayed ignition.
2. Insufficient draft.

D. Carbon forms in combustion chamber.

1. Improper or defective nozzle.
2. Nozzle clogged or dirty.
3. Insufficient air.
4. Oil spray impinges on walls. May be caused by misalignment of burner.
5. Drip from nozzle.
6. Excessive oil-burning rate.

E. Burner starts, runs properly and has proper oil pressure, but fails to ignite.

1. Nozzle may be clogged.
2. Electrodes out of adjustment.
3. No spark.

F. Objectionable odors or smoke.

1. Insufficient air admitted.
2. Excessive baffling of flue passages.
3. Combustion chamber too small.
4. Leaks in fuel-oil lines.
5. Insufficient draft.

Certain of the above suggestions are applicable only to gun-type burners.

Courtesy Standard Oil Co. (Indiana)

very accurately "by eye," most careful workmen will check performance with special instruments just to make sure before they okay the job, whether it be a routine seasonal servicing or a checkup on a new installation. One of the visible evidences of good or poor performance is indicated in Figs. 18 and 19. Poor or defective atomization forms large particles of oil which take a longer time to burn. Many particles do not burn at all and form coke deposits and soot. If the air supply is insufficient and mixing inadequate, unburned gases leave the furnace, resulting in a material loss of heat. Partly clogged nozzles or deflector vanes coated with soot deposit, often cause stratification of the oil-air stream, Fig. 18, which results in only a part of the atomized oil mixing properly with the air. This slows the burning rate, thereby producing smoky flames and undue quantities of excess air. Some excess of air over the theoretical quantity required to burn a given amount of fuel oil is always necessary. The quantity of excess air can be gauged by checking the percentage of carbon dioxide in the flue gas with a special instrument made for the purpose. This is an important test in determining the efficiency and performance of an oil burner. The carbon-dioxide, CO₂, content of the flue gases should be at least 10 percent with the burner properly adjusted. When everything is working correctly you get a flame something like that shown in Fig. 19. It's also important that the flames from a gun burner do not impinge on the sides of the combustion cham-

ber at any point. Manufacturers specify the size and shape of the combustion chamber in their installation instructions and these directions should be followed in detail.

Insufficient draft is a common cause of minor oil-burner troubles. In some basements there is so little air infiltration due to a lack of ventilation, that the furnace room may be "air locked." Such a condition can result in insufficient air for complete combustion. The chimney may be inadequate, partially clogged with soot, a piece of tile lining or other material, and the top may be lower than the roof ridge or a nearby tree or building. Any of these conditions can affect the efficient operation of the burner. In older heating plants, air leaks in the furnace firebox, especially in a cast-iron warm-air furnace, Fig. 11, and in the cleanout and fire doors, Fig. 12, may affect the operation of the burner and also can be the cause of objectionable odors in the house. Any openings in the smoke pipe, chimney or furnace cleanout doors, Fig. 13, details A, B and C, act as tiny check dampers. Figs. 14 to 17 inclusive suggest methods of remedying other chimney and smoke-pipe defects. Inspect the draft regulator supplied with the burner periodically to be sure it is working properly. Fig. 20 lists a number of ordinary troubles that sometimes occur. Although the remedies vary with different types of burners, in most cases correction of the trouble is quite simple.

In addition to the hints mentioned on care of your burner, remember that what

is true of almost all home-heating plants fired by other fuels is equally true of the oil-burning installation, that is, in rating efficiency the whole plant should be considered, and not merely the burner alone. Some of these points to be taken into account in both new and old installations do not relate directly to the operation of the burner, but do affect its efficiency indirectly. Take, for example, the heat loss from a building of average construction. Where the temperature inside the house must be maintained at a level higher than that outside—even though the variation is only a few degrees—there will be a constant loss of heat to the atmosphere. The variables which affect the rate of heat loss during a season are outside temperature, rain or snow, sunshine or cloudiness and wind velocity or exposure. Fig. 4 gives the average percentages of loss through various parts of the structure. Since the greatest loss is through the walls and roof, it is easy to see the value of insulation, Fig. 7, in slowing the rate at which heat is lost. Tight-fitting storm windows and storm doors, Fig. 5, will materially reduce the second percentage value given in Fig. 4 and weather stripping, Fig. 6, and caulking will stop infiltration of air through cracks. In many cases these inexpensive installations will reduce heat losses as much as 50 percent or more in old buildings as well as in new construction. Repeated opening and closing of doors in cold weather, windows open at night in sleeping rooms, hot water for baths, laundry, and dishwashing all add to the load on the heating plant and require extra fuel. Roughly, depending on locality, fuel consumption increases $2\frac{1}{2}$ percent or more for each degree that the inside temperature is maintained above 70 deg. F. This can be offset by lowering the inside temperature 10 deg. during the 8-hour sleeping period. However, as heat loss is directly related to outside temperature, it is likely that, as an average, the greatest saving will be effected by insulation on walls and ceilings and by installation of storm sash or double-glazed windows, and weather stripping.

Ruling Small Squares on Paper

If you want to rule small squares on a number of sheets of paper, the job can be done in a hurry with an old wooden ruler. After removing the metal straightedge, notch the ruler at every inch, half inch, quarter inch or other spacing you wish to use. Then draw a line with the ruler. This will leave a slight indentation wherever there is a notch and these marks are used to space the lines for the squares.

G. C. Steckley, Inglewood, Calif.

Eye-Forming Tool for Electricians Made From Old Shears

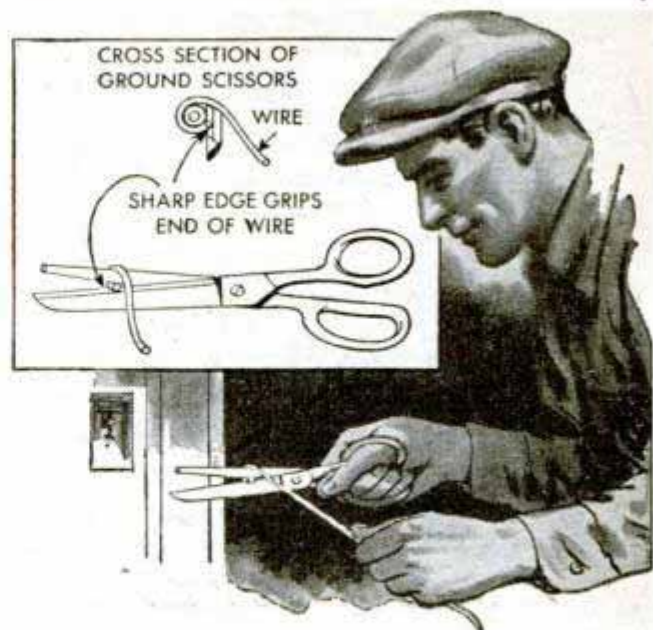

Electricians who are required to make eyes in the ends of wire will find that this forming tool speeds their work considerably. Grind one blade of an old pair of shears so that it has a tapering, round shape. Leave the other blade as it is. To use the tool, bend the wire around the tapered part, holding the free end as shown in the illustration above. Then complete the loop by closing the shears.

Drawing Board Has Spring Clip To Hold Sketching Paper

For those "on-the-spot" sketches, here's a drawing board that will do the job. A clip holds paper firmly on the board, and when you have finished the sketch, pressure on the underside of the clip will lift it to remove the paper. The clip is made of spring brass bent as shown in the detail. It extends the entire width of the board to provide a uniform grip on the paper.

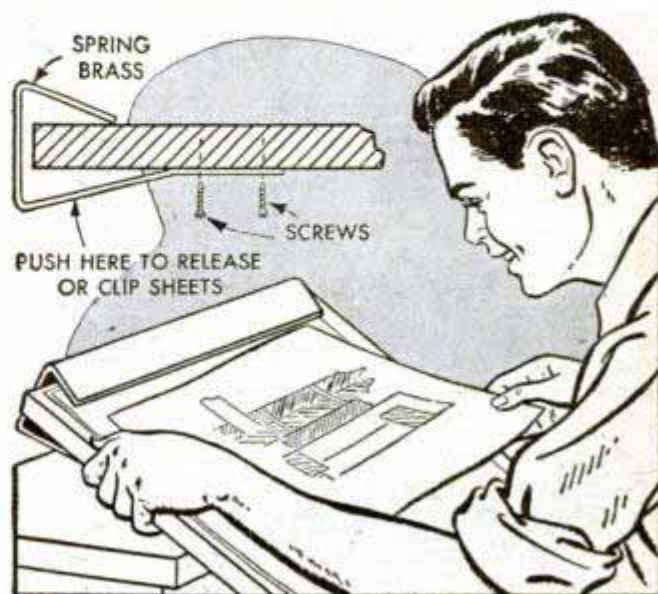

Glove Compartment Has Envelope To Hold Miscellaneous Papers

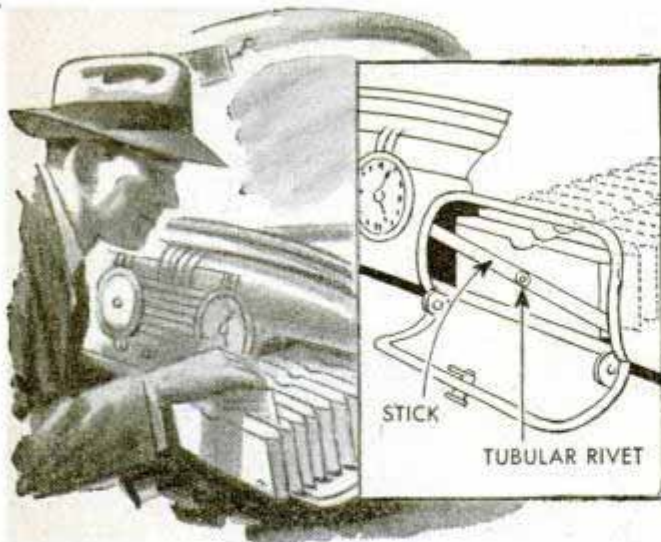

Safesmen and others who are compelled to carry prospect lists and miscellaneous papers with them will find this expanding envelope, which fits into the glove compartment of a car, a handy file. An envelope to fit the compartment can be purchased in most stationery stores and is cemented to the back of the compartment. A wooden stick that acts as a stop is riveted crosswise to the front envelope. The stick should pivot easily on the rivet.

Opie Read, Jr., Chicago

Metal Arrows on Control Chains Aid Operation of Hoist

To aid in identifying the "up" and "down" control chains on an electric hoist, metal directional arrows were attached to indicate which chain controlled the lifting



and which controlled lowering of the hoist. The arrows are made of sheet brass and are about 12 in. long. Each one is large enough to be seen at a glance.

John W. LaLonde, Newport News, Va.

Smooth Curve Bent in Heavy Tubing With Oxyacetylene Torch

Having to form a 90-deg. bend in a length of heavy steel tubing, I used an oxyacetylene torch to heat the inside radius of the tubing at equally spaced intervals, as shown. Pressure was applied at the same time the tube was heated to form the curve. This method left slight ridges across the tubing, but these were not objectionable.

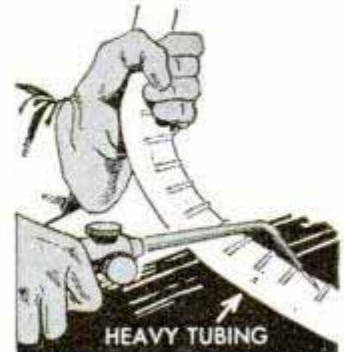

R. L. MacClean, High Bank, P. E. I., Can.

Hanger Bolts Are Set Quickly

When installing lavatories, water closets and other fixtures that are anchored to a wall or floor, one plumber has devised a quick way to set the bolt at the correct height. The number of threads required to extend through the fixture and allow for the cap nut are marked on the bolt end, which is then chucked in a brace at that point. The screw end is driven in up to where the end of the chuck touches the floor. The bolt is then at the correct height. Care should be taken when chucking the bolt not to damage the threads.

Arthur Davis, Vallejo, Calif.

Special Chisel for Concave Surfaces

For chipping inside the rounded surface of a shell or tank, or to cut off rivet heads, a special chisel with a curved end will do a neat and clean job. The curve is formed on a radius of about 7 in. by heating, bending and hardening. The edge is curved also, as shown in the right-hand detail. For smooth work, grind and oilstone the outer edge to produce a clean cut and to remove rust and scale easily.

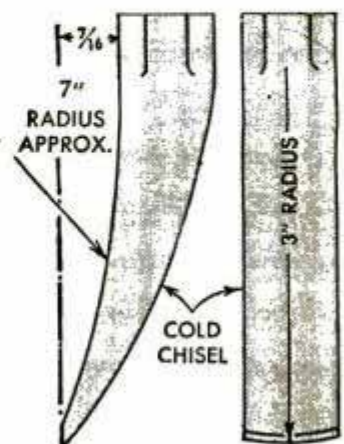

'Long Tom' Extension Grinder For Internal Work

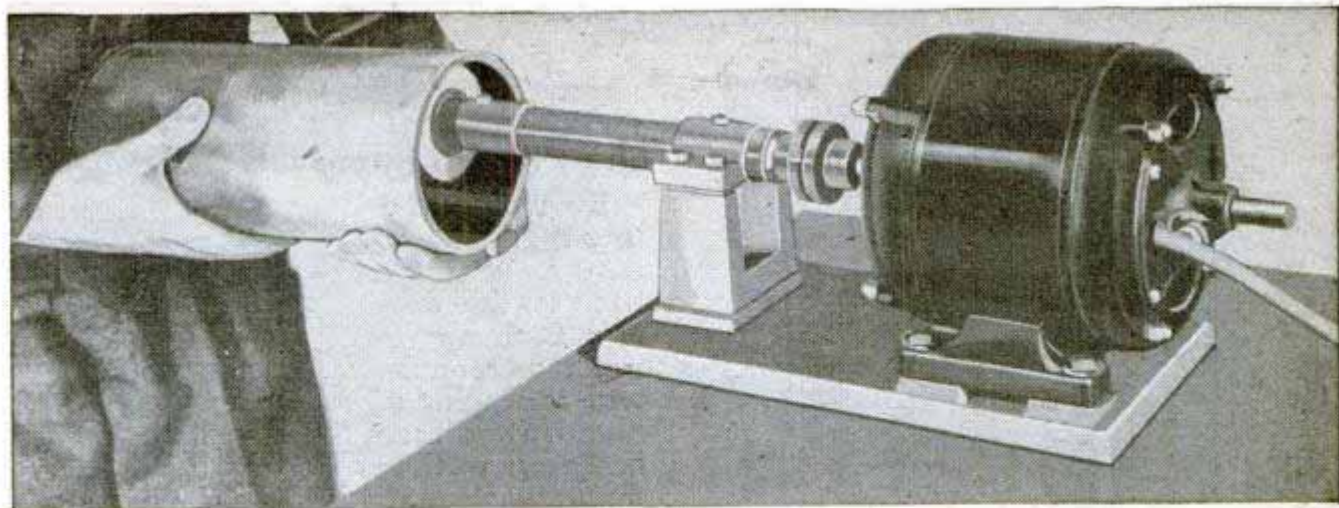

Practically every small machine shop at some time or other runs into a job that requires deep internal grinding, such as the inside of tubes and bearings where a casting or a welded joint may need smoothing. This outfit is designed for just such jobs as well as for deep external grinding and general all-purpose work. As detailed, it consists mainly of three cast-iron parts, namely, spindle housing, bearing support and base, which are cast from wood patterns made according to the dimensions given in the drawing.

First, machine the end of the spindle housing and then drill a $\frac{1}{16}$ -in. hole through it lengthwise. Next, counterbore the ends for $\frac{5}{8}$ -in. brass bushings. These can be purchased and should be a drive fit in the housing. The spindle itself is machined to fit the bushings. As standard 4-in. grinding wheels generally take a 1-in. arbor, two brass retaining collars are needed to adapt the wheel. Pack the housing with grease before installing the spindle. The bearing-support casting is faced top and bottom and then drilled and tapped for

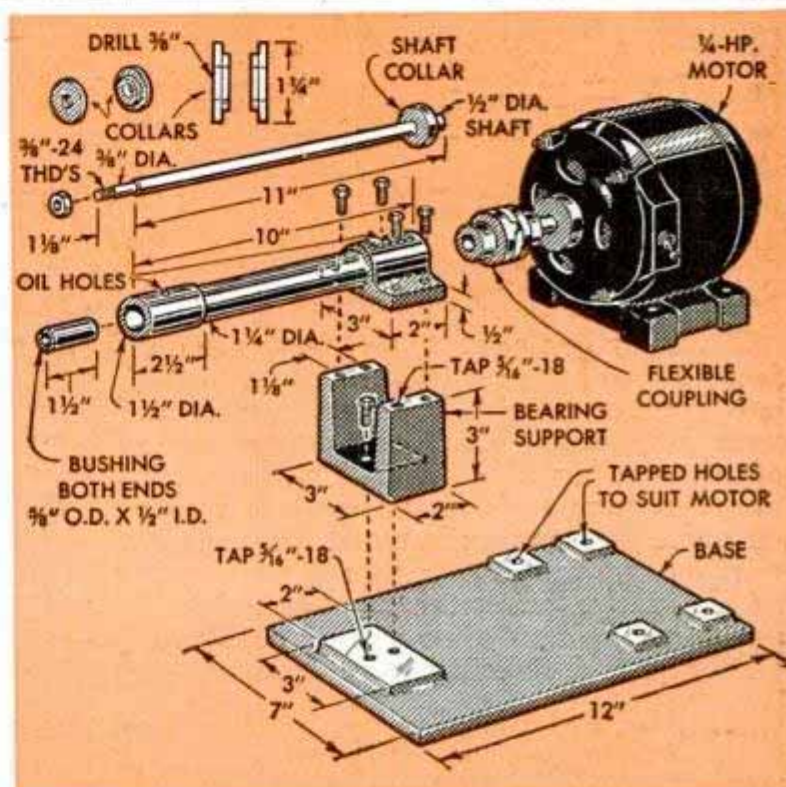

bolting to the housing and base, and a flexible coupling is used to connect the motor to the spindle. The height to make the bearing-support casting is determined by the motor used.

Jack Mellinger, West Orange, N. J.

Chamfered Metal Blocks Placed Face to Face Form Neat V-Blocks

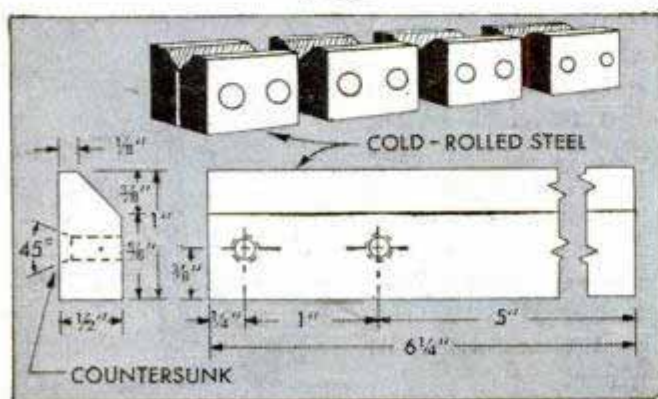

Needing several V-blocks, and not having the equipment to machine them from solid stock, I made some from two lengths of cold-rolled steel. One edge of each length was chamfered, after which the two pieces were riveted together to form a V-shape and then cut into sections. I roughed the 45-deg. chamfers on a grinder. Rivet holes were drilled through both pieces at once, and by countersinking the holes I was able to expand the rivets.

E. R. Goddard, Denver, Colo.

Bin Set Under Butcher's Block Receives Meat Scraps

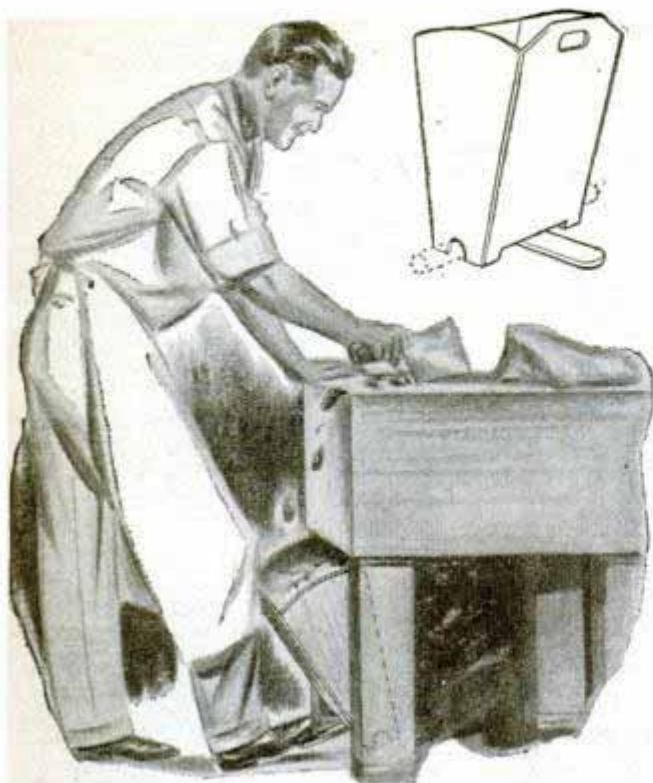

Disliking the unsightly scrap box usually placed on the floor beneath a meat block, one butcher provided his cutting blocks with disappearing bins. These may be made of plywood or sheet metal and are cut at the bottom ends of the sides to rotate on a rung extending between the legs of the block. A projecting piece of wood acts as a pedal to bring the bin to the "out" position. The bins are removed easily for emptying and cleaning.

Calf Feeder Kept in Position With Spring and Hinge

Here's a calf feeder that will keep calves from tipping a bucket over while feeding. An old bucket with the bail removed, a spring and a T-hinge are the materials re-



quired. The bucket is fastened to the bottom board with the hinge, and the spring runs from the top of the pail to the upright. The feed pail is set in the larger bucket.

Les Graff, Granger, Wash.

Short Angle Improves C-Clamp

By welding or brazing a short length of angle iron to the anvil of a C-clamp you won't be troubled with it slipping off round work. Such a clamp will be found particularly handy in holding both rod and flat stock together for welding. A shallow V-groove filed in the swivel jaw of the clamp will allow it to ride the work also, and a block placed in the angle iron permits clamping flat work as before.—Jerry Pokorny, Kewanna, Ind.

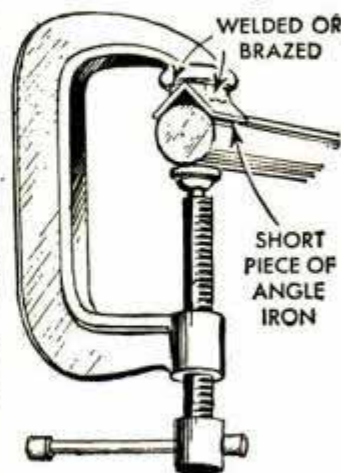

Solder Holds Gauge Screw Tight

Machinists and mechanics who use feeler gauges often find that the screw holding the blades together becomes loose and the gauge falls apart, resulting in lost or damaged blades. To prevent this, place a drop of solder so it covers part of the screw head and side of the gauge. This will keep the screw from turning.

Walter Peggar, Milwaukie, Ore.

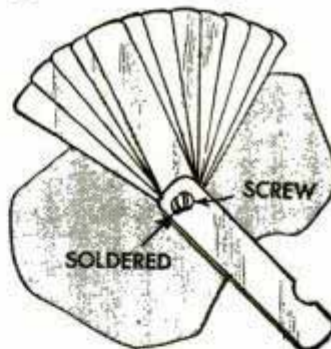

Hanger—Gauge to Apply Siding

It's easy to apply beveled siding with this combination hanger and gauge. A board about 2 ft. long is used to make it, the notches being cut to fit the siding. The top notch should be cut a little deeper so the board will slide under it after the gauge is nailed in place.

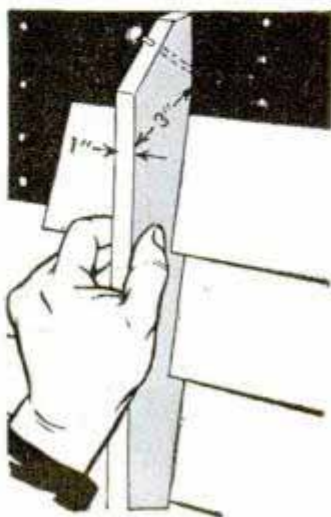



SPEAKER BAFFLE FOR P.A. SYSTEM

By Darrell Ward

WHERE several large speakers are required for sound installations in schools, and for industrial music systems, a baffle of good design is necessary for maximum results. The baffle detailed in Figs. 1, 2 and 3 is not difficult to build and is designed for a 12-in. PM speaker. For a small music system as illustrated in photos A and B, several speakers housed in these baffles can be connected in parallel with an adjustable shunt resistor of 15 to 30 ohms, as shown in Fig. 4, at each unit for controlling the volume. In this manner music can be beamed to various areas at desired volume levels.

The front and back panels of the baffle are made of $\frac{1}{4}$ -in. plywood. Please note that the 11-in. cutout for the speaker in Fig. 1 is not centered in the front panel as the enclosure tapers from top to bottom. The top, bottom and sides are made of standard $\frac{3}{4}$ -in. white-pine stock. Mount the front panel to the sides, top and bottom with small nails and glue, and glue the grille strips across the speaker opening. Grille cloth may be used to back this opening, but is not necessary; a narrow ring of linoleum or rubber can be used as a gasket for mounting the speaker. In open areas, or when suspended from ceilings, a back panel should be firmly screwed in place.

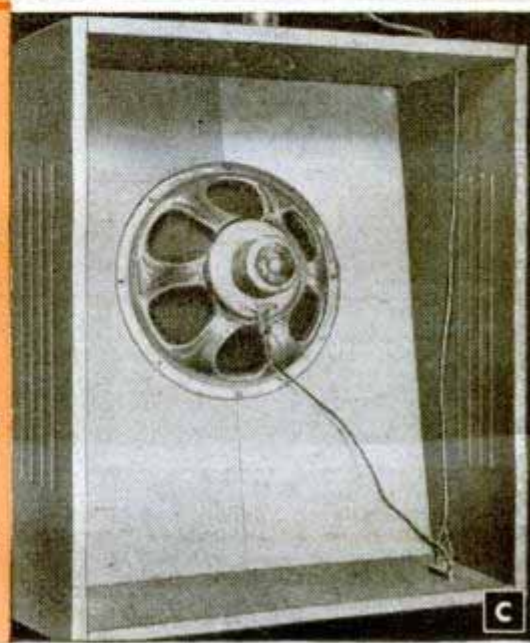
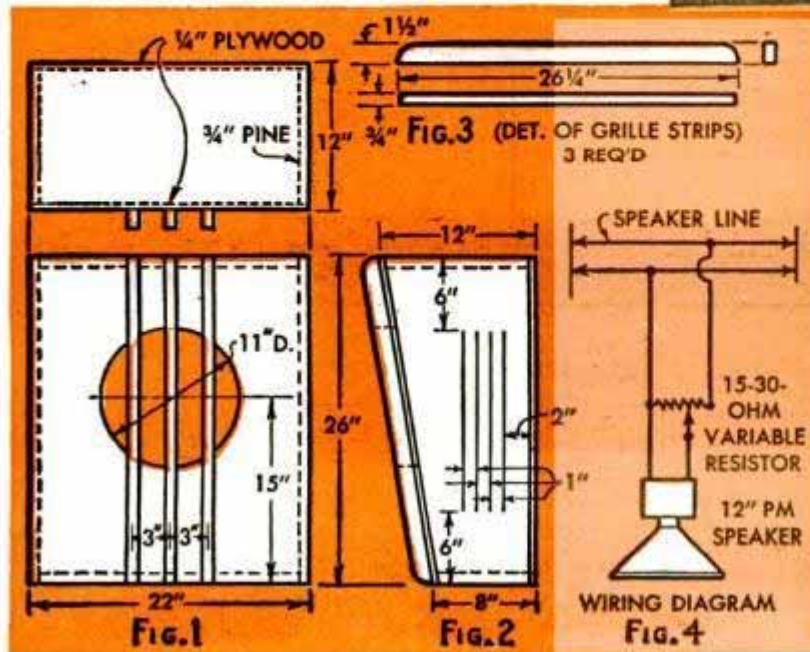
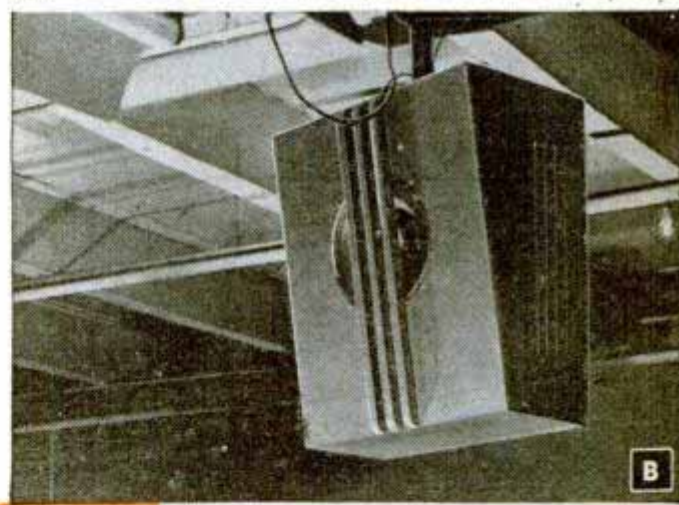

... Battery-Operated Amplifier for

By Joseph Vanella

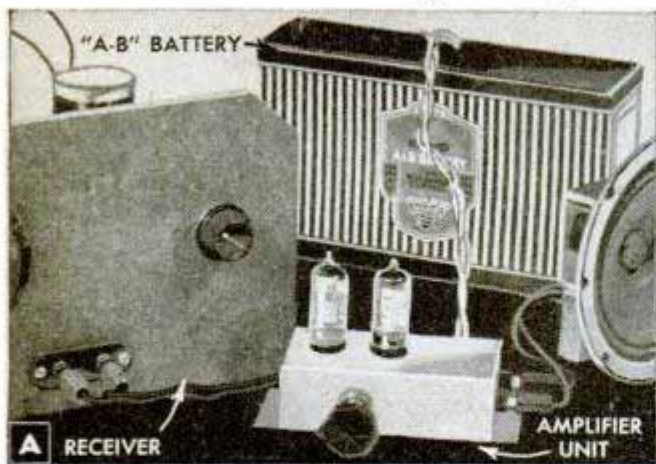

NOW YOU CAN convert that hand-wound portable phonograph into a full rich-toned electronically amplified record player and use it at the beach, or on picnics, with this simple 2-tube battery-operated audio amplifier. All that is necessary is to replace the mechanical pickup with a crystal pickup arm, and install the amplifier unit, batteries and speaker inside the portable case. This speaker replaces the conventional sound box and there is usually room in the case for all of these units. If not, the speaker with its universal output transformer may be mounted on a small hard-pressed-wood baffle, and the amplifier unit operated separately.

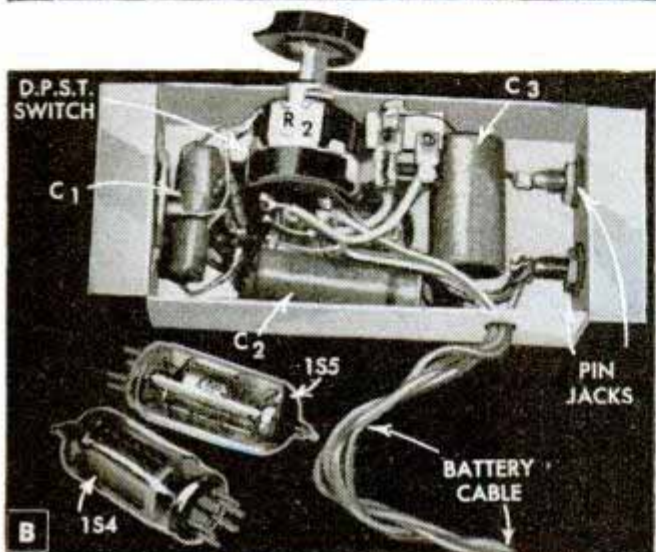

The speaker plugs into the insulated pin jacks on the side of the base; the connecting lead between the crystal pickup and the amplifier should consist of a short single-conductor shielded cable terminating in a standard phono input plug. Solder the center conductor to the insulated plug, then solder the woven-wire shield to the cap on the plug that makes contact with the grounded side of the phono input jack. Students and experimenters who have built the 1 and 2-tube headphone receivers described in past issues of the magazine can use this amplifier unit and obtain excellent volume with any small PM loud-speaker. When used with a small receiver, ordinary binding posts can be substituted for the phono input plug and jack. Connect the ground post directly to the base and be sure to in-

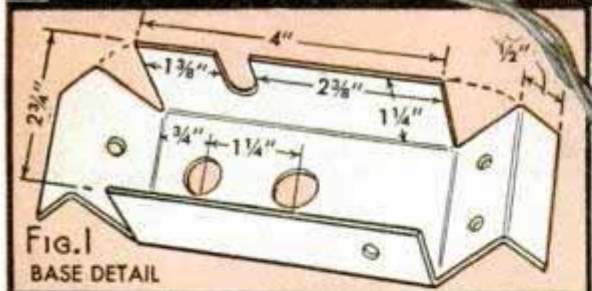
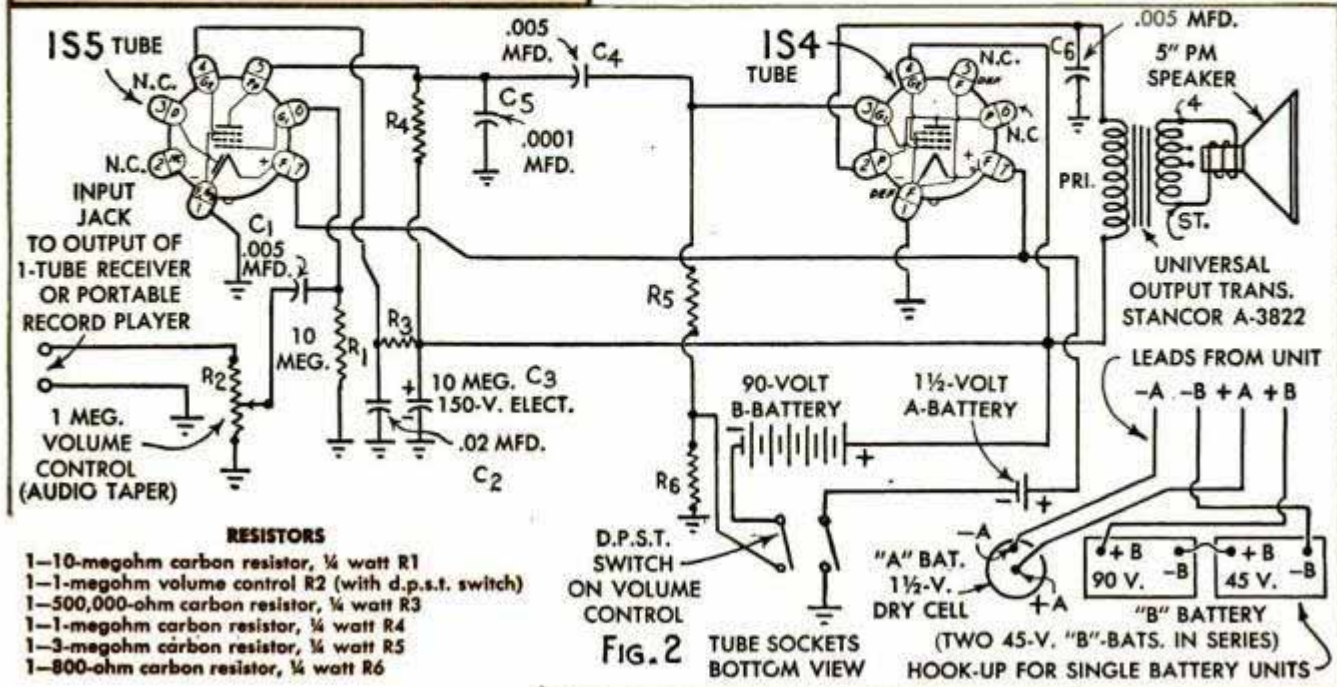

FIG. 1
BASE DETAIL



Portable Record Player or Small Set

sulate the post that feeds directly to variable resistor R2. Leads from these posts run to the phone posts on your receiver.

A sketch of the metal base appears in Fig. 1; the holes for the tube sockets are $\frac{5}{8}$ in. in diameter. The schematic circuit diagram is shown in Fig. 2, and the pictorial wiring diagram is given in Fig. 4. This amplifier may be powered either with a combination 1½-volt A-battery and 90-volt B-battery unit as shown in photo A and sketch C, or by a separate 1½-volt dry-cell A-battery, and two 45-volt B-batteries connected in series, as indicated at lower right in diagram Fig. 2. In this case, the battery plug illustrated in Fig. 4 and photos B and D, is not used. Detailed student material list R-359 is available from Popular Mechanics Radio and Electronics department upon receipt of ordinary letter postage.

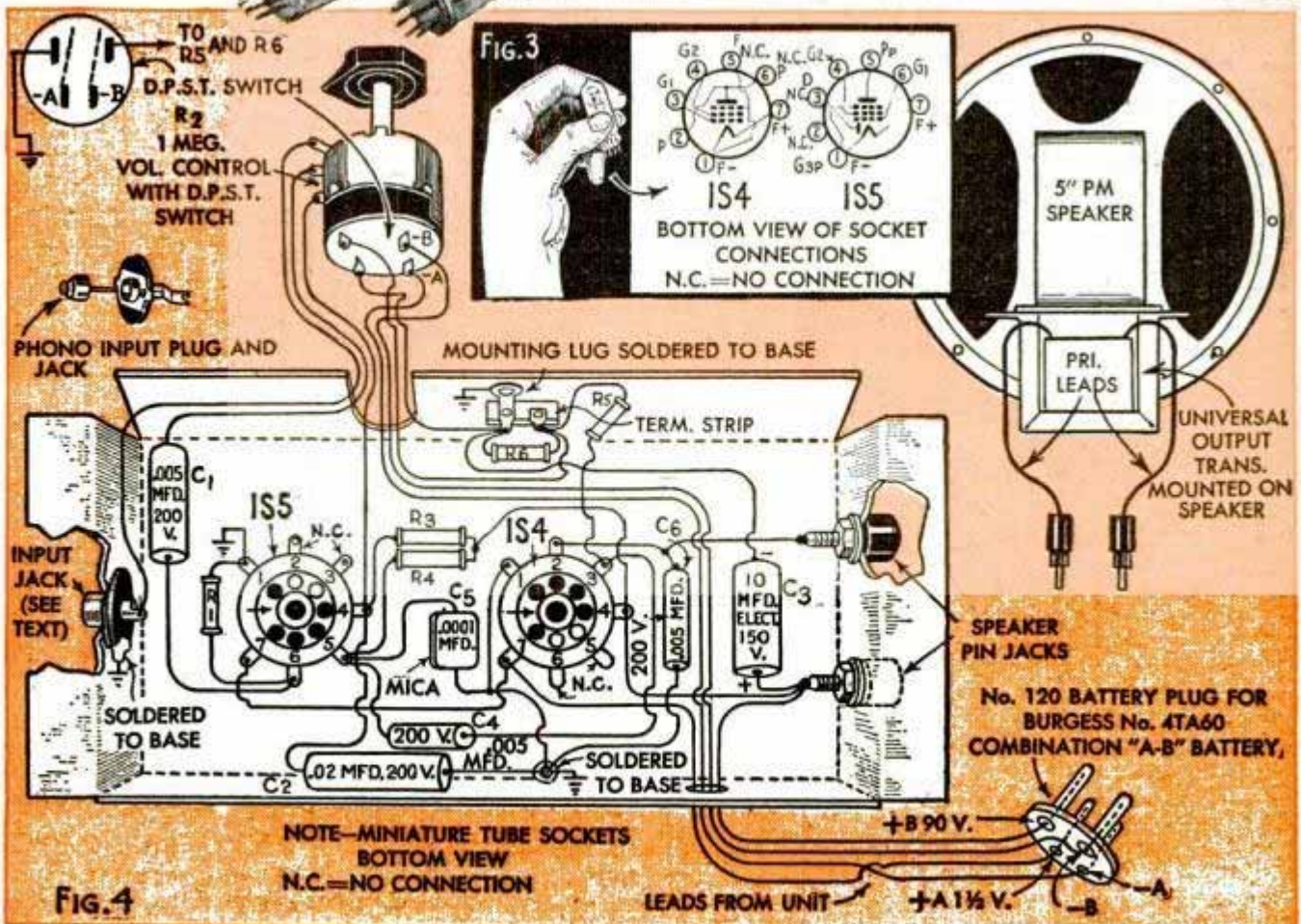
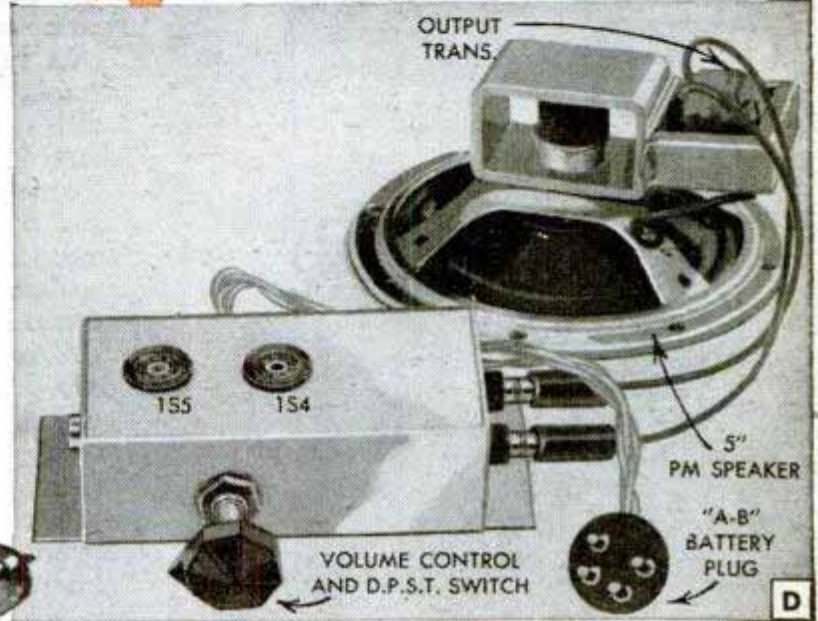
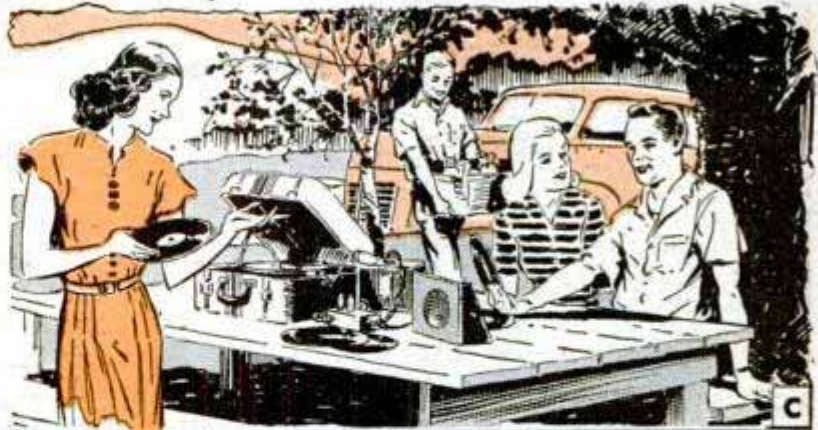

Simplified Volt-Ohm-Milliammeter

By L. M. Dezettel

One of the most important test instruments on the workbench of a radio serviceman, experimenter or "ham" operator is a combination unit known as a volt-ohm-milliammeter. It combines a voltmeter, ohmmeter and milliammeter in one compact low-cost instrument. The unit illustrated and described can be built from parts available at all radio supply houses.

The unit is based on a single 0 to 1 ma. d.c. milliammeter provided with a new paper dial having all the ranges to be used. This paper dial is listed as "Ham Crystals brand" H3C dial scale and is to be used with a Triplet model 321 d.c. 0-1 ma. milliammeter. All parts are specified in circuit diagram Fig. 1, and, at present prices, will cost the builder about \$12.00. The case is made from 1/2-in.-plywood stock; it is 3 1/2 in. deep, 6 in. wide, and 8 in. high, outside dimensions.

A 3/16-in. Bakelite panel, 6 in. wide and 8 in. long, is used to mount the entire assembly as shown in photos B and C; the panel employed was laminated Bakelite with alternate layers of white and black. An engraving machine was used to cut through the black layer and thus show the white letters and figures. It also can be hand tooled in the same manner. If a metal front panel is employed the test-lead tip jacks must be insulated by using shoulder-type fiber washers.

(Continued to page 228)

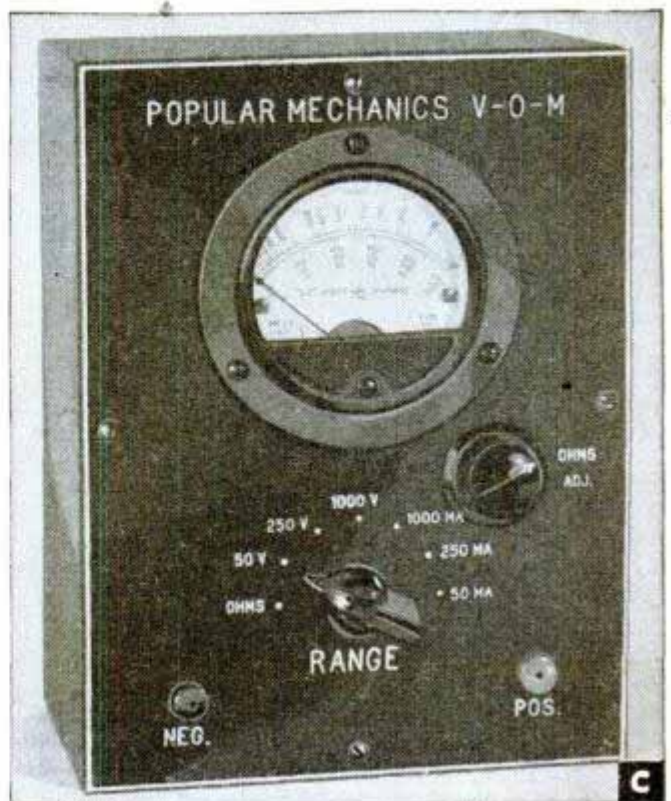
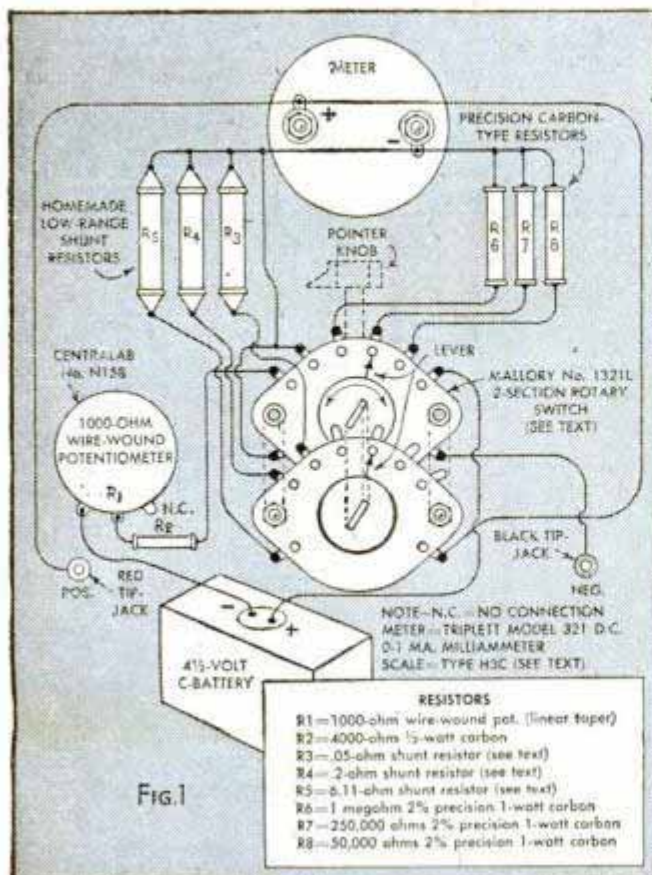
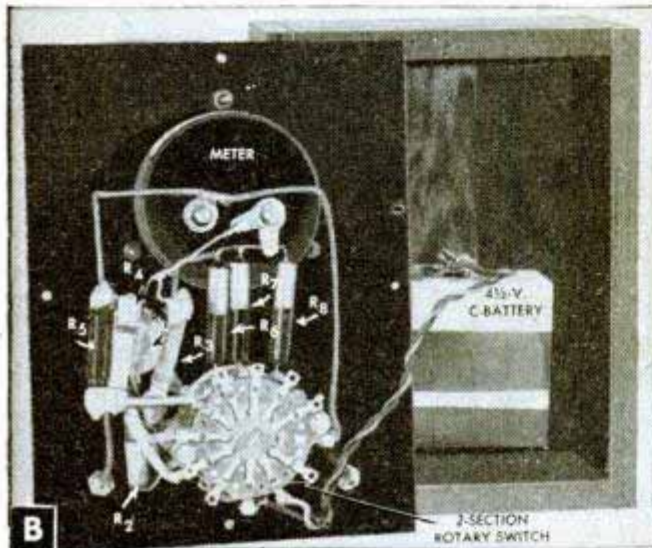

Better pictures are simpler with

the smart, competent
KODAK REFLEX
camera

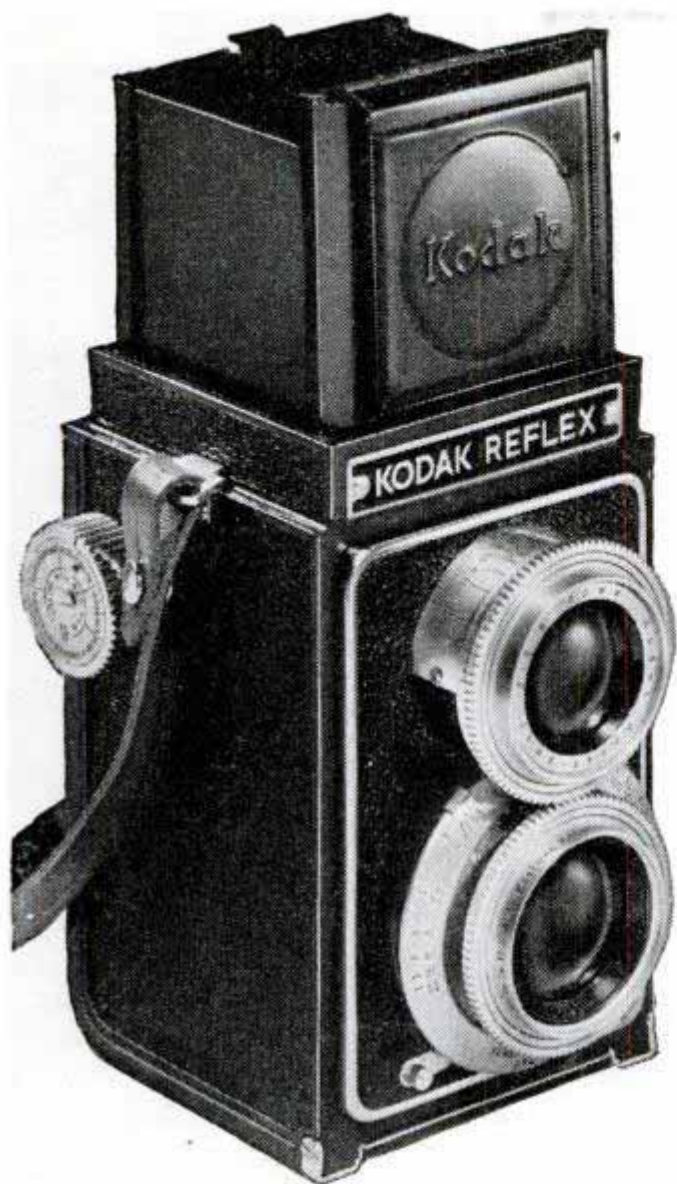

black-and-white . . . color . . . flash

- quick, expert composing of subject with extra-bright ground-glass finder . . . shows image details in full picture size
- sharp focusing—“punchy” pictures—with 4-element $f/3.5$ twin lenses . . . both *Lumenized* (ultrahard coated)
- fast shooting with shutter speeds up to $1/200$. . . built-in synchronization for flash with accessory Kodak Flashholder

See it at your Kodak dealer's

**WRATTEN
FILTERS**



use gelatin



for “pure color”



Famed for thirty years, *Wratten Filters* use gelatin sheets with pure organic dyes, between two pieces of matched optical glass . . . all sealed into one tight unit with the new cement, butyl-methacrylate.

Advantages: *Colors*—wide variety, each precisely adjusted for its particular

purpose. *Sealing*—moisture-resistant, prevents deterioration of filter. *Strength*—metal ring and new cement provide a more rugged unit than a single-glass filter. *Optically flat glass*—especially designed for use with quality lenses. *Cost* is moderate. Consult your nearest Kodak dealer.

Kodak

Eastman Kodak Co., Rochester 4, N. Y.

FLOODLIGHT

the Night

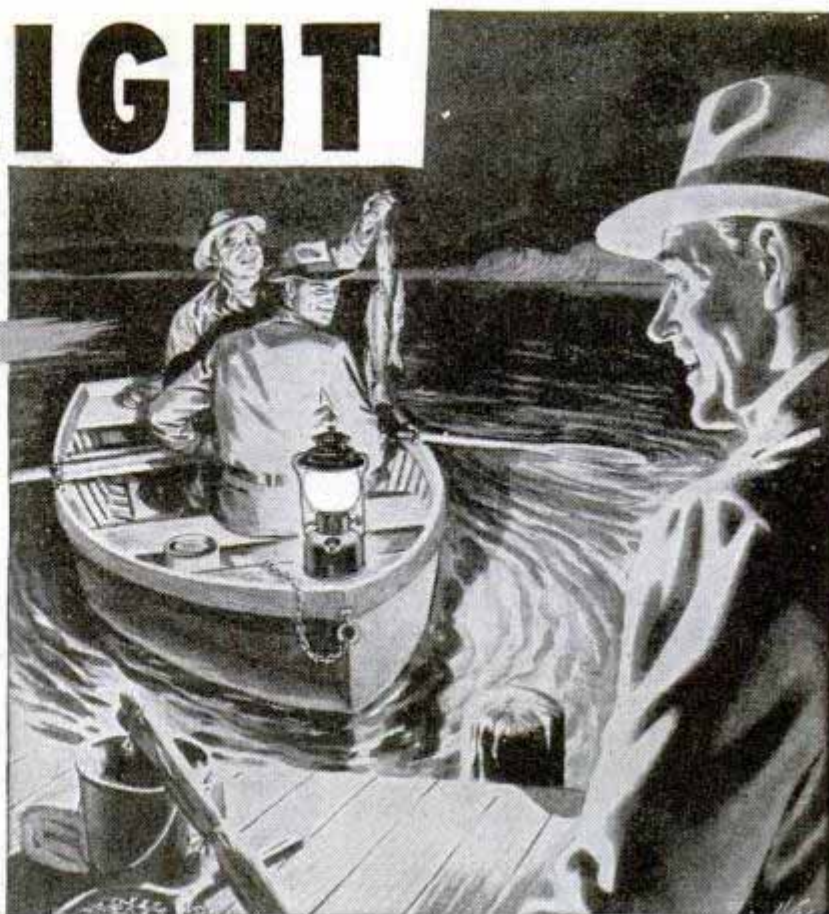
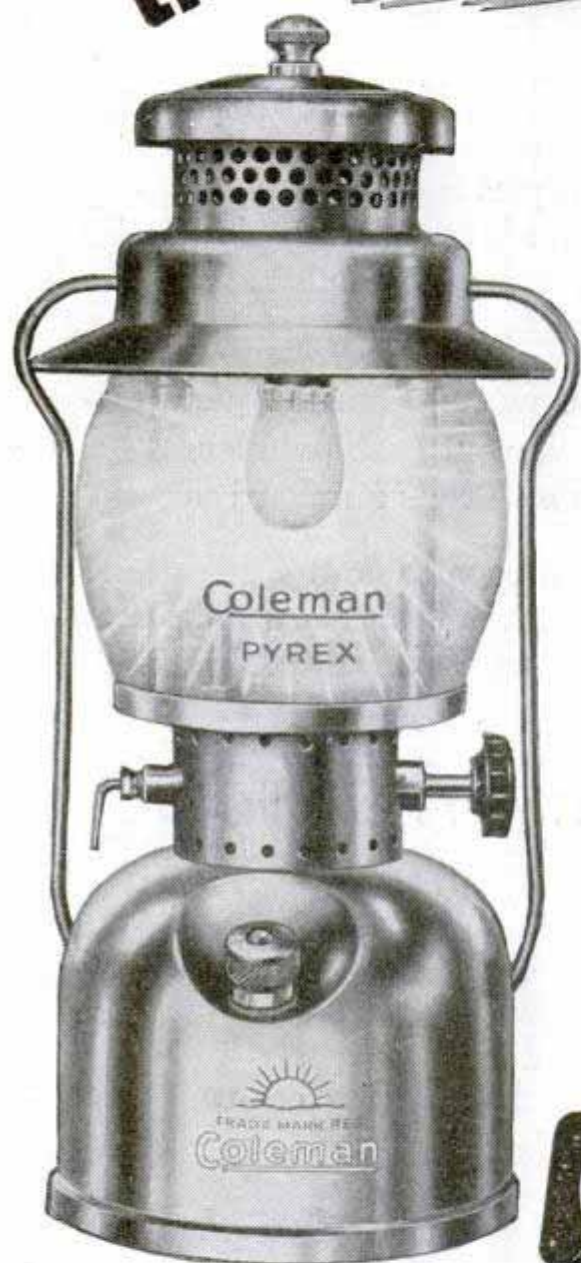

For Plenty of Light on every fishing, hunting and camping trip, take along a Coleman Floodlight Lantern. It floodlights your whole camp with light so bright you can read a newspaper 50 feet away. Instant lighting. Storm proof. Safety sealed fount can't spill fuel. Gives 40 hours of floodlight service per gallon of fuel. Pyrex glass globe protects mantles.

Lights Up the Whole Camp. Coleman Floodlight Lanterns are used and endorsed by famous guides and sportsmen as the perfect light for all outing trips. See a free demonstration at your Coleman dealer's now.

FREE— Write for illustrated book telling all about Coleman Lanterns, Stoves and other Coleman Appliances. Address nearest office.

THE COLEMAN COMPANY, INC., Dept. 106-PM, Wichita 1, Kans.; 401 N. Broad St., Philadelphia 8, Pa.; Los Angeles 54, Calif.; Honolulu, T. H.; Toronto, Can.

Coleman

FLOODLIGHT LANTERN

Coleman



Folding CAMP STOVE

A favorite for years for quickly and easily cooking big meals. Cooks like city gas. Carries like a suitcase. Two burners. Instant lighting. See it at your Coleman dealer's now.

Coleman

POCKET STOVE

3 lbs.—8½ in. high—Take it anywhere
The handiest little sport stove you ever saw; for cooking, heating drinks, boiling water. Burns any kind of gasoline; white or leaded. Aluminum case makes 2 cooking utensils. Get one from your dealer. Ask him to demonstrate it for you.



**YOU GET MORE
TURNING POWER
WITH**
Snap-on
Heavy-Duty Wrenches

For fast assembly and maintenance work, where large bolts must be tightened in hard-to-reach places, Snap-on Socket Wrenches combine speed and safety with powerful leverage to turn the biggest, tightest nuts.

Snap-on combinations, like the one illustrated above, are highly versatile tools and can be used on dozens of tough nut-turning operations throughout the plant.

Actual working performance has proved their value in stepping-up production . . . and on difficult operations, they are almost indispensable. Without doubt, they are the choice of better mechanics everywhere.

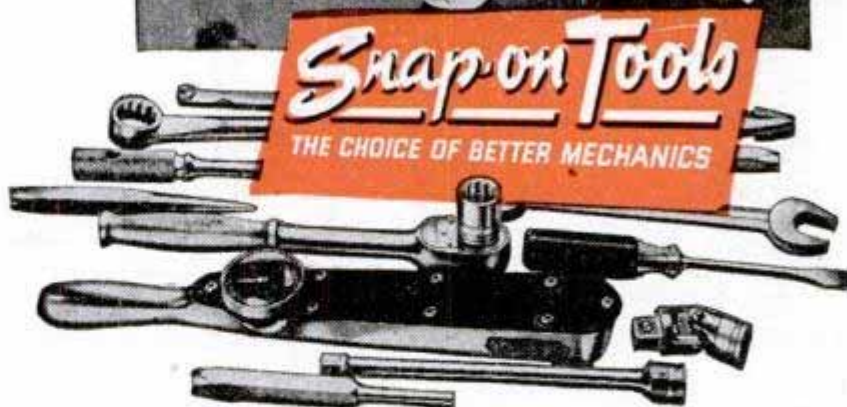

SNAP-ON TOOLS CORPORATION
8062-1 28th AVENUE • KENOSHA, WISCONSIN
INTERNATIONAL DIVISION: KENOSHA, WISCONSIN, U.S.A.

they're back!



**...MASTER NEEDLE
FILES BY MASTER FILE
MAKERS FOR MASTER CRAFTSMEN**

WHERE is the craftsman—professional or amateur—who doesn't rate himself entitled to fine tools? Back in full civilian production, Nicholson X.F. (Extra Fine) Swiss Pattern Needle Files are reappearing in hardware and hobby-tool shops everywhere. They're widely regarded as tops in precision files; and they come in the handsome orange-and-black plastic case shown above, with stand-up base holding a dozen assorted shapes. Tiny files like these need precision manufacture to assure best results. Demand Nicholson X.F. and get the finest! A popular size for the hobbyist is 5½-inch in No. 2 cut.



FREE BOOK, "FILE PHILOSOPHY," on kinds, use, and care of files; 48 highly informative, illustrated pages.



NICHOLSON FILE CO.
22 Acorn St., Providence 1, R. I.
(In Canada, Port Hope, Ont.)



NICHOLSON FILES FOR EVERY PURPOSE

Simplified Volt-Ohm-Milliammeter

(Continued from page 224)

The ohmmeter range requires the use of a 4.5-volt C-battery or, three 1.5-volt flashlight batteries connected in series, for the zero reading adjustment. This battery is held in the case with a metal strip. The rotary switch is a 2-section, 11-position nonshorting type, but only 7 of the switch positions are used. The switch has an adjustable stop which prevents the rotating contact from going beyond the 7 positions. It is necessary that the 1-megohm, 250,000-ohm, and 50,000-ohm resistors be of the precision carbon type. While wire-wound precision resistors would result in better-maintained accuracy, they are quite expensive, and not required in a simple test-bench unit of this type.

All of the low-range shunt resistors must be handmade. Three old r.f. chokes were stripped and rewound with resistance wire from spools which are available from radio supply houses marked with the ohms-per-foot resistance they are designed for. These wires can be cut to proper length for the shunt resistances specified for R3, R4 and R5. In the original model, these shunt resistors were made from plain copper wire and the values calculated on a Wheatstone bridge. Two of the resistors were wound to the proper resistance value with the wire that was on the r.f. chokes; the third resistor, R3, was wound with heavier No. 20 enameled wire for the .05-ohm value. The 4000-ohm carbon resistor R2, in series with the 1000-ohm potentiometer R1, need not be of the precision type. The variable resistor R1 is a standard midget volume control.

The voltmeter sensitivity of this instrument is 1000 ohms per volt. This means that when using the 50-volt range the total resistance is 50,000 ohms. When using the 250-volt range the total resistance is 250,000 ohms, etc., this high sensitivity voltmeter therefore is useful in circuits where the "loading" effect must be kept to a minimum. It is the standard sensitivity employed when servicing radio sets as in photo A. Most commercial radio receiver service diagrams show correct checking voltages at various points based on a "1000 ohms per volt" instrument.

Blueprints covering many simplified radio and electronic construction articles in this and past issues are available for 25 cents each. Detailed student material lists, additional general information or latest blueprint list can be obtained from our Radio and Electronics department without charge on receipt of ordinary letter postage



**PRECISION
IN METAL
TURNING
IS A GRAND FEELING**

**IT'S A GRAND FEELING, TOO,
WHEN YOUR CAR IS
CUSHIONED WITH MARFAK
CHASSIS LUBRICATION**

THAT CUSHIONY FEELING LASTS LONGER WITH MARFAK!

It's a grand feeling when your metal parts "mike up" right on the button. It's something like the feeling of perfection you get when you drive a smoothly operating *Marfak*-lubricated car. That cushiony feeling tells you that *Marfak* is on the job, with bearing surfaces scientifically protected against wear . . . for a thousand miles and more. *Marfak* resists wash-out, jar-out and squeeze-out because it clings to bearing surfaces. See your Texaco Man today . . . for smoother-riding miles with *Marfak* lubrication.



THE TEXAS COMPANY

TEXACO DEALERS IN ALL 48 STATES

Tune in: TEXACO STAR THEATER presents the TONY MARTIN show every Sunday night. See newspaper for time and station.



TOM: Orphan? What do you mean, Dad?

DAD: This chisel. There's no brand name on it.

TOM: What of it? Just feel that edge.

DAD: That's not much to go by when you're buying a chisel, son. Even a piece of cheese can have a sharp edge, you know.

TOM: You mean this chisel's no good?

DAD: I mean you can't be *sure* it's good. No brand name, no reputation to back it up. It's one of those bargain counter orphans—and they generally let you down.

TOM: Well, it didn't cost much, anyway.

DAD: Better get your money back—if you can. And then go over to the hardware store and buy a *good* chisel—one with an advertised brand name you can trust. The hardware man will always steer you right.

**Your HARDWARE DEALER sells QUALITY tools
and hardware... Buy from HIM**



POPULAR MECHANICS

Motorcycling is **TOPS**
for **FUN** and **THRILLS!**

Own a **HARLEY- DAVIDSON**

No wonder motorcycling is the favorite sport of so many fun-loving, vigorous, red-blooded young men and women! There's a thrill to riding a new 1947 Harley-Davidson that beats anything else on wheels. Owners have grand times — they belong to clubs—make new friends — compete in endurance runs, race meets and hillclimbs. They get out on the open road and tour the country — even tour other lands. Don't merely *wish* for good times — when you can roll up so many pleasure-filled miles on your own Harley-Davidson! Get set for the happiest evenings, weekends and vacations of your life — see your Harley-Davidson dealer NOW — and mail the coupon today.



**HARLEY-
DAVIDSON**
Motorcycles

HARLEY-DAVIDSON MOTOR CO.
Department P, Milwaukee 1, Wisconsin

Please send free copy of 24-page "ENTHUSIAST" Magazine, filled with motorcycle action pictures and thrilling stories.

Name.....

Address.....

City.....State.....



when worn connecting rod bearings cause oil pumping

Oil pumpers pour out wasted oil in smoky exhaust when worn engine bearings let excessive oil carbon-foul pistons, rings, valves and spark plugs. Worn engine bearings rob you of peppy pick-up, smoothness and economy. To stop oil pumping, to restore pep, power and economy—replace in sets with Federal-Mogul Oil-Control Bearings. *Ask your mechanic.*

FEDERAL-MOGUL SERVICE
DIVISION OF FEDERAL-MOGUL CORPORATION
COLDWATER, MICHIGAN



Replace in sets with Genuine
FEDERAL-MOGUL
Oil-Control Bearings

Flight Plan for London

(Continued from page 104)

true fix can be established at the point where its line of position intersects that of the first.

One of the most important safety factors, the weather ships monitoring zones in the North Atlantic, came into being during the war when vessels could no longer safely transmit weather information. When the full fleet of 13 is finally installed, there will almost always be one within an hour's flying distance. Three cutters rotate on a station, each getting relief after a 21-day patrol. They have a crew of 125, along with weather observers and meteorological equipment comparable to that at a first-class airport. On board are air and surface-search radar, complete ocean-rescue equipment—which is soon to include a helicopter, and a powerful radio beacon.

The ships are normally on station within a 10-mile-square area, but they can move short distances away on distress missions. Surface weather observations are made every three hours, winds-aloft observations four times daily and upper-air radio soundings twice a day. The results are fed into principal weather centers for international distribution.

They keep constant guard on four radio frequencies, two used by surface craft and two aircraft-to-ship voice frequencies. In addition, they have a 24-hour radio-beacon service in action at 05, 20, 35 and 50 minutes past each hour. It sends a signal strong enough for vessels 200 miles away to use in obtaining bearings.

On meeting a weather "front," the airliner captain will include in his hourly radio report all the essential information he can on cloud height and amount, outside temperatures and rain. This gives forecasters at stations on both sides of the Atlantic data on which to plot the course of the weather front for air traffic. In return, the captain from time to time gets messages altering earlier forecasts on weather ahead, based on reports from planes just passing through the zone and from weather ships.

A few hours before landing the captain receives a forecast on the weather expected at the terminal and at the same time sends a corrected time of arrival. If weather indications there are bad he still has ample time to decide on one of the alternate ports.

As soon as land is seen, the radio officer contacts the field for clearance, the pilot, copilot and engineer work as a team to bring the plane down to approach level, and the navigator checks ground points for

(Continued to page 236)

Closeup of a shining success!

How Johnson's Carnu,* the efficient, liquid type car polish, brings out your car's original "showroom shine"!

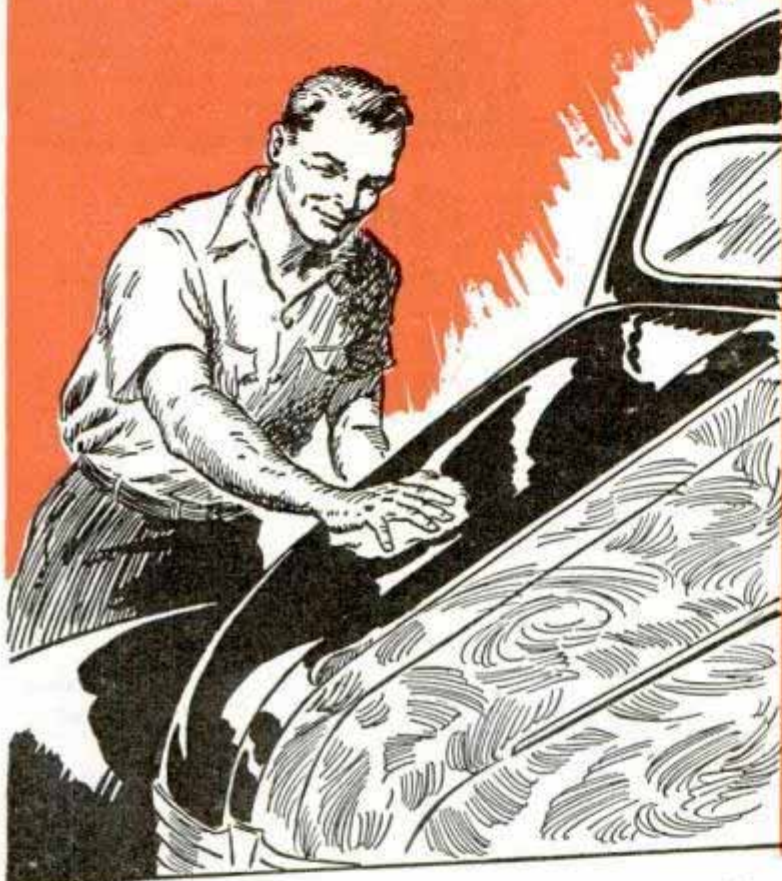

BEFORE CARNU:

Dirt and oxidized paint make your car's finish rough and dingy. Dirt sticks in crevices... won't wipe off readily.



AFTER CARNU:

Your car shines like new again, because Carnu both cleans and polishes in *one* application. The finish is lustrous and bright—the surface so smooth that future dust and dirt will wipe right off.



Just follow these simple directions



1. RUB CARNU ON!

It's easy... rub just hard enough to loosen the grime, then let Carnu dry completely to a white powder.



2. WIPE CARNU OFF!

Nothing to it!... just wipe off the powder. You'll find the dirt comes with it, leaving the finish shining like a brand new car. Yes, Johnson's Carnu cleans *and* polishes in one application.

Extra protection for the man who demands "perfection"

A tough, preservative coat of Johnson's Auto Wax does all these things:

1. Maintains the "Carnu" shine



2. Protects the finish



3. Helps preserve the color



This special car wax gives the finish a tough, protective film, protects it against sun, heat and moisture. Auto Wax also makes it easy to keep your car clean and shining because dirt can't get a foothold on the smooth, hard, waxed surface. Your auto supply store, filling station, or regular Johnson's Wax dealer has Johnson's Auto Wax. Try it!



© S. C. JOHNSON & SON, INC. • Racine, Wisc., 1947

*Trademark Reg. U. S. Pat. Off.

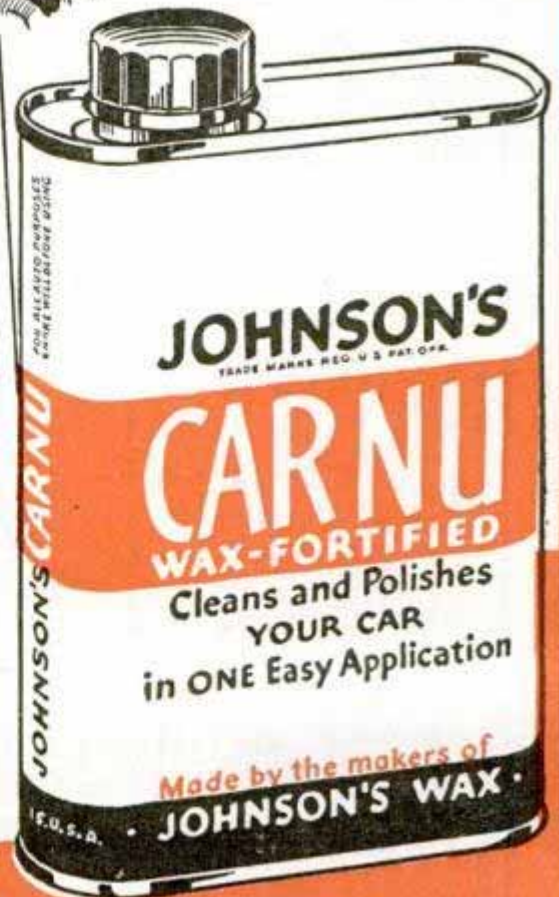



When you want to fix things fast... remember Weldwood Glue. It's quick to mix... easy to use... tremendously strong... stain-free... rot-proof... and permanent. At hardware stores, lumber yards, chain stores.



WELDWOOD PLASTIC RESIN WATERPROOF GLUE

United States Plywood Corporation, New York 18, N. Y.

LUMINALL PAINT



**makes furnishings
look their best**



Redecorate your interiors with Luminall for better lighting and purer color. See the lovely colors at your dealer's.
LUMINALL PAINTS, Chicago 9, Illinois

Save Fingers with Steel-Grip Finger Guards



Hundreds of factories are saving time and protecting workers with Steel-Grip Finger Guards. Used for handling rough, sharp articles, buffing, grinding, sanding, polishing, punch press work, many other jobs. Wear on fingers or thumb, front or back. Durable leather, elastic web back for snug, cool, comfortable fit. Easy on and off. One size fits all, men or women. Send 10c each for samples or trial order box of 50 at \$4.25 less 10%.

*Catalog of Steel-Grip Safety
Apparel free on request.*

INDUSTRIAL GLOVES COMPANY
646 Garfield Blvd., Danville, Ill.
(In Canada: Safety Supply Co., Toronto)

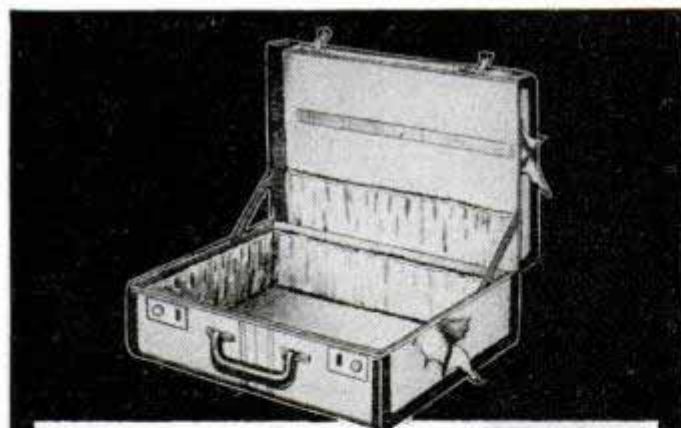

FIXES LUGGAGE, FURNITURE, DISHES, TOYS, AND BOOKS

It's transparent, water-proof, flexible and durable. Get a tube today.



DUPOCEMENT

REG. U. S. PAT. OFF.



WAKE UP YOUR SCALP Want better looking hair? Embarrassed by falling dandruff, itching scalp? Then try VITABRUSH, new electric driven scalp brush that gives your scalp a vigorous and invigorating "workout" in just three minutes of fun. Cleans scalp. Stimulates blood supply. Restful. Pleasant. Write *today* for complete information and satisfaction-guaranteed offer.
Hershey Mfg. Co., 3767 Field Bldg., Chicago 3

FIND UNDERGROUND MINERALS and METALS with M-SCOPE

Employs same principle as Army Mine Detector. Unsurpassed in Efficiency. Write for Free 16 page booklet.

FISHER RESEARCH LABORATORY, INC.
PALO ALTO CALIFORNIA

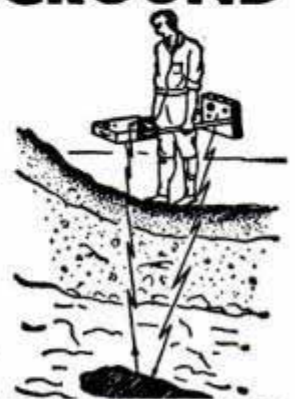

A New COMPLETE power driven workshop . . .

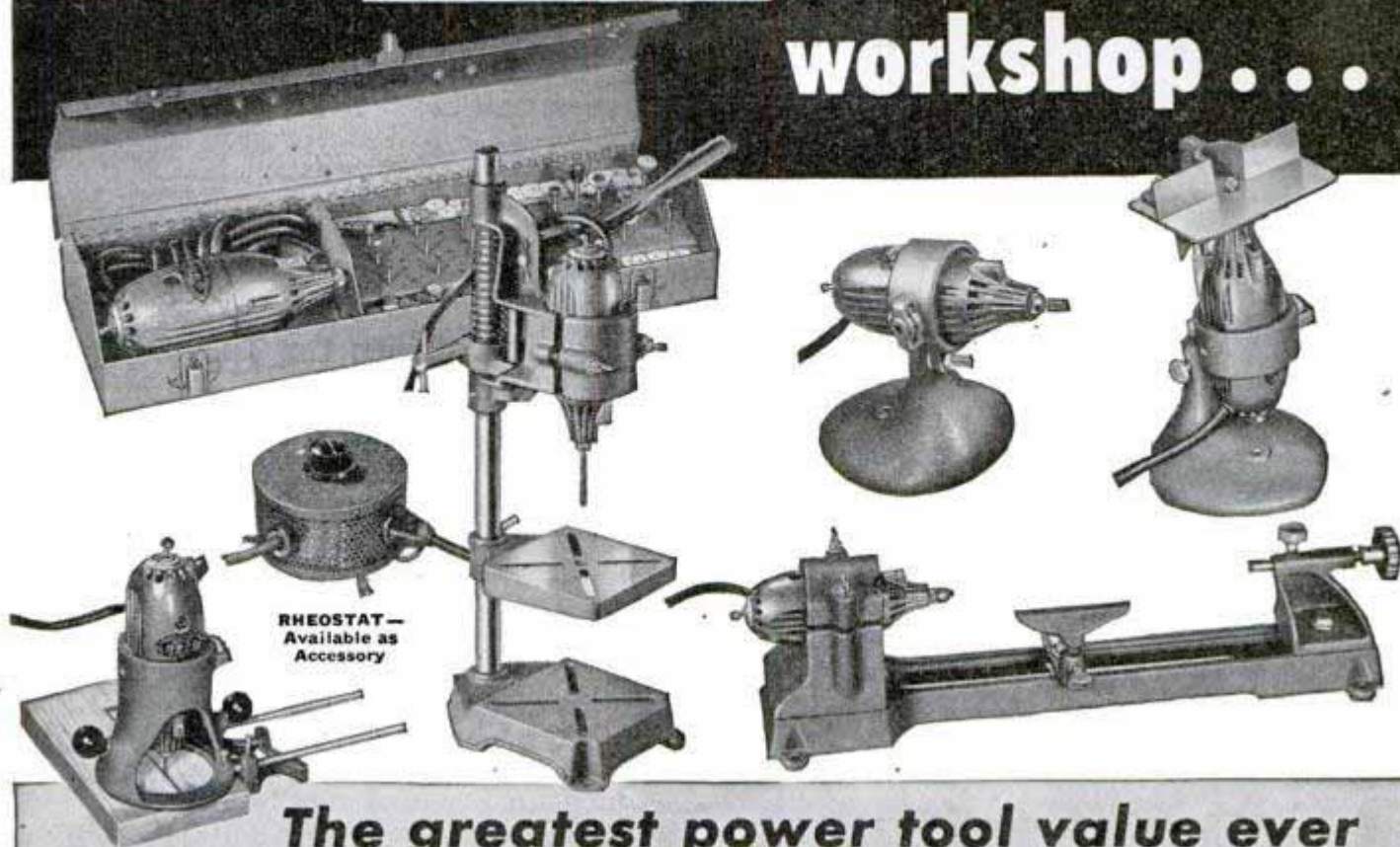

RHEOSTAT—
Available as
Accessory

The greatest power tool value ever offered to American craftsmen

\$69⁵⁰

6 Major Power Tools
Complete with Motor
and Full Assortment of Accessories

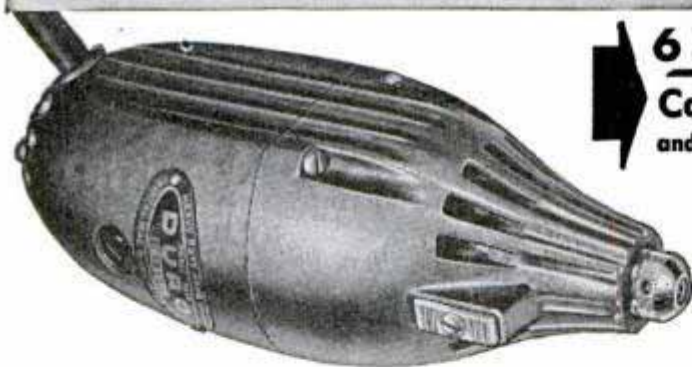

Made by a long-established power tool builder, many thousands of Duro tools have been used for years in home workshops, schools and industry. The motive power of this shop—the sturdy, rugged, Duro Hand Grinder—has long been recognized as one of the finest light grinders on the market—and is today in wide use in both industry and home shops.

Send for FREE Circular

giving complete description, specifications, and showing photographs of many unusual jobs that you can do with this shop. Also names of nearest dealers where you can see the shop on display. Mail coupon today!

Handles Scores of Operations

Designed primarily for light work in wood, plastics and light metals—this remarkable shop can be used in many ways by home craftsmen and model builders for—routing, shaping, engraving, grinding, polishing, carving, cleaning, buffing, de-burring, sanding, drilling, turning, etc. Here is the greatest value in power tools ever offered to the American craftsman. Consider this: You get a Power-driven Drill Press, Lathe, Shaper, Router, Bench Grinder, Hand Grinder—complete with AC-DC motor, all ready to operate—with a compact accessories kit containing 50 sanding, grinding, drilling, polishing accessories—all for only \$69.50.

DURO METAL PRODUCTS CO.
2676 North Kildare Avenue, Chicago 39, Illinois
Gentlemen:

Please rush me your free illustrated circular giving complete specifications and photos of the New Duro Workshop . . . plus a list of dealers where I can see the shop on display.

Name _____

Street Address _____

City _____ State _____

DURO METAL PRODUCTS CO.
2676 N. KILDARE AVE., CHICAGO 39, ILL.

Big date tonight



But car is grimy

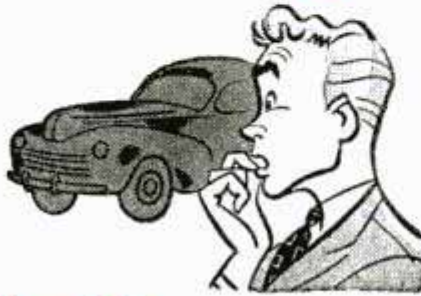

It'll shine up quick



If you just try me



Removes dull traffic film—restores the original color and lustre—quickly, easily and safely.

DU PONT

REG. U. S. PAT. OFF.

No. 7 POLISH

his craft's position. Lights flash as the familiar "No Smoking—Fasten Seat Belts" sign goes on and a whirring noise tells you the landing gear is lowering into place.

Soon the big ship touches ground, so gently that you are not even fully awakened from the pleasant nap that occupied the last part of your trip. Just long enough here on Irish soil at Shannon to stretch a bit before you're whisked back into the clouds for the final hour-and-a-half leg to London. It was a speedy voyage, luxuriously comfortable, and so simple—for you.

Unveiling the Tucker

(Continued from page 138)

The six cylinders are opposed but slightly offset, with a six-throw crankshaft that has four main bearings. Valves are operated by a hydraulic mechanism. If the oil supply gets low, the valve mechanism shuts off the engine to prevent any damage.

The engine is cooled by a sealed liquid system, with Prestone providing a temperature range from 250 degrees above zero to 50 below. Thermostats will keep the engine temperature at approximately 210 degrees, which Tucker considers ideal.

Mounted by only four bolts, the engine can be replaced in the manner of a storage battery in less than an hour. Airplane-type connectors for electrical, gasoline, oil and hydraulic lines can be unfastened in a single operation.

Under the service plan, Tucker dealers will keep a number of replacement engines on hand. When a Tucker owner brings his car in for engine repair, the old engine will be removed and a replacement engine installed so the car will be ready for use in an hour. Then the old engine will be sent to the factory for servicing.

In the Tucker engine the conventional power-transmission assembly is eliminated; in its place, hydraulic torque converters transmit power from both ends of the crankshaft to the rear wheels. This does away with transmission, clutch, drive shaft and torque tube, full-width rear axle and conventional differential. The Tucker has no drive-shaft tunnel to make a hump on the floor.

Each of the four wheels is individually suspended by heat-treated aluminum forgings that act independently when the car goes over obstructions or rough roads. Rubber assemblies replace leaf or coil springs. Up-and-down motions of the suspension arms are controlled by rubber "biscuits" fastened to the frame. Inside these biscuits, metal disks are bonded to

(Continued to page 240)

All you want in Modern Heating!

Perfection stands at the top in providing all the things you want in oil heating comfort. Since 1888, the highest standards of engineering and workmanship have produced dependable heaters for American homes . . . for *your* better living.

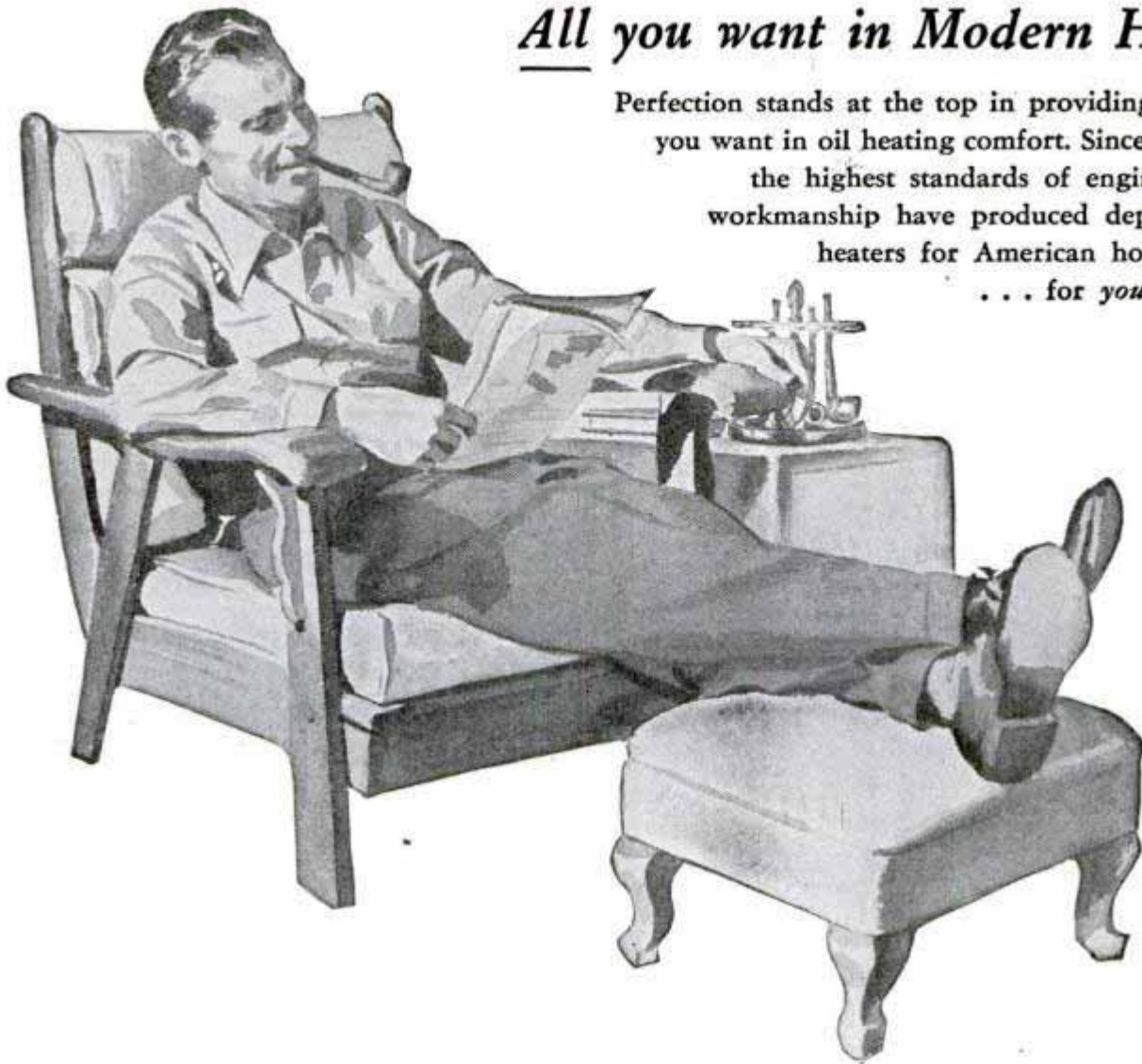

Enjoy the clean, comfortable warmth of Modern PERFECTION Oil Heat!

Uniform Heat—quick radiating and circulating warmth always there, day or night, when and where you want it.

Automatic Control—you can have fully automatic operation with an outside fuel supply tank and Accessory No. 12.

Clean Burning—soot-free, smoke-free, odor-free, result

of advanced Perfection engineering over the years.

Blower—addition of Blower No. 24 will carry heat to far corners and other rooms.

Quiet Operation—a silent servant producing the quick, clean comfort of better living. **and**—no coal to carry, no fires to build, no ashes to empty, no soot-streaked walls to clean!



*Ivanhoe Model 2205
Space Heater, other sizes
available*

PERFECTION

*The World's Largest Manufacturers of
Oil Burning Appliances for the Home*

PERFECTION STOVE COMPANY, 7897-A PLATT AVE., CLEVELAND 4, OHIO



*Firelight Portable
Model 750 for "spot"
heating anywhere*

Keep Brushes like New

BEFORE



AFTER



• 5c
• 10c
• 25c

**DICA DOO
PAINT
BRUSH
BATH**

Clean and Restore
PAINT BRUSHES

At Paint, Hardware, Dept., and 5 & 10c Stores
Patent Cereals Co. - Geneva, N. Y.

Now you'll stay
stuck-darn you!

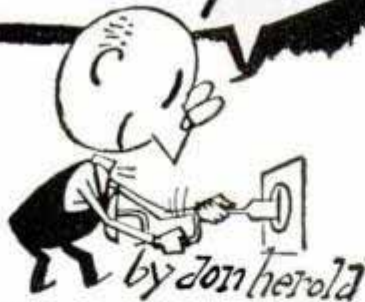

RESEATS SCREWS

Fix loose screws with Reardon's non-shrinking Water Putty. Also plug holes and cracks in wood, tile, metal or plaster.

Add water to powder as used. No waste, no caking in the can. Dries hard for nailing or painting.

Get a can at your hardware, paint, variety or department store **25c Lb. Can**

Made by The Reardon Co.

St. Louis • Montreal

Makers of BONDEX Cement Paint



**REARDON'S
WATER PUTTY**

**BUILD IT
YOURSELF**

COMBINATION WORK-BENCH and DRAWING BOARD

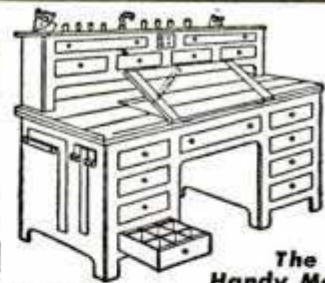

The
Handy Man's
Friend

This combination is entirely new and just what you need to help you build everything you want. There are drawers for everything—room to draw—room to work. Blueprint simplifies every step. Size can be regulated to your requirements—60", or larger, or smaller. Anyone handy with tools can make it. Start with this item, and be prepared to make anything you want. It's the first step to Big Profits—or an enjoyable hobby.

ALL FOR
\$100
Post Paid

Complete set of drawings and booklet "Let's Make It" — showing numerous new useful and beautiful pieces for home or office—things you'll be proud to own.

Send check, money-order, or cash today.

I. C. SHALKOP, Dept. A

1216 RIDGE AVE.

PHILADELPHIA 23, PA.

UTICA TOOLS

FOR MORE TOOL MILEAGE

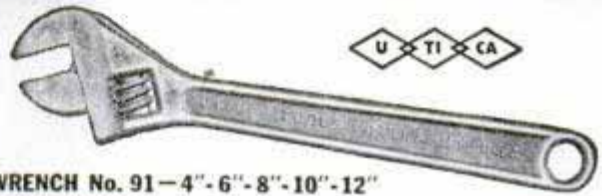

WRENCH No. 91—4"—6"—8"—10"—12"

UTICA DROP FORGE & TOOL

CORPORATION

UTICA 4, NEW YORK

THE GEM MAKER



Amateurs or professionals . . . hobbyists or jewelers . . . Polish your own gems with a B&I Gem Maker. You will find this a profitable adventure. All necessary lapidary equipment is furnished, including a super-charged diamond blade for sawing, and all wheels for grinding, shaping and polishing, also complete instructions. The complete equipment as shown, less motor and belt, for only \$29.50, f.o.b., Burlington, Wis. Write today for information and literature on the Gem Maker and accessories.

B&I MFG. CO., Dept. S, Burlington, Wis.

LAW

STUDY AT HOME for PERSONAL SUCCESS and LARGER EARNINGS. 39 years expert instruction—over 108,000 students enrolled. LL.B. Degree awarded. All texts furnished. Easy payments. Send for FREE BOOK. G. I. approved. **AMERICAN EXTENSION SCHOOL OF LAW** Dept. 81-M, 646 N. Michigan Ave., Chicago 11, Ill.

BUILD YOUR OWN POWER LAWN MOWER

WHY BREAK YOUR BACK
MOWING FIELD OR LAWN?

WRITE FOR
FREE
LITERATURE
The Rite-Way
Mower
Attachment
Ball Bearing

SAVE MONEY
SAVE TIME

Now anyone can save time and effort mowing field or lawn by building their own whirl type power mower. Build according to your own ideas and needs at small cost. Cut close to fences, walks, buildings, etc. Build in short time with parts and instructions we furnish. Save hours of time and back breaking labor. Write today for FREE information.



IT'S FUN TO BUILD

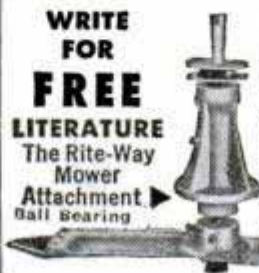

T & H MFG. CO., Dept. PM5
811 E. 31, Kan. City 3, Mo.

Logan

A NAME TO REMEMBER WHEN YOU
THINK OF BETTER LATHES AND SHAPERS

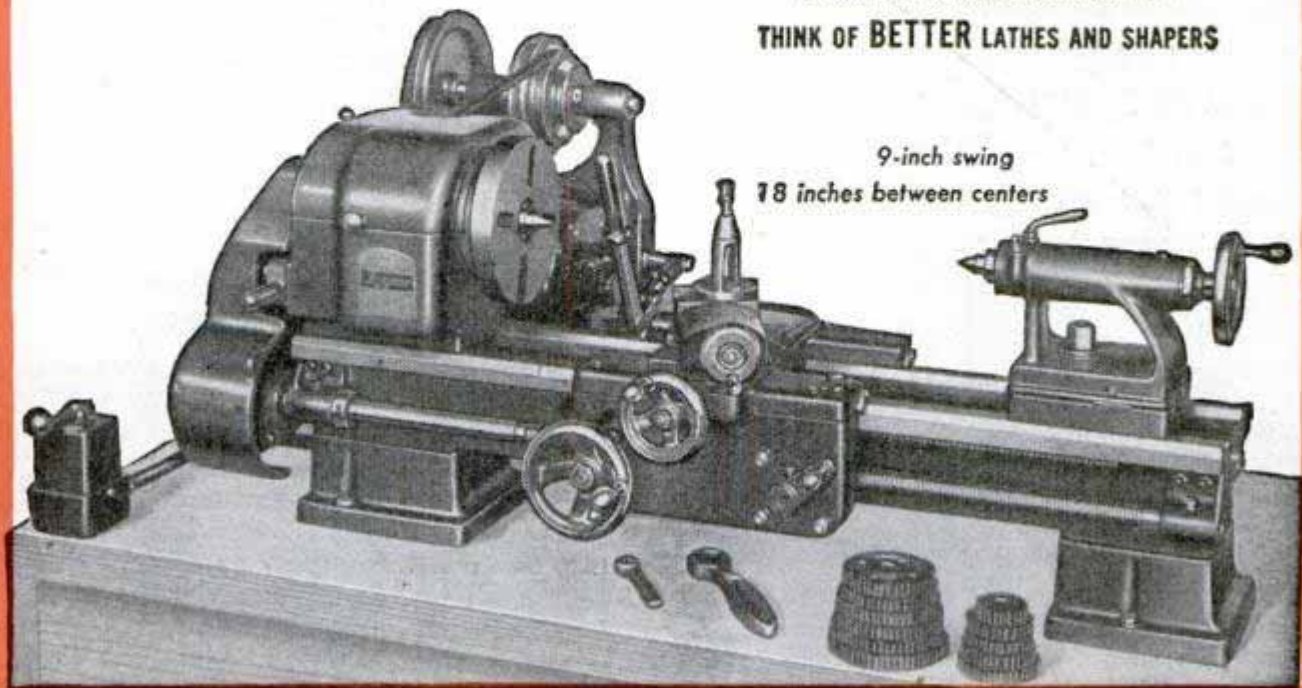

9-inch swing
18 inches between centers

**NEW 9-inch
Logan Lathe**

Logan performance
In a New Size
At a New Low Price

Here is something new in 9-inch lathes . . . Logan advanced design, accuracy, ruggedness, and all-around dependability built in a 9-inch size. The Logan 9-inch Lathe has all the basic features that have made larger Logan Lathes outstanding industrial performers. The spindle turns on ball bearing mountings inherently well adapted to high speed work. The two V-ways and two flat ways of the rugged bed are precision ground to within .0005" of parallelism. Massive construction insures steadiness on heavy cuts and durability. Self lubricating bronze bearings protect vital wear points. The result is a versatile lathe with the traditional Logan sustained accuracy, effective in precision manufacturing operations, general machine shop and tool room work, auto, and appliance repair, and for home workshop use. Complete information is available at your Logan Lathe dealer's, or on written request.

DISTRICT OFFICES:

WOOLWORTH BLDG.
NEW YORK 7, N. Y.
CORTLAND 7-8024

550 W. WASHINGTON BLVD.
CHICAGO 6, ILLINOIS
CENTRAL 1246

1672 MISSION STREET
SAN FRANCISCO, CALIF.
UNDERHILL 6682

700 COMMERCE ST.
DALLAS 2, TEXAS
CENTRAL 4075

LOGAN ENGINEERING CO., Dept. B-9 CHICAGO 30, ILL.

USE AC's FOR
**UTMOST
 RELIABILITY**

Dairies and milk producers use factory-recommended AC Spark Plugs to assure utmost reliability in milk delivery. Your AC dealer can supply you with factory-recommended AC's for your car, truck or tractor, designed for today's fuels and driving conditions.



Look for this sign



Spark Plugs cleaned and adjusted "By the AC Method" may save as much gas as 1 gallon in 10



**AC
 SPARK PLUGS**

AC SPARK PLUG DIVISION • GENERAL MOTORS CORPORATION

rubber with bars extending to each side of the upper suspension arms.

To increase safety and driving ease, the 13-inch wheels (which carry 7.00 by 13 tires) have a $\frac{1}{32}$ -inch toe-in in front and $\frac{1}{16}$ -inch toe-in in the rear. The front wheels have a special mounting which Tucker says will eliminate any swerving if a front tire blows out at high speed.

Tucker says the major operating parts—such as bearings with sealed-in lubricant—will require no repairs for "at least 100,000 miles." If the Tucker does everything its creator claims, it may revolutionize the automobile industry. Time will tell!

Filming the Waltz of the Flowers

(Continued from page 111)

the plant first pushes through the earth the lens is focused down on it, and when the plant is full-grown the camera still is on a plane with the subject.

Another little motor turns a shaft that runs across the table behind the cameras—but the shaft revolves so slowly the motion can't be seen. A cord runs from the front of each cable car to a pulley in front of the subject, then back beneath the car, over a wheel on the shaft, and back to the rear end of the car. As the shaft turns, the camera moves patiently up the track toward the subject, or if the cord is reversed, away from the plant. The camera may take a month to travel only two or three feet, yet when the resulting film is shown, the spectator rides the cable car in from a distance for a close-up. The sequence, which required months to film, may take only 5 or 10 seconds on the screen.

Other refinements in Ott's equipment include a solenoid attachment that automatically snaps the picture and a voltage transformer to prevent variations in the floodlight illumination.

Today he makes his equipment do specialized tasks outside his studio. One timer automatically waters the orchids in his greenhouse. Another is connected by cable with a box mounted on stilts beneath a maple tree in his yard. One of the branches of the tree runs into a hole in the front of the box. A camera inside the box is taking time-lapse movies of the development of maple leaves and buds. The mechanism works just like his basement equipment—shutting out all sunlight for a few seconds while a floodlight comes on and one frame of the film is exposed.

His experiments with plant nutrients, insect poisons and flower preservatives show the comparative value of similar products.

(Continued to page 244)

You change blades in a flash with the modern
Gillette

ONE-PIECE RAZOR

SHAVING is mighty quick and easy when you use a modern Gillette One - Piece Razor. There's nothing to take apart or put together. You change blades in jig time. Twist . . . the razor opens. Twist again . . . your blade's locked in position. For cleaning both razor and blade just loosen the holder, rinse and shake.

Enjoy utmost shaving comfort and convenience. Get a superb Gillette Aristocrat or Gillette Milord One-Piece Razor. They're the finest shaving instruments money can buy!

Gillette Safety Razor Co.
 Boston 6, Mass.



Gillette Aristocrat One-Piece Razor, gold plated, \$379
 with case and ten Gillette Blue Blades

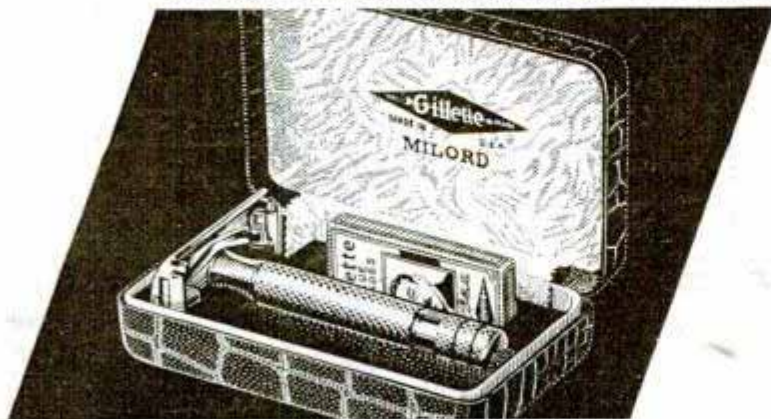

Gillette Milord One-Piece Razor, gold plated, \$250
 with case and five Gillette Blue Blades



Twist...It's Open



Twist...It's Closed

Copyright, 1947, by Gillette Safety Razor Company

look SHARP! feel SHARP! be SHARP! use Gillette Blue Blades

WITH THE SHARPEST EDGES EVER HONED

NEW! EASIER, FASTER, STRONGER OUTDOOR PROJECTS



with Easi-Bild® Patterns and
CASCOPHEN Resin Glue

"Easi-Bild Full-Size Patterns" take the mystery out of making things.

Just trace the pattern on the wood, saw it out and glue it together. There are 94 projects for furniture, toys, gifts, buildings, home needs.

And the designers of Easi-Bild Patterns recommend CASCOPHEN Resorcin Resin Glue for assembly of all outdoor projects. CASCOPHEN makes permanent waterproof, heatproof, mold-proof bonds. The *only* completely durable glue for home use!

Prove it yourself. See how easy it is to make better projects this new way. Start with the "Project of the Month," No. 32 Lawn Chair, shown above. Mail this coupon now!

*Trade-mark © 1947, Easi-Bild Pattern Co.

CASCO Pattern Dept. PM9
P. O. Box 215, Pleasantville, New York
Enclosed is 25c for full-size Easi-Bild Pattern No. 32 and folder describing over 100 Easi-Bild Projects.

Name _____
Street _____
City _____ Zone _____ State _____

Casein Company of America
(Division of The Borden Company)

SAY YOU SAW IT IN POPULAR MECHANICS

Now You Can GET THOSE MOTOR-CLUTCH- TRANSMISSION AND AUTO PARTS AXLE PARTS in stock

Why worry about parts when we have them . . . All you want, at a **BIG SAVING** . . . We ship within 48 hours . . . We also have **REBUILT UNITS** for EXCHANGE at Bargain Prices: **CARBURETORS — FUEL PUMPS — GENERATORS — STARTERS — SHOCKS AND KNEES** . . . It will pay you to **GET OUR PRICES**. — **RUSH YOUR ORDERS** —

and
**SAVE
MONEY**

Get Our
**BARGAIN
PRICE
LIST**
for parts
you want



If Car Owner Specify Make **IMMEDIATE SHIPMENT**
MECHANICS AUTO PARTS, Factory Warehouse
3807 No. Ashland Ave., Dept. PM-9 **CHICAGO 13**

A GREAT SURPLUS BARGAIN REDUCING GAUGE

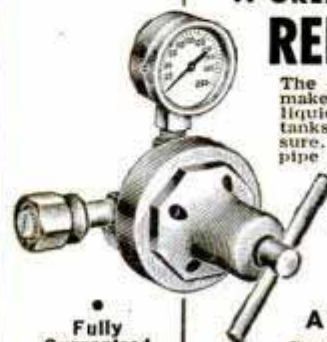

The buy of a lifetime in a standard make air pressure regulator. Used on liquid carbonic tanks and air pressure tanks of all kinds to regulate the pressure. Fitted with standard 1/2 inch pipe thread. Dial calibrated 0 to 200 lbs. Made by U. S. Gauge, Air Reduction Co., Walter Kiddle—all famous makers. Used by artists for air brush work, sign painters, retouchers, welders, etc. Used by soda fountains and taverns. All units are brand new. Satisfaction guaranteed.

A \$15 VALUE

\$5.95

Send check or money order. Ship same day.

GROBAN SUPPLY CO.
1522 S. Michigan Ave., Dept. PM9, Chicago, Ill.



Evinrude Catalog Free

Completely describes 1947 line of Evinrude outboard motors — light "singles", smooth "twins" and 3 thrilling four-cylinder models. Gives helpful information on boats, speeds, etc. Profusely illustrated. Address, **EVINRUDE MOTORS**, 5602 N. 27th St., Milwaukee 9, Wis.

EVINRUDE

NONE BETTER! SUPER DRILL GRINDER

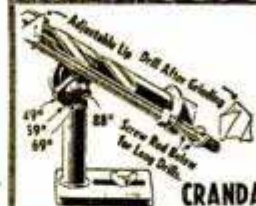

Sharpens round shank drills from 3/32" to 1-1/16" in diameter, up to 11" long. Grinds old drills like new in 4 different point angles, using hand or power grinding wheels. Money-back guarantee.

Price only \$2.95

At Dealers or Postpaid

CRANDALL MFG. CO. 1512 W. Stauson, Dept. FA-21, Los Angeles 44, Calif.



THE UNIVERSAL LIQUID CEMENT

The "Mr. Fix-it"
for "a million things"

Tops in quality for 37 years. Uses unlimited . . . sticks and mends permanently. Waterproof . . . quick drying. Keep a tube on hand always. Extra quality . . . extra strength. Ready to use. **LOOK!** Get acquainted with Ambroid quality. At your dealers or send 25c for big 2-oz. tube postpaid (U.S.A. only). Money back guarantee. **25c**

Also 50c 4-oz. tube.
Pts., qts., gals. for industrial use.

AMBROID CO.
303 Franklin St., Boston 10, Mass.

POPULAR MECHANICS

The Pipeline

PIPES COAL IN! PIPES ASHES OUT!

WARMTH WITHOUT WORK

All the work of furnace tending is done automatically by The Pipeline Coal Burner. Pipes bituminous coal from any bin to your present furnace, burns it smokelessly and efficiently, and even pipes ashes to dust-proof containers! Modulated warmth regulated by automatic controls.

Conversion models and complete winter air conditioners. Field-tested since 1934. Write for free 20-page booklet.

FITS ANY
COAL BIN

FITS ANY
FURNACE

DUSTPROOF
ASH CONTAINER



POCAHONTAS FUEL COMPANY INCORPORATED
Stoker Division • 344 East 131st Street • Cleveland 8, Ohio

CROSMAN *Silent* RIFLE



**POWER
without POWDER**

You'll like a Crosman because there is no recoil to spoil your aim... no noise... no odor... no cleaning! Rifled barrel for greater accuracy... adjustable power, too, for short or long range shooting indoors or out. Available in .177 and .22 cal. models.

AT YOUR DEALER OR WRITE DIRECT

CROSMAN ARMS CO., INC.

3 B HENRIETTA ST., ROCHESTER 7, N. Y.

Shoot CROSMAN *SuperPells*

The BETTER Ammunition for ALL .177 and .22 caliber Air Pistols and Rifles.

.177 cal. . . \$2.50 per M'

.22 cal. . . \$3.00 per M'

POSTAGE PREPAID

At your dealer or order direct



FOR
GREATER
ACCURACY
MAXIMUM
POWER

CROSMAN ARMS CO. HENRIETTA ST., ROCHESTER 7, N. Y.

FASTEST PLANER in the WORLD at this Low Price... \$195⁰⁰

Belsaw Multi-Duty Planer



Needed by every saw mill owner and woodworking shop to Speed Up Production — Increase Profits.

Belsaw high speed thickness planer provided for single surfacing stock up to 12" wide by 8" thick at the high speed rate of 24 lineal feet per minute for HIGH PRODUCTION. Planes GREEN or DRY sawed lumber into higher priced, valuable smooth and worked forms. Machine has welded all STEEL frame... nothing to break. Safety-type all Steel cutterhead runs in heavy duty ball bearings. Three HIGH SPEED Steel knives make 42 cuts per inch for smooth finish.

Belsaw Multi-Duty Planer is REALLY ECONOMICAL — adequately powered by any motor — developing 2 horsepower — REALLY PROFITABLE... lowest investment and operating costs, and takes inexpensive attachments for all common planing mill operations: Jointing, Rabbeting, Grooving, Matching. Produces 84 S. Finish (surfaced four sides) without the great investment required for 84 S. surfacers. Simple accessories provide for SHARPENING and JOINTING its own knives. You get BIG VALUE in Belsaw, and provide for your progressive growth. Write for FREE specifications, illustrations and low prices.

FREE
BOOK

BELSAW MACHINERY CO., 1011 Field Building
315 Westport Rd. Kansas City 2, Mo.
World's largest manufacturer of light sawmill and woodworking equipment.

a new
extra "car"

for only
\$249⁵⁰



... GET A

SERVI-CYCLE

THE COMPLETE POWERCYCLE!

SERVI-CYCLE IS AMERICA'S FIRST
AND FOREMOST POWERCYCLE!

It's not a motorcycle, not a bicycle. It's *the* lightweight, complete powercycle. Safe? You bet! Top speed 35 m. p. h. Exceeds all International Powercycle Association safety rules! Ride it, park it... easy as a bicycle!

100 MILES PER GALLON!

Drive your Servi-Cycle to and from work... for shopping, errands. Save wear, tear on your automobile. Your Servi-Cycle is built to last... and last... and what a money saver!

INCREASED PRODUCTION
PERMITS OUR APPOINTING
A FEW NEW DEALERS

National advertising (Saturday Evening Post) to support you. Write nearest Servi-Cycle factory, Dept. P, for complete information.

You're Safe and You Save with
SERVI-CYCLE

SIMPLEX
Mfg. Corp.
New Orleans
540 N. Carrollton Ave.

SERVI-CYCLE
Western Corp.
San Francisco
1821 Egbert Ave.

SERVI-CYCLE
Eastern Corp.
Baltimore
1205 S. Carey St.

NOW TRY Dustless SWEEPING



**Reduce Germ
Laden Dust
Eliminate
Sweeping Compound**

Dustless brushes used with Arbitrin sweeping fluid eliminate up to 97% of germ laden dust and reduce sweeping costs 20%. Arbitrin fluid, poured into a metal reservoir in the brush back, filters through the tufts and keeps dust down as you sweep. Dustless brushes are used in thousands of schools, factories, offices, stores, and institutions. There is a Dustless brush to fit your needs. Write for sizes, styles and prices today.



Milwaukee Dustless Brush Co.
530 N. 22nd St., Milwaukee 3, Wis.
Please send complete facts about Dustless Brushes.

Name _____

Street Address _____

City, State _____

For example, his film proves which of the nutrients does the best job on particular plants. The evidence is undeniable—it's on the screen for you to watch.

He's turned up several curiosities in his experiments. Once he photographed a soil-filled box covered with dead, dry leaves. When he developed and projected the film, the leaves were absolutely motionless at intervals and at other times they jumped around with amazing vitality. At first he thought the leaves might be affected by a slight movement of air in the studio, or that they weren't completely dry. He made another film strip of the same subject, but speeded up the exposure intervals to slow down the action on the screen. When he projected the new film the mystery was solved—angleworms in the soil had been coming out every night and shoving the leaves into new positions.

Today Ott is venturing into microscopic time-lapse work. With a special lens attached to a microscope he is photographing subjects so small they barely can be seen with the naked eye.

He hopes and expects that his technique will be used in many fields of research. He suggests many applications—by coupling time-lapse equipment to X-ray machines, medical research could have a visual history of the knitting of broken bones. With microscopic equipment the gradual change in the cells of aging lumber could be studied. Films could show the growth of bacteria and mold, and the effect of medicines on bacteria.

Ott has only a few cans of film representing 20 years of work in time-lapse photography. But his hobby has become a business and his patient work may pay dividends in wide fields of research.

Putting Life in Puppets

(Continued from page 159)

made up in three sizes ranging from 1½ to 14 inches in height, for use at different camera distances.

A puppet's body consists of wood or composition material and is provided with plug-in holes into which the arms, legs, and heads are inserted. Arms and legs usually consist of soft rubber molded around wire skeletons so they may be bent to any position. Half a dozen sets are made up for each character as replacements when the original arms and legs wear out during animation.

Often, too, a series of legs and feet imitating the different positions assumed in walking or running is made up. These are

(Continued to page 248)

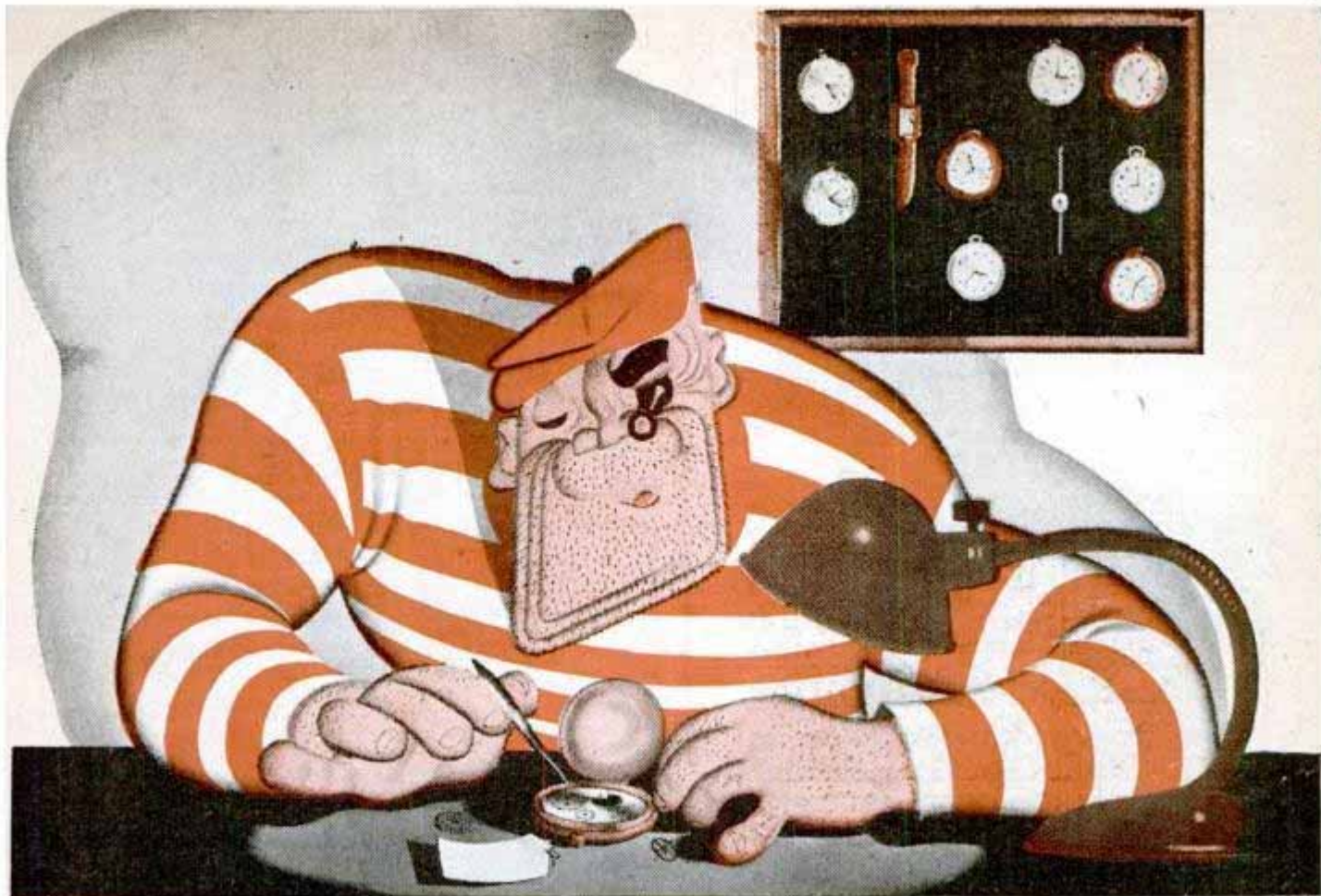

Piston Rings

WEAR OUT, TOO!

● Piston rings are designed to "take" the wear... to protect your engine. When they wear out they waste oil, cause loss of power and lead to excessive cylinder wear. Fortunately, piston rings can be replaced—again and again—restoring engine performance each time.

So, when your car first begins to smoke, use too much oil or lose power,

install Hastings Piston Rings at once. They *stop* oil-pumping, *check* cylinder wear, *restore* performance.

Remember that name, Hastings Piston Rings—the best money you can spend on your car.

HASTINGS MANUFACTURING COMPANY
HASTINGS, MICHIGAN
Hastings Ltd., Toronto



HASTINGS

STEEL-VENT PISTON RINGS

TOUGH on Oil-pumping
GENTLE on Cylinder Walls

More POWER! More ECONOMY!
Amazing war development
increases POWER & ECONOMY
of cars, trucks, tractors and
stationary motors!

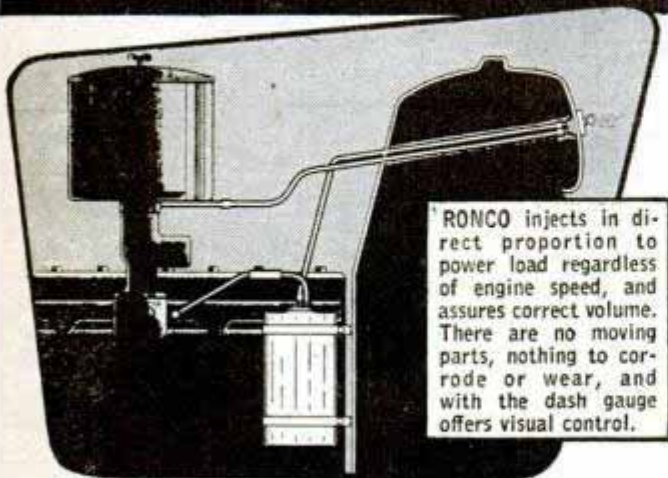

RONCO injects in direct proportion to power load regardless of engine speed, and assures correct volume. There are no moving parts, nothing to corrode or wear, and with the dash gauge offers visual control.

RONCO LIQUID INJECTOR

POSITIVE PRESSURE INJECTION

Install it yourself on any gasoline motor

RONCO INCREASES POWER

Applying the same principle used by fighting planes during the war, RONCO injects water into the gasoline mixture making your engine run smoother, cooler, and with more power, also prevents the formation of hard carbon on the valve stems and in the piston ring grooves.

RONCO SAVES MONEY

RONCO guards against costly repairs by removing waste deposits. RONCO adds MORE OCTANE to regular gas and INCREASES gasoline mileage.

- RONCO helps prevent hard carbon
- RONCO helps prevent excessive oil consumption
- RONCO Prevents detonation pre-ignition (PING)
- RONCO prevents dirty spark plugs
- RONCO increases gasoline mileage
- RONCO gives more power with all grades of gasoline
- RONCO adds life to your engine

\$29⁸⁵

DEALERS DISTRIBUTORS

There still are many desirable territories available. Write now for complete details.

MAIL THIS COUPON TODAY!

BEAUCHAMP DISTRIBUTING COMPANY

Exclusive Sales Agents
 473 SAN PABLO AVE., Richmond, California

Gentlemen: Please send me C.O.D. (plus postage) _____
RONCO LIQUID INJECTORS

* Please send me descriptive literature _____

NAME _____

ADDRESS _____

CITY _____ STATE _____

TYPE OF EQUIPMENT _____

Shoots
Light 800 Ft!

A genuine Delta for home and away. Spotlight and floodlight. 80-100 hrs. on a 6-volt battery. At hardware, sport, electrical **\$3⁹⁵** stores. Less battery



Delta ELECTRIC CO.
 MARION, INDIANA

POWERlite 2-LITE ELECTRIC LANTERN



MINIATURE ENGINES

Gasoline—Steam
 Air—Locomotive



THE WORLD'S MOST FASCINATING HOBBY

Build them yourself — In your own shop
With your own tools



Send 10 cents for my illustrated catalogue listing the world's largest selection of miniature engine castings and drawings.

McADED MODELS
 1313 S. TALMAN AVE.
 CHICAGO 8, ILLINOIS

MACHINE SHOP EQUIPMENT



Just off the press!—Every man who owns a workshop should have a copy of the new, up-to-the-minute, 200 page catalog of Machine Shop Equipment—the latest tools made by the biggest manufacturers in the U. S. Replete with illustrations, descriptions, prices. Prompt delivery on most tools listed in this book. Available at cost of printing—50c a copy—get yours today! **Price of Catalog Refunded on First Order over \$5.00.** Send check or Money Order to

CENTER TOOL CO., 153 Centre St., Dept. C, New York 13



EASY PROFIT IN PAINT SPRAYING

Paints walls, ceilings, screens, furniture and machinery faster, better. All complete as shown less motor. Carry anywhere. Fully guaranteed. Could be used with 1/4 H.P. motor or less. Price **\$35.00** less motor F.O.B. Chicago. \$5.00 deposit balance C.O.D. or see your dealer.

IDEAL AUTOMATIC PUMP CO., Dept. P.M. 8
 Chicago 7, Ill.

PULVEX
 "DDT"
 FLEA POWDER

Guaranteed by Good Housekeeping if defective or not as advertised therein

Kills the fleas *Quickly!*
 Keeps others off *for Days.*

Pulvex also comes with **ROTENONE**, the original formula. **BEST FOR CATS.**

Either Kind **25¢ & 50¢**



U. S. GOVERNMENT SURPLUS
TRIPODS
 Strong Wooden Tripods with adjustable legs. 5½ foot extension. Used by Government for engineers levels and transits. Can be used for holding Telescopes, Cameras, etc.
 Value 24.50 **\$4 95**

WHEATSTONE BRIDGES
 Used in excellent condition. Mfg. by Thompson Lever Mfg. Co., Philadelphia. Value **SPECIAL \$49.50**
 \$150.00

Engineers All Metal Army Type Hand-Sighting
LEVELS
\$2.00 PRECISION QUALITY 
PUBLIC SPORT SHOPS
 13 S. 16th St., Phila. 2, Pa. No COD's

FOR REAL DRIVING CONVENIENCE—
 THE NEWEST HULL
BEACONLITE
 OR VETERAN STREAMLINE
 New Illuminated Hull Automobile Compass — **BEACONLITE, \$5.95**; standard model **STREAMLINE, \$3.95**. At your dealer's. Write for literature.
HULL MFG. CO.
 P. O. Box 246-D8 Warren, Ohio



New THOR "B" ENGINE—\$6.95
 The new THOR "B"—Sensational miniature gasoline engine that really works. Super-power performance. Smooth, velvety power that roars into action with a "twist of the wrist." Over 25,000 already sold. 1/8 H.P. Complete with coil, condenser, and fully illustrated instructions, ready to run, only \$9.95. In KIT form, fully machined, 5 minutes to assemble, \$6.95, without coil and condenser. Powers all models. Send \$1.00—shipped collect same day C.O.D. Free. Send for 21-page illustrated hobby catalog.



AMERICA'S HOBBY CENTER
 DEPT. B-97, 156 WEST 22ND STREET, NEW YORK 11, NEW YORK

WALKIE SIREN
 Formerly \$15.00—Now Only **\$3.95**
 GOV'T SURPLUS. A precision instrument. Easy turn of crank produces CLEAR, FULL SIREN TONE. Can be heard for great distance. Ideal for Boats, Autos, Schools, Sporting Events, etc. Dimensions 7" x 4" x 5". Wt. 4 1/2 lbs. Price includes shoulder strap and waterproof cover. **SEND NO MONEY.** Just name and address. We'll ship C.O.D. for \$3.95 plus postage, or send money in advance, we'll ship prepaid. Canadian price \$4.50. **ILLINOIS MERCHANTISE MART, Dept. 400-B, 1227 Loyola Ave., Chicago 26, Ill.**



Made to U. S. Army Specifications!
15-JEWEL
ELGIN
\$18.95 
 Sturdy 15-Jewel ELGIN men's wrist watches. Waterproof. Sweep second hand. Stainless Steel back. Unbreakable crystal. **QUALITY! American made. Fully reconditioned with ONE YEAR GUARANTEE! Made for the U. S. Army Air Corps. They HAD to be good. SEND NO MONEY.** Simply pay postman \$18.95 plus 10% tax and postage on delivery. Cash orders sent postpaid. Limited supply. **UNITED PRODUCTS CO., 7941 S. Halsted St., Dept WES-409, Chicago 20, Ill.**

*You've never Fished
 With a Lure Like This!*



LOOKS LIKE A SHRIMP!
 SMELLS LIKE A SHRIMP!
 TASTES LIKE A SHRIMP!
 PAT. APP. FOR



NEW! NEW!
COLORFUL PLASTIC!
World's Greatest Bait Saver!
 Poor Fish—he gets a hook to the jaw . . . and you land the big ones every time with Manning's Tasty Shrimp Lure. Shrimp is "King of Natural Bait." You simply unscrew the head (see illustration) place real shrimp meat—or other bait—in cavity. One bait usually lasts all day. Whether casting, trolling or still fishing, Manning's Tasty Shrimp Lure hooks 'em and keeps 'em hooked. Get yours today! **MAY ALSO BE USED WITHOUT BAIT!**

Distributors
 Jobbers
 Dealers
 Write Dept. A for
 your prices now!

Retail Price
1.50
See Your Dealer

MANNING'S Tasty
SHRIMP LURE CO.
 828 Gravier St. New Orleans 12, La.

arc
welding
pays big—

start your own business
with this **HOBART**
simplified welder

QUICKLY PAYS FOR ITSELF!

Many of the large welding fabricators of today got their start with a single Hobart Electric Drive Arc Welder and they paid for it with a small percentage of their monthly earnings.

MULTI-RANGE CONTROL . . .

gives you the correct welding heat for each job, assuring you of the kind of work that brings customers back.

REMOTE CONTROL . . .

will save you time and enable you to work faster, and turn out more profitable jobs each day.

BUILD YOUR OWN.

You can even build up your own gas drive welder with a Hobart generator and go after the more profitable jobs in the field.

AC WELDER FOR SINGLE PHASE.

If you have only single phase current available, you can still start a profitable welding business with the Hobart 220 volt, single phase AC arc welder.

BE AN EXPERT WELDER.

If you lack confidence, attend the Hobart Trade School and you'll never worry about your ability to turn out good welding work. We have helped thousands to get started in the profitable welding business and we're ready to help you. Return coupon for particulars.

Hobart Bros. Co., Box M-97, Troy, Ohio
"One of the world's largest
builders of Arc Welders."

Get more information on

Hobart
arc welders
free!

HOBART BROTHERS CO., BOX M-97, TROY, OHIO

Without obligation, please send me information on items checked below.

- Electric Drive Welder. Build Your Own Welder.
- AC Transformer Type Welder.
- Hobart Trade School Booklet.

Also, please send me information on how to start a Job Welding Shop, so that I can earn some of the big money in welding.

NAME.....
ADDRESS.....
CITY..... STATE.....

used one after another, one per frame of film, in animation.

Different facial expressions such as smiling, frowning, laughing and the attitudes of conversation can't be imitated in a single head and so as many as a dozen heads, each with a different expression, are made up for each puppet. One head is removed from the body and another one is plugged in, between frames of film, to carry on the animation.

It takes ingenuity to costume the puppet actors because most striped or decorated fabrics would appear out of proportion on them. Often special fabrics must be woven for the characters; sometimes tiny designs are worked with thread into the cloth so that the material will appear in the proper scale. Real fur often is used. Jewelry and other tiny properties for the diminutive characters are fashioned with the aid of strong reading glasses. Infinite care goes into making the puppets and miniature sets, for a tiny mistake would be magnified greatly when it appears on the screen.

So You've an Invention to Patent

(Continued from page 85)

the wisdom of the founding fathers. More than 2,500,000 patents have been issued and there are estimated to be some 400,000 living patentees.

Business at the patent office began in 1790 when three patents were issued under authority of Thomas Jefferson who served as first administrator of the patent laws. In those days, obtaining a patent was simple. You merely sent an application, and in due time a clerk in Washington mailed you your patent certificate.

In 1836 with the growing complexity of invention, the patent regulations were revised and made part of our organic laws. Two men share the honor of being first to receive a patent; under the old regulations, Samuel Hopkins of Vermont was first; under the patent system established in 1836, Senator John Ruggles of Maine was first.

Making farming easier was the main spur to invention in those days. McCormick was granted a patent on his reaper in 1833 and Moore a patent on his harvester in 1836.

The electrical age began with Morse, who in 1832 obtained a patent on his electromagnetic telegraph. Thomas Davenport, a village blacksmith of Brandon, Vt., obtained patent No. 132 in 1837 on his method for obtaining rotary motion from an electromagnet. His model, submitted with his application, has all the essentials of a modern direct-current motor with a

(Continued to page 252)

13.5% more accuracy without winding

that's what you get with the

CROTON AQUAMATIC

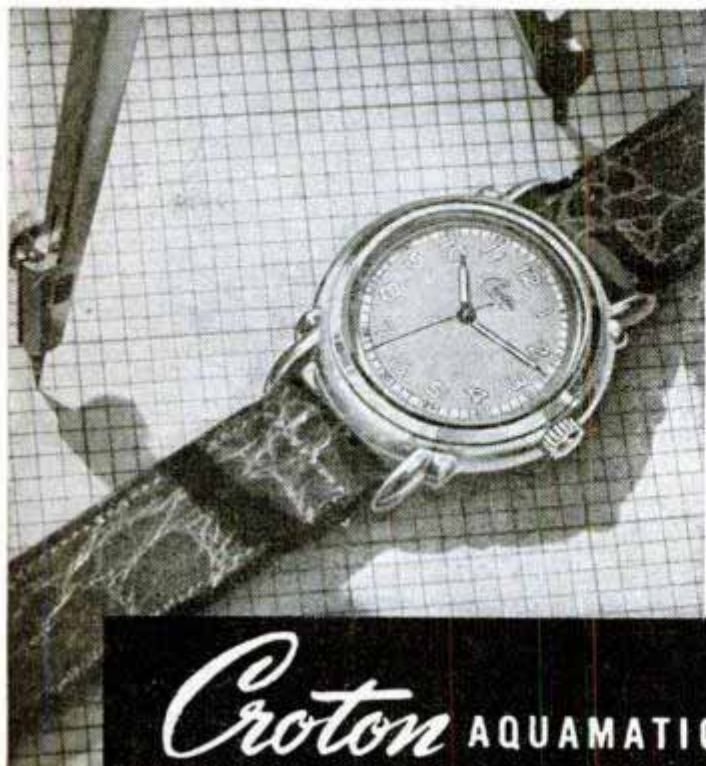

Croton AQUAMATIC

THE WORLD'S MOST CAREFREE WATCH

You're always *on time* because you *don't* wind your watch! Your Croton Aquamatic keeps itself wound just right, by the ordinary motions of your wrist. It can't run down, *can't overwind*. It keeps better time — 13.5% better time* than famous hand-wound watches. The Croton Aquamatic quietly and efficiently tends to its own business, while you go about yours. A wonderful idea for a wonderful gift — or for yourself. Made only by Croton — famous since 1878.



AQUAMATIC SHEDS WATER LIKE A DUCK!

Handsome, serviceable — the Aquamatic is *certified waterproof*, before it goes to your jeweler, by United States Testing Co. Inc. Just make sure *only* your Croton dealer opens, closes and services your watch.

Other features — dust-proof, shock-resistant, the dial's easy to read in the dark, *the glass crystal can't shatter!* Only \$57.50, including federal tax.

* 8 Aquamatics were tested against the average of 9 famous watches wound by hand, in a 30-day wearing test by a leading laboratory. Aquamatic proved 13.5% more accurate! Write for free booklet. Croton Watch Co., Inc., 48 W. 48th St., N. Y. 19. © 1947 Croton Watch Co., Inc.

NO. 78 X-acto COMPLETE CARVING SET

NEW!



20 different blades

Here's everything you need for a super-slick job, from toothpicks to totem poles. Super-sharp blades, firm-grip handles for light and heavy work. Ideal for wood, linoleum, plastics, etc. Contains: 6 different gouges, 4 routers, 2 punches, 6 regular blades, 2 three-inch blades, one No. 1 knife, one No. 5 knife. On wooden block, complete.....only \$5.00

*Reg. U. S. Pat. Off.

Other X-acto Knives, Blades, Tools and Sets, 50¢ to \$50
Prices slightly higher in Canada

At hobby, gift, hardware and department stores

X-acto Crescent Prod. Co., Inc., 440—4th Ave., N. Y. 16
In Canada: Handicraft Tools, Ltd., Hermant Bldg., Toronto

I GET MORE THAN
90 MILES a Gallon
on my COMET

Only
\$149⁵⁰
UP
F. O. B.
MPLS.



COMET features:

- All-steel frame
- Automatic clutch
- 1 1/2 HP 4-cycle engine
- Separate brake control
- Oversize balloon tires
- Rubber-mounted shock absorbing front fork
- Rubber cushioned engine mount
- Easy operating kick starter
- Aircraft design for lighter weight, better performance

Comet Motor Scooters are handier than a second car for the family! They're easy to ride, economical—they go more than 90 miles to the gallon—and ideal for any use. Ride a Comet to and from school or work, for easy shopping (no parking problem), for deliveries, after-school jobs, sports, vacation trips, fun on the highway. There are four Comet models. All are lightweight, safe, durable. Send coupon below for free booklet.

COMET

MOTOR SCOOTER

COMET SCOOTER MANUFACTURING CO.
9253 Nicollet Avenue Minneapolis 9, Minn.

Please send me, without obligation, your colorful, illustrated Scooter Booklet.

NAME _____ ADDRESS _____
CITY _____ ZONE () STATE _____

TRAILER AXLES • HUBS • WHEELS AND SPRINGS

1000 LB. CAPACITY STRAIGHT AXLE

58" Tread — 46" Spring Centers

Axle only, \$6.50—With Springs, \$22.00; Axle, wheels and hubs, \$30.50; Axle, wheels, hubs and springs, \$43.70.

1500 LB. CAPACITY STRAIGHT AXLE

58" Tread — 46" Spring Centers

Axle only, \$8.25—With Springs, \$24.50; Axle, wheels and hubs, \$32.25; Axle, wheels, hubs and springs, \$46.00; If 4" Drop Axle is wanted, add \$5.25 to above prices.

Wheels take 6.00-16 tires • Hubs equipped with roller bearings • Prices F.O.B. Fenton, Mich. • Remittance with order—No. C.O.D.

Write for Descriptive Literature

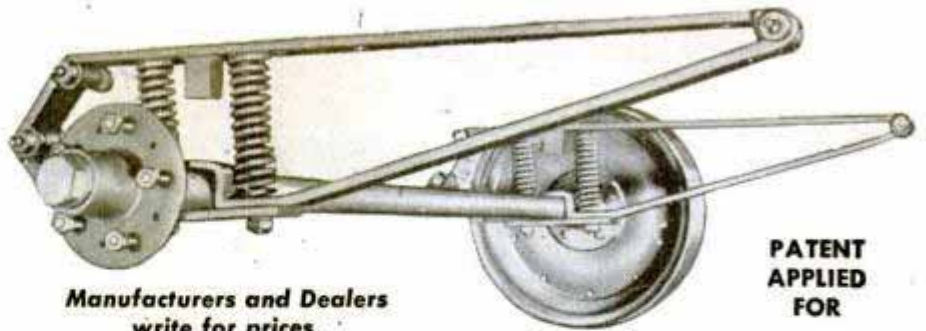

Manufacturers and Dealers
write for prices.

PATENT
APPLIED
FOR

200 S. LEROY ST. INDUSTRIAL MACHINE TOOL CO., INC. FENTON, MICHIGAN

MARGIE

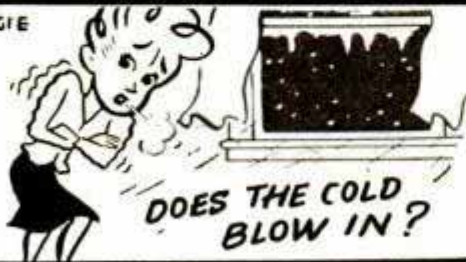

IT'S TIME TO
WEATHER-
STRIP
WITH
Mortite



KEEP WARM — SAVE FUEL

Don't put up with dangerous, drafty zones in your home when it's so easy and inexpensive to weatherstrip with Mortite. Simply press pliable Mortite around windows, doors, baseboards, etc. It keeps cold out, keeps heat in, shuts out dust and dirt, too! Mortite adheres to any clean, dry surface. No tools, no tacking needed. Anyone can apply it.

3 Sizes: 29¢ - 98¢ - \$1.25

Higher west of the Rockies and Canada

Get at stores or write for free circular



J. W. MORTELL CO., 522 Burch St., Kankakee, Ill.

SOLID BRASS 12 FT. PORTABLE

RADIO ANTENNAS

Real \$15 Value Now Only \$4.95 Postpaid
FOR HOMES, BOATS or AUTOS

JUST OUT! Gov't surplus used on Army tanks. These telescopic rustproof antenna have tremendous pickup eliminate dangerous wiring. Solid Brass throughout practically insuring NOISE FREE RECEPTION.

12
Exceptionally
Rugged Sections
compress into 1
ft. 4 in. Handy for
Camping Trips, also
Useful for Transmitting,
FM & Television sets.
Each antenna comes with clamps,
nut, lug, and wire. Easy to in-
stall anywhere.

QUANTITY LIMITED

ORDER TODAY. A real \$15 value for only \$4.95 Postpaid. Mail check or money order now or sent C.O.D. plus postage. Money back in 10 days if not satisfied.

RADIO HOSPITAL 1113 Lexington Ave., Dept. A-9
New York 21, N. Y.

New
War
Surplus

HOIST & WINCH

Eliminates Back Breaking Ordeals



Small But Mighty. Were made to be used on B-29s for lifting bombs. 2,000 lbs. capacity. Weight 16 lbs., perfect for lifting or moving loads in trailers or onto trucks, tractors, or any other movable machinery.

Fine for garages, implement stores, warehouses, assembly lines contractors and many other uses. Original cost, approx. \$100.00.

Sale Price complete with mounting brackets, \$26.30 only

Send check or money order for immediate delivery

SESCO ENGINEERING & SUPPLY CORP.

15th Ave. and Clay St.

Dept. PM

No. Kansas City, Mo.

The Chief WORK BENCH

Built to Last a Lifetime!

With Bottom Shelf and 18" Sq. Drawer. 2"x6", Solid Plank, Grooved and Dovetailed Top and 1"x8" Back Rail, Shellacked to a Smooth, Satiny Finish.

MOHAWK LUMBER CO. Dept. 32
14525 W. Chicago Blvd. Detroit 27, Mich.
Enclosed Check Money Order for \$.....
Ship..... CHIEF WORK BENCHES at

Quantity
\$16.95 each, F.O.B. Detroit, Mich.
 Send C.O.D., \$5 Deposit Enclosed.

NAME.....
ADDRESS.....
CITY..... STATE.....
No Priority Necessary!

• 6 Ft. Long • 34" High • 26" Deep. Shipped Knock-down, with Bolts, Nuts and Screws and ABC Chart for Quick, Simple Assembly.

Prompt Delivery
MOHAWK LUMBER CO.
14525 W. Chicago Boulevard
DETROIT 27, MICHIGAN



\$16.95
F.O.B. DETROIT

Send Check or Money Order, or Will Ship C. O. D. (\$5 Deposit)

PAINTERS' STRIPING TOOL

NEW, IMPROVED

A TOOL... NOT A BRUSH

Modern—streamlined—fits the hand like a fountain pen! Easy to use as a pencil. Draws parallel lines—straight, curve or circular. Does expert job on autos, furniture, toys, bikes, model planes, signs, bulletins, linoleum. (Makes wall board look like tile.) Every painter and craftsman needs one! Type "M" MASTER Painters' Striping Tool complete with tip for 1/16" stripe, \$1.00. Extra tips 1/64", 1/32", 3/64", 1/16", 5/64", 3/32", 1/8"—75c each. Tool with complete set of 7 tips \$5.00. (C.O.D. orders 25c extra.) Paint dealers, write!

\$1.00 POST PAID

EASY AS USING A PENCIL!

WENDELL MFG. CO.
4234-B Lincoln Ave., Chicago 18, Illinois

DRAIN YOUR CELLAR, POOL, WASH TRAYS, ETC.



LABAWCO Type P Pump keeps garden pools fresh. Circulates oil or refrigerant, etc. **DOES NOT CLOG!** 1500 Gals. per hr. — 300 Gals. at 30'. Uses 1/8 to 1/2 H.P. motor.

PUMP ONLY \$6.50 POSTPAID

\$13.95 POSTPAID

COMPLETE SELF-PRIMING UNIT (less motor): Pump, motor stand, special bracket, 18" flexible shaft, 14" length 1" suction hose, bolts, etc.

Pump alone \$6.50. Pump with complete self-priming unit . . . \$13.95. **POSTPAID if cash with order. West of Mississippi, add 50c.**

SEND ORDER TODAY

LABAWCO PUMPS
BELLE MEAD 4. N. J.

TURNER VT-73 DESK MICROPHONE



Here's the mike you want for your rig. It's got looks, it's tough, and man, oh man how it performs. It's a TURNER! Ask your dealer or write for Free Literature on other low cost Turner Microphones.

THE TURNER COMPANY
921 17th St., N.E., Cedar Rapids, Iowa

New MILLING ATTACHMENT



Sizes for 8" to 16" metal lathes

BUILD IT YOURSELF from our sets of semi-machined castings and save 88. Can be finished on your lathe alone. Complete working drawings and step-by-step instructions furnished with castings.

Mill keyways, slots, splines, dovetails, flutes in reamers, taps, hobs, and special cutters; produce spur, bevel, mitre and worm gears, ratchets and racks; mill flat surfaces, square shafts, mill hexes, spot face, drill spaced holes, bore, etc. on your lathe with this precision attachment. It has a T-slotted table, a vise which swivels for angular milling, a gear cutting fixture and dividing centers.

FREE! Illustrated folder and price list. Includes milling cutters, keyway cutters, drill rod, slitting saws and many hard to get shop items. Mention your lathe. Write today.

HURON MACHINE AND TOOL CO.
VALE 4, MICHIGAN

Stop PIPE JOINT LEAKS

This Quick, Practical Way



If it isn't possible or convenient to take the joint apart, shut off the water and apply Smooth-On No. 1 Iron Cement to the pipe threads where they enter the fitting.

Force the cement into the leak by winding soft iron wire around it. Twist ends of the wire together and let the cement harden before turning on the water.

You'll find you've stopped the leak surely and inexpensively.

To apply Smooth-On, you simply mix it with water—no heat necessary. It hardens like metal, expands slightly as it sets and stays tight.

Keep Smooth-On No. 1 handy for stopping leaks, sealing cracks, tightening loose parts, bolts, screws, handles, knobs, casters, etc. Buy it in economical 1 1/4-oz. or 7-oz. size at your hardware store. If they haven't it, write us.

GET THIS REPAIR HANDBOOK FREE

This 40-page, pocket size book shows many other time-saving, money-saving metal repairs you can make around the house, on the car, etc. Clear directions. 170 diagrams. Just send the coupon.



SO-208 **Sign and Send NOW**

Smooth-On Mfg. Co., Dept. 37J
570 Communipaw Ave., Jersey City 4, N. J.

Please send me my free Smooth-On Handbook

Name.....

Address.....

9-47.....

Do it with SMOOTH-ON THE IRON CEMENT OF 1 000 USES

SAY YOU SAW IT IN POPULAR MECHANICS



The New HOOVER

Fractional Horsepower Motors

Compact, power-packed...
watch-like precision,
work-horse stamina.
Made by the manu-
facturers of the
world-famous
Hoover Cleaner.

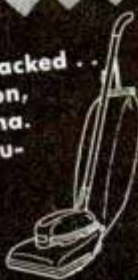

The Hoover name on the new Hoover Motors is your assurance of the finest in fractional horsepower motors.

The new Hoover Motors are designed with the same electrical engineering skill and know-how that have produced more than 6 million Hoover Cleaners.

FEATURES OF THE HOOVER MOTOR

Induction run... single phase... 60 cycles... 1725 R.P.M.
... heavy duty... built for continuous operation.

Capacitor start... more than 300% full load starting torque with minimum current flow.

No vibration or "shift"... integral feet, carefully machined to give solid mounting and quiet operation.

Low temperature... electrical and mechanical design for low-temperature operation. Ventilated open type. 40° C. Rise.

Laminated steel rotor... carefully ground and balanced for maximum efficiency.

Centrifugal starting switch... built for trouble-free operation.

High-grade ball bearings... sealed against dust and grit, give smooth performance and long wear.

Rotation... clock or counterclockwise.

POPULAR USES OF HOOVER MOTORS

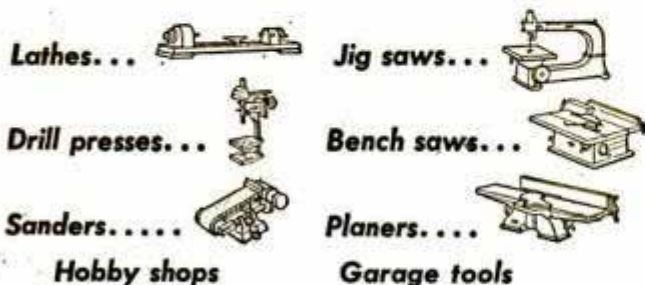

THE HOOVER COMPANY

Electric Motor Division, North Canton, Ohio

revolving armature, commutator and brushes.

By 1876 electricity began to be understood in experimental laboratories and Bell patented his battery-operated telephone that year. Edison appeared on the scene, patenting his talking machine in 1878 and his incandescent lamp in 1880. Tesla patented his induction motor in 1888, Hall his method for obtaining aluminum in 1889, and Mergenthaler his Linotype in 1890. An inventor was no longer viewed as a crank or a curiosity. Inventing became a profession that commanded respect.

An amazing number of inventions has come from a small group of men whose patented discoveries run several hundred or a thousand. One of these men was John F. O'Connor, a specialist-inventor whose 1000 patents were all in the railroad field. Another was Francis H. Richards, who required the services of ten draftsmen to put his ideas regarding weighing and packaging apparatus on paper. He patented 850 inventions.

A prolific inventor in a special field is John Hays Hammond, Jr., holder of nearly 800 patents in the electronic group. Starting with an invention at the age of 16, he collaborated with Alexander Graham Bell on long distance telephony and pioneered in vacuum tubes, frequency modulation and television.

With the notable exception of O'Connor, the "mass production" inventors started alone, but soon acquired a staff of assistants to multiply their genius. In this category may be placed important inventors such as Edison, Ford, and DeForest. Many of the leading patentees are found in the research laboratories of the nation's large industrial firms such as General Electric, Westinghouse, General Motors, Ford Motor Company, Chrysler Corporation and Du Pont.

War accelerated the flow of inventions, and a sudden increase in applications for patents early in 1945 showed that the nation's inventors were giving serious thought to new war devices.

Since the end of the war, inventors are coming up with civilian-use devices. Thus, because of the housing shortage, there are 75 applications filed every week for prefabricated structures. Some 3000 applications are awaiting examination by housing specialists at the patent office.

No matter what the problem, American inventors and gadgeteers are always ready to use their ingenuity to solve it. Under the protection of our patent system they've solved the problems of the past, and there is no reason to doubt that they will not solve those of the future.



IS YOUR CAR TIRED?

Rid your car of that sluggishness . . . give it new power and snap with a set of quick-seating Burd "Graf-Flox" Piston Rings.

Two free, handy booklets for car-owners are yours for the asking. Just print your name and address in the margin, alongside this ad, clip ad and mail it today!



BURD PISTON RING CO., DEPT. PM, ROCKFORD, ILL.

BOTTLEGAS EQUIPMENT FOR HOME-BOAT-TRAILER OR CABIN:



No. C-45 Cylinder Type ICC-4B 340 approved for use in any state in U. S. or foreign countries. May be filled from any other cylinder.

PRICE ONLY \$18.50



No. C-49 Regulator. Fits cylinder above, and any large cylinder. Requires only the piping to the appliance. Guaranteed.

PRICE ONLY \$15.00

Wholesale Prices on Request.



APPLIANCE SERVICE CO. Dept. 13 VIRGINIA-MINN.

STAY HOME AND MAKE MONEY!

—Men! Women! Get into profitable, uncrowded profession you can operate from your home or small office after short home training course. No capital required. No goods to buy. No age limit. Others earn \$50.00 to \$100.00 per week making famous Stephenson corrective foot devices to order. Foot sufferers everywhere pay gladly for relief. Send today for FREE BOOKLET.

STEPHENSON METHOD, Established 1894, 12-28 S. Market St., Boston, Mass.



STOP LEAKS!

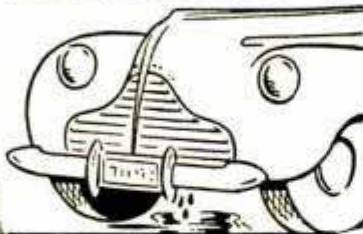

Cooling Systems Made Leak-Proof QUICKLY

WARNER LIQUID SOLDER—Non-Metallic—Deposits Tiny Fibers to Repair Leaks Anywhere in Cooling Systems. Simply pour in! Finds and REPAIRS every crack or hole. Do it yourself—or see your service man.

Warner-Patterson Co., 920 S. Michigan Ave., Chicago 5

YOU CAN'T BEAT AN American

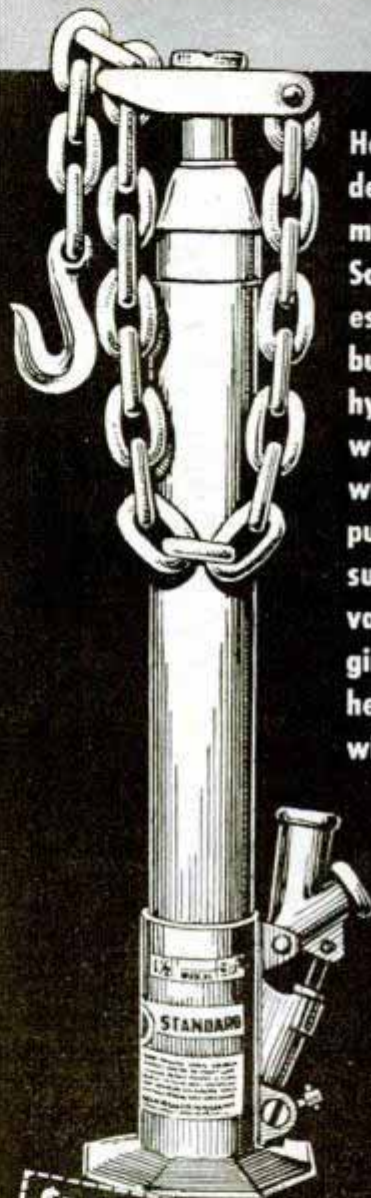

Here it is—the greatest development in automobile bumper jacks! Safest, quickest, easiest to use on any car built. Also an all-around hydraulic utility jack with hundreds of uses where easy lifting or pulling is required. Result of 15 years of advanced precision engineering. Extra long, heavy duty steel chain with forged steel grab hook picks up loads from 4" BELOW bottom of jack to 22" ABOVE. Base, handle socket, head and chain plate are all tough malleable iron castings. 17" hydraulic lift, 3000 lb. capacity.

\$14.50 Complete with chain, hook and handle

Order now at your dealer or write to

American Hydraulics Inc.
SHEBOYGAN, WISCONSIN

© 1947 AH, Inc.

The BEST IN SURPLUS

New AIRCRAFT RADIOS



Brand new 6 tube superheterodyne aircraft radios, 3 gang condenser, RF stage, 2 IF stages, tunes 6 to 9.1 Mc. built by Western Electric complete with tubes, in original carton. Shipping Weight 8 lbs.

\$4.95

Brand New Army T-30 THROAT MICROPHONES



Brand new Army T-30 throat microphones. Used in aircraft, tanks, etc. Use to broadcast through your radio, in noisy factories, hundreds of applications. Shipping Weight 1 lb.

\$1.

MINIATURE HEADPHONES



Miniature type headphones. Ideal for hearing aids, listening to radio in noisy places, in bed, etc. Complete with headband, cord and two sets rubber ear plugs. Shipping Weight 1 1/2 lbs.

\$1.

NEW DYNAMOTORS

New dynamotors built by Western Electric for Army. Consists of 6 to 24 volt electric motor operating 220 volt generator on same shaft. Hundreds of uses, motor alone worth \$5.00. Shipped in original carton. Shipping Weight 6 lbs.



\$1.50

ELECTRONIC KIT

An experimenter's paradise. Five pounds of new condensers, transformers, coils, switches, sockets, resistors, etc. Enough parts to try dozens of electrical experiments. All new useful parts. Shipping Weight 6 lbs.

\$1.

TUNING UNIT

The heart of the Army transmitter-receiver BC745. Contains transmitter crystal and tank coil, receiver coil, tuning condenser and crystal, ideal foundation for small amateur set. Shipping Weight 1 lb.

\$1.



THE HEATH COMPANY

BENTON HARBOR, MICHIGAN

Larson

"MAKE YOUR OWN" BACKYARD GYM SET

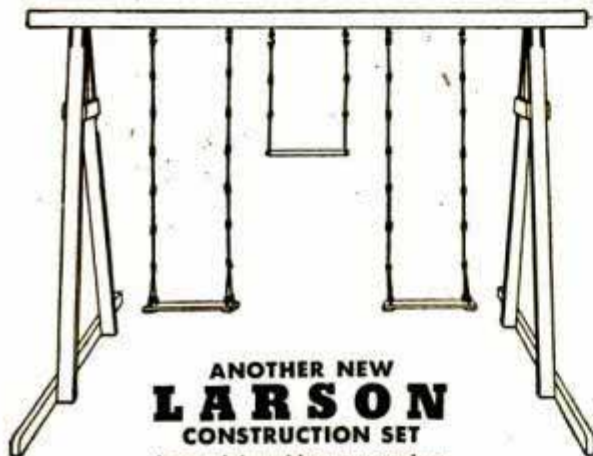

ANOTHER NEW
LARSON
CONSTRUCTION SET

A complete outdoor gymnasium.
Easy to construct from standard 2 x 4 lumber.

Complete with copyrighted instruction sheet and drawings. Parts built rigid for added safety. Everything furnished except lumber. Quickly taken apart for storage.

- Set No. 2024 as illustrated—2 swing prepaid.....\$ 8.00
- Set No. 1524 Single swing—prepaid 5.00
- Set No. 3024 2 swing, Trapeze and ladders—prepaid..... 10.00

CHAS. O. LARSON CO., BOX 358, STERLING, ILLINOIS

Ever Sit On A Gold Mine?



YOU can build your own business NOW in the new and flourishing field of coin-operated radios. We can show you the way to big earnings and a steady income with TRADIO, the radio functionally designed for coin-operation in hotels, tourist camps, hospitals, etc. Only a small investment is needed to assure yourself of financial independence for life. Write, wire or phone for complete information. No routes sold.

TRADIO, Inc. Dept. N-9, Asbury Park, N. J.
Tel: Asbury Park 2-7447



TORNADO GAS TORCH

The Modern Way of Soldering

Ideal for hard and soft soldering. Will heat quickly; solder will flow freely and smoothly. No compressed air required. Self-adjusting. Safe. Economical. Can be used for annealing small parts and bending metal parts. Generates a heat of 1700° F. Simply connect to any illuminating gas jet with a rubber hose and operate. Tornado Torch No. 119 comes with three tips, (1/8", 1/4", 3/8" blast).

Tornado Gas Torch No. 119 — Complete with 2 tips, for Natural Gas or Bottled Gas; with 3 tips for Manufactured Gas. \$2.95 per set. See your dealer or order direct. Send check or money order — post paid.

Robco Corporation, 202 E. 44th Street, New York 17, N. Y.

"I'LL TAKE THE WHITE ONE EVERY TIME!"



WYTEFACE
TRADE MARK
STEEL MEASURING TAPES



KEUFFEL & ESSER CO.



MOTO-TOOL ★ THE "POCKET-SIZE" MACHINE SHOP

A TOOL THAT PACKS EXTRA YEARS OF PLEASURE . . . LOOK AT THE REST, THEN BUY THE BEST

Here's a tool to please a man's heart . . . one that holds promise of endless creative hours. Dremel Moto-Tool . . . the little grinder that does big jobs . . . is a "war veteran" . . . used by all branches of the armed forces in far-flung repair bases . . . helped set production records at General Electric, Westinghouse, Remington Arms, Ford and others. Hobbyist or expert craftsman, first choice is Model 2 Moto-Tool Kit with its handsome felt-lined, highly finished wood case with rows of tools begging to be put to work. Write for FREE catalog of Moto-Tool attachments and accessories.

10 REASONS WHY MOTO-TOOL'S A BETTER BUY

Oil-less, sealed bearings • Patented automatic chuck lock pin • Over-size armature shaft, hardened, ground, polished • 110 Volt, AC-DC motor • Sliding snap-tape switch • Cord protector • Shockproof bakelite housing • Dust-filtered, air-cooling system • Weighs only 13 oz. • Dynamically balanced for vibrationless operation.

MONEY BACK GUARANTEE: Buy Dremel Moto-Tool and Accessories from your dealer. If he cannot supply you, order direct from factory on 10 day trial. Shipped postpaid for payment in full sent check or money order; or send only \$2.00, we will ship C.O.D. You pay balance plus postage.

DREMEL MFG. CO., Dept. 117-J Racine, Wisconsin



Approx. **27,000 R.P.M.**

- Burring
- Grinding
- Routing
- Polishing
- Engraving
- Sharpening
- Drilling
- Inlaying
- Sawing
- Sanding
- Carving
- Cutting



PRE-WAR PRICES STILL PREVAIL

Moto-Tool Kit No. 2, with 23 accessories (high speed steel cutters, grinding wheels, polishing accessories) and heavy-duty professional Model 2 Moto-Tool in natural

finish, hardwood case . . . **\$23.50.** Items purchased separately would cost about \$30.00; you save \$6.50!

Moto-Tool Kit No. 1 with 34 accessories and Model 1 Moto-Tool in wood case . . . **\$17.50.** Model 1 Moto-Tool with one wheel point . . . **\$9.85.**

AIRCRAFT SUPERCHARGER LUBE PUMP

Designed for Pumping Liquids Up to 3 G.P.M.

A gear type impeller pump with two pumping units in one housing. Precision built of aluminum, cast iron, bronze and steel. Compact construction—only 3 1/2" Dia. x 8 1/2" long.

- Vacuum, 29 1/2 inches of mercury.
- 1/2" Dia. Threaded and keyed shaft.
- Brand new! Sealed in Pliofilm.
- With Test Sheet and Instructions.

Immediate delivery. Order now! Post paid anywhere in U.S.A. upon receipt of check or M.O. C.O.D. orders include postage and extra fees.



Pressures up to 200 lbs. per Sq. In.
From 1 to 3900 R.P.M.

Originally cost \$24.00. Now only **\$39.50**

FISCHER LABS 1731 N. MOBILE, CHICAGO, 39, ILL.

ACE LATHE TOOL SET

Be permanently tooled-up for every operation on your Metal Cutting Lathe



The ACE Set is complete—there's nothing more to buy. Drop forged by the manufacturers of cutting tools used by 96 per cent of the plants and shops in industry they are correctly designed, are of special steel, are finely finished, are stronger—will last a lifetime. You can cut easier, faster and more accurately with ACE TOOLS.

At your Hardware Store—

ARMSTRONG BROS. TOOL CO.

"The Tool Holder People"
368 N. Francisco Ave., Chicago 12, U.S.A.

- 3 Turning Tools, 2 Cutting off Tools, Knurling Tool, Boring Tool
- Threading Tool, High Speed Steel Cutters and Blades, and 2 Wrenches in Fitted Steel Case.



Don't let good gas and oil money go up in smoke. Restore new car pep and power to your motor with a set of quick-seating Burd "Graf-Flox" Piston Rings.

Send name and address on margin of this ad for two free, handy booklets for car-owners.

BURD PISTON RING CO., DEPT. PM, ROCKFORD, ILL.



MACHINISTS + TOOLMAKERS

Gerstner tool chests in modern designs for your good tools. Free Catalog. **GERSTNER TOOL CHESTS** 447 Columbia St., Dayton 7, Ohio

SAY YOU SAW IT IN POPULAR MECHANICS

BUILD YOUR OWN SPORTS TRAILER

takes two days . . . saves you \$200

Now—this beautifully streamlined sports trailer—made and sold by Modernistic Trailer Manufacturing Co. for years at a price over \$500, is being shipped in a complete, prefabricated kit. Comes to you ready to assemble. It's easy—all you need is a screwdriver and wrench! Anyone can do it! Complete instructions furnished. Trailer has all-aluminum exterior. Accommodates 2 adults. Overall length, 12'7"; width 6'; height, 5'. Has roomy galley, and plenty of stowage space. Total weight slightly over 400 lbs.—hardly noticeable behind your car. Kit comes complete with every part needed, less tires and tubes.

Build this deluxe sports trailer for your own use—or sell it and make money! Order your prefab kit today . . . fit and quality of every section unconditionally guaranteed. Price only \$279.50, plus tax, f.o.b. Los Angeles. Enclose full remittance, or, if you desire C.O.D. shipment, enclose \$50 deposit. If more convenient to you we will ship trailer in two kits—one kit now, the other later when you're ready for it. Price is slightly higher but you pay for each when you order. First kit, containing chassis and outer shell sections, only \$157.50. Second kit, containing balance of trailer, \$139.00. Order today specifying complete kit or first half of kit. Write for free folder.

NATIONAL TRAILER STORES • Dept. 30 • Box 2353, Terminal Annex • Los Angeles 54, California

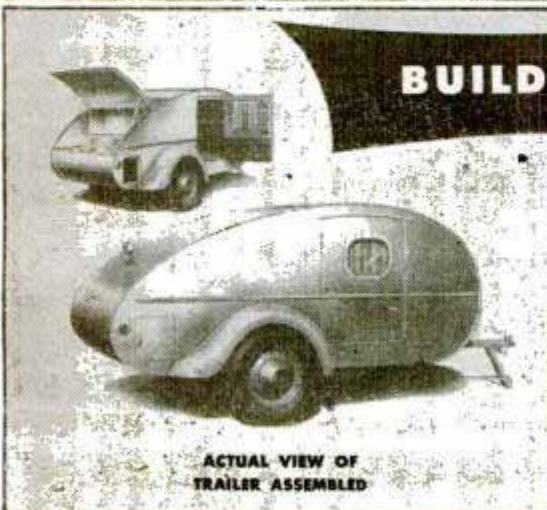

ACTUAL VIEW OF TRAILER ASSEMBLED

FREE!



SEND FOR
**ALLIED'S
BIG 164-PAGE
RADIO
CATALOG**

Everything in Radio at Lowest Prices!

Here is *everything* you want in Radio! New home radios and phono-radios, Ham receivers and gear, new kits, thousands of parts, tubes, tools, complete PA equipment, diagrams, latest radio books. The most complete stocks anywhere—in one *big* book—all at money-saving low prices!

**BUILD THIS
AMAZING
5 TUBE RADIO**



LOW-COST SUPERHET KIT
Complete with Plastic Cabinet,
Loop Antenna, and Tubes



It's here! The first ultra-modern 5 Tube AC-DC Superhet kit at so low a price! Here's what you get—full broadcast band coverage (550-1600 Kc); built-in loop antenna;

latest 5" PM dynamic speaker; handsome walnut plastic cabinet. Unbelievably easy to build; no special tools required. Sockets are riveted in place on chassis base; just assemble, wire and slip into cabinet. Outstanding for power and tone quality. Highest grade components only. Complete with all parts, tubes and full instructions. Nothing like it at the price! Shpg. wt., 10 lbs. **ONLY \$14.95**
No. 83-275. Complete

GET THESE VALUABLE ALLIED RADIO BOOKS!



- Radio Formulas & Data No. 37-752 . . . 10c
- Dictionary of Radio Terms No. 37-751 . . . 15c
- Radio Circuit Handbook No. 37-753 . . . 25c
- Radio Builders' Handbook No. 37-750 . . . 15c
- Simplified Radio Servicing No. 37-755 . . . 10c
- Radio Data Handbook No. 37-754 . . . 25c
- ALL 6 BOOKS above No. 37-799 . . . \$1.00
- Parallel Resistance and Series Capacitance Calculator. No. 37-960 . . . 25c
- R-F Resonance and Coil Winding Calculator. No. 37-955 . . . 25c



ALLIED RADIO

ALLIED RADIO CORP.
833 W. Jackson Blvd., Dept. 5-J-K
Chicago 7, Ill.

**FREE
CATALOG**

- Rush FREE 164-page Catalog
 - Send Kit No. 83-275
 - Send 6 Books No. 37-799
 - Send Calculators checked above
- } \$.....enclosed

Name.....

Address.....

City.....Zone.....State.....

World's Largest Crane

(Continued from page 128)

represents a cost of about \$10,000,000.

Started during the war, the cost of the project is regarded as cheap wartime insurance when a capitol ship's guns must be replaced in a hurry. The present world record for regunning a battleship is 5½ days, set by the Navy's floating crane Kearsarge when it regunned the Pennsylvania during the war. The new crane at Hunter's Point can do the same job faster and carry on other work at the same time.

Mounted on the hull of an old battleship, the Kearsarge has a capacity of 250 tons. This was our largest floating crane until a 350-ton-capacity floating crane was brought to the United States from Germany recently. Of jib-type lever-luffing construction, that unit has an over-all height of 375 feet. It floats on a 17-foot-deep pontoon 205 feet long and 108 feet wide, displacing 5000 tons, and has propellers both fore and aft. A crew of 23 are quartered in the pontoon. It is now being assembled at the Terminal Island Naval Base in California.

But the Hunter's Point monster tops them all. Completion of the giant lift makes Uncle Sam fastest on the draw among all nations in replacing a battleship's guns.

Task Force Furnace

(Continued from page 150)

their findings. Each soldier fills out a questionnaire each week, listing his reactions to the gear he has worn or tested. These reports are sent to the Quartermaster Corps headquarters in Washington where they will be passed on to manufacturers after approval.

Field laboratories set up by Furnace are conducting exhaustive tests in the canning of foods and medicines. "Our canned goods must be specially vacuum-packed," says Col. Richardson. "The tiniest air hole in a can causes it to swell in the heat until the can explodes."

Medicines are affected, too. Iodine, aspirin, boric acid, tooth powder—almost any of the medicine-chest items that require a measure of humidity—dry up, change color, or lose potency in the desert heat unless they are properly canned. The desert soldiers, for example, carry sulfa powders and other antiseptics in sealed cans or tubes that can be ripped open by pulling a little tab.

Already the regulation pack of the desert soldier has been cut by 25 percent

(Continued to page 260)

**NOW ADD
PRECISION
DRILL PRESS
OPERATIONS
TO YOUR SHOP'S
WORK RANGE**

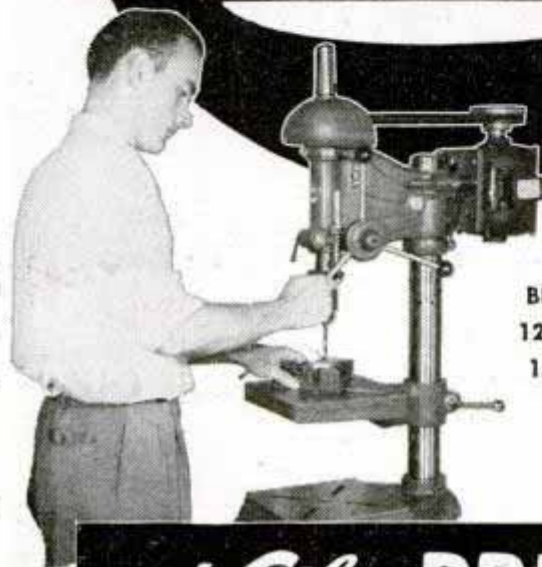

BENCH MODEL
12³/₄" — \$53.50*
15" — \$65.00*

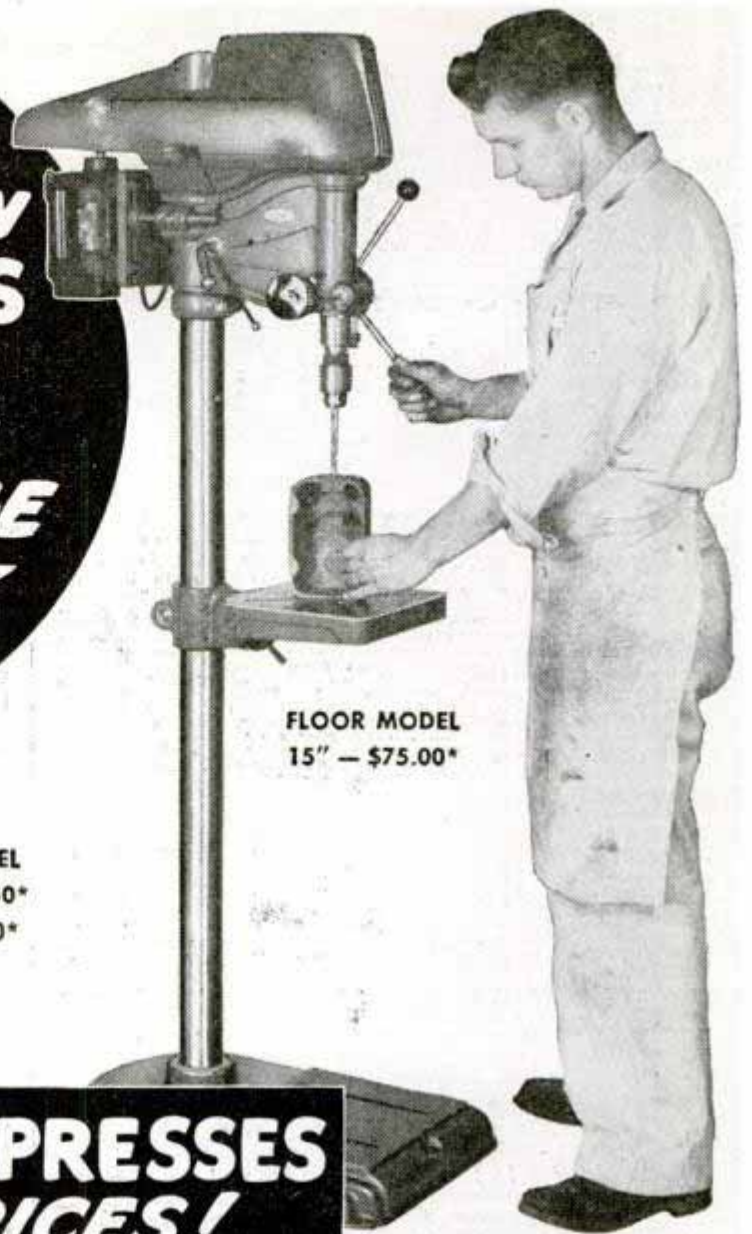

FLOOR MODEL
15" — \$75.00*

**with Atlas DRILL PRESSES
AT LOWER PRICES!**

Now you can equip for the most productive winter you've ever had in your shop! Atlas drill presses are again available at your distributors — at prices near pre-war levels!

**Amazingly Versatile — Give You
10 Different Types of Work**

Here are some of the operations you can handle easily and quickly with any Atlas drill press and its low cost accessories: precision drilling, tapping, reaming, and routing in metal and plastics; mortise and tenon joints for tables, chairs, doors, book-cases, cabinets, storm windows, screens; inlaying carving, dovetailing, shaping, and drum sanding — *all important additions to the practical "capacity" of any shop.*

Industrial Precision for Your Home Shop

From its finely balanced pulleys to its solid base an Atlas drill press is built to give you rigidity, smoothness, and life-time accuracy. Head, column, table and base are extra heavy. Precision-ground table tilts 90° right or left. The exclusive Atlas "floating-drive" spindle design — with deep-grooved ball bearings — keeps the precision-ground spindle accurately aligned for smooth operation. Ask your Atlas distributor to show you the bench and floor types in his display room, or send for latest literature. Atlas Press Co., 943 N. Pitcher St., Kalamazoo 13D, Mich.

* Prices, less motor, F.O.B. Kalamazoo.

Atlas 4 TOOL TEAM

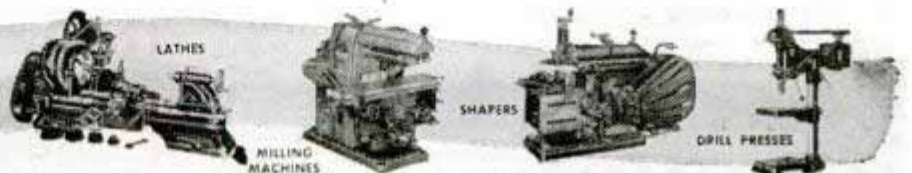

WAR SURPLUS BARGAIN SPECIAL

BRAND NEW!
VACUUM-AIR
HYDRAULIC
FUEL
PUMP

Original Cost
 \$45.00
 Now Only
\$9.95

Postpaid in U.S.A.

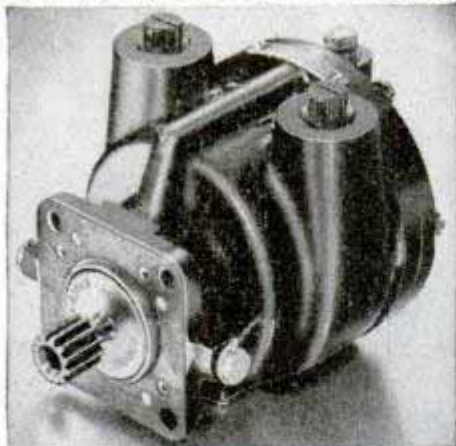

WORTH MANY TIMES THIS LOW SALE PRICE

USE THEM FOR
OIL BURNERS

SPRAYING
MACHINES

MILKING
MACHINES

COMPRESSORS

VACUUM PUMPS

HYDRAULIC
SYSTEMS

MANURE
LOADERS

PRESSES, etc.

Originally cost \$45.00. Used by the Air Corps to drive bomber de-icer boots, gyroscopes, automatic pilots, etc. May be used as air or fluid pump—for pressure or vacuum. Standard 3/8 inch pipe thread with interchangeable ports. Will pump 7 1/2 gal. SAE 30 oil per minute at 300 RPM. Builds air pressure of 30 lbs. per sq. in. at 1000 RPM. Vacuum will draw 26 inches of mercury at 1750 RPM. Develops up to 120 lbs. per sq. inch of hydraulic pressure, which in conjunction with a 3 inch hydraulic cylinder, will lift 840 lbs. minimum. Runs forward or reverse. Self-aligning shaft. Die cast aluminum housing 6x4x4 inches. Has stainless alloy steel vanes and impeller. Made by Bendix Avia. Corp. Spline terminal for direct drive—readily replaced with a pulley. Recommend a 1/4 H.P. or stronger electric motor as source of power. Rated capacity 1500 RPM with high overload factor. Special price for quantity users. Complete illustrated report and instruction booklet FREE with every pump. Send check or money order today. Postpaid in U.S.A.

\$9.95

GROBAN SUPPLY CO. 1522 So. Michigan Avenue
 Dept. PM9 Chicago 5, Ill.

Be Your Own Boss



There's a great feeling to being in something for yourself, where all the profits go into your own pocket. American floor sanders make it possible for you to realize this ambition without special schooling or a big investment. Begin small and work up to as large an enterprise as you desire... It all depends on your ambition to get ahead.

Ask for "tell-all" booklet entitled "Opportunities in Floor Surfacing". Use coupon and enclose 25 cents in coin or stamps to cover handling.

AMERICAN
FLOOR SURFACING MACHINE CO.

535 So. St. Clair St. • Toledo 3, Ohio

Gentlemen:
 Enclosed find 25c in stamps or coin for booklet "Opportunities in Floor Surfacing," telling me how I can start my own floor sanding business.

Name _____
 Street _____
 City _____ State _____



FINE TOOLS
NEED
FINE OIL!



• Lubricates



• Prevents Rust

• Cleans • Polishes

SOLD EVERYWHERE

3-IN-ONE Oil

\$6.95

POSTPAID
 including
 Two Arrows



CROSS-BOW
SPORTING

GUN

Compact powerful pistol grip gun. 35-lb. bow pull — ideal for small game hunting, frog spearing, target shooting, etc. Non-corrosion construction throughout.

Extra arrows \$3.50 per doz. — 45c ea. Special harpoon arrow for underwater goggle fishermen, \$1.40 ea. All C.O.D. orders 30c extra.

JERED ENGINEERING & MFG. COMPANY

1024 S. Washington St.

Royal Oak, Mich.



NEW WHITE WINDPROOF
Ski Parkas

\$1.25

P. P. 25c

Made of white twill. Can be dyed any color. Sizes, small, medium, and large. Suitable for hunting and outdoor wear. \$4.00 Value.

I. GOLDBERG & CO.

429 MARKET ST.

PHILADELPHIA 6, PA.

Send for Fall and Winter Catalog P.M.

SAY YOU SAW IT IN POPULAR MECHANICS

HOW TO EARN EXTRA PROFITS

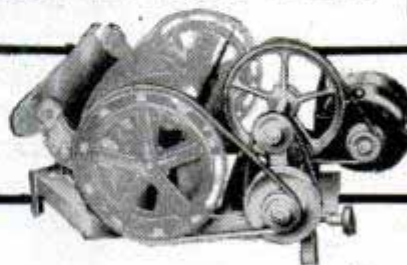

only
\$37.50
 LESS MOTOR

for this
 popular

"QUAD-CITY SHARPENER"

Get into profitable lawn mower sharpening at low cost with this highly successful machine. Order direct from **QUAD-CITY PRODUCTS CO., Box 42, Rock Island, Ill.**

NO SCREWING WITH WIGGINS NEW QUICK HOSE COUPLING!

Snap hoses on—and off! You get guaranteed leak-proof hose connections—stronger—withstands higher or lower pressures (even vacuum) than any other quick coupling.

WRITTEN GUARANTEE! LEAK PROOF—OR MONEY BACK!

Try one on your garden water hose. Then you'll see how you can use WIGGINS Quick-Disconnect Hose Couplings in your business for air pressure hoses, oils, steam, hydraulic, vacuum, liquids. Won't blow-out under terrific pressures. Won't leak in vacuum. Increases flow $\frac{1}{3}$ rd. Used by America's biggest firms. Send \$1.50 for sample $\frac{3}{4}$ " water hose coupling; $\frac{1}{4}$ " air hose coupling \$1.90. Write for information on other uses in your business. Written guarantee of money back unless delighted!



E. B. WIGGINS OIL TOOL CO., Inc.
Dept. P.M. 3424 East Olympic Blvd. Los Angeles 23, Calif.

BUILD YOUR OWN BARBECUE OVEN



**PICNIC IN YOUR OWN
BACK YARD—HAVE FUN**

SAVE MONEY—Now anyone can have a barbecue oven in his own back yard or in the lot next door, and have fun giving barbecue picnics and parties.

Build your own barbecue oven—we furnish complete information and parts. **WRITE TODAY!**
BAR-B-KIT, Dept. A1 704 Land Bank Bldg.
Kansas City, Mo.

WOODWORKERS ... Get this

CONSTANTINE MASTER MANUAL

Get the Most Fun From Your Hobby
Indispensable to woodworkers. Newest, biggest edition, more pages, more color, helpful how-to-do-it articles, pre-war and new items, more bargains. Send 25c today and we will include **FREE! FULL YRS. SUBSCRIPTION** to Chips and Chats, published bi-monthly. Keeps you up-to-date on everything in woodworking, offers big money-saving bargains. Send now.

ALBERT CONSTANTINE & SON, Inc.
791-J 135th Street, New York 54, N. Y.



SMOKING PIPES REPAIRED

Hard Rubber
Stems Fitted

\$1.00

Write for
**FREE Pipe
Catalog**



Orders sent
C. O. D.

Brandon Pipe Hospital, Dept. P.M. 3740 Richten
Detroit 6, Mich.

KAYAKS
AQUA VIR
Easy to Build
**OUTBOARDS
ROWBOATS**

25¢ COIN
FOR ALL
THREE

**BOATS for
Home Assembly**
"U-MAK-IT"
KAYAKS, ROWBOATS, DINGHIES,
INBOARDS, OUTBOARDS, RUNABOUTS
Cut-To-Fit for Quick Assembly. Everything
Complete plus Illustrated Instructions. No Ex-
perience Necessary. Simple as A. B. C.
SEND 25c POSTAGE (COIN) TODAY
FOR 3 MONEY SAVING ILLUS. CATALOGS
Showing all 47 Models (marine plywood)
and construction details.

AQUAMOBILE V-18

Designed for Auto Engines. Open or
with cab. Length 18 ft.
Fast VEE Bottom Hull.



KAYAK BOAT CO., 154P EAST 129th ST., NEW YORK 35, N. Y.

A TOOLSHOP IN YOUR HAND!



• GRIND • DRILL • ROUT
• POLISH • ENGRAVE
• CUT • SAND • SAW, etc.

Make Things From
Wood—Plastics—Met-
als—Glass—Linoleum
—Leather—Alloys—
Horn—Stone—Bone,
etc.

HANDEE

**TOOL OF
1001 USES**

Smooth, steady power at your fingertips! Perform precision operations not possible with any other portable tool! With a Handee you can turn out professional looking projects for pleasure or profit—ship, plane and train models, costume jewelry, wood carvings, puppets, initialed tumblers, etc. AC or DC. 25,000 r.p.m. Wt. 12 oz.

USE THE RIGHT ACCESSORIES! Choose them from the most complete line . . . more than 500 made right in the Handee plant.

**GET A GOOD START
GET THE
HANDEE KIT**

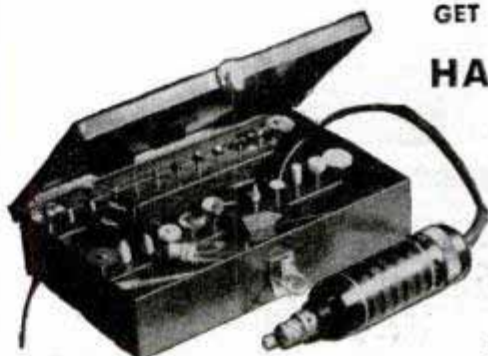

HANDEE Tool and 40 most popular accessories packed in compact steel carrying case. You'll be amazed at what you can accomplish! Complete, **postpaid, \$27.50**

Handee only, with 7 accessories,
\$20.50

**FOR YOURSELF OR A FRIEND...
THE GIFT OF A LIFETIME!**

NEW PRECISION ATTACHMENTS

Fit Handee only; enable novice or craftsman to do perfect work. Magically, easily, your offhand carving, routing, shaping will be exact as to depth of cut, accuracy of line. Set of 6 attachments with instructions, **post-paid, \$7.95**



ORDER NOW. SATISFACTION GUARANTEED!

FREE! NEW 52-PAGE MANUAL

CHICAGO WHEEL & MFG. CO.

1101 W. Monroe St., Dept. PM, Chicago 7, Ill.

Send Handee Kit Handee Tool Precision Attachments
 C.O.D. Remittance enclosed Send Manual

Name.....

Address.....

Your Drill Press will DO MORE

with a **GADREN**
SHAPER, PLANER, JOINER
ATTACHMENT!

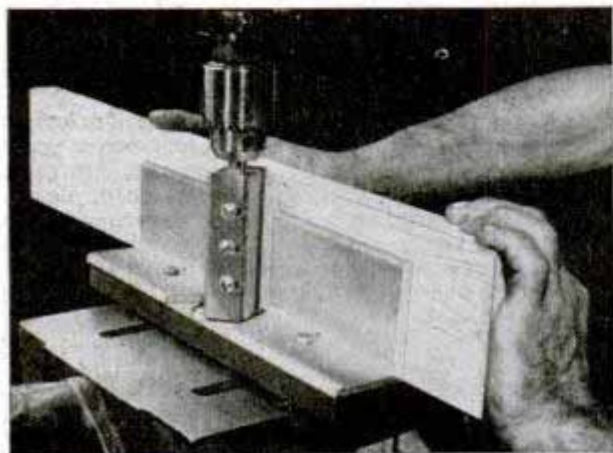

Full 4-in. Joiner Cutter in action

WOODWORKING made easy . . . attaches in 1 minute! Wider, deeper, smoother cuts — no strain on drill press; cutters are BALL-BEARING supported in the table itself! No extra adapters; fits ordinary ½ inch drill chuck! You get a FULL 4-INCH joiner or planer cut with NO CHATTER! Two blade piloted shaper cutter for all types joints, trims, moldings. (Extra cutters available — write for circular).

[10"x14" smooth machined cast iron TABLE WITH GUIDES; 1 4-in. wide JOINER CUTTER; 1 SHAPER CUTTER; 1 set hardened fine-ground tool steel BLADES. A complete unit!]

FOR A
LIMITED TIME

\$24⁹⁵
ONLY

Send Check, Money Order or Card
for C.O.D. Shipment to

GADREN MACHINE CO.
OAKLYN, NEW JERSEY

and Furnace command hopes to lighten the burden by 40 percent. Battle helmets, buckles, all metal objects that mean weight have been manufactured out of the same tensile aluminum and alloy found in refrigerator units. They're light and almost indestructible.

Much research has been conducted on what happens to the body under heat. The amount of heat produced by an adult, relaxed and warm in bed, is about 160 B.T.U.s per hour. This rises to 380 B.T.U.s per hour when seated at rest, to 1000 B.T.U.s per hour for normal home activity, and to 2500 B.T.U.s per hour for vigorous exercise or hard work. About 80 percent of this heat is carried to the skin surface by the blood and dissipated through the skin.

The body heat may leave the skin surface by radiation, conduction, convection and evaporation. When the air temperature is higher than the body temperature, both conduction and convection add to the body heat load. All cooling sources of the body fail when the relative humidity is 100 percent and the air temperature is over 100 degrees F. Even as it approaches these conditions, the heart is overworked and heat prostration may result.

The process of evaporation is controlled by the amount of moisture that reaches the skin surface, which is generally only enough to equal the amount evaporated. When the demand for heat removal increases beyond this point, Furnace specialists determined, perspiration is the effort of the heat-regulating system to try to increase the evaporation. If the heat-control system is not in frequent operation, it loses the flexibility required in an emergency. And war is a series of emergencies. Other bodily functions may slow down.

Clearly, the almost savage dryness of the desert requires apparel that will retain humidity. A thick lining for the Nylon uniforms is being developed that will carry with it a sustained moisture. This lining is a wool mixed with rayon that appears resistant to rapid drying. Worn against the skin in the desert, the lining gives a continuous feeling of coolness.

There is little doubt in the Furnace command that at the end of the experiments, perhaps some time next year, there will be a tremendous impact on the manufacture of civilian clothing and on house and car-cooling schemes, as well as radical alterations in what the well-dressed desert soldier will wear.

ⓁFoot-wide radar scopes on which airmen can "see" obstructions 100 miles ahead will be installed on Navy transports next year.

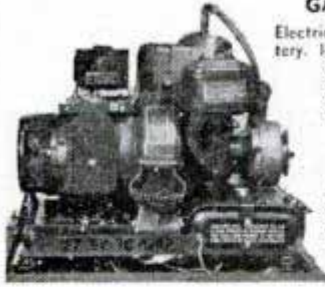

**27.5 V. DC — 70 AMP.
GASOLINE GENERATOR**

Electrical starting when connected to 24 V. battery. Ideal for power for emergency, cabins, aircraft, welding, etc. Originally used for auxiliary power on bombers.

Price..... \$72.50

**28½ V. DC — 170 AMP.
GASOLINE GENERATOR**

Powered by Ranger Aircraft 2 cycle, 9 hp, gasoline engine.

Price..... \$195.00



**BRAND NEW NAVY SURPLUS
HOSPITAL TENTS**

16'x50'—4' Side Walls 12½' Apex
EXTRA HEAVY NAVY CANVAS
Ropes Included (no poles)—Packed in Tarpaulin Cover
Formerly \$289.50

Now \$150.00



ALTIMETER

Wallsman sensitive. Used—good condition guaranteed.

\$12⁹⁵ each



**MAGNETIC
COMPASS**

Made by Bendix for the U. S. Army—luminous. Used—good condition guaranteed.

\$9⁵⁰ each



**ATTENTION, PROSPECTORS, MINERS,
OIL COMPANIES, PLUMBERS, ETC.
SCR-625 MINE DETECTORS
Brand New — Metallic Objects Only**

Used by the Army to detect buried metallic mines. Its private use suggests the location of underground or underwater pipes, cables and ore bearing rock, the location of metallic fragments in scrap materials, logs, etc., and the screening of personnel in plants for carrying of metallic objects.

New, complete in original overseas packing container. Originally sold by War Assets for \$166.00.

The U. S. Forestry Service has recommended procedure for using the SCR-625 Mine Detector to find concealed metal in tree logs and other timber products.

Price..... **\$67⁵⁰**

**TERMS
CASH WITH ORDER**

AMERICAN SURPLUS PRODUCTS CO.

537 N. CAPITOL AVE. — INDIANAPOLIS, IND.

QUALITY

**8" FLOOR MODEL
TILT-ARBOR SAW**



**UNCONDITIONALLY
GUARANTEED
1 YEAR**

Complete as shown with Trans-axial Ball Bearing Motor Drive, Ball Bearing Saw Arbor, Table including extension 18" x 25", Aluminum Fence & Saw Insert, Complete Mitre Gauge, 3½" steel column and cast iron base, Precision segments on mitre gauge and cradle.

**SAW
TILTS
•
TABLE
STAYS
LEVEL**

\$79⁵⁰

F. O. B.
ROYERSFORD, PA.
**UNUSUAL
VALUE**

BENCH MODEL, \$49.50
Shipping Wt., 110 lbs.

Cast iron table extension bracket furnished. Will support plywood top much larger than 9" x 18". Motor pulley and belt furnished. Blade & Motor NOT included. Overall height 35½", Shipping Wt. 156 lbs.

AMERICAN MACHINE & TOOL CO. Inc.
DEPT. 110 ROYERSFORD, PA.

Write for free illustrated folder.

RIDE WHILE YOU WORK!

... with this sturdy,
practical Dump Trailer

It's
Garden-All's
latest
attachment

Garden-All
LAWN and GARDEN TRACTOR



Now . . . Just in time for the fall clean-up of your garden . . . you can get a dump trailer to go with your Garden-All Tractor. The Garden-All Dump Trailer is 22" x 42" x 12" and made of 8 gauge material. All steel welded reinforced construction. Exclusive dumping feature.

**Holds
1000
lbs.**

Other attachments: Plow, Disc, Cultipacker, Cultivator, Sickle Bar, Utility Scraper.

**Write
for
Booklet**

GARDEN-ALL TRACTOR, INC.

Dept. P, 100 W. UNION STREET, LIBERTY, INDIANA

Our Finest Precision REBUILT
MOTOR BLOCK
ASSEMBLIES



\$5.00
Crating
Charge

FORD BLOCK ASS'Y.

Year	Type	Outright	Exch.
28-31	4 cyl.	\$ 98.00	\$73.00
32-47	6 & 8	139.00	89.00

Year	Type	Outright	Exch.
Mercury		149.00	99.00
39-47	V8		
Chevrolet		117.50	87.50
34-47	6 cyl.		

Sold Outright or Exchange

Rebuilt by skilled mechanics. Assembly has Reborn Block with New Pistons, Pins, Rings, Reground Crankshaft, and all New Bearings. Guaranteed 90 Days.

Allowance on Old Motor
We ship at outright price. Send your motor prepaid, must be suitable for rebuilding. Send in notarized bill of sale showing title number if any. We refund difference when we receive your motor.

DODGE—3 1/4" bore

Year	Type	Outright	Exch.
35-47	6 cyl.	\$129.00	\$99.00

Plymouth

Year	Type	Outright	Exch.
35-47	6 cyl.	129.00	99.00

Specify exact year, make and model when ordering. Send for catalog on motors not listed.

POWER TAKE-OFF for JEEP ENGINE



which pulley can be mounted. Hand lever controls clutch. PF4N-23J—Each

\$42.50

NEW 5 Gal. CANS



FOR GAS, OIL OR WATER
Vented for Safety.
Self-locking Safety Cap
Extra Heavy Construction
Will Float
When Full
Size of can, 18" high, 8 1/2" thick, 13" wide.
PA35U-60—
Lots of 5, ea. 1.15
Lots of 50, ea. 1.05
Lots of 100, Each 98c



\$5.00
Crating
Charge

60 HP. JEEP Engines

Reconditioned, Tested and Guaranteed in perfect running order and ready to run. Every part is checked to be perfect and carries a 90 Day Guarantee same as a new engine.
COMPLETE with . . . Generator, Starter, Distributor, Coil, Fan and Fan Belt, Water Pump, Fuel Pump, Intake and Exhaust Manifolds, Carburetor, Oil Filter, Spark Plugs, Flywheel, Clutch Assembly, Wiring. Outright, PG58R-003, Each **\$127.50**
Write for Special Price Quotations in Quantities.

SEND 25% CASH WITH ORDER, BALANCE C.O.D.

OUR AUTOMOTIVE PARTS CATALOG SENT ON REQUEST.

Brand New Willys Jeep Enclosed Engine Power Unit
60 HP. 4 cyl. 134.2 cu. in. displacement. 3 1/2 bore 4 3/4 stroke. Complete with radiator, gas tank, governor, clutch power take-off with 1 1/2" keyed shaft, and all accessories. **READY TO RUN. NEW UNIT \$325.00 COMPLETE, F.O.B. Chicago.**

J.C. WHITNEY & Co.
1917 Archer Ave. Chicago 16, Ill.

SEE...
What 10¢ brings You..

3 sets of plans for making handsome end tables, sewing chests, etc., at home. Simplified so beginners can follow.

PLUS—Full size jar of famous Rogers "Gorilla Grip" Glue—strongest glue on the market. Makes wood furniture, toys, etc., last a lifetime.

Offer good only until Feb. 1, 1948. Send 10c TODAY to Rogers Insulating & Glue Co., Gloucester, Mass.



ROGERS
the best LIQUID FISH GLUE
GLOUCESTER, MASS.



FLASHLIGHT INSPECTION LAMP ASSEMBLY

NEW—Govt. Surplus. Lights up the "Hard-to-get-at" places. Fine for mechanics, electricians, radio repairmen, filling station attendants, in the home, and many other uses. Plastic 12" extension (6" stiff and 6" flexible). Adjustable to any angle. Originally priced over \$4.00. Our price Postpaid.

\$1.80
Ea.

Hundreds other items—WRITE FOR CIRCULAR
National Surplus Sales Co. 719 E. 18th St. Kansas City, Mo.

MARCOT KEY MACHINE

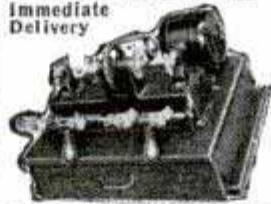

Immediate Delivery
Marcot No. 8 Key Machine Mounted on Cabinet..... \$ 82.50
Book on Modern Locksmithing. 3.95
Auto Code Book and Auto Depth Keys 12.50
162 Doz. Popular Key Blanks.. 77.75
Set Key Files, Tools, Pins, Springs, Thimble 10.50
\$187.21

A. J. MARCOTTE CO., 1200 N. KEDZIE AVE. DEPT. PM, CHICAGO 51, ILL.

148 PAGE WOODWORKERS CATALOG

ONLY 15 CENTS-REBATED ON FIRST ORDER
SHOWS IN NATURAL COLOR
22 inlay and overlay insets
32 veneer bandings—matched woods
30 kinds of world's finest woods in character grains and color
31 moulding, rosettes, ornaments and home wood working labor-saving tools and hard-to-find hardware
CRAFTSMAN WOOD SERVICE CO. 2729 S. Mary St., Dept. A-85, Chicago 8, Ill.
LISTS OVER 300 PIECES OF ARTISTIC FURNITURE SHOWN
Including cost of plans, lumber, hardware and finishing material, choice of MAHOGANY, WALNUT, BIRCH or MAPLE LUMBER-PLYWOOD-VENEERS UNEQUALLED BARGAINS
Make beautiful furniture at only 20% store prices.

SEALED POWER PISTON RINGS
save oil, save gas, restore original power
Send postal for free booklet on oil-saving.
SEALED POWER CORP., DEPT. 65, MUSKEGON, MICH.

No. 3 Hawaiian Wiggler

gets bass in lily pads

Many excellent catches are being made with the No. 3 in stumps, weeds and lily pads where big bass often hide. Write for free catalog.

FRED ARBOGAST & CO., 1609 North St., Akron 3, Ohio



\$1.10

Limited Stock! New, 27-Volt AC-DC AIR COMPRESSORS

- 1/2-HP Motor
- 3-Stage Compressor
- 4500 RPM
- Weighs 28 lbs. Boxed



- COMPRESSOR OUTPUT up to 1500 Lbs. High Pressure Low Volume
- IDEAL for Low Pressure Spray Gun

Precision built. Convert with transformer. Individually packed in wooden boxes and wrapped in plicofilm for double protection. Simple directions for hook-up included.

Cost the Government over \$200 to build

BARGAIN \$15 FOB for you K. C.

Send check or money order to expedite delivery.

TRANSFORMER, NEW, EACH... \$14.50 27 V. - 20 Amps, capable of operating above unit. Also can be used as a light welding transformer. Shipping wgt. 20 lbs.

Rush order, today.

GENERAL SURPLUS STORES, Dept. PM9

1439 Grand Avenue

Kansas City 6, Missouri



Model Builders Attention!

	V	V-2	V-3
Hex	1/2"	3/8"	5/16"
Thread	3/8"-24	1/4"-32	1/4"-32
Thread Length	7/32	7/32	3/32
Weight, Grams	8	3 1/2	2 1/2

Actual Size V-Plug

Champion Spark Plugs for model gas engines give the same dependable performance as regular Champions. Champion Ceramic insulation—Sillment sealed. Alloy needlepoint electrodes for easy starting. One piece construction.

CHAMPION

SPARK PLUG COMPANY • TOLEDO 1, OHIO

NEW!

HOBBY HANDBOOK



A GOLD MINE of INFORMATION on NEWEST EQUIPMENT, TOOLS for HOME CRAFTSMEN & MECHANICS

If you work in metals, wood, plastics or glass you need this Giant NEW Book of equipment, tools, parts and materials... including dozens of hard-to-get items you can't find in stores. Many things you must have for your home hobby or shop.

- HELPS YOU GET MORE PLEASURE, MORE PROFIT in**
- HOME CRAFTS
 - METAL CRAFTS
 - WOODWORKING
 - PLASTIC CRAFTS
 - HOME REPAIRS

A WAREHOUSE OF THINGS YOU NEED AND WANT

Over 100 items including Spray Guns; Power Bench Tools; Lathe; Drill Press; Drills; Grinders; Tank and Brush Electroplaters; Telephone System; Tool Chest; Model Tools; "Pin Money" Makers for your sparetime fun and profit! **SEND NAME and ADDRESS and 10c TODAY!** Price of Handbook refunded on first order.

WARNER ELECTRIC CO., Dept. N-16
1512 JARVIS AVENUE, CHICAGO 26, ILLINOIS

WALTHAM STOP WATCH

BRAND NEW! **only \$9.95**



ACTUAL SIZE

GUARANTEED! If not satisfied, return within 10 days for money back. But you'll keep and treasure this beautiful 9-jewel, 1/10 second pocket stop watch. Shockproof, water-resistant. Handsome non-corrosive, chromium-plated metal case. Unbreakable crystal. Sweep second hand. Precision-made by WALTHAM craftsmen to rigid specifications for U. S. Army.

BULOVA • WALTHAM ELGIN



YOUR CHOICE **\$22.50** ONLY

(PLUS 10% TAX)

U. S. GOV'T. SURPLUS
16-JEWEL WRIST WATCHES

CANNOT BE DUPLICATED AT DOUBLE THIS PRICE!

- Sweep Second Hand • Shockproof
- Moistureproof • Non-Magnetic

• Fully Guaranteed

Order one or both of these amazing watch values today! A fortunate quantity purchase makes this amazing offer possible. Send check, cash or money order for prompt postpaid shipment. C.O.D.'s accepted, but you pay postage.

ARCH SALES COMPANY
43 N. 11th STREET • PHILA. 7, PA.

A New Thrill . . . Streamlined 3 WHEEL ROLLER SKATE

**FASTER,
SMOOTHER,
EASIER
SKATING**

50% Lighter Than Most Ordinary Skates
• CHANGEABLE FROM ROLLER TO ICE SKATES

Introducing **JET** The Sensationally NEW Combination ROLLER-ICE SKATES

If you like Roller Skating . . . you will like the New "JET" Roller Skate . . . Its many New Features puts it way out in front of all standard type skates . . . Study the **THREE-IN-LINE-ROLLERS** . . . this principle alone overcomes many of the objections . . . goes over cracks and irregular surfaces with a new smoothness . . . an enjoyable feature to those who love to roller skate . . . The **3 BALL BEARING WHEELS-IN-LINE** Gives MORE SPEED with LESS EFFORT . . . When you want to stop **SIMPLY RAISE THE TOE** . . . The "JET" Skate is the **ONLY SKATE WITH THIS FEATURE** . . . Being much lighter in weight than regular skates makes it **EASIER TO SKATE FOR CHILDREN AND ADULTS**; even for the beginner . . . Another feature: you can quickly change to Ice Skates by replacing the rollers with the "JET" Ice Skate Attachment . . . This is another Exclusive with the "JET" Skate . . . A New Experience awaits you in Roller Skating from the minute you PUT ON A PAIR OF "JET" ROLLER SKATES.



3 BALL BEARING WHEELS in line gives MORE SPEED with LESS EFFORT.

ONLY \$4.95 A PAIR

To STOP QUICK Simply Raise The Toe.

BE FIRST IN YOUR LOCALITY

LARGE, SMALL, MEDIUM STATE SHOE SIZE

Postpaid in U.S.A. We Ship C.O.D. Plus Postage Ice Skate Attachment \$2.25 Extra

Mail Your Order Direct To Factory

AFCO PRODUCTS, INC., 4547 No. Clark St., Dept. P-9, CHICAGO 40, ILL.

MOW faster, cleaner with this BOLENS UNISICKLE Sickle Bar Cutter



Easily attached to a Bolens HUSKI 2-Wheel Tractor, this UNISICKLE Mower cuts swiftly, cleanly through grass and weeds — along lanes, in orchards, under fences. Easy to operate — amazingly low in first cost and operation.

SEE your nearest Bolens Dealer — or write for his name and illustrated "Unisickle" Folder.

BOLENS PRODUCTS DIVISION
Food Machinery Corporation
265-9 Park Street
Port Washington, Wisconsin



THE STANDARD FOR OVER 30 YEARS



U. S. SURPLUS BARGAIN

NEW NAVY GOGGLES

Brand new! In original packing. Each with three interchangeable lenses.

SHOCK PROOF FRAME — SHATTERPROOF LENSES

Use them for all outdoors sports, beach, motor-ing, boating—anything. Heavy windproof sponge rubber ventilated frame with chamomile sweat lining! Adj. elastic head band. Red, green, amber flexible shatterproof lenses, all instantly interchangeable. They won't last long at this price—it's smart to buy an extra. Post paid in U. S. A.

\$1.00 POST PAID

GROBAN SUPPLY CO., Dept. PM 9
1522 S. Michigan Ave. Chicago 5, ILL.

MYSTERY RADIO ONLY \$2.99



\$2.99 post paid

No Tubes
No Batteries
No Electricity

pillow speaker, ear piece for hard of hearing all in one. Very small unit. For home, camping, trips, etc. Send no money. Order today. Be first in your gang. Pay postman \$2.99 plus C.O.D. Postage on delivery.

CLAIRE DISTRIBUTORS, Box 23, Dept. PM-3, Glenview, Ill.

BUILD THESE PROJECTS

For garden or lawn. Easy to build. Easy to sell. Detailed Blueprints Model B-25 Dutch Windmill 50c; Model OM-60 Old Mill, 85c. Lawn Figure Patterns—Sunbonnet Girl, Dutch Boy, Tulip Girl. Holland Pair, 35c each; all 4—\$1. Catalog illustrating many models send 10c today.

CRAFTSMAN'S MODEL CO., Dept. P-107, 2030 N. 41st St., Milwaukee, Wis.



WRITE FOR YOUR FREE COPY OF THE NEW KRW HYDRAULIC PRESS BOOK

Describes all manner of Production and Shop Work on KRW Hydraulic and Bench Type Arbor Presses. 32 pages illustrating the new KRW Hand-operated, Electric-operated and Air-operated Hydraulic Presses. Write for your copy today.



K. R. WILSON, DEPT. 17, 215 MAIN ST., BUFFALO 3, N. Y.
Builders of Shop Equipment for Ford Dealers Since 1916

Ball-Bearing *SPEED WHEELS*



Juvenile wheels, solid tire
No Bearings

7" wheels.....	60c
6" wheels.....	50c
4" wheels.....	30c

Semi-pneumatic tired wheels

12 x 1.75".....	\$3.25
10 x 1.75".....	\$2.75
8 x 2".....	\$2.00

Industrial wheels for heavy loads

10 x 2.75".....	\$6.75
8 x 1".....	\$4.90
6 x 2".....	\$2.80

DEALERS WANTED

Free blueprints with all wheel orders.

JIM BROWN TOY COMPANY

1097 Home Ave.

Akron 10, Ohio

COMPLETE HOME WORKSHOP

5 POWER TOOLS IN 1

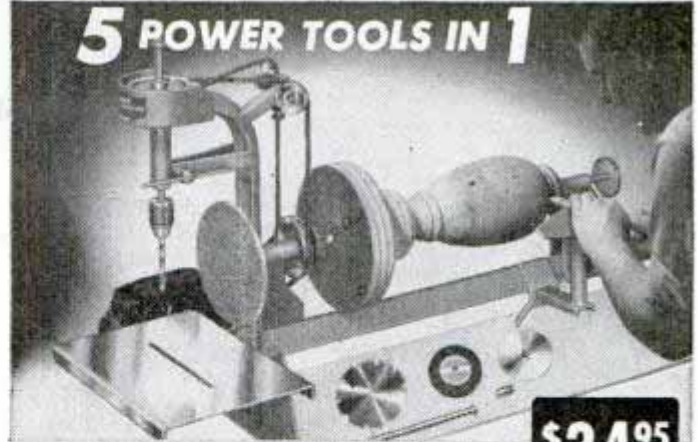

LATHE 10" swing, 30" between centers, 3/4" spindle, face plate, spur center, tool rest.

\$34⁹⁵

DRILL CONCRETE *The Easy Way!*

CONCRETE
ASPHALT
BRICK
SLATE
WALLBOARD
LIMESTONE



Tipped with CarboLOY Cemented Carbide—harder than the hardest steel.

SLIP A **CARBOLOY** MASONRY DRILL INTO YOUR ROTARY DRILL, HAND BRACE, OR DRILL PRESS, AND WATCH IT GO—**AND GO FAST!**

- DRILLS 4 TIMES FASTER!
- STAYS SHARP 50 TIMES LONGER!
- CUTS CLEAN, TRUE-SIZE HOLES!

Goodbye to back-breaking masonry drilling! Cut clean, true-size holes in masonry jiffy-quick! Use your rotary drill, hand brace, or drill press. Drill holes 1/8" apart without break-through. Ask about Handy 6-drill set, 3/16", 1/4", 5/16", 3/8", 1/2" and 5/8". In free canvas kit, \$13.70 postpaid, or C.O.D. See your dealer, or write.

CARBOLOY COMPANY, INC.

11185 E. 8 Mile Blvd., Detroit 32, Mich.

MAKE MONEY! Sell Warm **LEATHER** Jackets

HUNDREDS of prospects near you; sportsmen, workers in lumber yards, warehouses, stock rooms, factories, etc. Men of action demand their snug warmth, free-action comfort, sturdy construction.

COMPLETE LINE

Leather and wool jackets, work shirts, 250 shoe styles for men and women. Liberal Commissions. No experience necessary. Write TODAY for FREE SALES OUTFIT.

VICTOR THOMAS SHOE CO., Dept. V-815
610 W. VAN BUREN ST. CHICAGO 7, ILL.

CRESCENT TOOLS

Give Wings to Work

ASK YOUR
HARDWARE
DEALER

STARLIGHT LOW COST

PRECISION ENLARGER

LENS AND ALL ACCESSORIES

\$24
INCL.
TAX

1 PIECE OF EQUIPMENT DESIGNED FOR ENLARGING, REDUCING, COPY WORK, CONTACT PRINTING. Comes with a fine Ilex Anastigmat 3 1/2 inch f6.3 lens and Iris diaphragm. Takes any size negative up to 3 1/4 x 4 1/4. Easy to operate, no complicated gadgets.

Write for free folder M-9 and start making money.

PHOTO-SPHERE CO., Inc. 115 E. 23 ST. N. Y. 10, N. Y.



SAW

Takes 6" to 8" blade. Arbor handles scratch brush, grinder, buffer. Saw blade not included.

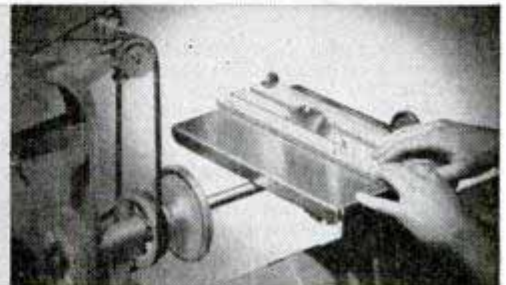

DRILL PRESS

Takes drills to 1/2". 2" travel, 1/2" spindle. Drills to center of 12" circle.

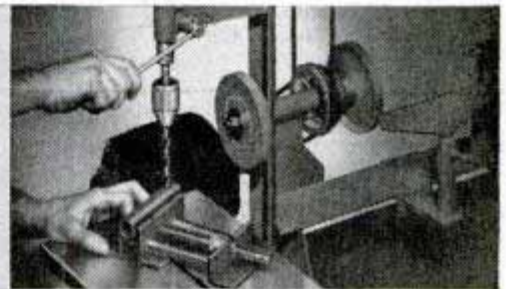

GRINDER

5" Emery wheel furnished. 4 step cone pulley. Spindles mounted in replaceable bronze bearings.

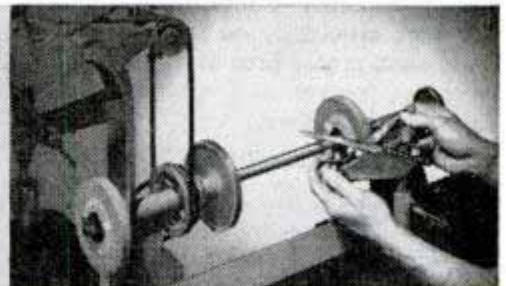

SANDER

8" diameter disc takes any type abrasive. Heavy construction lasts for years. Motor not included in price.

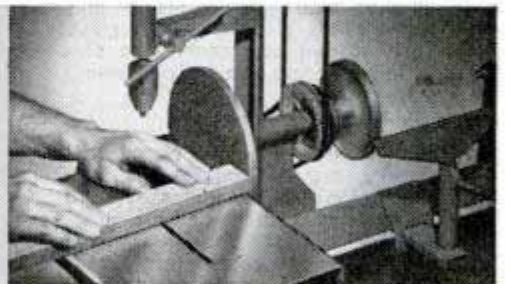

10 DAY TRIAL

EMRICK, Inc., 1739 Clinton St., Kalamazoo 24, Mich.

Ship on 10 Days Trial. I am enclosing \$17.50, balance C.O.D. Send Free Literature Send Free Tool List

NAME _____

ADDRESS _____

CITY _____

HOBBY CATALOG

NEW, BIG COLLECTION OF MATERIALS



Get this catalog for your shop. It lists and shows a wide variety of tools and materials—some hard-to-get items in addition to a big 20 page section on books and project information. A gold mine of practical help. Shows how we test and approve all materials and tools in our own shop before we offer them to you—your assurance that they are tops in quality—everything fully guaranteed or your money refunded. Hurry to get this catalog, save money with our new Book Dividend Plan. Send 25c today—do it now, to

JACKSON STUDIO, Dept. 35, 5440 N. Shoreland Ave., Milwaukee 11, Wis.

The SPEED SAW FILER

Saves You Time, Money

Now you can do expert saw filing at home. Lifetime tool makes precision filing easy for even the most inexperienced. Two simple adjustments make it fit any type hand saw. Keep your saws extra sharp and true-cutting with a Speed Saw Filer. Complete with file, ready to use. Money back guarantee. Cash with order, prepaid (C.O.D. postage extra.)

THE SPEED CO., Dept. PM
2025 N.E. Sandy, Portland 12, Ore.



ORDER NOW!

\$295

START BUSINESS FOR YOURSELF

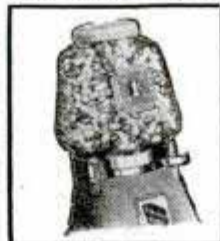

\$13.95 EACH

Own-Operate Silver King Bubbleball Gum Vending Machine in any retail store. Gum 65c per lb. Globe capacity 6 lbs.—170 balls to the lb. You pay the store-keeper 20% of the gross and you will have a profit of \$4.25 per refill.

Send 1/3 Deposit on Orders, Balance C.O.D.

CAMEO VENDING

DISTRIBUTORS

432 West 42 Street

New York, N. Y.

BUILD YOUR OWN TRAILER



Get these Modern Complete Plans

Select just the model you want—for hunting—travel—camping—or as a home. Each plan is complete with simple, step-by-step instructions and a bill of materials. Easy to follow. Three models!

STOCK No. H27 NATIONAL MODEL 27. A sleek 27-foot trailer with 3 rooms, lavatory, etc. Sleeps six. complete plan **\$1.00**

STOCK No. H20 NATIONAL MODEL 20. A good-looking, easily-built 20-ft. trailer. 3 rooms, sleeps four, complete plan **\$1.00**

STOCK No. H10 NATIONAL CAMPER. A compact unit for traveling, camping, hunting, fishing. Sleeps two. Complete plan **.50**
Special—Order all 3 of above plans.....\$2.00

FREE! Big parts catalog with any order

NATIONAL TRAILER STORES

Dept. 10 Box 2353 Terminal Annex - Los Angeles 54, Calif.



ONLY **\$89.50**
DIRECT FROM MANUFACTURER

Mount this New Model A-1 WiRecorder in Your Own Cabinet

EXCLUSIVE FEATURES

1. No "threading" or handling of wire necessary.
2. Automatic shut-off at start and finish of full hour's recording.
3. Constant speed, wow-proof capstan drive.
4. Precision-built of finest materials. Compact size: only 9" x 8" x 8".
5. Price includes time indicator, oscillator coil, one full hour recording wire and spools, and complete instructions for connections to amplifier.

Here's the perfected, professional-type wire recorder you've been waiting for! Used by scores of broadcasting stations. Works with any standard high-gain amplifier. Gives high fidelity performance from 100 to 6000 cycles. Immediate delivery. Order now direct from manufacturer, or send card for complete technical data and illustrations.

WiRecorder
CORPORATION
Department 101
7055 Intervale Detroit 4, Mich.

SAY YOU SAW IT IN POPULAR MECHANICS

Install Low-Cost Speed Reducer and Clutch . . .

Here's a 2-in-1 transmission that will work efficiently on lawnmower, band saw, motor bike or any place increased power and dependable clutch are required.

Works on Motors up to 1 1/2 h.p. with either 1/2 or 3/8 inch shaft. Equipped with pulley or sprocket from which to drive. Durably made of strong steel with oilite bearings throughout.

Simple and Easy to Mount

Push tubular shaft in reduction unit onto motor shaft. Tighten pulley screw. Secure either end of transmission stationary and you are ready to take-off to any machine.

10-day Free Trial

Sold on positive money back guarantee. Mail check or money order for \$14.40 . . . indicate size of shaft and whether you desire chain or belt drive. In Iowa add 2% state sales tax. If not completely satisfied at end of ten days return Belt Transmission and money refunded. No waiting. Send order today or write for information.

Write for dealer-agency information.

CRAIN-McCURDY CO.
600 Capital City Bank Bldg.
DES MOINES 9, IOWA

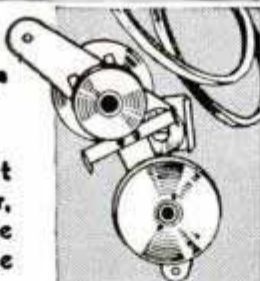

FRAZIER BELT TRANSMISSION



LAWNMOWERS



MOTOR SCOOTERS

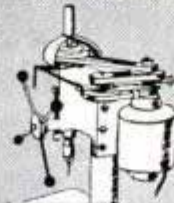

DRILL PRESSES and other power tools.

*Revolutionary
New*

Dumore Carvit makes you a skilled wood-carver in 20 minutes!

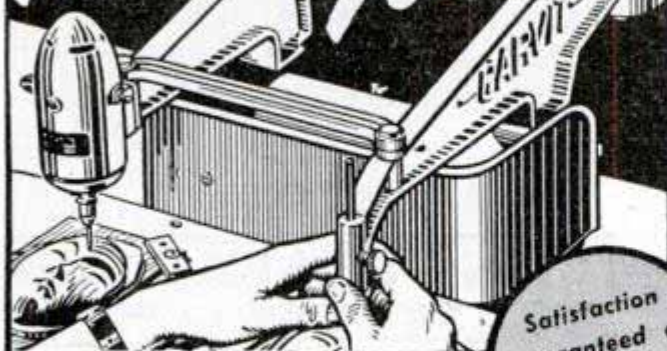

Here's a fascinating new hobby—complete in one tool. The unbelievable perfection of your first carving amazes your friends! Experienced craftsmen use the Carvit to give their woodworking projects

that professional touch.

With the Carvit, you make beautiful replicas of inexpensive objects you can find in any dime store or gift shop—in mahogany, walnut, and other fine woods.

You're an expert at once — with a Carvit!

Here's how the easy-to-use Carvit works: You clamp a model to the table below the tracer, and a wood block below the cutter. Then you switch on the motor and guide the tracer over the raised contours of your model. The cutter moves with the tracer to carve an exact duplicate of the model. With an index

attachment, you can carve objects in the round—statuettes, busts, etc.

Carving with the Carvit is fascinating fun for everyone. The Carvit is the ideal gift for your sweetheart, husband, or son! See this exciting new tool at your local hardware store today — or mail us the coupon below!

Satisfaction guaranteed or your money back in 10 days!

No skill or training needed to do work like this



Carve useful ornaments for the home — distinctive gifts for friends — fine carvings that sell!

Tear out coupon and mail today!

The Dumore Company, Dept. J-51, Racine, Wisconsin

- Please send complete information on the Carvit.
- Please send one Carvit. \$48.50 enclosed.
- Please send one Carvit with index attachment. \$58.25 enclosed. Shipping charges C.O.D.

Name.....
Address.....
City..... (.....) State.....

H-5

Get in on the ground floor! Be first in your area to enter this

profitable NEW business!

YOU'RE CERTAIN TO SUCCEED

BECAUSE DRYEX SUCCEEDS

WHERE EVERYTHING ELSE HAS FAILED!

DRYEX

**makes wet walls DRY
... and keeps them DRY!**



SELL OR APPLY DRYEX . . .
the great wartime discovery that will make big money for you!

Easy to brush on, easy to sell, DRYEX spells "opportunity" for you. Every owner of a leaky wall is your prospect, and there are thousands of them! Amazingly effective, DRYEX is the miracle plastic that seals leaky exterior walls definitely and enduringly. Stays tough, flexible and waterproof in all weather, all climates.

Your Territory May Still Be Open. Write Today for Details.

LASTING PRODUCTS COMPANY

Franklinton Road Plant, BALTIMORE 23, MD.

New "THERMO-SAW" (cuts with heat)

MAKE THINGS FOR THE HOME or FOR SALE

• ANY CHILD CAN USE IT •

No Noise—No Vibration—No Sawdust
Boys and Mechanics thrill over the many interesting things that can be made with this NEW ALL-STEEL THERMO-SAW. . . You can cut out any pattern or design in 1/2 the time. . . Difficult patterns are made QUICK and EASY. . . No turning of work. . . Cuts in every direction! . . . Cuts plywood 1/8" or 1/4" . . . Cuts 14" x 36" board. Will cut 1/8" Plexiglas very well. . . A special transformer produces high frequency current in a tough steel wire "blade" from ordinary Alternating (AC) Current. . . IMMEDIATE DELIVERY!

Extra Blades ONLY 30c per dozen. ORDER TODAY
Machine Measures 11" x 4" x 3 1/2" High. Throat 7" Deep. PATTERN INCLUDED FREE.

AN IDEAL GIFT

NOTE: Operates on 110-volt Alternating Current; 50 to 60 cycle.

\$6.23 in Canada & Mexico. \$6.48 elsewhere. On C.O.D. Orders Mail \$1 Deposit.

Manufactured by THE KING COMPANY
6 No. Batavia Ave., Dept. P-9 Batavia, Ill.

CUTS RAPIDLY AND CLEANLY THROUGH WOOD AND OTHER MATERIALS

Pat. No. 2,272,931 D-87-072

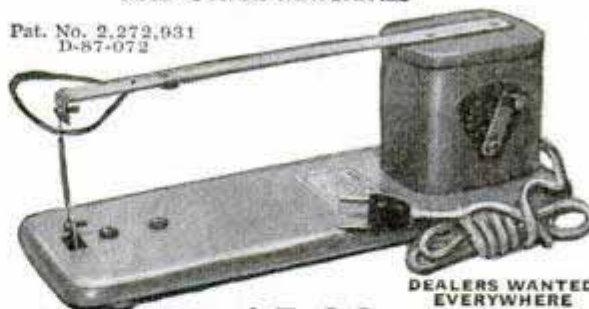

DEALERS WANTED EVERYWHERE

ONLY \$5.98 Postpaid

COMPLETE SAW outfit as illustrated with transformer and 12 spare blades. Ready to use.

A FEW OF THE MANY INTERESTING THINGS YOU CAN MAKE



Add Color and Sparkle to Your Drinks and Table

An amazing new and novel idea for cooling drinks. PLAST-I-CUBES are small transparent plastic cubes the size of ice cubes filled with colored distilled water. You simply place them in an ice tray and freeze them solid, then drop them in your drinks. Save the muss and fuss of removing regular ice cubes from trays. Can be used thousands of times—practically unbreakable. Use them for highballs and all mixed drinks. Ideal for that "TOO HOT" cup of coffee, beer, wine, fruit juices, or milk because they do not dilute the drink. Beautifully packaged in cellophane they make an ideal gift. Each cube monogrammed in gold letters for only 75c per package. If your dealer can't supply you, order by mail.

Package of 8 in Assorted Colors \$1.98 Postpaid

PLAST-I-CUBE CO.

Dept. 106, 1701 East 9th St.

Kansas City, Missouri

AMAZING PEN BARGAIN

ORDER THIS NEW BALL PEN



and

RECEIVE THIS EXTRA INK CARTRIDGE AS OUR GIFT

To quickly introduce our new, smooth-writing Compro Ball Pen, we'll include free of extra cost, one easy-to-change Ink Cartridge with new Ball Point! When pen needs re-filling, insert extra "Gift" cartridge and keep writing! Meanwhile, return other dry cartridge—we'll re-fill for only 15c plus 3c stamp. Satisfaction guaranteed. Pen has plastic barrel, nickel-plated cap, gold-plated clip. Hurry—before bargain offer withdrawn! SEND only 98c plus 2c for postage (\$1 bill) — or we'll ship COD, you pay postman 98c plus postage, fee. Order now! COMPRO CORP., Dept. A-9, 4840 N. Linder Ave., Chicago 30, Illinois.

BUILD YOUR POWER TOOLS

with our BALL BEARING ARBORS



New Departure Self Lubricating Bearings



10,000 R.P.M.

(No extra charge for left hand threads)
B33—\$4.95 PP. C4—1/2x12 1/2 spindle, housing 2x8 \$8.25 PP.
3/8 x 4 1/2 Spindle C5—3/4x12 1/2 spindle, housing 2x8, \$8.25 PP.
B15 Plain Spindle C6—3/4x12 1/2 spindle, housing 2 1/4x8, \$9.25 PP.
\$3.50 PP. D8—1x17 1/2 spindle, housing 2 5/8x11 \$17.00 PP.
1 INCH BETWEEN WASHER AND COLLAR

Plain Spindle models less threads and collars C-4—\$8.00, C5—\$8.00, C6—\$9.00, D8—\$16.00 all P.P.

SPECIAL SAW ARBORS MADE

Special Saw Arbors with 4 in., 5 in., 6 in., 7 in., housing length, add \$1.40. 1/2, 5/8, 3/4 models only. (30 day delivery).

SHAPER ARBORS 3 inches between collars, C4-1/2 \$14.25, C5-5/8 \$14.25, C6-3/4 \$15.25, D8-1 \$23.00. All P.P.

PILLOW BLOCKS — HEAVY DUTY — SELF ALIGNING

1 1/2"—\$3.90 ea., 3/8"—\$3.90 ea., 3/4"—\$4.25 ea., 1"—\$4.95 ea.
Sanding Discs—Poly Tru-Disc. 8" disc \$3.50 P.P., 10" disc \$5.00 P.P. Center hole 1/2, 5/8 or 3/4.

V Belts 5.02 per inch, Pulleys, 2" dia.—\$3.33, 2 1/4" dia.—\$3.50. State center hole 1/2 — 5/8 — 3/4

We Guarantee Complete Satisfaction

DEALERS WANTED

POLY PRODUCTS, 406 S. Chester, Ct. 1a, Pasadena 5, Calif.

Now a DYNAMIC Super-WELDER

IDEAL FOR AUTO • HOME APPLIANCE • FARM REPAIRS



DESIGNED TO DO HIGH GRADE WELDING INEXPENSIVELY!

Maintenance Men; Farmers; Mechanics; Machine Shops; Foundries; Auto, General Repair and Job Welding Shops; all using the DYNAMIC find it so indispensable and useful that they cannot afford to be without it. If inexperienced you can easily learn to do a variety of high grade welding jobs by following the practical, simplified operating and welding instructions furnished. Once you see a DYNAMIC in operation, you won't want to be without it. Its simplicity will amaze you. In a year the DYNAMIC only costs you about 6c a day. Helmet, rods, cables, holder and operating instructions, etc., furnished.

SAVES YOU VALUABLE TIME AND MONEY!

This portable industrial transformer type DYNAMIC WELDER easily carried right to the job, can be operated from any convenient, properly wired 110 Volt, 60 Cycle Line — has 8 metallic and carbon arc welding heat stages — does work you would think only possible with a larger more expensive machine. Can also be supplied for 220 volt, 60 cycle operation and other voltages and cycles at slight additional cost. Works on Iron, Steel, Brass, Bronze & other metals.

DYNAMIC WELDER CO., 13 East 23rd St., Rk, Chicago 16, Ill.

ONLY \$28.50

COMPLETE Available Now IMMEDIATE DELIVERIES

Write Today for Particulars GET DETAILS on our 10 day Trial Offer. Member Chicago Association of Commerce.

AVIATION SURPLUS

Radio headphones, Army type	\$ 1.95
Radio Hand Microphone T17.....	2.95
Radio Throat microphone, 3 for \$2.00, each.....	.95
Airplane Generator, 200 amps, 28 volts (for welders)	22.50
Gas mask bags, ideal for school, with strap, two for	1.00
Helmet, flying, A-9, OD cloth, two for only.....	1.00
Helmet, flying, B-6, leather, shearling lined, used..	1.50
Sun Glasses, gold rimmed, regular \$10.00, now....	4.95
Hand Lantern, stainless steel, streamlined, 6 volt.	2.95
Flying goggles, clear lens, Type AN6530.....	4.95
Boots, flying, A-6, leather, shearling lined, re-claimed, (sizes 9 and above only), with zipper...	5.95
Gauntlets, A-9 (long gloves), leather, fleece lined, new	5.95
Jacket, pilot's A-2 (not surplus). Genuine dark pony leather, elastic cuffs, etc. Cloth lined. New.	24.50
Jacket, flying, leather, shearling lining, used, has some patches, but redyed, reclaimed, has zipper.	4.95
Pants, leather, for above jacket, as described....	4.95
Coveralls, white, no pockets, new, sizes 40 to 50 only	4.95
Cap, leather, fleece lined, type B-2, square visor, (pilot's)	2.50
Cap, cloth, baseball style pilot's, long bill.....	1.00
Grease Gun, push type, for autos, planes, cycles, etc. New	1.00

(Deposit required on all COD orders)

AERO PARTS SUPPLY

Municipal Airport Houston 12, Texas

TRUCKS • TRACTORS • AUTOS

A TWIST OF THE WRIST AND YOU

SAVE

WITH CUNO AIRCRAFT TYPE OIL FILTER

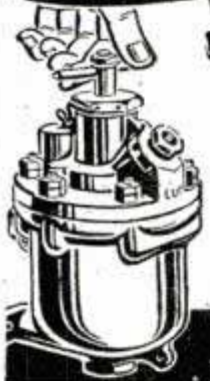

Keep oil clean without cartridge replacement...fits all cars, trucks and tractors...No parts to wear out...replaces all popular oil filters...installed at home in a few minutes...one turn of handle removes all dirt from permanent element...drain sludge and dirt from filter sump with each oil change...standard equipment on Airline, Army and Navy planes...

Every car owner, farmer, truck or fleet operator will save tremendously with the famous CUNO oil filter... save big money by ordering direct from this ad. Sent postage prepaid. Address Dept. 1412.

\$9.00

SHEFRIN SALES COMPANY

1329 W. 9th St. KANSAS CITY, MO.

ELECTRIC WELDER



AC or DC 110 Volts
Pre-war type—All metal—No chemical—5 year written guarantee. Welds 1/4" thick metal or money back. Repairs tanks, tools, fenders, machine parts, etc. Comes complete with rods, unit directions and eye shield. We also manufacture a set you can

\$6.45

Complete

learn with for only mailing charges extra.

ESSAY MFG. CO., INC., Dept. P.M., Quincy 69, Mass.

AMAZING NEW Star SCIENTIFIC GAS BURNER for

Automatic, Self-Acting • Needs No Adjustments • Jet Type • Cannot Backfire • Powerful in Performance Natural, Manufactured or Butane Gas

DEALER'S QUANTITY DISCOUNT

BIG PROFITS • ORDER NOW

DIRECT FACTORY TO YOU • MONEY BACK GUARANTEE

STAR HEATER COMPANY

1012-14 POWHATTAN • DALLAS 2, TEXAS

- STOVES
- KETTLES
- TUBS
- GRIDDLES
- HOT PLATES
- STEAM TABLES
- WATER HEATERS

PROMPT DELIVERY AVAILABLE

EASY ASSEMBLY IN LARGE UNITS WITH STANDARD PIPE FITTING!

MAN'S EXTRA FINE

ZIRCOLITE RING

Looks like a real diamond. Massive setting. Send No Money. Pay postman on delivery. Send remittance and save C.O.D. charge. Send ring size. Guaranteed.

\$3.50

Tax Included



VOGUE JEWELERS, Dept. PM9, 1003 Locust, St. Louis, Mo.

SHOOT LIKE A PRO WITH METEOR



The Camera with 12 "Professional" Features...

Action! Close-ups! Indoor Shots! . . . all easy with the Meteor—Universal's smart new low-priced camera with twelve "professional" features.

Streamlined Design! All-metal construction—lightweight aluminum—with pebble-grained cover.

Coated Miniscus Lens! For clear, sharp pictures every time!

Adjustable Diaphragm! For better pictures under any light conditions!

Collapsible Lens Mount! Ready for action at the flick of the wrist!

Rotary-Focusing Mount! No special attachments needed for close-ups, landscapes, etc.

Built-in Lens-Shade! Protects pictures from glare!

Built-in Exposure Meter, Calculator! Makes it easy to get proper exposures every time!

Built-in Synchronized Flash! Get those "professional" indoor shots!

Optical View Finder! See what you're getting before you shoot!

Chamber Loading! Takes standard 620 film in a unique chamber-loading device.

Tripod Socket!

Square Pictures! 2 1/4 x 2 1/4 exposures mean no gymnastics—camera never needs to be re-oriented!

See the Meteor at your dealer's today. It's the camera-bargain of the year at... **ONLY \$15**

UNIVERSAL CAMERA CORPORATION

NEW YORK CHICAGO HOLLYWOOD

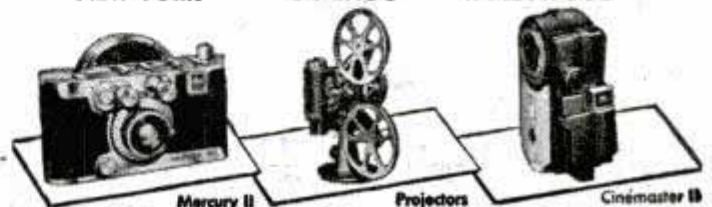

Mercury II

Projectors

Cinemaster II



the BEACON that never fails



EVEREADY CASE. Simulated brown leather, beautifully styled. **\$250**

Ever-faithful, the BEACON camera will always bring you top precision, miniature camera performance at low cost. The 46mm Whitlar coated lens — color corrected, gives you sharp, sparkling **\$995** incl. tax snapshots.

Safety lock shutter — no accidental snaps • Speeds 1/50, or time • Uses No. 127 film • Optically ground lenses, fluoride coated



Whitehouse Products, Inc.
360 Furman St., Brooklyn, N. Y.

**RIDE IT...
AND
YOU'LL
BUY IT!**

HERE'S WHY! A Whizzer Bike Motor takes you 125 miles on a gallon of gas! It's precision-engineered! Fits any man's balloon tire bike! Complete with all attachments necessary to motorize your bike! See your local Whizzer Dealer!

\$97⁵⁵ PLUS TAX

F. O. B. Pontiac, Michigan



WHIZZER

Whizzer Motor Company, Dept. 529, Pontiac, Michigan. I enclose \$99.97, which includes \$2.42 Federal Excise Tax () check or () money order. Send me one Whizzer Motor complete, ready for installation. If descriptive literature only is desired, check here ().

Name _____ City _____
Street _____ State _____

SMALL EFFICIENT SPEED REDUCER



\$18.56
NET — POSTPAID

Just the thing for the Home Work Shop, Hobby Shop, Bench Work, Animated Displays, Light Production work. Used daily in thousands of homes and shops. Sturdy, compact, (see dimensions). Case of heat treated aluminum. Gears, SAE 65 (British) Gear Bronze. Worm of case hardened steel. Timken Bearings throughout. Torque capacity 100 inch pounds. Available in 4 different assemblies (shown below) and in these standard ratios:

4-1	25-1	64-1	200-1
8-1	30-1	75-1	300-1
10-1	40-1	80-1	400-1
16-1	50-1	100-1	600-1
20-1	60-1	150-1	800-1

When ordering be sure to specify assembly and ratio required. Shipping weight in carton, 8 lbs. Full money back guarantee. Prompt deliveries.

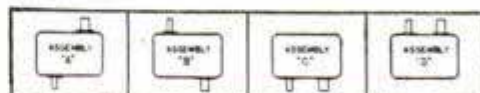

THE OHIO GEAR CO.
1406 EAST 179th ST. • CLEVELAND 10, OHIO

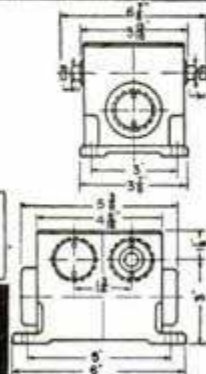

Have Your Own ELECTRO-PLATING Business

Profitable - Simple - Pleasant



The VARI-PLATER—110 V. A.C.—plus a glass or rubber tank and chemicals, which are always available, and accompanying handbook, that is illustrated and easy to understand, will give you many money making opportunities.

You can PLATE Gold—Silver—Chromium—Nickel—Copper—Cadmium, etc. on metals and non-metals with the VARI-PLATER.

FREE Write today for descriptive literature and price list.
LEWIS ELECTRICAL MFG. CO. 1266A Gun Hill Rd. New York 67, N. Y.

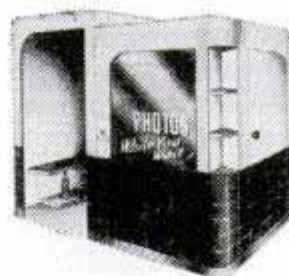

UP TO \$600 WEEKLY
with new 5 min. photo equipment.

No experience necessary.

Booth models—for your own small store location, arcades, department, variety, other stores, lobbies, depots, carnivals, parks, beaches, etc. Portable models for street corners, parks, near schools, picnics — anywhere.

Send 3c stamp for BIG PROFITS Plan.

FEDERAL IDENTIFICATION CO.
Dept. A1, 1012 N.W. 17th
Oklahoma City, Oklahoma

12 lbs. SURPLUS RADIO PARTS \$2.00

A gold mine of parts for repairmen, amateurs, and experimenters . . . sockets, condensers, resistors, transformers, coils, hardware, wire, etc. An outstanding bargain in usable parts! Send \$2.00 cash, check or M.O. today! (Pay small express charges on receipt.)

ELECTRONIC DISTRIBUTORS, Inc. Dept. M9 620 W. Randolph St. Chicago 6, Ill.



SURPLUS BRAND NEW 5 TON Hydraulic Jacks

Nationally Known—Limited Supply—Rush Orders. Regular List Price \$19.50. Our Sale Price, only **\$8.95** ea.

Prices FOB, K.C. Send money order or check. Get our prices on all Army built Truck Parts. Dodge—Chev.—G.M.C.—Studebaker—Intl., 6x6 — 4x4 — 6x4.

AMERICAN AUTO PARTS CO. 1830 LOCUST—DEPT. P. M. KANSAS CITY, MO.

GET INTO *Your Own* PROFITABLE BUSINESS



**BIG PROFITS IN
CONCRETE CINDER
BUILDING BLOCKS**

Capture Your Share of
the Big Building Boom.
Supply the Great Demand
for Quality Blocks Needed
Everywhere for Every Kind
of Construction Work.

How to Start and Operate A CONCRETE AND CINDER BLOCK PLANT

Men of Vision and Modest Capital See Prosperity and Financial Independence Secured Quickly in This Big Field Today. READ OFFERING BELOW AND THEN MAIL COUPON for FULL DETAILS.

Yes, there's UNLIMITED USES, TREMENDOUS DEMAND, for HIGH QUALITY BUILDING BLOCKS, an opportunity for profits never before equalled.

Our COMPLETE PACKAGED Concrete Block unit consists of Block Making Machine, Concrete Mixer, Material Elevator and Hopper—a complete block producing unit—HIGH PRODUCTION—LOW COST OPERATION. Pays for itself quickly after which you KEEP BIG PROFITS.

USERS SAY

"Easy to maintain production ONE HUNDRED CONCRETE BLOCKS PER HOUR PER MACHINE," says Concrete Block Products Co. of Junction City, Kansas. "Our block machine has been producing blocks at rate ABOVE number suggested in your literature. We anticipate need of another machine," says Parkville Concrete Products, Parkville, Mo. "After making 200,000 blocks your outfit is still in good working condition. We intend to place order for two more of your complete units," says Contractors & Builders Supply Co. of Kansas City, Kansas.

Get the facts about our famous Blocker Vibrator Concrete Building Block machine—what it does above all others—QUALITY BLOCKS AT LOW COST—800 to 1200 Blocks every day—why it is the fastest selling outfit today, EASY PAYMENT PLAN if desired. Fill the demand for building blocks in your territory NOW. MAIL COUPON or 1c POSTCARD for MONEY MAKING FACTS and FULL DETAILS.

CONCRETE BLOCK EQUIPMENT, Inc.

920 Central, Dept. 418

Kansas City 6, Mo. (Phone HARRISON 5797)

**NOW YOU
CAN MAKE
MONEY FAST**



MAIL THIS COUPON TODAY

Concrete Block Equipment, Inc.
920 Central, Dept. 418, Kansas City 6, Mo.

Rush me details of "How to Start and Operate a Concrete and Cinder Block Plant, an unusual money making opportunity."

Name _____

Address _____

City _____ State _____

(Paste on 1c Post Card and Mail)



Indian

WORLD'S FINEST
MOTORCYCLE
SPRINGFIELD, MASSACHUSETTS

"THE QUAD-CITY LATHE"



only \$32.50

F.O.B. Rock Island, Ill.

Here is an exceptionally well made machine. Has 8" swing, 4 speed ball-bearing head on a cast bed. 27" between centers.

QUAD-CITY PRODUCTS CO., Box 42, Rock Island, Ill.

Now
for EVERY WORK SHOP!

NEW
Invention

Electroplates by BRUSH



Easy to Plate CHROMIUM
GOLD, SILVER, NICKEL, COPPER
... For Pleasure and Profit!

If you have a workshop—at home or in business—you need this new Warner Electroplater. At the stroke of an electrified brush, you can electroplate models and projects—you can replate worn articles, faucets, tools, fixtures, silverware, etc. with a durable, sparkling coat of metal... Gold, Silver, Chromium, Nickel, Copper or Cadmium. Method is easy, simple, quick. Everything furnished—equipment complete, ready for use. By doing a bit of work for others, your machine can pay for itself within a week. So make your shop complete by getting a Warner Electroplater right away. Send today for FREE SAMPLE and illustrated literature. ACT AT ONCE! Mail Coupon.

WARNER ELECTRIC CO., DEPT. N-3
1512 Jarvis Avenue, Chicago 26, Ill.

FREE Details & Sample!

WARNER ELECTRIC CO., 1512 Jarvis Avenue, Chicago 26, Dept. N-3

Gentlemen: Send Free Sample and Details to:

Name _____

Address _____

City _____ State _____

**IT'S
HERE!**

THE *New* PRINT-O-MATIC

AUTOMATIC POST CARD DUPLICATOR

Look at these New Features:

ADJUSTABLE for any size card from 3"x5" to 4"x6".
FASTER. Prints clear at better than 2000 per hour.
HUNDREDS of uses. Every office, shop, school, club, church, library, etc., can save money and speed up mailing with the improved PRINT-O-MATIC.

ALL THE MATERIALS YOU NEED ARE FURNISHED

Each Print-O-Matic is delivered complete with sturdy supply kit—nothing else to buy.

4-Special-process cellulose Print-O-Matic Stencils.

1/4-lb. can special-formula, fast drying Print-O-Matic Ink.

1-Stylus for drawing, writing, etc.

1-Writing Plate for use with stylus.

1-Bottle of correction fluid.

1-Inking Brush.

Booklet of complete, easy-to-follow instructions.

\$13.
Add 25c for postage
Foreign orders add
\$2.50 for insurance

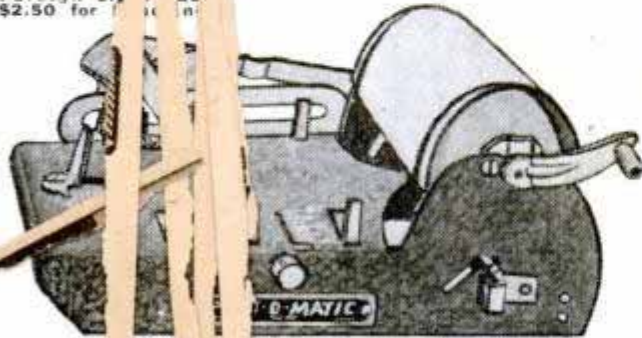

WRITE US TODAY FOR OUR FREE LIST

**Save UP TO 50%
on rebuilt machines**

- ★ TYPEWRITERS
- ★ ADDING MACHINES
- ★ CALCULATORS
- ★ MIMEOGRAPHS
- ★ ADDRESSING MACHINES
- ★ MULTIGRAPHS
- ★ MULTILITHS
- ★ ENVELOPE OPENERS
- ★ SEALERS
- ★ FOLDERS

Wanted

**WE PAY TOP PRICES FOR GOOD
USED MACHINES**

Write Us Today

Putt OFFICE MACHINES, INC.

309 W. MONROE ST. • CHICAGO 6, ILL.

YEARS OF REBUILDING AND SELLING GUARANTEED MACHINES

No other tool like it!

BURGESS
Vibro-Tool

\$7.50

Write on...
Watches
Glassware
Tools
Leather
Plastics

Costly Jewels
Pots and Pans
Sporting Equipment

Engrave your name . . . etch letters or designs . . . place permanent identification marks on anything with this unique hand tool. Carves wood and linoleum, cuts cardboard and balsa, tools leather. Just plug in on any 110 volt AC line. No home shop is complete without a Burgess Vibro-Tool. See your dealer or write for information.



DELUXE KIT

Vibro-Tool complete with 22 attachments in handsome, polished wood chest. . . . \$16.50

BURGESS BATTERY COMPANY
HANDICRAFT DIVISION
LAKE ZURICH, ILLINOIS

MINE DETECTOR SCR-625

Locates buried pipes, cables, ore bearing rocks, metal in wood. Screens personnel in plants. Will detect over 2 feet deep. All components in wooden chest.

Operating weight 15 lbs. Reconditioned. **\$39.50**
Originally sold for \$166.00. Only

SCHUH'S RADIO PARTS
1253 Loyola Ave. Chicago 26, Ill.

MUFFLERS

STEELS and ALUMINUMS
with a motorboat tone

**V-8
DUALS
& SINGLES**

SINGLES, Chev, V-8, Plymouth;
Steels \$5.50, Aluminum \$6.50.
Chry., Olds., Buicks, etc., Steels
\$7.50, Aluminum \$8.50. V-8 and
MERCURY DUALS, Steel \$17.50,
Aluminum \$20.00. Aluminums are
guaranteed for life of your car.

DEALERS WANTED

SANDEE MUFFLER CO.
7523 S. WESTERN AVE., LOS ANGELES 44, CALIF.

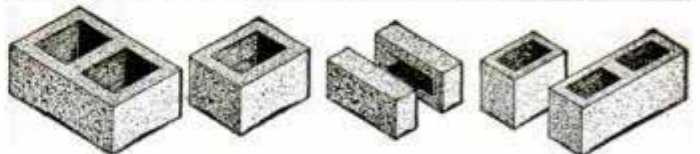

Profit by the Building Boom!

Start your own business manufacturing concrete building block and brick. Use Economy hand moulds. Make true, straight, easy-to-lay units which will pass any building code. Small investment, high production, big profits. One \$30.00 mould will make 1,000 5"x8"x12" blocks per day. Letters and repeat orders tell how pleased our customers are.

Post card brings free folder.

Economy Manufacturing Company
Dept. P Stone Mountain, Georgia

AUTO-LITE "Plug Tips"

Have you ever checked the Heat Range of your Spark Plugs?

THE HEAT range of a spark plug can be varied through such design factors as length of firing tip, insulator material, volume distribution in the firing end of the plug and material used in electrodes. Make sure your spark plugs are of the correct heat range for your engine. Auto-Lite spark plugs operate for any throttle range and load. Spark Plugs of correct heat range and a "Plug-Chek" at regular intervals using the Auto-Lite "Plug-Chek" Kit, will help stop power loss, gas waste and spark plug trouble. Mail the coupon today for the Auto-Lite "Plug-Chek" Kit which quickly helps you find spark plugs that are causing trouble or are of incorrect heat range. All you do is match plugs with pictures on the "Plug-Chek" Indicator—each example refers to a page in the "Plug-Chek" Data Book that shows you what needs to be done.

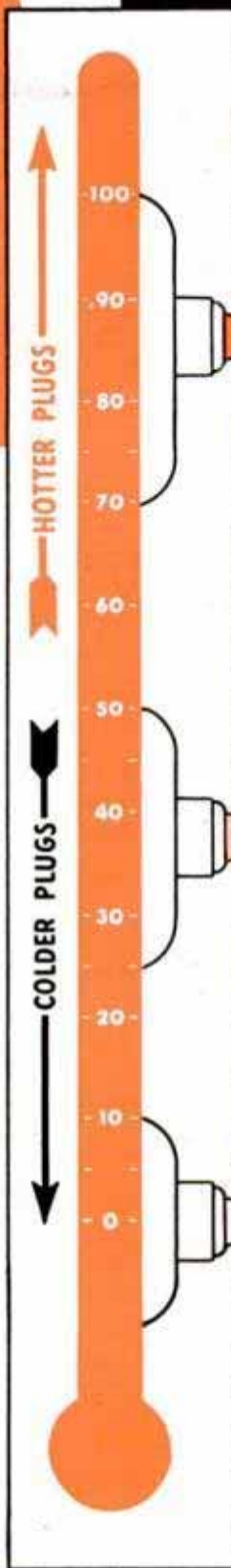

STOP-AND-CREEP DRIVING—Police cars, hearses, door-to-door delivery vehicles, etc. that have long periods of idling usually require a hot plug to prevent fouling.



AVERAGE DRIVING—The plug normally specified is of the proper heat range to handle all requirements under average driving conditions where the car is in reasonably good condition.



CONSTANT HIGH SPEED—Cars required to operate for long periods at high speed usually use colder plugs than normally specified, for best results.

Send for Auto-Lite "Plug-Chek" kit...only 10¢!

THE ELECTRIC AUTO-LITE COMPANY, Department PM4, Toledo 1, Ohio
Enclosed find ten cents for the Auto-Lite "Plug-Chek" Kit that includes both the "Plug-Chek" Indicator and Data Book.

Name _____
Address _____
City _____

Switch to
AUTO-LITE
SPARK PLUGS

"EXPERIENCE IS THE
BEST TEACHER!

... in bronc riding
... in smoking too,"
says bronc-riding star

Jerry Ambler

EXPERIENCE? 18 years of rodeo.
Most recent crown is the saddle
bronc championship
of the world.

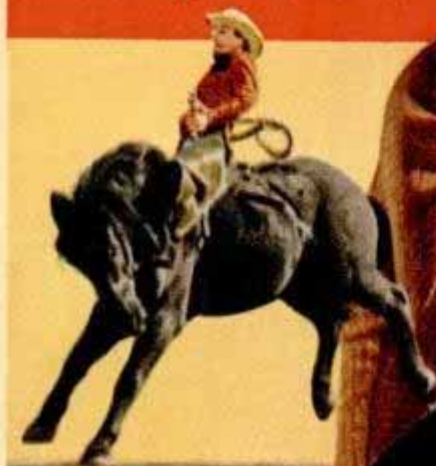

I HAD PLENTY OF
EXPERIENCE WITH
DIFFERENT CIGARETTES
DURING THE WAR...
IT'S **CAMELS**
WITH ME!

More people are smoking CAMELS than ever before!

The wartime cigarette shortage was an experience
that switched millions of critical smokers to Camels

BRONC-RIDING champion Jerry Ambler
is just one of millions, but his *experience*
during the wartime cigarette shortage is typical:

"I took any brand I could get. I couldn't help
comparing. Camels suit me best in every way.
It's swell to get Camels again regularly."

Yes, those choice Camel quality tobaccos
are available again in sufficient quantity
to insure all the Camels you want.

According to a recent Nationwide survey:

**MORE DOCTORS
SMOKE CAMELS**
than any other cigarette

When 113,597 doctors were asked by three independent
research organizations to name the cigarette they smoked,
more doctors named Camel than any other brand!



YOUR "T-ZONE" WILL TELL YOU
... T for Taste... T for Throat...
that's your proving ground
for any cigarette.
See if Camels don't suit your
"T-Zone" to a "T."

R. J. Reynolds Tob. Co., Winston-Salem, N. C.