

ANC

POPULAR MECHANICS MAGAZINE

WRITTEN SO YOU CAN UNDERSTAND IT

REG. TRADE MARK GREAT BRITAIN NO. 40625

REG. U.S. PAT. OFF.

**BUS TRAIN
PAGE 103**



HERE'S WHY NEW AUTO-LITE "Sta-ful" BATTERY...



needs
water only

3

times a year!*

BOTH BATTERIES FULL

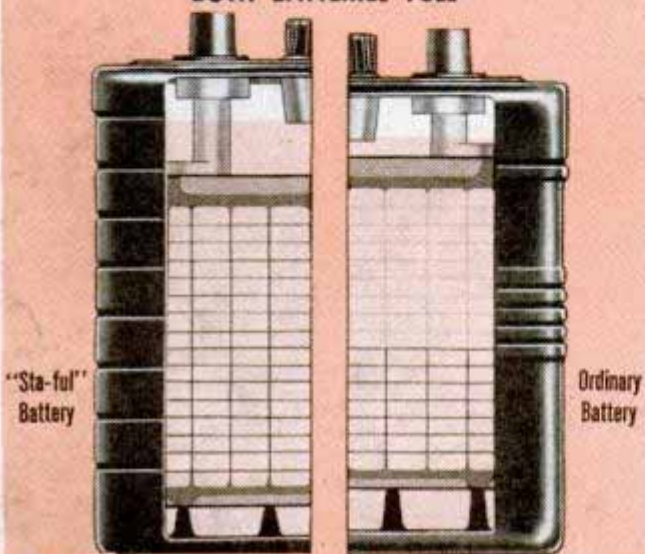

"Sta-ful"
Battery

Ordinary
Battery

FIRST STAGE OF EVAPORATION
Equal liquid loss from both batteries

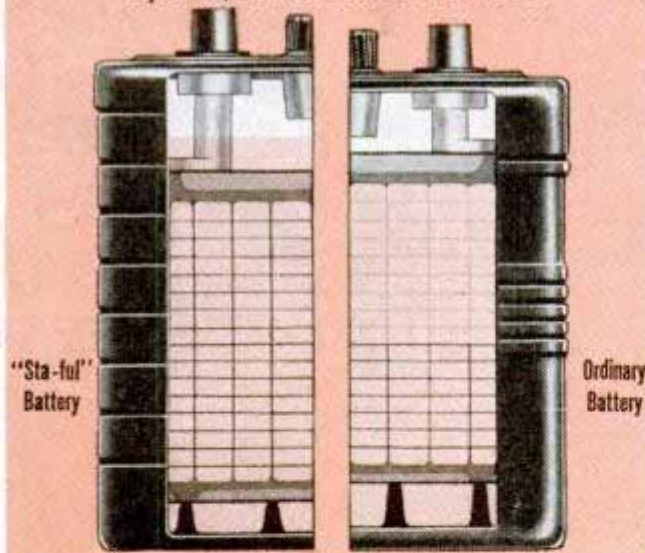

"Sta-ful"
Battery

Ordinary
Battery

ADVANCED STAGE OF EVAPORATION
Equal liquid loss from both batteries

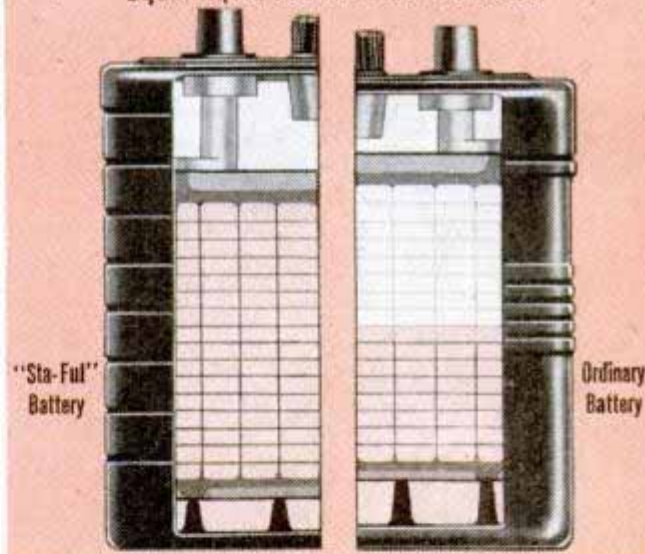

"Sta-Ful"
Battery

Ordinary
Battery

LASTS LONGER TOO! *In normal car use, because of "Sta-ful's" extra liquid reserve, plates are kept submerged to help deliver full life and power, when the same liquid loss leaves the plates in ordinary batteries exposed and inactive. This "Sta-ful" principle, oversize electrical capacity, plus Fibre-glass insulation, give longer life than batteries without Auto Lite "Sta-ful" features.

AUTO-LITE BATTERY CORPORATION
Toledo 1, Ohio

AUTO-LITE

**Sta-ful
BATTERIES**



More miles with
B.F. Goodrich
FIRST IN RUBBER



Typical example: the B. F. Goodrich tire that outwears prewar tires

CHARLES E. WATSON knows tires because they are part of his daily life. He services automobiles in Portland, Oregon, and does a lot of driving for both business and pleasure. In the picture above he is shown pointing to a B. F. Goodrich tire that has already given him over thirty-eight thousand miles of service. He writes:

"Less than eight months ago I purchased two B. F. Goodrich tires. The speedometer then read 35,504 miles. When these pictures were taken, it read 73,609. This represents 38,105 miles of the hardest possible passenger car service—and as you can see, there is plenty of tread left.

Though I am a service man, these tires were given no special attention."

Mr. Watson's report is *typical* of the experience of B. F. Goodrich owners, who state again and again that B. F. Goodrich Silver-towns outwear prewar tires. One of the reasons these tires give longer service is their wider, flatter tread. This tread puts more rubber on the road, spreads the wear more evenly, runs extra miles without wearing smooth.

Another worthwhile feature of this long-wearing tread is the hundreds of small curves molded into its rib edges to protect against skidding.

And B. F. Goodrich tires give you additional blowout protection, too . . . by means of double breaker strips to cushion sharp blows . . . a big, strong tire body made with cords of high tensile strength.

Prices Now Reduced!

Now you can get the tire that outwears prewar tires in all popular sizes at less than prewar prices! And there has been no lowering of quality. *The B. F. Goodrich Company, Akron, Ohio.*

B.F. Goodrich
FIRST IN RUBBER

A BILLION ORDERS A DAY

In a large modern telephone office 2,000,000 switch contacts await the orders of your dial to clear a path for your voice. They open and close a billion times a day.

At first, contacts were of platinum — highly resistant to heat and corrosion but costly. Years ago, Bell Laboratories scientists began looking elsewhere, explored the contact properties of other precious metals — gold, silver, palladium and their alloys — and with the Western Electric Company, manufacturing unit of the Bell System, restudied shape, size and method of attachment.

Outcome of this long research is a bar-shaped contact welded to the switch and positioned at right angles to its mate. For most applications, an inexpensive base is capped with precious metal.



Savings from these contacts help keep down the cost of telephone service. This is but one example of how Bell Laboratories serve the public through your Bell Telephone Company.

An engineer examines contacts in a cross-bar office. Horizontal bars seen in the cross-bar switches select contacts which are then operated by vertical bars to establish talking paths between subscribers.

BELL TELEPHONE LABORATORIES



EXPLORING AND INVENTING, DEVISING AND PERFECTING, FOR CONTINUED IMPROVEMENTS AND ECONOMIES IN TELEPHONE SERVICE

Popular Mechanics Magazine

Registered in U. S. Patent Office and Canada

H. H. WINDSOR, Founder

H. H. WINDSOR, Jr., Editor and Publisher



ESKIMO TOGS were donned for a visit in Florida by Aub Cookman, our Aviation Editor. After struggling out of his parka he stepped into a climate hotter than the tropics. This may sound confusing, but at Eglin Field he found climates made to order. Men of the Army Air Forces press a few buttons and vary the temperature of a big hangar from 70 degrees below to 165 above. It's a project to test aviation equipment for any climate. Aub's account, "Florida's Cold Spot," is on page 98.

NEXT MONTH "Flight Plan for London" will reveal all the jigsaw details that are fitted into a plan for a transocean hop. Another feature gives the low-down on how to patent an invention. Also, there'll be a story about a home-movie expert who makes a chorus of flowers perform a ballet to music in front of a movie camera.

SPORTSMEN will discover a heavy bill of fare in next month's Craftsman section. There's an article for hunters on building a duck boat, and a feature that tells how to convert the Enfield rifle into a sporting arm. Another article gives tips on preparing your oil burner for the first cold snap.

OWNERS of spring-wound record players and small radios can get loud-speaker volume with a battery-operated amplifier described in next month's Radio section.

Volume 88 AUGUST 1947 Number 2

Managing Editor.....Roderick M. Grant
Assistant Managing Editor.....Wayne Whittaker
Shop Notes and Crafts Editor.....James R. Ward
Radio and Electronics Editor.....Frank L. Brittin
Aviation Editor.....Aubrey O. Cookman, Jr.
Associate Editor.....John R. Kinsey
Eastern Editor.....Bill Reiche
Western Editor.....Thomas E. Stimson, Jr.
Art Director.....Frank Beatty

Assistant Editors
Donald R. Brooks Charles D. Emerson Clifford B. Hicks
 Arthur R. Railton

Assistant Editors, Shop Notes and Crafts
W. Clyde Lammey Wayne C. Leckey John F. Shrock A. E. Youngquist

In This Issue

- So You Want a Helicopter? - - - 73
- Railroad Fans on the Loose - - - 80
- Greased Lightning Strikes the Flats - 89
- Florida's Cold Spot - - - - - 98
- "Bad Man" of the Elements - - - 106
- Photographer of the Insect World - 114
- Teaching Old Rivers New Tricks - 121
- Mothering the Zoo Babies - - - 132
- Muscle Men of America - - - - 137
- They Dredge for Your Dinner - - 142
- Blowing Up Hollywood - - - - 154

For the Craftsman

- Row Gently - - - - - 170
- Oven for Heat-Forming Plastics - 180
- Mailboxes Can Be Made Attractive 186
- Make Your Darkroom Workable - 192
- Solder It Right - - - - - 201
- Brakes for Bending Sheet Metal - 207
- Radio and Electronics - - - - - 213

Table of Contents Continued on Page 8

Published monthly by POPULAR MECHANICS COMPANY, 200 East Ontario Street, Chicago 11, Ill. H. H. Windsor, Jr., president; Paul H. Dunakin, vice president and general manager; D. F. Windsor, vice president and secretary-treasurer; William Harrison Pettridge, vice president and assistant to the publisher; Clover L. Perkins, advertising manager; Alan M. Deyoe, circulation manager. Single copy in the United States and Canada, 25 cents; subscription rates in United States and possessions, Canada, and countries of the Pan-American Postal Union, 1 year, \$2.50; 2 years, \$4.50; 3 years, \$6.00. To all other countries add \$1.00 a year over United States prices for overseas postage. If you plan to move, notify us at least 60 days in advance so you will not miss an issue. Give both old and new addresses. Entered as Second Class Matter, September 15, 1903, at the Post Office at Chicago, Illinois, under Act of March 3, 1879. Entered as Second Class Matter at Post Office Dept., Canada, Copyright 1947, by Popular Mechanics Company, Copyright under International Copyright Union, Copyright in France. All rights reserved under Pan-American Copyright Union. Printed in the United States of America.

ALL KINDS OF WEATHER— UNDER ONE ROOF!

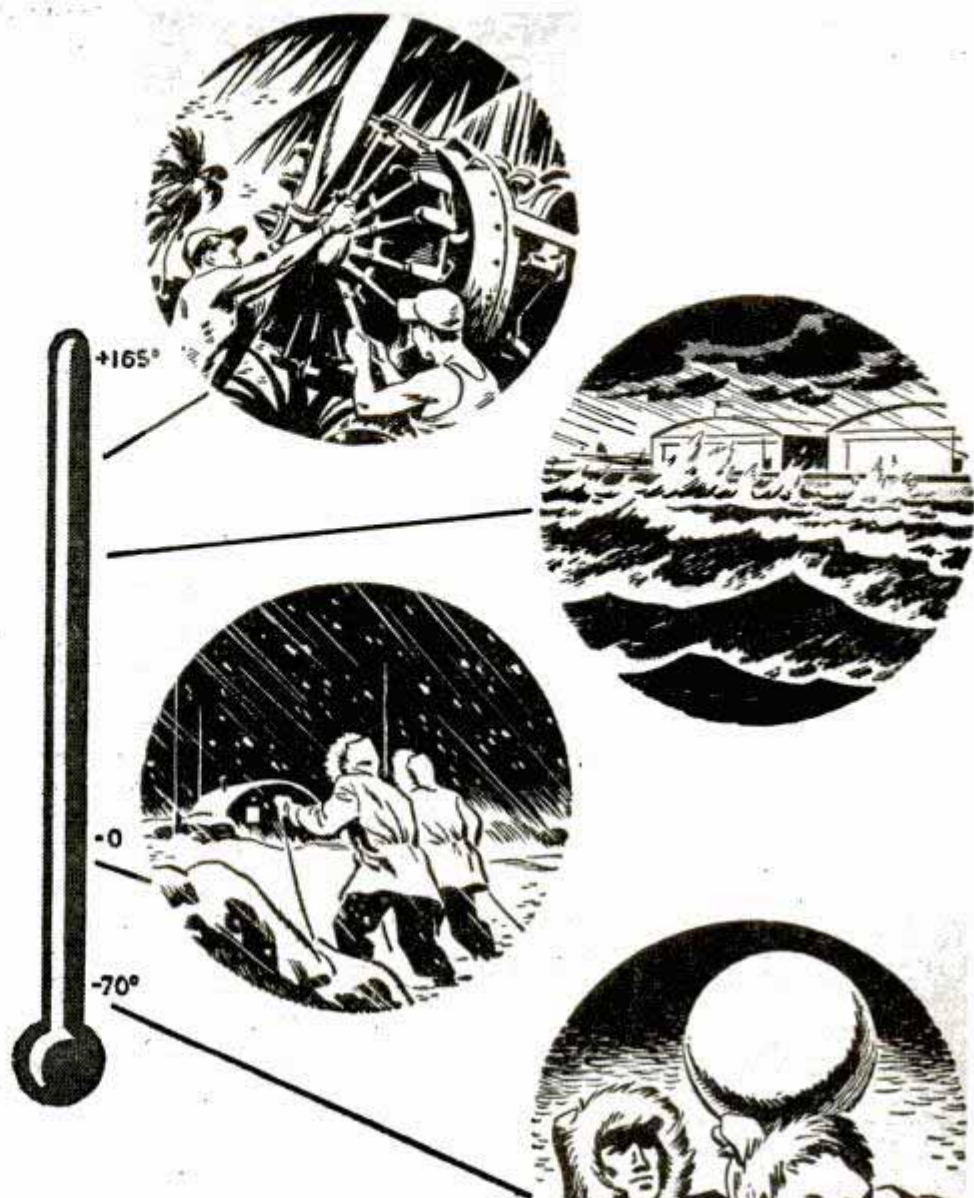

At Eglin Field, Florida, the Army Air Forces' Proving Ground Command has built a huge Climatic Hangar. Inside it, temperatures ranging from an icy 70 degrees below zero to a torrid 165 degrees above can be quickly produced.

Howling 100-mile-an-hour winds, artificial sunlight, strato-chambers, and other built-in facilities make most climatic extremes available—with no costly waiting for suitable outdoor test conditions.

The Climatic Hangar is another step in the Air Forces' quest for better, safer airplanes and equipment. If you are interested in a future in aviation, Air Force Day—August 1—gives you a chance to know your Air Forces better. See your nearest U. S. Army Recruiting Station today for details on AAF enlistments.

U. S. ARMY RECRUITING SERVICE

FROM DESERT HEAT TO ARCTIC ICE

In one building, 200 feet long by 250 feet wide, the Army Air Forces can simulate any one of the extreme weather conditions shown above.



How Ford brakes eliminate

"Nutcracker Squeeze"

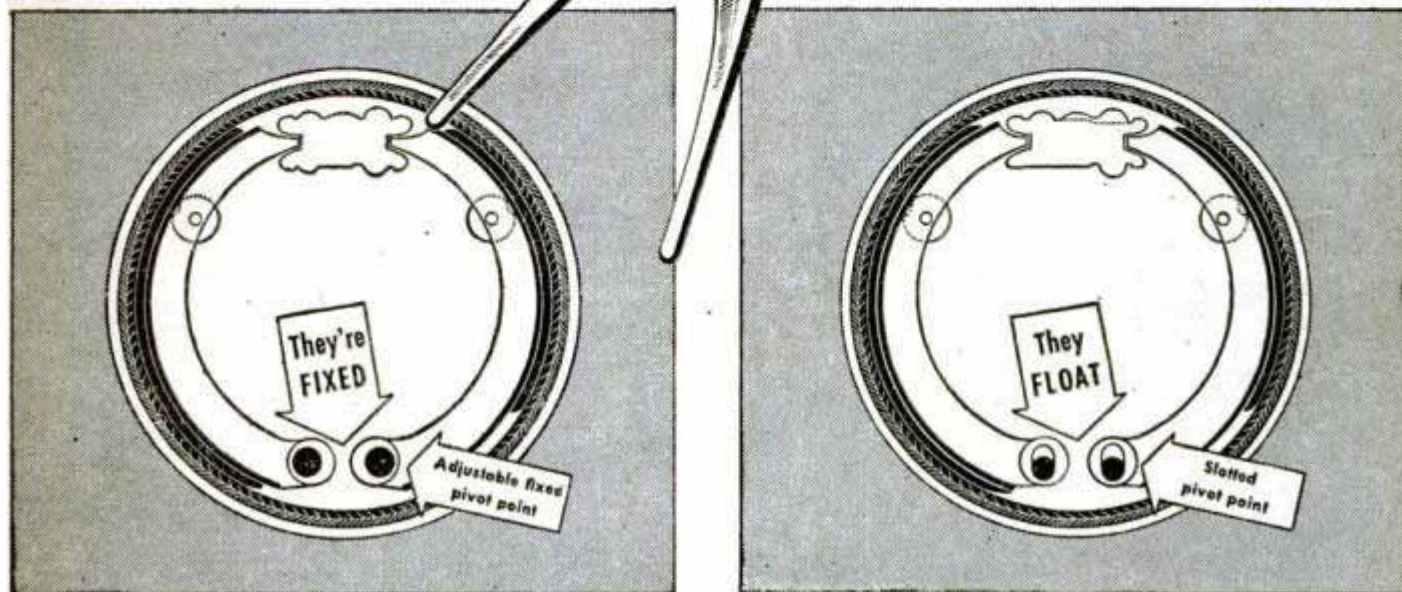

Old-type brakes use a nutcracker-type pivot. They have adjustable pivot points using eccentric anchor bolts on the bottom pivots, and a spread at the top. To eliminate the uneven contacts of such a pivot, Ford has developed a completely new type of hydraulic brake.

New type Ford brakes are *self-centering*. This design allows the brake shoes to *float* into complete contact with the drums for evenly distributed contact pressures and increased braking efficiency with 15% softer pedal action. And they're oversized for greater safety.



They're "King-size"

Ford oversized hydraulic brakes have 162 square inches of lining area, 264 square inches of drum area—the largest in their price class. This gives you braking areas greater in relation to car weight than even some of the heavier, higher-priced cars. 12-inch cast iron brake drums mean greater safety;

They're Self-centering

Ford's new floating shoe design, with fixed anchor and slotted brake-shoe pivot, centers the brakes against the drum for full-lining contact. This gives brakes even, long life . . . easier, less frequent adjustment.

They're Long-lasting Hydraulics . . .

Ford brakes get their longer life not only from their self-centering feature, but also from the long-lasting cast iron brake drums. *With features like these, no wonder "Ford's Out Front" for safety.*

There's a *Ford* in your future



This One



33NB-WJU-4W92



1200 magnifications reveal the structure of annealed forgings. Under the microscope, the laboratory technician can determine if the sample meets specifications.



The extent to which hardness penetrates is determined by the Rockwell test. In this procedure, a diamond test-point is

driven with equal, measured force into the sample at intervals. Readings at these points determine degree of hardness.

CRESCENT*

Quality

BEGINS IN THE LAB...

At Crescent, "Quality" is more than just a word... it is an inseparable part of the materials, production control and workmanship which goes into every Crescent tool. Each individual heat of tool-steel follows an exhaustive testing routine. A sample is Macro-etched to expose any cracks or other defects. Samples are also subjected to a Jominy hardenability test, a process of heating, then quenching the exposed tip of the test piece. Depth of the hardness penetration is then checked by the Rockwell hardness test.

Only steel which meets or surpasses Crescent's rigid laboratory standards is released for production—your assurance of durability and performance in Crescent Tools.

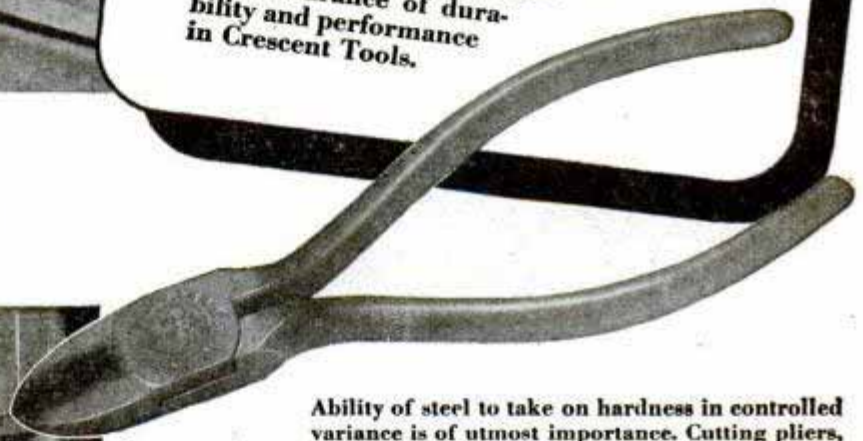

Ability of steel to take on hardness in controlled variance is of utmost importance. Cutting pliers, for instance, require extreme hardness at the cutting edges, backed up by an area of tough, but not so hard, metal. Handles, too, must be reasonably hard at the joint but springy farther back. This photograph is of a hardened sample which has been etched with acid to show location and degree of hardness.

* CRESCENT TOOLS

Give Wings to Work

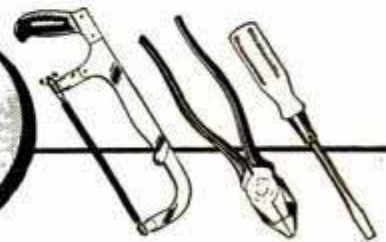

* "CRESCENT" is our trade mark registered in the United States and foreign countries for wrenches and other tools. "Crescent" tools are made only by Crescent Tool Company of Jamestown, N. Y., and are sold by leading distributors everywhere.

Why be a BOOKKEEPER?

...When Accountancy
offers more Money
and Success...

If you are a bookkeeper, you are right on the threshold of a profession that pays far above average—where there's real opportunity to get ahead and move up fast.

Why not step *UP* from bookkeeping—be an accountant—make *real* money!

You can learn Accountancy by the interesting LaSalle Problem Method—in your convenient spare time, at home, without losing a day from your work. You learn by *doing*... you study Accounting principles and solve Accounting problems under the clear guidance of experienced C.P.A.'s. You cover Accountancy from the basic principles right up through Accounting Systems and Income Tax Procedure—to advanced training for the C.P.A. degree if you so desire. And as you go along step-by-step, you master the principles of auditing, business law, statistical control, cost accounting, organization, management, finance, etc.

You go as fast or as slowly as you choose. And you may start "cashing in" on your new ability long before you complete the training—as thousands of others have proved. Many advance quickly to better positions, even before they are half way through. And that is only the *beginning* of a growing and continuing success for the rest of your business life.

Why remain "just a bookkeeper" when Accountancy holds so much for you? Our free 48-page booklet, "ACCOUNTANCY, THE PROFESSION THAT PAYS," tells you what you must know to be an Accountant, and how you can prepare in your leisure time, at moderate cost and on easy terms.

Send the coupon today. Get all the facts and judge for yourself. There is no obligation. You are already started in this field...find out how you can rapidly go to the top! Mail coupon NOW!

FREE BOOKLET

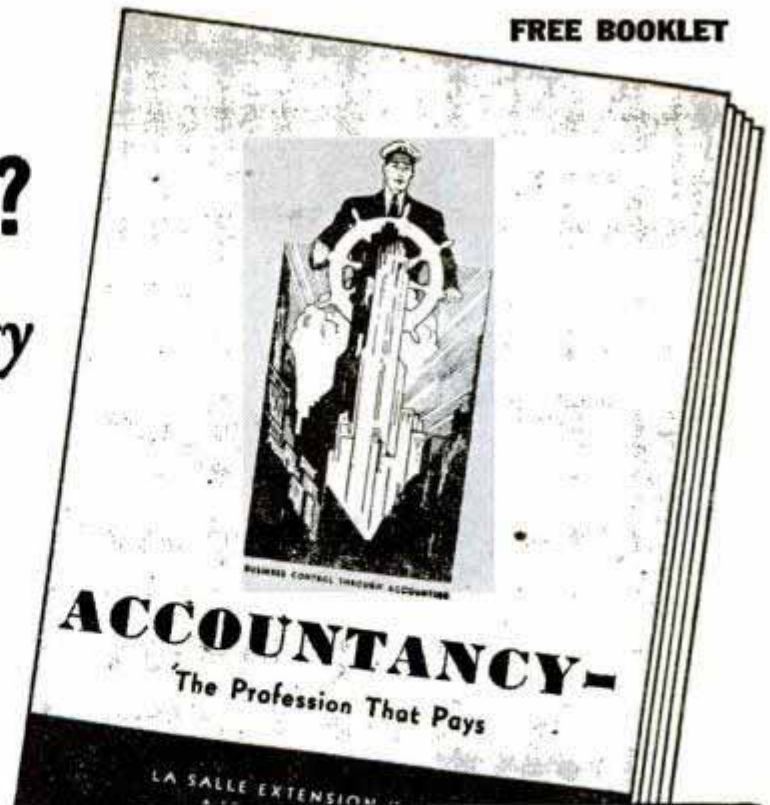

G. I.
APPROVED

LA SALLE Extension University

A Correspondence Institution

Dept. 864-H • 417 S. Dearborn • Chicago 5, Ill.

I'd like to know more about your home study program to help me prepare for an accounting career. Please send me your free 48-page booklet, "Accountancy, the Profession That Pays."

Name

Position Age.....

Address.....

City, Zone and State.....

**"I'm GOING
to be an
ACCOUNTANT!"**



LASALLE

EXTENSION UNIVERSITY

A Correspondence Institution

add PYROIL



carefree driving

Join the growing ranks of automobile owners who are underwriting car performance with Pyroil. Pyroil prevents undue wear by maintaining a film of oil on cylinder walls . . . it prevents rust and corrosion . . . eliminates the accumulation of dirt, sludge, gum and other contamination on surfaces . . . it reduces carbon formation.

Ask your gas station attendant to add Pyroil—and you'll add miles to your car.

Pyroil for Aircraft Engines

Use Aircraft Pyroil B for lubricating oil, Aircraft Pyroil A for gasoline.

Manufactured and Guaranteed by Pyroil Company, 70 Pyroil Bldg., La Crosse, Wisconsin.



PYROIL COMPANY

70 Pyroil Bldg., La Crosse, Wisconsin

I want my car to last and run properly. Please tell me more about Pyroil and how it can accomplish this for me.

Name _____

Address _____

City or Town _____ State _____



Jerry, the talking dog, is entertaining hospitalized veterans, by courtesy of the PYROIL Company. Picture of Jerry, sent on request.

TABLE OF CONTENTS (Continued)

AUTOMOTIVE

GM auto engine of future uses one third less gas.....	97
Passengers' cars carried on train.....	104
Handmade sport roadster.....	105
Rear-engine "Scap Box".....	110
"Gas tank" car.....	110
Indianapolis speedway racer purchased by movie actor.....	135
Cemented brake linings.....	148
Automobile trailer collapses in trunk.....	150
Safety cage for tire inflation.....	152
Single unit hub cap and trim.....	158
"Alarm" for lubrication trouble.....	158

AVIATION

Air-liner bar.....	86
Shortest phone line.....	97
Army's B-36 bomber.....	119
Navigator's periscope.....	130
Plane tie-down chain is adjustable.....	131
Flying-boat fighter.....	135
The President's plane.....	136
Aerial cab fleet.....	158
"Bottled lightning" guides pilots to runway.....	159
Air-bag wind tunnel.....	160

BOATS AND BOATING

Ship detector.....	86
Faise bow on tug fits it for ocean.....	105
Seamless plastic boat.....	152
Lightweight stainless-steel boat.....	158

HOUSE AND HOME

"Venetian" screens.....	79
Roofs built in ladder sections.....	87
Wnat's new for your home.....	94
Sprayed ice trays won't stick.....	97
House and furniture from kits.....	112
Automatic washer has separate units to wash and rinse.....	113
Heat-sealed packages hold food for home freezing.....	118
Nondrip rim for paint cans.....	120

INDUSTRY

Porks deliver orders to train crews.....	79
Hot-cold pipe.....	86
Czech locomotive.....	87
Rotary digger speeds harvesting of sweet potatoes.....	88
Cereal grains are exploded by compressed air.....	96
Locomotive oxygen "mask".....	97
Plastic glue supports jeep.....	102
Glass-topped train of tomorrow.....	111
Fins moving dirt triple scraper's efficiency.....	118
Streamliners abroad.....	120
Gas-turbine locomotive.....	128
Face lifting for a dam.....	148
Test labs behind the catalogues.....	153

LAWN AND GARDEN

Tractor for gardeners weighs less than 100 pounds.....	112
Grass seed "carpet".....	130
Root feeder.....	151
Seeder sows one by one.....	152

OUTDOOR RECREATION

Golf bag has folding wheels.....	88
Clamp-on golf cleats.....	98
Motor scooter from scrap parts.....	109
Minnowa ride "elevator" in bait bucket.....	113
Harness-race starting gate.....	160

PHOTOGRAPHY

Eye for AAP.....	110
High-speed printer for color photos.....	131
Camera arm supports floods.....	141
Speed Graphic—47 model.....	141
For camera fans.....	147

RADIO AND ELECTRICAL

Bacteria counted by electronics.....	102
Radio-guided rocket goes over 500 m.p.h.....	104
Radio beam guides builders.....	112
Weather chamber tests radar.....	141

TOOLS

Spring holds portable lamp.....	102
Metal case holds 29 drills.....	104
Winding machine handles 28 coils.....	138

MISCELLANEOUS

Swedish bus trailers.....	103
Explosion-proof gas generator.....	105
Telescoping leg for typewriter leaf.....	109
Race track sifting machine.....	109
Sit-down barber's chair.....	130
Striking tape cleans type faces.....	131
Slip-on cleats held in place by tension.....	131
Hospital "sandwich" bed.....	146
Two-faced owls aid in campaign against pesky starlings.....	151
Fence made of bombs.....	151
Pin-curl clip.....	159

Craftsman and Shop Notes Index

ART AND ARTIST

Magic catalogue provides models for studying hands.....	178
Drawings rolled in paper tube will not drag on floor.....	204
Absorbent cotton stuffed in covered box cleans drawing pencil.....	210
Clay holder for lettering pens.....	211

AUTOMOTIVE

Rubber hose used as siphon.....	168
Twelve-point spring inspection.....	185
Tissue dispenser in automobile is handy for passengers.....	190

(Continued to page 10)

DON'T READ ANOTHER WORD OF THIS ADVERTISEMENT



unless you're interested in a better job, a larger salary, greater responsibility! I. C. S. messages are not addressed to the idly curious—they're for the man who is curious with a purpose.

If you want to know how to start achieving advancement and success, we have important information for you.

We want to tell you that I. C. S. Courses covering more than 400 subjects are available for spare-time study at surprisingly low cost.

We want you to know that pay increases and job betterments are consistently reported to us by I. C. S. students in a volume as high as 600 and more letters a month.

Note, too, that successful I. C. S. graduates are numbered in the thousands and include presidents, production and research heads, superintendents, foremen in almost every branch of industry.

If you're truly curious, you'll want to know the details of what I. C. S. did for these men—and what it can do for you. The coupon brings you this full information. Mark and mail it *right now!*

INTERNATIONAL CORRESPONDENCE SCHOOLS



BOX 5609-K, SCRANTON 9, PENNA.

Without cost or obligation, please send me full particulars about the course BEFORE which I have marked X:

- | | | | |
|--|--|---|--|
| <p>Business and Academic Courses</p> <ul style="list-style-type: none"> <input type="checkbox"/> Accounting <input type="checkbox"/> Arithmetic <input type="checkbox"/> Business Administration <input type="checkbox"/> Business Correspondence <input type="checkbox"/> Certified Public Accounting <input type="checkbox"/> Commercial <input type="checkbox"/> Commercial Art <input type="checkbox"/> Cost Accounting <input type="checkbox"/> Federal Tax <input type="checkbox"/> First Year College <input type="checkbox"/> Foremanship <input type="checkbox"/> Good English <input type="checkbox"/> Higher Mathematics <input type="checkbox"/> Motor Traffic <input type="checkbox"/> Salesmanship <input type="checkbox"/> Sign Lettering <input type="checkbox"/> Spanish <input type="checkbox"/> Traffic Management <p>Air Conditioning and Plumbing Courses</p> <ul style="list-style-type: none"> <input type="checkbox"/> Air Conditioning <input type="checkbox"/> Heating <input type="checkbox"/> Refrigeration | <p>Chemistry Courses</p> <ul style="list-style-type: none"> <input type="checkbox"/> Chemical Engineering <input type="checkbox"/> Chemistry, Analytical <input type="checkbox"/> Chemistry, Industrial <input type="checkbox"/> Chemistry, Mfg. Iron & Steel <input type="checkbox"/> Petroleum Refining <input type="checkbox"/> Pulp and Paper Making <p>Civil Engineering, Architectural and Mining Courses</p> <ul style="list-style-type: none"> <input type="checkbox"/> Architecture <input type="checkbox"/> Architectural Drafting <input type="checkbox"/> Building Estimating <input type="checkbox"/> Civil Engineering <input type="checkbox"/> Contracting and Building <input type="checkbox"/> Highway Engineering <input type="checkbox"/> Lumber Dealer <input type="checkbox"/> Reading Structural Blueprints <input type="checkbox"/> Sanitary Engineering <input type="checkbox"/> Structural Drafting <input type="checkbox"/> Structural Engineering <input type="checkbox"/> Surveying and Mapping <p>Communications Courses</p> <ul style="list-style-type: none"> <input type="checkbox"/> Electronics <input type="checkbox"/> Practical Telephony <input type="checkbox"/> Radio, General <input type="checkbox"/> Radio Operating | <p><input type="checkbox"/> Radio Servicing</p> <p><input type="checkbox"/> Telegraph Engineering</p> <p>Electrical Courses</p> <ul style="list-style-type: none"> <input type="checkbox"/> Electrical Drafting <input type="checkbox"/> Electrical Engineering <input type="checkbox"/> Electric Light and Power <input type="checkbox"/> Lighting Technician <input type="checkbox"/> Practical Electrician <input type="checkbox"/> Power House Electric <input type="checkbox"/> Ship Electrician <p>Internal Combustion Engines Courses</p> <ul style="list-style-type: none"> <input type="checkbox"/> Auto Technician <input type="checkbox"/> Diesel-Electric <input type="checkbox"/> Diesel Engines <p>Mechanical Courses</p> <ul style="list-style-type: none"> <input type="checkbox"/> Aeronautical Engineer's, Jr. <input type="checkbox"/> Aircraft Drafting <input type="checkbox"/> Flight Engineer <input type="checkbox"/> Forging <input type="checkbox"/> Heat Treatment of Metals <input type="checkbox"/> Industrial Engineering <input type="checkbox"/> Industrial Metallurgy <input type="checkbox"/> Machine Shop <input type="checkbox"/> Machine Shop Inspection | <p><input type="checkbox"/> Mechanical Drafting</p> <p><input type="checkbox"/> Mechanical Engineering</p> <p><input type="checkbox"/> Mold-Loft Work</p> <p><input type="checkbox"/> Patternmaking—Wood, Metal</p> <p><input type="checkbox"/> Reading Shop Blueprints</p> <p><input type="checkbox"/> Sheet-Metal Drafting</p> <p><input type="checkbox"/> Sheet-Metal Worker</p> <p><input type="checkbox"/> Ship Drafting</p> <p><input type="checkbox"/> Tool Designing</p> <p><input type="checkbox"/> Welding—Gas and Electric</p> <p>Railroad Courses</p> <ul style="list-style-type: none"> <input type="checkbox"/> Air Brake <input type="checkbox"/> Diesel Locomotive <input type="checkbox"/> Locomotive Engineer <input type="checkbox"/> Locomotive Fireman <input type="checkbox"/> Railroad Section Foreman <p>Steam Engineering Courses</p> <ul style="list-style-type: none"> <input type="checkbox"/> Boilermaking <input type="checkbox"/> Combustion Engineering <input type="checkbox"/> Engine Running <input type="checkbox"/> Marine Engineering <input type="checkbox"/> Steam Electric <input type="checkbox"/> Steam Engines <p>Textile Courses</p> <ul style="list-style-type: none"> <input type="checkbox"/> Cotton Manufacturing <input type="checkbox"/> Rayon Weaving <input type="checkbox"/> Textile Designing <input type="checkbox"/> Woolen Manufacturing |
|--|--|---|--|

Name _____ Home Address _____
 City _____ State _____
 Age _____ Present Position _____ Working Hours _____ A.M. to _____ P.M.

Special tuition rates to members of the Armed Forces. Enrollment under the G.I. Bill of Rights approved for World War II Veterans.
 Canadian residents send coupon to International Correspondence Schools Canadian, Ltd., Montreal, Canada.

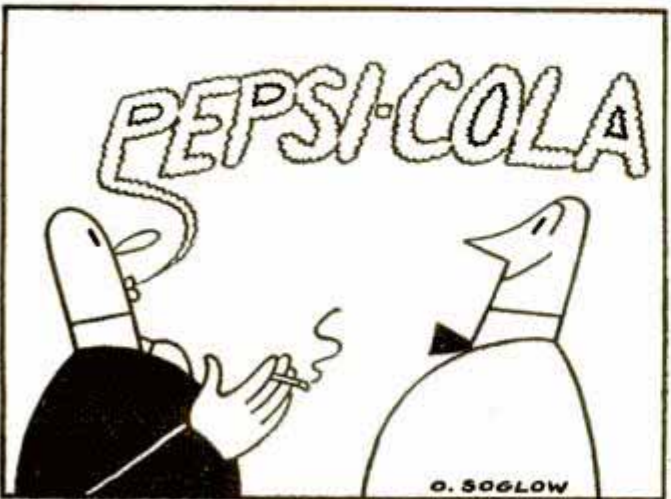
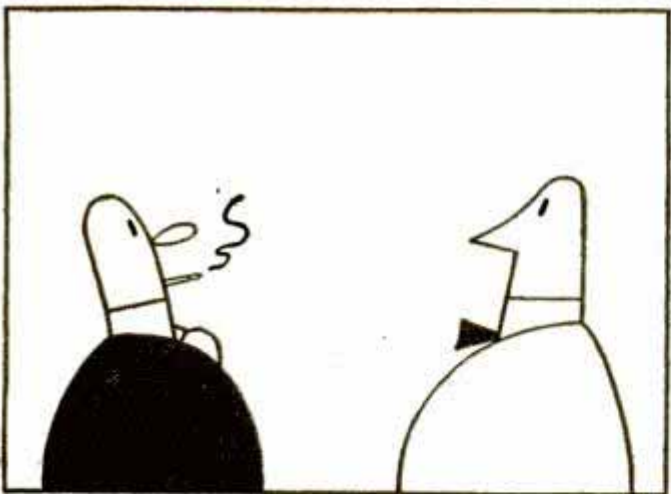
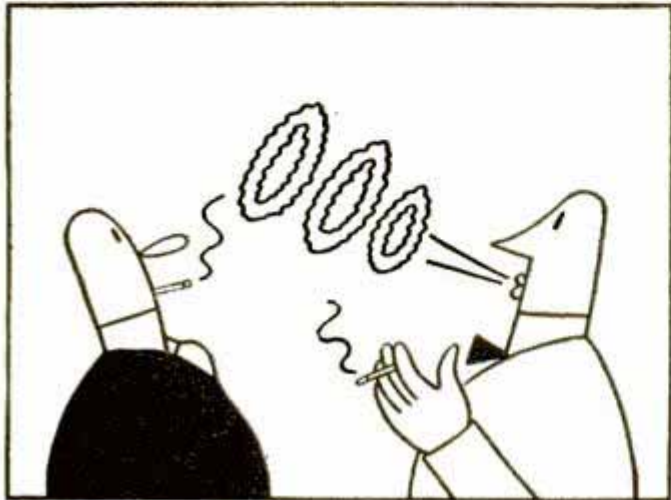
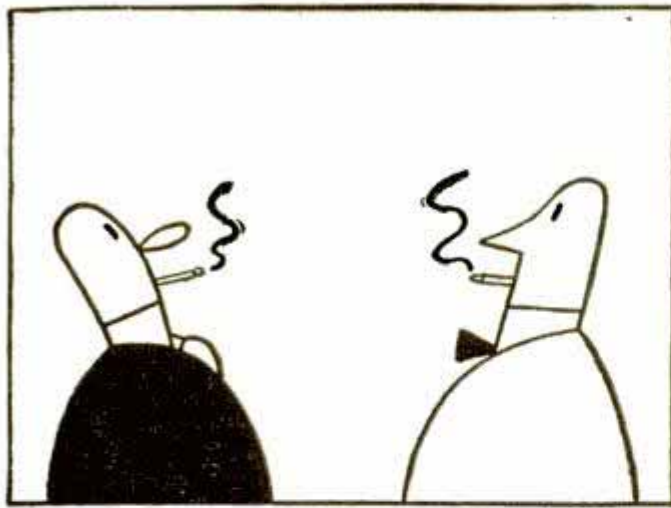

(Continued from page 8)

Repairing broken trunk hinge.....	198
Auto oil pump primed by air.....	212
Gravity feed for gasoline tank.....	212

BOATS AND BOATING

Wheeled dolly for small boats makes moving them easy.....	175
Chain guard on starter rope.....	182
Tire-tube catamaran.....	183

FARM

Extension attached to drawbar of tractor makes harrowing easier.....	211
Irrigation water filtered by backflow intake.....	211
Thermometer in perforated pipe tells temperature of grain.....	212

HOUSE AND HOME

Solving home problems.....	166
Pins in door prevent intruders.....	176
Rubber band will seal leak.....	176
Tap substitutes for bottle cap.....	182
Candle stubs will start fires.....	184
Multiple indoor clothesline has one adjustment.....	189
Roller won't tear off of shade if taped in place.....	189
Repairing broken water pipe.....	190
Tees provide for future outlets.....	198
Undercutting stair will save carpet.....	198
Inserting brads in picture frame.....	200

LAWN AND GARDEN

Portable barbecue and broiler.....	176
Light up your back yard.....	177
Simple rigging laces canvas "carryall" to avoid spilling contents.....	179

OUTDOOR RECREATION

Fish grilled between two stones.....	164
Paper pocket holds fishhooks.....	164
Spring "fired" harpoon is deadly against frogs.....	179
Knock-down target is replaced from shooting position.....	184

PHOTOGRAPHY

Scale for dry photographic chemicals.....	197
Siphon controls level of liquid in film-washing tank.....	197
Camera bellows makes lens shade.....	197
Wire frame holds film-tank rod.....	197

RADIO AND ELECTRONICS

Space-saving cabinets for radio and record-playing equipment.....	213
Beginner's five-band phone and CW transmitter.....	214
Six service hints for radio set owners.....	216

TOOLS

Removing nails from thin stock.....	164
Plywood panel on jigsaw table increases life of blades.....	168
Tool rack hanging from ceiling saves space in workshop.....	168
Bench stop slides out of way when not being used.....	176
Knockout holes in rotary hacksaw aid removal of work.....	178
Easy way to "drill" glass.....	178
Electric oven for heat-forming plastics.....	180
Hose sections nailed to wall provide holders for tools.....	182
Protecting sharp edge of chisel.....	182
Soldering large sheets of metal made easy by preheating.....	184
Cigarette lighter flint ignites torch.....	189
Drilling jig for centering rods.....	190
Adjustable metal holder for emery cloth.....	191
Craft quiz.....	199
Sanding drum fits drill press.....	200
Emergency chuck for small brace.....	200
Keeping miter work from slipping.....	200
Combination holder and lighter facilitates welding work.....	204
Pliers converted to staple puller.....	204
Anti-friction center-rest jaws.....	205
Trammel scribe for large work also used as beam compass.....	206
Cotter pins are installed easily with pronged spreader.....	206
Gauge for checking ball-bearing diameters.....	206
Extension welded to fan wrench.....	206
Feeler gauge made of scrap metal.....	206
"Manicure" for small commutators.....	210
Altered pliers spread cotter pins.....	212

TOYS AND NOVELTIES

Whirling toy for youngsters has helicopter action.....	166
Antique candleholder for basement playrooms.....	169
Hinge shapes train couplers.....	175
Prepared ink removed with cloth.....	182
Flashlight projects silhouettes that amuse children.....	184
"Faithful Fido" serves as eye-catching doorstop.....	191
Checkerboard of many woods.....	198

WOODWORKING

Welsh dresser for your best china.....	162
Rumpus-room armchair.....	165
Making glued dowel joints hold.....	188
Pencil sharpener points dowels.....	190

MISCELLANEOUS

Double-pole switches converted for multiple setup.....	164
How to cut terra cotta pipe.....	164
Protecting lunch box lining.....	176
Small frame that sifts materials has interchangeable screens.....	178
Trunk key hidden under handle.....	178
Disk blade bolted to wooden base holds small parts.....	190
Tar paper preserves canvas.....	191
Use funnel and tube to pour oil into small containers.....	198
Iron cement as sand-hole filler.....	200
Mousetrap that's always set.....	200
Links fasten handle to drawer.....	200
Index-card system locates files missing from cabinet.....	204
Removing small amounts of varnish.....	204
Telephone shelf under desk top.....	212

IMPORTANT NOTICE—It is the intention of this magazine to provide its readers with information regarding the latest developments in the mechanical arts. We take no responsibility as to whether the disclosures contained in our articles are covered by patents and advise readers to investigate this subject before making, using, or selling any of the products, machines, or processes described in order to avoid possible liability for patent infringements.

AUDELS REFRIGERATION & AIR CONDITIONING GUIDE.....\$4

New from Cover to Cover—1280 Pages, Fully Illus. Covering basic principles, servicing, operation & repair of household, commercial & industrial refrigeration & air conditioning. A gold mine of essential important facts for engineers, servicemen, users.

AUDELS CARPENTERS & BUILDERS GUIDES—4 Vols.\$6

A practical illustrated trade assistant on modern construction for carpenters, joiners, builders, mechanics and all woodworkers. 4 vols., 1600 pages, 3700 illustrations, flexible covers. Pocket size. Each volume sold separately \$1.50 a vol.

AUDELS AUTOMOBILE GUIDE.....\$4

A practical quick ready reference book for auto mechanics, service men, operators & owners. Explains theory, construction & servicing of modern motor cars, trucks, buses & auto type Diesel engines. 1700 pages, fully illustrated. 55 chapters. Indexed. A standard book for mechanics. New fluid drive covered.

AUDELS DIESEL ENGINE MANUAL..\$2

A practical, concise treatise with questions and answers on the theory, operation and maintenance of modern diesel engines including General Motors 2 cycle Diesel 384 pages, fully illus., flexible binding, pocket size. All details plainly brought out, this book is of extreme value to engineers, operators & students.

AUDELS WIRING DIAGRAMS.....\$1

210 Pages. Illustrated. Gives practical facts on wiring of electrical apparatus. It shows clearly how to wire apparatus for practically all fields of electricity. Each diagram is complete & self-explanatory. Highly Endorsed Pocket Companion.

AUDELS PLUMBERS & STEAMFITTERS GUIDES—4 Vols.\$6

A Practical Trade Assistant & Ready Reference. Explains in plain language & by clear illustrations, diagrams, charts, graphs, pictures principles of modern plumbing practice including Marine Pipe Fitting and Air Conditioning. 4 Vols.—1670 Pages—3642 Diagrams. Pocket size. Each Vol. Sold Separately \$1.50 a Vol.

AUDELS SHEETMETAL WORKERS HANDY BOOK.....\$1

Practical inside information. Fundamentals of Sheet Metal Work. 388 pages. Illustrated. 11 sections. Clearly written. Essential & important facts, figures, pointers in everyday language. Ref. Index.

AUDELS SHEETMETAL PATTERN LAYOUTS.....\$4

Developed by Experts for Sheet Metal Workers, Layout Men & Mechanics. A Practical Encyclopedia in 16 Sections, size 7 x 10 x 2—1125 Pages—350 Layouts—1600 Illustrations. 1001 Key Facts. Fully indexed for ready reference in answering your layout problems. Covers all phases of sheet metal work including Pattern Cutting, Pattern Development & Shop Procedure.

AUDELS ANSWERS ON BLUE PRINT READING.....\$2

For Mechanics & Builders. Covers all types of blue print reading including ship & airplane. 416 pages, fully illustrated.

AUDELS NEW MACHINIST & TOOLMAKERS HANDY BOOK.....\$4

Covers modern machine shop practice in all its branches. 5 practical books in 1. New from cover to cover. Tells how to set up & operate lathes, screw and milling machines, shapers, drill presses and all other machine tools. 1600 pages, fully illustrated, 5 x 6 1/2 x 2. Indexed. 5 sections. 1—Modern Machine Shop Practice. 2—Blue Print Reading & How to Draw. 3—Calculations & Mathematics for Machinists. 4—Shop Physics. 5—How to Use the Slide Rule. 60 chapters. Easy to read and understand. A shop companion that answers your questions.

AUDELS MATHEMATICS & CALCULATIONS FOR MECHANICS \$2

Mathematics for home study or reference. 700 pages, 550 illus. Practical mathematics from beginning. How to figure correctly. Easy, correct methods covering complete review. Illus. & Indexed.

AUDELS HANDY BOOK OF PRACTICAL ELECTRICITY.....\$4

For maintenance engineers, electricians & all electrical workers. 1440 Pages, 2600 illus. Covers important electrical information in handy form—including Marine Wiring, Radio Principles, Welding. Indexed. A Key to a practical understanding of electricity.

AUDELS RADIOMANS GUIDE.....\$4

A key to the practical understanding of radio including Frequency Modulation, Television, etc., Aircraft & Marine Radio. For radio engineers, servicemen, amateurs. 914 Pages, 633 Illustrations & Diagrams. Photos. Review Questions & Answers, Reference Index. Authentic, clear, concise.

AUDELS ELECTRONIC DEVICES.....\$2

Tells What You Want to Know About Electric Eye. Easily Understood. Covers photo-electric cells & their applications. Amplifiers, illumination, frequencies, voltage, photocell, tubes, Ohm's Law, wiring diagrams, etc.

AUDELS WELDERS GUIDE.....\$1

A concise, practical text on operation & maintenance of all welding machines for all mechanics. Over 400 pages, illustrated. Covers all methods of electric and acetylene welding including airplane work.

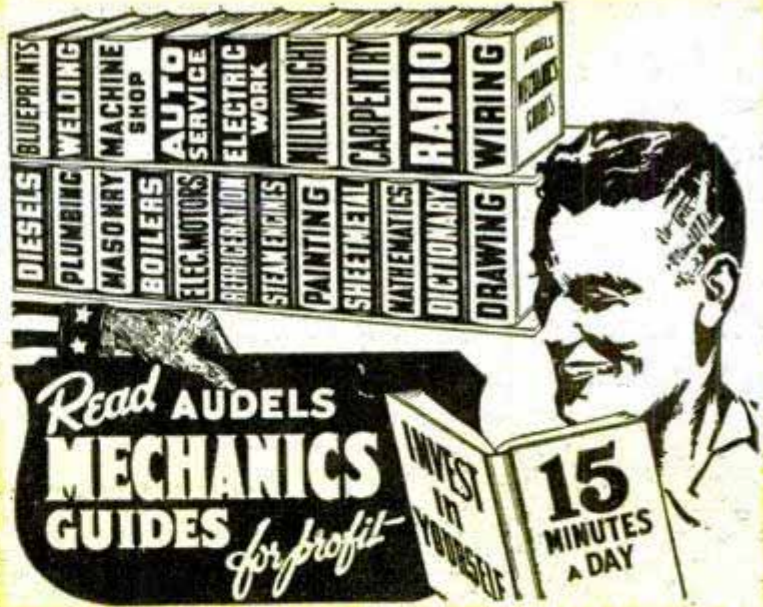

AN AUDEL GUIDE IS A GOOD FRIEND!

Step Up Your Own Skill with the Practical Facts and Figures of Your Trade. Save time and money with right methods, short cuts, labor saving ideas. CHECK NOW! You can look over any Audel Guide in your home. Start the Easy Payments if satisfied.

CUT HERE MAIL ORDER

THEO. AUDEL & CO., 49 W. 23 St., New York 10, N. Y.

Please mail me for 7 days' free examination the books marked (X) below. I agree to mail \$1 in 7 days on each book or set ordered, and to further mail \$1 a month on each book or set ordered until I have paid purchase price. If I am not satisfied with Guides I will return them.

- Audels ELECTRIC MOTOR GUIDE \$4.
- Audels OIL BURNER GUIDE 1.
- Audels REFRIGERATION & Air Conditioning Guide 4.
- Audels POWER PLANT ENGINEERS GUIDE 4.
- Audels PUMPS, HYDRAULICS & AIR COMPRESSORS 4.
- Audels WELDERS GUIDE 1.
- Audels BLUE PRINT READING 2.
- Audels SHEET METAL WORKERS Handy Book 1.
- Audels SHEET METAL PATTERN LAYOUTS 4.
- Audels AIRCRAFT WORKER 1.
- Audels MATHEMATICS and CALCULATIONS 2.
- Audels MACHINISTS & TOOLMAKERS Handy Book 4.
- Audels MECHANICAL Dictionary 4.
- Audels AUTOMOBILE GUIDE 4.
- Audels DIESEL ENGINE MANUAL 2.
- Audels MARINE ENGINEERS Handy Book 4.
- Audels MECHANICAL DRAWING GUIDE 1.
- Rogers MECHANICAL DRAWING and DESIGN 2.
- Audels MILLWRIGHTS and Mechanics Guide 4.
- Audels CARPENTERS and Builders Guides (4 vols.) 6.
- Audels PLUMBERS and Steamfitters Guides (4 vols.) 6.
- Audels MASONS and Builders Guides (4 vols.) 6.
- Master PAINTER and DECORATOR 2.
- Audels GARDENERS & GROWERS GUIDES (4 vols.) 6.
- Audels ENGINEERS & FIREMANS EXAMINATIONS 1.
- Audels ENGINEERS and Mechanics Guides 12.
- Nos. 1, 2, 3, 4, 5, 6, 7 and 8 complete 12.
- Audels Answers on Practical ENGINEERING 1.
- Audels ELECTRICIANS EXAMINATIONS 1.
- Audels WIRING DIAGRAMS 1.
- Audels Handy Book of PRACTICAL ELECTRICITY 4.
- Audels ELECTRICAL POWER CALCULATIONS 2.
- Audels ELECTRONIC DEVICES 2.
- Audels ELECTRIC Dictionary 2.
- Audels RADIOMANS GUIDE 4.
- Audels NEW ELECTRIC LIBRARY at \$1.50 a Volume 4.

Name.....
 Address.....
 Occupation.....
 Employed by.....

AUDEL, Publishers, 49 W. 23 St., N. Y. 10

What keeps YOU from making more MONEY?



Just what is the matter—why aren't you making more money? Look around you. Probably many of the people you know are doing a lot better than you are.

What's the reason?

Your own native ability is probably just as good as theirs—probably nothing wrong with your personality and appearance.

But—*they have something you lack.* The fact that they have a better job and more money proves that. Success in business today is measured by the dollar sign.

The secret is this—the man who prepares himself for the job ahead—is the one who gets advancement and more money. He doesn't need "pull." The man who really has something on the ball—"push" enables him to get what he wants.

Ambitious men and women have found in LaSalle the way to get ahead in business. This has been going on for 38 years. Hundreds of thousands of students have enrolled—our files are full of grateful letters from people who have bettered their earnings and position through LaSalle.

Perhaps we can help you. You should at least find out. The coupon below will bring full information. Just check the field of your choice and we'll send you full information, without obligation—the money making possibilities in that field, and how you can prepare in your spare time at moderate cost.

For a brighter future in the business world—more money and a better job—send the coupon today. Tomorrow you might forget.

***G. I. APPROVED**

LA SALLE Extension University
a Correspondence Institution
Dept. 864-R Chicago, Ill.

I want to better my position—make more money. Send me your free booklet on the field I have checked

- * Higher Accountancy
- * Expert Bookkeeping
- * Foremanship
- * Industrial Management
- * Business Management
- * Traffic Management
- * Law: LL.B. Degree
- Salesmanship
- Stenotypy (Machine Shorthand)

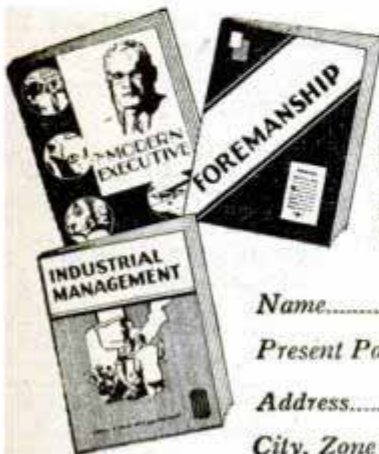

Name..... Age.....

Present Position.....

Address.....

City, Zone and State.....



I Will Show You How to Learn RADIO

by Practicing in Spare Time

I Send You Big Kits of Radio Parts

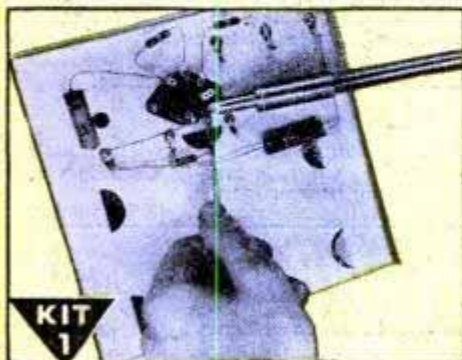

KIT 1
I send you Soldering Equipment and Radio Parts; show you how to do Radio soldering; how to mount and connect Radio parts; give you practical experience.

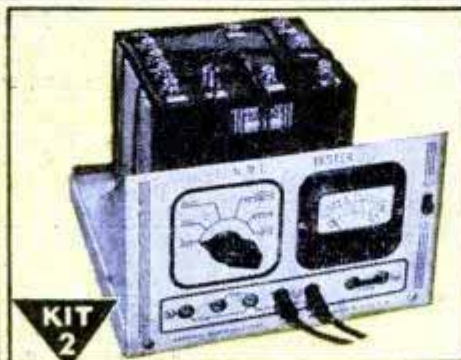

KIT 2
Early in my course I show you how to build this N.R.I. Tester with parts I send. It soon helps you fix neighborhood Radios and earn EXTRA money in spare time.

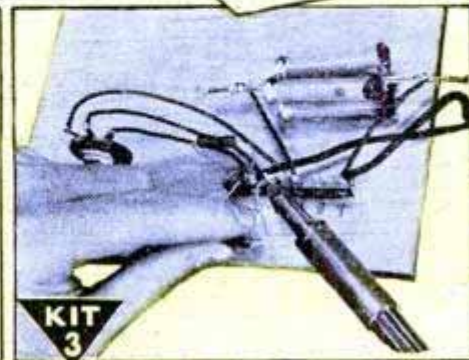

KIT 3
You get parts to build Radio Circuits; then test them; see how they work; learn how to design special circuits; how to locate and repair circuit defects.

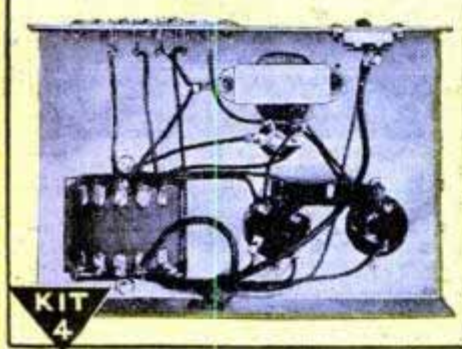

KIT 4
You get parts to build this Vacuum Tube Power Pack; make changes which give you experience with packs of many kinds; learn to correct power pack troubles.

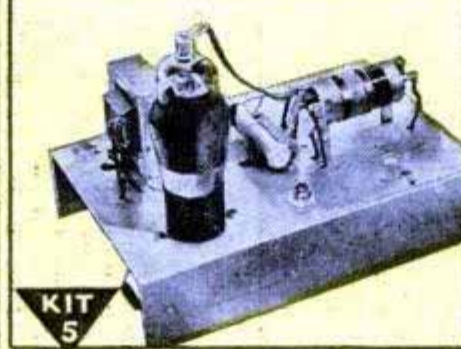

KIT 5
Building this A. M. Signal Generator gives you more valuable experience. It provides amplitude-modulated signals for many tests and experiments.



KIT 6
You build this Superheterodyne Receiver which brings in local and distant stations—and gives you more experience to help you win success in Radio.

KNOW RADIO - Win Success

I Will Train You at Home - SAMPLE LESSON FREE

Do you want a good-pay job in the fast-growing Radio Industry—or your own Radio Shop? Mail the Coupon for a Sample Lesson and my 64-page book, "How to Be a Success in RADIO—Television, Electronics," both FREE. See how I will train you at home—how you get practical Radio experience building, testing Radio circuits with BIG KITS OF PARTS I send!

Many Beginners Soon Make Extra Money in Spare Time While Learning

The day you enroll I start sending EXTRA MONEY JOB SHEETS that show how to make EXTRA money fixing neighbors' Radios in spare time while still learning! It's probably easier

to get started now than ever before, because the Radio Repair Business is booming. Trained Radio Technicians also find profitable opportunities in Police, Aviation, Marine Radio, Broadcasting, Radio Manufacturing, Public Address work. Think of even greater opportunities as Television, FM, and Electronic devices become available to the public! Send for FREE books now!

Approved for Training under GI Bill

Find Out What NRI Can Do For You
Mail Coupon for Sample Lesson and my FREE 64-page book. Read the details about my Course; letters from men I trained; see how quickly, easily you can get started. No obligation! Just MAIL COUPON NOW in envelope or paste on penny postal. **J. E. SMITH, President, Dept. 7HP, National Radio Institute, Pioneer Home Study Radio School, Washington 9, D. C.**

VETERANS
You can get this training right in your own home under G. I. Bill.
Mail coupon for full details.

Good for Both - FREE

Mr. J. E. SMITH, President, Dept. 7HP, National Radio Institute, Washington 9, D.C. Mail me FREE, your sample lesson and 64-page book. (No salesman will call. Please write plainly.)

GETTING ACQUAINTED WITH RECEIVER SERVICING

How to Be a Success in RADIO TELEVISION ELECTRONICS

Name _____ Age _____
Address _____
City _____ Zone _____ State _____

AUDELS ELECTRIC MOTOR GUIDE

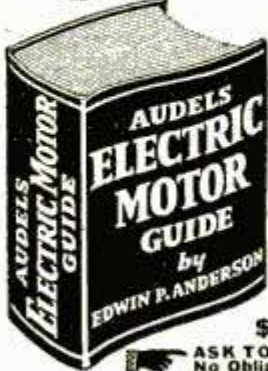

**1000 PAGES OF PRACTICAL
MOTOR INFORMATION**

JUST OUT! Audels Electric Motor Guide covering the construction, hook-ups, control, maintenance and trouble shooting of all types of motors including armature winding. Explains entire subject in every detail. 31 Chapters, 617 Illustrations and Diagrams. A Handy Guide Fully Indexed for Electricians and all Electrical Workers.

\$4 COMPLETE - PAY \$1 A MO.

ASK TO SEE IT!—Get This Information for Yourself No Obligation Unless Satisfied.

MAIL ORDER

AUDEL, Publishers, 49 W. 23rd St., New York 10, N. Y.
MAIL AUDELS ELECTRIC MOTOR GUIDE for free examination. If O. K. I will send you \$1 in 7 days; then remit \$1 monthly until price of \$4 is paid. Otherwise, I will return it.

Name _____
Address _____
Occupation _____
Employed by _____ PM

VETERANS Learn WATCHMAKING

A Lifetime Profession

Regardless of Conditions, Age, Sex, or Physical Limitations

Veterans—Civilians!
Your Opportunity—
LEARN WATCHMAKING

Lift yourself from a futureless job into a position paying better than your present work. Fit yourself for the job that will permit you to establish your own shop, or be employed in a pleasant environment.

Watch Repairing—Jewelry—Engraving will all ways be in ever greater demand. Our graduates wanted everywhere. Dignified positions \$50-\$75-\$100 per week. Veterans write today for latest FREE enrollment requirements.



Approved
G. I. Training

Kansas City School of Watchmaking
Largest Horological School in America
617-621 Wyandotte St. Kansas City 6, Mo.

SAY YOU SAW IT IN POPULAR MECHANICS

STUDY AT HOME

With An Educational Institution

Men with specialized training win higher positions, insure larger earnings, and are bigger successes in business and public life. Opportunities NOW greater than ever before. Send for our Catalog.

ARTS and SCIENCES

Courses in Philosophy; Education; Letters; Public Health; Medical Jurisprudence; Psychology; Sociology; Physics; Chemistry; Plastics; Geology; Political Science; Theology; Business and Commerce; Accounting; Mathematics; Statistics; Agriculture.

ENGINEERING

Courses in Electrical, Civil, Mechanical, Drafting, Architectural, Steam, Aeronautical, Radio, Structural, Mining, Industrial, Petroleum, Marine, Chemical, Diesel, Automobile, Refrigeration, and Air Conditioning Engineering.

LAW

Complete Professional Law Course includes 18 Hornbook Series college grade textbooks. Courses also in Commercial Law, Patent Law and Medical Jurisprudence.
McKinley-Roosevelt Incorporated, 4610-K, Sheridan Rd., Chicago 40, Ill.

PLAY GUITAR LIKE THE COWBOYS DO... 8 LESSONS

Just out—very latest guaranteed, simple, easy method, play cowboy songs the Western way in a few minutes by ear. Surprise and amaze your friends. Be in big demand at parties, camps, public entertainments, on the radio, etc. 12 Complete Lessons. **SEND NO MONEY.** Pay postman only \$1.00 plus postage and C.O.D. charges, or send \$1.00 and get EXTRA SONGS all postpaid. (Canada, \$1.25 money order only.) Nothing else to buy. Positive money back guarantee. Rush order today.
WESTERN RANGER STUDIOS, Dept. 158, Hutchinson, Kans.

"YOU ARE UNDER ARREST!"

Help Bring Crooks to Justice Through Scientific **CRIME DETECTION!**

We have taught thousands this exciting, profitable, pleasant profession. Let us teach you in your own home. Learn Finger Printing, Firearms Identification, Police Photography, Secret Service Methods thoroughly, quickly, at small cost. Over 800 of all American Bureaus of Identification employ I. A. S. students or graduates. We can prepare you for this fascinating work, during spare time. Write today, stating age, for "Blue Book of Crime."

INSTITUTE OF APPLIED SCIENCE, 1920 Sunnyside Ave., Dept. 135C, Chicago 40, Ill.

Learn NOVELTY MANUFACTURING!!

Today's best bet for a business of your own starting with little money is the Casting of Wall Plaques, Book Ends and other Novelties. Large orders and profits waiting. Start in garage or basement, quickly learned. **NO EXPENSIVE MOLDS TO BUY.** Our system has started many on the road to a splendid financial future. Write today for free particulars.

PLASTEX PRODUCTS, 711 Laguna St. San Francisco 2, Calif.

CORRESPONDENCE COURSES IN RADIO and ELECTRICAL ENGINEERING Tuition \$25

ELECTRICAL ENGINEERING. Get good grasp of wide electrical field. Modern. Very understandable. Theory made easy.
RADIO ENGINEERING. Extra fine course in radio, public address, photo-electric work. Trains you to be super-service man, real vacuum tube technician. Tuition ONLY \$25, either course. Deferred payment plan. Servicemen needed badly.
FREE LINCOLN ENGINEERING SCHOOL, Box 931-P104, Lincoln, Nebr.

MAKE MONEY AT HOME

RUBBER MOLDS Low as 6¢ EA.

Amazing rubber mold-making outfit makes perfect flexible molds of plaques, ash trays, book-ends, etc. Molds cost 6¢ to 25¢ each. Each mold makes hundreds of novelties and gifts to sell for \$1.00 apiece and more! No experience necessary. Everything furnished. Quick and easy. Start profitable business in your home—sell to stores, gift shops, friends, resorts, road stands, by mail. Full or spare time. Write for complete FREE details and easy instructions.

SO-LO WORKS, Inc., Dept. Z-800, Loveland, Ohio



INVENTORS



Learn how to protect your invention. The U. S. Patent Laws provide that any new and useful art, machine, article of manufacture, or composition of matter, or any new and useful improvement thereof, may be patented if the act of invention is involved. Therefore, every inventor with a valuable invention should take advantage of the Patent Laws and proceed for patent protection in order to safeguard his rights.

A patent gives the inventor the exclusive right to prevent others from making, using, or selling the invention claimed in the patent for a period of seventeen years.

The Patent Laws were enacted for the benefit of the inventor to give him protection for the features of his invention which are patentable. These features must be properly and concisely set forth and claimed in a formal application for patent, in order to comply with the requirements of the U. S. Patent Office. For that reason, the Patent Office advises the inventor, unless he is familiar with such matters, to engage a competent registered patent attorney or agent to represent him. We maintain a staff of registered patent attorneys ready to serve you in the handling of your patent matters.

A specially prepared booklet entitled "Patent Guide for the Inventor", containing detailed information with respect to patent protection and procedure, together with a "Record of Invention" form will be promptly forwarded to you without obligation upon request.

Patents
Trademarks
Copyrights

Registered Patent Attorneys

CLARENCE A. O'BRIEN
& HARVEY B. JACOBSON

71-H District National Building + Washington 5, D. C.

CLARENCE A. O'BRIEN & HARVEY B. JACOBSON
Registered Patent Attorneys
71-H District National Bldg., Washington 5, D. C.

Please send me copy of "Patent Guide for the Inventor" and also "Record of Invention" form. This request does not obligate me.

Name _____

Address _____

City _____ State _____

(Please write or print plainly.)

Give yourself the Backing of a
GREAT GROWING INDUSTRY



REFRIGERATION AIR CONDITIONING

Refrigeration and Air Conditioning have leading place in fast growing fields of our time. Trained men paid well to service, install, maintain, repair, rebuild household and commercial refrigerators. Important new developments such as Frozen Foods and many new industrial uses. Demand for commercial installations in restaurants, butcher shops, taverns, florists, bakeries, etc. — air conditioning in homes, offices, shops.



START NOW—Full and Part Time Earnings

There may never again be such opportunities for men who want better jobs or business of their own to get in on ground floor and go up fast!



Many started with small investment who built good, growing business. If over 17 and under 60 learn how you can get started. **CONSULTATION AND PLACEMENT SERVICE WHETHER YOU ARE INTERESTED IN WORTHWHILE JOB OR SETTING UP YOUR OWN BUSINESS.**

Begin Training at Home or Come Directly to Shops

Begin your training at home in spare time, finish in our big, modern shops, or come directly to shops. At home you get C.T.I.'s SHOP PROVED HOME STUDY instruction—actual shop experience has gone into the practical lesson assignments. That is why it is easy for mechanically inclined men to learn by our Home Study training and start on actual refrigeration work.



A NATIONALLY KNOWN INSTITUTION

C.T.I. was only civilian school selected by Army to train service men for refrigeration. Same quality training available to you now. The method that has made rapid progress possible. Commercial Trades Institute has established its place in Air Conditioning and Refrigeration industries, and that is important to you in making your start.

VETERANS

Veterans qualifying under "G.I. Bill" have tuition paid by Government plus monthly subsistence allowance while in school. Just mail coupon, we will handle all details. (LOW TUITION, EASY TERMS if you are not a veteran.)



COMMERCIAL TRADES INSTITUTE
Dept. A28

1400 W. Greenleaf Ave., Chicago 26, Ill.

FREE — Important Information Telling How to Get Started

CUT OUT COUPON BELOW

Fill Out, Cut Out, Mail Today

FACTS FREE for Men Who Want to Get Ahead
COMMERCIAL TRADES INSTITUTE, Dept. A28
1400 W. Greenleaf, Chicago 26, Ill.

Send free illustrated Brochures and other information about Refrigeration and Air Conditioning.

Veteran Non Veteran

Name.....

Address.....

City..... State.....

NEW MIDGET ELECTRIC

ARC WELDER

RETAILS ONLY

\$3.95

FULLY GUARANTEED



Plugs into Light Socket—AC or DC

It's new! It's handy! It's efficient! Use the Midget Electric Arc Welder for hundreds of light-metal jobs. Does comparable welding work with a 1/16 inch welding rod on thin metal as that of larger and higher priced welders. Operates on 15 ampere fuse, 110 volt 60 cycle A.C. or D.C. current, by use of our special standard-coated 1/16-inch welding rods. Generous supply of rods supplied with machine. Recommended for all light welding like automobile fenders, etc. Take the Midget Arc anywhere to the job. Sturdily built and fully guaranteed. Comes complete—ready to use. Nothing else to buy. No previous welding experience needed to strike an arc. In a short time, anyone mechanically inclined can learn to weld with this machine.

You'll find hundreds of money-saving, time-saving uses for the Midget Arc around your home, garage, or workshop. Also in garages, factories, repair shops, tin shops, mechanics, farmers, inventors, etc. Order a Midget Electric Arc Welder now! **SEND NO MONEY.** We'll rush one to you, complete with rods and helmet equipped with APPROVED welding glass. Pay postman only \$3.95 plus postage charges. If not satisfied, return Midget Arc in 5 days from receipt and we'll refund your money immediately. **RUSH YOUR ORDER NOW.**

MIDGET ARC WELDER CO., Strader Ave., Dept. B-202, Cincinnati 26, Ohio

Learn to MOUNT BIRDS

Tan SKINS, make up FURS
Be a Taxidermist. Double your hunting fun. We teach you at Home. Mount Birds, Animals, Fish, Heads, common specimens. Fun and profits. Decorate home and **den MAKE MONEY.** Mount game, tan for others. Big profits in spare time. **WRITE TODAY.** 100 game pictures in **FREE BOOK** Hunters, get your copy. It's **Now Free.** Send post card. State your AGE. **NORTHWESTERN SCHOOL OF TAXIDERMISTRY** Dept. 337C Omaha, Nebraska

FREE BOOK



WONDERFUL INVENTION! Corrects poor penmanship in few days—big improvement in 3 hours. No failures. Complete Outline Free. Write, Inventor Ozment, 34, St. Louis, Mo. Immediately.

Learn PLASTICS

Study at home or at school in Los Angeles or New York. Approved for Veterans — Available for non-veterans.

America's Oldest and Largest

PLASTICS INSTITUTE

1601 S. Western Dept. PM7-8 Los Angeles 6, Calif.



XMAS MONEY NOW!

SELLING MAYFAIR'S
21 Card Christmas Box Assortment For... **\$1.00**
Your Profit Up To 50c Per Box
Other Outstanding Values
REQUEST BOX ON APPROVAL
Rush Name and Address NOW!
MAYFAIR GREETING CARD

Dept. PM 40 East 20th St., New York 3, N. Y.

HOW JUST TWO WORDS TURNED MAC INTO A HE-MAN!

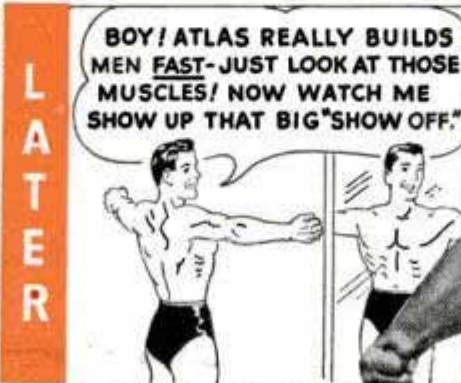

Charles Atlas

—actual photo of Charles Atlas, winner and holder of the title, "The World's Most Perfectly Developed Man."

I Can Make YOU a New Man, Too —in Only 15 Minutes a Day!

IF YOU (like Mac) are fed up with being "pushed around"—if you're sick and tired of having the kind of a body that people PITY instead of ADMIRE—then give me just 15 minutes a day! That's all I need to PROVE I can make you a NEW MAN!

I know what I'm talking about. I was once a thin, peppy, 97-pound "bag of bones" myself. Then I discovered my now-famous secret, "Dynamic Tension." It turned me into "The World's Most Perfectly Developed Man." And I have used this secret to rebuild thousands of other scrawny, half-alive weaklings into perfect, red-blooded specimens of real HE-MANHOOD. Let me prove that I can do the same for YOU!

"Dynamic Tension" Does It!

Using "Dynamic Tension" only 15 minutes a day, in the privacy of your own room, you quickly begin to put on muscle, increase your chest measurements, broaden your back, fill out your arms and legs. This easy, NATURAL method will make you a finer speci-

men of REAL MANHOOD than you ever dreamed you could be!

I don't care how old or young you are, or how ashamed of your present physical condition you may be. If you can simply raise your arm and flex it I can add SOLID MUSCLE to your biceps—yes, on each arm—in double-quick time!

FREE BOOK

Thousands of fellows have used my marvelous system. Read what they say—see how they look before and after—in my book, "Everlasting Health and Strength."

Send NOW for this book—FREE. It tells all about "Dynamic Tension." Shows you actual photos of men I've turned from puny weaklings into Atlas Champions. It tells how I can do the same for YOU. Don't put it off! Address me personally, Charles Atlas, Dept. 88, 115 East 23rd Street, New York 10, N. Y.



CHARLES ATLAS, Dept. 88,
115 E. 23rd Street, New York 10, N. Y.

I want the proof that your system of "Dynamic Tension" will help make a New Man of me—give me a healthy, husky body and big muscular development. Send me your free book, "Everlasting Health and Strength."

Name _____ Age _____
(Please print or write plainly)

Address _____

City _____ State _____

INVENTORS

Patent Laws Encourage The Development of Inventions

The Rules of Practice of the U. S. Patent Office advises— unless an inventor is familiar with such matters — that he employ a competent registered attorney or registered agent, as the value of patents depends largely upon the skillful preparation of the specifications and claims.

The firm of McMorrow, Berman and Davidson is registered to practice before the U. S. Patent Office. Additionally, it maintains a staff of attorneys able to readily understand inventors' disclosures, to advise concerning patentability, and to prepare appropriate specifications and claims for filing with the Patent Office.

If an inventor believes he has an invention, a search of the most pertinent prior U. S. patents should be made and a report obtained relative to its patentability. Where such report indicates that the invention appears patentable, in order to secure protection, diligence should be exercised in making application for a patent.

McMORROW, BERMAN & DAVIDSON

Registered Patent Attorneys

PATENTS — TRADE-MARKS — COPYRIGHTS

1358 VICTOR BUILDING, WASHINGTON 1, D. C.

McMORROW, BERMAN & DAVIDSON

Registered Patent Attorneys

1358 Victor Building, Washington 1, D. C.

Send me further particulars as to patent protection and procedure and "Invention Record" form at once. I understand that this request does not obligate me.

Name _____

Address _____

City _____ State _____

(WRITE OR PRINT NAME CLEARLY)



Most men are promoted on the strength of their records. Performance and training reports rank high in determining how fast and how far employees will advance. But, unless it shows up on the record—unless it is seen by the right men—ability may go unnoticed and unrewarded.

That's why International Correspondence Schools make a special point of reporting the progress of its students to their employers. This is a two-way service: it tells the employer which men in his organization are prepared for

greater responsibilities; it helps the ambitious employee get the recognition he deserves.

A stream of letters—from employers and employees alike—confirms the value and effectiveness of I. C. S. progress reports.

You want your record to speak for YOU! You want it to show you have trained for advancement. Then you'll appreciate the type of service that comes with sound, practical I. C. S. training. Courses cover more than 400 business and technical subjects. Act now. Mail this coupon for full information.

INTERNATIONAL CORRESPONDENCE SCHOOLS



BOX 5610-K, SCRANTON 9, PENNA.

Without cost or obligation, please send me full particulars about the course BEFORE which I have marked X:

- | | | | |
|--|--|--|---|
| <p>Air Conditioning and Plumbing Courses</p> <ul style="list-style-type: none"> <input type="checkbox"/> Air Conditioning <input type="checkbox"/> Heating <input type="checkbox"/> Refrigeration <input type="checkbox"/> Chemistry Courses <input type="checkbox"/> Chemical Engineering <input type="checkbox"/> Chemistry, Analytical <input type="checkbox"/> Chemistry, Industrial <input type="checkbox"/> Chemistry, Mfg. Iron & Steel <input type="checkbox"/> Petroleum Refining <input type="checkbox"/> Pulp and Paper Making <input type="checkbox"/> Civil Engineering, Architectural and Mining Courses <input type="checkbox"/> Architecture <input type="checkbox"/> Architectural Drafting <input type="checkbox"/> Bridge and Building Foreman <input type="checkbox"/> Building Estimating <input type="checkbox"/> Civil Engineering <input type="checkbox"/> Coal Mining <input type="checkbox"/> Contracting and Building <input type="checkbox"/> Highway Engineering <input type="checkbox"/> Lumber Dealer <input type="checkbox"/> Reading Structural Blueprints <input type="checkbox"/> Sanitary Engineering <input type="checkbox"/> Structural Drafting | <ul style="list-style-type: none"> <input type="checkbox"/> Plumbing <input type="checkbox"/> Steam Fitting <input type="checkbox"/> Plastics <p>Structural Engineering</p> <ul style="list-style-type: none"> <input type="checkbox"/> Structural Engineering <input type="checkbox"/> Surveying and Mapping <p>Communications Courses</p> <ul style="list-style-type: none"> <input type="checkbox"/> Electronics <input type="checkbox"/> Practical Telephony <input type="checkbox"/> Radio, General <input type="checkbox"/> Radio Operating <input type="checkbox"/> Radio Servicing <input type="checkbox"/> Telegraph Engineering <p>Electrical Courses</p> <ul style="list-style-type: none"> <input type="checkbox"/> Electrical Drafting <input type="checkbox"/> Electrical Engineering <input type="checkbox"/> Electric Light and Power <input type="checkbox"/> Lighting Technician <input type="checkbox"/> Practical Electrician <p>Internal Combustion Engines Courses</p> <ul style="list-style-type: none"> <input type="checkbox"/> Auto Technician <input type="checkbox"/> Diesel-Electric <input type="checkbox"/> Diesel Engines <input type="checkbox"/> Aviation <input type="checkbox"/> Gas Engines <p>Mechanical Courses</p> <ul style="list-style-type: none"> <input type="checkbox"/> Aeronautical Engineer's, Jr. <input type="checkbox"/> Aircraft Drafting <input type="checkbox"/> Flight Engineer <input type="checkbox"/> Forging <input type="checkbox"/> Heat Treatment of Metals <input type="checkbox"/> Foundry Work | <ul style="list-style-type: none"> <input type="checkbox"/> Industrial Engineering <input type="checkbox"/> Industrial Metallurgy <input type="checkbox"/> Machine Shop <input type="checkbox"/> Mechanical Drafting <input type="checkbox"/> Mechanical Engineering <input type="checkbox"/> Mold-Loft Work <input type="checkbox"/> Patternmaking—Wood, Metal <input type="checkbox"/> Reading Shop Blueprints <input type="checkbox"/> Sheet-Metal Drafting <input type="checkbox"/> Sheet-Metal Worker <input type="checkbox"/> Ship Drafting <input type="checkbox"/> Ship Fitting <input type="checkbox"/> Tool Designing <input type="checkbox"/> Toolmaking <input type="checkbox"/> Welding—Gas and Electric <p>Railroad Courses</p> <ul style="list-style-type: none"> <input type="checkbox"/> Air Brake <input type="checkbox"/> Diesel Locomotive <input type="checkbox"/> Locomotive Engineer <input type="checkbox"/> Locomotive Fireman <input type="checkbox"/> Railroad Section Foreman <input type="checkbox"/> Car Inspector <p>Steam Engineering Courses</p> <ul style="list-style-type: none"> <input type="checkbox"/> Boilermaking <input type="checkbox"/> Combustion Engineering <input type="checkbox"/> Engine Running <input type="checkbox"/> Marine Engineering <input type="checkbox"/> Steam Electric <input type="checkbox"/> Steam Engines | <p>Textile Courses</p> <ul style="list-style-type: none"> <input type="checkbox"/> Cotton Manufacturing <input type="checkbox"/> Rayon Weaving <input type="checkbox"/> Textile Designing <input type="checkbox"/> Woolen Manufacturing <p>Business and Academic Courses</p> <ul style="list-style-type: none"> <input type="checkbox"/> Accounting <input type="checkbox"/> Arithmetic <input type="checkbox"/> Business Administration <input type="checkbox"/> Business Correspondence <input type="checkbox"/> Certified Public Accounting <input type="checkbox"/> Commercial <input type="checkbox"/> Commercial Art <input type="checkbox"/> Cost Accounting <input type="checkbox"/> Federal Tax <input type="checkbox"/> First Year College <input type="checkbox"/> Foremanship <input type="checkbox"/> Good English <input type="checkbox"/> Higher Mathematics <input type="checkbox"/> Motor Traffic <input type="checkbox"/> Salesmanship <input type="checkbox"/> Sign Lettering <input type="checkbox"/> Spanish <input type="checkbox"/> Traffic Management <input type="checkbox"/> Advertising <input type="checkbox"/> Bookkeeping <input type="checkbox"/> French <input type="checkbox"/> High School <input type="checkbox"/> Postal Service <input type="checkbox"/> Secretarial <input type="checkbox"/> Stenography |
|--|--|--|---|

Name _____ Home Address _____

City _____ State _____

Age _____ Present Position _____ Working Hours _____ A.M. to _____ P.M.

Special tuition rates to members of the Armed Forces. Enrollment under the G.I. Bill of Rights approved for World War II Veterans. Canadian residents send coupon to International Correspondence Schools Canadian, Ltd., Montreal, Canada.

ADVICE for the INVENTOR

The United States Patent Office advises the inventor, unless he is familiar with such matters, to employ a competent, registered patent attorney or agent as the value of patents depends largely upon the skillful preparation of the specification and claims.

PRELIMINARY STEPS toward PATENT PROTECTION

The Evidence of Invention form mentioned below is offered as a convenience to the inventor in making his disclosure of invention. The inventor should date and sign his disclosure and have it witnessed by two or more persons who are capable of understanding his invention. The disclosure should then be mailed to the registered patent attorney or agent whom he selects to assist him. The disclosure should be accom-

panied by a letter authorizing the patent attorney or agent to conduct a preliminary search at the U. S. Patent Office among previously granted U. S. Patents for similar types of invention. The patent attorney or agent then prepares a report of the probable patentability of the invention and recommends the further course the inventor should take, provided the report indicates possible patentability.

Victor J. Evans & Company has a staff of experienced registered patent attorneys available to assist inventors in the preparation and prosecution of their cases before the Patent Office.

The **COUPON BELOW** is suggested as a convenience to the inventor in starting action on his invention.

**VICTOR J.
EVANS & Co.**

Merlin M. Evans
REGISTERED PATENT ATTORNEY

230-J Merlin Building, Washington 6, D. C.

PLEASE SEND DETAILED PATENT INFORMATION TOGETHER WITH CONVENIENT "EVIDENCE OF INVENTION" FORM.

Name.....

Address.....

City and State.....

Learn ELECTRICITY in the GREAT SHOPS OF COYNE

ACTUAL SHOP
SCENES AT
COYNE

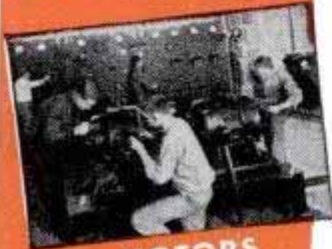

MOTORS



ARMATURES



REFRIGERATION



LIGHTING

COYNE

ELECTRICAL SCHOOL
500 S. Paulina St.,
Dept. C7-72,
Chicago 12, Illinois



ESTABLISHED 1899

NOT A "HOME-STUDY COURSE"

For nearly 50 years, the Great Shops of COYNE in Chicago have been training men to step into the better-paying jobs in ELECTRICITY. Here in just a few short weeks YOU can quickly prepare for amazing opportunities.



B. W. COOKE

As a Coyne student you work on real equipment—just like you'll use later on the job. We do not teach by mail. You get actual shop work plus necessary theory. Coyne training is practical. You make rapid progress at COYNE because it's a shop course.

GET ALL-AROUND TRAINING . . . in a Few Short Weeks

Why be satisfied with a "one-operation" job? At Coyne you learn Motors, Armature Winding, House and Factory Wiring, Appliances, Power Plant Work, Illumination, Electrical Maintenance—plus the fast-growing branch of Industrial Electronics. Whether you're experienced or not, we train you for a good job, then help you get it! Coyne graduates may use our Lifetime Employment Service as often as they wish.

INDUSTRIAL ELECTRONICS and REFRIGERATION Included

Added training in Electric Refrigeration—principles, testing, repairing—is included with this course. Industrial Electronics also given as part of our "all-around" Electrical Training.

VETERANS! Coyne is authorized to accept veterans for G. I. Training. Coupon brings special G. I. Bulletin.

NON-VETERANS who are short of cash can finance most of their tuition and pay it in easy monthly payments after graduation.

ANY MAN WITH A PHYSICAL DISABILITY whether a Veteran or not may qualify for Coyne training at no cost to himself for tuition or subsistence. Mail coupon for details.

MAIL COUPON for Big FREE Book

Find out NOW what Coyne offers in training for your future. Coupon brings big book filled with fascinating pictures of our great shops and our plans to help YOU. Get your copy FREE. No cost or obligation, and no salesman will call. Rush the coupon. TODAY.



B. W. Cooke, Director,
COYNE ELECTRICAL SCHOOL, Dept. C7-72,
500 S. Paulina St., Chicago 12, Ill.

Send me your Free Book and tell me about your plans to help me—including Student Finance and added Training in Industrial Electronics and Electric Refrigeration.

NAME.....

ADDRESS.....

CITY.....STATE.....

NOW! ALL 5 FAMOUS JOWETT COURSES—1 COMPLETE MUSCLE BUILDING VOLUME! FOR ONLY 25¢ AND MY PHOTO BOOK OF FAMOUS STRONG MEN! FREE!

LET ME PROVE I can make YOU



COMMANDO-TOUGH OR IT WON'T COST YOU A CENT!

says *George F. Jowett* WORLD'S GREATEST BODY BUILDER.

GIVE ME 10 MINUTES A DAY

LEARN MY TIME TESTED SECRETS OF STRENGTH

I'll teach you the "Progressive Power Method" through which I rebuilt myself from a physical wreck the doctors condemned to die at 15, to the holder of more strength records than any other living athlete or teacher! "Progressive Power" has proven its ability to build the strongest, handiest men in the world. And I stand ready to show you on a money back basis—that no matter how flabby or puny you are I can do the same for you right in your own home. Let me prove I can add inches to your arms, broaden your shoulders, give you a man-sized chest, powerful legs and a Rock-like back—in fact, power pack your whole body so quickly it will amaze you! Through my proven secrets I bring to life new power in you inside and out, until YOU are fully satisfied you are the man you want to be.

PROVE IT TO YOURSELF IN ONE NIGHT

Send only 25¢ for my 5 easy-to-follow, picture-packed courses now in 1 complete volume "How to Become a Muscular He-Man." Try it for one night! Experience the thrilling strength that surges through your muscles.

10 DAY TRIAL!

Think of it—all five of these famous courses now in one picture-packed volume for only 25¢. If you're not delighted with this famous muscle-building guide—if you don't actually FEEL results within ONE WEEK, send it back and your money will be promptly refunded!

Photo Book of Famous Strong Men!

FREE!

Photos that inspire you to might and muscle. Free with order.

I am making a drive for thousands of new friends fast—REGARD-
LESS OF COST!
SO GET NOW MY 5 Muscle Building COURSES
(Valued at \$5 each)
All in 1 Great Complete Volume Packed With How-To-Do-It Pictures!
Now, this "get-acquainted," extremely low price of only 25¢ is your chance to build a body you'll be proud of! Follow Jowett's easy method of muscle building NOW!



FREE GIFT COUPON!

Jowett Institute of Physical Culture Dept. PM-78
230 Fifth Avenue, New York 1, N. Y.

George F. Jowett:—Please send by return mail, prepaid, **FREE** Jowett's Photo Book of Strong Men, along with all 5 Muscle Building Courses. 1. Molding a Mighty Chest. 2. Molding a Mighty Arm. 3. Molding a Mighty Grip. 4. Molding a Mighty Back. 5. Molding Mighty Legs—Now all in One Volume "How to Become a Muscular He-Man." Enclosed find 25¢, NO C.O.D.'S.

George F. Jowett
Champion of Champions

NAME _____ AGE _____
(Please Print Plainly, Include Zone Number)

ADDRESS _____



GOVERNMENT JOBS!

Start \$1,756 to \$3,021 year

MEN—WOMEN. Thousands positions open. Prepare NOW for next Examinations. Write immediately for free 32-page book, with list of positions and particulars telling how to prepare. Veterans get preference.

FRANKLIN INSTITUTE

Dept. L85
Rochester 4, N. Y.

What Every Mason Wants



We have important Masonic books for Blue Lodge, Chapter, Commandery, Scottish Rite, and Shrine.

Our Rituals Are Used the World Over. Send for free catalog of books and rituals for Masons, Odd Fellows, Knights of Pythias, Knights of Columbus, etc.
EZRA A. COOK, Publisher, P. O. Box 796, PAT, Chicago 90, Ill.

Learn RADIO TELEVISION ELECTRONICS

Train at home, in spare time, for a good pay job or start a business of your own *without capital*—under our *proven* 2-Way method that helps you get into this money-making field of radio *quicker*. You receive Lessons *plus* Home Shop Practice including 9 kits of radio parts to make hundreds of tests. Many students earn money in spare time while learning. Write for **FREE** book "Your Opportunities in Radio" to Hollywood Radio & Television Institute, (Established 1929), Dept. A-7, 810 W. 6th St., Los Angeles 14, Calif.

Why spend years learning by hard experience what you can get from a practical book in a few hours.

Write for list of "How-To-Do-It" books on practical subjects. 1000's of pleased customers all over the world.

ADAMS BROWN COMPANY—BOOKS OF APPLIED SCIENCE
Dept. 178 Chestnut Hill 67, Massachusetts, U. S. A.

Please Mention Popular Mechanics When Answering Ads

TRI-STATE COLLEGE

B. S. Degree in 27 months in Engineering (7 branches); Bus. Admin., Acc't and Sec. Science. Graduates successful. 64th year. Enter Sept., Jan., March, June. Write for catalog.
487 College Ave., Angola, Ind.

LEARN MONEY-MAKING CARTOONING

IN SPARE TIME — by Easy Picture Chart Method

Same Simplified Method that has helped train creators of "Terry & Pirates," "Freckles," "Out Our Way," "Winnie Winkle," "Regular Fellers," "Strange As It Seems," "The Neighbors," and many others. Earn while learning. Send 10¢ for Picture Chart (to test your ability), and full details. (State age.)

Landon School of Cartooning, Dpt. 4708 Philadelphia 1, Pa.



Photography
for

PLEASURE or PROFIT

Learn at home. Spare time. Practical basic training. Long-established school. Many have earned while learning. Send coupon below for free booklet, "Opportunities in Modern Photography" and full particulars.

AMERICAN SCHOOL OF PHOTOGRAPHY
1315 Michigan Avenue Dept. 135C Chicago 5, Illinois

Send booklet, "Opportunities in Modern Photography," full particulars and requirements.

Name _____ Age _____
Address _____
City _____ Zone _____ State _____

WHICH OF THESE *Opportunities* INTERESTS *You* MOST?

Accounting
Air Conditioning
Architecture & Building
Automotive Engineering
Aviation—Practical
Aviation Drafting & Design
Better Foremanship
Bookkeeping
Business Management

Contracting
Diesel Engineering
Drafting & Design
Electrical Engineering
Electricity—Practical
Electronics, Industrial
High School Courses
Machine Shop Operations
Mechanical Engineering

Plastics Engineering
Plumbing—Practical
Private Secretary
Radio Operating & Servicing
Railway Training
Refrigeration
Sheet Metal Pattern Drafting
Shop Management
Tool Making

THINK! LOOK FORWARD!

Business is making big, new plans

Men and Women are preparing for the future

WHAT ARE YOU DOING ABOUT YOUR TOMORROWS?

● *Today*, choose the job you want—and prepare for it. Or if you are already engaged in the work you like best, start training *now* for quicker promotion. Acquire the knowledge that will help you to get ahead faster, make more money and have greater security.

Invest part of your spare time in more rapid progress. Start training now, in spare time in your own home. Be ready to grasp your opportunity and step out ahead of those who lack the ability you have attained.

American School, founded in 1897 as an educational institution *not for profit*, can help you to reach your goal just as it has helped others during the past fifty years. Give serious thought to the list above. Pick one or more subjects that interest you. Then check the coupon at right, add your name and address and mail it at once. The school will send you details on its training plan and outline of study prepared by specialists. There is no charge, no obligation, so send the coupon immediately.

PRACTICAL, EFFECTIVE HOME - STUDY TRAINING SINCE 1897

Take This First Easy Step

CHECK, CLIP AND MAIL COUPON NOW

AMERICAN SCHOOL, Dept. GC45, Drexel at 58th, Chicago 37, Ill.
Without obligation, Please send FREE and postpaid, bulletin and details of the Subject checked.

- | | | |
|--|--|--|
| <input type="checkbox"/> PLASTICS ENG'R | <input type="checkbox"/> Accounting | <input type="checkbox"/> Drafting and Design for Men and Women |
| <input type="checkbox"/> Refrigeration | <input type="checkbox"/> Electrical Engr. | <input type="checkbox"/> Radio |
| <input type="checkbox"/> Architecture and Building | <input type="checkbox"/> Electricity-Pract. | <input type="checkbox"/> High School |
| <input type="checkbox"/> Contracting | <input type="checkbox"/> Electronics, Industr. | <input type="checkbox"/> Air Conditioning |
| <input type="checkbox"/> Practical Plumbing | <input type="checkbox"/> Bookkeeping | <input type="checkbox"/> Mechanical Eng. |
| <input type="checkbox"/> Automotive Engineering | <input type="checkbox"/> Private Secretary | <input type="checkbox"/> Shop Management |
| <input type="checkbox"/> Aviation Drafting | <input type="checkbox"/> Diesel Engineering | <input type="checkbox"/> Tool Making |
| <input type="checkbox"/> Aviation | <input type="checkbox"/> Sheet Metal | <input type="checkbox"/> Better Foremanship |
| <input type="checkbox"/> Business Mgmt | <input type="checkbox"/> Pattern Drafting | <input type="checkbox"/> Machine Shop Operations |
| <input type="checkbox"/> Railway Training | | |

Name..... Occupation.....
Address..... Age.....
City..... State.....

AMERICAN SCHOOL

Dept. GC45, Drexel at 58th Street, Chicago 37

JUST OUT! NEW FROM COVER TO COVER

AUDELS REFRIGERATION and AIR CONDITIONING GUIDE



4 Books in One! Covering:

- Basic principles, Servicing, Operation, Repair of
- 1—Household Refrigeration
- 2—Special Refrigeration Units
- 3—Commercial & Industrial Refrigeration
- 4—Air Conditioning Systems

A gold mine of essential important facts for ENGINEERS, SERVICEMEN & USERS.
A Good Book is a Good Friend! Here you have at your fingers' ends a Complete Library in ONE VOLUME, the necessary data you have been looking for on: MODERN UNITS, SYSTEMS & MACHINES, REFRIGERANTS, including Freon, Lockers, Water Coolers, Quick Freezing & Air Conditioning Systems. 1280 Pages, 46 chapters all Fully Illustrated & indexed for Ready Reference.

ANSWERS YOUR QUESTIONS

Get This Information for Yourself. Mail Coupon Today. No Obligation Unless Satisfied. ASK TO SEE IT.

\$4 COMPLETE • PAY ONLY \$1. A MONTH ←

AUDELS, Publishers, 49 W. 23rd St., New York 10, N.Y.
MAIL AUDELS NEW REFRIGERATION GUIDE for free examination. If O. K. I will send you \$1 in 7 days; then remit \$1 monthly until price of \$4 is paid. Otherwise I will return it.

Name _____
Address _____
Occupation _____
Employed by _____ PM

Learn this Profitable Profession



IN 90 DAYS AT HOME

Money-Making Career Open to Men and Women, 18 to 50

Hundreds of men and women between 18 and 50 make \$10 to \$20 in a single day giving scientific Swedish Massage and Hydro-Therapy treatments. There is big demand from doctors, hospitals, sanatoriums and clubs. Graduates earn large full time incomes from these or in private practice in their own offices. Others make good money from home treatments given in spare time. Learn this interesting, money-making profession in your own home, through our home study course. Same instructors as in our nationally known resident school. You can win independence and prepare for future security by qualifying for your Diploma. Course can be completed in 3 to 4 months. Many earn while they learn. Begin your training at once.



Anatomy Charts & Booklet FREE

Enroll now and we will include, at no extra cost, many needed supplies. Fit yourself to help meet growing demand for Scientific Swedish Massage. Send the coupon at once for complete details. Anatomy Charts and 32-Page Illustrated Booklet, FREE, postpaid.

THE COLLEGE OF SWEDISH MASSAGE
Dept. 764K, 100 East Ohio St., Chicago 11, Illinois
Please send me FREE and postpaid, Anatomy Charts, 32-page Booklet and complete details on Home Training.

Name _____
Address _____
City _____ State _____

AVIATION

Aeronautical University Approved Training meets exacting standards of aviation industry, prepares for key positions, big opportunities.

Courses in:

- AERONAUTICAL ENGINEERING, B.S. degree.
- AERONAUTICAL ENGINEERING DRAFTING
- CERTIFIED ENGINE MECHANICS
- ADMINISTRATION—Including sales

PRE-ENGINEERING: Special course for high school graduates and veterans deficient in math and science.

Also refresher courses for Gov't Airplane and Engine Mechanics—Licenses for those with aviation experience.

Oldest fully approved aviation school. Outstanding faculty, modern equipment, outside employment, placement service. Day, evening. Approved for Veterans. Send today for FREE catalog "Opportunities in Aviation."

AERONAUTICAL UNIVERSITY
Dept. 77, 116 S. Michigan Ave., Chicago 3, Ill.

FOUNDED BY CURTISS-WRIGHT

LEARN MOVIE THEATRE MANAGEMENT



The Motion Picture Theatre Business offers big opportunities for trained men. Get into a fascinating field with a post-war future. Train at home in spare time. Free Catalog. Established 18 years.

THEATRE INSTITUTE, 370 Washington St., Elmira, New York

Master Watchmaking

The life-long profitable trade of thousands as taught by the Sweazey System.

"FAMED THE WORLD OVER"

CHICAGO SCHOOL OF WATCHMAKING

Founded in 1908 by Thomas B. Sweney
1608 N. Milwaukee Ave., Dept. 197 Chicago 47, Ill.

LEARN MASONRY

Get in on the biggest building boom in history. Prepare for a long and profitable career as a big-pay building tradesman. Actual shop training under expert instructors. Write for big free catalog today.

MIDWEST SCHOOL OF BUILDING TRADES
Dept. M-18, 411 N. Center St., Bloomington, Ill.



VETERANS ASK FOR GI PLAN

THERE'S MONEY IN CARTOONS!

RAYE BURNS will teach you HOW to CREATE ORIGINAL CARTOONS at home that you may SELL! Course contains 26 lessons and over 600 illustrations. All for Only...

\$2.85

Send name and address for free details.

RAYE BURNS SCHOOL, Dept. M, Box 3583, CLEVELAND, OHIO

Good Handwriting HELPS YOU WIN SUCCESS!

It's so important to write a good hand for business and social advancement. Poor illegible penmanship often causes costly errors and marks you for failure. Why write a poor hand? It's so easy to learn at home in spare time. Write for our new free booklet today. If you wish, send 10c for a penpoint suitable for shaded writing and your name beautifully written.

THE TAMBLYN SCHOOL OF PENMANSHIP
In Business Since 1895 N-441 Ridge Bldg., Kansas City, Mo., U. S. A.

MONEY for MEN ALL DATA FREE

THE PLASTEX Industry needs manufacturers on small scale and for big production of Lamp and Clock Stands, Art Goods and Novelties in Plastex and Marble imitation. Experience unnecessary. Lgc material makes regular 10c store sellers. Rubber moulds furnished for speed production. Small investment brings good returns. Big chain store orders now being placed. Ambitious men have chance for real prosperity. Our Free booklet will interest and benefit you.

PLASTEX INDUSTRIES, Dept. P, 1085 Washington Ave. New York, N. Y.



RADIO and ELECTRONICS offers YOU...

**REAL MONEY, REAL JOB,
AND REAL INDEPENDENCE**

FOLLOW THE ADVICE OF THE MASTERS

PREPARE today SUCCEED tomorrow!

Make good money ... get a real job ... be independent by owning your own business ... follow the advice of the masters ... "PREPARE TODAY TO SUCCEED TOMORROW."

Whether you are an ex-G.I., a teen-age youth or an older man, few other fields offer you such a vast variety of opportunities for real money and a brighter future as the colorful, fascinating field of RADIO and ELECTRONICS.

Get Late Facts

Use the coupon below! Get the late facts about the exciting news in F.M. Radio, Broadcast Radio, Television, Electronics, Radar, 2-Way Train Radio, Sound Motion Picture Equipment, Sound Recording — and other fast-moving branches of this field.

15 Years Experience In Training Men

Also see how readily YOU can prepare to enter the field of Radio and Electronics by means of the remarkably effective courses and Employment Help of DeForest's Training, Inc. that have been getting results for over 15 years.

DeForest's Training, Inc. is the first school of its kind ever to receive the CERTIFICATE OF MERIT of the New York Museum of Science and Industry. It won this award for the efficiency and thoroughness of its courses.

Prepare now for a job in Radio, Electronics and Communications, by attending RESIDENT LABORATORY courses in Chicago, or in your spare time at home. DeForest's Training, Inc. offers you these 4 BIG HOME TRAINING ADVANTAGES:

- (1) We supply you with a 16 Mm. motion picture machine with 12 reels of fact-packed information;
- (2) Illustrated loose-leaf lessons with handy fold-out diagrams;
- (3) 8 big commercial-type Radio Electronic Kits of assemblies and parts, from which you may work out more than 133 modern experiments including 7 different types of radio receivers at home; and
- (4) After you complete your training, you get the benefit of our effective employment service.

YOU NEED NO PREVIOUS ELECTRICAL OR RADIO EXPERIENCE

If you prefer, you can get ALL of your Training in our—

NEW CHICAGO LABORATORIES

... offering you some of the finest Radio-Electronic Training Facilities in the nation. Enjoy many post-war training advantages in a modern, new building, housing a wealth of "LEARN-BY-DOING" Equipment. Visitors invited.



VETERANS!!

Both the Home Study and Chicago laboratory courses of DeForest's Training, Inc. are accepted for your training. If you qualify under the "G. I. Law," you can obtain this training without cost.

DeFOREST'S TRAINING, INC.

2533-41 N. ASHLAND AVE. CHICAGO, ILLINOIS
Affiliated with DeVry Corporation, Chicago

DeFOREST'S TRAINING, INC.
2533-41 N. Ashland Ave., Dept. P.M.—D8
Chicago 14, Illinois, U.S.A.

Send me your big book "VICTORY FOR YOU", showing how I may make my start in Radio-Electronics with your modern home training plan. No obligation.

Name Age
Address Apt.
City Zone State

If under 16, check here If a discharged veteran of World War II, check here.



8 BIG BUILDING BOOKS

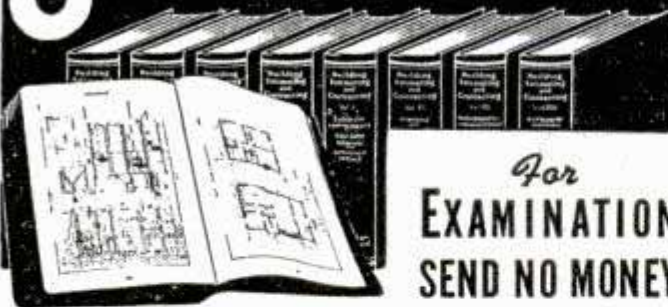

For
EXAMINATION
SEND NO MONEY

Learn to draw plans, estimate, be a live-wire builder, do remodeling, take contracting jobs. These 8 practical, profusely illustrated books cover subjects that will help you to get more work and make more money. Architectural design and drawing, estimating, steel square, roof framing, construction, painting and decorating, heating, air-conditioning, concrete forms and many other subjects are included.

BETTER JOBS — BETTER PAY UP-TO-DATE EDITION
The postwar building boom is in full swing and trained men are needed. Big opportunities are always for MEN WHO KNOW HOW. These books supply quick, easily understood training and handy, permanent reference information that helps solve building problems.

These books are the most up-to-date and complete we have ever published on these many subjects.

Coupon Brings Eight Big Books for Examination

AMERICAN TECHNICAL SOCIETY Vocational Publishers since 1898
Dept. GC19 Drexel at 58th Street Chicago 37, Ill.

You may ship me the Up-to-Date edition of your eight big books, "Building, Estimating and Contracting," without any obligation to buy. I will pay the delivery charges, only, and if fully satisfied in ten days, I will send you \$2.00, and after that only \$3.00 a month, until the total price of only \$34.80 is paid. I am not obligated in any way unless I keep the books.

Name _____
Address _____
City _____ State _____

Please attach a letter stating your age, occupation, employer's name and address, and name and address of at least one business man as a reference. Men in service, also please give home address.

AVIATION Career

MAXIMUM TRAINING IN MINIMUM TIME

CAL-AERO TECH TRAINING will add dollars to your pay check all the rest of your life. Specializing in AERONAUTICAL ENGINEERING and MASTER AVIATION MECHANICS since 1929, Cal-Aero Tech training is carefully designed for just one thing—TO MAKE MORE MONEY FOR YOU. An alumni of over 6000 successful graduates proves our career training is unsurpassed.

VETERANS —Write us about Aviation Training, as provided under "G.I. Bill of Rights."



MAIL THIS COUPON TODAY!

Cal-Aero Technical Institute, Grand Central Airport, Glendale 1, California
Please send full information on Aviation Training FREE—without obligation, Dept. PM-8

Name _____ Birth Date _____
Street _____
City _____ State _____

ANALYZE HANDWRITING

Qualify for Certified Grapho Analyst Degree at home, spare time. Credit, Employment, Personnel Managers, Business, Professional men, women use grapho-analysis in their work, earn substantial fees in spare time. Many study solely for personal benefit, no desire to earn money, find it so fascinating they start using it to add to their incomes. Entertainment field pays well, up to \$100 in a week reported. Others establishing profitable practices as Vocational and Family Problem Counselors, Personality Teachers, and lecturers.



GROWING—UNCROWDED PROFESSION

More and more police use grapho analysis handling suspects and criminals. They understand how criminals think. Their handwriting tells. Men like Hugh Dunlap, university student, Harry Allen, retired preacher, use it in court, win cases, earn fees even before graduation. Only school in world devoted to teaching grapho analysis offers thorough training to earnest, ambitious men and women regardless of where you live, small town, farm or city. Send for GRAPHO ANALYST, illustrated lesson, personal handwriting analysis offer, ALL FREE. Must be 21 or over. Address A. I. G. A. Inc., 120, Noel, Missouri.



SHORTHAND in 6 Weeks at Home

Famous Speedwriting system. No signs or symbols; uses ABC's. Easy to learn; easy to write and transcribe. Fast preparation for a job. Surprisingly low cost. 100,000 taught by mail. Used in leading offices and Civil Service. Write for free booklet. **SPEEDWRITING, Dept. 1508-7, 55 West 42 St., N. Y. 18**

PHOTOGRAPHY

for Today's—and Tomorrow's Better Opportunities

Ever-increasing demand for trained photographers in advertising, industry, science, publishing. N. Y. I.'s success-proved home study training qualifies you. Previous experience unnecessary. Details FREE! Also resident courses. **New York Institute of Photography, Dept. 48, 10 West 33 St., New York 1, N. Y.**

LEARN WATCH REPAIRING



AT HOME. By our modern and original system of instruction you can learn every part of the **WATCH REPAIRING TRADE AT HOME.** Prepare yourself for a well-paying position or start in business after completing our course of instruction. Good watch repairers are in demand and generally earn very good salaries. For particulars apply to the **Wisconsin School of Watch Repairing 759 North Milwaukee St., Milwaukee 2, Wis.**

HORSE MASTERY!

A FINE HOBBY — A GREAT VOCATION!

"The EXPERT HORSEMAN"



FREE BOOK — Tells how you can learn to: BREAK COLTS, GAIT SHOW HORSES, TRAIN RODEO, STOCK and RACE HORSES, BREAK BAD HABITS, HANDLE ANY HORSE, TRAIN CIRCUS TRICK HORSES. WRITE TODAY!

ANIMAL LOVERS ASSOCIATION
BOX KA-111 TARBANA, CALIFORNIA

SUBSCRIBE TODAY 50¢
One Year

SAY YOU SAW IT IN POPULAR MECHANICS

Learn Public Speaking

Learn theory and fundamentals at home—in spare time. Then acquire actual experience and practice. Send for FREE booklet "Power of Effective Speech."

North American School, Dept. 135C
1315 S. Michigan Ave., Chicago 5, Illinois



RAISE CHIN-CHINS

No experience needed. Just a few minutes daily and a few feet of backyard, garage or barn space. Several females and a male starts a large, profitable herd. WE FURNISH FREE INSTRUCTIONS. TREMENDOUS DEMAND for breeding and laboratory stock, meat, and world's most beautiful rabbit fur. Brokers cut off from imported rabbit pelts by world famine. **NEED CHIN-CHIN FURS NOW**, and for years to come! Write for free illustrated catalog today. **WILLOW BROOK FARM • R-36, SELLERSVILLE, PENNA.**

ELECTRICAL APPLIANCE REPAIRING

OFFERS BIG MONEY. — INDEPENDENCE

If now employed start your home appliance repair business NOW in your spare time and be set with a business of your own no matter what happens. Operate from your garage, basement, kitchen, vacant store, etc. Work as many hours as you wish—the home appliance repairman is his own boss. It is a profitable occupation, for on many types of repairs it is not unusual for a repairman to charge on the basis of \$5.00 to \$6.00 per hour! Remember, there are millions of electrical appliances in this country. Appliances such as refrigerators, irons, sewing machines, vacuum cleaners, heaters, toasters, washing machines, motors, etc. To replace any of them is mighty expensive. That is why mechanically inclined men will find the Electrical Appliance Repair Business one that offers the trained man unlimited earning possibilities.

YOU CAN QUALIFY

All you need to become a successful electrical appliance repairman is ambition plus a little training at home in your spare time. If you are mechanically inclined—that is to say—can hold and use tools, our profusely illustrated course written in simple, easy to understand language will prepare you for the years to come. It does not matter if you have not had a great deal of schooling or have had no previous training along these lines. WE WILL TEACH YOU. Age should be no barrier—nor should any minor physical handicap.



WE TEACH YOU

Profusely illustrated with photographs and simple drawings we show you what troubles to look for and how to make each repair on an electrical appliance. We give you a good sound working knowledge of electricity, and how to do welding, nickel plating, etc. Our course shows you how to solicit business and keep it coming to you. Not a theory course but an honest to goodness course written by and used by repairmen the country over. Price of course is so low that the savings on your own household appliance repairs will quickly pay for it. Why work for others at the wages they want to pay you? Learn a good trade and operate your own business and determine just how long you work each day and the amount of money you make. ACT NOW!



MAIL COUPON TODAY

CHRISTY SUPPLY CO.
2835 N. Central Ave., Dept. D-4803
Chicago 34, Illinois

Please send me free illustrated literature about America's Fastest Growing Industry — ELECTRICAL APPLIANCE REPAIRING.

Name _____

Address _____

City _____ State _____

Do you want

- ..to go to College?
- ..or to enter a Profession?

(Such as Accounting, Architecture, Nursing, Dentistry; Teaching, Social Work, Osteopathy, Beauty Culture, Optometry, Embalming, Chiropraxy, Law, Medicine, etc.)

- ..or get an Office Position?

To get anywhere, you practically **MUST** finish High School **FIRST**. You can complete our simplified High School Course in **SPARE** time at home, as **FAST** as your time and abilities permit. Equivalent to resident school work—prepares you for college, pre-professional examinations, business, industry. Standard texts furnished. Diploma. Credit for H. S. subjects already completed. Single subjects if desired. Low tuition, easy terms. American School, Chicago, est. 1897—endorsed by educators. Finish your high school education **NOW**, Write **TODAY!**

High School Course at Home

Many Finish in 2 Years

American School, Dept. HC45, Drexel Ave. at 58th St., Chicago 37, Ill.

Gentlemen: Send me **FREE** information covering special training in subjects checked below. No obligation on my part.

- | | |
|--|--|
| <input type="checkbox"/> High School Course | <input type="checkbox"/> Diesel Engineering |
| <input type="checkbox"/> Architecture and Building | <input type="checkbox"/> Drafting and Design for Men & Women |
| <input type="checkbox"/> Automotive Engineering | <input type="checkbox"/> Plastics |
| <input type="checkbox"/> Business Management | <input type="checkbox"/> Private Secretary |
| <input type="checkbox"/> Electrical Engineering | <input type="checkbox"/> Mechanical Engineering |
| <input type="checkbox"/> Elec. and Gas Refrigeration | <input type="checkbox"/> Aviation |
| <input type="checkbox"/> Air Conditioning | <input type="checkbox"/> Salesmanship |
| <input type="checkbox"/> Railway Training | <input type="checkbox"/> Radio |
| <input type="checkbox"/> Electronics, Industrial | |

Name.....

Address.....

Keep that "Car" TICKING



Every operator and mechanic needs **AUDELS AUTO GUIDE**.

This book saves time, money and worry. Highly endorsed. It presents the whole subject of auto mechanics:

- 1—Basic principles
 - 2—Construction
 - 3—Operation
 - 4—Service
 - 5—Repair
- Handy Size, Easily understood.

NEW FLUID DRIVE, HYDRAULIC SHIFT AND DIESEL ENGINES FULLY COVERED

Over 1500 pages—1540 illustrations showing inside views of modern cars, trucks and buses with instructions for all service jobs.

4 COMPLETE • PAY ONLY \$1. A MONTH ←

ASK TO SEE IT!—To Get This Assistance for Yourself Simply Fill in and Mail Coupon Today.

AUDELS Publishers, 49 West 23rd St., New York
MAIL AUDELS NEW AUTO GUIDE for free examination. If O. K. I will send you \$1 in 7 days; then remit \$1 monthly until price of \$4 is paid. Otherwise I will return it.

Name.....

Address.....

Occupation.....

Employed by..... PM

New Advertising Machine



Prints & Illustrates 1¢ Post Cards

FREE! Learn how thousands of merchants and business men are boosting sales in spite of product shortages with **1¢ messages**—printed in a few minutes on gov't postcards— with amazing new, patented **CARDMASTER**. Your "todays" ideas for specials, read by prospects next morning. Not a toy, but a sturdy, advertising machine, built to last many years. Low price, sold direct. Guaranteed, five years.

SEND NAME We'll send free illustrated book of money-making ideas for your business and complete, unique advertising plans. Rush your name today.

CARDMASTER COMPANY
4546 Ravenswood Dept. 138 Chicago 40, Ill.

BE A REAL ESTATE BROKER

PAYS BIG! **EASY TO LEARN**—Start and run your own business quickly. Many graduates report making up to \$1000 a month. Course of study covers Sales, Property Management, Appraising, Loans, Mortgages and hundreds of related subjects. Course offered in home study or residential classrooms.

FREE Big new illustrated catalog from this nationally known school. Send Post Card Today. G. I. Approved.

WEAVER SCHOOL OF REAL ESTATE
Dept. KA-6, 15 E. Pershing Road Kansas City, Mo.

EASY WAY to LEARN RADIO AT HOME

I Send You 8 Big Kits of Radio Parts Including Complete 6 Tube Superhet

Theory alone is the bunk! It takes "Service-Bench" practice to learn Radio right! My Course supplies the Equipment you need, shows you how to wire, connect, solder, build Circuits... how to test and repair all kinds of Radio-Electronic Equipment. Beginners learn fast! To get full details, send postal for **FREE BOOKS**:—"How to Make Money in Radio, Electronics and Television," and "How to Read Radio Diagrams and Symbols."

SPRAYBERRY ACADEMY OF RADIO, Room 1087, Pueblo, Colorado

LEARN ELECTROPLATING

Highly Paid, Uncrowded, Interesting Business. Part or Full Time, Common School Education Sufficient. Gold, Silver, Nickel, Chromium, etc. Money Making Secrets, Processes. Send postcard for **FREE** Electroplating Booklet and proof. **PLATER HYDE, Dept. M, P. O. Box 176, National City, California.**

ARTISTS MAKE MONEY

Do you like to draw? Send name, address, age and occupation for **FREE ART TEST**, to find out your ability.

ART INSTRUCTION, Inc.
8137 ART INSTRUCTION BLDG., MINNEAPOLIS 15, MINN.

MASTER MACHINIST • MECHANICAL DRAFTING TOOL-DIE DESIGNING • TOOL ENGINEERING

Completely equipped shops and drafting rooms, directed by an accredited staff of engineers and practical instructors. 18 years of successful training of men for industry.

Days, Evenings • Approved for Veteran Training
NEW CLASSES Now Forming • BULLETIN ON REQUEST

ALLIED SCHOOL OF MECHANICAL TRADES, INC.
42 ALLIED BLDG., 1336 S. MICHIGAN AVE. • CHICAGO 5, ILL.

GET INTO THE NEW FIELD OF

INDUSTRIAL

Electronics



THRILLING NEW FRONTIER OF OPPORTUNITY



AMERICA'S FOREMOST SCHOOL OF PRACTICAL TRAINING

Here is a **NEW** Industry—one that points the way to a vast new field of opportunity—Opportunities that beckon alike to men looking for new fields, and to experienced electrical men seeking a way to bigger earnings and a more secure future.

Industrial Electronics is *not* Radio. It has nothing to do with radio transmitters and receivers. It is a totally new application of electric power, applied to modern production by means of the magic of the vacuum tube. Everywhere industrial electronic devices are replacing the old-time electrical controls, and processes. Industrial Electronics is *Modern Industrial Electricity*.

GET READY NOW!

Now is the time to get into Industrial Electronics, while the field is in its infancy . . . and while it is rapidly developing a need for thousands of trained experts. Tomorrow's leaders are training today.

And here is a School equipped in every way to train you for Industrial Electronics work—one of the largest and most completely equipped, and one of the few of its kind in America—a School that already has trained thousands of men for industrial opportunities.

LEARN AT HOME OR COME TO OUR SCHOOL

Learn Industrial Electronics—now, while the time is ripe. You don't need any advanced schooling or previous experience. If you are at all mechanically inclined and have gone to highschool for at least one year or have an equivalent education, we can teach you Industrial Electronics.

You can take most of your training at home, in your spare time—or you can come to Chicago and take your entire training in our completely equipped shops and laboratories. Either way you quickly acquire the fine points, practical skill, and broad, technical "know how" that makes the expert Industrial Electronics Technician.

"Every electrician should know — must know — Industrial Electronics." That's what many Union leaders are telling their members, today. They know that the use of Industrial Electronics devices is growing by leaps and bounds. They know that to install and service this equipment, even the best of present-day electricians must first have had special

FACTS ABOUT THE I. T. I.

Founded in 1916. Has trained more than 400,000 men for practical work in industrial fields. From 1942 through 1945 trained specialized technicians, exclusively, for the Army, Navy, and Marine Corps. Now training thousands of veterans under the G. I. Bill, both in its Residence Schools and by home-study. Occupies five buildings of its own. Has over \$500,000 invested in training facilities, with an instruction staff of more than 100 men. Known everywhere as America's foremost school of practical training for industry.

training.

Get all the facts about the opportunities in this interesting field of work and about the I.T.I. system of training that has helped so many men into key jobs in industry. Fill out the information, coupon below and mail it TODAY. You will be under no obligation whatsoever.

AUTHORIZED TO ACCEPT VETERANS FOR G. I. TRAINING



GET THE FACTS ABOUT AMERICA'S FOREMOST SCHOOL OF PRACTICAL TRAINING

REGISTRAR, P1H

**INDUSTRIAL TRAINING INSTITUTE,
2150 LAWRENCE AVE., CHICAGO 25, ILL.**

Please send me, **FREE**, your "Camera Visit" booklet and information about the opportunities for trained men in **INDUSTRIAL ELECTRONICS**. It is understood that I will be under no obligation.

NAME

ADDRESS

CITY STATE

ARE YOU A VETERAN?

"a little land—a lot of living!"

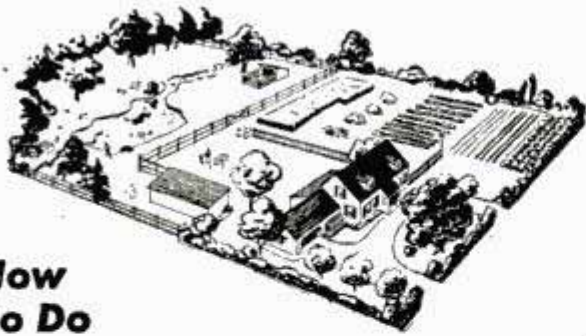

How To Do

Wonders on an Acre!

Our FREE BOOKLET will tell you all about our "HAVE-MORE" PLAN for "a little land—a lot of living" . . . how to do wonders with an acre or so of land . . . wonders with a garden, fruits, berries, poultry, livestock, etc. . . . all on a small scale . . . in your spare time!

How, thanks to the New Science of Miniature Farming, thanks to the quick freezer and many other new inventions, you can actually raise most of your family's food in a few hours of spare time a week and enjoy doing it. . . . How to add a "Harvest Kitchen" to make your house a more pleasant and productive home (your wife will love it!) . . . how this new way to live on an acre or so of land can mean better health, more happiness, more security and independence for you and your family.

SEND FOR FREE BOOKLET

We Robinsons know because we've lived this way for years. Our "HAVE-MORE" PLAN gives you the benefit of all our experience working out the small-scale, scientific, wonder-working methods we tell you about. (Perhaps you've seen the stories about our 2-acre miniature farm in *The Saturday Evening Post*, *Readers Digest*, *Better Homes and Gardens*, etc.)

If you'd like to do WONDERS with an ACRE . . . if you'd like to make the very most of the garden, farm or country home you now have—or hope to have some day—please write to me now for our FREE BOOKLET about our "HAVE-MORE" PLAN. I guarantee it will open your eyes to some mighty good new ideas—and to a far more satisfying way to live in these United States! Send now to:

Ed Robinson, Box 2708, Noroton, Conn.

AUDELS Carpenters and Builders Guides 4 vols. \$6

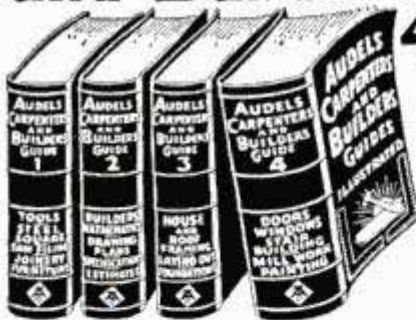

Inside Trade Information for Carpenters, Builders, Joiners, Building Mechanics and all Woodworkers. These Guides give you the short-cut instructions that you want—including new methods, ideas, solutions, plans, systems and money saving suggestions. An easy progressive course for the apprentice and student. A practical daily helper and Quick Reference for the master worker. Carpenters everywhere are using these Guides as a Helping Hand to Easier Work, Better Work and Better Pay. To get this assistance for yourself, simply fill in and mail the FREE COUPON below.

Inside Trade Information On:

How to use the steel square—How to file and set saws—How to build furniture—How to use a mitre box—How to use the chalk line—How to use rules and scales—How to make joints—Carpenters arithmetic—Solving mensuration problems—Estimating strength of timbers—How to set girders and sills—How to frame houses and roofs—How to estimate costs—How to build houses, barns, garages, bungalows, etc.—How to read and draw plans—Drawing up specifications—How to excavate—How to use settings 12, 13 and 17 on the steel square—How to build hoists and scaffolds—skylights—How to build stairs—How to put on interior trim—How to hang doors—How to lath—lay floors—How to paint



THEO. AUDEL & CO., 49 W. 23rd St., New York City

Mail Audels Carpenters and Builders Guides, 4 vols., on 7 days' free trial. If O.K. I will remit \$1 in 7 days, and \$1 monthly until \$6 is paid. Otherwise I will return them. No obligation unless I am satisfied.

Name

Address

Occupation

Reference

REFRIGERATION AND AIR CONDITIONING

TRAIN FOR YOUR OWN BUSINESS

Now, not "next week," is the time to start training for a top-pay job in this vital field. A drastic shortage of trained service experts exists. Many thousands more will be needed for big post-war expansion caused by new industrial uses. Train NOW to get your pick of best jobs. We will give you the practical training you need. For 2 years we trained men and women for the Army and Navy only, in fine-precision aircraft instrument work. So our methods must be right. Common schooling is all you need. Our unique system makes everything easy to grasp. You can train at home and in our big Chicago shops. Write for full facts TODAY, without obligation. Dept. P8H.

Approved for Veterans' G.I. Training

Millions of Old Units Need Expert Service. Big Building Boom Will Create Even More Opportunities.

INDUSTRIAL TRAINING INSTITUTE

2150 Lawrence Avenue, Chicago 25, Illinois

INVENTING

—FOR PROFIT! If you have an inventive turn of mind, write for free 28-page booklet explaining how the Institute of American Inventors is helping inventors pre-test the profit possibilities of proposed devices to fill today's unprecedented demand for useful new inventions.

INSTITUTE of AMERICAN INVENTORS

Dept. 4, 1926 Eye St., NW, Washington 6, D. C.



One should learn Rapid Business Writing, both for his own satisfaction and for the convenience of those who must read it. And if Fancy Shaded Writing is learned also, it makes one a still more skilful penman. Good penmanship prevents costly errors and helps to secure and hold good positions, and, like music or elocution naturally attracts persons of refinement and artistic inclinations. If you are dissatisfied with your present handwriting and wish to become a good writer, write for my FREE BOOK, "How to Become an Expert Penman," which contains specimens of penmanship and shows what others have learned by my Simplified Method. If you enclose 10c, I will send you one of my Favorite Pen Points suitable for plain or shaded writing, and your name with a beautiful flourished bird written on a card. Begin Now. Write for your copy of the Free Book today.

T. M. TEVIS, BOX 25K, CHILlicothe, MO.

WANTED DISTRICT PURCHASING AGENTS

No experience or money required. Exceptional opportunity for those who want to establish themselves in a steady, year 'round, well paying business.

For details: Write

PURCHASING MANAGER, DEPT. C
2719 LAWRENCE AVE. CHICAGO 25, ILL.

LEARN-WATCH REPAIRING at HOME

FREE information write—American Institute of Specialized Watch Repair—270-276 East Bldg., Grand Rapids, Mich.

Learn CARTOONING

HAVE FUN! MAKE MONEY! Cash in on your sense of humor at HOME—BY MAIL. No experience needed to start. Write today FOR FREE TRIAL LESSON and full particulars.



Moon Gag Cartoon School, Dept. P, Fall Creek, Wis.

NEW HELP FOR RUPTURE

is the amazing Treatise which explains simple, inexpensive, easy, proven way for curbing your rupture, right at home. This proven way has helped many rupture sufferers quickly. So don't let your rupture get worse. Send for FREE details today. Mailed to you in plain, sealed envelope. No obligation.

BRADNER PUBLISHING CO. (Established 1933) Dept. H, Dixon, Ill.

GET INTO RADIO

TELEVISION ELECTRONICS NOW!



You build this complete, modern super-heterodyne receiver with the equipment that comes with your National Training at no cost.

This practical shop instruction system gives you actual experience with a Home Radio Laboratory—part of the

SHOP METHOD HOME TRAINING

By A Real, Resident Trade School

FOR YOU—A REAL HOME LABORATORY IN MODERN RADIO

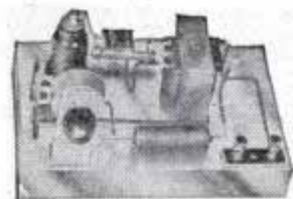

radio oscillator which you get to understand by building it yourself.

Your National Training Kits include equipment for over a hundred practical electronic experiments in your own home. You get standard radio parts for this au-

You learn modulation, beat frequencies, signal generation by actually building this small radio transmitter with your National shop parts.

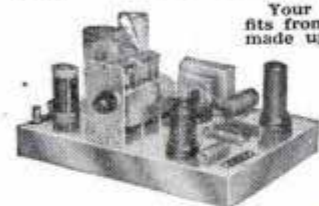
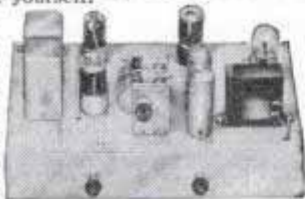

Get the details by mailing the coupon.

Your training outfits from National are made up of the most modern radio equipment—much of it just out of the experimental laboratory. You learn new ways of handling equipment by modern methods.

Send the coupon below immediately. Learn how this improved practical training can fit you for the **GREAT BUSINESS OF RADIO**—for the **NEW AND RAPIDLY EXPANDING FIELD OF FREQUENCY MODULATION (F.M.), TELEVISION AND ELECTRONICS.**

This is the thoroughly proved method used so extensively in wartime training—endorsed by the success of National men everywhere—a system by which you study in spare time—off hours, even minutes right in your home and yet have the **ADVANTAGE OF REAL SHOP EXPERIENCE** behind you.

Trained Radio Men Wanted

The man who really knows modern Radio is in greater demand today than ever before—not only in Radio proper but in Television and Electronics—in Aviation, Transportation, Manufacturing, Communications. Good jobs await the trained man. In the production, operation and maintenance of modern electronic equipment—in radio stations, in hun-

dreds of industries—in homes, theatres and studios. Good sound training in this important field is absolutely necessary. And now, National Schools brings such training to you **no matter where you live or what you may be doing**—not only the fundamental theory but the **actual experience that comes with knowing shop practice and working with real equipment**—demonstrating each step with first-hand knowledge. This is true **“learning by doing”**—direct from the great shops and laboratories of National Schools where new developments in methods, equipment and applications are constantly going forward.

National offers you such practical training and National has the facilities. **Sample this training yourself. MAIL THE COUPON FOR A FREE LESSON.**

VETERANS

If you qualify for training under G.I. Bill, check the coupon for a Special Bulletin.

SUCCESS and SECURITY for YOU

Radio is a Well-Established Business, Television and allied fields are just on the threshold of limitless expansion. Would you like to profit from these developments? An excellent job or perhaps into a business of your own? Answer these questions by reading the catalog sent you **FREE** from National Schools. Get the facts.

Check the Job You Now Have With These Opportunities in RADIO

1. Financial Security Radio has grown from \$100 million to \$5 billion in past few years.
2. Limitless Future predicted by over 1,800 manufacturers of equipment.
3. Television promises unrealized opportunity.
4. Electronics opens wide new fields in home and industrial use.
5. Your Own Business if you wish.

Get the details. Use the coupon!

FREE GET THESE **2** BIG BOOKS



NATIONAL TRAINING WINS BIG JOBS

NOW MANAGER OF SERVICE DEPARTMENT

“I am really proud to be a National Graduate—it has helped me to hold my present position. Now manager of service department for Valley Music Company. Times have changed since I enrolled for National Training I have an amateur Radio station to keep up on experiments in that field. W7HLP. Plus many, many sound installation problems. I have no time to call it ‘spare time’ anymore—thanks to National Schools.” Dwight J. Albright, Medford, Oregon.

COLLEGE PROFESSOR APPRECIATES COURSE

“I want to take this opportunity to tell you how much I appreciate this Course. Since being here at the College I have been able to put the theory to very good use. I have installed a P.A. system in the students’ dining hall; today I am purchasing the required equipment to install a similar system in the large assembly hall; and at all of the large meetings held so far I have been assigned the task of setting up the portable P.A. system. I have also repaired several Radios for the boys and the professors, including car Radios. So once again, thanks for a fine Course. I am looking forward to the rest of the training with pleasure.”

Brother V. Benedict, Saint Mary’s College, Calif.

NATIONAL SCHOOLS

LOS ANGELES 37, CALIFORNIA EST. 1905

MAIL OPPORTUNITY COUPON FOR QUICK ACTION

National Schools, Dept. 8-PM
4000 South Figueroa Street
Los Angeles 37, California

(Mail in envelope or paste on penny post card)

Mail me **FREE** the books mentioned in your ad including a sample lesson of your course. I understand no salesman will call on me.

NAME..... AGE.....

ADDRESS.....

CITY..... ZONE..... STATE.....

Check here if veteran of World War II

ELECTRICIANS

Get this Great Book

FREE

Book of 150 Shop Prints, Wiring Diagrams, Full Size 8 1/2" x 11"



For Merely Examining Coyne's NEW Pay Raising

7 Volume Set APPLIED ELECTRICITY

Here's a brand new set of electrical books to give you the "know how" on all branches of electricity from appliance repairing to D. C. and A. C. equipment, electrical refrigeration, etc. 3,000 subjects, 10,000 facts, latest methods all explained in easy to follow instructions. In order to prove how valuable and Practical this set of electrical books is I'm willing to give you a FREE copy of my book "150 Shop Prints and How to Read Them" just for looking over this set. Written by the Coyne Technical Staff and backed by 47 years' experience, this set has helped many ambitious electrical workers to bigger pay, better jobs & added opportunity.

OFFER LIMITED • ACT NOW! Here's my offer to you — if you act promptly, I'll send you the 7 volume set Applied Practical Electricity for 7 days FREE examination... together with the 150 Shop Print Book. Look this set over 7 days. If you like it send either \$19.75 cash or send \$3.00 after 7 days and \$3.00 per month until \$21 is paid. If you don't want the set, return it and YOU OWE NOTHING. In either event, however, you keep the 150 Shop Print Book absolutely FREE.

SEND NO MONEY! Coupon below is just a request to see the books free and to get my gift book for doing it. **ACT—Send coupon Today!** Technical Book Div., COYNE ELECTRICAL SCHOOL, 500 S. Paulina Street, Dept. C7-R6, Chicago 12, Ill.

FREE BOOK Coupon



B. W. Cooke
Director

COYNE ELECTRICAL SCHOOL, Dept. C7-R6
500 SOUTH PAULINA STREET, CHICAGO 12, ILLINOIS

Send me that 7 volume set APPLIED PRACTICAL ELECTRICITY and your FREE gift of a copy of "150 Shop Prints and How to Read Them". I'll either return the set in 7 days and owe nothing or send you either \$3 in 7 days and \$3 a month until \$21 is paid or \$19.75 cash. Regardless of whether or not I keep the 7 Volume Set the 150 Shop Prints is mine FREE as a Gift.

NAME _____ AGE _____

ADDRESS _____

TOWN _____ ZONE _____ STATE _____



AUTO

BOOKS ON APPROVAL



SEND NO MONEY. Just mail the coupon for a complete set of 4 Big, Thick Auto Books. 20th Edition. 2800 Pages! Whether you are a mechanic or helper, expert or apprentice, auto owner or driver, take immediate advantage of this FREE EXAMINATION OFFER.

MAKE GOOD MONEY NOW HOLD A PERMANENT JOB

America wants its automobiles kept in good repair. Men with "know how" are in demand, at big pay. These books will help you get and hold an important job, or give you a chance to go into business for yourself now or later. Any man who half tries to improve himself can learn auto servicing and repairing by this quick reference method. Use the JIFFY INDEX to find easily understood answer to any auto problem. These wonder books prepared by eleven of America's great automobile engineers. Many hundreds of valuable illustrations. Send the coupon TODAY.

A year's consulting privileges with our engineers now given with these books without extra charge.
Vocational Publishers Since 1898

CAN YOU FIX IT? These wonder books tell step by step HOW to make difficult repairs and adjustments, how to keep a car at maximum efficiency, including latest improvements in car design and operation. Engine troubles and how to correct them well covered. **4 BIG, THICK VOLUMES** 2800 pages, 2000 illustrations, wiring diagrams, etc., including Diesel engines. Beautiful modernistic, washable cloth binding.

AMERICAN TECHNICAL SOCIETY, Dept. AC19
Drexel Ave. at 58th St., Chicago 37, Ill.

I would like to examine your 4 Volume Set of Auto Books. I will pay the delivery charges only, but if I choose I may return them express collect. If after 10 days' use I prefer to keep them, I will send you \$2 and pay the balance at the rate of only \$3 a month until \$24.80 has been paid. Include consulting service as offered above.

Name _____

Address _____

City _____ State _____

Please attach letter stating age, occupation, employer's name and address and name and address of at least one business man as reference. Men in service, also please give home address.

FREE Sports BOOK FOLDER

• Boxing... Wrestling... Judo... Football... Body-Building... Strength & Health... and all sports.

Do you want to build up your body... Gain Strength... Become a Champion athlete... Gain or lose weight? You can do so!

Write for our large free folder for boys and men on our valuable books and courses on fighting, body-building, and all sports.

Send in your name, address and 10c in stamps or coin to cover mailing costs. We do the rest. **WRITE TODAY TO:**

CROSS COMPANY
Box 389, Dept. B-1, Kenosha, Wis

SUCCEED IN THE POULTRY BUSINESS!

You can make a good, comfortable living with poultry. For 26 years our course of Home Study training has been helping thousands. With a little study in spare time—you, too, can obtain the "know how" that means extra profits from the start.

Write today for prospectus describing courses, methods, service.

NATIONAL POULTRY INSTITUTE
Dept. 50 Adams Center, N. Y.

BUILDING

Millions of homes needed. Nation wide call for builders. Big opportunities. Learn now in spare time.—at home. Practical training with blue prints. No books. Send for FREE Trial Lesson and blue print plans.

CHICAGO TECHNICAL COLLEGE
K-151 Tech. Bldg., 2000 S. Mich. Ave. Chicago 16, Ill.

"How to Make Money With Simple Cartoons"

A book everyone who likes to draw should have. It is free; no obligations. Simply address

CARTOONISTS' EXCHANGE
Dept. 98D Pleasant Hill, Ohio

LEARN MEAT CUTTING At Home — In Spare Time

Get into the vital meat industry. Concise, practical Home Training based on 25 years proven instruction methods used at National's famous, resident school. Prepares you for bigger pay as Meat Cutter, Supervisor, market manager or more money in your own store. Go as rapidly as your spare time permits. Diploma. Start NOW to turn your spare hours into money. Send for FREE bulletin today. No obligation.

National School of Meat Cutting, Inc., Dept. U-84, Toledo 4, Ohio

RUPTURED?

Get Relief This Proven Way

Why try to worry along with trusses that gouge your flesh—press heavily on hips and spine—enlarge opening—fail to hold rupture? You need the Cluthe. No leg-straps or cutting belts. Automatic adjustable pad holds at real opening—follows every body movement with instant increased support in case of strain. Cannot slip whether at work or play. Light. Waterproof. Can be worn in bath. Send for amazing FREE book, "Advice To Ruptured," and details of liberal truthful 60-day trial offer. Also endorsements from grateful users in your neighborhood. Write:

CLUTHE SONS, Dept. 31, Bloomfield, New Jersey

PRACTICAL TECHNICAL TRAINING

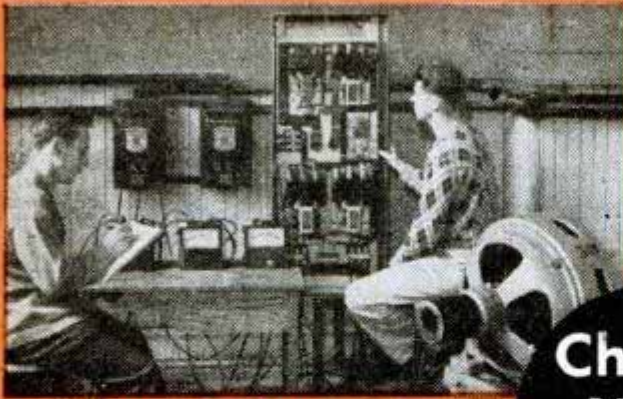

ELECTRICAL ENGINEERING



RADIO AND ELECTRONICS

**Choose
Your
Career**

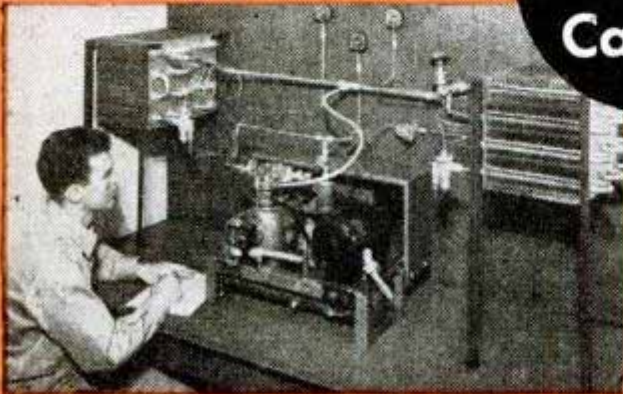

REFRIGERATION & AIR CONDITIONING



GAS AND ARC WELDING

CONCENTRIC CURRICULUM



Our time-tested CONCENTRIC SYSTEM enables you to build your career step by step. Each 6-month course is complete in itself. Stay as long as circumstances permit — until you reach your desired occupational objective.

COURSES

SERVICE . . . 6 Months

Practical Electricity
Practical Welding
Refrigeration Service
Heating Service

TECHNICIAN . . . 1 Year

Electro Technician
Radio Technician
Electronics Technician
Refrigeration, Heating, and
Air Conditioning Technician

PROFESSIONAL . . . 3 Years

Electrical Engineering
Bachelor of Science Degree — Major
in Machinery or Electronics

★ SPECIALIZE in 6 months to 3 years

Of utmost importance to anyone considering a technical school, is that school's history, facilities, faculty, and record of successful alumni. The Milwaukee School of Engineering was founded 44 years ago to train men for specific and substantial careers in industry. More than 35,000 former students in industries the world over attest the school's career-building value through its exceptional facilities in laboratories, class rooms, faculty of 63 specialists, and its comprehensive technical courses. 1292 students now enrolled from 48 states and 8 overseas countries. World-wide alumni counselor committee. Terms start **September**, January, April. **SEND COUPON TODAY!**

MILWAUKEE
SCHOOL of ENGINEERING

A Technical Institute

Milwaukee School of Engineering, Dept. PM-847
N. Broadway and E. State, Milwaukee, Wis.

Without obligation, send me free booklet "Career Building" and more details on course in.....

Name Age

Address

City State



THOUGHTS HAVE WINGS

You Can Influence Others With Your Thinking

TRY IT SOME TIME. Concentrate intently upon another person seated in a room with you, without his noticing it. Observe him gradually become restless and finally turn and look in your direction. Simple—yet it is a *positive demonstration* that thought generates a mental energy which can be projected from your mind to the consciousness of another. Do you realize how much of your success and happiness in life depend upon your influencing others? Is it not important to you to have others understand your point of view—to be receptive to your proposals?

How many times have you wished there were some way you could impress another favorably—*get across to him or her your ideas?* That thoughts can be transmitted, received, and understood by others is *now scientifically demonstrable.*

This FREE Book Points the Way

The tales of miraculous accomplishments of mind by the ancients are now known to be fact—not fable. The method whereby these things can be **INTENTIONALLY**, not accidentally, accomplished has been a secret long cherished by the Rosicrucians—one of the schools of ancient wisdom existing throughout the world. Write for the free copy of the fascinating sealed book, "THE MASTERY OF LIFE," which explains how you may receive this unique wisdom and benefit by its application. Address: Scribe K. N. L.

The ROSICRUCIANS

San Jose, (AMORC) California

USE THIS COUPON

Scribe K. N. L.
The Rosicrucians
San Jose, California

I am sincerely interested in an intelligent method of attaining a mastership of life. Send me without obligation, your FREE Book which explains how I may receive and use your age-old method.

Name.....
Address.....
City.....

Command a Substantial Salary

BE AN ACCOUNTANT

**FREE
WRITE
TODAY**

Hill's, one of America's leading Business Schools, offers you the opportunity to advance yourself to a well paying accountant's job. Our FREE book, "Through Hill's to Success," tells how and where the best positions are found and how you can qualify for them by study at home or in our resident school. We have thousands of successful graduates and maintain nation-wide employment service. G. I. Approved.

HILL'S EXTENSION SCHOOL
and BUSINESS UNIVERSITY
619 W. Main St. • Oklahoma City 2, Okla.

LEARN AT HOME TO MOUNT BIRDS



Animals, Heads, Fishes, Pets; to TAN. Be a Taxidermist. Profit and FUN.

Hunters, save your valuable TROPHIES. Mount ducks, squirrels, everything. Learn to TAN for leather and furs. Wonderful HOBBY Have a HOME MUSEUM.—BIG PROFITS mounting for others. INVESTIGATE NOW.

FREE BOOK With 100 fine game pictures. NOW absolutely FREE. Write TODAY.

Send Postal TODAY for FREE BOOK. State AGE. N.W. SCHOOL OF TAXIDERMISTRY, Dept. 337C Omaha, Neb.



One of America's Leading
Radio and Television Schools

NEW YORK TECHNICAL INSTITUTE OF NEW JERSEY

158 Market Street, Newark, New Jersey

"MAGIC AS A HOBBY!" LEARN OVER 100 MAGIC TRICKS

- Easy To Do . . .
- Make Magic Your Hobby
- Amaze Your Friends

\$1.00 brings illustrated book post paid showing how to do these tricks.

"THE BARON"

P.O. BOX 109

PRESCOTT, ARIZONA



Thrilling Work COLORING PHOTOS

Fascinating vocation learned at home by those with aptitude. Thrilling pastime. National method brings out life-like colors. Free booklet.

NATIONAL PHOTO COLORING SCHOOL
1315 S. Michigan, Dept. 135C, Chicago 5

LAW

STUDY AT HOME for PERSONAL SUCCESS and LARGER EARNINGS. 39 years expert instruction—over 108,000 students enrolled. LL.B. Degree awarded. All texts furnished. Easy payments. Send for FREE BOOK. G. I. approved.
AMERICAN EXTENSION SCHOOL OF LAW
Dept. 80-M, 646 N. Michigan Ave., Chicago 11, Ill.

SHINE WITHOUT 'POLISH'



New Invention! • Sells Like Wild

Replaces messy pastes, liquids. Simply glide over shoes—and PRESTO! —you have a lustrous, long-lasting shine. No mess. No muss. No soiled hands. Clean. Handy. WORKS LIKE MAGIC! For Men's, Women's and Children's Shoes. Low priced. Lightning seller!

SAMPLES FOR AGENTS Sample offer sent immediately to all who send name at once. A penny postal will do. SEND NO MONEY—just your name.
KRISTEE CO., 671 Bar Street, AKRON, OHIO

Now YOU Can Lick Any AUTO REPAIR JOB!

IN LESS TIME—WITH LESS WORK



**FREE
7-DAY OFFER**

MoToR's New Auto REPAIR MANUAL shows you how to service and repair ANY part of ANY car!

No auto repair job is too tough when you've got MoToR's AUTO REPAIR MANUAL! YOU can repair anything from carburetor to rear end—quickly, easily, right! Just look up make, model, and the job in the quick index—and go to work! Clear, illustrated instructions lead you step by step.

To make such an amazing book possible, the engineer-editors of MoToR Magazine collected and "broke down" 150 official factory shop manuals for you, spotted all the vital repair information you need, dove-tailed it all together into ONE handy, easy-to-understand book.

No Other Manual Like It!

This BIG book—856 pages, 8½x11 inches, bound in sturdy fabric—brings you nearly 200,000 service, repair, adjustment, replacement, tune-up facts on every car built from 1935 through 1946! More than 1000 cut-away photos, diagrams,

drawings show you exactly WHAT to do and HOW to do it! Used by the U. S. Army, trade and technical schools everywhere, thousands of auto servicemen.

Now YOU—without cost—can see for yourself what a wonderbook MoToR's Auto Repair Manual really is. TRY it—FREE for 7 days! Learn first-hand how it can pay for itself the first few times you use it.

SEND NO MONEY 7-Day Free Examination

Just mail coupon below—without money! When the postman brings your book, pay him nothing. First make it show you what it's got! Unless you agree this is the greatest time-saver and work-saver you've ever seen—return book in 7 days and pay nothing. Mail coupon today! Address: MoToR Book Department, Desk 1J, 572 Madison Ave., New York 22, New York.

USED BY
U. S.
ARMY



Clear, Pictured Facts on Every Job on Every Car Built Since 1935!

Nearly 200,000 service and repair facts on all these makes:

American	Ford	Oldsmobile
Bantam	Graham	Overland
Auburn	Hudson	Packard
Austin	Huppmobile	Pierce
Buick	Lafayette	Arrow
Cadillac	La Salle	Plymouth
Chevrolet	Lincoln	Pontiac
Chrysler	Lincoln	Reo
Cord	Zephyr	Studebaker
Crosley	Mercury	Terraplane
De Soto	Nash	Willlys
Dodge		

856 big pages; including 50 pages of carburetor text, charts, illustrations, covering all models. Over 500 charts, tables: Tune-up Chart; Valve Measurements; Compression Pressure; Torque Wrench Reading; Starting Motor; Engine Clearances; Generator; Clutch & Brake Specifications; Front End Measurements, etc.; Engines; Electric, Fuel, Cooling, Lubricating Systems; Transmissions; Universals; Front Ends; Wheels; Rear Ends, etc.

Same FREE 7-Day Offer Applies on

MoToR's TRUCK REPAIR MANUAL

For mechanics, truck specialists, service stations, fleet owners. Covers EVERY job on EVERY truck made since 1936! 1400 pictures, 952 pages, 300,000 facts. Used by Armed Forces. Warranted to contain every essential fact you need to know. Sturdy binding, size 8½x11.

Covers all types Gasoline En-

gines; Diesels and Hesselmans. Fuel Systems, Governors, Lubrication Systems, Ignition Systems, Starters, Generators, Clutches, Transmissions, Axles, Torque Dividers, Transfer Cases, Brakes, Steering, etc., etc.

ALSO SERVICES buses, farm and industrial tractors, contractor and road building equipment, stationary power machinery, etc. (on all parts described in Manual).

*Offered on same FREE 7-Day examination as Auto Repair Manual. Check box in coupon at right.



Published by MoToR, The Leading Automotive Business Magazine. MoToR's manuals assure high standards of repair work.

MAIL COUPON NOW FOR 7-DAY FREE TRIAL

MoToR Book Dept., Desk 1J, 572 Madison Ave., New York 22, N. Y. Rush to me at once: (check box opposite book you want)

MoToR's AUTO REPAIR MANUAL. If O.K. I will remit \$1 in 7 days, (plus 35c delivery charge), then \$2 monthly for 2 months, and a final payment of 95c one month later. (Book's price \$5.95.) Otherwise I will return book postpaid in 7 days. (Foreign price, remit \$8 cash with order.)

MoToR's TRUCK REPAIR MANUAL. (Described at left.) If O.K. I will remit \$2 in 7 days, and \$2 monthly for 3 months, plus 35c delivery charge with final payment (\$8.35 in all). Otherwise I will return book postpaid in 7 days. (Foreign price, remit \$10 cash with order.)

Print Name.....Age.....

Print Address.....

City.....(if any).....

State.....Occupation.....

SAVE 35c! Check here if enclosing full payment (Check, M.O. or Postal Note) WITH coupon. We pay 35c shipping costs. Same 7-day return-refund privilege.

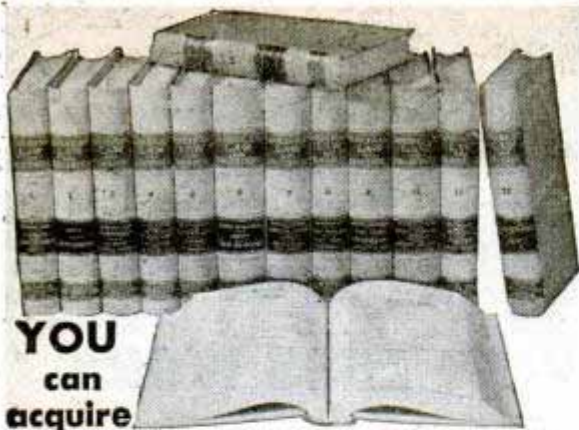

YOU
can
acquire

LAW NIGHTS AT HOME!
L.L.B. DEGREE

LaSalle's famous Law Library—used as reference in many Law libraries and Law offices—has enabled thousands to master Law surprisingly fast, in spare hours at home, for business and professional advancement.

These 14 remarkable volumes, compiled by leading professors and lawyers, cover the whole basic field of Law in condensed, orderly, simplified manner.

You advance rapidly with this great library, plus special lectures furnished. We guide you step-by-step with personalized Problem Method of instruction . . . you learn by doing—handling legal problems—not by memorizing rules.

Send for two FREE 48-page booklets, "Law Training for Leadership," and "Evidence," answering questions about Law and its value to you, and telling how LaSalle Law graduates are winning rapid advancement in business and public life. Mail coupon below. No obligation.

G.I. Approved

LA SALLE EXTENSION UNIVERSITY

A Correspondence Institution

417 S. Dearborn St. Dept. 864-L Chicago 5, ILL.

Send me your two FREE booklets described above, without obligation.

Name.....Age.....

Street.....

City, Zone & State.....

TEXAS COLLEGE OF PHOTOGRAPHIC ART
1st
IN THE GREAT SOUTHWEST!

SCENIC and HISTORIC SAN ANTONIO THE PHOTOGRAPHERS' WONDERLAND VETERANS MAY ENROLL UNDER G.I. BILL

LEARN PHOTOGRAPHY NOW

FASCINATING WORK — EXCELLENT PAY
FREE BOOKLET ADDRESS: DEPT. 14

Texas COLLEGE OF PHOTOGRAPHIC Art
SAN ANTONIO, TEXAS
"ONE BLOCK FROM THE ALAMO"

MAKE UP TO \$5⁰⁰ AN HOUR
In Your Own YEAR ROUND Business!

ONLY A FEW DOLLARS PUTS YOU IN BUSINESS!

Many Clearing as High as \$20 to \$30 a Day NET Renewing Rugs, Carpets, Upholstery. New Method Now Used for Auto Upholstery. Write for Facts About Quick, Easy Way to Get Started

Here is the chance you've been looking for to step into a pleasant, dignified, big-pay business of your own that offers you a steady, year 'round income. Start on "a shoestring," full or spare time, right from your own home. Equal opportunities for men and women, young or old, in small towns or big cities. No experience needed. Many making big money with new Americlean System just cleaning auto upholstery. Easy to learn. We send you complete instructions and quick-cleaning supplies so you can start making money the very first day! Quick method cleans upholstery, rugs and carpets like new without taking off floor! Tremendous demand in homes, apartments, hotels, stores, office and public buildings. Steady repeat business. Territories going fast. Write today for full FREE facts. No cost or obligation. Rush letter or postcard now to **AMERICLEAN CO., Inc.; Dept. G-8; 211 North 7 St.; St. Louis 1, Mo.**

WRITE FOR FREE DETAILS NOW!

OPPORTUNITIES AHEAD!
TRAIN FOR A FUTURE IN
DIESEL

● Prepare for the big earning power of **Diesel Trained Men**. Start learning at home, in spare time. UEI's easy, practical training covers all phases of DIESEL engine operation, fuel systems, auxiliary equipment, repairs and maintenance. When home course is completed, you come to Chicago for actual shop practice on DIESEL MOTORS under expert instructors, at UEI's fine, modern school. **BEGIN AT ONCE—GET ALL THE FACTS FREE. WRITE TODAY!**

DIESEL DIVISION UTILITIES ENGINEERING INSTITUTE
2521 Sheffield Ave. • Dept. 187-D • Chicago 14, Illinois

CARTOON TO SUCCESS!
Learn cartooning from a PROFESSIONAL! Let me show you how to create ORIGINAL cartoons and IDEAS. Send for FREE details about course.
Also **CARTOONIST'S MAGAZINE**—Lessons, plans and hints. Send 25¢ coin for copy.
CARTOONIST HARTMAN, 2776 California Court, LINCOLN 8, NEB.

There's MONEY in MAGIC!
Entertain For Profit or Fun! Earn money doing magic at parties, clubs, hotels, etc. Rush 25¢ for "MAGIC IS FUN" magazine. Teaches HOW to be a magician. FREE, with order, large catalog of magic apparatus.
D. Robbins & Co., Dept. M-108, 152 W. 42 St., N.Y. 18, N.Y.

STAMMER? GET THIS FREE BOOK!
This new 128-page book, "Stammering, Its Cause and Correction," describes the Bogue Unit Method for scientific correction of stammering and stuttering—successful for 46 years. **Benj. N. Bogue, Dept. 7801, Circle Tower, Indianapolis 4, Ind.**

SAY YOU SAW IT IN POPULAR MECHANICS

HAVE YOU AN APTITUDE FOR WRITING?

Storycrafters Guild determines your writing potentialities with a FREE APTITUDE TEST, then teaches you fundamentals of ALL creative writing. You study current material editors have bought and published. You learn how to write Stories, Articles, Radio, Motion-Picture, Novels, "Fillers"; specialty writing of all kinds under personal direction of Frederick Palmer. **EARN WHILE YOU LEARN** through Storycrafters Guild Manuscript Sales Service. Send for FREE APTITUDE TEST today!

STORYCRAFTERS GUILD, Dept. 58
5617 Hollywood Blvd., Hollywood 28, Calif.
Send FREE APTITUDE TEST and details of Home-Study Course in Creative Writing.
Mr. Mrs. Miss _____
Address _____
City _____ State _____

Learn **RADIO**

IN A FEW SHORT WEEKS

IN THE GREAT SHOPS OF COYNE

48 Years of Successful Training

Work on Actual Radio, Sound, Television Equipment! Expert Instructors Train You by Famous COYNE SHOP METHOD

Get ready quickly for YOUR FUTURE. Big opportunities are waiting for properly trained men in Radio Manufacturing, Radio Sales and Service, Television, Sound, Public Address. With COYNE "All Around" Training, many branches of Radio are open to you.

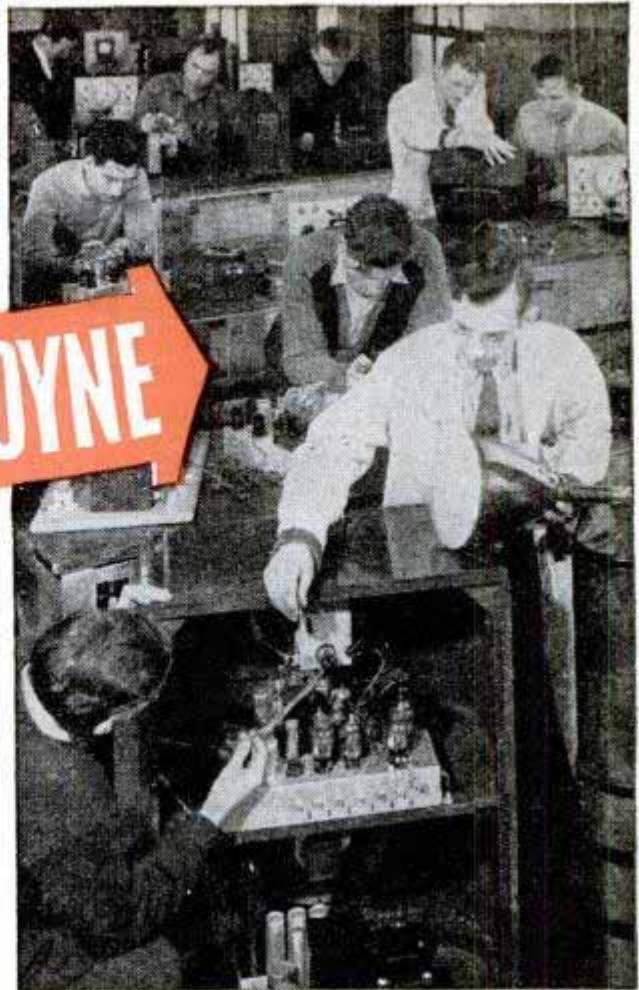

B. W. COOKE

NOT A "HOME-STUDY" COURSE

Learn Radio Fast!

As a Coyne student you work on real equipment in our great shops in Chicago — the Radio Center of the World. We do not teach by mail. All Coyne training is given right here in our big Shops in Chicago. You make rapid progress at Coyne because it's a shop course.

COYNE GRADUATES IN DEMAND

Whether you have had any actual Radio experience or not, we can train you in a few weeks for a better job, steady work and a real future in the Radio field.

First we train you for a good Radio job, then help you get it. Coyne graduates may use our **Lifetime Employment Service** as often as they wish.

Easy to Start Own Shop

If your ambition is to be your own boss, COYNE makes it easy! We include special training in how to start your own Radio Shop, how to get business, keep records, etc., right along with our course. Then we have Free Merchandising Service for graduates to solve many problems.

SEND FOR BIG FREE BOOK!

Our new, fully illustrated Coyne Radio Book tells all about our great Chicago shops and our plans to help you. Packed with facts and pictures. No salesman will call. No obligation.

We'll Finance Your Training

Non-veterans who are short of cash can finance most of their tuition and pay it in easy monthly payments after graduation. You may earn while learning, to help take care of living expenses while here. COYNE works with you to enable you to get the training you need.

VETERANS!

Coyne is authorized to train those who qualify for training under the G. I. Bill of Rights. Check coupon for special G. I. Bulletin.

Physical Disabilities

Men with physical disabilities may qualify for training at no cost for tuition and subsistence. Check coupon.



ADDED TRAINING

ELECTRIC REFRIGERATION

This valuable training now included with our Radio course.

B. W. COOKE, Director, Radio Division

COYNE

ELECTRICAL SCHOOL
500 S. Paulina Street
Dept. C7-3H
Chicago 12, Ill.
ESTABLISHED 1899



B. W. COOKE, Dir., Radio Div., COYNE ELECTRICAL SCHOOL, 500 S. Paulina St., Dept. C7-3H, Chicago 12, Ill.

Dear Mr. Cooke: Send me your Big Free Radio Book and all the facts . . . also full details of your "Student Finance" plan.

Send G. I. Bulletin.

Physical disability details.

NAME.....

ADDRESS.....

CITY..... STATE.....

MAIL FOR BIG Free BOOK

Practical Shop Training!

Learn a Trade!

- | | |
|--|---|
| <input type="checkbox"/> AUTO MECHANICS | <input type="checkbox"/> BODY AND FENDER |
| <input type="checkbox"/> DIESEL | <input type="checkbox"/> TOOL AND DIE |
| <input type="checkbox"/> REFRIGERATION | <input type="checkbox"/> MACHINIST |
| <input type="checkbox"/> WELDING | <input type="checkbox"/> MACHINE DRAFTING |
| <input type="checkbox"/> PIANOFORTE TECHNOLOGY | |

America's Leading School
7 Floors of Fully Equipped Shops
Established 1902
Over 45,000 Graduates
Expert Individual Instruction
Learn by Doing

You hear it everywhere:
"GREER SHOP TRAINING IS THE BEST"

MAIL THIS AD TO GREER SHOP TRAINING

(Dept. 287) 460 South State St., Chicago 5, Ill.

Please send without obligation free information regarding trade checked above. (Specify whether you are a Veteran or Civilian)

Name _____ Age _____

Address _____

City _____ State _____

New BRUSH Electroplater

ESPECIALLY BUILT FOR MECHANICS, MODEL MAKERS HOME CRAFTSMEN



Easy to Plate GOLD, SILVER, NICKEL, COPPER, etc... For Pleasure and Profit!

If you have a workshop—at home or in business—you need this new Warner Electroplater. At the stroke of an electrified brush, you can electroplate models and projects—you can replate worn articles, faucets, tools, fixtures, silverware, etc. with a durable, sparkling coat of metal... Gold, Silver, Nickel, Copper, Cadmium, and after a bit of practice, even Chromium! Everything furnished—equipment complete, ready for use. By doing a bit of work for others, your machine can soon pay for itself. So make your shop complete by getting a Warner Electroplater right away. Send today for FREE PLATING SAMPLE and illustrated literature. ACT AT ONCE.

WARNER ELECTRIC CO., Inc., Dept. N-30
 1512 Jarvis Ave., Chicago 26, Illinois

FREE Details & Sample!

WARNER ELECTRIC CO., Inc., 1512 Jarvis Ave., Chicago 26, Ill., Dept. N-30
 Gentlemen: Send Free Sample and Details to:

Name _____

Address _____

City _____ State _____



Iron Repair Kit

Contains a complete assortment of terminals, pins, porcelain insulators, mica, etc. that will fit most flat irons and appliances. Practically every part necessary in the ordinary repairing of flat irons in one handy kit. Additional supplies obtainable so that your kit can be replenished.

Entire kit sent postpaid for only \$3.10 plus 18c postage.

Electrical Appliance Repair Parts

Lead wire, Asbestos covered heater hook-up wire, 10 ft.	\$1.00
Heating element wire, 10 ft. coiled 1/4" O.D. #20	2.55
Heating element wire 10 ft. coiled 3/16" O.D. #22	1.77
Ribbon element heating wire Std. size 100 ft.75
Christy Electric Heating Element Welding FLUX for repairing flat irons, toasters, electric stoves, etc. Enough for 50 elements	1.00
Hot plate bricks 5/8" diameter, 6 for	1.62
Element cement, Withstand 3000° F., 1 lb. package	1.00
Carbon brush set, Assorted, 104 brushes, 15 Springs, Complete	3.00
REPAIR ELEMENTS FOR ELECTRICAL APPLIANCES	
Renualt iron element, Guar. 1 year, Package of 6	3.12
Irons, Porcelain shoes for 500-600 watt, Set of 4	1.00
Percolator elements, Universal flat type, 1 Yr. guar. 2 for	1.20
Percolator Element, Porcelain for new glass types, 2 for	1.80

HOW TO FIX IT BOOKS

Armature and Magnet Winding, 270 Pages	1.50
Practical Electricity and House Wiring, 200 Pages, 277 Illustrations	1.50
Modern Electric and Gas Refrigeration, 928 Pages, 408 Illustrations	5.00
Electric Motor Rewinding & Repair, 551 Pages, 900 Illustrations	5.00
Watch & Clockmakers Handbook, 551 Pages, 464 Illustrations 6.00	6.00

Here is your opportunity to save on repairing your own appliances and to earn extra money repairing appliances for friends and neighbors.

CHRISTY SUPPLY CO.

2835 N. Central Ave. Dept. T-1050 Chicago 34, Ill.



LEARN To Repair and Service Electrical Appliances, Sewing machines, motors, bicycles, lawn mowers, saw filing, cutlery grinding, etc.

Postcard Brings Free Details

Start with \$20.00 and a few common tools! Build low cost equipment while earning. Make up to \$6.00 an hour! Free details. Complete illustrated course only

\$5.50

5 Days Free Examination C.O.D. 35c Extra

REPAIRMAN'S SERVICE 222M 4th Ave., Janesville, Wis.

ARTIFICIAL ARMS

WRITE FOR FREE BOOK showing how CARNES ARTIFICIAL arms have PUT THOUSANDS BACK ON THE PAYROLL. Every appliance made to fit individual amputation. World-wide recognition of merit since 1904. BOOK SENT FREE—no obligation, send for it now.



CARNES ARTIFICIAL LIMB CORP.

Dealers and Representatives Everywhere
 906 East 12th Dept. B Kansas City 6, Mo.

Learn BAKING At Home

Baking is one of America's high industries in wages. Nearly depression-proof. Thorough basic home course lays sound foundation. If you have aptitude, write for FREE BOOKLET, "Opportunities in Commercial Baking."



Learn LANDSCAPE GARDENING

A thorough, interesting, home study course for those who wish to become LANDSCAPERS, GARDENERS, DESIGNERS, etc., for profit or pleasure. Write today for FREE BOOK to

APPROVED FOR VETERANS NATIONAL LANDSCAPE INSTITUTE
 Dept. P-8, 310 So. Robertson, Los Angeles 36.

RADIO Engineering, Broadcasting, Television, FM, Servicing, Electronics, Aviation, Marine, E-Police Radio taught thoroughly. Engineering course equivalent to 3 years' college radio work. Approved Veteran Training. Catalog free.
VALPARAISO TECHNICAL INSTITUTE, Dept. D, Valparaiso, Ind.



Begin today. Write now for our Free Book, "How to Become a Good Penman." It contains specimens and tells how others learned to write in spare time. Enclose 10c for your name beautifully written and a pen point suitable for shaded writing. Write today.

THE TAMBLYN SCHOOL OF PENMANSHIP
 N-441 Ridge Building, Kansas City, Mo.

Raise GOLDEN HAMSTERS

The new wonder animals from Syria. Look like Toy Red Bears. Delightful pets. Everybody wants them. Thousands needed by laboratories. Make money, get started now. Send 10c for illustrated literature, or send \$5 for a pair of hamsters and literature.



GULF HAMSTERY, 1536 BASIL ST., MOBILE 17, ALA.

DO ACTUAL ELECTRICAL WORK DAILY IN OUR LARGE SHOPS

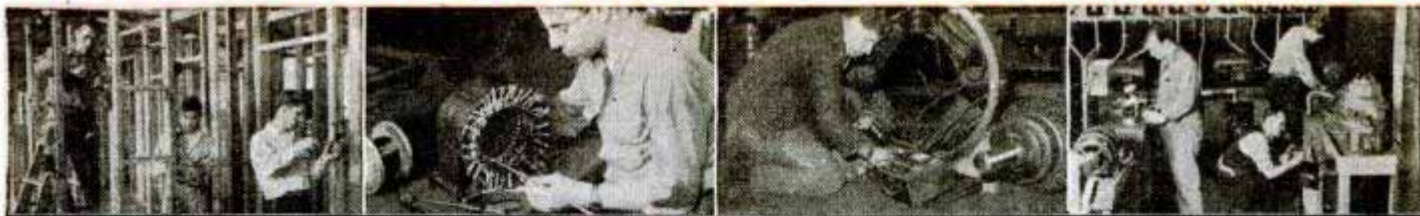

HOUSEWIRING

MOTOR WINDING

GENERATORS

INSTALLATION



GET INTO BIG-PAY

ELECTRICITY

**NATION'S
LARGEST
EXCLUSIVE
ELECTRICAL
SCHOOL**

QUICK, THOROUGH, EASY-TO-LEARN-TRADE

Steady job, good pay, clean work! . . . That's your future in this lifetime trade. Learn-by-doing in a few months on actual equipment . . . not "home study"—not "mail"—not "spare time"—**YOU GET PRACTICAL "A TO Z" EXPERIENCE** in our modern resident shops. Get ready fast for many electrical jobs now open everywhere! New classes start every few weeks. Living quarters arranged.

NO COST TO VETERANS Train at Gov't. expense. Receive \$65 to \$90 month while learning. Coupon brings details.



**MAIL TODAY FOR
QUICK ACTION**

MICHIGAN TECHNICAL INSTITUTE, Dept. PM-8
2281 W. Fort St., Detroit 16, Michigan

- Send me catalog and complete information.
 I am a GI. Send special information.
 Married. Single.

NAME _____
 ADDRESS _____
 CITY _____ ZONE _____ STATE _____

MICHIGAN TECHNICAL INSTITUTE

Department PM-8, 2281 West Fort Street, Detroit 16, Michigan

Be A MASTER PLUMBER

Earn \$15 To \$50 A Day
DON'T ENVY THE PLUMBER — BE ONE

Every skilled workman will tell you that Plumbers have the best of it. WINTER and SUMMER the Plumber is busy at top wages. No skilled Plumber is ever out of a job—compare his opportunities with any trade, plus the opportunities of having your own shop. We teach you Plumbing with TOOLS (not books) under Licensed Master PLUMBERS in one of the finest equipped schools in America. We make you a Plumber, every branch is taught thoroughly—Lead Work—Blueprint for plan reading—all other tricks.

LEARN IN 30 WEEKS WITHOUT PREVIOUS EXPERIENCE

If you like to work with tools you owe it to yourself to investigate. No need to ever work as an apprentice. Get free bulletin. Write now! G.I. APPROVED. Our 24th year.

UNIVERSAL PLUMBING SCHOOL

815 HOLMES STREET KANSAS CITY, MO.



DRAW for MONEY

BE AN ARTIST!

Trained Artists Are Capable of Earning \$50, \$60, \$75 a Week

Use Your Spare Time to Prepare for a Profitable Art Career! **COMMERCIAL ART, DESIGNING and CARTOONING**—all in ONE complete home study course. No previous Art experience necessary—we teach you step by step—hundreds have profited by our practical method. **TWO ART OUTFITS FURNISHED.** Full information in colorful, **FREE BOOK, "Art for Pleasure & Profit"**—tells all about our course, service—and commercial opportunities for you in Art. Course approved under G.I. Bill.

FREE BOOK gives details!

WASHINGTON SCHOOL OF ART
 Studio 128H, 1115 15th St., N.W., Wash. 5, D.C.

Send me your booklet and full particulars.

Name _____ AGE _____
 Street _____
 City _____ Zone _____ State _____
 I am entitled to G.I. Training

Please Mention Popular Mechanics When Answering Ads

Make MORE MONEY
 Learn

Screen Process Printing I SHOW YOU HOW This Easy Way at Home!



1 HOW TO START YOUR OWN BUSINESS
 —My training shows you how you may start your own business and cash in on the tremendous field open to you in Screen Process—with an investment of a few dollars.

No machinery. Print thru stencil mounted on silk stretched frame.

2 HOW TO GET A GOOD PAY POSITION
 —Many of my students earn extra money in spare time at home, while learning. My special "Earn While You Learn" lessons, with the Kit of Supplies I give you—show you how.



3 HOW TO EARN EXTRA MONEY IN SPARE TIME—If you are in the rut of a low pay, uninteresting job, Screen Process work offers you the opportunity to earn good wages and the better things of life for you and your family.

Make own stencils. Trace lines on stencil film. No art experience necessary.

Send for FREE BOOK

My big free illustrated book, "Opportunities in Screen Process," explains the big demand for Screen Process printed Signs and Displays, Toys and Games, Textiles, Decal Transfers, Plastics and Glass, Pictures and Greeting Cards, Advertising Agencies and other businesses. No art or previous experience required. You Learn While Doing with the 2 BIG KITS of SUPPLIES I give you. Write TODAY.



You can print signs, displays, toys, etc., with this simple equipment.

CALIFORNIA SCHOOL OF SCREEN PROCESS
 3740 OVERLAND BLVD., DEPT. PM87, LOS ANGELES 34, CALIF.

Prepare yourself

FOR A MASTER AIRCRAFT INSTRUMENT TECHNICIAN'S JOB

RIGHT NOW we have more calls for graduate Aircraft Instrument Technicians than we can supply!

Thirty-four weeks' intensive training includes complete maintenance, servicing, repairing, and testing of instruments in Mechanical, Pressure, Gyroscopic, and Electrical Groups.

There are also many applications of our thorough training to other industrial instrument fields.

Approved FOR VETERANS Available FOR NON-VETERANS
APPROVED BY NATIONAL COUNCIL
OF TECHNICAL SCHOOLS



IMMEDIATE ENROLLMENT IF YOU QUALIFY

MAIL COUPON BELOW FOR
FREE BOOKLET

American Schools of Aircraft Instruments
5145 West San Fernando Road, Dept. P-8
Los Angeles 26, California
Please send me FREE and without obligation, illustrated booklet describing Aircraft Instrument Field.
name _____ age _____
address _____
city _____ zone _____
state _____ veteran _____

Learn DRAFTING

I Will Train You at Home Until You Have a GOOD PAY JOB!

Engineer Dobe

Give Yourself a Chance to Make Good in this Big Opportunity Field

Don't be a fellow who "never had a chance" —for your big chance is right here now—in Drafting. The field for draftsmen is bigger now than ever before, for drafting is the basic profession and all new products start with the draftsman.

Get into Drafting now. I will train you at home, in your spare time and give you actual experience on actual work—the same kind of jobs you will do for the best paying firms. I will train you until you are competent, fully experienced and holding a position that will bring advancement and pay raises as deserved. Write me today!

WORKING TOOLS INCLUDED You get drafting instruments, table and other equipment when you start. Nothing for you to buy.

EXPERIENCE WHILE LEARNING

Don't forget! I train you through practical jobs—I give you experience. And I list this experience as a reference to employers when you are ready to go to work. Lack of starting knowledge or higher education should not hold you back. Low cost—and monthly payments, if desired.

ACT NOW!

Mail coupon to me today! No salesman will call, but you will get my big book and all details. Give your age to get reply.

MAIL COUPON FOR VITAL FACTS

Engineer Dobe, Div. 1A, Libertyville, Ill.

Send me the Vital Facts on Drafting and Industrial Designing, your Free Book and advertised list of positions for Draftsmen and Designers wanted.

Name _____ Age _____
Address _____
City _____ Zone _____ State _____

Get into Good Paying AUTO BODY and FENDER WORK



BIG DEMAND in Auto Body and Fender work. Start training now in your spare time at home for good pay work. Practical shop experience included. U. E. I. Training covers metal work, welding, painting, etc. Placement service—or we will show you how to start your own shop. Behind U. E. I. TRAINING is a large national organization founded 1927. Write today for FREE FACTS—No obligation.

Approved for Training under G.I. Bill

AUTO-CRAFTS DIVISION • UTILITIES ENGINEERING INSTITUTE
2523 SHEFFIELD AVE., DEPT. 187-X, CHICAGO 14, ILLINOIS

NEW Liquid Plastic

Special CASTOLITE Kit

Hobbyists, craftsmen: Get new CASTO-KIT containing everything to make useful objects with CASTOLITE, the new "magic" liquid casting plastic that pours without heat or pressure. Use crystal clear or color brilliantly. Make beautiful articles with New CASTO-MOLD—lamp bases, bookends, novelty jewelry. Also embed flowers, butterflies, photos, coins. Carve, saw or drill. Kit contains 1 lb. Liquid CASTOLITE, Construction Manual with step-by-step method, materials for immediate use. Big profits between now and Xmas. Send \$3.35 for kit prepaid or order C.O.D. Illustrated Manual alone is 25c.

THE CASTOLITE COMPANY
Dept. J-1 Box 211 Kenilworth, Ill.



20-Project
KIT
\$3.35

ELECTRICIANS' SCHOOL

HOUSE AND COMMERCIAL WIRING • MOTOR REPAIR
AND REWINDING • ELECTRIC REFRIGERATION

Approved for Veterans Training

PENNSYLVANIA INSTITUTE SCHOOL OF ELECTRICITY
42nd and SPRUCE STS. PHILADELPHIA 4, PENNA.

TRAIN Your VOICE!

Results GUARANTEED

We build, strengthen the vocal organs—not with singing lessons—but by sound, scientifically correct silent and vocal exercises and absolutely guarantee complete satisfaction with results. Write for Voice Book, FREE. Sent to no one under 17 years old unless signed by parent.
Perfect Voice Studios, Studio 135-C, Kimball Hall Bldg., Chicago 4, Ill.

CHAPMAN CHINCHILLAS

The originator of the first Chinchilla Farm in the United States. For information on purchasing the finest, selected breeding stock of these aristocratic animals that were virtually trapped to extinction write or visit—

Established 1919 Chapman Chinchilla Farm
4957 West 104th Street
Inglewood, California

REFRIGERATION

Repair, adjust all refrigerators. New large manual tells how. Charts and pictures to help you. Price only \$1, postpaid. Money back guarantee.
SUPREME PUBLICATIONS, 9 S. Kedzie Ave., Chicago 12, Illinois

MAGIC WONDERS EXPOSED!

Amuse! Confuse! Thrill Everyone! Vanishing light, Ghostly Pellet, Magic Smoke, Mystic Watch, Enchanted Match, Spirit writings, Magic Fire, Wizard's Candle, Etc. 32 Magic Lessons 25c. Free with order Big Catalog.
THE MAGICIAN, 2463 Kensington Ave., Dept. C, Philadelphia 25, Pa.

WATCH & CLOCK REPAIRING

LEARN AT HOME IN YOUR SPARE TIME! Prepare for a happy future, with security—and qualify for a good job NOW. A fascinating and thorough self-instruction training in American and Swiss watches and clocks. Special section on alarm clock repairs. Fast-growing field. Satisfaction is guaranteed. Success-Catalog Free.
NELSON CO., 1139 S. Wabash, Dept. H-02, Chicago 5, Ill.

IMAGINE THEIR JOY WHEN THEY FOUND THEY COULD PLAY

this easy-as-ABC way!



LEARNED QUICKLY AT HOME

"I didn't dream I could actually learn to play without a teacher. Now, when I play for people they hardly believe that I learned to play so well in so short a time."
*H.C.S., Calif.



PLAYS AT DANCES

"Your lessons have been most satisfactory. I can play all of the popular songs. I have earned money playing at dances."
*E.N.J., New York.



PLAYS ON RADIO

"I can't keep from telling you that I have a good position playing from KTHS, Hot Springs, Ark., every morning."
*J. S., Okla.

What Instrument Would You Like to Play?

JUST name your instrument and we'll show you how you can learn to play it—quickly, easily, in spare time at home. Never mind if you don't know one note of music from another—don't worry about "special talent." And forget all you've ever heard about music being hard to learn.

The truth of the matter is that *thousands now play who never thought they could!* Yes, men and women everywhere have discovered this amazingly easy way to learn music at home. Now they are enjoying the thrilling satisfaction of playing the piano, violin, guitar, saxophone or other favorite instruments. Some of them are playing in orchestras and over the radio; others are teaching music, making money in spare or full time. And thousands are having the time of their lives playing for their own enjoyment and the entertainment of their friends.

LEARN TO PLAY BY NOTE
Piano Guitar
Violin Saxophone
Organ Mandolin
Tenor Banjo
Hawaiian Guitar
Piano Accordion
Or Any Other Instrument

FREE PRINT AND PICTURE SAMPLE

Fascinating illustrated booklet answers all your questions; Free Print and Picture Sample shows how method works. If interested, just mail coupon. U. S. School of Music, 78 Brunswick Bldg., New York 10, N. Y.

*Actual pupils' names on request. Pictures by professional models.

U. S. SCHOOL OF MUSIC
78 Brunswick Bldg., New York 10, N. Y.

I am interested in music study, particularly in the instrument indicated. Please send me your free illustrated booklet, "How to Learn Music at Home" and the Free Print and Picture Sample.

Name _____ (PLEASE PRINT)
Address _____
Instrument _____ Have you Instrument? _____

HI-SPEED EQUIPMENT

High Compression Heads—Dual Manifolds
Dual Air Cleaners For V8's

Use these simple conversions to increase horsepower, speed acceleration, and increase top speed of your car. Write today for prices and full information.
SAND-EE MUFFLER CO. 7523 S. Western Ave. Los Angeles, Calif.

V-8
DUALS
& SINGLES

MUFFLERS

STEELS and ALUMINUMS
with a motorboat tone

SINGLES, Chev, V-8, Plymouth, Steels \$5.50, Aluminum \$6.50. Chry., Olds., Buicks, etc., Steels \$7.50, Aluminum \$8.50. V-8 and MERCURY DUALS, Steel \$17.50, Aluminum \$20.00. Aluminums are guaranteed for life of your car.

DEALERS WANTED

SANDEE MUFFLER CO.
7523 S. WESTERN AVE., LOS ANGELES 44, CALIF.

Become a Doctor of PSYCHOLOGY

Win the degree of Ps.D. Teach the secret of contentment, happiness. Solve mental worries. Experience the revelation of truth. Chartered college. Individual help. Write for FREE book. COLLEGE OF UNIVERSAL TRUTH, 5153-B North Clark St., Chicago.

APTITUDE TESTS

discover the kind of work or studies best for your success! You get a personal report—a guide for life—more happiness—more prosperity. For men, women, boys and girls. Write for complete facts.

VOCATIONAL COUNSELING INSTITUTE
956 Maccabees Bldg., Detroit 2, Michigan

BUILD YOUR OWN! FAST FREEZER

Plans \$1.00

It's easy to build this household appliance and profitable to use. Save up to 75%. Operates on 110 or 32 volts. Plans show 5 sizes and are easy to follow. ENJOY MAKING ONE OF these freezers from new or used parts. No expert knowledge needed. Mail \$1.00 bill or check for complete plans and catalog.

LEJAY MFG., 447 LeJay Bldg., Minneapolis 8, Minn.

5 sizes
8 to 40 cu. ft.

SAY YOU SAW IT IN POPULAR MECHANICS

Here is a Way YOU Can Get Ready for the BUILDING BOOM

Learn about Earning Opportunities in BUILDING CONTRACTING

FREE FACTS



USE OUR TRAINING PLAN TO LEARN AT HOME IN YOUR SPARE TIME

Do you want to be on the inside in the building boom—where big money is made? Learn about opportunities for Building Contractors whether or not you have previous experience in this field. Millions of dollars are going to be made in home and farm buildings, in construction of stores, garages, small industrial buildings. The building industry uses men with organizing ability by thousands in construction, supervision, management, sales. Properly trained men needed in production, distribution, finance, installation, and marketing.

Easy to Learn in Nationally Known School

Government estimates housing demand at 40 billion dollars! Others are preparing to get in now! Act immediately—get the facts!

HOME BUILDERS TRAINING INSTITUTE, Dept. D28
DIVISION COMMERCIAL TRADES INSTITUTE
1400 W. Greenleaf, Chicago 26, Ill.

Fill Out, Cut Out, Mail Today

FACTS FREE for Men Who Want to Get Ahead
HOME BUILDERS TRAINING INSTITUTE, Dept. D28
1400 Greenleaf, Chicago 26, Illinois

I am interested in the opportunities in the Building Industry. Please send me free information about getting a start as a building contractor.

Name _____
Address _____
City _____ State _____

LET HOLLYWOOD EXPERTS HELP YOU



MAKE GOOD IN
RADIO
TELEVISION
ELECTRONICS

APPROVED
FOR
VETERANS

LEARN FROM MEN CLOSEST TO RADIO-TELEVISION INDUSTRY!

Direct from Hollywood, center of America's Broadcasting, Television, Radio, Sound activities comes easy-to-learn, advanced home-instruction that quickly qualifies you for **Steady, Good-Pay Jobs** or business in Radio, Television, Electronics.

GET RADIO SHOP KNOW HOW

Radio Training Association of America's (R.T.A.) **Professional Methods** assure quick step-by-step success. R.T.A. is located right "on-the-spot" where new technical developments are introduced. You receive finest shop-type instruction in latest Radio-Television techniques. Every R.T.A. student **Gets Unlimited Consultation** from Hollywood on any subject pertaining to studies.

EXTRA MONEY WHILE LEARNING

When you enroll with R.T.A. you get **SPARE TIME JOB SHEETS** showing how

to earn extra money while being trained by R.T.A.'s **Hollywood Experts**. When friends, neighbors know you are studying radio, ample repair jobs are practically assured for you.

GET FACTS—Send for FREE Book

telling about R.T.A.'s streamlined training plan developed by veteran technicians in Hollywood, heart of vast Radio-Television field. Mail coupon today. **Send for Free Illustrated Book** showing newest Radio-Television pictures. No obligation. **Approved for Veterans**. Send for big free book now!

Mail Coupon NOW!



RADIO TRAINING ASSOCIATION OF AMERICA

RADIO TRAINING ASSOC. OF AMERICA, DEPT. PMB
5620 Hollywood Blvd., Hollywood 28, Calif.
Send **FREE BOOK** showing how to make good in Radio-Television through training by Hollywood experts.

NAME _____ AGE _____
ADDRESS _____
CITY _____ ZONE _____ STATE _____

Check box if **VETERAN** of World War II

5620 HOLLYWOOD BLVD - HOLLYWOOD 28, CALIF

INVENTORS

The inventor who believes he has a new and useful invention, and finds himself in need of advice, should consult a competent registered patent attorney.

The question as to whether a subject matter is patentable can be substantially determined by a search of the United States Patent records.

Without obligation, write us for information as to what steps an inventor should take to secure a Patent.

RANDOLPH & BEAVERS

Registered Patent Attorneys

11-D Columbian Bldg., Washington 1, D. C.

RANDOLPH & BEAVERS

11-D Columbian Bldg., Washington 1, D. C.

Please send me full information on how to secure Patents & Trademarks.

Name.....

Street.....

City.....State.....

Sensationally New Low Cost CASTING MIX

THERMOSETTING PLASTIC in POWDER FORM { self curing

ANY-ONE CAN MOLD QUICK AND EASY

"Kalon" is a NEW TYPE CASTING MIX . . . Does not require expensive equipment or presses to handle . . . Simply mix "Kalon" with water, stir and pour into mold . . . THAT'S ALL! . . . "Kalon" remains liquid about 15 minutes after mixing, after which time "hardening" process begins and lasts from 20 to 30 minutes to permit removing the cast from the mold. . . JUST THAT SIMPLE. Pins, Clasps, Hooks, etc. can be inserted for Costume Jewelry, Plaques and other ornaments, while it is hardening. We can supply **STOCK MOLDS** to produce saleable products . . . Catalog showing these molds mailed prepaid for 25c . . . A Novelty Mold is included without extra charge in the **INTRODUCTORY OUTFIT OFFER**.

STRONG, TOUGH, HARD

INTRODUCTORY OFFER

A Trial Kit contains a 16-oz. supply of "Kalon" . . . A pkg. of mold dressing . . . A Koroseal mold **READY TO USE** and a set of **INSTRUCTIONS** . . . Sell the articles at a **PROFIT**.

\$3.49

RUSH ORDER ONLY Postpaid
CLARENDON MFG. CO.
176 West Adams St. • Dept. P-8 • CHICAGO 3, ILL.

Men Needed For Outdoor Jobs!

Become a surveyors instrument man. 10 day home study course teaches use, care, operation, of surveyors transit and instruments. Brilliant future. Key jobs in surveying crew. Travel home and abroad. **INSTRUMENT MEN NEEDED** in all types of construction—airfields—shipyards—highways—oilfields—jungle clearance, etc. Big demand, high wages. Send \$1 for first lesson. If satisfied remit \$5.50 for balance of course, or send \$5.98 for complete course today, **POSTPAID**.

Course Valuable to Contractors and Builders
TECHNICAL PUBLICATIONS, Dept. B, Box 85, White Plains, N. Y.



COMB-A-TRIM The New Quick Trimmer

Something New! Trim your hair without any experience. It's easy! The excess hair comes off smoothly and easily by just pulling trimmer through hair like an ordinary comb. Save on hair-cut bills. . . Trim your own hair or the whole family's. Send 59c and your Comb-A-Trim will be sent at once, postpaid.

59c

SPECIAL OFFER Send \$1.00 for 2 Comb-A-Trim Trims. Save 18c **2 for \$1** 5 Extra Blades (Year's Supply) **25c**
COMB-A-TRIM CO., CAREW TOWER, Dept. R-21, Cincinnati, Ohio

MAKE MONEY 2-WAYS

LEARN REFRIGERATION & AIR-CONDITIONING.
Prepare for high-pay job or your own business. Approved G. I. training. Write Boston Technical Institute 4707 Euclid Ave., Cleveland 3, Ohio.

PATENTS "Proof of Invention" Folder mailed without obligation.

E. E. VROOMAN, Registered Patent Atty.
871 Woodward Building, Washington 5, D. C.

PATENTS AND TRADE MARKS
C. A. SNOW & CO.
REGISTERED PATENT ATTORNEYS
WRITE FOR INFORMATION TO
428 SNOW BUILDING, WASHINGTON 1, D. C.

INVENTORS

If you wish to protect your invention, you should take steps to protect it by a U. S. Patent. Write me for "Record of Invention" Form.

CARL MILLER
REGISTERED PATENT ATTORNEY

Woolworth Bldg., 35th Floor, Dept. 87A, New York City
Please send me "Record of Invention" form.

NAME.....
ADDRESS.....

War Surplus Terrific Bargains

Once in a Lifetime



NEW G.E. ARMY AIR FORCES SIGHTING STATION, consists of Lenses, Prisms, Selsyns, Gears, Motors, Pumps and Metal gadgets. May be used for research, experiments, and many other uses. Brand new **\$39.50 ea.** in original package.

ELEC. MOTORS, 1/2 H.P., 27 V. D.C., ea. \$3.50

DYNAMOTORS, G.E., Input-V 27, Output-V 115 D.C., ea. \$4.95

SPEED REDUCERS, G.E. (10 to 1 and 5 to 1), ea. \$4.95

G.E. SELSYN CONTROL TRANSFORMERS, ea. \$1.49

NEW FUEL PUMP VACUUM AIR HYDRAULIC, used for compressors, presses, hydraulic systems, etc., **\$4.95 ea.**

TOGGLE SWITCHES, 5A 125V. A.C. 35 A. 24 V. 12 or more, ea. 29c

In lots of 100 25c ea.

NEW BOMBSIGHT SIGHTING HEAD

TYPE T-1, IN ORIGINAL METAL CHEST, With zipper bag. Made of very costly optical parts and other scientific instruments. (A world of uses) for experiments, research and other scientific purposes, ea. **\$24.50**

Write us for other surplus materials.

All prices F.O.B. Kansas City. Express or postage collect. No COD's. Send check or money order.

SUPERIOR NOVELTY COMPANY

Dept. M-8, 2920 E. 27th St. Kansas City, Mo.



SHAW DU-ALL GARDEN TRACTORS and MOWERS

Get FREE FOLDER NOW!

Get details on 1 to 9 H. P. walking and riding tractors. Do 1000 jobs on small farms, estates, orchards, gardens. Low-priced. Send postcard today!

4508 Front Street, Galesburg, Kans.
668G North 4th St., Columbus, Ohio

SHAW MFG. CO.

TALK-SING thru your own radio with **RADIO MICROPHONE**

Be the life of the party. Put on your own broadcasts at home. Talk-Sing make announcements from any room. Wonderful voice practice. Microphone easily attached to any radio. Follow enclosed instructions. **SEND NO MONEY**—pay postman \$1.98 plus postage. Send Money Order or check and save postage.

EMPIRE RADIO & TELEVISION CO. (Dept. R2) 1521 Bedford Ave. Brooklyn 16, N. Y.

OLD GOLD JEWELRY WANTED

Dental gold teeth, plates and bridges with metal attached. Any broken pieces of gold jewelry. Immediate payment and free mailing container to you or your friends upon request.

LOWES, DEPT PM Holland Bldg., St. Louis 1, Mo.

INDIANA TECHNICAL COLLEGE

Engineering B.S. degree in 27 mos. Aeronautical, Chemical, Civil, Electrical, Mechanical and Radio Engineering. 2-yr. diploma, Air Conditioning and Refrigeration; Drafting. 1-yr. Gov't approved for G.I.'s; Low rate. Earn board. Large industrial center. Demand for graduates. Enter Sept., Dec., March, June. Catalogue, 587 E. Washington Blvd. Ft. Wayne 2, Ind.

Now CHEAP OIL BURNER
FOR HEATING AND COOKING STOVES - FURNACES

HEAT YOUR HOME, COOK YOUR MEALS WITH CHEAP FURNACE OIL

NO MORE SHOVELING COAL OR ASHES. Sensational Fuelizer Starter Vaporizing System turns Cheap No. 1 Furnace Oil, also Range, Heater, Tractor Distillate, Kerosene and like oils into oil heat—one of the quickest, hottest fires known. **LIFETIME GUARANTEE. \$1.00 Bonus Offer for Testing.** We will let you try it in your own stove or furnace for one month. Get yours for introducing. Big profits **QUICK.** Be first. Send in your name today for details and cash in on the tremendous demand for this Amazing Invention.

NORTHWEST MFG. CO., 608-K, Mitchell, S. Dak.

MAKE MORE MONEY IN AUTO BODY and FENDER REPAIRS

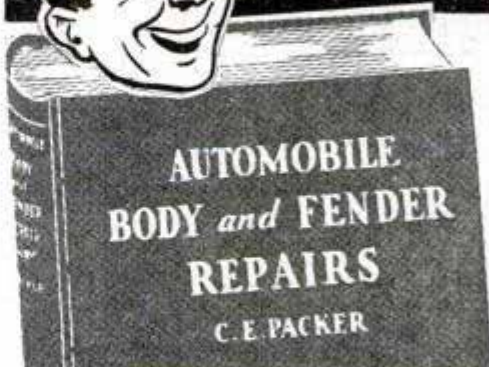

Get This Famous Book Today
FREE TRIAL in Your Home MAIL COUPON

QUICK, EASY, LOW COST! THE HELP YOU NEED!

Do it now! Get yourself a share of the big money car owners are spending to keep their older cars looking good. Get this famous and practical book that will put you right into this profitable business. No previous experience needed. Get a good job or start a business of your own with little or no capital.

Covers Methods, Tools, Equipment! Tells How to Get Business — How to Run a Shop and Make Money

Thousands of copies in use. A winner everywhere. Written by a man who knows the business thoroughly. Easy to use and easy to understand. Covers the use of tools and equipment, gives approved methods; describes materials and shows you how to actually do a professional job, operate a shop, etc. The very latest information and pictures on all interior and exterior body work and fender repairs—the kind of work people everywhere want and will pay big for when you can do it. Ideal for shop owners and every man who wants to get in on the millions being spent to make old cars look newer. Mail coupon today.

OTHER MONEY-MAKING BOOKS

HOUSE WIRING. New 6th edition. Gives complete, practical instruction. Goes further than most books on subject. Gives National Electric Code. 400 pages. 669 illustrations. Electrical work now at new high. Get this fine book. \$3.00

SHEET METAL LAYOUT. Makes sheet metal layout work so simple that anyone can learn. Get this new instructor and get into the easiest, cleanest and best paying part of all sheet metal work. 143 jobs worked out in drawings and carefully explained. Size of book 8 1/2 x 11 inches. Price \$3.50

GET STARTED NOW

To make money, get into body and fender work now—or one of the other big pay fields covered by these books. Select the book or books you need and order now.

Send No Money • Mail Coupon Today

Goodheart-Willcox Co.
2009 S. Michigan Ave., Dept. 1A, Chicago 16, Ill.
Send books checked C.O.D. including charges. If not satisfactory I will return in 5 days and you will refund money paid. (Outside U.S. remit with order). We will pay all postage charges if remittance accompanies order.

Body and Fender Repair, \$3.50 House Wiring, \$3.00
 Sheet Metal Layout, \$3.50

Name _____

Address _____

City _____ Zone _____ State _____

SURPLUS BARGAINS

ASSEMBLE YOUR OWN BINOCULARS!

Complete Optics! Complete Metal Parts!
Save More Than 1/2 Regular Cost



GOVERNMENT'S 7X 50 BINOCULARS

Complete Optics, new and ready for assembly. We supply full instructions. Limit—1 Set of Metal Parts and 1 Set of Optics to a customer.

METAL PARTS—Set includes all Metal Parts—completely finished—for assembly of 7X 50 Binoculars. No machining required. Bodies have been factory hinged and covered. A sturdy Binocular Carrying Case is included with each set of Metal Parts.

Stock #841-H.....\$36.20 Postpaid

OPTICS—Set includes all Lenses and Prisms you need for assembling 7X 50 Binoculars. These are in excellent condition—perfect or near-perfect—and have new low reflection coating.

Stock #5102-H.....\$25.00 Postpaid

NOTICE! If you buy both Binocular Optics and Binocular Metal Parts, add 20% Federal Excise Tax to above prices.

ARMY'S 6X 30 BINOCULARS—Complete Optics and Metal Parts for Waterproof Model. Would retail \$102.00 to \$120.00. All Optics perfect or near-perfect. Metal Parts new and perfect. Assembly instructions included.

Stock #830-H.....\$40.00 Postpaid, plus \$8.00 tax—
Total—\$48.00

NEVER HAS THERE BEEN SUCH A SENSATIONAL BARGAIN AS THIS!

BUBBLE SEXTANT—TYPE A-10

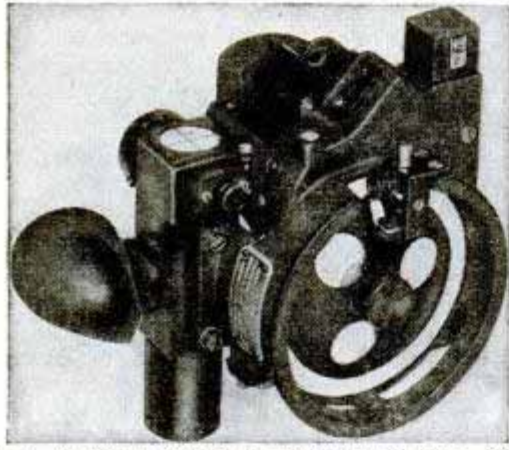

These Army Air Forces Bubble Sextants cost the Govt. about \$200 each. A real bargain at our price of \$12.50! Included with Bubble Sextant shipment is wooden Carrying Case, 5 spare waxed paper discs, flashlight with rheostat for night use (uses ordinary flashlight cells—not furnished) aux. 2-power Galilean Telescope, Allen wrench, 1 spare marking point. Wartime used, but where necessary completely repaired, collimated and put in good working order. If not satisfied that Sextant is exactly as represented, return within 10 days and money will be refunded. Full directions for use accompany each shipment.

Stock #924-H.....\$12.50 Postpaid

BATTERY COMMANDER'S PERISCOPE With Tripod—6 Power Instrument. Excellent condition. Length 27 1/2 inches—diam. 1 1/2 inches. Cost U. S. Govt. approximately \$175.00.

Stock #717-H.....\$20.00 F.O.B. Audubon

MOUNTED KELLNER TELESCOPE EYE PIECE—Perfect coated, in Ordnance sealed boxes. F.L. 1 3/4 inches. Outside dia. of steel mount 40 mm.

Stock #6198-H.....\$3.15 Postpaid

35 MM. KODACHROME PROJECTING LENS SET—Consists of Achromatic Lens for projecting, plus a Condensing Lens and piece of Heat Absorbing Glass with directions.

Stock #4025-H.....\$1.95 Postpaid

SCHMIDT OPTICAL SYSTEM. Black plastic body, size 3-15/16" by 5 1/2". F.L. 2.4".....with amazing speed of F 0.9. Used in Navy's Infra-Red Sniperscope and Signaling Units. Govt. cost \$134. Limit—1 to a customer.

Stock #720-H.....\$6.00 Postpaid

MOUNTED PROJECTING LENS SYSTEM. F.L. 91.44 mm. (just right for 35 mm. Projectors). Speed of F 1.9. Outside dia. of mount at one end 60 mm. Length of mount 64 mm.

Stock #4033-H.....\$3.00 Postpaid

We have literally millions of war surplus lenses and prisms for sale at bargain prices. Write for Catalog "H"—Sent Free!

Satisfaction Guaranteed

Order by Stock No.

EDMUND SALVAGE COMPANY
P. O. AUDUBON, NEW JERSEY

SAY YOU SAW IT IN POPULAR MECHANICS

GET THE BEST IN MUFFLERS V-8 DUALS & SINGLES



Finest Norman custom-built muffler sets—steel pack—torpedo type—heavy, perforated steel cores—chrome enamel finish—mellow, deep tone (improves with use)—designed to fit—all ways superior—double economy.

DUALS.....\$17.50 SINGLES.....\$7.50
V-8 Ford-Mercury Buick, Olds., Chrys.

SINGLES.....\$5.50 ORDER TODAY! Will outlast three ordinary mufflers.

Chev., Ford, Plym. Dealers—Write Today for Full Details

NORMAN'S MUSICAL MUFFLERS

Dept. PM-5, 1216 W. Slauson Ave., Los Angeles 44, Calif.

ELECTRICAL TRAINING

Intensive 32 weeks residence course in fundamentals of industrial electrical engineering, including radio, electronics. Prepares for technician, engineering aides. Approved for veteran training. 54th year. Catalog.

BLISS ELECTRICAL SCHOOL

7638 Takoma Ave., Wash. 12, D.C.



MAKE MONEY CASTING AT HOME

FREE FACTS SENT..



Cast thousands of perfect Plaques, Book Ends, Ash Trays, Etc. Plaster, Liquid Marble, Etc. ENORMOUS PROFITS. Start in basement or garage. LITTLE CAPITAL NEEDED. QUICK, EASY. NO PREVIOUS EXPERIENCE NEEDED. Rubber molds for speed production. MAKE YOUR OWN. Sample Kit \$1.00. Canadian \$1.50. Plastic Arts Studio, Route 5, Dept. 29, Muncie, Ind.



A PENNY POSTCARD MAY CHANGE YOUR FUTURE . . .

Get full information on the coin-operated vending machine industry. Start with a few machines and build to a wonderful future. We'll give you complete advantage of our "know-how."

Send For Free Booklet Today—No Routes Sold!

PIONEER VENDING SERVICE

Address all mail to Dept. PM
461 SACKMAN ST. • BROOKLYN 12, N. Y.

THOUSANDS OF SUFFERERS USE

BREATH EASY

FOR

ASTHMA

CARRY IT WITH YOU
USE IT ANYWHERE

Sold on Money-Back Guarantee

Write To Dept. PM

BREATH EASY DISTRIBUTORS, INC.
65 CEDAR STREET
SEATTLE 1 WASHINGTON

POPULAR MECHANICS

**WORLD'S
BEST
WANT AD
MEDIUM**

CLASSIFIED Advertisements



Advertisements in this section 60 cents per word, each insertion, minimum 10 words, payable in advance
To be inserted under proper classification, copy must be in our office the 25th of the
second month preceding date of issue

F. W. Johnson, Manager, Classified Advertising
Popular Mechanics Magazine, 200 East Ontario Street, Chicago 11, Illinois

**1190 CLASSIFIED
ADVERTISEMENTS**

**1190 OPPORTUNITIES
FOR YOU**

AUTOMOBILES, MIDGET CARS

"BURN Water"—Attention automobile owners, taxi drivers, truck, bus, fleet owners! Convert any car or tractor (1917-1947) to "Water Injection" (like late war planes) for only \$1.00 cost. More power, less gas, less oil, more speed, cooler engine. Includes copyrighted installation manual, complete printed diagrams, detailed directions, history, etc. Send dollar today. Newhouse Industries, 5941 Hereford "S," Los Angeles 22, Calif.

MIDGET Racer plans, blueprints, parts directory, 50c. Sibley, Mendon, Mass.

BUILD Automatic clutch, scooters, midget autos, tractors, shop machines. Catalog free. Nichols Equipment Co., Dept. 111, Purvis, Miss.

TWIN-TONE Mufflers for V-8 and Mercurys 35 to 47 models. Gives more mileage, without back pressure. Mufflers are straight through-type and produce deep mellow tone, \$20.00 a set. Single through-type mufflers for all cars \$6.50 ea. Chrome tail pipe extension 2 1/2" dia. \$2.50 ea. Satisfaction guaranteed. Elmer's Muffler Shop, 139 East Manchester Ave., Los Angeles 3, Calif.

HOLLYWOOD Hot-Rod Manual. Plans, photos, instructions, fast Ford's. \$1.50 p.p. Hollywood Hot-Rod, Box 9626P, Los Feliz Sta., Hollywood 27, Calif.

64 NEW Indianapolis 500 mile race pictures. 48 shots 1946 race. Over 500 photos of "500," 1911-1947. Big 9x12 picture book only \$1. Tower Official Photos, Indianapolis 19.

1947 INDIANAPOLIS "500" Race History Book. Complete details every car, driver competing. 100 photos, charts, drawings. \$1.00 postpaid. Large complete Indianapolis Race History Book, 352 pages, 1100 illustrations, all data 1909 to 1946 inclusive. Postpaid \$3.50; de luxe edition fabrikoid binding, gold lettering, \$5.00. Clymer, Dept. A-80, 2125 W. Pico, Los Angeles 6, Calif.

SELL Personal initialed individualized belts, buckles with beautiful racing emblems of big cars, midgets, motorcycles, also available in lapel pins, tie holders. Fast profits. Repeats. Write today. Special outfit offer. Hook-Fast Specialties, Dept. 30, Box 1425, Providence, Rhode Island.

AUTO Racing magazine subscriptions. Pacific Speedway News, \$6.00 yearly. National Speed Sport, \$4.00. Illustrated Speedway News, \$4.00. All give complete data midget, big car race results. Sample copy each 50c. Specify publication wanted. Clymer, Dept. A-82, 2125 W. Pico, Los Angeles 6, Calif.

SPEED & Mileage manual—Obtain greater speed, mileage, racing performance from any automobile! Includes simplified methods, speed tuning, gas saving secrets. Instructions on building economizers, speed equipment, duals, mufflers, superchargers, racing fuels, fast conversions, \$1.98. Almquist Engineering, Bx. 660, Brooklyn 1.

CLYMERTONE, Twin muffler sets, beautiful sound, complete with necessary welded pipes, E-Z installation. Ford V-8, \$20.00. Chevrolet set with split manifolds, \$37.50. Specify car model. Clymer, Dept. A-84, 2125 W. Pico, Los Angeles 6, Calif.

CLYMER'S Historical Motor Scrapbook No. 4, latest Clymer book old cars and motorcycles. Postpaid \$1.50; de luxe edition, \$2.50. Clymer, Dept. A-88, 2125 W. Pico, Los Angeles 6, Calif.

BELLY Tanks—75 gallon, new, steel. 6 ft. 4 in. \$7.50. Anzio Boat Co., Box 89, Merced, Calif.

AUTOMOTIVE Trouble shooting, 500 questions and answers. \$1.00 postpaid. Charles Nelson, 2908 Washington Avenue, Santa Monica, California.

TACHOMETER Kits for V8-85 \$27.00, V8-60 \$25.00. Kit includes 0-5000 or 0-8000 r.p.m. Tachometer, adapter, cable. Tachometer alone \$12.00. Zakarian Engineering, Box 416, East San Diego, Calif.

MUFFLER Manual. Convert easily to Hollywood, Laguna, Westwood, duals, etc. Includes construction details, regulations, diagrams. Postpaid \$1. Mellotone, Box 723E, Arcadia, California.

"CUSTOM-Styling" Manual. Easily make car look Hollywoodized, custom built, ultra-beautiful! New, simplified customizing, restyling, streamlining methods. Instructions, illustrations. Plans for accessories, refinishing, mufflers, model changes, sport, continentals, convertibles, jeeps, etc., \$2.00. Almquist Engineering, Bx. 660, Brooklyn 1.

AMAZING New way to back automobiles into short parking places. Back in where others fail. Four copyrighted photographs and instructions will make you an expert. Send 25c today for lifetime driving satisfaction. Whitley, 618 Brooks Avenue, Raleigh, N. C.

"STREAMLINED Roadster"—America's lowest priced car! Small, speedy, two passenger sportster! Amazingly easy to build from inexpensive material, small motor. Complete instructions, drawings, \$1.98. Almquist Engineering, Bx. 660, Brooklyn 1.

PROFESSIONAL Midget racer, motor-scooter, midget roadster, and midget motorcycle. Plans, specifications for all four contained in illustrated handbook. 25c. Big list bargain priced used motors, motorscooters, servicycles, etc., included free! Midwest, 3839 Drummond, Toledo, Ohio.

R & R Mfg. Co., marine and auto division. Anderson, Indiana. Robert M. Roof, \$1.00 for our new 1947 speed and power equipment catalogue with price sheet—showing racing cars, midgets, speed boats with recommendations how to rebuild your motors for racing. Dual ignition racing cylinder heads for V-60-100 and Mercury Ford engines. Dual intake manifolds, racing pistons, camshafts, compound valve springs, Lynite flywheels, quick change gear boxes and numerous other supplies.

DUALTONE Chrystalline packed mufflers. Single or twin mufflers for all cars. Duals priced complete V8's \$23.90, six cylinders \$33.00, eight cylinders \$36.00. Large chromed tailpipe extensions \$3.30. Polished carburetor velocity stacks \$1.30. Chromed Station Wagon stacks \$15.00. Request catalogue. Dualtone Mufflers, 2636C India Street, San Diego 1, California.

BUILD Speedy midget track racer from castoff parts! Plans, specifications, construction information, \$1.00. Motor Supply, Box CS-1682, Toledo, Ohio.

AUTOMOBILE Racing book, fifth edition, well illustrated. Instructions on building bodies, frames, engines, Ford A and B conversions. Plans, AAA rules, specifications. Roadster racing, Indianapolis cars. \$1.00 postpaid, \$1.30 C.O.D. Ray Kuns, Dept. 47, Madisonville, Cincinnati 27, Ohio.

CUSTOMIZE Your automobile. Illustrated, new restyling ideas, instructions, suggestions, specific model changes by simple methods. Postpaid \$1. Speedwheel, Box 723-E, Arcadia, California.

MAKE Your Ford fast! Complete details, photographs. How to construct 120 m.p.h. Hotrod. \$1 postpaid. California Bill, Box L-1, Eaglerock, Los Angeles 41, Calif.

SEE Our ad under Motorscooters for midget car bargains. Midget Motors Directory, Athens, Ohio.

AUTO SUPPLIES AND EQUIPMENT

AUTO Glass! Shock absorbers! Direct factory savings. State make, model, parts desired for immediate shipment or lowest quotations. Cooper Automotive Services, 3135 Lawrence, Chicago, Illinois.

CLOSEOUT Large stock auto seat covers. Full sets \$7.95. Fronts \$4.95. Cover Co., 1911-N, Lubbock, Texas.

AUTO Parts for all autos and trucks. Trans., motors, differentials, fenders, carburetors. Also body parts. Security Auto and Truck Parts, 1923 BJ Grace, Chicago 13.

DISTRIBUTORS Wanted for Ernie Tire Inflator, sample \$1.00, details free. Kramer Industries, P.O. 3505, Cleveland 18, Ohio.

DAB. Wipe-on auto paint color cards 25c; five \$1.00. Dab Distributors, 1911-N, Lubbock, Texas.

BIG Money in auto supplies, parts, radios, ammunition, guns, home supplies. Wholesale catalog for dime. Main Supply, Fairfield, Ill.

RECLAIM And save on motor oil! Inexpensive, clean, easy method. Guaranteed instructions and plans \$1.00. Oil Reclaimers, 233 North Kenneth, Chicago 24.

PROTECT Your car or trailer with Rapid-Glo that cleans, polishes and glazes in one easy operation. A little does a lot. Postpaid \$1.25 per pint. Results guaranteed. Sales franchise to gasoline station operators upon request. Rapid-Glo Products Company, 1024 Vernon Street, Grand Rapids 3, Michigan.

INITIALS For car, luggage, sports equipment, etc. Set of sixty, black on gold, 66c. Tepper Bros., 4301-18th Ave., Brooklyn 18, N.Y.

ATTENTION Chevrolet and GMC owners—If car or truck propeller shaft is worn, save replacing it by having National M-101 or M-102 Drive Shaft Bushing & Seal Assembly installed by your dealer, garage or repair-man. Unnecessary to tear down differential, goes back of U-joint, over old propeller shaft. New heavier bushing on unworn part of shaft saves buying new shaft. New, heavier seal protects transmission and differential by confining lubricant to proper cases. Quick repairs, low cost! Thousands in use throughout nation. If your dealer doesn't have M-101 or M-102, write National Machine Works, Box 4305, Oklahoma City 9, Okla.

PAINT Your car easily and quickly for \$6.95. No experience necessary. For free details write postcard to: Specialty Co., Dept. D, Box 243, Waco, Texas.

PLATINUM Ignition points for your car's nerve center. \$5.69. Jacon Industries, 3 Seaside Terr., Lynn, Massachusetts.

NEED Auto parts? We have them. New and rebuilt. Prompt shipment. Write requirements. Save money. Buy direct. (See our display advertisement page 254). Factory warehouse. Mechanics Auto Parts, 3807-PM-8 North Ashland, Chicago 13.

AMAZING Discovery. Master Glaze, puts brilliant glass-like surface on cars. Free sample, information. Big commissions. Master Glaze, Dept. 615, 7720 Harwood, Milwaukee, Wis.

MANIFOLD Whistle—Imitates "wolf whistle," siren, etc. Installed on any car manifold in 15 minutes. Send \$6.00 to Protectured Company, 4033 Windsor Rd., Youngstown 7, Ohio.

GRILLES For all cars. Meyers Auto Parts, 820 Dryades, New Orleans, La.

SELL Tires—Make money. Standard makes, first quality. No investment or experience required. Direct Tire Co., 962 E. 129 St., Cleveland, Ohio.

NEW And used automobile and truck parts. Lowest prices. Complete stock. Prompt reply. Babbitt Auto Parts, 2833 W. Chicago Ave., Chicago 22.

TIRES. Firestone, retail, wholesale. Page & Breton, Franklinville, N. Y.

GASOLINE Economizer. Ford, Mercury, Chevrolet, 1932-1947. Dodge, Plymouth, 1933-1938. Buick, AAV16. \$1.00. Walert Co., 3429 No. Tenth St., Milwaukee 6, Wis.

HAVING Car trouble? New, used, guaranteed auto, truck parts save money. Transmission specialists. Describe needs; immediate reply. Victory, 2930 1/2 Northwestern, Chicago 18.

PLATING Outfits for auto parts. Connect to a battery. No tanks used. Free particulars and proofs. Gunmetal Co., Ave. J. Decatur, Ill.

BURN Water in your car. Costs less than gas. More power, cleaner motor. Mail card for data on \$17.50 octa-gane water injecting carburetor. Ralph A. Shade, 563 Lake Road, Webster, N. Y.

AUTO TRAILERS

MANUAL Trailer, 17 foot Streamliner has everything. Circular illustrates 14 to 26 ft. designs, 10c. Craftsmann Books, Box 1153, P3 Milwaukee 1, Wis.

SOFT Tire indicators for trailers. \$5.95. Laidlaw Mfg. Co., Box 1108, Pasadena 20, California.

TRAILER Coaches—Learn about all types—sports, living or travel. Approximately 100 pages monthly; magazine tells all. Special rate, \$1 the year. Trail-R-News, Box 431-A, Glendale, California.

BUILD Your own trailer! Save money! Have every feature you want! Plans for house, sport, camp and utility trailers. Catalog describing 9 models 10c. 15c in Canada and overseas. Jim Dandy, Box 125-A, Wausau, Wisconsin.

MOTORCYCLES, BICYCLES, MOTOR-SCOOTERS AND SUPPLIES

1947 MOTORCYCLE Catalog. 15c. Indian and Harley parts. Pistons, chains, sprockets, carburetor and motor rebuilding, batteries, tires, chrome accessories. Bootz, 622 East Grand, Des Moines 9, Iowa.

WHEELS Of every description, 10x2.75 single valve tube pneumatic wheels @ \$7.25 each, 10x2.75 semi-pneumatic wheels @ \$6.75 each. Write us for free catalog. Jim Brown Toy Company, 1097 Home Avenue, Akron, Ohio.

MOTORCYCLE News—monthly. Yearly subscription \$1.00. Introductory copy 10c. Motorcycle News, 5424-A Sawyer, Chicago 25.

CUSHMAN Motorscooter \$15. Shaw bicycle motor \$15. Harley-Davidson motorcycle, \$35! Send 25c for bargain catalog #8 packed with money saving buys in motorscooters, motorbikes, midget cars, motors, wheels, tires and parts. Gail and Company, 538 Erie, Toledo, Ohio.

WHEELS, Axles, etc., for small cars. Behnke's Auto Supplies, 5721 Leland, Chicago 30, Ill.

BEAUTIFUL Bicycles, all sizes, new low prices. Send dime for list. Wholesale, retail. Century Cycle, 3447 Lawrence, Chicago, Illinois.

CUSHMAN Motorscooter \$20 (includes motor and extra tires). Midget racer \$15! Send 25c for big catalog #938 listing these and scores of other sensational bargains in motors, wheels, motorscooters, motorbikes, servicycles, tires, etc. Associated, Box CS-1764, Toledo, Ohio.

MOTORCYCLE Parts, new and used. Harley, Indian, Henderson, Super-X. List 10c. Ballak, 811 N. 9th. St. Louis 1, Mo.

MOTOR Scooters, bicycle engines, 120 miles gallon. Dime for catalog. Clymer, Desk A-85, 2125 W. Pico, Los Angeles 6, Calif.

MOTORBIKES. Scooters can now be equipped with the Tyco motorcycle type throttle control. Fits standard 7/8" handlebars. \$2.50 m.o. Moneyback guarantee. Tyco Engineering Co., 2225 Hervey, North Chicago, Ill.

MOTORCYCLE Cams ground for speed and power, carburetion. For information write Harold Schaller, 247 West Main, Turlock, Calif.

BOYS, Repair your own bike. "Bicycle Repair Manual" teaches brake repairing, rebuilding wheels, etc. 65c. Robert Klausner, Shelbyville, Ill.

TIRES, Inner tubes, wheels, for small trucks, wheelbarrows, power scooters, midget cars, farm equipment, carts, etc. Sizes 8" to 18" o.d. in 2, 4 and 6 ply first-line quality tires, with removable inner tubes and heavy duty demountable wheels. Also caster forks, straight or swivel types. Free circular and prices. Jahant Co., 626 East Exchange Street, Akron 6, Ohio.

1930 TWIN motorcycle \$25; motorscooters less motors \$15.75 up; motors \$3.50 up; Whizzers \$25 up; professional midget track racer; plenty midget racers for highway use; plenty brand new two horsepower motors in original crates; over 6500 small balloon tires for motorscooters and small cars, \$1 up. Mailorder only. Send 25c for Big War-Bargain Catalogue Number Nineteen, just out, listing the above and hundreds of other bargains in both new and used motorscooters, midget cars, motors, outboards, mowers, etc. (35c by first class mail). Midget Motors Directory, Athens, Ohio.

WHEELS—Steel disc, rubber tired, sizes 5"—6"—7"—8"—10". Available. United Wheels Mfg. Co., 11727 La Fayette Ave., Chicago 28, Ill.

HARLEY-DAVIDSON Parts, accessories, batteries, tires, and repair work. 24 hour service. Authorized factory dealer. Philadelphia Harley-Davidson Company, 857 North Broad Street, Philadelphia 23, Penna.

WHEELS! Build wagons, scooters, mowers, trailers, wheelbarrows, grocery carts, baby carts, play pens, baby carriages, 4' to 16". Free list. Truilen Mfg. Co., 811 E. 31, Kansas City, Mo.

BICYCLE Book, how to buy, rebuild, sell used bicycles 50c. John Collett, Handley, Texas.

TIRES And industrial wheels, suitable for scooters, wheelbarrows, farm equipment, etc. All sizes. Bicycles and accessories. Largest assortment in America. Send dime for list. Cycle Transport Company, 1241 So. Michigan Ave., Chicago 5, Illinois.

BUILD America's lowest priced motor-scooter speedster! Complete plans, specifications, \$1.00. Big list bargain priced used motors, etc., included free! Motor Supply, Box 1682-CS, Toledo, Ohio.

LARGE Stock Indian parts. Expert motor rebuilding. New and rebuilt Chief motorcycle, motors only. Indian Motorcycle Sales, Kansas City 1, Mo.

HARLEY-DAVIDSON—New and used 45" motors, service, parts, accessories, tires. Send \$2.25 for army motorcycle manual, 10c for bulletins. Knuth's (Harley-Davidson factory dealer), 2491 Fondulac, Milwaukee, Wis.

AVIATION

BUSHEL Basket full of surplus aviation items; electrical, radio, instruments. Used or damaged. Valuable source of parts. No c.o.d.'s. Shipped collect charges express, freight (state which). Bushel basket full, only \$9.95. Southwest Aero Supply, Box 468, South Houston, Texas.

VETERANS: Flight training under G.I. bill. Private, commercial and flight instructor ratings. Write for information. Gottschalk School of Aeronautics, Adrian, Michigan.

1945 STINSON Reliant, 5 place, 300 h.p., 80 hours, full instruments, licensed, plastic interior. Price \$6950.00. Penn Motors, 385 S. Oakland, Sharon, Penna.

SENSATIONAL Bargains in used Cubs, Taylorcrafts, etc.! Big, thousand-item catalog, 25c. (Includes listings of "easy to repair" crackups). National, Box 1682-CS, Toledo, Ohio.

B-29 COMPUTERS, 400 Cycle dynamometers, 60VDC Amplidynes and Servo amplifiers, turret drives, bomb releases, starter solenoids, collector rings. List. Erec. 2912 Hewitt, Everett 1, Washington.

AVIATORS Leather fleece lined boots, new zippers, used, size 9 and above, \$5.95. \$10 gold rimmed sun glasses, \$4.95. Stainless steel streamered six volt hand lantern, \$2.95. Airplane safety belts, \$2.00. Aero Parts Supply, Municipal Airport, Houston, Texas.

PROPELLERS—Airliner 3 blade, 2 blade, designed for ice-snow sleds, boats. Literature, Box 387, Ft. Worth, Texas. Standard Aircraft.

AVIATION Computractor navigation computer and protractor. Transparent pocket size \$1.25; plotter ideal charting navigation problems 60c; compass course protractor 60c; complete instructions, pilot log book, 100 pages, durable flexible binding, \$1.25. Send cash, check, money order or c.o.d. Pan Aero Company, 2054 No. Argyle, Los Angeles 28, Calif.

GIANT Glider kites. Double. 14x10 ft. Lifts 100 lbs., tows car, etc. Cost government \$108. Yours for \$20. Satisfaction guaranteed. Great Northern Mart, North Adams, Mass.

ENTER Aviation, U. S. or foreign. I can help you. Free information. Miller, 1333—18th Street, Santa Monica, Calif.

BATTERIES, GENERATORS

NEW Exide aircraft storage batteries, shielded, dry-charged, 12 volts, 17 amp., ideal for "ham" radios, government cost \$75.00, sacrificed \$6.95. Air Transport, Mineola, N. Y.

EDISON Non-acid lifetime storage batteries for home lighting, motors, radios, etc. Free complete interesting literature. T. Hawley Smith Company, Croton Falls, N. Y.

ELECTRICAL SUPPLIES, EQUIPMENT

FREE Catalog of build your own electric lawnmowers, motors, welders, freezers, fencers and electrical items. LeJay Company, Minneapolis 8, Minnesota.

LAMPS—All parts to build or repair. Catalog 10c. Gyro Lamps, 5416 Clark, Chicago 40.

MICRO Switches! All new! Type Z, \$2.00 value. Special \$1 or 12 for \$10; large micro switch, catalog No. WZETRQ-9TN, \$4.00 value. Now \$1.50; GE midget precision micro switches \$1.25 value, 50c each. Combination assortment, variety of 6 micro switches—only \$5. Real buy! No c.o.d. "Amazing Bachman's," Dept. KL, 23 Herman Street, Rochester 5, N. Y.

MAGNET, "Alnico" 4 oz. Horseshoe, powerful (lifts about 5 lbs.), \$1.00, 8 oz., (lifts 10 lbs.), \$1.50, 3 lbs., (lifts 20 lbs.), \$5.00 postpaid. Ross, C68 West Broadway, New York, N. Y.

BUILD Your own or electrify old clocks for fun and profit. Genuine, self-starting Synchron movement complete with hands. \$4.95 prepaid. Scott Industries, 306 E. McMillan, Cincinnati 19, Ohio.

BUILD Your own lamps. Save half. Be different. Write for free photos, also lamp parts. Buddy Products Mfg. Co., Dept. 30, 1123 W. Belmont, Chicago, Ill.

TATTOOING Machines, outfits, world's finest. Free catalogue. Jensen, 120 West 83rd Street, Los Angeles 3.

GRAB Bag, all brand new; box containing airplane lights with lenses, bulbs, toggle switches, plenty wire, spaghetti, terminals, plates, mountings, grommets, nuts, screws, rivets, washers, plugs, box, etc. Weight, 6 lbs., \$2.79 plus postage. Aero Instrument Company, Mun. Airport, Houston, Texas.

ELECTRIC Wire: Tirez 2 conductor #8 16 1/2 ft., 12 conductor #16 17c ft. Armored 3 conductor #10 9c ft. Over 1,000,000 feet in stock. 200 types including, rubber covered, braid covered, lead covered, lead armor and armored. Free list. Erec. 2912 Hewitt, Everett 1, Washington.

FRICITION Tape—(Gold Seal)—1/2 lb. package, 1 1/2" size, 7 rolls for \$1, 100 roll lots, \$10. Unsurpassed value! Order now! No c.o.d. orders. "Amazing Bachman's," Dept. KL, 23 Herman Street, Rochester 5, N. Y.

ELECTRIC Pen—Burns: Wood, plastics, etc. Embosses gold or silver leaf, \$2.00 postpaid. C.O.D.s accepted. Reb Industries, Box 265-X, Elmhurst, Illinois.

MAGNET Wire! 1/2 lb. coils No. 22. All new! Special 35c each, 3 for \$1. No c.o.d. "Amazing Bachman's," Dept. KL, 23 Herman Street, Rochester 5, N. Y.

ELECTRIC Pencil—Writes, engraves all metals. Battery model \$1.00—110 volt model \$2.00 postpaid. C.O.D.s accepted. Reb Industries, Dept. 265-X, Elmhurst, Illinois.

ELECTRICAL Instruments—Meters repaired and calibrated. Correspondence invited. Haledon Electrical Instrument Co., 319 Belmont Ave. (Haledon), Paterson 2, New Jersey.

EXPERIMENTERS. Student scientists—Experimental science manuals and kits. Send for list. Queens Experimental Supply Co., 25-12 Steinway Street, Long Island City 3, New York.

MAGNETS Alnico—free list. Terry Sales Company, 3726 South Detroit Avenue, Toledo 9, Ohio.

ELECTRIC Pencil: Writes, engraves all metals. \$1.00 postpaid. Beyer Mig., 229-H Dixon Blvd., Uniontown, Penna.

WELDING, SOLDERING, PLATING

NEW Model electric welder 110 volt a.c.-d.c.: will weld all metals; easy to use; full directions. Complete with power unit, flame and metallic arc attachments, carbons, fluxes, rods, mask; all for \$19.95. Used by the navy. Magic Welder Mig. Co., 229 MP8 Canal St., New York City.

ARC Thermatorch—Use with all welders. Best made. Use Plymouth-Arc carbons. All sizes for all torches. Bayonet plugs made to order. Money-back guarantee. Plymouth Equipment, 358, Plymouth, Michigan.

OXY-ACETYLENE Welding outfit including: Full oxygen and acetylene cylinders. \$72.95 complete, f.o.b. Cleveland, Ohio. New, supply limited. Check or deposit with order, balance c.o.d. Cylinders can be refilled anywhere. Ideal for hobbyists, garages, repair shops, etc., includes supply of rod. The Burdett Oxy-Weld Equip. Co., 3399 Lakeside Avenue, Cleveland 14, Ohio.

SEND For free samples sensational electrode. Use with any make 110 or 220 volt welder. All diameters available. Plymouth Equipment, 358, Plymouth, Michigan.

SOLDERTAPE Containing non-corrosive flux for small electronic work. Sixty inches 98c. M & G Hearing Aids Co., Dept. P3, P.O. Box 517, Wellston Station, St. Louis 12, Mo.

SAVE 50% On electric welders, torches, helmets, etc. Holgeron's Service, Canton, Kansas.

GOVT. Surplus generators, P1 aircraft, 200 amps., 28.5 volts, 5700 watts. Mig. by Ford motor. Low speed. Full rating at 2200 r.p.m. Easily converted into welder, etc. New in original case. Wt. 62 lbs. \$46.75. Keith Thorndyke, Pipestone, Minn.

ACETYLENE Welding outfits, new, with regulators, torch, tips, hose, connections, clamps, lighter. Limited quantity. \$29.95. Eagle Welding, Dept. PM, 5085 Broadway, Chicago 40.

FULL Information on how I successfully weld, braze, and solder gasoline tanks without explosion. Send \$1.00 to Alfred Schlatter, Francesville, Indiana.

WELD. Cut, braze with gasoline! Amazing discovery shatters costs. Range jewelry to railroad steel. For farm, factory, shop. New opportunities. New wealth. Important! Investigate. Matthews Mfg. Co., Calgary 21, Canada.

ELECTROPLATING Booklet includes full directions for plating jewelry, small parts, metallizing baby shoes. 50c. Hoover & Strong, Inc., 113 W. Tupper Street, Buffalo 1, N. Y.

WELDERS: New 200 ampere aircraft generators \$25.00. Blackhawk Distributors, Box 89, Olathe, Kansas.

A.C. Welders, 110 v., welds 1/2" steel, \$29. Money back guarantee. Paul Morris, 1850 State St., Schenectady 4, N. Y.

WELDING. Cutting, aircraft welding and soldering equipment. Electric arc welders. Superior Oxy-Acetylene Co., Hamilton, Ohio.

MACHINERY, TOOLS AND SUPPLIES

MACHINE Tool castings for woodwork-ing and metalworking tools. Machine them yourself, save up to 80%. Catalog describing 23 Lewis tools and projects sent for 10c. Lewis Machine Tool Co., 3217 Union Pacific Avenue, Dept. M, Los Angeles 23, California.

NEW Band saws for home or factory use. Special \$14.95. Your check or c.o.d. Circular free. Woodcraft Tools, 147 East Lake St., Minneapolis, Minn.

MILLING Cutters—Highspeed steel, re-grinds miscellaneous tools, carbide tips, half price. Hurry. James Kish, 1040 Vine-wood, Detroit 16, Michigan.

HOME Workshop labels. Send postcard for free sample. Hinds, 223 Second, Niagara Falls 1, N. Y.

NOW You can saw and file with hand drill. Revolutionary tool. Agents wanted. Dingerson, Georgetown, Colorado.

SHEBEL Saw filer \$7.50. Files all saws. Circular. Free trial. Shebel, 730B S. 2nd St., Milwaukee 4, Wis.

MACHINIST Tools and supplies. Diamond emery wheel dressers. Write Precision Tool Service, 55 E. Washington, Chicago 2, Ill.

DRILL Grinder for twist drills \$2.95. See ad on page 254.

TOOL Steel kit—25 6-inch rods, assorted diameters—for making small tools, drills, etc.—\$1.95 postpaid or c.o.d. Steel combination rule and depth gauge included. Extraordinary value. Bessemer Steel Co., Dept. 12, Chicago 19.

GEAR Reductions! Values ranging from \$50 to \$1100 each. All new! Complete with 1/2 h.p. motor a.c. or d.c. 110 volt. 25 or 60 cy. Single phase. Variable speeds. Bearing assembly with machined gears. Absolutely the thing for sanders, polishers, winches, hoist, conveyors. Adaptable for many uses. Special \$39.50. No c.o.d. "Amazing Bachman's," Dept. KL, 23 Herman Street, Rochester 5, N. Y.

GETS Saw teeth uniform. Details, Teeho, 316 North 2, Maywood, Illinois.

MECHANICS, Machinists, Hobbyists, Note! Amazing dual-drive assembly, geared 7 to 1 reduction, is driven by powerful 1/5 h.p. a.c. or d.c. motor. Operates on 6, 27 or 110 volts, 60 cy. Single phase. Simple standard attachments convert this amazing unit into a dual hand or table drill, polisher, buffer, router, sander, countless other uses. May be used as individual drill, sander, etc., by detaching flexible drive shaft. This wonder machine shop all in one comes set-up as drill equipped with 3 flexible-drive cables and mounting bracket. Original cost to government over \$300.00. Now! While they last, \$19.50. No c.o.d. "Amazing Bachman's," Dept. KL, 23 Herman Street, Rochester 5, New York.

HEIGHT Gages: 18 inch McGrath vernier height gages in wood case at 1/2 price. Guaranteed accurate. \$58.50 c.o.d. Overstocked. The Chief Tool Co., 138 E. Lake St., Minneapolis 8, Minnesota.

MACHINISTS, Hobbyists, Experiment-alists, Note! Precision built right angle drives. Excellent for home workshop. Complete with flexible drive cable. Only \$3.50. No c.o.d. "Amazing Bachman's," Dept. KL, 23 Herman Street, Rochester 5, New York.

ALUMINUM Handles. For socket screw keys. Wittle Manufacturing, 1041 Lititz Avenue, Lancaster, Penna.

LAY Cement block faster, more accu-rately. "Kingsley Bonder" does the job. Saves time and material. \$2.00 postpaid. Distributors wanted. Kingsley Shop, P.O. Box 1832, Atlanta, Ga.

HOME Shop owners attention.—Send for actual photograph and sample of the work our attachments will do. The photograph and sample speak for themselves. Have fun in your home shop. Cut gears, sprockets, ratchets, lay out holes accurately, cut keyways, build complete clocks and other interesting jobs. Build these attachments yourself from our reasonably priced blue prints. Don't limit your lathe to round work only. The Home Shop, 415 Raymond Avenue, Glendale 1, California.

WAR Surplus in small tools for machine shop—Send 15c for bulletin. Travers Tool Company, Dept. P, 5 Court Square, Long Island City, N. Y.

V-BLOCKS At low prices, 10 sizes for all purposes. Free literature. Miles Products, 2532 Wabash, Chicago 16.

CONCRETE Building block machines and molds. Catalog free. Concrete Machine Co., 5129 South Compton Ave., St. Louis 11, Mo.

DRILL Grinder—Grinds drills to factory accuracy. Calipers with direct reading scales. Circle cutters. New Tool grinder. Lowest prices. Free literature. Factory, 811-B East 31st, Kansas City 3, Mo.

DRILLS-TAPS — Reconditioned high speed, up to seventy-five percent off list. Send for free circulars. Perry Screw and Bolt Corporation, 4250 Grand River, Detroit 8, Michigan.

BOATS, OUTBOARD MOTORS, ETC.

CONVERT Your Ford V-8 to marine use. Water-cooled manifolds and all parts needed for only \$89.50. Conversion kits for jeeps, too. Prompt delivery on marine reverse gears for both Fords and jeeps. Complete catalogue 25c. Arthur Gershel, 51 Chambers St., New York 7.

ARMY Surplus rubber rafts. Big (21'x 6'x2'), Govt. price \$487.00. Complete for only \$29.95. Many uses. Money orders f.o.b. Chicago. Franklin-Weber Motors, 6111 N. Clark St., Chicago, Illinois.

CANOEES, Sails, canoe equipment, rud-ders, lee boards, etc., canvas, airplane wingdope, double blade paddles, carbide lamps, marine paints. Sailboat and motorboat supplies, catalogue. Alan-Clarke, 96 Chambers, New York City.

CATALOGUE Over 30 plywood plans—Kyacks to Cruisers—sent with William Deed's book "Plywood Building," send \$1.00. Marine Mart, Buffalo 7, N. Y.

TWENTY Plywood boat plans \$1.00. Catalog boat building plans 10c. The Rudder, 15 Murray Street, New York.

FIR Plywood—Waterproof marine grade for boat-building. 1/4" thickness 48"x96" \$6.40; 48"x144" \$12.48; 48"x192" \$16.64; 3/8" thickness 48"x96" \$9.60; 48"x144" \$15.84; 48"x192" \$21.12; 1/2" thickness 48"x96" \$11.20; 48"x144" \$18.24; 48"x192" \$24.32. Terms: Cash with order; shipment by express or freight. Carmen-Bronson Corporation, Dept. M-10, Mount Vernon, N. Y.

BUILD Your own boat by the Welch sys-tem, with knock-down kits. Save 2/3 cost. All models available. Send 10c for illustrated catalog. Midwest Boat Company, Menomonee Falls, Wisconsin.

AIRPLANE Jettison tanks —Stream-lined. 10 1/2 foot, tear drop shaped. 165 gallon. Of light weight lead coated steel, weighs 75 pounds. Floats over 1200 pounds. Ideal for making trim, inexpensive boats, canoes, kayaks, dinghys, duck boats, powered catamarans and runabouts. Prices \$12.50 complete. \$9.75 each for three or more. U. S. freight prepaid. General Sales, 205 Market, Grand Rapids 3, Michigan.

SURPLUS Aperiodic navigation compass with adjustable compensator magnets, 6" radium dial, rotating verge ring, jewel bearing in liquid-filled bowl. \$12.50. Salvage Supply, 3620 Agnes, Corpus Christi, Texas.

NEPTUNE Outboard motor parts, com-plete stock. Limited supply new motors, 1 1/2 to 9 1/2 h.p. Citizens Supply Co., P.O. Box 1241 M, Muncie, Indiana.

FOLDING Kayak plans \$1.00. 10 1/2 or 15 feet. H. E. Ward, 13211 Whitcomb, Detroit 27, Mich.

MARINE Power—Easily convert any Jeep or Ford motor (domestic or foreign) with Convo parts and kits. Complete catalog 25c (coin). Osco Motors Corporation, 2020B East Orleans Street, Philadelphia 34, Penna.

CARTOP Rowboats, Kayaks. Weldwood ready cut kits. Booklet, E. J. Croot Co., #103-D, Basking Ridge, N. J.

TACHOMETERS 0-5000 And 0-8000 r.p.m. \$12.00, specify rotation. Zakarian Engineering, Box 416, East San Diego, Calif.

P-38 BELLY Tanks, new, steel, 10 ft. 2 in. 165 gallon \$9.95. Anzio Boat Co., Box 89, Merced, California.

PROPELLERS —Airpulsion. Airliner 3 blade, 2 blade. Literature. Standard Aircraft, Box 387, Ft. Worth, Texas.

PROPELLERS: New army surplus, Mich-igan, 3 blade bronze, 12"x10" r.h.: 3/8" hub bore. Made for Johnson 22 h.p. outboard. Modify for other engines. Only \$5.65 each postpaid (with order). We will increase pitch to 11", 12" or 13" at \$1.00 additional per each propeller. Baker Bros. Supplies, Box 301-C, Palatine, Ill.

MARINE Catalogue, over 5,000 deliver-able items, pictured, priced. Send \$1.00. Marine Mart, Buffalo 7, N. Y.

NEW, Used, rebuilt marine motors. Marine conversions, fittings. Free catalog. Stokes Marine Supply, Dept. 24, Coldwater, Michigan.

KAYAK Blueprints, deluxe models—catalogue 10c. Viking Canoes, Merrick, N. Y.

OUTBOARD Motor parts, new and used, for all makes. New pistons, standard and oversize. Cylinders rebored. Outboard Motor Mart, Inc., 309 Atlantic Ave., Boston 10, Mass.

ALL Copper water jacketed exhaust manifolds for marine conversions of automobile and aviation engines and marine engine replacements; any make, model or age. Joseph Van Blerck & Son, 391 Woodcleft Ave., Freeport, N. Y.

MARINE Conversions for Ford and Jeep engines. Catalog 10c. Lehman Manufacturing Company, Department D, Newark 2, New Jersey.

USED Outboard motor parts. Outboard Exchange, 1194 Remsen Ave., Brooklyn 12, N. Y.

BOATS And all about them. How to select, build, repair and operate. For 40 years the leading practical boating magazine. Half price trial subscription. 12 issues for \$1.00. Motor Boat, 62 Gold Street, New York 7.

BOAT Designers are highly paid profes-sionals. Complete course by mail. Catalog. Westlawn, Montville, N. J.

COMPLETE Constructional details on seventeen low-cost boats—power, sail, row. Designed for home builder with limited tools, no experience and little money to spend \$1.25. Popular Mechanics Press, (C-43), 200 E. Ontario, Chicago.

ENGINES, MOTORS, DYNAMOS

MOTORS!—1 h.p., ball-bearing, 110 V, a.c. or d.c. units. Convert surplus yourself—efficient, inexpensive, good regulation, (no series field), no transformer req'd. Diagrams and instructions from experienced engineer. Send \$2.00 (money order or cash). P.O. Box 2284, Hollywood 28, Calif.

"BUILD Your Own" gas drive arc welder easily with Hobart Generator. Save \$300 to \$500, and need only add used auto engine and chassis to build portable gas drive welder that goes everywhere after profitable construction and repair jobs. Write for free instruction book, further details, Hobart Brothers Co., Box M-873, Troy, Ohio.

NEW Lauson 4 cycle motors— $\frac{3}{4}$ h.p. also $1\frac{1}{2}$ to 2 h.p. Arthur Gershel, 51 Chambers St., New York 7.

WELDING Generator, 150 ampere, \$47.50. Other bargains, Butler, 1885 Milwaukee, Chicago.

MOTORS! 27-Volt D.C. All new. Geared for 120 r.p.m. operates on a.c. with transformer or power supply. Can be used for model railroads, counter or window displays. Countless other purposes. A must for the workshop. Government cost over \$30.00. Now, only \$2.95. No c.o.d. Order today! "Amazing Bachman's," Dept. KL, 23 Herman Street, Rochester 5, N. Y.

MOTOR 25c. Flashlight cell operates. Parts complete, plus instructions. Two 45c. Send today! Eitro, Deer Park, N. Y.

HOLTZER-CABOT 148H 400 cycle inverters, unused, repainted, tested, \$14.75. Erec, 2912 Hewitt, Everett 1, Washington.

RANGER Engine-Aircraft. All new in original case, 570 hp, 12 cyl. V type. Engine Spec. No. 177. Complete with spark plugs. Original government cost over \$12,000.00 each. Special offer \$200. Crated weight 1200 lbs. No c.o.d. Write for complete description. "Amazing Bachman's," Dept. KL, 23 Herman Street, Rochester 5, N. Y.

A.C. 110-Volt motors. Selsyn Syncro differential. New in original package. A bargain at \$1.75 while they last. Lyell Hardware, P.O. Box 5, Rochester 11, New York.

CUT The tallest grass or weeds with a versatile power mower built from odd parts around home. Instructions \$1.00. Chas-Mower, Route 5, Box 159-D, Shreveport, Louisiana.

A.C. Motor winder, winds concentric coils for electric motors, adjustable $\frac{1}{8}$ to 2 h.p. Send for bulletin. Motor Industries, Quincy, Illinois.

DEALERS—Sell electric motors, gas engines, light plants, a.c. and d.c. generators, fans and ventilating equipment. Catalogue 10c. CMCO, 514 Van Buren, Chicago 7.

WINDING Data, listing 225 motors, single and three phase, \$1.00. Motor Data Co., Box 7631, Kansas City 3, Mo.

ATHLETIC EQUIPMENT, BODY-BUILDING COURSES

HEALTH—Build perfectly developed body. Enjoy youth, power, personality, popularity, success—fast and easy. World's greatest system. Results guaranteed. Literature free. Todd Foundation, 210-T Fifth Avenue, New York 10.

DEADLY Judo—Fiercest fighting technique. Trick knockouts. (200 photographs—plus illustrations). Expert instructions. Three volumes. Complete \$2.25. Variety House, Box 46-BU, Wall Station, New York 5.

ACROBATICS—Hand balancing, easily learned. Write. Power, 923a W. Vine, Kalamazoo, Michigan.

BARBELLS! Catalog! Bur Barbell Co., 319 Orient Way, Lyndhurst, N. J.

BARBELLS, Exercise equipment. Courses. Free booklet. Good Barbell Co., Reading, Penna.

SPORTING GOODS, GUNS, FISHING TACKLE, ARCHERY, TRAPPING

FISH Bite like hungry wolves. Amazing bait. Make it yourself for almost nothing. Guaranteed formula \$1.00. Baer, 1450 Elmdale, Chicago.

TO all fishermen who use a fly casting rod get this patented device placed on belt. Use 10 days, if not satisfied you can not cast farther, more accurate, with less effort, return and money will be refunded. Price \$2.00 postpaid. Norristown Novelty Co., Box 378, Norristown, Penna. State belt size.

CARTRIDGES: P-38's/9 mm. Lugers 15c each, 8 mm. Mausers/7.7 mm. Jap 25c each. Complete firearms-ammunition list 25c. Frank Farish, Vicksburg, Mississippi.

FLY Tying materials and tools. Professional grade only. We have imported hooks. Materials catalog 6c. Sierra Tackle Co., 4033 Mission Road, Los Angeles 32, Calif.

ARCHERY Equipment. Finest quality. 10c for catalogue. Sports Equipment Center, 5 Cherry Lane, West Haven, Conn.

FRESH-SALT Water spring steel rod, 12" wood handle, 47" overall, reel, hook, 30 ft. line, sinker, \$1.79 complete, 3 for \$5.00, prepaid anywhere U. S. A. No. c.o.d. Mr. Stuart, 300 Albany Ave., Brooklyn 13, N. Y.

DEVICE brings fishworms to surface. Fast, no digging. Send \$1.00. Jones, 312 Morgan, Slater, Mo.

5000 BARGAINS, Firearms, binoculars, war relics. Catalog 40c. Smith Firearms, Runnemed, New Jersey.

FISH At night with Johnstone Electric lighted Bobber \$1.00 prepaid. Circular on request. Dealers wanted. Johnstone Bobber Co., Aurora, Ind.

AUTOMATIC Lure—Positively weedless. Greatest invention in ages. Nothing like it. Circular free. Babcock Reel Co., Oak Harbor, Ohio.

BOWS-Arrows. Write headquarters for archery equipment. Quality products. Popular prices. Catalog 10c. Large illustrated hand book instructions, making and shooting, 50c. Archery, 617-B So. State, Chicago 5.

HUNTERS, Sportsmen: Here is what you have been looking for. A four piece steel cleaning rod with aluminum handle. Can be dismantled when not in use. Fits all shotguns and large caliber rifles. Only \$1.00 prepaid anywhere in U.S.A. Order now. Don't be disappointed later as supply is limited. Irving Goodman, Box 1998, Fargo, N. D.

AMMUNITION—New and used shotguns, rifles, handarms, fishing tackle. List 10c. Rudolph's, Atchison, Kansas.

FIELD GLASSES, TELESCOPES, MICROSCOPES, MAGNIFIERS

TELESCOPES, Binoculars, microscopes, big bargain catalog free. Brownscope Company, 24 West 45th Street, New York.

SAVE Money—Make own Galilean telescope, 5, 8, 15 powers. Achromatic, coated objective, 7 $\frac{1}{2}$ inch focal length, 1 $\frac{1}{4}$ inch diameter; 3 eye lenses; complete with instructions \$2.00 postpaid. Ross, C68 West Broadway, New York, N. Y.

POWERFUL Astronomical telescopes easily made. Perfect lenses and instructions. 100 power \$2.50, 100 and 200 power \$3.50, 100, 200 and 400 power \$5.50. Clear vision and full power guaranteed. Instructions alone 10c. Suffolk Science Service, Manorsville, N. Y.

SEE It closer! 3 power field glasses \$6.60; 3 power binoculars \$5.10; 5 power spy glass \$1.25; 50 power microscope kit \$2.98. Guaranteed. W. Wardell, 2509-A Clarendon Road, Brooklyn 26, N. Y.

REFLECTING Telescope kit, complete optical parts, fully finished; 3" diameter, 39" f.l., mirror and diagonal both hard aluminized, plus 3 lenses for high power eyepieces. Never again a bargain like this. All \$6.00 postpaid. Ross, C68 West Broadway, New York, N. Y.

GENUINE Polaroid glass—2 $\frac{7}{8}$ " (72 mm.) diameter, \$1.25 each, 2 for \$2.00. Ross, C68 West Broadway, New York, N. Y.

TELESCOPES, Microscopes, binoculars, barometers, books; buy, sell, repair. We guarantee. Lists 10c. Rasmussen & Reece, Amsterdam, N. Y.

REFLECTING Telescopes, complete. 3 $\frac{1}{2}$ " diameter, equatorially mounted. View planets, stars, \$19.75. Write Skyscope Company, 475-P 5th Ave., New York.

INFRA-RED Filters, glass, 1 $\frac{1}{4}$ inch (40 mm.) diameter, mounted. Snap on binocular or camera. \$1.00 per set. Ross, C68 West Broadway, New York, N. Y.

BINOCULARS, Telescopes, watches. Buy, sell, trade. Paul Schweer, Donnellson, Iowa.

DOGS, PETS, BIRDS, RABBITS

RAISE Diamond Seal rabbits. We pay \$30-\$60 each plus express charges. Literature 25c with hutch plans \$1.00. Hansen's Rabbit Institute, 1347 Miller Ave., Salt Lake City 6, Utah.

RAISING Rabbits profitably. Descriptive illustrated book 25c. Sibley, Mendon, Mass.

RAISE Giant chinchilla rabbits. Ideal moneymaking backyard project. Waters Rabbit Farm, Glennville, Georgia.

ANGORA Wool spinners, shearing tables, breeding stock. House of Angora, Springfield, Illinois.

RAISE Guinea pigs. Make money at home. Big demand. Booklet free. Taylor, Box 426A, Hapeville, Georgia.

\$2000 PER Year raising Angora rabbits. We buy your output. Contract particulars free. Wilsons, 1065 Shryer, St. Paul 8, Minn.

\$50.00 WEEKLY Raising Angoras for us. Free literature. Angoraville, 1215-34th Northeast, Cedar Rapids, Iowa.

MONEY In New Zealand Whites and Chinchillas. Increasing demand for breeders, meat, fur. Particulars free. Loughman's, Sandamar Farm, Newark, Ohio.

\$250.00 MONTHLY Raising angora rabbits. Particulars free. White's Rabbitry, Newark, Ohio.

ST. BERNARD Pups; Champion sired beauties. Franklin Young, R4, Riverhead, Long Island, New York.

BEAUTIFUL. Useful collie-shepherds, pups \$14.00. Paul Schultetus, New Liberty, Illinois.

70 VARIETIES—Pigeons, rabbits, pheasant, peafowls. Catalogue 10c. Jim Houck, Tiffin, Ohio.

INCREASE Your income by raising domestic rabbits. Small space needed. Ready market for delicious meat, fur and wool. Largest magazine in the industry tells you how. \$1 per year. Send dime for sample. No stamps. Small Stock Magazine, Lamoni 50, Iowa.

STANDARD Rabbit Journal, Milton, Pa. 3 years \$1.00, sample dime.

GUARANTEED Chin-Chin giant Chinchilla rabbits. Greatest amount of delicious meat. Largest, finest, most valuable furs. Tremendous demand for breeding stock. We buy youngsters. Contact world's largest breeder. Willow Brook Farm, R15, Sellersville, Penna.

ZOOLOGICAL And pet animals for sale. Illustrated catalogue, literature, 25c. Trails End Zoo-5, St. Stephen, S. C.

RAISING Rabbits, Cavies, Hamsters, Chinchillas is a growing and profitable industry. Magazine 10c. Descriptive book and magazine 25c. Book and magazine (monthly) one year \$1.00. Address Small Stock Farmer, Pearl River 15, N. Y.

FARMS, FARM LANDS, REAL ESTATE

STROUT'S Green farm catalog—Over 2500 bargains. Money-makers 32 states, coast to coast. Mailed free. Tell us what you want. Where? Price? Terms? Save time, money. Strout Realty, 255-P 4th Ave., New York 10, N. Y. 20 W. 9th St., Kansas City 6, Mo. 453 S. Spring, Los Angeles 13, Calif.

NEW Free fall catalog of farm bargains, 19 states, many equipped, many illustrated. Write today! United Farm Agency, 220 South State Street, Chicago 4, Illinois.

OZARK Guide. Eureka Springs, Arkansas. For homeseekers, tourists. Year \$1.00.

WEST'S 1947 Catalogue. Over 1000 farm and business bargains. Free copy write West's Farm Agency, Inc., HE-8, Pittsburgh 17, Penna.

\$5.00 MONTHLY Buys 40 acres near town; price \$200.00. Free list. Box 425-P, Carthage, Mo.

GOVERNMENT Lands \$2.00 acre up. Information all states twenty-five cents. National Tax Service, 834-A Majestic Bldg., Detroit.

HOMESITES \$450—Convenient payments. California's finest garden section. On Morro Bay's scenic shores. Wonderful fishing, hunting, boating, bathing. Fertile soil, softest water, temperate climate, congenial community. Free literature. Richard Motto, 6560 Hollywood Blvd., Hollywood 28, California.

GOOD Farms—Ranches. Washington, Minnesota, Montana, Idaho, Oregon, North Dakota. Dependable crops, favorable climate. Write for literature, lists describing typical postwar farm opportunities. Specify which state. J. W. Haw, 119 Northern Pacific Ry., St. Paul 1, Minn.

OZARK Lands for all purposes. Actual river frontages. 5 acres \$90.00 and upwards. Free list and literature. Hubbard, 424-I, Minnesota Ave., Kansas City 4, Kansas.

FREE—"Amazing New Book"—"Profits From Classified Advertising." Tells how and what to advertise. Be sure to read this book before you invest one cent in advertising. Remember—It's free! Write for your copy now. F. W. Johnson, Classified Advertising Manager, 200 East Ontario Street, Chicago 11, Illinois.

POULTRY, FARM SUPPLIES

RAISE Fryers new scientific way. \$6000 yearly possible in your backyard. Booklet free. Poultry Guild, 1046-A So. Olive, Los Angeles 15, California.

KNOW How to raise poultry for profit. Read Northeastern Poultryman. Every issue packed with helpful hints and practical suggestions. Latest articles on breeding, feeding and management. Subscribe now. 1 year 65c. 2 years one dollar, foreign subscriptions \$1.00 a year. Northeastern Poultryman, Dept. P.M., 376 Boylston St., Boston 16, Mass.

RAISE Turkeys the new way. Write for free information explaining how to make up to \$3000 in your own backyard. Address National Turkey Institute, Dept. 3, Columbus, Kans.

PROFITABLE OCCUPATIONS

ANNOUNCING Home study course in commercial baking. Practical basic training. Good field for those with aptitude. Nearly depression proof. Send for free booklet, "Opportunities in the Baking Industry." National Baking School, 1315 Michigan Ave., Dept. 3431, Chicago 5, Ill.

"RUG Scrubbing in Homes." 50 page book tells about it. \$1.00 postpaid. Langdon, 4614 Prospect, Cleveland, Ohio.

MAKE \$3.00 Hourly manufacturing new building product. Good market. Free information. Write, Products, Box 1844, Tampa, Florida.

WELDING—Electric arc. Learn profitable trade quickly through actual practice. Individual welder instructions at bare cost of materials. Full particulars free. Valuable welding lessons book 50c. Hobart Welding School, Box M-874, Troy, Ohio.

TADPOLES Make frogs, tremendous demand. Both make you money. 25c brings tell-how information. Chariton Corporation, Century Building, Chicago 4.

SPECIAL Rubber for making molds. Literature and sample free. Universal, Box 1076-B, Peoria, Ill.

YOU Can make real money raising Golden Hamsters, the new amazing tiny animal. Food costs less than 10c month per animal. Breeds in 16 days! Easily raised in basement, attic, garage, barn, or shed. Write for convincing details. Hudson Hamstery, Box 78-P, Palisades Park, N. J.

WOULD You pay 3%—first \$350 made? Color-illustrated book "505 Odd, Successful Enterprises" free! Some offer occasional "day off." Work home. Expect something odd! Pacific, Oceanside, Calif.

HOME Manufacturing business. Manufacture novelty ladies' lapel pins, materials penny dozen, sensational profits, no experience, no expensive equipment needed. Few dollars starts you. Write Plastex Products, 1025 Prague St., San Francisco 12, Calif.

METALIZE Baby shoes. Correct modern method. Information free. Universal, Box 1076-A, Peoria, Ill.

I Will show you how to make fortunes in farming, poultry. Nature's perfect system \$1.00 postpaid. Money back guarantee. Farmer, 281 Windsor St., Hartford 5, Conn.

WRITE Western stories! \$1 brings markets, requirements, rates, etc. Roman, Box 486, Huntington Beach, California.

EARN More than average. Send card for information about very lucrative trade. Lidemark, 226 Potomac Ave., Buffalo, N. Y.

846 FROM Square foot plywood. Jigsaw necessary. Free literature. Woodarts, X-30, Bridgewater, Mass.

MAKE Beautiful mirrors from window glass cheaply. Complete instruction folio \$1.00. Metallize baby shoes. Several methods. \$1.00. Learn profitable metal plating, with or without battery. \$1.00. Tes-Co, Box 189-MR, Wilkes-Barre, Penna.

NO Selling, operate vendors, amazing profits, details free. Silver-King, 622 Diversey, Chicago 14, Ill.

"THERE'S Big money in junk" and repairing batteries. Write, Batteryman, Grand Junction 5, Colorado.

HOW To set up and run a mirror shop! Resilver mirrors. For price write, John Sprinkle V50, Marion, Indiana.

MEDICAL Laboratory technicians in great demand. We train you in your spare time, in your own home. You can practice while studying. Write for free catalogue. Imperial Technical Institute, Box 973-T, Austin, Texas.

MUSHROOMS Grown. Boxes. Barrels. Illustrated instructions 50c. Spawn \$1.00. Gordons, 553 William, Winnipeg, Manitoba.

MAKE Beautiful costume jewelry at home for large profits, hobby or therapy. Free illustrated wholesale catalogue of sea shell, metal and plastic parts contains detailed instructions. Florida Supply House, Bradenton, Florida.

LOCKSMITHING—Profitable business or hobby! New course teaches you lock secrets, how to fit keys, de-code, masterkey, etc. Easy self-instruction lessons. Bargain price. Fascinating 100-page illustrated catalog free! Write Nelson Company, Dept. 2-02, Chicago 5.

TYPEWRITER Repairing instructions, standard typewriters. Webers', Box 1008, Canton, Ohio.

\$40.00 WEEKLY Made growing mushrooms, fresh, dried. Dominion patent 331583. Free spawn. North American, 169P Yonge, Toronto, Canada.

TYPEWRITER Repairmen urgently needed. Earn \$40 to \$50 weekly spare time. Our easy to learn home study course teaches how to repair typewriters. Write for free information. Houston Typewriter Repair Service, P.O. Box 5357A, Houston 12, Texas.

ELECTRIC Clocks are every where you go, buildings, homes, parking lots, factories. Repairs increasing. Our easy to learn course with pictures and drawings teach you how to repair these clocks. Electronic Supply Co., P.O. Box 2350A, Houston 1, Texas.

BOOKS, PERIODICALS, PICTURES, POSTCARDS

"1001 HOUSEHOLD Hints," a book of great value for every home. 50c. J. H. Cooper, P. O. Box 815, Augusta, Ga.

WHAT Every Mason wants. We have Masonic books for Blue Lodge, Chapter, Commandery, Scottish Rite and Shrine. Our rituals are used the world over. Send for free catalog of books and rituals for Masons, Odd Fellows, Knights of Columbus, etc. Ezra A. Cook, Publisher, P.O. Box 796-PAT, Chicago 90, Ill.

TRADE Magazines—Business, vocational, diversion, Current single copies. All fields. Choose from 885 periodicals. Free price-list. Commercial Engraving Publishing Co., 34C North Ritter, Indianapolis 19, Ind.

MONEY? "Pocket Millionaire." 112 pages, 1269 basic money-getting secrets of the rich. \$1. Satisfaction guaranteed. Stanley Service, 544 E. Jersey St., Elizabeth 1, N. J.

BEAUTIFUL View cards of Atlanta, Georgia, 3 for dime, 10 for quarter, 25 for 50c, 60 for dollar, all different. J. R. Hunt, Station E, Box 42, Atlanta, Ga.

VIEWS Of the hereafter. For copy of the remarkable book by Emanuel Swedenborg "Heaven and Its Wonders and Hell," send 5c to cover mailing. Swedenborg Foundation, Room 1649, 51 East 42nd St., New York 17, N. Y.

ALL Pocket books. Complete list free, includes latest reviews. Gordon's, 3882 Third Ave., Los Angeles, Cal.

ART Anatomy of The Human Body, \$1.00. Art of Drawing Women \$1.00. Secrets of Chinese Physicians \$1.00. Snappy book list with order. A. Faller Company, 201 Dewey Street, Newark 8, New Jersey.

TECHNICAL Books rented. Free list. Rodgers, Box 5286, Chicago.

100 BOOKPLATES (Gummed backs) and your name printed—both for \$1.00 postpaid. Square Deal Printers, 4640 Prospect Ave., Hollywood 27, California.

BOOKS Found free! All subjects. Send wants! Jaher Book Service, 620-P East 178 Street, New York 57.

SEND 25c For Alaska's attractive, pictureful magazine. The Alaska Sportsman, Box PM-118, Ketchikan, Alaska.

YES! We are again accepting agents to handle magazine subscriptions, books, greeting cards, complete details 25c (refunded). Cassell Publishers Service, Westfield, New Jersey.

GOOD "Used" self-instruction educational books on all subjects bought, sold, rented, exchanged. Satisfaction guaranteed. Complete information and 100-page illustrated bargain catalog free! Write—Nelson Company, Chicago 5.

SELF-EXPLAINING Bible: Illustrated circular free. Box 446-P, Minneapolis, Minn.

BIG Profits taking subscriptions for all magazines. Agents' confidential catalog listing over 2500 periodicals and complete starting supplies free. Pines Subscription Agency, Flushing, New York.

BOOKFINDERS! (Scarce, out-of-print unusual books.) Quickly supplied. Send wants. Clifton, Box 1377PM, Beverly Hills, Calif.

MAGAZINES (Back dated)—foreign, domestic, arts. Books, booklets, subscriptions, etc. Catalog 10c (refunded). Cicerone's, 863 First Ave., New York 17, N. Y.

MAGIC TRICKS, PUZZLES, JOKER NOVELTIES

200 ELECTRIC Stunts. 110 volts. \$1. Cutting Sons, Campbell, Calif.

WIDE Selection. Tricks, Joker novelties. Price list, 3c. Marvin Green, Box 287, Hollywood 28, Calif.

COMEDIAN'S Instruction booklet, 10c. Kleinman, 25-31-B 30 Road, Astoria 2, N. Y.

AMAZE And mystify your friends with highest quality magic. New catalogue 25c coin. Mazda Magic Co., 1135 Westgate Ave., Oak Park, Ill.

DISAPPEARING Key or card trick 35c; Ventrillo (voice thrower) 25c. Free list. Nick's Fun Shop, 450 Elizabeth Ave., Elizabeth, N. J.

GUARANTEED Magic tricks! Amateur, professional. Big 8 1/2 x 11 illustrated catalog, 10c. Newton's, 121-A Main, Bonham, Texas.

YOU'LL Wow 'em with DeLand's spectacular "Card Locator." Name exact location any card in ordinary deck! Deal straight royal flush. Only 10c, magic catalog, startling free offer details included. Magic Shoppe, 19J Springfield Ave., Newark 2, N. J.

PERFORM Clever, professional sleight-of-hand with an ordinary thimble. 42 actual photographs, full explanations describe complete routine. 50c. Garnet Specialty, Box 502, Valparaiso, Indiana.

"MAGIC Vanishing card." Throw it into air, it completely disappears, reproduce it later from spectators pocket. Easy to do. Complete, 25c with magic catalog. The Magician, 2463-C Kensington Ave., Philadelphia 25, Penna.

VENTRILOQUISM. Complete course and 36" vent-doll, only \$12.95. Magic catalog 25c. Herbert, P-192 N. Clark, Chicago 1.

500 TRICKS. Send only 10c for Douglas' famous 112-page catalog 500 tricks. New magic for amateur, professional. America's fastest service for 25 years. Douglas Magician, Dept. 1, Dallas, Texas.

TRUE Secret of ventriloquism. Send for booklet. Quackenbus, Big Flats, N. Y.

MAGICIAN'S Pin, ghost illusion, Houdini escapes, giant catalogue. Everything, complete 25c. Magic Wand-M, 9W Colorado, Pasadena, California.

BE A magician. Large professional magic catalog of latest tricks. 25c. Ireland, C-109 North Dearborn, Chicago 2.

VENTRILOQUISM Taught. 3c stamp bring particulars. Smith, 801 Bigelow, Peoria 5, Ill.

VANISHING Half dollar trick and catalog 25c. Sterling Magic Co., Royal Oak, Mich.

WORLD'S Largest professional magic shop, keeps you in touch with latest tricks. To receive mailings, send 35c for new catalog. Holden's, M220 West 42nd St., New York.

EARN Money in any crowd. Call names of strangers, tell unspoken questions. Professional course mind reading, faked spiritualism, etc., \$1. Henderson, Box 341, San Bernardino, Calif.

LARGE Illustrated professional catalog 10c. Williams, 900 Plymouth, Ellwood City, Penna.

FREE! Large catalog of magical apparatus if you remit 25c for "Magic Is Fun" magazine. Robbins Co., 152-F West 42nd Street, New York.

MAGIC Tricks, puzzles, books, cards, punch boards. Catalog 10c. Specialty, Box 671, St. Louis 1, Mo.

COINS, TOKENS, CURRENCY

UNCIRCULATED 1923 Peace dollar \$12.50, fine \$3.50. Postpaid. Complete list 3c. F. E. Burgess, President, Bendlecrest Corporation, 716 Genesee Bank Bldg., Flint 3, Michigan.

OLD Money wanted. Do you know that coin collectors pay up to \$100.00 for certain U. S. cents? And high premiums for all rare coins? We buy all kinds. Send 4c for large coin folder. May mean much profit to you. Numismatic Co., Dept. 20, Fort Worth, Texas.

LINCOLN Cent sale 1910 S, 1912 S, 1913 S, 1914 S, 1915 S, 1921 S, 1923 S, 1924 S, 1926 S, 1931 D, 1932 D, 1933 D, 10c each. Reynolds, 1118 Mathews, Flint 3, Michigan.

CASH For old coins and war relics. 48-page coin value guide, 50c. 25 different foreign coins, \$1.00. Royal Coin, 3 School St., Boston.

30 DIFFERENT Selected coins \$1.00. Oddehon, Box 482, St. Louis, Mo.

WORLD Coins—30 different \$1.00. Harry Elsholz, Box 9014, Pittsburgh 24, Penna.

COINS Wanted, will pay up to \$2000 for certain coins, send 25c for catalogue. Burton's, 111 So. Third, Columbus, Ohio.

UNUSUAL Worldwide collection twelve different foreign coins and bills only 25c. Webb, Box 473, San Bruno, Calif.

FOR Sale: 1893 Columbian World's Fair half dollar, 75c; U. S. 2-cent pieces or 3-cent pieces, 25c each; 50 assorted Indian head cents, \$1.25; large 50 page U.S. coin catalog, listing thousands of coins for sale at reasonable prices, 25c; Giant 72 page foreign copper-silver-gold catalog listing over 10,000 coins for sale, 25c. Ben's Coin Company, 72 West Washington, Chicago 2, Illinois.

GET Profit and pleasure in collecting old coins. Send 10c for 56 page illustrated coin catalog. You'll be delighted with it. Send for it now. B. Max Mehl, 370 Mehl Bldg., Fort Worth, Texas. Largest rare coin establishment in U.S. Established 47 years.

FREE! Foreign coin, banknote and coin collectors illustrated catalog to approval service applicants. Send 3c postage. Tatham Coinco, Springfield-125, Mass.

STAMP COLLECTING

VALUABLE Catalogs, 10c each: (1) "United States and British N. America" complete with 1000 illustrations; (2) "Airmail Stamps"; (3) "British Empire"; (4) "Modern Europe"; (5) "Annual Catalog" of albums, supplies, packets, advice to beginners, etc. Each catalog 128 or more pages, profusely illustrated, wonderfully informative! Harris & Co., 202 Transit Bldg., Boston 17, Mass.

ANNOUNCEMENT—Introductory offer—Cosmopolitan Stamp Co. resumes its well known approval service and desires the privilege of sending you choice selections. General foreign, U. S.; air mails; British Colonies, etc. Send only 25c and receive \$1.00 value of net price stamps from our initial gigantic selection. Don't delay. Write today. Cosmopolitan Stamp Co., 1457 Broadway, Dept. 8-E, New York City.

100 DIFF. Bohemia \$2.25, 100 diff. Switzerland 95c. A. Mont, P.O. Box 204, Forest Hills, L. I., N. Y.

HITLER, Will Rogers, Roosevelt stamps, 99 others, 10c with approvals. Walcott, Box 821M, New Orleans 2, Louisiana.

FREE! Ten mints: Ethiopia Red Cross plus Free French. With approvals. Florida Stamp Company, Box 807, Miami 5, Fla.

25 DIFFERENT India—3c with approvals. Premiums with purchases. Brandwein Stamp Co., Box 92-H, Bayonne, N. J.

GOLDEN Mixture, variety countries, 25c. MacDonald, 30-M Seaman Ave., New York 34.

BET You haven't these! South Georgia, South Orkneys, Grahamland, South Shetlands, Shortlived Falkland Dependencies. Everything 3c with approvals. Viking, 130ZZ Clinton St., Brooklyn, N. Y.

STAMP Magazine and "Valuable Tips"—Free! "Stamp Post," Station A, Pasadena, Calif.

500 MIXED Stamps 15c with approvals. Arthur Sibley, Mendon, Mass.

PENNY Approvals, beautiful selections. Write Oman, 642½ Broadway, St. Paul 1, Minn.

WHOLESALE Price list free. Arthur Grunwald, 337 E. 94th Street, New York 28.

VICTORY Packet free—Includes stamps from Tanganyika, British Cayman Islands, animal, scarce babyhead, Coronation, early Victorian, airmail, map stamps. Including big illustrated catalogue. Send 5c for postage. Gray Stamp Company, Dept. PM, Toronto, Canada.

25 DIFFERENT Hungary! 3c. Approvals. Star Stamp Company, Dept. M, Lakewood, New York.

PROTECT And beautify your stamps, blocks, covers, etc., with Crystal-Mount. Write for free samples. Harris & Co., 202 Transit Bldg., Boston 17, Mass.

FREE! Complete Balkan aviation set with approvals. Beaman, Elliston, Virginia.

100 DIFFERENT Including scarce diamond-shaped airmail 3c to approval service applicants. Avalon Stamp Co., Dept. M, Springfield 8, Mass.

FREE! Tiny Chinese "midget" war set. Approvals. Seminole, Elliston, Virginia.

MINT Pictorials free to approval applicants. Surf Stamp Co., Box 2296, Miami Beach 40, Florida.

FREE—Famous Americans set, plus Flag Set, plus the National Parks Set, plus the Presidential Set to the \$5. A total of 90 stamps absolutely free to customers for our unsurpassed U. S. or foreign selections. Send 3c postage for 15 of the above mentioned stamps and full particulars. Triboro Stamp Company, 145 Nassau St., Dept. 108, New York.

ERITREA, Ethiopia and huge Roosevelt stamp, all free with approvals. Logan Stamps, Box 4, New Lots Station, Brooklyn, N. Y.

WHOLESALE Approvals, airmails, commemoratives. References please. Amiel, Box 813, St. Petersburg, Florida.

WHOOPIE! Wowie! Pick 25c worth of U. S. stamps free! No obligations! Write M & N Co., 742A Sheffield Ave., Brooklyn 7, N. Y.

YOUR Choice 20 different Egypt or Costa Rica triangle set. Herman, 539 East 54 Street, Brooklyn 3, New York.

APPROVALS That fill spaces in new International album, 25 different free. Franciscan, 376 Oak, San Francisco 2, Calif.

6 DIFF. San Marino Roosevelts, 10c with ¼-½-1c approvals. Carroll's, 4357A S. Hoover, Los Angeles 37, Calif.

½c UP U. S. or foreign approvals by countries. Hurt & Fosse, Blue Ridge, Va.

SETS—Czechoslovakia, Mexico, Bolivia, Ceylon plus eight others. 25c with approvals. Wirth, Norwichtown, Conn.

FREE! Colorful pictorial British Colonial King George set from Jamaica. Approvals included. Quick service! "PG," 195 Park, Lewiston, Maine.

BEST Quality stamps—Royal visit \$2.10, South Africa victory \$4.00, Hungary beautiful Roosevelt \$4.25, Monaco Roosevelt \$1.20. Keep your collection going with the best of the new issues. Join the Stamps of the Month Club, 2855 Piedmont Road, N.E., Atlanta 5, Georgia.

FREE Flag stamp with U. S. approvals. Wenigman, 929 Oakdale, Chicago.

66 STAMPS From 33 countries 10c. Garrow, 84-M Montevista, Chula Vista, Calif.

MONACO Roosevelt triangle, Hitlerheads, Persia, others. Big packet 3c with approvals. Baird, P.O. Box 1713, Portland 7, Oregon.

"WORLD'S Best" United States or foreign approvals. America's lowest selling prices. "Stamps," Box Eighty-Seven, Albany 1, New York.

1000 WELL Mixed U. S. 25c. Monjar, 1750 Fairmont, Cincinnati 14, Ohio.

\$1.00 WILSON And commemoratives, 6c. Approvals. O. Burgett, Lima, Ohio.

NICARAGUA Managua diamond set, 10c with approvals. Vargo Stamps, 6044 South Fairfield, Chicago 29, Illinois.

FREE Attractive airmails, commemoratives, pictorials, eight countries, with approvals. Green and Company, Norwood 12, Ohio.

INNER Mongolia #1-7. All the stamps ever issued by this country! Price 65c. Ask for complete lists of many other unusual values. Mission Mart, Washington 17, D. C.

100 U. S. Commemoratives, etc.—10c, 300—25c. Kellermann, Box 457, Newark 1, New Jersey.

ZANZIBAR, Palestine, Manchukuo, Azerbaijan, Haiti, Iraq, Cayman, Siam, Roosevelt, Hitler, 5c. Approvals. Postzegel, Windham, N. Y.

WOW! 10.00 Worth of fun—only 10c! What a treasure hunt! Big package 500 foreign stamps just as received from foreign missions, other sources. Includes stamps from Africa, South America, Free French, Cape Juby, Palestine, etc. Includes airmails, commemoratives and stamps worth up to 50c. This offer sent for 10c to serious approval applicants only—one to a customer. Jamestown Stamp Co., Dept. 22, Jamestown, N. Y.

FREE 33, Transvaal, Haiti, Trinidad, others. Approvals. Robert Keating, Box 267m, Forest Hills, New York.

FREE! Six Greek wind airmails with approvals. El Rey Stamps, 5170 Sunset Blvd., Hollywood, California.

CUBA Roosevelt stamp and 25 different Switzerland only 1c to approval service applicants! Littleton Stamp Company, Littleton 42, New Hampshire.

FINLAND Red Cross—4 varieties cataloging \$1.00 only 10c to approval applicants. Elcerrito, 5611 Meade, San Diego 5, California.

FREE Gift with low-priced approvals. Russell, 3857 Third Ave. S., Minneapolis 8, Minn.

POSITIVELY Greatest free offer—Latest Scott's International \$6.00 stamp album—covering entire world, contains 36,000 illustrated descriptive spaces; Scott's 1948 Standard \$7.00 catalogues "Philately's Encyclopedia"—absolutely free to applicants for foreign approvals becoming customers. Plymouth Specialty Company, Dept. A9, Bell, California.

PYRAMIDS, Sphinx—25 different Egypt 10c with swell approvals. Eric Kardell, 1175 Clay, San Francisco 8, California.

100 AFRICANS, Different incl. Royal Visit \$1.50 postfree. Arend, Box 788, Pretoria, South Africa.

PERSIA And China packet free to approval applicants. Write "Everglades," Box 3222-M, Atlanta, Georgia.

BRITISH Colony pictorials free to approval applicants. Atlanta Stamps, 1241 Boulevard, N.E., Atlanta, Georgia.

SPECIALS 5c Each. Each stamp different. 5 Iraq, 3 British Moroccan Agencies, 10 San Marino, 10 Bohemia and Moravia, 5 British West Indies Islands, 10 Croatia. Address Stampdean, Box 202, Wilmette, Ill.

MINT U. S. sets complete bi-centennials \$1.65, parks \$1.35, Farley parks \$1.65, famous Americans \$7.50, flags \$1.10. Standard, 3817 Sackett, Cleveland 9, Ohio.

100 BRITISH Colonials: all fine, mixed, 50c. Smith, Box 111, Elgin, Ill.

NUDE Duchess (two values) 5c to approval applicants. Masters, Box 7027A, Baltimore 16, Maryland.

UNITED States bargain. It sounds unbelievable, but it's true! 50 different United States stamps ranging in age as far back as over 60 years and in face value as high as one dollar. Only postage, commemorative, and air mails included. Nothing else. Extra 2 Jap occupation of Philippines, all for only 10c to approval applicants. Please state whether approvals shall consist of U. S. or foreign stamps or both. Globus Stamp Company, 268 Fourth Avenue, New York 10, N. Y. Dept 211.

ARMY Navy set 10c. United States, foreign approvals. Yokums, Box 1327, San Antonio 6, Texas.

BIG Profits in own stamp business at home. 12,000,000 collectors. Proven method. Information write Largentiere Company, 6462 83rd Place, Forest Hills, New York.

FREE! Airmail packet with approvals. Deane Stamps, Box 87, Miami 35, Florida.

FREE—Adults, monthly illustrated price list. Neundorf, 22-A West Florida, Evansville 11, Ind.

SCARCE U. S. stamps nearly 100 years old, 1893 commemorative, \$5-\$10 stamps, Armed services pictorials complete, Roosevelt set, large allegorical figure of Commerce, old revenues, everything 5c to serious approval applicants. Metropolitan, 140 Nassau, New York 7.

WE Buy old postage stamps. Send 40c for our buying catalogue. 30c refundable. Stamp Market, 356-PM Clinton, Columbus 2, Ohio.

FREE—The Stamp Finder. Big new edition—32 pages profusely illustrated! Tells at a glance the country to which any stamp belongs and so where to place it in your album! Also: 25 different stamps from Vatican City, Palestine, Cyprus, San Marino, etc. All sent to approval applicants enclosing 3c postage. Garcelon Stamp Co., Box 900, Calais, Maine.

FREE—United States Columbian set—8 values, retailing \$3—Absolutely free to customers for our unusual approvals. Send 3c postage for selection plus full particulars. S. C. Engel, 38 Park Row, New York.

THREE Hitler heads, Mint with approvals. Enclose 3c postage. M. Green Stamp Co., P.O. Box 287, Hollywood 28, Calif.

25 BEAUTIFUL Stamps from 25 French Colonies and our price lists. One silver dime. Stampsales, Box 1649-P, Oakland 4, California.

50 DIFFERENT Stamps, triangle, airmails, etc., 5c with approvals. Carlton's, 10243 Silverton, Tujunga, California.

UNITED States approvals. Low prices! Gordon Davison, Box 1019X, Manchester, N. H.

FIRST Day covers on approval. Knobel, 1918 S.W. 12th St., Miami, Florida.

UNEQUALLED Bargain. Stamps from over 25 countries including Fiji, Swaziland, Pitcairn, Tonga, Trinidad, etc., everything 10c to approval applicants. Bennett's, Box 252, Terminal A, Toronto, Canada.

200 WORLDWIDE. 27c Postage. Pacific, P.O. Box 5704, Los Angeles, Calif.

250 DIFFERENT U. S. \$1.00, free list. Robert Ewing, Wapakoneta, Ohio.

"GOYA Nude" set, cataloging \$1.05, complete 35c. Approvals. Royal Stamp Company, Tamaqua, Penna.

STAMP Collection. Ten sets, 3c with approvals. Stoll Stamp Service, 2631 Burnett, Louisville 10, Kentucky.

ANIMAL, Map and triangle stamps, included in 50 different for 3c to approval buyers. Paul Bauer, 31 Wilkshire, Lancaster, N. Y.

ROOSEVELT, Churchill, Stalin, Hitler, Vatican City stamps free, to approval applicants. Flamingo Stamps, Box 517, Miami Beach, Florida.

30 BEAUTIFUL Airmails 10c, selected approvals. Louis Morrison, Milmont Park, Penna.

\$10.00 FOR \$1.00. Box full stamps valued Scott's \$10.00 and stamp album. Everything \$1.00. Longacre Shop, 108k West 42nd, New York City 18.

2,000 UNUSED Stamps from over 150 countries at face value. Postcard brings full information. Comet, G.P.O. Box 517-P, Brooklyn, N. Y.

EGYPT—15 Different, 5c to approval applicants. Bohemia Stamp Service—1, Bohemia, N. Y.

ILLUSTRATED Stamp Magazine, 26 weeks 25c. Stamp Journal, Kalamazoo, Michigan.

CANADA—75 Diff. 25c. Approvals. Lists. Victoria Stamp Co., London 4, Canada.

FINE Approvals, freshly mounted. Fast, personal service. Tell me what countries you prefer and I'll send their stamps. Skinner, 438 Locust, Long Beach 12, Calif.

WORLDWIDE, Different 200—25c; 500—60c; 1000—\$1.50. Beacon Sales, Maynard 2, Mass.

200 DIFFERENT Stamps, 6c, to approval service applicants. Tatham Stamp Company, Springfield 30, Mass.

BRITISH, Spanish and French Colonies, Vatican, Hitler heads, and airmail packet, free with approvals. Pan-American Stamp Co., Box 145, New York 33, N. Y.

DANDY U. S. approvals; write immediately. Sullivan, Endicott Building, St. Paul, Minnesota.

BERLIN Bears, complete set of eight and 100 different stamps only 10c to approval applicants. Reich Stamp Co., 4647 Kenmore, Chicago 40, Ill. Dept. M11.

STAMP Collections wanted. Complete collections, duplicate lots, surplus stock, mint and used. Prefer trade for printing or other items, buy outright if priced right. What have you, what's wanted? Vanroy Shirk, Lebanon, Penna.

SMOKY Mountain souvenir commemorative sheet and 30 different U. S. stamps, including commemoratives, airmail, etc. (catalog value exceeds 65c) for 10c to approval applicants. Curhan Stamp Company, Dept. H, Gloucester, Mass.

U. S. Price list. Send postage. State Stamp Service, 1225 Park Building, Pittsburgh 22, Penna.

1000 MIXED U. S. old and new—25c; 2 lb. \$1.25. Weatherby, Medina, Ohio.

OLD Scarce U. S. seconds on approval. Slightly defective, nice appearance, bargain prices. Hernfield, 551 Clinton, Newark 8, N. J.

ZOWIE-E! A barrel of fun for only a dime. 500 United States stamps—absolutely unpicked and unsorted—just as received from church missions. Many varieties, including large commemoratives, airmails, high denominations up to \$5.00! Stampdom's biggest package of fun—and you might find something really valuable! Price only 10c to serious approval service applicants. Money back if not delighted. Illustrated bargain lists with each order. Mystic Stamp Company, Dept. 80, Camden, New York.

U. S. Price list. Send postage. Stanley Gibbons, 38-P Park Row, New York.

PENNY Approvals, that satisfy. Neil Gronberg, Box 5441-P, Philadelphia 43, Penna.

50 DIFFERENT United States, 10c. Price-list free. Seidenberg, Cassopolis, Mich.

UNITED States approvals complete coverage, fine quality, attractive prices. Seminoe Stamps, Box 378, Coconut Grove, Florida.

FREE U. S. price list. Postage 3c. Mark Hanna, 335 - 5th Avenue, Pittsburgh 22, Penna.

WORLD'S Largest diamond and triangle stamps, free stamp magazine, stamps from fighting Free French, 20 stamps from 20 different countries, pictorials, airmails, big bargain 5c with approvals. Capital Stamps, Dept. 2, Little Rock, Ark.

DEALERS—Wholesale list. Postage 3c. Frank, 5031 Queensberry, Baltimore 15, Md.

HOBBIES AND COLLECTIONS

50 DIFFERENT Army patches postpaid for only \$1.00 (factory rejects). Catalog free with order. Insignia Mart, 703 Broadway, New York.

WANTED: Unusual toothbrushes. Dr. Blauston, Dentist, 89 Court St., White Plains, N. Y.

WANTED: Old cigarette cards. Write Charles Bray, East Bangor, Penna.

25 WOOD Samples. Thinnest plywood known each marked. 4 different 50c, 12 different \$1.00, 25 different \$2.00. Cards Of Wood, Manlius, N. Y.

FIFTY Unused Canadian bookmatch covers one dollar. Jolly Hobbies, 8230 Drolet, Montreal, Canada.

FREE Franklin D. Roosevelt memorial set complete. Other choice premiums. Catalogue 10c. Post Card Exchange, Box 116B, Boston 17, Mass.

FIRST Again: United Nations insignia 30c; military emblems 2c up. Send 10c for price lists. Hobbyguild, P-35 West 32nd St., New York.

UNUSED Match book covers. 100 all different \$1.00. 35 Royal Flash covers \$1.00. Free catalog. Charles Edelman, 1311C East 84, Cleveland 3, Ohio.

INVENTING Can be an interesting and profitable hobby. Write for complete particulars. Institute of American Inventors, Dept. 40-E, 1926-Eye St. N. W., Washington 6, D. C.

BOOKS—All Kinds—Homecraft, Radio, Plastics, Boat Building, Photography, Model Building. Catalog free. Popular Mechanics Press, 200 E. Ontario St., Chicago 11, Ill.

ANTIQUES, RELICS, INDIAN GOODS, CURIOS

30 COMMON Arrowheads \$1.00. 40 prehistoric Indian arrowheads, scrapers, knives and spearheads \$2.00. List free. Lear's, Box 569, Galveston, Texas.

SWORDS, Rapiers, daggers, pistols, armor. Illustrated catalog 50c. Robert Abels, 860-A Lexington Ave., New York.

PRECIOUS STONES, MINERALS

"GENUINE" Deep red Arizona rubies (garnets). Send quarter for packet. Mineral Specimens Company, Box 2651, Phoenix, Arizona.

PETRIFFED Woods. Rare. Beautifully grained. Six cubic inches \$1. Jesse Teer, Roosevelt 1, Oklahoma.

STONES Traded for old gold. Stones of all types from rings and jewelry. Trade us old gold, broken jewelry, spectacle frames, gold teeth, broken or usable watches. We will ship you equivalent value in stones. Write for free shipping container. B. Lowe, Trader, Dept. PM, Holland Bldg., St. Louis, Mo.

KING Jade—Not Nephrite or Jadeite, bluish green. Gem quality cutting material available to professionals and amateurs. Send 50c for cut sample. King Gems, Inc., Dept. PM, Box 1579, Colorado Springs, Colorado.

ZIRCONS, Genuine Siamese exotic gems. Flash, fire and sparkle of diamonds. Ancient Egyptian queens treasured the good luck bearing charm of these fascinating jewels. Mastercraftsman diamond cut, unmounted. Wholesale \$1.50 carat. Sample \$2.00. Two for \$3.00. Ten small glistening Zircons \$4.00. Imhusex, White Plains, New York.

METAL Detectors. The very latest circuit. Free literature. Hedden Metal Detectors, 538 N. Homewood Avenue, Pittsburgh 8, Pennsylvania.

MINERAL Specimens and gem material. Fluorescents. Free list. Plummer's, 5068 Brighton, San Diego 7, Calif.

LITTLE Library of Useful Information. 102 different books. Catalog free. Popular Mechanics Press, 200 E. Ontario St., Chicago 11, Ill.

CAMERAS AND PHOTO SUPPLIES

THREE Photographic filters—Red, green, yellow solid glass. Sizes range from 25 to 42 mm. Approximate sizes only. Value \$5.00. Special for only \$1.00. Ross, C68 West Broadway, New York, N. Y.

FAMOUS, Easily operated, guaranteed cameras: "Traveler" 2 1/4 x 3 1/4 (120) all metal press-view \$6.95. "Spartus Reflex" 2 1/4 x 2 1/4 \$9.95. Postpaid. Quentin, West Salem, Illinois.

35 MM. Film refills (frame-numbered) in metal cartridges, 3 for \$1.00. Box 188, Hollywood 28, Calif.

SALE Myco 16mm. cameras. Write Dingman's, 638 S. Beach, Daytona Beach, Florida.

CAMERAS, Enlargers, projectors. Lowest prices. Free catalog. Cavalier Camera, 1822 Center, Pittsburgh 19, Penna.

McKEON'S "Bromide Toner" tones all bromide papers. 8 oz. (makes 2 gallon single solution toner)—\$1.00. Guaranteed. Sulphur Products Co., Greensburg 15, Penna.

SPEED-O-COPY: Groundglass focusing attachment for Leica, Contax, Perflex, Argus C-2 & C-3. Send for literature. D. Paul Shull, Dept. PM-8, 240 S. Union Avenue, Los Angeles, Calif.

BASS Says! At the sign of the old "Horse Trader," 37th year. Thousands of satisfied customers everywhere! Finest brands including Kodak, Bell & Howell, Argus, Zeiss, Leitz, etc. Satisfaction always guaranteed, or your money back! Bass buys 'em, sells 'em, trades 'em. Write or wire. Bass Camera Company, Dept. AG, 179 W. Madison St., Chicago 2.

PHOTOGRAPHY For pleasure or profit. Learn at home. Practical basic training. Long established school. Write for booklet. American School of Photography, 1315 Michigan, Dept. 3431, Chicago 5.

HAVE You a camera? Improve your hobby of photography and learn how to make better pictures. Write today for our latest book catalog and sample copy of American Photography, containing articles and pictures by the world's foremost writers and photographers. Camera House, 601, 353 Newbury St., Boston 15, Mass.

OIL Coloring photographs can be a fascinating hobby or profitable sideline for those with artistic talent. Learn at home. Easy simplified method. Send for free booklet. National Photo Coloring School, 1315 Michigan, Dept. 3431, Chicago 5, Ill.

PHOTO FINISHING

SUPER Size Hyglos prints with eight exposure rolls developed—30c. Enlargement coupon. Other astounding offers. Hollintins, P-1350, Hollywood, California.

50 VELOX Reprints \$1. Suburban Studio, 1410-M Bond, Rockford, Ill.

FASTER! Rolls developed, sixteen sparkling fadeproof prints, professional 4x6 enlargement, beautiful frame—25c. Rolls developed—eight 4x6 enlargements—30c. Reprints 2c. Enlargements 4x6, 4c. Lifetone Photos, 853-39 Fifth, Des Moines, Iowa.

FREE Price list on quality developing, printing, enlarging. Write for it today. Bryan's Photo Shop, Dept. M, Panama City, Florida.

BEAUTIFUL Precision enlargements. Your photos may win as much as \$25.00 in cash. 4—5x7 enlargements for \$1.00; 3—8x10 for \$1.00; 15—3 1/2 x 5 for \$1.00. Your order automatically enters our contest. Details free. Desert Town Studio, 337-A West 43rd Street, Tucson, Arizona.

6-8 EXP. Rolls finished giant size 30c. Thrifty, P.O. Box 688, Sta. H, Los Angeles, Calif.

FREE 4x6 Enlargement with every ten reprints only 30c. Rolls developed 30c. Globe Photo Service, Dept. 112, La Crosse, Wis.

ROLLS Developed—8 Velox deckledge prints 25c. Enlargement coupons given. Fox Film Co., Florence, Alabama.

FREE! 5x7 Enlargement! Rolls developed and eight lifetime double-size Velox prints made by modern electronic equipment only 30c. Reprints from negatives, same size 3c; double-size 4c. Candid rolls, finegrain developed, 3x4 prints 12 exposures 45c, 16 or 18 exposures 65c; 36 exposures \$1.25. Return ad with roll and receive absolutely free 5x7 enlargement. Franklin Finishing, Box PM-8, Framingham, Massachusetts.

NOT 8 But 16 prints 35c. 6 or 8 exposure roll printed with double set of prints. Fast service. Miami Foto Mail, Box 1506, Miami Beach, Fla.

100 VELOX Reprints \$2.00. Roll developed 16 prints 25c. Box 5, River Grove, Ill.

ROLL Developed, 8 brilliant fadeproof Velox prints and two professional enlargements 25c. Overnight service. Young Photo Service, 405-C, Albany 2, N. Y.

PLASTIC Statuettes made by experts \$1.00. Illustrated literature free. Statuette Craft, 8448 Grand River, Detroit 4, Mich.

2c—VELOX Reprints. Roll developed 16 prints 25c. Photographer, Lake Geneva, Wis.

16 FOR 25c—Velox deckled prints with roll developed. Velox reprints 2c. Deckle-tone, Lake Geneva, Wis.

ENLARGEMENTS—5x7, 10c; 8x10, 25c; from your negatives. National Film Service, 3111 West Tuscarawas, Canton 3, Ohio.

FREE Snapshots! Free album! Mail this ad and two negatives for free snapshots complete in album! When you see these free samples you'll want more! Only one free offer to a customer. Artisto, Dept. 131, Drawer 220, Regina, Sask.

8 PRINTS All enlarged to nearly post-card size from your roll or negatives 25c; 16-50c. (Trial offer). Willard Studios, Box 3535A, Cleveland, Ohio.

THREE Prints each, 8 exposure roll 40c. Two each 35c. One each 25c. Reprints 3c. Fred D. Eastman, Bode, Iowa.

EVERY Picture an enlargement. Bigger and better snapshots than you have ever seen before! New electronic developments give you improved lifetime deckled-edge enlargements at our same low prices. Any 8 exposure roll developed and printed enlarge size 25c; reprints 3c each. Fast, accurate service guaranteed! Send for free mailers, today! Enlarge Photo Service, Box 791D, Boston, Mass.

LARGA-PIC—We have only one offer, but it's an outstanding one! Your roll developed and 8 prints made into brilliant Larga-Pic photos for 30c. Reprints from your negatives 4c each. Write for free mailers. Larga-Pic, Box 22, Brookline 46, Mass.

TWO Beautiful prints from each picture on roll 25c. Twenty-six years of satisfied customers. Quick service. Lens Photos, Dept. J4, Janesville, Wis.

16 VELOX Deckledge prints with roll developed 25c. Studio, River Grove, Ill.

BEAUTIFUL Enlargement from each picture on roll 25c. Cut Rate Photos, Dept. B4, Janesville, Wis.

NEW Color process makes full color prints from black and white film or negatives. Send dime for sample. We have films. Midwest Photo, Janesville 26, Wis.

ROLL Developed, two prints each exposure 25c. Additional reprints 3c each. Skrudland, 6444Z Diversey, Chicago.

8 BEAUTIFUL Double size pictures and roll developed 30c. 8 hour service. Free mailers. Pacific Photo Service, Box 666, San Francisco, Calif.

PHOTOGRAPHY For pleasure or profit. Learn at home. Practical basic training. Long established school. Write for booklet. American School of Photography, 1315 Michigan, Dept. 3452, Chicago 5.

ROLL Developed and 8 prints 30c. Overnight service. Free mailers. Tri-Plex Photo Service, Box 375, San Francisco, Calif.

2 BEAUTIFUL Hi-Gloss prints each good negative and enlarging coupon with each 6 or 8 exposure roll developed 28c. Owlphoto Co., Weatherford, Oklahoma.

GLOSS Finish enlargements. 4 5x7 for negative 50c. 3 5x7 from photo 50c. Robert Renshaw, Jr., P.O. Box 478, Chester, Penna.

MOTION PICTURES AND SOUND EQUIPMENT

JIU Jitsu movies, free list. Stone, Box 171-B Canal Sta., New York 13, N. Y.

8MM-16MM Films, equipment. Bargains! Towars, 935 North Fortieth, Philadelphia 4.

FILM—Movetone is back. It's Weston 12 nonhalation. Free processing 100 ft. 16 mm. \$3.25, 25 ft. double 8mm. \$1.50. Bulk film without processing 100 ft. 16mm. \$2.25, double 8mm. \$2.45. Free circulars. Wanted Eastman double 88 camera spools. Paying 35c. Fromader Genera, Davenport 4, Iowa.

COLOR. New Supercolor movie film. Weston speed 32. Free processing. 100 ft. roll 16mm., \$6.00 or 25 ft. roll double 8mm., \$3.25. Sent prepaid. Reliance Film, 354 W. 44th, New York 18, N. Y.

CAMERAS, Projectors, films. Silent, sound. Catalog 10c. Agents wanted. Liberal commissions. Richardson, Wyoming 2, Penna.

EXCHANGES: 8/16mm. silent, \$1.00 per reel. Rentals, sales at money-saving rates. Details for dime. Midland, Box 429, Oak Park 4, Illinois.

400 FT. 16mm. motor projectors \$17.50. Send stamp for 8mm., 16mm. lists. Sterling's, 679 Northampton, Easton, Penna.

TALKIES: Convert your silent 16mm. projector into sound with our guaranteed parts kit. Plays all 16mm. sound films. Quickly assembled at home. Special introductory offer. Send this ad now with \$25.00, check or money order, and we will include sound test film, instruction manual and full information on how to use with your radio. Kit includes photocell, exciter lamp, optic, which makes a sound head complete. Or send \$1.50 for complete blueprints showing how to make adapter yourself. Apex Video, Box 3071P, Hollywood 28, California.

8-16MM. Silent-sound films. Complete rental library. All latest subjects. Free catalogue, (sample film 10c). Garden Film, 317 West 50th, New York 19.

16-35MM. Silent Sound films. Bedner, 5300 So. Talman, Chicago.

COMPLETE Stocks always of Castle, Official, Pictorial films, 8mm., 16mm., sound. Musicals, soundies, free catalogs. We exchange your films and equipment, or buy them for cash. Frank Lane, 5 Little Bldg., Boston, Mass.

THRILLING 8mm.-16mm. Movies. Catalog, refund coupon, 25c. Fine Arts Productions, Box 2084, San Antonio 6, Tex.

PROJECTORS \$16.00 Up. Cameras, film available. Selco Products, Danvers, Mass.

RARE 8-16MM. silent-sound films. International, 2120 Strauss, Brooklyn, N. Y.

TITLES Of quality. Technicians, 3964 Ames St. N. E., Washington 19, D. C.

FINEST Movie screens, inexpensive, make them yourself. Free literature. Snow White Screen Company, Danville, Illinois.

BASS Says! 37 years of leadership means satisfaction to you! Finest equipment, 8 and 16 mm., sound cameras, sound projectors. Bass buys 'em, sells 'em, trades 'em. Satisfaction always guaranteed, or your money back! Bass Camera Company, Dept. A, 179 W. Madison St., Chicago 2.

BEAUTIFUL Kodachrome slide and lists 25c. Slide Supply Service, 3111 West Tuscarawas, Canton, Ohio.

GUARANTEED Fresh anti-halo outdoor movie film! Weston 12! Daylight loading! Processing free! Three spools double 8mm. \$3.45! Six single 8mm. for Univex, \$4.60! Postpaid! Catalog, Eso-S, 828-B West 39th, Kansas City 2, Missouri.

"THE World's Greatest Passion Play," all sizes sound and silent. Write Hemenway Film, 33-F Melrose St., Boston 16, Mass.

I BUY, Exchange, swap movie films. Harvey Iris, Box 539, Brockton, Mass.

MOVIE Camera films, 100' 16mm. \$2.50. 25' double 8mm. \$1.25. Free developing. Better Films, 742 NewLots, Brooklyn 7, N. Y.

MUSIC AND MUSICAL INSTRUMENTS

LYRICS Extraordinary \$2.00. James Woolman, 19952 Santa Barbara, Detroit 21, Michigan.

NEW And rebuilt musical instruments. Lower prices. Send for catalog. Give instrument interested in. Harden's Musical Merchandisers, Marion, M. Ohio.

ACCORDIONS—All sizes, makes. Wholesale. Write Metro Accordion, 44 North Albany, Chicago.

YOU Can play the piano by ear—in one week. By the quickest, easiest short cut system in the world. Gives all tricks and pointers for playing correct bass with left hand, the main secret in playing by ear. Write Shamrock Company, Dept. A, 309 Nelson Street, Yoakum, Texas.

PHONOGRAPH Records cheap. Catalogue. Paramount, MG-313 East Market, Wilkes-Barre, Penna.

WESTERN Records—Latest numbers 29c. Catalog 3c. F-L Shop, Box 19-L, New York City 35, N. Y.

DUO-FLEX Reeds, for clarinets and saxophones. Eliminate your reed troubles. Circular free. Duo-Flex Reeds, 1204 First Ave., Evansville, Ind.

POEMS Wanted for musical setting! Send poem for immediate consideration. Hamann Service, 614 Manhattan Building, Milwaukee, Wisconsin.

AMPLIFY Your accordion with our new Del Principe pickup, \$22.50. Install it yourself in one minute. Makes any accordion sound like an organ. Works with any amplifier. Special Del Principe amplifier and pickup only \$72.50. Write for details. Del Principe, 307 So. Wabash Ave., Chicago.

FREE Accordion pickup with each accordion purchased. New or used accordions for sale. Cash or terms, wholesale or retail. Write for bargain list. Del Principe, 307 So. Wabash, Chicago.

MUSIC Arranged. Songs printed. Frank Wildt, Music Publisher, Lancaster, Penna.

POEMS Wanted to be set to music. Free examination. Send poems. McNeil, Master of Music, 510-PM S. Alexandria, Los Angeles, California.

SONGWRITERS! Outstanding ethical offer. Hibbele, C5, 2157 N. Avers, Chicago.

BEFORE Sending your poem to be set to music, know your composer. Free folder. Al. Moquin, 5333 La Cresta Court, Hollywood 38, Calif.

POEMS Wanted for new songs. Send poem for free examination. Elliot Wright, Master Composer, 207 Rivoli Theater Building, Portland, Oregon.

POEMS Wanted for musical setting. Send poem for immediate consideration. Five Star Music Masters, 630 Beacon Building, Boston.

SONGWRITERS: Send poems for free examination and outstanding offer. United Music Service, 150, Salem, Indiana.

WRITE Songs. Big money and reputation. Write for information. J. Gordon Pub Co., 201 N. Hoyne Ave., Chicago.

SONG Writer's attention! The amazing demand for phonograph records, accelerated by more than 300,000 juke boxes and the hits popularized warrants your immediate consideration. We are offering song-poem writers the rare opportunity of having established composers collaborate on appealing material received this month. Recola Records, Box 987P, Hollywood 28, Calif.

RADIOS, SUPPLIES, INSTRUCTIONS

BEGINNERS! Experimenters! Make tubeless, batteryless, loud radio. Absolutely no crystal necessary! Use common household item instead! Exciting! Complete instructions 25c. Banas, Box 285, Syracuse 1, New York.

MINIATURE Headphones, military surplus similar to hearing aid phones. Ideal for crystal sets, outdoor use, hearing aids, etc., comfortable, comes complete two receivers, soft rubber ear inserts, headband and cord, brand new. Prepaid \$1.00. Heath Co., Benton Harbor, Michigan.

FREE New radio catalog is ready! Radionic's catalog lists radios, hard-to-get radio parts, books, amateur, test, and P.A. equipment. All available for immediate delivery. Send today to: Radionic Equipment Co., Dept. 206, 170 Nassau St., New York 7, N. Y.

RADIO Bargains. Joe T. Morrow, Wolfe City, Texas.

AMAZING New screw holding screw driver \$1.00. Salesmen wanted. Screw-gripper, Muscatine, Iowa.

BUILD "Loudest" crystal radio. Instructions and loud crystal, 25c. Amorose, Route Four, Richmond, Virginia.

WORLD'S Best crystal set. "HB-2"—24 page book, all details, including catalog, "Radiobuilder"—25c. 3 issues "Radiobuilder"—25c. Laboratories, I-c, San Carlos, California.

MICROPHONE. Hook to your radio. Follow simple instructions. Pay postman \$1.98 plus postage. Brotman Sales, 2333 Anoka Ave., Baltimore 15, Maryland.

RECEIVER Army aircraft type brand new 6 tube superheterodyne. 3 gang tuning condenser, vernier dial, latest type tubes, complete in aluminum case with tubes and circuit diagram prepaid \$6.00. Heath Co., Benton Harbor, Michigan.

WHOLESALE, Radios, tubes, parts. 5 tube kit complete \$16.25. Relays, 115 volt a.c. \$1.75. Tubes 30c up. Walmar Dist. Co., 3803 Beehler Ave., Baltimore 15, Md.

HALLCRAFTERS, National, other radios wholesale. Terms. Write. Henry Radio, Butler, Missouri.

"25 YEARS Experience" radio repairing at your fingertips. I've repaired 45,000 radios and have perfected system you can follow step by step. My methods are far simpler than any course published. Requires no calculations. Total price \$1.00 postpaid or c.o.d. Moneyback guarantee. Ross Radio Company, 14615 Grandriver, Detroit 27, Michigan.

BUILD One tube cigarette case radio. Easy to build. Plans 50c. Complete kit and plans less batteries \$5.00. Special miniature batteries \$1.75. Extra tube \$2.20. Money order or c.o.d. Electronic Manufacturers Co., Fifteenth and Greene, Augusta, Georgia.

RADIO tubes, parts, wholesale, retail large stock. Radio Mail Order Company, 46-13 188th St., Flushing, N. Y.

RADIOMEN, Servicemen, beginners—make more money, easily, \$250 weekly possible. We show you. Information free. Merit, 216-32A 132nd Avenue, Springfield Gardens 13, New York, N. Y.

RADIOS. Record players, tubes. Send for free list of bargain prices. Hallmark, 592 Communipaw, Jersey City, New Jersey.

AMERICA'S Best buys. Radio tubes 29c up. Free bargain lists, Potter, 1314-P McGee, Kansas City 6, Mo.

RADIO Service men and experimenters send stamp for our giant radio catalogue. Save dollars. United Radio Co., (1000-V) Newark 1, N. J.

MAKE Simple, tubeless, batteryless, distance-getting crystal radios. Crystal and illustrated instructions 25c postpaid. Allen, 427-P, Clinton, Missouri.

RADIO Technician and radio service courses. Training for federal licenses. American Radio Institute, 101 W. 63 St., New York City. Approved under G. I. Bill of Rights.

BUSINESS OPPORTUNITIES

RE-NEW Leather and leatherette—Make cloth into imitation leather with plastic discovery called Leather-New. Opportunity to make real profits taking care of sales resulting from national advertising. Write for free sample of Leather-New covered material and complete deal. 701 Land Bank, Kansas City, Missouri.

OPERATE America's most popular low priced precision penny vending machine. Big profits. Be independent. Write for bulletin and prices. Stock shipments. Fielding Mfg. Co., Desk 847PM, Jackson, Michigan.

EARN Dollars daily at home. Details. Tannehill, 745 N. Central Ave., Chicago 44, Ill.

COMPOSITION Flooring—made in most colors. Lifelong, soundproof, resilient. Flexible molds. Cast novelties, plaques, statuary. Big money—your own business. Catalog free. Write Bing Products, 88-A3H Broad Street, Boston 10, Mass.

GET Started in legal coin-operated amusement machine business. Small investment required. Terrific money maker. Write for full details. Skill Games Corp., 1145 DeKalb Ave., Brooklyn 21, N. Y.

FLOCK Finishing is easy. Supplies, equipment, instructions. Coast Industries, Los Angeles 44.

BUILD Your own business. Sell by mail. Start small, grow big. Mail dealers, beginners idea book. Send 25c for your copy now. Patterson Educational Service, 10226A 11 Ave. S.W., Seattle 66, Wash.

START Home business making statuary, plaques, novelties, garden furniture, artificial marble flooring, liquid marble. Make your own flexible molds. Amazing profits. Folder free. Creative Publishers, Box 236-L, Winnetka, Illinois.

FREE Folder explains many plans to start your own business. Small capital. Pleasant, dignified, profitable. Nelson's, 530-P Santa Clara, Alameda, Calif.

GET Plenty of mail steadily, samples, catalogs, seed books, masses of real bargains and opportunities. Every day a big mail day, when your name is listed in our big mail column. Only 25c. 6 months \$1.00, with free gift. Martin's Service, Box 295P, Bassett, Va.

ATTENTION! 315 Ways to make money by mail. \$1. Details free! Write, Clements, P.O. Box 1064, Orlando, Florida.

BIG Profits publishing local Amusement Guide, cities over 10,000. Your own business. Limited capital. No experience. We teach all. Get details now. Ward Associates, Dept. J2, Greendale, Wisconsin.

ADVERTISERS! I mail advertising circulars 9x12" or smaller sizes, 1000 for \$3.00. New name list just compiled! Send to, Joseph Banas, Box 285, Syracuse 1, New York.

TADPOLES Make frogs, tremendous demand. Both make you money. 25c brings tell-how information. Chariton Corporation, Century Building, Chicago 4.

THE Secret of getting ahead is told so plainly in our book "You Can Get Rich" that if you follow its directions you cannot fail to forge ahead immediately. New edition only \$1.00 postpaid. Granite House, Book Publishers, 54 Pine Street, Portland, Maine.

AGENT Or exclusive distributor for cigarette lighter mfg. MacGregor, Tahoe Valley 16, Calif.

BUYERS Wanted for plaster novelties. Painted—unpainted. Retail—wholesale. Write today for free information. Bing Products, 88-X3A Broad, Boston 10, Mass.

UNPAINTED Plaster ornaments 2½c up. Oman, 642 Broadway, St. Paul 1, Minn.

FREE Details of an unusual money making opportunity. Stamp appreciated. T. Flynn, 329 Taylor St., Staten Island 10, N. Y.

OPERATE Profitable mail order business. Splendid opportunity. For details write, Norbert A. Shelton, 924-A Herrick Ave., Racine, Wisconsin.

BIG Paying jobs in welding. Complete welding lessons and reference books, 516 pages, 41 lessons, \$2.00 copy. Money-back guarantee. Hobartweld, Box M-875, Troy, Ohio.

RUBBER Moulds made to order. Have developed methods for manufacturing perfect moulds; will not deteriorate by use; easy to duplicate any items with pliable moulds. We can assist beginners or large manufacturers. The Shop Technician, 1832 East 9th, Kansas City, Missouri.

ESTABLISH Your own real estate brokerage business. Our 137 page authoritative manual tells you how. Price \$2.00. Refundable. Literature free. Realtor, Box 2983, Houston 1, Texas.

OPERATE Profitable mail order business. Splendid opportunity. Free details. William J. Nette, 2718 W. Cambridge St., Philadelphia 30, Penna.

EXCLUSIVE Franchise distributorship for new patented outboard motor carrier. Sportsal, Tahoe Valley 6, Calif.

LIFETIME Business. Work locally and or mail. Fast moving, profitable repeat item. New plan. Elmer Sales, 150-23 115 Ave., Jamaica 4, N. Y.

GOOD Rubber molds 50c up. Winner-molds, 228 Grove, St. Paul 1, Minn.

BOOKKEEPERS — Operate your own bookkeeping and tax service. Part or full time. Free course, "How to Operate a Contract Bookkeeping Service." A. J. Hawthorne, Public Accountant, Decatur, Ala.

WOULD You pay 3%—first \$350 made? Color-illustrated book "505 Odd, Successful Enterprises" free! Some offer occasional "day off." Work home. Expect something odd! Pacific, Oceanside, Calif.

NAMES—Addresses, Wholesalers, manufacturers, etc. Dime each. Three 25c. National, 3337-C South Hoyne, Chicago 9.

OPERATE Profitable mail order business. Write Gallagher Publications, Box 691C, Kingsport, Tenn.

GOLD, Silver plating at home. New, amazing outfit. Does marvelous work and so simple. Just plug into electric socket and in a jiffy you begin to plate. Not a toy. No experience needed. Everything furnished. Absolutely guaranteed. Make money plating for others. Write immediately for full details. Louric Mfg. Co., 1809 Callowhill Street, Philadelphia 30, Penna.

200 OPPORTUNITIES To make money selling by mail, only 50c. Roy Kramer, 329 Cates, Maryville, Tenn.

SEA-STAR Guaranteed marine homing device. Designed for safety, entertainment, simplicity. \$69.50. Complete satisfaction guaranteed. Write: The Electrex Company, Dept. M, 114 Liberty St., New York City.

WHOLESALE Items, business plans and opportunities. Free. Holm Sales, Box 12A, Oaklandon, Indiana.

MAKE Money—Silvering mirrors \$1.00, earthworm culture 50c, brush plating \$1.00. Universal, Box 1076-A, Peoria, Ill.

MERCHANDISE 25% Off the standard advertised price. Catalog 10c, none free. Solomon Company, 813 Broadway, New York 3, N. Y.

DISTRIBUTORS Wanted for nationally advertised, guaranteed, high-quality brushless. Wipe-on Auto Paint and 1-coat Auto Spray Paint. Protected territory. No price competition, full profit margin. Easily make \$200 per week selling to jobbers and dealers. Requires \$500 to handle stock. Address Gold Seal Brands, 673 So. Coronado, Los Angeles 5, Calif.

OPERATE Profitable mail order business. Splendid opportunity. For details write B. Z. Holverstott, 2421 Saranac Ave., Pittsburgh 16, Penna.

FREE Booklet "Key to Greater Earnings." James Williams, Box M2215, Hollywood, Calif.

MAIL Order business operated profitably. Excellent idea. Write McGee's Service Office, Box 333, Ironton, Ohio.

GOODYEAR—Has natural rubber latex for molds, self-vulcanizing, air-curing. Quart \$3.00, gal. \$10.50. Free sample and instruction. Goodyear, Lake Geneva, Wis.

AT Home—Your own manufacturing business; making popular \$1.00 novelties. Cost you 3c to 15c. Everything supplied. Write So-Lo Works, Dept. X-600, Loveland, Ohio.

OPERATE Home mail order business. Small capital. Write. Browning Service, Box 4001, Miami 25, Fla.

RUBBER Molds. "Aircure," mold making liquid. "Plasticwood," plaster hardener. "Highluster," glaze. Free models. Free details 3c stamp. Rubbercoat, 3873-A, California, San Diego 1, California.

(\$1000 PLUS Royalty.) Exclusive state franchise (patent applied), improved exterminating device. Controlled, eventual economical necessity, for restaurants, hotels, stores, institutions and homes. Vogel Manufacturing Co., 4510 N. Paulina Street, Chicago 40, Ill.

\$40 WEEKLY, Spare time, your own home business. Many plans. Literature free. Carroll Service Company, 521-A North Pine St., Little Rock, Ark.

DISTRIBUTORS, Dealers, agents. We have the fastest selling item on the market today. 100% profit. Steady repeater. Rush \$2.98 for complete set-up or write for details. Now! Halco, 804 Anderson Building, Fort Worth, Texas.

FREE Water and our concentrates, makes flavors, lotions, shampoos, 72 products, labels, bottles furnished. Qualco, E-20030 Russell, Detroit.

UNPAINTED Wall plaques, statues. Variety of designs, free list. ArBo Products, A 195 E. 7th, St. Paul, Minn.

INTERESTED In Latin America and foreign employment? \$1.00 brings 1947 Foreign Service Directory listing oil, aviation, mining, transportation, manufacturing, construction concerns with foreign interests and tips for immediate application. Global Reports, 6417 Homewood Ave., Dept. P.M., Hollywood 28, Calif.

MUGS—Make your set or start your own business. Attractive, inexpensive, full instructions, 49c. J. Bryant, A-208, 911 Sherman Ave., Evanston, Ill.

SURE Fire mail-order book 25c prepaid. Coast-to-Coast, Box 63-E, Station H, Buffalo 14, New York.

TWO Amazing new typing opportunities. Earn up to several dollars hour, right at home. New, exclusive, different. Write Schroder, 221 E. Bush, Covington, Ky.

OPERATE Profitable mail order business. Splendid opportunity. For details write H. W. Wilson, Box 369, Nashville, Michigan.

300 MONEY Making plans, ideas, formulas, success schemes. Folio free. Formico Mart, Box 572, Dayton, Ohio.

MANUFACTURE High grade electric appliance. We supply all parts and instructions. No capital needed. Write: Southern Electric, Box 97A, Radford, Virginia.

LET Us tell you how to get into the coin-operated amusement machine, and vending machine business with only a small investment. Write us before you buy, and save money at factory prices. Dallas Enterprises, Inc., 905 West Jefferson Blvd., Dallas, Texas.

CAPITAL Raising made easy; millions available; send for Financing Your Business, large 250 page volume, complete details, only \$2.00. Publisher, Room 9, 317 W. Forsyth St., Jacksonville, Florida.

TATTOOING And engraving pays big profits. Experience unnecessary. Literature free. William Moore, 412M South Green, Chicago 7, Illinois.

RUBBER For molds and coatings. Apex Plastic Products, 1915 Lunt, Chicago.

LIQUID Rubber for making flexible molds. Qt. \$2.00, gal. \$5.75. Sample bottle 25c. Chaney, 1130 E. 16th St., Jacksonville 6, Fla.

LEARN To make sea shell jewelry, pins, earrings, hair ornaments, novelties. Book of instructions and designs free with \$2.00 and \$5.00 kits, postpaid. Catalogue 10c. Herbert Diamond Co., Box 4619, Miami 31, Florida.

BABY Shoes bronzing supplies, plastic, Onyx, book ends, ash trays, frames, pen sets. Hardening solutions. Box 2095, Wichita, Kansas.

1000 CONTRACT Bookkeepers needed. Start your own business. Part or full time. Free course of instructions. Write H. T. Bedford, 223 W. Maple Grove Ave., Fort Wayne, Indiana.

OPERATE Profitable mail order business. Martin, 2454 Wilson, Chicago 25, Illinois.

CHEMICAL Specialties manufactured under your name! Large factory. Guaranteed workmanship. State needs, quantities. The Chemo Company, 3800 Genessee, Kansas City 2, Missouri.

DISTRIBUTORS — Leather novelties, ideal sellers. Send \$10.00 for sample assortment. Supreme Leather Products, 78 Fifth Avenue, New York.

BUILD Your own independent, fascinating and very profitable business at home, spare or full time. \$75.00 and upwards weekly easily possible making beautiful brilliant, sparkling novelties, religious figures and popular sports souvenirs. Fast sellers through you, salesmen, stores. Quickly learned and few dollars starts you making real money. Successful manufacturer can tell you how and furnish everything. Start small, grow big. Write for full information and "Amazing Story of My Success" at once. Inghram Company, 2845 Sixth Street, Detroit 1, Michigan.

BRONZED Baby shoe mountings. All-metal bookends, ash trays, picture frames. Onyx and Italian marble bases. Hardening solution. Lead lined tanks. 30 amp. rectifiers \$75.00. Motors for agitation (8 r.p.m.), \$15.00. Write for list. Hollywood Bronze Supply, 1770 N. Vermont Ave., Hollywood 27, Calif.

MAKE Money selling "C-E Automatic Water Heaters," \$7.50 to \$26 on each sale. Write Crane Electric, Eugene 4e, Oregon.

SELL Books by mail. Large profits! Free! Literature. Clime-Porter, Box 6346 PB, Pittsburgh 12, Penna.

\$46 FROM Square foot plywood. Jigsaw necessary. Write, Woodarts, X-37, Bridgewater, Mass.

"ALASKA—The Last Frontier" offers thousands of excellent opportunities! \$1 brings 1947 official government map and copyrighted report with authentic listings in commercial fishing, mining, fur farming, prospecting, aviation, timber, business enterprises and government homestead lands. Alaska Opportunist, 6417 Homewood Ave., Dept. PM, Hollywood 28, Calif.

HOW To sell by mail. "Planned and profitable" mail order selling. New, different work-book of ideas and instruction for beginners, aspirants, established dealers. Send 25c for copy of leading mail order trade magazine and complete details. Year's subscription \$3. Mail Order Monitor, 356 So. Broadway, Suite 706-PM, Los Angeles 13, Calif.

JIFFY-TILL, The midget tractor with the "magic hoe" needs a dealer in your territory. Easy sales because of low, low price, small size, scientific tillage. Write Box 394, La Mesa, Calif.

CAPITAL Seekers, inventors. Startling information. Free. Write—Director White, 3439 Michigan, Chicago 16.

OWN A mail-order paper products business. Sell envelopes, tags, bags, boxes, by mail, wholesale. Tremendous demand. Steady profits. No capital necessary. Write Omaha Envelope Service, Dept. 214, 4721 California, Omaha 3, Nebraska.

MAIL Dealers, agents, opportunity seekers. Sell book 1001 household hints. Millions of prospects. Details. Hale Associates, 1216 Park Row Building, New York, N. Y.

GENUINE Natural Latex for rubber molds. Only two coats necessary for a heavy mold. Make money reproducing hundreds of objects. Write: Major Chemical Co., 131 Inman St., Cambridge 39, Mass.

INVESTIGATE Mail order or home business. 140 new ideas. Write Marshall, Box 655, Centralia 11, Washington.

BUBBLE Gum ball machines—New 1c Victor vendors. Also sell nuts and candy. \$11.75 each. Bernard Bitterman, 1405 Central, Kansas City 6, Missouri.

PACKAGE, Sell products under your name, mail, local. Dade Products, Box 1720D, Cleveland, Ohio.

TRAVEL Anywhere anytime. Earn \$85.00 week up. Be your own boss. No experience necessary. Less than \$5.00 investment required. Literature free. Traveler, La Grange 1, Indiana.

RUBBER Molds—We create, for making ash trays, novelties, religious figures, plaques, book-ends, etc. Make big money duplicating hundreds of items, own your own business, start in spare time. Latest factory and shop methods. Also molds made to order. Get our prices. Information free. Write Shop Technician, 314 Westport Rd., Kansas City, Mo.

1000% PROFITS Making 8 scarce materials for building boom. \$1.00. Enterprises, 157 Golddale, Toronto, Canada.

DON'T Be Mr. Average man. Be your own boss. Earnings unlimited. Operate from home. \$25.00 adequate investment for immediately earning \$200.00 weekly. Postal brings details. J. T. Van Zile, 79 Mills Street, Morristown, New Jersey.

RESILVER Mirrors at home. Formula 25c. Ideal Service, Park Ridge 6, Illinois.

SHELL Jewelry kits. All materials furnished with instructions \$2.60 and \$1.00 postpaid. Most distinctive and complete kit ever offered. Order today. Earn while you learn. Catalogue free. Shell-O-Craft Co., Box 365, Station A, St. Petersburg, Fla.

RECLAIM Used motor oil. Inexpensive method. Instructions 50c. Charles, 12-AP, Norwood, Ohio.

QUIT Wasting dollars trying to start a mail order business. Get and read the truth and save losses. Send quarter for idealful booklet of facts, not promises. Send for "How to Build Your Own Mail Order Business," and get "in right" for profits. Douglass Service, 3231-M 40th Avenue, S.W., Seattle 6, Wash.

BIG Profits and your own business casting latest 1947 metal toy autos, airplanes, ashtrays, savings banks, etc. Enormous wholesale and chain store demand keeps manufacturers busy. Spare or full time. No experience or special place needed. For full information write Metal Cast Products Co., Dept. A, 1696 Boston Road, New York 60, N. Y.

START Home manufacturing business making Cleaning Compounds, Soaps, Insecticides, Cosmetics, Polishes. No machinery. Literature free. Kemix, Park Ridge, Ill.

COLORGLAZED Concrete pottery made without molds. New, low cost, patented method. Cemetery products, novelties, tiles, floors, etc. Basement leaksealing. Other moneymaking projects. Booklet, details free. Men only. National Potteries Company, Grand Rapids, Minnesota.

"BULK Vending machines" make easy steady profits. Mechanically inclined persons are in their hay-day with this fascinating, profitable business. Big manual size book, by old head operator, explains inside methods to easy steady income with coin machines. Every day is pay day. Big machine book \$2.95 check or money order. Bill & Fay's Vending Service, 1051 "L" St., San Bernardino, Calif.

FOLLOW The ideas of a successful operator in the mail order business. Learn how to make, not lose money. Information free. Walter Seller, Dauphin, Penna.

MAIL Order businesses bought and sold. All types successfully handled through national brokers. List your business now, or tell us what you want to buy. Write for free facts. Turnipseed, Inc., Box 681, St. Louis, Mo.

FREE—Mexican novelty curiosities. Fast seller. Exceptional profits. "Productos," Apartado Postal 9318, Mexico City.

MAKE Liquid marble, flexible molds, statuary, art goods, novelties, artificial marble flooring. Literature free. Kemico, Park Ridge 50, Ill.

FOR Greater opportunity write, Leaf Service, Box 998, Ingleside, Texas.

DRAIN Tile and block machinery. Flower pot, love seat, block and brick molds. Aluminum lawn furniture. Data free. Concrete Machinery Company, Hickory 6, N. C.

RUBBER Molds, liquid rubber, statuary plaster, kits for beginners. Complete "Plastercraft" course free on request. Blue Rapids Supply, Blue Rapids, Kansas.

"IDEAS For Additional Income," copy 25c. MacLaughlan, 415 So. Fourth Ave., Puente, Calif.

"HOW To Make Money With Hobbies." Big profits! Send 3c stamp for free details. Business Service, 1101 Kings Highway, Shreveport 49, Louisiana.

BABY Shoes metalized the durable method. Complete instructions \$1.00. St. Albans Plating Industries, 135-17 135 Ave., So. Ozone, L. I., New York.

UP To \$1500 yearly selling by mail in spare time interest you? New ideas and plans every month. Details free. Idea of Month Club, 3023-A Greenmount, Baltimore 18, Md.

UNPAINTED Plaques, bookends, ash trays. List. Bava, 3655 E. Canfield, Detroit 7, Michigan.

HOW To build your own mail order business, Beginners Idea Book tells how. Quarter postpaid. Satisfaction guaranteed. J. P. Seery, North Conway 3, N. H.

OPERATE Dependable mail order business, supplied by us. Progress Mail Order, Box 1374, Indianapolis 6, Indiana.

METALLIZING Baby shoes makes you money! Learn this simple, profitable business from nationally recognized authority. Get professional results with professional "know-how"! Free particulars. Joseph B. Kushner, Metal Finishing Consultant, Stroudsburg 3, Pennsylvania.

COIN Machines earn big money! Machines are now available at \$11.75 that can earn as high as \$7 weekly profit. Place machines in stores, hotels, filling stations, etc., and your income starts immediately. Routes can be operated in spare or full time with no experience needed. We'll tell you how and send you a catalogue describing our nut, candy, gum, and postage vendors, also scales, amusement games, etc. Write immediately to Parkway Machine Corp., Dept. P, 623 W. North Ave., Baltimore 17, Md.

CO-PUBLISH And advertise in The Central Mail Advertiser. Sample copy for stamp. Low rates. Large circulation. Bagby Printing Co., Georgetown, Ohio.

MAILORDER Beginners! Save money by getting started right! Our new booklet may save you dollars. Only 10c. postpaid. Mail Order Mecca, 30 West Washington Street, Chicago 2, Illinois.

BIG Profits in carded merchandise, combs, blades, etc. Write for wholesale prices. Buford's, Box 54, Dallas, Texas.

HOW To set up and run a mirror shop! Resilver mirrors. For price write—John Sprinkle V60, Marion, Indiana.

WHY Job worry? Learn electroplating. Highly paid, uncrowded, interesting business. Gold, silver, nickel, chromium, etc. Send postcard for free booklet and proof. Plater Hyde, Dept. MC, P.O. Box 176, National City, Calif.

EARN Easy money, spare time. No experience. Lane, 548-B 61st Street, West New York, New Jersey.

SYNTHETIC Latex with Neoprene base for making flexible molds! Quick drying! Safe! For home, classroom, or industry! Quart \$2.00. Gallon \$5.95. Full instructions. Beginners' booklet on molding and plaster casting, 25c. Plastercraft Supply Company, 1406 East 43rd Street, Cleveland 3, Ohio.

GOT \$24,500 Using "schemes" from "Schemer" magazine, Alliance, Ohio, 49th year. \$1.00. Three samples 25c.

RAISING Canaries gives good profits. Valuable bird book—"Its Care, Breeding and Training." Price \$1.00. American Canary, 2839 N. Halsted, Chicago.

OPERATE Profitable mail order business. Write Walter Service, 4159-A East 112th, Cleveland 5, Ohio.

MEN—Women be your own boss start a home business with our collection of 137 plans. Send for particulars. Simon Waldman, Dept. P-1, 4444 Richmond St., Philadelphia 37, Penna.

IF You'd like to make \$5,000-\$10,000 yearly in the collection-credit agency business, write us at once. Outstanding opportunity. Cole Associates, Syracuse 2, N. Y.

MAKE Money making shell jewelry and novelties. Instruction book 75c. Kit \$5.00. Catalogue free. Palm Shellcraft Co., 220 W. 9th St., Sarasota, Fla.

METALLIZE Baby shoes. Excellent profits. New system insures success. Free details. "Treasures Forever," Metallizers, 89 Henry Ave., Lynn, Mass.

THE Mail Order News (54th year) shows you money making opportunities in every issue. Sample copy 25c. Veterans Business Publications, Charleston 1, Ill.

MAIL Order Beginners! "Business Development Plan," "Profitable Mail Selling Idea," "Pointers Along the Mail Order Trail." Noted mail sales specialist's, three-in-one, 10,000-word treatise shows "how" at home, spare time, small capital. From idea to mailbag. 25c postpaid. Satisfaction guaranteed. Maupin & Maupin, Lafayette 3, Indiana.

MAKE Strange plastic—1c pound. Makes durable, attractive floors, walls. Build with waste. Save half. Bays Laboratory, Oklahoma City 9.

INCORPORATE Your business. Delaware laws. Many advantages, free details. Tax Research Bureau, Inc., Delaware Trust Building, Wilmington, Delaware.

RECAST Old batteries into new. Latest achievements. Battery Laboratories, Minneapolis.

BIG Mail income. Free particulars. Murray's, 196 Circle, Forestville, Conn.

PARATOL—Amazing new rubber latex moulding compound for perfect detail castings of all kinds tested and approved in long service. No worries—easy to apply, quick drying, maximum strength and long life. Why pay more—buy direct! Quarts—\$1.60, 1 gal.—\$4.90, 5 gals. \$4.45 gal. 4 oz. samples on request. Send 25c to cover mailing and handling charges. Full instructions sent with each order. Testworth Laboratories, Inc., Manufacturers of coating and adhesive products of all kinds. 407 S. Dearborn Street, Chicago 5, Illinois.

BEST Tested moneymakers — 68 page book 25c (coin) postpaid. Business secrets, mail order plans, formulas. Wholesale supply sources. Money back guarantee. Frank R. Carpenter, Boyes Hot Springs, Calif.

OUR Unique service will help sell your idea or invention. Literature free. Ellis Martz, Representative, Muncy, Penna.

GROW Bean sprouts in dark room for market. Pays well. Free information. Mrs. Nickell, Rt. 1, Box 456, Bend, Ore.

START A home business in spare time. Make extra money. Experience unnecessary. Literature free. Ellmar Services, Muncy, Penna.

BIG Money in vending machines. Small-capital start brings immediate profits that build permanent profitable business. Starting instructions free. Becker Vendors, 105-A Dewey, Brillion, Wisconsin.

MAKE Perfumes. Profitable business. Free book tells how. Walter Lawson, 21 Joiner, St. Augustine, Florida.

BELTS! Make 'em and make money. No tools! Sample 50c. Artinc Leather, 411 Joseph Ave., Rochester 5, N. Y.

WINDSHIELD Wiper and fuel pump re-building bring big profits. Free particulars. H. & H. Products, P.O. Box 430, East Akron Station, Akron 1, Ohio.

MAIL Order opportunities. Full or spare time. Hundreds of chances. No charge. Postal brings copy. Blackstone Press, Somerville, New Jersey.

GREAT Opportunities and profits in mail order business at home. Free literature. F. Webster, Box 1972C, Hollywood, Calif.

LEARN Piano tuning, repairing, at home. Tremendous field! Piano parts, tools furnished. Established 1935. Empire School of Piano Tuning, 606-B East University Ave., Champaign, Ill.

MEN—Women—"Everybody likes candy." Learn to manufacture professionally at home. (Our 36th year). Ragsdale Candies, Dept. 4, East Orange, N. J.

HANDYMEN—Earn money home operating Community "Fix-It" Shop. Write Stafford, 708 Rawlings, Carbondale, Ill.

DO It with sea shells. Big profits. Werts, 1429 - 56th Avenue, Oakland 3, Calif.

BOOKKEEPERS—Operate your own simplified "Dollar-A-Week" bookkeeping and tax service. Full or spare time. Details free. Ellis, Box 200, Cedar Grove, North Carolina.

MAIL Order business course shows you how to make money, spare or fulltime. Teaches professional mail order technique—not penny-snatching schemes. Fascinating 100-page illustrated success-catalog free! Write, Nelson Company, Dept. 4-02, Chicago 5.

PLASTIC Discs, shapes, metal findings, wholesale, free catalog. "Secors," Bradenton Beach, Florida.

ELITE Collection contains 137 practical money-making plans; local and mail order. New edition. Particulars free. Elite Co., 220 Grand St., New York 13.

BRONZING And metallizing baby shoes! Gold, silver, copper, nickel, bronze, pearl, ivory, and "luminous glow" colors! Big profits! New field! Details free! Write R. O. Morgan, Box 349, Long Beach 2, Calif.

QUICK Money! "Repairing car batteries." At home! Easy too! Write, Batteryman, Grand Junction 5, Colorado.

SELL By mail!—Books and novelties! 35 different items! Large profits! Catalog free! Eifco, 432 N. Wells, Chicago 10.

OPERATE Profitable home business selling merchandise by mail. Fast sellers. Large profits. Powell Service, 5713 Euclid, Cleveland 3, Ohio.

INTERESTED In immediate mail order cash? Read "Advance"—Voice of mail order. Offers money-making opportunities. Personal guidance and benefits to all. Sample copy 25c. American Mail Trade Association, 313 East 21st Street, Dept. 400, New York 10, N. Y.

COPUBLISH Leading m.o. paper. Latest copy Mail Sale Advertiser and proposition, commemorative stamp. Vanroy Shirk, Lebanon, Penna.

START Profitable mail order business. PMT lists new propositions available; products, sources, accurate methods. Covers ad writing, letter logic, trade information. Send 10c for copy and get free instruction folio offer. Progressive Magazine, Sheboygan, Wisconsin.

START A clock shop. Fascinating, easily learned profitable business requiring little capital. We teach you how to repair all kinds of clocks. Information free. Houston Clock Shop, P.O. Box 5086A, Houston 12, Texas.

HOW And where to obtain capital. Fully explained. Particulars free. Star Service, Wapakoneta, Ohio.

SPECIALTY Manufacturing, the big money business that can be operated anywhere, start on a very small capital; we supply dependable formulas and complete instructions; get interesting free booklet, "Money-making Opportunities in Specialty Manufacturing." Howard Robinson, Ph.G., 1300-A South Ohio Street, Sedalia, Mo.

START Mailorder bookshop—Everything furnished; publisher cooperation. 25c brings booklet, exclusive setup, samples, exciting ideas. General Publications, Ossining, N. Y.

\$25 WEEKLY Working two hours daily. No canvassing. No manufacturing. Lycke, Box 2471, Cleveland 12, Ohio.

137 WAYS To make money, in home or office, business of your own. Full particulars free. Elite Co., 220 Grand St., New York 13.

BRUSH Plating outfits connect to a battery. No tanks necessary. Good paying business at home plating autoparts, bathroom fixtures, bicycles, reflectors, silvering mirrors. No shop or experience required. Outfits furnished. Free booklet. Gunmetal Co., Ave. H. Decatur, Ill.

NOVEL, Adjustable bookrack plans \$1.00. Woodcrafters, Box 245, Warrington, Penna.

MONEYMAKING OPPORTUNITIES

START Your own business! Big money manufacturing novelties, plaques, statuary. Free catalog. Write Bing Products, 88-A3K Broad Street, Boston 10, Mass.

BIG Mail of money making opportunities one dime. Levingston, Box 11, Dorchester, Center, Mass.

METALLIZE Baby shoes. Further information free. Metal Crafts, 5501 Suwanee, Tampa, Fla.

GET Lots of mail. Name listed 10c. Three times 25c. Banas, Box 285, Syracuse 1, New York.

SHIRTS \$1 Each for resale. Box 18, 93 Fourth Ave., New York.

MAGAZINE, Mail order plans 25c. Worth dollars! National, Woodbine, Maryland.

MANUFACTURE Sell custom arch supports. Jul Corsen, 2638 Geyer, St. Louis 4, Mo.

WHOLESALE Anything imaginable. New guaranteed list 25c. Refundable. La-salle Novelties, Box 2188, Waterloo, Iowa.

THE Mail Order News, oldest trade publication in America. (64th year). Shows many money making opportunities. \$1.50 year, sample copy 25c (coin). Silvercrest, 3040-P2, North Ave., Chicago 47.

SEWING Machine repairmen make big money lifetime. Start neighborhood shop. Complete repair manual, covering all makes, \$1.98 postpaid. Money back guarantee. Sewmachine Serviceman, Hamilton 9-D, Ohio.

EXTRA Money. Send for new plan. Free. Inspirational Books, Box 106 Old Chelsea Station, New York 11, N. Y.

WOULD You pay 3¢—first \$350 made? Color-illustrated book "505 Odd Successful Enterprises" free! Proven! Work at home, office. Expect something odd! Pacific, Oceanside, Calif.

NAMES—Addresses. Wholesalers, manufacturers, etc. Dime each. Three 25c. National, 3537-D South Hoyne, Chicago 9.

SHELLCRAFT Sells! Have fun making genuine marine shell jewelry. Make money selling to stores and friends. Save money buying direct from wholesaler. Large kit \$1.00. Jumbo \$2.49. Instructions free. Eastern Shellcraft, 985 Myrtle Ave., Brooklyn 6, N. Y.

NOVELTY Manufacturers: Our snappy new designs for plaster casting make you money. Book ends, wall brackets, plaques. Large illustrated catalog 25c. Plastex Products, 711 Laguna St., San Francisco 2, Calif.

MAKE Big money. Build your own lamps and sell. Write for free factory photos. Buddy Products Mfg. Co., Dept. 25, 1123 West Belmont, Chicago, Ill.

BIG Profits—Manufacture at home under own name; ask how. Kimia Testing Laboratory, South Bend 24, Indiana.

PROFITABLE Letter shop operation. Details free. Wollard, Box 54, Newark, Ohio.

EARN Money spare time, mailing circulars for mail dealers. Pioneer, P-404, Yonkers 1, N. Y.

EARN Money evenings, copying and duplicating comic cartoons for advertisers. Adservice, Argyle 1, Wisconsin.

300% PROFIT On fast selling line. Every home, office, and store a prospect. Write for details. Carolina Enterprises, Box 172, Hickory, N. C.

NEW Price lists for rubber molds. Val-lance Art Products, 1873 E. 70 Street, Cleveland, Ohio.

SAWDUST Wanted by cash buyers. List quarter. Smith, 375, Williamson, W. Va.

BEAT Higher costs of living by extra money, spare time, own home, no personal contacts. Provenly successful methods. Write Postway, Box 882, Fort Worth, Texas.

EARN Up to \$2000 year, inventing simple items for special cash markets. Hendrickson, Argyle 7, Wisconsin.

1947 GIGANTIC Directory of opportunities, advertisers' supplies, sources, trade information, mail order ideas, products, wholesalers, valuable tips—just published! Descriptive literature free. Wilkin & Co., Hillsboro, Ohio.

"KNOCK 'Em Cold" teaches secrets everyone should know. Free particulars. Mileson, 1818 Tyler Pkwy., Louisville, Ky.

START Home mail business! Exclusive setups built-to-order for financially responsible beginners, by leading M.O. Association's expert staff. Booklet free! N.M.D.A., 33-B Vassar, Dorchester, Mass.

BIG Money making shellcraft kits! \$1-\$3.50. Wholesale supplies. Shelart, 3027½ 6th St., So., St. Petersburg, Fla.

EARN Up to \$480 month part or full time keeping books for small firms. Simplified system. Write Tax-Saver System, Dept. E, Fort Worth, Texas.

SAWDUST—Turn it into cash. Spare time. Instructions 25c. Charles, 12-AQ, Norwood, Ohio.

THOUSANDS Articles wholesale. "Supply Source Directory" 10c. Ideal Service, Park Ridge 40, Illinois.

WHY Earn profits for somebody else? Build your own business, spare or full time. Small capital start, grow big! Be your own boss! Start today! Details free! Elliott, 177 Columbia, Edgewood 5, R. 1.

METALLIZE Flowers for profit! It's new, easy, sure fire! Free details. Joseph B. Kushner, Metal Finishing Consultant, Stroudsburg 3, Pennsylvania.

EARN Money at home! Thousands do! Free details. Sizemore, Box 7, 4917 Kostner, Chicago 30.

WIN Money on contests advertised in magazines and on radio. General Contest Bulletin, published monthly, gives hundreds of tips. Lists current contests and rules. Sample 25c. General Contests, 1609½ East 5th, Duluth, Minn.

EXCELLENT Profits raising mink. Details furnished. Franklin Young, Riverhead, New York.

MANUFACTURE Costume jewelry at home for profit, hobby, therapy. Free wholesale supply catalogue. Instructions. Florida Supply House, Bradenton, Florida.

I MAKE Big money in the mail-order business. You can do the same at home with my copyrighted system. Write me. I'll tell you how. F. Little, Box 8, Glen-shaw, Penna.

\$25 WEEKLY Working two hours daily. No canvassing or manufacturing. Lycke, Box 2471, Cleveland 12, Ohio.

THERE'S Big money in junk," and repairing batteries. Write, Batteryman, Grand Junction 5, Colorado.

\$246.50 MAKING Unusual secret device without skill, machinery, from former war material costing \$1.50! Simple, baffling invention, unbelievably profitable! Illustrated proofs free. Rollis Enterprises, 115-D West 16th, New York 11.

EARN Money at home—steady income. Write Successful Income Builders, 508-A, Hollywood 28, California.

FORTIFY The future! Start own business; home, office. Booklet describing "Collection of 137 Tested Plans" free. Elite Co., 220-A Grand St., New York 13.

PUBLISH Your own magazine. Handsome 52 page format, well edited, illustrated. Cost low as \$1.00 month. Brings you prestige, profits. 25c brings sample, details. National, Ord. Nebr.

FORMULAS, PLANS, ETC.

SPECIALIZING In auto, chemical formulas. All guaranteed. Free literature. Write Karen Chemical Co., P. O. Box 242, Pasadena 17, Calif.

100 SINGLE Ingredient formulas. 25c. Tes-Co., Box 189-MS, Wilkes-Barre, Penna.

KILL The ants. Effective destruction of the pests. Make and mix your own poison syrup. Tested formula \$1.00. Money refunded if dissatisfied. L. B. Crain, 615 Echandia St., Los Angeles 33, California.

ROOFING, 100% Fireproof, low cost, lasts indefinitely; make yourself; formula with instructions, \$1.00. Rav Roofing Co., P.O. Box 255 Petersburg, N. Y.

21 POPCORN, Candy apple, etc. formulas. All money-makers. \$1.00. We can supply equipment. Concession Supply Co., Dept. "A," Box 133 Sta. "B," Toledo, O.

MANUFACTURE Cleaners, soaps, polishes, flavors, cosmetics. Literature free. Kemico, Park Ridge 16, Illinois.

10,000 FORMULAS And trade secrets. Free literature. Stillman, 555 Kingston Ave., Brooklyn 3, N. Y.

REAL Manufacturing formulas. Lists free. Cummings, Chemist, Gordon Ave., Syracuse 4, N. Y.

PLASTICS

NEW Plastic discovery—Make beautiful transparent plastic articles with embedded real flowers, butterflies, etc., and harden them without heat, with our kit. Free particulars. State-Line Supply, 34 Vine St., Sharon, Penna.

PLEXIGLAS: B-29. New. Blisters, $\frac{3}{8}$ " square. Approximately 7 sq. ft., 18 lbs. \$10.00; nose section, $\frac{3}{8}$ ". Approximately 2 sq. ft., 4 lbs. \$2.50; triangular shapes, 23 sq. in. 50c. 3 for \$1.00. Shipped express collect or c.o.d. Olschansky Bros. Metal Company, 2222 Snyder, Cheyenne, Wyoming.

NEW Liquid plastic. Clear, colors. Cast without heat. Embed flowers, insects, coins. Saw, drill, carve. Manual tells how. Send \$3.35 for complete 20 project kit including one pound liquid Castolite. Castolite, Dept. J-21, Box 211, Kenilworth, Ill.

EDUCATIONAL Offer! Learn by doing! Sample kit containing odorless resin, accelerator, rubber mold, dye, lubricant plus all equipment necessary to make quick castings in lustrous Formalin! Complete with instructions and price lists for quantity orders of these excellent plastics casting materials: \$3.00 f.o.b. Formalin, Romeo, Michigan.

CLEAR Plastic sheet $13\frac{1}{2} \times 9 \times 1.25$ " or $1\frac{1}{2}$ ", \$1.25 postpaid. Other sizes. Aero Instrument Company, Municipal Airport, Houston, Texas.

LUCITE—Findings, Tenite rods-tubes, catalog dime, refunded first order. Special offer. Mid-West Plastic Supply, 1717 No. 66th, Omaha 4, Nebr.

PLEXIGLAS Sheets $1/10 \times 12 \times 15$ " 96c; $1/8 \times 11 \times 12$ " 98c; 13×17 " \$1.60; 6" dia. x 12" length x $1/4$ " wall clear cylinders \$1.60; ten colors rod assortment includes phosphorescent \$4.00. Include postage. Julian Rhodes Muehnc Co., 1527 W. Alabama, Houston 6, Texas.

PLASTICS, Sheets, rods, tubes. Free list. Swiss music units \$3.50. Plastic Supply Co., Dept. PM70, 2618 St. Louis Ave., St. Louis 6, Mo.

PLASTIC Injection machines; toy, industrial, commercial. Jewelry findings. Plexiglas, dyes, Polystyrene rods; tenite; kits, etc. Low prices. Free list. G. Baker Company, River Edge, New Jersey.

PLEXIGLAS Kits: Special offer: 18" tier-rack and coaster holder, \$2.50 value, now \$1.75. Free gift with each order. Free price list. Heah Mfg. Co., 5115 N. Neenah, Chicago 31, Ill.

METALLIZE Plastics for profit! Free particulars. Joseph B. Kushner, Metal Finishing Consultant, Stroudsburg 3, Pennsylvania.

MAKE Money assembling our pre-fabricated plastic kits. Sample kit 50c. Catalog free. Fabros, Box 156, Station F-1, Buffalo 12, N. Y.

CHEMISTRY

THE House of Winn, home of supplies for amateur chemists. See Winn's New Idea chemical kits and apparatus outfits for home experimenting. Send 10c for retail catalog. Established 1931. John H. Winn, Dept. 508, 124 West 23rd St., New York 11, N. Y.

HOME Laboratory chemicals. New low prices. Rush 10c for catalog. Cel-chem Laboratory 54, 4208 Holland Drive, Des Moines, Iowa.

LABORATORY Supplies at wholesale prices. Chemistry, biology, physics, geology. Catalogue 10c. National Scientific Company, Established 1908, 2204 W. North Ave., Chicago 47, Ill.

FREE Catalog: Chemistry, mineralogy, biology. Tracey Laboratories, 1907 Harrison, Evanston, Illinois.

SAVE! Get "Planning Your Laboratory." 25c, catalog 10c. Pilgrim Chemical, 348 Edith Avenue, Salt Lake City 4, Utah.

SPECTROSCOPE For quick chemical analysis \$3.00. Cutting Co., Box 457, Campbell 1, Calif.

NEW Laboratory supply catalog of chemicals and apparatus, contains over 5000 items with illustrations, 212 pages. Send 50c. Standard Science Supply Co., 1232 No. Paulina Street, Chicago 22, Ill.

CHEMICALS—LAB. Supplies. New catalog 10c. Mel-Glo Chemical Co., 258 Fourth Avenue, Brooklyn 15, N. Y.

CHEMICALS And apparatus for industrial, analytical, and private laboratories. Complete supply service for correspondence school students. Send 3c for catalog. Dept. M-43, Biological Supply Co., 1176 Mt. Hope Ave., Rochester 7, New York.

APPARATUS, Chemicals, ounce quantities, catalog 5c. Fleischer's Laboratories, Everett 49, Mass.

HELP WANTED

MAKE More money selling individualized buckles, belts, tie holders, cap badges. Choice of 2000 emblems. Quick profits—repeats. Special outfit offer, write Hook-Fast Products, Dept. A, Columbus 6, Ohio.

AGENTS WANTED

SHINE Shoes without "polish." New invention. Lightning seller. Shoes gleam like mirror. Samples sent on trial. Kristee 112, Akron, Ohio.

BIG Commissions. Boost income quickly. Sell stores, restaurants, bars. Plastic tickets, shelf moulding, menu covers, signs. Write today. Pricing Press, 124 White St., Dept. P, New York 13, N. Y.

MAKE Money easily. Sell 50 for \$1.00 Christmas cards. Cost you as low as 45c. Big line Christmas and everyday assortments. Sell only 50c to \$1.00; your profit 25c to 55c per box. Extra bonus. Write for free samples personal Christmas cards, name imprinted stationery and leader 21 card Christmas, 16 card feature all-occasion assortments on approval. Special offers. Elmira Greeting Card Co., M-56, Elmira, N. Y.

DISTRIBUTORS. Unusual \$2.98 photographic product. Levine's, 15-X, Boulevard Station, New York 59, N. Y.

EXCLUSIVE Protected territories to men calling on grocery stores, hardware, paint, drug, department stores, etc. Sell Wonder Plastic "Linoleum Finish" and the new Wonder Plastic "Wood Finish." Huge profits. Write Wonder Plastic Products Co., 2609 So. Kedvale Avenue, Chicago 23, Illinois.

AT Last! Something new and sensational in Christmas cards. Amazing "Ollette" cards. Like costly oil paintings. Designs never before offered. Quick orders. Beautiful 50 for \$1 cards, name imprinted. Big profits. 20 other assortments 60c to \$1. Samples on approval. Puro Co., 2801 Locust, Dept. 740K, St. Louis, Mo.

GREETING Card money-makers. Christmas, birthday, everyday. Catalog free. Greenport Art Company, Dept. 828P, Brooklyn 15, New York.

BIGGEST Profits selling most complete line Christmas and everyday cards, boxed and personal, gift wrappings, stationery. Special offers. Request samples. Heather Greetings, Dept. A47, Springfield 3, Mass.

SELL Ultra blue stock signs to stores, 1000 slogans, comedy, general, religious. 7x11, cost 6c, sells 35c. Make money. Sample free. Lowy, 8 West Broadway, Dept. 327, New York City 7.

BIG Profits! Plastic lace tablecovers. No laundering. Terrific demand. Free swatches. Star, 261 Fifth Ave., New York.

NEW. Extra money plan. Up to 100% profit showing friends unusual personal Christmas cards, box assortments, gift wrappings, humorous, all occasion, religious, social notes, personalized stationery. Extra bonus. Request free 50 for \$1.00, 25 for \$1.00, 25 for \$1.95 name imprinted Christmas cards and personalized stationery folder. Special offer. Thomas Terry Studios, 60 Union Avenue, Westfield, Mass.

CHRISTMAS Cards. Earn big money. Take orders galore from friends, 25 exquisite folders with name, \$1.25. Free samples 10 designs. America's fastest selling 21 Christmas folder box, costs 50c. Sells \$1. Request samples today. Sunshine Art, Dept. E-8, 115 Fulton St., New York 8, N. Y.

\$50 CASH For selling 100 assortments of 21 Christmas cards at \$1.00. Complete line. Free samples 50 for \$1.00 cards. Special offers. Write today. Hedenkamp, 343 Broadway, Dept. T-21, New York 13.

YOU Make \$25 for selling fifty \$1.00 boxes 50 beautiful assorted Christmas cards sell for only \$1.00 your profit 50c. Write today for free samples 50 and 25 for \$1.00 and other boxes on approval. It costs nothing to try. Cheerful Card Co., 129 White Plains, N. Y.

\$1 STARTS You in business. Sell DeLuxe ties, 100% wool interlining. Costs you only \$7 per dozen, you make \$5.00 dozen. Send \$1.00 for special introductory offer two DeLuxe ties. Catalog complete line free. Philip's Neckwear, 20 West 22nd St., Dept. K-14, New York 10.

SELL Joe Louis's champion cosmetics to colored men and Marva Louis's (his wife) cosmetics to colored women. Sells on sight, 100% profit. Joe Louis Products Co., Dept. P, 6 E. Garfield Blvd., Chicago 15, Ill.

QUICK Cash. Sell friends wonder-value 50 for \$1.00, extraordinary 25 for \$1.00 personal Christmas cards. Personal stationery. 32 sensational money makers. Up to 100% profit. Bonus. Write for 6 free self-selling sample portfolios of 50 for \$1.00 to 25 for \$2.50 name imprinted Christmas cards. Special offers. Rainbow Greeting Card Co., 36 East 12th St., Dept. 17-A, New York.

TREMENDOUS Profits selling new scientific soil acidity tester for lawns, farms, gardens. Sells \$2.00. Your profit \$1.00. Sample and full information \$1.00 postpaid. Willard Laboratory Supply, 2030-V Sunnyside, Chicago 25.

IMMEDIATE Big profits! Full or part time. Take orders for amazingly beautiful laminated lifetime plastic reproductions of any picture or negative. Customers everywhere! Write quickly. Gotham Products, Dept. A, Box 5427, Philadelphia 43, Penna.

100% PROFIT With new electric gas lighter, eliminates matches, pilot. Write Optical Research Products, Fairview, N. J.

NAMES—Addresses. Wholesalers, manufacturers, etc. Dime each. Three 25c. National, 3537-M South Hoyne, Chicago 9.

"SOLVEX" Cleans dirty hands without water. Exclusive territory. Solvex, Monticello, Iowa.

REBUILT Vacuum cleaners. Low prices. Easy sales. Big profits. Economical Distributors, Box 1402, Albany, N. Y.

DEALER Franchises. Power mower, gas model, \$74.00 net. Rotacut, M-2004, Excelsior Springs, Mo.

CHRISTMAS Card money-makers. 50, 25, 21, folder \$1.00 boxes. To 100% profit. Catalog free. Zeller, 1239P Riverside, Baltimore 30, Maryland.

SIGNS, Metallic letters for store windows, trucks, etc. Looks like gold leaf. 3 complete alphabets with numerals and catalog \$2.00. Globe, 61 W. Cordova, Vancouver, B. C., Canada.

EXTRA Money so easy. Sell friends beautiful 50 for \$1.00 name imprinted Christmas cards. Extensive line assortments 30c up. Profit to 100%. Extra bonus. Request free samples personal Christmas cards, stationery and leader \$1.00 Christmas, everyday assortments on approval. Special offers. Tom-Wat Studios, Dept. PM, Bridgeport, Conn.

FRIENDLY Social visits bring you big Christmas card profits. Show 33 different top-quality assortments as low as 30c each. Odd cards 2 $\frac{1}{2}$ c. Up to 100% for you. Cash bonus. Send at once for free samples 25 and 50 for \$1.00 personals, name imprinted stationery and feature \$1.00 assortment on approval. Special offers. New England Art Publishers, Box F, North Abington, Mass.

PROFITS And fast sales with famous Timex French Dry Wax Polish. A sensation! Different luster for all new and old cars, furniture, etc. Made by a long-established manufacturer. Good looking package that's a proven fast-seller with plenty of rapid repeat business. Quick and easy to apply. Gives hard, glass-like surface that lasts up to 6 months. Every car-owner, garage, service station, housewife, store-owner a live prospect. Good territories open on a money-making basis for aggressive representatives. Write for full details and quantity prices. Send \$1 for regular \$1.50 size. Money refunded on first order. Fully guaranteed. Timex Products Co., 5504 Virginia, St. Louis, Mo.

AGENTS, Big profits, fast selling plastic aprons and accessories. Free details. Texcraft Co., Manchester, N. H.

REAL Live Mexican jumping beans. 20, 25c; 125, \$1.00, 500, \$3.00; 1,000, \$5.00. J. J. Frank, 525 Palm, Rockford 1, Illinois.

MAKE \$300 Week selling patented auto towbars. Each \$2.73. Barnorari Industry, 19338 Griggs, Detroit, Mich.

NO Investment, throw rugs, big profits, good repeaters. Investigate this opportunity. Warren Rug Mills, Box 243B, Phillipsburg, New Jersey.

NU PROCESS Products Laboratories, Dept. 301, Aurora, Illinois, have some choice distributorships open. Exclusive territory franchise. Big profits. Wholesale and retail. Age no barrier. Men and women eligible. Cash profits start first hour. Two products (1) Silver Plating Liquid (NuSilver Trademark Patent No. 245,336 and Re-Plate-O Trademark Patent No. 367,355), and (2) Lectrik Silver Cleaner Plate for quick de-tarnishing of silverware. Full details free. Write them today.

FIRST Offering! New patented auto accessory. Sells on sight to jobbers, garages, filling stations. Only product of its kind, repeat orders, exclusive territory available. Send \$2 for sample display card with 12 fast selling accessories. Law Manufacturing Company, Box 628, San Diego 7, Calif.

300 MONEY Making deals. Ideas, formulas, plans, schemes. Polio free. Formico Service, Box 572, Dayton, Ohio.

NEW Bugwump cleans windshield. Dealers, agents. Sells on sight every car owner, gas station for 50c. Carton of six \$1.50. Season's ripe. Wheeler Corp., 1922 Raymond Com. Bldg., Newark 5, N. J.

WOMEN—Sell handkerchiefs. 20% commission. Ruth Pitts, Corinth, N. Y.

DISTRIBUTORS Wanted for unusual \$2.98 photographic product. Fine profits. No competition. Fast seller. Repeats for hundreds of dollars. Complete sample \$2.00—details free! E. E. Morrison, Box 9312-P, Sta. S, Los Angeles 5, California.

SALESPeople—Make extra profits selling our new 1947 greeting cards. Send 65c for sample box. Davis Specialty Shoppe, 607 Rialto Ave., Venice, California.

AGENTS Wanted for Evictor, DDT-Pyrethrum, refillable aerosol insecticide bomb. Nationally advertised, large profit item with profitable repeat orders assured. Haskris Co., 6700 N. Lincoln Ave., Chicago 45, Ill.

MAKE Money taking orders for "C-E Automatic Water Heaters." Write Crane Electric, Eugene 4b, Oregon.

MILLIONS Of dull scissors need our patented scissors sharpener. Sell to stores and homes. Exclusive territory. Demonstration sample 50 cents. Semco, Box 211, Lynwood, Calif.

PLASTIC Step blocks for machinists. Fast seller. Agents make over 100%. Sample, details \$1.00. Breese, Box 74, East Side, Providence, R. I.

AGENTS, Fast selling made-to-order show cards and signs. Parker, 246 Reo Blvd., Warren, Ohio.

SELL Superb line of stainless-steel bracelets with over 100% profit. Details and sample for \$1.50. Lastex, Box 391, Coraopolis, Penna.

SELL New, different, exclusive Christmas cards. 50 with name imprinted, \$1.00. Extra dollars with new bonus plan that earns you up to and over 100% profit. Compare our 21-folder "Champion" assortment, sells for \$1, sent on approval, no investment. Etchings, panoramas, florals, religious, gift wraps, birthdays, also stationery. Free samples of many extra-profit imprint lines. Work with a leader! Write today. Pen-n-Brush Studios, Dept. PM 8, 154 Nassau Street, New York 7, N. Y.

CHRISTMAS Cards. Earn \$5.00 with each ten \$1.00 21 card assortments you sell. Also new plastic cards, wrappings, imprint cards. Write for samples today. Howard P. Ellis, Dept. PM-9, Pitman, N. J.

A NATURAL! Big money selling new line one piece lace, plastic tablecloths. Sizes to 54x108. Also women's aprons; novel, embroidered cotton pillow cases. Free, "interesting" details. Royalty, Box 748-K, Passaic, N. J.

FREE! Big 32 page 8½x11 magazine, that tells how to make money in local or mail order selling! "Opportunities Preferred." 33-P Vassar, Dorchester, Mass.

LARGE Variety fast selling items from \$1. Manufacturers, 264—5th Ave., New York.

SALES Agents wanted to sell Fireaire fireplaces and furnaces in your localities. Every home owner is a prospect. Low in price. Variety of designs. See display advertisement elsewhere in this issue. Liberal commissions. Write for proposition. The Edwards Manufacturing Co., 235 Eggleston Ave., Cincinnati 2, Ohio.

MAGIC Cleaner and laundry soap deal. Hotter than a firecracker. Big profits. Sample free. Bestco, 5007 Irving Park, Chicago.

AMAZING Spare time earnings, sell name imprinted Christmas cards 50 for \$1.00. Leader box pays to 50c profit. 25 big moneymakers. Stationery. No money or experience needed. Approval samples. Empire Card, 155 Fox, Elmira, N. Y.

EARN Big money selling complete new line 1947 greeting and Christmas cards. Big profits. Liberal bonus. Sample on approval. Write today. Forest W. Kimball, New London, N. H.

HOUSE Numbers that glow in the dark. Luminous pictures, etc. Large mfr. wants factory representative. Wonderful new product. Fast seller. Free samples. Madison Mills, 303 4th Ave., New York City.

AGENTS—Sell white shirts direct from manufacturer. Liberal commission. Jarod Mfg. Corp., Rockville Centre, N. Y.

CHRISTMAS Card agents! New, exclusive, patented children's linnette books. Four books in attractive packet. Retail 50c. Sample on approval. Also cut-out valentine assortment. Elmcraft Card Co., 5928 South Western, Chicago 36, Illinois.

AMBITIOUS, Sell Xmas cards, stationery, big profits, colored catalog free. Beacon Hill Greetings, 115 Chauncey M, Boston, Mass.

FOOT-MASTER Tablets. Amazing seller to those afflicted with foot trouble. Proven seller 45 years. Good profit. Repeats fast. Write Master Products Co., 6 East Oak Avenue, Moorestown, New Jersey.

MEXICAN Feather pictures. Unusual novelty. \$1.00 (stamps) brings \$2.00 worth samples, details. Refunded if unsatisfied. Aztec Art-P, Apartado 762, Mexico City.

AGENTS, Dealers, distributors. We have the fastest-selling item on the market today. 100% profit. Steady repeater. No competition. Rush \$2.98 for complete set-up, or write for details now! Morrison, Box 9312, Station S, Dept. 12, Los Angeles 5, Calif.

EXCELLENT Sideline for printing and advertising salesmen. Decalcomania name plates in small quantities. Great demand. Also, make money with our line of automobile initials and sign letters. Free samples. "Ralco" XL-Roxbury, Boston 19, Mass.

SELL Personal Initialed individualized belts, buckles, cap badges, tie holders. 2,000 emblems to choose. Fast profits. Repeats. Write today special outfit offer. Hookfast Specialties, Box 1425, PM, Providence, Rhode Island.

AMAZING Discovery. Miracle glaze puts brilliant glass-like surface on cars. Free sample, information. Big profits. Miracle Glaze Company, 9714 S. Austin Ave., Oaklawn, Illinois.

JUST Out! History of World War II. Huge volume. Popular price. Authentic text. Official photographs. Big profits. Riverside Book Company, Iowa Falls, Iowa.

MAKE Money in your spare time! Helps furnished. Easy sales. Voluntary repeat orders. Liberal commissions. Write for free wholesale price list today! McGregor Magazine Agency, Dept. P.M.-7, Mount Morris, Illinois.

BIG Bargains for big profits. Over 100 sensational values. Men's used suits \$2.00, pants 35c, topcoats \$1.25, overcoats \$2.00, shoes 20c. Experience unnecessary. Free wholesale catalog. Superior, 1250-B Jefferson, Chicago 7.

90c PROFIT Each \$1 sale. Sell positive mothproofing solution to housewives, stores, agents. Experience unnecessary. Postal brings details. Kinford, Wayne 3, Penna.

GREETING Card agents, "line up" with "Pines" for bigger, better, quicker profits. Rush name, address on postcard today. Box 32, Flushing 5, New York.

AGENTS: Stamping names on pocket-key protectors. Sample check with your name, address, 25c. Stamping outfits. Emblem checks, check-fobs, name plates. Hart Mfg. Co., 303 Degraw St., Brooklyn, N. Y.

137 COMPLETE Plans for starting own business: local—mail order. Particulars free. Elite Co., 220 Grand St., New York 13.

AGENTS—300 % Profit selling genuine gold window letters; stores and offices. Free samples. Metallic Letter Co., 438-B North Clark, Chicago.

\$3 FIRE Extinguisher; quick sales, wholesale or direct; liberal profits. "Fire-Killer." 109 N. Franklin, Syracuse 1, N. Y.

PLATING Outfits for autopaarts, reflectors. Connect to a battery. No tanks necessary. Free booklet and particulars. Gunmetal Co., Ave. N, Decatur, Ill.

GOLD Lacquered window sign letters. Large sizes penny each. New foils. Absolutely beautiful. Free samples. Atlas, 544 W. 79th, Chicago 20.

SELL Personalized soap. Name on every cake. Ideal for gifts. Get sample offer. Dunbar Soap, New Brunswick, N. J.

HIGH-GRADE SALESMEN

SELL Delicious candies, nuts, gum. Immediate delivery. Write Casterline, 2031-K Sunnyside, Chicago 25, Illinois.

AUTOMATIC Fire extinguishers—new and unique plan for distributors. Wall, ceiling and amazing new dwelling units. Two sizes glass balls. 50% to 60% profits. Freight free. Red Ball Co., Box 1552, Salt Lake City, Utah.

MAKE \$100.00 Weekly. Sell yardgoods. Send \$1.00. Samples and information. Western Fabrics, 832 So. Spring, Los Angeles 14, Calif.

AMAZING New zipper shoe sells on sight. Big profits for salesmen. Leads line 200 splendid styles. Territories open. Get free sample outfit. Write. Consolidated Shoe, Dept. 5-799, Chippewa Falls, Wis.

START Your own business on our capital. Always your own boss. Hundreds average \$6,000 to \$25,000 annual sales. We supply stocks, equipment on credit. 200 home necessities. Selling experience unnecessary to start. Wonderful opportunity to own pleasant, profitable business backed by world-wide industry. Write Rawleigh's, Dept. H-U-PPM, Freeport, Ill.

MAKE Money selling genuine leather jackets. Prospects everywhere. Top quality, full cut, exclusive features. Big cash commissions. Also 250 styles fine shoes. Sample outfit free. Victor Thomas, Dept. V-813, 610 W. Van Buren St., Chicago 7.

ADVERTISING Book matches—Cash in on political campaigns. Sell union label matches. Cuts for all businesses and political parties. Free powerhouse selling kit. Low prices. Protection guaranteed on repeat orders. Cash commissions. Superior Match Co., Dept. M87, 7530 Greenwood, Chicago.

BIG First commissions, sensational automatic repeats, with new sales building plan for retailers. First since V-J Day. Customers get big value tableware; cost retailers nothing. Positively hottest deal in selling. Rush name for facts. Alco Sales Company, 215 West Ontario, Dept. C-615, Chicago 10, Illinois.

ADVERTISING Book matches—World's largest direct selling manufacturer of advertising book matches offers opportunity for profitable year 'round selling; every business a prospect. No experience needed to start; full or part time. Factory service. Low prices for high quality; repeats; sales kit furnished. Match Corp. of America, 3433-43 West 48th Place, Dept. E-10, Chicago 32, Illinois.

DISTRIBUTORS. Revolutionary new metal polish. Write Donald Brown, 2912 Delaware, Kenmore, N. Y.

LOOKING For something different? Automatic high speed nozzle. Every user water through hose prospect. Indispensable for homes, car washers, service stations, factories, greenhouses. When hose is dropped, flow stops. Good profit. Fast seller. Sample \$1.50 or write Water Master Sales Co., 19465-P3 Ward, Detroit 21, Mich.

SALESMEN—Free advertising and demonstrating sales kit to qualified men. Product sold 15 years. Prospects everywhere. First ad for new men since the war. Write 707 Red Comet Bldg., Littleton, Colo.

SELL Christmas cards! Choice of forty assortments! Earn 60c on dollar sales! Bulletins free! Elfco, 434 North Wells, Chicago 10.

NEW Amazing personal initialed buckles with belts, cap badges, tie holders, emblems, uniforms, shirts, caps, ties, etc. Big profits. Quick repeats. Easy selling outfits—make fast profits. Write, Hook-Fast Co., Dept. 12, Roanoke, Virginia.

ADVERTISING Campaigns for small businesses. Excellent commission. Shaw, 2678 California Street, San Francisco, Calif.

MILLIONS Want foot comfort! Amazing daily profits. Sensational new arch support body-balancer for men, women selling like hotcakes. Experience unnecessary. Complete outfit free. Special deal to distributors, crew managers. Write: Colt Shoe Company, 244-D8 Purchase, Boston 10, Mass.

MAKE Money taking orders for "C-E Automatic Water Heaters." Write Crane Electric, Eugene 4a, Oregon.

YEAR 'Round income above average selling maintenance supplies. National manufacturer. Write Box 392, Dallas, Tex.

SALESMEN To sell well known brands of appliances and furniture for old established store in all states. Box 21, Fairfield, Penna.

AMAZING Daily profits, repeat business, selling direct, Colt's sensationally new Whippets, \$6.95 loafer oxford with DuPont neoprene crepe soles. Men buy on sight, stores, garages, colleges, factories. Experience unnecessary. Free catalog, outfit, 216 styles, Colt Shoes, 601-D8 Atlantic, Boston 10, Mass.

RESTAURANT Sanitation course complete. Good commission. Institute, 2385 Edgewater, Los Angeles 26, Calif.

BONUS Commissions selling photographic creations. Samples. Creative photography. Box 315, Cooper Station, New York 3, N. Y.

DISTRIBUTORS, Salesmen, bigger commissions with lowest priced home and auto extinguisher. Exclusive contracts. Carbo-gas, Box 2141-A, Portland 14, Oregon.

12 FANCY Boxes pure Vermont maple sugar postpaid \$6.60. Retail \$1 each! Eulalia Turner, Poultney, Vermont.

PRESSURE Cookers. Now available. Selling like wildfire. Amazing profits. Write quickly, Morris Mandell, Inc., 131-P W. 14th St., New York 11, N. Y.

SELL Calendars full or part time—every business house a prospect—also wholesale to printers—calendars, novelties, sheet pictures. Fleming Calendar Company, 6535 Cottage Grove Avenue, Chicago 37, Ill.

ORANGE Concentrate direct from our Florida groves. One quart bottle makes six quarts delicious natural orange drink simply by mixing with five parts cold water. Groceries, foodmarts, hotels, restaurants, taverns, roadstands, sodafountains, hospitals, resorts, camps, farmers, big buyers. Money-back guarantee. No investment. Protected territory. Salesmen earn \$100.00 to \$200.00 repeat commission weekly. Sunset Valley, 3357 N. Clifton, Chicago 13, Ill.

FREE! Latest issue Opportunity Magazine. Salesman's Guide. Inspiring, constructive. Shows how to earn money selling for others or in your own business. Hundreds postwar opportunities. Send name and describe what you have sold or are selling. Illustrated copy sent free. Opportunity Magazine, 620 N. Michigan, Dept. 17, Chicago 11, Ill.

EDUCATIONAL AND INSTRUCTION

TRAIN For aviation mechanics high salaries. This famous school approved for veterans. Immediate enrollment. For information write California Flyers, Dept. M-8, Inglewood, California.

"HOW To Break and Train Horses"—A book every farmer and horseman should have. It is free, no obligation. Simply address Beery School of Horsemanship, Dept. 1108, Pleasant Hill, Ohio.

BE The one who directs the work of others. Learn industrial engineering. Free booklet gives you details of our money-making course. Herbert G. Hecketsweiler, Management Engineer, 3355 North Olcott Avenue, Chicago 34, Illinois.

GOOD Jobs and a sound substantial future await you in hotel and institutional field. Men and women—all ages—needed for well-paid positions that offer color, excitement, ever-new and fascinating duties. Record-breaking travel means even greater opportunities for trained men and women in hotels, clubs and institutions. Lewis School receiving calls for managers, assistant managers, stewards, hostesses, purchasing agents and 55 other types of important positions! From coast to coast there are important positions that offer splendid opportunities for advancement in a business where you are not dropped because you are over 40. Previous experience proved unnecessary! No need to leave your job to qualify. A good grade school education, plus Lewis Training qualifies you at home, in spare time. Our National Placement Bureau helps to place you—and our amazing Certified Job Plan—actually certifies you will "make good" when placed. Write today for Free book! Veterans: This course approved for veteran's training. Lewis Hotel Training School, Room LR-368, Washington 7, D. C. (First and only school of its kind—now in its 31st year.)

COURSES In journalism, advertising, catalog. Frazier Boyle Kellogg, Clinton, New York.

MODERN Welding school gives thorough training for one of industry's best paid jobs. Experienced instructors. Individual attention. Non-profit institution. Qualified under G.I. Bill. Write for literature and details. Hobart Brothers Co., Box M-876, Troy, Ohio.

MICROMETER And vernier micrometer. Learn to read in 2 to 5 minutes by new, sensational, copyrighted method. Never before anything like it. Send \$1.00 for complete instructions to S. L. Heylman, 4945 Edgemere Avenue, Baltimore 15, Md.

PRACTICAL Course—Automobile radiators, repairing, recoring, cleaning. Ralph Hendry, Galt, Canada.

NEW Writers wanted. Want to hear immediately from all who want to write for magazines. Enclose stamped envelope for \$1.00 gift. Editor, H Modern Psychologist, Springfield, Mo.

HOME Study courses. Any vocation. Free aptitude test. DeVoto Vocational Schools, 35 Vicente, San Francisco 16, Calif.

VOICE Builder. Speaker-singer. Less than cost of lesson. Free voice advice booklet. Victor Voice Institute, 6515 Wilshire, Studio 128, Los Angeles 36.

LEARN Secret of being irresistible—the key to success. Capitalize your hidden powers—"Winning Personality" shows how. \$1 copy. A. Doherty, Box 171, Station W, New York 24.

NOW You can have an office. Learn credit-collection business by new home study course. Many earn up to \$5000-\$15,000 annually. Free bulletin. Franklin Credit School, Dept. 202H, Roanoke 7, Va.

HOME Study course, drugless therapy. Free literature. Institute of Drugless Therapy, Tama, Iowa.

YOUR Last chance, at this price, to learn commercial leather and cloth sewing machine repairing with illustrating plates. Seven lessons \$10.00 cash. W. Sullivan, Box 286, Ilion, N. Y.

BECOME A chiropractic physician—Men and women qualify in this vital and dignified profession. Combined residence and home study methods. American University, 4123 McKinney Ave., Dallas, Tex.

LEARN Auctioneering by mail. Sample lesson free. Write Nelson School, Renville, Minn.

BE A Pedopactor:—Foot correctionist. Extension. Degree. Alaska Foot Institute, Juneau 1, Alaska.

RESORT Hotel business offers permanent career, travel, beautiful surroundings. Write for booklet. Lee Hotel Institute, 12A South Market St., Boston, Mass.

GOOD "Used" self-instruction educational books on all subjects bought, sold, rented, exchanged. Satisfaction guaranteed. Complete information and 100-page illustrated bargain catalog free! Write—Nelson Company, Chicago 5.

PREPARE For Civil Service Examination. Pay for course after securing position. Write Free School, Dept. PM4, Kokomo, Indiana.

USED Correspondence courses and educational books bought, sold, rented, catalog free. Educational Exchange, Henagar, Ala.

USED Educational books on all subjects sold, rented, also bought and exchanged. Moneyback guarantee. Write today for free catalog and details. Lee Mountain, Pisgah, Alabama.

INVESTIGATOR Training. Phillips Secret Service, 1917B North Kenneth, Chicago 39, Ill.

BIG Money rebuilding shoes. Help needed everywhere or start big-income business of your own. Learn practical, sure, easy way in 3 months. Anyone from 18-60 years can learn easily. Approved for GI training. Rush postcard today. Modern Shoe Rebuilding School, Est. 1927, 2935 Belmont, Chicago 18, Illinois.

29 LANGUAGES By Linguaphone. Russian, Spanish, Portuguese—Direct conversational method for mastering any language quickly, easily, correctly at home. Available under G.I. Bill of Rights. Send for free book. Linguaphone Institute, 83 RCA Bldg., New York 20.

SECRET Investigation. Experience unnecessary. Investigators particulars free. George Wagner, M 125 West 86th, New York.

MEDICAL Laboratory technicians in great demand. We train you in your spare time, in your own home. You can practice while studying. Write for free catalogue. Imperial Technical Institute, Box 973-E, Austin, Texas.

LEARN Photo-engraving at home or in oldest, largest school in America. Work for newspaper or establish own profitable business. New Tasope' Photo-Engraving equipment available soon. Write for information. Veterans ask about G.I. training. The Aurora School of Photo-Engraving, Tasope' Bldg., Aurora, Mo.

PLAYS, STORIES, MANUSCRIPTS

NEW Writers needed. Nonfiction material demand is booming. Many magazine editors buy features and "fillers" from new writers. Our earn as you learn lessons prepare you to meet their requirements. Experience unnecessary. Reasonable price, unexcelled service. Details, sample lesson free on request. Use postcard. No obligation. Comfort Writer's Service, 200-PN S. 7th St., St. Louis 2, Mo.

I WANT New writers to cash hundreds of checks for \$1 to \$100, offered each month. The easiest way to write for pay. No previous experience necessary. Send for free details. No obligation. Saunders M. Cummings, 467-M Independence Bldg., Colorado Springs, Colo.

BUSINESS SERVICE

OUR Specialized service provides you with source of supply on any American made article. Save time, money and effort. Three reliable manufacturers names 25c; 20, \$1.00. Send no money! Pay on approval. Donald Kelly, 9544-B Whitcomb, Detroit 27, Mich.

CONFIDENTIAL New York mail-address disclosed. Information. Levitt, 330 East 19th, New York City.

CALIFORNIA Office. Mail forwarded daily, \$2.00 monthly. Raven, 1232 Loew's State Building, Los Angeles, Calif.

CHICAGO Mail address. Or branch office service. Faultless, 3439 Michigan, Chicago 16.

BUSINESS Representation, world's principal cities. Associates wanted. Universal-PB, Butler Building, Chicago 1.

TO Whom it may concern. We will represent you in all principal cities of the world. Representatives wanted. Will send you assignments immediately. James W. Farley, Citizens Bldg., Cleveland 14, Ohio.

SPECIAL SERVICES

MAIL Forwarded daily 25c. Business, personal. Confidential. Free details. J. Banas, Box 285, Syracuse 1, New York.

POSTMARK Your mail, "Washington, D. C."! Letters mailed here, 10c each. Complete (receiving, re-forwarding) service. \$2.00 monthly. Hawkins, 1300-J Taylor.

PLANT Managers, manufacturers, anyone with that "pet problem," unsolved by various mechanics, solved by expert "trouble shooter" laid up account injuries. Send details, solution forwarded immediately. Then send check for value received. P. J. Farmer, Quincy, Fla.

DRAFTSMAN—Valuable information, write. Draftsman's Club, Box 198, Elyria, Ohio.

NEEDING Some information or something from Mexico? Let's know. Barrales Research Bureau, Bajio 131 Dept. 16, Mexico City, Mex.

REMEMBER Important dates. Avoid embarrassment. Our plan reminds you. Details free. Forget'em Not Shopping Service, 209 West Jackson Boulevard, Chicago 6, Illinois, Room 409.

QUANTITATIVE Analyses. Metals, water, textiles. Accurate routine determinations \$1.00. Industrial Laboratories, 123 Beaver, Albany, New York. Analytical reagents, standard solutions available.

SPECIAL Supply source on anything made in United States \$2.00. Unable furnish information, money returned. Business Service, 1101 Kings Highway, Shreveport, Louisiana.

GOOD "Used" self-instructional books on all subjects bought, sold, rented, exchanged. Satisfaction guaranteed. Complete information and 100-page illustrated bargain catalog free! Write—Nelson Company, Chicago 5.

CARTOONING, COMMERCIAL ART, SHOWCARD WRITING, SIGN PAINTING

"HOW To Make Money With Simple Cartoons"—a book everyone who likes to draw should have. It is free; no obligation. Simply address Cartoonists' Exchange, Dept. 98C, Pleasant Hill, Ohio.

LEARN Sign painting. New method. \$2.00. Particulars free. Haines System, Sabina, Ohio.

STENCIL Beautiful showcards without practice. Kwiksign Stencils, 30 West Washington, Chicago 2, Dept. M.

112 LESSON Course in sign painting, details free. Stewart Sign Co., Box 1329, Glendale, Calif.

LEARN Showcard writing at home in spare time. Fascinating lifetime business of your own. No special skill needed. Free information. Sherwood Publishing Co., Irvington 11-B, N. J.

BARGAINS. Art lessons, studies, magazines. Quick landscape painting. Free literature. Art Book Shop, Arnold, Mo.

ARTISTS—Students: Auto-scale saves half time copying, enlarging, reducing drawings. Guaranteed. \$4. Particulars free. Disco, Box 761, Glendale 5, Calif.

TALENT Test free. American School Commercial Art, Box 8066, Dallas 5, Texas.

MAKE Signs. 9 complete alphabet pattern sets. 3 complete numeral pattern sets and catalog \$1.00. Sign Letter Distributors, P.O. Box 101, Mineola, N. Y.

SIGN Painting taught at home by an old master. Ben Kerns, Box 812, Greenville, S. C.

CHALK Talks. Laugh producing program, \$1.00. Catalog 10c. Balda The Cartoonist, Oshkosh, Wisconsin.

ADVERTISING AGENCIES, LETTER WRITERS, FOR ADVERTISERS

MAILING Lists household names, also lists made up of any business, what do you need? 250 for one dollar or \$3 per 1000. Himes Service, 3341 Superior Ave., Cleveland, Ohio.

ADVERTISERS! Reach nearly 18,000,000 readers. 25 Sunday national key newspapers, 18 words, \$42.25. "Terrific pullers." 20 popular newspapers, \$8.50. "Free booklet." Special—One inch display 2,821,198 circulation, \$42.00. Newark's Advertising Agency, (Established 1893) 217-7th Ave., New York 11.

MAIL Order ads, circulars, letters, by leading advertising agency in mail order field. Low prices. Moran Advertising Agency, Box 104, Wilkes-Barre 3, Pennsylvania.

ADVERTISERS: Mail order ad covering United States—2,200,000 circulation—\$28.00 inch. Classified ad, 24 words. 20 metropolitan Sunday newspapers—\$25. Magazine, newspaper, mailing-list ratebook, advertising assistance—free. Chicago Advertising Agency, 20-PM West Jackson, Chicago 4.

NEW Names! White, negro teachers, rural housewives, automobile owners, births, etc. 1000 \$7.00. Trial 300 \$1.00. Business Service, 1101 Kings Highway, Shreveport, Louisiana.

ADVERTISE: 24 Words, 40 newspapers \$3.50. Lists free. Advertising Bureau, 229-C Dixon Blvd., Uniontown, Penna.

FREE! 1947 Advertisers Rate and Data Directory. 52 pages! E. H. Brown Advertising Agency, 20 N. Wacker, Chicago 6.

ADS Placed in out of town newspapers and magazines. Low rates. Catalogue free. Ideas that pay. Baker Advertising Agency, Successors Ankrum Agency, 189 W. Madison, Chicago 2.

MAILING Lists, certified, productive, inexpensive, \$5.00 1000. Homeworkers, agents, buyers, etc. Write Dixie Service, King, N. C.

24 WORDS in 64 weeklies \$4.96. H. J. Darnell, 730 Hays, Jackson, Tenn.

TYPEWRITERS, DUPLICATORS, OFFICE DEVICES

MODEL 36 Power multigraph complete. Excellent condition. Flexo typesetter, type accessories. Giard, Aurora, Missouri.

DUPLICATORS \$9.95 Up. (New.) Immediate delivery. "Free circular." Rucker, 2836-PM Slevin, Louisville 12, Ky.

"PRINTOMATIC" Selffeeding post card stencil printing duplicators \$9.50 up. Office size duplicators. Speedprints, Hilcos, Excellographs \$33.41 up. Literature free. Pittsburgh Typewriter Supply, 336-WK Fourth Avenue, Pittsburgh 23, Penna.

RECONDITIONED Typewriters, mimeograph, multigraph printing devices, appliances, supplies. Catalog. Dixiegraph Service, King, N. Carolina.

RUBBER STAMPS AND OFFICE SUPPLIES

SELF-INKING Pocket stamp (with name-address) to print stationery, etc., \$1.50. DuRaney, Johnstown, Penna.

2-LINE 60c. 3-Line 70c. 4-line 80c. pad 40c, dater 50c. Saunders, Tipton, Mich.

RUBBER Stamps to fit your needs. Reasonable. Write for free literature. Black's, Box 201, Bay City, Mich.

RUBBER Stamps. Buy direct from manufacturer. Literature free. Lee-Vall Press, Box 1242, Indianapolis 6, Indiana.

PRINTING, MULTIGRAPHING, MIMEOGRAPHING, GUMMED LABELS

SPECIAL! 500 6 $\frac{3}{4}$ Envelopes printed \$2.35. 24 hour service. Mango, 555-A South 20th, Newark 3, N. J.

1000 BUSINESS Cards (embossed) \$2.95—postpaid. Rubber stamps. Zephyr Printing, Box 312, Venice, Calif.

GELATINE Duplicator compound. Guaranteed formula, dollar. Edwin Kemp, Ardmore, Penna.

PRINTING Reasonable. Mail copy. Free estimates. Berliner, 3581 Milwaukee, Chicago 41.

1000 EMBOSSED Business cards \$2.95. Samples. J. Ortiz, 700 West 180 Street, New York, N. Y.

DOLLAR Printing. Special price list free. Fowl Printing Company, Muncie, Ind.

1000 BUSINESS Cards \$2.45; 1000 6 $\frac{3}{4}$ envelopes \$4.95; 1000 8 $\frac{1}{2}$ x11 letterheads \$4.95; 5000 2x1 $\frac{1}{4}$ gummed stickers \$4.95 (postpaid). Dept. PM, Madison Printing Service, Madison, Ohio.

1,000 FINE Business cards and pop-up case \$2.95, raised letters \$4.05. Globe, 605 West 151, New York 31.

500 BOND Letterheads printed \$3.50, 500 envelopes \$3.00. Quick service. Printing of all kinds. Ace Press, Clearwater, Fla.

DOLLAR Special. 30 sheets, 30 envelopes, 50 cards. Emagene, Box 11, Station A, Dayton, Ohio.

FINE Printing for every use. Samples. Treaster Printing, Milroy, Pennsylvania.

THOUSAND 10-Line postcards, \$5.95; 26-line double, \$10.65. Mohler, 4720 Salem, Dayton 6, Ohio.

MIMEOGRAPHING—Letters, circulars, booklets, pricelists. Lowest prices. Samples free. Martin Mimeo, 3212 Harper, St. Louis 7, Missouri.

QUALITY Printing—Reasonable prices. Fast service on catalogs, folders, publications. Write for prices. Bagby Printing Co., Georgetown, Ohio.

500 3x4 GUMMED Shipping labels \$1.45. Craftone, 2506 Park, Detroit 1.

50 BOOKS Matches—Your name and monogram, \$1.00. For circular write The Print Shop, 168 Mystic Ave., Medford 55, Mass.

ENVELOPES Printed. Bargain price list free. Michel, Box 76F, New York 16.

MIMEOGRAPHING Specialists—any copy. Reasonable. Mailers Service, Box 606-A, Chicago 90, Ill.

BUSINESS Cards finely printed by master craftsmen, \$2.75 per 1000. Samples, complete price list on request. Rubber stamps. The Pabor Press, 202 Third Street, Seal Beach, California.

SALES Letters, booklets. Multigraph type, typesetting. Ace Printing, Brentwood, Maryland.

QUALITY Printing: Reasonable prices. State requirements. Samples. Mero Products, 100 Morrison, Punxsutawney, Penna.

POSTCARD Brings our samples, prices. Valley Print Shop, St. Elmo, Tenn.

100—8 $\frac{1}{2}$ x11 HAMMERMILL Letterheads \$1.00 postpaid. Envelopes same. Race Printing, Hudson, New York.

500 3 $\frac{1}{2}$ x2 $\frac{1}{4}$ FOUR Line gummed stickers, 35c. Moritz Printery, Saginaw, Mich.

1000 BUSINESS Cards \$2.50, prepaid. Reliable Print Shop, 901 E. Jefferson, Louisville 6, Ky.

SEND 10c Now, for our 36-page 1947 pricelist—refunded first order. McColl Press, 1326 South 27th, Omaha, Nebraska.

MIMEOGRAPHING—Letters, pricelists, formulas, instructions. Lowest prices. Lem's Letter Shop, 5710 Stanton, Detroit 8.

PRINTING OUTFITS AND SUPPLIES

HAND Presses, cabinets, type, cutters. Your needs? Bulletins 3c. Box 918, New York 8.

PRINT At home—Send 10c for catalogue—presses, type, supplies. Barnhard Co., 6 Columbia St., Newark 5, N. J.

WE Save you money. Send for price list. Stamp appreciated. Brighton Printers Supply, 4234 So. Mozart, Chicago 32, Illinois.

PRINTING Presses, type, supplies. Send dime for complete illustrated printer's supply book, details and press samples. Kelsey, Inc., A-11, Meriden, Connecticut.

BARGAINS. Presses, type, supplies. Send stamp. 8 Walden, Cambridge 40, Mass.

HOME Made presses. Write Riegel, 1111 Harrison, Philadelphia 24, Penna.

SAVE On printing. Print for others. Printing multigraph; type; accessories. Prints letterheads; envelopes; anything to 8 $\frac{1}{2}$ x11" from type; linotype; cuts, 3,000 hourly. \$250.00 outfit, \$95.00. Power-operated; motor; automatic feed; accessories. \$500.00 outfit, \$195.00. Multilith offset press, \$245.00. Guaranteed rebuilt; prepaid. International Machines Corporation, 1515 Larimer, Denver, Colorado.

PRINTER'S Aprons. Best material, pockets, \$1.50. Z. Boone, 732 Chemeketa, Salem, Oregon.

INEXPENSIVE Home-made printing press. Details free. Novelty Shop, Downs-ville, Louisiana.

PATENT ATTORNEYS

PATENT Protection—The U. S. Patent Office recommends—"an applicant is advised, unless familiar with such matters, to employ a competent registered Patent Attorney or registered Patent Agent, as the value of patents depends largely upon the skillful preparation of the specification and claims." Preliminary steps to take to obtain patent protection will be sent upon request. Victor J. Evans & Co., 231-J Merlin Building, Washington 6, D. C.

INVENTORS—Patent laws encourage the development of inventions. The Rules of Practice of the U. S. Patent Office advises—unless an inventor is familiar with such matters—that he employ a competent registered attorney or registered agent, as the value of patents depends largely upon the skillful preparation of the specifications and claims. Write for further particulars as to patent protection and procedure and "Invention Record" form at once. No obligation. McMorror, Berman & Davidson, Registered Patent Attorneys, 134-R Victor Building, Washington 1, D. C.

INVENTORS: Learn how to protect your invention. The United States Patent Office advises the inventor to engage a competent, registered patent attorney or agent to represent him. We maintain a staff of registered patent attorneys ready to serve you in the handling of your patent matters. Special booklet "Patent Guide for the Inventor" containing detailed information concerning patent procedure with "Record of Invention" form will be forwarded upon request—without obligation. Clarence A. O'Brien & Harvey Jacobson, Registered Patent Attorneys, 71B-G District National Building, Washington, D. C.

C. A. SNOW & Co.—M-427, Snow Building, Washington 1, D. C. Registered Patent Attorneys. Write for information.

INVENTORS. For "Record of Invention" form, contact Carl Miller, Registered Patent Attorney, Woolworth Building, New York.

"INVENTOR'S Guide" free on request. Frank Ledermann, Registered Patent Attorney, 154 Nassau St., New York 7, N. Y.

PATENTS. "Proof of Invention" folder mailed without obligation. E. E. Vrooman, Registered Patent Attorney, 871 Woodward Building, Washington 5, D. C.

INVENTORS: Without obligation, write us for information as to what steps an inventor should take to secure a patent. Randolph & Beavers, Registered Patent Attorneys, 21-C Columbian Bldg., Washington 1, D. C.

INVENTORS: Write for free brochure "Evidence of Invention." Labiner, World Building, New York 7.

PATENTS—Trade marks. Irving L. McCathran, 315 McLachlen Bldg., Washington 1, D. C. Registered Patent Attorney.

PATENT And Trade-Mark Practice before U. S. Patent Office. Validity and infringement investigations and opinions. Booklet and form "Evidence of Conception" forwarded upon request. Lancaster, Allwine & Rommel, Registered Patent Attorneys, Suite 411, 815-15th Street, N.W., Washington 5, D. C.

FREE—"Amazing New Book"—"Profits From Classified Advertising." Tells how and what to advertise. Be sure to read this book before you invest one cent in advertising. Remember—It's free! Write for your copy now. F. W. Johnson, Classified Advertising Manager, 200 East Ontario Street, Chicago 11, Illinois.

FOR INVENTORS

INVENTORS—Patent laws encourage the development of inventions. The Rules of Practice of the U. S. Patent Office advises—unless an inventor is familiar with such matters—that he employ a competent registered attorney or registered agent, as the value of patents depends largely upon the skillful preparation of the specifications and claims. Write for further particulars as to patent protection and procedure and "Invention Record" form at once. No obligation. McMorro, Berman & Davidson, Registered Patent Attorneys, 134-S Victor Building, Washington 1, D. C.

INVENTORS—Victor J. Evans and Co. has a staff of registered patent attorneys, available to assist inventors in the preparation and prosecution of their cases before the U. S. Patent Office. Detailed information and the steps to take to obtain patent protection will be sent to you upon request. Victor J. Evans & Co., 232-J Merlino Building, Washington 6, D. C.

HAVE Buyers for practical inventions. Prior patents may kill value of yours. Have patent office search made, cost \$6.00. Unique patent application service includes preparation specifications, claims, drawings, filing and help to sell your invention. Details free. Charles Morton, 11 West 42nd Street, New York.

IDEAS! Pay big dividends! Manufacturers want your ideas! Don't delay—act today! Competent designing draftsmen draw and blue print your confidential ideas for the business world. Information on selling your ideas. Send ad and 35c (coins) for Evidence Form which includes free estimate without obligations. K&S Mechanical Drafting & Reproduction Co., Gardner, Mass.

INVENTIONS Wanted. Patented or pending. Inventors Exchange, Department B, Hartford 1, Connecticut.

UNPATENTED. Patented, and patent pending inventions urgently needed. Have hundreds of large manufacturers listed for new inventions. Lesloe Buford Stratton, 120 South La Salle Street, Chicago 3.

HOW To sell unpatented inventions. Send \$2.00. 477 Adair St., Longbeach, Calif.

INVENTORS: Learn how to protect your invention. The United States Patent Office advises the inventor to engage a competent, registered patent attorney or agent to represent him. We maintain a staff of registered patent attorneys ready to serve you in the handling of your patent matters. Special booklet "Patent Guide for the Inventor" containing detailed information concerning patent procedure with "Record of Invention" form will be forwarded upon request—without obligation. Clarence A. O'Brien & Harvey Jacobson, Registered Patent Attorneys, 71A-G District National Building, Washington, D. C.

HIGHEST Royalties and cash for your inventions when we market them. Free particulars without obligation. Universal Marketing Co., 126 Lexington Ave., New York 16, N. Y.

MARKET Your ideas and inventions through our "Product Study Brochure" plan for quick responses and known results. Spartan Sales, 600 Woodward Ave., Dept. 1006, Detroit 26, Michigan.

INVENTORS: Avoid unnecessary expense. Write for free booklet explaining how our consulting and advisory service can assist you in deriving greatest profit from inventing. Institute of American Inventors, Dept. 40-A, 1926-Eye St. N.W., Washington 6, D. C.

"**INVENTOR'S** Guide" free on request. Frank Ledermann, Registered Patent Attorney, 154 Nassau St., New York 7, N. Y.

THE inventor who believes he has a new and useful invention, and needs advice, should consult a competent registered patent attorney. Without obligation, write for full information on how to secure patents and trademarks. Randolph & Beavers, Registered Patent Attorneys, 11-E-Columbian Bldg., Washington 1, D. C.

I SELL Patents. Established in 1900. Charles A. Scott, 773PM Garson Ave., Rochester, N. Y.

INVENTIONS WANTED

INVENTORS! Have you good, patentable ideas? Write Patent Agent Metzler, 11 West 42d, New York.

WANTED—Practical inventions of all kinds. Write John D. & Son, 285 Howard Ave., Box 3213, Dept. PM8, Bridgeport 5, Conn.

MANUFACTURERS Want patented or pending inventions! Send patent copy or complete details. Universal Guaranty Company, Lakewood, New York.

INVENTORS: Hundreds of manufacturers have requested our assistance in locating marketable new products. Complete information, free. Institute of American Inventors, Dept. 40-D, 1926-Eye St. N.W., Washington 6, D. C.

PATENTS FOR SALE

HAIR Curler. Definitely superior type. Outstanding comfort, convenience. Inexpensive. Patented. Grace Broyles, P.O. Box 105, Kenosha, Wis.

PRACTICAL And efficient traffic control system. Patent No. 2407432. 3759 Cass, Detroit 1, Mich.

PATENTED Improved mechanical device that produces lifelike movements to game fish lures. Patent No. 2,418,527. William H. Riggan, Rt. 1, Box 167A, Warrenton, N. C.

NEW Improved coping saw. A real tool. David McNeely, Calvert, Texas.

INVENTORS: Test the commercial value of your patented or unpatented inventions, quickly and inexpensively. Write for free information. Institute of American Inventors, Dept. 40-B, 1926-Eye St. N.W., Washington 6, D. C.

MANUFACTURING

CONSULTING Service in design, manufacturing, management. Submit your problem for free preliminary survey. James Engineering Service, Box 648, Zanesville, Ohio.

MANUFACTURING, Gear cutting, tools. Dies, special machinery, stampings. Established 1896. Baum's Metal Specialties, Kansas City, Mo.

MANUFACTURE Paints, your garage a factory. Free information. Industrial Chemist, 1826 60th, Kenosha, Wis.

NAME Plates for manufactured products. Etched metal. Ad-Craft, La Crosse, Wis.

ROBBINS Aluminum Foundry. Castings made from your patterns. P.O. Box 2446, Denver 1, Colo.

EXPERIMENTAL Devices, models. Any material. Reasonable. Nelson Manufacturing, Woodburn, Oregon.

MODELS—Small lot manufacturing. Metals, plastics, etc. Milburn, Burlington, Kentucky.

A BRAND New inventor's service. Write for information. J and M Company, Burlington, Kentucky.

MODELS AND MODEL SUPPLIES

RAILROADERS New 50 watt 125 ohm rheostats for controlling speed. Regular price \$5.00, our price \$1.00 prepaid. Weston ammeters, 0-60 amps., brand new, with shunt \$2.95 prepaid. Heath Co., Benton Harbor, Michigan.

POWER Models—Steam and gasoline engines, steam traction engine, metals, tools. Catalog 35c. Chas. Cole, Ventura, Calif.

OPERATE 24 Volt d.c. midget motors and relays from 110 v. a.c. line, transformer and rectifier \$3.00. Mack, Box 123, New Hyde Park, New York.

STEAM Engines, boilers, castings. Catalog 25c. Anton Bohaboy, 2297 Price, Rahway, New Jersey.

HOBBYCRAFT Lumber, \$1.00, package of 25 pieces cedar or fir, 10 to 24 inches long, 1/8" thick, 2" wide. State size required. Lincoln, Box 172, Baldwin, N. Y.

FREE Estimates on patent models. Wood, metal, plastic. Rogay Industrial Models, 3818 Beecher Street, N.W., Washington 7, D. C.

LIVE Steamers! All castings and prints for Southern Pacific Atlantic A-6 in one inch scale now available. Also completed locomotive. Lists for Dime. Doc Fixit, 665 1/2 Ivy, Junction City, Oregon.

SHIP Model kits and fittings, most complete stock in New England. Boucher, Fisher, Marine Model and Model Ship-yachts fittings, blueprints and model yacht equipment at standard prices. Send 25c for new illustrated 1947 catalog and price list. Dept. M, James Bliss & Co., Inc., 220 State Street, Boston, Mass.

RAILWAY Models, complete informative catalog HO and O gauge. 128 pages, 35c. Walthers, 247 Erie, Milwaukee, Wisconsin.

FUN Building models—Airplanes, trains, ships. Everything furnished. Giant catalog 10c. Ben's Hobby Shop, 72 West Washington, Chicago 2, Illinois.

BALSA Wood. Generous supply \$1.00. Price list free. Saniader, Manitowoc, Wis.

SHIP Models and yacht supplies complete. Large 64 page catalogue 30c. Bill Wild's, 510 East 11 St., New York City 9.

LANDLOCKED Sailors! Here's a beautiful, richly illustrated, fully descriptive catalogue of famous model ships—whalers, slavers, corvettes, etc., authentic in every detail. Send for it today. Only 10c. Halesite Yacht Service, Inc., Halesite, Huntington, N. Y.

SHIP and Yacht model fittings; blueprints. Send 25c for illustrated catalog No. 20—listing hundreds of items. A. J. Fisher, 1002-1 Etowah Ave., Royal Oak, Mich.

MINIATURE Steam locomotives, 1/4", 1/2", 3/4" scales. Castings, parts, rail! Thorough drawings with instructions. Catalog 25c. Little Engines, Wilmington, Cal.

HOME CRAFTSMEN

LEARN Sea-Shell jewelry and novelty manufacturing. No tools or experience needed. Learn—earn within a week! Complete, beautifully photographed home instruction course, shows you how to make 110 designs of pins, earrings, brooches, hair ornaments, necklaces, bracelets, plaques, ash trays, dolls, animals, miniatures, etc. Explains pearlizing, tinseling, golding, dyeing, luminous processes. Illustrates 65 species sea shells. Lists 200 raw materials with wholesale prices. Complete course \$1 postpaid. Beginner's kit, \$3 (\$3.50 in Canada). House of Gifts, Box 4550FR, Coral Gables, Fla.

FREE! Our latest price list showing hundreds of items for the leather-crafter. 34 pages of tools and supplies. A complete selection of leather stock. All items shown available for immediate delivery. Write for this interesting list today! Handicraft Division, Russo Leather & Findings Co., 239 South Spring Street, Los Angeles 12, California, Dept. M.

EXOTIC Woods—Tigerwood, Lacewood, Zebra wood, Avodire, Rosewood, Aromatic Red Cedar, Walnut, Sedlo Company, P.O. Box 7161, New Orleans 19, La.

SHELLCRAFT Instruction book and kit for \$6 worth, including 450 Caribbean shells \$1. Satisfaction guaranteed. Shell Company, Miami 36, Florida.

LEATHERCRAFT Instructors buy your tools from Harte's Craft Shop, Holyoke, Colorado. Free catalog.

LEATHERCRAFTERS: Ready made leather projects simple to complete are fully illustrated in our 1947 catalog of projects, tools, hides and accessories. Write for free catalog. Ester Leather Company, 145 St. Paul St., Rochester 4, N. Y.

CERAMIC Jewelry supplies, bar pins, ear screws, for ceramic and woodworkers; also glass and seashell assemblers. Free catalog. Philadelphia Badge Co., Dept. B-1, 1007 Filbert St., Philadelphia, Penna.

1947-1948 LEATHERCRAFT Supply catalog 10c. Art Craft Supply, 1205 Throckmorton, Fort Worth, Texas.

35 PATTERNS Of action pull toys, trucks, carts, toy furniture, etc. \$1.00. Continental Homecrafters, 907 Birch, Eau Claire 3, Wisconsin.

FINE Hardwoods, plywoods, veneers. Send 15c for catalogue, \$1.50 for practical assortment. Wood Market, 3 North St., Mt. Vernon, N. Y.

WHAT-NOTS. Made of wood scraps, 24 inches high, beautiful designs, full size pattern 30c. 4 assorted patterns \$1. Illustrated folder 10c. Joanez Patterns, P.O. Box 141, Omaha 7, Nebr.

15,000,000 BABIES Born in U. S. in five years. Homecraftsmen, this is your opportunity. Manufacture "Swannie" combination rocker-swing-high-chair for profit. Engineered design. Complete plans including diagram of assembly jig and instructions \$2.00. Modern Home Furnishing, 7140 So. Greenwood, Chicago 19, Illinois.

MAKE Wood toys—Novelties for Xmas! 3 colossal scaled plans of running dog, novelty match holder, record rack. Send only \$1.00. Novelty Products Co., Box 62, Gardner, Mass.

SHELLCRAFT Beginner's kit with instruction book \$3.00. Price list free. Stelle Shellcraft Industries, 230 Randall Ave., Trenton, N. J.

MAHOGANY—Shipped direct to you from the tropics. Know the pleasure of working with this beautiful wood. Special offer of No. 1 furniture mahogany to home craftsmen. B. Hansbrough, Box 653, Coronado, Calif.

LEATHERCRAFTERS! Send for free catalog listing leathers, tools, supplies. Kit Kraft, 3203 W. Washington Blvd., Los Angeles 16, Calif.

STAINLESS Steel, bar or sheet assortment, \$2.00 postpaid. Industrial Engineering, Box 5989, Metro. Station, Los Angeles 55, Calif.

LEATHERCRAFT Reptile. Complete kits. Factory tanned skins. Quality leather linings. Lowest prices. Free catalogue. Marshall Bishop, Box 341, Coral Gables, Fla.

BUILD And sell lawn chairs. Plans \$1.00. We tell you how and where we sell. The Woodcraft Shop, Danby, Vermont.

PLASTIC Jewelry supplies. Free catalog. J & M Novelities, Box 464, Griffith, Indiana.

LEATHER Craftsmen: Don't spend hours tracing design. Start tooling immediately. Our designs on plastic require no tracing. May be used many times. Introductory offer \$1.00. Sample 10c. Lampkin Artcrafts, Box 641-M, Culver City, Calif.

COPPER Tooling—Material, tools, patterns and instructions \$1.00. Pacific Model Supply, Craft Division, 2509 West Manchester, Inglewood, Calif.

SHELLCRAFT—Instruction, supplies. A. Werts, 1429-56th Ave., Oakland 3, Calif.

RARE Woods for homecraftsmen—Rosewood, ebony, cocobolo, purpleheart, etc. Assortment of small pieces \$2.00. Venezuelan ebony turning blocks, 10" x 10" x 4" \$5.20 postpaid. Send for price list. Salisbury Cutlery Handle Co., Salisbury, Conn.

BRASS Rods, tube, sheet for home workshops. Send for catalog 201. Meier Brass, 1155 Bellevue, Detroit 7, Michigan.

WHITTLES Supplies, Redcut blanks, special woods, tools. Catalog 10c. Old Whittler, 1402 Charles, La Crosse, Wis.

LEATHERCRAFTERS! Belt kits, projects, leather, supplies. Write for catalog. Art Leather, 411 Joseph Ave., Rochester 5, N. Y.

WHAT-NOT Clever original designs, 5 full size. Will add beauty to any home, \$1.00. D. A. Wallace, 637-E Amelia, Orlando, Florida.

MAKE Your own jewelry! Findings in metal and plastics; earwires, pinbacks, cameos, stones, beads, clasps, sprays, combs, hairbars, plastic and metal chains. Hobby Art Corp., Dept. 7, P.O.B. 276, New York 18, N. Y.

KNOCKDOWN Cedar chest lumber veneers. Free price list. Giles-Kendall, Huntsville, Ala.

SHELLS, Plastics, findings. Lowest prices. Free catalog. Frances Jones, Box 251, Sarasota, Fla.

EXPERIMENTERS! Interested in electrical, mechanical devices from war surplus? List free. F. Siefke, Box 18, Station E, Buffalo 11, N. Y.

MAKE Shell jewelry—for gifts, as a hobby or start a business. Free catalogue and price list. Complete illustrated book of instructions 75c. Florida Shellcraft Company, Box 1840, Sarasota, Florida.

MAKE IT YOURSELF

SPECIAL De-luxe high quality coaster wagon. We ship you complete parts to assemble your own coaster wagon. (Includes nuts, bolts, washers, etc.) 10"x11.75" semi-pneumatic tires, automotive steering, patented hubless wheels, will support heavy loads. This is a high quality wagon at an amazingly low price. Buy direct from factory at \$9.95 each f.o.b. our factory. Send check or money order. Falls Welded Products, Inc., Menomonee Falls, Wisconsin.

BUILD Concrete block machine. 2 blocks per minute. Build concrete mixer. Easy, inexpensive. Details free. Horne, 206 West Wilder, Tampa 3, Florida.

BEAT The heat. Build efficient inexpensive air conditioner. Complete, simplified chart and instructions. \$1.00. Imperial Air Conditioning, 3778 West Chicago, Detroit 6, Mich.

BUILD Concrete block machines, portable sawmills. Shop, farm, home machines. 70 plans. Catalog-handbook free. Nichols Equipment Co., Dept. 110, Purvis, Miss.

HOT Water free—from sunlight system, efficient any locality year round. Standard materials, easily built, low cost. Facts free. Solar Water Co., Box 175, Dept. G, Coral Gables, Florida.

BEAUTIFULLY Carved wood shelf 10"x18" \$1.50 postpaid. Assemble yourself. Ritter, Box 1245, Corpus Christi, Texas.

FREE Folder—Sectional building construction for homes, cabins, small buildings, new method \$1.00. Mastercraft, West Salem, Wisconsin.

HOMES, Garages, build yourself. Cement block maker \$12. Write W. M. Grant, 1351 Gregan Pl., Dept. A, St. Louis 14, Mo.

DESIGN And build your own electric clocks. Guaranteed self-starting Scott movement complete with hands, dial, crystal, bezel, line cord. Only \$4.95 prepaid. Scott Industries, 314 E. McMillan, Cincinnati 19, Ohio.

SPECIAL Offer. Over 100 easy to make educational, action toys. All full size patterns. \$1.00. Masterprint Company, Buffalo 2, N. Y.

INCREASE Light where you want it! Get more for your electric dollar! Create beautiful lighting effects at home! "Light-Flex" scientifically developed, controls light rays. Easily applied on desired area of present bulbs increases light through reflectivity. Beautiful silver finish. Decorative "silhouettes" really marvelous. Use your ingenuity! Results amazing! Cost few cents a bulb. Simple directions assure satisfaction. Complete kit only \$1.00 postpaid. Light-Flex Company, Dept. 13, Box 877, Rochester 3, New York.

GRANDFATHER Clock building system, simple, shop-tested, thousands built, with Westminster weight movements pictured in production \$1. Kuempel Clock Works, Minneapolis 16, Minn.

SOFTENERS—Build your own, save up to 50%. We furnish everything. M-Z Co., 4526 Fond du Lac Ave., Milwaukee, Wis.

MAKE Your own musical novelties. Genuine first quality music movement. Choice of beautiful melodies for children or adults \$3.50 prepaid. Roger Gift Shop, 31-14 Broadway, Long Island City 2, N. Y.

NEW—Modern—Streamlined. Latest design in 10" all purpose wheels. Patented hubless wheel construction. Puncture proof 10" x 1.75" semi-pneumatic tires. Smooth running totally enclosed Chrysler Oilite bearings. For racers, 4 wheel trucks, wagons, market carriers, golf bag carriers, garden and porch furniture, etc. \$1.65 each. Set of 4—\$6.25 f.o.b. our factory. Money order or check with order. No c.o.d. Supply limited; order today! Falls Welded Prod., Inc., Menomonee Falls, Wisconsin. Dealers write for quantity prices.

PLANS AND BLUEPRINTS

AUTOMATIC Timer switch for radios, lights. Plans \$1.00. Breese, Box 74, East Side, Providence, R. I.

WATCHES, OLD GOLD, JEWELRY

WATCHES, Materials, tools, bought, sold. Catalog. Gales, Box 1000, Chicago.

WATCHMAKERS—Don't be without B & M Hairspring Vise. Price \$4.50. Meyer Mfg. Co., 3911 N. Figueroa St., Los Angeles 31, Calif.

OLD Gold: Top price paid. Mail old or broken jewelry, rings, watches, gold teeth, silverware, diamonds. Receive cash immediately. 100% satisfaction or articles returned. Information free. Old Gold Specialist Robert Wyndham, 1035 East 'A' Street, Ontario 1, California.

NEW Jewelry for old. Let us put your old jewelry and watches in like new condition. Free estimates. Chicago Jewelry Repair, 3317-A No. Clark, Chicago 13.

HIGH Class jewelry, payment plan. Fairchild Company, Mt. Vernon, Ohio.

DIAMONDS—Just out of pawn! Amazing savings on unredeemed diamond pledges sold direct to you! 1/4 carat (\$125 value) for \$49. 1/2 carat, \$200 value, now \$79, including tax. Send no money. Write for free circular of other valuable diamonds from \$5 to \$5000, now on sale at a fraction of regular prices. References: Equitable Trust Co. or your own bank. Write now to Beriman's Collateral Loan Bank, Dept. P-1, 636 W. Baltimore St., Baltimore, Md.

EXPERT Watch repairing. All makes repaired. Fast service. Reasonable prices. Fugate's Watch Shop, Saldee, Ky.

20 WATCH Movements broken for student practice work, \$10.00. 3 pounds broken costume jewelry, \$8.00. 1000 costume jewelry stones, \$3.50. Lowe's, Dept. PM 611, Holland Bldg., St. Louis 1, Mo.

JEWELRY Findings, lowest prices. George Sassen, 154 Nassau Street, New York 7.

WATCHES—Broken or usable; All kinds. Highest prices paid for jewelry, rings, spectacles, gold teeth, diamonds, sterling silver, etc. Cash mailed promptly. Write for free shipping container. Lowe's; Holland Building, St. Louis, Missouri.

GOLD \$35.00 Ounce—Mail old gold teeth, diamonds, jewelry, watches—receive cash by return mail. Satisfaction guaranteed. Free information. Dr. Weisberg's Gold Refining Company, 1500-Q Hennepin, Minneapolis, Minn.

GEMS, Precious and semi-precious, all genuine, from world wide sources. Deal direct, no overhead, save money. Catalog 10c. Hill Co., Route 7, Salem, Oregon.

CASH For old, broken jewelry. Highest prices paid immediately. Mail gold teeth, watches, rings, silverware, diamonds, spectacles. Satisfaction guaranteed. Information free. Rose Smelting Co., 29-A East Madison, Chicago.

WATCH And clock repairing—Complete practical course in modern horology. 66 illustrated self-instruction lessons. Just out! Low price. Fascinating 100-page illustrated catalog free! Write—Nelson Company, Dept. 3-02, Chicago 5.

WATCH Repairing easy learned by our home study course. Watch repairers are in demand and are among the highest paid craftsmen today. Write for free information. Houston Chronometer & Watch Co., P.O. Box 1140A, Houston 1, Texas.

TOBACCO, SMOKERS' SUPPLIES

PIPES Repaired—Hard rubber stems fitted \$1.00. Free catalog. Brandon Pipe Hospital, 3740 Richton, Detroit 6, Michigan.

CIGARETTES—\$1.50 Per carton of 200, postpaid. Save money on: Camel, Chesterfield, Luckies, Philip Morris, Old Gold, Pall Mall, Tareyton, Kool. Minimum 3 cartons; no order too large. We pay postage, insure, and always ship fresh cigarettes immediately. Act now! Mail check or money order, or request c.o.d. Don't delay! Send your order today. John Robert Sales Co., Box 1, Dept. P, Clayton 5, Missouri.

CIGARETTES—Popular brands \$1.49 carton postpaid. Send check or money order. Holly Products Company, 4815 Holly, Kansas City 2, Missouri.

PIPE Carving kits, \$1.00; factory rejects, 75c; literature free. Carvapipe, 2829 Dixie, Hamilton, Ohio.

MAKE Smoking pipes, briar blocks and stems. Send for circular. Michelson & Sternberg, 67 West 44th Street, New York 18.

CIGARS—Imported. 50 Coronas \$3.60 postpaid. Grebne Distributors, 1410 Ardmore, Grand Rapids 7, Mich.

SURVEYING INSTRUMENTS

GUARANTEED Factory rebuilt transits and levels for sale (cash or terms) or rent (with purchase option). We will repair, trade, or buy old instruments. Ship prepaid for estimate and valuation. For complete information, write for list M-38. Warren-Knight Co., (Manufacturers of Transits and Levels), 136 N. 12th St., Philadelphia 7, Penna.

FOR THE HOME

MEN'S Fine used suits. Good condition. Get circular. Campbell Doggins, Box 949, Lexington, Ky.

VENETIAN Blinds come like new with new mechanical cleaner. Free descriptive folder. Joseph Colapinto, 1161-44 St., Brooklyn 19, N. Y.

INSULATE Your home yourself. Old or new. Home Owners Insulation Manual \$1.00. Moneyback guarantee. Fuel Savings Service, Box 741-P, Canton, Ohio.

FOR SALE—MISCELLANEOUS

BALLOONS Wholesale, targets and toy. Samples \$2.00. 10 different items. S. & P. Novelty Co., 428 Sixth St. N.W., Washington 1, D. C.

DIVING Masks. As used by the Navy's secret Frogmen enables you to see underwater. Recover sunken motors, guns, valuables. \$2.75 postpaid. Underwater Diving Equipment Co., Miami 29, Fla.

REYNOLDS Rocket ball pen—writes years without filing. \$1.00 prepaid, \$1.25 c.o.d. Peerless, 2726 Sturtevant, Detroit 6, Mich.

JUMBO Bull frogs, wild rabbits, fishing poles, ball bats, land. Vol Brashears, Berryville, Arkansas.

GOVERNMENT Surplus wooden tripods with adjustable metal legs. Used by government for engineers levels and transits. 5 1/2 foot extension. Very strong. Can be used for holding telescopes, cameras, etc. Value \$24.50, special \$4.95 post paid. Send coin 25c for new list of guns, binoculars and powder flasks available for immediate shipment. Public Sport Shops, 13 S. 16th Street, Philadelphia, Penna.

HULL Automobile compass, for accurate road direction, brand new \$2.50. Prisms for 6x30 or 8x30 binoculars, brand new, \$1.50 each. Offset prisms to be attached to 7x50 B. & L. binoculars gives double the field of the ordinary 7x50 binocular. Cost \$98.00, special \$25.00. Green sunshades for binoculars, size 6x30 and 7x50, snap on type, value \$7.50, special \$1.25 per pair. Forward money order. No c.o.d. shipments. Send coin 25c for new list of guns, binoculars and powder flasks available for immediate shipment. Public Sport Shops, 13 S. 16th St., Philadelphia, Penna.

LITTLE Library of Useful Information. 102 different books. Catalog free. Popular Mechanics Press, 200 E. Ontario St., Chicago 11, Ill.

WANTED—MISCELLANEOUS

WANTED: Wrecked midget car. Motor not necessary. Or good buy. Robert E. Carney, 240 Short St., Erie, Penna.

WANTED. Small lathe and drill press work. Douglass McBrayer, 225 Society Street, Anderson, S. C.

SWAPPERS! Traders!—Free information. "Swappers" Gazette." 2836-PM Slevin, Louisville 12, Kentucky.

MERCURY (Quicksilver). Write for quotation stating quantity. Metallurgical Products Co., 35th and Moore Sts., Philadelphia, Penna.

BOOKS—All Kinds—Homecraft, Radio, Plastics, Boat Building, Photography, Model Building. Catalog free. Popular Mechanics Press, 200 E. Ontario St., Chicago 11, Ill.

PERSONAL

MEXICAN Law. General Practice Attorney, 1263 Arizona Street, El Paso, Texas.

HEALTH—Build perfectly developed body. World's greatest system. Literature free. Todd Foundation, 210-A Fifth Avenue, New York 10.

MAIL Everyday, opportunities galore. Name listed 10c. Sibley, Mendon, Mass.

RESEARCH—Your personal day! Birthdays, weddings. Do you know on what day you were born? We send exact day by copyrighted method, 25c, six for \$1.00. Any person; family, friends. Send accurate month, date, year, for each person. Research Enterprise, Dept. 3, Box 822, Port Arthur, Texas.

PRETEND Visiting Detroit to buy car. 3 postcards 25c, you address, we mail, letters forwarded 25c. La Barre, 12683 Terry, Detroit 27, Mich.

HAVE Fun! Pretend visiting Philadelphia! Ten beautiful scenic post cards \$1. Address, stamp, return for mailing. Thomas English, 7321 Sycamore Avenue, Philadelphia, Penna.

100 BOOKMATCHES With your name \$1.75. Hall's, Iowa City, Iowa. (Agent inquiries invited.)

HOLLYWOOD View cards mailed from So. California in your handwriting. You address, return, I remail free. 3-35c. Bates, Box 6081-B, Metro Sta, Los Angeles 55, Calif.

STREAMLINED Family Trailer—Build it yourself. Includes all conveniences—Cookstove, sink, ice box, electric lights, closets, cupboards, sleeping accommodations for four. Fifteen feet long. Weighs 1400 lbs. Complete set of 6 blueprints only \$1.50. Ask for Plans No. 937-942. Popular Mechanics Press, 200 East Ontario St., Chicago 11, Illinois.

MEXICAN Address. Mail received and forwarded. Scenic postcards 15c. Leather and silver articles. TiHotson, Apartado 1405, Guadalajara, Jalisco, Mexico.

VISIT Juarez, Mexico, by proxy. Three postcards 50c. Write Apartado 79, C. Juarez, Chihuahua, Mexico.

SURPRISE Your friends, 3 scenic cards of St. Petersburg 25c. Address, stamp, return, I remail. Cooper, 861 8th Ave. So., St. Petersburg 5, Fla.

THICKER, Lovelier hair for men and women. All about latest secrets, discoveries free. Write immediately. Henry Bruns, 3307 Fremont, Madison 4, Wis.

GREETINGS From Switzerland welcomed by your friends. Send dollar bill, for 4 postcards, or letters. Beautiful photoprints. You write, return, I mail them. Fontana, P.O. Box 80, Zurich, Switzerland.

HAIR Falling? Dandruff? Write Trichologist, 137 Lewis St., Phillipsburg, N. J.

RUPTURED? Positive comfort, no understraps, no steel, no elastic. Write Smith Manufacturing Company, Preston, Ontario.

HOW You can find out! Information discreetly developed, any matter, person, problem, anywhere. Personal-business assignments, representations, undertaken. Nation-wide. Officially licensed and bonded service established 1922. Reasonable. All inquiries confidential. William Herman, 170 Broadway, New York.

SELL Your patent through a small classified ad in Popular Mechanics. Many inventors have found buyers in this way. Ask me for proof—I'll gladly send it to you. F. W. Johnson, Manager Classified Advertising, 200 E. Ontario St., Chicago.

MISCELLANEOUS

YES, Men's shoes in sizes 11½ to 16. Widths AA to EEE. Finest quality, moderate price. Free circulars. Write King-size 235, Brockton, Mass.

SAFEGUARD All cylinder locks. Burglarproof, security guaranteed. Secret, \$1.00. Grand Enterprises, Box 313, New Rochelle, N. Y.

LUMINOUS Paint. (Shines at night). Supply 25c. Sibley, Mendon, Mass.

NYLONS, White shirts, electric appliances, washing machines, radios, bicycles, coaster wagons, etc. Big catalog free. Nelson's, 530 Santa Clara, Alameda, California.

SQUARE Dance instructions, 25 sets, \$1.00. Rayburn, Eureka Springs, Arkansas.

30 BOSTON View cards 50c; 100 different Biblical tracts 10c; 3 needle threaders 10c; Lady Guide magazine and five view cards 10c. Stanials, 183 West Canton St., Dept. 205, Boston 16, Mass.

A Thousand laughs. Unique jackass cigarette dispenser. Holds 10 cigarettes. Simply press donkey's head down, tail rises—presto—out slips cigarette. Satisfaction guaranteed. Sent postpaid for \$1.00 with order or \$1.15 c.o.d. Sanimo Industries, Dept. C-13, Spencer, Ind.

LUSH Salon paintings, oil portraits from photos, genuine home-murals. Paint to please. Low prices. Inquire, Von Hogan, 264 Main, Marlboro, Mass.

FREE—"Amazing New Book"—"Profits From Classified Advertising." Tells how and what to advertise. Be sure to read this book before you invest one cent in advertising. Remember—it's free! Write for your copy now. F. W. Johnson, Classified Advertising Manager, 200 East Ontario Street, Chicago 11, Illinois.

PANNING Gold—Free illustrated booklet-catalogue, mining books-supplies. Old Prospector, B-11 Dutch Flat, Calif.

GOVERNMENT Surplus—A thousand bargains. Write for list; a card will do. Army Navy Surplus Goods, 321-13th St., Richmond, Calif.

SENSATIONAL! Make and fly miniature rockets. Amaze friends. Simplest materials. Illustrated instructions 25c coin. Pokit-Rokit, 948 N. Mill Iron Rd., Muskegon, Mich.

INFORMATION. Any subject. The Roxbys, 747 S. New Hampshire, Los Angeles 5.

DO Your own gold and silver embossing with our simple kit, \$1.00. Send stamp for sample writing. The Village Embossing Shop, Jergins Trust Bldg., Long Beach, Calif.

FREE! Big new "Book of Values" catalog. Everything for the sport, bicycle and hobby fan at lowest prices. Write Minky's, 3330A Roosevelt Road, Chicago 24, Ill.

CUDDLES—The perfect doll for babies, small children, they cuddle it the minute they see it. 79c plus 10c mailing. J. Bryant, A-208, 911 Sherman Ave., Evanston, Ill.

DOOR Canopies. All metal. 48"x20". \$7.50 plus c.o.d. Venice Tin Shop, 231 Westminster, Venice, Calif.

CALENDAR 1753 To 2152. 35c postpaid. Tracy Newton, Decatur, Georgia.

BIG Mails, magazines, catalogs, samples. Name listed, 10c. American Directory, Robstown, Texas.

LITTLE Library of Useful Information. 102 different books. Catalog free. Popular Mechanics Press, 200 E. Ontario St., Chicago 11, Ill.

NAMEPLATE, Bronze casting 5½"x2¼" with ½" block letters cast in one solid piece. Easily mounted above door bell or mail box, also ideal for office doors or desks. Makes a wonderful gift. Print clearly two initials and name wanted. \$1.00 postpaid. W. W. Thumann, 3220 State St., Salem, Oregon.

SHOES—Save 30% for entire family—Buy direct; save the retailer's profit. Send for free catalog. Sutton Shoe Co., Dept. A-2, 32 Sutton St., Baltimore, Md.

DO You want a better job? Unique psychological scheme speeds prompt preference to your application by personnel departments big companies. Unusual strategy. \$1 complete. James, Lock Box 1141, Glendale, California.

KODACHROME Movies! "Beauty Brevities" plus 42 similar subjects, 8mm., 16mm. Catalog, 25c; with projection length sample, \$1.00. World In Color, Box 392-BB, Elmira, N. Y.

POUR Your own plastic printing cuts. New process. Easy. Economical. Proofs free. Pouroplastics, Argyle 1, Wisconsin.

TOPS. Free sample. See natural wonders. Colored California scenes. Write: Novelty Enterprises, Dept. 27; 127 E. Putnam Dr., Whittier, California.

WHAT 100,000,000 People have been waiting for: Our copyrighted humorous booklet, "How to Make a Living Without Working." Sensational! 25c. Kenarock Press, 401 North Second, Elkhart 1, Ind.

ELECTRIFY, Modernize your sewing machine, any make. New motor with control, \$21.50. Guaranteed. Installation instructions. Iris Stores, 235 East 59th, New York, N. Y.

MAKE Your own "Rustic Furniture." Our "Easy to Understand" plans tell how. You can make chairs, benches, tables, lamps, bird houses, summer house, and scores of other things. Our complete plan booklet only 25c. (Worth dollars.) Ask for Booklet No. 18. Popular Mechanics Press, 200 East Ontario St., Chicago 11, Illinois.

BRONZE Name plates for grave markers. P.O. Box 2446, Denver 1, Colo.

70 BIBLE Lessons, 25c. Bulletin, Box 87, Cathedral Station, New York 25.

AMA: NG New book "Tattooing World" for amateurs, professionals, and breeders. Successful method of removing tattoos. 250 illustrations. Sent in plain wrapper. Only \$1.00. Zeis Studio, 728 Lesley, Rockford, Ill.

JONESOTEX Statuettes: Soldier or sailor. Gold-foil \$5.00, silver-foil \$3.00, brown \$2.00, white \$1.00 ppd. Satisfaction guaranteed or money gladly refunded. Write Jones & Kimes, 809 7th St., Wasco, Calif.

"RECEIVE Mail." Moneymaking offers, opportunities, catalogs. Name listed 10c. Ideal Service, 100, Park Ridge, Ill.

MEXICAN Jumping beans. Dozen 25c; hundred \$1.00; thousand \$5.00. Mexican Products, 126 N. Main, Tulsa 3, Oklahoma.

TWO Pounds pure maple sugar, postpaid \$3.00. Eulalia Turner, Poulitney, Vermont.

SWISS Music box units. Choice of classical, waltz, popular. All ready to install. \$3.95 each. Postpaid when cash with order. Information on request. Swiss Novelty Co., Box 1201, Fall River, Mass.

BOOKS—All Kinds—Homecraft, Radio, Plastics, Boat Building, Photography, Model Building. Catalog free. Popular Mechanics Press, 200 E. Ontario St., Chicago 11, Ill.

WESTERN Belts \$1.00 up. Free list. Southwestern Import Company, P.O. Box 5052, Beacon Hill Station, San Antonio 1, Texas.

THE Lord's coming! Get free proofs. Time is short. International Evangelism, Box 263, Duluth, Minnesota.

GOOD "Used" self-instruction educational books on all subjects bought, sold, rented, exchanged. Satisfaction guaranteed. Complete information and 100-page illustrated bargain catalog free! Write—Nelson Company, Chicago 5.

BOOKPINDERS! (Scarce, out-of-print unusual books.) Quickly supplied. Send wants. Clifton, Box 1377PMM, Beverly Hills, Calif.

TATTOOING Outfits—engraving outfits. Circulars free. Write, Zeis Studio, 728 Lesley, Rockford, Illinois.

M-SCOPE Metal, mineral locators latest 1947 electronic type ready for immediate shipment. Fisher Research Laboratory, Inc. manufactured some of the finest metal-locators for the U. S. army. Experience gained is yours in the most efficient metal, mineral locator. Free 16-page booklet upon request. Credit plan available. Fisher Research Laboratory, Inc., Palo Alto, California.

STAMPS Wanted by thousands of our readers. Your ad in this space will bring you some nice orders. One advertiser sold 150,000 stamps. Write for positive proof. F. W. Johnson, Classified Advertising Manager, Room 301, 200 East Ontario St., Chicago 11.

LEARN THE TRADE WITH THE BIGGEST FUTURE!

Your Future's Assured

In any one of these essential, profitable trades—in the fields where there will be the most activity for years to come!

AUTOMOTIVE & TRACTOR

All-inclusive practical training course on latest models automobiles & tractors, complete overhaul, tune-up & service training with modern testing equipment. Includes complete training in all types Automotive Transmissions, Carburetors, Starters, Generators, Hydraulics, Wheel Balancing, Alignment, Brakes, Etc.

ELECTRICAL

We train in house wiring, industrial electricity, power wiring, power motors. You learn by DOING!

DRAFTING

Complete, college-level courses in architectural & mechanical drafting under instructors with engineering degrees.

PLUMBING

All phases: estimating, blueprint reading, lead work, pipes & fittings, plumbing codes, etc.

SHOE REPAIR

In addition to Building & Automotive Trades. A complete shop course. We show you how to open your own shop—at amazingly little cost!

Get Out of That Rut — and Become a Skilled Tradesman with a Lifetime of Good-Paying Jobs and Probably Your Own Business!

Thousands of skilled tradesmen are in great demand now (and will be for many years to come) in the Building and Automotive Industries. Our practical training courses cover all phases of 5 leading fields! Thoroughly trained instructors; references, credentials. Act NOW!

VETERANS! Approved by Veterans Administration. Government-paid tuition & subsistence pay while attending our school! Our references & credentials are tops. Full information on request.

IN ONLY 8 MONTHS YOU'RE READY FOR A FULL-TIME JOB IN YOUR CHOSEN FIELD! — Thorough, practical training courses require only 8 months! (Shoe Repair, 9 months).

5-HOUR CLASSES, 6 DAYS A WEEK permit ample time for outside jobs. Our Employment Dept. helps you. Get part-time work, FREE. Housing Counselor assists in locating living quarters for you during your training.

HERE'S THE FIRST STEP TO YOUR FUTURE—SEND FOR FREE INFORMATION NOW ON COURSES NOW

NATIONAL TRADE SCHOOL

2610 Grand Ave. Kansas City 8, Mo.

Please send me FREE information about your course checked below:

.....Automotive & Tractor
.....ElectricalDrafting
.....PlumbingShoe Repair

NAME.....

ADDRESS.....

CITY.....STATE.....

.....VETERAN. OCCUPATION.....

HOW to Make ART OBJECTS with RUBBER MOLDS

NOW READY FOR FIRST TIME Natural Rubber Latex FOR BETTER MOLDS

NEW MOLDING MANUAL 10¢

MOLD MAKERS: Now for the first time since the war, you can get superior natural rubber molding compound at new low prices. Natural Rubber gives you best physical properties: 70% concentration, high elasticity, freedom from permanent set, unusual elongation. Use FRANCIS Natural Rubber Red Latex to make longer-lasting molds. At our reduced prices, you can produce more and better casts per mold, at lower cost. New Illustrated Instruction Manual, showing how to mold and produce valuable novelties, gifts, accessories, mailed for only 10¢ (stamps or coin). Price list free. Francis Supply Company, Dept. J-2, 1836 East Fulton Street, Columbus 9, Ohio.



FIBRE ARMS AND LEGS!

Light, correctly fitted, strong and comfortable. Natural appearance. Braces for all deformities. Scientific design. Fair Terms.

BUCHSTEIN-MEDCALF 223 S. 6th St., Minneapolis, Minn.

Get on "UNCLE SAM'S" Payroll

START \$1,756 TO \$3,021 YEAR

Men—Women Thousands appointments being made. 32-Page-Book—FREE Mail Coupon today sure.

FRANKLIN INSTITUTE Dept. L86, Rochester 4, N. Y. Sirs: Rush to me without charge (1) 32-page book with list of U. S. Government Big Paid Jobs. (2) Tell me immediately how to prepare for one of these jobs. Name..... Address..... Vet?.....

Please Mention Popular Mechanics When Answering Ads

BE A BUILDER! Learn Estimating and Blueprint Reading at Home

MAKE MONEY IN BUILDING!

See this complete, simple, self-teaching course in building, estimating, blueprint reading for 10 days in your own home!

There is big money to be made in building! New home and commercial building construction will not equal demand for 5 to 10 years. Put yourself ahead of the next man by getting a good job as a highly-paid building cost estimator or start in business for yourself. Contract for building jobs — hire tradesmen to do the work and you take the profits.

The Tamblin System reduces building material and labor costs to simple factors so that you can estimate any job promptly and accurately after you have studied this system. Based on 40 years of actual experience. Thousands have used it successfully during the 25 years it has been helping men get ahead.

Mail the free coupon today and we will send you the complete course, including plans, specifications, estimate sheets, the Building Labor Calculator and complete instructions on 10-day free examination offer. Send no money—you be the judge. Consultation service free to every student without extra charge. No fancy books—plenty of sound and valuable instruction. We teach you down-to-earth estimating which will get you a good job or bring you profitable business. Mail the coupon now. See this unusual course for yourself.

FREE TRIAL

TAMBLYN SYSTEM, Johnson Bldg, PM8, Denver, Colo.

Send Tamblin System for 10 days free inspection. If satisfied, I will pay you \$5.00 per month until \$30.00 is paid. Otherwise I will return it.

NAME.....AGE.....

ADDRESS.....

CITY.....ZONE.....STATE.....

SEND NO MONEY • SEE IT FIRST!



It's YOUR future — Make the most of it!



Start now to earn the bigger pay in electrical repair

Was there ever such an opportunity to get started in electrical maintenance and repair—and at top-notch wages? Are you ready—with experience and ability—to cash in on it? Others are getting just the sort of background needed—quick! practical!—to handle the great variety of electrical maintenance and repair work TODAY—from this well-known electrical library. You can too!

THE LIBRARY OF ELECTRICAL MAINTENANCE AND REPAIR

5 vols., 1826 pages, 1724 illustrations

Gives you the "know-how" to tackle any wiring or motor job. Five books show you HOW—to install all types of motor and generator units—to inspect and repair motor starters and generators—to diagnose motor and generator troubles—to figure new windings for old cores—DC and AC windings—to test armature windings—test induction motors, etc., etc. One book is full of trouble-shooting charts that show quickly symptoms, causes, specific remedies, etc.

Take the first step toward improving YOUR future—Mail this coupon TODAY.

No money down—special price—easy payments—FREE trial

McGraw-Hill Book Co., 330 W. 42 St., New York 18, N. Y.

Send me for ten days' free examination the Electrical Maintenance and Repair Library. If satisfactory I will send you \$1.50 in 10 days and \$3.00 monthly until the price of \$16.50 is paid. If not wanted I will return books postpaid. (To insure prompt shipment write plainly and fill in all lines.)

Name.....
 Home Address.....
 City and State.....
 Company.....
 Position..... PM-8-47



20th EDITION • Auto Library in ONE Book Leader for 37 Years WORLD'S GREATEST AUTO BOOK

New Material on Transmissions, Trucks, Tractors, Diesels, Aircraft and Auto Engines

Now, with millions of cars needing repairs and thousands of men needed to do the work, you need the famous DYKE Auto Book more than ever before. 20th Edition covers all principles, construction, repair, adjustments, testing, troubles and remedies. Over a half million copies of 20 editions of Dyke's have been sold. Gives specifications of old and many newer cars. World's biggest book value, \$7.00. This big book, a complete auto library in one volume, has 1483 pages—4600 illustrations and diagrams—weighs 6 lbs.—equal to all books shown above.

MAIL COUPON

Goodheart-Willcox Co., Dept. 11-A, 2009 S. Michigan Ave., Chicago

Send Dyke's Auto Book at once. C.O.D. \$7.00 Enclosed. Payment refunded in 5 days if not pleased.

Name.....
 Address.....
 City..... State.....

How to Start YOUR OWN BUSINESS And Reap BIG Profits!

Plastics, one of the most revolutionizing and rapidly expanding industries, offers a great opportunity to all enterprising men and women. This is one of the few industries in which home manufacturers thrive and prosper. You can start even on a spare time basis in your own home, and expand rapidly into a full time business, paying good profits.

LIQUID MARBLE

Make LIQUID MARBLE the amazing Plastic, with a thousand uses. LIQUID MARBLE can be poured into FLEXIBLE MOLDS for casting all kinds of artistic and serviceable articles such as: ornaments, novelties, desk sets, paper weights, book-ends, souvenirs, statuary, toys, etc.

FLEXIBLE MOLDS

Make your own FLEXIBLE MOLDS. The cost is low—in fact, a large sized mold costs but a few cents. Hundreds of casts can be taken from a single mold.

NO EXPERIENCE NEEDED!

No skill, or previous knowledge is necessary. All you do is follow our easy-to-understand instructions.

UNLIMITED MARKET

The market is literally unlimited. You will find steady year-round demand in your own community. Your problem will not be in selling but in supplying the huge pent-up demand. Moreover, we supply you with names of buyers for your finished products.

WRITE TODAY

Bing Products will show you how to start with a small investment and build a permanent, independent, profitable business! Don't fail to grasp this opportunity! Write today for FREE CATALOG.

BING PRODUCTS

Dept. A-21, 88 Broad Street Boston 10, Mass.



"Say, Men, Here's Your Chance of a Lifetime!"

LEARN THE PLUMBING TRADE

Thousands of Skilled Plumbers Are In Increasing Demand in the Building Field!

Our 5-hr., 6-day course requires only 8 months! Includes estimating, blueprint reading, lead work, joint wiping, pipes, fittings, plumbing codes, etc. Trains you thoroughly—to work for others, or open your own business!

VETERANS! Approved by Veterans Administration. We help you get part-time work; assist in obtaining housing while you attend our school.

Write for FREE information TODAY! (State if Veteran)

NATIONAL TRADE SCHOOL 2610-P Grand Ave. Kansas City, Mo.



Quack! THE NEW ORIGINAL DRINKING DUCK

WITH THE BIG EYES AND REAL FEATHER TAIL AND STAND

This amazing new duck will fascinate young and old with his antics. No motor, no electricity, no springs. He just guzzles.

only \$2.98

MYSTERY DRINKING BIRD Complete with moving eyes and stand..... \$1.95

Rush Your Order Today Special price to dealers

BERNARD FINE CO. 501 Sixth Ave., Dept. PM, New York 11, N.Y.

NEW! LOW COST! RESPIRATOR

Wear when sanding, grinding, paint spraying, sweeping, dusting, furnace cleaning, etc. Handy as a pair of glasses. Just keep mouth closed and breathe through nose is all you do to operate. Protects against nuisance dusts, lint, coal, cement, grain dust, hay fever pollen, Hns 9 sq. in. filter. For EYE protection against paint spray, dust, gases, fumes, smoke, order our Fog-Proof Rubber GOGGLES..... \$2.00 p.p.

JERRY BRYANT, Dept. PM 919 N. Michigan Ave. Chicago 11, Ill.



FREE! FREE! FREE! For NEW VIGOR—STRENGTH—VITALITY...

Mail this coupon now PM 87

Alan Stephan, Post Office Box 1080, Chicago 90, Ill. Send me, free and without any obligation, your booklet, "Presenting Mr. America . . . Alan Stephan."

NAME.....
 ADDRESS..... CITY.....
 STATE..... DATE OF BIRTH.....

60 POWER TELESCOPE \$2.95

VARIABLE EYEPIECE 20X-40X-60X

NEW! Three telescopes in one, 3 different magnifications. 20 power for ultra-bright images with 40 and 60 power for extra long range. Guaranteed to bring distant objects, people, sports events, ships, moon, stars, etc., 60 times as close.



Most powerful for anywhere near the money. 5 sections. Closes to 1 ft. long. Not one of our high precision instruments but the biggest value. Contains 4 ground and polished lenses. The tubes are made of Kraft fiber, brass bound. It may also be used as a powerful compound microscope for examining objects too small to be seen with the naked eye. Directions included. Mass production methods enable us to sell this high-powered instrument at the amazing price of only \$2.95. We pay the postage. Get yours immediately.

BROWNSCOPE CO.

Dept. 8M 24 West 45 St. New York 19, N. Y.
Catalog of big values in binoculars, microscopes, etc. free on request

DANGER!

Don't attempt that wiring job unless you know how to do it correctly. An investment of only \$1.50 which might save you much trouble and expense will pay for a copy of this book which describes and illustrates proper methods of installation and repair of wiring for electric lights and appliances in accordance with Code regulations.

Get your copy from your local bookseller or write direct to the publishers, who will send your copy prepaid upon receipt of \$1.50. Satisfaction guaranteed or money refunded.

FREDERICK J. DRAKE & CO.

Dept. A-9 690 W. Van Buren St. Chicago 7, Illinois



Bar Bells

...at Factory Prices

\$8.95 up

WRITE FOR FREE BOOKLET AND PRICE LIST

INDEPENDENT IRON WORKS
2416 East 23rd Street, Dept. P5
Los Angeles 11, Calif.

NOW READY! Floyd Clymer's Newest and Best Motor Scrapbook of Historical Cars . . . No. 4. Illustrates, describes 200 early cars, motorcycles. Entirely different from books 1, 2, 3 (also available). \$1.50 each postpaid; \$2.50 for De Luxe edition.

LAW STUDY AT HOME for PERSONAL SUCCESS and LARGER EARNINGS. 39 years expert instruction—over 108,000 students enrolled. LL.B. Degree awarded. All texts furnished. Easy payments. Send for FREE BOOK, G. I. approved. AMERICAN EXTENSION SCHOOL OF LAW Dept. 80-M, 646 N. Michigan Ave., Chicago 11, Ill.

SAY YOU SAW IT IN POPULAR MECHANICS

BUILD THESE PROJECTS
For garden or lawn. Easy to build. Easy to sell. Detailed Blueprints Model B-25 Dutch Windmill 50c; Model OM-60 Old Mill, 85c. Lawn Figure Patterns—Sunbonnet Girl, Dutch Boy, Tulip Girl, Holland Pair, 35c each, all 4—\$1. Catalog illustrating many models, send 10c, today.

CRAFTSMAN'S MODEL CO., Dept. P-106, 2030 N. 41st St., Milwaukee, Wis.

Extra! JUST OUT Extra! U. S. PAT. PEND. NO. 702581
INSTANT NICKEL COMPLETE KIT
NO CURRENT OR BATTERIES USED \$2.50 POST PAID

Iron, Steel, Aluminum, Brass, Bronze, Copper and practically all Industrial Metals can now be HEAVILY nickel-plated WITHOUT equipment, vessels, electricity or previous copper plating, a blessing to Hobbyists, Doctors, Hospitals, Restaurants, Bar and Beauty shop owners. Recommended for Auto, Bicycle and Machinery parts and accessories, Musical Instruments, Electrical appliances, Coffee Urns, and practically anything made of metal.

IN THIS MARVELOUS NEW PROCESS the principles of the battery and electroplating have been harnessed in the INSTANT NICKEL formula, so when it is applied with a wet applicator on a clean metallic object, a permanent nickelplate instantly appears! Thickness of plating is regulated by number of applications.

JUMBO SHOP SIZE (nickelplates 75 sq. ft.) only \$8.75 postpaid. Sample offer \$2.50 postpaid. Nothing else to buy, free particulars. Send check or money order today! C.O.D.'s few Cts. extra for Postage.
INSTANT PLATING PRODUCTS, 3439 Michigan Ave., Chicago 16, Ill.

Get into a Big Branch of the Automobile Industry

Body & Fender Rebuilding



Body and Fender Rebuilding one of the best paid fields in automobile industry. Body and Fender shops make good profits in garages, service stations. Excellent opportunities for men who look forward to business of their own.

BEGIN TRAINING AT HOME OR COME DIRECTLY TO SHOPS

Begin your training at home in spare time, finish in our big modern shops, or come directly to shops. At home you get C.T.I.'s SHOP PROVED HOME STUDY instruction—actual shop experience has gone into the practical lesson assignments. That is why it is easy for mechanically inclined men to learn by our Home Study training and start on actual Body and Fender Work.

CONSULTATION AND PLACEMENT SERVICE WHETHER YOU ARE INTERESTED IN WORTHWHILE JOB OR SETTING UP YOUR OWN BUSINESS. Opportunities for full and part time earnings.



A NATIONALLY KNOWN INSTITUTION

VETERANS qualifying under "G.I. Bill" have all expenses paid by Government plus monthly subsistence while in school. Just mail coupon, we will handle all details. (LOW TUITION, EASY TERMS if you are not a veteran.)

Fill Out, Cut Out, Mail Today

FACTS FREE for Men Who Want to Get Ahead

CHICAGO MOTIVE TRADES INSTITUTE, Dept. F28
(Division Commercial Trades Institute)
1400 W. Greenleaf, Chicago 26, Ill.
Send free Illustrated Brochures and other information about Body and Fender Rebuilding.

Veteran Non Veteran

Name _____
Address _____
City _____ State _____



Learn Neon
★ Today's REAL MONEY OPPORTUNITY
\$100 a week and UP!

Be a Neon Expert in Glass Letter Bending, Neon Color Gassing, also Cold Cathod Lighting and Bombarding. Now you can qualify as a Neon Expert. Train under experienced Neon Instructors. Our graduates succeeding everywhere. Intensive 500 hour day or night course prepares you to take your pick of thousands of big money opportunities.—coast-to-coast. Prepare to make \$100 a week and UP. Or have your own business. Demand for ACME graduates is far bigger than we can supply. We can accept applications from men who want to get set for life in the uncrowded, highly paid field of Neon. Experience unnecessary. Send today for folder, "Get into the REAL MONEY." We assist you in obtaining living quarters near the school. Approved for G.I. Training.

ACME NEON INSTITUTE, LTD.
1648 West Van Buren Street, Dept. K-3, Chicago 12, Ill.

Gentlemen:
Send me your folder, "Get into the REAL MONEY" and complete facts about the Acme Institute Course in Neon.

Name _____
Address _____
City _____ State _____

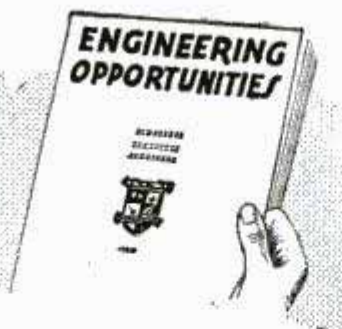

Send for this **FREE** book now!

● Find out about the opportunities in engineering and allied fields — Electrical, Mechanical, Aeronautical, Plastics, Civil, Mining, and other well-paid professions. Our free 118-page handbook outlines home study courses compiled by world authorities, including those listed below. Write now, without obligation, to Canadian Institute of Science & Technology, Ltd., 421 Century Building, 412, 5th Street N.W., Washington, D.C.

A.M.I.E.E. Electrical	Plastics Technology
A.M.I. Mech. E. Mech.	Geology and Mineralogy
A.M.I.C.E. Civil	Automobile
Radio and Telegraphy	Production Engineering

MAIL THIS COUPON NOW!

Canadian Institute of Science & Technology, Ltd.,
421 Century Building, 412, 5th Street N.W.,
Washington, D.C.

Please forward free of cost or obligation of any kind your 118-page handbook "Engineering Opportunities".

Name..... Age.....

Address

CANADIAN ENQUIRIES TO: 219 BAY ST., TORONTO

SAY YOU SAW IT IN POPULAR MECHANICS

RADIO or ELECTRICITY

including Industrial Electronics

Shop Training in a Nationally Known School

LEARN-BY-DOING —
GET READY IN FEW WEEKS

Vastly increased number of radio receivers, development of FM broadcasting, installation of public address systems, demand services of trained men who can repair, service sets and equipment.



Better Training in Better Trades

Get into big established field of Electricity where pay is high—prepare for tremendous new developments in Industrial Electronics. PLACEMENT SERVICE WHETHER YOU WANT BETTER JOB OR BUSINESS OF YOUR OWN. Make rapid progress by our modern shop methods. VETERANS qualifying under "G.I. Bill" have tuition paid by Government plus monthly subsistence allowance while in school. Just mail coupon, we will handle all details. **LOW TUITION, EASY TERMS** if you are not a veteran).

RADIO and ELECTRICAL DIVISIONS
COMMERCIAL TRADES INSTITUTE
Dept. C28, 6312 N. Broadway
Chicago 40, Ill.

FREE—Important Information Telling
How to Get Started



→ Fill Out, Cut Out, Mail Today ←

FACTS FREE for Men Who Want to Get Ahead

COMMERCIAL TRADES INSTITUTE, Dept C28
6312 N. Broadway, Chicago 40, Ill.

Send free illustrated Brochures and other information about the field I have checked below:

Radio Electricity

Name.....

Address.....

City.....

State.....



WHEN YOU'RE TRAINED TO BE A

Skilled Electrician!

Jobs in search of men! Our training course (5-hr., 6-day week) trains you in all House Wiring, Appliances, Industrial Electricity. Full course: only 8 months. We help you get part-time work and housing during your training with us.

VETERANS! Approved by Veterans Administration. Gov't.-paid tuition; subsistence pay!

Write for Further Details NOW!

NATIONAL TRADE SCHOOL 2610-E Grand Ave.
Kansas City, Mo.



BUILD a BOAT

Row Boat—12 Foot
Dinghy—8 Foot
Dinghy—14 Foot Sailing
Training Ship—5 Foot
Sea Sled—9 Foot
Outboard—12 Foot
Cruiser—18 Foot
Bicycle Boat—Kayak
Row Boat—Sectional
Dinghy—Sailing
Canoe—16 Foot
Sailing—12 Foot
Outboard—Runabout
Pontoon—Ice Yacht

FOR PLEASURE OR PROFIT
DESCRIBES 17 LOW COST BOATS
Get this outstanding book and build a boat at home for your own use or to sell at a profit. You can do it. Just the boat you've always wanted—power, sail or row boat—17 different kinds and sizes.

Order BUILD A BOAT on postal card and pay only \$1.50 plus postage on delivery. Return in 5 days if not pleased and get money back. Or send \$1.50 with order and we'll pay postage. (Outside U. S. \$1.70 with order.) Order today.

POPULAR MECHANICS PRESS
Dept. 598, 200 E. Ontario, Chicago 11

POPULAR MECHANICS Blueprints & Plans

HOME CRAFTSMEN ★ SPORTSMEN
HOBBYISTS ★ FARMERS ★ BOYS!

Greater faster plan service! Hundreds of plans and blueprints of easy-to-build projects which have appeared over the past few years in the POPULAR MECHANICS MAGAZINE, prepared as a service to you.

Boats, trailers, furniture, radio circuits, lawn and garden decorations, and children's toys are some of the subjects covered. Long typed list includes approximately 1000 items. Everything from a pin box to a house you can build yourself!

Send Now!

Use the coupon below to send for our latest and complete list of things to build. These lists are absolutely free as long as they last!

POPULAR MECHANICS MAGAZINE
200 E. ONTARIO ST., CHICAGO 11, ILL.

Please send me, without charge, your 25-page list including all of the plans and blueprints now available from your Blueprint Dept.

Name:.....

Street Address:.....

Town or City:.....

State:.....

POPULAR MECHANICS



Learn DIESEL

at home... **IN YOUR SPARE TIME!**

HEMPHILL DIESEL TRAINING is available to you at home. Study in your spare time, without interfering with your present employment. This pioneer Diesel educational institution, with thousands of successful graduates throughout the world, offers you the opportunity to learn Diesel at home. **THE DAY OF DIESEL POWER IS HERE!** Railroads, shipping, farming, manufacturing, transportation—almost every great industry is turning more and more to Diesel Power. Think of the opportunities which this presents to the qualified, trained Diesel man.

VETERANS

This comprehensive, practical Home Training course is approved under the G.I. Bill of Rights. You can get started quickly. Just mail the coupon today.

NON-VETERANS

Courses available to you on easy TERMS. Improve your worth on your present job—or future as a Diesel operator or mechanic. Mail the coupon today for complete details.

RESIDENT SCHOOLS LOCATED AT:

NEW YORK 31-29 Queens Blvd., Long Island I. N. Y.
LOS ANGELES 1601 S. Western Ave., Los Angeles 8, Calif.
MEMPHIS 311 S. Main St., Memphis 3, Tenn.

34 weeks practical training. If you would prefer to train at one of these three schools, indicate by check on coupon.

HEMPHILL DIESEL AND AUTOMOTIVE SCHOOLS
 Administrative Office: 1601 South Western Ave., Dept. PM-8
 Los Angeles 6, California

Gentlemen: Please send me FREE BOOKLET and information on your Diesel Courses. I am interested in Home Study Resident School at New York Memphis Los Angeles (Check school desired.)

Name..... Age.....
 Street..... Zone.....
 City..... State.....
 Veteran..... Non-Veteran.....

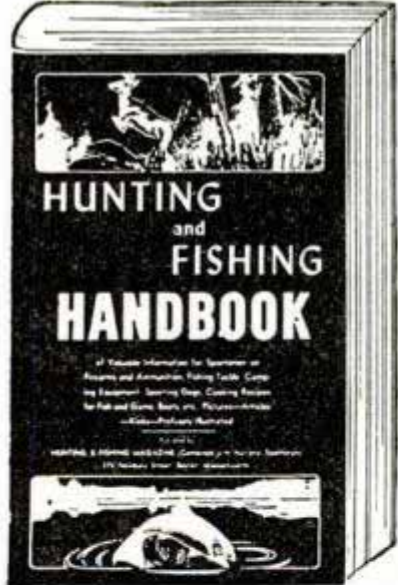

THIS HANDBOOK is crammed from cover to cover with countless ideas to add more fun and greater success to your days afield . . . full of up-to-the-minute information on Hunting—Fishing—Camping—Boating—Dog Training, etc. . . . tells you all about Duck Shooting, Deer Hunting, Upland Game, guns and rifles, sights, ballistics, fly, bait and surf fishing, and hundreds of informative and interesting facts. Over 100 pages and scores of helpful illustrations.

FREE--IF YOU ACT NOW!

This invaluable Handbook **WON'T COST YOU A PENNY**—if you act today! We want you to join our gang of real sportsmen who read **Hunting & Fishing** every month. **Hunting & Fishing** is published for and by its thousands of readers, who send in stories, items and pictures of actual experience—true-to-life, red-blooded accounts of their good times and adventures with rod, dog, rifle and gun. That's why **Hunting & Fishing** is the favorite magazine of true sportsmen everywhere!

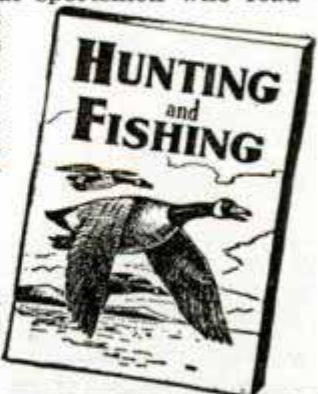

SPECIAL OFFER

Just fill in the coupon below and send it along with a little \$1.00 bill, and we will send you **Hunting & Fishing Magazine** for a whole year—12 big issues—PLUS a free copy of the **Hunting & Fishing Handbook**! Send the coupon and your dollar today!

HUNTING & FISHING MAGAZINE, 251 Sportsman's Building, Boston, Mass.

Name _____
 Address _____
 City _____ State _____

Learn to Repair ELECTRIC APPLIANCES

AT HOME Prepare now for a permanent future, independence and security with a business of your own. Our practical, easy-to-learn home course teaches you, during your spare time, how to repair washing machines, vacuum cleaners, electric ranges, lamps, motors, irons, etc., and do house wiring.

OPEN YOUR OWN SHOP Have a Secure Future

For the man who is handy with tools, and likes to work with his hands as well as his head, there is a **WIDE OPEN OPPORTUNITY** today, in this great growing field. If you own your own shop you can depend on making more money in good times . . . and not losing your job in a depression. You can start a business of your own in your garage or basement with \$20.00 worth of tools. One good repair job can pay for the cost of the entire course. Write today for further information, without obligation.

WRITE TODAY
for
FREE BOOK



PACIFIC TRAINING SCHOOL 7217 So. Broadway, Dept. P-108, Los Angeles 3, Calif.

Dear Sirs: Please send me, without obligation, your free catalog and free details.

Name _____
Address _____
City _____ State _____

VETERANS! INCREASE Your Earning Power!

BECOME A SKILLED AUTOMOTIVE & TRACTOR CRAFTSMAN in Only 8 Months!

Growing demand for our Automotive & Tractor Tradesmen! Let us train you for this profitable field. 5-hr., 6-day classes enable you to have a part-time job which our Employment Dept. helps you secure.



Write Now For **FREE** Information About Course Fully Approved by the Veterans Administration

NATIONAL TRADE SCHOOL 2610-A Grand Ave. Kansas City 8, Mo.

LEARN WATCH REPAIRING

GET PRACTICAL SELF-TRAINING IN YOUR HOME

through our new and complete book, "Modern Watch Repairing and Adjustment," \$2.50 postpaid. If C.O.D., plus fee. Money back guarantee.—We Supply All Books, Tools, Materials. Complete sets for Students, Watchmakers and Jewelers. Lowest cost.

NEW, ALL INCLUSIVE CATALOG, OVER 450 ILLUSTRATIONS, Send 25c. FREE with above book.

MODERN TECHNICAL BOOK & TOOL CO., Dept. MMC
55 West 42nd Street New York 18, N. Y.

SAY YOU SAW IT IN POPULAR MECHANICS

PROFESSIONAL TRAINING
IN A MINIMUM OF TIME

RADIO-ELECTRONICS TELEVISION • BROADCAST ENGINEERING

An Accredited Technical Institute nationally recognized for high calibre training. Prepares high school graduates for technical careers. Classes start every Monday. Comprehensive courses in Radio-Electronics Engineering, Broadcast and Television Engineering, Broadcast and Television Servicing; 2,100 hours classroom and laboratory study. Write today for free informative booklet, "RADIO ENGINEERING AS A CAREER."

CAPITOL RADIO ENGINEERING INSTITUTE

DEPT. P-8, 16th STREET & PARK ROAD, N. W. • WASHINGTON 10, D. C.

MAKE \$ MORE MONEY

Applying or Selling

CORKSTONE

A General Purpose Magnesium Oxychloride Flooring

THE MODERN PLASTIC FLOORING

EASY TO APPLY
Here's your opportunity to get into business for yourself applying or selling Corkstone, the economical, top-grade plastic flooring. Plenty of profit. Act without delay!

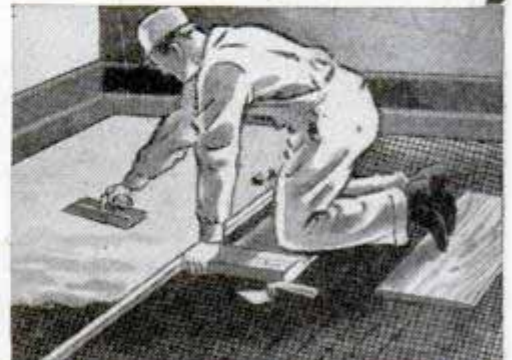

Dealers & Agents Wanted

WRITE FOR DETAILS

LASTING PRODUCTS COMPANY

200 Block S. Franklinton Rd., Baltimore 23, Md.

NOW YOU TOO CAN BUILD 15 RADIOS

COMPLETE KIT \$14.75

Absolutely No Knowledge of Radio Necessary

You Need **NO** Additional Parts

The **PROGRESSIVE RADIO KIT**

is the **ONLY** COMPLETE KIT. Contains everything you need. Instruction Book, Metal Chassis, Tubes, Condensers, Resistors and all Radio parts. The 36-Page Book written by Expert Radio Instructor teaches you to build radios in a Professional Manner. You start with a 1-tube receiver. Before you are done with this kit, you will have built 11 Receivers, 1 Public Address System and 3 Transmitters.

SPECIAL FREE OFFER!

Electrical and Radio Tester sent absolutely **FREE** with each Progressive Radio Kit. **PLUS FREE** membership in Progressive Radio Club. Entitles you to free expert advice and consultation service with licensed radio technicians.

Write for further information, or **ORDER** your KIT **\$14.75**

NOW! ONLY
Postage prepaid with check or money order
(Postage not prepaid with C.O.D. orders)

PROGRESSIVE ELECTRONICS CO., Dept. PM-1
22 Havemeyer Street Brooklyn 11, N. Y.



Money Making Pay Raising BOOKS Catalog FREE

SEND NAME AND ADDRESS TODAY—Selected books covering all trades, office helps, home workshop, spare time work, hobbies, etc. Learn how to earn more. 1947 edition.

Popular Mechanics Press
200 E. Ontario St., Chicago 11



MAGIC LIQUID CASTS PLASTICS



THE GREATEST THING IN PLASTICS!

A NEW LIQUID PLASTIC! Just pour PLASTICAST into any kind of mold or container and it hardens in a few minutes to a solid, smooth, clear as glass plastic! No machinery or tools required. PLASTICAST has UNLIMITED POSSIBILITIES... novelties, toys, jewelry, knick-knacks, fascinating brilliant, sparkling clear or colored plastic articles... an endless variety of useful things. Being transparent it is ideal for imbedding flowers, coins, photos, souvenirs, charms, etc. Can also be cast into rods, sheets, blocks, any shape. Make PLASTICASTING A THRILLING NEW HOBBY OR A PROFITABLE BUSINESS! No experience required; start casting 10 minutes after you receive your outfit. Full instructions and accessories provided.

COMPLETE MASTER OUTFIT, will make over 200 articles... \$3.00 ppd. (C.O.D. orders accepted with \$1.00 deposit).

FREE FIVE ATTRACTIVE MOLDS FREE with every order... Scottie, Indian, Airplane, etc. Valuable Plastics Manual also sent free for 3c stamp!

PLASTICAST CO., (Dept. C)

5961 Madison St. (Send order to nearest office) P.O. Box 987
Chicago, Ill. Palo Alto, Calif.

SAVE LIVES! SAVE EYES!

with the new

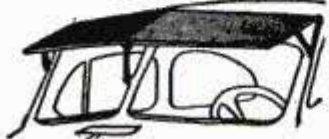

AUTO-VISE SUNSHADE

No Car Should Be Without One

- Eliminates the glare
- Keeps car cooler
- Protects windshield from rain and snow
- Defeats fogging
- Easily installed in 5 minutes
- No holes to drill on car
- It's smart looking, too!

At last! Perfect protection from sun or bright light glare! Regular Price \$29.75—NOW ONLY \$18.75.

HOW TO ORDER: Send name, address and specify make, model and year of car. Pay \$18.75 plus express charges, or send \$18.75 with order, and we will pay all express charges.

BROADWAY GRACE SALES CO., Dept. P
3755 Broadway Chicago 13, Ill.

NEW TOY PLANS

Tested and approved designs. Full size plan of Doll Cart (see illustration) with folder of other tested toy designs \$1.00 P.P. Catalog listing other plans—Weather-vanes, Novelties, Picture Cutouts, etc. . . . 10c. **THE ARTCRAFTERS, 158 So. Collingsworth, El Paso, Texas.**

PRESTO! ANYONE CAN MASTER GLAZE

LEAVES HARD GLASS-LIKE FINISH
EASY TO APPLY
PROTECTS THE SURFACE
NO SMEAR OR STREAKS AS WITH WAX
LASTS SIX MONTHS TO A YEAR

SEALS THE PORES OF THE SURFACE
WILL NOT FINGER-MARK
NO GILY FILM AS WITH POLISH
SAVES YOU MONEY

Car Owners! Meet Master Glaze—the sensationally different luster for new and used cars! Not a wax—not an oil polish—not a paint!—nothing that “smears” over the surface.

MASTER GLAZE is a unique discovery—a creamy liquid—quick and easy to apply! Gives a hard, glass-like surface. Even gasoline cannot dull it! Lasts six months to a year! Amazing luster—beautiful, sparkling clean and brilliant! Doesn't finger-mark—doesn't smear! A match box full glazes an entire car. Seals the pores—protects! NOTHING LIKE IT!

FREE SAMPLE

Just send your name and address to

MASTER GLAZE CO., 7720-616 W. Harwood Ave., Milwaukee, Wis.

Pay Is Good

for Trained mechanics in both these Big Industries

LEARN IN A FEW WEEKS IN OUR BIG MODERN TRAINING SHOPS

AUTOMOTIVE MECHANICS

DIESEL MECHANICS

NOW IS THE TIME TO PREPARE FOR YOUR PLACE IN A GIANT INDUSTRY

Automobile and Diesel Industries making up for lost time! There may never again be such opportunities for men who want better jobs or business of their own to get in on ground floor and go up fast! Yes—FOR MEN WHO ACT FAST, THINGS CAN HAPPEN FAST!

TRAIN ON ACTUAL EQUIPMENT

Chicago Motive Trades Institute makes rapid progress possible by Learn-By-Doing SUPERVISED SHOP TRAINING. In motive trades our institute gained nation wide fame training Auto Mechanics for U.S. Army. Same quality training available to you now. CONSULTATION AND PLACEMENT SERVICE WHETHER YOU ARE INTERESTED IN WORTHWHILE JOB OR SETTING UP YOUR OWN BUSINESS.

AUTOMOTIVE MECHANICS

Practical shop training on all types of equipment. Automotive mechanics needed to keep millions of cars, busses, trucks rolling. Efficient auto mechanics get fine pay. Can service, repair, install all mechanical and electrical parts of autos. Learn to overhaul and repair engines, transmissions, differentials, and other assemblies. Good pay, steady work, excellent opportunities for increased earnings for properly trained auto mechanics.



DIESEL MECHANICS

Diesel engines are used in locomotives, ships, trucks, busses, power plants, tractors, farm equipment. Trained men needed to repair, rebuild, install, maintain, operate equipment. A big field that promises even bigger things in the years right ahead.

A NATIONALLY KNOWN INSTITUTION

Rapid progress possible by supervised learn-by-doing SHOP TRAINING. C.T.I. is an old established school, backed by years of experience—with trained instructors—with completely equipped shops.

VETERANS qualifying under “G.I. Bill” have tuition paid by Government plus monthly subsistence allowance while in school. Just mail coupon, we will handle all details. (LOW TUITION. EASY TERMS if you are not a veteran).

CHICAGO MOTIVE TRADES INSTITUTE

Div. of Commercial Trades Inst.
1400 W. Greenleaf Ave., Chicago 26, Ill.

- FREE -

Important Information
Telling How to Get Started



CUT COUPON ALONG THIS LINE

Fill Out, Cut Out, Mail Today

FACTS FREE for Men Who Want to Get Ahead

CHICAGO MOTIVE TRADES INSTITUTE, Dept. B-25
1400 W. Greenleaf, Chicago 26, Ill.

Send free illustrated Brochures and other information about the field I have checked below.

- Automotive Mechanics Diesel Mechanics Veteran
 Non Veteran

NAME _____

ADDRESS _____

CITY _____

STATE _____

SAY YOU SAW IT IN POPULAR MECHANICS



Hey, Joe!
START TO SCHOOL NOW
400 MORE LUCKY "GIs"
CAN LEARN

DIESEL . . DIESEL-ELECTRIC . . ELECTRICITY
RADIO MECHANICS . AIR CONDITIONING . REFRIGERATION

Due to the tremendous demand for Bailey training, students have made reservations far in advance. Applicants have had to "get in line and wait."

Now, however, due to our expansion program, you can enter the Famous Bailey Technical Schools immediately. American industry wants Bailey graduates. Here's a typical comment. W. H. Husmann, president and co-founder of Husmann-Roper Freight Lines, Incorporated, says:

"Bailey School graduates are 'old hands' with Diesels from the first day. Shop training makes them thoroughly competent."

Bailey Schools teach you basic principles, fundamentals, plus the practical application of theory in actual shop work. You get the "tricks" of the trade which would take years to learn starting at the bottom of the job.

If you want a business of your own or an important job in industry, it will pay you to investigate the Bailey School of your choice NOW.



Theory in the Bailey Classroom

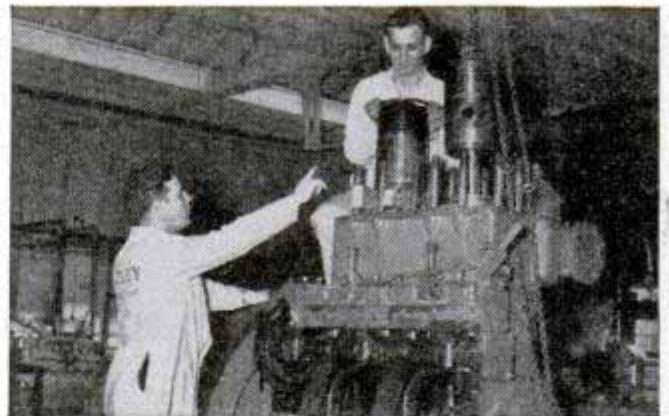

Shop practice

The BAILEY Technical SCHOOLS

Internationally Recognized

1651 S. Grand Blvd.

St. Louis 4, Missouri

SEND THIS APPLICATION

for information about enrollment today; you are under no obligation. Write to: Bailey Technical Schools, 1651 S. Grand Blvd., St. Louis 4, Missouri. Check the school in which you are especially interested.

- Diesel Diesel-Electric Electricity
 Radio Mechanics Air Conditioning Refrigeration

Please send information to:

Name.....

Address.....

.....

Bailey Technical Schools are
GI APPROVED
Industry Endorsed

Bailey Technical Schools are approved by the Missouri State Board of Education; approved under Public Law 16 (the highest level of acceptance); approved for State Rehabilitation Training by all states which have a rehabilitation program.

For free catalog giving complete information, cut out the application to the left and send it in.



AIR CORP GUN SIGHT

Worth many times this low price. Consists of a pentaoid filter, top surfaced prism mirror, actuating motors, compensating adjustments, calibrated dials for air speed, drift, strafing range, etc. Inventors and experimenters will find many valuable parts in this assembly. All brand new in orig. export packing. Weight 7 lbs. No. 215. Each only.....

\$4.95

HUNTING KNIFE



Has 5 inch blade with keen cutting edge. 9 1/2 inches overall. Dressed leather handle with plastic insets and guard. Sheath included. Wgt. 1 1/2 lbs. No. 197. Each.....

\$1.65

BINOCULAR CASE



Heavy cowhide, hand sewn. Die cut top for compass. Will fit 6x30 Bosch & Lomb or similar binocular. Wgt. 2 lbs. No. A191. Each.....

\$2.95

JUNGLE HAMMOCK



For back yard, country home and camp use. Has waterproof roof with mosquit-to-proof nylon netting side. Lets you sleep outdoors safely. Finest construction. Originally designed for U. S. Army use. Shp. wgt. 7 lbs. No. 134. Each.....

\$3.99

Shatterproof Goggles



All purpose type. Sponge rubber frame. Red shatterproof flexible lens. Adj. head band. With case. New. Wgt. 1 lb. No. 139-Each.....

39c

STILLS



Distill your own water with one of these fine portable stills. Purchased from the Gov't. Completely self contained. Has 1 gallon capacity; output 1 1/2 gal. per hour. Fitted with genuine Coleman double burner stove. Operates 5 to 7 hrs. on one filling. Heat output 20,000 BTU's. Stove alone is worth this price. All new and guaranteed. Instr. included. Weight 109 lbs. No. 206. Each.....

\$59.50

DECORATIVE CHROME STRIPS



For your car, boat, furniture, etc. Highly polished chrome finished strips with clinched edges for flush mounting to any surface. The 3 pound kit provides approx. 15 pieces in lengths from 6 inches to 3 feet and average 3/4 inches wide. Wgt. 4 lbs. No. R224. 3 lb. Assort. only.....

\$2.00

WAR SURPLUS AND HUNDREDS OF OTHER BARGAINS



TRAINING RIFLE

Regulation size and weight. Looks like the real thing. Fitted with adjustable sights and full size leather sling. Bolt action sets and individually packed. Shipping weight 8 pounds. Stock No. 192. Price, Each.....

\$4.50



FISHING KIT 18 Pcs. BRAND NEW

Here is a war surplus special that every fisherman will appreciate. It consists of hundreds of feet of line with lures, hooks, sinkers, etc. Fishing knife and gloves, all packed in a cloth roll up kit that also serves as an apron. Entire assembly of 18 pieces comes packed in a hermetically sealed can. Brand new! A real value. Shp. wgt. 4 lbs. Stock No. 413. Each only.....

\$2.95

BUBBLE SEXTANT Model A-12



A valuable piece of scientific apparatus that every boat or private plane operator will appreciate.

Made by Link Aviation Devices, Inc. for use in navigation. It is a precision instrument, finely constructed and calibrated for utmost accuracy. Each unit is complete—brand new and in a specially constructed protective box case. Stock No. 193.....

\$39.50

FISHING REEL



Full 100 ft. line capacity. Free acting brass bearings. Hatchet drag. Catlin handles. A real value at this low price. All metal shp. wgt. 1 lb. No. F412. Each.....

98c

SLIDE RULE CASE



Made by Kuffel & Esser. Of heavy formed leather throughout. Holds 10 inch Log-trig rule or equivalent. These cases are brand new. May be used for many other purposes. Shp. wgt. 1 lb. No. 194. Each.....

98c

15 JEWEL STOP WATCH



Air Corps. Surplus. Genuine Elgin 15 Jewel movement. One revolution in 10 seconds, graduated in 1/10 seconds. Stem wind, start, stop and reset. Shp. wgt. 1 lb. No. 200. Each.....

\$9.95

SHIP BELL



Purchased from U. S. Maritime Comm. Measures 10 inches high, 9 3/4 inch flare. Big 6 inch clapper. Weight 15 lbs. Fine for farms, clubs, estates, etc. All new. A-541, ONLY.....

\$9.85

RUBBER OVERBOARD SUIT



Here is a buy! All rubber suit with parka. Fits over your regular clothes and shoes. Can be cut apart for waist high waders, hip high or knee high boots, also arm length rubber gloves. Heavy gum rubber over fabric. Fine for those who work in the water, commercial fishermen, sewer diggers, etc. Use it as is or cut it up for waders. All brand new! Wgt. 14 lbs. No. 183. Each.....

\$4.95

7 LB. EXPERIMENTER PARTS ASSORT. KIT

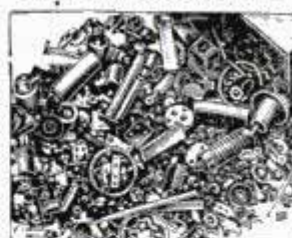

A "gold mine" for the radio serviceman. Hundreds of valuable radio parts, new radar and electronic parts and sub-assemblies, coils, resistors, trimming condensers—worth many times this low price. A130R -7 lbs.

\$1.79

G.I. PISTOL BELTS



Of heavy canvas webbing. Adjustable. Eyedleted all around. Used but perfect. Wgt. 2 lbs. No. 131. Each.....

98c

U.S. Govt. BOLO KNIFE



Extra heavy. For farm, home or jungle use. Blade of Govt. formula cutlery steel. Walnut riveted handle. 3 1/2 inch hilt. 10 1/2 inch blade. You'll find hundreds of uses for a Bolo knife. Blade will take and hold a keen cutting edge. Wt. 2 lbs. A112—with Army Sheath.....

\$4.95

POCKET KNIFE

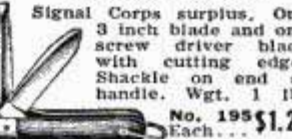

Signal Corps surplus. One 3 inch blade and one screw driver blade with cutting edge. Shackle on end of handle. Wgt. 1 lb. No. 195. Each.....

\$1.25

U. S. ARMY FLASHLIGHT BRAND NEW



Army surplus. Flashlight has all plastic case with right angle reflector. Positive acting safety switch. Has clip for attaching to belt. Spare bulb in base. Complete with batteries. Shp. wgt. 2 lbs. No. 196. Each.....

\$1.25

MEDICAL STERILIZER

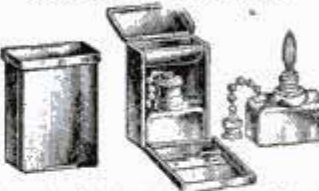

Consists of alcohol burner and sterilizing tray in hinged metal case 17x11x2 1/2 inches. Burner may be used separately. Bright nickel finish. All brand new. A125-Each.....

98c

Officers Watch Compass

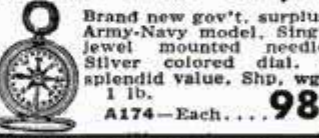

Brand new gov't. surplus. Army-Navy model. Single jewel mounted needle. Silver colored dial. A splendid value. Shp. wgt. 1 lb. A174—Each.....

98c

BERNARD WIRE PLIERS



Parallel acting jaws. Wire cutter at top. Brand new. Wgt. 2 lbs. No. 168. Each.....

\$1.29

ORDER DIRECT FROM THIS AD

Values galore! Hundreds of hard-to-find items for home, shop and outdoors. Make remittances by money-order, bank draft or personal check. Send 25% deposit on C.O.D. orders. No C.O.D.'s on orders for less than \$5.00. Include sufficient postage on parcel-post orders—any overage will be promptly refunded. All quotations F.O.B. Chicago. Used items and materials are guaranteed serviceable and as described. Your money back if not more than satisfied.

BIG ILLUSTRATED CATALOG FREE

STARK'S

Dept. PM847
509 So. State St.
CHICAGO 5, ILL.

The girls look twice
at the man with P.A.*

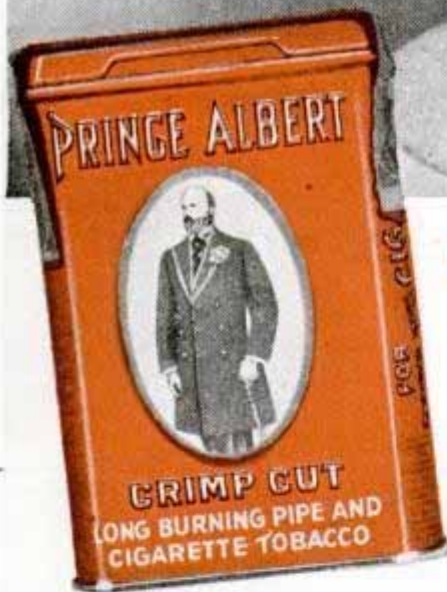

P.A.* means Pipe Appeal

A man with a pipe gets *extra* attention ... for there's something so *masculine* about men smoking pipes. Women find it appealing.

means Prince Albert

R. J. Reynolds Tobacco Co., Winston-Salem, N. C.



GREAT FOR CIGARETTE "MAKIN'S" TOO!

CRIMP CUT P.A.
ROLLS UP FAST AND NEAT
...RICH-TASTY-COOL!

A man with a pipeful of Prince Albert tobacco gets real smoking joy and comfort. P.A. is specially treated to insure against tongue bite. It's mild and easy on the tongue. Try crimp cut P.A.—and you'll see why more pipes smoke Prince Albert than any other tobacco!

THE NATIONAL JOY SMOKE



At the age of 19 the author amazed the aviation world when he designed, built and flew the first practical coaxial helicopter. Today, at 22, Hiller is president and general manager of United Helicopters, Inc., Palo Alto, Calif., engaged in research and manufacturing rotary-wing aircraft

POPULAR AUGUST 1947 MECHANICS

WRITTEN SO YOU CAN UNDERSTAND IT
VOL. 88 NO. 2

SO YOU WANT A HELICOPTER?

By Stanley Hiller, Jr.

"When will I be able to buy a helicopter for my personal use?"

That's a question often asked and my usual answer is that it will be several years yet at least before helicopters are ready for the general public.

It's true that we are testing a two-place machine that looks like an ideal personal vehicle. Powered by a 125-horsepower en-

All set for the take-off — the pilot and passenger in Hiller's two-place craft occupy "greenhouse" cockpit which he says is like sitting on edge of a cloud



gine, our trim coaxial Commuter rises easily from the ground, hovers at the pilot's will, and moves ahead at $\frac{1}{2}$ mile to 100 miles per hour. A tank of gas is enough for a 200-mile trip, cruising at 75 m.p.h. The craft can descend so slowly that you hardly know when you touch ground.

Several years ago, when our "airport" was a vacant lot next door to the factory in downtown Berkeley, a test pilot wanted to call on friends in the country and also wanted to do some fishing. For the trip we replaced the three landing wheels with a pair of large flotation bags so that the helicopter could land on water.

From the vacant lot the ship climbed straight up above the power lines and angled off slowly past some office buildings. The pilot located the highway he wanted and followed it out through the hills. After the pilot found the house, he hovered over his friend's swimming pool for a moment and then landed in the middle of it. Later, to show the helicopter was amphibious, he rose from the pool, climbed over the house and settled on the lawn on the other side. After lunch he headed for a lake 100 miles away, caught a few fish and was back at the factory before dark.

Reading this you doubtless wonder why thousands of helicopters aren't being used for business and pleasure today. There are several principal reasons:

1. Flight technique. Flying any of the present types of helicopters requires considerable training. The pilot must use both of his hands constantly and has little chance to relax.

2. Cost. At present, rotary-wing aircraft are much more expensive than light planes.

3. Landing places. There are few suitable landing places in metropolitan areas. Flat roof-top airports are an obvious solution, but few present roofs are strong enough for this purpose.

Helicopters are really just in the "Model-T" stage of evolution. Proper downtown landing places will be provided when the need increases and costs will go down as design becomes simplified and production steps up. Future helicopters will be much easier to fly. In fact, we are now testing a control system that greatly simplifies piloting and allows a helicopter to be maneuvered practically "hands off."

There are plenty of roles in industry, commerce and agriculture for which the present helicopters in the hands of trained pilots are ideal. They range all the way from forest patrol and crop dusting to pipeline inspection and mail delivery. These and comparable jobs represent the present market. At the same time the conviction that helicopters are to be the personal flying machines of the future is so widespread

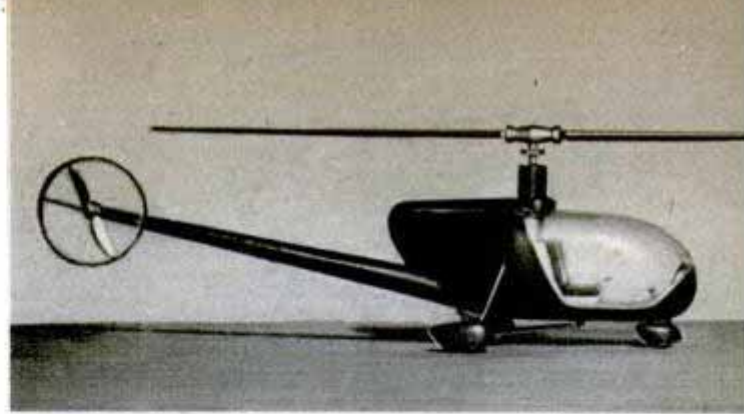

Below, cooling air is drawn down around engine from above. Here circulating fan above engine is being replaced. The Commuter has a 125-horsepower unit

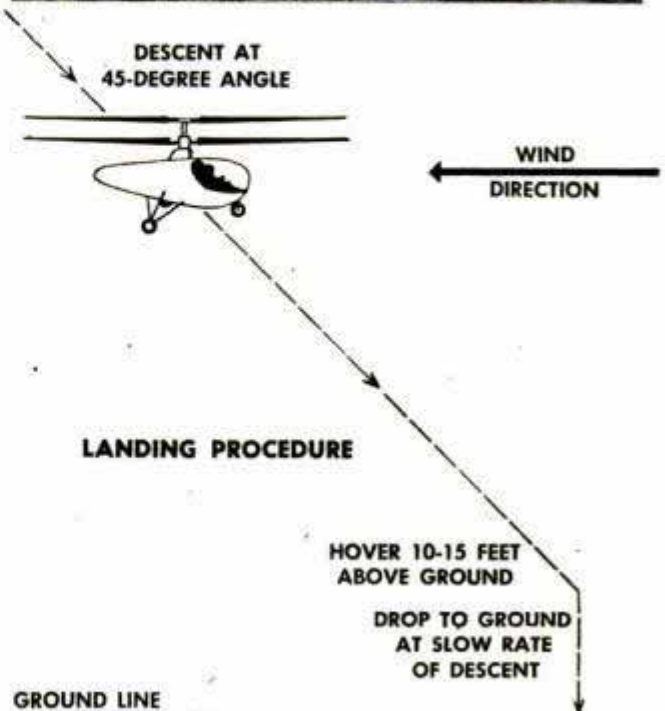
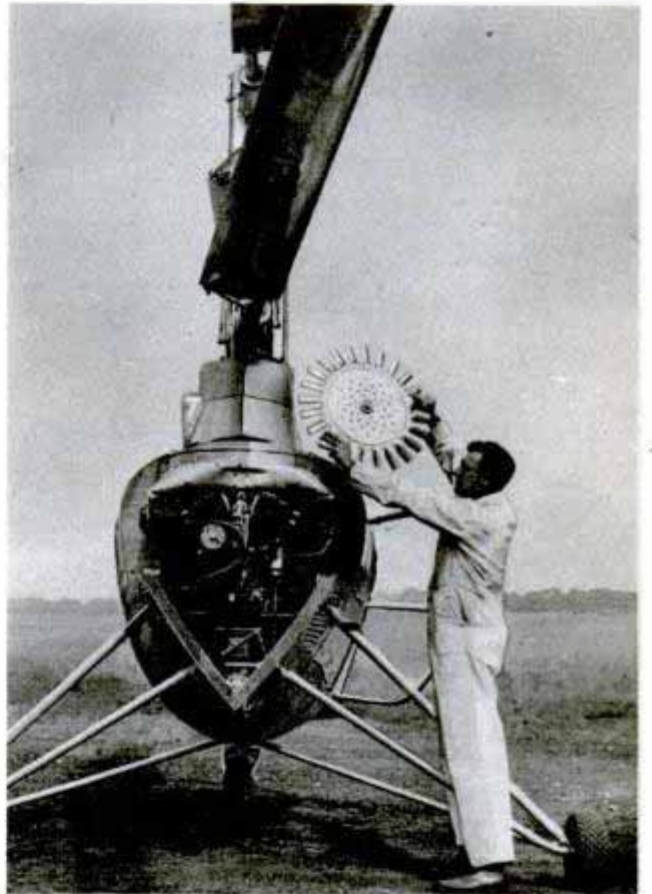

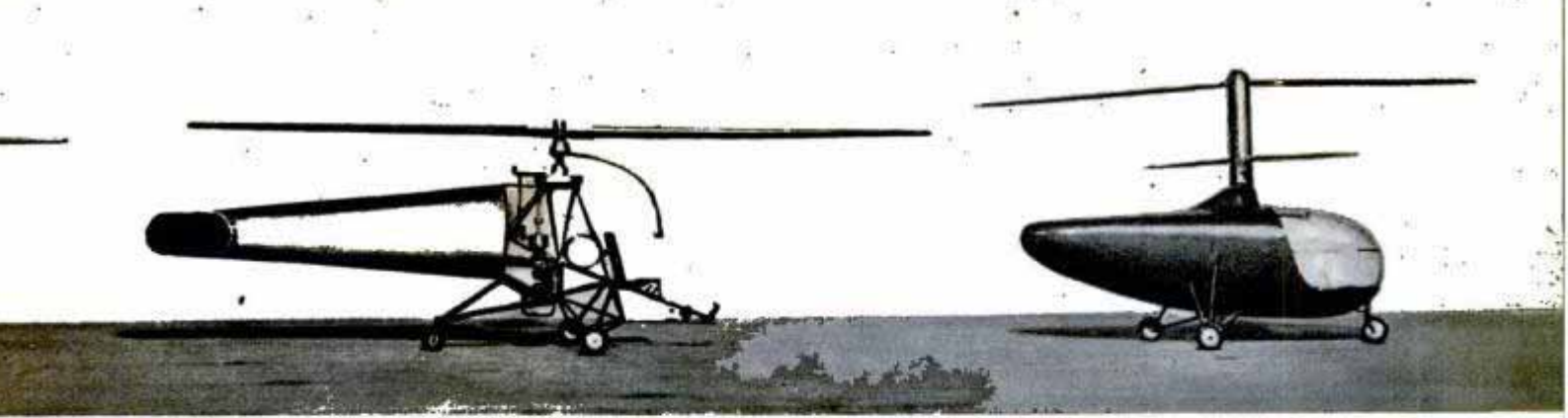

Helicopters at left and in the center counteract torque with a tail rotor and a tail jet, while coaxial type at right uses two overhead rotors for that purpose. Below left, checking mechanisms that change rotor blades' angle of attack. Right, with rotors and aluminum skin removed, helicopter is a maze of controls

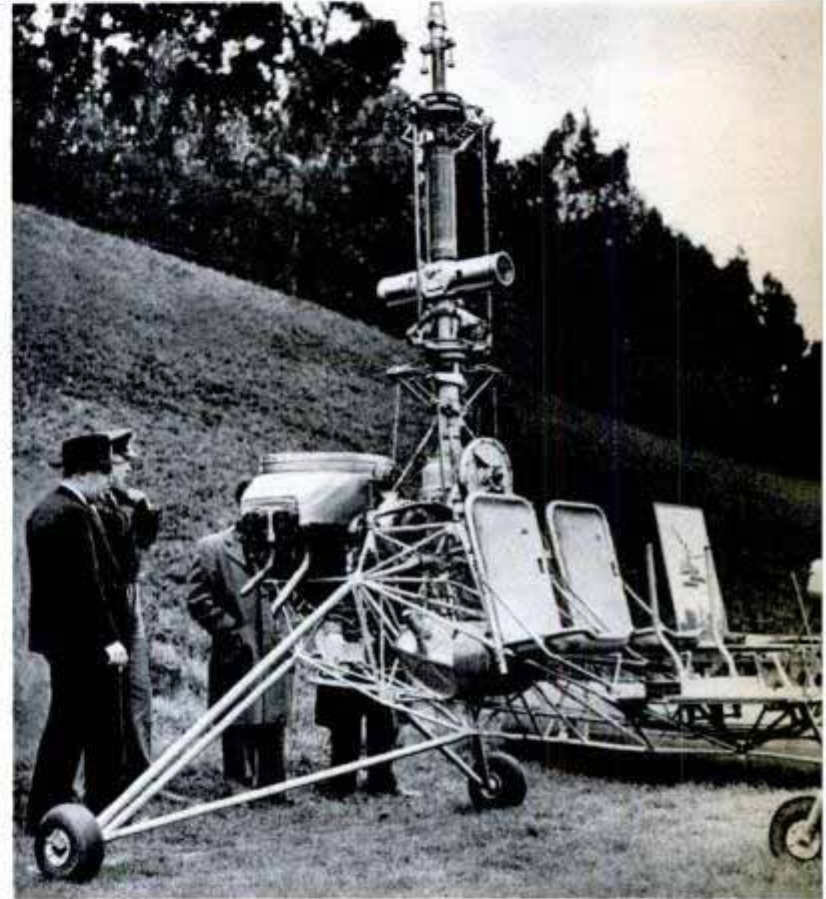

Heavy dotted line indicates typical take-off path. Light lines trace other angles of ascent possible with full throttle

WIND
DIRECTION

TAKE-OFF PROCEDURE

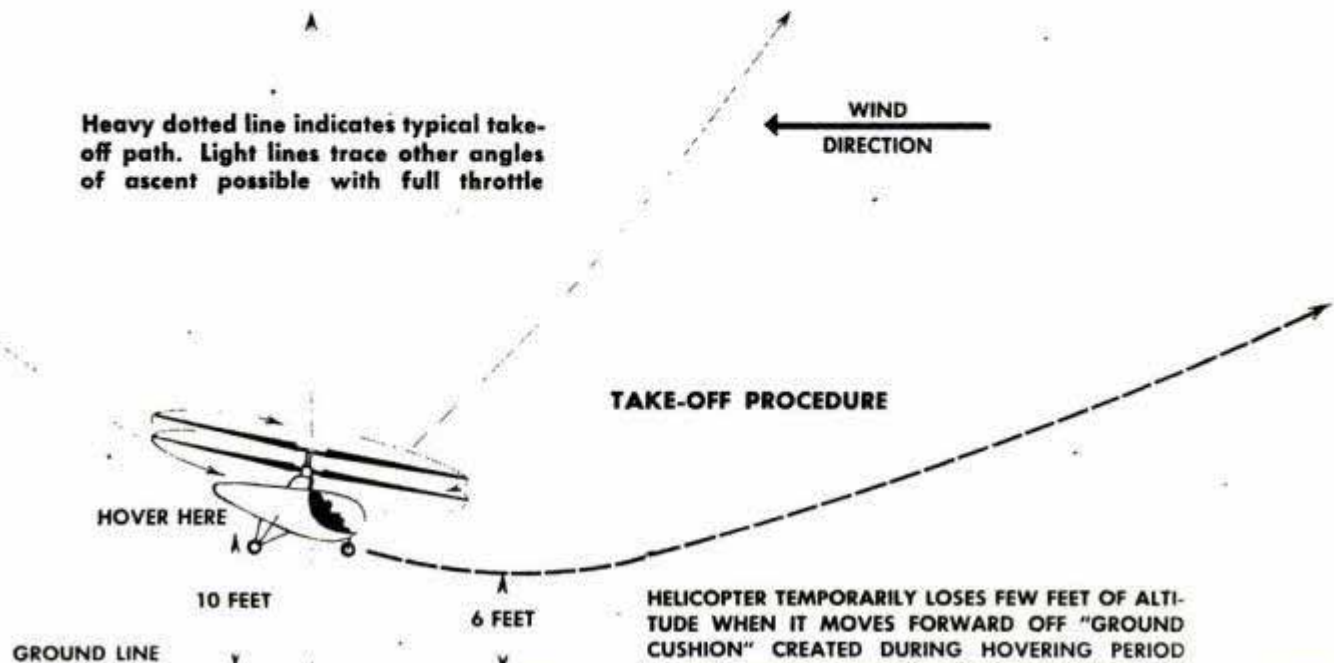

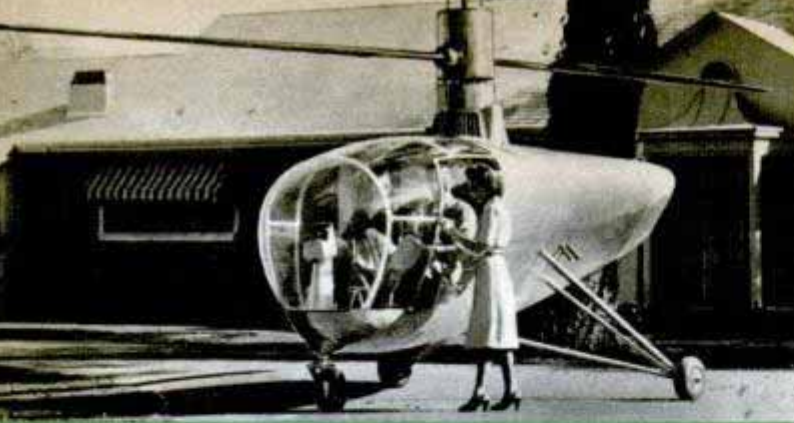

Taxiing out from under the trees, Hiller's craft can use the spacious lawn for vertical take-off. It rises from five to ten feet straight up before moving away



Firestone's two-seater can climb 1250 feet a minute and travel over 220 miles on 25 gallons of gasoline. This model has a 175-horsepower air-cooled engine



An old name in the rotary-wing-aircraft field, this Sikorsky carries loads up to 650 pounds. It weighs 1100 pounds empty. Below, a Bell model using pontoons. Many of these are used for rescue and patrol



that hundreds of individual experimenters are working on their own designs.

Vertical-lift aircraft in production at present are all basically the same, the chief difference being the methods used to overcome rotor torque. Uncontrolled, this thrust would cause the fuselage to rotate. Tail-rotor helicopters use a small propeller mounted sideways at the tail to counterbalance this pull. Jet thrust may also be used, directed sideways from the tail. Tandem rotors, side by side, that turn in opposite directions are another solution. In the coaxial type the two contrarotating rotors are mounted on the same axis and the torque of one cancels that of the other.

There is still another type, hardly past the theoretical stage, that uses jets or some other means of propulsion at the ends of the rotor blades. Its virtue is that torque is not created. However there are a number of serious design and construction problems connected with the idea.

Most helicopters to date have employed the same general system of control levers. Their effects are the same, but the specific actions vary with the type of machine.

The pilot of a coaxial Commuter, for example, has a climb stick at his left hand that he pulls up for ascent. Its grip is a twist-type engine throttle like that on a motorcycle.

Between the pilot's knees is a control stick that governs horizontal travel through the air. Push the stick forward and the machine moves forward. Pull it back and the helicopter comes to a stop, then begins to travel backwards. The helicopter moves in the direction toward which the stick is pushed or pulled. Conventional rudder pedals are used for turning the fuselage.

The actions of these controls are interesting. The climb stick simply applies pitch to the rotor blades. Pulling up on the stick increases the incidence of all blades equally and when the throttle is opened at the same time, the ship begins to rise.

The control stick governs cyclic pitch. It is linked to a wobble plate or ring that encircles the rotor mast and to which push-pull rods that control the pitch of the blades are attached. The control stick tilts the wobble plate in the desired direction of travel. This in turn causes the rotor blades to vary their pitch so as to remain "parallel" to the wobble plate. The pitch of each blade is increased and decreased during each 360-degree cycle and the craft moves in the direction toward which the wobble plate is dipped.

The rudder pedals control differential pitch. That is, they change the pitch of one rotor in reference to the other, creating left or right-hand torque and turning the fuselage in that direction. The fuselage can

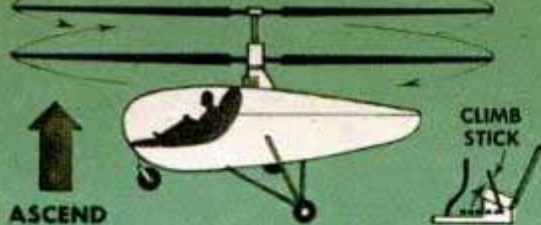

ASCEND

PULLING UP ON CLIMB STICK INCREASES PITCH OF ALL BLADES EQUALLY. TWISTING THROTTLE GRIP AT END OF STICK SPEEDS UP THE ENGINE



FORWARD

PUSHING CONTROL STICK FORWARD TIPS WOBBLE PLATE AND ROTOR BLADES IN SAME DIRECTION, CAUSING THE CRAFT TO MOVE STRAIGHT AHEAD



RIGHT

PULLING CONTROL STICK TO RIGHT SHIFTS FLIGHT PATH TO THAT DIRECTION. PRESSING RIGHT RUDDER PEDAL SWINGS FUSELAGE TO THE CORRECT HEADING



HELICOPTER'S HORIZONTAL MOTION IS OBTAINED BY PUSHING CONTROL STICK IN DIRECTION OF DESIRED FLIGHT. CRAFT MAY BE FLOWN FORWARD, SIDWAYS OR EVEN BACKWARDS.



HOVER

IT CAN BE MADE TO HANG IN AIR BY USING CLIMB STICK TO ADJUST PITCH OF BLADES AND TO VARY POWER OUTPUT OF ENGINE

ENGINE INSTRUMENT PANEL

CLIMB STICK

RUDDER PEDALS FOR DUAL-CONTROL FLIGHT

THROTTLE GRIP REGULATES SPEED OF THE ENGINE

RUDDER PEDALS TURN FUSELAGE BY CHANGING PITCH OF ONE ROTOR IN REFERENCE TO THE OTHER, GIVING GREATER TORQUE IN DIRECTION OF INTENDED TRAVEL

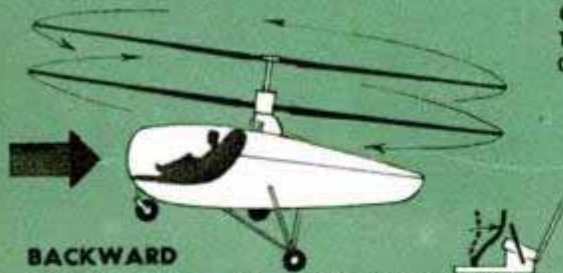

BACKWARD

PULLING BACK ON THE CONTROL STICK BETWEEN PILOT'S LEGS REVERSES DIRECTION OF FLIGHT



DESCEND

SHOVING CLIMB STICK FORWARD FLATTENS OUT PITCH OF BLADES AND CRAFT DESCENDS SLOWLY

be turned entirely independent of the direction in which the ship happens to be moving, depending, of course, on the effect of varying drag. Each of the controls operates individually or all of them may be operated collectively.

Flying a helicopter is quite different from flying an ordinary airplane. The helicopter can be taxied into the wind for an easy, slow-speed take-off but the usual procedure is to rise straight off the ground for five or ten feet and then to climb away at an angle into the wind, at about 40 miles

per hour ground speed and a rate of climb of around 500 feet per minute.

There is a good reason for not using full power to continue to ascend vertically. In case of power failure the landing gear can stand the impact of a 30-foot drop. Above 300 feet the pilot has room for achieving forward motion and then autorotating down to a slow landing. Between these altitudes it is recommended that forward motion be maintained at all times as a precaution in case of motor failure.

For the same reason the recommended



Hovering just off the ground, helicopter is pulled along by scarf in spectator's hand. Float-equipped, they bring Izaak Waltons direct to fishing haunts



"power on" landing procedure is to come down at an angle, as sharp as 45 degrees. Forward motion is maintained until within 10 or 15 feet of the ground, after which the craft is brought to a stop and allowed to settle in slowly.

Emergency landings after engine failures are handled practically the same as normal landings. Cyclic pitch is applied to the rotors by means of the control stick and the blades auto-rotate while the craft descends at about a 45-degree angle. Five or ten feet off the ground the control stick is moved in the opposite direction to kill the forward speed and more pitch is applied to the blades by pulling up on the climb stick. The blades act as a brake and the helicopter sinks to the ground at a safe, slow speed.

I've deliberately mentioned some of the limitations of helicopters to dispell the illusion that in the future you'll be able to hop into one of the machines and sail away in carefree flight, practically without instruction. Tomorrow's helicopters will be easy to fly, certainly, but skillful piloting will be based on training and practice. The types already in use are so safe that accidents due to pilot error are almost unknown. Today the industry is continuing its research in the hope that some day machines that are virtually foolproof will be developed for the public.

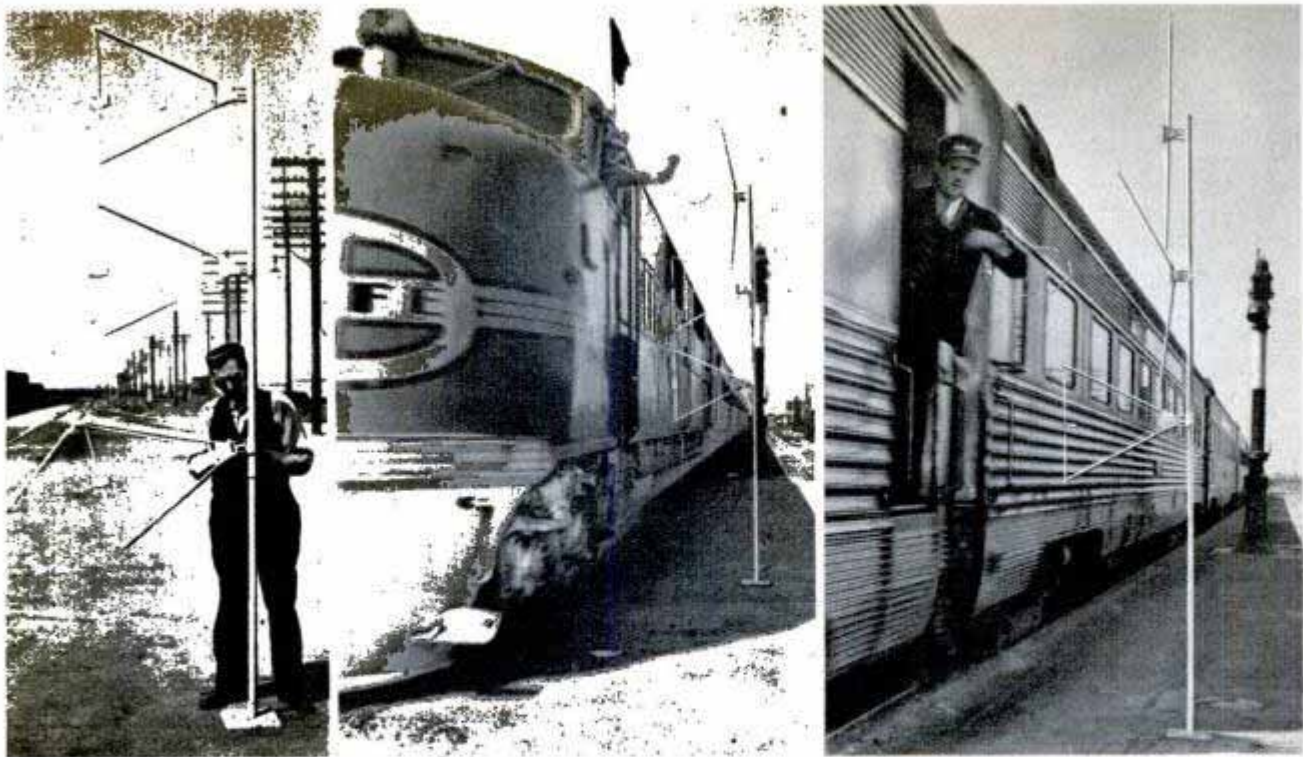

FORKS DELIVER ORDERS TO TRAIN CREWS

Train crews can pick up their orders from a multiple-unit delivery post while traveling at any speed. The messages are tied by cord to wooden forks which are attached to a telescoping post. This post is mounted in a permanent base beside the tracks when a delivery is to be made. The forks are attached to the post at three different heights with the engineer's orders at the top and messages for other crew members below. When the engineer approaches the delivery unit he thrusts his

arm out the side of the cab so that it passes between the arms of the top fork. The string with the attached message forms a loop around his arm. As the messages are delivered the arms swing apart. In one model several units can be attached at the same height with only one in delivery position. When the first message is delivered the fork snaps out of the way and another falls into place, making it possible to deliver orders to both engineers of a two-engine train traveling 90 miles an hour.

"Venetian" Screens

With tiny slots slanted downward and outward, a screen made from a continuous sheet of metal gives the same effect as a slightly tilted miniature Venetian blind. It keeps out the midday sun's glaring rays. The construction is said to afford greater ventilation with 20 percent more open space than woven screen. Made of either bronze or aluminum alloy, with 18 slots per inch, the screen comes in widths from 24 to 36 inches. The material can be cut with shears.

☐ Boeing Stratocruisers contain 435 feet of plastic water pipe which resists any chemical reaction.



RAIL FAN SPECIAL leaving on Track 3! All aboard!"

Ever wish you could charter a special train that would take you on exploration trips? A train you could stop whenever you wanted to snap a few pictures?

Thousands of railroad fans band together in groups of 100 or more and charter special trains for just that purpose.

Anyone can buy a ticket as a passenger on a main route; the rail fans prefer making gypsy trips along branch lines and over little-used tracks. They visit towns that hardly see a passenger train from year to year. They poke along old routes and stop wherever they like to take pictures of scenery and equipment.

Some short trips are completed in a day, others involve a week end and 1000 miles or more of travel. This summer one group of rail fans from the west coast traveled by special car to Colorado and spent a week riding the narrow-gauge railroads that were built during early mining days and are still in use.

Railroading has an enduring fascination for most Americans. Huge modern steam locomotives and Diesel engines thrill nearly everyone, and the dinky "tea kettles" of past years have a romance all their own. As a hobby, railroading is said to have nearly as many devotees as stamp collecting. Some enthusiasts build and operate model trains, others collect old train tickets, passes and

Railroad Fans



Pennsylvania Railroad photo

† More than 500 fans swarm off a rail special at Conowingo, Md., to snap photographs of huge dam and power plant. Stops are made to inspect old bridges, stations and rolling stock

operating schedules, and still others specialize in photographing different kinds of rolling stock. All of them are fascinated by railroad operations and look forward to the special fan trips and the occasional visiting days when they can tour roundhouses and shops. One big excursion of fans is scheduled for this month when hundreds of model-train operators in the East will charter special trains for a transcontinental run to Oakland where they will attend the National Model Railroad Association Convention.

The late Henry Ford was a rail fan. Many railroad employees spend leisure hours—playing with trains. Men, women and children all have the bug.

There are rail-fan clubs in all the large cities along the Atlantic coast, in the Midwest and on the Pacific coast. Many of these groups charter special trains several times a year at a cost of \$5 to \$65 per passenger depending on the length of the trip and the overnight accommodations desired.

BE A RAILROAD MAN FOR A DAY! "Off the Beaten Path" SCENIC AND HISTORICAL TOUR

- Sponsored by Chicago Chapter, Railway and Locomotive Historical Society.
- For a thrilling, interesting Sunday to be spent in a different way—

RIDE over the route and on the schedule of the famous "DETROIT ARROW"—fastest stream train in America!
SEE the engine house at Fort Wayne, which houses the steaming giant iron horses of the Pennsylvania Railroad.
ENJOY the scenic beauty of Northern Indiana in cool, lean, quiet comfort aboard the train.

Route of Tour



on the Loose

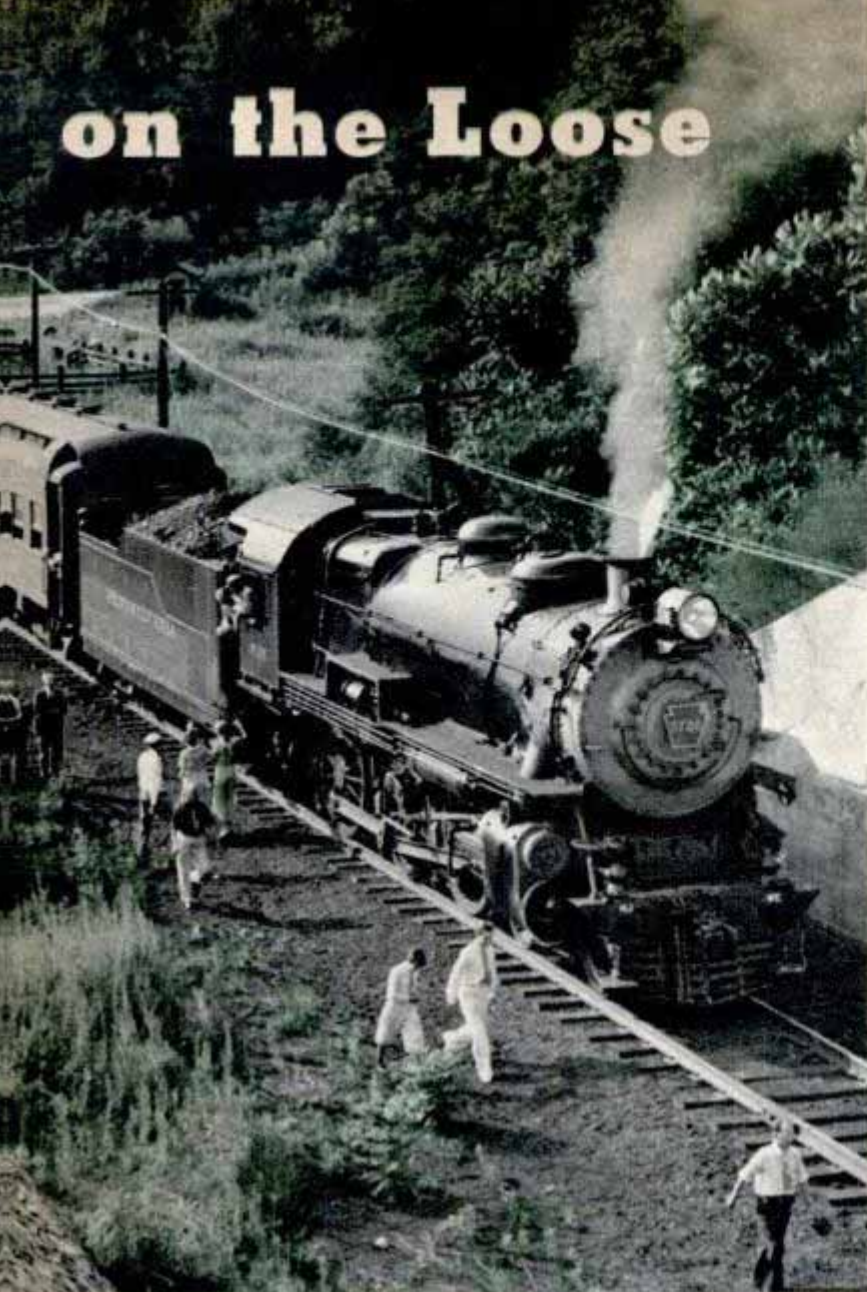

↓ Specials often nose through woods and back country along ancient tracks. Here the train has stopped on a spur no longer in use. The fans give the orders for stops along the route



↑ Most railroad "bugs" are also photographers and will hang from signals, freight cars and other equipment for unusual shots



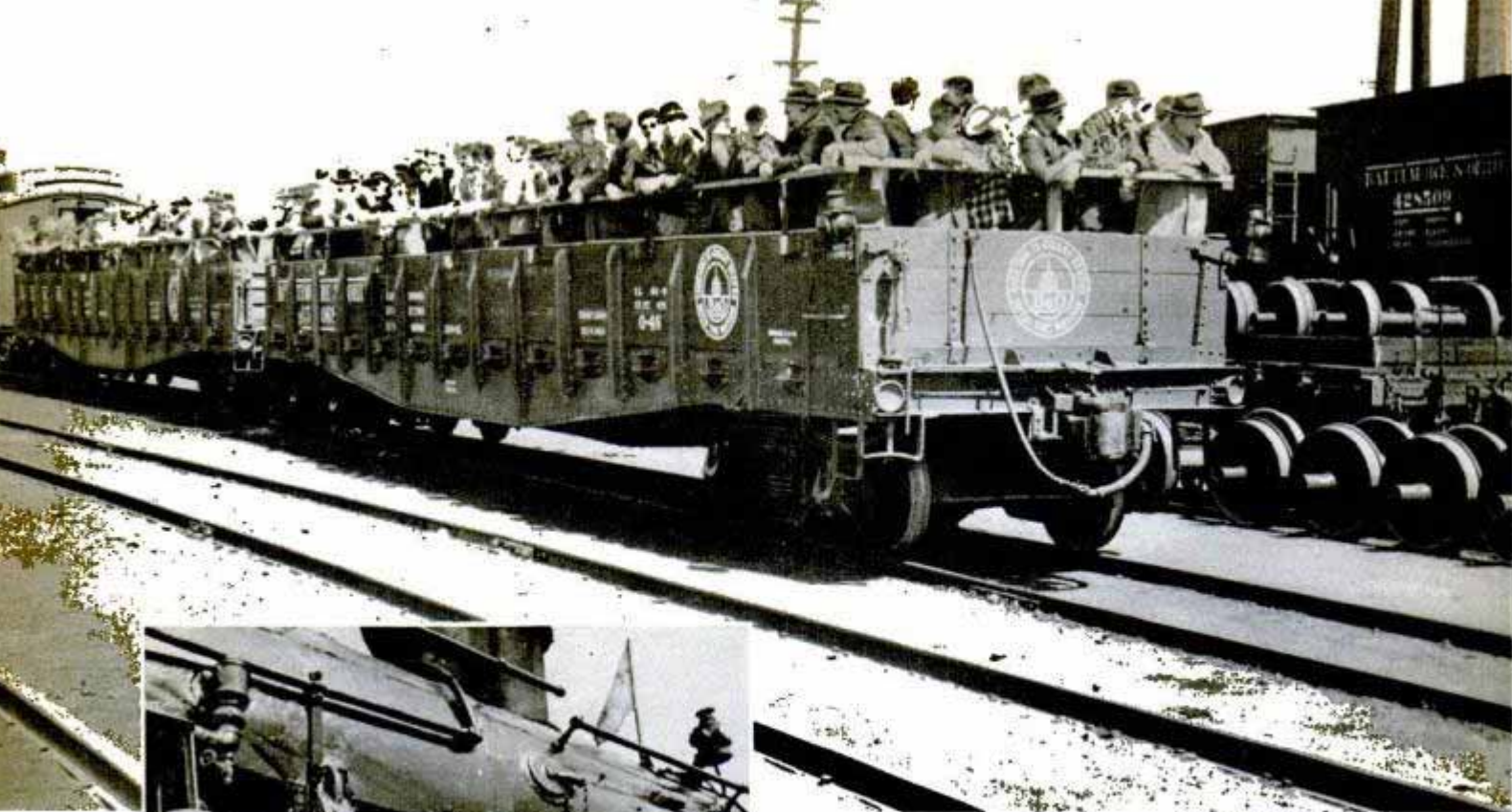

Baltimore & Ohio photo

↑ Flatcars often are used to carry fans through switching yards for a detailed study of operating procedures
 ← Locomotives are the favorite camera subject. This enthusiast is taking motion pictures of the engineer



Most railroads make up a special to fit the needs of the group, provided a certain number of tickets, usually around 125, is guaranteed.

Oldest of the railroad clubs is the Railway and Locomotive Historical Society that was established in Boston in 1920 and now has divisions in the Midwest, West, and Canada. The society has aided in the renovation and preservation of several historical locomotives and publishes numerous historical papers. The Railroadians of America is another historically minded organization with chapters in many large cities. There also are numerous unattached local groups of fans. The public relations department of your local railroad usually can provide the addresses of these clubs.

The electric railway systems have their own fan clubs. Probably the most active is the Central Electric Rail Fans Association with headquarters in Chicago. Some of the groups often hold their meetings in empty passenger coaches set out for them in local rail yards.

The bigger the engine the better, according to rail fans who ride the specials. But if a big engine can't be spared, the fans like to be pulled by some old type that is ready to be turned out to pasture. A typical fan special consists of engine and tender, open-door baggage car with safety bars for side-door photography, diner, day coach, Pullmans, lounge and observation car.

The special travels a route selected ahead of time to yield interesting sights and experiences. Sometimes fans take a "mystery" trip over an unannounced route. They have complete freedom of the train en route and a few, picked by lot or ticket numbers, make part of the trip in the locomotive cab. Safety rules, of course, are always enforced.

The special leaves its terminal at a time when it won't interfere with normal traffic, often pulling out as the second section of a famous luxury train. Once it gets off the main line it makes a number of stops adjacent to bridges, old equipment or other attractions so photos may be snapped.

One typical trip made recently by 150 members of the Railway Club of Southern California started from Los Angeles on a Saturday night and crossed the Tehachapi Mountains into the San Joaquin Valley, reaching Bakersfield in time for breakfast. During the day the train rolled along 250 miles of rustic branch lines and some passengers were taken on automobile side trips by a group of fans from the town of

Ward Kimball, who owns a full-size engine, inspects a model that develops steam when its boiler is fired

Orange Cove. The special traveled as far north as Fresno and returned to Los Angeles over main lines in time for breakfast Monday morning. The full distance amounted to 890 miles of railroading. Fourteen photo stops were made and some fans took several hundred pictures during the trip.

Most parts of the United States have little-known short lines or branch lines over which such excursions may be made. Off the beaten tracks, these lines normally carry nothing except freight and an occasional mixed train. New England has a number of small railroads that still use equipment which was modern early in the century. In the Midwest and South, rail enthusiasts sometimes spot relics of the early days of railroading that are still in use, and the West likewise has some unusual steam lines.

Excursions on the Pacific Coast Railway out of San Luis Obispo in central California were popular with rail fans until a few years ago when the line suddenly went out of business. Its demise was caused by a grade-crossing collision between its last narrow-gauge locomotive and a gasoline truck.

Another west coast narrow-gauge, the privately-owned Michigan-California that hauls lumber from the forest to a main line, is split by the 1200-foot-deep canyon of the south fork of the American River. The two pieces of trackage are connected, not by bridge, but by cables that span the chasm and carry an underslung tramcar. Two trains meet on either side of the canyon and exchange their cars, one by

Center, engine name plates are choice collectors' items for railroad fans. Right, built by a train enthusiast, this caboose has brakes, coupling pins, a stove and other furnishings

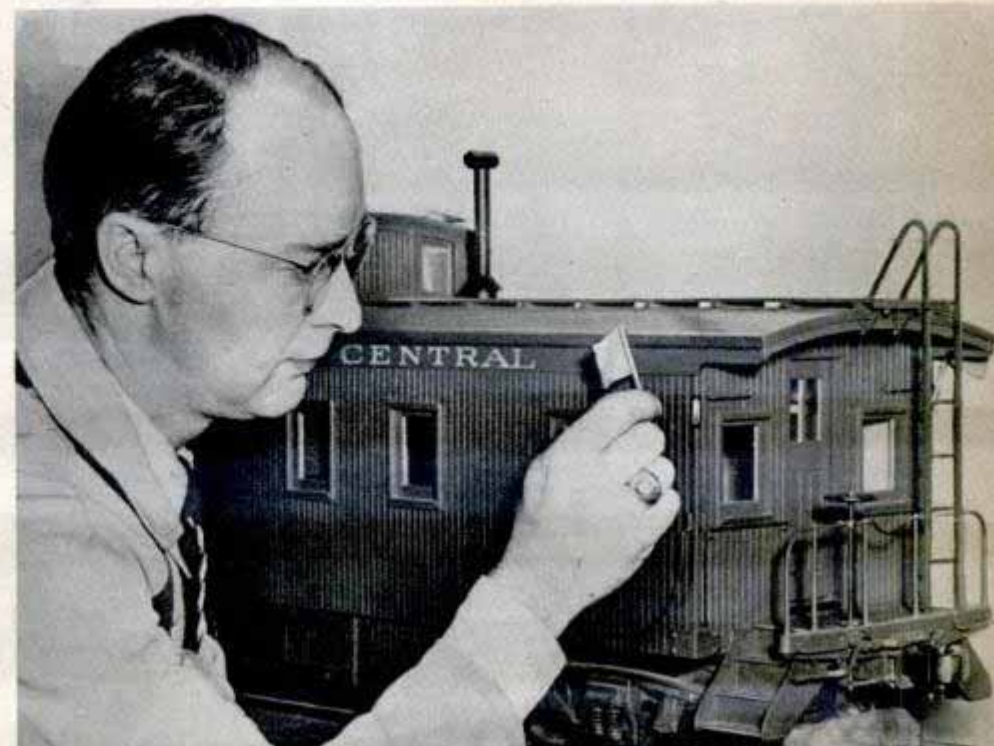
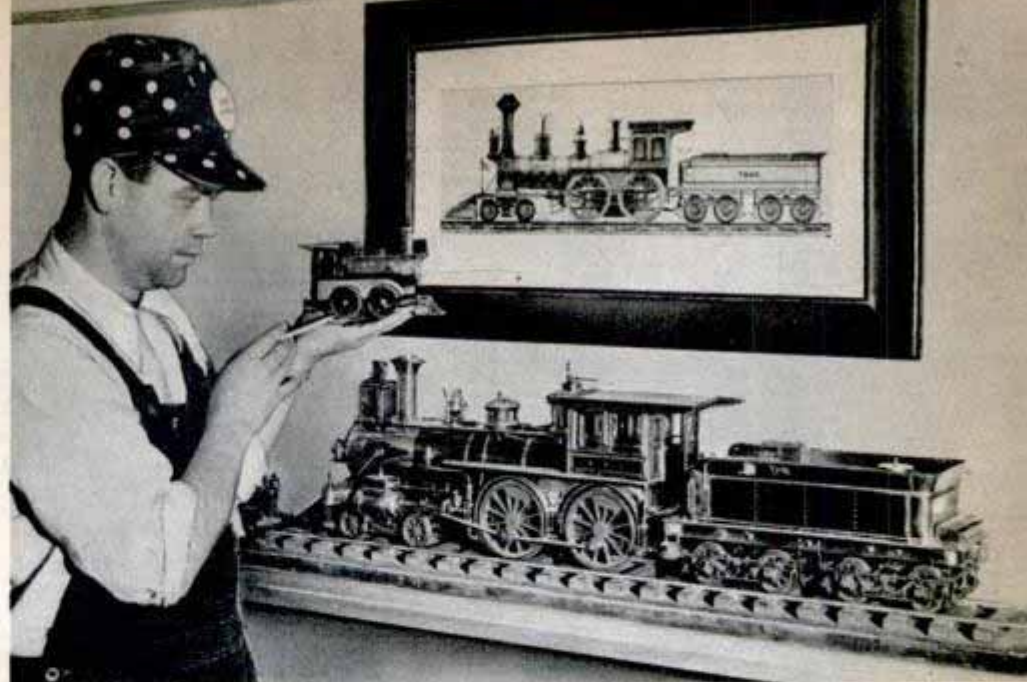

one, by means of the tramcar that shuttles back and forth on the cables. Railroad fans delight in visiting such oddities.

They also like to explain other little-known facts. For instance, they'll tell you that the side rods that drive a locomotive's wheels don't move back and forth but only in a forward direction. The rods are motionless during half their cycle while the engine moves ahead of them, then the rods move forward, pause again as the wheels go around, then move forward once more.

They tell the uninitiated about the "banana messengers," the specially trained refrigeration men who ride the fast freights carrying perishable cargoes of bananas.

Their unusual job is to watch and carefully adjust the temperatures inside the cars. They discuss the old 1875 locomotive, a relic of railroading's early days, that was put to work on the rails again during the war. Converted from wood to oil feed, it played its part as a switcher throughout the war.

Railroad fans in all parts of the country point to Ward Kimball of San Gabriel, Calif., an illustrator for Walt Disney, as an example of what can happen to a railroad enthusiast who becomes deeply interested in his hobby. Kimball started out with the idea of building a few 1/4-inch scale models and operating them over a few feet of track.

Later he began to collect old tickets, timetables and dining-car menus, ultimately developing an extensive reference file.

A bell from an old locomotive attracted him and he bought it, then purchased an old switch stand. Finally just before the war he blossomed out as owner and president of the Grizzly Flats Railroad Company, his own private line. He acquired the railroad after he heard that the old Nevada

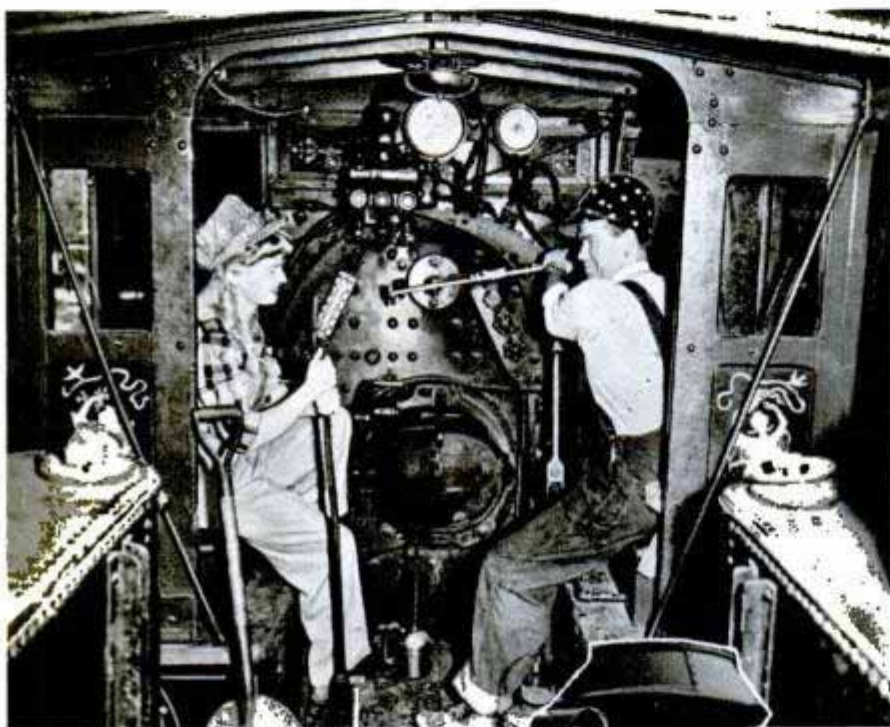

← Ward Kimball takes over throttle of his ancient engine while his wife serves as fireman. Below, the private Grizzly Flats line weaves through his orange grove

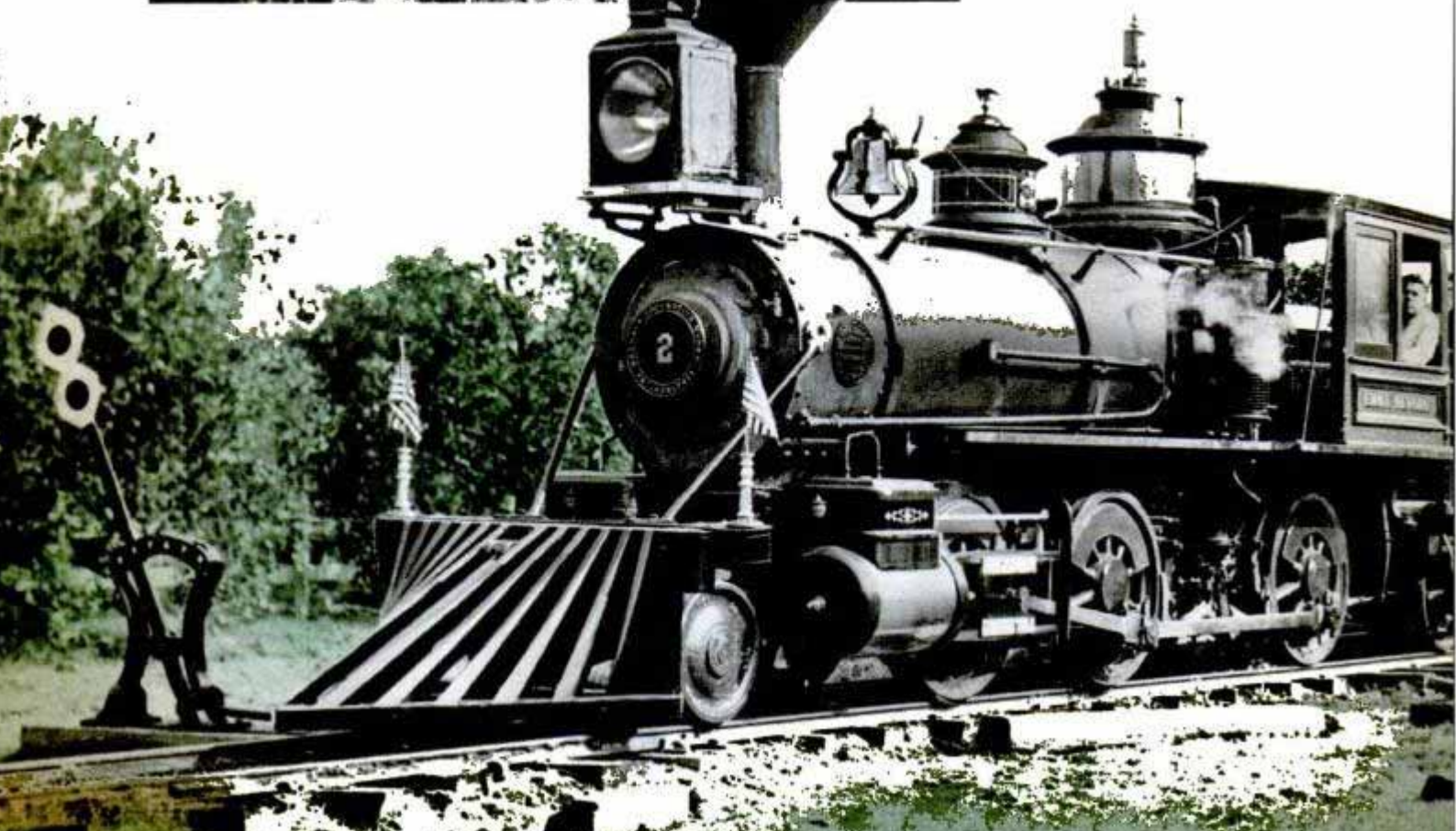

Central was disposing of ancient rolling stock at junk prices.

Kimball bought a 2-6-0 Baldwin locomotive complete with tender for only \$400. Built in 1881, it was old enough to make any railroad fan happy. At similar bargain prices he was able to purchase a passenger coach of early vintage, a freight car and a combination baggage car and caboose.

It took him two years to refinish and restore the old locomotive to its original appearance and to put its steam boiler in first-class shape. He built an engine shed in which to store it and installed 650 feet of track through the orange grove back of his home. Nowadays on birthdays and other special occasions, Kimball and his family fire up the old "Emma Nevada" and go for a jaunt over the line. He issues passes to friends and occasionally publishes an announcement of an "excursion over the great pleasure route of the Grizzly Flats R.R." on its "lightning express train." Every rail fan who gets an invitation invariably shows up.

The Only Line via Niagara Falls running the famous Dining Cars.



SEATING 75,000 Meals Served in these CARS To the PATRONS OF the Favorite Route Starting 1880.

NO DELAYS ON THE GREAT WESTERN RY FOR MEALS

Model Trains! Popular Features! WHICH THE TRAVELING PUBLIC APPRECIATE

CELEBRATED DINING CARS

AND THE NEW AND ELABORATELY EQUIPPED **SMOKING CARS,**

Fitted up with Reclining Chairs, Sofas, Locking Tables, &c.

ALL MEALS SERVED BETWEEN CHICAGO AND NIAGARA FALLS

THESE CARS ARE BUILT IN THE MOST ELEGANT MANNER IN THE COMPANY'S OWN SHOPS, AND ARE UNDER THEIR EXCLUSIVE CONTROL.

BILL OF FARE

First Class	Second Class	Third Class	Day	Night	Round Trip	Excursion	Special
Chicago to Niagara Falls	Chicago to Niagara Falls	Chicago to Niagara Falls	Chicago to Niagara Falls	Chicago to Niagara Falls	Chicago to Niagara Falls	Chicago to Niagara Falls	Chicago to Niagara Falls
Chicago to St. Louis	Chicago to St. Louis	Chicago to St. Louis	Chicago to St. Louis	Chicago to St. Louis	Chicago to St. Louis	Chicago to St. Louis	Chicago to St. Louis
Chicago to Kansas City	Chicago to Kansas City	Chicago to Kansas City	Chicago to Kansas City	Chicago to Kansas City	Chicago to Kansas City	Chicago to Kansas City	Chicago to Kansas City



INTERIOR VIEW OF RECLINING CHAIR CAR, DR. HORTON'S PATENT.

These Excursion Cars are run in all Through Trains, Day and Night, between Chicago and Kansas City, Chicago and St. Louis, and St. Louis and Kansas City, Without Change, VIA

Chicago & Alton R. R.

NO EXTRA CHARGE FOR SEATS IN THESE CARS.

↑ Old-time railroad advertisements and literature are prized by some collectors. Below, Kimball copies their style in issuing invitations for excursions on his "exclusive" line



ANNOUNCING AN **EXCURSION!**



Over The GREAT PLEASURE ROUTE OF THE **GRIZZLY FLATS RR.**

"THE ACETIC WONDER OF THE WEST!"



British Information Service photo

Air-Liner Bar

Accommodations on Britain's newest luxury air liner, the Avro Tudor II, include a plastic cocktail bar. The bar, which is the first to be built on a British plane, is located in the corner of the 14-foot-long observation lounge. Four Rolls Royce Merlin engines give the plane a 325-mile-an-hour top speed. It is 105 feet long and can carry 40 day or 22 overnight passengers comfortably.

Hot-Cold Pipe

Compressed air is divided into hot and cold blasts by a 15-inch research pipe with a built-in steel spiral that creates a whirlpool of rapidly spinning gases. Warm air at the outer edges of the whirlpool is drawn off through a small hole at one end of the pipe. Cold air in the center of the whirlpool comes out the opposite end. Westinghouse scientists who developed the pipe from a German design explain that it will be a useful laboratory tool to produce low-temperature air for experi-



General Electric photo

ments with mercury vapor pumps, mass spectrometers and leak detectors. The compressed air is pumped into the pipe through a nozzle at the right end.

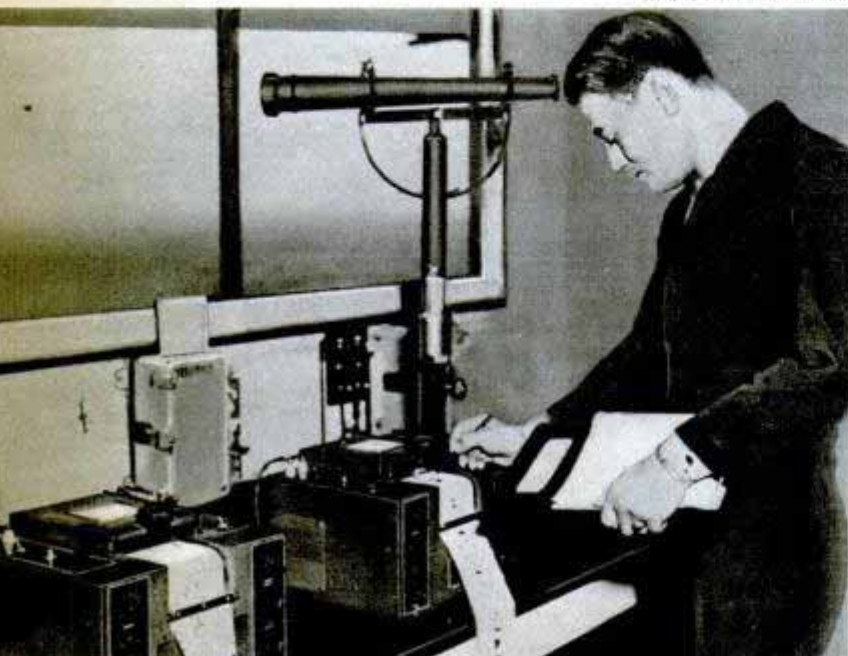

Ship Detector

Magnetic instruments installed on harbor bottoms in wartime guard against invasions by enemy ships under cover of darkness. One such "watchdog" is a fluxmeter which is connected to a loop of cables laid across the bottom of a harbor entrance. It detects the presence of iron or other magnetic materials in a ship passing overhead and flashes a warning to a shore-based meter.

You may wish to obtain additional information about new products described each month in Popular Mechanics. If you want to know the name and address of the manufacturer or distributor, just write to Bureau of Information, Popular Mechanics, 200 E. Ontario St., Chicago



ROOFS BUILT IN LADDER SECTIONS

Frames of tough steel built in ladder-like sections are replacing the normal wooden framework for tile roofs in some British buildings. The method is 10 times faster than building with wood, and the steel sec-

tions are light enough to be installed by one man. Donald Hamilton, the London architect who invented the system, says the steel will last 150 years and the sections can be installed by unskilled labor.

Czech Locomotive

Czechoslovakia's Skoda Works, recon-verted to locomotive production following the war, recently turned out a powerful engine weighing 175 tons. The 2800-horsepower rail giant is 82 feet long. In tests conducted by the government the locomotive made a speed of 90 miles an hour.





Stand unfolds from the bottom (top photograph) to balance the combination golf bag and caddy cart in an upright position (right). Lower picture shows the false bottom which contains stand, wheels and axles



GOLF BAG HAS FOLDING WHEELS

Wheels and handle are attached to a combination golf bag and caddy cart which takes up no more room than an ordinary golf bag. When not in use as a caddy cart, the axles are folded into a false bottom, wheels are stored in special compartments and the handle is folded against the bag. On a golf course, the outfit can be used as a caddy cart or carried as a golf bag.

HARVESTING SWEET POTATOES is speeded by a rotary digger which can be attached to a tractor or walking plow. The implement turns the soil over the vines and gently drops the potatoes on top of the ground. Tests have demonstrated that the device salvages from 15 to 20 bushels more per acre than hand labor and cuts labor costs in half. The digger is 18 inches long and has a shaft 2 inches in diameter, circled by a spiral sifter

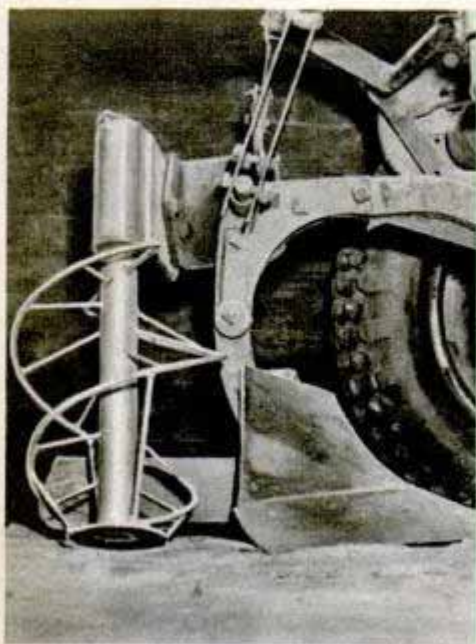

GREASED

CAN AN AUTOMOBILE be driven at the rate of 400 miles per hour?

Can a car travel 4000 miles in 24 hours' time?

Two of the world's great speed kings hope to find the answers to these questions this summer.

John Cobb of England is scheduled soon to attempt to break his own world record for the flying mile on Utah's Bonneville salt flats.

Ab Jenkins, former mayor of Salt Lake City and the holder of dozens of endurance records, will set out to cover 4000 miles in 24 hours around a circular track on the salt.

Cobb will drive the 3½-ton Napier-Railton with which he made his record of 368.9 miles per hour in 1939. Jenkins will be at the wheel of a Winfield Special built for the Indianapolis race and modified for the endurance grind. Using a relief driver part of the time, Jenkins hopes to average better than 166 miles an hour including time out for pit stops.

Known as the world's greatest speedway, Bonneville salt flats is to

By Thomas E. Stimson, Jr.

LIGHTNING

Strikes the Flats

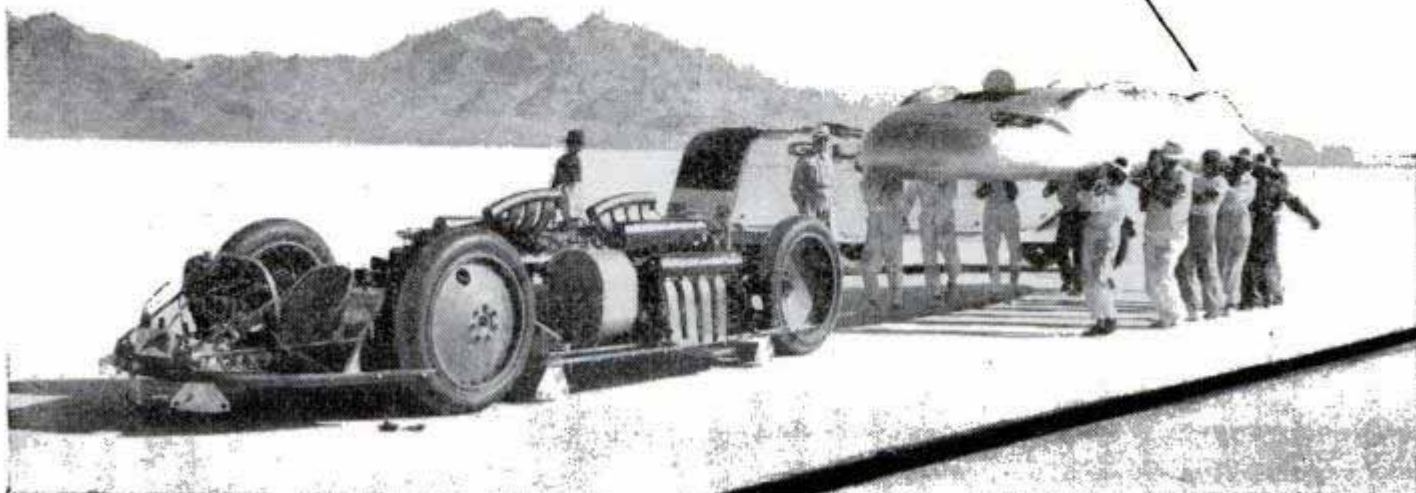
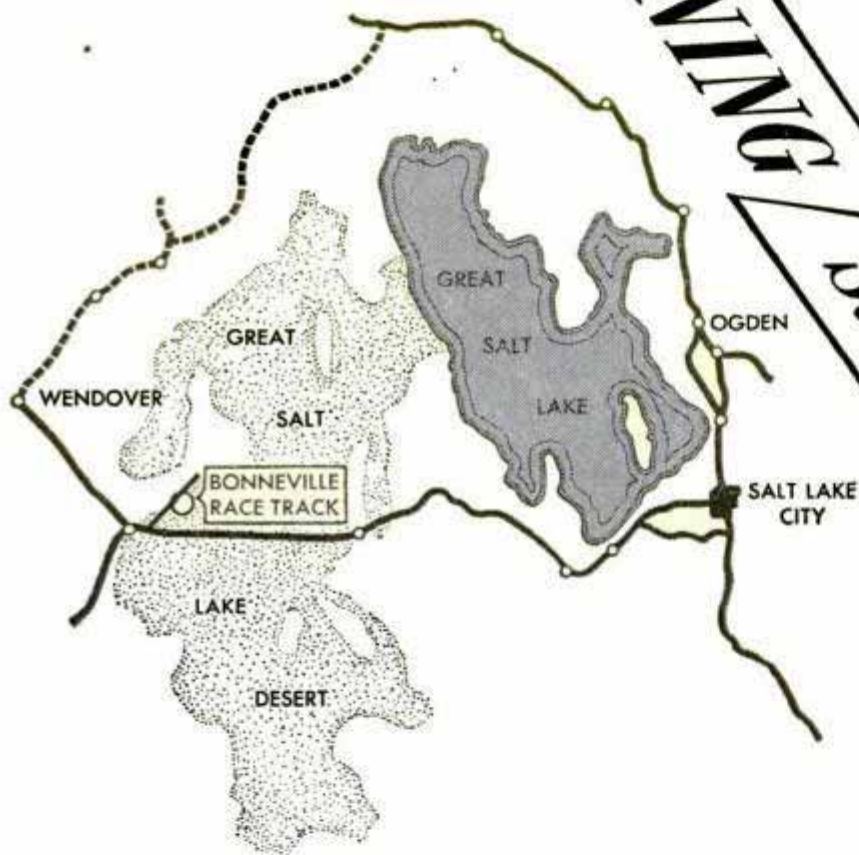

Mechanics "walk" aluminum body of Cobb's 368-mile-an-hour racer to chassis; car has two 1200-hp. engines

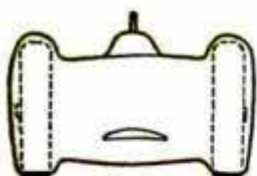

TWO SUPERCHARGED 1000-HORSEPOWER ENGINES

SKETCH OF PROPOSED 1948 RACING CAR DESIGNED FOR AB JENKINS



Ab Jenkins, holder of many endurance records and former mayor of Salt Lake City, pauses after a run on the salt of the Bonneville track. Note particles of salt sprayed over car. Below, Jenkins' endurance car; oil and water radiators are in front and above them is the air scoop that feeds superchargers and carburetors of the V-8 engine

be an arena of speed for several weeks this summer. Several stock cars have been nominated for races against time on the salt, seeking new speed and endurance marks in their classifications. A 250-mile competition in which the country's best drivers will compete also is planned.

All the events are contingent upon the condition of the salt. Each winter the flats are covered by a foot or more of water. Each summer the water evaporates, leaving a hard glistening surface that stretches to the foot of a distant mountain range. Some years the salt is too mushy for use but local predictions are that, barring unseasonal rains, the surface will be ideal this year.

The flats are in the midst of a

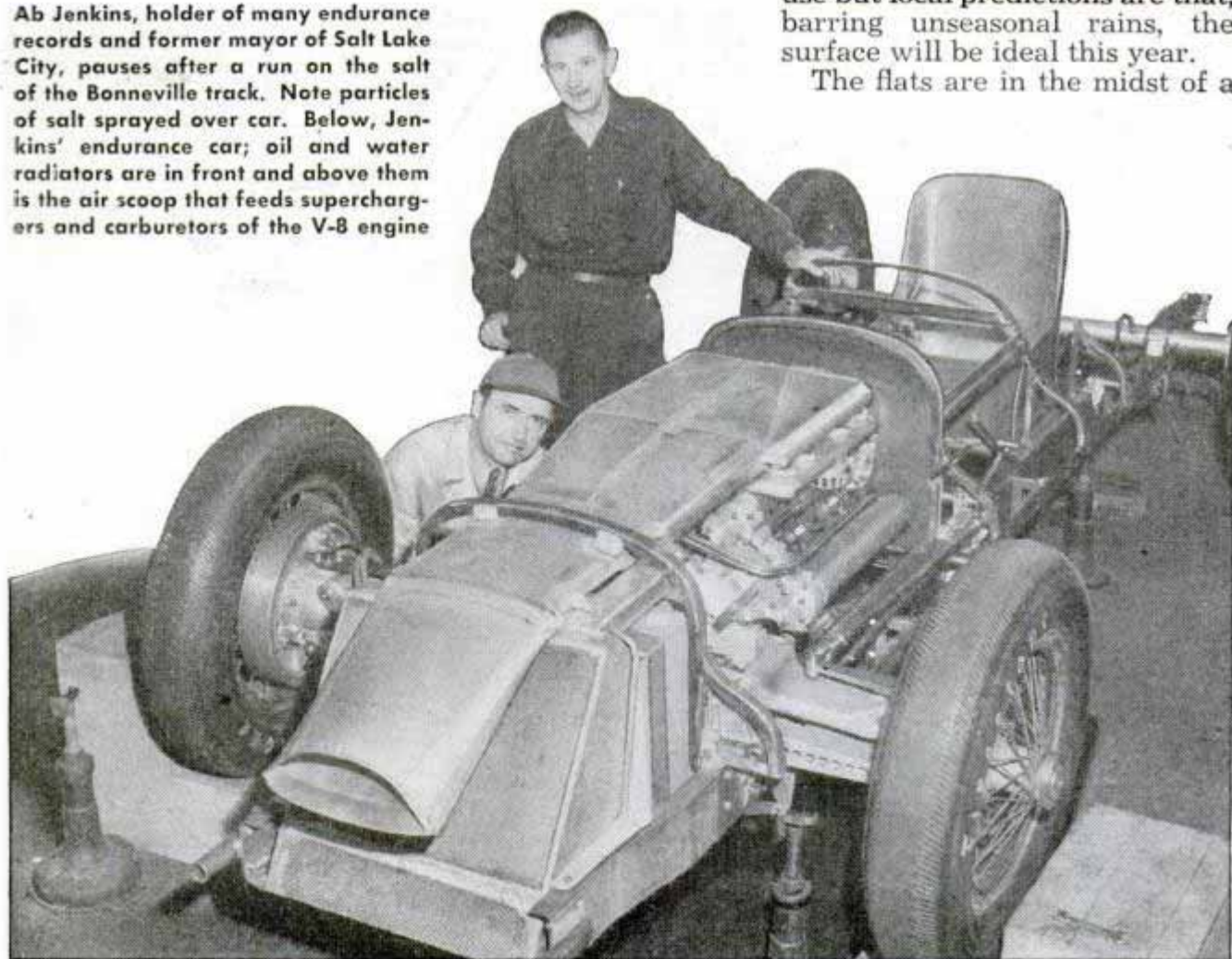



Gauges in Jenkins' car show oil temperatures at such crucial points as the connecting-rod bearings and gear box

Ab Jenkins' 500-hp. endurance car was built to travel 4000 miles in 24 hours. Including time out for pit stops, the car would have to average about 170 miles an hour in race

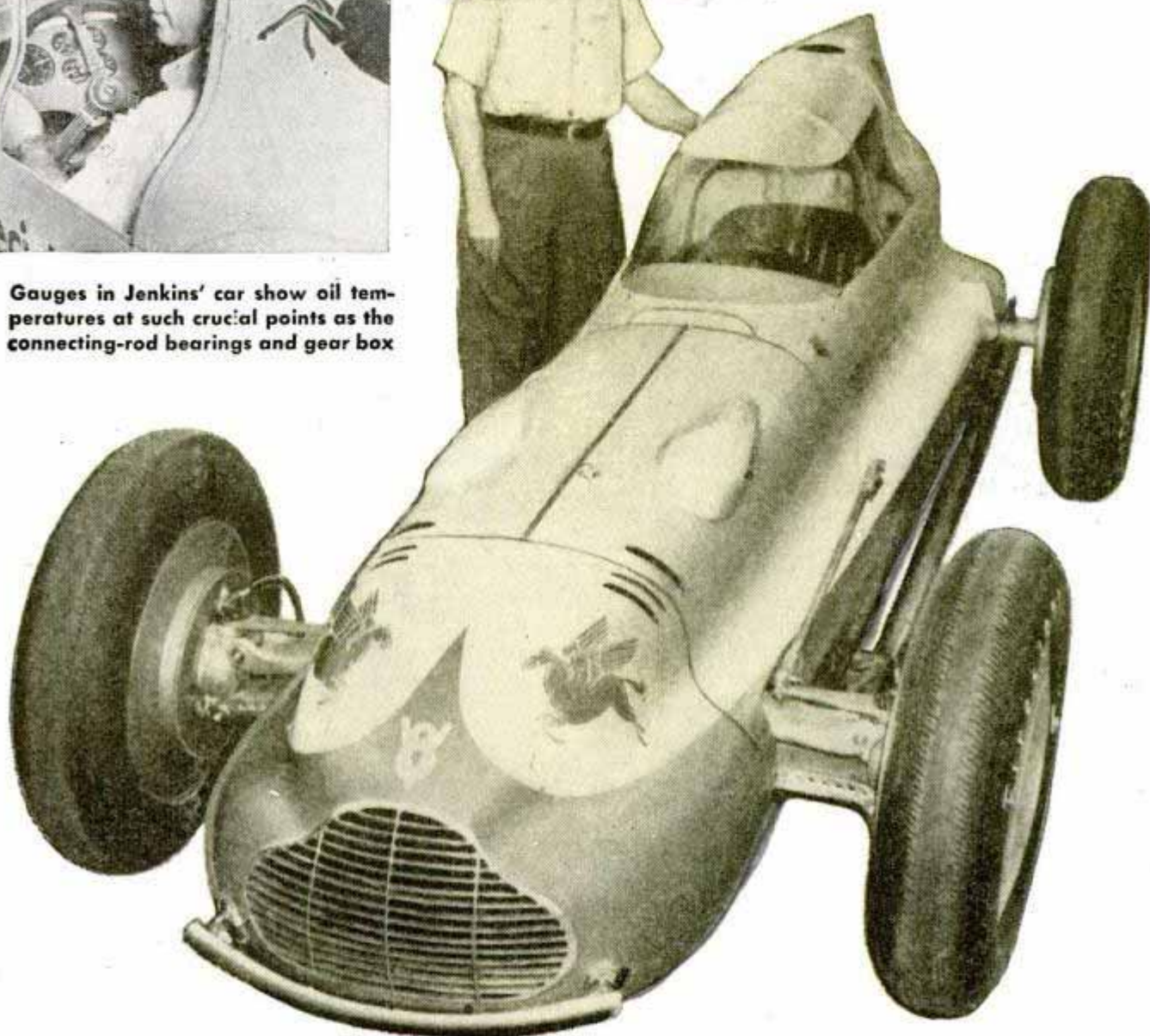

vast shimmering desert 120 miles west of Salt Lake City on Highway 40. The nearest habitation is 10 miles away and everything must be trucked to the site including food and water.

Weeks before Cobb makes his speed attempt a tent city will spring up on the salt and scores of technicians and officials will arrive to prepare for the event. Sleeping quarters, cook shacks, tire-balancing stations, repair facilities, and a heavy-duty electric power plant will be set up.

An exacting task is the surveying and smoothing of the 14½-mile straightaway course. A metal tape is pulled to exactly the same tension each time and "balanced" against expansion or contraction due to temperature changes. After the course is surveyed it is then scraped smooth by state highway equipment. An 18-inch-wide

black stripe is painted down its center as a marker for Cobb to follow.

Finally scores of men go over the course by hand. Tiny inequalities on the surface, every piece of trash is removed. Even a matchstick might blow one of the thin tires used in the high-speed runs. A tune-up course nearby is used for preparing the automobile for its world record attempt.

Meanwhile, too, officials set up and test the photoelectric beams of the timing system. A new world record for the mile almost automatically assures new world records in the one-kilometer, five-mile and five-kilometer, and ten-mile and ten-kilometer distances. Beams are aimed across the course at the start and finish of each of these distances. Wires from each receiving cell are led to the center of the course and then off to the timing apparatus that makes

a permanent record on tape of the speeds accomplished. The entire timing apparatus is certified by the Bureau of Standards as being accurate to within $\frac{1}{100}$ of a second. The official speed will be the average of two runs, one in each direction along the course.

Dead lines are set up 2000 feet away from the course for the safety of the thousands of spectators who drive out from Salt Lake City. No one except Cobb and his team of mechanics may trespass beyond the dead lines during the record attempts.

Similar care is taken in surveying and smoothing the circular courses on which Jenkins plans to shatter his own record of 3868 miles in 24 hours. Usually three or four circles of from 10 to 15 miles in circumference are surveyed so that the driver may select the one that traverses the most solid salt. The courses are then marked by laths set upright in the salt.

Both Cobb and Jenkins are to make their runs under the international sporting code of the Association Internationale des Automobile Clubs Reconnus. The American Automobile Association is the representative in the United States of the AIACR, and A. C. Pillsbury, member of the contest board of the AAA, is to be in full charge of the speed attempts. Working with him are Ernest Clover, official timer, and a dozen other AAA officials. Both events are sponsored by the General Petroleum Corporation of California.

Cobb's one-mile "aluminum turtle" is virtually unchanged from the time it set its present record. Reid Railton, designer of the car, has specified only one important modification, an improvement to the gear-shift mechanism to increase acceleration.

The car is 28 feet long, 8 feet wide, and 4 feet high. It is powered by two 1200-horsepower supercharged Napier-Lion aircraft engines, each of which drives one pair of wheels. Clutches are not used and the engines freewheel during changes of gear. In the past they tended to stall during the shifts, reducing acceleration. The present change permits a faster shift operation with a subsequent improvement in pickup.

"Today the car is entirely capable of 400 miles per hour," Railton states. "Barring breakdowns, Cobb's speed will depend on how much of the course is safe to use. This depends on the condition of the salt.

"Cobb had a 12-mile run in 1939. He used $5\frac{1}{2}$ miles to accelerate, reaching 300 miles per hour within three miles of his start. After going through the measured mile he used the last $5\frac{1}{2}$ miles to brake to a stop. If the salt is dry enough for a 12 or 13-mile run Cobb can do 400 miles or better."

Cobb sits in an enclosed cockpit in the nose of the car, forward of the front axle.

The power plants are behind him. He has four pedals for his feet, a throttle, brake pedal, locking pedal for freewheeling, and a footrest. The engines are cooled by water that circulates through tanks loaded with ice. Conventional radiators would create too much drag. Brakes are on the propeller shafts instead of on the wheels and each brake is cooled by water discharged from the engine cooling systems. Clouds of steam shoot out from the rear of the car when the brakes are applied.

Braking is the trickiest part of the record run. Cobb applies the brakes in short bursts only after the car slows down to 300 miles per hour. Each application causes such a violent deceleration that the driver is thrown forward in his cockpit.

Oddly enough, Cobb's car has an ordinary electric horn. He uses it to signal the push truck that he is ready to start. The car has no starters for its engines and is pushed along the course in gear until the engines begin to fire.

Jenkins, too, has his eyes on the world's unlimited speed record but his run this year will be for endurance only. Next year he hopes to build a car that will be clocked at 450 miles per hour across the flying mile.

For the endurance run this year he will drive a low-slung, 1900-pound front-end-drive race car powered with a supercharged V-8 engine that develops 500 horsepower at 8000 r.p.m. A special body including a streamlined enclosure over the cockpit will be used and extra fuel tanks will be installed. A pyrometer on the instrument board together with a selector switch allows Jenkins to check oil temperatures at such crucial points as the connecting-rod bearings and the gear box.

Making an endurance run on the salt can be an eerie experience because of the heat mirages. The region is noted for weird mirage effects, both night and day.

"Once when pounding around the course on an endurance run I was suddenly confronted by a huge truck and trailer on the course," Jenkins relates. "They were about a mile and a half ahead of me and since I was doing close to 175 miles per hour at the time I barely had time to turn out for them.

"Plain reasoning told me that the truck was a mirage, a reflection of an actual truck on an adjacent highway. That's what it proved to be but the illusion was too real to allow taking a chance. I turned out. I've had a mechanic beside me in the car drop to the floor in anticipation of a certain crash under similar circumstances.

"At night the heat mirage can almost convince you that your senses have departed. A familiar airway beacon on the horizon climbs much higher in the sky than

(Continued to page 256)

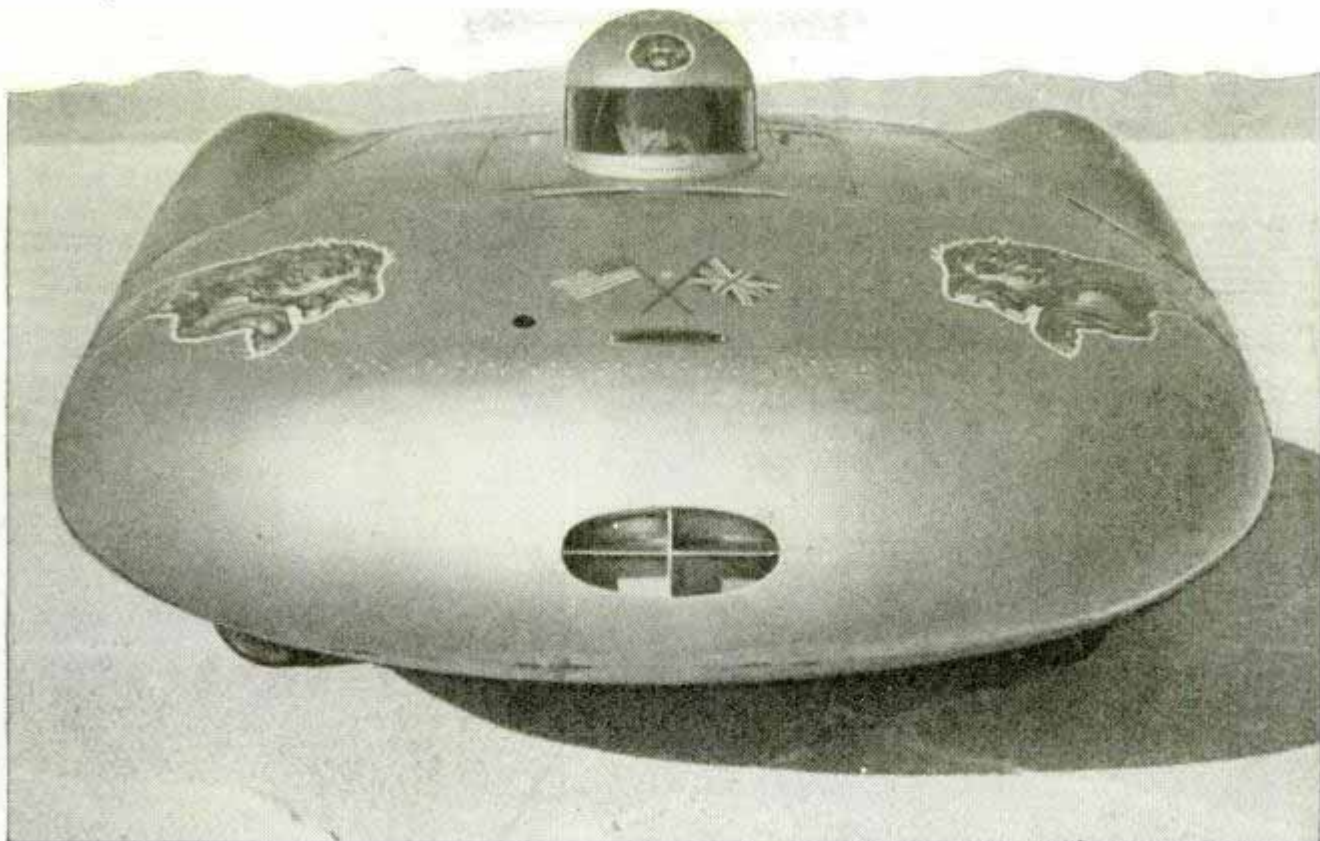

General Petroleum Corp. of California photos

Nose view of John Cobb's racer shows why he calls it his "aluminum turtle." This variety of turtle is the fastest thing on wheels and for the last eight years has held world record of 368.9 miles per hour

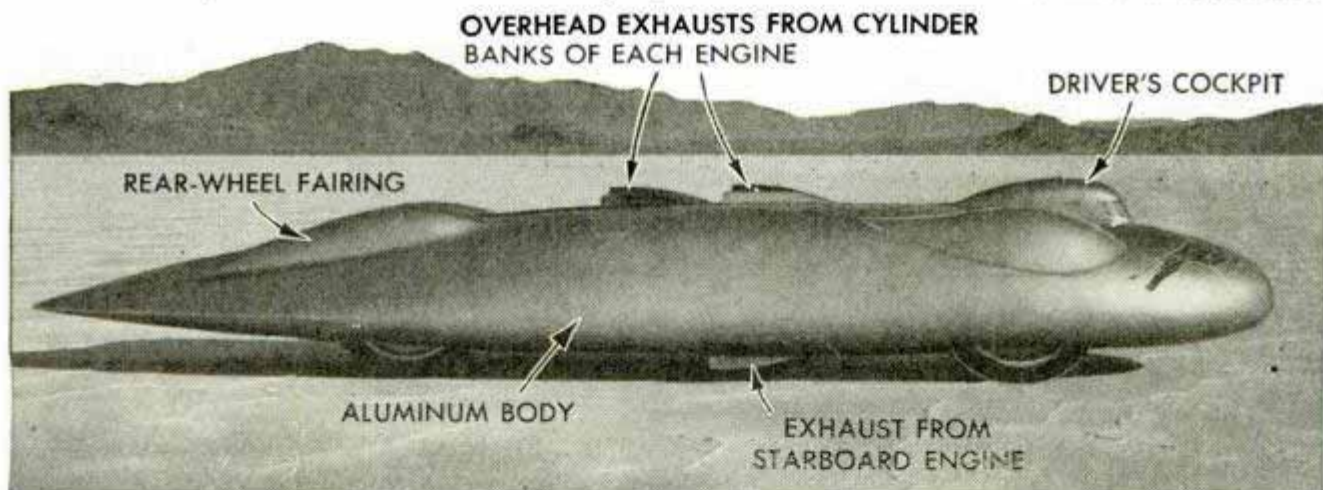

The strange-looking car below and with closeup of the driver's cockpit at right was found at the Daimler-Benz plant in Germany. It has a 3000-hp. engine designed to give it a top speed of 450 miles an hour

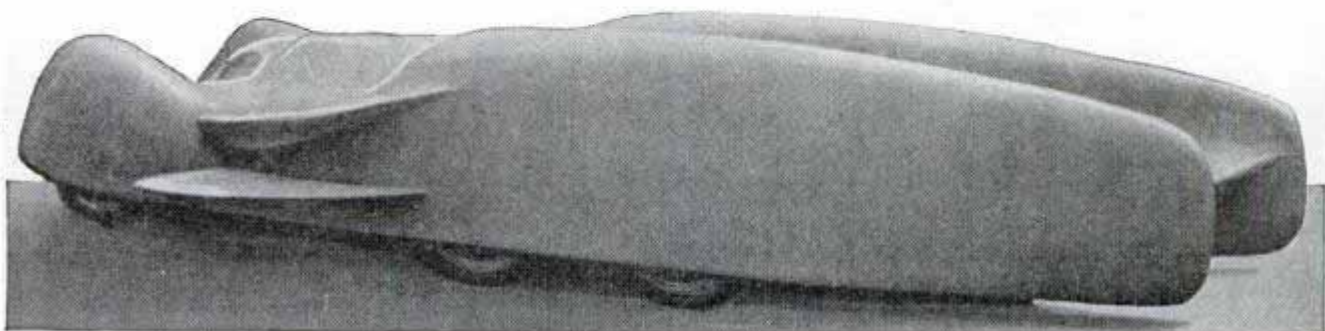
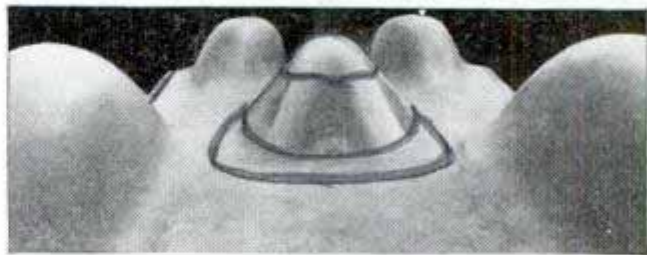

WHAT'S NEW *For Your Home*

SHAMPOO CHAIR with plastic drainboard can be adjusted to proper height for child or adult

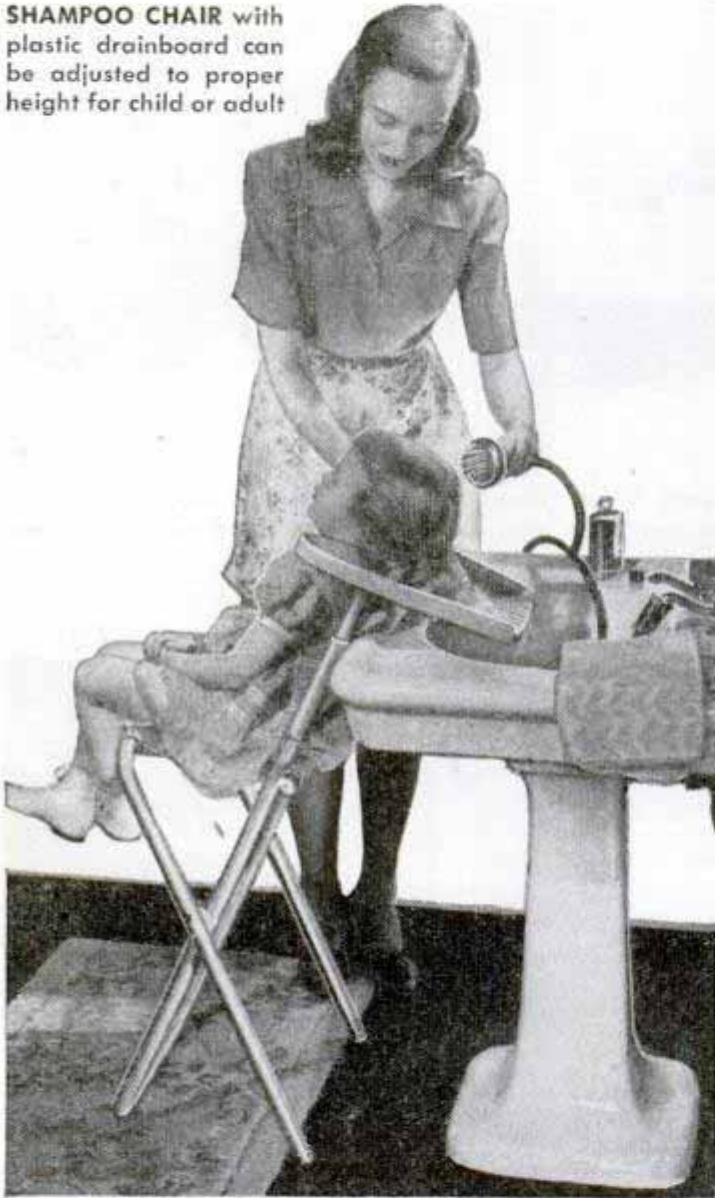

COMBINATION HASSOCK and record holder has dustproof storage for phonograph records

IRON HOLDER attached to wall keeps irons out of children's reach. The holder is fireproof

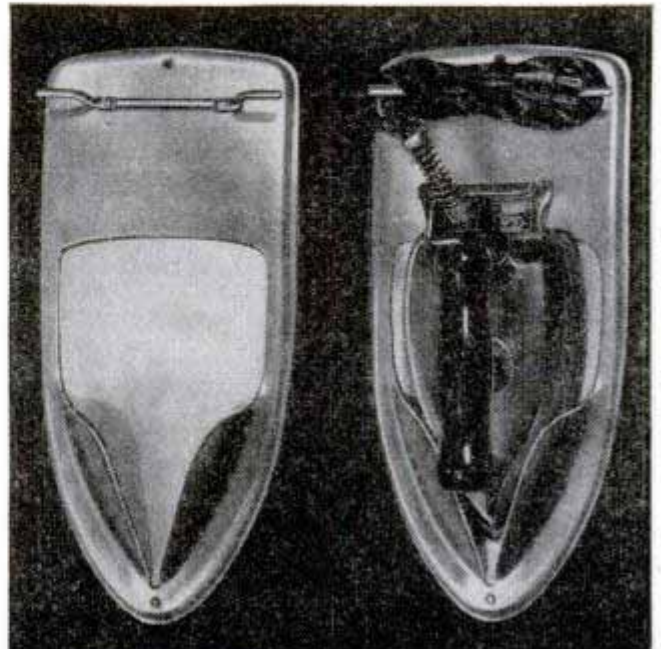

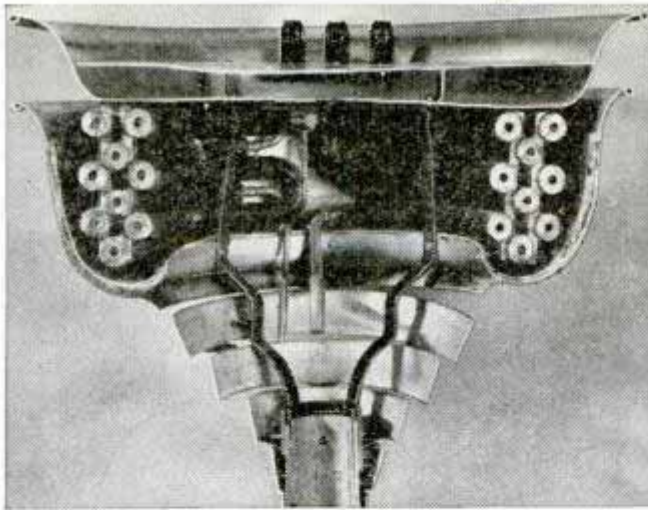

AIR CONDITIONER AND FLOOR LAMP are combined in one unit. Dome louver contains air inlet and outlet



WINDOW WASHING DEVICE with adjustable elbow and arm enables woman to clean panes from inside



BASE contains condenser, 1/2-hp. motor and controls



BATHTUB SEAT is anchored by suction cups

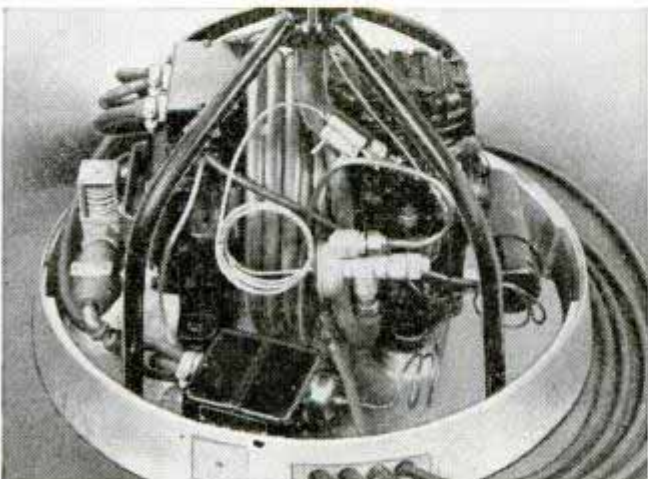

PORTABLE REFRIGERATOR weighs 55 pounds, is 16 by 22 by 28 inches in size, and operates on a.c. or d.c.

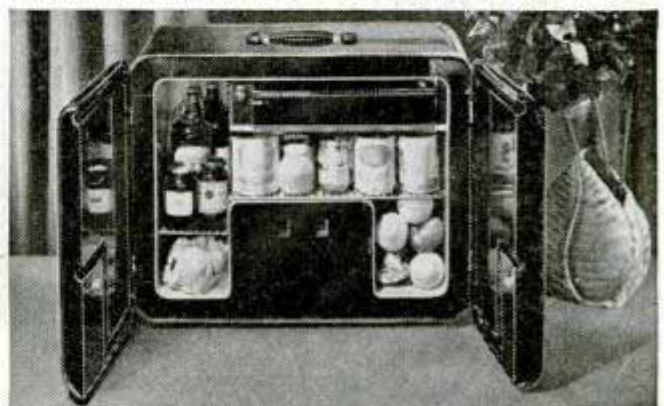

↑ SEE NOTATION ON WHERE-95
- AND IT SHEET IN FRONT

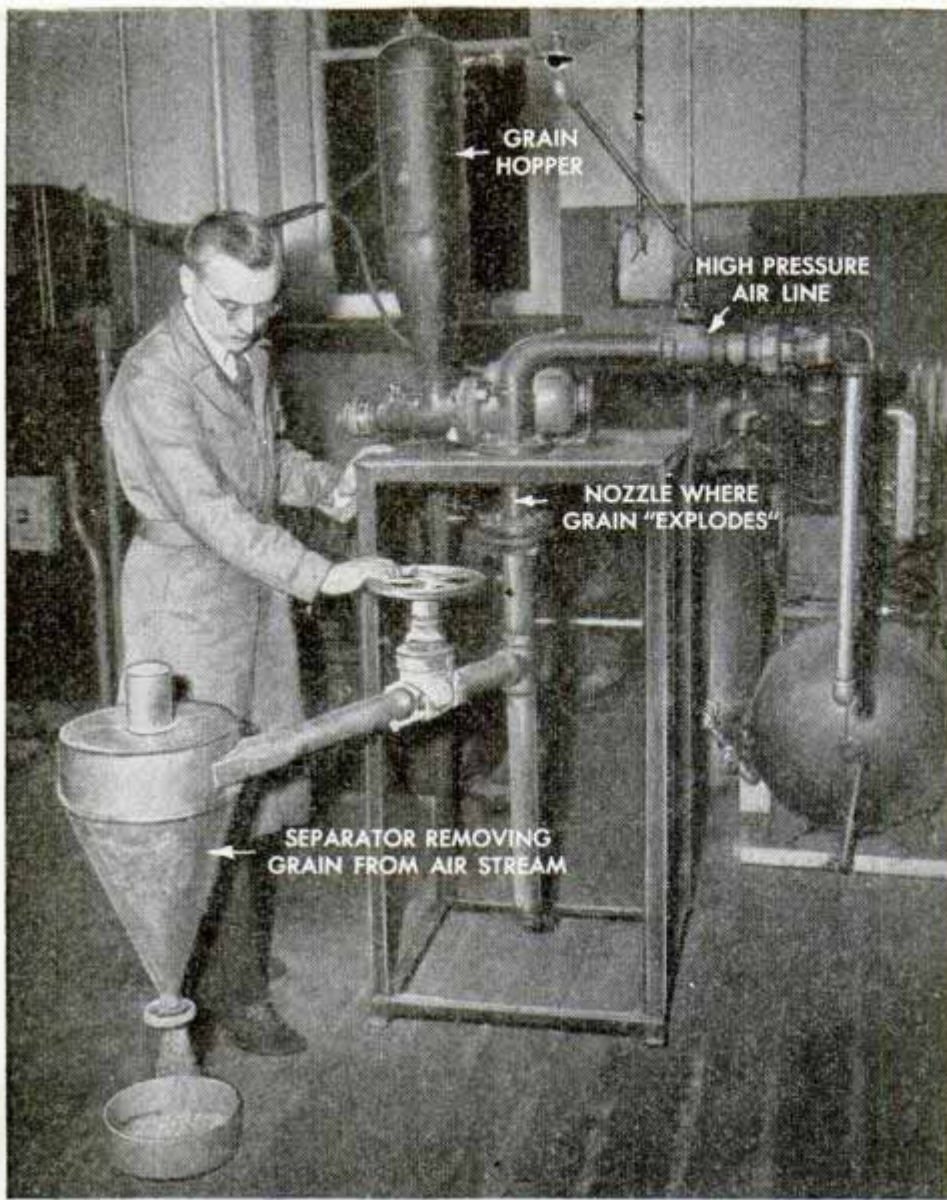

Grain fed through a nozzle within a pipe is shattered by the release of air pressure within the pockets of the grain. The results (right) reveal a sorghum berry (top) popping from its husk, and an oat berry emerging

CEREAL GRAINS ARE EXPLODED BY COMPRESSED AIR

Compressed air or other gases are used in a new method to explode cereal grains in the preparation of flour. Grain, under pressure, is fed through a nozzle within a pipe and is shattered by the instantaneous release of pressure within the pockets of the grain. Oat hulls can be removed completely without harm to the oat berry. With higher pressure, the oat is split and the

germ removed. With still higher pressures, oats or other grains can be pulverized. The Midwest Research Institute reports that this system offers possibilities of improved milling processes due to the easy separation of the component parts of cereal grains. Wheat flour, for example, can be made free of germ, a difficult procedure with conventional milling methods.

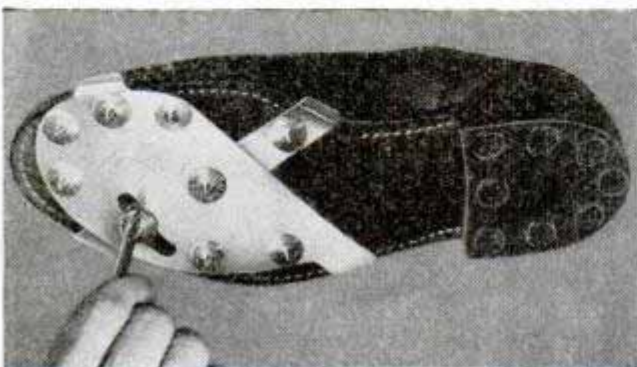

Clamp-On Golf Cleats

Cleats attached like skates, by twisting a key, convert ordinary shoes into golf shoes. The metal cleat plate is rustproof and adjustable to shoe sizes from 7 to 12. They are adjusted and locked in place at the same time. The cleats are removed easily and can be stowed in a golf-bag pocket, making a change of shoes unnecessary after the game.

Shortest Phone Line

One of the world's shortest telephone circuits is just 15 feet long. It extends from the underside to the cockpit of a big commercial air liner. The phone enables mechanics and flight engineers or pilots to talk back and forth despite engine and airport noises when checking last-minute details.

GM Auto Engine of Future Uses One Third Less Gas

Gasoline mileage is increased more than one third by an experimental automobile engine which has cylinder pressure of 1200 pounds per square inch, compared to 600-pound pressure in present engines. Developed by General Motors, the high-compression engine requires a special high-octane gasoline. The engine is designed along conventional lines except that it is rigid enough to stand up under the doubled compression ratio. It weighs about the same, per horsepower, as existing engines. Charles F. Kettering, retired research director of General Motors, says the engine offers a saving of \$1,000,000,000 a year to motorists. On 10 gallons of gas, it will take a car the same distance as 13 or 14 gallons in conventional type engines. Much cooperative



United Air Lines photo

research work by auto manufacturers and the petroleum industry is required before the new engine will come into wide use, Kettering points out.

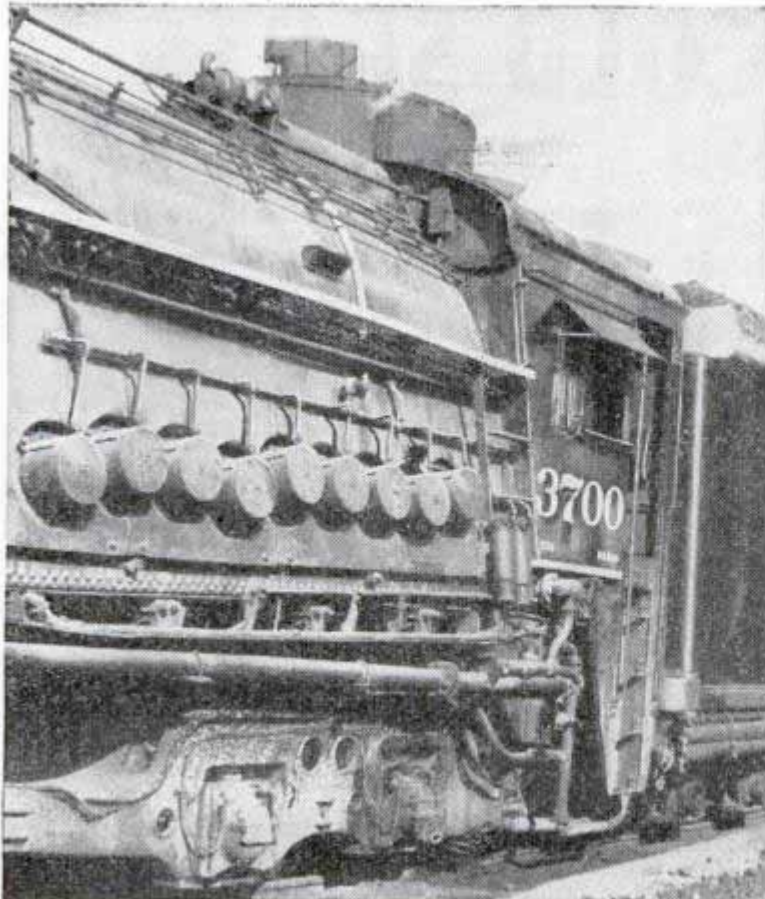

Locomotive Oxygen "Mask"

Oxygen "masks" increase the efficiency of steam locomotives that pull freight and passenger trains across the Rocky Mountain continental divide between Pueblo, Colo., and Salt Lake City, Utah. The Denver & Rio Grande Western Railroad reports that by piping additional oxygen to the boiler fire at high altitudes, better combustion is produced, efficiency is stepped up and most smoke is eliminated. The oxygen units—called overfire steam-fire jets—have been installed experimentally on 10 locomotives.

Sprayed Ice Trays Won't Stick

Ice trays and packaged foods won't freeze to refrigerator compartments sprayed with a chemically treated liquid. It is harmless, odorless and won't injure foods or liquids. A 2½-ounce bottle will service the average home refrigerator about six months.



Air Proving Ground Command photos

65-below-zero weather makes retractable gears, like this B-29 nose wheel, work about 60 times slower

FLORIDA'S COLD SPOT

IN FIVE MINUTES you can walk from the arctic to a desert, or even a jungle if you like your weather humid. It can almost be done before the hoarfrost that collects on your lashes and brows at 60 below zero completely melts away. And you can experience a whirling sandstorm quite as punishing as the frigid gales you just left.

Those aren't wild thoughts from the pages of a travel folder. It all actually happens beneath a roof in Florida; the realization of the dreams of a man who didn't like to travel.

The place is the Air Proving Ground Command's giant new climatic hangar at Eglin Field, where all the world's weather—from 70 degrees below zero to 165 above—can be faithfully duplicated. The man is Colonel Ashley C. McKinley, now retired, who covered thousands of desolate miles with Byrd and other scientific explorers.

Weary of travel, McKinley argued for years that service equipment could be tested more simply and more satisfactorily

—is also its hottest spot. In Eglin Field's weather factory Air Force technicians give Army equipment the frostbite and blister test at 70 below zero and 165 above

By Aubrey O. Cookman, Jr.

"in our own back yard," and at far less cost, if we'd only go ahead and manufacture our own weather. Fitting out large expeditions is both expensive and bothersome. Often they wait weeks and months for weather conditions suitable for certain tests, only to see them disappear before the work is half completed. Or, if faults are detected and corrections made, there's another season's wait before the item can be tested again.

Eglin's hangar is the answer. A tremendous building, uniquely constructed, it has a main weather room 200 by 250 feet, almost the size of a football field. In addition to that there are eight other specialized test



Pressured air entering "tail" of cooling suit at left, finally billowing out at the face and pants legs, forms protective layer over body for work at 165 above. Right, fur-lined cold-weather garb with face protector

chambers. Within its walls 100-mile-an-hour winds can be whipped up, in combination with sleet, snow, rain, dust and sand, and altitudes up to 100,000 feet have been simulated. A twist of the wrist produces artificial light as powerful as the midday desert sun.

The biggest planes, completely assembled, can be tested in the hangar, even to running up the powerful engines. Foot-wide pipes carry the exhaust gases outside. Helicopters can rise and descend under their own power, while nearby planes at the same time may be dropping dummy bombs or firing live shells. Trucks and tanks can run through their operational tests on a 14-foot-wide track extending 300 yards around the hangar's perimeter.

Eglin is no stranger to this kind of assignment. Its inhabitants have long been respected as the Army Air Forces' prize "fault finders." Whenever a new piece of equipment is under consideration it's sent to Eglin to determine its operational suitability—and frequently the answer is "no." This testing extends well into the tactical realm, for it was here that Doolittle's Tokyo raiders and the B-29s went through their first rehearsals. Eglin's 800 square miles

offer plenty of space and privacy for the most extensive secret maneuvers.

The "weather" is generated by three 2250-horsepower Freon 12 refrigerating units, a steam heating plant and a series of heating and cooling coils in the air-delivery systems. Cooling poses the toughest problems, taking 36 to 48 hours to bring the big room down to lowest temperatures.

One interesting phenomenon already noted is the long "cold soaking" period required, sometimes as much as 72 hours, before big objects are thoroughly chilled down to the temperature surrounding them. Also, organic materials and plastics change composition as the thermometer soars or plunges. Cold's slow-down effect on machinery is typically illustrated by an airplane landing gear, which normally retracts in three to five seconds but takes three minutes at 65 degrees below zero.

Although cold is generally thought to stimulate appetite, studies of workers in the indoor arctic show they don't eat well and some even lose weight. They are also more susceptible to colds, though inclined to shake them faster than the average.

The hangar's insulated floor, strong enough to bear a 300,000-pound airplane,

With the extreme temperatures involved, floor insulation was one of the knottiest problems. This construction cross section shows how it was finally done

Top layer is 12-inch thickness of concrete in 12½-foot blocks

Next comes a half inch of felt

Then there are three five-inch-thick layers of cellular-glass blocks. Each has asphalt binding and all the joints are offset

Under ¼ inch of felt are eight inches of concrete and 2½ feet of crushed rock at the bottom

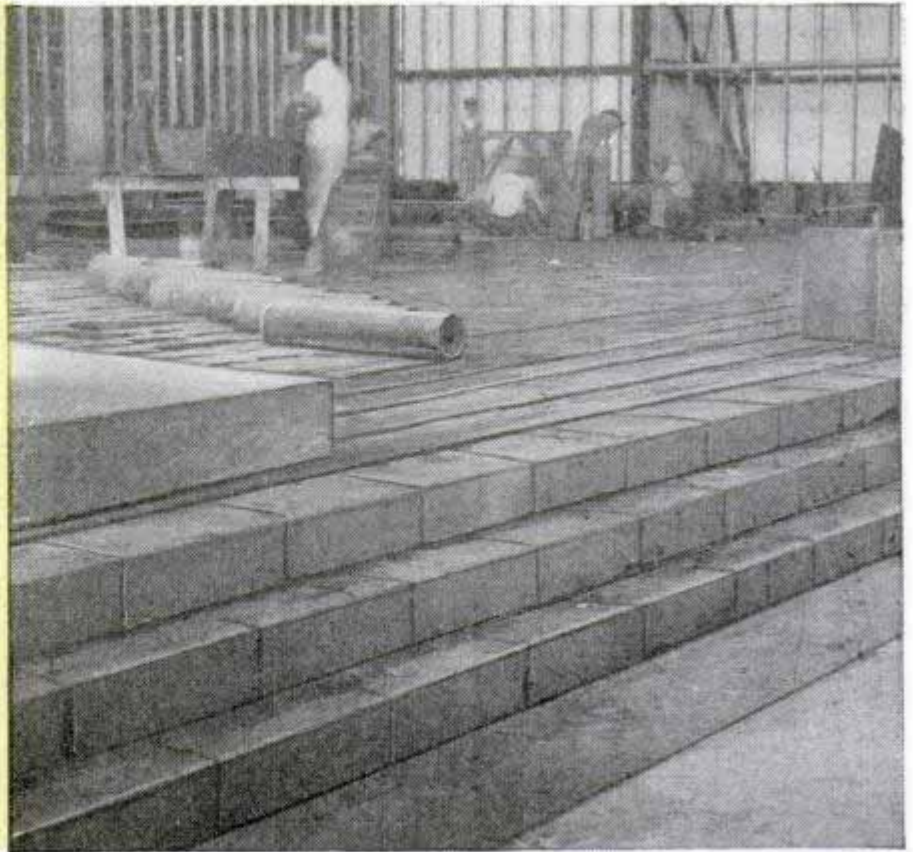

is 5½ feet thick from the bottom of its crushed rock base. The top layer is 12 inches of reinforced concrete. Then come three layers of five-inch cellular-glass block, vapor sealed at top and bottom with a half and a quarter inch, respectively, of roofing felt. Underneath are an eight-inch slab of concrete and 2½ feet of crushed rock. Copper flashing in the concrete near the surface, topped with an inch of mastic fill, allows expansion and contraction with temperature changes and prevents water from seeping into the insulation.

Three sides of the hangar are mainly

insulated with 13 inches of glass-wool board, interlaced with wood reinforcements and a layer of coated asbestos. Air spaces on either side separate the insulation from steel sheeting that forms inside and outside walls. Tiny pet cocks at floor level are opened periodically to drain off condensation in the air space.

The fourth side has 200-ton doors that operate on rails 25 feet wide. After they close, another mechanism pulls the upper part of the door about six inches closer to the hangar, allowing sponge-rubber gaskets to form a tight seal around the opening.

A cam forces rubber pads at the bottom of hangar doors against the floor. Despite their bulk, the doors can be driven closed in seven minutes.

In the wall opposite the hangar doors are five gun ports, which can be opened for firing onto an adjacent range. Surrounding these and all other openings are electric heater strips to prevent them from freezing tight during cold tests.

The ceiling is built on a corrugated-steel deck, hung from the trusses by

After the 200-ton doors slide closed, another mechanism seals them tightly against the hangar

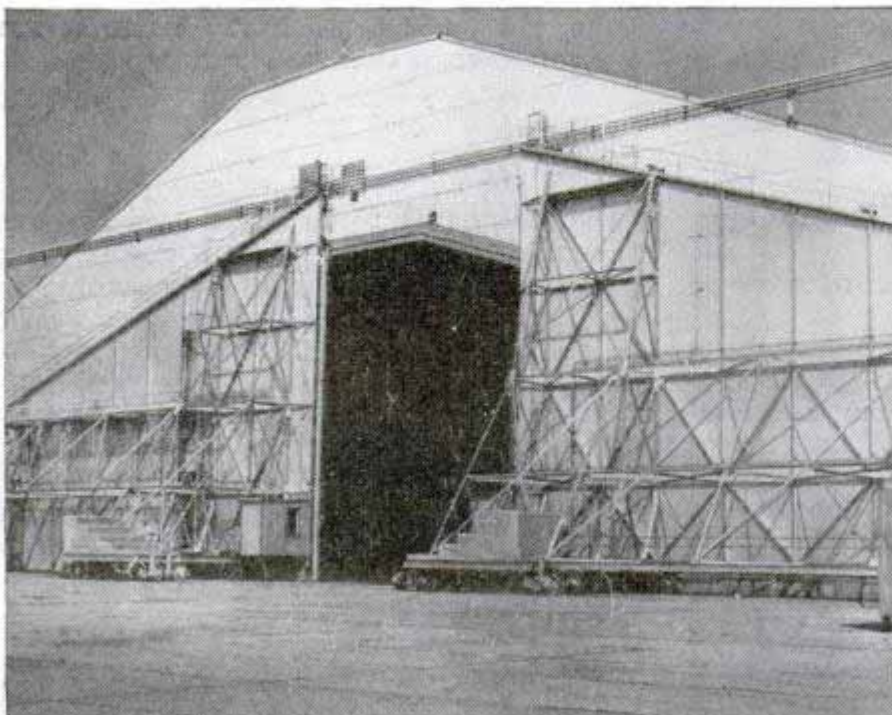



Mechanic examining effects of extreme cold on idler wheel of M-24 tank. Below, a P-47, mobile observation room and a Superfort occupy a small part of the huge hangar's 200 by 250 feet

chains. Heat transfer through it is small, since the chains are practically the only members piercing the insulation. The chain support also allows the ceiling to be semi-flexible to better adjust to thermal expansion.

Along the center line of the hangar is a pit 80 feet long, 10 feet wide and 9 feet deep for testing bomb racks and release mechanisms. The dummy bombs fall into the sand at the pit's bottom. High up on two sides are observation rooms, with multipaned glass windows that won't fog. Twenty feet square and equipped with microphones connecting into the hangar, the rooms are control centers for testing activities. Two mobile air-conditioned chambers, the larger 10 by 13 feet, can be moved

(Continued to page 260)

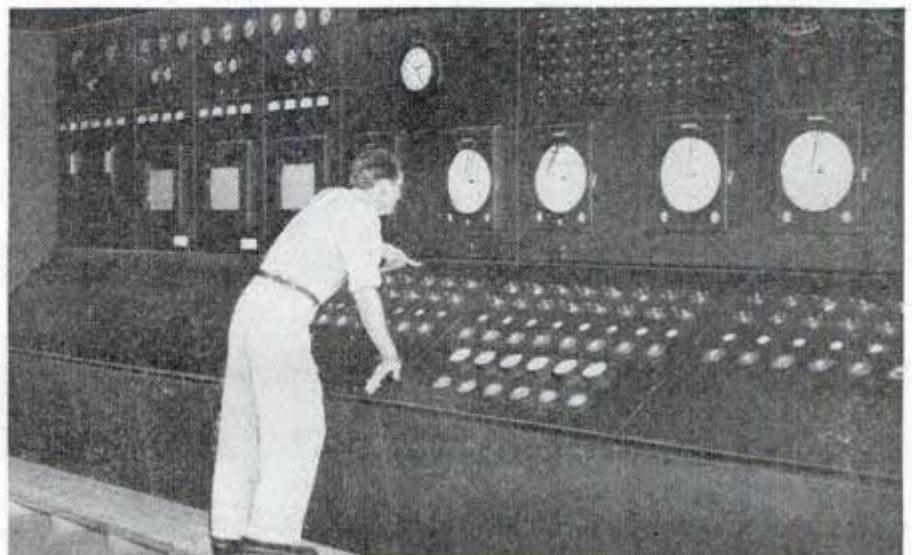
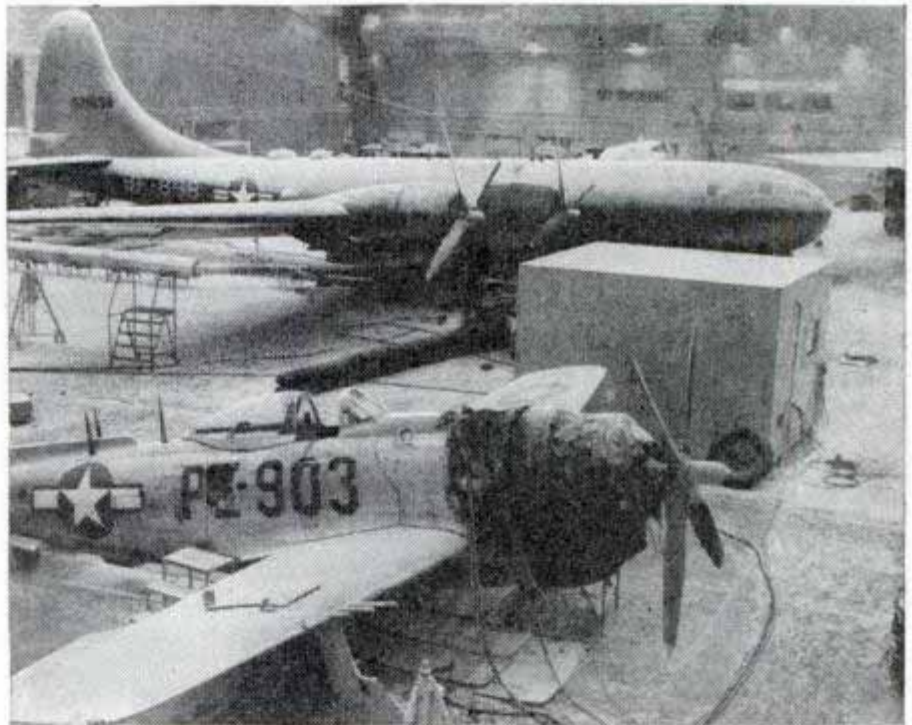

One "weatherman" who is never wrong. He controls climatic conditions in Eglin's big hangar



Plastic Glue Supports Jeep

Strong enough to support the weight of 160 jeeps, a new plastic glue withstands temperature changes from 60 degrees below zero to 300 above. The glue, reported to be 15 percent stronger than the strongest glue previously produced, hardens at room temperature and with exertion of high pressure. These characteristics make it ideal for many manufacturing processes where the use of ovens and presses is impractical. Two Westinghouse chemists developed the glue by "juggling" the ingredients of similar glues used during the war. The addition of oxygen and hydrogen atoms gives the glue its unique properties.

Striped block, made of two pieces of wood glued together, lifts a 2500-pound jeep

Bacteria Counted By Electronics

Smoke particles and bacteria as small as .000025 inch in diameter are counted automatically by a photoelectric instrument developed at Northwestern University. The counter makes its rapid calculations by translating into tiny electric pulses the light scattered by microscopic particles. Suggested uses for the instrument include testing contamination and detecting dust in factories which manufacture

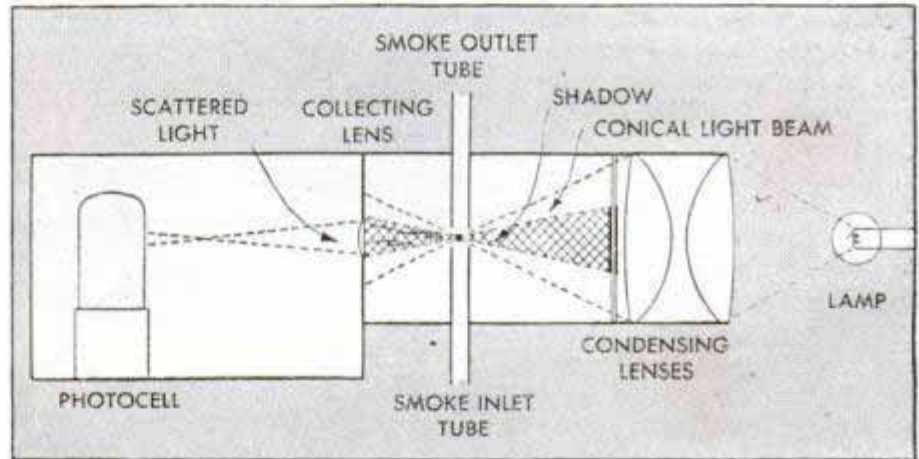

photographic film and optical instruments. Also, it will be useful in the production of penicillin and streptomycin.

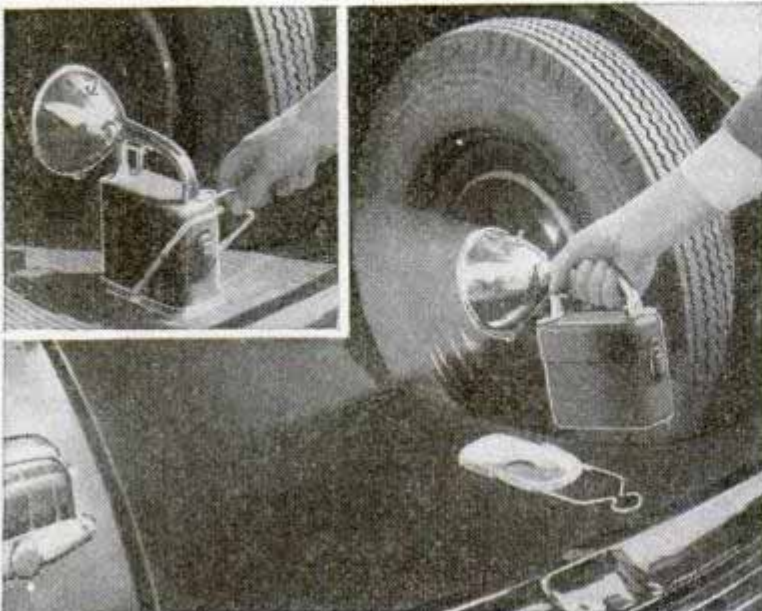

Spring Holds Portable Lamp

Light beams are thrown 1500 feet by a portable electric hand lamp that has a hold-down accessory to fasten it securely in auto trunks, boat prows or any flat surface. The lamp can be removed from the fastener by lifting a spring lever. Powered by standard dry cell batteries, it has main and auxiliary bulbs with a focus adjustment for spot or spread light.

☐ Fireproof fabrics designed for hotels, night clubs and schools are being woven of very fine glass fiber and flameproofed cotton yarn in a variety of colors.

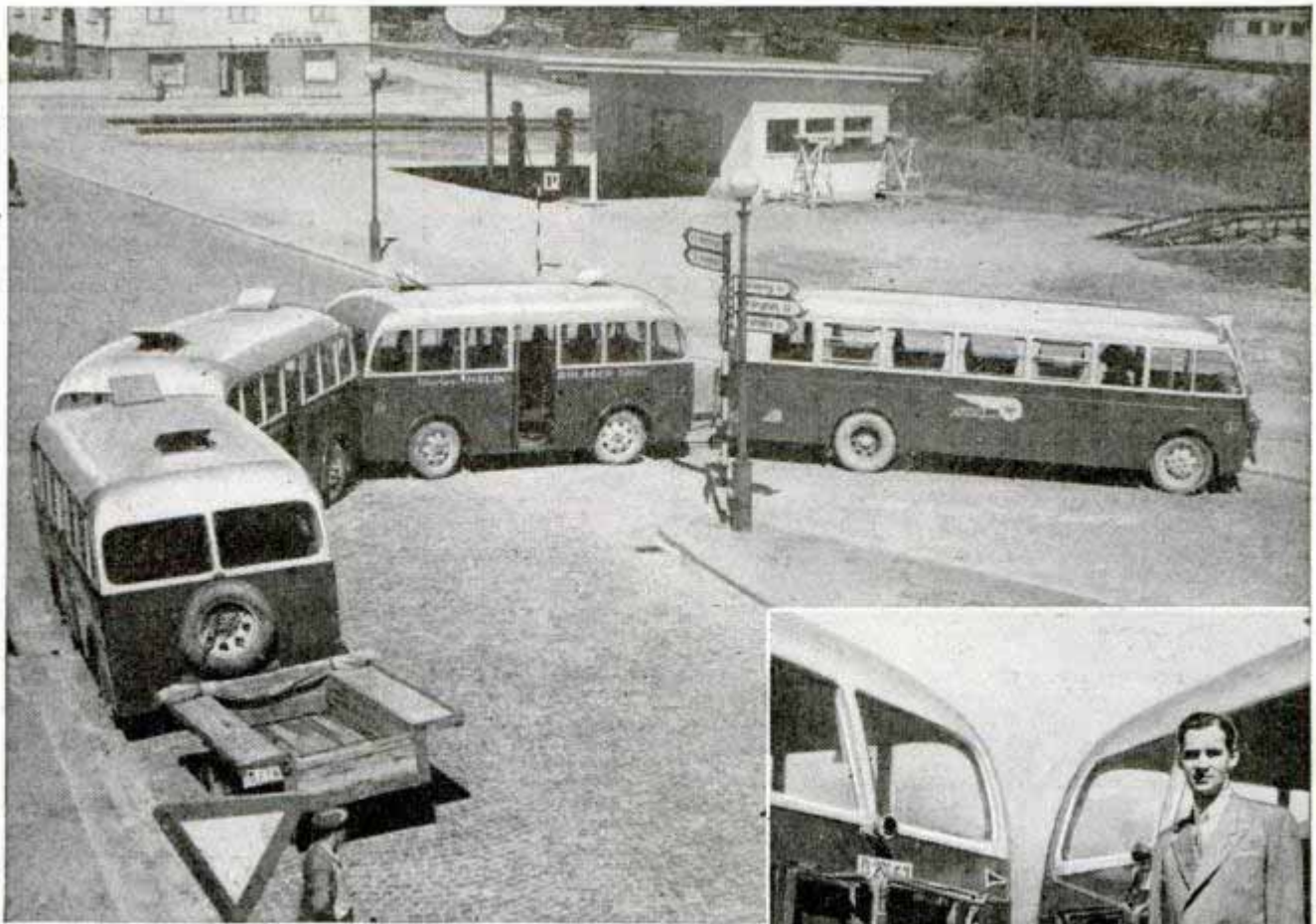

Gunnar Marden, Swedish engineer, stands beside the four-wheeled steering apparatus he developed for bus trailers. As a result of this mechanism, several trailers filled with passengers are pulled and steered by one bus. If the bus driver turns his steering wheel to the left, the direction change is transmitted immediately to the trailers' four wheels

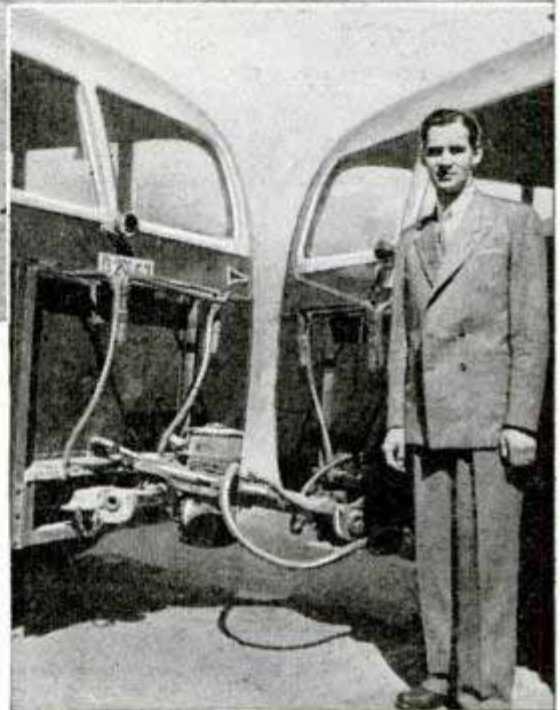

SWEDISH BUS TRAILERS

Three or more passenger trailers are pulled and steered by a single bus in a highway-train system (see cover painting) now operating in Sweden, Denmark and Norway. An automatic, four-wheeled steering device makes it possible for a bus and attached trailers to travel at speeds up to 60 miles an hour, negotiating bends and S-curves with ease. The trailers, each with a seating capacity of 26, are hitched to the parent bus or preceding trailer by a single ball-bearing-socketed arm which is connected to the steering system. Each trailer has four-wheel hydraulic brakes, plus an inverted vacuum braking system which assures immediate application of brakes if a coupling breaks while the train is in motion.

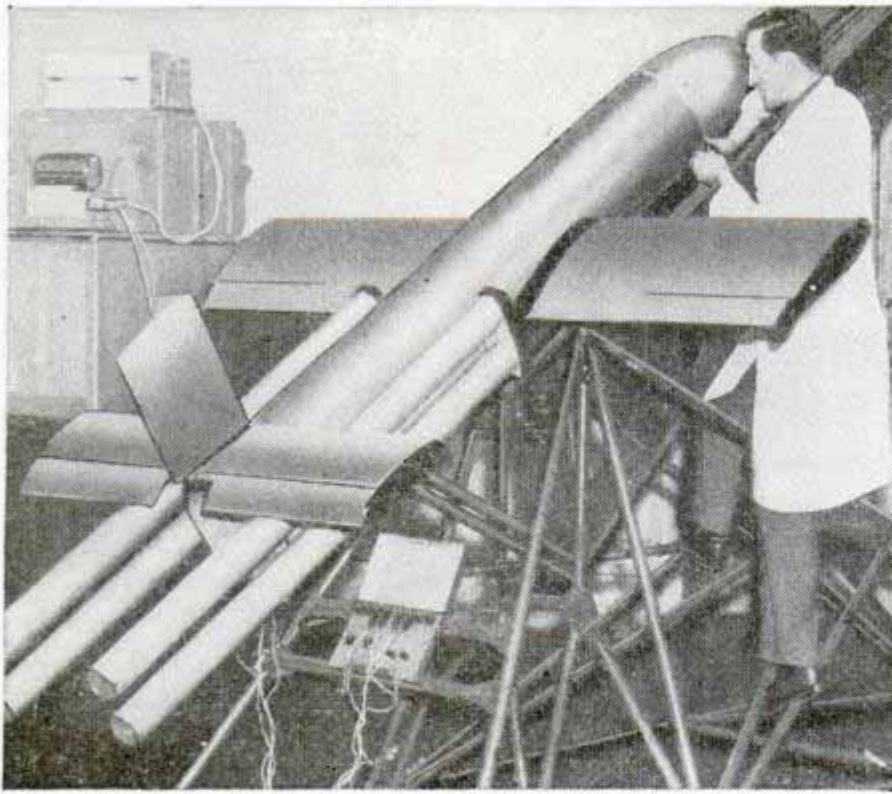

Radio-Guided Rocket Goes Over 500 M.P.H.

Britain's first pilotless radio-controlled rocket, the "Stooge," travels over 500 miles an hour within its eight-mile range. Originally designed to combat Japanese suicide bombers, the missile is also regarded as an effective weapon against planes carrying atom bombs. The cylindrical fuselage is 7½ feet long, has a 6-foot-10-inch wing span and weighs 738 pounds. It is propelled by eight rockets. The only control surfaces are elevators and ailerons. Tests have indicated that a rudder is unnecessary.

Metal Case Holds 29 Drills

Twenty-nine drills from ¼ to ½-inch are held by a metal drill case equipped with a built-in lock opened by finger-tip pressure. On the face of the case are tables listing drill sizes and angles, melting point of various metals and similar data. The case can be hung in a convenient position on a wall or placed upright on a bench or toolbox.

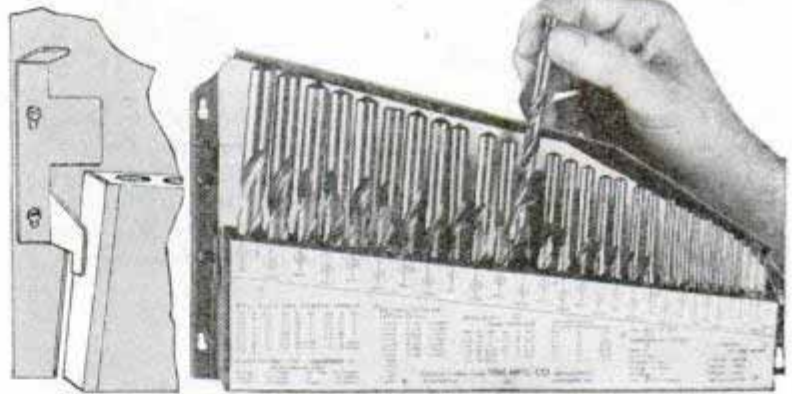

Passengers' Cars Carried on Train

Passengers on the Chesapeake & Ohio Railroad's run between Washington and Cincinnati can take their automobiles with them. An extra car with room for four autos is coupled to both westbound and eastbound passenger trains. The autos are loaded into the auto-car by ramp.

Information, including manufacturers' names, concerning products described in this issue may be obtained by writing Bureau of Information, Popular Mechanics, 200 East Ontario Street, Chicago 11

Explosion-Proof Gas Generator

Internal baffles in a new portable acetylene-gas generator prevent water from reaching carbide when the unit is tipped over and thus eliminate the danger of explosion. Due to gravity feed, carbide is not fed to the gas-water chamber when the tank is on its side. This feature enables the operator to carry a 37-pound unit in any position without worrying about an explosion.

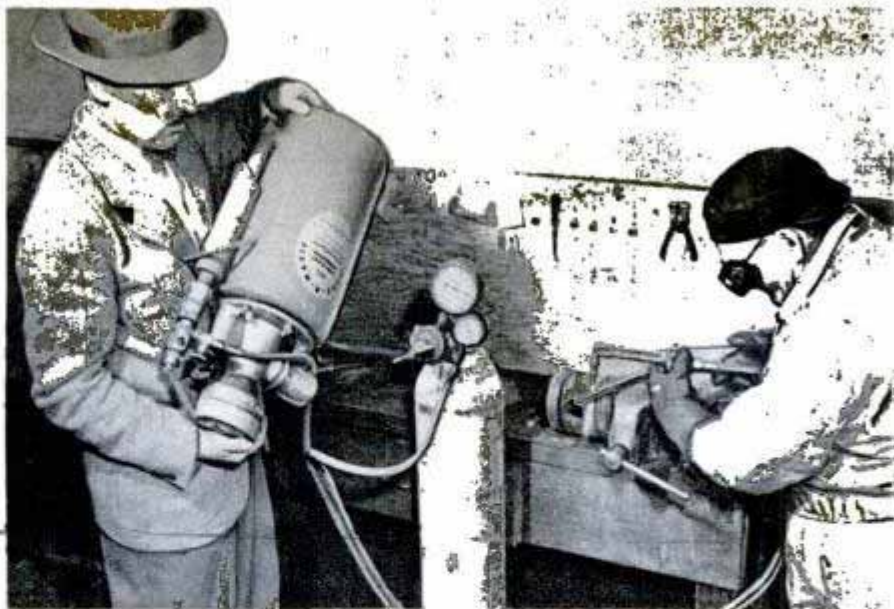

Handmade Sport Roadster

Designing and building his own sport roadster kept one ex-Air Forces pilot busy while he convalesced from combat injuries. Stock parts were used when they matched the design. Others were manufactured as necessary. The engine is a Mercury block with high-compression heads, dual manifolds and carburetors, and high-lift camshafts. Headlights are concealed behind the radiator grille. The top edges of the doors have been upholstered to serve as armrests. In bad weather a close-fitting top gives protection.

False Bow on Tug Fits It for Ocean

To enable a relatively small towboat to make an ocean voyage from Pittsburgh to Buenos Aires, the Dravo Corporation welded a false steel bow to the craft to absorb the shock of rough water. The craft was sold to the government of Argentina and made the trip from Pittsburgh by going down the Ohio and Mississippi Rivers to New Orleans, across the Gulf of Mexico, and down the east coast of South America. During the voyage it towed four barges.



Fluorine is so dangerous that it is loaded behind a barrier of steel and bulletproof glass. Here a worker checks the pressure of a cylinder

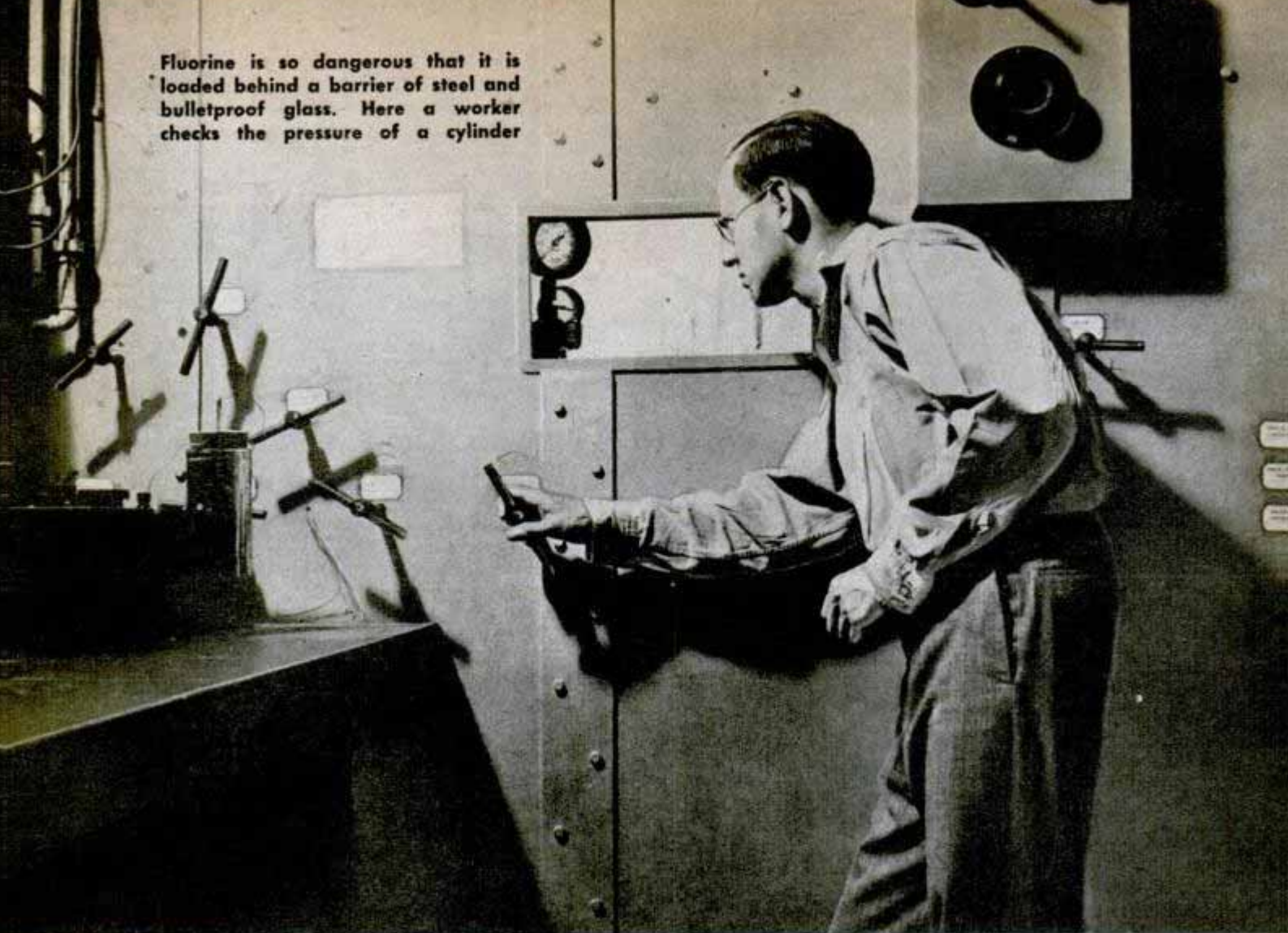

Pennsylvania Salt Manufacturing Co. photos

"BAD MAN" OF THE ELEMENTS

THEY'RE a tough family, the halogens. To chemists they've been powerful and unpredictable. Those famous gangster elements, chlorine and bromine, have been tamed only a short time. And today the most vicious member of the family—fluorine—has become a useful element.

For centuries chemists have been trying to put fluorine to work. The element is so dangerous that when combined with hydrogen it forms hydrofluoric acid, one of the most powerful and destructive reagents known to science.

Today, after years of heartbreaking experiments, science has transformed this bad man into a hard-working citizen. Now fluorine is an important ingredient of insecticides, plastics and refrigerating liquids. In its pure or elemental form, fluorine is used to make such materials as brilliant dyes; lubricating oils that won't oxidize; a gas that is nearly perfect insulation against high voltages; better fungicides; improved fumigants; solvents; fireproof-

By Eugene W. Nelson ing materials, and resins.

Fluorine's conversion from devil to angel has taken place within the past few years. This colorless, heavier-than-air gas with a highly irritating odor ranks twentieth in abundance among the elements.

From 1670 until 1886, some of the most brilliant minds in chemistry wrestled in vain with the problem of isolating pure fluorine. It remained for an obscure French chemist, Henri Moissan, to solve the problem. In 1886 he succeeded in isolating it by the use of the electrolytic process.

Today, after numerous false starts, a practical method for mass production of elemental fluorine has been perfected. Fluorine gas is being produced in a specially designed electrolytic cell which contains potassium fluoride and hydrogen fluoride. The temperature is maintained at 100 degrees Centigrade. As the electrolysis proceeds, both hydrogen and fluorine gases are produced. A special device prevents the two gases from combining for if they did

they would explode with such violence that the fluorine plant might disappear.

One big problem which faced the fluorine research men when they first attempted to market the pure gas was the production of a suitable container for packaging the diabolical stuff. Both steel and copper resist the corrosion caused by contact with fluorine gas at normal temperatures, but detailed research was necessary before suitable gasket material was developed to insure leakproof containers. When marketing the gas, only a small amount of fluorine is packed into each cylinder—about one half pound in a metal cylinder at 400 pounds pressure.

This pure fluorine has weird properties. Its atoms are extremely sociable. They rush to find chemical friends. In their hurry they often destroy other materials which we have always considered highly durable. For instance, silicon combines with fluorine to form a gas. Fluorine also has a much greater attraction for hydrogen than does oxygen.

So when a cylinder of pure fluorine gas is opened, glass, asbestos and rock disappear in puffs of smoke. They are all compounds of silicon and therefore unite easily with fluorine. If the jet of elemental fluorine is played over the surface of a pan of water, the water bursts into flame. This is because fluorine takes the hydrogen away from the oxygen. The energy set free by this unusual chemical reaction appears as flame. In like manner, heated steel goes up in smoke and wooden splinters blossom into flame.

Because elemental fluorine is so tricky, its sale at present is limited to experimental plants and laboratories where it will be handled by experienced men.

Although pure fluorine in large quantities is new, "mass production" fluorine

FLUORINE MAKES THEM ALL BURN



STEEL



ASBESTOS



EVEN WATER



Recently developed electrolytic cell finally makes possible the separation of pure elemental fluorine

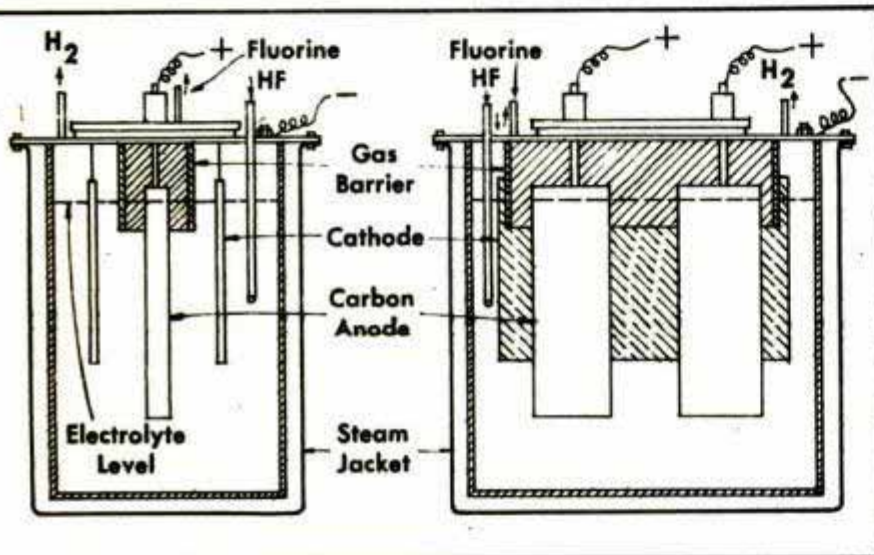

Courtesy Pennsylvania Salt Manufacturing Co.

Diagram shows how cell produces hydrogen and fluorine. Gas barrier prevents explosion. Below, into these cylinders is pouring the most active element known

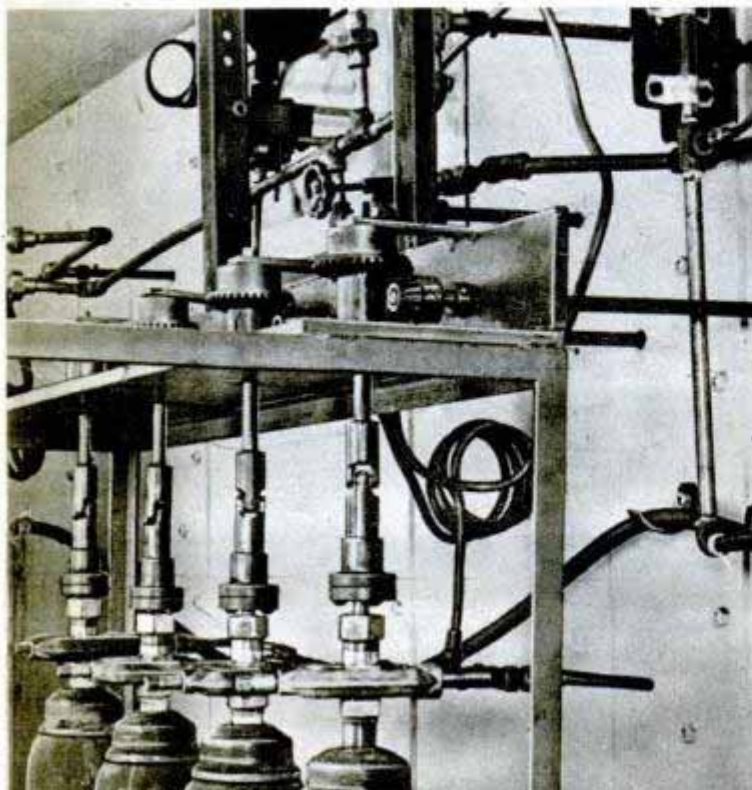

compounds have been put to work for some time. Fluor spar (fluoride of lime) is the principal fluorine ore. It is a beautifully clear, crystalline mineral, often delicately tinted in pastel shades. Its appearance gives no indication of the demon lurking inside.

Fairly large deposits of fluor spar are found in Illinois, New Mexico, Kentucky and a number of other states. Its abundance is fortunate because from six to eight pounds of fluor spar are added to every ton of steel produced by the basic open-hearth process. This small addition of the mineral speeds the purification of the melt, saves fuel and produces a better grade of steel.

In preparing the enamels that have transformed our kitchens into "show rooms," large amounts of fluor spar are used annually. The fluor spar lowers the melting points of the other ingredients used in the enamel and helps give a high gloss to the finished material. Fluor spar also gives toughness and durability to structural glass and helps impart an opalescence to electric light bulbs, lamp shades and other lighting fixtures.

When fluor spar is mixed with concentrated sulphuric acid, a gas with a choking odor is given off. The gas usually is absorbed in water to form a concentrated solution of hydrofluoric acid. For a long time, about the only use for this liquid was for etching glassware and as a powerful reagent in making industrial analyses.

Hydrofluoric acid finally came into its own during the late depression years. At that time, intensive research produced a series of complex compounds known as Freons. The most successful Freon was a gas commonly called F-12. Although derived basically from destructive hydrofluoric acid, F-12 is an ideal refrigerant. The development of this economical refrigerant did a great deal toward bringing refrigerators into the average home.

The other commercial ore of fluorine is cryolite, aluminum's partner. This mineral—sodium aluminum fluoride—is the electrolyte material used in the manufacture of aluminum. Greenland is the only known commercial source of the natural mineral. Cryolite was so important during the war that special convoys were provided to transport it from the Greenland mines to the United States.

Now that elemental fluorine can be supplied in quantity, what is the future of this reconstructed rebel element? It's plenty

(Continued to page 260)



Motor Scooter From Scrap Parts

Using only salvaged parts and scrap metal, G. G. H. Lentz of Fredericksburg, Tex., has built an efficient and practical motor scooter. As he had no welding equipment available, all the parts of the machine are riveted or bolted together. The frame is made of scrap bedstead angle beams. The front wheel is cushioned by a coil spring and the rear wheel by multiple-leaf springs. Tires and wheels are AAF war surplus and the engine came from an old washing machine. Grille and trim were taken from an old cookstove reservoir.

Race Track Soil Sifter

Surface soil at Hollywood Park, Calif., is screened by a huge machine which removes rocks and other debris that would injure horses' hoofs. The screener follows a scraper and picks up the loosened soil, carrying it to the top of a chute. The soil then goes through a sifter and is deposited in a long row to be spread across the track by harrows.

Weight of self-sealing airplane fuel tanks has been cut 40 percent by the Navy's new method of curing and processing rubber.



Telescoping Leg for Typewriter Leaf

Extra support for a desk typewriter leaf is supplied by a metal leg which can be adjusted in the manner of a telescope. A ball-locking mechanism holds the "crutch" at the desired height and rubber pads at top and bottom prevent slipping.





"Gas Tank" Car

Its body made from an Army bomber's auxiliary gasoline tank, a three-wheel car goes 75 miles on a gallon of gas while traveling at 40 miles per hour. Each of the three airplane wheels is equipped with a brake, and the car has automatic shifting and knee action. Norman Anderson, Vernon Servoss and Lester Sworthwood of Co-runna, Mich., who built the auto, plan to mass-produce it to sell at \$350.

Eye for AAF

Objects photographed with a 48-inch-long telephoto lens built for the AAF appear twice as large as they do with present standard 24-inch-focal-length equipment. Developed by Eastman Kodak, the new lens snaps sharp pictures from as high as 10 miles, where a built-in heating system counteracts effects of subzero temperatures. It is a foot wide, weighs 125 pounds and has an f:6.3 aperture. An aerial camera fits on the lens-mount base.



Eastman Kodak photo

↑ Comparing size of giant telephoto lens with one for 16-mm. movie camera



Rear-Engine "Soap Box"

With its 1½-horsepower engine mounted at the rear, a "soap box on wheels," built by 11-year-old Richard Aulerich of Detroit, goes 20 miles an hour and uses very little gasoline. The engine is connected by pulley to a hydraulic device once used with airplane retractable landing gears. This device, in turn, is connected to the car's rear axle by another pulley. Rubber-tired wheelbarrow wheels were used to complete the assembly.

☞ As much as 9000 feet of mud covers some parts of the Atlantic Ocean bottom between New York and Bermuda.



Four-car experimental train, pulled by a Diesel, has a glass-enclosed top deck on each car for all-around view

GLASS-TOPPED Train of Tomorrow

Comfort and entertainment for passengers are stressed in a luxurious four-car train pulled by a Diesel locomotive. The train was built by General Motors to contribute novel ideas toward the improvement of passenger travel. The outstanding feature of each car is the "Astra-Dome" built into the roof—a glass-paneled upper deck where passengers can enjoy an all-around view. The four cars consist of a chair car, sleeper, diner and observation car. Innovations in the new train include train-to-anywhere telephone service while the train is in motion, wire-recorded entertainment, a Diesel power unit for each car and a space-saving arrangement whereby the cars are built on either three or four levels. In the lounge car are 68 seats, more than half of them movable, arranged on four different levels. A suspension system originally designed for locomotives has outside swing hangers to reduce sideway. The train is now on an exhibition tour and will visit 30 leading cities.



"Penthouse" diners eat beneath heat-resistant glass

↓ Passengers enjoy a ride under the stars in the "Astra-Dome" of each car. Right, the luxurious observation car is built on four different levels. Note train-to-home telephone and the stairway that leads to the top deck



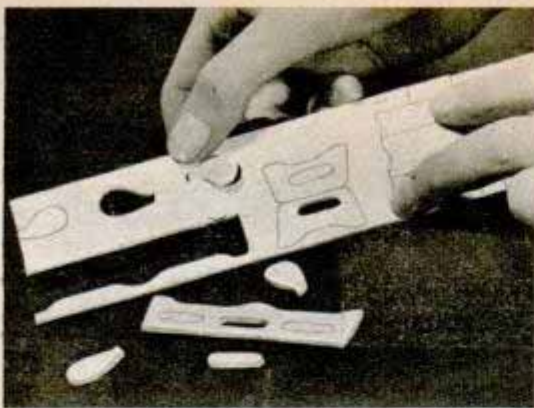

House and Furniture From Kits

With kits containing pre-cut parts modelmakers can build a miniature replica of a Cape Cod house complete with Early American style furniture. The walls and roof of the four-room house are nailed together. With the inside partitions removed, the entire interior can be seen through the picture window and with the garage attached the house can be used as two birdhouses. Complete furniture for the living room, dining room, kitchen and bedroom is available in separate kits. The parts are glued together and stained or covered with fabric scraps. The scale of the models is one half inch to one foot.

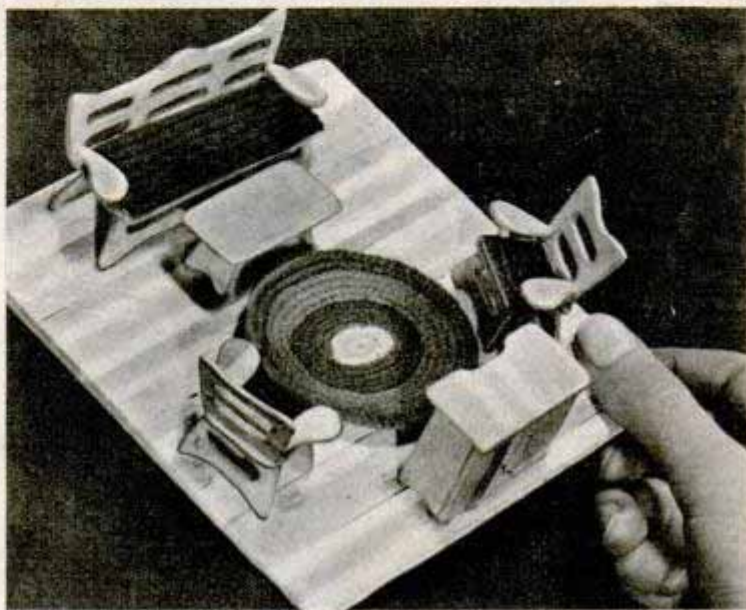

Tractor for Gardeners Weighs Less Than 100 Pounds



Suitable for gardening or small-scale farming, a midget tractor weighs less than 100 pounds. The tractor is controlled with levers on the handle bars. It has a $1\frac{1}{2}$ -horsepower engine and travels at four miles an hour—approximately walking speed. With the attachments now available the tractor can be used for plowing, furrowing, disking and seeding. Other attachments are being developed to convert the small tractor into a lawn mower or snowplow.

Radio Beam Guides Builders

Radio beams are guiding construction of the world's longest overhead power line on a straight path 600 miles long. Scheduled to be completed by 1950 at a cost of \$20,000,000, the line extends from northernmost Sweden to Hallsberg in the central section. Three thousand hollow 10-ton steel pylons will support the wires.

Automatic Washer Has Separate Units To Wash and Rinse

Separate washing and rinsing compartments in a new-type automatic washing machine permit full use of hot soapy water, thus conserving time, work, soap and water. The rinser floats away loosened dirt and graying particles of soap fat in a shower bath of clean water. The rinsing operation is performed in five steps and takes only three minutes. (1) Clothes travel through suds-extracting rolls; (2) then through penetrating sprays of fresh water; (3) a floating cylinder carries clothes into final rinsing stage; (4) cylinder dips, rinses and flexes clothes while submerged in water; (5) clothes pass through damp-drying rolls and drop into basket.

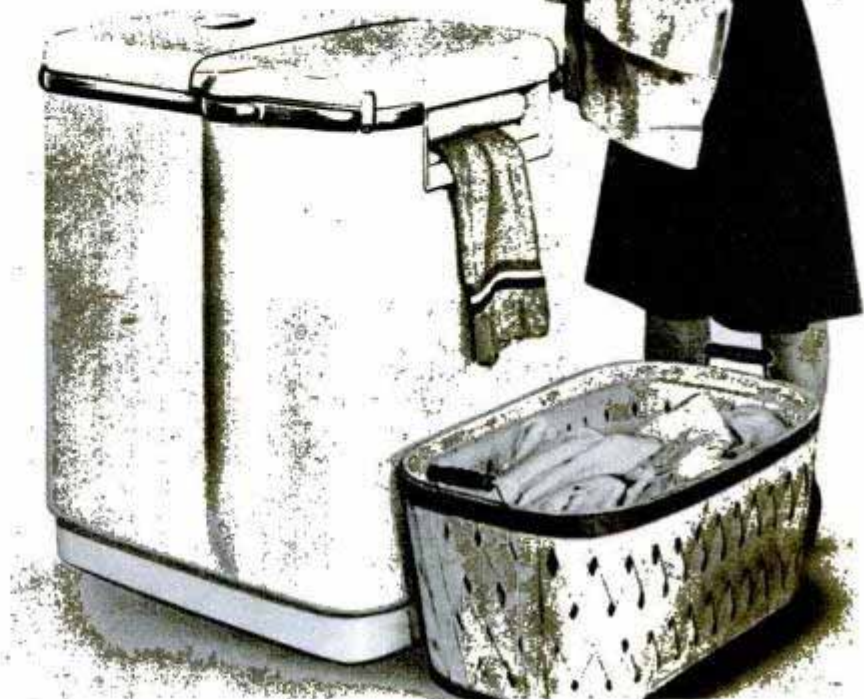

Minnows Ride "Elevator" In Bait Bucket

Minnows are brought to the surface of a floating bait bucket by an "elevator" tray that rises whenever the cover is removed. The bucket, made of Fiberglas impregnated with resin, is a double-cylinder, six-quart container. When it is placed in the water, the inner receptacle is flooded through perforations near the top, creating an air lock above the perforations to keep the bucket upright. Inside the inner cylinder is a sliding tray connected by Nylon cord with the lid. Lifting the lid raises the tray to the top of the bucket where the fisherman can pick up a minnow without searching for it. The bucket will not rust or corrode when used in salt water, according to the manufacturer.

⌘ Aircraft propeller blades could be "pressed out" at a rate of 80 an hour by a huge 30,000-ton hydraulic press discovered in Germany by postwar investigators.



By slicing through a paper-wasps' nest the photographer has bared the layers of paper walls and floors. His flash gun is plugged into a portable battery unit

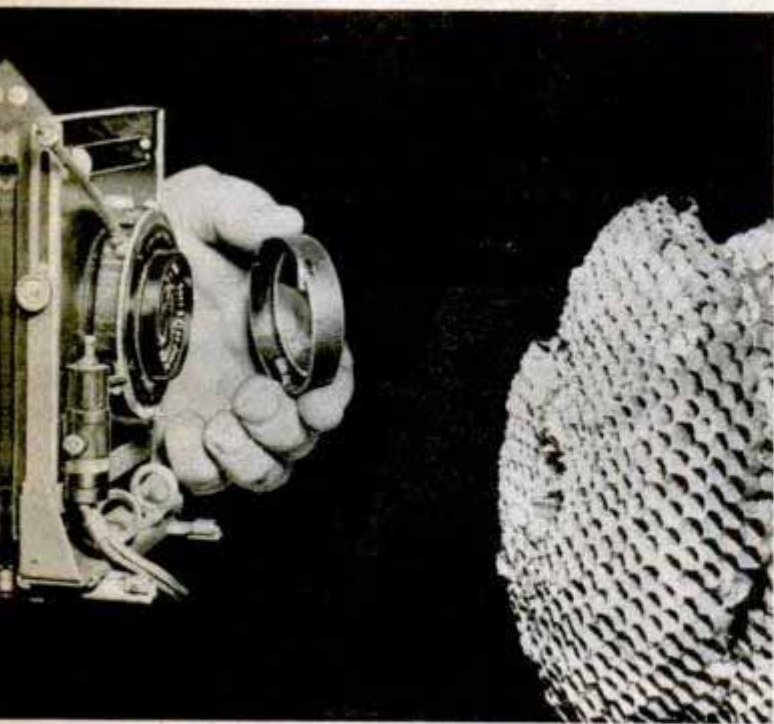

When photographing an extreme close-up Chace uses an enlarging lens over the camera lens. Here he prepares for an enlarged shot of the cells of the wasps' nest. Such shots always should be made from a tripod

Industrial Photographer of the **INSECT WORLD**

TO THE PHOTOGRAPHER seeking a new field of exploration there's always an exciting picture to be discovered in the insect world.

Exposing the working habits and private lives of weird bugs is like visiting a different planet. You'll find that insects are as businesslike in their jobs as we humans—and much more efficient in many cases.

Insects manufacture paper, spin silk, mix wax, carve wood and tailor their own clothing. The female horntail carries her home workshop with her wherever she goes; part

Insect Engineers

CLIFF DWELLERS

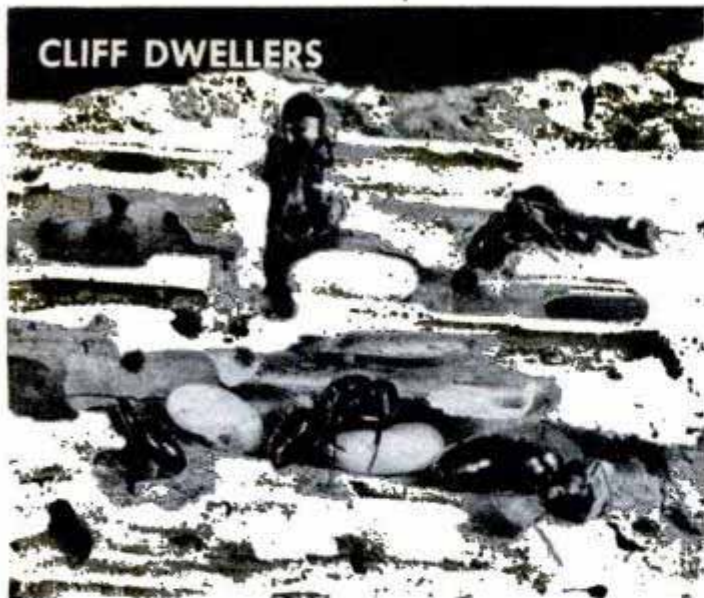

Carpenter ants, among Nature's finest wood carvers, cut their homes in logs with their sharp mandibles

of her job as a housewife is drilling wood.

These creatures have been doing the same tasks for millions of years—man was just a cave dweller long after they'd developed their working habits. Yet few photographers have investigated the wonderful opportunity for shots of insects at work.

Before you can start a camera adventure photographing insect industries you'll need the proper equipment. Mine is tailored to my needs and has been satisfactory for taking many such shots.

My camera is a 4 by 5 Speed Graphic, although any camera with a good bellows extension and a ground glass for focusing can be used. Both of these features are important, as the bellows extension is re-

By Lynwood M. Chace

Photos by the Author

quired for extreme close-up work and the ground glass makes possible clean-cut negatives. My lens is a Carl Zeiss Tessar f:4.5, but a good lens of slower speed will be satisfactory for most purposes.

For lighting I use an Everflash with a speed of 1/10,000 second. With it I can stop all motion, which helps when I'm trying to snap these quick-moving subjects. In extreme close-ups with the camera less than six inches from the subject I stop down my lens diaphragm to f:32, which gives the photo great depth of focus. But a high-speed flash isn't essential, as you can get fine results with any type of flash. Before I had a portable speed-flash I snapped pictures with nothing but a mirror for light. Even in woods you usually can find sunlight filtering through the trees which can be reflected to spotlight the subject.

AUGUST 1947

SILK SPINNER

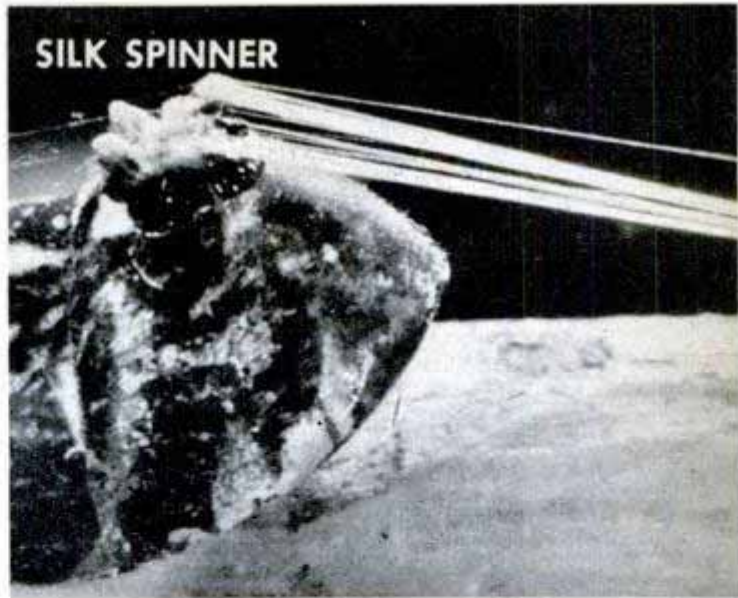

From the spinneret of the spider come fine strands of silk. The "fingers" control the thread's thickness

SUSPENSION BRIDGE

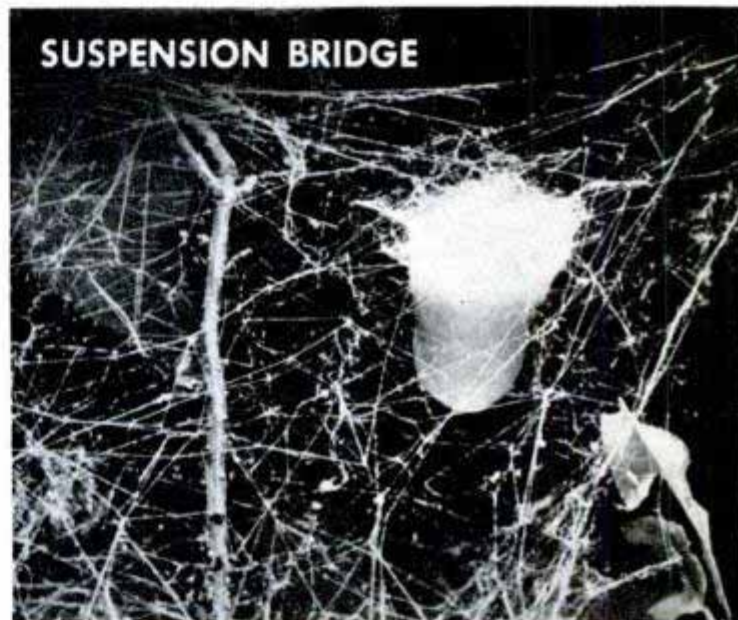

Thousands of silk guy lines support a spider's egg sac. The reinforced web will withstand strong winds

↓ Mud molded into shape becomes potter-wasp's home

ADOBE HUT

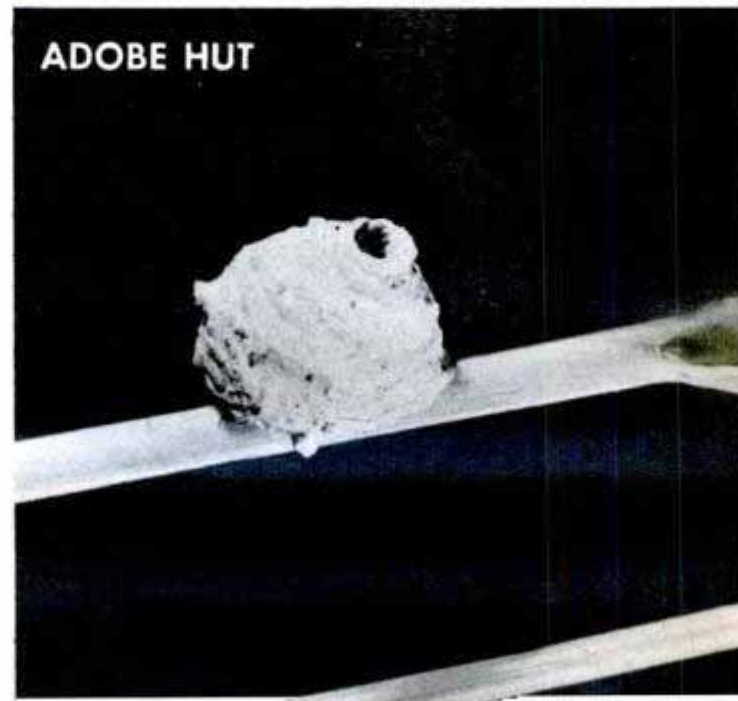



When the photographer cut away the side of a honeycomb he found young bees still in undeveloped state
 ↓ Sparkling dewdrops are supported by a spider web

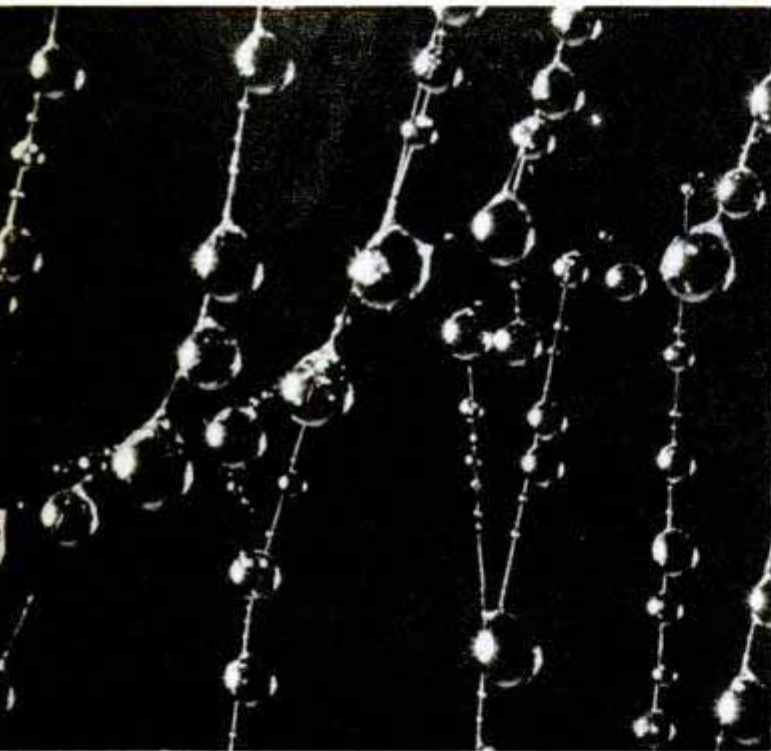

↓ Self-tailored coat! Caddis fly larva cuts sections of water grass and sews them into garment with thread

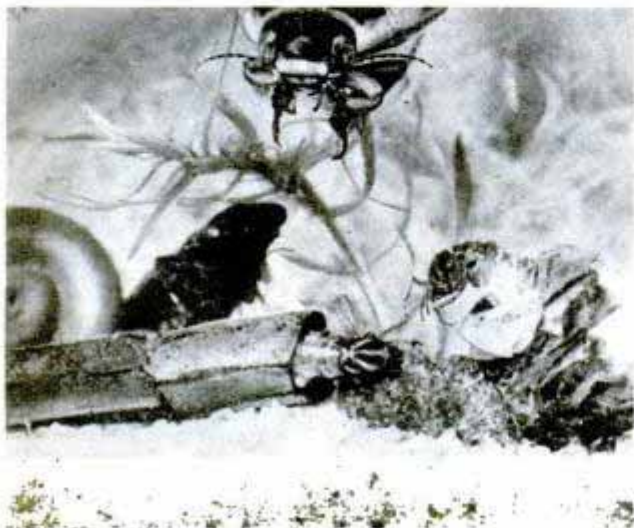

Fast film is best especially if a time exposure is necessary, which is often the case when the lens is stopped down to insure depth of focus and nothing but sunlight is used. I always have my camera on a tripod, and check the density of light with an exposure meter except when I'm using a flash. If the photo is to be a flash shot, the exposure is determined by the distance of the camera from the subject.

Prying into the working habits of subjects as small as insects usually requires an enlarging lens. With mine I can almost fill a 4 by 5 negative with a grasshopper's head or any other tiny object.

Insects outnumber in species all the rest of the animal kingdom so you have an unlimited field for "industrial" and home-life photography. For example, why not make a pictorial history of a butterfly? Snap the various stages starting with the butterfly egg, then the caterpillar, the magic transformation into the chrysalis, and finally the butterfly cracking his way out for his second look at life.

Once I cut away the side of a paper-wasps' nest and found a wonderful opportunity for "construction" shots which helped me in a photographic story on insect industries. No human works any harder than a wasp in building a home. First the wasp finds an old log that's dry and suitable for use as a building material. With his sharp mandibles he cuts thin strips of wood which he puts through his self-contained pulverizing machine, chewing the dry wood into a pulp and adding juices produced from glands in the mouth. When the paper pulp is just the right consistency he applies layer after layer, checking each layer for proper thickness. The dried pulp is a strong paperlike material which will withstand almost any kind of weather. The wasps divide the interior of their nests into tiers of cells in which they rear their

Female horntail carries her own workshop. With her drill she bores into wood and deposits her eggs inside

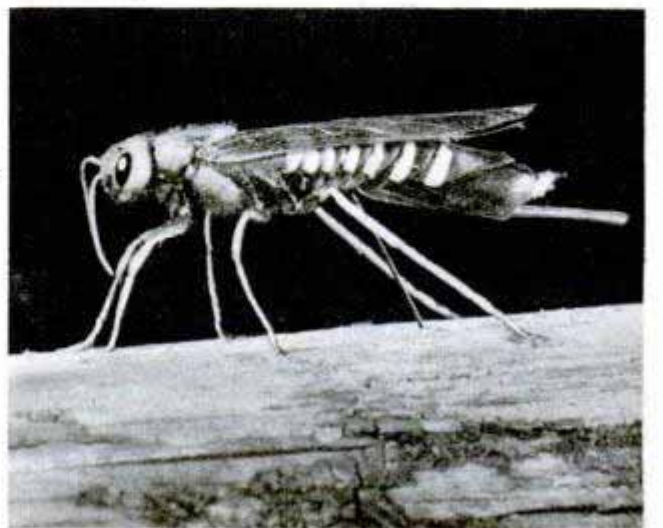

young. Frontier hunters often used this paper as wadding in their muzzle-loaders, preferring it to man-made materials.

For another picture story I decided to expose the craftsmanship of the golden garden spider. The spider is a skillful manufacturer of silk, turning out strands that are stronger than steel, weight for weight. By using my enlarging lens I photographed a bold close-up of the silk coming from the spider's spinning wheel, his "spinneret." A fine spotlight behind the subject brought out the silk strands in detail. Back-lighting is important in such shots, as the silken strands could not be seen plainly otherwise.

The horntail is a fascinating subject for industry photos. The female has a drill which she uses to bore holes in logs. In the hole she deposits her eggs. For a close-up of her drilling technique I extended my camera bellows full length and used no enlarging lens. The high-speed flash was 12 inches from the subject and the photo snapped at 1/10,000 second at stop f:32.

Millions of years before man started covering his body with skins the caddis fly larva was tailoring his own clothing. Here's an opportunity for both an industrial shot and a fashion photo. The larva cuts sections of grass with his mandibles and sews them together with a silken thread he produces. When the new cloak is finished the larva crawls inside the grass garment and walks away.

The carpenter ant is one of Nature's finest wood carvers, tunneling his way into wood with his sharp mandibles. Once I cut away an old log to take some shots of the ants at work inside their homes. One photo I prize shows the ants industriously lifting and carrying around the cocoons in which their young are developing. For this shot I used the high-speed flash. Incidentally, my unit has a six-pound portable battery which makes it ideal for field work.

As a construction expert the potter wasp is hard to beat. He builds his unusual home out of mud and the finished nest looks like a rare piece of pottery. For convenience and a sharper shot I took the nest to my studio and photographed it with a spotlight against a black background.

Honey bees are continually on the buzz making wax from honey. They eat the honey, then manufacture it into wax which is projected from their body under scales on the abdomen. They build the scales into a honeycomb which is used as a storehouse for honey and a home for their young.

With a little study and ingenuity you can find countless other insect industries that can be photographed. Exploring the insect world with a camera is exciting and you'll find your horizons limited only by your own imagination.



Fine craftsmanship goes into paper-wasps' home. Here a wasp applies the paper it manufactured from wood

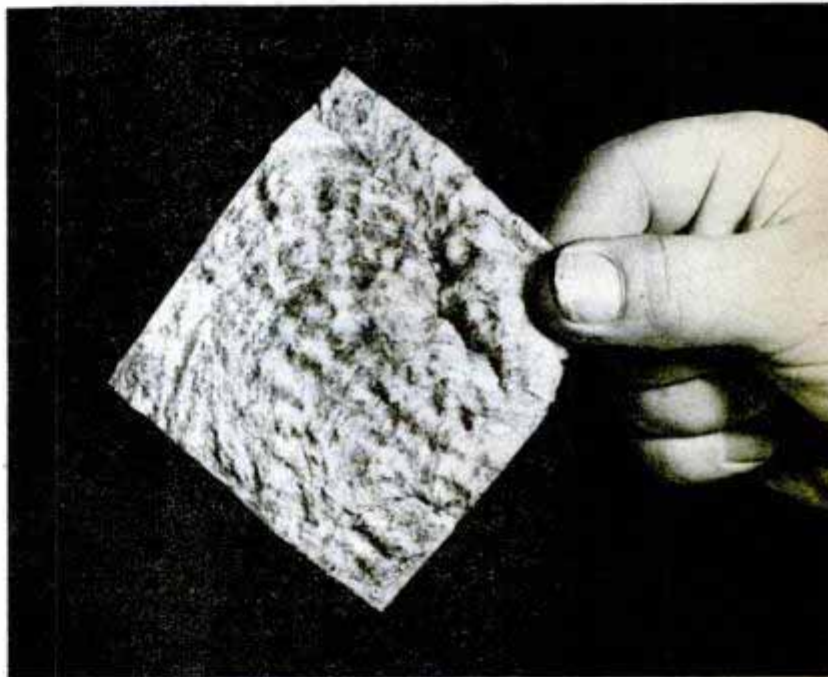

Paperlike material will withstand almost any weather

↓ Individual cells in the nest are capped with fine white paper. All other sections of the nest are gray

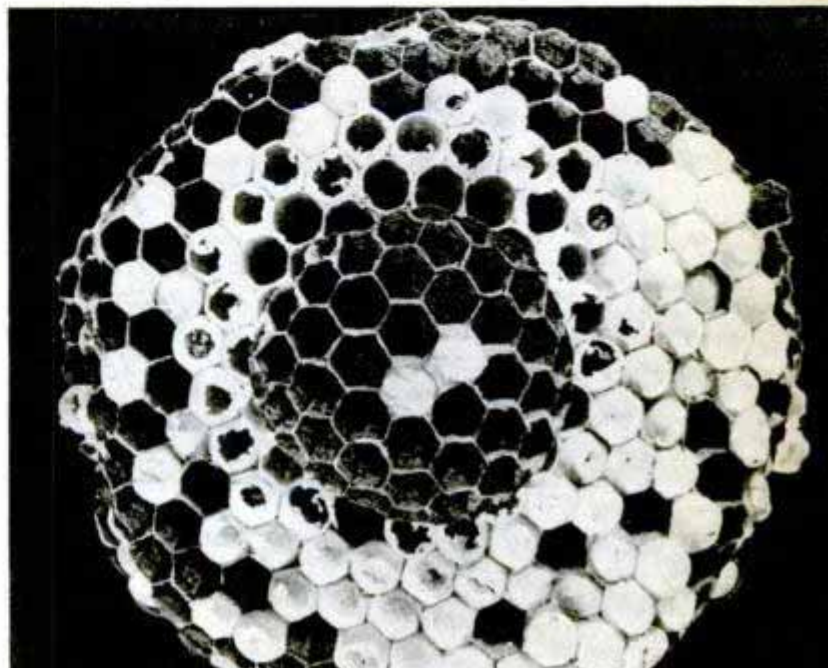

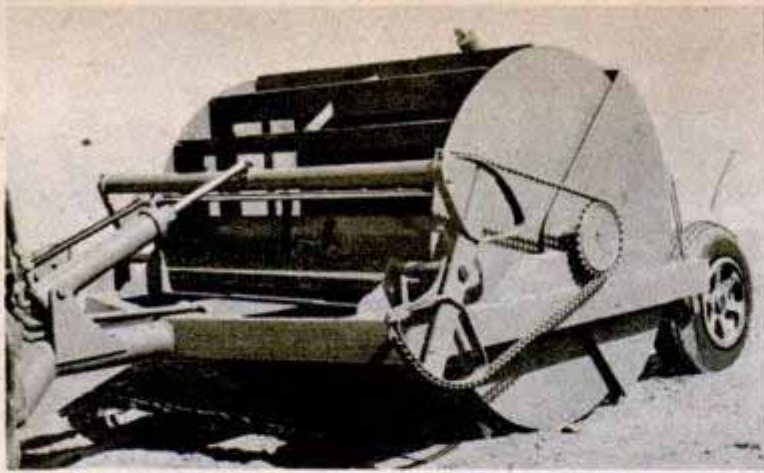

Fins Moving Dirt Triple Scraper's Efficiency

Power used to force earth into a scraper is saved in a unit with rotating fins that help carry the dirt away from the scraper blade to a container. It works a space three yards wide with a 12-horsepower engine now used on one-yard scrapers. Little more power is required to load the unit than is needed to pull it when fully loaded. The machine has an open-top cylindrical container and at either end, but not attached

to it, is a disk with 16 fins running parallel to the container. A hood over the rear starts at the cylinder opening and extends down to the scraper blade. As the earth is cut it is moved away from the blade by the rotating fins, traveling between the cylinder and hood, and dropped into the container. When working over grassy land the fins gouge the soil and loosen it for the scraper blade.

Heat-Sealed Packages Hold Food for Home Freezing



Fresh foods to be frozen for storage in lockers can be packaged conveniently in airtight Cellophane bags that fit inside waxed cardboard cartons. The packages are available in pint and quart sizes, folded flat for storage. When squeezed on the folds they spread into a box shape with the Cellophane bag in place. After the bag is filled, the top is heat-sealed with a curling iron or an electric iron. The contents of the carton can be identified through a window in the side of the package. The packages are available in quantities of 50 or in a kit that includes both pint and quart sizes, 100 feet of Cellophane, 50 feet of gauze for wrapping meats, and large Cellophane bags for miscellaneous storage.

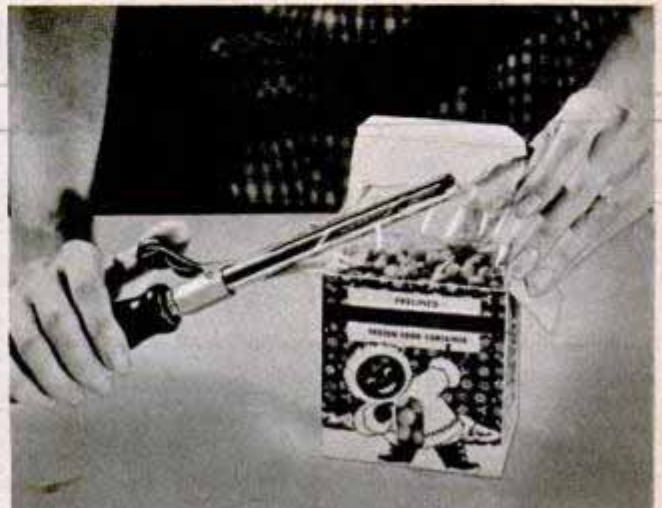

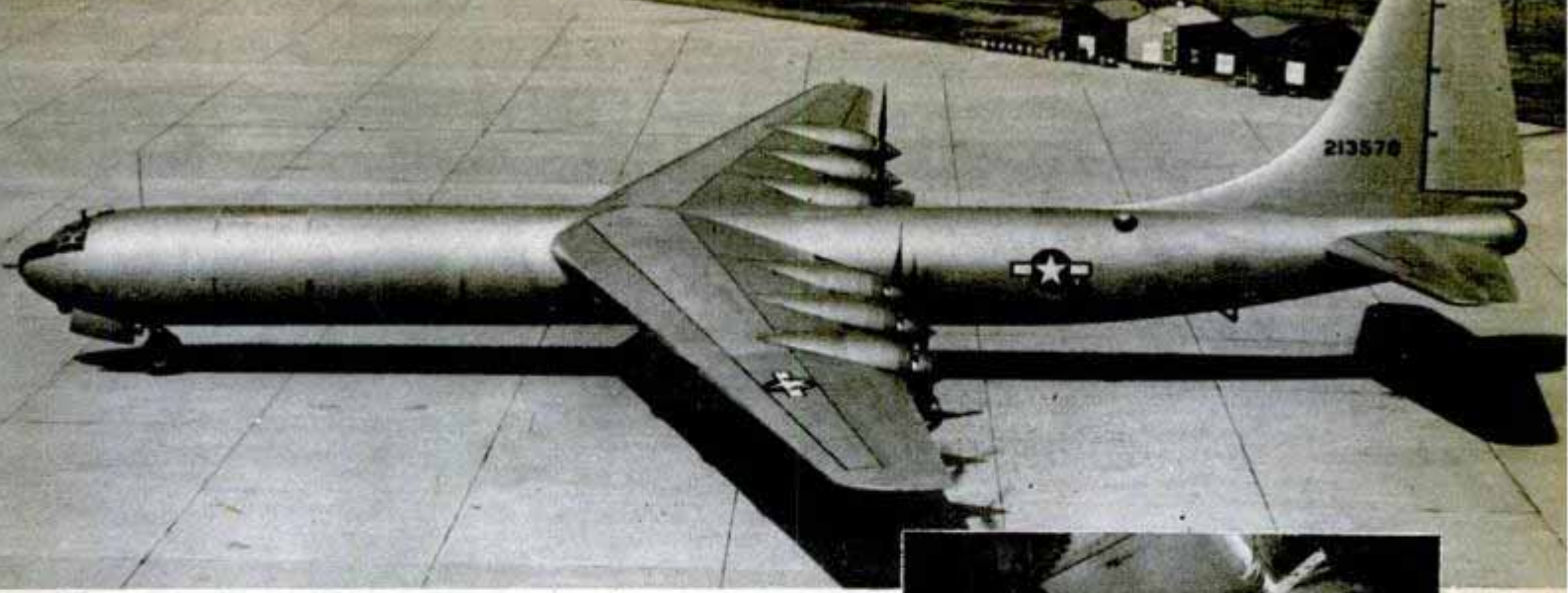

ARMY'S B-36 BOMBER

So big you have to ride a "railroad" from tail to cockpit, describing the B-36 requires generous use of superlatives. The fuselage of the world's largest bomber has cubic space equal to 10 large-size living rooms. It has lifted 139 tons. Crewmen stretch out on a four-wheel scooter and use an overhead trolley to pull themselves through the 85-foot tunnel

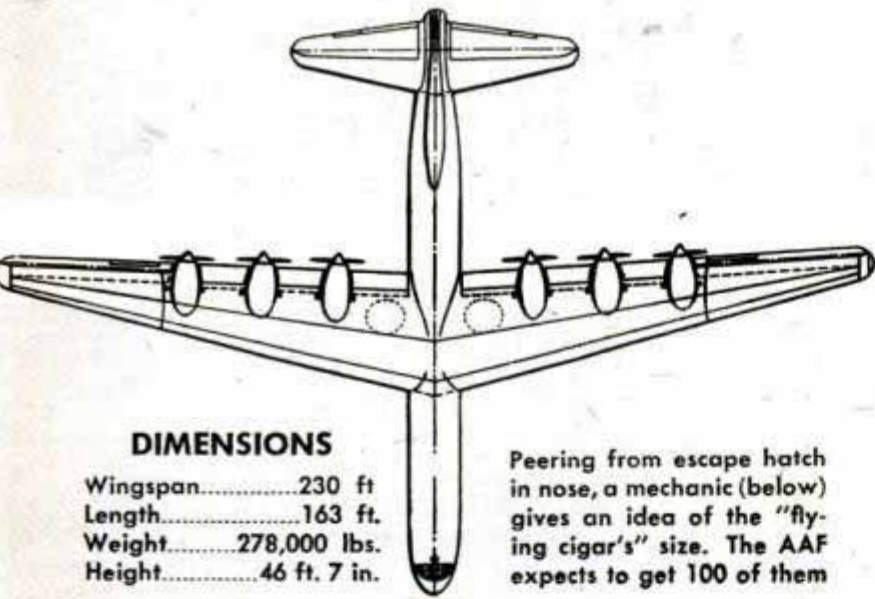

DIMENSIONS

Wingspan.....230 ft
 Length.....163 ft.
 Weight.....278,000 lbs.
 Height.....46 ft. 7 in.

Peering from escape hatch in nose, a mechanic (below) gives an idea of the "flying cigar's" size. The AAF expects to get 100 of them

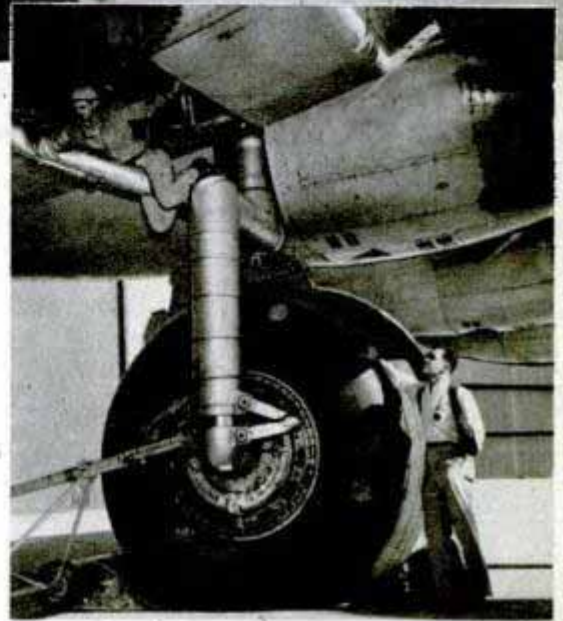

Inner tubes alone for these nine-foot-tall tires weigh 200 pounds. Below, tunnel scooter

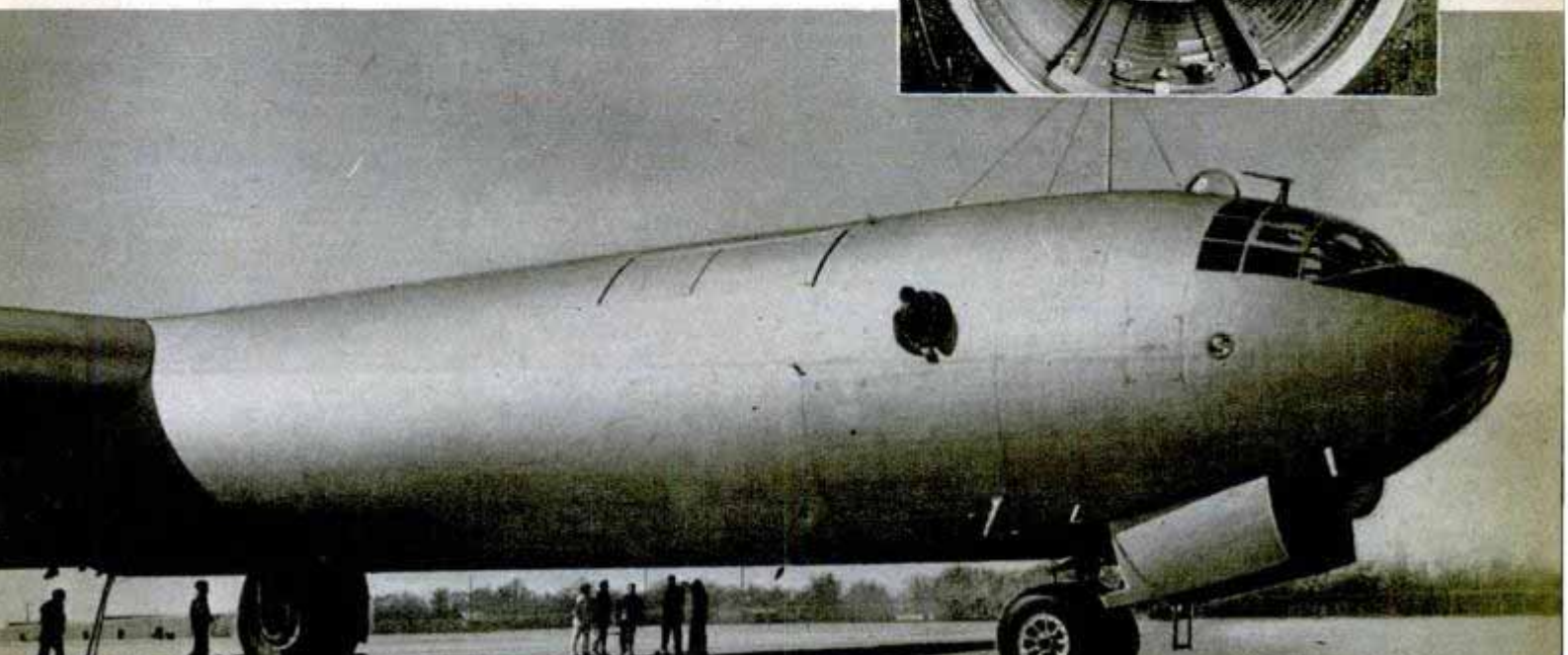
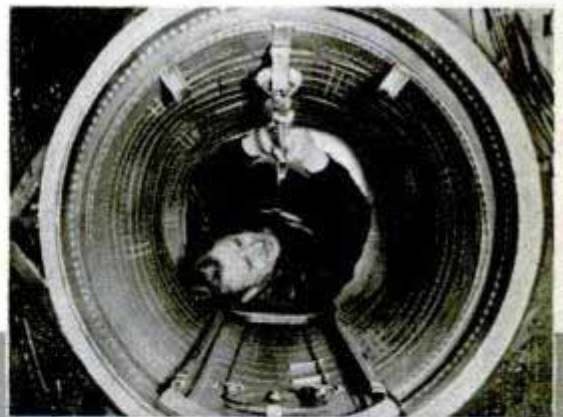

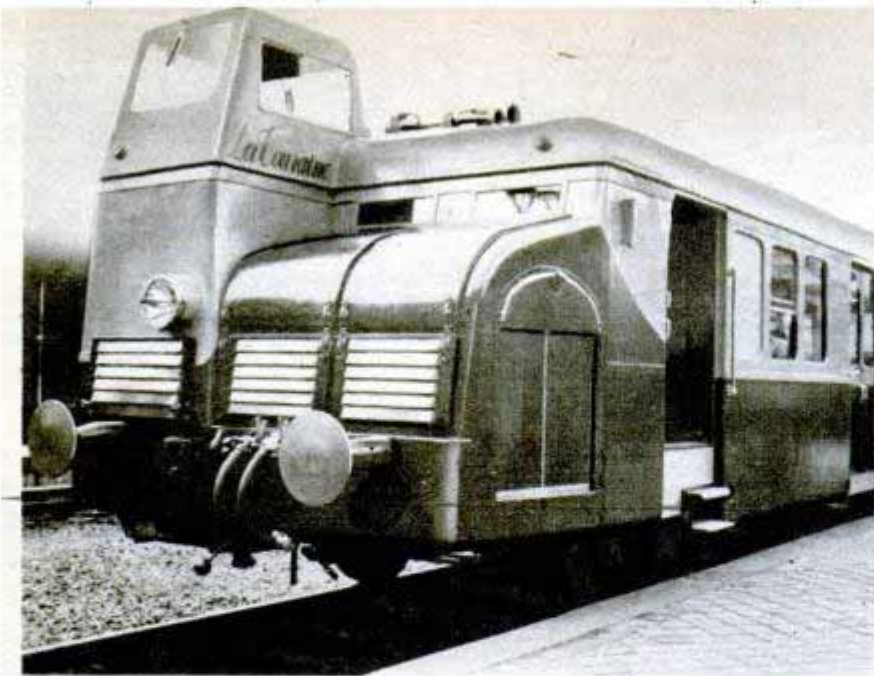

STREAMLINERS ABROAD

Postwar trains now rolling across several foreign countries are unique in appearance as well as motive power. French commuters are riding a train pulled by a locomotive with an automobile-type clutch. On the right side of the engine is a high tower that serves as the engineer's cab. In England, commuters on a short run are traveling in two luxurious self-powered coaches that were built for the Peruvian Central Railway. The coaches are being tested in England prior to shipment to Peru. Built to operate on a line that runs from sea level to 15,000 feet in the Andes, they have a powerful Diesel unit in the front end. Since

↑ French train with automobile-type clutch has a high cab for the engineer
↓ Coaches on train built for Peruvian railway have their own power unit

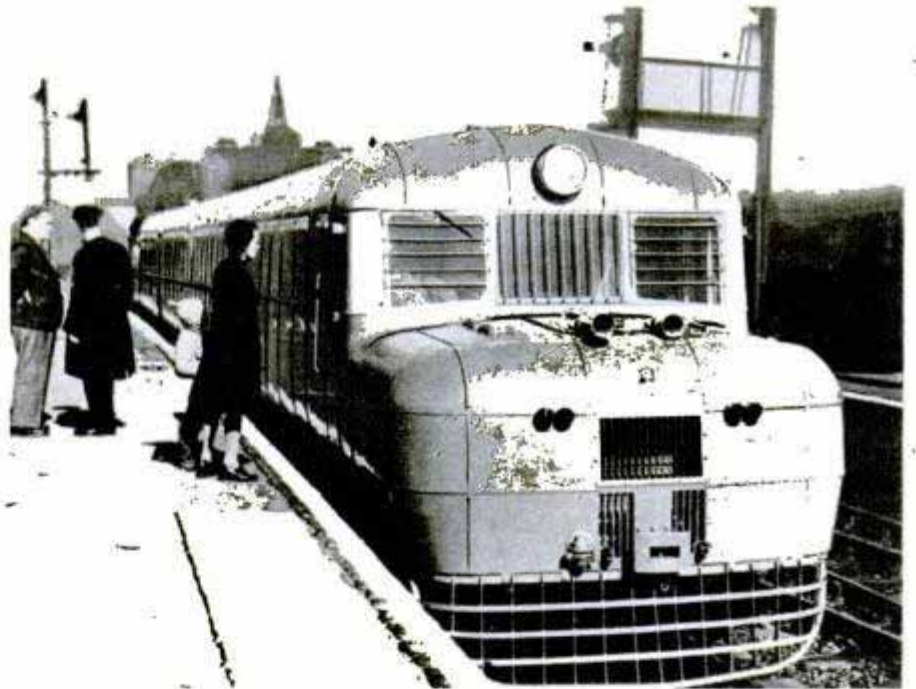

the war Peru has ordered six additional trains of the same type and Colombia has ordered five more-powerful versions.



Nondrip Rim

Less paint spills and drips over the side of cans when a lightweight metal rim is used as an extension of the top. The rim is jointed and flexible. It can be attached to any pint or quart can.

Many of the products described in this issue are already available or are ready to be marketed. If you want to know the name of the manufacturer or distributor, just write to Bureau of Information, Popular Mechanics, 200 E. Ontario St., Chicago 11



U. S. Bureau of Reclamation photos

Shasta Dam, shown here from 5000 feet altitude, harnesses turbulent flood waters to irrigate thirsty soil during the dry season

TEACHING OLD RIVERS NEW TRICKS

By J. A. KRUG
Secretary of the Interior

AN OLD RIVER can learn new tricks when it is taught by the reclamation engineers of the Interior Department.

The Department's 44-year-old Bureau of Reclamation is using river-taming techniques that have revolutionized the 4000-year-old science of irrigation.

The Colorado, the Columbia, the Sacramento, and the Missouri, which for centuries ran wild and free are now being leashed and put to work by monumental dams and hydroelectric plants. They are

being trained to fetch and carry and thus lighten the labors of many men.

These are not the only American rivers that will be taught to work for man. Almost 40 river basins or sub-basins are included in reclamation plans for full conservation and development of the water resources of the West.

To understand the great need for river regulation, we must look at a weather map of the United States. One third of the land area of the nation lies in a zone where rain-

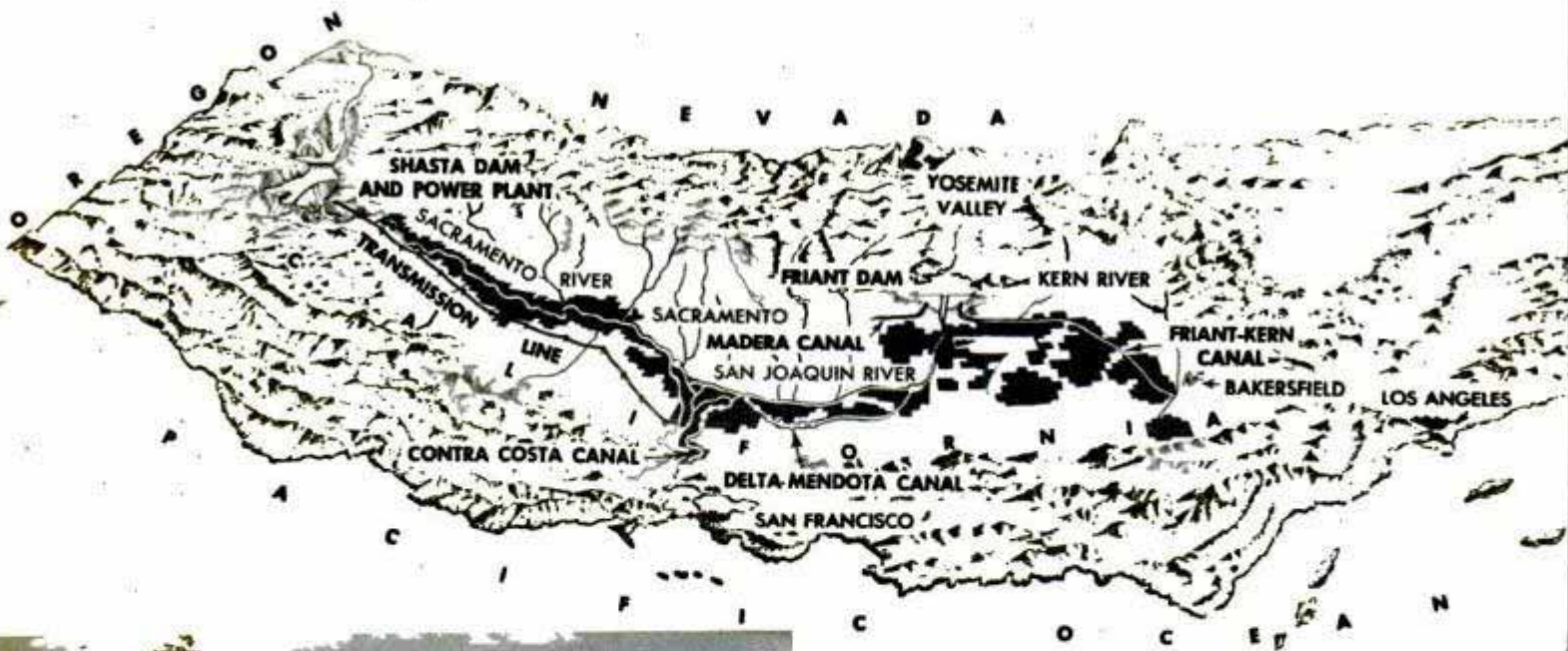

↑ Central Valley project will transform the desert heart of California into millions of acres of farms

← Near Fresno, once-useless lands now are irrigated to provide vast vineyards that stretch to the horizon

Reclamation Act. It provided for conservation and use of the water resources of the West on a scale theretofore impossible.

From projects providing only irrigation and flood-control benefits at the beginning of the century the Bureau of Reclamation has progressed to full-size river-resource-development programs. These include multiple-purpose projects, such as Central Valley in California, which provide irrigation and flood control as well as hydroelectric power development, silt retention, navigation, repulsion of salt-water intrusion and domestic water supply.

The Colorado, the Columbia, the Sacramento-San Joaquin reclamation projects already include many world-famous engineering devices for restraining these renegade rivers, harnessing their energies to serve homes and industries and sending their waters docilely on their way through canals and aqueducts to distant irrigation projects, farms and cities.

Hoover Dam, key feature of the Colorado River Basin development and highest dam in the world, celebrated a decade of accomplishments this year.

Each spring for 10 years Hoover Dam has

fall, except in the high mountains and on a narrow western coastal strip, is insufficient or improperly distributed for sustained crop production. For this reason, irrigation is essential for stabilized agriculture.

Early in our national history, western leaders realized that if the water that wasted into the sea were diverted to their arid but fertile soil, they could turn much of the desert wastelands into prosperous farm lands.

These men, however, had neither funds nor skills to construct vast engineering projects. After the limits of community effort and private capital had been reached in the construction of irrigation facilities, the West appealed to the federal government for help, and in 1902 Congress passed the

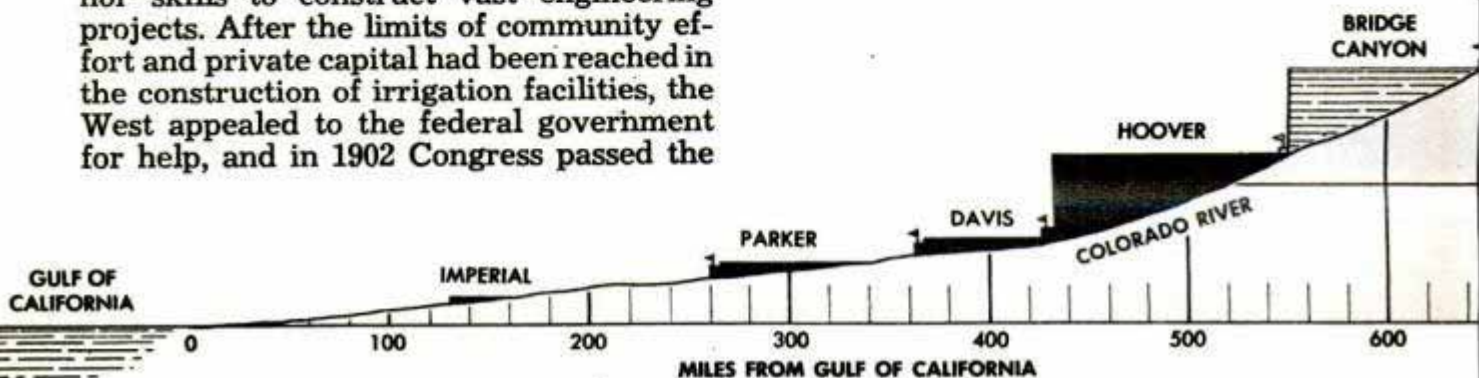

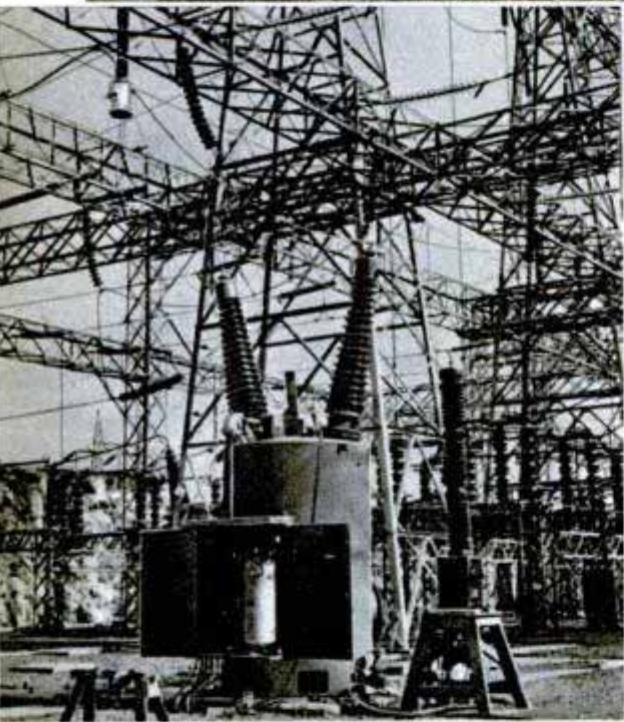
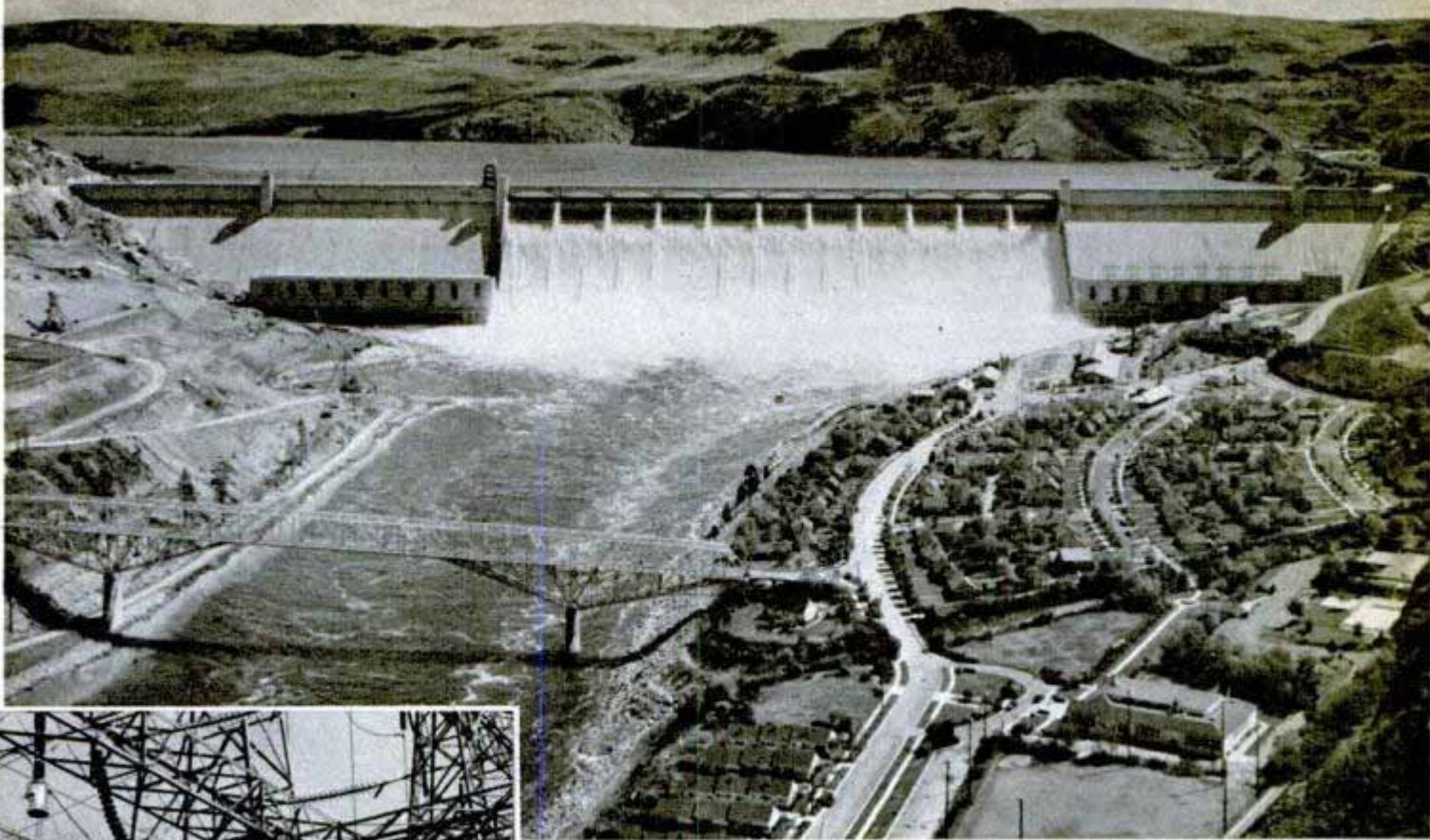

Grand Coulee, largest concrete dam, is cornerstone of the Columbia Basin project. Left, circuit breaker prevents lightning damage to power system. Below, Colorado River profile shows stair steps with the present dams in solid black and proposed dams shaded

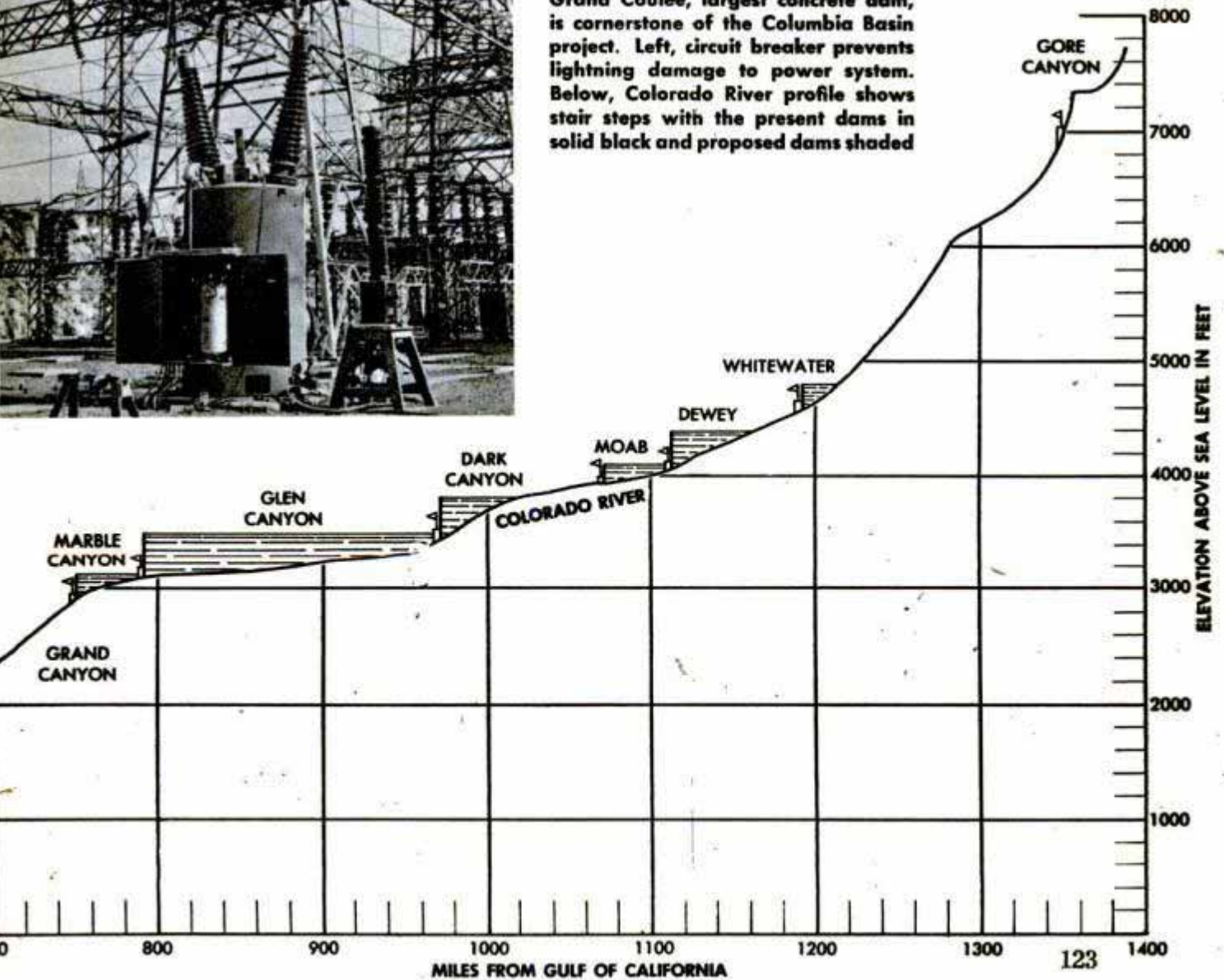

stored flood waters in its great reservoir—Lake Mead—and released these waters during late summer and fall to quench the thirst of irrigated lands downstream.

At present, about 500,000 acres of land in the Imperial Valley, (Calif.) are being irrigated with Colorado River water. Construction of a canal, 145 miles long, to bring water to 75,000 acres in the Coachella Valley (Calif.) is well under way. Other projects, such as the Yuma and Gila (Ariz.) are furnished an assured water supply. The several municipalities included in the Met-

ropolitan Water District of California also draw upon water stored in Hoover Dam's reservoir.

Hoover Dam's other role, however, is that of power producer for the Southwest. In 10 years, it has turned out more than 37,000,000,000 kilowatt-hours of electric energy which represent a gross value of \$57,000,000.

The first of the Colorado River Basin developments was Hoover Dam. Parker and Imperial Dams have already joined forces with Hoover. Soon Davis will take its place

AVERAGE ANNUAL PRECIPITATION

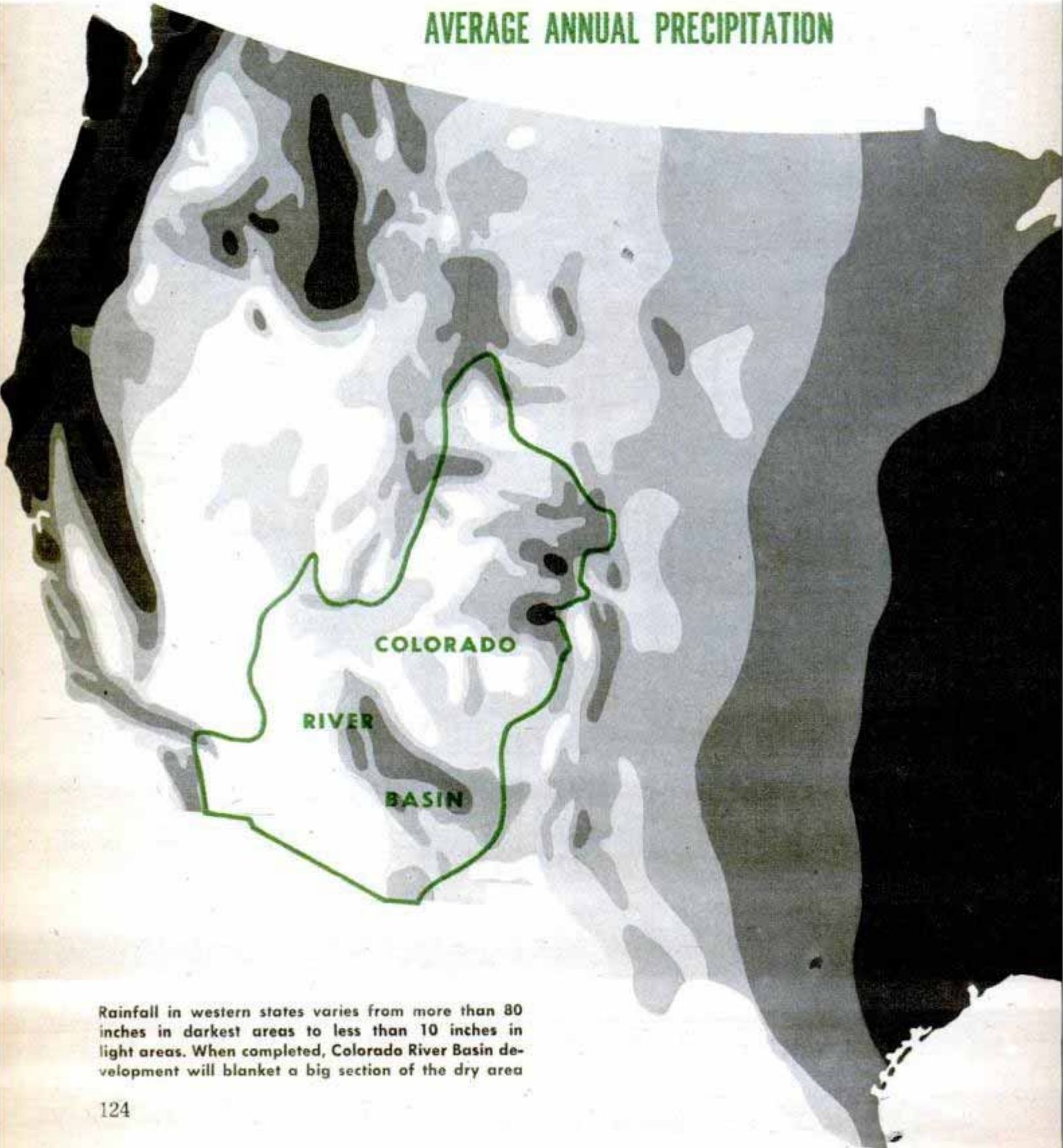

Rainfall in western states varies from more than 80 inches in darkest areas to less than 10 inches in light areas. When completed, Colorado River Basin development will blanket a big section of the dry area

Frank Hoover Dam in
 er upstream devel-
 by engineers.
 Basin report, re-
 ment of the Interior,
 es for further development
 river valley, is now in the
 the governors of the seven basin
 Out of this report should grow even
 water industrial and agricultural activity
 in this fertile area, once the report has been
 approved by the affected states, by appro-

We turn from the Colorado River Basin,
 setting of the highest dam in the world, to
 the Columbia River, site of the Grand Cou-
 lee, largest concrete dam ever built by man.
 The July 1946 issue of *Popular Mechanics*
 in an article "Garden in the Desert," by
 Thomas E. Stimson, Jr., featured the work
 of Grand Coulee Dam, foundation of the
 Columbia Basin project in the State of
 Washington.

The Bureau of Reclamation is rushing
 work on the irrigation distribution system

MAJOR DAMS AND PROPOSED MISSOURI VALLEY DAMS

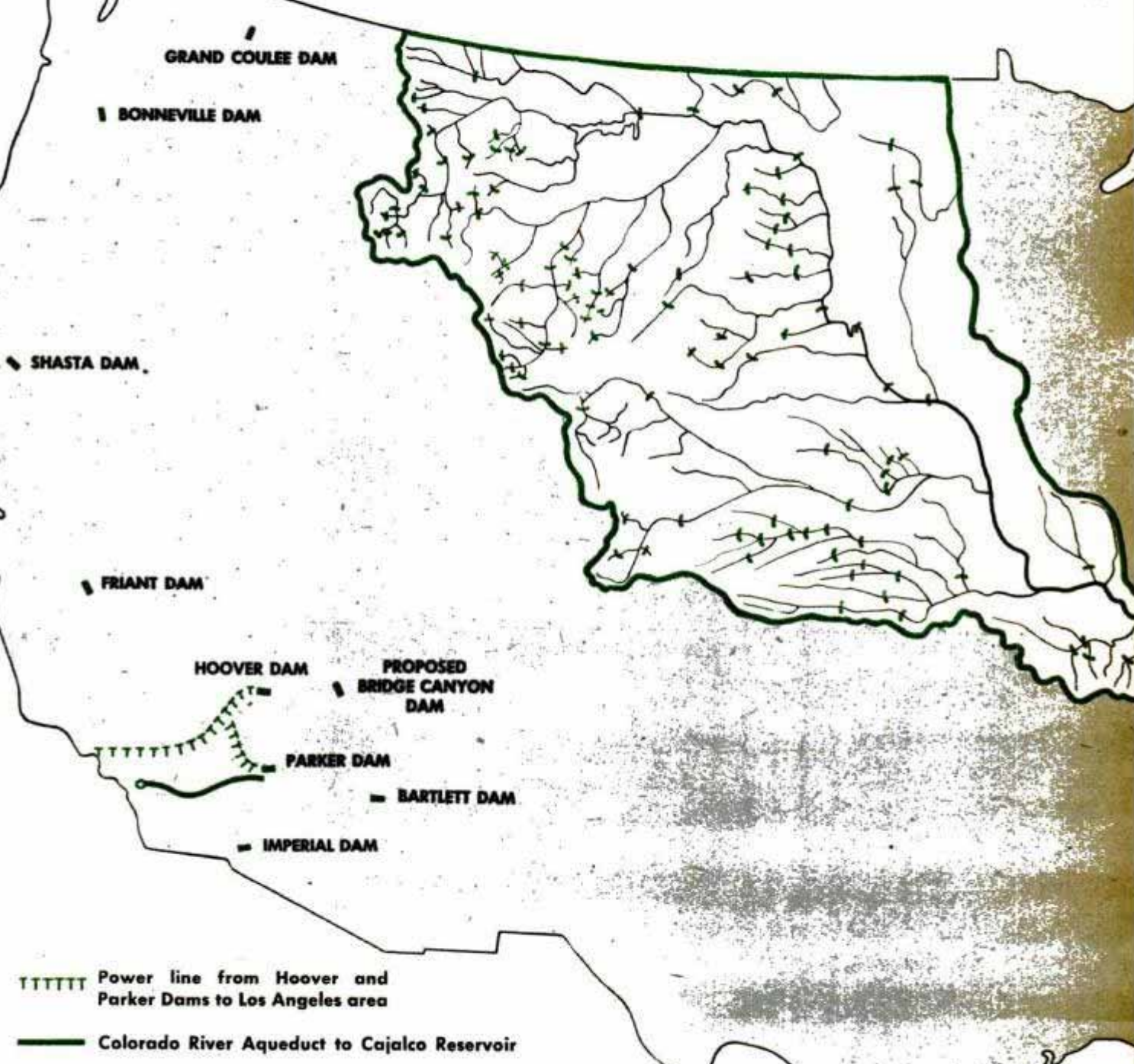



Concrete is chipped from massive generator at Grand Coulee so the power unit can be moved to Shasta Dam



↑ Workman drills concrete before removing it in blocks
↓ Power unit weighing 450 tons is lifted from temporary installation. It was loaned to Coulee during war

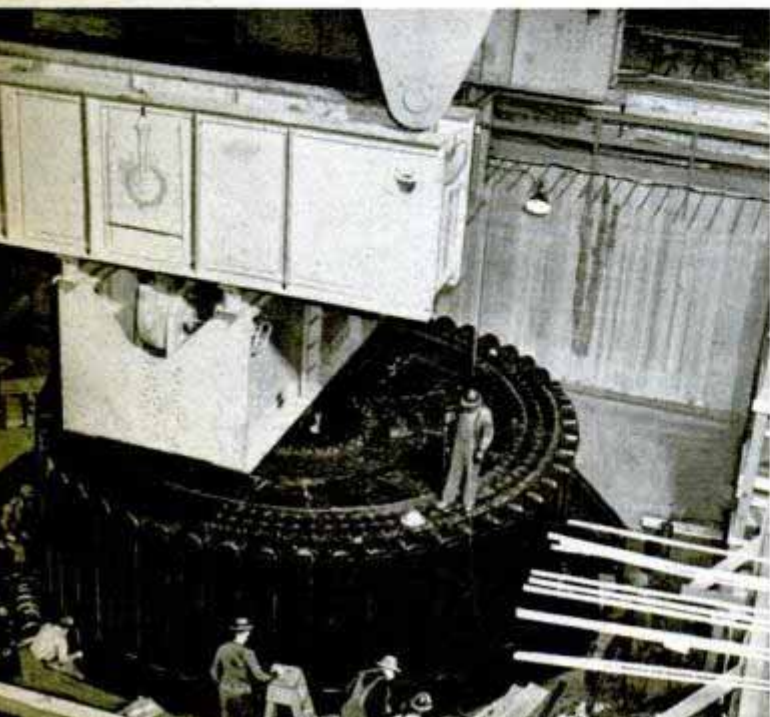

of this development so that 400,000 acres can be irrigated and made ready for settlement by 1950 or 1951. Ultimately 1,000,000 acres of land will be supplied with water from the giant dam and its smaller helpers.

Grand Coulee's power plant, which began operation during the war, is now proving its worth as a peacetime producer in the Pacific Northwest. In the five years the plant has been in operation its energy output has reached 20,000,000,000 kilowatt-hours—equal to the work performed by 1,000,000 men laboring eight hours daily every day for 79 years.

In addition to supplying energy for hundreds of industries mushrooming in the region, Grand Coulee power will be used to operate 65,000-horsepower motors to drive pumps which will provide water for the project distribution system. Each pump will be capable of lifting 12,000 gallons of water per second to a height of 270 feet. Ultimately 12 such giants will be placed in the pumping plant at Grand Coulee Dam.

A battery of six pumps will be installed initially in this plant built on a rock shelf of the canyon wall, upstream from the dam. Each pump, with its motor installation, will be approximately 50 feet high. Ten of them operating simultaneously for 19 minutes could pump the equivalent of a gallon of water for every man, woman and child in the United States.

Mammoth construction features are not the only wonders of the Columbia Basin project. Lake Roosevelt, the reservoir formed by Grand Coulee, is the West's longest lake. This 151-mile inland waterway creates at the dam site a magnificent waterfall that is a new mecca for travelers.

Reclamation engineers who designed the Columbia Basin project, where the Columbia River will flow uphill to irrigate an inland empire, have solved the problem of placing the Sacramento and San Joaquin Rivers in double harness. The San Joaquin River which normally flows north will be turned backward in its course to save an established agricultural region. Sacramento River floods during the stormy months of the year will be checked by Shasta Dam and stored for release during the dry season. Shasta Dam ranks second in size with Grand Coulee and second in height with Hoover as one of the world's largest concrete dams. Finishing touches are being given to Shasta and brother dams, Friant and Keswick, and work has been speeded on the network of canals and transmission lines needed to deliver water and power to the multimillion-acre Central Valley development.

Shasta Dam recently welcomed home two 75,000-kilowatt generators and their 103,000-horsepower turbines. While on spe-

cial detail to Grand Coulee they turned out more than 3,000,000,000 kilowatt hours of energy for war industries.

This power helped to produce plutonium for atomic bombs and also aided in making airplanes, ships, and materials for war at northwest industrial plants.

The huge generators, now installed in the plant for which they were designed, are helping to enlarge and to build more industries.

Additional power developments as well as irrigation benefits can be provided through the Central Valley Basin plan, which is an expansion of the multiple-purpose development. Some 760,000 of the valley's present 3,500,000 irrigated acres can be permanently rescued from impending water shortage, while 3,000,000 additional acres, now without water, can be irrigated.

The Sacramento, yoked with the San Joaquin, will be prevented from destroying life and property. The energy of the rivers, harnessed by great water-power plants, can provide 8,100,000,000 kilowatt-hours of energy each year for pumping irrigation water, for commercial and for domestic use. In addition, some 300,000 acre-feet of water annually can be supplied for industrial use.

In contrast to the Central Valley, the Columbia, and the Colorado, the Missouri River Basin Plan offers no world-challenging dams and power plants. The Missouri was, however, the first of the reclamation basin plans to be authorized by Congress. Features of other developments were started as projects that are now the keys for comprehensive valley developments.

Four reclamation dams, Kortes (Wyo.), Angostura (S. Dak.), Boysen (Wyo.), and Enders (Nebr.) were started this year—the first of a battery of 100 dams that will eventually master the Missouri.

The Missouri Basin, covering all or parts of 10 states, is one of the biggest resource-

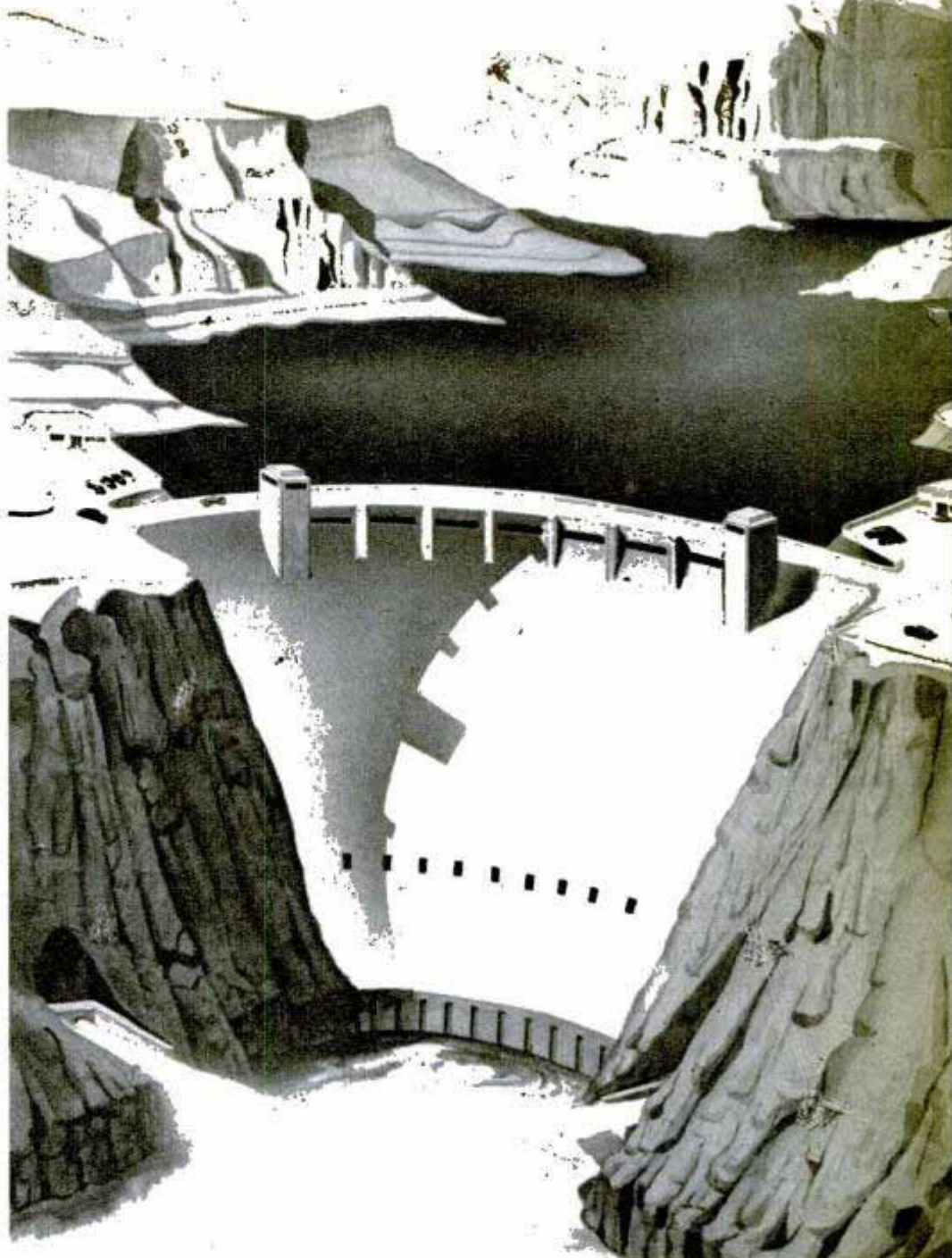

Artist's conception of mighty Bridge Canyon Dam which may be built above Hoover Dam. If built, it will be 730 feet high, 10 feet higher than Hoover

development programs ever undertaken.

Irrigation of almost 5,000,000 new acres of land, security for another 500,000 acres now inadequately irrigated, production of 5,500,000,000 kilowatt-hours of energy a year, flood prevention, domestic water supplies, improved navigation, recreational opportunities and wildlife preservation are included in the plan of the Bureau of Reclamation and the Army Corps of Engineers.

In addition to the Bureau of Reclamation, six other agencies of the Department of the Interior are cooperating on the development. They are the Bureau of Land Management, National Park Service, Fish and Wildlife Service, Indian Service, Geological Survey and Bureau of Mines.

Tamed and taught new and useful tricks, "Big Muddy" will soon join other domesticated rivers of the West.

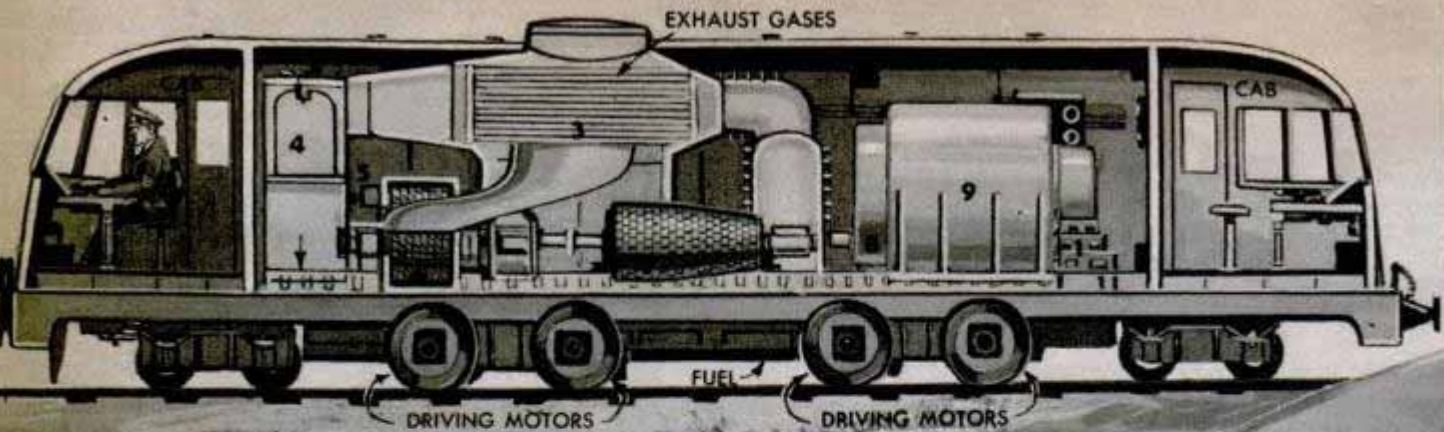

CYCLE OF OPERATION—The Diesel-electric starter (1) rotates a special compressor; the hot-wire firer (2) begins operation in the combustion chamber; air is drawn through heater (3) and then into combustion chamber (4) where it is fired with the fuel; excess air circulates around the heater chambers (5) to assist in cooling the engine; the combustion gases pass through and rotate the turbine (6), which is connected with the compressor (7) and the gears (8); the gears drive the generator (9) which supplies electric power to the driving motors located between the wheels



GAS-TURBINE LOCOMOTIVE

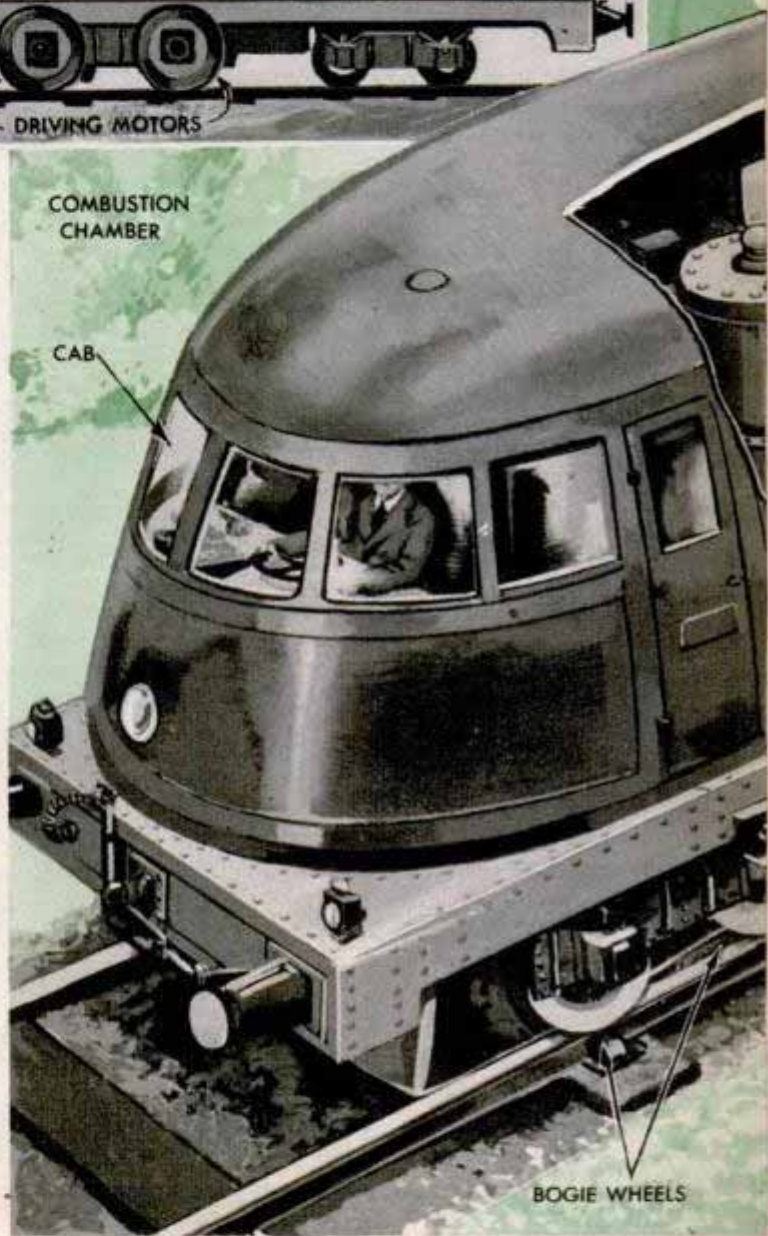

Under construction in England is a gas-turbine locomotive that is expected to develop 2500 horsepower which will be transferred to the wheels by electric motors on the axles. The experimental locomotive is being built for the Great Western Railway. It will average 80 to 90 miles an hour with relatively low fuel consumption. A smaller engine of the same type has operated successfully on the Swiss National Railways. The new gas-turbine locomotive will have many similarities to experimental locomotives being built in this country. Westinghouse is building four oil-burning gas turbines that will

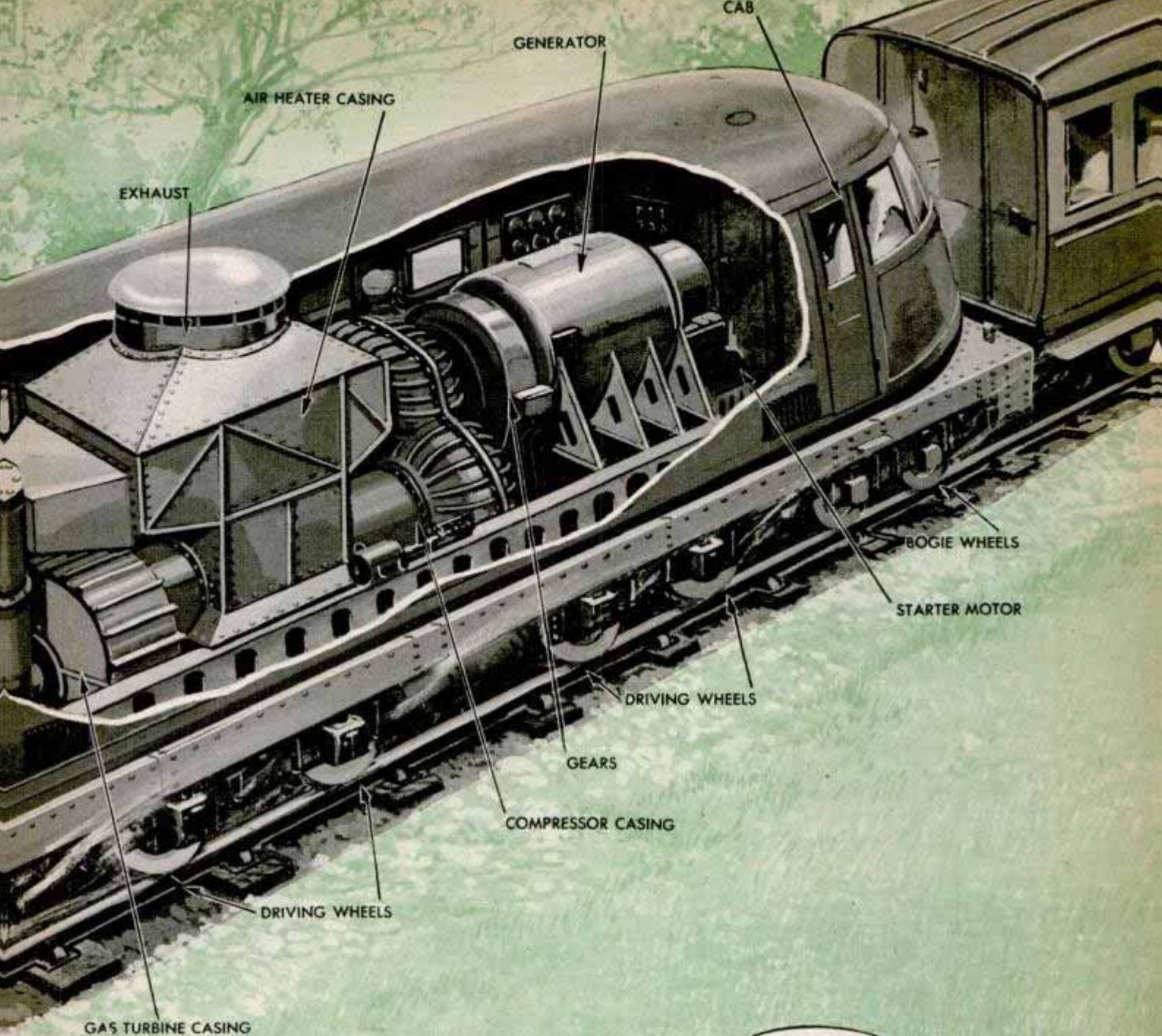

G HEAVIS
1947

drive an 8000-horsepower locomotive. The engine will be only half the size of a conventional Diesel-electric design and will have quick-starting characteristics that are impossible in old-type steam engines. Air is sucked into one end, compressed and mixed with fuel oil, then burned to bring the air temperature to 1350 degrees Fahrenheit, and finally exhausted back into the atmosphere after driving the turbine. Another revolutionary engine under development is a gas turbine that will burn coal. An atomizer pulverizes coal finer than face powder and it is then introduced into a stream of swirling air and ignited by a spark. The engine is expected to operate more economically than oil-burning locomotives.

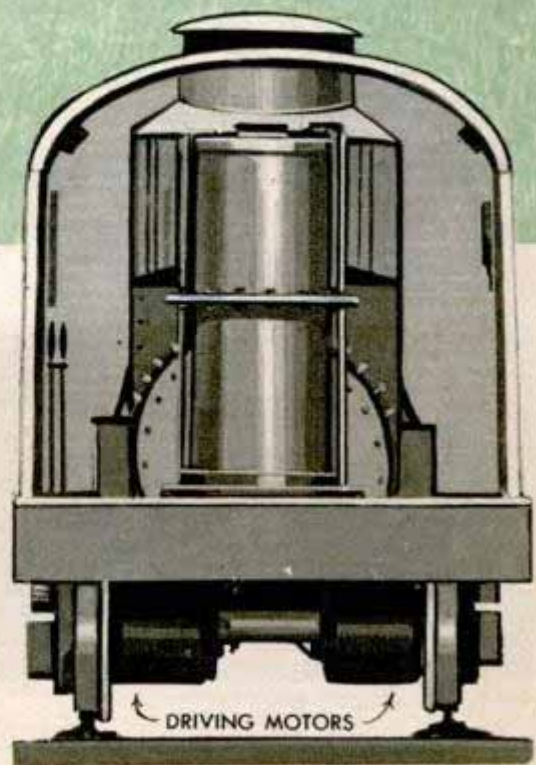



Sit-Down Barber's Chair

Tired of standing while trimming hair, Harry R. Gibson of Pueblo, Colo., rigged up a four-wheeled stool out of iron water pipe on which he mounted a bicycle seat. He also built a knee-high platform on which he can kneel if he gets tired of sitting. "No more footaches," Gibson reports.

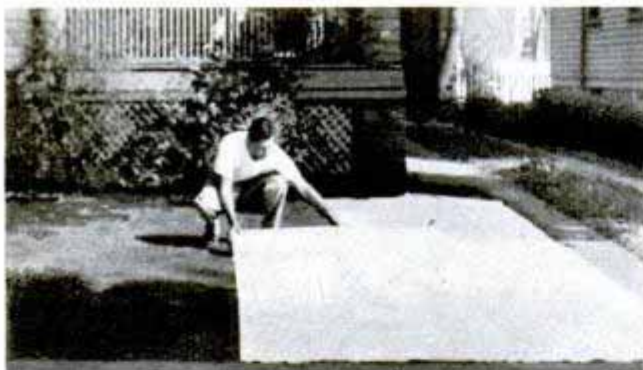

Kollsman Instrument photo

Navigator's Periscope

As a substitute for plastic astrodomes, there is now a periscopic sextant for plane navigators. A navigator was blown out of an air liner in mid-Atlantic when air pressure caused an astrodome to break. Only a small part of the periscope, 1 inch wide and 1½ inches high, is exposed through the top of the plane. The sextant is removed from its shock mounting when not in use. It boosts the speed by eliminating drag created by a protruding astrodome, and removes danger to passengers from explosive decompression.

Grass Seed "Carpet"

Grass seed now can be planted by spreading seed-impregnated sheets over a yard. The sheets, available in roll form, contain a mixture of grass seeds, fertilizer and root-stimulating hormone. Yards are spaded, raked and rolled before the seed "carpet" is applied and covered with straw. The yard is then watered. Seedlings grow up through the sheeting—cellulose wadding which disintegrates—and young roots penetrate to the soil below. The roll-type planting is particularly suitable for terraces for it prevents seed washouts during heavy rains.

Mesh fabric made of Saran plastic filled with an acetate and coated with metal provides a new material for home decoration. A thin film of aluminum is applied to one side of the mesh and finished with lacquer in both gold and silver colors. The decorative material can be stitched or cemented if the cement used does not attack acetates.



Striking Tape Cleans Type Faces

Typewriter-type faces can be cleaned by striking them against a strip of adhesive material. The strip, $\frac{1}{2}$ inch wide and $6\frac{1}{2}$ inches long, is centered on a sheet of paper and protected by gauze until used. A single cleaning space may be used repeatedly.

High-Speed Printer for Color Photos

Color enlargements are printed in mass quantities at high speed by a new printing machine. The printer has an electronic timer that simplifies the operation and gives greater uniformity to the prints. Black-and-white printing machines made by the same company are designed so that they can be converted to color printing in 15 to 20 minutes.



Plane Tie-Down Chain Is Adjustable

Instead of keeping a wide assortment of ropes and chains to tie down different kinds of planes, a flying service operator has contrived a link chain belt that is adjustable. Snaps at either end fit into eyes of sunken concrete blocks and onto the plane's wing struts. The chain can be adjusted to fit any type aircraft.

Tension Holds Cleats in Place

Sure footing on slippery surfaces is provided by slip-on cleats held in place by tension on the sides of the heel and sole. The cleats are easily attached or detached and do not mark the shoe. Devised for loggers, sportsmen and gardeners, they can be slipped into a pocket.

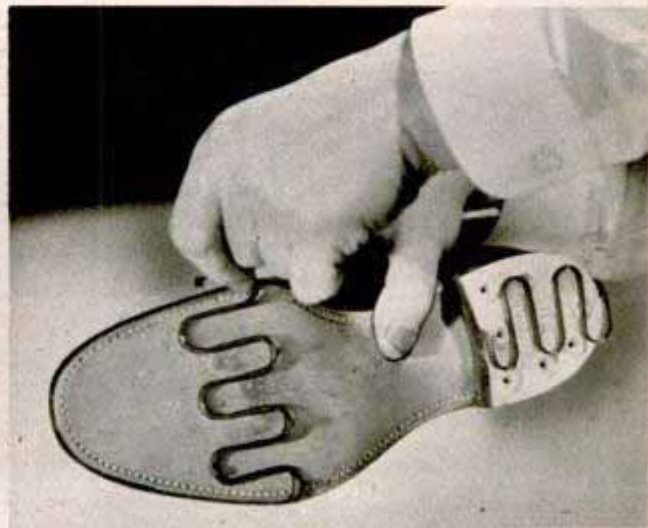

"Oh, oh, I've put on an ounce," a chimpanzee seems to say as Mrs. Helen Martini, Bronx-Zoo "mother," checks his weight



Mothering the

In her wild-animal nursery Mrs. Martini prepares special foods. "Want a banana, Chimpy?"

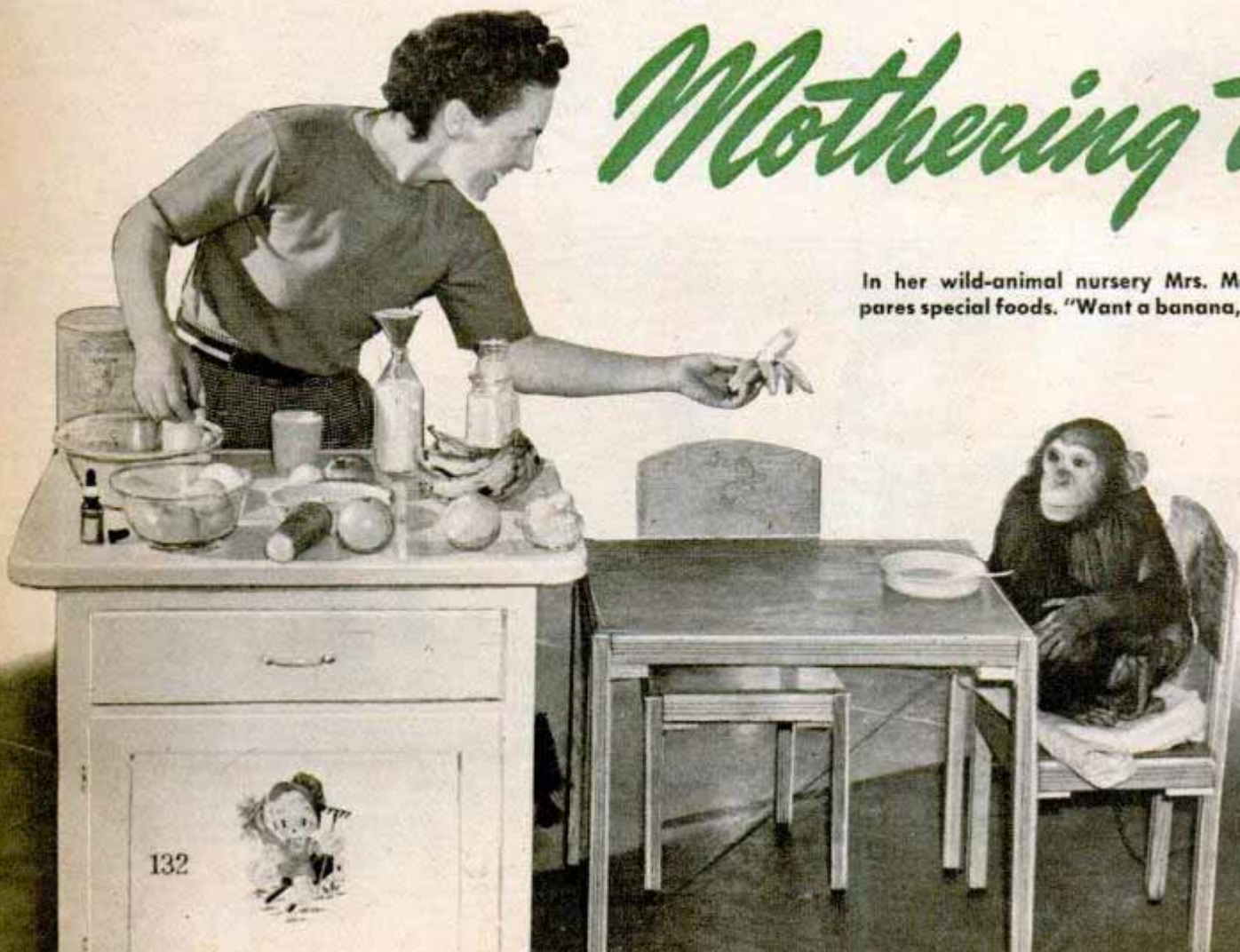

By Bill Reiche

WITH WILD ANIMALS for the zoo quoted at several dollars a pound, the business of bringing them up becomes a scientific specialty of considerable importance.

Something happens to the maternal instinct of captive wild animals and they often regard their young as unfortunate nuisances. When they refuse to bring up the infants born in New York's Bronx Zoo, it becomes the assignment of Mrs. Helen Martini, zoo "mother," to raise the babies.

It started in 1942 when a lioness refused to care for her cub, named MacArthur. Mrs. Martini's husband, Fred, was and is keeper of the lion house and the first thing the diminutive lady knew she was playing foster mother to a baby lion.

The procedure for raising lions from birth is fairly well established, since lions breed readily in captivity and all too often lionesses take the position that after they've given birth their responsibility is at an end. MacArthur grew and flourished and is a credit to his namesake.

But early in 1944 a much more serious emergency was at hand and this one was to end permanently the normal home life of the Martinis. A tigress refused to take care of her three cubs and Mrs. Martini took them home to her Bronx apartment.

No one at the Bronx Zoo—and, to the

Zoo Babies

best of the curator's knowledge, no one in the country—had ever raised a tiger. What should they be fed to be protected from pneumonia and rickets?

By a combination of hard common sense and intuition, she arrived at a successful diet. For the first two months she fed them a formula of one part evaporated milk and two parts water, heated to body temperature, every three hours. Then chopped meat and bone meal were added. But the little animals balked at cod-liver oil.

Few animals, or persons, will take straight cod-liver oil if it can be avoided. Pills are useless for animals because they chew everything they eat; forced feeding

Ring-tailed lemur perches on her shoulder as the zoo "nursemaid" cooks a bowl of cereal. Baby marmoset (center) likes fruit, vegetables and milk. Below, Arizona round-tailed squirrel nibbles sunflower seed



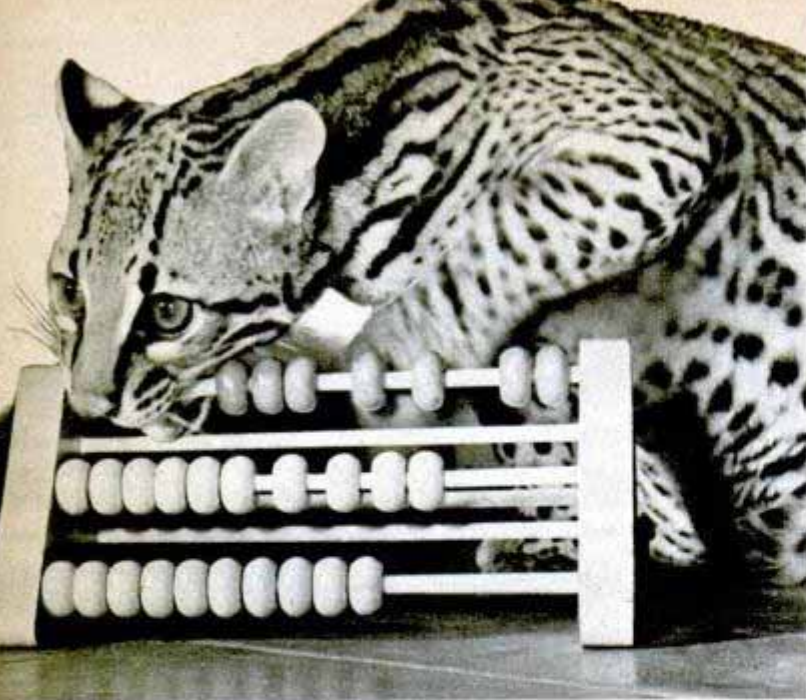

A baby ocelot from South America amuses herself by playing with the wooden beads on a youngster's toy

would arouse their antagonism and destroy their trust in their keeper.

It was then that hunger came to Mrs. Martini's aid. The fast-growing cats woke up each morning ravenous and would "wolf" down the first food they got without stopping to smell it. By putting the malodorous oil in a couple ounces of milk the baby Bengals would be digesting it before they suspected any medicinal monkey busi-

This 600-pound Royal Bengal tiger was the first animal that Mrs. Martini reared in her Bronx-Zoo nursery



ness. Today, oil is given in chopped meat.

At three months, chunks of solid meat appeared on the diet and for the first year the cubs got a daily dose of vitamin concentrate. The result is three of the biggest, healthiest and handsomest tigers ever raised anywhere—and worth \$1500 apiece.

These three practically ruined the Martinis' living room, and a pair of lions and a tiger later that year completed the job. In 1945 she moved into a former storeroom in the lion house and began a full-time career by bringing up a black leopard—one of the most vicious of creatures. Bagheera, now in his third year, is a perfect gentleman and likes to have his foster mother reach into the cage and scratch him.

Since she moved into the lion house she has raised more than 30 animals of many breeds. At the present time her nursery houses a pair of ocelots, two marmosets, a round-tail Arizona ground squirrel, a ring-tail lemur, a kangaroo rat, a chimpanzee and a hedgehog. The chief cause for concern in this group is the chimp—a lady—who is subject to respiratory complaints, but too smart to be an easy target for vitamins, via cod-liver oil.

For a day or two she had taken it readily in orange juice, heavily sugared, but the day the writer visited the zoo she had indicated quite plainly that she knew a hoax when she tasted one and would have no more of that. She also gets sun-lamp treatments to make up for the lack of sunshine.

The feeding problem is not vexing with the present roster. Most of them eat fruits and vegetables. The ocelots take the tiger diet with some fish occasionally; the marmosets have a weakness for rare steak and the lemur has a weakness for boiled potatoes—cold—and pretzels. He doesn't eat the latter, but enjoys licking the salt off.

There have been a few minor crises. When the hurricane hit New York the zoo lady sat up all night with her charges, who were undisturbed. And once she hollered for the veterinary and the curator because one tiger cub was limping, a sign of rickets. He had just been sleeping on one leg and had a kink in it.

Mrs. Martini, who also is in charge of the birdhouse, showed where she was headed early in life.

"When my mother would give me money for a pair of shoes, I would buy a bird," she relates. "When I got half a block from home I'd start to cry because I knew I'd be punished. But it never stopped me—I always had a lot of birds."

Now she is hoping for a fine, big litter of tiger cubs, from two that she raised. She points to the cod-liver oil the prospective parents have had and declares, hopefully, "I'm looking for a baker's dozen."

Winding Machine Handles 28 Coils

In 16 minutes one worker using a new winding machine can make 28,000 turns of fine wire on transformer coils. Developed by Westinghouse to speed production of fluorescent lighting units, the machine enables the operator to wind 28 coils at a time. The enameled wire, which is .028 inch in diameter, travels from overhead spools through pulleys to wire guides. It is then wound around a square paper tube. After the winding operation is completed, the tube is sawed into 28 sections, each a finished coil.

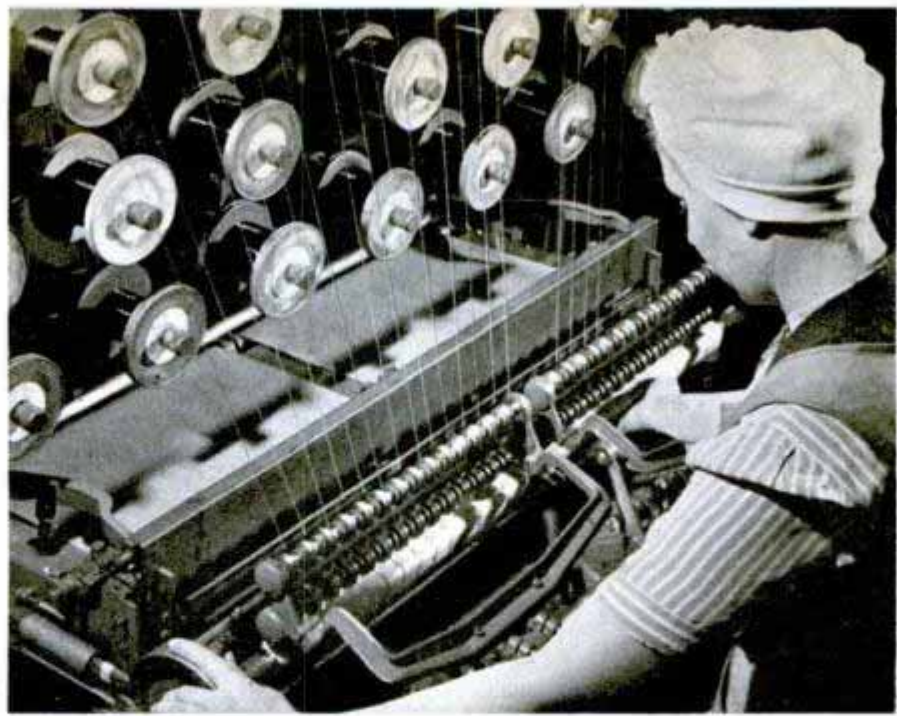

Flying-Boat Fighter

Guns and jet engines of the new Royal Air Force twin-jet flying boat are fitted in the hull for extra speed. The plane, a Saunders Roe A.1, is a high-wing single seater with semiretractable wing floats. Air intake for the two jet engines is in the nose. It is being tested to determine whether a flying-boat fighter can get into action faster in a naval battle than land-based planes.

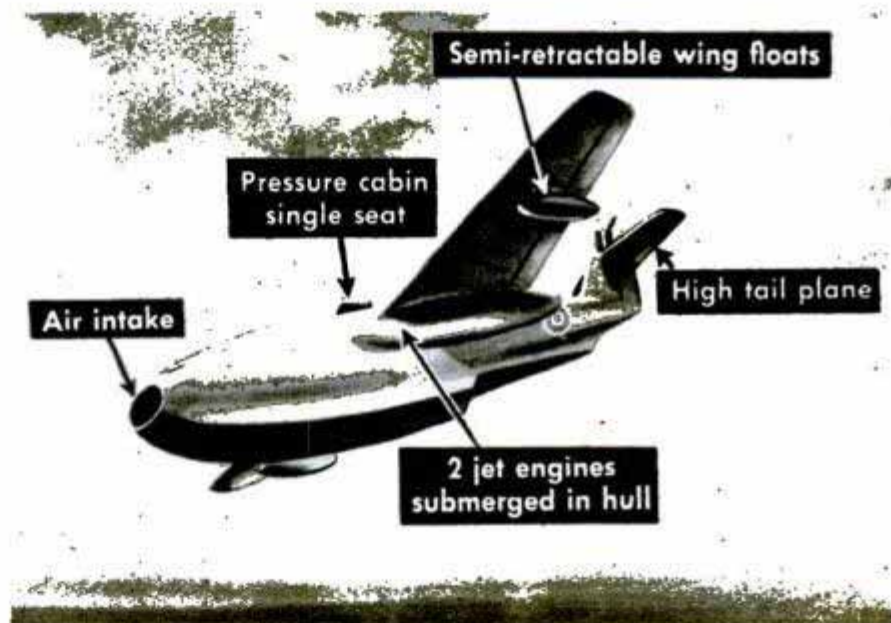

INDIANAPOLIS SPEEDWAY RACER purchased by movie actor Keenan Wynn for \$12,000 for cross-country personal appearance tour. At age of 11, he won honors as speedboat pilot

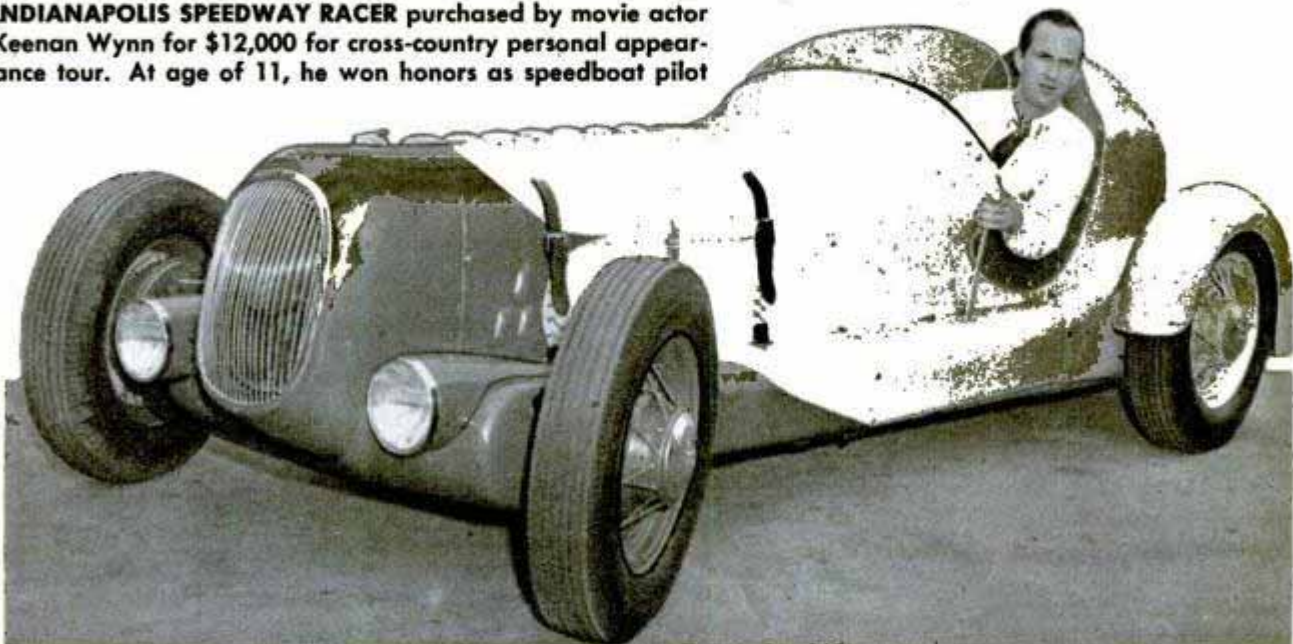

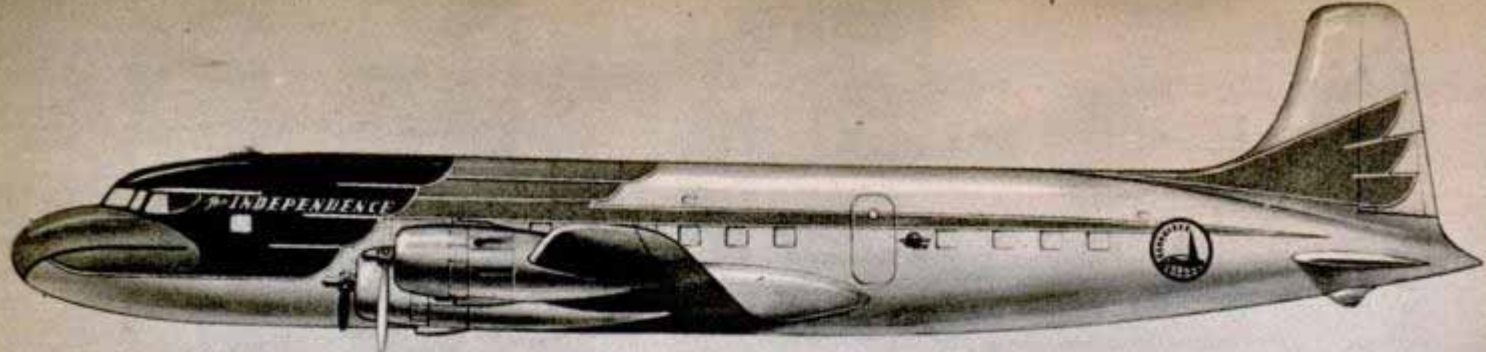

Painted to resemble the American eagle (note beak and tail "feathers") President Truman's new DC-6 has four 2100-horsepower engines and 4400-mile range. His private stateroom is aft. The forward section seats 24 or sleeps 12

The PRESIDENT'S PLANE



Special equipment on plane includes radio teletype-writer (above) which can code or uncode messages; it has 3000-mile range. Below, plastic nose of plane contains radar scanner for terrain or storm clouds



Phone circuits and controls for a concealed radio are in panel at left of President's chair in his stateroom. Below, inspecting a pair of new-style radio-compass loop housings projecting from plane



Muscle Men of America

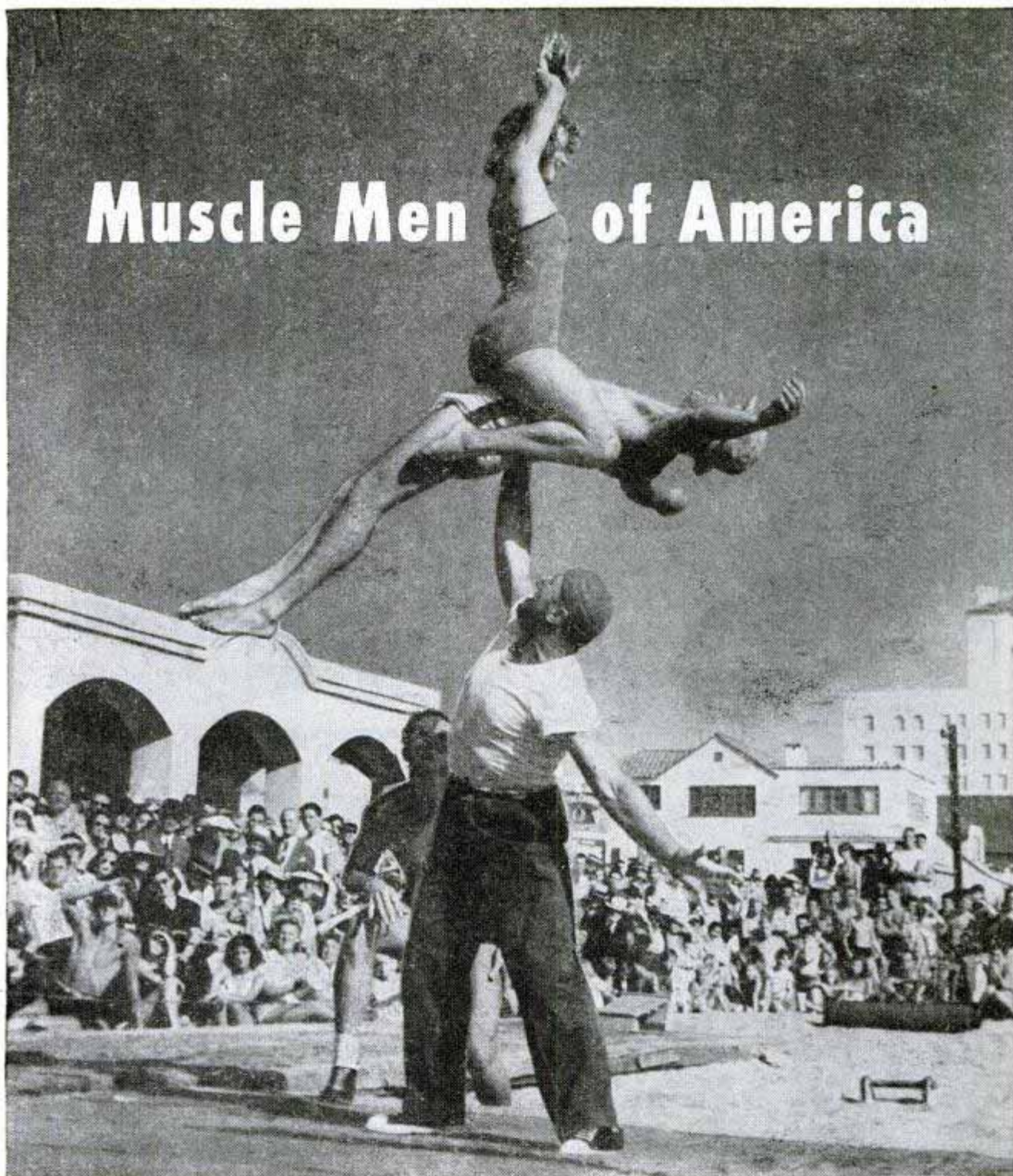

Weightlifter at the beach thrills crowd by hoisting human "barbells" over his head with one hand

THE ANCIENT Greeks, worshippers of strong bod-

ies, told a favorite story about Milo of Crotona. Milo was a puny little guy who set out to build himself up by lifting a calf over his head every day. When the beast had developed into a full-grown ox, Milo was the world's strongest man.

Americans, like the Greeks, take pride in healthy and strong bodies. More than just a fad, some 2,500,000 men and boys in garages, attics and basements all over the United States are improving their physique through weightlifting.

By George E. Wilcut

President, Southern California Weightlifting Assn.

About a year ago a thin, round-shouldered little man walked into my office. His name was Donovan. At the urging of his wife he had come to consult me about his condition.

"I weigh only 135 pounds," he began hesitantly. "I'd like to gain some weight. I think I'd feel better if I did."

It was apparent that the man had never done much exercise. I suggested a program of dumbbells and iron shoes. I didn't hear from him for about a year. Then he entered my office again.

"Guess you don't know me," he grinned.

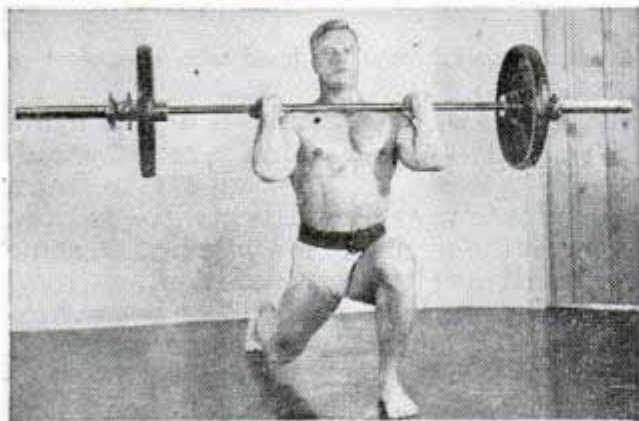

George Beedle of Santa Monica, Calif., demonstrates the three standard Olympic lifts. They are from top to bottom: **TWO-ARM MILITARY PRESS**, **TWO-ARM SNATCH** and the **TWO-ARM JERK**. See text for detailed description and world records for these lifts

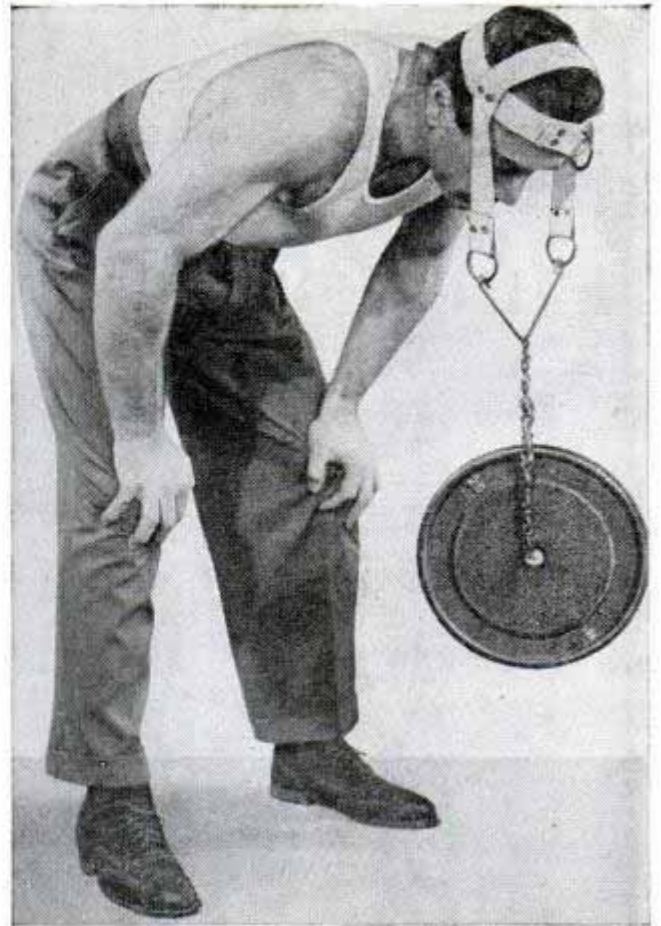

The 25-pound head-strap builds powerful neck muscles

Frankly, I didn't. His head was erect, his shoulders were broad and straight and a pair of 15-inch biceps bulged below the short sleeves of his sports shirt. He looked like a middleweight boxer.

Men and women in all walks of life are turning to weightlifting to keep in trim. The joy of weightlifting and weight-exercising lies not in the lifting itself, but in the muscles it develops and the feeling of well-being it promotes. Hollywood motion picture stars are aware of the values of physical fitness. Bing Crosby, Van Johnson, Gary Cooper, Fred MacMurray, Cary Grant, Bob Hope, Joel McCrea, Buster Crabbe and Randolph Scott are only a few of the male stars who regularly practice weightlifting.

The war did much to promote this form of exercise. The accent on physical fitness and combat-conditioning made weightlifting a popular sport in the Army and Navy. Not long ago American men and boys practiced furtively with barbells and dumbbells in the privacy of their own bedrooms. Today the sport has come out into the open and is one of the fastest-growing in the country. Some 52 nations belong to the International Weightlifting Federation and it promises to be one of the most interesting features of the 1948 Olympic games.

Through the years there has been much debate and speculation about the best way to build a strong and healthy body. The-



Tom Harmon keeps in trim with this rubber exerciser

ories have ranged from taking cold showers before breakfast to living on an all-vegetable diet.

But science has shown that the quickest way to build muscle on the human body is by continuous resistance. This resistance should be applied when the muscle is flexed. When stretched, the muscle supports weight like a rope—by fiber rather than dynamic energy. Exercise should be done slowly and rhythmically—so that the bloodstream can remove the products of fatigue. Rest between periods of exercise is extremely important so that the muscle can rebuild itself.

The principles of weight resistance for muscle building are not new. Roman athletes used weighted shoes to build up leg muscles and improve their running. Norse warriors practiced with weapons twice the weight of those used in battle. And ever since the birth of baseball in America, a player going to bat will swing two or three clubs before he steps up to the plate.

Recent experiments by Army doctors have shown the value of weightlifting from a medical point of view. At the Gardner General Hospital in Chicago, some of the nation's top orthopedists were turned loose on the problem of rebuilding torn muscles.

A soldier recovering from a serious leg wound was placed on a specially constructed hospital table. Weights were strapped to his foot and he was told to lift his leg up

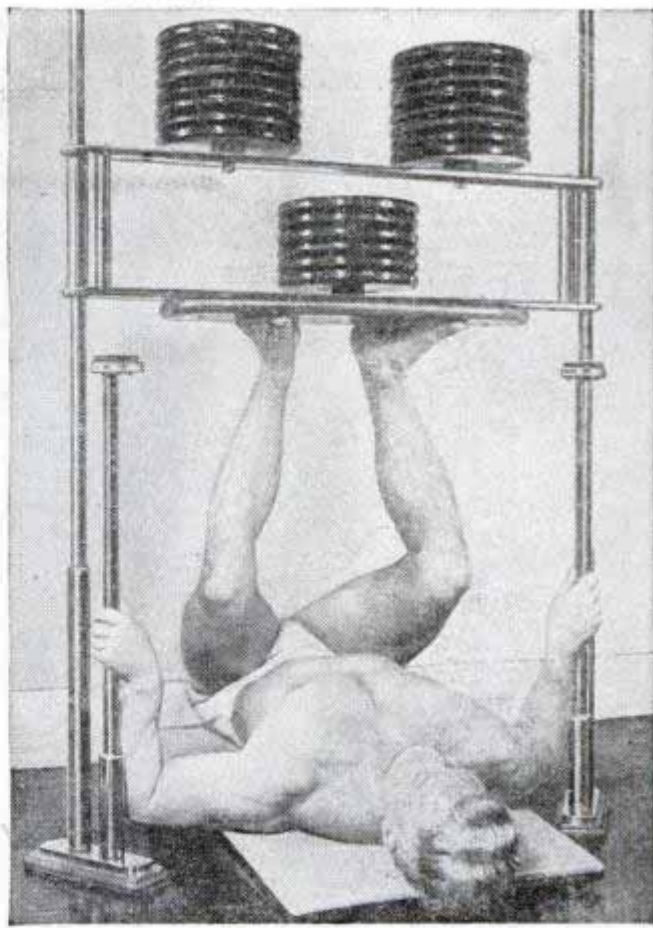

Calf and thigh-muscle builder—weightlifter uses foot press to hoist 440 pounds with his legs. Below, human body forms sturdy arch for a handstand





and down. He exercised the limb about 30 minutes each day—a few pounds being added to the weight each time. In three weeks the lifting power of his leg had increased from 10 to 80 pounds. The circumference of his thigh had grown two inches.

The preliminary experiment convinced the Army medics. They ordered the skip ropes, pulleys, springs and other apparatus in the hospital gymnasium ripped out. Weightlifting and weight-exercising were substituted and clinical observation was continued on 300 cases.

The results were spectacular. Patients immobilized for a year with broken bones of the upper leg—a difficult fracture—walked normally after four weeks' work with weights. Patients with machine-gun bullets through the chest increased their atrophied pectoral muscles to an even larger size than when wounded. The War Department was so impressed with these results that it ordered a motion picture made so that the experiment could be shown at other hospitals over the country.

What weightlifting can do for World War II veterans, it can do for you. A judicious weight-exerciser, starting with flabby muscles, cannot help but develop his body. And contrary to what you may have heard, you

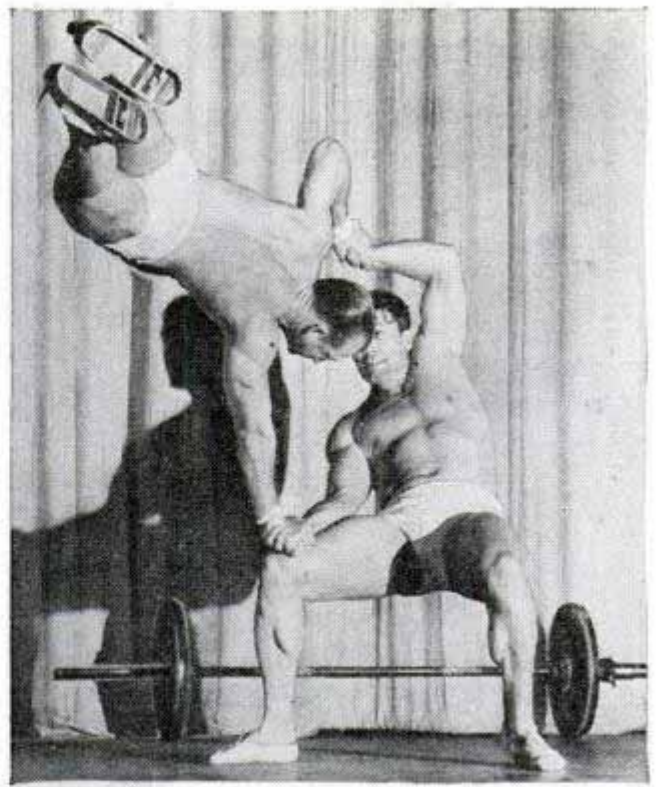

Weightlifters demonstrate balance and strength. The iron shoes on man above makes his headstand a difficult feat. At left, two performers combine tumbling and acrobatics with their own sport of weightlifting

don't have to worry about developing hernia, getting "muscle bound" or acquiring an "athlete's heart." Under proper supervision, a course in weightlifting will add or decrease poundage as you desire, will give you strength and suppleness and will promote a feeling of well-being.

Weights generally used are these: barbells and dumbbells for the arms, shoulders and upper torso; barbells and iron boots for the legs, and a headstrap for the neck. The problem is to apply weight to the specific muscle you want to build up. For legs, arms and neck, weight can be applied directly. For the more difficult muscles to get at—the back, back of the leg, the calf, back of the arm—pulleys may be rigged to throw weight in the proper direction.

You may start with equipment that can be purchased for as little as \$10 or \$15 and work up to a complete set of championship weightlifting and weight-exercising devices that may cost from \$250 to \$300. Some beginners will find it helpful to join a gymnasium where instruction is given; others may profit by subscribing to a course by mail in body-building and weightlifting.

A beginner will start slowly with the type of weight that he can best handle. Later, like Milo and his growing calf, he will increase the poundage. For the average person it is best to exercise with the weights in the evening after work. Allow at least an hour of rest before eating and

(Continued to page 248)



Speed Graphic—'47 Model

Completely redesigned, a series of Speed and Crown Graphic cameras has many improvements of value to news photographers and others who require cameras that can be used for almost any photo assignment. Changes have been made to provide a tilting front lens board, direct reading of the six focal-plane shutter speeds, and a frame finder with parallax stops. The back peep sight is round instead of rectangular and an elliptical spring snaps it back in place if it is touched by the photographer. The built-in body release trips either the front or focal-plane shutter. The focal-plane shutter speeds may be changed without firing the flash bulb through a redesigned shutter-synchronizing mechanism. Instead of fabric hoods the new cameras have removable four-sided hoods made of metal. An inertia governor cuts the three basic speeds in half to give a choice of six speeds to the photographer. All edges of the leather cover are bound with metal and the handle is adjustable.

Camera Arm Supports Floods

Photoflood bulbs can be fastened directly to the camera with an attachment that puts all the photographer's equipment in one hand and prevents the light from striking the lens. An aluminum arm is fastened to the base of the camera by a handle and holds two bulbs above and behind the lens. Whenever the camera is turned, the light source moves in the same direction. The attachment can be fastened to tripods and movie titlers.

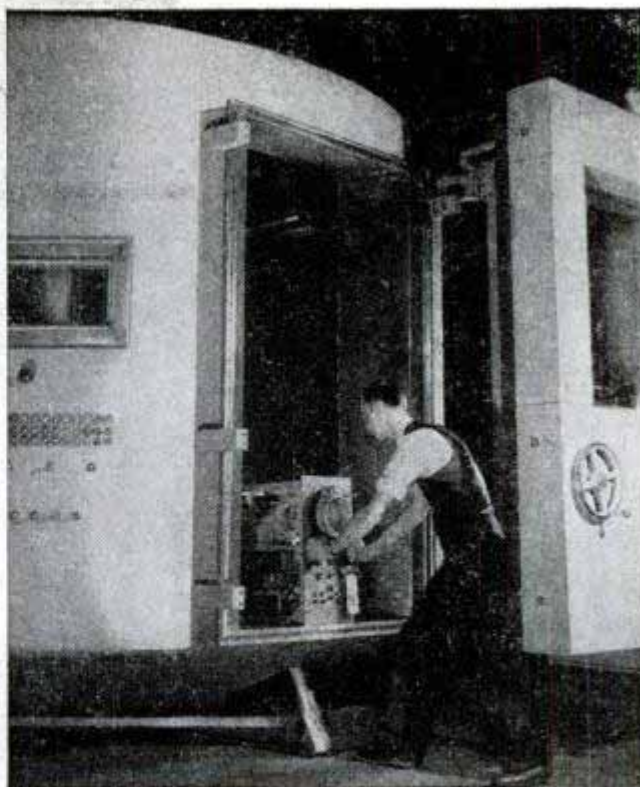

Weather Chamber Tests Radar

Weather chambers capable of a quick switch from a subzero arctic temperature to a humid tropical climate are used to test radar and communications equipment. Atmospheric conditions up to 80,000 feet are simulated inside the chamber. Because performance of electronic devices varies with weather changes, Westinghouse engineers test equipment at temperatures from 200 degrees Fahrenheit to 75 below.



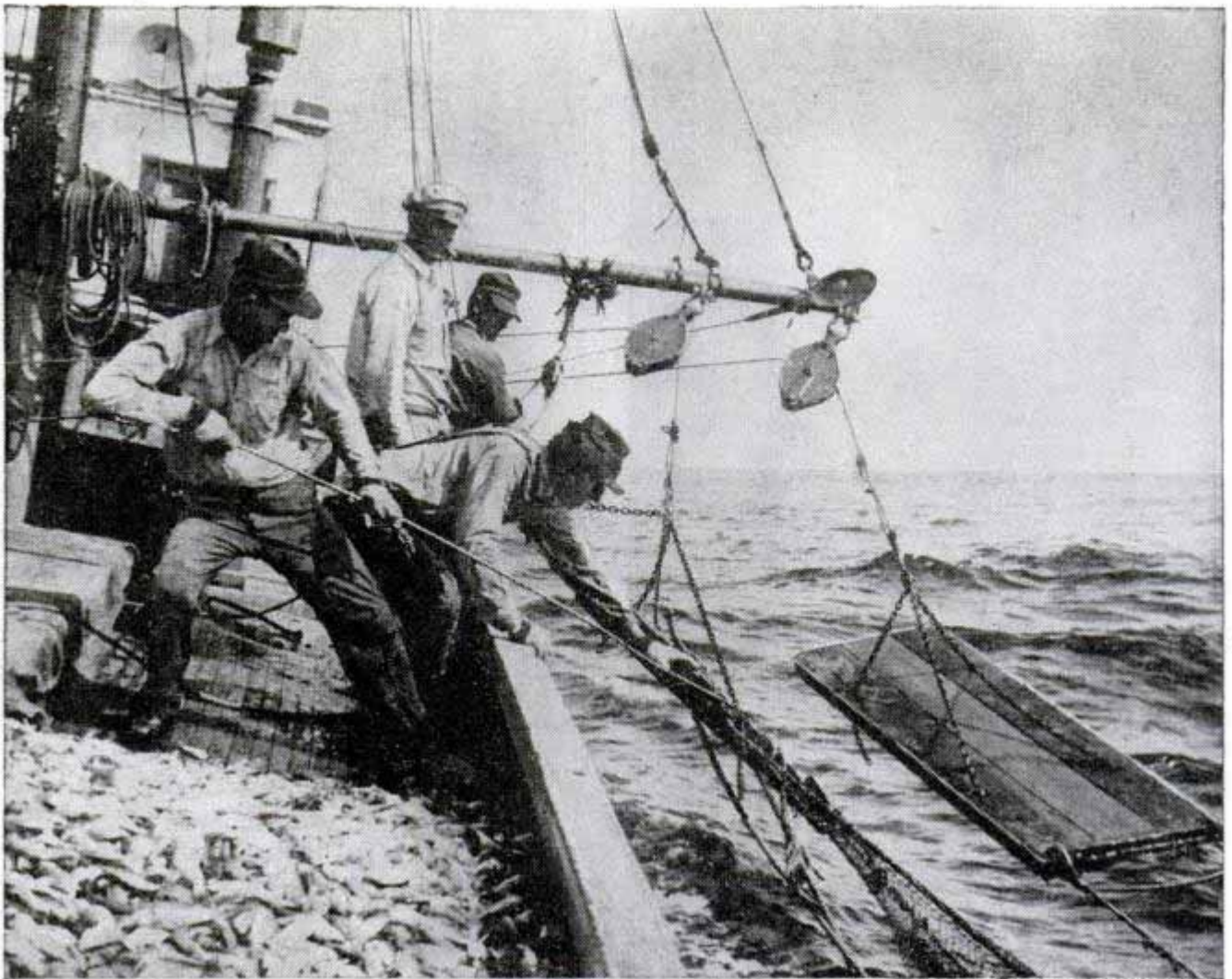

Fish and Wildlife Service photo

Shrimp fishermen drop net off Louisiana coast; weighted board held by towline forces net to the bottom

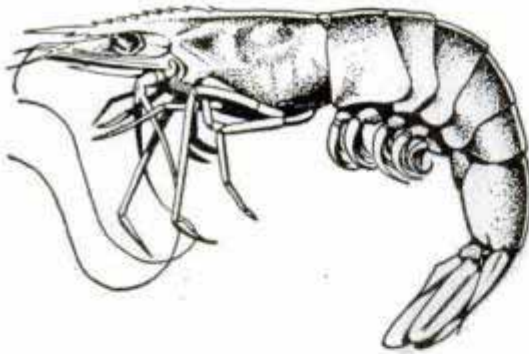

THEY DREDGE *for* YOUR DINNER

By Wayne Whittaker

AS THE OYSTER BOAT, Elroy, chugs into the vicinity of Square Handkerchief marker, Captain Dudley Langlinais yells to the engineman:

"Slow 'er down, Willis! Going to take a sounding."

The 60-horsepower Diesel, which powers the squat 50-foot Elroy, slows its pace. Captain Langlinais, veteran oyster fisherman, thrusts the long sounding pole into the warm salt waters of the Gulf of Mexico. The marker with the strange name of Square Handkerchief locates a reef a couple of miles out from Pass Christian, Miss. The oyster beds here, some of which extend for miles, are found in about 15 to 20 feet of water along the edges of the reefs.

After several tries the sounding pole strikes something hard, indicating oysters, and one of the Elroy's two dredges is swung over the side with its heavy iron chain going away out. The captain swings his foot over the rail and presses it against the chain to "feel" how the dredge is biting into the oyster bed. In a few minutes he gives the order "Roll!" and the power winch pulls in chain and dredge.

About four bushels of dripping shells and assorted marine life are dumped on the low sorting platform. Most of the shells in this sample haul are blue and "dead" and the few live oysters in the catch are too small for commercial use.

The Elroy moves on and after several

soundings and sample dredgings, a good haul is made. Over the side goes a buoy, consisting of an empty five-gallon can with anchor, to mark the spot. The sounding pole is stored away and the captain takes his position at the wheel in the pilot-house. The crewmen, two to starboard, two to port, take their positions at the two dredges and some concentrated oyster fishing gets under way. The crew is glad for some action because the early morning breeze is from the North and cold.

Soon other oyster boats that had been sounding along the reef move in to share the Elroy's find. The Elwood F, Lone Star, Mary Frances and the R.O.C., all out of Biloxi, Miss., join the merry-go-round circling about our buoy. This is an accepted procedure in oyster fishing along the Gulf—one boat's find is everybody's good luck.

The Elroy, one of a fleet of about 30 oyster and shrimp boats owned by the Mavar Shrimp & Oyster Co. Ltd., of Biloxi, is a typical oyster craft. It is manned by the captain and a crew of four. The crew works in pairs. With cotton

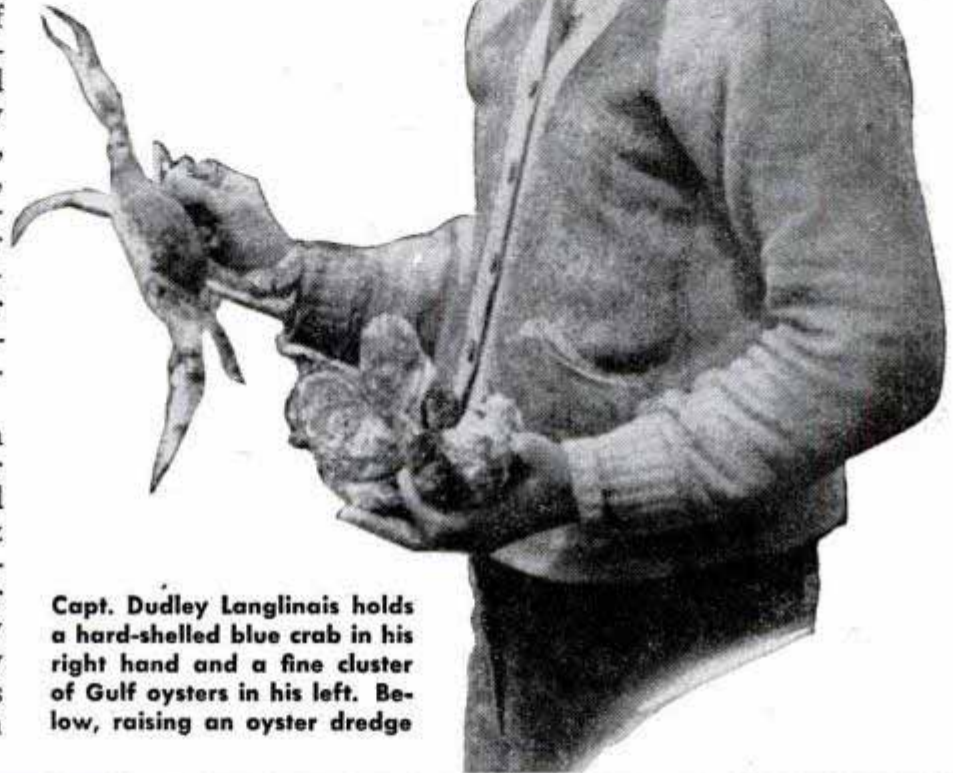

Capt. Dudley Langlinais holds a hard-shelled blue crab in his right hand and a fine cluster of Gulf oysters in his left. Below, raising an oyster dredge

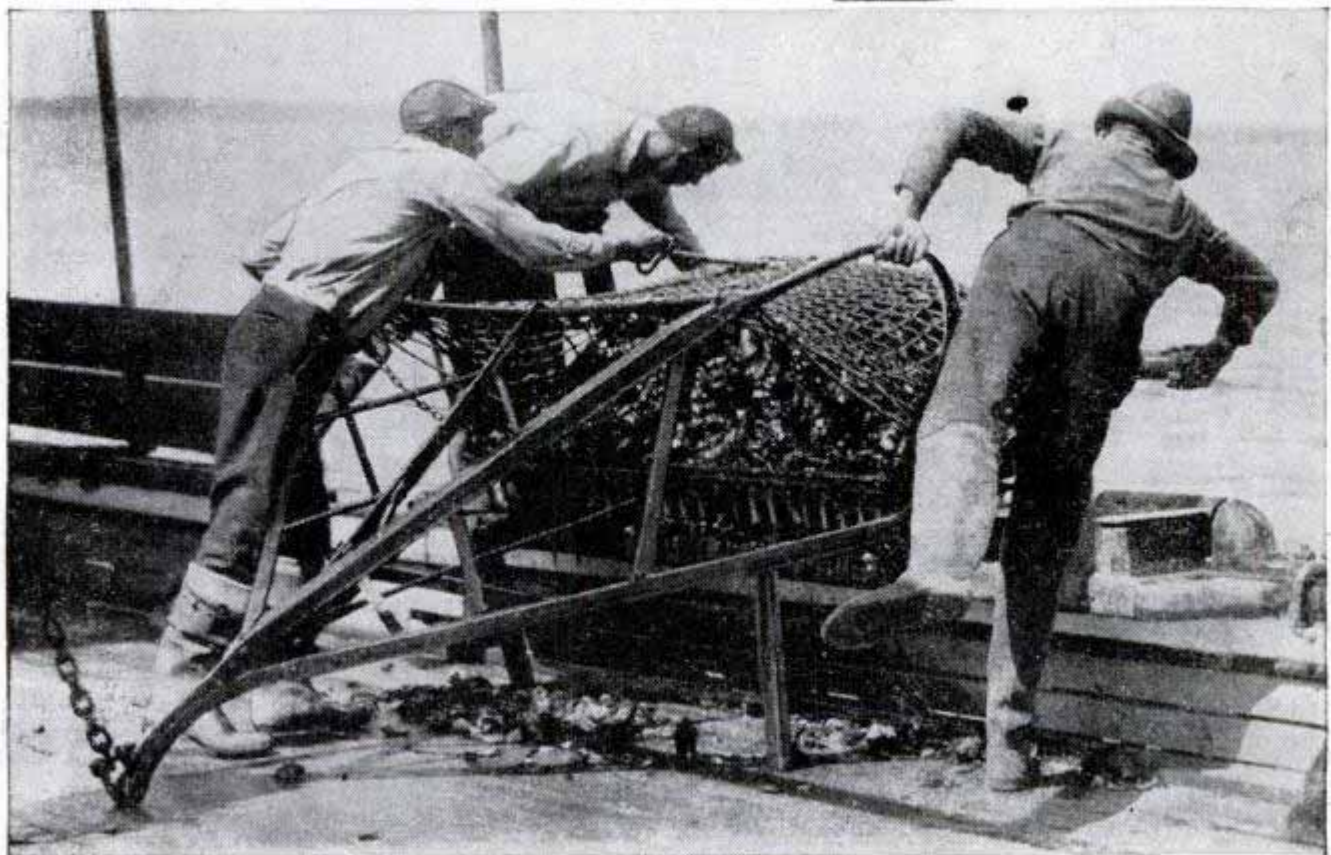



"How's this for a dredgeful of oysters?" asks Willis Albert of the Elroy crew. Catch also included a flounder and one hated sting ray

gloves to protect their hands, they quickly sort each dredgeful of rough-shelled oysters as they are dumped from the dredges. The clusters of good oysters are thrown back on the deck to be shoveled later into deck bins or hold. Rejects, dead shells and unwanted marine life (such as the treach-

erous sting ray) are shoveled back into the Gulf. Flounders and other choice fish, as well as hard-shelled blue crabs, are tossed into a wire basket to be sold on the wharf by the crew. They ask only fifty cents a dozen for the choice crabs.

To an inexperienced land-lubber the first dredgefuls of oysters look all alike—neither good nor bad. However, as you work alongside an expert fisherman at the sorting platform, you soon learn how to pick out the well-filled oysters of three-inch size or better. The best ones on the reefs seem to grow in clusters of half a dozen or more.

Working from dawn to dusk, it takes the Elroy's crew about three days to get a boatload of oysters. The capacity of the hold and bins is estimated at 330 barrels with a weight of 69,300 pounds. A full load pulls the boat deep into

the water and when the waves are high on a return trip the deck is often awash. During the oyster fishing season—Jan. 1 to May 1—the Elroy and boats like it plying South Atlantic and Gulf waters bring in a harvest of about 12,000,000 pounds of oysters. This is one fourth of the oysters

Bill Kennerson, Biloxi shrimp fisherman, feels one of the big nets to see if it's dry enough to put away

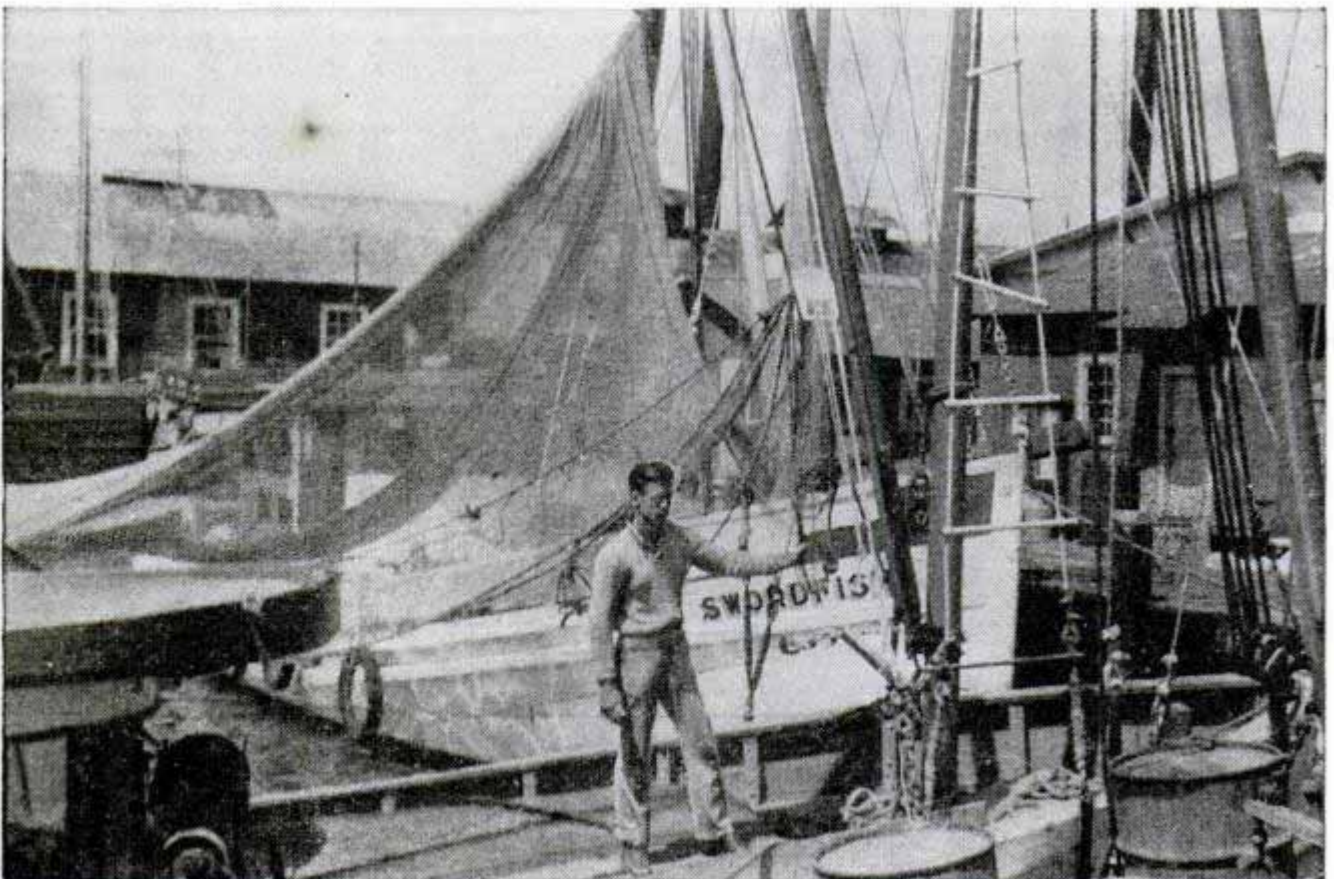

consumed in this country.

Oyster beds along the Gulf are under the close supervision of the conservation departments of the various states. Some of the beds are privately leased to "oyster farmers" who plant shells, gravel and other material to which the young oysters can cling and grow. These beds may be fished out of season like a privately-stocked fish pond. The public beds are cared for by the state conservationists and special permits are issued for every trip by a fishing boat. The reefs are policed by state vessels, or marine "cops." During mid-morning one of them pulled alongside the Elroy and asked Captain Langlinais to show his permit.

"These state regulations are all to the good and sure discourage any poaching," said the captain as the state boat pulled away. "Our oyster beds along here are just recovering from the fresh-water floods that killed most of the young ones a few years back. It takes three years for an oyster to grow to market size.

During the summer spawning season a female oyster lays several hundred million eggs. Although many of these eggs hatch into the larva stage, only a very few grow to maturity. During the first two weeks of an oyster's life he does all his traveling as a free-swimming larva about $\frac{1}{75}$ inch in diameter. Before the oyster can take on its adult form it must attach itself to a clean, hard object such as a shell or rock. This is called "setting" and millions of larvae die when they strike mud or marine growths to which they are unable to attach themselves. Two weeks after setting, the oysters have formed shells $\frac{1}{4}$ inch long and are known in this stage as "seed" oysters. Many of these are gathered and planted by oyster farmers in beds where they try to protect the young oyster from its enemies.

These enemies beset the

(Continued to page 236)



The Elroy edges toward Mavar dock with a 330-barrel load of oysters stored in the hold and deck bins. It takes three days to fill the boat

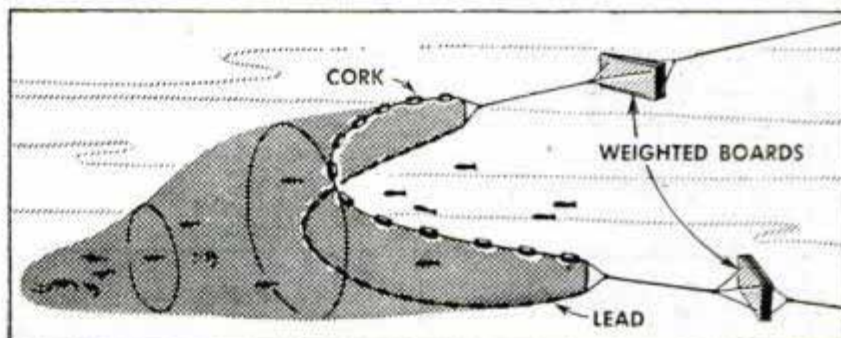

Bag of shrimp net known as otter trawl varies in length from 30 to 100 feet; a single four-hour drag may yield 40 barrels of shrimp. Below, rails on Mavar oyster pier carry the oysters in metal cars to cannery

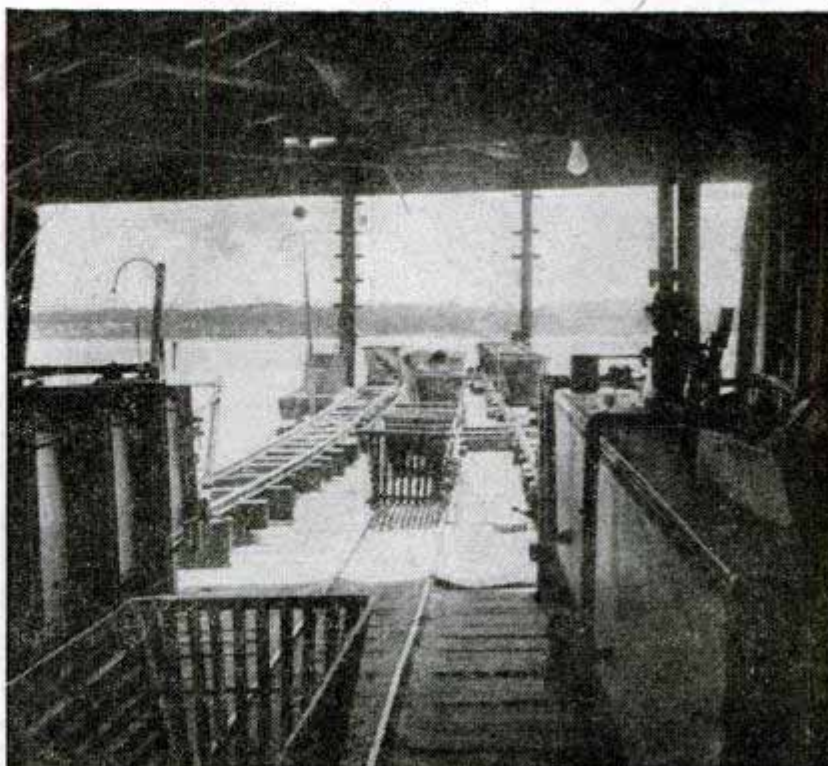

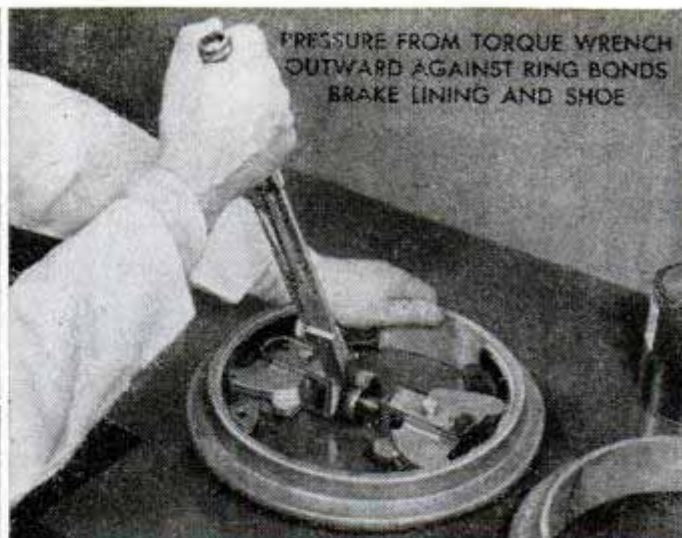
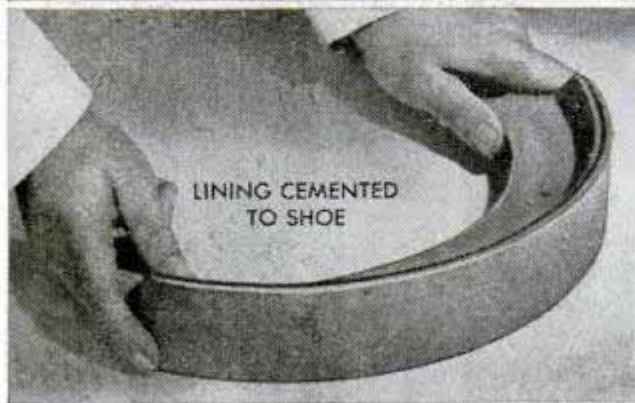
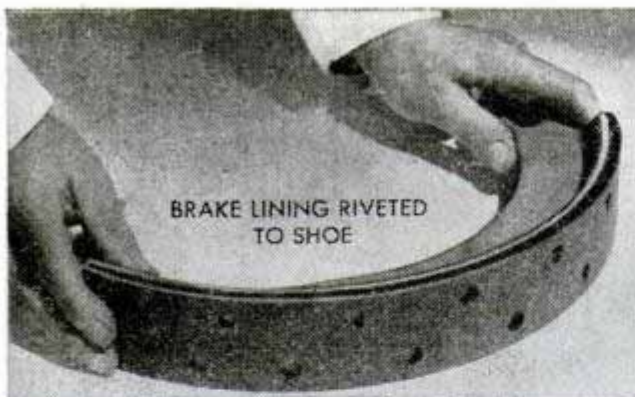

Goodyear photos

Comparison of riveted and cemented linings, left, shows larger braking surface provided by the latter. Cemented linings are "cured" in an oven after bonding

down to the shoe, instead of just to the rivet heads as was formerly the case. They also eliminate the drum scoring caused by abrasives that collect in the indentations above countersunk rivets. Better brake performance results from exposure of a larger contact area of the lining to the brake drum, increased by the absence of rivet holes. Tests indicate the cement's bonding efficiency is six to nine times greater than that of conventional rivets.

Cemented Brake Linings

Brake linings applied by a new cementing process last twice as long and perform better than those put on with rivets. The rivetless linings can be worn completely

Names and addresses of manufacturers of new products featured in this issue will be supplied by the Bureau of Information, Popular Mechanics Magazine, 200 E. Ontario St., Chicago 11

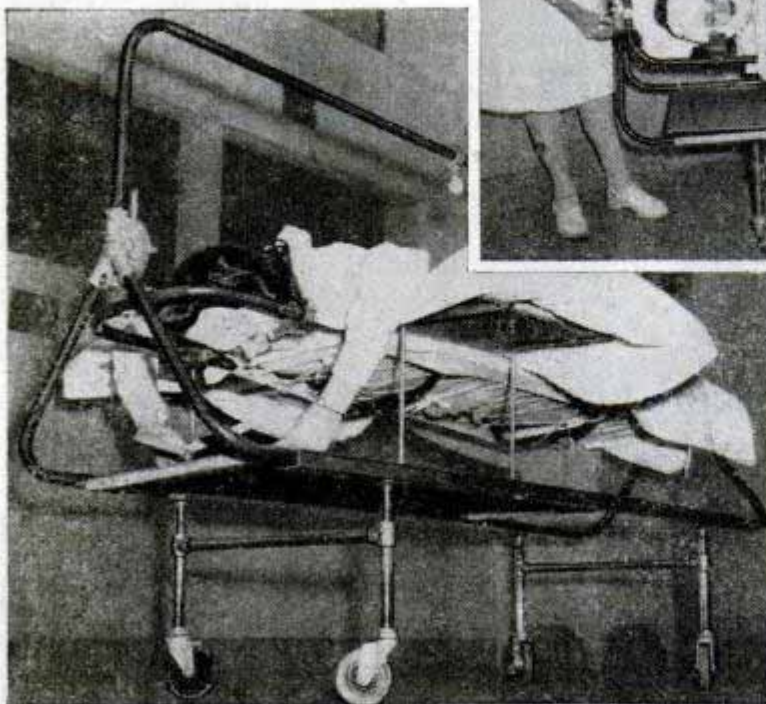
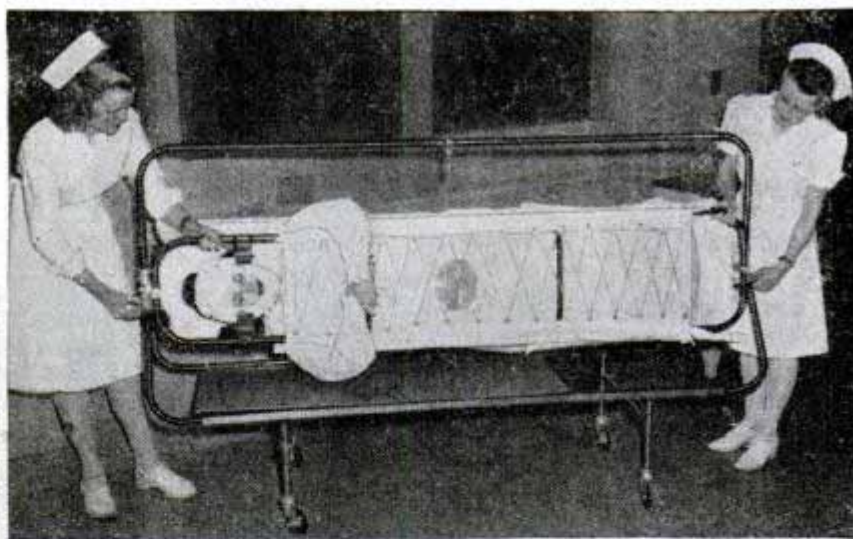

Hospital "Sandwich" Bed

Patients with severe fractures, particularly broken hips, can be turned painlessly in a "sandwich" bed. With the patient's back on one mattress, a second mattress is placed on top of him and secured to a frame. Nurses then rotate the frame and the patient is turned, stomach down, with the added mattress now beneath him. Turning fracture patients aids healing.

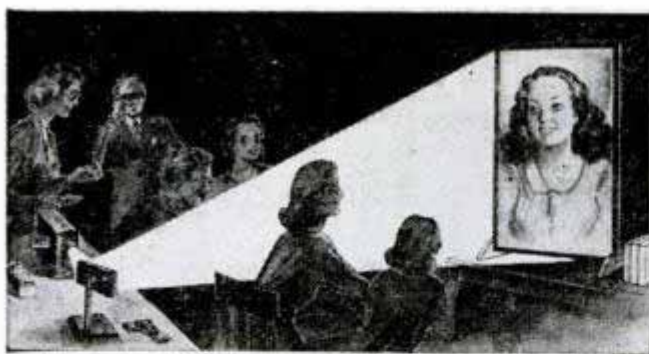

THREE-DIMENSION slides are thrown on screen by attachment for 35-mm. projectors. Viewers wear special glasses. Below, camera attachment snaps two photos at once for stereoscopic projection. Diagram shows how double mirror reflects both images to screen

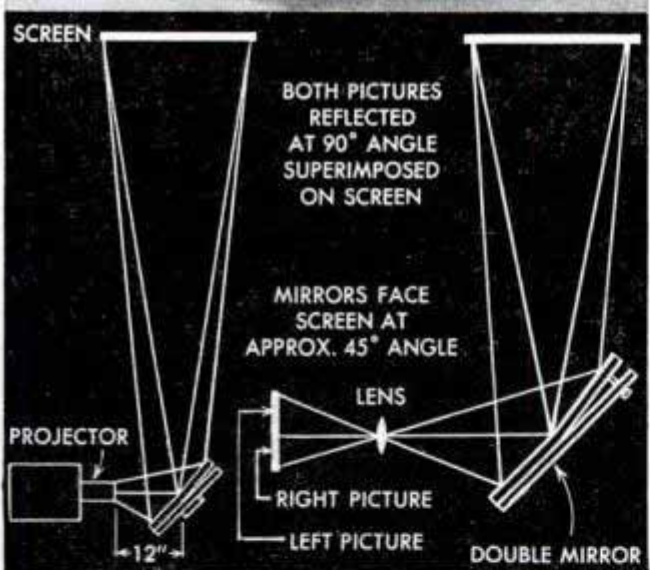

"ELEVATING" TRIPOD can be adjusted for height without manipulating the legs. By turning a crank the photographer raises or lowers the camera as much as 17 inches after the tripod legs have been tightened.

For CAMERA FANS

MAGNETIC SYNCHRONIZER for photoflash needs no batteries to fire the bulbs. Two magnets deliver a current of six watts. When trigger is pushed a spring moves an armature, releasing magnetic power to a coil which transfers the current to the flash bulbs

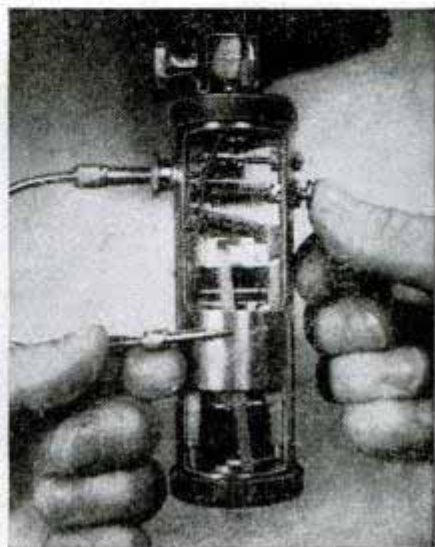
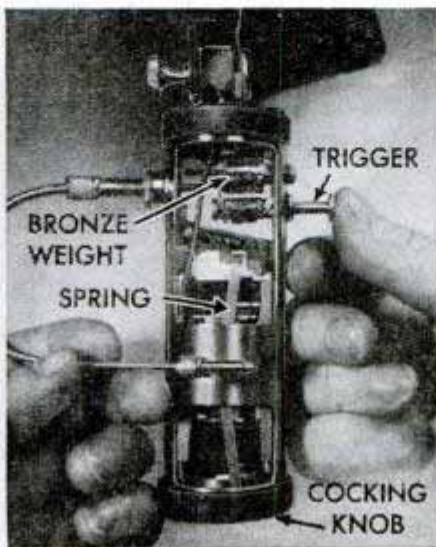

FACE LIFTING FOR

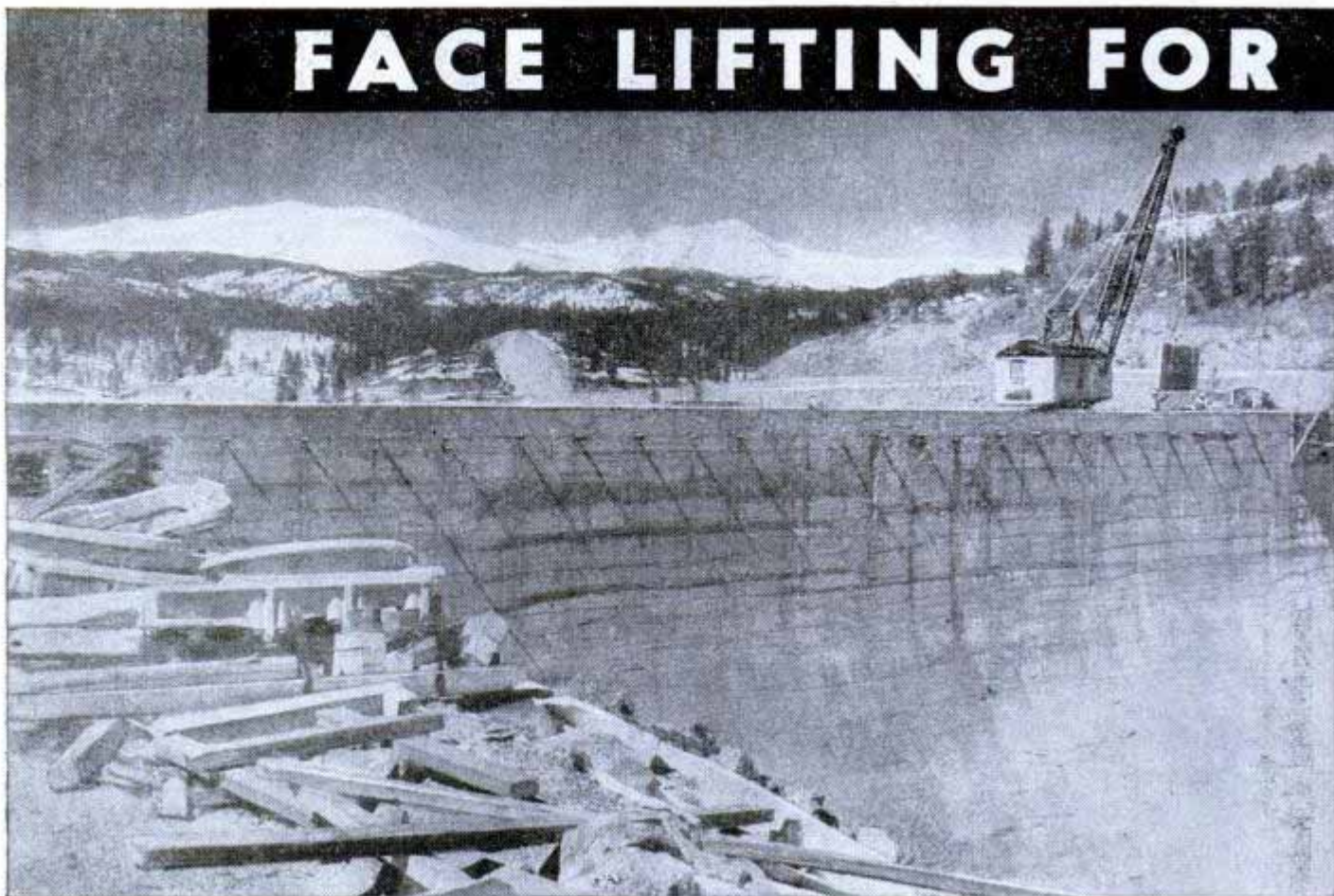

Crane lifts a prefabricated slab weighing seven tons into position for lowering down the face of the dam
↓ Workers dwarfed by the big dam clean decomposed concrete from the surface and install hangers for new face

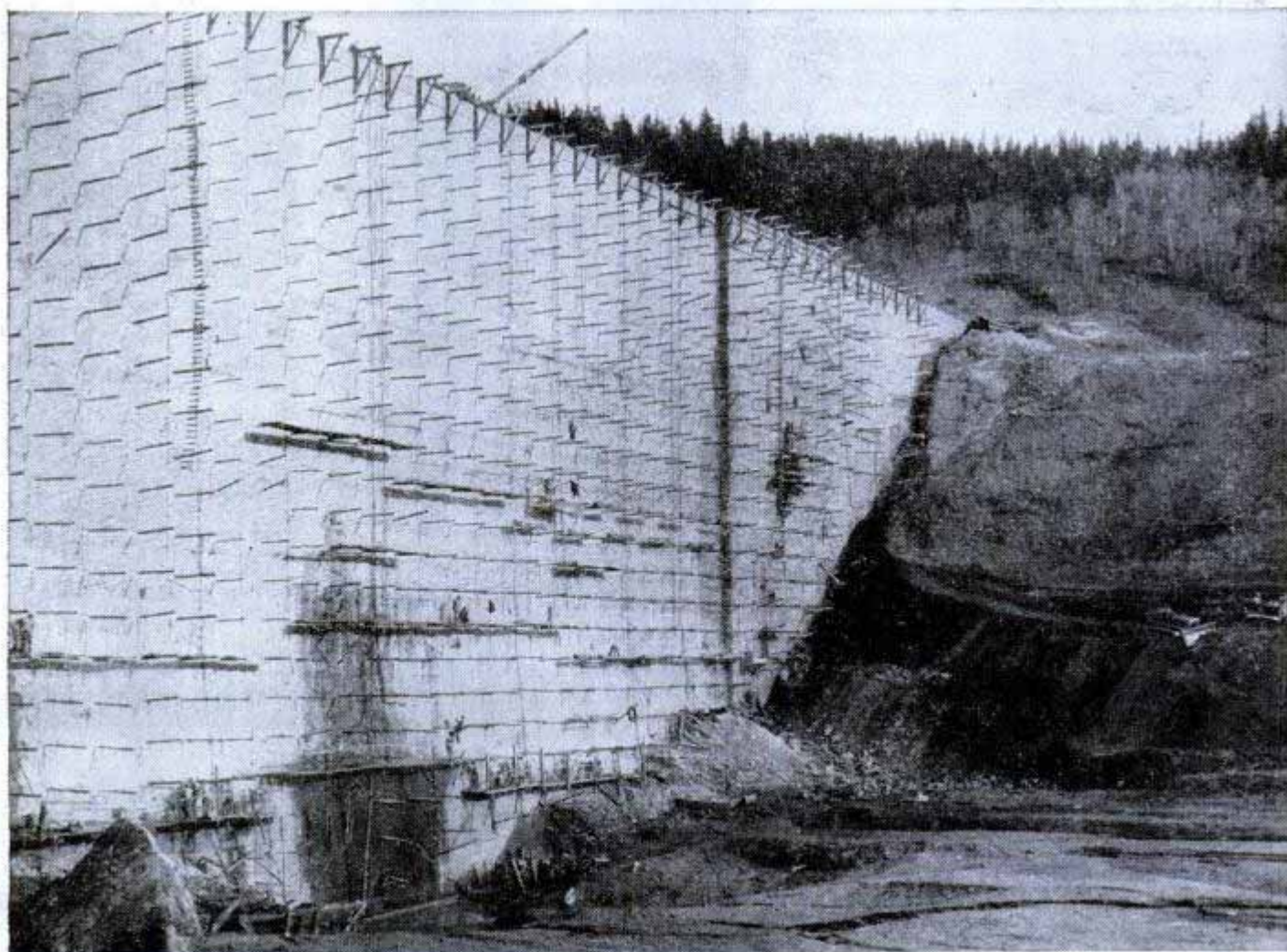

A DAM



Precast concrete slab is ready to be fastened like a building block in the new face. Below, the dowels are welded together to hold the wall rigidly in place

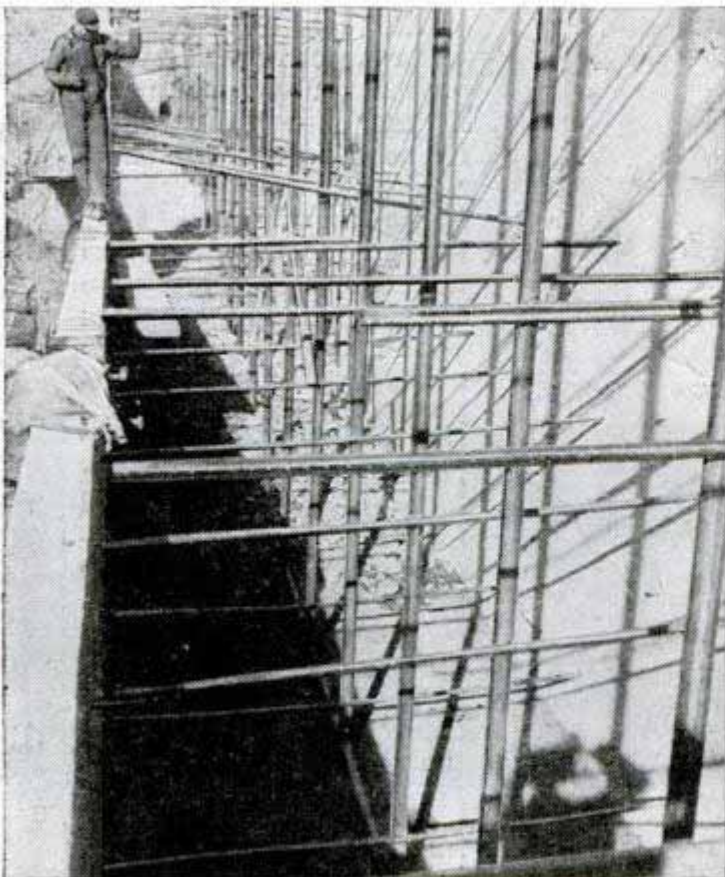

By Forest Crossen

IN A NARROW CANYON of the Rocky Mountains west of Boulder, Colo., a crew of specialists in concrete engineering is rapidly completing a unique project—lifting the face of 166-foot Barker Dam by installing a new upstream face of prefabricated concrete slabs. The dam is being rebuilt for additional water storage.

First it was necessary to drain away the water, chip all decomposed concrete from the upstream face and pour a new concrete footing along the foundation. In addition, workers used diamond drills to bore down to bedrock. Grout, a concrete mixture, was pumped in to fill all voids.

In the meantime the prefabricated slabs were cast. Special reinforcing steel bars were laid in the forms and concrete filled in around them. The finished slabs measure roughly 7 feet wide, 12 feet long and 8 inches thick. They weigh about four tons.

Six steel dowel pins one inch in diameter were inserted in one face of each slab. These were located with precision to match the same size dowels driven into the upstream face of the dam. They hold each slab in place until the space between the dam and new wall is filled with concrete and gravel.

When the concrete footings for the slabs had been poured at the bottom of the dam and steps built up each side into solid rock, the slabs were ready to be placed. They were lowered by a crane which held them in place until welders could weld the steel dowel pins of the slabs to the matching dowel pins in the face of the dam.

At the bottom of the dam the slabs were eight feet away from the dam. They were to slant upward until the two walls would be only 18 inches apart at the top.

As soon as the first row of slabs was in place, pipe fitters installed upright pipes two inches in diameter at intervals between the faces. These pipes had a series of slits $\frac{3}{8}$ inch wide and six inches long. As the slab wall went up, additional lengths of slotted pipe were welded to the first ones.

Also with the rise of the wall the joints were sealed with a special concrete mixture and clean, dry gravel was poured in to fill the void.

When the slab wall reaches the top, the space will be completely filled with gravel and the slotted pipes ready for use. Liquid grout containing a special ingredient which makes new concrete adhere to the face of old will be forced by a series of pumps down the slotted pipes. It will seep through the gravel to fill all holes between the walls.

Engineers say the resulting dam will be as strong as a completely new structure.

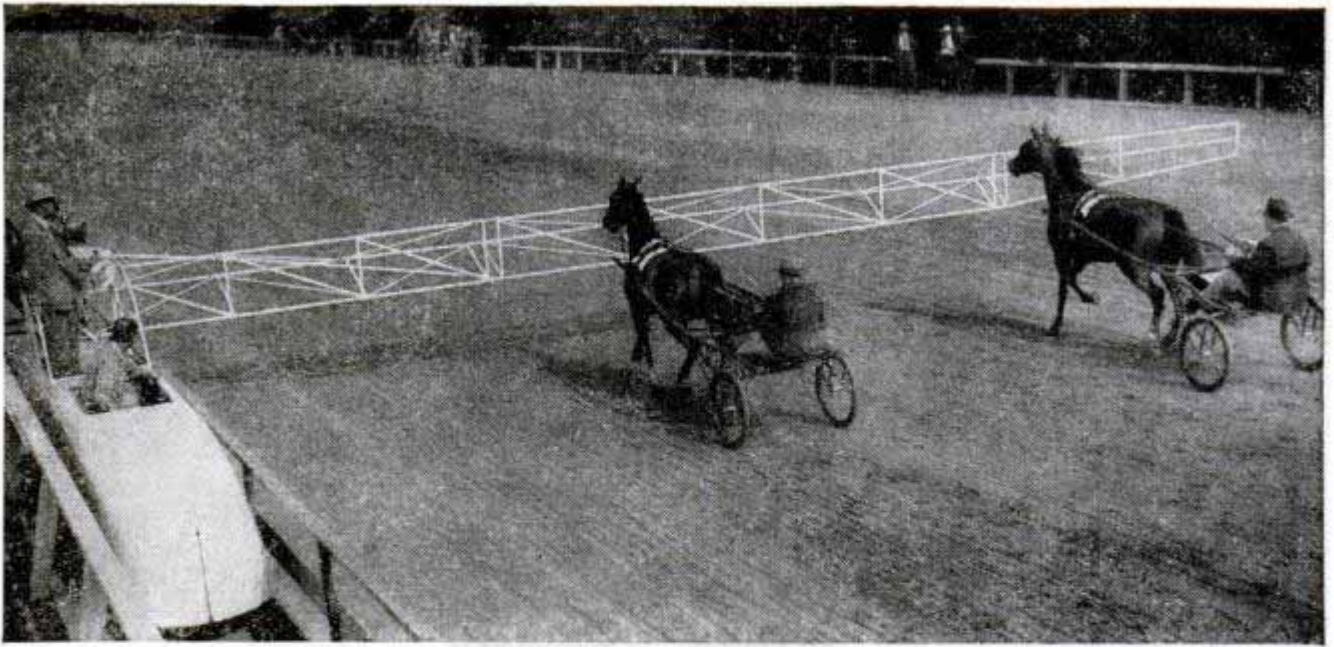

Harness Race Starting Gate

Two specially built cars, moving on steel tracks, operate the starting gates for harness races at Hollywood Park. A car on each side of the race track pushes the two arms of a gate, just in front of the horses. The six-cylinder Chrysler engines in both cars are synchronized to run at the same speed to assure perfect alignment of the

For starting only two horses, one gate arm is sufficient. Note car operator and starter with microphone

gate. An electrical cord connects the steel-tubing arms of the gate, but when the starter pushes a button the wire snaps apart and the arms swing forward and out of the way. A hydraulic shock absorber prevents damage to the gates as they swing open. The starter uses a public-address system to communicate with sulky drivers.

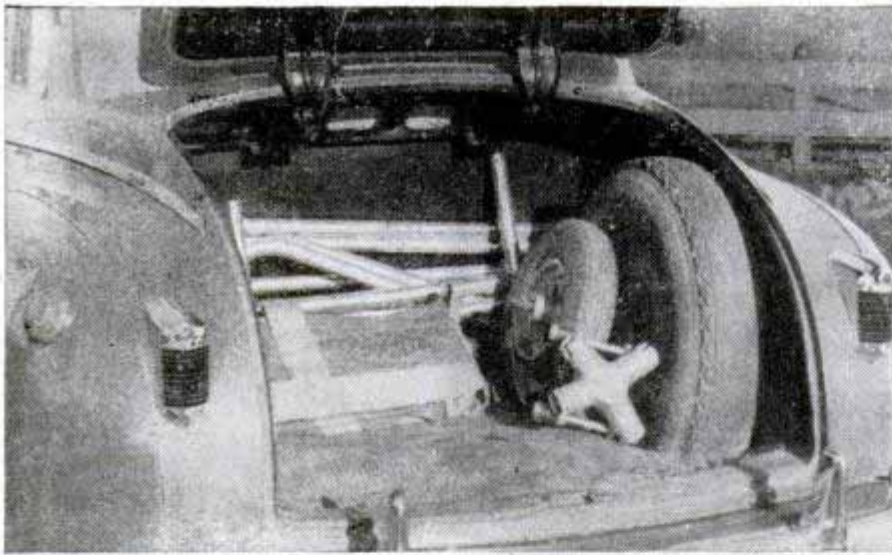

Automobile Trailer Collapses in Trunk

Built of waterproof canvas and tubular aluminum, a collapsible trailer can be stored in the rear compartment of an automobile when not in use. The trailer rides on a single wheel equipped with a pneumatic tire and a leaf spring. It takes less than five minutes to collapse the unit which occupies about one eighth of the average luggage compartment. In assembling the trailer, the tubular parts are slipped through loops in the canvas and locked in place. The trailer can be attached to the bumper of any car.



☞ Cotton can be sprayed with a chemical (pentachlorophenol) which has the same actions as a light frost—causing all balls to open at the same time to expedite picking.

ROOT FEEDER

Plants, grass and shrubs are watered and fertilized at their roots by a feeder tube that is inserted in the soil and connected with a garden hose. At the top of the tube is a transparent chamber which holds a chemical nutrient in cartridge form. When the water is turned on and a valve on the feeder is opened, the water swirls around in the chamber, dissolving the nutrient, then passes through the tube into the ground. The tube is inserted just a few inches for lawn treatments, about halfway for plants and all the way for trees. Cartridges are replaced easily when completely dissolved. Two different kinds are available, one for general use and the other for the feeding of specific plants.



Two-Faced Owls

Two-faced aluminum owls are aiding in an intensive campaign against pesky starlings at Decatur, Ill. City Pest Officer Joe Swisher discovered that the starlings shied away from the perch of an imitation owl. He and his co-worker, James Soules, invented a new species with two faces on a single body, hoping to double the owls' effectiveness. More than 30 of the aluminum owls have been placed in strategic spots about the city.

Fence Made of Bombs

Unexploded Nazi bombs have been rendered harmless and converted into makeshift fences by farmers on the island of Crete. The bombs were left behind after a German ammunition dump was smashed in an Allied air raid.

☞ Some frozen-food cabinets are equipped with a thermostat which flashes a light in case of power failure, giving warning before food thaws.





Seeder Sows One by One

Small seeds are sowed one at a time by a cylindrical tool which is operated by tapping the tube with the forefinger. Vegetable or flower seeds are poured into one end of the tube which has a removable cap. At the other end are small disks equipped with a thumb regulator to set the size of openings needed for various seeds.



Safety Cage for Tire Inflation

Tire repairmen are protected from injury if truck tire rings should blow off during inflation by a cage made of two-inch steel tubing. The safety cage, developed by the Firestone Tire and Rubber Company, weighs 425 pounds and will accommodate tires up to 1200-24 in size. It permits easy access to the tire during inflation. The cage is designed for operators of large trucking fleets.



Seamless Plastic Boat

Weighing only 80 pounds, a nine-foot rowboat made of seamless plastic can be handled by one person. The boat is molded in about two hours by building glass fibers and a synthetic resin into layers which are cured by steam heat under pressure. Three rope holes and four oarlock sockets are molded into the boat and an outboard motor can be attached. The craft can be stored in any climate and will not be affected by salt water. It can carry five persons.

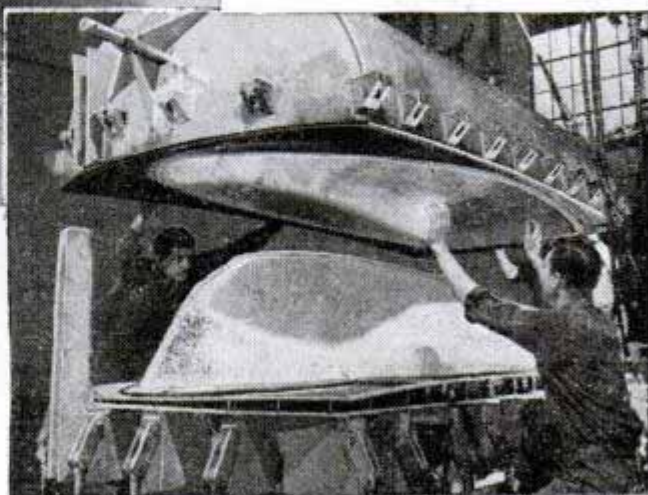

Refrigerators are defrosted automatically by a preset control that shuts off the motor for several hours during the night.

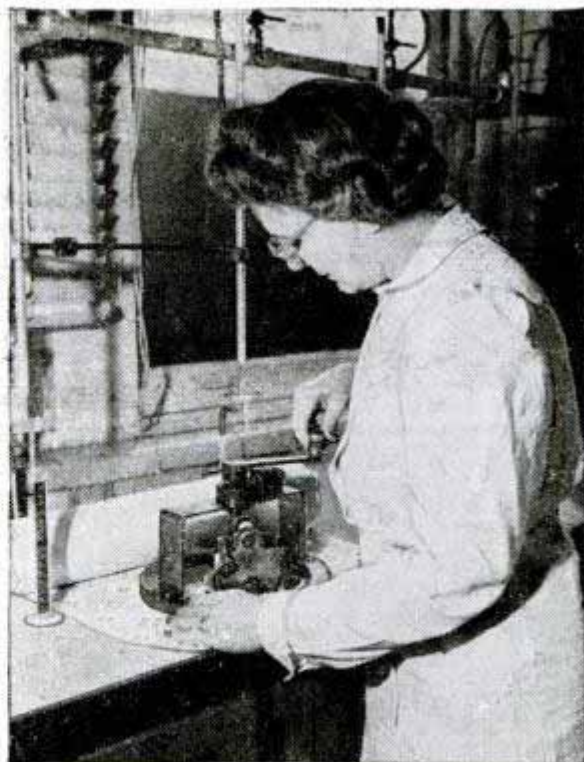
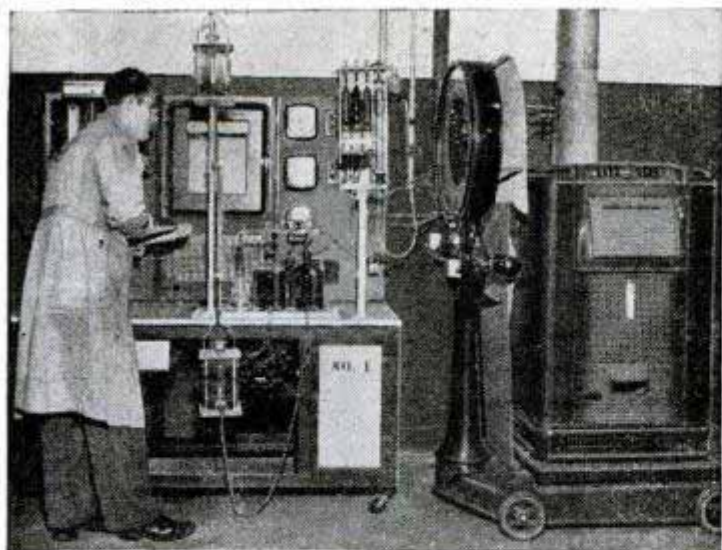

Above, a space heater undergoes test; at right, checking washability of wallpaper; left, testing the durability of dress fabric

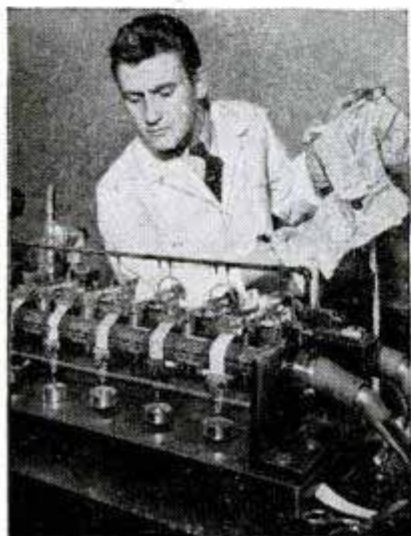

TEST LABS BEHIND THE CATALOGUES

"Combat conditions" are simulated in the research laboratories of large mail-order companies where the products offered in catalogues first must pass endurance tests. In a few days the testing machines reproduce the effect of sleeping on a mattress for years (below), and wearing a dress for months. For actual field tests hundreds of people serve as "guinea pigs" and are given samples of shoes, hose and other products. Farmers use free machinery to test its endurance—one even received a new aluminum roof for his barn.

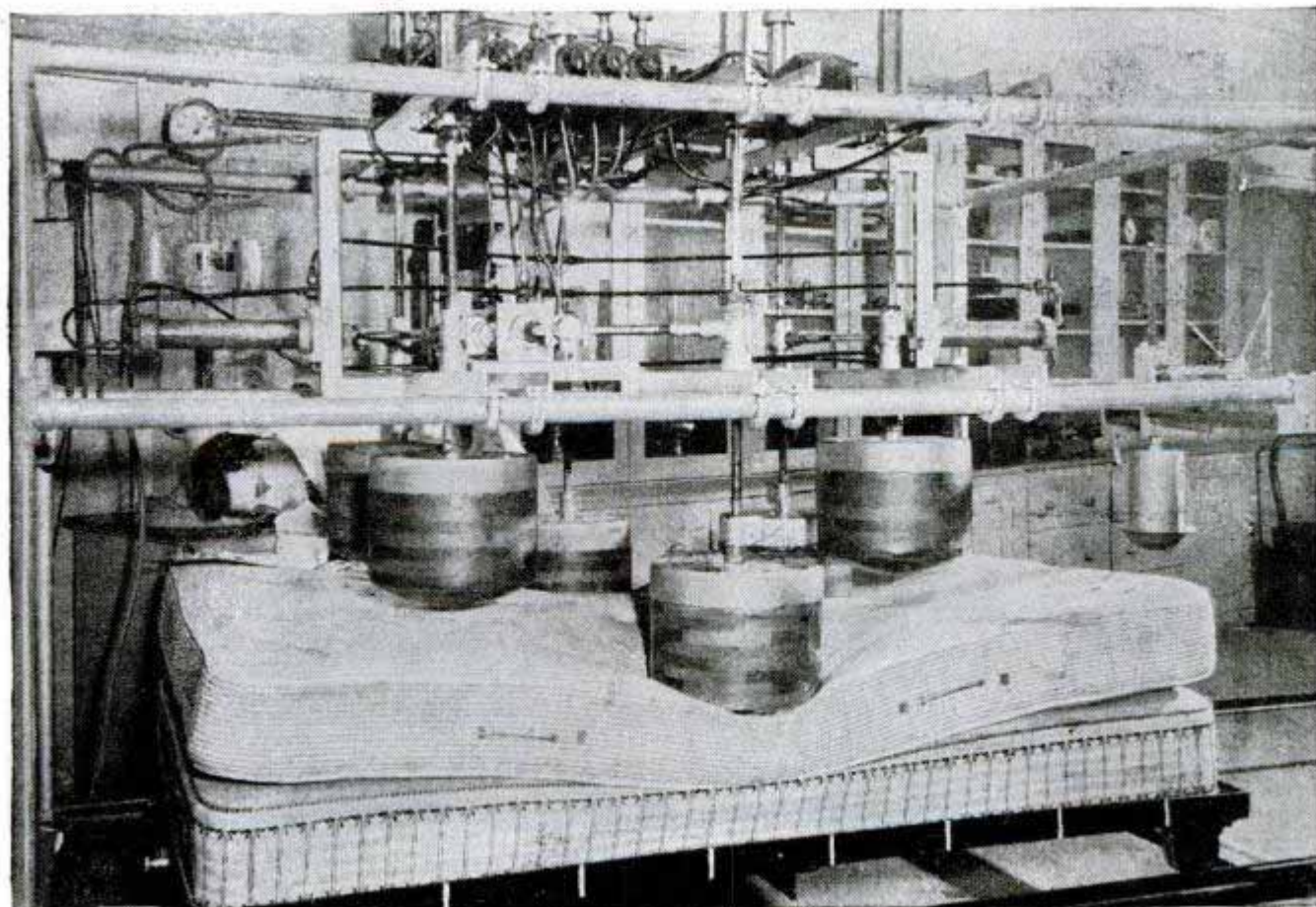

BLOWING UP HOLLYWOOD



By **Walter (Slim) Hoffman**

Explosives Engineer, Paramount Studios

DURING the past 35 years I've "killed" more than 300,000 persons. I've started wars in France, Germany, Russia, India, China, Pearl Harbor and Wake Island. I've dropped bombs and shells alongside Gary Cooper, Clark Gable, Betty Hutton, Bob Hope, Gloria Swanson and Dorothy Lamour. I've set off earthquakes, landslides, bridge explosions, fires, naval battles and volcanic eruptions.

Maybe we'd better get things straight before this gets out of hand. This is not the confession of a super war criminal. It's just a fancy way of saying that I've been handling explosives in the motion picture industry for more than three decades.

The Hollywood smoke-and-powder profession is one that has no counterpart anywhere in the world. At the same time you're creating the illusion of death and destruction, you're responsible for protecting the lives of hundreds of people and property worth millions.

It's a profession that was born in the early days of the D. W. Griffith and Cecil B. DeMille silent screen epics. And it has continued right up to the present—in spite of the fact that developments in miniature work create many of the illusions in today's motion pictures. Each of the major studios employs an explosives engineer—myself at Paramount, Lou Witte at 20th Century-Fox, Carl Hernandez at Columbia, Harry Redman at Universal, Clyde Peebles at M-G-M, Fred Ponedel at Warners and Lee Zavitz who works for the independents. In addition to these seven old-timers, a younger group of 25 or more smoke-and-powder boys is on the way up. Some of them are World War II veterans who have seen a lot of the real thing in Europe and the Pacific.

I've seen times, in years past, when a top-notch explosives man would be paid \$750 a week, \$1500 bonus for each picture, and earn \$14,000 a year. Today, in spite of the fact that no insurance company will bet a nickel on your life, the salary scale is around \$3 an hour. But money isn't everything and there is something in the profession that offers a challenge to skill and courage.

Explosives are a dangerous commodity that take a toll not only in broken bones and burned skin but sometimes loss of life. Nine Hollywood blow-up men have been killed making pictures during the time I've been in the profession. Most of these deaths were caused by carelessness—failure to make proper tests, failure to detect "hot" lines, failure to discover fire in the hole during a retake. A cardinal rule of this business of blowing up Hollywood is: don't take chances, someone might get hurt.

Personally I've been lucky. I've got scars from my younger days when I sometimes substituted courage for judgment. But I've had only one serious accident. While working on the picture "Painted Desert," my crew and I planted 1½ tons of dynamite in the side of a cliff. A premature explosion threw out chunks of sharp rock which cut my hands and broke a leg. A slight cut on the cheek was suffered by a young extra named Clark Gable.

Handling explosives on an outdoor location or on a huge sound stage, the explosives man is the boss—and even can override the decisions of the director. A first-rate explosives engineer always makes exhaustive tests before he sets off his charges. When actors and technicians get hurt, it's because they don't follow the advice of the smoke-and-powder man.

I am reminded of an incident that happened in the filming of "All Quiet on the Western Front." A battlefield scene was laid out and explosive charges were plant-

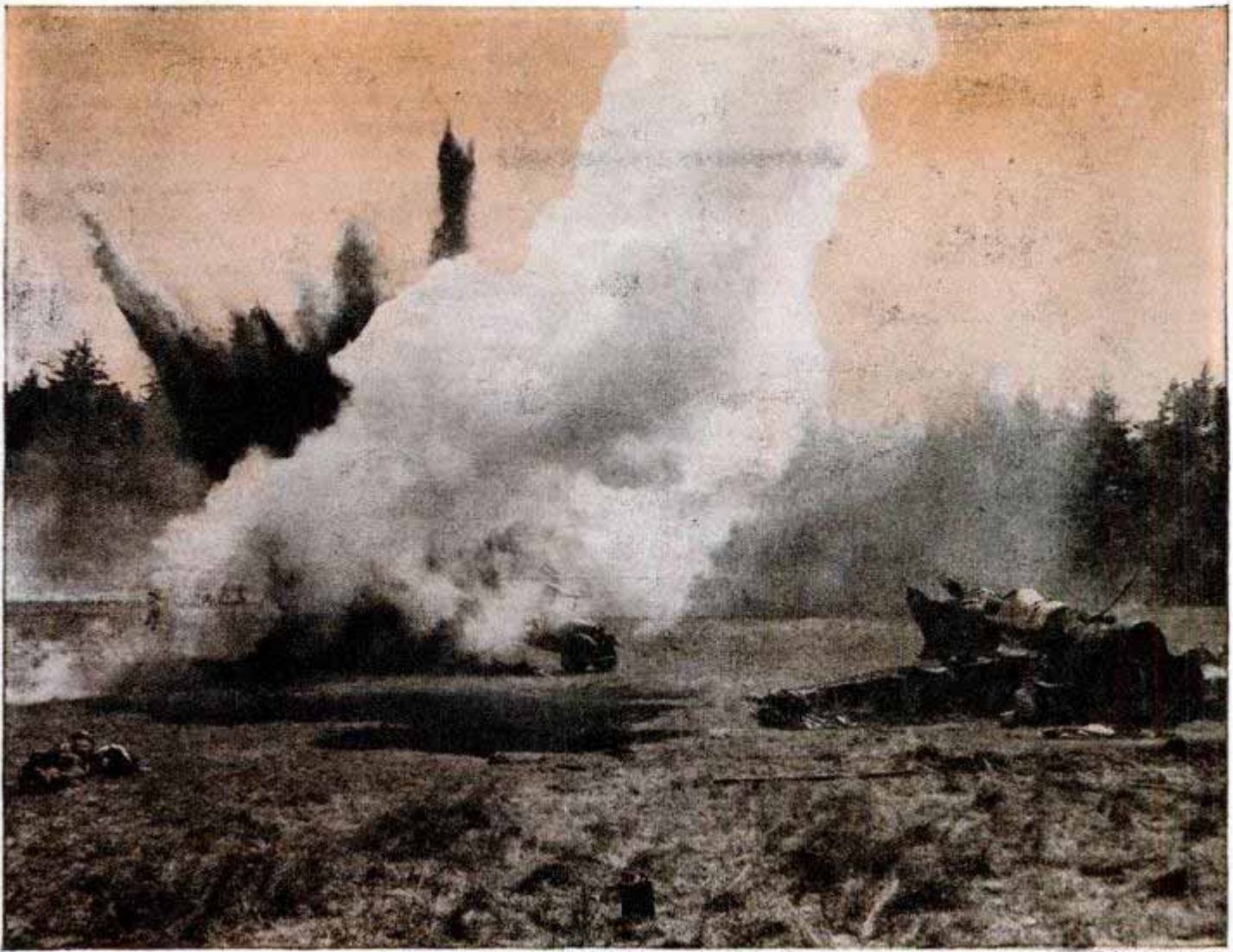

Columbia photo

Commandos strike—and explosives engineers must produce two-color smoke
 ↓ **Magic lacopodium blazes brightly without burning down the installations**
 Warner Bros. First National photo

ed. Before the charges were connected, a careful rehearsal took place so that the actors would know where to run and where to fall down.

Located at a master control board, I was high enough to watch the entire battlefield. The cameras turned and the scene came alive. Actors charged up out of the trenches. Some of them flopped on their stomachs, others fell as if dead. Explosions were popping all over the field. Suddenly I noticed that one actor had fallen on a charge that had not yet been exploded. I skipped that key and went on to the next.

When the scene was over, I beckoned to him.

"Come here and watch that place where you were lying a moment ago."

I flicked the explosives



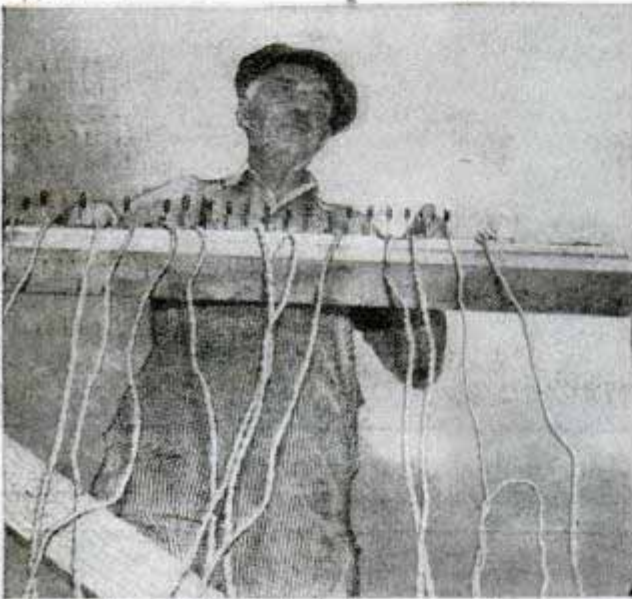

Explosives engineer must be an historian to duplicate the effects of old-time firearms and grenades. Top left, fireball used in Indian picture is handled with an asbestos mitt. Left, switches on panel give engineer control over battlefield scenes. Bottom, three dynamite charges are taped for a big explosion

key and the earth blew up in a geyser. He turned white and we saw no more of him that day.

From the smoke-and-powder man's point of view, the greatest picture ever made was "All Quiet on the Western Front." More than \$50,000 in explosives went up in flame and smoke in that picture. In an average film an explosives engineer has from 5 to 10 assistants. In "All Quiet" I had 68. We set off 10 tons of powder in 8000 separate charges—a record that has not been equaled since. Other pictures which called for heavy explosives work included "King of Kings," "What Price Glory," "The Fighting 69th," "For Whom the Bell Tolls," "Wake Island," and "So Proudly We Hail."

Tools of the smoke-and-powder profession include: dynamite, black powder, blasting caps and squibs, Primacord, springs, air mortars, dry ice, lacopodium, flamo and gasoline, plus your own wits and ingenuity. Because of the fast pace at which most pictures are filmed, you are often called upon to devise a trick explosion or flame sequence on the spur of the moment. That's where experience pays off.

Dynamite is probably the most useful



↑ Explosions, smoke and fire lend realism to tense battle scene from new film "Unconquered." Right, concealed ground charge gives effect of a five-inch-shell burst

tool that an explosives engineer works with. It's usually low-powered stuff—perhaps 20 or 25 percent nitroglycerine, the rest corn meal. Most of the new types of explosives developed in World War II, such as RDX and others, are useless for movie work because they are too fast. Old, reliable dynamite can be employed with safety because you know for sure how it will act.

Black powder is used to some extent, but it is not as trustworthy as dynamite. Black powder tends to follow the line of least resistance and you can never be sure of which direction it will explode. When I use black powder, I choose the slow-burning kind. Like the dynamite we use, it is only about 25 percent.

A smoke-and-powder man lays out a battlefield scene almost as carefully as an architect

(Continued to page 228)



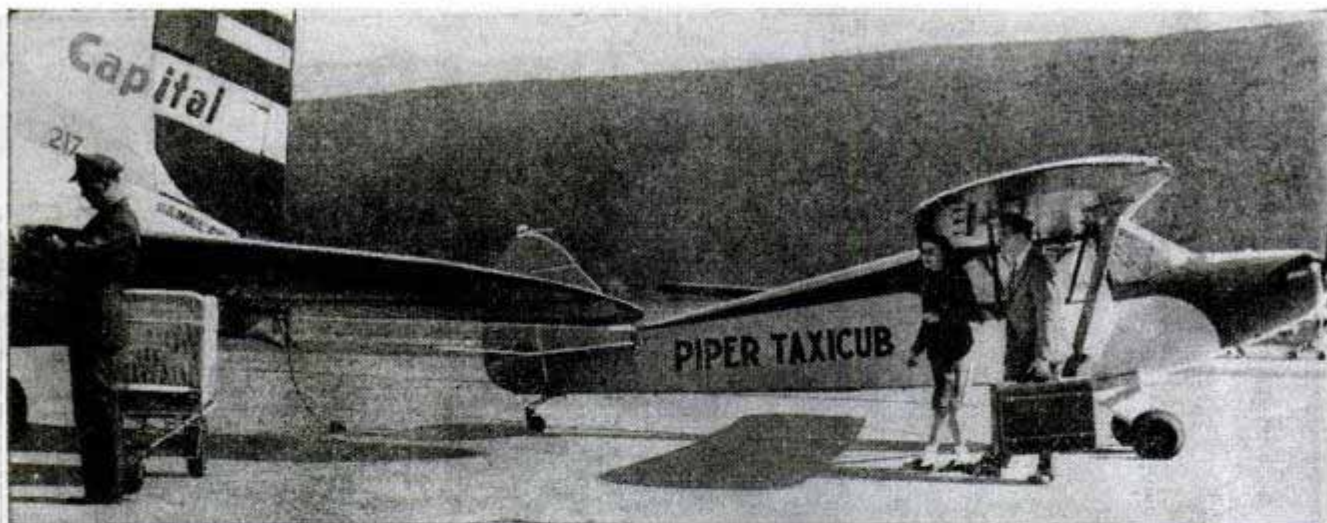

Piper Aircraft photo

AERIAL CAB FLEET

Aerial taxicab service at rates as low as six cents a mile has been started throughout the nation by a fleet of 1500 light planes. It is designed for service between air-line

stops and fields off the main routes, and for salesmen covering rural areas. Carrying two passengers and baggage, in addition to the pilot, the planes cruise at 105 miles an hour and have a range over 600 miles. They all have two-way radios.

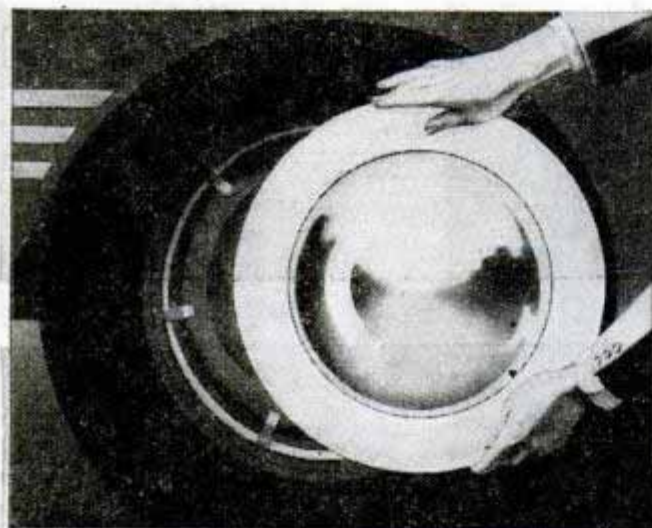

Single Unit Hub Cap and Trim

Hub caps with white wheel trim attached can be snapped on the wheels to give a distinctive appearance to both old and new cars. A spring retaining band is fastened to the rim to hold the cap on the wheel. The single unit is made of heavy-gauge steel with the hub finished in triple-plated chromium and the white trim given a baked-enamel coating. Sizes are available to fit most stock cars.

Lightweight Stainless-Steel Boat

Although it's built of stainless steel, a 12-foot round-bottom boat now being mass produced for sportsmen weighs only 120 pounds. It resists rust in salt water or fresh water and is virtually punctureproof. The boat has built-in full-length spray rails for extra safety and stability, dry performance and added strength.

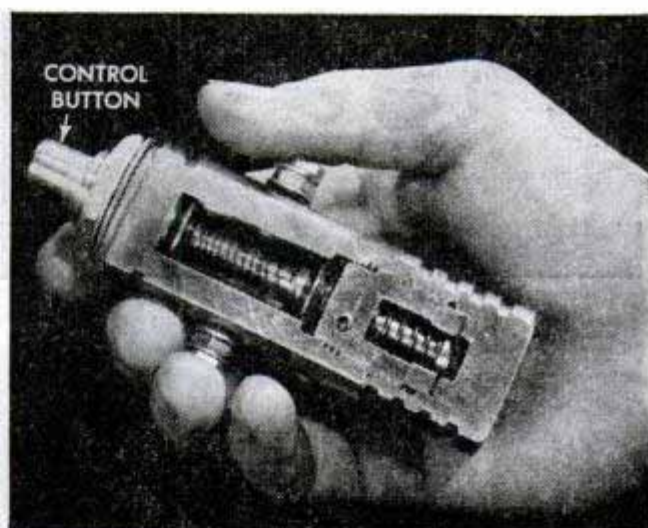

"Alarm" for Lubrication Trouble

Engine failures due to lubrication are prevented by a pressure-activated device that breaks the ignition circuit when the oil pressure drops low. It can be made to energize alarms or control systems to indicate insufficient pressure when used on engines without electrical ignition. When starting the engine a control button on the device is pushed down and oil pressure holds the switch closed. Any pressure drop below the preset minimum stops the engine. In emergencies on the highway or in traffic, pushing the button restores the system for temporary operation.

Popular Mechanics is always ready to supply further information to readers about various products described in any issue. Just write to Bureau of Information, Popular Mechanics, 200 East Ontario Street, Chicago 11, Ill., for a prompt reply

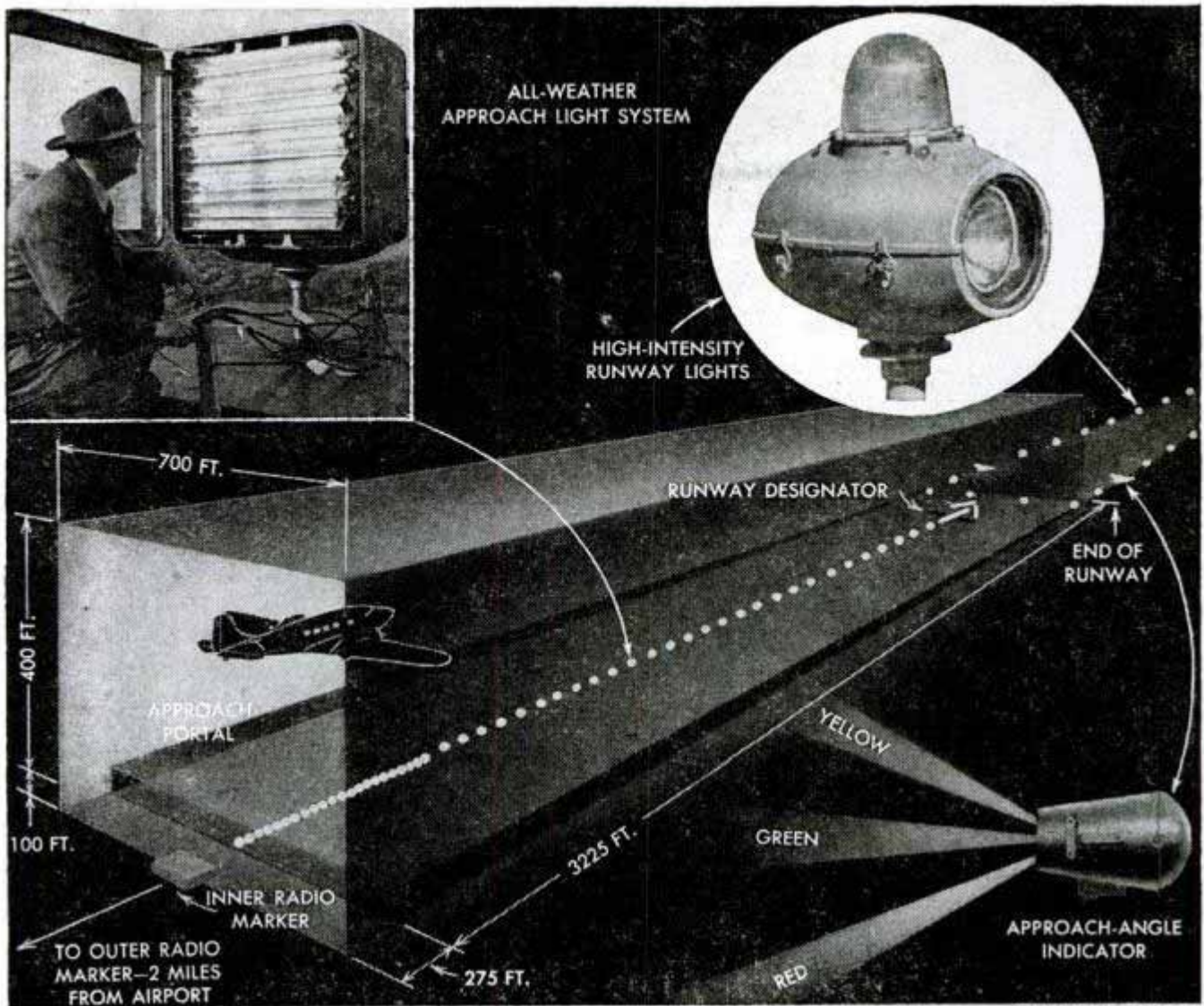

Westinghouse photos

"BOTTLED LIGHTNING" GUIDES PILOTS TO RUNWAY

"Bottled lightning" from the world's brightest lights is being tested to bridge the gap between instrument approach and visual touch down in all-weather flying. It is a 72-lamp approach system developed by Westinghouse, with 36 units each having over three million peak candlepower that is strong enough to penetrate any weather for 1000 feet. They are four-inch-long quartz tubes filled with krypton, a rare gas. They are arranged alternately with neon blaze units in a line about two thirds of a mile long beneath the approach path. In effect the illumination provides an "approach portal"—an imaginary frame of light 400

feet high and 700 feet wide. Flashing one after another toward the runway, 40 times a minute, the 72 lights appear as a stroke of lightning to the pilot. In poor visibility an 83-foot pattern of lights, forming a green arrow or a flashing red cross, serves as a last moment runway designator. The arrow indicates a clear runway and the cross is a warning not to land. Another part of the system is two approach angle indicators to guide the plane along the approach path. To the pilot, the indicators appear as flashing yellow lights if he is too high, red if he is too low and green if he is at the proper altitude.

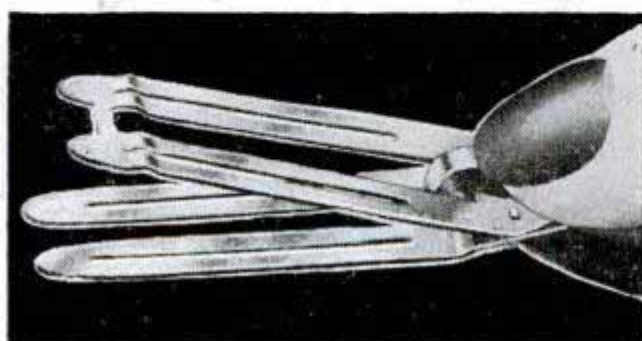

Pin-Curl Clip

Pin curls are held in place by a spring-steel clip devised for women who set their hair at home. The clip is nickel plated, light in weight and can be opened with one hand. They are designed so that users may sleep comfortably with them in their hair. The clips are also useful to hold bows or flowers and it is almost impossible to bend them out of shape.

Air-Bag Wind Tunnel

By using nine surplus tank cars and a barrage balloon, the University of Michigan and the AAF built a supersonic wind tunnel at Ann Arbor for one tenth the usual cost. It operates on an intermittent principle. The balloon forms a storage bag from which air rushes through the scale model test section at supersonic speeds for from 13 to 15 seconds. The vacuum causing the air torrent is created by pumping out the tanks, which are manifolded together to provide about 12,000 cubic feet of space. It takes 15 minutes to pump the air back from tanks to balloon.

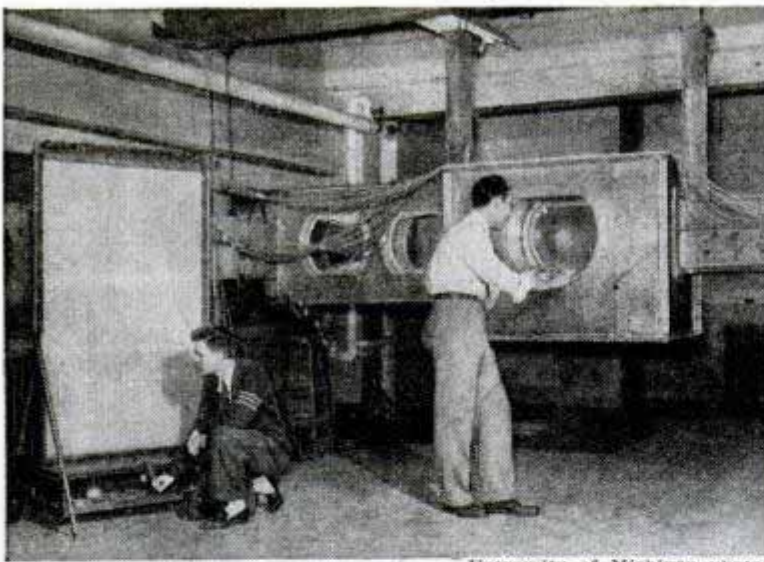

University of Michigan photos

Models up to a foot long "fly" for 15 seconds in test section above. It has a wind velocity of about 1250 miles per hour

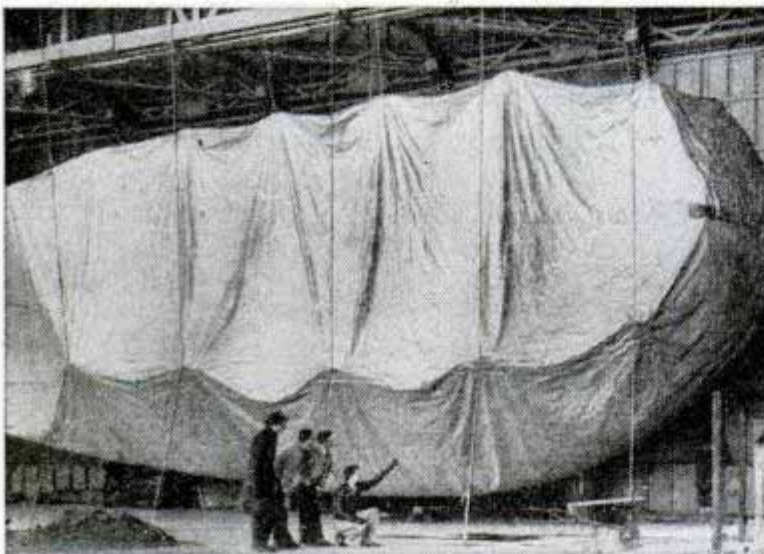

Surplus barrage balloon serving as storage bag, upper left, has a flexible capacity of 24,000 cubic feet. Tank cars at right were destined for Russia when war ended. Below, vertical view of tunnel arrangement

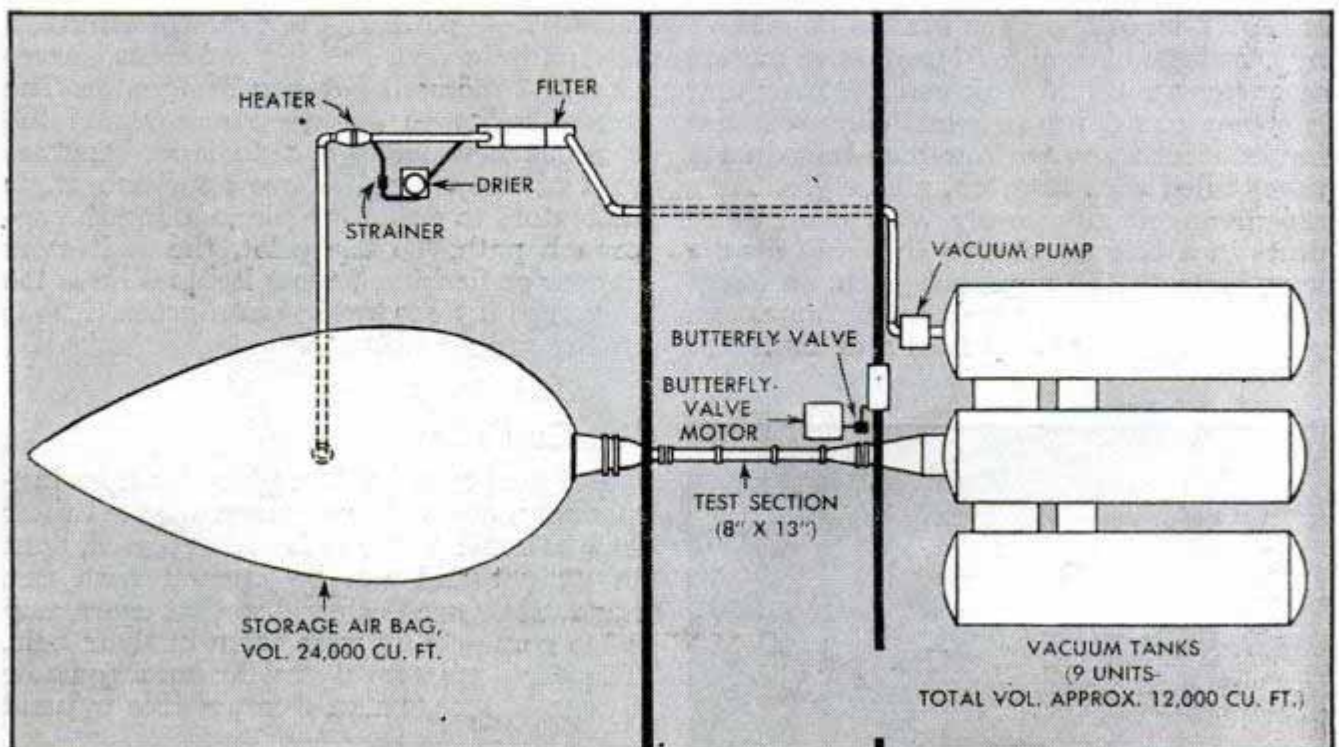



NEAT MAILBOXES

The CRAFTSMAN

★ If you were sitting in the stern of that row-boat you'd appreciate the fine points of the skilled oarsman. He doesn't give you a shower with each stroke, he doesn't stand up and scrape bottom with the blades, he doesn't zigzag. He learned expert rowing technique by reading the article on page 170.

★ Soldering is so simple, you might as well do it right the first time. Even if you've been at it a long time you can pick up some pointers from the article beginning on page 201: "Solder It Right."

★ Did you ever wonder how your tinsmith made those neat, square bends in the sheet-metal job he did for you? The chances are that he used a bending brake — a tool you can make for yourself from the directions on page 207.

★ You folks living on an RFD route ought to show the story on page 186 to all your neighbors. Then watch the clever and distinctive mailboxes spring up all along the roadside!



SHEET-METAL BRAKE

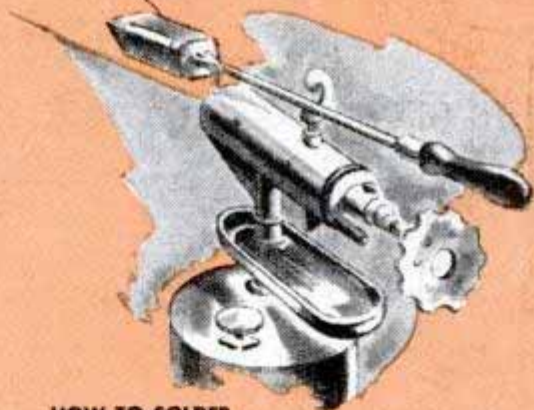

HOW TO SOLDER

ROW CORRECTLY



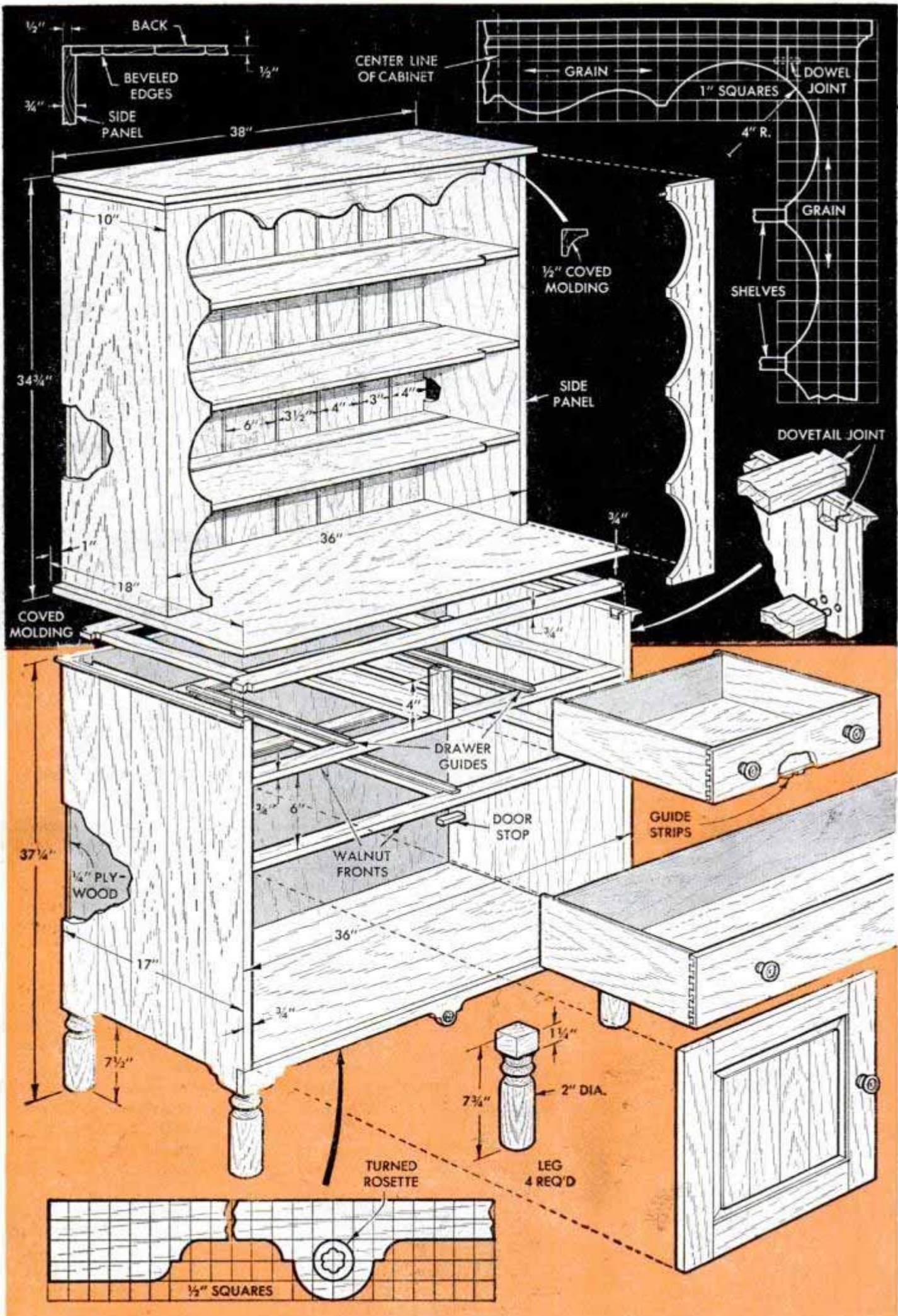

A fine, rugged piece of Early American furniture to lend authentic setting to your pewter or silver collection. Cabinet base provides storage galore for silverware, linen and china. Its plainness makes it simple to duplicate with ordinary tools

By W. W. Buffmire



Reproduce this WELSH DRESSER for your best china

To be traditionally authentic this quaint old piece should be reproduced in American black walnut, although it can be copied in maple or birch and finished to match other Early American pieces that you may have. A study of the pull-apart view on the opposite page will acquaint you with the way the whole job goes together. Start by gluing edgewise two or more $\frac{3}{4}$ -in. pieces to build up wide panels for the top and ends of the lower unit. Except for the plywood panel covering the back of the cabinet, solid stock is used throughout, although the bottom could be of plywood, too, as the front edge of it is faced with a scrolled apron. The bottom is set $1\frac{1}{4}$ in. up from the lower edge of the ends and the turned legs are glued and screwed in the corners formed by the apron across the front. The bottom, however, is not assembled until the three drawer frames are made ready, then the whole unit is clamped together at one time. Note in the detail that the top frame is fitted to the ends in dovetail mortises, while the other two are simply doweled and glued in blind holes.

The $\frac{1}{2}$ -in. shelves of the upper unit can be doweled or set in grooves cut in the sides. The scrollwork around the face of the unit fits flush in the notched shelves and the back of the unit is paneled vertically with $\frac{1}{2}$ -in. pieces of varying widths. Drawers and doors are assembled as shown, the latter being held shut with spring-type friction catches.

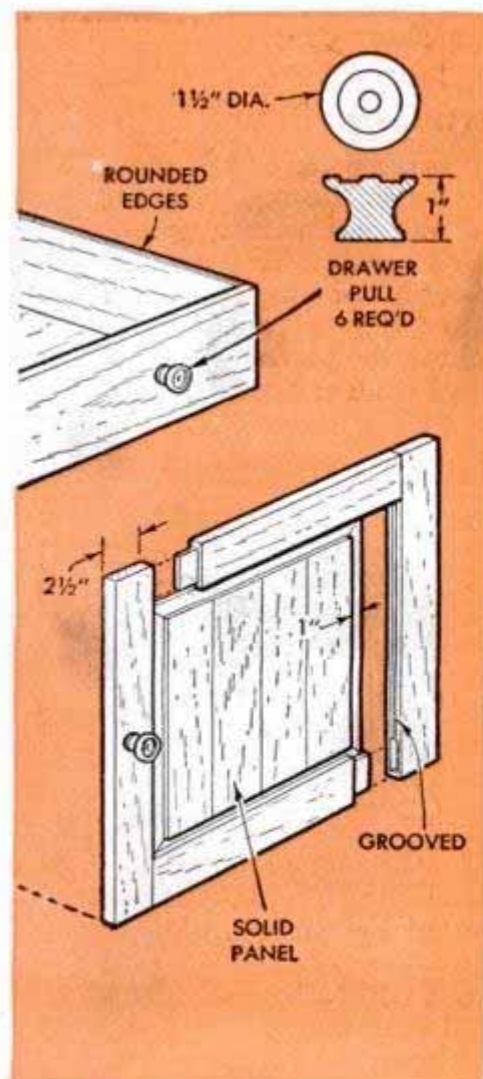

Double-Pole Switches Converted For Multiple Setup

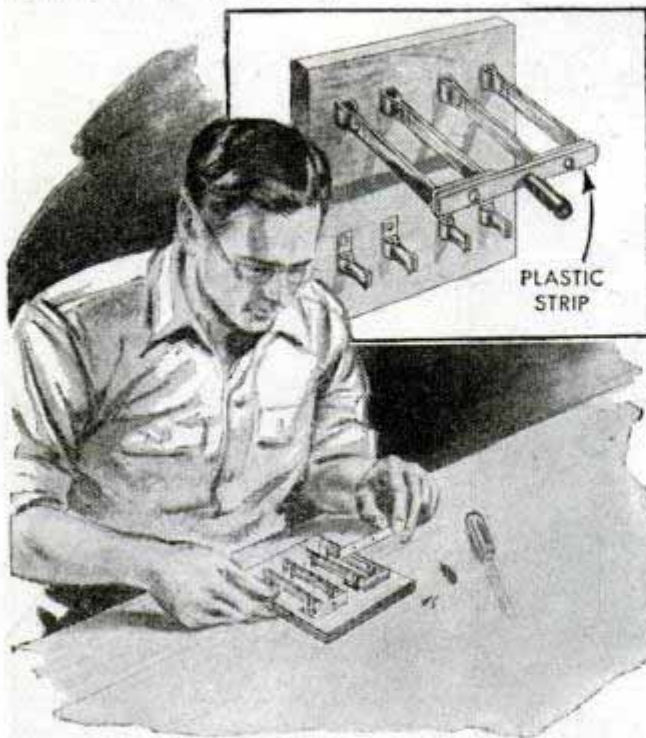

Double-pole knife switches can be converted to use for multiple setups, such as closing or opening several circuits with one operation, by using a common handle. First the switches and contacts are mounted on a common, insulated base, as in the upper right-hand detail, and the individual handles are removed. Then a strip of plastic or other insulating material is used to tie all switches together. A handle is fastened to the middle of this strip.

Bill J. English, Tucson, Ariz.

Paper Pocket Holds Fishhooks

Five different sizes of fishing hooks can be carried in a shirt pocket with this expanding paper holder. A lightweight,

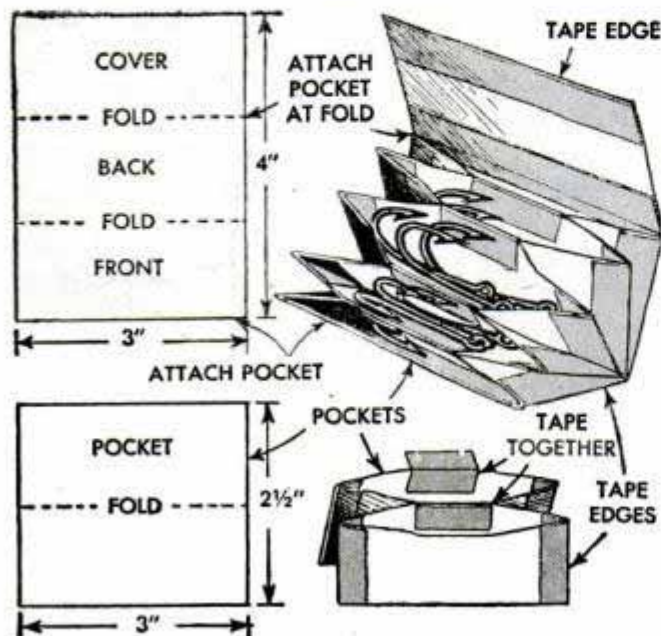

waxed cardboard should be used. Dimensions for the cover and individual pockets are given in the two left-hand details. All edges and folds are reinforced with tape.

R. A. Jenkins, St. Louis, Mo.

Fish Grilled Between Two Stones

Grilling fish or meat without a cooking utensil was an art practiced by the Indians but is little used today. One of the simplest ways to do this is to use two fairly large flat stones and four smaller ones about 3 in. high.

Lay one of the flat stones on the ground and place a 3-in.-high stone at each corner. Then place the second flat stone on top, leaving a space of 3 in. between the two. Pile dry branches around this improvised cooker; light the fire and heat the stones until they are hot. Allow the fire to die down and remove the coals from one side. With a leafy branch clean out any ashes between the slabs and slip the meat or fish between them. Cooking requires only a short time.

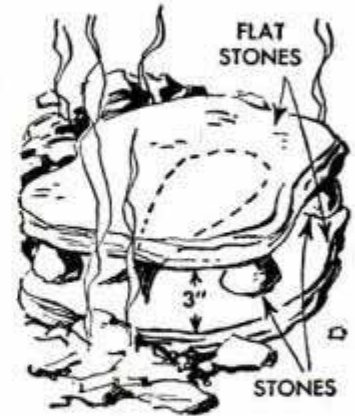

How to Cut Terra Cotta Pipe

When cutting off terra cotta or tile pipe, or when cutting holes in the material, fill the tile with sand and tap with a small, sharp chisel, working continuously around the line where the cut is to be made. If care is taken, almost any type of cut can be made without cracking the piece.

Frank J. Malloy, Windsor Locks, Conn.

Removing Nails From Thin Stock

Occasionally a nail is driven into the end or edge of a thin piece of wood in such a manner that the nail protrudes from the side. Removing the nail by tapping on the point with a hammer often damages the wood, but this can be prevented by using a nailset. Place the set against the point of the nail and then drive it out with a hammer. The hole should be filled with putty.

C. R. Schlegel, Jenkintown, Pa.

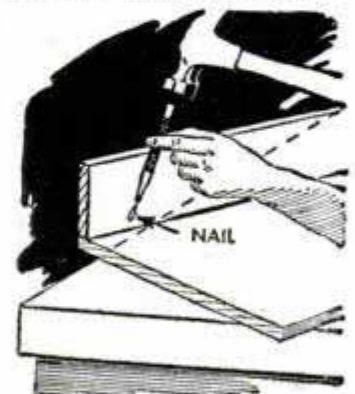

Rumpus-Room Armchair

Strictly in the modern mode, this plywood armchair is easy to make and adds just the right informal touch to a basement rumpus room or front porch. First, saw out the sides and the four pieces for the armrests, Fig. 2, and then cut the bottom and back, and fasten in place by means of cleats, Fig. 1. The armrests are glued and screwed in place. In addition to the bottom cleats, an under-seat brace is required, right-hand detail of Fig. 2. When the sides, back and bottom are assembled, the chair is ready to be upholstered. Pocketed springs are used and are covered with padding and a suitable cloth. If foam rubber is available, it can be used instead of padding with good results. Stain the wood and finish with three coats of shellac. Or by way of variety, you might use a colored enamel finish that contrasts with the pattern of the cloth covering.

Benj. Nielsen, Aurora, Nebr.

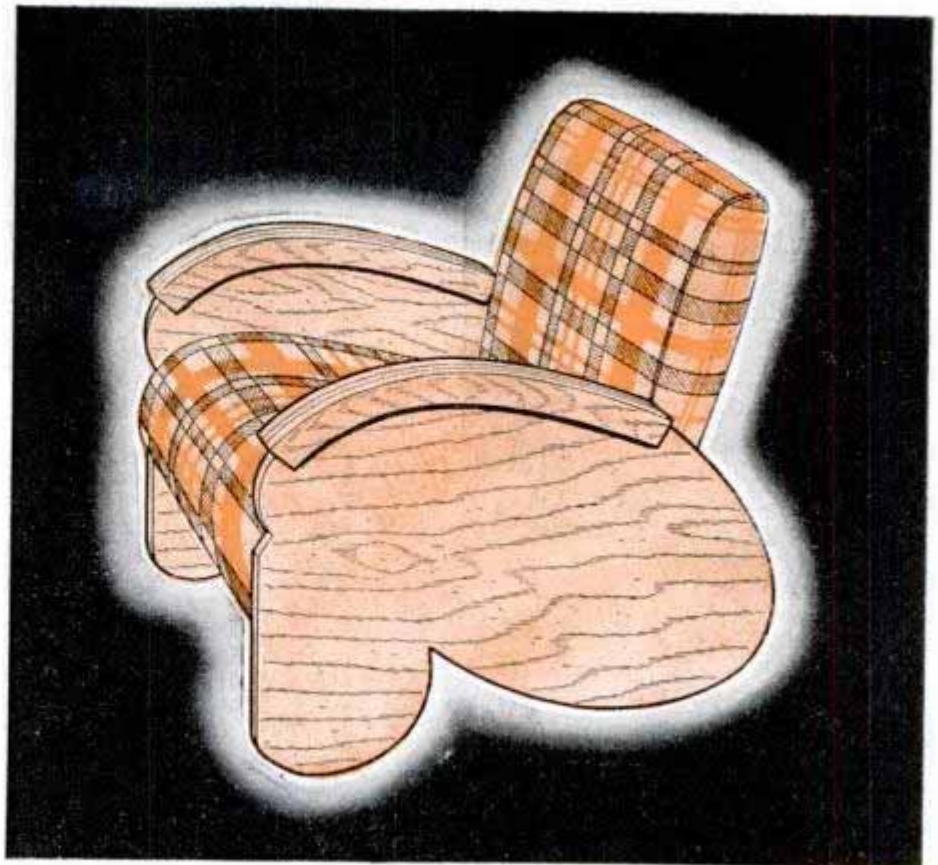

ARMREST
4 REQ'D

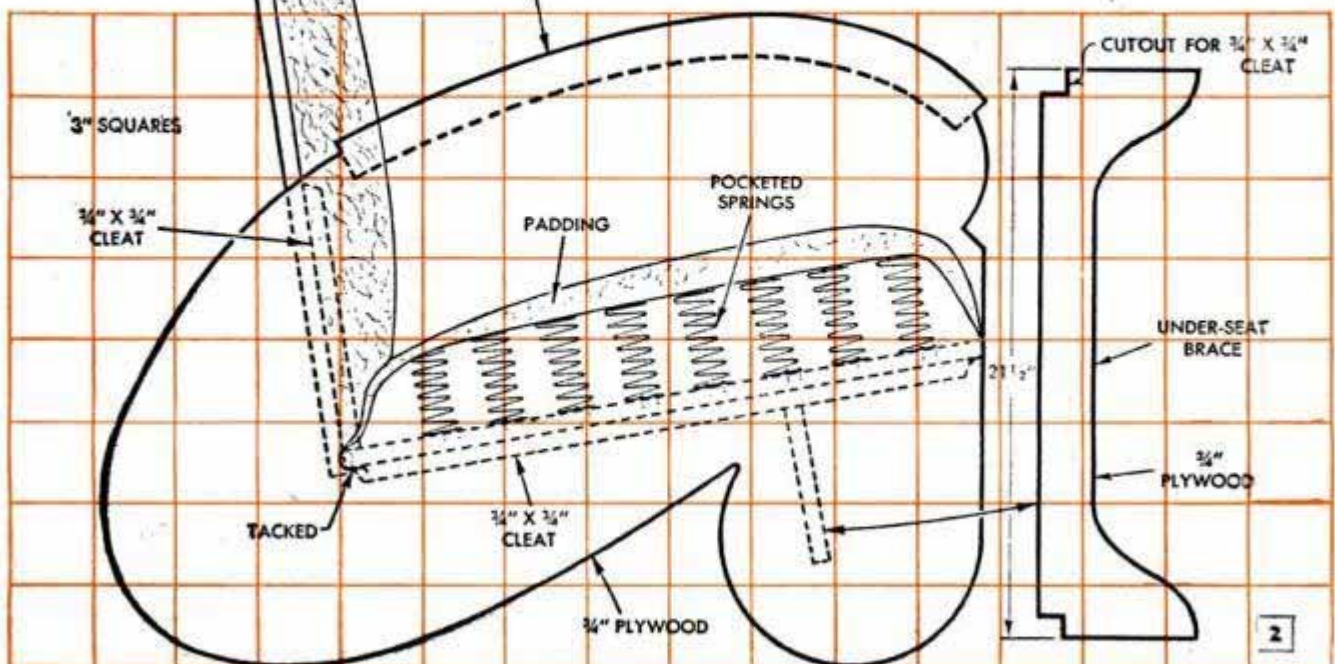

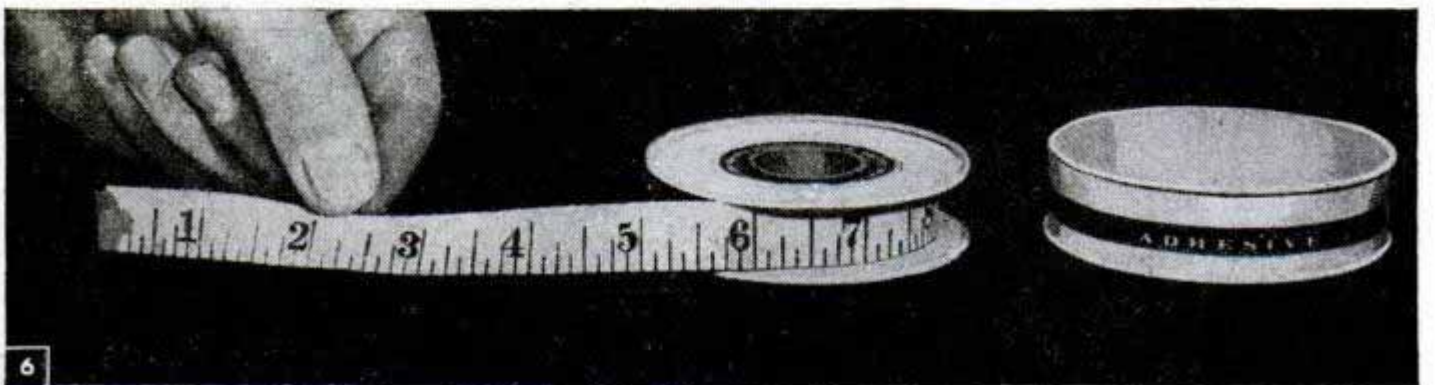
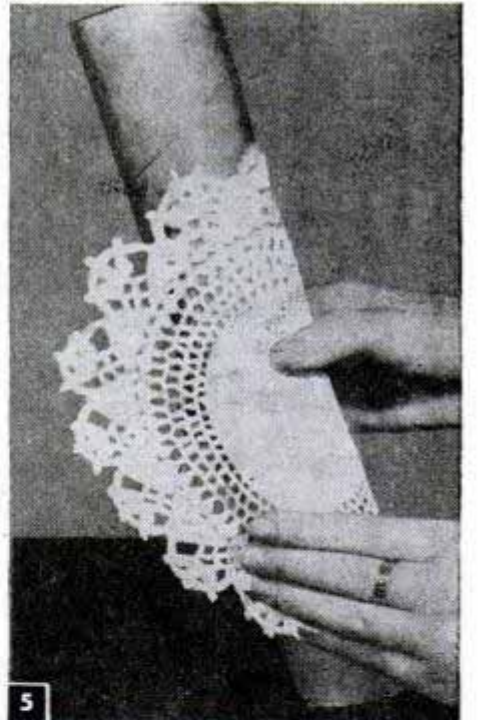
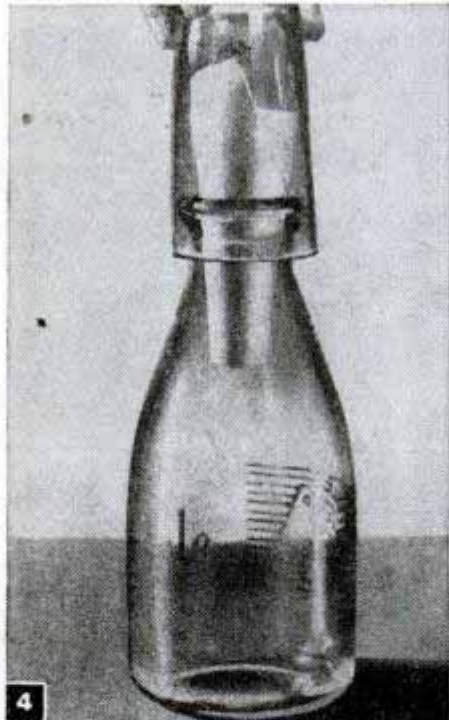
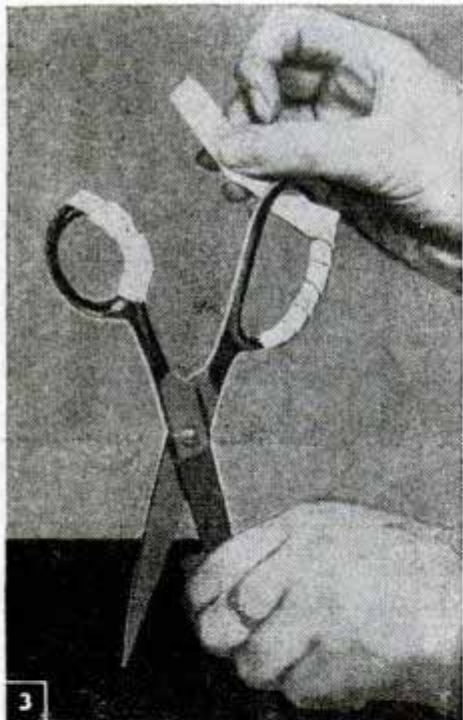
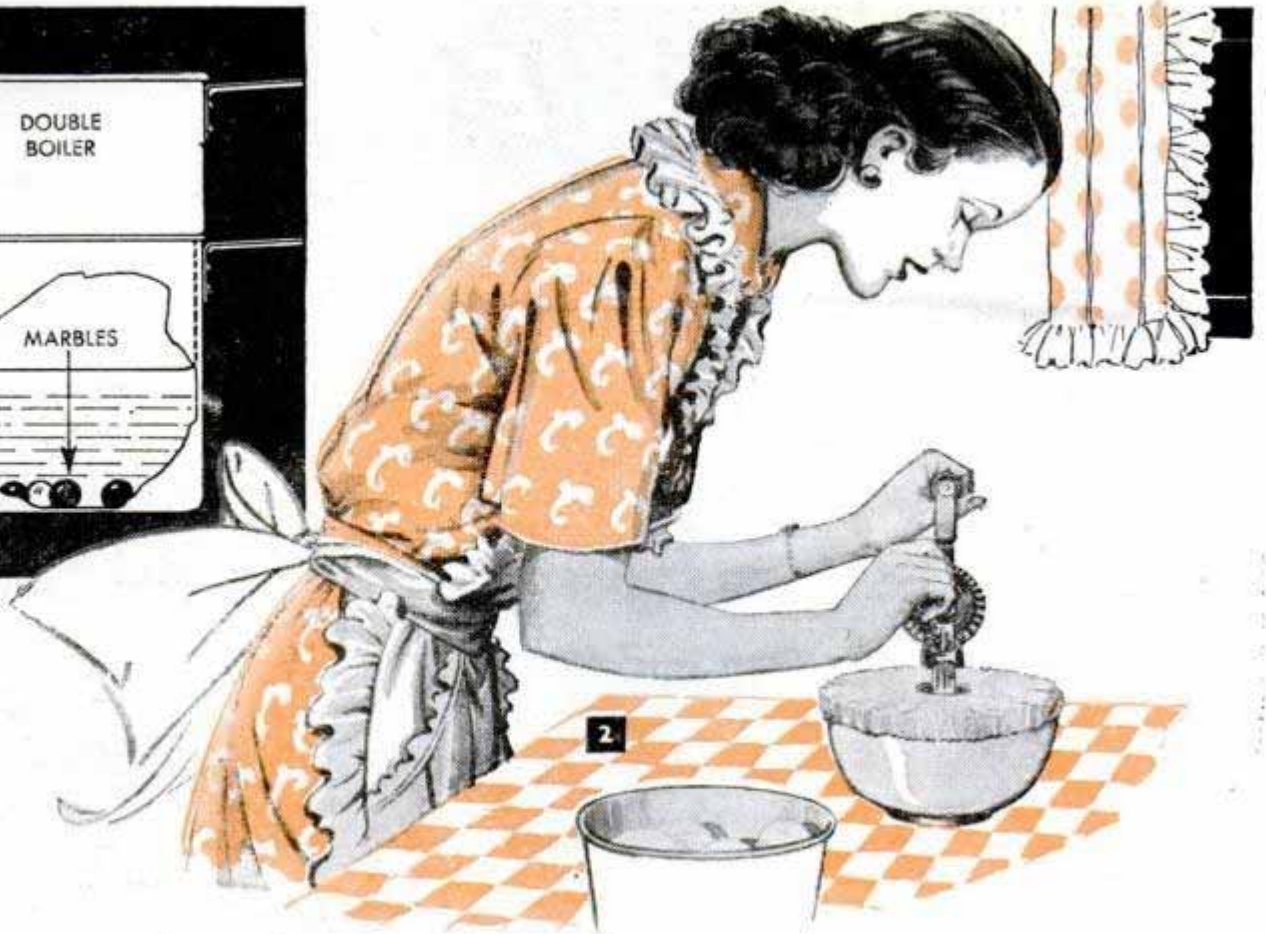
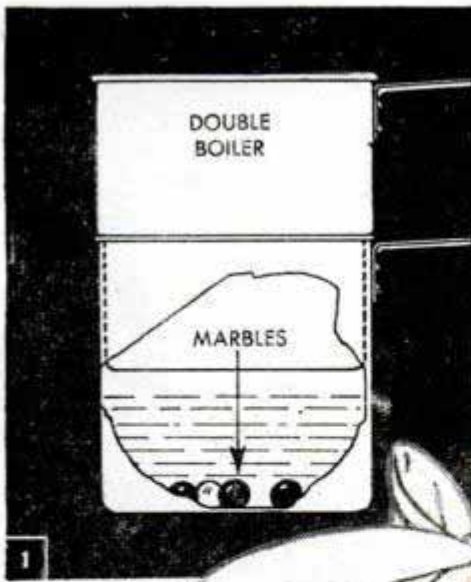

Solving HOME PROBLEMS

- 1 One way to tell when a double boiler is becoming dry is to place several glass marbles in the bottom pan. Then when the water level is too low, the marbles will rattle against the pan to serve as a warning.
- 2 To prevent spattering when beating eggs or whipping cream, use a plastic bowl cover with a hole in the center for the beater. Keep several sizes on hand.
- 3 Moleskin adhesive tape, which has a soft covering, can be wrapped around the handles of scissors to pad them and thus prevent sore or blistered fingers.
- 4 When leaving a note for the milkman, place a glass over the bottle as a protection from wind and rain.
- 5 Doilies and other fancy work will not crease when stored if they are wrapped around a cardboard tube.
- 6 Instead of keeping a linen tape measure loose in your sewing basket, wrap it around an empty adhesive-tape spool and then fasten the cover in place.
- 7 Slit rubber hose, slipped over the rim of a waste-basket, will keep it from scratching kitchen walls.
- 8 Because many electric-stove control dials are one color, it's not always easy to see the settings. However, if such areas are left white and the others are colored red, you can tell immediately what "heat" is on.
- 9 As an emergency repair for pots and pans, apply a coat of nail polish over the hole and dry at a low heat. If necessary, apply a second coat. Do not use the repaired pan over an open flame or a high heat.
- 10 Trousers that are hung on wire coat hangers wrinkle easily, but if a length of broom handle or dowel is stapled to the crossbar, this difficulty will be eliminated. Cut the handle so that it will be a snug fit.
- 11 Removing clothes from a hamper by lifting them out is an unpleasant and time-consuming task. To do the job in short order, fit the bottom of the container with hinges and a hook or catch. Then the clothes can be taken out in a hurry by opening the bottom.

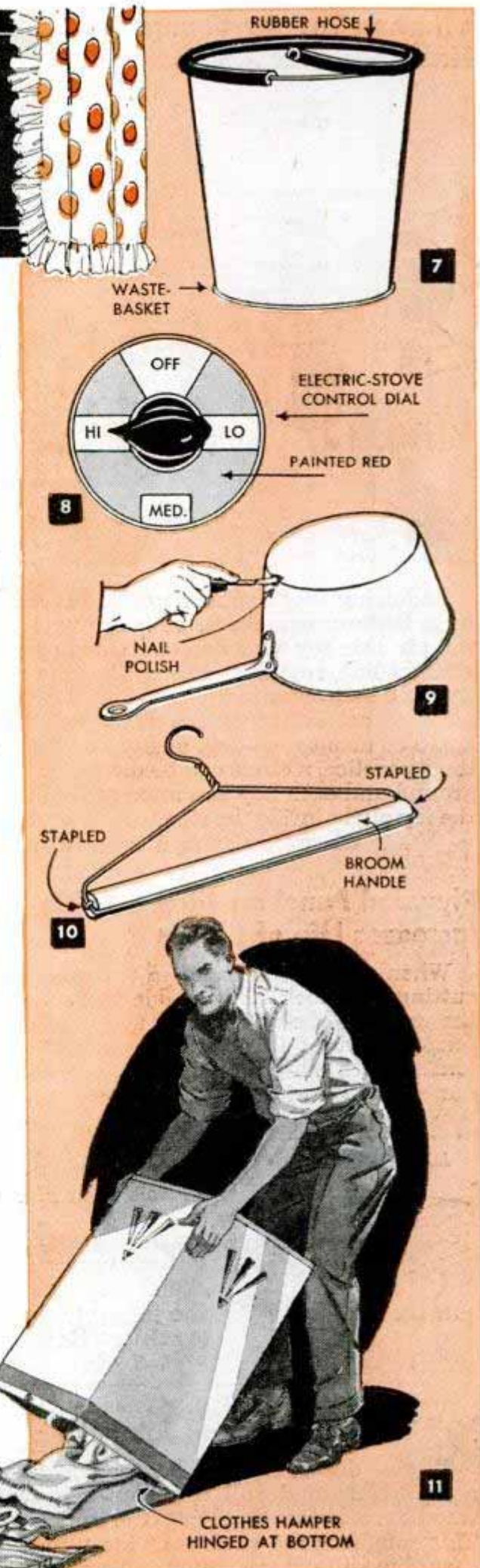

Whirling Toy for Youngsters Has Helicopter Action

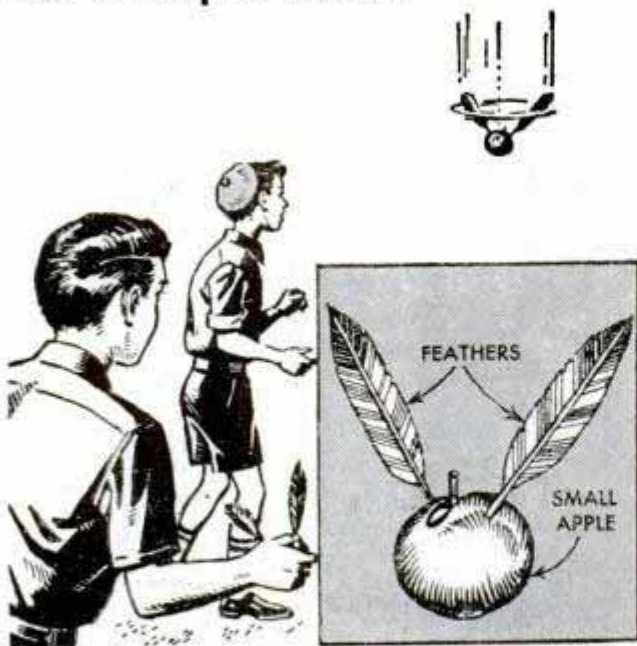

Requiring only a small apple and several large feathers to make it, when thrown into the air this toy will descend slowly in a straight line, resembling somewhat the action of a helicopter in flight. The two feathers that act as rotors are stuck into the apple at about a 45-deg. angle. For "spotting" practice, a circle can be drawn on the ground and each boy can attempt to make the toy alight inside the ring.

Clarence Kumb, Rockfield, Wis.

Plywood Panel on Jigsaw Table Increases Life of Blades

When using fine blades in a jigsaw for cutting thin stock, a false table will elevate the work and bring it into contact with an unused part of the blade, resulting in a longer cutting life. In many cases this will double the life of the blade. A piece of 1/2-in.

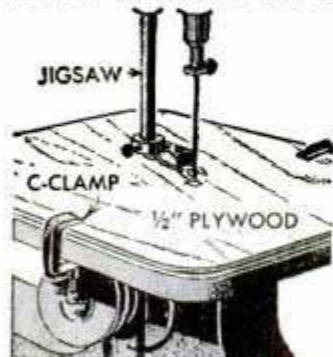

plywood makes an ideal table and C-clamps are used to hold it in place. For a neat-looking job, the wood is cut and sanded to the exact shape of the jigsaw table.—Arthur Beiser, New York.

Making Glued Dowel Joints Hold

To glue doweled joints, lay the dowel on a worktable and roll it under a coarse wood rasp before applying the adhesive. This roughens the surface of the wood so that glue will adhere better and a stronger

bond will result. Care must be taken when rolling the dowel not to reduce its diameter so that it is too loose a fit in the joint.

G. C. McClure, Los Angeles, Calif.

Rubber Hose Used as Siphon

If you want to drain several gallons of gasoline from the tank of a car, it can be done with a piece of rubber tubing long enough to reach from the gas tank to a container below the level of the tank. Insert the tube in the tank as far as it will go and then stop the open end with your thumb.



Still holding this end, insert it in the container you wish to fill and remove your thumb. The gas should start to flow immediately.

Buford E. Keen, San Francisco, Calif.

Tool Rack Hanging From Ceiling Saves Space in Workshop

To save space in his basement workshop, one craftsman devised a rack that would hold all his tool boxes and swing up against the ceiling, between joists, where it was out of the way. The boxes were pivoted to the sides of the rack by means of pipe which was capped at both ends to keep it from slipping out of place. When not in use, a hook holds the rack in place, but when tools are needed, the rack swings down against the wall.

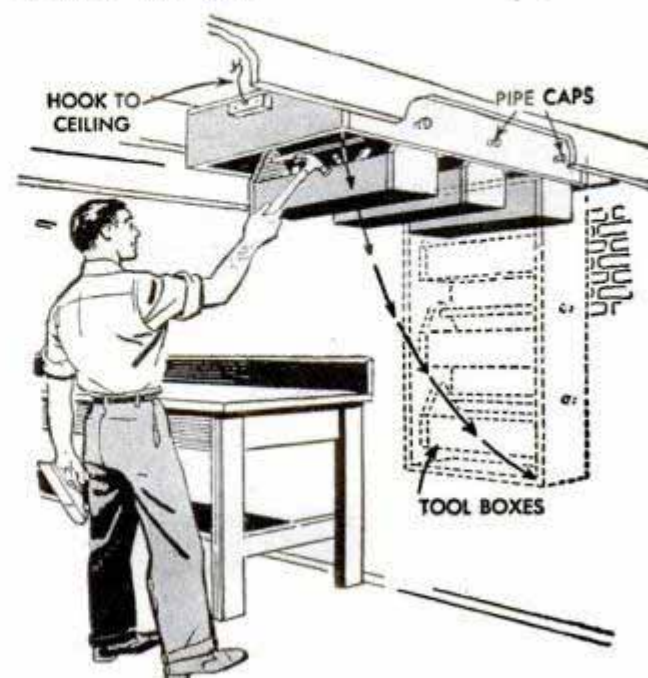

Antique Candleholder for Basement Playrooms



By D. C. Marshall

HOSTESSES will like this candleholder because it is especially suitable for the informal table, and home craftsmen with limited spare time will find that it's easy to build and requires the use of only a few simple tools. Although sheet copper can be used for all the parts, pieces of tin cut from coffee cans and used with the bright side out are the next best. If you use tin, be extra careful when cutting that the material is not sharply bent or dented in the process. Start with the base which consists of two sheet-metal disks and an encircling band, the ends of which overlap $\frac{1}{8}$ in. The decoration on the band is stamped into the metal with a short piece of pipe. Care must be taken to get the indentations of uniform size and equally spaced. Note that the same decoration is carried out on the four sides of the drip-tray support, except that here the full-circle indentation is made.

Cone-shaped sections which make up into the center ornament are formed separately and soldered together before soldering to the base. Form the drip-tray support over a block of hardwood, then shape the drip tray by beating down a sheet-metal disk into a circular recess cut in a block of wood. Use a wood mallet with a rounded end. The band of tin holding the candle is formed to the cylindrical shape by bending over a rod or pipe and is soldered to the center of the drip tray.

With all the parts made up, cut or file the drip-tray support to fit the curvature of the tray. Then solder all parts together. Use a small torch for soldering. The needle flame will get into those places where it is impossible to use an iron effectively. Final part in the assembly is the handle, which is a strip of metal bent to a scroll shape and

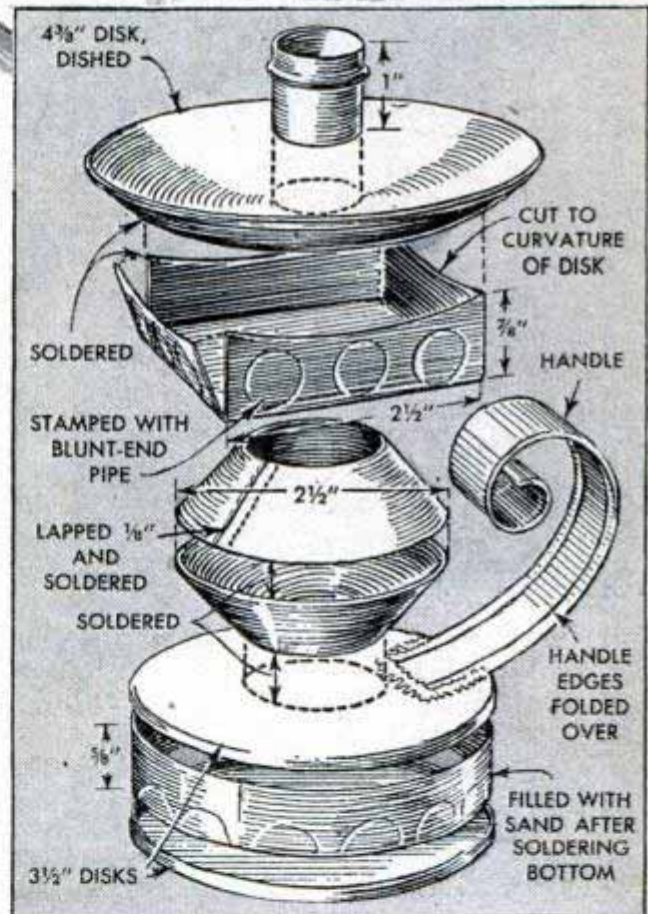

soldered to the base and the drip tray as shown in the photo. Note that the edges of the strip are turned or folded over to add strength. This is done before bending to the scroll shape. Smooth all edges bright, wash in a soda-water solution to remove the soldering flux and finish with a coat of water-white lacquer.

☛ Brighten discolored aluminum pans by boiling apple parings in them.

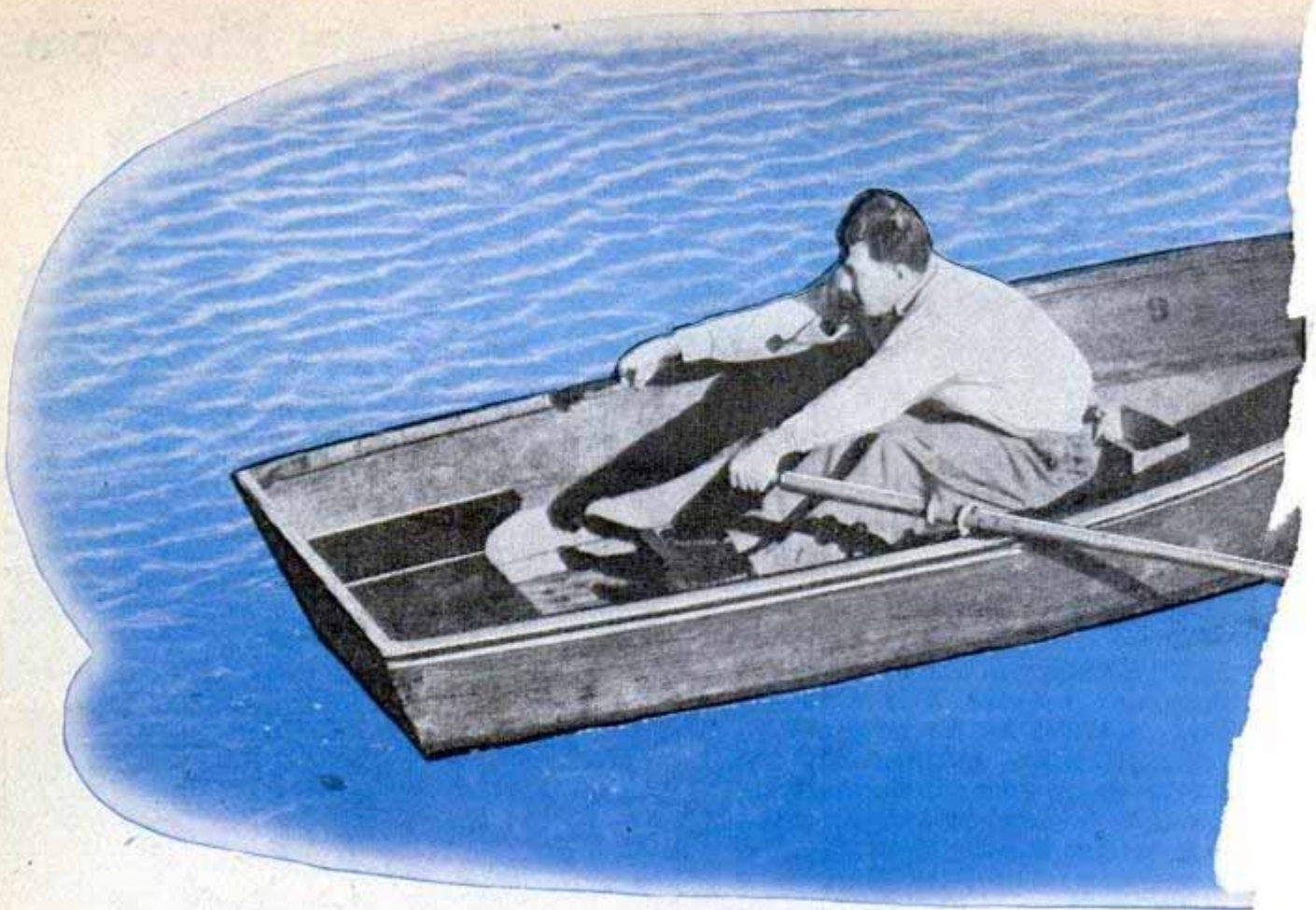

ROW GENTLY

YOU DON'T have to be a brawny weight lifter—or even half of one—to row a boat easily and well. The trick is in knowing how. Just watch an old-timer between the oars and you'll get a few pointers right away if you observe closely. There's no splattering of water, no rolls or gurgles—the stroke of the oars is slow, the rower's whole manner impresses one as plain lazy. But, unless you are a skilled boatman just jump in another rowboat and try to follow him singlehanded. He'll leave you behind as if you were painted on the landing.

Here are some of the reasons why: In the first place, for rowing on rough water the pretty technique of collegiate racing crews won't altogether do. The average rowboat is a tougher, more seaworthy craft than the average racing shell and it rides higher out of the water. It lacks such refinements as "roller-coaster" seats and sliding footrests. But there are some ideas in racing which can be applied to ordinary rowing and they'll give you more miles with less manpower.

While it is true that you'll learn a lot by watching good oarsmen, the only way really to learn correct rowing technique is to get the oars in your hands and begin rowing, just as you would with any other work or sport requiring the development of manual dexterity through continuous practice. While you're learning, go out in the boat only on quiet days. It's not a good idea to attempt handling a rowboat in rough water, unless, of course, you take an experienced oarsman along to coach you. Always take it slowly during the practice periods. Speed and skill come later. At first concentrate on handling the oars—how to drop the blades into the water and get them out again without throwing or splashing water to no practical purpose. Getting down to first principles the theory says simply that the energy spent throwing water into the air should have been expended pushing the boat forward.

The rower holding the straight course and getting away fast is the one to watch, for you can be sure he



Ordinarily it's common practice to use oars that are twice the beam width or roughly twice the width of the thwart. Chafing bands should center in the rowlocks when the oars are in position

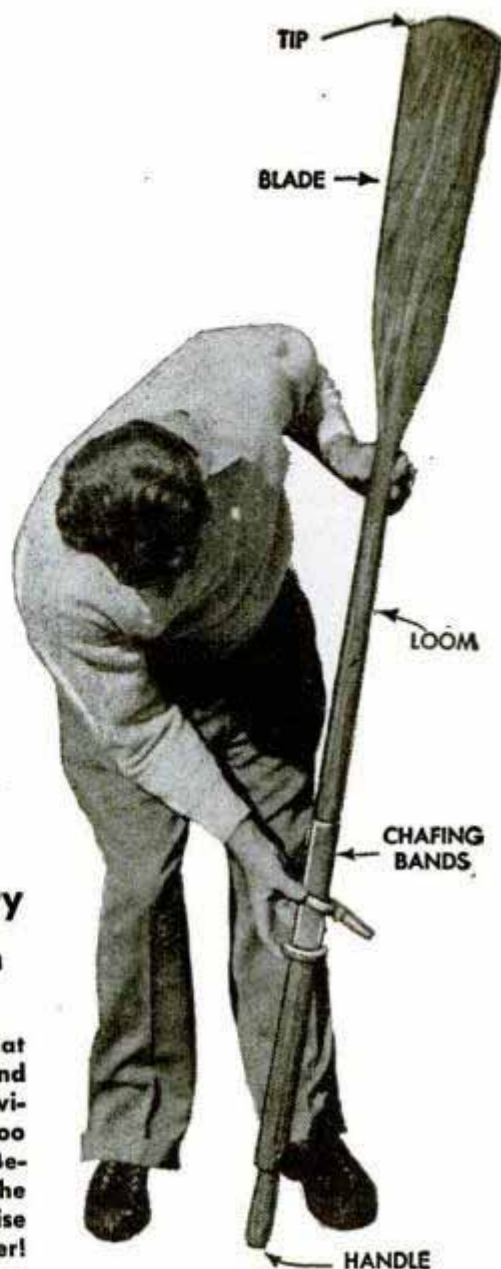
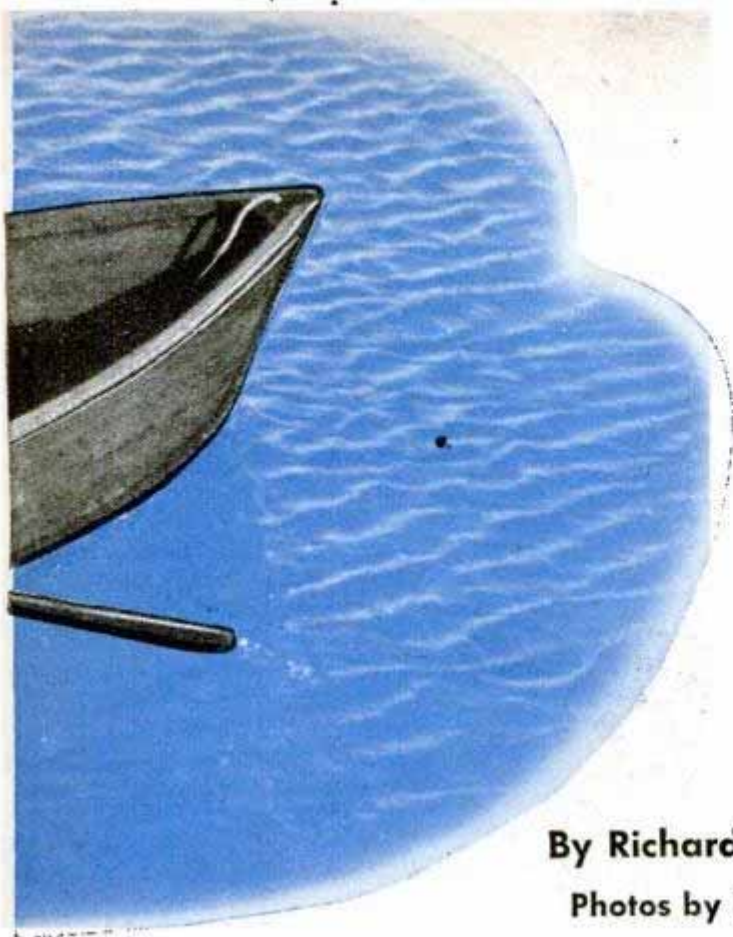

By Richard W. Emery
 Photos by Ray Chapin

Above, right, photo shows what a good oar should look like and also names its principal divisions. Oars should not be too springy in the loom section. Below, take that first step into the center of the boat, otherwise you may end up in the water!

knows exactly what he's doing, where he's going and about how long it will take him to get there.

Don't take out a boat without first making reasonably sure it will bring you back. If it's your boat, look it over carefully before you launch it. Make this a habit and you won't miss. Do the same with any craft you rent. Look sharply to the rowlocks, the seats, or thwarts, if you want to be salty, and to the bottom boards—those you walk on. Do all this before you bother to examine the oars. If you're going out on fairly deep water where the wind may come up and make the water choppy, provide life preservers, a bailing bucket and an anchor with plenty of line. These are just ordinary common-sense precautions without much to do

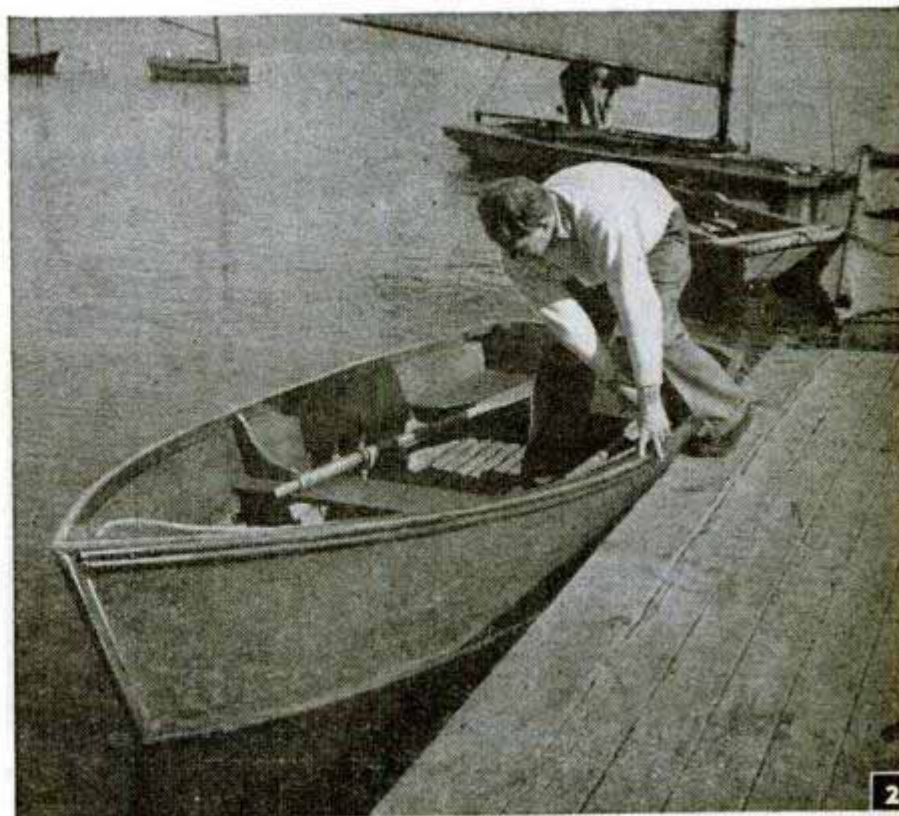

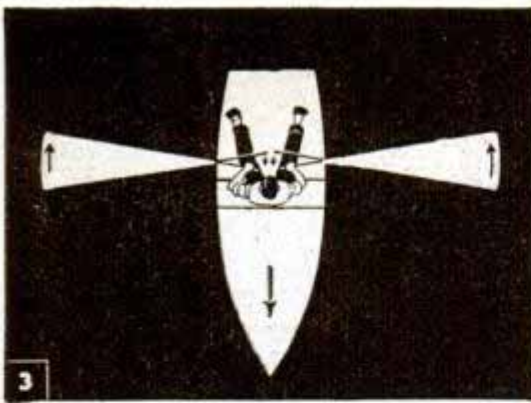

3 Short strokes get you away from the landing and well out into the open water. Long sweeping strokes will take you on from there

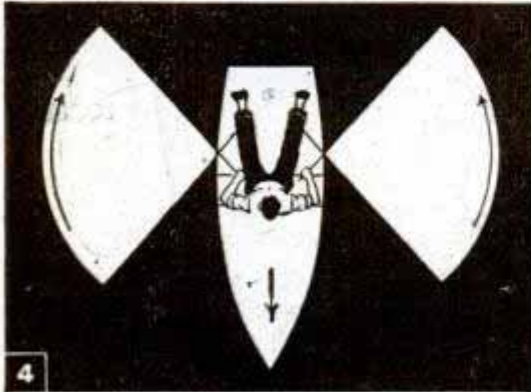

4 The arc described by the oars when making a full stroke is determined to some extent by reach of the rower. Above is average

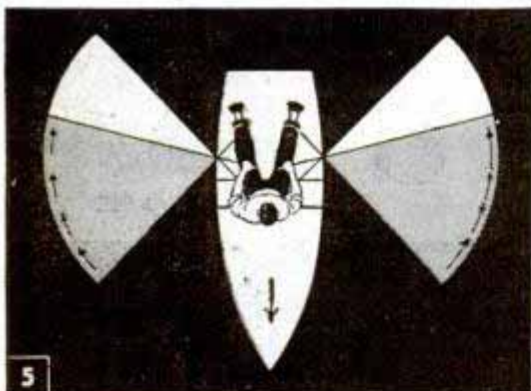

5 About two thirds of the power stroke is made with the arms very nearly straight. Some good rowers keep arms straight out

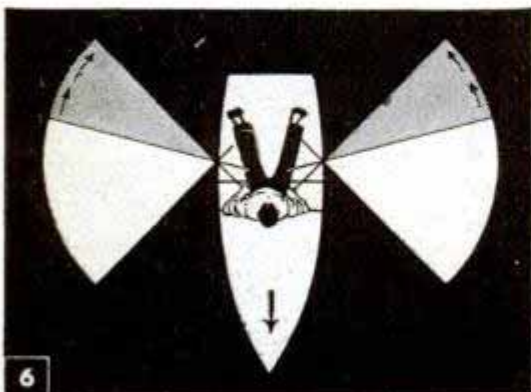

6 The final one-third stroke is made with the arms bending at the elbows but with wrists still "locked" until they reach the chest

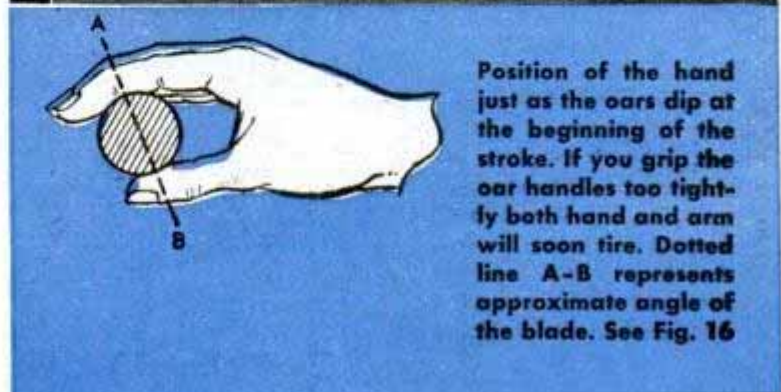

Position of the hand just as the oars dip at the beginning of the stroke. If you grip the oar handles too tightly both hand and arm will soon tire. Dotted line A-B represents approximate angle of the blade. See Fig. 16

with the actual rowing, but they may help to get you home again.

The oars should fit the boat. That's a first requirement. Fig. 1 gives the average proportions while the photo above Fig. 2 shows what a good, sound oar should look like and also tells what to call its principal divisions. Again the don'ts: Don't take out an oar that's warped or one that has a weather-roughened handle. It'll cut your hand to pieces on a hard row. A tear, break or bulge in the chafing band will bind in the rowlock and make the oar difficult to manipulate. Some oars, due to age or other causes, are too springy in the loom section for good rowing. An oar should be fairly stiff. Considerable pressure should be required to deflect a good one as much as 2 in. or so. When buying new oars or renting a boat for a long row on open water, check the oars for uniform weight and correct springiness. And note in Fig. 1, that the oar length is about twice the beam of the boat. That's an average requirement, not an absolute rule. But all things considered, oars of this length handle easier under average rowing conditions.

Another important feature is the position of the chafing bands. When you're in rowing position with the oars in place, ends of the handles should clear by at least 2 in. and the chafing bands should center in the rowlocks. Some good oarsmen like the ends of the handles farther apart, as much as 6 in. in some cases, but that of course is a matter of personal preference. In general the proportions of oar length to beam given in Fig. 1 give better purchase.

Stepping from the landing into a boat may be a trickier venture than it appears to be. If you step into the boat and push it away from the landing



8

Position of the hand as the oar nears the finish of the power stroke. Keep the elbows close to the body as you drop handles to lift blades clear. Line A-B is intended to show the approximate angle of the blade just before it leaves the water

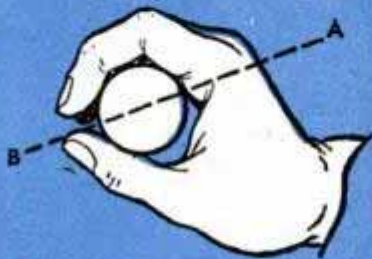

9

Keep arms close together, elbows down, as feathered oars move forward to start new stroke. When arms straighten the wrists rise



10

This is the angle the blade should make with the water as the stroke begins. Note lower edge of the blade is leading slightly

with one foot, while the other foot supports part of your weight on the landing, you may end up in the water. Hold the craft against the landing, place one foot well into the center of the boat and on the bottom boards. Keep your weight low, as in Fig. 2, then transfer quickly into the boat and sit down. Always "trim" a rowboat by sitting in the center of the thwart and instruct your passengers to position themselves so that the craft rides on an even keel. You can't row well if weight causes the boat to list to port or starboard. Also, if you have a load, the boat should be trimmed fore and aft as well. As a rule the bow should ride a little higher than the stern. You'll stay a lot drier if you never stand on a thwart, but always on the bottom boards. And if you are boating solo, stow everything for the trip within easy reach so that you won't have to leave the seat while offshore.

A gentle push will put the boat clear of the landing. Only then do you place the oars in the rowlocks. Once the craft is riding free, the beginner at rowing should resist the urge to dig the oars deep and give it the heave ho. From here on you take a tip from the racing crews and dip 'em gently. Drop the blades lightly into the water and take a series of short, light strokes, only about 18 in. or so until you get underway. Then lengthen the stroke to the full sweep, Figs. 3 to 7 inclusive, and settle down to that long, rhythmic swing that makes the workouts of collegiate rowing crews something to watch.

If the oar handles are gripped too tightly, arms and hands will tire quickly. You won't be able to feather the oars correctly and your back will do work that your fingers should do. At the start of each stroke, the pull of the handle should lie within



11

Three-quarters of the blade under is about right for average rowing. At this point oar will take pressure without throwing water



12

Chopping the blade into the water perpendicularly will likely cause it to bite too deep. Some boatmen call this "crabbing"



If you find you must turn around in a boat length, just back-stroke one oar and pull hard on the other. Around you go—fast!

the curve of your fingers and thumb, as in the detail below Fig. 7 where the dotted line A-B represents the angle of the blade. In this way, several inches are added to the length of the stroke. Through about two thirds of the power stroke, Fig. 5, your arms should be nearly straight. Your legs and back do most of the work. Then the arms take over, for the final third of the stroke, Fig. 6, bending at the elbows and bringing the oar handles close to your chest. As the stroke ends, the wrists drop, and the blades emerge at a 45-deg. angle, dotted line A-B, Fig. 8, complete their turn to a 90-deg. angle parallel with the surface, and are ready to return to the starting point of the next power stroke. Study Figs. 8 to 12 inclusive, and also Fig. 16.

When you bend your elbows in that final one third of the power stroke, keep them close to your body, Fig. 14. Then they will be in position for easiest flexing of the wrists to make the special twist of the blades known as "feathering." This is necessary to prevent the wind from catching the flat blades and slowing forward speed. A little extra push or flip to the last part of the stroke gives speed to the boat just as a pitcher's fingers give speed to a ball. It also helps to bring the blades cleanly out



This happens when you pull hard on an oar which enters with the blade perpendicular to the water. It dips too deep. See Fig. 12



Power stroke nearly completed. Wrists do not bend until almost against the chest. Then the wrists snap down and hands rise



Blade at a 45-deg. angle at completion of stroke. Blade slips out without splashing water. Twist of wrist feathers the blade

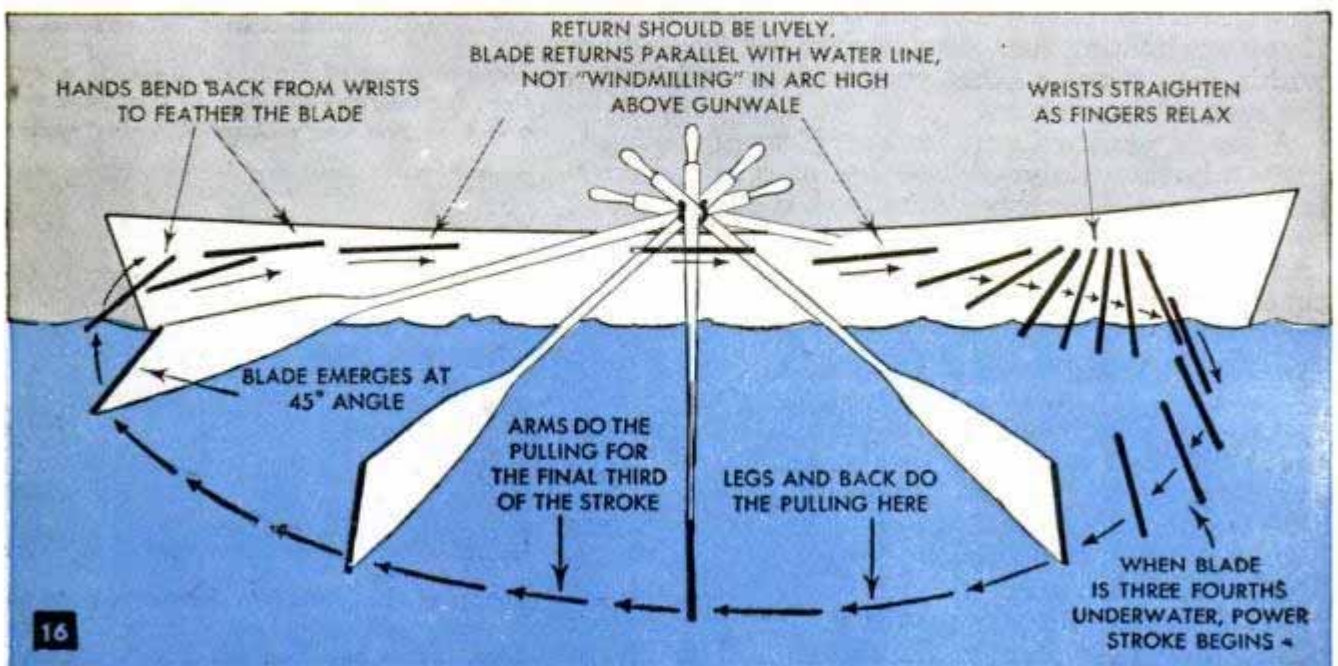

of the water, Fig. 15. Catching the oars on the rebound from that final flip against the water, and returning them briskly in feathered position, conserves strength and provides a resting point just before the beginning of a new power stroke. The rest is only momentary, of course, but it relaxes your arms, legs and back. The blades turn from feathered position in order to dip again into the water. See Fig. 16. Blades should be slightly off vertical, with the lower edges leading. This whole maneuver is a neat trick and it's worth a lot of practice. Fig. 16 shows the cycle of one complete stroke in ordinary rowing—not the racing stroke where feathered oars are skipped along the surface of the water.

Starting the power stroke before the blades are three-quarters immersed, Figs. 10 and 12, wastes strength and upsets rhythm. A skilled oarsman knows by the feel of the blade when to start the power stroke. From long practice he learns just when the blade will "bite" with full effect.

With a light grip on the handles you can slip the blades into the water without splashing. A moderate chop won't bother, once you get the knack of feeling for the water before pulling on the oars. In rougher waters, one blade probably will take hold before the other. This may be troublesome at first, but the same gentle pressure on the oars, until they both get a grip on the water, will bring you home dry.

To hold a straight course is generally quite easy. Just use the boatman's trick of taking a sight on two distant objects astern which happen to line up conveniently and then vary the pressure on one oar or the other, without breaking the rhythm of your rowing. You'll find a good boat quite sensitive to variations in pressure on the oars which makes it easy to keep the objects in line. After a time this dodge will be unnecessary. You'll get eyes "in the back of your head" like all good rowboat men. For maneuvering in close quarters, you may find single-stroking very handy. To rowing, it's what dog-paddling is to swimming. Stroke alternately, port and starboard, making the oars "walk" through the water. This stroke is restful, too, after rowing a long distance. You can turn a boat almost in its own length by pulling on one oar and pushing on the other. See the photo at the left of Fig. 13. Pull on the right oar to turn left and vice versa. By making quick, short strokes with one oar without lifting the blade out of the water you can warp a boat sidewise up to a landing or alongside another craft anchored well offshore. Finally, when anchoring in open water ship the oars. Don't take any chances on losing an oar. It floats, of course, but might be hard to recover in rough water.

Wheeled Dolly for Small Boats Makes Moving Them Easy

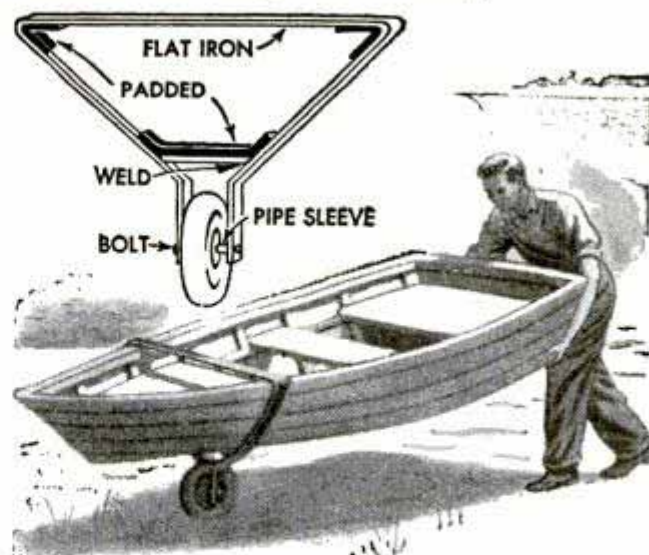

One man can handle small boats easily with the help of this dolly. It is made of flat iron formed to slip over the bow of the boat. Two legs extend downward to act as a fork for the wheel which is, preferably, one that has a large rubber tire. A bolt serves as an axle and spacing sleeves are used on both sides of the wheel to keep it centered. The corners of the dolly are padded to prevent scratching the finish on the sides of the boat.

Hinge Shapes Train Couplers

Needing a jig to shape train couplers, one craftsman screwed the leaf of a butt hinge to a small block of wood, after first cutting a section out of the eye of one of the hinges to form a slot indicated by the arrow. In use, a small finishing nail is inserted in the slot with the hinge in the open position; then the hinge is rotated and one bend of the coupler is formed. The nail is reversed to shape the other end.

H. Y. Nobles, Shreveport, La.

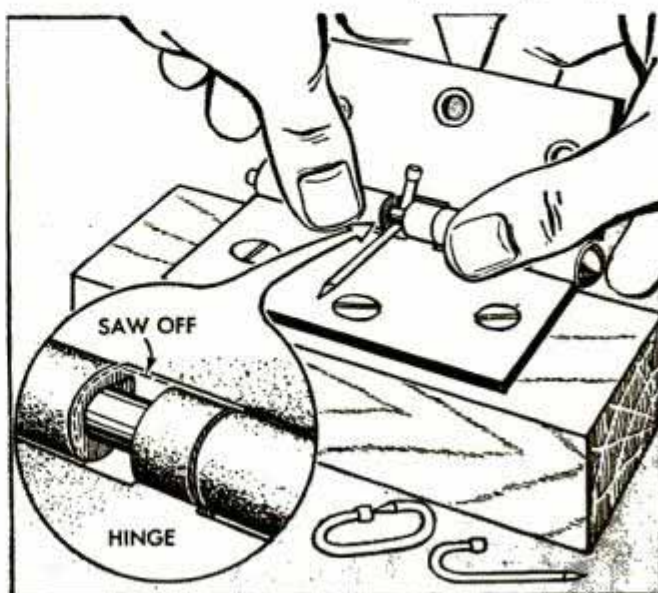

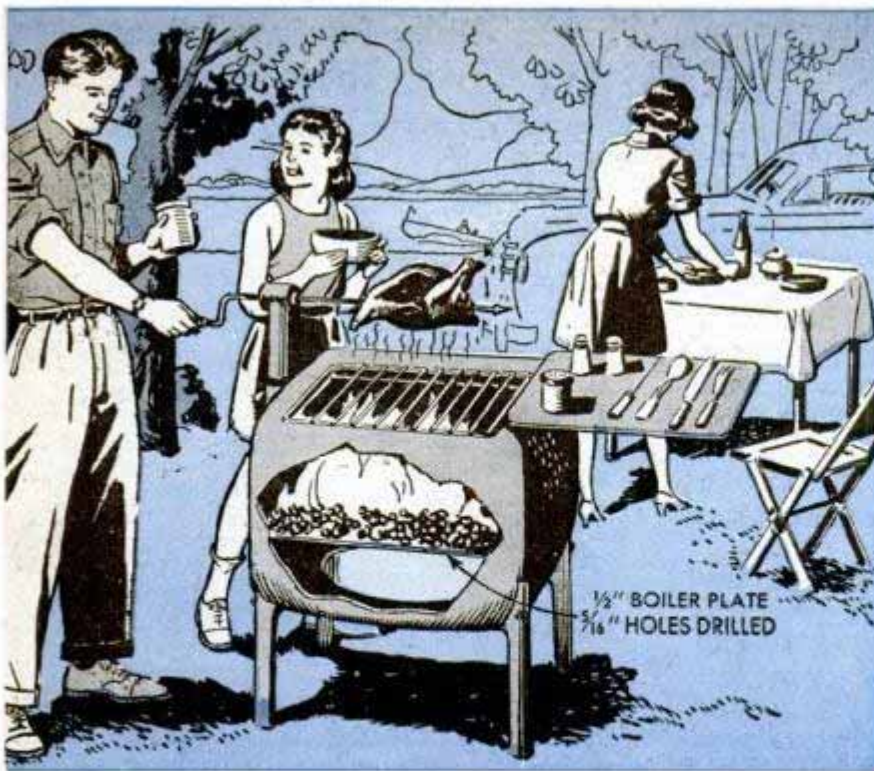

Portable Barbecue And Broiler

If you have a discarded washing machine with a cast-aluminum body, it can be made into a portable barbecue and broiler. Remove the agitator, motor, wringer and all driving mechanisms. A $\frac{1}{2}$ -in. plate with $\frac{5}{16}$ -in. holes is attached to the inside of the body and serves as a grate. Since the top of the machine usually is recessed somewhat, it should be easy to fit the grill in place. Note that the lid serves as a table when opened. The wringer post acts as a bearing for the spit.—Martin A. Tristine, Stratford, Conn.

Pins in Door Prevent Intruders

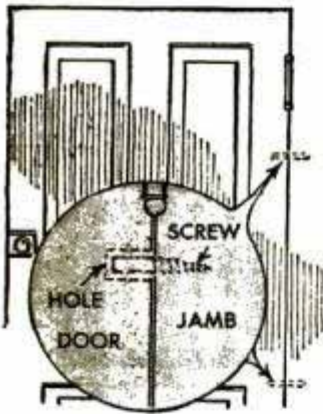

Any door which is hung with pin-type hinges having the pins outside can be opened easily by intruders, even though the door has a good lock. All that's necessary is to remove the pins and pry the door away from the jamb. To prevent

this, drive two or three fairly large lag screws into the door frame between the top and bottom hinges, allowing about $\frac{3}{4}$ in. of the screw to project. Then saw off the heads. Opposite the screws, drill holes in the edge of the door to fit as shown in the circular detail. Make the holes large enough to fit over the screws. This arrangement makes it difficult to remove the door.

Rubber Band Will Seal Leak



To stop a leak that has developed around the plug in a hot-water bottle, use a rubber band. Wrap it around the last thread at the top. The same remedy is applied to other attachments with threads that leak.

Protecting Lunch Box Lining

Metal lunch boxes have a tendency to rust at the inside corners after the box has been used for a time. To correct this, clean the rusted surfaces with steel wool or fine sandpaper and give the inside several coats of spar varnish. Water that may be left inside the box when it is washed will have little effect on these coated surfaces.

E. W. Moses, Jr., Blacksburg, Va.

Bench Stop Slides Out of Way When Not Being Used

Here's a handy bench stop that will slide out of the way when it's not in use. Dimensions for the bracket and the sliding member that acts as the stop are given in the left-hand detail. The stop is slotted and a wing nut is bolted through the bench and stop so the height of the latter can be adjusted to suit.—E. J. Wiczorek, Chicago.

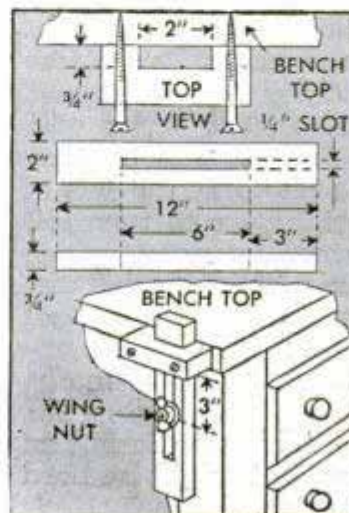



By Dick Hutchinson

FLOODLIGHTING your garden living room is another way of lengthening summer days for such sports activities as croquet, tennis, archery or the evening barbecue. And the plain utilitarian purposes of a back-yard light are served the year 'round, as well.

The general design of this lamppost is patterned after the early American street lamp. It provides a permanent fixture for two 150-watt flood lamps of the reflector-bulb type. The lamppost and frame supporting the lamp sockets are made entirely of wood. The 4 by 4-in. post is 9 ft. long and is hand hewn on all four sides, the corners being broken slightly with a hewing adz. The frame is made from 1-in. white pine cut out as shown in the detail and it is assembled at the top of the post with finishing nails or screws.

Two holes are drilled in the 4 by 4-in. top plate for porcelain tubes and two weatherproof sockets are attached to the frame and wired to a switch either at the house or garage. All wiring must be weatherproof and should comply with the local code.

If the post is placed directly in the ground, the bottom end should be coated with asphaltum to prevent rotting. If it is set in concrete, all the wood may be merely stained a weathered brown by painting with repeated coats of creosote. Or it can be painted above ground with an outside oil paint of whatever color you choose.

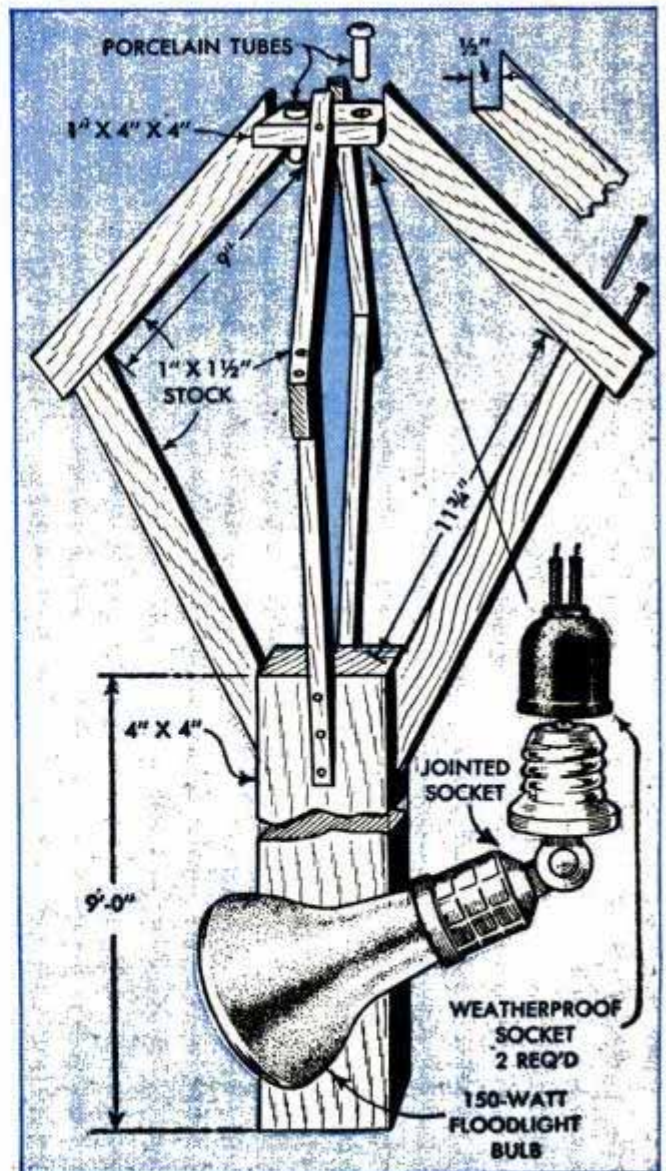

Small Frame That Sifts Materials Has Interchangeable Screens

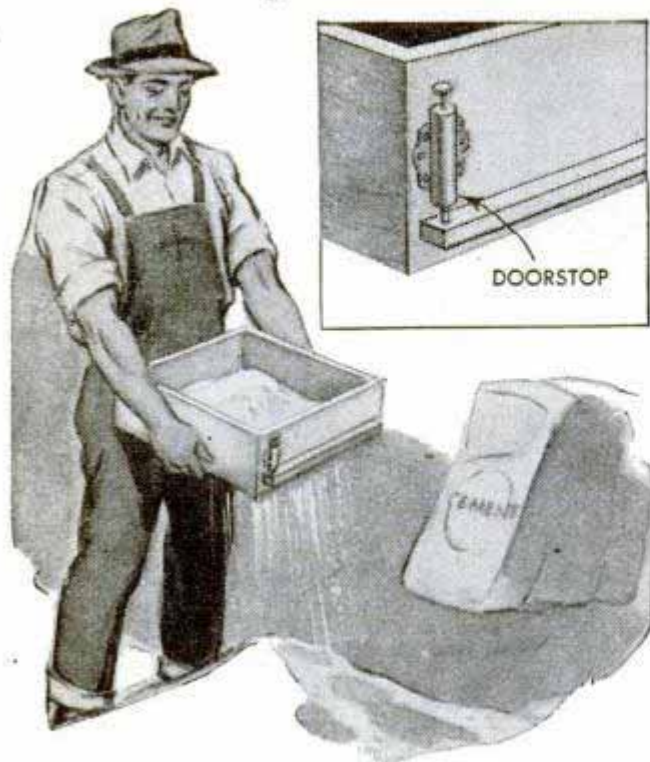

For the person who has occasion to mix small amounts of concrete now and then, this sifter frame with interchangeable screens is handy and will handle several grades of material. The sides can be of any suitable dimensions, with a slot cut near the bottom of one for insertion and removal of the screens. Guides or slots in the other sides will hold the screen in place. A doorstop, upper right-hand detail, locks the screen in place. For average work, a coarse, medium and fine-mesh screen will do.

Magic Catalogue Provides Models For Studying Hands

Many an amateur artist is stumped when it comes to finding models for hands in various positions. When there is no one avail-

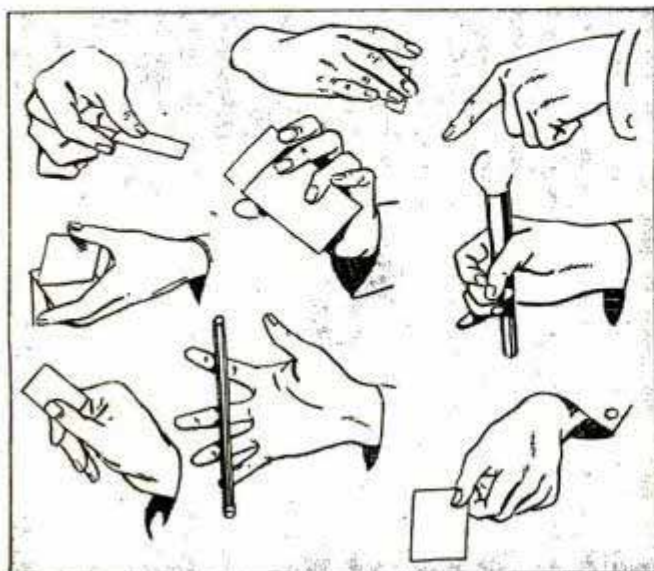

able to pose, he will find that catalogues of magic goods will furnish drawings of hands—used to illustrate tricks—in almost any pose desired. Usually such catalogues may be purchased from dealers for a small amount.—G. E. Hendrickson, Argyle, Wis.

Knockout Holes in Rotary Hacksaw Aid Removal of Work

If several knockout holes are drilled in a rotary hacksaw holder, removal of disks cut by the saw will be easier. The holes are equally spaced and large enough for a $\frac{3}{16}$ -in. rod, used as a knockout.

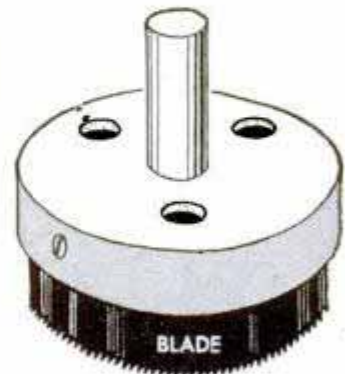

Easy Way to "Drill" Glass

Sometimes it's desirable to make a small hole in a pane of glass when no cutting tools are handy. In such a case, a soldering iron and length of wire solder will do the trick. Build a small dam of moist clay around the spot where you want the hole, leaving a small area of glass uncovered. Then let a drop of melted solder fall into the opening. Unless the glass is too thick, a small piece of about the right size will drop out.

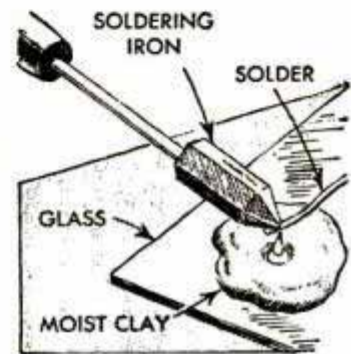

Trunk Key Hidden Under Handle

Should you ever lose the key to a trunk and have to force the lock to open it, you'll appreciate having this extra key which is concealed under a handle of the trunk. Since such keys are generally rather small, it can be taped to the underside where it will not be noticed.

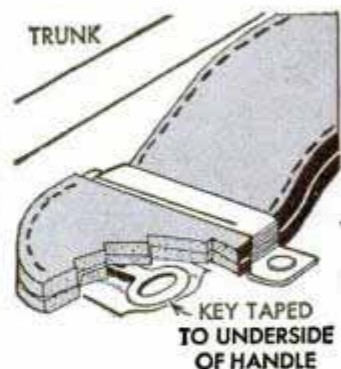

Opie Read, Jr., Chicago.

☐ To straighten a carpet that has curled at the corner, apply a warm iron to the underside and it will lie flat.

Spring "Fired" Harpoon Is Deadly Against Frogs

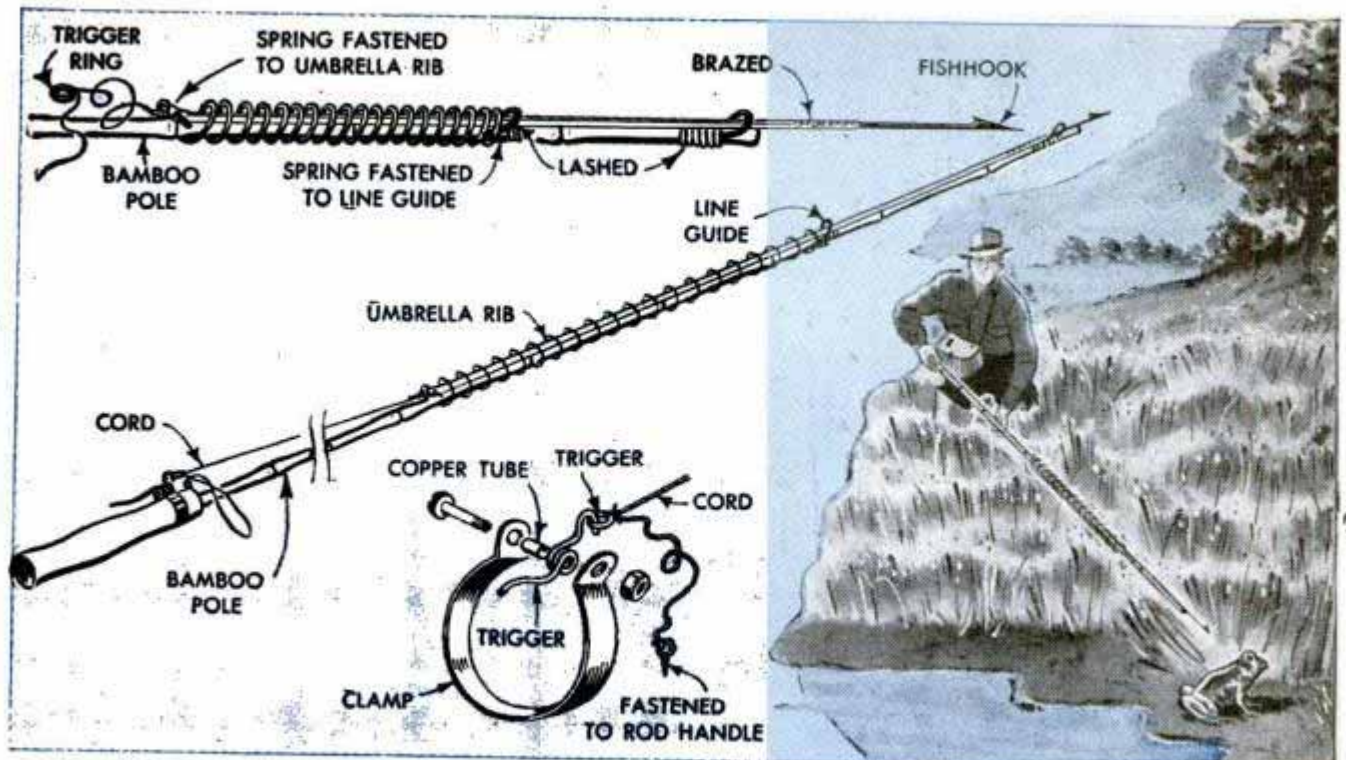

Frog spearing is made both sporting and profitable with this simple, yet accurate harpoon. Simply cock it, draw a bead and zing — you've got your frog if your aim is good. The harpoon is rigged from an old bamboo bait-casting pole, an umbrella rib, a piece of strong fishline and a coil spring. As shown in the drawing, the pole is fitted with two spear guides of wire lashed near the end and a trigger assembly clamped to the handle. The umbrella rib forms the spear which has a large bass or turtle-type hook straightened and brazed to one end and a coil spring attached to the other; the spring being fastened in turn to one of the

spear guides. The fishline is tied securely to the end of the spear or rib and is fitted with a small ring and screw eye which anchors the line to both trigger and pole handle. With the spear in an extended or "fired" position, the line should be of such a length as to allow slack in it when the spear has reached its target.

The harpoon is cocked by drawing back on the ring, which expands the spring, and hooking it on the trigger. When cocked, respect it as a deadly weapon and take the same safety precautions in using it as you would in handling a firearm.

William P. Houser, Organ, N. Mex.

Simple Rigging Laces Canvas "Carryall" to Avoid Spilling Contents

The practice of raking leaves and grass onto a canvas or other large cloth and grabbing the four corners to carry it often results in eventually losing grip and spilling the load. To overcome this one gardener riveted a sheet-metal strip, having a hole at each end, to one edge of his canvas and fitted two eyelets, correspondingly spaced, along the opposite edge. Then he tied a 3-ft. length of clothesline or sash cord to each eyelet.

In use, the canvas is heaped with leaves in the usual way, two sides are folded inward as shown and then the ends are brought over. Finally, the ropes are threaded through the holes in the metal strip and drawn up snugly and tied. Wrapped in this manner, the load can be carried or dragged easily without spilling.

D. Roscoe Baldwin, Bellefontaine, Ohio.

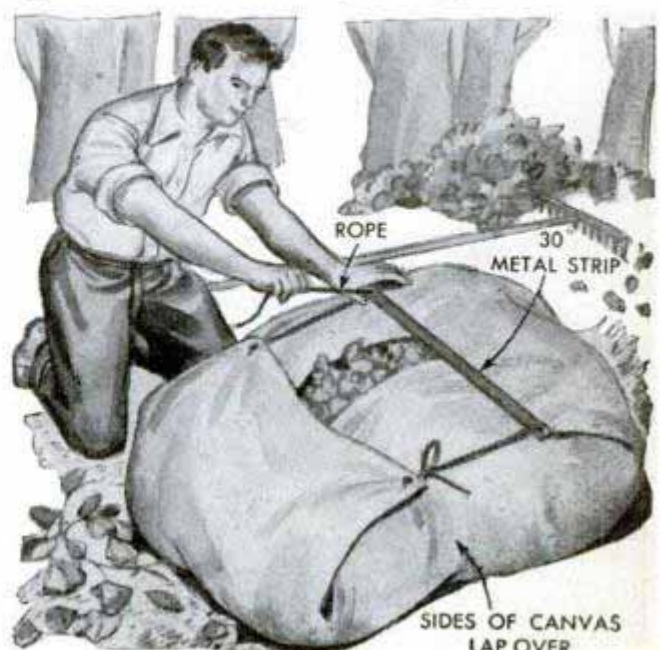

ELECTRIC

By
R. J. Dierkes

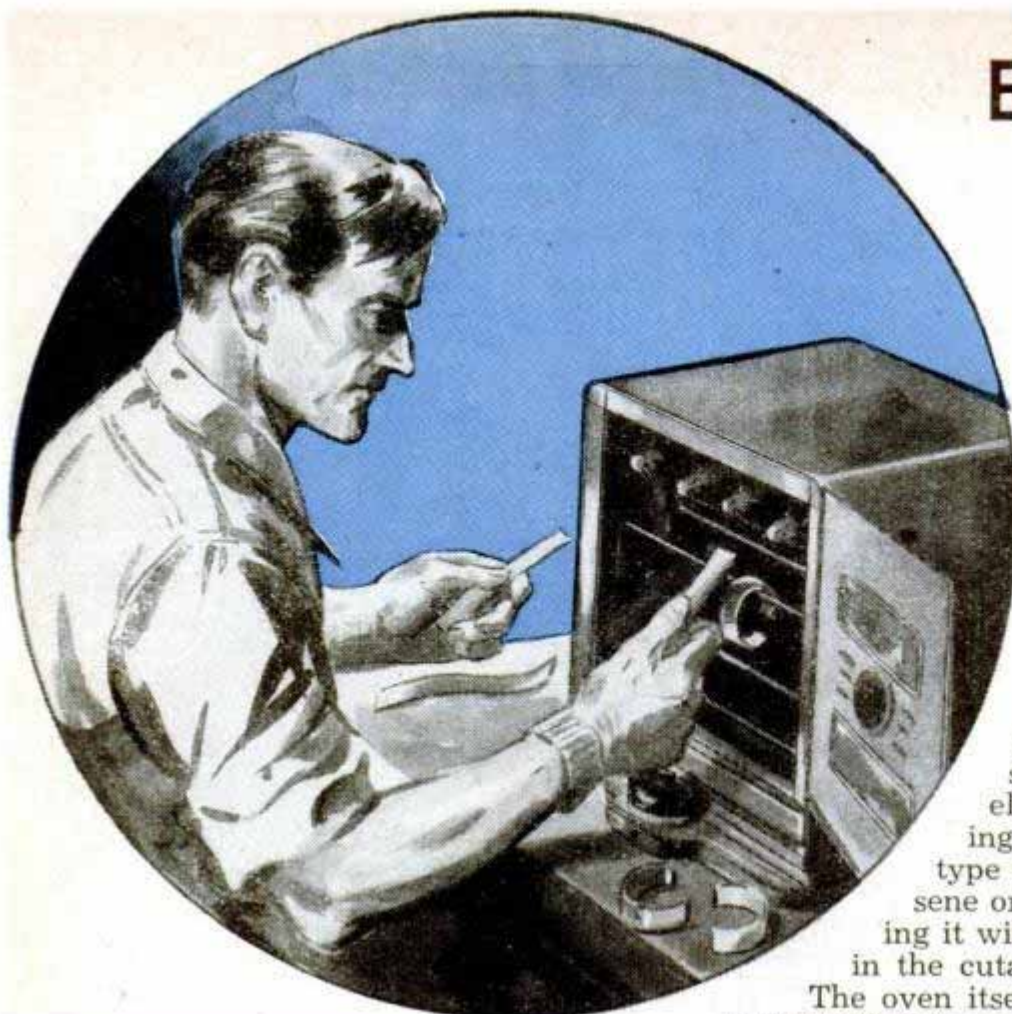

FORMING thermo-plastic material into novelties, bracelets and other useful articles requires a suitable oven in which to heat the work to make it pliable. While an ordinary kitchen oven can be used for this purpose, you can furnish your shop with a neat little electric unit by purchasing a portable oven of the type used on top of a kerosene or heating stove and wiring it with an element as shown in the cutaway drawing in Fig 2.

The oven itself is not altered except for installing four element-support bars on the inside above and below the oven shelves. The bars are shaped of 11-ga. wire according to the detail at the top of Fig. 2, and are threaded with insulators before being installed. Suitable insulators can be molded of ceramic clay and fired, or you can buy aviation-type antenna insulators, sometimes called "egg" insulators. Note that the end insulators on the rear bars are fitted with small bolts for connecting the 110-volt line. The Nichrome heating element required is removed from the cone core of a regular heater element of 250-watt size and threaded through the insulators in the manner shown in Fig. 2.

The oven sets on an asbestos-covered base within a wood molding bordering the edge, but before the asbestos sheet is fastened to the base, the bulb-and-switch wiring is first installed as indicated by the dotted lines in Fig. 2. Use asbestos, heat-resistant fixture wire for this, and insulate the socket from the wood base. You have a choice of wiring the elements either in series or in parallel as shown in Fig. 1. In series, a temperature of approximately 285 deg. F. is had; in parallel, the temperature is increased to 800 deg. With the higher temperature the thickness of the asbestos board covering the wood base must be increased to provide adequate insulation. Conduit encasing the wires connecting the two elements is formed by wrapping strips of asbestos paper around the wires to build up a thick insulation as shown. Heating thermoplastic material requires 5 to 10 minutes, depending on the thickness of the plastic and the nature of the work. When heated, the material becomes almost as flexible as rubber and can be bent by hand.

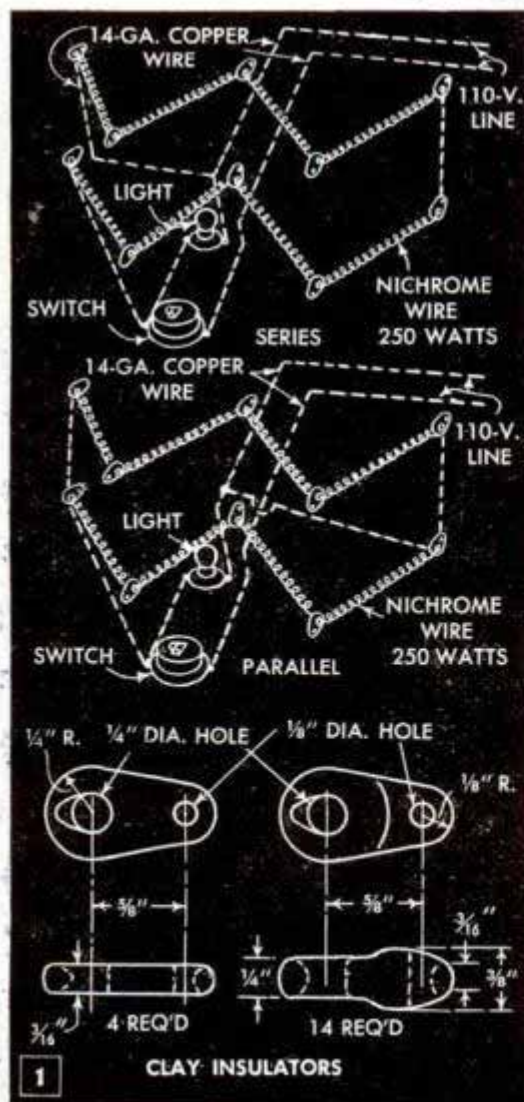

OVEN for heat-forming PLASTICS

Here's how you can take a portable (on-the-stove type) oven and wire it with a Nichrome heating element to produce temperatures up to 800 deg. F., for heat-shaping Lucite, Plexiglas and other thermoplastics

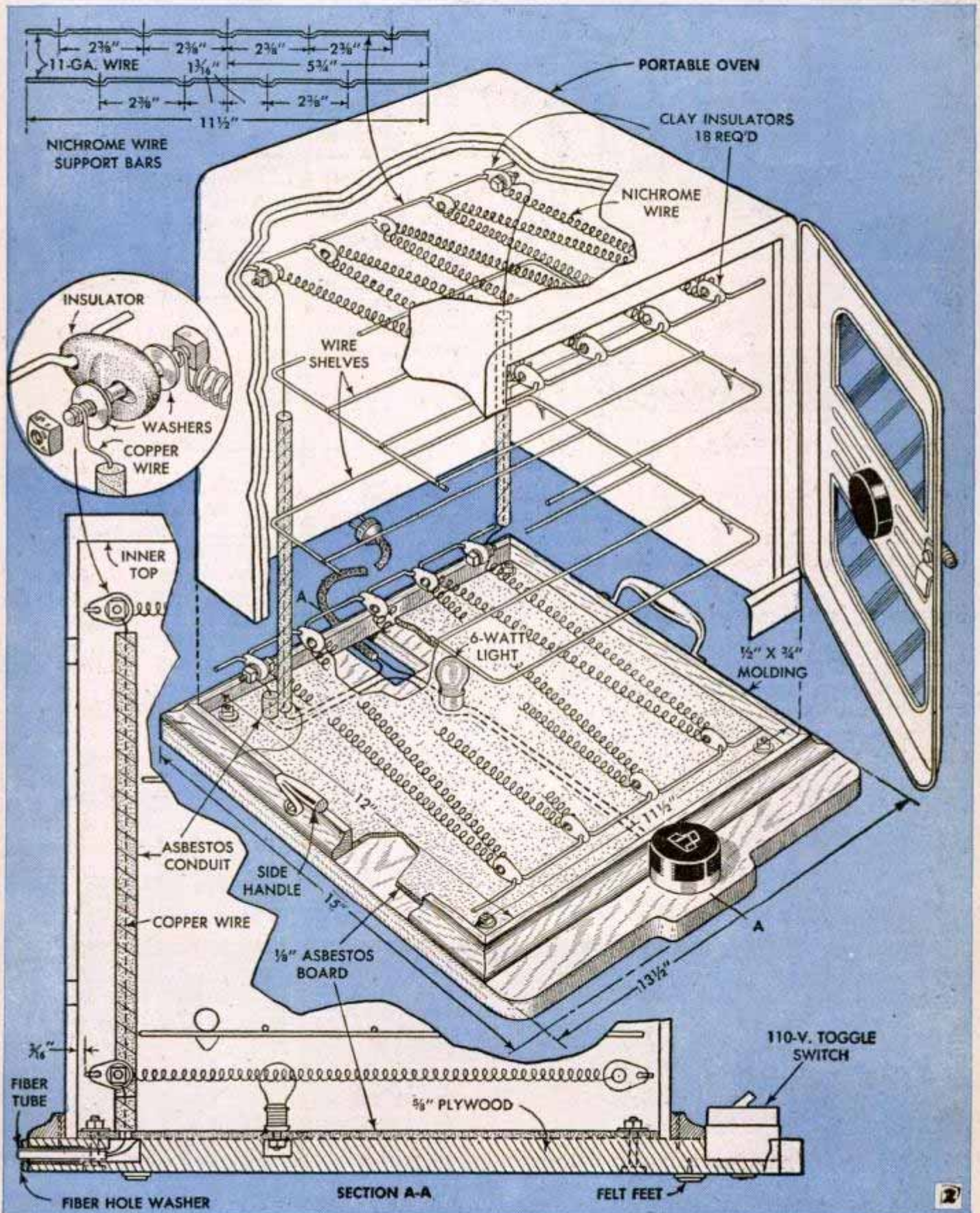

Hose Sections Nailed to Wall Provide Holders for Tools

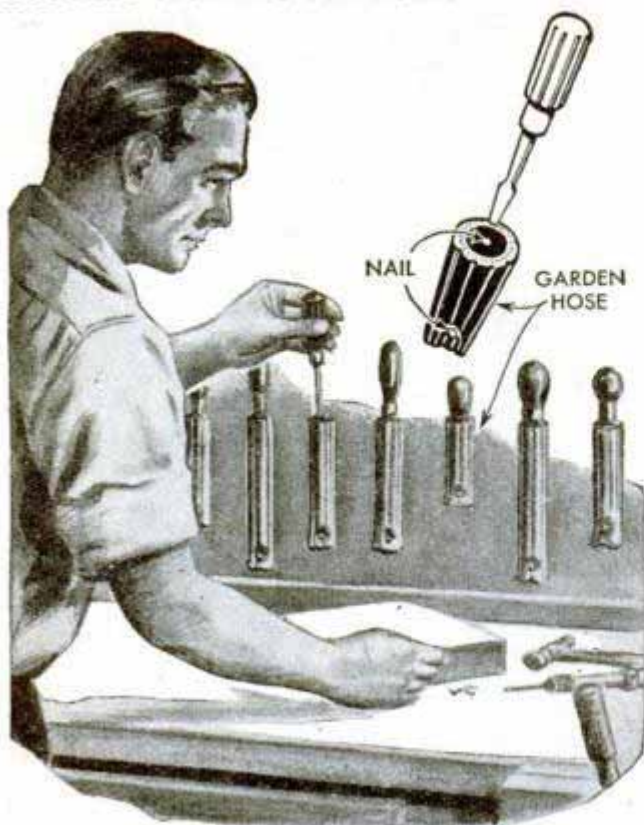

Sections of discarded garden hose cut to the proper length will make safe holders for sharp-edge tools. Each section should be long enough to cover the tool up to the handle. To attach, nail through the hose at the bottom and through one side at top.

Prepared Ink Removed With Cloth

The magic of invisible inks takes a new turn with this simple trick—instead of slowly fading, or not appearing until brought out by some chemical process—this ink appears perfectly legible and non-fading, but it can be erased with the wipe

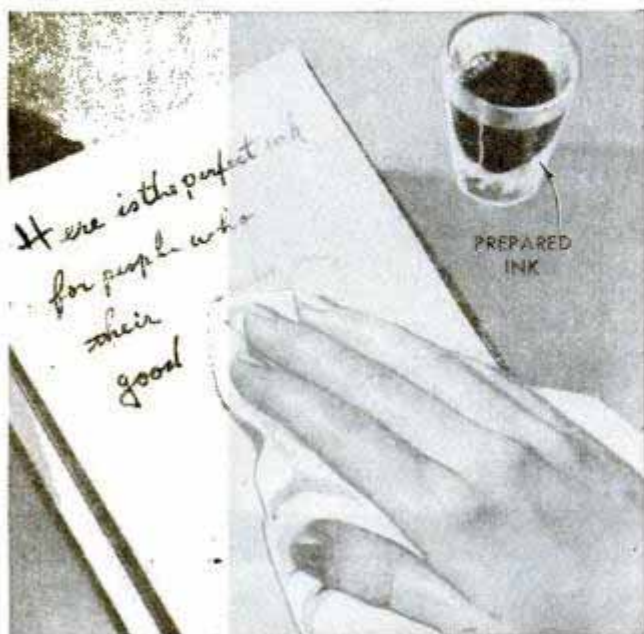

of a cloth. The secret lies in the composition of the ink, which is made by adding 1 teaspoon of cornstarch to 12 drops of tincture of iodine and 1/2 oz. of water. A message penned with this fluid will vanish when rubbed over with the cloth.

Tape Substitutes for Bottle Cap

Should the cap or cork become lost from a bottle, two short strips of adhesive tape and a small square of waxed paper can be used as a substitute. The paper should be large enough to cover the opening in the bottle. Cross the two strips of tape as indicated in the upper detail and place the paper in the center. When applying (lower detail) press the tape tightly against the neck.

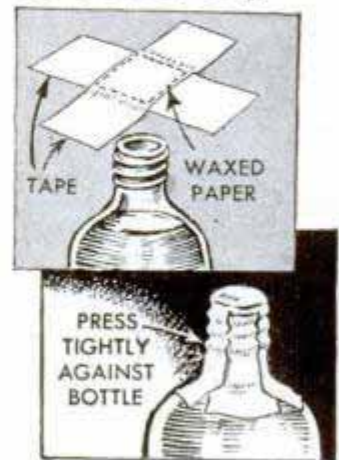

Melvin R. Hickok, San Francisco, Calif.

Protecting Sharp Edge of Chisel



When you've honed a sharp edge on a chisel, it's disappointing to have it dulled or nicked through careless handling on the part of someone. A good way to protect a chisel is to cut a slot in a piece of

radiator or garden hose and slip it over the tip. The fit should be a snug one.

Gordon P. Jones, Seattle, Wash.

Chafe Guard on Starter Rope

If an outboard motor is a little balky in starting and requires repeated effort, chafed fingers and blisters caused by the starting rope will result. To prevent this, slip a length of rubber tubing over the rope and enlarge the hole in the handle enough so the tubing will fit into it. This provides a smooth surface for the fingers.

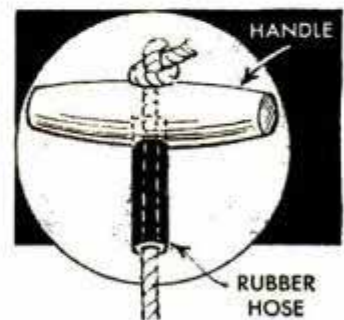

Albert M. Lindner, Jr., Cold Spring, N. Y.

TIRE-TUBE CATAMARAN



NOW that auto-tire tubes are on the market again, you can still get some use out of those old ones by building this novel catamaran. It keeps you high and dry above the water and it won't tip over easily.

The tubes are slipped over wooden frames after inflating, the valves being on the inside. Ample space is provided for action of the paddle. A foot-operated rudder, used in conjunction with the paddle, enables the passenger to make short turns. Although the rudder can be made of wood, using outdoor plywood for the blade, a slotted seamless-steel tube and galvanized sheet-metal blade make a better, more durable job. Curved brackets, band-sawed from $\frac{3}{4}$ -in. pine, support the seat. If you want a more durable job make the whole frame from oak. In either case use screws for joining all parts. The rear brackets, being set at an angle, serve to reinforce the entire structure. Paint the wood lemon yellow, or finish hardwood in the natural color with black striping. Either way you will have a smart craft.

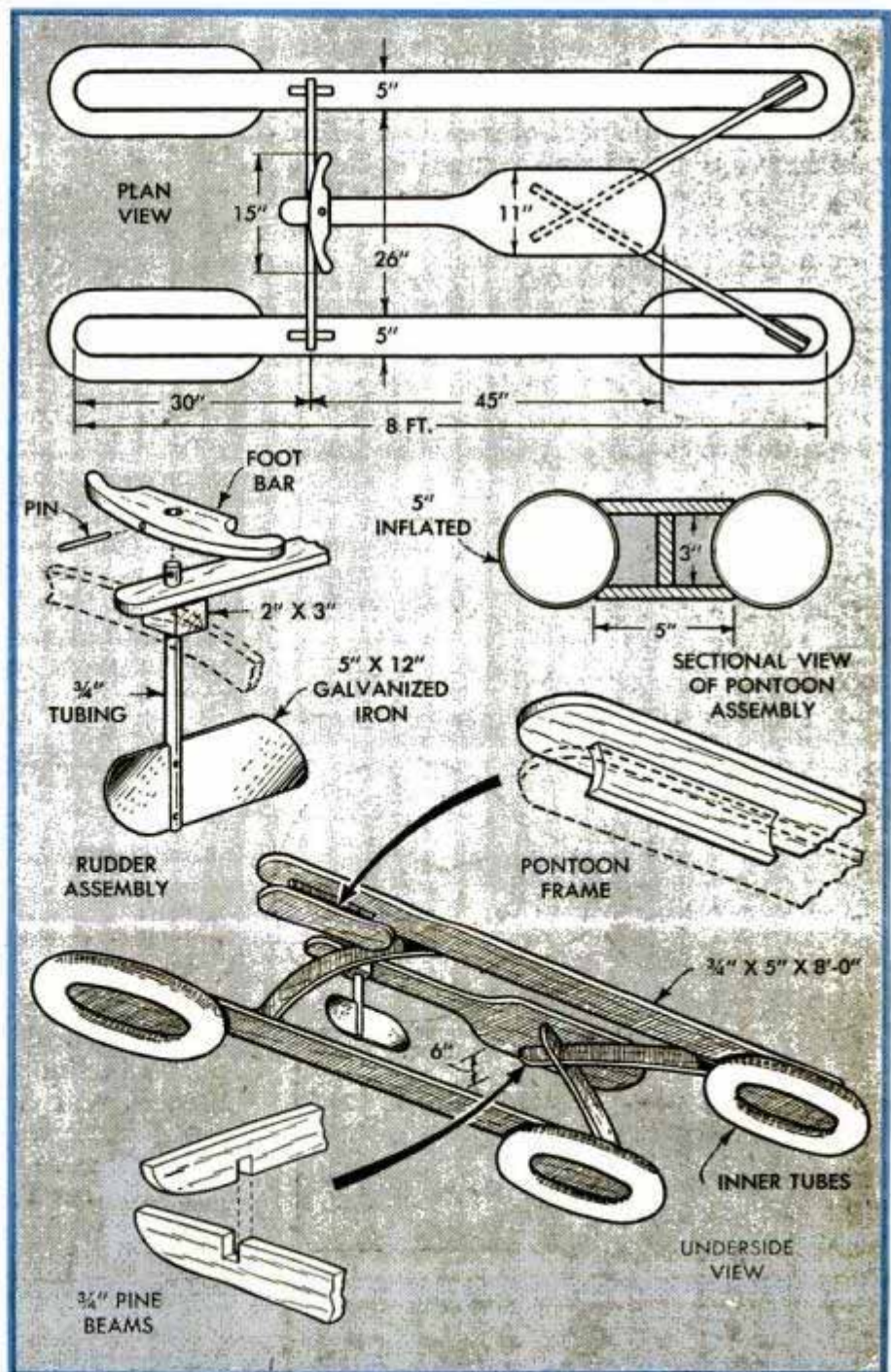

Soldering Large Sheets of Metal Made Easy by Preheating



Because a large sheet of metal will dissipate heat quickly from a small soldering iron, it is often difficult to solder large areas. However, by preheating the metal over a burner and maintaining that heat, the job becomes quite simple. It's necessary to determine first the proper temperature for the metal, and also how far the work must be kept from the burner. The over-all temperature of the sheet should be just below the melting point of the solder.

Flashlight Projects Silhouettes That Amuse Children

Here's a simple silhouette projector that is made easily and will amuse children for hours. All that's needed is a flashlight, some paper, strips of Cellophane, tape and



a length of wire. Cut the silhouettes out of the paper and paste them on a strip of Cellophane, fastening another Cellophane strip over them with tape to make a panel or "slide." Then fashion a wire holder that will slip over the light and hold the slide. A "focusing" type flashlight will make the best pictures. As you move the flashlight, the figures will go sailing across the wall.

Knock-Down Target Is Replaced From Shooting Position

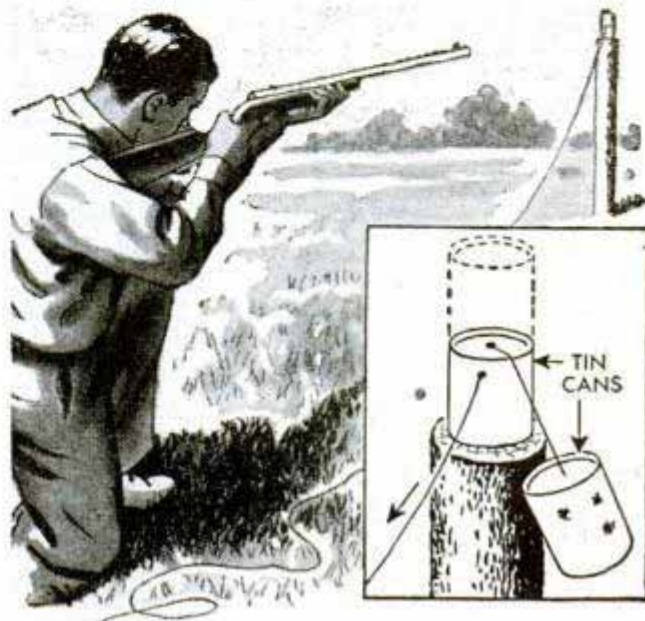

You can knock this target over and then pull it back in place without so much as moving from your shooting position. Two tin cans are required for this setup, one for the target and one for the base. Holes are punched in the end and side of the base, which is attached to the post. Then a cord is fastened to the bottom of the can used for the target and run through the end and side of the base. Whenever the target is knocked off the base, it is returned to its original position by pulling on the string. When setting up the target, be sure there is a suitable backstop for the bullet or other missile that is fired.

Candle Stubs Will Start Fires

Short ends of candles are useful when starting a fire with damp kindling. Light one or several candles and place at various points in the stack of kindling. In a short time it will dry sufficiently to burn. As soon as the wood ignites, remove the candles and save them for future use.

Margaret Tatroe, Edmonton, Alta., Can.

☐ Cut windows in your hatboxes and cover them with a piece of Celluloid or Cellophane. This will facilitate locating the desired hat.

12-POINT SPRING INSPECTION

In most cases auto or truck springs do not break suddenly or unexpectedly. Rather they tend to deteriorate gradually by processes of metal fatigue. Usually a "tiring" spring will give you plenty of warning with such common symptoms as you see illustrated in detail below



Courtesy Maremont Automotive Products, Inc.

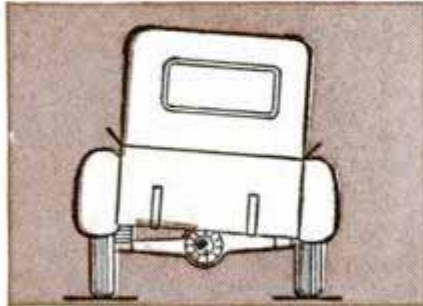

A low corner is almost sure to mean a broken spring or one that allows the body of the car to sag because of several cracked leaves

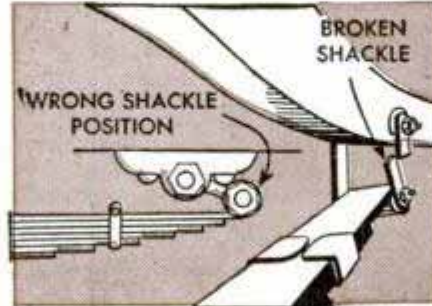

When the spring is weakened for any reason it pushes the shackle out of position. A broken shackle will eventually result from this

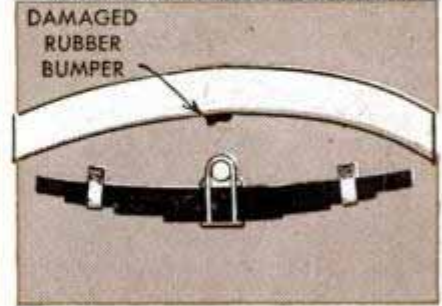

"Striking through" damages the rubber frame bumper. This not only indicates spring fatigue but sooner or later ruins the bumper entirely

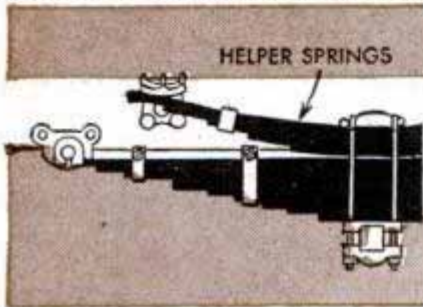

Should the helper springs touch the brackets when the truck is empty, the main springs should be replaced or repaired immediately

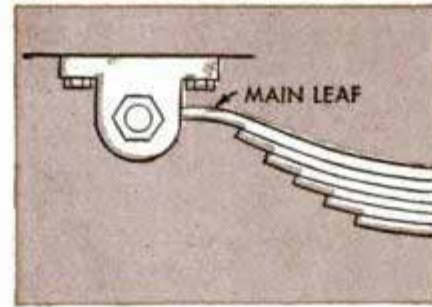

A frozen shackle will "seize" the spring eye and this will likely break the main leaf. Free the shackle, repair or replace the leaf

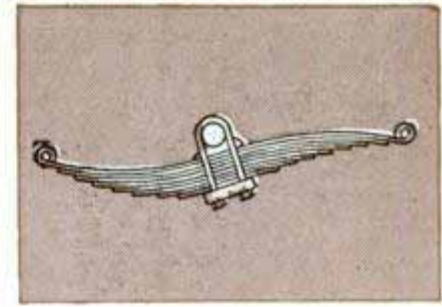

A "wrapped" spring is usually due to "rabbit" starts or repeated sudden, violent stops. Causes rapid axle wear due to misalignment

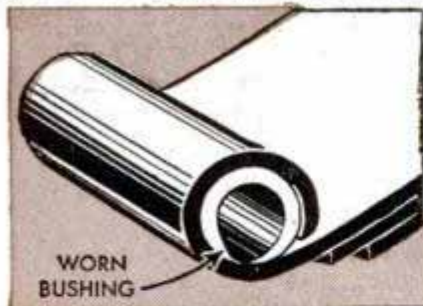

Worn bushings cause annoying knocks and rattles that are hard to locate unless you know symptoms. New bushings are the remedy

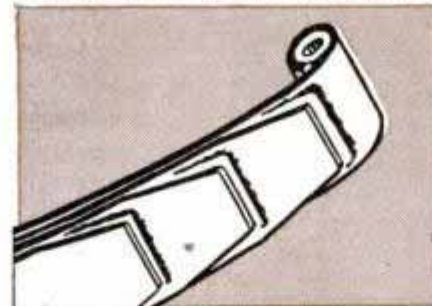

If the ends of the spring leaves cut in due to heavy loading, the spring will be weakened because of reduced thickness of the metal

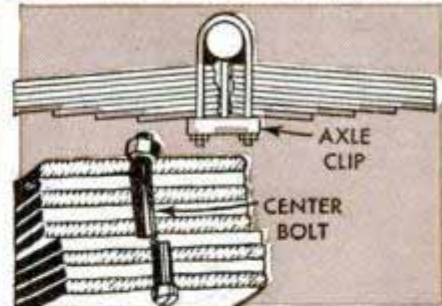

Sheared center bolts allow the spring leaves to shift. This quite often loosens the axle clip and causes breakage of entire spring

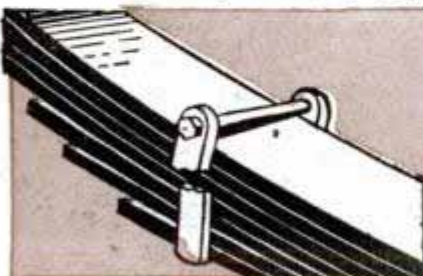

Broken rebound clips also permit the leaves to shift. This often has the effect of shifting the loading, causing springs to wrap or break

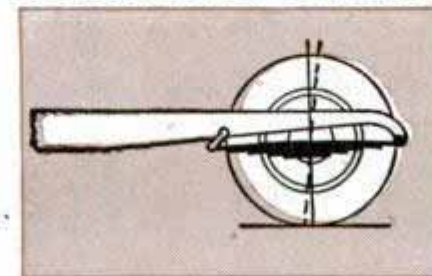

A sagged or broken front spring amounts to much the same thing as a shift in wheel alignment. It results in excessive wear on the tires

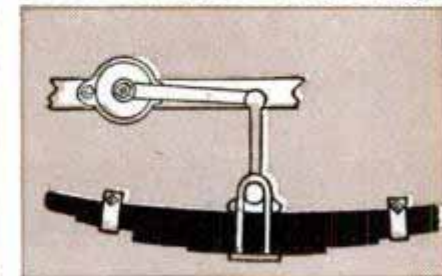

Defective shock absorbers can cause plenty of spring troubles, too. Keep them in good working order by periodic service and inspection

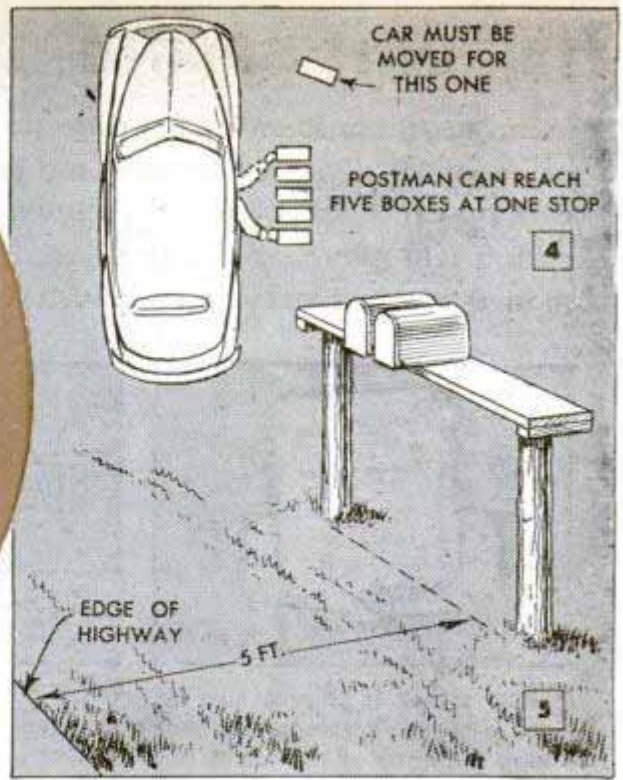
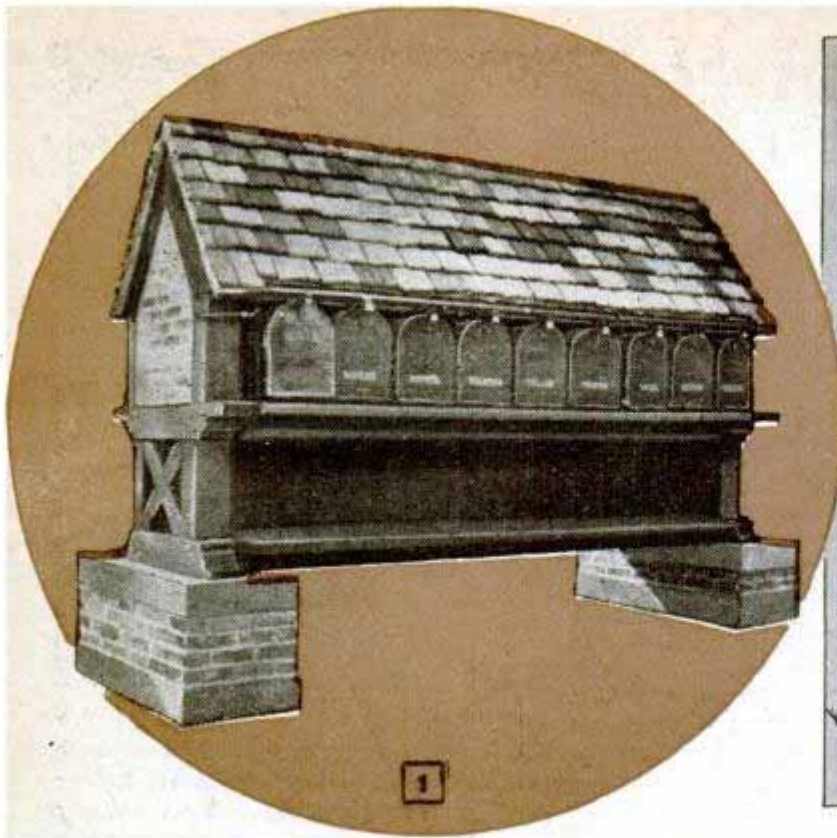

MAILBOXES

By Hi Sibley

BOTH THE RURAL mail carrier and the neighbors will thank you for promoting the idea of arranging the neighborhood mailboxes in a neat, orderly row. They'll all be glad to lend a hand in obtaining the material and constructing such attractive units as those shown in Figs. 1 and 3. Compare these with the usual unsightly group in Fig. 2 and you'll agree that either one is a much simpler arrangement than mounting the boxes on individual posts. Moreover, these structures are approved by the Post Office Department.

Where the boxes are at a uniform height of 4 ft., the postman can service five boxes with one car stop, Fig. 4, but he must move his car for any beyond this reach. Placed in two tiers, ten boxes can be handled at one stop.

A very simple arrangement suitable for a rustic setting is to mount the boxes on a horizontal log raised 4 ft. above ground, as in Fig. 6. The top is hewn flat and also cut in low steps for boxes. Another one, Fig. 7, consists of iron pipe and fittings assembled in a candelabra style. Weld or pin the pipe fittings so that they cannot turn.

Where wood wagon wheels are available, boxes can be mounted in a turntable style very convenient for the postman. A 36-in. wheel is recommended, its spindle being anchored solidly to the post in a vertical position, Fig. 9. These wheels



The three illustrations, above and below, should make it easier for any community to decide to do something about that leaning cluster of rural mailboxes. Almost everybody will be glad to pitch in and help line them up

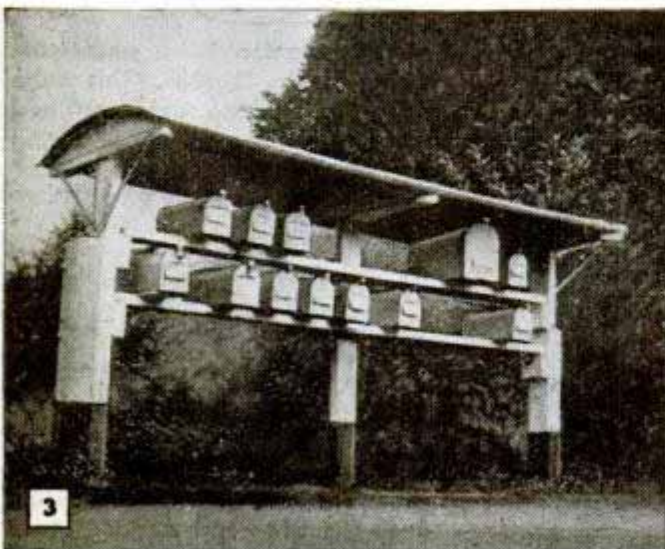

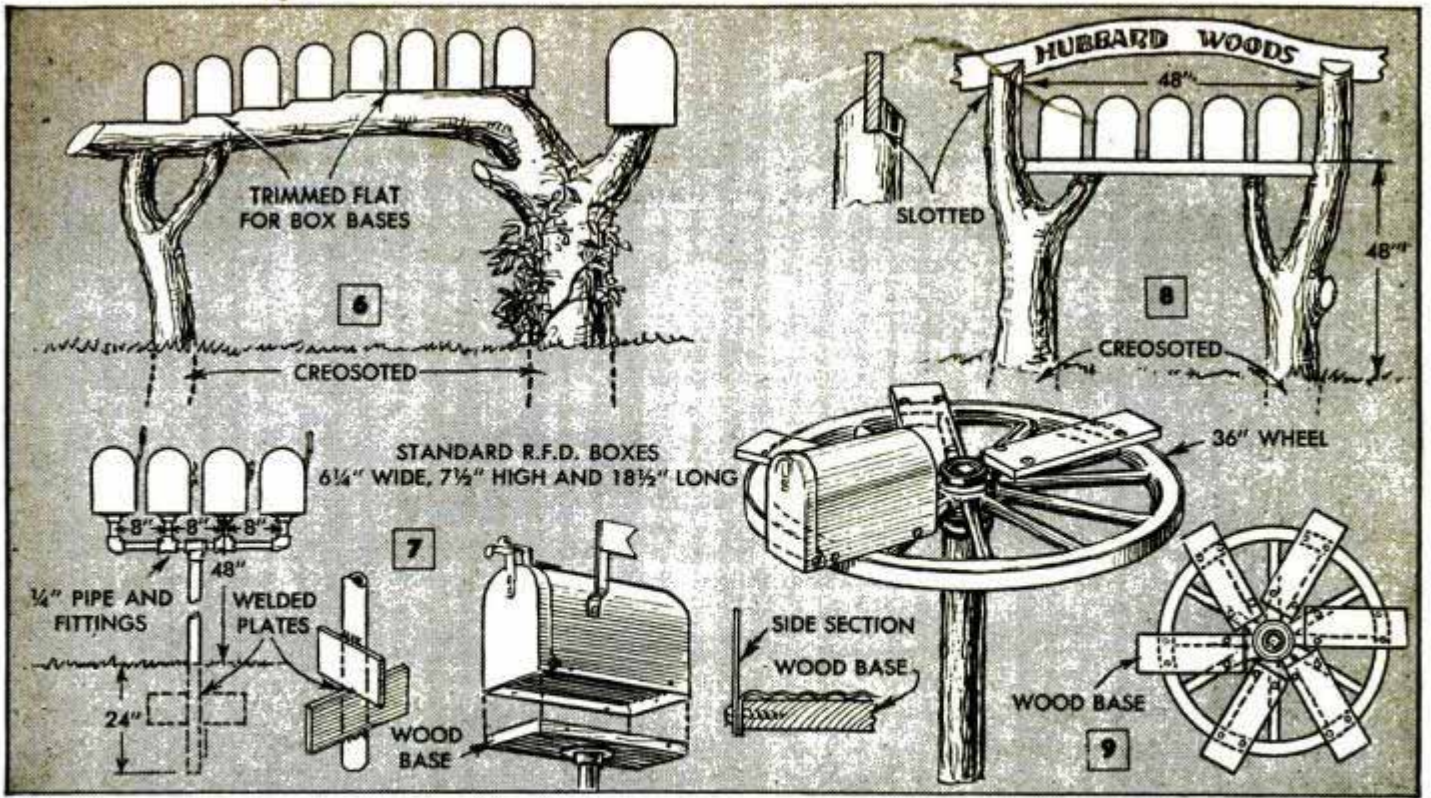

CAN BE MADE ATTRACTIVE

are large enough so that five boxes can be mounted radially, or six placed at an angle. This refers to the standard R.F.D. mailbox which is $6\frac{1}{4}$ by $7\frac{1}{2}$ by $18\frac{1}{2}$ in., inside dimensions. A wooden base is first screwed to the wheel rim and spokes, and the box is then screwed to the base.

An arbor effect is illustrated in Fig. 8, built along conventional lines and with the curved top members made in three pieces, glued and doweled together. Set two crotched logs in the ground to support the shelf. A curved branch adzed to a flat

section and mounted in slots, with the community name burnt into the wood, makes a pleasing job. All rustic construction should be of thoroughly seasoned logs, with the bark removed.

The design of the unit in Figs. 1 and 10 is patterned after the English timbered style. It can be built to shelter about eight boxes of the parcel-post size. Brick piers are mounted on concrete slabs. Where a single parcel-post box is to be used, place it in the center of the row of boxes as in the V-type mounting, Fig. 13.

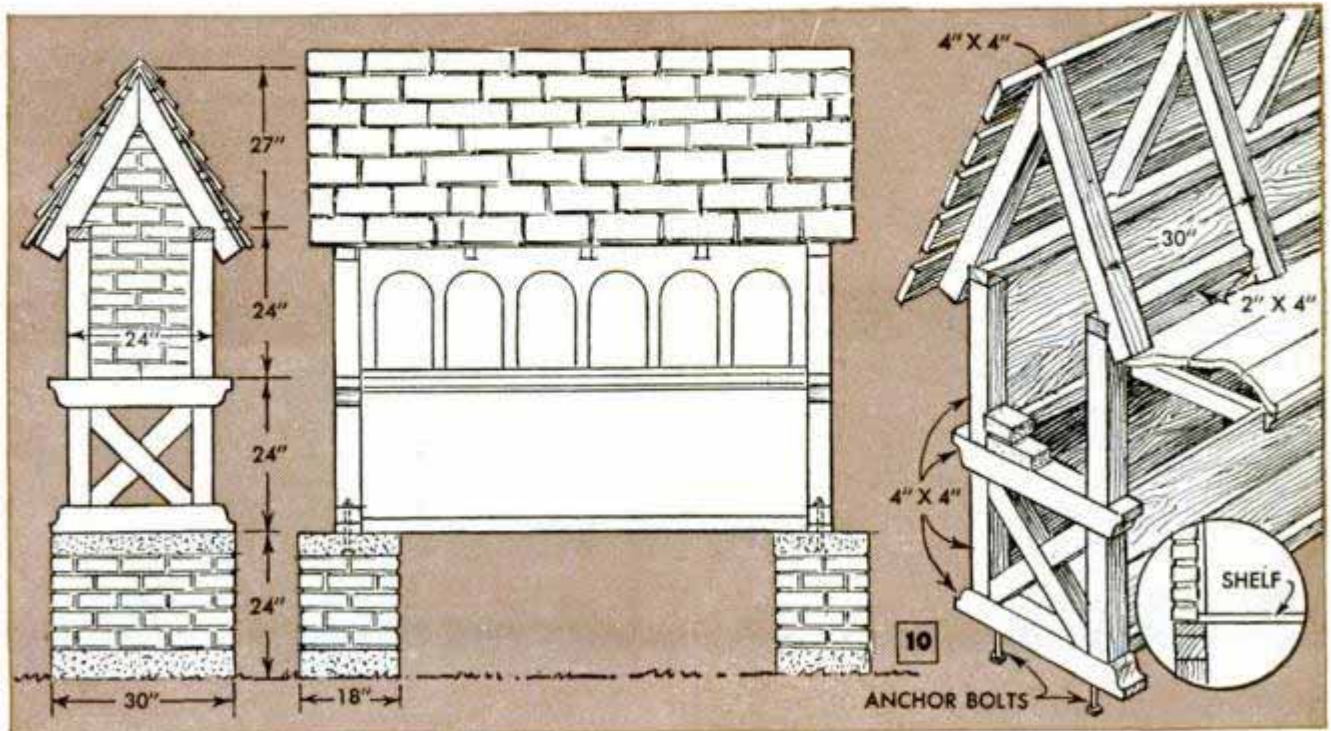

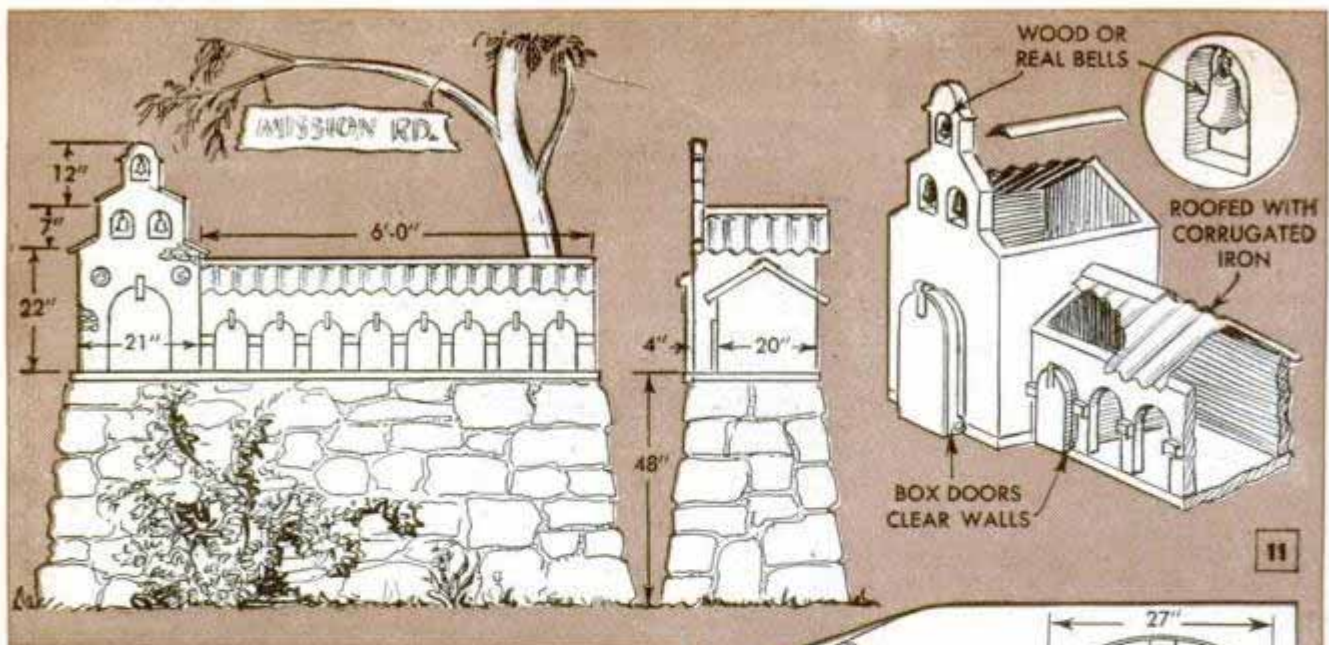

Another one, Fig. 11, is patterned after the mission style. It's mounted on a stone pier which can rest on a concrete slab. Use stock sizes of pine lumber for the box unit. The archways, typical of mission design, house the mailboxes. These should extend out far enough so the hinged fronts will swing out freely, Fig. 11, the right-hand detail. Corrugated iron roofing, or aluminum roofing painted brick-red resembles tile roofs quite closely. Wooden bells, or if you desire, real bells of suitable size can be mounted in the tower.

In Fig. 12, a simple canopy accommodates a number of boxes arranged in one or two tiers. Essentially the same design is pictured in Fig. 3. Allow 8 in. of space for standard boxes, and at least 12 in. for the parcel-post size. Another design, Fig. 14, is suitable for roadside installation in the country.

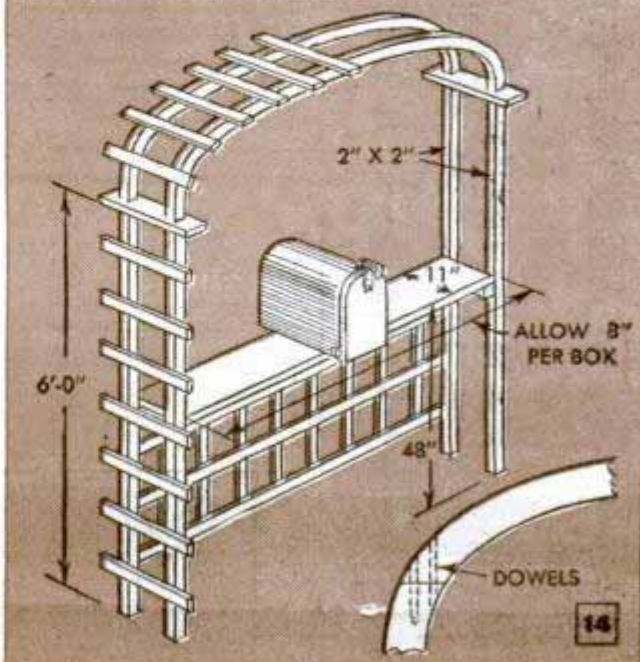
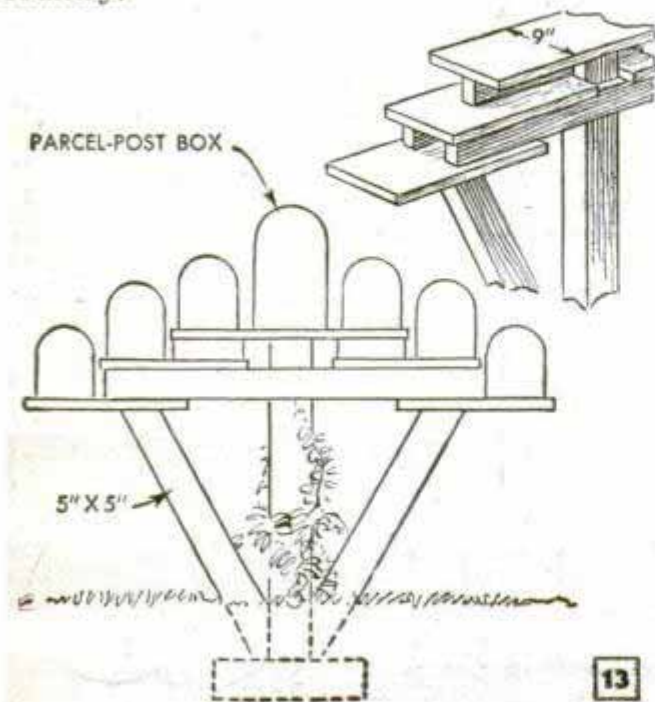
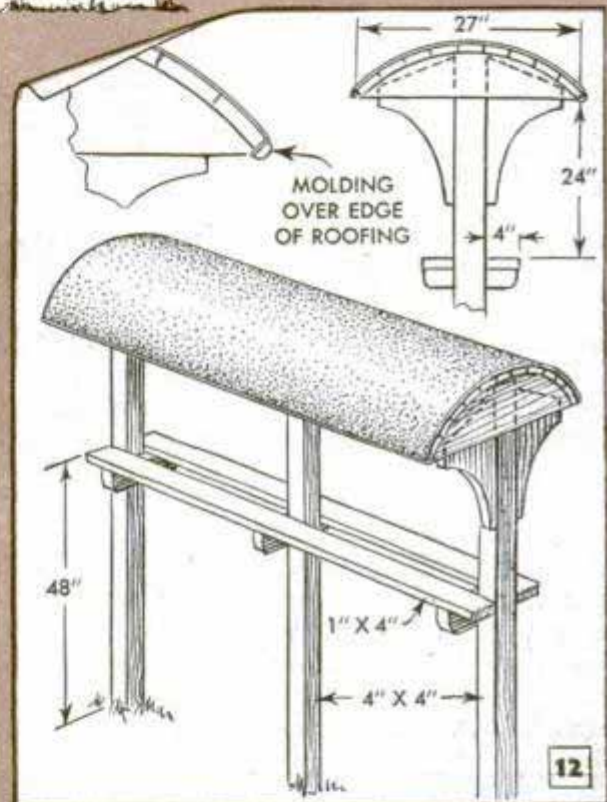

Multiple Indoor Clothesline Has One Adjustment

Instead of having to adjust each line, as is usually the case, this multiple indoor clothesline is connected by a series of pulleys so that adjustment is simply a matter of tightening one end and then wrapping it around a cleat. Another feature of the line is that it can be taken down with little effort. After the rope is removed from the pulleys, the two end pieces are lifted from the hooks that hold them and are stored out of the way until needed next wash day. The width of the end pieces is given as 46 in., and this will comfortably accommodate about eight lines. However, this width and the number of lines can be varied to suit the family's requirements. The manner in which the screw eyes are mounted in the end pieces for connection to the wall hooks and pulleys is shown in the lower right-hand detail. Care should be taken to space the screw eyes so that the pulleys and the

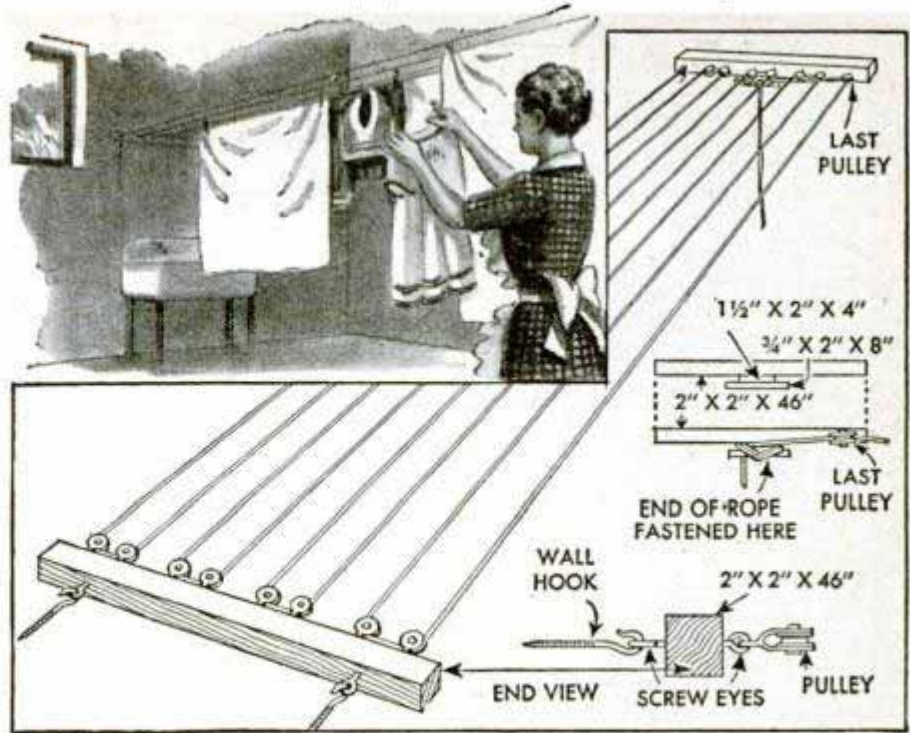

line will not be too close together when the latter is tightened. The wall hooks must be firmly secured to carry the weight and tension on the lines. Details and dimensions for the construction of the cleat that fastens the line after it has been pulled up are given in the center right-hand detail.

C. L. Meehan, Lakeview, Ont., Can.

Cigarette Lighter Flint Ignites Torch and Saves Hunting for Match

In order to eliminate hunting for matches, which are always somewhere else, one craftsman fastened the flint mechanism

from a cigarette lighter to the side of a small blowtorch where it was always at hand. A holder for the lighter was made by wrapping a metal strip around the torch and bending one end to form a tube. It's not necessary to fill the lighter with fluid since the vapor from the fuel in the torch will ignite readily from the spark.

Robert Eichberg, Arlington, Va.

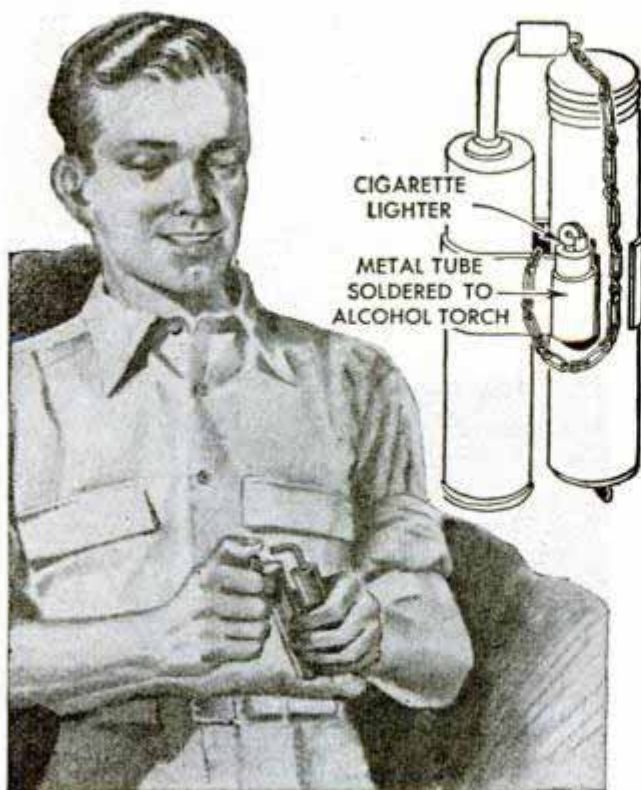

Roller Won't Tear Off of Shade If Taped in Place

By wrapping a strip of adhesive tape around each end of the roller and attaching it to the unrolled shade, as shown in the illustration, the latter can be pulled all the way down with little danger of its tearing off, as frequently happens when there is no tape reinforcement. If adhesive tape is not available, cellulose tape can be used.

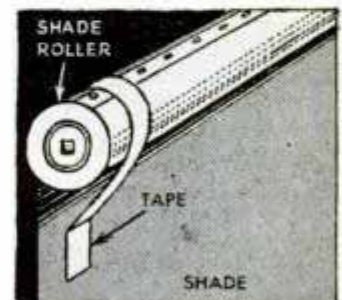

Disk Blade Bolted to Wooden Base Holds Small Parts

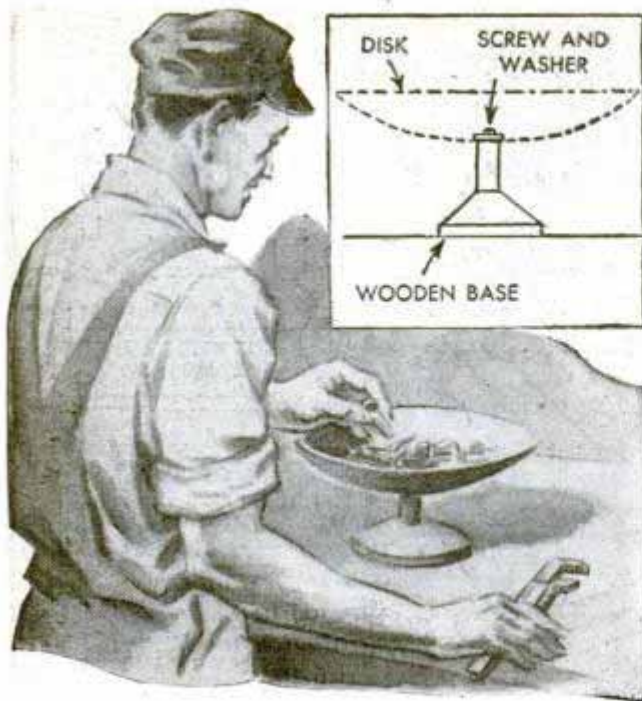

If you have one or more blades from an old disk harrow, they can be made into ideal holders for screws, bolts and other small parts. A wooden base similar to the one in the upper right-hand detail will prove satisfactory. The disk is fastened to the base with a screw and washer.

Tissue Dispenser in Automobile Is Handy for Passengers

Conveniently mounted on the side panel of a car underneath the dashboard, a cleansing tissue dispenser will be handy for all passengers in the car. Any metal dispenser will do as long as it has some provision for mounting with screws. Or, if necessary, flanges for the screws can be



soldered to the ends of the container. Best location for the dispenser is, as shown, on the right-hand side of the car. In this position it will not interfere with the driver.

D. E. Horn, River Forest, Ill.

Drilling Jig for Centering Rods

For locating and drilling centers in plastic rods and wooden dowels, this jig is fast and accurate. Of course, you'll need a different jig for each size of rod. To make the device, select a length of tubing that will be a snug fit over the rod to be centered and use a rivet that will slip inside the tube. Drill a hole through the rivet for a small centering drill and adjust the latter to drill to the right depth by using a washer and pin as a stop. Then solder the rivet in the tube and the jig is ready for use.

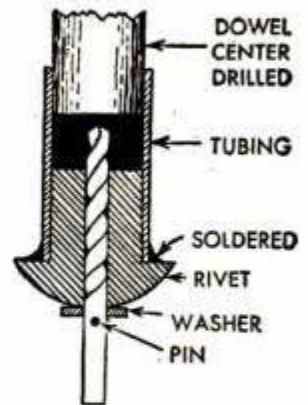

Alfred D. Beavin, Benson, Vt.

Pencil Sharpener Points Dowels

When there are a number of small dowels to be pointed, an ordinary pencil sharpener will do the trick in short order and all points will be uniform. More accurate fits will result than if the points were made with a knife or small chisel.

Repairing Broken Water Pipe

Provided the break in a water pipe is not too long, it can be fixed with a few odds and ends found around the house so the leak will be stopped until a permanent repair can be made. After shutting off the water, cover the broken part with a piece of inner-tube rubber and wrap lightweight galvanized sheet metal around it. Secure the patch with rope or cable tied around the metal and twist the cable tight by using a wooden or iron rod as a lever. Wire the free end of the lever to the pipe.

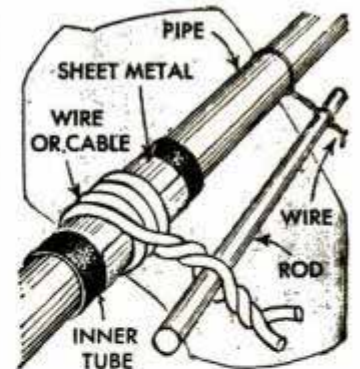

C. L. Meehan, Lakeview, Ont., Can.

Blotting paper is an excellent substitute for felt when applied to bases of table lamps and book ends to prevent scratching polished surfaces.

"Faithful Fido" Serves as Eye-Catching Doorstop

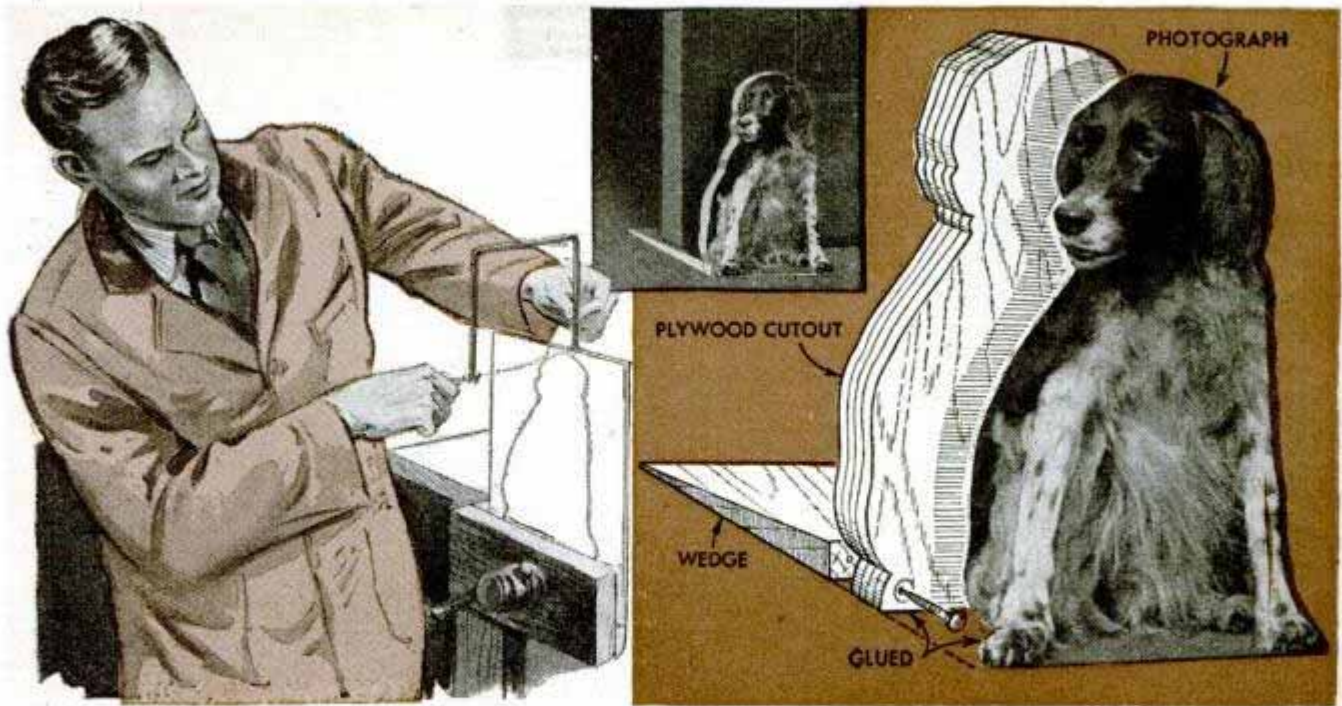

Even though he's only a cardboard cutout, this friendly dog will find a ready spot in your home to serve as a doorstop. The cutout is an enlarged photograph mounted on a plywood panel. Use a piece of stock large enough to take the entire picture and cut to shape on a jigsaw or bandsaw. The wedge which slides under the door is sawed from solid stock and secured to the panel with glue and brads or flathead wood

screws. If the latter are used, countersink them below the surface and fill the hole with wood filler or a plug. After the doorstop is assembled, sand the edges and surfaces, and then use an enamel that harmonizes with the trim as a finish. If you have the proper paints, you might retouch the photograph in color. Instead of the dog, a picture of any household pet will do.

Wm. H. Freeman, Baldwin, N. Y.

Adjustable Metal Holder for Emery Cloth Polishes Uneven Surfaces

For polishing metal molding or other pieces of metal having irregular surfaces, this holder can be adjusted to the contour of the material to do the job in short order.

A number of rectangular pieces of sheet metal are used, each piece being slotted for horizontal and vertical adjustment. A wing nut, bolt and washer hold the pieces together. In use, an edge of the holder is made to fit the piece being polished; the emery cloth is wrapped around this edge.

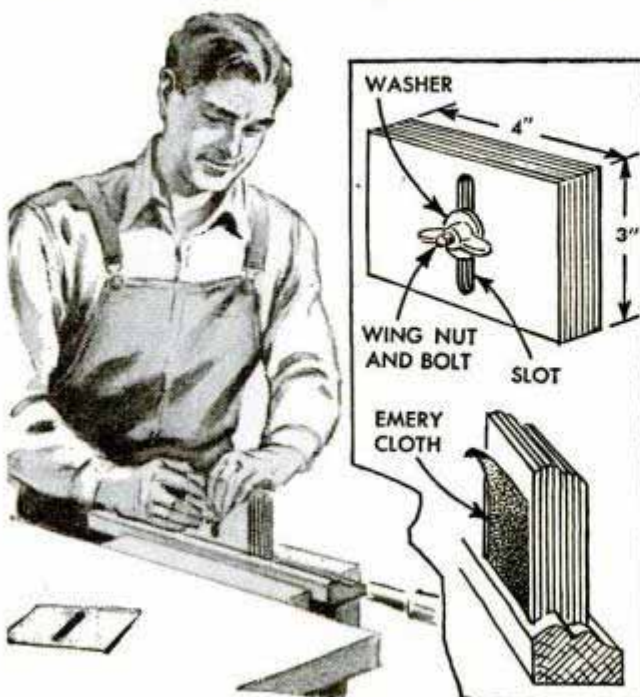

Tar Paper Preserves Canvas

If you want to keep a roll of canvas or a tarpaulin from being damaged by rats and mice, roll it up with a strip of tar roofing paper when storing it. The canvas should be folded so that it is the same approximate width as the paper when rolled. As a double protection, suspend the roll from roof joists by means of several wires, which will make it almost impossible for the rodents to get at the canvas.

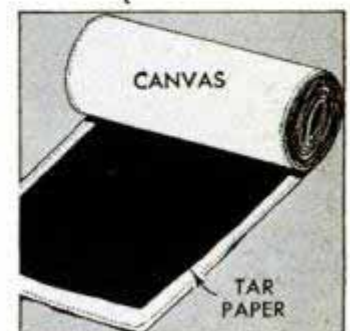



In the darkroom you spend considerable time working either in total darkness or in very subdued light. Likely you know the place as well as you know the inside of your pocket but unless there is adequate storage space you may discover at a critical moment that some needed item has been mislaid. Groping for it in the dark may give you ideas about how things should be arranged. Here are good, practical suggestions that will help

By Richard W. Emery

Photos by Ray Chapin

MAKE YOUR



INVESTMENT ALONE won't make a darkroom easy to work in, but a carefully planned darkroom, even one very modestly outfitted, will enable you to save time as well as money. Also a darkroom well planned may enable you to improve the quality of your work. For example, vibration caused by a machine in the building may be fogging enlarged prints. If the darkroom is in your home, the motor of an electric refrigerator or automatic heating plant might transmit enough vibration through a floor to your enlarger to cause this trouble. Traffic on a busy street also could set up a vibration that would affect an enlarger. To prevent this, place thick pieces of sponge rubber under either the enlarger or the feet of the table on which it sets. A simple layout with all materials and equipment conveniently at hand is best. Figs. 1 to 4 inclusive are good examples.

Most photographers—amateurs and professionals alike—are inventive and resourceful. Their ideas on darkroom time-



Keep extra trays on shelves under the sink board. With this arrangement it won't be necessary to stack them one on top of the other. If you turn each one upside down it will always be dry and free from dust

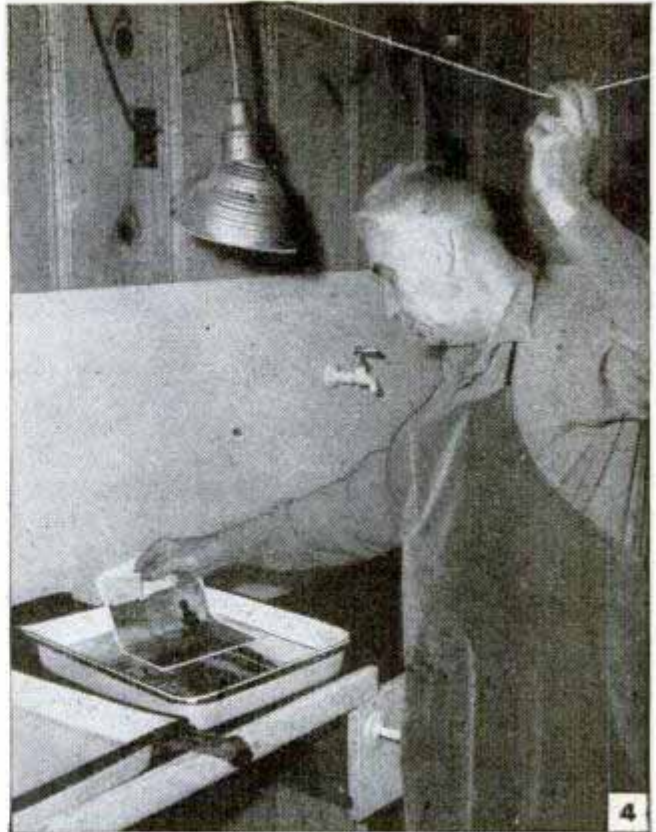

Reaching for a metal pull chain on an outlet-box switch with wet hands isn't accepted practice in the safe, workable darkroom. Attach cords to switches and let them swing above your head within easy arms' reach

DARKROOM WORKABLE

savers are worth studying closely. In a few darkrooms you will see a complicated system of light switches. Some of these may be located where wet hands must grope near an electrical outlet box or reach high for a metal pull chain. Not so good, in fact, this arrangement could be dangerous under certain conditions—maybe a wet floor or faulty wiring. A better, handier and safer arrangement is shown in Fig. 4 where the lights are operated by cords attached to the switch and to the wall so that they swing at an easy-to-reach height above the operator's head. In the course of average work in the darkroom, you will often find it necessary to turn on a white light. Unless this light is shielded effectively you'll be momentarily blinded. Not only inconvenient and uncomfortable, but a serious strain on the eyes if continued for any length of time. It's a simple matter to rig shades over or around the lighting fixtures so that light will be directed upon the work.

When processing prints, it's annoying to have to fumble under the sink for the necessary trays. Build a rack for them under

the sink board where they can lie upside down, Fig. 3. That way they'll stay dry and they won't get dusty. Wastebaskets that permit discarded wet prints to drip puddles on the floor are troublemakers. A basket too small to hold an evening's quota of discards is a time waster. Get one that's big enough and make sure it's watertight. Install it under the drainboard where it's always handy.

If your darkroom "puts its mark" on your clothing, it is possible you can save expense by fastening buffers around the sink and drainboard. Measure the edges and buy towel racks, or make them of 3/4-in. dowels. Fasten to the business edge of the sink and drainboard where they will protect your clothing as you lean over the work. To further protect your clothes and to add a handy accessory, hang thick towels over the buffers by thumbtacking one end of each towel to the lower edge of the board and draping the towel over the buffer as in Fig. 2. Run a splash bead or rail around the edge of the drippy area, to prevent chemicals from slopping over onto

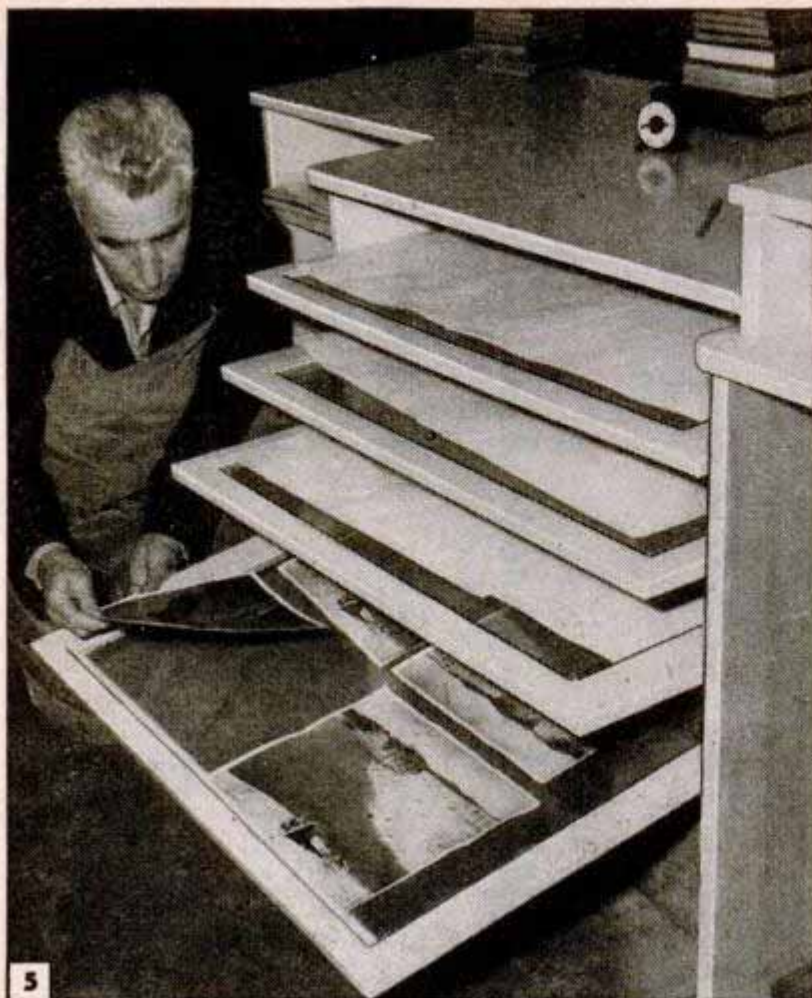

5—Frames screened with galvanized wire and built into the space under a table provide a convenient means of drying matte prints between blotters

6—To prop the wash tray at a more convenient height use glass jars with screw tops. Level the tray by turning the screw caps up or down

7—A windshield wiper is just the thing for squeezing wet prints. Treated in this way, prints will dry between the blotters in less than half the time

8—This hinged shelf supports a ferrotyping tin while prints are being placed on it from the wash water. The drippings naturally run into the sink

9—An addition to the drainboard folds back against the wall when it's not needed. This makes extra floor space available for any other work

10—Plug-in outlets are a convenience, and thought must be given to the location of each one. All wiring should be installed in thin-walled conduit

11—Correct temperature for developer is important. If darkroom temperature varies, use a baby-bottle warmer. It warms the solution in a jiffy

the floor. Rubber aprons are clothes-savers, too. You'll see them in many a good darkroom. The money they save in clothing and cleaning bills can be invested toward a new print trimmer or maybe a box of matte paper.

If your darkroom has a concrete floor, you can cushion your feet by wearing wool socks and thick-soled shoes. Or better, do a little light carpentry. Nail 2-in. strips on cross-pieces, with ½-in. spaces between strips, to form a springy floorwalk. There's a lot of footwork in the darkroom and a little attention to comfort at floor level pays real dividends.

Many a darkroom boasts an imposing collection of thermometers, but often lacks the one that it should have. That's the one hanging on the wall near the developing tray. Air temperature acts on open trays of developer, regardless of how many heaters or chillers you may have. With a thermometer

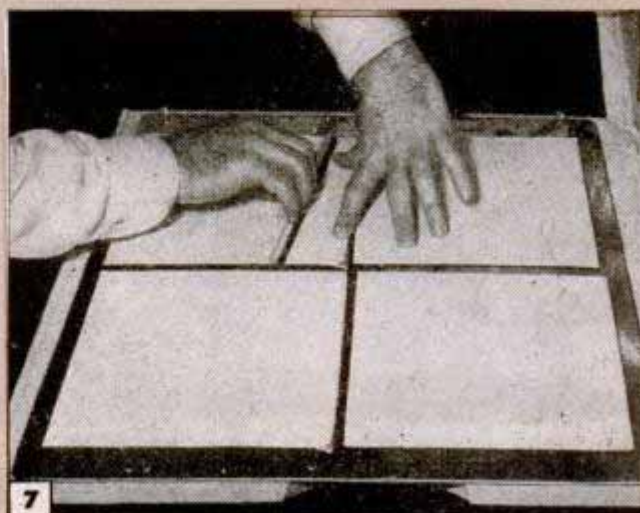

telling you what's happening to the air temperature, it's easier to keep watch on temperatures of the stop-bath and hypo.

Those hard-working blotters deserve a place all their own. Frames screened with galvanized wire, built into the space under a table or wide shelf, provide means of drying matte prints between blotters or under blotters, Fig. 5. Then too, you can sandwich ferrotype tins between them to save the tins from accidental scratching.

Raising the wash tray a few inches above sink-board level for protection against splashing is simply and quickly accomplished by placing three or four glass jars under the tray. To level a tray on a sloping surface, put screw-top jars under it and adjust the tops until water level in the tray looks right, Fig. 6.

For speeding up the drying time of prints, give them a squeegeeing with a windshield-wiper blade before rolling the prints under blotters. You'll save wear and tear on the blotters and you'll keep the floor drier. Do the squeegeeing on a ferrotype tin, Fig. 7.

Slapping wet prints on ferrotype tins always has been a swampy part of photography. You can eliminate much of the dripping by building a hinged drainboard to hold the tin while you're putting the

prints on it, Fig. 8. Let it drain into the sink. A half-moon shape cut from the upper end of the board will give you a place to take hold of the slippery tin. Two screws near the lower edge will prevent the tin from sliding into the sink. Hinge the board to the wall and provide a hook or cleat to hold it up out of the way, Fig. 9.

One of the stand-by items in the average darkroom is the rubber roller for rolling wet prints under blotters. A useful, indispensable tool, but it's always in the way unless a special place is provided for it. If you build a rack especially for the roller, where it will be at hand when needed, you add workability to one more phase of darkroom routine. Electrical gadgets are used frequently and they're great time-and-trouble savers. But if you have to rig up double or triple sockets and yards of extension cord, your darkroom will have the appearance of an ill-concealed booby trap. A few extra outlets in the electrical circuit will solve the problem. Because you'll be handling the electrical equipment with wet hands, foolproof wiring is essential, Fig. 10. See that those extra outlets are properly wired and insulated. To warm the developer, try an electric baby-bottle warmer, the kind that you immerse, Fig. 11.

It's only when you have the darkroom

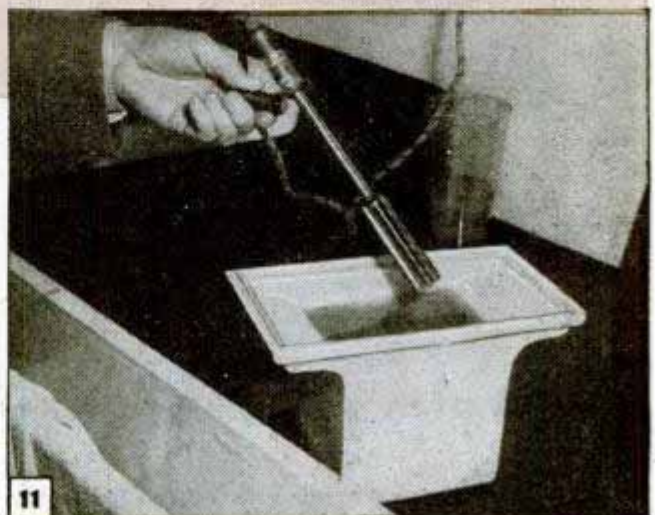
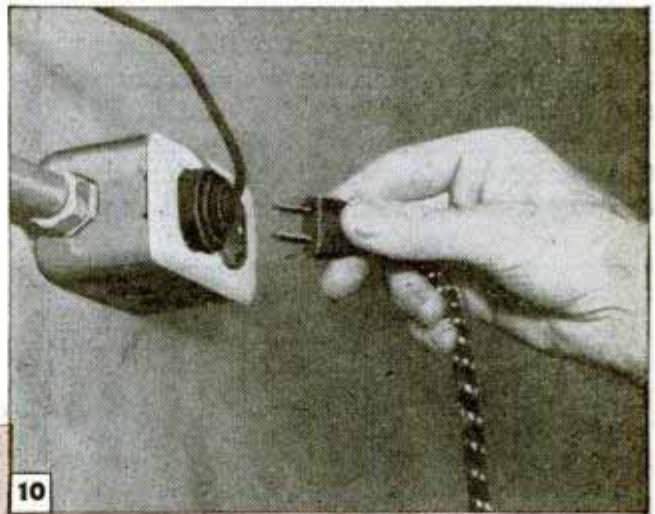
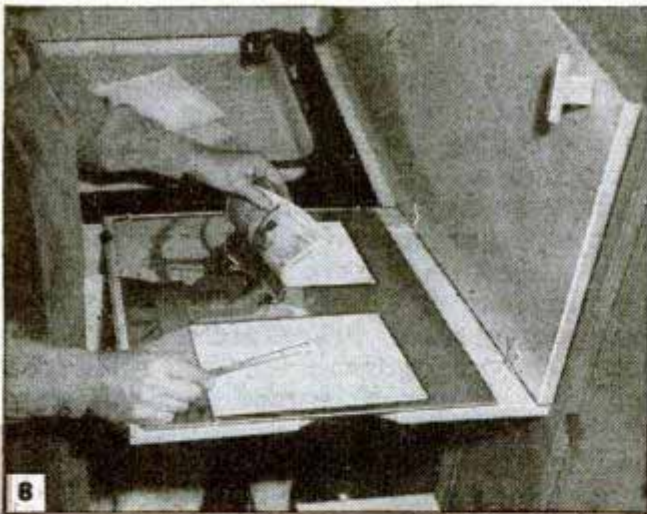



12

open or the white lights on that a good paint job on the walls, ceiling and fittings shows up. But paint regularly applied helps keep the place clean. Use flat black on surfaces where you don't want glare. Walls and ceiling can be most any color desired. It's best to use a semiflat paint rather than a high-gloss finish. Keep the painting material handy in a cabinet like that in Fig. 14.

A considerable portion of your work in the darkroom is spent in focusing the enlarging camera. Unless the easel is placed



14



13

Left, shelves near the enlarger are handy for printing paper. Incidentally, build a platform like this to raise your enlarging easel to a convenient height. It saves a lot of squint and stoop. Above, darkroom should have housed shelf compartments. They take more time to build, of course, but you've got to "live" with the furnishings a long time, so have them handy

at a convenient height, you have to bend your back and twist your neck. This kind of thing isn't permissible in the smooth-working darkroom. Take time to build a platform to raise the easel waist-high. Leave the front open, and use the former table-top as a handy shelf, Fig. 1. If your enlarger is extremely high and cramped by a low ceiling, maybe a hole can be cut in the ceiling and boxed in to admit the lamp house.

Because they are of top-heavy construction, enlargers have a tendency to wobble. A wobbly enlarger wastes time and good printing paper. Vibration can be avoided by applying sturdy braces of flat iron to the top of the enlarger column. Two extra feet will provide a wobbleproof stance. Fasten the braces to the wall or ceiling, where they will be out of the way.

Spare corners are good spots for shelves, Figs. 12 and 13. The average darkroom has sufficient space but often the furnishings are not arranged to make the most of the space available. Shelves help. Big ones or little, they are needed for storing supplies where they won't clutter up the floor. They simplify the filing problem. If you want real efficiency and have the space, build a darkroom annex to be used as a film room. It's a smaller version of the main darkroom, but limited to the loading and processing of films. It will permit two-man operation and will give your films a higher degree of protection from light, dust and chemicals. In this film annex, you can build a lot of workability into a small space. A hinged shelf will make a film-loading table.

Photographic Scale For Dry Chemicals

Inexpensive to make, this photo scale will prove satisfactory in measuring quantities of dry chemicals up to about 2½ oz. in weight. Most of the parts are formed from light-gauge metal, principal exceptions being the spring (taken from an electric ironing cord) that supports the balancing arm and the wire indicator. The arm assembly is detailed in photo 2, and the fulcrum and indicator is shown in photo 3. Note that all stationary parts are soldered together. After the unit is assembled, photo 1, the scale can be calibrated with regular weights. — R. Scott, Saltsburg, Pa.

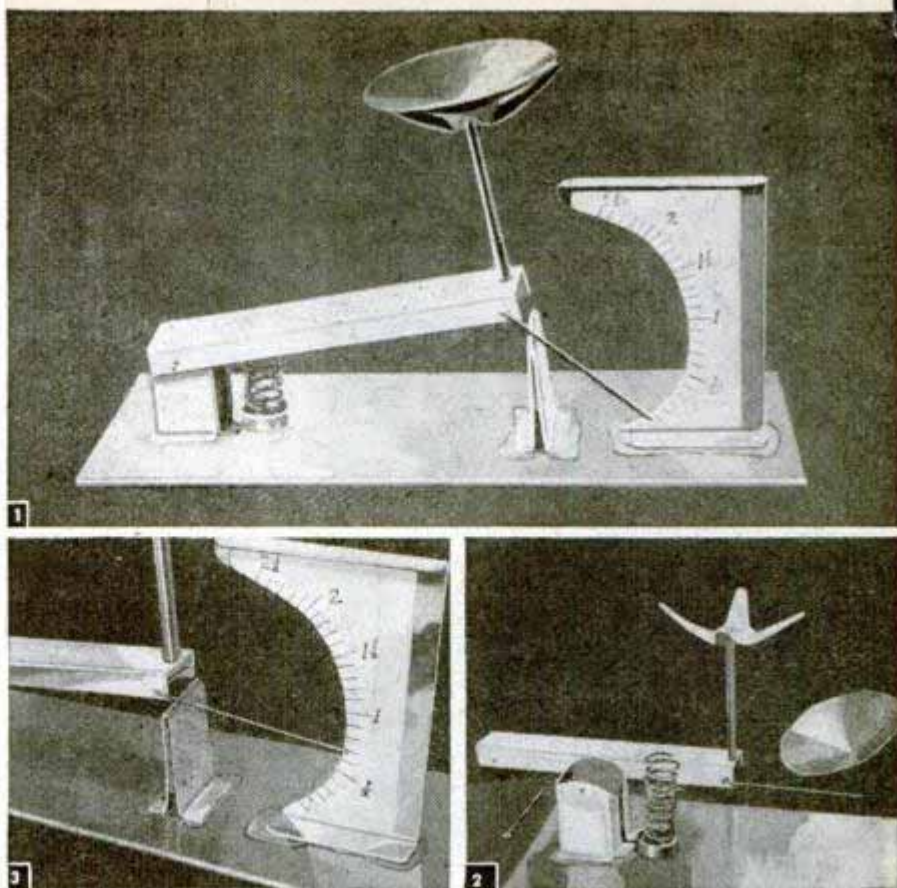

Siphon Controls Level of Liquid With Novel Arrangement

Constant level is maintained in a film-washing tank by means of a siphon and trap effect. Or for that matter, the same idea can be used in many containers where it is desirable to keep flowing water at the same level. The supply water from the tap runs through a tube to a point near the bottom of the container. The inlet side of the siphon is held at the desired level by means of a wire hook and the outlet spills into a smaller container that serves as a trap. From here the water is wasted. It is necessary to start the unit by drawing water through the siphon, but once all adjustments are made, it is merely necessary to turn the water on and off to use the tank.

Glenn McCoun, Rockford, Ill.

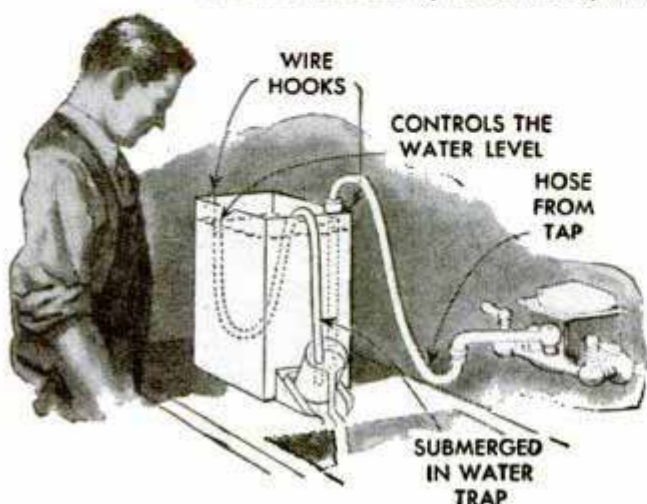

Camera Bellows Makes Lens Shade

If you have a small camera that has been discarded, the bellows will make an excellent lens shade for a larger one. No dimensions or directions for attaching to the lens are given as this will vary with the size and type of camera to which the shade is fitted. Stiff pieces of wire are used to hold the shade in place so it does not obscure the field of vision. When not in use, these are removed and the bellows collapsed for storing in the camera case.

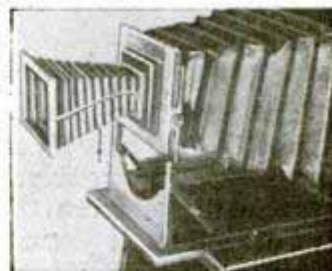

Wire Frame Holds Film-Tank Rod

Often the film-tank agitating rod is misplaced when the tank is being loaded or while the cover is removed to wash the film. A handy bracket to hold the rod when it is not in use can be made from heavy wire, such as coat-hanger wire. It is bent around the tank and twisted to form a loop for the rod. Kept here, the agitator is always at hand. — Richard Hanscom, Elmhurst, Ill.



Use Funnel and Tube to Pour Oil Into Small Containers

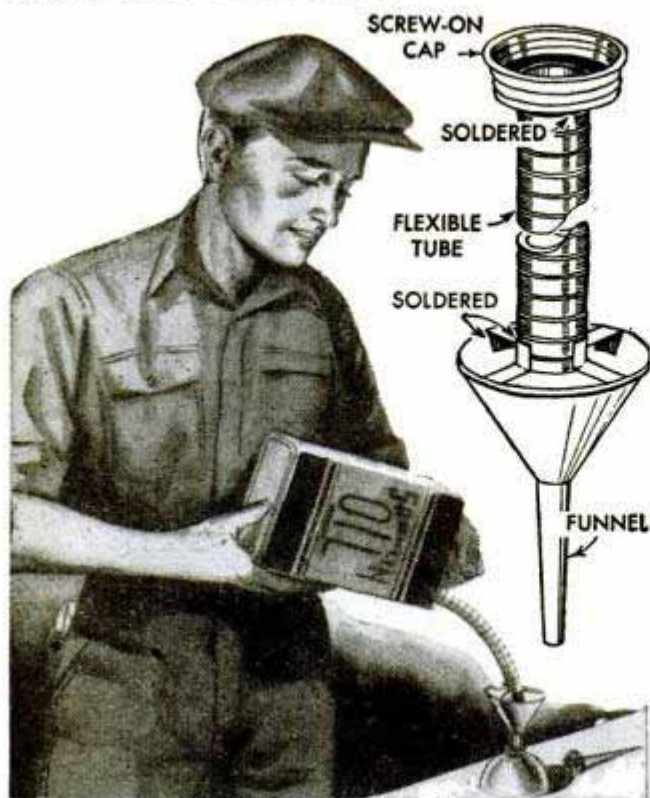

If you've ever tried to pour oil from a large-mouthed container into a smaller one, you will appreciate this funnel-and-tube arrangement. A hole is cut in the screw cap of the container and a length of flexible tubing is soldered to it. A funnel is soldered to the free end of the tube by means of brackets fastened to the mouth of the funnel.

Repairing Broken Trunk Hinge

Broken auto-trunk hinges can be repaired inexpensively by using an ordinary strap hinge as reinforcement. Remove the broken hinge from the trunk and cut the pin off where it joins the two leaves. Then

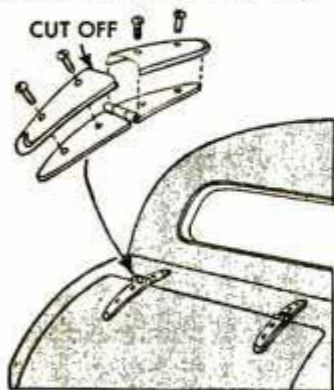

fit these parts over a suitable strap hinge and fasten the two to the trunk and deck using chromium-plated nuts and bolts. The repair will look well and provide long service. — Francis C. Zuiker, Chicago.

Tees Provide for Future Outlets

When installing water lines, if a tee is used instead of an elbow at some point near a fixture and close to the wall, it will provide a connecting point for a future exten-

sion. The branch for the extension is, of course, plugged. If a heavy drain is expected from both installed and planned fixtures, it would be well to oversize the pipe that feeds them, especially if the drawoff from both occurs simultaneously.

G. H. Preston, Cincinnati, Ohio.

Undercutting Stair Will Save Carpet

In cases where it would be necessary to cut odd shapes in carpeting or other floor covering to make it fit, you may sometimes find it more economical to undercut stairs or other built-in fixtures that are in the way. It's necessary only to cut enough to allow for the thickness of the carpet and in most cases this will not weaken any structure that does not carry a bearing load.



R. E. Murray, Fremont, Ohio.

Checkerboard of Many Woods Helps Instruct Children

Children will learn to identify many species of woods with this unique checkerboard. Each dark square is a different wood and the light squares are painted white, or if enough squares of light wood can be found, they may be used. The name of each kind of wood should be labeled on the proper square. Protect the finished board with several coats of clear lacquer.



CRAFT QUIZ

10 HAMMERS—can you identify them?



1

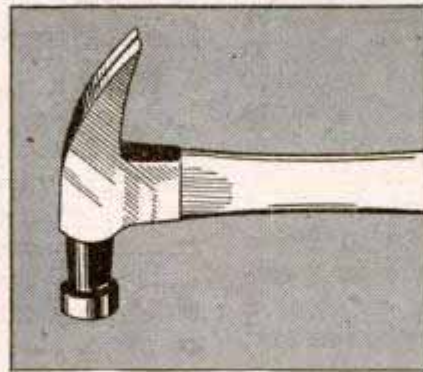

2

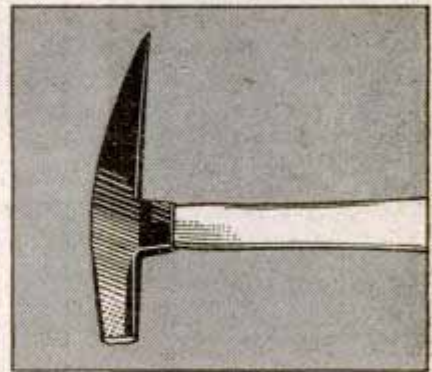

3

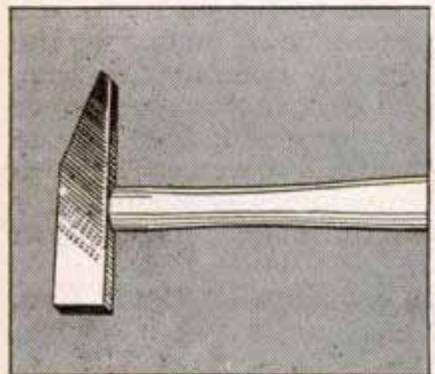

4

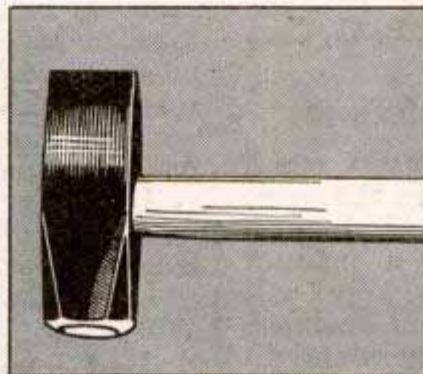

5

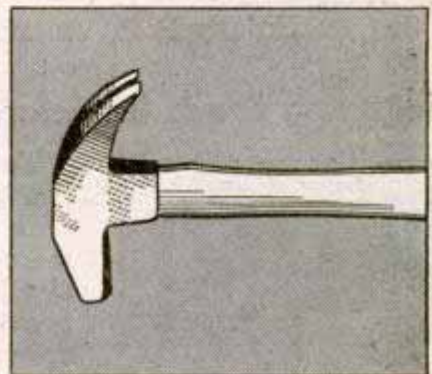

6

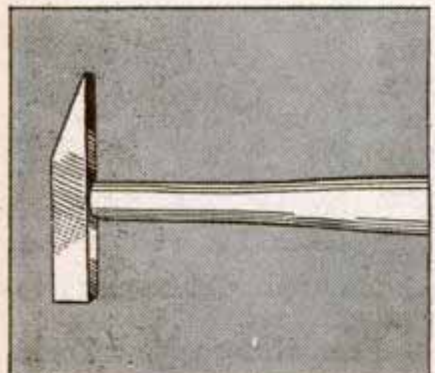

7

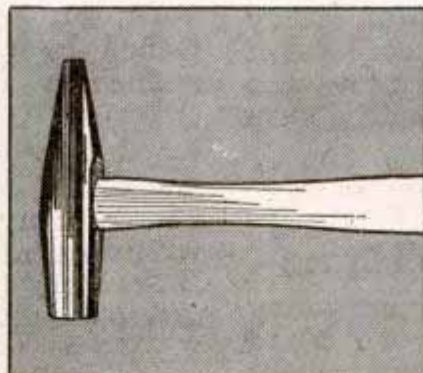

8

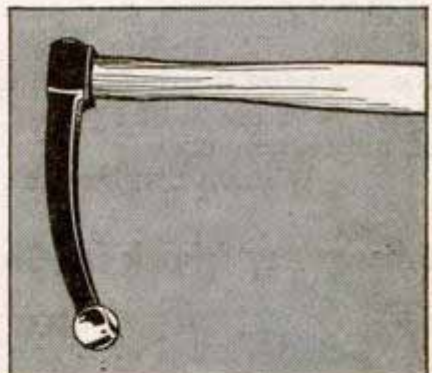

9

ANSWERS: 1—Packer's Hammer; checked face. Used in shipping rooms but preferred by some workmen for roof shingling. 2—Carpenter's Ripping Hammer, bell-faced, with a straight claw especially suited to removing forms, siding, etc. 3—Geologist's Hammer or "pick"; used by geologists and prospectors for breaking out rock and ore samples. 4—Paneing Hammer, made especially for tinmiths. 5—Cooper's Hammer; used by the trade in making barrels and casks. 6—Farrier's Hammer, especially designed for horseshoers. 7—Tile-Setter's Hammer; used by the trade. Note similarity to Paneing Hammer. 8—Billposter's Magnetic Hammer, which is similar to the magnetic tack hammer used by upholsterers and others. 9—Fender-Bumping Hammer; used by the trade in repairing damaged auto fenders. Shape of head allows working on underside of fender without removing the wheel. 10—Offset Dinging Hammer for auto-body repair. Offset faces enable user to work on a curved surface

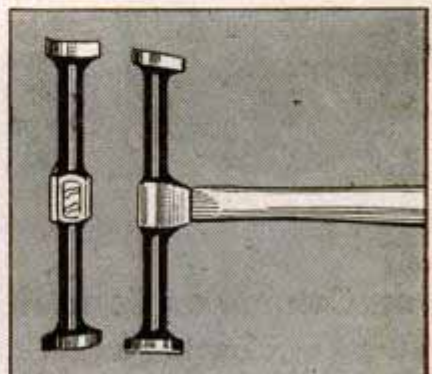

10

Sanding Drum Fits Drill Press



Neat and efficient, this sanding drum is made from two hardwood disks 1½ in. in diameter and ½ in. thick plus a piece of radiator hose of the same diameter and 1 in. long. The abrasive paper is fastened around the hose and held in position by expansion of the wooden end disks when the ¾

in. bolt and nut that passes through them is tightened. The end of the bolt, of course, is chucked in the drill press.

Sidney Pott, Victoria, B. C., Can.

Inserting Brads in Picture Frame

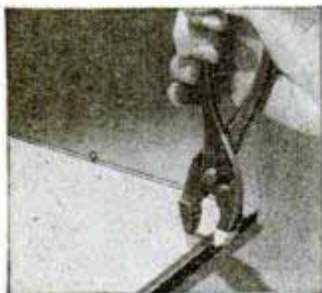

To insert small brads in the back of a light picture frame, a pair of slip-jaw pliers will prove to be more convenient and do a neater job than a hammer. Open the pliers to the

“wide” position and apply a firm, steady pressure with the jaws against the head of the brad and the outside of the frame. The outer jaws should be padded with a strip of adhesive tape.

William Swallow, Brooklyn, N. Y.

Emergency Chuck for Small Brace

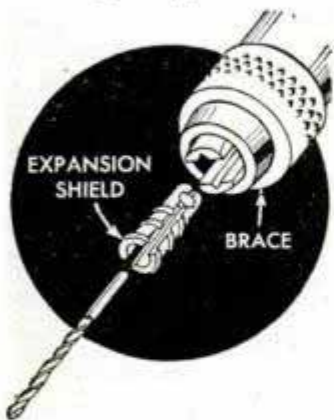

An emergency chuck to hold small twist drills in a brace when the proper hand drill is not available can be improvised easily. Insert the drill in an expansion shield and chuck it in the brace.—H. Klein, Pittsburgh, Pa.

Iron Cement as Sand-Hole Filler

Sand or blow holes which occur in castings, while not always detrimental to the piece, are often unsightly and can be filled. One craftsman uses a good grade of iron

cement, after first filling the hole with steel wool. A second application of the cement may be necessary to insure a good “plug,” and a third coat is added and smoothed to make a finished-looking repair.

H. W. Swope, Danville, Pa.

Mousetrap That's Always Set

With a pail, a baking-powder can, a board and a length of wire, you can make a mousetrap that won't require resetting to catch any number of mice. Holes are punched in both ends of the can for the wire axle, which rotates in two holes punched in the side of the pail near the top. The board is used as an incline for the mice to walk on. To operate the trap, spread cooking fat over the can and cover with bread crumbs or grain; then fill the pail about one-third full of water. The mice will walk up the incline, and jumping for the food, roll off the baking-powder can into the water.

Paul Criton, Jr., Kayville, Sask., Can.



Links Fasten Handle to Drawer

Wire handles or workshop drawer pulls can be attached by using sash-chain links. One link is fastened over each end of the handle and held in place with wood screws.

Links from brass chain should be used to add to the decorative effect.

Frank Shore, New York.

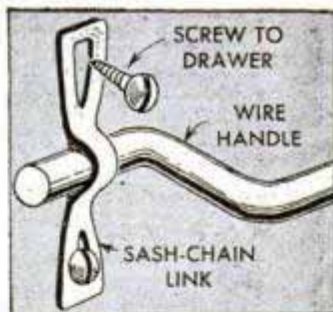

Keeping Miter Work From Slipping

When work is being cut at an angle on the circular saw, it usually has a tendency to slip or creep, making the resultant cut inaccurate. This can be prevented by coating the work face of the miter gauge with rubber cement and allowing it to dry before use. The cement provides a non-slip surface for the work.—Kenneth Murray, Colon, Mich.

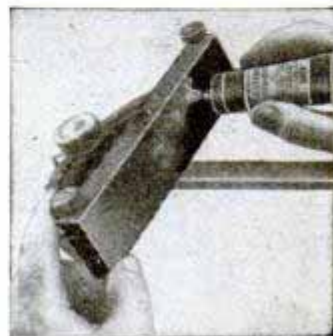

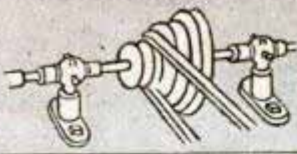

Solder it RIGHT

By Wm. Riederich

SOLDERING is something like painting—at some time or other nearly everyone finds it necessary or desirable to do the job himself and save both time and money. But in making the average soldered joint the procedure is so simple that there is a tendency to slight some of the details essential to good work. Correctly made, a soldered joint is durable. Take as an example gutter and downspouts, the parts of a building which are exposed to the most severe weathering. If you examine old gutters which have long since eroded to the point where they no longer serve their purpose you will see that in nearly every instance the soldered joints are still sound. The same will be found true of many other kinds of work, parts of which have been joined by soldering.

There are three general requirements for good soldering on average light work. They are, a correctly-tinned iron heated to the proper temperature, the right flux for the job, and a clean surface. Tools required for the ordinary job are a soldering iron or bit, as it is often called, a suitable means of heating the iron or the work quickly and efficiently, a coarse file, sandpaper and a wire brush, a damp cloth and clamps to hold the parts to be joined firmly in place. Of course, if the work is of such a nature that it can be dipped, you will need a ladle of sufficient size. If you use an electrically heated iron exclusively then that disposes of the heating problem.

A new iron must be tinned and where the iron is in continuous use frequent retinning is necessary. The chief purpose of tinning is to prevent the formation of copper oxides on the bevels of the tip. Oxides act as an insulator, interfering with rapid heat transfer from the iron to the work. Also an untinned bit won't "take" the solder properly. To tin a new iron or retin one that has been in use, first heat it to a temperature of 500 to 700 deg. F., and clean with a wire brush.

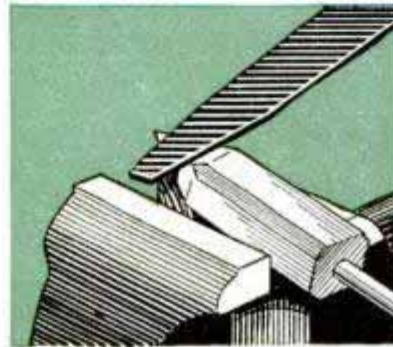

The soldering iron must be cleaned before tinning. Use a coarse file but be careful not to remove more copper than necessary

Heat the iron with a blowtorch and watch that it does not get too hot. Always place the iron in the special rack as indicated

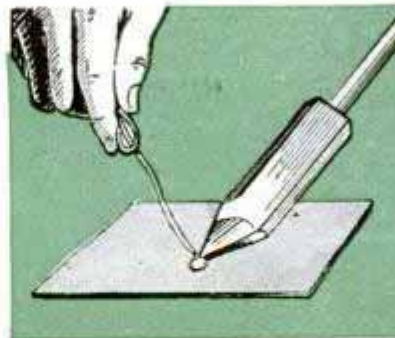
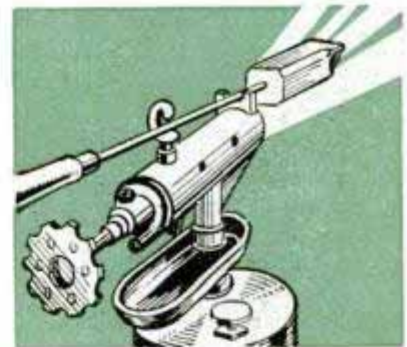

Apply flux to the tip, then coat the four bevels with solder. Build up sufficient solder so that it can be spread out evenly

Finally, wipe and twist the tip on a damp cloth to spread patches that remain on the surface. Re-heat if necessary





Here's what happens when the iron is too cold. The solder won't flow, but only softens to a waxlike consistency on the surface

But when the iron is heated to just the right temperature the solder flows or "draws" smoothly into joint without piling up

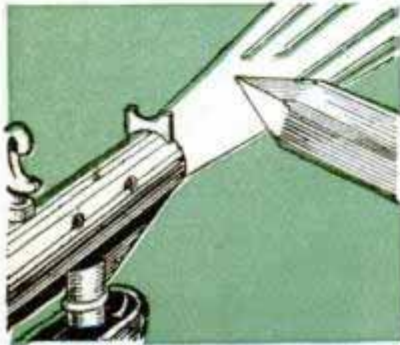

Don't hold the tip of the iron in the blowtorch flame this way. Direct flame will overheat the iron and remove the tinning

Trick of sweat-soldering one small part securely to another is easy if you proceed correctly in the preparation of the work

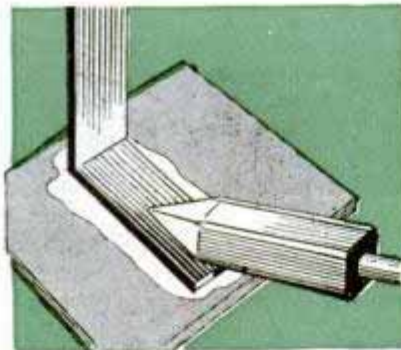

TABLE I
MELTING POINT OF VARIOUS SOLDER ALLOYS

Tin	Lead	Antimony	Melting Point °F.
0	100	0	618.8
10	90	0	577.4
20	80	0	532.8
30	70	0	491.0
31	67	2	370.4
38	60	2	370.4
40	60	0	446.0
49.25	50	.75	365.0
50	50	0	401.0
60	40	0	368.0
66	34	0	356.0
70	30	0	365.0
80	20	0	388.4
90	10	0	419.0
100	0	0	450.0
0	0	100	1166.

Sometimes it will help to rub the beveled tip on a block of sal ammoniac or ammonium chloride. Usually, however, it is only necessary to apply a rosin flux to the cleaned tip and flow on solder until the entire tip of the iron is covered. Finally, wipe and twist the tip on a damp cloth to spread the solder in a uniform coating.

The purpose of a flux is in most cases twofold—to help clean the work and to prevent the formation of oxides which interfere with the flow of solder. There is no all-purpose flux. Different metals require different fluxes. See Table II. Two commonly used fluxes are those made from rosin and from muriatic acid (hydrochloric acid) which has been "cut" with zinc, forming zinc chloride. Most fluxes are available ready to use in both liquid and paste forms. For light work you use the handy wire solder with acid core. The acid flux is contained in the hollow wire so no separate flux is necessary. Solder is also supplied in solid-wire form without the flux and in convenient bars. It comes in varying proportions of lead and tin, and in lead-tin-antimony and lead-tin-bismuth alloys. These are all commonly known as "soft" solders. A 50-50 solder, 50 percent tin and 50 percent lead, is good for average light work, although these proportions do not give maximum strength. Where the greatest holding power and resistance to bending or flexing is called for, a 60-40 solder, 60 percent tin and 40 percent lead, is generally used. Some alloys contain 67 percent tin and 33 percent lead. On the other hand, for special jobs such as soldering pewter, a solder composed of 1 part lead, 1 part tin and 3 parts bismuth is quite commonly used. The melting point of this alloy is only 240 deg. F. See Table I.

Cleaning of work to be soldered is done with sandpaper or emery cloth, steel wool, files or a wire brush. A power-driven wire wheel speeds up the job of cleaning where the size or shape of the work allows its use. Tinsmiths use reduced solutions of muriatic acid to clean galvanized sheet metal. Hydrochloric acid is an excellent cleaner on some metals, but it is necessary to give the work a thorough washing in a strong solution of soda water immediately after soldering to remove all traces of the acid and stop its corrosive action. Small, irregular-shaped parts, difficult to clean by brushing or by other means, can be dipped in hydrochloric acid. Suspend these on a wire and don't get the acid on your hands or clothing. Avoid breathing the acid fumes at any time. Some metals and certain types of work won't stand the acid bath. Don't use it to clean electrical work.

The requirements of the soldering opera-

tion are just as simple as actually doing the job. The first of these essentials is that the parts to be soldered shall be heated as nearly as possible to a temperature equal to the melting point of the solder. This assures the strongest bond. On large parts to be joined which contain considerable metal or where the cross sections of the parts are thicker than ordinary, preheating usually is necessary. This ordinarily is done with a blowtorch. Where work must be preheated it is necessary that it be held together with clamps during the heating period, also for a time after soldering until the work cools well below the melting point of the solder. Work soldered in this way should not be subjected to any strain during the cooling period. Where seams, butt joints, corner joints, and curved work are to be joined by soldering, parts must always be carefully fitted beforehand and provision made for holding the assembly in place while soldering. Galvanized sheet-metal parts should always be held together with clamps or by other means. Where you have an intricate assembly requiring soldering several joints in close proximity, use damp or wet cloths to protect the joints already soldered. When using a torch to heat large work preparatory to soldering, heat all the area about the joint but avoid playing the flame directly on the meeting surfaces or on the solder as it is applied. When doing such a job, flux the work first then heat until the flux boils. Apply the solder immediately. When it melts and flows into the joint, withdraw the heat and allow the work to cool to room temperature before removing the clamps or other fasteners that hold the parts together.

Soldering with an iron is much the same as with the torch except that the iron is used to heat the work and melt the solder in a more or less simultaneous operation. A suitable flux is applied to the work which is then heated by applying the iron to the surface. After a preliminary heating, solder is flowed into the joint. On some types of work such as a common butt joint, flowing the solder onto the iron as it moves slowly along the joint will often give the smoothest job. If the temperature is right the molten solder will flow off the iron onto the work in just the right amount.

Making a lap joint on two flat surfaces is done by a method known as "sweat-soldering." First the edges are fluxed and tinned. The tinned surfaces are then placed together and heat applied. Where an acid flux is used wash the work immediately with a solution made by dissolving 1/2 lb. baking soda in a gallon of water. This will remove all remaining traces of acid and stop any corrosive action on the metal.

When soldering small parts such as a wire splice, hold the iron under the work. The solder will "draw" into the joint neatly

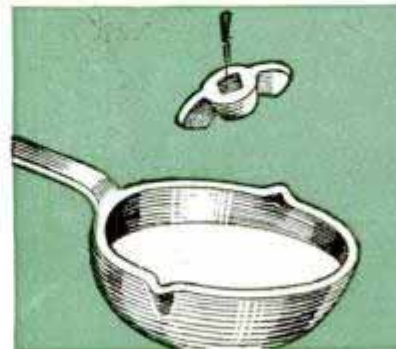
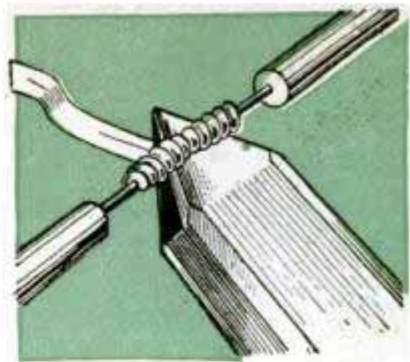

Small parts can be rustproofed by tinning in a bath of molten solder. Attach a wire to work and hold in solder until heated

To repair a cracked tube, wrap it with wire, closely spaced, then heat and run solder until spaces between wires are filled

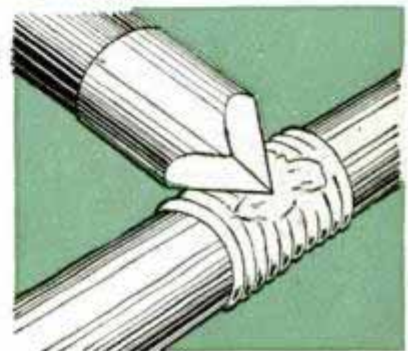

Wash parts to remove the flux. A shallow porcelain-enameled pan is generally the best. Always do a good job of washing

TABLE II
SOLDERING FLUXES USED FOR VARIOUS METALS

Meta:	Flux
Iron - - -	Ammonium chloride or zinc chloride
Steel - - -	Ammonium chloride or zinc chloride
Copper - - -	Ammonium chloride or zinc chloride
Brass - - -	Ammonium chloride or zinc chloride
Bronze - - -	Ammonium chloride or zinc chloride
Gun metal - - -	Ammonium chloride or zinc chloride
Nickel - - -	Ammonium chloride or zinc chloride
Lead - - -	Resin or tallow
Steel (Tinned) -	Zinc chloride or resin
Galvanized steel	Hydrochloric acid
Zinc - - -	Hydrochloric acid
Pewter - - -	Tallow
Silver - - -	Chloride of zinc
Gold - - -	Chloride of zinc
Cast iron - - -	Chloride of zinc with tallow added
Stainless steel -	Muriatic acid

Combination Holder and Lighter Facilitates Welding Work



With this combination holder and lighter, a welder will not waste time looking for a place to lay a lighted torch, and when he wants to light it, the facilities are at hand. The base is fairly heavy material; the column can be of pipe threaded to fit the base and the two arms for the torch are made of flat iron. A small hand-operated generator is bolted to the pipe and connects to a spark plug mounted on top of the column. The plug is operated by turning the generator. Elmer Vandrey, Truman, Minn.

Index-Card System Locates Files Missing From Cabinet

When papers and other records are removed from file folders, much time is wasted looking for the missing data, especially where several people use the same file. By slipping this index card onto the

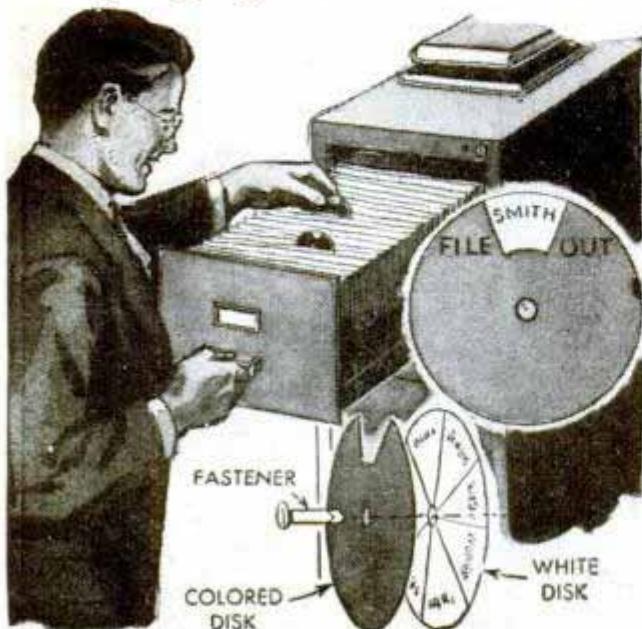

folder when papers are removed, any of the office staff know where they are. The marker is made of two disks held together with a paper fastener. The names of persons authorized to remove material from the files are printed on the rear disk and they appear through an opening cut in the front disk.—G. E. Harrington, New York.

Pliers Converted to Staple Puller

Alter the ends of a pair of pliers so one overlaps the other, as shown, and you have a handy staple puller that is easy to carry in your pocket. The dotted lines in the lower detail show how the pliers are filed or ground down and the lower part of the detail indicates the manner in which the puller is used to remove staples.

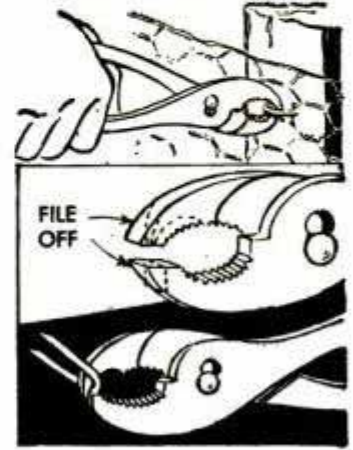

A. H. Waychoff, Phoenix, Ariz.

Removing Small Amounts of Varnish

One sign painter who uses small amounts of varnish at a time finds that by punching two small holes near the edges of the can he can pour liquid easily. Nails or small pieces of wood are used to plug the holes in the can.



Drawings Rolled in Paper Tube Will Not Drag on Floor

If half a tracing-paper tube is tacked to each end of the table when making drawings that are longer than the board and using a drafting machine, the extra length of paper can be rolled in the tube to prevent its dragging on the floor. This will keep the drawing neat and it is not apt to be torn.

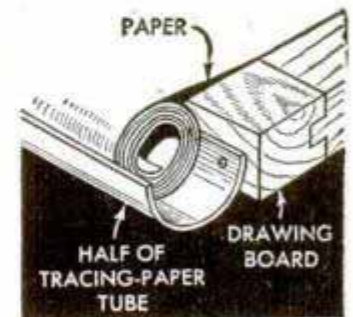

W. B. Eagan, Charleston, W. Va.

ANTI-FRICTION CENTER-REST JAWS

By Roy V. Hamlin

A few hours spent on the alteration of the standard lathe center rest will save a lot of time ordinarily spent in polishing out the marks left on finished lathe work by the center-rest jaws. The ball-bearing jaws shown in Fig. 3 will carry any load at any speed without leaving a mark on the work. Because there is less friction, it is possible to get a closer grip on the work when it is being set up. Also the rolling contact provided by the three jaws precludes any tendency to chatter, even when work of small diameter is being turned.

Three new jaws are milled from cold-rolled steel to fit the steady-rest frame. These are in the form of yokes, as you see in Fig. 2. The width, length and depth of the slot in which the jaws slide must be taken from the present jaws now in use in the rest, as well as the length of the elongated slot in which the lock screw is placed. All other dimensions can be taken from the rollers, which are ball bearings.

A double-sealed bearing, Fig. 2, with the inner race extending beyond the outer race width is best, although a regular bearing can be used with washers as shown in Fig. 1. Each bearing, which serves as a roller, is supported on a shaft which is simply a standard 1/2-in. steel dowel pin.

The really critical point to watch in machining the three yokes, or blocks, is to make certain that the drilled and reamed hole for the bearing shaft (dowel pin) is at a 90-deg. angle to the back surface—otherwise the roller will ride on one edge only and may mar the work. If you make sure this hole is correctly located in all three blocks, then you'll have no trouble. Be sure when making the setup that there are no metal chips on the sliding surfaces of the blocks or frame. Even a small metal shaving can throw a roller out of line.

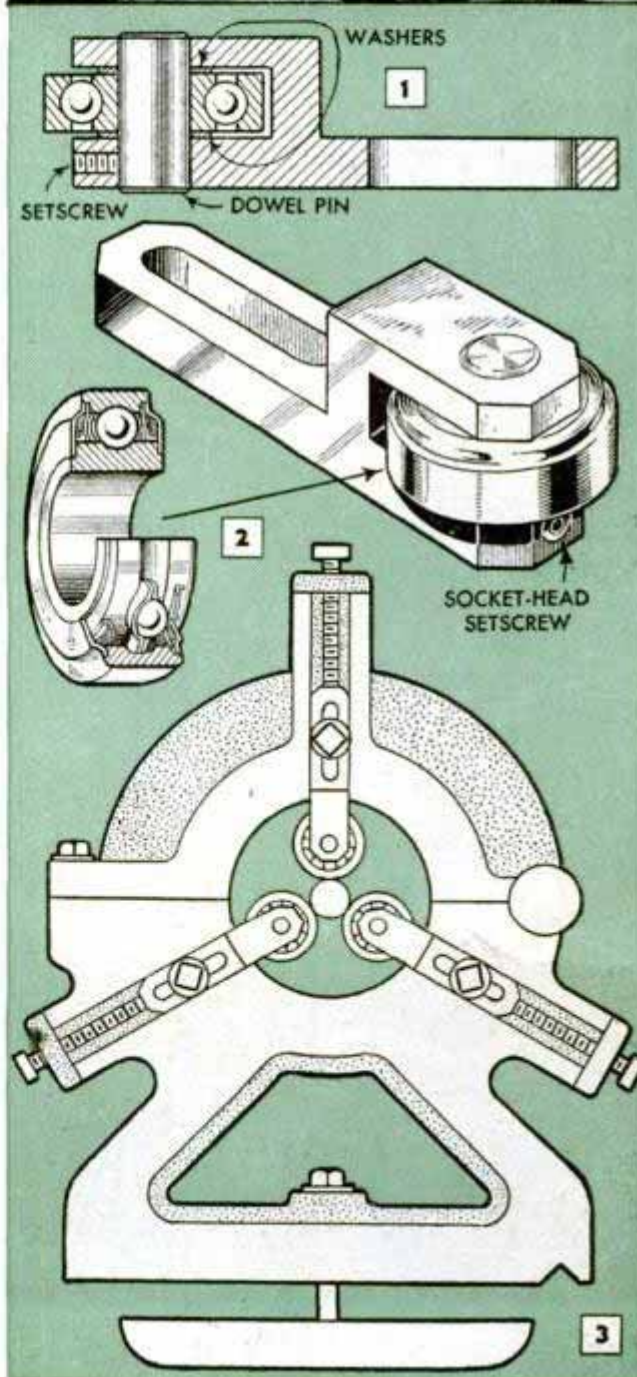

Trammel Scribe for Large Work Also Used as Beam Compass

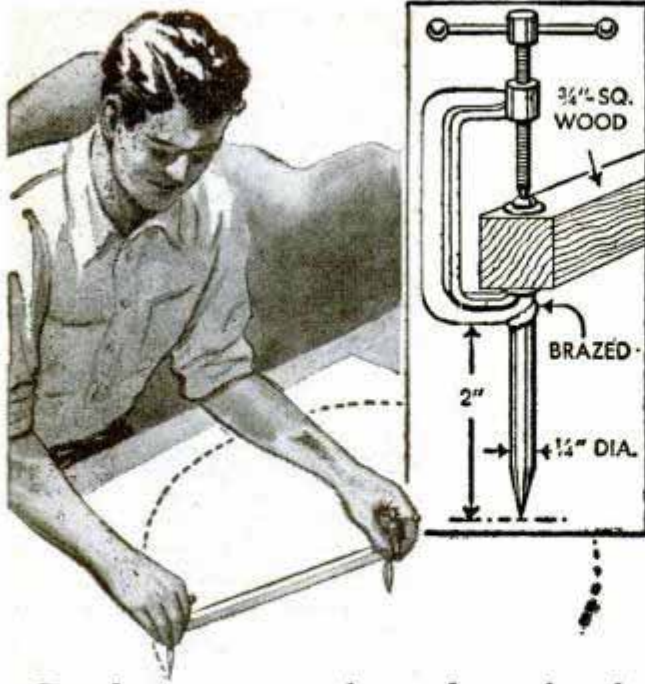

For laying out work too large for the ordinary dividers, a trammel scribe can be made with two C-clamps. Points are brazed to the bottom of each clamp and the clamps are fastened to a $\frac{3}{4}$ -in. wood beam. The points should be hardened to retain their sharpness. By brazing an empty cartridge case, which serves as a pencil holder, to a C-clamp, the scribe will serve as a beam compass also. Or a clip to hold a soapstone pencil could be used.

Phillip Wilson, Streator, Ill.

Cotter Pins Are Installed Easily With Pronged Spreader

If you have a number of cotter pins to install and want to save time doing the job, here's a spreader that will speed the work.

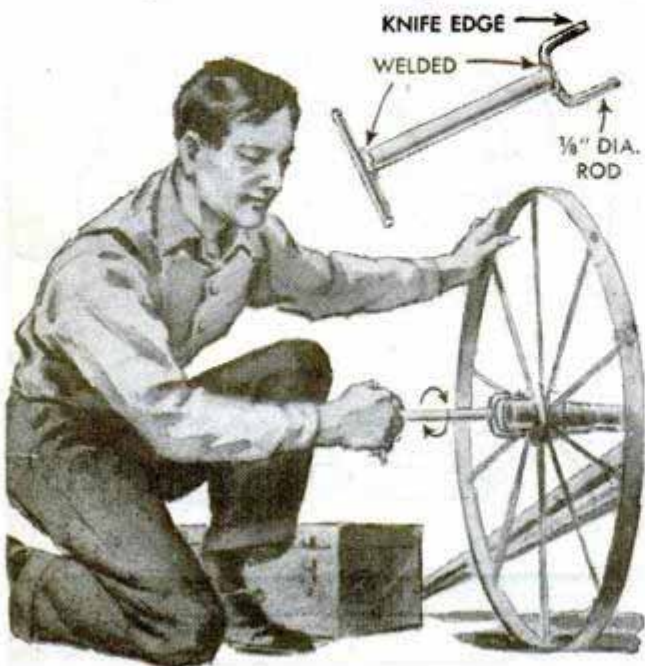

It is made as shown in the upper right-hand detail. One prong is left round and the other is ground to a knife edge. In use, the round prong is inserted in the eye of the pin and serves as a pivot. The knife prong slips between the legs of the pin, after which the tool is rotated to spread these two parts. All parts of the spreader are either rod or pipe.

Checking Ball-Bearing Diameters

Here's an easily made gauge to check the diameter of ball bearings. Secure a number of blank key checks having the shape illustrated and drill each piece for a different size of ball bearing.



When you have completed a set that will suit your purposes, rivet or bolt the leaves together.

Extension Welded to Fan Wrench

Using a box wrench of a suitable size, you can make a tool that will be easy to use when removing a fan or getting at other inaccessible parts of a car.

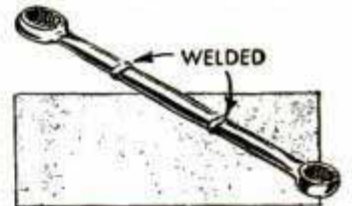

The wrench is cut in half and an extension piece is welded between the halves to increase the length. The extension can be of any length to suit your purposes.

Feeler Gauge Made of Scrap Metal

Mechanics who work with sheet metal will find this feeler or thickness gauge a welcome addition to their set of tools. The one illustrated is made of aluminum scrap ranging from .016 to .250 in. in thickness.

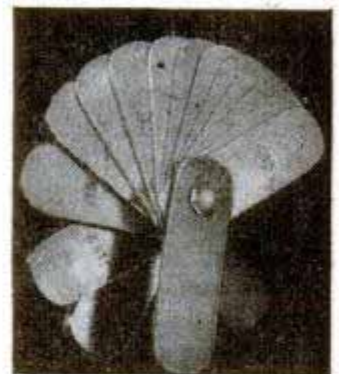

Cut the leaves uniform in size and use either metal or hardwood for the covers. Clamp the pieces together and smooth the edges with a file. Then drill a hole for the bolt that holds them together. Finally, identify each piece by stamping the thickness on it. When assembled, peen the end of the bolt over the nut so the gauge will not come apart.—R. J. DeCristoforo, New York.

BENDING BRAKES

for Your Sheet-Metal Jobs

By Sam Brown

THESE bending brakes will simplify sheet-metal fabrication. Two designs are described, both capable of bending 24-ga. galvanized iron the width of the brake, or heavier metal when the bend is not at full 12-in. capacity. Design No. 2, Fig. 8, while more difficult to make, is somewhat superior in that it offers stronger construction and also permits partial (tab) and reverse bends which are not possible with No. 1 design.

Design No. 1: Both designs are of the folding-leaf variety, and the general features of construction are grasped easily from Fig. 3. The essential feature is that the center of hinge pin must line up exactly with the meeting edges of folding leaf and table. This is diagrammed in Fig. 4. The working of the brake is shown in Fig. 1, the metal being clamped under the forming bar and then bent by pulling up on the folding leaf. The forming bar should be notched for easy removal. It is positioned exactly for duplicate work by means of two sliding

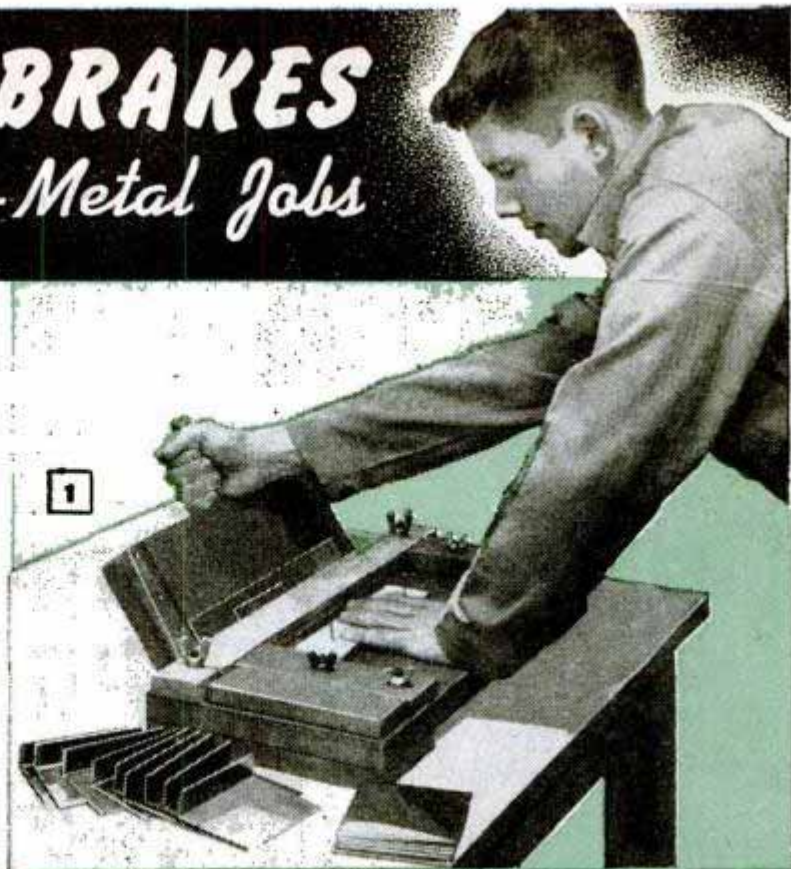

BENDING METAL TILE—ONE OF MANY JOBS POSSIBLE WITH BRAKE

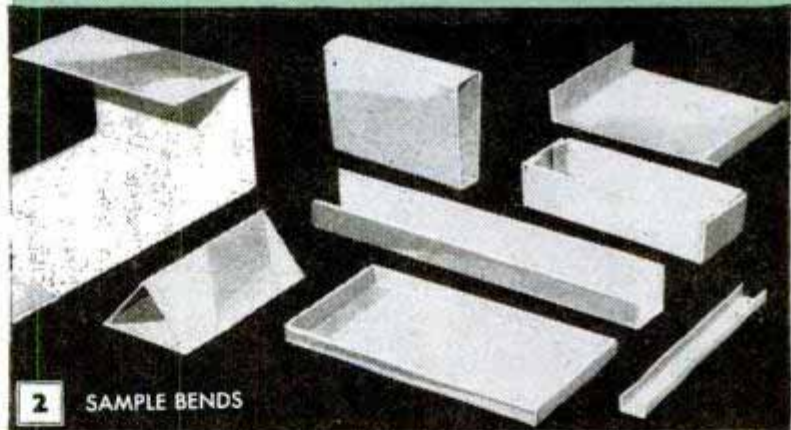

SAMPLE BENDS

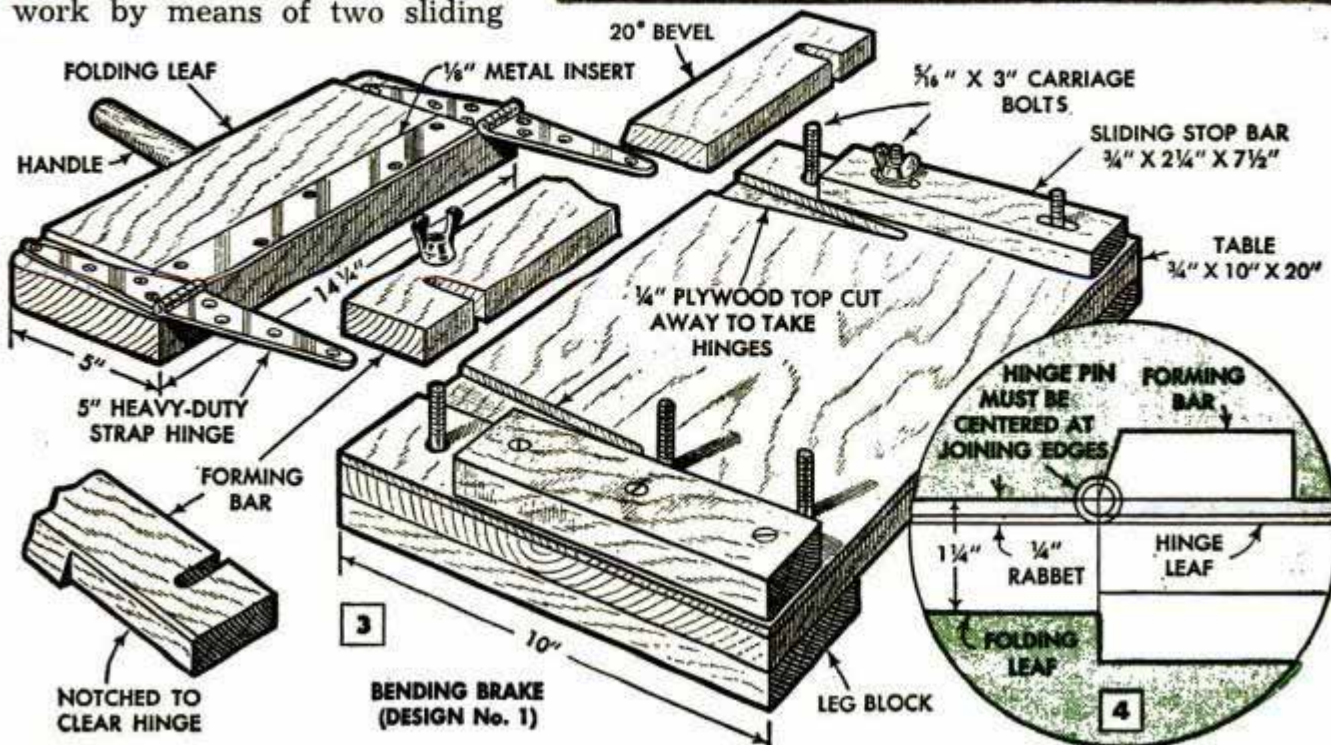

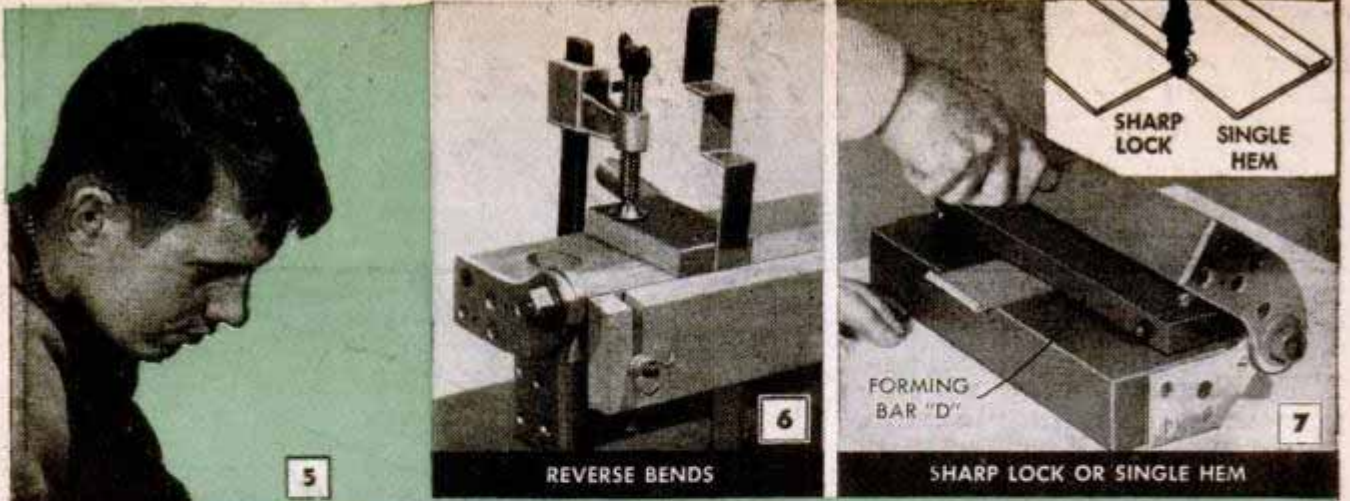

5

6

7

REVERSE BENDS

SHARP LOCK OR SINGLE HEM



USING No. 2 BRAKE TO MAKE TAB BEND

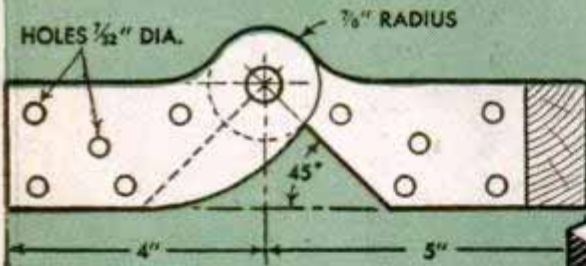
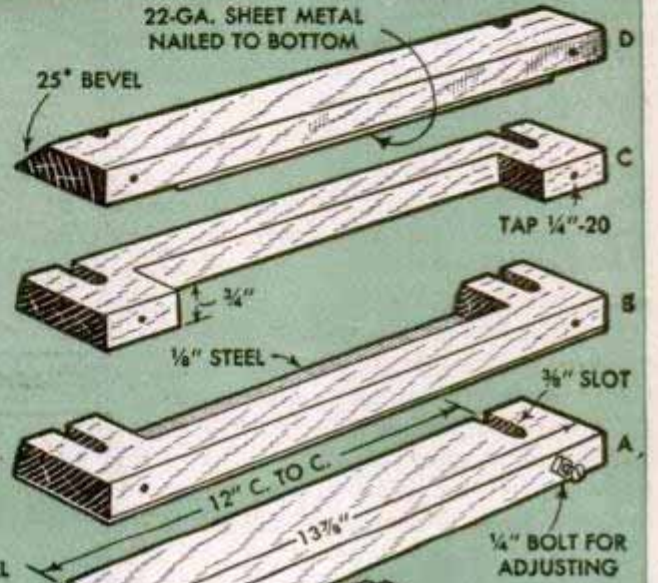

HINGE LAYOUT
PIN MUST BE EXACTLY
CENTERED AT JOINING
EDGES

BENDING BRAKE
(DESIGN No. 2)

8

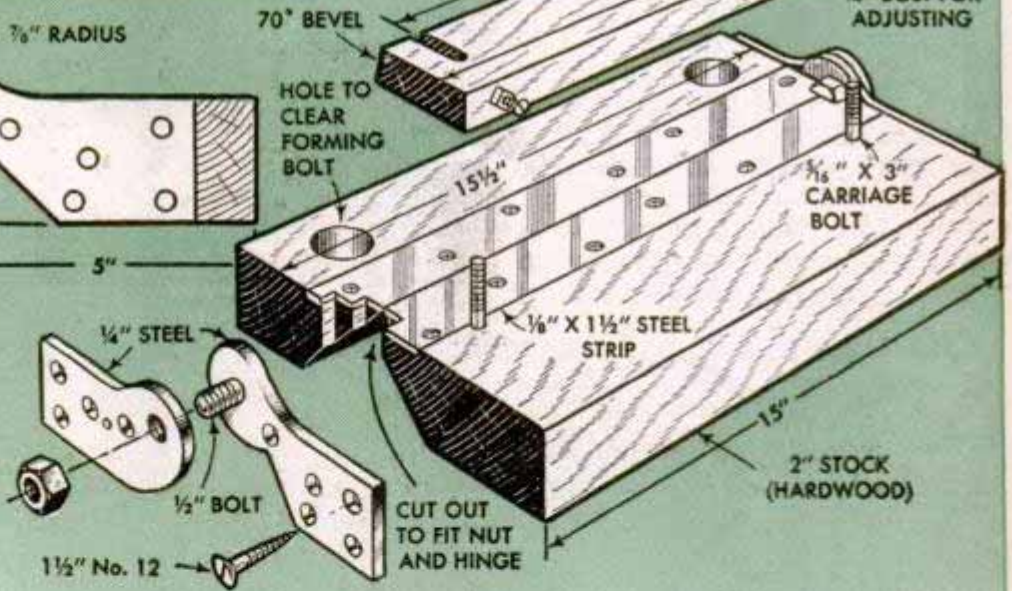

stop bars, as can be seen in Fig. 3. One of these works along a fixed block to provide a guide for right-angle bends. Any kind of wood can be used for folding leaf and table, but the forming bar must be hardwood or softwood faced with metal. The hinge should not be lighter than specified and is better made a little heavier.

Design No. 2: This is shown in Fig. 8. It is a heavier and more compact design than No. 1, and requires special hinges

cut from 1/4-in. steel, as shown. The 45-deg. cut on the underside of leaf and table weakens the construction somewhat, but offers an arrangement that is essential for reverse bends. The four styles of forming bars shown in Fig. 8, will handle all ordinary work. Care should be taken in assembly to get the pivot points in exact alignment. This design also works out nicely with hinges made from 3/4-in. plywood, pinning the bolt to the table member and providing



a brass bushing in the other to prevent wear.

Tab and reverse bends: Tab and reverse bends are worked on No. 2 brake by mounting the brake on edge in a vise and folding the leaf all the way back. A block of wood is clamped to the folding leaf and becomes the forming member. Fig. 5 shows the operation on a tab bend; Fig. 6 shows the same setup for reverse bends. Neither can be done on the No. 1 brake.

Standard operations:

The sharp lock, Fig. 7, is made by using the brake in a normal position with a style D forming bar. This bend is used frequently for fastening two pieces of metal together. If the bend is at full capacity (12 in. long), it is best to form it to a flange with the stronger A or B bar and then complete the lock with the sharp-edge D bar. The single sharp lock when pressed tightly together in a vise or by hammering becomes the single hem or bend, as shown. If the single bend is hemmed again, it makes a double hem. At full capacity on a narrow hem less than $\frac{1}{4}$ in. wide, this bend offers the ultimate strength and accuracy test for your brake—a poorly made brake will fail in this double-hem operation.

Large return bends or channels are made with the standard forming bar (style A), and offer no difficulties. Smaller channels are made with the B bar, which permits working as small as $\frac{1}{8}$ -in. cross section. This operation is shown in Fig. 9. The B bar is used also for bending small closed forms, as shown in Fig. 10. As can be seen, the brake does not fully close the form on the final bend, but it is close enough so that a little springing by hand will complete it. Style C bar offers another way of working small closed forms, as shown in Fig. 11. Complete closure is possible with

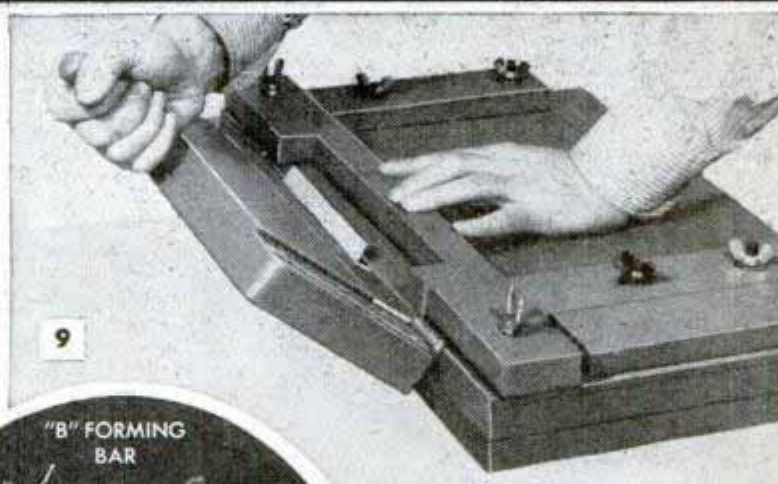

MAKING A CHANNEL WITH STYLE "B" FORMING BAR

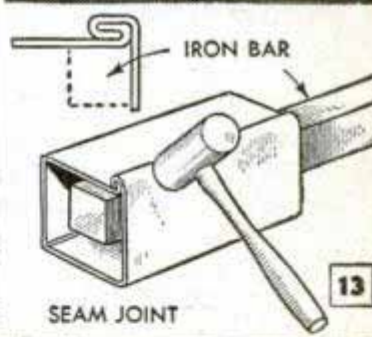
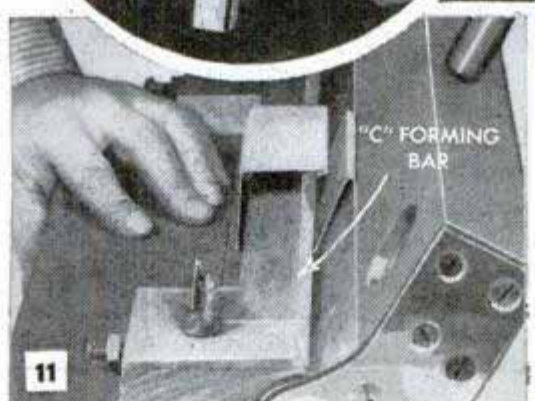
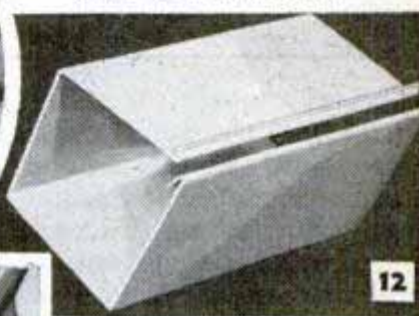

SEAM JOINTS ON SMALL CLOSED FORMS CAN BE MADE WITH "B" OR "C" BARS

this bar, but the work must be resprung to remove it from the bar. When the closed form has a seam joint, Fig. 12, the final bend, as in Fig. 11, is really a reverse bend and is best worked by the method shown in Fig. 5. However, the reverse caused by the narrow flange is slight and does not materially affect the bending operation. Fig. 13 shows how the seam joint is closed by hammering. This is not an easy joint to make and should be practiced before you attempt it on finished work.

Box bends: One of the most used forms of sheet-metal work is the simple square box. Like its companion in wood, it can be made a dozen different ways. Simplest way is to cut out the corners and then bend the work over a forming block, Fig. 14, or over

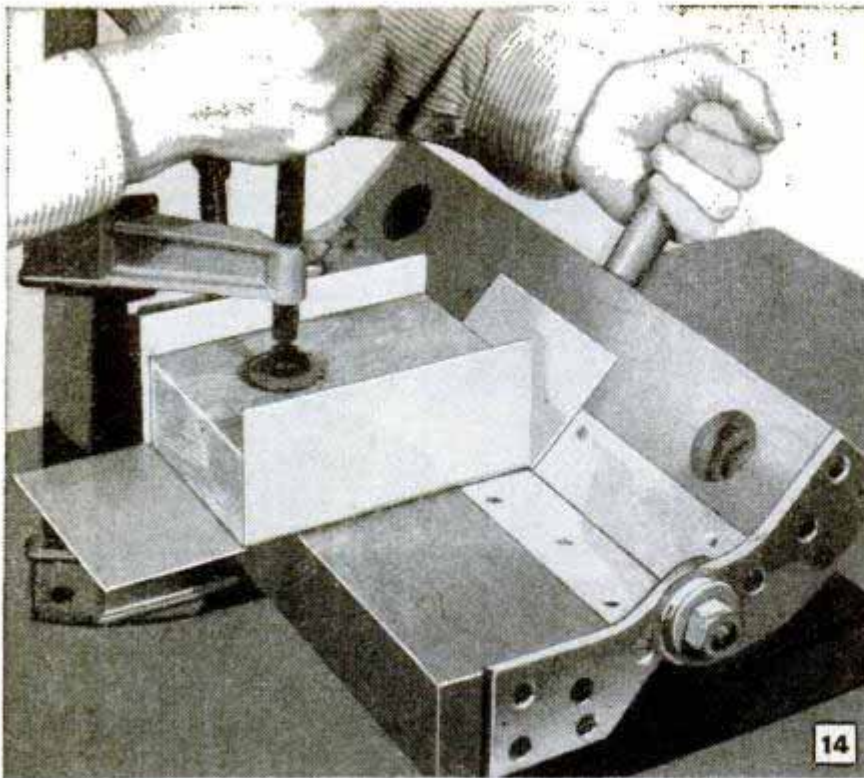

MAKING A BOX WITH USE OF FORMING BLOCK

flange which can be riveted or soldered to the sides (a sample is shown in Fig. 2), and this style is made easily by first forming the tabs, working as shown in Fig. 5, and then bending the sides over a forming block.

Work capacity: Work capacity of both brakes described is about 12 in. No. 2 design will work satisfactorily up to about 18-24 in. No. 1 brake will not handle metal thicker than 24 ga. (usual furnace-pipe weight as obtained at tin shops); No. 2 brake will work 22-ga. material. Both will handle much thicker metal if the bend is short. Dimensions given are working specifications and can be varied.

a special style A forming bar, Fig. 15. For the latter operation, the forming bar has notches cut to accommodate the flanges previously turned up. The notches (saw kerfs) do not affect the bend, and one bar can be notched many times to suit different sizes of work. The simple style of box shown, while easy to bend, presents a fair amount of work in soldering the corners. Some shapes in this style (such as lids), if shallow, are often strong enough not to require soldering. Most larger boxes make use of some kind of inside or outside



BOX MADE WITH USE OF NOTCHED "A" BAR

Absorbent Cotton Stuffed in Covered Box Cleans Drawing Pencil

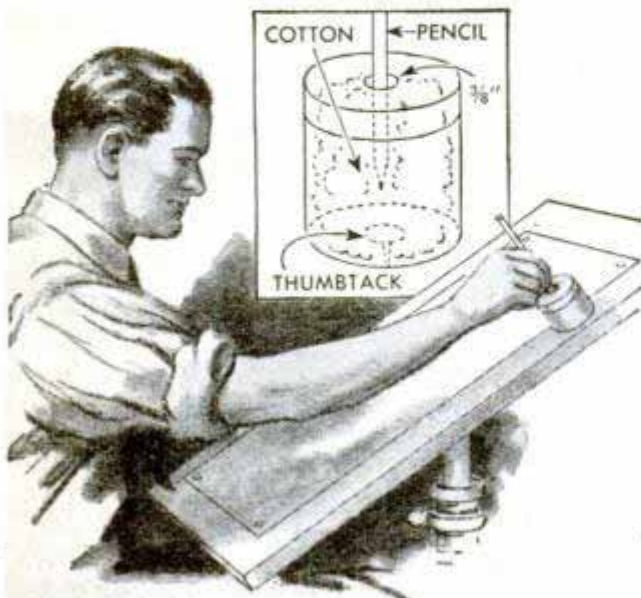

Finding a way to clean the point of a pencil after sharpening it is always a problem for the draftsman. One solution is to fill a small, covered box with absorbent cotton. Cut a hole in the top large enough for the pencil. To clean the point, insert it in the hole and rotate in the cotton. This will remove powdered lead.

"Manicure" for Small Commutators

Emery boards, which are strips of fine sandpaper bonded together to form a resilient blade shaped like a nail file, are well suited to the job of cleaning, smoothing and polishing the commutators of small generators and motors. Because of the low cost, a new one can be used for each job.

Paul H. Woodruff, Chicago.

Irrigation Water Filtered by Backflow Intake

Farmers who want an irrigation intake basin free from floating debris, whether a gravity or pump-operated system, will find this backflow arrangement satisfactory. Main points to watch in the construction are that the upstream wall of the basin, A, terminates in the center of the stream, C, and that the spillway of the dam, I, is the same width as the original stream, indicated by the darker color. The intake is located upstream of the dam and can be on either side, depending upon the irrigation requirements. Note that the pond formed by the dam is Y-shaped and the downstream wall of the basin, B, is located near the stem of the Y. The basin proper, H, is a shallow pit having as many tile outlets as are required and an intake channel, G, protected by an iron grating. The manner in which the current moves to

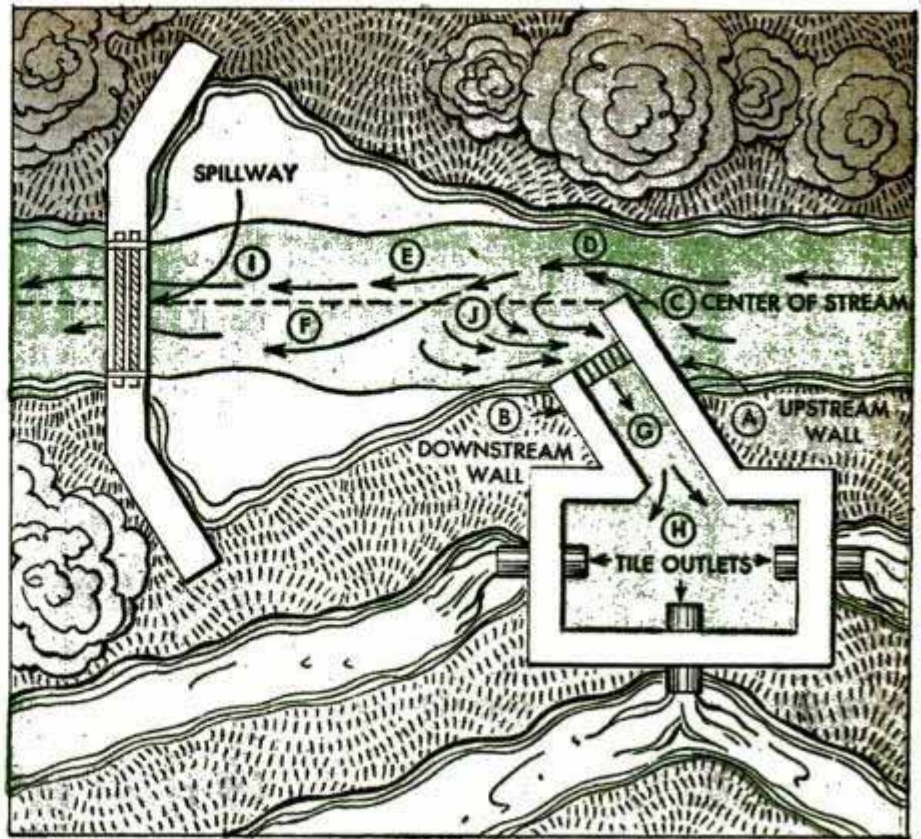

produce a backflow is indicated by the directional arrows D, E, F and J. This keeps the intake water free of debris.

Gilmer F. Horton, Mount Airy, N. C.

Extension Attached to Drawbar of Tractor Makes Harrowing Easier

Harrowing with a tractor is made easier if an extension piece which extends beyond the rear wheels on both sides is bolted to

the drawbar. If available, a heavy piece of angle iron will serve well for this purpose, although any suitable length of rigid metal, such as a channel or piece of flat iron would do just as well. This method has proved to be better than using a long, chain hitch, especially when making turns at the ends of the field. Because the extension is bolted in place, it's easy to remove when not in use.

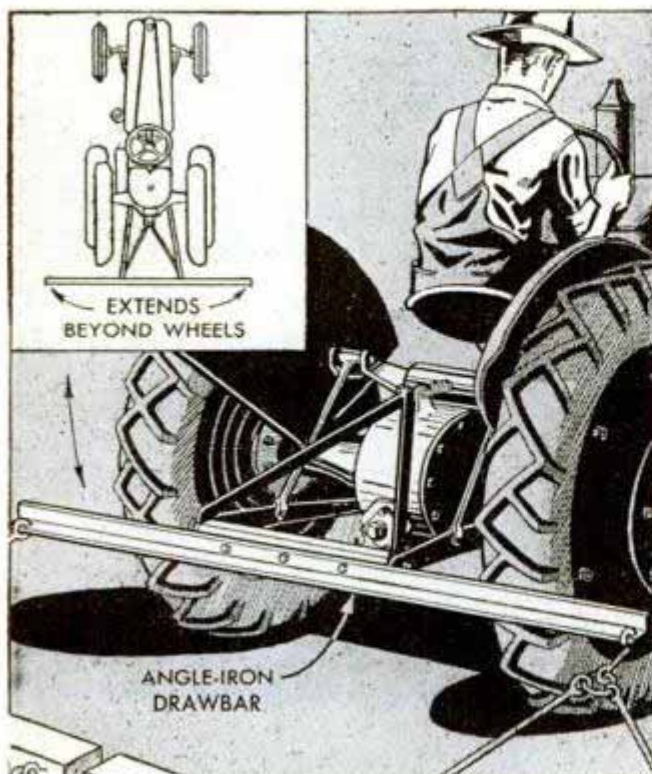

Clay Holder for Lettering Pens

Press a ball of modeling clay onto the metal top of a bottle of lettering ink to provide a holder for lettering pens. Then you will have a wide choice from which to make a selection at hand without having to search through a box of pens. When doing a lettering job, it's a good idea to select the pens you will need and put them in the holder.



Thermometer in Perforated Pipe Tells Temperature of Grain



To tell the temperature in the interior of a corn crib or other grain bin that has been filled, use a length of pipe about 5 ft. long and a thermometer tied to a stick. The end of the pipe inserted in the crib should be perforated with a number of holes so that a quick reading can be obtained. To use, insert the pipe in the crib and then slip the thermometer into the pipe to the point where the perforations are; after a short time the thermometer is withdrawn and the temperature is noted.

Telephone Shelf Under Desk Top



In order to keep the top of his desk uncluttered, one office worker made a telephone shelf and fastened it to the kneehole side of the desk. Kept here, the phone was always within easy reach.

Auto Oil Pump Primed by Air

One mechanic found that a new or overhauled oil pump could be made to pick up suction by applying air pressure to the crankcase. After trying other methods on many makes of cars, the following proved effective: First, the rear breather tube, which leads down from the side of the mo-

tor to carry away oil fumes, was plugged with a rag. Then an air hose was inserted in the oil-filler tube, the nozzle being wrapped with rags to make a tight fit. With the motor idling, the air was turned on to force oil through the internal tubing and into the pump. Suction started immediately and the pump began circulating oil.

D. W. Brentlinger, Richmond, Calif.

Altered Pliers Spread Cotter Pins

By grinding one jaw to a chisel edge and drilling a depression in the other, a pair of slip-joint pliers can be altered to serve as a tool to spread cotter pins. To use, set the head of the pin in the depression in the one jaw and close the pliers to bend one of the legs down; then reverse the tool and bend the other leg.

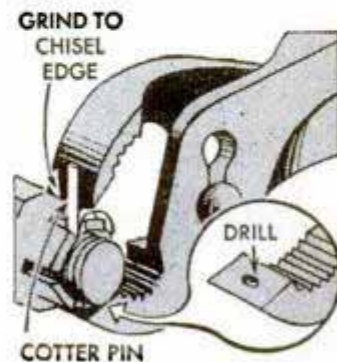

Gravity Feed for Gasoline Tank

Doing away with the need for a pump, this gasoline storage tank is suspended on two pipe columns and is emptied by gravity. The footings, columns and bands that hold the tank will have to be of heavy construction to support the weight of the full tank. An access ladder is welded to one end. The tank should not be built in areas where the fire code does not approve.

Glenn Lindberg, Cut Bank, Mont.

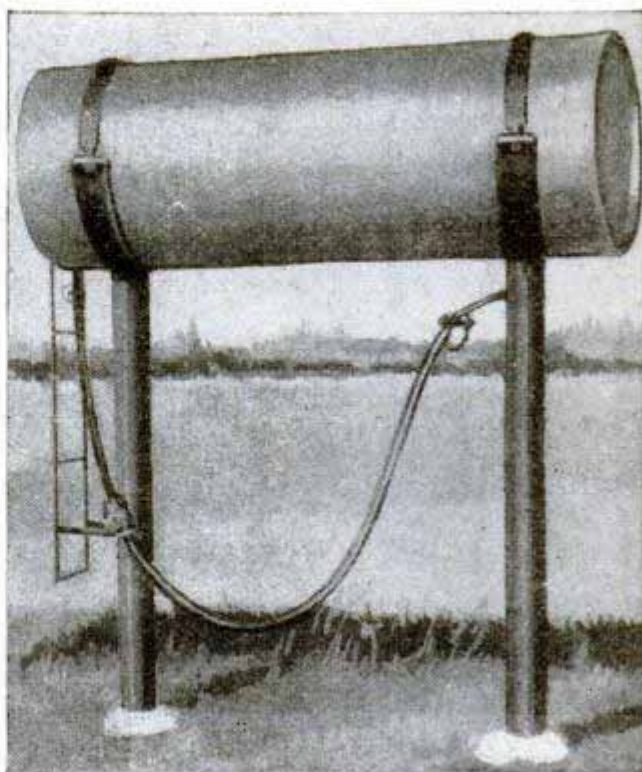



Space-Saving Cabinets for Radio And Record-Playing Equipment

Solving a common problem where space is at a premium, these wall cabinets brought joy to the wife of a small-home owner. Sliding doors hide all of the equipment from view. In this case there were valuable records to be cared for, and it was necessary to provide easy access to rather bulky radio equipment.

Photos A and B show the cabinets closed and opened; the small sliding door at right closes the cabinet with the hinged top which houses an automatic record changer and FM receiver. The high doors slide across the large cabinet at left. A loud-speaker is built in the wall above the adjacent curtained closet.

An outstanding feature is the telescoping tables with wheels, below the record shelves. A Hammarlund Super Pro radio is mounted on the large table; a high fidelity amplifier rests on the table below. These tables may be rolled out in the room permitting easy access for repairs, adjustments and cleaning. Antenna lead-in wires are run through conduits.

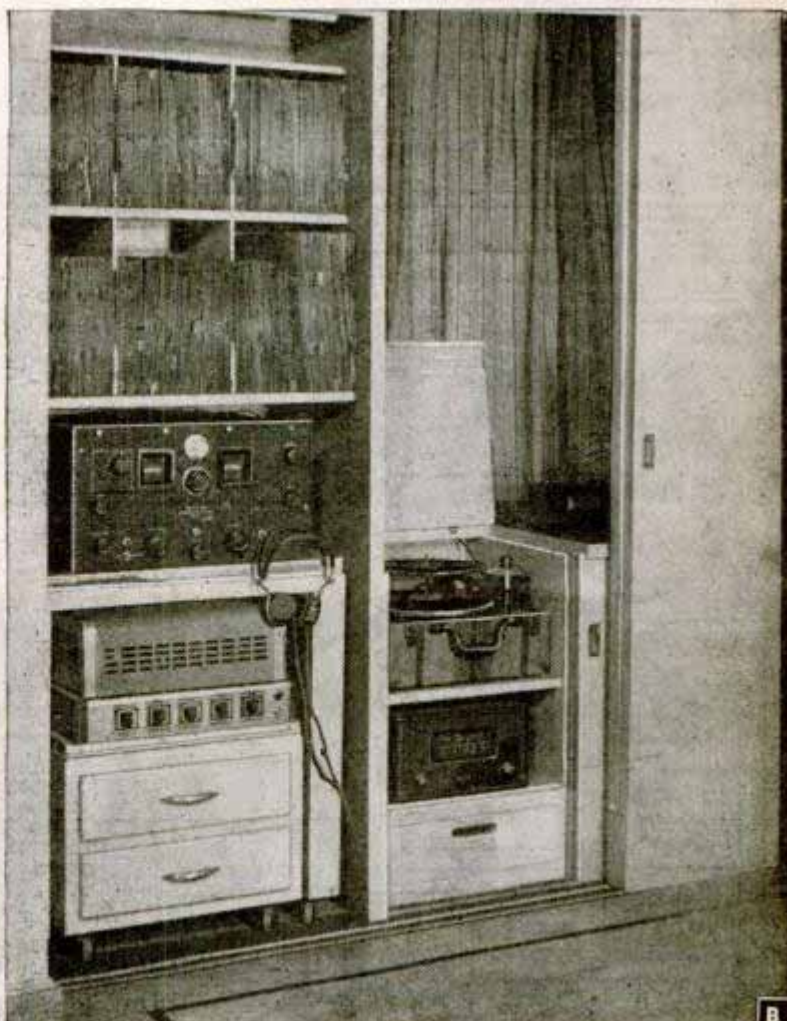
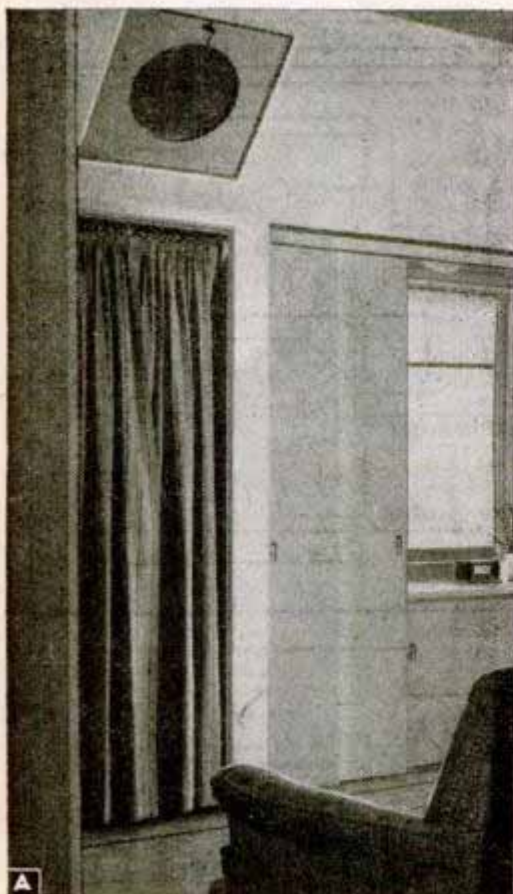

BRILLIANT "41-Q 50" FIVE-BAND

By L. M. Dezettel—W9SFW

F. L. Brittin—W9DCX



CAREFUL attention to the layout of important parts has resulted in the compact design of this low-power transmitter for the beginner "ham." It is hard to beat for efficiency and versatility. The horizontal position of the 807 final amplifier tube makes very short leads possible in both the plate and grid connections, thus losses are kept at a minimum and parasitics are prevented from developing.

The transmitter consists of three main parts, the R. F. section, the modulator and the power supply, as shown in diagram Fig. 1. It is complete on a single chassis base 17 in. long, 13 in. wide and 3 in. high. The R.F. section has a 6V6-GT crystal-controlled oscillator and 807 power amplifier. This crystal circuit is the familiar Tri-tet

RESISTORS

- | | |
|--------------------------------|--|
| R1—100,000 ohms, 1-watt carbon | R13—1 megohm, 1/2-watt carbon |
| R2—200 ohms, 10-watts (WW) | R14—1000 ohms, 1/2-watt carbon |
| R3—1000 ohms, 1-watt carbon | R15—1 megohm, 1/2-watt carbon |
| R4—20,000 ohms, 7-watts (WW) | R16—220,000 ohms, 1-watt carbon |
| potentiometer Mallory E20MP | R17—500,000-ohm pot. (audio gain) |
| R5—10,000 ohms, 10-watts (WW) | R18—1000 ohms, 1-watt carbon |
| R6—10,000 ohms, 10-watts (WW) | R19—15,000 ohms, 1-watt carbon |
| R7—15,000 ohms, 1-watt carbon | R20—30,000 ohms, 20-watts (WW) |
| R8—22 ohms, 1/2-watt carbon | R21—100,000 ohms, 1-watt carbon |
| R9—50,000 ohms, 10-watts (WW) | R22—100,000 ohms, 1-watt carbon |
| R10—30,000 ohms, 20-watts (WW) | R23—1500 ohms, 50-watts (WW) |
| R11—400 ohms, 10-watts (WW) | Note—(WW) = wire-wound |
| R12—Meter shunt (see text) | Note—(gain control R-17 = audio taper) |

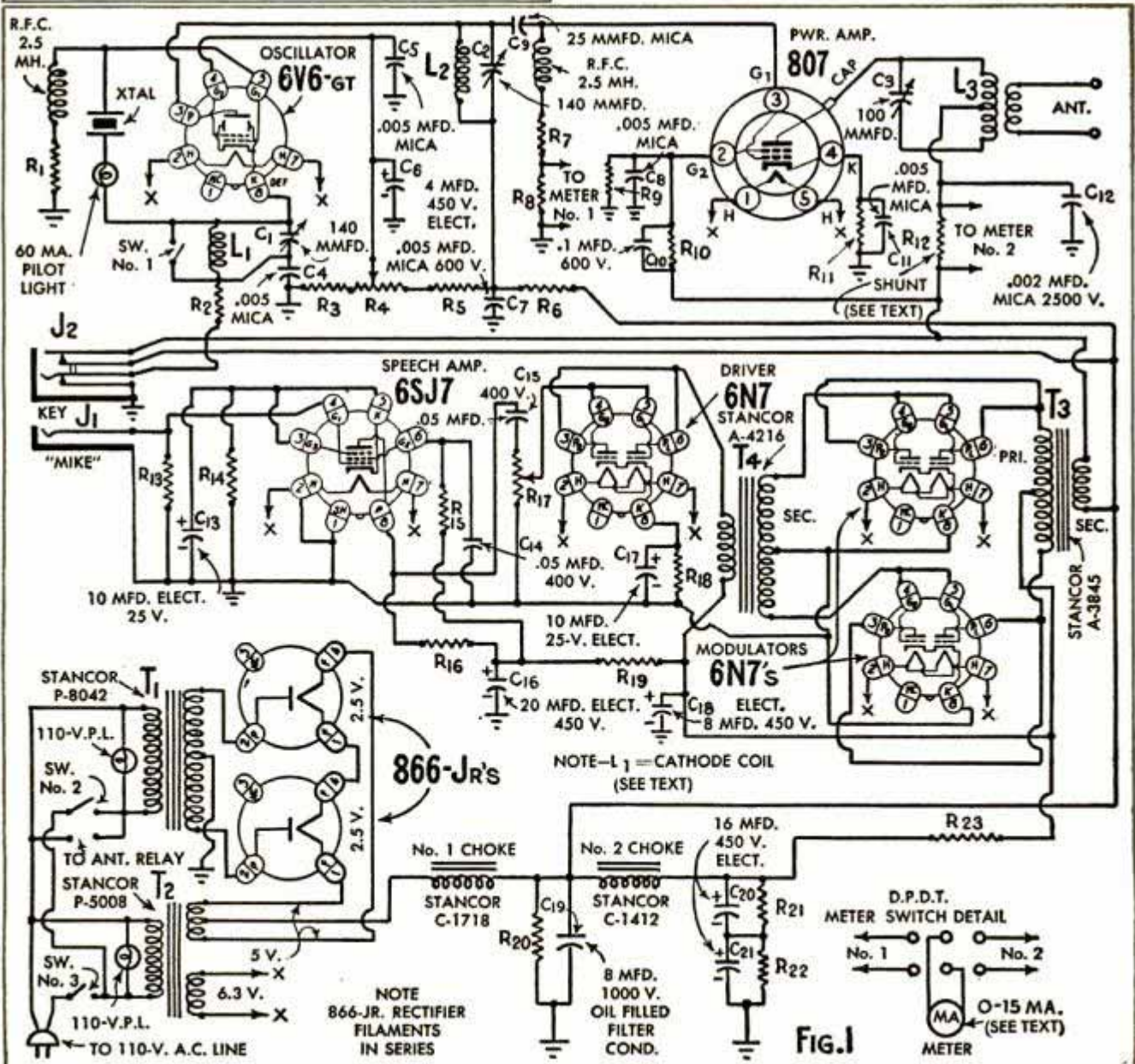

PHONE AND CW TRANSMITTER

type, famous for generating strong useful harmonics by means of a tuned circuit in the cathode of the tube. Only two cathode coils are required for operation on any band with either an 80-meter or 40-meter crystal. These (L1) cathode coils are wound on Hammarlund SWF-5 plug-in coil forms having a 1½-in. winding diameter. The 40-meter L1 coil consists of 6½ turns of No. 20 enameled wire spaced out to ¾ in.; the 80-meter L1 coil consists of 13 turns of No. 20 enameled wire close wound. Hammarlund APC-140 mmfd. air padding condensers (C1) are mounted inside each cathode coil form. For straight-through operation on the fundamental crystal frequency a switch on the front panel cuts out this cathode coil. The 807 tube operates as a class "C" R.F. power amplifier. Plate tank coils L2 and L3 for the oscillator and amplifier are standard Bud OES and OLS series plug-in types for the 10, 15, 20, 40 and 80-meter bands. These coils fit into Amphenol 5-prong steatite tube sockets. The amplifier coil has a movable center pickup link for varying the "load" to the antenna. Photos A, B, C and D show various views of the completed 50-watt rig.

The modulator tube lineup begins with a 6SJ7 microphone amplifier. Any good crystal microphone such as the Cardax, or similar type, may be used; the 6SJ7 tube feeds into a 6N7 tube which, in turn, drives a pair of 6N7 tubes as a class "B" modulator. The modulation transformer matches the load of the R.F. amplifier to that required for the modulator stage, and Stancor power-supply transformers and chokes furnish the required voltage and current to all of the tubes. The Taylor 866-Jr. rectifiers have very low voltage loss, and easily carry the needed current. This power supply delivers 600 volts to the R.F. power stage; resistors are used to drop the voltage for all the

(Continued to page 220)

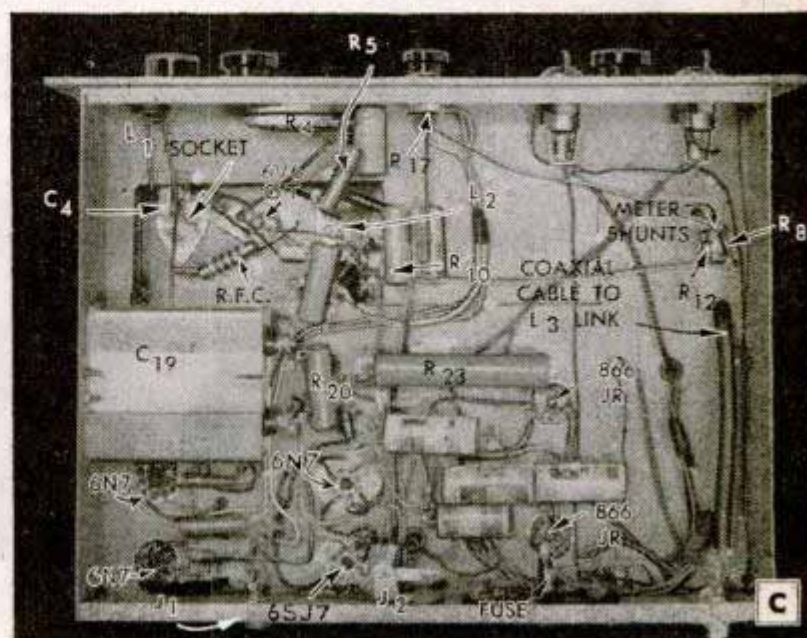
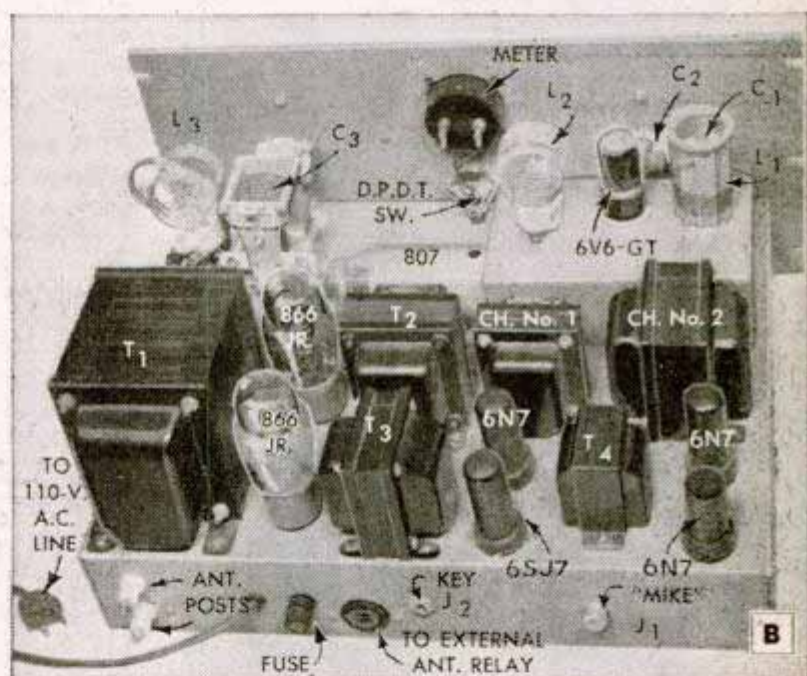
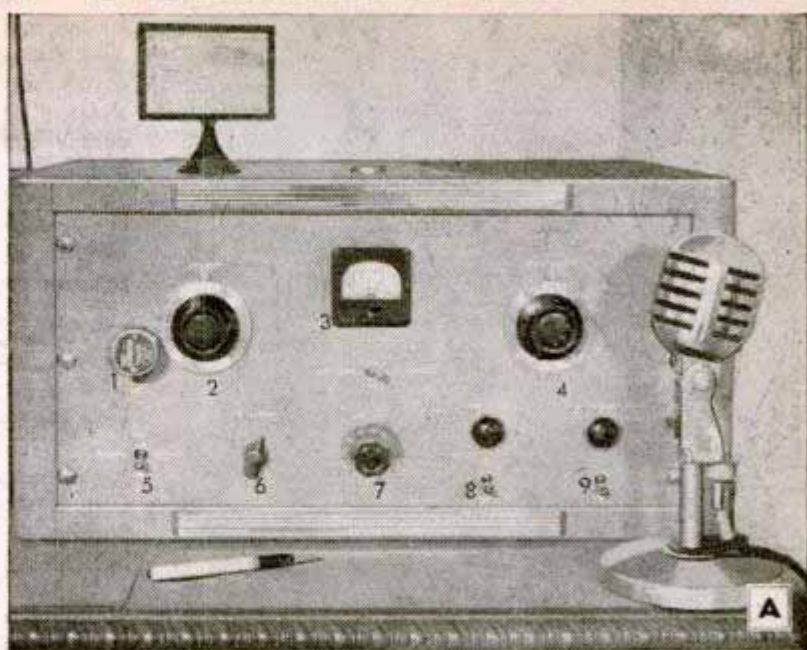

SERVICE HINTS FOR SET OWNERS

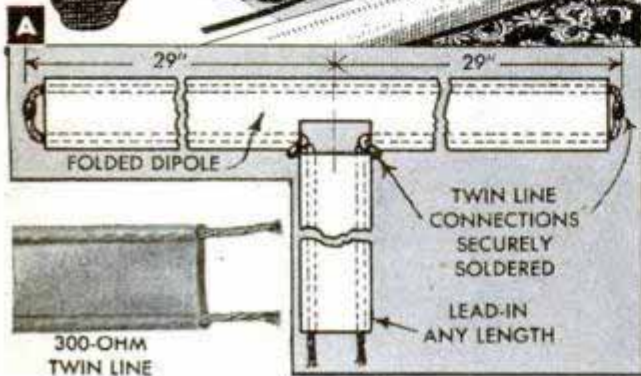

(A) An inexpensive folded-dipole FM receiving antenna, made from flexible 300-ohm twin-line transmission cable, can be placed flat on the floor under a rug. Cut approximately $\frac{1}{2}$ wave length long, it is shorted at both ends, with one conductor cut in the center for the lead-in point; insulating lacquer is applied to the soldered connecting wires.

(B) A short length of wire twisted around split tube shields will hold them together when the original snap-in spring wire rings are lost.

(C) When wires on built-in loop antennas come loose, a coat of clear shellac, or "coil dope," applied with a flat brush, will hold them in place and prevent damage when the chassis is removed.

(D) When small radio sets, not provided with rubber feet, make scratches on table tops, use a piece of "moleskin" adhesive cut to fit as shown. This adhesive material has a soft coating on one side.

(E) Many small table-type sets have a flexible speaker cable that often rests against the power tube, or other tubes, which in time burns or weakens the cable insulation. A thumbtack and a piece of string arranged as shown will solve the problem in wood cabinets; in plastic cabinets use adhesive tape.

(F) A piece of heavy plate glass with slightly beveled edges will hold magazines, radio manuals and diagrams open on the workbench, and will also protect the pages from tools and soldering damage.

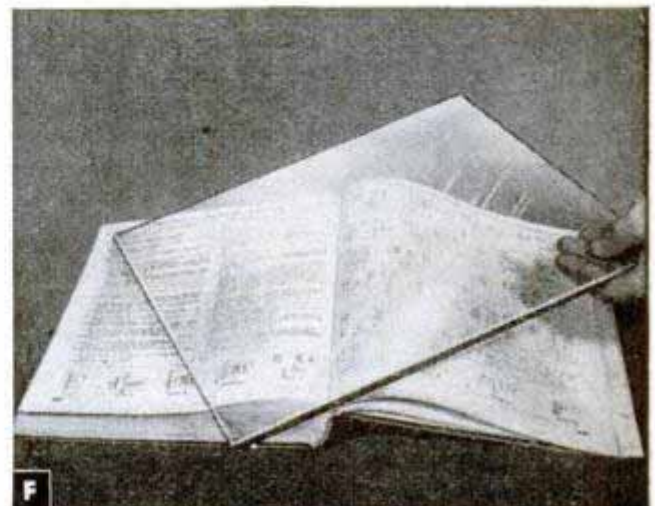
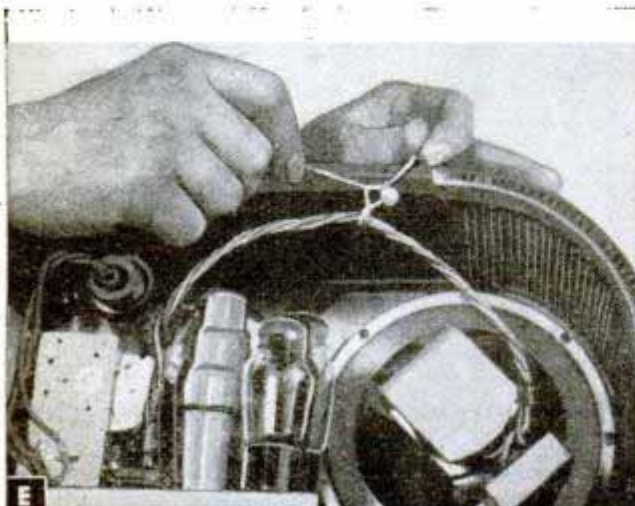
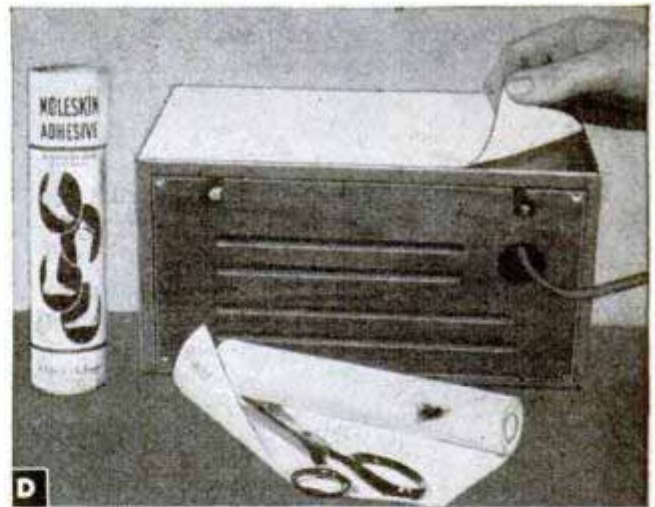
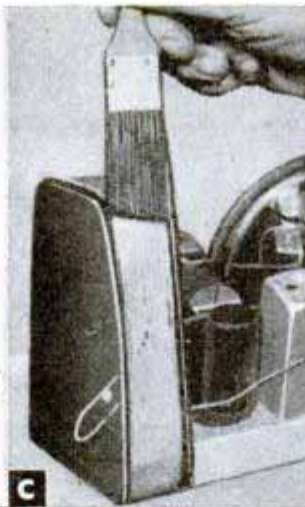
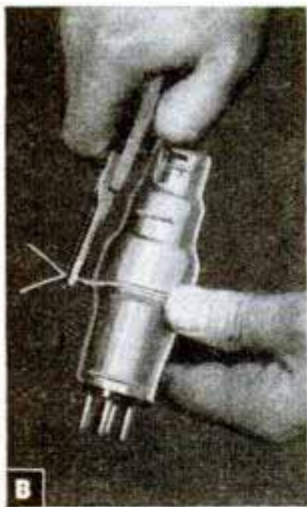



Announcing the new 1000-watt
Kodaslide Projector
Master Model
 for home or auditorium

This handsome, compact instrument delivers more light to your home screen than was ever before possible with any 2 x 2-inch slide projector . . . brings out shades and shadow detail you never dreamed existed.

Fast Lenses and Powerful Lamps . . . snap a vivid image onto the screen even in a room only half-dark. That's a great help, at your club, school, or church. The crisp image shines bright throughout, no dingy corners or hot-spot center.

Entire Optical System Lumenized . . . condensers and projection lenses are Lumenized (hard-coated) to supply maximum light. A new type of heat-absorbing glass blocks 85% of the heat . . . and it's one solid piece, which leaves no black streaks on the image.

Five superb Kodak Projection Lenses . . . For theatres and auditoriums, a powerful 11-inch $f/3.7$ Kodak Projection Ektar; for club, church, or school, two 7½-inch lenses—the $f/2.3$ Ektar or $f/4$ Ektanon; for home shows, two 5-inch lenses—the $f/2.3$ Ektar or $f/3.5$ Ektanon.

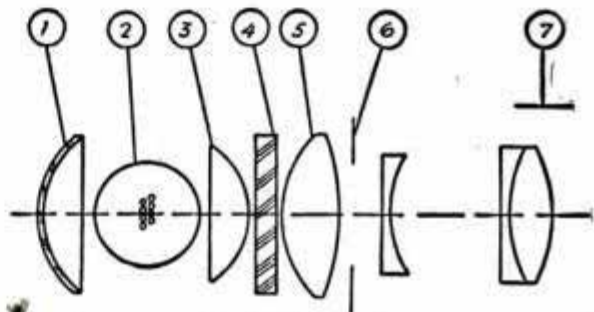

Optical System of Kodaslide Projector, Master Model
 (1) Spherical Reflector, (2) Projection Lamp—300 to 1000 watts, (3) Rear Condenser Lens, (4) Heat-Absorbing Glass, (5) Front Condenser Lens, (6) Aperture for Transparency, (7) Kodak Projection Ektar or Ektanon Lens (relative position depends upon choice of lens).

Keeps Kodachrome Transparencies Cool . . . a quiet turbine-type fan in the base forces cool air *three ways*—to the lamp, to the condenser system, and to both sides of the slide.

Descriptive, full-color folder free at your Kodak dealer's . . . EASTMAN KODAK COMPANY, ROCHESTER 4, N. Y.



KODASLIDE PROJECTOR, Master Model, is supplied with a carrying case. Price, from \$181 to \$295, depending upon lens selected.

Kodak

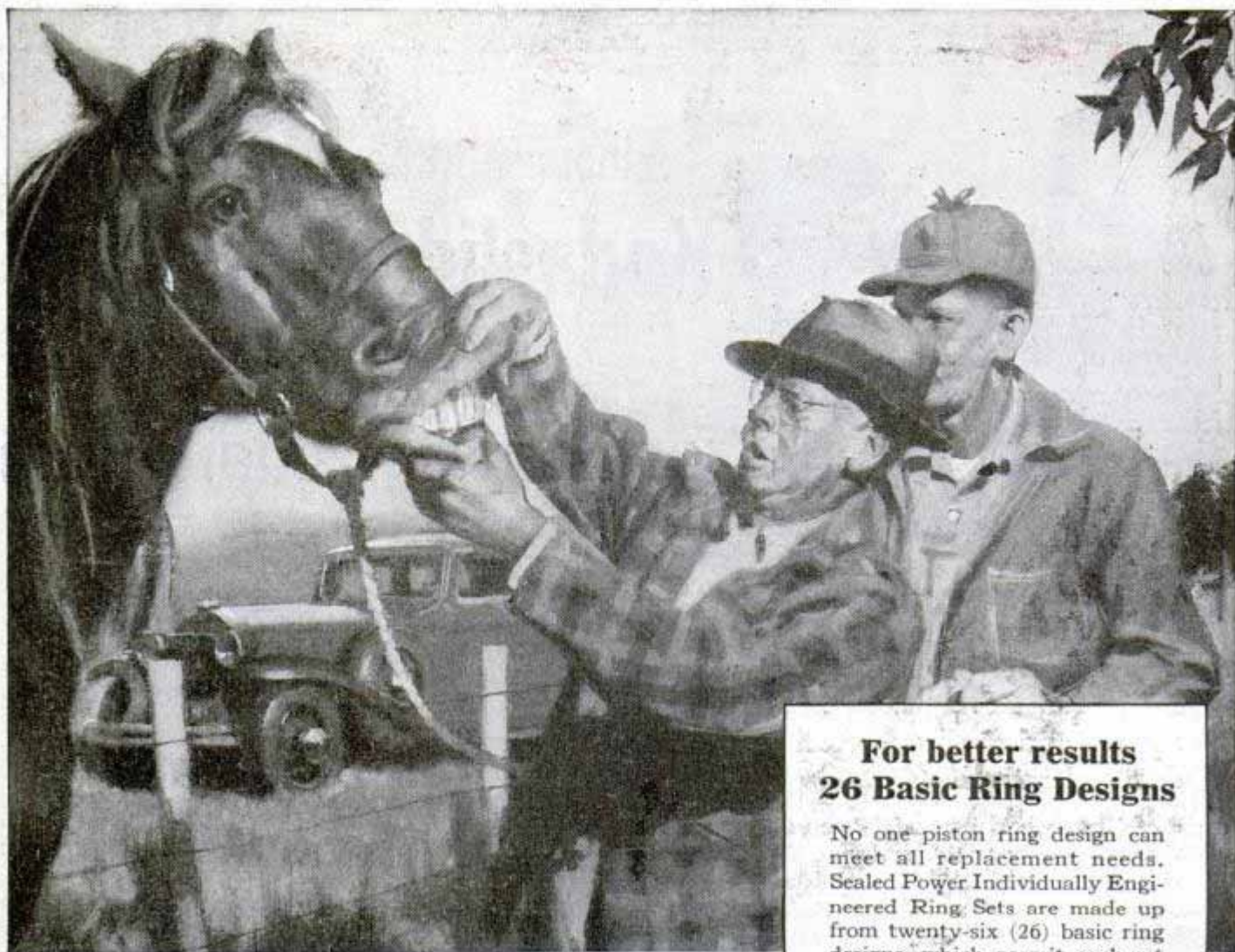

**An old horse is old for keeps—
but an old engine can be made young again**

YOU can't look an engine in the teeth, but you can tell its age by its performance—and new Sealed Power Piston Rings can knock years off its age, saving oil, saving gas, and lengthening engine life.

Whatever the make, model, or degree of cylinder wear in your car, truck or tractor, there is a Sealed Power Piston Ring Set specifically engineered to do the best possible job. These sets are made up from twenty-six (26) basic designs of piston rings, proud product of 36 years' use as original equipment by major engine builders. See your Sealed Power Franchise Dealer. Send a postal for illustrated, informative new booklet on 7 ways to save oil. It's free and may save you lots of money. Sealed Power Corporation, Dept. G-8, Muskegon, Mich. In Canada: Stratford, Ontario.

**For better results
26 Basic Ring Designs**

No one piston ring design can meet all replacement needs. Sealed Power Individually Engineered Ring Sets are made up from twenty-six (26) basic ring designs, which permit each set to be specifically engineered to do the best possible job in a particular make of engine.

These ring sets are engineered to save gas without sacrifice of oil economy, to save oil without inducing friction and cylinder wear. Each set gives balanced performance in a particular engine.

In addition to Sealed Power Individually Engineered Piston Ring Sets, ask for Sealed Power Pistons, Cylinder Sleeves, Valves, Water Pumps and Chassis Parts.



KEEP YOUR WAR BONDS! GET \$4 FOR \$3! © 1947, Sealed Power Corp

SEALED POWER PISTON RINGS

BEST IN NEW CARS! ★ BEST IN OLD CARS!

NEW

EVEREADY

TRADE-MARK

FLASHLIGHT BATTERIES

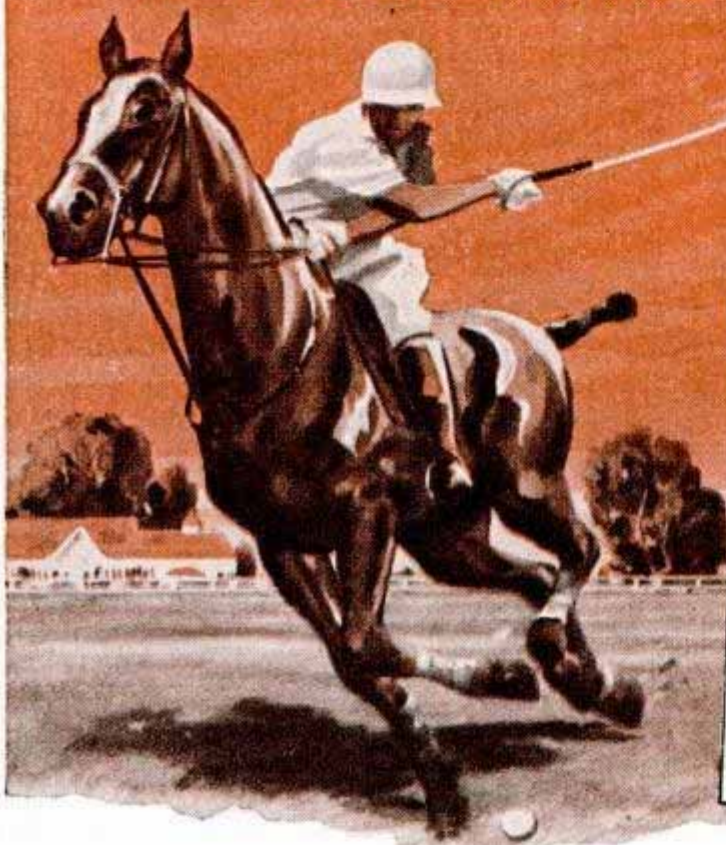

*Now last
93% longer!**

**Drive 7 Goals with a
Flashlight Cell?—Yes!**

Properly released, the electric energy in one tiny "Eveready" flashlight cell could drive a polo ball the full length of the field—300 yards—and do it 7 times, to score 7 goals!

● It takes POWER to make light. And it takes power-packed new "Eveready" flashlight cells to make *your* flashlight give you *better* light, longer! Today, with *energy* and *value* nearly doubled, "Eveready" brand flashlight batteries are first choice everywhere for **l-a-s-t-i-n-g LIGHT!** Plenty available—good dealers have them—no price increase!

The registered trade-mark "Eveready" distinguishes products of
NATIONAL CARBON COMPANY, INC.
30 East 42nd Street, New York 17, N. Y.
Unit of Union Carbide and Carbon Corporation



NOW
1941
93%
MORE
ENERGY



*To you, this means nearly *twice* the electric energy ...almost *two times longer* life of bright, white light. And it's yours for the pre-war price. Still only 10¢.



High Energy
**MEANS BRIGHTER LIGHT,
LONGER LIFE**

NOW TRY Dustless SWEEPING



Reduce Germ Laden Dust
Eliminate Sweeping Compound

Dustless brushes used with Arbitrin sweeping fluid eliminate up to 97% of germ laden dust and reduce sweeping costs 20%. Arbitrin fluid, poured into a metal reservoir in the brush back, filters through the tufts and keeps dust down as you sweep. Dustless brushes are used in thousands of schools, factories, offices, stores, and institutions. There is a Dustless brush to fit your needs. Write for sizes, styles and prices today.

Milwaukee Dustless Brush Co.
530 N. 22nd St., Milwaukee 3, Wis.
Please send complete facts about Dustless Brushes.

Name _____

Street Address _____

City, State _____



Beginner's Five-Band Transmitter

(Continued from page 215)

other stages. The modulator easily develops the 30 watts needed to modulate the final amplifier about 100 percent.

All controls are mounted on a $\frac{3}{16}$ -in. crackle finished hard-pressed-wood relay rack panel, 19 in. long and $8\frac{3}{4}$ in. high; this panel will fit any standard $10\frac{3}{4}$ by $14\frac{1}{2}$ by 22 in. cabinet rack such as the one shown in photo D. The panel controls are labeled with Millen white decals. The controls numbered from left to right in photo A

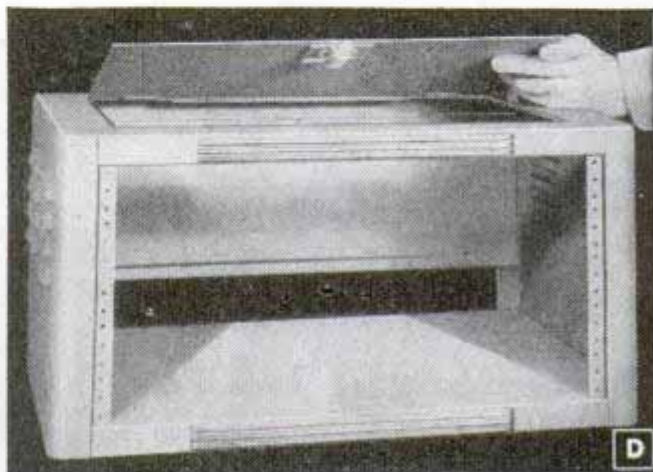

are as follows: No. 1 is the crystal; No. 2, oscillator dial; No. 3, the 0-15 ma. meter, with switch below; No. 4, power amplifier dial; No. 5, "on-off" switch for the frequency multiplier; No. 6, screen current; No. 7, audio gain; No. 8, "on-off" switch for high voltage; No. 9, "on-off" switch for the tube filaments. Red and green pilot lights are above these switches. Photos B and C clearly show the placement of parts.

Because of the ease with which the Tritet oscillator quadruples in this transmitter, only two crystals are necessary to operate all bands except the 15-meter band. A separate crystal is required for this band. Keying is done in the cathode of the oscillator; keying is clean and no additional key-click filter is required. It will be noted that a single 0-15 ma. meter is used for tuning; it is switched from the grid to the plate of the 807 tube by means of the D.P.D.T. switch. When switched to the plate, a resistor is placed in the circuit across the meter which multiplies the scale readings by 10. This shunt (R12) is handmade and consists of $9\frac{1}{2}$ in. of No. 22 resistance wire wound on a small piece of Bakelite.

The secret of the excellent performance of this rig is the method of obtaining short leads in the oscillator and R.F. section. This is accomplished with an additional small box-like chassis, built above the

(Continued to page 224)

Dependable

CHAMPION

AMERICA'S FAVORITE SPARK PLUG



AIR TRAVEL IS A HIGHLY ORGANIZED AND STABLE BUSINESS . . .

To handle increased traffic, no other form of public transportation has had to expand its facilities so rapidly. Last year more passengers were carried more miles than ever before, with the finest safety record in airline history—one that compares favorably with any other form of public transportation. The use of dependable Champion Spark Plugs by most airlines is a vote of confidence you should consider when buying spark plugs for your car. Specify *Champion* for better performance—it's America's favorite spark plug. Champion Spark Plug Company, Toledo 1, Ohio.

FOLLOW THE EXPERTS

DEMAND NEW DEPENDABLE

CHAMPIONS FOR YOUR CAR

Listen to the **CHAMPION ROLL CALL . . .** Harry Wismer's fast sportscast every Friday night, over the ABC network

HALL O'WELL**HOME AND HOBBY KIT**

**With Interchangeable Tools
A "TOOL BOX" IN THE
PALM OF YOUR HAND**

which contains, within its hollow, red plastic handle, a carefully chosen assortment of tools ideally suited to "odd" jobs around the home, office or on the farm . . . or "modelling" work if there are hobbycrafters in the family. Handle is rugged and durable . . . tools are of high-grade alloy steel.

Available at your local Hardware Dealer or Industrial Distributor. Write for descriptive literature.



An Ideal Gift, Premium or Prize.

Kits: Pats. Pend.

Over 44 Years in Business

STANDARD PRESSED STEEL CO.

JENKINTOWN, PA. BOX 802

BOSTON • CHICAGO • DETROIT • INDIANAPOLIS • ST. LOUIS • SAN FRANCISCO

SAY YOU SAW IT IN POPULAR MECHANICS

**SHAMEFUL!**

With houses so scarce, why don't people protect their homes from fire?

Fire damage to homes last year was \$120 million, enough to off-set new home construction for that period. Keep yours safe from fire with Pyrene* Fire Extinguishers. At home and auto supply dealers. Buy yours now.



* T. M. Reg. U. S. Pat. Off.

Pyrene Manufacturing Company

NEWARK 8 • NEW JERSEY

Affiliated with C-O-Two Fire Equipment Company

NEW GENUINE AAF RUBBER BOATS

FIVE-MAN—Complete with CO₂ tank, oars, hand pump, carrying case. 8' x 5'.
F. O. B. Sacramento, \$37.50

ONE-MAN—Complete with sail, mast, CO₂ tank. 5'6" x 3' \$15.95 Pp.

Write for Free War Surplus Catalog!

Send
Check or
Money
Order

PACIFIC FUR & WOOL CO.

War Surplus Department

Box 926-PM

Sacramento, California

**CROSMAN Silent RIFLE**

Most Amazing Gun Ever Invented for Target and Small Game Shooting

The ideal rifle for year 'round shooting indoors or out. Shoots low-cost SUPER PELLETS without noise, odor or recoil. Requires no cleaning. At your dealer or write direct.

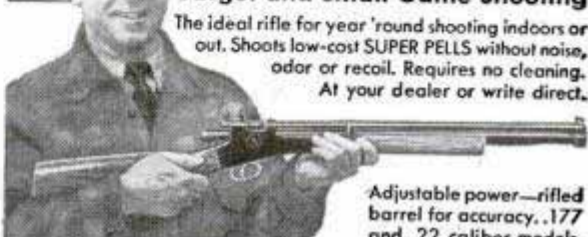

Adjustable power—rifled barrel for accuracy. .177 and .22 caliber models. Write for information.

CROSMAN ARMS CO., INC.

3A HENRIETTA ST., ROCHESTER 7, N. Y.

Shoot CROSMAN SuperPellets

The BETTER Ammunition for ALL .177 and .22 caliber Air Pistols and Rifles.

.177 cal. . . \$2.50 per M

.22 cal. . . \$3.00 per M

POSTAGE PREPAID

At your dealer or order direct



FOR
GREATER
ACCURACY
MAXIMUM
POWER

CROSMAN ARMS CO. HENRIETTA ST., ROCHESTER 7, N. Y.

MARCOT KEY MACHINE

Immediate Delivery



Marcot No. 8 Key Machine Mounted on Cabinet \$ 82.50
Book on Modern Locksmithing 3.95
Auto Code Book and Auto Depth Keys 12.50
162 Doz. Popular Key Blanks 77.76
Set Key Files, Tools, Pins, Springs, Thimble 10.50

\$187.21

A. J. MARCOTTE CO., 1200 N. KEDZIE AVE., DEPT. PM, CHICAGO 51, ILL.

Thompson BEATS the World on BOATS

**Better Built
Lower Prices**

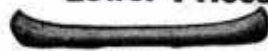

Canoes



Rowboats



Outboards



Light Boat for Auto

Safe Boats With Full Length Spray Rails
Keep passengers perfectly dry—even at high speeds. Catalog also shows two new models of "Take-Along" Boats. Two big factories—save you freight.

CATALOG FREE
Write for your copy. State kind of boat in which you are interested.

THOMPSON BROS. BOAT MFG. CO. (161)
213 Ann St. (Write to either place)
PESHIGO, WIS. 113 Elm St. CORTLAND, N.Y.

POPULAR MECHANICS

WELLER SOLDERING GUN

5 SECOND HEATING

Specially engineered lightweight transformer produces soldering heat in loop tip 5 seconds after trigger switch is closed. A time saver and money-maker for radio service men.

DEPENDABLE

Always ready to use when picked up. Fast cooling makes it safe to lay down on bench.

TROUBLE FREE

Thousands in daily use—some as long as 5 years. No tip burning, nothing to break or burn out.

Get a Weller Soldering Gun from your radio parts or electronic distributor or write direct for bulletin.

100 Watts
115 Volts
60 Cycles

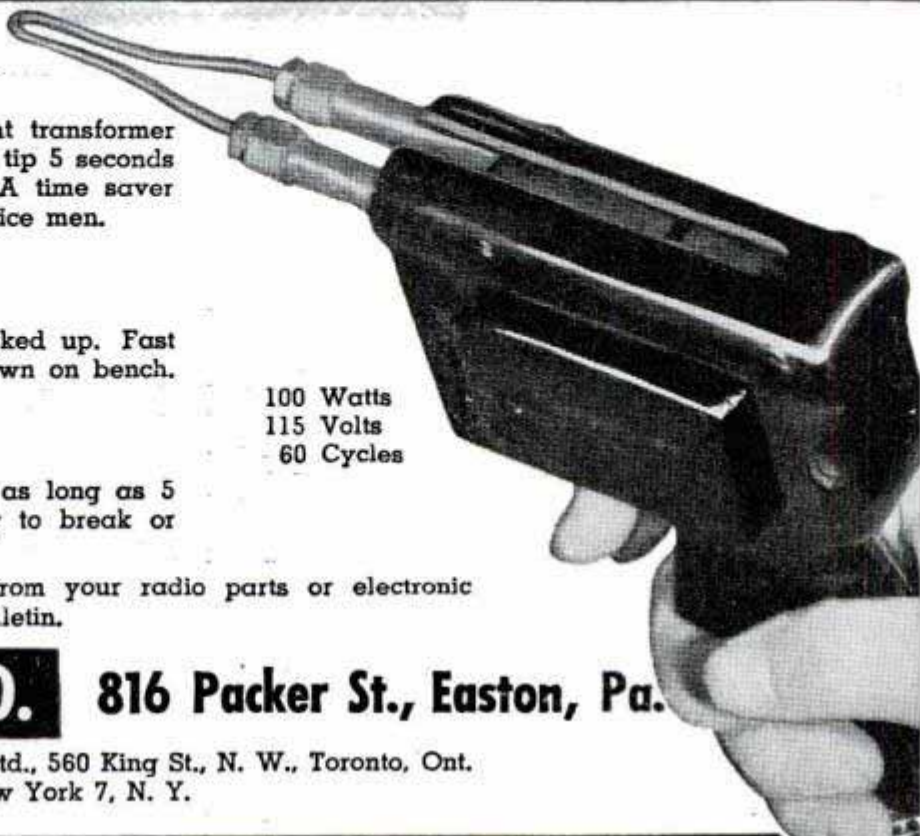

WELLER MFG. CO.

816 Packer St., Easton, Pa.

In Canada: Atlas Radio Corp., Ltd., 560 King St., N. W., Toronto, Ont.
Export Dept.: 25 Warren St., New York 7, N. Y.

\$12.85 List



GENUINE TURNER MICROPHONE

MODEL 20X

Record at home, parties, etc. Get high quality results with new Turner crystal type hand microphone. Improved circuit. Light weight. Convenient. Low cost. Use with any high impedance recorder. Ask your dealer or write for bulletin. Free literature on all Turner Microphones.

THE TURNER COMPANY
921 17th Street N. E., Cedar Rapids, Iowa

Best for Reels...



LUBRIPLATE

The universal white lubricant reduces friction and wear.
Waterproof • Prevents rust • Stays put • Lasts longer

20c at your dealers

In U. S. A.

Ideal for the HOME WORKSHOP

SEE and BE SEEN for SAFE NIGHT CYCLING



DEPENDABLE BRIGHT BIKE LIGHTS
AT ALL RIDING SPEEDS!

MAKE-A-LITE BICYCLE LIGHT Generator

Ride safely after dark! Make-A-Lite generates brilliant light for head and tail lamps at all riding speeds—good steady light even at a walk. Patented automatic voltage control prevents blowing bulbs. No batteries needed!

New swanky baked-enamel finish head and tail lamps look like a million. See them today!



INSTALLED
in a JIFFY

Now at your bicycle, sporting goods, automotive or hardware store

MAKE-A-LITE DIVISION Chefford Master Mfg. Co., Inc.
FAIRFIELD, ILLINOIS

a
**Bigger Income
for You**

**Be Independent!
Start your own ARC
WELDING business**



Hobart arc welders



..... make welding better
and more profitable

They're Simplified . . . to give you wide-range current control for superior welding on all sizes and types of jobs. You save time and money with a HOBART Welder.

Small Investment . . . makes it easy for you to start your own business. HOBART Arc Welders are available for every type of work, pay for themselves in no time at all.

"Build Your Own" road type welder . . . using a HOBART Multi-Range Generator and a reconditioned auto engine for the big pay jobs in the field. Save \$300-\$500. Ask us for FREE book also.

HOBART a c Type . . . for single phase 220 Volt lines. Costs you less, yet lets you in on the big profit possibilities of arc welding.

HOBART Arc Welding School —modern building with latest welding equipment and experienced instructors. Operates under G. I. Bill.

Hobart Brothers Company
BOX M-87, TROY, OHIO

Hobart "One of the
World's Largest Builders of Arc Welders"

Ask for the new catalog on HO-
BART Arc Welders

Free!

HOBART BROTHERS CO., BOX M-87, TROY, OHIO

YES, I'm interested in how HOBART Arc Welders can start me out in a profitable business of my own, with big earnings. Send me information on items checked below:

- HOBART Electric Drive
- Gas Engine Drive
- "Build Your Own" Arc Welder
- HOBART AC Transformer Welder
- FREE BOOK "How to Build Your Own."

NAME _____

ADDRESS _____

main chassis, for mounting most parts in this section. The cathode coil, the oscillator tube and its plate tuning coil are mounted on top of this 2½ by 4 by 7-in. metal box, the bottom side of which is open over a rectangular hole about 4 in. by 7 in., cut in the main chassis. The 807 tube socket is mounted on the end of the metal box and it is shielded with a Millen No. 80010 tube shield. Install all sockets in position so coupling condensers and other connections between grids and plates follow shortest paths.

Operating and tuning procedure is as follows: for 80 meters use an 80-meter crystal and 80-meter plug-in coils in both the oscillator and output stages. Throw the "frequency multiplier" switch "off" to short out the cathode coil, and switch the meter to "grid." Tune the oscillator to maximum grid current; the "screen current" control should be at maximum. Grid current reading will be about 5 to 7 ma. Reduce the "screen current" control to a grid reading of about 2 to 3 ma. Now switch the meter to "plate" and, with the antenna disconnected, tune the amplifier condenser (C3) for lowest reading. Next, connect the antenna. Start adjustments with the antenna coil L3 link almost all out. Bring the link coupling in closer to the coil little by little, each time readjusting the amplifier tuning condenser for minimum plate reading on the meter. Be sure to shut off the plate voltage each time you make a link adjustment. If you are using an 80-meter crystal for 40 meters, operation is the same except that the frequency multiplier switch is in the "on" position and the 80-meter cathode coil must be in its socket. For 20 meters, either an 80 or 40-meter crystal may be used. Tuning is the same as above except that, of course, 20-meter coils are used in both the oscillator and R.F. stages. When doubling from a 40-meter crystal the 40-meter cathode coil is used, and in both above cases the frequency "multiplier switch" is in the "on" position. For 10 meters use a 40-meter crystal, with "multiplier switch" "on," and the grid current at from 3 to 4 ma. Always adjust grid mils and the swinging link for maximum output. The screen current should be at the maximum possible setting, just before the point where the output begins to drop due to overdriving the grid of the 807 tube. The type of antenna used is optional with the builder; half-wave types with matched Amphenol twin-line feeders connected to the adjustable link of the output-stage tank coil are simple and efficient; other types require special tuning systems. Detailed student material list R-358 is available from Popular Mechanics Radio and Electronics department upon receipt of ordinary letter postage.

How to magnify the beauty of your car

This efficient liquid-type car polish makes car shining easy
... cleans and polishes in one operation

1. RUB CARNU ON! It's easy... rub only hard enough to loosen the grime. Then let Carnu *dry* completely to a white powder.

2. WIPE CARNU OFF! Nothing to it... just wipe off the powder. Dirt goes right along with it and the finish shines like a brand new car. The operation takes less than an hour!

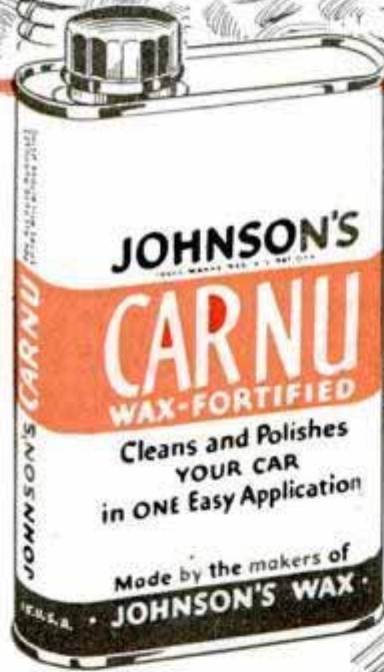
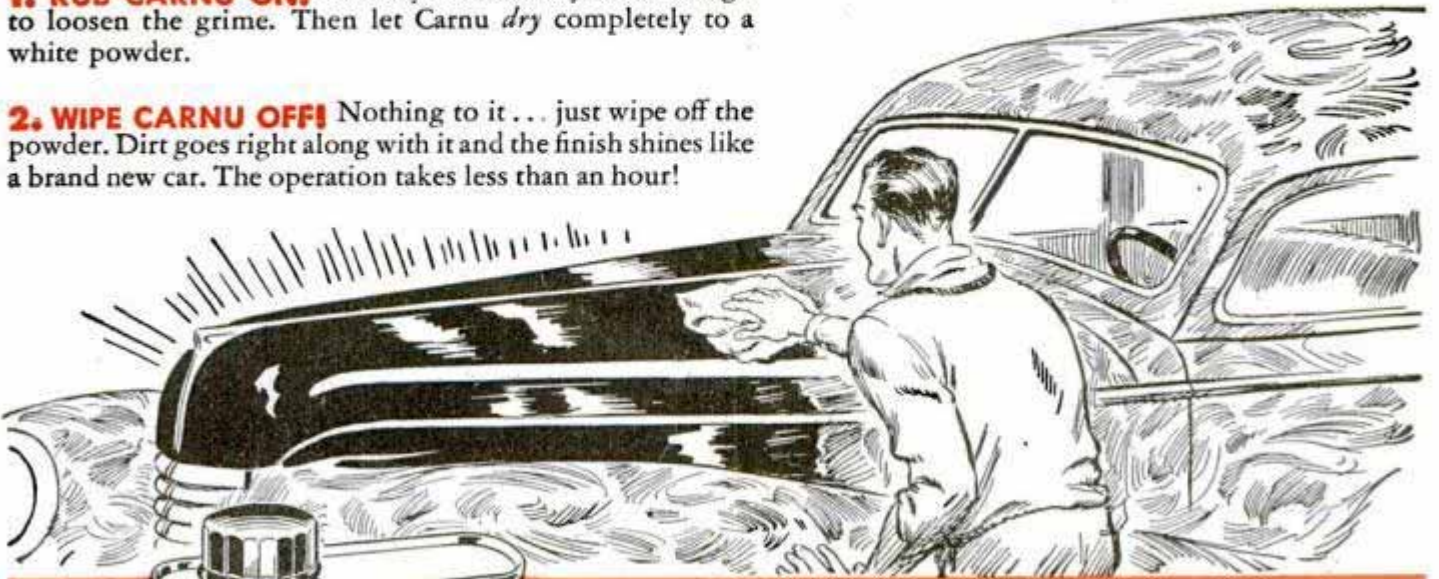

Look at
the difference
Carnu makes!

BEFORE CARNU Dirt and oxidation make finish rough, lusterless.

AFTER CARNU "Showroom shine" is restored. Finish is bright and beautiful — and so smooth dust and dirt may be wiped off in a jiffy!

EXTRA PROTECTION FOR THE MAN WHO DEMANDS "PERFECTION"

A tough, preservative coat of Johnson's Auto Wax does all these things:



1. Maintains the "Carnu" shine.

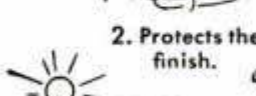

2. Protects the finish.



3. Helps preserve the color.

If you're the type who wants that "little bit extra"... and are willing to spend a little time to get it... Johnson's Auto Wax is right up your alley.

This special easy-buffing car wax gives your car a tough, protective film, protects it against sun, heat and moisture. Auto Wax also makes it easy to keep your car clean and shining because dirt can't get a foothold on the smooth, hard, waxed surface. Your auto supply store, filling station or regular Johnson's Wax dealer has Johnson's Auto Wax... Try it!



S. C. JOHNSON & SON, INC., RACINE, WISCONSIN

FUN TO USE—this fast, easy-to-handle powerful tool for use in home or shop

THE Bantam GRINDER



Polishing
Grinding
Carving
Drilling
Buffing
Plastic
Glass
Metal
Wood
Bone

You'll be surprised how many interesting, money-saving jobs you can do with the Bantam Grinder. Balanced for easy handling. Precision-built of quality materials for years of dependable service. Plenty of power—operates on 110-115 Volt AC-DC. Speed approx. 20,000 R.P.M. Internal ventilating fan. Finger-tip switch. Weight only 15 oz. 8-ft. cord and plug. 23 useful accessories. Attractive gift box. Get the Bantam now for faster, finer work, for more pleasure in your work shop.



At your dealers—or order from us today **\$25**
—immediate shipment—postpaid—only

SMALL MOTORS Inc.

Dept. 80, 2076 Elston Avenue, Chicago 14

Fill Holes, cracks, dents, gouges . . .

These BETTER FILLERS

- HARDEN FASTER
- SHRINK LESS
- STAY IN!

FILLS HOLES IN ONLY 1 APPLICATION

FILLS DENTS AND SCRATCHES

SAND OR POLISH IT

TAKES HIGH FINISH

CRACKS ARE EASILY FILLED

Duratite Wood Dough will fill rough or irregular cavities in wood, metal, plastic or plaster in one application. (Duratite Surfacing Putty for shallow cavities). Can be sawed, cut, milled, sanded; are waterproof, fire resistant. Seven wood colors, in tubes or cans, at Hardware and Paint stores. Made by Manufacturers of famous Arrowhead Cement.

LARGE TUBE 25c Postpaid

WEBB PRODUCTS CO.

228 South G Street, San Bernardino, California or Webb Company • Dept. M • Norcross, Georgia.



DURATITE

WOOD DOUGH AND SURFACING PUTTY



Indian

WORLD'S FINEST
MOTORCYCLE
SPRINGFIELD, MASSACHUSETTS

SAVE MONEY

build your own

SMITH COMPRESSOR

Now, use the world-famous Smith Air Compressor to operate rock drills, paving breakers, spray guns, sandblasting, etc., at low cost! Just order the Smith Compressor Head and Accessories with complete instructions for assembling. All you need is a Ford Motor and shop facilities. Capacity 60 cu. ft.—ample power for most compressor jobs. Pressure up to 100 lbs. per square inch. Head equipped with high speed compressor valves; automatic unloading and idling.

WRITE **GORDON SMITH & CO., Inc.**
TODAY! 410 College Street Bowling Green, Ky.

READY! AMAZING NEW MAGNETIC JIG SAW!

WRITE FOR FREE SYNCRO CIRCULAR

essential! Ideal for hobbyists, craftsmen, light production. Perfect for models, displays, inlays, etc. Cuts intricate designs on 3/4" soft wood, 1/2" plywood and thinner hardwoods, metals, plastics . . . NOT for ordinary lumber. Leaves NO ragged undersides on plywood or heavy cardboard. Special magnetic safety stroke feature! Nothing else like it! Sold on 10 days Moneyback Trial! Prompt delivery guaranteed. Rush name, address on postcard for FREE details, Trial Offer. Hurry!

SYNCRO SAW CORP., Dept. A-87, Rochester, Mich.

FIND UNDERGROUND MINERALS and METALS with M-SCOPE

Employs same principle as Army Mine Detector. Unsurpassed in Efficiency. Write for Free 16 page booklet.

FISHER RESEARCH LABORATORY, INC.
PALO ALTO CALIFORNIA

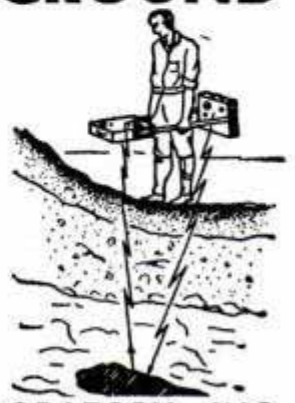

**"That hammer?
You're kidding!"**



FRED: It's a fact, Bill. I've been using this same hammer for 29 years. It helped to build the house you were born in.

BILL: Well, I don't know how you do it. I hardly ever *use* a hammer, and yet I've broken two of them in the last year or so.

FRED: That so? What kind of hammers were they? What brand, I mean.

BILL: Gosh, I don't know. Guess they didn't *have* any brand names. But they were good bargains.

FRED: That's where the trouble is, Bill. Look . . . see the name on this hammer? Whenever you see that brand name, you

know it's a good hammer. Stick to the well-known, advertised brands when you buy tools, and in the long run you'll save a lot of money.

BILL: That makes sense, Fred. I'll remember it.

FRED: And do your buying at the hardware store, where they don't try to sell you anything but quality tools. That way you'll always get your money's worth.

**Your HARDWARE DEALER sells QUALITY tools
and hardware... Buy from HIM**



POPULAR MECHANICS

THE FAITHFUL
HEART
OF YOUR FUEL
SYSTEM



AC FUEL PUMPS

Pulsing steadily, hundreds of times a mile, your AC Fuel Pump is the strong, reliable heart of your fuel system. It has given you long, faithful service because of its inbuilt quality and scientific design.

You can prolong that faithful service indefinitely, if you insist upon an AC when you replace your present pump with a new or rebuilt one.

AC SPARK PLUG DIVISION • GENERAL MOTORS CORPORATION

Blowing Up Hollywood

(Continued from page 157)

plans a house. He must know exactly where every charge is buried and the time at which it must be exploded. He must know how close the actors can approach with safety. He usually makes a sketch of the layout and plants his charges accordingly. Dynamite is placed several feet below the surface in a V-shaped trench. Soil is carefully screened to remove rocks and other sharp-pointed objects and then repacked on top. Wires from the charges run to a central control board. Overhead charges are strung on invisible wires 5 to 25 feet above ground. After careful planning and planting, the explosives engineer plays his symphony of destruction.

The highest compliment that an explosives engineer can have paid him runs something like this:

Bill Boyd, who has made famous the character of "Hopalong Cassidy," was doing a picture that required him to run across a bridge. Just as he reached the far side it was to be blown up.

"Who's handling the dynamite?"

"Slim Hoffman," the director said.

"In that case, it's O.K.," Boyd declared. "I'd let myself be blown to kingdom come if Hoffman were handling the explosives."

One of the newer tools fast becoming more useful in the profession is the air mortar. It generates a sudden gust of compressed air that produces a force similar to a weak explosion. For small objects, such as a hat or a vase, hidden springs or electrical squibs accomplish the same result. In the new picture "Road to Rio" a scene calls for a match to be dropped on Bob Hope's hat which catches fire. Actually the fire was started by electrical contact of two tiny wires, carrying 110 volts, which ran up Hope's back. A dangerous trick unless handled right.

Primacord is one of the very few materials of World War II that can be used by the Hollywood special effects department. When first demonstrated to me by Army officers at Fort Rosecrans, Calif., several hundred feet of it were laid a few inches below the surface of the earth. One end was set off, but the detonation traveled so fast that it appeared as if the entire length had exploded at one time. About 38,000 feet per second, the officers said.

At that time I was working on the picture "O.S.S.," starring Alan Ladd. I was confronted with the problem of trying to show a 5-inch shell landing near Ladd and ricocheting away. When I saw the Prima-

(Continued to page 232)

For radiator
PURR-FECTION...



Clean out rust with

DU PONT Cooling System CLEANSER

Here's a safe, sure way to clean out rust and scale—to avoid engine overheating. Just pour a can of DU PONT COOLING SYSTEM CLEANSER into your radiator, run the engine for 30 minutes or more, and drain. No reverse flushing needed. No fussing with the hose or flush gun. A clean cooling system paves the way for top engine efficiency.



Keep out rust with

DU PONT Acid and Rust INHIBITOR

After cleaning out the radiator, you can keep it free from rust all season by pouring in a can of DU PONT ACID AND RUST INHIBITOR. It prevents rust forming, and keeps out acid, too.



Avoid radiator leaks with

DU PONT Cooling System SEALER

You can stop leaks quickly and securely—and make the cooling system LEAK-PROOF—by pouring in DU PONT COOLING SYSTEM SEALER. It will not clog the radiator or harm hose or metal parts.

DU PONT

REG. U.S. PAT. OFF.

BETTER THINGS FOR BETTER LIVING
...THROUGH CHEMISTRY



When you want to fix things fast... remember Weldwood Glue. It's quick to mix... easy to use... tremendously strong... stain-free... rot-proof... and permanent. At hardware stores, lumber yards, chain stores.



WELDWOOD PLASTIC RESIN WATERPROOF GLUE

United States Plywood Corporation, New York 18, N. Y.

SAY YOU SAW IT IN POPULAR MECHANICS

FREE BIG NEW LAFAYETTE RADIO BOOK

COMPLETE with the greatest values in radio. Send for it now. Typical values:

K10448—ALL WAVE 2 TUBE AC-DC RECEIVER KIT
110 volts AC-DC; 12S7 regenerative detector, 11L7GT power amplifier-rectifier; 4 coils cover 10-200 meters; headphone jack; complete with punched chassis, panel, plug-in coils and tubes. Only \$17.95.

K10451—BATTERY OPERATED ALL WAVE RECEIVER KIT
As above. Only \$16.95 complete.

Lafayette Radio
RADIO WIRE TELEVISION INC.
100 6th Ave., NEW YORK 13
110 Federal St., BOSTON 10
24 Central Ave., NEWARK 2

LAFAYETTE RADIO, Dept. LH-7
100 Sixth Avenue, New York 13, N. Y.
RUSH new big radio catalog to:

Name _____
Address _____
City _____ State _____

PASTE
COUPON ON
POSTCARD —
MAIL IT NOW!

A TOOL... NOT A BRUSH

\$1.00 POST PAID

NOW! PAINT STRIPING MADE EASY!

PAINTERS' STRIPING TOOL

Easy to use as a pencil! Draws parallel lines, straights, curves, circles with paint, enamel, lacquer, etc. Do your own striping on autos, furniture, toys, bikes, model planes, signs, linoleum... make wall board look like tile. Painters—craftsmen, order today! Type "M" Master Painters' Striping Tool complete with tip for 1/16" stripe, \$1.00. Extra tips 1/64", 1/32", 3/64", 1/16", 5/64", 3/32", 1/8"—75c each. Tool with complete set of 7 tips \$5.00. (C.O.D. orders 25c extra.) Dealers write!

WENDELL MFG. CO.
4234-B Lincoln Ave., Chicago 18, Illinois

A 10-Ton Press at Low Cost

Pressing, separating, bending, and straightening jobs in your shop are easy with this press. Ten-ton capacity provides ample pressure. Adjustable table takes work up to 18 inches wide and 11 1/2 inches high. Send for free bulletin showing press and wide variety of accessories.

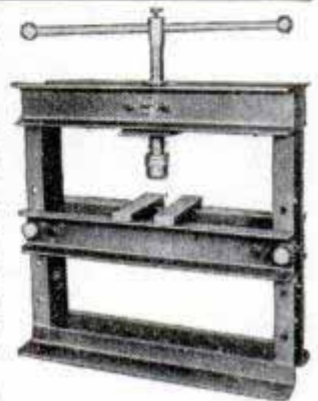

UT-10A Press f.o.b. factory \$28.25

DAKE ENGINE COMPANY

624 Seventh Street, Grand Haven, Michigan

What keeps the pages
nice and neat
And guarantees the
set's complete?

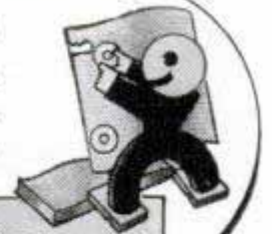

Dennison

GUMMED REINFORCEMENTS
At Stationery Departments Everywhere

\$2.95

TORNADO GAS TORCH

The Modern Way of Soldering

Ideal for hard and soft soldering. Will heat quickly; solder will flow freely and smoothly. No compressed air required. Nothing to pump. Self-adjusting. Safe. Economical. Can be used for annealing small parts and bending metal parts. Generates a heat of 1700° Fahrenheit. Simply connect to any illuminating (manufactured) gas jet with a rubber hose and operate. Tornado Torch No. 119 comes with three (3) tips, (3/8", 1/4", 3/16" blast).

The Tornado Gas Torch No. 119, complete with three tips, is \$2.95. See your dealer or order direct. Send check or money order—post paid.

Robco Corporation, 202 E. 44th Street, New York 17, N. Y.

ELECTRICITY *Anywhere*

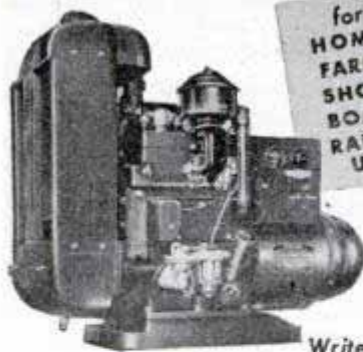

for
HOMES
FARMS
SHOPS
BOATS
RADIO
USE

● Onan gasoline-engine-driven Electric Plants supply reliable, economical electric service for any use. Portable, stationary or stand-by models. Water or air-cooled, compact and rugged.

A.C.: 350 to 35,000 watts in all standard voltages and frequencies. D.C.: 600 to 10,000 watts, 115 and 230 volts. BATTERY CHARGERS: 500 to 3,500 watts; 6, 12, 24, 32 volts.

Write for folder

D. W. ONAN & SONS INC.

2532 Royalston Ave., Minneapolis 5, Minn.,



The *SPEED* SAW FILER

Saves You Time, Money

Now you can do expert saw filing at home. Lifetime tool makes precision filing easy for even the most inexperienced. Two simple adjustments make it fit any type hand saw. Keep your saws extra sharp and true-cutting with a Speed Saw Filer. Complete with file, ready to use. Money back guarantee. Cash with order, prepaid (C.O.D. postage extra.)

THE SPEED CO., Dept. PM
2025 N.E. Sandy, Portland 12, Ore.

Now
FILE
YOUR OWN
SAWS

ORDER
NOW!



\$295

BUILDING CONSTRUCTION



with composition cement and cheap wood builds 3 room house low as \$250, farm buildings low as \$50. Homemade forms make blocks, panels and tiles in color, and wallboard of sawdust and other compositions. Wall-high blocks, insulated, with finished sides. Stream-lined roof and walls. Cement gutters, troweled roofs and floors. Ten formulas. Cabins, stores and sectional. 100 money and labor saving ideas. Mixer and saw easily made from an old auto. Make doors and windows. Guaranteed, book, 100 illustrations, \$1.00.

SHEET METAL COTTAGES. The coming thing. Box wall floor and roof panels. Cheap, movable, insulated, moisture proof, fire proof, no plastering, modern appearance. Instructions, 50c.

SIDEWALK MANUFACTURING BUSINESS. Make like cement block. Easy to lay. Make own forms. Illustrated instructions, 50c.

FURNITURE OF COMPOSITION. Cement, sawdust, asbestos, etc., 50c. 60 selected ways to earn up to \$20.00 a day, 25c.

SHOP MACHINES FROM OLD AUTO PARTS: Band, jig, hack, and circular saws, electric drills, sanding wheels, forge, tools, electric weed cutters, tractors, hoist, wood splitter, grinders and many other things from old auto parts and 1/4 HP, used motors. Illustrated, 50c.

HOME MFG. ENTERPRISE. 50 selected home shop projects, illus., 50c. Special: All seven booklets described above, \$2.00 postpaid.

HOME INDUSTRIES, 1318 So. 30th Ave., Dept. PM., Omaha 5, Nebr.

New Improved Electric MOTO-SAW

Only
\$5.85
Postpaid



SAFE AS A HAND SAW
JUST GUIDE IT!

More like magic than any tool you ever saw. Imagine an electric scroll saw only slightly heavier than a hand coping saw... a tool that takes no effort to run, no pressure to feed. Works at any angle—on big assembly jobs or on the tiniest piece you can hold in your fingers. Runs 7200 strokes a minute... so fast the blade seems to stand still. Sturdily built... only two moving parts... never needs oiling. Easily cuts intricate designs—so smooth it eliminates sanding. A thrill awaits you when you get a Moto-Saw in your hand. Thousands of satisfied users.



U. S. Patent 2233862
Other Patents Pending

No Limit To Length Of Stock It Will Cut, Saws To Center Of 19" Widths

It's fast... cuts on an average of 1 ft. per minute up to 3/4" medium hard wood. Operates on 110-120 V. 50 or 60 cycle alternating current. If your dealer does not yet have Moto-Saw, send \$5.85... we'll pay postage. Or send \$1. pay postman balance plus postage. MONEY BACK if not delighted after 5 days trial.

DREMEL MFG. CO., Dept. S117-H, Racine, Wisconsin

FOR TOP-NOTCH
Vacation Thrills!



See the country on a
HARLEY-DAVIDSON

Enjoy the most thrilling vacation of your life on a Harley-Davidson Motorcycle! Visit the country's natural wonders and historic places. Your Harley-Davidson will take you anywhere fast and economically. You can do more and see more on a Harley-Davidson — "explore" the out-of-the-way regions and beauty spots not reached by other methods. What's more, your Harley-Davidson turns evenings, holidays and weekends into *extra pleasure time* — as you go gypsy touring with other fun-loving riders, or take in race meets, hillclimbs, and other thrill-packed motorcycle events. See your Harley-Davidson dealer NOW — and mail the coupon today!

HARLEY-DAVIDSON
Motorcycles

HARLEY-DAVIDSON MOTOR CO.
Dept. P, Milwaukee 1, Wis.

Please send me free copy of 24-page ENTHUSIAST Magazine, filled with motorcycle action pictures and stories; also catalog.

Name.....
Address.....
City..... State.....

Performance
goes up
in smoke...



when worn
connecting rod bearings
cause oil pumping

Pep, power, economy escape in smoky exhaust when worn engine bearings let excess oil burn to carbon, choke up pistons, rings, valves and spark plugs. Cars start sluggishly, lack pick-up at traffic lights, waste performance when bearings are worn. To restore pep, power, economy — replace in sets with Federal-Mogul Oil-Control Bearings. Ask your mechanic!

FEDERAL-MOGUL SERVICE

DIVISION OF FEDERAL-MOGUL CORPORATION
COLDWATER, MICHIGAN



Replace in sets with Genuine

FEDERAL-MOGUL
Oil-Control Bearings

cord in action I knew my problem was solved. I borrowed some of it from the Army and produced the effect of a large shell skipping along the ground.

Dry ice, or solidified carbon dioxide, has proved a boon to Hollywood's special effects men. Smoke, fog, haze, steam, clouds and other atmospheric effects are produced with the stuff. A wind machine will blow it in any direction you desire. It's heavy and does not disperse easily.

Another useful chemical is lacopodium—used by circus side-show fire eaters. It can be applied to almost any object—cloth, paper, wood—and it will burn brightly and briskly. The object it covers, however, won't even be scorched by the heat. Real fire is slow and colorless and most movie fires are pepped up with lacopodium.

Credit for the greatest fire scenes ever filmed must go to Lee Zavitz for his work in "Gone With the Wind" when he burned down sets representing 40 blocks of downtown Atlanta during the Civil War days. Zavitz rigged up an ingenious arrangement of gasoline and water pipes. The gasoline made the fires burn brighter; the water kept the blaze under control, according to the action required by the script.

The secret of success in the Hollywood blow-up business is to know what your explosives will do and to time them with the action and cameras. As a matter of fact, explosives are a lot easier to handle than people. You know what dynamite will do, but you can't always depend upon the unpredictable human element.

The psychology of fear is a curious thing. Almost anyone can walk along a curbstone. But lift that curbstone 50 feet in the air and the age-old fear of high places will grip the most courageous man. So with explosives. I've seen times when an actor would be so nervous that he would refuse to go through with an explosives scene. Such occasions call for strategy on the part of the explosives man.

A trick that I learned long ago to instill confidence in an actor is this: a dynamite charge is planted under several bags of sand, and a length of rope, head high, is rigged in front of the charge. A sheet of tissue paper is fastened with a clothespin in the approximate position that the actor will take. Then the blast is set off and the tissue paper sways a little in the wind but remains untouched.

If this doesn't work there are other methods. With the cooperation of the director, the explosion scene is delayed until the end of the shooting schedule. While the actor is told that the special effects depart-

(Continued to page 236)



Commercial shipping on the high seas and inland waterways is now freed by radar from delays caused by bad weather.

RCA Radar—enables ships to see through

**fog
darkness
storms**

With shipboard radar, developed and produced by engineers of the Radiomarine Corporation of America—a service of RCA—a pilot watches a viewing screen (similar to a television screen) that shows a large, clear, maplike picture of the area under observation.

With this radar picture he can safely pass through heavy fogs that would ordinarily force the most experienced pilots to anchor, sometimes for days at a time.

The same research at RCA Laboratories that contributed to the achievement of radar—are con-

stantly applied to all RCA products to keep them at the top in their fields. So when you buy an RCA Victor radio, television receiver, Victrola radio-phonograph, phonograph record or radio tube, you know you are getting one of the finest products of its kind science has achieved.

"VICTROLA"—U. S. REG. U. S. PAT. OFF.

A cordial invitation is extended to you to visit the new RCA Exhibition Hall, 36 W. 49 St., Radio City, N. Y., open daily and Sunday—free admission.

Radio Corporation of America, RCA Building, Radio City, New York 20. Listen to the RCA Victor Show, Sundays, 2:00 P. M., Eastern Daylight Saving Time, over NBC.



A twelve-inch viewing screen reveals objects as close as 80 yards—or as far away as 50 miles! For further details, write to Radiomarine Corporation of America, 75 Varick Street, New York, N. Y.



RADIO CORPORATION of AMERICA



They're putting the bite on me!

• Fleas are like poor relatives after a rich uncle—they're out for all they can get.

Mother told me there'd be days like this—times when the best thing to do is bathe me with Sergeant's SKIP-FLEA Soap, followed by regular dustings with SKIP-FLEA Powder. The powder contains proved anti-flea ingredients, and it brings fast relief... it's tested for safety, too. For economy, try the new 50c size.

Sergeant's 73 years of clinical research and laboratory testing have developed 19 dog care products, each of which helps you to give your dog the care he deserves.



• You can pick up a number of valuable hints on dog training and dog health in Sergeant's new Dog Book. It's FREE for the asking at drug and pet stores, or by writing to Sergeant's, Richmond 20, Va.

Sergeant's DOG CARE PRODUCTS

KAYAKS
AQUA V-18
Easy to Build

OUTBOARDS ROWBOATS

BOATS for Home Assembly
"U-MAK-IT"
KAYAKS, ROWBOATS, DINGHIES, INBOARDS, OUTBOARDS, RUNABOUTS
Cut-To-Fit for Quick Assembly. Everything Complete plus Illustrated Instructions. No Experience Necessary. Simple as A. B. C.

SEND 25c POSTAGE (COIN) TODAY FOR 3 MONEY SAVING ILLUS. CATALOGS Showing all '47 Models (marine plywood) and construction details.

25¢ COIN FOR ALL THREE

AQUAMOBILE V-18
Designed for Auto Engines, Open or with cab, Length 18 ft.
Fast VEE Bottom Hull

KAYAK BOAT CO., 154P EAST 129th ST., NEW YORK 35, N. Y.

**FOR SAFER DRIVING IN STORMS AHEAD
ASK YOUR GAS PUMP MAN TO PUT ON FOR YOU**

New "DEAD-LOCKER" Models
ANCO RAIN-MASTER
Windshield Wiper Arms and Blades

Made in U. S. A. by
THE ANDERSON COMPANY GARY, INDIANA

WHEELS AT BARGAIN PRICES

... 4" wheel & tire, 5/16" sleeve bearing & hub cap	\$0.45 ea.
... 5" wheel 3/8" solid tire 5/16" shaft hole	0.65 ea.
... 6" wheel 3/8" solid tire 5/16" shaft hole	0.75 ea.
... 7" wheel 3/8" solid tire 3/4" shaft hole	0.85 ea.
... 8" wheel 1" solid tire 1/2" sleeve bearing	1.25 ea.
... 8x2" wheel, semi-pneumatic tire 7/16" ball bearing	2.50 ea.
... 10x1.75 wheel semi-pneumatic tire 7/16" ball bearing	3.25 ea.
... 12x1.75 wheel semi-pneumatic tire 1/2" bronze bearing	4.00 ea.
... 10x2.50 wheel semi-pneumatic 1/2" ball bearing	5.50 ea.
... 6x2" wheel 3/8" ball bearing, solid tires	3.95 ea.

BUILD YOUR OWN— Wagons — Scooters — Soap Box Racers — Welding Carts — Baby Pens — Etc.
To order above wheels write number wheels wanted in space provided, tear out and mail this ad with check or money order and your name and address. If other sizes are wanted write for FREE LIST.

TRULSON MFG. CO., 811 E. 31 St., Dept. M5, Kansas City, Mo.

BECOME A PISTOL EXPERT WITH A HY-SCORE AIR PISTOL

- No Pumping
- Powerful, Fast
- Single Shot
- Precision-Made
- 30 1/2 oz.
- 10 1/4" long

HY-SCORE PELLETS FIT ALL PISTOLS Cal. 177 2.50 Cal. 22 3.00 net 1000

SEE YOUR DEALER

Send For Free Circular Dept. M8

HY-SCORE ARMS CORP. · BROOKLYN 1, N. Y.

EXHAUST BLOWERS • PEDESTAL FANS

PHOTOGRAPHERS • HOSPITALS • LABORATORIES • WORK SHOPS • LAUNDRIES
OFFICES • RESTAURANTS • PRINTERS • PLAYROOMS

SOLVE ANY VENTILATION PROBLEM WITH THESE 2 AIR CONDITIONERS

At last! A real post war fan to banish summer heat. Far superior to any pre-war product. Made of the finest materials to give perfect service indefinitely.

- 18" Fan Blades • Adjustable from 6 1/2 ft. to 8 ft.
- Aluminum Blades • Chromium Slide Bar • Cadmium Guard.

Continuous duty Ball Bearing Motor guarantees long, trouble free operation. 110 Volts, A.C., 50-60 cycles.

SEND CHECK OR MONEY ORDER FOR \$65

This RUGGED BLOWER & EXHAUST DELIVERS 100 CU. FT. AIR PER MINUTE. Quick and simple to install. Anyone can do it with ordinary household tools.

Continuous duty BALL BEARING MOTOR assures quiet, trouble free operation. Tough housing insures long life. 110 Volts, A.C., 50-60 cycles.

ONLY \$65⁰⁰

FOB Yonkers
Freight Collect

WORTH \$50

Only \$15⁸⁵

Send check, money order. No C.O.D.'s. West of Mississippi add \$1.00 for mailing, handling.

UNIVERSAL YONKERS CORP. (Dept. M-8) 41 Locust St., Yonkers 2, N.Y.

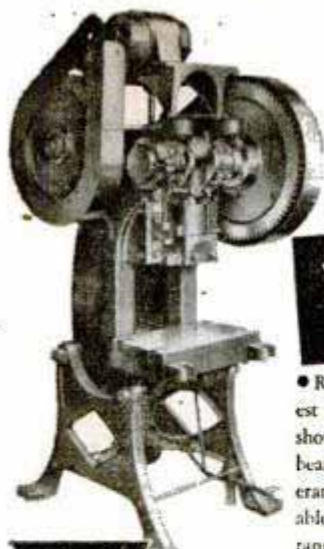

Diamond

31 TON BACK-GEARED PUNCH PRESS

*Strain Gauge Analyzed
for greatest
frame strength!*

• Re-designed to take utmost advantage of latest strain-gauge testing methods. Test results show over 5 times safety factor! Micro-finished bearing and sliding surfaces; manufacturing tolerances so exact parts are uniformly interchangeable. Today's most modern punch press! Prices range from \$340 to \$1595 FOB Los Angeles.

• WRITE FOR FREE CATALOG. Describes 9-14-30-31-Ton Diamond Punch Presses; Diamond Milling Machine.

DIAMOND MACHINE TOOL CO.
DEPT. 1 • 3429 E. OLYMPIC BLVD. • LOS ANGELES 23, CALIF.

MANUFACTURERS OF THE DIAMOND LINE
OF PRECISION MACHINE TOOLS AND ACCESSORIES

RUST! RUST! RUST!

WHAT a headache! Here's the answer! A new liquid RUST REMOVER—quickly dissolves rust on iron or steel, tools, hardware, machinery, etc. NO RUBBING or hard work. Brush, swab, spray or dip. Put ON—let SET—wipe off—RUST GONE! On sale at all Sears Retail Stores in HARDWARE DEPTS. 50c and \$1.00 in Mid-West (slightly higher elsewhere.) Valuable manual of rust control FREE with each bottle.

SEARS, ROEBUCK and CO.

For further information, write ALLIED PRODUCTS COMPANY, Dept. J-1, 1133 Newport Ave., Chicago, Ill. Manufacturers of CorOdex.



CORODEX Liquid RUST REMOVER **\$1 PER QT.**

LAW

STUDY AT HOME for PERSONAL SUCCESS and LARGER EARNINGS. 39 years expert instruction—over 108,000 students enrolled. LL.B. Degree awarded. All texts furnished. Easy payments. Send for FREE BOOK. G. I. approved. AMERICAN EXTENSION SCHOOL OF LAW
Dept. 80-M, 646 N. Michigan Ave., Chicago 11, Ill.

Start a NEW BUSINESS

Sharpen Dull Pipe Wrenches

Or Add to Your Present
Repair Business

Write for Information.



J. C. MOORE INDUSTRIES P. O. Drawer 276
FREDONIA, PA.

MUFFLERS

STEELS and ALUMINUMS
with a motorboat tone

SINGLES, Chev, V-8, Plymouth, Steels \$5.50, Aluminum \$6.50. Chry., Olds, Buicks, etc., Steels \$7.50, Aluminum \$8.50. V-8 and MERCURY DUALS, Steel \$17.50, Aluminum \$20.00. Aluminum are guaranteed for life of your car.

DEALERS WANTED

V-8
DUALS
& SINGLES



SANDEE MUFFLER CO.
7523 S. WESTERN AVE. LOS ANGELES 44, CALIF.

AUGUST 1947

BOLTS, SCREWS, RIVETS Tightened to STAY

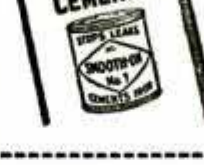

Tighten loose bolts, nuts, screws, rivets, parts and fixtures with Smooth-On No. 1 Iron Cement. They will stay tight, because Smooth-On expands slightly as it hardens. You apply it like putty, no heat required. It hardens like metal.

Use it, too, to seal cracks, stop leaks in heating and plumbing systems, autos, etc. It can often save you a lot of trouble and expense.

Keep Smooth-On handy for emergencies. Buy it in economical 1 3/4 oz., 7-oz. or larger size at your hardware store. A little goes a long way. Does not deteriorate in container. If your store hasn't Smooth-On No. 1, write us.

REPAIR HANDBOOK FREE

Practical, tested, time-and-money-saving directions for making metal repairs of many kinds around the house and garage. 40 pages. 170 diagrams. Send the coupon for your free copy.

-----Sign and Send Now-----

SMOOTH-ON MFG. CO., Dept. 37H,
570 Communipaw Ave., Jersey City 4, N. J.

Please send me a Smooth-On Handbook.

NAME

ADDRESS

8-47

Do it with **SMOOTH-ON**
Iron Cement of 1000 Uses

SAY YOU SAW IT IN POPULAR MECHANICS

235

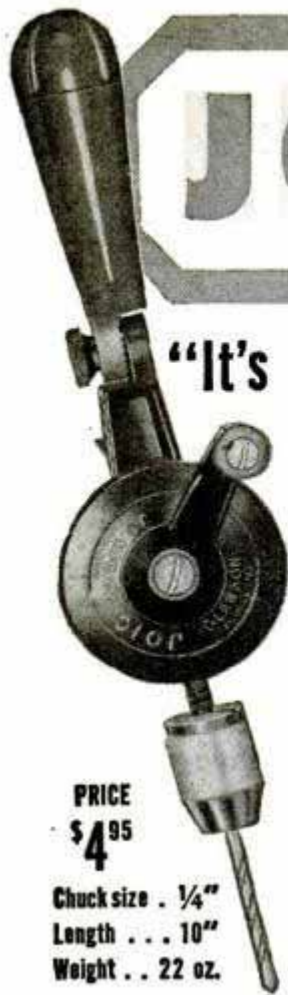

"It's the Wonder Drill"

Craftsmen say so
Hobbyists say so
You'll say so, too

PRICE
\$4.95

Chuck size . 1/4"
Length . . . 10"
Weight . . 22 oz.

JOIC can even drill around a corner. Here's why. It's adjustable, the only hand drill with swivel chuck and handle.

JOIC is a handy tool for easy drilling in tight places. For example, you can drill any number of holes at exactly the same height. (See top illustration at right.) JOIC will be a must, once you get your hands on it.

JOIC Hand Drill is all metal construction, rust proofed, and enameled. The removable end cap of the handle is convenient for storing drills.

This wonder drill is available almost everywhere. If your dealer's stock is exhausted, or does not include JOIC, kindly send us his name so we can make sure you are promptly supplied.

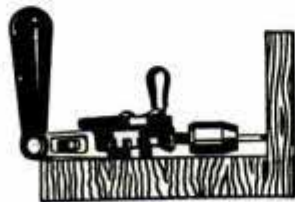

Drill's flat side holds bit parallel to surface.



Handle's 180-degree range locked by thumb screw.



Turret locks chuck in seven different positions

ment will dub in the explosion later, hidden charges are actually placed on the scene without his knowing it. At the appropriate moment, the explosion is set off—and you can be sure that the emotions registered by nervous actors are genuine.

Two of the bravest stars I've ever worked with are Gloria Swanson and Henry B. Walthal. Miss Swanson never complained about a scene that called for the use of explosives. In scenes that might call for blowing out the side of a room, she was as calm as if serving tea in her own home. Walthal was once buried under 12 feet of dirt and it took 6 minutes to dig him out. His only comment when dragged from his temporary grave was:

"Great work, Slim."

Among the current heroes and heroines, Gary Cooper, Ray Milland, Betty Hutton and Paulette Goddard seem to be without fear of special effects.

As far as directors go, the one who stands head and shoulders above all the others is Cecil B. DeMille. He produces pictures on a lavish scale and his battle scenes call for a maximum amount of smoke and noise.

His latest, "Unconquered," which tells the story of the fight between British Colonials and the Seneca Indian chief, Gwaysuta, illustrates the point. In that picture we used 1500 arrows without flames, 500 arrows with flaming heads, 50 flintlocks, 300 fireballs made of dried moss and dipped in gasoline, 500 pounds of black powder, 300 pounds of dynamite and 50 pounds of flash powder.

Up to now, Hollywood explosives men have been stumped by only one type of explosion—and that is the atom bomb. In M-G-M's picture "The Beginning or the End," newsreel shots of the New Mexico tests and the actual dropping of the bomb on Hiroshima and Nagasaki were used. So destructive and terrifying are the forces unleashed in the bomb that even Hollywood doesn't attempt to reproduce them.

They Dredge for Your Dinner

(Continued from page 145)

oyster from its earliest stages to maturity and old age. They include the conch, drumfish, various rays and parasites. In dredge fishing, many newly emptied shells are pulled up with a well-fed snail-like conch attached. Birds, especially the scaup duck, prey on oyster beds near shore that are exposed at low tide. Oyster farmers sometimes construct elaborate fences to keep fish away from choice beds.

As the Elroy crew was pulling in its buoy

(Continued to page 240)

JO MANUFACTURING COMPANY
8442 OTIS STREET • SOUTH GATE, CALIF



**THIS IS FOR
KEEPS**

**...and his life hangs
on a drop of OIL!**

In gun actions—where failure may mean death itself
—a famous Federal Law Enforcement Agency relies on
FIENDOIL!

Explorers, riflemen, hunters, police officials
of world-wide fame choose FIENDOIL, and
so also do rangers, linesmen, outdoorsmen
everywhere—who live *dangerously*.

The same tested reliability is yours in FIENDOIL
when you use FIENDOIL in your home workshop
for the care of *fine tools, mechanisms, and small
motors.*

**A PREMIUM OIL — with dynamic polar action, it
Cleans — Protects — Lubricates**

In the stark, glacial coldness of the Far North—
Alaska, Canada, Sweden—where Nature rules with
man-defying ruthlessness, equipment *has* to work,
without gumming, without freezing, without rust,
without even much care. Up there, they rely on
FIENDOIL. In the black, steaming swampland of
the Sugar Cane Country, cursed with salt air, rust
does irreparable damage overnight. They rely on
FIENDOIL there and it's FIENDOIL, too, with tur-
pentine men whose workshop is the Everglades.

**WHERE IT HAS TO WORK, IT'S FIENDOIL.
SO, MAKE YOUR HOME WORKSHOP OIL
FIENDOIL**

—the oil that's used where it can mean either life
or death.



Ask for this dramatic new action oil for tools . . .
weapons . . . fishing tackle . . . electric fans . . .
small home and shop mechanism of all kinds.
Fiendoil is an amazing new protection for all
metal—spectacular in its results.

Ask your hardware dealer, or sports store, for a
3-ounce can. If he doesn't have it in stock, send
us *his name and address*—and we'll send you a
sample with FREE booklet of FIENDOIL endorse-
ments by authorities on guns and mechanisms.

Sole Manufacturers: THE McCAMBRIDGE & McCAMBRIDGE Co. . . . Baltimore 23, Md.

A Real Sensation!

Here's something needed in every shop

the New

L-W Medium Duty 4-Jaw Independent CHUCKS for Small Lathes

They will save you a lot of time and labor and permit much more accurate work.

PRICED WITHIN THE REACH OF ALL!

Semi-steel bodies. Face and outer edge surfaces ground. Steel jaws. Hardened and ground steps. Heat-treated steel screws. Complete with wrench.

Finished adapter back plates are suitable for some models of Atlas, Clausing, South Bend and Logan lathes.

ORDER TODAY or write for complete catalog

MPGRS. UNIVERSAL AND INDEPENDENT LATHE CHUCKS • MILLING MACHINE VISES • POWER BACK SAWS • DIVIDING HEADS • MAGNETIC CHUCKS • RECTIFIERS • DEMAGNETIZERS

L.W. CHUCK CO., 31 So. St. Clair St., Toledo 4, Ohio

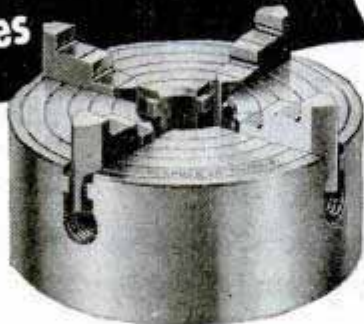

6" HEAVY DUTY \$16.95

Semi-finished, ready to mount adapter back plate, 1½" — 8 thread \$3.00. Rough adapter back plate casting, \$1.25.

RUGGED 8" MEDIUM DUTY \$21.

Semi-finished, ready to mount adapter back plates, 1½" — 8 thread \$3.60. Rough adapter back plate casting, \$1.50.

"Handie Talkies"

The most famous radio developed by the Army. Same type used with great success on all battlefronts. Sends and receives voice from 1 to 5 miles. Weighs only 5 lbs. including batteries. Preset crystal controlled operation in the amateur radio band on 3885 KC. May be tuned to other frequencies if necessary.

Highly recommended for airports, utilities, surveyors, police and fire departments, explorers, amateurs, boats, etc.

Price only \$49.75 each or \$99.50 per pair F.O.B. Chicago. Limited quantity. Send your check (or M.O.) today.

Brand new — complete with batteries and telescopic antenna — ready to operate. Fully guaranteed.

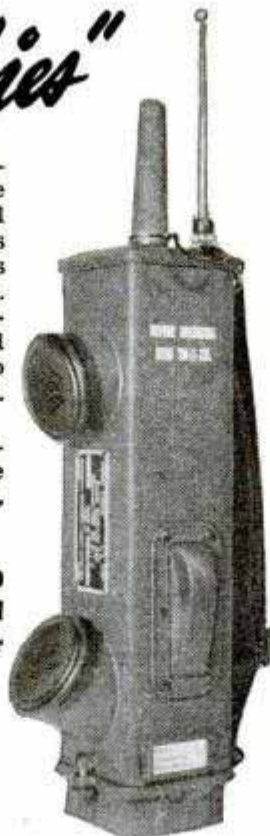

WELLS SALES, INC.

320 N. LA SALLE ST.
Dept. P-8, Chicago 10, Illinois

Electrically Welded Endless

Paramount

BAND SAW BLADES



Made in widths from 1/8" to 1-3/4"

Make your band saw do more work for you. The proper width of blade will extend the scope of this important machine. Burrill's Paramount Blades are made from tough Nickel Alloy Steel properly tempered. Teeth accurately set and filed, and all saws carefully straightened. Send order and check today. Delivery will be made as promptly as conditions permit, from a few days to a week or two. You can obtain these saws at the following prices:

3/8"-3/16"-1/4"-3/8" wide, 5'6" long.....\$.90 each
1/2"-3/16"-1/4"-3/8" wide, 6'6" long..... .95 each
5/8"-3/16"-1/4"-3/8" wide, 7'6" long..... 1.10 each

Other sizes at proportional prices

NO C.O.D. SHIPMENTS ACCEPTED

State Make of Machine

Your satisfaction is guaranteed

BURRILL SAW & TOOL WORKS

407 E. Main St., Ilion, N.Y.

THE SCOUT SENIOR

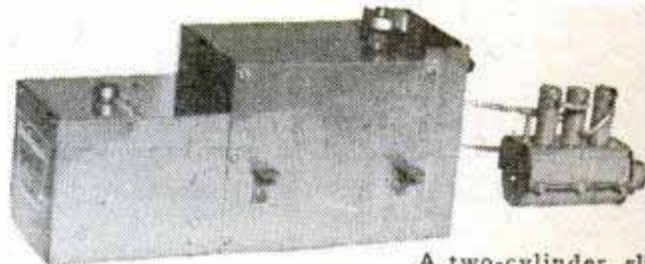

A two-cylinder, slide valve engine for boats 18" long and larger. 7/16" bore by 3/8" stroke. Aluminum pistons. High-pressure, brazed boiler. Drives a 2 1/4", two-bladed prop of 3" pitch at 2000 r.p.m. for almost 20 minutes. Burns alcohol. Price postpaid, complete ready to run with 70-lb. safety valve and prop rig..... **\$950**

PHILIP STEVENSON CO.

Box 162, Station D

Cincinnati 6, Ohio

SAY YOU SAW IT IN POPULAR MECHANICS

\$24.95
Full Set



MICROMETERS

Six piece set, in velvet lined leather case. Special price, only \$24.95. Precision machined in one thousandths, up to 4" outside and 3 3/4" inside measurements. Guaranteed accurate, easy to read and adjust. Satisfaction guaranteed or money back. Also indicators and gauges. Shipped prepaid on receipt of remittance. On C.O.D. shipments, send deposit of \$2.00.

FREE FOLDER

MICRO PRODUCTS, 8655 E. Jefferson, Detroit 14, Mich.

MACHINE SHOP EQUIPMENT



Just off the press!—Every man who owns a workshop should have a copy of the new, up-to-the-minute, 200 page catalog of Machine Shop Equipment—the latest tools made by the biggest manufacturers in the U. S. Replete with illustrations, descriptions, prices. Prompt delivery on most tools listed in this book. Available at cost of printing—50c a copy—get yours today! **Price of Catalog Refunded on First Order over \$5.00.** Send check or Money Order to

CENTER TOOL CO., 153 Centre St., Dept. C, New York 13

U. S. GOVERNMENT SURPLUS
TRIPODS
 Strong Wooden Tripods with adjustable metal legs. 5½ foot extension. Used by Government for engineers levels and transits. Can be used for holding Telescopes, Cameras, etc.
 Value 24.50 **\$4 95**

WHEATSTONE BRIDGES
 Used, in excellent condition. Mfg. by Thompson Lever Mfg. Co., Philadelphia. Value \$150.00 **SPECIAL \$49.50**

Engineers All Metal Army Type Hand-Sighting LEVELS
\$2.00 PRECISION QUALITY

PUBLIC SPORT SHOPS
 13 S. 16th St., Phila. 2, Pa. No COD's

STAINLESS STEEL AIR TANK WITH 100 USES

Perfect
 PRESSURE TANK FOR PAINT SPRAYING, MOTH PROOFING, INSECTICIDE SPRAYING, TREE, SHRUB AND GARDEN SPRAYING.

MAKES IDEAL PORTABLE AIR TANK TO CARRY IN CAR. WILL COMPLETELY INFLATE FOUR TIRES FROM ONE FILLING. WONDERFUL FOR BUOYS AND MANY OTHER USES.

SPECIFICATIONS Non-corrosive Stainless Steel, non-shatterable. Tested for 450 pound pressure. Volume, 2100 cubic inches. Size, 12½" x 24" Has 1½" female pipe thread opening at each end.

DEALERS INQUIRIES INVITED

W. F. TEAGUE & COMPANY
 714 CENTRAL, KANSAS CITY 6, KANSAS

LIST PRICE **\$5.00**
 TAX INCLUDED POST PAID

OK's CO₂ IGNITIONLESS ENGINE ¾ OZ.

No Spark-Plug • Gasoline; No Coil (Wiring), Batteries
 Smallest, lightest expansion-type, reciprocating-action power plant. For model planes (Tractor or pusher types) Race Cars, Speed, Boats, CO-2 delivers spectacular power-to-weight; 7000 RPM; 20 to 60 sec. runs from single carbon-dioxide cartridge. Positive "dip" starting, speed adjustable. 1 pc. steel cylinder, fitted piston-precision to 1/10,000".
 Displ. .0178 Bore .275 Stroke .300
 CO-2 is made & gtd. by makers of 'OK' TWIN and other palm size gasoline engines. At hobby dealers or write factory.

Complete With Holder **\$7.50**

HERKIMER TOOL AND MODEL WORKS, INC.
 ats. Pend'g. Herkimer 4, New York

Cut NEW TEETH in 3 Min.

With FOLEY RETOOTHER

For All HAND SAWS

No need to grind off old teeth — cut new ones over them. Fast, accurate, no eye-strain. Cuts filing time in half.

Cuts 20 sizes of teeth from 4 to 16 points per inch. Immediate delivery

FOLEY MFG. CO.
 890-7 Foley Bldg., Minneapolis 18, Minn.
 Send full details on Foley Retoother.

Name.....
 Address.....

LOW PRICED
FOR THE FIRST TIME IN YEARS!

REGULAR \$2345 VALUE
NOW ONLY \$14.95

Real fractional horsepower AC-DC Electric Motor

FAMOUS CASCO POWER WORKSHOP
 New portable all-purpose Electr-O-Tool Kit FOR MECHANICS, HOBBYISTS, HOME CRAFTSMEN

Works on wood, metal, glass, plastics, leather. Long life, powerful 20,000 RPM motor in unbreakable plastic case, oil-less bearings, air-cooled. Exclusive built-in finger grip for perfect control. Fully guaranteed. 20 interchangeable precision-made accessories in fitted chest. Free descriptive literature on request.

SPECIAL LOW PRICE OFFER
 Price of power tool alone \$14.95
 20 accessories and valuable Project Book 8.50
 Total Value **\$23.45**
ALL 21 PIECES FOR ONLY \$14.95



CASCO

See Casco's other big value: Casco Electri-Craft Power Tool Kit, complete with 36 accessories in fitted steel chest. \$32.95 value for only \$22.50.

CASCO PRODUCTS CORPORATION • BRIDGEPORT 2, CONN.

Have

Lovelier Floors...

with Less Care!

You'll enjoy new freedom with Self-Polishing SIMONIZ on your floors. The same durable long-lasting brilliance that makes SIMONIZ so famous for cars saves you lots of work... your floors clean up sparkling beautiful with a damp cloth.

Shines
as it
Dries



Self-Polishing
SIMONIZ
For Floors

to desert Square Handkerchief for another likely reef, known as Telegraph, a shrimp boat caught their attention.

"That's the life—shrimpin'," said Dorian "Tack" Romer, who has fished the Gulf for 23 years.

His fellow crewman, Joe Senseney, nodded agreement. "One drag with the big shrimp nets takes about four hours," he explained. "That's four hours when all you have to do is just sit. Then you pull her up and maybe you got 40 barrels of live gray shrimp."

Tack laughed. "Yeah, and maybe a shark or two to add to the excitement."

Sharks often play havoc with shrimp nets, tearing great rents in them in their wild efforts to escape. The big 65-foot shrimp boats, such as the Olivia Mavar and Pan American Clipper of the Mavar fleet, use a fishing gear known as the otter, or shrimp, trawl. The net is in the shape of a long bag and varies in width from 30 to 100 feet. Wings of netting at each side guide the shrimp into the bag while the "otter boards" at the end of each wing keep them stretched apart and force the net down. Towlines are fastened to the boards.

The Gulf provides practically all of the shrimp consumed in the U. S. with an annual catch of 150,000,000 pounds. Shrimp vessels are equipped to stay at sea for 12 to 14 days. The larger boats are powered by 120-horsepower Diesels, carry two-way radio and the most up-to-date navigating devices. The fishing captains, who know every reef and marker from Mobile to New Orleans and who have spent most of their lives in the open waters of the Gulf, regard these modern aids with a tolerant grin.

The big Diesel shrimp boats must carry 20 tons of crushed ice to keep a 250-barrel cargo fresh. This is a costly nuisance with which oyster fishermen do not have to bother. Oyster fishing ends before the hot summer weather and during the spring season oysters will keep in their shells on deck or in the holds for about a week.

The best shrimp-fishing grounds in the Gulf, Captain Langlinois explains, are 10 to 20 miles off the Louisiana shores near the mouth of the Mississippi River. Here is where the 8 to 10-inch "jumbo" shrimp were discovered by the Fish & Wildlife Service a decade ago. Before that time no one knew where the Gulf shrimp disappeared after they had spawned.

Compared with oysters, shrimp grow rapidly and reach marketable age in a few months. They spawn but once, at the age of about one year, and then retire to the shoals where they grow to jumbo size and die in

(Continued to page 244)

A GREAT SURPLUS BARGAIN REDUCING GAUGE

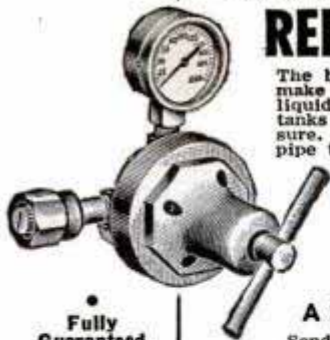

The buy of a lifetime in a standard make air pressure regulator. Used on liquid carbonic tanks and air pressure tanks of all kinds to regulate the pressure. Fitted with standard 1/2 inch pipe thread. Dial calibrated 0 to 200 lbs. Made by U. S. Gauge, Air Reduction Co., Walter Kiddie—all famous makers. Used by artists for air brush work, sign painters, retouchers, welders, etc. Used by soda fountains and taverns. All units are brand new. Satisfaction guaranteed.

A \$15 VALUE **\$5.95**

Send check or money order. Ship same day.

GROBAN SUPPLY CO.
1522 S. Michigan Ave., Dept. PMS, Chicago, Ill.

Fully Guaranteed

All Brand New and in Perfect Condition

NEW TOOL READY

QUICKLY SHAPES, SANDS, CARVES, PROFILES, BANDSANDER
GRINDS, BEVELS, SMOOTHS, POLISHES, CLEANS!
Industry's most versatile machine—THE MEAD BANDSANDER—now available to hobbyists, craftsmen, model makers, pattern makers, home workshops—cuts fast and clean on wood, metal, plastics! Works equally well on inside cut-out openings or irregular outside edges, on intricate scrolls, curves. Saves hours of tiresome hard work—does better job. Nothing else like it. IDEAL TO GIVE OR GET FOR WORKSHOP! Sold on 5 Day's Trial, money back GUARANTEE.



FREE!

Write for free, lavishly illustrated Circular describing how Bandsander—the machine that amazed the experts—saves time, money, trouble. Write now—a post card will do!

MEAD SPECIALTIES CO.
4114 N. Knox Ave., Dept. 187, Chicago 41, Ill.



MOTORS

110 VOLT — 60 CYCLE
HEAVY DUTY
CONSTRUCTION

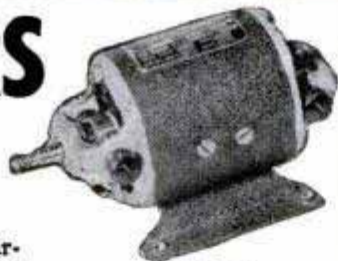

Your price

\$4.95

Fractional H.P. ball bearing—brand new. Ideal for power tools, fans, models—100 other uses. \$15.00 value.

In Lots of 10 \$4.50 ea.

ALL PRICES F.O.B. N. Y. CITY
REMIT 20%—BALANCE C.O.D.

MANUEL KLEIN 74 CORTLANDT ST.
NEW YORK 7, N. Y.



BE FAIR
TO YOUR
Hair

WAKE UP YOUR SCALP Want better looking hair? Embarrassed by falling dandruff, itching scalp? Then try VITABRUSH, new electric driven scalp brush that gives your scalp a vigorous and invigorating "workout" in just three minutes of fun. Cleans scalp. Stimulates blood supply. Restful. Pleasant. Write today for complete information and satisfaction-guaranteed offer. Hershey Mfg. Co., 3755 Field Bldg., Chicago 3

AUGUST 1947

FREE!



SEND FOR
ALLIED'S
BIG 164-PAGE
RADIO
CATALOG

Everything in Radio at Lowest Prices!

Here is *everything* you want in Radio! New home radios and phono-radios. Ham receivers and gear, new kits, thousands of parts, tubes, tools, complete PA equipment, diagrams, latest radio books. The most complete stocks anywhere—in one *big* book—all at money-saving low prices!

POPULAR MECHANICS RADIO KITS



"LITTLE GIANT" SUPERHET. Model R-353. Latest 5 tube Popular Mechanics AC-DC receiver. Features "permeability" tuning. Covers full broadcast band. Sliderule dial. Permeability tuned coil assembly and IF transformers are supplied preset. Mounts on punched steel chassis, 1 1/2" x 10" x 5", ready for easy assembly. With 5" PM speaker, tubes, all parts and blueprint. Wt., 8 lbs.

No. 83-678. NET ONLY..... \$19.95

No. 98-931. Attractive walnut-finished wood cabinet for above kit. Wt., 3 lbs. NET..... \$3.95

10-WATT PHONO AMPLIFIER. Model R-331. A famous Popular Mechanics kit. Ideal for record playing or for use with FM or AM tuner. Resistance coupled circuit uses 5 tubes. Has inverse feedback for quality reproduction. High impedance input for crystal pickup. Includes all parts, punched chassis, blueprint and tubes. Wt., 15 lbs.

No. 83-675. NET ONLY.. \$30.95

GET THESE VALUABLE ALLIED RADIO BOOKS!



Radio Formulas & Data No. 37-752...10c
Dictionary of Radio Terms No. 37-751...15c
Radio Circuit Handbook No. 37-753...25c
Radio Builders' Handbook No. 37-750...15c
Simplified Radio Servicing No. 37-755...10c
Radio Data Handbook No. 37-754...25c
ALL 6 BOOKS above No. 37-799.....\$1.00
Parallel Resistance and Series Capacitance Calculator. No. 37-980...25c
R-F Resonance and Coil Winding Calculator. No. 37-955.....25c

ALLIED RADIO

ALLIED RADIO CORP.
833 W. Jackson Blvd., Dept. 5-H-7
Chicago 7, Ill.

FREE CATALOG

- Rush FREE 164-page Catalog
 Send Kit No. 83-678
 Send Kit No. 83-675
 Send 6 Books No. 37-799

} \$.....enclosed

Name.....
Address.....
City.....Zone.....State.....

TRUCK BUYERS!



Here's America's Lowest-Cost Transportation... the great, new

CROSLEY

a FINE car

You can save money with the new, fine Crosley! Get 35 to 50 miles on a gallon of ordinary gasoline! Both the new Crosley Pick-Up Truck and the Crosley Sedan are more maneuverable in traffic (20 inches narrower at the fenders than most cars); park easily in "impossible" places!

FOR YOUR SALESMEN—The comfortable 4-Passenger Sedan is ideal for salesmen and for light delivery. Plenty of leg-room for 4 huskies—ample baggage space—seats are removable. Plenty of speed, power, pep. All-steel body, extra low center of gravity. America's lowest price car—lowest operating costs as well!

FOR LIGHT HAULING—The Crosley Pick-Up Truck has steel body, full quarter-ton capacity; steel drop tailgate. Big, roomy cab. Plenty of power, too. Can operate inside the plant. America's lowest price, lowest cost truck!

NEW CROSLEY COBRA ENGINE (Copper BRAZED) Weighs only 59 lbs. All steel, copper brazed. 4 cylinder, valve-in-head, water cooled. Most revolutionary development in 40 years. Delivers 26.5 horsepower; 35-50 miles per gallon; speeds to 60-plus! Precision-built for long, trouble-free operation. Get facts and figures today!

See your local Crosley Dealer or write for full information.

CROSLEY MOTORS, Inc.

2532-HC Spring Grove Ave., Cincinnati, 14, O.



STOP LEAKS!

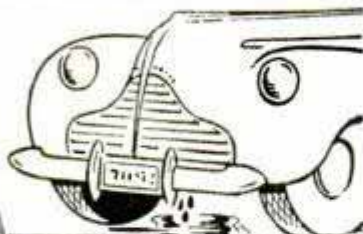

Cooling Systems
Made Leak-Proof QUICKLY

WARNER LIQUID SOLDER—Non-Metallic—Deposits Tiny Fibers to Repair Leaks Anywhere in Cooling Systems. Simply pour in! Finds and REPAIRS every crack or hole. Do it yourself—or see your service man.

Warner-Patterson Co., 920 S. Michigan Ave., Chicago 5

PLANS FOR 5 PROJECTS

that are fun to build

— only
\$1.00
postpaid

Special combination offer includes easy-to-read

plans for: 1. Folding Lawn Chair
2. Child's Teeter Tottler 3. Child's Glider Swing
4. 24-room Swallow House 5. Bird Feeder
Mail your dollar bill today! Ask for Package "Z".

DELTA MANUFACTURING DIVISION
Rockwell Manufacturing Co.

680-H E. Vienna Ave., Milwaukee 1, Wis.

Deltacraft®

ACTION

FOR YOUR MECHANICAL CONSTRUCTION SETS

Here's a low cost electric motor to operate your mechanical construction sets—cranes, windmills, etc. Looks and runs just like a big motor, using 2 flash or dry cells or 5 volt AC. "Junior Genius" Motor with windmill plans...\$2.00. "Junior Genius" Motor Kit (you build it yourself, no soldering) \$1.50. Shipped prepaid for check or money order, or C.O.D.



junior genius

228B No. Front St., Burbank, Calif.

THE GEM MAKER

Amateurs or professionals... hobbyists or jewelers... Polish your own gems with a B&I Gem Maker. You will find this a profitable adventure. All necessary lapidary equipment is furnished, including a super-charged diamond blade for sawing, and all wheels for grinding, shaping and polishing, also complete instructions. The complete equipment as shown, less motor and belt, for only \$29.50, f.o.b., Burlington, Wis. Write today for information and literature on the Gem Maker and accessories.

B&I MFG. CO., Dept. S, Burlington, Wis.

DUAL TAIL PIPE EXTENSION FOR YOUR CAR. \$2.95
DEEP TONE,
PRODUCED BY 2 1/2 IN. OUTLETS
Chrome Plated -- Fits All Cars
Postage Free on Money Order, Check or Cash
PAT. PEND. LYONS PRODUCTS Co. 2319 Ridgeley Dr. Los Angeles 16, Cal.

LAW

STUDY AT HOME FOR PERSONAL SUCCESS and LARGER EARNINGS. 39 years expert instruction—over 108,000 students enrolled. LL.B. Degree awarded. All texts furnished. Easy payments. Send for FREE BOOK. G. I. approved. **AMERICAN EXTENSION SCHOOL OF LAW** Dept. 80-M, 646 N. Michigan Ave., Chicago 11, Ill.

Assemble KING MIDGET



Practical highway racer runabout. New model. We supply all parts. Just bolt together. Low cost. Ready for delivery NOW. One or two cylinder, 40 m.p.h., up to 100 miles per gallon. Send 25c for complete new literature with large picture, 4-view drawings, price of parts, or send \$1 (refunded with first order) for the above, plus 24-page assembly book with 42 photographs and drawings.

MIDGET MOTORS, Athens, Ohio



LUMINALL
Paint does more
for rooms and
furnishings

LUMINALL,
in lovely
new colors,
brightens
your home
at low cost.
At your dealer's.

Its purer colors
give better
lighting



LUMINALL PAINTS, Chicago 9, Illinois

PRESS-TITE CAULKING AND SEALING CORDS



Keep cold out!
Seal holes and cracks!

Soft, rope-like Press-Tite Cords effectively seal windows and doors against cold and dust. Save fuel.

Press-Tite Cords will not harden—they stay soft and seal tight. Use also to fill any cracks or holes in wood, plaster, masonry or brick. Just press into place—no tools needed.



PRESSTITE ENGINEERING CO.

3978 Chouteau Ave., St. Louis 10, Mo.

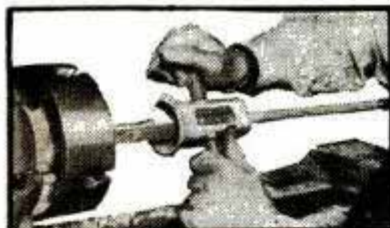

DOWELS

Make Your Own And
SAVE

No wanting or waiting for mahogany, cherry, or any dowel with SPEE-DOWL. Let this amazing tool start saving its cost now.

FREE LITERATURE

on this and new never-dull carbide tipped wood-turning tools. **WRITE TODAY!**

Model 8 (not shown), 2, 3, 4, 5, 6, 7 & 8/16". Only \$1 each size. SPECIAL: 4 for \$3.50; 7 for \$6.
Model 20 (shown) \$2.65 each size—9 to 20/16". All 12 for \$25.
Unconditionally guaranteed. Postpaid in North America.

JOHNS MFG. CORP. DEPT. C-11 DUNELLEN, N. J.

**BE
YOUR
OWN
BOSS**

Men and women make up to \$100.00 or more a week! Design and fit corrective arch supports by the time-tested Stephenson Method. A profitable, full or part-time, profession. Train at home; pay as you go. No costly equipment to buy. No capital needed. Send for FREE booklet today.

STEPHENSON METHOD, 12-28 South Market St., Boston, Mass.

DIE-LESS DUPLICATING

Many small parts can be formed without dies, to duplicated accuracy of .001" with DI-ACRO Precision Machines. — Benders, Brakes, Shears. Save die expense and time delay. Ideal for experimental and research work, making samples, models, etc., as well as regular production runs. Write for descriptive literature.

O'Neil-Irwin Mfg. Company
341 8th Ave.
Lake City, Minnesota



SHEAR



BENDER



BRAKE



there's always a JOB FOR FILES

A new back is needed for a plank-bottom chair . . . a drawer or a door sticks . . . there's a saw to be sharpened or a home-appliance part to be fitted—jobs like these are always cropping up around the house. Then, too, there's "the other kind" of jobs: those done for the sheer satisfaction of creating—like building a working model . . . finishing up a workshop project . . . making toys and games for the kids.

Yes, there's always a job for files. That's why it's a good idea to keep a popular assortment of Nicholson or Black Diamond files on hand. Then, for both hobbying and repairing, you can be sure of choosing and using *The right file for the job*. Your hardware dealer has them—or can get them—in cuts, shapes and sizes to meet your every need.

Write for Free Book, "FILE PHILOSOPHY"

NICHOLSON
U.S.A.

NICHOLSON FILE CO.
22 Acorn St., Providence 1, R. I.
(In Canada, Port Hope, Ont.)



NICHOLSON FILES

FOR EVERY PURPOSE

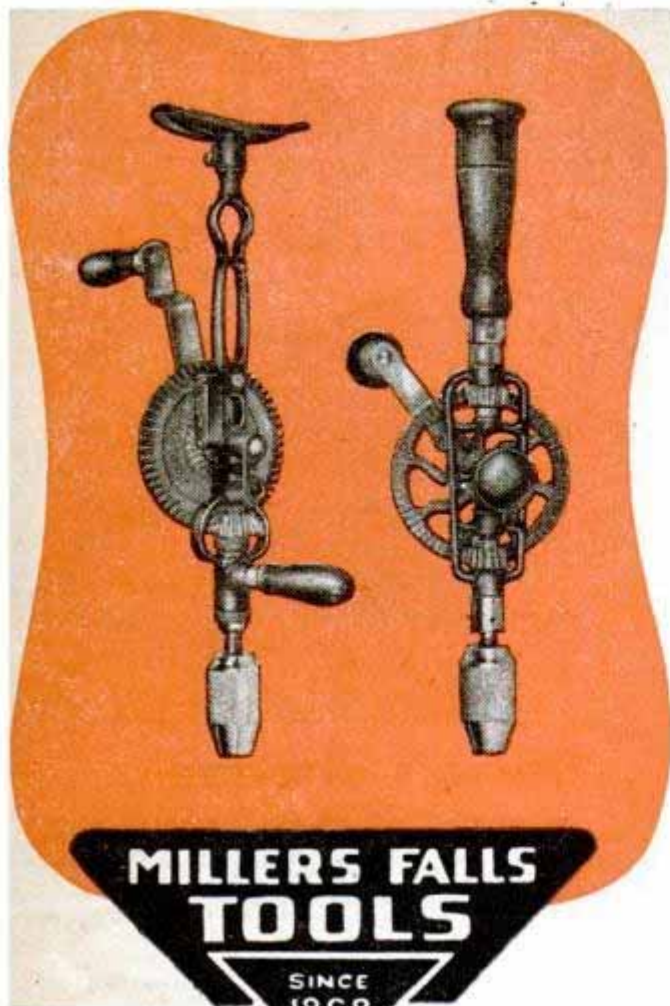

THE MARK OF QUALITY

Hand drills, breast drills, any of the wide variety of tools with the Millers Falls trademark have one thing in common—quality. Built to rigid standards of excellence Millers Falls tools, for nearly 80 years, have demonstrated their ability to do their work quickly, easily and economically.

Whether it's a drill, plane, brace, screwdriver, or some other tool, you'll find one that fits your needs in the Millers Falls lines. But be sure to look for the familiar Millers Falls trademark. It's your guarantee of quality and satisfaction in the tools you buy.

**MILLERS FALLS
COMPANY
Greenfield, Mass.**

about another year. The catch of jumbo shrimp is hailed as particularly valuable because it has increased the yield by millions of pounds without endangering a new crop of this most popular shellfish. Morgan City, La., a fisherman's boom town since 1937, processes 20,000,000 pounds of jumbo shrimp a year.

With native pride, Captain Langlinois reports that Biloxi is the big oyster-canning center of the world with an annual production of about 1,200,000 seven-and-a-half-ounce cans. Another major product of the Gulf and South Atlantic fisheries is crab meat with an annual yield of 33,000,000 pounds. However, more menhaden is caught in this area than all other species of fish and shellfish combined—250,000,000 pounds. This fish is little known to the public because almost the entire catch is used to make oil and meal, the latter a favored food for poultry and livestock. The menhaden is found all the way from Nova Scotia to Florida and the total U. S. annual catch is 600,000,000 pounds.

The big Florida fisheries produce by far the greatest and choicest varieties of fish: mullet, red snapper, Spanish mackerel, kingfish, bluefish, sharks, grouper and redfish. The smaller fisheries supply the market with spiny lobsters, pompano, blue runner, sheepshead, jacks and clams.

The thriving 21-year-old Mavar Company at Biloxi presents a typical setup for shellfish packers. The layout includes a small U-shaped harbor always full of boats waiting to unload or set forth on fishing trips, a newly completed canning plant with oyster and shrimp piers extending out to the boats, two dry docks, a boat building where at least one full-sized vessel is always under construction, warehouses and office building.

As the Elroy, with bins and hold crammed with oysters, makes its way toward the Mavar wharf of a spring evening, the tired crew loaf on the afterdeck. They talk about "layoff" time in the early part of the summer before the heavy shrimping begins. The favorite vacation sport of the crew is—you guessed it—going fishing! But not for oysters or shrimp, and not with dredge or net. Their choice is trout and they find some big ones, Joe says, in the waters near Cat Island about 30 miles out from the Bay of Biloxi.

"We sure missed our boats and fishing during the war," says Elmer Alleman. "All of us except Tack, who's too old, were in the Army. Although we sure tried hard, none of us could get in the Navy." He grinned. "Guess we didn't know enough about boats."

RADIO SERVICE KITS

all NEW parts • STANDARD BRANDS only • we are DEPENDABLE

- #101—Volume Controls—25 asstd carbon & ww; 5-20 megs. \$4.95
 - #102—Tube Sockets—40 asstd wafer-moulded-mica 4-8 pr. 2.95
 - #103—Mica Condensers—100 asstd .00001 to .01mfd/300-600 V. 4.95
 - #104—Circuit Selector Switches—25 asstd (2-24 positions) 6.25
 - #105—Wirewound Resistors—40 asstd fixed & adjustable; 5-100 V. 6.95
 - #106—"AC" Switches—15 asstd Toggle-Rotary-Push-Micro 4.45
 - #107—Precision Resistors—100 asstd carbon & ww; 6 ohms to 10.0 megs; 1/4 to 2% tol. 14.95
 - #108—Carbon Resistors—100 asstd 1 ohm to 10.0 megs; 1/2 & 1 W. 2.50
 - #109—Dual Potentiometers—10 asstd carbon & ww; 20 ohms to 2.0 megs. 5.95
 - Also: Westinghouse & GE METERS 0-1 ma DC; 3" square, 1000 ohms per volt. 3.95
 - 60" Voltmeter Test Leads (Mueller); Ban/All. .95
 - #110—Power Rheostats—10 asstd 10 to 15K ohms; 25 W. 9.95
 - #111—Electrolytic Condensers (in cans) 20 asstd; 4-2500 mfd/10 to 600 V. 9.95
 - #112—By-Pass Condensers 50 asstd .0005 to .5 mfd/200 to 800 V. 2.95
 - #113—Knobs 50 asstd Bar, Pointer, Instrument, Panel etc. 3.95
- Every Radio "Handyman" Needs These Basic Kits!
25% deposit required. Add 25c for postage & handling
Alamo Radio Sales, Dept. PM, 161 Washington St., N.Y.C. 6, N.Y.

DIG HOLES SITTING DOWN

The Danuser Digger attachment for most popular makes of tractors—easily installed—one-man operation. Digs straight holes 500 to 600 per day. 4" to 18" augers for Post and Seedling holes. Tractor owners make extra money digging holes for neighbors. Write for details. Dept. P.



DANUSER MACHINE CO., Fulton, Mo.

AMAZING NEW WOOD PRESERVATIVE • DOUBLES LIFE OF LUMBER AND MILLWORK

COP-R-NAP offers a simple, easy and inexpensive method of preserving, protecting and greatly increasing the life of all types of lumber...porch flooring, fencing, sills, joists, sash and millwork, rope, sails, tarpaulins, boat planking and framing. Prevents decay, kills fungi, mildew and "blue stain". Easy to apply by dip, spray or brush methods. 1 Gal. treats 400 sq. ft. of wood. Paint right over it, makes paint last longer. Order a trial gallon for only \$3.00 post paid anywhere in U. S. Big discounts on larger quantities. Osmose Wood Preserving Co., Dept. M., 1437 Bailey Ave., Buffalo 12, N.Y.

BUILD ARC WELDER FROM OLD GENERATOR

For Light or Heavy Work. 75-200 amperes. Complete PLANS 35c. Send today and we'll include FREE our Big NEW Catalog.

LEJAY MANUFACTURING CO. 1347 LeJay Bldg., Minneapolis, Minn.



BUILD YOUR OWN TRAILER

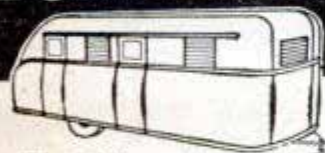

Get these Modern Complete Plans

Select just the model you want—for hunting—travel—camping—or as a home. Each plan is complete with simple, step-by-step instructions and a bill of materials. Easy to follow. Three models!

STOCK No. H27 NATIONAL MODEL 27. A sleek 27-foot trailer with 3 rooms, lavatory, etc. Sleeps six. complete plan \$1.00

STOCK No. H20 NATIONAL MODEL 20. A good-looking, easily-built 20-ft. trailer. 3 rooms, sleeps four. complete plan \$1.00

STOCK No. H10 NATIONAL CAMPER. A compact unit for travelling, camping, hunting, fishing. Sleeps two. Complete plan .50

Special—Order all 3 of above plans.....\$2.00

FREE! Big parts catalog with any order

NATIONAL TRAILER STORES

Dept. 10 Box 2353 Terminal Annex - Los Angeles 54, Calif.

GET THERE

SAFE!

35 MILES-PER-HOUR TOP SPEED!

Servi-Cycle ... America's only complete powercycle...far exceeds every I. P. A. safety rule. America's safest powercycle.



GET THERE and

SAVE!

100 MILES TO THE GALLON!

Servi-Cycle slashes travel, delivery expense up to 75%. Cost: just a fraction of a cent for every mile you drive.



GET THERE

EASY!

SIMPLE TO DRIVE—LIGHTWEIGHT!

Servi-Cycle handles easy as a bike. Rugged engine and sturdy frame are single unit. Thousands of satisfied owners, since 1931.



GET A

SERVI-CYCLE!



\$249.50 DELIVERED
Slightly higher on East and West coasts
SEE IT! TRY IT!
at your Dealer's

For Name of Dealer,
See Phone Directory or Write to Nearest Servi-Cycle Factory

NEW ORLEANS 19	SAN FRANCISCO 24	BALTIMORE 30
540 N. Carrollton Avenue	1821 Egbert Avenue	1205 South Carey Street



'QUICK-CHANGE' GEAR BOX

CUT THREADS — 4 TO 224 PER INCH

Approximately .003 feed, for fine turning.
 New reverse furnished with box for Atlas.
 Bronze bearings throughout entire unit.
 Aluminum casting — All steel gears.
 Maintained accuracy.
 Speeds up production.
 Easy to install.
 Simple to set.
 Immediate delivery.

Only **\$75⁰⁰**

F.O.B. Chicago
 Guaranteed

FOR- Atlas, Logan, Craftsman
 and Power-Kraft Lathes

Write for information or order direct. Full instructions with shipment.
 O'BRIEN MACHINE CO., Sales Dept. PM, 1620 Highland Ave., Chicago, Ill.



DRILLS CAN'T FALL OUT!
SHAKE 'EM!
UP-END 'EM!

RUBBERGRIP DRILL HOLDER and GAGE

Drills cannot fall out even when holder is shaken or turned upside down.

Has rubber base with metal gage top.

- HOLDS 18 DRILLS
- SIZES 1/16" TO 21/64"
- SIZES APPEAR IN BOTH DECIMALS AND FRACTIONS

SEND ONLY
\$1⁰⁰
 FOR
 HOLDER
 (Post paid)

GALE & POGUE
 4128 FULLERTON AVE. • CHICAGO 39, ILL.

BRAND NEW SOLID BRASS 12 FT. PORTABLE

RADIO ANTENNAS

Real \$15 Value Now Only \$4.95 Postpaid
 FOR HOMES, BOATS or AUTOS

JUST OUT! Gov't surplus used on Army tanks. These telescopic rustproof antenna have tremendous pickup eliminate dangerous wiring. Solid Brass throughout practically insuring **NOISE FREE RECEPTION.**



12 Exceptionally Rugged Sections
 compress into 1 ft. 4 in. Handy for Camping Trips, also Useful for Transmitting, FM & Television sets. Each antenna comes with clamp, nut, lug, and wire. Easy to install anywhere.

QUANTITY LIMITED
ORDER TODAY. A real \$15 value for only \$4.95 Postpaid. Mail check or money order now or sent C.O.D. plus postage. Money back in 10 days if not satisfied.

RADIO HOSPITAL 1113 Lexington Ave., Dept. A-8 New York 21, N. Y.

148 PAGE WOODWORKERS CATALOG

ONLY 15 CENTS - REBATED ON FIRST ORDER

SHOWS IN NATURAL COLOR
 22 inlay and overlay insets
 32 veneer bandings—matched woods
 30 kinds of world's finest woods in character grains and color
 31 moulding, rosettes, ornaments and home wood working labor-saving tools and hard-to-find hardware
CRAFTSMAN WOOD SERVICE CO.
 2729 S. Mary St., Dept. A-84, Chicago 8, Ill.

LISTS OVER 300 PIECES OF ARTISTIC FURNITURE SHOWN
 including cost of plans, lumber, hardware and finishing material, choice of MAHOGANY, WALNUT, BIRCH or MAPLE LUMBER-PLYWOOD- VENEERS UNEQUALLED BARGAINS
 Make beautiful furniture at only 20% store prices.



AMAZING NEW FLYING WING

ANYONE can make a scientific flying wing model in 5 minutes at a penny cost. No glue—no balsam—no mess—only two parts. Glides and soars. COMPLETE ILLUSTRATED INSTRUCTIONS, full sized patterns (4 different models), material for 12 Flying Wings. Free "Sky Hook" data for experienced builders. \$1.00 postpaid, currency, money order or C. O. D.

WINGS RESEARCH 614-618 S. Minnesota Wichita 9, Kansas
 "The Air Capital of the World"



WRITE FOR YOUR FREE COPY OF THE NEW KRW HYDRAULIC PRESS BOOK

Describes all manner of Production and Shop Work on KRW Hydraulic and Bench Type Arbor Presses. 32 pages illustrating the new KRW Hand-operated, Electric-operated and Air-operated Hydraulic Presses.
 Write for your copy today.



K. R. WILSON, DEPT. 17, 215 MAIN ST., BUFFALO 3, N. Y.
 Builders of Shop Equipment for Ford Dealers Since 1916

CHANGE BLADES IN 10 SECONDS

Without opening the case



QUICK-CHANGE BLADES are featured on all Carlson Rules. CHIEF is available in 6-, 8- and 10-foot lengths; WHITE CHIEF and HOBBY in 6- and 8-foot lengths. Keep a "spare" replacement blade on hand.

SOLD BY LEADING HARDWARE DEALERS



CARLSON STEEL TAPE RULES



MINIATURE ENGINES

Gasoline—Steam
Air—Locomotive



THE WORLD'S
MOST FASCINATING HOBBY

Build them yourself — In your own shop
With your own tools



Send 10 cents for my illustrated catalogue listing the world's largest selection of miniature engine castings and drawings.

McADED MODELS
1313 S. TALMAN AVE.
CHICAGO 8, ILLINOIS

SELF-CONTAINED - COMPLETE SPRAYING OUTFIT

No hose or elec. cords; no pumping



Completely self-contained, portable spray gun—fully guaranteed. Sprays paints, enamels, insecticides. For home, workshop, garden, farm. For pressure uses a CO₂ Cartridge available at all drug stores at 10c or less. One cartridge will spray one quart. Complete, ready for use; with one cartridge.

Price, postpaid\$18.50

SULLIVAN-BECKER 6705 14th Ave.
Kenosha, Wisconsin



handy SPRING kit

ASSORTED SPRINGS Compression, extension, torsion. Same quality as used in industry. Several dozen springs in kit. Send check or money order, Dept. B
NEW ENGLAND SPRING MFG. CO.
Unionville • Connecticut

\$1.10
Postpaid

MAKE BIG MONEY!

Be a floor surfacing contractor and sand both new and old floors. Sanders are easy to operate and better still, you're your own boss. Write for latest "tell-all" booklet entitled "Opportunities in Floor Surfacing", enclosing 25 cents in coin or stamps to cover handling.

AMERICAN
FLOOR SURFACING MACHINE CO.
235 So. St. Clair Street - Toledo 3, Ohio

ONE TON "BITE"

BERNARD Parallel Action Pliers—with the "ONE TON BITE"—have the cutters on the outside of the head, easy and convenient to use. Jaws close parallel, like a vise, hold tight, won't slip. Average grip exerts one ton of pressure!



ONE TON

<p>BERNARDS</p>	<p>ORDINARY PLIERS</p>	
<p>BERNARDS work like a wrench. Parallel jaws fit snug on nut.</p>		<p>Cutters on outside of head. Easily cuts baling wire.</p>
<p>Compound leverage doubles gripping power. 6 1/2" size cuts 8-penny nail.</p>		<p>Breaks glass perfectly. Jaws close flat against glass.</p>

At your local hardware store... Send for complete catalog

FAITHFUL  QUALITY SINCE 1870

BERNARD

TRADE MARK REGISTERED

WM. SCHOLLHORN CO.
7508 Chapel Street, New Haven 9, Conn.

USE AC's FOR
**UTMOST
RELIABILITY**

"The mail must go through"—and does, with the help of today's AC's in thousands of mail cars and trucks. You can enjoy utmost reliability in spark plug performance by having your spark plugs checked to be sure they are right for today's driving and fuels.



Look for this sign



Spark Plugs cleaned and adjusted "By the AC Method" may save as much gas as 1 gallon in 10



**AC
SPARK PLUGS**

AC SPARK PLUG DIVISION • GENERAL MOTORS CORPORATION

Muscle Men of America

(Continued from page 140)

about an hour and a half after your meals.

It is important to exercise regularly every other day—seven times during a two-week period. The length of the exercise period will depend upon what you wish to accomplish. From 5 to 15 minutes will do wonders for the busy person who merely wants to keep in good physical condition. For those who want to concentrate upon building up their muscles and entering weightlifting contests, from 30 to 60 minutes with the weights is recommended. Three months' regular practice should show marked improvement.

At present, weightlifting is a young man's game. Perhaps 65 percent of those engaged in the sport are under the age of 21. But with barbell exercises you can improve until the age of 50, stay at your peak until around 60 and be in better shape than many men half your age. At the age of 60, for example, John Y. Smith won the title of Strongest Man in New England.

Women, too, are taking up weightlifting to keep in physical trim and to remove avoirdupois. Claudette Colbert, Dorothy Lamour, Paulette Goddard and Joan Bennett keep in shape by a program of weight exercising. In a few instances even women are entering weightlifting contests. We have held several weightlifting contests for women in Los Angeles in recent months.

Weightlifting as a sport has grown enormously in the last few years. It was getting a good start before World War II and, in the two years of peace, has caught public interest. Local, state and national weightlifting contests draw thousands of spectators.

Originally the idea was to lift the greatest amount of weight over your head—regardless of how you got it there. Huge men with considerable excess flesh and large stomachs would hoist a tremendous weight to the chest in from two to four struggling movements and then jerk it overhead.

A modern weightlifting contest, however, puts more emphasis on skill and allows those with less weight and a somewhat more symmetrical figure to compete in their weight division. Weightlifters are divided somewhat like boxers: featherweights, lightweights, middleweights, light-heavies and heavyweights.

The three standard types of lifts are:

(1) The two-arm military press—in which the weight is pulled to the chest with two hands and then, holding the body erect, or in the military position, is pressed to arms' length overhead.

(Continued to page 252)



There's a "Four" for YOU—



—just right in size, power, performance . . . in Evinrude's complete line of 3 thrilling four-cylinder models!

If you want a motor developing 5 horsepower or more — why not enjoy the *extra* smoothness — the *extra* thrill of performance — *that are yours with an Evinrude "four"?*

There's nothing like them — for any boat, or any kind of service! No other type of outboard motor to match their velvety surge of power, their responsiveness and flashing get away!

See your Evinrude dealer — look for his name under "Outboard Motors" in your classified telephone directory. Catalog of the complete Evinrude line of 7 models sent on request. Write for it today—address, EVINRUDE MOTORS, 5605 North 27th Street, Milwaukee 9, Wis.



EVINRUDE "ZEPHYR"

A smooth-as-silk four in "every man's" size—bringing light motor performance to a new level of smooth and spirited action. A favorite for powering fast dinghies and for auxiliary power on sail boats up to 25 feet. Develops 5.4 O.B.C. certified brake H.P. at 4,000 R.P.M. Write for the Evinrude catalog.

EVINRUDE
FIRST IN OUTBOARDS • 38TH YEAR

In Canada: Evinrude Motors, Peterboro, Ontario.

GOVERNMENT SURPLUS

Real bargain buys—priced 2 to 3 times below actual value! ALL NEW, never used U. S. Army and Navy items. Order now from this ad. Send check or money order. C.O.D. order requires 25% deposit. Include 5% postage on parcel post orders—overage promptly refunded. (All prices f.o.b. Chicago.) Each item guaranteed serviceable or money back.

CHICAGO OUTLET, INC.

Dept. P M 8
1618 W. Chicago Ave.
Chicago 22, Ill.



Herringbone Twill ARMY COVERALLS
of tough, durable O.D. twill. Four roomy pockets; adjustable sleeve cuffs, trouser bottoms; all-around belt with metal buckle. All sizes. A terrific value... only... **\$4.95**



NAVY RAINSUIT
Protects from wind, rain, sleet and spray. 2-piece type, with roomy flap pockets, lace-front jacket, draw strings at hood and bottom. **\$4.95**



PONCHO
Durable wear-resisting, water and windproof rubberized fabric. Protects against rain, sleet, snow. Ideal for ground cloth, shelter half, tarpaulin, etc. Reclaimed, like new. Excellent Condition. **\$1.99**
New... \$2.95

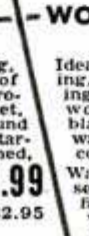

WOOL SLEEPING BAG
Ideal for fishing, hunting, camping and watching outdoor sports. 100% wool. Warmth of two blankets. Complete with waterproof poplin cover. Only... **\$4.95**
Waterproof poplin cover separate \$1.95. Comforter filled type bag complete with poplin waterproof cover... **\$12.95**

NAVY DECK JACKET

Rugged, comfortable Navy Jacket. Made of tough water repellent cotton poplin, lined with alpaca pile. Zipper front with button-flapped alpaca collar. Sizes 36 to 42. Priced 1/3 original gov't cost. **\$11.95**



T SHIRTS

Regulation Navy style. Light, white, cool cotton. Neat, comfortable, and ready for action. Sizes from 32 to 44... **79c**



Heavy Duty Blue Denim SHOP APRON

NAVY RAINSUIT

Navy-released—great for working around the house or shop. Two roomy pockets—one with divider. Only **\$1.49**



New SUN GLASSES

Air Corps Type

Protect your eyes with these attractive sun glasses. Gold plated—Ground lenses—

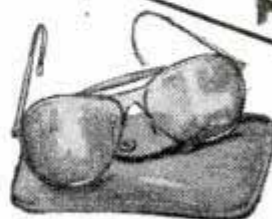

Each pair made to highest optical standards and completely guaranteed. Glasses meet all U.S. Gov. specifications for absorption of ultra-violet and infra-red rays.

4 Base \$8.00 Value for only... **\$3.95**

6 Base (Deep Curve Lens) \$12.00 Value... **\$5.95**
12 K. Gold Filled (60 Millimeter) \$15 Value **\$7.95**

Heavy Duty Black RUBBER RAINCOAT

The kind used by Firemen and Policemen. Sturdily made of slick black rubber with eyelet fasteners down the front. Collar reinforced with corduroy fabric. Sure protection in wettest weather... **\$6.95**

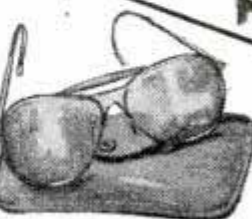

Larson

"MAKE YOUR OWN" BACKYARD GYM SET



ANOTHER NEW **LARSON CONSTRUCTION SET**

A complete outdoor gymnasium. Easy to construct from standard 2 x 4 lumber.

Complete with copyrighted instruction sheet and drawings. Parts built rigid for added safety. Everything furnished except lumber. Quickly taken apart for storage.

Set No. 2024 as illustrated—2 swing prepaid... **\$ 8.00**
Set No. 1524 Single swing—prepaid... **5.00**
Set No. 3024 2 swing. Trapeze and ladders—prepaid... **10.00**

CHAS. O. LARSON CO., BOX 358, STERLING, ILLINOIS

THIS IS THE BUSINESS YOU DREAM ABOUT

QUICK STEADY PROFITS

CORADIO

The Coin Operated Radio

IT'S the new, fast-growing, depression-proof business. Coin operated radios are

placed in hotels, tourist courts, clubs, hospitals, etc. on a commission basis—play 1 or 2 hours for 25c and produce immediate profits. The best coin operated radio is CORADIO

ACT NOW

Start your own lifetime business, full or part time. Send For Free Catalogue And Complete Information.

WRITE TODAY Dept. P. M.



CORADIO
COIN OPERATED RADIO
108 W. 31st ST. N. Y. 1, N. Y. WISCONSIN 7-5902

New Type OILER!
Just Squeeze-It SQUIRTS!

GOLDEN ROD SQUIRT PUMP OILER

You'll sure like this new-type, Pump Oiler! So much faster, cleaner, easier to operate than ordinary oil cans. Just Squeeze-IT SQUIRTS! Light finger-touch operates pump to discharge a drop or solid stream—in any position, even upward. Pumps out almost every drop. Ideal for every oiling use about home, workshop, garage, farm.

ORDER NOW from your dealer. If he hasn't it, send Back Guarantee. Get yours at once! **\$1.25**
DUTTON-LAINSON CO. Dept. S Hastings, Nebr.



SHOPMASTER *Tools*

Shopmaster tools are designed for accurate workmanship even under hard usage. Frames are of heavy cast aluminum alloys. Working parts are machined to extra close tolerances. Con-

trols are precise and easy to operate. All are quality tools, priced for the beginner yet fulfilling the requirements of master hobbyists and professional workers.



er Model 15-Inch
g Table Jig

(1) Saw—Meets every demand for exact working. Among its features are an improved blade holder, an efficient blower, large table capacity and a mechanism enclosed in oil for long life.

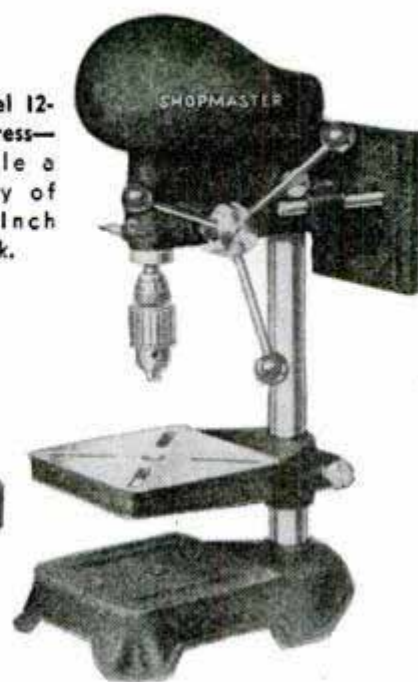

Master Model 12-Inch Drill Press—Will handle a wide variety of work. 1/2-Inch Jacob Chuck.



Master Model 12-Inch Tilting Table Band Saw—with many special features, fully enclosed mechanism, and sealed-for life ball bearings.

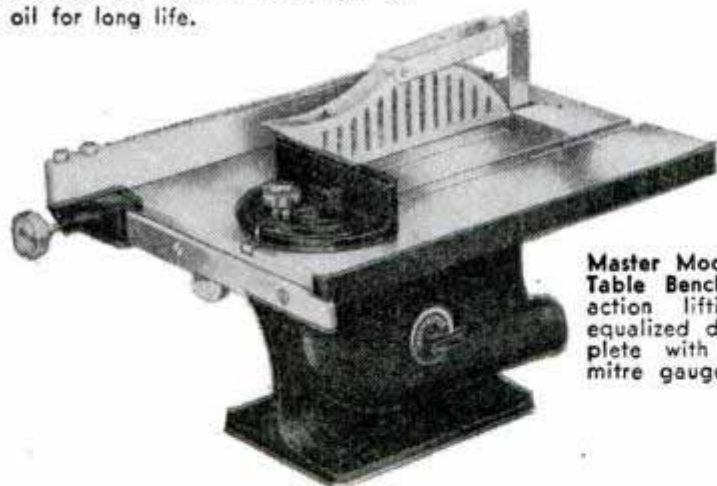

Master Model 8-Inch Tilting Table Bench Saw—with fast action lifting arbor and equalized drive. Sold complete with rip fence and mitre gauge.

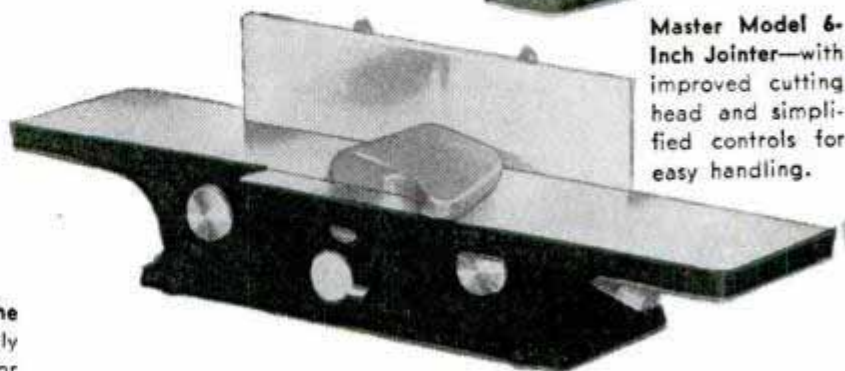

Master Model 6-Inch Jointer—with improved cutting head and simplified controls for easy handling.



Master Model 31-Inch Lathe—with 10-inch swing, rigidly built with 4-step-pulley for wide range of speeds.

See These Tools at the Better Stores or Write.



SHOPMASTER INC.
MINNEAPOLIS, MINN.

SHOPMASTER, INC.

1214 Third St. S. Minneapolis 4, Minn.

Pals...

your good right hand and
that good Stanley Hammer.



NO. 51½
16 OZ.

STANLEY

Trade Mark

**THE TOOL BOX
OF THE WORLD**

You'll want
these two books

The first book is free . . . "The Joy of Accomplishment", a brief introduction to tools and their uses. The second is the famous textbook, "How to Work with Tools and Wood", recently revised, fully illustrated. The cost is just \$1.

Stanley Tools, 187 Elm St., New Britain, Conn.

Please send by return mail

FREE booklet: "The Joy of Accomplishment."

188-page book: "How to Work with Tools and Wood." \$1.00 enclosed.

(In Canada: Send order to Stanley Tool Co. of Canada, Ltd., Roxton Pond, Quebec.)

Name.....

Address.....

City.....State.....

● Almost the moment you wrap your hand around the handle and heft a Stanley Hammer you know you've found a pal.

Drop-forged from special analysis steel and given two "super heat treatments" to make a tougher head and stronger claws. Claws have a uniform split and beveled grip that bites into a nail shank. The handle of young, live hickory is in the head to stay . . . the eye pre-shrunk to exclude moisture. Make friends with a Stanley Hammer and have a friend for life.

(2) The two-arm snatch—in which the weight is pulled from the floor to arms' length overhead in one motion.

(3) The two-arm jerk—in which the weight is pulled to the chest in one clean movement and then by using the legs with a jump, is jerked overhead.

Records for these lifts are:

TWO-ARM MILITARY PRESS

Featherweight—Juitsu Nan—Japan—231½.

Lightweight—Fein—Austria—239¼.

Middleweight—El Touni—Egypt—259.

Light-Heavy—Novak—Russia—286½.

Heavyweight—Manger—Germany—319¼.

TWO-ARM SNATCH

Featherweight—Juitsu Nan—Japan—226.

Lightweight—Shams—Egypt—256¼.

Middleweight—El Touni—Egypt—269.

Light-Heavy—Novak—Russia—286½.

Heavyweight—Davis—U.S.A.—303¼.

TWO-ARM JERK

Featherweight—Fiad—Egypt—288¼.

Lightweight—Shams—Egypt—338½.

Middleweight—Ferrari—France—345.

Light-Heavy—Ferrari—France—372¼.

Heavyweight—Kutsenko—Russia—377.

The science of weightlifting should be studied by those who work on farms, on construction projects, in factories or at other jobs which require lifting heavy objects. The United States Department of Labor recently made a study of industrial accidents and its report showed that lifting accidents were caused principally by lifting the wrong way and by those physically incapable of tackling a lifting job.

Other reliable estimates indicate that as much as 25 percent of all industrial accidents cause strain, sprain and hernia. A hernia usually lays up a worker for about eight weeks while a bad back sprain may incapacitate him for 18 to 20 weeks.

A knowledge of the principles of scientific weightlifting would go far toward banishing these hazards. Here are some practical suggestions:

Use your leg muscles, the largest and strongest in your body, when you're hoisting a heavy weight such as a trunk or a basket of clothes. Don't bend over and try to support a heavy object with your arm, shoulder and back muscles. Squat down, grasp the object and straighten up—thus using your big thigh muscles.

Get as close as you can to the weight you're trying to lift. When lifting a wheelbarrow, for example, don't stand back of the handles. Get between them and as close to the load as possible.

Balance your weights as a Chinese coolie balances his burdens on a pole across his

(Continued to page 256)

Twist...It's Open

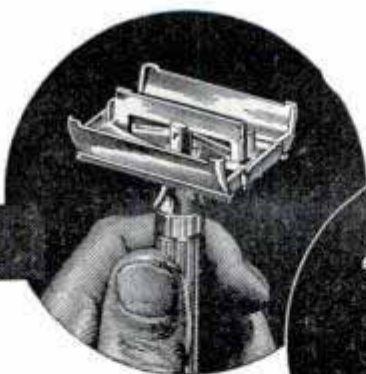

Twist...It's Closed

See how quick and easy shaving can be... with the modern

Gillette One-Piece Razor



YOU get utmost shaving comfort and convenience with a Gillette One-Piece Razor. There's nothing to take apart or put together. Blade changing's a cinch. Twist . . . the razor opens. Twist again . . . your blade's locked in position. To clean, just loosen the holder, rinse, shake.

Enjoy the quickest, easiest shaves you ever had. Ask for the superb Gillette Aristocrat One-Piece Razor or the Gillette Milord.

Gillette Safety Razor Co., Boston 6, Mass.

Copyright, 1947, by Gillette Safety Razor Co.



Gillette Aristocrat One-Piece Razor, 10 Gillette Blue Blades \$3.79



Gillette Milord One-Piece Razor, 5 Gillette Blue Blades \$2.50

look SHARP! feel SHARP! be SHARP! use Gillette Blue Blades WITH THE SHARPEST EDGES EVER HONED

X-acto*

**HANDICRAFT
KNIVES & TOOLS**



Choice of experts in every art and craft field. Singly and in sets, 50c to \$50.00. (Slightly higher in Canada.)

Buy where you see this sign —
At hobby, hardware and gift shops.

X-acto Crescent Products Co., Inc., N. Y.
In Canada, Handicraft Tools, Ltd., Toronto
*Reg. U.S. Pat. Off.

Now You Can GET THOSE MOTOR-CLUTCH- TRANSMISSION AND AXLE PARTS in stock

Why worry about parts when we have them . . . All you want, at a BIG SAVING . . . We ship within 48 hours . . . We also have REBUILT UNITS for EXCHANGE at Bargain Prices: CARBURETORS — FUEL PUMPS — GENERATORS — STARTERS — SHOCKS AND KNEES . . . It will pay you to GET OUR PRICES. — RUSH YOUR ORDERS —

NEW AUTO PARTS

and
**SAVE
MONEY**

Get Our
**BARGAIN
PRICE
LIST**
for parts
you want

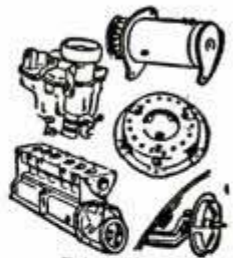

If Car Owner Specify Make IMMEDIATE SHIPMENT
MECHANICS AUTO PARTS, Factory Warehouse
3807 No. Ashland Ave., Dept. PM-8 CHICAGO 13

AMPLIFIER

For Call System
or Phono. Amplifier

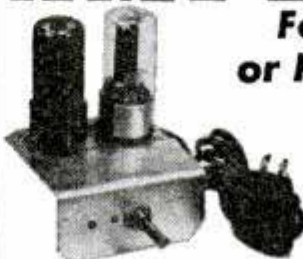

\$1.95

COMPACT-WIRED
READY TO OPERATE
USES 35Z5-50L6

25% Deposit Required

N. J. INDUSTRIAL CO., 309 Elm St., Newark 5, N. J.

NONE BETTER! SUPER DRILL GRINDER

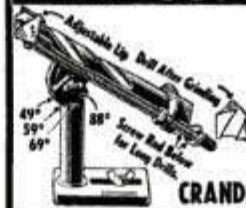

Sharpens round shank drills from 3/32" to 1-1/16" in diameter, up to 11" long. Grinds old drills like new in 4 different point angles, using hand or power grinding wheels. Money-back guarantee.

Price only \$2.95

At Dealers or Postpaid

CRANDALL MFG. CO. 1512 W. Slauson, Dept. FA-20, Los Angeles 44, Calif.

ELECTRIC LIGHT FLOWER



only

\$1.49

Amuse and astonish your friends. Have fun at parties. Electric Light Flower is worn in a man's lapel or woman's hair. Simply press magic button hidden in your pocket and bulb flashes on and off. Complete with attractive flower wire, bulb and batteries. Rush your order today.

ELECTRIC LIGHT BOW TIE Complete with battery and bulbs. . . . **\$1.49**

Special Price to Dealers

BERNARD FINE CO. 501 Sixth Ave. Dept. PM New York 11, N. Y.

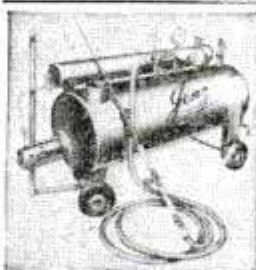

LOW PRICED STEAM CLEANER Jenz Super Chief

Portable—No moving parts—Cleans anything—Motors—Chassis—Machinery—Floors—Buildings—Remove wallpaper—Dairy & Creamery—Oil Rigs etc. Oil fired—Economical—fully tested and warranted. 75# Steam in less than 10 min. Complete as illustrated. **\$249.50**

F.O.B. factory.

HI-PURE LABORATORIES
EVANSVILLE, IND.

HOW TO CUT RAFTERS

New vest pocket book gives lengths, Side cuts, Plumb cuts, Deductions. For all rafters for any building from one inch to forty feet wide. Gives numbers to cut on square. Also degrees for same cuts for Radial Saws. All standard pitches from 1/4 to 3/4. Just open book to pitch page and there are your lengths, side cuts, etc. Anyone who knows what a jack rafter is can frame a roof if he has this great book. Price one dollar pre-paid. BUILDERS' TOPICS, Dept. M, Lock Box 828, Seattle, Washington. Original teachers of the square in five easy lessons by mail. SEND FOR FREE LIST OF TECHNICAL BOOKS. Learn to read blueprints etc.



the BEACON that never fails

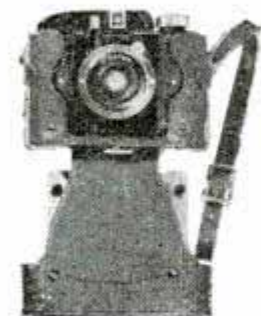

Ever-faithful, the BEACON camera will always bring you top precision, miniature camera performance at low cost. The 46mm Whitlar coated lens — color corrected, gives you sharp, sparkling snapshots. **\$9.95** incl. tax

EVEREADY CASE. Simulated brown leather, beautifully styled. **\$2.50**

Safety lock shutter — no accidental snaps • Speeds 1/50, or time • Uses No. 127 film • Optically ground lenses, fluoride coated



Whitehouse Products, Inc.
360 Furman St., Brooklyn, N. Y.



"YANKEE" VISES

*hold work through every step
without a misstep*

Any job locked in a "Yankee" Vise, is correctly positioned for every operation . . . hand or machine. Lifts on and off swivel base at bench. Machined accurately . . . top, bottom, sides and front end . . . V-grooved block for rounds. Four sizes, with and without swivel base . . . 1½", 2", 2¾" and 4" jaw widths. At your dealer's.



Write for
"Yankee"
Tool Book

NORTH BROS. MFG. CO.
Philadelphia 33, Pa.

YANKEE TOOLS NOW A PART OF
STANLEY
THE TOOL BOX OF THE WORLD

HOW TO EARN EXTRA PROFITS

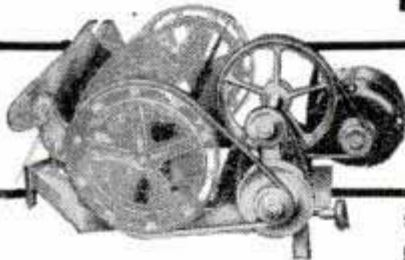

only
\$37.50
LESS MOTOR

for this
popular

"QUAD-CITY SHARPENER"

Get into profitable lawn mower sharpening at low cost with this highly successful machine. Order direct from **QUAD-CITY PRODUCTS CO., Box 42, Rock Island, Ill.**

Jiffy Jr.
ELECTRIC
HEATER

BOILING HOT WATER IN A JIFFY!!



Only
\$2.95
HOT WATER
IN A JIFFY
plus twenty five cents for postage

Place the Jiffy Electric Water Heater into the water and insert the plug in the nearest electric wall or light plug. You will have hot water in less than five minutes for baby's bath, your washing, shaving and a great many other uses in the home, camping, business, and on the farm. Mailed complete, including six feet of rubber covered wire and plug. One year guarantee. **JIFFY ELECTRIC COMPANY, Dept. PML, 23221 Stephenson Highway, Hazel Park, Mich.**

BUILD YOUR POWER TOOLS

with our
BALL BEARING ARBORS

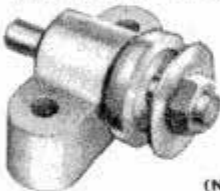

New Departure
Self-Lubricating
Bearings

10,000
R.P.M.



(No extra charge for
left hand threads)

C5—5/8
Pictured

B33—\$4.95 PP.
5/8 x 4 1/2 Spindle
B15 Plain Spindle
\$3.50 PP.

Plain Spindle models less threads and collars C-4-\$8.00, C5-\$8.00, C6-\$9.00, D8-\$16.00 all P.P.

Special Saw Arbors with 4 in., 5 in., 6 in., 7 in., housing length, add \$1.40. 1/2, 5/8, 3/4 models only. (30 day delivery).

SHAPER ARBORS 3 inches between collars, C4-1/2 \$14.25, C5-5/8 \$14.25, C6-3/4 \$15.25, D8-1 \$23.00. All P.P.

Sanding Discs—Poly Tru-Disc. 8" disc \$3.50 P.P., 10" disc \$5.00 P.P. Center hole 1/2, 5/8 or 3/4.

Complete stock V belts and pulleys
POLY PRODUCTS, 406 S. Chester, Ct. 1a, Pasadena 5, Calif.

Courtesy to Dealers

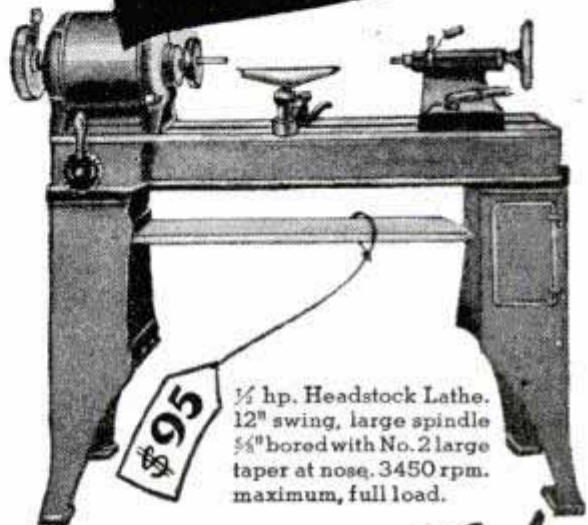

1/2 hp. Headstock Lathe.
12" swing, large spindle
5/8" bored with No. 2 large
taper at nose. 3450 rpm.
maximum, full load.

Get Yours Today

- Take your pick from hundreds of models
- All priced 25% or more below used market
- No priorities needed to get prompt delivery
- Price lists from your WAA office

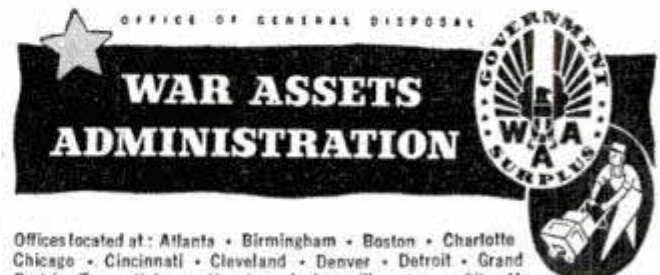

Offices located at: Atlanta • Birmingham • Boston • Charlotte
Chicago • Cincinnati • Cleveland • Denver • Detroit • Grand
Prairie, Tex. • Helena • Houston • Jacksonville • Kansas City, Mo.
Little Rock • Los Angeles • Louisville • Minneapolis • Nashville • New Orleans
New York • Omaha • Philadelphia • Portland, Ore. • Richmond • Salt Lake City
St. Louis • San Antonio • San Francisco • Seattle • Spokane • Tulsa 1103-2

Customer Service Centers in these and many other cities.

"ON A BICYCLE BUILT FOR TWO"



SOMETHING NEW!

Turn your bicycle into a "Bicycle built for two" and take your companion with you on your bike trips. Light in weight and takes a jiffy to put on or take off.

Will seat adult riders as well as boys and girls.

The "Tally-Ho"
Companion Seat

Attachment **\$3.95**

Spring Seat **\$2.50**

Seat or Attachment can be purchased together or separately.

For Whizzer Motor Bike owners include 50c additional for extra long axle.

TEAR OUT AND MAIL TODAY

Tally-Ho Bicycle Products
131 East 119th Street
New York 35, N. Y.

Please send me Tally-Ho Attachment
 Spring Seat

Enclosed is my check or money order for _____

Name _____
Please print

Address _____

City _____ State _____



War Surplus Bargain!

ALL STEEL CABINETS

Here's the home work-shop tool and storage cabinet you've been waiting for! Keep your tools, parts, equipment, safe and in one place. All-steel construction, with 11 large and 3 small drawers. Hinged top opens to roomy storage space for large tools, parts, etc. Large drawers have 32 removable metal dividers to make 60 bins of any size desired. 3 small drawers have 30 metal dividers make ideal nut, bolt, screw and small parts storage compartments. Each drawer has drop handles and index card holder. Rust-resistant baked-on enamel finish is an attractive green. Composition top makes handy desk or non-slip work table. 2 locking bars keep contents safe—need only 1 padlock. Sturdily constructed to last a lifetime. 39" high, 47" long; 24" deep.

Worth at least \$100.00
Our price to you.....

\$59.75

F.O.B. Orditt, Ill.

Dealer Inquiries Invited

ACME EQUIPMENT CO., INC.

128 South Clinton St.

Chicago 6, Illinois

shoulders. It is more difficult to carry a 100-pound suitcase in one hand than it is to carry two 75-pounders evenly balanced.

Get the weight on top of your body whenever possible. Instead of carrying a sack of flour, a box or a heavy plank in front of your body, hoist it to your shoulder where the weight will be borne by the entire body and not just the arms.

Building up your body through scientific weightlifting will enable you to handle loads and weights that were once far beyond your capacity.

Weightlifting is no cure-all for the medical ills and aches of 20th Century America. And if you inherited a small frame, it won't give you the physique of Joe Louis. But it will add hard muscles to any man's body and make him feel fitter than ever before. There's only one way to find out—try it!

Greased Lightning Strikes the Flats

(Continued from page 92)

usual and the marker lights on your own big speed course appear to dip below the horizon. You seem to be racing around on a very steep slope.

"The men in the pits sometimes get similar illusions. Now and then, they tell me, my car seems to be suspended in the air hundreds of feet off the ground at the far side of the course. They can actually see a distant mountain under my wheels."

Jenkins' proposed one-mile car with which he hopes to challenge Cobb's record is in the preliminary planning stage. Ed and Bud Winfield and Leo Goossen of Los Angeles have designed a machine that has a theoretical top speed of about 450 miles per hour. This, of course, is faster than most aircraft can fly.

The American challenger would have less powerful engines than the Napier-Railton but also would be smaller and lighter. It would weigh 2½ tons, about one ton less than Cobb's machine. Specifications are: length, 21 feet; wheel base, 140 inches; height, about 30 inches; power plant, two specially built supercharged 1000-horsepower engines.

Each power plant would be connected to one pair of wheels and each would be ice cooled. The only opening in the body would be that of the carburetor air intake.

Radically streamlined, the car would be low and flat with a high fairing along each side to house the wheels. This design provides a channeling effect that reduces the frontal area and causes the air to sweep straight back over the body, contributing to stability. To fit into the car the driver would lie in a semireclining position.

● POWER LAWN MOWER

NEW ATTACHMENT CONVERTS ANY
HAND MOWER TO
A POWER MOWER
IN LESS THAN
ONE
HOUR

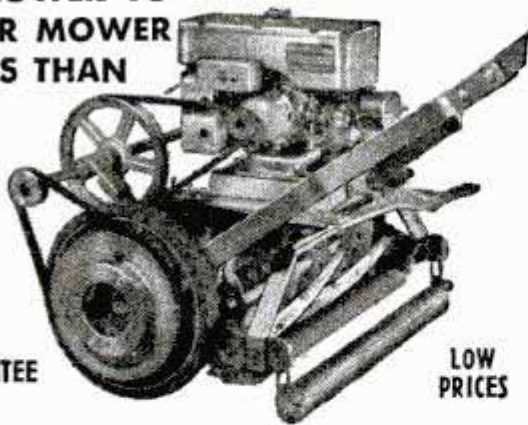

**MONEY
BACK
GUARANTEE**

**LOW
PRICES**

We supply complete attachment that fits ANY make or size of mower, with or without 1 H.P. gas engine. Complete assembly, easily installed in less than one hour. Relieve yourself of that unnecessary back-breaking drudgery and try this attachment on your mower—it'll pay for itself. Thousands in use. Immediate delivery at low prices. Dealers wanted.

ABSOLUTE GUARANTEE

Attachment and engine precision made from the best material available. If you are not completely satisfied, your money will be promptly refunded.

**FREE
FOLDER**

ROYAL OAK LAWN MOWER SHOP

P.O. BOX 48

ROYAL OAK, MICHIGAN

Made to U.S. Army Specifications!

15-JEWEL

ELGIN

\$18⁹⁵



Sturdy 15-Jewel ELGIN men's wrist watches. Waterproof. Sweep second hand. Stainless Steel back. Unbreakable crystal. **QUALITY!** American made. Fully reconditioned with **ONE YEAR GUARANTEE!** Made for the U. S. Army Air Corps. They **HAD** to be good. **SEND NO MONEY.** Simply pay postman \$18.95 plus 10% tax and postage on delivery. Cash orders sent postpaid. Limited supply. **UNITED PRODUCTS CO.,** 7941 S. Halsted St., Dept. WES-309, Chicago 20, Ill.



OFF TO VACATIONLAND by Hull Automobile Compass

Drive by the time-proved, sure guide of motorists. Don't let direction worries, wrong-way travel, lost time upset your vacation trip. **BEACONLITE** illuminated (shown), \$5.95; **STREAMLINE**, \$3.95. At your dealer's. Write for circular.



HULL MFG. CO.
P.O. Box
246-D7,
Warren, Ohio.

ARMY RADIO PHONES



**They're Weather — Water
and Shock Proof**

When we say they are made to Army specifications, that's enough assurance they must be of best quality. These Army Radio Phones are perfect and were O.K.'d by Signal Corps Inspectors. These Dynamic Mikes and Receivers, were used on aircraft and tank inter communication systems. Use them for recording, for battery-less phone, for pocket size set loud speaker or talk through your radio set. We bought a good many of these Radio Phones, they are brand new, and cost a great deal more than you can get them for. A complete dynamic hand mike, 2 earphones, headband, cord set. A wonderful buy for only... **\$3⁴⁵**

Send check or Money Order. FOB warehouse

LEEDS RADIO CO.

75 Vesey St. Dept. PM4 New York City 7

New War Surplus HUNTING KNIVES

for Hunters and Fishermen!

Originally priced at \$5, \$6, \$7!

SAVE \$4.⁰⁰ or 4^{MORE}

Leather sheath included



\$1.⁰⁰

6-inch
blade

\$1.²⁵

7-inch
blade

\$1.⁵⁰

8-inch
blade

- ★ Rust-proof blade!
- ★ Gun-metal finish!
- ★ Tempered steel!
- ★ Laminated leather handles!

Orders filled promptly. Money orders, please—no checks. Add 10c postage. None sold C. O. D. or wholesale.

MAIL COUPON TODAY!

Baltimore Lumber Co. (War Surplus Division)
418 N Howard St., Baltimore 1, Md.

Enclosed find _____ for which send me
_____ Hunting Knives size (s) _____

NAME _____

ADDRESS _____

CITY _____ STATE _____

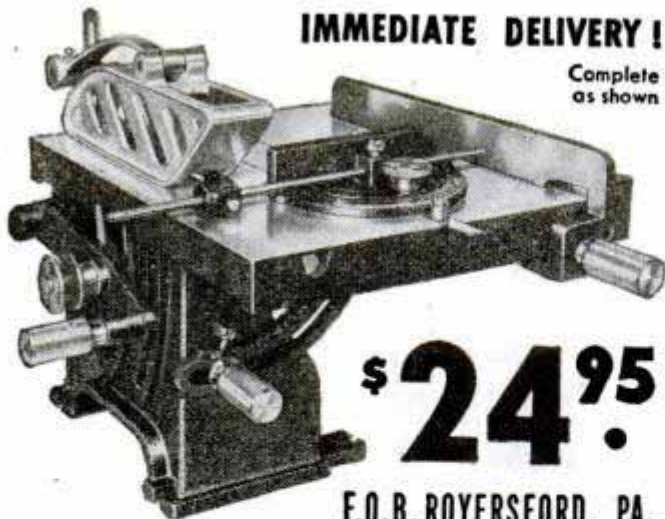

IMMEDIATE DELIVERY!

Complete as shown

\$24.95

F.O.B. ROYERSFORD, PA.

QUALITY 8" BENCH SAW
CUTS THROUGH 2 5/16"

UNCONDITIONALLY GUARANTEED ONE YEAR

(Write for Free Booklet and Guarantee Bond)

Comes complete with Floating motor mount—miter gauge with adjustable stop—aluminum guard—soft aluminum insert—spring steel splitter—heavy gray iron fence—(no motor—no blade). Table 12" x 14". Tilts to 45°—Oilite bearings. Shipping Wt. 50 lbs.

AMERICAN MACHINE & TOOL CO. Inc.

DEPT. 100

ROYERSFORD, PA.

Sheppard Diesel
GENERATED
ELECTRICITY
costs less...is more dependable

This 2,000 watt Sheppard generating set operates on low-cost furnace oil. Rugged diesel construction assures long life! Simple to service... easy to operate. Write for detailed information.

DIESEL'S THE POWER Sheppard's THE DIESEL

R. H. SHEPPARD COMPANY, INC.
56 Middle St., Hanover, Pa.

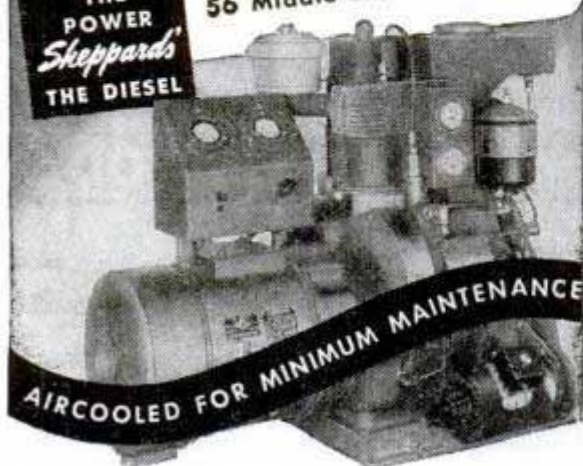

Generating sets to 36,000 watts. Power units to 62 H. P.

New "THERMO-SAW" (CUTS WITH HEAT)
MAKE THINGS FOR THE HOME or FOR SALE

• Any Child Can Use It!

- NO NOISE
- NO VIBRATION
- NO SAWDUST

CUTS RAPIDLY AND CLEANLY THROUGH WOOD AND OTHER MATERIALS... AN IDEAL GIFT! Difficult patterns are made QUICK and EASY... No turning of work... Cuts in every direction... Cuts plywood 1/8" or 1/4"... Cuts 14"x36" board... Special Transformer produces high frequency current in a tough steel wire "blade" from ordinary Alternating (AC) current. No radio interference. IMMEDIATE DELIVERY!



Machine Measures 11x4 ONLY 3 1/2" High, Throat 7" **\$4.50** Deep. PATTERN FREE. Postpaid COMPLETE SAW outfit as illustrated with transformer and 12 spare blades. READY TO USE.

NOTE: Operates on 110 volt Alternating (AC) Current: 50 to 60 cycle. NO C.O.D.'s

ORDER \$4.75 in Canada and TODAY Mexico. \$5 Elsewhere.

BOISSELIER MFG. CO., Dept. P-8, GLEN ELLYN, ILL.

SURPLUS HARDWARE SPECIALS

- Mack Saw Blades, High Speed, Star Moly 10-32. Listed for \$40 per gross, Our price \$130 Doz., or \$12 gross.
- Set of 4 Phillips Screwdrivers #1 to 4 \$1.00 Set
 - Set of 5 Common Screwdrivers, 1 1/2"-2"-4"-6"-8" \$1.25 Set
 - Set of 6 Cold Chisels, Hand Type 4" to 8" \$1.80 Set
 - A Carton—10 GE 110 Volt 2 1/2 Watt Glow Lamp Standard socket listed at \$5.50 ea. \$2.00 Cart.
 - Roll, Brown Duck, 26"x52"—49 Pockets \$1.25 Ea.
 - Mack Saw Frames, Adjustable, Mfgd. by Union Hdwe. \$.60 Ea.
 - A Set of 3 Rasps—14" Cabinet, 14" Half Round, 12" Flat \$1.80 Set
 - A Set of 12 Assorted Amer. Std. Files 6" to 14" \$2.25 Set

10% Discount allowed on orders \$5.00 or over. Postpaid.

INDUSTRIAL SUPPLY CO., 312 East 33rd St., N. Y. City 16, N. Y.

SURPLUS BRAND NEW 5 TON

Hydraulic Jacks



Nationally Known—Limited Supply—Rush Orders. Regular List Price \$19.50. Our Sale Price, only **\$8.95** ea.

Prices FOB, K.C. Send money order or check with order. Get our prices on all Army built Truck Parts.

AMERICAN AUTO PARTS CO. 1830 LOCUST—DEPT. P. M. KANSAS CITY, MO.

FLASHLIGHT INSPECTION LAMP ASSEMBLY

NEW—Govt. Surplus. Lights up the "Hard-to-get-at" places. Fine for mechanics, electricians, radio repairmen, filling station attendants, in the home, and many other uses. Plastic 12" extension (6" stiff and 6" flexible). Adjustable to any angle. Originally priced over \$4.00. Our price



\$1.80 Ea.

National Surplus Sales Co. 715 E. 18th St. Kansas City, Mo.

HAVE YOUR OWN BUSINESS!

Operate pleasant, profitable Silk Screen Printing Shop. NO experience needed. Work at home in spare room or basement. Big demand! Large profits! Few dollars starts you. Start small, grow big. Real future possibilities! Eye-opening literature FREE.

W. E. WOLFF CO., 817 High St., Anderson, Indiana

AUTOMATIC SAW SET

HAND AND BAND SAWS

Set saw teeth automatically—400 per minute without effort. Perfect hammer and anvil action sets teeth uniformly—tensions metal. No tooth breakage. Write today!

SAW SHOPS NEED THESE MACHINES

With Motor

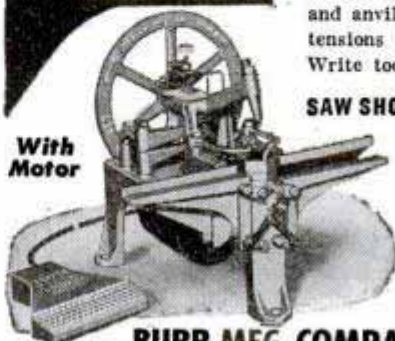

AUTOMATIC SAW RETOOTH

Cuts new saw teeth in 50 seconds—any size 4 to 16 points. Old teeth fall off as chips. Simple to operate. A perfect job.

BURR MFG. COMPANY 8933-G Venice Blvd. Los Angeles 34, Calif.

The
TRAVEL COACH
that is
a Perfect
Palace Home



**Solves Both
the Travel and the
Housing Problem**

The Palace Travel Coach! A luxurious home to take with you when traveling — or to live in until houses again become plentiful. Has combination living room, dinette and kitchen, and separate bedroom — all completely furnished. Efficient air and heat circulation. "Uniflow" lighting and a host of other unusual features.

**The Only Trailer
With An Automobile-type Body**

It has a die-formed, "Pan-L-Frame," aluminum body — an exclusive Palace feature, resulting in increased durability and, at the same time, reduced weight. It's the trailer, above all others, that you will want to own. Moderately priced. Send postcard for name and address of nearest dealer.

PALACE CORPORATION
Flint, Michigan



**A TOOLSHOP
IN YOUR HAND!**

- GRIND • DRILL • ROUT
- POLISH • ENGRAVE
- CUT • SAND • SAW, etc.

Make Things From
Wood—Plastics—Metals—Glass—Alloys—
Leather—Alloys—
Horn—Stone—Bone,
etc.



HANDEE TOOL OF 1001 USES

Smooth, steady power at your fingertips! Perform precision operations not possible with any other portable tool! With a Handee you can turn out professional looking projects for pleasure or profit—ship, plane and train models, costume jewelry, wood carvings, puppets, initialed tumblers, etc. AC or DC. 25,000 r.p.m. Wt. 12 oz. USE THE RIGHT ACCESSORIES! Choose them from the most complete line . . . more than 500 made right in the Handee plant.

GET A GOOD START
GET THE
HANDEE KIT

HANDEE Tool and 40 most popular accessories packed in compact steel carrying case. You'll be amazed at what you can accomplish! Complete, postpaid, \$27.50



Handee only, with 7 accessories, \$20.50

FOR YOURSELF OR A FRIEND...
THE GIFT OF A LIFETIME!

NEW PRECISION ATTACHMENTS

Fit Handee only; enable novice or craftsman to do perfect work. Magically, easily, your offhand carving, routing, shaping will be exact as to depth of cut, accuracy of line. Set of 6 attachments with instructions, postpaid, \$7.95



ORDER NOW. SATISFACTION GUARANTEED!
FREE! NEW 52-PAGE MANUAL

CHICAGO WHEEL & MFG. CO.
1101 W. Monroe St., Dept. PM, Chicago 7, Ill.
Send Handee Kit Handee Tool Precision Attachments
 C.O.D. Remittance enclosed Send Manual

Name.....
Address.....
.....

**HANDY DANDY MOWER
CONVERSION KIT**

Build power mowers with our Handy Dandy Conversion Kit. All necessary parts to convert 16, 18, or 20 inch hand lawn mowers to a dandy power mower. Complete with chain drive and cone clutch. Write to—



Write for Details
Dealers Wanted

LE CLAIRE MFG. CO. Le Claire, Iowa

MYSTERY RADIO ONLY \$2.99

post paid
No Tubes
No Batteries
No Electricity



Radio, Fun Maker, Microphone, under pillow speaker, ear piece for hard of hearing all in one. Very small unit. For home, camping, trips, etc. Send no money. Order today. Be first in your gang. Pay postman \$2.99 plus C.O.D. Postage on delivery.

CLAIRE DISTRIBUTORS, BOX 23, GLENVIEW, ILL.

PULVEX "DDT" FLEA POWDER



Guaranteed by Good Housekeeping

Kills the fleas Quickly! Keeps others off for Days.

Pulvex also comes with ROTENONE, the original formula. BEST FOR CATS.

Either Kind 25¢ & 50¢

**I GET MORE THAN
90 MILES a Gallon
ON MY COMET**



Only
\$149⁵⁰
UP
F. O. B.
MPLS.

**COMET
features:**

- All-steel frame
- Automatic clutch
- 1 1/2 HP 4-cycle engine
- Separate brake control
- Oversize balloon tires
- Rubber-mounted shock absorbing front fork
- Rubber cushioned engine mount
- Easy operating kick starter
- Aircraft design for lighter weight, better performance

Comet Motor Scooters are handier than a second car for the family! They're easy to ride, economical—they go more than 90 miles to the gallon—and ideal for any use. Ride a Comet to and from school or work, for easy shopping (no parking problem), for deliveries, after-school jobs, sports, vacation trips, fun on the highway. There are four Comet models. All are lightweight, safe, durable. Send coupon below for free booklet.

COMET 
MOTOR SCOOTER

COMET SCOOTER MANUFACTURING CO.
9253 Nicollet Avenue Minneapolis 9, Minn.

Please send me, without obligation, your colorful, illustrated Scooter booklet.

NAME _____ ADDRESS _____
CITY _____ ZONE (____) STATE _____

The easy way to paint!

Speedy Sprayer

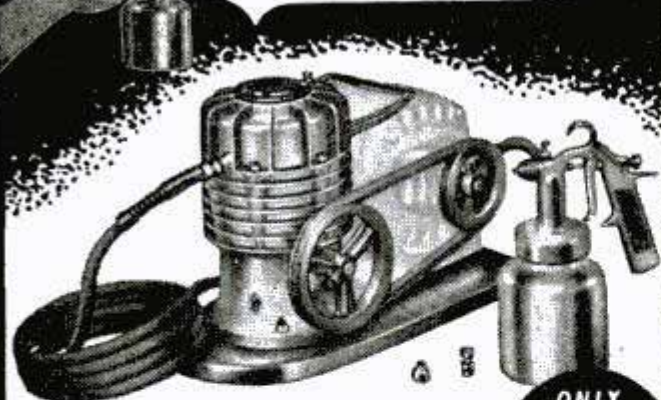

Favorite of home owners and craftsmen for 20 years! SPEEDY SPRAYER gives your work that professional paint finish everyone admires. Sprays paint, enamel, varnish, lacquer, etc. . . . 4 to 7 times faster than hand brushing! Lightweight, portable, uses any 1/4 H.P. motor. Improved diaphragm principle assures clean, oil-free air. You'll find dozens of time and money saving uses for SPEEDY SPRAYER, including spraying insecticides 2-4-D and DDT. Complete outfit, without motor, only \$26.95.

ONLY
\$26⁹⁵
LESS
MOTOR

At leading hardware, lumber, and auto supply dealers.
FREE—write for handy booklet "How to Spray."

W. R. BROWN CORPORATION
5717 Armitage Ave. • Chicago 39, Ill.

"Bad Man" of the Elements

(Continued from page 108)

bright, say scientists who study the stuff.

For instance, one forecast says that a fluorine compound soon will be used to produce a lubricating oil so stable that it will stand up under the most rugged of present-day mechanical operations and make practical new engines that are impossible today because no lubricant can withstand the terrific pressure and friction. Incidentally, hydrofluoric acid is now being used in petroleum refineries to produce high-octane gasoline, and sodium fluoride is added to the water supply of several cities to reduce tooth decay.

Elemental fluorine will also be used, say the scientists, to manufacture a gas that is a nearly perfect insulator for the tremendously high voltages used in modern X-ray and other electronic work.

Then there is a new line of chemical tools for industry formed by compounds known as the metal fluoroborates. Sodium fluoroborate is coming into use as a preservative for protecting wood against insect attack, as a cleaning agent to remove iron stains in laundries, for cleaning stone and concrete surfaces and for exterminating bugs and rats.

The fluoroborates of lead, tin, copper and zinc are proving superior for high-speed industrial metal-plating processes. Potassium fluoroborate is an excellent fluxing material in the welding of numerous metals.

Some of the other products using fluorine which soon will be available include heat transfer materials, better insecticides and solvents, germicides, superior anesthetics, fireproofing materials, plastics, weed killers, fumigants and synthetic rubber with improved insulation qualities.

That's a brilliant, law-abiding record for the former "bad man" of the elements.

Florida's Cold Spot

(Continued from page 101)

into position where close observation within the hangar is necessary.

To whip up 100-mile-an-hour winds there's a mobile unit with a 53-inch fan, driven by a 250-horsepower motor. Sand and dust fed into its hoppers will do a thorough job of duplicating nature's harshest storms. Another device is being built to test landing gear in a manner simulating landing and take-off operations.

As a check against carbon monoxide and explosive vapor, an electrical detecting

(Continued to page 264)



MOTO-TOOL ★ THE "POCKET-SIZE" MACHINE SHOP



Moto-Tool Kit No. 2, with 23 accessories (high speed steel cutters, grinding wheels, polishing accessories) and heavy-duty professional Model 2 Moto-Tool in natural finish, hardwood case... **\$23.50.** (Items purchased separately would cost about \$30.00; you save \$6.50.)
Moto-Tool No. 2 with one emery wheel point... **\$16.50.**

"MAN... WHAT A POWERHOUSE!" A TOOL THAT PACKS YEARS OF PLEASURE

Here's a tool to please a man's heart... one that holds promise of endless creative hours. Dremel Moto-Tool... the little grinder that does big jobs... is a "war veteran"... used by all branches of the armed forces in far-flung repair bases... helped set production records at General Electric, Westinghouse, Remington Arms, Ford and others. Hobbyist or expert craftsman, first choice is Model 2 Moto-Tool Kit with its handsome felt-lined, highly finished wood case with rows of tools begging to be put to work. Write for FREE catalog of Moto-Tool attachments and accessories.

MOTO-TOOL FEATURES:

Oil-less, sealed bearings • Patented automatic chuck lock pin • Over-size armature shaft, hardened, ground, polished • 110 Volt, AC-DC motor • Sliding snap-type switch • Cord protector • Shockproof bakelite housing • Dust-filtered, air-cooling system • Weighs only 13 oz. • Dynamically balanced for vibrationless operation.

MONEY BACK GUARANTEE: Buy Dremel Moto-Tool and Accessories from your dealer. If he cannot supply you, order direct from factory on 10 day trial. Shipped postpaid for cash in full; or for \$2.00 sent C.O.D. for balance plus postage.

DREMEL MFG. CO., Dept. 117-H
 Racine, Wisconsin

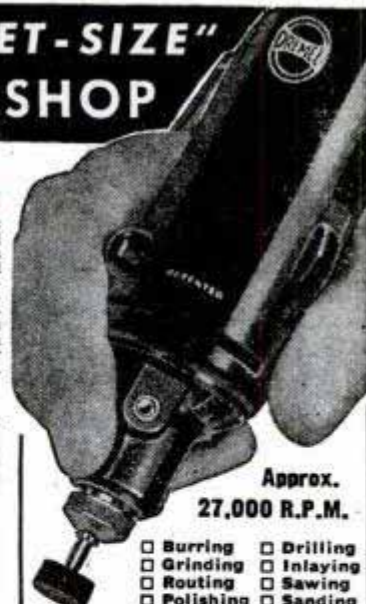

Approx. **27,000 R.P.M.**

- Burring
- Grinding
- Routing
- Polishing
- Engraving
- Sharpening
- Drilling
- Inlaying
- Sawing
- Sanding
- Carving
- Cutting

AMAZING NEW Star SCIENTIFIC GAS BURNER for

Automatic, Self-Acting • Needs No Adjustments • Jet Type • Cannot Backfire • Powerful in Performance Natural, Manufactured or Butane Gas

DEALER'S QUANTITY DISCOUNT
BIG PROFITS - ORDER NOW
 DIRECT FACTORY TO YOU - MONEY BACK GUARANTEE
STAR HEATER COMPANY
 1012-14 POWHATTAN • DALLAS 2, TEXAS

STOVES
 KETTLES
 TUBS
 GRIDDLES
 HOT PLATES
 STEAM TABLES
 WATER HEATERS

PROMPT DELIVERY AVAILABLE

EASY ASSEMBLY IN LARGE UNITS WITH STANDARD PIPE FITTINGS

\$2.00

WRITE FOR **Free Sample**

★ ★ **Make Big Money** ★ ★

GLOWS IN THE DARK

Be the first to sell luminous house numbers and light switch plates. Also luminous pictures, statues, etc. Religious, nursery, glamour and other subjects. Sell on sight. Represent a Large Manufacturer Est. 1913
MADISON MILLS • 303 Fourth Ave. • New York 10, N. Y.

SAY YOU SAW IT IN POPULAR MECHANICS

Amazing Value. AUTO SEAT COVERS Fits All Cars!



ARIDEX FIBRE In Colorful Plaid

Protect clothing and upholstery... slide in and out of car with ease and comfort. Tough Aridex fibre, water-repellant, long-lasting; covers both seat and back. Brilliant multi-color pattern. Harmonizing cloth trim. Install in a jiffy with elastic grips. No pins, no tacks. 3 types FIT ALL CARS.

ONLY **\$2.98** EACH
 2 FOR **\$5.00**

ORDER NOW!
 Satisfaction Guaranteed
 Or Your Money Back!

Your Choice Any Style

- A SOLID BACK**
 For 4-door Sedan, front or rear; or Coach rear; or Coupe.
- B DIVIDED BACK SOLID SEAT**
 For Coupe or Coach front.
- C INDIVIDUAL SEATS**
 For divided back and seat.

MAIL THIS COUPON TODAY!

SANGERS, 325 N. Wells St., Chicago 10, Ill. Dept. 5090
 Please rush.....Aridex Plaid Fibre Seat Covers @ \$2.98 each or 2 for \$5.00, as checked below:

TYPE A _____ TYPE B _____ TYPE C _____

Send Postpaid. Full payment \$.....enclosed.
 Send C.O.D. plus postal charges.

Name.....
 Address.....
 City..... Zone..... State.....

CONTINUOUS DUTY

MOTOR AND METERING PUMP

A precision built unit, made by Black and Decker, formerly used on military aircraft. 24-volt fractional h.p. motor D. C., will operate on A. C. Can be adapted to innumerable uses, such as operating running tools, as a small hand drill, for toys, for experimental work, etc. The metering pump has a capacity of 2 gallons per hr. which can be increased by enlarging the inlet and outlet fluid passages.

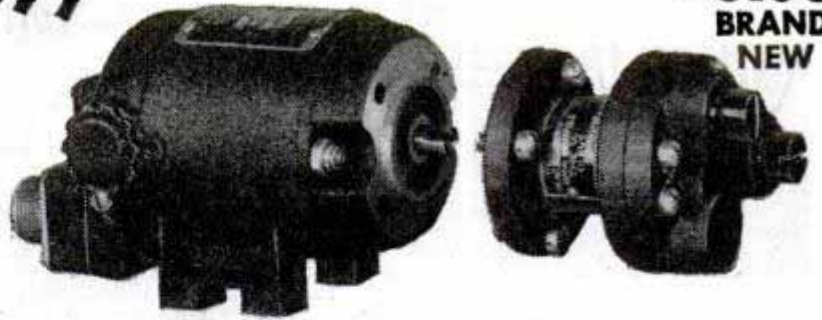

\$5.95
BRAND
NEW

POSTAGE PREPAID IF CASH WITH ORDER, OTHERWISE C. O. D.
SOUTHLAND AERO SUPPLY CO.
P. O. BOX 868 NORFOLK, VIRGINIA.

DON'T THROW IT AWAY • FIX IT! with this complete **ELECTRIC SOLDERING SET**

Set No. 207 includes:

- Underwriters Approved Pencil Iron
- 8-page Folder Soldering Instructions
- Two sizes of Copper Tips
- Flux & Brush
- Core Solder
- Emery Cloth



\$2.25
POSTPAID

HEATING UNIT
Guaranteed Forever!

COMPLETE
No Extras Needed

For soldering tin, brass, copper, etc. A necessity for every home workshop. Ideal for general repair, model, hobby, electronic, radio work, and other hard-to-reach jobs requiring exactness and speed. New 20-watt design gives 100-watt performance.

10-DAY MONEY-BACK GUARANTEE

See your dealer or send \$2.25 direct to

UNGAR Electric Tools

Box 2255-M, Terminal Annex, Los Angeles 54, Calif

Please Mention Popular Mechanics When Answering Ads

"THE QUAD-CITY LATHE"



only **\$32.50**

F.O.B. Rock Island, Ill.

Here is an exceptionally well made machine. Has 8" swing, 4 speed ball-bearing head on a cast bed. 27" between centers.

QUAD-CITY PRODUCTS CO., Box 42, Rock Island, Ill.



\$2.95
POSTPAID
ANY
WHERE
IN U.S.A.
OR
CANADA

JEFFY KEY RETRIEVER

The only key holder that retrieves your keys. Fastens to your belt. Easy to reach. After using keys, just release them. They will return to your belt. Good looking, chrome plated, small and compact. Especially handy and safe for all R.R. men, Policemen, Service Station Oprs., Janitors or any one using keys. Satisfaction guaranteed.

Special discount to dealers or agents.

Send direct to: Margason-Lummis Mfg'rs., KEY RETRIEVERS
2288 Casa Grande, Pasadena 7, Calif.



AUTOMATIC IRON TESTER

Pilot Light Flashes on and off with thermostat.

For checking temperatures and re-setting thermostats. Graduated for RAYON, SILK, WOOL, COTTON, LINEN—Also in degrees from 200° to 700° F. Has a specially designed precision thermometer. Unsurpassed in quality. ONLY \$18.50 postpaid — MONEY BACK GUARANTEE.

Write for circular.

HANLAN CO., 1419-A, W. Jefferson, LOS ANGELES 7, CALIF.

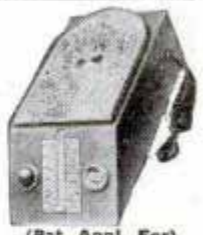

(Pat. Appl. For)

A New Thrill... Streamlined 3 WHEEL ROLLER SKATE

FASTER,
SMOOTHER,
EASIER
SKATING

Introducing **JET** The Sensationally NEW Combination ROLLER-ICE SKATES

If you like Roller Skating . . . you will like the New "JET" Roller Skate . . . Its many New Features puts it way out in front of all standard type skates . . . Study the THREE-IN-LINE-ROLLERS . . . this principle alone overcomes many of the objections . . . goes over cracks and irregular surfaces with a new smoothness . . . an enjoyable feature to those who love to roller skate . . . The 3 BALL BEARING WHEELS-IN-LINE Gives MORE SPEED with LESS EFFORT . . . When you want to stop SIMPLY RAISE THE TOE . . . The "JET" Skate is the ONLY SKATE WITH THIS FEATURE . . . Being much lighter in weight than regular skates makes it EASIER TO SKATE FOR CHILDREN and ADULTS; even for the beginner . . . Another feature: you can quickly change to Ice Skates by replacing the rollers with the "JET" Ice Skate Attachment . . . This is another Exclusive with the "JET" Skate . . . A New Experience awaits you in Roller Skating from the minute you PUT ON A PAIR of "JET" ROLLER SKATES.

RING-LITE Jr. LIGHT & KEY IN ONE HAND for Pocket or Purse. Complete with Battery . . . Only \$1

AFCO PRODUCTS, INC., 4547 No. Clark St., Dept. P-8, CHICAGO 40, ILL.

50% Lighter Than Most Ordinary Skates
• CHANGEABLE FROM ROLLER TO ICE SKATES



PAT. NO. 2113862

NOTE THE EXCLUSIVE BRAKE

LARGE, SMALL, MEDIUM STATE SHOE SIZE

ONLY **\$4.95** A PAIR

Postpaid in U.S.A. We Ship C.O.D. Plus Postage
Ice Skate Attachment \$2.25 Extra

3 BALL BEARING WHEELS in line gives MORE SPEED with LESS EFFORT.

To STOP QUICK Simply Raise The Toe.

Mail Your Order Direct To Factory

BE FIRST IN YOUR LOCALITY

Order Yours Today

Get in on the ground floor! Be first in your area to enter this

profitable NEW business!

YOU'RE CERTAIN TO SUCCEED BECAUSE DRYEX SUCCEEDS WHERE EVERYTHING ELSE HAS FAILED!

DRYEX

*makes wet walls DRY
... and keeps them DRY!*

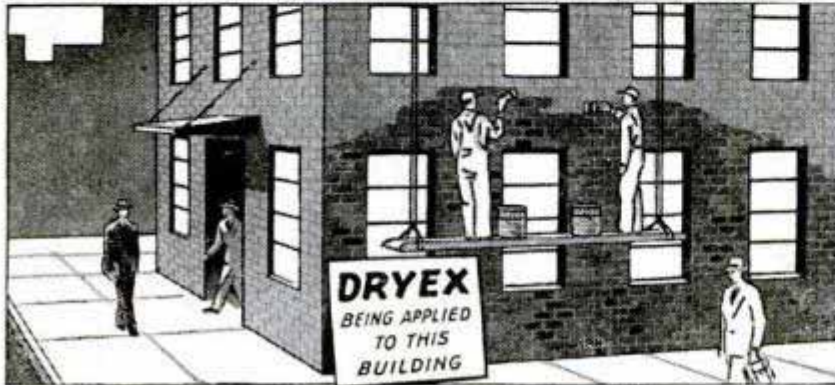

SELL OR APPLY DRYEX...
the great wartime discovery that will make big money for you!

Easy to brush on, easy to sell, DRYEX spells "opportunity" for you. Every owner of a leaky wall is your prospect, and there are thousands of them! Amazingly effective, DRYEX is the miracle plastic that seals leaky exterior walls definitely and enduringly. Stays tough, flexible and waterproof in all weather, all climates.

Your Territory May Still Be Open. Write Today for Details.

LASTING PRODUCTS COMPANY

200 Block S. Franklinton Rd., BALTIMORE 23, MD.

LOW COST PHOTO ENLARGERS

New improved **STARLIGHT ENLARGER** gives Better Results up-to-the-minute Features. Equipped with fine **ILEX ANASTIGMAT 3 1/2 inch F6.3 LENS** and **IRIS DIAPHRAGM**. Takes negatives up to 3 1/4" x 4 1/4". Makes Low Cost enlargements **ANY SIZE** for yourself or friends. Profitable easy business or hobby. Work at home. **COSTS ONLY \$24**. Inc'l. Tax and Lens, to own and operate. Write today for Free folder "B2" giving full details.

PHOTO-SPHERE CO. INC.

115 EAST 23RD ST. NEW YORK 10

FREE TRAILER PARTS CATALOG

"Safety Engineered"



BULL DOG Hitches & Parking Jacks, TORQ-LESS Axles,
Drop a card to Box 115

HAMMER BLOW TOOL CO., WAUSAU, WIS.

For Better Seedbeds and Better Crops

Get a SEAMAN ROTARY TILLER

Used by U. S. Dept. of Agriculture for Many Years.

The **SEAMAN TILLER** helps produce better yields by: (1) thorough soil pulverization; (2) hastening and promoting earlier and more complete seed germination; (3) milling fertilizer and green manure into the *Growing Area* of the seedbed; (4) helping to increase the supply of nitrogen through seedbed aeration; (5) eliminating "Air Pockets" and hard plow soles; (6) helping to destroy many crop pests and certain varieties of fungus; (7) providing more effective weed control; (8) reducing soil erosion.

SEAMAN ROTARY TILLERS are available in both power take-off and motorized models, 3 ft. to 7 ft. tillage widths. Write for complete information.



SEAMAN MOTORS, Inc.

364 No. 25th Street
Milwaukee, Wis.



"Yes, sir! I saved \$150.00 when I installed my Delta Oil Burner myself in a few hours. I shopped around but couldn't get a burner installed for less than \$350.00. The work was easy because of the Delta Photo-Installation Manual..."

Made by the **WORLD'S LARGEST MANUFACTURER** of Oil Burners



PAY AS LITTLE AS \$6.26 A MONTH!

Now you can enjoy *fully automatic* heat in your home by installing it yourself simply and quickly with a few tools. You can save at least \$150.00 in your spare time! The Delta Oil Burner comes completely assembled along with everything necessary for the complete installation by you for the low price of only \$195.00. Includes the famous Delta Photo-Installation Manual showing step-by-step photographs of an actual installation. And—you need not pay a single penny to get the Delta Oil Burner because a simple deferred payment plan is available. Just send the coupon below for full information and free brochure in color describing how you can install and enjoy *fully automatic* heat in your home. Mail today!

PASTE COUPON ON PENNY POSTCARD

DELTA HEATING CORP.

85-07 Northern Blvd., Jackson Hgts., New York City

Please send **FREE** Color Brochure and full information

NAME _____

ADDRESS _____ CITY _____

PM 8

**THE Natural WAY
TO LIGHT A PIPE**



- Windproof
- Lightweight
- Large Flame

DOWN-DRAFT CHIMNEY-ACTION

\$3.50
AT YOUR DEALER

Unconditionally Guaranteed

Nimrod

PIPELITER

If your dealer's unable to supply you, send \$3.50 direct.

WARD-NIMROD COMPANY
Dept. 35-E, 2968 Jessamine St., Cinti. 25, Ohio

IT'S FUN TO CUT GRASS!

**with the STURDY,
VERSATILE,
EFFICIENT**

Garden-All
LAWN and GARDEN TRACTOR

36-inch
Cut!



Write for
Booklet

- Cuts tall, tough weeds with ease!**
- Adjustable for various cutting needs.**
- Center Cut for fence rows.**
- Side Cut for getting under overhanging shrubs.**

Now lawn care becomes a pleasure! Garden-All cuts grass so quickly and efficiently . . . goes through weeds with ease as the weed deflector neatly throws them to one side. Garden-All also plows, discs, cultivates and plows snow. Be sure to see Garden-All before you buy!

GARDEN-ALL TRACTOR, INC.
Dept. P, 100 W. UNION STREET, LIBERTY, INDIANA

system continuously draws air samples from eight points in the hangar and four in the engine test chamber. If the concentration of either reaches a danger mark, a horn or bell sounds and a red light pin-points the offending area.

Extreme precautions are also taken against fire, another hazard of aircraft testing. All areas are covered by water fog, foam and stream systems, along with hand extinguishers and lines that lead to 15,000 pounds of carbon dioxide. As a last resort a deluge system can saturate a fire site with 600,000 gallons of water in an hour.

While the hangar takes care of large-scale projects, there are eight other locations in the building particularly suited to specialized testing. Largest is the engine and equipment room, believed to be the best equipped in the world for testing both jet and piston engines. The inertia block beneath the test stand is completely isolated from the floor with cork to prevent any vibration of engines from affecting the rest of the building.

An all-weather chamber is used for physiological proof testing of personnel and personal equipment under extreme conditions. It is insulated with 12 inches of corkboard, covered by a stainless-steel interior liner. Because of its smaller size, temperatures in this chamber can be brought down from 170 above to 70 below in 26 hours. A rain-and-mist-generating apparatus simulates a fall of 15 inches per hour and the room can be partly filled with water for testing such items as life rafts and immersion suits.

In conjunction with the all-weather room there's a strato-chamber to make further tests at various altitudes and their corresponding temperatures. In preliminary trials the chamber has "flown" to 100,000 feet and a minus 104 temperature. In just three minutes it can go to 50,000 feet and 70 degrees below zero.

Small items can be tested at a much lower operating cost in the five remaining test rooms, all of which are about 13 feet square. The jungle, tropic-marine and desert cells can operate long periods at cycled day-and-night weather conditions, allowing more accurate checks on long-range weathering effects. Two others, the hot and cold chambers, can be held at extremes for an indefinite time.

Though the weather factory represents a \$10,000,000 outlay, officials believe it will save more than that in a short time. In addition to canceling the need for many large government research expeditions, it will probably be made available to industry for research at an appropriate cost.

First Choice

Hand and power grinders to fit all needs. Sold at leading hardware stores.

LUTHER GRINDER & TOOL CO.
Sheboygan, Wis.

Luther

HAND AND POWER GRINDERS

Est. 1896

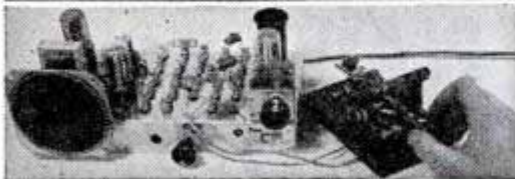

MAGI-KLIPS KIT

TEACH YOURSELF RADIO & ELECTRONICS

BUILD 18 EXPERIMENTS WITHOUT TOOLS!

You've read about this radically new kit designed by former Navy radar engineers. Pre-wired chassis enables you to build 18 different circuits — radio receiver, code oscillator, home broadcaster, photoelectric relay, etc.—by "clipping in" basic components as directed in simply-diagrammed manual. 110 v. AC or DC. Kit's 58 parts alone would cost double this low price.

Order your *Magi-Klips* Kit today and learn electronics quickly at home. Send for FREE illustrated booklet—**\$29.75** "Electronics Made Easy"—to show friends interested in learning electronics and radio. complete

DEER & TAYLOR COMPANY Dept. K, 1340 Milvia St. Berkeley 9, California

heavy duty — ball bearing — all purpose
MANDREL



Length Overall 14"
Diameter OD 1 3/4"
Shaft 1/2" or 5/8" Optional
Lugs 1/2"x1 1/4"x3/32"
2" between collars
Right or left hand Thread Optional
TRIO MACHINE CO., Box 187, Dept. PM, Willoughby, Ohio

Precision ground ball-bearings; Bessemer steel shaft, completely enclosed; seamless steel body. For home, farm and shop—saws, shapers, fans, power take-off, wind mills etc. Be sure to state shaft size and thread (R or L) desired. Send Money Order or Certified Check. Full money back guarantee. If your dealer cannot supply you, write.

PISTON TYPE COMPRESSOR



EASY PROFIT IN PAINT SPRAYING

Paints walls, ceilings, screens, furniture and machinery faster, better. All complete as shown less motor. Carry anywhere. Fully guaranteed. Could be used with 1/4 H.P. motor or less. Price **\$35.00** less motor F.O.B. Chicago. \$5.00 deposit balance C.O.D. or see your dealer.

IDEAL AUTOMATIC PUMP CO., Dept. P.M.8
801 W. Washington Blvd. Chicago 7, Ill.

MOTORS — 12 ALL DIFFERENT — \$2500 Prepaid

24-27 VDC, Permag., shunt and series wound. Some operate on 6-12-24 volts AC or DC. 20 varieties to choose from — Mouse-power to 3/4 H.P. Some geared head with extras.

CHAFF DISPENSERS containing 2 motors 1/20 H.P. 27-VDC, over 50 gears and moving parts, Micro-switch, in aluminum case 5"x7"x18", plus separate control box, \$4.95 prepaid.

Free surplus gadgets with every order — Big Bargain List free, listing all types motors, actuators, fuel, water and hydraulic pumps, microswitches, gunights, scopes, lenses, prisms, ball bearings, radio parts, relays, lamps.

QUINN'S GADGET SHOP, 1940 E. 14th St., Oakland 6, Calif.

12 lbs. SURPLUS RADIO PARTS \$2.00

A gold mine of parts for repairmen, amateurs, and experimenters . . . sockets, condensers, resistors, transformers, coils, hardware, wire, etc. An outstanding bargain in usable parts! Send \$2.00 cash, check or M.O. today!
(Pay small express charges on receipt.)

ELECTRONIC DISTRIBUTORS, Inc. Dept. MB 620 W. Randolph St. Chicago 6, Ill.

Time & Date
AT A GLANCE



BELL
GUARANTEED
CALENDAR WATCH

Tells time, name of day and date. Day name changes automatically.

No. HL382 — Calendar watch, 17 jewels water-shock resistant, non-magnetic, radium dial and hands, stainless steel back. **\$49.75**

OTHER SPORTS WATCHES WATER-SHOCK RESISTANT

NOW AT RECORD LOW PRICES

Precision tested, guaranteed, 17 jewels, non-magnetic, radium dial and hands, unbreakable crystal, sweep second hand.

No. HL198 — Stainless Steel Back **\$24.75**

No. HL220 — ALL STAINLESS STEEL CASE . . . **\$29.95**

ORDER BY MAIL: Send check, money order or pay postman C.O.D. Prices Incl. Fed. Tax and Postage. Write for FREE Booklet "HL".

REPAIR SERVICE: All types and makes of quality watches. FREE estimate on request.

BELL WATCH COMPANY, INC.

Time and Life Bldg., Rockefeller Center, New York 20, N. Y.

SAY YOU SAW IT IN POPULAR MECHANICS

YOU'VE READ ABOUT IT . . . HEARD ABOUT IT . . .
THAT MIRACULOUS NEW CAMERA

IT'S HERE AT LAST

★ TAKES PICTURES

★ DEVELOPS and

★ PRINTS WITHIN 10 MINUTES RIGHT ON THE SPOT!



ANYONE CAN USE IT!

AMAZING LOW PRICE ONLY **\$12.95**

FILM PAPER FOR 12 PICTURES And Chemicals **\$1.00**

Send money order or check for Camera, plus \$1.00 ea. for kits of film paper and chemicals. WE PAY POSTAGE. Order C.O.D. Pay postman, plus postage. Order several of the KITS at \$1.00 ea.

SPEED-O-MATIC
It's miraculous! If there's water around and you can pour water . . . you can develop and print your pictures as fast as you take them in this REVOLUTIONARY CAMERA! It's that simple! It's that amazing! And . . . the SPEED-O-MATIC has 5 lens openings, built-in exposure meter, requires no focusing! If you thrill to PROGRESS in SCIENCE, you'll certainly want this Camera!

WE PAY POSTAGE

IMMEDIATE DELIVERY! ORDER NOW FROM KENT JEWELRY CO. 13933 E. JEFFERSON DETROIT 15, MICHIGAN

SpeedWay



No. 89 1/2" DRILL
\$2995



No. 209
Drill Stand
(less drill)
\$1295

Why tote around a heavy "production type" drill (designed to run continuously at full capacity on some production line), when you can get a light weight handy SpeedWay Drill that makes all ordinary drilling easier and gives you

years of service. Regardless of what you pay, you cannot get a better 1/2" drill for general use, than the SpeedWay No. 89. With its No. 209 drill stand it doubles as a capable drill press at sav-

ings that will go a long way in paying for other equipment. You'll find the same sensible economy in the little SpeedWay No. 69 Drill and its No. 229 drill stand. This low cost pistol grip drill will drill straight holes up to 3/4" diameter in steel.

No. 229
Drill Stand
(Less Drill)
\$525

Write for circular and name of your nearest dealer.

No. 69 \$1180
1/4" Drill



SPEEDWAY MANUFACTURING CO.
1863 S. 52nd Ave., Cicero, Ill

ALLISON ENGINES

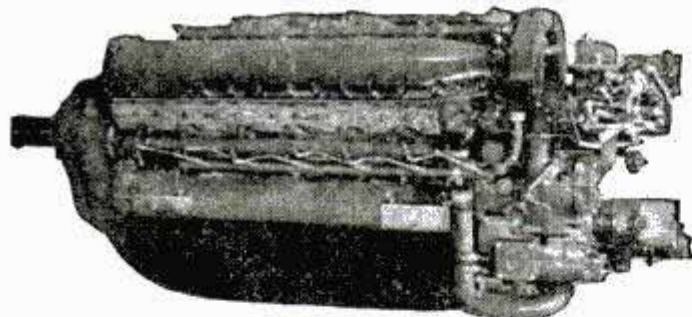

WAR SURPLUS ENGINES IN PERFECT CONDITION OFFERED TO YOU AS THE GREATEST POSTWAR BARGAIN OF ALL TIME

MODEL 1710-12 CYLINDER-V TYPE
LIQUID COOLED-1100 H.P. AT
2600 R.P.M.-2 to 1 REDUCTION

This is the famous Allison engine manufactured by Allison division of General Motors to be used as the power plant for the P-38, P-39 and P-40 fighter planes.

These engines turn up a normal speed of 2600 R.P.M. and are equipped with a 2 to 1 reduction gear which may be dismantled as a unit if desired.

Each engine is complete with magnetos—carburetor—supercharger—ignition harness—oil pumps—oil filter and water cooling pump. Engines average 300 hours use and are in excellent condition.

This power unit is easily adaptable for use in speedboats—cruisers or auto-racers or as a stationary or portable power plant for drilling rigs or electric generators.

ORIGINAL COST
TO GOVERNMENT
\$12,000.00

Our Selling Price

\$200⁰⁰

FOB New Orleans
Crated and Ready
for Immediate
Delivery

STARTERS and
GENERATORS
Extra \$5.00 Each

INDUSTRIAL SUPPLY CO.

4163 Bienville St. P. O. Box 381 Tel. GA. 1181
New Orleans 1, La.

Ball-Bearing SPEED WHEELS

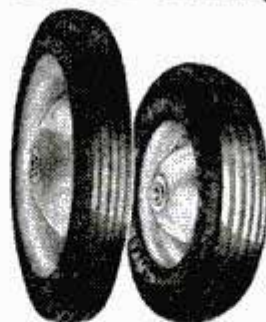

Juvenile wheels, solid tire
No Bearings

7" wheels.....60c
6" wheels.....50c
4" wheels.....30c

Semi-pneumatic tired wheels

12 x 1.75".....\$3.25
10 x 1.75".....\$2.75
8 x 2".....\$2.00

Industrial wheels for
heavy loads

10 x 2.75".....\$6.75
8 x 1".....\$4.90
6 x 2".....\$2.80

**DEALERS
WANTED**

Free blueprints with all wheel orders.

JIM BROWN TOY COMPANY

1093 Home Ave. Akron 10, Ohio

LIGHT PLANTS

Used Gov't Surplus — Lowest Price
Ever Offered — 3,000 watt, 110 volts.

Powered by Briggs-Stratton or Wisconsin 6 H.P. air-cooled engine. For stationary or portable use. REBUILT-GUARANTEED, good mechanical and operating condition. Our price **\$14950**
F.O.B. Kansas City....



Limited Supply — Immediate Delivery — Order Now
Write for Illustrated Circular

MIDWEST SURPLUS SALES 1520 LOCUST ST.
KANSAS CITY, MO.

NEW B-M POWER MOWERS



For Modern Lawn Care

Newest type three-wheel rotary blade mower. Prompt shipment with 1 1/2 h.p. Clinton engine. Choose from two models of assembled mowers or Build-it-yourself kit of parts. Guaranteed. Write for FREE literature and prices!

B-M MOWER COMPANY
Box 66-N Blue Mound, Kansas

At
LOW
FACTORY
COST

Dealers
Wanted

Why spend years learning by hard
experience what you can get from
a practical book in a few hours.

Write for list of "How-To-Do-It"
books on practical subjects. 1000's of
pleased customers all over the world.

ADAMS BROWN COMPANY—BOOKS OF APPLIED SCIENCE
Dept. 178 Chestnut Hill 67, Massachusetts, U. S. A.

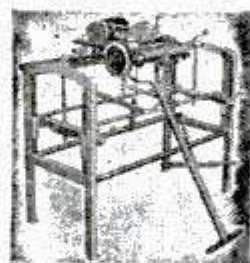

MASTER CHAMPION LAWN MOWER SHARPENER

Also Mfg., Saw Sharpening
& Key Machines

FRANK'S MFG. CO.

Dept. PM9
2501 E. Imperial Highway
Los Angeles 2, Calif.

DRILL ROD TOOL STEEL



\$1.95
POSTPAID
OR C.O.D.

For Making
SMALL TOOLS
CHISELS, DRILLS
CAMs, GEARS
BUSHINGS, Etc.

Sampler Kit of 25 rods assorted diameters.
FREE—Tempered Steel DEPTH GAGE
with every kit.
BESSEMER STEEL CO., Dept. 11
Small Shops Div. Chicago 19, Ill.

War Surplus

For the Sportsmen — Young or Old
All Year 'Round Use



Perfect all wool
Olive Drab
**SLEEPING
BAG**

Comes in handy for fishing trips, hunting, camping, boating, just roughing it or use as auto robe and many other purposes. Has warmth of 2 blankets; zipper slide fastener; tie-strap on bottom; approx. Gov't cost \$12.00, our price, Ea. **\$3.95**
Outside Cover for Sleeping Bag—Water repellent.....\$2.39

ARMY PUP TENTS Perfect Without Pole..... **\$2.95**

DROP CLOTHS—(used) perfect, 6x6 1/2 ft.....\$1.59
Perfect **CANTEENS** — used, 65c **SPURS**—Cavalry, New...95c
Perfect **MESSKITS** — used, 65c **CANTEEN CUPS**.....40c

NEW AIR CORPS SUNGLASSES

Manufactured by Bausch & Lomb for U. S. Air Corps. Quality and Style with Bone Nose Cross Bar, individual case. Priced at big savings which **INCLUDES** postage..... **\$5.95**

NEW GOGGLES Set comes complete (boxed) with 9 extra interchangeable shatter-proof, flexible, cellulose acetate lenses. Amber, Green and white colors. A rubber flexible chamois lined goggle frame. Back adjustment head strap. Made for A. A. F. Cost Gov't approx. \$4.50. Ea. **\$1.59**

Add 10% for postage — No COD — Send check or money order.

AMERICAN SUPPLY CO. Dept. P.M., 5th & Broadway
Kansas City, Mo.



HEAT BURNERS FURNACES GAS - OIL

L. P. PROPANE Gas Burners, Floor furnaces. Blowers, Cooling Coils, Exhaust Fans, Controls. Card for free literature. Wholesale & Retail.

Peerless Sales

4318 Sheridan Lincoln 6, Nebr.

NEW INK Etches ON METAL

Simply write your name, initials, etc., on tools, dies, instruments, jewelry, etc. The writing is actually etched in—permanently—in a few minutes on gold, silver, aluminum, copper, brass or tool steel. Amazingly quick and easy. Nothing else like it. It's insurance against loss.

Write on METAL with "MAGI-CHEM"

Not an Acid, but a new kind of ink that etches into the metal exactly what you write with an ordinary pen—and it STAYS THERE as a PERMANENT TRADE MARK or Personal Identification. Harmless to skin. Get yours NOW . . . bottle, with instructions, postpaid, only...\$1.00
HEWIG CO., Box N-143, Grand Central Annex, New York

3 NEW PLASTICS MANUALS

FABRICATING **CARVING**
CASTING MANUAL Now Only **\$1.00**
Make beautiful objects of Plexiglas, Lucite, Catalin, Polystyrene and Castolite at home. Jewelry, novelties, accessories. Three new manuals show how to fabricate, cast and carve latest plastic materials. 20,000 words, 23 special designs, 43 photos, charts, diagrams and hundreds of suggestions. Price prepaid \$1.00. Or get FREE information and price list. House Beautiful Plastics, Dept. J3, 5534 W. Harrison St., Chicago 44, Ill.

DRILL-INDEX A compact container for indexing and filing twist drills. Eliminates search. Made entirely of steel in nine sizes. See your dealer or write to
HUOT MANUFACTURING CO.
555 No. Wheeler St. Paul 4, Minn.

Big Money for Workers In Home or Shop

Licensed Concrete Specialists wanted. No experience needed. Make *Colorglazed* concrete pottery without molds. New, low cost, patented method. Cemetery products, novelties, tiles, etc. Basement leaksealing. Other big pay projects. Booklet, details free. Men only.
NATIONAL POTTERIES COMPANY
415 Third Avenue, W., Grand Rapids, Minnesota

IMMEDIATE DELIVERY Portable PAINT SPRAYERS

ONLY \$26⁹⁵



Uses 1/4 Hp. Motor

Complete as illustrated, less motor. Sprays all kind of paint, lacquer, varnish, etc. Oil-less ball bearing compressor, 2 cu. ft. air per minute. 15 to 50 lb. pressure. Sprays paint 5 times faster than hand brushing.

No. 890. Outfit complete as shown with "V" belt, motor pulley, 15 ft. high test air hose and No. 112 gun, but without motor. **\$26.95.**

No. 4 4 Outfit, twin cyl. 4 cu. ft. production type gun, 15 ft. air hose, reg. and gauge. V belt and motor pulley. Complete less motor, **\$47.50.** Uses 1/2 Hp. motor.

Spray Guns—Low Pressure

Operate on 15 to 50 lb. pressure
No. 112—1 Qt. cup.....\$6.50
No. 121—Production Type 7.95
No. 125—External Mix... 9.50
Regulator & Gauge 0 to 160 lb..... 4.95
Air Hose—25 ft..... 2.75
3 gal. Paint Tank (with hose).....16.50

NEW BLACK & DECKER DRILLS—110V AC-DC

3/4" 2250 rpm., Drill.... \$18.95
3/4" 375 rpm., Drill.... 35.95
3/4" Drill Stand..... 11.45
3/4" Drill Stand..... 17.45

Check or M. O. with order shipped prepaid. COD's plus charges. Write for Free Catalog.

INDIANA APPLIANCE CO., 20 E. Sycamore
Dept. PM-125 • Evansville, Ind.

NEW WHIZZER "STATION WAGON" DOUBLES YOUR BIKE'S USEFULNESS

Here's a great new bike trailer that's built to last. What's more, the extra-light, extra-strong WHIZZER "Station Wagon" fits any bike. Full swivel hitch. Quickly attached and detached . . . makes an ideal hand cart around the yard and for shopping in stores. Carries bulky loads easily, safely . . . does not affect balance or control of bike. For low-cost delivery . . . drug stores and groceries . . . paper routes . . . personal shopping—get a WHIZZER "Station Wagon" today! Ideal for week-end trips and summer camping. Comes in knock-down package form.

Only **\$14.95**
F.O.B. PONTIAC, MICH.

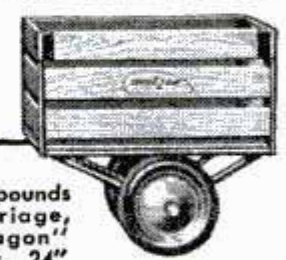

SPECIFICATIONS—Rated over 200 pounds capacity. Strong steel undercarriage, natural finish wood "station wagon" sides. Semi-pneumatic 10-in. tires. 24" long, 18" wide, 20" deep.

See your local bike dealer or order from
WHIZZER MOTOR SALES CO.
PONTIAC, MICHIGAN

Carries the Same 90 DAY GUARANTEE As a New Motor Assy.

Our Finest Precision REBUILT

MOTOR BLOCK ASSEMBLIES

Sold Outright or Exchange

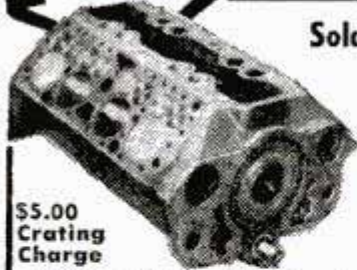

\$5.00 Crating Charge

FORD BLOCK ASS'Y.			
Year	Type	Outright	Exch.
28-31	4 cyl.	\$ 98.00	\$73.00
32-47	6 & 8	139.00	89.00
Mercury			
39-47	V8	149.00	99.00
Chevrolet			
34-47	6 cyl.	117.50	87.50

Rebuilt by skilled mechanics. Assembly has Reborn Block with New Pistons, Pins, Rings, Reground Crankshaft, and all New Bearings. Guaranteed 90 Days.

Allowance on Old Motor
We ship at outright price. Send your motor prepaid, must be suitable for rebuilding. Send in notarized bill of sale showing title number if any. We refund difference when we receive your motor.

DODGE—3 1/4" bore			
Year	Type	Outright	Exch.
35-47	6 cyl.	\$129.00	\$99.00
Plymouth			
35-47	6 cyl.	129.00	99.00

Specify exact year, make and model when ordering. Send for catalog on motors not listed.

POWER TAKE-OFF for JEEP ENGINE

Bolts to clutch housing on the Jeep engine. Has a spline shaft to engage with clutch and extending from rear is a keyed shaft on



which pulley can be mounted. Hand lever controls clutch. PF4N-23J—Each.....

\$4250

NEW 5 Gal. CANS



FOR GAS, OIL OR WATER. Vented for Safety. Self-locking Safety Cap Extra Heavy Construction Will Float When Full. Size of can, 18" high, 8 1/2" thick, 13" wide. PA35U-60—Lots of 5, ea. 1.15
Lots of 50, ea. 1.05
Lots of 100, Each 98c



60 HP. JEEP Engines

Reconditioned, Tested and Guaranteed in perfect running order and ready to run. Every part is checked to be perfect and carries a 90 Day Guarantee same as a new engine.

COMPLETE with . . . Generator, Starter, Distributor, Coll, Fan and Fan Belt, Water Pump, Fuel Pump, Intake and Exhaust Manifolds, Carburetor, Oil Filter, Spark Plugs, Flywheel, Clutch Assembly, Wiring, Outright, PG58R-003, Each \$12750

Write for Special Price Quotations in Quantities.

\$5.00 Crating Charge

SEND 25% CASH WITH ORDER, BALANCE C.O.D.

OUR AUTOMOTIVE PARTS CATALOG SENT ON REQUEST.

J.C. WHITNEY & Co.

1917 Archer Ave. Chicago 16, Ill.

NOW YOU CAN PAINT WITH PLASTICS

The brilliant glistening beauty of pure phenolic plastics is now yours for as large a surface as you want, at an infinitesimal fraction of the cost of solid plastics. A block of the cheapest wood or other material can be made as beautiful, as durable, as chemical-proof, as brilliantly polished, as a block of pure plastic, for PHENOPLAST is nothing but 100% phenolic resin which due to new scientific compounding methods, can now be made to actually "set" or "polymerize" ON YOUR WORK, instead of requiring huge ovens or gigantic molding-presses. ALL THE ADVANTAGES OF SOLID PLASTICS ARE RETAINED—yet you just BRUSH IT ON, WIPE IT ON, or DIP IT.

COAT ANYTHING WITH PHENOPLAST—and you have an object that looks, feels, shines, lasts and acts like solid plastic. You can turn burlap or cotton batting into strong shock-proof automobile bodies, you can carve small objects in pine and make them look like ruby or jade, you can put down a floor finish that never needs waxing, you can paint a boat-hull that resists fungi, teredos and barnacles and cannot peel, you can turn linoleum into "tile," you can put a permanent finish, with a permanent polish, on ANYTHING with PHENOPLAST—it sets with the highest gloss and the hardest surface of ANY finish.

PHENOPLAST the new cold-setting liquid phenolic resin was developed by A. J. Lockrey, plastics expert and author of "PLASTICS," the text book used in most vocational schools.

SEND FOR TRIAL PACKAGE—a quart of clear transparent PHENOPLAST, three bottles of ruby, jade and amber dyes and complete instructions for dozens of fascinating uses, only.....

\$300

LOCKREY PLASTIC PRODUCTS

40-16 150TH

FLUSHING, N. Y.

AIRPLANE GENERATOR

25 AMP.

Can be used on homebuilt Electric Welder, Wind Charger, Battery Charger, Light Plant, etc. Also can be used on boats, trucks, airplanes. Fits nearly any 24 volt airplane system.

Built by Leece-Neville, 24 volt, 25 amp. Model L-3.

BRAND NEW! Original cost \$212, NOW, only..... \$24.25

\$2.00 deposit required on CODs. Generators shipped Express charges collect.

AERO INSTRUMENT COMPANY MUNICIPAL AIRPORT HOUSTON 12, TEXAS



MACHINISTS + TOOLMAKERS

Your good tools deserve the care that only a GERSTNER chest can provide. Free catalog. GERSTNER TOOL CHESTS 447 Columbia St., Dayton 7, Ohio

SAVINGS IN SURPLUS MATERIAL FOR WOOD CARVERS—MODEL and DECAY MAKERS

Large pieces of LAMINATED Balsa wood cut from surplus life rafts. Soft, easily-worked, reinforced with occasional short 1/2" hardwood pegs.

- 11"x11", with rounded corners, x25" . . . approx. 25 lbs. . . . \$1.00
- 11"x11", with rounded corners, x5' 10" . . . approx. 70 lbs. . . . \$2.50
- 15"x15", with rounded corners, x4' . . . approx. 90 lbs. . . . \$3.00
- 15"x15", with rounded corners, x8' 4" . . . approx. 190 lbs. . . . \$6.00

Send check or money order now for immediate delivery. Shipping charges C.O.D. — specify Freight or Railway Express.

D. BILLS Rt. 1, Box 331 Mill Valley, Calif.

SAY YOU SAW IT IN POPULAR MECHANICS



All Types Of Wood Shaping

Aladdin's Tool

THE "GENI" OF A THOUSAND AND ONE USES !!!



The Design Co., 2016 E. 31, Dept. P. 38, Kansas City, Mo.

Tongue & Groove - Fluting - Notching - Inlay - Any Joint

Complete With 6 Ground Blades - And New Adaptor

Dealers Write for Information

Makes 12 Different Cuts. Makes any cut wood shaping tools costing up to \$300.00 can make—more too. Sturdily built, lasts a lifetime. Complete—makes 12 standard cuts and over 100 variation shapes. See your dealer or if he does not stock, send \$7.95 for immediate delivery to your door. All other orders C. O. D. plus postage.

\$7.95



Save 75%-90%
of Set-Up Time
in CENTERLESS
GRINDING...

Porter-Cable Centerless BELT GRINDER

Eliminates truing,
balancing... and continued wheel dressing

Since the Contact Roll is behind the endless abrasive cutting belt, it is not subject to wear. Therefore, it always has a flat, smooth, true-running surface and square edge. Does not nick, round or chip. Furthermore, its resiliency eliminates chatter... compensates for irregularities of stock.

For different size stock, simply advance or retract the Regulating Wheel Assembly to or from the abrasive belt. It's simple, fast, true set-up in just a few minutes!

This Porter-Cable Model L-4 handles a wider range of operations. Takes stock $\frac{3}{8}$ " to $2\frac{1}{4}$ " in diameter, in lengths from $\frac{3}{4}$ " to 2' in one fixture. (Adaptable to longer lengths also).

SAVE MONEY!
Read what the L-4 will
do for YOU! Write to-
day for information.

The L-4 is now available
at a revolutionary low price!
Any shop can afford it!

PORTER-CABLE MACHINE CO.
2050-8 N. Salina St. Syracuse 8, N. Y.



Not An Inboard—Not An Outboard

Do you have a small gasoline motor? Then you can make your boat power driven by simply fastening your motor to the MOTOR TROLLER and clamping on to your row boat. Suitable for small $\frac{1}{2}$ -1 $\frac{1}{2}$ H.P. motors such as used on lawn mowers, washing machines, etc. Ideal for fishing.



WRITE FOR FREE CIRCULAR

*Pat. Pend.

\$28.50

The MOTOR TROLLER CO., Dept. P 292 Riverside Ave. Westport, Conn.

BUILD YOUR OWN Battery Driven ELECTRIC LAWN MOWER.. PLANS ONLY

This ultra-modern rotary-blade mower can be made from inexpensive parts and an old auto generator. Plans complete, easily followed. Mower cuts forward or backward, tall or short grass, and weeds.

35¢
WRITE TODAY

LEJAY MFG. CO.
847 LeJay Bldg., Minneapolis 8, Minn.

"LITTLE WONDER" Crystal Radio

NO-ELECTRIC—NO BATTERIES—NO TUBES
One of the smallest genuine crystal radio sets in the world. Slider-contact tuning, binding posts for aerial and ground. Extra long range. SEND NO MONEY. Just send your name and address and when your "Little Wonder" arrives simply pay the postman \$1.99 plus a few cents postage. Sent prepaid if you enclose check or money order with your order.

MART DISTRIBUTORS

Box 3472 Merchandise Mart, Chicago 54, Illinois, Dept. P14

WASHING MACHINE PARTS

ALL MAKES
Wringer gears, Agitators, Rolls, Pumps, Gear cases, Shafts, etc. 10,000 parts.

NORTHEAST BURNER, 1358-M H St. N.E., Washington, D. C.

8x2" TIRE & WHEEL - COMPLETE

Here is the Wheel you will want for your Wagon, Scooter, etc. Will never RUST! No painting needed—hub of cast aluminum—nuts & bolts cadmium plated. ARGUTO OILLESS bearing— $\frac{7}{16}$ " bore. Never need be oiled! "Clipper" semi-pneumatic tire. Use as is—polished hub very attractive.

(Dealers & Manufacturers write for quantity discounts)

\$2.60 each ★ A set of 4 Wheels \$10.00

C. L. WALKER, P. O. Box 1023, Plant City, Fla.



...FIT
BETTER
LAST
LONGER

YOUR
HARDWARE
STORE

displays many styles and sizes - Get the sizes you need - have them ready for use.

ALWAYS
RIGHT FOR THE JOB!

Billings have everything you look for in quality wrenches — balance, strength, lightness and feel. Easy on you... Tough on the job... Write for our new catalog of Wrenches and Wrench Sets. Ask for FF-48-2

Billings
DROP FORGED
WRENCHES
for FARM-HOME-INDUSTRY

TOOL CRAFTSMEN SINCE 1849
THE BILLINGS & SPENCER CO. HARTFORD 1, CONN.

More Fun Fishing with BOB-ER-LITE



Fish Bites
Bobber
Lites

\$1.98

Now, with Bob-Er-Lite, you can fish at night from boat or pier, safely, comfortably, without eye strain — add many extra hours to your days sport. When fish bites, bobber lites. Nothing to adjust, nothing to get out of order, guaranteed performance. Thousands are already in use. Bulb and battery are standard—readily replaced when worn out. Enjoy this extra thrill yourself. At better stores—or use the convenient order coupon.

Enclosed is M. O. or check for _____ Bob-Er-Lites at \$1.98 each

Name _____

Address _____

Send to Pasch Bros. 229 N. WATER ST. Dept. 18 MILWAUKEE 2, WIS.



Patents
applied for

WAR SURPLUS BARGAIN SPECIAL

BRAND NEW!
VACUUM-AIR
HYDRAULIC

FUEL PUMP

Original Cost
\$45.00
Now Only
\$9.95

Postpaid in U.S.A.

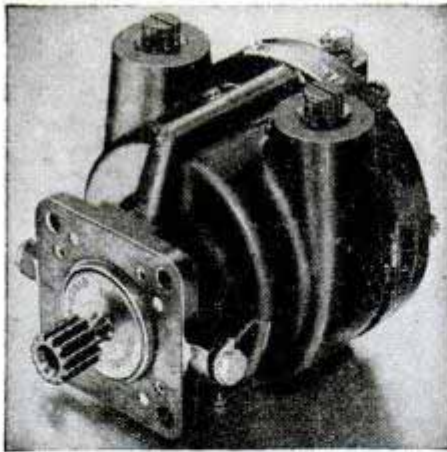

WORTH MANY TIMES THIS LOW SALE PRICE

USE THEM FOR
OIL BURNERS

SPRAYING
MACHINES

MILKING
MACHINES

COMPRESSORS

VACUUM PUMPS

HYDRAULIC
SYSTEMS

MANURE
LOADERS

PRESSES, etc.

Originally cost \$45.00. Used by the Air Corps to drive bomber de-icer boots, gyroscopes, automatic pilots, etc. May be used as air or fluid pump—for pressure or vacuum. Standard 3/8 inch pipe thread with interchangeable ports. Will pump 7 1/2 gal. SAE 30 oil per minute at 300 RPM. Builds air pressure of 30 lbs. per sq. in. at 1000 RPM. Vacuum will draw 26 inches of mercury at 1750 RPM. Develops up to 120 lbs. per sq. inch of hydraulic pressure, which in conjunction with a 3 inch hydraulic cylinder, will lift 840 lbs. minimum. Runs forward or reverse. Self-aligning shaft. Die cast aluminum housing 6x4x4 inches. Has stainless alloy steel vanes and impeller. Made by Bendix Avia, Corp. Spline terminal for direct drive—easily replaced with a pulley. Recommend a 1/4 H.P. or stronger electric motor as source of power. Rated capacity 1500 RPM with high overload factor. Special price for quantity users. Complete illustrated report and instruction booklet FREE with every pump. Send check or money order today. Postpaid in U.S.A.

\$9.95

GROBAN SUPPLY CO. 1522 So. Michigan Avenue
Dept. PM8 Chicago 5, Ill.

Special! BUILD YOUR OWN "Personal Radio" NEW MEISSNER RADIO KITS

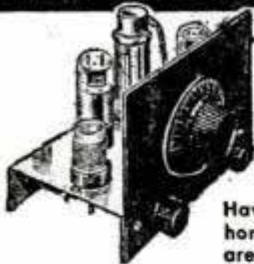

2-TUBE \$5.65
AC-DC Model

3-TUBE \$6.30
AC-DC Model

Have your own "Personal Radio" at home. These fine new Meissner kits are not toys, but real radio sets that receive signals from great distances. Supplied with plug-in coils for broadcast bands. Two controls. Pictorial diagram makes assembly very simple with screwdriver, pliers and soldering iron. All parts and material supplied, except tubes, phones, aerial. For 110 volts AC or DC. 5 lbs. No. A-10998 2-Tube, No. A-10999 3-Tube Kit.

Kit of 2-Type 76 Tubes for above.....\$1.48
Kit of 3-Type 76 Tubes.....\$2.22
Set of Head Phones.....\$1.95

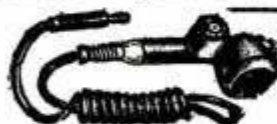

T-17B MICROPHONE

All Brand New — Perfect Carbon Hand Mikes. Light Weight, 200 ohms. Single button, press-to-talk

switch. 5 ft. rubber cord, plug dust cover. Terrific at **99¢**
F.O.B. N. Y. or Chicago • Send for Bargain Bulletins

NEW YORK
Offices & Warehouse
242 W. 55th St., N.Y. 19

NEWARK CHICAGO
323 W. Madison St.
Chicago 6, Ill.
ELECTRIC COMPANY, INC.

New York City Stores: 115-17 W. 45th St & 212 Fulton St.

World's Finest Quality TOILET SEATS

Model 201 E Open Front Toilet Seat will fit all elongated bowls. In black Satin Finish. Individually cartoned. Weight 3 lbs. Price \$5.25 ea. (2 for \$10.00)



Model 100 CR Toilet Seat and Cover. Will fit all regular bowls. Finished in lustrous white plastic enamel. Individually cartoned. Weight 5 lbs. \$7.95 each. (2 for \$15.00)

PERMANENT MOLDED CAST ALUMINUM

• Lifetime One Piece Construction Will Not Crack or Warp.

• Acid Proof! Moisture Proof! So Easy to Keep Clean!

• Fire Baked Plastic Enamel Coating Over High Polish Cast Aluminum.

Aluminum, one of the fastest conductors of heat. Seat quickly absorbs room temperature.

It's the ultimate in Design... Sanitation... Durability. No seams or joints. Has concealed hinges and rubber bumpers, mounted with machine screws. Standard, non-corrosive brass fittings. Will add sparkle and beauty to any bathroom. Mail your order today. State model(s) desired. Orders including Check or Money Order sent prepaid. C.O.D. plus postage.

WARE PRODUCTS, Dept. 49-K
325 N. Wells Street, Chicago 10, Illinois

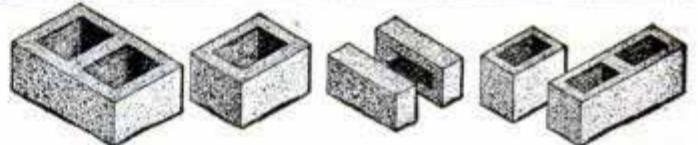

Profit by the Building Boom!

Start your own business manufacturing concrete building block and brick. Use Economy hand moulds. Make true, straight, easy-to-lay units which will pass any building code. Small investment, high production, big profits. One \$30.00 mould will make 1,000 5"x8"x12" blocks per day. Letters and repeat orders tell how pleased our customers are. Post card brings free folder.

Economy Manufacturing Company
Dept. P Stone Mountain, Georgia

ROUGH DIAMONDS

Genuine Diamonds: exactly as found in the famous African mines, uncut and unpolished. Each diamond guaranteed to weigh one carat or more. A real bargain for collectors, mineralogists, dealers, mechanics, and agents. Send only \$5.85, full price, postpaid, diamond will be sent promptly by insured U. S. Mail. Larger size diamonds available. No literature. Remember—you are buying real diamonds!

SECURITY JEWELRY CO.

610 South Broadway Los Angeles 14, California
In the jewelry business for over 40 years.

AMAZING LOW COST BRONZE FOUNDRY CAST ALUMINUM, SILVER, ETC. — ALL NON FERROUS METALS

Make money in the foundry business casting Engines, Machinery, Art Objects, Statues, Inventions and all other foundry work. Castings up to 6# made quickly with new invention called Foundryette. Operates on 110 V AC and Domestic Gas. Write for complete FREE information.

KANS. CITY SPECIALTIES
Box 6022B Kans. City, Mo.

**Sand Casting
Forging-Heat
Treating-Case
Hardening**

MAKE YOUR OWN POWERED EQUIPMENT

with these LOW COST

SKF BALL BEARING ARBORS

(RIGHT OR LEFT HAND THREADS)

No. 1000	Die.	Spindle	Housing	Price Each
	1/2"	1 1/2"	6"	\$ 7.95 PP
	3/8"	1 1/2"	8"	8.95 PP
	3/4"	1 1/2"	8"	10.95 PP
	1"	1 1/2"	11"	19.95 PP

A & P EQUIPMENT and MERCHANDISE CO. DEPT. 1-C
520 West 15th Street LONG BEACH 13, CALIF.

MORE PROFITS

with

MODERN LAWN MOWER SHARPENER



SHARPEN ANY LAWN MOWER from 5-inch Edger to 36-inch Power Mower in ten to twenty minutes with a **MODERN LAWN MOWER SHARPENER** because dismantling is unnecessary—neither handle, roller, wheels nor motor need be removed when sharpening any mower. . . . the **MODERN SHARPENER** eliminates all hand filing; it precision grinds to the extreme ends of both left or right reel blades. Bottom knife is held in same brackets for sharpening. **NO EXTRA ATTACHMENTS!** Order today! Price \$241.50 (less motor) f.o.b. Pasadena. (1/2 or 1/4 H.P. single phase motor recommended.)

Modern Mfg. Co., 156 N. Fair Oaks, Pasadena 1, Calif.

BUILD YOUR OWN MOTOR CAR!

Here's news so thrilling, so sensational, it's almost too good to be true. Imagine. Now, you can build your own auto starter motor car right in your own back yard. A swell deluxe model that travels

over the highways, just like the big cars. A real thrill for anyone who likes to "tinker." Every red blooded boy will want to build one. Cause with this kind of auto, he'll be the "big shot" in his town. This is a real powered auto, not a toy. Rush postcard or letter and let us tell you all about it.

CONSTRUCTIVE ENTERPRISES

BOX 554, RIVERDALE STATION DAYTON 5, OHIO

New THOR "B" ENGINE-\$6.95



The new THOR "B"—Sensational miniature gasoline engine that really works. Super-power performance. Smooth, velvety power that roars into action with a "twist of the wrist." Over 25,000 already sold. 1/8 H.P. Complete with coil and condenser. Ready to run, only \$9.95. In KIT form, fully machined, 5 minutes to assemble, \$6.95, without coil and condenser. Powers all models. Fully illustrated instructions. Send \$1.00—shipped collect same day C.O.D. FREE—Send for 24-page illustrated hobby catalog.

AMERICA'S HOBBY CENTER
Dept. 887 156 West 22nd Street New York 11, New York



You Now Can BE YOUR OWN BOSS
Start a business with this new modern invention. With a small investment you can, without exaggerating, make from \$75.00 to \$250.00 per week. No experience necessary. Write for FREE literature.
Precision Key Mfg. Co.
657 Columbia Street Dept. 5
San Diego 1, California

SIGNS EASILY AND EXPERTLY PAINTED WITH LETTER PATTERNS AND SHOWCARDS

MANY SIZES & STYLES WRITE FOR FOLDER!

JOHN F. RAHN
1330-31 N. Central Ave.
CHICAGO 51, ILL.

IMMEDIATE DELIVERY

"CESCO" HEAVY DUTY GRINDER



4" BALL BEARING BENCH GRINDER
3450 RPM 110 V 60 cycle AC
only Guaranteed

12.95
FOR NEWARK

"CESCO" 8" POWER SAW



19.95
FOR NEWARK

8" SAW BLADE
2.84 extra

HEAVY DUTY STEEL RIGID TABLE AND BASE PRECISION ALIGNMENT 14" x 18" tilt table adjustable to 45°. Adjustable fence—safety guard—2" V-belt pulley—attractively finished in aluminum enamel—adjustable blade—ball bearing spindle. Motors also available.

Save Collect Charges—Send Check or Money Order
CESCO 145 MULBERRY ST., NEWARK 2, N. J.

Harley-Davidson U. S. Gov't Surplus Used Motorcycle Engines

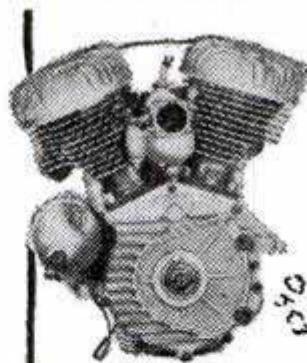

- For '37 to '46 H-D Motorcycles!
- For Economical Portable Power!

59.95

Immediate Delivery
Write for Credit Terms

Worth \$265 when new! Completely inspected and OK'd! The replacement parts alone are worth more than you'll pay for the complete engine! Use it as a motor replacement on your 1937 to 1946 Harley-Davidson motorcycle. Use it on the farm or in the factory as a source of economical portable power or as inboard motor on boats, 2-cylinder, V-type, L-head engine, N.A.C.C. Horsepower rating is 6.05. Mail the coupon TODAY!

Goldblatt's

—Clip This Coupon—

Goldblatt Brothers, 333 S. State St., Chicago 4, Ill.
State, Jackson, Van Buren Sts., Chicago 4, Ill.
Please Send Me _____ Harley-Davidson Used Motorcycle Engines at \$59.95 each.

Name _____
Address _____
City _____ State _____ Zone _____
 Charge Money Order \$20 Deposit on C.O.D.
Illinois Residents Add 3% Occupational Tax, Extra Freight Charge for Shipping Outside of Regular Delivery Zone.

BUILD! DESIGN! CREATE!

With

TECH

the New

CREATIVE MODEL MAKER



An amazing NEW construction set of durable colorful plastic! Makes an immediate hit with the youngsters because it is so simple and easy to assemble without screws, bolts or nuts. A marvel for the model maker because parts are precision engineered to 1/1000 of an inch accuracy. Duplicates appearance and action of actual machines with fascinating realism. Gears, wheels, pulleys, girders, blocks, LOOK and WORK like real ones. Finished models may even be operated electrically. Erect engines, lathes, cranes, airplanes and 100 other designs that come with set or develop models of your own invention. Parts are big and strong, mar-proof, non-fading, brilliantly colored clear through. Don't wait! Get a TECH Creative Model Maker—now—and enjoy endless hours of instructive entertainment.

only \$6.00

Delivered to your door

Send For **FREE** Descriptive Folder in Color that pictures and clearly explains the wonderful possibilities of building with **TECH**.

ORDER DIRECT on MONEY-BACK GUARANTEE

If your dealer cannot supply you, order your TECH Set direct. Sent postpaid upon receipt of remittance. If not entirely satisfied, return within 10 days and your money will be refunded.

CINDERELLA MANUFACTURING CO., Jackson, Michigan

ONLY ONE UNIT * NO SEPARATE BATTERIES

The ONLY **HEARING AID**

with the "Magic Mike"

ALL YOU WEAR

VACOLITE

★ **MINIMUM SIZE** plus
★ **MAXIMUM EFFICIENCY**

Write for FREE booklet

Vacolite Company, Dept. PM
3003 N. Henderson Ave., Dallas 6, Texas

Name.....

Address.....

Town..... State.....



U. S. SURPLUS BARGAIN

NEW NAVY GOGGLES

Brand new! In original packing. Each with three interchangeable lenses.

SHOCK PROOF FRAME — SHATTERPROOF LENSES

Use them for all outdoors sports, beach, motor-ing, boating—anything. Heavy windproof sponge rubber ventilated frame with chamois sweat lining! Adj. elastic head band. Red, green, amber flexible shatterproof lenses, all instantly interchangeable. They won't last long at this price—it's smart to buy an extra. Post paid in U. S. A.

\$1.00
POST PAID

GROBAN SUPPLY CO., Dept. PM 8
1522 S. Michigan Ave. Chicago 5, Ill.

SURPLUS BLANKET OFFER

Here's How You Can S-A-V-E On Blankets. These blankets are only slightly used, but small repairs are needed. Any of them can be put in good repair with a small amount of work. Use them for double beds, auto seat covers, sports events, etc. 100% WOOL—DOUBLE BED SIZE—HEAVY WEIGHT FINE QUALITY—COLOR: OLIVE DRAB.

A good quality blanket even though repaired is much better than a thin cheap one that is perfect. We made the price very low for blankets of this quality; we promise you good blankets; you run no risk; note **GUARANTEE BELOW**. Shpg. Wt. 2 blankets 8 Lbs.

SPECIAL \$3.39 — 2 FOR \$6.42

NEW SURPLUS ARMY FATIGUE PANTS

as adv. in June Popular Mechanics, pg. 276. Olive Drab heavy Herringbone Twill; two large side pockets. Size 32 waist only; 31 & 33 lengths; give 2nd choice for length if possible. Shpg. Wt. 4 lbs.

2 Pr. for \$4.38

If sending cash with order **ADD POSTAGE** to remittance. **WE SHIP C.O.D. PAY POSTMAN ON DELIVERY. SATISFACTION GUARANTEED OR MONEY REFUNDED PROMPTLY.**

FREE Illustrated circular of **SURPLUS** and Civilian clothing sent with order, or free on request. Send for your copy today.

ADDISON UNIFORM CO., Dept. P.M.8, Cambridge, Ohio

AGENTS 300% Profit SIGN LETTERS
For Store Fronts and Office Windows. Anyone can put them on. Free Samples. Liberal Offer to General Agents.
METALLIC LETTER CO., 430 N. Clark, Chicago 10

MEN ARE NEEDED FOR ENGINEERING RADIO TELEVISION ELECTRONICS

Thorough training in radio, including fundamentals, math, repair, sales, broadcasting, communications, with modern laboratory facilities and experienced faculty.

APPROVED FOR VETERANS TRAINING

Moderate tuition and living costs
New Classes Start Each Month

Dept. 3

Albuquerque, New Mexico

EGGERT RADIO INSTITUTE

THIS BOOK SHOWS
HOW TO DO IT

STEEL SQUARE POCKET BOOK

Completely Revised



This concise and handy little book illustrates and describes the best methods of using the carpenter's steel square in laying out all kinds of carpentry work. It is easy to understand as a picture of the square laying directly on the work shows exactly how the various cuts are made. Its compact and handy size makes it convenient to carry in the pocket for quick reference.

Price \$1.25 Postpaid

POPULAR MECHANICS PRESS
DEPT. 627 200 E. ONTARIO, CHICAGO 11, ILL.

POPULAR MECHANICS

PAIN'T YOUR CAR WITH WYPE™ for \$3.95

Amazing NEW AUTO ENAMEL

You WIPE ON Instead of Brushing & Spraying

Get Beautiful Mirror-Like Finish That Looks Like Spray Job!

At last! Practically anyone can now paint his car with WYPE and get a beautiful high-gloss job that gives you an expensive finish such as is sprayed on by Professional Auto Painters—at a fraction of regular cost! With WYPE you need NO BRUSH, NO SPRAY, NO MASKING! Just WIPE ON with Powder Puff—which we furnish at no extra charge. You get a brilliant, glossy finish that is truly "factory-like." No streaks. No lap-marks. Guaranteed for TWO years not to crack, peel, chip or fade, if simple directions are followed. Takes about an hour to apply. Dries dust-free in an hour. WYPE comes in eight most popular shades including those on newest model cars. Goes over any other color, lacquer or enamel.

NEW MONEY-MAKING BUSINESS!
WYPE 2 CARS DAILY for \$25.00 each—
Gross Up to \$260.00 Weekly Profit!

Start making BIG MONEY Now! Sell WYPE in cans or go into business painting cars yourself (or hire others to do work). Send for FREE details of powerful money-making plan. Why wait! Start now by ordering one quart or more of WYPE!

SEND NO MONEY! ORDER WYPE TODAY!

Color	Price Per Quart
BLACK	\$3.95
GREEN (Brewster-Dark or Jewel-Light)	3.95
BLUE (Washington-Dark or Monticello-Light)	3.95
GRAY	3.95
RED or MAROON	3.95

Order one quart or more today! SEND NO MONEY! Mail penny postcard. Then pay your mailman for WYPE plus postal charges. Or, if you send money with order, WE pay postage. See your dealer or order direct.

WYPE CORP.

Dept. 49-H, 2214 Dolman St.

ST. LOUIS, MO.

2-YR Guarantee

NO MASKING NEEDED

NO STREAKS or LAP-MARKS looks like SPRAY JOB



ANYONE CAN DO BEAUTIFUL JOB

ONE QUART DOES ENTIRE JOB! DRIES TO GLISTENING PROFESSIONAL FINISH!

WYPE is a new Miracle Enamel for Autos. It is NOT a wax or polish but a hard high lustre ENAMEL finish! With WYPE, ANYONE can do a beautiful job! Order a quart to paint your car or to get started in this BIG-MONEY Business!

MAKE YOUR OWN DISC SANDER

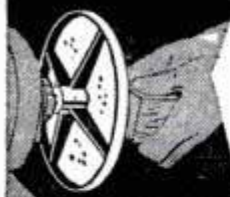

Mount this 8" cast aluminum sanding disc on any 1/2", 5/8" or 3/4" spindle. Sturdy ribbed design. Order direct—\$2.00 postpaid. Threaded bore 25¢ extra. Abrasive paper discs, 8"—1 doz. asst. grits \$1.25.

1738 Clinton Street

EMRICK INC. KALAMAZOO, MICH.

WRITE FOR FREE TOOL LIST.

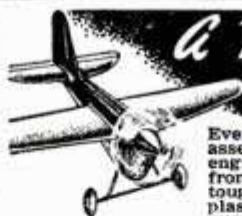

A Real (CONTROL LINE) Flying Plane

Everyone can fly this completely assembled and painted gasoline engine powered model plane, from 80 to 90 M.P.H. Made of tough, crash resistant laminated plaster—NOT A KIT—Satisfaction guaranteed—A perfect gift—Send (No Stamps please).

27.50

In your order today **TOM RHODES, 714 South Isis St., Inglewood, Calif.**

Now A DYNAMIC Super-charged WELDER

IDEAL FOR AUTO • HOME APPLIANCE • FARM REPAIRS

DESIGNED TO DO HIGH GRADE WELDING INEXPENSIVELY!

Maintenance Men; Farmers; Mechanics; Machine Shops; Foundries; Auto, General Repair and Job Welding Shops; all using the DYNAMIC find it so indispensable and useful that they cannot afford to be without it. If inexperienced you can easily learn to do a variety of high grade welding jobs by following the practical, simplified operating and welding instructions furnished. Once you see a DYNAMIC in operation, you won't want to be without it. Its simplicity will amaze you. In a year the DYNAMIC only costs you about 6¢ a day. Helmet, rods, cables, holder and operating instructions, etc., furnished.

SAVES YOU VALUABLE TIME AND MONEY!

This portable industrial transformer type DYNAMIC WELDER easily carried right to the job, can be operated from any convenient, properly wired **110 Volt, 60 Cycle Line**—has 8 metallic and carbon arc welding heat stages—does work you would think only possible with a larger more expensive machine. Can also be supplied for 220 volt, 60 cycle operation and other voltages and cycles at slight additional cost. Works on Iron, Steel, Brass, Bronze & other metals.

DYNAMIC WELDER CO., 13 East 23rd St., RG, Chicago 16, Ill.

ONLY \$28.50

COMPLETE Available Now IMMEDIATE DELIVERIES

Write Today for Particulars **GET DETAILS on our 10 day Trial Offer.** Member Chicago Association of Commerce.



BARGAIN 3X ARMY TELESCOPE

Original Cost \$150.00 — Our Price \$7.50



ALL COATED LENSES — BRAND NEW

An ideal gift for viewing objects, landscapes, seashores, etc. The high resolving power of the six coated lenses, five of them achromats will bring out great details. For the experimenter it can be dismantled and used for hundreds of projects. Length 22½ inches. 36° Field. Postpaid \$7.50.

500,000 Lenses and Prisms. Send 3c stamp for "Bargain" List

A. JAEGER'S

123-26P ROCKAWAY BLVD., SO. OZONE PARK 20, N. Y.

AIR RIFLES **BENJAMIN** AIR PISTOLS PIONEERS - LEADERS

SEND FOR FREE FOLDER OF LATEST MODELS TODAY
If you want a REAL GUN FOR PRACTICAL USE inside or outdoors get a **SAFE - CLEAN - ECONOMICAL - BENJAMIN** with Adjustable Power and Amazing Accuracy. For **BEST RESULTS** use **BENJAMIN H-C PELLETS**. WRITE AT ONCE. **BENJAMIN AIR RIFLE CO., 812 MARION ST., ST. LOUIS 4, MO.**

Say you saw it in
POPULAR MECHANICS

FIREDAIRE Circulating Fireplace

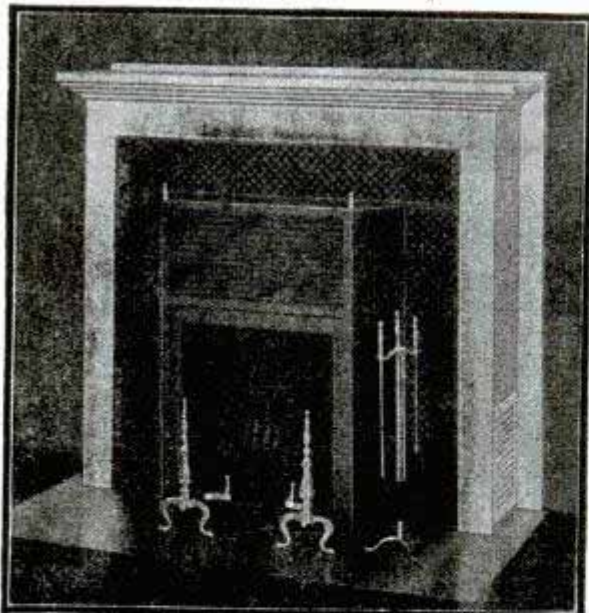

Just what you have wanted for your living room... can be installed in a few hours... no damage to your walls... no structural changes in your chimney

FIREDAIRE Circulating Fireplace is the most revolutionary development in the history of fireplace engineering and design. About 2½ times as efficient as built-in fireplace of steel and brick and 10 times as efficient as an ordinary masonry fireplace and grate.

Draws cool air from floor level, passes it completely around the firebox and delivers it at desired temperature through grilles in the mantel. Burns any fuel. Complete range of sizes and designs. Prices begin at \$80. Write for details.

THE EDWARDS MANUFACTURING CO.

235 EGGLESTON AVE.

CINCINNATI 2, OHIO

free CONCORD Radio Catalog



Radio Parts • Radio Sets • Record
Changers-Players • Kits • Ham Gear • Amplifiers • Testers

It's here! The big, new 1947 Concord Catalog with a vast, complete selection of everything in Radio and Electronics for building, experimenting, testing, repair and maintenance. Thousands of items—hundreds now available for first time—latest 1947 prices. Now LOWER prices on Radio Sets, Receivers, Kits, Record Changers, Players, Portables, Amplifiers. Latest listing standard items. Complete stocks—IMMEDIATE SHIPMENT. Write for FREE COPY—please address Dept. P-87.

CONCORD RADIO CORP.

LAFAYETTE RADIO CORPORATION

CHICAGO 7

ATLANTA 3

901 W. Jackson Blvd.

265 Peachtree Street

FIND OUT WHY THE DEAF

CALL THE **Beltone** HEARING AID
ONE-UNIT A "MIRACLE"

Write for FREE BOOKLET

BELTONE HEARING AID CO., Dept. PM-78
1450 W. 19th Street Chicago 8, Ill.

WIGGINS QUICK WATER HOSE COUPLING

SNAP, it's on! PULL, it's off! Easy fast! Wiggins coupling is guaranteed leakproof! Saves water, time. No bruised fingers or twisted hose. Precision made of solid aluminum for lifetime use. Order yours today! Send check or money order: \$1.50 postpaid. If you prefer C.O.D., send \$1.00 deposit.



E. B. WIGGINS OIL TOOL CO., INC.
3424 E. OLYMPIC BLVD., LOS ANGELES 23

WOOD SHAPER ^{3/4", 5/8" or 1/2" Spindle, Ball Bearing with adjustable table. Bench type. Write for details.}

WOODCRAFT TOOL & SUPPLY CO., Sylacauga, Ala.

ONE-MAN SAWMILL LESS THAN \$200.00 Easy To Turn Trees Into Money

Makes lumber, ties, shingles, crates, bath, studding, siding.



Belsaw Models
in 10 to 24 foot sawing lengths.

MECHANICAL FEED, accurate set works and positive dogs. Use tractor or old auto engine for low cost power. Thousands used for commercial sawing. Pays for itself quickly. Send post card today for FREE booklet, "How To Make Lumber" and Catalog of Woodworking Equipment.

BELSAW MACHINERY CO., 2811P Field Bldg.
315 Westport Road Kansas City 2, Mo.

Print Your Own

Cards, stationery, circulars, tags, labels, photo and movie titles, advertising, etc. Save money. **Print for Others, Good Profit!** easy rules sent. Raised Printing like Engraving, too. Send dime for press samples, supply book, all details and advice on your needs. No obligation. **KELSEY INC., B-37, Meriden, Conn.**

WOODWORKERS... Get this CONSTANTINE MASTER MANUAL

Get the Most Fun From Your Hobby
Indispensable to woodworkers. Newest, biggest edition, more pages, more color, helpful how-to-do-it articles, pre-war and new items, more bargains. Send 25c today and we will include **FREE! FULL YRS. SUBSCRIPTION** to Chips and Chats, published bi-monthly. Keeps you up-to-date on everything in woodworking, offers big money-saving bargains. Send now.

ALBERT CONSTANTINE & SON, Inc.
791-H 135th Street, New York 54, N. Y.



POPULAR MECHANICS

BIG MONEY and YOUR OWN BUSINESS

LIQUID IVORY



FREE INFORMATION ON A GREAT NEW MONEY MAKING OPPORTUNITY

SEND FOR FREE DETAILS

Regardless of your age, sex, previous experience, we will send you astonishing free facts about the great possibilities—in your own business—with amazing LIQUID REPLICIA IVORY. To secure this information, absolutely free, fill in coupon below or send a letter or postcard. No salesman will call on you now or ever. Write TODAY! Offer limited!

LIQUID IVORY is one of the most marvelous synthetics developed in years. With it you can easily and simply produce a wide variety of wonderful items that almost defy detection from genuine ivory. No expensive equipment is needed. You can work in a corner of your basement or garage with a few hours of work producing handsome profits. Here is unexcelled opportunity for all ambitious people that want a profitable business of their own.

A MONEY-MAKING BUSINESS FOR THE LITTLE MAN! NO EXTENSIVE CAPITAL NEEDED!

Forget big investment worries. We tell you how to get your own fast-moving business going with very little money. We feature only one sound business course. You will never find us confusing this successful vocation with other diverting business ideas. We tell you all about one great business and how you can make money in it exclusively. Write for full FREE information today!

GREAT OPPORTUNITIES NOW!

Stop being a slave to a time clock! Stop worrying about layoffs and depressions stealing your livelihood. NOW is the time to line up your own money-making business. We offer this great opportunity to aggressive people. Get into your own profitable business with LIQUID IVORY. Get the FREE FACTS today!

Copyright 1947

EMPIRE TRADES and HANDICRAFTS
Box 1340 PMB St. Louis, Mo.

FREE INFORMATION COUPON

EMPIRE TRADES & HANDICRAFTS, BOX 1340-PM8, ST. LOUIS, MO.

Please send me free details about your BIG money making LIQUID IVORY. I am anxious to get started in a profitable business of my own. Please rush!

Name

Address

City.....State.....

Terrific BARGAIN

ABRASIVE TOOLS
Save over 200%

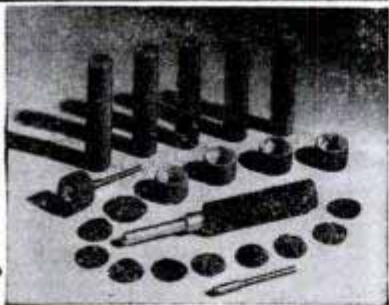

Greatest abrasive tool assortment bargain yet! Strictly quality merchandise from big manufacturers like Carborundum, Behr Manning, Minnesota Mining, etc. Money back if not satisfied.

LOOK!

- 100 Abrasive Roll Cartridges (assorted Grits)
- 1 Mandrel for rolls.
- 1 Drum Sander, 3/4"x1 1/2" on 1/2" arbor
- 20 Bands for Drum Sander
- 400 Sanding Discs. (Assorted Grits and Sizes)
- 1 Mandrel for Sanding Discs.

LIST PRICE \$15.95

OUR PRICE \$5.95
POST PAID IN U.S.

RUSH order today. Send check or M.O. for assortment postpaid in U. S. Or send \$2.00 deposit on C.O.D. order and pay balance to postman plus small delivery charge. Supply limited! Act Today. Write:

D. SCHUPAK 2256 E. 75th St., Dept. 8, Chicago 49, Ill.

Tools You Want and Need



FUN and PROFIT For Home Shops

Immediate Delivery!

Do any jig-sawing and painting job—easier—quicker—better. Here are super tools that will save time and make money for you.

Syncro Jig Saw

The Powered, Smooth-Cutting Saw That Needs No Motor

Cuts 1" soft wood or 1/2" hard wood—thin metals and plastics too. Clearance 13 1/2". Heavy table plate 10" x 10" and adjustable guide. Complete, ready to use. For 60 Cycle A.C. 110-120 Volts. \$19.95.

Portable Sprayers

All-Purpose SPRAYIT

High quality, low price, 1/4 h.p. piston compressor outfit. Professional type spray gun, 12 ft. hose and belt. Rack with handle. Complete as illustrated. Less motor, \$34.50.



COLOR DABBER

New Low-Cost Outfit!

Plastic spray gun, 4 paint containers, new foot air compressor, 7 1/2 ft. air hose and expansion tank. Perfect results on all average size paint or touch-up jobs. \$8.95.



Send check or M.O. We ship prepaid. If C.O.D., send \$1.00 deposit. Charges are extra. . . .

HOME-SHOP PRODUCTS COMPANY

DEPT. 1A, 4821 SHERIDAN ROAD CHICAGO 40

SAY YOU SAW IT IN POPULAR MECHANICS

ATTENTION — RADIO SET BUILDERS!

• BUY DIRECT AND SAVE •

- 5-tube punched chassis 35c
- Pair of matched I.F. coils—456 K.C., pr. \$1.23
- Oscillator coil 20c
- Antenna coil to match above, ea. 20c

5" P.M. speaker with output transf., ea. \$2.48

QUANTITIES LIMITED!

ORDER NOW!

IMMEDIATE DELIVERY!

Mail orders filled promptly. 20% deposit on all orders. Please add sufficient postage.

SEND FOR FREE BARGAIN LIST

METRO RADIONIC CO., 79 Fourth Ave., N. Y. 3, N. Y.

HEADLINERS

MOTORS 3/4 HP 110/220....\$46
1 HP 110/220....\$59
Ball Bearing—1750 RPM

ELECTRIC DRILL

Heavy duty 3/4" drill. Light weight. Three jaw keyless chuck. Oil bronze bearings. 6 ft. flexible rubber cord with plug. 900 rpm at full load. Operates at 110 V, AC or DC. Each **\$17.95**

Band Saw 14" \$79.50

Paint Sprayers \$26.95

Sprays all kind of paint, lacquer, varnish and etc. Oil-less ball bearing compressor. 2 cu. ft. air per minute. 15 to 50# pressure. Sprays paint 5 times faster than hand brushing.

HOME WORKSHOP TOOLS of all kinds.

Ohio Machinery & Supply Co.

420 E. PEARL ST.

CINCINNATI 2, OHIO

Atlas
6"-10"
LATHES

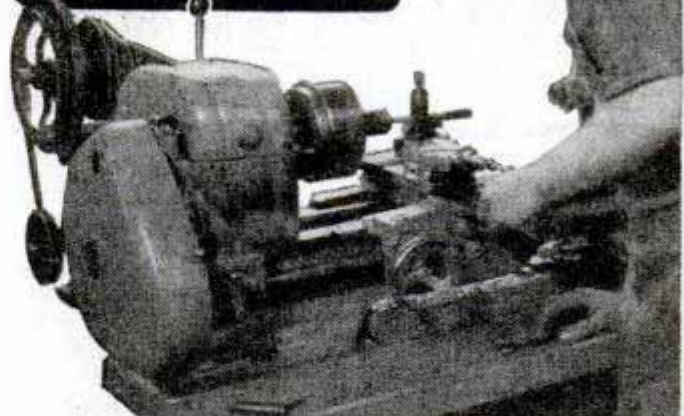

NOW AVAILABLE AT NEW LOW PRICES

Good news for home shop owners! Now you can equip your shop for precision metalworking — with today's greatest values in compact precision lathes! See them at your Atlas distributor, or send for literature. Prices, less motor, F.O.B. Kalamazoo: 6" — \$104.75; 10" — \$195.00.



ATLAS PRESS CO.

843 N. Pitcher St., Kalamazoo 130, Mich.

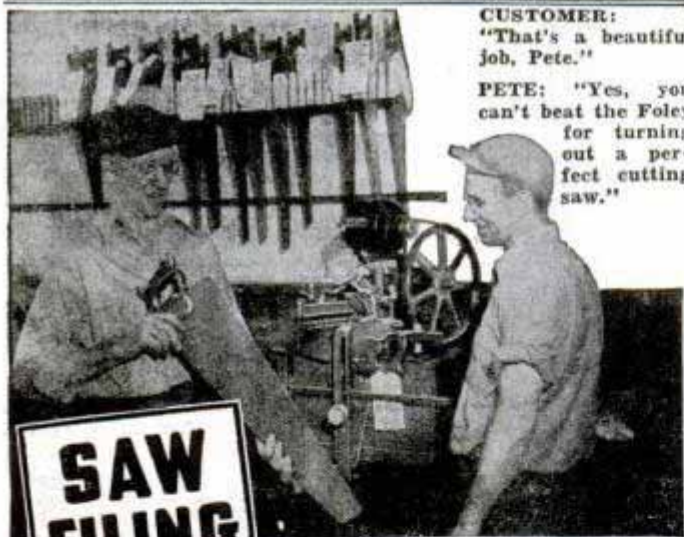

CUSTOMER:
"That's a beautiful job, Pete."

PETE: "Yes, you can't beat the Foley for turning out a perfect cutting saw."

SAW FILING

is a Good Business

With the Foley Automatic Saw Filer you can have a fine cash business with steady customers and make a good living. The Foley automatically joints the saw, making all teeth even in size, shape, spacing. The Foley is the only machine that files all hand saws, also band and cross-cut circular saws.

SEND FOR FREE PLAN—Shows how to start a saw repair shop. No canvassing. Send coupon today.

FOLEY Automatic SAW FILER

FOLEY MANUFACTURING CO.
816-7 Foley Bldg., Minneapolis 18, Minn.

Send Free Plan on Saw Filing business, no obligation

Name _____

Address _____



WAR SURPLUS BARGAIN SPECIAL

BELT DRIVEN CENTRIFUGAL PUMP
READY TO USE ON ANY PUMPING NEED

NOW ONLY \$29⁷⁵

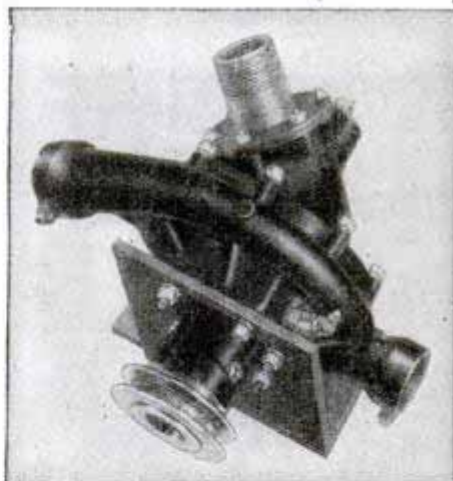

FOR HOME WATER SYSTEMS, IRRIGATION, FIRE PROTECTION, DRAIN BASEMENTS, PONDS, ETC.

A super value for all types of intermittent service in pumping large volumes of liquid for stock watering, home and shop water systems, irrigation, draining pools, basements, etc. At 1750 RPM on 23 foot head will pump 42 gallons per minute; at 3600 RPM on 52 foot head will move 88 gallons per minute. Cast aluminum housing. Accurately machined bronze impeller vanes. Complete with mounting bracket and 4 inch V belt pulley. Run with electric motor, gasoline engine, power take-off on tractor, etc. Shaft rotates on sealed ball bearings with grease gun fitting. Has 2 inch intake, two 1 inch outlets. Use one or both as necessary. Made for Packard Motor Car Co. for use in Rolls-Royce Merlin Aircraft engines. Comes complete with pulley and mounting bracket. Original cost approx. \$147.00. Sold F.O.B. Chicago. Shipping weight 23 pounds. You can't beat this pump value at anywhere near this price. Satisfaction guaranteed.....\$29.75

ORIGINAL COST APPROX. \$147.00 \$29⁷⁵

IMMEDIATE DELIVERY FOB CHICAGO SPECIAL PRICE, WHILE THEY LAST

GROBAN SUPPLY CO. 1522 SO. MICHIGAN AVENUE DEPT. PM 8, CHICAGO 5, ILL.

SMALL EFFICIENT SPEED REDUCER

Just the thing for the Home Work Shop, Hobby Shop, Bench Work, Animated Displays, Light Production work. Used daily in thousands of homes and shops. Sturdy, compact. (see dimensions). Case of heat treated aluminum. Gears, SAE 85 (British) Gear Bronze. Worm of case hardened steel. Timken Bearings throughout. Torque capacity 100 inch pounds. Available in 4 different assemblies (shown below) and in these standard ratios:

4-1	25-1	64-1	200-1
8-1	30-1	75-1	300-1
10-1	40-1	80-1	400-1
16-1	50-1	100-1	600-1
20-1	60-1	150-1	800-1

When ordering be sure to specify assembly and ratio required. Shipping weight in carton, 6 lbs. Full money back guarantee. Prompt deliveries.

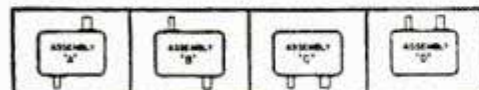

THE OHIO GEAR CO.
1405 EAST 179th ST. • CLEVELAND 10, OHIO



\$18.56
NET — POSTPAID

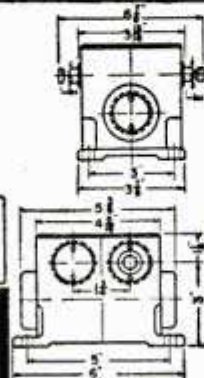

Opportunity Knocks

With **TRADIO** . . . the radio **FUNCTIONALLY DESIGNED** for coin operation in Hotels, Motels, Stopovers, Clubs, Hospitals, Stations, Etc. Big Earnings . . . Steady Income . . . No Clock To Punch . . . Full Or Part Time!

● **QUANTITY DELIVERIES DAILY . . . ONLY SMALL INVESTMENT**
Grow With A Young Industry! Get In On The Ground Floor and Be Independent For Life. It's Easy!
Send for Complete Information Today . . . No Routes Sold
Write To **TRADIO, INC.** Dept. NS, Asbury Park, N. J. **RIGHT NOW!**

AIR or LIQUID TANKS

Airplane oxygen tanks (used) good condition, holds up to 400 lbs. pressure; non-rusting stainless steel, weighs 18 lbs., 10 1/2 gal. capacity, 24" long x 12" diam., \$4.98. Same specifications 24" long x 6" diam., weighs 5 lbs., 3 gal. capacity, \$2.98. Ends tapped for 1/4" standard pipe thread. Air check-valve to fit tanks, \$5.00 value, 98c. Ideal for compressed air tanks, any bottled gas, or liquids, water supply for house trailers, compressors, floating rafts, buoys, net floats, air horns, air brakes, etc.

Prices FOB, Kansas City — No COD orders

MIDWEST BUY ANYTHING CO.

1520 Locust St. Kansas City, Mo.
Hundreds of other bargains — Write for Circular

Giant Astronomical Telescope

100 diameters magnification. (10,000 area magnification) Steel main tube 3 inches diameter, 50 inches long. Brass focusing tube. Tripod 6 feet tall. Equatorial mounting. Ready to set up and use. Full power and clear vision guaranteed. Price \$12.50. 25% deposit on C.O.D. orders.

SUFFOLK SCIENCE SERVICE, Dept. CT, MANORVILLE, N.Y.

CRAFT FINISHES SUPPLIES

Materials to produce a professional finish on every type article. Industrial finishes for the home craftsman's use on wood, metal, plastics, plaster, etc. Electroplating and shop supplies, novelty finishes. Catalog free.

CRAFT FINISHES Box M 467 Arlington, Virginia

New Designs in FRANZITE GRIPS

Modernize Your Gun! Improve Your Score!
Most durable grips made. Positively unbreakable! For Colt, Smith & Wesson, Hi-Standard, Ortgies, Luger & Mausers in a wide choice of beautiful designs in ivory, pearl, walnut, onyx, etc. Low prices. **FREE CATALOG.** Dealers Wanted.
SPORTS, INC., (Mfrs.) 5501 Broadway, Dept. P-8, Chicago 40, Ill.



MODERN, LOW-COST HEAT for Your Home or Shop

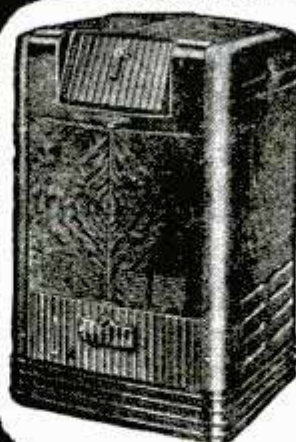

MODEL 420-A with Built-in Automatic Draft Regulator. 100-lb. Coal Capacity.

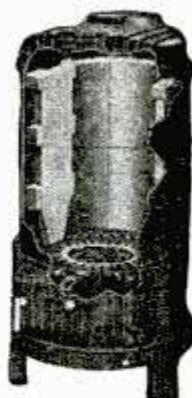

Other Models from 30-lb. to 200-lb. Coal Capacity. All exclusive, patented construction.

WARM MORNING COAL HEATER

No other heater like the **WARM MORNING!** Exclusive, patented interior brings amazing heating results and big fuel saving. Burns any kind of coal, coke or briquets. Heats all day and night without refueling. Holds fire several days on closed draft. Start a fire but once a year. The lowest cost dependable heat that you can buy. Be sure to see the **WARM MORNING** at your dealer's. Four models from which to choose.

Get This SMALL HOMES PLAN BOOK!

A handsome 16-page book in full colors with 12 beautiful, low-cost homes designed by nationally-known architect. A regular 50c book for only 25c. Send a quarter for your copy . . . NOW!



LOCKE STOVE COMPANY

Dept. M, 114 W. 11th St., Kansas City 6, Mo.

AMAZING PLASTIC FILM

keeps paint off glass -- speeds window painting

Paint-Shield
liquid miracle "masking tape"



Speed painting — save muss . . . with the miracle plastic film that keeps paint off glass. Apply like paint, peel off like tape . . . unique! Order from paint or hardware dealer or send for generous trial jar (does 15 to 20 windows.) Remember — Paint-Shield!

TRIAL OFFER Big Jar, Postpaid...
RAMELL PRODUCTS, INC.
DES MOINES 5, IOWA

RAMELL PRODUCTS, INC., Des Moines 5, Ia.
Enclosed is \$1, for which send Cottage Size Trial Jar of Paint-Shield postpaid to:

Name _____
St. and No. _____
City and Zone _____ State _____

RUNNING HOT WATER INSTANTLY!

From Your Cold Water Faucet

with ROLEY Instant Hot Water Heater



Here's one of the greatest household inventions of all time . . . back again for the first time in many years. Now you can actually have all the hot water you need the instant you need it . . . FROM YOUR COLD WATER FAUCET! This new postwar type heater quickly attaches to any cold water faucet . . . in the basement for extra hot laundry work . . . in the bathroom for bathing needs . . . in the kitchen for dishes, cooking and cleaning. You regulate the temperature and quantity with your faucet handle. Just plug the cord in any electric outlet (AC or DC, 110-120 volts), turn the faucet and PRESTO—Hot Water, anytime of day or night, as much and as hot as you want. Easy to install, complete with 6-foot extension cord. Order one or more TODAY.

Guaranteed to give running hot water instantly.

\$8.49

SEND NO MONEY

Just write today . . . order your Roley electric Water Heater and pay the postman \$8.49 plus postage when delivered, or send \$8.49 and we will pay the postage. Try for 5 days and if not completely satisfied return to us and we will gladly refund full purchase price. No C.O.D.'s outside U. S. A.

ROLEY SALES CO., INC., Dept. FJ-72, 15 Spruce St., New York 7, N. Y.

Name _____

Address _____

City & Zone _____ State _____

MILL IT... ON YOUR LATHE!

PALMGREN

MILLING ATTACHMENT

3 SIZES
No. 250 Illustrated

2 1/2" JAW **\$24.75**
Only

CONVERT LATHE IN 10 SECONDS

Now you can Mill, Slot, Grind, Groove, Square Shafts, Saw at Angles, Recess and many other important jobs. **SAVE TIME AND MONEY!** Why send work out or use costly methods when a PALMGREN MILLING ATTACHMENT will solve your problem. Precision built, it has accurate graduations for rotary angle adjustments, also graduated vertical feed screw. Fits South Bend, Atlas, Craftsman, Logan, Sheldon and all other lathes. Thousands now in use in small and large machine shops, repair shops, railroads, schools, home work shops, etc. **ORDER SIZE NEEDED TODAY!**—it will quickly pay for itself.

IMMEDIATE DELIVERY

Nos.	Width Jaws	Depth Jaws	Jaws Open	Weight Pounds	Fits Tool Post	Price F.O.B. Factory
150	1 1/2"	1"	1 5/8"	6 1/2	1" Dia.	\$18.75
250	2 1/2"	1 7/16"	2 1/2"	11	1 1/4" Dia.	24.75
400	4"	1 1/2"	4"	25	2" Dia.	39.75

Order From Your Dealer or Jobber; Write for Circular No. 351
Mfrs. of PALMGREN PRODUCTS Since 1915
8365 South Chicago Ave. Chicago 17, Ill.

CHICAGO TOOL and ENGINEERING CO.

JUST A FEW OPERATIONS YOU CAN DO ON YOUR LATHE!

ACTUALLY \$50.00 WORTH OF GRINDING WHEELS

Abrasive discs, felt and buffing wheels, mandrels, rotary files, sheets, etc.

327 PIECES
ASS'T. SIZES
FOB CHICAGO

\$6.95

ALL FOR ONLY

A BONANZA FOR THE HOME WORKSHOP

The buy of a lifetime! 327 pieces including 35 ass't. Grinding and Cut-off wheels up to 10 inches diameter, 1 1/16 to 1 1/4 in. face, 1/8 to 3 in. holes. Assorted grits—all brand new—made by Norton, Carborundum, Macklin, Bay State, etc. Also included are 100 slotted disc cloths; 100 paper discs; 3 round wire brushes on handles; 2 felt bobs; 2 felt wheels; 1 4" rag buff; 3 honing stones; 10 abrasive sleeves; 10 mounted stones, 1/4 and 1/2 shank; 2 mandrels; 2 rotary files, 1/4 shank; 50 abrasive discs; 2 7/2" abrasive belts; 5 9x11 abrasive sheets. Satisfaction guaranteed. Order today. It's better than a \$50.00 value for only **\$6.95**

GROBAN SUPPLY CO. 1522 SO. MICHIGAN AVENUE DEPT. PM 8, CHICAGO 5, ILL.

SIGNAL FLASH LAMP

\$6.95

BRAND NEW

Made for the Signal Corps to transmit messages in Morse code day or night in red or white flashes of light. Operates on 5 dry cell batteries. By operating trigger, or trigger box assembly, can signal from shoulder. 15 ft. cord with hand key attached, made for remote control signaling, by mounting Signal Lamp on 42" tripod. Daytime flashes can be observed 1000 to 2000 yards; night flashes from 2 1/2 to 5 miles. The Signal Lamp, 15' cord, hand key, gunstock, tripod, goggles, bulbs, technical manual are packed in 12 oz. duck bag. Shipping weight 8 1/2 lbs. Lamp can be used as flashlight for spotting planes, animals and many other objects approx. 300 yards. Just the thing for hunting, camping, fishing, scouting.

MICHAEL STAHL, Inc.
39 VESEY ST. DEPT. PM8 NEW YORK 7, N. Y.

WAR SURPLUS NAVY DUAL TUBES

\$1.00 while they last

Brand NEW!

Inflated by mouth in a jiffy. Fills out to 55" long. Deflates to a folded 18". Adjustable. Use as water horse, safety belt, beach mattress, portable mat, play boat. Hundreds of uses for campers, fishermen, boaters, and water fun. Three tubes attached make excellent raft. Order yours today! Send only \$1.00 plus 20c for postage.

NATIONAL MATERIALS CO.
126 W. KINZIE ST. CHICAGO 10, ILLINOIS

BUILD YOUR OWN TRAILER

NEW AXLE AND WHEELS

\$26.35 Without Tires or Tubes

IMMEDIATE DELIVERY

\$5800 with First Line 6:00x16 Passenger Tires and Tubes

10% With Order—Bal. C.O.D.

- TIMKEN BEARINGS
- 59" TREAD — DEMOUNTABLE WHEELS
- 1 1/2" SQUARE AXLE-TESTED 4,000 LBS.
- 16" DROP CENTER WHEELS

STANDARD EQUIPMENT CO.
999 SECOND AVE. S.W. CEDAR RAPIDS, IOWA



STD. MODEL
ONLY
\$44.50
FOB L.A.

"AIR-SPEED" ^{*} SAW AND FILE

Dependable air-powered saw and file tool. Variable speed. Adjustable stroke. Cuts and files steel, wood, light metals, plastics, fibre, etc. Light weight. Portable. Perfect for difficult, close quarter jobs. Simplifies scroll or circle cutting. Uses saw blades or bench filing machine files. Fully guaranteed.



NEW "AIR-SPEED" VALVE GRINDING ATTACHMENT

Compact, simple conversion head now turns "Air-Speed" Saw and File into efficient heavy-duty valve grinding and re-seating tool. For automotive and airmotive use. Furnished complete, with valve head attachments, carbon scraper, valve guide scraper and valve lifter spring. Job-tested, low cost, long life unit. Makes single "Air-Speed" tool a "tool of more trades!" Fully guaranteed.

Ask Your Dealer For a Demonstration.



For Literature write:

AIR-SPEED TOOL COMPANY

1500 West Slauson Ave.,
Los Angeles 44, Calif.
Dept. PM-19.

Attachment Kit
ONLY

\$18.50

FOB L.A.

* TRADE MARK

AVIATION SURPLUS

- Sun Glasses, gold rimmed, regular \$10, now.....\$ 4.95
- Hand Lantern, stainless steel, streamlined, 6 volt...\$ 2.95
- Flying Goggles, clear lense, type AN6530.....\$ 4.95
- Compass, aircraft magnetic type, panel mounting...\$ 7.95
- Boots, flying, A-6, leather, fleece lined, reclaimed, (sizes 9 and above only).....\$ 5.95
- Gauntlets, A-9 (gloves), leather, fleece lined, new...\$ 5.95
- Jacket, pilot's, type A-2, (not surplus), Genuine dark pony leather, elastic cuffs, etc. New.....\$24.50
- Jacket, flying, leather, fleece lining, used, has patches, redyed (no refunds).....\$ 4.95
- Pants, for above jacket, as described.....\$ 4.95
- Coveralls, white, no pockets, new, sizes 40 to 50...\$ 4.95
- G.I. Raincoats, used.....\$ 1.50
- Cap, leather, fleece lined, type B-2, square visor...\$ 2.50
- Cap, cloth, baseball style, long bill.....\$ 1.00
- Helmet, flying, A-9, o.d. cloth, two for.....\$ 1.00
- Helmet, flying, B-6, leather, fleece lined, used.....\$ 1.50

(Send cash, check or money order; we ship charges collect)

AERO PARTS SUPPLY

Municipal Airport Houston 12, Texas

Say You Saw It in
POPULAR MECHANICS

PLASTIC-CRAFT HOBBYISTS

Save ^{\$1.00} with this special offer

\$4.00
WORTH OF
BARSPECIAL
PLASTIC
SUPPLIES
FOR ONLY
\$3.00

Present this ad to your plastic supply, hobby or hardware dealer. He will allow you \$1.00 discount on any purchase of BARSPECIAL supplies totalling \$4.00 or more. You can't go wrong with BARSPECIAL quality products. They have been used by hobbyists from Coast to Coast for years • BARSPECIAL dealers carry everything needed for quality plastic work. PORT-O-TOOL plastic decorating sets, plastic-craft kits, plastic dyes, cements, cleaning and polishing compounds and jewelry parts. If your dealer does not carry them, write direct and we will mail you our free catalog. This discount offer good on direct orders. As a favor please include your dealer's name and address so we can contact him.

BARNETT SPECIALTY CO. 5104 HOLLYWOOD BLVD.
HOLLYWOOD 27, CALIF.

I have purchased _____ worth of BARSPECIAL supplies from
DEALER _____
ADDRESS _____
CITY _____ STATE _____
YOUR NAME _____
ADDRESS _____
CITY _____ STATE _____
This offer expires Jan. 1, 1948.

FREE

PIPE SMOKER'S Handbook!

Published to help you enjoy your pipe more. Tells pipe history, facts about pipe care, types and how to smoke a pipe. A "must" for every smoker's library.

Nothing to Buy! Write Today to

WRIGHT PIPE CO.
TAMAQUA, PENNA.

2 BIG SPECIAL BARGAINS at LOW PRICES

BRIGGS & STRATTON LIGHTING PLANTS and GENUINE AUTO-LITE GENERATORS



Made For the Government: All NEW . . . Never Used

BRIGGS & STRATTON Portable Lighting Plant priced at a fraction of the original cost. Built to rigid Government requirements. Especially built for Field Use or for permanent installation in Cottage, Farm, Trailer, Boat, etc. Complete with 1 3/10 H.P. Gasoline Engine, Hand Starter. Rated 250 Watts will develop 500 Watts. With Spare Parts and Tools. Mounted on permanent base . . . Rubber cushioned . . . Ready for Immediate Use anywhere . . . At this LOW PRICE they won't last long . . . Better Hurry only \$129.50.

GENUINE AUTO-LITE GENERATOR . . . 12 Volt-55 Amp. with Apparatus Box (Voltage Regulator; enclosed and fully protected) and Amp. Meter. Protected with Sturdy Metal Cover, easily removed. Louvers for ventilation. Safety Guard for V-Belt Drive . . . Ideal for Boats, Cottages, Light Plants, Trucks, Busses, etc. Mounted on Permanent Base . . . Ready to connect to power unit for Immediate Use . . . A good dependable Generator priced ESPECIALLY LOW. \$85.00.

Cash with order or we will ship C.O.D. if 25% deposit accompanies the order. These prices F.O.B. Chicago.



Complete Ready to Connect To Power Unit . . . **\$85.00**
Only

Complete With Power Plant . . . **\$129.50**
Only

ACE SURPLUS SALES CO., Inc., 1449 West 69th St., Dept. P-8, CHICAGO 36, ILL.

PRESSURE QUEEN

FOUR CYLINDER
PORTABLE AIR COMPRESSOR
SPRAY PAINTING OUTFIT

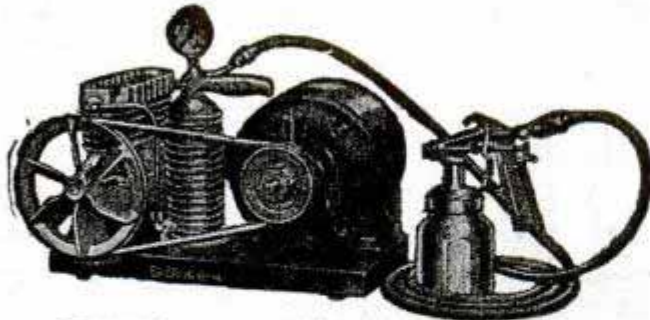

COMPACT • RUGGED • POWERFUL

The ideal air supply for home and farm workshop, machine shop, garage and contracting painter; for product finishing, inflating tires, painting automobiles, trucks, machinery, etc. Indispensable for building maintenance, interior and exterior. Handles any paint, insecticide or disinfectant.

This 4 cylinder compressor has drop forged crankshaft, stainless steel, heat treated valves; bronze bearings and positive forced feed lubrication. Maximum pressure 50-60 lbs., free from pulsation. Standard equipment includes the compressor mounted on steel base with carrying handle, belt, compressor pulley, air chamber, air gauge, 15-ft. hose, spray gun. Requires 1/2 or 3/4 h.p. motor or gas engine.

If your dealer does not sell Pressure Queen write direct

THE CAMPBELL-HAUSFELD CO.

1046 RAILROAD AVE.,

HARRISON, OHIO

QUALITY

8" FLOOR MODEL
TILT-ARBOR SAW



UNCONDITIONALLY
GUARANTEED
1 YEAR

SAW
TILTS
•
TABLE
STAYS
LEVEL

Complete as shown with Trans-axial Ball Bearing Motor Drive, Ball Bearing Saw Arbor, Table including extension 18" x 25", Aluminum Fence & Saw Insert, Complete Mitre Gauge, 3 1/2" steel column and cast iron base, Precision segments on mitre gauge and cradle.

\$79.50
F. O. B.
ROYERSFORD, PA.
UNUSUAL
VALUE

BENCH MODEL, \$49.50
Shipping Wt., 118 lbs.

Cast iron table extension bracket furnished. Will support plywood top much larger than 9" x 18". Motor pulley and belt furnished. Blade & Motor NOT included. Overall height 35 1/2", Shipping Wt. 156 lbs.

AMERICAN MACHINE & TOOL CO. Inc.
DEPT. 110
ROYERSFORD, PA.

Write for free illustrated folder.

Now
for EVERY WORK SHOP!

NEW
Invention
Electroplates
by BRUSH



Easy to Plate CHROMIUM
GOLD, SILVER, NICKEL, COPPER

... For Pleasure and Profit!

If you have a workshop—at home or in business—you need this new Warner Electroplater. At the stroke of an electrified brush, you can electroplate models and projects—you can replate worn articles, faucets, tools, fixtures, silverware, etc. with a durable, sparkling coat of metal... Gold, Silver, Chromium, Nickel, Copper or Cadmium. Method is easy, simple, quick. Everything furnished—equipment complete, ready for use. By doing a bit of work for others, your machine can pay for itself within a week. So make your shop complete by getting a Warner Electroplater right away. Send today for FREE SAMPLE and illustrated literature. ACT AT ONCE! Mail Coupon.
WARNER ELECTRIC CO., DEPT. N-2
1512 Jarvis Avenue, Chicago 26, Ill.

FREE Details & Sample!

WARNER ELECTRIC CO., 1512 Jarvis Avenue, Chicago 26, Dept. N-2

Gentlemen: Send Free Sample and Details to:

Name _____

Address _____

City _____

State _____

GET INTO YOUR OWN
**PROFITABLE
BUSINESS!**

**BIG PROFITS IN
CONCRETE CINDER
BUILDING BLOCKS**

Capture Your Share of
the Big Building Boom.
Supply the Great Demand
for Quality Blocks Needed
Everywhere for Every Kind
of Construction Work.

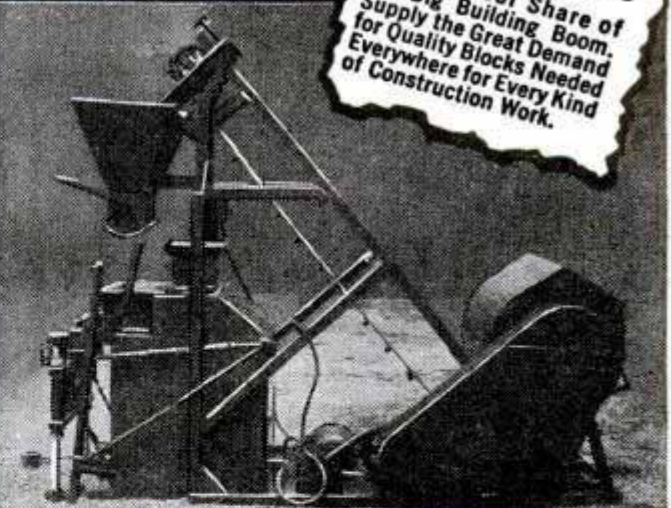

HOW TO START AND OPERATE A
CONCRETE AND CINDER BLOCK PLANT
PAYS FOR ITSELF IN A FEW MONTHS

Prosperity, Financial independence may be secured quickly in this fast moving, highly profitable field today.

UNLIMITED USES—SHORTAGES EVERYWHERE. Get the facts about our famous Blocker Vibrator Concrete Cinder Building Block Machine—what it does above all others—**QUALITY BLOCKS AT LOW COST**—800 to 1200 blocks every day—why it is the fastest selling outfit today. Easy Payment Plan if desired.

WRITE for MONEY MAKING FACTS for men of vision and modest capital. Write today—a 1c postcard will do.

CONCRETE BLOCK EQUIPMENT CO. INC.

920 Central, Dept. 417

Kansas City 6, Mo.

JUST OUT - WAR SURPLUS - BRAND NEW DIAMOND SAW BLADES

With Actual Diamond Dust on Cutting Edge

Formerly Sold up to \$30 each!
Now at greatly reduced prices

6 inch \$3.60 - 8 inch \$4.70 - 10 inch \$5.80 POST PAID
(All have 3/8 inch arbor hole)

Useful for cutting of any hard material such as tile, glass, ruby, plastics, slate, stone, marble, quartz, etc. Ideal for Hobbyists, Mechanics, Jewelry, Glass and Porcelain Workers, Marble Cutters and all who need a fast, true cutting saw blade for hard substances.

Fit Skill saws and any ordinary motor shaft. Especially treated steel disks—original packing—Quantity Limited. Mail order today. Enclose check or M.O. All prices postpaid. Sent C.O.D. plus cost, if you wish. Add 28c for foreign postage.

DIAMOND DISKS Dept. A-3—140 West 42 St. New York 18, N. Y.

BIG MONEY IN YOUR OWN BUSINESS

Amazing, scientifically developed LIQUID IMITATION MARBLE, FIBER-TITE, FLOORING, FLEXIBLE MOLDS brings you a fast money making opportunity. Work full or spare time and make big profits. Experience unnecessary. No large investment required. Work from your home. Write for FREE CATALOG and full details.

COMPOSITION PRODUCTS CO. Dept. PM6, 5853 Delmar St. Louis 12, Mo.

Ottawa Self-Propelled Buzz Master

CLEAR LAND FAST! Powerful 7-HP motor with friction clutch for safe operation. Cuts down timber, brush and hedge; turn blade vertically and saw logs to length. Also furnished with post hole diggers. Has clutch pulley for belt work.



OTTAWA MFG. CO., 1-727 Brush Ave., Ottawa, Kansas

\$13.50 Value for Only \$2.49

8000 ohm impedance Head Phones, produced to Air and Signal Corps specs. Extremely sensitive, lightweight (only 9 oz.). With 5 1/2 ft. cord, plug, jack and ear cushions. Every One **BRAND NEW**
No. 17A37, Special Per Pair.....**\$2.49**
Plus 25c each for Postage.



Burstein-Applebee Co. 1012 McGee, Kansas City 6, Mo.

WAR SURPLUS

Lathes, Milling Machines, Drill Presses, Sawing equipment, Motors and thousands of miscellaneous items. Also information on Helicopters, Sleeper Trailers, Garden Tractors, Power Lawn Mowers, Welders, Jet Impulsion for Cars and Tractors, etc. Rush name for free literature.
THE WAYNE ENGINEERING CO., DEPT. 1126, GREENVILLE, OHIO

CHANITE SELF-WELDING FLUX

REPAIRS ALL ELECTRIC HEATING ELEMENTS

So simple anyone can make repairs in your broken or burnt-out electrical appliances—irons, toasters, sockets, etc. Guaranteed nothing like it. From our mines to your appliances. \$1.00 per package. \$7.50 per doz. Stick form 25c \$2.00 per doz.
CHANITE SALES COMPANY, 914 So. Main, Fort Worth 4, Texas

INVENTIONS WANTED Pat'd or Unpatented

FREE List of 280 buyers who want many hundreds of ideas sent on request. Or mail us your drawings for fast action—cash or royalty.

INVENTORS SALES & ENGINEERING BUREAU, 208 Clinton, Oak Park, Ill.

PLASTIC SUPPLIES

Plexiglas, Lucite, Sheets, Rods, Tubes, Cement Dyes, Buffs, Equipment, Etc. Lowest prices. Send 3c stamp for catalog.
PLASTICS MFG. & SUPPLY CORP.

Dept. M-8 4707 Euclid Ave. Cleveland 3, Ohio.

SELL MERCHANDISE by Mail

OPERATE Profitable Lifetime Business Selling Merchandise by Mail. Large Profits on Fast Selling \$1.00 Items. **WRITE TODAY!**

POWELL CO. DEPT. A SAMPLER BLDG., CLEVELAND 3, OHIO



**7X 50 NAVY
BINOCULARS
\$135.00**

COATED OPTICS!

Mfgd. to U.S. Navy Standards! (Alignment guaranteed to .001"). Brand new glasses. Dust proof! Climate proof! Individual eye adjustment. Instant focusing. Coated optics insure sharp, clear images! Ideal for long range hunting, yachting, watching planes, etc. This magnificent 7 power 50 mm. Navy Binocular gives better detail, heightening image contrast. Complete with carrying case only \$135.00 plus 20% Federal tax.

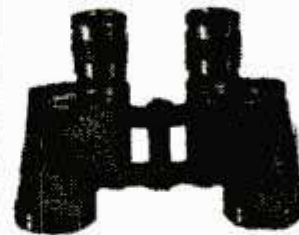

**6X 30 ARMY
BINOCULARS
\$62.50**

Brand new! Lightweight! Made to rigid Army specifications. Individual focusing eye pieces. Compact glasses made to withstand rough usage. Come complete with case and straps ready to use. **WHILE THEY LAST!** \$62.50 plus 20% tax.

OTHER BINOCULARS (3 to 16 POWER!)

12x40	Carl Zeiss. Like new	\$200.00
16x50	Carl Zeiss. Used	225.00
16x40	Weerasport. Used	125.00
16x45	French Monte Carlo. New	135.00
12x38	French Monte Carlo. New	100.00
10x32	French Monte Carlo. New	79.00
10x50	German Dienstglass. Used	140.00
9x50	Sportscope. Monocular	77.00
8x40	Carl Zeiss Field Glass. Used	49.50
8x34	French Monte Carlo. New	67.00
8x30	Wollensack. Coated. New	85.00
8x30	French Monte Carlo. New	62.00
8x25	French Monte Carlo. New	57.00
8x25	French Monte Carlo. Used	45.00
7x50	Carl Zeiss. Used	150.00
7x50	Barr-Stroud. British Admiralty. Lens Shades. Used	90.00
7x50	Same as above, but Coated	110.00
7x50	Bausch & Lomb. Coated. New	140.00
7x50	German Dienstglass. Used	130.00
7x50	Sard. U. S. Navy. Coated. New	152.00
6x30	Carl Zeiss. Used	90.00
6x30	Bausch & Lomb. Used	37.50
6x30	Carl Zeiss. Used	75.00
6x30	Talbot. U. S. Army. Used	36.50
6x30	German Dienstglass. Used	65.00
6x30	Wollensack. Coated. New	75.00
6x25	Ross. London. Used	50.00
6x30	Bausch & Lomb. Coated. Objectives. Used	49.50
6x30	Naval Gun Factory. Used	34.50
6x30	Navy. Navigation. Coated. Used	45.00
6x30	Universal. Navy. Lightweight. Coated. Used	47.50
6x30	Universal. Navy. Lightweight. Coated. New	62.50
6x24	USN. Turner Reich. Lightweight. Used	38.50
5x40	Nat'l. Field Glass. Coated optics. New	50.00
4x30	Super Eye Field Glass. No Case. New	29.75
4x40	Airguide Field Glass. New	12.00
5x40	Airguide Field Glass. New	20.00
4x40	Wollensack Field Glass. New	22.00
10x, 20x, 30x, 40x, Variable Telescope. Not Taxable. New		16.25
		42.50

5 to 15 POWER VARIABLE TELESCOPE



Simply twist dial to change power! Sturdily made of durable Aluminum! Achromatic Lens. Compact! **BRAND NEW**, \$27.50 not taxable.

Add 20% For Federal Excise Tax. Carrying case and straps included. Supply limited. Give second choice.

MONEY BACK GUARANTEE

Use for 20 days at our risk and expense. If not fully satisfied, return for full refund of your money. **ORDER TODAY!** Send \$2.00 deposit and we will ship C.O.D. for balance. Cash orders sent postpaid.

UNITED PRODUCTS CO.

7941 S. Halsted Dept. ARF-508 Chicago 20, Ill.
(Reference Dun & Bradstreet)

MICROSCOPES SUPPLIES-ACCESSORIES & SCIENTIFIC INSTRUMENTS
BEL SPENCER NEW USED LEITZ ZEISS MEDICAL INDUSTRIAL AMATEUR
BOUGHT-SOLD-EXCHANGED-REPAIRED
Send for **FREE LIST**
NATIONAL SCIENTIFIC INSTRUMENT CO. 119 CHAMBERS ST NY7

SAY YOU SAW IT IN POPULAR MECHANICS

BUILD YOUR OWN FAN with that old motor
One piece cast aluminum propeller used for cooling and ventilating. Also available to dealers at discount.

Size	Polished	Unpolished	Bore				
Inches 2 Blade 3 Blade 3 Blade 3 Blade			Inches				
15	\$2.50	\$3.50	\$2.00	\$3.00	1/2	3/4	3/4
18	3.00	4.00	2.50	3.50	1/2	3/4	3/4
20	3.25	4.25	2.75	3.75	1/2	3/4	3/4
24	3.50	5.00	3.00	4.25	1/2	3/4	3/4
30	5.00		4.00		1/2	3/4	3/4

Let us give you our prices on your aluminum castings.

KLOPPENBORG ALUMINUM FOUNDRY, Dept. PM87, Davenport, Iowa

**GOVERNMENT PAID \$15,000
FOR COMPLETE UNIT
Portable Power Plant
BRAND NEW! AND ONLY**

Mobile tow bar—72" wheel base—5 ft. high—600x16 tires—Tail light—hand brake—Ford V 8 axle—30 gal. gas tank—All steel frame and chassis—Ideal for hundreds of industrial uses—Also suitable as electric welder with small adjustments

HERCULES 6 cyl. gas engine—Model JXD 4x4½—air cleaner—self starter

WESTINGHOUSE ¾ HP fan motor—6-blade fan—24" diameter



\$695
EACH
Lots of 3
\$650 Each

Complete operating panel, gas gauge, ammeter oil pr. gauge, temperature gauge, tachometer, Choke starter button throttle—115V plug—115V switch—Fan switch, winter, summer—Ignition switch—6V plug—Voltmeter—115V Ampmeter—300 A-rheostat—Main switch



Westinghouse marine generator, type SK—direct current—Style 1B7494—1100 RPM, 16.2 KW, 162 Amp., 100 volts—1400 RPM, 24.8 KW, 210 Amp., 118 volts

**800 MILLION CANDLE
POWER SEARCHLIGHTS**
Complete with remote control station

(\$300 ea. in lots of 3)

\$349
EACH

Mobile unit has four 600x16 tires. Performs perfectly with power plant. Ideal for carnivals, outdoor games, advertising purposes, hundreds of other uses.

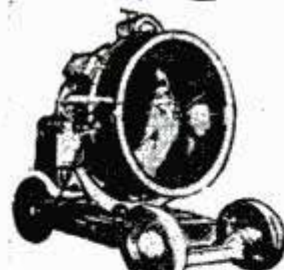

(Send 25% with order, balance C.O.D.)

CHICAGO SURPLUS CO.

THE MOTOR TRUCK BROKER
4545 W. Madison St. Dept. PM8 Chicago 24, Ill.

SAY YOU SAW IT IN POPULAR MECHANICS

STOPS LEAKS PERMANENTLY

Cut your fixture replacement, water and fuel bills with Economy Renewable Seats. Make economical, permanent repairs quickly and easily with the Junior Kit (illus.). Repair bathroom, kitchen and laundry fixtures. Everything you need included in steel box. This is a natural for the "Fixit" shops—get extra income from making permanent repairs on your customers' faucets.

Senior Master Kit also available—repairs faucets and valves up to 1" pipe. At Better Jobbers and Hardware Stores . . . or Write Direct

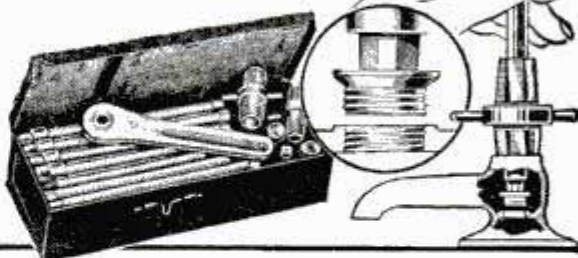

ECONOMY VALVE SEAT CO.
2811 W. Fletcher Street Chicago 18, Ill.

PLASTICS!

Fabricating plastics offers you a fascinating hobby or a profitable business. New Carmen-Bronson Plastics Handbook tells you how; gives construction plans. New Carmen-Bronson Catalog lists all needed materials—Plexiglas, Lucite, Bakelite, Lignolite, Tenite II, Lumarith in sheets, rods, tubes, special shapes—clear and glowing colors. Also plastics dyes, cements, accessories and supplies. 25c (refundable with first order), brings you both catalog and handbook. Send for them today.

CARMEN-BRONSON COMPANY
165 EAST 3RD STREET, DEPT. 8-B, MOUNT VERNON, N. Y.

LAWN ORNAMENT-NOVELTY PATTERNS

28 Lawn Ornament Patterns, 25c. Other patterns; 15-20" high; Dutch Girl, Dutch Boy, Pirates, Bull Terrier, Mexican Girl, Mexican Boy, Dwarf, Penguin, Flower Girl, 10c each. 25 Novelty Patterns, 30c. All 62 Full Size Patterns, \$1.00 Postpaid. Strother Pattern Service, Dept. Y-8, Box 383, Belington, W. Va.



Balance 4" x 9" Base. With either Metric or Avoirdupois Weights . . . **\$6.00**

Catalog with 3000 Illustrations of laboratory apparatus, and over 10,000 prices sent for \$1.00. Catalog of 80 Scientific books, Price \$1.10.

LABORATORY MATERIALS CO.
7321 Vincennes Ave. Chicago 21, Ill.

WATCHES WANTED

BROKEN OR USABLE

All kinds. Highest Prices paid for jewelry, rings, spectacles, gold teeth, diamonds, Sterling Silver, etc. Cash mailed promptly. Write for free shipping container.

LOWE'S, Dept. PM, Holland Bldg., St. Louis 1, Missouri

BRUSH PLATING OUTFITS

for re-plating articles in the home and shop. No tanks necessary. Free particulars.

GUNMETAL CO., AVE. M, DECATUR, ILLINOIS

ENSHRINE THEIR MEMORIES WITH

U.S. MONUMENTS \$14. UP
Freight Paid
There is none better. Our free catalog is ready for you. Write today. A-18 U. S. Marble & Granite Co., Oneco, Fla.

**No. 3 Hawaiian Wiggler
gets bass
in lily pads**

\$1.10

Many excellent catches are being made with the No. 3 in stumps, weeds and lily pads where big bass often hide. Write for free catalog.

FRED ARBOGAST & CO., 1608 North St., Akron 3, Ohio



Kohler

(Kohler Of Kohler, Wisc.)

LIGHT PLANTS

GUARANTEED UNUSED
1500 WATT—115 VOLT A.C.
4 Cylinder Gasoline Engine
Water Cooled Manual Starting

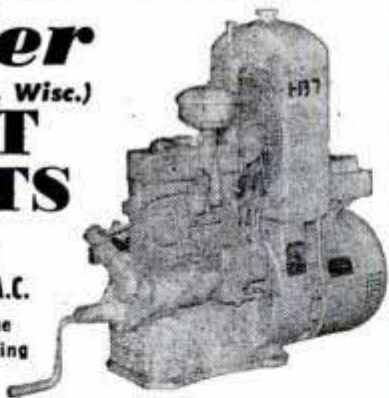

OUR PRICE **\$385** MARKET PRICE **\$696**
(INCLUDES SPARE PARTS)

QUANTITY DISCOUNT UPON APPLICATION

BUILDING OWNERS, INC.

Route 1, Box 949

Portland, Oregon

TRAILER HITCHING SIMPLIFIED!

Patent Pending.



Here's the Newly Engineered and Expertly Designed

KEYSTONE "LIGHTNING" BUMPER HITCH

for Utility Trailers

- Can Be Attached and Detached Instantaneously
- Fully Adjustable to Fit Practically All Car Bumpers Including '46 and '47 Models
- Will Fit:

MODEL D
FORD • CHEVY • PLYMOUTH • DODGE • CHRYSLER
DESOTO • MERCURY • HUDSON • CADILLAC (BUICK
LINCOLN) • PACKARD TAKES 2 COUPLINGS WITH A
CROSS BAR.)

• Made of sturdy pressed steel, 3/8" thick, has additional slots for easier adjustment.

STRONG • STURDY • DEPENDABLE • SAFE

• Acclaimed by Trailer Rental and Sales Co's. & utility trailer owners as "THE PERFECT BUMPER COUPLING."

NOW AVAILABLE FOR IMMEDIATE DELIVERY—\$6.45 ONLY

Send Check or Money Order to Ball Not Furnished

KEYSTONE TRAILER SALES

5501-29 LANCASTER AVENUE, DEPT. P.M., PHILA. 31, PA.
• Dealerships and Distributorships available •

1 1/2" - 2" Abrasive Cloth 4-ROLL BARGAIN

GREATEST ABRASIVE VALUE IN U.S.A.

Tool and die men, pattern makers, hobbyists, foundry men, other tool-minded men, here's a tremendous "find" in abrasive cloth. By reaching you direct with this ad, we can let you have four 50 yd. aluminum oxide rolls for finest abrasive cloth from Mfgs. like Minn. Mining, Carburundum, Sandpaper, Inc. at way under regular list prices.

LOOK!

Bargain Assortment consists of:
One 1 1/2" wide 50 yd. roll—400 grit
One 1 1/2" wide 50 yd. roll—100 grit
One 2" wide 50 yd. roll—120 grit
One 2" wide 50 yd. roll—150 grit
Dealers and Jobber Inquiries invited

Very Special—One 50 yd. aluminum oxide roll 60 grit. Limited supply—now only **\$3.35**
This extra special 60 grit roll cannot be included as part of big 4 roll ass't above. Hurry! Cash, check or money order must accompany order for this 60 grit roll.

S & G SALES
2256 East 75th Street
Dept. 8, Chicago 49, Ill.



GUARANTEE Our abrasives are guaranteed to be top quality. Return for money back IN FULL if not satisfied.

RUSH ORDER
Send check or money order now, 4 roll ass't price only \$9.95, post paid in U.S. Or send \$2.00 deposit and pay balance C.O.D. plus small delivery

\$36.80 LIST NOW ONLY \$9.95
POST PAID IN U.S.

charge. ACT TODAY. Limited supply will go fast at this money-saving price.

LUCKY 13

FOR TOOL USERS!



WRENCHES • PLIERS
PUNCHES • CHISELS
SCREWDRIVERS
SPECIAL TOOLS
SOCKETS & HANDLES
PULLERS
TOOL BOXES

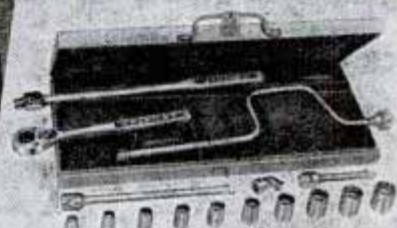

Socket Set for Nut Turning
1/2" Drive

Production 13 times as great as in 1940 permits Plomb to make finer tools than ever at prices close to pre-war levels—even below on some. Make your job more profitable—get tools you'll be proud of from your Plomb dealer today! Write for catalog to

PLOMB TOOL COMPANY
2255E Santa Fe Avenue
Los Angeles 54, California



PLOMB

streamlined
TOOLS

Please Mention Popular Mechanics When Answering Ads

ONE GALLON = 125 MILES!

Put a Whizzer Motor on your bike and discover really thrifty transportation! 125 miles to the gallon! 35 MPH! Fits any man's balloon tire bike. Complete with all attachments necessary to motorize your bike! See your local Whizzer Dealer!

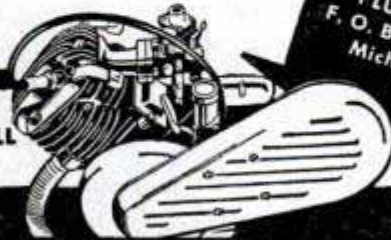

RIDE ONE AND YOU'LL BUY ONE!

\$97.55
PLUS TAX
F. O. B. Pontiac,
Michigan

ON A
WHIZZER

Whizzer Motor Company, Dept. 528, Pontiac, Michigan. I enclose \$99.97, which includes \$2.42 Federal Excise Tax () check or () money order. Send me one Whizzer Motor complete, ready for installation. If descriptive literature only is desired, check here ().

Name _____ City _____
Street _____ State _____

MORE POWER!
MORE CAPACITY!
MORE FLEXIBILITY!

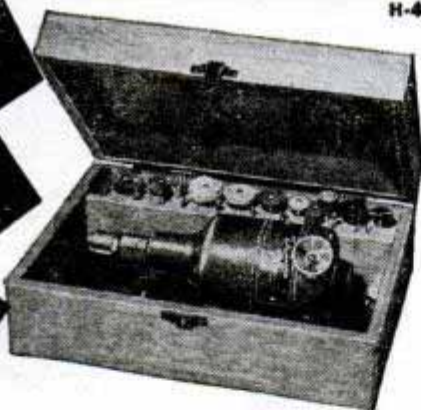

H-4

... than any other homeshop handgrinder

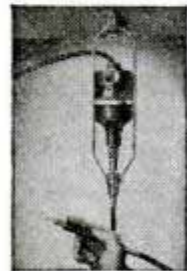

Now you can have the handgrinder you've always wanted for your workshop! Its full 1/14 HP motor has the extra power for "heavy" jobs. Its extra-capacity chuck takes all 3 tool sizes — 1/4", 1/8", 3/32". Attachments convert it instantly for bench, lathe, and flexible-shaft work!

Think what you can do with the extra power, capacity, and versatility of the Duplex. Work in wood, metal, and plastics is faster, easier—and twice the fun!

Tear out this coupon and mail today!

- The Dumore Company, Dept. H-51, Racine, Wisconsin
- Please send complete information on Duplex Grinder
 - Send me Deluxe Duplex Kit (27 accessories). \$27.50 enclosed
 - Send me Standard Duplex Kit (9 accessories). \$19.75 enclosed
- Shipping charges C.O.D.

Name _____
Address _____
City _____ (____) State _____

FOR 7" STROKE OR LESS... You Can't Buy a MORE ACCURATE LOWER PRICED SHAPER!

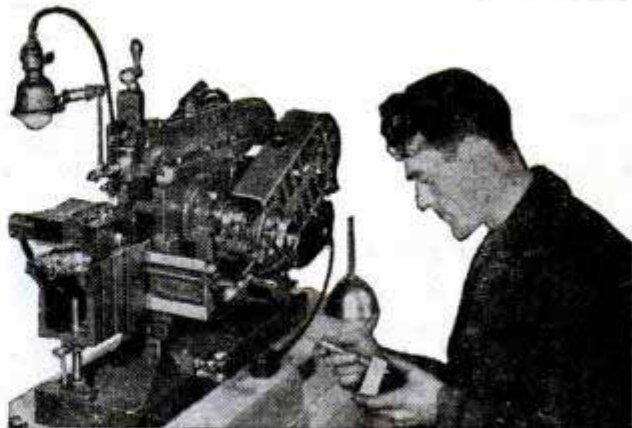

No big machine on the market surpasses the Ammco in accuracy, yet its operating expense is remarkably low. Compact in design for plant or home use, low in price, the Ammco 7" Shaper is ideal for all work of 7" stroke or less. Bench or portable cabinet models. Write today for literature and prices. Address Dept. PM-87

AMMCO TOOLS, INC.
COMMONWEALTH AVENUE
NORTH CHICAGO ILLINOIS

THE AMMCO SHAPER
Saves on:

1. Time
2. Labor
3. Floor Space
4. Electricity
5. Set-up Expense

SKILL IS BUILT INTO EVERY AMMCO PRODUCT!

SEND FOR THEM NOW!

- SWITCHBOX:**
contains 2 toggles, 2 binding posts, indicator light and 2 bond nuts..... \$2.95
- MARK-18 GUN SIGHT:**..... 8.95
- SELSYN CONTROL TRANSFORMER:**.... 1.95
- SELSYN CONTROL GENERATOR:**..... 1.95
- CABLE:**
7 wire, insulated, 35 ft..... 3.49
- TANK INTERPHONES:**
in weatherproof steel boxes. Ideal for house in barn, cellar to attic, etc. Operates on 6 volts, pr..... 29.50
- AIR COMPRESSORS:**
27 V, 20 amp., AC or DC 3 stage, 1500 lbs. pressure. Complete with motor and tank. 14.95
- SHEET MAGNESIUM:**
- .051 thickness—3' x 10', sheet..... 9.00
 - .051 thickness—3' x 12', sheet..... 10.80
 - .064 thickness—3' x 10', sheet..... 11.40
 - .064 thickness—3' x 12', sheet..... 12.90
 - .072 thickness—3' x 10', sheet..... 12.30
 - .072 thickness—3' x 12', sheet..... 14.40
- BULLET PROOF GLASS:**
10" x 20" x 1 1/2"..... 4.94
- FAIRCHILD GUN SIGHTS:**..... 12.95
- BOMBER SIGHTING STATIONS:**..... 98.50
- FAIRCHILD POWER UNIT FOR SIGHTS:** 12.95
- FAIRCHILD CONTROL BOX UNIT:**..... 12.95
- 1/4 TON BOMB HOIST:**
Chainfall Type 6.95
- GE FRICTION TAPE:**
82 1/2 ft.69
- AIRCRAFT TOGGLE SWITCH:**..... .45
- AIRCRAFT MOMENTARY TOGGLE SWITCH:**45
- Send Check, Money Order or Cash. No C.O.D.'s.
Express Collect.

BUFFALO SURPLUS CO.
26 E. NORTH ST. PHONE GARFIELD 7706
BUFFALO 3, N. Y.

BALL BEARING STEEL WHEELS

Complete with GOODYEAR, GATES or OSBORN PUNCTURE-

Made to Outwear
Other Type Wheels

PROOF Semi-Pneumatic Tires

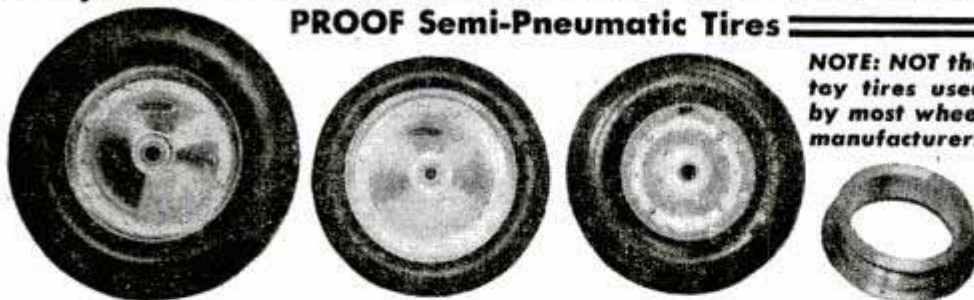

NOTE: NOT the toy tires used by most wheel manufacturers

ALL-PURPOSE Chassis

For garden, truck, outboard motor cart, shopping cart, bike trailer, spray equipment or material handling. Load 250 lbs. 10" Ball Bearing Wheels. Channel iron construction. Frame 18"x30" removable handle.



Only **\$10.50** same 24" x 26" only **\$12.00**

12" x 2 1/2" Load—150 lbs. 1 1/2" or 5/8" Ball Bearings	10" x 1 3/4" Load—125 lbs. 1 1/2" or 5/8" Ball Bearings	10" x 2 1/2" Load—250 lbs. 5/8" Ball Bearings
ONE \$5.50	ONE \$3.00	ONE \$5.50
TWO \$10.00	TWO \$5.50	TWO \$10.00
FOUR \$18.00	FOUR \$10.00	FOUR \$18.00

Three as above and One V-Pulley Drive & Brake Drum Wheel ... \$21.00
Three as above and One V-Pulley Drive & Brake Drum Wheel ... \$13.00
Three as above and One HEAVY DUTY INDUSTRIAL Add 10% for Prepaid Shipment in U.S.A.

COMBINATION V-PULLEY DRIVE & BRAKE DRUM Assembled to our 12"x2 1/2" or our 10"x 1 3/4" wheels extra ... \$3.00 Without wheel \$3.50 each.

1 1/2" dia. x 20" Long Axles with hangers, washers, cotter pins... each \$1.50
1 1/2" dia. x 30" Long... each \$1.75
5/8" dia. x 24" Long... each \$1.75
5/8" dia. x 30" Long... each \$2.00

SPECIAL OFFER: A Real Bargain

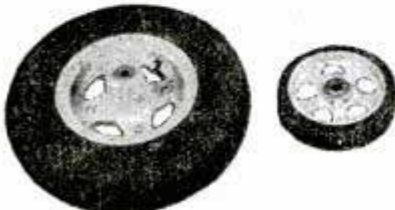

FOUR . . . 4.00x8- 4 ply heavy duty, separate tube, Pneumatic Tires, 1" Roller Bearings 5" hub width, 10" O.D. Complete; wheels, tires, tubes, \$50.00 etc. 4 only

\$13.50 each
add 10% for Prepaid shipment in U.S.A.

—Also—
"Thermoid" Industrial Wheels . . . Ball Bearing—solid rubber with Aluminum Wheel.
6" O.D. x 1 5/8" wide 2 1/2" hub. 3/4" bore. Load 450 lbs. each \$7.85,
8" O. D. x 1 7/8" wide 3" hub. 3/4" bore. Load 640 lbs. each \$10.35.

1948 MODEL "B" RACER

76" Long x 30" Wide—12 x 2 1/2" Wheels, Internal Brakes, Release and Brake Pedals, 12 Volt Electric Motor and Speed Reductor, Pulleys, Idler, Belt, etc. READY TO RIDE. Runs on level 6 hours on one charge at 6 miles per hour. Uses 2-6 Volt Auto Batteries. Four Speeds Forward. Control can be placed anywhere you desire. 12" Steering Wheel; left side drive. 2 passenger. As shown less batteries (with charger \$165.00)

only **\$150.00**

Chassis Less Power Unit only **\$56.00**

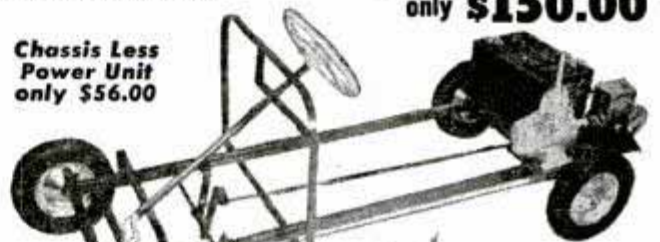

Electric Motor only **\$33.50**

Electric WHEEL CHAIR For Any Age

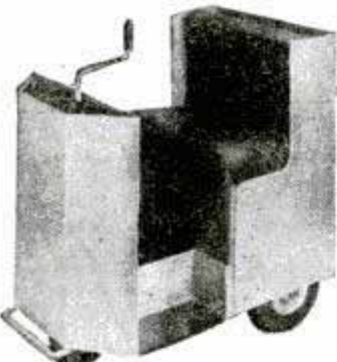

Four Speeds Forward and Reverse. Runs on 2-6 Volt Auto Batteries. Steering, Power and Brakes, hand operated. Built-in Battery Charger. Runs 6 hrs. on level at 6 miles per hour. 40" long, 28" wide by 40" high. Ideal for homes, hospitals, plants and amusement centers. Our 12"x2 1/2" Ball Bearing Wheels in rear and 10"x2 1/2" front. Turns in less space than its length. Driven by 12 Volt Motor through a 18 to 1 ratio Boston Speed Reductor, V-Pulley and Belt to left rear wheel. Ruggedly built to give miles of trouble free travel.

Less Batteries Prepaid anywhere in U. S. A. only **\$275.00**

Front Assemblies

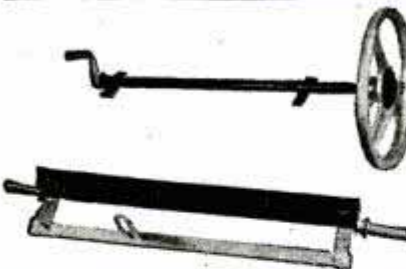

12" Aluminum Steering Wheel with semi-hard rubber center dome. Steering rod, Steering column and mounting brackets.

OR—
Auto type Front Axle—30" wide 5/8" dia. 1 1/2"x2" channel, tie links, tie rod and loop.

Either of above only . . . **\$5.50**

REAR ASSEMBLIES

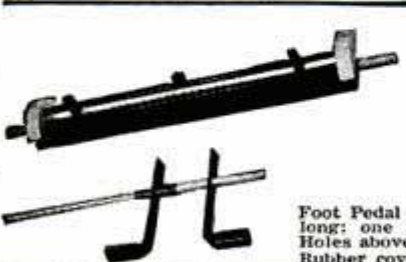

Rear Axle 5/8" dia. 30" long with channel iron brace and internal Maple Brake Shoes to fit our Combination V-Pulley and Brake Drum Unit. Only . . . **\$5.50**

Foot Pedal Assembly 1/2" dia. rod 20" long; one pedal fixed, the other free. Holes above and below shaft. Rubber covered pedals. Only **\$3.00**

Homecrafters TREASURE KIT

- 2 pieces 3/4"x1 1/2"x1 1/2"x24" long Channel
- 2 pieces 1"x1" Angle 24" long
- 2 pieces 7/8"x1/4" Bar 24" long
- 2 pieces 2"x1 1/2" Flat 24" long
- 2 pieces 3"x1/2" Flat 24" long
- 2 pieces 5/8" dia. x 24" long Round

The above Material to Build Your Project, ONLY **\$5.00**

ADD 10% FOR PREPAID SHIPMENT IN U. S. A.

GASOLINE AND ELECTRIC POWER PLANTS

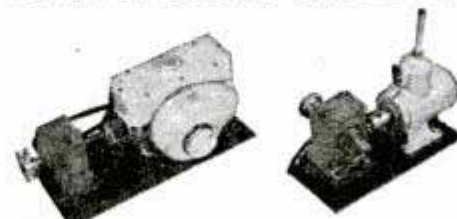

17 lb. 1 H.P. "Powers" Gasoline Engine; easy starting with Boston 9 to 1 or 18 to 1 ratio Speed Reductor, pulleys, tension idler and V Belt, mounted and READY TO RUN. **\$99.50** Only . . .

12 Volt D.C. 1/3 H.P. Electric Motor with FOUR Speed Control, flexible coupling, tension idler, pulley and base, 9 to 1 or 18 to 1 ratio Boston Speed Reductor. Only . . . **\$65.00**

NOTE: If you desire the shipment Prepaid simply add 10% to your remittance on all items except the Chassis. Without Power Units add 15%.

When requesting circulars please include 10c to cover cost of mailing.

OSBORN WHEEL COMPANY, 115 So. Main St., Dept. P-8, Doylestown, Penn.

RUSH YOUR ORDER

It's Here!

BARRON ALL METAL SHAPER FENCE

Fits ANY Drill Press

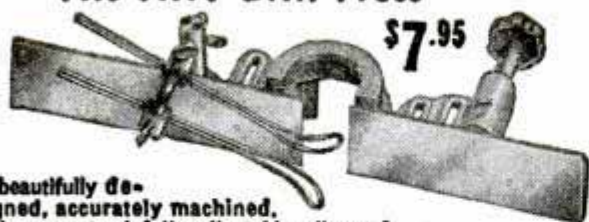

\$7.95

A beautifully designed, accurately machined, fully guaranteed, fully adjustable, all-metal shaper fence. Made throughout of aluminum and non-rusting steel. No cast iron—no wood! Complete with anchor bolts, 2 hold down springs. A real value. See it at your dealer or shipped direct

FAMOUS 5-IN-1 DRILL PRESS PLANER

Planes-Rabbets
Panels
Tenons
Grooves

\$7.50

COMPLETE

NEW 2 1/2" DRUM SANDER

Fits All Makes
of Drill Presses
or Motor
Shafts

\$3.95

Includes 5
sanding sleeves



OTHER DRILL PRESS ACCESSORIES

4" ROTARY SURFACE SANDER \$5.95 1/2" DOVETAIL CUTTER \$1.95
ALL-METAL AUXILIARY DRILL PRESS PLANING AND SHAPER TABLE \$9.85
TAPERED AND THREADED SPINDLE ADAPTERS
ROUTER AND ROUND END MORTISING BITS 1/8" TO 1/2" SET OF 6 \$9.50

Liberal 10 Day Money Back Guarantee

Workshop Guide FREE

BARRON TOOL CO.

569 Architects Bldg., Detroit 1, Mich.

BARRON PRECISION TOOLS WORK SHOP

TABLE SAW ATTACHMENTS



fit any saw . . . SHAPER HEAD

Fits 1/2", 3/8" or 3/4" shaft . . . three 1" wide hardened and ground high speed steel knives furnished, other shapes available. Body is cast steel, precision made and balanced. When ordering specify side of saw (when facing saw) snapper is to fit. 3 3/8" diameter size . . . \$14.95
4 1/2" diameter (hole size 1" to 1 1/2"), prepaid . . . \$16.95



GROOVE-MASTER

for grooving, dadoing, tenoning, etc. Cuts with or against grain. 5 1/2" dia. with 5/8" or 1 1/2" shaft hole. Set consists of two—3/32" thick outside saws plus six—1/16" thick inside filler cutters, prepaid . . . \$5.95

Money Back Guarantee: these attachments are guaranteed as advertised and as to quality or your money back.

Immediate Delivery

ORDER DIRECT

UNIVERSAL TOOL CO.

919 E. Redondo Blvd., Inglewood, Calif.

Send me the following postage prepaid.

- SHAPER HEAD Diameter _____ Hole Size _____ Side of Saw _____
 GROOVE-MASTER Dado Set _____ dia. hole _____
 I enclose _____ in check or money order
 Ship C.O.D., deposit of \$1.00 enclosed on each item ordered

NAME _____

ADDRESS _____

CITY _____

STATE _____

MARGIE



DIRT and DUST
YOUR DOUBLE-TROUBLE?



Fix it with *Mortite*

a household friend

Shut out dirt and dust! Press pliable Mortite around windows, doors, baseboards, etc. It's done in a jiffy. Keeps out ants, insects; fine for caulking, stops rattles; the ideal weatherstripping. Roll covers about 80 ft. At Hardware, Paint, Dept. Stores, Lumberyards. Write for free booklet.

\$1.25 Higher West of Rockies and Canada

J. W. MORTELL CO.,

522 Burch St., Kankakee, Ill.

Radio SAMBA

From California comes a blend of U. S. Technical skill and Latin-American charm to give high performance, rich quality and a new experience in radio enjoyment. The SAMBA, excellent 5 tube AC-DC radio, in Walnut or Ivory plastic. For short time only, \$14.50 Cash or \$15.00 C.O.D. Catalogue sent on request.



Power Engineering Co., 178 Grand Ave., Oakland 12, Calif.

WORLD'S LOWEST PRICED ADDING MACHINE

VEST POCKET SIZE

IDEAL FOR BUSINESS OR PERSONAL USE

FREE TRIAL
ONLY \$2.50
TOTAL COST
SEND NO MONEY

Fits vest pocket or purse. Guaranteed accurate. Operated as easily, and as reliable, as machines costing many times as much. Not a toy. Substantially made of 28-gauge steel—guaranteed for life against defects in construction. You positively can't buy a calculator of equal quality for as little money. ACCEPTED AS THE FINEST LOW PRICED CALCULATOR FOR OVER 30 YEARS! Operates with a flick of your finger. Adds, subtracts, multiplies, divides—counts up to ten million. Pays for itself over and over in mistakes avoided, and time saved. MAKES IDEAL GIFT.

Sold on a positive money back guarantee. Send only \$2.50, Calculator sent postpaid, or send name and address and pay postman \$2.50 plus postage. MONEY BACK IN 10 DAYS IF NOT DELIGHTED! (If outside U. S., send \$3.00.)

AGENTS WANTED.

CALCULATOR MACHINE CO. (Mfrs.)
Dept. 193, P. O. Box 248, Glenview, Illinois

Each Baby Calculator in Beautiful, rich-looking Leatherette case—at no extra cost. FREE!!



UP TO
SAVE 85%

in WAR SURPLUS...SENSATIONAL VALUES
IN MANY ITEMS WE HAVE
THE WORLD'S LARGEST SUPPLY
at **'GADGETEER'S HEAVEN'**

New Hydraulic Cylinders
VALVES, PUMPS, FITTINGS, HOSE & TANKS
The World's Largest Supply. 1001 Labor Saving Adaptations for pulling, pushing, lifting operations.
Finest precision workmanship and materials. Liquid and/or air operation, developing terrific power.
15% OF GOVERNMENT COST!
Write for Catalogue



A Real Buy!
A 1001 USES!
WINCH HOIST
Capacity 2500 lbs. Controlled worm gear drive winch, with 19 ft. 1/4" diam. alloyed steel cable. Ideal for garages, truck loading, machine shops, boat building, etc.
#100A Without handle... **\$10.75**
#100 With handle... **\$12.50**



BATTERIES
NEW! FULL STRENGTH For portable Radios, Signal Lamps, Boats, Electric Trains, etc.
#516 9 Volt 8 1/2 x 6 x 4 in. 3 run, 24 Volt Motor... **79c**
#515 90 & 1 1/2 Volt... **69c**
#517 67 1/2 & 1 1/2 Volt Battery... **69c**



PNEUMATIC RIVET GUNS
Pistol & Gooseneck Type
#180 100 Uses, Chipping, Peening, Drilling and Breaking down body work
Chicago Pneumatic, Cleco, Ingersoll Rand Makes.
E3, E2, 3X, 2X, OY
\$55 Value
\$8.95
#181 Pistol
#186 Squeezer
PNEUMATIC ALLIGATOR SQUEEZER
\$80 Value
\$15.95



MESS TRAY
6 COMPARTMENTS
Rustless, Stainless Steel. Can be used for cooking as well. Ideal for restaurants. The perfect companion for that vacation trip, barbecue picnical. Saves dishwashing.
#311
NEW - 79c ea.



PLEXIGLASS DOMES
15"x19 1/2"x6" deep. 1/4" thick.
Can be used for home hot-house, fish bowl, washbowl, ornamental light. Can be flattened in oven and will make flat sheet 15"x19 1/2"x1/4". Weight 3 1/4 lbs.
#700 **\$1.69**
Also 200,000 lbs. of other plexiglass sizes and shapes.



NEW Amplidyne Motor-Generator
With 24 volt current, it gives 60 volt output. This unit has been adapted to independent coil and rind lighting power.
Welding and many other uses.
Weight 28 lbs.
Gov't. Cost Approximately \$237.00
#311
A Steal at **\$8.95**



AIR DRILLS
CLEVELAND THOR CHICAGO PNEUMATIC 1/4" JCB Chuck
Straight \$17.95
Angle Drill \$19.50



WINDSHIELD WIPER KIT
1/8 H.P. 24 volt, D.C. series wound motor, with 30" flexible shaft, switch circuit breaker, 10,000 forward or 5,000 reverse R. P. M.
Wiper & wiper bracket, or 2 in blade & switch.
only **\$7.95**



PLASTIC CRAFT KIT
24 PIECE
Make beautiful Jewelry, boxes, bookends, etc. for Pleasure or Profit Kit contains Lucite & Plexiglass material, 3 colors of dye, cement, and book of projects and easy-to-follow instructions for cutting, fabricating, carving, drilling.
#701 **\$2.39**



OPTICAL GYROSCOPE!
MARK 18 GYRO-SIGHT
An engineering marvel worth hundreds of dollars - Our Price **\$8.35**
Airforces Gun-Sight, #103 NGA, with polarizing variable density \$2.95
L3 Type, #102, Triple Lense \$1.95



ELECTRIC DRILLS
CLARK and THOR
110 V. A.C. 50,000 cycle, 1/4 inch bit & JCB Chuck. Both side and trigger handle. High Speed. For commercial or home use. The best there is. Gov't. Cost Approx. \$60.00
A TERRIFIC VALUE **\$17.95**



NEW! PRESSURE TANKS
Stainless steel, shatter proof, 400 lbs. sq. in. G-1 2100 CU. IN. 26 x 12 in. #105 **\$4.75**
D-2 500 cu. #104 **\$2.25**



COMPASSES
#151 Marching, lensite, with luminous dial... **\$1.69**
#152 Matchbox, both jewel & liquid floating dial... **33c**
#153 Jeweled Pocket Watch Compass... **\$1.19**
#154 Wrist strap Compass... **69c**



Electric GYRO PILOT Assembly Part
2 solenoids for reverse and forward motor control. 2 solenoids throw clutch to engage drive. With brake assembly. Can be used as boat rudder control, converted for lathe tapping and slow speed motor tool, wt. 29 lbs. Finest precision workmanship.
Cost Gov't. Thousand \$8.95
Your Cost **\$8.95**



1/3 to 1/5 Gov't. Cost (approx.)
Air Corp. Fleece-lined
LEATHER JACKET
To keep you warm in the coldest wind.
• Made to last practically a lifetime.
• Full sheepskin gab.
• Fleeced-lined collar.
• Leather tipped seams.
• Full length zipper.
• 2 slanted, deep, slash pockets.
• Adjustable strap & buckle at throat.
• Type D-1. Dyed for easy, hand-free action.
• Soft, elastic, "aviation type" leather.
Made to U.S. Gov't. specifications - "out and in!"
Sizes: #401, small; #402, medium; #403, large.
YOU'VE NEVER SEEN THEM AT THESE PRICES. RECONDITIONED, CLEANED AND BRUSHED.
PERFECT CONDITION! **\$8.95 WHILE THEY LAST!**



Valuable GEARS BARGAINS
#112
#1 Rate Spindle Drive #110... **\$2.98**
4 to 1 with screw shaft #111... **\$4.95**
Reversible #112... **\$3.25**
#113 1 to 1 Gear type... **\$1.19**
#114 2 to 1... **\$1.14**
#115 3 to 1... **\$1.10**



All Purpose HAMMER
As a hammer combination for wood & metal work. 3 1/2 lbs. 14 1/2" hardwood handle, hard steel cutting edge.
69c
Compound METAL SNIPS
Action
Hard steel blades. Expansion spring. Locking device.
New **\$2.59**



SLEEPING BAG
NEW! 100% wool. Mummy type. Heavy duty 30" zipper.
\$1 extra Gov't. cost \$22.00 for use **\$1.95**
water repellent cover.



ELECTRIC SOLDERING IRON
#198
200 WATT "SOLDER MASTER" **\$3.95**
105, 110, 120 Volt
Nul-Sed



RUBBER GOODS
#201
#202
#203
#204
#205
#206
#207
#208



COMPRESSOR complete with tank and fittings.
G. E. 2-stage, A.C. or D.C. 1/2 h.p. 1000 lbs. sq. in. Spray-lub. laboratory use, inflating.
NOW #506... **\$17.95**
Compressor and 24 volt motor can be adapted to 110 A.C. with transformers or 4 1000 heating elements. We stock both.
ELECTRIC MOTORS
New 1/2 H.P. 27 Volt D.C. 24 Volt A.C. #508... **\$5.45**
#509 Cdn. also be easily adapted to 110 A.C. by changing leads. We have direct & drawing for \$1. extra.

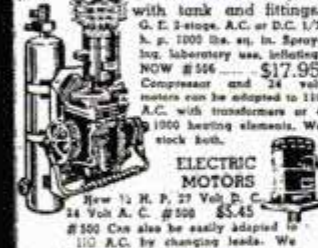

COMPARE THESE PRICES
#301 CANTEEN, 1 qt., alum., plastic top... **29c**
#305 GOGGLES, New, Colored Polaroid flexible lens. Shatterproof... **59c**
Sponge Rubber Frame...
#400 WORK HELMET, Plastic, 12 oz. 59c
#510 & 511 Amp. & Volt Meters ea. **\$2.50**
GADGET MIX
Rivets, spacers, nuts, clamps, bolts, gears.
Radio parts, etc.
A gold mine... **\$1.19**



Fire Extinguishers
Kiddie Lux CO2 Type
Built in Gov't. Spec. 4 lb. Trip. con. with horn. fully recharged.
\$30.00 value #61 \$10.75
2 LB. CO2 TYPE
\$22.50 value #62 \$8.75
10 lb. Chgd. CO2 with Horn \$80.00 value #63 \$29.50
7 1/2 lb. Weigh. Portable Control \$70.00 value #64 \$7.50
indispensable for small or large planes, trucks, auto, home, factories, etc.



LEATHER FLEECE-LINED BOOT INSERTS
For hunting or around house as slipper, sizes: medium.
\$7.00 Value \$1.89 pr.



BEARING MIX
Needle, ball and roller bearings in excellent assortment. Sizes from 1/2" to 2".
#170 Introducing this shell treasure - Assortment of 15 Bearings at... **\$2.95**



#313 BOAT FENDER-21 in. long 5 in. diam. Protection against docks for small boats.
\$6.50 VALUE A STEAL AT \$1.95
#314
4.16" PUTE HOPE 2 Thread Strand, Night Lay, 50 Ft. #314
3/4" SISAL ROPE 50 Ft. #315
5 lb. Ball 3/16" Hoop Twice Treated #316

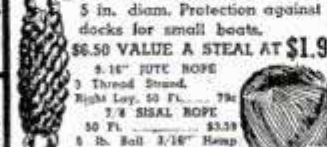

CLAMPS
Adel Aluminum, rubber lined. Mixed. #121 4 dozen... **89c**
Aero-Seal, Rust Resistant. Slotted with screw top. 1/2" to 3". #120 Regular 27c
Now 10c \$1.00 doz.



HORSEHIDE WORK GLOVES
ALL LEATHER GAUNTLET TYPE REINFORCED PALMS & FINGERS STITCHING.
LENGTH 13 1/2" #291 **\$1.95 pr.**
ALL LEATHER WRIST Length 10 1/2" #292 **\$1.55 pr.**
Barbed wire, welding, all purpose work gloves.
A Steal... Gov't. cost many, many times more.



ORDER DIRECT FROM THIS AD
All sales final. Make remittances by money-order, bank draft or personal check. Purchase orders acceptable from D & B firms. All quotations F.O.B. Los Angeles.
BIG ILLUSTRATED CATALOGUE AVAILABLE
Send 25% deposit with C.O.D. orders. Also Aircraft Supply Catalogue

SAFETY BELT
New, Original Box, Type B-14 Lap Safety Belt. Adjustable - full length 48", width 3". Forged steel, foot proof safety catch. Ideal for planes, jeeps, fun rides, farm equipment, etc. Try to beat this at **99c**



PALLEY SUPPLY CO. THE LARGEST FIRM OF ITS TYPE IN THE WORLD DEPT. P. M. 87 - 6321 SAN FERNANDO RD. GLENDALE 1, CALIFORNIA

NOW available On Easy Terms Immediate Delivery

SOUTH BEND 9" LATHES

South Bend 9" Lathes are the answer for men who are not satisfied with mediocre shop equipment. Built for industry's finest toolmaking, experimental, and production work, their use makes it possible to duplicate industrial performance in small shops. Their accuracy, versatility and ease of operation will improve your craftsmanship.

Made in three models
priced from \$145.00



COMPARE THESE FEATURES! 9" Model A Lathe

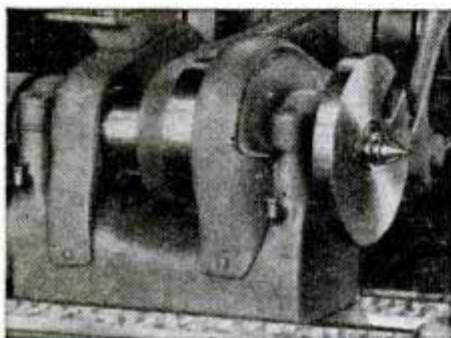

HEADSTOCK

Large diameter heat-treated spindle provides extreme rigidity. Bearing surfaces superfinished to 5 micro-inches rms. (.000005"), adjustable journal bearings, and ball thrust bearing assure precision. Direct belt drive for smooth operation at high speeds. Back gear drive for slow speeds.

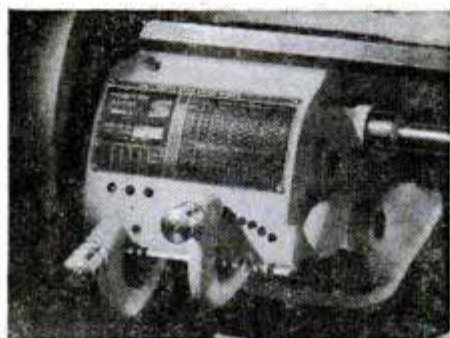

QUICK CHANGE GEAR BOX

Makes available 48 pitches of screw threads—8 to .224 per inch instantly selected by changing two levers, coarse threads from 4 to 7 per inch after changing stud gear. 48 power longitudinal feeds—.0015" to .0853", and 48 power cross feeds—.0004" to .0252" are similarly selected.

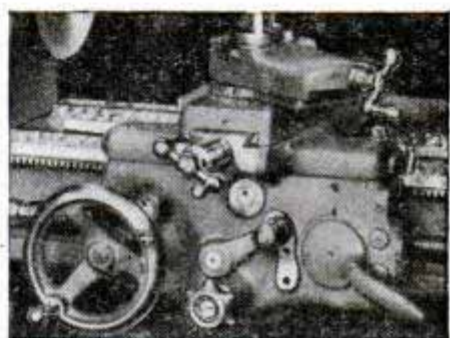

CARRIAGE

Saddle travels on two V-ways. Compound Rest Cross Slide operated by power or hand feed. Compound Rest Swivel adjustable through 180° for machining bevels and short tapers. Apron has worm drive from lead screw through friction clutch for all power feeds and half-nuts for thread cutting.

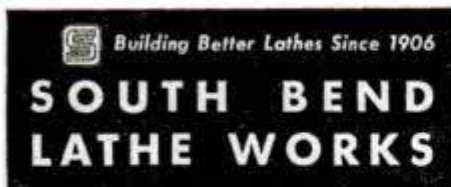

South Bend Lathe Works
455 E. Madison St., South Bend 22, Ind.

Please send items checked:

- Catalog of 9" South Bend Lathes
- Catalog of 10" to 16" Lathes
- Time Payment Plan Outline

Name _____

Street _____

City _____

State _____

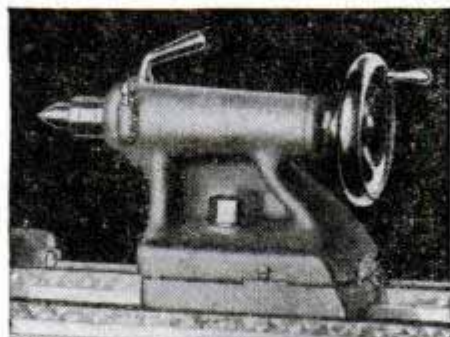

TAILSTOCK

Graduated spindle of special quality spindle steel. Hardened, self-ejecting center. Tailstock off-set top has set-over for taper turning. Long hand-scraped bearing surfaces for flat and V bed ways assure perfect alignment and reduce wear. Positive action spindle lock and tailstock clamp.

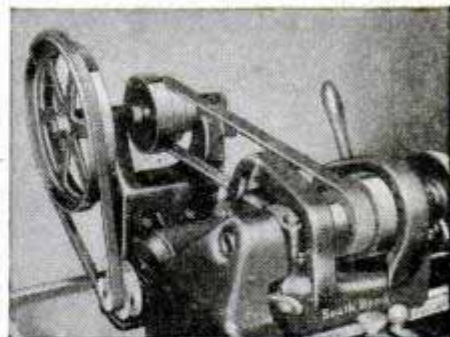

DRIVE

Practical, trouble-free, horizontal motor drives. Vibration-free and exceedingly quiet. Tension release makes selection of spindle speeds fast and simple. Positive belt tension adjustments. TWELVE-SPEED DRIVE provides spindle speeds from 41 to 1270 r.p.m., SIX-SPEED DRIVE from 41 to 658 r.p.m.

GIVE HORSEPOWER

Get-up-and-go

You'll be surprised how much easier your car breezes along after a Casite tune-up. Coughs, jerks and sputters quickly disappear—new smoothness, zip and power take over.

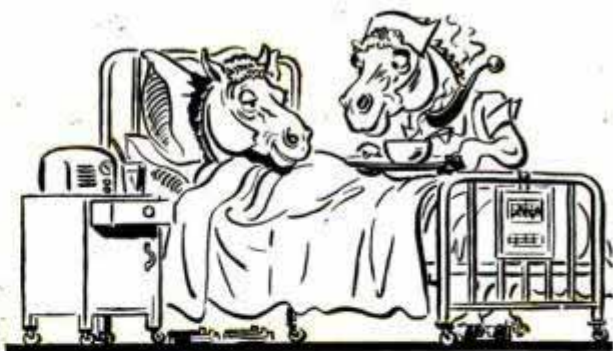

AND KEEP IT
rarin' to go...

Casite speeds lubrication . . . retards formation of sludge and gum . . . makes your motor really hum. Use Casite regularly—a pint through the air intake every three months and a pint in the crankcase every oil change.

THE *Guaranteed* **WAY!**

Double-Your-Money-Back if your car doesn't run better and smoother with Casite. And Casite makes this famous guarantee no matter what kind of motor oil you're using. You can't lose. Try Casite today at your service station, garage or car dealers. The Casite Corporation, Hastings, Michigan and the Casite Division, Hastings Ltd., Toronto.



CLEANS MOTORS
KEEPS
MOTORS CLEAN



65¢
A PINT
IN CANADA
75¢

SHEAFFER'S QUALITY IN TRIPLICATE



Color Photograph by Wesley Bowman

SHEAFFER'S *Threesome*

Three superlative writing instruments—one for each of your writing needs . . . and all of them Sheaffer's. Just try all three . . . You'll want all three because you need all three!

"TRIUMPH" pen for personalized character writing—for putting you on paper. 16 different points of 14-K gold to select from.

STRATOWRITER, most dependable ball-tip writing

instrument—for permanent notes in red, green or blue, for making carbons, addressing packages.

FINELINE pencil for erasable writing—figuring, sketching, jotting notes. Its Sleeve-Tip reduces lead breakage.

SENTINEL DE LUXE THREESOME—"TRIUMPH" PEN, \$15; STRATOWRITER, \$10; Pencil, \$5; complete set, \$30.00. No Federal Tax.

Copyright 1947, W. A. Sheaffer Pen Co.

LISTEN EVERY SUNDAY to SHEAFFER'S PARADE with Carmen Cavallaro—NBC Complete Network: 2 P.M. E. S. T.; 3 P.M. E. D. T.
LISTEN EVERY SATURDAY to SHEAFFER'S ADVENTURERS CLUB—CBS Complete Network: 10:30 A.M. E. S. T.; 11:30 A.M. E. D. T.