

ANC

POPULAR MECHANICS

MAGAZINE

WRITTEN SO YOU CAN UNDERSTAND IT

REG. TRADE MARK, GREAT BRITAIN, No. 410428

U.S. PAT. OFF.

JULY 1947
25 CENTS



BUBBLE BOAT
PAGE 88

"De LUXE" YOUR TIRES IN 5 MINUTES!

...Snap on metal

Lyon
WHITEWALLS*

*TRADE MARK



...and add the **final touch** of smartness!

The easiest way to make your car look a hundred per cent smarter is also the most inexpensive and practical. Snapping on metal Lyon Whitewalls takes less than five minutes. They cost less than half what you used to pay for white sidewall tires . . . are *easy* to clean . . . *can't* scuff on curbs . . . have *no* upkeep expense . . . and they achieve the car-appearance

designers have always sought—even *smarter* wheels to give your car a *longer, lower* look than ever before! Ask your dealer to show you Lyon Whitewalls next time you stop for gas.

★ ★ ★

PRICES: Standard Steel Model (16" Wheels) \$6.95 Set of Four. De Luxe Steel Model (15" and 16" Wheels) \$9.95 Per Set of Four. Sets of Five Priced Higher. A Lyon Trade Product Sold Under Applicable Fair Trade Laws.

WHITEWALLS* ARE THE EXCLUSIVE TRIM RING PRODUCT OF LYON, INCORPORATED, 13881 WEST CHICAGO BLVD., DETROIT 27, MICHIGAN



Typical example: the B. F. Goodrich tire that outwears prewar tires

THERE'S always a chance that any tire, of any make, will roll an impressive mileage if all factors are just right. But it's more than chance when *all four* of the tires on a car used for hauling on gravel roads deliver over 30,000 miles each—and are still going strong.

Let Bill Hamilton, who drives for the Pacific Guano Company, Berkeley, California, tell the story in his own words:

"My territory was in a farming area. Many of my miles were over gravel and dirt roads. My four B. F. Goodrich Silvertown tires took an awful beating, for I traveled better than 1,000 miles a week, hauling a sack loader be-

hind the car. Despite these conditions, my B. F. Goodrich tires have covered over 30,000 miles each. There still remains enough tread for several thousand miles more, but since the weather is wet, I will take no chances and will recap them now."

Pipe in hand, Mr. Hamilton appears above, pointing to one of these 30,000-mile tires. He concludes, "I have received nearly half again as much mileage from these tires as I did from prewar tires."

One reason B. F. Goodrich tires outwear prewar tires is that the tread is *wider* and *flatter*. This improved tread supports the weight more evenly, spreads the wear,

absorbs the pounding of rough roads. Today we are receiving letter after letter from pleased B. F. Goodrich owners telling us that this wider tread works out as well in practice as it does in theory—gives more miles of service than any prewar tire they ever owned.

If you need tires, it's probably good news to you to know that your B. F. Goodrich dealer now has most sizes right in stock. You can probably get tires right off his rack without waiting. *Talk to your B. F. Goodrich Company, Akron, O.*

B.F. Goodrich
FIRST IN RUBBER



Big boat . . .



Little boat . . .



There's an



Evinrude



for every



type of boat!

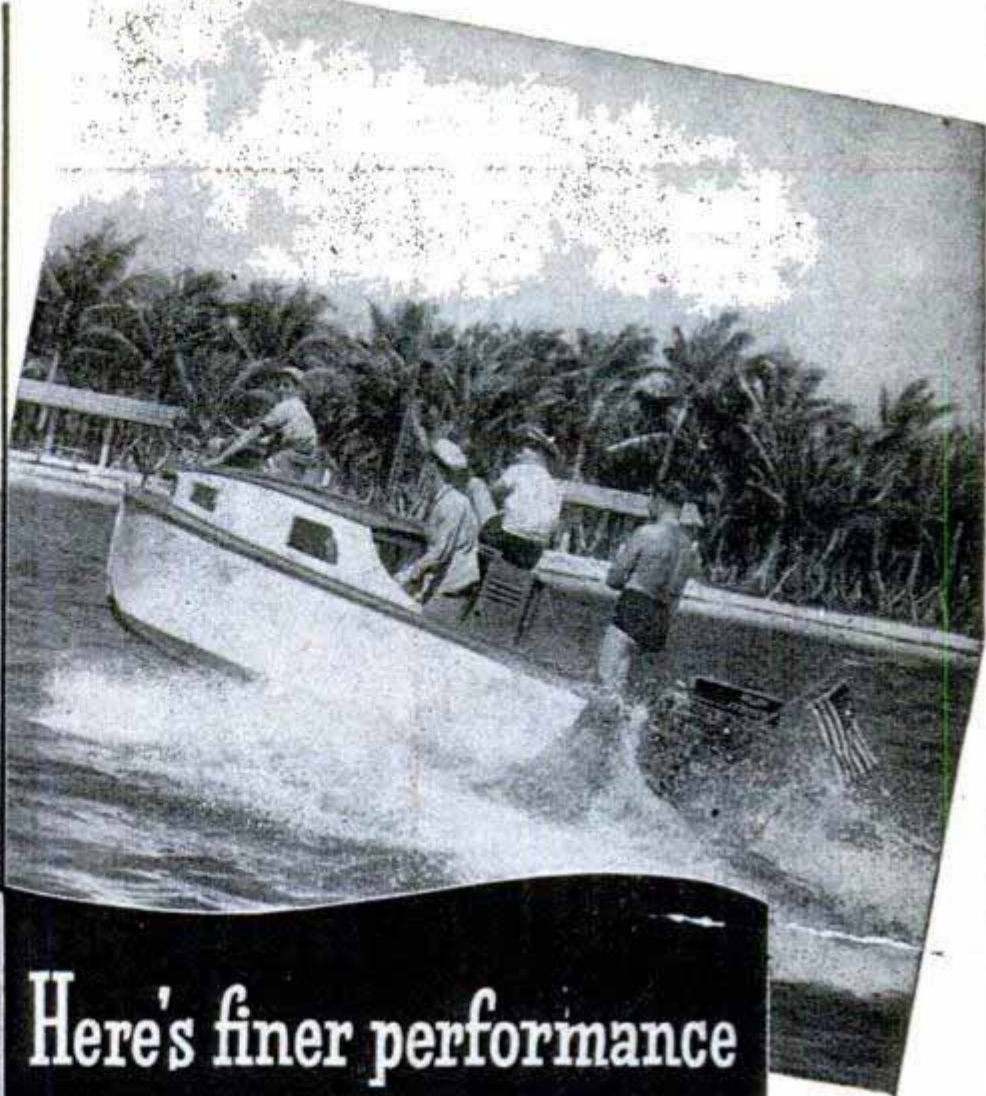

Here's finer performance for YOUR BOAT!

What a difference the *right motor makes* . . . in boat performance . . . in boating fun! It's easy to choose the *right motor* for any boat from Evinrude's *complete* line of 7 models . . . 2 handy "singles" . . . 2 smart twins . . . and 3 famed four-cylinder motors . . . the smoothest on the water! *Only Evinrude dealers* enjoy the extra sales-and-profit opportunities offered by a complete line of light motors . . . in addition to a complete line of four-cylinder models!

EVINRUDE MOTORS, 5589 N. 27th Street, Milwaukee 9, Wisconsin.
In Canada: Evinrude Motors, Peterboro, Ontario.



EVINRUDE

FIRST IN OUTBOARDS — 38TH YEAR

Popular Mechanics Magazine

Registered in U. S. Patent Office and Canada

H. H. WINDSOR, Founder

H. H. WINDSOR, Jr., Editor and Publisher



GETTING intimate with lions is all in a day's work for our editors and photographers. When Frank Fritz, PM cameraman, wanted a lion closeup for "School for the Big Cats" (page 80) the trainer handed him a whip and invited Frank into the cage. Cliff Hicks, assistant editor, stepped in with him and shot this picture while Frank was trying to convince his ferocious models it was all in fun. The lions weren't impressed.

NEXT MONTH Stanley Hiller, Jr., young inventor of the first practical co-axial helicopter, answers the question you've been asking—How soon will helicopters be ready for you? Other August features include a story of the speed runs on the Utah salt flats and an article by J. A. Krug, Secretary of the Interior, "Teaching Old Rivers New Tricks."

HOW to row, row, row your boat and really get some place is the theme of a practical article in next month's Craftsman section. Also, you'll appreciate the bending brake described in another story if you've ever tried to make right-angle bends in sheet metal. Photography fans will be intrigued with a "workable darkroom" where articles are never mislaid.

RADIO ham beginners will find an excellent 5-band phone and CW transmitter featured next month in the Radio and Electronics section.

Volume 88

JULY 1947

Number 1

Managing Editor.....	Roderick M. Grant
Assistant Managing Editor.....	Wayne Whittaker
Shop Notes and Crafts Editor.....	James R. Ward
Radio and Electronics Editor.....	Frank L. Brittin
Aviation Editor.....	Aubrey O. Cookman, Jr.
Associate Editor.....	John R. Kinsey
Eastern Editor.....	Bill Reiche
Western Editor.....	Thomas E. Stimson, Jr.
Art Director.....	Frank Beatty

Assistant Editors		
Donald R. Brooks	Clifford B. Hicks	Virgil T. Swanson

Assistant Editors, Shop Notes and Crafts			
W. Clyde Lamme	Wayne C. Lecky	John F. Shrock	A. E. Youngquist

In This Issue

They Fish for Trouble	73
School for the Big Cats	80
On Guard—It's Forest Fire Time	90
Pacific Shooting Gallery	99
Uncle Sam's Plow Boys	106
Typewriter Artist	116
Growing a Crop Under Tents	132
Standing Room Only	137
Flying Fish—At Home Anywhere	148
Ammunition for the War on Disease	155

For the Craftsman

Luggage From Your Own Shop	162
Homemade Fluorescent Fixtures	170
Checking for Refrigerator Ills	186
"Skimmer"—a Plywood Kayak	190
Modernize That Old Lathe	202
How to Use Concrete	208
Radio and Electronics	213

Table of Contents Continued on Page 8

Published monthly by POPULAR MECHANICS COMPANY, 200 East Ontario Street, Chicago 11, Ill. H. H. Windsor, Jr., president; Paul H. Dunakin, vice president and general manager; D. F. Windsor, vice president and secretary-treasurer; William Harrison Fetridge, vice president and assistant to the publisher; Clover L. Perkins, advertising manager; Alan M. Deyoe, circulation manager. Single copy in the United States and Canada, 25 cents; subscription rates in United States and possessions, Canada, and countries of the Pan-American Postal Union, 1 year, \$2.50; 2 years, \$4.50; 3 years, \$6.00. To all other countries add \$1.00 a year over United States prices for overseas postage. If you plan to move, notify us at least 60 days in advance so you will not miss an issue. Give both old and new addresses. Entered as Second Class Matter, September 15, 1903, at the Post Office at Chicago, Illinois, under Act of March 3, 1879. Entered as Second Class Matter at Post Office Dept., Canada. Copyright 1947, by Popular Mechanics Company, Copyright under International Copyright Union. Copyright in France. All rights reserved under Pan-American Copyright Union. Printed in the United States of America.

Ingenious New Technical Methods

To Help You
Simplify Production

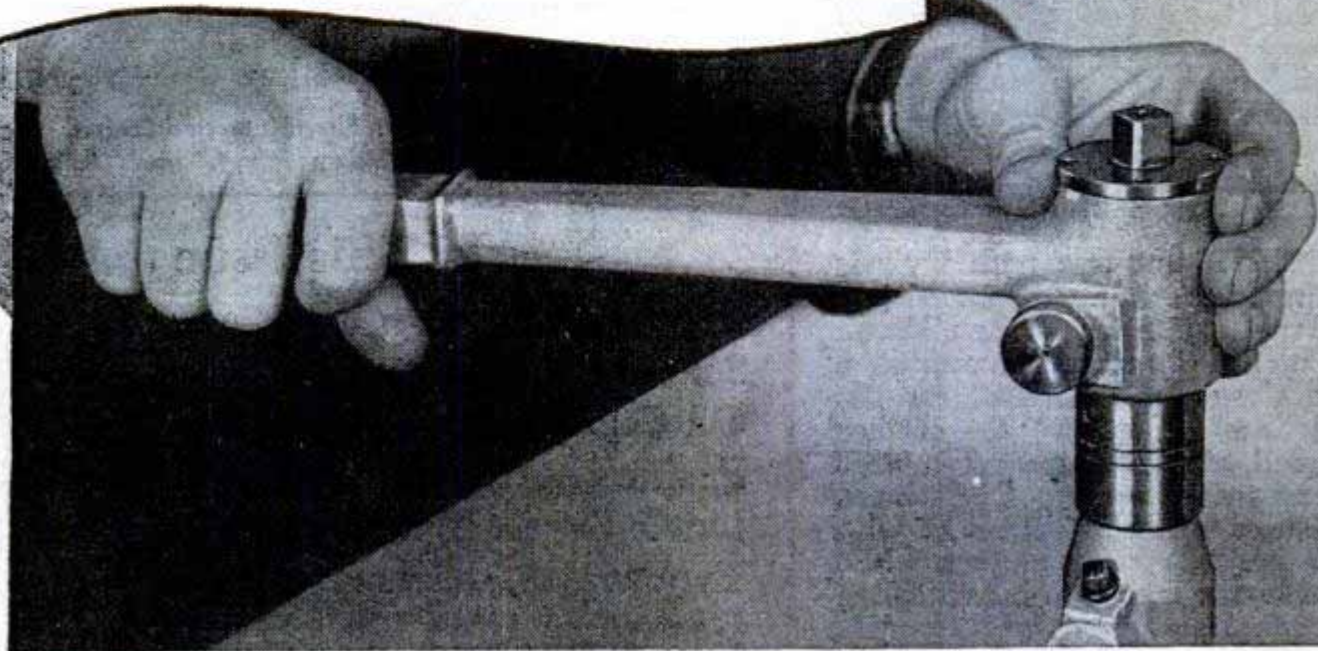

New Type of Torque Tools Incorporate Spring Clutch!... Are 98% Accurate!

Acme Torque Wrench and Screw Driver both incorporate spring clutches, with easily operated control. After setting control to desired torque, the operator merely turns tool in the usual way. When the torque required to drive the threaded part exceeds the pre-set value, the tool slips. Impact doesn't cause driving torque to increase. Oil doesn't affect setting which is reproducible within 2% or better.

The Wrench offers right and left-hand drive, ratchet action and withdrawal. Spring clutch may be set from 0 to 500 inch pounds. Standard sockets are interchangeable. The Screw Driver may be set for any value of torque from 0 to 35 inch pounds. A ratchet action is incorporated. The same tool will also withdraw screws. Standard bits, including socket types, may be easily inserted. The tool is made of pressure cast aluminum.

Another Time-Saver on the job, is chewing gum. The act of chewing aids the workers' concentration—seems to make the work go easier. Chewing gum may be used even when workers' hands are busy; reducing interruptions from the job. For these reasons many plant owners have made Wrigley's Spearmint Gum available to everyone.

*You can get complete information from
Acme Scientific Company, 1450 W. Randolph St., Chicago 7, Ill.*

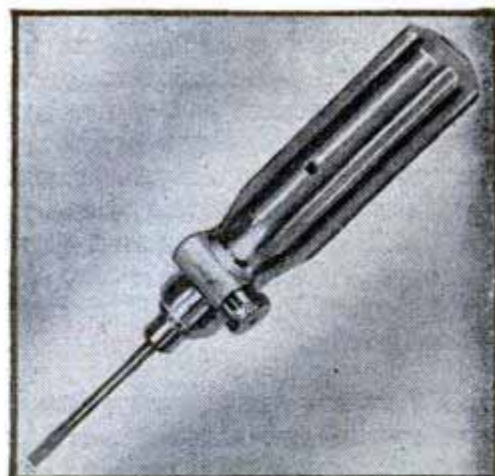

Torque Screw Driver



AB-68

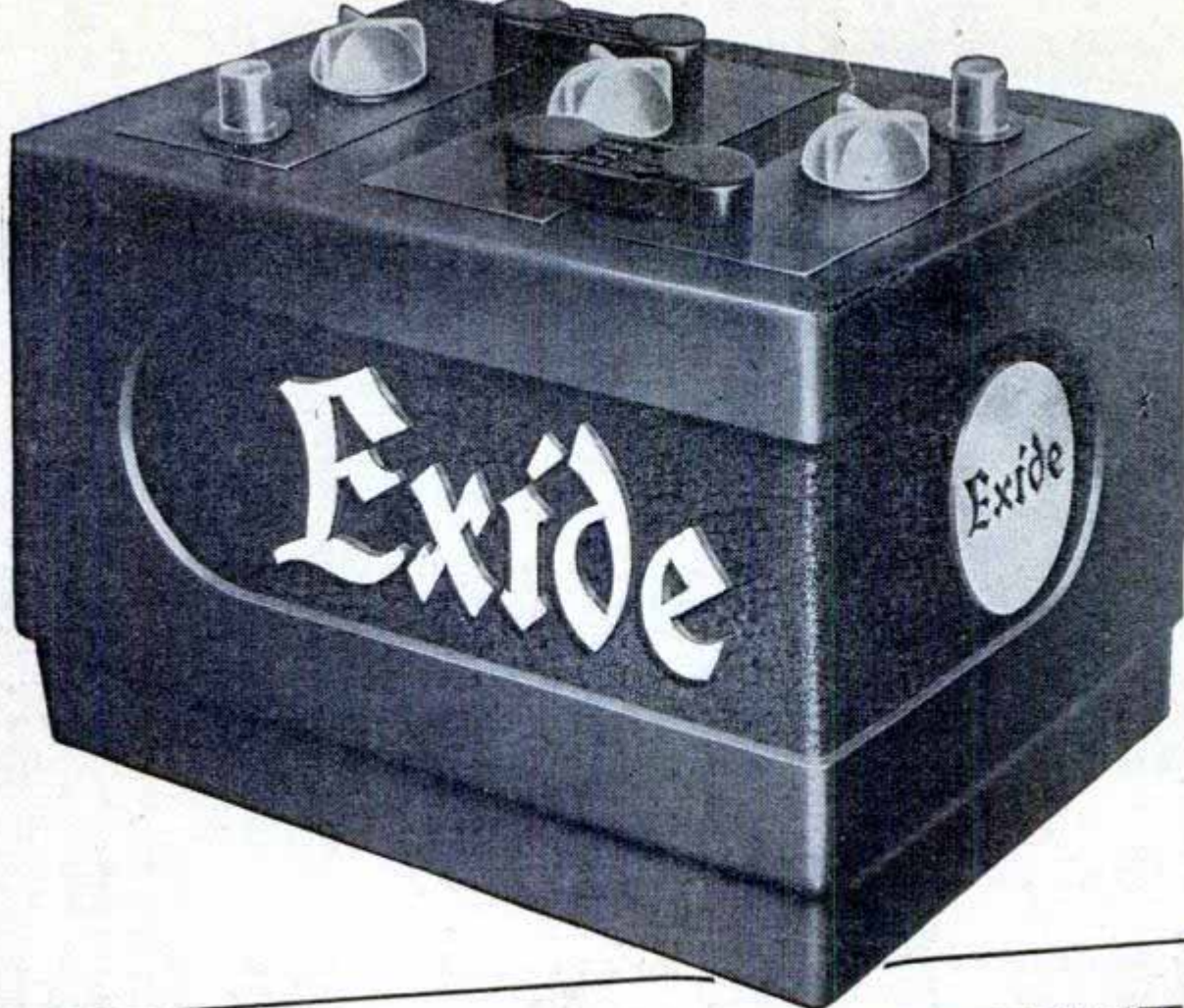

THE NEW EXIDE BATTERIES

Finest ever to bear the famous *EXIDE* name

In the New Exide Automotive Batteries are combined the results of ceaseless research and development by Exide engineers, plus wartime experience on automotive equipment of all kinds—serving in every climate under the severest conditions a storage battery ever had to endure. In every respect, these are the best Exide Batteries ever offered to the car owners of America.

NOTE THESE NEW FEATURES

- Extra-duty capacity—for greater power
- Heavy, over-size plates—for longer life
- Double insulation between plates
- Self-cleaning, non-spitting vent plugs
- "Bull's Eye" electrolyte leveling device
- Heavy, over-size inter-cell connectors.

If you would like to know more about storage batteries, write for FREE booklet, "THE STORAGE BATTERY, Its Fundamentals, Use and Maintenance."

WHEN IT'S AN EXIDE : : . YOU START

THE ELECTRIC STORAGE BATTERY COMPANY, Philadelphia 32

Exide Batteries of Canada, Ltd.

This One



EU2H-EKS-J79U

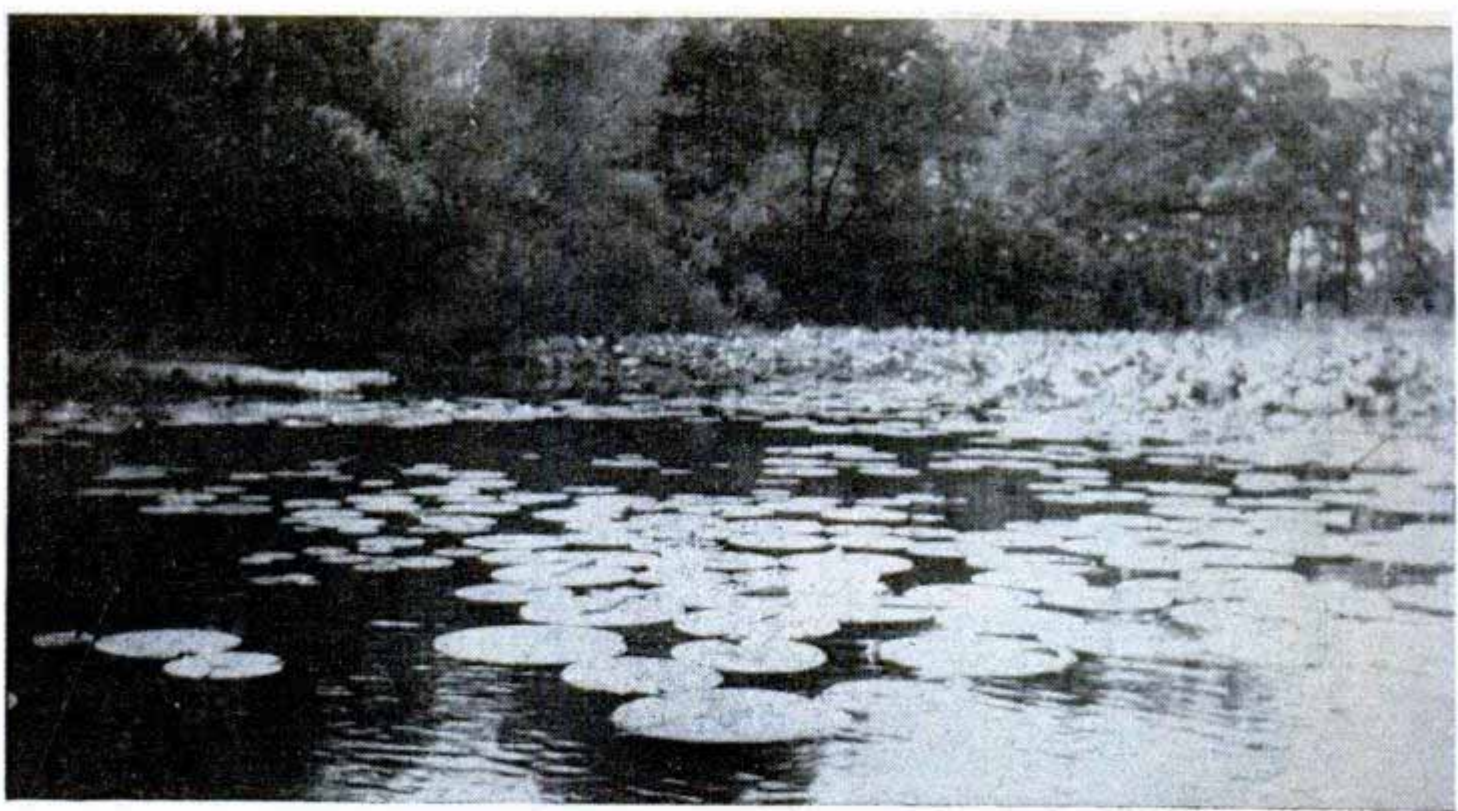

No. 3 Hawaiian Wiggler Gets Bass in Lily Pads



Henry White, veteran guide at Chaffey's Locks, Ontario, with string of bass taken out of lily pads with No. 3 Hawaiian Wiggler.

No. 3 Hawaiian Wiggler goes to work in tough cover. Many excellent catches are being reported where anglers have used them in stumps, weeds and lily pads where big bass often hide. The No. 3 Hawaiian works its way through rushes and weeds without snagging. It is a very easy bait to cast. Write for my free catalog on Hawaiian Wigglers, Jitterbugs and Hula Dancers. Also available, 16 mm. colored movies of bass fishing in Canada, Michigan and Florida for showing to sportsmen's clubs. Write for booking.

No. 3 Weedless
Hawaiian Wiggler
\$1.10



FRED ARBOGAST & CO., 1607 North St., Akron 3, Ohio



If YOU were Boss would YOU promote "YOU"?

valuable asset to any business organization. He never wants for a good job and above average earnings. He gets ahead.

We have helped thousands of men achieve promotion and more money—success sometimes beyond their dreams—a success that was started by a coupon similar to the one below.

Get out of that rut—don't be satisfied with a mediocre job at small pay—be a success in business—this coupon may be your first step.

So send it today—right now—tomorrow never comes for the man who consistently puts things off.

G. I. APPROVED

La Salle Extension University A Correspondence Institution

Dept. 764-R

417 S. Dearborn, Chicago 5

If you can help me get the ability and knowledge for real promotion, I want to know it. Please send me your free 48 page booklet telling how I can succeed in the field I have checked below. I understand you will send this without obligation to me.

- | | |
|--|--|
| <input type="checkbox"/> Accounting | <input type="checkbox"/> Law: LL.B. Degree |
| <input type="checkbox"/> C. P. A. Coaching | <input type="checkbox"/> Foremanship |
| <input type="checkbox"/> Bookkeeping | <input type="checkbox"/> Industrial Management |
| <input type="checkbox"/> Business Management | <input type="checkbox"/> Traffic Management |
| <input type="checkbox"/> Effective Speaking | <input type="checkbox"/> Business English |
| <input type="checkbox"/> Stenotypy (Machine Shorthand) | |

Name.....Age.....

Position.....

Address.....Zone, if any.....

City and State.....

Be honest now—

suppose that a better job had opened up in your company—carrying with it promotion and more money—could you qualify?

If you were boss, would you select "YOU" for that better job?

Consider before you answer.

First of all, could you *fill* the job? Has your experience fitted you for the step forward—have you been preparing for promotion apart from experience gained on the job?

Or have you just been filling a niche, doing daily tasks well but making no real and intelligent effort to learn and qualify for the job ahead so that if an opening should occur you would be ready to fill it?

The man who gets real promotion makes his own breaks—the man who slaves in the ordinary job at low pay just wishes and dreams of promotion and more money. Which are you?

Business is always willing to pay the man who knows—and pay him well. The man who is ready and willing to take responsibilities—and capable of directing the efforts of other men is a

they're
neither
too young
nor too old
for...



PYROIL!

Whether you are one of the lucky ones driving a '46 or '47 or you are still marveling at how the old bus is holding up, you'll be wise to add Pyroil when you stop for gasoline. For Pyroil adds life to your car regardless of age. It gives oil the property of clinging to cylinder walls. It won't drain off to permit corrosion or to permit metal-to-metal friction when starting. Pyroil removes gums and carbon formation. When you buy gas or oil—simply say "add Pyroil" and you'll add miles of carefree driving.

Pyroil for Aircraft Engines

Use Aircraft Pyroil B for lubricating oil, Aircraft Pyroil A for gasoline.

Manufactured and Guaranteed by Pyroil Company, 69 Pyroil Bldg., La Crosse, Wisconsin.



PYROIL COMPANY

69 Pyroil Bldg., La Crosse, Wisconsin

I want my car to last and run properly. Please tell me more about Pyroil and how it can accomplish this for me.

Name _____

Address _____

City or Town _____ State _____



Jerry, the talking dog, is entertaining hospitalized veterans, by courtesy of the PYROIL Company. Picture of Jerry, sent on request.

AUTOMOTIVE	
Wings aid tire testing.....1
Auto bottle warmer.....1
Midget car has lightweight one-piece body.....1
Shopping list for motorists.....1
Lift parks autos in tiers.....1
Shade for headlight glare.....1
Rim gauge "sees through" tire.....1
Stapladder for big trucks.....1
Tire powder eliminates static electricity in radios.....1
Cross-striped tire grips road.....1
AVIATION	
Machine to solve supersonic flight problems.....1
Safety harness for navigators.....1
Navy's Banshee "most powerful" shipboard fighter.....1
Landing field on a rail car.....1
Air-mail helicopter.....1
Air liner phone calls anywhere.....1
Sweden's first jet fighter plane.....1
Stall warning indicator.....1
BOATS AND BOATING	
Mileage dial for nautical charts.....1
Belly-tank boat.....1
"Bubble" boat.....1
Fuel-tank sea raft.....1
Patrol boat converted into a floating home.....1
Rubber boat fender.....1
ELECTRICAL	
Electric wheel chair has radio and lights.....1
Two-ton optics installed along Norwegian coast.....1
Small clip light.....1
Giant "spark plug" insulates 230,000 volts of electricity.....1
Germ-killing lamp creates ozone.....1
Electronic color television.....1
FISH AND FISHING	
Plunger frees snagged hook.....1
Fishermen's spoon "swims".....1
"Shooting" buoy recovers tackle.....1
Motor-powered reel dries fishing line.....1
Fishing rod holder leaves hands free.....1
Brake for fishing reels.....1
HOUSE AND HOME	
Phone number index.....1
Stools of dinette set slide beneath table.....1
What's new for your home.....1
Suitcase-size heater for small homes.....1
INDUSTRY	
Shock tester.....1
Giant concrete mixer.....1
Hose transfers fish from boats to tanks.....1
Chemical elements named.....1
Knockdown autos for movie close-ups.....1
Tree "mower" operates like a snowplow.....1
Giant crane unloads barges.....1
Vacuum still vaporizes glass.....1
Ethyl alcohol from whey.....1
LAWN AND GARDEN	
Power lawn mower built from scrap parts.....1
Power lawn mower assembled by basement inventor.....1
Soil fumigant kills insects in the garden.....1
Ventilated lawn umbrella.....1
OUTDOOR RECREATION	
"Bicycle built for two"—without a back-seat driver.....1
Silent earlocks for hunters' boats.....1
Camper's tent on wheels.....1
Spear-type stand holds golf bag upright on the fairway.....1
Motor scooters solve transportation problem for California family.....1
They call it snaphooting.....1
Plug balances aluminum golf club.....1
PHOTOGRAPHY	
Photo-negative analyzer.....1
Matchbox camera used by underground during war.....1
Shutter-speed tester.....1
TOOLS	
Drill converted to saw.....1
Buffing compound applicator.....1
Nut gatherer eliminates stooping.....1
Tool removes auto bearings.....1
Painter's ladder hook.....1
Metal benders.....1
Disposable spray paint containers save time in changing colors.....1
"Dual control" on dentist's drill.....1
Rotary sander has plate cushioned by sponge-rubber pad.....1
TRANSPORTATION	
Big tower—long trip.....1
Plexiglas roof on railway coach increases vision.....1
Giant tank shipped by flatcar.....1
MISCELLANEOUS	
Tin-can plane model.....1
Weed snatcher.....1
"Bachelor" home on wheels.....1
Shield for motorcycle rolls into cylinder.....1
Swimming trailer.....1
Platform elevates piano pedals.....1
Window lids for containers.....1
Lightweight unloading platform.....1
Easy-to-erect garage.....1
Rumble seat on basket holds child in grocery store.....1
Infrared detects painting forgeries.....1

(Continued to page 10)

SEE YOURSELF 10 YEARS FROM NOW!



No Time Machine required. All you have to do is look around you. The routine worker of 10 years ago who failed to prepare himself for larger responsibilities is a routine worker today. But the man who mastered technical or business subjects is collecting substantial rewards.

You count yourself among the ambitious today. Prove it—if you expect to find yourself among the successful. The proof, of course, rests on whether you are taking special training that will qualify you for a better position.

This is the training in which the International Correspondence Schools have specialized for more than 50 years. I. C. S. Courses cover more than 400 technical and commercial subjects. You're in a class by yourself . . . study in your own home . . . progress just as fast as your ability and ambition permit.

Thousands of successful graduates demonstrate that today's I. C. S. student is tomorrow's leader. Mail the coupon today for complete information.

INTERNATIONAL CORRESPONDENCE SCHOOLS



BOX 5607-K, SCRANTON 9, PENNA.

Without cost or obligation, please send me full particulars about the course *before* which I have marked X:

- | | | | |
|---|--|---|---|
| <input type="checkbox"/> Air Conditioning and Plumbing Courses
<input type="checkbox"/> Air Conditioning
<input type="checkbox"/> Heating <input type="checkbox"/> Plumbing
<input type="checkbox"/> Refrigeration <input type="checkbox"/> Steam Fitting
Chemistry Courses
<input type="checkbox"/> Chemical Engineering
<input type="checkbox"/> Chemistry, Analytical
<input type="checkbox"/> Chemistry, Industrial
<input type="checkbox"/> Chemistry, Mfg. Iron & Steel
<input type="checkbox"/> Petroleum Refining <input type="checkbox"/> Plastics
<input type="checkbox"/> Pulp and Paper Making
Civil Engineering, Architectural and Mining Courses
<input type="checkbox"/> Architectural Drafting
<input type="checkbox"/> Architecture
<input type="checkbox"/> Bridge and Building Foreman
<input type="checkbox"/> Building Estimating
<input type="checkbox"/> Civil Engineering
<input type="checkbox"/> Coal Mining
<input type="checkbox"/> Contracting and Building
<input type="checkbox"/> Highway Engineering
<input type="checkbox"/> Lumber Dealer
<input type="checkbox"/> Reading Structural Blueprints
<input type="checkbox"/> Sanitary Engineering
<input type="checkbox"/> Structural Drafting | <input type="checkbox"/> Structural Engineering
<input type="checkbox"/> Surveying and Mapping
Communications Courses
<input type="checkbox"/> Electronics
<input type="checkbox"/> Practical Telephony
<input type="checkbox"/> Radio, General
<input type="checkbox"/> Radio Operating
<input type="checkbox"/> Radio Servicing
<input type="checkbox"/> Telegraph Engineering
Electrical Courses
<input type="checkbox"/> Electrical Drafting
<input type="checkbox"/> Electrical Engineering
<input type="checkbox"/> Electric Light and Power
<input type="checkbox"/> Lighting Technician
<input type="checkbox"/> Practical Electrician
Internal Combustion Engines Courses
<input type="checkbox"/> Auto Technician <input type="checkbox"/> Aviation
<input type="checkbox"/> Diesel-Electric
<input type="checkbox"/> Diesel Engines <input type="checkbox"/> Gas Engines
Mechanical Courses
<input type="checkbox"/> Aeronautical Engineering
<input type="checkbox"/> Aircraft Drafting
<input type="checkbox"/> Flight Engineer
<input type="checkbox"/> Foundry Work
<input type="checkbox"/> Heat Treatment of Metals | <input type="checkbox"/> Industrial Engineering
<input type="checkbox"/> Industrial Metallurgy
<input type="checkbox"/> Machine Shop
<input type="checkbox"/> Mechanical Drafting
<input type="checkbox"/> Mechanical Engineering
<input type="checkbox"/> Mold-Loft Work
<input type="checkbox"/> Patternmaking—Wood, Metal
<input type="checkbox"/> Reading Shop Blueprints
<input type="checkbox"/> Sheet-Metal Drafting
<input type="checkbox"/> Sheet-Metal Worker
<input type="checkbox"/> Ship Drafting <input type="checkbox"/> Ship Fitting
<input type="checkbox"/> Tool Designing
<input type="checkbox"/> Toolmaking
<input type="checkbox"/> Welding—Gas and Electric
Railroad Courses
<input type="checkbox"/> Air Brake <input type="checkbox"/> Car Inspector
<input type="checkbox"/> Diesel Locomotive
<input type="checkbox"/> Locomotive Engineer
<input type="checkbox"/> Locomotive Fireman
<input type="checkbox"/> Railroad Section Foreman
Steam Engineering Courses
<input type="checkbox"/> Boilermaking
<input type="checkbox"/> Combustion Engineering
<input type="checkbox"/> Engine Running
<input type="checkbox"/> Marine Engineering
<input type="checkbox"/> Steam Electric <input type="checkbox"/> Steam Engines | Textile Courses
<input type="checkbox"/> Cotton Manufacturing
<input type="checkbox"/> Rayon Weaving
<input type="checkbox"/> Textile Designing
<input type="checkbox"/> Woolen Manufacturing
Business and Academic Courses
<input type="checkbox"/> Accounting <input type="checkbox"/> Advertising
<input type="checkbox"/> Arithmetic <input type="checkbox"/> Bookkeeping
<input type="checkbox"/> Business Correspondence
<input type="checkbox"/> Business Management
<input type="checkbox"/> Certified Public Accounting
<input type="checkbox"/> Commercial
<input type="checkbox"/> Cost Accounting
<input type="checkbox"/> Federal Tax
<input type="checkbox"/> First Year College
<input type="checkbox"/> Foremanship <input type="checkbox"/> French
<input type="checkbox"/> Good English <input type="checkbox"/> High School
<input type="checkbox"/> Higher Mathematics
<input type="checkbox"/> Illustrating <input type="checkbox"/> Motor Traffic
<input type="checkbox"/> Postal Service
<input type="checkbox"/> Salesmanship <input type="checkbox"/> Secretarial
<input type="checkbox"/> Sign Lettering
<input type="checkbox"/> Spanish <input type="checkbox"/> Stenography
<input type="checkbox"/> Traffic Management |
|---|--|---|---|

Name _____ Age _____ Home Address _____

City _____ State _____ Present Position _____

Working Hours _____ A.M. to _____ P.M. Length of Service in World War II _____

Special tuition rates to members of the Armed Forces. Enrollment under the G.I. Bill of Rights approved for War II Veterans. Canadian residents send coupon to International Correspondence Schools Canadian, Ltd., Montreal, Canada.

Craftsman and Shop Notes Index

AUTOMOTIVE

- Eliminating rattle in shift lever.....164
- Repairing battery hydrometer.....182
- Name printed on auto hub cap.....182
- Sling to lift generator from car.....204
- Patterns for auto windows are fastened underneath table.....203
- Toothbrush wired on grease gun handy when cleaning fittings.....204
- Display sign is part of bumper.....206

BOATS AND BOATING

- Coat hooks used as oar rests.....165
- Wooden key container floats.....168
- Outboard motor locked in place.....182

FARM

- Tractor hookup prevents fire.....201
- Angle "break" in wire fence.....201
- How to secure singletree irons.....201
- Drive your well.....207
- Keeping chickens from roosting on poultry feeders.....212
- Sack covering protects ensilage.....212

FISH AND FISHING

- Growth rings on scales of fish indicate approximate age.....168
- Bait net made from umbrellas.....178
- "Weedless" dip net made from hardware cloth.....185
- Live-bait minnows can be carried in glass fruit jar.....185
- Leather thumb gives protection.....185
- How to waterproof minnow nets.....189
- Red ribbon tied to fishing fly will attract frogs.....198
- Fresh water for minnow tank keeps them alive longer.....206

HOUSE AND HOME

- Solving home problems.....166
- Damaged screen door repaired by using wood strip.....168
- How to "frost" strawflowers.....168
- Locked guard for snap switch.....176
- Costumer for child's room.....177
- Way to repair cigarette burns.....178
- Paste and tissue paper mixture fills hole in wall.....178
- Removing a broken light bulb.....182
- Dust cover fits record holder.....182
- Spacers for box gutters.....189
- Key concealed in screen door is readily accessible.....189
- Razor blade holds window glass.....212

LAWN AND GARDEN

- Swinging grill converts fireplace into barbecue.....169
- Garden-hose "snake" in tree keeps robins away.....176
- Novel tree seat for the outdoor living room.....179
- Young trees are set in sand to prevent disease.....206

PHOTOGRAPHY

- Midget tripod for table-top shots.....193
- Making enlargements from 8-mm. film.....194
- Spring clip and machine screw hold dark slide in place.....196
- Unobstructed picture of parade taken with reflex camera.....196
- Reflector substitutes as tripod.....196
- Pencils help secure reflector to photoflood standard.....196

RADIO AND ELECTRONICS

- Tuning a television receiver.....213
- How to build a dual-purpose signal generator.....214
- Wooden towers for rotary beam antennas.....216

STORE AND OFFICE

- Locking desk pen in holder.....169
- Substitute for wire paper clip.....182
- Rotating stand for wire spools makes dispensing easy.....200
- Price and number of eggs shown by crate "blackboard".....205

TOOLS

- Blade guard for pointed tools preserves sharp edges.....165
- Nonslip tread for ladder rungs.....168
- Hacksaw blade fastened to rod used as grass cutter.....176
- Broken mower wheel repaired.....176
- Wooden clamp around tin can makes sawing it easy.....184
- Flat pulley used as V-belt drive.....184
- Wire bracket will hold brushes.....184
- Roundhead rivet serves as stop for small hand drill.....192
- Dental tools used in small lathe.....192
- Screw and shield expand tubing.....192
- Simple clamp holds small parts while painting them.....192
- Craft quiz.....197
- Drill-press circle cutters.....199
- Wire solder clamps small work.....206
- Extension rod on power drill.....206
- Duplicate work turned in lathe by using full-size scale pattern.....212
- Auto wheel makes rotary table for paint spraying.....212

TOYS AND NOVELTIES

- Colored picture is transferred onto other surfaces.....178
- Perpetual calendar for children duplicates cylinder type.....178
- Ball is dipped in colored chalk to leave mark on target.....179
- Plastic picture frames.....180
- Plaques finished with varnish.....182
- "Frog men" swimming paddles.....183
- Watch strap formed from scale.....184
- Toy will stop or slide on string at secret command of operator.....189

MISCELLANEOUS

- Powerful spotting scope made from binocular body.....164
- Strap fits over arms of seat and holds child at movies.....176
- Slots are cut in length of pipe to support weiner forks.....184
- Flashlight case is dampproof.....192
- Colored rope aids in splicing.....198
- Handy knobs for tin containers.....198
- Nail keeps bolt from turning.....198
- Small-parts holders from pistons.....201
- Etching designs in sheet metal by using acid solutions.....204
- How to secure foundry type.....205

IMPORTANT NOTICE—It is the intention of this magazine to provide its readers with information regarding the latest developments in the mechanical arts. We take no responsibility as to whether the disclosures contained in our articles are covered by patents and advise readers to investigate this subject before making, using, or selling any of the products, machines, or processes described in order to avoid possible liability for patent infringements.



PEPSI-COLA

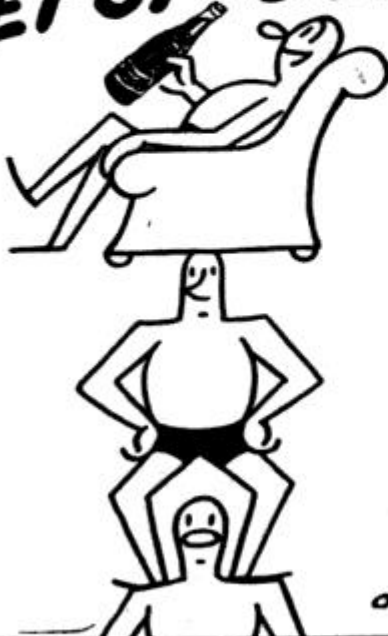

O. SOGLOW

AUDELS REFRIGERATION & AIR CONDITIONING GUIDE.....\$4

New from Cover to Cover—1280 Pages, Fully Illus. Covering basic principles, servicing, operation & repair of household, commercial & industrial refrigeration & air conditioning. A gold mine of essential important facts for engineers, servicemen, users.

AUDELS CARPENTERS & BUILDERS GUIDES—4 Vols.\$6

A practical illustrated trade assistant on modern construction for carpenters, joiners, builders, mechanics and all woodworkers. 4 vols., 1600 pages, 3700 illustrations, flexible covers. Pocket size. Each volume sold separately \$1.50 a vol.

AUDELS AUTOMOBILE GUIDE.....\$4

A practical quick ready reference book for auto mechanics, service men, operators & owners. Explains theory, construction & servicing of modern motor cars, trucks, buses & auto type Diesel engines. 1700 pages, fully illustrated. 55 chapters. Indexed. A standard book for mechanics. New fluid drive covered.

AUDELS DIESEL ENGINE MANUAL.\$2

A practical, concise treatise with questions and answers on the theory, operation and maintenance of modern diesel engines including General Motors 2 cycle Diesel. 384 pages, fully illus., flexible binding, pocket size. All details plainly brought out, this book is of extreme value to engineers, operators & students.

AUDELS WIRING DIAGRAMS.....\$1

210 Pages. Illustrated. Gives practical facts on wiring of electrical apparatus. It shows clearly how to wire apparatus for practically all fields of electricity. Each diagram is complete & self-explanatory. Highly Endorsed Pocket Companion.

AUDELS PLUMBERS & STEAMFITTERS GUIDES—4 Vols.\$6

A Practical Trade Assistant & Ready Reference. Explains in plain language & by clear illustrations, diagrams, charts, graphs, pictures principles of modern plumbing practice including Marine Pipe Fitting and Air Conditioning. 4 Vols.—1670 Pages—3642 Diagrams. Pocket size. Each Vol. Sold Separately \$1.50 a Vol.

AUDELS SHEETMETAL WORKERS HANDY BOOK.....\$1

Practical inside information. Fundamentals of Sheet Metal Work. 388 pages. Illustrated. 11 sections. Clearly written. Essential & important facts, figures, pointers in everyday language. Ref. Index.

AUDELS SHEETMETAL PATTERN LAYOUTS.....\$4

Developed by Experts for Sheet Metal Workers, Layout Men & Mechanics. A Practical Encyclopedia in 10 Sections, size 7 x 10 x 2—1125 Pages—350 Layouts—1600 Illustrations. 1001 Key Facts. Fully indexed for ready reference in answering your layout problems. Covers all phases of sheet metal work including Pattern Cutting, Pattern Development & Shop Procedure.

AUDELS ANSWERS ON BLUE PRINT READING.....\$2

For Mechanics & Builders. Covers all types of blue print reading including ship & airplane. 416 pages, fully illustrated.

AUDELS NEW MACHINIST & TOOLMAKERS HANDY BOOK.....\$4

Covers modern machine shop practice in all its branches. 5 practical books in 1. New from cover to cover. Tells how to set up & operate lathes, screw and milling machines, shapers, drill presses and all other machine tools. 1600 pages, fully illustrated. 5 x 6 1/2 x 2. Indexed. 5 sections. 1—Modern Machine Shop Practice. 2—Blue Print Reading & How to Draw. 3—Calculations & Mathematics for Machinists. 4—Shop Physics. 5—How to Use the Slide Rule. 60 chapters. Easy to read and understand. A shop companion that answers your questions.

AUDELS MATHEMATICS & CALCULATIONS FOR MECHANICS \$2

Mathematics for home study or reference. 700 pages, 550 illus. Practical mathematics from beginning. How to figure correctly. Easy, correct methods covering complete review. Illus. & Indexed.

AUDELS HANDY BOOK OF PRACTICAL ELECTRICITY.....\$4

For maintenance engineers, electricians & all electrical workers. 1440 Pages, 2600 Illus. Covers important electrical information in handy form—including Marine Wiring, Radio Principles, Welding. Indexed. A Key to a practical understanding of electricity.

AUDELS RADIOMANS GUIDE.....\$4

A key to the practical understanding of radio including Frequency Modulation, Television, etc., Aircraft & Marine Radio. For radio engineers, servicemen, amateurs. 914 Pages, 633 Illustrations & Diagrams. Photos. Review Questions & Answers, Reference Index. Authentic, clear, concise.

AUDELS ELECTRONIC DEVICES.....\$2

Tells What You Want to Know About Electric Eye. Easily Understood. Covers photo-electric cells & their applications. Amplifiers, illumination, frequencies, voltage, photocell, tubes, Ohm's Law, wiring diagrams, etc.

AUDELS WELDERS GUIDE.....\$1

A concise, practical text on operation & maintenance of all welding machines for all mechanics. Over 400 pages, illustrated. Covers all methods of electric and acetylene welding including airplane work.

AUDEL, Publishers, 49 W. 23 St., N. Y. 10

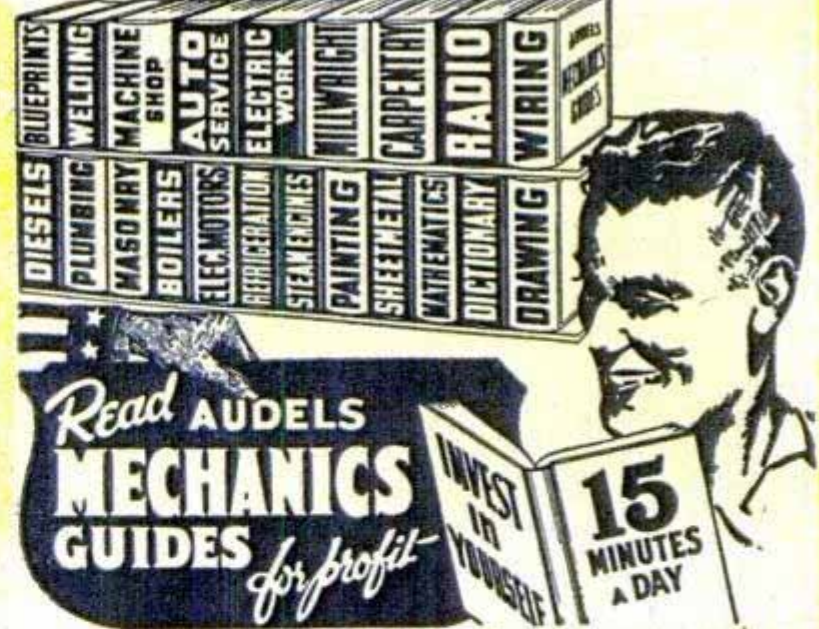

AN AUDEL GUIDE IS A GOOD FRIEND!
Step Up Your Own Skill with the Practical Facts and Figures of Your Trade. Save time and money with right methods, short cuts, labor saving ideas. CHECK NOW! You can look over any Audel Guide in your home. Start the Easy Payments if satisfied.

CUT HERE MAIL ORDER

THEO. AUDEL & CO., 49 W. 23 St., New York 10, N. Y.

Please mail me for 7 days' free examination the books marked (X) below. I agree to mail \$1 in 7 days on each book or set ordered, and to further mail \$1 a month on each book or set ordered until I have paid purchase price. If I am not satisfied with Guides I will return them.

- Audels **ELECTRIC MOTOR GUIDE** \$4.
- Audels **OIL BURNER GUIDE** 1.
- Audels **REFRIGERATION & Air Conditioning Guide** 4.
- Audels **POWER PLANT ENGINEERS GUIDE** 4.
- Audels **PUMPS, HYDRAULICS & AIR COMPRESSORS** 4.
- Audels **WELDERS GUIDE** 1.
- Audels **BLUE PRINT READING** 2.
- Audels **SHEET METAL WORKERS Handy Book** 1.
- Audels **SHEET METAL PATTERN LAYOUTS** 2.
- Audels **AIRCRAFT WORKER** 1.
- Audels **MATHEMATICS and CALCULATIONS** 2.
- Audels **MACHINISTS & TOOLMAKERS Handy Book** 4.
- Audels **MECHANICAL Dictionary** 4.
- Audels **AUTOMOBILE GUIDE** 4.
- Audels **DIESEL ENGINE MANUAL** 2.
- Audels **MARINE ENGINEERS Handy Book** 4.
- Audels **MECHANICAL DRAWING GUIDE** 1.
- Rogers **MECHANICAL DRAWING and DESIGN** 2.
- Audels **MILLWRIGHTS and Mechanics Guide** 4.
- Audels **CARPENTERS and Builders Guides (4 vols.)** 6.
- Audels **PLUMBERS and Steamfitters Guides (4 vols.)** 6.
- Audels **MASONS and Builders Guides (4 vols.)** 6.
- Master **PAINTER and DECORATOR** 2.
- Audels **GARDENERS & GROWERS GUIDES (4 vols.)** 6.
- Audels **ENGINEERS & FIREMANS EXAMINATIONS** 1.
- Audels **ENGINEERS and Mechanics Guides** 12.
- Nos. 1, 2, 3, 4, 5, 6, 7 and 8 complete 12.
- Audels **Answers on Practical ENGINEERING** 1.
- Audels **ELECTRICIANS EXAMINATIONS** 1.
- Audels **WIRING DIAGRAMS** 1.
- Audels **Handy Book of PRACTICAL ELECTRICITY** 4.
- Audels **ELECTRICAL POWER CALCULATIONS** 2.
- Audels **ELECTRONIC DEVICES** 2.
- Audels **ELECTRIC Dictionary** 2.
- Audels **RADIOMANS GUIDE** 4.
- Audels **NEW ELECTRIC LIBRARY at \$1.50 a Volume** 4.
- Vols. I, II, III, IV, V, VI, VII, VIII, IX, X, XI, XII

Name _____
Address _____
Occupation _____
Employed by _____

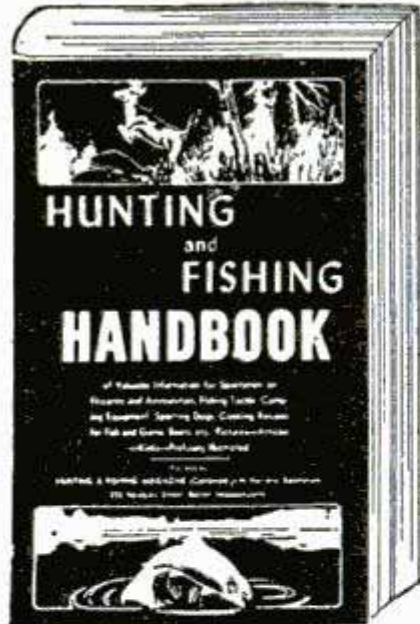

THIS HANDBOOK

is crammed from cover to cover with countless ideas to add more fun to your days afield . . . full of up-to-the-minute information on Hunting—Fishing—Camping—Boating—Dog Training, etc. . . . tells you all about Duck Shooting, Deer Hunting, Upland Game, guns and rifles, sights, ballistics, fly, bait and surf fishing, and hundreds of informative and interesting facts. Over 100 pages and scores of helpful illustrations.

FREE--IF YOU ACT NOW!

This invaluable Handbook WON'T COST YOU A PENNY — if you act today! We want you to join our gang of real sportsmen who read Hunting & Fishing every month. Hunting & Fishing is published for and by its thousands of readers, who send in stories, items and pictures of actual experience — true-to-life, red-blooded accounts of their good times and adventures with rod, dog, rifle and gun. That's why Hunting & Fishing is the favorite magazine of true sportsmen everywhere!



SPECIAL OFFER

Just fill in the coupon below and send it along with a little \$1.00 bill, and we will send you Hunting & Fishing Magazine for a whole year—12 big issues—PLUS a free copy of the Hunting & Fishing Handbook! Send the coupon and your dollar today!

HUNTING & FISHING MAGAZINE, 251 Sportsman's Building, Boston, Mass.

Name _____
 Address _____
 City _____ State _____

SURPLUS BARGAINS ASSEMBLE YOUR OWN BINOCULARS!

Complete Optics! Complete Metal Parts!
 Save More Than 1/2 Regular Cost



GOVERNMENT'S 7X 50 BINOCULARS

Complete Optics, new and ready for assembly. We supply full instructions. Limit—1 Set of Metal Parts and 1 Set of Optics to a customer.

METAL PARTS—Set includes all Metal Parts—completely finished—for assembly of 7X 50 Binoculars. No machining required. Bodies have been factory hinged and covered. A sturdy Binocular Carrying Case is included with each set of Metal Parts.

Stock #841-H \$36.20 Postpaid
OPTICS—Set includes all Lenses and Prisms you need for assembling 7X 50 Binoculars. These are in excellent condition—perfect or near-perfect—and have new low reflection coating.
 Stock #5102-H \$25.00 Postpaid
NOTICE! If you buy both Binocular Optics and Binocular Metal Parts, add 20% Federal Excise Tax to above prices.

NEVER HAS THERE BEEN SUCH A SENSATIONAL BARGAIN AS THIS!

BUBBLE SEXTANT—TYPE A-10

These Army Air Forces Bubble Sextants cost the Govt. about \$200 each. A real bargain at our price of \$12.50! Included with Bubble Sextant shipment is wooden Carrying Case, 5 spare waxed paper discs, flashlight with rheostat for night use (uses ordinary flashlight cells—not furnished) aux. 2-power Galilean Telescope, Allen wrench, 2 spare marking points. Wartime used, but where necessary completely repaired, collimated and put in good working order. If not satisfied that Sextant is exactly as represented, return within 10 days and money will be refunded. Full directions for use accompany each shipment.
 Stock #924-H \$12.50 Postpaid

We have literally millions of war surplus lenses and prisms for sale at bargain prices. Write for Catalog "H" — Sent Free!

Satisfaction Guaranteed Order by Stock No.

EDMUND SALVAGE COMPANY
 P. O. AUDUBON, NEW JERSEY

Please Mention Popular Mechanics When Answering Ads

HORSE MASTERY!

A FINE HOBBY — A GREAT VOCATION!

"The EXPERT HORSEMAN"



FREE BOOK—Tells how You can learn to:
 BREAK COLTS, GAIT SHOW HORSES, TRAIN
 RODEO, STOCK and RACE HORSES, BREAK BAD HABITS,
 HANDLE ANY HORSE, TRAIN CIRCUS TRICK HORSES. WRITE TODAY!

ANIMAL LOVERS ASSOCIATION
 BOX KA-111 TARZANA, CALIFORNIA

SUBSCRIBE TODAY
50¢
 One Year



TRAIN

Your VOICE!

Results **GUARANTEED**

We build, strengthen the vocal organs—not with singing lessons—but by sound, scientifically correct silent and vocal exercises and absolutely guarantee complete satisfaction with results. Write for Voice Book, FREE. Sent to no one under 17 years old unless signed by parent.
 Perfect Voice Studios, Studio 135-B, Kimball Hall Bldg., Chicago 4, ILL.

**MASTER MACHINIST • MECHANICAL DRAFTING
 TOOL-DIE DESIGNING • TOOL ENGINEERING**

Completely equipped shops and drafting rooms, directed by an accredited staff of engineers and practical instructors. 18 years of successful training of men for industry.

Days, Evenings • Approved for Veteran Training

NEW CLASSES Now Forming • BULLETIN ON REQUEST

ALLIED SCHOOL OF MECHANICAL TRADES, INC.
 42 ALLIED BLDG., 1336 S. MICHIGAN AVE. • CHICAGO 5, ILL.

BE A REAL ESTATE BROKER PAYS BIG!

EASY TO LEARN—Start and run your own business quickly. Many graduates report making up to \$1000 a month. Course of study covers Sales, Property Management, Appraising, Loans, Mortgages and hundreds of related subjects. Course offered in home study or residential classrooms.

FREE Big new illustrated catalog from this nationally known school. Send Post Card Today. G. I. Approved.

WEAVER SCHOOL OF REAL ESTATE
 Dept. KA-5, 15 E. Pershing Road Kansas City, Mo.



KIT 1 (left) I send you Soldering Equipment and Radio Parts; show you how to do Radio Soldering; how to mount and connect Radio parts; give you practical experience.

KIT 2 (left) Early in my course I show you how to build this N. R. I. Tester with parts I send. It soon helps you fix neighborhood Radios and earn EXTRA money in spare time.

VETERANS

You can get this training in your own home under G.I. Bill. Mail coupon for full details.



Be a RADIO Technician

Learn by PRACTICING in Spare Time

with **BIG KITS** of **RADIO PARTS** I send you

KIT 3 You get parts to build Radio Circuits; then test them; see how they work; learn how to design special circuits; how to locate and repair circuit defects.

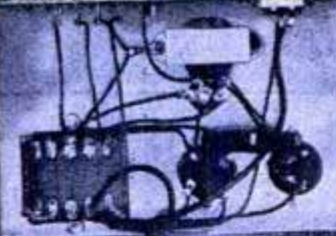
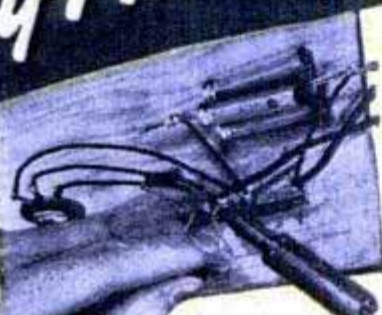

KIT 4 You get parts to build this Vacuum Tube Power Pack; make changes which give you experience with packs of many kinds; learn to correct power pack troubles.

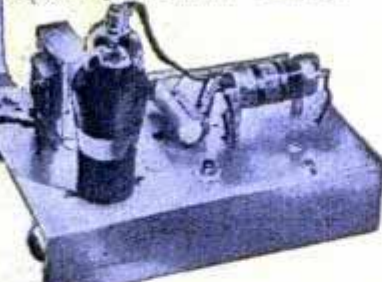

KIT 5 Building this A. M. Signal Generator gives you more valuable experience. It provides amplitude-modulated signals for many tests and experiments.



KIT 6 You build this Superheterodyne Receiver which brings in local and distant stations—and gives you more experience to help you win success in Radio.

Do you want a good-pay job in the fast-growing Radio Industry—or your own Radio Shop? Mail the Coupon for a Sample Lesson and my 64-page book, "How to Be a Success in RADIO—Television, Electronics," both FREE. See how I will train you at home—how you get practical Radio experience building, testing Radio circuits with **BIG KITS OF PARTS** I send!



Many Beginners Soon Make Extra Money in Spare Time While Learning

The day you enroll I start sending EXTRA MONEY JOB SHEETS that show you how to make EXTRA money fixing neighbors' Radios in spare time while still learning! It's probably easier to get started now than ever before, because the Radio Repair Business is booming. Trained Radio Technicians also find profitable opportunities in Police, Aviation, Marine Radio, Broadcasting, Radio Manufacturing, Public Address work. Think of even greater opportunities as Television, FM, and Electronic devices become available to the public! Send for FREE books now!

Find Out What NRI Can Do For You

Mail Coupon for Sample Lesson and my FREE 64-page book. Read the details about my Course; letters from men I trained; see how quickly, easily you can get started. No obligation! Just MAIL COUPON NOW in envelope or paste on penny postal. J. E. SMITH, President, Dept. 7GP, National Radio Institute, Pioneer Home Study Radio School, Washington 9, D. C.

Sample Lesson **FREE**
64 Page Book



Mr. J. E. SMITH, President, Dept. 7GP
National Radio Institute
Washington 9, D. C.

Mail me FREE, Sample Lesson and 64-page book. (No salesman will call. Please write plainly.)

Age.....

Name.....

Address.....

City..... State.....
(Please include Post Office Zone number)

My Course
Includes Training in
TELEVISION • ELECTRONICS
FREQUENCY MODULATION

G-E EXPOSURE METER
offers extra help for your camera!

These 3 new masks snap on the G-E meter in place of hood to let you read INCIDENT LIGHT (light on subject) the professional way. Gives better quality in color, stills, movies. With hood on, the meter provides extreme accuracy for reflected light. Easy to use. Many other advantages. Get a G-E meter and get better vacation pictures. General Electric, Schenectady 5, N. Y.

Ask your photo dealer for the

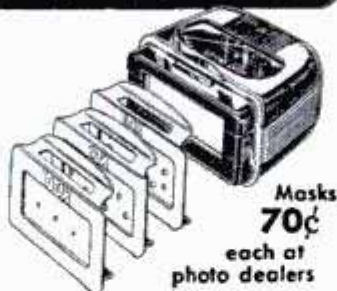

Masks
70¢
each at
photo dealers



Type DW-58
\$26.95
Federal tax incl.



Exposure Meter

...it's 3 meters in One!

GENERAL ELECTRIC
606-198D

SHOP TRAINING
for G.I.'s *and* CIVILIANS

Not correspondence courses

Practical Shop Training
America's Leading School
7 Floors of Fully Equipped Shops
Established 1902
Over 45,000 Graduates
Expert Individual Instruction
Learn by Doing

You hear it everywhere:
"GREER SHOP TRAINING IS THE BEST"

MAIL COUPON!

Erwin Greer, President
Dept. 277, 460 S. State St., Chicago, Ill.
Please send "Shop Training Facts" on trade checked below:

- | | |
|---|---|
| For G. I. Training | For Civilian Training |
| <input type="checkbox"/> Diesel Mechanics | <input type="checkbox"/> Body & Fender |
| <input type="checkbox"/> Welding | <input type="checkbox"/> Tool & Die |
| <input type="checkbox"/> Refrigeration | <input type="checkbox"/> Machinist |
| <input type="checkbox"/> Auto Mechanics | <input type="checkbox"/> Machine Drafting |

Name _____

Address _____ Age _____

City _____ State _____

Out of town men: Check here if a veteran
 Check here if a civilian

Call, write, telegraph or phone me personally.
—Erwin Greer

AT HOME • AT WORK

Plan Now for Greater Income
10,000 Industrial Secrets, Ideas

The rapid expansion of American Industry constantly demands NEW ideas, NEW products, NEW discoveries. Thousands of opportunities exist TODAY. Amateur and professional alike may rise to Fame and Fortune with a single idea. NOW—YOU can prepare to share these rich rewards. Work at home. LEARN the actual Methods, Processes and Formulas used in producing thousands of practical products.

A MASTER BOOK OF VITAL KNOWLEDGE

The authentic guide to correct procedure. HOW to do things—HOW to make things. Detailed instructions for over 10,000 various products. Professional advice and information. Illustrated workshop and laboratory methods. Authentic Formulas and Processes for Soaps, Metals, Plastics, Paints, Cosmetics, Waxes, Household items, Perfumes, Medicines, Fishes, Steel, Photography, Petroleum, Rubber, and thousands more for almost every phase of American Industry.

NO EXPERIENCE REQUIRED — START NOW

Hundreds have used this massive Book of Knowledge to increase their income—to reach new fields of employment—to become an authority at work—to make thrilling experiments—profitable discoveries. Previous experience is necessary. This practical volume offers complete guidance in NON TECHNICAL language. Chemical terms simplified. Easy laboratory methods clearly explained. Start NOW—this vital knowledge to develop your OWN ideas. Let these professional methods guide YOU quickly and accurately. LEARN—DISCOVER—PROFIT. Order this valuable book TODAY. Endorsed by School Libraries, Trade Journals. 900 pages. Cloth bound. **\$3.50** Postpaid.

No C.O.D. Shipments. Canada or Foreign \$3.85 U. S. Funds.

ARGYLE BOOKS, DEPT. A

1412 Great Northern Bldg.

Chicago 4, Ill.

Command a Substantial Salary

BE AN ACCOUNTANT



Hill's, one of America's leading Business Schools, offers you the opportunity to advance yourself to a well paying accountant's job. Our FREE book, "Through Hill's to Success," tells how and where the best positions are found and how you can qualify for them by study at home or in our resident school. We have thousands of successful graduates and maintain nation-wide employment service. G. L. Approved.

HILL'S EXTENSION SCHOOL
and BUSINESS UNIVERSITY
819 W. Main St. • Oklahoma City 2, Okla.

ELECTRICAL TRAINING

Intensive 32 weeks residence course in fundamentals of industrial electrical engineering, including radio, electronics. Preparation for technician, engineering aides. Approved for veteran training. 54th year. Catalog.

BLISS ELECTRICAL SCHOOL
7636 Takoma Ave., Wash. 12, D.C.



TEENERS Mystify Your Friends
With **Mystricards**

12 Cards 35c
100 Cards \$1.00

Be a hit! Send secret messages, greetings, etc. Fun, educational, easy to make. Hurry! Be first! Materials, instructions, samples all postpaid.

Mystricard, B-3, P.O. Box 915, Anderson, Ind.

CHAPMAN CHINCILLA

The originator of the first Chinchilla Farm in the United States. For information on purchasing the finest, selected breeding stock of these aristocratic animals that were virtually trapped to extinction write or visit—

Established 1919

Chapman Chinchilla Farm
4957 West 104th Street
Inglewood, California

INVENTORS

Learn how to protect your invention. The U. S. Patent Laws provide that any new and useful art, machine, article of manufacture, or composition of matter, or any new and useful improvement thereof, may be patented if the act of invention is involved. Therefore, every inventor with a valuable invention should take advantage of the Patent Laws and proceed for patent protection in order to safeguard his rights.

A patent gives the inventor the exclusive right to prevent others from making, using, or selling the invention claimed in the patent for a period of seventeen years.

The Patent Laws were enacted for the benefit of the inventor to give him protection for the features of his invention which are patentable. These features must be properly and concisely set forth and claimed in a formal application for patent, in order to comply with the requirements of the U. S. Patent Office. For that reason, the Patent Office advises the inventor to engage a competent registered patent attorney or agent to prepare his application for patent and represent him before the U. S. Patent Office Examiner.

A specially prepared booklet entitled "Patent Guide for the Inventor", containing detailed information with respect to patent protection and procedure, together with a "Record of Invention" form will be promptly forwarded to you without obligation upon request.

Patents
Trademarks
Copyrights

Registered Patent Attorneys

CLARENCE A. O'BRIEN & HARVEY B. JACOBSON
Registered Patent Attorneys

71-G District National Bldg., Washington 5, D. C.

Please send me copy of "Patent Guide for the Inventor" and also "Record of Invention" form. This request does not obligate me.

Name _____

Address _____

City _____ State _____

(Please write or print plainly.)

CLARENCE A. O'BRIEN
& HARVEY B. JACOBSON

71-G District National Building + Washington 5, D. C.



AUTO BOOKS ON APPROVAL



CAN YOU FIX IT?

These wonder books tell step by step HOW to make difficult repairs and adjustments, how to keep a car at maximum efficiency, including latest improvements in car design and operation. Engine troubles and how to correct them well covered.

6 BIG VOLUMES
2800 pages, 2000 illustrations, wiring diagrams, etc., including Diesel engines. Beautiful modernistic, washable cloth binding.

SEND NO MONEY. Just mail the coupon for a complete set of Six Big Auto Books, 20th Edition. Whether you are a mechanic or helper, expert or apprentice, auto owner or driver, take immediate advantage of this FREE EXAMINATION OFFER.

MAKE GOOD MONEY NOW HOLD A PERMANENT JOB

America wants its automobiles kept in good repair. Men with "know how" are in demand, at big pay. These books will help you get and hold an important job, or give you a chance to go into business for yourself now or later. Any man who half tries to improve himself can learn auto servicing and repairing by this quick reference method. Use the JIPPY INDEX to find easily understood answer to any auto problem. These wonder books prepared by eleven of America's great automobile engineers. Many hundreds of valuable illustrations. Send the coupon TODAY.

[A year's consulting privileges with our engineers now given with these books without extra charge.]
Vocational Publishers Since 1895

AMERICAN TECHNICAL SOCIETY, Dept. AB19
Drexel Ave. at 58th St., Chicago 37, Ill.

I would like to examine your Six-Volume Set of Auto Books. I will pay the delivery charges only, but if I choose I may return them express collect. If after 10 days' use I prefer to keep them, I will send you \$2 and pay the balance at the rate of only \$3 a month until \$24.80 has been paid. Please include consulting service as offered above.

Name
Address
City State

Please attach letter stating age, occupation, employer's name and address, and name and address of at least one business man as reference. Men in service, also please give home address.

AUDELS ELECTRIC MOTOR GUIDE

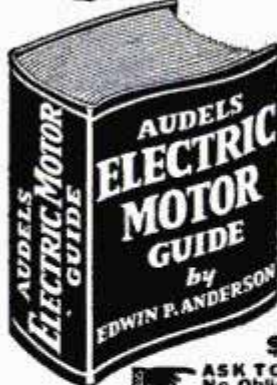

1000 PAGES OF PRACTICAL MOTOR INFORMATION

JUST OUT! Audels Electric Motor Guide covering the construction,

hook-ups, control, maintenance and trouble shooting of all types of motors including armature winding. Explains entire subject in every detail. 31 Chapters, 617 Illustrations and Diagrams. A Handy Guide Fully Indexed for Electricians and all Electrical Workers.

\$4 COMPLETE • PAY \$1 A MO.

ASK TO SEE IT!—Get This Information for Yourself No Obligation Unless Satisfied.

MAIL ORDER

AUDEL, Publishers, 49 W. 23rd St., New York 10, N. Y.

MAIL AUDELS ELECTRIC MOTOR GUIDE for free examination. If O. K., I will send you \$1 in 7 days; then remit \$1 monthly until price of \$4 is paid. Otherwise, I will return it.

Name.....
Address.....
Occupation.....
Employed by..... PM

PROTECT YOUR HOME

with these **MODERN**
Low Cost **FIRE**
EXTINGUISHERS



A little foresight now may save LIVES and property later! Equip your home, your garage, your boat with **AUTOFYRSTOP**, the modern fire extinguisher and alarm that is setting new efficiency records. Write for free literature:

KILLS FIRE BY ITSELF

AUTOFYRSTOP CO. Dept. PM-47
2035 Washington Av., Philadelphia 46, Pa.

MONEY MAKING OPPORTUNITY

We have openings for high grade salesmen in choice territories. Write for Plan.



LEARN To Repair and Service

Electrical Appliances, Sewing machines, motors, bicycles, lawn mowers, saw filing, cutlery grinding, etc.

Postcard Brings Free Details
Start with \$20.00 and a few common tools! Build low cost equipment while earning. Make up to \$6.00 an hour! Free details. Complete illustrated course only..... **\$5.50**
5 Days Free Examination C.O.D. 35c Extra

REPAIRMAN'S SERVICE 222 4th Ave.,
Janesville, Wis.

"How to Make Money With Simple Cartoons"

A book everyone who likes to draw should have. It is free; no obligations. Simply address
CARTOONISTS' EXCHANGE

Dept. 97D Pleasant Hill, Ohio

CORRESPONDENCE COURSES IN RADIO and ELECTRICAL ENGINEERING

Tuition \$25

ELECTRICAL ENGINEERING. Get good grasp of wide electrical field. Modern. Very understandable. Theory made easy.
RADIO ENGINEERING. Extra fine course in radio, public address, photo-electric work. Trains you to be super-service man, real vacuum tube technician. Tuition ONLY \$25, either course. Deferred payment plan. Servicemen needed badly. Write for free copies of school catalogs, student magazines, etc.
FREE LINCOLN ENGINEERING SCHOOL, Box 931-P103, Lincoln, Nebr.

TRADE MAGAZINES BUSINESS VOCATIONAL DIVERSION

Complete Directory of more than 3800 periodicals, classified by fields covered, name and address of each, date established, frequency of issue, domestic and foreign single copy and subscription rates. New edition, \$1.00.

COMMERCIAL ENGRAVING PUBLISHING CO.
34HH North Ritter Ave. Indianapolis 19, Indiana



CARTOON TO SUCCESS!
Learn cartooning from a PROFESSIONAL! Let me show you how to create ORIGINAL cartoons and IDEAS. Send for FREE details about course.
Also **CARTOONIST'S MAGAZINE**—Lessons, plans and hints. Send 25c coin for copy.
CARTOONIST HARTMAN, 2776 California Court, LINCOLN 8, NEB.

RUPTURED?

Get Relief This Proven Way

Why try to worry along with trusses that gouge your flesh—press heavily on hips and spine—enlarge opening—fail to hold rupture? You need the Cluthe. No leg- straps or cutting belts. Automatic adjustable pad holds at real opening—follows every body movement with instant increased support in case of strain. Cannot slip whether at work or play. Light. Waterproof. Can be worn in bath. Send for amazing FREE book, "Advice To Ruptured," and details of liberal truthful 60-day trial offer. Also endorsements from grateful users in your neighborhood. Write:

CLUTHE SONS, Dept. 31, Bloomfield, New Jersey

HOW JOE'S BODY BROUGHT HIM FAME INSTEAD OF SHAME



Charles Atlas

—actual photo of the man who holds the title, "The World's Most Perfectly Developed Man."

I Can Make YOU A New Man, Too in Only 15 Minutes A Day!

IF YOU, like Joe, have a body that others can "push around"—if you're ashamed to strip for sports or a swim—then give me just 15 minutes a day! I'll PROVE you can have a body you'll be proud of, packed with ed-blooded vitality! "Dynamic Tension." That's the secret! That's how I changed myself from a spindled, anked, scrawny weakling to winner the title, "World's Most Perfectly Developed Man."

"Dynamic Tension" Does It!

Using "Dynamic Tension" only 15 minutes a day, in the privacy of your own room, you quickly begin to put on muscle, increase your chest measurements, broaden your back, fill out your arms and legs. Before you know it, this easy, NATURAL method will make you a finer specimen of

REAL MANHOOD than you ever dreamed you could be! You'll be a New Man!

FREE BOOK

Thousands of fellows have used my marvelous system. Read what they say—see how they looked before and after—in my book, "Everlasting Health And Strength."

Send NOW for this book—FREE. It tells all about "Dynamic Tension," shows you actual photos of men I've turned from puny weaklings into Atlas Champions. It tells how I can do the same for YOU. Don't put it off! Address me personally: Charles Atlas, Dept. 87, 115 East 23rd St., New York 10, N. Y.



CHARLES ATLAS, Dept. 87,
115 East 23rd St., New York 10, N. Y.

I want the proof that your system of "Dynamic Tension" will help make a New Man of me—give me a healthy, husky body and big muscular development. Send me your free book, "Everlasting Health and Strength."

Name _____
(Please print or write plainly)

Address _____

City _____ State _____

INVENTORS

Patent Laws Encourage The Development of Inventions

The Rules of Practice of the U. S. Patent Office advises— unless an inventor is familiar with such matters — that he employ a competent registered attorney or registered agent, as the value of patents depends largely upon the skillful preparation of the specifications and claims.

The firm of McMorrow, Berman and Davidson is registered to practice before the U. S. Patent Office. Additionally, it maintains a staff of attorneys able to readily understand inventors' disclosures, to advise concerning patentability, and to prepare appropriate specifications and claims for filing with the Patent Office.

If an inventor believes he has an invention, a search of the most pertinent prior U. S. patents should be made and a report obtained relative to its patentability. Where such report indicates that the invention appears patentable, in order to secure protection, diligence should be exercised in making application for a patent.

McMORROW, BERMAN & DAVIDSON

Registered Patent Attorneys

PATENTS — TRADEMARKS — COPYRIGHTS

1357 VICTOR BUILDING, WASHINGTON 1, D. C.

McMORROW, BERMAN & DAVIDSON

Registered Patent Attorneys

1357 Victor Building, Washington 1, D. C.

Send me further particulars as to patent protection and procedure and "Invention Record" form at once. I understand that this request does not obligate me.

Name _____

Address _____

City _____ State _____

(WRITE OR PRINT NAME CLEARLY)

"Why, he knows all about me!"

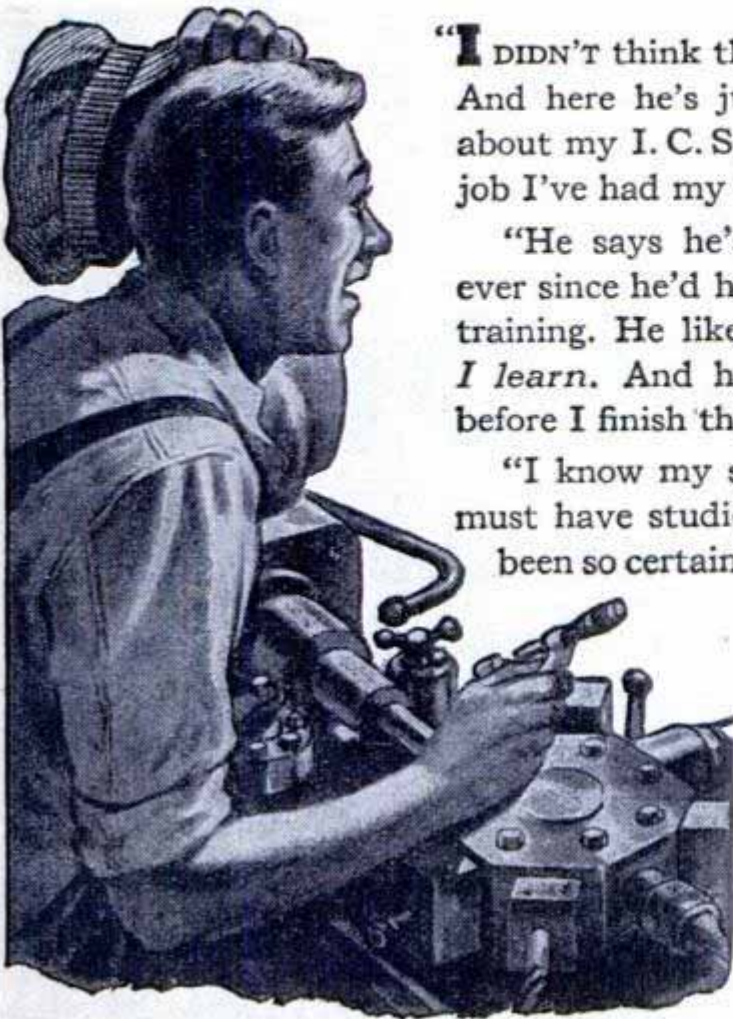

"I DIDN'T think the boss knew my name. And here he's just stopped by to talk about my I. C. S. Course and the bigger job I've had my eye on.

"He says he's had *his eye on me* ever since he'd heard I was getting that training. He likes the idea of my applying what I learn as *I learn*. And he says there'll be good news for me even before I finish the course.

"I know my studies showed in my work. But I guess he must have studied with I. C. S. himself or he couldn't have been so certain about just where I was getting my training."

Quite possibly the boss *is* an I. C. S. graduate. Thousands of employers are. Whether he is or isn't, however, he knows about your studies. I. C. S. regularly reports student progress to superiors. Letters of employer appreciation for this service are a regular part of our mail. So are student and graduate letters telling us of advancements—600 a month on an average. There *must* be a connection. Mail the coupon for full information.

INTERNATIONAL CORRESPONDENCE SCHOOLS



BOX 5608-K, SCRANTON 9, PENNA.

Without cost or obligation, please send me full particulars about the course *before* which I have marked X:

- | | | | |
|--|---|--|--|
| <p>Air Conditioning and Plumbing Courses</p> <p><input type="checkbox"/> Air Conditioning</p> <p><input type="checkbox"/> Heating <input type="checkbox"/> Plumbing</p> <p><input type="checkbox"/> Refrigeration <input type="checkbox"/> Steam Fitting</p> <p>Chemistry Courses</p> <p><input type="checkbox"/> Chemical Engineering</p> <p><input type="checkbox"/> Chemistry, Analytical</p> <p><input type="checkbox"/> Chemistry, Industrial</p> <p><input type="checkbox"/> Chemistry, Mfg. Iron & Steel</p> <p><input type="checkbox"/> Petroleum Refining <input type="checkbox"/> Plastics</p> <p><input type="checkbox"/> Pulp and Paper Making</p> <p>Civil Engineering, Architectural and Mining Courses</p> <p><input type="checkbox"/> Architectural Drafting</p> <p><input type="checkbox"/> Architecture</p> <p><input type="checkbox"/> Bridge and Building Foreman</p> <p><input type="checkbox"/> Building Estimating</p> <p><input type="checkbox"/> Civil Engineering</p> <p><input type="checkbox"/> Coal Mining</p> <p><input type="checkbox"/> Contracting and Building</p> <p><input type="checkbox"/> Highway Engineering</p> <p><input type="checkbox"/> Lumber Dealer</p> <p><input type="checkbox"/> Reading Structural Blueprints</p> <p><input type="checkbox"/> Sanitary Engineering</p> <p><input type="checkbox"/> Structural Drafting</p> | <p><input type="checkbox"/> Structural Engineering</p> <p><input type="checkbox"/> Surveying and Mapping</p> <p>Communications Courses</p> <p><input type="checkbox"/> Electronics</p> <p><input type="checkbox"/> Practical Telephony</p> <p><input type="checkbox"/> Radio, General</p> <p><input type="checkbox"/> Radio Operating</p> <p><input type="checkbox"/> Radio Servicing</p> <p><input type="checkbox"/> Telegraph Engineering</p> <p>Electrical Courses</p> <p><input type="checkbox"/> Electrical Drafting</p> <p><input type="checkbox"/> Electrical Engineering</p> <p><input type="checkbox"/> Electric Light and Power</p> <p><input type="checkbox"/> Lighting Technician</p> <p><input type="checkbox"/> Practical Electrician</p> <p>Internal Combustion Engines Courses</p> <p><input type="checkbox"/> Auto Technician <input type="checkbox"/> Aviation</p> <p><input type="checkbox"/> Diesel-Electric</p> <p><input type="checkbox"/> Diesel Engines <input type="checkbox"/> Gas Engines</p> <p>Mechanical Courses</p> <p><input type="checkbox"/> Aeronautical Engineering</p> <p><input type="checkbox"/> Aircraft Drafting</p> <p><input type="checkbox"/> Flight Engineer</p> <p><input type="checkbox"/> Foundry Work</p> <p><input type="checkbox"/> Heat Treatment of Metals</p> | <p><input type="checkbox"/> Industrial Engineering</p> <p><input type="checkbox"/> Industrial Metallurgy</p> <p><input type="checkbox"/> Machine Shop</p> <p><input type="checkbox"/> Mechanical Drafting</p> <p><input type="checkbox"/> Mechanical Engineering</p> <p><input type="checkbox"/> Mold-Loft Work</p> <p><input type="checkbox"/> Patternmaking—Wood, Metal</p> <p><input type="checkbox"/> Reading Shop Blueprints</p> <p><input type="checkbox"/> Sheet-Metal Drafting</p> <p><input type="checkbox"/> Sheet-Metal Worker</p> <p><input type="checkbox"/> Ship Drafting <input type="checkbox"/> Ship Fitting</p> <p><input type="checkbox"/> Tool Designing</p> <p><input type="checkbox"/> Toolmaking</p> <p><input type="checkbox"/> Welding—Gas and Electric</p> <p>Railroad Courses</p> <p><input type="checkbox"/> Air Brake <input type="checkbox"/> Car Inspector</p> <p><input type="checkbox"/> Diesel Locomotive</p> <p><input type="checkbox"/> Locomotive Engineer</p> <p><input type="checkbox"/> Locomotive Fireman</p> <p><input type="checkbox"/> Railroad Section Foreman</p> <p>Steam Engineering Courses</p> <p><input type="checkbox"/> Boilermaking</p> <p><input type="checkbox"/> Combustion Engineering</p> <p><input type="checkbox"/> Engine Running</p> <p><input type="checkbox"/> Marine Engineering</p> <p><input type="checkbox"/> Steam Electric <input type="checkbox"/> Steam Engines</p> | <p>Textile Courses</p> <p><input type="checkbox"/> Cotton Manufacturing</p> <p><input type="checkbox"/> Rayon Weaving</p> <p><input type="checkbox"/> Textile Designing</p> <p><input type="checkbox"/> Woolen Manufacturing</p> <p>Business and Academic Courses</p> <p><input type="checkbox"/> Accounting <input type="checkbox"/> Advertising</p> <p><input type="checkbox"/> Arithmetic <input type="checkbox"/> Bookkeeping</p> <p><input type="checkbox"/> Business Correspondence</p> <p><input type="checkbox"/> Business Management</p> <p><input type="checkbox"/> Certified Public Accounting</p> <p><input type="checkbox"/> Commercial</p> <p><input type="checkbox"/> Cost Accounting</p> <p><input type="checkbox"/> Federal Tax</p> <p><input type="checkbox"/> First Year College</p> <p><input type="checkbox"/> Foremanship <input type="checkbox"/> French</p> <p><input type="checkbox"/> Good English <input type="checkbox"/> High School</p> <p><input type="checkbox"/> Higher Mathematics</p> <p><input type="checkbox"/> Illustrating <input type="checkbox"/> Motor Traffic</p> <p><input type="checkbox"/> Postal Service</p> <p><input type="checkbox"/> Salesmanship <input type="checkbox"/> Secretarial</p> <p><input type="checkbox"/> Sign Lettering</p> <p><input type="checkbox"/> Spanish <input type="checkbox"/> Stenography</p> <p><input type="checkbox"/> Traffic Management</p> |
|--|---|--|--|

Name _____ Age _____ Address _____

City _____ State _____ Present Position _____

Working Hours _____ A.M. to _____ P.M. Length of Service in World War II _____

Special tuition rates to members of the Armed Forces. Enrollment under the G.I. Bill of Rights approved for War II Veterans. Canadian residents send coupon to International Correspondence Schools Canadian, Ltd., Montreal, Canada.

PATENT PROTECTION *for* INVENTORS

A PATENT IS A VALUABLE RIGHT

On the basis of a provision in the Constitution of the United States, Congress has established a system under which inventors may secure the exclusive right to prevent the unauthorized use, manufacture and sale of their inventions for periods of seventeen years. The inventor secures this protection by obtaining a patent from the United States Patent Office.

VICTOR J. EVANS & CO. has a staff of experienced registered patent attorneys, available to represent inventors in the preparation and prosecution of their cases before the Patent Office. Detailed information and the steps to be taken in obtaining patent protection will be furnished upon request.

FORM BELOW FOR MAILING CONVENIENCE

**VICTOR J.
EVANS & Co.**

Merlin M. Evans

REGISTERED PATENT ATTORNEY

230-H Merlin Building, Washington 6, D. C.

Please forward to me detailed information regarding procedure to obtain Patent Protection, together with your convenient "Evidence of Invention" form.

Name

Address

City and State

PATENTS • TRADEMARKS • COPYRIGHT

LEARN EITHER

Electricity OR Radio IN A FEW WEEKS

in the GREAT SHOPS of COYNE

**NOT "Home Study" Courses
...All Practical Training and
Necessary Theory Given in
Our Famous Chicago Shops!**

Why spend years learning Electricity or Radio, when COYNE prepares you for good jobs in either field in a few short weeks? Our training not only saves time; you're ready to step into the better pay that much sooner. You make rapid progress because you work under expert instructors here in our great shops. We do not teach by mail. Select course you prefer and send coupon TODAY!

ELECTRICITY

RADIO including SOUND and TELEVISION



Including Industrial Electronics

Big future in Power Plant Work, Motors, Armature Winding, House and Factory Wiring, Industrial Electronics, Home Appliances, Lighting, Auto Electricity, Electrical Maintenance — all covered at COYNE. Here you get "all-around" Electrical training!

TRAIN ON REAL EQUIPMENT

You use, test, repair full-size apparatus — just like you'll later handle on the job. Previous experience unnecessary.

If you prefer Radio, COYNE gives quick, practical training in Radio Construction, Testing, Repair; also Public Address, Sound Systems, FM, Television. Many branches of Radio open to you.

Want to be Your Own Boss?

Hundreds of Coyne graduates have successful Radio shops of their own. We show you how to start, how to build for a lifetime future. No previous experience required to take Coyne Radio Course.



FREE ELECTRICAL BOOK

Send now for big, illustrated book on COYNE Electrical Training. Many large pictures of our shops. Tells about Free Lifetime Employment Service to Coyne graduates. Other vital facts. Check coupon for "ELECTRICITY" and mail today.

FREE RADIO BOOK

Check coupon for "RADIO" to receive our big FREE book of photos and facts about Coyne Training in Radio, Sound and Television. Describes the vast new opportunities in this field, and how we make it easy to get ahead. Rush coupon NOW.

COYNE HAS BEEN TRAINING MEN SINCE 1899

For nearly 50 years, the great shops of COYNE have been turning out men and young men trained for better jobs in practical fields. Coyne graduates hold responsible positions in many leading electrical and radio firms.



B. W. COOKE

NON-VETERANS who are short of cash can finance their tuition and pay it in easy monthly payments after graduation.

VETERANS! Coyne is authorized to accept veterans for G. I. training. Coupon brings bulletin.

ADDED TRAINING in **ELECTRIC REFRIG-ERATION** included with either course

COYNE ELECTRICAL SCHOOL
Dept. B7-72H
500 S. Paulina Street, Chicago 12, Ill.

CHECK COUPON FOR ELECTRICITY OR RADIO-MAIL NOW!

B. W. COOKE, Director,
COYNE ELECTRICAL SCHOOL,
500 S. Paulina St., Dept. B7-72H Chicago 12.

Send me your **BIG FREE BOOK**—for the Course checked below, and tell me about your special plans to help me. This does not obligate me and no salesman will call.

ELECTRICITY **RADIO**

NAME.....
ADDRESS.....
CITY.....STATE.....

Do you want

- .. to go to College?
- .. or to enter a Profession?

(Such as Accounting, Architecture, Nursing, Dentistry; Teaching, Social Work, Osteopathy, Beauty Culture, Optometry, Embalming, Chiropractic, Law, Medicine, etc.)

- .. or get an Office Position?

To get anywhere, you practically **MUST** finish High School **FIRST**. You can complete our simplified High School Course in **SPARE** time at home, as **FAST** as your time and abilities permit. Equivalent to resident school work—prepares you for college, pre-professional examinations, business, industry. Standard texts furnished. Diploma. Credit for H. S. subjects already completed. Single subjects if desired. Low tuition, easy terms. American School, Chicago, est. 1897—endorsed by educators. Finish your high school education **NOW**. Write **TODAY!**

High School Course at Home

Many Finish in 2 Years

- American School, Dept. HB45, Drexel Ave. at 58th St., Chicago 37, Ill.
- Gentlemen: Send me **FREE** information covering special training in subjects checked below. No obligation on my part.
- | | |
|--|--|
| <input type="checkbox"/> High School Course | <input type="checkbox"/> Diesel Engineering |
| <input type="checkbox"/> Architecture and Building | <input type="checkbox"/> Drafting and Design for Men & Women |
| <input type="checkbox"/> Automotive Engineering | <input type="checkbox"/> Plastics |
| <input type="checkbox"/> Business Management | <input type="checkbox"/> Private Secretary |
| <input type="checkbox"/> Electrical Engineering | <input type="checkbox"/> Mechanical Engineering |
| <input type="checkbox"/> Elec. and Gas Refrigeration | <input type="checkbox"/> Aviation |
| <input type="checkbox"/> Air Conditioning | <input type="checkbox"/> Salesmanship |
| <input type="checkbox"/> Railway Training | <input type="checkbox"/> Radio |
| <input type="checkbox"/> Electronics, Industrial | |

Name.....

Address.....

AUDELS Carpenters and Builders Guides

4 vols. \$6

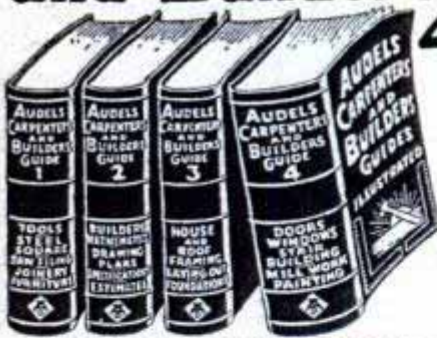

Inside Trade Information for Carpenters, Builders, Joiners, Building Mechanics and all Woodworkers. These Guides give you the short-cut instructions that you want—including new methods, ideas, solutions, plans, systems and money saving suggestions. An easy progressive course for the apprentice and student. A practical daily helper and Quick Reference for the master worker. Carpenters everywhere are using these Guides as a Helping Hand to Easier Work, Better Work and Better Pay. To get this assistance for yourself, simply fill in and mail the **FREE COUPON** below.

Inside Trade Information On:

How to use the steel square—How to file and set saws—How to build furniture—How to use a mitre box—How to use the chalk line—How to use rules and scales—How to make joints—Carpenters arithmetic—Solving mensuration problems—Estimating strength of timbers—How to set girders and sills—How to frame houses and roofs—How to estimate costs—How to build houses, barns, garages, bungalows, etc.—How to read and draw plans—Drawing up specifications—How to excavate—How to use settings 12, 13 and 17 on the steel square—How to build hoists and scaffolds—skylights—How to build stairs—How to put on interior trim—How to hang doors—How to lay floor—How to paint



THEO. AUDEL & CO., 49 W. 23rd St., New York City

Mail Audels Carpenters and Builders Guides, 4 vols., on 7 days' free trial. If O.K. I will remit \$1 in 7 days, and \$1 monthly until \$6 is paid. Otherwise I will return them. No obligation unless I am satisfied.

Name.....

Address.....

Occupation.....

Reference..... **PM**

BIG MONEY NOW

In a Profitable Business of Your Own! Full or Spare Time!

We'll tell you how you can easily start a profitable business of your own with our amazing Liquid Imitation Marble, Fibre-Tile Flooring and Flexible Molds. No big investment necessary and you can work right from home. These amazing products have already started many on the road to success and financial independence. No experience necessary. We tell you how!

FREE CATALOG AND FULL DETAILS

Today send your name and address and get started along the road to financial success.

Composition Products Co.
5853 DELMAR BLVD., DEPT. 71, ST. LOUIS 12, MO.

Learn Penmanship

One should learn **Rapid Business Writing**, both for his own satisfaction and for the convenience of those who must read it. And if **Fancy Shaded Writing** is learned also, it makes one a still more skilful penman. Good penmanship prevents costly errors and helps to secure and hold good positions, and, like music or elocution naturally attracts persons of refinement and artistic inclinations. If you are dissatisfied with your present handwriting and wish to become a good writer, write for my **FREE BOOK**, "How to Become an Expert Penman," which contains specimens of penmanship and shows what others have learned by my **Simplified Method**. If you enclose 10c, I will send you one of my Favorite Pen Points suitable for plain or shaded writing, and your name with a beautiful flourished bird written on a card. Begin Now. Write for your copy of the Free Book today.

T. M. TEVIS, BOX 25K, CHILLICOTHE, MO.

LAW...

STUDY AT HOME Legally trained men win higher positions and bigger success in business and public life. Greater opportunities now than ever before. We guide you step by step. You can train at home during spare time. Degree of **L.L.B.** We furnish all text material, including 14-volume Law Library. Low cost, easy terms. Get our valuable 48-page "Law Training for Leadership" and "Evidence" books **FREE**. Send **NOW, G. I. APPROVED.**
LASALLE EXTENSION UNIVERSITY, 417 South Dearborn Street
A Correspondence Institution Dept. 764-L Chicago 5, Ill.

LEARN MONEY-MAKING CARTOONING

IN SPARE TIME — by Easy Picture Chart Method
Same Simplified Method that has helped train creators of "Terry & Pirates," "Freckles," "Out Our Way," "Winnie Winkle," "Regular Fellers," "Strange As It Seems," "The Neighbors," and many others. Earn while learning. Send 10c for Picture Chart (to test your ability), and full details. (State age.)
Landon School of Cartooning, Dept. 4707 Philadelphia 11 Pa.



LEARN MEAT CUTTING

At Home — In Spare Time

Get into the vital meat industry. Concise, practical Home Training based on 25 years prove instruction methods used at National's famous resident school. Prepares you for bigger pay as a Meat Cutter, Supervisor, market manager or more money in your own store. Go as rapidly as your spare time permits. Diploma. Start **NOW** to turn your spare hours into money. Send for **FREE** bulletin today. No obligation.

National School of Meat Cutting, Inc., Dept. U-83, Toledo 4, Ohio

BUILDING HUMAN STATURE

"I grew 6 inches during a year I followed instructions given in 'BUILDING HUMAN STATURE,'" says the younger man at left. "Now I am a head taller than my father."
If you wonder why you are short send for **FREE** outline of this remarkable book loaded with practical information.

CARILLON BOOKS
Dept. 114, 3439 S. Michigan Ave., Chicago 16, Ill.



DE FOREST'S TRAINING, INC.
 CHICAGO ILLINOIS
 AFFILIATED WITH DE VRY MOTION PICTURE COMPANY, CHICAGO



Step Out in

RADIO-ELECTRONICS

...LET US SHOW YOU HOW!

VETERANS!

Distinguish yourself as a leader. Get the real money, the better opportunities which go with leadership and initiative. Let us show you how you may find all of these things in the opportunity-packed fields of Radio and Electronics. Begin your training today so you will be prepared for leadership and opportunity tomorrow — either on a payroll or in a profitable business of your own.

Whether you are an ex-G.I., a teen-age youth or an older man, there can be a place for you in these fascinating fields.

Mail coupon below right now for late facts about the exciting events in F.M. Radio, Broadcast Radio, Motion Picture Sound, Electronics, Sound Recording, the future developments in Radar and other branches.

You don't have to know a thing about Radio and Electronics. Over a period of 15 years, DeFOREST'S TRAINING, INC. has perfected a method of home training that GETS RESULTS.

We provide, for use in your own home, a **BIG FOUR** method that includes (1) commercial type Radio-Electronic parts and assemblies for valuable "LEARN-BY-DOING" experience at home; (2) a 16 Mm Motion Picture Projector and 12 reels of action-packed "LEARN BY SEEING" instructive movies to speed your understanding of important principles at home; (3) many easy-to-read loose-leaf lessons illustrated with handy fold-out diagrams; and (4) an effective **EMPLOYMENT SERVICE** to help you get started toward a good Radio Job when trained — or to assist you in starting your own Radio Business.

Both the Home Study and Chicago Laboratory courses of DeForest's Training, Inc. are accepted for your training. If you qualify under the "G.I. Law," you may obtain either training without cost to you.

No previous radio or electrical experience is necessary.

YOU CAN BUILD 7 DIFFERENT RADIO RECEIVERS

You "Learn-By-Doing" at home from 8 big Kits of radio parts and assemblies (similar to the equipment shown here). You build 7 different radio receiving circuits and dozens of other fascinating projects.

EMPLOYMENT SERVICE

Our effective Employment Service goes to work immediately upon the completion of your course to help you get started.

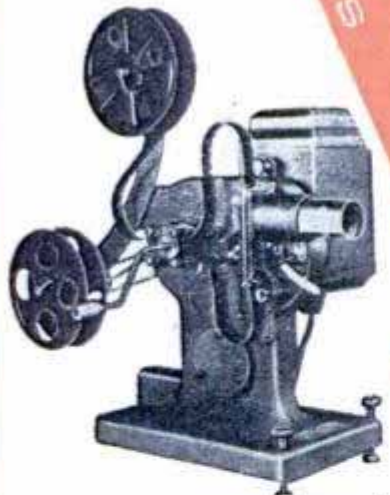

You use "learn-by-seeing" movies. We supply you with a 16mm Motion Picture projector and 12 reels of information-packed film.

DeForest's Training, Inc. includes instruction in motion picture sound equipment, F.M. Radio and Television. In addition to our Home Study courses, **RESIDENTIAL TRAINING** is available in our new, modern Chicago laboratories. Ask us for information regarding same.



YOU CAN BUILD 133 FASCINATING EXPERIMENTS

DeFOREST'S TRAINING, INC.
 2533-41 N. Ashland Ave., Dept. PM-D7.
 Chicago 14, Illinois, U.S.A.

Send me your big book "VICTORY FOR YOU" showing how I may make my start in Radio-Electronics with your modern home training plan. No obligation.

Name _____ Age _____
 Address _____ Apt. _____
 City _____ Zone _____ State _____

- If under 16, check here for special information.
- If a discharged veteran of World War II, check here.



AVIATION

Career

MAXIMUM TRAINING IN MINIMUM TIME

CAL-AERO TECH TRAINING will add dollars to your pay check all the rest of your life. Specializing in AERONAUTICAL ENGINEERING and MASTER AVIATION MECHANICS since 1929, Cal-Aero Tech training is carefully designed for just one thing—TO MAKE MORE MONEY FOR YOU. An alumni of over 6000 successful graduates proves our career training is unsurpassed.

VETERANS —Write us about Aviation Training, as provided under "G.I. Bill of Rights."



KAL - AERO TECHNICAL INSTITUTE
 MAJOR C. C. MOSELEY PRES. SINCE 1929
 FORMERLY QUINCY SCHOOL OF TECHNICAL INSTITUTE
 GRAND CENTRAL AIR TERMINAL
 GLENDALE 1, CALIFORNIA
 LOS ANGELES COUNTY

MAIL THIS COUPON TODAY!

Cal-Aero Technical Institute, Grand Central Airport, Glendale 1, California
 Please send full information on Aviation Training FREE—without obligation. Dept. PM-7

Name _____ Birth Date _____
 Street _____
 City _____ State _____

NOW! Build Your Future On



DIESEL Opportunities

LOOK around you. See the way tractors, trucks, buses, railroads, ships, power plants and equipment of many kinds are "going Diesel." Every day new opportunities are opening—in industrial and farming communities—for trained men who can install, maintain, operate and repair Diesel engines. Plan now to build your future in this growing field.

Diesel Knowledge is Earning Power

You don't have to give up your present job. Now, you can begin learning DIESEL in spare time at home. UEI practical training teaches you, step by step, how Diesel engines operate, how fuel systems work, repairs, accessories and auxiliary equipment; a world of Diesel "know how." Includes actual practice on Diesel equipment in our shop under expert guidance. UEI training methods are successful. For 20 years they have helped mechanically inclined men better themselves.

NOW IT'S UP TO YOU!

Coupon below brings you all the facts without cost or obligation. Get going today! MAIL COUPON NOW.

UTILITIES ENGINEERING INSTITUTE
 Diesel Division
 2521 Sheffield Ave.
 Dept. 177-D,
 Chicago 14, Ill.



Send Coupon for FREE FACTS

UTILITIES ENGINEERING INSTITUTE, Diesel Division
 2521 Sheffield Ave., Dept. 177-D, Chicago 14, Ill.
 Please send me Free Facts about Diesel opportunities and training.

NAME _____ Age _____
 ADDRESS _____
 CITY _____ Zone or County _____ STATE _____
 Check here for special information if you are under 17.
 Check here if Veteran of World War II.

HOME TO MOUNT BIRDS



Animals, Heads, Fishes, Pets; to Taxidermy. Be a Taxidermist. Profit and Fun. Hunters, save your valuable TROPHIES. Mount ducks, squirrels, everything. Learn to TAN for leather and furs. Wonderful HOBBY. Have a HOME MUSEUM.—BIG PROFITS mounting for others. INVESTIGATE NOW. **FREE BOOK** With 100 fine game pictures. NOW absolutely FREE. Write TODAY. Send Postal TODAY for FREE BOOK. State AGE. N.W. SCHOOL OF TAXIDERMY, Dept. 337B, Omaha, Neb.



WHY DON'T YOU WRITE?

Writing short stories, articles on business, homemaking, gardening, shop crafts, sports, local and club activities, etc., will enable you to earn extra money. In your own home, on your own time, the New York Copy Desk Method teaches you how to write—the way newspaper men learn, by writing. Our unique "Writing Aptitude Test" tells whether you possess the fundamental qualities essential to successful writing. You'll enjoy this test. Write for it, without cost or obligation.

Veterans: This course approved for Veterans' Training.
NEWSPAPER INSTITUTE OF AMERICA
 SUITE 559-L, ONE PARK AVENUE, NEW YORK 16, N.Y.

"YOU ARE UNDER ARREST!"



Help Bring Crooks to Justice Through Scientific **CRIME DETECTION!** I have taught thousands this exciting, profitable, peace profession. Let me teach you in your own home. Learn Finger Printing, Firearms Identification, Police Photography, Criminal Investigation thoroughly, quickly, at small cost. 53% of all American Bureaus of Identification employ I. A. S. students or graduates. I can prepare you for the fascinating work, during spare time. Write today, stating age, for "Blue Book of Crime."

Institute of Applied Science, 1920 Sunnyside Ave., Dept. 135-B, Chicago 40, Ill.

What Every Mason Wants



We have important Masonic books for Blue Lodge, Chapter, Commandery, Scottish Rite, and Shrine. Our Rituals Are Used the World Over. Send for free catalog of books and rituals for Masons, Odd Fellows, Knights of Pythias, Knights of Columbus, etc. EZRA A. COOK, Publisher, P. O. Box 796, PJ, Chicago 90, Ill.

ARTISTS MAKE MONEY

Do you like to draw? Send name, address, age and occupation for FREE ART TEST, to find out your ability.

ART INSTRUCTION, Inc.
 7137 ART INSTRUCTION BLDG., MINNEAPOLIS 15, MINN.

Learn BAKING At Home

Baking is one of America's high industries in wages. Nearly depression-proof. Thorough basic home course lays sound foundation. If you have aptitude, write for FREE BOOKLET, "Opportunities in Commercial Baking." National Baking School, 1315 Mich. Ave., Dept. 135B, Chicago 5, Ill.



WANT A U.S. GOVERNMENT JOB?

START \$1,756 to \$3,021 Year

Men—Women Get Ready Immediately / **FRANKLIN INSTITUTE** Dept. K86, Rochester 4, N.Y.

Common education usually sufficient / Sirs: Rush to me without charge (1) 32-page book with list of many U. S. Government Big Pay Dependable Jobs. (2) Tell me how to get one of these jobs.

Veterans Get Preference Name _____
Mail Coupon today sure Address _____
 Vet7

ELECTRICAL APPLIANCE REPAIRING

OFFERS BIG MONEY — INDEPENDENCE

If now employed start your home appliance repair business NOW in your spare time and be set with a business of your own no matter what happens. Operate from your garage, basement, kitchen, vacant store, etc. Work as many hours as you wish—the home appliance repairman is his own boss. It is a profitable occupation, for on many types of repairs it is not unusual for a repairman to charge on the basis of \$5.00 to \$6.00 per hour! Remember, there are millions of electrical appliances in this country. Appliances such as refrigerators, irons, sewing machines, vacuum cleaners, heaters, toasters, washing machines, motors, etc. To replace any of them is mighty expensive. That is why mechanically inclined men will find the Electrical Appliance Repair Business one that offers the trained man unlimited earning possibilities.

YOU CAN QUALIFY

All you need to become a successful electrical appliance repairman is ambition plus a little training at home in your spare time. If you are mechanically inclined—that is to say—can hold and use tools, our profusely illustrated course written in simple, easy to understand language will prepare you for the years to come. It does not matter if you have not had a great deal of schooling or have had no previous training along these lines. **WE WILL TEACH YOU.** Age should be no barrier—nor should any minor physical handicap.



WE TEACH YOU

Profusely illustrated with photographs and simple drawings we show you what troubles to look for and how to make each repair on an electrical appliance. We give you a good sound working knowledge of electricity, and how to do welding, nickel plating, etc. Our course shows you how to solicit business and keep it coming to you. Not a theory course but an honest to goodness course written by and used by repairmen the country over. Price of course is so low that the savings on your own household appliance repairs will quickly pay for it. Why work for others at the wages they want to pay you? Learn a good trade and operate your own business and determine just how long you work each day and the amount of money you make. **ACT NOW!**



MAIL COUPON TODAY

CHRISTY SUPPLY CO.

2835 N. Central Ave., Dept. D-4703

Chicago 34, Illinois

Please send me free illustrated literature about America's Fastest Growing Industry — **ELECTRICAL APPLIANCE REPAIRING.**

Name _____

Address _____

City _____ State _____

Keep that "TICKING"

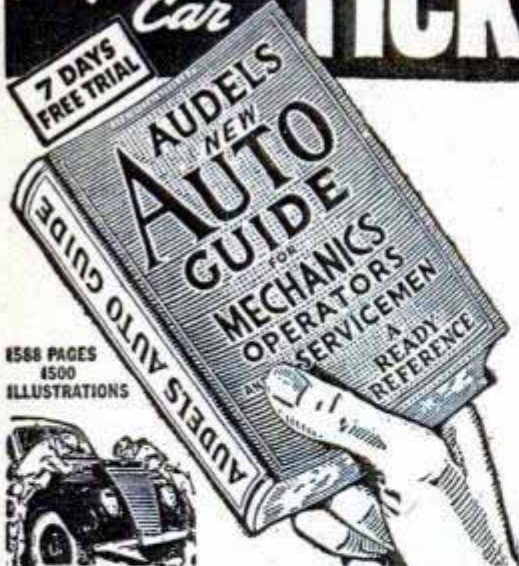

6588 PAGES
1500
ILLUSTRATIONS

Every operator and mechanic needs AUDELS AUTO GUIDE.

This book saves time, money and worry. Highly endorsed. It presents the whole subject of auto mechanics:

- 1—Basic principles
 - 2—Construction
 - 3—Operation
 - 4—Service
 - 5—Repair
- Handy Size. Easily understood.

NEW FLUID DRIVE, HYDRAULIC SHIFT AND DIESEL ENGINES FULLY COVERED

Over 1500 pages—1540 illustrations showing inside views of modern cars, trucks and buses with instructions for all service jobs.

\$4 COMPLETE • PAY ONLY \$1. A MONTH ←
ASK TO SEE IT!—To Get This Assistance for Yourself Simply Fill in and Mail Coupon Today.

AUDEL Publishers, 49 West 23rd St., New York
MAIL AUDELS NEW AUTO GUIDE for free examination. If O. K. I will send you \$1 in 7 days; then remit \$1 monthly until price of \$4 is paid. Otherwise I will return it.

Name _____
Address _____
Occupation _____
Employed by _____ PM

Learn this Profitable Profession



IN 90 DAYS AT HOME

Money-Making Career Open to Men and Women, 18 to 50

Hundreds of men and women between 18 and 50 make \$10 to \$20 in a single day giving scientific Swedish Massage and Hydro-Therapy treatments. There is big demand from doctors, hospitals, sanatoriums and clubs. Graduates earn large full time incomes from these or in private practice in their own offices. Others make good money from home treatments given in spare time. Learn this interesting, money-making profession in your own home, through our home study course. Same instructors as in our nationally known resident school. You can win independence and prepare for future security by qualifying for your Diploma. Course can be completed in 3 to 4 months. Many earn while they learn. Begin your training at once.



Anatomy Charts & Booklet FREE

Enroll now and we will include, at no extra cost, many needed supplies. Fit yourself to help meet growing demand for Scientific Swedish Massage. Send the coupon at once for complete details. Anatomy Charts and 32-Page Illustrated Booklet, FREE, postpaid.

THE COLLEGE OF SWEDISH MASSAGE
Dept. 764H, 100 East Ohio St., Chicago 11, Illinois
Please send me FREE and postpaid, Anatomy Charts, 32-page Booklet and complete details on Home Training.

Name _____
Address _____
City _____ State _____

STUDY AT HOME

With An Educational Institution

Men with specialized training win higher positions, insure larger earnings, and are bigger successes in business and public life. Opportunities NOW greater than ever before. Send for our Catalog.

ARTS and SCIENCES

Courses in Philosophy; Education; Letters; Public Health; Medical Jurisprudence; Psychology; Sociology; Physics; Chemistry; Plastics; Geology; Political Science; Theology; Business and Commerce; Accounting; Mathematics; Statistics; Agriculture.

ENGINEERING

Courses in Electrical, Civil, Mechanical, Drafting, Architectural, Steam, Aeronautical, Radio, Structural, Mining, Industrial, Petroleum, Marine, Chemical, Diesel, Automobile, Refrigeration, and Air Conditioning Engineering.

LAW

Complete Professional Law Course includes 18 Hornbook Series college grade textbooks. Courses also in Commercial Law, Patent Law and Medical Jurisprudence.
McKinley-Roosevelt Incorporated, 4610-K, Sheridan Rd., Chicago 40, Ill.



You can make a good, comfortable living with poultry. For 26 years our course of Home Study training has been helping thousands. With a little study in spare time—you, too, can obtain the "know how" that means extra profits from the start.

Write today for prospectus describing courses, methods, service.

NATIONAL POULTRY INSTITUTE

Dept. 50 Adams Center, N. Y.



WONDERFUL INVENTION! Corrects poor penmanship in few days—big improvement in 3 hours. No failures. Complete Outline Free. Write, Inventor Oxment, 34, St. Louis, Mo. Immediately.

LAW STUDY AT HOME FOR PERSONAL SUCCESS and LARGER EARNINGS. 38 years expert instruction—over 108,000 students enrolled. LL.B. Degree awarded. All texts furnished. Easy payments. Send for FREE BOOK—"Law and Executive Guidance." **AMERICAN EXTENSION SCHOOL OF LAW** Dept. 79-M, 646 N. Michigan Ave., Chicago 11, Ill.

INDIANA TECHNICAL COLLEGE

Engineering B.S. degree in 27 mos. Aeronautical, Chemical, Civil, Electrical, Mechanical and Radio Engineering. 2-yr. diploma, Air Conditioning and Refrigeration; Drafting, 1-yr. Gov't approved for G.I.'s. Low rate. Earn board. Large industrial center. Demand for graduates. Enter Sept., Dec., March, June. Catalogue, 577 E. Washington Blvd., Ft. Wayne 2, Ind.

SAY YOU SAW IT IN POPULAR MECHANICS



START \$1,756 TO \$3,021 YEAR

MEN—WOMEN
Veterans get special preference. Prepare IMMEDIATELY.
FRANKLIN INSTITUTE
Dept. K85, Rochester 4, N. Y.
Sirs: Rush (1) 32-page book with list of many U. S. Government Big Pay Jobs. (2) Tell me how to prepare for one.

Mail Coupon Today
Name _____
Address _____ Vet? _____

POPULAR MECHANICS

TOMORROW'S LEADERS ARE TRAINING

**NOW IS THE TIME TO GET
READY FOR A KEY JOB OR
BUSINESS OF YOUR OWN**

IN

**REFRIGERATION and
AIR CONDITIONING**

Today

**AMERICA'S FOREMOST
SCHOOL OF
PRACTICAL TRAINING
FOR INDUSTRY**

Here is an industry that offers every opportunity you could ask for. Good jobs—security—plenty of chance for advancement—a business of your own.

And here is a school equipped in every way to train you for Refrigeration and Air Conditioning work—one of the largest and most completely equipped schools of its kind in America—a school that already has trained thousands of men for just such opportunities.

GET READY NOW!

Learn Refrigeration and Air Conditioning—now, while the time is ripe. You don't need any advanced schooling or previous experience. If you are at all mechanically inclined and have gone to high school for at least one year or have an equivalent education, we can teach you Refrigeration and Air Conditioning.

LEARN AT HOME OR COME TO OUR SCHOOL

You can take most of your training at home, in your spare time—or you can come to Chicago and take your entire training in our completely equipped shops and laboratories. Either way you quickly acquire the fine points, practical skill, and broad, technical "know how" that makes the expert Refrigeration and Air Conditioning Technician.

Get all the facts about the opportunities in this interesting field of work, and about the I. T. I. system of training that has helped so many men into key jobs in this industry. Fill out the information coupon below and mail it TODAY. You will be under no obligation whatsoever.

AUTHORIZED TO ACCEPT VETERANS FOR G. I. TRAINING

FACTS ABOUT THE INDUSTRIAL TRAINING INSTITUTE

Founded in 1916. Has trained more than 400,000 men for practical work in industrial fields. From 1942 through 1945 trained specialized technicians, exclusively, for the Army, Navy and Marine Corps. Now training thousands of veterans under the G. I. Bill, both in its Residence Schools and by home-study. Occupies five buildings of its own. Has over \$500,000 invested in training facilities, with an instruction staff of more than 100 men. Known everywhere as America's foremost school of practical training for industry.



**INDUSTRIAL TRAINING
INSTITUTE WILL TRAIN
YOU**

**SEND FOR THIS BIG
FREE BOOK**



REGISTRAR P-1G

INDUSTRIAL TRAINING INSTITUTE

2150 Lawrence Ave. • Chicago, 25, Ill.

Please send me, FREE, your "Camera Visit" booklet and information about the opportunities for trained men in Refrigeration and Air Conditioning. It is understood that I will be under no obligation.

Name.....

Address.....

City..... State.....

Are you a veteran?.....

GET THE FACTS TODAY!

NEW production plans
mean



BIGGER PAY FOR MACHINISTS

Master shop work quickly with these books

This big home-study and reference course gives you the practical facts on machines and methods you need to advance in machine shop work. Take advantage of the other man's experience as found in books, to solve your problems, increase your efficiency, with

The AMERICAN MACHINISTS' LIBRARY

6 volumes—2368 pages—2516 illustrations

(A combined home-study course and reference library)

This library of machine shop practice was written for practical men. It gives you the best methods for every kind of machine shop work. It fully explains lathes, drills, and other machine tools and their operation, automatic screw machines, speeds and feeds, gear design and production, jigs and fixtures, punch and die work, metal surfacing, etc., etc. Plainly written—completely illustrated—the best kind of help to the machine shop man who wants to advance himself.

No money down—special price—easy payments.

EXAMINATION COUPON

McGRAW-HILL BOOK CO., 330 W. 42nd St., N. Y. 18

Send me for ten days' examination the American Machinists' Library. If satisfactory I will send you \$4.00 in 10 days and \$4.00 monthly until the price of \$20.00 is paid. If not wanted, I will return the books postpaid. (To insure prompt shipment write plainly and fill in all lines.)

Name _____
Home Address _____
City and State _____
Company _____
Position _____

PM-7-47

DRAW CARTOONS at HOME!



Learn How! Act NOW! . . . Send only

You'll say it's the best dollar you ever invested! Learn how to draw cartoons in 10 EASY lessons . . . learn where and how to SELL them, rates of pay, how to approach big magazines and syndicates. Many other valuable tips. ALL for one dollar! Act NOW! Address . . . EASY CARTOONS, 4305 Crown St., Indianapolis 8, Ind. **\$1.00**



PHOTOGRAPHY

FOR FUN OR PROFIT

STUDY AT HOME—Photography offers leisure time enjoyment and well-paid, fascinating career. Ever-increasing opportunities! Successful N.Y.I. training qualifies you at home! Also resident courses. Details FREE! NEW YORK INSTITUTE OF PHOTOGRAPHY (37th Year) Dept. 49, 18 West 33 St., New York 1, N. Y.

SHORTHAND in 6 Weeks at Home

Famous Speedwriting system. No signs or symbols uses ABC's. Easy to learn; easy to write and transcribe. Fast preparation for a job. Surprisingly low cost. 100,000 taught by mail. Used in leading offices and Civil Service. Write for free booklet! **SPEDWRITING, Dept. 1507-7, 55 West 42 St., N. Y. 1**

FREE! Do YOU Want to Build Up Your Body . . . Gain Strength . . . Become a Champion Athlete . . . Gain or Lose Weight?



To inspire and help you: We will send FREE a big 12x19 in. poster of "AMERICA'S BEST DEVELOPED ATHLETE", ALAN STEPHAN—officially recognized by Nat'l A.A.U. Also free information on our valuable body-building, training, and health books for boys and men.



Send us your name and address and 20c stamps or coin to cover part of handling and mailing costs! We do the rest! WRITE TODAY to **CROSS COMPANY, Box 389, Dept. A-1, Kenosha, Wisconsin**

STAMMER ?

This new 128-page book, "Stammering, Its Cause and Correction," describes the Bogue Unit Method for scientific correction of stammering and stuttering—successful for 46 years. Benj. N. Bogue, Dept. 7800, Circle Tower, Indianapolis 4, Ind.



Learn Public Speaking

Learn theory and fundamentals at home—spare time. Then acquire actual experience and practice. Send for FREE booklet "Power of Effective Speech."

North American School, Dept. 135B 1315 S. Michigan Ave., Chicago 5, Illinois

Learn LANDSCAPE GARDENING

A thorough, interesting, home study course for those who wish to become LANDSCAPERS, GARDENERS, DESIGNERS, etc., for profit or pleasure. Write today for FREE BOOK to

APPROVED FOR VETERANS NATIONAL LANDSCAPE INSTITUTE Dept. P7, 310 So. Robertson, Los Angeles 3

MAKE MONEY AT HOME

RUBBER MOLDS Low as **6¢ EA.**

Amazing rubber mold-making outfit makes perfect flexible molds of plaques, ash trays, bookends, etc. Molds cost 6c to 25c each. Each mold makes hundreds of novelties and gifts to sell for \$1.00 apiece and more! No experience necessary. Everything furnished. Quick and easy. Start profitable business in your home—sell to stores, gift shops, friends, resorts, road stands, by mail. Full or spare time. Write for complete FREE details and easy instructions.

SO-LO WORKS, Inc., Dept. X-800, Loveland, Ohio



8 BIG BUILDING BOOKS



For EXAMINATION SEND NO MONEY

Learn to draw plans, estimate, be a live-wire builder, do remodeling, take contracting jobs. These 8 practical, profusely illustrated books cover subjects that will help you to get more work and make more money. Architectural design and drawing, estimating, steel square, roof framing, construction, painting and decorating, heating, air-conditioning, concrete forms and many other subjects are included.

BETTER JOBS — BETTER PAY UP-TO-DATE EDITION

The postwar building boom is in full swing and trained men are needed. Big opportunities are always for MEN WHO KNOW HOW. These books supply quick, easily understood training and handy, permanent reference information that helps solve building problems.

These books are the most up-to-date and complete we have ever published on these many subjects.

Coupon Brings Eight Big Books For Examination

AMERICAN TECHNICAL SOCIETY Vocational Publishers since 1898 Dept. GB19 Drexel at 58th Street Chicago 37, Ill.

You may ship me the Up-to-Date edition of your eight big books, "Building, Estimating and Contracting," without any obligation to buy. I will pay the delivery charges only, and if fully satisfied in ten days, I will send you \$2.00, and after that only \$3.00 a month, until the total price of only \$34.80 is paid. I am not obligated in any way unless I keep the books.

Name _____
Address _____
City _____ State _____

Please attach a letter stating your age, occupation, employer's name and address, and name and address of at least one business man as a reference. Men in service, also please give home address.

PRACTICAL TECHNICAL TRAINING



ELECTRICAL ENGINEERING



RADIO AND ELECTRONICS

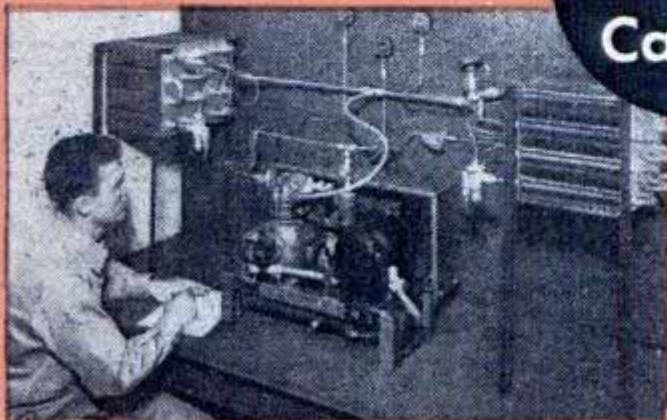

REFRIGERATION & AIR CONDITIONING



GAS AND ARC WELDING

**Choose
Your
Career**

CONCENTRIC CURRICULUM



Our time-tested CONCENTRIC SYSTEM enables you to build your career step by step. Each 6-month course is complete in itself. Stay as long as circumstances permit — until you reach your desired occupational objective.

COURSES

SERVICE . . . 6 Months

Practical Electricity
Practical Welding
Refrigeration Service
Heating Service

TECHNICIAN . . . 1 Year

Electro Technician
Radio Technician
Electronics Technician
Refrigeration, Heating, and
Air Conditioning Technician

PROFESSIONAL . . . 3 Years

Electrical Engineering
Bachelor of Science Degree — Major
in Machinery or Electronics

★ SPECIALIZE in 6 months to 3 years

Of utmost importance to anyone considering a technical school, is that school's history, facilities, faculty, and record of successful alumni. The Milwaukee School of Engineering was founded 44 years ago to train men for specific and substantial careers in industry. More than 35,000 former students in industries the world over attest the school's career-building value through its exceptional facilities in laboratories, class rooms, faculty of 63 specialists, and its comprehensive technical courses. 1292 students now enrolled from 48 states and 8 overseas countries. World-wide alumni counselor committee. Terms start September, January, April. SEND COUPON TODAY!

MILWAUKEE
SCHOOL of ENGINEERING
A Technical Institute

Milwaukee School of Engineering, Dept. PM-747
N. Broadway and E. State, Milwaukee, Wis.

Without obligation, send me free booklet "Career Building" and more details on course in.....

Name Age

Address

City State

ELECTRICIANS

Get this Great Book

FREE

Book of 150 Shop Prints, Wiring Diagrams, Full Size 8 1/2" x 11"



For Merely Examining
Coyne's NEW Pay Raising

7 Volume Set APPLIED ELECTRICITY

Here's a brand new set of electrical books to give you the "know how" on all branches of electricity from appliance repairing to D. C. and A. C. equipment, electrical refrigeration, etc. 8,000 subjects, 10,000 facts, latest methods all explained in easy to follow instructions. In order to prove how valuable and Practical this set of electrical books is I'm willing to give you a FREE copy of my book "150 Shop Prints and How to Read Them" just for looking over this set. Written by the Coyne Technical Staff and backed by 47 years' experience, this set has helped many ambitious electrical workers to bigger pay, better jobs & added opportunity.

OFFER LIMITED - ACT NOW! Here's my offer to you - if you act promptly, I'll send you the 7 volume set Applied Practical Electricity for 7 days FREE examination... together with the 150 Shop Print Book. Look the set over 7 days. If you like it send either \$19.75 cash or send \$3.00 after 7 days and \$3.00 per month until \$21 is paid. If you don't want the set, return it and YOU OWE NOTHING. In either event, however, you keep the 150 Shop Print Book absolutely FREE.

SEND NO MONEY! Coupon below is just a request to see the books free and to get my gift book for doing it. ACT - Send coupon Today!

FREE BOOK COUPON

Technical Book Div., COYNE ELECTRICAL SCHOOL, 500 S. Paulina Street, Dept. B7-R6, Chicago 12, Ill.



S. W. Cooke Director

COYNE ELECTRICAL SCHOOL, Dept. B7-R6
500 SOUTH PAULINA STREET, CHICAGO 12, ILLINOIS

Send me that 7 volume set APPLIED PRACTICAL ELECTRICITY and your FREE gift of a copy of "150 Shop Prints and How to Read Them". I'll either return the set in 7 days and owe nothing or send you either \$3 in 7 days and \$3 a month until \$21 is paid or \$19.75 cash. Regardless of whether or not I keep the 7 Volume Set the 150 Shop Prints is mine FREE as a Gift.

NAME _____ AGE _____
ADDRESS _____
TOWN _____ ZONE _____ STATE _____

VETERANS Learn WATCHMAKING

A Lifetime Profession

Regardless of Conditions, Age, Sex, or Physical Limitations
Veterans—Civilians!
Your Opportunity—
LEARN WATCHMAKING



Approved G. I. Training

Lift yourself from a futureless job into a position paying better than your present work. Fit yourself for the job that will permit you to establish your own shop, or be employed in a pleasant environment.

Watch Repairing—Jewelry—Engraving will always be in ever greater demand. Our graduates wanted everywhere. Dignified positions \$50-\$75-\$100 per week. Veterans write today for latest FREE enrollment requirements.

Kansas City School of Watchmaking
Largest Horological School in America
617-621 Wyandotte St. Kansas City 6, Mo.

Learn to MOUNT BIRDS



Tan SKINS, make up FUR

Be a Taxidermist. Double your hunting fun. teach you at Home. Mount Birds, Animals, Fish, Heads, common specimens. Fun and profits. Decorate home and **make MONEY**. Mount game, taxidermy. Big profits in spare time. **WRITE TODAY!** 100 game pictures in FREE BOOK. Hunters, get your copy. It's Now Free. Send post card. State your Address. NORTHWESTERN SCHOOL OF TAXIDERMISTS, Dept. 3378, Omaha, Nebraska

FREE BOOK

RADIO 10¢ BOOKS

Get Started in Radi

TEN "HOW-TO-DO-IT" BOOKS
Get a solid foundation in radio by means of 10 timely text books. Each clearly written, fully illustrated, contains over 15,000 words. You'll be amazed at the wealth of information packed into these handy books. Excellent reference—ideal for technical library. Money back if not satisfied.

5 Books for 50¢ -- 10 Books for \$1.00
SENT TO YOU POSTPAID
We cannot send less than 5 books

- No. 1—How To Make Four Doerle Short Wave Sets
- No. 2—How to Make The Most Popular All-Wave 1 and 2 Tube Receivers
- No. 3—Alternating Current for Beginners
- No. 4—All About Aerials
- No. 5—Beginners' Radio Dictionary
- No. 6—How To Have Fun With Radio
- No. 7—How To Read Radio Diagrams
- No. 8—Radio for Beginners
- No. 9—Simple Electrical Experiments
- No. 10—Television

Remit by check or money order—register letter if you send cash or stamps.
RADIO PUBLICATIONS, 23-U West Broadway, New York

Learn PLASTICS

Study at home or at school in Los Angeles or New York
Approved for Veterans — Available for non-veterans.

America's Oldest and Largest

PLASTICS INSTITUTE

1601 S. Western Dept. PM7-7 Los Angeles 6, Ca

LEARN MOVIE PROJECTION THEATRE MANAGEMENT

The Motion Picture Theatre Business offers big opportunities for trained men. Get into a fascinating field with a post-war future. Train at home in spare time. Free Catalog. Established 18 years.

THEATRE INSTITUTE, 370 Washington St., Elmira, New York

THERE'S MONEY IN CARTOONS

RAYE BURNS will teach you HOW to CREATE ORIGINAL CARTOONS at home that you may SELL! Course contains 26 lessons and over 600 illustrations. All for Only... **\$28**

Send name and address for free details.
RAYE BURNS SCHOOL, Dept. M, Box 3583, CLEVELAND, OH



FREE! Large folder on valuable BODY-BUILDING TRAINING, HEALTH, and STRENGTH books for boys and men. Also free an inspiring picture of well-developed athlete (Wallet-size, 3 1/2 x 5 1/2). **FREE! Photograph.** Send us your name and address and 10¢ stamps or coin to cover mailing cost. Write Today to **CROSS COMPANY, Box 389, Dept. V-1, Kenosha, W.**



There's MONEY in MAGIC

Entertain For Profit or Fun! Earn money doing magic parties, clubs, hotels, etc. Rush 25¢ for "MAGIC IS FUN" magazine. Teaches HOW to be a magician. FREE, with order, large catalog of magic apparatus.
D. Robbins & Co., Dept. M-101, 152 W. 42 St., N.Y. 18, N.Y.

Store Route Plan PAYS BIG MONEY

SELL COUNTER CARD PRODUCTS
Build a good-paying business of your own! Call on dealers of all kinds; show nationally-advertised Aspirin, Vitamins, Cosmetics and 200 other necessities. Big 5¢ and 10¢ retail packages, high quality. Attractive counter displays sell goods fast. Free book gives amazing facts. Write!
World's Products Co., Dept. 18-R, Spencer, Ind.





Now ANY AUTO REPAIR JOB Can Be "Duck Soup" For You!

**MoToR's New AUTO REPAIR MANUAL
Shows You How to Service and Repair
ANY Part of ANY Car!**

**FREE 7-DAY
OFFER!**



NOW you can "polish off" the HARDEST jobs the EASIEST way! MoToR's AUTO REPAIR MANUAL is ready to show you how to repair anything from carburetor to rear end—with the least possible amount of time and effort!

Suppose plain-talking car engineers from every auto plant in America got together and showed you all the things you needed to know about repairing and servicing the cars they had designed and manufactured! That's really what you get in this big manual! Right at your fingertips, the main "dope"

from 150 Official Factory Shop Manuals, covering every make car built since 1935!

Easy to use, too! Quick-index leads you to right page in jiffy! Just follow simple instructions step-by-step.

SEE HOW MUCH YOU GET!

856 pages, 8½x11 inches, bound in sturdy covers. 200,000 service, repair, adjustment, replacement, tune-up facts on all makes and models, 1935 through 1946. More than 1000 cut-away photos, diagrams, drawings show you exactly WHAT to do and HOW to do it. Used by U. S. Army, trade and technical schools everywhere, thousands of auto servicemen.

Now YOU—without cost—can see for yourself what a wonderbook MoToR's Auto Repair Manual really is. TRY it—FREE for 7 days! Learn first-hand how it can pay for itself the first few times you use it.

SEND NO MONEY 7-Day Free Examination

Just mail coupon at right, without money! When the postman brings your book, pay him nothing. First make it show you what it's got! Unless you agree this is the greatest time-saver and work-saver you've ever seen—return book in 7 days and pay nothing. Mail coupon today! Address: MoToR Book Dept., Desk 1H, 572 Madison Ave., New York 22, N. Y.

Published by MoToR, The Leading Automotive Business Magazine. MoToR's manuals assure high standards of repair work.

**Covers
All These
Makes!**

American
Bantam
Auburn
Austin
Buick
Cadillac
Chevrolet
Chrysler
Cord
Crosley
De Soto
Dodge
Ford
Graham
Hudson
Hupmobile
Lafayette
La Salle

Lincoln
Lincoln
Zephyr
Mercury
Nash
Overland
Oldsmobile
Packard
Pierce
Arrow
Plymouth
Pontiac
Reo
Studebaker
Terraplane
Willys

Clear, Pictured Facts on Every Job on Every Car Built Since 1935!

Nearly 200,000 service and repair facts on all 31 makes. 856 big pages; including 50 pages of carburetor text, charts, illustrations, covering all models. Over 500 charts, tables; Tune-up Chart; Valve Measurements; Compression Pressure; Torque Wrench Reading; Starting Motor; Engine Clearances; Generator; Clutch & Brake Specifications; Front End Measurements, etc.; Engines; Electric; Fuel, Cooling, Lubricating Systems; Transmissions; Universals; Front Ends; Wheels; Rear Ends, etc.

Same FREE 7-Day Offer Applies on MoToR's TRUCK REPAIR MANUAL

For mechanics, truck specialists, service stations, fleet owners. Covers EVERY job on EVERY truck made since 1936! 1400 pictures, 952 pages, 300,000 facts. Used by Armed Forces. All types Gasoline Engines, Diesels, Hesselman. Fuel Systems, Governors, Lubrication Systems, Ignition Systems, Starters, Generators, Clutches, Transmissions, Axles, Torque Dividers, Transfer Cases, Brakes, Steering, etc. ALSO SERVICES buses, farm and industrial tractors, contractor and road building equipment, stationary power machinery, etc. (on all parts described in Manual.) Check box in coupon at right.



MAIL COUPON NOW FOR 7-DAY FREE TRIAL

MoToR Book Dept., Desk 1H, 572 Madison Ave., New York 22, N. Y.

Rush to me at once: (check box opposite book you want).

- MoToR's AUTO REPAIR MANUAL. If O.K. I will remit \$1 in 7 days. (plus 35c delivery charge), then \$2 monthly for 2 months with a final payment of 95c one month later. (Book's price \$5.95.) Otherwise I will return book postpaid in 7 days. (Foreign price, remit \$8 cash with order.)
- MoToR's TRUCK REPAIR MANUAL. (Described at left.) If O.K., I will remit \$2 in 7 days, and \$2 monthly for 3 months, plus 35c delivery charges with final payment (\$8.35 in all). Otherwise I will return book postpaid in 7 days. (Foreign price, remit \$10 cash with order.)

Print Name.....Age.....

Print Address.....

City.....Zone No.State.....

(if any)

Occupation.....

SAVE 35c! Check here if enclosing full payt. (check, m.o., postal note) WITH coupon. We pay 35c shipping cost.

Same 7-day return-refund privilege.

MAKE GOOD IN
RADIO
TELEVISION
ELECTRONICS

APPROVED FOR VETERANS

LEARN FROM MEN CLOSEST TO RADIO-TELEVISION INDUSTRY!
 Direct from Hollywood, center of America's Broadcasting, Television, Radio, Sound activities comes easy-to-learn, advanced home-instruction that quickly qualifies you for **Steady, Good-Pay Jobs** or business in Radio, Television, Electronics.

GET RADIO SHOP KNOW HOW

Radio Training Association of America's (R.T.A.) **Professional Methods** assure quick step-by-step success. R.T.A. is located right "on-the-spot" where new technical developments are introduced. You receive finest shop-type instruction in latest Radio-Television techniques. Every R.T.A. student **Gets Unlimited Consultation** from Hollywood on any subject pertaining to studies.

EXTRA MONEY WHILE LEARNING

When you enroll with R.T.A. you get **SPARE TIME JOB SHEETS** showing how

to earn extra money while being trained by R.T.A.'s **Hollywood Experts**. When friends, neighbors know you are studying radio, ample repair jobs are practically assured for you.

GET FACTS—Send for FREE Book

telling about R.T.A.'s streamlined training plan developed by veteran technicians in Hollywood, heart of vast Radio-Television field. Mail coupon today. **Send for Free Illustrated Book** showing newest Radio-Television pictures. No obligation, **Approved for Veterans**. Send for big free book now!



RADIO TRAINING ASSOCIATION OF AMERICA

RADIO TRAINING ASSOC. OF AMERICA, DEPT. PM7
 5620 Hollywood Blvd., Hollywood 28, Calif.

Send FREE BOOK showing how to make good in Radio-Television through training by Hollywood experts.

NAME _____ AGE _____
 ADDRESS _____
 CITY _____ ZONE _____ STATE _____

Check box if **VETERAN of World War II**

5620 HOLLYWOOD BLVD. HOLLYWOOD 28, CALIF.

JUST OUT! NEW FROM COVER TO COVER

AUDELS
REFRIGERATION
and AIR CONDITIONING GUIDE



4 Books in One! Covering:
 Basic principles, Servicing, Operation, Repair of
 1—Household Refrigeration
 2—Special Refrigeration Units
 3—Commercial & Industrial Refrigeration
 4—Air Conditioning Systems
 A gold mine of essential important facts for **ENGINEERS, SERVICEMEN & USERS**.

A Good Book is a Good Friend! Here you have at your fingers' ends a Complete Library in **ONE VOLUME**, the necessary data you have been looking for on: **MODERN UNITS, SYSTEMS & MACHINES, REFRIGERANTS**, including Freon, Lockers, Water Coolers, Quick Freezing & Air Conditioning Systems. 1280 Pages, 46 chapters all Fully Illustrated & indexed for Ready Reference.

ANSWERS YOUR QUESTIONS
 Get This Information for Yourself. Mail Coupon Today. No Obligation Unless Satisfied. **ASK TO SEE IT.**

\$4 COMPLETE • PAY ONLY \$1. A MONTH ←

AUDEL, Publishers, 49 W. 23rd St., New York 10, N.Y.

MAIL AUDELS NEW REFRIGERATION GUIDE for free examination. If O. K. I will send you \$1 in 7 days; then remit \$1 monthly until price of \$4 is paid. Otherwise I will return it.

Name _____
 Address _____
 Occupation _____
 Employed by _____ PM

AVIATION

Aeronautical University Approved Training meets exacting standards of aviation industry, prepares for key positions, big opportunities.

Courses in:
AERONAUTICAL ENGINEERING. B.S. degree.
AERONAUTICAL ENGINEERING DRAFTING
CERTIFIED ENGINE MECHANICS
ADMINISTRATION—including sales
PRE-ENGINEERING: Special course for high school graduates and veterans deficient in math and science.

Also refresher courses for Gov't Airplane and Engine Mechanics Licenses for those with aviation experience.

Oldest fully approved aviation school. Outstanding faculty, modern equipment, outside employment, placement service. Day, evening. Approved for Veterans. Send today for **FREE** catalog "Opportunities in Aviation."

FOUNDED BY CURTISS-WRIGHT

AERONAUTICAL UNIVERSITY
 Dept. 77, 116 S. Michigan Ave., Chicago 3, Ill.

Be A MASTER PLUMBER

Earn \$15 To \$50 A Day

DON'T ENVY THE PLUMBER — BE ONE

Every skilled workman will tell you that Plumbers have the best of **WINTER** and **SUMMER** the Plumber is busy at top wages. No skill Plumber is ever out of a job—compare his opportunities with a trade, plus the opportunities of having your own shop.

We teach you Plumbing with **TOOLS** (not books) under License **Master PLUMBERS** in one of the finest equipped schools in America. You make you a Plumber, every branch is taught thoroughly—Lead Work Blueprint for plan reading—all other tricks.

LEARN IN 30 WEEKS WITHOUT PREVIOUS EXPERIENCE

If you like to work with tools you owe it to yourself to investigate. No need to ever work as an apprentice. Get free bulletin. Write now. **G.I. APPROVED.** Our 24th year.

UNIVERSAL PLUMBING SCHOOL
 815 HOLMES STREET KANSAS CITY, MO

LEARN WATCH REPAIRING

AT HOME. By our modern and original system of instruction you can learn every part of the **WATCH REPAIRING TRADE AT HOME.** Prepare yourself for a well-paid position or start in business after completing our course of instruction. Good watch repairers are in demand and generally earn very good salaries. For particulars apply to **Wisconsin School of Watch Repairing** 759 North Milwaukee St., Milwaukee 2, WI

INVENTING

—FOR If you have an inventive turn of mind write for free 28-page booklet explaining **PROFIT!** how the Institute of American Inventors is helping inventors pre-test the possibilities of proposed devices to fill today's unprecedented demand for useful new inventions.

INSTITUTE of AMERICAN INVENTORS
 Dept. 4, 1926 Eye St., NW, Washington 6, D. C.

ANALYZE HANDWRITING

Qualify for Certified Grapho Analyst Degree at home, spare time. Credit, Employment, Personnel Managers, Business, Professional men, women use **grapho-analysis in their work, earn substantial fees in spare time.** Many study solely for personal benefit, no desire to earn money, find it so fascinating they start using it to add to their incomes. Entertainment field pays well, up to \$100 in a week reported. Others establishing profitable practices as Vocational and Family Problem Counselors, Personality Teachers, and lecturers.

FREE

GROWING—UNCROWDED PROFESSION

More and more police use grapho analysis handling suspect and criminals. They understand how criminals think. The handwriting tells. Men like Hugh Dunlap, university student, Ha Allen, retired preacher, use it in court, win cases, ea fees even before graduation. **Only school in world devoted to teaching grapho analysis** offers thorough training to earnest, ambitious men and women regardless of where you live, small town, farm or city. Set for **GRAPHO ANALYST**, illustrated lesson, person handwriting analysis offer, **ALL FREE.** Must be 21 or over. Address **A. I. G. A. Inc., 120, Noel, Missouri**

WHICH OF THESE *Opportunities* INTERESTS *You* MOST?

● Today, choose the job you want—and prepare for it. Or if you are already engaged in the work you like best, start training now for quicker promotion. Acquire the knowledge that will help you to get ahead faster, make more money and have greater security.

American School, founded in 1897 as an educational institution *not for profit*, can help you to reach your goal just as it has helped others during the past fifty years. Check the coupon at right, add your name and address and mail it at once. The school will send you details on its training plan and outline of study prepared by specialists. There is no charge, no obligation, so send the coupon immediately.

CHECK, CLIP AND MAIL COUPON NOW

AMERICAN SCHOOL, Dept. GB45, Drexel at 58th, Chicago 37, Ill.
Without obligation, Please send FREE and postpaid, bulletin and details of the Subject checked.

- | | | |
|--|---|--|
| <input type="checkbox"/> PLASTICS ENGR | <input type="checkbox"/> Accounting | <input type="checkbox"/> Drafting and Design for Men and Women |
| <input type="checkbox"/> Refrigeration | <input type="checkbox"/> Electrical Engr. | <input type="checkbox"/> Radio |
| <input type="checkbox"/> Architecture and Building | <input type="checkbox"/> Electricity—Pract. | <input type="checkbox"/> High School |
| <input type="checkbox"/> Contracting | <input type="checkbox"/> Electronics, Industrial | <input type="checkbox"/> Air Conditioning |
| <input type="checkbox"/> Practical Plumbing | <input type="checkbox"/> Bookkeeping | <input type="checkbox"/> Mechanical Eng. |
| <input type="checkbox"/> Automotive Engr. | <input type="checkbox"/> Private Secretary | <input type="checkbox"/> Shop Management |
| <input type="checkbox"/> Aviation Drafting | <input type="checkbox"/> Diesel Engineering | <input type="checkbox"/> Tool Making |
| <input type="checkbox"/> Aviation | <input type="checkbox"/> Sheet Metal Pattern Drafting | <input type="checkbox"/> Better Foremanship |
| <input type="checkbox"/> Business Mngmt. | | <input type="checkbox"/> Machine Shop Operations |
| <input type="checkbox"/> Railway Training | | |

NAME _____ OCCUPATION _____
ADDRESS _____ AGE _____
CITY _____ STATE _____

AMERICAN SCHOOL

Dept. GB45, Drexel at 58th Street, Chicago 37



Bar Bells

...at Factory Prices

WRITE FOR FREE BOOKLET
AND PRICE LIST

\$8.95
up

INDEPENDENT IRON WORKS
2416 East 23rd Street, Dept. P5
Los Angeles 11, Calif.

Get this New **RADIO RULE!**



Needed by all radio engineers, students, draftsmen and technicians. This accurate 6 inch symbol rule saves you time and money. Sent immediately upon receipt of \$1.00.

COLETTE PRODUCTS CO.
413A FOX BLDG.
DETROIT 1, MICH.

SAY YOU SAW IT IN POPULAR MECHANICS

INDIANAPOLIS "500" RACE HISTORY BOOK

352 pages, 1100 illustrations. Covers every race since 1900. Postpaid \$3.50; cloth-bound \$5.00. 32-page book on 1946 race only, \$1.00. Book on 1947 race (ready in July) \$1.00. CLYMER, Dept. A-7, 2125 W. Pico, Los Angeles 6, Calif.

GET THE BEST IN MUFFLERS V-8 DUALS & SINGLES



Finest Norman custom-built muffler sets—steel pack—torpedo type—heavy, perforated steel cores—chrome enamel finish—mellow, deep tone (improves with use)—designed to fit—all ways superior—double economy.

DUALS.....\$17.50 SINGLES.....\$7.50

V-8 Ford-Mercury Buick, Olds., Chrys.

SINGLES.....\$5.50 ORDER TODAY! Will outlast three ordinary mufflers.

Chev., Ford, Plym.

Dealers—Write Today for Full Details

NORMAN'S MUSICAL MUFFLERS

Dept. PM-5, 1216 W. Slauson Ave., Los Angeles 44, Calif.

GOLD TEETH WANTED

Dental gold teeth, plates and bridges with metal attached. Any broken pieces of gold jewelry. Immediate payment and free mailing container to you or your friends upon request.

LOWES, DEPT PM

Holland Bldg., St. Louis 1, Mo.

DRAW for MONEY... Be an ARTIST!

Trained Artists are Capable of Earning
\$50 — \$60 — \$75 OR MORE A WEEK!

You can learn to draw at home in your spare time the well-known WSA way. COMMERCIAL ART, DESIGNING, CARTOONING—all in ONE complete course. No previous art experience necessary—we teach you step-by-step. Prepare now for a fascinating hobby or profitable career. For 33 years WSA graduates have been making good—WHY NOT YOU?

Veterans!
WSA is approved for training under the G. I. Bill

Write today for FREE BOOK, "Art for Pleasure & Profit," it fully describes our up to date course, instruction service, and commercial opportunities for you. TWO ART OUTFITS and other features included with training.

WASHINGTON SCHOOL OF ART, Studio 127H
1118—15th St., N.W., Washington 5, D. C.

Please send me full information and your Free Book, "Art for Pleasure and Profit."

Name..... AGE.....

Street.....

City..... Zone..... State.....

I am entitled to training under the G. I. Bill.

NOW!
ALL 5 FAMOUS JOWETT COURSES—1 COMPLETE MUSCLE BUILDING **VOLUME!**
 FOR ONLY **25¢**
 AND MY PHOTO BOOK OF FAMOUS STRONG MEN **FREE!**

LET ME PROVE I can make YOU

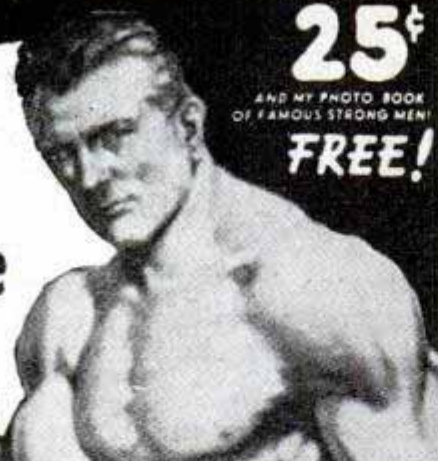

COMMANDO-TOUGH
OR IT WON'T COST YOU A CENT!

by: *George F. Jowett* WORLD'S GREATEST BODY BUILDER

GIVE ME 10 MINUTES A DAY
LEARN MY TIME TESTED SECRETS OF STRENGTH

I'll teach you the "Progressive Power Method" through which I rebuilt myself from a physical wreck the doctors condemned to die at 15, to the holder of more strength records than any other living athlete or teacher! "Progressive Power" has proven its ability to build the strongest, handsomest men in the world. And I stand ready to show you on a money back basis — that no matter how flabby or puny you are I can do the same for you right in your own home. Let me prove I can add inches to your arms, broaden your shoulders, give you a man-sized chest, powerful legs and a Rock-like back—in fact, power pack your whole body so quickly it will amaze you! Through my proven secrets I bring to life new power in you inside and out, until YOU are fully satisfied you are the man you want to be.

PROVE IT TO YOURSELF IN ONE NIGHT
 Send only 25c for my 5 easy-to-follow, picture-packed courses now in 1 complete volume "How to Become a Muscular He-Man." Try it for one night! Experience the thrilling strength that surges through your muscles.

10 DAY TRIAL!
 Think of it—all five of these famous courses now in one picture-packed volume for only 25c. If you're not delighted with this famous muscle-building guide—if you don't actually FEEL results within ONE WEEK, send it back and your money will be promptly refunded!

Photo Book Of Famous Strong Men!

I am making a drive for thousands of new friends fast—REGARD-LESS OF COST!

SO GET NOW MY 5 Muscle Building COURSES
 (Valued at \$5 each)

All in 1 Great Complete Volume Packed With How-To-Do-It Pictures!

Now, this "get-acquainted," extremely low price of only 25c is your chance to build a body you'll be proud of! Follow Jowett's easy method of muscle building NOW!

For Only 25c

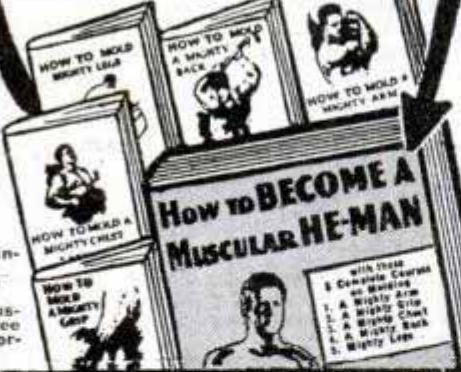

FREE!

Photos that inspire you to might and muscle. Free with order.

FREE GIFT COUPON!

Jowett Institute of Physical Culture
 230 Fifth Avenue, New York 1, N. Y. Dept. PM-77

George F. Jowett:—Please send by return mail, pre-paid, **FREE** Jowett's Photo Book of Strong Men, along with all 5 Muscle Building Courses. 1. Molding a Mighty Chest. 2. Molding a Mighty Arm. 3. Molding a Mighty Grip. 4. Molding a Mighty Back. 5. Molding Mighty Legs—Now all in One Volume "How to Become a Muscular He-Man." Enclosed find 25c. NO C.O.D.'S.

George F. Jowett
 Champion of Champions

NAME _____ AGE _____
 (Please Print Plainly, Include Zone Number)

ADDRESS _____

"The Pickpocket"



Laugh packed short comedy feature. Ben pulls series of insane "hi-jinks" as a professional pickpocket. Captured, escapes and re-captured.

16mm. Kodachrome With Sound..... **\$17.50**
 16mm. Black and White With Sound..... **\$7.50**

At your dealers or direct. Send check with order to—
HOLLYWOOD FILM ENTERPRISES, Inc.
 6060 Sunset Blvd., Dept. 115 Hollywood 28, Calif.

Learn to Service and Repair ELECTRICAL APPLIANCES

Open your own electrical appliance service shop. Complete illustrated course covering washing machines, vacuum cleaners, elec. ranges, motors, fluorescent lights, house wiring, etc. Send today for **FREE BOOKLET** without obligation.

PACIFIC TRAINING SCHOOL
 7217 So. Broadway, Dept. P-107, Los Angeles 3, Calif.

Why spend years learning by hard experience what you can get from a practical book in a few hours.

Write for list of "How-To-Do-It" books on practical subjects. 1000's of pleased customers all over the world.

ADAMS BROWN COMPANY—BOOKS OF APPLIED SCIENCE
 Dept. 177 Chestnut Hill 67, Massachusetts, U. S. A.

BUILDING

Millions of homes needed. Nation wide call for builders. Big opportunities. Learn now in spare time. — at home. Practical training with blue prints. No books. Send for **FREE Trial Lesson** and blue print plans.

CHICAGO TECHNICAL COLLEGE
 H-151 Tech. Bldg., 2000 S. Mich. Ave. Chicago 16, Ill.

Learn PHOTOGRAPHY at Home

Splendid opportunities. Prepare in spare time. Practical basic training. Long-established school. Send for free book, "Opportunities in Photography." No obligation.

American School of Photography, 1315 S. Michigan Ave., Dept. 135B, Chicago 5, Ill.

STAMP COLLECTION FOR SALE!

Worldwide Collection of 1000 Different Postage Stamps and 1000 Hinges—Only \$2.

Bargain List FREE!

NEPTUNE STAMP CO. DEPT. C-2 NEPTUNE, NEW JERSEY

Learn to Write

Begin today. Write now for our Free Book, "How to Become a Good Penman." It contains specimens and tells how others learned to write in spare time. Enclose 10c for your name beautifully written and a pen point suitable for shaded writing. Write today.

THE TAMBLYN SCHOOL OF PENMANSHIP
 N-441 Ridge Building, Kansas City, Mo.

AN ASTONISHING MEMORY

Wonderful new memorizing tricks. Pass examinations, give shows, make stunning public speeches, remember anything. Your success in life depends on your memory..... only \$1

CARILLON BOOKS, Dept. 10, 3439 S. Michigan Ave. Chicago 16, Ill.

Raise GOLDEN HAMSTERS

The new wonder animals. Look like toy bears. Delightful pets. Everybody wants them. Thousands needed by laboratories. Make money, get started now. Send 10c for illustrated literature, or send \$5 for a pair of hamsters and literature.

GULF HAMSTERY, 1536 BASIL ST., MOBILE 17, ALA.

GET INTO RADIO

TELEVISION ELECTRONICS NOW!

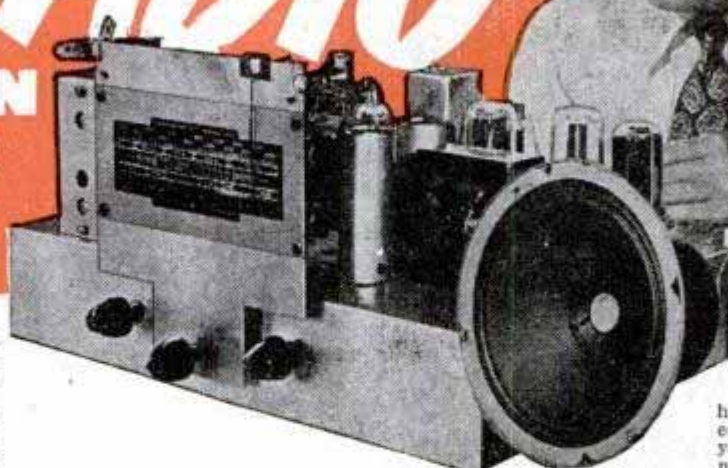

You build this complete, modern super-heterodyne receiver with the equipment that comes with your National Training at no cost.

This practical shop instruction system gives you actual experience with a Home Radio Laboratory—part of the

SHOP METHOD HOME TRAINING

from one of the world's Oldest and Largest Technical Trade Schools

FOR YOU—A REAL HOME LABORATORY IN MODERN RADIO



Your National Training Kits include equipment for over a hundred practical electronic experiments in your own home. You

get standard radio parts for this audio oscillator which you get to understand by building it yourself.

You learn modulation, beat frequencies, signal generation by a actually building this small radio transmitter with your National shop parts.

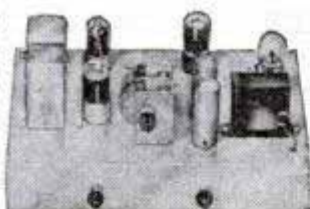

Your training outfits from National are made up of the most modern radio equipment—much of it just out of the experimental laboratory. You learn new ways of handling equipment by modern methods.



Get the details by mailing the coupon.

Send the coupon below immediately. Learn how this improved practical training can fit you for the GREAT BUSINESS OF RADIO—for the NEW AND RAPIDLY EXPANDING FIELD OF FREQUENCY MODULATION (F.M.), TELEVISION AND ELECTRONICS.

This is the thoroughly proved method used so extensively in wartime training—endorsed by the success of National men everywhere—a system by which you study in spare time—off hours, even minutes right in your home and yet have the ADVANTAGE OF REAL SHOP EXPERIENCE behind you.

Trained Radio Men Wanted

The man who really knows modern Radio is in greater demand today than ever before—not only in Radio proper but in Television and Electronics—in Aviation, Transportation, Manufacturing, Communications. Good jobs

await the trained man, in the production, operation and maintenance of modern electronic equipment—in radio stations, in hundreds of industries—in homes, theatres and studios. Good sound training in this important field is absolutely necessary. And now, National Schools brings such training to you no matter where you live or what you may be doing—not only the fundamental theory but the actual experience that comes with knowing shop practice and working with real equipment—demonstrating each step with first-hand knowledge. This is true "learning by doing"—direct from the great shops and laboratories of National Schools where new developments in methods, equipment and applications are constantly going forward.

National offers you such practical training and National has the facilities. Sample this training yourself. MAIL THE COUPON FOR A FREE LESSON.

SUCCESS and SECURITY FOR YOU

Radio is a Well-Established Business, Television and allied fields are just on the threshold of limitless expansion. Would you like to profit from these developments? An excellent job or perhaps into a business of your own? Answer these questions by reading the catalog sent you FREE from National Schools. Get the facts.

Check the Job You Now Have With These Opportunities in RADIO

1. Financial Security Radio has grown from \$100 million to \$5 billion in past few years.
2. Limitless Future predicted by over 1,800 manufacturers of equipment.
3. Television promises unrealized opportunity.
4. Electronics opens wide new fields in home and industrial use.
5. Your Own Business with little capital.

Get the details. Use the coupon!

FREE GET THESE 2 BIG BOOKS



NATIONAL SCHOOLS

LOS ANGELES 37, CALIFORNIA EST. 1905



MAIL OPPORTUNITY COUPON FOR QUICK ACTION

National Schools, Dept. 7-PM
4000 South Figueroa Street
Los Angeles 37, California

(Mail in envelope or paste on penny post card)

Mail me FREE the books mentioned in your ad including a sample lesson of your course. I understand no salesman will call on me.

NAME..... AGE.....

ADDRESS.....

CITY..... ZONE..... STATE.....

Check here if veteran of World War II

NATIONAL TRAINING WINS BIG JOBS

You, too, can share the success of National graduates. Clifford Hannah, Portage La Prairie, Manitoba, Canada, writes: "My training has brought results as I'm in line for another raise, thanks to National's encouragement and thorough training. You can count on me as a real National booster and I am glad I used such good judgment in getting into a live and growing field."

While still a student of National training, I. Wilson of Vallejo, California, writes: "My pay has jumped from \$52.18 a week to \$72.65, and the end is not in sight. I am proud of my National Course."

VETERANS

If you qualify for training under G.I. Bill, check the coupon for a Special Bulletin.

\$2000

of Old Line Legal Reserve LIFE INSURANCE

(at age 21) \$ **178** A MONTH*
ONLY — Other ages in proportion

*One Half Permanent Rate in effect 5th year

Buy as little as \$1500. of this solid protection—or more—at proportionately low rates. *But buy your Postal Policy now!*

Postal Life of New York has specialized for 40 years in insurance by mail and over the counter. The savings due to this direct dealing are passed on to policy holders. Current dividends 9½%. Further savings are made if premiums are paid quarterly, semi-annually or annually.

POSTAL LIFE OF NEW YORK

operates under the rigid New York State Insurance Laws and has paid out over

\$60,000,000.00

to its Policy Holders and Beneficiaries.

Postal issues all Standard Policies to men or women, from ages 10-60, at low cost.

Send coupon today for rates on this Modified "4" Policy at your age and other details. *Life Insurance is vital!*

CLIP AND MAIL COUPON TODAY

POSTAL LIFE INSURANCE COMPANY

511 Fifth Ave., Dept. M-714
New York 17, N. Y.

Mail me without obligation complete information about your low-cost Modified "4" Policy at my age.

Name

Date of Birth

Occupation

Address

(Street and No., Zone, City and State)

NO OTHER LIKE IT

OTTAWA
Self-Propelled
BUZZ
MASTER



7-H-P
MOTOR

The land-clearing and all-round machine you have been waiting for. Furnished with post hole digger and sickle bar attachments if desired. Eliminates the hard work of clearing land and making fence. Propels itself anywhere—up hill and down. Two speeds for sawing and road travel. Powerful 7 H-P motor. Use engine for many belt jobs when not sawing. Plenty of opportunity for profitable custom work. Costs too little to do without. Other power attachments available soon. Patents pending on exclusive OTTAWA features. Low factory-to-user prices. Send for Free details.

OTTAWA MFG. CO., 1-727 WALNUT ST., OTTAWA, KANSAS

LEARN WATCH REPAIRING

IN YOUR OWN HOME!

THERE'S BIG MONEY and a secure future for YOU in watch repairing even if you're just a beginner. Get PRACTICAL SELF-TRAINING through our "MODERN WATCH REPAIRING & ADJUSTMENT." This new and complete book is easy to understand. Every step in repairs, adjustment, construction, Theory, operation. Covers all needed tools and their \$2.50 Post use. Fully illustrated. Only..... MONEY BACK GUARANTEE (if C.O.D., plus charges.)

WE SUPPLY ALL TOOLS, MATERIALS AND PARTS AT LOWEST COST—PROMPT DELIVERY!

NEW, all inclusive tool catalog. Over 450 illustrations. SEND 25c. FREE with above book. Complete sets for STUDENTS and WATCHMAKERS.

MODERN TECHNICAL BOOK & TOOL CO.
Dept. MMC, 55 W. 42nd Street, New York 18, N. Y.
ALL Books on Jewelry, Metalcraft, Handicraft, Etc.

MAKE MONEY CASTING AT HOME

FREE FACTS SENT



Cast thousands of perfect Plaques, Book Ends, Ash Trays, Etc. Plaster, Liquid Marble, Etc. ENORMOUS PROFITS. Start in basement or garage. LITTLE CAPITAL NEEDED. QUICK, EASY, NO PREVIOUS EXPERIENCE NEEDED. Rubber molds for speed production. MAKE YOUR OWN. Sample Kit \$1.00. Canadian \$1.50. Plastic Arts Studio, Route 5, Dept. 29, Muncie, Ind.

EASY WAY to LEARN RADIO AT HOME

I Send You 8 Big Kits of Radio Parts Including Complete 6 Tube Superhet

Theory alone is the bunk! It takes "Service-Bench" practice to learn Radio right! My Course supplies the Equipment you need, shows you how to wire, connect, solder, build Circuits... how to test and repair all kinds of Radio-Electronic Equipment. Beginners learn fast! To get full details, send postal for FREE BOOKS:—"How to Make Money in Radio, Electronics and Television," and "How to Read Radio Diagrams and Symbols."

SPRAYBERRY ACADEMY OF RADIO, Room 1077, Pueblo, Colorado

APTITUDE TESTS

discover the kind of work or studies best for your success! You get a personal report—a guide for life—more happiness—more prosperity. For men, women, boys and girls. Write for complete facts.

VOCATIONAL COUNSELING INSTITUTE
956 Maccabees Bldg., Detroit 2, Michigan



Balance 4" x 9" Base. With either \$6.00 Metric or Avoirdupois Weights ...

Catalog with 3000 Illustrations of laboratory apparatus, and over 10,000 prices sent for \$1.00. Catalog of 80 Scientific books. Price \$1.10.

LABORATORY MATERIALS CO.
7321 Vincennes Ave. Chicago 21, Ill.

LET ANGORA RABBITS GROW YOUR INCOME
Earn up to \$3000.00 a year or more. Wool brings top prices. Plenty markets. Steady cash income. Future prospects bright. Write today for free information, prices and markets.

WHITE'S RABBITRY, Dept. P, Newark, Ohio

PLASTIC HOMES New Building Material! Resurface old homes; build new ones. Colorful. Beautiful! **LIQUID MARBLE**—Color-glazed! Molded, brushed, sprayed. **SANITARY COMPOSITION FLOORING**—Dustless, noiseless; put on like plaster; resilient—yielding as cork; lasts like stone; plain or marked in the design. **RUBBERLASTIC Mold Compound**—Mold novelties, statuary, toys, gifts, plaques, plaster animals. **COLORS POTTERY**—Birchbaths, garden furniture, vases. **TILEX** colored roofing. Illustrated literature **FREE**. **RAPID MARBLEIZING SERVICE**, Dept. 10-B, Edwardsville, Illinois

Now While these Great Industries Go Forward

Make Your Decision

For a Better Job
or a
BUSINESS of YOUR OWN
NOW'S the TIME

AIM HIGH—PICK ONE OF THESE BIG FIELDS

- REFRIGERATION AND AIR CONDITIONING
- AUTOMOTIVE MECHANICS
- BODY, FENDER REBUILDING
- ELECTRICITY
- DIESEL

REFRIGERATION and Air Conditioning, the Automotive Field, the Electrical Industry are rapidly making up for lost time. There may never again be such opportunities for men who want better jobs or business of their own to get in on ground floor and go up fast! Yes—FOR MEN WHO ACT FAST, THINGS CAN HAPPEN FAST!

**YOU CAN'T AFFORD TO WAIT
YOUR FUTURE DEPENDS
ON WHAT YOU DO TODAY.**

A Few Short Weeks Can Make All the Difference

COMMERCIAL TRADES INSTITUTE was only civilian school selected by Army to train service men for refrigeration. In motive trades our institute gained nationwide fame training Auto Mechanics for U.S. Army. Same quality training available to you now. If over 17 and under 60 learn how you can get started. **CONSULTATION AND PLACEMENT SERVICE WHETHER YOU ARE INTERESTED IN WORTHWHILE JOB OR SETTING UP YOUR OWN BUSINESS.**

TRAIN AT HOME
IN SPARE TIME OR IN OUR
WELL EQUIPPED SHOPS

REFRIGERATION *and* AIR CONDITIONING

Trained men paid well to service, install, maintain, repair, rebuild household and commercial refrigerators. Important new developments such as Frozen Foods, and many new industrial uses. Opportunities for full time, spare time earnings. Begin training at home in spare time, finish in our big modern shops, or come directly to shops.

At home you get C.T.I.'s SHOP PROVED HOME STUDY instruction—actual shop experience has gone into the practical lesson assignments. That is why it is easy for mechanically inclined men to learn by our Home Study training, and start on actual refrigeration work.

AUTOMOTIVE MECHANICS • BODY & FENDER REBUILDING



Progress rapid by our learn-by-doing SUPERVISED SHOP TRAINING. Efficient auto mechanics get excellent pay. Learn to overhaul and repair engines, transmissions, differentials and other assemblies.

Body and Fender Rebuilding offers profitable work. Get good, practical "all-around" training—welding, aligning, mixing and matching colors, spray painting, power and hand tools. Values increased when used cars are made to "look like new."

MODERN SHOP TRAINING **ELECTRICITY** & INDUSTRIAL ELECTRONICS

Modern Shop Training in Electricity

Get ready for good job or business of your own. Electricity and Industrial Electronics are the heart of modern industry. Electricians always needed, earn higher pay, work year around. Make rapid progress in step-by-step practical shop training in Electrical Wiring and Circuits; Armature Winding; Electrical Appliance Repairs; and Electro Plating. Rural Electrification, the Building Boom, many new uses of Electricity opening more opportunities in this vast field. Get training under thoroughly experienced instructors, be ready in few short weeks for Job Opportunities in Electricity.

COMMERCIAL TRADES INSTITUTE, DEPT. E-27
1400 Greenleaf, Chicago 26, Ill.

FILL OUT • CUT OUT • MAIL TODAY!

FACTS FREE FOR MEN WHO WANT TO GET AHEAD

COMMERCIAL TRADES INSTITUTE, Dept. E-27
1400 W. Greenleaf, Chicago 26, Ill.

Send free illustrated Brochures and other information about the field I have checked below.

- | | |
|---|---|
| <input type="checkbox"/> Refrigeration and Air Conditioning | <input type="checkbox"/> Automotive Mechanics |
| <input type="checkbox"/> Electricity | <input type="checkbox"/> Diesel |
| | <input type="checkbox"/> Body & Fender Rebuilding |

Name _____

Address _____

City _____ State _____

- Veteran Non-Veteran

A NATIONALLY KNOWN AND RECOGNIZED INSTITUTION

DIESEL

Diesel engines are used to power entire fleets of trucks and buses, to drive tractors and other farm equipment. Diesels have revolutionized the railroads, are employed for passenger and freight trains as well as for switching engines. They are used to power road equipment, and even are being tested for airplanes and passenger cars. A big field that promises even bigger things in the years right ahead. Modern shop training on actual equipment under experienced instructors. Learn Diesel under direction of men who trained Diesel mechanics for U. S. Army.

HOME OF **VETERANS**—C.T.I.



Veterans qualifying under "G.I. Bill" have tuition paid by Government plus monthly subsistence allowance while in school. Just mail coupon, we will handle all details. **(LOW TUITION, EASY TERMS if you are not a veteran.)**

FREE—IMPORTANT INFORMATION
Telling HOW TO GET STARTED
IN ONE OF THESE GREAT FIELDS



MY DOBE TRAINING WAS ALL PRACTICAL EXPERIENCE!

I WILL TRAIN YOU AT HOME UNTIL YOU GET A GOOD PAY JOB!

Get Started NOW in DRAFTING

EXPERIENCE WHILE LEARNING

Your training will be experience because I give you practical jobs to do. And I list your experience and send it to employers as a reference when you are ready. All Dobe trained men start out with experience. You will too, because I will train you until you get a good pay job in drafting.

Take the first step now and step into Drafting—the big opportunity field—as an experienced, well paid draftsman. Act now for a better job, better pay and better working conditions. The field for draftsmen is bigger now than ever before for all new products, machines, construction start with the draftsman. Get into drafting now. I will train you at home in your spare time, and give you actual experience on actual work—the same kind of jobs you will do with the best paying firms. I will train you until you are competent, fully experienced, and holding a position that will bring advancement and pay raises. Write me today.

WORKING TOOLS SENT WHEN YOU START

All drafting instruments and table and other needed equipment sent when you start. Nothing to buy. Act today. Mail coupon to give age.



MAIL COUPON FOR VITAL FACTS

Engineer Dobe, Div. 17, Libertyville, Ill.

Send me the Vital Facts on Drafting and Industrial Designing, your Free Book and advertised list of positions for Draftsmen and Designers wanted.

Name..... Age.....
 Address.....
 City..... Zone..... State.....

INVENTORS

The inventor who believes he has a new and useful invention, and finds himself in need of advice, should consult a competent registered patent attorney.

The question as to whether a subject matter is patentable can be substantially determined by a search of the United States Patent records.

Without obligation, write us for information as to what steps an inventor should take to secure a Patent.

RANDOLPH & BEAVERS
Registered Patent Attorneys
 11-D Columbian Bldg., Washington 1, D. C.

RANDOLPH & BEAVERS
 11-D Columbian Bldg., Washington 1, D. C.

Please send me full information on how to secure Patents & Trademarks.

Name.....
 Street.....
 City..... State.....

REFRIGERATION

AND AIR CONDITIONING

BECOME A SERVICE EXPERT

Now, not "next week," is the time to start training for a top-pay job in this vital field. A drastic shortage of trained service experts exists. Many thousands more will be needed for big post-war expansion caused by new industrial uses. Train NOW to get your pick of best jobs. We will give you the practical training you need. For 2 years we trained men and women for the Army and Navy only, in fine-precision aircraft instrument work. So our methods must be right. Common schooling is all you need. Our unique system makes everything easy to grasp. You can train at home and in our big Chicago shops. Write for full facts TODAY, without obligation. Dept. P8g.

Approved for Veterans' G.I. Training

Millions of Old Units Need Expert Service. Big Building Boom Will Create Even More Opportunities.

INDUSTRIAL TRAINING INSTITUTE
 2150 Lawrence Avenue. Chicago 25, Illinois

Master Watchmaking

The life-long profitable trade of thousands as taught by the Sweazey System.

"FAMED THE WORLD OVER"

CHICAGO SCHOOL OF WATCHMAKING

Founded in 1908 by Thomas B. Sweazey

1608 N. Milwaukee Ave., Dept. 197 Chicago 47, Ill.

Learn NOVELTY MANUFACTURING!!



Today's best bet for a business of your own starting with little money is the Casting of Wall Plaques, Book Ends and other Novelties. Large orders and profits waiting. Start in garage or basement, quickly learned. **NO EXPENSIVE MOLDS TO BUY.** Our system has started many on the road to a splendid financial future. Write today for free particulars.

PLASTEX PRODUCTS, 711 Laguna St. San Francisco 2, Calif.

RADIO ENGINEERING

Broadcasting, Television, FM, Servicing, Electronics, Aviation, Marine & Police Radio taught thoroughly. Engineering course equivalent to 3 years' college radio work. Approved Veteran Training. Catalog free.

VALPARAISO TECHNICAL INSTITUTE, Dept. D, Valparaiso, Ind.

PATENTS AND TRADE MARKS

C. A. SNOW & CO.

REGISTERED PATENT ATTORNEYS

WRITE FOR INFORMATION TO
 428 SNOW BUILDING, WASHINGTON 1, D. C.

PATENTS

"Proof of Invention" Folder mailed without obligation.

E. E. VROOMAN, Registered Patent Atty.
 871 Woodward Building, Washington 5, D.C.

INVENTORS

If you wish to protect your invention, you should take steps to protect it by a U. S. Patent. Write me for "Record of Invention" Form.

CARL MILLER

REGISTERED PATENT ATTORNEY

Woolworth Bldg., 35th Floor, Dept. 77A, New York City
 Please send me "Record of Invention" form.

NAME.....
 ADDRESS.....

GET INTO HIGH-PAY WORK!

ELECTRICITY

NATION'S
LARGEST
EXCLUSIVE
ELECTRICAL
SCHOOL

PRACTICAL "Learn-by-Doing" TRAINING LEARN QUICKLY, EXPERTLY, THOROUGHLY

Here's the trade that's bound to boom . . . *Electricity!* Learn Electricity in a short time . . . in one complete course at Nation's Largest Exclusive Electrical School. Learn House Wiring, Factory Wiring, Construction and Industrial Maintenance, the Operation, Maintenance and Repair of AC and DC Motors, Generators, Controls, other Power Equipment in office buildings, hotels, factories, etc., Armature and Motor Rebuilding.

"Learn-by-doing" . . . latest, most advanced methods . . . easily, quickly, thoroughly. Course supplemented with movies and slide films as proved by success of Army training. Expert instructors, individual attention. Day and evening classes, full or part time. We will finance your training. Coupon brings more information. Close supervision between Veterans Administration and school.

MICHIGAN TECHNICAL INSTITUTE

Dept. PM-7 2281 W. Fort St., Detroit 16, Mich.

APPROVED FOR TRAINING UNDER GI BILL

VETERANS!

Take this course at no cost to you, and receive \$65 to \$90 a month while training. Complete details furnished.

MAIL COUPON TODAY!

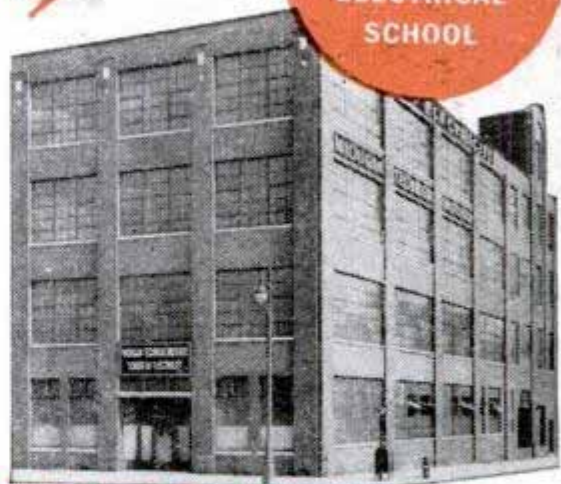

MICHIGAN TECHNICAL INSTITUTE Dept. PM-7
2281 W. Fort St., Detroit 16, Michigan

- Send me catalog and complete information.
 I am a GI. Send special information.
 Married. Single.

NAME _____

ADDRESS _____

CITY _____

STATE _____



V-8
DUALS
& SINGLES

MUFFLERS
STEELS and ALUMINUMS
with a motorboat tone
SINGLES, Chev, V-8, Plymouth,
Steels \$5.50, Aluminum \$6.50.
Chry., Olds., Buicks, etc., Steels
\$7.50, Aluminum \$8.50. V-8 and
MERCURY DUALS, Steel \$17.50,
Aluminum \$20.00. Aluminums are
guaranteed for life of your car.
DEALERS WANTED

SANDEE MUFFLER CO.
7523 S. WESTERN AVE., LOS ANGELES 44, CALIF.

NOW 93% MORE ENERGY, LONGER LIFE

Get the New "Eveready" Flashlight Batteries

The word "Eveready" is a registered trade-mark of National Carbon Co., Inc.

BE A SECRET CODE EXPERT!

euuv aouv dpbv dggv5-drgv6 bfhv

Form Code Clubs—Spare time sales. Absorbing-educational
Two coding outfits in colors prepaid for \$1.00
3 dials-finder-vocabulary-message forms. **CODE**

Name _____

Address _____

to FLAVAROMA-CODE P Suite 2270, 50 Church St., N. Y. 7, N. Y.

STOP OIL AND FUEL LOSSES!

If your car "eats" gas and oil, chances are, worn piston rings are the cause. Take a tip from race car drivers . . . install a set of quick-seating Burd "Graf-Flox" Piston Rings . . . watch fuel and oil bills go down.

Two free, handy booklets for car-owners, mailed on request. Just print your name and address in margin alongside this ad, clip ad and mail today!

BURD PISTON RING CO., DEPT. PM, ROCKFORD, ILL.

SAY YOU SAW IT IN POPULAR MECHANICS

YOU CAN BE THE MOST POPULAR PERSON AT THE PARTY . . .

EARN BIG MONEY IN YOUR SPARE TIME! LEARN CHARACTER ANALYSIS AND NUMEROLOGY
THE SECRETS OF THE COUNTRY'S TOP EXPERT • NOW AVAILABLE TO YOU

A Profitable Profession . . . A Fascinating Hobby. Brings you Rich Rewards in Friendship & Popularity. Learn this stimulating new profession and build a business of your own . . . with unlimited possibilities! Thousands of men and women today are eager to have their aptitudes and potentialities revealed through character analysis. Easy to learn in a short time. No educational requirements. Course includes textbook, six correspondence lessons, plan of operating when course is completed, and sample advertising to be used. ELAINE WHITNEY, Internationally Famous Character Analyst of Motion Picture Stars, Director. Send \$1.00 for Introductory Analysis of YOUR KEY NUMBER and a short introductory treatise of Character Analysis and Numerology.

Dept. PM-77, SCHOOL OF CHARACTER ANALYSIS AND NUMEROLOGY, 202 E. Third Street, Los Angeles 13, Calif.

DIPLOMA
PRESENTED
TO ALL
GRADUATES

VAndike 4616

CAN YOU ? INVENT A NEW FASTENING

A successful midwest fastening manufacturer would like to hear from you if you have an idea for a new fastening product. It can be a metal, plastic, rubber or chemical product to be used either in industry or by the general public.

Your information should be in the form of an issued patent or—in the interest of your own protection—should contain information from your pending application for letters patent. Those whose ideas are selected for further study will be contacted direct by our client. Product ideas judged worthy of purchase will be offered either a cash or royalty plan of payment.

Business Research Corporation
79 West Monroe Street
Chicago 3, Illinois

Now for EVERY WORK SHOP! NEW Invention

Electroplates by BRUSH



**Easy to Plate CHROMIUM
GOLD, SILVER, NICKEL, COPPER
... For Pleasure and Profit!**

If you have a workshop—at home or in business—you need this new Warner Electroplater. At the stroke of an electrified brush, you can electroplate models and projects—you can replate worn articles, faucets, tools, fixtures, silverware, etc. with a durable, sparkling coat of metal... Gold, Silver, Chromium, Nickel, Copper or Cadmium. Method is easy, simple, quick. Everything furnished—equipment complete, ready for use. *By doing a bit of work for others, your machine can pay for itself within a week.* So make your shop complete by getting a Warner Electroplater right away. Send today for **FREE SAMPLE** and illustrated literature. **ACT AT ONCE!** *Mail Coupon.*
WARNER ELECTRIC CO., DEPT. N-1
1512 Jarvis Avenue, Chicago 26, Ill.

FREE Details & Sample!

WARNER ELECTRIC CO., 1512 Jarvis Avenue, Chicago 26, Dept. N-1
Gentlemen: Send Free Sample and Details to:

Name _____
Address _____
City _____ State _____

NEW MIDGET ELECTRIC ARC WELDER

RETAILS ONLY \$3.95

FULLY GUARANTEED

Plugs into Light Socket—AC or DC

It's new! It's handy! It's efficient! Use the Midget Electric Arc Welder for hundreds of light-metal jobs. Does comparable welding work with a 1/16 inch welding rod on thin metal as that of larger and higher priced welders. Operates on 15 ampere fuse, 110 volt 60 cycle A.C. or D.C. current, by use of our special standard-coated 1/16-inch welding rods. Generous supply of rods supplied with machine. Recommended for all light welding like automobile fenders, etc. Take the Midget Arc anywhere to the job. Sturdily built and fully guaranteed. Comes complete—ready to use. Nothing else to buy. No previous welding experience needed to strike an arc. In a short time, anyone mechanically inclined can learn to weld with this machine.

You'll find hundreds of money-saving, time-saving uses for the Midget Arc around your home, garage, or workshop. Also in garages, factories, repair shops, tin shops, mechanics, farmers, inventors, etc. Order a Midget Electric Arc Welder now! **SEND NO MONEY.** We'll rush one to you, complete with rods and helmet (equipped with APPROVED welding glass). Pay postman only \$3.95 plus postage charges. If not satisfied, return Midget Arc in 5 days from receipt and we'll refund your money immediately. **RUSH YOUR ORDER NOW!**
MIDGET ARC WELDER CO., Strader Ave., Dept. A-202, Cincinnati 26, Ohio

*One of America's Leading
Radio and Television Schools*

NEW YORK TECHNICAL INSTITUTE OF NEW JERSEY

158 Market Street, Newark, New Jersey

POWERFUL ASTRONOMICAL TELESCOPES

easily made by anyone. Full power and clear vision guaranteed. Perfect lenses and detailed instructions. 100 power \$2.50, 200 power \$3.50, 400 power \$5.50. Instructions alone 10c. 25% deposit on C.O.D. orders. Unconditional money back guarantee.

SUFFOLK SCIENCE SERVICE

DEPT. CK MANORVILLE, N.Y.

**TALK-SING thru your own radio
with
RADIO MICROPHONE**

Be the life of the party. Put on your own broadcasts at home. Talk-Sing make announcements from any room. Wonderful voice practice. Microphone easily attached to any radio. Follow enclosed instructions. **SEND NO MONEY**—pay postman \$1.98 plus postage. Send Money Order or check and save postage.

EMPIRE RADIO & TELEVISION CO. (Dept. R2) 1521 Bedford Ave. Brooklyn 16, N. Y.

SAY YOU SAW IT IN POPULAR MECHANICS

A PENNY POSTCARD MAY CHANGE YOUR FUTURE . . .

Get full information on the coin-operated vending machine industry. Start with a few machines and build to a wonderful future. We'll give you complete advantage of our "know-how."
Send For Free Booklet Today—No Routes Sold!

PIONEER VENDING SERVICE

Address all mail to Dept. PM
461 SACKMAN ST. • BROOKLYN 12, N. Y.

TO THOSE WHO THINK LEARNING MUSIC IS HARD

Just strike these notes and you're playing the beginning of the "Merry



Widow" Waltz. Look at the diagram. The first note of the music is "D." Following the dotted line to the keyboard you'll find "D" is the white key between the two black keys near the middle of the keyboard. Now read below how you can learn to play any instrument quickly and easily.



EASY AS A-B-C—COSTS JUST A FEW CENTS A DAY!

● Perhaps you think learning music is a tedious grind. It isn't any longer! Long hours of practicing scales and monotonous exercise are over.

You have no excuse for not getting started toward musical good times now! For through an easy method you can now learn to play right at home—without a teacher—for a few cents a day.

SUCCESS!

Here's what one of our thousands of pupils writes: "I learned more from your course than many of my friends who studied under private teachers, have for years. The fact that I've already taken 2 courses and am now enrolling for a third should speak for itself." F. A. S., Indiana.

Learn to Play by Playing

The lessons come to you by mail from the famous U. S. School of Music... complete instructions, clear diagrams, and all the music you need. You learn to play by playing real tunes by note. First you are told how to do a thing. Then a picture shows you how. Then you do it yourself and hear it. Remember, don't confuse our method with any system claiming to teach music "by ear" or by trick methods. We teach you to play only from real notes!

Don't delay. Send now for our Illustrated Free Booklet and "Print and Picture" Sample which fully explain this remarkable method. So decide which instrument you want to play and mail the coupon today. U. S. School of Music, 77 Brunswick Bldg., New York 10, N. Y. (Successful 49th Year)

FREE PRINT AND PICTURE SAMPLE

U. S. School of Music
77 Brunswick Bldg., New York 10, N. Y.

Please send me Free Booklet and Print and Picture Sample. I would like to play instrument checked below.

Piano	Saxophone	Modern Elementary
Hawaiian Guitar	Trumpet, Cornet	Harmony
Violin	Reed Organ	Mandolin
Piano Accordion	Tenor Banjo	Practical Finger Control
	Clarinet	

Name _____ Have You Instrument? _____

Address _____

City _____ State _____

Save 2c—Stick Coupon on Penny Postcard



HERE IS YOUR GUIDE FOR THAT PAINTING JOB!

This book fully explains and illustrates the tools, materials and method of application for any painting or decorating problem. Contains 388 pages which include 228 illustrations. Cloth Bound. Price \$3.50.

Get your copy at your local bookseller or write direct to the publisher, who will send you a copy upon receipt of price. Satisfaction Guaranteed. Send for Free Catalogue.

FREDERICK J. DRAKE & CO., Dept. A8
600 West Van Buren Street
Chicago 7, Illinois

REFRIGERATION

Repair, adjust all refrigerators. New large manual tells how. Charts and pictures to help you. Price only \$1. postpaid. Money back guarantee. Supreme Publications, 9 S. Kedzie Ave., Chicago 12, Illinois



ACTION
FOR YOUR MECHANICAL CONSTRUCTION SETS
Here's a low cost electric motor to operate your mechanical construction sets—cranes, windmills, etc. Looks and runs just like a big motor, using 2 flash or dry cells or 5 volt AC. "Junior Genius" Motor with windmill plans...\$2.00. "Junior Genius" Motor Kit (you build it yourself, no soldering) \$1.50. Shipped prepaid for check or money order, or C.O.D.

junior genius
719B South Mateo St., Los Angeles 21, Calif.

INCREASE YOUR INCOME — Learn LANDSCAPE GARDENING My 3 Way Plan Shows You How To —

1. Start Your Own Business!

Thousands of opportunities now open for Landscape Gardeners. My course shows how you may cash in on this tremendous field and start your own successful business without capital.

2. Earn Extra Money in Spare Time!

Many students take my course to earn extra money in spare time. My book tells how you, too, may be able to increase your earnings with a few hours of pleasant, profitable work. Special "Earn While You Learn" lessons included in course.

3. Get a Better Job!

My Consultation and Placement service help qualify you for healthful and pleasant jobs in nursery industry, large estates, parks, playgrounds, airports, golf courses, etc.



Hundreds of thousands of new homes are being built, and many more older homes need the professional advice and services of Landscape Gardeners. No previous training or special education is needed to learn this profitable, healthful profession. Course is written in easily understood language. Hundreds of inspirational pictures carry you step by step through practical and professional landscaping. Actual landscape work is part of the course so that you gain actual experience. **FREE BOOK**—write today for copy of "How to Learn Landscape Gardening for Pleasure or Profit" and see how easily and quickly you may get started on a new, successful career. **AIR MAIL REACHES ME OVERNIGHT.** **APPROVED FOR VETERANS**—Use the GI Bill to learn this interesting, healthful profession. Many hundreds already have!

NATIONAL LANDSCAPE INSTITUTE
310 S. Robertson Blvd., Dept. P7, Los Angeles 36, Calif.



NORMAN A. MORRIS
Landscape Architect



**7X 50 NAVY
BINOCULARS
\$135.00
COATED OPTICS!**

Mfgd. to U.S. Navy Standards! (Alignment guaranteed to .001"). Brand new glasses. Dust proof! Climate proof! Individual eye adjustment. Instant focusing. Coated optics insure sharp, clear images! Ideal for long range hunting, yachting, watching planes, etc. This magnificent 7 power 50 mm. Navy Binocular gives better detail, heightening image contrast. Complete with carrying case only \$135.00 plus 20% Federal tax.

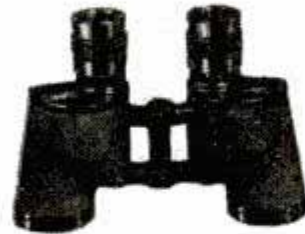

**6X 30 ARMY
BINOCULARS
\$62.50**

Brand new! Lightweight! Made to rigid Army specifications. Individual focusing eye pieces. Compact glasses made to withstand rough usage. Come complete with case and straps ready to use. **WHILE THEY LAST!** \$62.50 plus 20% tax.

OTHER BINOCULARS (3 to 16 POWER!)

12x40	Carl Zeiss, Like new	\$200.00
7x50	Carl Zeiss, Used	150.00
16x45	French Monte Carlo, New	135.00
12x38	French Monte Carlo, New	100.00
10x32	French Monte Carlo, New	79.00
10x50	German Dienstglass, Used	140.00
8x34	French Monte Carlo, New	67.00
8x30	Wollensack, Coated, New	85.00
8x30	French Monte Carlo, New	62.00
8x25	French Monte Carlo, New	57.00
8x25	French Monte Carlo, Used	45.00
7x50	Bausch & Lomb, Coated, New	140.00
7x50	German Dienstglass, Used	130.00
7x50	Sard, U. S. Navy, Coated, New	152.00
8x30	Carl Zeiss, Used	90.00
6x30	Bausch & Lomb, Used	37.50
6x30	Carl Zeiss, Used	75.00
6x30	Talbot, U. S. Army, Used	36.50
6x30	German Dienstglass, Used	65.00
6x30	Wollensack, Coated, New	75.00
6x25	Ross, London, Used	60.00
6x30	Universal, Navy, Light Weight, Used	35.50
6x24	USN, Turner Reich, Lightweight, Used	60.00
5x40	Nat'l. Field Glass, Coated optics, New	29.75
4x50	Super Eye Field Glass, No case, New	12.00
4x40	Fee & Stenwedel Field Glass, New	20.00
5x40	Fee & Stenwedel Field Glass, New	22.00
4x40	Wollensack Field Glass, New	16.25
10X, 20X, 30X, 40X, Variable Telescope		42.50

Add 20% For Federal Excise Tax. Carrying case and straps included. Supply limited. Give second choice.

MONEY BACK GUARANTEE

Use for 20 days at our risk and expense. If not fully satisfied, return for full refund of your money. **ORDER TODAY!** Send \$2.00 deposit and we will ship C.O.D. for balance. Cash orders sent postpaid.

UNITED PRODUCTS CO.

7941 S. Halsted Dept. ARF-408 Chicago 20, Ill.
(Reference Dun & Bradstreet)

SAY YOU SAW IT IN POPULAR MECHANICS

PRESTO! ANYONE CAN MASTER GLAZE



Car Owners! Meet Master Glaze—the sensationally different luster for new and used cars! Not a wax—not an oil polish—not a paint!—nothing that “smears” over the surface.

MASTER GLAZE is a unique discovery—a creamy liquid—quick and easy to apply! Gives a hard, glass-like surface. Even gasoline cannot dull it! Lasts six months to a year! Amazing luster—beautiful, sparkling clean and brilliant! Doesn't finger-mark—doesn't smear! A match box full glazes an entire car. Seals the pores—protects! **NOTHING LIKE IT!**

AGENTS
An unusual opportunity!
Quick, flashy demonstrator.
Big profits.
Good territory.
Write today!

FREE SAMPLE

Just send your name and address to **MASTER GLAZE CO., 7720-607 W. Harwood Ave., Milwaukee, Wis.**

**Sensationally New Low
THERMOSETTING PLASTIC
in POWDER FORM { self curing**

**Cost
CASTING
MIX
STRONG,
TOUGH,
HARD**

NOW ANY-ONE CAN MOLD QUICK AND EASY

“Kalon” is a NEW TYPE CASTING MIX . . . Does not require expensive equipment or presses to handle . . . Simply mix “Kalon” with water, stir and pour into mold . . . THAT'S ALL. “Kalon” remains liquid about 15 minutes after mixing, after which time “hardening” process begins and lasts from 20 to 30 minutes to permit removing the cast from the mold. **JUST THAT SIMPLE.** Pins, Clasps, Hooks, etc. can be inserted for Costume Jewelry, Plaques and other ornaments, while it is hardening.

INTRODUCTORY OFFER

A Trial Kit contains a 16-oz. supply of “Kalon” . . . A pkg. of mold dressing . . . A Koroseal mold **READY TO USE** and a set of **INSTRUCTIONS** to get the articles at a **PROFIT.**

We can supply **STOCK MOLDS** to produce saleable products . . . Catalog showing these molds mailed prepaid for 25c . . . A Novelty Mold is included without extra charge in the **INTRODUCTORY OUTFIT OFFER.**
Start Molding Many Things
CLARENDON MFG. CO.
176 West Adams St. • Dept. P-7 • CHICAGO 3, ILL.

\$3.49
RUSH ORDER ONLY Postpaid

Learn RADIO TELEVISION ELECTRONICS

Train at home, in spare time, for a good pay job or start a business of your own *without capital*—under our *proven 2-Way* method that helps you get into this money-making field of radio *quicker*. You receive *Lessons plus Home Shop Practice* including 9 kits of radio parts to make hundreds of tests. Many students earn money in spare time while learning. Write for **FREE** book “Your Opportunities in Radio” to Hollywood Radio & Television Institute, (Established 1929), Dept. A-6, 810 W. 6th St., Los Angeles 14, Calif.

TRI-STATE COLLEGE

B. S. Degree in 27 months in Engineering (7 branches); Bus. Adm., Acc't and Sec. Science. Graduates successful. 64th year. Enter Sept., Jan., March, June. Write for catalog.
477 College Ave., Angola, Ind.

**NEW! LOW COST!
RESPIRATOR**



Wear when sanding, grinding, paint spraying, sweeping, dusting, furnace cleaning, etc. Handy as a pair of glasses. Just keep mouth closed and breathe through nose is all you do to operate. Protects against nuisance dusts, lint, coal, cement, grain dust, hay fever pollen. Has 9 sq. in. filter. For **EYE** protection against paint spray, dusts, gases, fumes, smoke, order our **Fog-Proof Rubber GOGGLES** . . . \$2.00 p.p.

JERRY BRYANT, Dept. PM
919 N. Michigan Ave. Chicago 11, Ill.

Order Today \$1.00 POST PAID

ELECTRIC LIGHT JAZZ BOW TIE!

only **\$1.95**



Astonish, amaze your friends. Be the life of the party. Have lots of fun. Easily put on. Flashes on and off by simply pressing battery button hidden in your pocket. Complete with attractive bow tie, cord, two bulbs and battery. Mail your order today. Write for **FREE** catalog. Special price to dealers.

BERNARD FINE CO. 501 Sixth Ave., Dept. PM
New York 11, N. Y.

3 NEW PLASTICS MANUALS

FABRICATING CARVING
CASTING MANUAL
Now Only **\$1.00**

Make beautiful objects of Plexiglas, Lucite, Catalin, Polystyrene and Cast-olite at home. Jewelry, novelties, accessories. Three new manuals show how to fabricate, cast and carve latest plastic materials. 20,000 words, 23 special designs, 45 photos, charts, diagrams and hundreds of suggestions. Price prepaid \$1.00. Or get **FREE** information and price list. **House Beautiful Plastics, Dept. H-3, 5534 W. Harrison St., Chicago 44, Ill.**

REAL RELIEF FOR RUPTURE



Thousands of wearers tell of **real relief**. Scientifically shaped, made of strong washable materials, gives the **RIGHT** support **WHERE NEEDED**. Satisfaction **GUARANTEED**. Write for **FREE** literature **NOW**.

The WEB Truss Co. Dept. P-8, Hagerstown, Md.

How to Start YOUR OWN BUSINESS

Make Flexible Molds, Composition Flooring

NO EXPERIENCE — UNLIMITED MARKET

Start your own business at home in your spare time. Tremendous money-making opportunities for both men and women.

FLEXIBLE MOLDS

Make your own FLEXIBLE MOLDS. Cast novelties, statuary, desk sets, book ends, etc. Hundreds of casts made from single mold. Large size mold costs but a few cents. No experience necessary. Steady year-round demand.

COMPOSITION FLOORING

Make floors that last a lifetime with amazing COMPOSITION FLOORING! New discovery now enables you to lay artistic floors, in beautiful patterns in most colors and shades. Can be laid over wood, concrete, brick, steel, etc. This composition flooring offers unlimited money-making possibilities.

Free Catalog!

For FREE information about these and many other profitable business opportunities, WRITE TODAY!

BING PRODUCTS

Dept. A20, 88 Broad Street BOSTON 10, MASS.

LEARN

MASONRY

Get in on the biggest building boom in history. Prepare for a long and profitable career as a big-pay building tradesman. Actual shop training under expert instructors. Write for big free catalog today.

MIDWEST SCHOOL OF BUILDING TRADES
Dept. M-17, 411 N. Center St., Bloomington, Ill.

*Free
FACTS*

VETERANS ASK FOR GI PLAN

WATCH & CLOCK REPAIRING

LEARN AT HOME IN YOUR SPARE TIME! ... Prepare for a happy future, with security—and qualify for a good job NOW. A fascinating and thorough self-instruction training in American and Swiss watches and clocks. Special section on alarm clock repairs. Fast-growing field. Satisfaction is guaranteed. Success-Catalog Free. Nelson Co., 1139 S. Wabash, Dept. G02, Chicago 5, Ill.

CARTOONING

HAVE FUN! MAKE MONEY! Cash in on your sense of humor AT HOME—BY MAIL. No experience needed to start. Write today FOR FREE TRIAL LESSON and full particulars. Moon Gag Cartoon School, Dept. B, Fall Creek, Wis.

THOUSANDS OF SUFFERERS USE

BREATHESAY FOR ASTHMA

CARRY IT WITH YOU
USE IT ANYWHERE

*Sold on Money-Back
Guarantee*

Write To Dept. PM

BREATHESAY DISTRIBUTORS, INC.
65 CEDAR STREET
SEATTLE 1 WASHINGTON

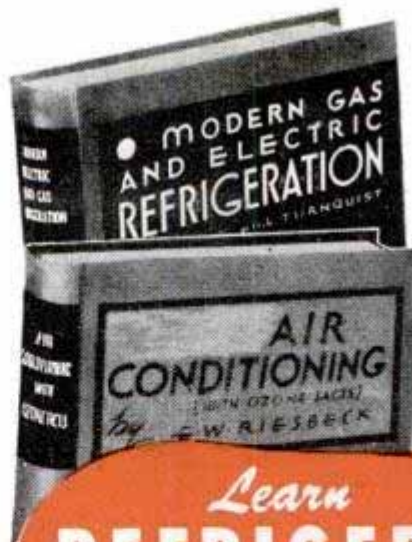

Prepare Now!
**Unusual
Opportunities**
in these two
**Big Pay
Fields!**
Mail Coupon

Learn REFRIGERATION AIR CONDITIONING

This QUICK,
LOW COST
EASY Way

FREE TRIAL in Your Home
Use The Handy Coupon Below

Two of the biggest and best money-making fields today are Refrigeration and Air Conditioning with opportunities never before equaled. Men with the know-how are being paid big to service, install, rebuild and maintain household and commercial refrigerators and frozen food equipment. Air Conditioning, delayed by the war, is coming into its own and men with specialized knowledge will be needed in every branch for home and business installation.

Modern Gas-Electric
REFRIGERATION
Almost 1000 Pages
408 Pictures
17 Color Diagrams
Thousands of Copies
Used by U. S.
Army for G.I.
Training
Complete Cost
Only \$5.00

**AIR
CONDITIONING**
With Ozone Facts
Over 450 Pages
232 Pictures
Complete Cost
Only \$4.00

15 Million Refrigerators Need Service

Air Conditioning Growing by Leaps and Bounds

Get ready for a good job or a profitable business of your own. Get your share of the millions to be spent on new equipment and to keep older devices going. Send today for Modern Gas and Electric Refrigeration, by Althouse and Turnquist, and Air Conditioning, by Riesbeck.

Complete, Practical, Non-Technical — Easy to Read and Understand — Finest Reference Guide

These famous Willcox Books contain the same type material and subject matter included in the best shop courses yet they cost you only a small fraction of what such courses usually cost. Each book is complete and written so you can understand it. Hundreds of pictures make all types of equipment, methods and approved practice plain as day. Each book is a full self-training course prepared especially for men who want to reap the rich rewards these big fields offer. Men already engaged in the work will find the books worth many times their cost for reference use only.

Used by Thousands of Successful Men

You take no chances. You too must be satisfied. Money refunded if books do not please you after 5 day examination. Order today.

Send No Money
Mail Coupon

Goodheart-Willcox Co.,
2009 S. Michigan Ave., Dept. 17,
Chicago, Ill.

Send books checked C.O.D. including charges. If not satisfactory I will return in 5 days and you will refund money paid. (Outside U.S. remit with order.) We pay all postage charges if remittance accompanies order.

Gas & Electric Refrigeration, \$5.00 Air Conditioning \$4.00

Name _____

Address _____

City _____ Zone _____ State _____

Accountancy Home-Study

made interesting and practical
thru problem method

YOU know as well as we do that Accountancy fits many men for positions that pay three and five and ten thousand dollars a year—gives many other men unusual opportunity to start a profitable growing business of their own.

You probably realize also that the accounting profession faces the greatest opportunity it has ever had.

The only question is—just how practical is it for *you* to train yourself adequately in Accountancy through home study?

And the answer lies in the LaSalle Problem Method.

For this modern plan of training not only makes Accountancy study at home thoroughly practical but makes it interesting as well.

And here's how:

You Learn by Doing

Suppose it were your privilege every day to sit in conference with the auditor of your company or the head of a successful accounting firm. Suppose every day he were to lay before you in systematic order the various problems he is compelled to solve, and were to explain to you the principles by which he solves them. Suppose that one by one you were to work those problems out—returning to him every day for counsel and assistance—

Granted that privilege, surely your advancement would be far faster than that of the man who is compelled to pick up his knowledge by study of theory alone.

Under the LaSalle Problem Method you pursue, to all intents and purposes, that identical

plan. You advance by solving problems.

Only—instead of having at your command the counsel of a single individual—one accountant—you have back of you the organized experience of a great business training institution, the authoritative findings of scores of able accounting specialists, the actual procedure of the most successful accountants.

Thus—instead of fumbling and blundering—you are coached in the solving of the very problems you must face in the higher accounting positions or in an accounting practice of your own. Step by step, you work them out for yourself—until, at the end of your training, you have the kind of ability and experience for which business is willing and glad to pay real money.

One-Tenth of All C. P. A.'s Are LaSalle Trained

If you want still more proof, remember that over 2300 C.P.A.'s—approximately one-tenth of all those in the United States who have passed the difficult examination for this coveted degree—are LaSalle alumni.

And knowing these facts, ask yourself if there can be any further question about the practicability of this training for you—ask rather if the real question is not about the size of your own ambition and the quality of your determination.

For Accountancy is no magic wand for the lazy or the fearful or the quitter—it offers success only to the alert adult who has the courage to face the facts and the will to carry on till the job is done.

If you are that individual, the coupon below, filled out and mailed, will bring you free the information that may open up to you the future of which you have dreamed—ability and income and success. Is it not worth getting that information?

G. I. APPROVED

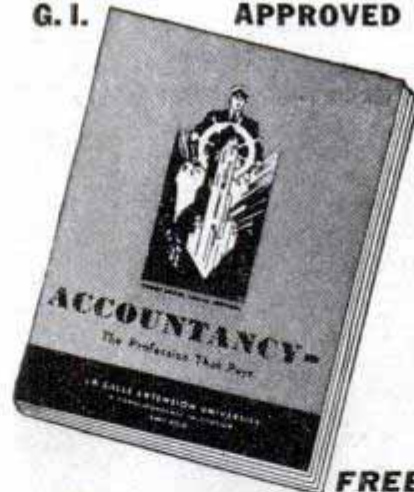

FREE
SEND FOR THIS...BOOK

LaSalle Extension University

A Correspondence Institution

Dept. 764-H 417 S. Dearborn St., Chicago 5, Ill.

Please send me, free of all cost or obligation, your 48-page illustrated book "Accountancy, the Profession That Pays," telling about the profession of accountancy and your training for success in that field.

Name.....

Address.....City & Zone.....

Position.....Age.....



**WORLD'S
BEST
WANT AD
MEDIUM**

CLASSIFIED Advertisements



Advertisements in this section 60 cents per word, each insertion, minimum 10 words, payable in advance
To be inserted under proper classification, copy must be in our office the 25th of the
second month preceding date of issue

F. W. Johnson, Manager, Classified Advertising
Popular Mechanics Magazine, 200 East Ontario Street, Chicago 11, Illinois

1291

CLASSIFIED
ADVERTISEMENTS

1291

OPPORTUNITIES
FOR YOU

AUTOMOBILES, MIDGET CARS

CAR Owners! Amazing new discovery. Our Non-Corrosive Battery Washer stops sulphation of plates and prevents starter failure, generator trouble, run down batteries, destroyed cables and connections and many other troubles caused by battery corrosion. Adds months of useful life to your battery and gives it new zip and pep. Time tested—factory guaranteed. Easily installed by anyone. Send 25c stamps or coin for 6 months guaranteed protection. Salesmen—send 25c for sample and agency offer. Order from R. & Y. Enterprises, Arcade Bldg., Wauseon, Ohio.

1947 INDIANAPOLIS "500" Race History Book. Complete details every car, driver competing. 100 photos, charts, drawings. \$1.00 postpaid. Large complete Indianapolis Race History Book, 352 pages, 1100 illustrations, all data 1909 to date. Postpaid \$3.50; Deluxe edition Fabrikoid binding, gold lettering, \$5.00. Clymer, Dept. A-70, 2125 W. Pico, Los Angeles 6, Calif.

INDIANAPOLIS 500 Mile race! New packet 4½x6½ inch pictures cars and drivers! \$1. New catalogue! 500 illustrations cars and drivers 1911-1946! \$1. Tower Photographers, 5454 E. Washington, Indianapolis 19.

SPEED Age—The new picture and story auto and motorcycle racing monthly magazine. Year, \$3.00, trial copy, 25c. Box 237-M, Hyattsville, Maryland.

AUTO Racing magazine subscriptions. Pacific Speedway News, \$6.00 yearly. National Speed Sport, \$4.00 yearly. Illustrated Speedway News, \$4.00 yearly. All give complete data midget, big car race results. Sample copy each 50c. Specify publication wanted. Clymer, Dept. A-72, 2125 W. Pico, Los Angeles 6, Calif.

MIDGET Racer plans, blueprints, parts. Buying directory 25c. Arthur Sibley, Mendon, Mass.

CONVERT Your automobile to popular town and country sportsman type. Complete plans, instructions \$1.00. Thomas, 12528 Brackland, Cleveland 8, Ohio.

SPEED & Mileage manual— Obtain greater speed, mileage, racing performance from any automobile! Includes simplified methods, speed tuning, gas saving secrets. Instructions on building economizers, speed equipment, duals, mufflers, superchargers, racing fuels, fast conversions, \$1.98. Almqvist Engineering, Bx. 660, Brooklyn 1.

CLYMER'S Historical Motor Scrapbook No. 4. Latest Clymer book old cars and motorcycles. Postpaid \$1.50; Deluxe edition, \$2.50. Clymer, Dept. A-78, 2125 W. Pico, Los Angeles 6, Calif.

AUTOMOTIVE Trouble shooting, 500 questions and answers. \$1.00 postpaid. Charles Nelson, 2908 Washington Avenue, Santa Monica, California.

TACHOMETER Kits for V8-85 \$27.00, V8-60 \$25.00. Kit includes 0-5000 or 0-8000 r.p.m. tachometer, adapter, cable. Tachometer alone \$12.00. Zakarian Engineering, Box 416, East San Diego, Calif.

MUFFLER Manual. Convert easily to Hollywood, Laguna, Westwood, duals, etc. Includes construction details, regulations, diagrams. Postpaid \$1. Mellotone, Box 723E, Arcadia, California.

CLYMERTONE, Twin muffler sets, beautiful sound, complete with necessary welded pipes, E-Z installation. Ford V-8, \$20.00. Chevrolet set with split manifolds, \$37.50. Specify car model. Clymer, Dept. A-74, 2125 W. Pico, Los Angeles 6, Calif.

CONVERT Ford V-8 to V-4, outmileage the Jeep. Use present parts. Only cost, new gaskets. Instructions \$1.00. Pat Pardo, Box 183, Salem, Mass.

"CUSTOM-Styling" Manual. Easily make car look Hollywoodized, custom built, ultra-beautiful! New, simplified customizing, restyling, streamlining methods. Instructions, illustrations. Plans for accessories, refinishing, mufflers, model changes, sport, continentals, convertibles, jeeps, etc., \$2.00. Almqvist Engineering, Bx. 660, Brooklyn 1.

"REX May's Racer," 1/16 scale model of 1947 Indianapolis Speedway Classic, six rich colors. Heavy duty motor, long runs from 150 to 175 feet at speeds up to 15 miles per hour, then free-wheeling. Aluminum fin brake drums. Custom built rubber tires. Radiator grill design. Off-set cockpit. Flared headpiece. Steering-wheel that turns. \$3.00 postpaid. (Agents wanted). Moore Mechanical Laboratory, Dept. #1, 1371 Elizabeth St., Pasadena, California.

RACING Photos—700 different, action, stills. List, sample, 25c plus name on mailing list. Frank Smith, Midland Park, New Jersey.

BELLY Tanks—75 gallon, new, steel, 6 ft. 4 in. \$7.50. Anzio Boat Co., Box 89, Merced, Calif.

HOLLYWOOD Supertone dual muffler sets for Ford and Mercurys. Easily installed parts and simple instructions \$20.00. New stabilizer spring for Ford, Mercury and Zephyr. Give your Ford that knee action ride. Eliminates sway, restores arch to spring. '35 to '47, \$12.00. State whether front or rear. Supertone Mufflers, 2470 E. Slauson Ave., Huntington Park, Calif.

HIGH Speed engine tuning for beginners. Manual on heads, rods, shafts, carbs., over fifty questions and answers. Non-technical, instructive. \$1.00 postpaid. \$1.50 c.o.d. George Fawns, A-2552 N. 17th St., Philadelphia 32, Penna.

AMAZING New way to back automobiles into short parking places. Back in where others fail. Four copyrighted photographs and instructions will make you an expert. Send 25c today for lifetime driving satisfaction. Whitley, 618 Brooks Avenue, Raleigh, N. C.

"STREAMLINED Roadster"—America's lowest priced car! Small, speedy, two passenger sportster! Amazingly easy to build from inexpensive material, small motor. Complete instructions, drawings, \$1.98. Almqvist Engineering, Bx. 660, Brooklyn 1.

SCOOTER Roadster! Use scrap parts easily build inexpensive two passenger, three wheeled, small motor runabout. Also two passenger midget "Jeep." Complete plans, specifications for both, \$1.00. Universal, 2671 Algonquin, Toledo 6, Ohio.

WATER Injection for your car. More power, smoother performance. Wrench installs in half hour, \$14.65. Give make, model, year of car. Spee-Dee Products, 2409 South 10th St., Tacoma 6, Wash.

PROFESSIONAL Midget racer, motor-scooter, midget roadster, and midget motorcycle. Plans, specifications for all four contained in illustrated handbook, 25c. Big list bargain priced used motors, motorscooters, servicycles, etc., included free! Midwest, 3839 Drummond, Toledo, Ohio.

RACING Car performance for all cars. Complete specifications, \$1.00. Increase power, speed. Special "custom-built" equipment. Free literature. Write Lee Motorcraft, 1412-A Great Northern Bldg., Chicago 4, Illinois.

R & R Mfg. Co., marine and auto division, Anderson, Indiana, Robert M. Roof, \$1.00 for our new 1947 speed and power equipment catalogue with price sheet—showing racing cars, midgets, speed boats with recommendations how to rebuild your motors for racing. Dual ignition racing cylinder heads for V-80-100 and Mercury Ford engines. Dual intake manifolds, racing pistons, camshafts, compound valve springs, Lynite flywheels, quick change gear boxes and numerous other supplies.

DUALTONE Crystalline packed mufflers. Single or twin mufflers for all cars. Duals priced complete V8's \$23.00, six cylinders \$33.00, eight cylinders \$36.00. Large chromed tailpipe extensions \$3.30. Polished carburetor velocity stacks \$1.30. Chromed Station Wagon stacks \$15.00. Request catalogue. Dualtone Mufflers, 2636C India Street, San Diego 1, California.

BUILD Speedy midget track racer from castoff parts! Plans, specifications, construction information, \$1.00. Motor Supply, Box CS-1682, Toledo, Ohio.

AUTOMOBILE Racing book, fifth edition, well illustrated. Instructions on building bodies, frames, engines. Ford A and B conversions. Plans. AAA rules, specifications. Roadster racing, Indianapolis cars. \$1.00 postpaid, \$1.30 C.O.D. Ray Kuns, Dept. 47, Madisonville, Cincinnati 27, Ohio.

MAKE Your Ford fast! Complete details, photographs. How to construct 120 m.p.h. Hotrod. \$1 postpaid. California Bill, Box L-1, Eaglerock, Los Angeles 41, Calif.

CUSTOMIZE Your automobile. Illustrated, new restyling ideas, instructions, suggestions, specific model changes by simple methods. Postpaid \$1. Speedwheel, Box 723-E, Arcadia, California.

USED-CAR Handbook. "Judging the Used Car." Dealers' tricks exposed, comprehensive simple tests, photographs. Postpaid \$1. Truvalu, Box 723-E, Arcadia, California.

SEE Our ad under Motorscooters for midget car bargains. Midget Motors Directory, Athens, Ohio.

AUTO SUPPLIES AND EQUIPMENT

PROTECT Your car or trailer with Rapid-Glo that cleans, polishes and glazes in one easy operation. A little does a lot. Postpaid \$1.25 per pint. Results guaranteed. Rapid-Glo Products Company, 1024 Vernon Street, Grand Rapids 3, Michigan.

MANIFOLD Whistle—Imitates "wolf whistle," siren, etc. Installed on any car manifold in 15 minutes. Send \$6.00 to Protected Company, 4033 Windsor Rd., Youngstown 7, Ohio.

AMAZING Discovery, Master Glaze, puts brilliant glass-like surface on cars. Free sample, information. Big commissions. Master Glaze, Dept. 609, 7720 Harwood, Milwaukee, Wis.

GRILLES For all cars. Meyers Auto Parts, 820 Dryades, New Orleans, La.

SELL Tires—Make money. Standard makes, first quality. No investment or experience required. Direct Tire Co., 962 E. 129 St., Cleveland, Ohio.

NEW And used automobile and truck parts. Lowest prices. Complete stock. Prompt reply. Babbitt Auto Parts, 2833 W. Chicago Ave., Chicago 22.

TIRES, Firestone, retail, wholesale. Page & Breton, Franklinville, N. Y.

GASOLINE Economizer. Ford, Mercury, Chevrolet, 1932-1947. Dodge, Plymouth, 1933-1938. Buick, AAV16. \$1.00. Walert Co., 3429 No. Tenth St., Milwaukee 6, Wis.

BIG Money in auto supplies! Buy wholesale. 50% off, accessories, parts, radios, home supplies. Catalog free. Main Supply, Fairfield, Ill.

BROKEN Keys removed easily from all automobile locks. A must for car owners, gas stations, parking lots. Tool, instructions, 35c. Weitman, 2212 Avenue "X," Brooklyn 29, New York.

RECLAIM Used motor oil. Inexpensive method. Instructions 50c. Charles, 12 AH, Norwood, Ohio.

REDEX Hand choke adapters stop automatic troubles. Four types fit most carburetors. \$3.00 postpaid. Guaranteed. Redex Machine, Rochester 13, New York.

CALIFORNIA'S Deep motorboat tone single and dual mufflers for all cars. Shipped anywhere c.o.d. Von Esser, 2840 No. Kedzie Ave., Chicago 18, Ill.

MAGIC Motor tune-up tunes motor instantly. Proven gas saver. Guaranteed. \$1.00. Midland, Box 1745, Waterbury 89, Conn.

PLATINUM Ignition points assist your car's nerve center. \$5.69. Jacon Industries, 3 Seaside Terr., Lynn, Massachusetts.

NEED Auto parts? We have them. New and rebuilt. Prompt shipment. Write requirements. Save money. Buy direct. (See our display advertisement page 250). Factory warehouse. Mechanics Auto Parts, 3807-PM-7 North Ashland, Chicago 13.

1947 SUPERIGNITIONER: \$5.50 Atomic pep, starting, mileage. EG Mfg., Elmsford, N. Y. 1.

NEED Moving parts? Truck & Auto Parts Center, Box 123, Bergenfield, N. J.

HAVING Car trouble? New, used, guaranteed auto, truck parts save money. Transmission specialists. Describe needs; immediate reply. Victory, 2930½ Northwestern, Chicago 18.

AUTO Parts for all autos and trucks. Trans, motors, differentials, fenders, carburetors. Also body parts. Security Auto and Truck Parts, 1941 BJ Eddy, Chicago 13.

PLATING Outfits for auto parts. Connect to a battery. No tanks used. Free particulars and proofs. Gunmetal Co., Ave. J. Decatur, Ill.

TIRES (Brand new) cut rate, famous brands, 600x16 \$11.95, 650x16 \$14.45. Limited quantities. Money orders, f.o.b. Chicago. Chief Motor Products, Rm. 909, 160 N. LaSalle, Chicago, Ill.

SEAT Covers to 1933. Save \$10. Good plaid fiber. Leatherette trim. Full sets \$10.45. Fronts \$6.95 COD, postpaid, immediately. Lubbock Cover Co., 1911-N, Lubbock, Texas.

GASOLINE Saving vacuum supercharger, uses gasoline motor's waste, more power, speed, smoother motor, reported savings high as 25%. Price \$12.85. Self addressed stamped envelope for pamphlet showing this great patented invention. McDowell Co., 2000 NE. Union, Portland 12, Oregon.

BURN Water in your car. Costs less than gas. More power, cleaner motor. Mail card for data on \$17.50 octa-gane water injecting carburetor. Ralph A. Shade, 563 Lake Road, Webster, N. Y.

TWIN-TONE Mufflers for V-8 and Mercurys 35 to 47 models. Gives more mileage, without back pressure. Mufflers are straight through-type and produce deep mellow tone, \$20.00 a set. Single through-type mufflers for all cars \$6.50 ea. Chrome tail pipe extension 2½" dia. \$2.50 ea. Satisfaction guaranteed. Twin-Tone Mufflers, 139 East Manchester Ave., Los Angeles 3, Calif.

MAGIC Motor tune-up, tunes your motor instantly. Extra miles per gallon. Only \$1.00. United Sales Co., Aberdeen, So. Dak.

HOT-ROD Manual; plans, photos, instructions, fast Fords. \$1.50 p.p. Racing parts list, 10c p.p. Hollywood Hot-Rod, Box 9626P, Los Feliz Sta., Hollywood 27, Calif.

GRILLES For all cars. Wagner Grille Co., Bernville Route #2, Penna.

AUTO TRAILERS

TRAILER, 14 Foot Vagabond has everything. Manual drawings, instructions, parts list \$1.00. Tandem 26 feet, three-room trailer floor plan, 24x36, six view dimensions, etc. \$1.00. Circular illustrated 14 to 26 foot designs 20c. Craftsmann Books, Box 1153-P3, Milwaukee, Wis.

A \$300,000 Stock. All types. Parts and supplies. What are your requirements? Sellhorn's, Sarasota, Florida, or East Lansing, Mich.

COMPLETE Foundation for your trailer home. Chassis frames, Tor-Q-Les axle, spring and wheel assemblies, hitches, tires and tubes. Order a complete unit or specify items desired. Literature on request. General Trailer Company, 705 S. 3rd Ave., Wausau, Wis.

SOFT Tire indicators for trailers. Inquire. Laidlaw Mfg. Co., Box 1108, Pasadena 20, Calif.

BUILD Your own trailer! Save money! Have every feature you want! Plans for house, sport, camp and utility trailers. Catalog describing 9 models 10c. 15c in Canada and overseas. Jim Dandy, Box 125-A, Wausau, Wisconsin.

MOTORCYCLES, BICYCLES, MOTOR-SCOOTERS AND SUPPLIES

MOTORSCOOTERS 1947 Models. Immediate delivery. 10c for illustrated catalogue. Johnson's Motorscooter Sales Co., Milford, Ind.

MOTORCYCLE Cams ground for speed and power, carburetion. For information write Harold Schaller, 247 West Main, Turlock, Calif.

BOYS, Repair your own bike. "Bicycle Repair Manual," teaches brake repairing, rebuilding wheels, etc. 65c. Robert Klausner, Shelbyville, Ill.

CUSHMAN Motorscooter \$20 (includes motor and extra tires), midget racer \$15! Send 25c for big summer catalog #938, just printed, listing these and scores of other sensational bargains in motors, wheels, motorscooters, motorbikes, Servicycles, tires, etc. Associated, Box CS-1764, Toledo, Ohio.

TIRES, Inner tubes, wheels, for small trucks, wheelbarrows, power scooters, midget cars, farm equipment, carts, etc. Sizes 8" to 18" o.d. in 2, 4 and 6 ply first-line quality tires, with removable inner tubes and heavy duty demountable wheels. Also caster forks, straight or swivel types. Free circular and prices. Jahant Co., 626 East Exchange Street, Akron 6, Ohio.

CUSHMAN Motorscooter \$15, Shaw bicycle motor \$15. Harley-Davidson motorcycle #35! Send 25c for bargain catalog #8, just off the press, packed with money saving buys in motorscooters, motorbikes, midget cars, motors, wheels, tires and parts. Gail and Company, 538 Erie, Toledo, Ohio.

1930 TWIN motorcycle \$25; motorscooters less motors \$15.75 up; motors \$3.50 up; Whizzers \$25 up; professional midget track racer; plenty midget racers for highway use; plenty brand new two horsepower motors in original crates; over 6500 small balloon tires for motorscooters and small cars, \$1 up. Mailorder only. Send 25c for Big War-Bargain Catalogue Number Nineteen, just out, listing the above and hundreds of other bargains in both new and used motorscooters, midget cars, motors, outboards, mowers, etc. (35c by first class mail). Midget Motors Directory, Athens, Ohio.

MOTOR Scooters, bicycle engines, 120 miles gallon. Dime for catalog. Clymer, Desk A-75, 2125 W. Pico, Los Angeles 6, Calif.

MIDGET Car axles, etc. Write Behnke's Auto Supplies, 5721 Leland Ave., Chicago 30, Ill.

WHEELS—Steel disc, rubber tired, sizes 5"—6"—7"—8"—10". Available. United Wheels Mfg. Co., 11727 La Fayette Ave., Chicago 28, Ill.

HARLEY-DAVIDSON Parts, accessories, batteries, tires, and repair work. 24 hour service. Authorized factory dealer. Philadelphia Harley-Davidson Company, 857 North Broad Street, Philadelphia 23, Penna.

WHEELS! Build wagons, scooters, mowers, trailers, wheelbarrows, grocery carts, baby carts, play pens, baby carriages. 4" to 16". Free list. Truilen Mfg. Co., 811 E. 31, Kansas City, Mo.

BICYCLE Book, how to buy, rebuild, sell used bicycles 50c. John Collett, Handley, Texas.

TIRES And industrial wheels, suitable for scooters, wheelbarrows, farm equipment, etc. All sizes. Bicycles and accessories. Largest assortment in America. Send dime for list. Cycle Transport Company, 1241 So. Michigan Ave., Chicago 5, Illinois.

BUILD America's lowest priced motor-scooter speedster! Complete plans, specifications, \$1.00. Big list bargain priced used motors, etc., included free! Motor Supply, Box 1682-CS, Toledo, Ohio.

LARGE Stock Indian parts. Expert motor rebuilding. New and rebuilt Chief motorcycle, motors only. Indian Motorcycle Sales, Kansas City 1, Mo.

HARLEY-DAVIDSON — New and used 45" motors, service, parts, accessories, tires. Send \$2.25 for army motorcycle manual, 10c for bulletins. Knuth's (Harley-Davidson factory dealer), 2491 Pond-dulac, Milwaukee, Wis.

BEAUTIFUL New bicycles, all makes, \$34.95. Free catalog. Century Cycle, 3447 Lawrence, Chicago 25, Ill.

AVIATION

GIANT Kites, \$34.50. Powerful 10x14 ft. double decker. Lifts light person. Tows car. The answer to aerial photography, advertising, aeronautical experiments, unusual thrills, etc. Send card for complete description. Great Northern Mart, North Adams, Mass.

PROPELLERS—Airliner 3 blade, 2 blade, designed for ice-snow sleds, boats. Literature. Standard Aircraft, Box 387, Ft. Worth, Texas.

ENTER Aviation, U. S. or foreign. I can help you. Free information. Miller, 1333—18th Street, Santa Monica, Calif.

B-29 COMPUTERS, Dynamotors, am-plidyne, auto pilots, amplidyne servo amplifiers, compressors, gun chargers, turret drives, generators, starters, Plexiglas domes, sighting stations, etc. Free list. Eresco, 1006 Hewitt, Everett 1, Washington.

CUBS, Wacos, Taylorcrafts, Aerocraft. Big catalog, 25c, lists these and thousands of other sensational airplane bargains. Some are "easy to repair" crackups. National, Box 1682-CS, Toledo, Ohio.

PROPELLERS For ice-snow sleds, air boats. Catalog 10c. Banks Propellers, R.F.D. 12, Ft. Worth, Texas.

BATTERIES, GENERATORS

EDISON Alkaline storage batteries. Light, Power. Non-acid. Odorless. Fifteen year life. Five year unconditionally guaranteed. Free illustrated literature. See-Jay Company, 321 Yonkers Avenue, Yonkers, New York.

EDISON Non-acid lifetime storage bat-teries for home lighting, motors, radios, etc. Free complete interesting literature. T. Hawley Smith Company, Croton Falls, N. Y.

ELECTRICAL SUPPLIES, EQUIPMENT

ELECTRONIC Scriber is no toy pencil; it vibrates, permanently writes, engraves all metals. Mechanics, farmers, sportsmen. Prepaid \$3.50. J. E. Hammers Co., Aberdeen, S. D.

TATTOOING Machines, outfits. Free catalogue. Jensen, 120 West 83rd Street, Los Angeles 3.

FLUORESCENT Lights: Make your own. Ideal for home and shop. Complete electrical parts for 20-watt fixture with all necessary detailed instructions. Postpaid for only \$2.00. Write Fluorokit, 332 E. Reservoir, Milwaukee, Wis.

ELECTRIC Pencil—Writes, engraves all metals. Battery model \$1.00—110 volt model \$2.00 postpaid. C.O.D.s accepted. Rob Industries, Dept. 265-X, Elmhurst, Illinois.

ELECTRICAL Instruments—Meters re-paired and calibrated. Correspondence invited. Haledon Electrical Instrument Co., 319 Belmont Ave. (Haledon), Paterson 2, New Jersey.

ELECTRIC Instruments, a.c. and d.c. New, used, repair service all types. Cleveland Electric Laboratories, 1988 E. 66 St., Cleveland 3, Ohio.

WASHING Machine parts. All makes. Northeast Burner, 1358-M H Street, Washington 2, D. C.

MAGNET Wire—#20 Formvar, 750 feet, \$4.75. J. I. Weeks, 919 Neland, Grand Rapids 7, Mich.

MAGNETS Alnico—free list. Terry Sales Company, 3726 South Detroit Avenue, Toledo 9, Ohio.

SOLENOID Assembly. All new! Contains over 1 pound magnet wire. Over \$30 value. Special \$1.50 each. Four for \$5. No C.O.D. "Amazing Bachman's," 23 Herman Street, Rochester 5, N. Y.

VINYLLITE Plastic tubing. Splendid electrical insulation. Sizes 1/10" up to 5/16" diameter. 2c per foot. All new! Available in coils from 250 to 1,000 feet. Send for listing. "Amazing Bachman's," 23 Herman Street, Rochester 5, N. Y.

FLUORESCENT Fixtures. Factory prices. Free catalogue. Naturalite, 1520 Ardmore, Chicago 26.

EXPERIMENTERS, Student scientists—Experimental science manuals and kits. Send for list. Queens Experimental Supply Co., 25-12 Steinway Street, Long Island City 3, New York.

BUILD Your own lamps. Save half. Be different. Write for free photos, also lamp parts. Buddy Products Mfg. Co., 1123 W. Belmont, Chicago, Ill.

B-29 FIRE-CONTROL Computers GE2-CH1C1. Single parallax. New \$75.00. Free list. Ereco, 1006 Hewitt, Everett 1, Washington.

LAMPS—If you build or repair, had trouble finding parts, your search is ended. Chrome push sockets 25c, harps, pipes, switches, vase caps, clusters, etc. Illustrated catalog 10c. Gyro Lamps, 5416 Clark, Chicago 40.

EXPERIMENTS—Re-light burned 2-40W fluorescent with 5 volts, \$1.00. Pamats, 227 Woodbine, Brooklyn, N. Y.

ELECTRIC Pencil: Writes, engraves all metals. \$1.00 postpaid. Beyer Mfg., 229-H Dixon Blvd., Uniontown, Penna.

ELECTRIC Fan assemblies. Assemble your own. Ted Riseman, 207 North Fifth, Springfield, Illinois.

1000 AMPERE Starter solenoid relays. \$2.45. New. Specify coil voltage desired. Free list. Ereco, 1006 Hewitt, Everett 1, Wash.

PRACTICAL Winding of a.c. motors. A course of instruction on winding, connecting, and testing single, two, and three phase motors. Clearly written in everyday non-technical language. Illustrated throughout. This book is recommended for beginners interested in learning motor re-winding and repair. Satisfaction guaranteed or remittance refunded. \$2.00 prepaid. Educational Advancement Co., Dept. Y, Lakewood, New York.

WELDING, SOLDERING, PLATING

ARC Welders, lowest prices. Catalog 10c. Frazee Electric, Box 179, Santa Rosa, Calif.

WELDERS—Govt. surplus tested gasoline driven. Save up to 50%. Iowa Machinery Co., Des Moines.

NEW Model electric welder 110 volt a.c.-d.c.; will weld all metals; easy to use; full directions. Complete with power unit, flame and metallic arc attachments, carbons, fluxes, rods, mask; all for \$19.95. Used by the navy. Magic Welder Mfg. Co., 239 MP7 Canal St., New York City.

ELECTROPLATING Booklet includes full directions for plating jewelry, small parts, metallizing baby shoes. 50c. Hoover & Strong, Inc., 113 W. Tupper Street, Buffalo 1, N. Y.

WELDERS (Acetylene), double present earnings welding white metal (pot) using own rod made from scrap. La Combe, Oakland 6M, Calif.

WELDERS: New 200 ampere aircraft generators \$25.00. Blackhawk Distributors, Box 89, Olathe, Kansas.

SAVE Time and money. Use Mendall Metal for quick, permanent repairs on motor blocks, cylinder heads, radiators, plumbing, kitchen utensils, etc. Write for free facts. Four A, Dept. 11, Littleton, Colorado.

NEW Aircraft generators, model R. 2, volts 12 to 30 (adjustable), 300 amp. d.c. shipping weight, 69 lbs.; size 16"x7", price each, \$39.50; air cooled. Cost about \$250.00 each. Immediate shipment; check with order. Greer Co., 460 S. State St., Chicago 5, Illinois.

A.C. Welders, 110 v., welds 1/2" steel, \$29. Money back guarantee. Paul Morris, 1850 State St., Schenectady 4, N. Y.

WELD, cut, braze with gasoline! Amazing new discovery shatters costs. Boosts profits. Important! Write Matthews Mfg. Co., Calgary 21, Canada.

WELDING, Cutting, aircraft welding and soldering equipment. Electric arc welders. Superior Oxy-Acetylene Co., Hamilton, Ohio.

MACHINERY, TOOLS AND SUPPLIES

UNIVERSAL Mechanics tools: Dandy 10-piece set: Ridgid pipe-wrench, Channel-grip pliers, adjustable wrench, Ceetee pliers, diagonal cutters, ballpeen hammer, plastic screwdriver, waterpump pliers, hacksaw and blade, cold chisel, \$19.85. Remit today. New catalog free. Universal Tool Company Has It. 1527 Grand, 10C, Kansas City, Missouri.

ALUMINUM Handles. For socket screw keys. Wittle Manufacturing, 1041 Lititz Avenue, Lancaster, Penna.

INSTRUMENT Gears, assemblies; hundred assorted, \$7.50; literature. Scientific, Box 438, Hackensack, New Jersey.

AIR Hammers—Drills, Ingersoll Rand Model AVC-11 pneumatic riveting hammers. Rivet size 5/32" aluminum pistol grip handle. Regular price \$66.00. Our price \$22.00, slightly used guaranteed like new. In lots of 10 or more 20% discount. Air drills Ingersoll Rand Type OJ Multi-Vane 2250 r.p.m. Capacity 1/4" with #7B Jacobs chuck aluminum pistol grip. Regular price \$66.00. Our price \$32.50. Guaranteed like new. In lots of 10 or more 10% discount. Sold with money back guarantee. C. & M. Equipment Co., 1831 S. State St., Chicago 16, Ill.

PRECISION Jewelers screw drivers. Complete set of 8. Same type set used by U. S. Navy for instruments, watches during war. Brass knurled handles, finest tempered steel blades. Sizes 2-9. Money back if not satisfied. C.O.D. \$2.00 plus postage or send \$2.00 and we pay postage. Fine Watch Co., Rm. 24, 29 Eldridge St., New York 2, N. Y.

FOUNDRY Castings, blueprints, materials for woodworking and metalworking machine tools. Suitable for commercial or home shop production. 23 items, catalog 10c. Lewis Machine Tool Co., 3217 Union Pacific Avenue, Dept. M, Los Angeles 23, California.

GOVERNMENT Surplus, new, Delco aircraft generators, 28.5 volt 200 amp. convert to welder, battery charger, auxiliary power plant, etc. Complete with new Westinghouse voltage control, \$48.00 f.o.b. Pecos, Texas. Lee Lumber Co., Pecos, Texas.

HI-SPEED Drills, 25 for \$2.00. A carefully selected assortment of number and fractional sizes. Free decimal chart with all orders. Lampke Surplus Tools, 11607 Linwood, Detroit 6, Mich.

MACHINISTS, Starrett 454A 10" height gauge, with case, \$32.50 cash with order, postpaid; or c.o.d. Lippincott Supply Co., Box 931, Benicia, California.

TEEHO-TOOL, Hand saw sharpening guide. Gets teeth uniform. 25c. Satisfaction guaranteed. 316 North 2, Maywood, Illinois.

THREAD Restorer! Eight in one thread file! Save that worn bolt stud or shaft thread. #1 for 11, 12, 13, 14, 16, 18, 20, 24; #2 for 9, 10, 15, 16, 20, 26, 28, 32 threads per in. Either tool \$2.00 postpaid. Bowers Hardware, Box 175, Sta. A, Canton, Ohio.

TOOL Steel kit—25 6-inch rods, assorted diameters—for making small tools, drills, etc.—\$1.95 postpaid or c.o.d. Steel combination rule and depth gauge included. Extraordinary value. Bessemer Steel Co., Dept. 10, Chicago 19.

MAKE Your own power tools with our low-cost ball bearing arbors, 3/8", \$6.95; 1/2", \$7.95; 5/8", \$8.95; 3/4", \$10.95; 1", \$19.95; right or left hand threads. Adjustable shaper arbors, 1/2", \$22.50; 5/8", \$22.50; 3/4", \$36.50; 1", \$36.50. SKF equipped, postpaid. Write for details. A. & P. Equipment, Dept. 1-A, 520 W. 15th, Long Beach 13, California.

BALL Bearings one-fourth list price; gears, switches, rheostats. Free list. Burgess, Box 168, Ferguson, Mo.

LAY Cement block faster, more accurately. "Kingsley Bondor" does the job. Saves time and material. \$2.00 postpaid. Distributors wanted. Kingsley Shop, P.O. Box 1832, Atlanta, Ga.

BENCH, Jig saws, sanders, drills, etc. Immediate delivery. Circulars 3c. Sunshine, Berkshire Heights, Penna.

DRILL Grinder for twist drills \$2.95. See ad on page 250.

INDEX Head for sale. Sixty-two divisions. Used on lathes up to twenty inch swing, drill-presses, milling machines, etc. Make gears, hobs, cutters, etc. Very accurate and durable. Used by shops, factories and machinists. Write for free folder. Long's Index Head, 2117 East B Street, Torrington, Wyoming.

BUILD Quickchange gear box without castings for \$10.00. Craftsman, Atlas, adaptable other lathes. Complete drawings \$3.75. Stevens, 2604 Military, Los Angeles 34.

HOME Shop owners attention.—Send for actual photograph and sample of the work our attachments will do. The photograph and sample speak for themselves. Have fun in your home shop. Cut gears, sprockets, ratchets, lay out holes accurately, cut keyways, build complete clocks and other interesting jobs. Build these attachments yourself from our reasonably priced blue prints. Don't limit your lathe to round work only. The Home Shop, 415 Raymond Avenue, Glendale 1, California.

WAR Surplus in small tools for machine shop—Send 15c for bulletin. Travers Tool Company, Dept. P, 5 Court Square, Long Island City, N. Y.

V-BLOCKS At low prices. 10 sizes for all purposes. Free literature. Miles Products, 2532 Wabash, Chicago 16.

CONCRETE Building block machines and molds. Catalog free. Concrete Machine Co., 5129 South Compton Ave., St. Louis 11, Mo.

DRILL Grinder—Grinds drills to factory accuracy. Callipers with direct reading scales. Circle cutters. New Tool grinder. Lowest prices. Free literature. Factory, 811-B East 31st, Kansas City 3, Mo.

DRILLS-TAPS—Reconditioned high speed, up to seventy-five percent off list. Send for free circulars. Perry Screw and Bolt Corporation, 4250 Grand River, Detroit 8, Michigan.

BOATS, OUTBOARD MOTORS, ETC.

OUTBOARD Motor mount for your rubber boat, same as used by air corps and navy at \$3.95 each prepaid. Check or money order payable to Wilcox Holding Corporation, Mt. Carmel, Conn.

MARINE Power—Easily convert any Jeep or Ford motor (domestic or foreign) with Convo parts and kits. Complete catalog 25c (coin). Osco Motors Corporation, 2020B East Orleans Street, Philadelphia 34, Penna.

\$35 SEA Shell pre-fabricated 8' plywood rowboat. Free illustrated folder. Hagerty, Cohasset, Massachusetts.

CARTOP Rowboats, Kayaks. Weldwood ready cut kits. Booklet. E. J. Croot Co., #103-D, Basking Ridge, N. J.

WHY Lug your outboard motor? New carrier \$8.75. Folder free. Sportspal, Tahoe Valley 6, California.

SAILS, Canvas for decks, cabins, canoes, trailers, airplane dope, cement. Boat hardware, paints, etc. Catalogue. Alan-Clarke Co., 96 Chambers, New York City.

TACHOMETERS 0-5000 And 0-8000 r.p.m. \$12.00, specify rotation. Zakarian Engineering, Box 416, East San Diego, Calif.

BUILD Your boat from full size paper patterns, boats representing forty years careful designing. Send 10c for folders. Up to the minute book on small boat construction, \$1.50 postpaid. Germain Boat Company, Dept. 3, Saginaw, W. S., Mich.

P-38 BELLY Tanks, new, steel, 10 ft. 2 in. 165 gallon \$9.95. Anzio Boat Co., Box 89, Merced, California.

MAKE Money building-selling boats new easy way with ready-made hulls. Brochure 10c. Plastic Boats, Box 844, Grand Central Station, New York 17.

NEW Chemold plastic 12'x5' beam—\$195.00; one man carrier—\$45.00; 5'x7' 6' head room tents, steel poles, plastic screens, 4 sides—\$69.50; one-half hp. electric lawn mowers—\$99.50. Sellhorn's, Sarasota, Florida, or East Lansing, Michigan.

PROPELLERS—Airluison, Airliner 3 blade, 2 blade. Literature. Standard Aircraft, Box 387, Ft. Worth, Texas.

PROPELLERS: New army surplus. Michigan, 3 blade bronze, 12"x10" r.h.; 3/8" hub bore. Made for Johnson 22 h.p. outboard. Modify for other engines. Only \$5.65 each postpaid (with order). We will increase pitch to 11", 12" or 13" at \$1.00 additional per each propeller. Baker Bros. Supplies, Box 301-C, Palatine, Ill.

MARINE Catalogue, over 5,000 deliverable items, pictured, priced. Send \$1.00. Marine Mart, Buffalo 7, N. Y.

THRILLS! Excitement! Paddle or sail your own kayak. Plans for 10 1/2' or 15'. Rush \$1.00 today. Hoosier House Cl, P.O. Box 1264, Indianapolis 6, Indiana.

UNPAINTED Mahogany plywood boats, \$79.50 f.o.b. Suitable for oars or outboard motor. 12' long, 48" beam, 13" sides. Skiff type construction. All galvanized fastenings. Cypress framing and mahogany plywood construction throughout. A real saving. Write for literature, or send check or m.o. Widney R. Hale Boat Wks., New Iberia, La.

CATALOGUE Over 50 plywood plans—Kyacks to Cruisers—sent with William Deed's book "Plywood Building." send \$1.00. Marine Mart, Buffalo 7, N. Y.

NEW, Used, rebuilt marine motors. Marine conversions, fittings. Free catalog. Stokes Marine Supply, Dept. 24, Coldwater, Michigan.

ARMY Surplus rubber rafts, big (21'x 6'x2') Govt. price \$487.00. Complete for only \$40.00. Many uses. Money orders, f.o.b. Chicago. Franklin-Weber Motors, 6111 N. Clark St., Chicago, Ill.

KAYAK Blueprints, deluxe models—catalogue 10c. Viking Canoes, Merrick, N. Y.

BOOK—20 Complete plywood boat plans, with building guide. Send \$1.00. Marine Mart, Buffalo 7, N. Y.

OUTBOARD Motor parts, new and used, for all makes. New pistons, standard and oversize. Cylinders rebored. Outboard Motor Mart, Inc., 309 Atlantic Ave., Boston 10, Mass.

ALL Copper water jacketed exhaust manifolds for marine conversions of automobile and aviation engines and marine engine replacements; any make, model or age. Joseph Van Blerck & Son, 391 Woodcleft Ave., Freeport, N. Y.

MARINE Conversions for Ford and Jeep engines. Catalog 10c. Lehman Manufacturing Company, Department D, Newark 2, New Jersey.

USED Outboard motor parts. Outboard Exchange, 1194 Remsen Ave., Brooklyn 12, N. Y.

BOATS And all about them. How to select, build, repair and operate. For 40 years the leading practical boating magazine. Half price trial subscription. 12 issues for \$1.00. Motor Boat, 62 Gold Street, New York 7.

TWENTY Plywood boat plans \$1.00. Catalog boat building plans 10c. The Rudder, 15 Murray Street, New York.

BOAT Designers are highly paid professionals. Complete course by mail. Catalog. Westlawn, Montville, N. J.

ENGINES, MOTORS, DYNAMOS

"BUILD Your Own" gas drive arc welder easily with Hobart Generator. Save \$300 to \$500, and need only add used auto engine and chassis to build portable gas drive welder that goes everywhere after profitable construction and repair jobs. Write for free instruction book, further details. Hobart Brothers Co., Box M-773, Troy, Ohio.

NEW 1/2 HP G. E. motors, 220 volts a.c. Irvso, 2919 Oakley Avenue, Baltimore 15, Maryland.

NEW Motors—1/100th h.p. 110 volt 60 cycle a.c. housing type. Hundreds of uses. Will operate 8 inch four blade fan 2000 r.p.m. Price \$3.50 each postage prepaid. Check or money order. David Tann, 3750 East Outer Drive, Detroit 12, Mich.

DYNAMOTORS. All new! 400-cycle, GE5D21N3A. 27VDC to 110VAC. 485 watts. Sensational offer! \$8.95 each. Three for \$25. Order today! No c.o.d. "Amazing Bachman's," 23 Herman Street, Rochester 5, N. Y.

400 CYCLE Dynamotors. GE5D21N3A. 27VDC to 110VAC. 485 watts, shaft extension. Will operate 60 cycle radio equipment. \$12.50. Free list. Erco, 1006 Hewitt, Everett 1, Washington.

AMPLIDYNE Motor-Generators. All packed—new! GE5AM31N9A. Output 60 VDC, input 27 VDC. 530 watts. Original cost \$120.00. Now! \$7.95 each. Three for \$20. Order today! No c.o.d. "Amazing Bachman's," 23 Herman Street, Rochester 5, N. Y.

DEALERS—Sell electric motors, gas engines, light plants, a.c. and d.c. generators, fans and ventilating equipment. Catalogue 10c. CMCO, 514 Van Buren, Chicago 7.

SELSYN Motors. Bendix 3 1/2"x5 1/2" heavy duty 115 volts, 60 cycles, \$10.25 per pair. J. A. Weber, 150E Maple, Hershey, Penna.

MOTORS! 1/2 Hp.—All New—High speed 110 volt. 25 or 60 cycle, d.c. converted to a.c., ball-bearing motors with forward and reverse switches. Actual cost about \$100.00. Now \$19.50, three for \$50—or—same motor without reverse switch \$15. Three for \$40. Countless uses for home mechanics. Order today! No c.o.d. orders. "Amazing Bachman's," Dept. PM, 23 Herman Street, Rochester 5, N. Y.

WINDING Data, listing 225 motors, single and three phase, \$1.00. Motor Data Co., Box 7631, Kansas City 3, Mo.

AMPLIDYNE Motor-generators. GE5A-M31N9A. Input 27VDC, output 60-0-60 VDC. 530 watts. Shaft extension. New \$15.00. Free list. Erco, 1006 Hewitt, Everett 1, Washington.

SELSYNS—All new! Transformers—GE model 2J1G1. 57.5—57.5V 400 cy; Generators—GE model 2J1F1. 115—57.5V 400 cy. With gears. Sensational offer! \$1.50 each. Quantity lots \$15 dozen. Order now! No c.o.d. "Amazing Bachman's," 23 Herman Street, Rochester 5, N. Y.

LITTLE Library of Useful Information. 102 different books. Catalog free. Popular Mechanics Press, 200 E. Ontario St., Chicago 11, Ill.

ATHLETIC EQUIPMENT, BODY BUILDING COURSES

HEALTH—Build perfectly developed body. World's greatest system. Literature free. Todd Foundation, 210 Fifth Avenue, New York.

DEADLY Judo—Fiercest fighting technique. Trick knockouts. (200 photographs—plus illustrations). Expert instructions. Three volumes. Complete \$2.25. Variety House, Box 46-BT, Wall Station, New York 5.

BARBELLS! Catalog! Bur Barbell Co., 319 Orient Way, Lyndhurst, N. J.

BARBELLS. Exercise equipment. Courses. Free booklet. Good Barbell Co., Reading, Penna.

SPORTING GOODS, GUNS, FISHING TACKLE, ARCHERY, TRAPPING

FISHING Tackle catalog free. Sportsman, 670 E. 42nd, Brooklyn 3, N. Y.

YOU Will catch more bass with a presto lure. Free circular. Hugh Mallett, Bradford, Illinois.

5000 BARGAINS, Firearms, binoculars, war relics. Catalog 40c. Smith Firearms, Runnemede, New Jersey.

FISHING Poles: Old-fashioned native canes and bamboos all kinds. Nylon line, 50 yard spool, 45 pound test, finest quality, \$2.25 prepaid. 3-piece jointed native cane \$2.50. Ferrules all sizes. Reel seats: finest Duralumin, surf size \$2.25; fly or casting \$1.85. Live crawfish for restocking or bait \$8.50 per 100. Surf reels, fly reels, casting reels, electric bobbers, leaders, gaffs, creels, baseball bats of finest ash, guides, tops, grips, butts, cork handles, rod blanks of split bamboo, excellent quality, rod repair kits, etc. Order from this ad and get price lists. Dealer inquiries invited. Bob Pace, Combs, Ark.

SWAPPING My guns, cameras, sporting equipment. List. Marvin LaCharity, 1637-E. 13th St., Bethlehem, Penna.

FISH At night with Johnstone Electric lighted Bobber \$1.00 prepaid. Circular on request. Dealers wanted. Johnstone Bobber Co., Aurora, Ind.

BAIT Casting plug for bass and pickerel, proven. Send \$1.10, no c.o.d. please. D. C. Tackle, 605 Bedford St., Stamford, Conn.

AUTOMATIC Lure—Positively weedless. Greatest invention in ages. Nothing like it. Circular free. Babcock Reel Co., Oak Harbor, Ohio.

BOWS—Arrows. Write headquarters for archery equipment. Quality products. Popular prices. Catalog 10c. Large illustrated hand book instructions, making and shooting. 50c. Archery, 617-B So. State, Chicago 5.

GUNSMITHS—Now available, complete polishing kit for refinishing your guns. Long experience in refinishing guns qualifies us to furnish you at low cost proper wheels correctly shaped and sized to repolish guns at your plant or in your home. Write for complete information. Middletown Metal Finishing Co., Inc., River Road, Middletown, Connecticut.

HUNTERS, Sportsmen: Here is what you have been looking for. A four piece steel cleaning rod with aluminum handle. Can be dismantled when not in use. Fits all shotguns and large caliber rifles. Only \$1.00 prepaid anywhere in U.S.A. Order now. Don't be disappointed later as supply is limited. Irving Goodman, Box 1998, Fargo, N. D.

AMMUNITION—New and used shotguns, rifles, handarms, fishing tackle. List 10c. Rudolph's, Atchison, Kansas.

NOW Available a complete Du-Lite installation for finishing guns and other small metal parts for \$150.00. Use it in your home or garage. Good money-making proposition. Further particulars from Middletown Metal Finishing Company, 45 River Road, Middletown, Connecticut.

FIELD GLASSES, TELESCOPES MICROSCOPES, MAGNIFIERS

GENUINE Polaroid glass—2 1/2" (72 mm.) diameter. \$1.25 each, 2 for \$2.00. Ross, C68 West Broadway, New York, N. Y.

TELESCOPES, Microscopes, binoculars, barometers, books; buy, sell, repair. We guarantee. Lists 10c. Rasmussen & Reece, Amsterdam, N. Y.

50 POWER Microscope and microscience kit, \$2.98. Guaranteed. Free literature. W. Wardell, 2509-A Clarendon Road, Brooklyn 26, N. Y.

REFLECTING Telescopes, complete. 3 1/2" diameter, equatorially mounted. View planets, stars. \$19.75. Write Sky-scope Company, 475-P 5th Ave., New York.

BINOCULARS, Telescopes, watches. Buy, sell, trade. Paul Schweer, Donnellson, Iowa.

INFRA-RED Filters glass 1 1/4" (40 mm.) diameter, mounted. Snap on camera or binocular. \$1.00 per set. Ross, C68 West Broadway, New York, N. Y.

60 POWER Telescope, \$2.95. 250 power microscope, \$2.45. Send for free catalog of telescopes, binoculars and microscopes. Brownscope Company, 24 West 45th Street, New York.

DOGS, PETS, BIRDS, RABBITS

CAN Furnish puppies most any breed. Ann's Kennels, Paw Paw, Ill.

RABBITS, Fancy pigeons, pheasants. Prices free. Jewel Game Farm, Danville, Ill.

RAISE Guinea pigs. Make money at home. Big demand. Booklet free. Taylor, Box 426A, Hapeville, Georgia.

\$2000 PER Year raising Angora rabbits. We buy your output. Contract particulars free. Wilsons, 1065 Shryer, St. Paul 8, Minn.

\$50.00 WEEKLY Raising Angoras for us. Free literature. Angoraville, 1215-34th Northeast, Cedar Rapids, Iowa.

ANGORA Wool spinners, shearing tables, breeding stock. House of Angora, Pl. Springfield, Illinois.

MONEY In New Zealand Whites and Chinchillas. Increasing demand for breeder's meat, fur. Particulars free. Loughman's, Sandamar Farm, Newark, Ohio.

POLICE Puppies, black, white, cream. Ansonia Kennels, Mose, N. Dak.

RAISE Diamond Seal rabbits. We pay \$30-\$60 each. Continuous market. Prices guaranteed. Particulars free. Hansen's Rabbit Institute, 1347 Miller Ave., Salt Lake City 6, Utah.

RAISE Golden hamsters. Thousands needed by laboratories. Delightful pets. Literature 10c. Hamstery, 1519 Basil, Mobile, Ala.

\$250.00 MONTHLY Raising Angora rabbits. Particulars free. White's Rabbitry, Newark, Ohio.

ST. BERNARD Pups: Champion sired beauties. Franklin Young, R4, Riverhead, Long Island, New York.

SUPERIOR Chinchilla Giants—Other varieties. Breeding stock supplied credit terms. Beautiful picturesque catalogue. Complete instructions, 25c. Behrens Farms, Pearl River 4, New York.

BEAUTIFUL, Useful collie-shepherds, pups \$14.00. Paul Schultetus, New Liberty, Illinois.

ANGORAS, Chinchillas, giant rabbits—finest pedigree! Catalogue free. Book "Profitable Rabbit Raising" tells everything \$1.00; scientific self-cleaning hutch plans \$1.00; automatic feeder plans \$1.00. All three \$2.50. Grinsteads, Dept. 15-E, Edwardsville, Illinois.

70 VARIETIES—Pigeons, rabbits, pheasant, peafowls. Catalogue 10c. Jim Houck, Tiffin, Ohio.

INCREASE Your income by raising domestic rabbits. Small space needed. Ready market for delicious meat, fur and wool. Largest magazine in the industry tells you how. \$1 per year. Send dime for sample. No stamps. Small Stock Magazine, Lamoni 50, Iowa.

STANDARD Rabbit Journal, Milton, Pa. 3 years \$1.00, sample dime.

GUARANTEED Chin-Chin giant Chinchilla rabbits. Greatest amount of delicious meat. Largest, finest, most valuable furs. Tremendous demand for breeding stock. We buy youngsters. Contact world's largest breeder. Willow Brook Farm, R15, Sellersville, Penna.

ZOOLOGICAL And pet animals for sale. Illustrated catalogue, literature, 25c. Trails End Zoo-5, St. Stephen, S. C.

RAISING Rabbits, Cavies, Hamsters, Chinchillas is a growing and profitable industry. Magazine 10c. Descriptive book and magazine 25c. Book and magazine (monthly) one year \$1.00. Address Small Stock Farmer, Pearl River 15, N. Y.

FARMS, FARM LAND, REAL ESTATE

WEST'S 1947 Catalogue. Over 1000 farm and business bargains. Free copy write West's Farm Agency, Inc., HE-7, Pittsburgh 17, Penna.

\$5.00 MONTHLY Buys 40 acres near town; price \$200.00. Free list. Box 425-F, Carthage, Mo.

CALIFORNIA Tax lands. \$1 to \$3 acre minimum offer. Ranch, agricultural, timber tracts. Descriptive, illustrated literature, 10c (coin). Western Tax Lands, 6417 Homewood, Dept. PM, Hollywood 28, Calif.

THERE'S A Farm In Your Future—and you may find it in the exciting pages of United's new free summer catalog of up-to-the-minute bargains! Farms, ranches, orchards, summer homes, water frontage, business opportunities—over 100 pages with many photographs, from the northern dairy section to the famous Ozarks, from the midwest corn belt to glamorous California, 19 states. Write today for your free copy! United Farm Agency, 220 S. State St., Chicago 4, Ill.

FLORIDA, Acre in park near St. Petersburg, Warranty deed, \$600. Owner, Romme, 109 Atlantic, Stamford, Conn.

GOVERNMENT Lands \$2.00 acre up. Information all states twenty-five cents. National Tax Service, 834-A Majestic Bldg., Detroit.

FLORIDA Lands on easy payments. R. W. Stewart, Inverness, Florida.

STROUT'S Green farm catalog. Over 2500 bargains, money makers, 32 states, coast to coast. Mailed free. Tell us what you want. When? Where? Price? Terms? We will try to save you time and money. Strout Realty, 255—4th Ave., New York 10, N. Y.; 20 W. 9th St., Kansas City 6, Mo.; 453 S. Spring, Los Angeles 13, Calif.

HOMESITES \$450—Convenient payments. California's finest garden section. On Morro Bay's scenic shores. Wonderful fishing, hunting, boating, bathing. Fertile soil, softest water, temperate climate, congenial community. Free literature. Richard Motto, 6560 Hollywood Blvd., Hollywood 28, California.

GOOD Farms—Ranches. Washington, Minnesota, Montana, Idaho, Oregon, North Dakota. Dependable crops, favorable climate. Write for literature, lists describing typical postwar farm opportunities. Specify which state. J. W. Haw, 119 Northern Pacific Ry., St. Paul 1, Minn.

OZARK Lands for all purposes. Actual river frontages. 5 acres \$90.00 and up-wards. Free list and literature. Hubbard, 424-I, Minnesota Ave., Kansas City 4, Kansas.

POULTRY, FARM SUPPLIES

KNOW How to raise poultry for profit. Read *Northeastern Poultryman*. Every issue packed with helpful hints and practical suggestions. Latest articles on breeding, feeding and management. Subscribe now. 1 year \$1.00. *Northeastern Poultryman*, Dept. P.M., 376 Boylston St., Boston 16, Mass.

RAISE Turkeys the new way. Write for free information explaining how to make up to \$3000 in your own backyard. Address National Turkey Institute, Dept. 3, Columbus, Kans.

PROFITABLE OCCUPATIONS

PROFIT Quickly! Establish your own welding and/or electroplating business. Complete business informational \$2.00. Refundable. Details free. Beshears, 66 Second Street, Brooklyn 31, N. Y.

OPERATE Profitable mail order business. Splendid opportunity. For details write B. T. Holverstott, 2421 Saranac Ave., Pittsburgh 16, Penna.

SHELL Jewelry, novelties. Easy to make at home as hobby or to sell. Beginners kit \$1.00. Catalog 5c. Burton, Box 27, Station A, St. Petersburg, Fla.

SCRAP Metal cast into novelties brings steady profits. Illustrated instructions \$1.00 postpaid. Literature free. Fritz Foundry & Supply, 623 N. Fulton, Allentown, Penna.

NO Selling, operate vendors, amazing profits, details free. Silver-King, 622 Diversey, Chicago 14, Ill.

WELDING—Electric arc. Learn profitable trade quickly through actual practice. Individual welder instructions at bare cost of materials. Full particulars free. Valuable welding lessons book 50c. Hobart Welding School, Box M-774, Troy, Ohio.

SMALL Capital builds independent-prosperous business. Results amazing. Details free. Felsert, R-4, St. Paul 4, Minn.

EARN Money at home with typewriter! Addressing envelopes, circulars, typing. 25c brings details also 68-page book of moneymaking opportunities. Ace-1801, Box 183, Birmingham, Ala.

RABBITS For "Pleasure and Profit." Descriptive book 25c. Arthur Sibley, Mendon, Mass.

INTERESTED In foreign employment? \$1 brings list of concerns with foreign projects or affiliates. Foreign Service Institute, Box 1897-D Riverside Station, Miami 35, Florida.

THIS Is it! Paint unpainted wall plaques! Sell locally, artists' brushes, paints, instruction books, molding rubber available. Pioneer Art, Austin, Minnesota.

OPERATE Profitable employment agency, complete instructions by former agency operator—\$1.00. Charles, 12 AJ, Norwood, Ohio.

SEWING Machine repairing, step by step instructions on repairing, rebuilding and converting all types home sewing machines, \$5.00. Hubbard, 293 Magnolia, Cranston 10, R. I.

PIXILATED Pictures make big money! Take orders for third dimensional Pixilated Pictures—the characters come right out of their frames! Nothing like them! Thousands have been sold in the few weeks on the market. Ideal for offices, dens, clubs, rumpus and children's rooms. 4x7 moulded marbelite plaques, hand painted in rich colorings. Each one in a gift box. Act now! Send post card or letter for free illustrations, prices. Or if you want to start earning money immediately send for our \$2.00 (cash or money-order) salesman's selling kit containing three different Pixilateds (saleable), illustrated catalogue, price lists and order blanks. Pixilated Pictures Company, 712 South Walker Street, Oklahoma City 4, Oklahoma.

MAKE \$100 A week in your spare time. Write for free literature. Schick Mfg. Comp., 257 William Street, New York City.

PROFITABLE Business plans. Free particulars. Roy, Box 531-B, Waterbury, Conn.

INTERESTED In South America and foreign employment? \$1 brings 1947 Foreign Service Directory listing oil, aviation, mining, transportation, manufacturing, construction firms with foreign interests and hot tips for application. Global Reports, 6417 Homewood Ave., Hollywood 28, Calif.

"ALASKA, The Last Frontier," offers excellent opportunities! \$1.00 brings official government map and 1947 copyrighted report describing potential opportunities and listing of firms with interests in fishing, mining, fur farming, prospecting, aviation, lumber, business enterprises, homestead lands. Alaska Opportunist, 6417 Homewood Ave., Dept. PM, Hollywood 28, Calif.

LEARN Novelty manufacturing, start small, grow big. Cast wall plaques, book ends, other novelties. Large profits, quickly learned, large orders waiting. Successful manufacturer offers sensational course, fast selling designs, all materials. Start garage or basement. Plastex Products, 711 Laguna, San Francisco 2.

EARN More than average. Send card for information about very lucrative trade. Lidemark, 226 Potomac Ave., Buffalo, N.Y.

MAKE Beautiful mirrors from window glass cheaply. Complete instruction folio \$1.00. Metallize Baby shoes. Several methods, \$1.00. Tesco, Box 189-MP, Wilkes Barre, Penna.

"THERE'S Big money in junk," and repairing batteries. Write, Batterymen, Grand Junction 5, Colorado.

HOW To set up and run a mirror shop! Resilver mirrors. For price write, John Sprinkle V50, Marion, Indiana.

START Back yard, perennial plant business. Much more profitable than Ginseng. Instructions \$1.00. Richland Gardens, Martin, Tennessee.

MEDICAL Laboratory technicians in great demand. We train you in your spare time, in your own home. You can practice while studying. Write for free catalogue. Imperial Technical Institute, Box 973-T, Austin, Texas.

MAKE Beautiful costume jewelry at home for large profits, hobby or therapy. Free illustrated wholesale catalogue of sea shell, metal and plastic parts contains detailed instructions. Florida Supply House, Bradenton, Florida.

LEATHERCRAFT Supplies. Catalog 10c. Art Craft Supply Company, 1205 Throckmorton, Fort Worth, Texas.

WOULD You pay 3¢—first \$350 made? Color-illustrated book "505 Odd, Successful Enterprises" free! Some offer occasional "day off." Work home. Expect something odd! Pacific, San Clemente, Calif.

LOCKSMITHING—Profitable business or hobby! New course teaches you lock secrets, how to fit keys, de-code, masterkey, etc. Easy self-instruction lessons. Bargain price. Fascinating 100-page illustrated catalog free! Write Nelson Company, Dept. 2-02, Chicago 5.

MUSHROOMS Grown. Boxes, Barrels. Illustrated instructions 50c. Spawn \$1.00. Gordons, 553 William, Winnipeg, Manitoba.

TYPEWRITER Repairing instructions, standard typewriters. Webers', Box 1008, Canton, Ohio.

\$40.00 WEEKLY Made growing mushrooms, fresh, dried. Dominion patent 331583. Free spawn. North American, 169P Yonge, Toronto, Canada.

TYPEWRITER Repairmen urgently needed. Earn \$40 to \$50 weekly spare time. Our easy to learn home study course teaches how to repair typewriters. Write for free information. Houston Typewriter Repair Service, P.O. Box 5357A, Houston 12, Texas.

ELECTRIC Clocks are every where you go, buildings, homes, parking lots, factories. Repairs increasing. Our easy to learn course with pictures and drawings teach you how to repair these clocks. Electronic Supply Co., P.O. Box 2350A, Houston 1, Texas.

BOOKS, PERIODICALS, PICTURES, POSTCARDS

MIDGET Bible—World's tiniest. Amaze your friends. Send today. 10c. Austin Specialties, 818 Waller, Chicago 51, Ill.

WHAT Every Mason wants. We have Masonic books for Blue Lodge, Chapter, Commandery, Scottish Rite and Shrine. Our rituals are used the world over. Send for free catalog of books and rituals for Masons, Odd Fellows, Knights of Columbus, etc. Ezra A. Cook, Publisher, P.O. Box 796-PJ, Chicago 90, Ill.

VETERANS! Be financially independent. Changes in Loan Guaranty not generally known offer amazing opportunities for financial success. Write today. H. B. Smith, Box 747, Dept. M, Youngstown, Ohio.

BOOKS Found free! All subjects. Send wants! Jaher Book Service, 620-P East 178 Street, New York 57.

MAGAZINES — Business, vocational, diversion. Current single copies. Choice over 850 periodicals. All fields. Free price-list. Commercial Engraving Publishing Co., 34C North Ritter, Indianapolis 19, Indiana.

BACK-DATE Magazines, books. Specific issues—years. Arkell's, Tarzana, Calif.

ATOMIC Diary—Exciting \$2,000,000,000 story atomic bomb. Eye witness account stupendous effect Hiroshima. Illustrated. \$1.00 post paid. United Technical Labs., Box 425-D, Morristown, N. J.

ART Anatomy of the Human Body \$1.00; Secrets of Chinese Physicians \$1.00. Free catalogue of unusual books included. A. Fuller Company, 201 Dewey Street, Newark 8, New Jersey.

SEND 25c For Alaska's attractive, picturesque magazine. The Alaska Sportsman, Box PM-118, Ketchikan, Alaska.

MAKE Money raising fur and trapping. 16 page descriptive booklet free. Fur Trade Journal, 588 Mt. Pleasant Road, Toronto, Ontario.

HOW To accumulate money. Free details. Stanley, 544 East Jersey Street, Elizabeth 1, N. J.

GOOD Books by mail. Free catalog PM. H. H. Evans, 1157 Sutter, San Francisco 9, California.

\$1.00 BRINGS 20 Beautiful, large 8x10 size, colored art pictures of scenes, etc. Marvelous, Box 2343, New Orleans 16, La.

YES! We are again accepting agents to handle magazine subscriptions, books, greeting cards, complete details 25c (refunded). Cassell Publishers Service, Westfield, New Jersey.

BOOKS! (Out-of-print, scarce): Quickly supplied. Send wants. Spotlight, 141 Broadway, New York 6.

GOOD "Used" self-instruction educational books on all subjects bought, sold, rented, exchanged. Satisfaction guaranteed. Complete information and 100-page illustrated bargain catalog free! Write—Nelson Company, Chicago 5.

SELF-EXPLAINING Bible: Illustrated circular free. Box 446-P, Minneapolis, Minn.

BIG Profits taking subscriptions for all magazines. Agents' confidential catalog listing over 2500 periodicals and complete starting supplies free. Pines Subscription Agency, Flushing, New York.

BOOKFINDERS! (Scarce, out-of-print unusual books.) Quickly supplied. Send wants. Clifton, Box 1377PM, Beverly Hills, Calif.

MAGAZINES (Back dated)—foreign, domestic, arts. Books, booklets, subscriptions, etc. Catalog 10c (refunded). Cicerone's, 863 First Ave., New York 17, N. Y.

MAGIC TRICKS, PUZZLES, JOKER NOVELTIES

PERFORM Clever, professional sleight-of-hand with an ordinary thimble. 42 actual photographs, full explanations describe complete routine. 50c. Garnet Specialty, Box 502, Valparaiso, Indiana.

MAKE Money, entertain, mystify, with one of magic's great secrets, "Magic Square." Create impression you are mathematical genius. Instructions \$1.00. Safeguard secret by destroying formula when memorized. Box 815, Sherman Oaks, California.

"**MAGIC** Vanishing card." Throw it into air, it completely disappears, reproduce it later from spectators pocket. Easy to do. Complete, 25c with magic catalog. The Magician, 2463-C Kensington Ave., Philadelphia 25, Penna.

PERFORM Astounding stunts with Alnico. Defy gravity. Mystify your friends. Two bar magnets. (4 oz.) instructions. 60c postpaid. Ross, C68 West Broadway, New York, N. Y.

"**MAGIC** As a hobby"—a book of 100 magic tricks you can do. Familiar objects used. Make your friendship sparkle with magic. \$1.00. The Baron, P.O. Box 109, Prescott, Arizona.

500 TRICKS. Send only 10c for Douglas' famous 112-page catalog 500 tricks. New magic for amateur, professional. America's fastest service for 25 years. Douglas Magician, Dept. 1, Dallas, Texas.

"**VENTRILLO.**" Professional voice throwing instrument and catalog 25c. Box 971-PM, Philadelphia.

DOLLAR Magic set free with mammoth catalog 25c. Mysto, 4462 Germantown, Philadelphia.

SNEEZING, Itching powders, 18 other tricks, free with joker's catalog 25c. Factory, 2404-N Fifteenth, Philadelphia.

THE Latest and best. Howard Thurston's Book of Card Tricks 50c. Specialty House, Box 542, Danville, Illinois.

VENTRILLOQUISM. Complete course and 36" vent-doll, only \$12.95. Magic catalog 25c. Herbert, P-192 N. Clark, Chicago 1.

TRUE Secret of ventriloquism. Send for booklet, Quackenbus, Big Flats, N. Y.

50c MAGIC Frame and lists, 25c. Frix-Trix, 642 Madison, Evansville 13, Indiana.

COIN Disappearing trick, magic safety pin trick, disappearing card trick; all three for \$1.00. Mystic, 1241 Quebec Road, Cincinnati, 5, Ohio.

MAGICIAN'S Pin, ghost illusion, Houdini escapes, giant catalogue. Everything, complete 25c. Magic Wand-M, 9W Colorado, Pasadena, California.

FREE Catalogue magic, puzzles, tricks. Scheetz's, 98-N Branch, Sellersville, Penna.

BE A magician. Large professional magic catalog of latest tricks, 25c. Ireland, C-109 North Dearborn, Chicago 2.

VENTRILLOQUISM Taught. 3c stamp bring particulars. Smith, 801 Bigelow, Peoria 5, Ill.

VANISHING Half dollar trick and catalog 25c. Sterling Magic Co., Royal Oak, Mich.

WORLD'S Largest professional magic shop, keeps you in touch with latest tricks. To receive mailings, send 35c for new catalog. Holden's, M220 West 42nd St., New York.

EARN Money in any crowd. Call names of strangers, tell unspoken questions. Professional course mind reading, faked spiritualism, etc., \$1. Henderson, Box 341, San Bernardino, Calif.

LARGE Illustrated professional catalog 10c. Williams, 900 Plymouth, Ellwood City, Penna.

FREE! Large catalog of magical apparatus if you remit 25c for "Magic Is Fun" magazine. Robbins Co., 152-F West 42nd Street, New York.

MAGIC Tricks, puzzles, books, cards, punch boards. Catalog 10c. Specialty, Box 671, St. Louis 1, Mo.

COINS, TOKENS, CURRENCY

WE Pay \$2 to \$200 each for hundreds of old or odd coins. Indianhead, Lincoln and foreign coins wanted. You may have valuable coins. Keep all until posted. Send 20c for new Ill's Coin Value Book. 4x6. Buying and selling prices. 40 years in business. Coin Exchange, (7), LeRoy, N. Y.

PRICE Lists and foreign coin 3c. Oliver Arnold, Macon, Mo.

FREE \$10.00 Mexican currency with each order. Large old cent 35c. 10 different Indian cents 35c. Illustrated Coin Book 35c. All for \$1.00. Coins, Box 77, Alameda, California.

OLD Money wanted. Will pay fifty dollars for nickel of 1913 with Liberty head (no buffalo). We pay cash premiums for all rare coins. Send 4c for large coin folder. May mean much profit to you. Numismatic Co., Dept. 20, Fort Worth, Texas.

WILL Pay \$10.00 each for certain Lincoln pennies; Indianheads \$50.00; dimes \$1,000.00. Catalogue 10c. Federal Coin Exchange, 7-PM, Columbus, Ohio.

COINS For collectors, reasonable prices. Free lists. Hutchinson, 3463 "I" Street, Philadelphia 34, Penna.

WORLD Coins—30 different \$1.00. Harry Elsholz, Box 9014, Pittsburgh 24, Penna.

COINS Wanted, will pay up to \$2000 for certain coins, send 25c for catalogue. Burton's, 111 So. Third, Columbus, Ohio.

FOREIGN Coins on approval on request. Del Monte, 40 W. 18, New York 11.

LARGE Old cent 35c, two cent piece 35c, illustrated coin book 35c. All for \$1.00. Coins, Box 77, Alameda, Calif.

OLD Large currency—New \$1.00 bill \$2.50, new \$2.00 bill \$6.00, both \$8.00. New half dollars—Iowa \$3.75, Booker T. Washington \$1.25, Stone Mountain \$1.25, 3-legged buffalo nickel \$1.00, 20 different Indian cents \$1.00, 10c postage extra. Retail catalogue 10c. Bebee Coin Company, 1180 East 63rd, Chicago 37, Illinois.

COINS wanted! Exclusive buying agents for collectors will pay highest prices. Send dime for catalogue listing prices paid. Franklin Coin Company, Mishawaka 10, Indiana.

UNUSUAL Worldwide collection twelve different foreign coins and bills only 25c. Webb, Box 473, San Bruno, Calif.

FOR Sale: 1893 Columbian World's Fair half dollar, 75c; U. S. 2-cent pieces or 3-cent pieces, 25c each; 50 assorted Indian head cents, \$1.25; large 50 page U.S. coin catalog, listing thousands of coins for sale at reasonable prices, 25c; Giant 72 page foreign copper-silver-gold catalog listing over 10,000 coins for sale, 25c. Ben's Coin Company, 72 West Washington, Chicago 2, Illinois.

GET Profit and pleasure in collecting old coins. Send 10c for 56 page illustrated coin catalog. You'll be delighted with it. Send for it now. B. Max Mehl, 370 Mehl Bldg., Fort Worth, Texas. Largest rare coin establishment in U.S. Established 47 years.

FREE! Foreign coin, banknote and coin collectors illustrated catalog to approval service applicants. Send 3c postage. Tatham Coinco, Springfield-125, Mass.

STAMP COLLECTING

FREE—The Stamp Finder. Big new edition—32 pages profusely illustrated! Tells at a glance the country to which any stamp belongs and so where to place it in your album! Also: 25 different stamps from Vatican City, Palestine, Cyprus, San Marino, etc. All sent to approval applicants enclosing 3c postage. Garcelon Stamp Co., Box 900, Calais, Maine.

"**WORLDS** Best" United States approvals. Mint or used, Americas lowest selling prices. Fort Orange Stamps, Albany 1, New York.

GIBRALTAR Packet free—Nice collection Gibraltar, New Zealand Centennial, British Uganda, French Colonials, early British Colonial, West Indies, South American, war stamps plus Philatopic Monthly Magazine. All for 5c postage. Empire Stamp Company, Dept. PM, Toronto 5, Canada.

POSITIVELY Greatest free offer—Latest Scott's International \$6.00 Stamp album, covering entire world, contains 36,000 illustrated descriptive spaces; Scott's 1947 Standard \$6.00 catalogues "Philately's Encyclopedia"—absolutely free to applicants for foreign approvals becoming customers. Bargain Stamp Service, Santa Ana, California.

128-PAGE United States catalog, complete with 1,000 illustrations, only 10c. Harris & Co., 202 Transit Building, Boston, Mass.

FREE—United States Columbian set—8 values, retailing \$3—Absolutely free to customers for our unusual approvals. Send 3c postage for selection plus full particulars. S. C. Engel, 38 Park Row, New York.

THREE Hitler heads. Mint with approvals. Enclose 3c postage. M. Green Stamp Co., P.O. Box 287, Hollywood 28, Calif.

500 U. S. Stamps, 50 different 20 cents with approvals. Chas. Walcott, Box 821, New Orleans 2, La.

25 BEAUTIFUL Stamps from 25 French Colonies and our price lists. One silver dime. Stampsales, Box 1649-P, Oakland 4, California.

ABSOLUTELY Free! Genuine foreign airport stamp—catalog price 50c; with illustrated "Get Acquainted Folder" describing other stamps given with our valuable catalogs. Harris & Co., 202 Transit Bldg., Boston 17, Mass.

CANADA, Newfoundland British Colonies approvals, Elkins, Stamford Centre, Ontario, Canada.

50 COLOMBIA, 33c; 25 Congo, 39c; 50 San Marino 36c. Lists. Edward Hammond, Auburndale, Mass.

TRIANGULAR Roosevelt free with approvals. Granada, 4891 Southwest 5th Street, Miami 34, Florida.

50 DIFFERENT Stamps, triangle, airmails, etc., 5c with approvals. Cariton's, 10243 Silverton, Tujunga, California.

FREE! Swell airmails, pictorials. Approvals. Al. Johnson, 727 North Foote, Colorado Springs, Colorado.

ZANZIBAR, Palestine, Manchukuo, Azerbaijan, Haiti, Iraq, Siam, Cayman, foreign, Roosevelt, 5c, approvals. Postzegel, Windham 1, N. Y.

UNITED States approvals. Low prices! Gordon Davison, Box 1019X, Manchester, N. H.

25 DIFFERENT India—3c with approvals. Customer gifts. Brandwein Stamp Company, Box 92H, Bayonne, N. J.

25 ITALIAN Commemoratives 10c with approvals. Davis, 810 North 31st, Waco, Texas.

HUNGARY 20 Different post-war 3c, with approvals, Bradley, Cairo, Ohio.

FIRST Day covers on approval. Knobel, 1918 S.W. 12th St., Miami, Florida.

EXCHANGE Stamps universe. Particulars free. "Exchangers," Bry 126, Seine, France.

DEALERS—United States wholesale price list free. Box 87, Albany 1, New York.

PYRAMIDS, Sphinx—25 different Egypt 10c with well approvals. Eric Kardell, 1175 Clay, San Francisco 8, California.

COLLECTORS Magazines—List of 19, 35c. Complete classified directory 3800 business, vocational, diversion magazines. Publishers' domestic, foreign, single copy, subscription rates. New edition \$1.00. Commercial Engraving Publishing Co., 34KK North Ritter, Indianapolis 19, Indiana.

COVERS Five different interesting foreign 25c. Walter Brooke, Boyertown, Pennsylvania.

PHILIPPINE Occupation (set 8) only 5c to applicants for inexpensive, world wide approvals. Doyle's, 320-F E. First, Long Beach, California.

SAN Marino honors Roosevelt. 6 values mint only 10c to approval applicants. Wm. Thiem, Cape Vincent, New York.

HINDENBURG Zeppelin set 5c. Approvals. Thode, 14302D 119 Avenue, Jamaica, New York.

UNEQUALLED Bargain. Stamps from over 25 countries including Fiji, Swaziland, Pitcairn, Tonga, Trinidad, etc., everything 10c to approval applicants. Bennett's, Box 252, Terminal A, Toronto, Canada.

THREE African picture postcards, picturesque stamps, addressed to you or friends registered airmail. Or six postcards surface registered. Send one dollar. Rudolph Heller, Kitale, Kenya, Africa.

5000 DIFFERENT \$24.00. Pay \$2.00 weekly. Emil Auer, 16 Duerstein, Buffalo 10, N. Y.

120 DIFFERENT Stamps only 3c with approvals. Appleman, Ida, Mich.

SIXTEEN Hitlers for 15c. Foreign-U. S. approvals accompany order. Yokums, 308 Moore Building, San Antonio 6, Texas.

50 DIFFERENT British Colonies 5c to approval applicants. Elcerrito, 5611 Meade, San Diego 5, California.

FREE Beautiful new issues, eight countries, with approvals. Green and Company, Norwood 12, Ohio.

100 U. S. Commemoratives, etc. 10c. 30¢—25c. Kellermann, Box 457, Newark 1, New Jersey.

FREE! Monaco "Roosevelt" triangle! Approvals. Keating, 637 Bergen, Jersey City, N. J.

QUALITY Counts! Better approvals. References. Philately, 823½ Maple, Santa Monica, California.

15 U. S. Comms 5c. Approvals. Jay-Dee Sales, 49 Chalmers, Youngstown, O.

56 VARIETIES U. S. commemoratives, quarter. No approvals. Roth, 25 Maple, Bloomfield, N. J.

U. S. Commemoratives. Free French, even approval applicants. Hill Stamps, Box 732M, Woodmere, N. Y.

MONACO Roosevelts (3) including triangle 5c with approvals. Collins, 71 Cole-ridge, San Francisco 10, Calif.

RELAX With some of these new giant packets which have just arrived from overseas! 50 different Greece 25c. 25 different Lebanon 40c. 50 different Great Britain 45c. 100 different India 95c. 100 different Poland \$1.25. 150 different Chile \$2.25. 300 different Italy \$2.65. 500 different Portuguese Colonies \$4.75. 300 different Netherlands \$12.50. Ask for complete lists. Mission Mart, Washington 17, D. C.

SUPERB Approvals, net prices. Stamps 1/3 to 1/2 catalog. P. G. Beals, 170A Tremont St., Boston, Mass.

WOW! 95 Different U. S. 25c; 200 different \$1.00. Approvals. Victor Logsdon, Hyndman, Pennsylvania.

200 WORLDWIDE, 27c Postage. Pacific, P.O. Box 5704, Los Angeles, Calif.

25 DIFFERENT Denmark 10c with approvals. G. D. Durden, Box 373, Clemson, S. C.

250 DIFFERENT U. S. \$1.00, free list. Robert Ewing, Wapakoneta, Ohio.

FREE Packet; unusual approvals. Stamp-box, 2439 S. 5th, Philadelphia 48.

SAVE Stamps! Start with 500 different worldwide collection for \$1; receive 500 hinges free! Send your dollar today! Bargain list free! Neptune Stamp Co., Neptune 2, N. J.

ROOSEVELT Monaco set (3), including triangle only 5c! Applicants requesting U. S. or foreign approvals. Elliott, Box 51-X, Miami Beach 39, Florida.

"GOYA Nude" set, cataloging \$1.05, complete 35c. Approvals. Royal Stamp Company, Tamaqua, Penna.

TEN Beautiful mints free with Grade A approvals, fast service. Cornell, Box 4259F, Miami 26, Fla.

FIRST See them, then buy them. United States approvals plus unique premiums. Jarr, 217-K Madison Square, New York 10.

HUNGARY—25 Different large pictorials 10c with approvals. Baird, Box 1713, Portland 7, Oregon.

WHOOPIE! Wow! 25c worth of U. S. stamps free! No obligations! Write M. & N Co., 742A Sheffield Ave., Brooklyn 7, N. Y.

STAMP Collection. Ten sets, 3c with approvals. Stoll Stamp Service, 2631 Burnett, Louisville 10, Kentucky.

STAMP Magazine—Copy free! "Stamp Post," Station A, Pasadena, Calif.

U. S. 1909 Alaska commemorative. This scarce stamp 5c with approvals. Willett Stamp Co., Box 507, Port Chester, N. Y.

ANIMAL, Map and triangle stamps, included in 50 different for 3c to approval buyers. Paul Bauer, 31 Wilkshire, Lancaster, N. Y.

HOBBY Parcel. (Stamps, magazines). One quarter. Dr. Korstoft, Randers, Denmark.

PERSIA And China packet free to approval applicants. Write "Everglades," Box 3222-M, Station F, Atlanta, Georgia.

ROOSEVELT, Churchill, Stalin, Hitler, Vatican City stamps free, to approval applicants. Flamingo Stamps, Box 517, Miami Beach, Florida.

ANNOUNCEMENT—Introductory offer—Cosmopolitan Stamp Co. resumes its well known approval service and desires the privilege of sending you choice selections. General foreign, U. S.; air mails; British Colonies, etc. Send only 25c and receive \$1.00 value of net price stamps from our initial gigantic selection. Don't delay. Write today. Cosmopolitan Stamp Co., 1457 Broadway, Dept. 7-E, New York City.

FREE—French Coat of Arms. Hitler heads, airmails, Vatican, with approvals. Gulfstream, Drawer 71, Miami 1, Florida.

VATICAN City! Four varieties of Vatican City (world's smallest country) including portrait of Pope Pius! Also stamps from Afghanistan, Cape Juby, Libya, Macao, Palestine, Syria, Liechtenstein, San Marino, and many other interesting countries. All together 48 different stamps, total catalog price over \$2.50!—only 10c to approval applicants! Methuen Stamp Service, Inc., Dept. 211, Methuen, Mass.

BECOME Successful stamp dealer. Details free. Postage please. Sample book \$7 with trade stimulators. Bing Co., Minneapolis 9, Minn.

30 BEAUTIFUL Airmails 10c, selected approvals. Louis Morrison, Milmont Park, Penna.

FLAG Stamp free with approvals. Wenigman, 929 Oakdale, Chicago.

1/2c UP. Popular approvals. Small Stamp Dealers, 2616 Cortez, Chicago 22.

\$10.00 FOR \$1.00. Box full stamps valued Scott's \$10.00 and stamp album. Everything \$1.00. Longacre Shop, 108k West 42nd, New York City 18.

2,000 UNUSED Stamps from over 150 countries at face value. Postcard brings full information. Comet, G.P.O. Box 517-P, Brooklyn, N. Y.

SCARCE U. S. stamps nearly 100 years old, 1893 commemorative, \$5-\$10 stamps, Armed services pictorials complete, Roosevelt set, large allegorical figure of Commerce, old revenues, everything 5c to serious approval applicants. Metropolitan, 140 Nassau, New York 7.

EGYPT—15 Different, 5c to approval applicants. Bohemia Stamp Service—1, Bohemia, N. Y.

FREE! 33 Transjordan, Trinidad, Haiti, others. Approvals. Robert Keating, Box 267M, Forest Hills, New York.

ILLUSTRATED Stamp Magazine, 26 weeks 25c. Stamp Journal, Kalamazoo, Michigan.

CANADA—75 Diff. 25c. Approvals, Lists. Victoria Stamp Co., London 4, Canada.

FINE Approvals, freshly mounted. Fast, personal service. Tell me what countries you prefer and I'll send their stamps. Skinner, 438 Locust, Long Beach 12, Calif.

WORLDWIDE, Different 200—25c; 500—60c; 1000—\$1.50. Beacon Sales, Maynard 2, Mass.

200 DIFFERENT Stamps, 6c, to approval service applicants. Tatham Stamp Company, Springfield 30, Mass.

PORTUGAL—30 Different 10c. Approvals on request. Stamp Chest, Box 748-A, Jamestown, New York.

BRITISH, Spanish and French Colonies, Vatican, Hitler heads, and airmail packet, free with approvals. Pan-American Stamp Co., Box 145, New York 33, N. Y.

EXOTIC Pictorial collection: Tahiti spearfishing, Melanesian idol, Ingavi battle, Reunion, Madagascar, St. Pierre Miquelon, Djibouti, Wurttemberg, Dutch Indies, Newfoundland, many others. This outstanding offer only 5c. Imperial, Box 1491, Tampa, Florida.

FREE—Famous Americans set, plus Flag Set, plus the National Parks Set, plus the Presidential Set to the \$5. A total of 90 stamps absolutely free to customers for our unsurpassed United States or foreign selections. Send 3c postage for 15 of the above mentioned stamps and full particulars. Triboro Stamp Company, 145 Nassau St., Dept. 103, New York.

\$2,000 IN Stamps free to contest winners. Particulars, entry blank, to approval applicants enclosing only 10c for scarce Roosevelt Mourning stamps from Nicaragua, Greece and Argentina, plus photograph of "Roosevelt Collecting Stamps." National Stamp Sales, 276A West 43rd Street, New York 18, N. Y.

DANDY U. S. approvals; write immediately. Sullivan, Endicott Building, St. Paul, Minnesota.

SMOKY Mountain souvenir commemorative sheet and 30 different U. S. stamps, including commemoratives, airmail, etc. (catalog value exceeds 65c) for 10c to approval applicants. Curhan Stamp Company, Dept. H, Gloucester, Mass.

BERLIN Bears, complete set of eight and 100 different stamps only 10c to approval applicants. Reich Stamp Co., 4647 Kenmore, Chicago 40, Ill. Dept. M11.

FIVE Vatican City stamps free to approval applicants. Florida Stamp Company, Box 807, Miami 5, Florida.

STAMP Collections wanted. Complete collections, duplicate lots, surplus stock, mint and used. Prefer trade for printing or other items, buy outright if priced right. What have you, what's wanted? Vanroy Shirk, Lebanon, Penna.

WOW! \$10.00 Worth of fun only 10c. What a treasure hunt! Big package 500 foreign stamps—just as received from foreign missions other sources. Includes stamps from Africa, South America, Philippines, Free French, Cape Juby, Palestine, etc., including airmails, commemoratives, and stamps worth up to 50c and 75c. This amazing offer is given for 10c to serious approval applicants only. One to a customer, money back if not more than delighted. Jamestown Stamp Co., Dept. 22, Jamestown, New York.

U. S. Price list. Send postage. State Stamp Service, 1225 Park Building, Pittsburgh 22, Penna.

1000 MIXED U. S. old and new—25c; 2 lb. \$1.25. Wenth, Medina, Ohio.

Slightly used, but in excellent condition, bargain price. New York 8, N. Y.

ZOWIE-E! A barrel of fun for only a dime. 500 United States stamps—absolutely unpicked and unsorted—just as received from church missions. Many varieties, including large commemoratives, airmails, high denominations up to \$5.00! Stampdom's biggest package of fun—and you might find something really valuable! Price only 10c to serious approval service applicants. Money back if not delighted. Illustrated bargain lists with each order. Mystic Stamp Company, Dept. 80, Camden, New York.

U. S. Price list. Send postage. Stanley Gibbons, 38-P Park Row, New York.

PENNY Approvals, that satisfy. Neil Gronberg, Box 5441-P, Philadelphia 43, Penna.

50 DIFFERENT United States, 10c. Price-list free. Seidenberg, Cassopolis, Mich.

FREE! Negro Triangle; Turks Islands "Cactus"; Dakar; Guinea; Palestine; "Fairy Tale," Pirate Chart, Map, Ship, Sea Lion and Snake stamps; French, British, Portuguese Colonies, etc. Free for 3c postage. Approvals. Potomac Stamps, Washington 10, D. C.

UNITED States approvals complete coverage, fine quality, attractive prices. Seminole Stamps, Box 378, Coconut Grove, Florida.

50 DIFFERENT Including scarce diamond-shaped airmail 3c to approval service applicants. Avalon Stamp Co., Dept. M, Springfield 8, Mass.

1000 GRABAGS 15c Each. Super bags 25c. Zandy, 630 Bingham, Reading, Pa.

FREE U. S. price list. Postage 3c. Mark Hanna, 335 - 5th Avenue, Pittsburgh 22, Penna.

FREE! Canadian sets, royal visit, George VI, George V, coronation, jubilee, others, to approval applicants. Ensign, Box 118-M, South Orange, N. J.

WORLD'S Largest diamond and triangle stamps, free stamp magazine, stamps from fighting Free French, 20 stamps from 20 different countries, pictorials, airmails, big bargain 5c with approvals. Capital Stamps, Dept. 2, Little Rock, Ark.

DEALERS—Wholesale list. Postage 3c. Frank, 5031 Queensberry, Baltimore 15, Md.

25 DIFFERENT Swiss 10c—with 1/4, 1/2, 1c approvals. Carroll's, 4357A S. Hoover, Los Angeles 37, Calif.

HOBBIES AND COLLECTIONS

25 WOOD Samples. Thinnest plywood known each marked. 4 different 50c, 12 different \$1.00, 25 different \$2.00. Cards Of Wood, Manlius, N. Y.

FIFTY Unused Canadian bookmatch covers one dollar. Jolly Hobbies, 8230 Drolet, Montreal, Canada.

PRIZE Contests again booming. Contest Magazine lets you in on how to win. Send \$1.00 today for four issues, you'll be surprised at the wealth of information. Contest Magazine, Drawer 259, Upland, Indiana.

EASY Instructions for cutting and polishing stones, description necessary equipment. \$1.00. Westlap, 117—23rd St., Manhattan Beach, Calif.

FREE Franklin D. Roosevelt memorial set complete. Other choice premiums. Catalogue 10c. Post Card Exchange, Box 116B, Boston 17, Mass.

MILITARY Insignia—Metal regimental crests; 1001 items. 25c sample crest, catalogue. Bon-Lee Co., Dept. N, 5801 15 Ave., Brooklyn 19, N. Y.

FIRST Again: United Nations insignia 30c; military emblems 2c up. Send 10c for price lists. Hobbyguild, P-35 West 32nd St., New York.

MAKE Money with hobbies. Fun and profit at the same time. Literature free. F. W. Kimball, Woodhaven, New London, N. H.

FREE Catalog pocket tricks, magic. Scheetz's, 98-S Branch, Sellersville, Penna.

INSIGNIA Collectors, our bargain assortment ten army patches. Send fifty cents. Box 228, New York 10, N. Y.

UNUSED Match book covers, 100 all different \$1.00. 35 Royal Flash covers \$1.00. Free catalog. Charles Edelman, 1311C East 84, Cleveland 3, Ohio.

INVENTING Can be an interesting and profitable hobby. Write for complete particulars. Institute of American Inventors, Dept. 40-E, 1926-Eye St. N. W., Washington 6, D. C.

COLLECTING Hobbyists! Exchange duplicates. "Hobbyswap Contacts" directory 10c. C. Bishop, Route 8, Kalamazoo 88, Michigan.

COLLECT Colorful Army patches. Pictures, prices and sample patch only 10c. Insignia Mart, 703 Broadway, N. Y.

ANTIQUES, RELICS, INDIAN GOODS, CURIOS

PREHISTORIC Indian relics. 25 assorted arrowheads, spearheads, knives, scrapers, \$2.00. Catalog free. Nirscher, 27 South 10th, Belleville, Illinois.

20 COMMON Or 7 fine arrowheads, \$1. Lynn Crandall, Box 697, Idaho Falls, Idaho.

SWORDS. Rapiers, daggers, pistols, armor. Illustrated catalog 50c. Robert Abels, 860-A Lexington Ave., New York.

4 FINE Ancient arrowheads \$1.00. Stone tomahawk \$1.00. List free. Lear's, Box 569, Galveston, Texas.

PRECIOUS STONES, MINERALS

GENUINE Siamese zircons. Perfect for earrings, brooches, rings. Beautifully cut. Unexcelled fire and sparkle. Wholesale \$1.50 carat. Sample \$2.00. Two for \$3.00. Imhusex, White Plains, N. Y.

METAL Detectors. The very latest circuit. Free literature. Hedden Metal Detectors, 538 N. Homewood Avenue, Pittsburgh 8, Pennsylvania.

MINERAL Specimens and gem material. Fluorescents. Free list. Plummer's, 5068 Brighton, San Diego 7, Calif.

JEWELRY Stones removed from rings, etc. 100 assorted \$2.40. 50 large ones \$2.40. B. Lowe, Holland Building, St. Louis 1, Mo.

CAMERAS AND PHOTO SUPPLIES

200 POWER Telephoto camera easily made. Objects miles away photograph close up. Telephoto lens and instructions \$3.00. Instructions alone 10c. Carl Jamer, Manorville, N. Y.

NOT Government surplus but Ansco fresh stock. 100 ft. 35 mm. Ultraspeed or Supreme Panchromatic film special \$5.50 prepaid and many other bargains. Visit or write us. Gary Camera Co., 619 Washington, Gary, Indiana.

EXPOSURE Meters. DeJur Auto Critic with case. Regular \$25.75. Reduced to \$19.90. Pierce, 3214 D Street S.E., Washington 19, D. C.

SPEED-O-COPY Ground-glass focusing attachment for Leica, Contax, Argus C-2 and C-3. Send for literature. D. Paul Shull, Dept. PM7, 240 S. Union, Los Angeles, California.

COLOR Photographs in oil. Beginners' simplified instructions. Details free. Goynes Skills, Lock Drawer 1784-B, Orange, Texas.

EASTMAN Models 20, 25, 60, movie titlers. Special prepaid at \$1.19. Gary Camera Co., 619 Washington, Gary, Indiana.

PRINT Your own pictures. Kit \$1.00. Spada, 10 Lexington, Wethersfield 9, Conn.

EASTMAN Roll and movie films. Allan's, 16516 Detroit Avenue, Cleveland 7, Ohio.

35-16MM. Films, equipment reasonable. Stamps for listings. Mertz Films, Springfield, Illinois.

MOVIE Cameras! 16mm. electric, magazine-loading, famous mfgs. With telescopic optical viewfinder, famous-make f3.5 anastigmat lens, battery, coupling cord and automatic release. Value over \$200, complete, ready-to-operate only \$55.00. 100% satisfaction—Money back guarantee! Order today! Free booklet. Quality movie film Panchromatic, Weston 32, 16mm. 50' magazine, \$3.25; 100' \$4.50. 50' \$2.40; double 8mm. 25' \$2.15. Semi-Ortho, Weston 8, 16mm. 100' \$2.85; 50' \$1.75; double 8mm. 25' \$1.55. Free processing. Fotoshop, Inc., Room 19, 18 E. 42 St., New York City.

BASS Says! At the sign of the old "Horse Trader," 37th year. Thousands of satisfied customers everywhere! Finest brands including Kodak, Bell & Howell, Argus, Zeiss, Leitz, etc. Satisfaction always guaranteed, or your money back! Bass buys 'em, sells 'em, trades 'em. Write or wire. Bass Camera Company, Dept. AG, 179 W. Madison St., Chicago 2.

LENSES, binocular, etc., duplicated, resurfaced, cemented. Prompt service. Workmanship guaranteed. Send lenses for estimates. Gould Lens Service, 26 Franklin Ave., Binghamton, N. Y.

PHOTOGRAPHY For pleasure or profit. Learn at home. Practical basic training. Long established school. Write for booklet. American School of Photography, 1315 Michigan, Dept. 3431, Chicago 5.

HAVE You a camera? Improve your hobby of photography and learn how to make better pictures. Write today for our latest book catalog and sample copy of American Photography, containing articles and pictures by the world's foremost writers and photographers. Camera House, 601, 353 Newbury St., Boston 15, Mass.

OIL Coloring photographs can be a fascinating hobby or profitable sideline for those with artistic talent. Learn at home. Easy simplified method. Send for free booklet. National Photo Coloring School, 1315 Michigan, Dept. 3431, Chicago 5, Ill.

PHOTO FINISHING

ENLARGEMENTS—(Beautiful hand oil colored) from your favorite negatives. 5x7—45c, 8x10—85c. Black and white double-weight enlargements—5x7—20c, 8x10—40c. From pictures or proofs, send 35c extra for each enclosed. Send cash or money orders only. No C.O.D.'s. Snapshots Co., Dept. PE, General P.O. Box 979, Newark, N. J.

NOT 8 But 16 prints 35c. 6 or 8 exposure roll printed with double set of prints. Fast service. Miami Foto Mail, Box 1506, Miami Beach, Fla.

100 VELOX Reprints \$2.00. Roll developed 16 prints 25c. Box 5, River Grove, Ill.

FREE! 5x7 Enlargement! Rolls developed and eight lifetime double-size Velox prints made by modern electronic equipment, only 30c. Reprints from negatives, same size 3c; double-size 4c. Candid rolls, Finegrain developed, 3x4 prints, 12 exposures 45c; 16 or 18 exposures 65c; 36 exposures \$1.25. Return ad with roll and receive absolutely free 5x7 enlargement. Franklin Finishing, Box PM6, Framingham, Massachusetts.

DOUBLE Value—6 or 8 exposure rolls developed and 2 deckle-edged prints of each negative—30c. 16 exposure rolls (printed 2 on 1)—30c. 12 exposure rolls—40c. Quick service. Free mailing envelope and price list upon request. Snapshots Co., Dept. PR, General P.O. Box 979, Newark, N. J.

SENSATIONAL Introductory offer! Send snapshot or negative, this ad and 10c. We'll send you a beautiful 7x5" enlargement! Or, Kodak roll developed and printed (with free coupon) only 25c; or 8 giant prints from roll, 30c. Reprints from negatives, any quantity, regular size, 3c; Giant size, 4c. Candid rolls—36 exp. 35mm. developed, vapo-rated, enlarged to 3x4. \$1.00, 18 exp. 50c. Free mailers. Free premium offers sent on request. American Studios, Dept. 364, La Crosse, Wisconsin.

ROLL Developed, 8 brilliant fadeproof Velox prints and two professional enlargements 25c. Overnight service. Young Photo Service, 405-C, Albany 2, N. Y.

ROLL Or negatives, 16 pictures 25c. Edd's, 2960 Gresham, Chicago 18.

PERSONALIZED Developing. We produce more and better prints by individual processing. Rolls, 25 cents. Reprints 3 cents. Satisfactory workmanship guaranteed. Prompt service. Laurent Photo Service, Box 116-B, Eastwood, Syracuse 6, N. Y.

1 HAND Colored enlargement and 1 black and white enlargement. 5x7, only \$1.00 postpaid. Bus' Photo Enlarging Studio, 57 W. Burton Pl., Chicago 10, Ill.

FLASH! 12 Pictures for 1c without waiting, worrying. Portable \$3.98 kit develops roll, prints pictures in 10 minutes at home. Send no money. Order c.o.d. today! Take-N-Makit, Box 546D, Boston 2, Mass.

PLASTIC Statuettes made by experts \$1.00. Illustrated literature free. Statuette Craft, 8448 Grand River, Detroit 4, Mich.

2c-VELOX Reprints. Roll developed 16 prints 25c. Photographer, Lake Geneva, Wis.

16 FOR 25c—Velox deckled prints with roll developed. Velox reprints 2c. Deckletone, Lake Geneva, Wis.

SPECIALIZING 35MM. fine grain developed, 36 big 3 1/2 x 5 hi-gloss enlargements, \$1.50. Photoshop, Linton 3, Indiana.

ENLARGEMENTS—5x7, 10c; 8x10, 25c; from your negatives. National Film Service, 3111 West Tuscarawas, Canton 3, Ohio.

FREE Snapshots! Free album! Mail this ad and two negatives. Free processing. Complete in 10 minutes. Free samples. Free off 131. P. O. Box 131, Binghamton, N. Y.

8 PRINTS All enlarged to nearly post card size from your roll or negatives 25c. 16-50c. (Trial offer). Willard Studios, Box 3535A, Cleveland, Ohio.

THREE Prints each, 8 exposure roll 40c. Two each 35c. One each 25c. Reprints 3c. Fred D. Eastman, Bode, Iowa.

PRINTS Enlarged 3 1/4 x 4 1/2—35mm. (36 exposures) \$1.00; 18 exp. 60c; 16 exp. split 50c; 8 exp. 30c; reprints 3 1/2c. Holly Finishers, Box 625 B, Succasunna, N. J.

EVERY Picture an enlargement. Bigger and better snapshots than you have ever seen before! New electronic developments give you improved lifetime deckle-edged enlargements at our same low prices. Any 8 exposure roll developed and printed enlarge size 25c; reprints 3c each. Fast, accurate service guaranteed! Send for free mailers, today! Enlarge Photo Service, Box 791D, Boston, Mass.

LARGA-PIC—We have only one offer, but it's an outstanding one! Your roll developed and 8 prints made into brilliant Larga-Pic photos for 30c. Reprints from your negatives 4c each. Write for free mailers. Larga-Pic, Box 22, Brookline 46, Mass.

TWO Beautiful prints from each picture on roll 25c. Twenty-six years of satisfied customers. Quick service. Lens Photos, Dept. J4, Janesville, Wis.

PHOTO Copied, 25 reprints, \$1. Suburban, 1410-M Bond, Rockford, Illinois.

16 VELOX Deckledge prints with roll developed 25c. Studio, River Grove, Ill.

BEAUTIFUL Enlargement from each picture on roll 25c. Cut Rate Photos, Dept. B4, Janesville, Wis.

NEW Color process makes full color prints from black and white film or negatives. Send dime for sample. We have films. Midwest Photo, Janesville 26, Wis.

ROLL Developed, two prints each exposure 25c. Additional reprints 3c each. Skrudland, 6444Z Diversey, Chicago.

8 BEAUTIFUL Double size pictures and roll developed 30c. 8 hour service. Free mailers. Pacific Photo Service, Box 666, San Francisco, Calif.

PHOTOGRAPHY For pleasure or profit. Learn at home. Practical basic training. Long established school. Write for booklet. American School of Photography, 1315 Michigan, Dept. 3452, Chicago 5.

ROLL Developed and 8 prints 30c. Overnight service. Free mailers. Tri-Plex Photo Service, Box 375, San Francisco, Calif.

8 HOUR Service. Your 8 exposure roll printed jumbo or regular size, 25c; 12 exposures, 35c; 16 exposures, 50c; 36 exposures, \$1.00. Reprints jumbo or regular, 3c. Regular prints deckled. Fine grain developing. Send for free mailers. Quality Photo Service, Box 468, San Francisco 1, Calif.

2 BEAUTIFUL Hi-Gloss prints each good negative and enlarging coupon with each 6 or 8 exposure roll developed 25c. Owlphoto Co., Weatherford, Oklahoma.

GLOSS Finish enlargements. 4 5x7 from negative 50c. 3 5x7 from photo 50c. Robert Renshaw, Jr., P.O. Box 478, Chester, Penna.

MOTION PICTURES AND SOUND EQUIPMENT

BENSEN Light—Fits on all movie and still cameras. Uses reflector floodlights. Eliminates clamplights. At dealers or send money order, \$9.45. (Includes tax. Less bulbs.) Free booklet. A. L. Bensen & Co., Staten Island 2, N. Y.

ATTENTION Projector owners—Exchange 8-16mm. films. 25c. 50c. Free details. Ben Harris, Box 247-M, Toms River, N. J.

PROCESS Your own 8mm.-16mm. movie film. Literature. Duro Movie Products, 1519 Eggert, Eggertsville 21, N. Y.

8-16MM. Films, equipment. Bargain lists, 3c! Towers, 935 North Fortieth, Philadelphia 4.

16-35MM. Silent Sound films. Bedner, 5300 So. Talman, Chicago.

COMPLETE Stocks always of Castle, Official, Pictorial films, 8mm., 16mm., sound. Musicals, soundies, free catalogs. We exchange your films and equipment, or buy them for cash. Frank Lane, 5 Little Bldg., Boston, Mass.

THRILLING 8mm.-16mm. Movies. Catalog, refund coupon, 25c. Fine Arts Productions, Box 2084, San Antonio 6, Tex.

PROJECTORS \$16.00 Up. Cameras, film available. Selco Products, Danvers, Mass.

FILM—Free processing 100 ft. 16mm. 100' \$2.95. Weston 24 \$4.90. Weston double 8mm. Weston 12 \$1.89. Weston 64 \$1.99. Fromader Genera, Davenport 4, Iowa.

MOVIE Film at tremendous savings! Kodak Super X, Weston 32, government stock. Tested—unconditionally guaranteed. 16mm.-100 ft. \$1.95; 50 ft. 98c; 50 ft. magazine \$1.35. Double 8mm. 25 ft. 75c. Processing extra; 50 ft. 75c; 100 ft. \$1.00; 25 ft. 8mm. 75c. Fast service! Photo Surplus Sales, Box J-1, 12 Duane Street, New York City.

8-16MM. Silent-sound films. Complete rental library. All latest subjects. Free catalogue, (sample film 10c). Garden Film, 317 West 50th, New York 19.

WESTERNS, Comedies, 8mm., 16mm. Stamp brings lists. Sterling's, 679 Northampton, Easton, Pennsylvania.

RARE 8-16MM. silent-sound films. International, 2120 Strauss, Brooklyn, N. Y.

TITLES Of quality. Technicians, 3964 Ames St. N. E., Washington 19, D. C.

FINEST Movie screens, inexpensive, make them yourself. Free literature. Snow White Screen Company, Danville, Illinois.

BASS Says! 37 years of leadership means satisfaction to you! Finest equipment, 8 and 16 mm., sound cameras, sound projectors. Bass buys 'em, sells 'em, trades 'em. Satisfaction always guaranteed, or your money back! Bass Camera Company, Dept. A, 179 W. Madison St., Chicago 2.

8MM., 16MM. Features. Lists. Sams Electric Shop, Passaic, New Jersey.

BEAUTIFUL Kodachrome slide and lists 25c. Slide Supply Service, 3111 West Tuscarawas, Canton, Ohio.

35MM. Sound features, westerns. C. Rogers, Box 26, East Atlanta, Ga.

LEARN Professional motion picture technique at home. Approved for veteran training under G.I. Bill. Free catalog. Motion Picture Institute, Birmingham 4, Mich.

GUARANTEED Fresh anti-halo outdoor movie film! Weston 12! Daylight loading! Processing free! Three spools double 8mm. \$3.45! Six single 8mm. for Univex, \$4.60! Postpaid! Catalog. Eso-S, 828-B West 39th, Kansas City 2, Missouri.

"THE World's Greatest Passion Play," all sizes sound and silent. Write Hemenway Film, 33-F Melrose St., Boston 16, Mass.

I BUY, Exchange, swap movie films. Harvey Iris, Box 539, Brockton, Mass.

UNUSUAL Home movies: Travel, adventure, sports, comedies. Silent-Sound. Many film bargains. Big illustrated 1947 catalog, sample—dime. Audet, Box 6520BG, Philadelphia 38, Penna.

EXCITING Films — bullfights, movie stunts. Unusual subjects. Send only dime for sample film and special list. Exciting Films, 1071-F El Centro, Hollywood, Calif.

MOVIE Camera films, 100' 16mm. \$2.50. 25' double 8mm. \$1.25. Free developing. Better Films, 742 NewLots, Brooklyn 7, N. Y.

LEARN Movie projection, management. Free catalog. Theatre Institute, Elmira, N. Y.

MUSIC AND MUSICAL INSTRUMENTS

CLARINET Players—Play your clarinet as a flute. 2½ octave range. Amazing tone. Instructions and fingering \$1.00. Clariflute, Box 1562-A, Baltimore 33, Md.

PIANISTS—Popular music chord chart; Shows names; symbols; readings; enharmonics; notation; 648 treble, 180 bass positions. Sensational! Desirable! Practicable! Only \$1.00. Carol Music Chart Co., Box 21 PM-Lefferts, Brooklyn 25, N. Y.

POEMS Wanted for musical setting! Send poem for immediate consideration. Hamann Service, 614 Manhattan Building, Milwaukee, Wisconsin.

FRANK Furllett—96 page complete song writer can set you on the right road if you want to become a song writer. The cost is \$2.00 prepaid. Puritan Publishing Co., 343 South Dearborn St., Chicago 4, Illinois.

PHONOGRAPH Records cheap. Catalogue. Paramount, MF-313 East Market, Wilkes-Barre, Penna.

CHORD-O-MATIC Spanish guitarists greatest discovery. Play any chord, key, position, transpose instantly. No book \$1.00. Trebb Sales, Lorain 5, Ohio.

SONGWRITERS: Send your songs to be recorded. Professional singer, piano accompaniment. \$5 per song. National Radio Broadcasting, 424 Godchaux Bldg., New Orleans, La.

REAL Composer of music will co-operate with lyric writers in song production. Fine publication proposition. Nationwide distribution of publications. Recordings made. Copyrights secured. Write now. C. Isabel Mayer, Box 3896, Portland 8, Ore.

THE Composer of "What's Cookin', Good-Lookin'" and "Let's Go Rockin' on the Moon," both songs published by recognized New York publishers, is looking for original lyrics. If you think you have some good ideas, contact Yvonne Carmel, 13 2nd St., Pittsfield, Mass.

USED Records \$1.95 dozen, \$15 per hundred, good selection. Send no money, pay postman f.o.b. Cleveland, Record Rack, 5511 Euclid Ave., Cleveland 3, Ohio.

BARGAINS: Harmonicas, accordions, guitars, drums. Catalog 25c. Musician's Shop, 2 E. Centre Street, Baltimore 2, Md.

ACCORDIONS, Wholesale prices. Request circular. New streamline accordions. All sizes and makes. Metro Accordion Co., 44 N. Albany Ave., Chicago, Ill.

CATCHY Song melodies written. Beautiful manuscripts. Sholl, 2217 Penn St., Harrisburg, Penna.

AMPLIFY Your accordion with our new Del Principe pickup, \$22.50. Install it yourself in one minute. Makes any accordion sound like an organ. Works with any amplifier. Special Del Principe amplifier and pickup only \$72.50. Write for details. Del Principe, 307 So. Wabash Ave., Chicago.

ARE You writing a song? Let us help you prepare it for publication. Free examination. Ace Songwriters, 27 Spring St., Elizabeth, N. J.

FREE Accordion pickup with each accordion purchased. New or used accordions for sale. Cash or terms, wholesale or retail. Write for bargain list. Del Principe, 307 So. Wabash, Chicago.

MUSIC Arranged. Songs printed. Frank Wildt, Music Publisher, Lancaster, Penna.

POEMS Wanted to be set to music. Free examination. Send poems. McNeil, Master of Music, 510-PM S. Alexandria, Los Angeles, California.

SONGWRITERS—Protect your songs. Get the facts first. Free booklet, attractive offer. Song Service, 331-C West 46th, New York.

SONGWRITERS! Outstanding ethical offer. Hibbler, C5, 2157 N. Avers, Chicago.

BEFORE Sending your poem to be set to music, know your composer. Free folder. Al. Moquin, 5333 La Cresta Court, Hollywood 38, Calif.

POEMS Wanted for new songs. Send poem for free examination. Eliot Wright, Master Composer, 207 Rivoli Theater Building, Portland, Oregon.

POEMS Wanted for musical setting. Send poem for immediate consideration. Five Star Music Masters, 630 Beacon Building, Boston.

SONGWRITERS: Send poems for free examination and outstanding offer. United Music Service, 150, Salem, Indiana.

WRITE Songs. Big money and reputation. Write for information. J. Gordon Pub Co., 201 N. Hoyle Ave., Chicago.

SONG Writer's attention! The amazing demand for phonograph records, accelerated by more than 300,000 juke boxes and the hits popularized warrants your immediate consideration. We are offering song-poem writers the rare opportunity of having established composers collaborate on appealing material received this month. Recola Records, Box 987P, Hollywood 28, Calif.

POEMS Wanted for musical setting. Send poem for immediate consideration and free rhyming dictionary. Richard Brothers, 24 Woods Building, Chicago.

RADIOS, SUPPLIES, INSTRUCTIONS

FINEST Crystal sets (Kitcraft) with big instruction book. \$1.98 postpaid. New army telegraph keys, 3 for \$1.00 (worth \$2.75 each). Beautiful hand microphone (carbon) \$1.95. Offenbach-Reimus, 372 Ellis, San Francisco, California.

FREE New radio catalog is ready! Radionic's catalog lists radios, hard-to-get radio parts, books, amateur, test, and P.A. equipment. All available for immediate delivery. Send today to: Radionic Equipment Co., Dept. 207, 170 Nassau St., New York 7, N. Y.

BUILD "Loudest" crystal radio. Instructions and crystal, 25c. Amorose Radio, Route Four, Richmond, Virginia.

RADIO tubes, parts, wholesale, retail large stock. Radio Mail Order Company, 46-13 188th St., Flushing, N. Y.

TELEVISION — Television kits. Complete, guaranteed parts and tubes, instructions, no technical knowledge required. Only tools needed are screwdriver, cutting pliers and soldering iron. Your cost for 7" picture \$145, 10" picture \$298, 15"-\$350, 20"-\$525. In ordering (or information on completed sets) mail check, money order. 50% cash if c.o.d. to E. Soffer (PM), 1537 Fulton Ave., New York City 57.

LOUD Crystal radio, also one tube radio, new design. Illustrated plans for both 25c postpaid. Radio Leader, 427 Yale Avenue, Claremont, California.

RADIOMEN, Servicemen, beginners—make more money, easily, \$250 weekly possible. We show you. Information free. Merit, 216-32A 132nd Avenue, Springfield Gardens 13, New York, N. Y.

RADIOS, Record players, tubes. Send for free list of bargain prices. Hallmark, 592 Communipaw, Jersey City, New Jersey.

AMERICA'S Best buys. Radio tubes 29c up. Free bargain lists. Potter, 1314-P McGee, Kansas City 6, Mo.

RADIO Service men and experimenters send stamp for our giant radio catalogue. Save dollars. United Radio Co., (1000-V) Newark 1, N. J.

MAKE Simple, tubeless, batteryless, distance-getting crystal radios. Crystal and illustrated instructions 25c postpaid. Allen, 427-P, Clinton, Missouri.

RADIO Technician and radio service courses. Training for federal licenses. American Radio Institute, 101 W. 63 St., New York City. Approved under G. I. Bill of Rights.

BUSINESS OPPORTUNITIES

BIG Profits and your own business casting latest 1947 metal toy autos, airplanes, ashtrays, savings banks, etc. Enormous wholesale and chain store demand keeps manufacturers busy. Spare or full time. No experience or special place needed. For full information write Metal Cast Products Co., Dept. A, 1696 Boston Road, New York 60, N. Y.

EXCLUSIVE Wholesale agency! Amazing screw holding screw drivers! Remove, hold, insert screws hard-to-get places! Tremendous market, eye-catching counter displays make fast sales, big profits. Refundable trial offer! Write now! Millen Mfg., 600 Miller Bldg., Boston, Mass.

STATE Distributors and salesmen to sell simplified bookkeeping and tax record system small stores. Retail \$13.50. Salesmen commission \$6.00. State distributors \$8.00. Hawthorne Sales Co., Decatur, Ala.

START Home manufacturing business making Cleaning Compounds, Soaps, Insecticides, Cosmetics, Polishes. No machinery. Literature free. Kemix, Park Ridge, Ill.

BIG Paying jobs in welding. Complete welding lessons and reference books, 516 pages, 41 lessons, \$2.00 copy. Money-back guarantee. Hobartweld, Box M-775, Troy, Ohio.

EARN Up to \$480 month part or full time keeping books for small firms. Simplified system. Write Tax-Saver System, Dept. P, Ft. Worth, Texas.

EARN Money with textile painting course. Details. Gundrum, LeRoy, Mich.

LEARN To make sea shell jewelry, pins, earrings, hair ornaments, novelties. Book of instructions and designs free with \$2.00 and \$5.00 kits, postpaid. Herbert Diamond Co., Box 4619, Miami 31, Florida.

COLORGLAZED Concrete pottery made without molds. New, low cost, patented method. Cemetery products, novelties, tiles, floors, etc. Basement leaksealing. Other moneymaking projects. Booklet, details free. Men only. National Potteries Company, Grand Rapids, Minnesota.

"BULK Vending machines" make easy steady profits. Mechanically inclined persons are in their hay-day with this fascinating, profitable business. Big manual size book, by old head operator, explains inside methods to easy steady income with coin machines. Every day is pay day. Big machine book \$2.95 check or money order. Bill & Fay's Vending Service, 1051 "L" St., San Bernardino, Calif.

FOLLOW The ideas of a successful operator in the mail order business. Learn how to make, not lose money. Information free. Walter Seiler, Dauphin, Penna.

MAIL Order businesses bought and sold. All types successfully handled through national brokers. List your business now, or tell us what you want to buy. Write for free facts. Turnipseed, Inc., Box 681, St. Louis, Mo.

IDEAL Business stamping metal key protectors, social security plates. Information upon request. General Products, 11 No. Pearl (M), Albany, N. Y.

SALESPEOPLE Make \$1000 profit calling our new 1947 greeting cards. Send 65c for sample box. Davis Specialty Shoppe, 607 Rialto Ave., Venice, Calif.

FREE—Mexican novelty curiosities. Fast seller. Exceptional profits. "Productos," Apartado Postal 9318, Mexico City.

WE Can help start you in mail order business. With books, plans, advice. Write to Opportunities Through Mail, 3540 West 49th Street, Cleveland 2, Ohio.

MORE Profits from Lightmaster cigarette lighters. Distributors wanted. McGregor, Tahoe Valley 16, California.

MAKE Liquid marble, flexible molds, statuary, art goods, novelties, artificial marble flooring. Literature free. Kemico, Park Ridge 50, Ill.

DOLLARS Daily! Cleared \$1900 in two months. Details. Loeb, 7201-A7 Montgomery, Cincinnati.

BUYERS Wanted for plaster novelties. Painted—unpainted. Retail—wholesale. Write today for free information. Bing Products, 88-X2A Broad, Boston 10, Mass.

GOODYEAR—Has rubber for molds, self-vulcanizing, air curing. Quart \$3.00, gal. \$10.50. Free sample and instruction. Goodyear, Lake Geneva, Wis.

BE An advertising agent! Send for copyrighted booklet "How to Start an Advertising Agency." Mail \$1.00 to Basil B. Barnett, Reservoir Park, 268 Claremont, Louisville, Ky.

LIQUID Rubber for making flexible molds. Qt. \$2.00, gal. \$5.75. Free sample. H. Chaney, 1130 E. 16th St., Jacksonville 6, Fla.

MAKE \$3000 Yearly. Mail order business. Claude Bolton, 710½ West 7th Street, Sioux City 17, Iowa.

\$5 COMMISSION On booked distant moving jobs you recommend. United, 243 West 60th Street, New York, N. Y.

OPPORTUNITIES Galore. "Mail from everywhere" everyday. Name listed, 10c. Arthur Sibley, Mendon, Mass.

COMPOSITION Flooring—made in most colors. Lifelong, soundproof, resilient. Flexible molds. Cast novelties, plaques, statuary. Big money—your own business. Catalog free. Write, Bing Products, 88-A3C Broad Street, Boston 10, Mass.

"RUBBERCOAT": Aircure mold making liquid. Make your own, overnight. Manufacture plaques, statuettes. 22 ounces \$2.00. Directions, free model. Rubbercoat, 3873-A California Street, San Diego 1, California.

10,000 WORD Book tells, "How To Build Your Own Mail Order Business" at home! Plans, instruction, ideas galore! 25c postpaid. J. Scott, 282 West 117th St., New York 26.

MAIL Order magazine. Sample free. Schultheis, Box 449, Irwin, Penna.

\$100.00 A Week possible. Your own mail order business. Newest mail-order and agency proposition. Write today. Norman S.P.M. Rorick, 3514 Columbia Parkway, Cincinnati 26, Ohio.

OPERATE Profitable home mail order business on \$5 capital. Details free. Darwin, Box 631, Grand Junction, Colo.

INFORMATION Locating articles and products (wholesale), etc. Literature free. 3537C South Hoyne, Chicago 9.

FOR Greater opportunity write, Leaf Service, Box 998, Ingleside, Texas.

OWN Your business. Tell me how I can build a good service business. Employ others. Year around. Small investment for equipment and merchandise. Protected territory. Write Hinson & Company, Inc., Richmond, Indiana.

OVER 300 Ways to make money by mail. \$1 information free. Write, Clements, P.O. Box 1064, Orlando, Florida.

HEADLINES Pay big money. We furnish press, type, 4-page newspapers for your own "Sensational Headlines." Complete outfit only \$9.95 postpaid. Big profits: fairs, schools, weddings, births, etc. Sample headline 52 letters 25c. KFC Co., P.O. Box #16, Lisbon, Ohio.

UNPAINTED Bookends, plaques, statuettes, figurines. List. Haverly Products, 1219 8th Ave., Altoona, Penna.

METALIZE Baby shoes. Correct modern method. Information free. Universal, Box 1076-A, Peoria, Ill.

DRAIN Tile and block machinery. Flower pot, love seat, block and brick molds. Aluminum lawn furniture. Data free. Concrete Machinery Company, Hickory 6, N. C.

ACCOUNTANTS, Bookkeepers—Operate on **SRFS** accounting and tax system. Full or part time. No franchise fee. Barnhart & Kennedy, Public Accountants, Chambersburg, Penna.

EARN Extra money taking subscriptions for leading magazines. Write, American Readers' Service, Lansdale, Penna.

OPERATE Own wholesale candy business. Sell stores. Free list. Information. Sally Dee Candies, 142-Sims, Newport, R.I.

BARGAINS, Wholesale items, business plans and opportunities. 10c. Holm Sales, Box 12A, Oakland, Indiana.

MAKE Money—Silvering mirrors \$1.00, earthworm culture 50c, brush plating \$1.00. Universal, Box 1076-A, Peoria, Ill.

EXCELLENT Mail order business. Free literature. Postoffice Box 40, New York 18.

RUBBER Molds, liquid rubber, statuary plaster, kits for beginners. Complete "Plastercraft" course free on request. Blue Rapids Supply, Blue Rapids, Kansas.

SURE Fire mail order book 25c prepaid. Box 63E Station H, Buffalo 14, N. Y.

MANUFACTURE Modern overhead garage doors. Big demand. You can start with little capital; few tools. We furnish hardware; plans. Gardo Engineering, Dept. 2A, 3819 Riviera Drive, San Diego 9, Calif.

200 MONEY Making deals, Plans. Rare formulas. Schemes, Folio free. Formico Mart, Box 572, Dayton, Ohio.

OPERATE Profitable mail order business. Splendid opportunity. For details write Eastern Sales Service, 46 Violet Ave., Floral Park, N. Y.

"IDEAS For Additional Income." copy 25c. MacLaughlan, 415 So. Fourth Ave., Puente, Calif.

TERMITE Exterminator. Inexpensive. Easy to mix. Formula 25c. Charles, 12 AK, Norwood, Ohio.

FREE Booklet—"Key to Greater Earnings." James Williams, Box 2215, Hollywood, Calif.

START Mail order business, free 10,000 word how booklet. Details. Whittier Service Bureau, 17½ No. Lewis, Tulsa 4, Oklahoma.

MAKE Money building-selling boats new easy way with readymade hulls. Brochure 10c. Plastic Boats, Box 844, Grand Central Station, New York 17.

"HOW To Make Money With Hobbies." Big profits! Send 3c stamp for free details. Business Service, 1101 Kings Highway, Shreveport 49, Louisiana.

BIG Money selling Bobby-Jo baby shoes by mail; everything furnished; tested; successful plan free. No-Co-Ro, Oakland 6, Calif.

BABY Shoes metalized the durable method. Complete instructions \$1.00. St. Albans Plating Industries, 135-17 135 Ave., So. Ozone, L. I., New York.

A Rare offer! Start a spare time business of your own! Practical, easy and highly profitable. We carry a complete line of vending machines. Write for details! Cameo Vending Distributing Co., 432 West 42nd Street, N. Y. Medallion 3-1334.

WANT Security? Vending machines have provided me dependable income past 20 years; depression proof. Start route now while locations plentiful, or buy several for your own store or factory. Stock shipment nut venders, ball gum venders, best quality ball gum. Free literature. Hawkins, 906 M Howard, Palestine, Texas.

"SUPER" Profits manufacturing plaques, statuary, stoneware. "No guesswork" complete instructions, from start to finish. \$2.00 postpaid. (Mail 50c with order) balance c.o.d. Jay Tee Products, Inc., 1223 Franklin Ave., Columbus 5, Ohio.

WANT Money by mail? New course tells how. Write McKittrick, Box 58, Mt. Vernon, Ill.

EARN Money by mail, spare time. Definite instructions. Literature free. Robotti Service, Rm. 422-PM 1133 Broadway, New York City.

WHY Labor? Wonderful money maker. Domestic fire alarm. Essential. Inexpensive. Free details. Regent, 70 Rockland St., Boston 19, Mass.

BE Our full time representative in your community for taking subscriptions to leading magazines. Liberal commissions. Write for details. National Literary League, Inc., 981 The Arcade, Cleveland, Ohio.

INVESTIGATE Mail selling! What's the one best thing to sell, happily, honestly, profitably? We know! Get free particulars, exciting proof. What-To-Do Shop, Box 1082, Tacoma, Washington.

BRONZED Baby shoe mountings. Beautiful all-metal bookends, onyx plaques, etc. Wholesale only. Write for list. Hollywood Bronze Supply, 1770 No. Vermont, Hollywood 27, Calif.

FISHWORMS—Easy raise hundreds or millions. Instructions 25c. Charles, 12 AK, Norwood, Ohio.

WILL You give your permission to let us send you free, complete mail order information immediately? Versatile Enterprises, Westfield, New York.

UP To \$1500 yearly selling by mail in spare time interest you? New ideas and plans every month. Details free. Idea of Month Club, 3023-A Greenmount, Baltimore 18, Md.

EARN \$75-\$100 And up weekly. No investment required. Immediate earnings. National Sales, Gulfport 1, Burlington, Iowa.

UNPAINTED Plaques, bookends, ash trays. List. Bava, 3655 E. Canfield, Detroit 7, Michigan.

HOW To build your own mail order business. Beginners Idea Book tells how. Quarter postpaid. Satisfaction guaranteed. J. P. Seery, North Conway 3, N. H.

CANDEE-SMITH Governor business. Factory, name, mailing and agency files \$25,000. Advertised in Popular Mechanics for 27 years. See March 1947 ad, page 294. Owner 75 years old. Business needs younger blood.

94c PROFIT From every \$1.00 received. No selling, manufacturing, \$1.00. Pamata, Woodbine, Brooklyn 21, N. Y.

EARN Money at home. Raise and sell orchid seeds by mail. Complete details 25c. Lyle, Box 1231, Santa Barbara, California.

START Profitable mail order business. Write, Tesco, Box 189-MR, Wilkes Barre, Penna.

UNPAINTED Plaster ornaments 2½c up. Oman, 642 Broadway, St. Paul 1, Minn.

WHOLESALE Directory \$1.00. Business opportunities \$1.00. Reimer, E-1119 Chestnut, Saginaw, Michigan.

\$20.00 PER Day possible with new plan, no personal selling, no manufacturing, spare, full time, details free. W. Williams, 5514 Speedway Drive, Speedway 24, Ind.

COIN Machines earn big money! Machines are now available at \$11.75 that can earn as high as \$7 weekly profit. Place machines in stores, hotels, filling stations, etc., and your income starts immediately. Routes can be operated in spare or full time with no experience needed. We'll tell you how and send you a catalogue describing our nut, candy, gum, and postage venders, also scales, amusement games, etc. Write immediately to Parkway Machine Corp., Dept. P, 623 W. North Ave., Baltimore 17, Md.

IDEA Men! Let's get together and get some money out of our ideas, instead of promises. James Corubia, Lakewood, New Jersey.

FOR More business, establish office address, requiring no room, or box number. Rates, \$7.30 and \$14.60 yearly. Co-operative Service, 126 Lexington Avenue, New York 16.

YOUR Name as publisher, 80 page mail order magazine. Free ad. Only \$4.50 needed. Sample copy 25c. "RBCO", 542x Fifth Ave., New York 19.

OPERATE Dependable mail order business, supplied by us. Progress Mail Order, Box 1374, Indianapolis 6, Indiana.

OPERATE America's most popular low priced precision penny vending machine. Big profits. Be independent. Write for bulletin and prices. Stock shipments. Fielding Mfg. Co., Desk 547PM, Jackson, Michigan.

OWN A mail-order paper products business. Sell envelopes, tags, bags, boxes, by mail, wholesale. Tremendous demand. Steady profits. No capital necessary. Write Omaha Envelope Service, Dept. 212, 4721 California, Omaha 3, Nebraska.

CO-PUBLISH And advertise in The Central Mail Advertiser. Sample copy for stamp. Low rates. Large circulation. Bagby Printing Co., Georgetown, Ohio.

METALLIZING Baby shoes makes you money! Learn this simple, profitable business from nationally recognized authority. Get professional results with professional "know-how"! Free particulars. Joseph B. Kushner, Metal Finishing Consultant, Stroudsburg 3, Pennsylvania.

"PROFITS From Plastics" pamphlet, samples, 25c. Technicraft, 1156 Commonwealth, Boston 34, Mass.

BRONZED Baby shoe supplies. Hardening solution, mountings, etc. Send stamp for list. Limited number of kits, complete with materials and equipment to bronze 10 shoes plus a free, easy to understand instruction course at the amazingly low price of \$6.95 prepaid. Send check or money order to Western Bronze Supply, Dept. P, 5419-21-23 Melrose Ave., Hollywood 38, Calif.

PACKAGE. Sell products under your name. Dade Products, Box 1720A, Cleveland 5, Ohio.

MAILORDER Beginners! Save money by getting started right! Our new booklet may save you dollars. Only 10c, postpaid. Mail Order Mecca, 30 West Washington Street, Chicago 2, Illinois.

BIG Profits in carded merchandise, combs, blades, etc. Write for wholesale prices. Buford's, Box 54, Dallas, Texas.

HOW To set up and run a mirror shop! Resilver mirrors. For price write—John Sprinkle V60, Marion, Indiana.

WHY Job worry? Learn electroplating. Highly paid, uncrowded, interesting business. Gold, silver, nickel, chromium, etc. Send postcard for free booklet and proof. Plater Hyde, Dept. MC, P.O. Box 176, National City, Calif.

SUPER X liquid molding rubber. Sample jar 25c, quart \$3.00, gallon \$10.00. Free sample. W. Wooley, 115-A Donald, Peoria, Ill.

OPERATE Profitable mail order business. Write Gallagher Publications, Box 691C, Kingsport, Tenn.

BABY Shoes preserved. Formulas, instructions \$1.00. Novelty Bronzing, Box 56, Hyde Park 36, Mass.

EARN Easy money, spare time. No experience. Lane, 548-B 61st Street, West New York, New Jersey.

SYNTHETIC Latex with Neoprene base for making flexible molds! Quick drying! Safe! For home, classroom, or industry! Quart \$2.00. Gallon \$5.95. Full instructions. Beginners' booklet on molding and plaster casting, 25c. Plastercraft Supply Company, 1406 East 43rd Street, Cleveland 3, Ohio.

RELIABLE Distributors wanted. Make money helping us. Distributors, Box 67, Sebastopol, Calif.

GOT \$24,500 Using "schemes" from "Schemer" magazine. Alliance, Ohio. 49th year, \$1.00. Three samples 25c.

A Grand little business of your own. For details write Lilliss Specialties, Box 151, Athens, Penna.

RAISING Canaries pays good profits. Valuable bird book—"Its Care, Breeding and Training." Price \$1.00. American Canary, 2839 N. Halsted, Chicago.

CURRENT Names homeworkers, 200-\$1.00. Johnson, Box 203-P, Brookport, Ill.

OPERATE Profitable mail order business. Write Walter Service, 4159-A East 112th, Cleveland 5, Ohio.

JUST Out. New. Tops them all. "Queen of queens" plan and product mail order business. It's old and beginner's grand opportunity. Saccani, Box 3825-M, Cleveland 10, Ohio.

1947 GIGANTIC Directory of opportunities, advertisers, supplies sources, trade information, mail order ideas, products, wholesalers, valuable tips. Just published. Descriptive literature free. Wilkin & Co., Hillsboro 3, Ohio.

MEN—Women be your own boss start a home business with our collection of 137 plans. Send for particulars. Simon Waldman, Dept. P-1, 4444 Richmond St., Philadelphia 37, Penna.

IF You'd like to make \$5,000-\$10,000 yearly in the collection-credit agency business, write us at once. Outstanding opportunity. Cole Associates, Syracuse 2, N. Y.

MAKE Money making shell jewelry and novelties. Instruction book 75c. Kit \$5.00. Catalogue free. Palm Shellercraft Co., 220 W. 9th St., Sarasota, Fla.

METALLIZE Baby shoes. Excellent profits. New system insures success. Free details. "Treasures Forever," Metallizers, 89 Henry Ave., Lynn, Mass.

THE Mail Order News (54th year) shows you money making opportunities in every issue. Sample copy 25c. Veterans Business Publications, Charleston 1, Ill.

46 FROM Square foot plywood. Jigsaw necessary. Write, Woodarts, X-36, Bridgewater, Mass.

EXTRA Dollars, or a good living, with your typewriter. New, exclusive opportunity. Never before offered. Get details now. Schroder, 221 E. Bush, Covington, Ky.

MAIL Order Beginners! "Business Development Plan." "Profitable Mail Selling Idea." "Pointers Along the Mail Order Trail." Noted mail sales specialist's, three-in-one, 10,000-word treatise shows "how" at home, spare time, small capital. From idea to mailbag. 25c postpaid. Satisfaction guaranteed. Maupin & Maupin, Lafayette 3, Indiana.

MAKE Strange plastic—1c pound. Makes durable, attractive floors, walls. Build with waste. Save half. Bays Laboratory, Oklahoma City 9.

YOUR Own lifetime business at home. Preserve real live flowers in all their beautiful coloring and fragile beauty. Demand year around. Amazing new simple discovery. Child can do work. No equipment needed. Large profits. Full instructions, enough raw material to preserve \$100 worth of flowers sent for \$2.98. E. Morrison, Box 9312-N Station S, Los Angeles 5, Calif.

INCORPORATE Your business. Delaware laws. Many advantages, free details. Tax Research Bureau, Inc., Delaware Trust Building, Wilmington, Delaware.

LIQUID Marble—Colorful, glazed! Molded, brushed, sprayed! Composition floors. Rubberlastic molds. Particulars free. Marbleizing Service, Edwardsville, Ill.

RECAST Old batteries into new. Latest achievements. Battery Laboratories, Minneapolis.

BIG Mail income. Free particulars. Murray's, 196 Circle, Forestville, Conn.

PLASTIC Homes—Build yourself! Resurface old buildings! Wonderful building material. Particulars free. Marbleizing Service, Edwardsville, Illinois.

PARATOL—Amazing new rubber latex moulding compound for perfect detail castings of all kinds tested and approved in long service. No worries—easy to apply, quick drying, maximum strength and long life. Why pay more—buy direct! Quarts—\$1.60, 1 gal.—\$4.90, 5 gals. \$4.45 gal. 4 oz. samples on request. Send 25c to cover mailing and handling charges. Full instructions sent with each order. Testworth Laboratories, Inc., Manufacturers of coating and adhesive products of all kinds, 407 S. Dearborn Street, Chicago 5, Illinois.

BEST Tested moneymakers—68 page book 25c (coin) postpaid. Business secrets, mail order plans, formulas. Wholesale supply sources. Money back guarantee. Frank R. Carpenter, Boyes Hot Springs, Calif.

YOUR Own business. Bronze baby shoes. Make bronze castings, novelty castings, liquid marble, flexible molds. New methods, easier, quicker, more profitable. Productive Arts Co., Dept. M-7, Box 221, Seattle 11, Wash.

OUR Unique service will help sell your idea or invention. Literature free. Ellis Marts, Representative, Muncy, Penna.

SELL Pin earring sets, novelty jewelry, \$2.50, \$5 sellers. Order assortment \$15 dozen. Manufacturers, 264 5th Ave., New York.

GROW Bean sprouts in dark room for market. Pays well. Free information. Mrs. Nickell, Rt. 1, Box 456, Bend, Ore.

START A home business in spare time. Make extra money. Experience unnecessary. Literature free. Ellmar Services, Muncy, Penna.

YOUR Own plastic business at home. Produce costume jewelry, novelties, statuettes. Liquid plastic, liquid marble. Flexible molds. Write for free book. American Trades, Box 1016-A, Peoria, Illinois.

POPCORN Machines, peanut roasters, carameltorn equipment, vending machines, new, used. Northside Sales, Indianola, Iowa.

BIG Money in vending machines. Smallest capital start brings immediate profits that build permanent profitable business. Starting instructions free. Becker Vendors, 105-A Dewey, Brillion, Wisconsin.

MAKE Perfumes. Profitable business. Free book tells how. Walter Lawson, 21 Joiner, St. Augustine, Florida.

BELTS! Make 'em and make money. No tools! Sample 50c. Artnic Leather, 411 Joseph Ave., Rochester 5, N. Y.

WINDSHIELD Wiper and fuel pump rebuilding bring big profits. Free particulars. H. & H. Products, P.O. Box 430, East Akron Station, Akron 1, Ohio.

MAIL Order opportunities. Full or spare time. Hundreds of chances. No charge. Postal brings copy. Blackstone Press, Somerville, New Jersey.

GREAT Opportunities and profits in mail order business at home. Free literature. F. Webster, Box 1972C, Hollywood, Calif.

LEARN Piano tuning, repairing, at home. Tremendous field! Piano parts, tools furnished. Established 1935. Empire School of Piano Tuning, 606-B East University Ave., Champaign, Ill.

MEN—Women—"Everybody likes candy." Learn to manufacture professionally at home. (Our 36th year). Ragdale Candies, Dept. 4, East Orange, N. J.

HANDYMEN—Earn money home operating Community "Fix-It" Shop. Write Stafford, 708 Rawlings, Carbondale, Ill.

DO It with sea shells. Big profits. Wer 1429 - 56th Avenue, Oakland 3, Calif.

WOULD You pay 3%—first \$350 made? Color-illustrated book "505 Odd, Successful Enterprises" free! Some offer occasional "day off." Work home. Expect something odd! Pacific, San Clemente, Calif.

BOOKKEEPERS—Operate your own simplified "Dollar-A-Week" bookkeeping and tax service. Full or spare time. Details free. Ellis, Box 200, Cedar Grove, North Carolina.

MAIL Order business course shows you how to make money, spare or fulltime. Teaches professional mail order technique—not penny-snatching schemes. Fascinating 100-page illustrated success-catalog free! Write, Nelson Company, Dept. 4-02, Chicago 5.

PLASTIC Discs, shapes, metal findings, wholesale, free catalog. "Secors," Bradenton Beach, Florida.

ELITE Collection contains 137 practical money-making plans; local and mail order. New edition. Particulars free. Elite Co., 220 Grand St., New York 13.

OPERATE Profitable home business. Levine's, Box 15-X, Boulevard Station, New York 59, N. Y.

BRONZING And metallizing baby shoes! Gold, silver, copper, nickel, bronze, pearl, ivory, and "luminous glow" colors! Big profits! New field! Details free! Write R. O. Morgan, Box 349, Long Beach 2, Calif.

LEARN Shell jewelry manufacturing. No tools or experience needed. Learn-earn within a week! Complete home instruction course, beautifully photographed, shows how to make 75 styles of pins, earrings, brooches, hair ornaments, dress clips, necklaces, bracelets, candy dishes, wall plaques, ash trays, candle sticks, etc. Includes pearlizing, golding, dyeing, luminous methods. Illustrates 55 species of sea shells. Lists hundreds of raw materials with wholesale prices. Complete course \$1.00, postpaid. Beginner's kit, \$3.00. (\$3.50 in Canada). House of Gifts, Box 4550-RF, Coral Gables, Fla.

QUICK Money! "Repairing car batteries." At home! Easy too! Write, Batterymen, Grand Junction 5, Colorado.

SELL By mail!—Books and novelties! 35 different items! Large profits! Catalog free! Elfoo, 432 N. Wells, Chicago 10.

OPERATE Profitable home business selling merchandise by mail. Fast sellers. Large profits. Powell Service, 5713 Euclid, Cleveland 3, Ohio.

COLOR Concrete with chemicals. Make Hollywood style pottery; home or shop. Marbling, water-paints, 10c brings sample pictures. Hollywood Cementcraft, 8527 Wonderland, Hollywood 46, Calif.

INTERESTED In immediate mail order cash? Read "Advance"—Voice of mail order. Offers money-making opportunities. Personal guidance and benefits to all. Sample copy 25c. American Mail Trade Association, 313 East 21st Street, Dept. 400, New York 10, N. Y.

COPUBLISH Leading m.o. paper. Latest copy Mail Sale Advertiser and proposition, commemorative stamp. Vanroy Shirk, Lebanon, Penna.

START Profitable mail order business. PMT lists new propositions available; products, sources, accurate methods. Covers ad writing, letter logic, trade information. Send 10c for copy and get free instruction folio offer. Progressive Magazine, Sheboygan, Wisconsin.

HOW And where to obtain capital. Fully explained. Particulars free. Star Service, Wapakoneta, Ohio.

START A clock shop. Fascinating, easily learned profitable business requiring little capital. We teach you how to repair all kinds of clocks. Information free. Houston Clock Shop, P.O. Box 5086A, Houston 12, Texas.

SPECIALTY Manufacturing, the big money business that can be operated anywhere, start on a very small capital; we supply dependable formulas and complete instructions; get interesting free booklet, "Moneymaking Opportunities in Specialty Manufacturing." Howard Robinson, Ph.G., 1300-A South Ohio Street, Sedalia, Mo.

START Mailorder bookshop—Everything furnished; publisher cooperation. 25c brings booklet, exclusive setup, samples, exciting ideas. General Publications, Ossining, N. Y.

\$25 WEEKLY Working two hours daily. No canvassing. No manufacturing. Lycke, Box 2471, Cleveland 12, Ohio.

137 WAYS To make money, in home or office, business of your own. Full particulars free. Elite Co., 220 Grand St., New

BRUSH Plating outfits connect to a battery. No tanks necessary. Good paying business at home plating autoparts, bathroom fixtures, bicycles, reflectors, silvering mirrors. No shop or experience required. Outfits furnished. Free booklet. Gunmetal Co., Ave. H. Decatur, Ill.

MONEYMAKING OPPORTUNITIES

SEWING Machine repairmen make big money lifetime. Start neighborhood shop. Complete repair manual, covering all makes, \$1.98 postpaid. Money back guarantee. Sewing Machine Serviceman, Hamilton 9-C, Ohio.

SELL Oil burners for kitchen ranges. Great demand—terrific profits. Oil Burner Supply, Box 327, Cambridge, Mass.

START Your own business! Big money manufacturing novelties, plaques, statuary. Free catalog. Write Bing Products, 88-AJE Broad Street, Boston 10, Mass.

SELL By mail. Unique dealership open. Business basis. No plans or schemes. Schulte, Box 2983, Houston 1, Texas.

EARN Up to \$480 month part or full time keeping books for small firms. Simplified System. Write Tax-Saver System, Dept. Q, Fort Worth, Texas.

\$1 STARTS You in business. Sell by mail, or direct. California deluxe ties sell for \$2.50, costs you \$1.25. Send \$1 for complete plan and sample \$2.50 tie. Creamer of Hollywood, 832 North Edinburg, Dept. 7-P, Hollywood, California.

MONEYMAKING At home. 80 page magazine 25c. "RBCO," 542P Fifth Ave., New York 19.

THOUSANDS Articles wholesale. "Supply Source Directory" 10c. Ideal Service, Park Ridge 40, Illinois.

EARN Good money spare time entertaining with musical glasses. Information free. MacDermid, 1013B Quarrier St., Charleston 25, West Virginia.

PROFITABLE Business at home. Real opportunity. Up to date edition. Details free. Mitchell's Enterprises, 119 South Emerson Ave., Indianapolis 1, Indiana.

BECOME Independent selling by mail. Write Success, Box 513, Berkeley, Calif.

AGENT Or exclusive distributor for cigarette lighter manufacturer. MacGregor, Tahoe Valley 16, California.

OPPORTUNITIES! The Mail Order News (54th yr.) magazine shows you. \$1.50 yr. Sample copy 25c (coin). Silvercrest, 3040-P North Ave., Chicago 47.

AMAZING Profits in home operated distinctive, exclusive art-gifts specialty business. Write for starting ideas. Valvick, Warba, Minnesota.

OPERATE Profitable home mail order business on \$5 capital. Details free. M. F. Eberst, 216 Crawford Ave., Altoona, Penna.

FREE Details of an original, profitable, mail order business. Holiday Service Bureau, 3806 Carlyle, Cleveland 9, Ohio.

INFORMATION Locating articles and products (wholesale), etc. Literature free. 3537C South Hoyne, Chicago 9.

HAVE Your own paying business. "Plastic Trade Secrets & Formulas" tells how. \$2. Details free. Little, 1020-Towson, Fort Smith, Ark.

BIG Money making shellcraft kits! Violet spray \$1. Chatelaine \$1. Cameo \$1. Instruction book 35c. Shelart, 3027 6th Street, South St. Petersburg, Fla.

HOW To set up and run a mirror shop! Resilver mirrors. For price write, John Sprinkle V55, Marion, Indiana.

START Your own business metalizing baby shoes. Complete instructions \$1.00. Technical Aid & Supply, P.O. Box 668-P, Los Angeles 53, Calif.

TRAVEL, Make money; 20 ideas \$1.00. No personal checks. George Clark, 129 North Rose, Kalamazoo 12, Michigan.

SAWDUST—Turn it into cash. Spare time. Instructions 25c. Charles, 12 AN, Norwood, Ohio.

WHY Earn profits for somebody else? Build your own business, spare or full time. Small capital start, grow big! Be your own boss! Start today! Details free! Elliott, 177 Columbia, Edgewood 5, R. I.

FIVE Successful ads and the schemes behind them \$1.00. Cy Bibbs, 2233 Eastern Ave., Indianapolis, Ind.

OVER 300 Opportunities to make money selling by mail. Send 3c stamp for free details. Piyers Service, Box 474, Elmwood, Ill.

METALLIZE Flowers for profit! It's new, easy, sure fire! Free details. Joseph B. Kushner, Metal Finishing Consultant, Stroudsburg 3, Pennsylvania.

EARN Money at home! Thousands do! Free details. Sizemore, Box 7, 4917 Kostner, Chicago 30.

CONCRETE Fence posts—Full blueprints and information for making forms and posts. \$1.00. W. R. Hale, New Iberia, La.

WIN Money on contests advertised in magazines and on radio. General Contest Bulletin, published monthly, gives hundreds of tips. Lists current contests and rules. Sample 25c. General Contests, 1609½ East 5th, Duluth, Minn.

MEN—Women! Sell "Aroma of Flowers" sachets! In demand everywhere! Over 200% profit! Details free. Mountain Specialties, Box 72, Westcliffe, Colo.

MAKE Big money. Build your own lamps and sell. Write for free factory photos. Buddy Products Mfg. Co., 1123 West Belmont, Chicago, Ill.

LEARN Mail order, dime magazine. Diehl's, 168 Clinton, Buffalo, New York.

THE Knack of making money in any job, business or profession. Postal brings details. L. R. Schulz, 216 W. Jackson, Chicago 6.

EMBOSS, Beautifully, stationery, cards. New, amazing inks, gold, silver, easily applied. Free literature. Crawford, 174P Nichols, Bridgeport 8, Conn.

MAIL Order magazine, dime. Acme, Fifty Bristol, Buffalo, New York.

MAGAZINE Of ideas, schemes, plans—25c. "The Circuit," Woodbine, Maryland.

WHOLESALE Anything imaginable. New guaranteed list 25c. Refundable. Lasalle Novelties, Box 2188, Waterloo, Iowa.

500%-1000% PROFIT And up. Your own interesting service business. Tremendous demand everywhere. Experience unnecessary. We teach, help, supply everything. Practically no capital needed. Resistal, Inc., 1757-B Sunnyside, Chicago 40.

EXCELLENT Profits raising mink. Details furnished. Franklin Young, Riverhead, New York.

MANUFACTURE Costume jewelry at home for profit, hobby, therapy. Free wholesale supply catalogue. Instructions. Florida Supply House, Bradenton, Florida.

BIG Mail including mail order magazines 10c. Mallo, 767-PM Leith, Flint 5, Mich.

I MAKE Big money in the mail-order business. You can do the same at home with my copyrighted system. Write me. I'll tell you how. F. Little, Box 8, Glenshaw, Penna.

\$25 WEEKLY Working two hours daily. No canvassing or manufacturing. Lycke, Box 2471, Cleveland 12, Ohio.

WOULD You pay 3%—first \$350 made? Color-illustrated book "505 Odd Successful Enterprises" free! Proven! Work at home, office. Expect something odd! Pacific, San Clemente, Calif.

THERE'S Big money in junk," and repairing batteries. Write, Batteryman, Grand Junction 5, Colorado.

\$246.50 MAKING Unusual secret device without skill, machinery, from former war material costing \$1.50! Simple, baffling invention, unbelievably profitable! Illustrated proofs free. Rolls Enterprises, 115-D West 16th, New York 11.

EARN Money at home—steady income. Write Successful Income Builders, 508-A, Hollywood 28, California.

200 MONEY Making deals, plans, rare formulas. Schemes. Folio free. Formico-Eng., Box 572, Dayton, Ohio.

FORTIFY The future! Start own business; home, office. Booklet describing "Collection of 137 Tested Plans" free. Elite Co., 220-A Grand St., New York 13.

PUBLISH Your own magazine. Hand-some 52 page format, well edited, illustrated. Cost low as \$1.00 month. Brings you prestige, profits. 25c brings sample, details. National, Ord. Nebr.

FORMULAS, PLANS, ETC.

ROOFING, 100% Fireproof, low cost, lasts indefinitely; make yourself; formula with instructions. \$1.00. Rav Roofing Co., P.O. Box 265 Petersburg, N. Y.

21 POPCORN, Candy apple, etc. formulas. All money-makers. \$1.00. We can supply equipment. Concession Supply Co., Dept. "A," Box 133 Sta. "B," Toledo, O.

MAKE Cosmetics, perfumes, flavors, etc. 100 formulas \$1. M. Elsbury, 717 N. Dearborn, Chicago 10.

100 SINGLE Ingredient formulas 25c. co., Box 189-MS, Wilkes Barre, Penna.

MANUFACTURE Cleaners, soaps, polishes, flavors, cosmetics. Literature free. Kemico, Park Ridge 16, Illinois.

ANY Formula \$1.00 each. All tested and workable. Williams Co., Box 385, Galesburg, Ill.

NEED Chemists? Products duplicated? Formulas? Analyzes? Consulting Scientific Company, Swarthmore, Pennsylvania.

10,000 FORMULAS And trade secrets. Free literature. Stillman, 555 Kingston Ave., Brooklyn 3, N. Y.

REAL Manufacturing formulas. Lists free. Cummings, Chemist, Gordon Ave., Syracuse 4, N. Y.

FORMULAS—Latest, best. Analysis. Giant formula catalog and chemical instruction sheet 10c. Refunded first order. Belfort, Engineering Building, Chicago 6.

"LUMINOUS Paint," Resilvering Mirror formulas 25c each. Ideal Service, 300, Park Ridge, Ill.

PLASTICS

RENEW Leather and leatherette—Make cloth into imitation leather with plastic discovery called Leather-New. Opportunity to make real profits taking care of sales resulting from national advertising. Write for free sample of Leather-New covered material and complete deal. 704 Land Bank, Kansas City, Missouri.

NEW Plastic! Plastell! Gorgeous colors! Available now for big profits. Information, 1947 illustrated catalog, details cash prize contest—10c. Write today! Beilco Plastics, Inc., Dept. 06, 98 Gramatan Ave., Mt. Vernon, N. Y.

PLASTICS—8 Colors sheets and rods, stamp brings price list. Hanson Plastics, 7625 South Parkway, Dept. 44, Chicago 19.

PLASTICS—Best materials, lowest prices. Send for free price list. Plastex Products, Curtis and Filbert, Baltimore, Maryland.

PLASTICS, Sheets, rods, tubes. Free list. Swiss music units \$3.50. Plastic Supply Co., Dept. PM70, 2618 St. Louis Ave., St. Louis 6, Mo.

NEW Liquid plastic. Clear, colors. Cast without heat. Embed flowers, insects, coins, saw, drill, carve. Manual tells how. Send \$3.35 for complete 20 project kit including one pound liquid Castolite. Castolite, Dept. H-21, Box 211, Kenilworth, Ill.

SPECIAL Sale. Catalin plastics. Sheets, rods, tubes, scrap. Less than factory price. Hurry. Price list free. Plastics, Scottsville, N. Y.

PLASTIC Injection machines; toy, industrial, commercial. Jewelry findings, Plexiglas, dyes, Polystyrene rods; tenite; kits, etc. Low prices. Free list. G. Baker Company, River Edge, New Jersey.

2 LB. Plexiglas first grade \$2.50. 2 lb. clear scrap 70c. 5/32", 3/16", 1/4", 5/16", 3/8", 1/2" inch. Schick Mfg. Co., 257 William St., New York City.

EDUCATIONAL Offer! Sample kit containing odorless resin, accelerator, rubber mold, lubricant, dye; plus all equipment necessary to make quick castings in lustrous Formalin! Complete with instructions and price list, \$3.00 f.o.b. Formalin, Romeo, Michigan.

"WORKING With Plexiglas," the latest and best book on plastics. Full of illustrations and instructions. Only \$1.50 postpaid. Craftsman Supply House, Scottsville, N. Y.

PLEXIGLAS—Colors 1/4", \$1.90; 3/16", \$1.65; 1/8", \$1.35 sq. ft. Clear scrap 25c lb. Four lbs. minimum. Prices f.o.b. Rain-bow Plastic Company, Arlington, Texas.

PLEXIGLAS—Masked, 12"x12"—1/16", 95c plus 10% postage. Free listings. Craft Plastics, Box 129P, Somerville, New Jersey.

LUCITE—Sample 25c; catalog, dime, refunded. Mid-west Plastic, 1717 No. 66, Omaha 4, Nebr.

PLEXIGLAS Kits: Special offer: 18" tie-rack and coaster holder, \$2.50 value, now \$1.75. Free gift with each order. Free price list. Heah Mfg. Co., 5115 N. Neenah, Chicago 31, Ill.

NEW, Self-adhering, transparent plastic film. Lifetime protection for maps, charts, sketches, drawings, blueprints, valuable papers, sheet music, book covers, index cards and hundreds of other uses. Easy to use. Waterproof, dirtproof, germ-proof, washable. One dollar for 5 foot by 12 inch roll. R. E. Heyman, 123 Center Terrace, Newark, New Jersey.

AMAZING New book "Light and Plastics," tells in simple language how to use light in plastics (Lucite and Plexiglas). Covers fabrication and includes 5 project plans for making edge-lighted mural, bench spotlight, lighted wall shelf, decorative flower pot, lighted clock. All for \$1.00. Plastic Press, 1108 S. Albany, Chicago.

METALLIZE Plastics for profit! Free particulars. Joseph B. Kushner, Metal Finishing Consultant, Stroudsburg 3, Pennsylvania.

MAKE Money assembling our pre-fabricated plastic kits. Sample kit 50c. Catalog free. Fabros, Box 156, Station F-1, Buffalo 12, N. Y.

LEARN Internal carving in plastics for pleasure and profit. No special skills or long training required. It's easy, exciting. Complete instruction folder shows how to carve flowers, animals, landscapes of colorful, thrilling beauty in solid Plexiglas plaques and cubes. Explains dyeing, filling. Illustrates power tool, drills, materials needed. Complete information plus price list, catalog of metal findings and jewels, only 10c. Plastic Parts & Sales, 1157 S. Kingshighway, Dept. H-26, St. Louis 10, Mo.

LUCITE Sheets, rods, dyes, cements, cheap. Free price list. Thomas Cavaliere, 2141 So. Beechwood St., Philadelphia 45, Penna.

PLEXIGLAS Sheets. 1/10"x12"x16" \$1.05; 1/8"x11 1/2"x12" 98c; 13"x16 3/4" \$1.60; 1/4"x8 1/2"x12" 90c. Ten colors in 12" rod assortment, one Fluorescent \$4.00. Plexiglas cylinders 6" o.d. x 1/4" wall x 12" length \$1.60. Julian Rhodes Muench Co., 1527 W. Alabama, Houston 6, Texas.

CHEMISTRY

THE House of Winn, home of supplies for amateur chemists. See Winn's New Idea chemical kits and apparatus outfits for home experimenting. Send 10c for retail catalog. Established 1931. John H. Winn, Dept. 507, 124 West 23rd St., New York 11, N. Y.

SPECTROSCOPE For quick chemical analysis \$3.00. Cutting Co., Box 457, Campbell 1, Calif.

FREE Scientific catalog. Fourteen hundred exceptional items. Tracey Laboratories, 1907 Harrison Street, Evanston, Ill.

LABORATORY Supplies at wholesale prices. Chemistry, biology, physics, geology. Catalogue 10c. National Scientific Company, Established 1908. 2204 W. North Ave., Chicago 47, Ill.

SOMETHING New! Student chemists send 5c for catalog and free copy of N-1 "Know Your Chemicals" series. Met & Co., Dept. 10, 160 Hillside Avenue, Nutley, New Jersey.

NEW Laboratory supply catalog of chemicals and apparatus, contains over 5000 items with illustrations, 212 pages. Send 50c. Standard Science Supply Co., 1232 No. Paulina Street, Chicago 22, Ill.

CHEMICALS-LAB. Supplies. New catalog 10c. Mel-Glo Chemical Co., 258 Fourth Avenue, Brooklyn 15, N. Y.

HANDBOOK For chemical experimenters, illustrated, hundreds of experiments, 50c. Experiment booklet 15c. Supply catalog 5c. Reading Scientific Company, Reading, Penna.

CHEMICALS And apparatus for industrial, analytical, and private laboratories. Complete supply service for correspondence school students. Send 3c for catalog. Dept. M-43, Biological Supply Co., 1176 Mt. Hope Ave., Rochester 7, New York.

APPARATUS, Chemicals, ounce quantities, catalog 5c. Fleischer's Laboratories, Everett 49, Mass.

HELP WANTED

A FEW Seasoned executives to help merchandise telephone electronic equipment and other electrical products. Correspondence held confidential. Mac Call Telephone Electronic Equipment, Box 8186, Norfolk 3, Va.

MAKE More money selling individualized buckles, belts, tie holders, cap badges. Choice of 2000 emblems. Quick profits—repeats. Special outfit offer, write Hook-Fast Products, Dept. A, Columbus 6, Ohio.

REPAIRMEN And installers for Mac Call Dictagraph Teletalk, Stromberg Carlson Amplicall and Bogan wanted by United Intercommunications, Post Office Box 8128, Norfolk 3, Virginia.

AGENTS WANTED

AGENTS. Sell finest food products direct to homes. Successfully sold for 25 years. Big profits. Powerful combination sale plans make sales easy. Permanent repeat business. Samples furnished. Live territories open to distributors. Mother Hubbard Products Co., 4139 Grand, Dept. P.M., Chicago.

NEW Miracle heavy wire cutter! Pocket size. Big money maker! One ton cutting pressure in one hand, cuts anything: heavy gauge spring wire, nuts, bolts, etc.; replaces bulky cutters many times its size, weight and cost. Every mechanic, factory, farm and home owner needs it. Specially low priced at \$7.50. Sells on sight! Make up to 125% profit selling direct or dealers. Demonstrating sample \$3.75 post-paid, remittance with order or write for free selling plans. Security Mfg. Co., 144 West 27th St., New York City.

SALES Agents wanted to sell Fireaire fireplaces and furnaces in your localities. Every home owner is a prospect. Low in price. Variety of designs. See display advertisement elsewhere in this issue. Liberal commissions. Write for proposition. The Edwards Manufacturing Co., 235 Eggleston Ave., Cincinnati 2, Ohio.

\$1 STARTS You in business. Sell DeLuxe ties, 100% wool interlining. Costs you only \$7 per dozen, you make \$5.00 dozen. Send \$1.00 for special introductory offer two DeLuxe ties. Catalog complete line free. Philip's Neckwear, 20 West 22nd St., Dept. K-13, New York 10.

SILVER Plating liquid. Simply rub on with cloth. Cleans, silverplates, polishes, one rubbing. Genuine silverplate. Renew silverplated ware. Also silverplates brass and copper. Male and female sellers wanted. Part or full time. NuProcess Products, Aurora, Illinois.

EXTRA Money quick. Sell personalized stationery, matches, napkins, coasters, playing cards, greeting cards, gift wrappings. Up to 100% profit. Sample all-occasion assortment on approval. Large portfolio personalized stationery showing over 40 different styles. Senrab Co., 212-N West Washington St., Syracuse, N. Y.

MAGIC Cleaner and laundry soap deal. Hotter than a firecracker. Big profits. Sample free. Bestco, 5007 Irving Park, Chicago.

AMAZING Spare time earnings, sell name imprinted Christmas cards 50 for \$1.00. Leader box pays to 50c profit. 25 big moneymakers. Stationery. No money or experience needed. Approval samples. Empire Card, 155 Fox, Elmira, N. Y.

AT Last! Something new and sensational in Christmas cards. Amazing "Oilette" cards. Like costly oil paintings. Designs never before offered. Quick orders. Beautiful 50 for \$1 cards, name imprinted. Big profits. 20 other assortments 60c to \$1. Samples on approval. Puro Co., 2801 Locust, Dept. 740J, St. Louis, Mo.

CHRISTMAS Cards: Easy money, quick. Free literature tells all! Evers, Elmhurst, N. Y.

PROFIT Selling genuine imported briar pipes direct to consumer. Terrific values. Samples, \$1.00 each. Details. Abbott Pipes, 62-B East 87th St., New York, N. Y.

EARN Big money selling complete new line 1947 greeting and Christmas cards. Big profits. Liberal bonus. Sample on approval. Write today. Forest W. Kimball, New London, N. H.

EASY Money making opportunity showing friends famous Wear Wright brand nylon hosiery, lingerie, blouses, sportswear, greeting cards. Tremendous demand, steady repeats, big profits. Four special outfit offers. Free lingerie sample display card. Wear Wright Company, 1709 Arch St., Dept. B, Philadelphia, Penna.

TREMENDOUS Profits selling new scientific soil acidity tester for lawns, farms, gardens. Sells \$2.00. Your profit \$1.00. Sample and full information \$1.00 post-paid. Willard Laboratory Supply, 2030-T Sunnyside, Chicago 25.

CHRISTMAS Cards. Earn big money. Take orders galore from friends. 25 exquisite folders with name, \$1.25. Free samples 10 designs. America's fastest selling 21 Christmas folder box, costs 50c. Sells \$1. Request samples today. Sunshine Art, Dept. E-7, 115 Fulton St., New York 8, N. Y.

HOUSE Numbers that glow in the dark. Luminous pictures, etc. Large mfr. wants factory representative. Wonderful new product. Fast seller. Free samples. Madison Mills, 303 4th Ave., New York City.

EXCLUSIVE Franchise for first class agent, permanent, no competition. A. Thompson, Marysville 68, Calif.

COSTS 20c. Sells \$1.00. Millions prospects. \$20 daily. Samples free. Burns Company, Johnstown, Penna.

AGENTS—Sell white shirts direct from manufacturer. Liberal commission. Jarod Mfg. Corp., Rockville Centre, N. Y.

TO 100% Profit selling greeting card box assortments. Details and assortment sent on approval. Glorian, 515 East 45th Street, Brooklyn, New York.

STATE Agency open for Lightmaster cigarette lighters. Macgregor, Tahoe Valley 16, California.

\$50 CASH For selling 100 assortments of 21 Christmas cards at \$1.00. Complete line. Free samples 50 for \$1.00 cards. Special offers. Write today. Hedenkamp, 343 Broadway, Dept. Y-21, New York 13.

SHIRTS \$1 Each for resale. Box 18, 93 Fourth Ave., New York.

CASH In quick on tremendous demand for new low priced burglar alarm for cars, homes and farm buildings. Nothing like it. Everybody wants one. Big profits. Unique sample offer. Northwest Electric Co., Dept. E-42, Pukwana, S. Dak.

MAKE Money the easy way, be an agent. List of 100 large companies looking for agents \$1.00. Roy Kramer, 329 Cates St., Maryville, Tenn.

AGENTS—Excellent, repeating profits. Opportunity establish own business with exclusive territory. Additive lubricant. Automotive, marine, aeronautical, industrial fields wide open. Write Kidder Oil Co., LaCrosse 5, Wis.

INFORMATION Locating articles and products (wholesale), etc. Literature free. 3537C South Hoyne, Chicago 9.

MEN And women—Large daily profits selling guaranteed household products to friends and neighbors, all or spare time. We start you. Write Crest Tested Products, 2118 East 15th, Kansas City 1, Mo.

WE Buy old type Singer sewing machines, your profit up to \$25.00 on each. Write for literature. Essex Shop, 172 Washington St., Newark 2, N. J.

CHRISTMAS Card agents! New, exclusive, patented children's linenette books. Four books in attractive packet. Retail 50c. Sample on approval. Also cut-out valentine assortment. Elmcraft Card Co., 5928 South Western, Chicago 36, Illinois.

SELL Christmas cards! New, different, exclusive, 50 with name imprinted, \$1. Make extra dollars with new bonus plan that earns you up to and over 100% profit. Compare our 21-folder "Champion" assortment, sells for \$1. Sent on approval, no investment. Etching, panoramas, florals, religious, gift wraps, birthdays, also stationery and personal de luxe album. Free samples of many extra-profit imprint lines. Work with a leader! Write today. Pen-N-Brush Studios, Dept. PM7, 154 Nassau Street, New York 7, N. Y.

GUARANTEED Money making sales offer. Free details. Men, women write today. Popular Products, 1472 Broadway, New York.

24-KARAT Gold-plated ball point pens. Sample pen \$1.00, sells for \$1.98. Edison Ball Point Pen Co., 126 Lexington Ave., New York 16, N. Y.

MYSTERY Drinking bird. Drinks constantly. \$1.98 prepaid. H. Hayes, Blue Earth, Minnesota.

AMBITIOUS. Sell Xmas cards, stationery, big profits, colored catalog free. Beacon Hill Greetings, 115 Chauncey M. Boston, Mass.

"TWINPHONE" Sensational new telephone device, two people listen at once, every home, business, are customers. Sells for \$3.75. Send \$2.35 for sample, particulars. Soroka, 131 Rockaway Parkway, Brooklyn, N. Y.

POCKET \$1.25 On each sale. Hand-colored 8x10 enlargement in gorgeous new metal photo frame—sells on sight for \$2.98. Write for sales plan. Monogram Studios, Box 233, Department A, Forest Hills, N. Y.

NEW Spee-Dee hose coupling for standard garden hose. Easy on, easy off. Sample 50c. White Specialty Manufacturing Company, 4628 W. Auer Ave., Milwaukee 10, Wis.

ROTACUT Power mower—\$66.00 net. Express prepaid. Farm Products, M-2006, Excelsior Springs, Mo.

BALLOONS \$2.00 Gross; rubber toys; balls. Kids cowboy metal spurs \$2.00 dozen. Complete \$10 retail value assortment for \$5.00. Start own route. Buy wholesale—sell merchants everywhere. Newest specialty line. Big profits. Ellswood Distributors, La Junta, Colorado.

AMAZING Leather or plastic buckleless expanding watch bracelets fit all watches. Retail \$1.50. \$25.00 daily easy. Particulars free. 2 samples \$1.00. Safety Watch, 309 E. 105th, New York City.

HOW To start your own business. Send for big free catalog full of electrical appliances, lamps, housewares and giftwares. Big profits. Quality merchandise. No investment required. Bilmar Brothers, Dept. 7-C, 711 W. Lake Street, Chicago 6, Ill.

CHRISTMAS Cards. Earn \$5.00 with each ten \$1.00 21 card assortments you sell. Also wrappings, note paper and imprint cards. Write for samples today. Howard P. Ellis, Dept. PM-8, Pitman, N. J.

REFLECTING House numbers \$1.00, name-plates \$2.50. Mail box signs \$5.00. Carl Sign Co., Wooster, Ohio.

KEROSENE Cook stove, 2 burner \$8.75; fluorescent 2 light kitchen fixture (less bulbs) \$4.50; oil burner, 3 controls \$125.00. Prices f.o.b. Essex Shop, 172 Washington St., Newark 2, N. J.

A Natural! Make good money with fast-selling, new line of plastic tablecloths and women's aprons! Also novel, embroidered cotton pillow cases! Write for "interesting" details. Royalty Sales, Box 748-C, Passaic, N. J.

FREE! Big 32 page 8 1/2 x 11 magazine, that tells how to make money in local or mail order selling! "Opportunities Preferred," 33-P Vassar, Dorchester, Mass.

AGENTS: See display ad, page 250 this issue. Heel-Eez, top selling auto accessory; volume to dealers.

FOOT-MASTER Tablets. Amazing seller to those afflicted with foot trouble. Proven seller 45 years. Good profit. Repeats fast. Write Master Products Co., 6 East Oak Avenue, Moorestown, New Jersey.

MEXICAN Feather pictures. Unusual novelty. \$1.00 (stamps) brings \$2.00 worth samples, details. Refunded if unsatisfied. Aztec Art-P, Apartado 762, Mexico City.

WHOLESALE—New item for women. Free particulars. Renee, 8 Cumberland St., Boston, Mass.

FINGER Nail clips. Tool steel cutting edges stay sharp. Bright nickel. Retail 50c, sample 15c. Twelve on display card, \$1.80 dozen plus postage. Fast seller. Kearney, 180 Seventh Avenue, New York 11, New York.

AGENTS, Dealers, distributors. We have the fastest-selling item on the market today. 100% profit. Steady repeater. No competition. Rush \$2.98 for complete set-up, or write for details now! Morrison, Box 9312, Station S, Dept. 12, Los Angeles 5, Calif.

WHY Need money! Our product offers excellent profits with thousands of prospects. Free information. Atlas Products Company, Dept. 17, Box 388, Oklahoma City, Oklahoma.

AGENTS: All ages, earn \$30 to \$50 weekly selling for yourself, fibre brooms, mops, and floor dusters, start now. Write Burtz Fibre Broom Co., Columbia, Penna., Dept. A.

EXCELLENT Sideline for printing and advertising salesmen. Decalcomania name plates in small quantities. Great demand. Also, make money with our line of automobile initials and sign letters. Free samples. "Ralco" XL-Roxbury, Boston 19, Mass.

EARNING Less than \$200 weekly? Boost income quickly. Fast selling celluloid price tags, metal molding, menu covers. Every store, restaurant buys. Pricing Press, Dept. PX, 124 White Street, New York.

SELL Personal Initialed individualized belts, buckles, cap badges, tie holders. 2,000 emblems to choose. Fast profits. Repeats. Write today special outfit offer. Hookfast Specialties, Box 1425, PM, Providence, Rhode Island.

AMAZING Discovery. Miracle glaze puts brilliant glass-like surface on cars. Free sample, information. Big profits. Miracle Glaze Company, 9714 S. Austin Ave., Oaklawn, Illinois.

AGENTS—Distributors \$28.00—\$140.00 daily. Flo-Glo plastic linoleum finish. Write, Acme, Box 404, Mount Vernon, N. Y.

JUST Out! History of World War II. Huge volume. Popular price. Authentic text. Official photographs. Big profits. Riverside Book Company, Iowa Falls, Iowa.

MAKE Money in your spare time! Helps furnished. Easy sales. Voluntary repeat orders. Liberal commissions. Write for free wholesale price list today! McGregor Magazine Agency, Dept. P.M.-7, Mount Morris, Illinois.

BIG Bargains for big profits. Over 100 sensational values. Men's used suits \$2.00, pants 35c, topcoats \$1.25, overcoats \$2.00, shoes 20c. Experience unnecessary. Free wholesale catalog. Superior, 1250-B Jefferson, Chicago 7.

90c PROFIT Each \$1 sale. Sell positive mothproofing solution to housewives, stores, agents. Experience unnecessary. Postal brings details. Kinford, Wayne 3, Penna.

GREETING Card agents, "line up" with "Pines" for bigger, better, quicker profits. Rush name, address on postcard today. Box 32, Flushing 5, New York.

AGENTS: Stamping names on pocket-key protectors. Sample check with your name, address, 25c. Stamping outfits. Emblem checks, check-fobs, name plates. Hart Mfg. Co., 303 Degraw St., Brooklyn, N. Y.

137 COMPLETE Plans for starting own business: local—mail order. Particulars free. Elite Co., 220 Grand St., New York 13.

AGENTS—300 % Profit selling genuine gold window letters; stores and offices. Free samples. Metallic Letter Co., 438-B North Clark, Chicago.

200 MONEY Making deals, Plans, rare formulas. Schemes. Polio free. Formico Service, Box 572, Dayton, Ohio.

\$3 FIRE Extinguisher; quick sales, wholesale or direct; liberal profits. "Fire-Killer," 109 N. Franklin, Syracuse 1, N. Y.

PLATING Outfits for autoparts, reflectors. Connect to a battery. No tanks necessary. Free booklet and particulars. Gunmetal Co., Ave. N, Decatur, Ill.

FREE Water and our concentrates, makes flavors, lotions, shampoos, 72 products, labels, bottles furnished. Qualco, E-20030 Russell, Detroit.

GOLD Lacquered window sign letters. Large sizes penny each. New foils. Absolutely beautiful. Free samples. Atlas, 544 W. 79th, Chicago 20.

SELL Personalized soap. Name on every cake. Ideal for gifts. Get sample offer. Dunbar Soap, New Brunswick, N. J.

AGENCIES WANTED

SURE Success! Appoint William Finau Store, Nukualofa, Friendly Island, Oceania, your distributor, annual sales: \$20,000. Bankers: Bank of New Zealand, Auckland. Interesting lists gratis.

HIGH-GRADE SALESMEN

ADVERTISING Book matches—World's largest direct selling manufacturer of advertising book matches offers opportunity for profitable year 'round selling; every business a prospect. No experience needed to start; full or part time. Factory service. Low prices for high quality; repeats; sales kit furnished. Match Corp. of America, 3433-43 West 48th Place, Dept. E-9, Chicago 32, Illinois.

SALESMEN—1948 Calendar and novelty line ready. Buyers everywhere. Low prices. Big commissions advanced. Samples free. Consolidated-Modern Press, Inc., 329P South Wood, Chicago 12.

POCKET Pal: All-purpose cutting tool. Sell dealers nickel plated model. 50c seller. Sell advertisers imprinted colored Pocket Pal. State preference. Either sample 25c. Nelson Mfg. Co., Box 525, St. Paul, Minn.

ADVERTISING Book matches—Cash in on political campaigns. Sell union label matches. Cuts for all businesses and political parties. Free powerhouse selling kit. Low prices. Protection guaranteed on repeat orders. Cash commissions. Superior Match Co., Dept. M77, 7530 Greenwood, Chicago.

BRAND Spanking new. Business and professional men need it the year 'round. Repeat orders and exclusive territory. Write or wire for details. Continental Service, 907 Birch, Eau Claire 2, Wisconsin.

TAKE Orders for solid brass nameplates. Immediate commissions. We deliver. Metro Engraving Co., 362 Cross Street, Malden, Mass.

DISTRIBUTORS, Salesmen—Patented cigarette case holder for automobiles, trucks. Fine seller. New. 200% profit. Sample 25c. Literature free. Little Giant Holder Company, 919 South Vermont, Los Angeles 6, California.

1000 CONTRACT Bookkeepers needed. Start your own business. Part or full time. Free course of instructions. Write H. T. Bedford, 222 W. Maple Grove Ave., Fort Wayne, Indiana.

START Your own business on our capital. Always your own boss. Hundreds average \$6,000 to \$25,000 annual sales. We supply stocks, equipment on credit. 200 home necessities. Selling experience unnecessary to start. Wonderful opportunity to own pleasant, profitable business backed by world-wide industry. Write Rawleigh's, Dept. G-U-PPM, Freeport, Ill.

SELL Delicious candies, nuts, gum. Immediate delivery. Write Casterline, 2031-C Sunnyside, Chicago 25, Illinois.

RESTAURANT Sanitation course complete. Good commission. Institute, 2385 Edgewater, Los Angeles 26, Calif.

SELL Plastic and wooden cocktail specialties, coldrink spoons, spir-its, stir-stics; gold stamped imprint. Free samples. 25% commission. Kay-Gordon Company, 210 Fifth Ave., New York City 10.

DOUBLE Your money by distributing California's golden Veronica Health Water. Millions of bottles used. First to reply will receive enough territory and "know-how" for financial independence. Write Hardy Hoover, 40 North Hemlock, Ventura, California.

BONUS Commissions selling photographic creations. Samples. Creative photography, Box 315, Cooper Station, New York 3, N. Y.

DISTRIBUTORS Calling on mill supply jobbers with processed oil specialties for New York, New Jersey, Pennsylvania. F. W. Boyde & Co., 731 N. 24 St., Philadelphia 30, Penna.

DISTRIBUTORS, Salesmen, bigger commissions with lowest priced home and auto extinguisher. Exclusive contracts. Carbo-gas, Box 2141-A, Portland 14, Oregon.

PLASTIC Imprinted cocktail spoons. Big comm. Timesaver, Box 2495, New Orleans.

NATIONALLY Known manufacturer of industrial stapling machines, tackers, stitchers and staples—now reopening territories. First year salesmen earn \$5,000 to \$7,000. Large repeat business will double your income. Excellent opportunity to advance in large expanding organization. Write The Heller Co., 2139 Superior Ave., Cleveland 14, Ohio.

SELL Scheall's \$1.25 guaranteed fire extinguishers. Sold, used throughout America. Astounding profits. Scheall, Box 263-P, Duluth, Minnesota.

ATTENTION Salesmen! Tremendous profits, sensational new specialties for all types trade. Industries, 919 Brooklyn, St. Louis 6, Missouri.

\$13.50 PROFIT On every sale and prospects galore! Drug stores, gas stations, sporting goods, post exchanges, jewelry, variety, cigar stores, etc. "snap-up" this attractive \$46.40 sunglasses and cabinet deal. Fast sellers. Full commission on restocking assures you regular, automatic income. No samples to buy or carry. Write for free full information and free selling equipment. Midwest Scientific Co., 1148 Chicago Ave., Dept. 500, Chicago 22, Ill.

SENSATIONAL Window wizard cleans glass surfaces in 10 seconds. Long profits, big bonus. Sample \$1.25. Wizard Mfg. Co., Box 63, Downey, California.

SALESMEN Here is an opportunity for you selling Telephone Electronic Equipment and other electrical products. Mac Call Telephone Electronic Equipment, Norfolk, Virginia.

YOU Can make \$40 to \$50 weekly selling guaranteed children's shoes. Big opportunity, tremendous field. Big advance commissions. Get special free offer! See Home Service Shoe Corporation advertisement on page 250. Act now.

12 FANCY Boxes pure Vermont maple sugar postpaid \$6.60. Retail \$1 each! Eulalia Turner, Poultney, Vermont.

PRESSURE Cookers. Now available. Selling like wildfire. Amazing profits. Write quickly. Morris Mandell, Inc., 131-P W. 14th St., New York 11, N. Y.

SELL Filling stations, sales tested specialties. Good profits. General Sales Co., 915 Brooklyn, St. Louis 6, Mo.

SELL Calendars full or part time—every business house a prospect—also wholesale to printers—calendars, novelties, sheet pictures. Fleming Calendar Company, 6535 Cottage Grove Avenue, Chicago 37, Ill.

ORANGE Concentrate direct from our Florida groves. One quart bottle makes six quarts delicious natural orange drink simply by mixing with five parts cold water. Groceries, foodmarts, hotels, restaurants, taverns, roadstands, sodafountains, hospitals, resorts, camps, farmers, big buyers. Money-back guarantee. No investment. Protected territory. Salesmen earn \$100.00 to \$200.00 repeat commission weekly. Sunset Valley, 3357 N. Clifton, Chicago 13, Ill.

QUICK Profits selling full or part time, individualized buckles, belts, cap badges, tie holders, uniform shirts, caps, ties. Choice of thousand emblems. Sure repeat orders. Easy-selling outfit offer. Write Hook-Fast Company, Dept. 12, Roanoke, Virginia.

FREE! Latest issue Opportunity Magazine. Salesman's Guide. Inspiring, constructive. Shows how to earn money selling for others or in your own business. Hundreds postwar opportunities. Send name and describe what you have sold or are selling. Illustrated copy sent free. Opportunity Magazine, 620 N. Michigan, Dept. 17, Chicago 11, Ill.

EDUCATIONAL & INSTRUCTION

WIN A well-paid job in travel—step into a new world of glamorous opportunity! Today more Americans are "going places" than ever before in history. As a result—the hotel and institutional field is surging ahead to new prosperity. Successful Lewis graduates "making good" everywhere in luxurious hotels, fashionable resorts, smart restaurants, and clubs. Free book explains how to qualify at home for a well-paid position in this ever-growing business where you are not dropped because you are over 40—shows how you are registered free of extra cost in the Lewis National Placement Service. Veterans: Course approved for Veterans' Training. Write today. Room LO-395, Lewis Hotel Training School, Washington 7, D. C. (Now in its 31st year.)

VOICE Builder for speaker or singer at less than the cost of a lesson. Free voice advice booklet. Victor Voice Institute, Studio 127, 6515 Wilshire, Los Angeles 36.

LEARN Auctioneering by mail. Sample lesson free. Write Nelson School, Renville, Minn.

WANT A government job? Start \$1756-\$3021 year. Men—women. Prepare now for next examinations. Veterans get preference. 32-page booklet free. Write. Franklin Institute, Dept. K24, Rochester, N. Y.

HAVE An office. Many earn up to \$5,000-\$15,000 annually. Learn credit-collection agency business by home study course. Write for free bulletin. Franklin Credit School, Dept. 202-H, Roanoke 7, Virginia.

BOOKKEEPING Self-Taught. Complete course \$1.00. Premier Sales Company, Box 681, Greenville 4, South Carolina.

MODERN Welding school gives thorough training for one of industry's best paid jobs. Experienced instructors. Individual attention. Non-profit institution. Qualified under G.I. Bill. Write for literature and details. Hobart Brothers Co., Box M-776, Troy, Ohio.

BECOME A Doctor of Psychology or Metaphysics. Teach secret of contentment, happiness. Win degree of Ps.D. or Ms.D. Solve mental worries. Free book. College of Universal Truth, 5153-B North Clark, Chicago.

LEARN Tile setting. Easy home method. Bartell, 15020 Mansel, Lawndale, Calif.

JOIN:—Alaska Chiropractors Association. Many advantages. Box 2894, Juneau 1, Alaska.

BE A Pedagogue:—Foot correctionist. Extension. Degree. Alaska Foot Institute, Juneau 1, Alaska.

TRAIN For aviation mechanics high salaries. This famous school approved for veterans. Immediate enrollment. For information write California Flyers, Dept. M-7, Inglewood, California.

PLASTICS—Get into nation's fastest growing industry. Amazing opportunities for trained men in this billion dollar field. Fall classes now forming; day or evening. Veterans approved. Free catalog. Kansas City School of Plastics, 3827 Main St., Kansas City, Mo.

FACTS, Figures, faces, stick like burrs! New improved Supermemory course. Write Thor Books, ZC-7, Box 1210, Chicago.

SENSATIONAL New magic shorthand and typing course. Copy 50c. Laramie Sales, 4800 S. Laramie Ave., Chicago, Ill.

AMAZE Others. Add faster than adding machine. Free details. Math Institute, Box 633, Mobile 4, Ala.

BOATING. Learn at home. Seamanship and piloting. Cruise scientifically. Prepare for a job on the water. Yacht captains earn to \$500 monthly. Write for particulars. Fairway School, Box 811, Old Greenwich, Conn.

PAINT Beautiful pictures quickly, easily, inexpensively. Free literature. Art Book Shop, Arnold, Mo.

3800 LATEST Used correspondence courses. Catalog 50c. EG, Elmsford, N.Y. 1.

RESORT Hotel business offers permanent career, travel, beautiful surroundings. Write for booklet. Lee Hotel Institute, 12A South Market St., Boston, Mass.

CALENDAR 1753 To 2152. 35c postpaid. Tracy Newton, Decatur, Georgia.

LEARN Secret of being irresistible—key to success. Capitalize your hidden powers. "Winning Personality" shows how. \$1 copy. A. Dolberty, Box 171, Station W., New York 24.

GOOD "Used" self-instruction educational books on all subjects bought, sold, rented, exchanged. Satisfaction guaranteed. Complete information and 100-page illustrated bargain catalog free! Write—Nelson Company, Chicago 5.

PREPARE For Civil Service Examination. Pay for course after securing position. Write Free School, Dept. PM4, Kokomo, Indiana.

USED Correspondence courses and educational books bought, sold, rented, catalog free. Educational Exchange, Henagar, Ala.

USED Educational books on all subjects sold, rented, also bought and exchanged. Moneyback guarantee. Write today for free catalog and details. Lee Mountain, Pisgah, Alabama.

INVESTIGATOR Training. Phillips Secret Service, 1917B North Kenneth, Chicago 39, Ill.

BIG Money rebuilding shoes. Help needed everywhere or start big-income business of your own. Learn practical, sure, easy way in 3 months. Anyone from 18-60 years can learn easily. Approved for GI training. Rush postcard today. Modern Shoe Rebuilding School, Est. 1927, 2935 Belmont, Chicago 18, Illinois.

29 LANGUAGES By Linguaphone. Russian, Spanish, Portuguese—Direct conversational method for mastering any language quickly, easily, correctly at home. Available under G.I. Bill of Rights. Send for free book. Linguaphone Institute, 83 RCA Bldg., New York 20.

LEARN Photo-engraving at home or in oldest, largest school in America. Work for newspaper or establish own profitable business. New Tasope Photo-Engraving equipment available soon. Write for information. Veterans ask about G.I. training. The Aurora School of Photo-Engraving, Tasope Bldg., Aurora, Mo.

SECRET Investigation. Experience unnecessary. Investigators particulars free. George Wagner, M 125 West 86th, New York.

MEDICAL Laboratory technicians in great demand. We train you in your spare time, in your own home. You can practice while studying. Write for free catalog. Imperial Technical Institute, Box 973-E, Austin, Texas.

PRACTICAL Mathematics—Details free. Math Tutor, Box 1214-C, Indianapolis 6, Indiana.

LITTLE Library of Useful Information. 102 different books. Catalog free. Popular Mechanics Press, 200 E. Ontario St., Chicago 11, Ill.

PLAYS, STORIES, MANUSCRIPTS

NEW Writers needed. Nonfiction material demand is booming. Many magazine editors buy features and "fillers" from new writers. Our earn as you learn lessons prepare you to meet their requirements. Experience unnecessary. Reasonable price, unexcelled service. Details, sample lesson free on request. Use postcard. No obligation. Comfort Writer's Service, 200-PN S. 7th St., St. Louis 2, Mo.

I WANT New writers to cash hundreds of checks for \$1 to \$100, offered each month. The easiest way to write for pay. No previous experience necessary. Send for free details. No obligation. Saunders M. Cummings, 467-M Independence Bldg., Colorado Springs, Colo.

BUSINESS SERVICE

PHOTOCOPYING—Valuable papers, discharge certificates, etc., 75c, 3—\$2.00. Russell Photocopy Service, Box 366 (P), New Philadelphia, Ohio.

TO Whom it may concern. We will represent you in all principal cities of the world. Representatives wanted. Will send you assignments immediately. James W. Farley, Citizens Bldg., Cleveland 14, Ohio.

STENCILS—Save time in shipping and making your own signs. 40c per line, 3 lines \$1.00. Sent postpaid promptly. Send for free list 100 stock stencils and stenciling supplies. Velivis, 537 Harrison St., Allentown, Penna.

BUSINESS Representation—World's principal cities. Associates wanted. Universal—PB, Butler Building, Chicago 1.

MONTREAL Address. Your mail received and forwarded. Confidential. Free details. P.O. Box 106 Station R, Montreal, Quebec.

WHERE To find it? Our specialized service provides you with source of supply on any article or material made in the United States. We save you time, money and effort. Reliable information on any single item only \$1. For ten different articles, \$5. Send no money! Pay on approval of information sent you. Tell us what you want to locate. Donald Kelly, 9544-A Whitcomb Ave., Detroit 27, Mich.

MANUFACTURERS. Any article. Two names 25c; 15, \$1.00. Pittshire, Box 90, Pittsfield, Mass.

SPECIAL SERVICES

QUANTITATIVE Analyses. Metals, water, textiles. Accurate routine determinations \$1.00. Industrial Laboratories, 123 Beaver, Albany, New York. Analytical reagents, standard solutions available.

MAIL Forwarded. 25c each letter. Banas, Box 285, Syracuse, New York.

SPECIAL Supply source on anything made in United States \$2.00. Unable furnish information, money returned. Business Service, 1101 Kings Highway, Shreveport, Louisiana.

SEND Your mechanical, electrical or structural design problems for analysis by our staff of graduate engineers. To cover preliminary expenses, cost estimate and opinion, enclose \$1.00. Arnold and Smith, Consulting Engineers, P.O. Box 7103, New Orleans, La.

FOR More business, establish office address, requiring no room, or box number. Rates, \$7.30 and \$14.60 yearly. Co-operative Service, 126 Lexington Avenue, New York 16.

QUESTIONS Answered about Canada. \$1.00 each. P.O. Box 106 Station R, Montreal, Quebec.

WANT, Washington, D. C., mail address? \$2.00 monthly maintains business, personal service. Letters reforwarded daily. "Hawkins," 1300-1 Taylor.

NEW York address. Your mail received and forwarded. Confidential. Free details. Arlington, 131-H West 42nd, New York 18.

LETTERHEAD Designing; artwork; 200 attractive stationery designs, \$1.25; folder free. Jacobson's, 3510 Palmer, Chicago 47.

ALASKA. Letters stamped, forwarded, 25c coin. Tolovana Traders, Tolovana, Alaska.

GOOD "Used" self-instructional books on all subjects bought, sold, rented, exchanged. Satisfaction guaranteed. Complete information and 100-page illustrated bargain catalog free! Write—Nelson Company, Chicago 5.

TECHNICAL Bottlenecks delaying your electronic, machining, or sheetmetal projects? Advice on reasonable technical problems rendered by competent electrical, mechanical, industrial engineers for just \$3.00. Inventors, amateurs, etc.—Here is your opportunity to obtain professional consultation at a nominal fee. Electronic circuits, cost estimates, etc. Or will quote on more extensive service. Technical Consulting Service, 36 River Bend Drive, Dayton 5, Ohio.

CARTOONING, COMMERCIAL ART, SHOWCARD WRITING, SIGN PAINTING

OUR Proven courses, including drawing from blueprints, adapted for training by mail. Write for full details. Laingor Commercial Art School, Central Station Box 1445, Toledo 3, Ohio.

"HOW To Make Money With Simple Cartoons"—a book everyone who likes to draw should have. It is free; no obligation. Simply address Cartoonists' Exchange, Dept. 97C, Pleasant Hill, Ohio.

EARN Money evenings, copying and duplicating comic cartoons for advertisers. Adservice, Argyle (1-B), Wisconsin.

LEARN Sign painting. New simplified method. Particulars free. Haines System, Sabina, Ohio.

ARTISTS—Students: Auto-scale saves half time copying, enlarging, reducing drawings. Guaranteed. \$4. Particulars free. Disco, Box 761, Glendale 5, Calif.

TALENT Test free. American School Commercial Art, Box 8066, Dallas 5, Texas.

MAKE Signs. 9 complete alphabet pattern sets, 3 complete numeral pattern sets and catalog \$1.00. Sign Letter Distributors, P.O. Box 101, Mineola, N. Y.

FREE Catalog of cartoon markets, cartooning courses, artists' books and materials. Write now. Lawrence Publications, Box 22-A, New York 23, N. Y.

EARN Big money. Become a skilled sign painter with our 112 lesson course. Results guaranteed. Write for details. Stewart Sign Co., Box 1329, Glendale, Calif.

SIGN Painting taught at home by an old master. Ben Kerns, Box 812, Greenville, S. C.

CHALK Talks. Laugh producing program, \$1.00. Catalog 10c. Balda The Cartoonist, Goshosh, Wisconsin.

ADVERTISING AGENCIES, LETTER WRITERS, FOR ADVERTISERS

ADVERTISERS! Reach nearly 18,000,000 readers. 25 Sunday national key newspapers, 18 words, \$42.25. "Terrific pullers." 20 popular newspapers, \$8.50. "Free booklet." Special—One inch display 2,821,198 circulation, \$42.00. Newmark's Advertising Agency, (Established 1893) 217-7th Ave., New York 11.

THOUSANDS Of names and addresses of eager mail order buyers only \$3.50 per 1000. Roy Kramer, 329 Cates St., Maryville, Tenn.

MAIL Order ads, circulars, letters, by leading advertising agency in mail order field. Low prices. Moran Advertising Agency, Box 104, Wilkes-Barre 3, Pennsylvania.

ADVERTISERS: Mail order ad covering United States—2,200,000 circulation—\$28.00 inch. Classified ad, 24 words, 20 metropolitan Sunday newspapers—\$25. Magazine, newspaper, mailing-list ratebook, adwriting assistance—free. Chicago Advertising Agency, 20-PM West Jackson, Chicago 4.

NEW Names! White, negro teachers, rural housewives, automobile owners, births, etc. 1000 \$7.00. Trial 300 \$1.00. Business Service, 1101 Kings Highway, Shreveport, Louisiana.

SELL The veterans' market. List of 1200 vets World War 2 living in Iowa, "the mail order paradise." \$3.00. Vets Advertising Service, Box 621, Des Moines, Iowa.

ADVERTISE: 24 Words, 40 newspapers \$3.50. Lists free. Advertising Bureau, 229-C Dixon Blvd., Uniontown, Penna.

FREE! 1947 Advertisers Rate and Data Directory. 52 pages! E. H. Brown Advertising Agency, 20 N. Wacker, Chicago 6.

ADS Placed in out of town newspapers and magazines. Low rates. Catalogue free. Ideas that pay. Baker Advertising Agency, Successors Ankrum Agency, 189 W. Madison, Chicago 2.

INCH Display advertisement Mallorder World, year \$24. Wood's Popular Services, Atlantic City, New Jersey.

ADVERTISING Service, art work, C. Sanford, 5029 Maple, St. Louis, Mo.

MAILING Lists, certified, productive, inexpensive, \$5.00 1000. Homeworkers, agents, buyers, etc. Write Dixie Service, King, N. C.

24 WORDS In 64 weeklies \$4.96. H. J. Darnell, 730 Hays, Jackson, Tenn.

TYPEWRITERS, DUPLICATORS, OFFICE DEVICES

DUPLICATORS \$19.50. Use no stencils. Prints to 8½x14. Particulars free. P. Nelson, 530-D Santa Clara, Alameda, Calif.

DUPLICATORS \$9.95 Up. (New.) Immediate delivery. "Free circular." Rucker, 2836-PM Slevin, Louisville 12, Ky.

"PRINTOMATIC" Selffeeding post card stencil printing duplicators \$9.50 up. Office size duplicators, Speedoprints, Hilcos, Excellographs \$33.41 up. Literature free. Pittsburgh Typewriter Supply, 336-WK Fourth Avenue, Pittsburgh 22, Penna.

RECONDITIONED Typewriters, mimeograph, multigraph printing devices, appliances, supplies. Catalog. Dixiegraph Service, King, N. Carolina.

RUBBER STAMPS AND OFFICE SUPPLIES

PICTORIAL Rubber stamps (rabbits, ships, birds, beasts, clowns, patriotics, etc.) only 25c each. Request catalog. Stampico, 8837 Quincy, Detroit 4, Michigan.

NAME—Address, 70c; pad 40c, dater 50c, numberer 60c. P. Saunders, Tipton, Mich.

RUBBER Stamps. Buy direct from manufacturer. Literature free. Lee-Vall Press, Box 1242, Indianapolis 6, Indiana.

PRINTING, MULTIGRAPHING, MIMEOGRAPHING, GUMMED LABELS

600 ENVELOPES (Forward-return), including letterheads \$5.00. Manning, 3749 Ellis, Chicago 15.

150 HAMMERMILL 8½x11 Letterheads and 150 6¼ envelopes with your name and address beautifully printed, \$2.25 postpaid. Ducit, Ashburn, Ga.

PRINTING, Multigraphing, Monotype-cast multigraph type, composition. Sharp multilith mat, other reproduction on proofs. Ace Printing, Brentwood, Maryland.

OUR Printing satisfies. Mail your sample for quotation. William Moyer, Alvin, Texas.

1000 FOUR Line stickers \$1.00. Labels, printing. Best, cheapest in country. Imprint, Emporia, Kansas.

MULTILITH Printing at mimeographing prices. Write for free samples. American Photocopy Service, 311 E. Main St., Stockton, California.

MIMEOGRAPHING—Letters, circulars, booklets, price lists. Lowest prices. Samples free. Martin Mimeo, 3212 Harper, St. Louis 7, Missouri.

200 SHEETS 5½x8½, 100 envelopes, \$2.00 postpaid. Samoset Press, Plymouth, Mass.

PRINT Your own letterheads, envelopes, circulars, etc. Multigraph press complete with type from \$59.50. Reconditioned Machines, 639 West 18th St., Chicago 16, Illinois.

CLEAR Cut printing, request samples, prices. H. J. Vrazel, Yoakum 1, Texas.

200 6¼ ENVELOPES, \$1.00. Print copy. H. Hagberg, Gothenburg, Nebr.

QUALITY Printing: Reasonable prices. State requirements. Samples. Mero Products, 100 Morrison, Punxsutawney, Penna.

5000 ELEGANT Envelope slips \$4.75; circulars, folders, imitation letters at low prices. Goodprint, Harrisonburg, Virginia.

KELSEY 4x6 Press. Like new. Radio Lab., 41 Ferry, Buffalo, N. Y.

FAST Service on printing guaranteed. Ad-Man, 305½ Liberty Bldg., Indianapolis, Indiana.

QUALITY Personalized stationery, 300 note sheets and 150 envelopes \$2.00, postpaid. Name, address, printed in blue. Gift boxed. Haas Press, Sleepy Eye, Minn.

POSTCARD Brings our samples, prices. Valley Print Shop, St. Elmo, Tenn.

QUALITY Printing at reasonable prices. Write for latest price list. Bagby Printing Company, Georgetown, Ohio.

PHOTO-OFFSET, Printing, multigraphing. Samples free. Mango Printing Company, 555-A, South 20th, Newark 3, N. J.

100—8½x11 HAMMERMILL Letterheads \$1.00 postpaid. Envelopes same. Race Printing, Hudson, New York.

\$1 FOR 1,000 Assorted gummed labels 1½x3". Glass, fragile, c.o.d., rush, etc. Useful to any business. Stock Labels, F. E. Point, South Amboy, N. J.

250 LETTERHEADS \$1.75. Envelopes same. Mallo, 767 Leith, Flint 5, Mich.

500 ¾x2¼ FOUR Line gummed stickers, 35c. Moritz Printery, Saginaw, Mich.

1000 BUSINESS Cards \$2.50. prepaid. Reliable Print Shop, 901 E. Jefferson, Louisville 6, Ky.

SEND 10c Now, for our 36-page 1947 price list—refunded first order. McCall Press, 1326 South 27th, Omaha, Nebraska.

BETTER Grade printing reasonable. Estimates on anything. Economic Press, Leonia, N. J.

MIMEOGRAPHING—Letters, pricelists, formulas, instructions. Lowest prices. Lem's Letter Shop, 5710 Stanton, Detroit 8.

BOOKS—All Kinds—Homecraft, Radio, Plastics, Boat Building, Photography, Model Building. Catalog free. Popular Mechanics Press, 200 E. Ontario St., Chicago 11, Ill.

PRINTING OUTFITS AND SUPPLIES

SAVE On printing. Print for others. Printing multigraph; type; accessories. Prints letterheads; envelopes; anything to 8½x11" from type; linotype; cuts, 3,000 hourly. \$250.00 outfit, \$95.00. Power-operated; motor; automatic feed; accessories. \$500.00 outfit, \$195.00. Multilith offset press, \$245.00. Guaranteed rebuilt; prepaid. International Machines Corporation, 1515 Larimer, Denver, Colorado.

PRINTING Presses, type, supplies. Send dime for complete illustrated printer's supply book, details and press samples. Kelsey, Inc., A-11, Meriden, Connecticut.

PRINTER'S Aprons. Best material, pockets, \$1.50. Z. Boone, 732 Chemeketa, Salem, Oregon.

MAKE Your own plastoplate printing cuts. Simple, easy process. Plastoservice, Argyle (1-A), Wisconsin.

CUTS—Make real halftones, line cuts yourself! Samples 25c. Particulars free. Rapid Chemical Service, Edwardsville, Ill.

HOME-MADE Presses. Proofs free. Riegel, 1111 Harrison, Phila. (24), Penna.

INEXPENSIVE Home-made printing press. Details free. Novelty Shop, Downsville, Louisiana.

PATENT ATTORNEYS

INVENTORS—Patent laws encourage the development of inventions. The Rules of Practice of the U. S. Patent Office advises—unless an inventor is familiar with such matters—that he employ a competent registered attorney or registered agent, as the value of patents depends largely upon the skillful preparation of the specifications and claims. Write for further particulars as to patent protection and procedure and "Invention Record" form at once. No obligation. McMorrow, Berman & Davidson, Registered Patent Attorneys, 134-M Victor Building, Washington 1, D. C.

INVENTORS: Learn how to protect your invention. The United States Patent Office advises the inventor to engage a competent, registered patent attorney or agent to represent him. We maintain a staff of registered patent attorneys ready to serve you in the handling of your patent matters. Special booklet "Patent Guide for the Inventor" containing detailed information concerning patent procedure with "Record of Invention" form will be forwarded upon request—without obligation. Clarence A. O'Brien & Harvey Jacobson, Registered Patent Attorneys, 71B-G District National Building, Washington, D. C.

INVENTORS—A patent is a valuable right. Detailed information and the preliminary steps to take to obtain patent protection will be sent to you upon request. Victor J. Evans & Co., 231-H Merlin Building, Washington 6, D. C.

C. A. SNOW & Co.—M-427, Snow Building, Washington 1, D. C. Registered Patent Attorneys. Write for information.

REGISTERED Patent attorney offers services. Sanders, 6430 Evans, Chicago 37.

INVENTORS. For "Record of Invention" form, contact Carl Miller, Registered Patent Attorney, Woolworth Building, New York.

"INVENTOR'S Guide" free on request. Frank Ledermann, Registered Patent Attorney, 154 Nassau St., New York 7, N. Y.

PATENTS, "Proof of Invention" folder mailed without obligation. E. E. Vrooman, Registered Patent Attorney, 871 Woodward Building, Washington 5, D. C.

INVENTORS: Without obligation, write us for information as to what steps an inventor should take to secure a patent. Randolph & Beavers, Registered Patent Attorneys, 21-C Columbian Bldg., Washington 1, D. C.

INVENTORS: Write for free brochure "Evidence of Invention." Labiner, World Building, New York 7.

PATENTS—Trade marks. Irving L. McCathran, 315 McLachlen Bldg., Washington 1, D. C. Registered Patent Attorney.

PATENT And Trade-Mark Practice before U. S. Patent Office. Validity and infringement investigations and opinions. Booklet and form "Evidence of Conception" forwarded upon request. Lancaster, Allwine & Rommel, Registered Patent Attorneys, Suite 411, 815-15th Street, N.W., Washington 5, D. C.

FOR INVENTORS

INVENTORS: Learn how to protect your invention. The United States Patent Office advises the inventor to engage a competent, registered patent attorney or agent to represent him. We maintain a staff of registered patent attorneys ready to serve you in the handling of your patent matters. Special booklet "Patent Guide for the Inventor" containing detailed information concerning patent procedure with "Record of Invention" form will be forwarded upon request—without obligation. Clarence A. O'Brien & Harvey Jacobson, Registered Patent Attorneys, 71A-G District National Building, Washington, D. C.

INVENTORS—Patent laws encourage the development of inventions. The Rules of Practice of the U. S. Patent Office advises—unless an inventor is familiar with such matters—that he employ a competent registered attorney or registered agent, as the value of patents depends largely upon the skillful preparation of the specifications and claims. Write for further particulars and "Invention Record" form at once. No obligation. McMorrow, Berman & Davidson, Registered Patent Attorneys, 134-P Victor Building, Washington 1, D. C.

1,000 INVENTORS Wanted to display their inventions (to manufacturers). Exhibition only 10c daily. Particulars, write The House of Inventions, Inc., 631-3rd Avenue, New York.

INVENTORS—Victor J. Evans and Co. has a staff of registered patent attorneys, available to assist inventors in the preparation and prosecution of their cases before the U. S. Patent Office. Detailed information and the steps to take to obtain patent protection will be sent to you upon request. Victor J. Evans & Co., 232-H Merlin Building, Washington 6, D. C.

FREE Pamphlet! How to develop your inventions. Elo Development Company, Department F, Chatham Phoenix Building, Long Island City 1, New York.

PATENTED Unpatented inventions promoted. M. Joyce Humphries, 1424 Land Title Bldg., Philadelphia 10, Penna.

PROVING Invention date, your problem? Use ironclad Aaberly routine; special form, 10c. Outranks registered letters, "invention copyrights" and other unreliable makeshifts. No relationship whatsoever to free "evidence forms." For dependability, guaranteed next to patent pending! No disclosure to me or other strangers! Complete patent applications. Drawings. Preliminary searches for experienced inventors willing to pay slightly more for searching with painstaking care! Rely on 31 years "know how." N. Aaberly, Patent Engineer, Woodward Building, Washington.

FREE Estimates on patent models. Wood, metal, plastic. Rogay Industrial Models, 3818 Beecher Street, N.W., Washington 7, D. C.

IDEA Men!—Let's get together and get some money out of our ideas, instead of promises. James Corubia, Lakewood, New Jersey.

HIGHEST Royalties and cash for your inventions when we market them. Free particulars without obligation. Universal Marketing Co., 126 Lexington Ave., New York 16, N. Y.

MARKET Your ideas and inventions through our "Product Study Brochure" plan for quick responses and known results. Spartan Sales, 600 Woodward Ave., Dept. 1006, Detroit 26, Michigan.

WANTED By live manufacturer. Home work shop and hobby gadgets—devices, ideas for tools. We manufacture and sell. Do not send models. Simply send description and illustrations of what you have. Warner Electric Co., 1512 Jarvis Ave., Chicago 26, Ill.

INVENTORS: You save up to 300% when dealing with your patent searcher direct. Complete search with patent copies \$6.00. Reports mailed in 5 days. Invention protection forms free. Write Raymond L. Smith, Patent Searcher, 703-M Albee Building, Washington 5, D. C.

INVENTORS: Avoid unnecessary expense. Write for free booklet explaining how our consulting and advisory service can assist you in deriving greatest profit from inventing. Institute of American Inventors, Dept. 40-A, 1926-Eye St. N.W., Washington 6, D. C.

"INVENTOR'S Guide" free on request. Frank Ledermann, Registered Patent Attorney, 154 Nassau St., New York 7, N. Y.

THE Inventor who believes he has a new and useful invention, and needs advice, should consult a competent registered patent attorney. Without obligation, write for full information on how to secure patents and trademarks. Randolph & Beavers, Registered Patent Attorneys, 11-E-Columbian Bldg., Washington 1, D. C.

I SELL Patents. Established in 1900. Charles A. Scott, 773PM Garson Ave., Rochester, N. Y.

INVENTIONS WANTED

WANTED—Practical inventions of all classes by manufacturers. John D. & Son, Dept. PM-7, Box 3213, 285 Howard Ave., Bridgeport 5, Conn.

EARN Up to \$2,000 year, inventing simple items for special cash markets. Ideas only. No patents. Hendrickson, Argyle (7-B), Wisconsin.

IF Your invention is not protected by a patent write for copy of my double service plan of patent application, preparation and filing with patent office at low charges, payable six monthly installments and how I assist inventors in selling their inventions. My files contain manufacturer request for inventions covering 507 different classifications. Patent search with copies \$6.00. Invention record details free. Charles R. Morton, Patent Broker, Established 1919, Dept. 72, 11 West 42nd Street, New York.

WANTED: Practical inventions for sale through 5c-\$1.00 stores, cigar stores; also special of all kinds. Write Matt, Northern Bldg., Chicago 4.

MANUFACTURERS Want patented or pending inventions! Send patent copy or complete details. Universal Guaranty Company, Lakewood, New York.

INVENTORS: Hundreds of manufacturers have requested our assistance in locating marketable new products. Complete information, free. Institute of American Inventors, Dept. 40-D, 1926-Eye St. N.W., Washington 6, D. C.

MANUFACTURING

DECALS. Small lots quick. Write Armstrong, 267 Twelfth, Oakland, Calif.

MANUFACTURING. Dies, Gear cutting, models inventions. Baum' Specialties, Kansas City, Mo.

PRE-FABRICATED Aluminum hamburger-lunch stands. Write Jeffy Structure, 6125 Glen Oak, Los Angeles 28, California.

EXPERIMENTAL Devices, models. Any material. Reasonable. Nelson Manufacturing, Woodburn, Oregon.

PRECISION Models of all types; metal, plastics or wood. Trade Engineering Company, 2316 Third Ave., New York City.

PERMANENT Moulds for plastics, aluminum castings. Send drawings. Unamit Mould & Machine Company, Bunker Hill, Ill.

ENGINEERING. Designing, tooling. Complete engineering service. Porsberg, Northfield, Ohio.

MODELS—Small lot manufacturing. Metals, plastics, etc. Milburn, Burlington, Kentucky.

A BRAND New inventor's service. Write for information. J and M Company, Burlington, Kentucky.

PATENTS FOR SALE

NEW Improved coping saw. A real tool. David McNeely, Calvert, Texas.

PATENT For sale. Metal archer's bow, sport mfg. or novelty co. prospects for large sales, good profits. Hancil Cordrey, Box 846 Chula Vista, Calif.

PATENTED Rubber heel, rotates, wears even, lasts longer! Unlimited field. P. H. Kellar, 1218 1st Ave., San Diego, Calif.

PATENT On a loud speaker attachment for telephones. Outright or royalty. James Hale, (Buchanan Box), Coeburn, Va.

BATTERY Cable terminal. Apply with fingers. Simple and practical lever action. Address Stanley S. Wyman, 159 Crescent St., Willimantic, Conn.

INVENTORS: Test the commercial value of your patented or unpatented inventions, quickly and inexpensively. Write for free information. Institute of American Inventors, Dept. 40-B, 1926-Eye St. N.W., Washington 6, D. C.

MODELS AND MODEL SUPPLIES

SHIP Model kits and fittings, most complete stock in New England. Boucher, Fisher Marine Model and Model Shipways fittings, blueprints and model yacht equipment at standard prices. Send 25c for new illustrated 1947 catalog and price list. Dept. M, James Bliss & Co., Inc., 220 State Street, Boston, Mass.

RAILWAY Models, complete informative catalog HO and O gauge. 128 pages, 35c. Walthers, 247 Erie, Milwaukee, Wisconsin.

FUN Building models—Airplanes, trains, ships. Everything furnished. Giant catalog 10c. Ben's Hobby Shop, 72 West Washington, Chicago 2, Illinois.

BALSA Wood. Generous supply \$1.00. Price list free. Sanlader, Manitowoc, Wis.

MIDGET Permag motors. 12-27VDC. 80-250RPM. Reversible. \$2.35, new. Free list. Ereco, 1006 Hewitt, Everett 1, Wash.

SHIP Models and yacht supplies complete. Large 64 page catalogue 30c. Bill Wild's, 510 East 11 St., New York City 9.

LANDLOCKED Sailors! Here's a beautiful, richly illustrated, fully descriptive catalogue of famous model ships—whalers, slavers, corvettes, etc., authentic in every detail. Send for it today. Only 10c. Halesite Yacht Service, Inc., Halesite, Huntington, N. Y.

SHIP and Yacht model fittings; blueprints. Send 25c for illustrated catalog No. 20—listing hundreds of items. A. J. Fisher, 1223 J. Elsworth Ave., Royal Oak, Mich.

HOME CRAFTSMEN

METAL-WORKERS Patterns! Giraffe smoking stand 31" high, bird lawn ornament 20", antique drawer pull, ornamental hinge made the easy way, small hanging vase holder, scone candlestick, small shelf. Make of copper, aluminum, or iron. Welding unnecessary. For shop-tested, full size patterns, drawings, photographs send \$1.00 to Reitz and Patzold, Box 3263, Seattle 14, Wash.

REPTILE Leathercraft. Complete kits. Factory tanned skins. Quality leather linings. Lowest prices. Free catalogue. Marshall Bishop, Box 341, Coral Gables, Fla.

BUILD And sell lawn chairs. Plans \$1.00. We tell you how and where we sell. The Woodcraft Shop, Danby, Vermont.

WHAT-NOTS Of scrap wood. 12 full size patterns \$1. Albright Service, 6901 Railroad Ave., Omaha 7, Nebr.

BUY Sea shells—Findings direct. Kits, dollar up. Free catalogue. Dixie Shell Service, Lakeland, Fla.

DRILL Sets—Save almost 50%. Brand-new Cleveland twist drills #1 through #60, carbon steel. War surplus bargain at \$4.95 a set. Waterproof, rustproof packed. Mercantile Wholesalers, 2107 Pennsylvania N.W., Washington 7, D. C.

COMPLETE Band saw service—Longer lasting saws for any machine. Broken saws factory welded 40c. Guaranteed. A. G. Bauer, Seaford, N. Y.

OUTDOOR Furniture—Lawn chairs, tables and benches. 5 different plans \$1.00. 10-\$2.00. Summercraft Studio, 42 Vernon Street, Newton 58, Mass.

PLASTIC Jewelry supplies. Free catalog. J & M Novelties, Box 464, Griffith, Indiana.

GUARANTEED: We are America's lowest priced hobby supply house. Write for free price lists. Allcraft Products, Hempstead, New York.

LEATHER Tools, lacing, supplies. Retail. Mail orders. Catalog. National Handicraft Co., 30 Frankfort St., New York City 7.

SHELLCRAFT Instruction book with 450 Caribbean shells, including findings for making \$6 worth, \$1; or beautiful African gold shell 75c earrings, including outfit making ten more pairs, with book, \$1. Satisfaction guaranteed. Shell Company, Miami 36, Florida. State representatives wanted.

LEATHER Craftsmen: Don't spend hours tracing design. Start tooling immediately. Our designs on plastic require no tracing. May be used many times. Introductory offer \$1.00. Sample 10c. Lampkin Artercrafts, Box 641-M, Culver City, Calif.

COPPER Tooling—Material, tools, patterns and instructions \$1.00. Pacific Model Supply, Craft Division, 2509 West Manchester, Inglewood, Calif.

SHELLCRAFT—Instruction, supplies. A. Werts, 1429-56th Ave., Oakland 3, Calif.

INLAY Strips, exotic veneers, Spanish cedar and mahogany turning squares, plywoods, other craftsmen's materials. Sedlo Company, P.O. Box 7161, New Orleans, La.

MAKE Beautiful shellcraft jewelry; a highly profitable business or hobby. Simple, illustrated instructions, "Making Shell Jewelry" 25c. Sample instructions and price list, 10c. Store of Novel Findings, Box 27, Yuba City, California.

LEATHERCRAFTERS And dealers: Metal plates emboss floral, western designs on belts, billfolds, etc. No machine necessary. Imprint free. Saddle stamps. Hunter Mfg. Co., 135 N. Hillside, Wichita, Kansas.

HAWAIIAN Woods. 5 samples \$1.00. M. Nelson, Lahaina, Maui, T. H.

RARE Woods for homecraftsmen—Rosewood, ebony, cocobolo, purpleheart, etc. Assortment of small pieces \$2.00. Venezuelan ebony turning blocks, 10" x 10" x 4" \$5.20 postpaid. Send for price list. Salisbury Cutlery Handle Co., Salisbury, Conn.

BRASS Rods, tube, sheet for home workshops. Send for catalog 201. Meier Brass, 1155 Bellevue, Detroit 7, Michigan.

LEATHERWORKER'S Bible. Every leatherworker should own this completely illustrated catalogue combined with valuable instructions and information. Largest in this field. Actual leather samples. \$1.00 postpaid. Satisfaction guaranteed. Artcraft Leather of California, Dept. PM-7, 271 Twelfth St., Oakland 7, Calif.

WHITTLES Supplies, Redicut blanks,

SHELLCRAFT Beginner's kit with instruction book \$3.00. Price list free. Stelle Shellcraft Industries, Route 1, Box 69X, Orlando, Florida.

GENUINE Leather scraps for leathercraft items, assorted colors, 6 pounds, \$2.00. Send 10c for sample. International Cushion Co., 515 No. Halsted, Chicago 22, Illinois.

ATTRACTIVE Pieces of good quality leatherette assorted colors, suitable for many handicraft items, 8 lbs., \$2.00. Send 10c for sample. International Cushion Co., 515 No. Halsted, Chicago 22, Illinois.

LEATHERCRAFTERS! Send for free catalog listing leathers, tools, supplies. Kit Kraft, 1607 S. Western, Los Angeles 6, Calif.

PILING Operations with jig saw. Fast! Accurate! Blueprint and instructions, \$1.00. R. LaBarre, 12683 Terry, Detroit 27, Michigan.

JEWELRY, Made in your own home, economically. We supply findings, imitation gems, small Lucite and Plexiglas squares, chemicals, ideas. Send for the big illustrated Craftsman's catalog, only 25c (refunded on first order). Pittshire, Box 90, Pittsfield, Mass.

SHELLS, Findings, for making shell jewelry. Free catalogue. Tamiami Gift Shop, P.O. Box 507, Bradenton, Fla.

LEATHERCRAFTERS! Belt kits, projects, leather, supplies. Write for catalog. Art Leather, 411 Joseph Ave., Rochester 5, N. Y.

WHAT-NOT Clever original designs, 5 full size. Will add beauty to any home, \$1.00. D. A. Wallace, 637-E Amelia, Orlando, Florida.

MAKE Your own jewelry! Findings in metal and plastics; earwires, pinbacks, cameos, stones, beads, clasps, sprays, combs, hairbars, plastic and metal chains. Hobby Art Corp., Dept. 7, P.O. Box 276, New York 18, N. Y.

KNOCKDOWN Cedar chest lumber veneers. Free price list. Giles-Kendall, Huntsville, Ala.

MASONITE Mill ends, 10# \$1.00, plus postage. Carl Sign Co., Wooster, Ohio.

SHELLS, Plastics, findings. Lowest prices. Free catalog. Frances Jones, Box 251, Sarasota, Fla.

EXPERIMENTERS! Interested in electrical, mechanical devices from war surplus? List free. F. Siefke, Box 18, Station E, Buffalo 11, N. Y.

MAKE Shell jewelry—for gifts, as a hobby or start a business. Free catalogue and price list. Complete illustrated book of instructions 75c. Florida Shellcraft Company, Box 1840, Sarasota, Florida.

SHELL Jewelry supplies. Wholesale only. McFarland Plastic Co., Sarasota, Fla.

MAKE IT YOURSELF

SPECIAL De-luxe high quality coaster wagon. We ship you complete parts to assemble your own coaster wagon. (Includes nuts, bolts, washers, etc.) 10"x1.75" semi-pneumatic tires, automotive steering, patented hubless wheels, will support heavy loads. This is a high quality wagon at an amazingly low price. Buy direct from factory at \$9.95 each f.o.b. our factory. Send check or money order. Falls Welded Products, Inc., Menomonee Falls, Wisconsin.

SOFTENERS—Build your own, save up to 50%. We furnish everything. M-Z Co., 4526 Fond du Lac Ave., Milwaukee, Wis.

BUILD Real heavy duty machines, using our production tested plans. 30" band-saw, 12" lathe, dowel machine, portable sawmill, planer, concrete block machines, mixers, 70 machines for shop, farm, home. Catalog-handbook free. Nichols Equipment Co., Dept. PM, Purvis, Miss.

PLANS For building kitchen cabinets, concrete block machine, mixer, toys, garden furniture, etc. Free list. Masterprint Company, White Building, Buffalo 2, N. Y.

POWER Lawnmower, 90% parts in your home. Plans \$1.00. Weiler, 732 Homestead Ave., Metairie, La.

BASEBALL Pitching device — Brand new. Recently patented. Delivers regulation baseball about every 5 seconds. Speedballs. Curves. No fielding. Practice batting in backyard. Tested and proven. Easy to build and operate. \$3.00 covers material cost. Plans \$1.00. A. Rankin, Route 4, Hagerstown, Md.

BUILD Your own modern overhead garage door of weatherproof plywood. We furnish hardware; plans. Inexpensive. Garde Engineering, Dept. 1A, 3819 Riviera Drive, San Diego 9, Calif.

MAKE \$100.00 A day with bench lathe. Every clothesline owner a sure prospect. Mail \$1.00 for drawings of new idea. Nillo Waisanen, 11204 Republic, Van Dyke, Mich.

HOT Water free—from sunlight. System efficient any locality year 'round. Standard materials, easily built, low cost. Facts free. Solar Water Co., Box 175, Dept. D, Coral Gables, Florida.

NEW—Modern—Streamlined. Latest design in 10" all purpose wheels. Patented hubless wheel construction. Puncture proof 10" x 1.75" semi-pneumatic tires. Smooth running totally enclosed Chrysler Oilite bearings. For racers, 4 wheel trucks, wagons, market carriers, golf bag carriers, garden and porch furniture, etc. \$1.65 each. Set of 4—\$6.25 f.o.b. our factory. Money order or check with order. No c.o.d. Supply limited; order today! Falls Welded Prod., Inc., Menomonee Falls, Wisconsin. Dealers write for quantity prices.

SAVE Money "Rustic Fire Places" complete plans—50c. Box 3302, Seattle 14, Washington.

BEAT The heat. Build efficient inexpensive air conditioner. Complete, simplified chart and instructions. \$1.00. Imperial Air Conditioning, 2778 West Chicago, Detroit 6, Mich.

THRILLS! Excitement! Paddle or sail your own kayak. Build 10½' or 15'. For plans rush \$1.00 today. Hooster House C2, P.O. Box 1264, Indianapolis 6, Indiana.

GRANDFATHER Clock building system, simple shop-tested, thousands built, with Westminster movements; pictured price list, \$1.00. Kuempel Chime Clocks, Minneapolis 16, Minn.

MAKE Brooches, earrings from seashells. Instruction book 35c. Supply catalog free. Whyteson, 5726 1st St. So., Arlington, Va.

DELICIOUS Wieners in 2 minutes! Build amazing electric roaster from scrap materials. Plans 50c. Emco Sales, Box 116, Cambridge 38, Mass.

NEW. Electric signal trap for fishing. Efficient. Inexpensive. Instructions, \$1.00. Paul Kayholm, 137 Central Ave., Hackensack, New Jersey.

"BUILD Your House as a Hobby." Save 50%. No mortgage. No rent. 24 page booklet: drawings, instructions on how to build. \$1.00. H. C. Lightfoot, Civil Engineer, Buck County, Richboro 1, Penna.

SHELLS And all supplies for making shell jewelry, wholesale prices. Russ Renaud Novelty, Little River, Florida.

"CONCRETE Block Homes." 24 page booklet: drawings, instructions on how to build. \$1.00. H. C. Lightfoot, Civil Engineer, Richboro 1, Penna.

BUILD Concrete block machine. 2 blocks per minute. Build concrete mixer. Easy, inexpensive. Details free. Horne, 206 West Wilder, Tampa 3, Florida.

PLANS AND BLUEPRINTS

BUILD Your own home. Working blue prints at fraction of usual cost. Comply with F.H.A. and G.I. regulations. Send \$1.00 for book showing 71 distinctive, economical small homes. Griffin-Patterson Company, Box 1190B, Glendale, California.

AUTOMATIC Timer switch for radios, lights. Plans \$1.00. Breese, 77 Williams St., Providence, R. I.

WATCHES, OLD GOLD, JEWELRY

EXPERT Repairing, chronographs a specialty. One week service. All work guaranteed. Send your trial order. Estimates submitted before we proceed. Royal Watch Co., 29 Forsyth St., New York 2, N. Y.

SAVE. Buy directly from importer, Swiss waterproof and shockproof, anti-magnetic, fine 15-jewel wrist watches. Plata American Trading, Inc., 42 Broadway, New York 4, N. Y.

AT Last! Ball pen for only \$1.00. Fine quality. Writes smooth. Lasts years! For office, school, home, gift. Sent prepaid. Beacon, 649 Anderson Ave., Cliffside, N. J.

GUARANTEED Watch, clock, jewelry repairs, also chronometers and selfwinding watches. One week service. Blue Hill Jewelry Co., 137c Blue Hill Avenue, Roxbury, Mass.

JEWELRY—Rings, repaired, sized. Send insured for free estimate. Reasonable. Joe Worsham, Gold Laboratory, Madison Heights, Va.

AMAZING Surplus scoop! Gift watches —½ less. Nationally advertised brands—reconditioned, guaranteed one year. Free booklet. Write Paul Revere, The Nation's Watchman, 606 W. Wisconsin Avenue, Room 317A, Milwaukee 3, Wisconsin.

SAVE 35-50%. Bulova, Elgin, Waltham, Hamilton rebuilt-like-new pocket or wrist watch; lady's, man's late styles; gift boxed; long service, accuracy, guaranteed. Catalogue free. Brookins, B-1975A, Little Rock, Ark.

20 WATCH Movements broken for student practice work, \$10.00. 3 pounds broken costume jewelry, \$8.00. 1000 costume jewelry stones, \$3.50. Lowe's, Dept. PM 611, Holland Bldg., St. Louis 1, Mo.

LEARN Watchmaking, special home course, free information. Perfect Time School, 1112 West 79th St., Chicago, Ill.

SEND Your discarded jewelry, watches, crowns, bridges, spectacles, silver, etc., for cash offer. Goods returned promptly if offer unsatisfactory. Old State Metal Co., P.O. Box 1054, Houston, Texas.

JEWELRY Findings, lowest prices. George Sassen, 154 Nassau Street, New York 7.

WATCHES—Broken or usable; All kinds. Highest prices paid for jewelry, rings, spectacles, gold teeth, diamonds, sterling silver, etc. Cash mailed promptly. Write for free shipping container. Louis's, Holland Building, St. Louis, Missouri.

GOLD \$35.00 Ounce—Mail old gold teeth, diamonds, jewelry watches—receive cash by return mail. Satisfaction guaranteed. Free information. Dr. Weisberg's Gold Refining Company, 1500-Q Hennepin, Minneapolis, Minn.

GEMS. Precious and semi-precious, all genuine, from world wide sources. Deal direct, no overhead, save money. Catalog 10c. Hill Co., Route 7, Salem, Oregon.

CASH For old, broken jewelry. Highest prices paid immediately. Mail gold teeth, watches, rings, silverware, diamonds, spectacles. Satisfaction guaranteed. Information free. Rose Smelting Co., 29-A East Madison, Chicago.

WATCH And clock repairing—Complete practical course in modern horology. 66 illustrated self-instruction lessons. Just out! Low price. Fascinating 100-page illustrated catalog free! Write—Nelson Company, Dept. 3-02, Chicago 5.

WATCH Repairing easy learned by our home study course. Watch repairers are in demand and are among the highest paid craftsmen today. Write for free information. Houston Chronometer & Watch Co., P.O. Box 1140A, Houston 1, Texas.

TOBACCO, SMOKERS' SUPPLIES

HARD Rubber pipe stems fitted \$1.00. Free catalog. Brandon Pipe Hospital, 3740 Richton, Detroit 6, Michigan.

CIGARETTES—Popular brands; minimum 3 cartons. Price \$1.45 per carton; postpaid. Send check or money order. Ace Mail Order Co., East Orange 84, N. J.

MAKE Smoking pipes, briar blocks and stems. Send for circular. Michelson & Sternberg, 67 West 44th Street, New York 18.

CIGARS—Imported. 50 Coronas \$3.60 postpaid. Grebne Distributors, 1410 Ardmore, Grand Rapids 7, Mich.

FOR THE HOME

GREEN Billiard cloth—Superb quality, all wool, for billiard, pool, poker tables, etc. \$6.95 yd. 60" wide. Postpaid. No c.o.d. Money-back guarantee. Pastime Billiard Supply, 207 Tramway Bldg., Denver 2, Colo.

MANY Unsuspected benefits common household articles. Save money, time, energy. Free details. Goynes Skills, Lock Drawer 1784-HB, Orange, Texas.

ROSE Plants, grade one, two years old, \$1.50. Perennials \$1.00. Weed killer, sensational X7, \$1.00. Lee's Summit Nurseries, 1015 East 75 Terrace, Kansas City 5, Missouri.

FIREPRUF Plastic insulation, easily troweled on cement block, basement walls, wood. Blue, Excelsior, Minn.

INSULATE Your home yourself. Complete plans, illustrations, instructions, \$1.00. Moneyback guarantee. Details free. Fuel Savings Service, P.O. Box 741-P, Canton, Ohio.

SPECIAL Discounts. Household products. Gifts. Free information. Hazel Gardiner, 36 Hillside Ave., Providence 6, R. I.

SAVE Time, money. List of 109 prefabricated homes manufacturers \$1.00. Fabrication Service, Box 804, Battle Creek, Mich.

LITTLE Library of Useful Information. 102 different books. Catalog free. Popular Mechanics Press, 200 E. Ontario St., Chicago 11, Ill.

FOR SALE—MISCELLANEOUS

GOVERNMENT Surplus wooden tripods with adjustable metal legs. Used by government for engineers levels and transits. 5½ foot extension. Very strong. Can be used for holding telescopes, cameras, etc. Value \$24.50, special \$4.95 post paid. Send coin 25c for new list of guns, binoculars and powder flasks available for immediate shipment. Public Sport Shops, 13 S. 16th Street, Philadelphia, Penna.

MEN'S Fine used suits. Good condition. Get circular. Campbell Doggins, Box 949, Lexington, Ky.

AIR Hose—All new—5 size assortment. Lengths up to 5 feet. Over \$10.00 value. Special \$2. Real buy! No c.o.d. "Amazing Bachman's," 23 Herman Street, Rochester 5, N. Y.

HULL Automobile compass, for accurate road direction, brand new \$2.50. Prisms for 6x30 or 8x30 binoculars, brand new, \$1.50 each. Offset prisms to be attached to 7x50 B. & L. binoculars gives double the field of the ordinary 7x50 binocular. Cost \$98.00, special \$25.00. Green sunshades for binoculars, size 6x30 and 7x50, snap on type, value \$7.50, special \$1.25 per pair. Forward money order. No c.o.d. shipments. Send coin 25c for new list of guns, binoculars and powder flasks available for immediate shipment. Public Sport Shops, 13 S. 16th St., Philadelphia, Penna.

FLEXIBLE Drive cables. All new! Three sizes. 10"—25"—72". Adaptable for many uses. Over \$5.00 value. Combination offer of all 3 sizes, while they last \$1.75. No c.o.d. "Amazing Bachman's," 23 Herman Street, Rochester 5, N. Y.

NEWEST Miles midjet "telemike" picks up, records 2-way telephone conversations with your amplifier or recorder. Physical telephone contact unnecessary. \$25.00 postpaid. Miles Reproducer Co., 812 Broadway, New York 3.

WANTED—MISCELLANEOUS

WANTED: Common weeds by steady buyers! Details, stamp. Farm Garden, A-771, Whittier, California.

SWAPPERS! Traders!—Free information. "Swappers' Gazette," 2836-PM Slevin, Louisville 12, Kentucky.

MERCURY (Quicksilver). Write for quotation stating quantity. Metallurgical Products Co., 35th and Moore Sts., Philadelphia, Penna.

PERSONAL

REPRESENTATION New York vicinity. Hourly rate \$1.00. Minimum charge \$1.00. Herman Brown, 116 Mill Street, Brooklyn 31, N. Y.

HOLLYWOOD View cards mailed from So. California in your handwriting to surprised friends, 3-35c. Bates, Box 6081 Metro Sta., Los Angeles 55, Calif.

BORROW By mail. Loans \$50.00 to \$300.00 to employed men and women. Easy, quick. Completely private, confidential. No endorsers. Repay in convenient monthly payments. Details free in plain envelope. Write State Finance Company, 216 Savings and Loan Bldg., Dept. P-20, Des Moines, Iowa.

PRETEND You visited New York. Send friends greeting cards. Forward 25 cents. I send three stamped cards. You address and return. I mail. Souvenir folder. 30 cents. Dooley Service, 2323 Bouck Ave., New York, N. Y.

ELECTRIC Shavers repaired — Send shaver for free estimate or post card for details. Shaver Clinic, 5225 Wilshire, Rm. 421, Los Angeles 36, Calif.

MEXICAN Law. General Practice Attorney, 1203 Arizona Street, El Paso, Tex.

FALSE Teeth tightened without powders, liners, etc. Complete outfit \$1.00 postpaid. Vacudent, 1649 Grant, San Francisco, Calif.

MEXICAN Address. Your mail received and forwarded. Free information. Scenic postcards 15c. Remailed free. Tillotson, Apartado 1405, Guadalupe, Jalisco, Mex.

RUPTURED? Beltless, bulbless, strapless truss. Brandon, North Quincy, Clinton, Illinois.

FALLING Hair, its cause and prevention, fully explained in an informative and educational pamphlet entitled "How to Keep Your Hair Till Ninety." Price 25c. James Hilton, 4819 Fourth Ave., Brooklyn 20, N. Y.

PRETEND Visiting Wisconsin's vacationland—3 scenic cards 25c, address, return. I remail. E. R. Miller, 1008 S. Minnesota Ave., Stevens Point, Wis.

HAIR Falling? Dandruff? Write Trichologist, 137 Lewis St., Phillipsburg, N. J.

"PLANNED And profitable" mail order selling. New, different work-book of ideas and instruction for beginners, aspirants, established dealers. Send quarter for copy of leading mail order trade magazine and details. Special year's subscription \$3. National Publishing Co., 356 So. Broadway, Suite 706-PM, Los Angeles 13, Calif.

RUPTURED? Positive comfort, no understraps, no steel, no elastic. Write Smith Manufacturing Company, Preston, Ontario.

HOW You can find out! Information discreetly developed, any matter, person, problem, anywhere. Personal-business assignments, representations, undertaken. Nation-wide. Officially licensed and bonded service established 1922. Reasonable. All inquiries confidential. William Herman, 170 Broadway, New York.

MISCELLANEOUS

START Home business making statuary, plaques, novelties, garden furniture, artificial marble flooring, liquid marble. Make your own flexible molds. Amazing profits. Folder free. Creative Publishers, Box 236-X, Winnetka, Illinois.

SWISS Musical movements \$3.85. Music boxes. Lucite wedding-baby albums. Novelties of Distinction, 131 W. 42nd, New York City.

DIVING Gear. Deep sea and shallow water. Free information. Diving masks \$2.75. Spearfishing guns \$8.75. Illustrated 200 page Divers Manual \$2.00. Underwater, P.O. Box 4844, Miami 29, Florida.

LUMINOUS Paints, simple formulas, five colors \$1.00. Willies, 7723 W. Grant, Milwaukee 14, Wis.

YES, Men's shoes in sizes 11½ to 16. Widths AA to EEE. Finest quality, moderate price. Free circulars. Write King-size 207, Brockton, Mass.

MAKE Beautiful pictures of baby and children. Our book, "How to Photograph Children," tells how with any camera. Full of photographic tips. Sent postpaid 25c. Child's Publishers, 401 North Second, Elkhart 1, Indiana.

JONESOTEX Statuettes: Soldier or sailor. Gold-foil \$5.00, silver-foil \$3.00, brown \$2.00, white \$1.00 ppd. Satisfaction guaranteed or money gladly refunded. Write Jones & Kimes, 809 7th St., Wasco, Calif.

"RECEIVE Mail." Money-making offers, opportunities, catalogs. Name listed 10c. Ideal Service, 100, Park Ridge, Ill.

BANISH Dampness from your basement, closets. Free folder. Dri-Air Products Co., 1800 E. Forest, Detroit 7, Mich., Dept. 12.

LUMINOUS Paint "shines at night." Supply with instructions 25c. Arthur Sibley, Mendon, Mass.

MEXICAN Jumping beans. Dozen 25c; hundred \$1.00; thousand \$5.00. Mexican Products, 126 N. Main, Tulsa 3, Oklahoma.

SENSATIONAL New insoles for sweaty feet sufferers; keeps feet dry; can be washed. Long lasting. For men, women. \$1.00 pair. Edwin Foot Products, Box 452, Norwalk, Conn.

TWO Pounds pure maple sugar, postpaid \$3.00. Eulalia Turner, Poultney, Vermont.

LARGE Size aluminum waffle mold and recipes. \$1.50. Free information. Mowrey's, 450 E. 9 St., Ashland, Ohio.

NITEGLO. Non-poisonous luminous gold and silver paint adds worlds of fun safely. Complete kit \$1.00. Manor-B, 4515 Cottage Grove, Chicago 15, Illinois.

PANNING Gold—Free illustrated booklet-catalogue, mining books-supplies. Old Prospector, A-98 Dutch Flat, Calif.

GOLD Decal letters ¼", ½", 1" 325 assorted \$1.00. Larger available. Photo-Cal Decals, 1140 Harbor Dr., P.O. Box 2044, San Diego, California.

BLAZEMASTER Pump-Action dry powder type fire extinguisher. Amazingly effective on contact with minor fires from gasoline, oil, paint, wood, electrical apparatus, upholstery. Easy to use. Safe around livestock because it does not spread injurious chemicals or acids. Instant protection when fire threatens home, store, shop, barn, garage, or car. \$1.85 postpaid. Reed Products Co., Dept. PM7, 2423 Cass, St. Louis, Mo.

STAMPS Wanted by thousands of our readers. Your ad in this space will bring you some nice orders. One advertiser sold 150,000 stamps. Write for positive proof. F. W. Johnson, Classified Advertising Manager, Room 301, 200 East Ontario St., Chicago 11.

SWISS Music box units. Choice of classical, waltz, popular. All ready to install. \$3.95 each. Postpaid when cash with order. Information on request. Swiss Novelty Co., Box 1201, Fall River, Mass.

ORIGINAL Mayan silver filigree. Cigarette cases \$12.00, bracelets \$4.00, earrings, pair \$2.50. Money order or bank draft. Postpaid. M. Diaz Massa, 58-490, Merida, Yucatan, Mexico.

LIQUID Concentrate plus water makes finest showcase cleaner. H-C Products, 8225 Robinwood, Detroit 12.

HYDRAULIC Computing scale. Pocket size. Plastic. One setting gives feet head, horsepower, gallons per minute, efficiency. One dollar, postage paid. J. K. Haigh, 1396 Linda Vista Ave., Pasadena 2, Calif.

HEADQUARTERS For Masonic rituals. Free literature. Daggett Publishing Company, Oshkosh, Wis.

COMPLETE Instructions for building rammed earth homes \$2.00. Henry Iversen, So. Haven, Mich.

WESTERN Belts \$1.00 up. Free list. Southwestern Import Company, P.O. Box 5052, Beacon Hill Station, San Antonio 1, Texas.

NYLONS. Beautiful irregular seamless nylons, all sizes. The defect very slight, hardly noticeable. \$1.00 pair. Carl Bohman, Saratoga Springs, New York.

A THOUSAND Laughs. Unique Jackass cigarette dispenser. Holds 10 cigarettes. Simply press donkey's head down, tail rises, presto, out slips cigarette. Satisfaction guaranteed. Sent postpaid for \$1.00 with order or \$1.15 c.o.d. Sanimo Industries, Dept. C-12, Spencer, Ind.

SHOP By mail. 24 page merchandise catalog just off the press 6c stamps. R. E. Reese, Emmaus, Penna.

SHOES—Save 30% for entire family—Buy direct; save retailer's profit. Send for free catalog. Sutton Shoe Co., Dept. A. 32 Sutton St., Baltimore, Md.

MAKE Your own "Rustic Furniture." Our "Easy to Understand" plans tell how. You can make chairs, benches, tables, lamps, bird houses, summer house, and scores of other things. Our complete plan booklet only 25c. (Worth dollars.) Ask for Booklet No. 18. Popular Mechanics Press, 200 East Ontario St., Chicago 11, Illinois.

YOUR Own home for \$990.00—U-Build-It. Cottage, over 500 square feet, with plumbing and electricity. Construction details, diagrams, and bill materials. Complete \$1.00 postpaid. U-Build-It, P.O. Box 748-A, Hollywood 28, Calif.

JOIN Gadget-Of-The-Month Club. Receive a new gadget every month. Send \$1.00 for 6 months trial. G. M. C., Sta. G, Box 2000, Los Angeles 54, Calif.

ALNICO Magnets, eight, plus 100 experiments, \$2.00. Experiments, 25c. Powerful disc magnets, pair, \$2.00. Micro switches, 120V, 10A, \$1.00. Eljay, Box 891, Newark 1, N. J.

THE Lord's coming! Get free proofs. Time is short. International Evangelism, Box 263, Duluth, Minnesota.

LARGE Detailed maps—Every county in Washington, Oregon, Idaho and California. Write "Metsker Maps," Tacoma, Wash. for price list.

THE Sensational mystery drinking bird, only \$2.25. Specialty House, Box 542, Danville, Illinois.

GOOD "Used" self-instruction educational books on all subjects bought, sold, rented, exchanged. Satisfaction guaranteed. Complete information and 100-page illustrated bargain catalog free! Write—Nelson Company, Chicago 5.

BOOKFINDERS! (Scarce, out-of-print unusual books.) Quickly supplied. Send wants. Clifton, Box 1377PMM, Beverly Hills, Calif.

70 BIBLE Lessons. 25c. Bulletin, Box 87, Station H, New York 25.

TATTOOING Outfits—engraving outfits. Circulars free. Write. Zeis Studio, 728 Lesley, Rockford, Illinois.

M-SCOPE Metal, mineral locators latest 1947 electronic type ready for immediate shipment. Fisher Research Laboratory, Inc. manufactured some of the finest metal-locators for the U. S. army. Experience gained is yours in the most efficient metal, mineral locator. Free 16-page booklet upon request. Credit plan available. Fisher Research Laboratory, Inc., Palo Alto, California.

FREE—"Amazing New Book"—"Profits From Classified Advertising." Tells how and what to advertise. Be sure to read this book before you invest one cent in advertising. Remember—it's free! Write for your copy now. F. W. Johnson, Classified Advertising Manager, 200 East Ontario Street, Chicago 11, Illinois.

**SECRETS ENTRUSTED
TO A FEW**



*The Unpublished
Facts of Life*

THERE are some things that can not be generally told—*things you ought to know*. Great truths are dangerous to some — but factors for *personal power and accomplishment* in the hands of those who understand them. Behind the tales of the miracles and mysteries of the ancients, lie centuries of their secret probing into nature's laws—their amazing discoveries of *the hidden processes of man's mind, and the mastery of life's problems*. Once shrouded in mystery to avoid their destruction by mass fear and ignorance, these facts remain a useful heritage for the thousands of men and women who privately use them in their homes today.

THIS FREE BOOK

The Rosicrucians (not a religious organization), an age-old brotherhood of learning, have preserved this secret wisdom in their archives for centuries. *They now invite you to share the practical helpfulness of their teachings*. Write today for a free copy of the book, "The Mastery of Life." Within its pages may lie a new life of opportunity for you. Address Scribe M.T.V.

The ROSICRUCIANS
(AMORC)

San Jose California, U.S.A.

**MAKE UP TO \$5.00 AN HOUR
In Your Own YEAR ROUND Business!**

**ONLY A FEW
DOLLARS
PUTS YOU IN
BUSINESS!**

Many Clearing as High as \$20 to \$30 a Day **NET** Renewing Rugs, Carpets, Upholstery. New Method Now Used for Auto Upholstery. Write for Facts About Quick, Easy Way to Get Started

Here is the chance you've been looking for to step into a pleasant, dignified, big-pay business of your own that offers you a steady, year 'round income. Start on "a shoestring," full or spare time, right from your own home. Equal opportunities for men and women, young or old, in small towns or big cities. No experience needed. Many making big money with new Americlean System just cleaning auto upholstery. Easy to learn. We send you complete instructions and quick-cleaning supplies so you can start making money the very first day! Quick method cleans upholstery, rugs and carpets like new without taking off floor! Tremendous demand in homes, apartments, hotels, stores, office and public buildings. Steady repeat business. Territories going fast. Write today for full FREE facts. No cost or obligation. Rush letter or postcard now to **AMERICLEAN CO., Inc.; Dept. G-7; 211 North 7 St.; St. Louis 1, Mo.**

**WRITE
FOR FREE
DETAILS
NOW!**

Get into Good Paying
AUTO BODY and FENDER WORK



BIG DEMAND in Auto Body and Fender work. Start training now in your spare time at home for good pay work. Practical shop experience included. U. E. I. Training covers metal work, welding, painting, etc. Placement service—or we will show you how to start your own shop. Behind U. E. I. TRAINING is a large national organization founded 1927. Write today for **FREE FACTS**—No obligation.

*Approved
for Training
under G.I. Bill*

AUTO-CRAFTS DIVISION • UTILITIES ENGINEERING INSTITUTE
2523 SHEFFIELD AVE., DEPT. 177-X, CHICAGO 14, ILLINOIS

WANTED

DISTRICT PURCHASING AGENTS

No experience or money required. Exceptional opportunity for those who want to establish themselves in a steady, year 'round, well paying business.

For details: Write

PURCHASING MANAGER, DEPT. C

2719 LAWRENCE AVE. CHICAGO 25, ILL.



Thrilling Work **COLORING PHOTOS**

Fascinating vocation learned at home by those with aptitude. Thrilling pastime. National method brings out life-like colors. Free booklet.

NATIONAL PHOTO COLORING SCHOOL
1315 S. Michigan, Dept. 1358, Chicago 5



**GOVERNMENT
JOBS**

START \$1756 to \$3021 YEAR

Prepare Now for Next Examinations. Vets Get Preference **MEN - WOMEN** Mail Coupon Today.

COUPON
Name _____
Address _____
FRANKLIN INSTITUTE
Dept. K87, Rochester 4, N. Y.
Sirs: Rush without charge, (1) 32-page book with list of U. S. Government Jobs; (2) Tell me how to prepare for one.

**BUILD REALISTIC
MODELS OF YOUR
INVENTIONS**



Much more than simply "a construction toy," ARKITOY employs perfectly co-ordinated modular dimensions, permitting construction of a great variety of models to approximate scale. In combination with grooved pulleys and wheels, utilizing approximately 350 pieces of material and 150 assorted machine screw bolts with hex nuts, the No. 4 ARKITOY Set provides a handy and practical kit for "visualizing" your ideas in practical form.

At your dealer or order direct \$5.00 postpaid (\$5.50 west of Rockies). No C. O. D.'s please.

CARROM INDUSTRIES, INC.

Dept. A Ludington, Michigan, U.S.A.

OTTAWA TRACTOR SAW

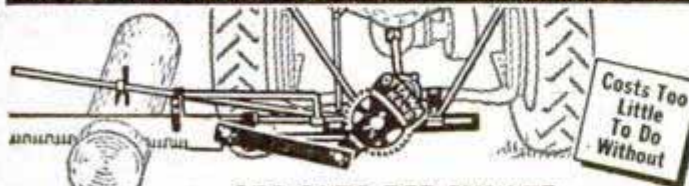

350 CUTS PER MINUTE

Make money sawing wood. Use Ottawa—fastest cutting. Cuts large, small logs easiest way. Fells trees. One man operates. Thousands in use. Built to last with heavy, stiff saw blade. Positive safety clutch control: uses power take-off any tractor.

OTTAWA MFG. CO., 3-727 Forest Ave., Ottawa, Kan.

New THOR "B" ENGINE—\$6.95



The new THOR "B"—Sensational miniature gasoline engine that really works. Super-power performance. Smooth, velvety power that roars into action with a "twist of the wrist." Over 20,000 already sold. 1/6 H.P. Complete with coil, condenser, and fully illustrated instructions, ready to run, only \$9.95. In KIT form, fully machined, 5 minutes to assemble, \$6.95, without coil and condenser. Powers all models. Send \$1.00—shipped collect same day C.O.D. Free. Send for 24-page illustrated hobby catalog.

AMERICA'S HOBBY CENTER, INC.
DEPT. B77, 156 WEST 22ND STREET, NEW YORK 11, NEW YORK

ELECTRICIANS SCHOOL

PRACTICAL TRAINING IN
HOUSE AND COMMERCIAL WIRING
MOTOR REPAIR AND REWINDING
ELECTRIC REFRIGERATION
Approved for Veterans Training

PENNSYLVANIA INSTITUTE SCHOOL OF ELECTRICITY
42nd & SPRUCE STS. CATALOG PHILADELPHIA 4, Pa.

HOW TO CUT RAFTERS

New vest pocket book gives lengths, Side cuts, Plumb cuts, Deductions. For all rafters for any building from one inch to forty feet wide. Gives numbers to cut on square. Also degrees for same cuts for Radial Saws. All standard pitches from 1/4 to 3/4. Just open book to pitch page and there are your lengths, side cuts, etc. Anyone who knows what a jack rafter is can frame a roof if he has this great book. Price one dollar pre-paid. **BUILDERS' TOPICS**, Dept. M, Lock Box 828, Seattle, Washington. Original teachers of the square in five easy lessons by mail. **SEND FOR FREE LIST OF TECHNICAL BOOKS.** Learn to read blueprints etc.

12 lbs. SURPLUS RADIO PARTS \$2.00

A gold mine of parts for repairmen, amateurs, and experimenters . . . sockets, condensers, resistors, transformers, coils, hardware, wire, etc. An outstanding bargain in usable parts! Send \$2.00 cash, check or M.O. today!
(Pay small express charges on receipt.)

ELECTRONIC PARTS, Inc. Dept. M7 622 W. Randolph St., Chicago 6, Ill.

JOIN OUR FAMILY OF HOME MONEY-MAKERS!

Show this Sparkling 9-piece ALUMINUM SET to Your Friends and Neighbors

YOU MAKE \$3.00 ON EVERY SALE!

Complete Set Sells for Under \$10 and Includes Sensational 5-in-1 Combination Cooker Pictured



Make full-time money in your spare time. No sales experience necessary. This gorgeous aluminum set sells on sight! Has everything the modern housewife wants: 9 gleaming aluminum pieces including the sensational 5-in-1 Combination Cooker. Complete set sells for under \$10 . . .

You Pocket \$3 Immediately on Every Sale!

You simply take the orders, collect your commission; we do the rest. Be first in your community to offer this guaranteed 'Regal' Aluminum Set. What's more, this gives you a chance to buy your own set — at agent's wholesale prices.

WRITE TODAY! Send no money. Your complete sales kit will be sent free by return mail. Send your name and address NOW to:
I. B. URY CO., Dept. 12, 222 4th Ave., New York 3

TERRIFIC VALUE
Set includes 5-in-1 Cooker pictured above PLUS 1-, 2- and 3-quart sauce pans, a super 9-in. frying pan and a big sparkling, 6-quart covered pot.

GET IN ON THE GROUND FLOOR!

be first in your area to enter this Profitable NEW Business!

. . . Where Everything Else Has Failed

DRYEX

Makes Wet Walls DRY . . . and Keeps Them DRY



Sell or Apply **DRYEX**
THE GREAT WAR-TIME DISCOVERY THAT WILL MAKE BIG MONEY for YOU

Easy to apply, easy to sell, DRYEX is a money-maker for you! Seals leaky exterior walls definitely and enduringly. Stays tough, flexible and waterproof in all weather, all climates.

Dealers & Agents Wanted

Write Today for Details

LASTING PRODUCTS COMPANY
200 SO. FRANKLINTOWN ROAD BALTIMORE 23, MD.

New JUNGLE HAMMOCK

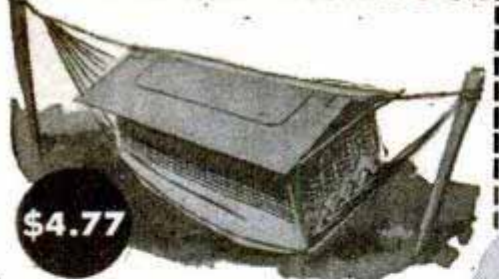

\$4.77

Insect-proof, with canopy, all-around netting and full-length zipper opening. Nylon; mildew- and waterproof. Ideal for hunting, fishing trips, porch, backyard. Cost gov't \$40.
Your cost, only.....\$4.77

COMPASS



New

Official U. S. Compass made by America's leading precision watch makers. Has hinged protective cover that snaps open to large luminous dial with accurate bar-type jeweled needle and breakproof crystal. Heavy casing protects highly sensitive needle.

\$4.75 value for only **98c**

PONCHO



Just like new

\$165

Just released. The G. I.'s most useful item in Southwest Pacific. Of durable wear-resisting, water and windproof rubberized fabric. Ideal protection against rain, sleet, snow. Can be used for ground cloth, shelter half, tarpaulin, etc.

New ..\$2.95

New SCOUT KNIFE



All-purpose, used by armed force men everywhere. Big blade, small blade, can-opener, awl, screwdriver. All steel with sturdy bone handle **\$1.95**

Air Corp Type

New SUN GLASSES

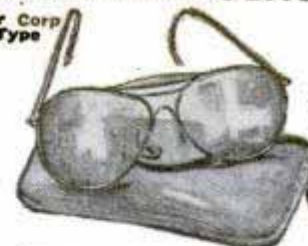

\$8 Value for only

\$3.95

Protect your eyes with these attractive sun glasses. Gold plated — Ground lenses — Each pair made to highest optical standards and completely guaranteed. Glasses meet all U. S. gov. specifications for absorption of ultra-violet and infra-red rays.
6 Base (Deep Curve Lens) **\$12 Value\$5.95**
12K. Gold Filled (60 millimeter) **\$15 Value\$7.95**

GOVERNMENT SURPLUS

REAL BARGAIN BUYS priced 2 to 3 times below actual value! All NEW U.S. Gov't items. Send check or money order. C.O.D. order requires 25% deposit. Include 5% postage on parcel post orders, overage promptly refunded. All prices f.o.b. Chicago. Order now from this ad—each item **GUARANTEED SERVICE-ABLE** or money back.

CHICAGO OUTLET INC., P.M.7
1618 W. Chicago Ave., Chicago 22

New SOU'WESTER

You're headed right for stormy weather with this official Navy sou'wester of slick, sturdy oilskin and lined in fannel. **98c**



New SAILOR CAPS



Made for the Navy. White or gray. Wear it for play or anywhere. Washable. ... **98c**

Brand New—Wind and dustproof full size aviation goggle with ground and polished lenses curved to fit the face. White metal polished frame, hinged bridge. First quality adjustable elastic head band. Made by Bausch and Lomb and American Optical Company. **\$15.00 Value. \$4.75**

GOGGLES



AIR RIFLES

BENJAMIN

AIR PISTOLS

ARE AVAILABLE

SEND FOR FREE FOLDER OF LATEST MODELS TODAY
If you want a REAL GUN for PRACTICAL USE inside or outdoors get a SAFE - CLEAN - ECONOMICAL - BENJAMIN with Adjustable Power and Amazing Accuracy. For BEST RESULTS use BENJAMIN H-C PELLETS. WRITE AT ONCE. BENJAMIN AIR RIFLE CO., 812 MARION ST., ST. LOUIS 4, MO.

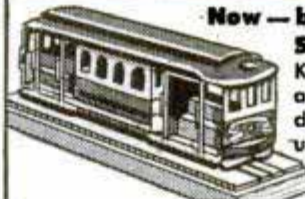

Now — build your own authentic 1873 SAN FRANCISCO CABLE CAR

Kit consists of easy-to-construct accurately shaped wooden parts—detailed drawings and instructions — Can be used with "0" gauge trucks. Model 11"x4"x3 1/2". Scale 3/4" to 1". Send only \$2.95 for complete kit to

NATIONAL HOBBY-CRAFT SALES CO.
272 Fremont Street San Francisco, California

Stop Thief!



WITH "SURE-CATCH" AUTOMATIC FLOAT AND SINKER

Patented automatic aluminum float and sinker with built-in trigger which trips at slightest bite. Strong spring jerks hook 1 1/2" setting it securely. Free-running line after strike. Can be attached or detached in five seconds without removing hook or lure.

Get your "Sure-Catch" for more fishing fun. Works like magic. Don't worry about hooking 'em. Let "Sure-Catch" do it.

Order today. Float \$2.00. Sinker \$1.00, postpaid. Send cash, check or money order. If not satisfied, return before using for refund.

DISTRIBUTORS AND DEALERS WANTED

SHAW & LUCAS, INC.

418-F NO. GLENDALE AVE., DEPT. 24, GLENDALE 6, CALIF.

BE THE LIGHT of the PARTY with a Mystery Light Bulb



No wires attached... lights up in your hand or pocket. Formerly used only by magicians... now YOU can have one of these amazing bulbs. Mystify your friends and entertain parties with this marvelous bulb. Causes endless amusement and fun. Send for one today.

SEND ONLY **\$2.95** plus 5c postage

MYSTERY BULB CO.

815-D Olson Highway Minneapolis, Minn.

WATCH REPAIRERS TRAINED FAST!

Earn \$25 to \$50 Per Day. New Short-Cut Training. Complete Edition By 3 Of World's Foremost Experts. 19 Streamlined Lessons. Over 200 Illustrations. Professional Tools Furnished To Students. Complete Training \$2.95... or C.O.D. Plus Post.

MODERN WATCH REPAIR SYSTEM, Box 414, Greenville, N. C.

LAW

STUDY AT HOME for PERSONAL SUCCESS and LARGER EARNINGS. 38 years expert instruction—over 108,000 students enrolled. LL.B. Degree awarded. All texts furnished. Easy payments. Send for FREEBOOK—"Law and Executive Guidance."

AMERICAN EXTENSION SCHOOL OF LAW
Dept. 79-M, 646 N. Michigan Ave., Chicago 11, Ill.

BE YOUR OWN BOSS
Men and women make up to \$100.00 or more a week! Design and fit corrective arch supports by the time-tested Stephenson Method. A profitable, full or part-time, profession. Train at home; pay as you go. No costly equipment to buy. No capital needed. Send for FREE booklet today.
STEPHENSON METHOD, 12-28 South Market St., Boston, Mass.

BIG MONEY and YOUR OWN BUSINESS

LIQUID IVORY



FREE INFORMATION ON A GREAT NEW MONEY MAKING OPPORTUNITY

SEND FOR FREE DETAILS

Regardless of your age, sex, previous experience, we will send you astonishing free facts about the great possibilities—in your own business—with amazing LIQUID REPLICATED IVORY. To secure this information, absolutely free, fill in coupon below or send a letter or postcard. No salesman will call on you now or ever. Write TODAY! Offer limited!

LIQUID IVORY is one of the most marvelous synthetics developed in years. With it you can easily and simply produce a wide variety of wonderful items that almost defy detection from genuine ivory. No expensive equipment is needed. You can work in a corner of your basement or garage with a few hours of work producing handsome profits. Here is unexcelled opportunity for all ambitious people that want a profitable business of their own.

A MONEY-MAKING BUSINESS FOR THE LITTLE MAN! NO EXTENSIVE CAPITAL NEEDED!

Forget big investment worries. We tell you how to get your own fast-moving business going with very little money. We feature only one sound business course. You will never find us confusing this successful vocation with other diverting business ideas. We tell you all about one great business and how you can make money in it exclusively. Write for full FREE information today!

GREAT OPPORTUNITIES NOW!

Stop being a slave to a time clock! Stop worrying about layoffs and depressions stealing your livelihood. NOW is the time to line up your own money-making business. We offer this great opportunity to aggressive people. Get into your own profitable business with LIQUID IVORY. Get the FREE FACTS today!

Copyright 1947

FREE INFORMATION COUPON

EMPIRE TRADES & HANDICRAFTS, BOX 1340-PM7, ST. LOUIS, MO.

Please send me free details about your BIG money making LIQUID IVORY. I am anxious to get started in a profitable business of my own. Please rush!

Name

Address

City.....State.....

EMPIRE TRADES and HANDICRAFTS
Box 1340 -PM7 St. Louis, Mo.

MAGIC WONDERS EXPOSED!

Amuse! Confuse! Thrill Everyone! Vanishing light, Ghostly Pellet, Magic Smoke, Mystic Watch, Enchanted Match, Spirit writing, Magic Fire, Wizard's Candle, Etc. 32 Magic Lessons 25c. Free with order Big Catalog.
THE MAGICIAN, 2463 Kensington Ave., Dept. C, Philadelphia 25, Pa.

WANT TO EARN MORE MONEY?

Learn SILK SCREEN PROCESS At Home. FREE big illustrated Book explains how my training enables you to start your own successful business or train for a better job in this well paid, uncrowded Advertising Field. Learn and Earn in your spare time. Complete Kit of Supplies included. Write TODAY.

CALIFORNIA SCHOOL OF SCREEN PROCESS
Dept. PM77 3740 Overland Blvd. Los Angeles 34, California

The GLENWOOD MEMORIAL

Freight Paid Anywhere in U.S.A.

In all its beauty and durability is pictured in our free catalog of genuine Marble and Granite. Write for yours today.
U. S. MARBLE & GRANITE CO., A-18, Oneco, Fla.



RAISE CHIN-CHINS

No experience needed. Just a few minutes daily and a few feet of backyard, garage or barn space. Several females and a male starts a large, profitable herd. WE FURNISH FREE INSTRUCTIONS. TREMENDOUS DEMAND for breeding and laboratory stock, meat, and world's most beautiful rabbit fur. Brokers, cut off from imported rabbit pelts by world famine, NEED CHIN-CHIN FURS NOW, and for years to come! Write for free illustrated catalog today.
WILLOW BROOK FARM • R-36, SELLERSVILLE, PENNA.

BE A BUILDER! Learn Estimating and Blueprint Reading at Home

MAKE MONEY IN BUILDING!

See this complete, simple, self-teaching course in building, estimating, blueprint reading for 10 days in your own home!

There is big money to be made in building! New home and commercial building construction will not equal demand for 5 to 10 years. Put yourself ahead of the next man by getting a good job as a highly-paid building cost estimator or start in business for yourself. Contract for building jobs — hire tradesmen to do the work and you take the profits.

The Tambllyn System reduces building material and labor costs to simple factors so that you can estimate any job promptly and accurately after you have studied this system. Based on 40 years of actual experience. Thousands have used it successfully during the 25 years it has been helping men get ahead.

Mail the free coupon today and we will send you the complete course, including plans, specifications, estimate sheets, the Building Labor Calculator and complete instructions on 10-day free examination offer. Send no money—you be the judge. Consultation service free to every student without extra charge. No fancy books—plenty of sound and valuable instruction. We teach you down-to-earth estimating which will get you a good job or bring you profitable business. Mail the coupon now. See this unusual course for yourself.

FREE TRIAL

TAMBLYN SYSTEM, Johnson Bldg, PM7, Denver, Colo.

Send Tambllyn System for 10 days free inspection. If satisfied, I will pay you \$5.00 per month until \$30.00 is paid. Otherwise I will return it.

NAME _____ AGE _____
ADDRESS _____
CITY _____ ZONE _____ STATE _____

SEND NO MONEY • SEE IT FIRST!



MONEY MEN ALL DATA FREE

THE PLASTEX Industry needs manufacturers on small scale and for big production of Lamp and Clock Stands, Art Goods and Novelties in Plastex and Marble imitation. Experience unnecessary. 1/2c material makes regular 10c store sellers. Rubber moulds furnished for speed production. Small investment brings good returns. Big chain store orders now being placed. Ambitious men have chance for real prosperity. Our Free booklet will interest and benefit you.

PLASTEX INDUSTRIES, Dept. P, 1035 Washington Ave., New York, N.Y.



Now Your
Dream Home
Comes True!

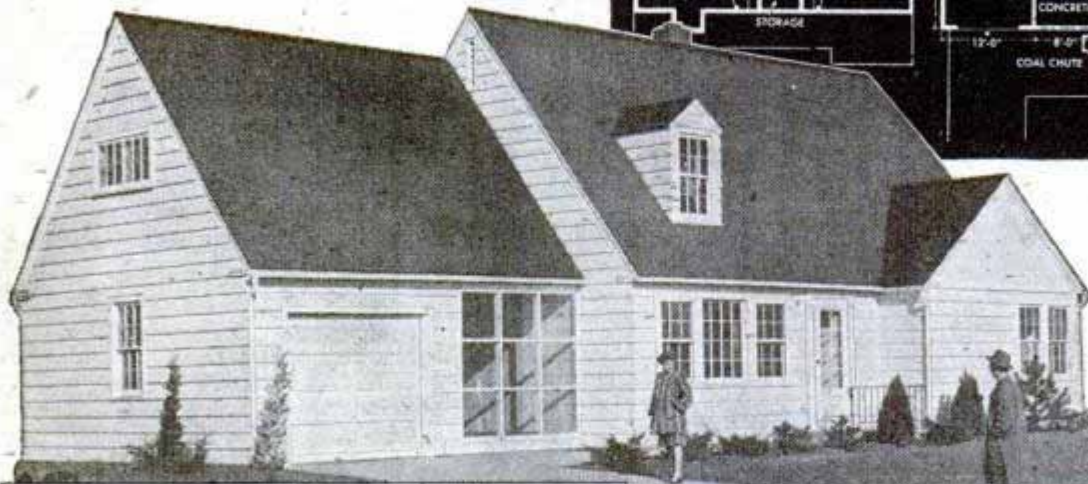
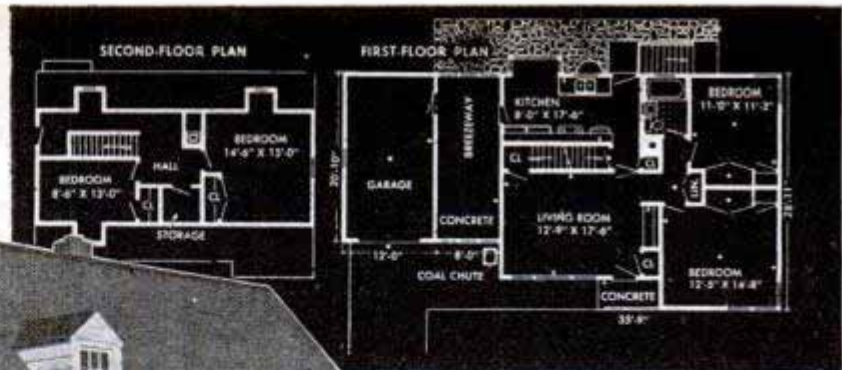

**The House That
Jack Built**

From actual photograph of Build-It-Yourself House with breezeway and garage as built by Jack Brownson, Aurora, Illinois, a twenty-three-year-old veteran.

**YOU CAN BUILD
THIS HOUSE
YOURSELF!**

**MAIL COUPON FOR BIG NEW BOOK
AND PLANS • BUILD IT YOURSELF
OR HAVE IT BUILT AT A BIG SAVING!**

Can you use a hammer—saw a board straight—use common, everyday tools as well as the average *Popular Mechanics* reader? Then, startling as it may at first seem, you too, can build this modern house in any of its five designs, and do it easily and quickly, at a tremendous saving. *Popular Mechanics* and a famous firm of architects have designed it and worked out every detail so you can do every part of the job yourself, even though you have no experience whatever.

**GET THE BOOK NOW!
STUDY THE PLANS NOW!**

Start Building When You Can

You can get "Your Home and How to Build It Yourself" and complete plans by mailing the coupon below. Book is plastic bound and contains 100 pages, size 8½ x 11 inches. Three-fifths of the book consists of photographs and drawings. Several sections are printed in extra colors and a four-page, four-color insert shows just how your own house will look in actual colors. Every detail of the house and its construction are discussed in this book with minute details of Build-It-Yourself instruction that will guide you in every step.

**PLANS YOU CAN READ
AND FOLLOW**

Plans consist of eight working size blueprints, giving floor plans, elevations, notes on construction, framing, lumber list, millwork list, specifications, plumbing and wiring diagrams. Every measurement is marked, every detail made as clear as A-B-C. With the book to guide you and the plans to follow, any handyman who can use simple tools can build this remarkable house and enjoy every minute of the work while saving thousands of dollars.

**SPACE FOR LIVING AND
FAMILY GROWTH**

Illustrated is the *Popular Mechanics* "build-it-yourself" house Jack Brownson built from our plans, in Aurora, Illinois, with one inexperienced helper. This beautiful, modern house is 1½ stories, with basement, living room, kitchen, dining nook, two bedrooms, bath, plenty of closets and space for 2 additional bedrooms on the second floor. The house itself is 35'-9" x 28'-11"; breezeway 20'-10" x 8'; garage 20'-10" x 12 feet.

**THE HOUSE THAT HAS
EVERYTHING**

The big, basic idea behind the design is ease of construction and the most living space and the most useful space, at the least cost, considering attractiveness and suitability for any neighborhood and most income groups. On top of this is its adaptability to other types of architecture, such as modified Dutch Colonial, modified Cape Cod, plain gable roof house without dormer windows, or the house as pictured, but without garage and breezeway.

**USE CONVENIENT ORDER
COUPON**

You may never have thought about actually building your own house, but you can do it. And now that building restrictions have been lifted, it's easier than you think. So send for the big new book—Your Home and How to Build It Yourself, and set of construction plans, today. Even if you engage a contractor or builder to build this house for you, you will need the plans. Then too, you will certainly want the book, which can easily save you countless hundreds of dollars whether you build this house or any other house of your choosing.

• 100 Pages
52 in Color
60% Illus.
8½"x11"



MAIL COUPON FOR BOOK AND PLANS

Popular Mechanics Press,
200 E. Ontario Street, Chicago 11.

I enclose \$_____ Send me the items checked at once.

- Your Home and How to Build It Yourself \$ 3.00
- Complete set of plans for Popular Mechanics Home 12.50
- Book and Plans at reduced price 14.00
- Duplicate set of plans 5.00

Name _____

Address _____ Zone _____

City _____ State _____

HOW TO EFFECT ANY KIND OF Motion or Movement

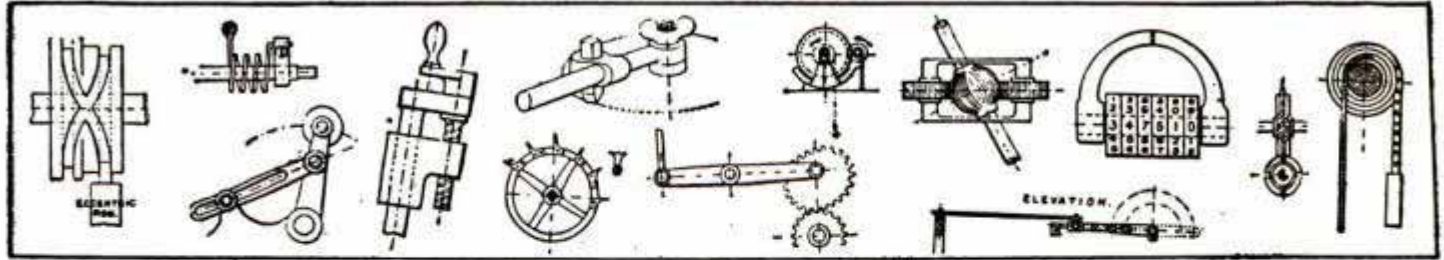

A Book That Shows You

3000 ILLUSTRATIONS and DESIGNS of Mechanical Movements, Devices, Contrivances & Details!

Every conceivable kind of mechanical motion and work is briefly explained and illustrated in this unusually helpful book. As far as known, the only work in existence which aims to provide side by side suggested sketches of the various methods in use for accomplishing any particular mechanical movement or work, in a form easily referred to. Every engineer, inventor or mechanic finds the need of devising, simplifying or improving some mechanical process or method. In doing this he has to rely on memory or experience. Here is a reference book of nearly 3000 MEANS AND METHODS for producing any kind of movement or work, classified and arranged for easy reference!

SUCH AS: Accumulators, Anti-friction, Ball and Socket, Bearings, Blowings, Brakes, Cams, Chain Gear, Chopping, Chucks, Circular Motions, Clutches, Conveying, Cranes, Cranks, Cutting, Doors, Drilling, Eccentrics, Engines, Expanding, Filtering, Gears, Governors, Grips, Grinds, Heating, Hinges, Hydraulics, Indicators, Journals, Levers, Links, Lowerings, Lubricators, Measuring and Weighing, Mixing, Nozzles, Parallel Motions, Pipes, Pivots, Power, Propulsion, Raising, Ratchets, Rotary Engines, Safety Appliances, Shafting, Signals, Slides, Sounds, Speed, Spindles, Springs, Starting, Striking, Swivels, Tanks, Traps, Turbines, Valves, Water Wheels, Winding, Wipers, etc.

If you work with machinery of any kind, you need this ENGINEERS' SKETCH BOOK by Thomas W. Barber—355 pages, durably printed and bound in cloth. Mailed postpaid if you send order with \$2.98 or sent C.O.D. if preferred plus postage. Money back guarantee if not exactly as described or if not satisfied.

KNICKERBOCKER PUB. CO., Dept. M-4
120 Greenwich St., New York 6, N. Y.

Send me a copy of ENGINEERS' SKETCH BOOK. If I am not satisfied, I can return book and my money will be refunded.

- I enclose \$2.98; send book postpaid.
- Send book C.O.D. for \$2.98 plus postage.

Name _____
Address _____
City & Zone _____ State _____

FOR YOUR COLLECTION . . .

GENUINE METEORITE!

To introduce you to fascinating new magazine, Earth Science Digest, we will send rare, valuable, genuine METEORITE from Arizona's famous meteor crater. Makes important addition to any collection.



Sent With Order for Sample Copy of America's Newest Geology Magazine

Features the scientific and human interest side of geology. Packed with absorbing articles, photos, maps, etc. Contains most complete information about sources of minerals, fossils and supplies. Invaluable to students, teachers, collectors, hobbyists, gem cutters. Used in Geology Dept. of leading universities. Fascinating. Issued monthly.

WRITE for big Sample Copy and Meteorite. Send name and only 25c for packing and mailing. Supply limited. ORDER YOURS NOW!

THE EARTH SCIENCE DIGEST, Box P-57, Omaha 3, Nebr.

HOW to Make ART OBJECTS with RUBBER MOLDS

NEW MOLDING MANUAL 10c

NOW READY FOR FIRST TIME Natural Rubber Latex FOR BETTER MOLDS

MOLD MAKERS: Now for the first time since the war, you can get superior natural rubber molding compound at new low prices. Natural Rubber gives you best physical properties; 70% concentration, high elasticity, freedom from permanent set, unusual elongation. Use FRANCIS Natural Rubber Red Latex to make longer-lasting molds. At our reduced prices, you can produce more and better casts per mold, at lower cost. New Illustrated Instruction Manual, showing how to mold and produce valuable novelties, gifts, accessories, mailed for only 10c (stamps or coin). Price list free. Francis Supply Company, Dept. H-2, 1836 East Fulton Street, Columbus 9, Ohio.



SAY YOU SAW IT IN POPULAR MECHANICS

Learn NEON

at Chicago's First Glass School

Fully approved for training under GI Bill of Rights
All phases of neon processing including GLASS LETTER BENDING . . . NEON COLOR GASSING and BOMBARDING.

Small weekly payments — Free placement service
Evening classes enable you to learn this interesting trade while you work during the day. Length of course is only 500 hours, approximately 13 weeks. No home studies—no course books—all work done in the shop under the watchful eye of skilled technicians. There is now a tremendous need for trained neon technicians all over the country.
Enroll now for fall and winter courses.

COUPON

Send me additional information about your school:

Name _____
Address _____
City _____ State _____ Dept. P-77

ACME NEON INSTITUTE, Ltd.
1648 West Van Buren St. Chicago 12, Ill.

Hobart
helps you
SUCCEED

in ARC WELDING

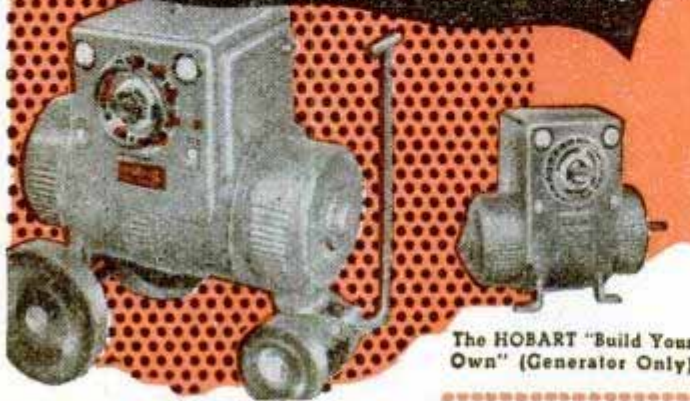

The HOBART "Build Your Own" (Generator Only)

A Big Pay Business—and it's all yours! It's so easy to start your own job welding shop and reap the big dividends that Hobart Arc Welders bring you. There's plenty of arc welding repair and construction work everywhere, customers even bring it to you.

Hobarts Weld Better—that's because of exclusive operation features that save you time and money. The exact welding heat is easy to get, for Hobart lets you select from 1000 volt-amp combinations. Hobart's Remote Control saves valuable time by allowing you to adjust welding heat at the work. Hobarts last longer because they're built better!

"Build Your Own"—and save hundreds of dollars! Make your own gas drive portable arc welder using the Hobart "Build Your Own," a reconditioned motor and chassis. Free booklet gives complete instructions.

Send the Coupon—for complete details on the Hobart Arc Welder you desire—there's no obligation.

HOBART Jr. Electric 150 Ampere Welder



The HOBART A. C. Welder for single phase lines

The HOBART SCHOOL of ARC WELDING

It's a modern trade school in which students learn by doing. Expert instructors give individual attention. Each student has own welding booth and welder. Fully accredited under G. I. Bill of Rights. Send coupon.

HOBART BROTHERS COMPANY
BOX M-77, TROY, OHIO. "One of the World's Largest Builders of Arc Welders"



HOBART

HOBART MFG. CO., BOX M-77, Troy, Ohio

Send me a Free Book, and also information on item we checked below:

- Electric Drive A. C. Welder
 "Build Your Own" Welding School

Free!

Arc Welder's Vest Pocket Guide contains tables, equations, charts, etc.



NAME _____

ADDRESS _____



LOOK TALLER INSTANTLY!

WEAR HITE-BUILDERS IN YOUR OWN SHOES



Want more respect? ... more opportunities? Then increase your height INSTANTLY with Davis Hite-Builders. Slip them inside your own shoes. Invisible ... comfortable ... easy to wear. Made to last for years. Amazingly low-priced!

SEND NO MONEY

Rush name, address, and shoe size today. Pay postman only \$1.00 plus few cents postage for your pair of Hite-Builders, mailed in plain package. If not delighted with immediate result, just return them and we'll refund your money at once. Or send \$1.00 now and save postage. Same guarantee ... of course. Order today, look TALLER next week!

DAVIS MFG. CO.
DEPT. B-335, LOVELAND, OHIO

Only \$1.00 A PAIR

Say You Saw It in POPULAR MECHANICS

GET INTO

REFRIGERATION AND AIR-CONDITIONING

Build your future in fast-growing industry. Prepare for high pay jobs or get into your own business. Resident classes only.

Send ad with name and address for information. VETERANS Eligible for training under G. I. Bill. Check here

BOSTON TECHNICAL INSTITUTE
School of Refrigeration, 4707 Euclid Ave., Cleveland 3, Ohio

WAR SURPLUS 110 VOLT - 60 CYCLE - 2500 WATT POWER PLANT GENERATOR
WEIGHT 200 LBS LIST PRICE \$276.00

NEARLY NEW



Ranchers, taverns, sportsmen generate your own electricity. Powerful portable plant. Complete except engine. Small engines easy to pick up or you can use water or wind power. Fine standby power for farms. Contractors use for on-job power saws, drills, etc. Full instr. installing, using. Guaranteed perfect. Order now or write for details.

Only \$89.40
FREIGHT PREPAID U.S.A. ONLY

LECO ENGINEERING CO. Box 908 PM-A, Lincoln, Nebr.

Cash In - RUN A MAIL BUSINESS

40,000 Words in Text, 68 Pages. Business Secrets Formulas, Wholesale Sources, Mail Order Plans, Book has no ads. Plus Big Mail, 25c Postpaid.

"RBCO," 542p FIFTH AVE., NEW YORK CITY 19



LEARN-WATCH REPAIRING at HOME

FREE information write—American Institute of Specialized Watch Repair—270-276 East Bldg., Grand Rapids, Mich.

Money Making Pay Raising BOOKS Catalog FREE

SEND NAME AND ADDRESS TODAY—Selected books covering all trades, office helps, home workshop, spare time work, hobbies, etc. Learn how to earn more. 1947 edition. **Popular Mechanics Press** 200 E. Ontario St., Chicago 11

ONE-MAN SAWMILL

● EASY TO TURN TREES INTO MONEY... BELSAW

MODELS in 10 to 24 foot sawing lengths. MECHANICAL FEED, accurate set works and positive dogs. Use tractor or old auto engine for

Makes lumber, ties, shingles, crates, lath, studding, siding.



low cost power. Thousands used for commercial sawing. Pays for itself quickly. Mr. Nettleton of California reports, "Have sawed over five million feet of lumber since I got my BELSAW selling it at \$35 per M.B.M." Send a postcard today for FREE booklet, "HOW TO MAKE LUMBER"—and Catalog of Woodworking Equipment.

LESS THAN \$200⁰⁰

BELSAW MACHINERY CO., 2811NS Field Bldg. 315 Westport Road, Kansas City 2, Missouri

DRAFTO PORTABLE DRAWING MACHINES for MECHANICS and ENGINEERS

Make the drawings you need on the job!

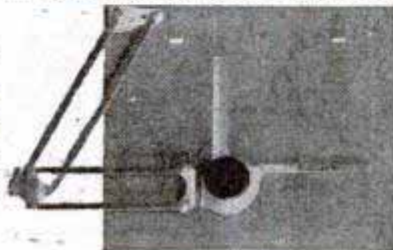

Save time and energy

AT DRAFTSMEN'S SUPPLY HOUSES

OR WRITE

DRAFTO CORPORATION, Cochran, Pa.

PROFESSIONAL TRAINING IN A MINIMUM OF TIME BROADCAST & TELEVISION RADIOENGINEERING

An Accredited Technical Institute; preparing high school graduates for technical careers. CREI graduates are in demand—in every branch of radio; Classes start every Monday. Comprehensive courses in Radio-Electronics Engineering, Broadcast and Television Engineering or Servicing; 2,100 hours classroom and laboratory study.

Write for FREE booklet, "Radio Engineering as a Career."

CAPITOL RADIO ENGINEERING INSTITUTE

Dept. P-7, 16th & Park Road, N.W., Washington 10, D. C.

SEEKING HEALTH? A WINNING PERSONALITY?



Learn my secrets for regaining Health. Overcome weakness, disease, Nature's safe way. Be Strong, Confident, Popular, Poised, Gain Weight, Build POWERFUL Physique. Thousands satisfied. Hurry... ACT QUICK!

FREE Beautiful COLOR PHOTOS of MUSCULAR MARVELS. State health problem, enclose stamps.

DR. FREDERICK TILNEY

Dept. PM2-161, Coral Gables, 34, Florida.

HOME-PLANNERS • BUILDERS

IN 10 SECONDS!! All 11 lengths and angles of rafters for any size and shape of simple or hip roof. Struggle no more with tables. Just set dial to "pitch" and "run" and the measurements show up in windows. Save time and materials. The RAFTER DIAL \$1 95

E. Weyer, Dept. B, P.O. Box 153, Planetarium Station, New York 24, N. Y.

FREE! FREE! FREE!

For NEW VIGOR—STRENGTH—VITALITY...

Mail this coupon now PM 77

Alan Stephan, Post Office Box 1080, Chicago 90, Ill. Send me, free and without any obligation, your booklet, "Presenting Mr. America..." Alan Stephan.

NAME _____

ADDRESS _____ CITY _____

STATE _____ DATE OF BIRTH _____

You'll Save Money and Oil!

When your service station makes this Free AC Oil Test and the AC Test Pad shows this

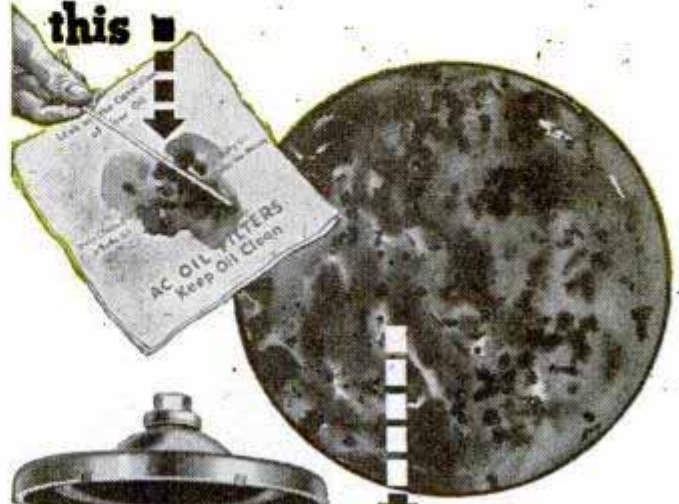

YOU TELL THE SERVICE MAN TO PUT IN THIS

OR PUT IN THIS

Dirty oil wastes gasoline, as well as oil, and clogs vital oil slots in the piston rings. Then, carbon forms faster, valves gum, power is lost. Overhaul expense soon follows. So, get the FREE AC Oil Test, regularly, wherever you see the yellow- and -black

official AC Sign. Keep your oil clean with AC replacement Elements and AC Oil Filters.

AC SPARK PLUG DIVISION • GENERAL MOTORS CORPORATION



SAY YOU SAW IT IN POPULAR MECHANICS



My druggist
took a
prescription
from me!

ED'S MY DRUGGIST... a good one, too! And since I've been his Doctor of Motors for years, I could talk to him like a Dutch uncle.

"Look, Ed," I said, "you're happy with the way your car runs now, but you have only had part of my prescription."

Then I told him what I'd done. Ground the valves, replaced the gaskets, installed a set of Perfect Circle Piston Rings to stop her oil pumping—and a lot of other things she'd needed for a long time.

"If you want to *keep* your car in tip-top shape," I said, "Here's the rest of my prescription—just bring it in regularly for periodic checkups. Then I can correct little troubles before they become big ones—and save you a lot of worry and money."

Ed said he would follow that suggestion and that it sounded like a good prescription for every car owner. He's right, too!

R FOR CAR OWNERS: When piston rings are needed, get Perfect Circles, available at any automotive repair shop. Your mechanic—your Doctor of Motors—recommends them. Perfect Circle Corporation, Hagerstown, Ind. The Perfect Circle Company, Ltd., Toronto, Ont.

Your Doctor of Motors
restores power... saves gas...
... saves oil with

**PERFECT
CIRCLE** PISTON
RINGS

THEY FISH FOR TROUBLE

By Richard H. Parke

TO A LANDLUBBER'S EYE they look like millionaires' yachts. They're sleek with clipper bows and cruiser sterns, slender masts and white superstructures. But the Lord Kelvin and Cyrus Field are not bucking North Atlantic gales for pleasure.

Mariners know the ships' peculiar trade by the two red balls and diamond-shaped cones swinging lazily from the foretrucks. The signals, displayed only when the ships are at work, spell out in international code "Cable ship, all others stand clear."

The 2641-ton Kelvin and the 1288-ton Field roam the sea lanes repairing breaks in Western Union's 10 transatlantic cables. Their highly trained crews, using instruments of miraculous precision, plumb the depths to locate the armor-plated strands of wire, no bigger 'round than a man's thumb, that tie the two continents together. They haul the damaged cables up, splice broken parts with a surgeon's skill and return them to their watery homes.

The Kelvin and Field are responsible for the maintenance of the largest single cable system between this country and Europe. They fish for trouble in all kinds of weather, at all seasons of the year, in waters from the Gulf to the arctic currents.



Lucas grapnel, used in deep water, cuts the cable in two. When the grapnel strikes the strand, huge jaws automatically bite the cable and hold one of the free ends so it can be lifted to the surface

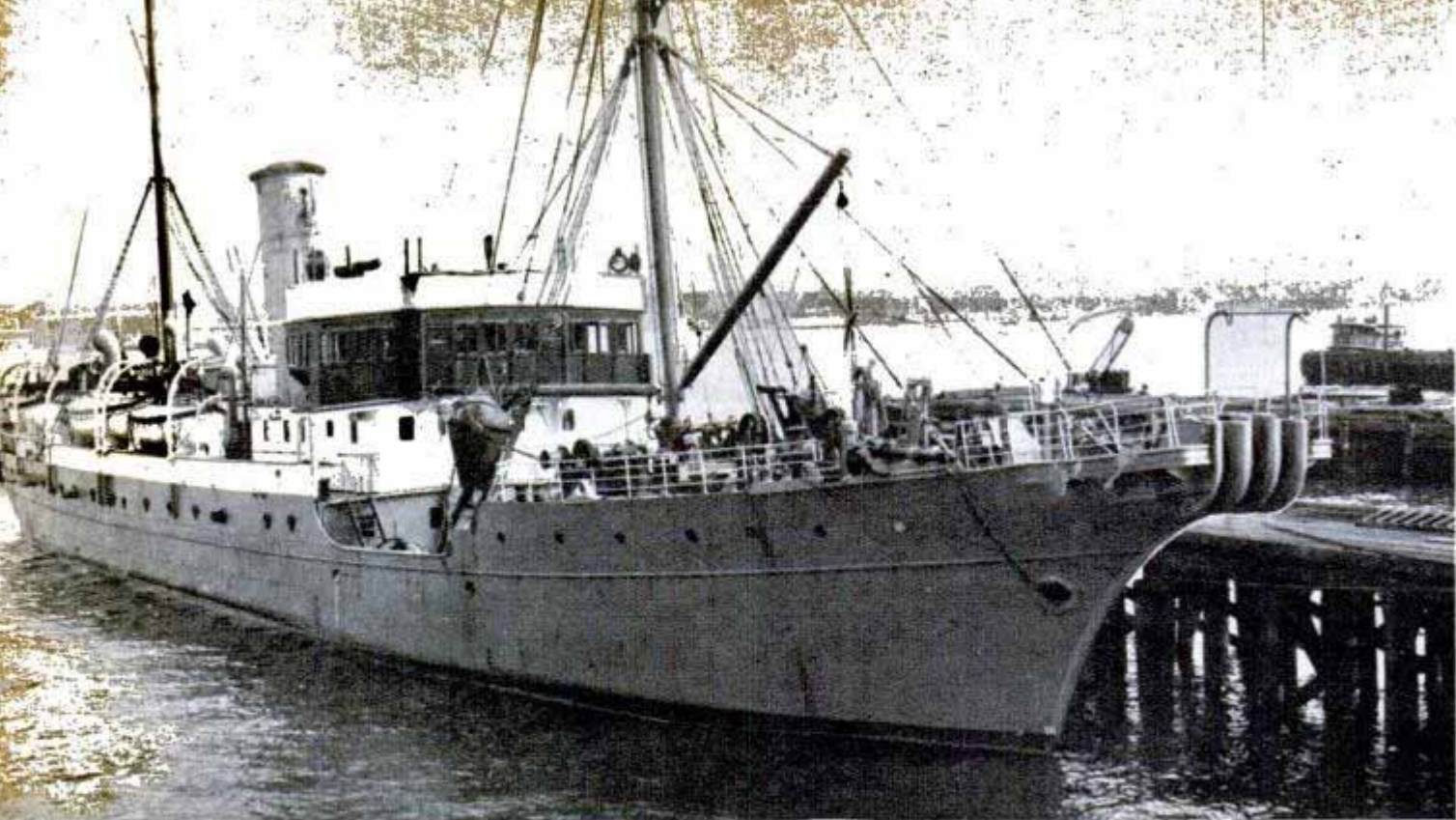

Cable ship *Cyrus Field* ties up at dock between calls. She's always ready for a quick trip to the scene of a break. Right, bo'sun coils the strand into one of the four storage tanks which hold 600 miles of cable

Not long ago the *Kelvin* and *Field* finished their biggest job—keeping the under-sea cables in service throughout the war. Virtually all top-secret messages affecting Allied war strategy were transmitted by cable. The two ships dodged enemy subs, planes and mine fields to keep the vital threads of communication open. They were guarded by the American, British and Canadian Navies and Air Forces on their repair missions.

Each ship narrowly escaped torpedoing. The *Kelvin*, traveling in a convoy off St. John's, Newfoundland, saw the wake of the torpedo that sank the ship directly abeam of her. The *Field* stopped short of danger off Port Judith, R.I. She anchored in a fog while a collier that was accompanying her continued on. Minutes later the collier was sunk by a U-boat that had been waiting, dead ahead, for both vessels to pass the periscope sights.

The 332-foot *Kelvin* and the smaller 238-foot *Field* often were sent far out to sea accompanied only by small escort vessels. On one such mission in 1943 the *Kelvin* was at work on one of the main cables, nearer Europe than America. Her escort ran dangerously low on fuel before the repairs could be finished. Work was abandoned while both vessels high-tailed it for the nearest port—Londonderry, Ireland. It was a hazardous trip through submarine-infested waters and Allied mine fields but the ships arrived safely. The Naval ship refueled and returned with the *Kelvin* to com-

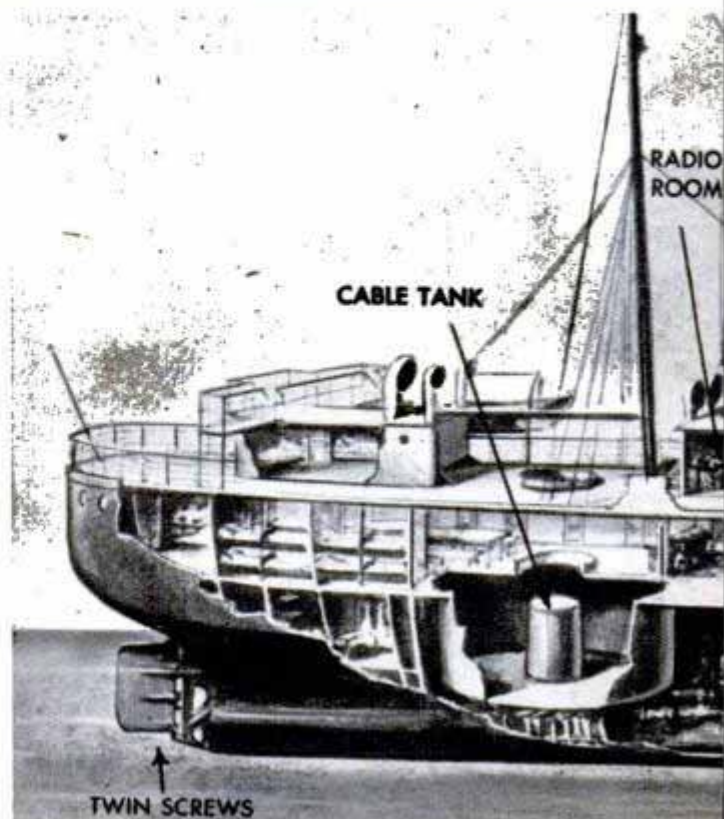

plete the cable job without further trouble.

Fortunately the Germans, so far as authorities know, never attempted to cut an Atlantic cable. The breaks that occurred were all results of normal wear and tear. But the two vessels often were delayed in reaching the scene of a break because of the scarcity of escort vessels. Days and sometimes weeks would pass before the Navy was able to put escorts at their disposal or assign them to coastwise convoys going in the direction of a break.

Convoys, incidentally, were always a headache to cable maintenance men because of the danger that the ships' anchors would become fouled in the undersea lines while in port. New York Harbor boasts an intricate cable system but it is continually menaced by anchors.

One night an inbound convoy, caught in winds of gale force, arrived outside the harbor and was unable to proceed in through The Narrows. The vessels anchored and a few of the big hooks became hopelessly entangled in a section of cable. The cable snapped. By coincidence the Field was in the vicinity and in response to an urgent radio from Western Union engineers was able to reach the area and begin repair work within a matter of hours.

The dragging anchor always has been a cause of cable damage. In the Firth of Forth in Scotland, 13 ships' anchors once were found ensnared in a four-mile length of cable. High on the nuisance list, too, are the iron-studded trawls which fishing vessels drag along the ocean's bottom. Corrosion eats the wires and they are constantly chafed against sharp rocks and bits of

Cutaway drawing of Cyrus Field shows how cable runs through dynamometer and down to storage tanks



Tension on the grapnel rope is determined by the dynamometer to show when grapnel strikes cable. Below, all grapnel ropes are run through the bow sheaves

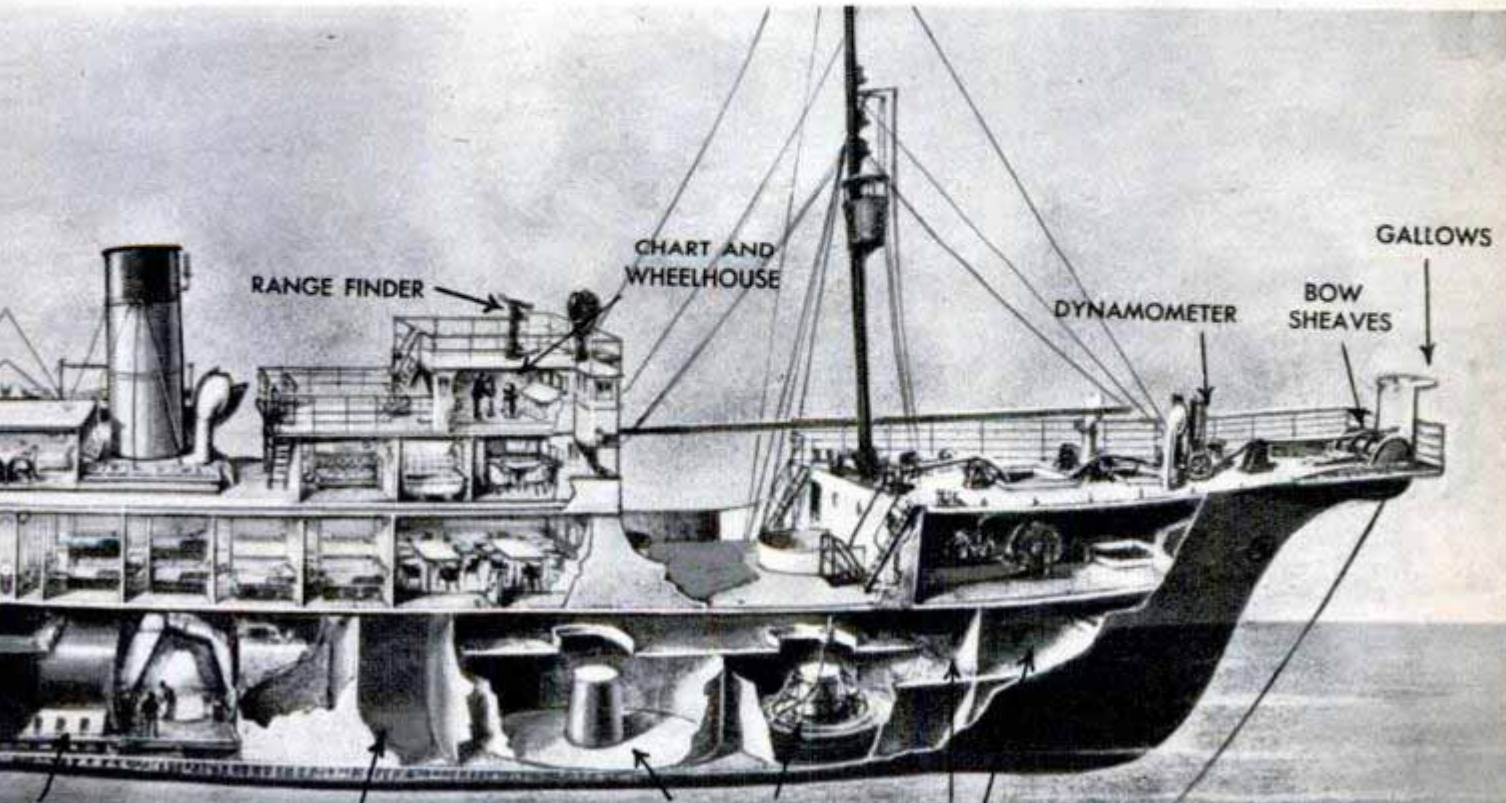

wreckage. Ice has been known to crush cables in the northern latitudes and there is at least one authenticated case of a cable being damaged by an inquisitive whale.

Eight of the 10 Western Union cables, which the Kelvin and Field nurse, run from Trinity Bay in Newfoundland to Valentia, Eire, and from Conception Bay, Newfoundland, to Penzance on the westernmost tip of England. The other two lines tie New York City and Newfoundland to Horta in the Azores, where feeder lines connect them with the European continent.

Since the steamship Great Eastern laid the first successful Atlantic cable in July, 1866, the cables themselves and the ships that lay and repair them have undergone

layers of jute yarn impregnated with tar and pitch cover the entire cable.

Stout as they are, cables deteriorate with time and exposure. The two oldest cables operated by Western Union were laid in 1873 and 1874. By now repair ships have replaced with new cable all but about 14 percent of the 1873 line and all but two percent of the 1874. The newer cables have undergone less replacement because of improvements in protective sheathing.

New cable is drawn from a reserve stock worth \$800,000 which Western Union stores at Halifax, Nova Scotia. Halifax is the base for the Kelvin and Field, chosen because it is centrally located for coastwise cable repairs and has a year-round ice-free harbor. The crews of both ships—Canadians, British and a few Newfoundlanders—have settled there and regard it as home.

Both ships are under British registry, carrying on a custom inaugurated many years ago when it became apparent that more men could be recruited for this type of work under the Union Jack than the Stars and Stripes. Their crews—85 and 60 men—are mostly old-timers, some having served on cable ships of the Anglo-American Telegraph Company which Western Union took over in 1911.

Esprit de corps runs high among them. It is compounded partly of pride in their calling and partly of a feeling of security because they have a permanent home. But if their life is fairly routine it does have the glamour of unexpectedness—like firemen they never know when they will be called out or what they will find.

The ships are not dispatched on a job until shore-based engineers have plotted accurately the area involved. As soon as a break is reported the cable stations conduct a series of tests. These involve applying a current of electricity through the damaged cable and calculating the distance, measured in terms of electrical resistance, between the testing point and the point of failure. Once this is determined engineers consult charts showing the known course of the particular line and the depths at which the cable is located along its path.

Given the geographical position of the break, the repair ship steams to within grappling range. On arrival she drops a "mark buoy," the nautical equivalent of a land surveyor's stake, but doesn't begin grappling until she has checked and rechecked her position in relation to the damaged cable. In bad weather or heavy overcast this may require considerable jockeying, for like all other vessels the repair ship must "shoot" the stars and sun to obtain an accurate "fix" for position.

If the cable lies in deep water the repair ship stands off a mile or so from the point

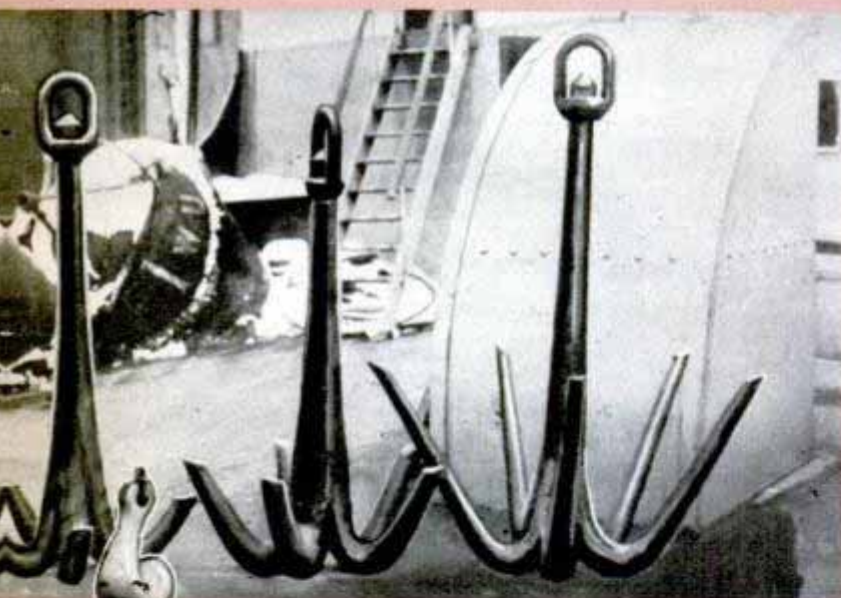

↑ Common grapnel resembles boat anchor with five prongs welded or forged to a common shank
← Gifford grapnel has a series of hooks facing in four directions and forming links in a long chain

many changes for more efficient service.

A typical submarine cable today has five layers. The current-carrying section usually is composed of a central copper wire over which are laid copper tapes or more copper wires to form a completed conductor. It measures about $\frac{1}{8}$ inch in diameter. This core is wrapped with a thin tape or wire made of magnetic nickel and iron alloy. Over this goes an insulation of gutta percha which, in turn, is wrapped in several layers of tanned jute yarn. Next comes an armored sheath, composed of as many as 19 galvanized-steel wires. Finally two



at which she believes the faulty cable is located. She pays out the grapnel and slowly tows it at right angles to the cable, searching with huge jaws for the strand.

The grapnel is attached to a line that passes through a shipboard dynamometer, a device that measures the tensile stress which the line is undergoing. The skipper watches the dynamometer, signalling the engine room promptly if it appears that the grapnel has become fouled in some underwater obstruction.

Old-time cable ship skippers have another and more picturesque means of checking stress and one that they swear is as infallible as the "dyna." They climb up on the ship's forecastle head, where the line is being payed out slowly over the vessel's stern. Over the line goes a mat and on top of the mat sits the skipper. He'll tell you he can feel vibrations that indicate when the grapnel's jaws make contact with the cable.

Locating the cable by grapnel is the trickiest part of the job. In shallow water it's made a lot easier by a "leader gear"—two bared copper electrodes which are submerged and towed across the suspected course of the cable at the smallest angle practicable.

While the ship uses the leader gear the shore station nearest the break sends through the cable a dot-dash message which identifies the station. Men on the ship can hear these signals through ear-phones. The strength increases as the vessel approaches the break and reaches a climax when the ship is directly over the broken ends. This position is plotted on a

Wire in core of cable is made of → copper and carries electric current

If wire breaks, these flexible cop- → per tapes carry current around gap

Alloy tape has magnetic qualities → which keep messages from jumbling

Thick protective covering of gutta → percha holds messages to their paths

Jute wrapping cushions pressure → of three miles of water above cable

Nineteen steel armor wires pro- → tect the cable from abrasion by rocks

Final wrapping of tarred jute → yarns seals out ooze of ocean floor



"grappling sheet." The ship then stands off to begin grappling.

There are several types of grapnel. The simplest is an oversize boat anchor with five prongs welded or forged to a common shank. The Gifford is a series of short hooks oriented 90 degrees apart. A patented grapnel known as the Lucas is used in deep water to raise cable that must be cut before it can be surfaced. It grips the cable and cuts one end free in a single operation.

(Continued to page 252)

Crew recovers a "mark buoy" upon completion of job. Lamp on the buoy burns three weeks without attention

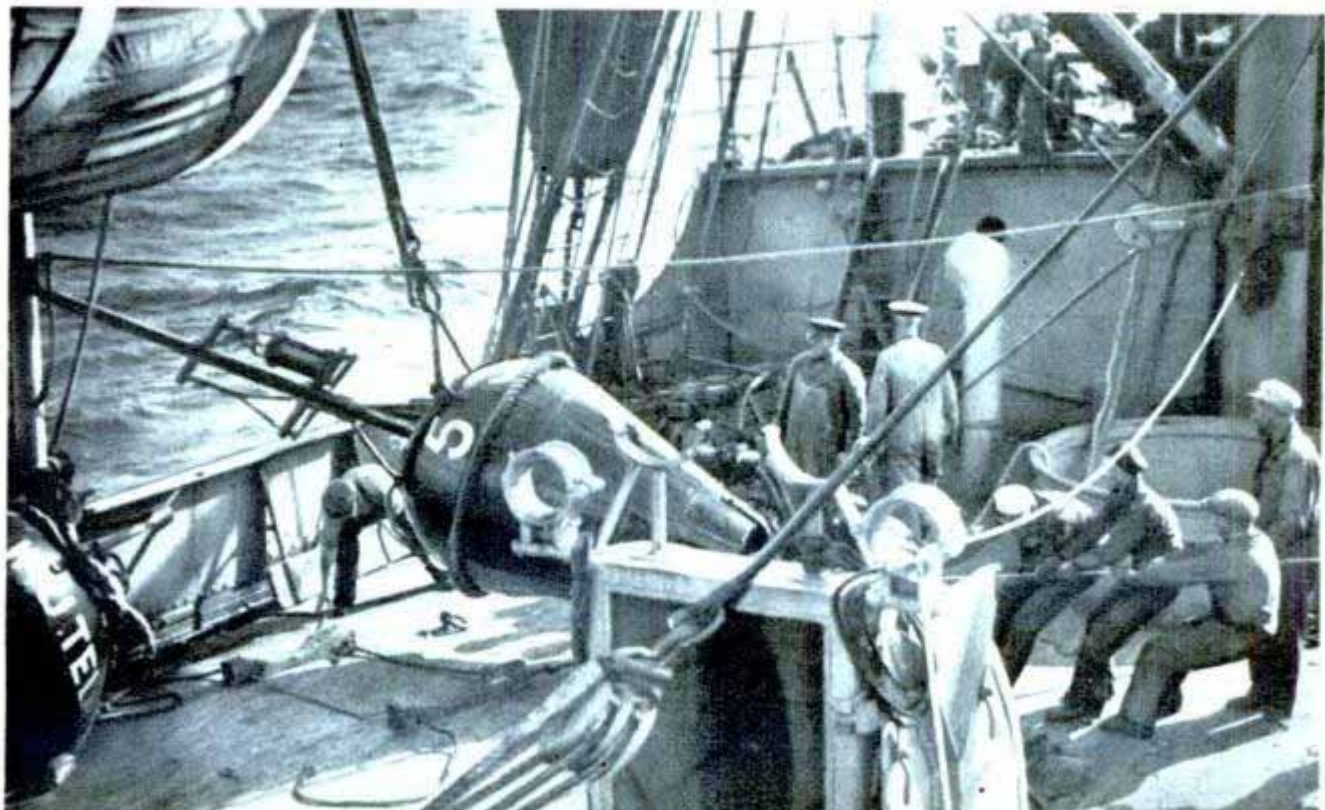



Drill Converted to Saw

Electric and pneumatic drills are converted into power saws by a cutting tool that knifes through plastic, sheet metal, rods, bars and tubing. When used with $\frac{1}{4}$ -inch drills, the circular saw will cut 10-gauge mild steel and $\frac{3}{16}$ -inch aluminum. No starting hole is required and the cuts are made with milled-edge saws that eliminate burring or filing. An adjustable guide shoe regulates the cutting depth.

Mileage Dial for Nautical Charts

Nautical chart distances are translated quickly into miles with a rolling dial which is handy for boatmen. The dial is placed on the chart and rolled along from the point of departure to the destination. No matter how intricate the course, the instrument automatically records the distance in miles. Four separate mileage scales match the charts most commonly used.

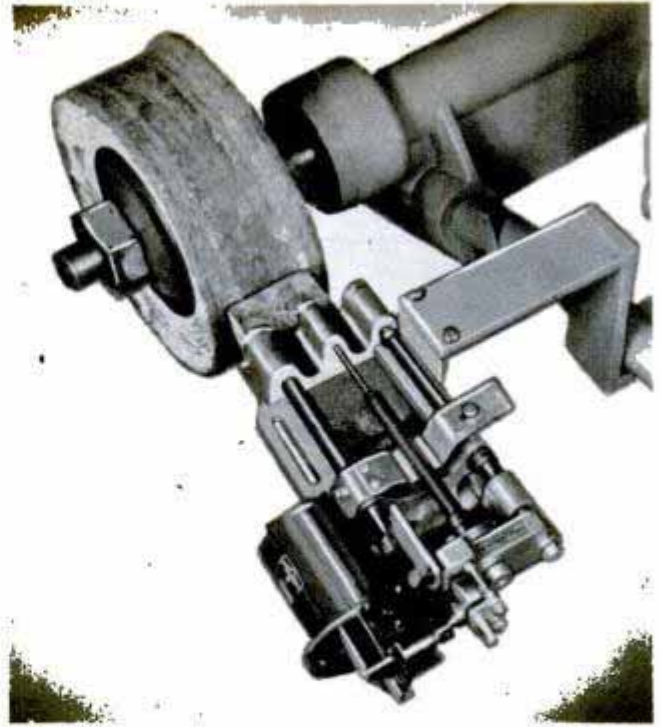

Buffing Compound Applicator

Buffing compound is applied automatically by a motor-driven applicator that can be mounted on any buffing machine, either right or left-hand. The applicator has an intermittent control that feeds the stick of compound against the wheel. Sticks of compound any length up to four inches are held in the applicator clamp, with special carriers available for wide sticks. Power is supplied by an enclosed motor available for 110, 220 or 440 volts.

Phone Number Index

Telephone numbers are easy to find in a card-index box that snaps directly to the telephone. The record file is made of plastic in several colors and has a swing-back top that keeps dust off the alphabetical cards. An individual snap attachment is made for each style of telephone. The index box also holds a pencil.





Photo-Negative Analyzer

Density and contrast range of any photo negative—necessary information for selecting the proper grade of paper for a print—can be determined accurately with a photographic analyzer. A concentrated beam of light inside the instrument penetrates a tiny aperture in the viewing plate. The negative is placed over this plate and an arm above the plate is lowered. The light passes through the negative to a photocell inside the arm and a built-in meter shows the density of that part of the negative. By measuring maximum and minimum densities of a negative the photographer determines the contrast range and selects the correct paper. The instrument can also be used as an illumination meter.



Nut Gatherer Eliminates Stooping

Bending and stooping are eliminated from the job of picking up pecans and other nuts when a spring-headed gatherer is used. Attached to a long wooden handle, the steel spring picks up nuts by wedging them between its coils. The worker then taps the spring on the edge of a basket and the nuts fall in. The design of the spring prevents it from picking up leaves or trash.

Wings Aid Tire Testing

Tires now get 90-mile-an-hour proving tests on autos with airplane wings. Attached vertically, the wing section deflects sufficient air to offset 300 pounds of side thrust that would otherwise pull a circling car off course and cause tire sides to "scrub." In earlier tests this produced abnormal wear on tire treads and made it impossible to obtain accurate results. The testing was shifted from highways to an oval desert track when a 30-mile-an-hour speed increase made the former method unsafe. The idea of adding a balance wing was developed by United States Rubber Company engineers.

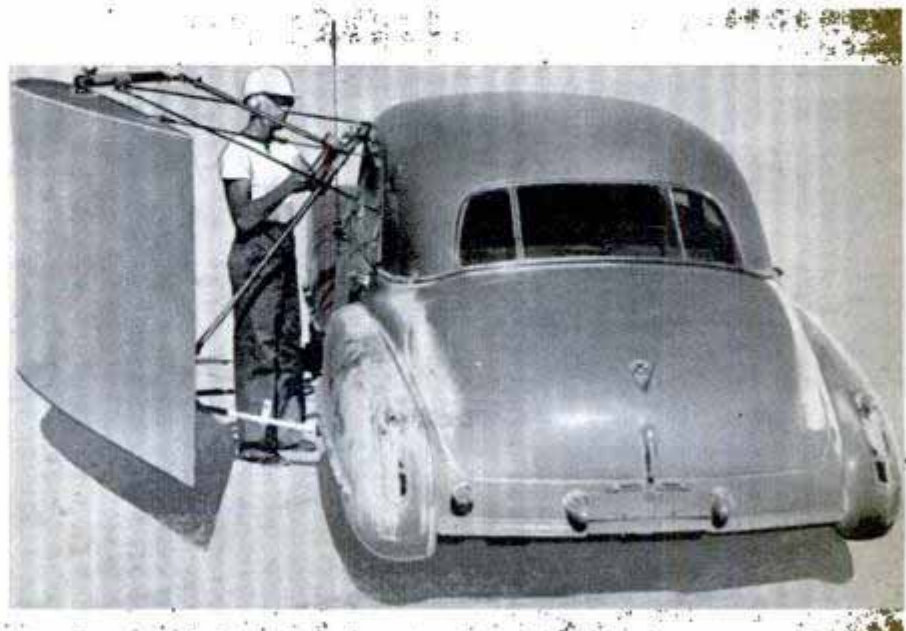



"Kindergarten" lessons are learned quickly by Prince, a 15-month-old cub. Here Clemens teaches the lion to follow tip of whip through a hoop

DICK CLEMENS is as mild-mannered as any school teacher. His scars betray the ferocity of his pupils. Every morning he slips through the door of the big cage in his back yard and puts his pack of full-grown lions and tigers through the ABCs of jumping through fire hoops, playing leapfrog and carrying him piggyback. Four hours later he slips out, relieved that he has proved he is still the boss.

Clemens is one of the country's four leading wild-animal trainers. He plays in Shrine circuses and benefit shows on an independent circuit.

Every day that he's not on the road the 47-year-old trainer holds school for the big cats at his home in Creve Coeur, a small town near Peoria, Ill. The scars that cover his body are proof that spending four

"Crutch" aids trainer in teaching a cat to sit up. Lion leans against the support until he can balance himself. Then the back rest is lowered by rope

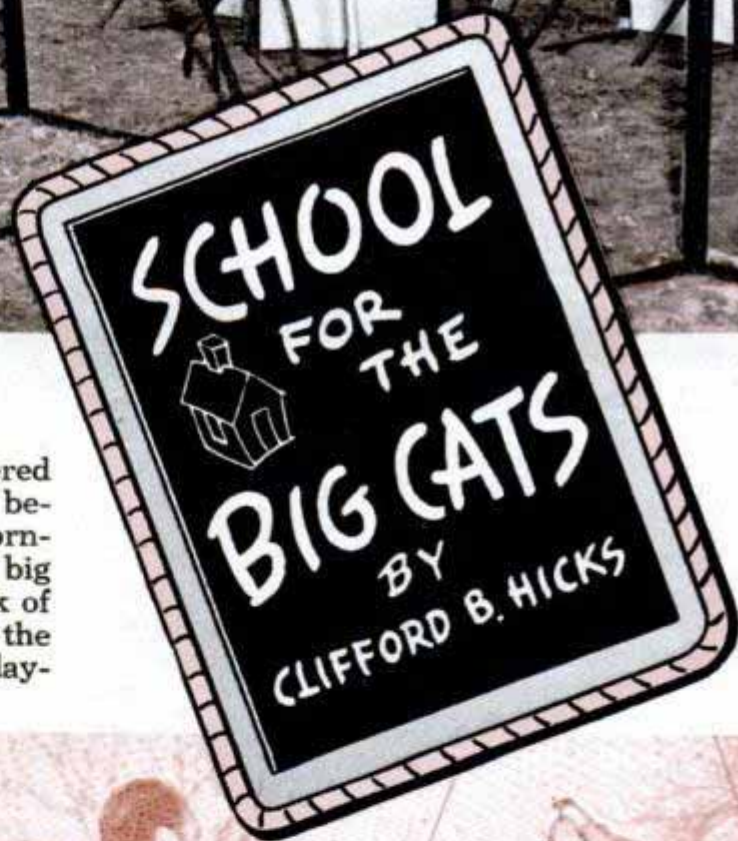



Even Clemens is nervous when he works with the tigers, who are moody and treacherous. Note the talons on the striped cat pictured above. One false step and the trainer will be maimed or killed by those razor-sharp claws

hours daily in prepping the lions and tigers for their circus act isn't exactly a healthy way to make a living.

Take his famous "door bounce," in which he plays a dangerous game of tag with an angry lion. Clemens taunts the snarling cat until it leaps from its pedestal. Then he drops his whip and races across the cage

for the door. The cat crosses the arena in a couple of bounds. Just as it makes a final lunge for the trainer's back, Clemens slips through the door and the 500-pound lion crashes into the bars.

The "door bounce" is a good reason why Clemens can't get a life insurance policy. To make sure that our photographer got a

Tyrone and Patsy, two full-grown lions, snarl at Clemens' whip. Right, here's how the trainer looks to the cats





Early in the schooling Clemens opens his fist whenever lions snarl. Later, during the act, the cats snarl whenever he spreads his fingers



↑ Teaching a tiger to roll over on command is a ticklish stunt

↓ In the "door bounce" Clemens is chased by a 500-pound lion, slips through the door by a whisker. The lion isn't fooling, either!



good shot, he made his dangerous dash for safety five times. Each time he was a little slower, and the fifth time the lion missed him by a whisker.

"Some people think it's all an act—that Duke wouldn't hurt me if he should catch me," says Clemens. "They're wrong. Duke's instinct tells him to kill me if he has a chance, and he couldn't stop suddenly even if he wanted to. Once when I was putting on my show in Chicago an attendant failed to open the door fast enough. Duke's inch-long talons ripped through my left shoulder. I was lucky to get out before he did any more damage."

It took a doctor four hours to repair the wound in Clemens' shoulder. At two o'clock in the morning he returned and put his animals through the complete act—with two watchmen the only spectators.

"A trainer who leaves the act because of an injury is no good," declares Clemens. "The animals may think they can get away with it again, but more important, the trainer will lose his nerve."

A lion trainer continually changes his act as a safety measure, he explains. If he did the same thing every day he'd get careless, and a careless man hasn't a chance in the big cage.

School for the big cats starts early each morning when they're turned into the exercising cage. Promptly at 10 o'clock Clemens slips through the door, armed with a pole, whip, two pistols loaded with blanks, and sometimes a chair.

Clemens won't say exactly how he teaches his cats some of their tricks, for a good reason. It may take him years to discover a method to teach a lion a particular trick, but once the method is known other trainers could teach their cats the same stunt in half an hour.

Only a lion that has confidence in himself makes a good animal for training. The big cat usually acquires this self-reliance when he's about 1½ to 2 years old. Clemens' basic training is aimed at developing an understanding between himself and the lion. He never mistreats his cats and has

nothing but contempt for anyone who deliberately harms any animal.

If the lion is vicious or tough when he starts to school, Clemens puts him in a "squeeze cage" where he can't move. Then a collar and chain are fastened around the cat's neck and a "V" chain fastened to the collar from the rear. When the animal is released from the cage Clemens hangs onto the forward chain while his assistants keep the animal under control with the rear chain. This theoretically teaches the lion "respect of distance" from the trainer.

It's only theoretical, though. For example, Nerc, a high-strung animal, forgot all his training in Minneapolis three years ago. Clemens was in the middle of his act when a helper pulled the wrong door and Nero went to the wrong pedestal.

A lion act must have stop-watch precision and Clemens was faced with the task of getting Nero to the right seat. He brought the cat down in a leap from the pedestal but as he was backing across the cage he



Above right, Clemens rides piggyback on his most trustworthy animal, always a crowd-thrilling stunt. Note the look of pain on his face. This photo was taken the day after he was clawed from shoulder to hip, a wound that required 118 stitches. Below, tigers sulk on their pedestals while he polishes a lion act in his back-yard arena





Split-second footwork! In one stunt he provokes lioness into leaping at him, stepping aside as she hits the sand

stumbled over a prop. Nero leaped for his stomach. Clemens put up his legs to protect himself and the cat crunched down on his left thigh.

Clemens gets a faraway look in his eyes when he describes what happened then. The big animal flipped him into the air and

Many tricks are possible after the cats learn to follow the whip. Here one bounds across another's back in pursuit of the stick



carried him clear around the arena. Clemens says he had no sensation of fear or pain—just dizziness. The trainer's wife, standing just outside the cage, fired a blank in the lion's face. The loud report startled Nero momentarily and he dropped the man. Instantly Clemens was on his feet, whip in hand, forcing Nero to his pedestal. Then he calmly backed out of the cage and went to the hospital for five weeks. He says, a little bitterly, that a lot of the audience thought it was part of the act that night.

After the lion has been taught to keep his distance from the trainer, Clemens teaches him to move in the right direction. This is done by tapping him gently on the nose with the whip. He'll lean for it, then follow it as the trainer moves it in the proper direction.

"Seat-breaking"—an animal—training him to go to the proper
(Continued to page 236)

Electric Wheel Chair Has Radio and Lights

Tilting or turning the steering post operates all the controls of a unique motor-driven wheel chair for invalids. The chair, invented by Kenneth Ginsterblum of Osage, Iowa, has a reversing switch in the center of the steering column to permit backing up. All the controls are conveniently located and can be operated by one hand. Two special batteries furnish power to the 12-volt $\frac{1}{2}$ -horsepower motor, allowing seven hours' traveling time without recharging. The chair moves at speeds up to six miles an hour and has enough power to pull double its own weight up an 11-percent grade. The two front wheels have balloon



tires, and the rear wheel, which steers the chair, has a shock-absorbing fork. Other features include a portable radio, a removable steering post, built-in head and tail-lights, and upholstered armrests that open up to reveal aluminum storage boxes.



Belly-Tank Boat

Made from the spare belly tank of a bomber, a tiny racing boat is driven by a one-horsepower in-board motor. Fay Elrod of Jonesboro, Ark., built the compact little craft in his basement. Six feet long by three feet wide, it weighs only 85 pounds. The carved wooden keel is protected by a metal strip and the propeller shaft and bearings were fashioned on a lathe. The steering wheel is a band of scrap steel with a half dozen screwdriver handles for spokes. The fuel tank holds only two gallons, enough to operate the boat most of the day.

Tin-Can Plane Model

"Hedge hopping" over the front yard of Herbert E. Fey at New Braunfels, Texas, is a DC-3 transport complete to the last detail in $\frac{1}{8}$ -inch scale. While the model doesn't fly, Fey has it mounted in flying position. He built it in 3 $\frac{1}{2}$ months at a total cost of only \$5.50. Its riveted "aluminum" skin is formed of 1044 tin sheets which Fey salvaged from 600 discarded tin cans. It is 9 feet 3 inches long with a wing span of 13 feet 1 inch. Contributing to its weight of 150 pounds



are 3275 nails, 1108 rivets, 262 wood screws and five machine bolts. It has a retractable landing gear.



"ON A BICYCLE BUILT FOR TWO"—without a back-seat driver. Built like an overgrown tricycle, two rear wheels insure greater stability and fewer spills

ERRORS, their nature and location are signaled by a machine that solves supersonic flight problems. It is 16 times faster than a trained mathematician
National Advisory Committee for Aeronautics photo



HELD BY a safety harness, a navigator takes a "fix" over the mid-Atlantic. The belt was rigged up after a pressurized transoceanic air liner blew its astrodome

SEA AND AIRMEN 40 miles away will see light from two-ton optics being installed along the Norwegian coast. They'll flash nearly 40 million candlepower

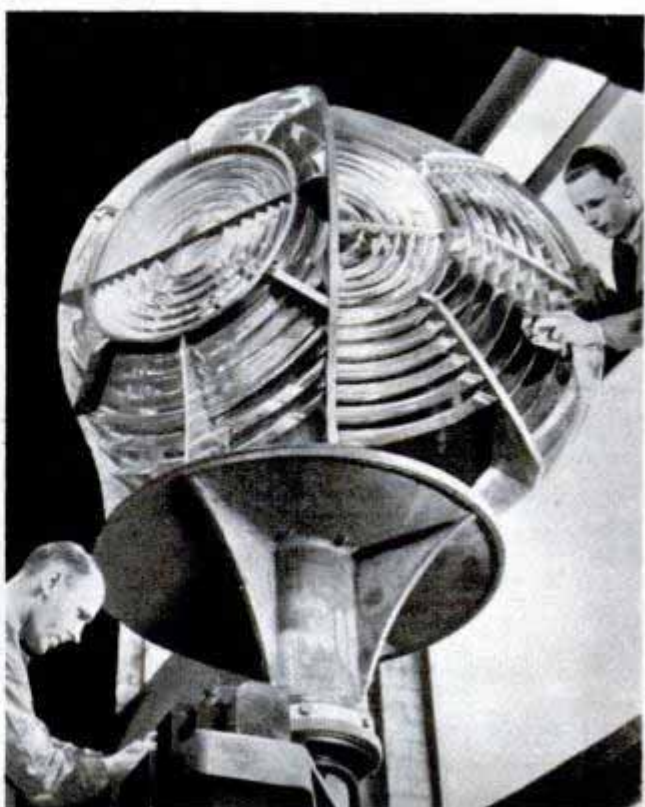

Auto Bottle Warmer

Baby bottles are heated en route during an automobile trip by a bottle warmer that clamps on the steering post. The warmer, made of metal with a baked enamel finish, is connected to any live wire beneath the dashboard and grounded against the steering post. A heating element in the bottom of the cup operates automatically under the weight of the bottle and goes off when the bottle is removed. Small cans of baby food also can be heated in the unit.



Tool Removes Auto Bearings

Without marring or damaging the bearing, a new tool for the automobile mechanic is said to remove any clutch pilot bearing in 60 seconds. It is furnished with six collets and two pins—all that is necessary to remove any automotive clutch pilot. With the tool inserted, a wrench is used to remove the bearing assembly. The bearing remover exerts a straight, square pull which insures removal without scoring. The tool also will remove bushings.

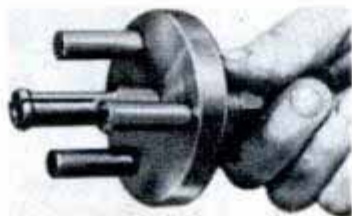

Shock Tester

Anchored firmly in 40 tons of concrete, a dry-land "battleship" tests shock resistance from simulated direct hits by big guns or exploding mines. Developed by Westinghouse, the battleship set-up is used for radar tests and to try out other complex instruments. Equipment to be tested is fastened to a gigantic anvil which is struck from below by a 3000-pound hammer. The hammer, suspended from a heavy shaft, is pulled above the horizontal and then released. Swinging like a pendulum, it moves down and then up to strike the anvil a 3,600,000-pound blow. The shock produced lasts only $\frac{1}{1000}$ second.

Information, including manufacturers' names and addresses, concerning products described in this issue may be obtained by writing to Bureau of Information, Popular Mechanics Magazine, 200 E. Ontario St., Chicago 11, Illinois

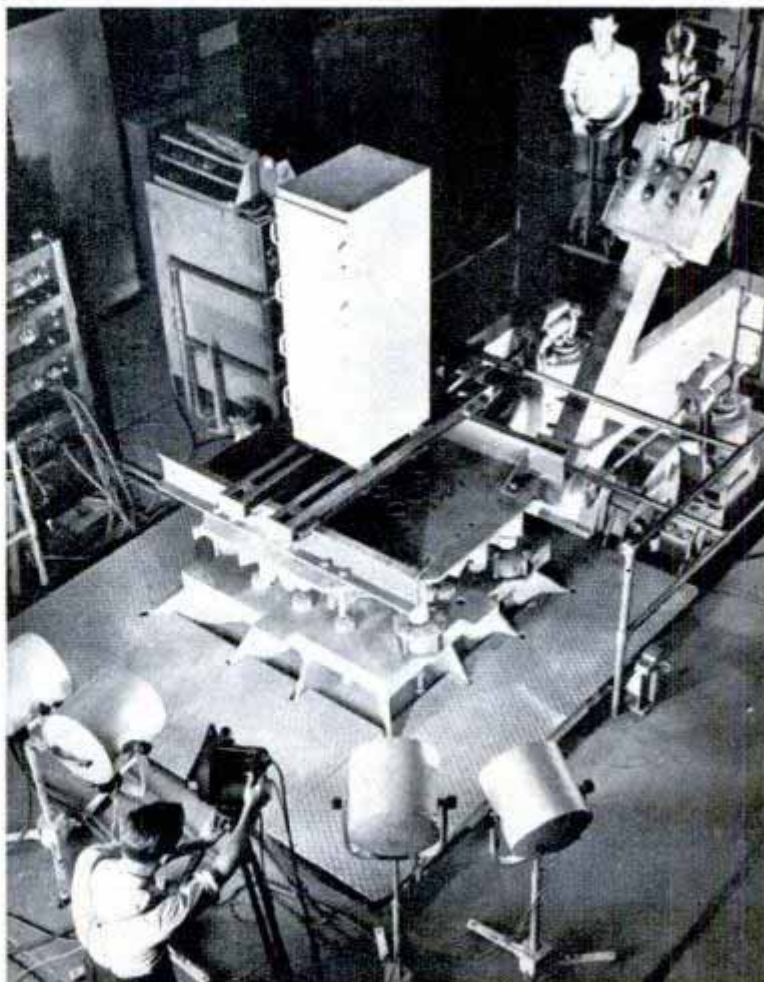



Rudder lines from motor are guided by pulleys for "remote-control" steering. Below, boat is carried upside-down atop car. Lower right, Hageman starting the motor

"Bubble" Boat

Because his Plexiglas boat is practically invisible a short distance away, James R. Hageman of Glendale, Calif., appears to be sitting on top of the waves when he goes for a ride. He built the "bubble" boat by bolting together two upper nose sections of a Douglas A-26 bomber and filling the seam with plastic cement. An aluminum crossbar stiffens the craft amidships and a Plexiglas keel gives her more stability. With a small outboard motor on the stern Hageman can travel six to eight miles an hour. A system of rudder lines and pulleys gives him "remote-control" steering when he sits in the bow. Two sections of canvas fire hose pad the hull when the boat is carried on top of his car.



Plunger Frees Snagged Hook

Fishing plugs and hooks that are snagged on underwater weeds or branches are jolted free by a retriever, or plunger, that operates like a miniature pile driver. The retriever consists of a weight fastened to a guide line which is wrapped on a spool. The snagged line is slipped through a zigzag slot in the side of the retriever. When the weight is released it speeds down the line, delivering a solid blow to the plug to jolt it loose from the snag. If the plug is not disentangled by the first impact the guide line can be pulled and released again to deliver repeated blows against the snag. The retriever, made of a high-strength alloy, is small enough to fit into a tackle box.

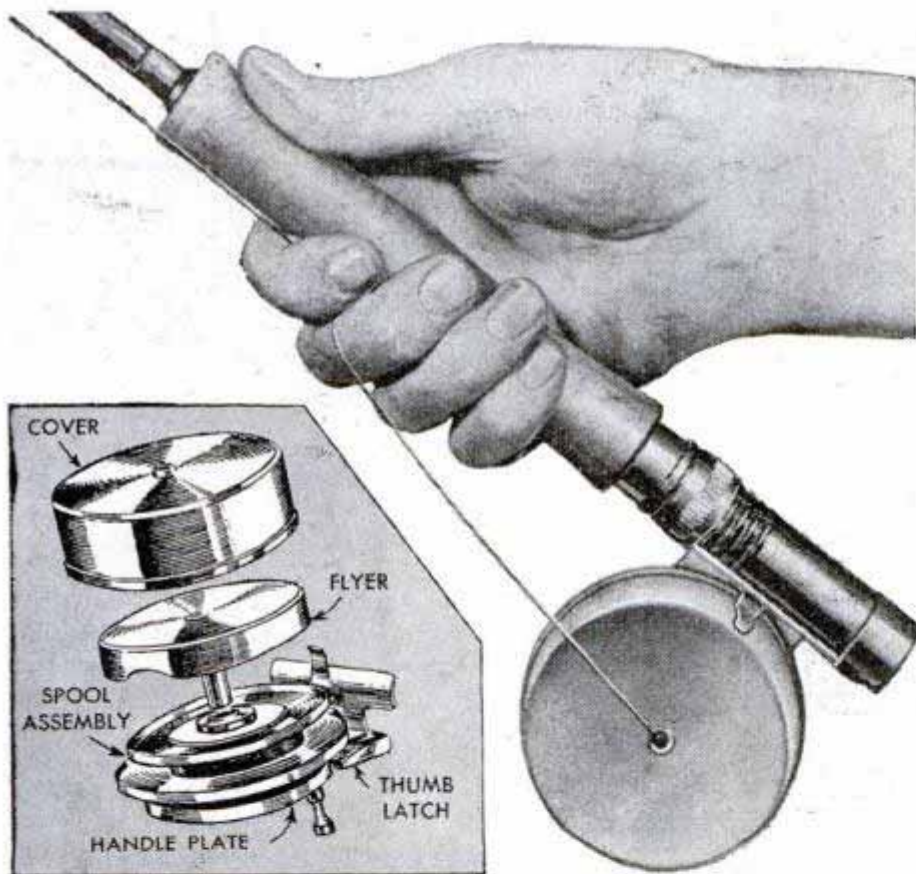
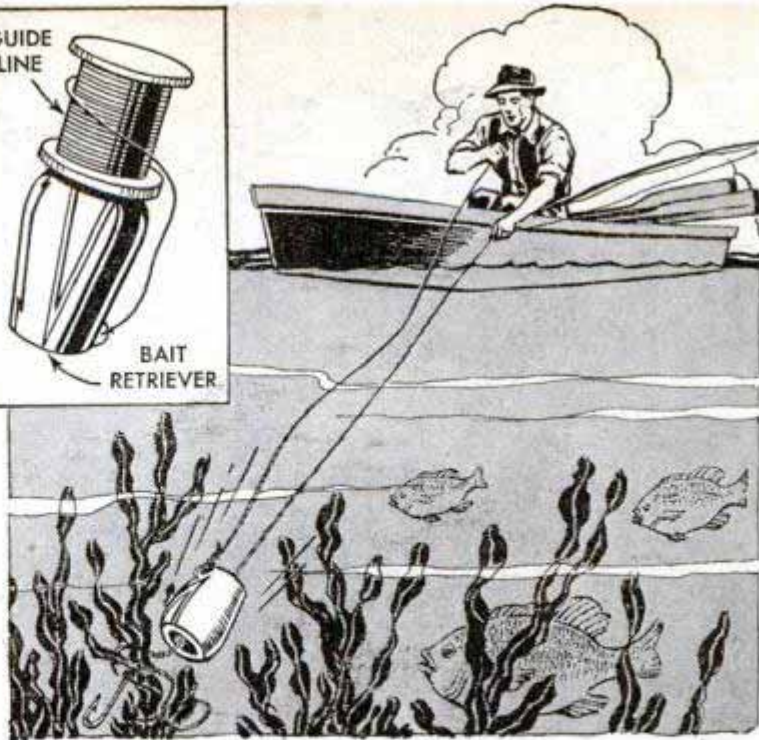

Fishing Spool Reel Eliminates Backlash

Backlash is eliminated by a new type stationary spool reel which enables a fisherman to cast his lure a great distance. The spool remains stationary during the cast but the line feeds out freely. A thumb latch sets it for retrieving the line. No special pole is required and the reel can be used with fly or bait rod to cast 1/8-ounce to one-ounce lures.

☐ American duck and geese populations have declined drastically for the last three years with a drop this year of 26,000,000, leaving only an estimated 54,000,000 waterfowl in the country.

Fishermen's Spoon "Swims"

Hinged in two places, a fishing spoon simulates the action of a crippled herring darting around and turning over in the water. The spoon is available in two lengths, 4-inch for salmon and bass and 2 1/2-inch for trout. The spoons, finished in nickel and brass, and painted to resemble a herring, are strong enough to support a 100-pound weight.

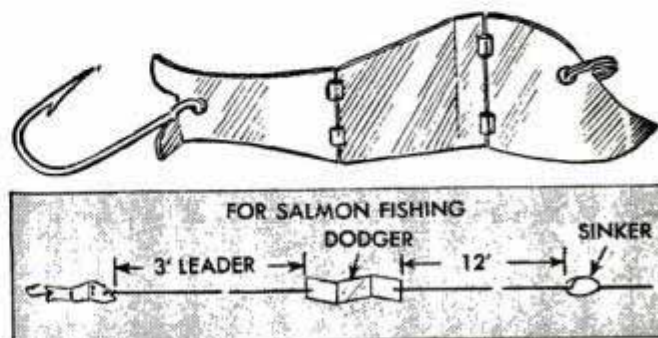



**ON GUARD...IT'S
FOREST FIRE TIME**

American Forest Products Industries photos
Flames leap through timber near Puget Sound. Biggest problem is to keep small fires under control.
↓ Forest patrolman "localizes" a blaze by working on fringes. Charred logs might spring to life again



POOILING MEN, machines and materials, the "tree farmers" of Oregon's Douglas fir country are standing by for fire weather in the big timber. It's tourist and camper season in the forests and the radio at North Fork Guard Station is crackling its fire messages.

"Humidity 19, visibility four miles, wind east-northeast."

When the men at the fire-guard station receive such a transmission they move fast, for the message means that the woods are dry, the visibility poor, and a strong wind is coming up—the ideal situation for the kind of fire which will sweep thousands of acres unless the tree farmers are on their toes.

Fire-conscious private forest owners—the tree farmers—have

Right, first signs of a blaze are detected from modern lookout towers
↓ Guard sights through his alidade to "fix" a distant column of smoke



organized this group to battle the red demon that continually threatens the nation's last great stands of timber. In their short history the tree farmers have chopped annual fire loss on protected land to .12 of one percent, considerably below the .20 of one percent which the United States Forest Service considers an acceptable annual blaze loss.

George Bunke, chief fire warden for the tree farmers at North Fork, Ore., has under his direction some 50 "smoke eaters," the service's lookouts and forest guards. Now that the summer dry season is here his outfit has been increased by a squad of high school boys who form a fire suppression crew.

The observers, guards and suppression crew are clamping a tight





Crewman reports progress of a battle against flames over a shortwave radio mounted on a high-speed truck. Right, more than 170 miles of telephone wire thread the forest and patrolmen can tap in anywhere for reports

watch over 500,000 acres this season—nearly 100 square miles of fine timber that could go up in smoke. It takes vigilance plus the service's modern equipment to patrol an area that size.

The chief warden's fire control headquarters is a rustic log-sided station. But you won't find him at his desk for long during the dry season. You'll find Vic Johnson, his assistant, manning special equipment designed to receive fire reports and plot the location of smoke signals. With "cross-shot" reports from several lookout stations perched atop mountains scattered

over tree-farmer territory, Johnson can quickly pin-point on the central map in the North Fork station any sign of smoke.

These mechanized forest rangers use radio for fast communication. Just behind Johnson is a big stand-by set, tuned to the wave band assigned the Oregon State Forester's office for statewide use.

A flip of the radio switch at either the lookout station or dispatcher's office provides two-way communication between units of the ground forces. Patrolmen are equipped with walkie-talkies to extend facilities into the dense forest areas where

Locomotives pull tank cars filled with water and cabooses carrying crews to fires along lumberers' railroad

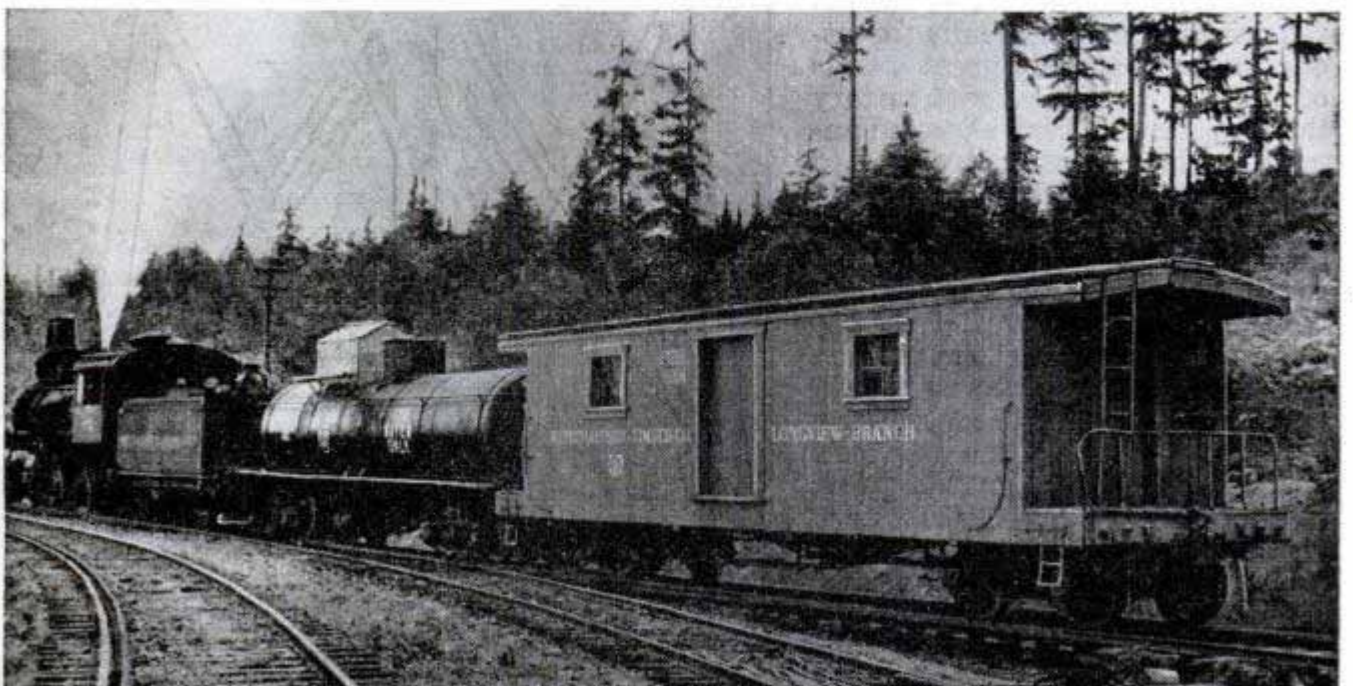

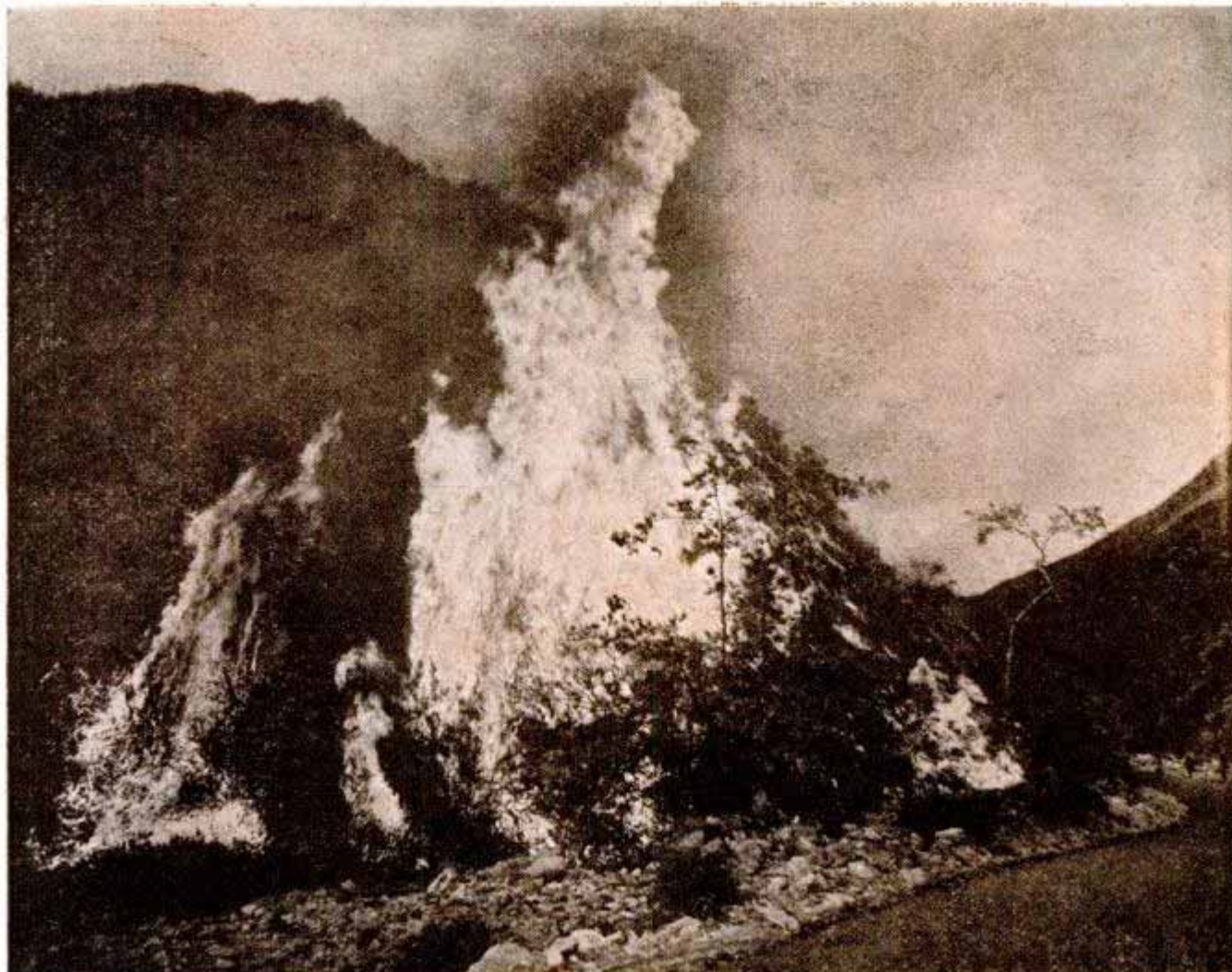

U. S. Forest Service photo

Flames, probably started by a cigarette tossed out along the highway, leap through brush in a western canyon

a wisp of smoke may become a sheet of flame within a few minutes.

The founders of the tree-farmers' organization, the Clackamas-Marian Counties Fire Patrol Association, started their fire fighting with nine men, a few hand tools, a team of horses and a buggy. To fight this summer's battles along the forest trails they have a 500-gallon fire truck equipped with power take-off, a pickup truck with a 150-gallon tank, five additional pickups, a passenger car, seven portable fire pumps with hose and nozzles and enough hand tools such as brush hooks and axes to keep 400 men busy.

This equipment is strategically placed so that it can reach any point in the forest in a few minutes. The tree farmers boast 104 miles of road and truck trails supplemented by 171 miles of telephone

line, which the fire fighters can tap to call headquarters. Seven primary lookouts are the "eyes" of the network. The lookout

(Continued to page 256)

When blaze breaks out in scrub area a pumper is rushed into action, fed by a nearby stream. All of the tree-farmer equipment is highly mobile



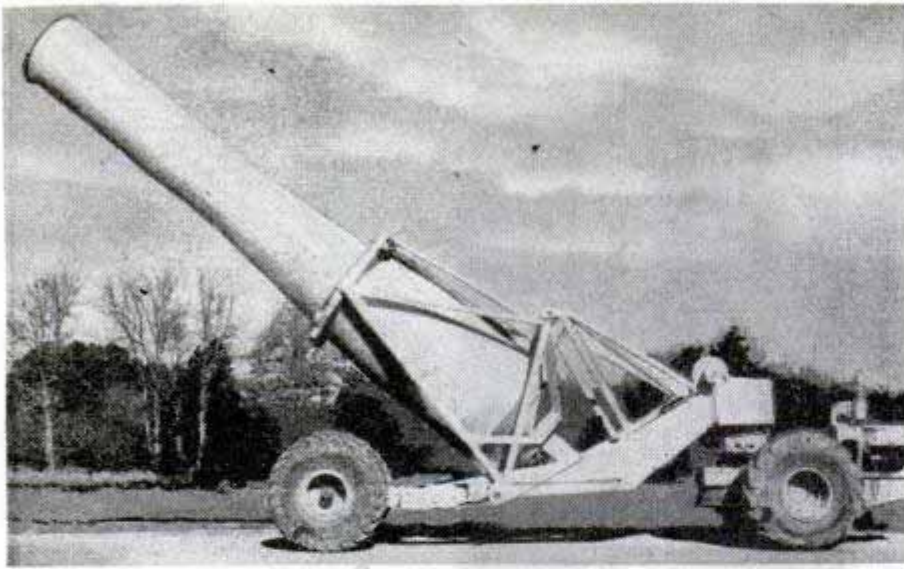

Giant Concrete Mixer

Mass production of concrete houses is speeded by a giant mixer which churns seven cubic yards of concrete en route to the pouring site and lifts the mixture to forms 20 feet or higher. The machine weighs 30,000 pounds and is nine feet wide and 45 feet long. It was designed by R. G. LeTourneau, Inc., to work with the Tournalayer, an enormous machine which "lays" concrete houses.

"Shooting" Buoy Recovers Tackle

Safety floats that can be attached to fishing rods, tackle boxes and other items of value permit the fisherman to recover his equipment if it is dropped overboard accidentally. The float is two inches long and can be screwed to the handle of a fishing rod or snapped on other equipment. If the article disappears over the side, water penetrates the little cylinder and in three to seven minutes causes a chemical reaction which breaks open a cartridge. One end of the cartridge remains attached to the article and the other end forms a buoy which is thrust upward by water-generated carbon dioxide with sufficient force to penetrate weeds. As the buoy ascends, a reel of 30-pound tensile strength Nylon line unwinds, one end of which is attached to the article

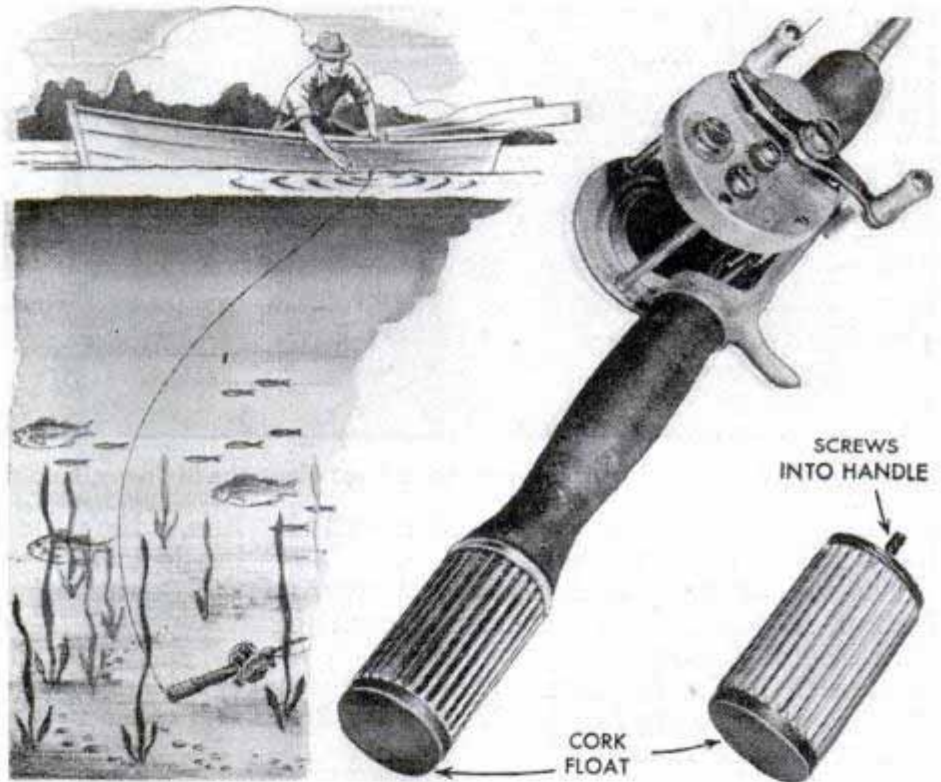

and the other to the buoy. When the buoy reaches the surface a dye is discharged to mark its location. The article is recovered by hauling in the line. A larger model for outboard motors releases two 65-pound-test Nylon lines.

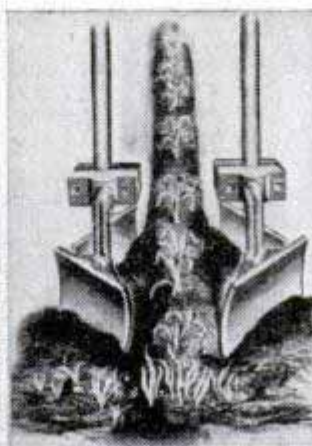
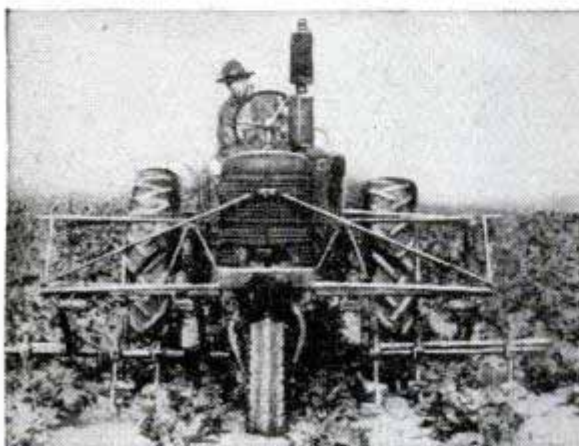

Weed Snatcher

Twin pairs of "shoes" attached to any cultivator kill the weeds between rows. The four shoes are attached in place of two cultivator teeth working next to the crop row. The front shoes push crusted soil and weeds away from the row and the deep-set rear shoes deposit moist soil along the rows.



U. S. Navy photos

BANSHEE IS NAVY'S "MOST POWERFUL" FIGHTER

World's most powerful carrier-based fighter is the Navy's description of the new turbo-jet Banshee. Top speed is still a secret, but they admit it exceeds 600 miles an hour fully armed and climbs more than 9000 feet a minute.

The Banshee lands at 70 miles an hour, close to the lowest speed of wartime ship-board fighters, and takes off in a short run with virtually no warm-up. It demonstrated exceptional "wave off" qualities, vital to carrier operation, almost touching down with flaps and landing gear fully extended before taking the signal to gun the engines and fly away.

Though slightly heavier and larger, it closely resembles the Phantom, also built for the Navy by McDonnell Aircraft. Principal difference and key to its high performance are two Westinghouse 24-C Yankee engines. They are axial-flow type, with the air never changing direction of flow from the time it enters at the front until it streams out with a powerful push at the rear.

The two engines turn up the equivalent of more than 5500 horsepower, where 2000 horsepower was about tops for fighters two years ago. Lindbergh eked 200 "horses" out of his then remarkable power plant, in flying to Paris 20 years ago.

Another carrier asset of

the new twin jet is "kneeling," which makes room for about 50 percent more planes on deck. In kneeling, the nose wheel is electrically retracted, as it is in flight, until the bowing plane rests on a caster attached to the underside of the nose tip. The tail is then so high that adjacent aircraft can be moved up beneath it for stowage.

The Banshee's service designation will be XF2D-1. Its stub-end wings spread 41 feet opened and 18 feet folded for deck storage. The plane is 39 feet long. The pilot sits forward of the wings and his head is above the fuselage, giving good visibility.

Since jets are efficient only at or above 85 percent of full power, a single unit is recommended for cruising, rather than using both at reduced power. The engines are close together at the wing roots, so there is little yaw when only one operates.

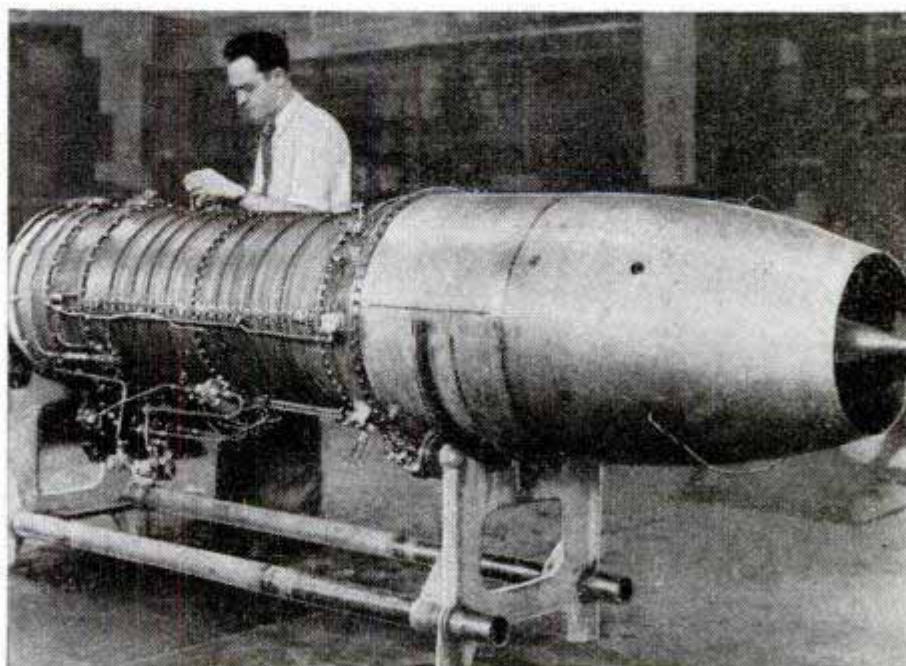

From two of these Westinghouse 24-C jets comes the Banshee's over 600-mile-an-hour speed

LANDING FIELD ON A RAIL CAR

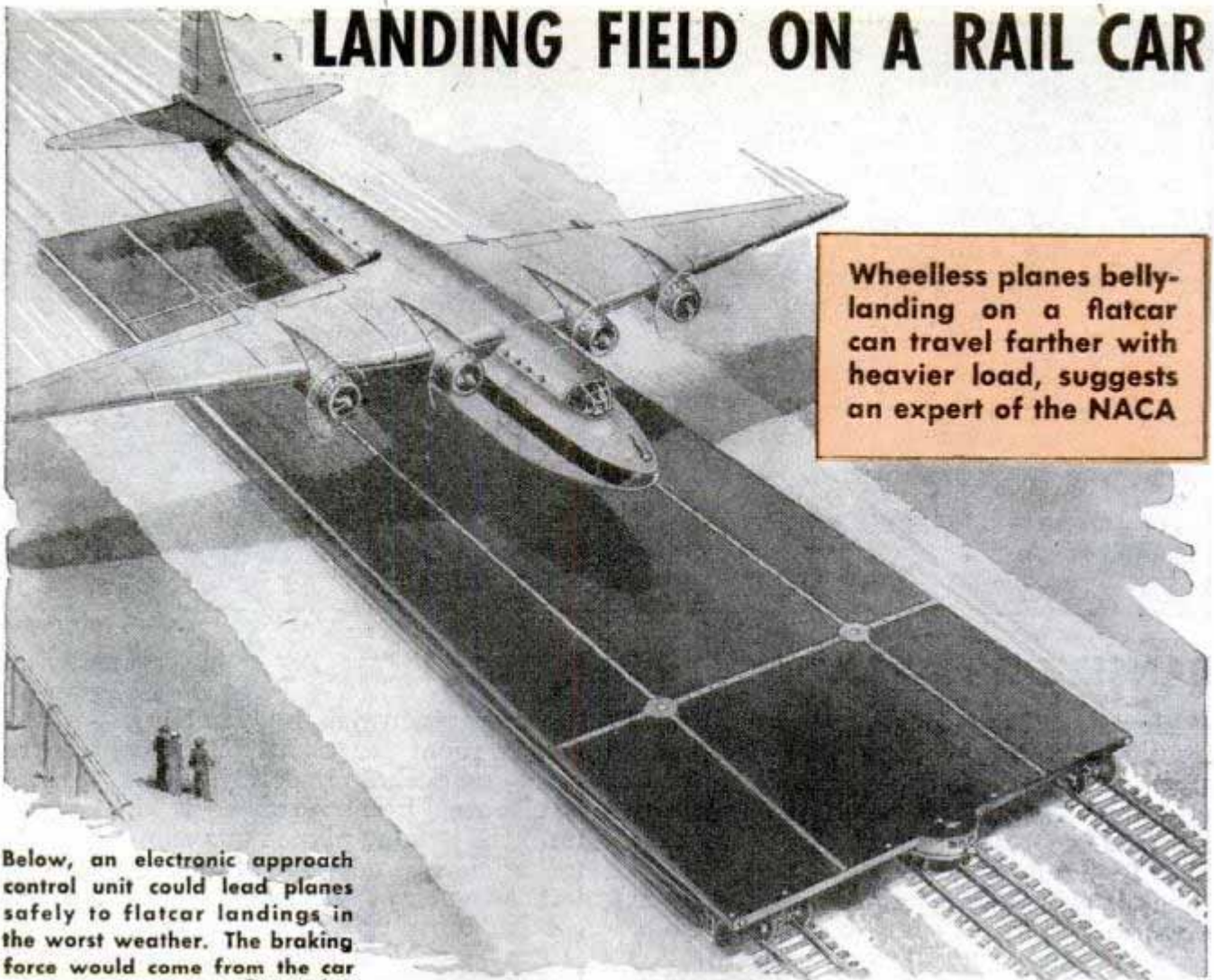

Wheelless planes belly-landing on a flatcar can travel farther with heavier load, suggests an expert of the NACA

Below, an electronic approach control unit could lead planes safely to flatcar landings in the worst weather. The braking force would come from the car
Sperry photo

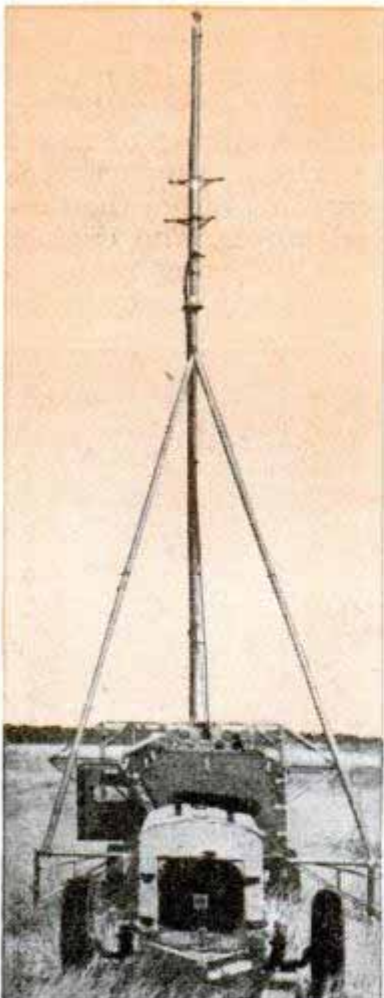

Air liners can carry an extra 5000 pounds or more, in the same size plane, if designers produce a substitute for landing gear. Many believe landings on railway flatcars or moving belts are the best, and safest, answer.

Engineers like Lewis A. Rodert of the National Advisory Committee for Aeronautics say it's the only way the industry can keep up with the trend to faster and longer flights. On present planes the gear is about a tenth of the gross weight—a stiff penalty in pay-load dollars and cents for equipment used only a few minutes during each trip. Other than those few useful moments, the gear is operational dead weight.

Rail launchings aren't new. Along with declined runways, catapults and a cable attached to a falling weight, they were used during the Wright brothers' era. Glider pickups, the Electropult and jato, of course, are comparatively recent developments.

Rodert suggests substitution of high-wing monoplanes, with strong, flat fuselage bottoms, suitable not only for belly landings but for protecting passengers and cargo in emergencies. The high-wing design would keep the power plants, jet or piston, safely clear of the landing surface.

In landings the plane would follow the radio range and glide path control equipment to "home" on the fast-moving car, started automatically by the plane passing over a range beacon. The engines would be manually or automatically adjusted to hold a constant air speed until the plane was arrested by the landing platform. All the braking effort, shock absorption and arresting gear would be contained in the car.

The single-direction railway, in contrast to the multidirec-



tional runways now required, would operate from either end. A large enough yaw angle would be furnished by the arresting gear between the plane's longitudinal axis and the car's direction to compensate for the wind. Launching would be accomplished by accelerating the car and releasing the plane at climbing speed.

Use of flat-bottomed planes would also eliminate the hazards and problems of failures in the complicated landing gear system. Today's planes, not built for emergency belly landings, are generally badly damaged when forced to resort to one.

Another solution suggested would utilize a series of high-speed moving belts, running at ground level and separated by rollers. The belts would operate in sections to make repair and maintenance simpler. Constant movement would keep them free of snow and ice in even the worst weather.



Landing gear is about tenth of plane's weight. On a B-35 it amounts to 12,000 pounds

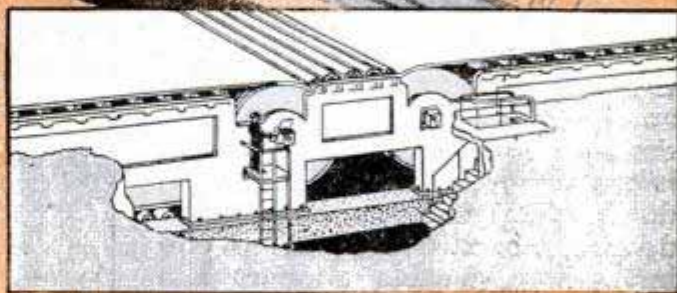
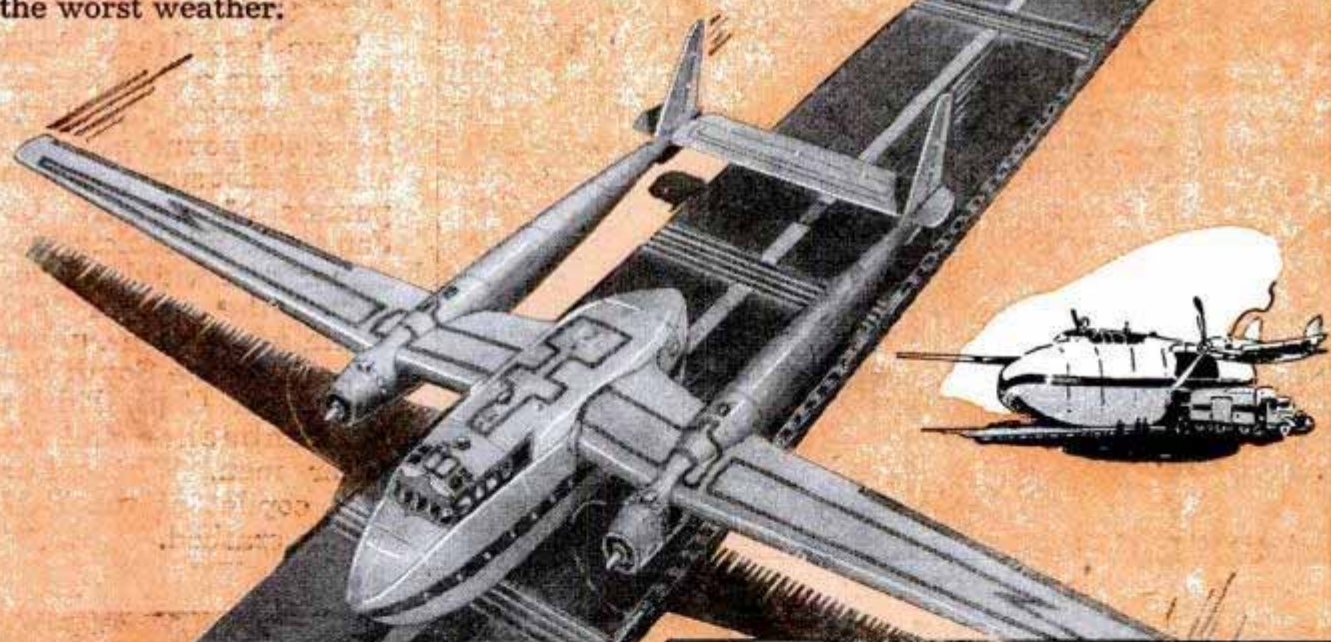

For ease of maintenance and repair, the speeding belts would be in sections. The surface would always be free of snow and ice in bad weather



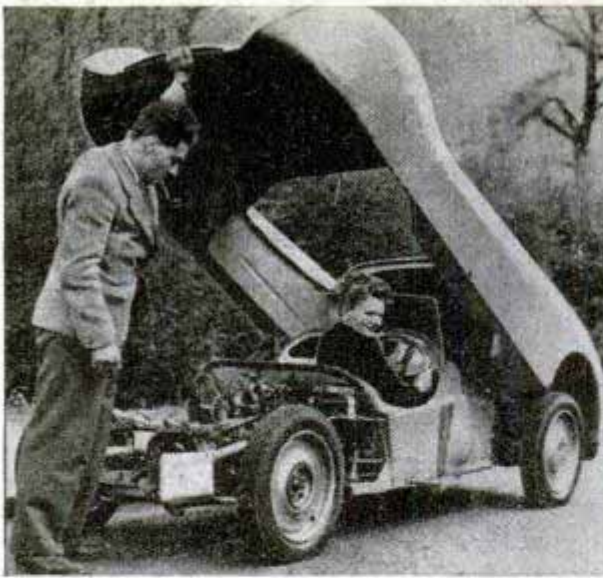

MIDGET CAR HAS LIGHTWEIGHT ONE-PIECE BODY

Hinged at the front, the lightweight one-piece body of a small streamlined English car is lifted easily by Charles Cooper, the designer, who built the auto during his spare time. With a five-horsepower engine

mounted at the rear, the car can go 70 miles an hour and travel 65 miles on a gallon of gas at moderate speeds. Cooper, who lives at Surbiton, England, believes the car could be marketed for less than \$1000.



Fuel-Tank Sea Raft

Two auxiliary fuel tanks from a P-38 fighter plane provide the floats for a 400-pound pleasure sea raft that supports 2600 pounds of weight. Lt. James C. Whittaker, designer and builder, conceived the raft in 1942 while adrift in a rubber life raft in the South Pacific with Capt. Eddie Rickenbacker and six other men. Whittaker was copilot of the B-17 which crashed.

'Bachelor' Home on Wheels

Complete housekeeping facilities for one person are provided by an eight-foot trailer weighing under 800 pounds. It has a full-length bed, galley, ice chest, sliding windows with screens, and a Dutch door. The headroom is six feet one inch. Two wheels support the trailer, which is easily maneuvered behind a car.

☐ Removal of paint from spray booths is made easier by applying a special coating to booth walls before painting, the entire coat being readily peeled off afterward.



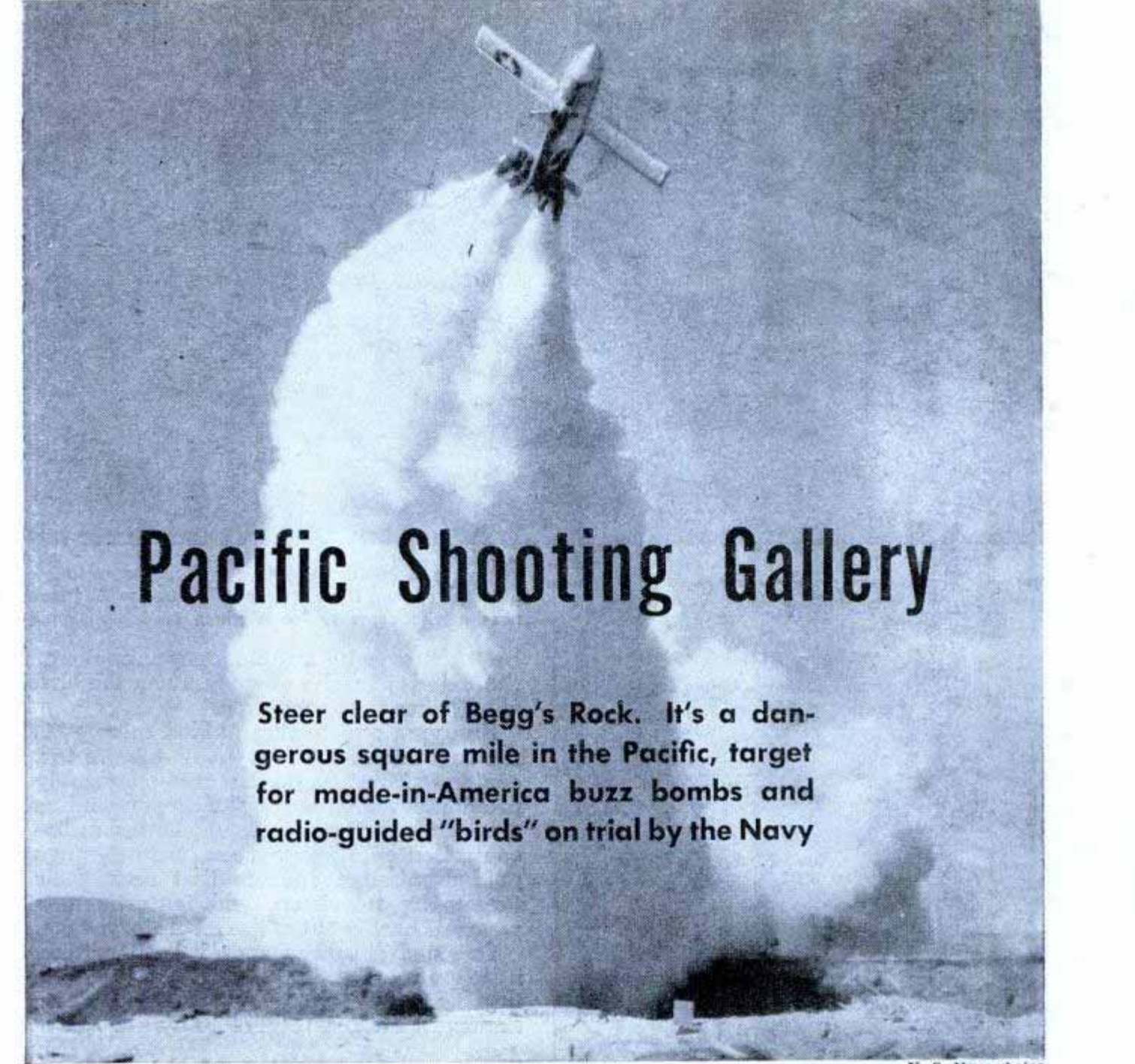

Pacific Shooting Gallery

Steer clear of Begg's Rock. It's a dangerous square mile in the Pacific, target for made-in-America buzz bombs and radio-guided "birds" on trial by the Navy

U. S. Navy photos

Blast of the four rockets, lasting less than two seconds, carries Loon 50 miles out over the ocean

INSIDE THE COMBAT information center at

By Thomas E. Stimson, Jr.

Point Mugu, Calif., you focus your attention on a green pip of light traveling slowly back and forth across the translucent radar screen before you.

"That's the P-80," the Navy commander at your elbow explains. "The pilot is waiting for the Loon to be fired, then he will chase it. He has orders to shoot it down if it runs wild."

A steady roaring noise commences outside the building and is quickly lost in a giant swish of sound.

"The bird is on its way," reports a technician with earphones sitting at a charting table. On the radar screen are two pips of light, the bird and the P-80, moving steadily toward the southwest. As you watch,

the leading pip begins to veer off to the south.

Hastily the commander reaches for his radio control box, dials a number, and holds down a switch for a moment. The pip moves back on course.

"Could have been a strong gust of wind that threw the bird off," he says. "To bring it back on course I dial the amount of turn required and then press the 'left' or 'right' switch to indicate the direction of turn. All the commands go by radio to an automatic pilot on the bird.

"Its altitude is preset and is controlled by a gyro. This other switch on the control box is the dive switch, for diving the missile into its target. We won't use it on this flight because the target is beyond the range of this particular radar. Control will

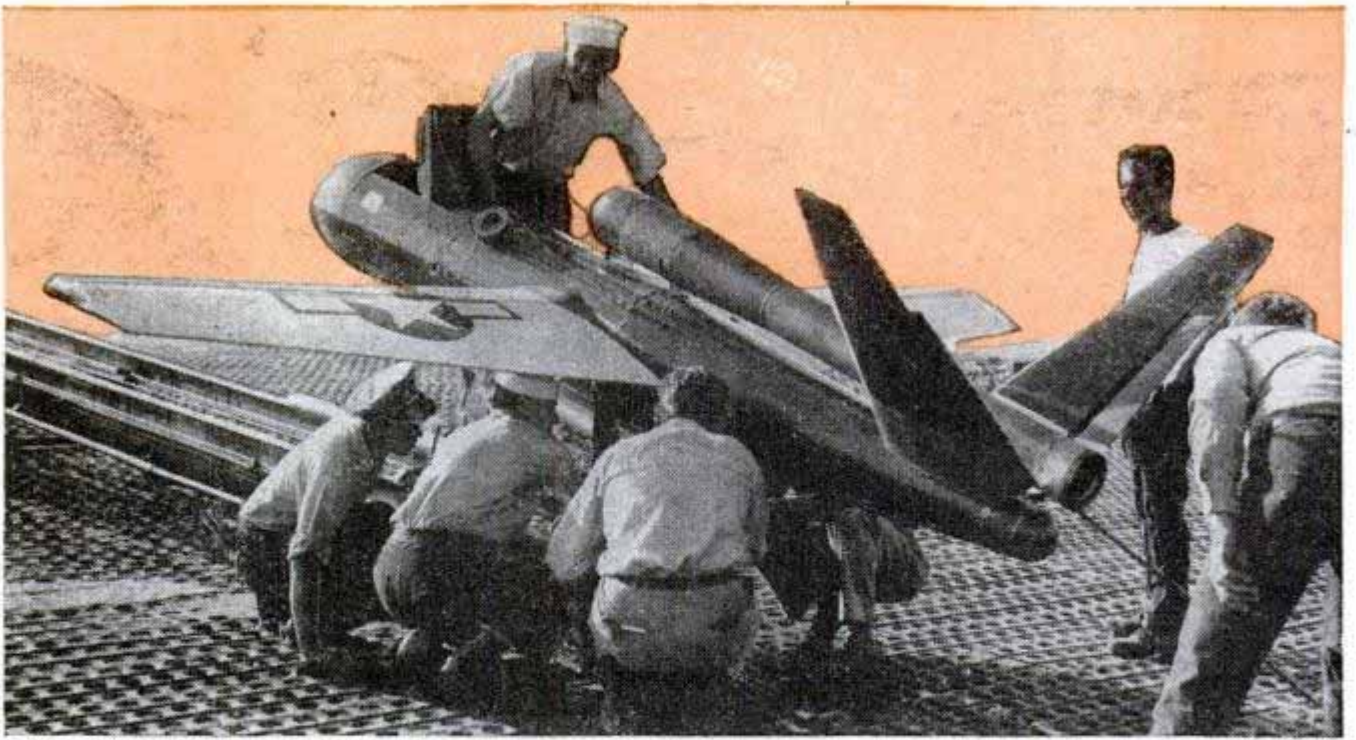

Preparing to launch small target plane, powered by pulse jet engine, from a gunpowder catapult. Open nose carries chute to lower plane on radio signal

be taken over by a radio station on one of the islands 50 miles offshore when the bird approaches the target area."

Studying and testing guided missiles is the function of the Navy's air-missile test center at Point Mugu. Located on a sandy promontory 50 miles up the coast from Los Angeles, the test center evaluates radio-controlled pilotless aircraft, long-range guided missiles, rockets that seek their targets by television, and fantastic new weapons hardly out of the laboratory stage.

One such future weapon is the Neptune, a 235-mile rocket that is expected to get its first tests next June here and at White Sands, N. Mex. A total of 10 will be deliv-

Missile's path is observed on round radar screen and corrections made by means of control panel at left. Lower left, radar feeds data on the flight of the "bird" to a plotting table. Below, interior of a concrete blockhouse from which firing is controlled



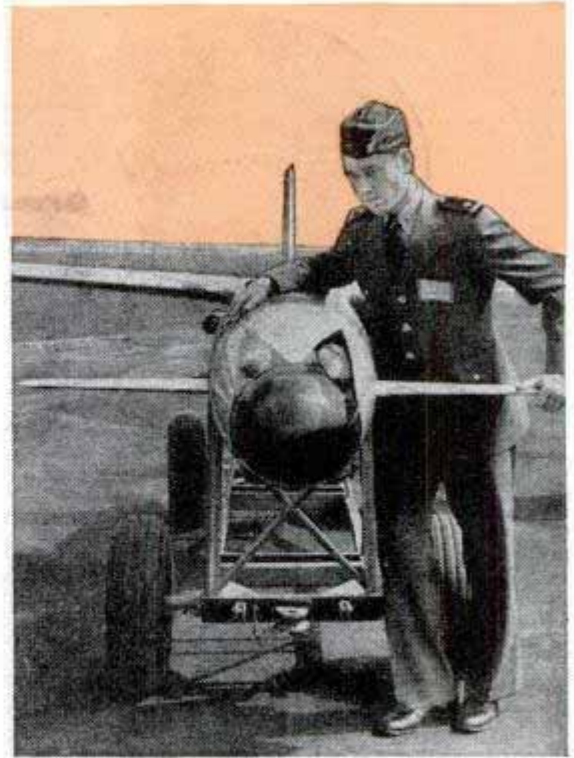
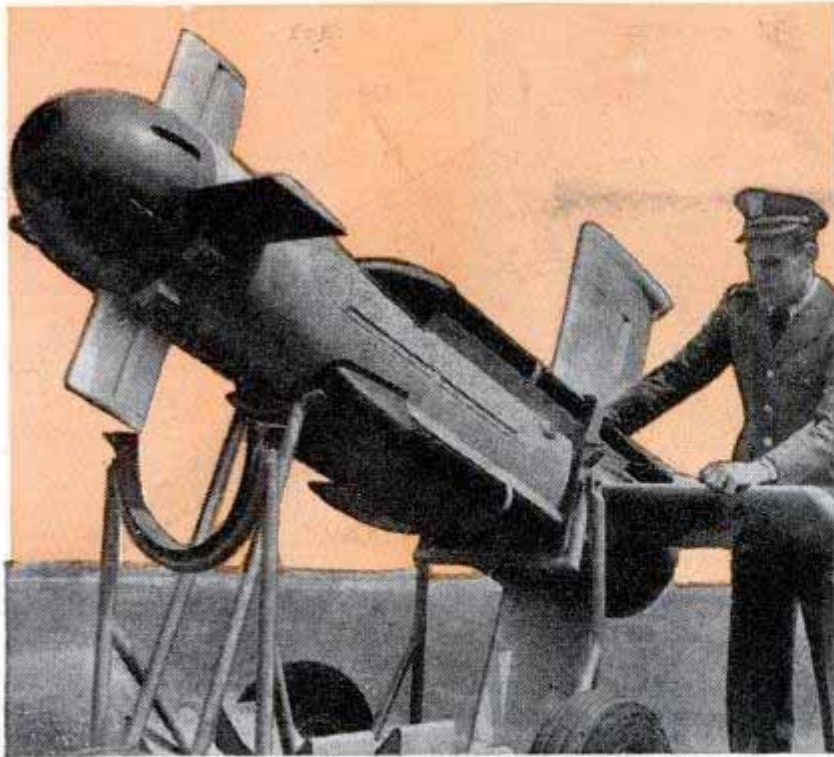

Checking antenna attached to tail of Little Joe, a radio-controlled rocket missile. Oblong window in the nose of Gorgon, upper right and below, allows it to "home" on target after being launched from plane

ered by 1951. The largest rocket which could conveniently be fired from a ship, it will be 45 feet long and carry up to 2000 pounds of measuring instruments. Span across the fins will be 98 inches. Much slenderer than the German V-2 and about a third its weight, the Neptune will be launched from a vertical position.

The stabilization problem is handled by mounting the engine in gimbals, with a gyro guiding changes in direction of thrust. This saves weight, increases thrust for the fuel used and is expected to lengthen the rocket's burning time to 75 seconds, eight seconds longer than the V-2. The engine, fueled with oxygen and alcohol, is being built by Reaction Motors to produce approximately 200,000 pounds thrust for its brief flight.

The program is intended to provide basic knowledge and techniques that will be needed if and when the world ever engages in push-button warfare. More specifically, Navy technicians are studying air-to-air, air-to-ship, ship-to-air, and other special purpose missiles. They are seeking for each type the best kind of launching system, air frame, propulsion unit, and guidance system. Propulsion motors in the sonic, trans-sonic, and supersonic ranges are or will be studied.

Guidance is a big problem all by itself. Among the various systems are the preset mechanisms such as steered the German V-1 and V-2 missiles, target-seeking devices such as direct the Bat glide bomb on a collision course with its target, the com-

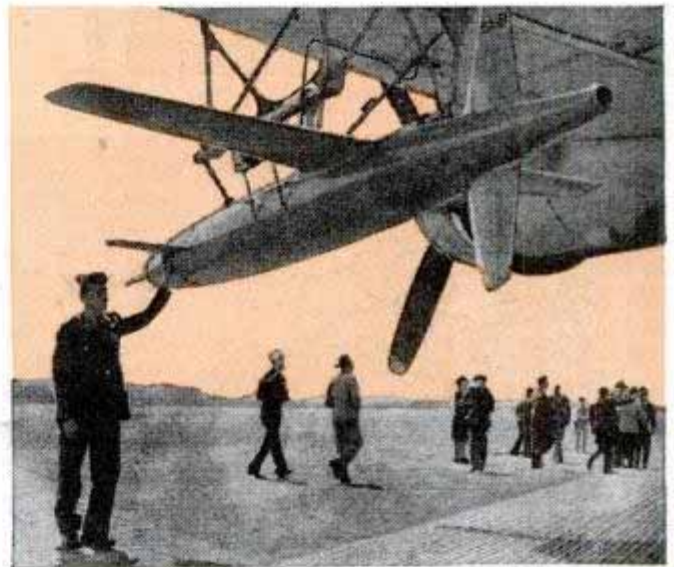

mand system by which radio impulses or other signals are used to control the missile during flight, and the course-seeking system by which a beam of light or radio energy is pointed at the target and along which the missile flies until it hits the target. More than one of these guidance systems can be used with the same missile.

As an "impact area" for this research the Navy uses an area of water, roughly fan-shaped, that extends 80 miles out into the Pacific from Point Mugu. No suitable test range of the desired length could be found ashore. The specific target for most of the long-range missiles is the square mile of ocean that surrounds Begg's Rock, a tiny pinnacle that rises out of the water more than 50 miles offshore. Radar stations on the mountain peaks behind Point Mugu and on several offshore islands are used for watching the missiles while in the air.

When a "bird" is scheduled to be fired,

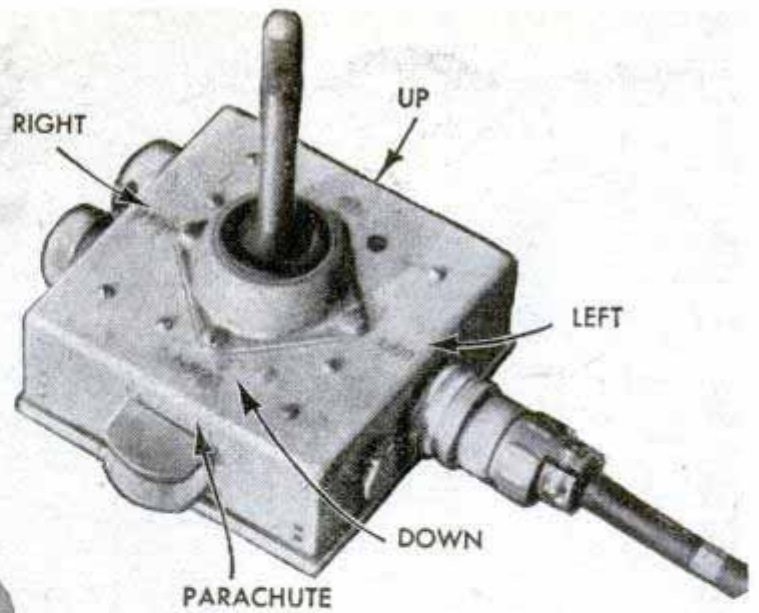

"Pilot" on ground maneuvers target plane by means of radio impulses from control box in his hand to receiver in plane, which in turn operates automatic pilot. Below, the Pacific shooting gallery and the Begg's Rock target

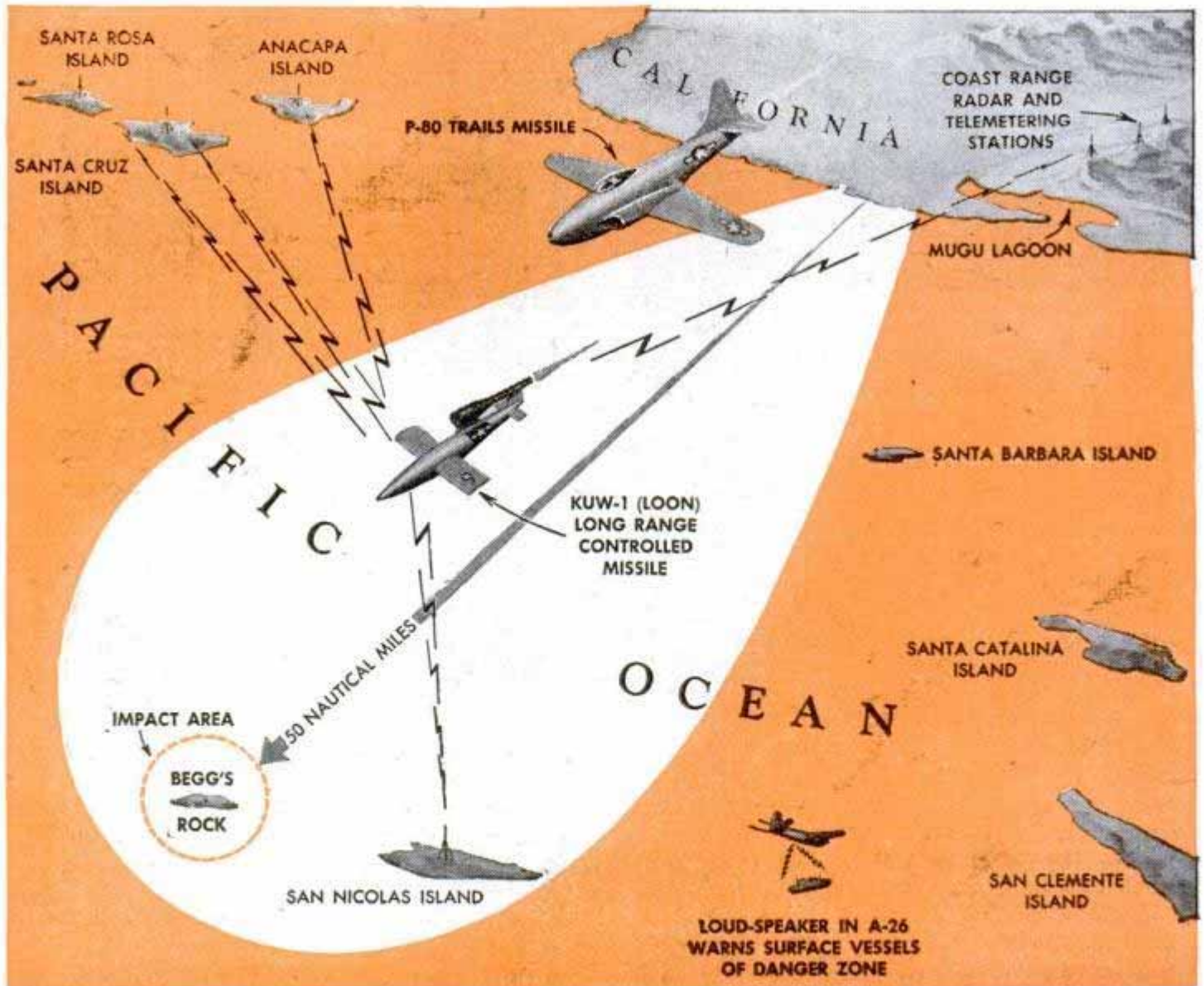

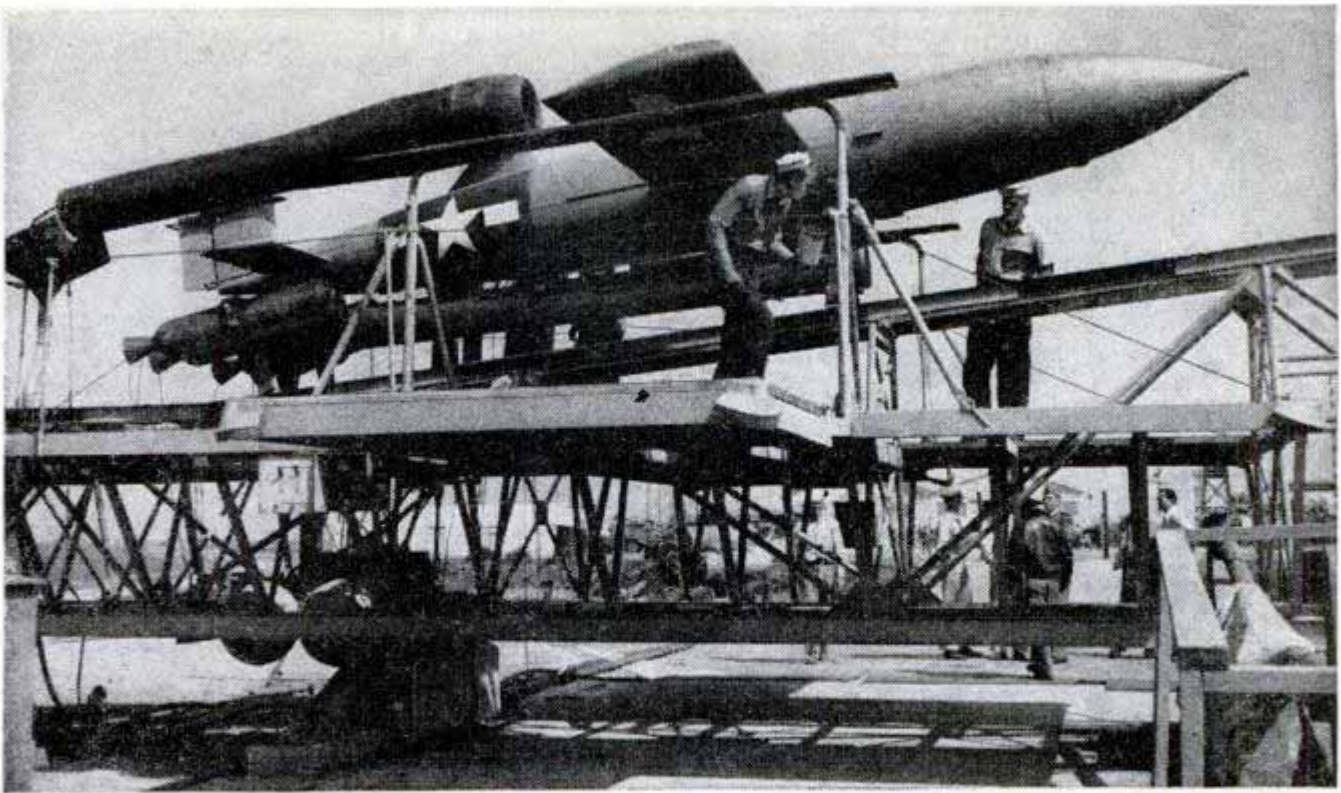

From rocket take-off, above, the Loon gets an impetus of only seven Gs, against 18 from gun-powder catapult. Right, view of four rocket motors below tail

radio warnings are first broadcast to ships and fishing vessels that might be in the area, then radar searches for any vessels that might not have heard the warnings. A patrol plane with a loud-speaker pointing down from its tail is sent to any such ship to warn it to get clear.

Each long-range missile is observed all through its flight by the pilot of the P-80 chaser plane and in addition is tracked by the chain of radar stations. At the same time, instruments inside the missile continuously measure its roll, yaw, pitch, the performance of its various parts, and other data, and transmit this information by telemeter radio to the ground stations.

One of the most useful long-range birds for carrying on some kinds of research is the stub-winged V-1 buzz bomb that is powered by a pulse jet engine. An American version of this German weapon was built in large numbers in the United States during the latter part of the war and some of these are now used as research vehicles.

Designated by the Navy as the KUV-1 and nicknamed the Loon, the improved V-1 missiles have a range of more than 150

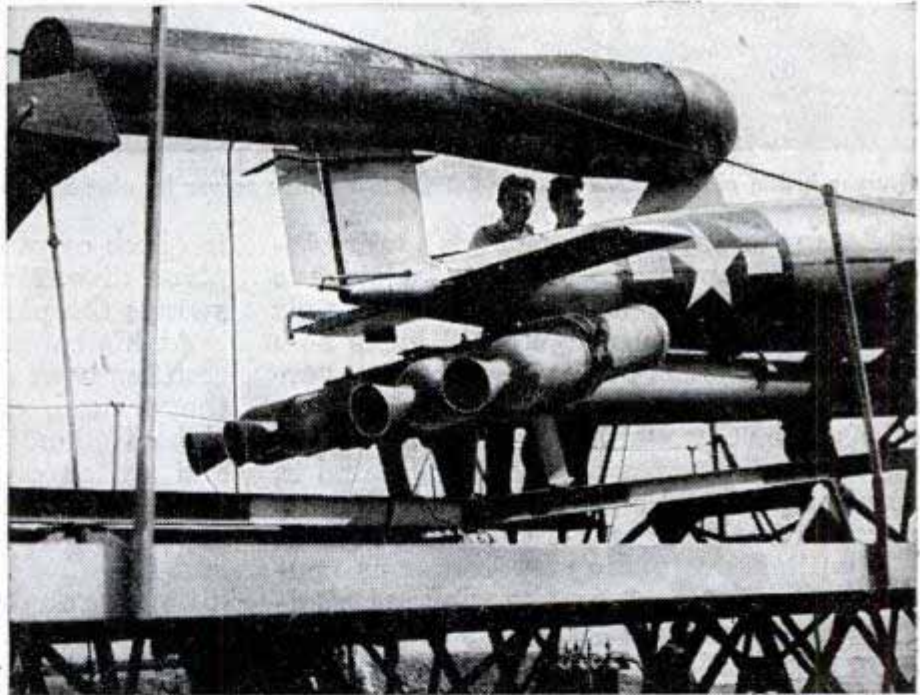

miles and a speed in excess of 425 miles per hour. Some are launched from the rails of a 150-foot catapult, the powder charges of which impose an acceleration of 18 Gs on the Loon and build up its speed to 260 miles per hour by the time it leaves the rails.

Other Loons are fired by means of a launching carriage or sled to which are attached four large rocket motors. The rockets drive the sled and Loon up into the air with a force of 7 Gs, then when the motors burn out the sled falls free and the Loon continues on its way.

Smaller missiles that are being studied at Point Mugu include Little Joe, a ship-launched radio-controlled rocket of 2-mile



Gauges inside plane record results of flight test under power by nine-inch pulse jet engine below the fuselage

range for use against suicide planes or other missiles, the radio-controlled Gargoyle for air-to-ground use, and the air-to-air Gorgon that has a range of 12 miles at a speed of 500 miles per hour. Improved versions of the Bat glide bomb are being tested, as is the German X-4 anti-aircraft rocket that trails $3\frac{1}{2}$ miles of fine wire behind it, receiving control signals over the wire as a way of avoiding jamming of radio signals.

Simultaneously the test center is conducting research on a wide range of pilotless target aircraft. These small drones have a wing span of around 10 feet. All are controlled by radio from the ground. They are used as targets by anti-aircraft gunners and also for the testing of new radio control systems for pilotless aircraft or missiles. Some are powered by conventional gasoline engines, some by pulse jets. Some can fly at the rate of 240 miles per hour, climb 25,000 feet, and remain aloft for more than an hour.

Radio control of the drones has been perfected to the point where the "pilot," standing on the ground, maneuvers one of the craft with as much dexterity as if he actually had his hands on the plane's controls. Holding a small control box from which protrudes a switch handle similar to the control stick of an airplane, the pilot pulls back on the stick to cause the drone

to climb or pushes it forward to make the plane dive. Moving the stick left or right swings the plane in the desired direction.

At his command the plane loops, spins, shuttles back and forth only a few feet off the ground, or climbs practically out of sight. He lands the plane by tripping a special switch on the side of the box. This switch sends out the radio impulse that pops open a hatch in the plane's fuselage and frees its parachute, at the same time killing its engine. The plane floats down to a slow landing.

Push-button warfare is still in the future. "We are not yet ready to push the button," remarks Captain A. B. Scoles, director of tests at Point Mugu, "but we are doing everything possible to wire up the button so that if the occasion arises, our buzz will be just as loud and just as effective as the other fellow's."

Chemical Coating Insulates Exhaust Pipes

Fire danger from hot exhaust pipes is lessened by a chemical coating which kills 90 percent of the visible red glow and invisible infrared radiation. The coating, made from oxides of calcium, titanium and antimony, is the outgrowth of wartime research to develop a material to black out the red glow created by bomber exhaust pipes.

Shield for Motorcycle Rolls Into Cylinder

Lowered or raised like a window shade, a new motorcycle windshield gives a rider protection in any kind of weather. When raised for rain or cold weather the shield is rigidly reinforced by two steel uprights. The waterproof curtain rolls into a small chromium-plated container which fits on the handle bars.

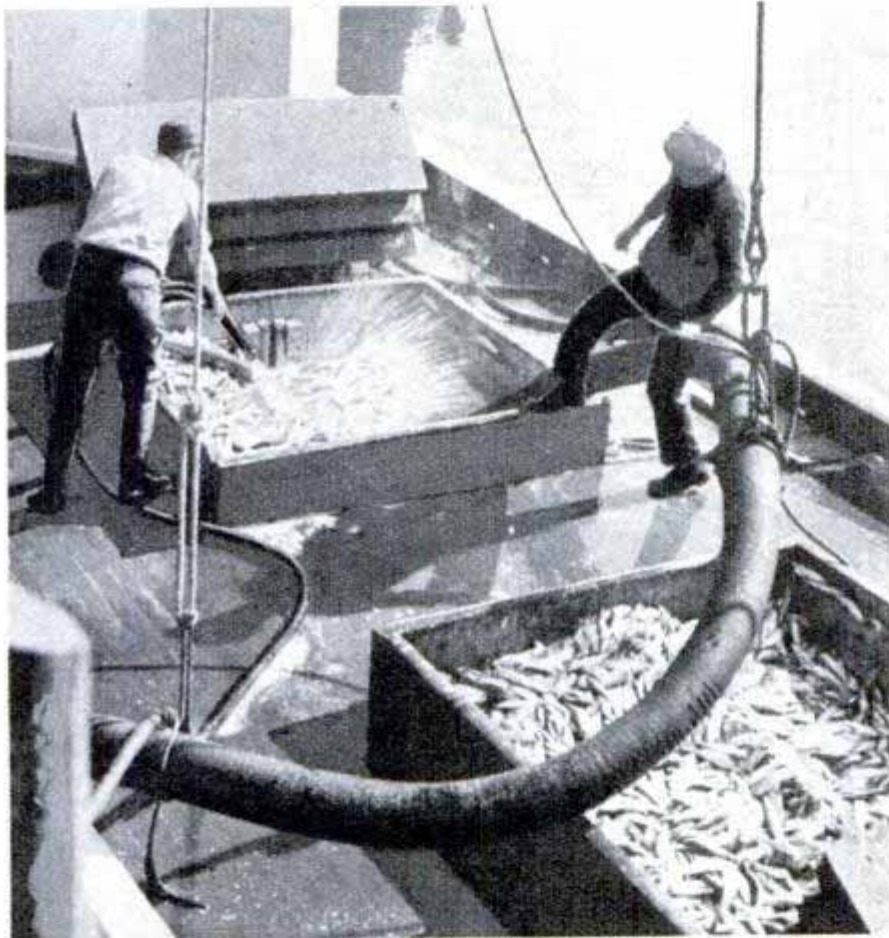
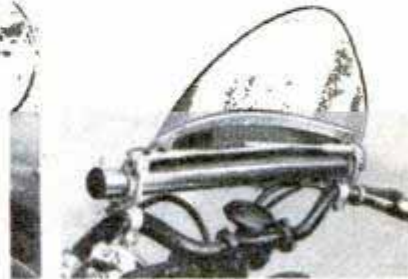
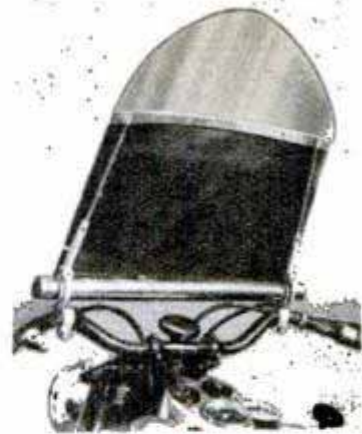
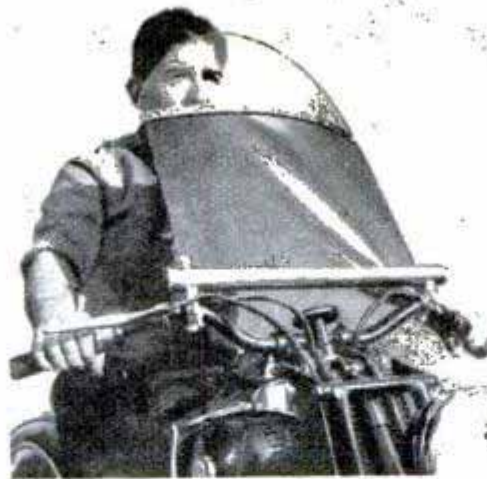

Hose Transfers Fish From Boats to Tanks

Fish are transferred from boats to a Maine cannery through a six-inch rubber hose. To prevent injury, the fish are floated in water pumped through the hose into a 12-inch pipe that discharges them into storage tanks. By this method, fish can be handled at the rate of 2500 pounds per minute, six times as fast as by conventional methods of unloading.

Stools of Dinette Set Slide Beneath Table

To economize on space in her kitchen, an Australian woman designed a dinette set with stools that can be stored beneath the table when not in use. The stools, which are made with tubular legs and wooden seats, slide into slots under the table top. The table is equipped with casters so it can be shoved into a corner to save even more space in the kitchen.

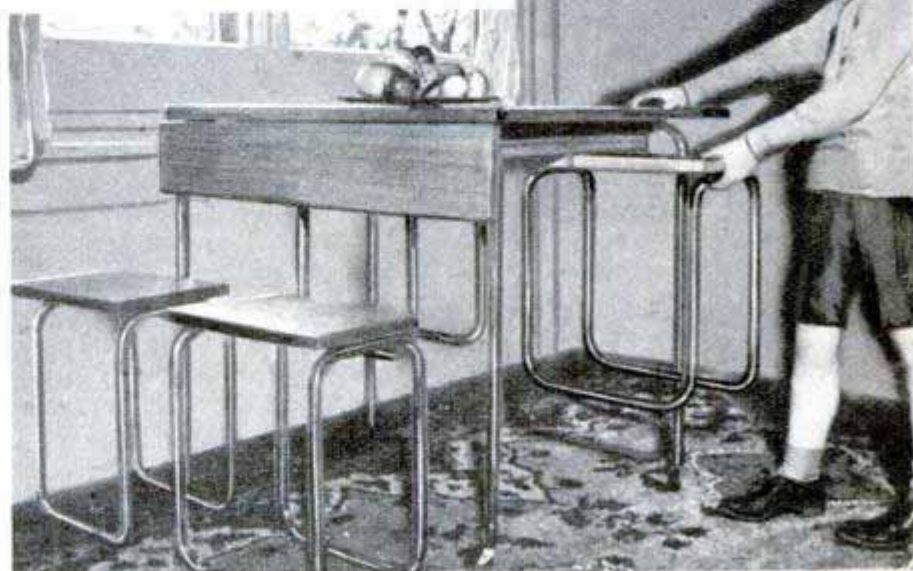

Uncle Sam's

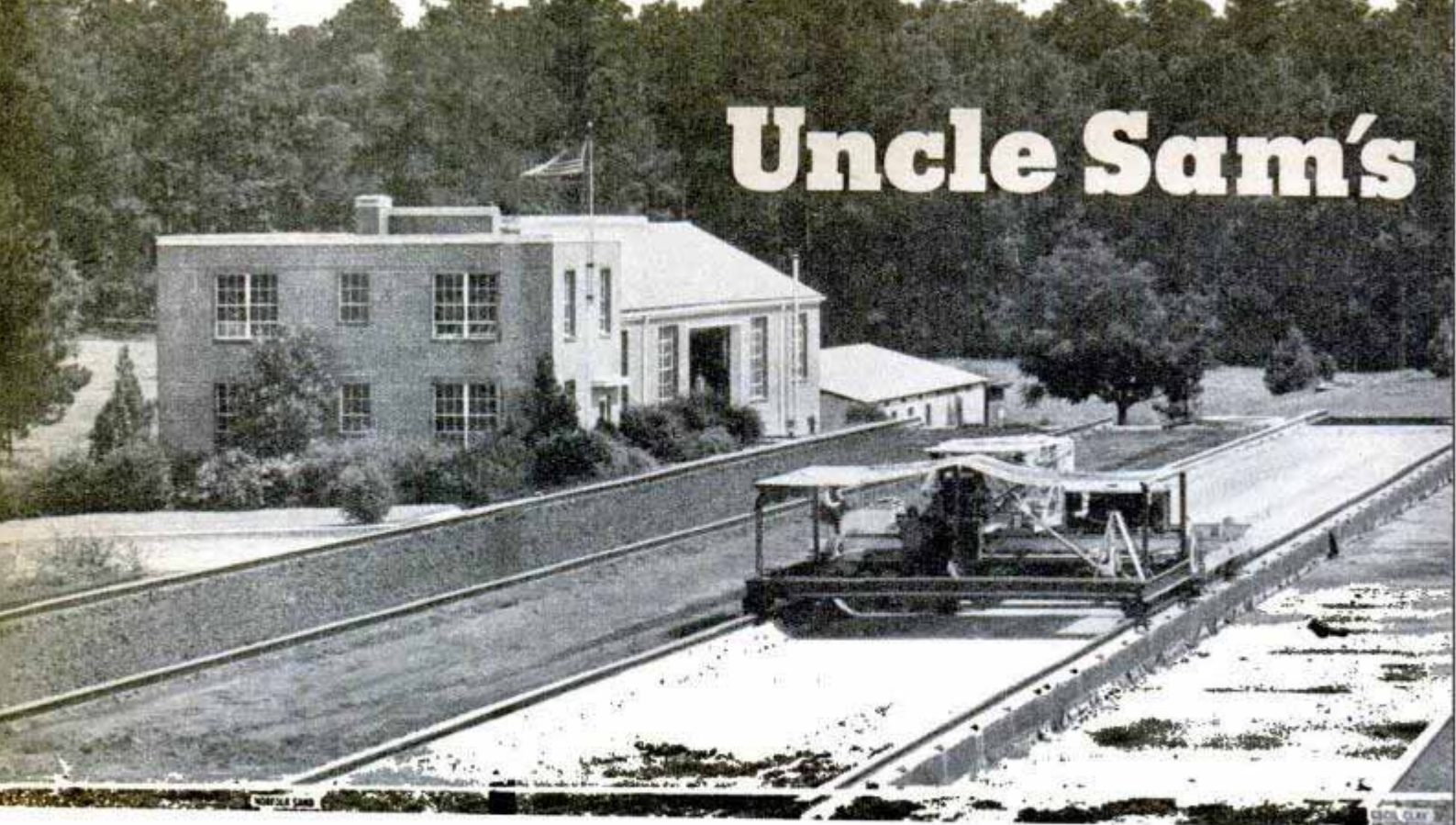

On homemade plots of soil at Auburn, Ala., government scientists put to trial tillage implements for U. S. farms

By Wayne Whittaker



DOWN in Auburn, Ala., people come from miles around to see the U. S. government's \$20,000 "mule." This mechanized mule, the only one of its kind in existence, performs its wonders—naturally enough—on a proving ground for farm machinery which is the only one of its kind in the world.

Before the war Germany had a similar laboratory on a small scale which worked with models. The Auburn Tillage Machinery Laboratory operated by the Department of Agriculture is believed to be the only full-size institution of its kind ever built, according to I. F. Reed, senior engineer and director of operations at Auburn.

The high-priced mule, nicknamed Twenty Grand, is used for testing equipment over specially prepared beds of soil. It is a power car driven by a 135-horsepower engine and has a speed variation from .2 to 10 miles an hour with a drawbar load of 5000 pounds. A dynamometer on the car measures and records pull. The vertical and side loads of plow bottoms,

I. F. Reed, chief of Auburn lab, watches results of plow test on recorder as the \$20,000 "mule" pulls rail-mounted car

Plow Boys

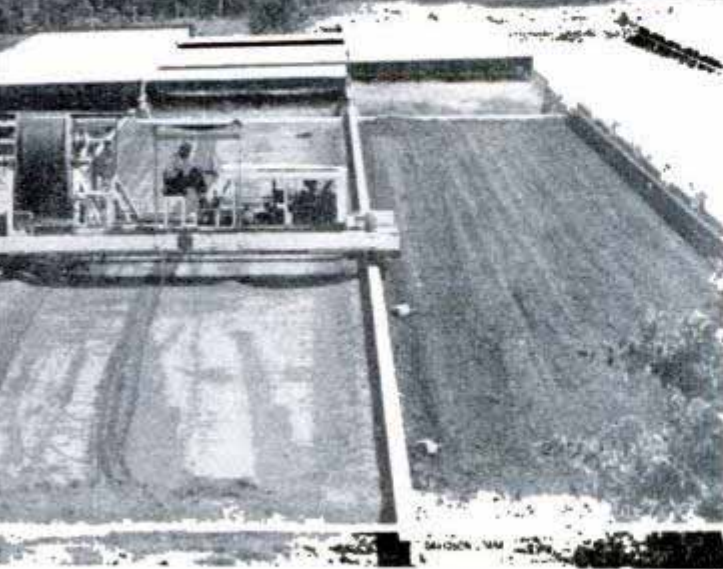

disks and other tillage implements are also recorded.

One Alabama native who had observed the constant activity at the lab for many months expressed concern over results.

"Seems like them gov'ment engineers just can't make up their minds," he said. "First they plow, then they disk, then they roll, then they sprinkle and roll once more. Then just like as not they plow the whole place up again and start from scratch. Nothing ever has a chance to come up!"

That's where the observer is all wrong. The things that "come up" in those harassed soil beds are helping find the answers to such pertinent questions as: How do different plow designs affect different types of soil? How do the various tilling methods affect the soil? What effects do tool design, speed of operation and soil conditions have on tractor requirements? What new tillage tools will help the farmer do a better job?

The experts have tried for years to find the answers with field tests. The results have been unsatisfactory because of varying soils—even in the same field—and moisture conditions beyond control. For the first time, tests under rigidly controlled conditions of both the soil and the tools are being made at Auburn. Nine soil beds, each 20 by 250 feet and two feet in depth, are used in the tests. Two of the plots are divided to make four beds 20 by 125 feet, thus making room for 11 types of soil. Soils vary from heavy clay to light sand.

Rails are mounted on low walls between

Boon to tung nut growers, an experimental pickup machine was developed at lab. Closeup below shows how steel brushes kick nuts into spiral conveyor

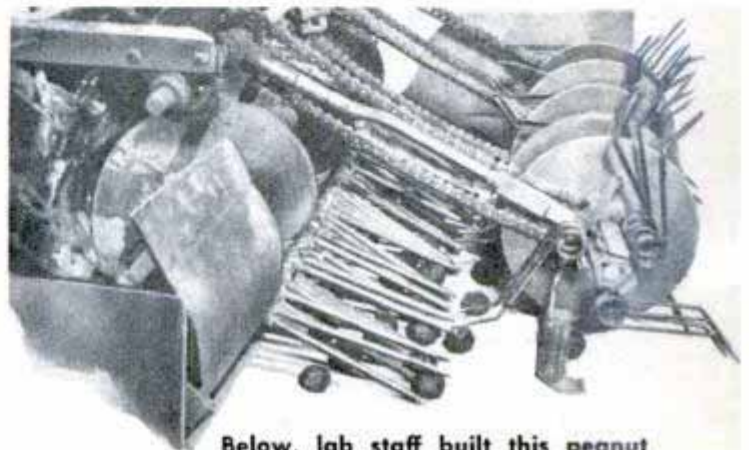
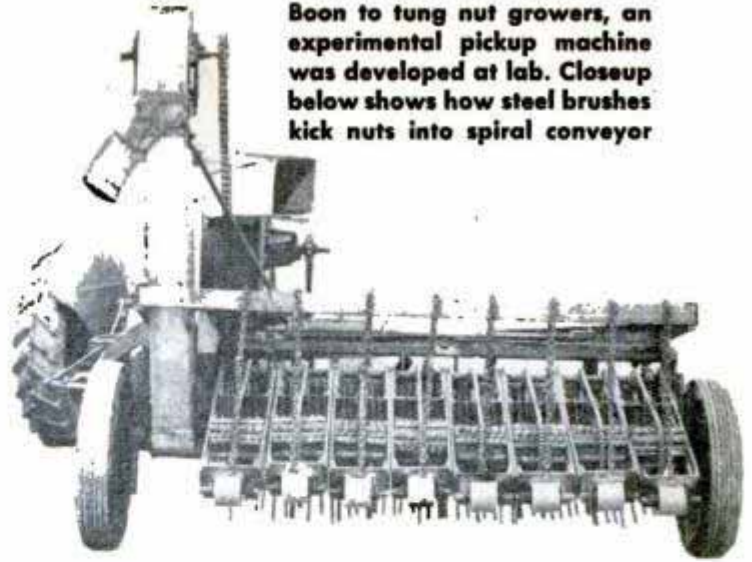

Below, lab staff built this peanut sheller—300 times faster than man

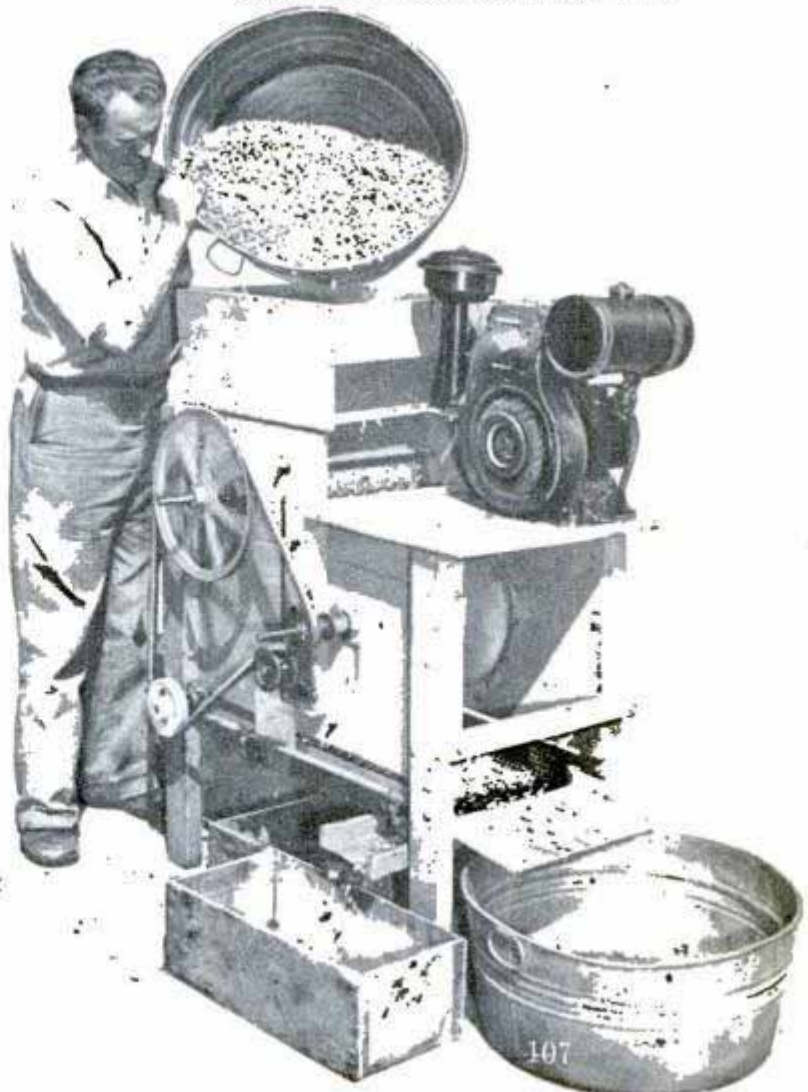

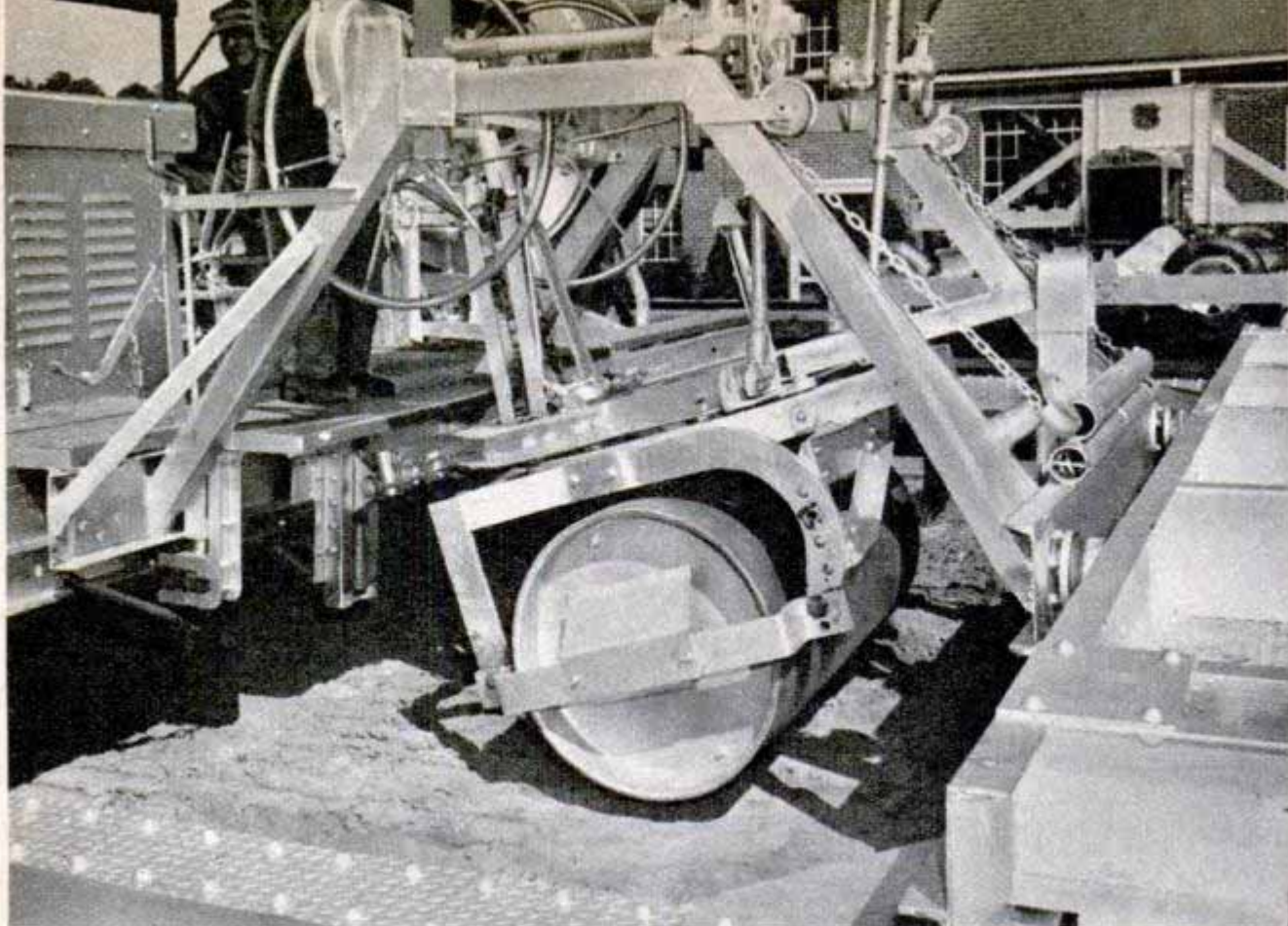

Soil-fitting car rolls soil bed before test; it also has grader, disk and subsurface packer attachments

the soil beds and over these rails ride the power car and a unit known as a soil-fitting car. The latter, powered by a truck motor, prepares the plots for the tests. Grader blade, disk unit and subsurface packer or roller are attached to this utility car. A sprinkling unit is mounted on top. The rails also support sheet metal "cover" cars which can be placed over any plot to protect it from the weather.

After the fitting car has done its prepara-

tory work, soil samples are taken to determine moisture content and soil texture. Then the car is rolled back out of the way with an ingenious switching arrangement and test equipment advanced over the plot. This equipment consists of two major units, the power car with dynamometer and the test unit car itself. During a test, only the tool being studied contacts the soil. While the power car measures pull, the test unit records the forces necessary to hold the tool being tested in working position. Loads are measured on six hydraulic cells strategically located to give complete support to the tool.

Mr. Reed and his staff have probably spent more time testing the plow—one of the earliest farm implements known to man—than any other tool. The major problem was to learn the effect on each type of soil of every plow design. Careful study of the breaking up of a fur-



Portable tung nut huller operated in orchard saves trucking to distant hulling plant. This machine is a laboratory "baby"

row slice has pointed the way to better designs to help a farmer bring a particular soil to its best planting condition.

Extensive tests have been conducted with tractors to compare the packing effect of rubber tires with that of steel lugs or track equipment. These tests indicate that rubber tires form a more compact layer of soil. Another tractor-plow test was concerned with determining the proper speed for best results. This was important to the designers of tractors and plowing equipment because the recent trend has been away from heavy, low-speed tractors to light, high-speed machines. Tests show that speeds should not advance much beyond four or five miles an hour to obtain the most economical results.

Leading farm machinery manufacturers bring newly designed tools to the laboratory for testing. One company saved a full year of field tests on an improved type of plow bottom using a simplified low-cost share by making use of laboratory facilities.

The laboratory staff not only tests tools designed by manufacturers but develops many implements which may be patented. These patents immediately become public property and the tools may be manufactured by any company. During the war, tillage operations were reduced in order that the staff might specialize on equipment for the production and harvest of oil-bearing crops. This has resulted in successful experimental models of a portable tung nut huller, castor bean huller, tung nut pickup machine, variable depth cotton seed planter, improved peanut sheller, and a peanut digger and shaker which leaves the plants in windrows.

All of these machines were built in the well-equipped laboratory ma-

Rubber belts on lab's peanut planter drop seeds evenly and close to the ground. Holes in Belt A catch nuts as they drop from hopper and Belt B made of soft rubber holds nuts in place until they

Dynamometer on test car measures and records pull up to 5000 lbs. Reed (foreground) watches recorder showing loads of plow bottom

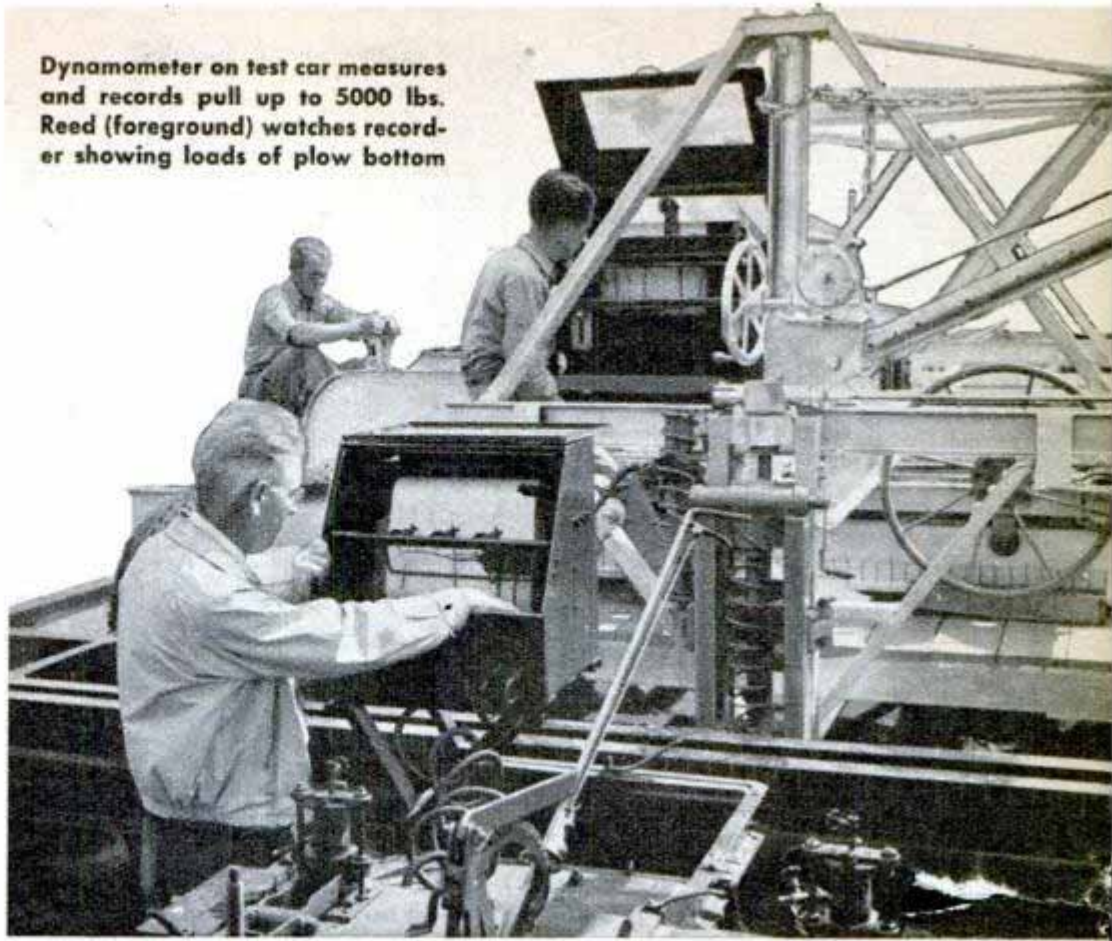

chine shop. Two of them — the tung nut huller and pickup—may prove a tremendous boon to one of America's newest industries. The production of tung oil, once imported from China in excess of 100,000,000 pounds a year, is now a \$10,000,000 industry in this country. This year the region along the Gulf Coast from Florida to Texas will produce about 20,000,000 pounds of the valuable oil. It is one of the fastest drying oils known and is in great demand by the paint and varnish industry. Tung oil is also used as a waterproofing agent for linoleum, transformers, electrodes, brick, masonry, and in a variety of inks.

The tung industry in this country has been hampered by the high cost of gathering the nuts and by the shortage of labor. The tung nut pickup which is pulled behind a tractor was developed largely by R. E.

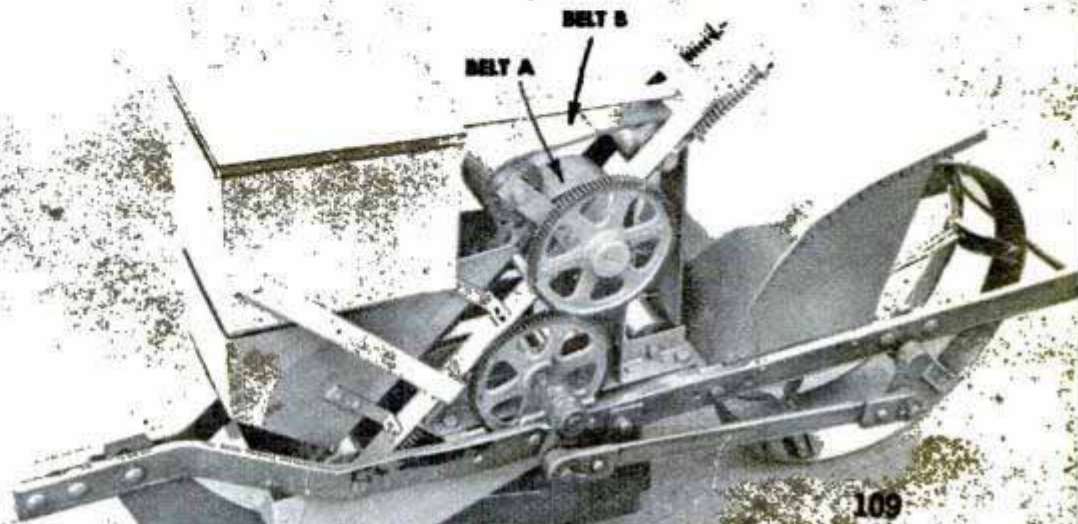

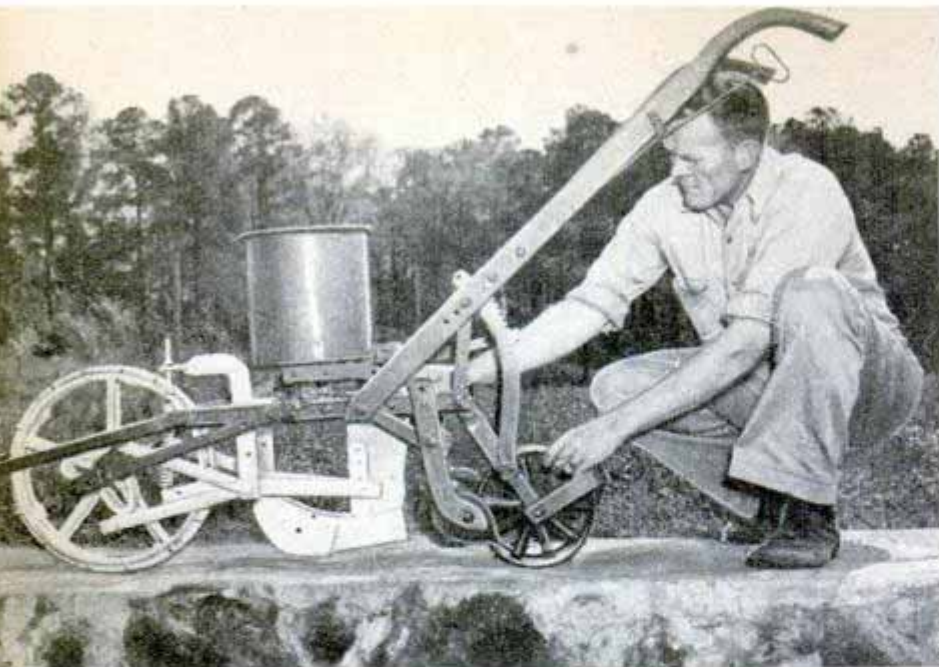

Experimental variable depth cotton seed planter assures good stand in a wet or dry season; planting depth varies 1½ inches

Jezek, associate engineer at the laboratory. Steel brushes kick the nuts into a spiral conveyor which carries them to an elevator from which they can be dropped into bags or other containers. The nuts are guided into the conveyor by long steel fingers which pass over the fallen fruit as the machine moves through an orchard. Considerable research has been expended on this machine. The original model, pushed before a tractor, was found to be unsatisfactory in field tests and had to be torn apart and redesigned.

Here are some of the important features of laboratory developments: The portable tung nut huller operates in the field and

saves shipping or trucking the nuts to a big hulling plant. The castor bean huller can be operated by one man and turns out 35 to 40 bushels an hour. The cotton seed planter assures a good stand in wet or dry weather by varying the depth to which the seeds are planted by about 1½ inches. The peanut sheller is designed for shelling seed peanuts and does not crack as many of the tender nuts as commercial shellers; it shells 300 pounds an hour, as much as 30 men can shell in a 10-hour day. Another ingenious invention is a belt-type peanut planter. (See illustration.) One of the belts is perforated to catch the nuts as they drop from the hopper. Another belt, made of soft rubber, presses against the perforated belt to hold the nuts in place until they

are close to the ground for proper spacing.

In addition to the work at the Tillage Machinery Laboratory, cooperative projects are carried on with other divisions of the Department of Agriculture and various state agencies.

"At present there is great need for some sort of 'Bureau of Standards' for farm machines," says Mr. Reed. "I look upon the unique facilities here at the laboratory and my staff of two engineers, three mechanics and two helpers as the possible nucleus for such an institution."

Rainfall by request helps prepare soil bed for controlled test; utility car is powered by truck engine

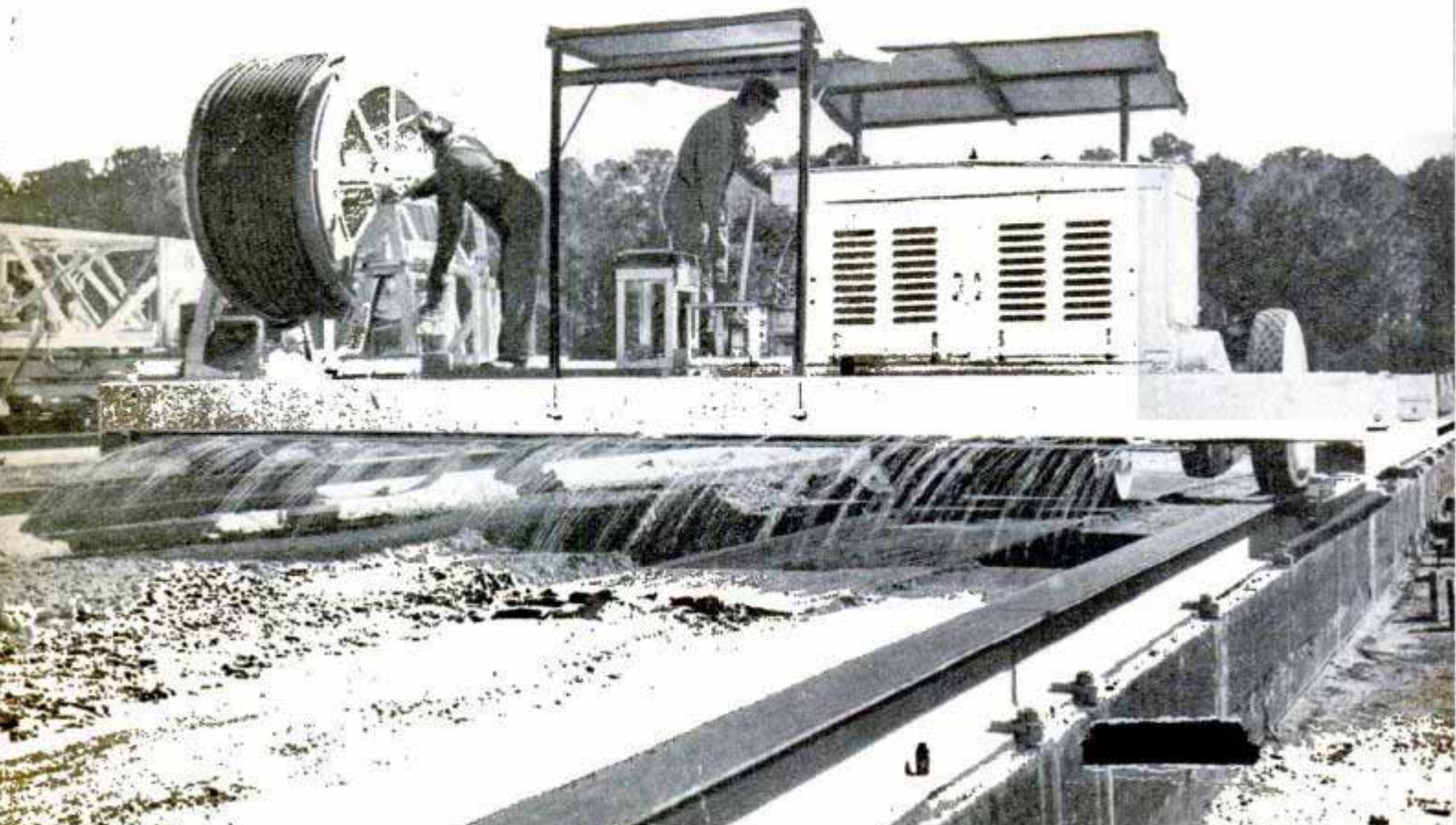

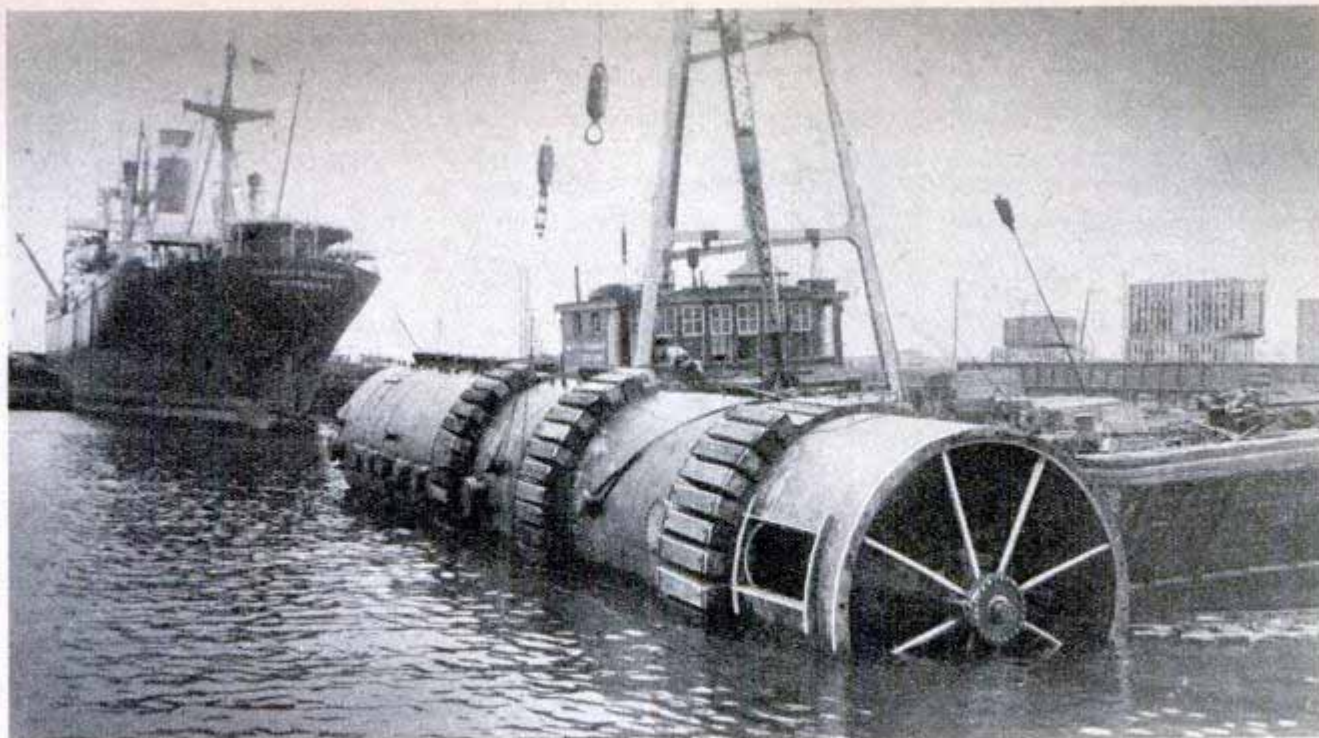

BIG TOWER—LONG TRIP

How would you go about moving a 117-foot steel drum weighing 165 tons halfway across the country? This transportation problem was solved recently by both rail and water over a distance of 2025 miles. The huge drum, a tower 16 feet in diameter, was built in Jersey City for a petroleum catalytic cracking plant in Sugar Creek, Mo. First the drum was loaded on three box cars and moved by rail to the Hudson River where it was dumped into the water and partially loaded with sandbags as ballast. It then was towed by tug up the Hudson, through the New York State barge canal and through another canal to Buffalo where the tug and tower entered Lake Erie. The trip across the Great Lakes to Chicago was made at an average speed of eight miles an hour. From Chicago, a river tug towed the drum through the Illinois waterway to Seneca, Ill., where it was loaded on a barge as there was insufficient water to handle the 7½-foot draft. The tug and barge then moved along the Illinois waterway to the Missouri River and up the Missouri to Sugar Creek. The 2025-mile trip to the refinery required 32 days.

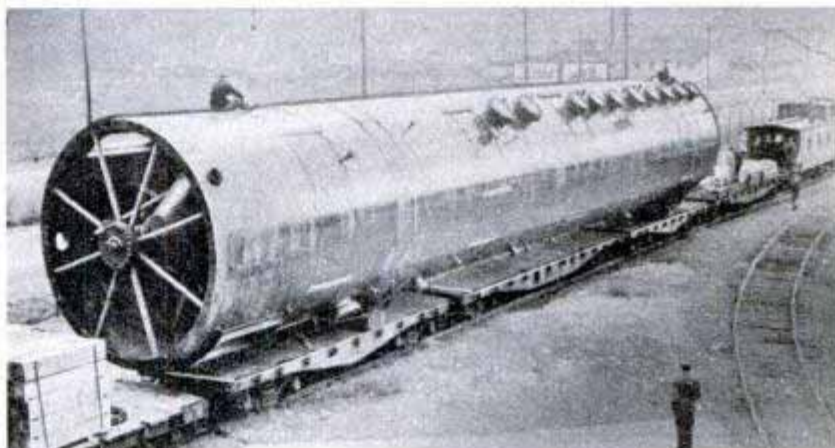

Top, reinforcing strips are fastened around the tower. Above, the 117-foot drum was moved to the harbor on three rail cars. Below, 165 tons of steel are lifted from the rails to be dropped into the water

General Motors Cleveland Diesel Engine Division photos

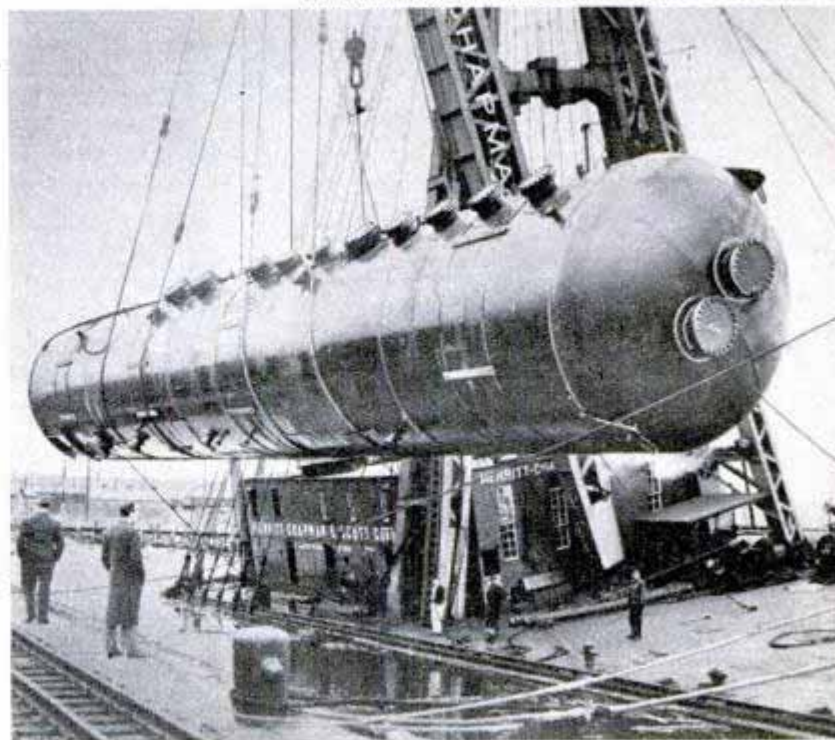

SHOPPING LIST FOR MOTORISTS

*Electric "Creeper"
Bumper Jack
Puncture Detector
Parts Cleaner
Paint Sprayer*

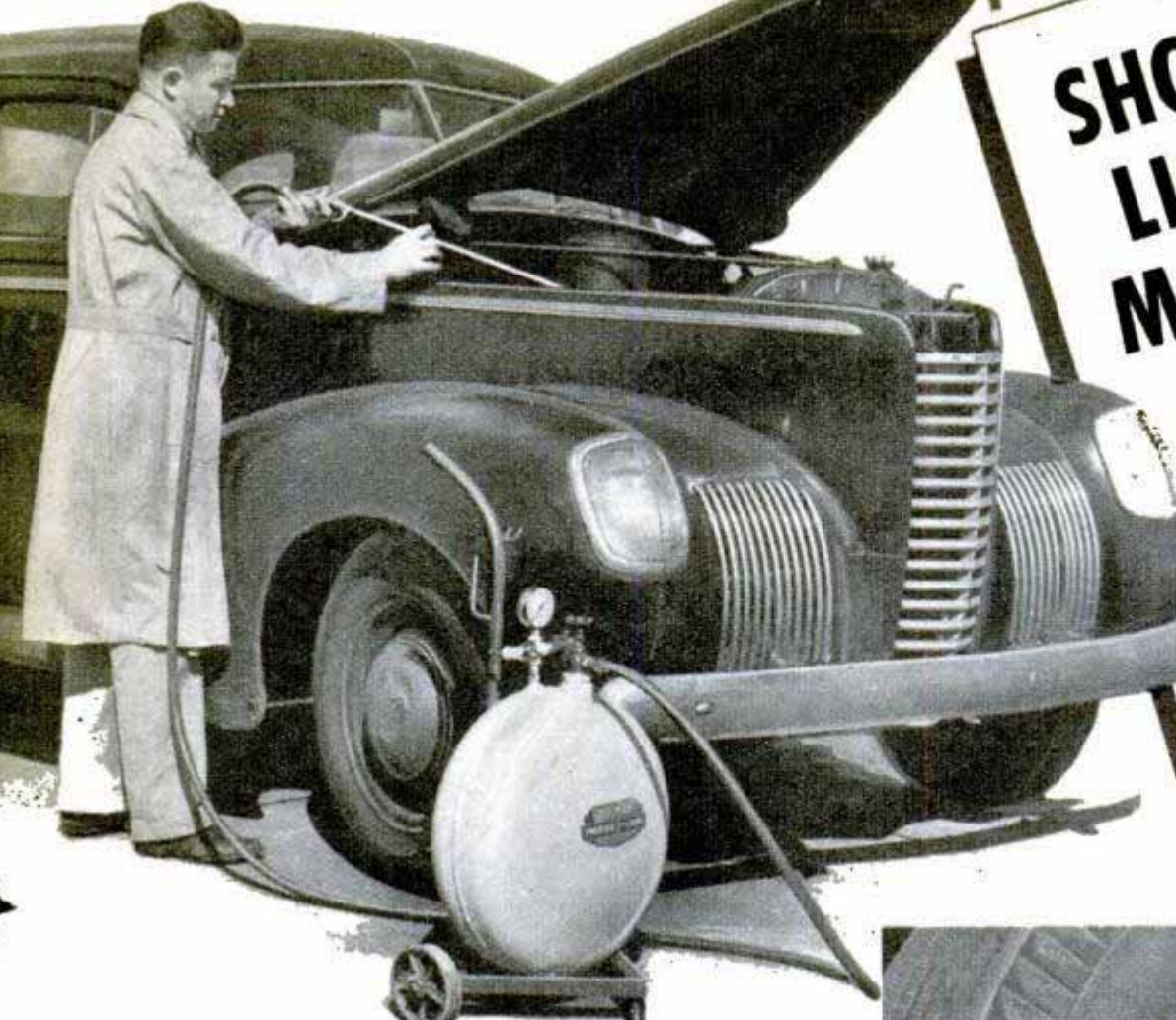

CLEANING SOLUTION sprayed from an air gun at 50 pounds pressure removes all grease and dirt from automobile engines, fenders and wheels. Liquid cleaner is placed in a six-gallon tank connected to air hose. The outfit is rolled right up to car for quick job

ANTI-STATIC POWDER injected by air hose into inner tube (right) gives better radio reception in auto and prevents shocks. One tablespoonful to each tube does the trick; only one injection is needed

RADIATOR-SCALE DISSOLVER below slips inside the top radiator hose and decomposes rust or scale by electrical and chemical action. The unit is easily inserted and held snugly by prongs on either end



PROTECTION for the underside of cars (below) is provided by spraying with a new rubberized sealing compound. It not only reduces damage from flying rocks but retards rust and discourages rattles

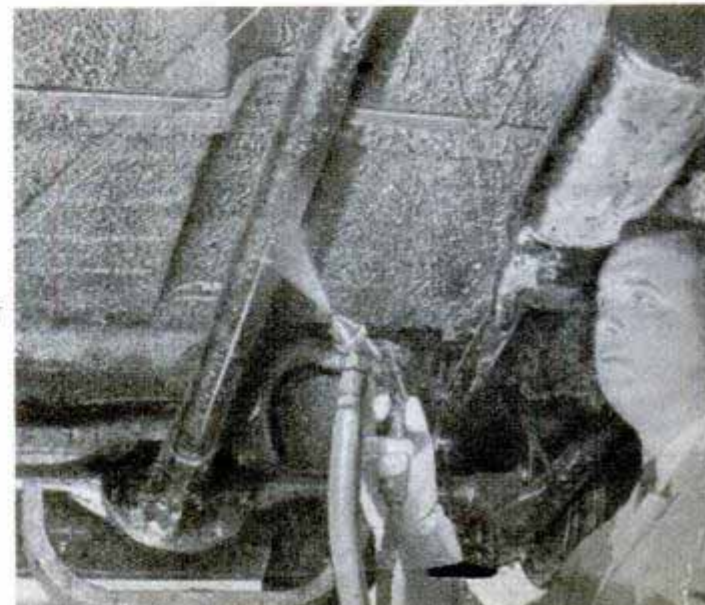
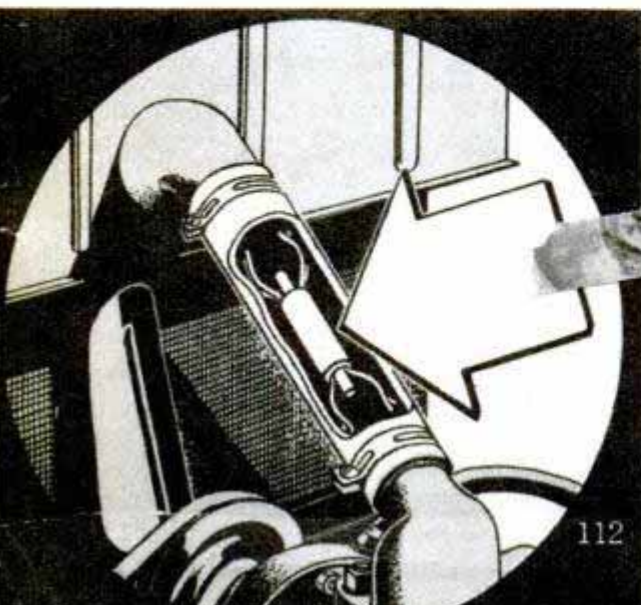

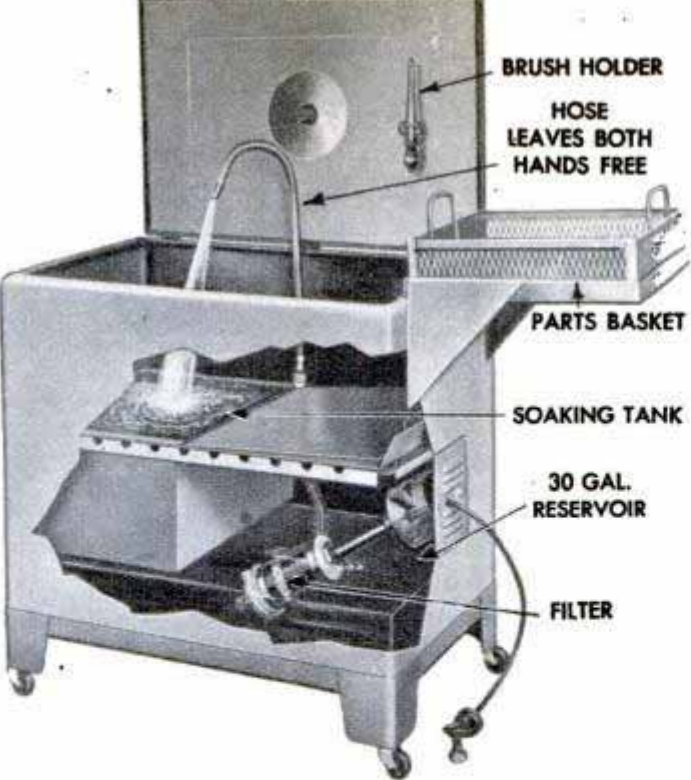

NAIL DETECTOR locates any metal object inside a tire casing that might work in and cause a puncture. A floating permanent magnet signals the presence of metal in the casing, yet its range is so limited it is not affected by metal rim or any wire reinforcement. A six-volt lamp provides signal flash

CABINET for washing auto parts has a filter for the cleaning fluid so it can be used over and over. Reservoir in bottom of cabinet holds 30 gallons and electric pump provides steady flow to soaking tank

SLOTS cut in the front and rear bumpers of Kaiser and Frazer cars (right) simplify the job of jacking up auto to change a tire. The slots are located in the exact spot for the best jacking efficiency



PRETTY SOFT—Sponge-rubber pillow and adjustable lamp attached to mechanic's "creeper" make the job of working beneath an auto a lot pleasanter than it used to be. The lamp can be cocked at any angle

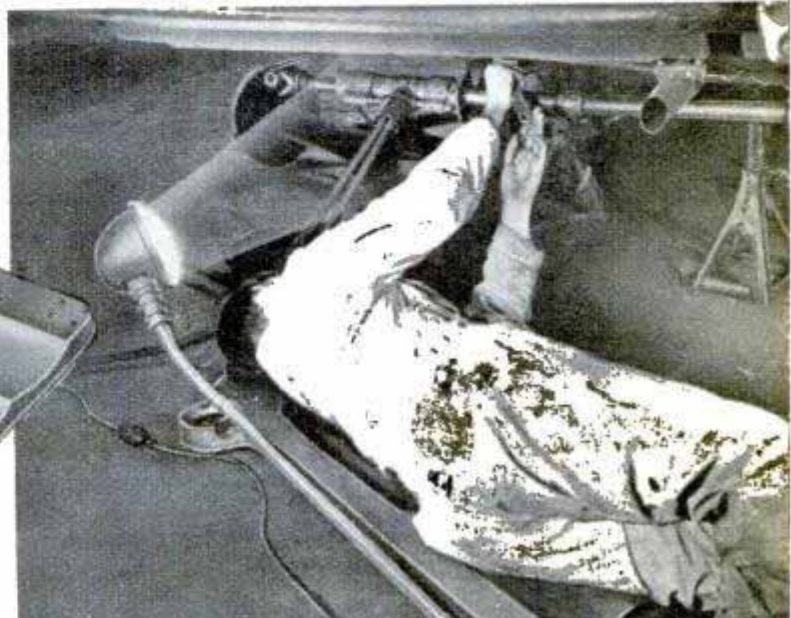
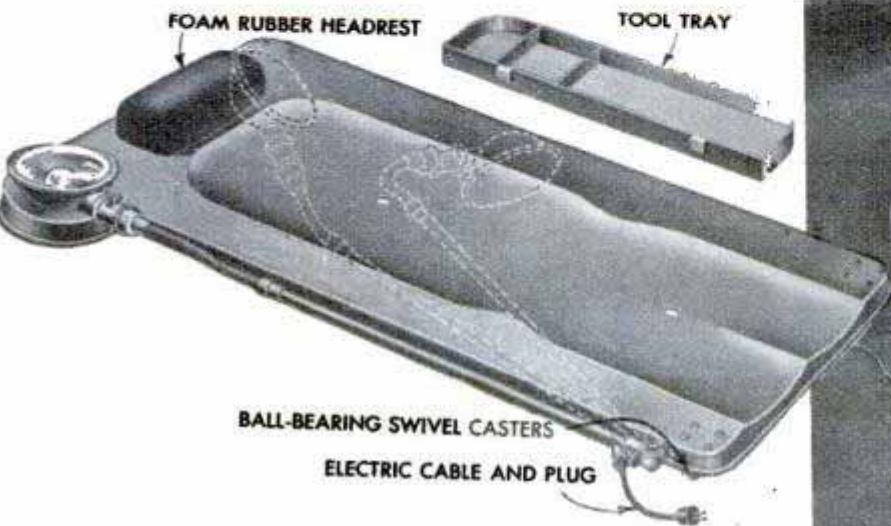



Power Lawn Mower From Scrap Parts

By cutting down an automobile rear axle and using the universal and transmission, J. F. Zornes of Nipomo, Calif., has made himself an efficient lawn mower that the operator can ride. The unique machine is powered by a five-horsepower, one-cylinder gasoline motor and guided by a single wheel in front as well as by applying individual brakes to the rear wheels. Three mowers pulled by a boom cut a 40-inch swath.

Clip Light

You can read a map in an auto with a small flashlight that turns on when clipped to a pocket. It can also be clamped to a purse mirror, or to the breast pocket of a coat or mechanic's jacket, leaving the hands free. With key chain attached, it is convenient when locating keyholes in the dark.

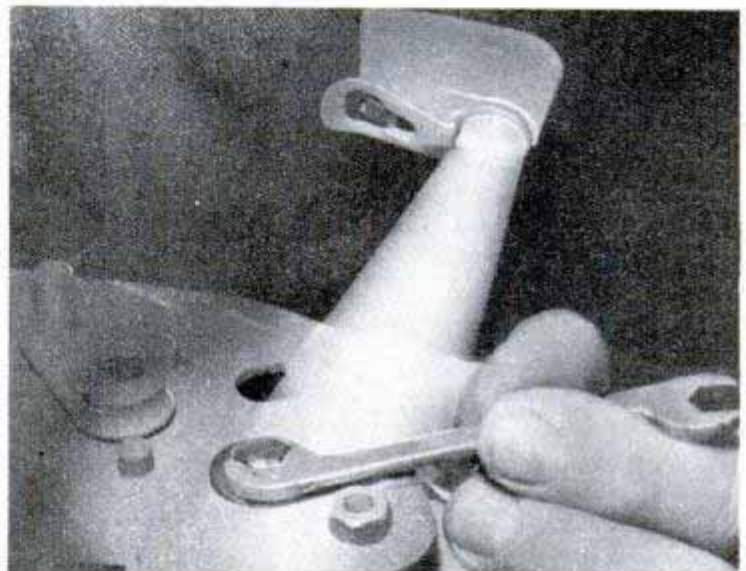
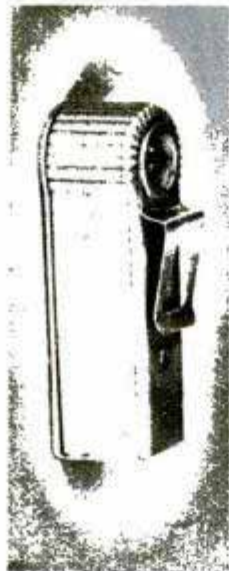

Air-Mail Helicopter

Side compartments on helicopters can hold over 500 pounds of air mail. A row of hooks at the top holds mail bags in place. The helicopters, designed for new helicopter air-mail routes, are being built with either an open or enclosed cockpit.

Popular Mechanics is always ready to supply further information to readers about various products described in any issue. Just write to Bureau of Information, Popular Mechanics, 200 East Ontario Street, Chicago 11, Illinois

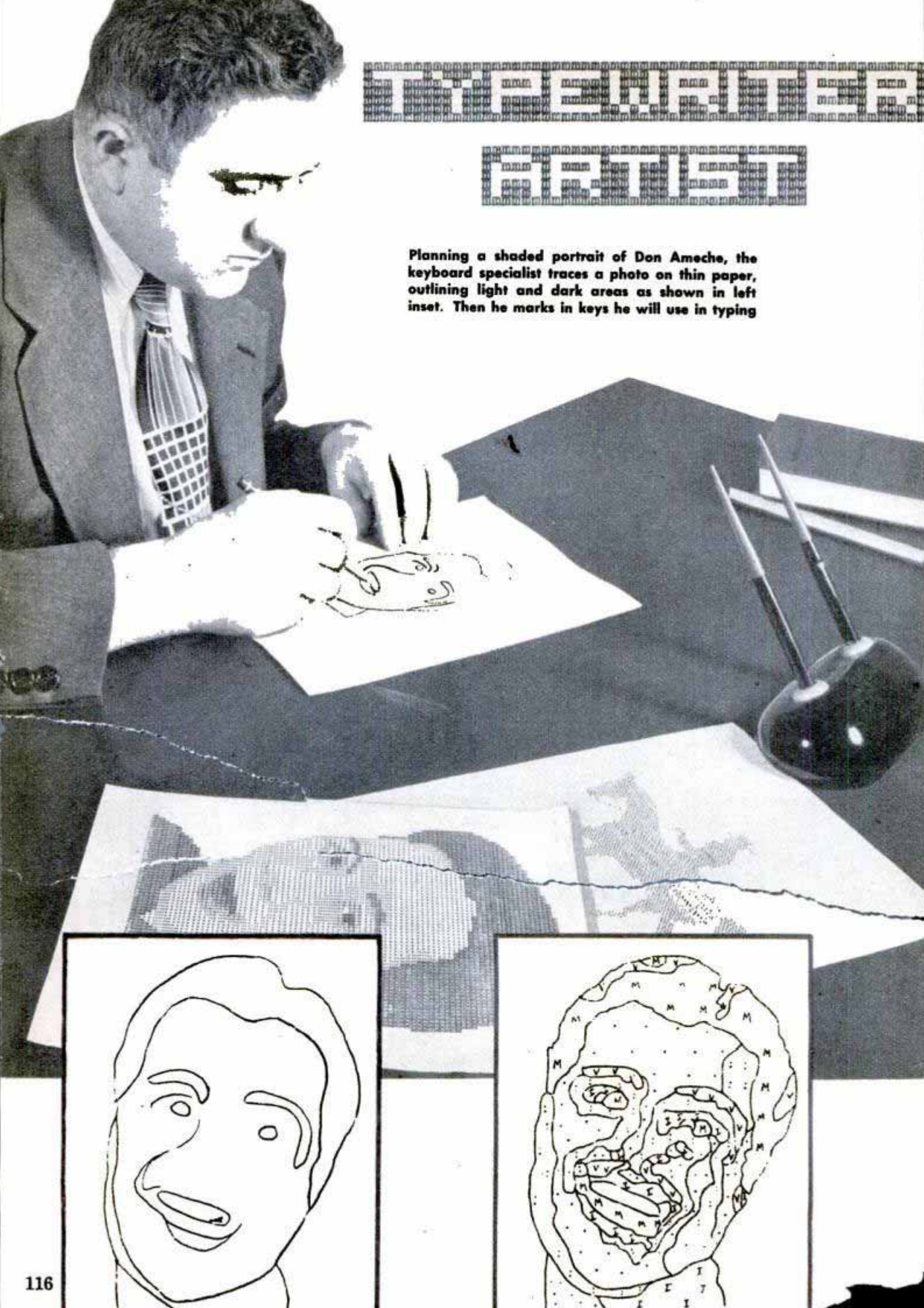

THE NEW YORK TIMES

NEW YORK

Planning a shaded portrait of Don Ameche, the keyboard specialist traces a photo on thin paper, outlining light and dark areas as shown in left inset. Then he marks in keys he will use in typing

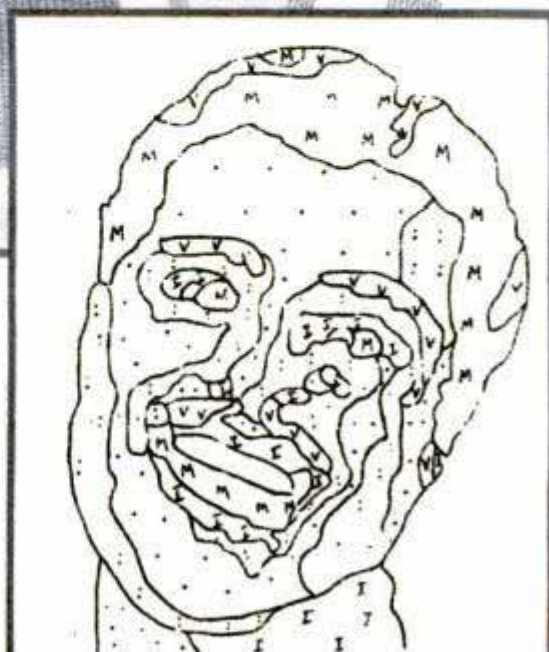
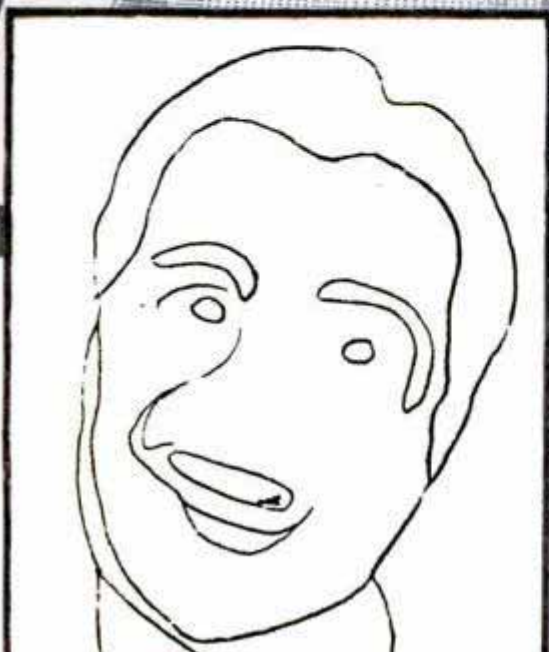



SWIMMING TRAILER

Two watertight trailers, each loaded with 12 men, are towed easily by a jeep. The three photos below show how trailers are fastened together with aluminum tracks to form a bridge

When a watertight trailer made of aluminum is pushed into the water it becomes a ferry or bridge to transport heavy vehicles. Weighing only 829 pounds, the trailer is as useful in the water as on land. An ordinary automobile can tow eight of the trailers on the highway. For water use, tracks made of aluminum are installed on the top deck to provide footing for the vehicles. Applicable to military as well as civilian operations, the trailers can be used as temporary piers, emergency bridges to replace washed-out structures and as a means of moving marooned cars and trucks.

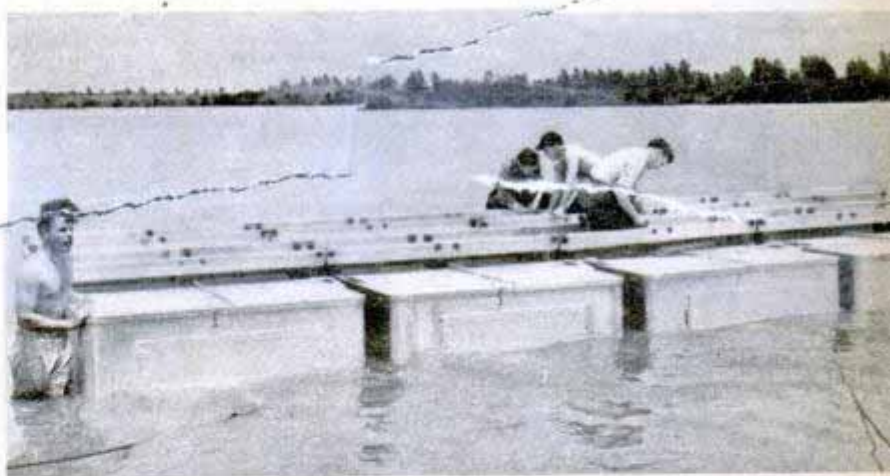
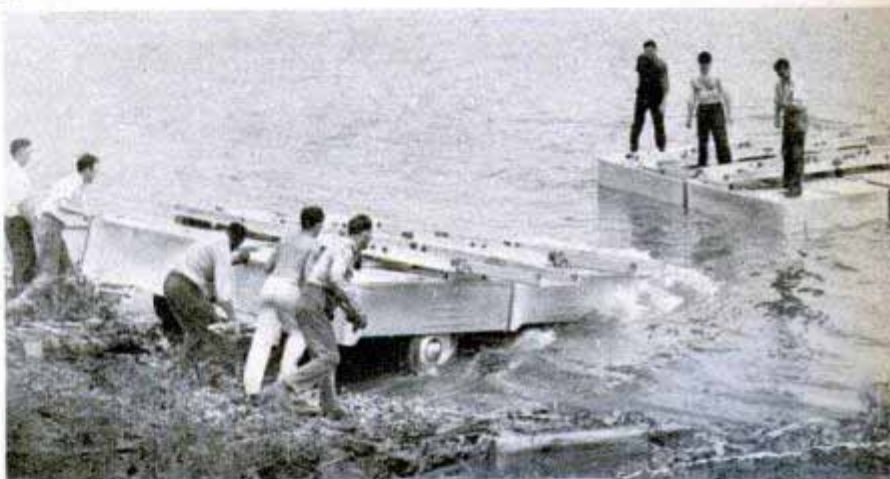

Trailer ferries a jeep across a lake. Tracks are fastened to trailer before it is shoved into the water. The jeep is driven up additional tracks, an outboard motor fastened to trailer, and the ferry glides across the lake





Power Lawn Mower From Scrap Parts

By cutting down an automobile rear axle and using the universal and transmission, J. F. Zornes of Nipomo, Calif., has made himself an efficient lawn mower that the operator can ride. The unique machine is powered by a five-horsepower, one-cylinder gasoline motor and guided by a single wheel in front as well as by applying individual brakes to the rear wheels. Three mowers pulled by a boom cut a 40-inch swath.

Clip Light

You can read a map in an auto with a small flashlight that turns on when clipped to a pocket. It can also be clamped to a purse mirror, or to the breast pocket of a coat or mechanic's jacket, leaving the hands free. With key chain attached, it is convenient when locating key-holes in the dark.



Air-Mail Helicopter

Side compartments on helicopters can hold over 500 pounds of air mail. A row of hooks at the top holds mail bags in place. The helicopters, designed for new helicopter air-mail routes, are being built with either an open or enclosed cockpit.

Popular Mechanics is always ready to supply further information to readers about various products described in any issue. Just write to Bureau of Information, Popular Mechanics, 200 East Ontario Street, Chicago 11, Illinois

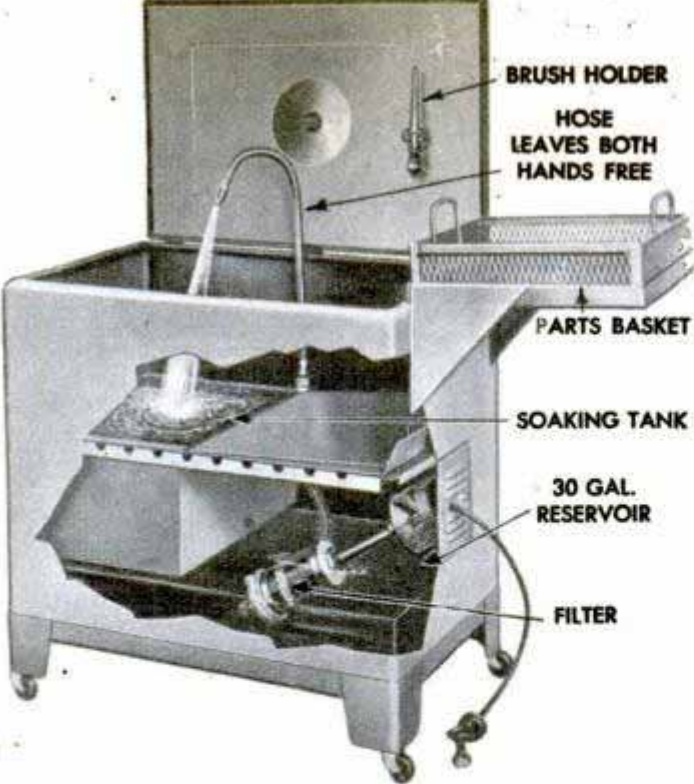

CABINET for washing auto parts has a filter for the cleaning fluid so it can be used over and over. Reservoir in bottom of cabinet holds 30 gallons and electric pump provides steady flow to soaking tank

SLOTS cut in the front and rear bumpers of Kaiser and Frazer cars (right) simplify the job of jacking up auto to change a tire. The slots are located in the exact spot for the best jacking efficiency



NAIL DETECTOR locates any metal object inside a tire casing that might work in and cause a puncture. A floating permanent magnet signals the presence of metal in the casing, yet its range is so limited it is not affected by metal rim or any wire reinforcement. A six-volt lamp provides signal flash

PRETTY SOFT—Sponge-rubber pillow and adjustable lamp attached to mechanic's "creeper" make the job of working beneath an auto a lot pleasanter than it used to be. The lamp can be cocked at any angle

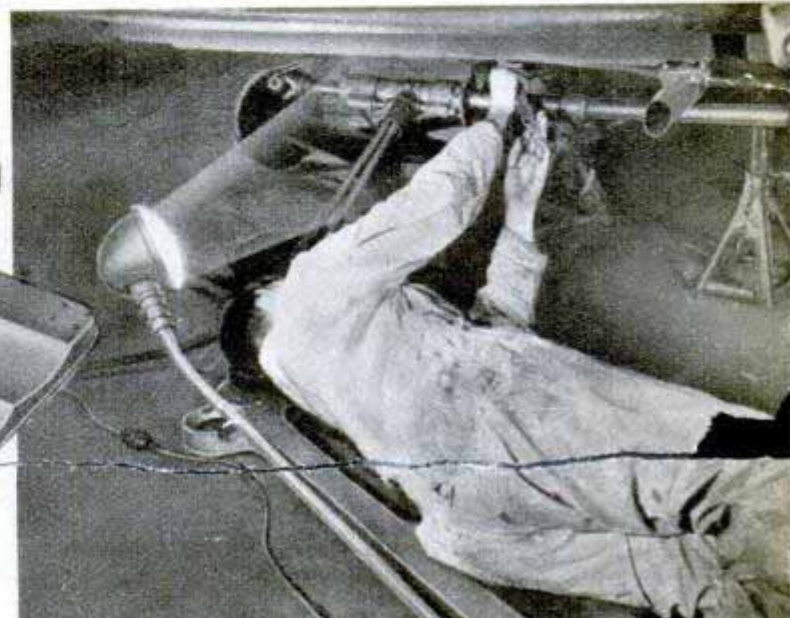
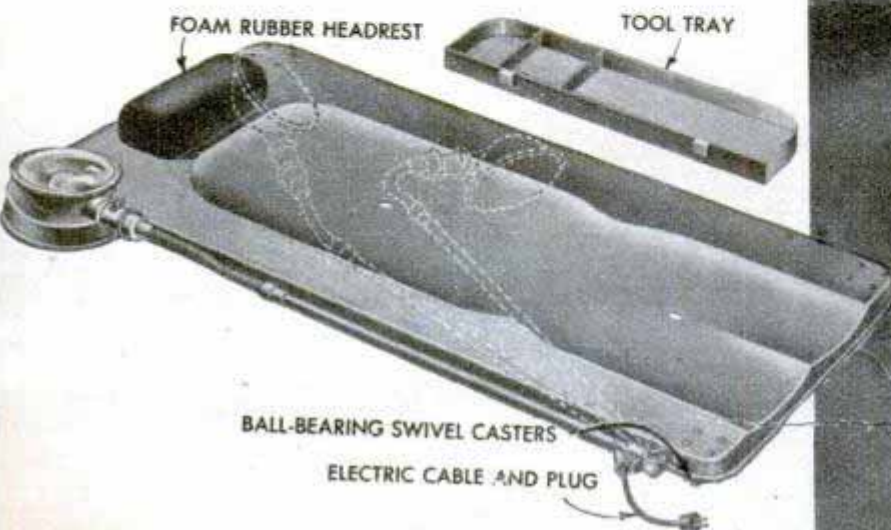

SHOPPING LIST FOR MOTORISTS

*Electric "Creeper"
Bumper Jack
Puncture Detector
Parts Cleaner
Paint Sprayer*



CLEANING SOLUTION sprayed from an air gun at 50 pounds pressure removes all grease and dirt from automobile engines, fenders and wheels. Liquid cleaner is placed in a six-gallon tank connected to air hose. The outfit is rolled right up to car for quick job

ANTI-STATIC POWDER injected by air hose into inner tube (right) gives better radio reception in auto and prevents shocks. One tablespoonful to each tube does the trick; only one injection is needed



RADIATOR-SCALE DISSOLVER below slips inside the top radiator hose and decomposes rust or scale by electrical and chemical action. The unit is easily inserted and held snugly by prongs on either end

PROTECTION for the underside of cars (below) is provided by spraying with a new rubberized sealing compound. It not only reduces damage from flying rocks but retards rust and discourages rattles

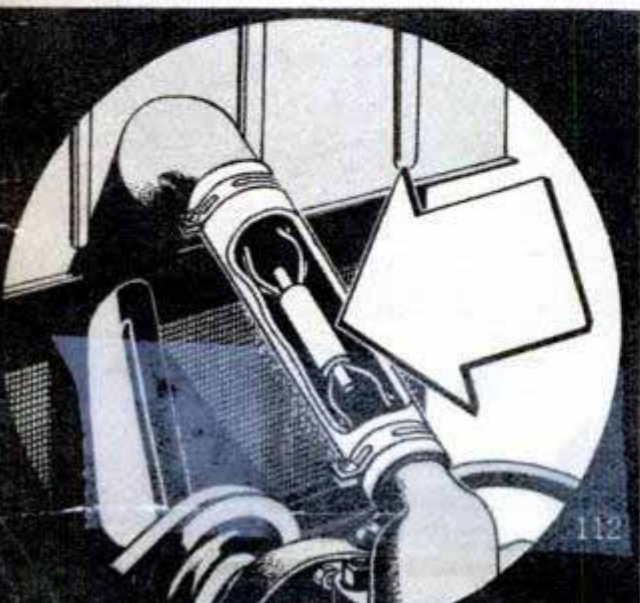

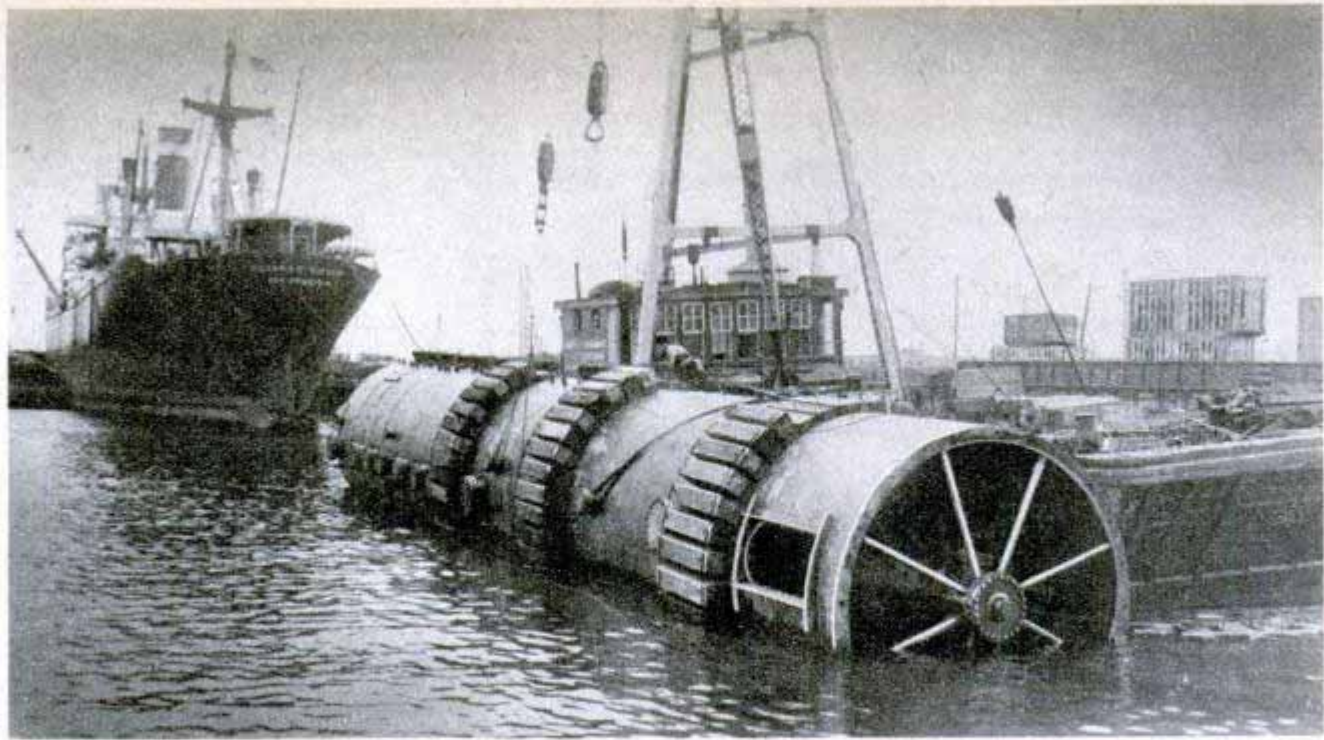

BIG TOWER—LONG TRIP

How would you go about moving a 117-foot steel drum weighing 165 tons halfway across the country? This transportation problem was solved recently by both rail and water over a distance of 2025 miles. The huge drum, a tower 16 feet in diameter, was built in Jersey City for a petroleum catalytic cracking plant in Sugar Creek, Mo. First the drum was loaded on three box cars and moved by rail to the Hudson River where it was dumped into the water and partially loaded with sandbags as ballast. It then was towed by tug up the Hudson, through the New York State barge canal and through another canal to Buffalo where the tug and tower entered Lake Erie. The trip across the Great Lakes to Chicago was made at an average speed of eight miles an hour. From Chicago, a river tug towed the drum through the Illinois waterway to Seneca, Ill., where it was loaded on a barge as there was insufficient water to handle the 7½-foot draft. The tug and barge then moved along the Illinois waterway to the Missouri River and up the Missouri to Sugar Creek. The 2025-mile trip to the refinery required 32 days.

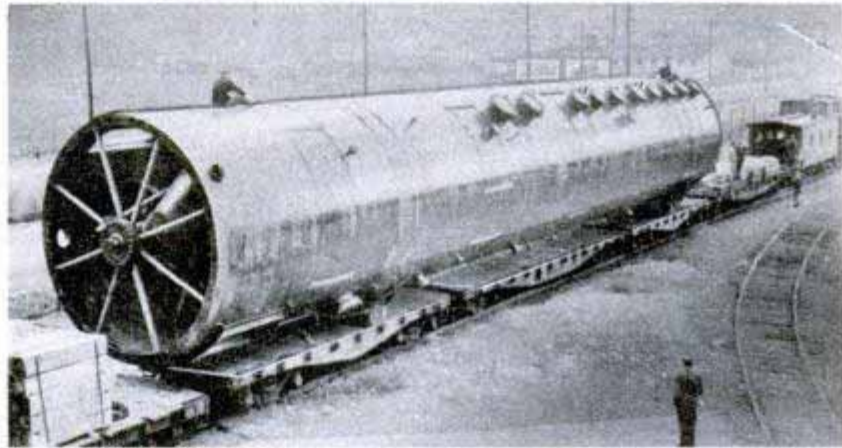

Top, reinforcing strips are fastened around the tower. Above, the 117-foot drum was moved to the harbor on three rail cars. Below, 165 tons of steel are lifted from the rails to be dropped into the water
General Motors Cleveland Diesel Engine Division photos

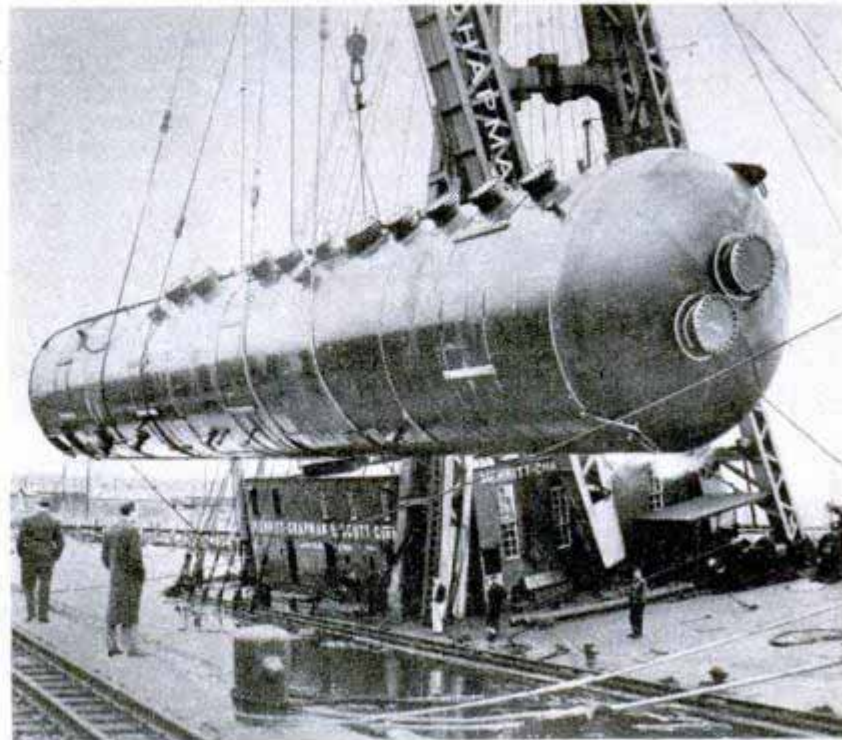



Experimental variable depth cotton seed planter assures good stand in a wet or dry season; planting depth varies 1½ inches

Jezeq, associate engineer at the laboratory. Steel brushes kick the nuts into a spiral conveyor which carries them to an elevator from which they can be dropped into bags or other containers. The nuts are guided into the conveyor by long steel fingers which pass over the fallen fruit as the machine moves through an orchard. Considerable research has been expended on this machine. The original model, pushed before a tractor, was found to be unsatisfactory in field tests and had to be torn apart and redesigned.

Here are some of the important features of laboratory developments: The portable tung nut huller operates in the field and

saves shipping or trucking the nuts to a big hulling plant. The castor bean huller can be operated by one man and turns out 35 to 40 bushels an hour. The cotton seed planter assures a good stand in wet or dry weather by varying the depth to which the seeds are planted by about 1½ inches. The peanut sheller is designed for shelling seed peanuts and does not crack as many of the tender nuts as commercial shellers; it shells 300 pounds an hour, as much as 30 men can shell in a 10-hour day. Another ingenious invention is a belt-type peanut planter. (See illustration.) One of the belts is perforated to catch the nuts as they drop from the hopper. Another belt, made of soft rubber, presses against the perforated belt to hold the nuts in place until they

are close to the ground for proper spacing.

In addition to the work at the Tillage Machinery Laboratory, cooperative projects are carried on with other divisions of the Department of Agriculture and various state agencies.

"At present there is great need for some sort of 'Bureau of Standards' for farm machines," says Mr. Reed. "I look upon the unique facilities here at the laboratory and my staff of two engineers, three mechanics and two helpers as the possible nucleus for such an institution."

Rainfall by request helps prepare soil bed for controlled test; utility car is powered by truck engine

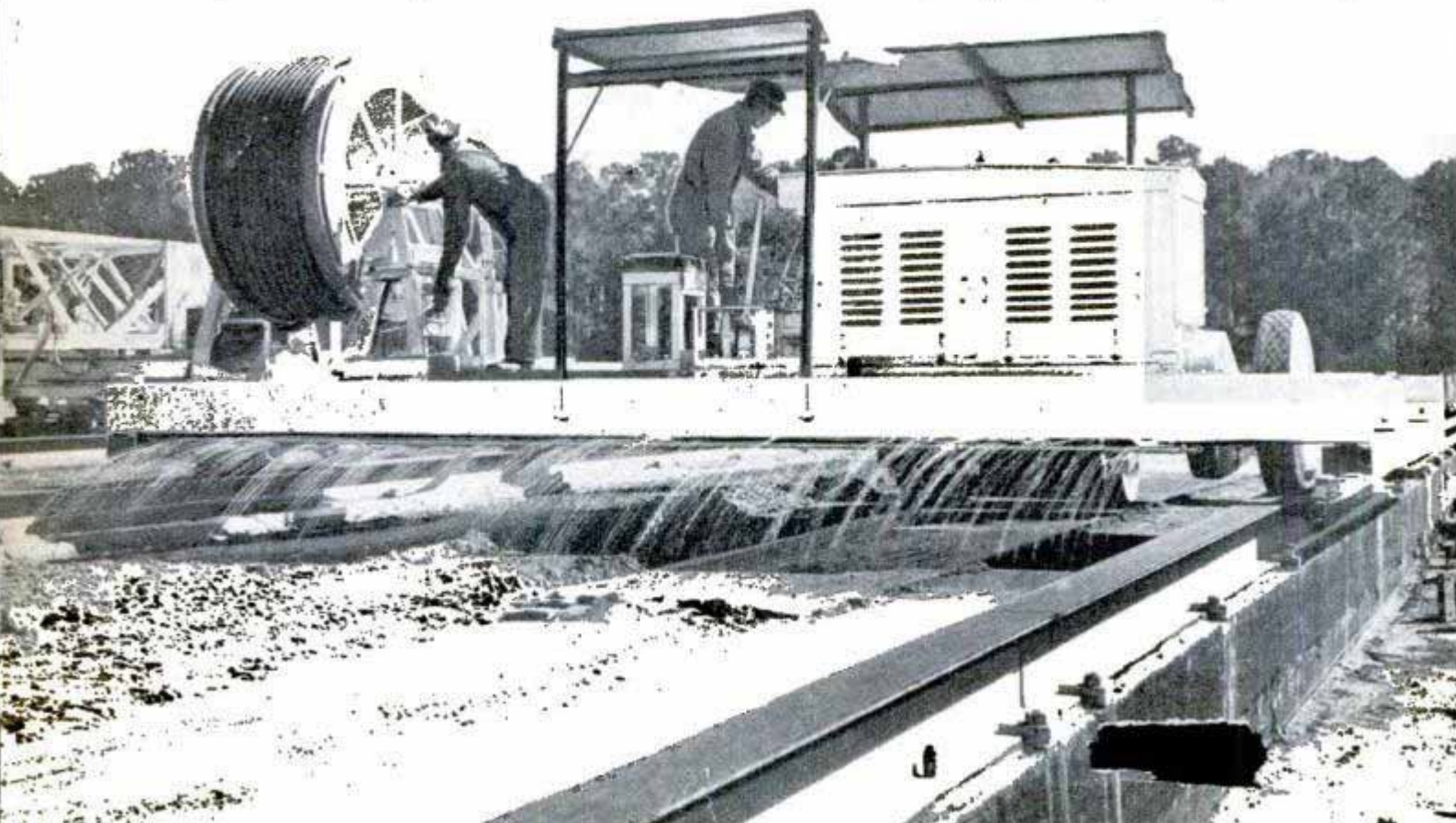

row slice has pointed the way to better designs to help a farmer bring a particular soil to its best planting condition.

Extensive tests have been conducted with tractors to compare the packing effect of rubber tires with that of steel lugs or track equipment. These tests indicate that rubber tires form a more compact layer of soil. Another tractor-plow test was concerned with determining the proper speed for best results. This was important to the designers of tractors and plowing equipment because the recent trend has been away from heavy, low-speed tractors to light, high-speed machines. Tests show that speeds should not advance much beyond four or five miles an hour to obtain the most economical results.

Leading farm machinery manufacturers bring newly designed tools to the laboratory for testing. One company saved a full year of field tests on an improved type of plow bottom using a simplified low-cost share by making use of laboratory facilities.

The laboratory staff not only tests tools designed by manufacturers but develops many implements which may be patented. These patents immediately become public property and the tools may be manufactured by any company. During the war, tillage operations were reduced in order that the staff might specialize on equipment for the production and harvest of oil-bearing crops. This has resulted in successful experimental models of a portable tung nut huller, castor bean huller, tung nut pickup machine, variable depth cotton seed planter, improved peanut sheller, and a peanut digger and shaker which leaves the plants in windrows.

All of these machines were built in the well-equipped laboratory ma-

Rubber belts on lab's peanut planter drop seeds evenly and close to the ground. Holes in Belt A catch nuts as they drop from hopper and Belt B made of soft rubber holds nuts in place until they

Dynamometer on test car measures and records pull up to 5000 lbs. Reed (foreground) watches recorder showing loads of plow bottom

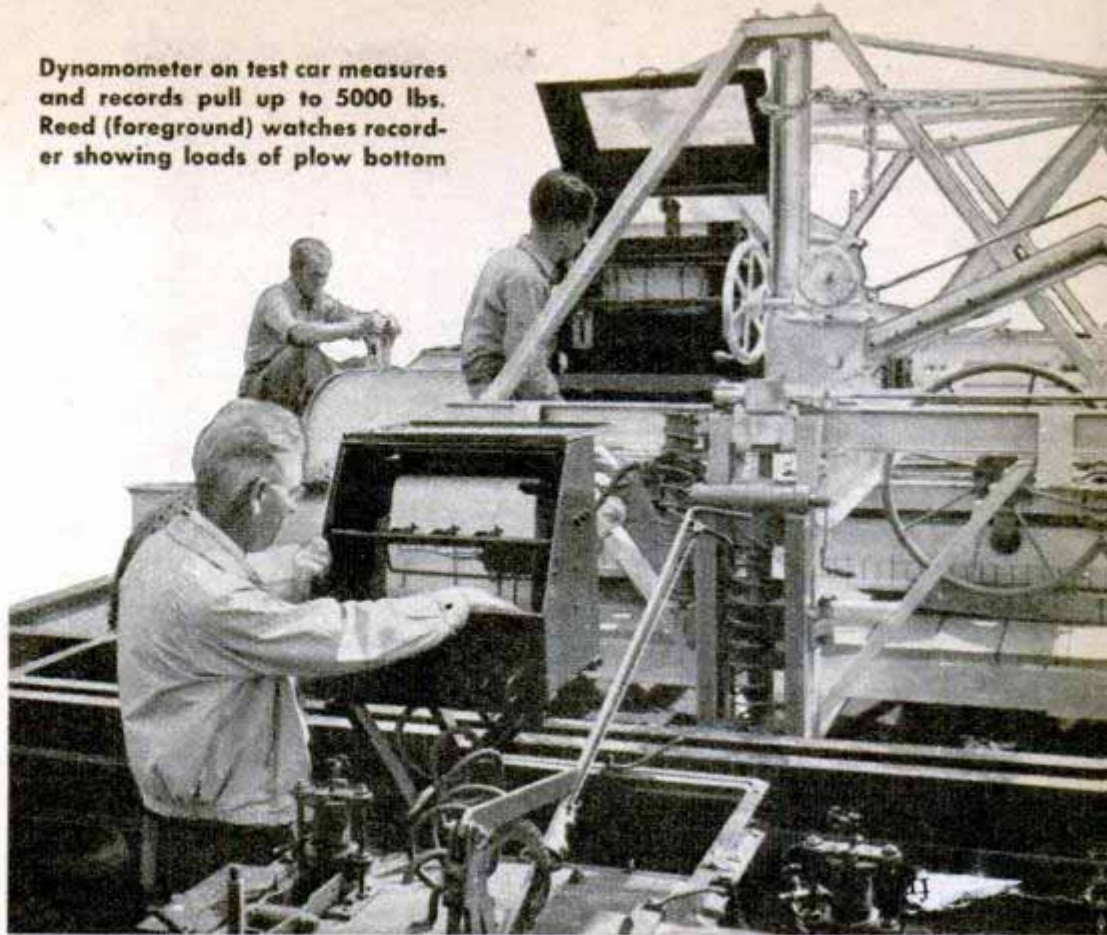

chine shop. Two of them — the tung nut huller and pickup—may prove a tremendous boon to one of America's newest industries. The production of tung oil, once imported from China in excess of 100,000,000 pounds a year, is now a \$10,000,000 industry in this country. This year the region along the Gulf Coast from Florida to Texas will produce about 20,000,000 pounds of the valuable oil. It is one of the fastest drying oils known and is in great demand by the paint and varnish industry. Tung oil is also used as a waterproofing agent for linoleum, transformers, electrodes, brick, masonry, and in a variety of inks.

The tung industry in this country has been hampered by the high cost of gathering the nuts and by the shortage of labor. The tung nut pickup which is pulled behind a tractor was developed largely by R. E.

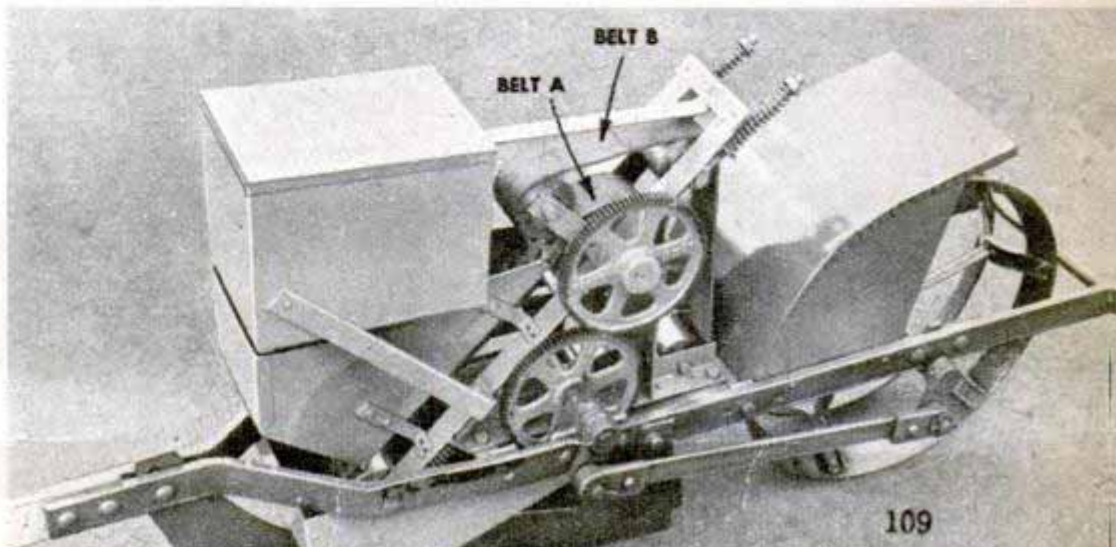

MIND your p's and q's in drawing portraits" is the advice of Julius Nelson of Baltimore.

Nelson is an artist without paints or brushes. His easel is a typewriter carriage and he performs pictorial tricks with \$ and # signs.

Seat him in front of a typewriter and he'll beat a tattoo on the keys to draw a portrait, cartoon or landscape. "Artying" he calls it. He's written two books on the subject and "Who's Who" listed him as the man who developed this new art.

Several years ago Nelson broke his wrist and started doodling on a typewriter to strengthen the ligaments. Soon he was trading pictures with other artypists. Today he is acclaimed by professional artists as the leader in a new field of design and was voted the "originator of a new type of graphic art" by Canadian newspapers.

Every year Nelson, who is president of a business school, conducts a contest for artypists. He has accumulated more than 12,000 examples of their art and expects another 1500 in this year's contest. In the past he has received entries from penal institutions, schools for the blind and from countries all over the world including China, India, British Guiana and Puerto Rico. The pictures are drawn on paper, cloth, silk, cardboard—even worked out on special paper with Braille typewriters. The largest entry he ever received was a full length portrait of Lincoln measuring four feet in each direction.

Nelson's advice to doodlers on the typewriter is to begin with some of the simpler art forms—border

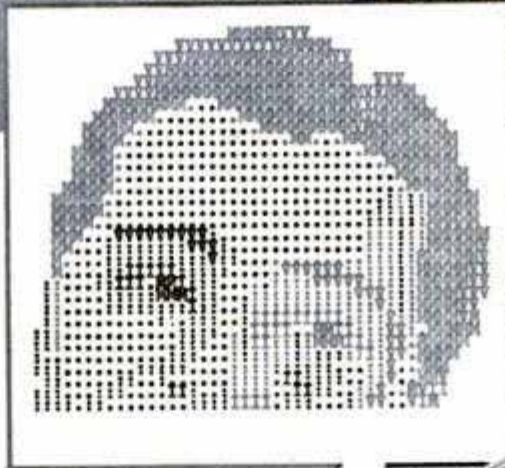
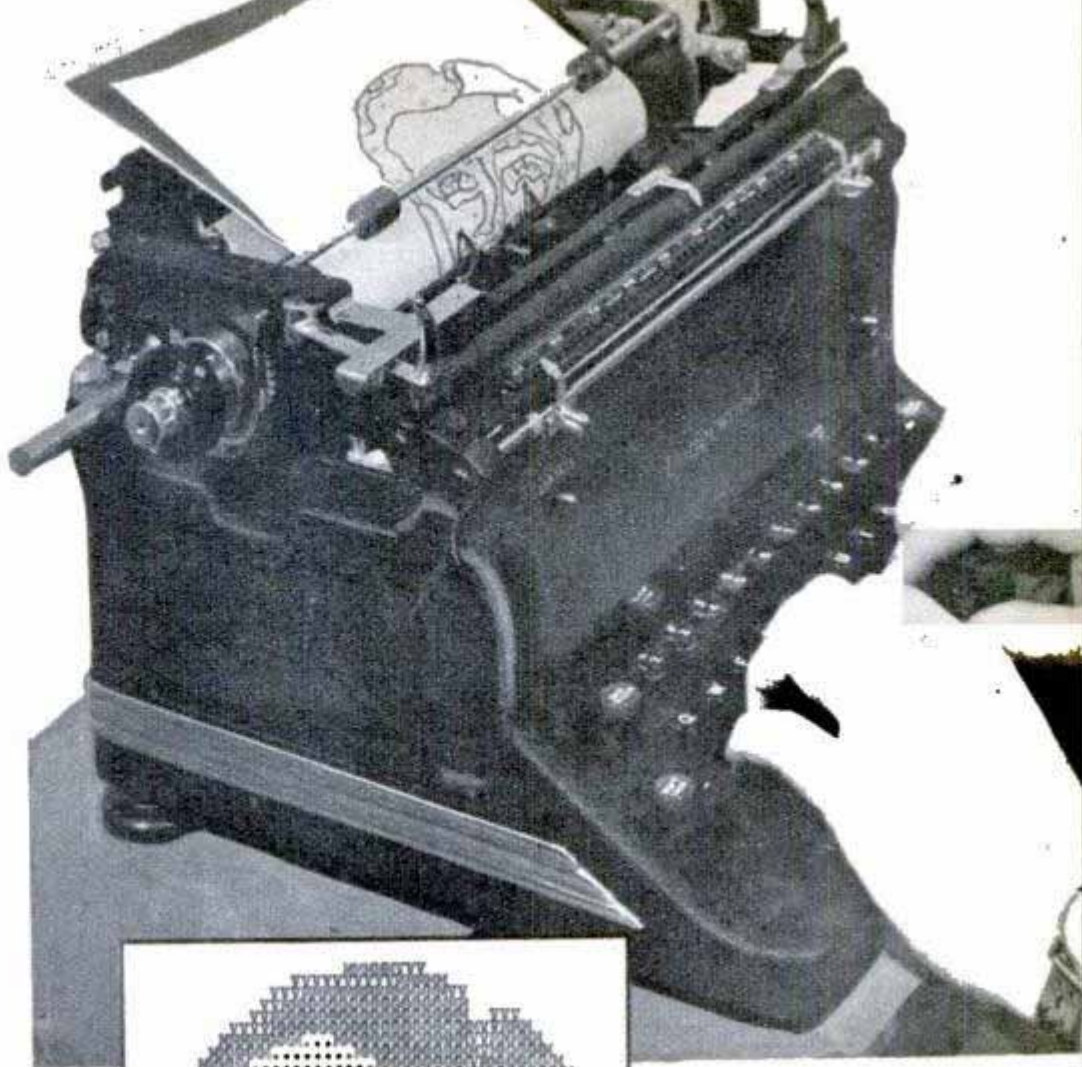

Traced pattern is placed over a carbon and a clean sheet of paper. By following his key marks Nelson draws the portrait. Inset at left shows how different characters produce different shades in finished drawing

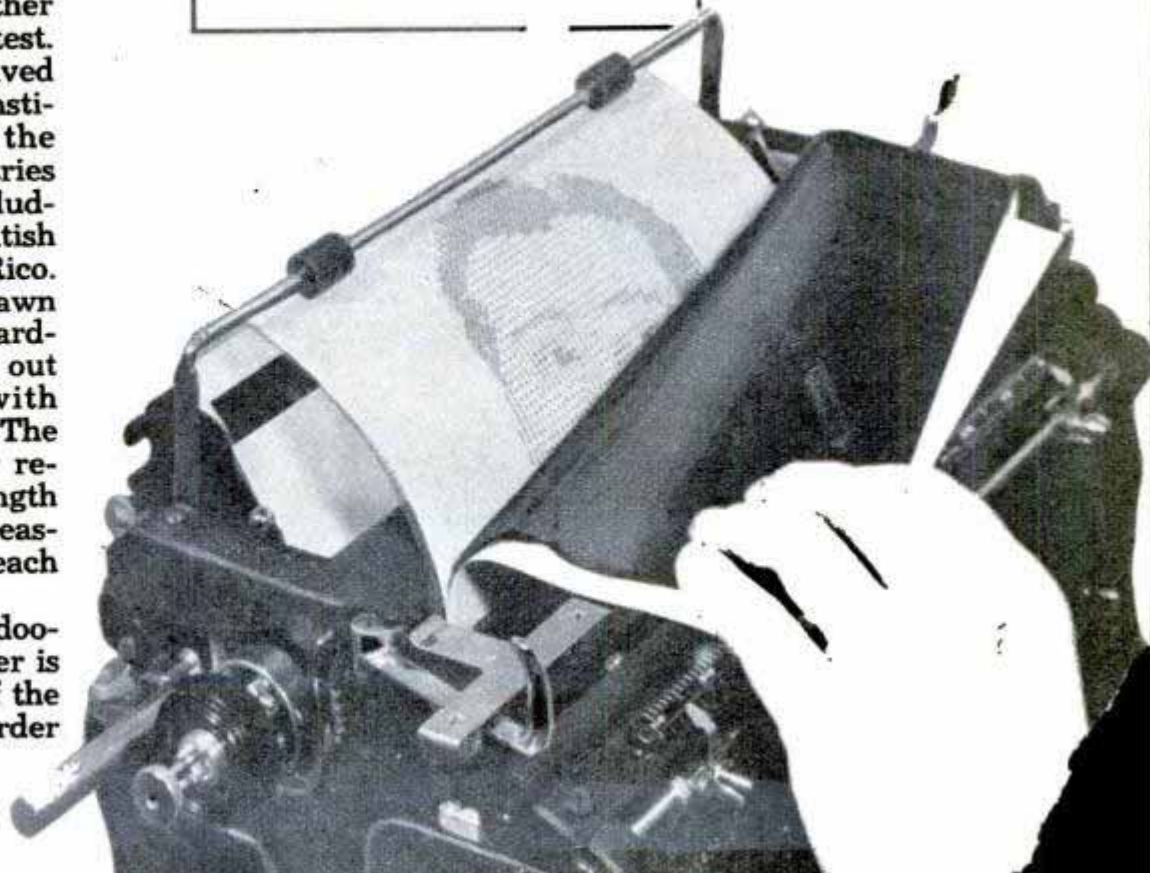



designs and cutouts. To make a cutout, trace a silhouette or draw a picture such as the horse and rider on the following page, and cut it out of the paper. Use the sheet as a pattern, placing it over a sheet of ordinary paper and inserting both in a typewriter. By filling in the pattern with a typewritten letter or character you reproduce the design.

Cartoons are easy for anyone with a little imagination, according to Nelson. Favorite characters for these funmakers are parentheses, diagonal marks, periods and underscore marks.

Portraits are the most difficult to draw and require the most patience. The portraits of General MacArthur, Madame Chiang Kai-shek and Edward G. Robinson shown on these pages required many hours of planning and typing. Nelson recommends a three-step procedure in making a shaded portrait.

First he chooses a good photograph of the

subject and traces it on a sheet of thin paper. Areas are outlined according to how light or dark they are.

In the second step he compares the tracing with the photograph and chooses the characters to be typed into each area. This requires good judgment of the shade each character will produce. For example, a period gives the lightest shade, a semicolon slightly darker, "I" an intermediate shade, "V" and "N" darker yet, and "m" the darkest single character. For black areas several characters may be typed over each other. Symbols of each character are marked in the proper area on the tracing.

Nelson then places a carbon over a clean sheet of paper, the tracing over the carbon, and inserts all three in the typewriter. The characters are typed into the proper area as marked. Some areas can be shaded even more by half-spacing, a trick that's done by holding down the space bar or back spacer every other time the key is struck.

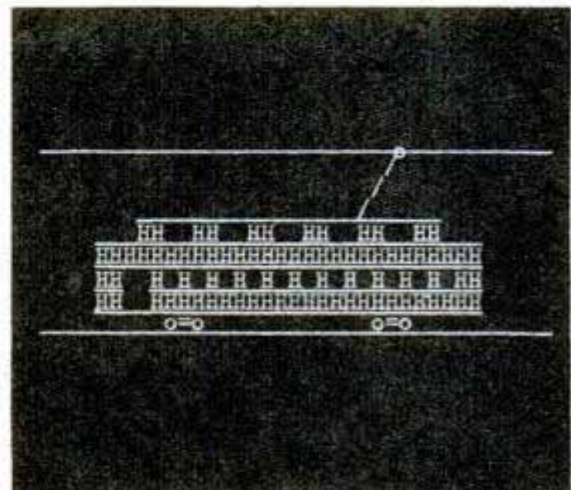
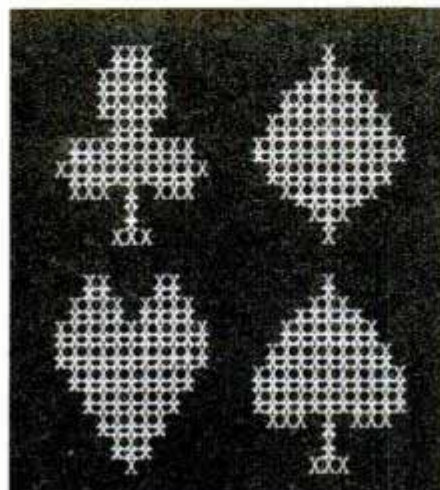
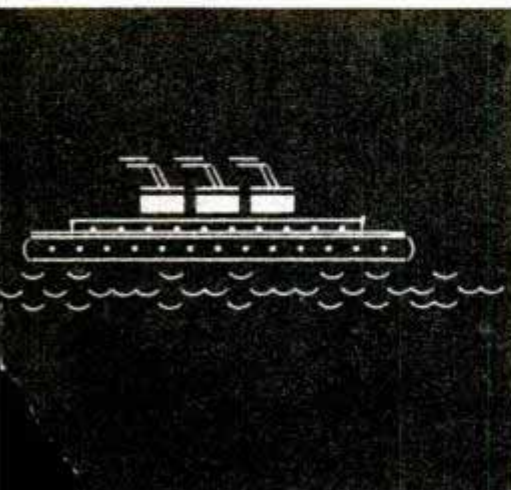

One of Nelson's favorite pastimes is inventing "typewriter mysteries" which he sells for a few cents. By following a printed sheet of instructions the typist can draw a picture without knowing what he's producing until he's almost finished.

Nelson likes to slip messages into his landscapes which can be read when the pattern is discovered. You might find the Gettysburg Address or "Now is the time for all good men to come to the aid of their party" forming the beach of a palm-framed tropical scene.

Artying is more than just doodling with typewriter keys or drawing the familiar "soldiers," says Nelson. It teaches students to manipulate the parts of the typewriter and relieves the monotony of class practice. Artying can be used in decorating school papers, programs, menus, Christmas cards, handbills and cover designs.

"Besides," says Nelson with a grin, "it's a lot of fun!"

TYPEWRITER MYSTERY

Follow these directions and you'll type your own cartoon. What is it? Try it yourself to find out. Instructions are given line by line. For example, in typing the first line set the carriage at the left margin, strike the space bar 39 times, then strike the capital X four times.

Line	Line
1. 39sp, 4X	16. 13sp, 26X
2. 35sp, 10X	17. 9sp, 30X
3. 34sp, 12X	18. 3sp, 36X
4. 33sp, 11X	19. 38X
5. 33sp, 9X, 1sp, 10X	20. 37X
6. 32sp, 21X	21. 1sp, 35X
7. 32sp, 11X	22. 3sp, 32X
8. 32sp, 8X	23. 5sp, 28X
9. 32sp, 8X	24. 7sp, 24X
10. 31sp, 9X	25. 9sp, 19X
11. 31sp, 9X	26. 12sp, 14X
12. 28sp, 12X	27. 16sp, 10X
13. 23sp, 17X	28. 19sp, 7X
14. 19sp, 21X	29. 20sp, 4X
15. 16sp, 24X	30. 19sp, 8X
	31. 17sp, 13X

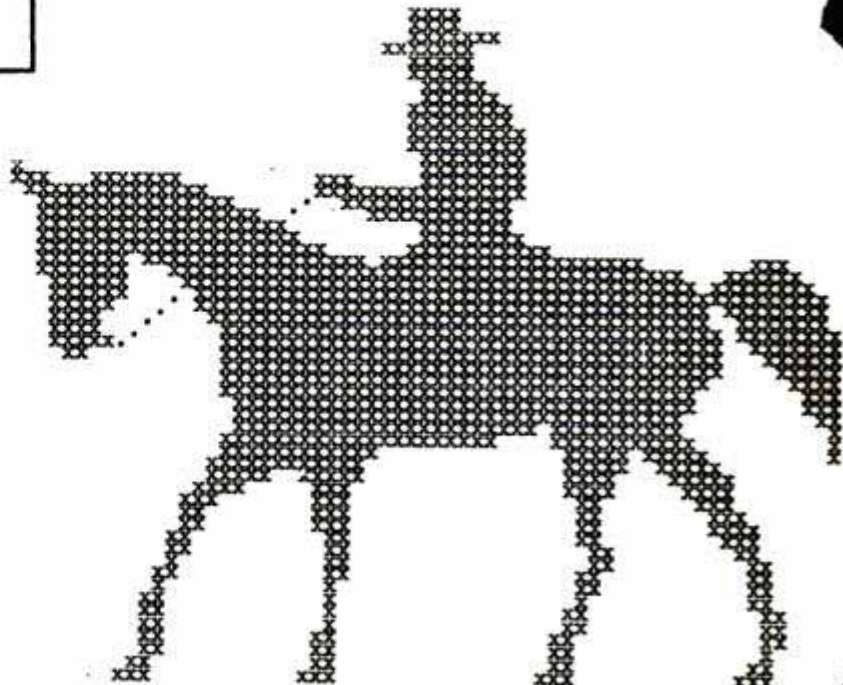
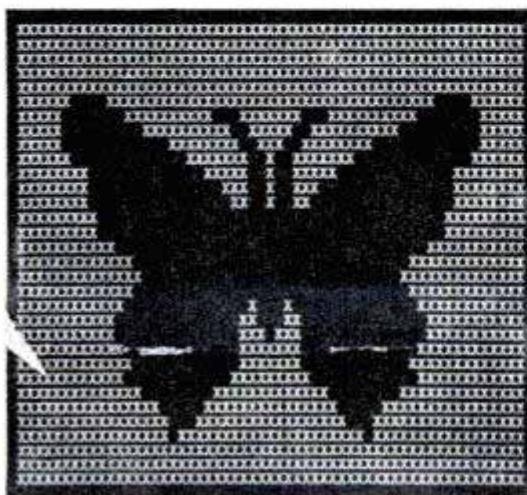
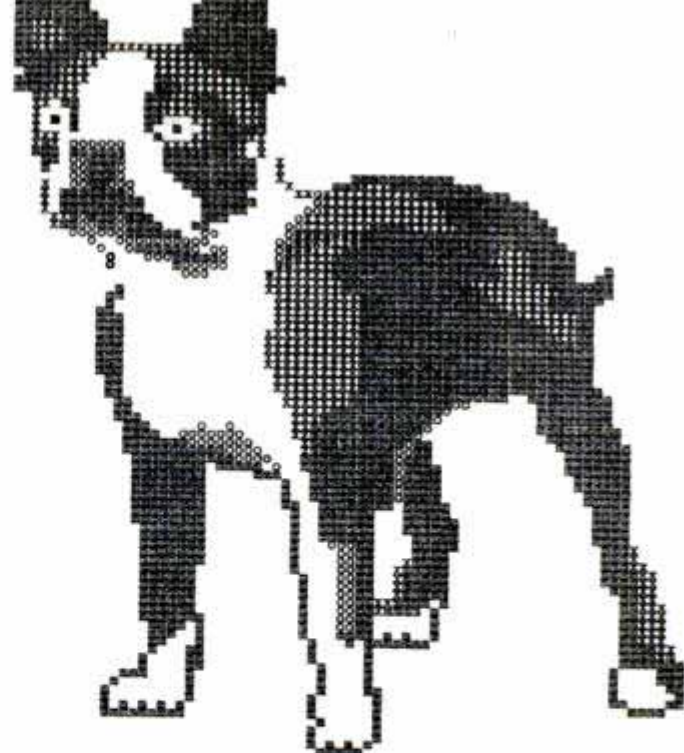

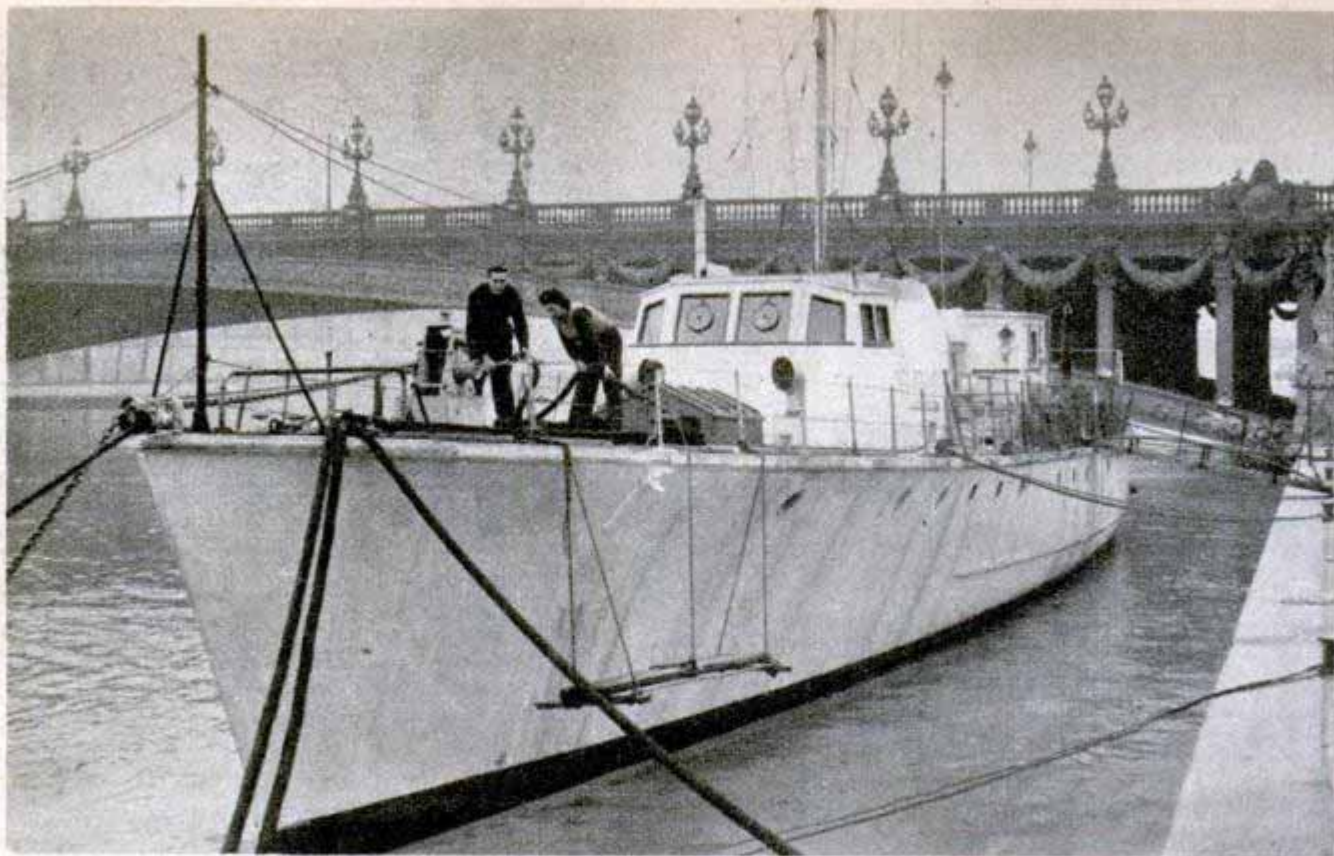

They're at Home In a Patrol Boat

By remodeling a British war boat, Marcel Baudouy, French war veteran, now has a floating home for his English wife and four children. As a member of the Free French forces during the war he commanded a small torpedo boat. When he couldn't find a home because of the housing shortage he bought a British motor launch and fitted it for private use. Double-deck bunks were installed for the children. On his first civilian trip he berthed the boat in the Seine River while taking his family sight-seeing in Paris.



Lift Parks Autos in Tiers

Cars are parked in tiers by a lift that "files" them four high in a framework designed for garages. Each unit of the framework has four platforms, one on top of the other, which are just large enough to accommodate a car. Autos to be parked are driven onto the lift, which raises them to the correct height, then slides them into the proper storage bin. In a recent demonstration at Spokane, Wash., each car was parked in less than two minutes.

POPULAR MECHANICS

Air Liner Phone Calls Anywhere

Telephone calls anywhere can be made to and from air liners equipped with air-to-ground sets. They are the conventional hand-type instruments and are used in the same manner. Direct contact can be made to land stations within 100 miles and from there the connection is completed over wires. At greater distances the closest mobile service station, also used to handle calls between motor vehicles and homes or offices, is contacted to act as a relay point. At 19,000 feet the plane can reach relay facilities within 150 miles. Calls to the craft are made through long distance and then a mobile service operator, who signals the plane over a specially assigned radio channel. The signal causes a bell to ring and a light to flash in the cabin of the plane.



United Air Lines photo

Motor-Powered Reel Dries Fishing Line

Fishing lines are dried on a motor-driven reel built from salvaged parts by a Los Angeles angler. The reel is fashioned from the ends of an apple box, a dozen dowels, the motor from a discarded auto heater and the rheostat transformer of an old electric train. The reel, 14 inches long and 10 inches in diameter, is connected with the motor by a cord belt and its winding speed is regulated by the rheostat.

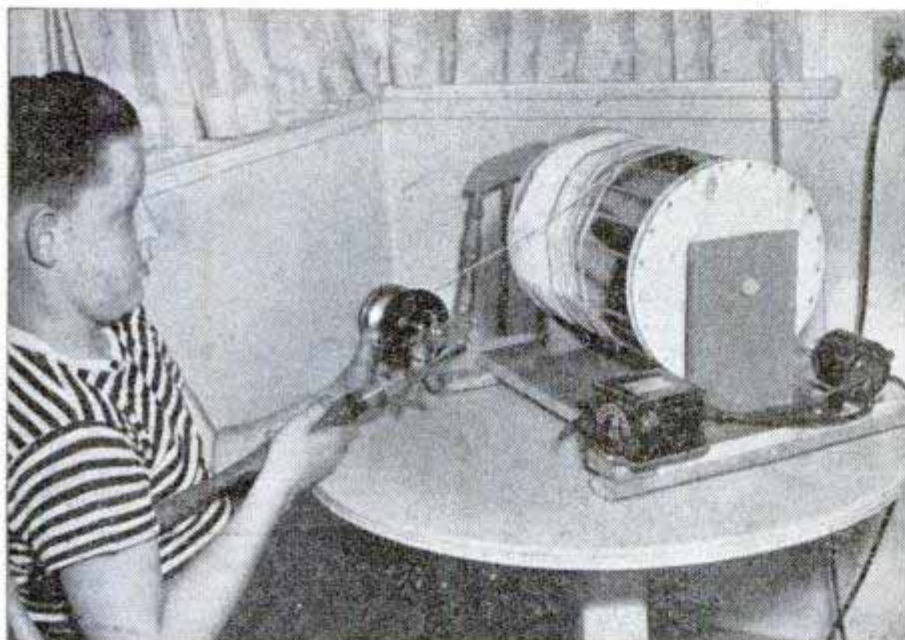

Shade for Headlight Glare

Glare from the headlights of oncoming cars is reduced by a safety shade that fastens to the windshield and can be flicked quickly into position to shield the eyes. The shade is transparent although it is a dark color which transmits little light. A suction cup holds it to the windshield at eye level. When not in use the shade can be swung out of the way.

Discoveries of new oil reserves in the United States alone will equal or surpass the vast quantities already discovered, in the opinion of Standard Oil Company (New Jersey) geologists.

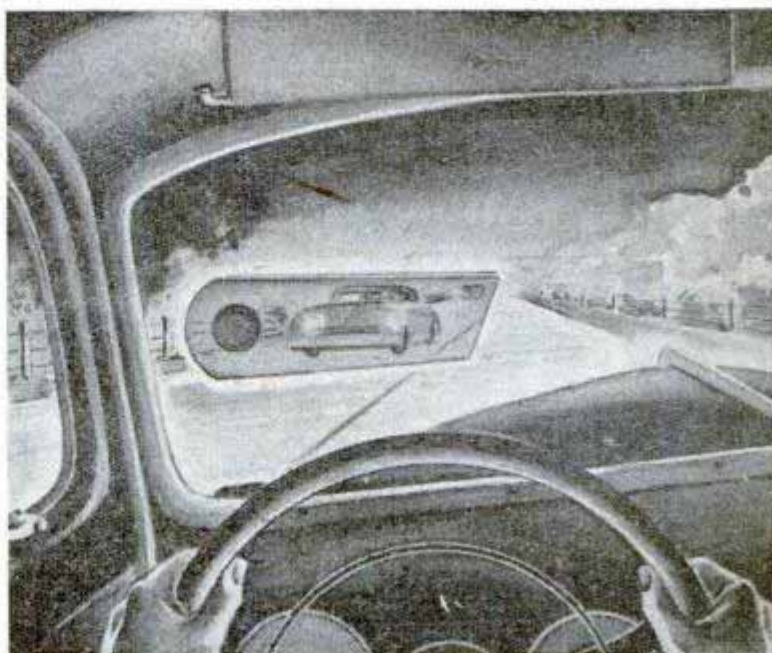

WHAT'S NEW *For Your Home*

A four-page "shopping section"
dedicated to modern homemakers



↑ **GAS PLUG** for stoves and other appliances can be plugged into wall socket, permitting use of flexible pipe

↓ **HOT WATER** flows instantly from faucet with this electric water heater. Slow stream gives the greatest heat

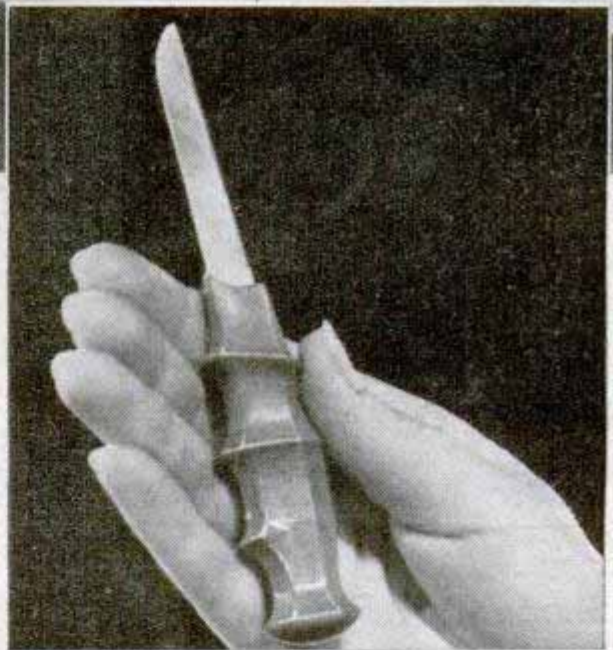

↑ **KNIFE HANDLE** assures safe grip with finger impressions molded in plastic. Knife floats in water

↓ **ELECTRIC BARBECUE** holds 10 pounds of meat or fowl on spit. Through glass sides you can watch meat cook, turned slowly by an electric motor

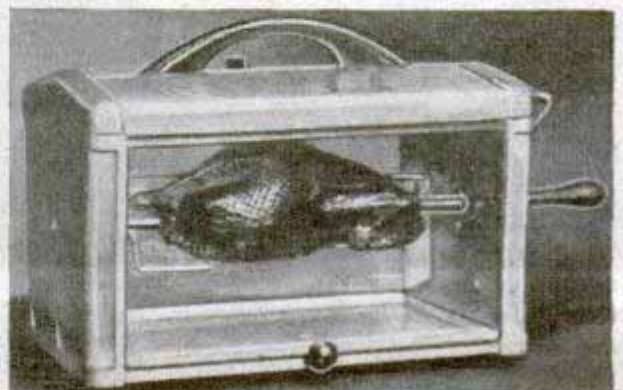

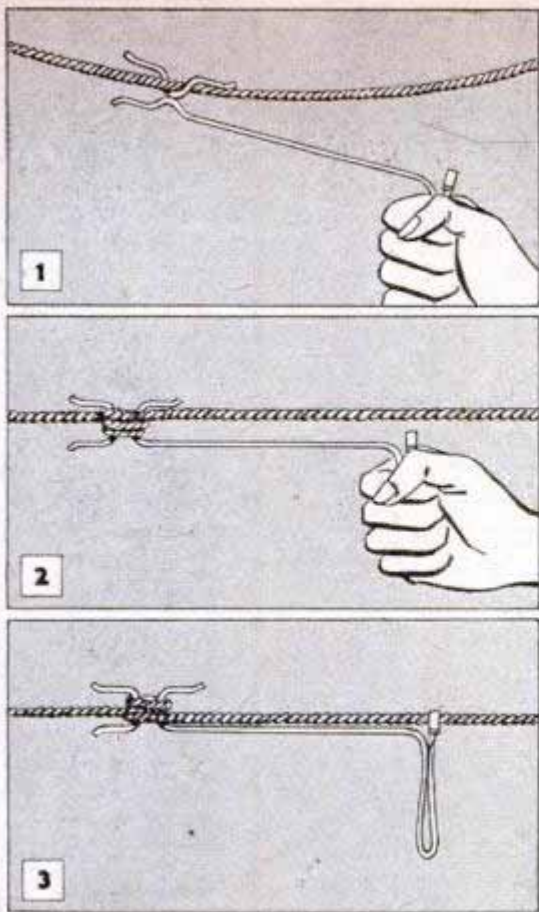

CLOTHESLINE TIGHTENER turns like a crank to give lift to sagging lines. When line is taut, a hook on handle secures the crank

BARBECUE-BROILER at right has two gas burners. Meat is threaded on skewers and automatically rotated by an electric motor

! FORK FOR TIDBITS spears food, drops it neatly on plate when a button is pushed

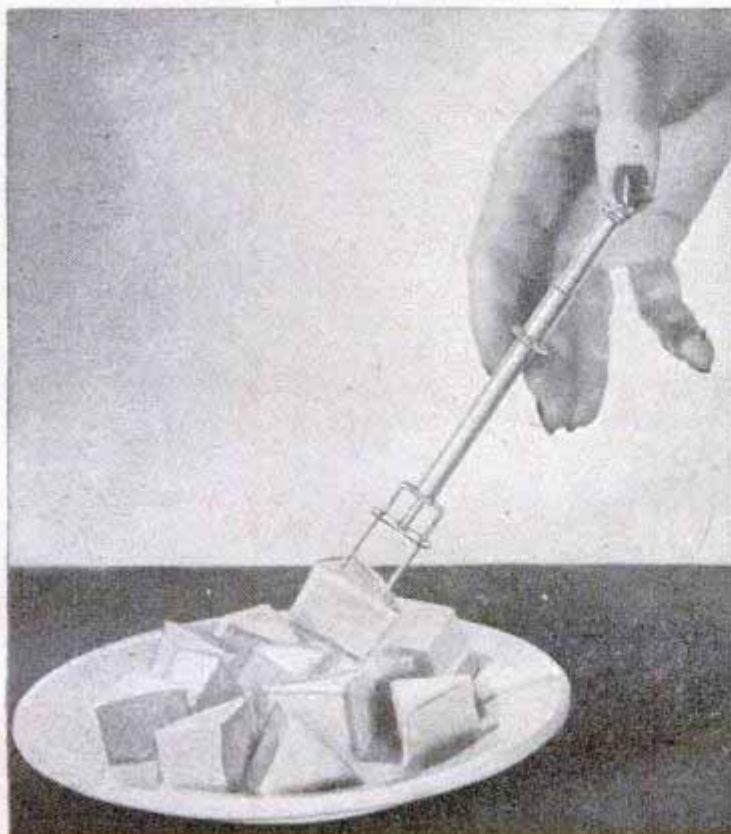

SOFA BY DAY, this space-saver unfolds at night into the comfortable full-size bed shown below. Innerspring mattress is folded inside back and seats



WHAT'S NEW *For Your Home*

Continued from preceding page

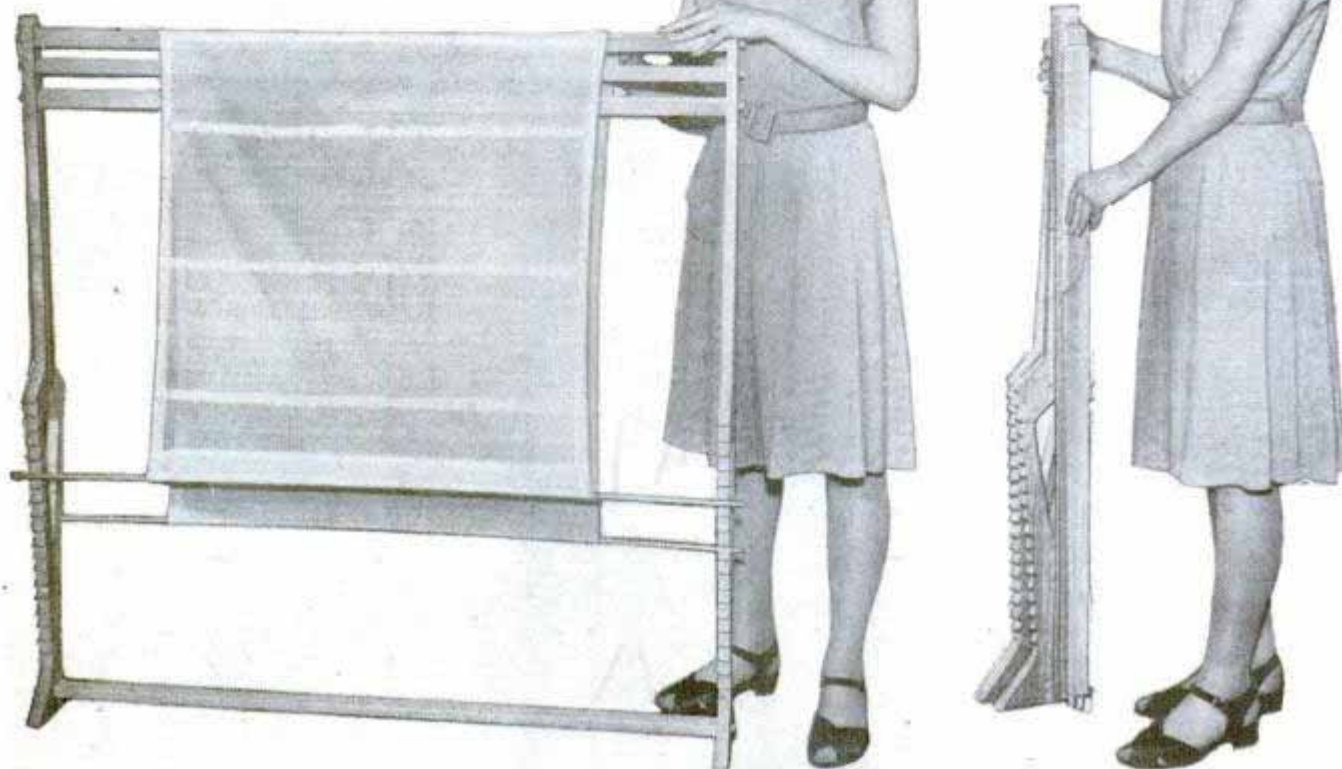

CURTAIN STRETCHER has no pins that might damage fine curtains. The stretcher is a compact bundle when collapsed, can be assembled in less than three minutes. It holds three curtains at once, stretching them through bars inserted in the hems

SLIDING EGG TRAY that hooks beneath refrigerator shelves makes use of precious space that is ordinarily wasted and offers better protection for eggs

DRAPERY "CRANE" holds drapes several inches beyond the window frame, making the windows appear larger. It holds curtain rods, too

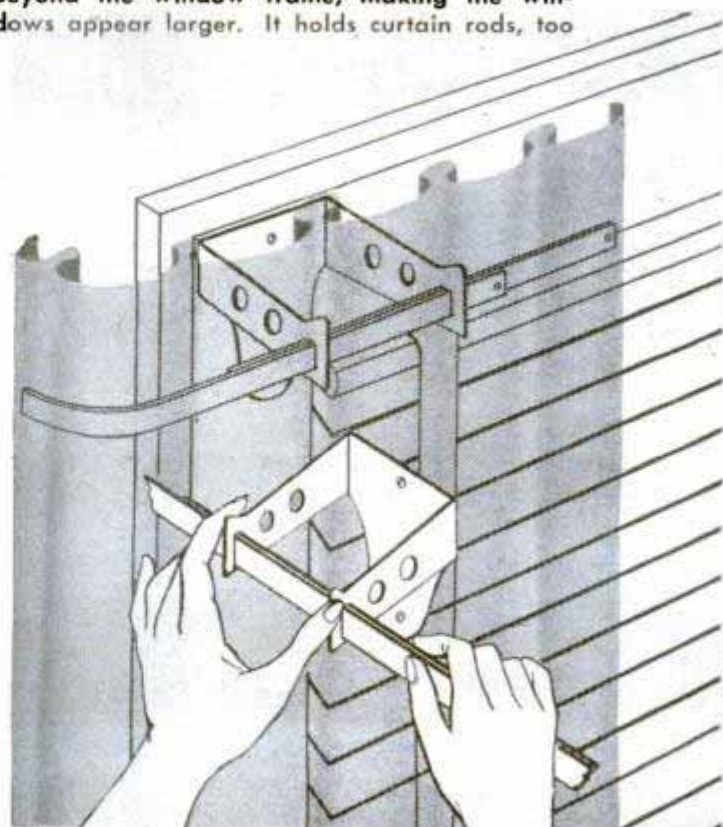
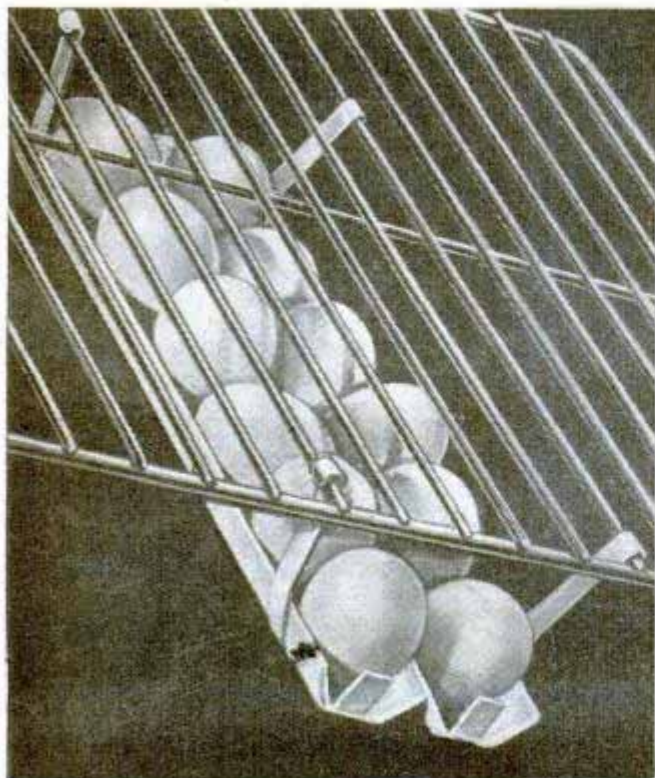



RIPPING KNIFE for home tailors slashes out unwanted seams quickly. Blunt end of the forward finger slides along beneath the material



DOUBLE DUTY BULB converts any lamp to indirect light. Frosted top shoots soft beam upward, bottom gives bright light

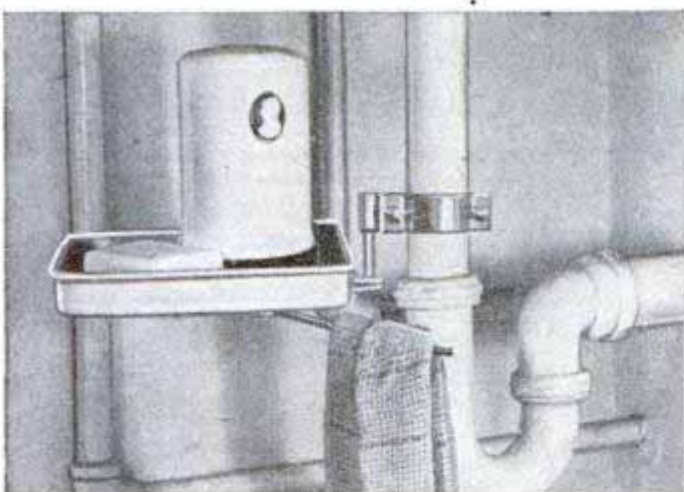

SWINGING TRAY clamps beneath sink to hold soap and other household needs out of sight

↓ **GREASE SHIELD** made of aluminum fits top of standard 10-inch skillets to trap flying grease



↓ **BUILT-IN PRESSURE COOKER** is the feature of a new electric range. Six-quart cooker can be removed and the heating element raised to the surface when desired





BASEMENT INVENTOR

Neighborhood "small fry" are eager to mow the lawn of William Lusk of Chicago because they are permitted to drive the powered mower he invented. Lusk bought a small motor, added a chassis and three wheels and now the scooter-type vehicle pulls a creeping-bent mower around the neighborhood lawns. By loosening a few bolts he can substitute a conventional lawn mower for the front wheel. The operator sits on a tractor seat and drives the mower with controls on the handle bars that are simple enough for a child to operate. A machine manufacturer by trade, Lusk has invented several other time-saving machines. Last winter he developed a power snow sweeper with a revolving brush and metal blades to clean his sidewalk. Among his other inventions are a device to prevent accidental discharge of shotguns, a powered crib for babies, and an air purifier.



Top left, snow sweeper with brushes cleans sidewalks. Top, "scooter" pulls creeping-bent mower. Above, the front wheel can be replaced with a manual lawn mower for a quick job on ordinary grass

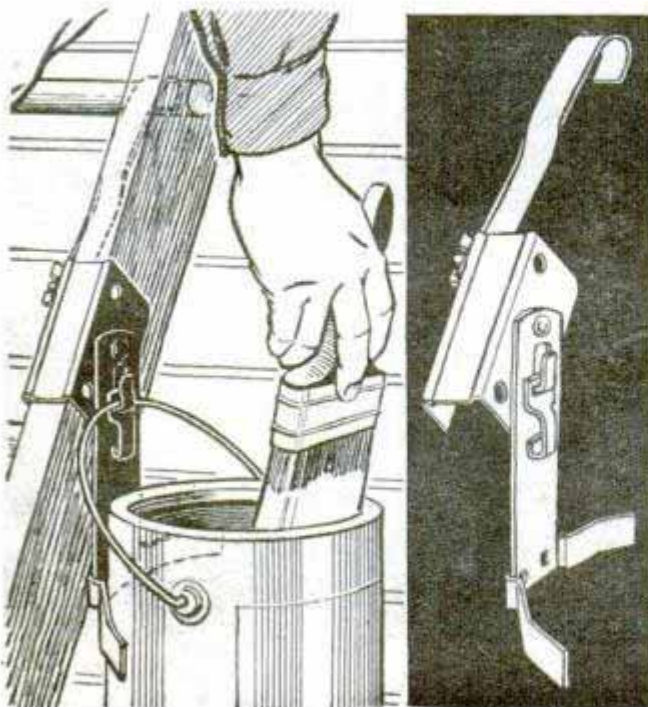

Painter's Ladder Hook

Cans of paint are held in an upright position by an attachment that hooks onto the rung of a ladder. A self-adjusting swivel compensates for the angle of the ladder. The device accommodates pint, quart, and gallon cans.

Chemical Elements Named

Three chemicals, previously known only by a number on the periodic table of elements, have been named. Element 43 is called technetium; 85, astatine, and 87, francium. Technetium was the first element artificially made by atomic bombardment of molybdenum. Astatine also was produced by atom smashing, with alpha particles used to break up bismuth. Francium, with the symbol Fr, was named in honor of France by its discoverer, Mlle. M. Perey.



Platform Elevates Piano Pedals

Small children are able to operate piano pedals by means of a platform and pedal attachments that can be adjusted to reach from five to seven inches above the floor. The platform is made of sheet metal, finished in dark mahogany and covered with corrugated rubber to prevent foot slipping.

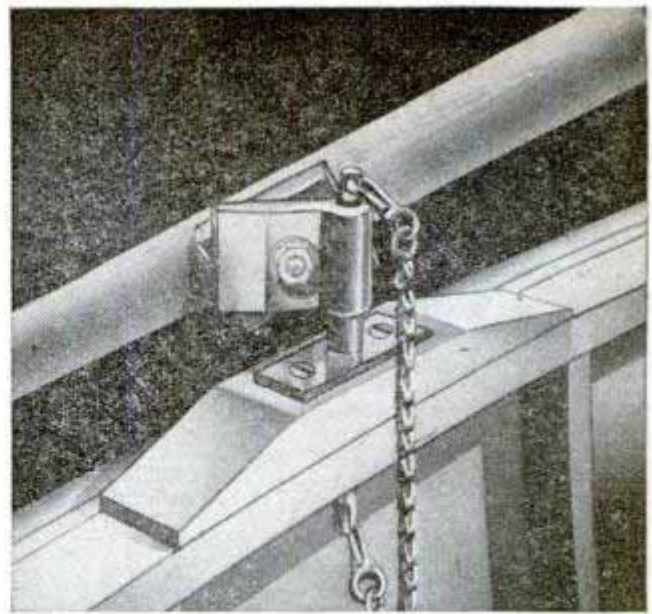

Silent Oarlocks for Hunters' Boats

Oarlocks designed for silent operation permit hunters to approach game quietly by boat. The lower half of the thole pin is tapered to fit snugly into the socket on the gunwale, reducing noise as the oar is pulled. The bolt through the oar passes through a smooth facing plate and then through the swinging plate on the lock. This gives two flat surfaces moving against each other. The locks are made of brass.

Camper's Tent on Wheels

Two beds, icebox, food compartment, gasoline stove and two folding chairs are carried with a folding tent on a two-wheel trailer. Campers and tourists uncouple the trailer from their car and put the tent up in 10 minutes. The trailer serves as the base for the tent which has screened windows and door. Total weight of the trailer and tent is 1000 pounds, but only 60 pounds rest on the car coupling. The tent, which resists water, fire, mildew and mosquitoes, is 8 by 10½ feet.

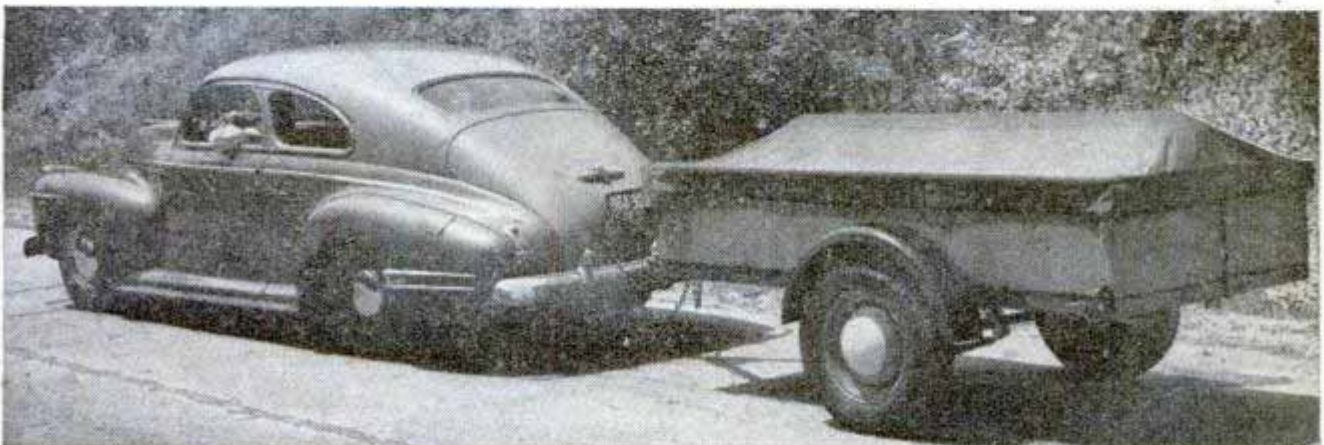

Three steps (top to bottom) produce a curved channel. In Step 1, material is sheared to correct size
 O'Neil-Irwin Mfg. Co. photos



Metal

EVER WONDER how manufacturers make all those curved pieces of metal that go into thousands of products—from miniature hearing aids to heavy agricultural equipment, from model airplanes to automobiles? One method employs a variety of hand-operated machines which bend the pieces into the desired shapes. No dies are used and yet dimensional accuracy to a thousandth of an inch is



In the second operation, the piece of metal is transformed by a brake machine from a flat shape into the desired channel effect

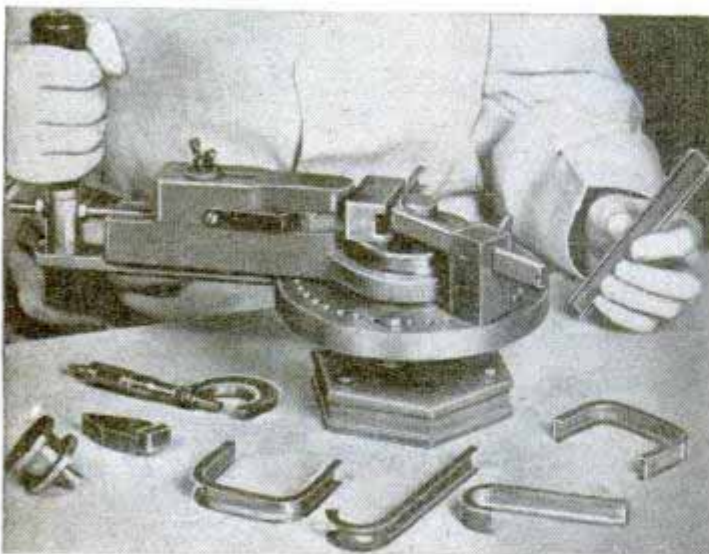
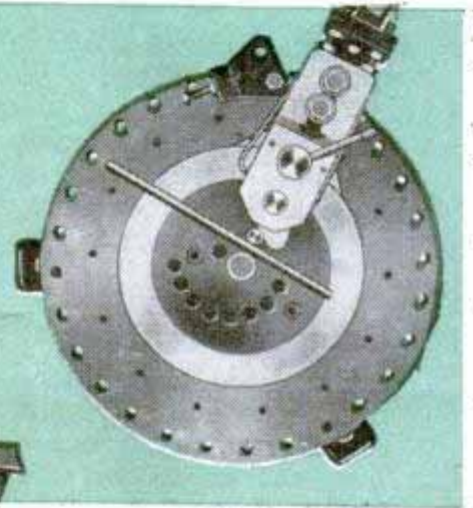

Step 3—bending the channel to the specified radii. At the right is a multitude of shapes that are mass-produced by similar bending machines



Benders

obtained. The machines are adjusted and set so that hundreds or thousands of curved pieces can be produced with virtually no variance in dimensions. Metal benders are often used to turn out a limited volume of parts when it would be uneconomical to buy blanking dies. These two pages show several machines and the pieces they produce.

Flat piece of metal is formed into corrugated shape (right). Below are shown four steps in forming an eye on end of a rod

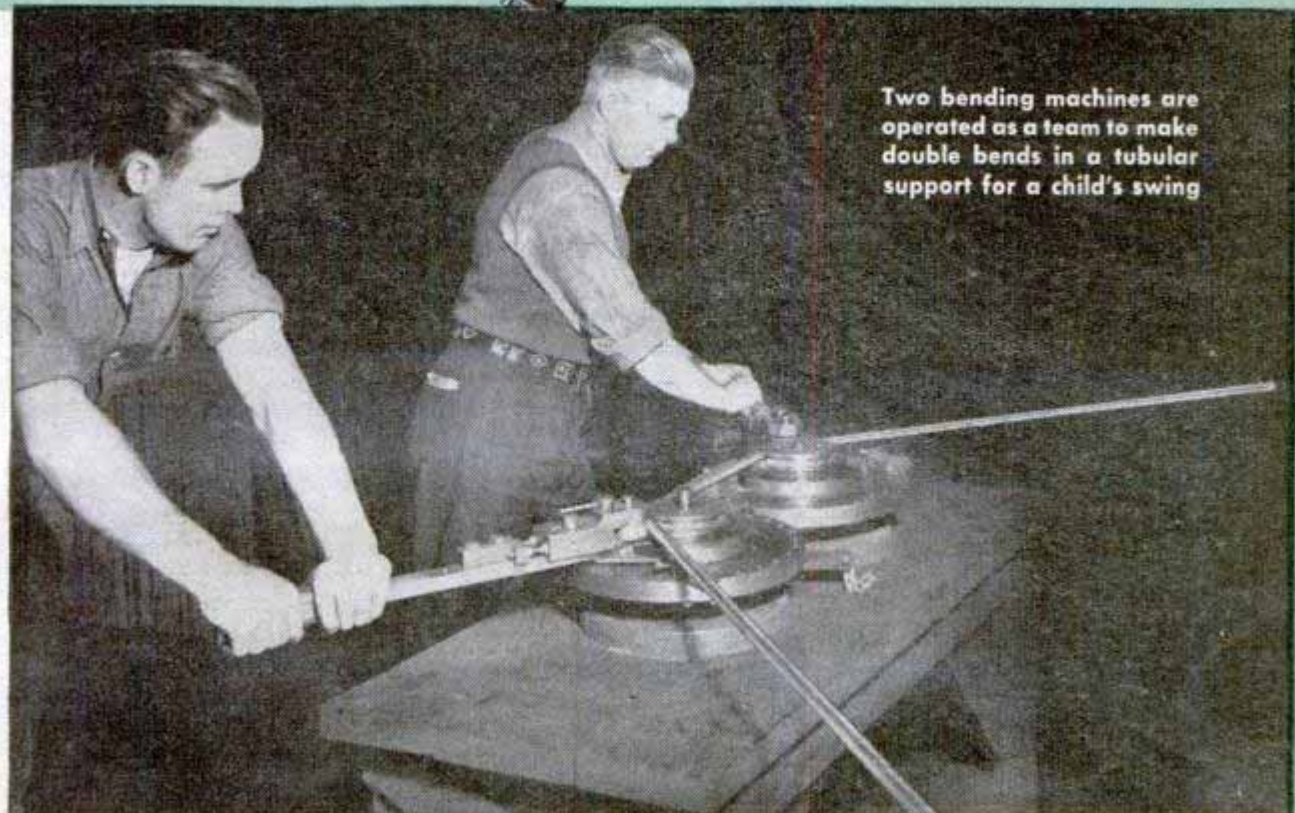
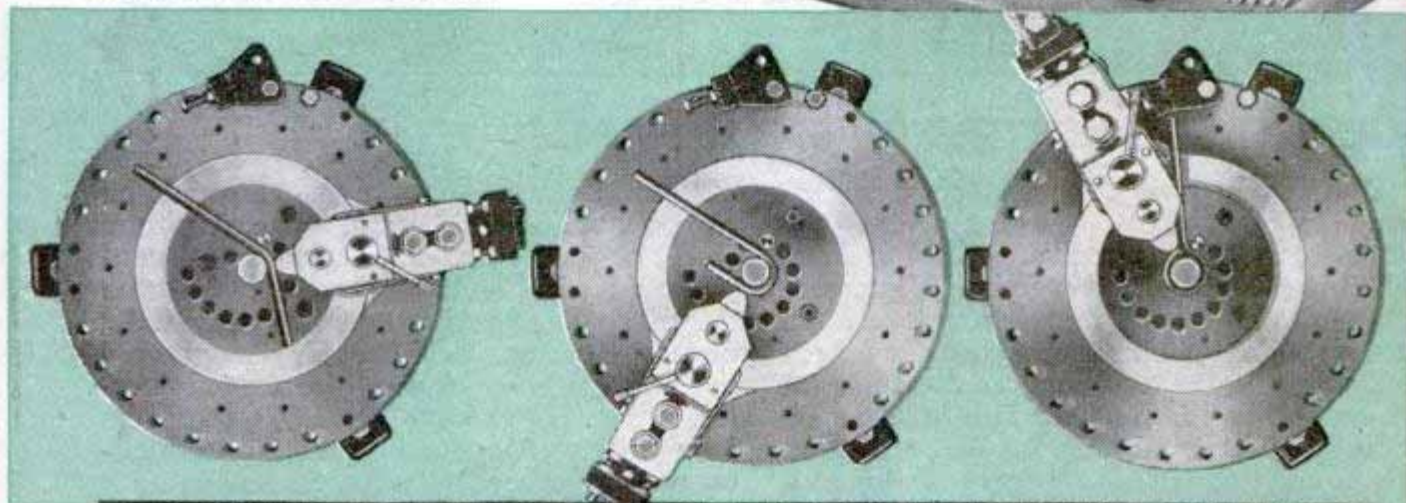

Two bending machines are operated as a team to make double bends in a tubular support for a child's swing

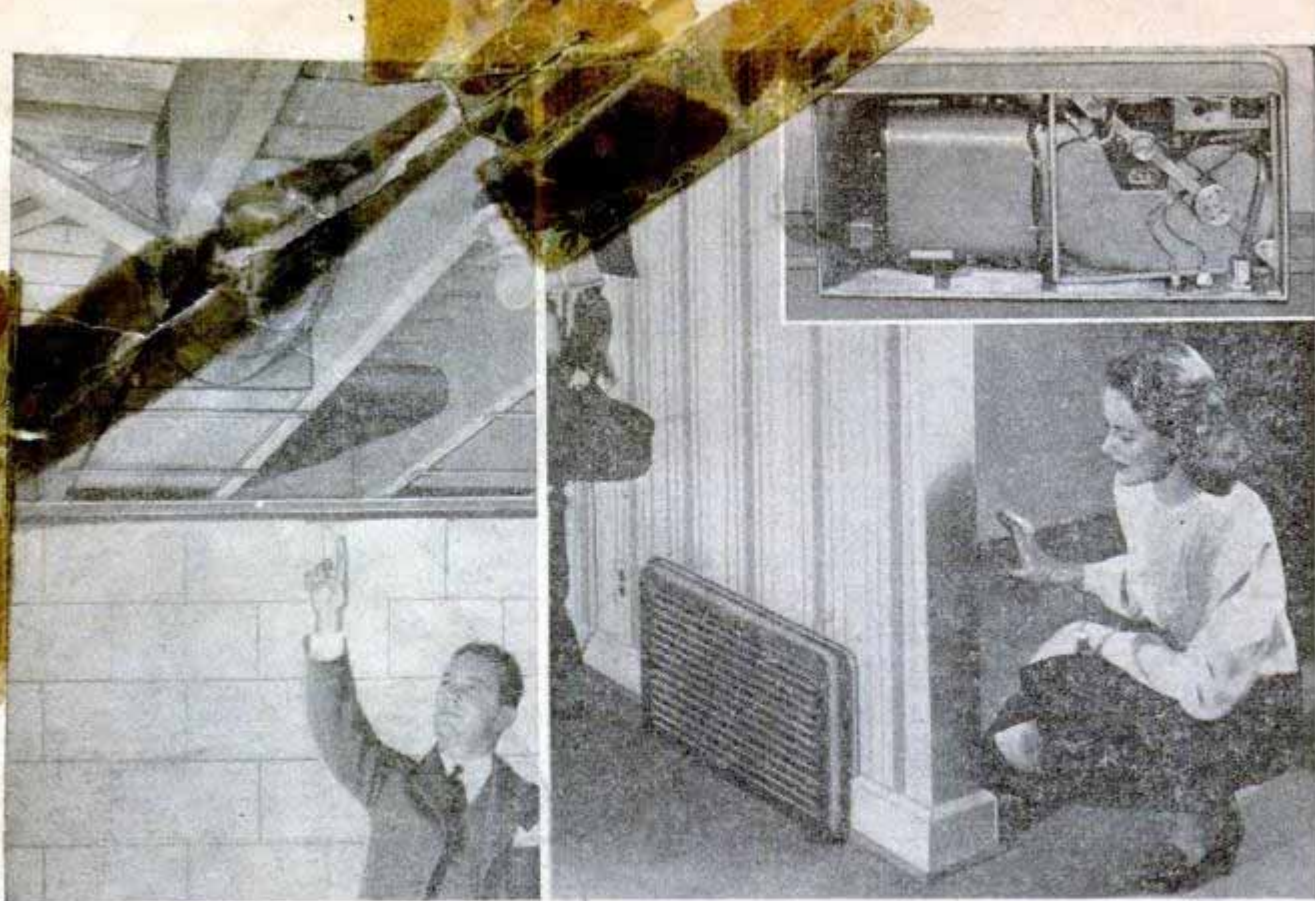

SUITCASE-SIZE HEATER FOR SMALL HOMES

Taking the place of a furnace, two gas-burning heaters, each about the size of a suitcase, will keep the average house comfortably warm in cold weather. Patterned after gasoline heaters used in automobiles and airplanes, the house heater has a hermetically sealed combustion chamber in which the fuel is burned. The fuel can be natural, mixed, manufactured or bottled gas. Since the cabinet always remains at a

safe temperature, the midget heater can be placed in the wall, under the floor, in a closet or in the attic. It uses a small vent pipe instead of a chimney and requires no ducts in some installations and only short ducts in others. Each heater is operated independently by its own thermostat, making it possible to have 70-degree temperature in living room, dining room and kitchen, and 65 degrees in bedrooms and bath.

Matchbox Camera Used by Underground During War

Cameras the size of a matchbox and "vestpocket" darkroom kits were developed during the war by Eastman Kodak Company for agents of the Office of Strategic Services and the underground forces

in Europe. Although the cameras were small enough to be concealed in an agent's hand, they snapped photographs about 1/2-inch square that could be enlarged many times and still be clear. Film for the camera was furnished in two-foot lengths wound on spools which provided 30 exposures. The camera had a shutter speed of 1/50 second. For copying photos or printed material the camera was set in a small stand equipped with a close-up lens. There was no view finder and the exposure was made simply by aiming at the subject and pushing a plunger. The tiny darkroom kit contained rolls of 16-mm. film, developing and fixing chemicals in pill form, a small chamois for wiping dry the developed film, a mixing spoon, film clips and a small stick for agitating solutions.



Knockdown Autos

Automobile bodies that may be taken apart in a few minutes enable motion picture studios to make close-up scenes of actors inside a car. Sections of a car body are removed to provide room for camera, sound microphone and studio lights. Mounted on cross-springs, the bodies are bounced up and down when the illusion of motion is desired. The breakaway bodies come apart in three sections. Doors or an entire side may be removed; the roof may

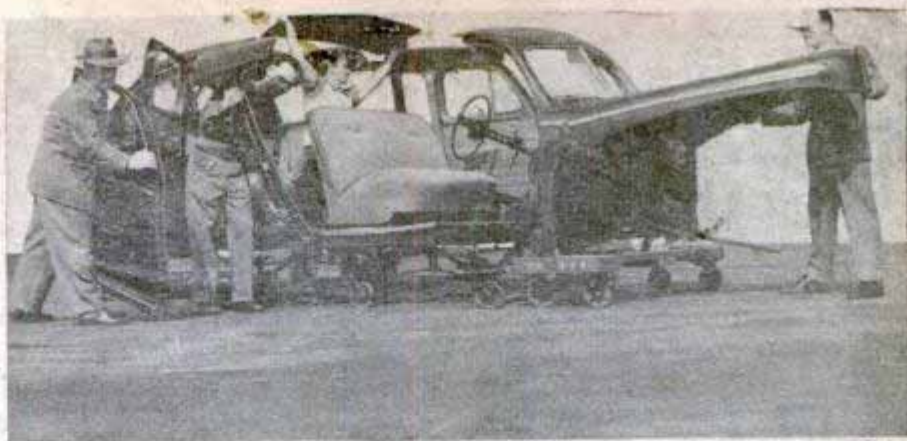

be taken away, and the front or rear sections may be wheeled off. Assembled, the body has a standard appearance. Stock bodies are rebuilt for come-apart action.

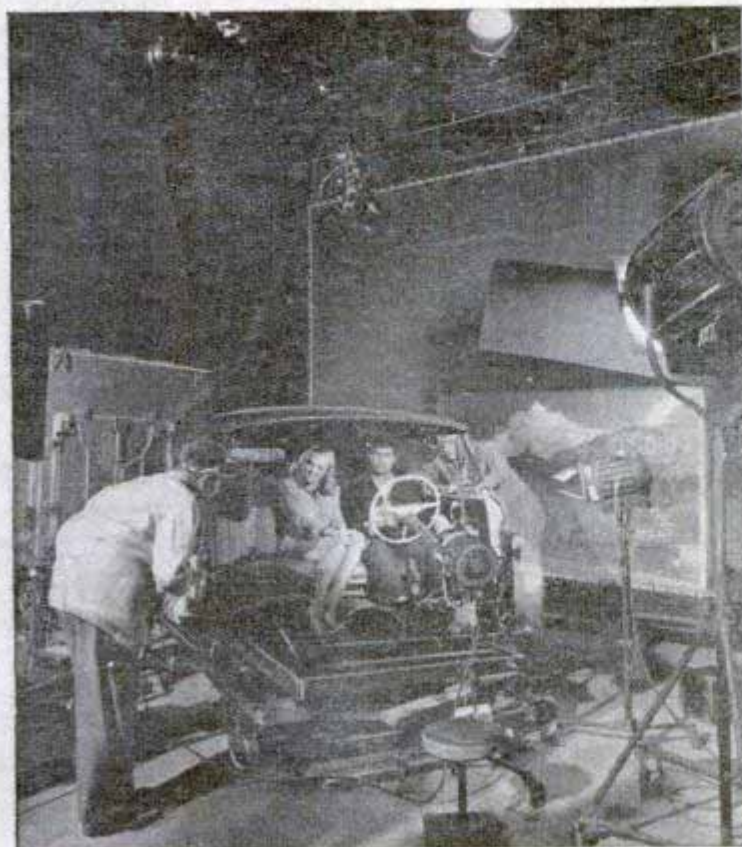
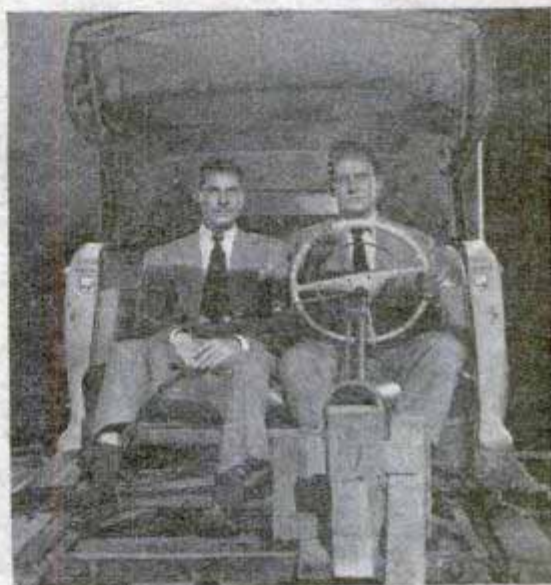
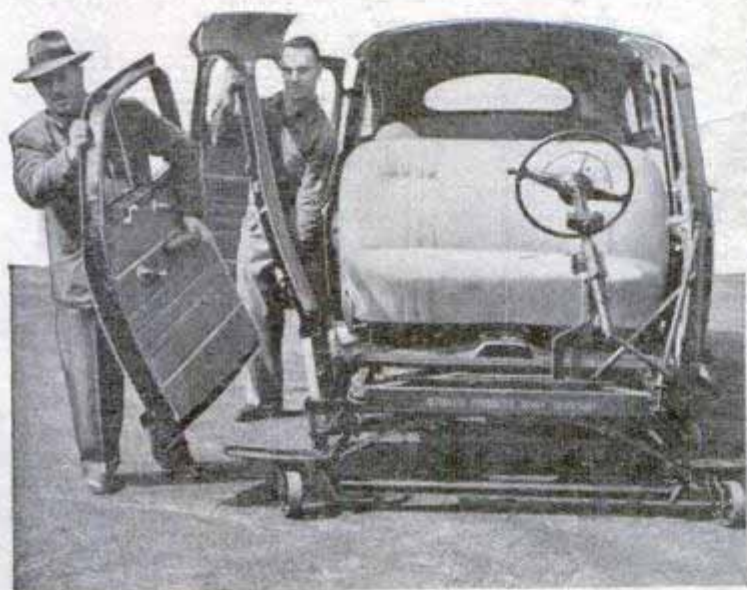

Come-apart automobile body (top photo) divides into three sections for movie close-ups. Front and doors and part of roof can be removed from a sedan body. Or the front and both sides can be taken away, as in the picture directly above. With the front and sides eliminated from a convertible body (left), the camera is moved in close to get the shot shown below. Note the realistic appearing background produced by screen visible at left



GROWING A CROP UNDER TENTS

By Ralph L. Guyette

IN THE rolling Connecticut Valley one of the most valuable crops in the world is harvested under tents that cover thousands of acres. It's shade-grown tobacco. The leaves are used for wrapping fine cigars and this tobacco can be grown in only a few spots on earth.

Years ago the finest type of shade tobacco was grown in Cuba and Sumatra, but high tariff duties put the squeeze on American cigar manufacturers. They solicited the aid of the Department of Agriculture in 1900. After much research the department discovered that a good shade tobacco could be grown in the Connecticut River Valley and in a small area along the Georgia-Florida border.

The Connecticut Valley is one of the most highly industrialized areas in the country and consequently has a high

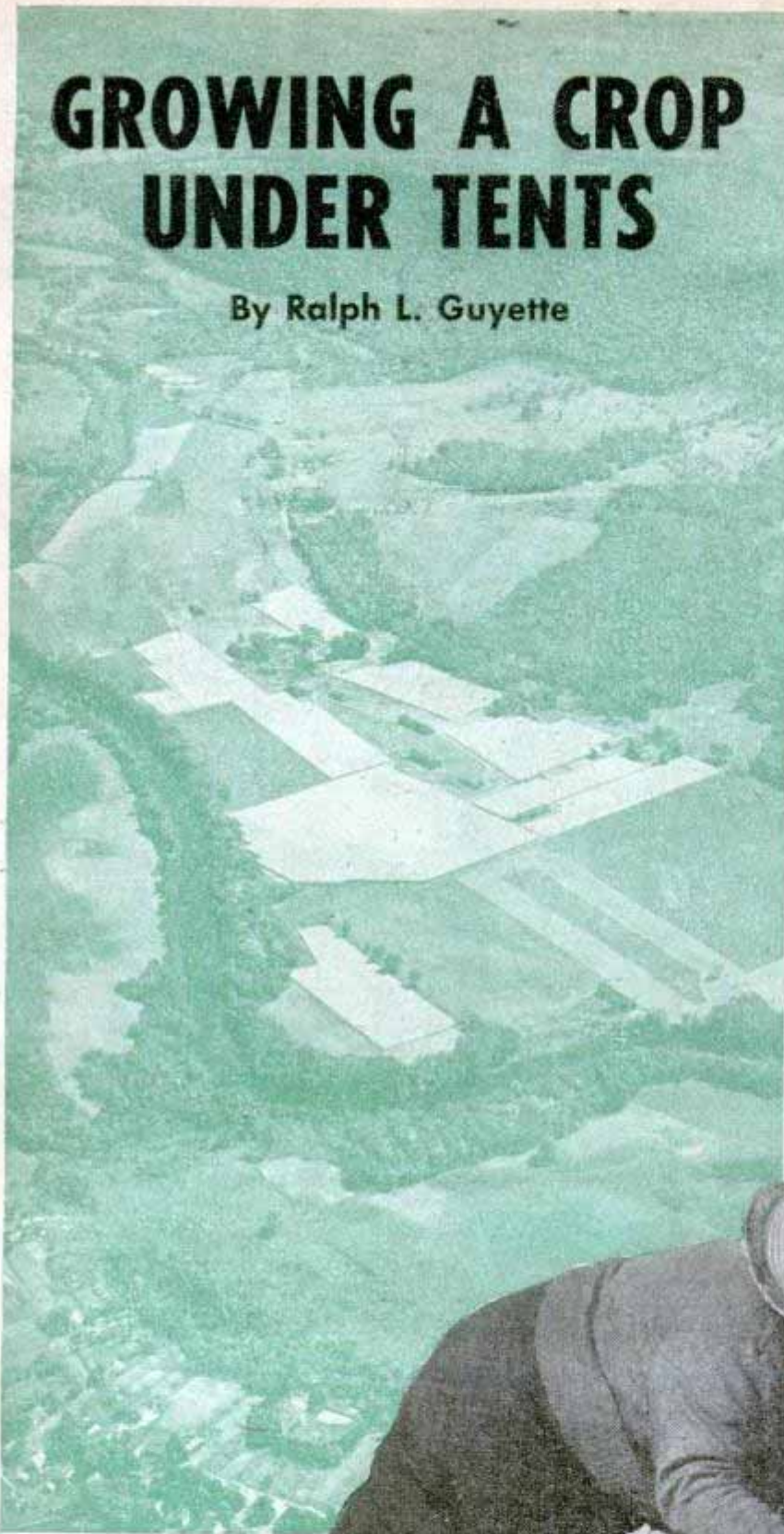

↑ Air view of cheesecloth tents that protect crop. Right, workers choose sturdiest plants from seed beds





Hartford Courant photo

Girls hoe the tobacco beneath miles of tents. Cultivation of the crop requires much hand labor

wage scale. The growing of shade tobacco requires large amounts of hand labor and that is the reason wrapper tobacco is among the most high priced of all agricultural products.

In Cuba and Sumatra the high humidity, temperate climate and a prevailing overcast of low clouds create conditions favorable to the production of fine wrapper leaf. Because all these conditions do not exist in New England, the Department of Agriculture was stumped until it discovered that gigantic cheesecloth tents could be erected over the crop to bring tropical climates to New England. Tents become "clouds" to shield tender leaves from the rays of the sun and boost

Wires stretched on poles support the cheesecloth. Tents prevent the hot sun from burning the tobacco

Library of Congress photo

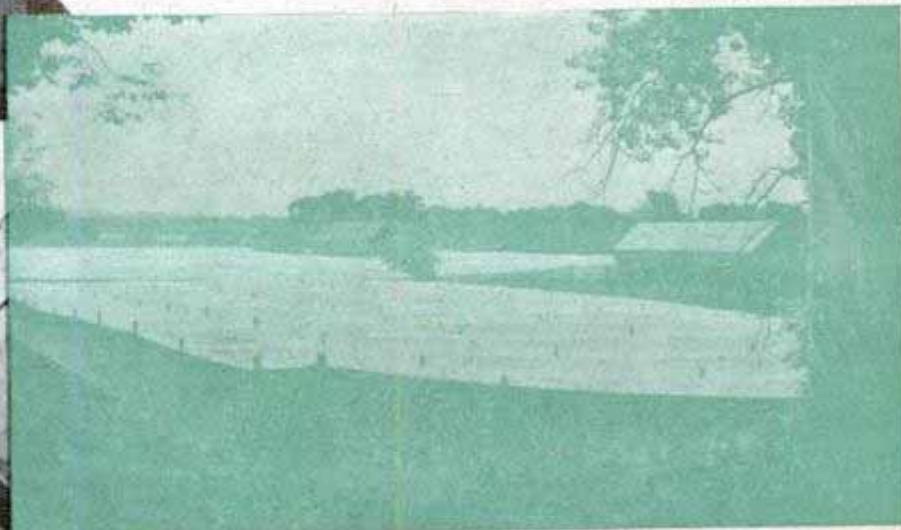
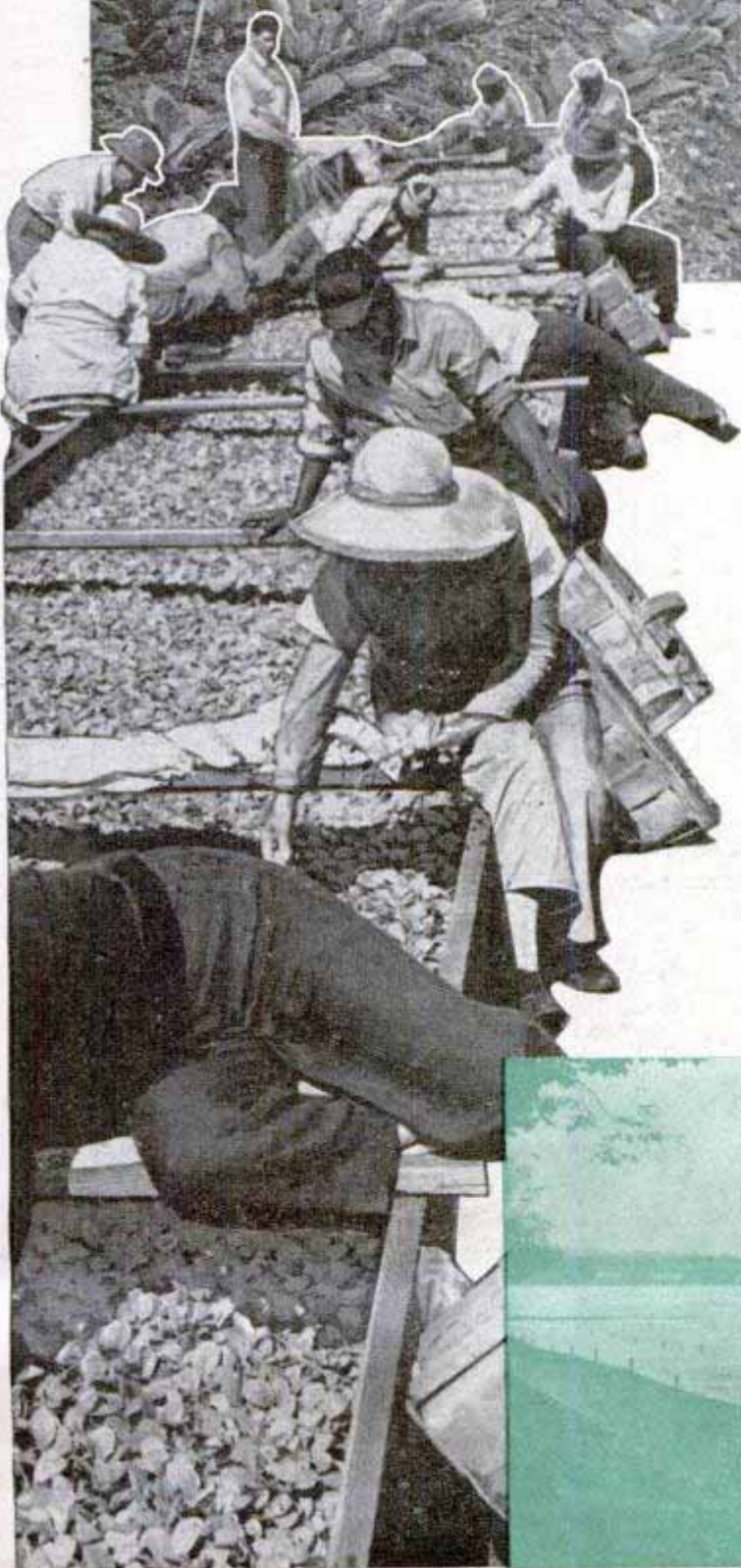



Connecticut Development Commission photo

↑ Long bundles of tobacco leaves are strung to the peaks of air-ventilated curing sheds like those at right

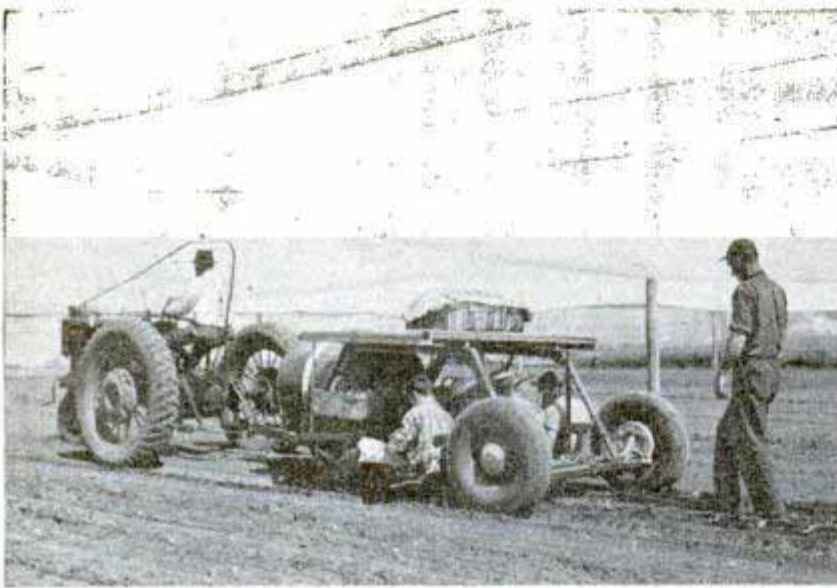

Planting machine makes a trench and fills it with water. Workers set out the plants by hand. Below, the crop is harvested five or six times a season, as the leaves at the bottom mature most quickly

Shade Tobacco Growers Agricultural Association photo



the humidity some 20 degrees.

In the Connecticut Valley is the world's greatest humidifier—8700 acres of cheesecloth tents. Stretching along the river for about 75 miles through Connecticut and Massachusetts, these covers shelter millions of dollars worth of delicate wrappers.

Raising shade-grown tobacco is an art which has been studied and improved through decades. First step is the sterilization of the seed beds under glass. Years ago this was done by injecting live steam into the soil, but today a chemical is sprayed on the beds which penetrates deeply into the ground, minimizing fungus diseases and the growth of weeds. The seeds then are sown and allowed to sprout.

As the plants break through the loose loam they are thinned out and only the sturdiest plants survive. In about six to eight weeks these are transplanted to the fields. Meanwhile the huge tents have to be set up and the land fertilized.

The tents are supported by wooden poles 12 feet high and set at intervals of 33 feet in each direction. They are left in the ground from year to year and replaced only when necessary. Wires are stretched tightly between the poles and

(Continued to page 220)



SPEAR-TYPE STAND equipped with foot pedal holds golf bag upright on the fairway while a golfer takes a shot

PLEXIGLAS ROOF on Pike's Peak sight-seeing railway coach increases vision



MOTOR SCOOTERS solve the transportation problem for Clarence White and his three children in Claremont, Calif. The scooters are economical and have automatic clutches and transmissions for easy operation



SWEDEN'S FIRST JET fighter plane, the J-21-R, has reached speeds in excess of 500 miles an hour at the air force base at Norrkoping. The plane is similar in appearance to the British De Havilland Vampire

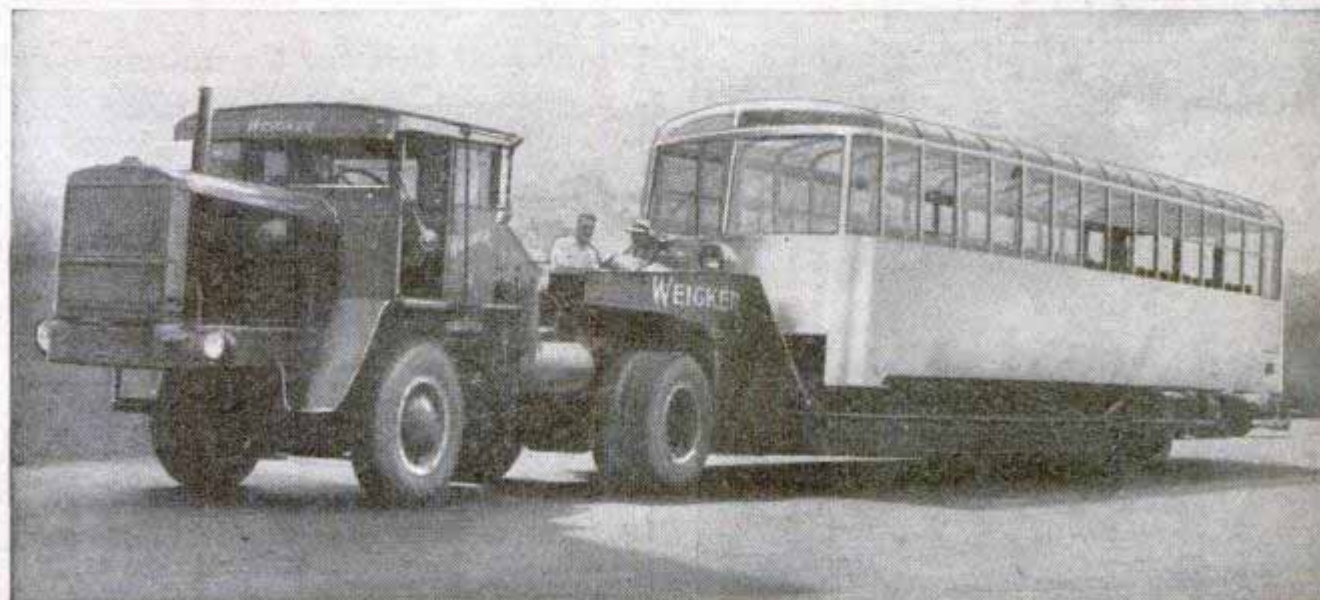

Disposable Spray Paint Containers Save Time in Changing Colors

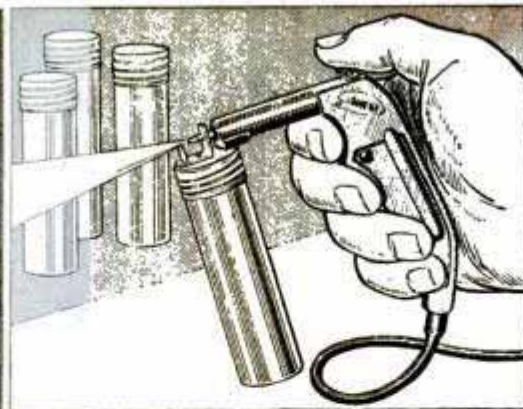

Inexpensive paint containers supplied with a new spray gun outfit eliminate messiness and bother in changing colors. Used containers are thrown away instead of being cleaned and refilled. The air hose uses compressed air from bottled pressure, insecticide sprayer tank, tire pump or an auto spare tire.

Soil Fumigant Kills Insects →

Destructive garden insects are killed by a soil fumigant that can be used without special equipment by the home gardener. The liquid contains ethylene dibromide, a compound that gives off gases which kill many soil pests including wireworms and nematodes. The fumigant is poured into a system of trenches or holes, then covered and packed. It spreads as a gas 10 inches from the point of application and penetrates to a depth of 16 inches. Following treatment, the soil is left idle 14 days before planting.

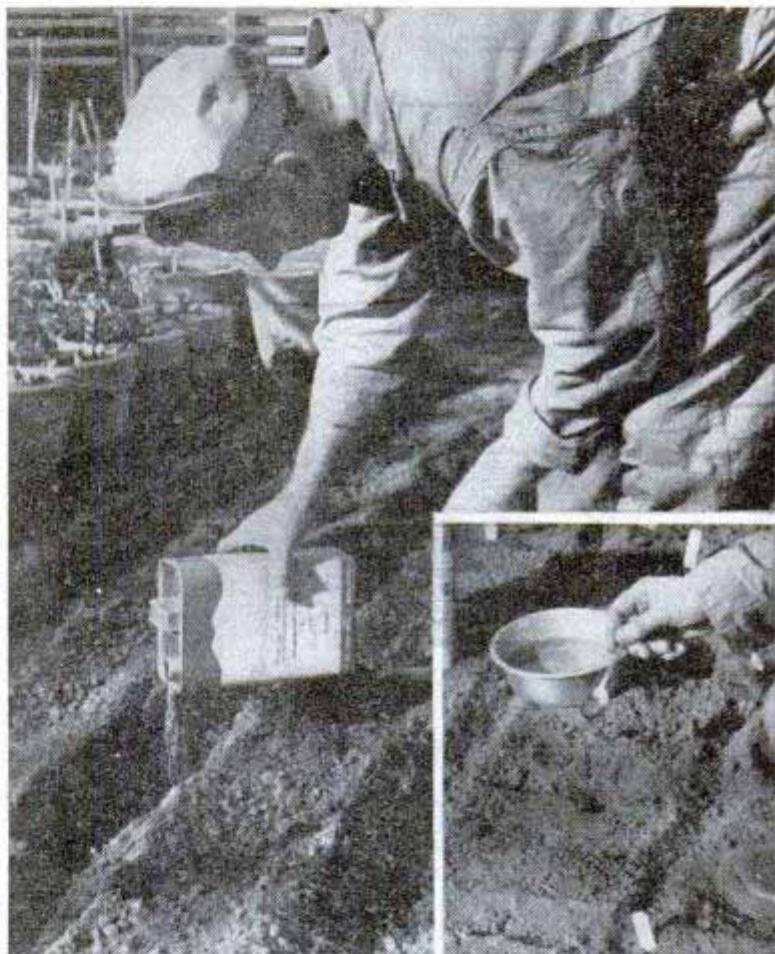

Windowed Lids for Containers

Plastic windows in the lids of metal containers keep the contents in view and do away with the need for labels. In addition to storing small parts and odds and ends, waxes, pastes and ointment can be kept in the containers without deteriorating. They are made in deep and shallow styles in 10 sizes up to three inches in diameter.

You may wish to obtain additional information about the new products described each month in *Popular Mechanics*. If you want to know the name and address of the manufacturer or distributor, just write to Bureau of Information, *Popular Mechanics*, 200 East Ontario Street, Chicago 11, Ill.

**STANDING
Room
ONLY**

**LOS ANGELES
CITY LIMITS**

THE ARRIVAL of a string of pack animals used to be quite an event in the sleepy little village of La Ciudad de Nuestra Senora La Reina de Los Angeles.

Today the same town is concerned with the building of 247 miles of superexpress highways to lighten its traffic load. The dusty hamlet of a century ago has grown into a sprawling industrial colossus.

Los Angeles leads the world in aircraft production, motion pictures, oil-field equipment and sports apparel. It is second only to Akron in tires and tubes, second to New York in the creation of all wearing apparel, third in petroleum refining and food processing, and fourth in furniture manufacturing. The county ranks first in farm production and was second as a war-production center.

Los Angeles' harbor leads all American ports as a fishing center. A quarter million tons of tuna, mackerel, sardines and other fish valued at \$17,000,000 pass through the port each year. Hollywood, an industry as much as a geographical place closely allied with Los Angeles, spends about \$125,000,000 a year to produce



Once upon a time Los Angeles produced movies and weather. Suddenly it is a colossus of industry

motion pictures that draw around \$270,-000,000 at the nation's box offices.

Now Los Angeles County is clinching its claim to second place in the automotive industry as well. Before the war, Ford and General Motors assembled up to 154,000 cars a year in the Los Angeles area. Today these concerns are expanding their facilities and other motor makers are moving in.

Assembly plants for Buick, Chevrolet, Chrysler, Dodge, Ford, Kaiser-Frazer, Lincoln, Mercury, Nash, Oldsmobile, Plymouth, Pontiac, Studebaker and Willys are to turn out 650,000 units or more per year for distribution in the 11 western states. Seventeen thousand workers not including those in the area's steel, rubber, battery, sub-assembly and accessory shops are to be employed in the assembly plants.

This industrialization in the West parallels the westward shift of population that is occurring today. The West was growing by leaps and bounds before the war, then this growth was stepped up by the recruiting of hundreds of thousands of workers in the East and Middle West to work in the war production centers along the Pacific Coast. It was supposed that most of the new population would return home after the emergency. Los Angeles in particular was bursting at the seams and sighed with relief when the war ended.

Then came a surprising aftermath. Tens of thousands of people left Los Angeles almost at once but most of them went home simply to wind up their affairs. They returned in a few weeks, often being followed west by their former neighbors. The influx of population continued and today it is estimated that the Los Angeles metropolitan area has a permanent population of about 3,500,000 people. Predictions that the area some day will support 10,000,000 people no longer seem fantastic.

Some war plants, especially in plastics and light metals, switched over to civilian production without a hitch when the war ended. Vast plants that were built solely to manufacture military aircraft were occupied by new concerns as rapidly as leases could be arranged. In 1946 alone 263 new industrial enterprises were established in Los Angeles County and 389 existing plants were expanded. This represented a one year's investment in excess of \$155,000,000. Current industrial employment is 85 percent greater than it was before the war and amounts to more than half the total industrial employment in the whole state.

All this created an acute housing shortage that still continues in spite of tremendous efforts to catch up with the demand. Vast tracts that before the war were cattle ranches or grain fields are now communities of modern homes complete to paved

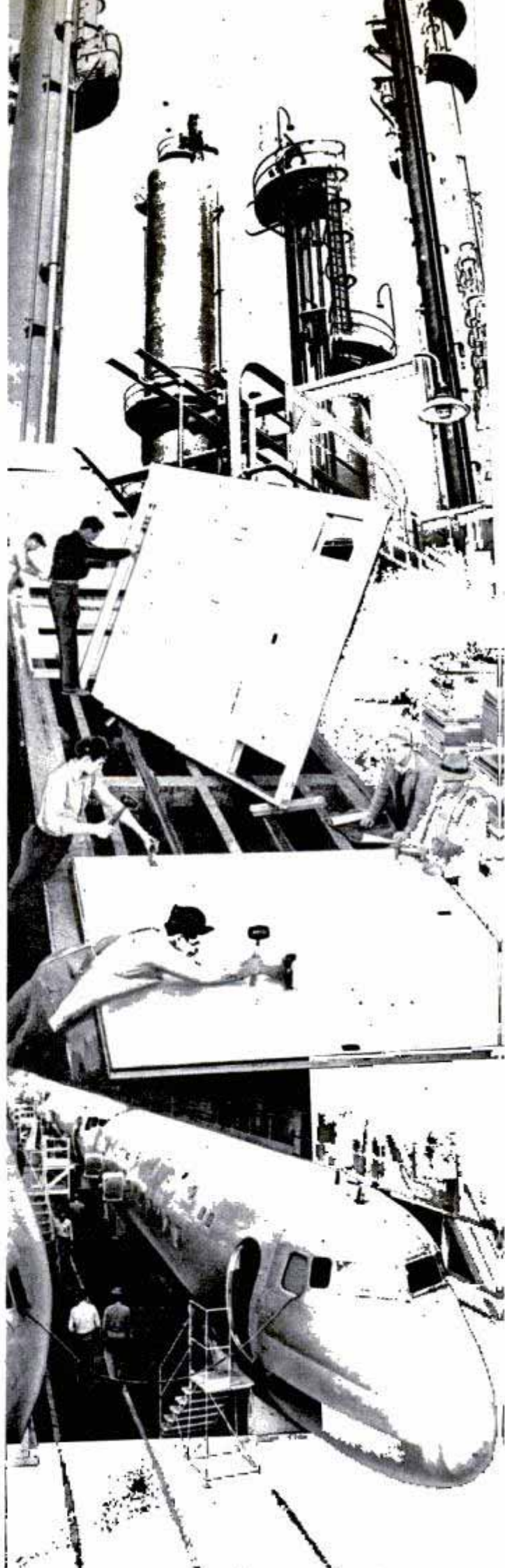



From movies to synthetic rubber (processing towers at top of opposite page) and from prefabricated houses and automobiles to vacuum cleaners, beach balls and sportswear—that's industrial L.A. in action



Engineer lifts model to show how future superhighways planned for city will pass through buildings; note ramps and parking levels. Below, multiple-lane highway from San Fernando Valley

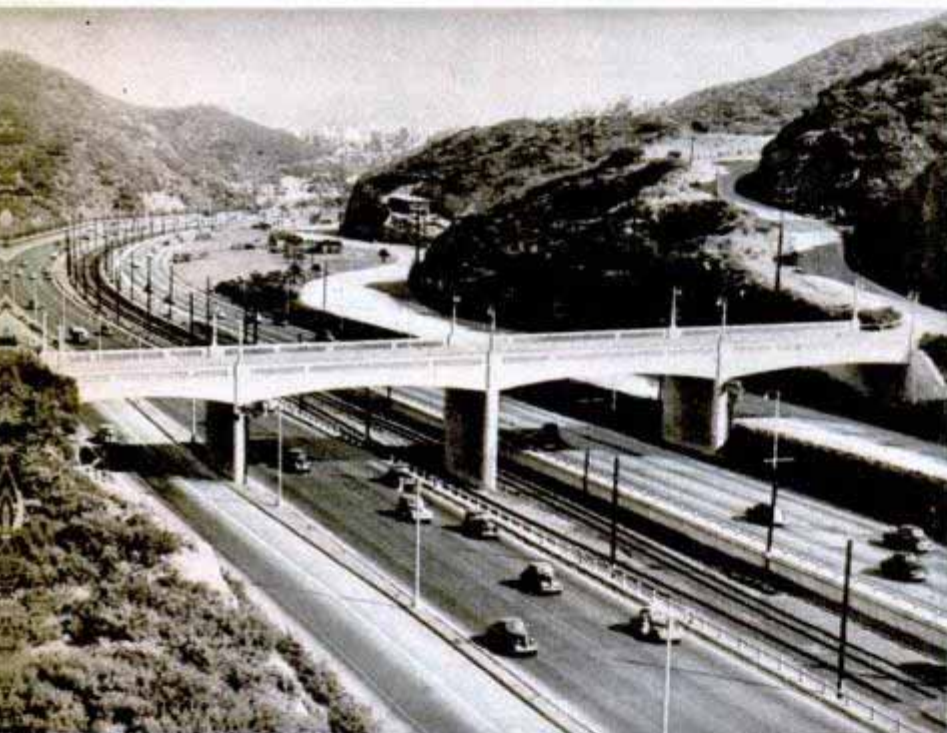

Model of big trailer park under construction (below) and aerial view to the right tell the story of booming Los Angeles. All homes seen from air here were finished in last couple of years



streets, traffic signals and shopping centers. Kaiser Community Homes, as one example of mass building, is constructing thousands of houses on a factory production basis, virtually all of which are purchased while they are being assembled. The new owners move in the day after the painters and decorators finish their work. Vast tenementlike apartment houses are practically unknown in the West and the average family has its own backyard garden, often including a few orange, avocado or walnut trees.

Private residential and commercial construction in Los Angeles amounted to \$220,637,000 last year, far above the nongovernment building permits of any other American city. Even so, homes are still scarce. Apartments are practically impossible to find and hotel rooms are in such demand that the stay of each guest is limited.

The housing shortage will ease this year or next, it is expected, and meanwhile Los Angeles is fighting two other problems that have accompanied its expansion. Noted in the past for its clear skies, the area now is plagued by a "smog" condition of smoke and industrial gases during some parts of the year. A unique temperature inversion in the atmosphere plus the background of mountains literally converts the Los Angeles basin into a closed room during some seasons. Smoke and gases lie stagnant in the air instead of being dissipated by the wind. The large



synthetic rubber plants and other principal sources of irritating fumes now use filter traps in their stacks. "Smog detectives" are tracing the smog that still exists so that similar remedies may be applied where needed.

Metropolitan Los Angeles includes an area of about 1200 square miles that stretches from San Fernando to Long Beach and from Santa Monica to San Bernardino. The region grew up during the automobile age and never felt the need for mass rapid transit systems of the types required in densely settled portions of the East. Private cars plus good roads and a few interurban electric lines always were adequate.

Today the number of automobiles has increased to the point where streets and highways are clogged with traffic during rush hours. Some kind of rapid transit must be provided and the city is studying a number of ideas, including a proposed jet-propelled overhead monorail system that would serve all nearby communities.

Most probable solution to the transportation problem appears to be large fleets of automotive buses that will operate over an expanded system of high-speed motorways. Construction of these has started. One freeway or parkway is being built from downtown Los Angeles through Hollywood and connecting to the San Fernando valley. The Santa Ana Freeway toward Orange County is under construction, as are portions of the Terminal Island Parkway.

Within the next 12 years the city, county and state propose to build 247 miles of freeways within the area. This tremendous multibillion dollar project

(Continued to page 244)



Los Angeles' fishing port is America's greatest, and these giant sea bass prove there's sport here too. Below, searchlights at coliseum criss-cross the night sky

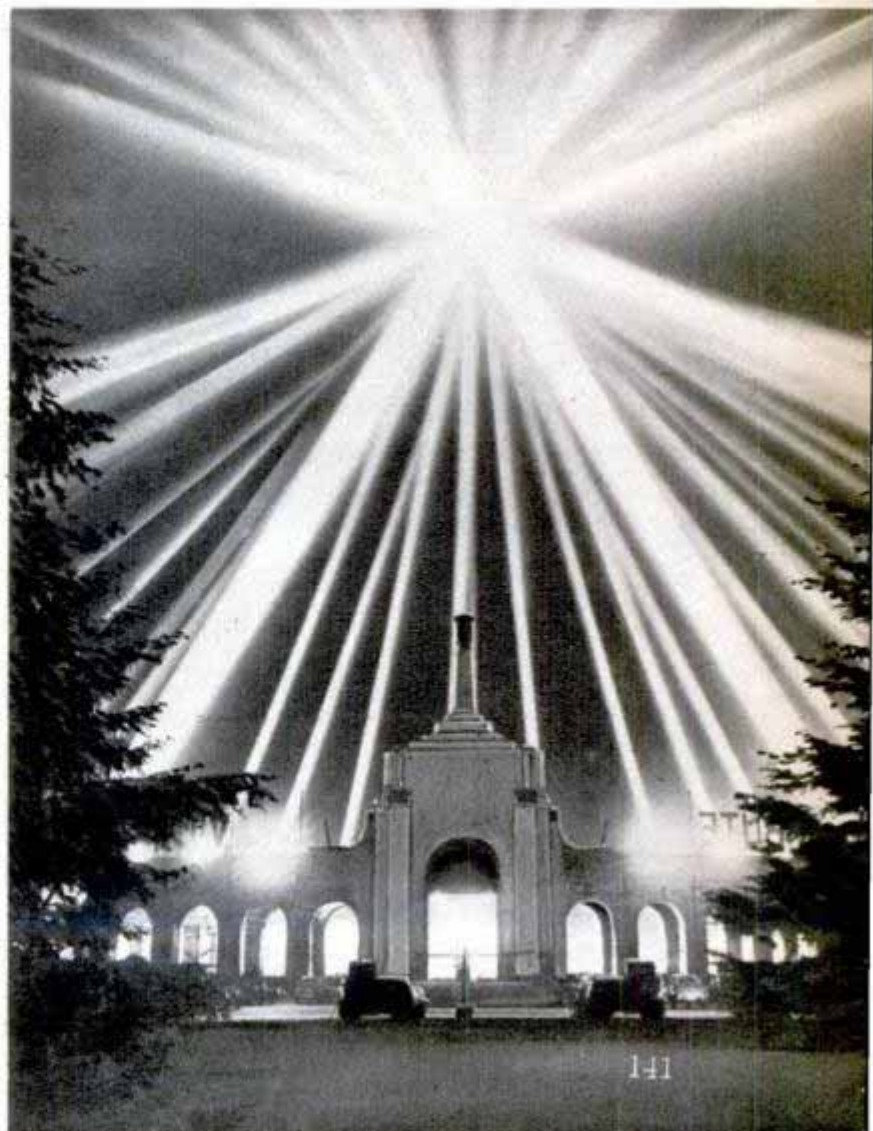

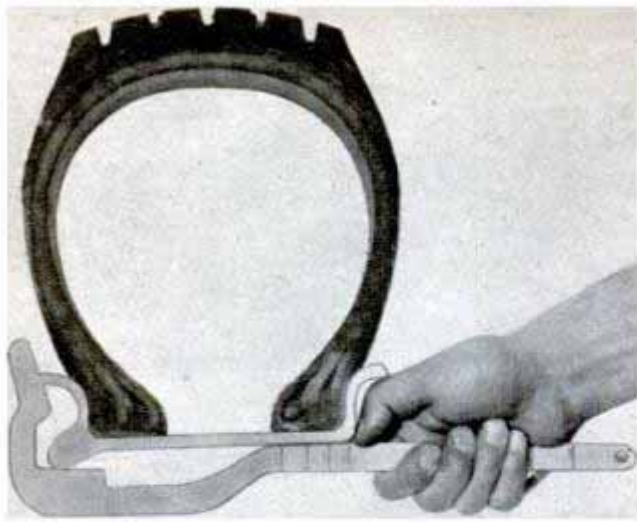

Rim Gauge "Sees Through" Tire

Rim size for most wheels can be measured with a gauge that makes it unnecessary to remove the tire and tube. The gauge is made of lightweight aluminum. Tires have to be removed only on dual wheels where the space band between rims doesn't permit insertion of the gauge.



Stepladder for Big Trucks

Mechanics are able to reach the engines in big trucks with ease by standing on a metal step which fits over either front wheel. The step clamps on tires of all sizes and can be adjusted to various heights.

Lightweight Unloading Platform

Magnesium-alloy dock boards, forming unloading "bridges" between freight cars and platforms, create no sparks and thus eliminate explosion and fire hazards. Lightweight and easy to handle, the magnesium dock boards are available in nonskid, raised pattern safety tread or smooth finish floor plate, in 527 sizes and shapes.



'Dual Control' on Dentist's Drill

At last the patient with a dentist's drill in his mouth gets a break. A Pueblo, Colo., dentist has rigged up a control which the patient holds in his hand. If the going gets too rough he just presses the button and, regardless of the dentist, the drill stops. Its originator says just holding the control gives patients more assurance, though few actually use it.



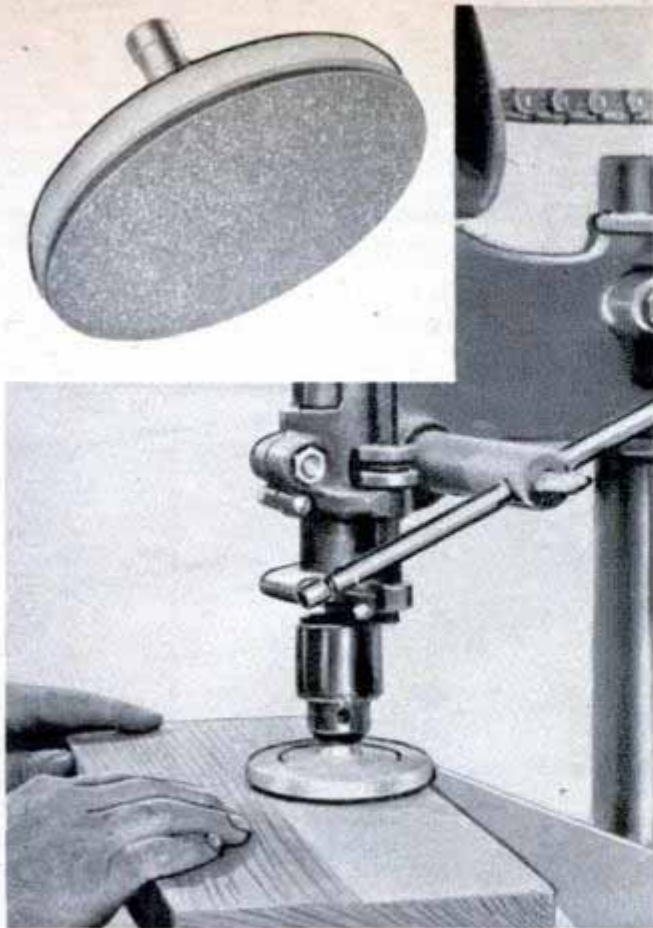

ROTARY SANDER has a four-inch plate cushioned by a sponge-rubber pad $\frac{3}{8}$ inch thick. The steel arbor permits use in any chuck or collet of $\frac{1}{2}$ -inch capacity

GIANT "SPARK PLUG" installed in a power station which serves several communities insulates 230,000 volts of electricity. The insulator weighs more than 6000 pounds

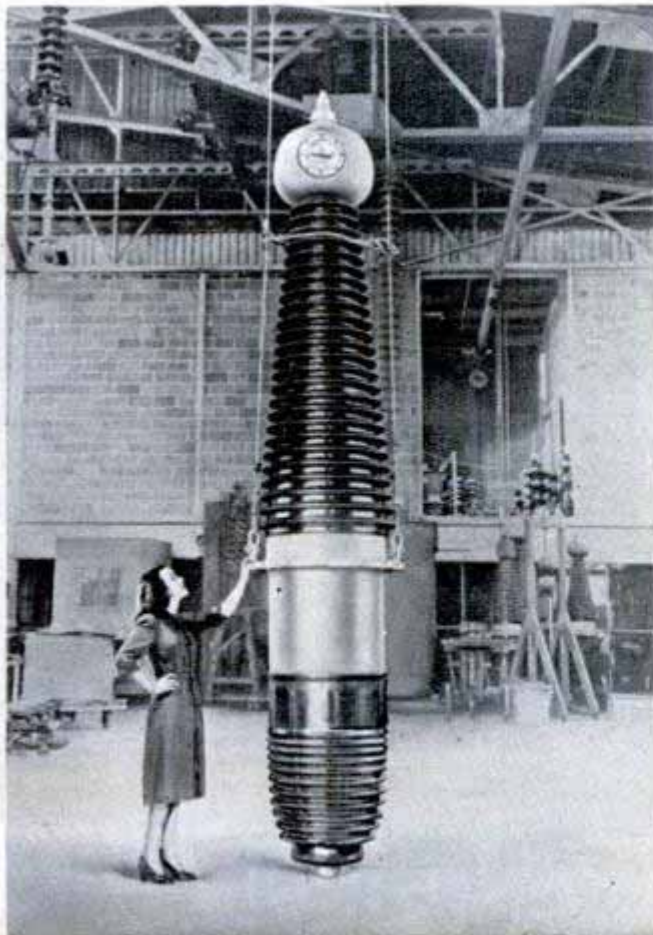

EASY-TO-ERECT GARAGE designed in Sweden comes in six precut parts. The model shown here can be ready for the car 30 minutes after two men start to build it

TREE "MOWER" operates like a snowplow to cut 14-foot willow saplings off river land. With the machine one man can clear 20 acres of overgrown land in one day



THEY CALL IT

Herb Parsons, who takes pot shots at flying targets, can "drill" the hole of a washer and shatter three eggs before they hit the ground. All it takes is plenty of practice, he says



Hitting grapefruit with a high-velocity bullet is a spectacular stunt because target practically disintegrates in the air

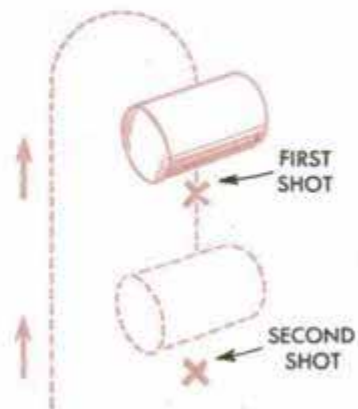
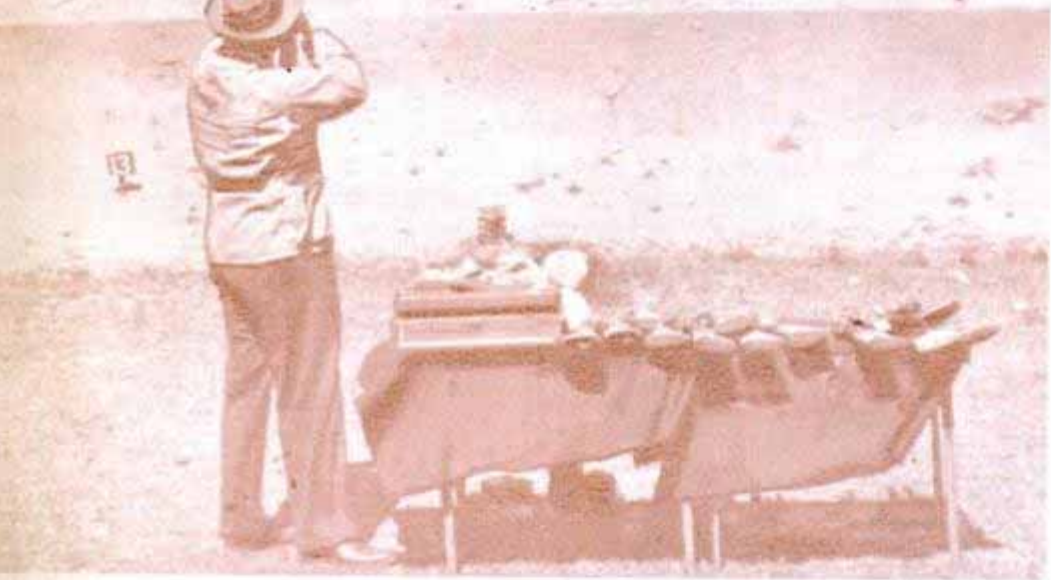

TWO SHOTS AT A SINGLE TARGET



Two quick shots at bottom bottle, top one falls in line for second shot

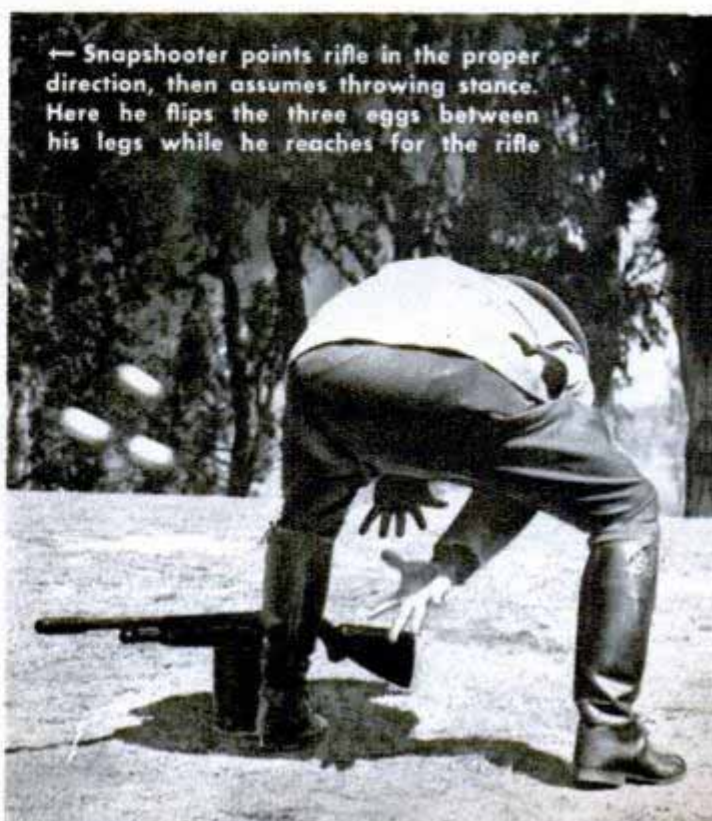

← Snapshooter points rifle in the proper direction, then assumes throwing stance. Here he flips the three eggs between his legs while he reaches for the rifle

SNAPSHOOTING

MOST gun enthusiasts could perform spectacular shots at flying targets if they followed a few basic rules and put in lots of time practicing. That's the contention of Herb Parsons, ace exhibition shooter for Winchester-Western.

One of Parsons' stunts is to toss three marbles into the air and shatter them with three fast shots before they touch the ground. In another he pastes a stamp across the hole in a metal washer and shoots out the stamp after the washer is in the air. "Snapshooting" is what his split-second firing technique is called.

Years of practice are required for such shooting but Parsons says the rudiments are easy to master. A .22-caliber rifle is ideal for snapshooting. He warns that snapshooting never should be attempted in an inhabited area.

First, he says, the shooting must be done with both eyes open. Start with a quart tin can. Kick it out in front of you, then snap the rifle to your shoulder and squeeze the trigger instantly.

After you've mastered the ground firing, try hitting objects tossed into the air by someone else. The trick is to fire right under the target just after it has reached the peak of its trajectory, according to Parsons. Always hold low on falling targets, as most missed shots are too high.

Two shots can be put into the same target by shooting below it once and then dropping the sights for the second shot. In firing at two targets in the air, always fire



Parsons instructs one of his pupils where to aim—just below target after it passes the peak of its trajectory

at the lower one first. Small blocks of wood make good practice targets. Tomatoes, apples and oranges also are good for stunt shooting as they practically disintegrate when hit while they are in the air.

Speed in snapshooting comes with practice but accuracy is most important. Actually a tossed target stays in the air a long time, as Parsons frequently demonstrates. He throws an egg over his shoulder, stoops down to pick up an empty shotgun, loads one shell and hits the egg before it touches the ground. In another egg-and-shotgun trick he tosses three eggs into the air from between his legs, picks up a shotgun, whirls around and fires three shots, smashing all three eggs while they're still in the air.

← One second gone! He drops to knee and picks up shotgun. Below, he shatters egg nearest ground before hitting the other targets





300-FOOT CRANE

Thirty-ton loads of steel are removed from barges in one "bite" by a 300-foot crane shown reaching out from the Mississippi River shore near Vicksburg. The crane was built by R. G. LeTourneau, Inc.,

manufacturer of earth-moving machinery, to unload barges stranded in the river by low water. Thirty tons can be lifted to a height of 150 feet, as high as a fifteen-story building. The crane, which makes snappy work of unloading the barges, is mounted on four wheels eight feet in diameter.



Ventilated Lawn Umbrella

Sun rays are kept out but cool breezes circulate through the alternating aluminum layers of a colorful umbrella designed for lawn or beach use. Air spaces are provided in the eight-foot-wide umbrella between two layers of aluminum strips. It is easy to set up and adjust and is available in a variety of color combinations.

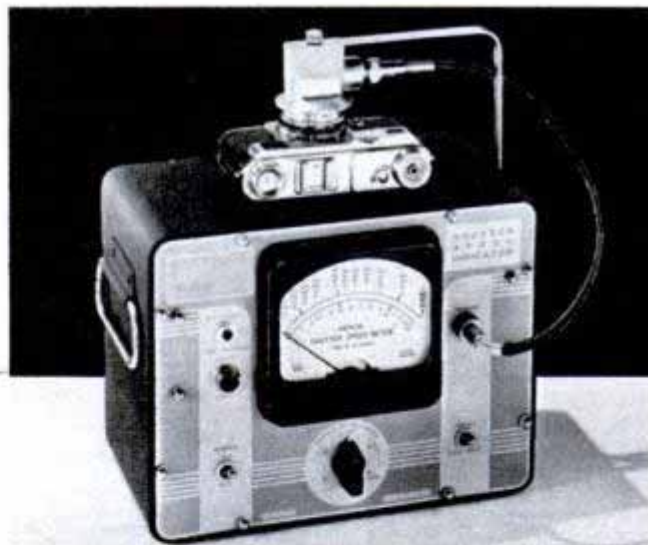

Shutter-Speed Tester

Camera shutter speeds from $\frac{1}{2500}$ second up to $1\frac{1}{2}$ seconds can be tested accurately with a photocell meter now available. The camera shutter is placed between the photocell and an adjustable light source in the meter. When the shutter is tripped, the meter indicates the length of time it remains open. The device is particularly useful to color photographers who must have accurately controlled exposures for good color definition.



Vacuum Still Vaporizes Glass

Solids and liquids never before vaporized are "distilled" in a powerful molecular still developed for petroleum research. By creating a near perfect vacuum, the still evaporates materials into hundreds of parts according to the size of their molecules. Oils, greases and waxes divide into several hundred parts which are analyzed for viscosity, stability and change with temperature. So powerful is the process that in time the glass walls of the still itself are evaporated. Distillation of solids less volatile than grease or wax takes so long, however, that study of their "distilled" parts is impractical. The complex still, built around a five-foot glass tower, was developed by the Gulf Oil Corporation.



Germ-Killing Lamp Creates Ozone

Room air is purified by a lamp which combines an ultraviolet-ray tube with an electric sanitizing unit to kill airborne germs and create ozone, free from harmful irritating substances. The lamp is used in offices, restaurants, factories and laboratories. In animal hospital tests, the lamp lowered mortality by keeping the air sterile.

Giant Tank Shipped by Flatcar

With a capacity of 50,000 gallons, a storage tank 52 feet long and 12½ feet in diameter recently was shipped by rail to the B. F. Goodrich Company. The giant tank was interlined with 1½ tons of rubber and will be used to store muriatic acid. It is near the maximum size that can be shipped on a flatcar.

¶Ninety-eight percent of all common plastic objects can be mended or joined with a welding compound that dissolves the surface material. It can be used with all thermoplastics, including Lucite, Plexiglas and Celluloid. The compound dries and disappears completely, leaving the pieces joined as a single unit.



FLYING FISH...

At Home Anywhere



Republic Aviation photo

YOU FIND the versatile seaplane every-

where now, from river bases a stone's throw from Wall Street to lakes and streams in the Canadian wilds. The float-equipped plane is fast proving it can do almost everything a landplane does, even to alighting on hard-surface runways—as well as a few things the more conventional landbound species can't do.

Take the case of the shiny all-metal Lus-

By William Winter

combe perched on the bait box of the tuna clipper, Liberator, operating off southern California. In the best naval air tradition, the "eye of the boat" is lowered over the side by the net boom and pilot George McKusick takes off to patrol for schools of fish.

This system works so well that the Liberator gets her full catch of fish in fewer days than formerly, and can make more trips than "old-fashioned" clippers without

When winter comes the light floatplane operates on snow or ice. Take-offs are even made from dampened grass

Piper Aircraft photo

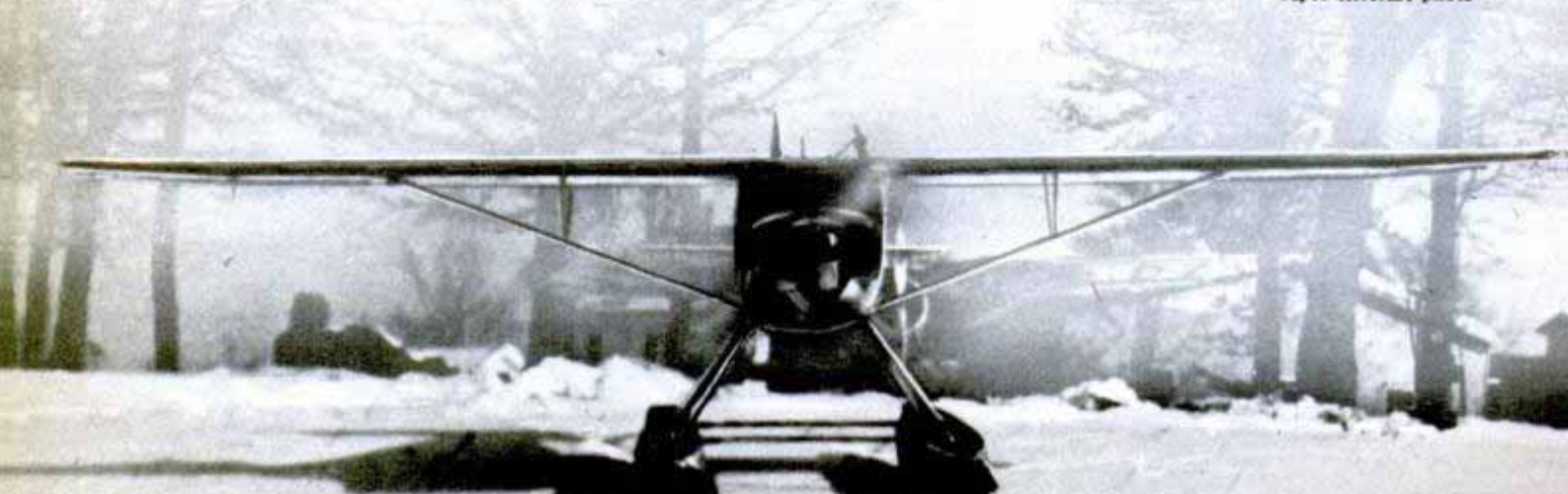



Edo Aircraft photo

Big cities, with their convenient river-front seaplane bases, aren't unusual backdrops for floatplane travel

such a lofty crow's-nest. When McKusick comes in from his patrol, a boom whisks George, Luscombe and all back to the bait box, where the plane sits like a gigantic kingfisher.

Flying a seaplane, you find yourself surprised at the many possible landing places. The plane is by no means limited to seacoasts or big lakes and rivers. When hunters and fishermen staged an aerial blitz on the Maine lakes, the Inland Fisheries and Game Department was forced to fight fire with fire; now the game warden rides the range in a Piper plane. During one patrol, six trappers were apprehended in northern Maine. On skis in winter and floats in summer these ships have been ideal for "airportless" flying.

Besides regular patrol, the planes check game population and the condition of the deer herds. When deep snows prevent the deer from finding food, it is

dropped to them. In the spring, the planes stock streams and lakes with fish.

During Maine's hunting season you can take a train to Masardis and then drive 10 miles to Oxbow, Milton B. Hall's headquarters for the Bradford Recreation Camps.

Lack of airport facilities didn't stop these flying Nimrods from bagging birds a few hours from home





Hall operates a string of camps in the deep woods of the headwaters of the Aroostook. There you take your choice—either a two-day canoe trip to get started, or a 40-minute seaplane ride. Once at the outlying camps you are 36 miles from the nearest settlement. All necessary supplies are ferried in by plane.

Proof that some old airplanes never die is furnished by the Alaska Coastal Airlines. The company operates 12 sturdy floatplanes of nostalgic vintage. There are several Lockheed Vegas—a mighty slick airplane in the '20s—old Curtiss Kingbirds, Bellancas and

a Fairchild Pilgrim. In the maze of islands between Juneau and Ketchikan these rugged old seaplanes are the only dependable means of transportation. They even carry dog teams!

The famous Alaskan bush pilots land seaplanes on water, mud flats and even grass fields. There is a regular routine of change each season from wheels to skis to floats. One pilot landed at Nome after a trip on skis to Kotzebue in a 1926 Bellanca. The sea ice was covered with surface water so he flew over to a nearby strip of cleared land and put on wheels. However, quick changes like this are the exception rather than the rule.

The seaplane is as much at home in the heart of a city as it is in the Alaskan backwoods. Albert Buck started out with one seaplane in the center of Pittsburgh. His first customers were office workers who



A popular trail for float enthusiasts is the Inland Waterway, top, stretching down the coast to Florida. Above, "curb service" for guests arriving at island hotel. Below, fishing in luxury from the ship's nose

Republic Aviation photo



watched his take-offs and landings from their windows. Soon Buck was doing a yearly gross of \$80,000 and in five years of flying had no accidents. Even when snows stop all other flying for weeks at a time at western Pennsylvania airports, Buck's seaplanes buzz up and down the river.

So many seaplane bases are strung along the meandering Hackensack River, just across the Hudson from New York, that the place is called "Edo Meadow" after the manufacturer of virtually all the floats in the country. At the foot of Webster Street on the Oakland Estuary, Howard Norton, an ex-Navy pilot, recently started a service, and there is another on New York's East River. Such close-in bases are not a novelty. You can find them across the nation from the Wall Street Downtown Skyport in New York, where businessmen come and go in their expensive Grumman amphibians, to Gard Safley's base at Jantzen Beach, Portland, Ore.

A big reason for the popularity of seaplane flying is that Nature sup-



Edo Aircraft photo

Attaching small boat to the pontoons for a fishing week end. It is always a good idea to check the floats before take-off to be sure they are watertight



On this trip the Seabee carried four hunters, guns, ammunition, decoys, oars, a rubber boat and a portable shooting blind. Below, making a jet-assisted take-off from dry land in a float-equipped Cessna. The condition of the ground made it necessary to put an airplane dolly beneath the floats





En route to a town eight miles from water, an ingenious pilot buckled on a motorcycle to ride the last lap

plies the landing fields. Sometimes she even supplies magnificent airways, such as the Inland Waterway that runs down the coast to Florida.

Facilities may consist of a landing dock on empty fifty-gallon oil drums that rise and fall with the tide, or the elaborate Orlando Aviation Country Club in Florida, complete with restaurant, tourist's cabins and featuring speedboating, hunting, fishing, water skiing and dancing. Biggest item in an operator's overhead is the pontoons themselves, costing about \$1000 for the average lightplane.

The question of "how do we get to town" was well answered by the General Oglethorpe Hotel on Wilmington Island, Ga., where you can tie the plane to a dock in the front yard and have your bags carried in just as if you had come by car. Guests have been known to fly into the center of Savannah, landing on the river close to the city hall.

Recently, Minden, La., was set agog by a trim little seaplane that landed on Caney Lake six miles from town. It wasn't the seaplane that caused the excitement, but the motorcycle strapped to the port float. The pilot unstrapped his mechanical steed and sprinted into town for lunch, conducted his business and was away within two hours.

At a seaplane base at Ossining, on the Hudson, the operator makes a habit of taking off and landing on the ice. If anything, take-offs are quicker. Since floats lack shock absorbers, the tech-

nique is to use a power landing, which eases the plane down, rather than a three-pointer which can be jolting. Last winter a Cub was used several times as an ice-breaker. This operation must be done with care for thin ice cuts like a knife.

One of the best air show acts in the country is put on regularly by George Lambros and Walter Kulik. The "script" calls for Lambros to shut off the engine when the plane gets over the field. Then Kulik climbs out on the float and inches his way forward

(Continued to page 248)

Just behind the iceboat is a seaplane taking off at an Ossining, N. Y., base
Piper Aircraft photo



Fishing Rod Holder Leaves Hands Free

Either a rod and reel or a cane pole can be supported by a rustproof holder that leaves the angler's hands free to operate the boat. The upper half of the holder swivels in any direction to keep the line free when a fish strikes. To place the rod in the holder it merely is passed over one section of a heavy wire and under another. This leaves the handle free at all times. If the tip of the rod is too low the holder can be adjusted by bending it near the rod handle. The holder clamps to the seat of the boat.



Brake for Fishing Reels

Backlash and snarled fishing lines are prevented by a brake which fits detachable type reels. If the reel overruns and creates slack, the brake automatically sets with no thumb action necessary. The brake is a combination of a drum fastened to the reel handle and an attachment clamped to the rod. It has a line-guide arm and a brake shoe.

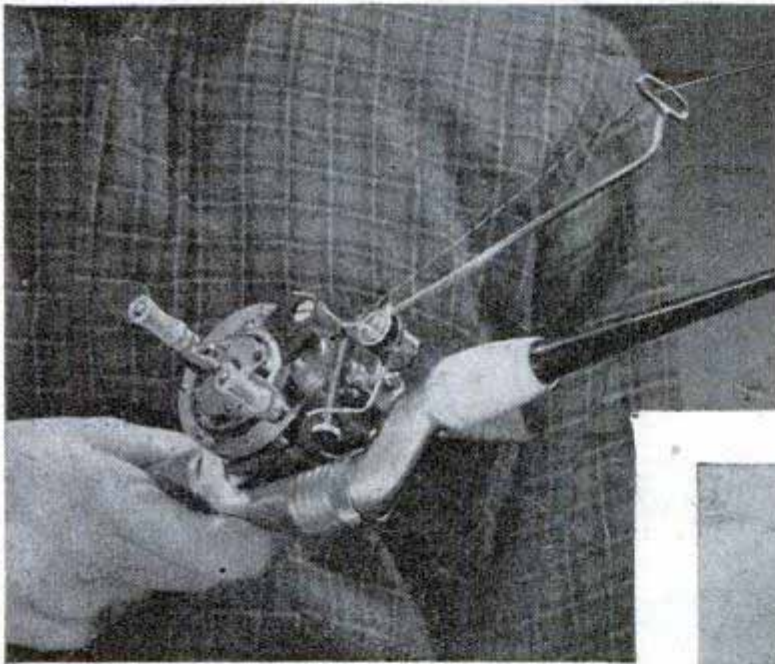

Rubber Boat Fender

Boat hulls are protected from bumping against docks by a synthetic rubber cushion filled with air at five pounds pressure. In addition to guarding the hull, the white float can be used as a buoy or emergency lifesaver. It is available in 12, 16 and 20-inch lengths.

Tire Powder Eliminates Static Electricity In Radios of Cars and Trucks

Automotive engineers have discovered how to prevent tires from generating static electricity which causes squeals and sputterings in car and truck radios. A black powder, injected into inner tubes, collects the static electricity and dissipates it.





Rumble Seat on Basket Holds Child in Grocery

Rumble seats for babies have been added to wheel-mounted shopping baskets in a Pueblo, Colo., grocery store. The manager said he got tired of asking shoppers to keep their youngsters off the baskets, so he designed a safe, comfortable seat.

Plug Balances Aluminum "Wood"

Weight and balance of a new aluminum-headed golf club are regulated by a removable plug to suit the player. The plug is unscrewed and weights are added or taken away. Sets of four matching "woods" are made, with a fiber insert on the face to prevent any metallic sound when a ball is hit. Shafts are made of chrome molybdenum steel.

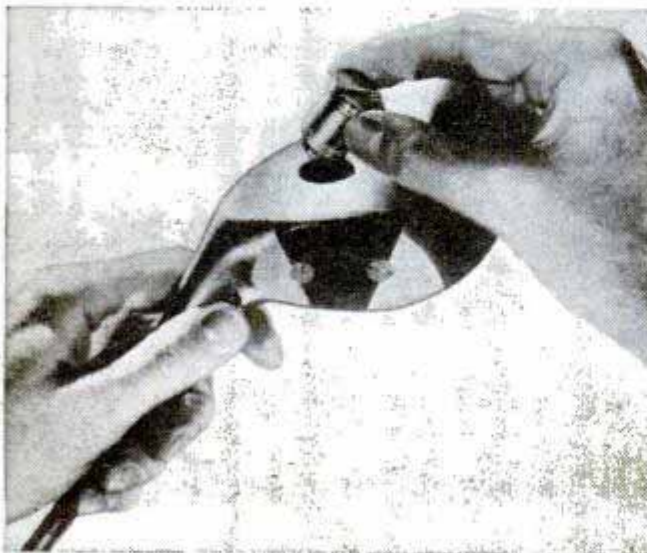

Stall Warning Indicator

Airplane stalls—the cause of most light-plane crashes—may be prevented with a warning indicator on the wings. When the plane speed drops to a critical point, the indicator flashes a red light and blows a horn to warn the pilot. It consists of a small metal tab mounted in the leading edge of a wing and an electric circuit to the cabin instrument panel. Its operation is based on the aerodynamic fact that part of the air passes above a wing and the rest below it. The indicator's metal tab is located so that in normal flight the air flow keeps the circuit open. But as the plane approaches a stall, the air flow moves down on the leading edge of the wing and causes the metal tab to flip up. This closes the circuit,

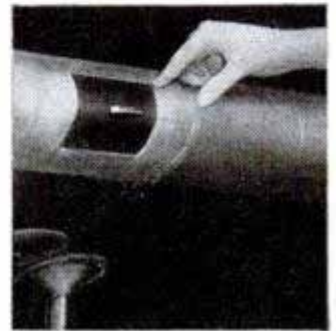
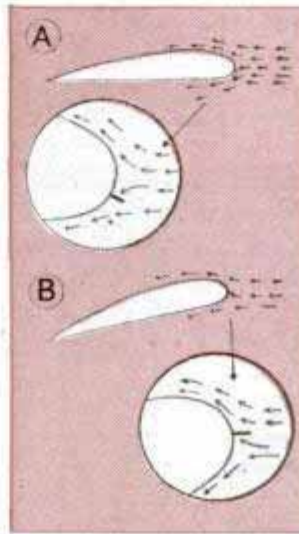

Drawing A shows wing in normal flight with vane held down by rush of air. In B, nearing a stall, air flow pushes vane up and actuates warning device

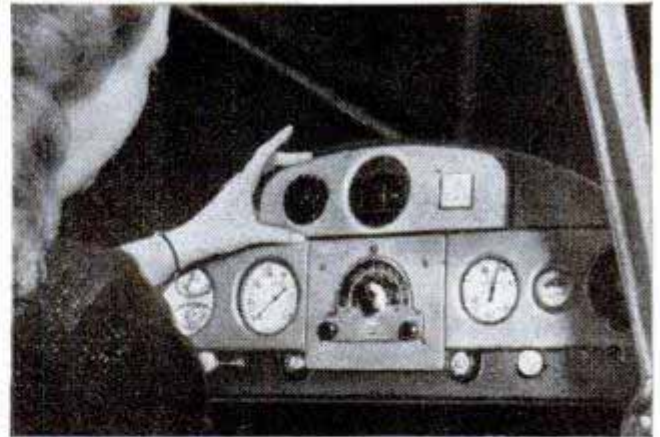

causing the horn to blow and the red light to flash. The indicator was developed by the CAA and Dr. Leonard M. Green of New York City.

Ethyl Alcohol From Whey

Ethyl alcohol is made from milk sugar in whey by a process developed by the U. S. Department of Agriculture. The alcohol can be made as a by-product of cheese or casein manufacture by using steam to concentrate the alcohol. The remaining whey protein serves as cattle feed.

AMMUNITION for the WAR ON DISEASE

By JOHN R. KINSEY

WAR AGAINST HUMANS is over. Now, war is directed against germs and disease to keep humans alive. The demand for such drugs as streptomycin and penicillin grows greater as new curative powers are discovered. Doctors, hospitals and patients cry for more and more medicine.

And they get it.

America's drug manufacturers are accustomed to going into action fast to produce tons of some newly discovered germ killer.

A year ago, streptomycin production was less than two pounds per day. Now, 1100 pounds of the white powdery stuff are produced every month. Penicillin output has climbed to 2500 billion units (nearly



Medical "war map" is photomicrograph of organism that produces streptomycin. Note beadlike spores

3300 pounds) per month, or enough to treat about 2,500,000 patients.

When a new drug is discovered, research men experiment in pharmaceutical laboratories until they learn how the medicine can be produced. Then engineers design and set up the machinery and equipment to make it in vast quantities.

Once these dual jobs are accomplished,

First step in producing streptomycin—adding mold organism to brothy liquid to start seed culture growth

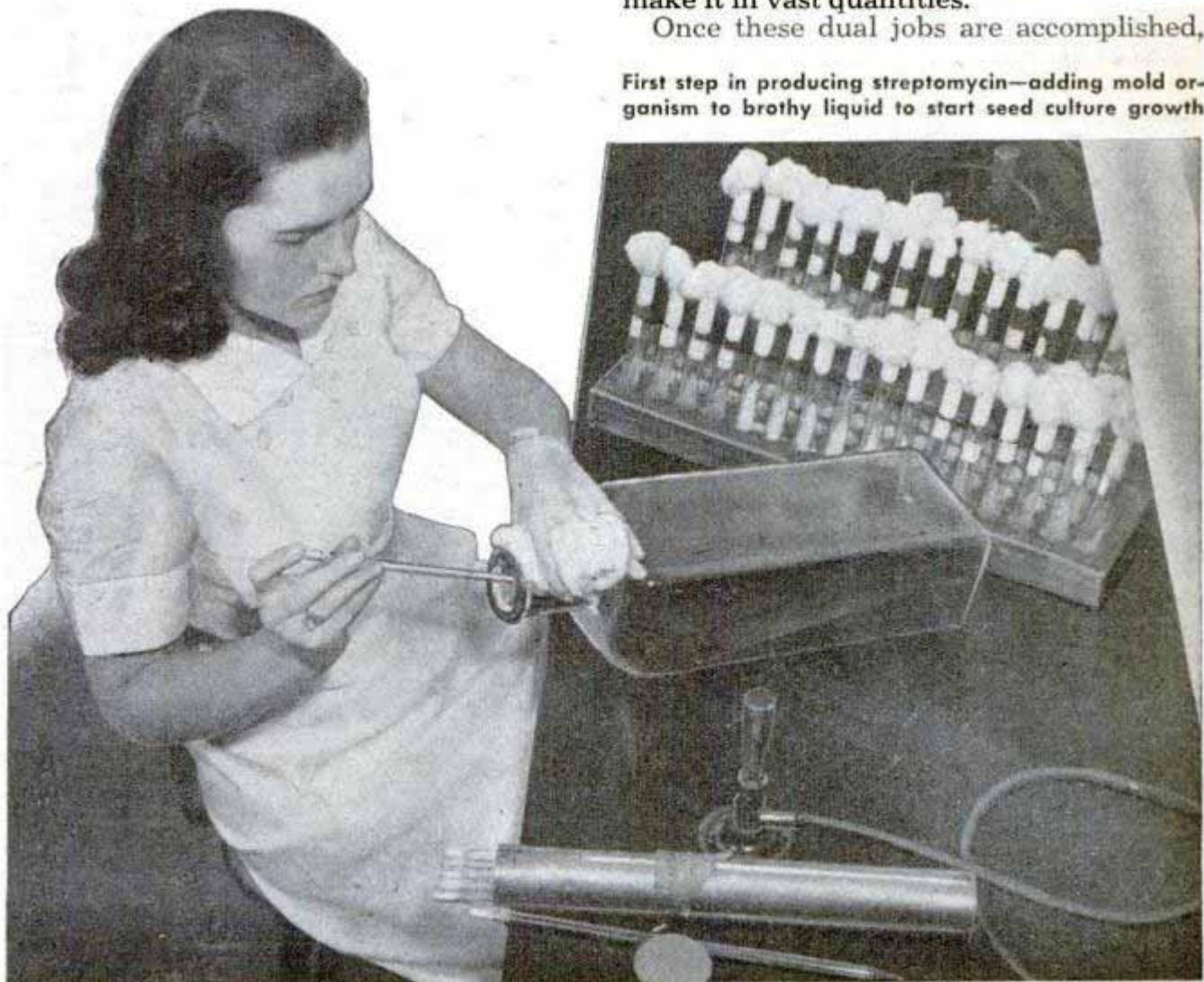

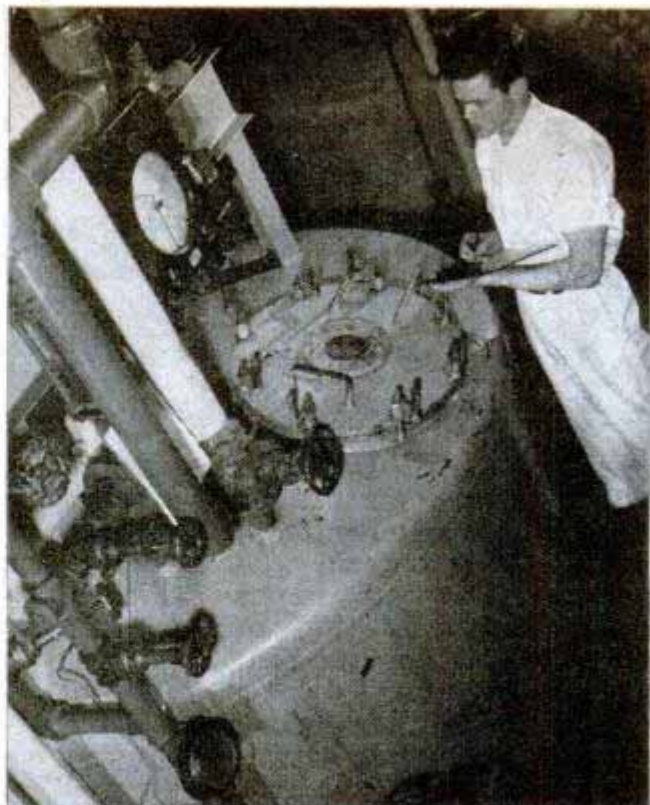
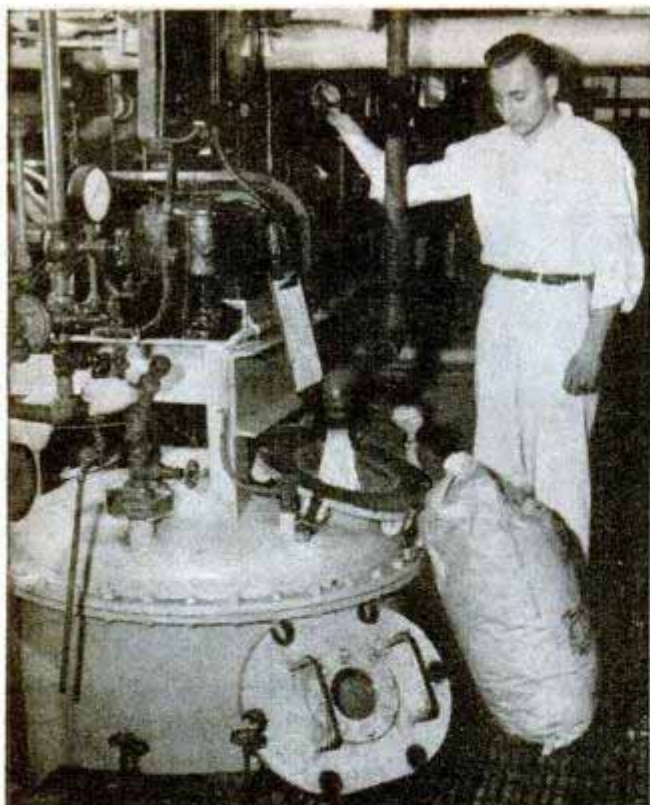

Photos by John C. Michalek, Abbott Laboratories

Seed culture grown in bottles, poured into 300-gallon tanks, produces large quantities of streptomycin seed

the new medicine pours out—pure and powerful—from an assembly line which is almost entirely automatic. Machines make the medicine, bottle it, cap and label the bottles and put them in cartons. About the only nonautomatic jobs are constant tests by chemists to safeguard purity, proper mixtures and exact quantities going into bottles, capsules and tablets.

Testing streptomycin for toxicity, potency and purity



Fermentation is next step. From a 5000-gallon tank of broth three pounds of streptomycin are extracted

At Abbott Laboratories in North Chicago, Ill., production of streptomycin is mainly a matter of turning valves to send soupy liquids swishing through pipes and into fermentation tanks, then through filters and stills to drying machines.

They start with less than a thimbleful of mold organism taken from the soil, and end up with 5000 gallons of "soup" which is converted into about three pounds of pure streptomycin. Penicillin is produced in much the same manner.

The effectiveness of penicillin against numerous diseases has been widely pub-

Machine applies tamperproof seals to bottles of drug

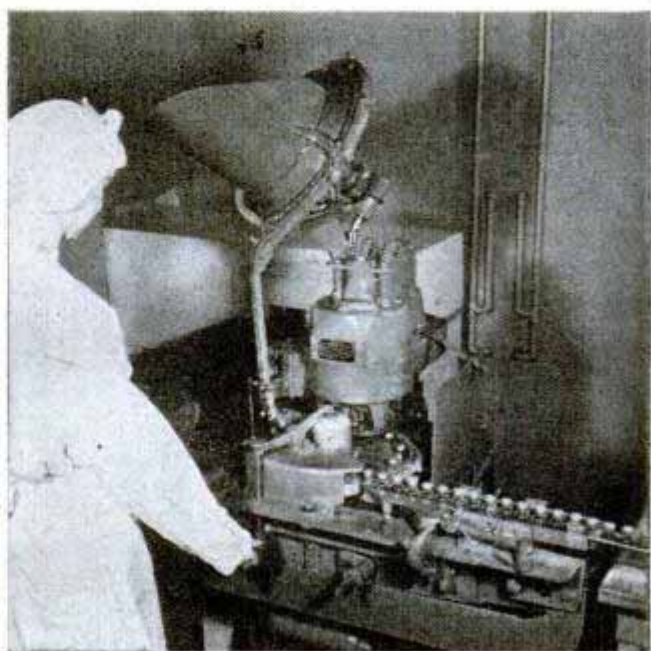

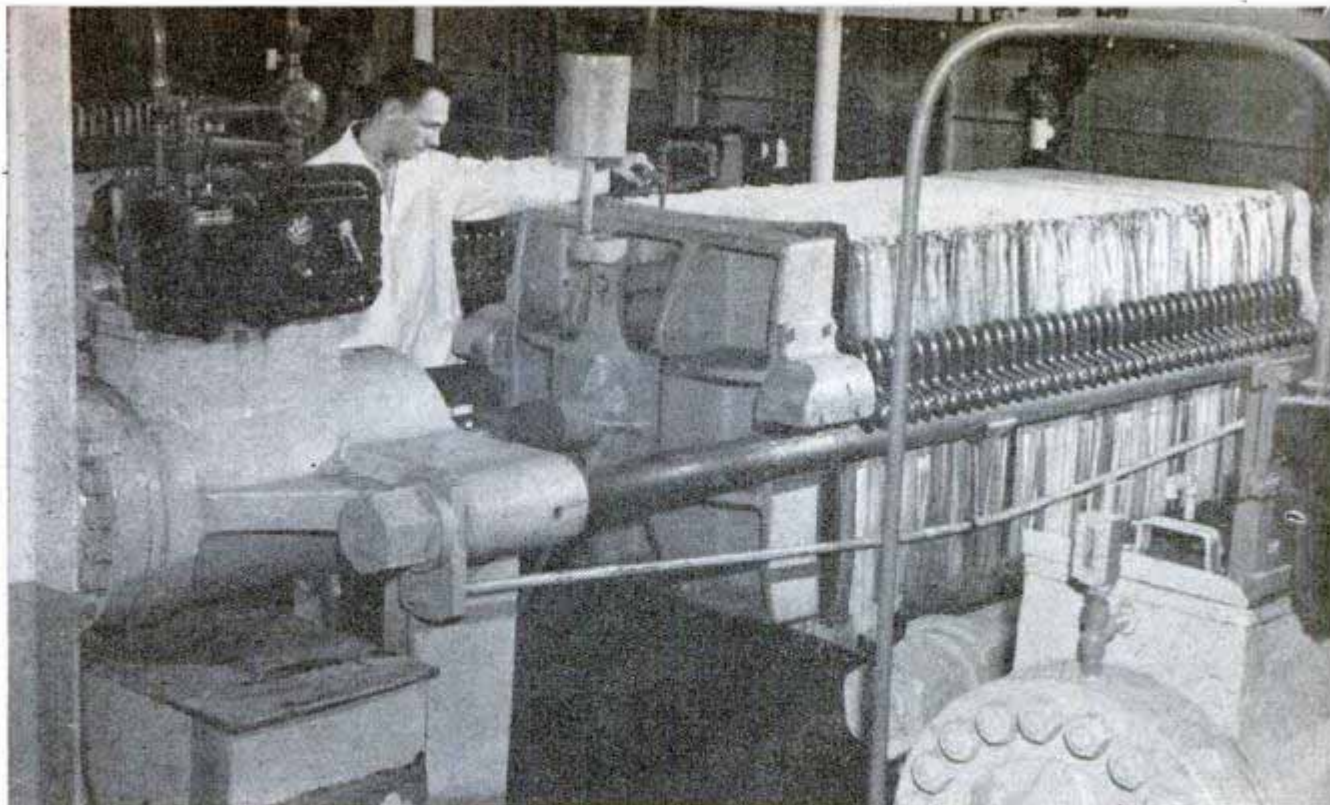

Filter presses remove vegetative cells and concentrate liquid material which contains the drug, streptomycin

licized. Streptomycin, still being tested clinically, has proved effective against septicemia (a blood infection), tularemia (rabbit fever), influenzal meningitis, infections of the urinary tract, peritonitis and some types of tuberculosis.

Like streptomycin, vitamin capsules are made by robotlike machines, one turning out 700,000 capsules per day. Here's how it works: Gelatin material is formed into a continuous strip which is cut automatically into 10-inch squares. An operator places the lower half of a square on the lower plate of a capsule mold. Then vacuum is

applied to pull the gelatin down into the cavities of the mold.

Next, a row of nozzles squirt the vitamin material into the gelatin-lined holes. The top half of the gelatin square then is folded over the vitamin-filled holes, followed by the top plate of the mold. Then the entire mold is put in a hydraulic press.

Pressure is applied and vitamin capsules

Streptomycin (white area) widens the circle of its attack against bacteria that cause urinary infections

White, powdery streptomycin is dissolved in a special solution and injected into a patient's muscles or veins

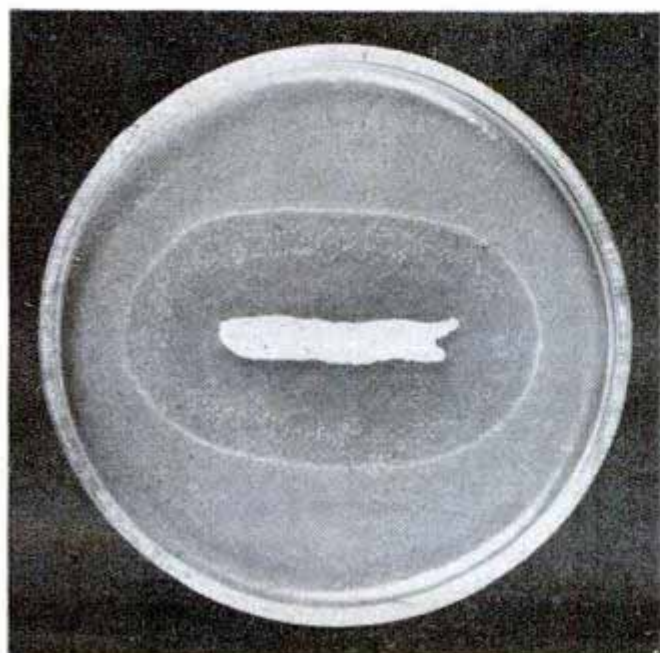

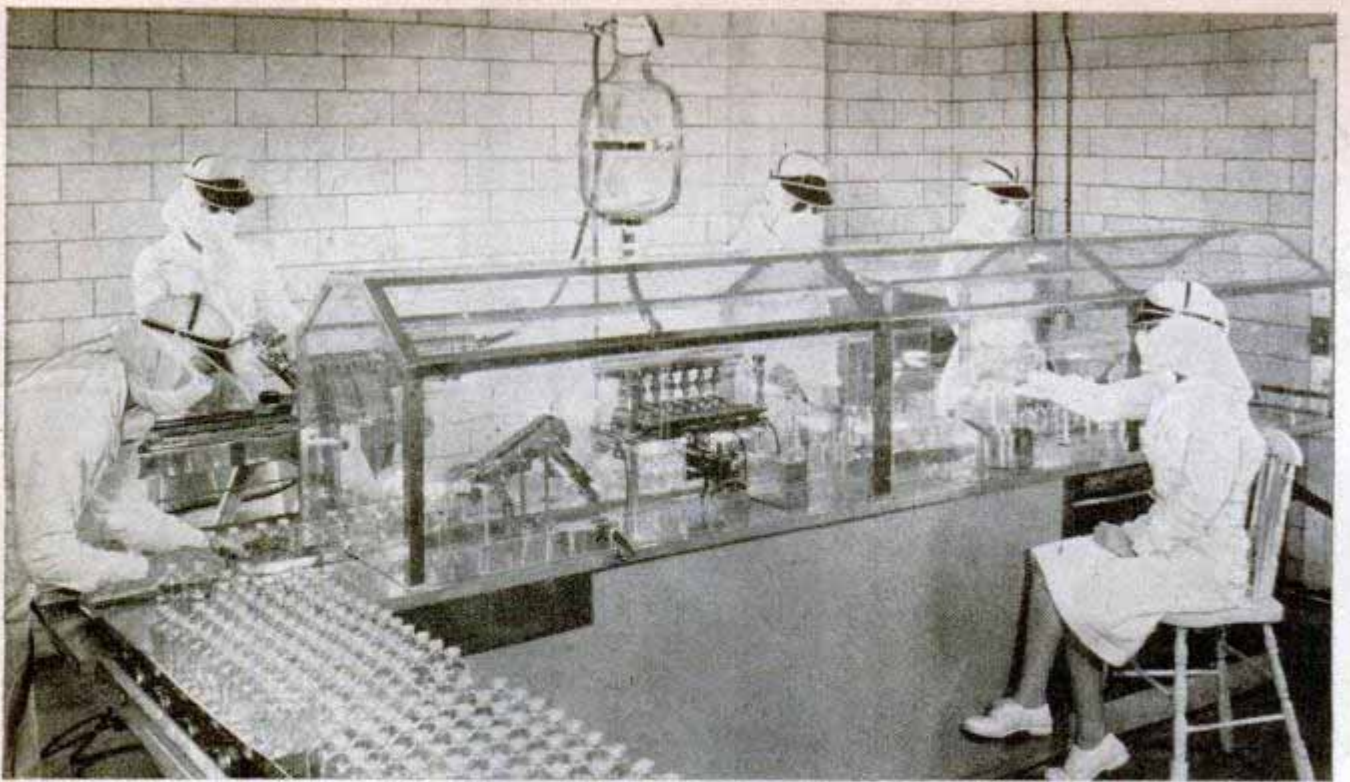

Courtesy of Frederick Stearns & Co.

Moving bottles are constantly subjected to germ-killing ultra-violet rays in a medicine filling machine shielded by Plexiglas

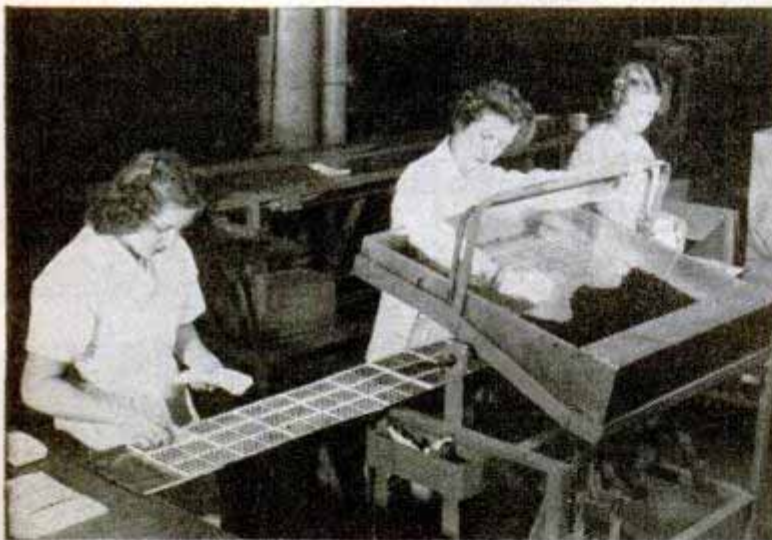

In filling vitamin capsule boxes, girl tilts frame toward her and capsules roll into place. Below, machine spins Tridione, a drug for treatment of epilepsy, to separate crystals from liquid

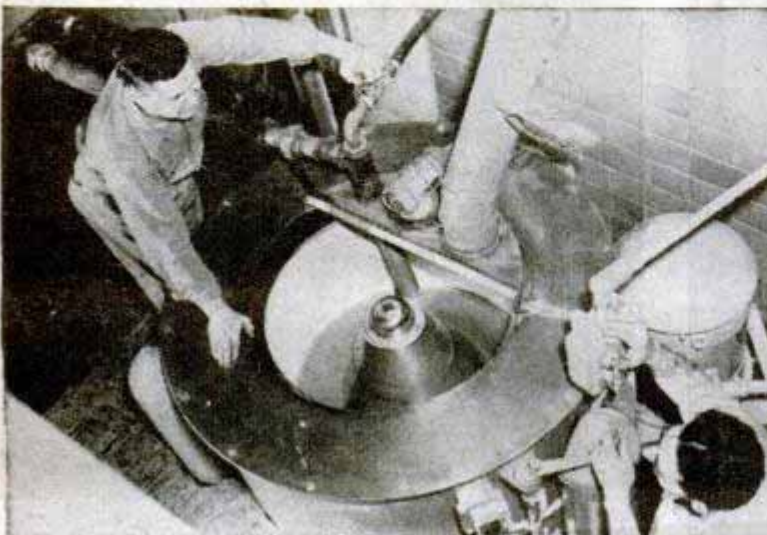

roll out. Still warm and pliable, they are placed on drying trays where they remain for two days to dry and harden. After being inspected for size and shape, they are washed in a liquid solvent, dried and packaged. Frequent tests are made for purity and vitamin content, and samples are set aside for periodic stability tests.

Packaging operations, likewise, are almost completely automatic. One box-filling machine operates something like a teeterboard. Vitamin capsules are deposited in one end of the frame. At the other end are placed open vitamin boxes containing small compartments for the capsules. When the operator tilts the frame, the capsules roll into the niches in the boxes.

Making tablets is another nearly automatic operation. The drug is mixed with the tablet "body," consisting of starch, sugar and other materials. After being moistened, the mixture goes into an extruding machine which produces future tablets in spaghetti-like form. These sprouts break into lumps which are dried until they become powdery.

The powder is shoveled into a tablet machine equipped with punches and dies. As the powder falls into holes in the dies, punches press down and compress the material into tablets. The tablets are whirled around in another machine to remove excess powder,

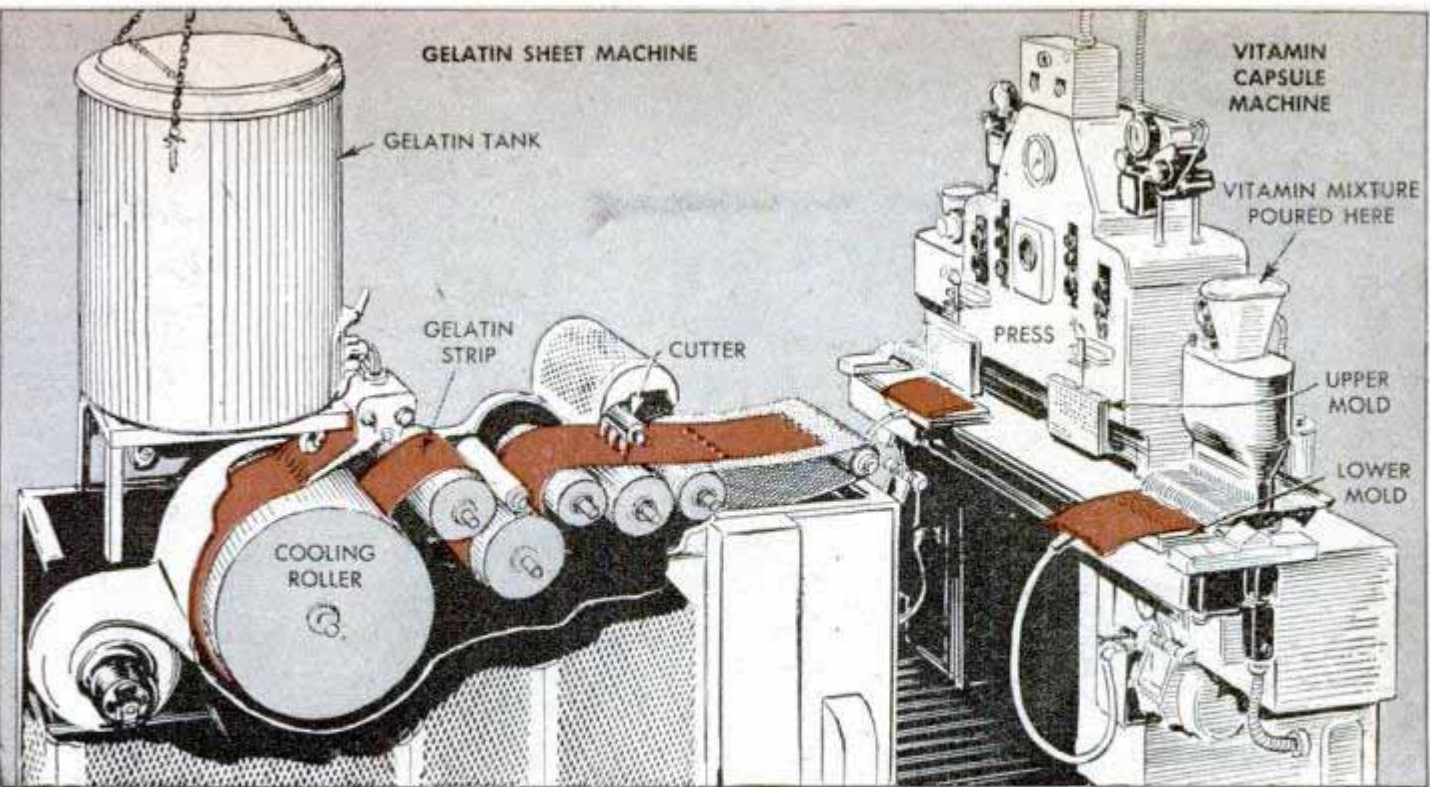

Gelatin sheet machine produces the coating for vitamin capsules. Machine at right forms the finished capsules

and then they're ready to be packaged, shipped—and taken with a glass of water.

These and other drug manufacturing and packaging processes are the result of years of experiments. Almost every day, an improvement is developed. Sometimes, two steps are combined by a new machine.

In the case of Tridione (medicine for treating epilepsy), five production steps were combined into two. Output of the white powdery medicine was boosted from 20 to 300 pounds per day. This means that more people suffering from petit mal (mild form) epilepsy are able to get relief.

While still in the development stage, Tridione had one objectionable characteristic. It smelled bad. Various substances were mixed with it, but the odor persisted.

One day a salesman for a flavor manufacturing firm called on Abbott Laboratories and left a sample of a new synthetic coconut flavor—a product he had been unable to sell to anyone. The chemist in charge of producing Tridione—having tried just about everything—poured a few drops of the coconut flavoring into a batch of the medicine. Immediately, the objectionable odor vanished.

The raw materials for pharmaceutical products come from near and far, from trees, from the ocean bottoms. Honey for cough syrup from middle western farms. Herbs from India for hay fever medicine. Sheep glands for hormone products. Ergot (from Russia and Spain) for obstetrical medicine. Fish oils and liver extracts for vitamins.

Even curare, the detective story poison,

is used. Pure curare, administered in safely minute concentrations, relaxes a patient for surgery. Curare—a plant secretion—is obtained from South American Indians. However, they add other things which multiply the chemical processes required to extract pure curare.

As Dr. D. L. Tabern, Abbott chemist, explains: "The native is no expert botanist.

(Continued to page 224)

Pouring vitamin mixture into capsule machine. Nozzles deposit exact amount for each capsule in mold cavities



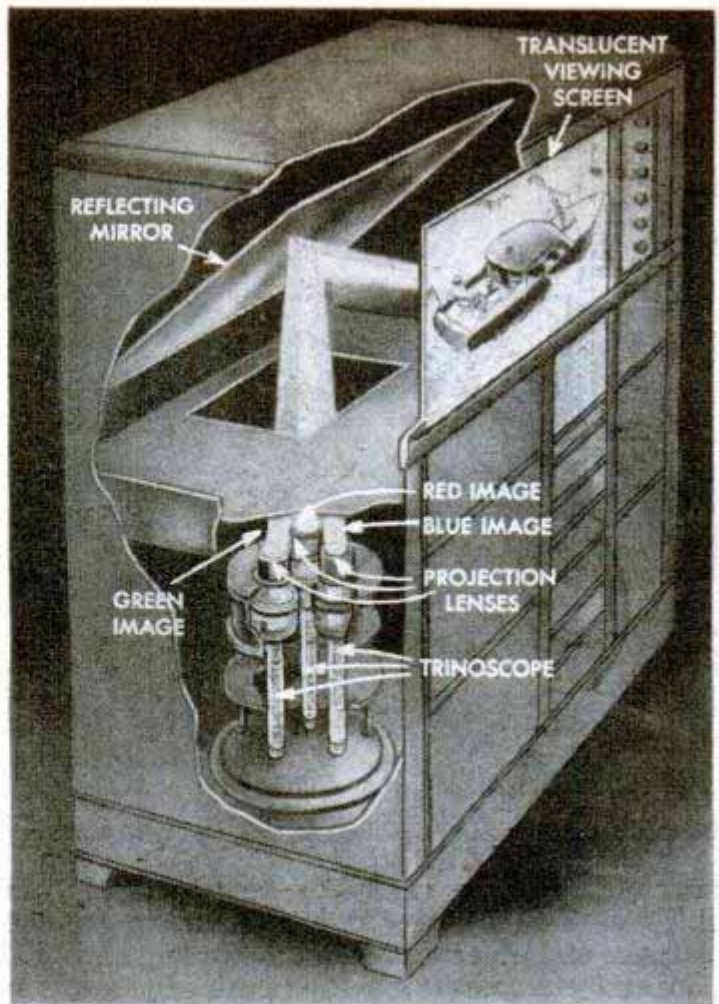
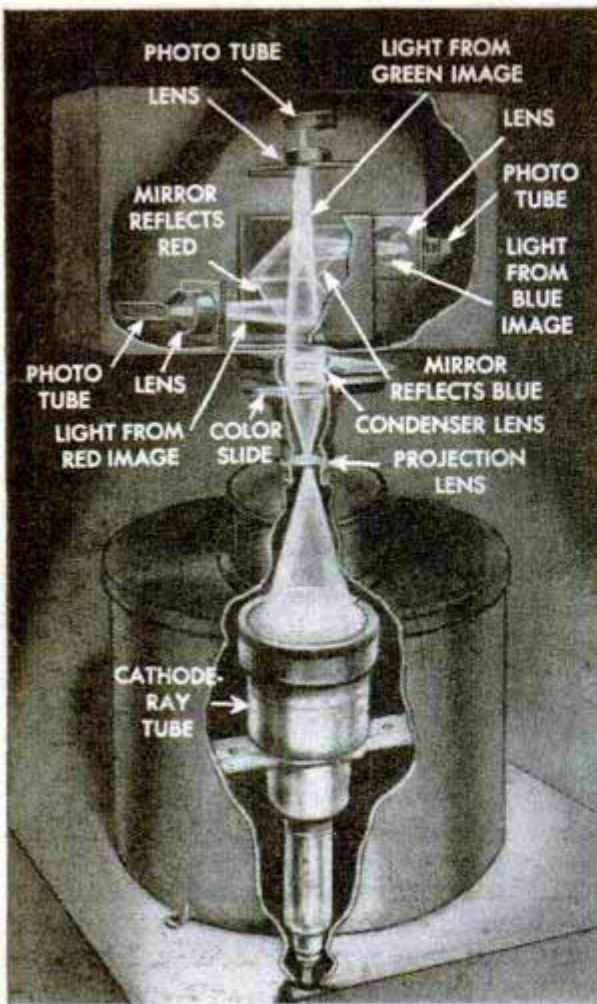

† Inside television camera a light beam from cathode-ray tube is projected through Kodachrome and split into three colors. Radio signals are sent for each color. Receiver at right projects three colors on screen at once

Color television developed by RCA uses electronic instruments instead of rotating disks to produce full colors on a viewing screen. A new color-television camera used in demonstrations photographs colored slides and transmits the pictures to the receiver. The camera splits the light image into three color components—red, blue and green—

Electronic Color Television

and transmits radio signals for each of the three images.

The receiver picks up the three transmissions, changes them back into three light images and projects them on the screen together to reproduce the full-color picture. The electronic system is said to produce pictures that are free from any flicker, color fringes or break-up of color.



Cross-Striped Tire Grips Road

Cross-stripe inserts of soft white rubber give better braking action to a new type automobile tire. The inserts are placed crosswise in the tread, creating hundreds of independently acting tread blocks which are exceptionally pliable and grip the road to bring the car to a quick stop.

Infrared Detects Painting Forgeries

Infrared photographs often aid in detecting forgeries or proving the authenticity of paintings. This is done in two ways: (1) By bringing to light the original signature, covered over in forgeries, or (2) by revealing paint layers beneath the visible surface. The first free strokes used by famous artists in starting a painting display characteristics which are known to expert critics.



LUGGAGE



FLUORESCENT LIGHTING

The CRAFTSMAN

★ Top feature this month, page 186, is a practical article on refrigerator maintenance: what you can do yourself and what you ought to have done either to keep the old box going a while longer or to maintain the new one at peak efficiency. It'll look a lot simpler after you go over this story.

★ Lighting up fluorescents will get a spark of interest from nearly every homeowner these days. And if it's building the fixtures that stumps you, you'll find this angle pretty well covered in an article beginning on page 170.

★ It's no trick at all to put in a good concrete walk from the house to the street or from the back door to the garage if you know how to go about it. The story giving the details begins on page 208. Figure the money you'll save on just a few feet of walk.

★ And, incidentally, did you ever think about building a suitcase for your own use? Well, it's been done, and a feature on page 162 tells how.



CONCRETE WALKS



REFRIGERATOR MAINTENANCE



LUGGAGE

from your own shop

By C. C. White

NEAT and serviceable luggage made in your own home shop need not have a "homemade" appearance if you're careful about a few of the details. Overnight cases, a full-size suitcase or any size in between can be made with hand tools from materials which are readily available. Figs. 1 and 2 picture two cases of the same size and of exactly the same construction except that the case shown in Fig. 1 is partly cloth-covered and has a plastic handle. Fig. 3 shows the case open, the interiors of both styles being the same. The inside of the lid is fitted with a cloth pocket with shirred edge. An elastic band keeps the pocket from sagging open when empty.

Figs. 4 and 5 give the construction details. The frame is made of either soft or hardwood. Rabbits are cut in each frame piece so that the hard-pressed-board panels fit flush. Fig. 5 gives the joinery details. Ends of the top, bottom and center frame members are mitered, then joined with corrugated fasteners and waterproof glue. Frames are joined to the square corner posts with screws. Panels are attached with glue and small brads as in the sectional view, Fig. 5. With the frame and lid assembled, hinge the parts together, then put in the cloth lining. This is glued in as in Section AA, Fig. 5, being tacked only at the top edge

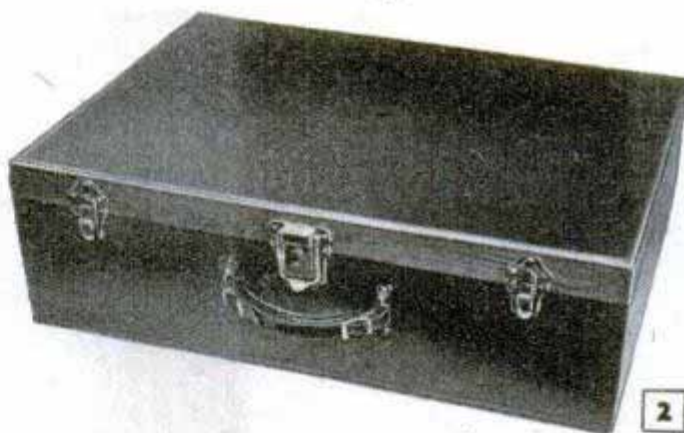

Frame detail

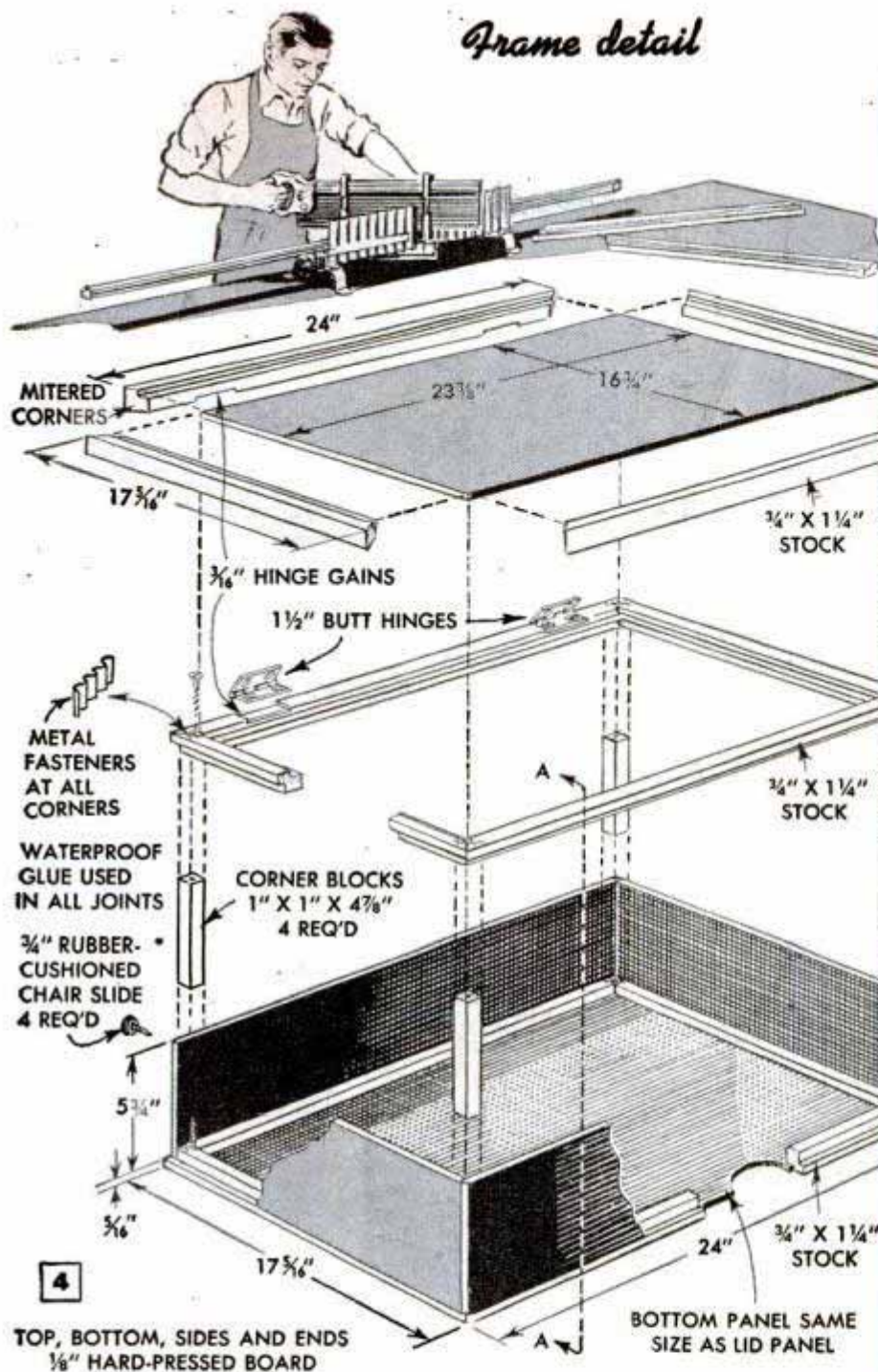

4
TOP, BOTTOM, SIDES AND ENDS
1/8" HARD-PRESSED BOARD

BOTTOM PANEL SAME
SIZE AS LID PANEL

Joints

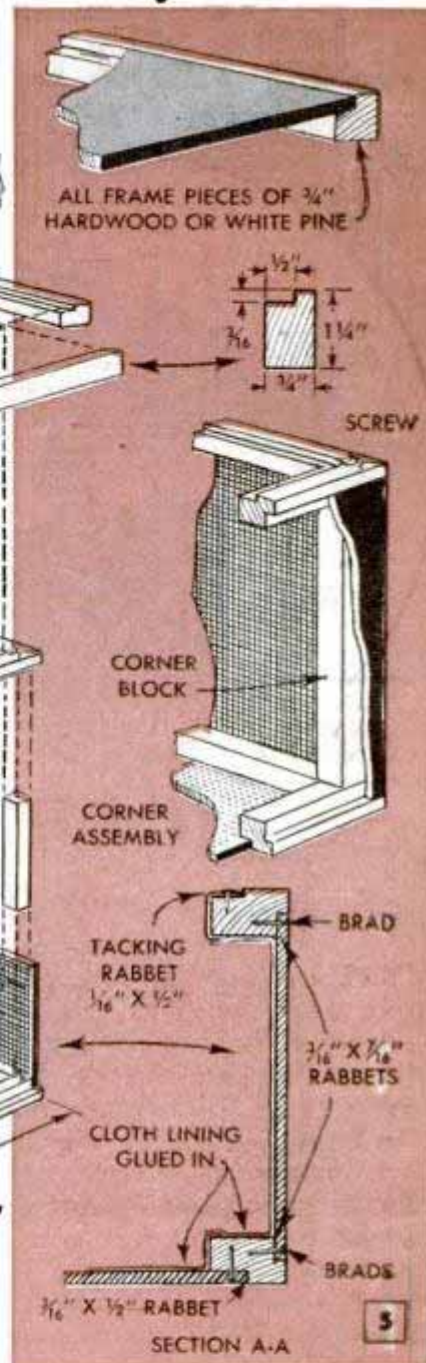

SECTION A-A

as indicated. Be sure there are no wrinkles in the cloth. Standard sample-case hardware is used. This includes a lock, two catches and leather carrying handle. Chair glides are attached at the corners of the back to prevent marring when the case is set on the floor. The catches are attached with short screws but the sample-case lock is riveted in place. Fig. 2 shows the plain case without cloth covering across the ends and narrow sides. In finishing this style the wood is simply stained to match the hard-pressed panels as nearly as possible, and then the whole thing is given two coats of spar varnish. The cloth-covered case takes another step. Oxford-gray twill is used to cover the top, bottom and ends. "Bottom" used here refers to what is ordinarily the back of the case. Measure the width of the case and then add 3/4 in. on each side for the hem. Round corners of the case and apply glue. Apply the cloth over the glue, allowing one edge to extend over the side panel 1 in. Fold the corners as in Fig. 6. Do the same with the edge of the lid. Then finish the corners as in Fig. 6, using a triangular piece of hard board, and cover this with a piece of leather.

Cloth corners

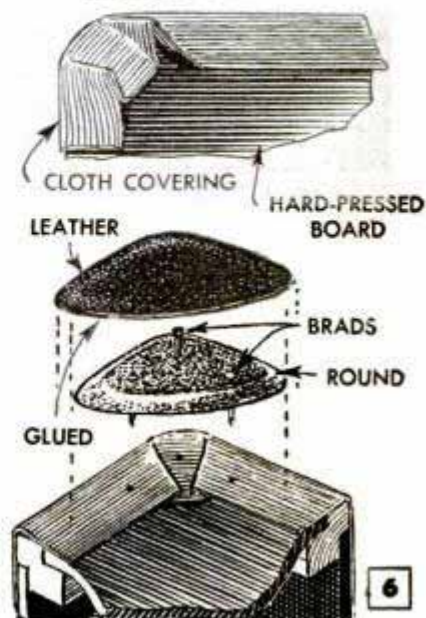

6

Powerful SPOTTING SCOPE

Made from BINOCULAR BODY

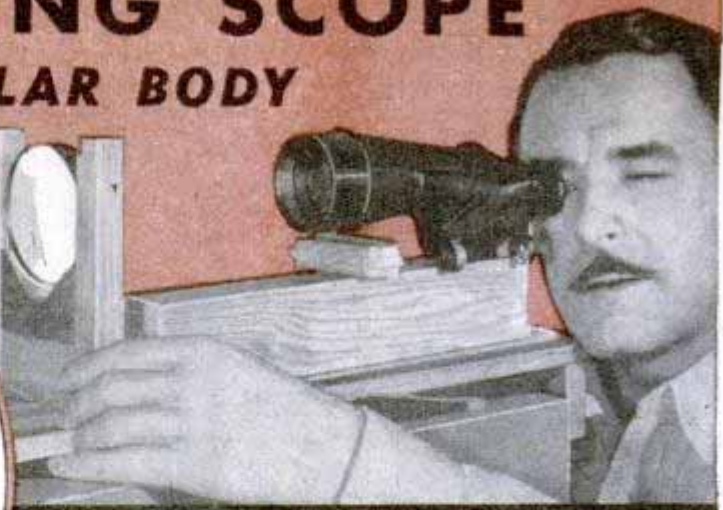

DETERMINING POSITION OF OBJECTIVE



FINISHED SCOPE MOUNTED ON CAR-DOOR STAND

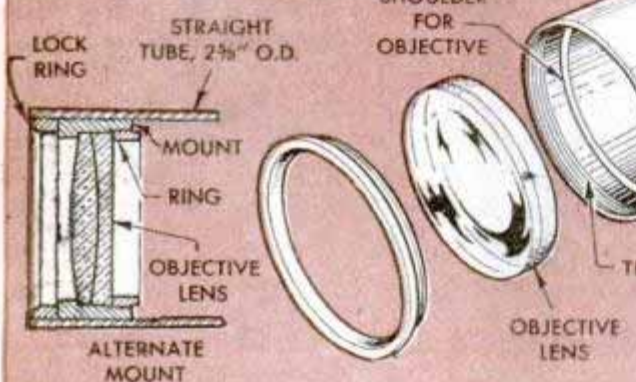
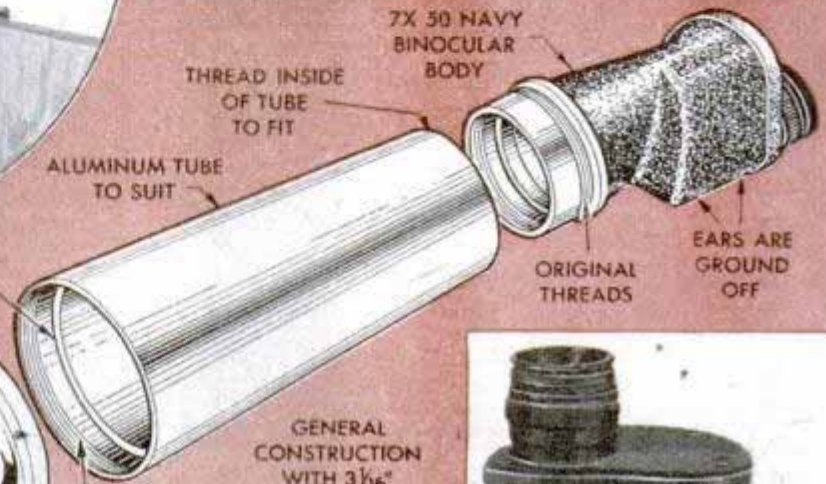

GENERAL CONSTRUCTION WITH 3 1/16\"/>

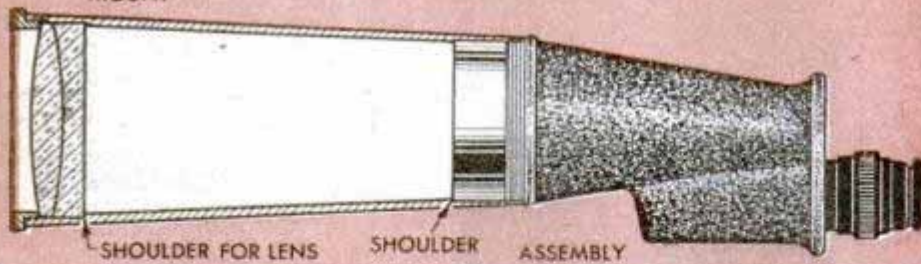

Photo courtesy Edmund Spalve Co.

Approximate Data on Various Lens Combinations

Objective		27.5-mm. Eyepiece			22-mm. Eyepiece			1 1/2" Eyepiece		
Diameter	Focal Length	Pwr.	Field	Illum.	Pwr.	Field	Illum.	Pwr.	Field	Illum.
1 3/4" (44 mm.)	20" (508 mm.)	18X	44	25%	23X	30	15%	40X	13	5%
2" (50 mm.)	16" (407 mm.)	15X	52	44%	18X	38	31%	32X	16	9%
2" (55 mm.)	18" (458 mm.)	16X	49	50%	21X	33	27%	36X	15	9%
2 1/4" (58 mm.)	12 1/4" (308 mm.)	11X	71	119%	14X	50	73%	24X	22	25%
2 1/2" (64 mm.)	19" (482 mm.)	17X	46	58%	22X	31	35%	38X	14	12%
2 5/8" (66 mm.)	18" (458 mm.)	16X	49	66%	21X	33	38%	36X	15	13%
2 3/4" (70 mm.)	18" (458 mm.)	16X	49	76%	21X	33	44%	36X	15	15%
*3" (78 mm.)	14 7/8" (378 mm.)	14X	56	122%	17X	41	83%	30X	17	26%
3 1/8" (80 mm.)	23 3/4" (600 mm.)	22X	35	53%	27X	26	35%	47X	11	12%

* Illustrated

Field is given in yards at 1000 yds. distance. Best field is obtained with Navy 27.5-mm. eyepiece. Illumination is percentage of light as seen by naked eye . . . should not fall below 15% for best results.

Only Requires Changing Lens

ONE of the simplest and best ways to make a high-power spotting scope or monocular is to use the body of a 7x 50 Navy binocular, adding a new objective lens. As shown in the center drawing, the rear portion of the scope is the body of the binocular, with the ears ground off. Either the right or the left side can be used. As stated, the original objective lens is not used, but the eyepiece and all the other optics and prisms, as well as the metal parts that are used to mount them, are retained. With the binocular body assembled and with the focusing eyepiece turned completely in, the position of the new objective can be determined by moving the lens forward and backward until the image is sharp. A setup similar to that shown in the upper right-hand photograph should be used when checking the lens. Measuring the distance from objective to binocular body threads will give you the length of additional main tube that is needed. Always be sure the eyepiece is turned in when making this test, and focus only on an object that is at least 100 yds. distant. The over-all length of the scope will be about the same as the focal length of the objective that is selected.

If an objective of over 2½ in. in dia. is used, construction of the main tube will not be easy because it will require both inside and outside taper turning from suitable casting stock. As far as being easy to make, the best objective is one having a diameter of about 2½ in. This can be fitted inside a straight tube 2⅝ in. in dia. and the tube will fit the end diameter of the binocular body also. Smaller objectives are practical and can be made as shown by the alternate mount, center left-hand detail, where the lens is fitted into a cell and the cell is screwed into the tube. This method is advantageous also for the final focusing adjustment. The table at the bottom of the preceding page shows various combinations that are possible, many of which are available from surplus Army-Navy stocks. A car-door stand mounting for the finished monocular is indicated in the upper left-hand detail.

When making a scope, don't try for too much power—14x is about the limit for a hand-held monocular and 18x is all that's needed for target spotting at 100 yds. Finish the inside of the main tube with a flat black paint that will minimize light reflection. For the outside, the best finish is a black or dark green crinkle varnish baked on at a very low heat in the kitchen oven (leave the oven door open). If you use this finish, make a test panel first to be sure that the right results will be obtained.

Blade Guard for Pointed Tools Preserves Sharp Edges



To protect the sharp edges on chisels and similar tools, one craftsman made holders with cloth sleeves and wooden-plug ends that proved satisfactory. Each plug is larger in diameter than the width of the tool and is slotted to fit the edge. A cloth sleeve, long enough to extend above the ferrule, is attached to each plug. Cloth tape is used to tie the holders shut.

Coat Hooks Used as Oar Rests

Instead of allowing the ends of oars to float free in the water or putting them inside the boat when not rowing, screw wire coat hangers to the sides of the boat to hold the oar blades out of the water. When the oars float free, the handles may be in the way of the people in the boat, and when the oars are inside the boat, water drips on the seats and bottom.



Solving

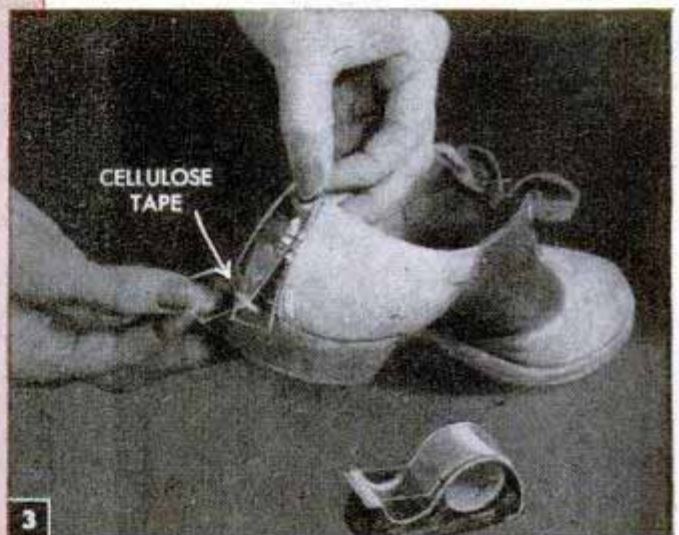

1 To prevent bending the lid on a jar of preserves when prying it off, insert half a spring-type clothespin between the lid and the can opener. Place the end of the pin flush with the edge of the lid

2 Tape a package of coffee filter pads to the lid of a coffee jar and both will always be at hand. Transfer the pads when you open a fresh jar of coffee

3 When cleaning and polishing two-tone shoes, apply cellulose tape to mask the portion that is not being cleaned. The tape can be stripped off easily

4 It's easy to find the thumbtacks when you want them if they're stuck in a large cork and kept in a drawer

5 Although a transparent plastic ruler is handy and easy to work with, when used on a dark surface or if dropped to the floor, it's hard to locate. However, a few spots of brightly colored nail polish spaced along the center make the ruler easy to see

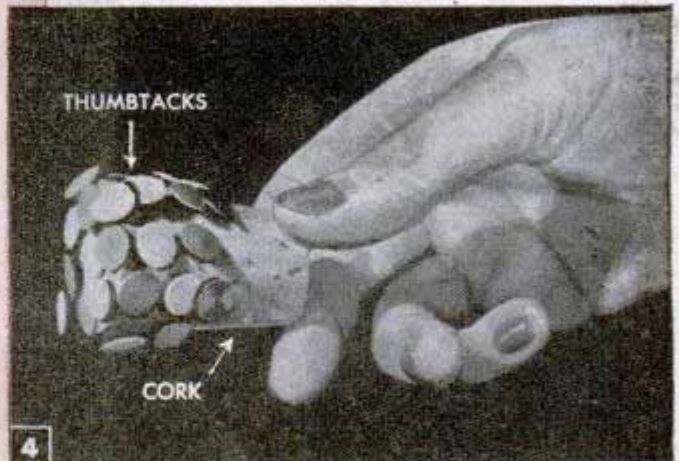

HOME PROBLEMS

6 If a clothesline pole is too long to be stored conveniently, it can be made to pull apart into two sections. A metal tube couples the lengths together.

7 By gluing a triangular piece of metal to the cardboard back of a picture frame, sufficient weight is added to make the picture hang level on the wall.

8 Safety and a longer life are added to an electric washing-machine cord if the length that ordinarily lies on the floor is sheathed by a piece of garden hose. Close the two open ends with friction tape.

9 Since many small gas and electric stoves have cooking plates about 6 in. in diameter, larger pots and pans extend over this area and are unevenly heated. A metal collar covered on the outside with asbestos will distribute the heat evenly underneath the pan.

10 For a better and faster job when polishing silverware, try a new lambskin shoe buffer. Cover about half the surface of the buffer with polish before using and the treatment will serve you a long time.

11 One way to draw parallel lines is to insert pencils in a strip of corrugated cardboard and use as shown.

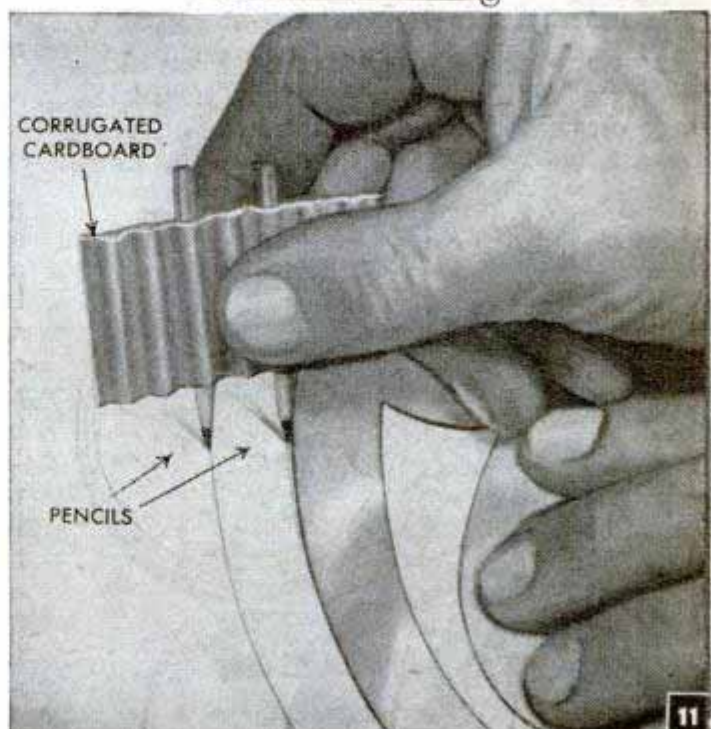
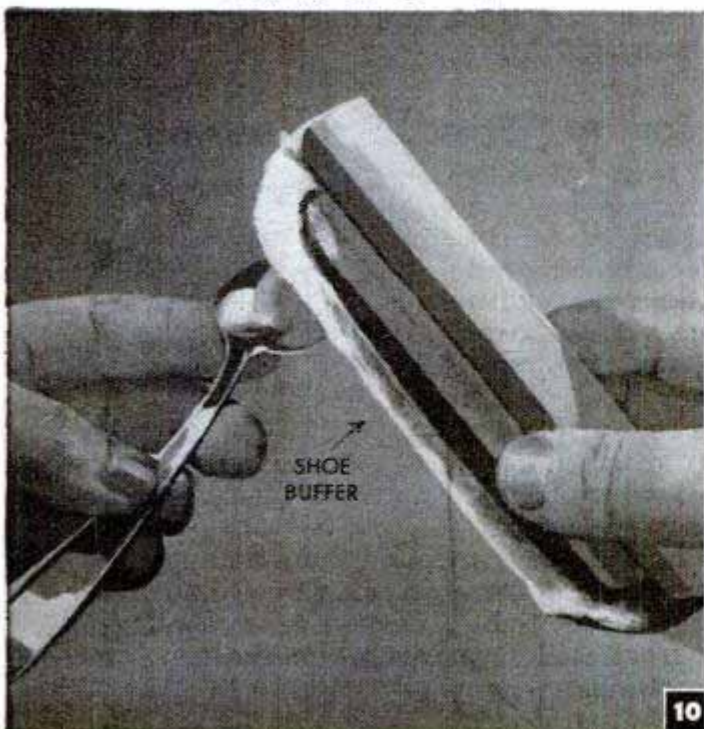
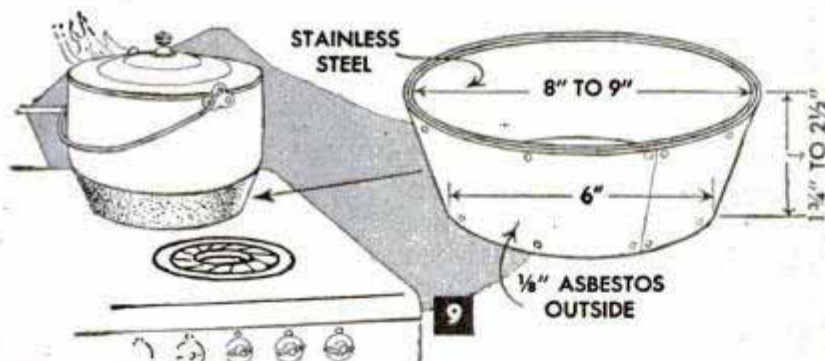
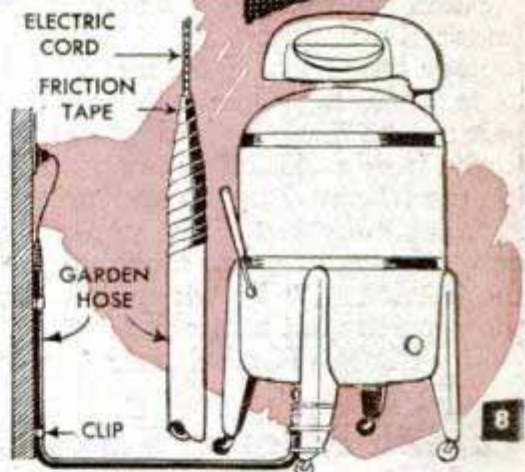
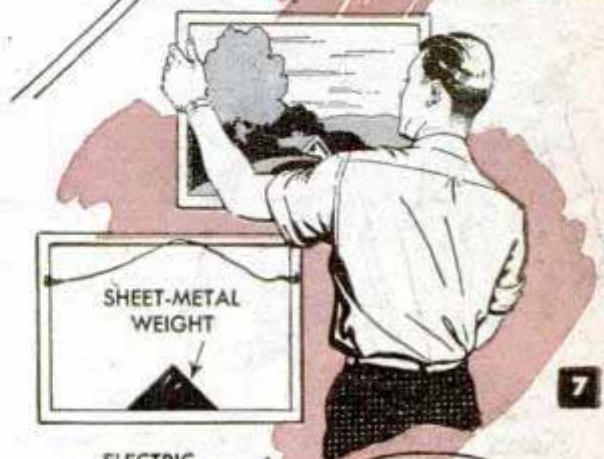

Damaged Screen Door Repaired By Using Wood Strip

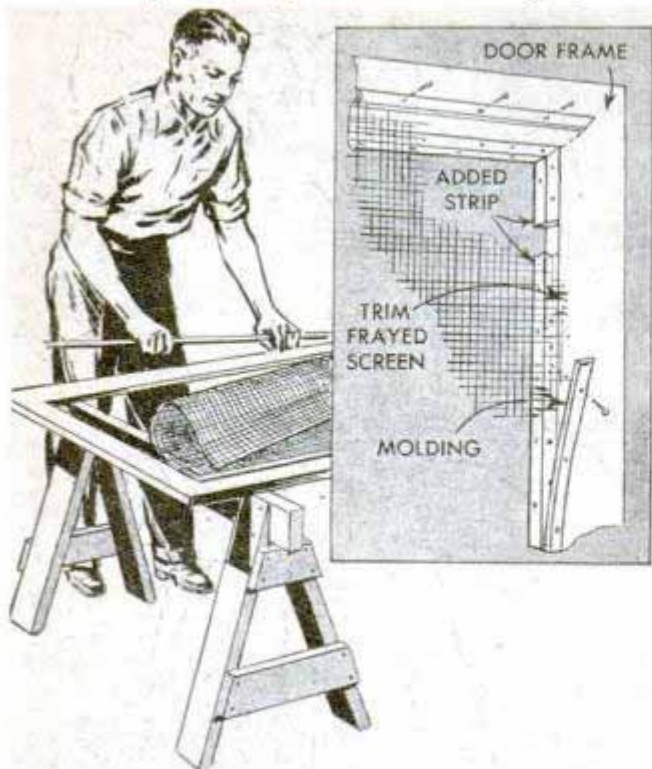

Should the screen in a door be torn from under the molding, renailling is not satisfactory usually because many of the wires have been torn loose. A satisfactory repair can be made by nailing a strip of wood to the inside of the frame and then fastening the trimmed screen and molding to this strip, as indicated in the upper right-hand detail. Except for the fact that one side of the frame is a little wider than the others, the repair is not noticeable.

Charles Kimball, Los Angeles, Calif.

Growth Rings on Scales of Fish Indicate Approximate Age

If you're more interested in how old a fish is rather than how big it is, count the rings on the scales. As in the case of trees, these rings indicate annual growth, there



being one ring for each year. It may be necessary to use a magnifying glass to see the rings clearly. It should be remembered, however, that this is not an exact index and does not apply equally well to all species of fish.

Nonslip Tread for Ladder Rungs

Instead of discarding ribbed lawn hose when it is badly worn, you can use it to make nonslip treads for a ladder. Cut the hose into lengths that will fit between the up-rights and slit each piece lengthwise. Fasten the hose around the rungs, using linoleum cement as a binder.—Kenneth Murray, Colon, Mich.

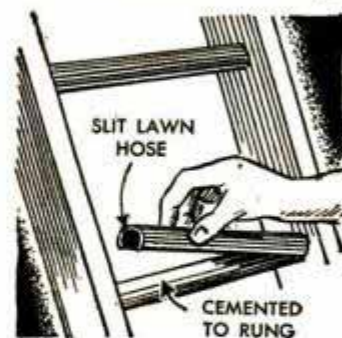

Eliminating Rattle in Shift Lever

In many makes of cars the gear-shift lever is attached to the steering column or post by means of a bracket and, at times, develops an annoying rattle. To eliminate this condition, one motorist wraps a piece of rubber tubing and wire around the shaft between the lever and bracket to serve as a bushing. Wire and tubing of the right size must be used to make a tight fit.



How to "Frost" Strawflowers

When a few grains of benzoic acid are placed in a loosely covered bottle, along with some strawflowers, and the container is carefully heated above a Bunsen burner, the acid will sublime and crystallize on the flowers, giving them an appearance of being covered with hoar frost. If the bottle is tightly corked after cooling, the frost will remain on the flowers for some time.

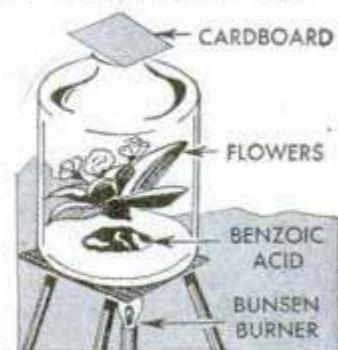

Nathan Bogoch, Winnipeg, Man., Can.

Swinging Grill Converts Fireplace Into Barbecue



Any outdoor open fireplace becomes a barbecue when you install this adjustable grill. The grill rack hangs from a swinging crane and is adjusted for height above the glowing coals by hooking into different links of the supporting chains. The crane hinges are anchored in the masonry while

the fireplace is being built, as shown in the detail. Otherwise holes are cut into mortar joints with a star drill and expansion bolts installed. All parts are of wrought iron, the grill rack being a built-up job consisting of flat-iron bars welded to lengthwise members.

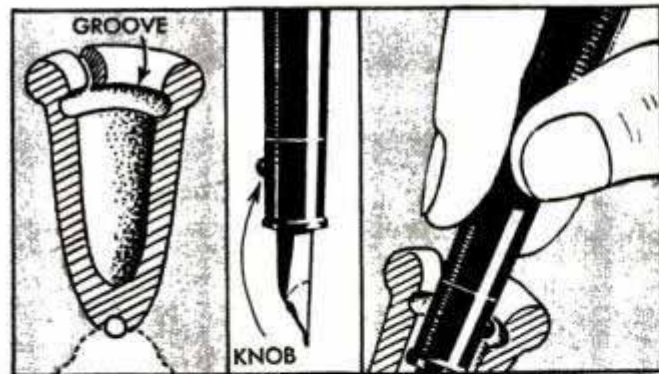

Desk Pen Is Locked in Holder

By adding a small knob to the tapered portion of a fountain pen and cutting vertical and circular grooves in the holder, the pen can be locked in position to prevent its easy removal and use by many different people. Too many writers using the same pen will often spoil the point. The left-hand detail shows how the grooves are cut and the center detail indicates the size and location of the knob.

Wooden Key Container Floats

Made of balsa wood, this container or holder is ideal for boat and tackle-box keys because it won't sink if accidentally dropped into the water. The two blocks that form the sides of the holder should be large enough to provide buoyancy and float the weight of the metal. Brass screws, which will not rust and are resistant to the action of salt water, are used to hold the keys in place. Your name and address can be burned, cut or stamped into the wood as a means of identification.

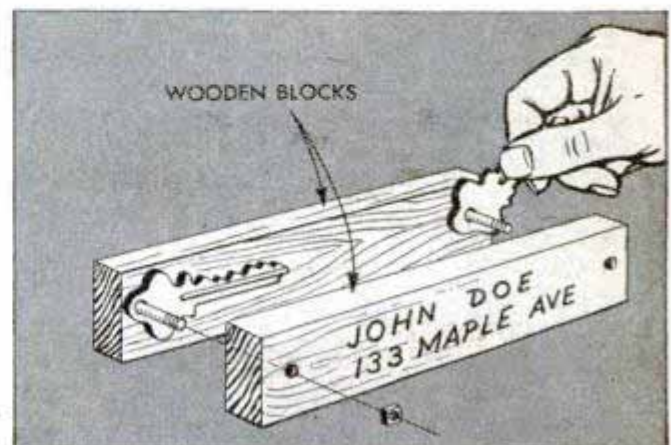

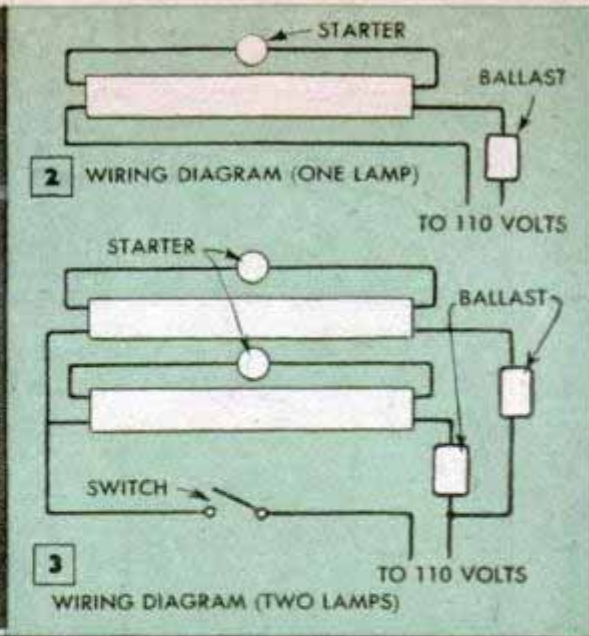
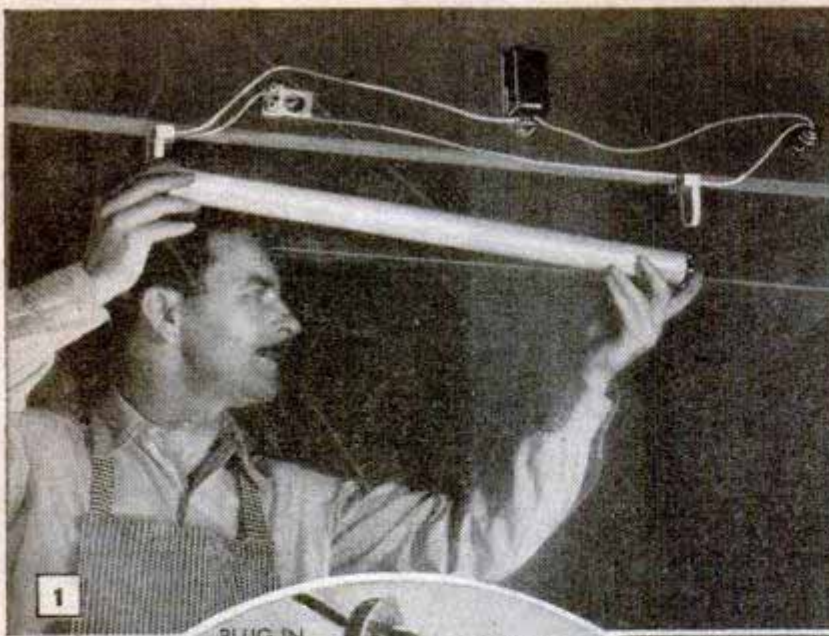

LIGHT UP

W T M 49 By Sam Brown

ALTHOUGH fluorescent lighting is not a new subject, it did not find widespread application until a few years ago, and then its uses were largely industrial and commercial. Today, however, this type of lighting is becoming increasingly pop-

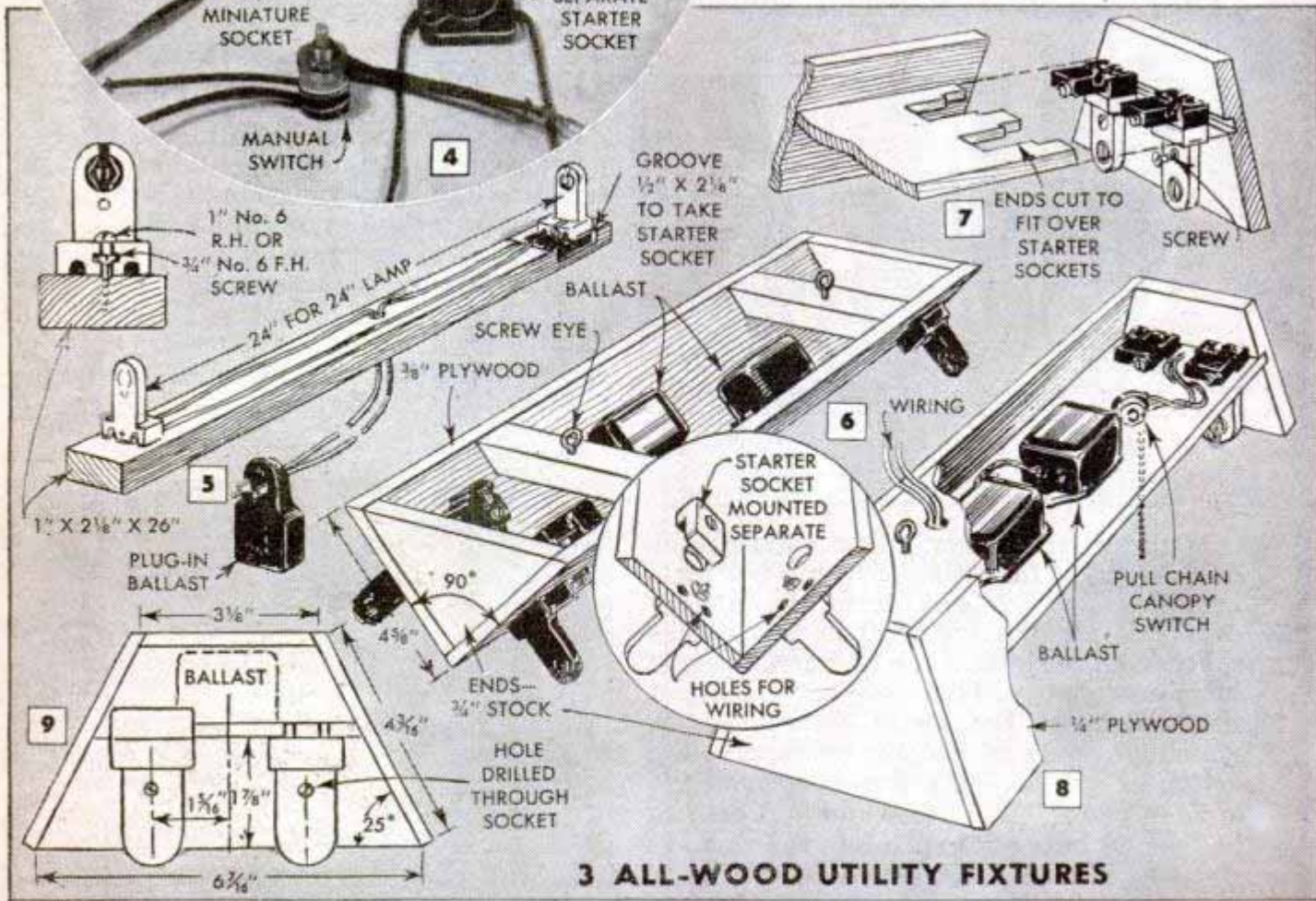
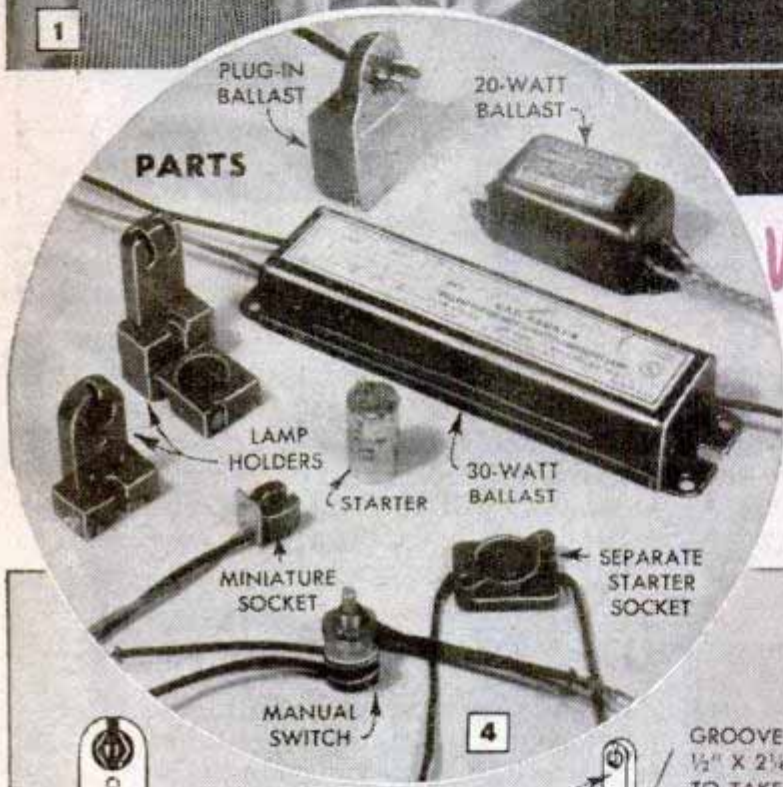

3 ALL-WOOD UTILITY FIXTURES

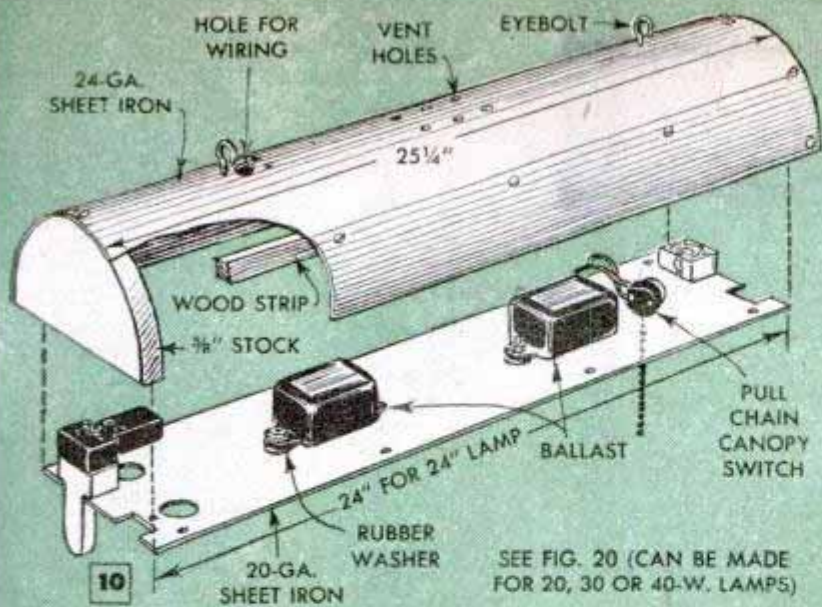

FLUORESCENT

with Homemade FIXTURES

ular in the home and workshop as a source of superior, low-cost illumination. Assembled from standard parts, fluorescent fixtures are not difficult to build for almost any lighting condition. Like ordinary filament lamps, the simplest installation of the fluorescent tube is a surface mounting, such as shown in Fig. 1. Bare as this is, it does the trick in certain locations. The basic wiring diagram is shown in Fig. 2, consisting of two circuits, one of which supplies current to start the lamp or tube and then plays no further part in operation, while the second circuit supplies the operating current. This line must carry a suitable ballast to limit the current to the amount needed for any particular lamp. A two-or-more lamp circuit is shown in Fig. 3, and requires either a separate ballast for each lamp, or two ballasts mounted in one case.

Parts: Parts are shown in Fig. 4. Included are ballasts having the proper capacity, and lamp holders, the latter consisting of one lamp holder and one combination lamp holder and starter socket. Also needed are either automatic starting switches, or one of the manual types which are for push, turn and pull operation and control one or two lamps. Always be sure the ballast is for the proper wattage, frequency and voltage range.

All-wood fixtures: Fluorescent lamps generally are considered to radiate less than one half the heat of filament lamps and can be mounted satisfactorily in all-wood fixtures, such as shown in Figs. 5 to 9. Fig. 5 is a simple light strip using a plug-in type of ballast, while the other two use standard ballasts mounted inside the fixture. These units can be made up to 40-watt size, the lamp length determining the length of fixture (see Fig. 20 for lamp sizes). The lamp-holder mounting for the fixture shown in Fig. 8 is not



11

A TWO-LAMP SHOP LIGHT

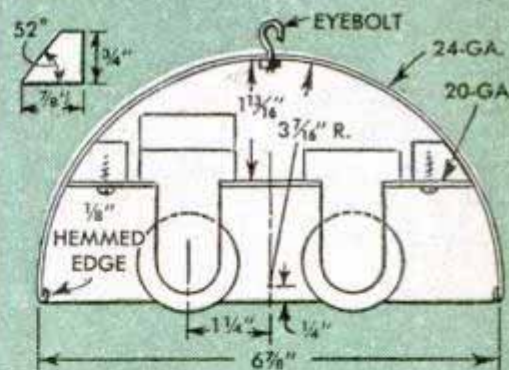

12 MINIMUM SECTION—CAN BE MADE SLIGHTLY LARGER AS DESIRED. FOR TWO 40-WATT LAMPS USE TULAMP THIN SECTION BALLAST (1 3/8" X 2 1/4" X 1 1/4").

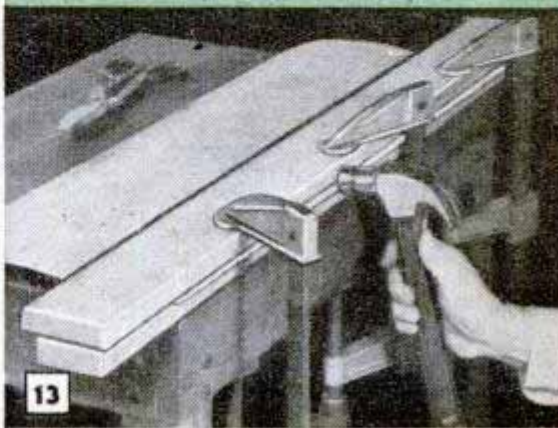

13

METHOD OF HEMMING EDGE

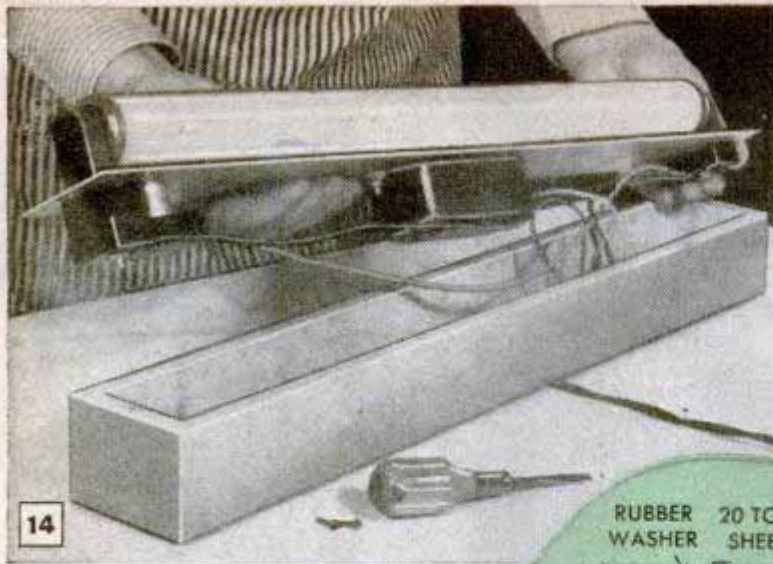

14

CHANNEL STRIPS IN WOOD BOXES

provided for in the original socket and requires drilling a screw hole through the socket, as can be seen in Fig. 7.

Two-lamp shop light: A better type of construction combines wood and sheet iron as shown in Figs. 10, 11 and 12. Fig. 13 indicates a method of hemming the edge of the metal housing. Two 20-watt lamps make an excellent bench light, while two 40s serve nicely for general illumination. It can be seen that this same general construction can be used for the fixtures shown in Figs. 6 and 8. All two-lamp fixtures can also be made up for only one lamp by narrowing the width of the base.

Channel strips: Channel

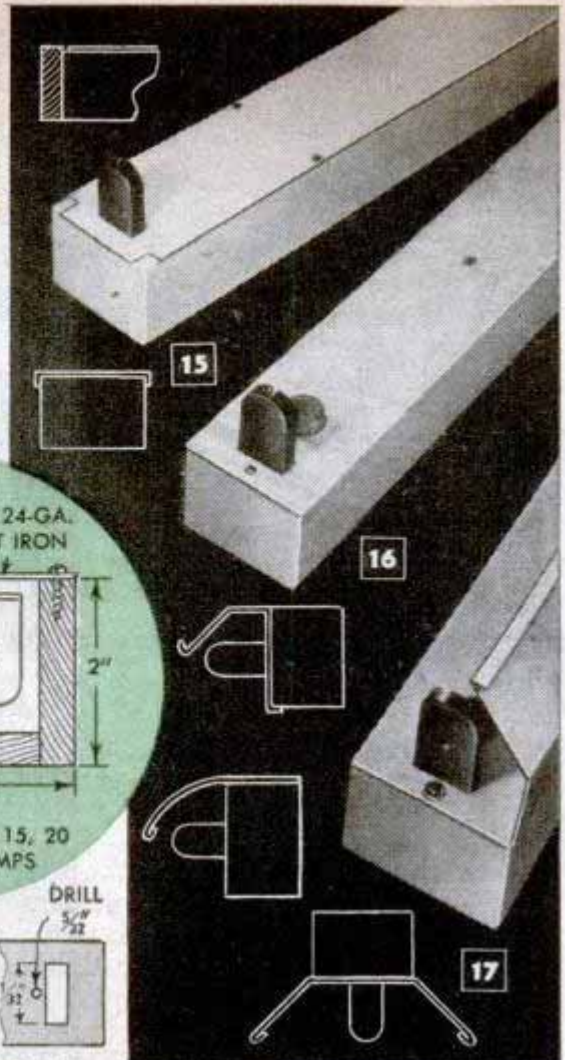

15

16

17

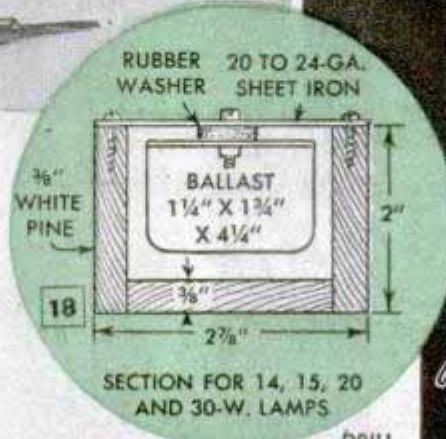

SECTION FOR 14, 15, 20
AND 30-W. LAMPS

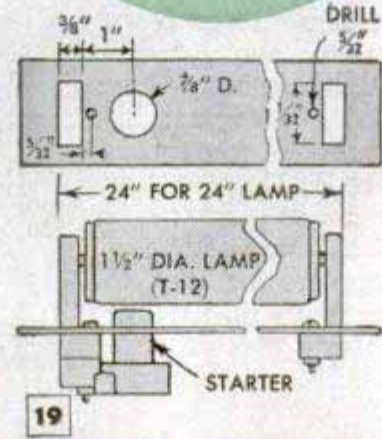

MOUNTING DIMENSIONS

strips, Figs. 14 through 17, are basic fluorescent-light units used extensively as fixture bases or for special built-in installations. The strips can be made up of wood boxes with sheet iron or metal mounting bases, as shown. Sectional

20 FLUORESCENT LAMP SIZES ^① AND ELECTRICAL DATA							
Lamp	Diameter	Length ^②	Lamp Holder	Total Watts ^③	Filament Lamp Equal ^④	Lamp Life (Hrs.)	Ballast Size ^⑤
6-Watt	5/8"	9"	Miniature Bipin	8	20-Watt	2500	1 1/4" X 1 3/4" X 4 1/4" (1 Lamp)
8-Watt	5/8"	12"	Miniature Bipin	11	25-Watt	2500	
13-Watt	5/8"	21"	Miniature Bipin	20	40-Watt	2500	
14-Watt	1 1/2"	15"	Medium Bipin	18	30-Watt	2000	1 1/4" X 1 3/4" X 4 1/4" (1 Lamp)
15-Watt	1"	18"	Medium Bipin	20	40-Watt	2500	
15-Watt	1 1/2"	18"	Medium Bipin	20	40-Watt	2500	1 1/4" X 1 3/4" X 6 1/2" (2 Lamps)
20-Watt	1 1/2"	24"	Medium Bipin	25	50-Watt	2500	
30-Watt	1"	36"	Medium Bipin	40	75-Watt	2500	1 1/4" X 1 3/4" X 6 1/2" (1 Lamp)
40-Watt	1 1/2"	48"	Medium Bipin	50	100-Watt	2500	1 3/8" X 2 1/4" X 8 3/4" (1 Lamp) 2 3/8" X 3 1/8" X 9 1/2" (2 Lamps)
100-Watt	2 1/2"	60"	Mogul Bipin	125	200-Watt	3000	2 3/8" X 3 1/8" X 14 3/8" (1 lamp)

① Lists all common sizes — some other sizes and styles also available.
 ② Over-all mounted length of one-lamp and two-lamp holders.

③ Lamp watts plus watts lost at ballast.
 ④ Filament lamp which gives same approximate light as fluorescent lamp listed.
 ⑤ Smallest size — some other sizes available.

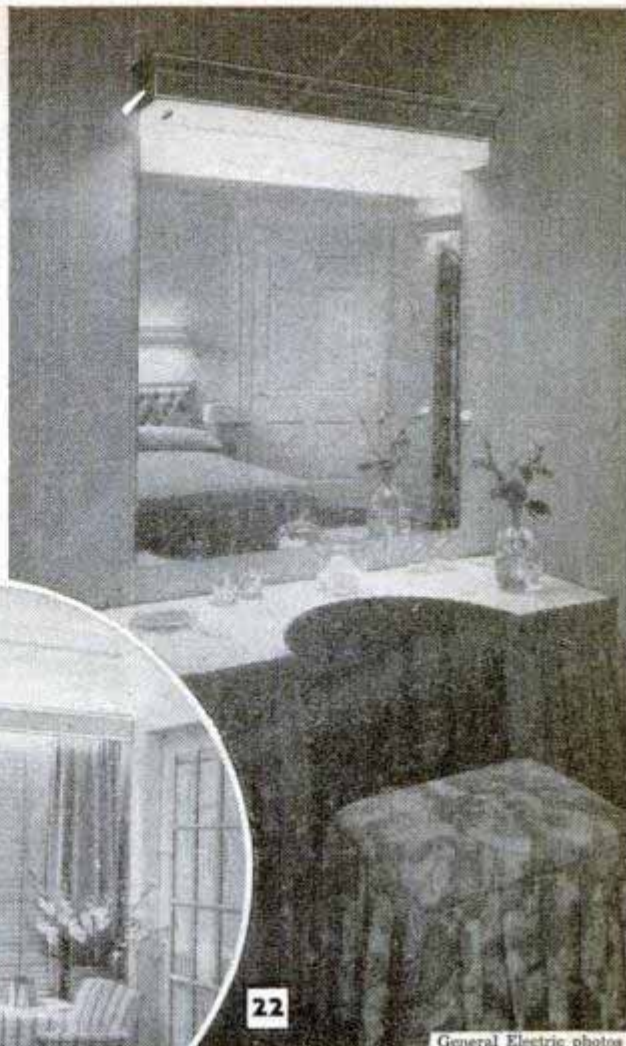
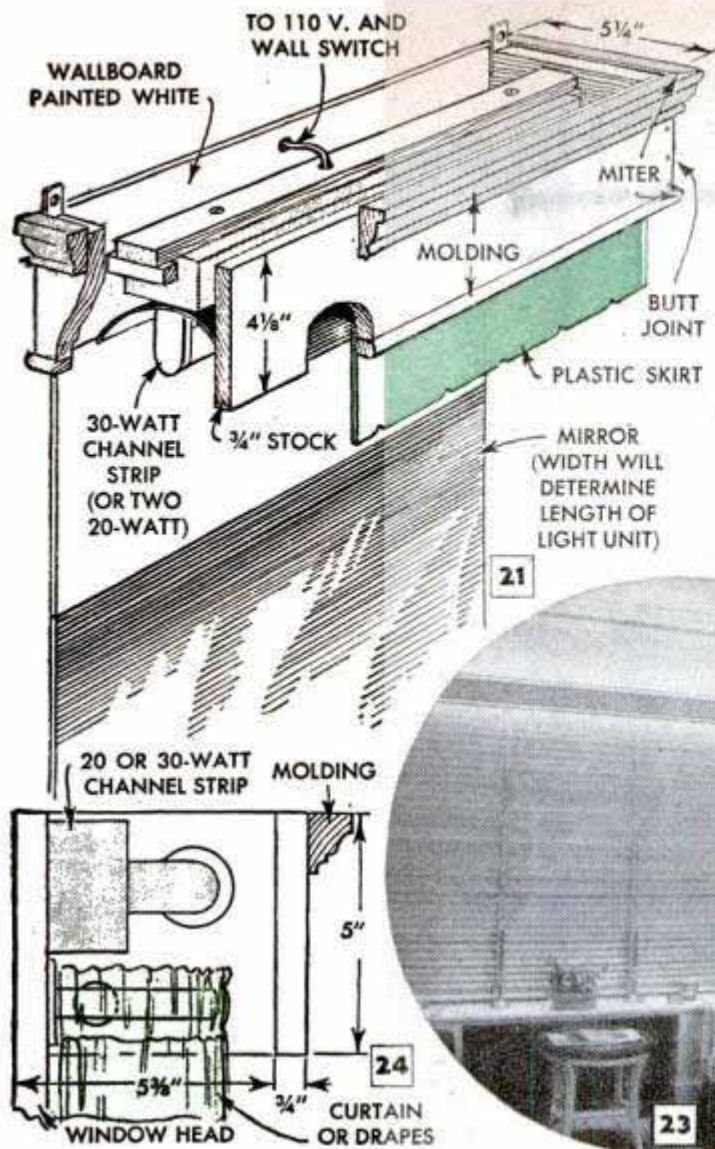

General Electric photos

COVE LIGHTING
FOR WINDOW CORNICES
OR VANITY MIRROR

dimensions, Fig. 18, will accommodate lamps up to 30 watts. The 40-watt size will require a slightly larger box to suit the larger size ballast. Fig. 19 gives dimensions for socket mountings, and these dimensions apply to any style of fixture using 14, 15, 20, 30 or 40-watt lamps.

Cove lighting: The two examples of cove lighting, Figs. 21 through 24, are typical channel strip installations. General construction details, which can be altered to fit individual requirements, are given in Figs. 21 and 24. If possible, the power line should be concealed in the wall, with control from a wall switch. However, the simpler method of tacking the wiring along woodwork and then to a receptacle can be used.

Bed lamps: Bed lamps, Fig. 25, introduce the problem of magnetic ballast hum. All fluorescent-lamp ballasts make a low humming sound, which is inaudible in most locations but like a bee in flight in the quiet of a bedroom. Fortunately, it is practical to cut the ballast in at some remote point in the power line, and the noisemaker thus can be shifted to a far corner of the room, or, even better, to some distant location like the basement or attic. However, for

successful operation, the voltage drop must not be too great, and this may occur when the ballast is located too far from the lamp. As a general rule, do not locate the ballast more than 50 ft. from the lamp and avoid locations where there is extreme moisture or where the surrounding air temperature is higher than 120 deg. F. Without the ballast, the basic light unit takes the form of a flat box housing the lamp holders and starting switch. All-wood construction can be used for the 1-in.-dia. tubes (15 and 30 watts) and the housing can be held to 1 in. thickness, as shown in Figs. 28 and 29. This tiltboard style makes a very practical bed lamp, allowing rotation of the light to any desired position. The fixed headboard style, as shown in Fig. 30, uses the lamp-housing box flat against the wall, with a combination wood and metal shade extending outward, as can be seen in Fig. 31.

Series hookup: Two 14-watt lamps (this one size only) can be connected in series and operated with a small 60-volt lamp as a resistance ballast, as shown in Fig. 27. Total wattage of lamps and ballast is about 45 watts. This circuit can be used on alternating or direct current. It has no ballast



25 **BED LAMPS**
... SHOULD HAVE BALLAST
APART FROM FIXTURE

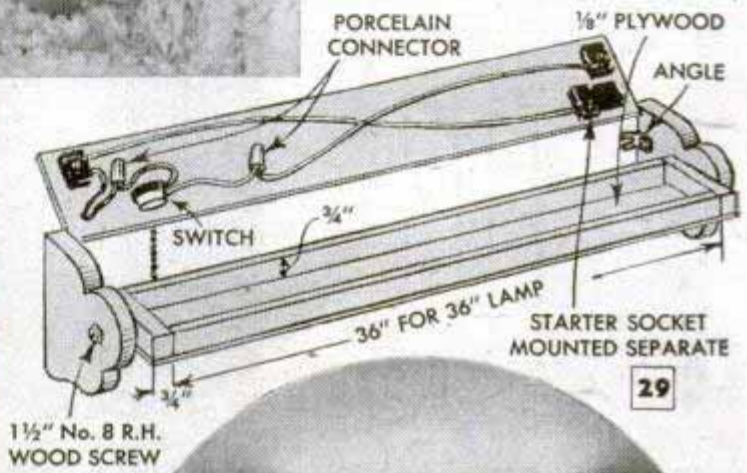
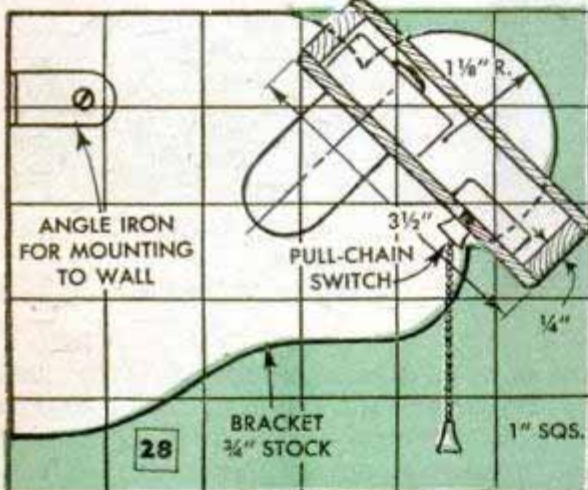
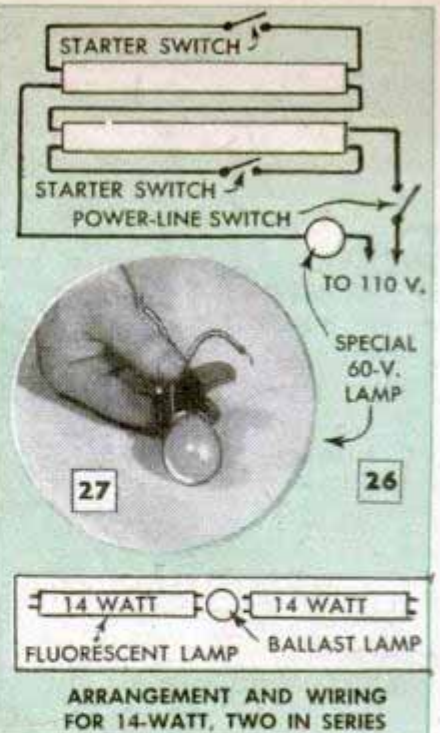

hum, making it ideal for bed lamp use. The wiring diagram, Fig. 26, shows three separate switches in order to prevent confusion, but actually the three switching operations (two starters and one power line) are combined in one manual fluorescent switch. The switch must be the type designed to operate two lamps; a manual fluorescent switch for one lamp will not work.

Wall shelves: Illuminated wall shelves are attractive and practical—one of the best applications of fluorescent lighting in the home. A typical unit is shown in Fig. 32 and is fully dimensioned in Figs. 33 and 34. The lamp is a 15-watt T-8 (T means tubular and the number gives the diameter of the tube in eighths of an inch, in this case 8/8 in.); such a size is easier to conceal than the larger T-12. The switch is a manual type, push button, for one lamp. This switch is operated by pushing it in, holding for a few seconds until the lamp lights, and

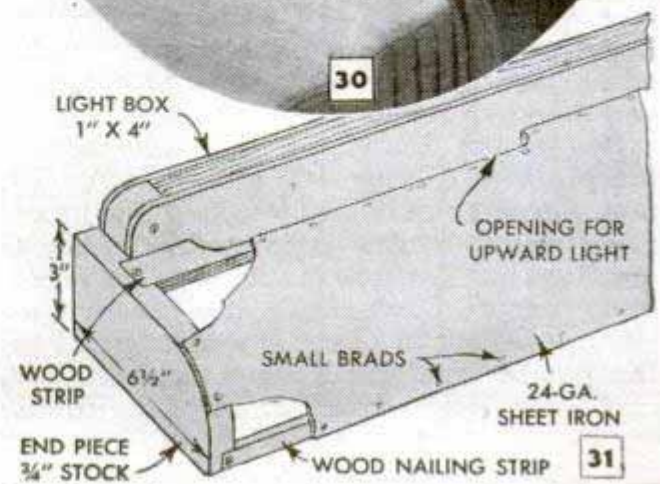

then releasing. It combines a starting switch and power-line switch in one unit, and has four lead wires. Power leads usually are black and are wired into the power circuit (see Fig. 2), while the second pair of wires is cut in on the starting circuit. The ballast is mounted apart from the shelf, using a plug-in type or running wiring to the regular ballast which can be mounted in the basement or on a wall. A modification of the shelf-type holder, a living-room installation, is illustrated in Fig. 35, and a method of

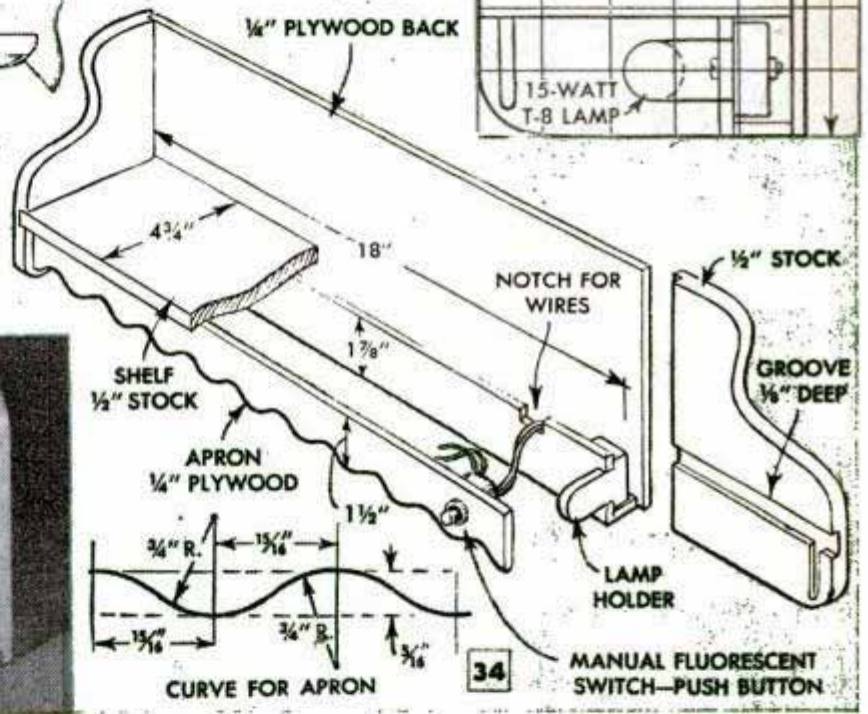
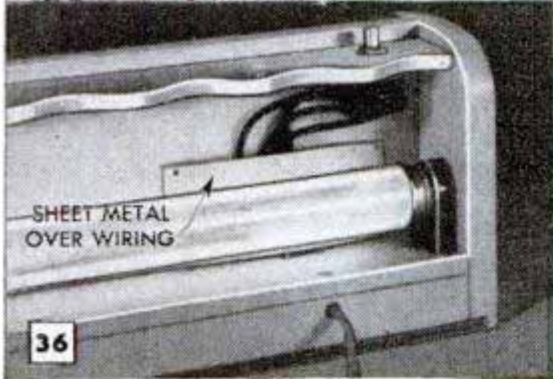

keeping wiring from coming in contact with the lamp for this and similar fixtures is shown in Fig. 36.

T-5 lamps: T-5 lamps are available in 6, 8 and 13 watts, as tabulated in Fig. 20. Although not shown in any of the plans, these lamps are excellent for shelves, picture lighting, portable trouble lamps, etc., where their small dimensions and low wattage are important considerations. Wiring is standard, and switching can be done with automatic starters or manually, the same as with the larger-diameter lamps. Whenever connecting starters, ballasts, etc., if wiring diagrams are included with the equipment, refer to these as a double check.

Installation applications: Don't use a

one-lamp fixture as a lathe light or for illuminating any revolving machinery; the best unit for such installations is a two-lamp unit and, further, ballasted with a two-lamp high power-factor ballast. Don't overrate the light value of fluorescent lamps; a sound conservative rating is twice the illumination of a similar wattage filament lamp. "Light Up Fluorescent" with one or two simple units, and then, as your appreciation of this new and better lighting grows, make other installations as dictated by your own experience.

Carriage lamps on an old surrey make excellent door lamps. After rubbing down, paint them black, wire for electricity and install on each side of the entrance door.

Strap Fits Over Arms of Seat And Holds Child at Movies

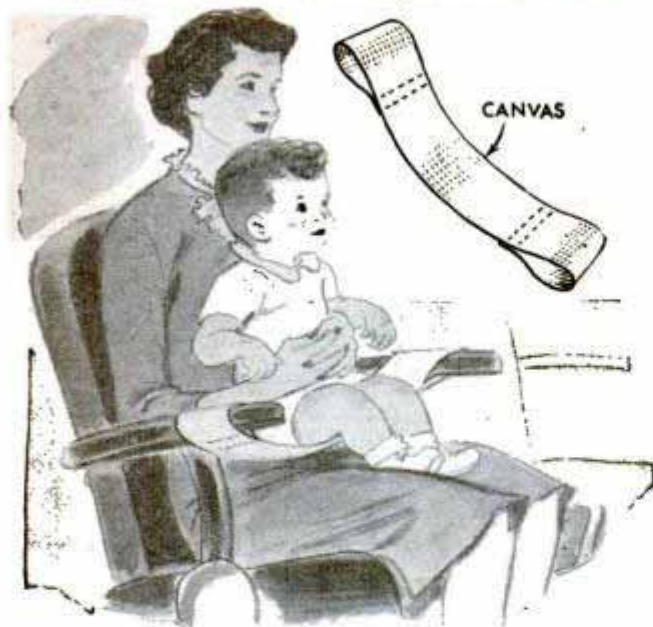

Making the burden of holding a child on her lap at the movies easier, one mother sewed together a supporting strap of heavy cloth that would slip over the arms of the seat and bear the weight of the youngster. A wide strip of canvas is ideal for the purpose. Loops about 6 in. in dia. will fit over the arms of most seats. Allowance must be made for slack in the strap so it will be comfortable.

Hacksaw Blade Fastened to Rod Used as Grass Cutter

Grass and weeds that are too tall to be cut with a lawn mower will fall before this cutter, which is made from a power hacksaw blade and a length of iron rod. The teeth of the blade are ground off and both edges are sharpened. Then the rod is bent as indicated in the upper right-hand detail and the blade is locked in place with two

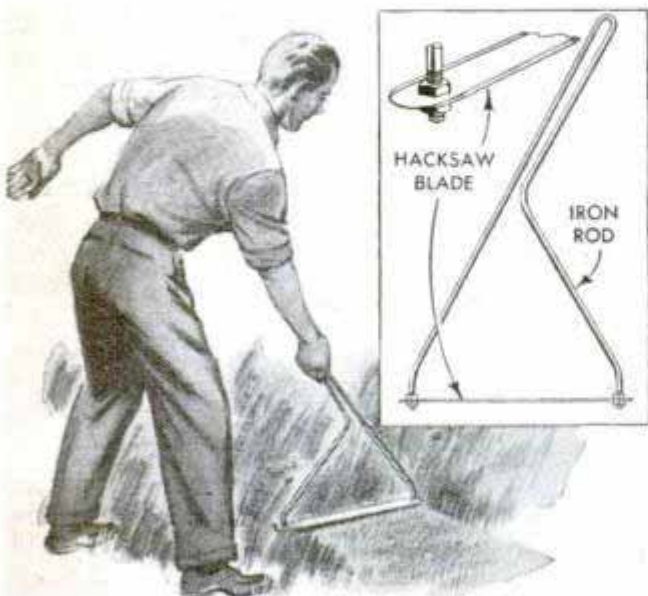

nuts on each end of the rod. The rod, of course, is threaded to fit the holes in the ends of the hacksaw blade. When cutting grass, a long, sweeping motion is used.

E. W. Moses, Jr., Blacksburg, Va.

Locked Guard for Snap Switch

To keep any unauthorized person from turning on a snap switch such as is used for power tools, or to prevent its being turned on accidentally, a sheet-metal guard and padlock will prove effective. The base of the guard slips

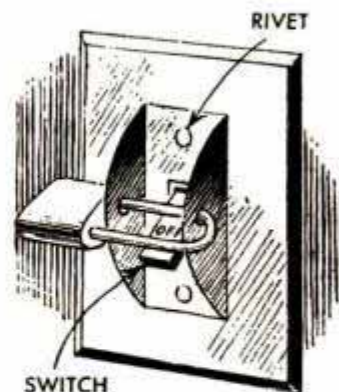

over the switch toggle and the semicircular sides are drilled to receive one leg of the lock. This latter feature prevents the switch from being thrown from the up to the down position or vice versa. Even with the lock removed, it's almost impossible to turn the switch on or off accidentally.

Garden-Hose "Snake" in Tree Keeps Robins Away

One orchardist has found an unusual way to keep robins out of his cherry trees. He arranged a length of old garden hose among the branches to resemble a snake, which is so realistic that the birds stay away as long as it remains in the tree.

Oren P. Tresslar, Vincennes, Ind.

Broken Mower Wheel Repaired

Because a cast-iron wheel on a lawn mower is broken doesn't mean that it must be discarded. A simple repair can be made with a piece of sheet metal and several flat-head machine screws. Fit the broken piece to the wheel and drill

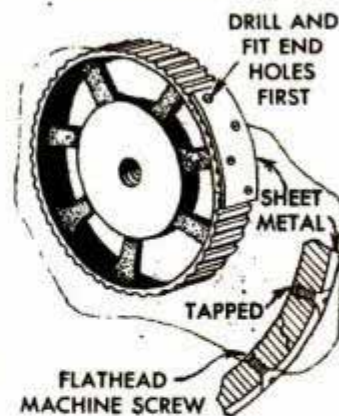

and tap several holes on each side of the cracks. Then bend a length of metal to cover the cracks and fit the curvature of the wheel. Holes are drilled in the metal to fit the holes in the wheel and the former is fastened in place with machine screws. Bevel the ends of the metal "patch."

W. H. McClay, Pasadena, Calif.

Hang'em up

THIS child's-room costumer makes it easier for youngsters to hang hats and coats neatly on a rack. Pony heads in cut-out design, which serve as braces for the column, and a pint-sized Scotty sitting at attention on the top effectively match the usual decorations of a child's room. The whole thing's easy to make, too. All you need are hand tools and a few pieces of suitable hardwood. Birch is especially recommended because it is so easy to finish with either colored enamels or varnish to match the other furnishings. Parts are joined with screws and all edges are sanded smooth before finishing.

Chas. E. Pilon, Newport, R. I.

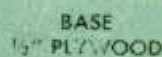
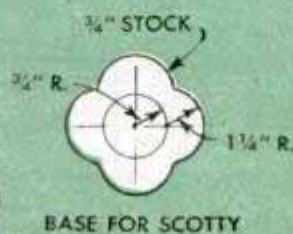
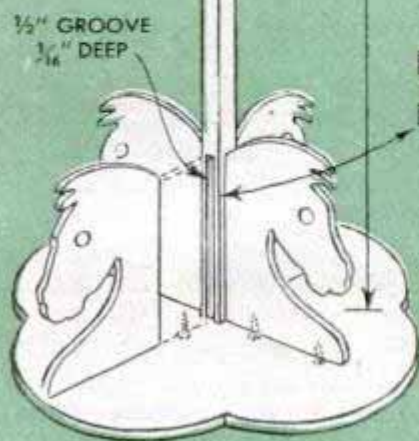
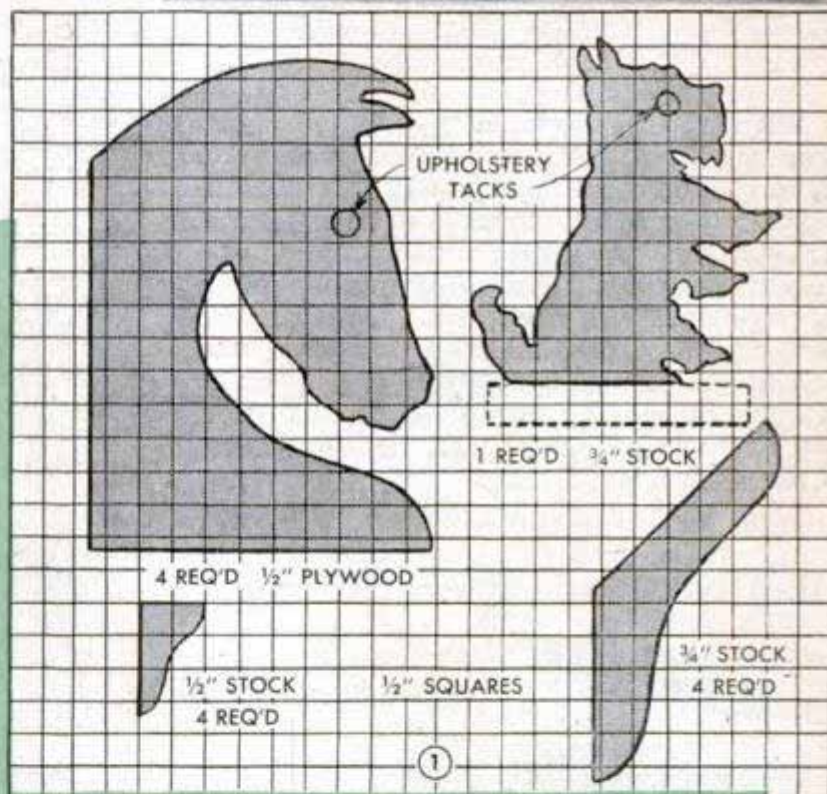
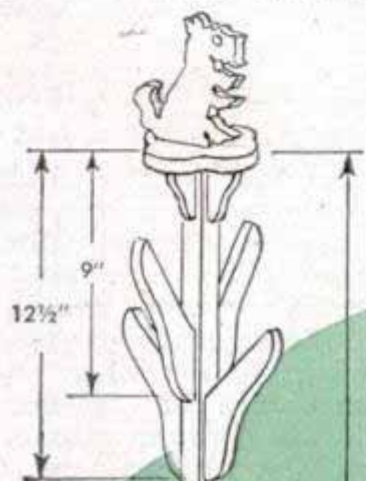

Colored Picture Is Transferred Onto Other Surfaces



Without any special paper, you can transfer colored designs and pictures found in magazines and newspapers to embroidery cloth or other surfaces in many cases. Take a sheet of white writing paper and rub the surface thoroughly with a piece of paraffin. Then press the waxed surface against the design to be transferred and rub the back with the bottom of a spoon or similar object. To complete the transfer, lay the waxed surface on the cloth and press with a hot iron.

Paul Hadley, Philadelphia, Pa.

Bait Net Made From Umbrella

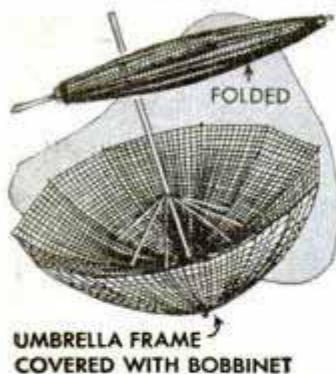

An easily carried minnow net that will fit into a small space can be made from a discarded umbrella frame. Cut fine-meshed bobbinet to fit the ribs of the frame, using linen fish line as thread to sew the net to the frame. The handle is removed and a fairly heavy cord is tied to the shaft of the umbrella when seining for minnows.

Way to Repair Cigarette Burns

Because it is difficult to find a matching piece of cloth to repair a cigarette burn in upholstered furniture, yarn can be used

with fairly good results. Select one whose color matches, or is close to, the material that has been burned. Darn the hole so that it is well covered and iron the patch level, using a damp pressing cloth.

Francis W. Henry, Pottsville, Pa.

Paste and Tissue Paper Mixture Fills Hole in Wall

As an emergency expedient, use white tissue paper that has been soaked in paste to plug a hole in a plastered wall. You can mold it into a solid mass and, after it is applied, smooth it down until even with the plaster. The patch can be finished to match the wall.

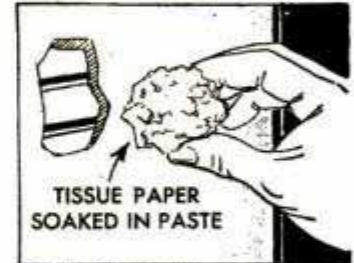

Opie Read, Jr., Chicago.

Perpetual Calendar for Children Duplicates Cylinder Type

A perpetual calendar for the children's room, similar to the cylinder type, can be made with a few pieces of mailing tube and some scraps of wood. The tube is cut into three sections with a window in each one for the month, day and year. Three wooden dowels or other round wooden pieces, which rotate on a wire shaft, fit into the tubes and are marked for months of the year, days of the month and a series of years. The ends of the shaft are bent and fastened to a wooden base.

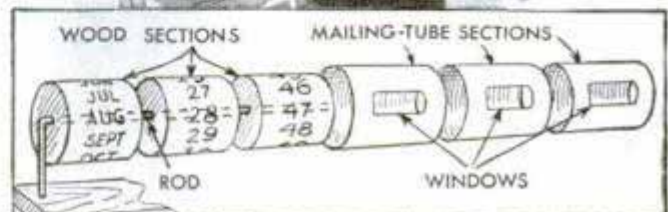

Novel Tree Seat for the Outdoor Living Room

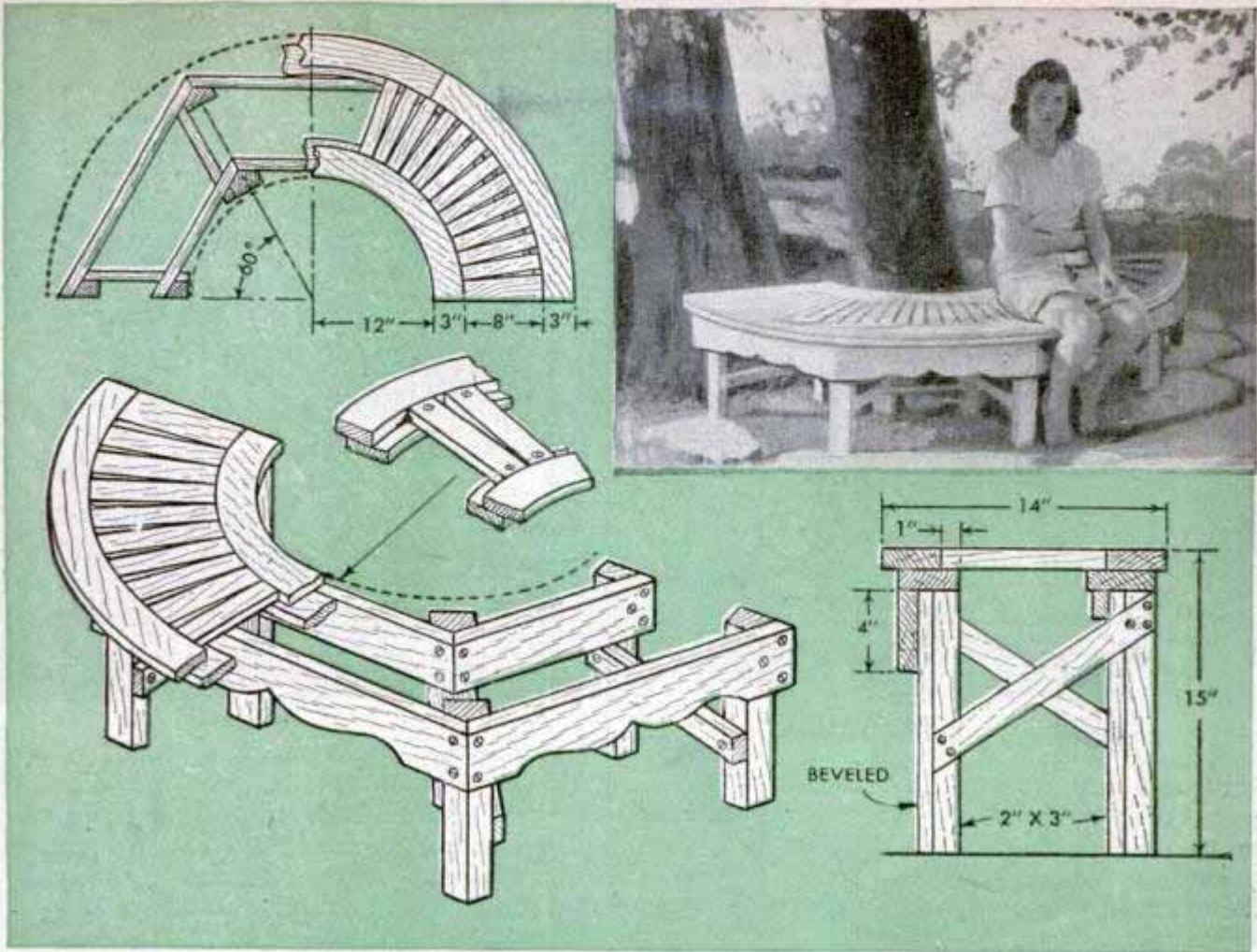

This seat can be made semicircular as shown or in duplicate sections to encircle a tree trunk completely. Either way the construction is the same except that when two semicircular sections are made you duplicate all the parts. Notice that the legs are beveled to take the aprons front and back and that cross braces stiffen the structure when assembled. Use screws to join the parts. Driving screws takes more time, of course, but the job will be much more

lasting as a result. Also, it's a good idea to paint all joining surfaces before assembly. This will prevent absorption of moisture. Circular members are built up from two layers of segments, the lower layer being offset 1 in. to form a ledge for the radial pieces. This method substitutes for the cutting of a rabbet on thicker stock, which would be a difficult operation without special equipment. Finish with two coats of white outside paint.

Ball Is Dipped in Colored Chalk to Leave Mark on Target

Here's a game that's safe for children because it does not require the use of pointed darts to determine the score on the target. Instead of darts, soft rubber balls are used and each player dips them in a box of powdered chalk, there being a different color for each player. After each round, the score is figured from the colored spots left on the target by the balls.

When sewing buttons on trousers, overalls or other garments where there is a good deal of strain, try sewing a button on each side of the material back to back. It prevents the cloth from tearing out.





Pictures are Pretty

9 Attractive Designs You Can Make



Frame No. 1
Courtesy Vargish & Co.

SIMPLE in design, these plastic picture frames depend largely on the beauty and crystal clarity of the material for their effectiveness. Some of the frames, such as Photos 1, 2, 3 and 4 at the tops of these pages, use plastic for both frame and glass. Construction details are shown in the correspondingly numbered photo and line drawings at the side and bottom of this page. These frames are best worked on a strip heater, which confines the bending heat to the area required. Sharp bends are worked by heating the plastic along the bending line and then rubbing the joint gently with a cloth-covered block as the plastic cools. Large-radius bends are made by heating the required area and pressing the free end against any smooth, clean surface until the desired curvature is obtained. If the correct curve is not made on the first attempt, it's a simple matter to reheat the piece and repeat the bending process as often as is necessary.

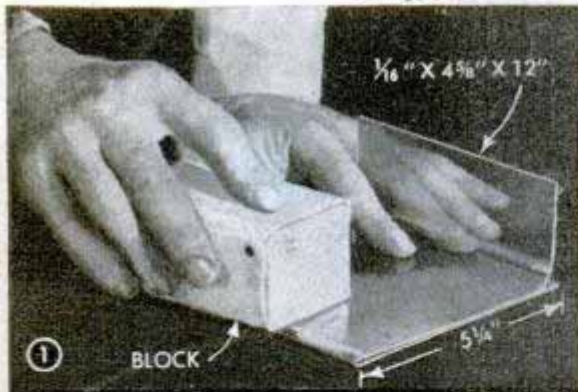

FOR A CLEAN, SHARP BEND, RUB THE HEATED PLASTIC WITH A CLOTH-COVERED BLOCK

Bent frames are illustrated by two simple designs, Photos 5 and 6. This type of construction always requires a form. The form for No. 6, illustrated by Fig. 6, is a simple arrangement of

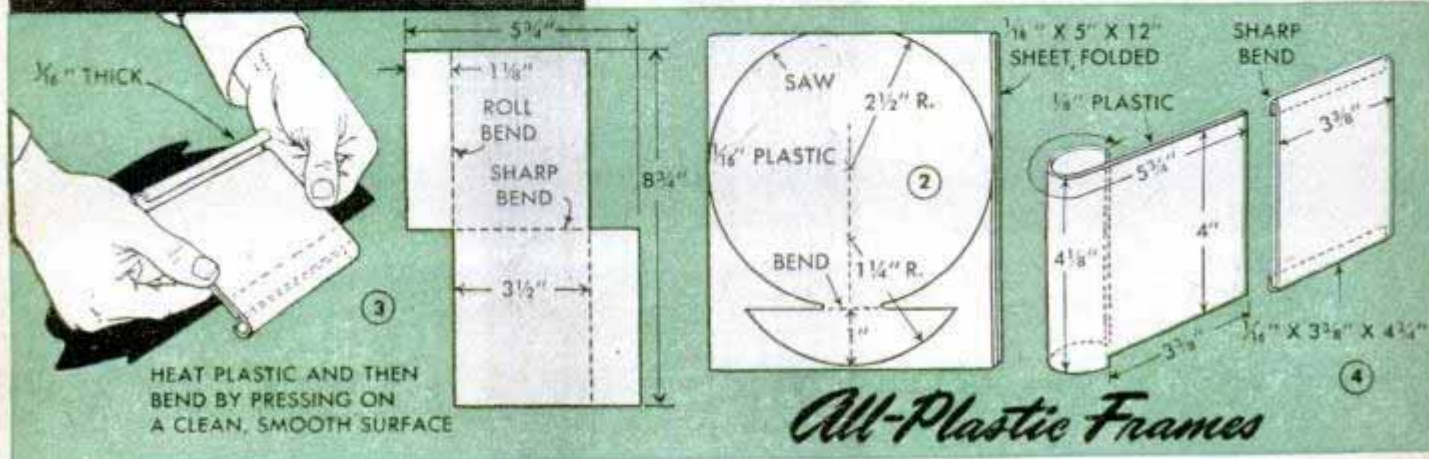

All-Plastic Frames



in Plastic



6 $\frac{3}{32}$ " X $\frac{3}{4}$ " PLASTIC

$\frac{3}{8}$ " DOWELS ON $\frac{1}{8}$ " CENTERS

pegs; the form for No. 5 is bandsawed to the shape shown in Fig. 5. The wood should be sanded until it is very smooth to prevent mark-off. Slots for the picture glass in design No. 5 are cut previous to bending. An over-all heat, commonly obtained by placing the strip in an oven, is used for all bent frames when smooth-flowing curves are required.

Straight frames, such as shown in Photo 7 and Fig. 7, are made from straight sections of plastic assembled with cemented butt joints. A solvent-type cement, such as methylene dichloride or vinyl trichloride, gives firm, clear joints on work of this kind and is easily and quickly applied. This type of frame has the edges sanded with 100-grit wet-or-dry paper used with water, which gives a frosty effect that combines nicely with the crystal plastic. Alternate designs for straight frames are suggested by Figs. 8 and 9. The same type of assembly and construction is used.

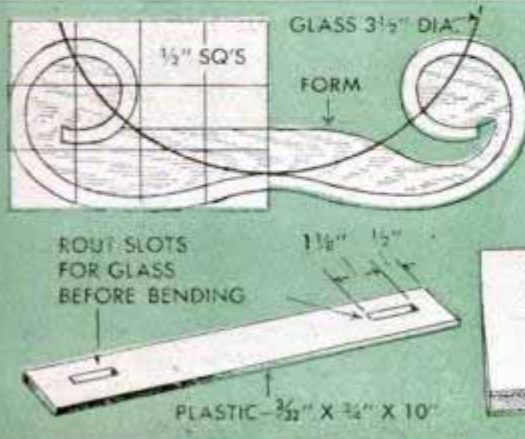
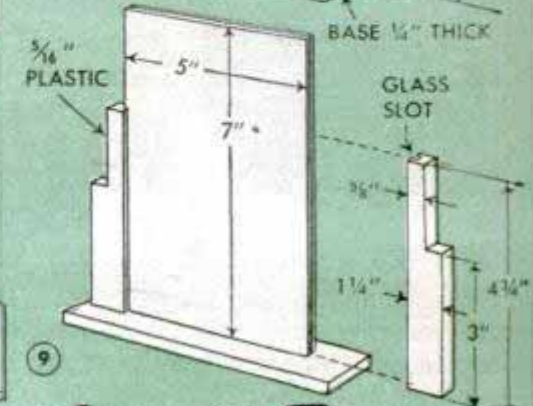
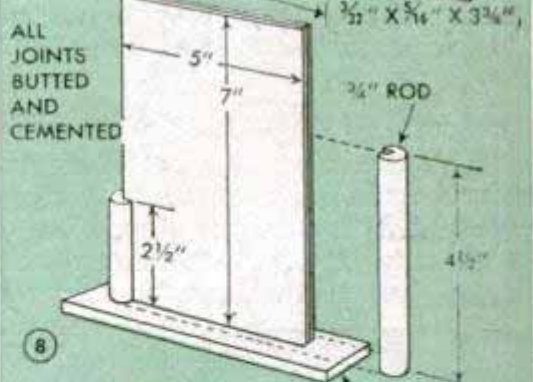
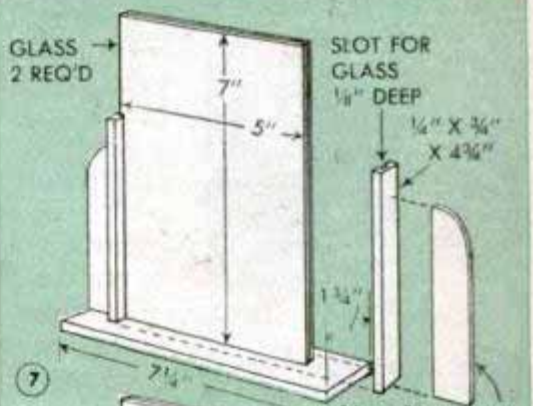

Straight Frames

Outboard Motor Locked in Place



By inserting eyebolts through the heads of wing-nut mounting bolts, after the wings have been removed, it's possible to lock an outboard motor to the transom of a boat so the motor will be difficult to remove. The manner in which the eyebolts are inserted will vary with the different makes of motors, but one method is suggested in the photograph. When the eyes of the bolts are in the position shown, a padlock is slipped through them to prevent removal of the motor.

Walter A. Dewey, Oakland, Calif.

Removing a Broken Light Bulb



Should an electric light bulb break off in the socket, it can be removed with a cork without danger of cutting your hand on the jagged edges. Press the cork into the base of the bulb and unscrew it. A large cork is best.

Repairing Battery Hydrometer

Don't throw away a battery hydrometer if the nozzle has been broken off. It can be repaired with a rubber stopper and a length of glass tubing. Select a stopper that will fit snugly into the hydrometer and drill it



to receive the tubing. Press the assembly into position and the hydrometer is again ready for use. — Julius R. Jung, Jr., New Orleans, La.

Plaques Finished With Varnish

When making clay plaques and figurines, you can dispense with the more or less complicated business of firing by covering the work with two thin coats of clear varnish. It's better to do the front of a plaque before it's quite dry to prevent cracks.

Moisture will evaporate through the back. In the case of a figurine, a small area could be left in the back or base for the evaporation of moisture.

Dust Cover Fits Record Holder

Most phonograph record holders can be equipped with this cover to keep dust off favorite selections. A shade and roller are cut down to fit the width of the holder and the shade also should be shortened and fitted with snaps on the free end.

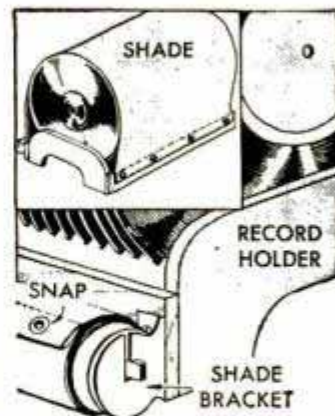

Mounting brackets for the shade are nailed to one side of the base of the holder and matching parts for the snaps on the shade are attached to the other. When the records are not being played, the cover is pulled over them and held in place with the snaps of the button or turnbutton type.

Substitute for Wire Paper Clip

If regular wire paper clips aren't available, heavy paper cut in narrow strips will serve as a substitute to hold a number of papers together. Cut two slits in the papers to be fastened together and slip the strips between these, as shown in the illustration. This will not disfigure the paper in any way.



Beatrice E. Reese, St. Petersburg, Fla.

Name Printed on Auto Hub Cap

The large hub caps on present-day automobiles sometimes are scraped off when rubbing against curbstones, lost in traffic or forgotten when changing a tire. However, if your name and address are stenciled, scratched or printed on the inside of the cap, you have a chance of having it returned if it becomes lost and is picked up by another motorist.





"FROG MEN" SWIMMING PADDLES

ONCE you get used to wearing them, these "frog feet" will enable you to swim greater distances at speeds you couldn't achieve otherwise. Although good swimmers will be able to use them to advantage in a number of swimming strokes, many users probably will find the side crawl the least tiring for long-distance work. Details below show how to make the paddles, each of which consists of two parts: a shoe, or sandal, and a hinged flap, or wing, which is cloth-covered. The wing is hinged in such a way that it can swing in an arc of only about 50 deg. However,

this is sufficient to allow it to "feather" properly on the return stroke when swimming. The cloth covering or web of lightweight canvas is stretched over a wire frame, sewed as indicated, then treated with airplane dope, which waterproofs and shrinks the cloth tight on the wire frame. The sandal is cut from waterproof plywood and is fitted with a "counter" cut from an old inner tube. Web straps attached to the counter tie over the ankle. Notice that the sandal is covered with leather or rubber of about the same thickness as the toe strap. This prevents chafing. Edges of the plywood are sanded smooth and all exposed parts are given two coats of shellac or spar varnish.—C. L. Meehan, Lakeview, Ont., Can.

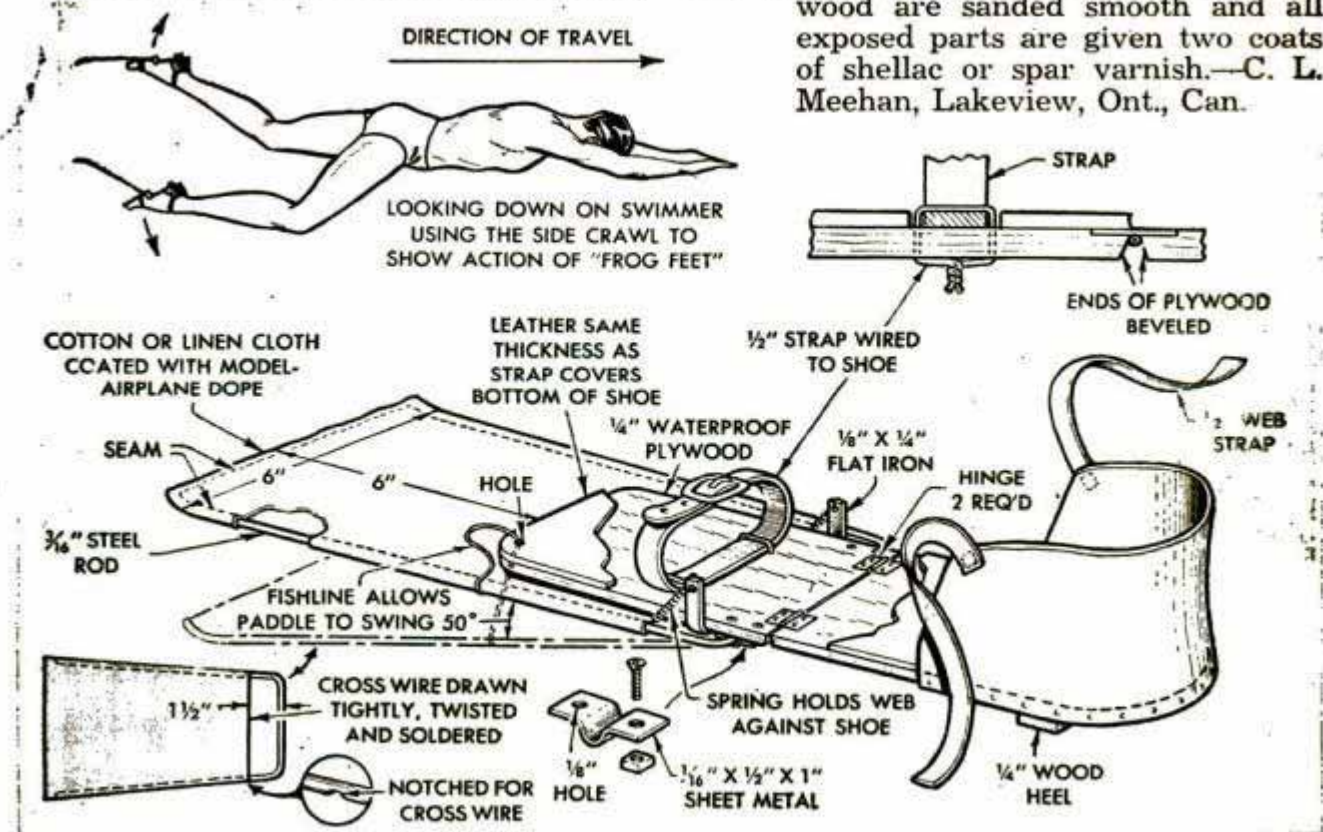

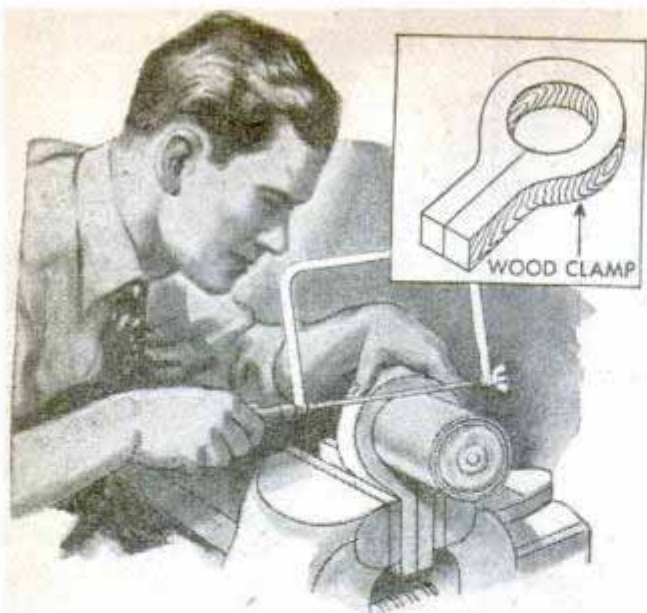

Wooden Clamp Around Tin Can Makes Sawing It Easy

The edge of a tin can will not buckle or bend out of shape if it is held in this clamp while being sawed. The inside diameter is a little larger than the can and the slot between the two legs that are held by the vise should be wide enough to make the clamp a tight fit around the can when in position. Use a fine-tooth blade and make the cut as close to the clamp as possible.

Slots Are Cut in Length of Pipe To Support Wiener Forks

This simple holder for wiener forks is made by sawing a number of slots in a length of pipe. Before the slots are cut, however, small holes are drilled through the pipe, at a point where the cuts are to end, to keep the forks from slipping out. The end of the pipe is pointed so it can be driven into the ground easily. Use galvanized or wrought-iron pipe to make the holder.

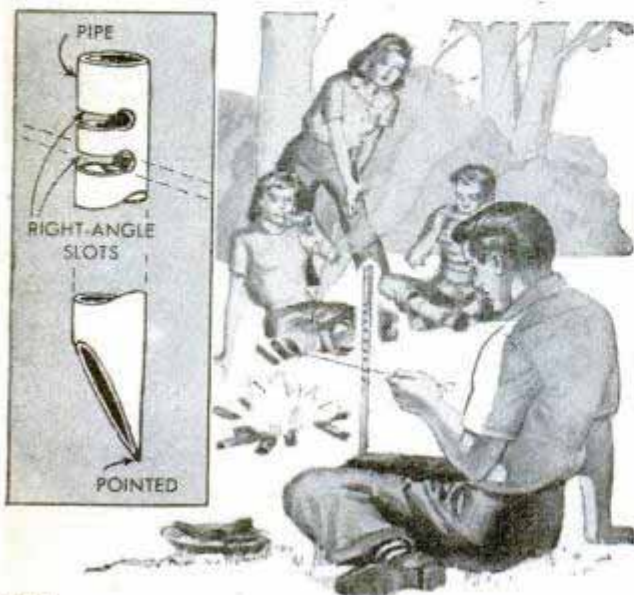

Wire Bracket Will Hold Brushes

Made from a piece of heavy wire bent at a right angle, this holder will keep several brushes suspended in a can of cleaning solution and not allow the bristles to rest on the bottom so they will be bent. The bracket is fastened to the wall or side of a shelf and, because of this method of mounting, can be slid up and down to remove brushes without moving the can and spilling liquid. Of course, it's necessary to drill holes in the handles of the brushes to slide them on the bracket.

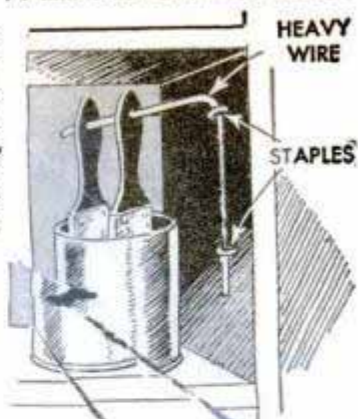

R. Hoppough, Waukegan, Ill.

Watch Strap Formed From Scale

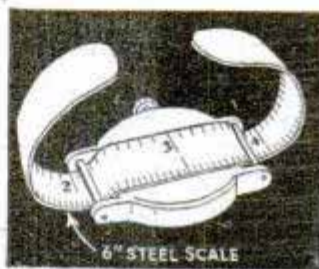

By taking a regular 6-in. stainless-steel scale and bending it to the desired shape, an unusual wristwatch band can be made for very little expense. One

advantage of using the scale is that the markings can be used to gauge the symmetry of the bends, starting with the 3 in. mark as the center. The square corners of the scale should be filed round and the edges should be beveled slightly.

Donald S. Henningfeld, Ft. Belvoir, Va.

Flat Pulley Used as V-Belt Drive

Flat-belt pulleys can be converted to V-belt drives by using a length of discarded V-belt. Two strips of the latter are reversed and bolted to the pulley in such a manner that the wide side of the belt is against the face of the pulley. The space between the belts is just wide enough for the drive. This conversion will not work as well on smaller pulleys because of the difficulty in reversing and bolting V-belts to a surface having a small radius.—Albert A. Mihalovich, Rathbun, Iowa.

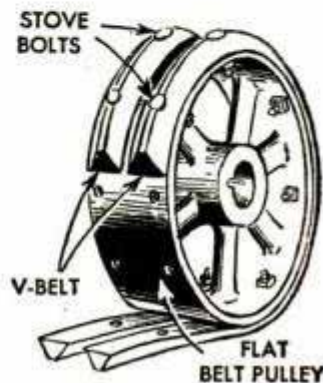

"Weedless" Dip Net Made From Hardware Cloth

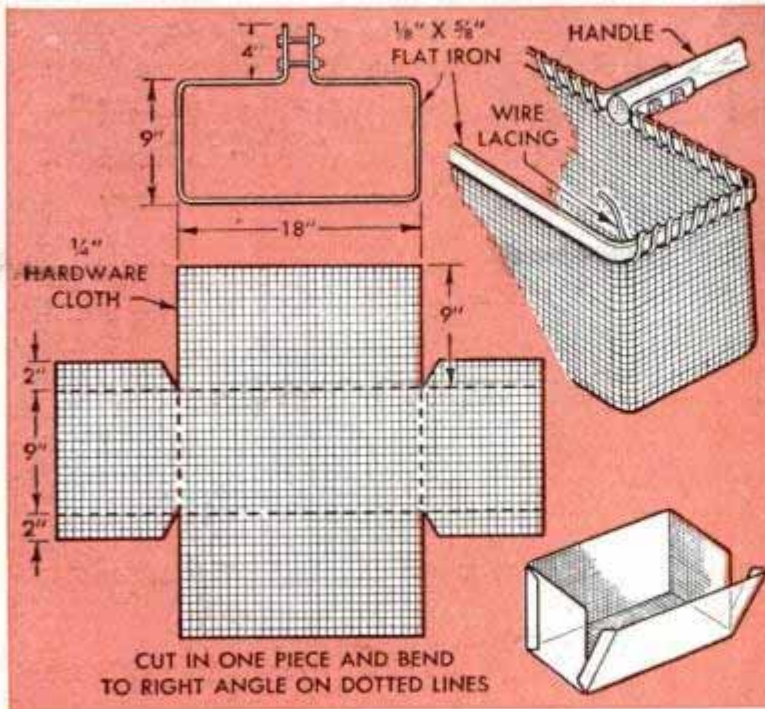

For netting fingerlings under grassy banks, around tree roots or aquatic plants, or just dipping up minnows from open water, this rigid net has several advantages over other types. It will withstand a lot of rough usage because it's made of metal and attached to a sturdy wood handle. The frame is bent from flat iron and fastened to the handle with small bolts as shown in

the details. Then, from hardware cloth, cut a single piece of the shape and size indicated. Bend this to a rectangular, boxlike shape, solder the overlapping corners and lace it to the iron frame with wire, using a simple over-and-under lacing and pulling each loop tight. A coat of green enamel will make the net less visible in the water. The handle should be about 6 ft. long.

Live-Bait Minnows Can Be Carried in Glass Fruit Jar

When fishing in midstream and using live minnows for bait, the necessity of making a trip to shore every time bait is needed can be eliminated by using a glass-

jar container that will carry five to six minnows. Fill a pint jar half full of fresh water and screw on the lid to make it airtight. A cord, which slips over the shoulder, is fastened around the neck of the jar. Bait kept this way will remain alive for an hour or more.—R. A. Jenkins, St. Louis, Mo.



Leather Thumb Gives Protection

One fisherman wears the thumb cut from a leather glove when casting. This serves as protection when "thumbing" the reel. The material should be leather, since cotton or any similar fabric material would not overcome the heat generated by friction of the line, and rubber would have too much braking action.

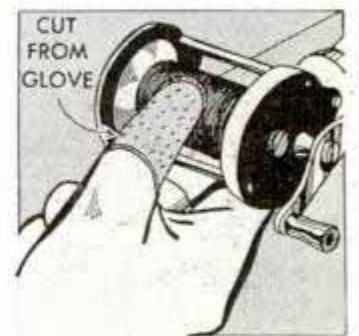

☞ Picnic salads can be served cold if packed in a double boiler with ice in the outer container.

Checking V V V for Refrigerator Ills

Much of the repair work done on domestic refrigerators requires special tools and equipment, but if you know how a refrigerator works—and why—there are simple maintenance routines that you can follow to keep the unit in condition and make frequent calls for a serviceman unnecessary

✓ Like any fairly complex mechanical refrigerator must be serviced properly and maintained if it is to deliver the peak performance for which it was designed. Some repairs, which do not require “opening” or “pumping down” the system, are fairly easy to make and can be done with ordinary tools. (Opening or pumping down a system refers to the removal, or partial removal, of all refrigerant to get at some particular part. To do this, special equipment is needed and generally it is better to have a serviceman do the work. Also, when a system is opened, you may be handling gases that are toxic and, therefore, dangerous.) Only repair and maintenance that do not require opening the system are discussed here.

✓ Fig. 1 shows schematically how a refrigeration system works. Warm, low-pressure refrigerant vapor is admitted to the compressor where its temperature and

By John F. Shrock

pressure are raised and then it passes to the condenser

where the vapor is liquefied and partially cooled. From here the liquid goes to the receiver, which functions as a storage tank to supply refrigerant according to the fluctuating demands of the system. At the expansion valve the liquid is metered and admitted into the evaporator or cooling coils; these are the coils that generally encase the ice-cube trays and also refrigerate the interior of the cabinet.

✓ From the point where the refrigerant is compressed to where it passes through the expansion valve or a similar metering device, it is under high pressure and this generally is referred to as the “high” side of the system. At the expansion valve the pressure and temperature are reduced so that the liquid will absorb heat and “boil,” thereby evaporating and cooling the interior of the refrigerator. After the refrigerant passes through the cooling coils, it returns to the compressor and the cycle is repeated. From the point where the liquid leaves the expansion valve to where it is compressed again, it is under low pressure and this is the “low” side of the system.

✓ While the foregoing isn't typical of any one unit, it's a general indication of how mechanical refrigeration by means of a compressor is accomplished. Other types of compressor systems include those which have high and low-side float valves, restrictors and capillary tubes instead of expansion valves. In some units a plate-type

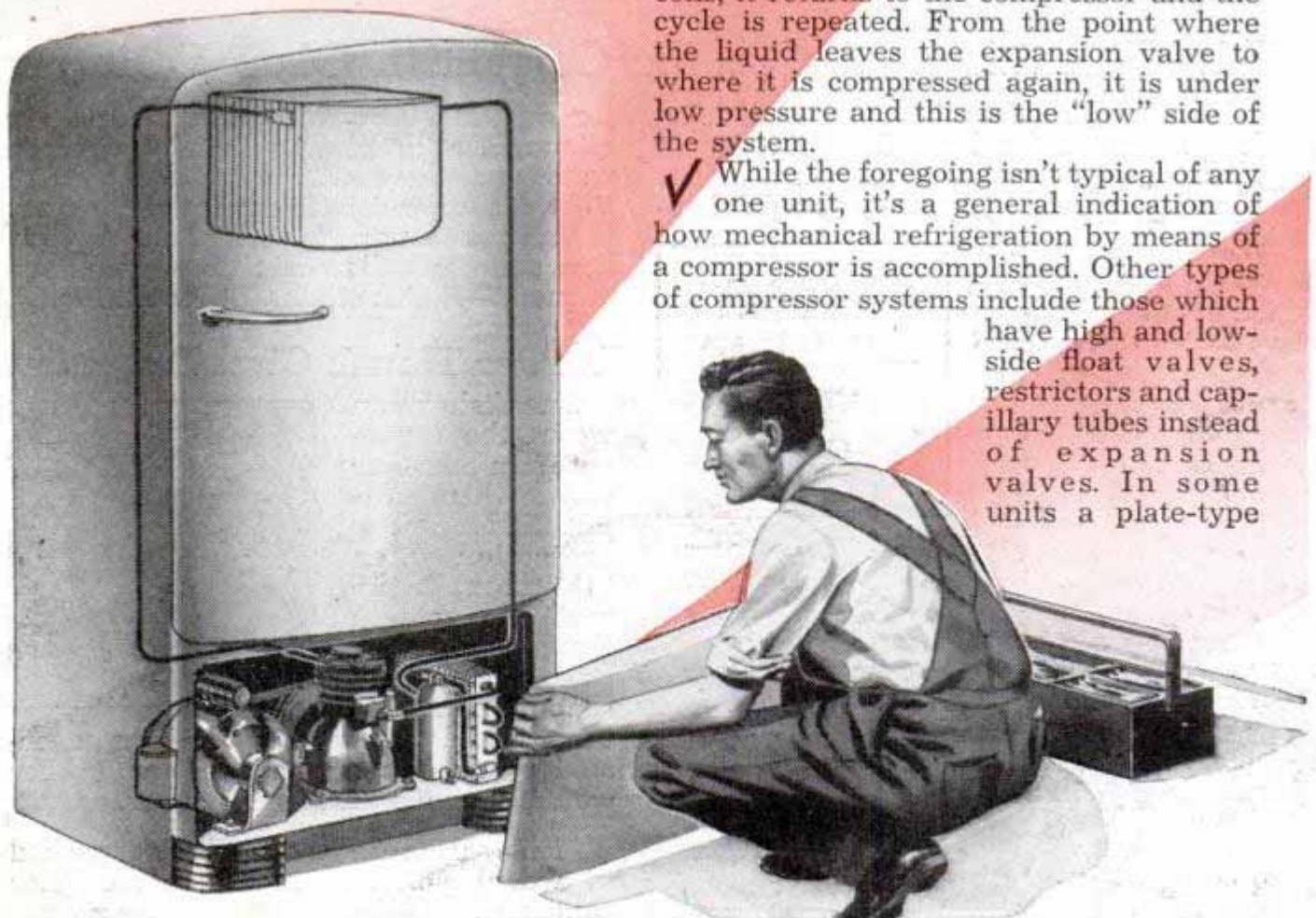

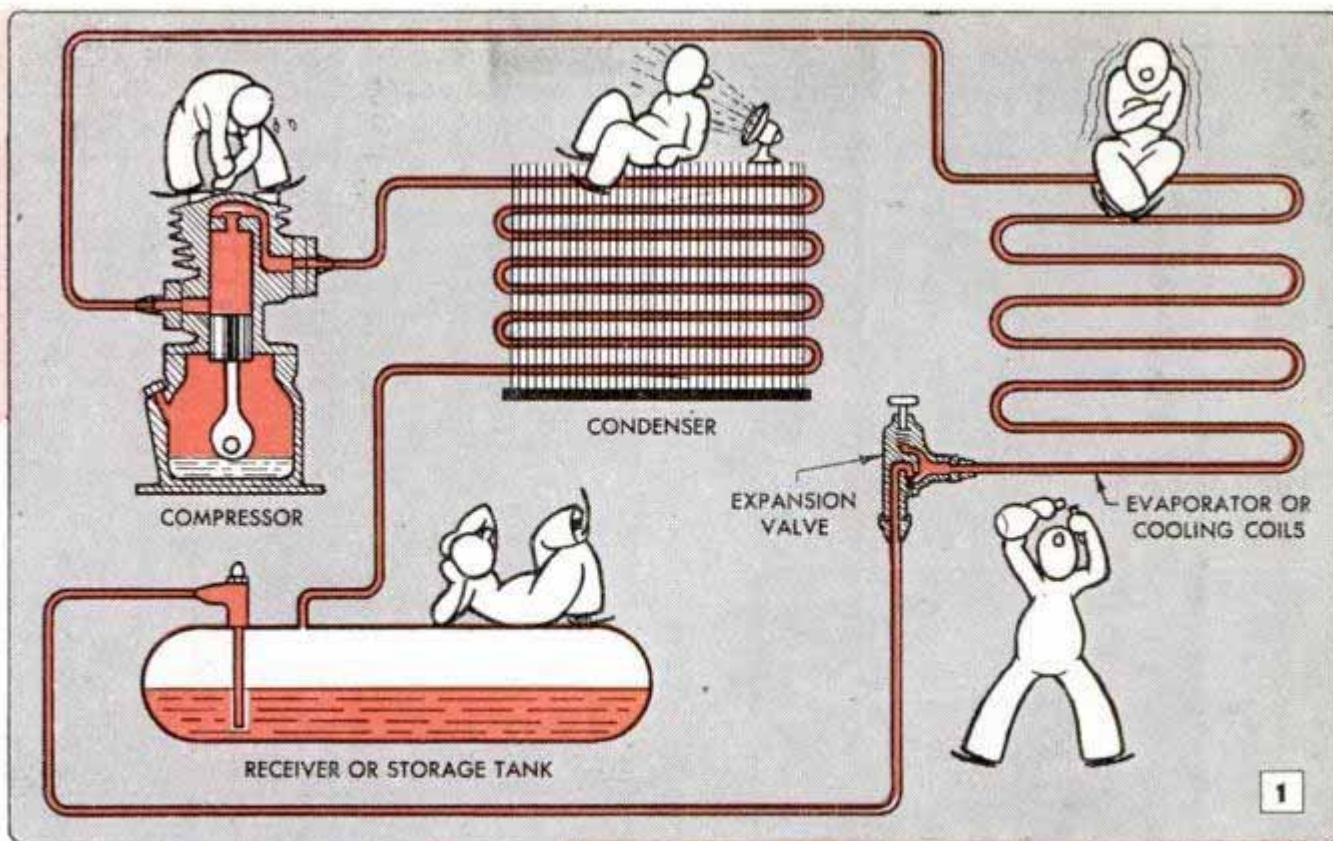

In brief, here's what happens during a compression refrigeration cycle: Refrigerant is raised to a high-pressure gas in the compressor, liquefied in the condenser, stored in the receiver, metered at the expansion valve, "boiled" in the evaporator to cool the interior of the cabinet, and returned to the compressor to complete the cycle

condenser is combined with the receiver and is air-cooled instead of being the fin-and-tube type, Fig. 4, that is cooled by a fan.

✓ To start and stop the unit when refrigeration is needed, there is a system of automatic controls. Usually these are switches or relays that are operated by temperature or pressure, and if they do not function properly, they should be adjusted or replaced by a serviceman. Sometimes adjustments can be made by referring to instruction sheets pasted inside the cover of the switch box. However, first check the electrical current to be sure that it is supplying power and test the motor for proper operation. When possible, also check the wiring for shorts, grounds and continuity. If the unit is of the "hermetic" type, the motor and compressor are sealed in a housing and require replacement as a unit if defective in operation. The "open" unit has the motor connected to the compressor by a V-belt drive. "Semihhermetics" are a combination of the open and hermetic types, having a sealed compressor that is direct-connected to the motor. Any of these types can have either a reciprocating compressor, which has pistons that function like those in an automobile engine, or a rotary compressor that is like a positive-action pump.

✓ An efficient machine is one that's clean, and a condensing unit (compressor, condenser, receiver, metering device and evaporator) is no exception. Ac-

cumulations of dust, dirt and oil act as insulation and prevent proper air circulation and removal of heat from the unit. This is especially true of the condenser. Both the fin-and-tube type and the plate condenser should be cleaned with a brush to remove any accumulated dirt, Fig. 4. With the fin-type condenser, be sure that the passages between the fins are free of obstructions



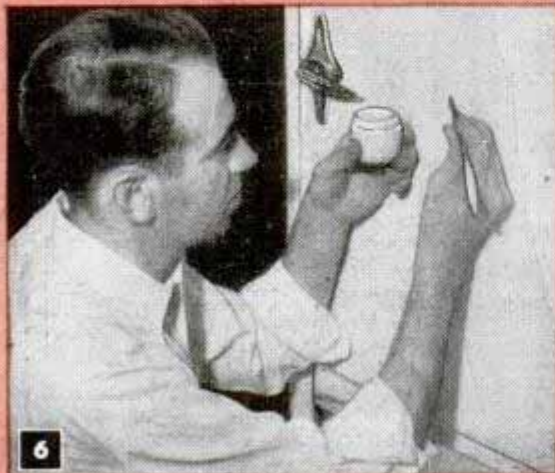
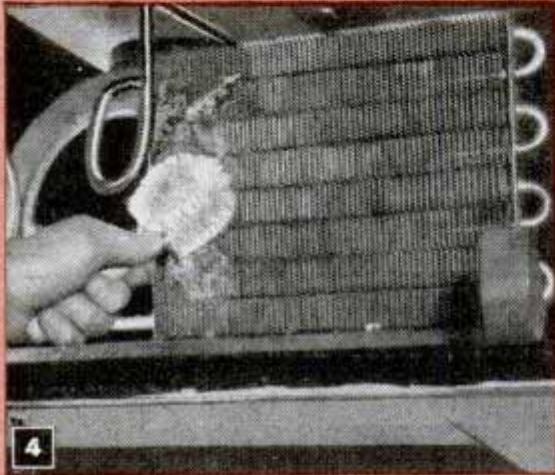
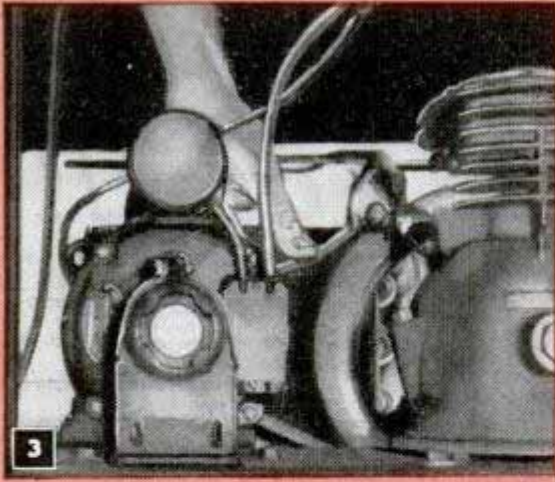

and check to see that the fan blades are not bent or otherwise operating improperly. When working around an open condensing unit, always disconnect the refrigerator from the power supply as operation of the unit is automatic and it may start or stop at any time, catching a tie or loose clothing.

✓ In connection with air circulation, another point to check is the location of the refrigerator. For most makes there should be at least 3 in. between the back of the cabinet and the wall, Fig. 2, and as much or more space above and at the sides. Any pockets which restrict the free flow of air cause inefficient operation. This may be indicated when the refrigerator operates in short cycles; that is, starts and stops frequently.

✓ When going over an open condensing unit, always check the V-belt drive for tension and alignment. Tension can be tested by pressing the belt with the thumb, Fig. 3. There should be about $\frac{1}{2}$ in. deflection. If the belt is too loose, there will be slippage and loss of power. One of the simplest ways to check alignment is to place a straight-edge against the face of the compressor pulley and see that it is parallel with the face of the motor pulley. When a belt becomes loose or frayed it should be replaced. This is done by loosening the motor-mounting bolts and sliding the motor toward the compressor. After the belt has been replaced, check the new one for tension and alignment, but remember that it will stretch somewhat.

✓ Although most motors do not require frequent oiling, if they run dry they will overheat and burn out bearings. Lubricate the motor according to instructions for the particular type that you have, but do not use too much oil or grease, as this, too, will cause overheating. Be careful not to drop oil on the V-belt as this causes deterioration of the rubber. When testing the drive, tighten all mounting bolts to eliminate a possible cause of excessive vibration.

✓ Sometimes a compressor runs continuously or too long. Some causes for this are an excessive refrigeration load, or food placed in such a way as to obstruct the circulation of air inside the cabinet so that only the space around the evaporator coils is cooled. When placing food in the refrigerator, do not have it above room temperature.

✓ It may be necessary to replace the gasket around the refrigerator door if it becomes loose and allows cold air from inside the cabinet to leak and cause frequent operation of the condensing unit. The gasket can be replaced by removing the screws or loosening the metal flanges that hold it in place, Fig. 5, and inserting new strips. To keep the unit neat appearing, repair chips or scratches with porcelain enamel or glaze, Fig. 6, or use a lacquer. Clean the damaged area before patching.

When you know the secret command, this little man will slide down the string or stop when you tell him to, but for anyone else he'll only slide and refuse to stop until he reaches the bottom of the string. The real secret lies in the position of the dowel that fastens the two arms. There is a hole drilled in it through which the string passes, and if this hole is aligned as shown in detail A, it will be impossible to stop the toy. However, if the hole is out of alignment, as shown in detail B, the man will slide when there is little tension on the string and stop when it is pulled tight. Care must be taken to be sure that

the dowel is a tight fit in the body for the toy to work properly. The man is carved from a broomstick and he has hard-pressed-board arms and legs. Shingle nails, staples, brads and a toothpick serve as features and decoration. Gaily colored enamels will give the toy an attractive appearance.—Peter B. Horsley, Calgary, Alta., Can.

Toy Will Stop or Slide on String At Secret Command of Operator

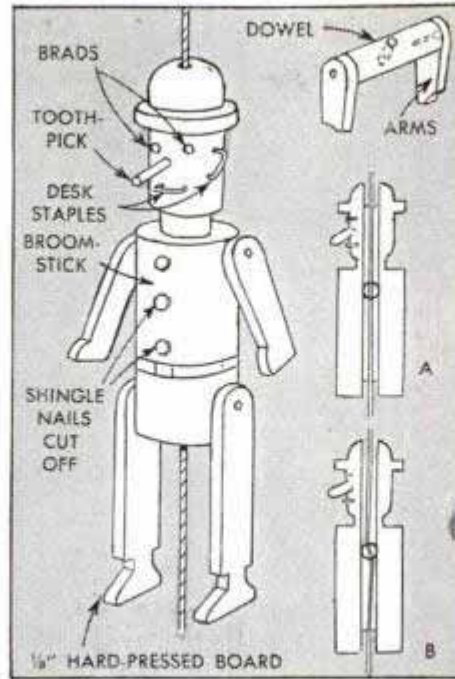

Key Concealed in Screen Door Is Readily Accessible

Here's a place to keep the door key where it will be readily accessible to all members of the family without having to bend over to pick it up from underneath the door mat. On the hinged edge of the screen door, mortise an opening into which the key will fit. This should be at a convenient height. A similar mortise is cut into the storm door where the key can be concealed during the winter.

Joseph St. Laurent, Bremerton, Wash.

Spacers Are Bent Around Pipe

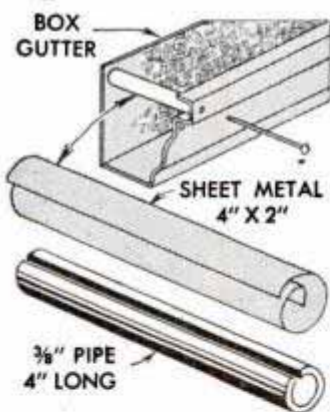

Spacers for box gutters are formed quickly and easily with a piece of $\frac{3}{8}$ -in. pipe 4 in. long. If longer or shorter spacers are required, the length of the pipe is varied accordingly. Cut a slit in the pipe to hold one side of the sheet

metal. After the metal is inserted, it is rolled around the pipe and then slipped off. This insures spacers that are uniform in length and diameter.—Richard Verbrughe, Grosse Pointe Park, Mich.

How to Waterproof Minnow Nets

If a minnow net or seine is to be waterproofed, it should be thoroughly dry before it is treated. The net is soaked for half an hour in raw linseed oil and spread over bushes or hung on a line to dry. Nets given this treatment will not absorb water and after use they can be shaken to throw off moisture and immediately packed in a car.

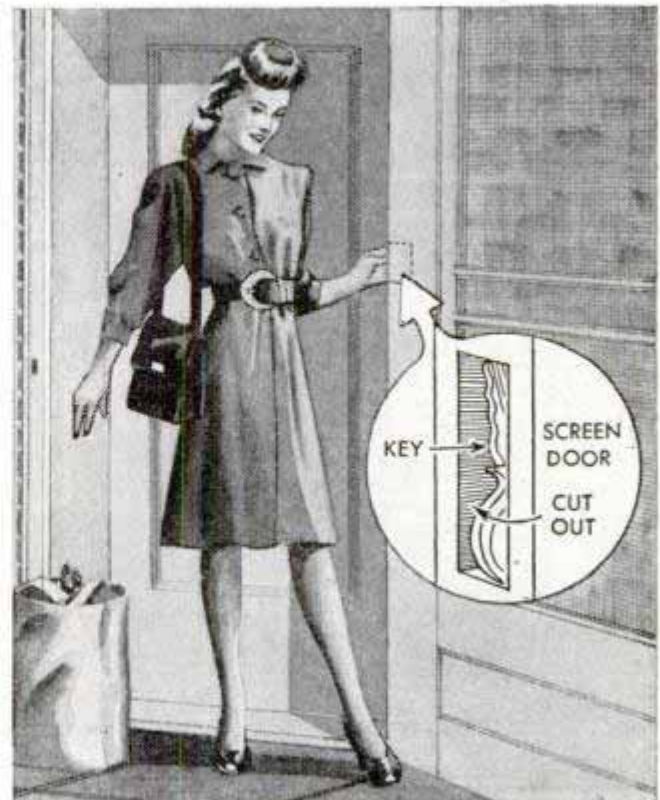



"Skimmer" A STURDY

You can put a kayak together in no time — it's not a lengthy all-season boat building project

By Hi Sibley

THIS KAYAK is staunch and seaworthy because it's built of waterproof plywood over a conventional frame. Sides are vertical and only 6 in. high from the bottom edge of the chine to the top edge of the sheer batten, but this gives enough free-board to keep off moderately rough water. Fig. 1 gives the deck and profile plans. Start building by laying out the frames full size on heavy brown paper, following the dimensions in Fig. 2. Then transfer the outlines to $\frac{5}{8}$ -in. waterproof plywood, making duplicates of frames A, B and C. Saw to the outlines with a jigsaw. Where plywood is not used make frames as in Fig. 4. Cut $\frac{3}{4}$ by 1-in. notches for the chine and sheer battens and a $\frac{3}{4}$ by 2-in. notch for the keelson in each frame. Make a rough frame or "building board" on which you can assemble the frame of the kayak upside down. Cut out the stem and stern parts, the cutwater, filler blocks and knees as duplicates, detail G of Fig. 3. Then

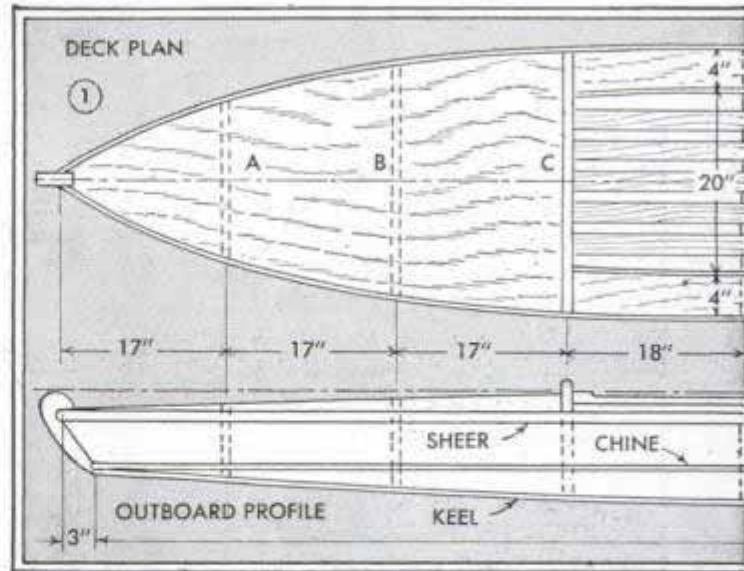

assemble on the building board with frames, stem and stern parts, keelson and the chine and sheer battens fastened with glued and screwed joints. Use galvanized screws for joining the frame. Before the glue dries make sure the frames are square and that the assembly is level. Note also from detail A in Fig. 2 the fairing on the chine, sheer batten and keelson. This must be done carefully with a plane so that the deck, sides and bottom will lay properly. Fit the plywood sides first, then coat the chine with marine glue and lay on $\frac{1}{2}$ -in.

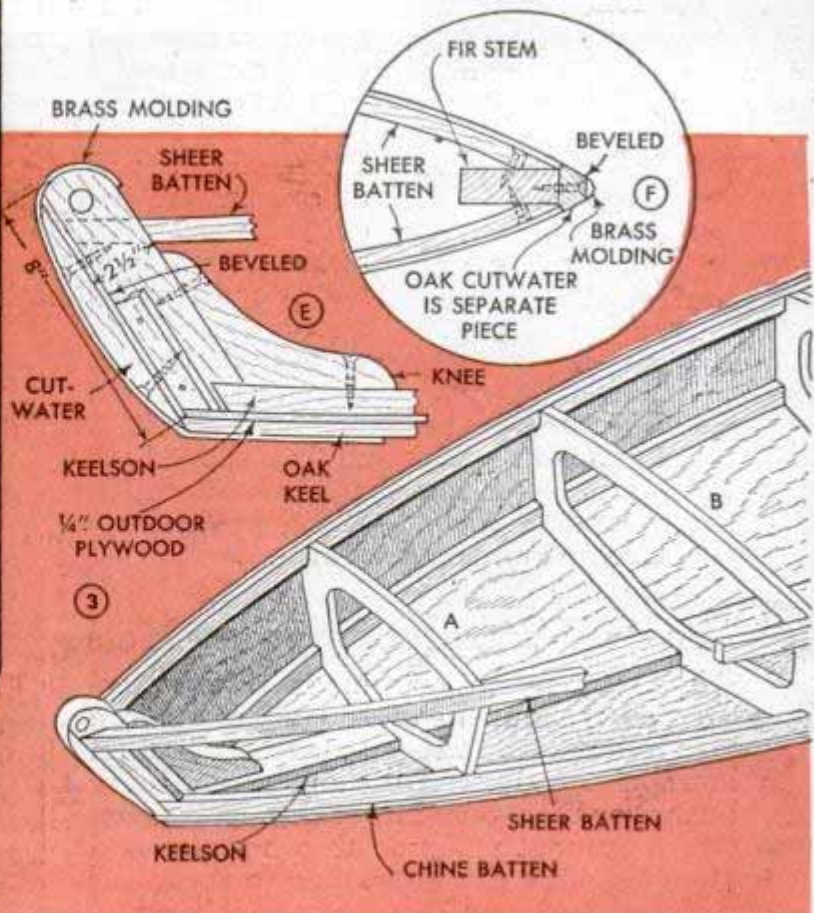
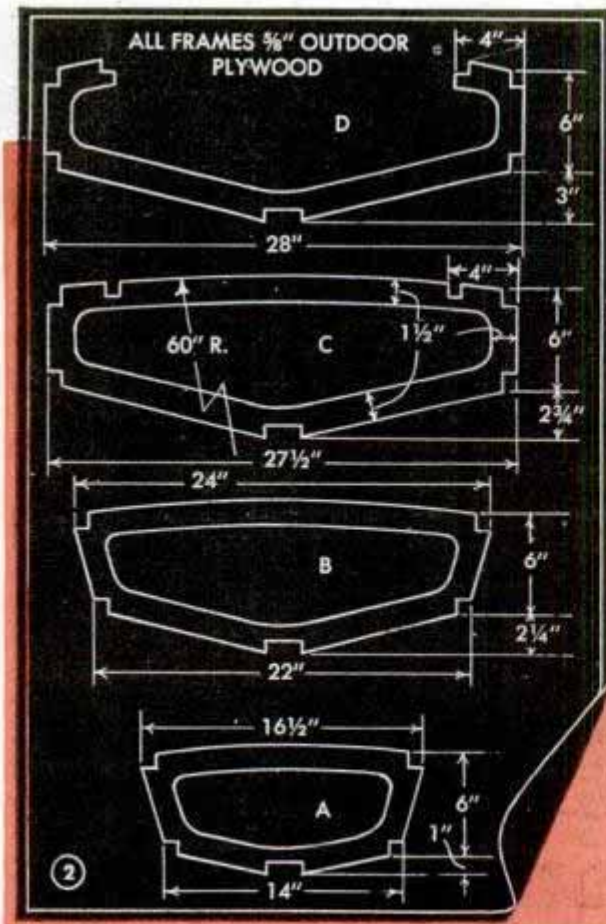

PLYWOOD KAYAK

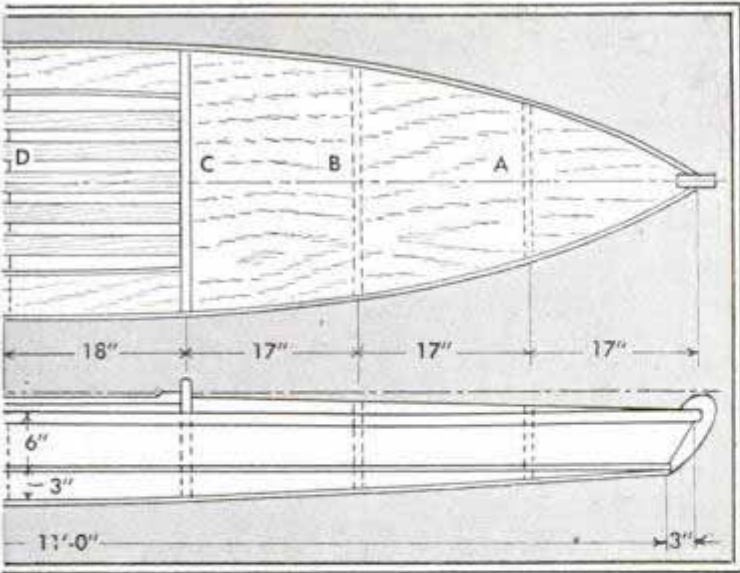
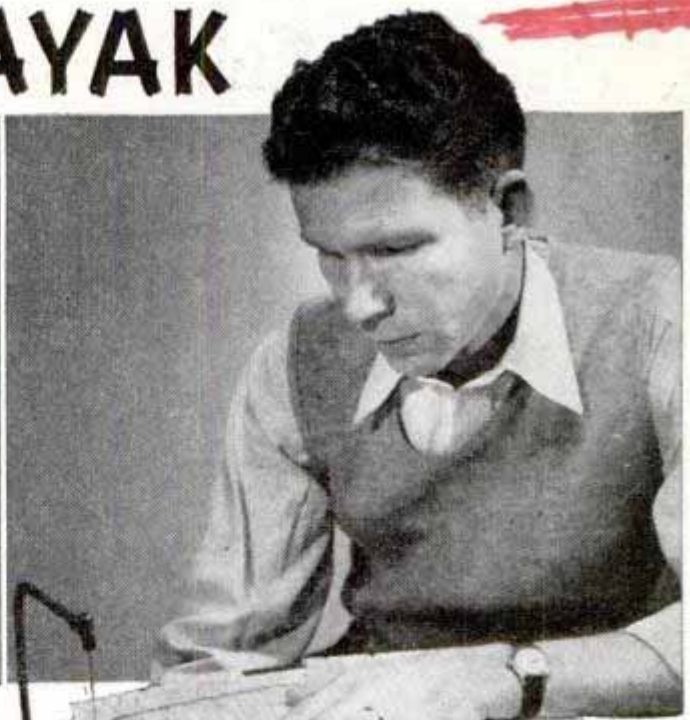

binding tape as indicated. Apply marine glue to the sheer batten also. Then screw the sides in place. Many builders make the same joint at the chine and keelson. Either way, apply marine glue liberally and uniformly. Space the screws the same as on the sides. This leaves only the deck, coaming and false bottom to be fitted. The splashboards, Fig. 3, should be bandsawed to the exact curvature of the deck. One effective color combination is cream or white on the sides, Chinese red on the bottom, and other parts natural color.

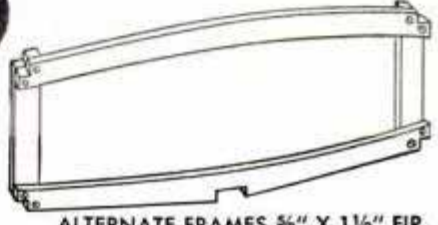

ALTERNATE FRAMES $\frac{5}{8}$ " X $1\frac{1}{2}$ " FIR, SCREWED TOGETHER

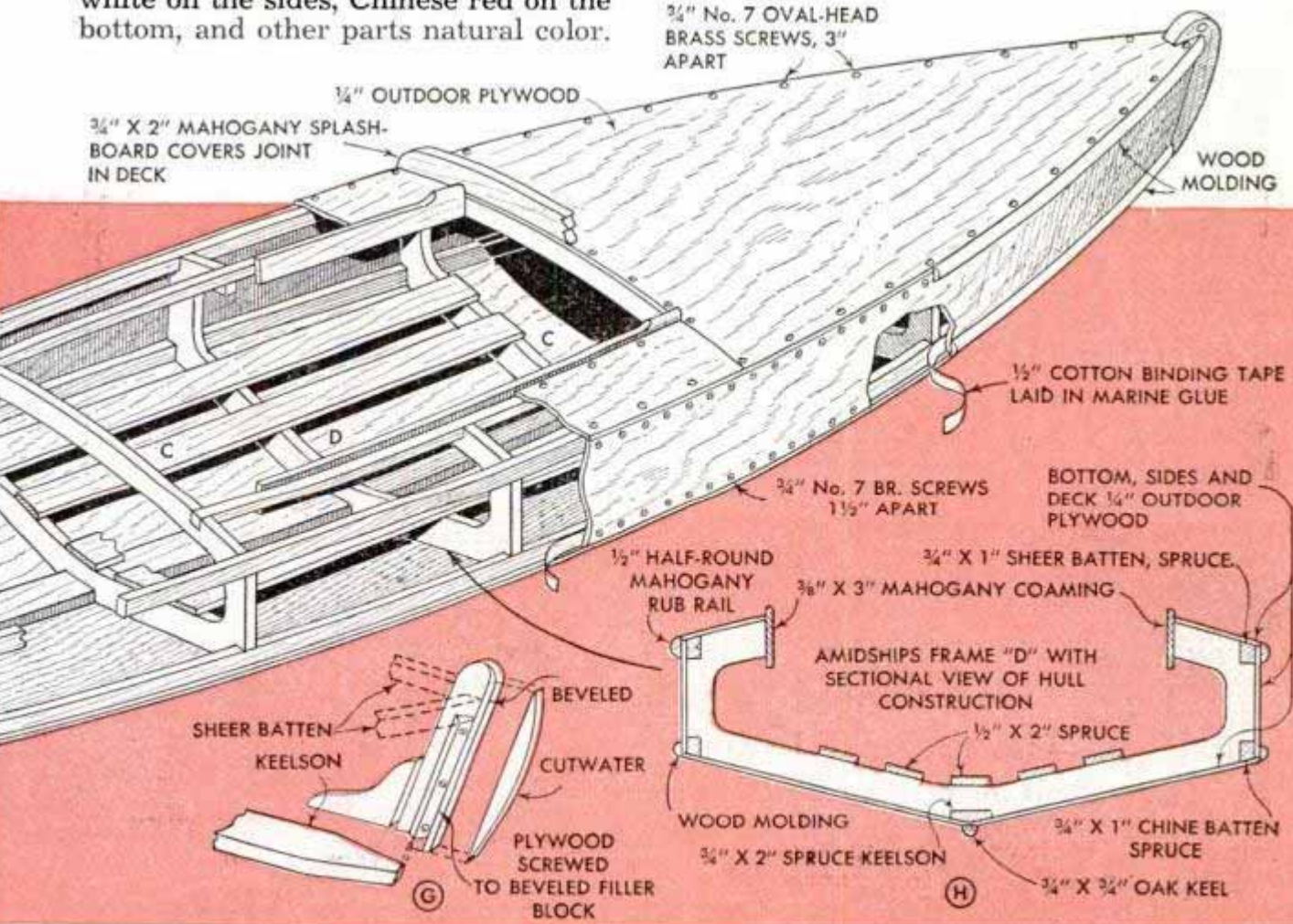

Roundhead Rivet Serves as Stop For Small Hand Drill

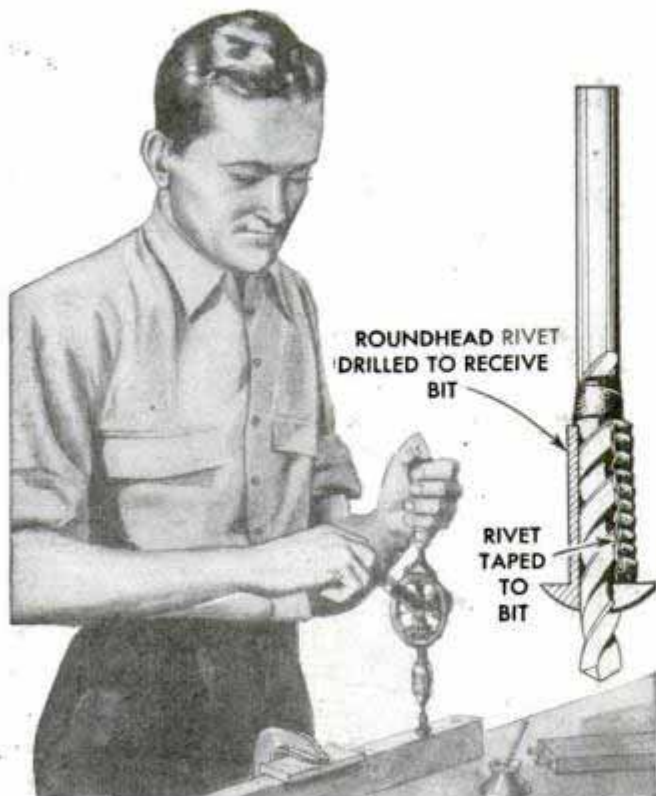

With a roundheaded rivet and a short length of friction tape, a very serviceable drill stop can be made. The rivet is drilled to be a close fit over the bit and is slipped on with the head down. The "stop" is held at the desired position with the tape.

Robert A. Horacek, Burbank, Calif.

Flashlight Case Is Dampproof

Proof against damp air, this flashlight case will slip over a belt where it is readily accessible when needed. Cut a piece from a motorcycle inner tube long enough to fit over the flashlight and allow for a flap at the top. The two slits at the back form a loop for attachment to the belt and another slit is cut in the flap to serve as a button hole for the button on the front of the case. The bottom is cemented and riveted. All slits should be reinforced at the ends to prevent them from tearing.

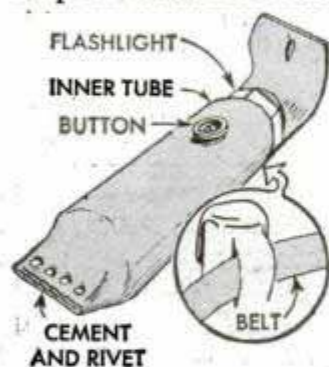

The bottom is cemented and riveted. All slits should be reinforced at the ends to prevent them from tearing.

Dental Tools Used in Small Lathe

Small lathe tools for boring and inside threading on fine work can be made from broken dental tools which are usually easy to obtain. To prepare the tools, anneal the metal and bend it to the desired shape,

using a file to make the cutting edge. Then harden it by heating and quenching in oil or water. Touching up the edge with an oilstone completes the process.

Grover G. Strother, Belington, W. Va.

Screw and Shield Expand Tubing

Thin-wall tubing that has been dented at the ends so the threaded portion will not take a fitting can be straightened by using a lag screw and expansion shield. The screw and shield are slipped inside the tube and the former is turned until the dents are removed. Be careful not to stretch the tube beyond its original diameter.

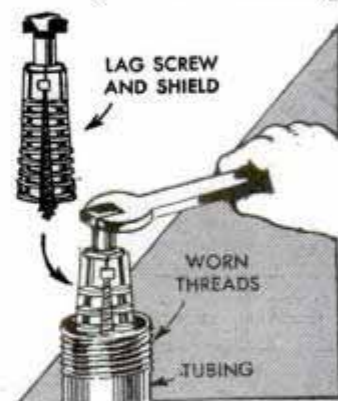

A. H. Waychoff, Phoenix, Ariz.

Simple Clamp Holds Small Parts While Painting Them

Tired of getting paint on his hands and smearing the work, one craftsman made an adjustable clamp to hold small objects that were to be finished. Both the wooden upright and the two arms are slotted for wing nuts so adjustment can be made for pieces of various sizes. A nail is driven through the end of each arm to hold the work in place. The upright is bolted to the work table.—E. J. Wiczorek, Chicago.

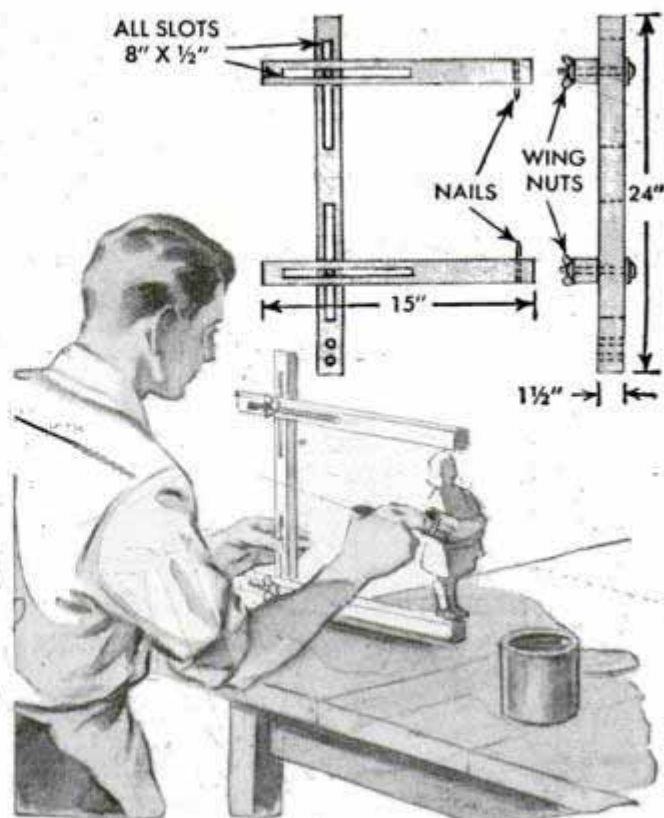

MIDGET TRIPOD

for table-top shots

By E. Peter Smith

IT'S A MUST for any photographer who wants to take close-up shots with a small camera. With this stand, natural-history close-ups, caricatures or any other type of table-top photography are made just about as easy as the simplest outdoor snapshot.

Construction details below show how to put the stand together. Plywood is indicated as the material to use but of course you can substitute any solid hardwood. The important detail to notice is the half-circle quadrant which is laid out in 15-deg. angles. Holes are drilled at these points and small bolts and wing nuts allow the camera to be shifted and locked at any angle. A camera support is screwed to the straight edge of the quadrant, reinforced by an off-center brace located to permit easy access to the center bolt. A $\frac{1}{4}$ -in. stove bolt of the proper length usually fits the threaded tripod bushing of American-made cameras. Foreign-made cameras require a special bushing. Drilling the proper-size hole in the camera support and inserting the tripod screw completes the stand. As you can see, it is possible to adjust both the height and angle of the camera as desired. By shifting the camera and stand alternately you get practically a universal adjustment. This makes it easy to use the camera and support directly on the table top or on an adjacent stand.

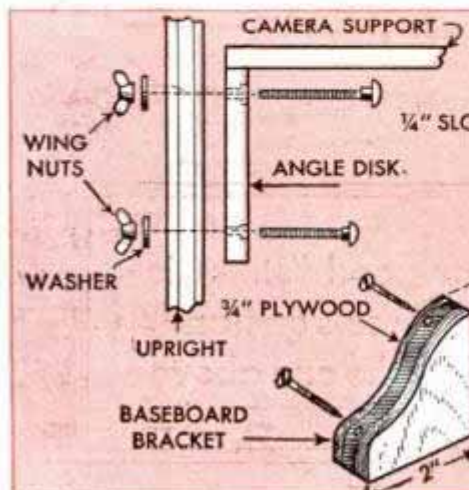
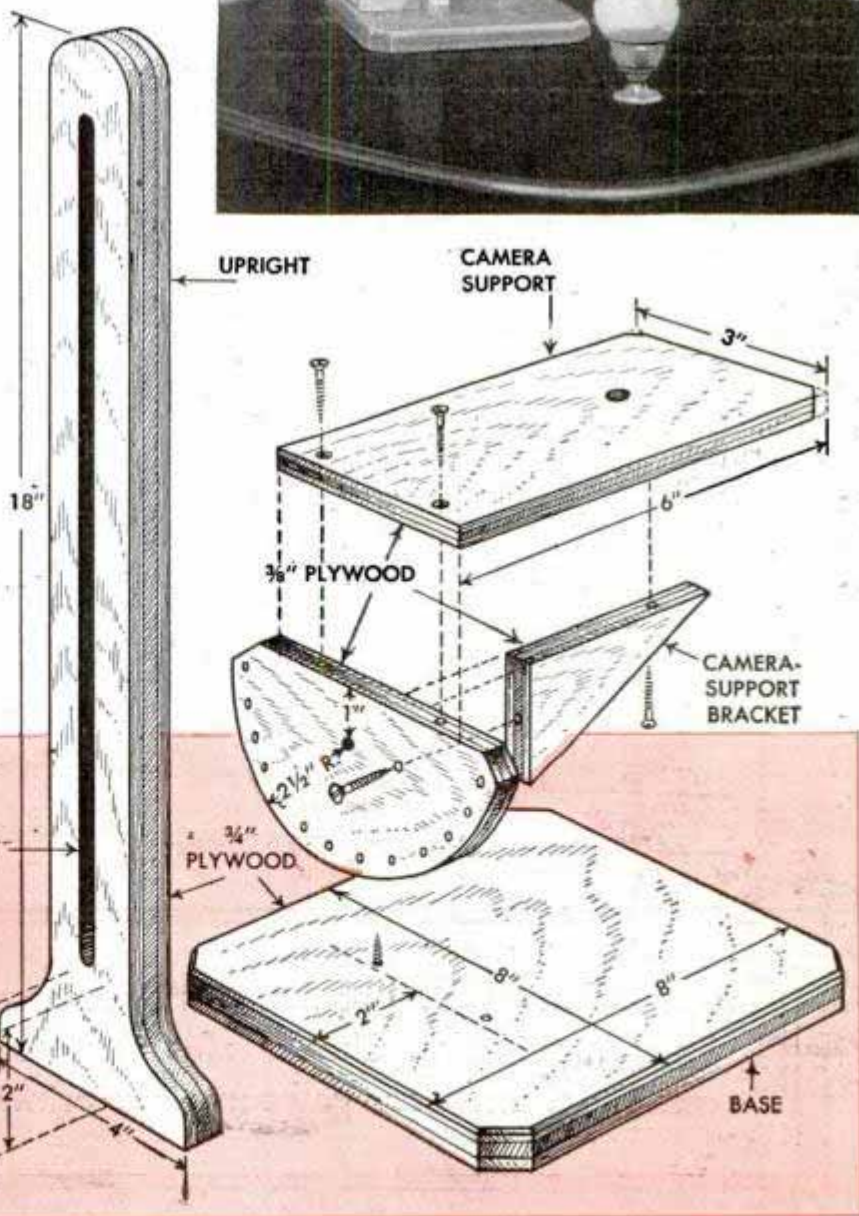

MAKING ENLARGEMENTS



A much-neglected source of negatives for good "stills" is 8mm. movie film. Choose a few frames from reels on hand, and the chances are you can make prints like the one above

From 8mm. film

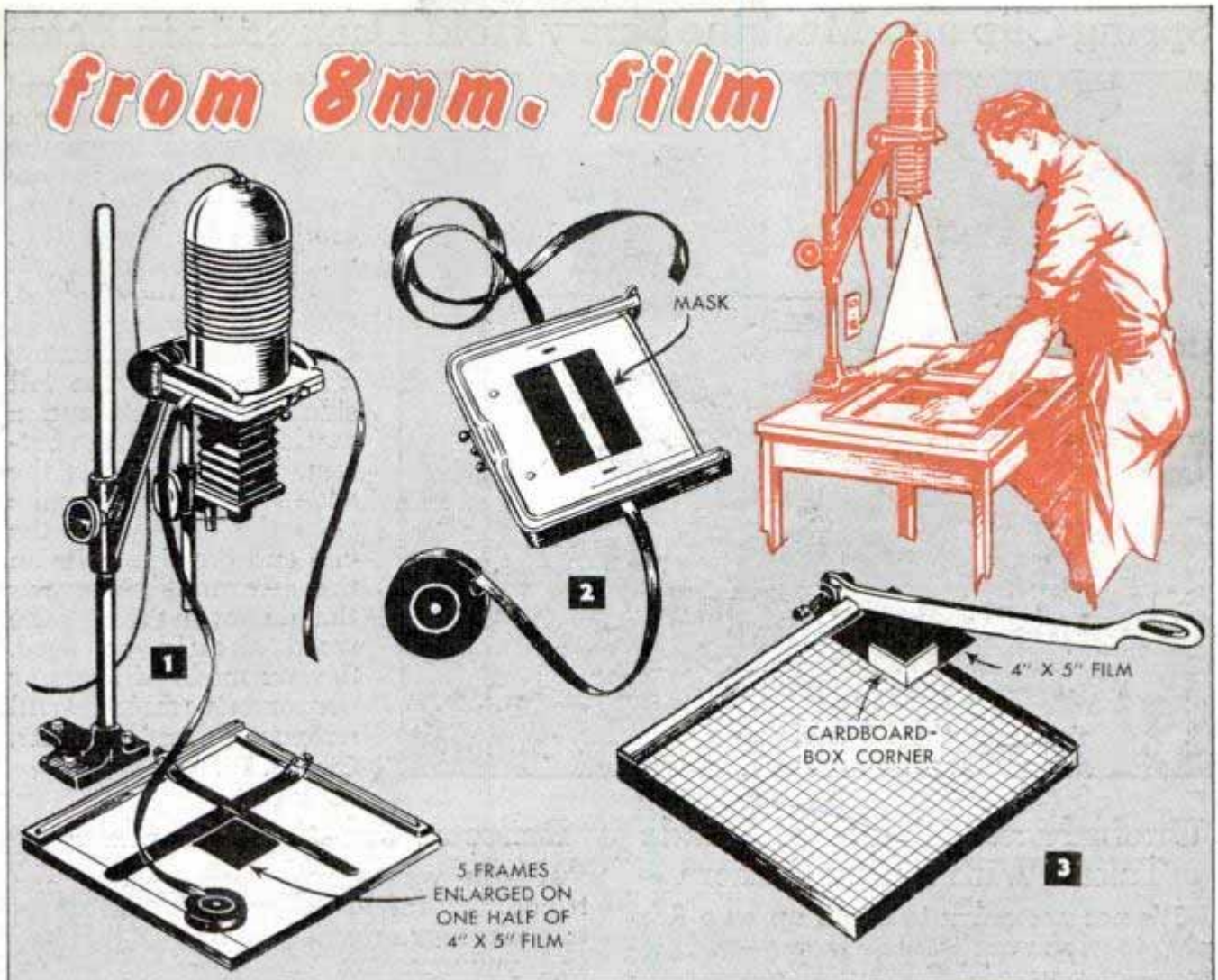

All that's needed to make enlargements from 8mm. movie film is an enlarger, some 4 by 5-in. cut film and a fine-grain developer. The procedure is much the same as when making any enlargement except that the movie-film positive is projected on regular film first to produce the negative from which the final print is made. The film for the negative should be a fine-grained panchromatic type.

First step, of course, is selection of the scenes from the movies that you wish to enlarge. Because the picture will be magnified many times, the frames should be those which are in sharpest focus. Place the film strip in the negative carrier of the enlarger so that at least five frames of the scene can be projected at the same time, and be sure to mask the strip carefully, Fig. 2. If the enlarger has a glassless carrier, place one edge of the strip so that its entire length is held between the carrier plates to prevent possible buckling. Then, as before, mask off the rest of the opening. Let the loose ends of the film hang down out of the way, Fig. 1.

In the darkroom, cut the 4 by 5-in. film lengthwise so there are two strips, each 2 by 5 in. If a cardboard-box corner is used to position the film on the trimmer, Fig. 3,

By Marion Schwerman

the task will be much easier and the results will be accurate. To project the movie film, place the carrier in the enlarger and focus on the easel so that each frame is about 1 in. wide. Then place the cut film on the easel and project the 8mm. frames on it. Five frames should about cover the length of the strip.

With five frames on the same film, it's possible to give each one a different exposure, much in the same way that a test strip is made on enlarging paper. At first it will be necessary to do a little experimenting; for example, try exposures of 1 sec., 2 sec., 4 sec., 8 sec. and 16 sec. with the lens set at f:11. However, the exposure will depend somewhat upon the light source in the enlarger and the speed of the film being exposed. Once the approximate exposure range necessary for the materials and equipment you have has been determined, the 5-test strip should cover scenes from most films.

The negatives that are made will be about the same size as 35mm. film. As mentioned, use fine-grain developer and avoid too much contrast. Then select the best frame and enlarge it as you would any other negative, using a matte-finish or similar paper to avoid grain.

Spring Clip and Machine Screw Hold Dark Slide in Place

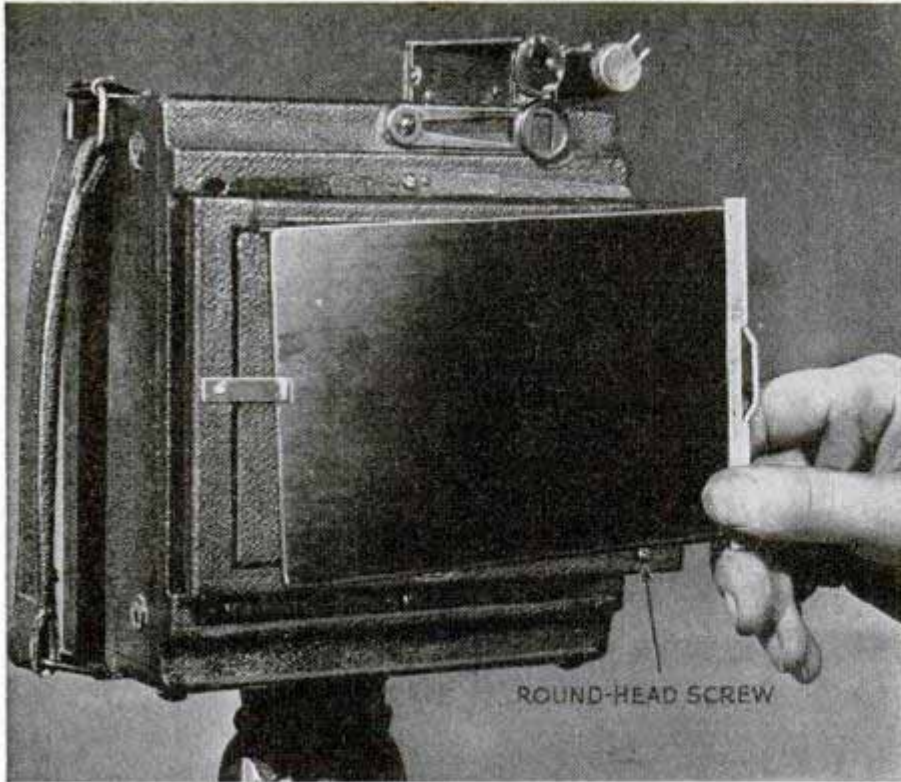

After you've focused and are all set to take a picture, where to put the dark slide of a press-type camera is a problem. Generally it's too big to fit in a pocket, and if you lay it anywhere, it may be lost. One photographer solved this problem by attaching a spring clip to the left side of the back and a machine screw at the bottom. When he pulls the slide to take a picture, he slips the end under the clip and the side rests on the screw. Short screws that do not go through the wood should be used. Screws made of brass or noncorrosive material will not rust.—Frank P. Fritz, Cicero, Ill.

Unobstructed Picture of Parade Taken With Reflex Camera

It's not necessary to climb up on a fire-plug to get an unobstructed view—and picture—of a parade. Owners of reflex cameras will find that they can be held upside down, above the heads of the crowd, and the picture taken from this position. The ground glass is used to frame and focus the picture, just as is done when the camera is held in the normal manner at waist level.

Bob Hurst, Chicago.



Reflector Substitutes as Tripod

If you want a tripod for tabletop photography and your camera is small, you can use a photoflood reflector and clamp to advantage. The camera is held by the rubber-covered jaws. Be sure the ball-and-socket joint is tight enough to hold the camera.



Pencils Help Secure Reflector To Photoflood Standard

When working with photoflood clamp-on reflectors, sometimes it is necessary that one or more be fastened in a low position on the stand to obtain the desired lighting effect. However, usually the clamp will not grip the shaft of the stand tightly and the reflector tends to tilt downward, throwing the light on the floor. If two pencils are slipped through the loops of the clamp as indicated, the reflector will be held firmly in position.—R. F. Donovan, Jersey City, N. J.

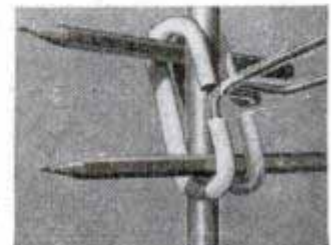

CRAFT QUIZ

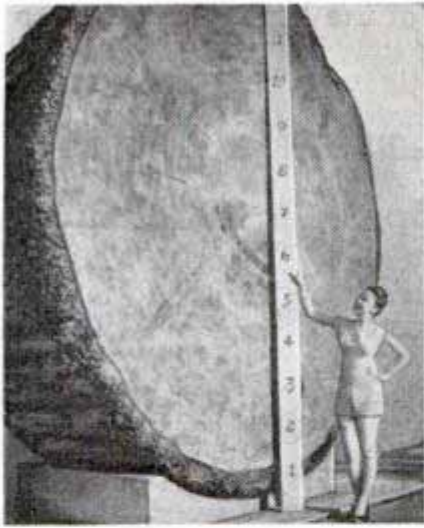

1. Largest in United States is—
 (a) 26-ft. diameter (c) 32-ft. diameter
 (b) 19-ft. diameter (d) 47-ft. diameter

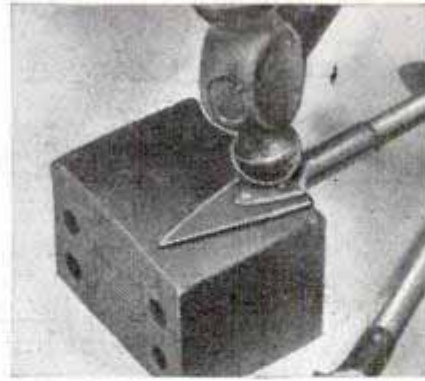

2. Hammer used for riveting is—
 (a) Planishing (c) Ball pein
 (b) Cross pein (d) Blocking



3. Most plastic articles are—
 (a) Phenolics (c) Acetates
 (b) Acrylics (d) Ureas



4. Tool used here is a—
 (a) Harpoon (c) Bolas
 (b) Sky hook (d) Peavey

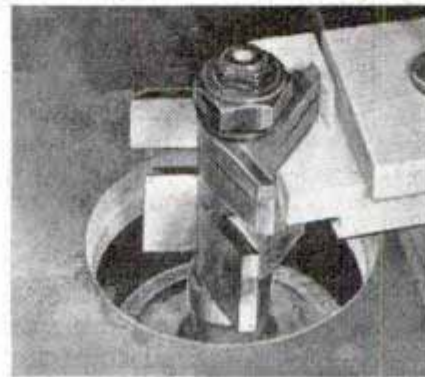

5. Wood being shaped is—
 (a) Pine (c) Mahogany
 (b) Walnut (d) Rosewood



6. This cart is sometimes called—
 (a) An Escalator (c) A dolly
 (b) A wanigan (d) A dado



7. A 9-amp. iron pulls about—
 (a) 1000 watts (c) 750 watts
 (b) 500 watts (d) 400 watts



8. Wall treatment here is—
 (a) Ship lap (c) Batten seam
 (b) Drop siding (d) Square sticking



9. You'll find the most trees in—
 (a) United States (c) Brazil
 (b) Russia (d) China

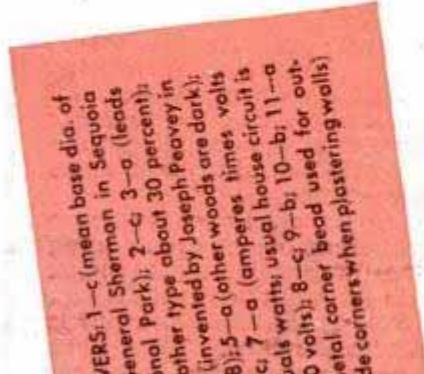

10. An oak table like this is—
 (a) Sheraton (c) Old world
 (b) Mission (d) Adam

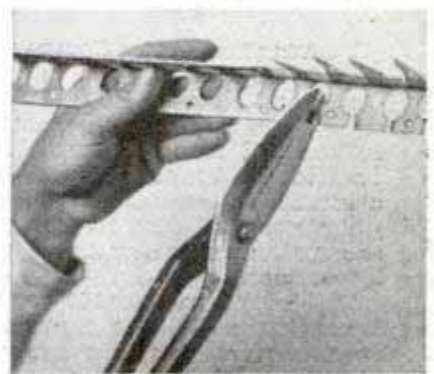

11. This goes with—
 (a) Plaster (c) Flagstones
 (b) Plastics (d) Shingles

ANSWERS: 1—c (mean base dia. of the General Sherman in Sequoia National Park); 2—c (leads any other type about 30 percent); 3—d (invented by Joseph Peavey in 1858); 4—d (other woods are dark); 5—c (amperes times volts equals watts; usual house circuit is 110 volts); 6—c; 7—c; 8—b; 9—b; 10—b; 11—d (metal corner bead used for outside corners when plastering walls)

Red Ribbon Tied to Fishing Fly Will Attract Frogs



TROUT FLY AND RED RIBBON

Many fishermen use a long, limber cane pole and a light line to reach over into the lily pads and moss when fishing for frogs. With this setup, a trout fly makes an ideal lure, and if a short piece of red ribbon or wool yarn is tied to the bait so the ends hang down over the fly, it will prove more attractive. Some fishermen use just the ribbon or yarn tied to an ordinary hook.

Nail Keeps Bolt From Turning



One way to keep a carriage bolt from turning or working loose is to drill a hole at an angle through the

projecting part of the head. Then drive a nail through the hole into the wood. If the nut is pulled up tight and held in place with a lock washer, there is little likelihood that the bolt or nut will become loose.

Colored Rope Aids in Splicing

For the novice in rope tying, it's hard to see just how a splice or knot is made because the various strands, being the same color, are difficult to trace. When making splices, color each strand a different color, and when tying knots, color the ropes differently. This will eliminate confusion and make learning an easier process. Inks, very thin paint or dye may be used.

Andrew Vena, Philadelphia, Pa.

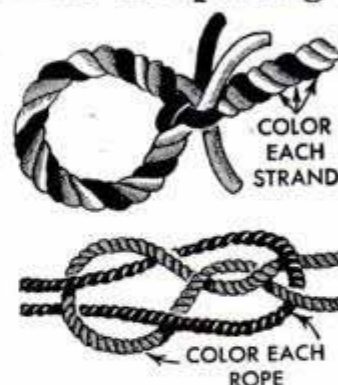

Handy Knobs for Tin Containers

Tin cans that are used around the workshop for nuts, bolts and other small parts will look neater and be much handier if the lids are fitted with knobs. Regular household pot-cover knobs will do. Holes are punched in the top of the lids and the knobs are attached with nuts and washers. Painting and labeling the cans will improve their appearance. —Ivan J. Stretten, Detroit, Mich.

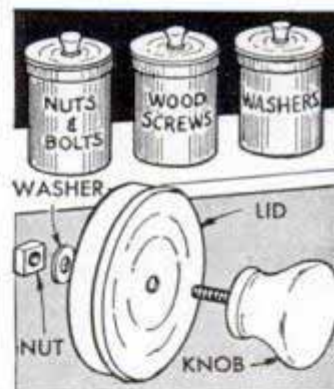

BUILD YOUR HOME YOURSELF

Popular Mechanics Company is pleased to announce the publication of both a book, *Your Home and How To Build It Yourself*, and a set of ten working-size blueprints for our "Build-It-Yourself House." These are our contribution to the crucial housing shortage, and, as a service to our many readers who have been unable to find comfortable living quarters, we are making these available through our Book Department.

The book contains 100 pages—three-fifths of it consisting of photographs and working drawings. Several sections are printed in colors showing just how your own house will look. Every construction detail is given step by step and board by board, so that even the most

inexperienced person can understand it easily.

The blueprints give floor plans, elevations, framing, plumbing, wiring diagrams, etc. Of course, the house is easily adaptable to other types of architecture, such as modified Dutch Colonial, modified Cape Cod, and plain gable roof without dormer windows.

Should you plan on building another house or remodeling your present one or even adding on another room the information in this book will enable you to do the work yourself.

Your Home and How To Build It Yourself is \$3.00—complete set of plans \$12.50. When both the book and plans are purchased together there is a special reduced price of \$14.00. Duplicate sets of plans are \$5.00 each.



DRILL-PRESS

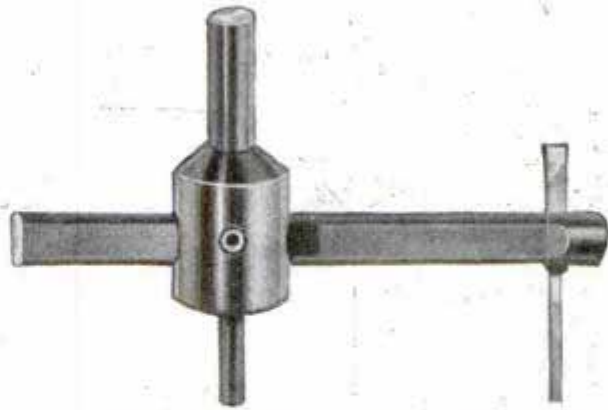

CIRCLE CUTTERS

By Wm. E. Danneman

IN THE AVERAGE JOB SHOP there's only occasional need for a circle cutter, but when you do need one you generally need it badly. It does work which is impractical to do by any other means except in a lathe or perhaps with a hole saw, that is, if you happen to have one just the right size for the work at hand. Within its limits the circle cutter is adjusted quickly to cut different sizes of circular disks or holes in any ordinary material such as wood, fiber, plastic, aluminum, brass or mild steel. Not only that, but by grinding shapes on the cutters you can cut disks with molded edges as in Fig. 2. Or by grinding a shape on the outside edge of the cutter you can cut holes with molded edges. The swinging arm, made from drill rod, carries the cutting bit and must be hardened and drawn on both sizes of the circle cutters detailed. All turning, milling, tapping and broaching must be done first, of course. Broaching required is merely the squaring of the hole taking the larger cutter bit and this can be done with a small file if necessary. The flat on one side of the arm can be milled or ground to size according to the facilities available. Hardening procedure is quite simple. First you heat the part to a cherry red and quench in No. 20 lubricating oil. Clean with fine emery cloth to remove the scale completely. Again heat slowly and uniformly until the metal comes to a light straw color. This temperature is quite critical and the process must be closely watched. At the instant the metal turns uniformly straw color, and before it turns blue, quench in cold water. This process hardens the part sufficiently to prevent the locking setscrew from cutting into the milled surface.

The holder, Fig. 1, is a simple machining job

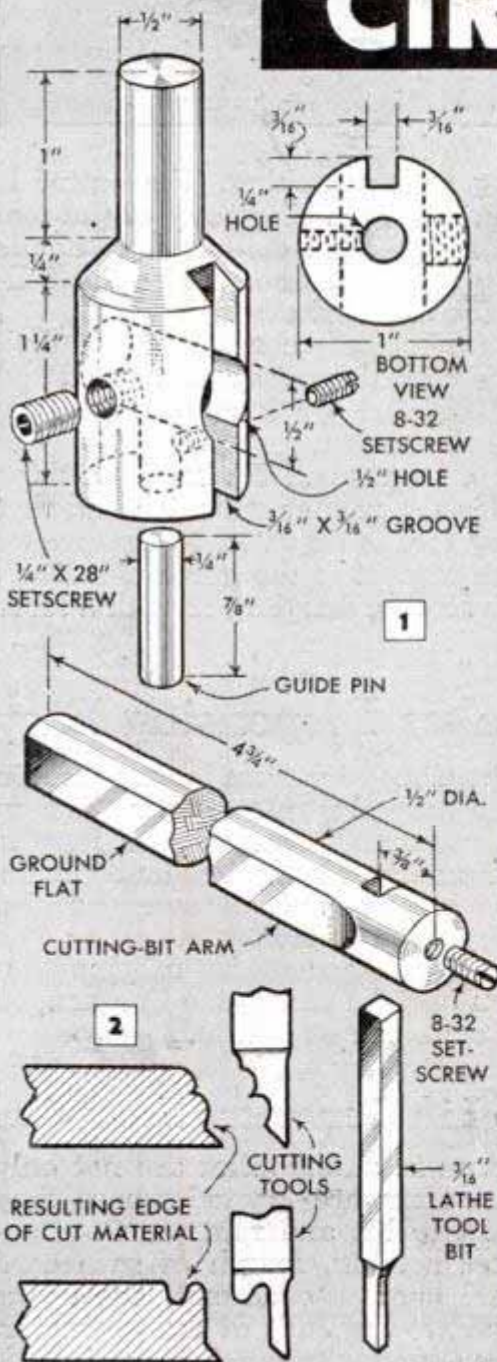

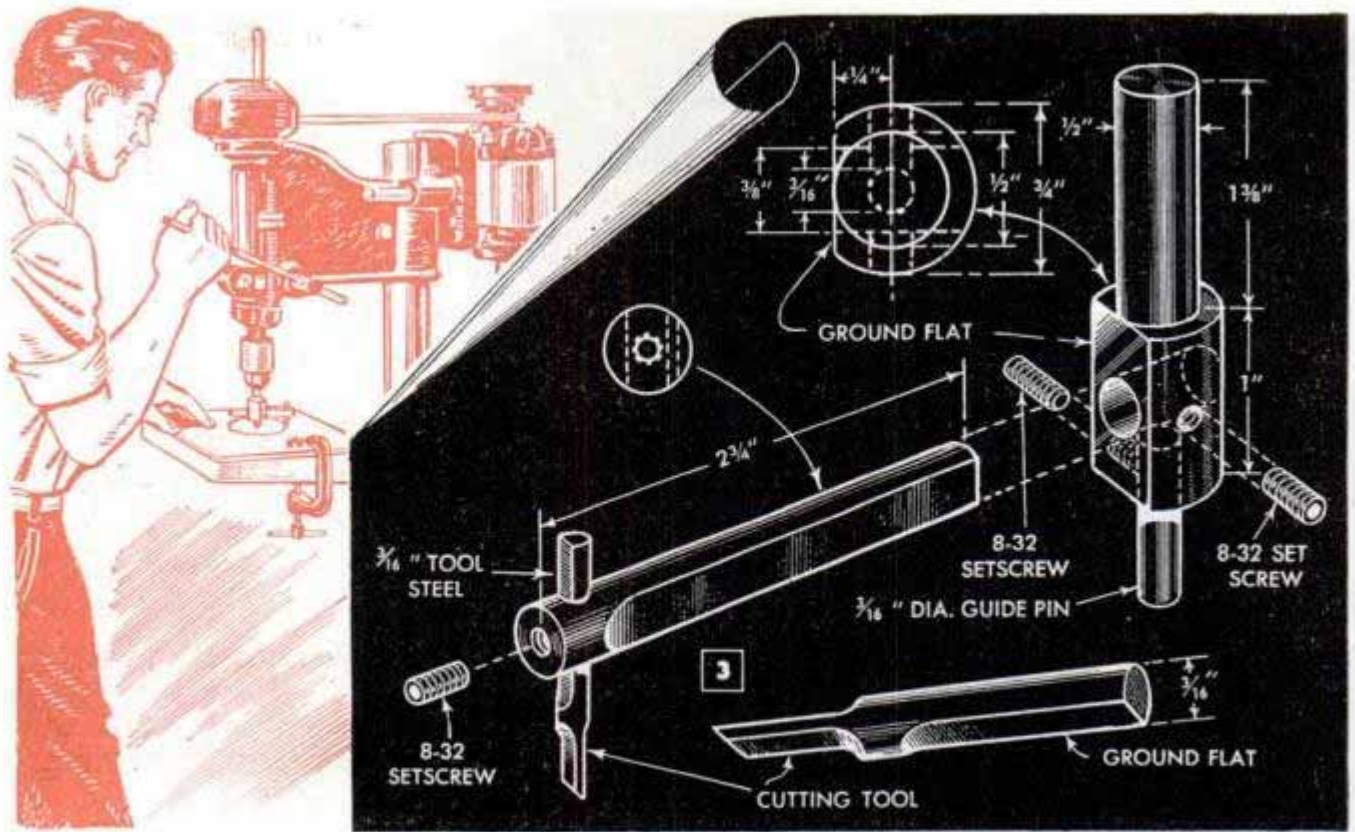

in mild steel. If desired, the guide pin can be hardened by the process already described. It will last much longer if hardened. Holes drilled in the holder for the guide pin and the arm carrying the cutting bit are reamed to final size. The groove milled in the body of the holder allows the cutting arm and the bit to slide to within $\frac{5}{16}$ in. of the center of the pilot hole. This brings the minimum hole size that the tool will cut down to $\frac{5}{8}$ in.

The small cutter detailed in Fig. 3 is made up in essentially the same way as the larger size already described. The cutting tool is made from $\frac{3}{16}$ -in. drill rod, hardened

by heating and quenching. The cutter is not drawn, however. The body of the tool is turned from $\frac{3}{4}$ -in. drill rod. A flat is milled or ground on one side of the full-diameter section as shown.

When using circle cutters in the drill press drive with slowest spindle speed and always clamp the work securely to the table, using bolts, fixtures or C-clamps. Use a cutting oil on steel. Be sure that the pilot hole is the proper diameter and that the cutting tool is adjusted to the proper depth with respect to the guide pin. Don't work with sleeves dangling or with a loose necktie.

Rotating Stand for Wire Spools Makes Dispensing Easy

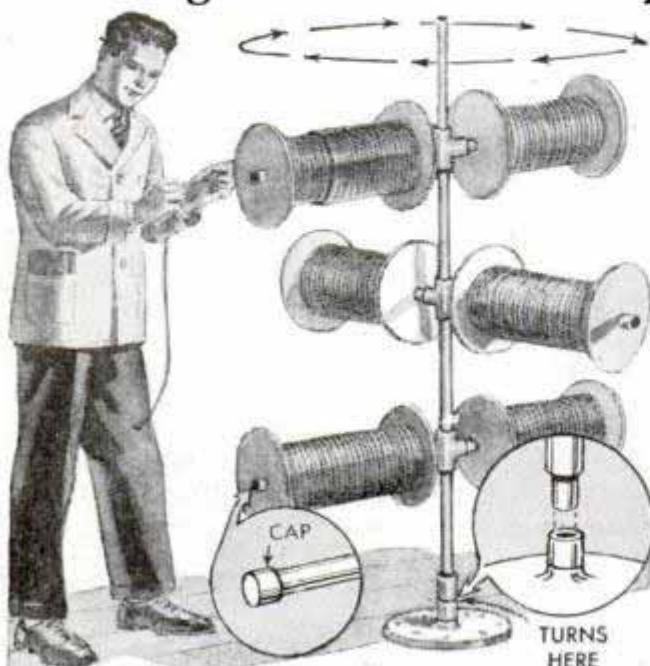

For dispensing wire from large spools in a hardware store, this rotating stand is easy to use and requires little space. The lengths of pipe that serve as spindles or arms for the spools are capped on one end and screwed into pipe crosses at the other. The crosses fit into other pieces of pipe that serve as an upright and rotate in a flanged base. The arms are staggered.

Sling to Lift Generator From Car

Generators in automobiles are not only heavy, but often are located where they are difficult to lift and remove. One mechanic uses a 36-in. length of sash cord with a wire hook at each end. The hooks are attached to the ends of the generator, which is removed with much less effort.

W. V. Athanas, Ashland, Ore.

Tractor Hookup Prevents Fire

Instead of pulling a load of hay into a barn with the tractor coupled directly to the wagon, one farmer uses a rope and pulley as shown. This keeps the tractor out of the barn so that there is no possibility of a spark from the tractor exhaust igniting dry hay already in the barn. One end of the rope is tied to the wagon tongue, run over a pulley at the back of the barn and then out to the tractor. The rope should be long enough to permit keeping the tractor well away from the hay load on the wagon. If this should be fired, possibilities of losing the barn by fire would be almost as great as if the hay inside the barn were ignited.

Henry Droege, Pottstown, Pa.

Angle "Break" in Wire Fence

Here's a simple way to build a fence that will permit people to pass through the opening but will stop most large animals. Two arms are built, as shown, and the other side of the fence extends almost to the bottom of the Y. Because it requires no special hardware or fittings, this opening is constructed quickly and easily. When it can be used, it costs less than a gate.

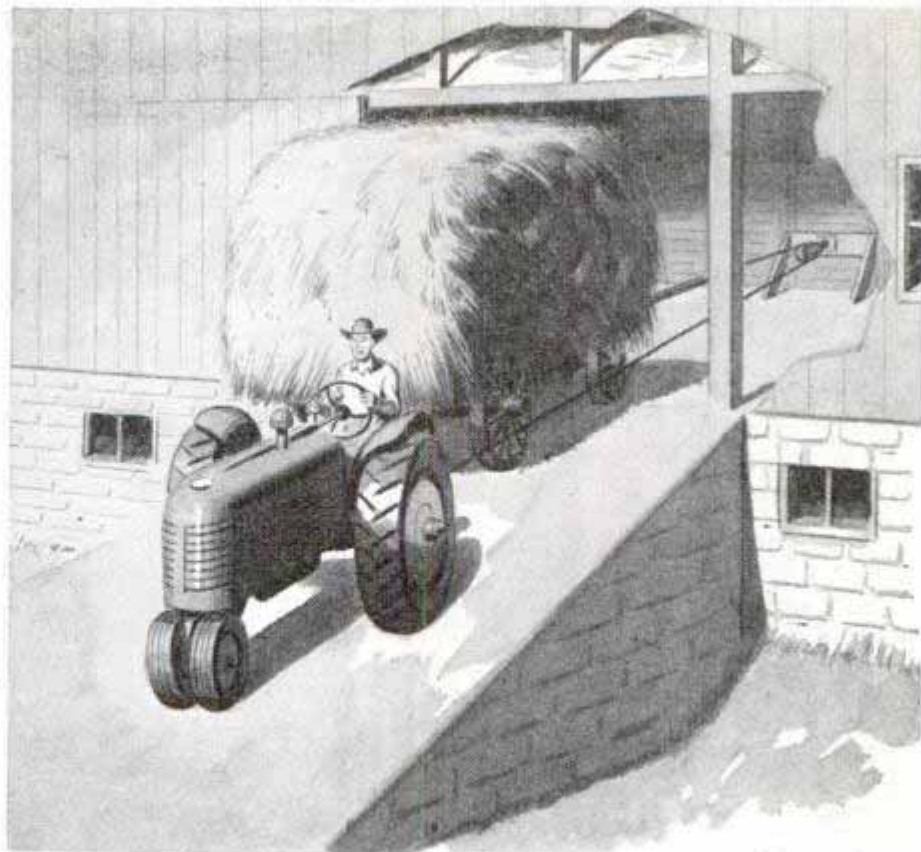

Small-Parts Holders From Pistons

Discarded automobile pistons, pivoted on a length of pipe or rod, make convenient holders for small parts. Wood brackets support the ends of the pipe. To use, tilt the piston so the parts fall into your hand. After it is released, the container will then swing back into the normal position.—T. H. Johnston, Ottawa, Ont., Can.

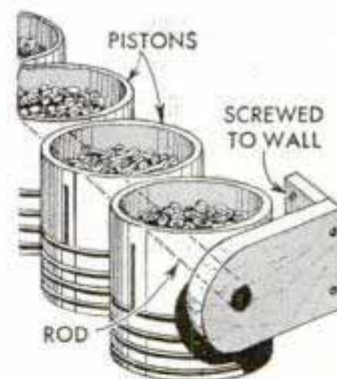

How to Secure Singletree Irons

Singletree irons will not slip off easily when they are secured with thin strips of sheet metal. Tack a strip to the singletree, letting it extend out beyond the end for a short distance. Then slip the iron in place and bend the metal back over it as shown in the illustration. This will make a firm fit and prevent the iron from working loose.—Paul Criton, Jr., Kayville, Sask., Can.

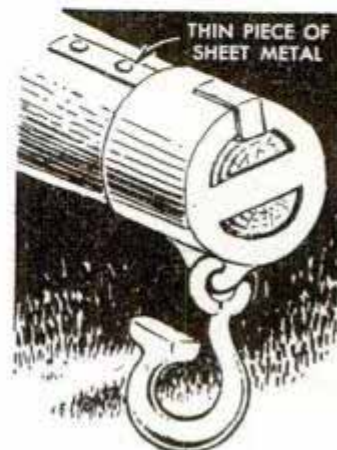

MODERNIZE THAT OLD LATHE

By
Jack
Mellinger



Blocking up the head and tailstock of a small wood-turning lathe will practically double its usefulness, especially in the home shop where the work varies greatly in size

MANY older lathes of the interchangeable-parts type—you bought a piece at a time and then assembled—may be getting rather loose and wobbly by this time, particularly where the machine has had hard service. Remarkably good for the price asked, these small tools filled the needs of many a home-shop owner. But now after years of service they may need a little fixing.

Usually the swing of lathes of the type shown in Fig. 1 ranges from 6 to 8 in., which definitely limits the diameter of faceplate or screw-center work that can be done without using the outer end of the headstock spindle. A lot of work in the home shop requires a larger swing. Increasing the swing, that is, increasing the diameter of work the lathe will swing, is simply a matter of blocking up headstock, tailstock and tool-rest holder to equal heights as in Fig. 2. Just how much machining and fitting this will require depends on the type of lathe bed. If the bed ways are raised like those shown, then the raising blocks will require the milling of a narrow rabbet on each lower corner, Fig. 5. If the ways are flat the same rabbet cut must be made, only somewhat wider so as to leave a projection on the lower face of each of the raising blocks. The projection will slide between the ways and act as a guide to keep the three parts—headstock, tailstock and tool

rest—in proper alignment. Any metal that will machine well can be used for the raising blocks. The proportion and height of the blocks should be given careful consideration before you begin cutting any metal. Original swing of the lathe determines the height, and width of the bed fixes the width of the blocks within pretty close limits. If the original swing was, say, 6 in. and you want to increase it to 8, or maybe 10 in., then the blocks should be either 2 or 4 in. high as the case may be. Swing of the lathe, of course, is reckoned as the largest diameter of work that can be turned on the faceplate. An allowance for clearance of the bed is always made, that is, if the lathe is rated as 6-in. swing the distance from the spur center, measured from its axis, to the bed will be slightly over 3 in.

If you use blocks cut from solid stock it will be necessary to machine them all over. This can be done in a metal-turning lathe as in Fig. 4. If you use castings, only the top and bottom will need to be machined. Usually this will call for milling to fit the lathe ways and the bottom of the head and tailstock castings. Have this done at a machine shop unless you have facilities for

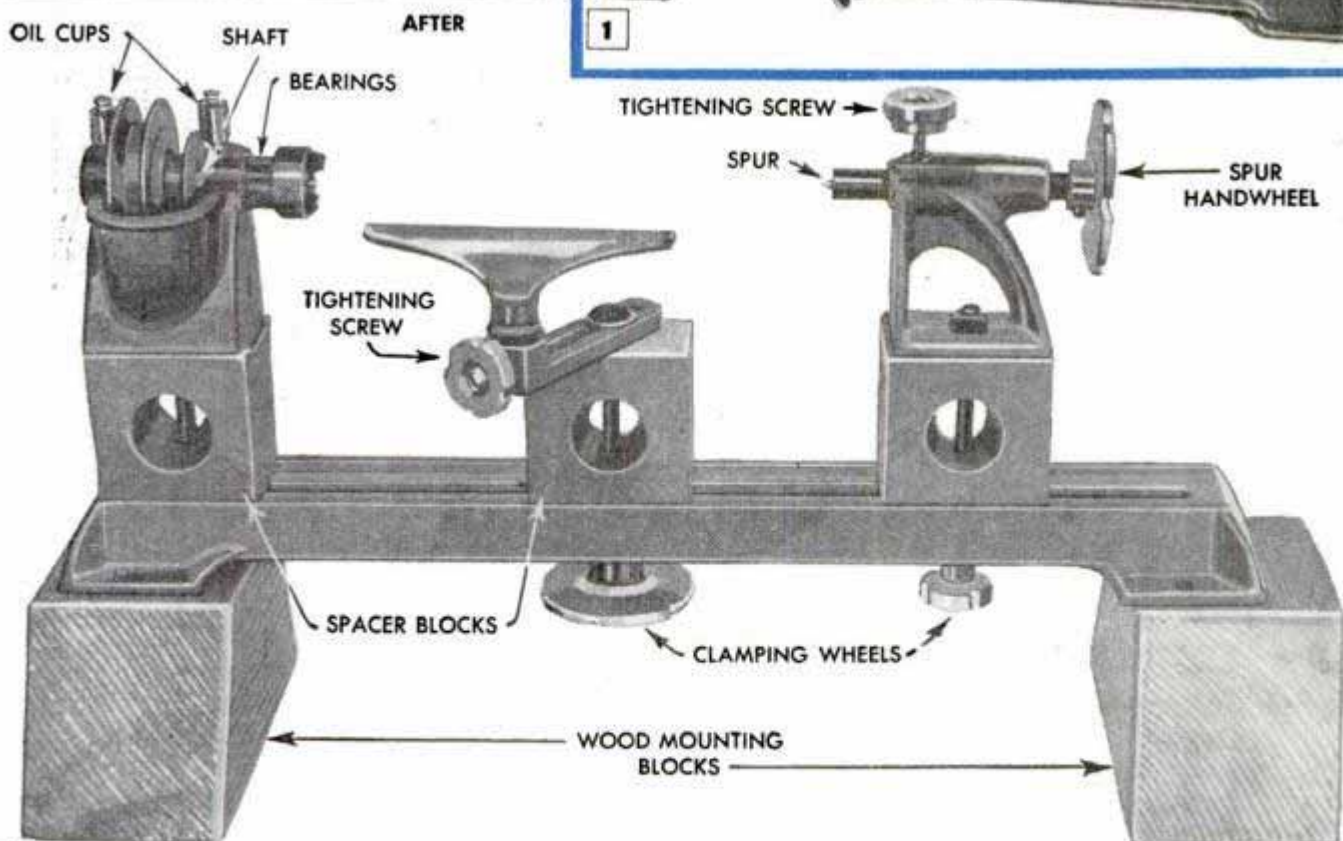
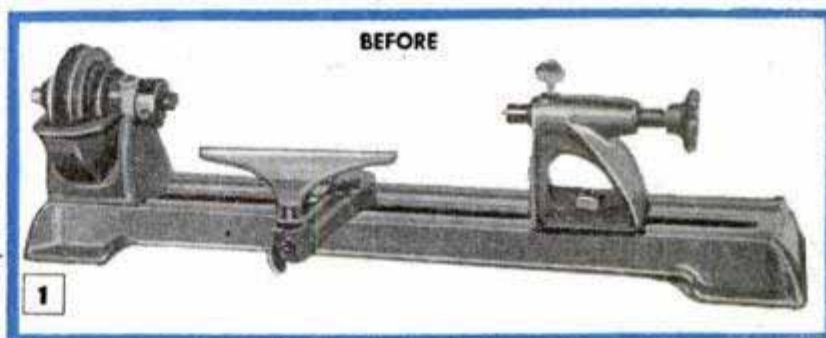

ADDED IMPROVEMENTS TO THE OLD WOOD-TURNING LATHE

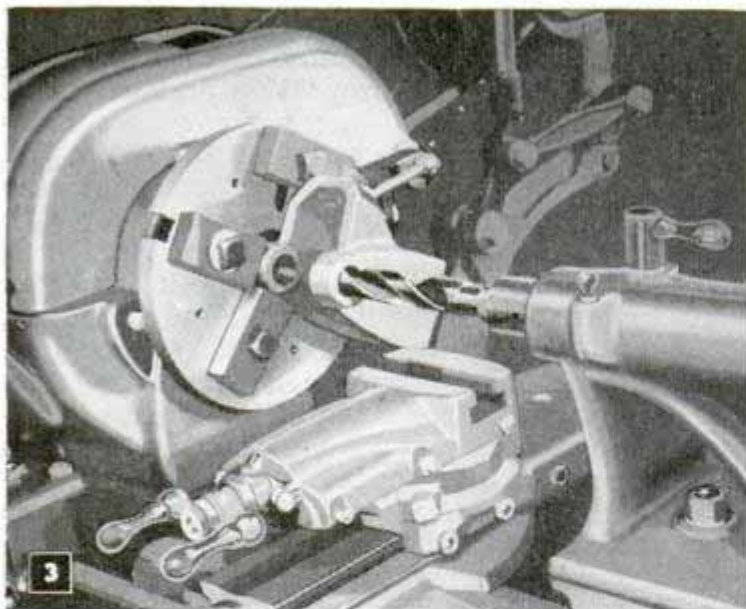

Above, bore out headstock-bearing seats for larger bushings. Ream holes so that bushings are a snug drive fit. Below, mill raising blocks in a special fixture to fit the lathe bed

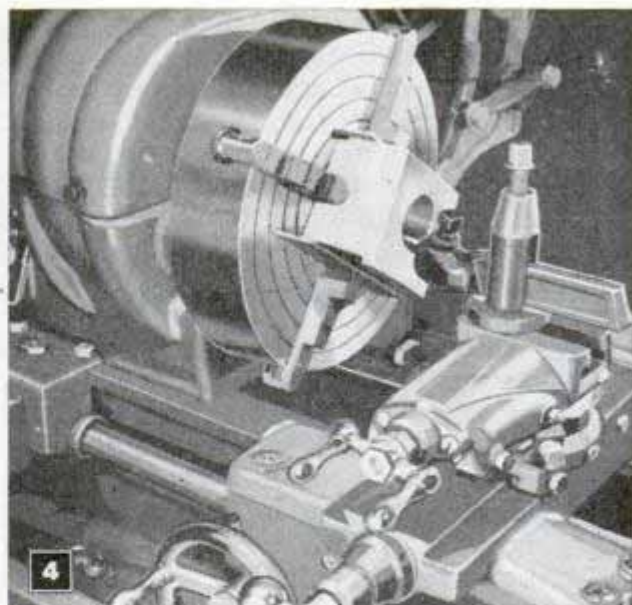

If raising blocks are made from solid stock they should be machined all over. The center hole is not necessary; it's only ornamental

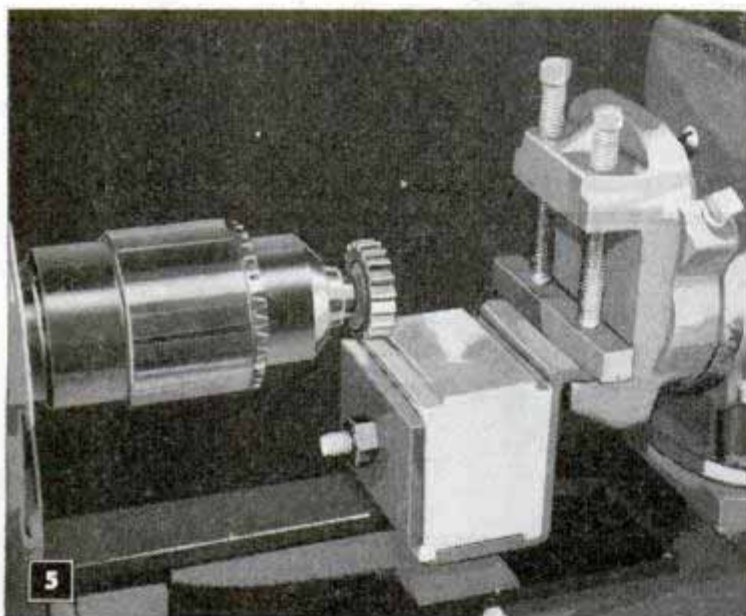

this work. That's about all there is to the raising process except drilling the blocks and substituting larger bolts holding the three raised parts. If you want to go farther and replace the small handwheels, or palm wheels, with larger parts, these are quite easily made by turning disks from sheet steel and then filing or grinding fingerholds in the edges. Finally, if the headstock bearings are badly worn it's a good idea to replace them and also the headstock spindle. Dismantle the headstock and bore out the bearing seats as in Fig. 3. Drive in larger bushings and turn a new spindle to fit. Provide oil cups for frequent lubrication.

Etching Designs in Sheet Metal by Using Acid Solutions

Before etching any kind of metal, the material must be well cleaned. Aluminum and nickel silver are prepared by going over the surface with steel wool or some fine abrasive such as slaked lime or plaster of paris. Copper and brass are cleaned with a 40 percent solution of nitric acid by rubbing with a swab dipped in the liquid. Then the metal is plunged into cold water, dried and rubbed with a dry abrasive. When annealing copper and brass, if the heated metal is immediately plunged into cold water most of the scale will be removed. All parts that are to be protected from the acid are covered with asphaltum varnish. If a design is to be etched, the entire surface is coated. When the varnish is dry, trace the design with a pencil and then cut in sharply with a scratch awl. To etch copper or brass, lower it into full-strength commercial ni-

tric acid. This will cut to a depth of about .002 in. in one minute. Around five minutes are required to etch nickel silver to the same depth. Although a 50 percent solution takes longer, it should be used where a deep etch is desired. Aluminum is etched in the same manner as copper except that full-strength muriatic acid, which will cut to a depth of .003 in. per minute, is used. Here again, it is sometimes better to use dilute solutions to obtain better control. Etching solutions should always be mixed and kept in glass containers. Acids should be mixed slowly and carefully, and, when working with weak solutions, the tray should be rocked to prevent bubbles and scale from interfering with the action of the solution. If acid burns occur, use standard first-aid treatment.

Dick Hutchinson, Alhambra, Calif.

Instead of having separate cutout patterns for windshields and car windows stacked on the table or kept elsewhere, one glazier draws them on window shades and rollers that are attached underneath the table by means of roller brackets. When a particular pattern is wanted, the blind on which it is drawn is unrolled so that it lies flat on the table top. Then the glass is laid over the pattern and the glazier cuts it to shape by following the outline with a glass cutter. In this way, a number of patterns are always at hand when needed.—Edgar Barnhart, Whittier, Calif.

Patterns for Automobile Windows Are Fastened Underneath Table

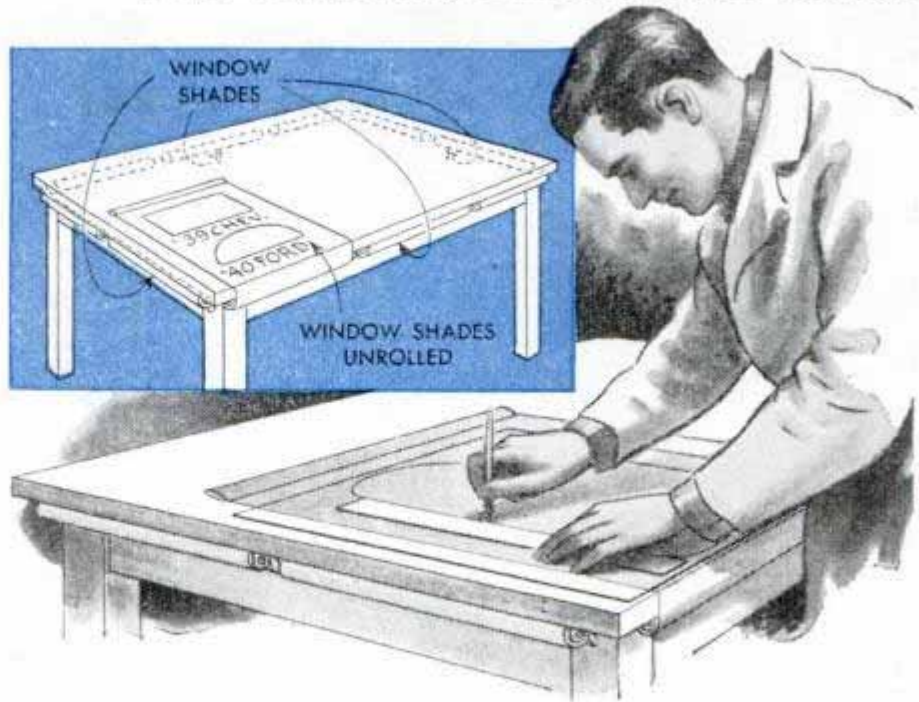

How to Secure Foundry Type

Frequently the compositor in a print shop will find it necessary to place a line of foundry type in such a position in a form that there is danger of the line becoming pried if not carefully handled. However, if the line is wrapped with cellulose tape it will be held firmly and may be handled as easily as a slug line. The tape is peeled off the metal easily when the type is ready for distribution.

Keith B. Wiley, Earlysville, Va.

Toothbrush Wired on Grease Gun Handy When Cleaning Fittings

To prevent dirt from getting into pressure fittings when greasing, one mechanic found that by wiring a toothbrush to the

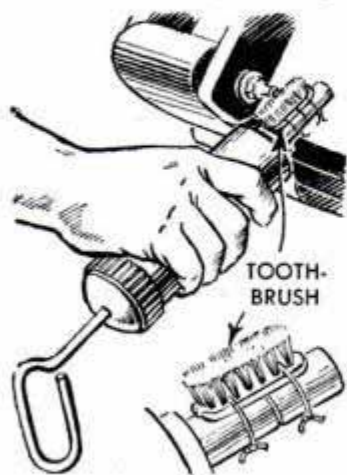

nipple of the gun it was easy to wipe the fitting before applying the grease. The handle is cut off the brush before it is fastened in place with wire. Fittings in inaccessible places are easy to get at with this arrangement.—Fred W. Schneider, Towaco, N. J.

Price and Number of Eggs Shown By Crate "Blackboard"

In many stores where farmers bring eggs in small crates holding 12 doz. or less, mistakes sometimes occur when the report slip is lost and the dealer does not know the quantity or condition of the eggs. To avoid such errors, one merchant uses blackboard paint to cover half of the top of each crate. Then the necessary information can be written on this surface with chalk and will not become lost. Also, the owner's name or initials are stenciled on the crate as a means of identification.



Ⓢ Attaching more than one electrical tool to any given outlet for use at the same time causes an excessive drain on the current.



Display Sign Is Part of Bumper

Additional protection for the front end of delivery trucks is provided by this display sign which also serves as a bumper. The letters are formed of 1-in. extra-heavy pipe and are assembled by welding. Then the top and bottom strips of flat steel are welded to the letters to complete the sign. This provides protection for the radiator grille without interfering with the circulation of air. Bolts and braces are used to attach the sign to the bumper. Aluminum paint provides a protective finish.

Elton Sterrett, Houston, Tex.

Fresh Water for Minnow Tank Keeps Them Alive Longer

Those who sell minnows for bait often find it difficult to keep them alive and in good condition when the water becomes stale. In other words, stale water eats the profit before the fish get a chance to eat the minnows. One dealer solved the problem



by securing a large tank which was provided with two inlets and two outlets at each end, the latter being screened. Water is circulated through the tank constantly. To lessen the possibility of any chemical reaction between the metal of the tank and the water, the interior was finished with several coats of aluminum paint. The water should be pure and the correct temperature.

Wire Solder Clamps Small Work

When setting up small rods for a machine operation, often it will be found that a standard V-block is too large to be used conveniently. In such a case, wrap wire solder around the work

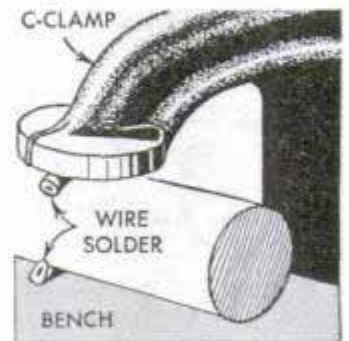

where it will come in contact with a C-clamp and the work table. As the clamp is tightened, the solder will adjust to the shape of the rod and hold it firmly in place.

F. E. Averill, Santa Ysabel, Calif.

Young Trees Are Set in Sand To Prevent Disease

By setting young fruit and shade trees in a bed of sand, one grower found that damage caused by insects and disease was prevented. An excavation for the tree about 3 ft. in diameter and 8 in. deep is made, and just enough soil is placed around the roots to keep the tree standing. Then the hole is filled with sand. After the tree starts, it is watered until it has a firm foothold.—Ralph Underhill, Beebe, Ark.

Extension Rod on Power Drill

With this extension for a hand power drill, hard-to-get-at places are reached easily. A piece of cold-rolled rod is threaded at one end to fit a small drill chuck, the other end fitting into the chuck on the power drill. To use, fit the extension in place and insert the drill in the chuck on the end of the rod. Use a large rod so the extension will be rigid.

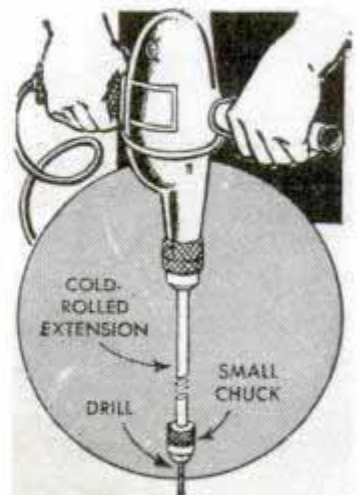

Frank E. Wilson, Palo Alto, Calif.

DRIVE YOUR WELL

Where water-bearing strata are quite near the surface it's easy to put down a well

By Raymond J. Karpen

IN MANY LOCALITIES where the ground is fairly level over comparatively large areas you can generally tap a good water supply by merely driving down a pipe fitted with a well point. If you plan to drive a well you may save time by making inquiry about the depth of wells in the vicinity. Experienced well drillers often can tell with remarkable accuracy, just by the look of things, where you will be most apt to strike water with a well point and at approximately what depth. Once you have good advice on these points the rest is quite easy to accomplish.

Begin as in Fig. 1 with a 3-in. posthole auger of the type having a handle of pipe. Have at hand several 3-ft. lengths of pipe threaded to fit the handle, together with couplings. Run the auger down as far as it will go easily, then unscrew the handle, turn on another section of pipe and proceed, lengthening the auger handle in the same way until you reach a depth of 8 to 12 ft. Here the auger with its long handle becomes unwieldy and, besides, in most localities, a depth of 8 ft. will put the pump cylinder below the maximum frost depth. Now drive a length of 3-in. pipe into the auger hole to serve as a casing, Fig. 2. Next, assemble the well point and one or more lengths of pipe of sufficient combined length to reach above ground when the well point touches the earth at the lower end of the casing. Draw these joints tight. Screw on the drive cap, Fig. 3, and you're ready to go. Take it easy with the sledge, as heavy blows may buckle the pipe or have the effect of deflecting the point. As a rule the pipe drives quite easily. From there on it's merely a matter of adding pipe in short lengths until the driven point reaches water. Usually you can tell quite accurately when the point enters water-bearing strata. Check with a weighted cord lowered inside the pipe. If the point strikes a rock on the way down, it's usually best to pull it and start over again. Any attempt to force the point past a stone by heavy sledging may cause buckling.

When you're sure of water, assemble the pump cylinder, Figs. 4 and 5, and drive this down until the top end of the pipe reaches to a point an inch or so above the casing. Then install the pump as in Fig. 6 and pour a concrete platform as in Fig. 7. Slope the platform so water runs off on all sides.

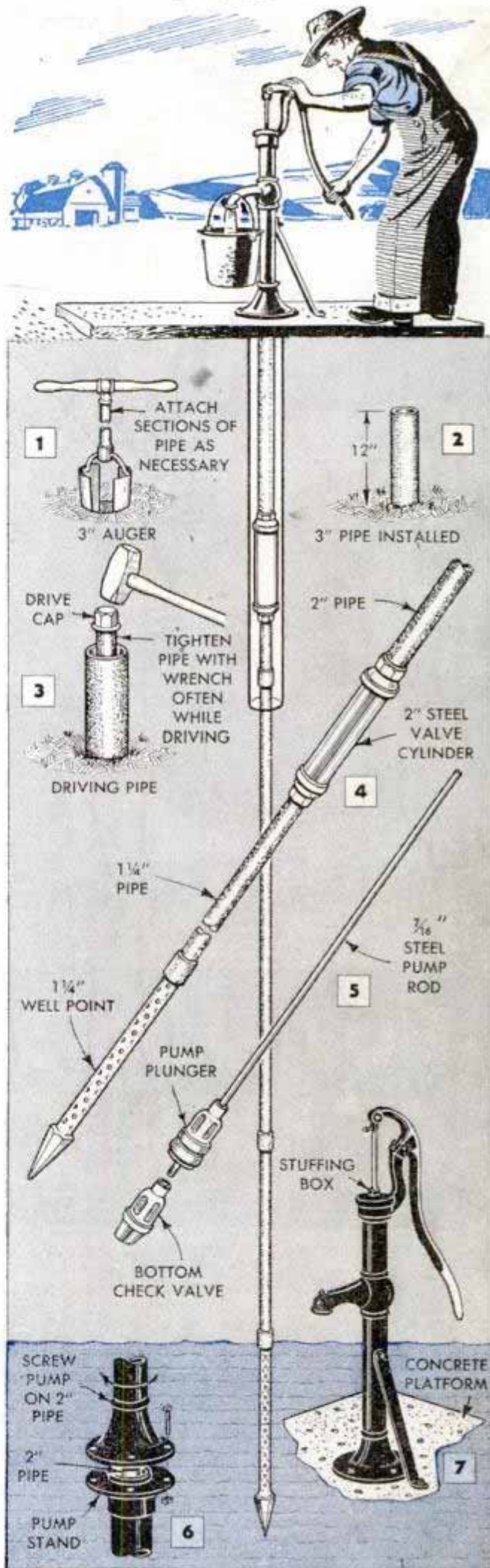

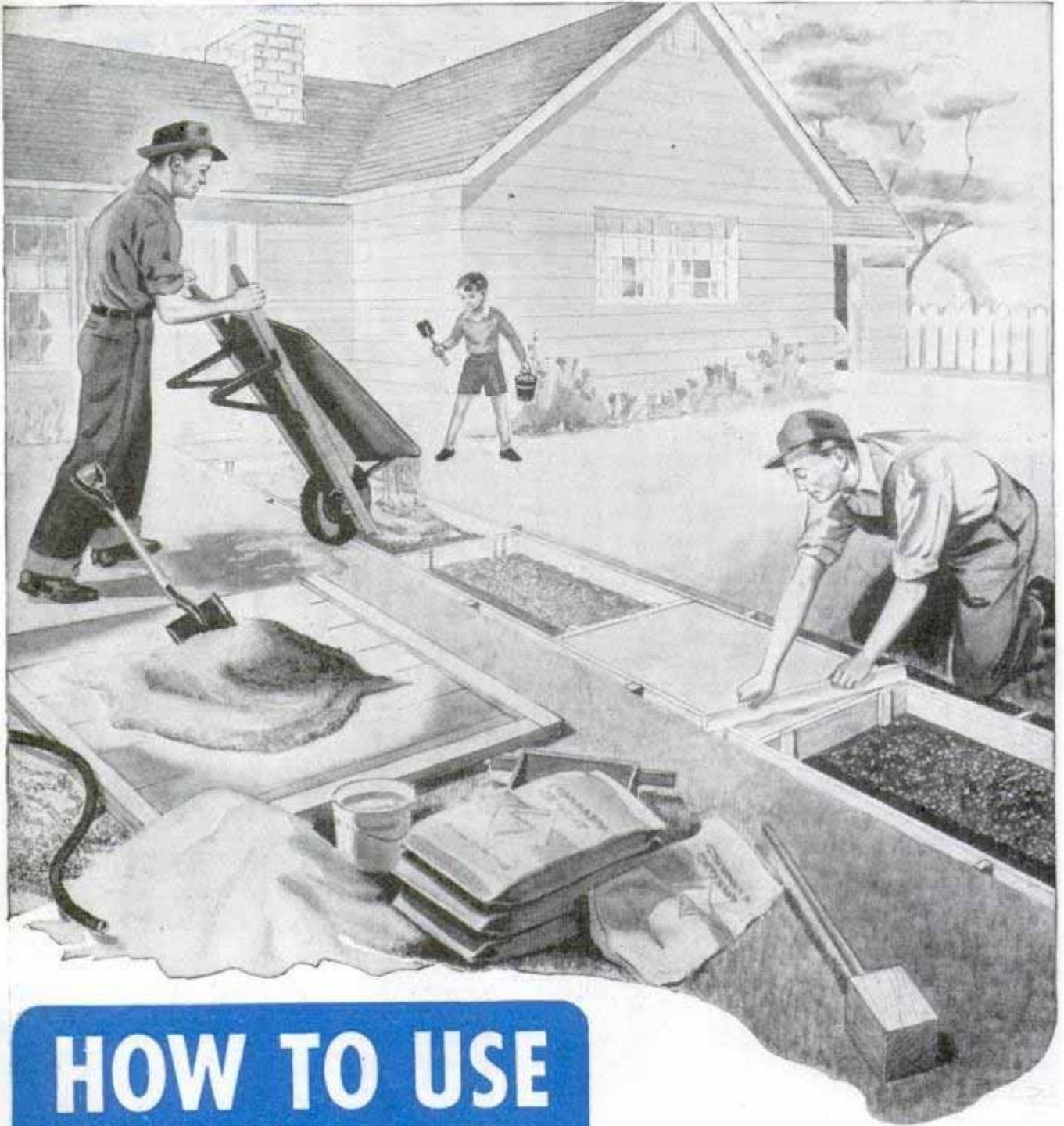

HOW TO USE CONCRETE

By Thomas Trail

YOU DON'T have to be a concrete craftsman or a professional mason to do some of the ordinary concrete jobs that require a minimum of special equipment. Laying a sidewalk is a good example. All you really need in the way of equipment are a few form boards and stakes, hammer, handsaw and shovel, a mixing platform and the necessary amounts of sand, gravel and cement. A rubber-tired wheelbarrow and a measuring box and tamper, Fig. 2, are helpful accessories. And, of course, anyone contemplat-



First add together measured amounts of cement, sand and gravel as at A above. Each bag of cement contains 1 cu. ft.

ing laying a sidewalk or doing any other similar concrete job about the home must have a willingness to bend his back, for it's going to take some work. However, no homeowner will have trouble with this part if he takes time to figure the money that can be saved by doing the job himself.

Main sidewalks such as those leading from the street to the house should be between 3 and 4 ft. wide. Secondary walks, Fig. 7, need not be more than 2 to 2½ ft. wide. An average thickness is 4 in. Locate and align the walk and then drive stakes along what will be the sides, allowing 2 in. on each side for the thickness of the wood form. Tack a string to the posts on each side to serve as a guideline in making the excavation.

If the soil is well drained, remove it to a depth of 2 in. and pack the ground with the wooden tamper. If the soil is wet and poorly drained, excavate to a depth of 8 in. and lay a subbase of clean cinders or coarse gravel 6 in. thick. Pack with the tamper.

Next build the form as in Fig. 1. Use 1 by 4-in. lumber set on edge for the sides of the form. Drive stakes into the ground alongside the form boards and nail them to the form lightly. Level one side of the form ¼ in. higher than the other. Expansion joints should be spaced apart about the width of the walk. Place a 1 by 4-in. divider board with stakes to hold it in place at each end of alternate sections as shown.

Construct a watertight mixing platform of tongue-and-groove lumber. The best mix proportions for sidewalks are 1 sack portland cement, 2¼ cu. ft. of sand, 3 cu. ft. of gravel or crushed stone and 5 gal. of water. This amount of water applies when the sand is average in moisture content. See Fig. 3. If the sand is very wet use only 4¼ gal. of water per sack of cement; if damp or dry, use 5½ gal. per sack.

The sand should contain particles of

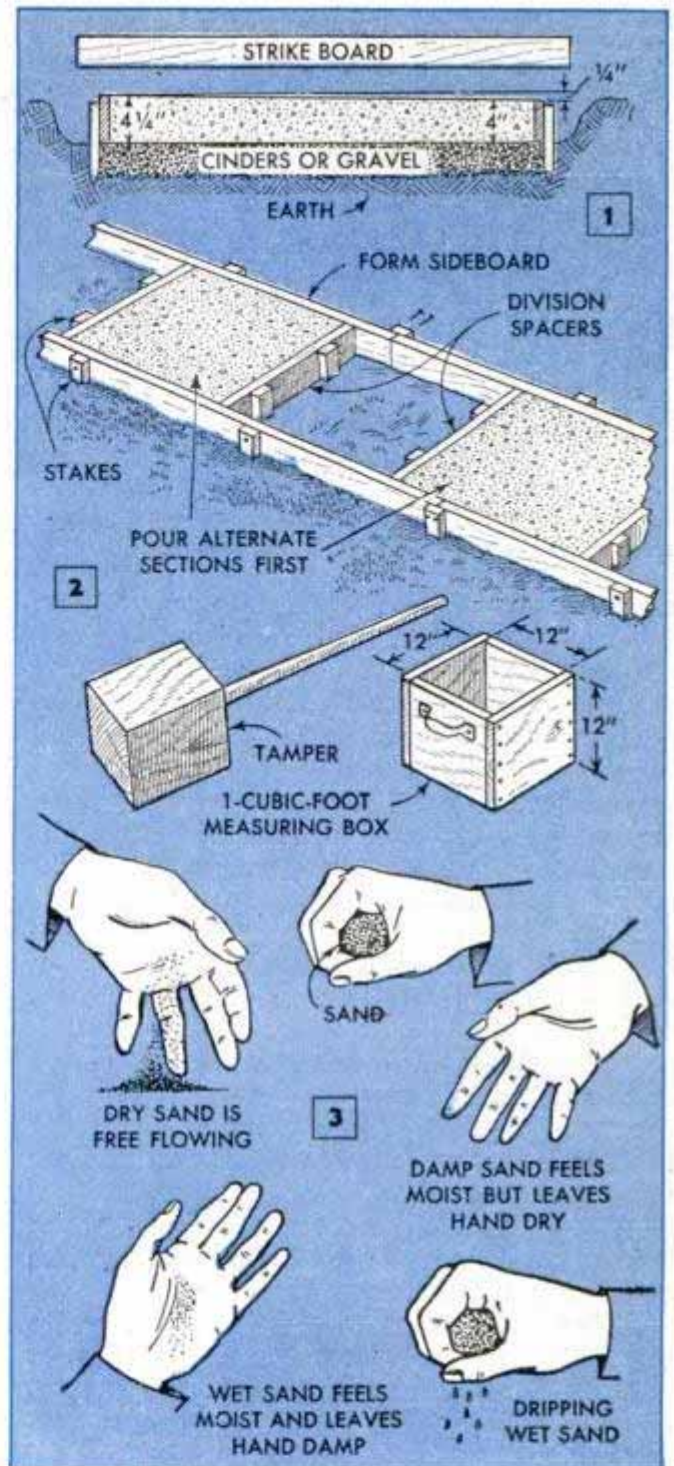

In mixing, measure the sand and gravel in a 1-cu.-ft. measuring box as at B above. Then mix the material dry by shoveling the mass over several times as at C. Finally, make a depression at the center of the pile and add a measured quantity of water in small amounts, detail D. Mix thoroughly by shoveling as before



After pouring the section as at E, settle the mixture all around the edges with a trowel or shovel. Level with the strike board as at F and finish with a float. Don't edge the work until mixture stiffens slightly

assorted sizes from very fine to about $\frac{1}{4}$ in. in diameter. The gravel or crushed stone should range from about $\frac{1}{4}$ in. to $1\frac{1}{2}$ in. in diameter. Mix together the dry cement and sand until no brown or gray streaks remain, then add the measured amount of gravel or crushed stone and continue mixing until the pebbles are well distributed throughout the mixture. Cement requires no measuring since each sack holds 1 cu. ft.

When the dry materials are mixed thoroughly scoop out a depression in the heap and pour in part of the measured amount of water. Continue mixing and adding water until all the water has been used and each pebble is completely coated with cement, Fig. 4. Pour the concrete into the alternate section forms within 30 min. after mixing and level off with a strike board as in Fig. 1. As the concrete is poured, work it into the corners of the form with a spade or the edge of a trowel, Figs. 5 and 6.

After the concrete has become quite stiff but is still workable, use a wood float to level the surface and smooth out uneven spots. This will also leave an even, gritty,

nonslip surface. Finish the edges of the sides and ends of each section of the walk with an edging tool to provide a rounded surface. After removing the divider boards pour a freshly mixed batch of concrete into the alternate empty sections of the form. Finish these sections in the manner already described, giving special attention to finishing the edges. When hardened sufficiently, cure the concrete by covering with several thicknesses of burlap or canvas, or a 2-in. layer of sand, and keep this covering moist for a week or more. Details A to H show the step-by-step process of laying the walk.

Although it's a more detailed undertaking, an attractive and convenient concrete driveway can be constructed in much the same manner as a walk. Usually it's better to rent a power-driven mixer for a driveway job. Driveways are built 8 to 10 ft. wide and should be at least 6 in. thick. Practically the same methods of excavation and cinder fill are used, except that 6 in. of earth should be removed from the driveway site. The excavation should be 5 in.

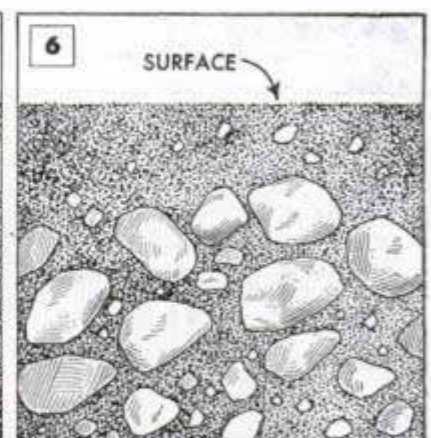
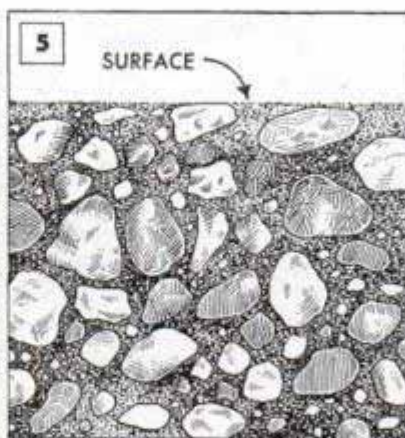

Cross sections cut through concrete walks clearly show the difference between well troweled concrete (left) and improperly troweled concrete (right). The layer of weak material at the right is the result of over troweling, which brings an excess of the fine material to the surface of the walk



Cure concrete by covering with burlap. Keep the covering moist

deep at the center and should slope evenly to 6 in. deep at each side.

The form boards are 1 by 6-in. lumber, as are also the division boards. These are placed across the form every 20 ft. to provide expansion joints between the sections. The driveway is poured in alternate sections and each section leveled off with a curved-edge strike board to produce a crowned surface, Fig. 8. The same procedure is followed in smoothing, edging and grooving, and in pouring the second set of alternate sections. The same curing procedure also is followed.

Curbs are not necessary where the driveway surface is poured to grade level, but if the driveway is built below grade level, curbs should be provided. These should be about 4 in. high. They are formed by means of a template on the end of the strike board as in Fig. 9. Use 2 by 10-in. form boards. Unless there is severe freezing and thawing the cinder fill can be omitted except in poorly drained areas.

The following amounts of various mate-



rials required for constructing sidewalks and driveways include 10 percent allowance for waste and the particular type of sand and gravel used.

For each 10 sq. ft. of 4-in.-thick sidewalk $\frac{7}{8}$ sack of portland cement, 2 cu. ft. of sand and $2\frac{1}{2}$ cu. ft. of gravel will be required. For every 10 sq. ft. of 6-in. driveway, $1\frac{1}{4}$ sacks of cement, $2\frac{7}{8}$ cu. ft. of sand and $3\frac{3}{8}$ cu. ft. of gravel will be needed. In calculating materials required for sunken driveways, measure the overall width and add 6 in. extra width to take care of curb thickness. This figure multiplied by the driveway length gives the total square feet.

Where a 6-in. subbase of gravel or cinders is required, 5 cu. ft. of either of these materials will be needed for each 10 sq. ft. of sidewalk. If greater than 6-in. thicknesses of subbase are necessary, $\frac{1}{12}$ cu. ft. of gravel or cinders will be required for each inch of subbase thickness per sq. ft. of sidewalk or driveway.

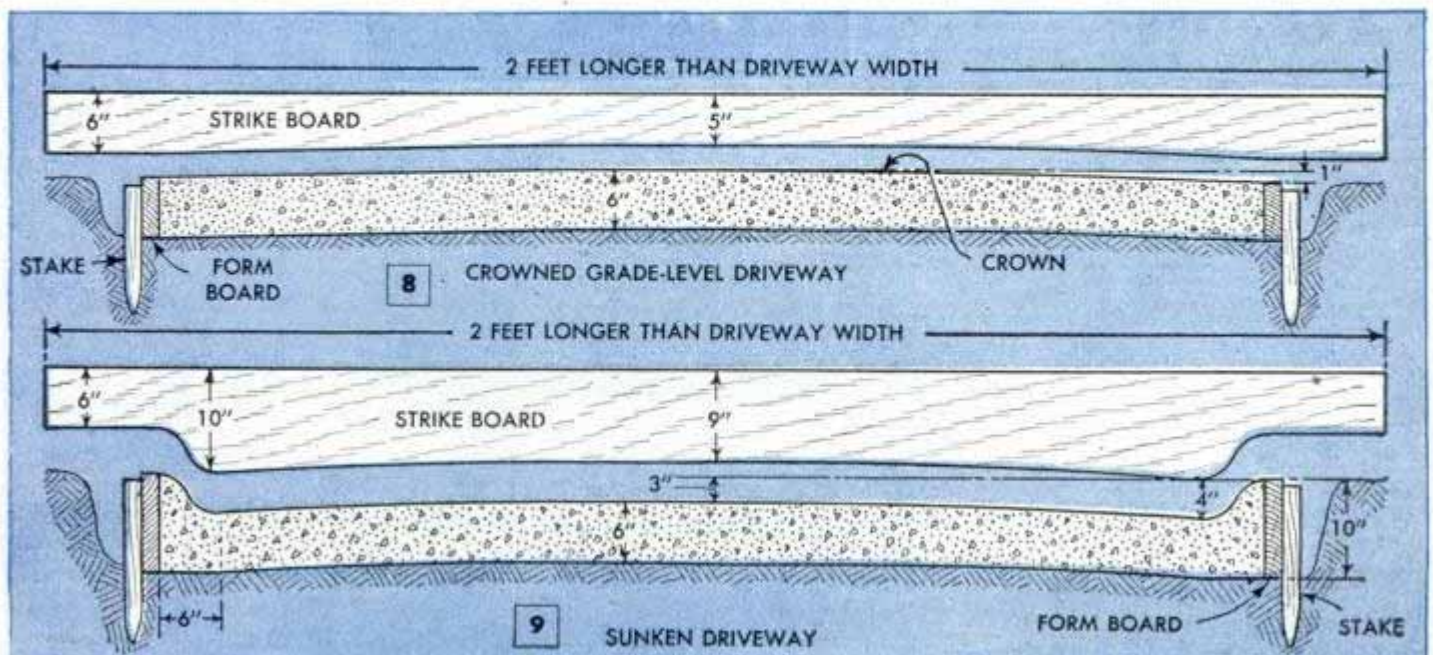

Duplicate Work Turned in Lathe By Using Full-Scale Pattern



Having a number of duplicate pieces to turn in a short time, one machinist hit upon the idea of making a full-scale drawing and using it as a tool guide on the lathe, the latter serving as a modified version of a profile machine. The drawing was thumb-tacked to a board which was attached to the base, flush with the cross-feed. Then a pointer that extended over the board was screwed to the cross-feed apron. The tool bit was set against the work at its widest point and the drawing was adjusted so the pointer was against the corresponding line on the drawing. Following, the longitudinal feed of the lathe was engaged, and by using hand control on the cross-feed, the pointer was made to follow the lines on the drawing. This work is not too accurate, but it proves satisfactory where close tolerances are not required. The pointer is used to make rough cuts as well as the final cut.

R. G. Eaneman, Berkeley, Calif.

Razor Blade Holds Window Glass



When it's necessary to install a large pane of glass in a sash without removing it from the frame, one glazier uses a number of discarded razor blades to hold the glass while fitting

it and preparing to drive the points. Single-edge blades are used to lessen the chance of cutting fingers.

G. E. Hendrickson, Argyle, Wis.

Keeping Chickens From Roosting On Poultry Feeders

By mounting a rod horizontally above a poultry feeder and stringing tin cans along it, chickens can be prevented from roosting there. If they attempt to perch on this "roost," the cans will rotate and throw them off.



Sack Covering Protects Ensilage

To keep ensilage from spoiling, one farmer tramps the surface down once a day for two or three days after the silo has been filled. Then a covering of several layers of heavy fertilizer sacks is laid on top of it. This provides an almost airtight cover.

Auto Wheel Makes Rotary Table For Paint Spraying

If part of the front-wheel assembly of an automobile is available, a rotary table for small paint-spray work can be made with little effort. Mount the wheel spindle on a pedestal that has footings of the type illustrated. Height of the wheel can be a little below the waist. Provision should be made for the removal of paint-spray "fog."

Walter R. Bridgforth, Houston, Tex.





Tuning a Television Receiver

Anyone can soon learn to tune a television receiver correctly. Reception of a picture with the accompanying sound from a television station that is broadcasting in your area is a simple tuning process. Check to see that the television station is on the air and note the channel number of the station. At the present time program schedules are published in the newspapers or may be obtained from the local station upon request.

Typical controls are illustrated in the sketch of the RCA Victor model. Their purpose is as follows: (brightness) sets picture brilliance; (horizontal) stops picture moving from side to side; (vertical) stops picture moving up or down. On the right side of the picture tube, the picture control varies picture contrast, light or dark; off-on sound turns set on and off and adjusts sound volume; station selector selects and indicates the station channel and the number appears in a window. The fine tuning control tunes the receiver for best sound reception.

A test pattern and music are usually broadcast for about 15 minutes preceding each program. In this pattern, when the receiver is correctly adjusted as indicated in Fig. 5, the design is clear and steady, and five distinct shades are discernible on the central circles. When sound is distorted, or if bars flicker across the picture in step with speech or music as shown in Fig. 1, adjustment of fine tuning is indicated. Fig. 2 identifies auto-ignition interference. Figs. 3 and 4 show conditions corrected easily with the contrast control and horizontal control.

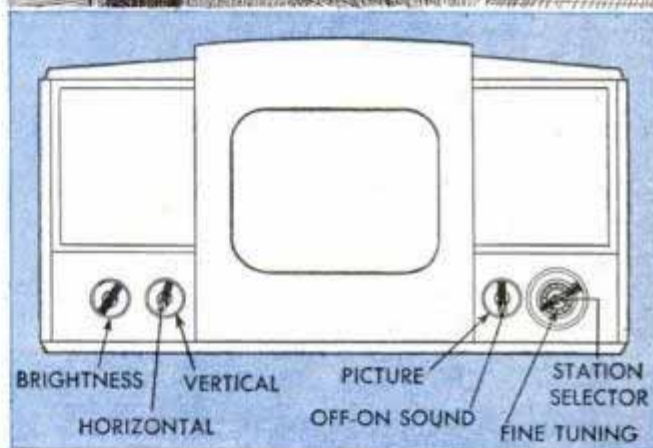
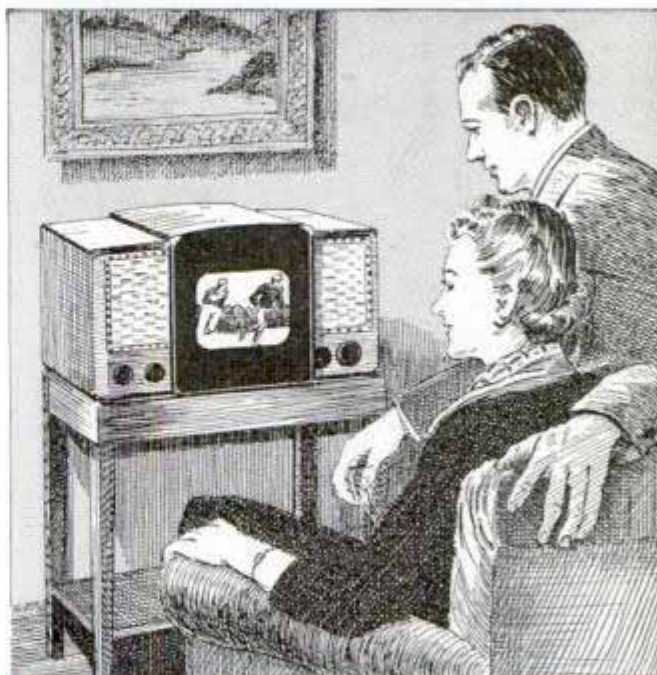

Fig. 1—Sound Bars



Fig. 2—Automobile Interference



Fig. 3—Too Much Contrast

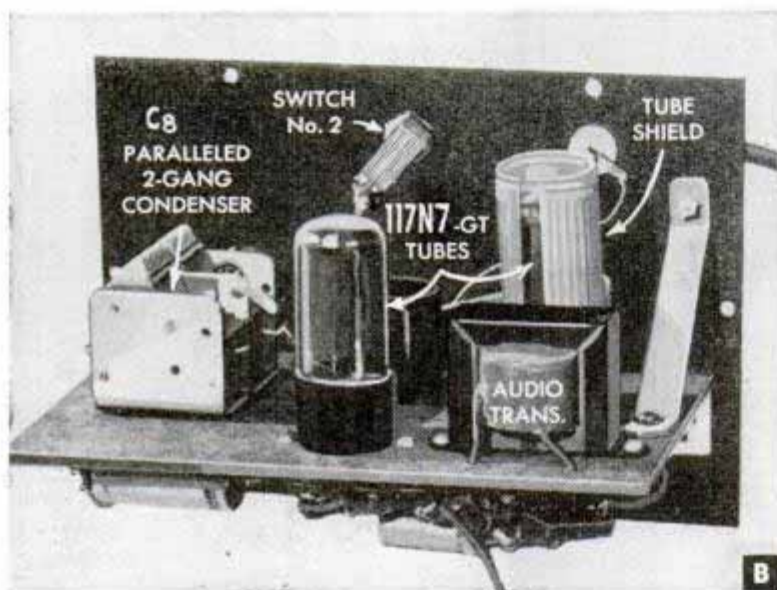
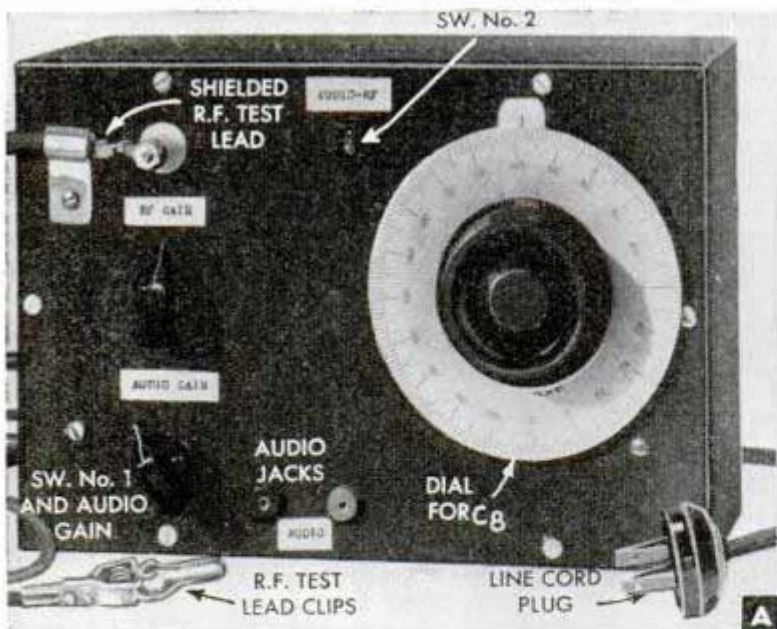

Fig. 4—Off Center



Fig. 5—Correctly Adjusted

HOW TO BUILD A DUAL-PURPOSE



CAPABLE of producing both a modulated radio-frequency signal and an audio signal for lining up broadcast receivers, or for isolating trouble by the popular "signal substitution" method commonly used by radio servicemen, this useful homemade signal generator is well within the pocket-book range of the average radio experimenter who does not require an expensive precision laboratory instrument.

Although definitely not intended for beginners, it is a highly satisfactory unit for students and experimenters as it is inexpensive to build and operate. Standard parts are employed with the exception of the coil, which is hand-wound on a 4-prong tube base, and the control device which governs the r.f. frequency output of the generator. This unorthodox but effective control device consists of a standard insulated panel bearing and a short shaft to which is cemented a piece of $\frac{1}{8}$ by $\frac{5}{8}$ by $2\frac{3}{4}$ -in. hard-pressed wood carrying a $\frac{5}{8}$ -in. square of sheet aluminum. This aluminum square, which is fastened to the end of the pressed-wood strip with a short machine screw and nut, is connected by means of a piece of very flexible wire to the feed-through

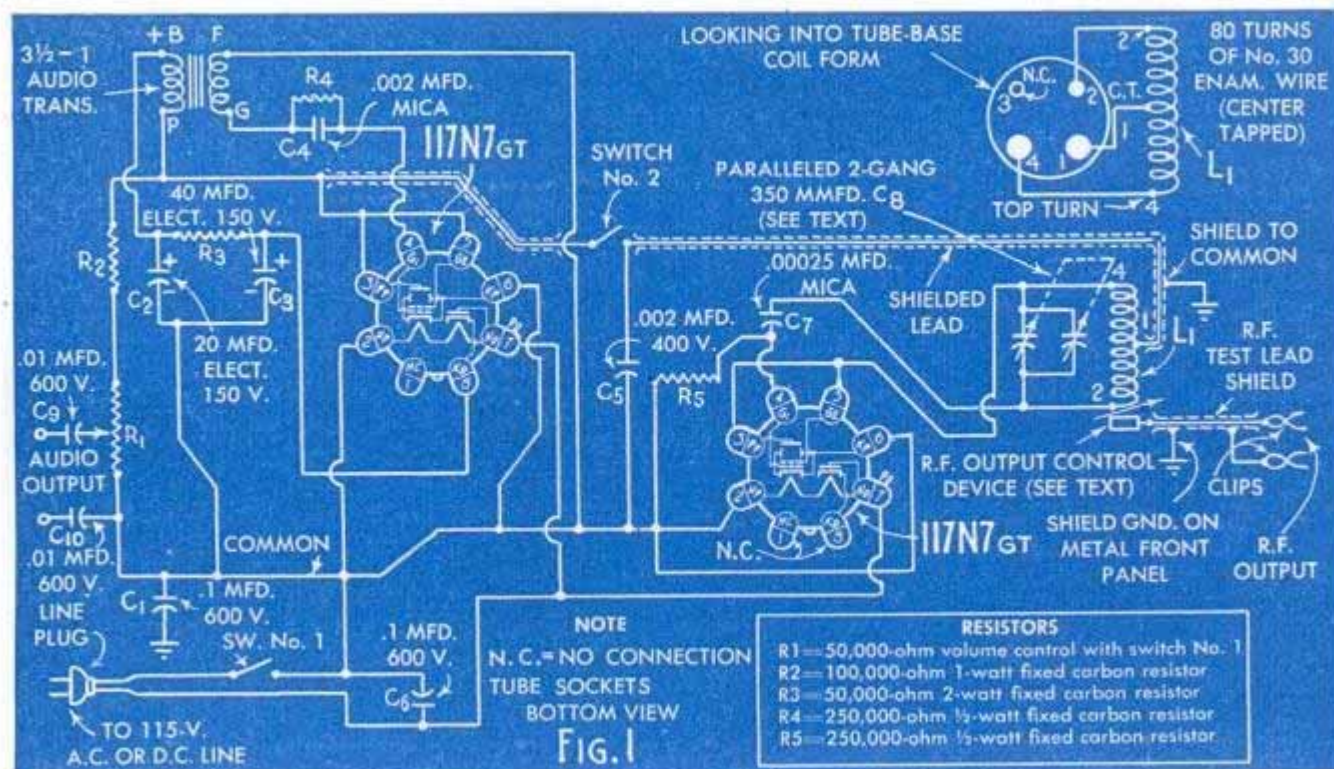

SIGNAL GENERATOR FOR SET TESTING

insulator which serves as the r.f. output terminal. Rotating the bearing shaft varies the position of the aluminum square in relation to the r.f. coil, and thus controls the amount of radio-frequency output which is picked up from it at a distance of about $\frac{1}{2}$ in., with a minimum effect upon the tuning of the oscillator.

With a single coil, this signal generator provides a radio frequency of approximately 400 kilocycles to 1600 kilocycles, covering the most popular intermediate-frequency band, plus the entire broadcast band. The radio-frequency signal is modulated by a 400-cycle audio tone. This 400-cycle tone is also available for use in the audio portions of the circuits. One 117N7-GT tube serves as a radio-frequency oscillator, and the other as a combination audio-oscillator and rectifier for the a.c.-d.c. power-pack section.

The unit is built up on a $\frac{1}{8}$ -in. hard-pressed-wood base and is housed in a standard metal cabinet 9 in. long, 5 in. wide and 6 in. high. Its front and back plates are removable and one serves for the front panel. This metal case provides the necessary shielding. The insulated base is made necessary by the fact that the unit employs an a.c.-d.c. circuit which cannot be directly grounded to the metal cabinet in the usual manner, as a line short might occur when the shielded r.f. output cable from the signal generator is connected to the set under test. Therefore, please note that the only ground connection to the metal case is made through fixed condenser C1 to the panel bracket as shown in underside photo F (see page 232); all other grounds indicated are made to the common floating ground.

Photos A, B, C, D and E show various views of the completed unit; the schematic circuit diagram is given in Fig. 1. The metal panel and pressed-wood base details appear in Fig. 2; the base is supported on the panel by means of aluminum, or sheet-metal, brackets. When wiring the circuit it is important to keep the leads, especially those in the r.f. portion of the unit, as short as possible.

When completed, the audio-frequency output should be tested first. This is done by merely plugging a pair of headphones in the audio jacks. If everything is working properly, you should hear an audio signal of approximately 400 cycles. The frequency of the tone

(Continued to page 228)

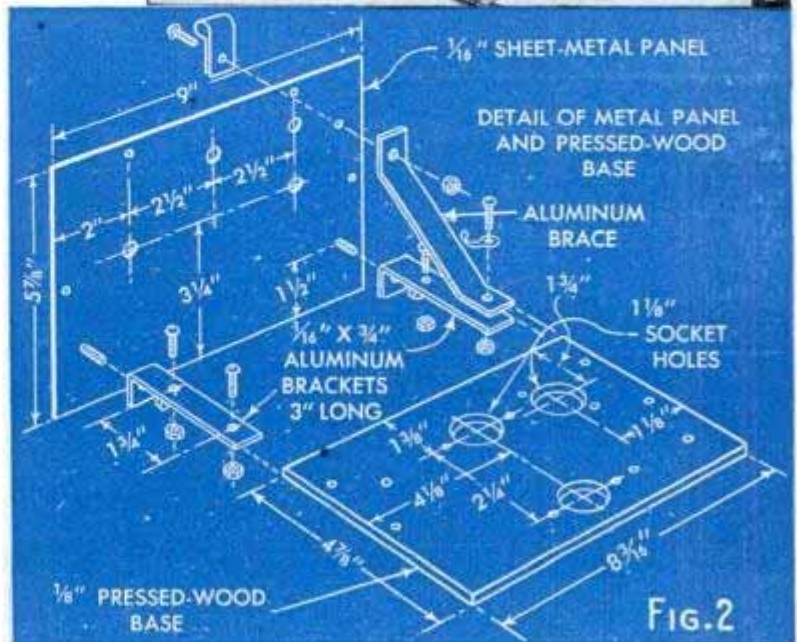
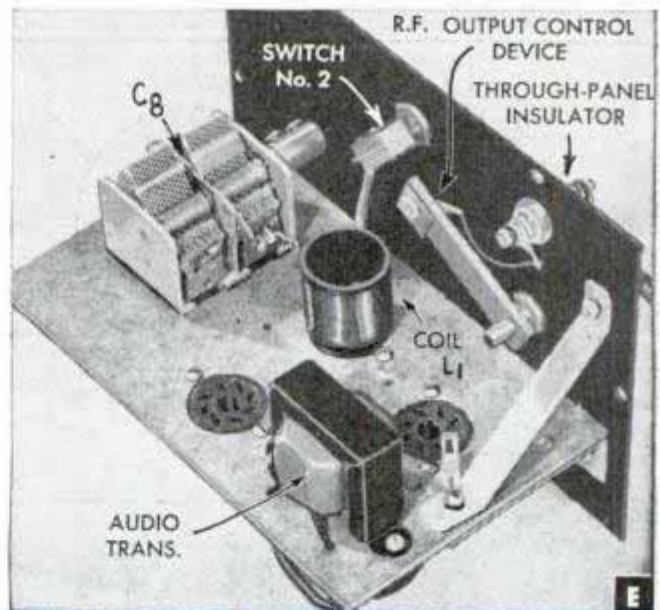
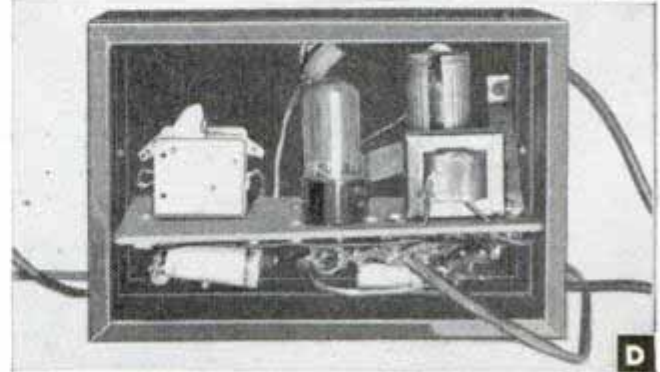

Wooden Towers for Amateur Radio Rotary Beam Antenna Arrays

Solving a common problem for those amateur radio operators who wish to take advantage of the possibilities of a good directive beam array that can be rotated by means of one of the new motor-operated rotating devices, these "Sky-Lane" wooden self-supporting towers are now available in kit form, with two sides assembled. All necessary hardware and instructions for completing the assembly are included.

To be effective the beam array should be in the clear and above surrounding buildings. Those lucky "hams" who have a back yard or vacant lot prefer the 32-ft. tower illustrated in photo A. This comes in two 16-ft. sections which are connected by a butt joint which is secured by steel plates and bolts. Two pairs of inner horizontal cross braces and full truss construction are claimed to prevent deformation and distribute any strain over a large portion of the tower. An additional 16-foot section can be added later if desired. This tower is mounted on four tapered 6-ft. cedar posts as detailed in Figs. 1 and 2. As this is an important operation the most accurate way of setting the posts in position is to first assemble the tower and then make a light framework jig, using as a pattern the bottom legs of the tower. When the posts are finally set in concrete, the tower is raised and bolted in position as indicated in Fig. 1. The 16-ft. roof assembly, photo B, is ideal where ground space is not available; one man can raise or lower it by merely walking it up or down as you would raise a ladder. This Sky-Lane "Topper" model is 47 in. square at the base, and 11 in. at the top.

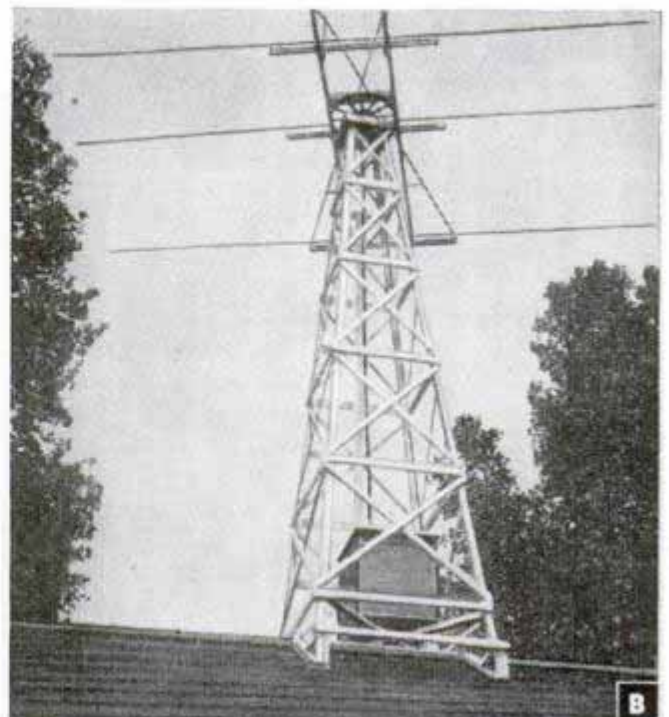
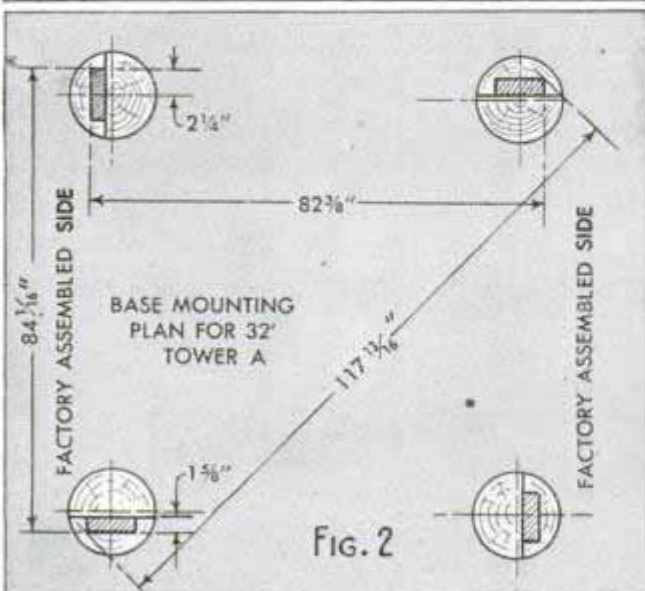
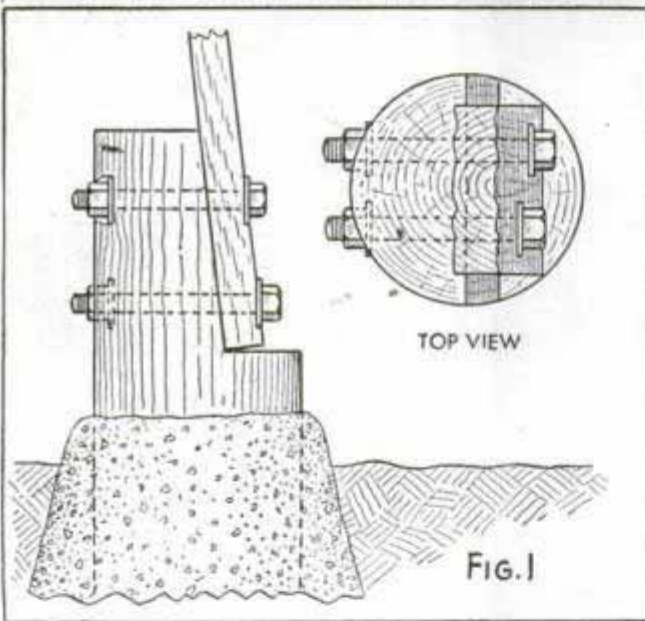
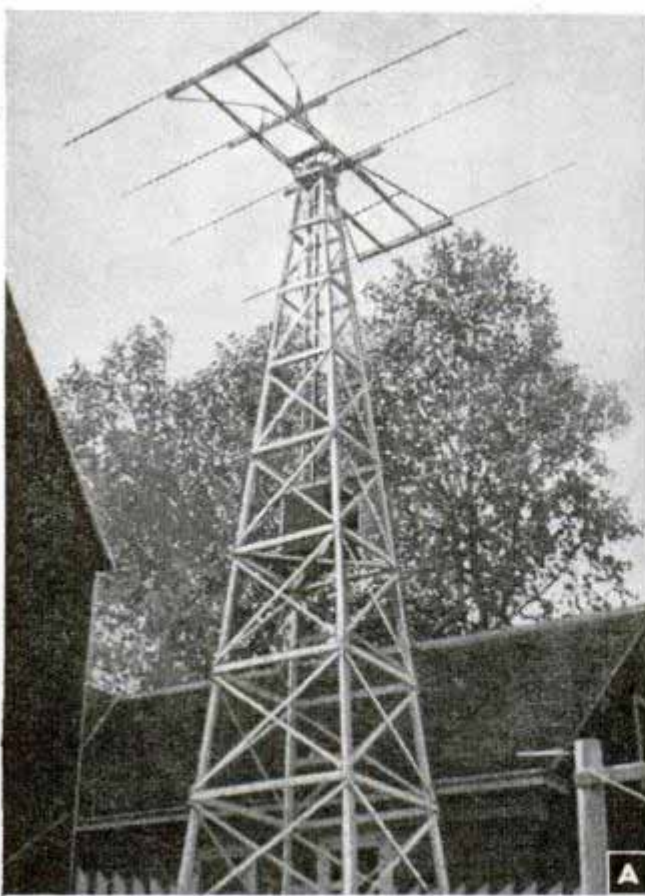

Carries better... Looks better...

and, of course, it's safer...
...in a **KODAK
CARRYING CASE**

FOR KODAK 35 with Range Finder...

Handsome Field Case of top-grain sole leather, with shoulder strap. Built-in ruggedness... quick accessibility for instant, easy shooting.

(Below)

FOR KODAK VIGILANT SIX-20...

Kodak Snapsack... russet sole leather with hand strap... illustrative of pouch-type case so popular for folding cameras. Also takes Kodak Monitor Six-20.

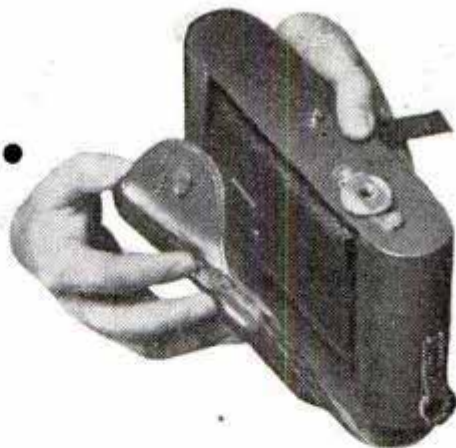

FOR KODAK MONITOR...

De Luxe Field Case... top-grain cowhide, special stitching, skived leather straps, metal-reinforced inner section make it a truly de luxe case.



FOR YOUR BANTAM...

Handsome leather Field Case with neck strap... permits manipulation of all camera controls without removing from case... tripod socket in base. At your Kodak dealer's... Eastman Kodak Company, Rochester 4, N. Y.



FOR ANY CAMERA WITH TRIPOD SOCKET...

Ounces of prevention... Kodak Hand Straps... Kodak Neck Straps... light, strong, woven leather... make it practically impossible to drop your camera.



Kodak

Why Ford engines don't overeat!

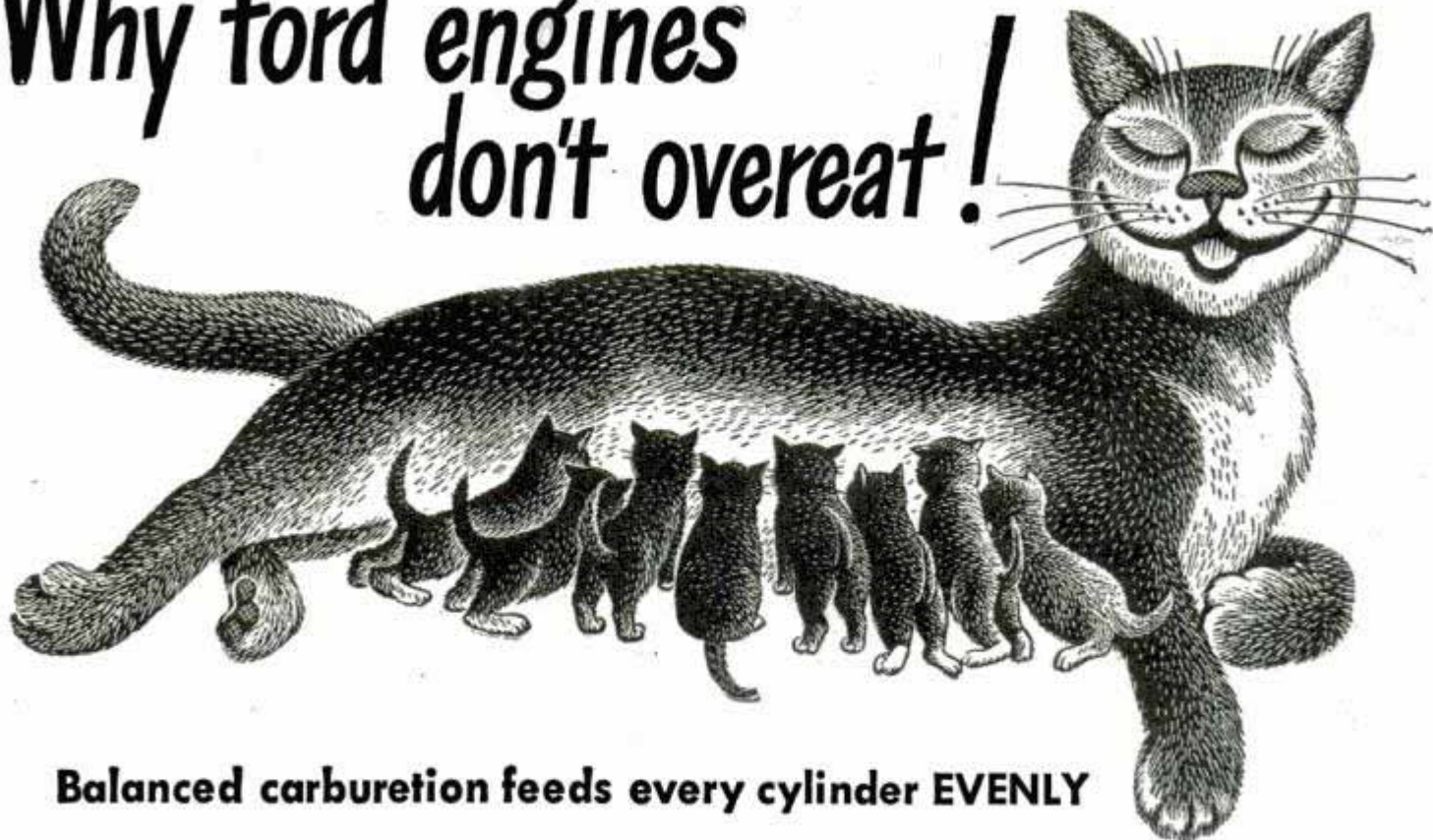

Balanced carburetion feeds every cylinder EVENLY

● Whether you own the Ford Six or the V-8, you're sure to get balanced down-draft carburetion. You're sure that every cylinder is properly fed . . . and economically, too!

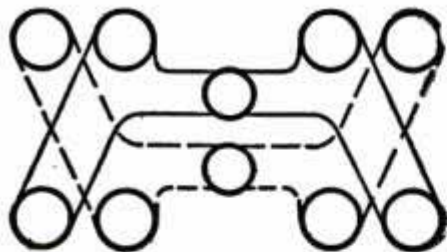
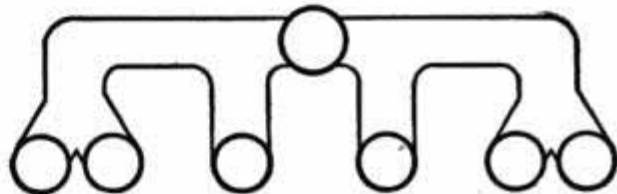

In the Ford V-8 engine, the dual carburetor feeds the cylinders through a duplex manifold. Each manifold serves four cylinders whose place in the firing sequence prevents simultaneous suction by any two cylinders.

In the SIX the downdraft carburetor serves the cylinders through a unique four-port manifold with dual leads. Two leads serve the two center cylinders, the others serve the end pairs. As in the V-8, this results in even feeding.

In both SIX and V-8, you get greater economy from Ford's accelerating pump which sends extra fuel into the carburetor when the engine needs extra power, but saves this fuel in normal driving. And in cold weather Ford's new Automatic Manifold Heat Control routes warm exhaust heat past the carburetor for quick warm-up, then back through normal channels.

These and many other features put FORD OUT FRONT for fuel efficiency.



There's a **Ford** in your future

THRILL-PACKED TRAVEL!

THE
AMERICAN
Moto-Scoot
WAY

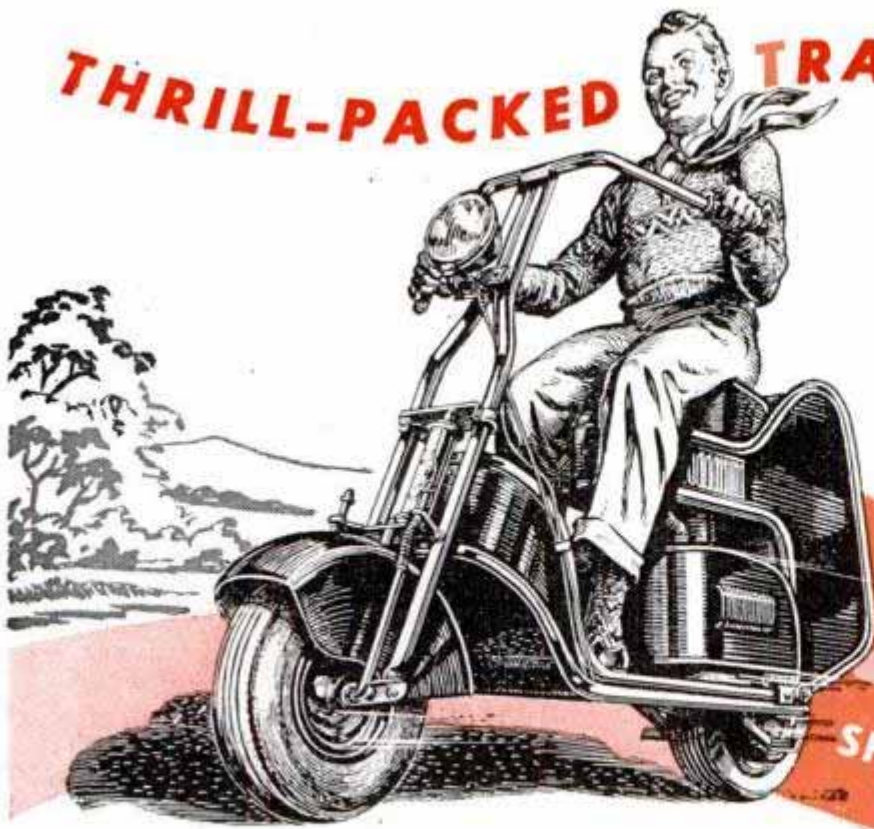

80 MILES TO THE GALLON!
SPEEDS UP TO 40 M.P.H.!

GOES EVERYWHERE
PARKS ANYWHERE

Ride with the pride of knowing that a single penny buys miles of power. Functional design, precision-engineering and scientific construction give you AMERICAN Moto-Scoot—to suit *your* work and pleasure needs. See AMERICAN Moto-Scoot . . . try it today. You'll agree it's America's **BIGGEST** power travel value.



ECONOMY

More mileage per gallon . . . less upkeep — swifter, *thriftier* performance all the way!



POWER

Power to *spare* . . . wherever you're headed you get there quickly, easily, smoothly!

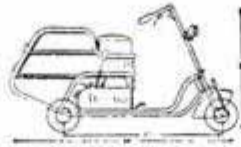

VALUE

From headlight to tail-light, from top to tires, you get more for your money!



OPPORTUNITY FOR YOU

Have a "Spare Time" Income! Earn extra money in many ways!

SEE YOUR DEALER OR MAIL COUPON FOR FREE BOOKLET

QUALIFIED DEALERS WANTED
—WRITE FOR FULL DETAILS:



AMERICAN
MOTO-SCOOT COMPANY
1305 W. Carroll Ave.
Chicago 7, Illinois

Please send immediately—FREE 12-page color Booklet.

Name _____

Address _____

City _____ County _____ State _____

PM-77

Why Wait?

**QUALITY TOOLS ARE
A GOOD BUY NOW**



One of Plomb's popular 3/8" Drive Socket Sets for efficient nut turning.

Great volume enables Plomb to give you higher quality tools—at prices close to pre-war levels. That's why it will pay you to buy the tools you need *now*—to make your set complete and up-to-date. Get them from your Plomb dealer today. Write for catalog to Plomb Tool Company, 2255H Santa Fe Avenue, Los Angeles 54, California.

4765

PLOMB
streamlined
TOOLS

Growing a Crop Under Tents

(Continued from page 134)

stapled. Cheesecloth in sheets 400 inches wide is then pulled by hand over the wires, stretched to its full width and sewn. Each acre requires 5000 square yards and new cloth must be used every year for all but the sidewalls.

Fertilizing the fields amounts virtually to dietetics, for the continuous use of the same soil for tobacco robs the land of calcium, magnesium, aluminum and sulphur.

The seedlings are planted by machine except around the poles where it is necessary to plant by hand. The planting machine is operated by a driver and four men. As it moves slowly over the land it digs shallow trenches and fills them with water. The men set the plants firmly into the ground at regular intervals, planting from two to three acres a day.

After planting, the grower must maintain a constant guard against insects. Some 20 different species of bugs, ranging in size from tiny thrips, that barely can be seen, to common grasshoppers, continually threaten the tobacco and are fought off with powder repellent.

Harvesting or "priming" is done by hand in from four to six steps. Since the leaves ripen most quickly on the bottom of the plant, the first priming consists of picking three or four leaves from a spot on the plant nearest the ground. Three more primings are necessary at intervals later.

As the pickers go from stalk to stalk they remove the leaves from the plants and lay them on the ground between rows. Other workers gather them in canvas baskets and drag their loads to the edge of the field for delivery to curing sheds.

The leaves are strung on wooden laths and hung from waist height to the roofs of the curing sheds. Within eight weeks the rich green color changes to the pale brown.

(Continued to page 224)



Model Builders Attention!

	V	V-2	V-3
Hex	1/2"	3/8"	5/16"
Thread	3/8"-24	1/4"-32	1/4"-32
Thread Length	7/32	7/32	5/32
Weight, Grams	8	3 1/2	2 1/2

Actual Size V-Plug

Champion spark plugs for model gas engines give the same dependable performance as regular Champions. Silliment sealed. Sillimanite insulator. Alloy needlepoint electrodes for easy starting. One piece construction.

CHAMPION

SPARK PLUG COMPANY • TOLEDO 1, OHIO

Dependable

CHAMPION

AMERICA'S FAVORITE SPARK PLUG

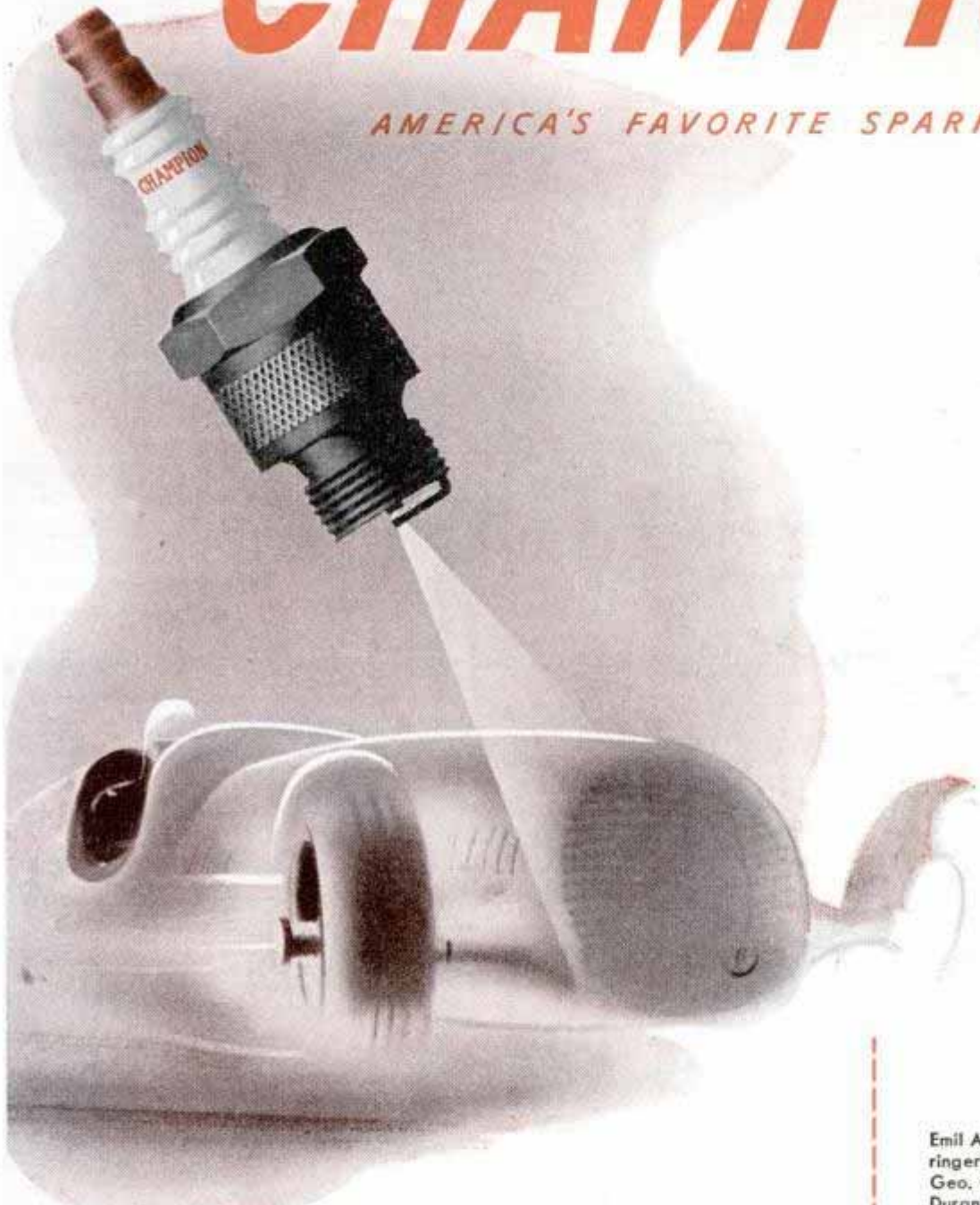

MEMBERSHIP LIST

Emil Andres • Billy Arnold • Geo. Barringer* • Cliff Bergere • Bob Carey* • Geo. Connor • Bill Cummings* • Louis Durant • Dave Evans • Fred Frame • Chet Gardner* • Ralph Hepburn • Ted Horn • Jimmy Jackson • "Doc" MacKenzie* • Rex Mays • Lou Meyer • Zeke Meyer • Chet Miller • Lou Moore • Kelly Petillo • Ray Pixley* • Floyd Roberts* • Geo. Robson* • Wilbur Shaw • Russell Snowberger • Jimmy Snyder* • Babe Stapp • "Stubby" Stubblefield* • Joe Thorne • Louis Tomei • Gigi Villorosi • Frank Wearne • "Howdy" Wilcox*

*Deceased

The Champion 100-Mile-an-Hour Club, the "world's most exclusive club," is composed of those race drivers who have driven the full 500 miles in the Indianapolis Race, at an average speed of 100 m.p.h., *without* relief. Of all the race drivers who have competed in this international speed classic, only 35 have achieved the distinction of becoming members and are entitled to wear the club emblem. 32 of these 35 qualified for membership using dependable Champion Spark Plugs.

FOLLOW THE EXPERTS — DEMAND DEPENDABLE CHAMPIONS FOR YOUR CAR

Listen to the CHAMPION ROLL CALL . . . Harry Wismer's fast sportscast every Friday night, over the ABC network

SpeedWay



No. 89
1/2" ELECTRIC DRILL
\$29.95



No. 209
Drill Stand
 (less drill)
\$12.95

Light in weight, convenient and handy, this improved drill has a special aligning grip that makes straight drilling natural. Backed by 35 years of electric drill manufacturing, produced in great quantities by modern methods, this is today's best drill buy.

For every day farm, garage, construction and maintenance use, you can't get a better drill at any price. Specially wound, long life, high torque, fan-cooled motor. Cut steel gears, self-lubricating bearings, sturdy die cast case and a full sized snap action chuck (no key to lose).

With a No. 209 Drill Stand, the 89 Drill makes a capable lever operated drill press. Order from your local SpeedWay dealer.

SPEEDWAY MANUFACTURING CO.
 1863 S. 52nd Ave., Cicero, Ill.

*Don't worry, Madam,
 We'll fix it in a jiffy
 with WELDWOOD GLUE*



When you want to fix things fast . . . remember Weldwood Glue. It's quick to mix . . . easy to use . . . tremendously strong . . . stain-free . . . rot-proof . . . and permanent. At hardware stores, lumber yards, chain stores.



WELDWOOD
 PLASTIC RESIN
WATERPROOF GLUE

United States Plywood Corporation, New York 18, N. Y.

MOW-MASTER Rotary Mower

Cuts Tall Grass and Weeds Easily--Quickly

It's fun to mow with the MOW-MASTER! Powered by famous POWER-PAK 2 H. P. air-cooled gasoline motor with muffler. Light weight. Advanced design.

AT YOUR DEALER'S



PROPULSION ENGINE CORP.
 Dept. 202 7th & White Eagle Rd.
 Kansas City, Kansas

DRILL CONCRETE *The Easy Way!*

CONCRETE
 ASPHALT
 BRICK
 SLATE
 WALLBOARD
 LIMESTONE



SLIP A CARBOLOY MASONRY DRILL INTO YOUR ROTARY DRILL, HAND BRACE, OR DRILL PRESS, AND WATCH IT GO—AND GO FAST!



and most other construction materials.

- DRILLS 4 TIMES FASTER!
- STAYS SHARP 50 TIMES LONGER!
- CUTS CLEAN, TRUE-SIZE HOLES!

Tipped with Carbide Cemented Carbide—harder than the hardest steel.

Goodbye to back-breaking masonry drilling! Cut clean, true-size holes in masonry jiffy-quick! Use your rotary drill, hand brace, or drill press. Drill holes 1/8" apart without break-through. Ask about Handy 6-drill set, 3/16", 1/4", 5/16", 3/8", 1/2" and 5/8". In free canvas kit, \$13.70 postpaid, or C.O.D. See your dealer, or write.

CARBOLOY COMPANY, INC.
 11185 E. 8 Mile Rd., Detroit 32, Mich.

A BIG 25¢ WORTH OF TOOL TIPS



Everything about tools . . . at a glance. More than 2000 views of boring and cutting tools, squares, gauges, jigs, etc. Years of tool experience in one, low-priced book . . . 25¢ postpaid. Write today. Stanley Tools 177 Elm St., New Britain, Connecticut.

STANLEY

Trade Mark

PULVEX "DDT" FLEA POWDER



Kills the fleas **Quickly!**
 Keeps others off **for Days.**



Pulvex also comes with ROTENONE, the original formula. BEST FOR CATS.

Either Kind **25¢ & 50¢**

**Piston rings
wear out, too!**

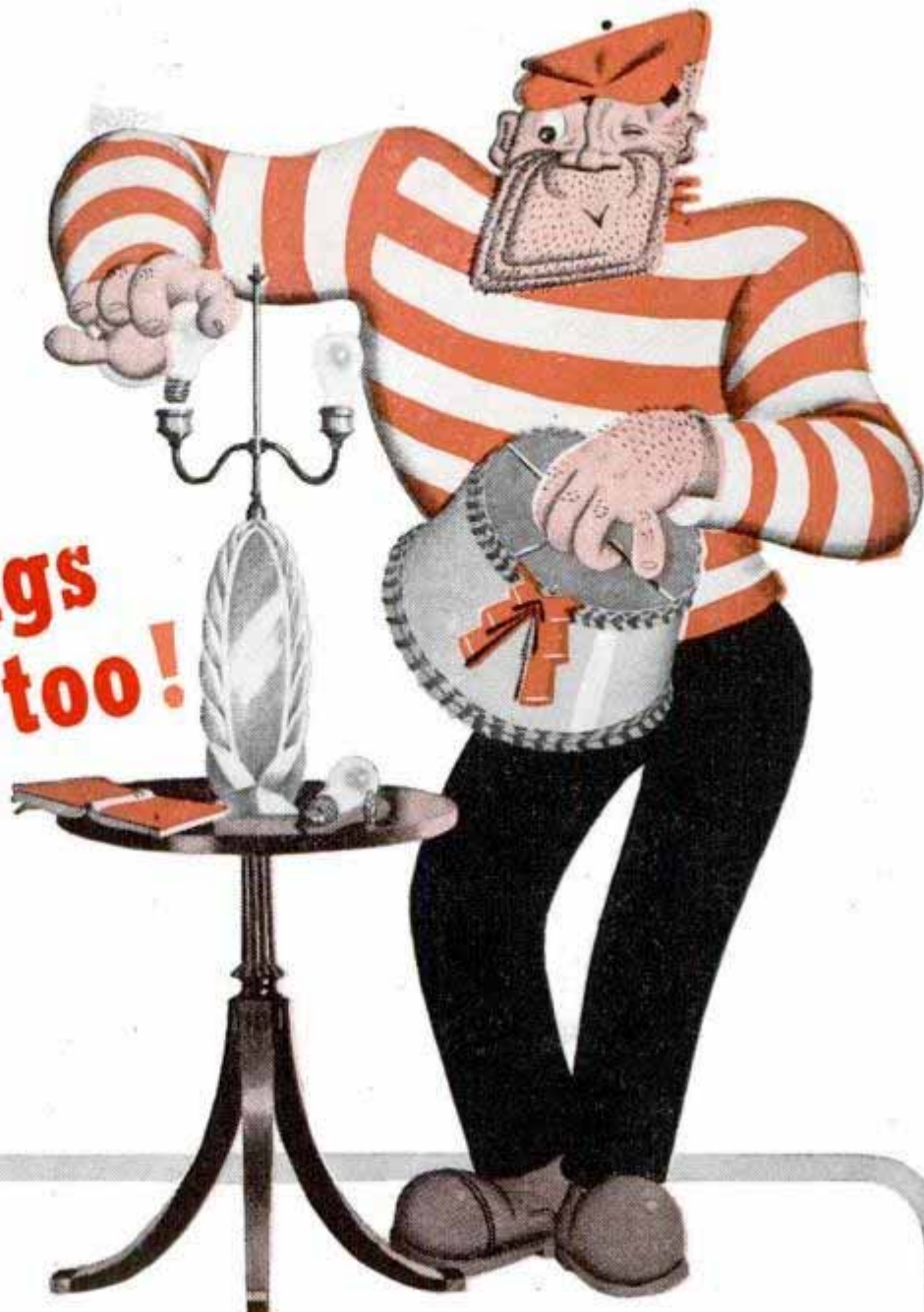

Engine wear is mostly *parts* wear. Certain parts, like piston rings, are designed to "take" the wear and be replaced again and again.

When your car begins to smoke, waste oil or lose power,

it will pay you to install Hastings Piston Rings *at once*. They *stop* oil-pumping, *check* cylinder wear, *restore* performance. It's the best money you can spend on your car.

Hastings Manufacturing Company, Hastings, Mich.
Hastings Ltd., Toronto



HASTINGS

STEEL-VENT PISTON RINGS

TOUGH on Oil-pumping **GENTLE** on Cylinder Walls

FOR THE FINEST VACATION EVER



Go "Exploring" on a HARLEY-DAVIDSON

For fun and thrills, there's nothing to equal a vacation tour the Harley-Davidson way! Just pick the historic places and natural beauty spots you want to see most — and your dependable Harley-Davidson will take you there *fast and economically*. Go where and when you please — stop over any time — no set timetables to follow. You can do more and see more — even visit out-of-the-way places not reached by other methods. And all season long your Harley-Davidson turns evenings, holidays, and week ends into *extra pleasure time* — as you join other riders on trips and gypsy tours, or take in race meets, hillclimbs, and other thrilling motorcycle events. See your Harley-Davidson dealer NOW — and mail coupon today!



HARLEY-DAVIDSON

Motorcycles

Harley-Davidson Motor Co., Dept. P, Milwaukee 1, Wis.

Please send at once free copy of 24-page "ENTHUSIAST" Magazine, filled with thrilling motorcycle action pictures and stories.

Name.....

Address.....

City..... State.....

which characterizes fine wrapper tobacco.

Before the leaves are ready for fermentation they must be restored to their moist and flexible state so they will not break when handled. This can be done by steaming, but usually Nature helps with an evening mist or rain.

The damp leaves are bundled, tied into "hands" and shipped to the processing warehouse. Here the tobacco is packed into "bulks" weighing from 4000 to 5500 pounds.

Thermometers are placed in the center of the bulks to measure the rise in temperature as the tobacco ferments. Workers turn the bulks every eight days, replacing the inside hands with tobacco that has been on the outside. The process is repeated until the moisture evaporates from the tobacco and the temperature falls to around 75 degrees. The tobacco then is dampened again, sorted, sized and tied.

For baling the leaves modern hydraulic or electric presses have replaced old-fashioned presses in some cases, but many growers insist that the hand press still produces the best results. Finally the bales are sewn into paper covers that are porous enough to permit air circulation around the still fermenting tobacco.

Connecticut Valley shade is ready at last for shipment to manufacturers and eventually to the glass cases of cigar counters.

Ammunition for the War on Disease

(Continued from page 159)

Into his curare 'poison arrow stew' he tosses various plants and a few small animals, perhaps to increase the potency. This means that our chemists have quite a job extracting pure curare from the mixture."

While the ultimate goal of a plant like Abbott Laboratories is to produce medicines and other pharmaceutical products in huge quantities, there are many steps that come before mass production.

One of these is chemical analysis of tiny samples—possibly one drop of liquid or a speck of powder. Midget-size utensils, weighing machines, filters and other equipment are used.

The weighing machine, or microbalance, is accurate to 1/30,000 ounce. It is so delicate that a downy feather would be a staggering load. A dot made by a pencil can be weighed; in fact, it has, and it weighs about .008 milligram. The balance is operated in a room in which temperature and humidity are rigidly controlled.

The tiny bottles, beakers, crucibles and casseroles employed in this fine work are

(Continued to page 228)

IT'S A
GRAND FEELING.
TO BUILD A
MINIATURE HOUSE



IT'S A GRAND FEELING, TOO,
WHEN YOUR CAR IS
CUSHIONED WITH MARFAK
CHASSIS LUBRICATION

THAT CUSHIONY FEELING LASTS LONGER WITH MARFAK!

It's a grand feeling to work at your hobby . . . the same grand feeling you get from your smooth riding, *Marfak* lubricated car.

A smooth riding car means *Marfak* is doing its job . . . and it sticks to the job for a thousand miles and more. *Marfak* is scientifically designed to cling to bearing surfaces, to resist wash-out, jar-out and squeeze-out. Now is the time to see your Texaco Man and say: "*Marfak*, Please!"



THE TEXAS COMPANY

TEXACO DEALERS IN ALL 48 STATES



Tune in: TEXACO STAR THEATER presents the TONY MARTIN show every Sunday night. See newspaper for time and station



Let's get this show on the road!

• I'm unwilling host to some underfed fugitives from a flea circus—and I'm the only one who's fed up!

What I need is a bath with Sergeant's SKIP-FLEA Soap, followed by regular dustings with SKIP-FLEA Powder. The SKIP-FLEA combination knocks 'em dead . . . and it's safe for me. Ask for the new 50c economy size of the powder.

SKIP-FLEA Soap and Powder are only two of the 19 dog care products developed by Sergeant's in over 73 years of thorough clinical research and testing.

Each one helps to keep your dog healthy and happy.



• Learn more about how to give your dog the care he deserves with Sergeant's new FREE Dog Book. It contains a lot of interesting, useful advice on dog care and training. Ask for it at your drug or pet store, or write to Sergeant's, Richmond 20, Va.

Sergeant's DOG CARE PRODUCTS

SAY YOU SAW IT IN POPULAR MECHANICS

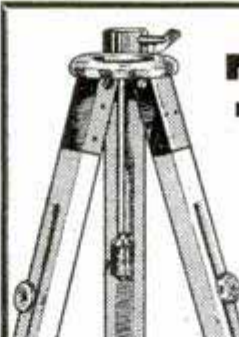

U. S. GOVERNMENT SURPLUS **TRIPODS**

Strong Wooden Tripods with adjustable metal legs. 5½ foot extension. Used by Government for engineers levels and transits. Can be used for holding Telescopes, Cameras, etc.

Value \$24.50
\$4.95

WHEATSTONE BRIDGES

Used, in excellent condition. Mfg. by Thompson Lever Mfg. Co., Philadelphia. Value \$150.00 **SPECIAL \$49.50**

Engineers All Metal Army Type Hand-Sighting

LEVELS

\$2.00 PRECISION QUALITY



PUBLIC SPORT SHOPS

13 S. 16th St., Phila. 2, Pa.

No COD's

FOR SAFER DRIVING IN STORMS AHEAD
ASK YOUR GAS PUMP MAN TO PUT ON FOR YOU

New "DEAD-LOCKER" Models

ANCO RAIN-MASTER

Windshield Wiper Arms and Blades

Made in U. S. A. by

THE ANDERSON COMPANY

GARY, INDIANA



NEW SAW EASY HANDLING BIG POWER

New American Portable Electric Saw saves time, labor and money in production work. Not a hobby tool. One hand operation. Cuts any angle. 8" blade. Write . . . give occupation.

AMERICAN

FLOOR SURFACING MACHINE COMPANY
535 So. St. Clair St. Toledo 3, Ohio

SEALED POWER PISTON RINGS

save oil, save gas, restore original power

Send postal for free booklet on oil-saving.

SEALED POWER CORP., DEPT. 65, MUSKEGON, MICH.

SELL ULTRA-BLUE STOCK SIGNS



To General Stores over 1000 Different Slogans and Sayings. Fine Line of Religious Ultra-Blue Signs for Homes and General Display. Make Money on these Fast Selling Signs. 3c Sellers. 15—Sample Ultra-Blue Store Stock Signs—7x11, \$1.00 postpd. 15—Sample Ultra-Blue Religious Signs—7x11, \$1.00 postpaid. 100—Ultra-Blue Stock Signs—7x11, \$6.00. No C.O.D.'s.

L. LOWY, 8 WEST BROADWAY, NEW YORK 7, N.Y.—DEPARTMENT 323

THEY CAN'T SHAKE LOOSE FROM A

FLATFISH!

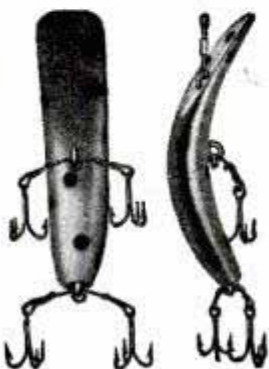

Once the Flatfish gets its hooks into a fish, the fish is as good as in your creel. This is because Flatfish hooks are not the conventional kind of hooks. They're smaller and sharper. They penetrate more easily and more quickly. Then, too, the Flatfish has a hooking arrangement that hooks the easy striker. With the hooks offset from the body of the lure, the fish cannot obtain sufficient purchase on the body of the bait to enable it to throw the hook. World's largest selling plug. Over 3,000 sold every day! Lures in 21 colors. Underwater, surface and trolling models, \$1.20 each. Musky, \$1.35. Flyrod size, 95c. Write for FREE 32-page Color Catalog, including 4,000 word treatise on plug fishing.



Flyrod Model

Two fly-rod sizes — 1/12 or 1/16 oz. for casting or trolling. 95c each.

HELIN TACKLE CO.

6342 PULFORD

DETROIT 7, MICH.

Free CATALOG

"Hope this won't make
you mad, Jerry..."



JERRY: What's on your mind, Uncle Pat? I can take it.

UNCLE PAT: Well, you'd better return that saw and get your money back—if you still *can*.

JERRY: What do you mean? What's the matter with this saw?

UNCLE PAT: It's one of those bargain counter orphans, Jerry. No brand name. No reputation. Nothing behind it to back it up. It'll let you down just as sure as you're born.

JERRY: Brand names aren't *that* important, are they?

UNCLE PAT: They are to *me*. I want *quality* when I buy tools. That's why I always do my buying at the hardware store, where they carry the best in every line. And believe me, I never put my money down till I see a brand name I can trust.

Your **HARDWARE DEALER** sells **QUALITY** tools
and hardware... Buy from HIM



POPULAR MECHANICS



**THE
NEW**

KABINKOOK

A new streamlined two burner gasoline stove for cabins, trailers, boats—or for any small kitchen.

Lights instantly. Approved for safety and efficiency. Removable tank for safe filling. Automatic pressure gauge. Wide burner spread—10¾ inches—permits use of standard utensils. With satin-smooth stainless steel top, light grey body, maroon tank, the AGM Kabinkook is attractive as well as convenient.

GALLEY RAIL

Galley rail available as a slip-on accessory for use in boats. Kabinkook's compactness makes it the ideal galley stove—19¾ x 12½ x 7¼ inches.

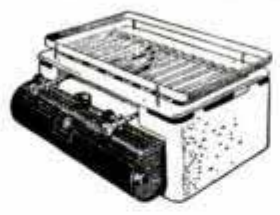

... READY-LITE Backed by fifty years of AGM lamp building experience. One and two mantle models. 8 to 10 hours of brilliant steady white light on one filling.

PRODUCTS OF
AMERICAN GAS MACHINE COMPANY
Albert Lea, Minnesota



"Equipment Most Sportsmen Like Best"

much smaller than doll dishes. One bottle holds only a single drop of liquid.

While the men in the microlaboratory are dealing with thumbnail quantities, workers in the nearby liquid and ointment department are busy with carload lots. In one big room are 30 big 1000-gallon tanks and 50 smaller tanks—all glass-lined. Then there are pumps, filters, mills, homogenizers and electrically operated mixers.

In another room, goggle-protected workers concentrate on making a synthetic vitamin D called viosterol. They dissolve ergosterol (extracted from yeast) in ether and suspend the solution in quartz flasks over banks of ultraviolet lamps. The ether evaporates and the vitamin product is purified and dissolved in an edible oil.

Constant tests assure that all products are pure and effective. From the standpoint of visitors going through a drug plant, the tests are perhaps the most interesting part. Rats, mice, guinea pigs, monkeys and humans are used. Fifty Abbott employes formed the "Human Guinea Pig Club" and volunteered to submit to various tests. They give blood, taste new tablets and hold still while hypodermic needles are stuck into their arms.

Partly because of their spirit, it was possible to find new methods to produce better penicillin, streptomycin and other lifesaving drugs.

Dual-Purpose Signal Generator

(Continued from page 215)

is controlled by the capacity of condenser C5, and it may be raised or lowered by using a different value of condenser. A smaller condenser will give higher tone, and a larger condenser a lower-frequency tone. If the audio portion of the generator is working properly the next step is to connect the unit to a radio receiver by means of the 4-ft. shielded lead. This is a single-conductor shielded rubber-covered lead connected to the through-panel insulator; its woven metal shield is grounded on the metal panel under the clamp. This r.f. test lead terminates in two spring clips, one attached to the conductor and the other to a short lead soldered to the woven-wire shield. The clip on the center wire is attached to the antenna post of the receiver and the shield clip to the ground post. With the receiver tuned to the middle of the broadcast band, the dial C8 of the signal generator is rotated. Somewhere near the 50-degree mark on the dial you will hear the signal from the generator. Paralleled 2-gang condenser C8 can be 360 or 365

(Continued to page 232)

Do a Better Job WITH ONE OF THESE EMPIRE LEVELS

EMPIRE TORPEDO LEVEL
Smallest, most handy and accurate Level made. "Cigar-shaped"—no sharp corners to tear pocket. Aluminum stock. Only 3 oz. wt. 9" long. Has Level, Plumb, 45° Vials.
No. 26\$1.75



ALUMINUM LEVEL — No. 151
Cast and Machined, a Beautiful Tool, with Patented, Removable Level and Vial.
With 2 Plumb, 2 Levels, 2 — 45° Vials. 18"\$6.00
24"\$6.50 28"\$7.00
Order EMPIRE LEVELS from your local dealer.
Write direct for literature.

EMPIRE LEVEL MFG. CO.
717 S. 6th St. Dept. P-247 Milwaukee 4, Wis.

FIND UNDERGROUND MINERALS and METALS with M-SCOPE

Employs same principle as Army Mine Detector. Unsurpassed in Efficiency. Write for Free 16 page booklet.

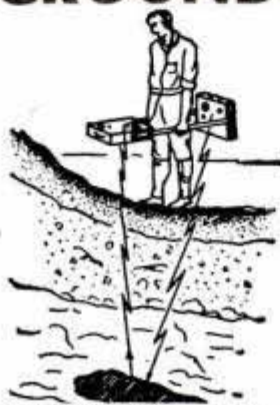

FISHER RESEARCH LABORATORY, INC.
PALO ALTO CALIFORNIA

Amazing Low Cost Addin's Tool DOES ALL TYPES WOOD SHAPING

**ROUTING, TONGUE and GROOVE, FLUTING
NOTCHING, INLAY, ANY TYPE OF JOINT**



Comes with 2 ground blades and 4 blank blades for grinding to shape needed for any particular job. These 6 blades will make 12 different cuts. Send \$5.95 check, cash or money order for prepaid shipment, or name and address on the postcard for C.O.D. shipment.
DESIGN CO 2016 East 31st St. Dept. P27 Kansas City, Mo.

If your dealer does not stock this item order direct giving his name & address so we may credit him.

**\$5.95
COMPLETE**

GET A NEW THRILL IN NIGHT FISHING

with the New
BITE LITE BOBBER

When the Fish Bites
The Bobber Lights

Have more fun! Catch more fish! Beautiful, streamlined colored plastic case. Has exclusive line locking Depth Control Device. Good for day fishing, too. Long life battery flashes only when fish bites. New batteries only a few cents anywhere. Individually boxed, complete with battery, only \$1.50 at your dealer. Legal in all states.
If your dealer cannot supply you we ship direct, postage paid. Write for literature on other outstanding fishing accessories.

GLO LITE BOBBERS INCORPORATED
912 FRANCIS PALMS BLDG. • DETROIT 1, MICHIGAN

Radio's Greatest
Buying Guide!

FREE



ALLIED'S NEW RADIO CATALOG

Send for this Big
Value Book NOW!

Send for your FREE copy of the leading Buying Guide for Everything in Radio! Here's the handiest catalog for Servicemen, Dealers, Soundmen, Amateurs, Builders and Experimenters. Features the world's largest and most complete stocks of quality radio and electronic supplies—all at lowest prices! Get the equipment, the speedy service, the expert help you want, from ALLIED—Radio's Largest Supply House!

164 PAGES — RADIO'S BIGGEST!



HUGE STOCKS—MORE THAN 10,000 ITEMS

Everything for every radio use: new model home radios, phono-radios, communications receivers, Ham kits and gear, radio parts, tubes, tools, test instruments, public address equipment, low-cost easy-to-build radio kits, diagrams, instructive radio books, radio's most complete stocks—all at lowest prices!

HELPFUL RADIO BOOKS!

Radio Formulas & Data No. 37-752 . . . 10c
Dictionary of Radio Terms No. 37-751 . . . 15c
Radio Circuit Handbook No. 37-753 . . . 25c
Radio Builders' Handbook No. 37-750 . . . 15c
Simplified Radio Servicing No. 37-755 . . . 10c
Radio Data Handbook No. 37-754 . . . 25c
ALL 6 BOOKS above No. 37-799 . . . \$1.00
Parallel-Resistance and Series
Capacitance Calculator. No. 37-960 . . . 25c
R-F Resonance and Coil
Winding Calculator. No. 37-955 . . . 25c

ALLIED RADIO

ALLIED RADIO CORP.
833 W. Jackson Blvd., Dept. 5-G-7
Chicago 7, Illinois

**FREE
CATALOG**

Rush FREE 1947 Catalog
 Send 6 Books No. 37-799
 Send Books checked above
 Send Calculators checked above } \$.....enclosed

Name.....

Address.....

City.....Zone.....State.....

LOW PRICED

FOR THE FIRST TIME IN YEARS!

DOES ALL
THESE JOBS
EASIER, BETTER



SANDING



POLISHING



CARVING



ROUTING



GRINDING



DRILLING



ENGRAVING



SHARPENING



CLEANING

Real fractional horsepower AC-DC Electric Motor



FAMOUS CASCO POWER WORKSHOP

New portable all-purpose Electr-O-Tool Kit
FOR MECHANICS, HOBBYISTS, HOME CRAFTSMEN

Speed your work on wood, metal, glass, plastics, leather with this professional all-purpose tool. More exclusive features than any other tool on the market. Long life, powerful 20,000 RPM motor in unbreakable plastic case, oil-less bearings, air-cooled. Exclusive built-in finger grip for perfect control in fine detail work. Weighs only 12 1/2 oz. Fully guaranteed. Complete with 20 precision-made accessories in fitted chest. Hobby or professional work is easier with this whole shop full of tools in one. Do hundreds of jobs by simply changing the versatile accessories.

Buy at your dealer's today. If he cannot supply, write direct to factory giving dealer's name. Free descriptive literature on request.

SPECIAL LOW PRICE OFFER

Price of power tool alone \$14.95
20 accessories and valuable Project Book 8.50
Total Value \$23.45

ALL 21 PIECES FOR ONLY \$14.95

ANOTHER
BIG VALUE!
CASCO
ELECTRI-CRAFT
POWER TOOL KIT
complete with
36 accessories in
fitted steel chest
**\$32.95 value
for only \$22.50**



CASCO

CASCO PRODUCTS CORPORATION • BRIDGEPORT 2, CONN.

EXTRA \$'s in CONCRETE BLOCKS

SPARE TIME or FULL TIME, YOU'LL MAKE EASY, EXTRA MONEY

There's a concrete block shortage you can turn into extra cash. Or, if you're planning to build, you can save on material costs by making blocks for your own use. Either way, you make money.

MAKE UP TO 25 STANDARD BLOCKS PER HOUR

With the DANDY BOY Block Maker you can easily build up to 25 standard (8x8x16) blocks per hour. Many styles and patterns. Earn — or save — up to 17c per block. Operating costs are small.

BIG MARKET IN YOUR HOME TOWN

Your friends and neighbors, planning to build garages, sheds, workshops and many other structures, are good prospects for concrete blocks. Get the DANDY BOY Block Maker story and see how easily you can cash in on the demand. Complete instructions for the machine. Inexpensive. Write for Booklet B3 today.



The MIDLAND Co., So. Milwaukee, Wis.

Sand Casting—Forging—Heat Treating—Case Hardening BRONZE FOUNDRY



is again available in limited quantity without priority. Orders filled in sequence as received. INVENTORS—SCHOOLS—CRAFTSMEN use FOUNDRYETTE for making castings quickly for new inventions, for instruction, and general purpose. Order now for early delivery. Three sizes are available capable of making bronze castings of 1 1/2, 3, and 6 pounds weight, aluminum, copper, brass, etc. Domestic gas supply and 110 volt AC or DC energy required for operation.

Write for circular.

KANSAS CITY SPECIALTIES CO.

Box 6022, Dept. P-80

Kansas City, Mo.



The Modern PLASTIC for lasting Home Repairs

PERMANENTLY mends cracks or holes in wood, tile, stone or plaster. Sticks and stays put—Does not chip, shrink or fall out. Easy to use. Economical. Mold it, chisel it, polish or paint it. If unobtainable from your lumber, paint or hardware dealer, the big 4-lb. (in U.S.) for only \$1. Full money-back guarantee, order now.

DONALD DURHAM CO.
Box 804-G, Des Moines, Iowa

BUILD YOUR OWN TRAILER

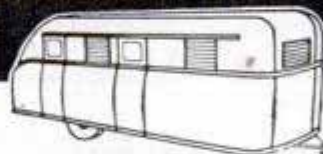

Get these Modern Complete Plans

Select just the model you want—for hunting—travel—camping—or as a home. Each plan is complete with simple, step-by-step instructions and a bill of materials. Easy to follow. Three models!

STOCK No. H27 NATIONAL MODEL 27. A sleek 27-foot trailer with 3 rooms, lavatory, etc. Sleeps six, complete plan \$1.00

STOCK No. H20 NATIONAL MODEL 20. A good-looking, easily-built 20-ft. trailer, 3 rooms, sleeps four, complete plan \$1.00

STOCK No. H10 NATIONAL CAMPER. A compact unit for traveling, camping, hunting, fishing. Sleeps two. Complete plan .50

Special—Order all 3 of above plans.....\$2.00

FREE! Big parts catalog with any order

NATIONAL TRAILER STORES

Dept. 10 Box 2353 Terminal Annex - Los Angeles 34, Calif.



Brighten your rooms at modest cost... Redecorate with Luminall. There's a dealer near you.

Luminall Paints, Chicago 9.

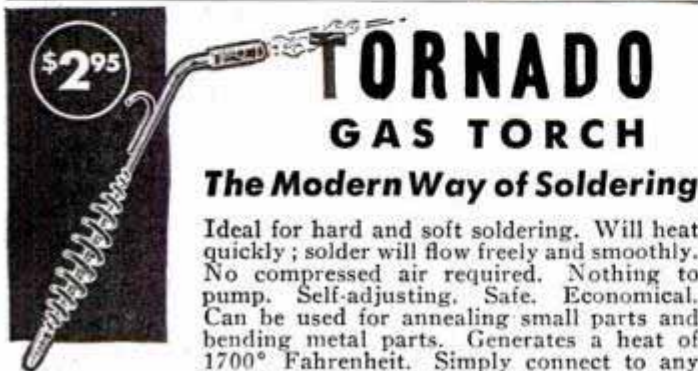

TORNADO GAS TORCH

The Modern Way of Soldering

Ideal for hard and soft soldering. Will heat quickly; solder will flow freely and smoothly. No compressed air required. Nothing to pump. Self-adjusting. Safe. Economical. Can be used for annealing small parts and bending metal parts. Generates a heat of 1700° Fahrenheit. Simply connect to any illuminating (manufactured) gas jet with a

rubber hose and operate. Tornado Torch No. 119 comes with three (3) tips, ($\frac{1}{8}$ ", $\frac{1}{4}$ ", $\frac{3}{8}$ " blast).

The Tornado Gas Torch No. 119, complete with three tips, is \$2.95. See your dealer or order direct. Send check or money order—post paid.

Robco Corporation, 202 E. 44th Street, New York 17, N. Y.



THE UNIVERSAL LIQUID CEMENT

The "Mr. Fix-it" for "a million things"

Tops in quality for 37 years. Uses unlimited... sticks and mends permanently. Waterproof... quick drying. Keep a tube on hand always. Extra quality... extra strength. Ready to use. LOOK! Get acquainted with Ambroid quality. At your dealers or send 25c for big 2-oz. tube postpaid (U.S.A. only). Money back guarantee. **25¢**

AMBROID CO.
303 Franklin St., Boston 10, Mass.

Also 50c 4-oz. tube, Pts., qts., gals. for industrial use.



BE FAIR TO YOUR Hair

WAKE UP YOUR SCALP Want better looking hair? Embarrassed by falling dandruff, itching scalp? Then try VITABRUSH, new electric driven scalp brush that gives your scalp a vigorous and invigorating "workout" in just three minutes of fun. Cleans scalp. Stimulates blood supply. Restful. Pleasant. Write today for complete information and satisfaction-guaranteed offer.. Hershey Mfg. Co., 3735 Field Bldg., Chicago 3

JULY 1947

HOW YOU CAN SEAL CRACKS IN CAST METAL

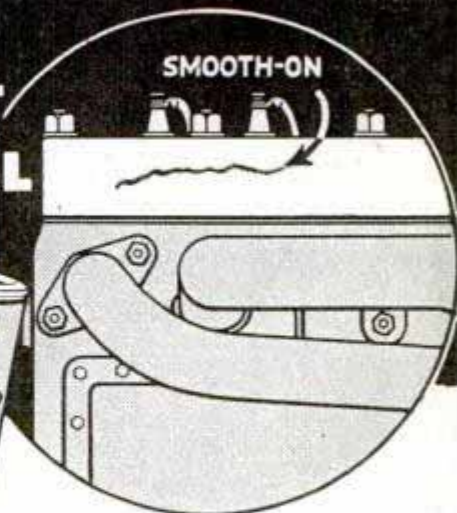

Do as professional repairmen do—seal small cracks and porous holes in metal castings with Smooth-On No. 1 Iron Cement.

You simply mix Smooth-On with water and force the mixture into the opening. It hardens like metal and stays tight, because Smooth-On expands slightly as it sets.

Sealing cracks is only one of many useful metal repairs you can make with Smooth-On around the house, in the garage, etc. Use it to stop pipe leaks, tighten loose bolts, screws, knobs, casters, fixtures and parts. Saves time. Saves money.

Keep Smooth-On handy for emergency repairs. Buy it in economical 1 $\frac{3}{4}$ -oz. or 7-oz. size at your hardware store. If they haven't it there, write us.



FREE HANDBOOK SHOWS HOW

Send the coupon for this 40-page pocket size manual. Gives clear, tested directions for making metal repairs without using heat, on household equipment, auto parts, utensils, tools, cutlery, etc. 170 diagrams. Describes also other useful Smooth-On Cements for special purposes.

— — — Sign and Send NOW — — —

Smooth-On Mfg. Co., Dept. 37G
570 Communipaw Ave., Jersey City 4, N. J.

Please send me my free Smooth-On Handbook

Name.....

Address.....

7-47

SO-207

Do it with SMOOTH-ON
The Iron Repair Cement of 1000 Uses

SAY YOU SAW IT IN POPULAR MECHANICS

231

USE AC's FOR UTMOST RELIABILITY

Factory-recommended AC's, of correct Heat Range for today's fuels and driving speeds, help millions to be punctual. Have your plugs checked to be sure that you have the right plugs for today's driving and fuels.



Look for this sign



Spark Plugs cleaned and adjusted "By the AC Method" may save as much gas as 1 gallon in 10.

AC SPARK PLUGS

AC SPARK PLUG DIVISION • GENERAL MOTORS CORPORATION

mmfd. The generator can now be calibrated by using known broadcast band signals.

The "signal substitution" method of trouble shooting is briefly as follows: As the generator provides both audio and radio-frequency signals it can be used to trace both of these circuits in the receiver. Starting with the audio end, plug standard test leads in the audio jacks; ground one lead on the chassis of the receiver under test and apply the other lead to the grid prong of the final audio output tube in the set. If this stage is working properly, the 400-cycle tone will be heard in the loud-speaker. Reverse the unit line plug in the wall socket if hum is present. Next, the signal is applied to the audio driver stage; again the signal should be heard, louder this time because of the extra gain provided by the

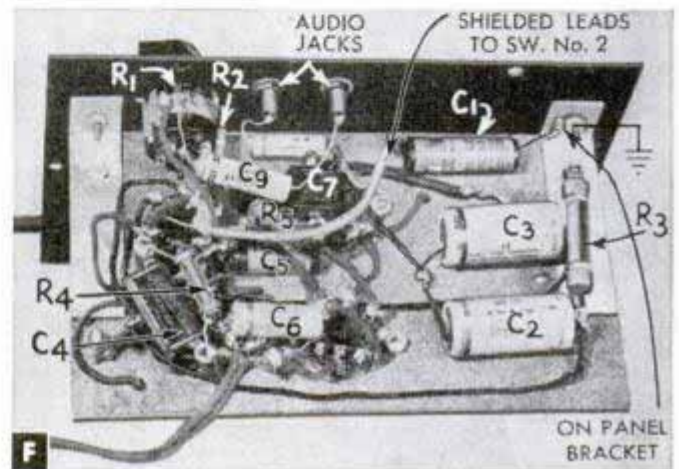

additional tube. The next step is to throw the audio-r.f. switch No. 2 to r.f. and use the shielded r.f. output lead. The center test-lead clip is then applied to the plate of the detector tube (assuming it is a diode detector of a superheterodyne set) and the signal generator is tuned to the i.f. frequency. If the detector is working properly the signal will again be heard in the speaker. In sequence, the generator r.f. signal is applied to the plate and the grid of the i.f. tube and then to the plate of the mixer tube. Finally the generator is retuned to the frequency to which the mixer stage of the receiver is tuned in its grid circuit, and then r.f. signal is applied to the grid of this stage. Again the signal should be heard in the loud-speaker. In any of the above steps if it is impossible to get the signal through the stage under test the chances are good that the trouble is in that stage. A voltmeter is then used to check all voltages and resistors in this stage. The signal generator isolates the trouble to one tube. Detailed student material list R-357 is available from Popular Mechanics Radio and Electronics department upon receipt of ordinary letter postage.

It Pays to Buy an
**AIRCOOLED
DIESEL POWERED
Generating Set**



Uses low-cost
furnace
fuel oil,
and less of it!

No electrical
ignition
to service

No
explosive
fuel to
store

Steady voltage
power... free
from outside
interference

Literature containing complete information is available. Just mail a post card today.

R. H. SHEPPARD CO., INC.
48 Middle St., Hanover, Pa.

DIESEL'S THE POWER...

Sheppard's the Diesel

Stop This!



with original

HaCAR Safety Locks

2 DOOR SAFETY ON 4 DOOR CARS

Perfect safety for every rear seat occupant. Ideal theft protection, too. Simple, concealed HaCAR installation makes it impossible for the rear doors to be opened accidentally.

Easily installed by any garage. From your dealer or write for complete descriptive literature.

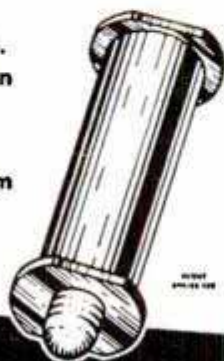

**Consolidated
Sales Co., Inc.**

4525 12TH STREET
DETROIT 8, MICHIGAN

GET THERE

SAFE!

**35 MILES-PER-HOUR
TOP SPEED!**

Servi-Cycle... America's only complete powercycle... far exceeds every I. P. A. safety rule. America's safest powercycle.

**SAFETY
FIRST**



GET THERE and

SAVE!

**100 MILES TO THE
GALLON!**

Servi-Cycle slashes travel, delivery expense up to 75%. Cost: just a fraction of a cent for every mile you drive.



GET THERE

EASY!

**SIMPLE TO DRIVE—
LIGHTWEIGHT!**

Servi-Cycle handles easy as a bike. Rugged engine and sturdy frame are single unit. Thousands of satisfied owners, since 1931.



GET A

SERVI-CYCLE!



**\$249.50
DELIVERED**
*Slightly higher
on East and
West coasts*
**SEE IT!
TRY IT!**
at your Dealer's

For Name of Dealer,
See Phone Directory or Write to Nearest Servi-Cycle Factory

NEW ORLEANS 19
540 N. Carrollton
Avenue

SAN FRANCISCO 24
1821 Egbert
Avenue

BALTIMORE 30
1205 South Carey
Street



WRITE FOR YOUR **FREE** COPY OF THE NEW **KRW HYDRAULIC PRESS BOOK**

Describes all manner of Production and Shop Work on KRW Hydraulic and Bench Type Arbor Presses. 32 pages illustrating the new KRW Hand-operated, Electric-operated and Air-operated Hydraulic Presses. *Write for your copy today.*



K. R. WILSON, DEPT. 17, 215 MAIN ST., BUFFALO 3, N. Y.
Builders of Shop Equipment for Ford Dealers Since 1916

TireX INFLATES FLAT TIRES INSTANTLY



She Won't Be Late. Thanks to TireX!

In 60 seconds that flat tire will be inflated and ready to go. TireX contains enough compressed CO₂ to fill 3 flat tires. Just attach it to the tire as you would an air hose, turn the handle and up comes the tire without any effort whatever.

TireX—A Wonderful Fire Extinguisher, Too!

CO₂ is ideal for smothering any fire likely to occur in an automobile. It works fast. The CO₂ "snow" evaporates immediately without a trace. It can't damage the car finish, engine, or upholstery.

If your dealer can't supply, send check for \$4.00 for \$4.00 and your TireX will be sent prepaid. Money-back guarantee. Refillable for life-time use.

BREAKSTONE & CO.

2155 West Harrison St. • Chicago 12, Illinois

SAY YOU SAW IT IN POPULAR MECHANICS

Thompson BEATS the World on BOATS



Better Built Lower Prices



Safe Boats With Full Length Spray Rails
 Keep passengers perfectly dry—even at high speeds. Catalog also shows two new models of "Take-Along" Boats. Two big factories—save you freight.

CATALOG FREE
 Write for your copy. State kind of boat in which you are interested.
THOMPSON BROS. BOAT MFG. CO. (151)
 213 Ann St. PESHIGO, WIS. (Write to either place) 113 Elm St. CORTLAND, N.Y.

Light Boat for Auto

Here's the **OUTDOOR FIREPLACE** YOU CAN BUILD YOURSELF!



only \$29.50*

The Grill King is a barbecue beauty, a self-contained unit ready for masonry... easy to build and sure to make a hit with your picnic crowd! All you have to do is add stonework or bricks in the design you like best.

Outdoor cooking's a real treat with the Grill King. Made of sturdy steel, it has adjustable grids for use with any solid fuel. Grate size is 13 1/2" x 24". Complete assembly instructions and design suggestions are sent with each grill.

Get set for your outdoor parties now—order a Grill King today. Satisfaction guaranteed. Send check or money order to...

GRILL KING

*E. O. B. Youngstown

BOX B, WEST SIDE • YOUNGSTOWN 9, OHIO

"I'LL TAKE THE WHITE ONE EVERY TIME!"



WYTEFACE
 TRADE MARK
STEEL MEASURING TAPES



KEUFFEL & ESSER CO.



CROSMAN *Silent* RIFLE

**POWER
without POWDER**

You'll like a Crosman because there is no recoil to spoil your aim...no noise...no odor...no cleaning! Rifled barrel for greater accuracy...adjustable power, too, for short or long range shooting indoors or out. Available in .177 and .22 cal. models.
AT YOUR DEALER OR WRITE DIRECT

CROSMAN ARMS CO., INC.
3 HENRIETTA ST., ROCHESTER 7, N. Y.

Shoot CROSMAN *Super*Pellets

The BETTER Ammunition for ALL .177 and .22 caliber Air Pistols and Rifles.



.177 cal...\$2.50 per M
.22 cal...\$3.00 per M
POSTAGE PREPAID

FOR
GREATER
ACCURACY
MAXIMUM
POWER

At your dealer or order direct

CROSMAN ARMS CO. HENRIETTA ST., ROCHESTER 7, N. Y.

The Papoose

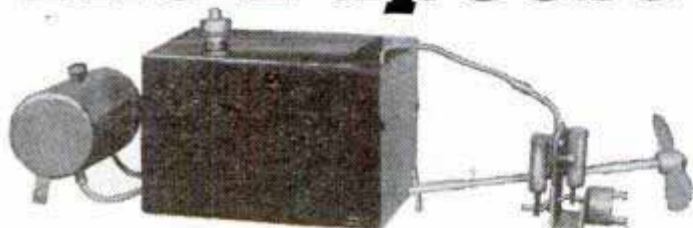

Model SE-7 is the most efficient engine we have ever made. Designed for boats 18" long and larger it turns a 2 1/4" propeller, larger in diameter than the height of the engine itself. The PAPOOSE is a two-cylinder oscillating type engine of 5/16" bore by 1/2" stroke. Burns alcohol. Runs 12 minutes.

Price postpaid, complete ready to run, with boiler, burner, propeller, shaft and fittings, and 70-lb. safety valve..... **\$6.50**

PHILIP STEVENSON COMPANY

Box 162, Station D Cincinnati 6, Ohio

New Idea for Hobbycrafters!



Fla-Master

**Valve Controlled
Fountainbrush**



MARKS • DRAWS • WRITES... ON ANYTHING!
Indispensable for marking tools, making patterns and layouts, sketching, labelling, etc., etc. Use it on metal, glass, wood, paper, cloth, cellophane. Streamlined, pocket size, leakproof. Permanent, waterproof, instant drying Cado Inks in black and 7 colors.

\$3.00 with Ink (\$3.25 Denver & West) at Stationery, Hardware and Art Supply Stores, or order direct.

CUSHMAN & DENISON MFG. CO.

135PM West 23rd St. New York 11, N. Y.

\$12.85 List

**GENUINE
TURNER
MICROPHONE**

MODEL 20X

Record at home, parties, etc. Get high quality results with new Turner crystal type hand microphone. Improved circuit. Light weight. Convenient. Low cost. Use with any high impedance recorder. Ask your dealer or write for bulletin. Free literature on all Turner Microphones.

THE TURNER COMPANY

921 17th Street N. E., Cedar Rapids, Iowa

**YOU CAN
"FEEL" THE
DIFFERENCE**

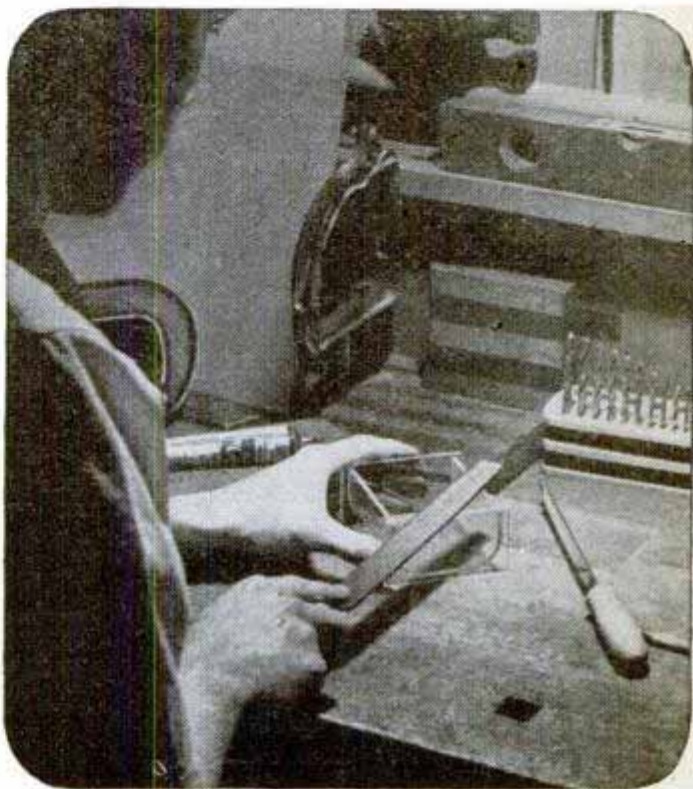

It takes a careful eye to see the difference between Nicholson or Black Diamond files and ordinary file brands. Yet most any hand can *feel* the difference with just a few strokes of these master quality files. It shows up in their trim balance... in the way they hold to the line... in the smooth, even bite of their teeth. It's qualities like these that make Nicholson and Black Diamond the favorite files among home and industrial craftsmen. They're easy to obtain—good hardware stores have them or can get them for you.

Write for free, 48-page book, "File Philosophy," containing helpful information on the selection, use and care of files.



NICHOLSON FILE CO.
22 Acorn St., Providence 1, R. I.
(In Canada, Port Hope, Ont.)



**NICHOLSON
FILES FOR EVERY PURPOSE**



Performance!

Put a Scott-Atwater on the back of your favorite craft for a trial run. See how it flashes into action on the first pull of the starter! Speed across the lake—watch your boat race through the waves! Then idle down to a creep—your boat barely moves, yet the Scott-Atwater purrs smoothly on.

This sensational performance is the result of experienced, progressive engineering. For example—Scott-Atwater's *multiple feather-valve intake system*. Scott-Atwater feather valves *automatically change timing* to maintain a full fuel charge at *all speeds*. This guarantees easy starting, slow trolling and full top speed.

Send coupon today for the new fishing book, "How to Catch More Fish."

4 MODELS

A Standard and De Luxe Single, developing 3.6 horsepower at 4,000 r.p.m. OBC certified.

A Standard and De Luxe alternate firing Twin, developing 7½ horsepower at 4,200 r.p.m. OBC certified.



"HOW TO CATCH MORE FISH!"
by Frank R. Steel, national authority on fishing.

Tells you how to fish by revolutionary method of water temperatures. Specific information concerning at what depth fish will be according to temperature of water. 48 pages, illustrated in color, diagrams of lakes and streams. Send coupon.

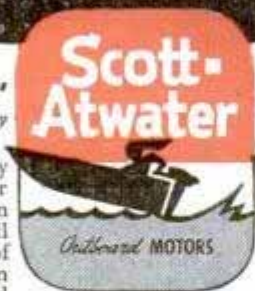
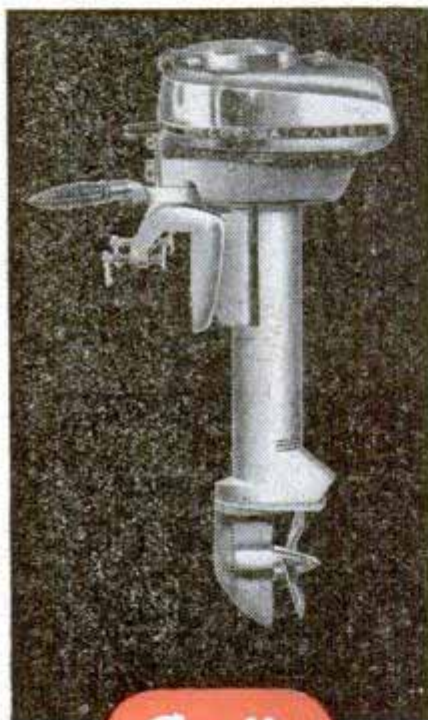

SCOTT-ATWATER MFG. CO., INC.

2901 East Hennepin Avenue
Dept. PM77, Minneapolis, Minn.

Enclosed find 10 cents for which please send me a copy of Frank R. Steel's new booklet, "How to Catch More Fish."

Name

Address

City State

School for the Big Cats

(Continued from page 84)

pedestal and sit down—may take a half hour or two years. But this and the more intricate tricks are based on the trainer's ability to make the animal follow the tip of a whip or stick.

Roars, snarls and spits from the animals dress up any lion show. Clemens has a neat little trick he uses to make his cats bellow on cue. During the first stages of training they instinctively snarl and roar at the whip that dangles above their noses. Clemens holds his right fist toward their faces. Whenever a lion roars, the trainer spreads his fingers. Eventually the process is reversed in the lion's mind. Whenever Clemens opens his hand the lion roars. It's what a psychologist would call a conditioned reflex but to Clemens it's just a training trick.

During Clemens' act there are 10 lions, two tigers and one man in the cage. The animals build pyramids, walk planks, roll over, jump through fire hoops, sit up and play leapfrog.

Clemens' more spectacular stunts include riding a lion's back like a horse, taunting one of the cats until it leaps at him from a high pedestal, and holding his head inside the mouth of his most trustworthy animal.

To teach an animal to balance himself on his hind legs the trainer uses a mechanical "crutch"—an ordinary pedestal fitted with a hinged support along one side. A rope runs from the support through a pulley in the top of the cage to an assistant outside. Clemens lifts the cat off his front feet by dangling the whip above his nose. The lion finds himself sitting straight up, leaning against the hinged support for balance. The assistant gradually drops the support until the lion is sitting by himself.

Meat often is used as a bait in teaching tricks to the tigers. According to Clemens, these striped cats are sneaky as a snake, treacherous as a mule, and a lot more dangerous than either. He frankly admits he's nervous whenever they're in the cage. After a two-hour warm-up with the lions, he switches to the tigers for an hour. It isn't a very pleasant change. Clemens considers lions reasonably safe as long as they're on their pedestals—it's when they're on the ground that they become dangerous. Tigers are dangerous all the time.

After a nerve-racking hour with the tigers he polishes the entire act for 12 minutes, then drives the animals back to their cages. Then he may train his "punks," the 1½-year-old cubs, for a while, which he considers a more or less pleasant pastime.

(Continued to page 240)



**Snap-on's BLUE-POINT BOXOCKETS
combine socket wrench grip
with direct leverage!**

Straight handle Boxocket wrenches are designed with heads set at a 15° angle so that they can be used in many corners where an offset wrench might prove cumbersome.

The 15° angle provides ample clearance from obstructions . . . avoids skinned knuckles . . . and gives you long, direct, pulling leverage. Add to this the many advantages of Boxocket construction, including the fact that they need only half the space required by an end wrench when handle movement is limited, and you have a husky, "no-slip, no-spread" Boxocket wrench to speed your work. Sizes range from 3/16" to 1 1/4" with different size openings in each end for double duty service. Other Boxocket styles, 3/16" to 3 1/8". Available through Snap-on's nationwide, direct-to-user tool service.

SNAP-ON TOOLS CORPORATION
8062-G 28th AVENUE • KENOSHA, WISCONSIN
International Division: Kenosha, Wisconsin, U.S.A.



XD-6K BOXOCKET SET
12 popular wrench sizes ranging from 7/16" to 1" without duplication, offset at 15° angle on 6 long-leverage handles. Complete in sturdy leatherette kit for **\$1100** only

MAIL YOUR ORDER . . . Our local representative will deliver the set to you. Give business address if possible.

Snap-on Tools
THE CHOICE OF BETTER MECHANICS



"In the new 4-passenger Crosley convertible I think we've struck a note in harmony with the youthful heart!"

Powell Crosley, Jr.

PRESIDENT, CROSLY MOTORS, INC.

Have you a flair for youth and beauty? Then the new fine CROSLY Convertible is the car of your dreams! One ride will prove it.

Here's big-car roominess, ample for 4 husky 6-footers, plus baggage. An easy-to-manage top that snaps into a snug weather-proof in a jiffy. Real CROSLY economy that won the fine CROSLY Sedan a place in America's warm heart! CROSLY COBRA (Copper BRAZed) steel engine, of course — that 59 lb. 4-cylinder, valve-in-head powerhouse that gives 35-50 miles on a gallon of ordinary gasoline; speeds up to 60-plus. And typical CROSLY maneuverability, pick-up, sure-footed nimbleness! The new fine CROSLY Convertible is The Youth-Car-Of-The-Year. Clever new type convertible cloth top. See it today!



EXAMINE THESE FEATURES. ALL STEEL body, low center of gravity, great safety factors, MODERN Streamlining. "the Aircraft Flavor" gives extraordinary beauty. CAR WEIGHS only 1150 lbs., curb-side; perfectly balanced, weight-to-power. EASY DRIVING, virtually "parks on a dime"; oversize shock absorbers. MORE MANEUVERABLE in traffic; 20 inches narrower than most cars. ECONOMY that's almost unbelievable; speeds to 80-plus.

For information and literature write: Crosley Motors, 2532-HB Spring Grove Ave., Cin'ti 14, O.



MACHINISTS • TOOLMAKERS

Gerstner Tool Chests are better in quality, higher in value. Free Catalog.

GERSTNER TOOL CHESTS
447 Columbia St., Dayton 7, Ohio

PERFECT DOWELS

... easily made



With AMAZING NEW SPEE-DOWL

on your lathe or drill press. SAVES its cost, works on any wood, makes perfect burnished dowels for any of your projects. Get yours now on our MONEY BACK GUARANTEED! Two size ranges: Model 8 shown at left, 2, 3, 4, 5, 6, 7 and 8/16", only \$1 ea. Special: any 4 for \$3.50 or all 7 for \$6. Model 30 shown above—9 to 20/16" at \$2.65 each size. Send Postal Note or check NOW! We pay postage

In North America. **FREE LITERATURE.**
JOHNS MANUFACTURING CORP.
DEPT. C-10 DUNELLEN, N. J.



MAGI-KLIPS KIT

TEACH YOURSELF RADIO & ELECTRONICS
BUILD 18 EXPERIMENTS WITHOUT TOOLS!

You've read about this radically new kit designed by former Navy radar engineers. Pre-wired chassis enables you to build 18 different circuits — radio receiver, code oscillator, home broadcaster, photoelectric relay, etc.—by "clipping in" basic components as directed in simply-diagrammed manual. 110 v. AC or DC. Kit's 58 parts alone would cost double this low price.

Order your *Magi-Klips* Kit today and learn electronics quickly at home. Send for illustrated folder to show **\$29.75** complete friends interested in learning electronics this easy way!

DEER & TAYLOR COMPANY Dept. K, 1340 Milvia St. Berkeley 9, California

Universal Jigs



New positioning tools hold 2 pieces of metal, wood, plastic, glass, firmly during fabrication. Adjustable to any angle, 0 to 180. Scaled protractor.

Increases accuracy, reduces spillage, saves time.

Indispensable tool for model builders, maintenance and repair men, welders, brasers, cabinet and pattern workers.

All parts spatter-proof. Other shapes and sizes combine to form 3-Way jigs from \$9.50 to \$42.50. Circulars on request.

Model C-1
1 1/2 in. Cl.
opening

\$14.85
Postpaid

WEBB SALES CO., Lockland, Ohio

Genuine **BENDIX HYDROVAC**

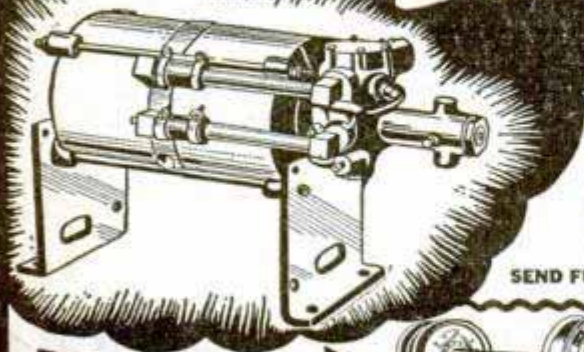

Newest Thing In POWER BRAKES

EASILY ATTACHED TO MOST 1 1/2 To 3 Ton TRUCKS & BUSES
Increases Your Hydraulic Brake Power To Maximum

NOW STANDARD EQUIPMENT ON MOST NEW TRUCKS—CHEV.—DODGE—FORD—INT'L.—ETC.

Unit is easily attached anywhere on Truck, Truck-Tractor or Bus hydraulic brake system to amazingly increase brake power to MAXIMUM. Hydraulic-Vacuum action! Your Master Cylinder controls and activates the Unit! Supplied complete with Installation Parts Kit for most trucks... includes supply Wagner Brake Fluid. List price complete packaged Unit and Kit, \$84.00!

War Surplus Buy!

OUR PRICE \$28.50

Including Parts Kit
(Quantity Discount To Dealers)

SEND FULL REMITTANCE OR 25% DEPOSIT WITH BALANCE C.O.D.

- 20,000 LB. CAPACITY TRAILER AXLE ASSEMBLY \$158 Complete (Less Wheels). New, with Double Cyl. Hydraulic Brakes, 6-Hole Budd Hubs, Etc.
- 20x7 - 6 HOLE BUDD WHEELS TO FIT ABOVE ASSEMBLY \$6.75 EACH.
- 10,000 LB. CAPACITY 16 in. DUAL WHEEL ASSEMBLY \$109 Complete (Less Wheels). New, with Hydraulic Brakes, 5-Hole Hubs, Etc. For 15 in. to 20 in. Single or Duals.
- 16x7.50 - 5 HOLE BUDD WHEELS TO FIT ABOVE ASSEMBLY \$12.50 EACH.

MORE WAR SURPLUS BUYS

NORTHWESTERN AUTO PARTS CO. (DEPT. 7 - 834 NO. 7th ST. MINNEAPOLIS 11, MINN.)

AMERICA'S LARGEST MAIL ORDER DISTRIBUTOR OF ITS KIND - Est. 1918 - "29th Year" • SEND FOR CATALOG • Specify Items You're Interested In!

NO MORE RUPTURES! SKINNED KNUCKLES! LOOSE OR FROZEN NUTS!

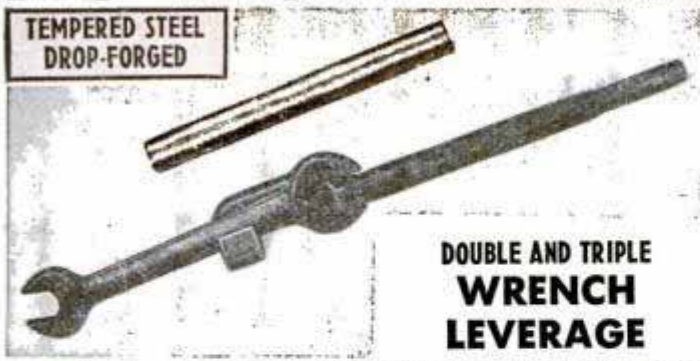

**DOUBLE AND TRIPLE
WRENCH
LEVERAGE**

with the Miller WRENCH EXTENSION
DOUBLE POWER WITH EXTENSION BAR
TRIPLE POWER WITH TUBE HANDLE OVER BAR

Yes, with the MILLER WRENCH EXTENSION, it's goodbye to all strain when you have nuts to tighten or loosen! It's the tool you've always dreamed about—strong and durable—built for lifetime service. **ORDER YOURS TODAY!**
SEND CHECK OR MONEY ORDER

**COMPLETE
\$2.00
POSTPAID**

SORRY, NO C.O.D.'s

L. B. MILLER CO., 394 State St., Stamford, Conn.



READY!

**AMAZING NEW
MAGNETIC
JIGSAW!**

**WRITE FOR
FREE
SYNCR0
CIRCULAR**

Ready for Delivery!

SYNCR0 . . . new, remarkable, patented, magnetic jig saw . . . needs no belts . . . no motor . . . no gears . . . no oiling! Just plug into any 60 cycle A.C. 110-130 volt outlet—and saw! Portable . . . world's safest saw! Cuts clean, smooth . . . no sanding necessary! Ideal for hobbyists, craftsmen, light production. Perfect for models, displays, inlays, etc. Cuts intricate designs on 3/4" soft wood, 1/2" plywood and thinner hardwoods, metals, plastics . . . **NOT** for ordinary lumber. Leaves NO ragged undersides on plywood or heavy cardboard. Special magnetic safety stroke feature! Nothing else like it! Sold on 10 days Moneyback Trial! Prompt delivery guaranteed. Rush name, address on postcard for FREE details, Trial Offer. Hurry!
SYNCR0 SAW CORP., Dept. A-77, Rochester, Mich.



Giffy ELECTRIC HEATER

**HOT WATER
IN FIVE MINUTES**

For baby's bath, your washing, shaving and many other uses in the home, camping business or on the farm.
One Year Guarantee
See your local Dealer or order direct . . .
AMBORY CORPORATION
Dept. PM-4 Hazel Park, Michigan

OLD SAWS MADE NEW

With FOLEY

Handsaw Retoother

You don't even remove the handle—just put saw in machine and in 3 minutes you have a perfect set of new teeth.

Accurate—positive—easy to use. Cuts 20 sizes of teeth from 4 to 16 points per inch on any handsaw. Saves filing time,—no eyestrain. Send for circular.



FOLEY MFG. CO.,
790-7 FOLEY Bldg., Minneapolis 18, Minn.
Send full details on Foley Retoother

Name
Address

Wife's in a huff



Car's a sight!

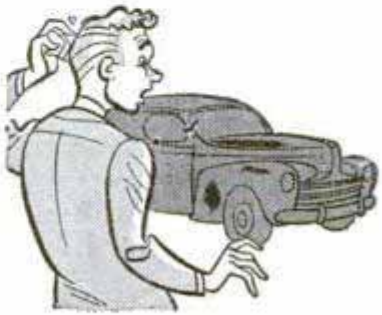

Here's the stuff



To shine it bright



Removes dull traffic film—restores the original color and lustre—quickly, easily and safely.



Nº 7 POLISH

*
**Only *Martin* gives you
 mechanically-controlled
 poppet valves!**

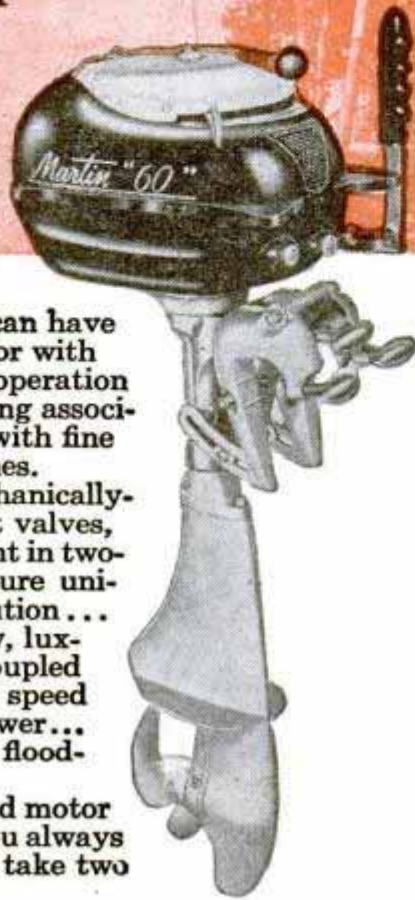

NOW sportsmen can have an outboard motor with the flexibility of operation and ease of starting associated in the past with fine automotive engines.

MARTIN'S mechanically-controlled poppet valves, an exclusive patent in two-cycle motors, insure uniform fuel distribution... unbelievably slow, luxurious cruising coupled with exhilarating speed and maximum power... instant, virtually flood-proof starting...

It's the outboard motor that does what you always thought it would take two motors to do!

MARTIN gives you all you'd expect in a fine outboard, PLUS many exclusive features—

- * **Power-head swivel, 360° (patented)**—Swings lower unit into boat, facilitates checking.
- * **New Martin Vertical Stern Adjustment (patent pending)**—Enables easy adjustment while underway.
- * **New Streamlined, Leak-proof Filler Cap**—Combines vent and spare shear pin clip.

Other highly desirable features: Full reverse steering • Steering stabilizer • Propeller clutch • Depend-a-pull starter • Easy grip stern bracket handles • Synchronized and centralized controls • Resiliently mounted handles and power head • Quiet underwater exhaust • Positive rotor water pump • Long-life sintered bronze rust-proof bearings • Positive oil and grease seals • Alternate firing.

See the new MARTIN at your dealer's, or write for free booklet to: MARTIN MOTORS, Dept. PM-4723 Eau Claire, Wisconsin.

Martin

The New Standard of Performance in

Outboard Motors

He may also require "jugheads" to stay after school if they've acted up during the regular training period. "Jugheads" are animals that aren't quite as bright as Clemens would like them to be.

The "weapons" that he carries into the cage aren't really weapons at all. Clemens says there's nothing short of steel bars or a rifle shot that can prevent a big cat from killing him. His safety depends upon how well he can bluff the cats into thinking they can't reach him. He does it by jabbing a pole or chair toward them. There are half a dozen old chairs around the cage at his home. With legs battered off, they're good evidence that a lion or tiger can reach the trainer any time he wants to—he just doesn't know it.

Whips are seldom used directly on the animals, as a cat that can be whipped into submission doesn't belong in his act. He uses the whip to break up fights, dress up the act and give emphasis to his spoken commands.

Blanks are fired whenever an animal has made up his mind to do something he shouldn't. The loud report makes him forget his plan momentarily and gives the trainer a chance to change the cat's mind.

Clemens points out the discomforting fact that if one lion jumps the trainer the other cats likely will pile in. But there's bad blood between lions and tigers and the striped cats rarely will help any animal except another tiger.

This bad blood leads to frequent scraps inside the cage. One day last year Clemens decided to work four "punks" into the act. It was the first appearance of the cubs and it upset the older animals. Instantly the cage was a melee of fighting cats with Clemens in the middle. When he'd driven the animals back through the chutes one of the cats lay dead and another was so badly wounded it had to be shot. An expensive day.

One of the first questions a stranger asks the trainer is how he got into the dangerous business. Clemens has a wanderlust and dangerous occupations have a magnetic attraction for him. He ran away from home to join a circus when he was 14 and fell naturally into the job of cage boy for the lion trainer. After drifting around for five years he landed a job at the Minneapolis Zoo, a job that lasted only three weeks. The director discovered him training the zoo's lions at night.

He drifted from circus to circus for a while, then wandered around the world from Siberia to Samoa. Returning to the States, he became a deep-sea diver, dredge-

(Continued to page 244)



STOP LEAKS!

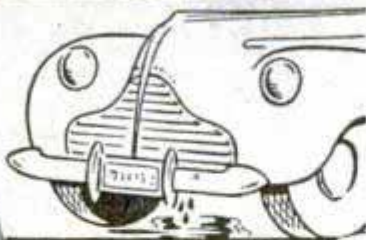

Cooling Systems
Made Leak-Proof QUICKLY

WARNER LIQUID SOLDER—Non-Metallic—Deposits Tiny Fibers to Repair Leaks Anywhere in Cooling Systems. Simply pour in! Finds and REPAIRS every crack or hole. Do it yourself—or see your service man.

Warner-Patterson Co., 920 S. Michigan Ave., Chicago 5

it's so Easy
to...
RE-PAINT IT Yourself



with
EASY-ON
"Just Wipe It On!"

New wonder paint gives you a lustrous, mirror-perfect, factory-like finish in one hour! Just wipe it on with a powder puff! Green, Light Green, Maroon, Gray, Blue, Black, Tan, Yellow, Red. See your local dealer or write. Cash orders sent postpaid, C.O.D.'s accepted. Distributor and dealer inquiries invited.
GUARANTEE PRODUCTS, Inc. Dept. M, 3118 Broadway Chicago 14, Ill.

BUILD YOUR OWN POWER LAWN MOWER

WHY BREAK YOUR BACK MOWING FIELD OR LAWN?

WRITE FOR
FREE
LITERATURE
The Rite-Way
Mower
Attachment
Ball Bearing



SAVE MONEY
SAVE TIME

Now anyone can save time and effort mowing field or lawn by building their own whirl type power mower. Build according to your own ideas and needs at small cost. Cut close to fences, walks, buildings, etc. Build in short time with parts and instructions we furnish. Save hours of time and back breaking labor. Write today for FREE information.



IT'S FUN TO BUILD

T & H MFG. CO., Dept. PM4
811 E. 31, Kan. City 3, Mo.

A TOOLSHOP IN YOUR HAND!

- GRIND • DRILL • ROUT
- POLISH • ENGRAVE
- CUT • SAND • SAW, etc.

Make Things From
Wood—Plastics—Metals—Glass—Linoleum—Leather—Alloys—Horn—Stone—Bone, etc.

HANDEE TOOL OF 1001 USES

Smooth, steady power at your fingertips! Perform precision operations not possible with any other portable tool! With a Handee you can turn out professional looking projects for pleasure or profit—ship, plane and train models, costume jewelry, wood carvings, puppets, initialed tumblers, etc. AC or DC. 25,000 r.p.m. Wt. 12 oz. USE THE RIGHT ACCESSORIES! Choose them from the most complete line . . . more than 500 made right in the Handee plant.

GET A GOOD START GET THE HANDEE KIT

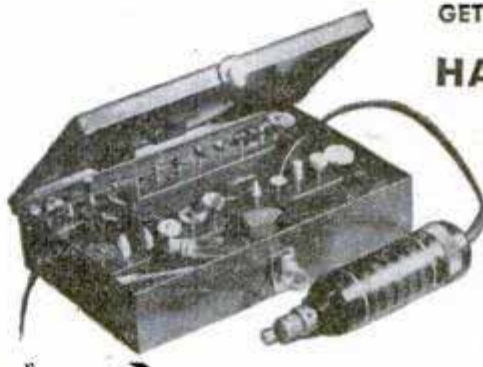

HANDEE Tool and 40 most popular accessories packed in compact steel carrying case. You'll be amazed at what you can accomplish! Complete, postpaid, \$27.50

Handee only, with 7 accessories, \$20.50

FOR YOURSELF OR A FRIEND...
THE GIFT OF A LIFETIME!

NEW PRECISION ATTACHMENTS

Fit Handee only; enable novice or craftsman to do perfect work. Magically, easily, your offhand carving, routing, shaping will be exact as to depth of cut, accuracy of line. Set of 6 attachments with instructions, postpaid, \$7.95

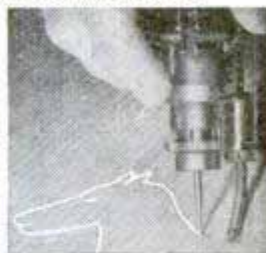

ORDER NOW. SATISFACTION GUARANTEED!

FREE! NEW 52-PAGE MANUAL

CHICAGO WHEEL & MFG. CO.

1101 W. Monroe St., Dept. PM, Chicago 7, Ill.

Send Handee Kit Handee Tool Precision Attachments
 C.O.D. Remittance enclosed Send Manual

Name.....

Address.....



... Quick Easy Way to BIG PROFITS

Read What Others Are DOING!

"Enclosed you will find 56 orders representing 9 1/2 hours' work on Monday and Tuesday."
 "Enclosed are twelve orders secured after supper this p.m."

Housewives are Enthusiastic

Everyone that sees this outstanding Cell-U-Mop immediately wants one. That's the reason why our distributors are so successful. You also have the advantage of our other QUICK SELLING PRODUCTS that step up your Volume Sales and Profits.

Hands Never Touch the Water—Can be put in Boiling Water. Housewives Like It.

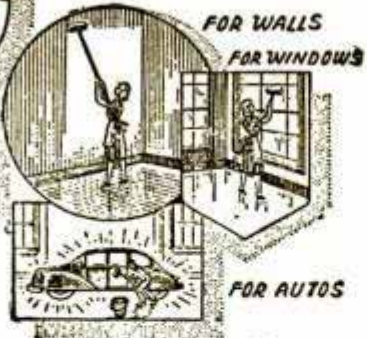

48" Long Handle

Sales QUICK, EASY Every Locality

SALES ARE EVERYWHERE. Sells quick to Taverns, Clubs, Hotels, Hospitals, Stores, Restaurants, Large and Small Buildings and the Homes. Scores can be sold on a single street. Note the Drain Bracket in the illustration. This squeezes out the water so thoroughly that HANDS NEVER TOUCH THE WATER. Makes no difference what you ever sold, you will like this proposition. Your name on a Post Card will bring you FREE PARTICULARS.

CELL-U-MOP CO., Dept. P-7, FREEPORT, Ill.

• We Teach You How •

Gets down under and around for **MOPPING, DUSTING or WASHING**
 Get Choice Territory **NOW!**

DOES THE WORK OF 6 TOOLS IN 1

Holds 20 times its weight in water.



DUAL TAIL PIPE EXTENSION FOR YOUR CAR. \$2.95
 DEEP TONE,
 PRODUCED BY 2 1/2 IN. OUTLETS
 Chrome Plated -- Fits All Cars
 Postage Free on Money Order, Check or Cash
 PAT. PEND. LYONS PRODUCTS Co. 2319 Ridgeley Dr. Los Angeles 16, Cal.

STOP CORROSION and FRICTION
 Use Fiendoil on tools, electrical appliances, household devices. It actively Lubricates - Cleans - Prevents Rust
 3-oz. Spout Can **40c**
FIENDOIL
 "The Enemy of Corrosion and Friction"

MAKE MORE MONEY

APPLYING OR SELLING

CORKSTONE PLASTIC FLOORING

EASY TO APPLY

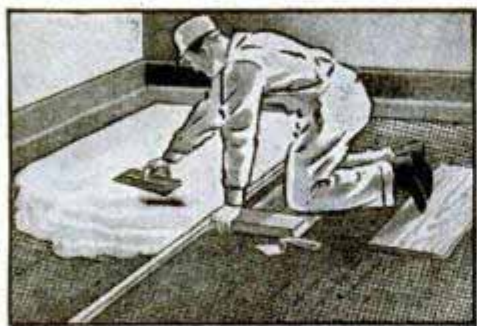

Here's your opportunity to get into business for yourself applying or selling Corkstone, the economical, top-grade plastic flooring. Plenty of profit. Act without delay!

Dealers & Agents Wanted

WRITE FOR DETAILS

LASTING PRODUCTS COMPANY
 FRANKLINTOWN ROAD PLANT, BALTIMORE 23, MARYLAND

\$24.95 Full Set **MICROMETERS**
 Six piece set, in velvet lined leather case. Special price, only \$24.95. Precision machined in one thousandths, up to 4" outside and 3/4" inside measurements. Guaranteed accurate, easy to read and adjust. Satisfaction guaranteed or money back. Also indicators and gauges. Shipped prepaid on receipt of remittance. On C.O.D. shipments, send deposit of \$2.00.
FREE FOLDER
MICRO PRODUCTS, 8655 E. Jefferson, Detroit 14, Mich.

BUILD YOUR OWN FAN with that old motor
 One piece cast aluminum propeller used for cooling and ventilating. Also available to dealers at discount.

Size	Polished	Unpolished	Bore
Inches 15	\$2.50	\$3.50	\$2.00 \$3.00 1 1/2 5/8 3/4
18	3.00	4.00	2.50 1 1/2 5/8 3/4
20	3.25	4.25	2.75 1 1/2 5/8 3/4
24	3.50	5.00	3.00 1 1/2 5/8 3/4
30	5.00	4.00	1 1/2 5/8 3/4 1

KLOPPENBERG ALUMINUM FOUNDRY, Dept. PM77, Davenport, Iowa

SAY YOU SAW IT IN POPULAR MECHANICS

Now CHEAP OIL BURNER
 FOR HEATING AND COOKING STOVES - FURNACES
 HEAT YOUR HOME, COOK YOUR MEALS WITH CHEAP FURNACE OIL
NO MORE SHOVELING COAL OR ASHES. Sensational Fuelizer Starter Vaporizing System turns Cheap No. 1 Furnace Oil, also Range, Heater, Tractor Distillate, Kerosene and like oils into oil heat—one of the quickest, hottest fires known. **LIFETIME GUARANTEE. \$1.00 Bonus Offer for Testing.** We will let you try it in your own stove or furnace for one month. Get yours for introducing. Big profits QUICK. Be first. Send in your name today for details and cash in on the tremendous demand for this Amazing Invention.
NORTHWEST MFG. CO., 608-J, Mitchell, S. Dak.

POPULAR MECHANICS



MOTO-TOOL ★ THE "POCKET-SIZE" MACHINE SHOP

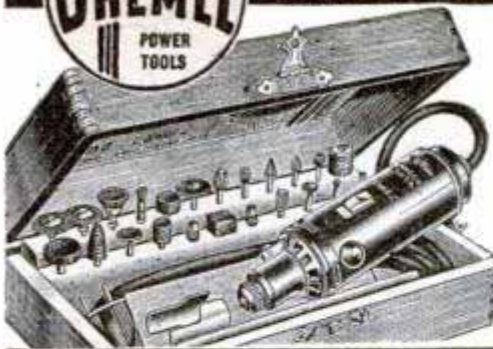

Moto-Tool Kit No. 2, with 23 accessories (high speed steel cutters, grinding wheels, polishing accessories) and heavy-duty professional Model 2 Moto-Tool in natural-point finish, hardwood case... **\$23.50**. (Items purchased separately would cost about \$30.00; you save \$6.50.)

Moto-Tool No. 2 Tool with one emery wheel point... **\$16.50**.

Moto-Tool Kit No. 1 with 34 accessories and Model 1 Moto-Tool in wood case... **\$17.50**.

Model 1 Moto-Tool with one emery wheel point... **\$9.85**.

"MAN... WHAT A POWERHOUSE!" A TOOL THAT PACKS YEARS OF PLEASURE

Here's a tool to please a man's heart... one that holds promise of endless creative hours. Dremel Moto-Tool is a "war veteran"... used by all branches of the armed forces in far-flung repair bases... helped set production records at General Electric, Westinghouse, Remington Arms, Ford and others. Hobbyist or expert craftsman, first choice is Model 2 Moto-Tool Kit with its handsome felt-lined, highly finished wood case with rows of tools begging to be put to work. Write for **FREE** catalog of Moto-Tool attachments and accessories.

MOTO-TOOL FEATURES:

Oil-less, sealed bearings • Patented automatic chuck lock pin • Over-size armature shaft, hardened, ground, polished • 110 Volt, AC-DC motor • Sliding snap-type switch • Cord protector • Shockproof bakelite housing • Dust-filtered, air-cooling system • Weighs only 13 oz. • Dynamically balanced for vibrationless operation.

MONEY BACK GUARANTEE: Buy Dremel Moto-Tool and Accessories from your dealer. If he cannot supply you, order direct from factory on 10 day trial. Shipped postpaid for cash in full; or for \$2.00 sent C.O.D. for balance plus postage.

DREMEL MFG. CO., Dept. 117-G, Racine, Wisconsin



Approx. **27,000 R.P.M.**

- Burring
- Grinding
- Routing
- Polishing
- Engraving
- Sharpening
- Drilling
- Inlaying
- Sawing
- Sanding
- Carving
- Cutting

BUY SHOES DIRECT SAVE the Retailers Profit 20 Million Prs. Sold WRITE FOR FREE MONEY SAVING CATALOG.

—showing how Sutton brings you finer shoes for less by saving you the RETAILERS PROFIT! Gift Free with each order. Make shoe Dollars Do Extra Duty this modern way, proven best since 1898. Over half million shoes in stock. For Special Value Catalog and Gift offer, send name and address on postcard to **GEO. M. SUTTON SHOE CO., DEPT. P-2** 32 Sutton St. Baltimore 1, Md.

AMAZING NEW FLYING WING

YOUNG AMERICA! Now, by a new principle. ANYONE can make a scientific flying wing model in 5 minutes at a penny cost. No glue—no balsa—no mess—only two parts. Glides and soars. COMPLETE ILLUSTRATED INSTRUCTIONS, full sized patterns 16 different models; enough material for 12 Flying Wings. Free "Sky Hook" data and pattern for experienced builders. \$1.00 currency, money order or C. O. D.

WINGS RESEARCH
514-618 S. Minnesota Wichita 3, Kansas
"The Air Capital of the World"

MARCOT KEY MACHINE

Immediate Delivery

Marcot No. 8 Key Machine Mounted on Cabinet.....	\$ 82.50
Book on Modern Locksmithing.....	3.95
Auto Code Book and Auto Depth Keys.....	12.50
162 Doz. Popular Key Blanks..	77.76
Set Key Files, Tools, Pins, Springs, Thimble.....	10.50
	\$187.21

A. J. MARCOTTE CO., DEPT. PM, CHICAGO 51, ILL. 1200 N. KEDZIE AVE.

Portable Paint Sprayers

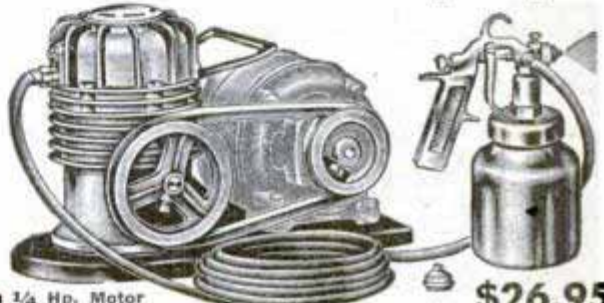

Uses 1/4 Hp. Motor **\$26.95**

Complete as illustrated, less motor. Sprays all kind of paint, lacquer, varnish and etc. Oil-less ball bearings compressor. 2 cu. ft. air per minute. 15 to 50# pressure. Sprays paint 5 times faster than hand brushing.

No. 890—Outfit complete as shown, with "V" belt, motor pulley, 15 ft. high test air hose and No. 112 gun, but without motor. **\$26.95**

No. 444—Outfit, twin cyl. 4 cu. ft., production type gun, 15 ft. air hose, reg. and gauge, V belt and motor pulley. Complete less motor. **\$47.50**. Uses 1/2 hp. motor.

Spray Guns—Low Pressure
Operate on 15 to 50# pressure

#112—1 qt. cup.....	\$6.50
#121—Production type..	7.95
#125—External mix.....	9.50
Regulator&Gauge 0 to 160#	4.95
Air Filters.....	1.85
Air Hose—15 ft.....	1.75
Air Hose—25 ft.....	2.75
3 Gal. Paint tanks, with hose, reg. and gauge.....	24.95
Less reg. and gauge.....	16.50

NEW BLACK & DECKER DRILLS
110V AC-DC

1/4" 2250 rpm.....	\$16.95
1/2" 375 rpm.....	31.95
1/4" Drill Stand.....	9.95
1/2" Drill Stand.....	14.95

AIR COMPRESSORS — PAINT SPRAYING SUPPLIES
Immediate delivery—check or M.O. shipped prepaid, cod's plus chgs.

INDIANA APPLIANCE CO.
20 East Sycamore Dept. PM-15 Evansville, Ind.

EXHAUST BLOWERS • PEDESTAL FANS

PHOTOGRAPHERS • HOSPITALS • LABORATORIES • WORK SHOPS • LAUNDRIES
OFFICES • RESTAURANTS • PRINTERS • PLAYROOMS
SOLVE ANY VENTILATION PROBLEM WITH THESE 2 AIR CONDITIONERS

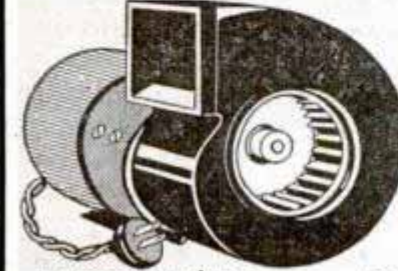

At last! A real post war fan to banish summer heat. Far superior to any pre-war product. Made of the finest materials to give perfect service indefinitely.

- 18" Fan Blades • Adjustable from 6 1/2 ft. to 8 ft.
- Aluminum Blades • Chromium Slide Bar • Cadmium Guard.

Continuous duty Ball Bearing Motor guarantees long, trouble free operation. 110 Volts, A.C., 50-60 cycles.

SEND CHECK OR MONEY ORDER FOR \$65

ONLY \$65.00



This RUGGED BLOWER & EXHAUST DELIVERS 100 CU. FT. AIR PER MINUTE. Quick and simple to install. Anyone can do it with ordinary household tools.

Continuous duty BALL BEARING MOTOR assures quiet, trouble free operation. Tough housing insures long life. 110 Volts, A.C., 50-60 cycles.

WORTH \$50 Only **\$15.85** Send check, money order. No C.O.D.'s. West of Mississippi add \$1.00 for mailing, handling.

UNIVERSAL YONKERS CORP. (Dept. M-7) 41 Locust St., Yonkers 2, N.Y.

NOW TRY Dustless SWEEPING



**Reduce Germ
Laden Dust
Eliminate
Sweeping Compound**

Dustless brushes used with Arbitrin sweeping fluid eliminate up to 97% of germ laden dust and reduce sweeping costs 20%. Arbitrin fluid, poured into a metal reservoir in the brush back, filters through the tufts and keeps dust down as you sweep. Dustless brushes are used in thousands of schools, factories, offices, stores, and institutions. There is a Dustless brush to fit your needs. Write for sizes, styles and prices today.



Milwaukee Dustless Brush Co.
530 N. 22nd St., Milwaukee 3, Wis.
Please send complete facts about Dustless Brushes.

Name _____

Street Address _____

City, State _____

man and steel-mill hand. After his marriage he and his wife moved to a small piece of land near Peoria and set up a cage in the back yard, where he developed his highly successful act. Incidentally, his wife is his top assistant.

Clemens has trained more than 100 big cats during his life and his body shows it. One of his popular tricks is holding a lion's food between his lips until the cat crunches down on it. There's a recent scar on his mouth from a cat that was a bit too hungry.

He can also show you a scar on his back that slants down from one shoulder to the opposite hip, a reminder of an Oakland, Calif., incident. Clemens was "working" one lion when an assistant tripped over a guy wire that held up the cage. The shaking framework nudged another cat off its pedestal behind Clemens. The animal immediately jumped for the trainer's back, raking him from shoulder to hip. After Clemens finished the act he was rushed to the hospital. The seam in his back required 118 stitches. He gave a scheduled performance the next afternoon.

Clemens hasn't lost his appetite for danger but he's getting philosophic now that he has a big-time act. "Most people who have sense enough to pick out a goal early in life, work until they die to attain it. Ever since I was a kid I've had one ambition—to hit the big time with my own lion act. Maybe it wasn't much but I've done it. Now there's still half a life for me to live. What's a guy supposed to do from here on in?"

Standing Room Only

(Continued from page 141)

already has been mapped. The motorways will travel across country toward their destinations above or below the existing networks of streets. Most will have four lanes in each direction and all will be served by converging collector roads so as to eliminate all cross traffic. The complete system will be part of a total of 613 miles of super-highways that are to be built in the five southern counties of the state during the next decade or two.

Private capital is expected to take care of the demand for adequate parking in downtown Los Angeles by constructing so-called "motorway buildings" around and above portions of the freeways. The streets, in other words, will run right through the buildings. Each of the buildings will have three or four levels of parking space reached by ramps that lead from the street.

One of the reasons why Los Angeles is experiencing its fabulous growth, of

(Continued to page 248)

Govt. Surplus Guaranteed PHOTOGRAPHIC SUPPLY BARGAINS

OUTDATED OF COURSE BUT GOOD AS GOLD

16MM 50 ft. magazine film, super X or XX processing not inc.	\$1.75
35MM 100 ft. rolls panatomic X or Plus X	2.79
4x5 Anseo Super Pan Press Film Packs, each ('46 dated)	1.74
8x10 Eastman Kodagraph process Pan cut film, per 2 doz.	3.83
8x10 Anseo Super Pan Portrait Cut Film; per 2 doz.	7.30
7" x 18" Super XX 1916 dated Kodacolor per roll	4.55
8x10 Reprolith Pan C.F. per doz.	3.62
8x10 Def. Process Pan C.F. per doz.	3.62
8x10 1/2 Semi Matt Enlarg. paper #2 per gross	6.30
5 1/2 x 20 ft. Super XX Aerial Film	1.95
5 1/2 x 20 ft. Aero Kodacolor (1946)	3.25

SURPLUS PAPER — GUARANTEED

4 1/4" x 825' roll Kodabromide A4, light weight	2.83
7" x 125' roll Aero Bromide, water resistant in sealed tins. S.W. (similar to Kodabromide Grade N)	3.83
8x10 Azo S.W. glossy, 1, 2, and 3, per gross	2.53
10x20 Anseo Convira, S.W. glossy, 2, 4, 5, per gross	4.87

NATIONAL PHOTOGRAPHIC SUPPLY CO.

272 Fremont St. San Francisco 5, Calif.



BUILD YOUR OWN MOTOR CAR!

Here's news so thrilling, so sensational, it's almost too good to be true. Imagine. Now, you can build your own auto starter motor car right in your own back yard. A swell deluxe model that travels

over the highways, just like the big cars. A real thrill for anyone who likes to "tinker." Every red blooded boy will want to build one. Cause with this kind of auto, he'll be the "big shot" in his town. This is a real powered auto, not a toy. Rush postcard or letter and let us tell you all about it.

CONSTRUCTIVE ENTERPRISES

BOX 554, RIVERDALE STATION DAYTON 5, OHIO



BE A HAM!

It isn't such a big job to build your own ham station. Doesn't cost much either—not when you buy all your parts from Lafayette—World's Largest Radio Supply House. Our new FREE catalog lists everything you need—even the tools, at swell savings. Send for FREE catalog today.

LAFAYETTE RADIO Dept. L6-7
100 6th Ave., New York 13, N. Y.



BOATS for Home Assembly

"U-MAK-IT"
KAYAKS, ROWBOATS, DINGHIES,
INBOARDS, OUTBOARDS, RUNABOUTS
Cut-To-Fit for Quick Assembly. Everything
Complete plus Illustrated Instructions. No Ex-
perience Necessary. Simple as A. B. C.

25¢
COIN
FOR ALL
THREE

SEND 25c POSTAGE (COIN) TODAY
FOR 3 MONEY SAVING ILLUS. CATALOGS
Showing all '47 Models (marine plywood)
and construction details.

AQUAMOBILE V-18

Designed for Auto Engines. Open or
with cab. Length 18 ft.
Fast VEE Bottom Hull.



KAYAK BOAT CO., 154P EAST 129th ST., NEW YORK 35, N. Y.

MARGIE



DIRT and DUST
YOUR DOUBLE-TROUBLE?



Fix it with *Mortite*

a household friend

Shut out dirt and dust! Press pliable Mortite around windows, doors, baseboards, etc. It's done in a jiffy. Keeps out ants, insects; fine for caulking, stops rattles; the ideal weatherstripping. Roll covers about 80 ft. At Hardware, Paint, Dept. Stores, Lumberyards. Write for free booklet.

• \$1.25 Higher West of Rockies and Canada

J. W. MORTELL CO., 522 Burch St., Kankakee, Ill.

Please Mention Popular Mechanics When Answering Ads



SEE and BE SEEN
for SAFE NIGHT CYCLING

DEPENDABLE BRIGHT BIKE LIGHTS
AT ALL RIDING SPEEDS!

MAKE-A-LITE
BICYCLE LIGHT Generator

Ride safely after dark! Make-A-Lite generates brilliant light for head and tail lamps at all riding speeds—good steady light even at a walk. Patented automatic voltage control prevents blowing bulbs. No batteries needed!

New swanky baked-enamel finish head and tail lamps look like a million. See them today!



INSTALLED
in a JIFFY

Now at your bicycle, sporting goods, automotive or hardware store

MAKE-A-LITE DIVISION Chefford Master Mfg. Co., Inc.
FAIRFIELD, ILLINOIS

PRESSURE QUEEN

FOUR CYLINDER
PORTABLE AIR COMPRESSOR
SPRAY PAINTING OUTFIT

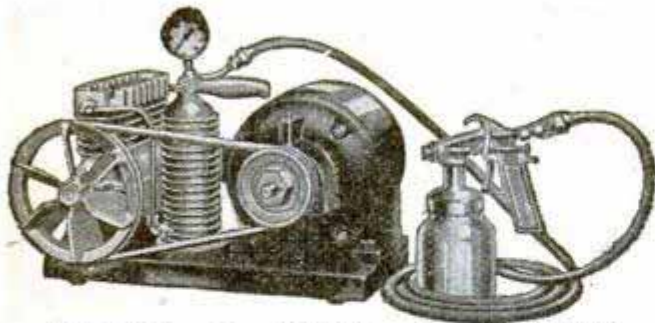

COMPACT • RUGGED • POWERFUL

The ideal air supply for home and farm workshop, machine shop, garage and contracting painter; for product finishing, inflating tires, painting automobiles, trucks, machinery, etc. Indispensable for building maintenance, interior and exterior. Handles any paint, insecticide or disinfectant.

This 4 cylinder compressor has drop forged crankshaft, stainless steel, heat treated valves; bronze bearings and positive forced feed lubrication. Maximum pressure 50-60 lbs., free from pulsation. Standard equipment includes the compressor mounted on steel base with carrying handle, belt, compressor pulley, air chamber, air gauge, 15-ft. hose, spray gun. Requires 1/2 or 3/4 h.p. motor or gas engine.

If your dealer does not sell Pressure Queen write direct

THE CAMPBELL-HAUSFELD CO.

1046 RAILROAD AVE.

HARRISON, OHIO

SAY YOU SAW IT IN POPULAR MECHANICS

New STEEL ADJUSTABLE BRACKETS & STANDARDS For HEAVY DUTY SHELVING



Locks
in Place—

Easy to Raise or Lower

JIFFY STANDARDS and BRACKETS give every store, garage, factory, work-shop, homeowner and all others solid, easily adjusted shelving. JIFFY BRACKETS can be easily raised or lowered 1 1/2" variation. They're all steel, engineered for strength, give strongest support required by heaviest load.

Anybody Can Install Jiffy Standards and Brackets

Standards are bolted or screwed into wall vertically. Brackets readily slide into place and are safely locked by patented principles. Rearrangement of shelving requires very few minutes. You can build mass displays for stores in a Jiffy. Homeowners will find this the neatest, easiest to install shelving available. Inexpensive—will last a lifetime. No special tools required for installation.

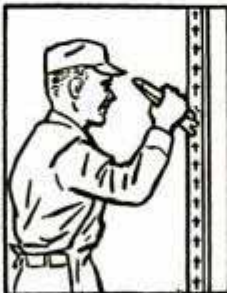

BIG PROFITS for Simple Installation Work—

You can earn big profits installing JIFFY EQUIPMENT in your neighborhood, spare or full time. Write for free literature giving complete details and prices.

JACKSON MFG. CO. Dept. M, 622 East Third St. Kansas City 6, Mo.

PAINTERS' STRIPING TOOL

NOW you can do your own expert striping on furniture, bikes, model planes, bulletins, autos, toys, signs, linoleum, wall board . . . make plain walls look like tile! It's easy to paint straight, curved, circular, even parallel lines with any color. Handiest paint tool in your workshop! Type "M" Master Painters' Striping Tool complete with tip for 1/16" stripe, \$1.00. Extra tips 1/64", 1/32", 3/64", 1/16", 5/64", 3/32", 1/8"—75c each. Tool with complete set of 7 tips \$5.00. (C.O.D. orders 25c extra.) WENDELL MFG. CO., 4234 -B Lincoln Ave., Chicago 18, Ill.

STRIP
WITH
PAINT
EASY
AS
USING
A
PENCIL

A TOOL . . .
NOT A BRUSH

Dealers
Write
Today!

NU-WAY
Lawn Mower

**BUILD YOUR OWN
ROTARY TYPE
LAWN MOWER**

Write for
Free Circular

We Supply Cutting Unit
Complete

No Increase in Price

PRICE

12.50

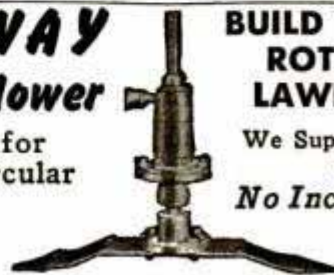

Tractor-Lite Mfg. Co.

Spirit Lake, Iowa

WHY PAY MORE?

DEALER SALESMEN . . .

Nation's Fastest Growing Concern Paying Top Commission. Interested in Hiring Only High Caliber Salesmen with Reputable Background and Exp. in Selling to Appliance, Sporting Gds., Hdwe., Toy and Dept. Stores. Terrs. Protected. Write Counties You Can Cover Fully. Earnings up to \$10,000 Yearly.

AMERICAN WHOLESALE COMPANY
627 W. Lake St. Chicago 6, Ill.

LIVE STEAMERS!!

All Castings and prints for Southern Pacific Atlantic A-6 in one inch scale now available. Also completed Locomotive. Lists for Dime.
DOC FIXIT, 665 1/2 Ivy, Junction City, Oregon



GREAT FUN
NOVELTY **ELECTRIC** BOW
TIE

LIGHTS-UP AT YOUR COMMAND

Agents &
Dealers Price
\$12.00 per dozen

Lights go on and off! Nobody knows how but you. Fine quality bow tie with replaceable bulbs and battery. Only \$2.00 postpaid. Send money order or cash today. No C.O.D.
D. ROBBINS & CO., Dept. P, 152 W. 42 St., N. Y. 18, N. Y.

MACHINE SHOP EQUIPMENT



Just off the press!—Every man who owns a workshop should have a copy of the new, up-to-the-minute, 200 page catalog of Machine Shop Equipment—the latest tools made by the biggest manufacturers in the U. S. Replete with illustrations, descriptions, prices. Prompt delivery on most tools listed in this book. Available at cost of printing—50c a copy—get yours today! Price of Catalog Refunded on First Order over \$5.00. Send check or Money Order to

CENTER TOOL CO., 153 Centre St., Dept. C, New York 13

MORE PROFITS

with

MODERN LAWN MOWER SHARPENER

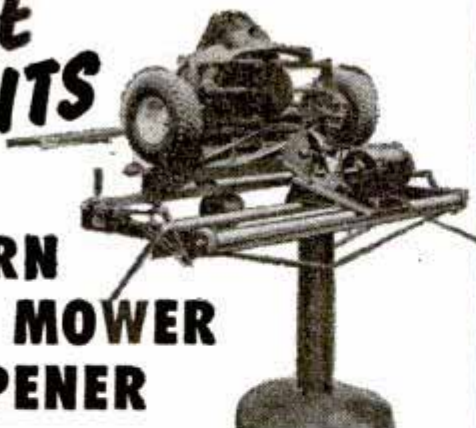

SHARPEN ANY LAWN MOWER from 5-inch Edger to 36-inch Power Mower in ten to twenty minutes with a **MODERN LAWN MOWER SHARPENER** because dismantling is unnecessary — neither handle, roller, wheels nor motor need be removed when sharpening any mower. . . . the **MODERN SHARPENER** eliminates all hand filing; it precision grinds to the extreme ends of both left or right reel blades. Bottom knife is held in same brackets for sharpening. **NO EXTRA ATTACHMENTS!** Order today! Price \$241.50 (less motor) f.o.b. Pasadena. (1/3 or 1/4 H.P. single phase motor recommended.)

Modern Mfg. Co., 156 N. Fair Oaks, Pasadena 1, Calif.

MAKE DOWELED DOORS



on your shaper with our high speed steel—pattern ground—shaper knives 1 1/4", 1 3/8", and 1 3/4" for O. G. Cove and bead doors. 4 knives; 2 coping and 2 sticking, priced at \$19.44. 2 1/4" over all length. Prompt shipments — also other knives. Send 10c for Catalog.

WOODWORKERS TOOL WORKS
QUINCY & JEFFERSON CHICAGO, ILLINOIS

NEW AUTO RADIATOR FILTER

JUST OUT! STOPS CLOGGING RADIATORS, overheating of motors. Prevents scale from going into radiator. Gives better circulation. Rust-proof. Anyone can install in few minutes. **\$1** POST-PAID. Simple. Easy to attach.

Send dollar bill today for filter only—New hose with filter installed \$1.50 postpaid. **STATE MAKE AND YEAR OF CAR.**

H. SARKISIAN, MFRG.
215-08 — 35th Ave., Bayside, L. I., N. Y.
"Agents write for Special Offer."



SAY YOU SAW IT IN POPULAR MECHANICS

Special Castolite Kit

- Cast without heat or pressure.
- Crystal clear or dye any color — transparent, opaque, phosphorescent, fluorescent.
- Can be sawed, drilled, carved, turned.
- Embed flowers, butterflies, photos, novelties.
- Make figurines, statuettes, other beautiful objects in New Flexible CASTO-MOLD.
- Easy, fascinating. See illustrated manual.
- Send \$3.35 for kit prepaid, or order COD. For manual alone, send 25c.

THE CASTOLITE COMPANY
Dept. H-1, Box 211 Kenilworth, Ill.

NEW Liquid Plastic



20-Project
KIT
\$3.35

HOLLOWELL HOME AND HOBBY KIT



WITH INTERCHANGEABLE TOOLS

Contains many useful tools — in convenient, hollow, red plastic handle — which can be used to make emergency repairs in the Home, Office and on the Farm. And, if there are hobbycrafters in the family, it can be employed, by them, to fashion whatever they are interested in making.

Available at your local Hardware Dealer or Industrial Distributor. Write for free, descriptive literature about this ideal gift or prize.

Kits: Pat's. Pend.

Over 44 Years in Business

STANDARD PRESSED STEEL CO.

JENKINTOWN, PA. BOX 802

BOSTON • CHICAGO • DETROIT • INDIANAPOLIS • ST. LOUIS • SAN FRANCISCO

A PENNY BUYS A 6 MILE RIDE!



Get the thriftiest power on wheels, with a **WHIZZER Motor** on your bike. 125 miles to the gallon! 35 m.p.h.! And it's so easy to learn . . . fits any man's balloon tire bike! Complete with gas tank, oversize stand, and all necessary attachments.

ONLY \$97.55 PLUS TAX F.O.B. Pontiac Mich.

RIDE ONE AND YOU'LL BUY ONE!



ON A

WHIZZER

Whizzer Motor Company, Dept. 527, Pontiac, Michigan.

I enclose \$99.97, which includes \$2.42 Federal Excise Tax () check or () money order. Send me one WHIZZER Motor complete, ready for installation. If descriptive literature only is desired, check here ().

Name _____ City _____
Street _____ State _____

X-acto*

HANDICRAFT KNIVES & TOOLS



Choice of experts in every art and craft field. Singly and in sets, 50c to \$50.00. (Slightly higher in Canada.)

Buy where you see this sign —
At hobby, hardware and gift shops.

X-acto Crescent Products Co., Inc., N.Y.
In Canada, Handicraft Tools, Ltd., Toronto
*Reg. U.S. Pat. Off.

Safe Trailering Demands



Safety Engineered Trailer Parts

- TORQ-LESS AXLES
- BULL DOG HITCHES
- BULL DOG PARKING JACKS

What's behind Safety-Engineering? Drop us a card today with your address and you'll receive the full story in our new FREE Catalog by return mail.

Send for FREE Catalog Today



HAMMER BLOW TOOL CO.

DEPT. 415

WAUSAU, WISCONSIN



course, is that many people always have desired to move west but were hindered in the past because of the lack of jobs. Now that more jobs than ever before are available, the Pacific Coast is filling up all the way from San Diego to Seattle.

The most equable portion of southern California is a narrow and semiarid belt constricted between the ocean to the west and the mountains and desert to the east. The region appeared good for little more than cattle ranching at the beginning of the century and the only thing that Los Angeles had was its climate. On the face of it the area never would amount to much.

Then Yankee ingenuity created Los Angeles Harbor by dredging out some tidal mud flats. Next the city went hundreds of miles away, up into the Sierra Nevada mountains, for water and electricity. Today it taps the Colorado River as well. Now it is getting ready to augment the fuel oil and natural gas that it gets from California fields by means of a pipe line that will extend to Texas, bringing in natural gas from the midcontinent fields. Ideas like these are building up the whole West.

Flying Fish... At Home Anywhere

(Continued from page 152)

to flip the prop from behind. At Bendix, N. J., the engine was balky. All you could hear as the seaplane neared terra firma was the sound of the wind in the struts as Lambros came in for a forced landing. It was a three-pointer smack on the hard runway! Neither Kulik nor float was injured.

From the pilot's point of view seaplanes have many advantages. The student can shoot landings one after another in a straight line for mile after mile. At a busy land port he would have to taxi back to the head of the runway after each landing and wait his turn for take-off, thus wasting valuable flying time.

Experienced pilots claim they can keep going in weather that would ground land planes. Flying close to the water, they know they can "sit down" when things get too bad. This, they argue, is far better than being caught out on wheels and worrying where to put them down.

Seaplane pilots probably get more surprises than any other private flyers. Once Bob Fogg, a skilled water pilot, was flying toward the Gulf of Mexico when he found himself pinched between two weather fronts. With visibility dwindling he managed to make a landing on what appeared to be a lake. He climbed out of the plane to discover he had landed in an oil field with derricks sticking up on all sides!

DUAL MUFFLERS

1935 to 1947—V-8 FORD
and MERCURY

- More Horse Power
- Better Gas Mileage
- Less Back Pressure
- Blow - Out Proof
- Straight Thru Mufflers

DEEP TONE
Guaranteed

**FORD & MERCURY
DUAL SETS**

\$20.00 C.O.D.

F.O.B. LOS ANGELES

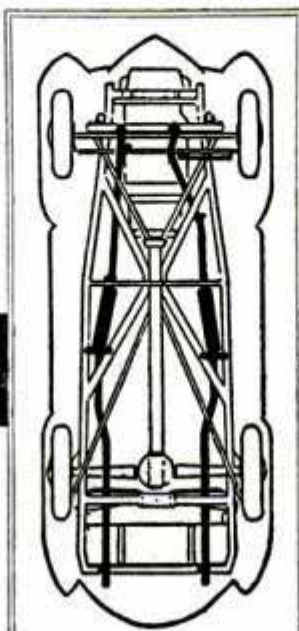

ORDER BY YEAR AND MODEL

- Simplified Installation
- No Welding, Cutting, Drilling of Holes.

All Fixtures Furnished
Rubber Insulated Clamps

LONG LIFE
Guaranteed

DEEP TONED SINGLE MUFFLER

Ford, Chevrolet, Ply. \$4.86

All others.....\$5.50

2½" CHROME TAIL PIPE TIPS \$1.75

ADVANCE MUFFLERS • 6800 So. Vermont Ave. • Los Angeles 44, Calif.

AUTOMATIC SAW SET

WITH
MOTOR

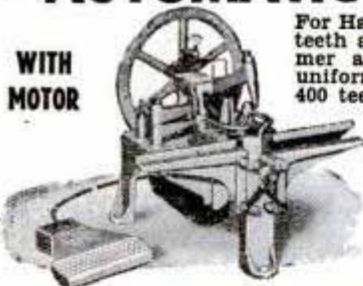

For Hand and Band Saws. Set saw teeth automatically. Perfect hammer and anvil action sets teeth uniformly. Easy to operate. Sets 400 teeth a minute.

Also Automatic
Retoolers Available
Saw Shops Need These
Machines—Write Today!

BURR MFG. CO.
8933-F Venice Blvd.
Los Angeles 34, Calif.

MAKE YOUR OWN POWERED EQUIPMENT

with these **LOW COST**

SKF BALL BEARING ARBORS

(RIGHT OR LEFT HAND THREADS)



No. 1000

Dia.	Spindle	Housing	Price Each
½"	10½"	6"	\$ 7.95 PP
¾"	12½"	8"	8.95 PP
1"	12½"	8"	10.95 PP
1"	18"	11"	19.95 PP

A & P EQUIPMENT and MERCHANDISE CO. DEPT. 1-C
520 West 15th Street LONG BEACH 13, CALIF.

S AGENTS 300% Profit SIGN LETTERS

For Store Fronts and Office Windows. Anyone can put them on. Free Samples. Liberal Offer to General Agents.

METALLIC LETTER CO., 430 N. Clark, Chicago 10

New Designs in  **FRANZITE GRIPS**

Modernize Your Gun! Improve Your Score!

Most durable grips made. Positively unbreakable! For Colt, Smith & Wesson, Hi-Standard, Ortgies, Luger & Mausers in a wide choice of beautiful designs in ivory, pearl, walnut, onyx, etc. Low prices. **FREE CATALOG.** Dealers Wanted.
SPORTS, INC., (Mfrs.) 5501 Broadway, Dept. P-7, Chicago 40, Ill.



the **BEACON** that
never fails

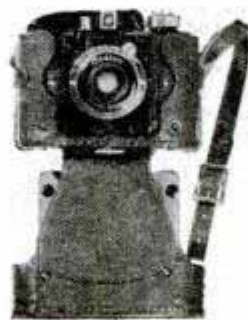

EVEREADY CASE. Simulated brown leather, beautifully styled. **\$250**

Ever-faithful, the BEACON camera will always bring you top precision, miniature camera performance at low cost. The 46mm Whitlar coated lens — color corrected, gives you sharp, sparkling **\$995** snapshots. incl. tax

Safety lock shutter — no accidental snaps • Speeds 1/50, or time • Uses No. 127 film • Optically ground lenses, fluoride coated



Whitehouse Products, Inc.
360 Furman St., Brooklyn, N. Y.

I'm an un-handly
man - BUT -

by
don herold



... but here is something that even an all-thumbs guy like me can use to plug holes and cracks around the house.

Reardon's Water Putty — a powder you mix with water as needed. No waste, no caking in the can. Dries hard and can be painted over. Does not shrink or loosen. Good for re-seating screws, repairing furniture. Works on wood, metal, plaster, tile. Good, good, good!

Get a can at your hardware, variety or department store. **25c Lb. Can**

Made by The Reardon Co.
St. Louis 6, Mo., U.S.A.
Makers of BONDEX Cement Paint



**REARDON'S
WATER PUTTY**

WALKIE-TALKIES!

**Complete Army Sets
Ready to Operate**

Portable radio telephone sends and receives 10 to 15 miles! Used by the Army with great success. Ideal for amateurs, police, explorers, airports, utilities, boat owners, Government services, etc. Operates anywhere in the 28 to 52 MC band. Renewed by the Government and guaranteed. Shipped, ready to operate, complete with tubes, microphone, telescope antenna and new batteries. Price—only **\$45.00** each.

Extra batteries (80 hours continuous service)..... **\$4.75** each



Radio-Telegraph Sending Keys

Real S-37 Signal Corps keys for your radio or telegraph set or for code practice. They have coin silver contacts and full adjustments. Valued at 3 times our low price. Send \$1.00 plus 20c for postage anywhere in U. S. Guaranteed.



**WELLS
SALES, INC.**

320 N. La Salle St., Dept. P-7
Chicago 10, Illinois

**TAKE THE FATIGUE OUT
OF DRIVING WITH**

HEEL-EEZ HEEL ANCHOR

A MARVELOUS little patented device of pliable rubber anchors heel in safe, comfortable driving position, eliminates foot and leg strain, PREVENTS SCUFFING HOLES IN EXPENSIVE FLOOR MATS! Fits both men's and women's heels. Once used, you wouldn't give it up for many times its low cost! Installed in 2 or 3 minutes; just remove adhesive backing and press firmly on floor mat, UNCONDITIONAL MONEY-BACK GUARANTEE, C.O.D. or cash with order any place in U. S. A. (Canada, add 10c.) POSTPAID..... **60c**



BROWN INDUSTRIES, 816 West Arthington St., Chicago 7, Illinois

AGENTS: Write for sales plan. Top selling 1947 accessory for 25,000,000 automobile market. Sell in volume to Service Stations, Garages, Tire Dealers, Accessory Stores, others. Send 60c for pre-paid sample; commission rebated on first order of dozen or more.

Now You Can GET THOSE MOTOR-CLUTCH- TRANSMISSION AND AXLE PARTS in stock

Why worry about parts when we have them . . . All you want, at a BIG SAVING . . . We ship within 48 hours . . . We also have REBUILT UNITS for EXCHANGE at Bargain Prices: CARBURETORS — FUEL PUMPS — GENERATORS — STARTERS — SHOCKS AND KNEES . . . It will pay you to GET OUR PRICES. — RUSH YOUR ORDERS —

and
**SAVE
MONEY**

Get Our
**BARGAIN
PRICE
LIST**
for parts
you want



If Car Owner Specify Make IMMEDIATE SHIPMENT
**MECHANICS AUTO PARTS, Factory Warehouse
3807 No. Ashland Ave., Dept. PM-7 CHICAGO 13**

**YOU
CAN MAKE
\$40 to \$50
PER WEEK!**

Selling Guaranteed Children's Shoes

Big opportunity, tremendous field, big advance commissions. Act now. Give hard working mothers this chance to save that trip-to-the-store . . . At no extra cost!



GET SPECIAL FREE OFFER!
Limited number of Free selling kits available. Avoid delay. Send in TODAY for your opportunity to a future of security. Send post-card to:

**HOME SERVICE SHOE CORP.
DEPT. S-2, BOX 232, KNOXVILLE, TENN.**

SUPER DRILL GRINDER

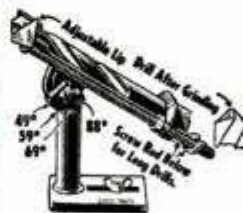

Sharpens round shank drills from 3/32" to 1-1/16" diameter. Grinds Old Drills like new in 4 different drill point angles. Grinds Short, Medium and Long Twist Drills from 1 1/2" up to 11" long, for hand or power grinding wheels.

200,000 IN USE!

Grinds your drills like factory in 25 seconds. Gives perfect center and clearance. Saves drills, time and money. No shop should be without the Super Drill Grinder. Guaranteed to do the work or money back. The Grinder that gives a rounded point!

Only
\$2.95

At Your Dealer's or Postpaid
CRANDALL MFG. CO.

1512 West Slauson, Dept. FA-19

Los Angeles 44, Calif.

BARGAIN 3X ARMY TELESCOPE

Original Cost \$150.00 — Our Price \$7.50



ALL COATED LENSES — BRAND NEW

An ideal gift for viewing objects, landscapes, seashores, etc. The high resolving power of the six coated lenses, five of them achromats will bring out great details. For the experimenter it can be dismantled and used for hundreds of projects. Length 22 1/2 inches. 36° Field. Postpaid \$7.50.
500,000 Lenses and Prisms. Send 3c stamp for "Bargain" List

A. JAEGER'S

123-26P ROCKAWAY BLVD., SO. OZONE PARK 20, N. Y.



LIGHT PLANTS

Used Gov't Surplus — Lowest Price Ever Offered — 3,000 watt, 110 volts.

Powered by Briggs-Stratton or Wisconsin 6 H.P. air-cooled engine. For stationary or portable use. **RE-BUILT-GUARANTEED**, good mechanical and operating condition. Our price **\$149.50**
F.O.B. Kansas City...

Limited Supply — Immediate Delivery — Order Now
Write for Illustrated Circular

MIDWEST SURPLUS SALES 1520 LOCUST ST. KANSAS CITY, MO.

POWER LAWN MOWER

BUILD ONE YOURSELF FROM YOUR OLD MOWER

We supply complete attachments that fit any make or size of mower, with or without 1 H.P. gas engine. Easy to install in less than an hour. No more back breaking mower pushing. Immediate delivery, at low prices.

MONEY BACK GUARANTEE

You'll be delighted! Complete satisfaction or your money back. Write for

FREE FOLDER
Dealers Wanted.

ROYAL OAK LAWN MOWER SHOP
Box 48 Royal Oak, Mich.

Opportunity Knocks

With **TRADIO** . . . the radio **FUNCTIONALLY DESIGNED** for coin operation in Hotels, Motels, Stopovers, Clubs, Hospitals, Stations, Etc. Big Earnings . . . Steady Income . . . No Clock To Punch . . . Full Or Part Time!

QUANTITY DELIVERIES DAILY . . . ONLY SMALL INVESTMENT
Grow With A Young Industry! Get In On The Ground Floor and Be Independent For Life. It's Easy!
Send for Complete Information Today . . . No Routes Sold

Write To **TRADIO, INC.** Dep't. PM, Asbury Park, N. J. **RIGHT NOW!**

AUTO ENGINE SPEED CONTROL GOVERNORS

Give constant or changeable speed to any auto or truck engine, when used for power. Guaranteed. Instructions. Oil ring bearing, \$14.25. Full ball bearing, \$21.75. Postage, 50c; east of Miss., 85c. COD, or— Postage any country \$1.00 each.



These valves used where carburetors have outside attachments.

State exact size of opening and distance between bolt holes. Send gasket if possible.

1", \$3.75; 1 1/4", \$5.25; 1 1/2", \$6.50; 1 3/4", \$7.50; We can supply up to 2 1/2", V8, \$8.00. Note difference between A and B types. Mailing weight, 3 lbs. If remitting, enclose for postage.

Stocks carried: in Canada, Montreal 15: 7546 Wiseman St. In Skaneateles, N. Y.: Horle Welding Supply. Circulars.

CANDEE, Dept. P-7, 2641 S. Hill, Los Angeles 7, Calif.



Two New SCHULT Models to Suit Your Purse and Purpose

One modest investment in a Schult offers you complete accommodations for years of comfortable living, plus mobility. You get every real facility of a furnished home, at a mere fraction of the cost. Two popular sizes:

LUXURY LINER

Famous 26-foot model with three separate rooms. Comfort and privacy for four adults. "Accent on Living."

COMMODORE

A 21-foot luxury travel coach that sleeps four and is amazingly spacious and has most "big coach" features.



LIVING ROOM
of Luxury Liner. Both models have separate bedrooms and completely equipped kitchens.

WRITE FOR CATALOG



SCHULT CORP. Dept. 3207, ELKHART, IND.

In Canada: John Inglis Co., Ltd., Toronto

SCHULT *BUILT TO LAST* Trailer Coaches

LAW STUDY AT HOME for PERSONAL SUCCESS and LARGER EARNINGS. 38 years expert instruction—over 108,000 students enrolled. LL.B. Degree awarded. All texts furnished. Easy payments. Send for FREE BOOK—"Law and Executive Guidance."
AMERICAN EXTENSION SCHOOL OF LAW
Dept. 79-M, 646 N. Michigan Ave., Chicago 11, Ill.



Without Pulley

AGENTS WANTED
Parts and Implement Dealers, Garages, Welders, Wreckers, Catalog and Mailing List Houses, etc.

UNIQUE SINGLE FRAME
MAKES THIS THE

BEST CAMERA
FOR COLOR!



UNIQUE SINGLE FRAME feature makes the Mercury II especially designed for color . . . and outstanding for black-and-white . . . for it permits the incorporation of the three important factors that camera experts agree are necessary for good color photography.

1. SHARPNESS OF NEGATIVE. Universal engineers discarded the old-fashioned idea of negative size and incorporated into the Mercury the same size 35mm. negative as is used for the projection of motion pictures. By using this single frame size, it was possible to attain a short focal length, which results in an amazing depth of focus at any given aperture, thus assuring sharpness of negative over a much greater area. This extreme depth of focus assures excellent results for color projection or the making of enlarged color prints.

2. SHUTTER ACCURACY. Mercury II's rotary focal plane shutter, with speeds up to 1/1000th, has been proven more accurate by actual test. It is used and endorsed by Harvard Observatory.

3. LENS CORRECTION. Universal's experience in the grinding and polishing of lens and prisms for precision optical instruments resulted in the color corrected anastigmat Mercury II lens.

To cap it all, Mercury II cuts color costs almost in half . . . you get 36 pictures on a standard 20-exposure cartridge. Yes, Mercury II is the only minicamera especially designed for color. That's why we state that Mercury II is "second to none" for natural, vivid, fresh, true-to-life color results. No wonder photo experts are turning to Mercury II for natural color! Look it over at your dealer's today!

MERCURY II—It's a Universal

UNIVERSAL CAMERA CORPORATION
NEW YORK CHICAGO HOLLYWOOD

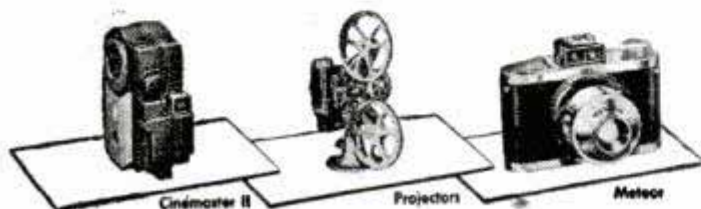

They Fish for Trouble

(Continued from page 77)

When the cable is hauled up, the ends are lashed to buoys. Tests are made to determine whether there is electrical continuity through it to the shore station. Repairs don't start until this continuity is established for a cable ship must keep in constant communication with the shore station through the cable it is working on. Progress reports on repairs are transmitted to the plant engineer in New York and the ship also receives orders through the cable.

The extent of the break and the condition of the cable determine the length of time required for repairs. A few years ago, for example, a break in one of the older Western Union cables necessitated splicing in 270-odd miles of new cable, a task requiring many days. Frequently bad weather forces a repair ship to suspend work temporarily.

Just before the last splice is made on every job the cable ship signals to the home station the traditional message "now finaling." This means the job has been completed and that the ship, after dropping the cable into position and picking up buoys, is ready for a new assignment.

The various cable companies frequently use one another's ships for repair work. When not engaged on Western Union work, the Kelvin can be chartered for \$2000 a day, the Field for \$1500. The contracts state that the ship, while working on a competitor's lines, shall be under the management and control of the parent company.

The cable still is regarded as the workhorse of the communications system. Virtually unaffected by atmospheric disturbances that plague the air waves, it carries messages with speed, precision and dependability. When a break is reported the Kelvin and Field drop a hook over the side—fishing for trouble.

Electrical Ceilings Heat a House

Heat for an experimental house in Knoxville, Tenn., is supplied by electrified ceilings controlled by thermostats. The heating element, developed by United States Rubber Company, is conductive rubber sandwiched between two thin layers of plastic. It costs only \$72 a year to heat the one-story bungalow which consists of living room, bedroom, hall, combination dining room-kitchen, and glass-enclosed porch and bath, all equipped with ceiling heat. Power rates in Knoxville are lower than in most sections of the country, but the builders believe electrified ceilings are practical anywhere if the house is properly designed and insulated.

Ball-Bearing **SPEED WHEELS**



Juvenile wheels, solid tire
No Bearings

7" wheels.....60c
6" wheels.....50c
4" wheels.....30c

Semi-pneumatic tired wheels

12 x 1.75".....\$3.25
10 x 1.75".....\$2.75
8 x 2".....\$2.00

Industrial wheels for
heavy loads

10 x 2.75".....\$6.75
8 x 1".....\$4.90
6 x 2".....\$2.80

**DEALERS
WANTED**

Free blueprints with all wheel orders.

JIM BROWN TOY COMPANY

1093 Home Ave.

Akron 10, Ohio

ELECTRICITY *Anywhere*

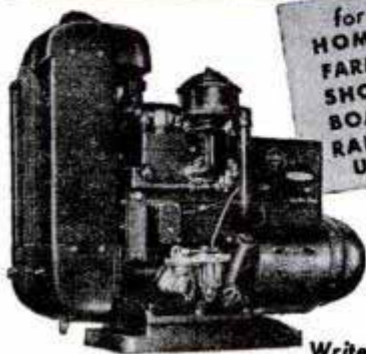

for
HOMES
FARMS
SHOPS
BOATS
RADIO
USE

● Onan gasoline-engine-driven Electric Plants supply reliable, economical electric service for any use. Portable, stationary or stand-by models. Water or air-cooled, compact and rugged.

A.C.: 350 to 35,000 watts in all standard voltages and frequencies. D.C.: 600 to 10,000 watts, 115 and 220 volts. BATTERY CHARGERS: 500 to 3,500 watts; 6, 12, 24, 32 volts.

Write for folder



D. W. ONAN & SONS INC.

2531 Royalston Ave., Minneapolis 5, Minn.

NAVY STANDARD BATTERY (Brand New)

Made by Gould Storage Battery Corp. 6 volt 15 amp. hour. Excellent for motors, motorcycles, amateurs, experimenters, radio servicemen, etc. Shipped dry, with complete instructions for charging. 4 3/4" wide, 4 3/4" deep, 6 3/4" high. Shipping weight 12 lbs. While they last....

\$4.95



MICHAEL STAHL, Inc.

39 Vesey Street

New York 7, N.Y.

Dept. P.M.7

**AMAZING NEW DISCOVERY VANISHES
INGRAINED HAND GRIME LIKE MAGIC!**

**Rub WATERLESS
hand cleanser**

Wonder formula for mechanics, painters, electricians, gardeners. Revolutionary cleanser dissolves grease, grime, even paint and ink in a flash. Keep a jar handy for quick clean-ups.

- No Scrub to Rub—Just wipe off dirt!
- Contains No Abrasives or Ammonia
- Economical Pint Size

Order
by Mail

75c

POSTAGE
PREPAID



JAN-ACE CO. DEPT. M1

435 S. LA CIENEGA BLVD. LOS ANGELES 36, CALIF.

ORDER BY MAIL! PROMPT DELIVERY!
SEND M.O. OR CHECK. NO COD'S PLEASE!

**INDUSTRIAL PRECISION
for YOUR HOME SHOP**

**Atlas
DRILL
PRESS**

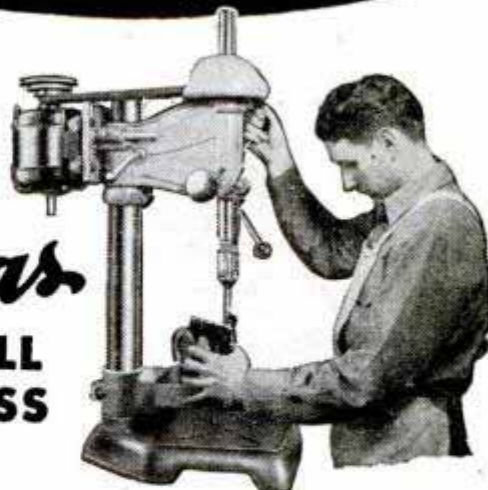

**HELPS YOU HANDLE MORE PROJECTS
with "PROFESSIONAL" Workmanship**

An Atlas drill press and accessories is a real time saver. Handles precision drilling and tapping in metals—gives you "professional" results on mortise and tenon joints for tables, chairs, doors, cabinets, storm windows, and screens. Send for free catalog.



ATLAS PRESS CO.

743 N. PITCHER ST., KALAMAZOO 13D, MICH.

LATHES - DRILL PRESSES - SHAPERS - MILLING MACHINES

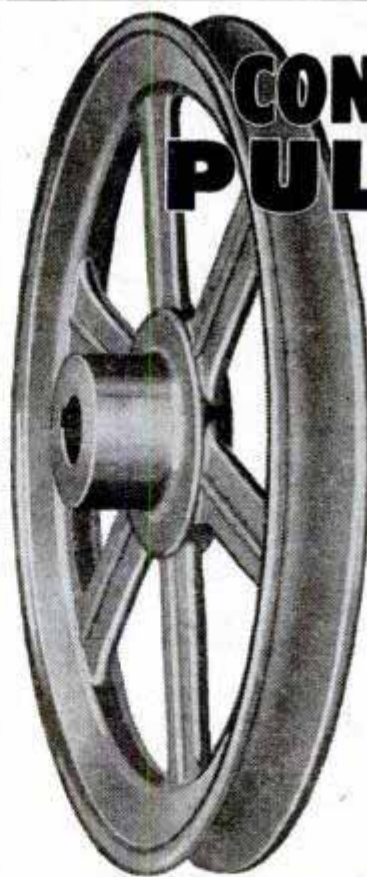

**CONGRESS
PULLEYS**

**Still at
PRE-WAR
PRICES**

America's finest pulleys—diamond-bored, tested for true-running—in all popular sizes, at your hardware store. Insist on Congress—your best buy in pulleys.



Sign of an Authorized
Congress Dealer

CONGRESS DIAMOND-BORED DRIVES

3750 EAST OUTER DRIVE

DETROIT 12, MICHIGAN

Barton Bargains

Automobile

TROUBLE LITE



Fits into ANY Cigarette Lighter Socket
Indispensable for road repairs, tire changing, trouble shooting, emergency lighting, camp illumination, luggage handling, map reading and distress signals. Complete with bulb, lamp guard, 12 ft. cord. Reaches all parts of any car

\$1.95

Barton

ELECTRIC PHONOGRAPH

An electric phonograph—sturdily constructed—light weight—finished in ivory and brown. Unique speaker design assures free flow of sound and perfect tonal reproduction. Noise-free motor. Plays 10" or 12" records. So simple a child can operate it. Built to stand rough treatment.



VIBRANT TONE SPEAKER

\$14.85

Barton MODEL H 2

PORTABLE ALL-PURPOSE AIR COMPRESSOR

A sturdy, well built, trouble free air compressor for garage, home workshop, factory, farm, nursery or home. Economical—easy to operate. Weight 7 1/4 lbs., height 9". Uses 1/4 H.P., 110 volt, 1425 R.P.M. or 1750 R.P.M. motor with three inch pulley. Oil impregnated main bearing—shielded crank bearing—ball bearing self-lubricating. No valve trouble—never regrind outlet valves. Built to last a lifetime



\$14.50
LESS MOTOR

Barton MODEL S 2

SPRAY GUN

A worthy companion for the all-purpose compressor. Simple and efficient design, easy to operate. Its versatility and low cost make this syphon type spray gun a valuable asset in the home, shop and farm.



\$4.90

HOSE 12 1/2 feet.....\$1.70
23 1/2 feet.....\$3.00



Barton

ENGINEERING CO. Stephenson Building
Detroit 2, Michigan

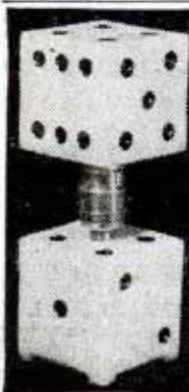

GOOD LUCK DICE LAMP

with natural appeal

A novel, useful lamp suitable for any room in the home, office, store, etc. Made of Opal White Glass with Black, Red, or Green dots. Height 9".

\$2.98 each

Shipped prepaid, state color.

SYLVAN CO. 154 E. ERIE CHICAGO 11, ILL.
Agents and dealers write for quantity prices.

BRAND NEW SOLID BRASS 12 FT. PORTABLE

RADIO ANTENNAS

Real \$15 Value Now Only \$4.95 Postpaid
FOR HOMES, BOATS or AUTOS

JUST OUT! Gov't surplus used on Army tanks. These telescopic rustproof antennas have tremendous pickup eliminate dangerous wiring. Solid Brass throughout practically insuring NOISE FREE RECEPTION.

12 Exceptionally Rugged Sections

compress into 1 ft. in. Handy for Camping Trips, also Useful for Transmitting, FM & Television sets. Each antenna comes with clamps, nut, lug, and wire. Easy to install anywhere.

QUANTITY LIMITED

ORDER TODAY. A real \$15 value for only \$4.95 Postpaid. Mail check or money order now or sent C.O.D. plus postage. Money back in 10 days if not satisfied.

RADIO HOSPITAL 1113 Lexington Ave., Dept. A-7
New York 21, N. Y.

WOODWORKERS... Get this

CONSTANTINE MASTER MANUAL
Get the Most Fun From Your Hobby
Indispensable to woodworkers. Newest, biggest edition, more pages, more color, helpful how-to-do-it articles, pre-war and new items, more bargains. Send 25c today and we will include FREE! FULL YRS. SUBSCRIPTION to Chips and Chats, published bi-monthly. Keeps you up-to-date on everything in woodworking, offers big money-saving bargains. Send now.

ALBERT CONSTANTINE & SON, Inc.
791-G 135th Street, New York 54, N. Y.



Giant Astronomical Telescope

100 diameters magnification. (10,000 area magnification) Steel main tube 3 inches diameter, 50 inches long. Brass focusing tube. Tripod 6 feet tall. Equatorial mounting. Ready to set up and use. Full power and clear vision guaranteed. Price \$12.50. 25% deposit on C.O.D. orders.

SUFFOLK SCIENCE SERVICE, Dept. CT, MANORVILLE, N. Y.

MUFFLERS

STEELS and ALUMINUMS
with a motorboat tone

SINGLES, Chev, V-8, Plymouth, Steels \$5.50, Aluminum \$6.50. Chry., Olds., Buicks, etc., Steels \$7.50, Aluminum \$8.50. V-8 and MERCURY DUALS, Steel \$17.50, Aluminum \$20.00. Aluminums are guaranteed for life of your car.

DEALERS WANTED

SANDEE MUFFLER CO.
7523 S. WESTERN AVE., LOS ANGELES 44, CALIF.

POPULAR MECHANICS

More Fun Fishing with BOB-ER-LITE



Fish Bites
Bobber
Lites

\$1.98

Now, with Bob-er-Lite, you can fish at night from boat or pier, safely, comfortably, without eye strain—add many extra hours to your days sport. When fish bites, bobber lites. Nothing to adjust, nothing to get out of order, guaranteed performance. Thousands are already in use. Bulb and battery are standard—readily replaced when worn out. Enjoy this extra thrill yourself. At better stores—or use the convenient order coupon.

Patents applied for

Bob-er-Lites at \$1.98 each



Enclosed is M. O. or check for
Name _____
Address _____

Send to **Pasch Bros.** 229 N. WATER ST. Dept. 18 MILWAUKEE 2, WIS.

NEW GENUINE AAF RUBBER BOATS



FIVE-MAN—Complete with CO2 tank, oars, hand pump, carrying case. 8' x 5'

F. O. B. Sacramento, \$37.50

ONE-MAN—Complete with sail, mast, CO2 tank. 5'6" x 3' \$15.95 Pp.

Write for Free War Surplus Catalog!

Send
Check or
Money
Order

PACIFIC FUR & WOOL CO.

War Surplus Department Box 926-PM
Sacramento, California

INDEPENDENCE DAY FOR MOTORISTS



With a Hull Streamline Automobile Compass, that Fourth of July trip will be safer, happier, free from lost directions and speeding to make up time. Twelve years of leading acceptance. At your dealer's. Write us for circular. Price \$3.95.



HULL MFG. CO., P. O. Box 246-D6, Warren, Ohio



WORLD'S SMALLEST RADIO

USE ANYWHERE

\$2.98

- No Tubes
- No Batteries
- No Electricity

Sensationally tiny! But with this remarkable CRYSTAL RECEIVER, you can get strong reception . . . indoors or outdoors! Just connect one clip to ground and another to a bit of aerial wire. Or, for DOUBLE fun, attach two RADA-PHONES for a walkie-talkie, hear up to 100 feet. Trim unbreakable hard rubber receiver. 2 attachment clips, 5 feet insulated rubber wire. SEND NO MONEY. Just pay postman \$2.98 each, plus postage or order C.O.D. Special Price to Dealers.

BERNARD FINE CO., Dept. PM, 501 Sixth Ave., New York 11, N. Y.

ELECTRIC MOTORS

Brand new 1/25 H.P. Standard Make, Electric Motors for Immediate shipment. 5/16 inch shaft, CCW rotation, 4 pole heavy duty. A million uses, polishers, grinders, fans, etc. \$2.00 cash with order — balance \$6.50 C.O.D.

VIC WALTERS, 719 Wyandotte St., Kansas City 6, Mo.



8x2" TIRE & WHEEL - COMPLETE

Here is the Wheel you will want for your Wagon, Scooter, etc. Will never RUST! No painting needed—hub of cast aluminum—nuts & bolts cadmium plated. ARGUTO OILLESS bearing—7/16" bore. Never need be oiled! "Clippers" semi-pneumatic tire. Use as is—polished hub very attractive.

(Dealers & Manufacturers write for quantity discounts)

\$2.60 each ★ A set of 4 Wheels **\$10.00**

C. L. WALKER, P. O. Box 1023, Plant City, Fla.

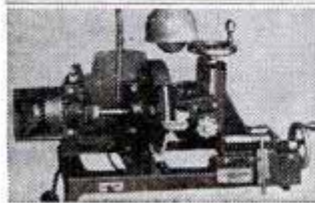

Start a NEW BUSINESS

Sharpen Dull Pipe Wrenches

Or Add to Your Present Repair Business

Write for information.

J. C. MOORE INDUSTRIES P. O. Drawer 276 FREDONIA, PA.

Install Your Own Combination CIRCULATING FIREPLACE AND WARM AIR FURNACE

Take down that troublesome parlor stove for the last time. Connect a FIREDAIRE to the same chimney. Set up the handsome steel cabinet mantel and start your fire.



FIREDAIRE is revolutionary in engineering and design. About 10 times as efficient as an ordinary masonry fireplace at 1/3 the cost. Draws cool air from floor level. Passes it completely around firebox and delivers it at desired temperature through grilles in mantel. Attach doors and same unit becomes a heater, capable of winter-conditioning 3 to 7 rooms.

Burns any fuel. Holds fire over night. No exposed smoke pipes. Can be installed without damage to walls or changes in chimney construction. Designs and prices for cottage and mansion. Write for details.

THE EDWARDS MANUFACTURING CO.

235 EGGLESTON AVENUE, CINCINNATI 2, OHIO

Time & Date AT A GLANCE

BELL GUARANTEED CALENDAR WATCH

Tells time, name of day and date. Day name changes automatically.

No. KA382 — Calendar watch, 17 jewels water-shock resistant, non-magnetic, radium dial and hands, stainless steel back. **\$49.75**

OTHER SPORTS WATCHES WATER-SHOCK RESISTANT

NOW AT RECORD LOW PRICES

Precision tested, guaranteed. 17 jewels, non-magnetic, radium dial and hands, unbreakable crystal, sweep second hand.

No. KA196 — Stainless Steel Back **\$24.75**

No. KA220 — ALL STAINLESS STEEL CASE . . . **\$29.95**

ORDER BY MAIL: Send check, money order or pay postman C.O.D. Prices Incl. Fed. Tax and Postage. Write for FREE Booklet "KA".

REPAIR SERVICE: All types and makes of quality watches. FREE estimate on request.

BELL WATCH COMPANY, INC.

Time and Life Bldg., Rockefeller Center, New York 20, N. Y.

*"Soft Pedal Stops
are yours with
Grizzly"*



"Like my new hat, Joe?" she asks. "The boy friend says it gives me that angel look."

"Humph," I snort.

"Why the gloom, sour-puss?" she asks. "Indigestion?"

"No," I shoot back. "It's just I'm thinkin' if you don't reline those brakes, you may *really* look like an angel."

"Oh," she says casually, "I can still stop can't I?"

"Not quick enough or easy enough," I reply.

"Well, it does take a lot of pressure to stop this old bus," she admits grudgingly. "Will new lining make it easier to stop?"

"My Grizzly Brake Lining will," I tell her. "Plus giving you greater stopping safety, Grizzly also permits you to slow down and stop with a 'soft' pedal. That's why Grizzly is the perfect lining for both men and women drivers and—"

"Whoa," she laughs, "that's enough. Reline 'er with Grizzly, Joe, and I'll drive relaxed!"



BIG FOOT . . . LITTLE FOOT
Grizzly Brake Lining is designed to give sure, smooth stops to both. Demand Grizzly—a leading brand of brake lining for over 30 years! Grizzly Manufacturing Company, Paulding, Ohio.

"Bear in Mind" . . . ask for

GRIZZLY
BRAKE LINING

WHEREVER BRAKES ARE SERVICED

On Guard . . . It's Forest Fire Time

(Continued from page 93)

stations are modern towers equipped with radios and fire-finders.

Headquarters for fire-fighting crews are three guard stations where crewmen are ready to go into action as fast as any city fire department. Local farmers and residents serve as voluntary patrolmen to blanket the area further.

House Mountain Lookout Station is one of the key spots in the network. The 3925-foot elevation is capped with a 110-foot tower. Several times a week the lookout "shoots" fires or suspected fires with his fire-finder, reporting by telephone to Vic Johnson at North Fork. Johnson immediately contacts other stations, the blaze is "lined up" and within minutes the rigs are on their way.

Some fires, known as "permit fires," are welcomed. Bunke issues over 1000 slash-burning permits every year to tree farmers on semi-agricultural lands within the area. Every precaution is taken. Some fires require three field trips—one for preliminary inspection, one for burning supervision and a third for a safety check.

But these are the only fires that are tolerated. Oregon's tree farmers are on sentinel duty in their war against the forest's ruthless enemy.

Weight-Balance Tool

Weight balances are attached or removed from automobile wheels by a leverage tool equipped with fixed and movable jaws. All types of balances for passenger cars, trucks and buses can be handled by the tool. It removes weights without breaking them, permitting their re-use.

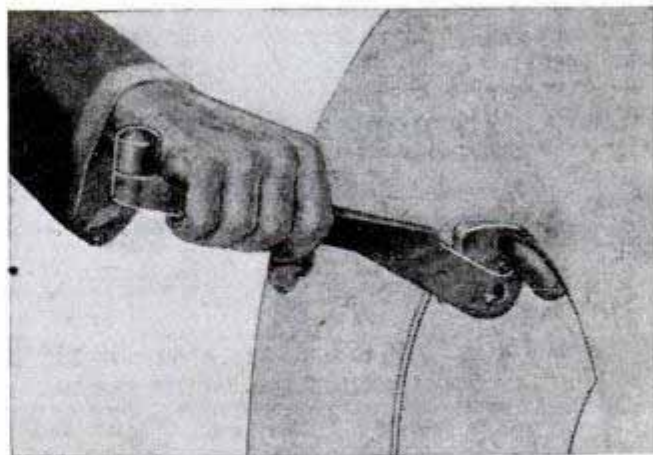

Equipment that can test aircraft engines up to 20,000 horsepower, the biggest load ever carried by a motor-power testing machine, has been built by General Electric for the Wright Aeronautical Corporation.



Indian

WORLD'S FINEST
MOTORCYCLE

SPRINGFIELD, MASSACHUSETTS

NEW TOOL READY

QUICKLY SHAPES, SANDS, CARVES, PROFILES, BANDSANDER
GRINDS, BEVELS, SMOOTHS, POLISHES, CLEANS!
Industry's most versatile machine—THE MEAD
BANDSANDER—now available to hobbyists,
craftsmen, model makers, pattern makers, home
workshops—cuts fast and clean on wood, metal,
plastics! Works equally well on inside cut-out
openings or irregular outside edges, on intricate
scrolls, curves. Saves hours of tiresome
hard work—does better job. Nothing else
like it. IDEAL TO GIVE OR GET FOR
WORKSHOP! Sold on 5 Day's Trial,
money back GUARANTEE.



FREE!
Write for free, lavishly illustrated
Circular describing
how Bandsander—the machine that
amazed the experts—
—saves time, money, trouble. Write
now—a post card
will do!



MEAD SPECIALTIES CO.
4114 N. Knox Ave., Dept. 177, Chicago 41, Ill.

AMAZING *Star* SCIENTIFIC GAS
NEW BURNER for

Automatic, Self-Acting • Needs No
Adjustments • Jet Type • Cannot
Backfire • Powerful in Performance
Natural, Manufactured or Butane Gas

DEALER'S QUANTITY DISCOUNT
BIG PROFITS - ORDER NOW
DIRECT FACTORY TO YOU • MONEY BACK GUARANTEE
STAR HEATER COMPANY
3072-14 POWHATTAN • DALLAS 2, TEXAS

STOVES
KETTLES
TUBS
GRIDDLES
HOT PLATES
STEAM
TABLES
WATER
HEATERS

PROMPT DELIVERY AVAILABLE

EASY ASSEMBLY IN
LARGE UNITS WITH
STANDARD PIPE FITTINGS

\$2.00
POSTPAID

ATOMS, PLANETS AND STARS

A Drawing to Scale

16 graphic representations
covering solar system,
movements of
planets, time table for
rocket ships, the elements,
and many other
Astronomical facts.



Size 48" x 23"

"Your Beautiful drawing
should be made accessible to all schools
in the country" Dr. A. Einstein.

"The drawing is excellent and informative."
Dr. Forest Ray Moulton.
"Never before shown so skillfully." Dr. M. M. Leighton.

Printed on 70 lb. white
finish. Only \$2.50 post-paid.
Order yours today!!

JAMES OLIVER HOGG, JR. (Member, Burnham Astronomical Society)
11501 Longwood Drive Chicago 43, Illinois

BLOWERS Blower wheels, bearings, etc.
Cooling equipment—Colls, Exhaust fans. Gas and oil burners and furnaces. Floor furnaces, fire boxes, Liquid Petroleum gas burners. Free literature. Wholesale and retail. Card for details. **PEERLESS SALES.**
4318 Sheridan Blvd., Lincoln 6, Nebr.

SHEATH

THE POLARIZED RUST PREVENTIVE
FOR GUNS, TOOLS, TACKLE
At your dealers 50c & \$1.00



Brownell Industries, Inc., Montezuma, Iowa

TELEVISION IN YOUR HOME NOW FOR \$159.50 ONLY Complete



This easy-to-assemble kit plus a few hours time gives you a highest quality television set . . . at only half the price you'd pay for the lowest priced set on the market!

Designed by television experts, this kit contains everything . . . dipole antenna, 7" picture tube, pre-tuned R.F. unit . . . even solder! Nothing extra to buy. All you need is a screw driver and soldering iron. Assembly

instructions are non-technical and simple to follow. All complex units are pre-assembled at Transvision factory.

EQUALS HIGH-PRICED SETS IN PERFORMANCE

Perfectly focused, clear picture even in brightly lit room. Over 6,000 Transvision sets assembled by novices are in perfect operation today. Cabinet available at low cost. Each set has a factory guarantee. Order one now and see the ball games in the comfort of your living room!

BEACON TELEVISION, Inc.

Distributors for Transvision Television Kits

143 East 49 St. New York 17, N. Y.

BEACON TELEVISION, INC.
143 East 49 St., New York 17, N. Y. PM-7

Gentlemen:

I'm interested in your easy-to-assemble Transvision Television Kit. Please send me more information.

Please send me a Transvision Kit at once at \$159.50. Enclosed is my check (or money order) for \$25.00 as deposit. Ship it C.O.D., F.O.B. New York and I will pay balance on delivery.

Name _____

Street _____

City _____ State _____

WAR SURPLUS BARGAIN SPECIAL

BRAND NEW! VACUUM-AIR HYDRAULIC FUEL PUMP

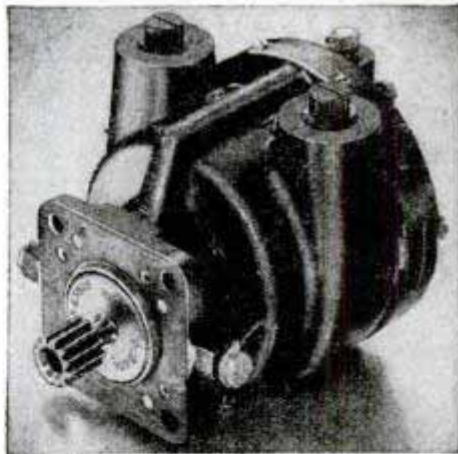

Original Cost
\$45.00
Now Only
\$9.95

Postpaid in U.S.A.

WORTH MANY TIMES THIS LOW SALE PRICE

USE THEM FOR
OIL BURNERS

SPRAYING
MACHINES

MILKING
MACHINES

COMPRESSORS

VACUUM PUMPS

HYDRAULIC
SYSTEMS

MANURE
LOADERS

PRESSES, etc.

● Originally cost \$45.00. Used by the Air Corps to drive bomber de-icer boots, gyroscopes, automatic pilots, etc. May be used as air or fluid pump—for pressure or vacuum. Standard 3/4 inch pipe thread with interchangeable ports. Will pump 7 1/2 gal. SAE 30 oil per minute at 300 RPM. Builds air pressure of 30 lbs. per sq. in. at 1000 RPM. Vacuum will draw 26 inches of mercury at 1750 RPM. Develops up to 120 lbs. per sq. inch of hydraulic pressure, which in conjunction with a 3 inch hydraulic cylinder, will lift 840 lbs. minimum. Runs forward or reverse. Self-aligning shaft. Die cast aluminum housing 6x4x4 inches. Has stainless alloy steel vanes and impeller. Made by Bendix Avia. Corp. Splicing terminal for direct drive—readily replaced with a pulley. Recommend a 1/4 H.P. or stronger electric motor as source of power. Rated capacity 1500 RPM with high overload factor. Special price for quantity users. Complete illustrated report and instruction booklet FREE with every pump. Send check or money order today. Postpaid in U.S.A.

\$9.95

GROBAN SUPPLY CO. 1522 So. Michigan Avenue
Dept. PM7 Chicago 5, Ill.

**ALWAYS EASY
ALWAYS POSITIVE**

**YOUR
HARDWARE
STORE**

HAS MANY STYLES & SIZES
FOR ALL NUTS, BOLTS & CAP
SCREWS - BUY "BILLINGS"

Billings
DROPPED FORGED
WRENCHES
for FARM-HOME-INDUSTRY

TOOL CRAFTSMEN SINCE 1849
THE BILLINGS & SPENCER CO., HARTFORD 1, CONN.

**NEW
WHIZZER
"STATION
WAGON"
DOUBLES YOUR
BIKE'S
USEFULNESS**

Here's a great new bike trailer that's built to last. What's more, the extra-light, extra-strong WHIZZER "Station Wagon" fits any bike. Full swivel hitch. Quickly attached and detached . . . makes an ideal hand cart around the yard and for shopping in stores. Carries bulky loads easily, safely . . . does not affect balance or control of bike. For low-cost delivery . . . drug stores and groceries . . . paper routes . . . personal shopping—get a WHIZZER "Station Wagon" today! Ideal for week-end trips and summer camping. Comes in knock-down package form.

**Only
\$14.95**

F. O. B. PONTIAC, MICH.

SPECIFICATIONS—Rated over 200 pounds capacity. Strong steel undercarriage, natural finish wood "station wagon" sides. Semi-pneumatic 10-in. tires. 24" long, 18" wide, 20" deep.

See your local bike dealer or order from
WHIZZER MOTOR SALES CO.
PONTIAC, MICHIGAN

FINE *Cabinet* WOODS

For immediate delivery! Thousands of feet in sizes and grades to exactly meet your homecraft or wood-shop needs. Bargains in Turning Blocks, Mouldings, Plywoods.

CATALOG OFFER: (U.S.A.)

Complete Hobbywoods catalog with periodic helpful supplements sent along with a twenty-five cent can of Waterproof Veriply (urea resin) Glue—Both prepaid for 25c.

Hobbywoods

Eastern Ave. and Cedar
Baltimore 3, Md.

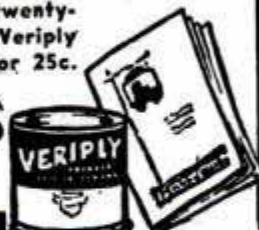

NEW—WAR SURPLUS JUNGLE HAMMOCKS

For the home, yard, farm, camping, scouting and many other uses. Can also be used for Pup tents.



Made of high grade Poplin for the U. S. Army. Complete with ropes and canopy for protection against mosquitoes and other insects. Comes individually packed. Ready for immediate shipment. Order yours today. Add 10% for **\$4.95** postage

Special quantity discounts

RoKo Company

729 Baltimore

Kansas City, Mo.

BECOME A PISTOL EXPERT WITH A HY-SCORE AIR PISTOL

- No Pumping
- Powerful, Fast
- Single Shot
- Precision-Made
- 30½ oz.;
- 10¼" long

HY-SCORE
PELLETS
FIT ALL PISTOLS
Cal. 111 2.50
Cal. 22 3.00
per 1000

SEE YOUR
DEALER
Send For Free Cir-
cular Dept. M7



HY-SCORE ARMS CORP. · BROOKLYN 1, N. Y.

● AMAZING NEW WOOD PRESERVATIVE ● DOUBLES LIFE OF LUMBER AND MILLWORK

COP-R-NAP offers a simple, easy and inexpensive method of preserving, protecting and greatly increasing the life of all types of lumber... porch flooring, fencing, sills, joists, sash and millwork, rope, sails, tarpaulins, boat planking and framing. Prevents decay, kills fungi, mildew and "blue stain". Easy to apply by dip, spray or brush methods. 1 Gal. treats 400 sq. ft. of wood. Paint right over it, makes paint last longer. Order a trial gallon for only **\$3.00 post paid anywhere in U. S.** Big discounts on larger quantities. **Osmose Wood Preserving Co., Dept. M., 1437 Bailey Ave., Buffalo 12, N. Y.**

WALLET
SIZE



PRESERVE IT IN PLASTIC

The Armed Forces sealed millions of I.D. cards in plastic. Have your cards & photos sealed the same way. Will not soil—fade—tear. Send item & 50c to:

PLASTICRAFT, Box 135, Wollaston, Mass.
(Agents wanted—Sample & Details 10c)

Assemble KING MIDGET



Practical highway racer runabout. New model. We supply all parts. Just bolt together. Low cost. Ready for delivery NOW. One or two cylinder. 40 m.p.h., up to 100 miles per gallon. Send 25c for complete new literature with large picture, 4-view drawings, price of parts, or send \$1 (refunded with first order) for the above, plus 24 page booklet showing complete assembly with 30 photographs and drawings.

MIDGET MOTORS, Athens, Ohio

ARMY RADIO PHONES

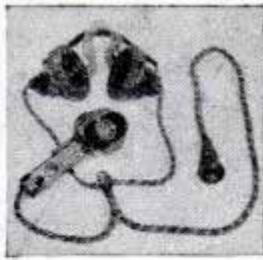

They're Weather - Water and Shock Proof

When we say they are made to Army specifications, that's enough assurance they must be of best quality. These Army Radio Phones are perfect and were O.K.'d by Signal Corps Inspectors. These Dynamic Mikes and Receivers, were used on aircraft and tank inter communication systems. Use them for recording, for battery-less phone, for pocket size set loud speaker or talk through your radio set. We bought a good many of these Radio Phones, they are brand new, and cost a great deal more than you can get them for. A complete dynamic hand mike, 2 earphones, headband, cord set. A wonderful buy for only... **\$3.45**

Send check or money order. FOB warehouse.

LEEDS RADIO CO.

75 Vesey St. Dept. PM4 New York City 7

Extra! JUST OUT Extra! U. S. PAT. PEND. NO. 702581
INSTANT NICKEL COMPLETE KIT
NO CURRENT OR BATTERIES USED **\$2.50** POST PAID

Iron, Steel, Aluminum, Brass, Bronze, Copper and practically all Industrial Metals can now be HEAVILY nickel-plated WITHOUT equipment, vessels, electricity or previous copper plating, a blessing to Hobbyists, Doctors, Hospitals, Restaurants, Bar and Beauty shop owners. Recommended for Auto, Bicycle and Machinery parts and accessories, Musical Instruments, Electrical appliances, Coffee Urns, and practically anything made of metal.

IN THIS MARVELOUS NEW PROCESS the principles of the battery and electroplating have been harnessed in the INSTANT NICKEL formula, so when it is applied with a wet applicator on a clean metallic object, a permanent nickelplate instantly appears! Thickness of plating is regulated by number of applications.

JUMBO SHOP SIZE (nickelplates 75 sq. ft.) only \$8.75 postpaid. Sample offer \$2.50 postpaid. Nothing else to buy, free particulars. Send check or money order today! C.O.D.'s few Cts. extra for Postage. INSTANT PLATING PRODUCTS, 3439 Michigan Ave., Chicago 16, Ill.

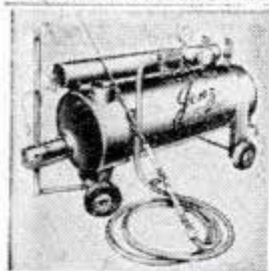

LOW PRICED
STEAM CLEANER

Jenz Super Chief

Portable—No moving parts—Cleans anything — Motors — Chassis — Machinery — Floors — Buildings — Remove wallpaper — Dairy — Creamery — Oil Rigs etc. Oil fired — Economical—fully tested and warranted. 75# Steam in less than 10 min. Complete as illustrated. **\$198.00** F.O.B. factory.

HI-PURE LABORATORIES
EVANSVILLE, IND.

A New Lightweight **CHUCK-LOCK ROD HANDLE**

NOW 1 HANDLE for all your rods

★ WEIGHS 4½ OZ.
★ FITS ALL RODS
★ POSITIVE REEL LOCK

An entirely new type rod handle. Makes assembly and disassembly simple and easy. Chuck-lock screw device holds rod securely. Cork grip. Absolutely guaranteed for quality. **\$4.95 Ppd.** (No COD's), Mered Mfg. Co. Box 237, Wauwatosa 13, Wis.

USE Fine Walton Wheels to Make Your Own **WAGONS—SHOPPING CARTS and RACERS**



65¢

Each in Sets of 2 or 4 — plus 10c ea. for postage. 4½-inch with 3/8-inch bushing

Coaster wagons, scooters, shopping carts, bike trailers, golf bag carriers, etc., are easy to make. Use fine Walton Deluxe Wheels! They're strong welded pressed steel construction. Ideal for making many things for use and play. Solid rubber tires. Red enameled. Send check or money order. No C.O.D.'s. Dealers and manufacturers write.

WALTON WHEEL COMPANY, Dept. J-4
Plankinton Bldg. Milwaukee 3, Wis.



••• **INSTALL YOUR OWN LAWN SPRINKLERS—UNDERGROUND \$1.49** each with **AQUA-SPRAY HEADS**

6 HEADS SPRAY UP TO 800 SQUARE FEET Easily installed—fully adjustable to any shape lawn—full instructions—money-back guarantee. Send check or money order to

AQUA-SPRAY LAWN SPRINKLER CO.
439 EAST FORT STREET, DETROIT 26, MICH.

Install Low-Cost Speed Reducer and Clutch . . .

Here's a 2-in-1 transmission that will work efficiently on lawnmower, band saw, motor bike or any place increased power and dependable clutch are required.

Works on Motors up to 1½ h.p. with either ½ or ⅝ inch shaft. Equipped with pulley or sprocket from which to drive. Durably made of strong steel with oilite bearings throughout.

Simple and Easy to Mount
Push tubular shaft in reduction unit onto motor shaft. Tighten pulley screw. Secure either end of transmission stationary and you are ready to take-off to any machine.

10-day Free Trial
Sold on positive money back guarantee. Mail check or money order for \$14.40 . . . indicate size of shaft and whether you desire chain or belt drive. In Iowa add 2% state sales tax. If not completely satisfied at end of ten days return Belt Transmission and money refunded. No waiting. Send order today or write for information.

\$14.40
MONEY-BACK GUARANTEE

Write for dealer-agency information.

CRAIN-McCURDY CO.
600 Capital City Bank Bldg.
DES MOINES 9, IOWA

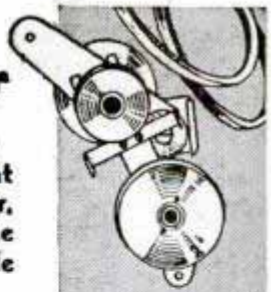

FRAZIER BELT TRANSMISSION



LAWNMOWERS



MOTOR SCOOTERS

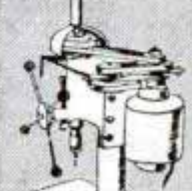

DRILL PRESSES and other power tools

WHAT A JOB IT DOES!

Garden-All does everything because Garden-All has everything!

Garden-All
LAWN and GARDEN TRACTOR



Instant Tool Attachment!

Exclusive Depth Control!

A Tool for Every Need!

Write for Booklet

Once you've seen Garden-All in action you'll agree: —There's nothing at all like Garden-All! Because Garden-All does so many jobs . . . so thoroughly . . . so speedily! Garden-All plows, discs, cultivates, cuts grass and plows snow. There's a tool for every job . . . for every season of the year . . . and every tool is so easy to attach and detach. So, before you buy any power lawn or garden equipment, be sure to see Garden-All! There's nothing like it!

GARDEN-ALL TRACTOR, INC.
Dept. P, 100 W. UNION STREET, LIBERTY, INDIANA

SAY YOU SAW IT IN POPULAR MECHANICS

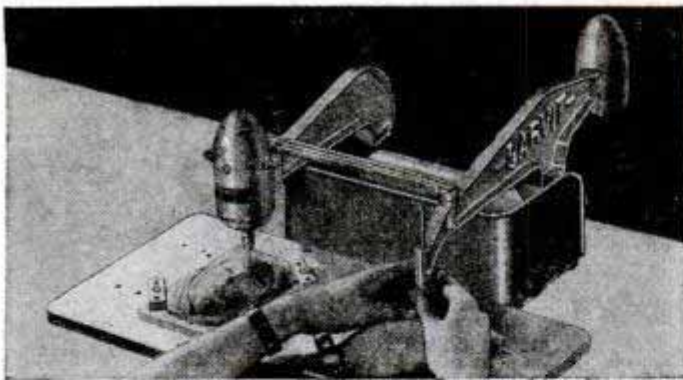

New! Sensational! Carvit makes you a skilled wood carver in 20 minutes!



Here's a fascinating new hobby — complete in one tool! The unbelievable perfection of your first carving amazes your friends! Experienced craftsmen use the Carvit to give their projects that professional touch.

With the Carvit, you make beautiful replicas of inexpensive objects you can find in any dime store or gift shop — in mahogany, walnut, and other fine woods; useful ornaments for your home, distinctive gifts for your friends — fine carvings that *sell!*



TEAR OUT THIS COUPON AND MAIL TODAY!

The Dumore Company, Dept. G-51, Racine, Wis.

Please send complete information on the Carvit.
 Please send one Carvit. \$48.50 enclosed. Shipping charges C.O.D.

Name _____

Address _____

H-3 City _____ (____) State _____

Small Saw Removes Tight Rings

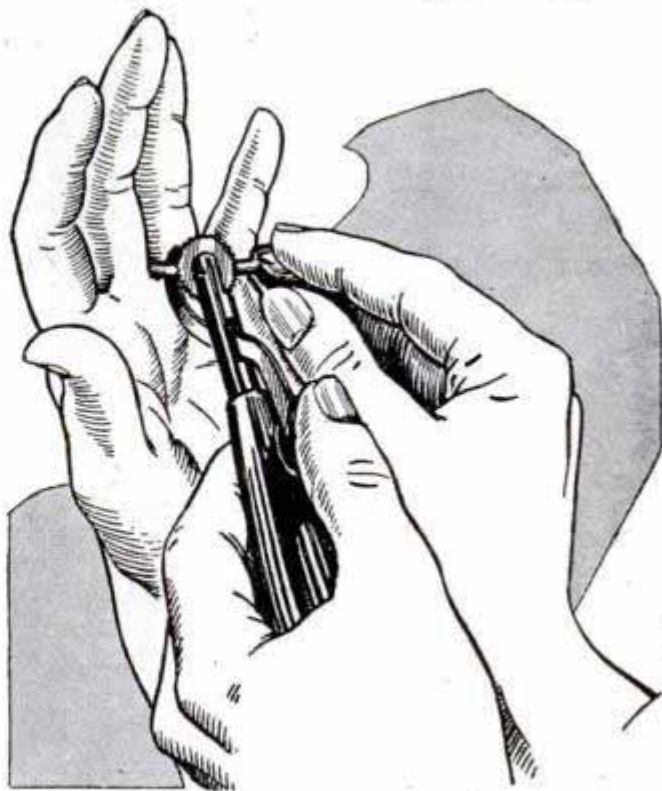

Rings are removed quickly and easily from injured fingers by a cutting tool specially designed for such emergencies. To remove a bent ring from a swollen finger, a smooth-edged, curved arbor is slipped between finger and ring. Then a lever is pressed and a knob turned to gently apply a small circular saw to the ring.

Dead Ducks 'Framed' for Decoys

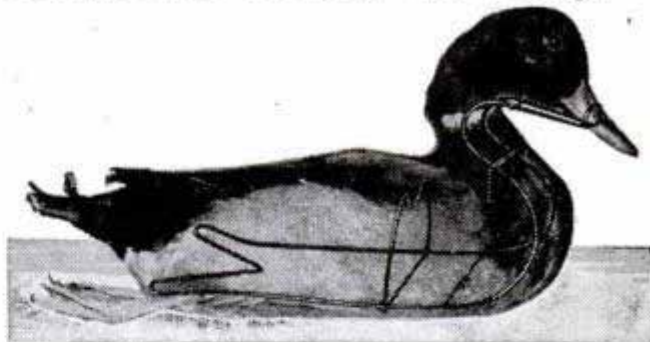

Dead ducks held in lifelike position by a wire frame are used by hunters as decoys. The rustproof steel wire frame, weighing about two ounces, conforms to the shape of the duck and holds its head up. The wire frame is concealed by roughing up the duck's feathers so that they lap over it.

Four electric motors, each as big as a six-room house, are under construction by Westinghouse to supply power for an irrigation project at Grand Coulee Dam that could, when completed, supply a glass of water every three minutes for every person in the United States.

BUILD YOUR OWN RADIO With These Wonderful Meissner Kits

5 TUBE AC-DC SUPERHET KIT

Complete—No Extras to Buy

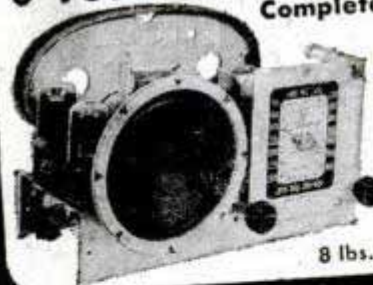

Made by leading Mfr. Have fun building it. Fine performance on full broadcast band. Quality parts. Improved circuit. Loop Antenna. 5" PM speaker, 5 new type tubes, simple instructions. 110 volts AC or DC. Wgt. **\$18⁷⁵**
8 lbs. including Tubes.

6 Tube, 2 Band SUPERHET

Gets Full Broadcast and Short Wave Bands



Meissner's Best! Full sized 3 controls, finest parts, new circuit. Gets Foreign and American Stations. A Deluxe set! 6 new type tubes, 5" PM speaker, simple instructions. 110 volts AC or DC. Wgt. 8 lbs. **\$24⁷⁰**
Complete with Tubes.

Send for Regular Bargain Bulletins

INCLUDE POSTAGE—20% Deposit Required with Mail Orders

NEW YORK
Offices & Warehouse
242 W. 55th St., N.Y. 19

NEWARK
ELECTRIC COMPANY, INC.

CHICAGO
323 W. Madison St.
Chicago 6, Ill.

New York City Stores: 115-17 W. 45th St. & 212 Fulton St.

New "THERMO-SAW" (CUTS WITH HEAT)

MAKE THINGS FOR THE HOME or FOR SALE

• Any Child Can Use It!

- NO NOISE
- NO VIBRATION
- NO SAWDUST

CUTS RAPIDLY AND CLEANLY THROUGH WOOD AND OTHER MATERIALS... AN IDEAL GIFT! Difficult patterns are made QUICK and EASY... No turning of work... Cuts in every direction... Cuts plywood 1/8" or 3/4"... Cuts 14"x36" board... Special Transformer produces high frequency current in a tough steel wire "blade" from ordinary Alternating (AC) current. No radio interference. IMMEDIATE DELIVERY!



NOTE: Operates on 110 volt Alternating Current: 50 to 60 cycle. NO C.O.D.'s

Machine Measures 11x4x 3 1/2" High. Throat 7" ONLY \$4.50 Deep. PATTERN FREE. Postpaid

ORDER \$4.75 in Canada and TODAY Mexico. \$5 Elsewhere.

BOISSELIER MFG. CO., Dept. P-7, GLEN ELLYN, ILL.

SAVE up to 85% on NEW HYDRAULIC CYLINDERS



VALVES, PUMPS, FITTINGS, HOSE, TANKS

The World's Largest Supply, 1001 labor saving adaptations for pulling, pushing, lifting operations. Finest precision workmanship and materials. Liquid and/or air operation. 15% GOVERNMENT COST

PNEUMATIC RIVET GUNS

Chicago, Cleveland and All Other Standard Makes



Used but in Swell Condition.

Send for Free War Surplus Catalogue

#181 \$8.95

PALLEY SUPPLY CO.

Dept. PM-77 6321 San Fernando Rd. Glendale 1, California

TORPEDO DIRECTOR SIGHT... \$4.50

Rack & Pinion assembly, achromatic lens, polaroid filter, packed in plywood carrying case.

K-3 COMPUTING GUN SIGHT... \$12.50

110 precision bearings; 200 gears and drives, motor, lens, etc.

SIGHTING STATION... \$49.50

B & L & Eastman. 30 coated lenses, prisms, selsyns, pump, etc. Orig. cost \$9,854.00

Everything Brand New ASSOCIATED SURPLUS CO.

10838 Ventura Blvd. North Hollywood, California

\$13.50 Value for Only \$2.49

8000 ohm impedance Head Phones, produced to Air and Signal Corps specs. Extremely sensitive, lightweight (only 9 oz.). With 5 1/2 ft. cord, plug, jack and ear cushions. Every One BRAND NEW.

No. 17A37, Special Per Pair... \$2.49

Plus 25c each for Postage.



Burstein-Applebee Co. 1012 McGee, Kansas City 6, Mo.

BRAND NEW RUBBER BOATS

ONLY \$12.75

Includes: sturdy built boat, paddles, anchor, repair kit, carrying case, bailing cup, etc.

Quantity is limited so order yours today.

Send check or money order to:



ROCKAWAY SALES COMPANY

Route #6 Box 362-PM Rockaway, N. J.

Send for free circular on balsa wood floats.

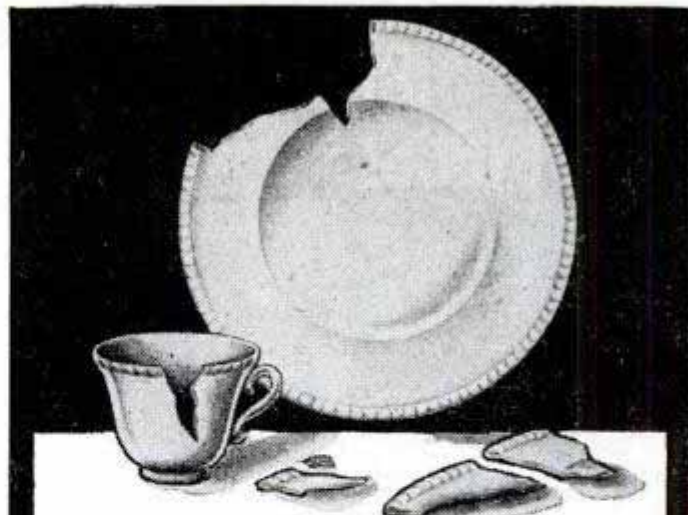

MENDS

BROKEN CHINA, TOYS, ETC.

It's transparent, waterproof, flexible and durable.



DUCO CEMENT

REG. U. S. PAT. OFF.



Have YOUR OWN Business

SAW FILING

You can have a good, steady, cash business of your own reconditioning saws with the Foley Automatic Saw Filer, which makes old saws cut like new again. The Foley is the ONLY machine that files all hand saws, also band and circular saws. Easy to operate—no eyestrain.

SEND FOR FREE PLAN—shows how to start in spare time—no canvassing. Send coupon today—no salesman will call.

FOLEY Automatic SAW FILER

FOLEY MANUFACTURING CO.

716-7 Foley Bldg., Minneapolis 18, Minnesota

Send Free Plan on Saw Filing business, no obligation

Name _____

Address _____



GET INTO YOUR OWN
**PROFITABLE
BUSINESS!**

**BIG PROFITS IN
CONCRETE CINDER
BUILDING BLOCKS**

Capture Your Share of
the Big Building Boom.
Supply the Great Demand
for Quality Blocks Needed
Everywhere for Every Kind
of Construction Work.

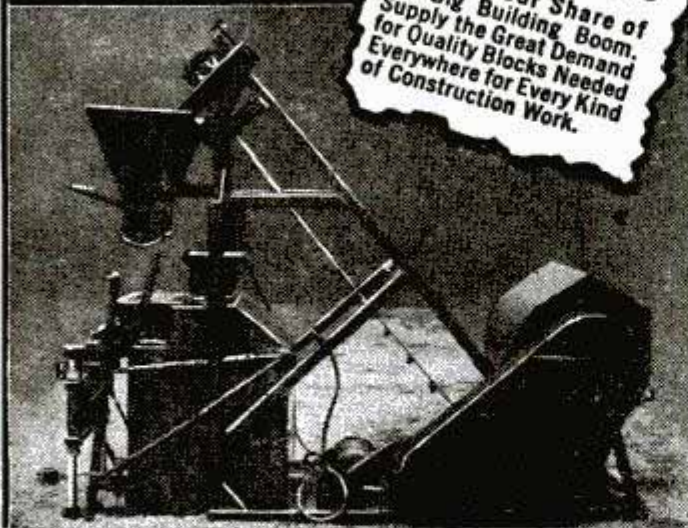

Here's an OPPORTUNITY Never Before Equalled
PAYS FOR ITSELF IN A FEW MONTHS—

and then you have a real profitable business of your own. One user, (Concrete Products Co. of Junction City, Kansas) says: "Easy to maintain production ONE HUNDRED CONCRETE BLOCKS PER HOUR PER MACHINE." Quick delivery now to get these operating in many different localities at once.

WRITE for MONEY MAKING FACTS for men of vision and modest capital. Write today—a 1c postcard will do.

CONCRETE BLOCK EQUIPMENT CO. INC.
920 Central Dept. 415 Kansas City 6, Mo.

War Surplus

For the Sportsmen — Young or Old
All Year 'Round Use



Perfect all wool
Olive Drab
**SLEEPING
BAG**

Comes in handy for fishing trips, hunting, camping, boating, just roughing it or use as auto robe and many other purposes. Has warmth of 2 blankets; zipper slide fastener; tie-strap on bottom; approx. Gov't cost \$12.90, our price, Ea. **\$3.95**

Outside Cover for Sleeping Bag—Water repellent.....**\$1.89**

ARMY PUP TENTS Perfect Without Pole.....**\$2.95**

BLANKETS—Wool O. D., excellent condition.....**\$4.85**

Perfect CANTEENS — used. 65c **SPURS**—Cavalry, New.. 95c

Perfect MESSKITS — used. 65c **CANTEEN CUPS**..... 40c

RAIN PONCHOS (used) Good condition.....**\$2.25**

FLASHLIGHTS Angle Head—clipon—New.....**\$1.00**

WATER PURIFIER—"Sunstill" New. Used by Air Forces and Navy to distill salt water into **FRESH DRINKING WATER**. Original Gov't cost, approx. \$70.00. **\$9.95**

Our price.....

Pump Type GARDEN & TREE SPRAY

Slightly used, perfect condition. Can be used also as fire extinguisher, whitewash spray, etc. **\$3.95**

4 gal. capacity

NEW AIR CORPS SUNGLASSES

Manufactured by Bausch & Lomb for U. S. Air Corps. Quality and Style with Bone Nose Cross Bar, individual case. Priced at big savings which **INCLUDES** postage..... **\$8.95**

NEW GOGGLES Set comes complete (boxed) with 9 extra interchangeable shatter-proof, flexible, cellulose acetate lenses. Amber, Green and white colors. A rubber flexible chamouis lined goggle frame. Back adjustment head strap. Made for A. A. F. Cost Gov't approx. \$4.50, Ea. **\$1.59**

White Mattress Covers, 81x31". Excellent condition.....**\$1.49**

Knitted SHORTS—White, New, Men's size 32 to 48—3 for **\$1.00**

MACKINAWs (used)—Water repellent, excellent condition, blanket lined, high collar with belt. Perfect as hunting, fishing coat, etc. Small, medium and large sizes.... **\$4.95**

RAIN COATS (used)—Good condition. Small, medium and large sizes..... **\$2.49**

Add 10% for postage — No COD — Send check or money order.

AMERICAN SUPPLY CO. Dept. P.M., 5th & Broadway Kansas City, Mo.

SCOOT KING SCOOTER



- The Sturdiest All Steel Scooter Made!
- 10" x 1.75" Semi-Pneumatic Tired Disc Wheels
- Double Row Radial Ball Bearing
- Beautifully finished in red — wheels in ivory
- Rubber hand grip; kick-type brake, motorcycle kickstand.
- 10" x 1.75" BALL BEARING WHEELS — \$2.75 Ea.

CECO SALES CO.
507 Fifth Ave.
New York 17, N. Y.

\$6.00
Each

Order today!

Check or Money Order . . . No C.O.D.

Sampler Kit * 25 Rods Finest



**DRILL ROD
TOOL STEEL**

\$1.95
POSTPAID
OR C.O.D.

Assorted Diameters — for 1001 Uses —
For **CRAFTSMEN, HOBBYISTS, MECHANICS, Etc.**

For Making
**DRILLS
CHISELS
ENGRAVING
TOOLS,
SMALL CAMS
& GEARS,
BUSHINGS,
Etc.**

Easily worked with
Lathe, File, or average
workshop tools, yet
can be toughened to
file hardness.

Hardening instructions included!

Order Your Kit Today

FREE
With Every Kit
TEMPERED STEEL
6-in. Comb. Rule &
DEPTH GAGE
graduated in
32's and 64th's of
an inch.
With Pocket Clip

We can supply tool steel in any size or shape, also "Dyna-cut" Tool Bits, for all purposes. Write for quotation on your needs.

BESSEMER STEEL COMPANY OF AMERICA
Small Shops Division Chicago 19, Illinois

folding STEEL SAW HORSES!

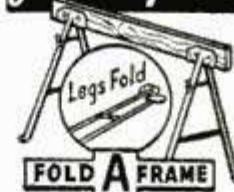

Save time! Space! Money! **Fold-A-Frame** fits 3/4" to two 2 x 4s lumber, any length! Model 24, Standard, 24" high. Model 40, legs adjustable 24" to 40" At all hardware and lumber dealers. Write for detailed folder. **National Tool and Die Co., Louisville 1, Ky.**

THE GEM MAKER



Amateurs or professionals . . . hobbyists or jewelers . . . Polish your own gems with a B&I Gem Maker. You will find this a profitable adventure. All necessary lapidary equipment is furnished, including a super-charged diamond blade for sawing, and all wheels for grinding, shaping and polishing, also complete instructions. The complete equipment as shown, less motor and belt, for only \$29.50, f.o.b., Burlington, Wis. Write today for information and literature on the Gem Maker and accessories. **B&I MFG. CO., Dept. S, Burlington, Wis.**

DRAIN TILE

BRICK

BLOCK

ROOF TILE

MANUFACTURING OPPORTUNITIES

The great building industry is your profitable market for these masonry products. Low investment . . . high returns. The biggest building years in the nation's history are just beginning. Use our modern, low-cost machinery to insure finest quality products at lowest manufacturing costs. Sold direct from factory to user. . . backed by 40 years' of doing business with men like you. Write for new catalog. Describes complete line of equipment with prices plainly given. Early delivery.

Concrete Equipment Company
512 OTTAWA AVENUE HOLLAND, MICH.



GIVE YOUR CAR WINGS!

After a Burd re-ring job, you can "hit it up" the first mile... no need to lose time in "run-in." Try a set of quick-seating Burd "Graf-Flox" Piston Rings; feel the difference in power and pep.

Free on request... two handy booklets for car owners. Print your name and address in margin of this ad, clip ad and mail today!



BURD PISTON RING CO., DEPT. PM, ROCKFORD, ILL.

A GREAT SURPLUS BARGAIN REDUCING GAUGE

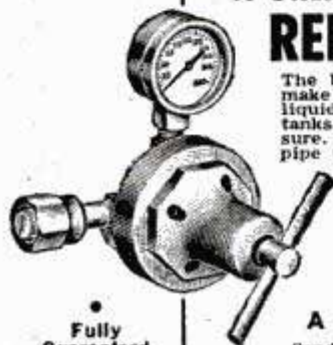

The buy of a lifetime in a standard make air pressure regulator. Used on liquid carbonic tanks and air pressure tanks of all kinds to regulate the pressure. Fitted with standard 1/2 inch pipe thread. Dial calibrated 0 to 200 lbs. Made by U. S. Gauge, Air Reduction Co., Walter Kiddie—all famous makers. Used by artists for air brush work, sign painters, retouchers, welders, etc. Used by soda fountains and taverns. All units are brand new. Satisfaction guaranteed.

A \$15 VALUE

\$5.95

Send check or money order. Ship same day.

GROBAN SUPPLY CO.
1522 S. Michigan Ave., Dept. PM7, Chicago, Ill.

Fully Guaranteed
All Brand New and in Perfect Condition

Send for Free List of Leading Books and Catalog of Tools For Watch and Clock Repairing—Engraving, Aircraft Instruments Etc. Address Dept. P10. Use Letterhead.

HENRY PAULSON & CO.
37 SO. WABASH AVE., CHICAGO 3, ILL.



WOOD WORKERS

LUMBER—PLYWOOD AVAILABLE
Harold Hunt wants to send new No. 15 catalog. Over 148 pages of woodworking ideas. UNEQUALED BARGAINS in imported and American woods, supplies, hard-to-find hardware. Send only 15c to cover postage and handling.

CRAFTSMAN WOOD SERVICE CO.
2729 S. Mary St., Dept. A-83, Chicago 8, Ill.

only
15¢



PLASTICS

Get started now in a profitable business or fascinating hobby. Write today for FREE list complete plastic supplies for fabricating and casting, plastic kits, complete plans for plastic projects and plastic accessories.

CENTURY ENTERPRISE

Box 56-PM, Station A Los Angeles 31, Calif.

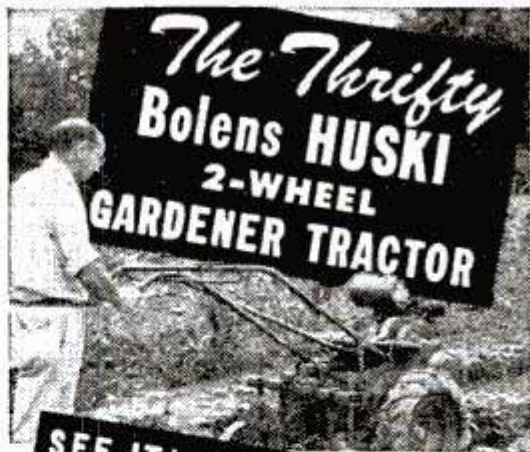

The Thrifty
Bolens HUSKI
2-WHEEL
GARDENER TRACTOR

SEE IT! TRY IT! BUY IT!

DO A BEAUTIFUL JOB of crop raising in your garden — on your farm — with this popular 3 H.P. Bolens HUSKI Gardener Tractor. Plow, disc, seed, cultivate, fertilize, and mow — easier, faster, at less cost. So easy to use, a boy can run it. All the implements and tools attached in a minute's time. Absolutely essential for garden or small farm. See your BOLENS Dealer or write for Illustrated Folder.

BOLENS PRODUCTS DIVISION
FOOD MACHINERY CORP.

Bolens HUSKI 265-7 Park St.,
2-WHEEL Port Washington
TRACTORS Wis.

IMMEDIATE DELIVERY!

Complete as shown

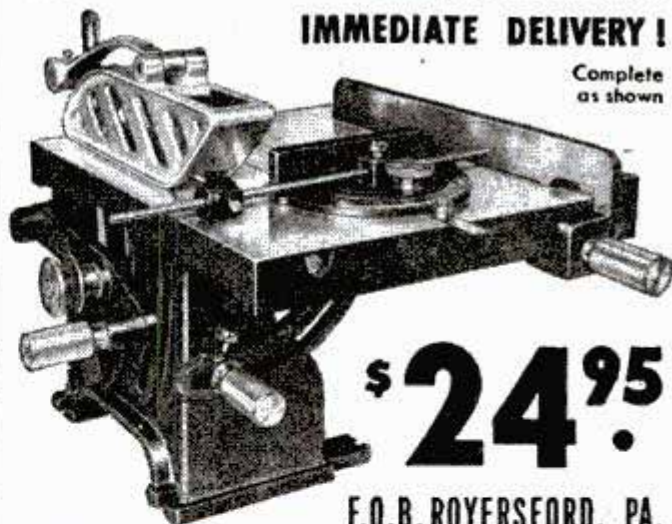

\$24.95

F.O.B. ROYERSFORD, PA.

QUALITY 8" BENCH SAW
CUTS THROUGH 2 5/16"

UNCONDITIONALLY GUARANTEED ONE YEAR
(Write for Free Booklet and Guarantee Bond)

Comes complete with Floating motor mount—miter gauge with adjustable stop—aluminum guard—soft aluminum insert—spring steel splitter—heavy gray iron fence—(no motor—no blade).
Table 12" x 14". Tilts to 45°—Oilite bearings. Shipping Wt. 50 lbs.

AMERICAN MACHINE & TOOL CO. Inc.
DEPT. 100 ROYERSFORD, PA.

FOR AMAZING PRECISION WORK AT HOME OR IN THE PLANT!

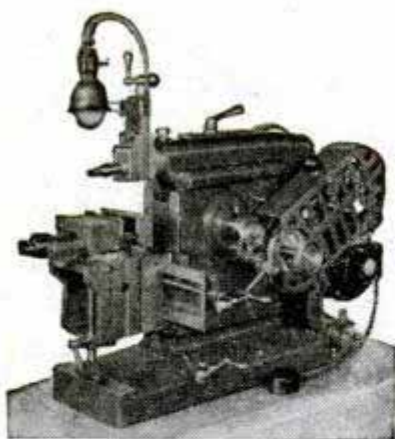

LOW PRICED AMMCO 7" SHAPER

You'll be amazed at the wide variety of jobs this AMMCO 7" SHAPER can handle quickly, accurately, economically. It does the precision work of a larger machine . . . has many features found only in the big expensive shapers.

Compactly designed for home and plant use, sturdily constructed for long life—it comes in bench or portable models. At its new low price, you now can afford this Shaper of a "thousand uses".

Address Dept. PM-77 for specifications and prices.

AMMCO TOOLS, INC.

COMMONWEALTH
AVENUE



NORTH CHICAGO
ILLINOIS

SKILL IS BUILT INTO EVERY AMMCO PRODUCT

PALMGREN

ROTARY TABLE

WITH
DOUBLE CROSS-FEED

A Rotary Table with full 360° movement and 4" cross-feed travel. Has 8" Circular Table provided with free moving adjusting wheels and dials graduated in degrees.



Cross-feed adjusting screws have acme threads and are provided with adjustable dials graduated in thousands.

Base has four convenient bolt slots and key slots for bolting to machine table.

Palmgren No. 83—
Rotary 8" Table **\$49.50**

Prompt Delivery

Order from your dealer. If he cannot supply you, write, wire or telephone factory:

CHICAGO TOOL AND ENGINEERING CO.
8365 South Chicago Avenue Chicago 17, Illinois
Telephone — Saginaw 9675

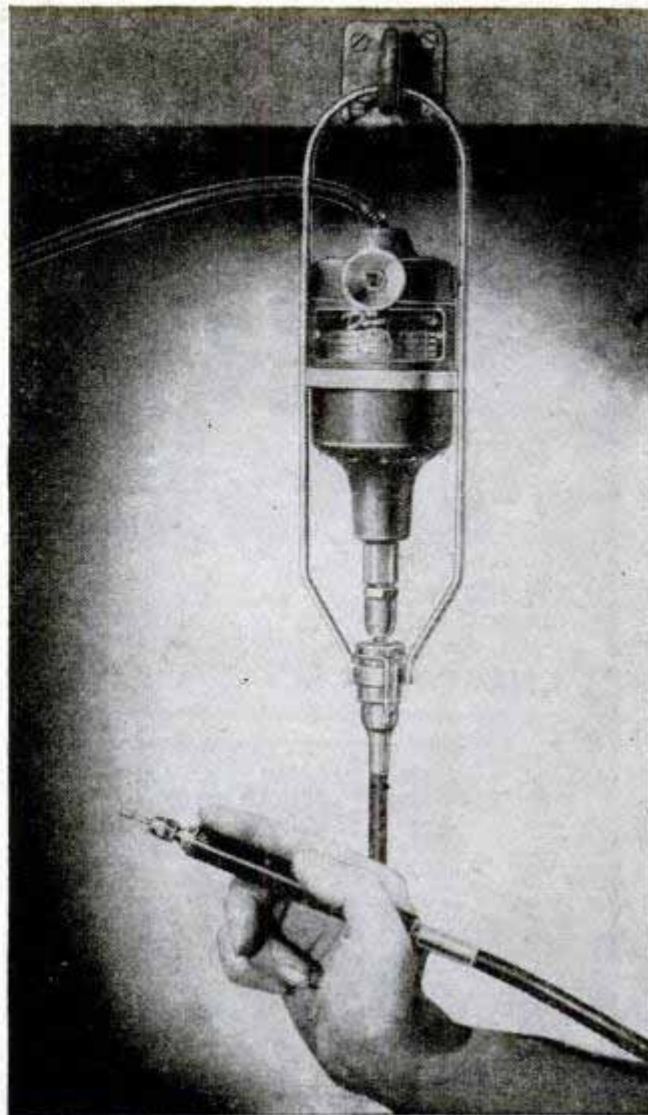

Five-in-One Electric Grinder

Powered by a 1/4-horsepower motor, an electric hand grinder designed for home workshop and industrial use can be converted into a flexible-shaft tool. The shaft attachment includes a bail or hanger to which the grinder is clamped, a 36-inch flexible shaft and a choice of three different hand pieces for special work. The grinder's chuck is of 1/4-inch capacity and can be adapted with collet sleeves to take the 3/32-inch and 1/8-inch mounted tools used for sanding, sharpening, sawing, drilling and polishing. With two other attachments, the grinder can be used for bench and lathe-mounted work. It is available in two kits, one with nine accessories including mounted wheels, files and arbors, and the other with 27 different accessories.

DDT "Paint" for Barn Interiors

Insect-killing DDT is combined with white coating material to cover the interiors of dairy barns, poultry and pig houses and dog kennels. The material is mixed with water and sprayed or brushed on metal, wood, stone, cement or cinder block.

Handy Mail Order List

Little Library of Useful INFORMATION

5 for \$1.00
12 for \$2.00
25¢ Each

Here at amazingly low cost is the practical help and information you have always wanted. Articles in previous issues of Popular Mechanics have been classified according to subject and are now available in these handy reprint booklets.

How to Use Measuring Tools—Micrometers, Calipers, etc.—109.

Power Driven Saws—74.
Drill Presses, Grinders, Etc.—79.
Wood, Metal Turning—Lathes—81.
Filing Machine, Hacksaw, Cutoff Wheel, Shaper—82.

Lathe Tools You Can Make—101.
Workbenches—Tool Cabinets—47.
Spray Painting—94.
From Pattern to Casting—91.
Tool and Saw Sharpening—92.
Sharpening Drills, Wood Bits—90.

Successful Wood Turning—32.
How to Read Blueprint—71.
Metal Turning Lathe Kinks—99.
Operating a Metal Lathe—100.
Heat Treating, Hardening—102.
Working With Glass—103.

Servicing Elec. Motors—75.
Electromagnets & Solenoids—44.
Transformer Construction—41.
The Boy Electrician—43.
Soldering and Brazing—17.
Arc and Spot Welders—5.

Electroplating With Nickel, Chromium, Cadmium, Etc.—86.
Plating Leather, Wood, etc.—87.
Lower Your Fuel Costs—31.
Curing Leaky Basements—45.
Fitting Home Game Room—55.

Indoor & Outdoor Fireplaces—88.
Backyard Gardening—39.
Lawn and Garden Novelties—72.
Trellises, Pergolas, Fences—76.
Lawn and Garden Furniture—77.

Playground Equipment—73.
Concrete Garden Furniture—6.
Making Serving Trays—53.
Sanders—80.

House Wiring—89.
Treasure Finders—13.
Hanging Wallpaper—38.
Built-in Fixtures—78.
Bird Houses—7.

Magazine Racks—49.
Clock Cases—50.
Book Ends—52.
Small Tables—54.
Smoking Stands—56.
Desks—58.
Book Cases—59.
Action Toys—66.
High Flying Kites—67.
Telescopes—20.
Metal Craft—28.

Knots and Ropework—105.
Working With Plastics—61.
Simple Home Improvements—104.
Ridding Home of Insect Pests—107.
Children's Room Furniture—51.

Jigsaw Novelties—57.
Doll House & Doll Furniture—60.
25 Shelves You Can Make—64.
Novelties Turned on Lathe—62.
Inlay Pictures—Veneering—63.

Wood, Soap Carving—65.
Windmills & Weather-vanes—68.
Lamps from Wood, Metal—69.
Rustic Furniture—18.
Wood Finishing—40.

Boats—14 ft. Outboard—2.
Boats—14 ft. Sail Dinghy—26.
Boats—21 ft. Sloop—46.
Rowboats, Small Dinghy—83.
Small Sail Boats—84.

Two Outboard Runabouts—85.
Build Own Canoe, Kayak—30.
Build Class-E Ice Yacht—22.
Auto Kinks, Shortcuts—10.
Building Trailers—27.

Motor-Driven Midget Cars—34.
Stop Auto Elec. Troubles—95.
Photo Printers and Dryers—25.
Photo Darkroom Equipment—98.
Trick and Table Top Photos—97.

Cosmetic Formulas—12.
Poultry Houses—108.
Guns and Decoys—109.
Re-Silvering Mirrors—70.
Chemical Experiments—93.

Log Cabins, Tourist Houses—14.
Trapping Small Animals—33.
Farm and Garden Tractors—8.
Building Extra Attic Rooms—23.
Attractive Basement Rooms—24.

Small Looms—37.
Gem Cutting—42.
Photo Enlargers—1.
Photo Kinks—98.
Cleaning Formulas—11.

Taxidermy—9.
Magic—29.
Training Dogs—35.
Small Furnaces—36.

Check Titles Wanted, Clip, Mail with Remittance to

POPULAR MECHANICS PRESS, Dept. 635, 200 E. Ontario, Chicago 11

POPULAR MECHANICS Blueprints & Plans

HOME CRAFTSMEN * SPORTSMEN
HOBBYISTS * FARMERS * BOYS!

Greater faster plan service! Hundreds of plans and blueprints of easy-to-build projects which have appeared over the past few years in the POPULAR MECHANICS MAGAZINE, prepared as a service to you.

Boats, trailers, furniture, radio circuits, lawn and garden decorations, and children's toys are some of the subjects covered. Long typed list includes approximately 1000 items. Everything from a pin box to a house you can build yourself!

Send Now!

Use the coupon below to send for our latest and complete list of things to build. These lists are absolutely free as long as they last!

POPULAR MECHANICS MAGAZINE
200 E. ONTARIO ST., CHICAGO 11, ILL.

Please send me, without charge, your 25-page list including all of the plans and blueprints now available from your Blueprint Dept.

Name: _____

Street Address: _____

Town or City: _____ State: _____

PAINT YOUR CAR WITH WYPETM for \$3.95

Amazing NEW AUTO ENAMEL

You WIPE ON Instead of Brushing & Spraying

Get Beautiful Mirror-Like
Finish That Looks
Like Spray Job! One
Quart Does Entire Job!

2-YR
Guarantee
NO MASKING
NEEDED
NO STRIANS
IN LAP-
MARKS
Looks like
SPRAY
JOB

At last—you can paint your car with WYPE for \$3.95 and get a beautiful, high-gloss finish that rivals an expensive, professional spray job. With WYPE you need NO BRUSH, NO SPRAY, NO MASKING! You just WIPE ON with Powder'Puff, furnished. Takes about an hour to apply. No streaks, no lap-marks. WYPE dries dust-free in one hour. Guaranteed for TWO years not to peel, chip, crack or fade, if simple directions are followed.

DRIES TO GLISTENING, PROFESSIONAL FINISH!

WYPE is a new Miracle Enamel for autos. It is NOT a wax or polish but a hard, high-lustre ENAMEL finish. With WYPE, anyone can do a beautiful job. Get a quart to paint your car or to get started in this BIG-MONEY business! See your dealer or order direct.

SEND NO MONEY!

Order WYPE Today!

8 POPULAR COLORS:

Black Brewster (dark) Green
Red Jewel (light) Green
Maroon Washington (dark) Blue
Gray Monticello (light) Blue

All \$3.95 per Quart

Order one quart or more today! Just send postcard. Then pay mailman for WYPE plus postal charges. Or send money with order and WE pay postage.

NEW MONEY-MAKING

BUSINESS! WYPE 2 Cars

Daily for \$25.00 each —

Gross up to \$260 Weekly!

Start making BIG MONEY now! Sell WYPE in cans or go into business painting cars yourself (or hire others). Send for FREE details of powerful money-making plan. Why wait? Start now by ordering one quart or more of WYPE today!

WYPE CORP., Dept. 16-G, 2214 Dolman St., St. Louis, Mo.

LOOK!



WAR SURPLUS

FIELD JACKETS

Ideal for

Farmers • Lumbermen
Truck Drivers • Laborers
and for

Plain and Fancy Loafing

ONLY

\$1.88

EACH

Nothing like it has ever been
offered at this low price!

This full-zipper front, bi-swing back, fine poplin Army FIELD JACKET is the favorite of G.I.s all over the world. Although used EVERY jacket is guaranteed to be in perfect condition. Sizes 34 to 40. Send name, address and size and on delivery pay postman \$1.88 plus C.O.D. charges, or send \$1.88 with your order and we will pay postage. Order yours today!

S & B SURPLUS SALES CO., Dept. P10
2905 W. Madison St. Chicago 12, Ill.

actual TESTS prove MIN-O-LIFE

Positively Keeps MINNOWS Alive and Lively HOURS LONGER

Transport live minnows in standard bait buckets for long distances in your car with Min-O-Life. Simple valve attachment agitates and aerates water.

Connect Min-O-Life with rubber hose to vacuum line beneath auto dashboard. Fresh air is drawn into jar by system of intakes and outlets.



37.5
Postpaid.

You can probably get your Min-O-Life at your Hardware or Sporting Goods Dealer; if not, order direct.

LEE SALES CO., 608 Main, Dallas, Texas

AMAZING MYSTERY BUTTON

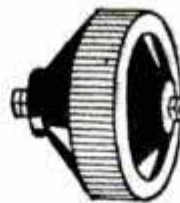

Startles Everybody. With this Electronic Button you can make your own Telephone-Amplifier-Detectophone. Attach this button to piece of cardboard—transmit conversation to another room. Music also transmitted to distant places. Most interesting electrical apparatus ever discovered. Enables you to perform hundreds of experiments. So tiny it can be concealed in dozens of places. A Pre-War Product. Electronic Button including 5000 word instruction booklet with 50 illustrated experiments. postpaid, only... **\$1.00**
Electronic Products Company, Saint Charles 4, Ill.



NOW! Electroply

1 PLIER DOES 3 JOBS—Cuts—Strips—Forms!

Send to-day! C.O.D. \$3.95 plus postage — or send \$2.00 and we pay postage. Send today! Agents! Write for proposition!

Patented nose forms connections, loops, bends! Cutting edges snip wire up to 1/4" — stripping edges strip insulation! Makes amateur work professional; professional work faster, neater! Rubber handles, drop forged, heat treated, polished! Send for yours today! **Electroplier Company, Dept. P** State Bank Bldg., Palatine, Illinois

BUILD YOUR OWN! FAST FREEZER PLANS \$1.00

It's easy to build this household appliance and profitable to use. Save up to 75%. Operates on 110 or 32 volts. Plans show 5 sizes and are easy to follow. ENJOY MAKING ONE of these freezers from new or used parts. No expert knowledge needed. Mail \$1.00 bill or check for complete plans and catalog.
LE JAY MFG., 447 LeJay Bldg., Minneapolis 8, Minn.

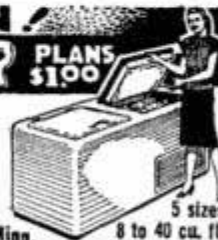

NEW SCIENTIFIC DRINKING \$298 PINK ELEPHANT



Complete with Glass and Stand
TUMBO will capture the hearts of young or old, with his antics. He has movable eyes, curling trunk, flapper ears and four legs. He's always dipping his curling trunk for a "shot" of liquid. Mail your order today.

MYSTERY DRINKING BIRD with Movable Eyes, Feathered Body & Stand... **\$1.89**
Special Price to Dealers
BERNARD FINE CO.
501 Sixth Ave. Dept. P.M. N. Y. 11, N. Y.

WIGGINS QUICK WATER HOSE COUPLING

SNAP, it's on! PULL, it's off! Easy fast! Wiggins coupling is guaranteed leakproof! Saves water, time. No bruised fingers or twisted hose. Precision made of solid aluminum for lifetime use. Order yours today! Send check or money order: \$1.50 postpaid. If you prefer C.O.D., send \$1.00 deposit.



E. B. WIGGINS OIL TOOL CO., INC.
3424 E. OLYMPIC BLVD., LOS ANGELES 23

HAVE YOUR OWN BUSINESS!

Operate pleasant, profitable Silk Screen Printing Shop. NO experience needed. Work at home in spare room or basement. Big demand! Large profits! Few dollars starts you. Start small, grow big. Real future possibilities! Eye-opening literature FREE.

W. E. WOLFF CO., 817 High St., Anderson, Indiana

CRESCENT TOOLS

Give Wings to Work

ASK YOUR
HARDWARE
DEALER

BRUSH PLATING OUTFITS

for re-plating articles in the home and shop. No tanks necessary. Free particulars.
GUNMETAL CO., AVE. M, DECATUR, ILLINOIS

Big Money for Workers In Home or Shop



Licensed Concrete Specialists wanted. No experience needed. Make Colortized concrete pottery without molds. New, low cost, patented method. Cemetery products, novelties, tiles, etc. Basement leaksealing. Other big pay projects. Booklet, details free. Men only.

NATIONAL POTTERIES COMPANY
415 Third Avenue, W., Grand Rapids, Minnesota

New 'Mohawk' KAYAK KIT

SAFE...STURDY
TWO MAN, 14 FT., 39 LBS.

A beautiful streamlined, pre-cut and fitted canvas covered boat, ideal for hunting, fishing or boating. Just a few evenings of your spare time, spent in following our instruction sheets; anyone can easily assemble the boat ready for the water—the boat forms itself. The kit comes to you complete to the last screw and includes STAINLESS STEEL RIBS, FINE WOOD COAMINGS and PADDLE. You need only the simplest of common hand tools to own for yourself this finest of postwar boats. In the water it handles perfectly... and safely (two 190 lb. men trying with all their might could not roll it over.) On land, a child carried it without aid to the car from the water and fastened it down for hauling home. The finest boat for its purpose obtainable.

If not at your dealer's, order direct mentioning his name. Price \$69.50 F.O.B. Phila. Free booklet upon request.

THE MOHAWK BOAT WORKS

DEPT. P-11-13 PRESTON ST., PHILA. 4, PA.

DRIVING AN OIL-EATER?

Cut fuel and oil bills... give your car new zip... install a set of quick-seating Burd "Graf-Flox" Piston Rings.

Send, today, for two free, handy booklets for car-owners. Print name and address in margin, clip and mail ad today!



BURD PISTON RING CO., DEPT. PM, ROCKFORD, ILL.

thinking of
building a
home?

Then you
need . . .

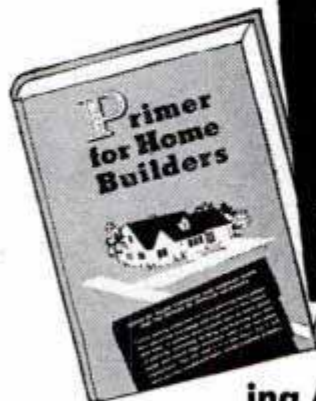

**PRIMER
for
HOME
BUILDERS**

The New Book by 12
Leading Home Build-
ing Authorities That can so
Easily Save You Hundreds of Dollars!

**Answers These and Other
Perplexing Questions**



- Can I Afford to Build a Home?
- What Should I Know About Financing?
- What to Look for When Buying a Lot.
- What Community Is Most Suitable for My Family?
- How to Go About Definite Planning.
- What Is Most Suitable Inside Arrangement of Working and Living Space?
- Should I Employ an Architect?
- What Should Be My Guide When Buying an Older House?
- Legal Rights and How to Protect Them.
- How to Work with Contractors and Builders.

Whether you are actually planning to build a home or just hoping that some day you can, Primer for Home Builders is the most important book you can own. It's the combined work of twelve leading authorities and contains real down-to-earth facts on every phase of planning, contracting, building and financing a home, plus typical legal documents used in all real estate transactions. You can read it in a few hours but it can save you hundreds of dollars and a lot of time, trouble and tears.

**A Book for Beginners - That
Makes You Feel Experienced!**

You'll like the way this book goes right into the business of building a new home, or buying an old one. Right from the start of "just dreaming," through whether or not to employ an architect and how to select an architect and work with him and contractors, how to plan the house, how to finance it, how to avoid legal difficulties, up to the time you take possession. You'll learn a hundred things you ought to know and probably don't know now.

Get Primer for Home Builders Now!

Don't wait until you are ready to start building. Before you do another day of thinking or planning or dreaming, get this most practical 184-page book to help you save time, worry and money.

MAIL COUPON TODAY

WINDSOR PRESS
A Division of Popular Mechanics Co.
200 E. Ontario St., Chicago

Rush _____ copies of Primer for Home Builders at \$2.50 each. Remittance enclosed.

Name _____

Address _____

City _____ Zone _____ State _____



COMPLETE HOME WORKSHOP

Here is power tool pleasure and profit in a ruggedly built, HEAVY steel unit—the Emrick Universal Woodworker. Handles big work. Drill press pulls 1/2" drill in steel. Saw takes 6" to 8" blade. Lathe 10" swing, 30" centers, spindle dia. 3/4". Takes all standard accessories. Sander 8" dia. Emery wheel 5". Bronze bearings, replaceable throughout.

**10
DAY
TRIAL**

Price does not include motor and saw blade. Order today.

1737 CLINTON STREET
EMRICK, Inc. KALAMAZOO 24, MICH.

Ship on 10 Days Trial. I am enclosing \$17.50, balance C.O.D. Send free literature.

Name _____
Address _____ City _____

Larson

**"MAKE YOUR OWN"
BACKYARD GYM SET**

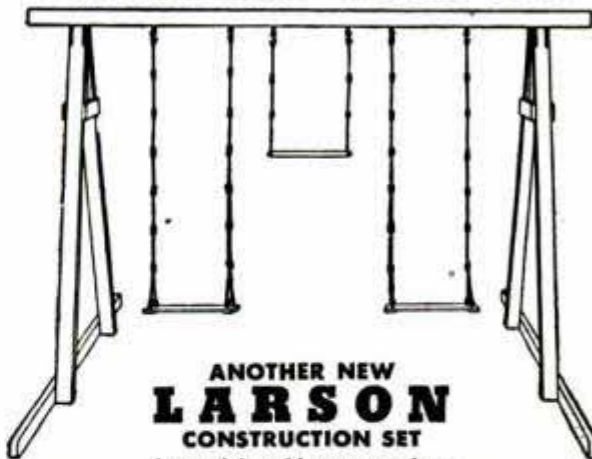

ANOTHER NEW
LARSON
CONSTRUCTION SET

A complete outdoor gymnasium.

Easy to construct from standard 2 x 4 lumber.

Complete with copyrighted instruction sheet and drawings. Parts built rigid for added safety. Everything furnished except lumber. Quickly taken apart for storage.

- Set No. 2024 as illustrated—2 swing prepaid.....\$ 8.00
- Set No. 1524 Single swing—prepaid 5.00
- Set No. 3024 2 swing, Trapeze and ladders—prepaid..... 10.00

CHAS. O. LARSON CO., BOX 358, STERLING, ILLINOIS

Does More Grinding Operations

FASTER!

because it's an
Abrasive Belt
Grinder CN-2
by
PORTER-CABLE

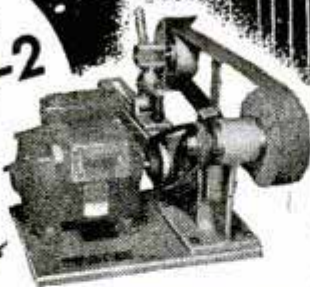

The CN-2 increases output over ordinary bench grinder by 200%... because it eliminates wheel loading, wheel digging, wheel dressing. Cutting element—the abrasive belt—keeps sharper longer. Reduces operator fatigue. Maintains high production all day.

Grinds on contact wheel, platen or free belt. Use the CN-2 for deburring, bevelling, chamfering, clean-up, knocking-off corners... and for many other operations in assembling and machining departments, tool rooms, job shops, service stations, home shops.

Easily adjusted for vertical or horizontal use within 90° arc. Weighs only 60 lbs. Furnished with or without motor. Write today for full information. Ask for demonstration by local Porter-Cable distributor.

PORTER-CABLE MACHINE CO.
2050-7 N. Salina Street Syracuse 8, N. Y.

WHEELS



Spotwelded	Heavy Gauge Steel	
5", 3/8" solid tire, 3/8" bushing, ea.		\$.59
8", 1" solid tire, 1/2 & 3/8 bearing, ea.		.99
8" same as above with hubcap ea.		1.09
10", 10x1.75 semi-pneumatic tire, 1 1/2" Killian Ball Bearings, ea.		2.69
BOYS' EXPRESS CART KIT—includes 4-8" rubber tire wheels, axles, hangers, braces, steering assembly, instructions for 15"x34" wagon. Factory-to-you price.		\$5.98

ADD 16% to ALL prices for F.P. 15% West of Miss. Check, money order only. Satisfaction guaranteed.

C. W. Young Mfg. Corp.
208 Burnet Ave. Syracuse, N. Y.

free
CONCORD
Radio
Catalog



Radio Parts • Radio Sets • Record Changers-Players • Kits • Ham Gear • Amplifiers • Testers

It's here! The big, new 1947 Concord Catalog with a vast, complete selection of everything in Radio and Electronics for building, experimenting, testing, repair and maintenance. Thousands of items—hundreds now available for first time—latest 1947 prices. Now LOWER prices on Radio Sets, Receivers, Kits, Record Changers, Players, Portables, Amplifiers. Latest listing standard items. Complete stocks—IMMEDIATE SHIPMENT. Write for FREE COPY—please address Dept. P-77.

CONCORD RADIO CORP.

LAFAYETTE RADIO CORPORATION

CHICAGO 7

ATLANTA 3

901 W. Jackson Blvd.

265 Peachtree Street

PAY RAISING—EXTRA MONEY BOOKS

Use these books to prepare for a better job—bigger pay—to start a profitable spare time or full time business of your own, improve your home, start a hobby. Popular Mechanics specializes in Popular Mechanics specializes in books on many subjects. Send

supplying outstanding self-help books on many subjects. Send for our FREE catalog.

- Shop Notes for 1947 Now ready. For every man who uses tools 60c
- Shop Notes Library 5 Vols.—1946, 45, 44, 42, 41 (No Dup. Mat.) \$3.00
- Painting, Furniture Finishing and Repairing \$1.50
- Rewinding and Servicing Electric Motors (No. 75) 25c
- Elementary School Subjects for Home Study Covers high points of grammar, spelling, arithmetic, history, science, geography, etc. 635 pages, \$1.89
- High School Self Taught Covers 25 subjects with study guide and self-testing quizzes. Completely revised and enlarged edition, 1280 pages, 300 illustrations, \$3.95
- Garden Book Build own trellises, lawn furniture, fireplaces, ornaments, etc. \$1.00
- Diving, Cutting and Welding in Underwater Salvage Operations Only book of its kind .. \$2.00
- Picture Framing Modern methods for making and painting picture frames. Fully illustrated, \$2.75
- Frog Industry Breeding, feeding, dressing and marketing \$1.00
- New Fields for the Writer Television, radio, film, drama \$1.00
- Making Amateur Photography Pay How and where to sell your pictures \$1.00
- 20 Careers of Tomorrow Covers plastics, metallurgy, textiles, radio, electronics, television, transportation, chemistry, etc. \$2.50
- Breaking Into Advertising \$1.00
- Into the Freezer and Out A complete handbook on the home freezing of foods. \$2.50
- Concrete Handbook New book on using concrete around home, garden, farm \$1.50
- The Vegetable Growing Business \$3.50
- This Way Up The successful philosophy of practical business men \$2.00
- Welding, Brazing and Soldering How to build own equipment and how to use it effectively \$1.25
- Modern Refrigeration Electric, Gas. Be service expert. \$5.00
- Dyke's Auto Ency. (includes Diesels, airplane engines) New 20th Ed. World's greatest book for mechanics \$7.00
- Household Mechanics The "fix-it" book to end all "fix-it" books. Covers electric appliances, painting, carpentry, etc. \$2.75
- Oil Burner Handbook \$2.50
- Build Your Own Boat Describes 17 popular boats—rowboats, sailboats, plywood outboard, etc. 192 pages \$1.50
- House Wiring (No. 89) ... 25c
- Turn Scrap Into Money Convert old auto generators into motors, welders, etc. \$1.00
- Woodworking for Everybody The first complete book on this subject. Considers tools, explains cutting and shaping of wood, and has 46 useful projects \$2.75

- Sheet Metal Work \$3.00
- Tool and Saw Sharpening (No. 92) 25c
- Forging Practice \$1.50
- Action Toys (No. 66) Plans for 21 easy-to-make toys 25c
- Foundry Work \$2.25
- Pattern Making Wood, metal \$2.25
- Forty Power Tools Build own saw, drill, lathe, sander, etc., from scraps—save money \$1.25
- Carpentry \$2.50
- The Young Craftsman Over 450 things boys can make \$1.50
- Five Acres and Independence How to make money on small farm \$2.50
- Your Home and How to Build It Yourself Step by step construction of the famous POPULAR MECHANICS house. Wonderfully illustrated \$3.00
- Photo Guide Construct own equipment, gadgets. Make better photos \$1.50
- Knots, Ties and Splices For everyone who uses rope \$1.25
- Plastics Latest information on manufacture and use \$5.00
- LeJay Manual of Homemade Electric Equipment How to construct 100 items that are scarce and valuable \$1.50
- How to Estimate for the Building Trades: Material and labor costs for masonry, plumbing, electricity, carpentry, heating, hardware, painting, etc. 629 pp \$5.50
- A Small Store and Independence Guide to successful retailing \$2.50
- Rabbits for Food and Fur . \$2.50
- Tool Making \$4.00
- Tool Design \$4.50
- Plumbing Installation & Repair \$2.00
- Ropp's Calculator Figuring made easy .. 50c
- Slide Rule Simplified ... \$2.75
- Drake's Refrigeration Service Manual \$2.00
- Primer for Home Builders All the information you need to know in building a house \$2.50
- How to Remodel a House Nothing is omitted ... \$5.00
- Toys You Can Make of Wood \$2.50
- A.B.C. of Poultry Raising \$2.50
- Ice Cream for Small Plants Some technical formulas for ice cream, ices and frozen desserts on a commercial scale \$2.50
- Furniture Joinery \$2.50
- Essentials of Upholstery \$3.25
- Radio Physics Course A thorough training in radio fundamentals \$5.00
- Science Digest Reader Fascinating articles on astronomy, atomic energy, psychology, medicine, etc. \$3.00



MAIL THIS COUPON TODAY

Check the books you want, write your name and address below, and mail this advertisement with money order or check. Outside U. S. A. include 15% additional for shipping charges.

Books selected will be mailed promptly on our "money back if you're not entirely satisfied" guarantee.

Name _____

Address _____

City _____ State _____

Mail to **POPULAR MECHANICS PRESS**

Dept. 650—200 East Ontario St., Chicago 11, Ill.

BUILD YOUR OWN Battery Driven ELECTRIC LAWN MOWER..

PLANS ONLY

35¢

WRITE TODAY

LEJAY MFG. CO.

847 LeJay Bldg., Minneapolis 8, Minn.

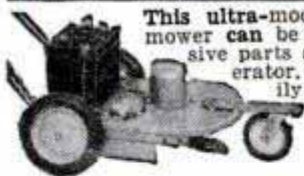

This ultra-modern rotary-blade mower can be made from inexpensive parts and an old auto generator. Plans complete, easily followed. Mower cuts forward or backward, tall or short grass, and weeds.

SHALLOW WATER DIVING UNIT

For salvage, rescue, exploration dives and pool cleaning. Comfortable and efficient; seals absolutely. Low cost with long life. Also, complete line deep-diving gear. Write for details.

- Mask
- Weighted Belt
- Air Hose
- Portable Compressor

DIVING EQUIPMENT & SUPPLY CO.
1121 N. Water Street, Milwaukee 2, Wis.

PLASTICS!

Fabricating plastics offers you a fascinating hobby or a profitable business. New Carmen-Bronson Plastics Handbook tells you how; gives construction plans. New Carmen-Bronson Catalog lists all needed materials—Plexiglas, Lucite, Bakelite, Lignolite, Tenite II, Lumarith in sheets, tubes, special shapes—clear and glowing colors. Also plastics dyes, cements, accessories and supplies. 25c (refundable with first order), brings you both catalog and handbook. Send for them today.

CARMEN-BRONSON COMPANY
165 EAST 3RD STREET, DEPT. 7-B, MOUNT VERNON, N. Y.

TRADE SIX NECKTIES \$1

Trade your neckties. It's simple. It's fun. Send us one to six ties you're tired of, but which are still serviceable, and we will mail you a like number of beautifully cleaned and DIFFERENT TIES obtained in the same manner. Upon receipt you pay postman \$1.00 plus postage.

TIETRADE P. O. Box 5267 plus postage
Chicago, Ill.

heavy duty — ball bearing — all purpose

MANDREL



Length Overall 14" Postpaid \$8.00
Diameter OD 1 3/4" Shaft 1 1/4" or 5/8" Optional
Lugs 1/2" x 1 1/4" x 3/8" in U. S.
2" between collars
Right or left hand Thread Optional

TRIO MACHINE CO., Box 187, Dept. PM, Willoughby, Ohio



ELECTRIC WELDER

AC or DC 110 Volts
Pre-war type—All metal—No chemical—5 year written guarantee. Welds 1/8" thick metal or money back. Repairs tanks, tools, fenders, machine parts, etc. Comes complete with rods, unit directions and eye shield. We also manufacture a set you can

learn with for only \$3.95 complete. On C.O.D. mailing charges extra.
ESSAY MFG. CO., INC., Dept. P.M., Quincy 69, Mass. **\$645** Complete

MAKE BIG MONEY AT HOME

Preserving baby shoes in metal, pearl, gold, silver, bronze. No experience necessary. 500%-1000% profit. Your own business.
KIKTAVI CO., 8620 So. Ruthelen, Los Angeles 44, Calif.

HUOT DRILL INDEX No. 29 \$3

KEEP YOUR TWIST DRILLS CONVENIENT AND SAFE.

HUOT'S ALL STEEL DRILL INDEX No. 29 holds twist drills from 1/16" to 1/2" by 64ths. ORDER YOURS TODAY. Huot makes a Drill Index for every need. Eleven Sizes. Write for details or see your dealer. Get No. 29 today—Send \$3.

HUOT MFG. CO. 555 North Wheeler
ST. PAUL 4, MINN.



Back in Production BLUE STAR 8" TILTING ARBOR TABLE SAW

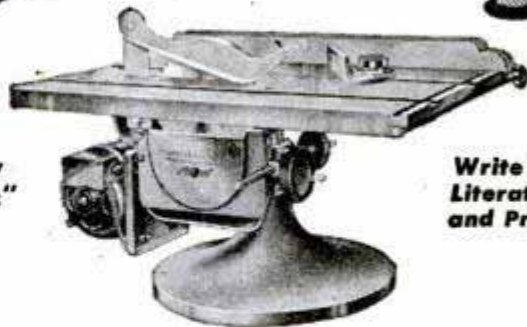

Capacity 0" to 2 1/2"

Write for Literature and Prices

Long recognized for quality tools by Home Craftsmen and Hobbyists, Blue Star now makes this 8" Table Saw again available. It handles a wide variety of sawing jobs easily, quickly, economically. The 3/8" ball-bearing Arbor tilts 45° to right and 5° to left keeping work flat for all cuts. Large Table 20" x 26" with milled grooves for miter and fence. Large Base 18" in diam. holds unit firm for accurate operation. 24" adjustable Aluminum Fence with steel guide. 8" Rip Blade raises or lowers for various thicknesses. Two 10 1/2" Miter Gauges accurately graduated in degrees. Shipping Weight 185 lbs. complete with 1/2 H.P. motor. Write at once for literature and prices.

BLUE STAR PRODUCTS

617 W. Kirkwood Street
FAIRFIELD, IOWA

A Division of St. Paul Foundry & Mfg. Co.

A GIANT IN YOUR HAND! NEW!

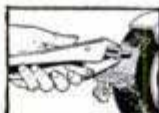

1,000's of Uses



"Snap-Lock" PLIER-WRENCH

Pat. App. For



Serves as a plier or wrench—or jaws can be quickly locked tight, so that hand pressure can be released and tool used as a hand vise or clamp. PARALLEL-UNIVERSAL JAWS afford full grip on either straight or angular objects. Terrific grip; any object held in jaws can not slip or be twisted loose! Pressed steel body, hardened (replaceable) jaws. Guaranteed, 10" size, \$2.25; 7", \$1.75. If not yet at your dealer's, order from us but give his name.

Send for free circular.

SEYMOUR SMITH & SON INC.
900M Main Street, Oakville, Conn.



**Insist on the
Genuine**

**WISE-GRIP
WRENCH**
REG. U.S. PAT. OFF.

The original, the strongest, the best designed. Never equalled. Most powerful, most useful hand tool. Exerts more than ton pressure. Locks to work with hands removed. Super-plier action. Fine alloy steel. Specially hardened. Nickel plated. Two sizes — still \$1.65, \$1.95.

Sold thru Dealers and Tool Jobbers
Invented, Developed and Made World-Famous by
PETERSEN MFG. CO., Dept. 30, DeWitt, Nebr.

Export Dept.: Irwin Herzfelder, 130 Water St., New York City

3 in 1 OTTAWA SAW

THE WORLD'S FASTEST.

6-H. P. EASY TO MOVE

FELLS TREES, SAWS BIG LOGS, SMALL LOGS, LIMBS

One motor performs all three operations. Furnished with or without attachments shown below. Thousands in use.

Make **BIG** profits in the ever increasing wood business. Pulley for belt work. Fully guaranteed. Low direct-to-user prices. **FREE** details—write **TODAY**.

OTTAWA MFG. CO., 2-727 Pine St., Ottawa, Kansas

FIND OUT WHY THE DEAF

CALL THE **Beltone** A "MIRACLE"

Write for **FREE BOOKLET**

BELTONE HEARING AID CO., Dept. PM-77
1450 W. 19th Street Chicago 8, Ill.

PLANS FOR 5 PROJECTS
that are fun to build

— only **\$1.00** postpaid

Special combination offer includes easy-to-read plans for: 1. Folding Lawn Chair 2. Child's Teeter Totter 3. Child's Glider Swing 4. 24-room Swallow House 5. Bird Feeder
Mail your dollar bill today! Ask for Package "Z".

DELTA MANUFACTURING DIVISION
Rockwell Manufacturing Co.
680-G E. Vienna Ave., Milwaukee 1, Wis.

Deltacraft

ROUGH DIAMONDS

Genuine Diamonds: exactly as found in the famous African mines, uncut and unpolished. Each diamond guaranteed to weigh one carat or more. A real bargain for collectors, mineralogists, dealers, mechanics, and agents. Send only \$5.85, full price, postpaid, diamond will be sent promptly by insured U. S. Mail. Larger size diamonds available. No literature. Remember—you are buying real diamonds!

SECURITY JEWELRY CO.

610 South Broadway Los Angeles 14, California
In the jewelry business for over 40 years.

LOW COST PHOTO ENLARGERS

New improved **STARLIGHT ENLARGER** gives Better Results up-to-the-minute Features. Equipped with **FINE ILEX ANASTIGMAT** 3 1/2 inch **F6.3 LENS** and **IRIS DIAPHRAGM**. Takes negatives up to 3 1/4" x 4 1/4". Makes **Low Cost ENLARGEMENTS ANY SIZE** for yourself or friends. Profitable easy business or hobby. Work at home. **COSTS VERY LITTLE** to own and operate. Write today for Free folder "B" giving full details.

PHOTO-SPHERE CO. INC.

115 East 23 St. New York 10

METAL FORMING TOOLS

12" BRAKE. Fits in vise, or bolts to bench. Forms angles, channels, boxes and crimps in sheet metal and thin strap iron. \$14.50 PP.

VISE FORMING TOOL. Makes cylinders, ovals, cones, hoops and round corners in sheet metal, wire and 1/2"x2 steel strap, 2" to 60" in dia., 18" wide. \$10.00 PP.

VISE IRON BENDER. Easily bends 1/2" square or round; 1/4" up to 2" wide. Makes hooks, rings, brackets, eyelets, etc. Screw adjustment for accurate work. All steel. Price \$10.00 PP. Immediate delivery.

Order direct, or send for details. Sheet metal and wire forming booklet, 50c.

VISE BRAKE MFG. CO., Dept. P.M.
1318 So. 30th Ave. Omaha 5, Nebr.

CRAFT FINISHES SUPPLIES

Materials to produce a professional finish on every type article. Industrial finishes for the home craftsman's use on wood, metal, plastics, plaster, etc. Electroplating and shop supplies, novelty finishes. Catalog free.

CRAFT FINISHES Box M 467 Arlington, Virginia

CHANITE SELF-WELDING FLUX

REPAIRS ALL ELECTRIC HEATING ELEMENTS

So simple anyone can make repairs in your broken or burnt-out electrical appliances—irons, toasters, stoves, etc. Guaranteed nothing like it. From our mines to your appliances. \$1.00 per package. \$7.50 per doz. Stick form 25c. \$2.00 per doz.
CHANITE SALES COMPANY, 914 So. Main, Fort Worth 4, Texas

LAWN ORNAMENT-NOVELTY PATTERNS

28 Lawn Ornament Patterns, 25c. Other patterns; 15-20" high; Dutch Girl, Dutch Boy, Pirate, Bull Terrier, Mexican Girl, Mexican Boy, Dwarf, Penguin, Flower Girl, 10c each. 25 Novelty Patterns, 30c. All 62 Full Size Patterns, \$1.00 Postpaid. Strother Pattern Service, Dept. X-3, Box 383, Belington, W. Va.

WORK APRONS

On the job—On your hobby—Protect your clothes. Heavy white cotton drill—3 pockets—full length. Send \$1.00 money order. Prompt delivery. Postpaid. Quantity prices on request.

H. F. MONTGOMERY 101 PALM STREET NEWARK 6, N. J.

FIBRE ARMS AND LEGS!

Light, correctly fitted, strong and comfortable. Natural appearance. Braces for all deformities. Scientific design. Fair Terms.
BUCHSTEIN-MEDCALF 223 S. 6th St., Minneapolis, Minn.

A AND N SUPPLY CO.

Thousands of Bargains in Military, Outdoor & Sport Goods for Hunter, Farmer, Scout. Send 10c for 32-page catalogue returned with first order.

A and N SUPPLY CO.
4720 Lester St. Richmond 15, Va.

RECTIFIERS

For electroplating, battery charging and other applications. Out of stock or Made to Order. Also special transformers. Buy direct from the factory. Advise us of your particular requirements.

STRICKLAND ELECTRIC COMPANY, Columbus 11, Ohio

BALL BEARING STEEL WHEELS

Made To Outwear Other Type Wheels

Complete with GOODYEAR, GATES or OSBORN PUNCTURE-PROOF Semi-Pneumatic Tires.

NOTE: Not the toy tires used by most wheel manufacturers.

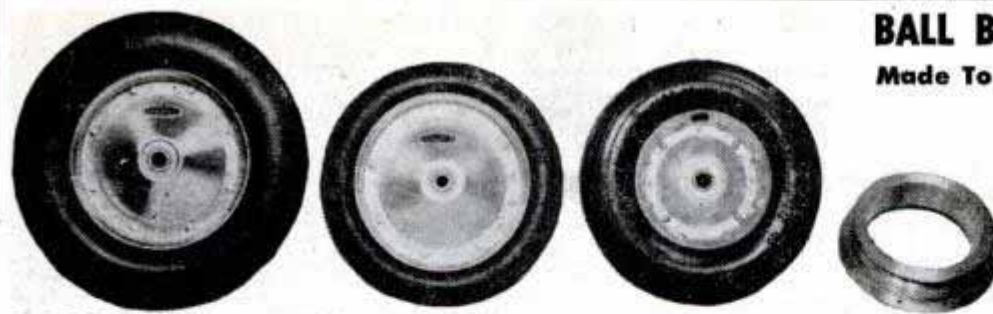

12" x 2 1/2" Load—150 lbs. 1/2" or 5/8" Ball Bearings ONE \$5.50 TWO \$10.00 FOUR \$18.00	10" x 1 3/4" Load—125 lbs. 1/2" or 5/8" Ball Bearings ONE \$3.00 TWO \$5.50 FOUR \$10.00	10" x 2 1/2" Load—250 lbs. 5/8" Ball Bearings ONE \$5.50 TWO \$10.00 FOUR \$18.00
--	---	--

Three as above and One V-Pulley Drive & Brake Drum Wheel ... \$21.00
Three as above and One V-Pulley Drive & Brake Drum Wheel ... \$13.00
Three as above and One HEAVY DUTY INDUSTRIAL Add 10% for Prepaid Shipment in U.S.A.

Write for Circular on our 1948 MODEL "B" RACER, 30" Wide x 70" Long. With Internal Brakes. . . Equipped with FOUR 12" x 2 1/2" WHEELS, Combination V-Pulley Drive to back wheels. . . PRICE . . . \$58.00 . . . With 1-H.P. "Powers" Gasoline Engine; Gear Reductor; Controls, etc. Chassis Complete READY TO RIDE. \$175.00. Same with Electric 12-Volt Motor . . . \$150.00. Add 15% for Racer Chassis prepaid in U. S. A. . . . Steering Wheels, Auto Type Front Axle assemblies.

OSBORN WHEEL COMPANY, 115 So. Main St., Dept. P-7, DOYLESTOWN, PENN.

12-Volt
ELECTRIC MOTOR
3-Speed Control

ONLY \$3350

17-lb. Powers 1-H.P. Gasoline Engine \$6800

Rush order

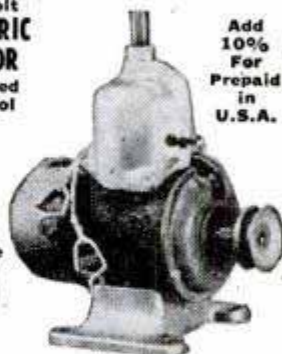

Add 10% For Prepaid in U.S.A.

MAKE YOUR OWN RECORDS



with Risco 3-way Home Recorder
5 MINUTES RECORDING ON A 10" RECORD

Ready to operate with 6" Spkr., Crystal Mike **\$4950**

4-Tube Amplifier Only \$25

1. Ideal for music lessons, parties, your child's cutes sayings, etc.
2. High quality phonograph play-back reproduction.
3. High output for a public address.

25% on C.O.D. Orders — FREE Catalog — Complete Details
WHOLESALE DISTRIBUTORS **RISCO ELECTRONICS** 22 Warren St. N. Y. 7, N. Y.

AUTOMATIC IRON TESTER

(Pat. Appl. For)

For checking temperatures and re-setting thermostats. Graduated for RAYON, SILK, WOOL, COTTON, LINEN—200° to 700° F. ONLY \$18.50 postpaid — MONEY BACK GUARANTEE.

Write for circular.

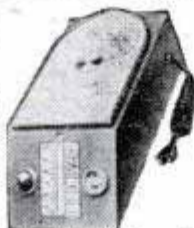

HANLAN CO., 1419-A, W. Jefferson, Los Angeles 7, California

★ ★ PRICE REDUCTIONS ★ ★ EXPANDED STOCKS

Aluminum flats to 4", squares, rounds, hexagons, angles, tubing. Drill rod in rounds, squares, flats and octagons. Plastic in sheets, rods and tubing, clear and color. Also Decorative Panels. Many other items. Listing (A47) on above 5c. Catalog 1046-E and Listing A47 which lists tools, supplies, equipment, etc. 15c.
METPLAS SUPPLY COMPANY, 1420 S. 16TH, MAYWOOD, ILLINOIS

Say You Saw It in POPULAR MECHANICS

NOW *Sound* FOR YOUR SILENT PROJECTOR Economically

\$5995 Convert your 16mm silent projector to sound (regardless of make) with Apex sound head & radiofilm adapter. Guaranteed excellent performance. Write today for free information.

APEX VIDEO • 12209B Branford St., Roseme, Calif.

"LITTLE WONDER" Crystal Radio

NO ELECTRIC—NO BATTERIES—NO TUBES

One of the smallest genuine crystal radio sets in the world. Slider-contact tuning, binding posts for aerial and ground. Extra long range. **SEND NO MONEY.** Just send your name and address and when your "Little Wonder" arrives simply pay the postman \$1.99 plus a few cents postage. Sent prepaid if you inclose check or money order with your order.

MART DISTRIBUTORS
Box 3472 Merchandise Mart, Chicago 54, Illinois, Dept. P13

ALUMINUM SPEED WHEELS

10" Dia. to Outside of 10x1.250 Tire . . . Rust Proof . . . Super Strength . . . Two Precision Seated Ball Bearings . . .

PRICED AT ONLY \$2.25 Ea. . . .

Chrome Hub Caps 15c Ea. . . 7/16"x18" Threaded Steel Axle With Stop Nuts 75c Ea. or 7/16"x5" Steel Stub Axles With Nuts, Threaded One End 15c Ea.

SEND CHECK OR MONEY ORDER

MacCLATCHIE MANUFACTURING CO.
P.O. Box 430 Compton, Calif.



For.. BIG Money-Making.. Doing ALL Work .. the NEW, EIFEL-LINE SUPER-TOOLS

4 Great KITS, with 10 Attachments
.. to Make 17 World-Beating Combinations

EIFEL-GEARED PLIERENCH KITS

- 1) The 7" KIT, Famous in the Small-work field, makes Universal-PIPE-WIRE Combinations.
- 2) The Famous 8 1/2" KIT, with same Combinations for the HUSKY Work and much surprisingly Fine work too!
- 3) The New GIANT-KIT . . . the 8 1/2" Kit with the 4" GIANT-Jaw added . . . to give a Million Sizes from 0" to 3"!

4) THE MASTER KIT

Comprises the 8 1/2" Plierench + PIPE-Jaw + WIRE-Jaw + TUBING-Cutter-Set + Grip-CLAMP . . . in a Handy 3 Pocket Holster. It Folds to 3" x 1 1/4" x 11" . . . It's THE Kit of the Atomic Age!

• These 3 great Accessories Can be Used in All EIFEL-GEARED Plierenches . . . made since 1932.

• Also there are those famous Eifel PICK-ALLS . . . 11", 15", 24" and 30"; and the Eifel-Multitool pictured below . . . the "world's Most Useful little tool."

• Current Orders leave only a Small supply for New customers, and this First Ad' in 6 years is meant specially for inactive past Plierench Salesmen; and to help Users bring their Kits up to date. Tools beyond repair have a small Trade-in Value.

MAIL this Part of Ad TODAY with your address (on a Postcard will do). Get **FREE**—this 6-Edge-End & Angle SCREWDRIVER (It Turns Screws in ALL Positions and does many useful things) . . . and 101-PICTURE MANUAL OF MECHANICS, with . . . □ User Offer; or, with . . . □ DISTRIBUTOR, Territory and Demo. Kit Offers!



NEW FREE
Bottle-Cap Opener, etc.

AMERICAN PLIERENCH CORP'N 4611 N. Ravenswood Avenue Dept. PM-77, Chicago 40, Illinois



Build Your Power Tools With OUR BALL BEARING ARBORS

New Departure Self Lubricating Bearings

10,000 R.P.M.



(No extra charge for left hand threads)

B33—\$4.95 PP.
5/8 x 4 1/2 Spindle
B15 Plain Spindle
\$3.50 PP.

C4—1/2 x 12 1/2 spindle, housing 2x8 \$8.25 PP.
C5—5/8 x 12 1/2 spindle, housing 2x8, \$8.25 PP.
C6—3/4 x 12 1/2 spindle, housing 2 1/4 x 8, \$9.25 PP.
D8—1 x 17 1/2 spindle, housing 2 5/8 x 11 \$16.95 PP.

1 INCH BETWEEN WASHER AND COLLAR

Shaper Arbors C4, C5, C6, D8, 3 inches between collars, add \$6.00. Plain Spindle models less threads and collars C4-\$8.00, C5-\$8.00, C6-\$9.00, D8-\$16.00 all P.P.

BUILD YOUR DISC SANDER WITH OUR ARBOR, DISC AND PLANS



8" x 5/8 Tru-disc \$3.50
8 1/2 x 3/8 S.B. Arbor 3.50
2" x 5/8 pulley 0.35
35" V Belt 1.15
Plans 0.10
Total 8.60

Special Offer... \$8.00 P.P.
Or Complete Machine \$9.75 P.P.

10" disc instead of 8" add \$1.50 to Special Offer. 8" disc \$3.50 P.P., 10" disc \$5.00 P.P. Center hole 1/2, 5/8 or 3/4. Complete stock V belts and pulleys. Courtesy to Dealers.

Make the above Disc Sander with our B15 Ball Bearing Arbor and 8" or 10" Tru-disc. See special offer.

POLY PRODUCTS, 406 S. Chester, Ct. 1a, Pasadena 5, Calif.

UTICA TOOLS

FOR MORE TOOL MILEAGE

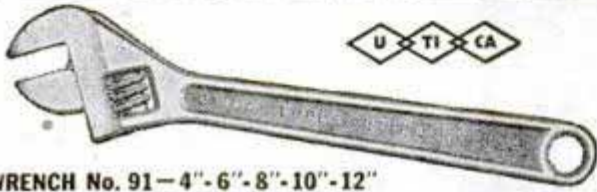

WRENCH No. 91—4"-6"-8"-10"-12"

UTICA DROP FORGE & TOOL CORPORATION

UTICA 4, NEW YORK

JIFFY KEY RETRIEVER

The only key holder that retrieves your keys. Fastens to your belt. Easy to reach. After using keys, just release them. They will return to your belt. Good looking, chrome plated, small and compact. Especially handy and safe for all R.R. men, Policemen, Service Station Oprs., Janitors or any one using keys. Satisfaction guaranteed.

Special discount to dealers or agents.

Send direct to: Margason-Lummi Mfg'rs., KEY RETRIEVERS
2288 Casa Grande, Pasadena 7, Calif.



\$2.95
POSTPAID
ANY
WHERE
IN U.S.A.
OR
CANADA

SPECIAL FREE BELT OFFER

YES, A GENUINE COW HIDE LEATHER BELT FREE WITH YOUR PURCHASE OF 2 OUTFITS. And that's not all; we absolutely GUARANTEE you complete satisfaction with your purchase, and that the belt is a first quality, high grade work belt 1 1/4 inches wide with metal tongue buckle. Color: Black.

GULF GREEN HERRINGBONE TWILL SHIRTS AND PANTS TO MATCH

VAT DYED • LONG WEARING SANFORIZED SHRUNK

Here is an excellent outfit for wear in summer and fall. Just the right weight to give good wear and comfort. Made neat and strong; the color shade is similar to a Teal Blue; one of the most attractive work outfits you could choose. Our price is attractive for such quality, but on top of that you get the leather belt free with 2 outfits. Rush your order to-day.



TROUSERS 29 to 42 waist; 30 to 34 lgths. SHIRTS: 14 to 17 neck.

2 OUTFITS

(2 shirts and 2 Trousers)..... \$11.96
Single Outfits (No Belt Free) \$5.98, Shpg. Wt. 2 outfits 5 lbs. If sending cash with order add postage, tax to remittance. OR WE WILL SHIP C.O.D. PAY POSTMAN ON DELIVERY. SATISFACTION GUARANTEED OR MONEY REFUNDED PROMPTLY.

FREE Illustrated circular of SURPLUS and civilian clothing sent with order, or Free on request. Send post card for your copy today.

ADDISON UNIFORM CO., Dept. PM-7, CAMBRIDGE, OHIO



Keep Up With the Changing World

Understand How Science is Changing the World and the Habits of its Peoples!

Look Behind the Fascinating Scenes of Science at Work!

Fortify Yourself with Science News And Facts—More Interesting than Fiction!

Today... Get the SCIENCE DIGEST READER

Bring yourself up to date in the world wide drama of science at work. The Science Digest Reader gives the "whys" and "wherefores" of what is going on and what the vast changes being made mean to you. Don't feel that progress is passing you by; leaving you in an old-fashioned past. Read the Science Digest Reader and get the best of the thousands of volumes of scholarly books and magazine articles pouring from scientific pens.

Fascinating, Intriguing, Informative— Drawn from Hundreds of Authoritative Sources

The editors of Science Digest scan hundreds of books, scientific journals and popular periodicals every month for articles on subjects that hold interest for every thinking person. They select the cream—the finest—in subject matter, in writing, and sheer interest, and speed them up for quick reading by fact-hungry people. The Science Digest Reader, with over 300 pages, contains 72 of these articles—the very best of the best—published in the last ten years, on such subjects as aviation, medicine, weather, animals, building, speech, crime, astronomy and others.

SOME TYPICAL SUBJECTS

What Atomic War Will Be Like	Helping the Deaf to Hear
What Happens When People Starve	We're All a Little Crazy
Building Tomorrow's House Today	Eat and Grow Thin
Farming Fish for Food	Your Mental Age
	How to Develop Ideas Profitably
	Jet Planes—Almost Too Simple

72 Articles in all

A STOREHOUSE OF KNOWLEDGE

Science Digest Reader gives you, at your finger tips, hundreds of facts you will want to know for your own personal satisfaction or to make you outstanding in conversations or group discussions.

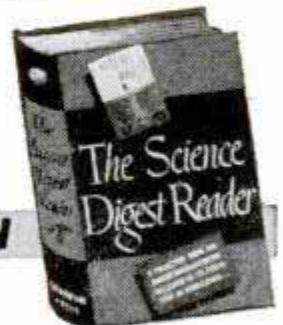

MAIL COUPON

WINDSOR PRESS
A Division of Popular Mechanics Co.
200 E. Ontario Street, Chicago 11

Send me _____ copies of Science Digest Reader at \$3.00 each. Remittance enclosed.

Name _____

Address _____

City _____ Zone _____ State _____

Now Handy Sander Makes it Fun to Finish the Job →

Mail this TODAY



SAVES WORK — PROTECTS YOUR HANDS

No more fumbling with wood block that crimps away and snags. No more skinned fingers. **HANDY SANDER** is especially designed to do finishing jobs better—faster—easier. You can more easily sand down woodwork, metal, other materials with this clever **HAND-y Sander**. So novel and practical. 2,000,000 already sold! Less "elbow grease" needed! Fast cutting. More uniform finishes. Fits hand. Holds roll of quality abrasive **CLOTH** that **OUTLASTS** ordinary sandpaper. When worn down, tear off; pull out fresh section; clamped secure by spring.

FOR Hobbyists
Model Builders
Cabinet Workers
Auto Body Workers

Boat Owners
Painters
Metal Workers
Wood Workers, Etc.

MASTER SANDER — Professional size. Uses 1½" abrasive **CLOTH**. Neoprene pad. Tool comes with strip, and 2 rolls refills (1 fine; 1 medium), 36" long. Post-paid, U.S.A.—\$2.

You'll Enjoy Working With It!

A quality tool, well machined, electro-plated steel; strong; light weight. Cushioned with ¼" sponge rubber, relieving hand, arm fatigue; giving even pressure on flat surfaces, contours, irregular shapes, radii, round work. Saves time, abrasives. **TWO EXTRA REFILLS** (1 fine and 1 medium), 20" long; 1½" wide. All sent post-paid, U. S. A.

Satisfaction guaranteed. (Additional Refills—20" . . . 7 for \$1). Order today!

\$1

Complete with Refills

PREFERRED PRODUCTS, Box 115-A, Riverside, Illinois

PREFERRED PRODUCTS
Box 115-A, Riverside, Ill.
Enclosed \$1. Please send postpaid
(HANDY) SANDER size SANDER with re-
fills.

Name _____
Address _____

Why spend years learning by hard experience what you can get from a practical book in a few hours.

Write for list of "How-To-Do-It" books on practical subjects. 1000's of pleased customers all over the world.

ADAMS BROWN COMPANY—BOOKS OF APPLIED SCIENCE
Dept. 177 Chestnut Hill 67, Massachusetts, U. S. A.

BUILD THESE PROJECTS

For garden or lawn. Easy to build. Easy to sell. Detailed Blueprints Model B-25 Dutch Windmill 50c; Model OM-60 Old Mill, 85c. Lawn Figure Patterns—Sunbonnet Girl, Dutch Boy, Tulip Girl, Holland Pair, 35c each, all 4—\$1. Catalog illustrating many models, send 10c, today.

CRAFTSMAN'S MODEL CO., Dept. P-105, 2030 N. 4 1st St., Milwaukee, Wis.

SAY YOU SAW IT IN POPULAR MECHANICS

START A BATTERY FACTORY

—at home; the latest achievement; re-cast junk batteries into new. Complete instructions. We supply everything. Big Profits!

THE BATTERY LABORATORIES
Dept. PM Minneapolis 13, Minn.

WAR SURPLUS

Lathes, Milling Machines, Drill Presses, Sawing equipment, Motors and thousands of miscellaneous items. Also information on Helicopters, Sleeper Trailers, Garden Tractors, Power Lawn Mowers, Welders, Jet Impulsion for Cars and Tractors etc. Rush name for free literature.

THE WAYNE ENGINEERING CO., DEPT. 1123, GREENVILLE, OHIO

WATCHES WANTED

BROKEN OR USABLE

All kinds. Highest Prices paid for jewelry, rings, spectacles, gold teeth, diamonds, Sterling Silver, etc. Cash mailed promptly. Write for free shipping container.

LOWE'S, Dept. PM, Holland Bldg., St. Louis 1, Missouri

SELL MERCHANDISE by Mail

OPERATE Profitable Lifetime Business Selling Merchandise by Mail. Large Profits on Fast Selling \$1.00 Items. **WRITE TODAY!**

POWELL CO. DEPT. A SAMPLER BLDG., CLEVELAND 3, OHIO

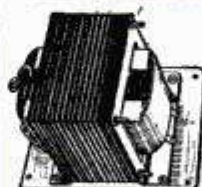

Make Your Own Selenium RECTIFIER for:
Plating . . . Battery Charging . . . DC Supply (for Model Trains) . . . Welding . . . Operating low-voltage Equipment . . . Experimenting, etc.

For 12 Volt - 10 Amp. DC Unit:

- 1—Transformer 110V to 15V.
- 1—Full Wave Bridge Rectifier.
- Capacity: 12 Volts—10 Amps.

PRICE: — \$14.75 per set.

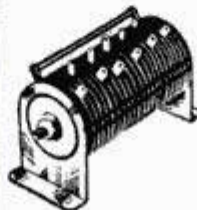

For 24 Volt - 8 Amp. DC Unit:

- 2—Transformers (in series) 110V to 30V.
- 1—Full Wave Bridge Rectifier.
- Capacity: 24 Volts—8 Amps.

PRICE: — \$19.75 per set.

25% Deposit required with all orders.

POWERTRON CO. 119A Lafayette Street
New York 13, N. Y.



Kentucky Tavern BARBECUE ASH TRAY

ALSO AN INCENSE BURNER!
It's different! It's beautiful! It's useful . . . attractive for home and office. Handcolored to look like the real firestones. Smoke curls out the chimney. Holds generous supply of cigarettes and matches. Has metal fireplace grill cover which lifts out to remove ashes. Ideal gift. \$1.98—includes a package of incense.

Rush this COUPON

\$1.98
SEND NO MONEY! ILLINOIS MERCHANDISE MART
Dept. 1468, 1227 LOYOLA AVENUE, CHICAGO 26, ILLINOIS
[] Rush Barbecue Ash Tray C.O.D. for \$1.98 on money back guarantee.

NAME _____
ADDRESS _____

A New Thrill . . . Streamlined 3 WHEEL ROLLER SKATE

FASTER, SMOOTHER, EASIER SKATING

Introducing JET The Sensationally NEW Combination ROLLER-ICE SKATES

If you like Roller Skating . . . you will like the New "JET" Roller Skate . . . Its many New Features puts it way out in front of all standard type skates. . . Study the **THREE-IN-LINE-ROLLERS** . . . this principle alone overcomes many of the objections . . . goes over cracks and irregular surfaces with a new smoothness . . . an enjoyable feature to those who love to roller skate . . . The **3 BALL BEARING WHEELS-IN-LINE** Gives MORE SPEED with LESS EFFORT . . . When you want to stop **SIMPLY RAISE THE TOE** . . . The "JET" Skate is the **ONLY SKATE WITH THIS FEATURE** . . . Being much lighter in weight than regular skates makes it **EASIER TO SKATE FOR CHILDREN and ADULTS**; even for the beginner . . . Another feature: you can quickly change to Ice Skates by replacing the rollers with the "JET" Ice Skate Attachment . . . This is another Exclusive with the "JET" Skate . . . A New Experience awaits you in Roller Skating from the minute you PUT ON A PAIR OF "JET" ROLLER SKATES.

RING-LITE Jr. LIGHT & KEY IN ONE HAND for Pocket or Purse. Complete with Battery . . . Only \$1

BE FIRST IN YOUR LOCALITY

Order Yours Today

AFCO PRODUCTS, INC., 4547 No. Clark St., Dept. P, CHICAGO 40, ILL.

50% Lighter Than Most Ordinary Skates
• CHANGEABLE FROM ROLLER TO ICE SKATES



PAT. NO. 2113862

ONLY **\$4.95** A PAIR

NOTE THE EXCLUSIVE BRAKE

3 SIZES: LARGE, SMALL, MEDIUM

Postpaid in U.S.A. We Ship C.O.D. Plus Postage
Ice Skate Attachment \$2.25 Extra

3 BALL BEARING WHEELS in line gives MORE SPEED with LESS EFFORT.

To STOP QUICK Simply Raise The Toe.

Mail Your Order Direct To Factory



Blades of finest custom made steel, HAND HONED under oil. Ask your good neighbor, the local hardware or sporting goods dealer. We're doing our best to keep him supplied.



Ka-MILL-us

No. 72
3 3/8" closed

CAMILLUS CUTLERY COMPANY, New York 17, N. Y.
Established 1876 . . . Factory at Camillus, N. Y.

HOLD-E-ZEE

AUTOMATIC GRIP
SCREWDRIVERS
MORE WORK
IN LESS
TIME!



Hold-E-Zees do the job better, faster. They excel wherever screwdrivers are used. Gripper instantly released by spring action, sliding up out of way when not in use. All materials highest quality.

AT LEADING DEALERS EVERYWHERE

BUILD AN ARC WELDER FROM OLD GENERATOR

For Light or Heavy Work. 75-200 amperes. Complete PLANS 35c. Send today and we'll include FREE our Big NEW Catalog.

LEJAY MANUFACTURING CO.
1347 LeJay Bldg., Minneapolis, Minn.



New Improved Electric MOTO-SAW

Only
\$5.85
Postpaid



SAFE AS A HAND SAW
JUST GUIDE IT!

More like magic than any tool you ever saw. Imagine an electric scroll saw only slightly heavier than a hand coping saw . . . a tool that takes no effort to run, no pressure to feed. Works at any angle—on big assembly jobs or on the tiniest piece you can hold in your fingers. Runs 7200 strokes a minute . . . so fast the blade seems to stand still. Sturdily built . . . only two moving parts . . . never needs oiling. Easily cuts intricate designs—so smooth it eliminates sanding. A thrill awaits you when you get a Moto-Saw in your hand. Thousands of satisfied users.

U. S. Patent 2233862
Other Patents Pending

No Limit To Length Of Stock It Will Cut. Saws To Center Of 19" Widths
It's fast . . . cuts on an average of 1 ft. per minute up to 3/4" medium hard wood. Operates on 110-120 V. 50 or 60 cycle alternating current. If your dealer does not yet have Moto-Saw, send \$5.85 . . . we'll pay postage. Or send \$1, pay postman balance plus postage. MONEY BACK if not delighted after 5 days trial.

DREMEL MFG. CO., Dept. S117-G, Racine, Wisconsin

Made to U. S. Army Specifications!

15-JEWEL

ELGIN

\$18.95



Sturdy 15-Jewel ELGIN men's wrist watches. Waterproofed. Sweep second hand. Stainless Steel case. Unbreakable crystal. QUALITY! American made. Fully reconditioned with ONE YEAR GUARANTEE! Made for the U. S. Army Air Corps. They HAD to be good. SEND NO MONEY. Simply pay postman \$18.95 plus 10% tax and postage on delivery. Cash orders sent postpaid. Limited supply. UNITED PRODUCTS CO., 7941 S. Halsted St., Dept. WES-209, Chicago 20, Ill.



SHAW DU-ALL GARDEN TRACTORS and MOWERS

Get FREE FOLDER NOW!

Get details on 1 to 9 H. P. walking and riding tractors. Do 1000 jobs on small farms, estates, orchards, gardens. Low-priced. Send postcard today!

4507 Front Street, Galesburg, Kans.

SHAW MFG. CO. 668G North 4th St., Columbus, Ohio

MYSTERY RADIO

No Tubes — No Batteries
No Electricity

Electronic mystery marvel of the century! Get radio reception anywhere from strongest nearby station—at home, at the beach, in the woods or camping, fishing or hunting trips. Complete with ground and ear phone. Weighs only few ounces. Carry in pocket or purse. Fascinate and mystify friends. Lasts forever; permanent crystal. Rush order with only \$2.99 before limited supply is exhausted. Send NO MONEY just name and address and you pay postman \$2.99 plus few cents postage. Write TODAY



CLAIRE DISTRIBUTORS Dept. PM-1, Box 23
Glenview, Illinois

ONLY \$2.99
POSTPAID

BUILD YOUR OWN MACHINE TOOLS!

Blueprints \$1.00 - Catalog FREE

We supply quality Foundry Castings for Lewis Shapers, Milling Machines, Drill Presses, 8" Circular Saws, 9" Jointers, etc. Construction blueprints for above 6 tools postpaid \$1.00.

Illustrated 32 page Catalog sent free with Blueprint Order—describes 23 Lewis Tools.

WRITE TODAY!

LEWIS MACHINE TOOL CO.
P. O. Box 7446, Sta. L, Dept. M, Los Angeles 23, Calif.



New 1947 WHAT TO MAKE out now!

Our annual reprint of articles selected from our "CRAFTSMAN" Department is better than ever. It contains hundreds of ideas you can use around the home and in your workshop. 208 pages. Over 400 illustrations. Get the 50c paper edition from your News Dealer. We shall not sell this edition at all this year. We shall have it and the seven previous volumes bound in durable library cloth at \$1.25 each or \$9.00 for the complete set. Send for a complete set today!

POPULAR MECHANICS PRESS
Dept. 640 200 E. Ontario St. Chicago 11



THIS BOOK SHOWS
HOW TO DO IT

STEEL SQUARE POCKET BOOK

Completely Revised

This concise and handy little book illustrates and describes the best methods of using the carpenter's steel square in laying out all kinds of carpentry work. It is easy to understand as a picture of the square laying directly on the work shows exactly how the various cuts are made. Its compact and handy size makes it convenient to carry in the pocket for quick reference.

Price \$1.25 Postpaid

POPULAR MECHANICS PRESS
DEPT. 627 200 E. ONTARIO, CHICAGO 11, ILL.



IMMEDIATE DELIVERY

Stepless Variable Voltage

TRANSFORMERS

(Powerstat)

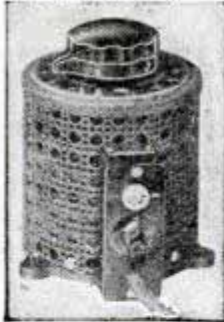

Electrical men find the variable-voltage transformer most versatile equipment for all control applications, research work, etc. Powerstat is a stepless variable voltage transformer rigidly constructed, and simple to use (varies voltage from 0-135 volts) by turning the knob.

Ideally suited for: Electrical Repair Shops, Electrical Mfg, Radio Shops & Labs, Heat Control, Light Control (Stage Lighting) and Photographic Work.

Larger units also available. 25% Deposit Required with all orders.

ELECTRO-TECH EQUIPMENT CO.
117-A Lafayette St., New York 13, N. Y.

No. 116

Input Volts: 115V
Output Volts: 0-135V
Capacity: 1 KVA, 7.5 Amps.

Price: \$23.00

VACATION FUN With a KAYAK!



Here's a light, safe, sturdy 10 1/2' Boat just made to order for vacation sport on the water. Easy to assemble in a few interesting, pleasant evenings. Kayak comes absolutely complete, nothing extra to buy. Paddle is included. Weight complete 26 pounds.

Safe, stable, ideal for all water sports. Write TODAY for free literature. **IMMEDIATE DELIVERY ON KITS!**

KAYAK KIT CO.

DEPT. 18 BLOOMFIELD, N. J.

AIR or LIQUID TANKS

Airplane oxygen tanks (used) good condition, holds up to 400 lbs. pressure; non-rusting stainless steel, weighs 18 lbs., 10 1/2 gal. capacity, 24" long x 12" diam., \$4.98. Same specifications 24" long x 6" diam., weighs 5 lbs., 3 gal. capacity, \$2.98. Ends tapped for 1/4" standard pipe thread. Air check-valve to fit tanks, \$5.00 value, 98c. Ideal for compressed air tanks, any bottled gas, or liquids, water supply for house trailers, compressors, floating rafts, buoys, net floats, air horns, air brakes, etc.

Prices FOB, Kansas City — No COD orders

MIDWEST BUY ANYTHING CO.

1520 Locust St. Kansas City, Mo.
Hundreds of other bargains — Write for Circular

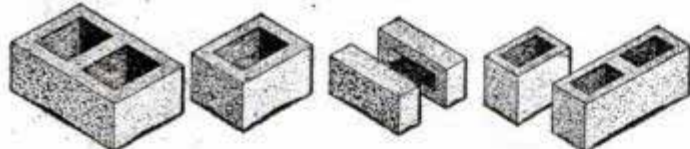

Profit by the Building Boom!

Start your own business manufacturing concrete building block and brick. Use Economy hand moulds. Make true, straight, easy-to-lay units which will pass any building code. Small investment, high production, big profits. One \$30.00 mould will make 1,000 5" x 8" x 12" blocks per day. Letters and repeat orders tell how pleased our customers are. Post card brings free folder.

Economy Manufacturing Company
Dept. P Stone Mountain, Georgia

SAY YOU SAW IT IN POPULAR MECHANICS

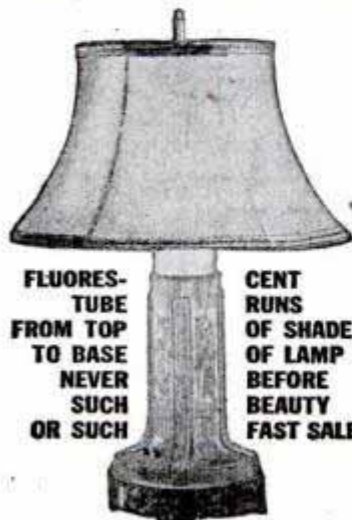

FLUORESCENT
TUBE
FROM TOP
TO BASE
NEVER
SUCH
OR SUCH

CENT
RUNS
OF SHADE
OF LAMP
BEFORE
BEAUTY
FAST SALES

Agents

FIRST to utilize the exclusive feature of UPRIGHT fluorescent illumination, the ALL-LITE gives off a soft, even distribution of light without glare—from shade top to bottom of base.

Selling like mad. Men order sample, show it and reorder in gross lots. Instant appeal. Plug it in and watch them buy. Comes complete with tube and plastic shade.

MAXILUME COMPANY

Our Finest Precision REBUILT MOTOR BLOCK ASSEMBLIES

Carries the Same
90 DAY
GUARANTEE
As a New
Motor Assy.

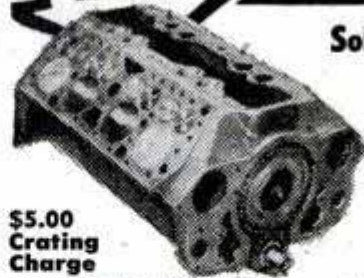

\$5.00
Crating
Charge

FORD MOTORS
Year Type Outright Exch.
28-31 4 cyl. \$ 98.00 \$73.00
32-47 6 & 8 149.00 99.00

MERCURY MOTORS
Year Type Outright Exch.
39-47 V8 149.00 99.00

CHEVROLET MOTORS
Year Type Outright Exch.
34-47 6 cyl. 117.50 87.50

Sold Outright or Exchange

Rebuilt by skilled mechanics. Assembly has Rebored Block with New Pistons, Pins, Rings, Re-ground Crankshaft, and all New Bearings. Guaranteed 90 Days.

Allowance on Old Motor

We ship at outright price. Send your motor prepaid, must be suitable for rebuilding. Send in notarized bill of sale showing title number if any. We refund difference when we receive your motor.

DODGE MOTORS —

3 1/4" bore
Year Type Outright Exch.
35-47 6 cyl. \$139.00 \$109.00

PLYMOUTH MOTORS

Year Type Outright Exch.
35-47 6 cyl. 139.00 109.00

Specify exact year, make and model when ordering. Send for catalog on motors not listed.

POWER TAKE-OFF for JEEP ENGINE

Bolts to clutch housing on the Jeep engine. Has a spline shaft to engage with clutch and extending from rear is a keyed

shaft on which pulley can be mounted. Hand lever controls clutch.
PF4N-23J—
Each

\$4250



\$5.00
Crating
Charge

SEND 25% CASH WITH ORDER, BALANCE C.O.D.

NEW 5 Gal. CANS

FOR GAS, OIL
OR WATER

Vented for Safety
Self-locking Safety
Cap

Extra Heavy Construction
Will Float When
Full

Size of can, 18" high, 6 1/4" thick, 13" wide.

PA35U-60—
Lots of 5, ea. 1.15
Lots of 50, ea. 1.05

Lots of 98c
100, Each



60 HP. JEEP Engines

Reconditioned, Tested and Guaranteed in perfect running order and ready to run. Every part is checked to be perfect and carries a 90 Day Guarantee same as a new engine.

COMPLETE with . . . Generator, Starter, Distributor, Coil, Fan and Fan Belt, Water Pump, Fuel Pump, Intake and Exhaust Manifolds, Carburetor, Oil Filter, Spark Plugs, Flywheel, Clutch Assembly, Wiring. Outright, \$11750
PG58R-003, Each

Write for Special Price
Quotations in Quantities.

J.C. WHITNEY & Co.

1917 Archer Ave. Chicago 16, Ill.

For the First Time— FLUORESCENT All-Lite TABLE LAMP!

FREE SAMPLE OFFER

DON'T send a penny. Sample offer is free. Rush name for selling outfit and make money from the day it arrives. We will show you how to sell to hundreds of homes, restaurants and public places and to stores by the dozens for resale. Also immediate delivery on standard fluorescent fixtures. Get going with the MAXILUME line. It's a winner for others—it can bring big, fast profits to you. Rush name on penny postcard.

125 W. HUBBARD STREET, Dept. 87
CHICAGO 10, ILL.

APPLY FERTILIZER OR WEED KILLER

Automatically

while Sprinkling with

Ferto-Spray

Pat. Pending



Produces Soft,

**Rainlike Spray Within 30 Foot Circle
While Fertilizing Grass Or Killing Weeds**

WITH ONLY ordinary water pressure, this amazing new patented "FERTO-SPRAY" sprinkles like rain while automatically fertilizing your lawn with "AQUA-VITA" or other chemical fertilizers. With "FERTO-SPRAY," you cannot burn grass. Adjustable to any strength treatment by means of 2 valves—one for water, one for air. Sturdily made of aluminum, with brass fittings. Will serve and last a lifetime. "AQUA-VITA" Fertilizer replacements available from manufacturer.

Price
\$12.95
Postpaid

Including a supply of "Aqua-Vita."

ORDER this "All-In-One" Fertilizer, Weed-killer and Sprinkler direct from factory. Satisfaction, or price refunded within 10 days. Send check or money order. **DEALERS WANTED!**

REPUBLIC TOOL & MACHINE CO.

229 E. Lincoln Ave. Milwaukee 7, Wis.

PORTABLE GASOLINE-ELECTRIC GENERATORS

Bargain—Only

\$124.95

450 watts,
30 amperes D.C.,
6 to 22 volts

Army surplus of highest quality. Cost Government over twice this price. Weight 62 pounds; power enough for nine 50 watt lamps, to charge storage battery, or run small appliances; runs 7½ hours on gallon fuel; automatic starter. Ideal for farms, boats, cabins, trailers, etc. Comes complete in canvas carrying case containing spare parts, all necessary tools, and technical manuals. Limited quantity only. Mail checks or money orders for immediate delivery, or send for descriptive folder.

\$124.95 F.O.B. San Francisco
Shipped Freight Collect

PHALANX CORPORATION

510-7th Street, San Francisco 3, Calif.

**WORLD'S LOWEST PRICED
ADDING MACHINE**

VEST POCKET SIZE

IDEAL FOR BUSINESS OR PERSONAL USE

FREE TRIAL
ONLY \$2.50
TOTAL COST
SEND NO MONEY

Each Baby Calculator in Beautiful, rich-looking Leatherette case—**at no extra cost. FREE!!**



Fits vest pocket or purse. Guaranteed accurate. Operated as easily, and as reliable, as machines costing many times as much. Not a toy. Substantially made of 28-gauge steel—guaranteed for life against defects in construction. You positively can't buy a calculator of equal quality for as little money. **ACCEPTED AS THE FINEST LOW PRICED CALCULATOR FOR OVER 30 YEARS!** Operates with a flick of your finger. Adds, subtracts, multiplies, divides—counts up to ten million. Pays for itself over and over in mistakes avoided, and time saved. **MAKES IDEAL GIFT.**

Sold on a positive money back guarantee. Send only \$2.50, Calculator sent postpaid, or send name and address and pay postman \$2.50 plus postage. **MONEY BACK IN 10 DAYS IF NOT DELIGHTED!** (If outside U. S., send \$3.00.)

AGENTS WANTED.

CALCULATOR MACHINE CO. (Mfrs.)
Dept. 192, P. O. Box 248, Glenview, Illinois

**FIVE ACRES
AND INDEPENDENCE**

A Practical Guide to the Selection and Management of the Small Farm

By **M. G. Kains**

This book is a complete, practical guide to the selection and management of a small farm. It explains how a small farm can be self-supporting. What farms not to buy. How to choose the right farm, based on proper soil, location, irrigation, elevation, climate, etc. Then a detailed explanation of what crops to plant and how to make them yield results, sure-fire methods of grafting, rotation, transplanting, etc. Finally, how to make a profit by selling your excess crops, livestock and preserves. Written by an expert who has made a



real success with many small farms. Revised, enlarged edition. 413 pages, profusely illustrated. Price **\$2.50** Only \$2.50, Postpaid in U. S. A. (Outside U. S. \$2.75). Order Today

POPULAR MECHANICS PRESS Room 490 • 200 East Ontario St., Chicago

SAY YOU SAW IT IN POPULAR MECHANICS

★ ★ ★

**MAKE YOUR OWN
POWER TOOLS
at Low Cost**
from old Auto Parts, etc.



A New Edition

Featuring **TOOLS of WOOD**

Now you can have a good lathe, drill press, circular and band saw and other power tools in your home workshop, at a cost of only a few dollars each. Make them yourself from old auto parts, discarded sewing machines and other odds and ends that cost little or nothing. Get this new book—"Forty Power Tools You Can Make." Costs only \$1.25 postpaid. This book gives every detail in plain language you can understand and follow. Hundreds of pictures and plans show every step to follow in making the power tools you want. Actual photographs of finished machines included. Send \$1.25 today. Money back if not satisfied.

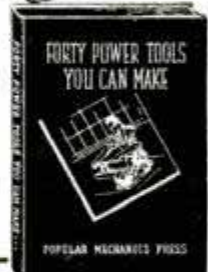

MAKE EVERY POWER TOOL NEEDED IN YOUR HOME WORKSHOP

- Some of the power tools you can make are:
- | | |
|--------------------|------------------------------|
| 2 Hand Saws | 2 Drill Presses |
| 9 Sanding Machines | 1 Scroll Saw |
| 2 Circular Saws | 2 Wood Turning Lathes |
| 1 Metal Lathe | 3 Grinders |
| 1 Power Hack Saw | 1 Shaper or Moulding Machine |
| 1 Jig Shears | 1 Vibrating Pencil |
| 1 Cut-Off Wheel | and others |
- Information too, about pulleys, belts, motors and drive methods. Just published. No other book like it. Order today.

POPULAR MECHANICS PRESS

Dept. 621 • 200 E. Ontario Street, Chicago 11

HAND MICROPHONE



Top quality hand microphone with control button in handle. Highly sensitive. Has rubber covered cord and tel. plug. Fine for use on home recorders, public address systems, etc. Brand new—perfect. Shp. wgt. 2 lbs. Stock No. 170. Each... **\$1.95**

MESS KITS

Regulation two-piece Army Mess Kits with folding handle. Used, but perfect. Weight 2 lbs. No. A116—Ea. **69c**



CANTEENS

Reg. U. S. issue canteens. Plastic screw top chained to body. Slightly used but perfect. Wgt. 1 lb. 117—Metal **69c**
118—Plastic—Ea. **69c**



CANTEEN CUPS

All metal. Folding handle. Wgt. 1 lb. No. A120—Each... **25c**

CANTEEN COVERS

Heavy canvas. Button fastener. New No. 530—**69c**
Each Used No. 119—**35c**

ARMY BANDOLEERS

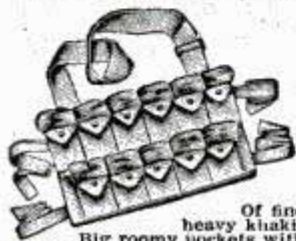

Of fine heavy khaki. Big roomy pockets with snap button fasteners. Fine for hunters, campers, boy scouts, etc., also for shop work in carrying small parts, etc. Material alone is worth this price. Shp. wt. 1 lb. 11 Pocket **49c** | 5 Pocket **29c**
Type No. 129 Each

WOOL BLANKET

Full size and 100% wool. Used but renovated for reissue. Use for camping, etc. Shp. wgt. 3 lbs. No. 233—Each... **\$4.89**

BAYONET BLADE

Fine forged steel. Ground but not polished. May be made into throwing or hunting knife or spear. Blade 6 3/4 x 1 1/2 inches, 11 3/4 inches overall. Will take and hold a fine edge. Shp. wgt. 1 lb. No. 664-R—Each... **49c**

PROF. TELEGRAPH KEY

Purchased from the gov't. Finest design and construction. Base measures 3x4 3/4 inches. Original value \$2.50. All parts of instrument brass. Adjustable. A-147. Each... **98c**



LIFE PRESERVER BELTS

Right from the invasion beaches. Consists of two air chambers. May be inflated automatically with "sparklet" cartridges or manually by attached hose. Adjustable in waist size. One air chamber guaranteed air tight—other may need a tire patch. All belts are used and slightly soiled but a bargain at this low price. No. 1261—Each... **\$1.00**

SPARKLET CARTRIDGES

May be used with above belts. In boxes of 10. Stock No. 254. Per Box... **50c**

WAR SURPLUS AND HUNDREDS OF OTHER BARGAINS

POPULAR RECORD ASSORTMENT



Fifty records of modern dance, race, blues and hillbilly selections. No two alike. Famous name bands and artists included. Used in juke boxes, but guar. perfect. Shipped exp. collect only—no exchanges or refunds. Wgt. 28 lbs. No. A303—50 records... **\$9.64**

No A300—25 Records. All Dance. Wgt. 14 lbs... **\$4.88**

No. A301—25 Records. Hillbilly, Race and Blues. Wgt. 14 lbs. Set... **\$4.88**

No. 302—25 Records. All Hillbilly numbers. Wgt. 14 lbs. Set... **\$4.88**

TELESCOPING BAIT AND FLY ROD

Combination 4 piece telescoping bait and fly casting rod. Screw locking reel seat. Cork grip. Snake Guides. Extends to 9 feet, telescopes to 38 inches. Shp. wgt. 1 lb. No. F411—Each... **\$3.65**

SACHEL POUCH

Heavy canvas pouch. Ideal for totting lunches, shopping, books, etc. Has 11x12 inch pocket. Brand new, guaranteed perfect. Has oversize flap with single strap fasteners. A113—**Each \$1.69**



RADIO HEAD-PHONES

Extremely sensitive with 4000 ohms resistance. Brand new and fully guaranteed. With moisture-proof cord and phone plug. A splendid value for the radio serviceman and experimenter. A106—PAIR... **\$2.95**
New super sensitive phones. A108—Pair... **\$5.95**



Plastic 8 oz. Flask

For hunters, scouts, fishermen. Waterproof and transparent. Use it for liquids. Use it for matches, flies, bait, etc. Has screw cap top for liquids, plus full open top. Size 5 1/2 x 4 1/2 x 1 1/2 ins. Has hundreds of other uses. Wgt. 1 lb. No. A347. Each... **29c**



BINOCULAR CASE

Heavy cowhide, hand sewn. Die cut top for compass. Will fit 6x30 Bausch & Lomb or similar binocular. Wgt. 2 lbs. No. A191. Each... **\$2.95**



7 LB. EXPERIMENTER PARTS ASSORT. KIT

A "gold mine" for the radio serviceman. Hundreds of valuable radio parts, new radar and electronic parts and subassemblies, coils, resistors, trimming condensers—worth many times this low price. A130R—7 lbs... **\$1.79**

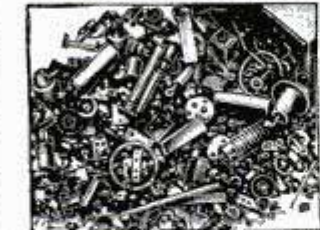

CAVALRY SPURS

Genuine wishbone type cavalry spurs. Nickel plated brass. A102, Pair... **98c**
A103, Spur straps per set of four... **50c**



SHERRILL COMPASS

A finely balanced liquid immersion accurately calibrated compass with mtg. bracket. Measures 5x3 inches. Compensating adjustments. Worth much more. Shp. wgt. 5 lbs. No. A122. **\$9.85**



WOOL SLEEPING BAG

G.I. type 100% wool with 30 inch Talon zipper. Used but renovated for reissue. Shp. wgt. 3 lbs. No. 165. **\$3.95**



FISHING REEL

Exceptional quality for this low price. Has rugged one piece frame. Ratchet drag. Single action. Attractive cast iron handles. Brass bearings for smooth operation. Full 100 yard line capacity. Brand new! A splendid value at this low price. No. F412, Each... **98c**



RAIN SUITS

New 2 piece rain suits. Of durable wear resisting water and wind repellent OD fabric. Bib style pants, zipper fly. Jacket has parka attached. Guaranteed 100% weatherproof. Small, medium and large sizes. Shp. wgt. 3 lbs. No. R549. Ea. **\$4.95**



2 Man Mountain Tent

Regulation Army type two man mountain tent. Complete with poles, guy ropes, etc. Of durable nylon with reinforced seams. Ideal for outdoorsmen, campers, etc. Shp. wgt. 10 lbs. A splendid value. Stock No. 202—Each... **\$9.95**



PUP TENTS

Regulation Army Pup Tents of durable, brown canvas. Used, but in good condition. Fine for campers, outdoorsmen, boy scouts, etc. Wgt. 8 lbs. A100—Tent only... **\$3.95**
A110—Tent, new... **\$7.95**
A101—Ropes, wooden poles and stakes for above. Per set **\$1.00**



27 LENSES, ALL NEW, PERFECT.

For experimental work in optics. Consists of 27 precision ground and polished prisms and lens elements in assorted diameters and focal lengths. Big variety, positive, negatives, etc. Actual value over \$100.00. A519—27 PIECES... **\$7.95**



50 LENSES SEMI-FINISHED

Lenses similar to above but not polished. All are blanked and formed ready for polishing. Negatives, positives and prisms in Crown and Flint glass. Worth many times this low price. A520-50—**LENSES, ONLY... \$1.95**



ONE MAN RUBBER BOAT

Similar to above but smaller. Designed for one man use. Each boat complete with oxygen tank—packed in a special parachute bag. Wgt. 15 lbs. No. 526—Each... **\$17.95**

METAL TOOL CHEST

All metal welded construction 16x8 1/2x11 overall. Has 3 roomy, easy sliding drawers. Hinged drop front. Metal top and end handles. Use it for tools, small parts, etc. Shp. wgt. 48 lbs. Stock No. 282. Each... **\$9.75**



CAMERA TRIPOD

Purchased from Gov't. Used but perfect. For cameras up to 8x10 inches. Folds to 32 inches, extends to 58 inches. Needs adapter to mount camera. Wgt. 14 lbs. Stock No. 190, Ea. **\$4.95**



ORDER DIRECT FROM THIS AD

Values galore! Hundreds of hard-to-find items for home, shop and outdoors. Make remittances by money-order, bank draft or personal check. Send 25% deposit on C.O.D. orders. No C.O.D.'s on orders for less than \$5.00. Include sufficient postage on parcel-post orders—any overage will be promptly refunded. All quotations F.O.B. Chicago. Used items and materials are guaranteed serviceable and as described. Your money back if not more than satisfied.

Big Illustrated Catalog Free
WRITE FOR YOUR COPY TODAY

STARK'S
Dept. PM747
509 So. State St.
CHICAGO 5, ILL.

Announcing THE BARRON DRUM SANDER FOR DRILL PRESS USE

● Another new Barron development. Will fit any 1/2" drill press chuck, collet chuck, adapter or 1/2" I.D., Spindle. Has 1/2" ground steel shank, rubber cylinder, compression cups, light steel cylinder and full length arbor. Extra light in weight, runs smooth as a top. A fine, precision sander, complete with 5 sanding sleeves 2 1/2" dia. x 3" long. The first drum sander of its size and design ever offered at so low a price! Try it on our 10 day money back guarantee.



\$3.95
COMPLETE



\$7.50 COMPLETE

MULTI-PURPOSE DRILL PRESS PLANER

The greatest all-purpose drill press tool on the market. Planes, parallels, rabbets, routs, panels, beads, tenons, grooves, etc. NO EXTRA BLADES TO BUY! It's complete, ready to use. Does any or all operations without a single blade change or adjustment. Harmless to drill press. Safe, accurate, perfectly balanced. Over 75,000 now in use!

OTHER DRILL PRESS ACCESSORIES

4" ROTARY SURFACE SANDER \$5.95 1/2" DOVETAIL CUTTER \$1.85
ALL-METAL AUXILIARY DRILL PRESS PLANING AND SHAPER TABLE \$9.85
TAPERED AND THREADED SPINDLE ADAPTERS
ROUTER AND ROUND END MORTISING BITS 1/8" TO 1/2" SET OF 6 \$9.50

Liberal 10 Day Money Back Guarantee

Workshop Guide FREE



BARRON TOOL CO.

569 Architects Bldg., Detroit 1, Mich.

BARRON PRECISION TOOLS WORK SHOP

60 POWER TELESCOPE \$2.95

VARIABLE EYEPIECE 20X-40X-60X

NEW! Three telescopes in one, 3 different magnifications. 20 power for ultra-bright images with 40 and 60 power for extra long range. Guaranteed to bring distant objects, people, sports events, ships, moon, stars, etc., 60 times as close.



Most powerful for anywhere near the money. 5 sections. Closes to 1 ft. long. Not one of our high precision instruments but the biggest value. Contains 4 ground and polished lenses. The tubes are made of Kraft fiber, brass bound. It may also be used as a powerful compound microscope for examining objects too small to be seen with the naked eye. Directions included. Mass production methods enable us to sell this high-powered instrument at the amazing price of only \$2.95. We pay the postage. Get yours immediately.

BROWNSCOPE CO.

Dept. 7M 24 West 45 St. New York 19, N. Y.
Catalog of big values in binoculars, microscopes, etc. free on request

The SPEED SAW FILER

Saves You Time, Money

Now you can do expert saw filing at home. Lifetime tool makes precision filing easy for even the most inexperienced. Two simple adjustments make it fit any type hand saw. Keep your saws extra sharp and true-cutting with a Speed Saw Filer. Complete with file, ready to use. Money back guarantee. Cash with order, prepaid (C.O.D. postage extra.)

THE SPEED CO., Dept. PM
2025 N.E. Sandy, Portland 12, Ore.



ORDER NOW!

\$2.95

NEW B-M POWER MOWERS

For Modern Lawn Care

Newest type three-wheel rotary blade mower. Prompt shipment with 1 1/2 h.p. Clinton engine. Choose from two models of assembled mowers or Build-it-yourself kit of parts. Guaranteed. Write for and prices!

AT LOW FACTORY COST



Dealers Wanted

B-M MOWER COMPANY
Box 66-M Blue Mound, Kansas

FREE literature

COLOR CONCRETE WITH CHEMICALS

Get into business on small capital working at home, or shop. There is real money in making Hollywood style pottery and bird-baths without moulds. Our instructions cover a large variety of designs. Washing-wells, benches, garden light-houses, stucco-rock, imitation marble, cement water-paints and many more. 10c brings sample, details and pictures.



HOLLYWOOD CEMENTCRAFT
8529 Wonderland Ave., Hollywood 46, Calif.

You Now Can BE YOUR OWN BOSS

Start a business with this new modern invention. With a small investment you can, without exaggerating, make from \$75.00 to \$250.00 per week. No experience necessary. Write for FREE literature.

Precision Key Mfg. Co.
657 Columbia Street Dept. 5
San Diego 1, California



LAW

STUDY AT HOME FOR PERSONAL SUCCESS and LARGER EARNINGS. 38 years expert instruction—over 108,000 students enrolled. LL. B. Degree awarded. All texts furnished. Easy payments. Send for FREEBOOK—"Law and Executive Guidance."

AMERICAN EXTENSION SCHOOL OF LAW
Dept. 79-M, 646 N. Michigan Ave., Chicago 11, Ill.

Please Mention Popular Mechanics When Answering Ads

Now A DYNAMIC Super-charged WELDER

IDEAL FOR AUTO • HOME APPLIANCE • FARM REPAIRS

DESIGNED TO DO HIGH GRADE WELDING INEXPENSIVELY!

Maintenance Men; Farmers; Mechanics; Machine Shops; Foundries; Auto, General Repair and Job Welding Shops; all using the DYNAMIC find it so indispensable and useful that they cannot afford to be without it. If inexperienced you can easily learn to do a variety of high grade welding jobs by following the practical, simplified operating and welding instructions furnished. Once you see a DYNAMIC in operation, you won't want to be without it. Its simplicity will amaze you. In a year the DYNAMIC only costs you about 6c a day. Helmet, rods, cables, holder and operating instructions, etc., furnished.

SAVES YOU VALUABLE TIME AND MONEY!

This portable industrial transformer type DYNAMIC WELDER easily carried right to the job, can be operated from any convenient, properly wired 110 Volt, 60 Cycle Line—has 8 metallic and carbon arc welding heat stages—does work you would think only possible with a larger more expensive machine. Can also be applied for 220 volt, 60 cycle operation and other voltages and cycles at slight additional cost. Works on Iron, Steel, Brass, Bronze & other metals.

DYNAMIC WELDER CO., 13 East 23rd St., RF, Chicago 16, Ill.

ONLY \$28.50

COMPLETE Available Now IMMEDIATE DELIVERIES

Write Today for Particulars
GET DETAILS on our 10 day Trial Offer.
Member Chicago Association of Commerce.

FARM IMPLEMENTS

BICYCLE REPAIRS

SHOP WORK

HOME APPLIANCES

AUTOMOBILE REPAIRS

ACT NOW and SAVE \$8.50 on This Shopful of Tools!

FAMOUS CASCO 23-Pc. *Portable* ELECTRIC WORKSHOP

SOME OF ITS 10,000 USES

IT ENGRAVES!
Engraves and designs accurately.

IT CLEANS!
Ideal for cleaning cavities.

IT POLISHES!
Perfect for polishing your silver.

IT CUTS!
Cuts glass or metal. Makes hand work easy.

IT GRINDS!
Grinds glass or metal to size needed.

IT CARVES!
Just right for carving, routing and shaping.

IT SAWS!
Saws and undercuts wood and plastics.

IT SANDS!
Quickly smooths and finishes.

IT BUFFS!
Cleans jewelry without damage or injury.

IT ETCHES!
Easily etches those difficult round solid lines.

IT DRILLS!
High Speed drill. All-purpose. Ideal for home.

IT BRUSHES!
Flat and firm, it brushes, and cleans thoroughly.



All 23 Pieces For Only \$14.95 POST PAID

REGULAR PRICE Power Tool .. \$14.95 Accessories .. 8.50 Total Value .. \$23.45

You Save \$8.50

THE GREATEST VALUE EVER OFFERED TO HOME CRAFTSMEN—HOBBYISTS—MECHANICS

Whether you tinker for profit or to save money or just for the sheer fun of it—this new nationally famous Casco Power Workshop is practically made to order for you! The powerful 20,000 R.P.M. power-tool is dynamically balanced, designed to be gripped like a pencil for easy, one-hand operations. Its motor is sealed in a shock-proof Tenite case . . . oilless bearings . . . air cooled. Each of its twenty accessories make a completely different tool *in an instant!* No home, farm, shop or hobby-room is complete without this wonderful Power Workshop . . . and you owe it to yourself to get yours now at a saving of \$8.50. This offer is limited to our present supply . . . and we reserve the right to reject orders after our stock is exhausted. Yes, it's first come, first served—so you'd better **ACT NOW** before the sell-out! **ORDER TODAY**

PUT THIS SHOPFUL OF TOOLS TO WORK FOR YOU!



Valuable Project Booklet

Included "Things To Make And How To Make Them"

AT NO EXTRA COST

Here's a handy man's delight that's worth its weight in gold to folks who get a real kick out of making things with their own hands—and just think, it comes to you at **no extra cost** as part of your portable Power Workshop!



Exclusive Safety Collar for Protection! It permits operation only after the thumb releases it!



Underwriters approved cord and plug.

Includes CHEST

Power-Tool is 7 1/2 inches long & weighs only 12 1/2 ounces & 20 watts — 110 volts AC - DC **FACTORY GUARANTEED** for steady days

HERE'S WHAT YOU GET

*** ELECTRIC POWER TOOL**

- * 1 Rubber Polishing Wheel
- * 1 One 1/8" Ball Cutter
- * 1 One 1/6" Speed Drill
- * 1 Sturdy Leatherette Chest
- * 1 Valuable Project Booklet
- * 3 Bristle Brushes
- * 2 Abrasive Separating Discs
- * 3 Mandrels
- * 1 Felt Wheel
- * 2 Collets
- * 1 Dressing Stick
- * 1 Wrench
- * 4 Emery Wheels

MAIL COUPON TODAY

SEND NO MONEY

SANGERS — Dept. CW-6
325 N. Wells St. — Chicago 10, Ill.

Please send me the Genuine Casco Power Workshop checked off below. If not delighted I may return it in 5 days for refund.

The 23-piece Power Workshop complete with chest

The 39-piece Deluxe Power Workshop with Steel Chest and lift-out tray—a \$32.95 value for only \$22.50—saving me all of \$10.45.

—saving me all of \$8.50.

CHECK I am enclosing \$_____ in full payment. Send postpaid.

ONE Send C.O.D.—I will pay postmen \$_____ plus postage.

Name _____

Address _____

City _____ Zone _____ State _____





Makes Your Shop
Complete

SOUTH BEND

The Multi-Purpose
Lathe



METAL TURNING



WOOD TURNING

You get more enjoyment and use out of your shop when you have a South Bend Lathe. It opens up new fields for you—new hobbies, new projects and a diversification of work that is both interesting and profitable.

This better metal working lathe reduces to a minimum your investment in basic shop equipment—its ruggedness and built-in accuracy will help you to turn out better work. And available attachments and accessories make possible the performance of many operations ordinarily done on other machines. Mail coupon for catalog.

Lathe prices start at \$145.00, f. o. b. factory.



MILLING

South Bend Lathe Works
455 E. Madison Street, South Bend 22, Indiana

Please send latest South Bend Lathe catalog.
Size lathe in which I am interested is _____

Name _____

Street _____

City _____

State _____

**SOUTH BEND
LATHE WORKS**



BUILDING BETTER LATHES
SINCE 1906

SPEAKING OF SPEED

by
FRANK
WILLIAMS

23-YEAR-OLD TEST PILOT OF AMERICA'S FIRST
SUPERSONIC ROCKET SHIP, THE BELL XS-1...

CHALMERS
"Slick" **GOODLIN**
...PREPARES TO FLY FASTER THAN SOUND!



HE LOOKS
SHARP!

IF SMILES NONCHALANTLY AND
SAYS HE THINKS... FLY THE
XS-1 THROUGH THE WALL OF
COMPRESSIBILITY AND LIVE TO
TELL THE STORY!

NO EXHIBITIONIST, "SLICK"
IS A 20TH CENTURY COLUMBUS
EXPLORING THE DANGEROUS,
UNKNOWN REALMS OF TRANSONIC
AND SUPERSONIC SPEEDS!



HE FEELS
SHARP!

...SPURTING THROUGH
SPACE IN THE "HOTTEST"
SHIP EVER BUILT...
THE XS-1 IS DESIGNED TO
FLY 1,700 MILES AN HOUR
TO AN ALTITUDE OF 26
MILES OR MORE!



THOSE
FLIES GET
BIGGER AND
BIGGER!

look **SHARP**
feel **SHARP**
be **SHARP**

use
Gillette
Blue Blades
with the **SHARPEST** edges
ever honed!

● You *look* sharp for you enjoy the
swellest shaves ever. You *feel* sharp
because they're refreshing and give
you a lift. You *are* sharp for you get
far more shaves per blade and save
money. Ask for Gillette Blue Blades.



5 FOR 25¢ 10 FOR 49¢

ENJOY BOXING
EVERY FRIDAY NIGHT
OVER ABC NETWORK. GILLETTE'S CAVALCADE OF SPORTS
ALSO AIRS THE ALL-STAR BASEBALL GAME, JULY 8, AND
OTHER CLASSICS YEAR 'ROUND.

Gillette Safety Razor Company, Boston 6, Mass.



PILOTS
USED TO
BUZZ "SLICK"
WHEN, AT 16,
HE MILKED COWS
DOWN ON THE FARM...
NOW, AT 23, HE'S
SKIMMING THE
CREAM OFF
THE MILKY
WAY!



HE IS **SHARP!**

...SLICK IS THE WORD FOR THE SHAVES
HE GETS, TOO. YES, "SLICK" GOODLIN GETS
THE BEST-LOOKING, MOST REFRESHING
SHAVES IN THE BOOK. FOR HE ALWAYS USES
GILLETTE BLUE BLADES
WITH THE **SHARPEST** EDGES EVER HONED.
REMEMBER, MEN,
**DOUBLE EDGES MEAN
DOUBLE ECONOMY!**

Copyright, 1947, by Gillette Safety Razor Company

EXPERIENCE IS THE BEST TEACHER!

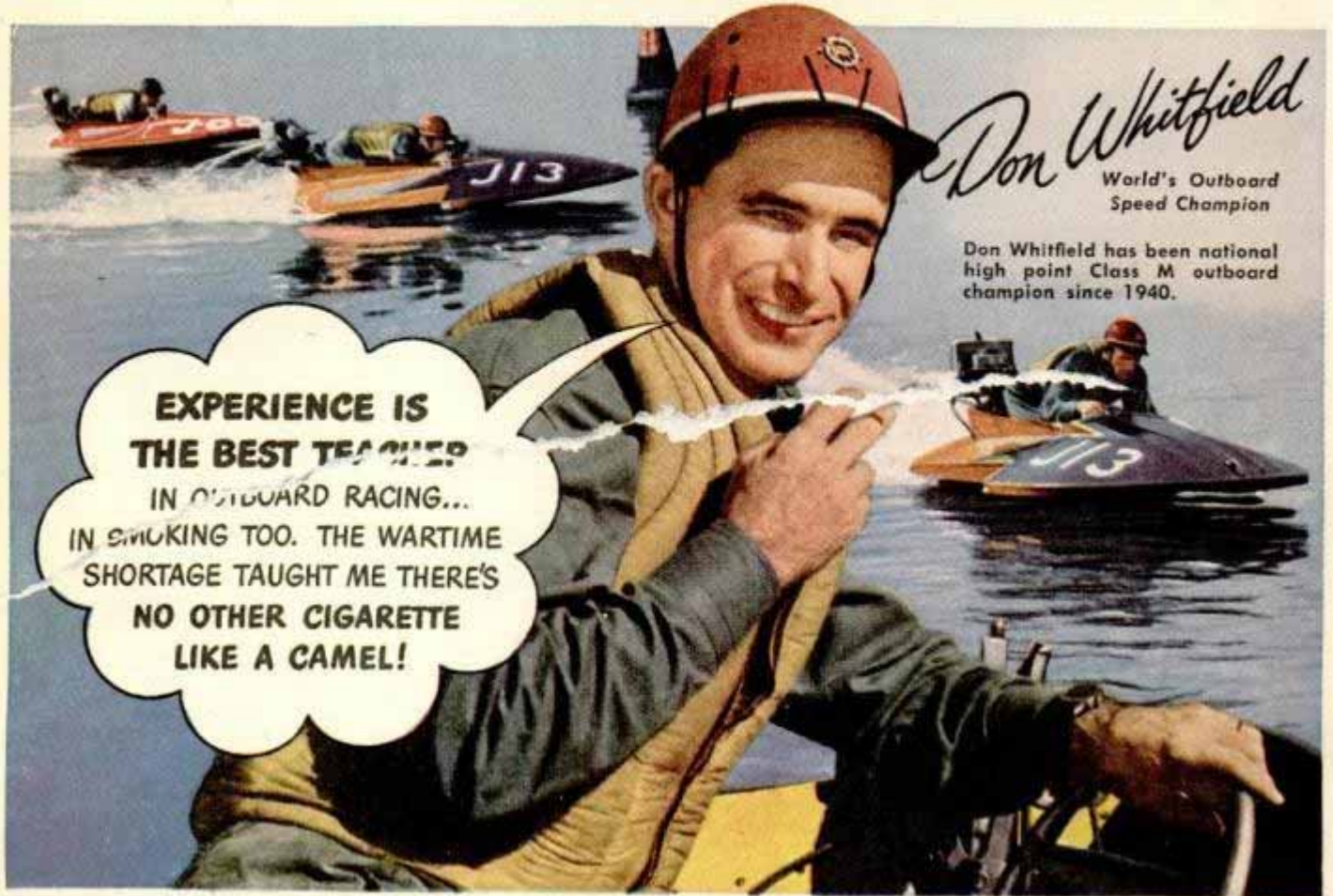

Don Whitfield
World's Outboard
Speed Champion

Don Whitfield has been national high point Class M outboard champion since 1940.

EXPERIENCE IS THE BEST TEACHER
IN OUTBOARD RACING...
IN SMOKING TOO. THE WARTIME SHORTAGE TAUGHT ME THERE'S NO OTHER CIGARETTE LIKE A CAMEL!

More people are smoking CAMELS than ever before!

Yes, like Champion Don Whitfield, millions who tried many different brands during the shortage now smoke Camels.



YOUR 'T-ZONE' WILL TELL YOU...
T for Taste...
T for Throat...
That's your proving ground for any cigarette. See if Camels don't suit your 'T-Zone' to a 'T'!

• You know what it was like during the war shortage: you took any brand you could get. That's when smokers discovered that Camel's rich taste and cool mildness added up to a pleasure you didn't find in any other cigarette. Today the demand for Camels is the greatest in history! But, no matter how great the demand:

We don't tamper with Camel quality. Only choice tobaccos, properly aged, and blended in the time-honored Camel way, are used in Camels.



DURING the war shortage of cigarettes...that's when your "T-Zone" was trying many brands. That's when millions learned the full meaning of the phrase, "Camels suit my 'T-Zone' to a 'T'!"

R. J. Reynolds Tob. Co., Winston-Salem, N. C.

According to a recent Nationwide survey:
MORE DOCTORS SMOKE CAMELS
than any other cigarette

When 113,597 doctors from coast to coast in every field of medicine were asked by three independent research organizations to name the cigarette they smoked, more doctors named Camel than any other brand!