

ANC

# POPULAR MECHANICS

## MAGAZINE

WRITTEN SO YOU CAN UNDERSTAND IT

REG. TRADE MARK GREAT BRITAIN NO. 410425

REG. U.S. PAT. OFF.



DRESS PARADE ON RAILS  
PAGE 97



"DE LUXE" YOUR TIRES IN 5 MINUTES!

... Snap on

**Lyon**

**WHITEWALLS\***

\*TRADE MARK

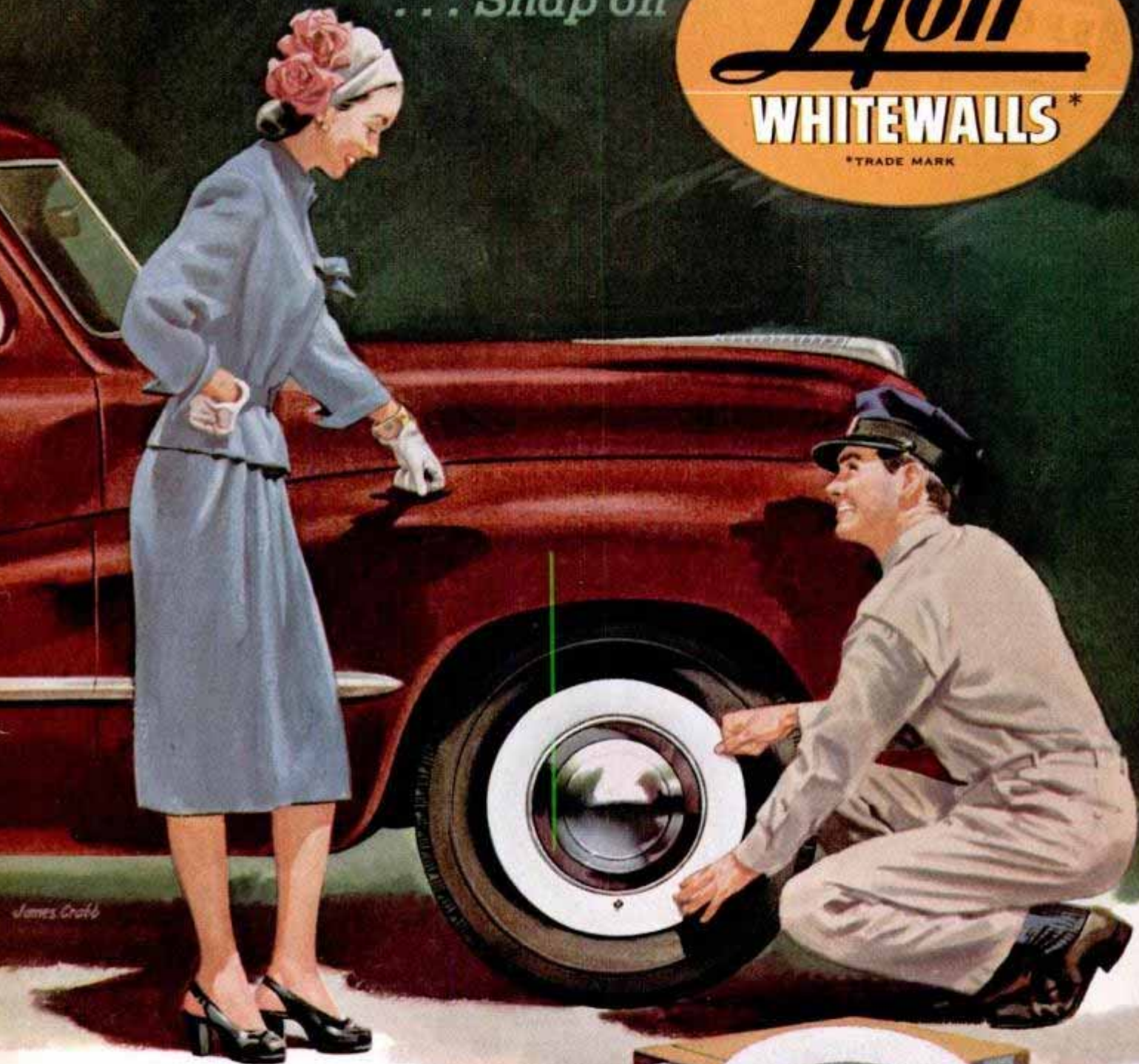

**Sold by leading  
Tire Dealers everywhere!**

When you snap on a set of gleaming Lyon White- walls, you have more than your eyes to tell you you're right in style. You have the recommenda- tion of leading designers whose aim is to make tires look larger and wheels smaller than ever before to get smarter car appearance. Only Lyon Whitewalls achieve this appearance-effect so well. That's why thousands of dealers of leading tire

manufacturers enthusiastically recommend and sell Lyon Whitewalls. Have your dealer snap a set on *your* car the next time you get gas. It only takes 5 minutes.

**PRICES:** Standard Steel Model (16" Wheels) \$6.95 Per Set of Four. De Luxe Steel Model (15" and 16" Wheels) \$9.95 Per Set of Four. Sets of Five Priced Higher. A Fair Trade Product Sold Under Applicable Fair Trade Laws.

WHITEWALLS® ARE THE EXCLUSIVE TRIM RING PRODUCT OF LYON INCORPORATED, 13881 WEST CHICAGO BLVD., DETROIT 27, MICHIGAN



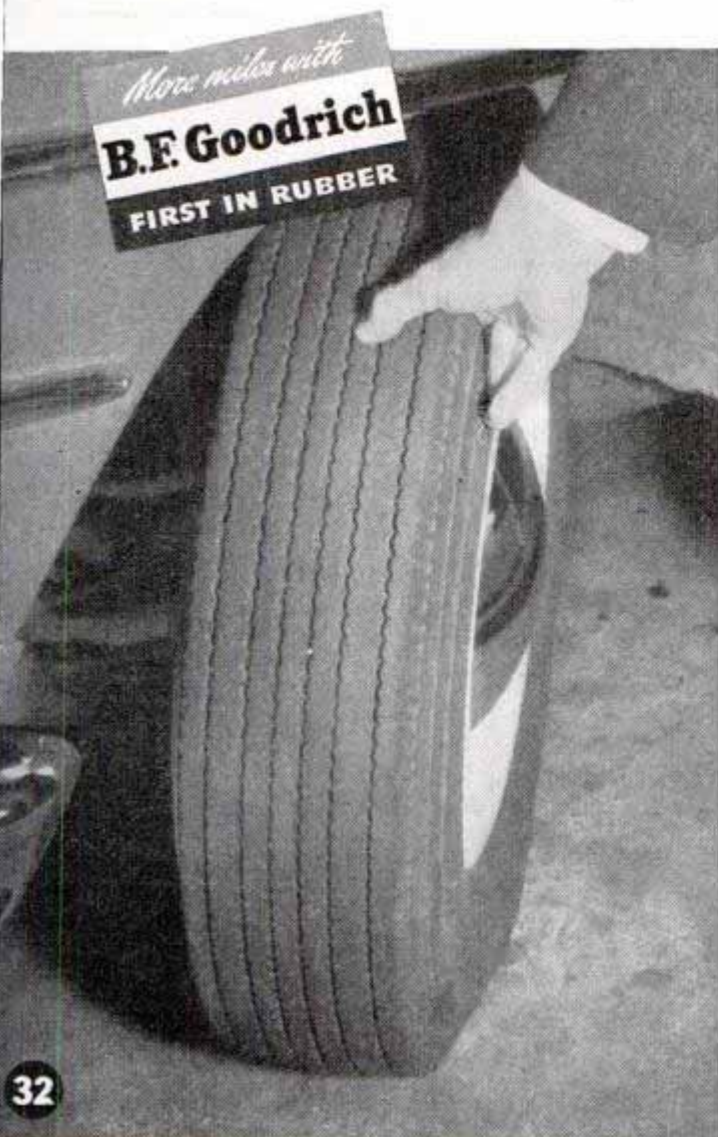

## TYPICAL EXAMPLES: THE B. F. GOODRICH TIRE THAT OUTWEARS PREWAR TIRES

*Typical example No. 32.* "I equipped my new car with five B. F. Goodrich Silvertowns," says Raymond Harris, Chester, Pa., and started on a trip to California and return. I traveled all types of roads and in all weather-conditions. Did not make a single stop because of tire trouble. These tires have now covered 18,054 miles and, as you can see from the picture, show but very little wear."

*Typical example No. 39.* "In my opinion the new B. F. Goodrich tire is 50% better than any prewar tire used on my cabs," says "Tex" Martin, owner of a fleet of

taxicabs in Pelly, Texas. "A set of these tires to date has been driven approximately 55,000 miles. The tire in the picture is one of these 55,000-mile tires, and I estimate it is good for another 10,000 without recapping."

*Typical example No. 27.* "The speedometer has registered 34,112 miles since this B. F. Goodrich tire was installed," states Ray Anderson, General Manager of the Western Automobile Leasing Co., Los Angeles, Calif. "Indications are that it will deliver over 15,000 miles more before center tread will disappear.

This tire used in rental service—including special delivery, mail, and emergency runs—in a city which is practically all signal-operated heavy traffic."

If you need tires for your car, it is probably good news to you to know that your B. F. Goodrich dealer now has most sizes right in stock. You can probably get tires right off his rack without waiting. *The B. F. Goodrich Company, Akron, Ohio.*

**B.F. Goodrich**  
FIRST IN RUBBER



# Long-distance Television is twenty years old



*At the 1927 demonstration, Dr. Herbert E. Ives explained the television system developed in Bell Telephone Laboratories.*

APRIL 7 is a notable day in communication history, for on that day in 1927 was the first demonstration of television over long distances. Large-scale images were flashed from Washington, D. C., by wire and from Whippany, N. J., by radio to a demonstration in New York City. "It was," said a newspaper, "as if a photograph had suddenly come to life and begun to smile, talk, nod its head and look this way and that."

That was the first of many public demonstrations, each to mark an advance in the television art. In 1929 came color television, and in 1930 a two-way system between the headquarters buildings of A. T. & T. and Bell Laboratories. When

the first coaxial cable was installed in 1937, television signals for 240-line pictures were transmitted between Philadelphia and New York and three years later 441-line signals were transmitted. By May, 1941, successful experiments had been made on an 800-mile circuit.

End of the war brought a heightened tempo of development. Early in 1946 began the regular experimental use of coaxial cable for television between New York and Washington, and a few months later a microwave system for television transmission was demonstrated in California.

Transmission facilities will keep pace as a great art advances to wide public usefulness.

**BELL TELEPHONE LABORATORIES**



*Exploring and inventing, devising and perfecting, for continued improvements and economies in telephone service*



# Popular Mechanics Magazine

Registered in U. S. Patent Office and Canada

H. H. WINDSOR, Founder

H. H. WINDSOR, Jr., Editor and Publisher



SOUTH of the border, thousands of eager Spanish speaking neighbors are reading the first issue of MECANICA POPULAR, Spanish edition of our magazine

which is being printed in Mexico City. Fifty thousand copies of *Mecanica Popular* are now being distributed throughout Mexico, Central America, and all the way down to Argentina. Senor Samuel Melo, Jr., who served with the U. S. Army in a hard-hitting Ranger battalion, is general manager of the Spanish edition, and Rafael Reynoso y M., a director of the Mexican Chamber of Industry and noted as a brilliant editor, is technical director. As in the case of our French edition, *Mecanique Populaire*, published in Paris, the cover painting, text and illustrations are flown by air express from Chicago. Our publisher and staff proudly regard *Mecanica Popular* as a friendly hand extended to our southern neighbors.

NEXT month a feature on light seaplanes should fire the imagination of anyone with "itchy wings." Other July headlines: "School for the Big Cats" and "Ammunition for the War on Disease."

PRACTICAL features in the July Craftsman section include an article on home refrigerator servicing, and one on making fluorescent lighting fixtures for your home. For those who will bend their backs to save a little money, there's a feature telling how to lay a concrete walk.

RADIO builders will find a handy trouble shooter in the dual-purpose signal generator featured in the July Radio section.

Volume 87

JUNE 1947

Number 6

Managing Editor.....Roderick M. Grant  
Assistant Managing Editor.....Wayne Whittaker  
Shop Notes and Crafts Editor.....James R. Ward  
Radio and Electronics Editor.....Frank L. Brittin  
Aviation Editor.....Aubrey O. Cookman, Jr.  
Associate Editor.....John R. Kinsey  
Eastern Editor.....Bill Reiche  
Western Editor.....Thomas E. Stimson, Jr.  
Art Director.....Frank Beatty

Assistant Editors  
Donald R. Brooks      Clifford B. Hicks      Virgil T. Swanson

Assistant Editors, Shop Notes and Crafts  
W. Clyde Lamme    Wayne C. Lecky    John F. Shrock    A. E. Youngquist

## In This Issue

<u>Where Are Our New Frontiers?</u>	81
<u>Germs Put the Squeeze on Oil</u>	92
<u>Dress Parade on Rails</u>	97
<u>Report From Antarctica</u>	108
<u>New Wealth From Waste</u>	116
<u>Hobbyist of the Month</u>	123
<u>What Makes an Athlete Tick?</u>	130
<u>Baking Biscuits by Reflection</u>	140
<u>Industry Also Breathes Oxygen</u>	145
<u>Electric Orchestra</u>	155
<u>Tricks of the Green Men</u>	161

## For the Craftsman

<u>The Build-It-Yourself House</u>	168
<u>Rods, Reels and Lures</u>	177
<u>Sweeping a Rug Is Not Enough</u>	193
<u>"Detectives" Spot Good Drivers</u>	197
<u>Profits in Roadside Pictures</u>	202
<u>Workshop "Floor Lamps"</u>	213
<u>Radio and Electronics</u>	221

## Table of Contents Continued on Page 8

Published monthly by POPULAR MECHANICS COMPANY, 200 East Ontario Street, Chicago 11, Ill. H. H. Windsor, Jr., president; Paul H. Dunakin, vice president and general manager; D. F. Windsor, vice president and secretary-treasurer; William Harrison Fetridge, vice president and assistant to the publisher; Clover L. Perkins, advertising manager; Alan M. Deyoe, circulation manager. Single copy in the United States and Canada, 25 cents; subscription rates in United States and possessions, Canada, and countries of the Pan-American Postal Union, 1 year, \$2.50; 2 years, \$4.50; 3 years, \$6.00. To all other countries add \$1.00 a year over United States prices for overseas postage. If you plan to move, notify us at least 60 days in advance so you will not miss an issue. Give both old and new addresses. Entered as Second Class Matter, September 15, 1903, at the Post Office at Chicago, Illinois, under Act of March 3, 1879. Entered as Second Class Matter at Post Office Dept., Canada. Copyright 1947, by Popular Mechanics Company, Copyright under International Copyright Union. Copyright in France. All rights reserved under Pan-American Copyright Union. Printed in the United States of America.



# "We Get Good Results with Jitterbug"

"Dear Fred:

"Enclosed is a picture of a nice mess that were caught on a frog Jitterbug, and a black Jitterbug. They were taken from Orange Lake, near Newburgh, N. Y., at night. The four largest weighed 6 lbs. apiece, and they totaled 46 lbs. We get good results from all patterns of Jitterbugs, especially at night."—Capt. P. C. Harold, S/Sgt. F. M. Stockwell, Newburgh, N. Y.

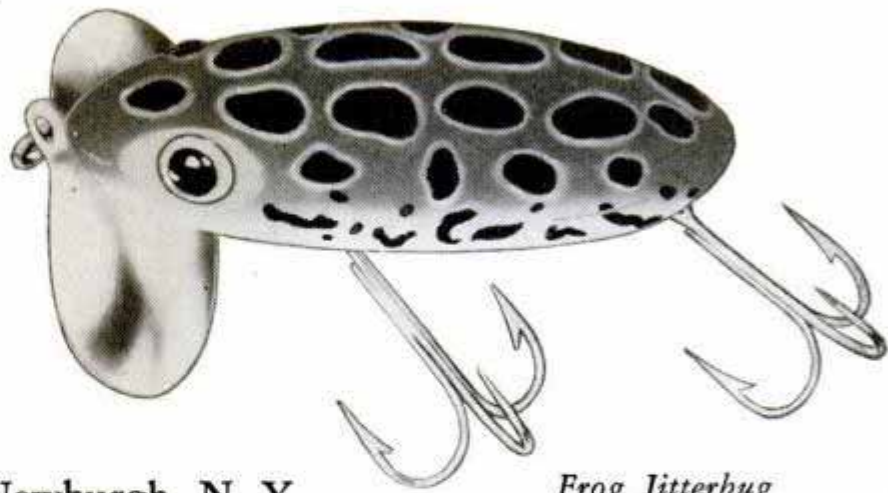

*Frog Jitterbug  
or choice of 5 other  
colors — \$1.21 each.  
3/8 or 5/8 oz. same price.*

## Bass Strike It Viciously!

Fishermen get a kick out of using the Jitterbug. Its gurgling, paddling action is as fascinating to them as it is to fish. Bass strike it viciously. And the thrill-packed action is right on the surface where you can see and hear it.

### Write for Free Catalog

Beautifully illustrated in colors. Contains many photographs and letters from fishermen telling where and how record catches were made with Jitterbugs, my famous surface bait, Hawaiian Wigglers and Hula Dancers. Also available, 16 mm. colored movies for showing to sportsmen's clubs.

**FRED ARBOGAST & CO.**

1626 North St., Akron 3, Ohio

*Capt. Harold and Sgt. Stockwell with their  
string of bass caught on Frog Jitterbug*

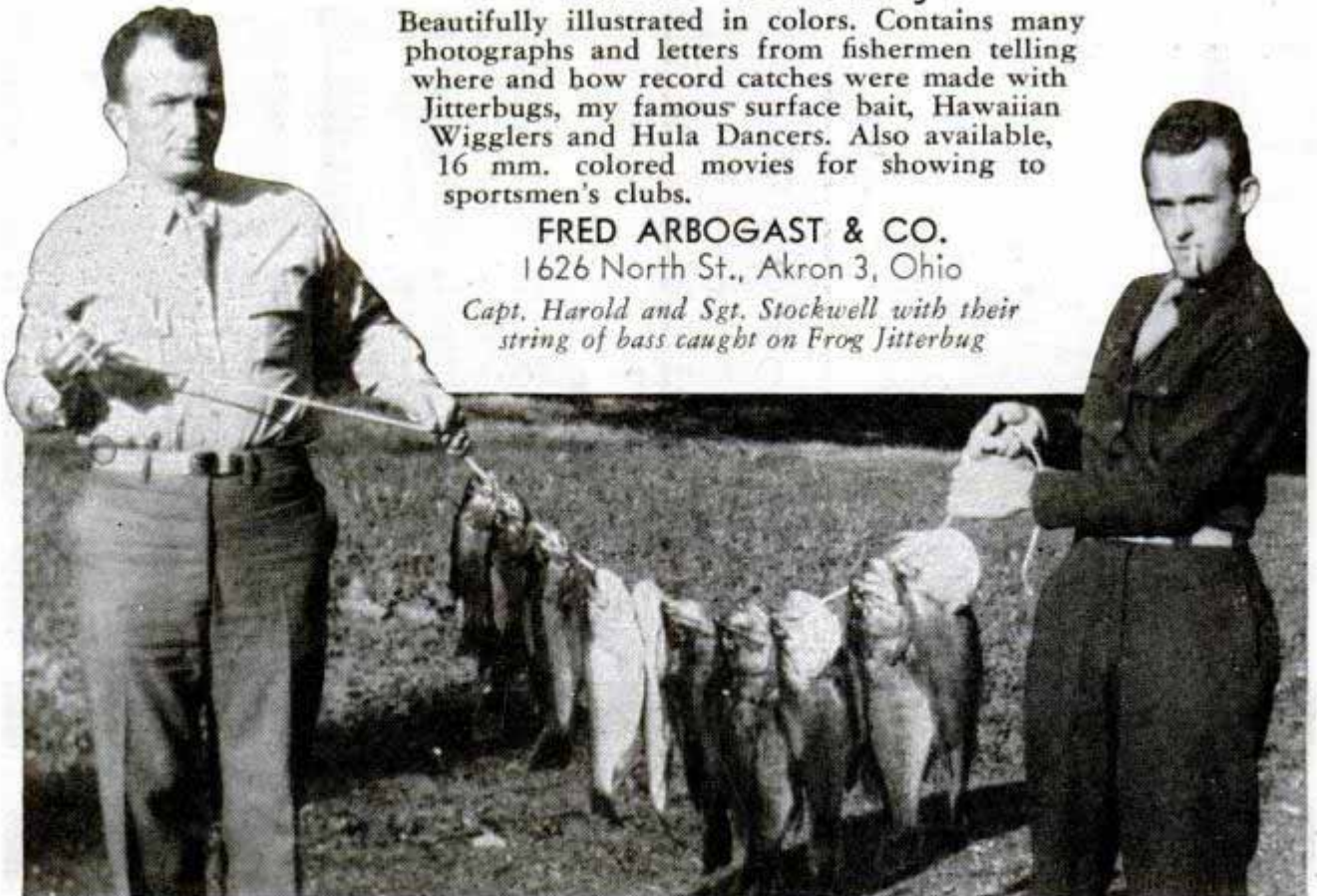



# Clean up your Horsepower

New smoothness, zip and power—that's what a Casite motor clean-up does for your car. Casite frees sticking valves and rings . . . retards formation of sludge and gum . . . speeds lubrication.

## and keep it clean...

Everyone knows a clean motor runs better and lasts longer; so use Casite regularly—a pint through the air intake every three months and a pint in the crankcase every oil change.

## the Guaranteed Way!

Double-Your-Money-Back if your car doesn't run better and smoother with Casite. And Casite makes this famous guarantee no matter what kind of motor oil you're using. Service stations, garages and car dealers everywhere sell Casite. The Casite Corporation, Hastings, Michigan, and the Casite Division, Hastings Ltd., Toronto.



**CLEANS MOTORS**  
**KEEPS MOTORS CLEAN**

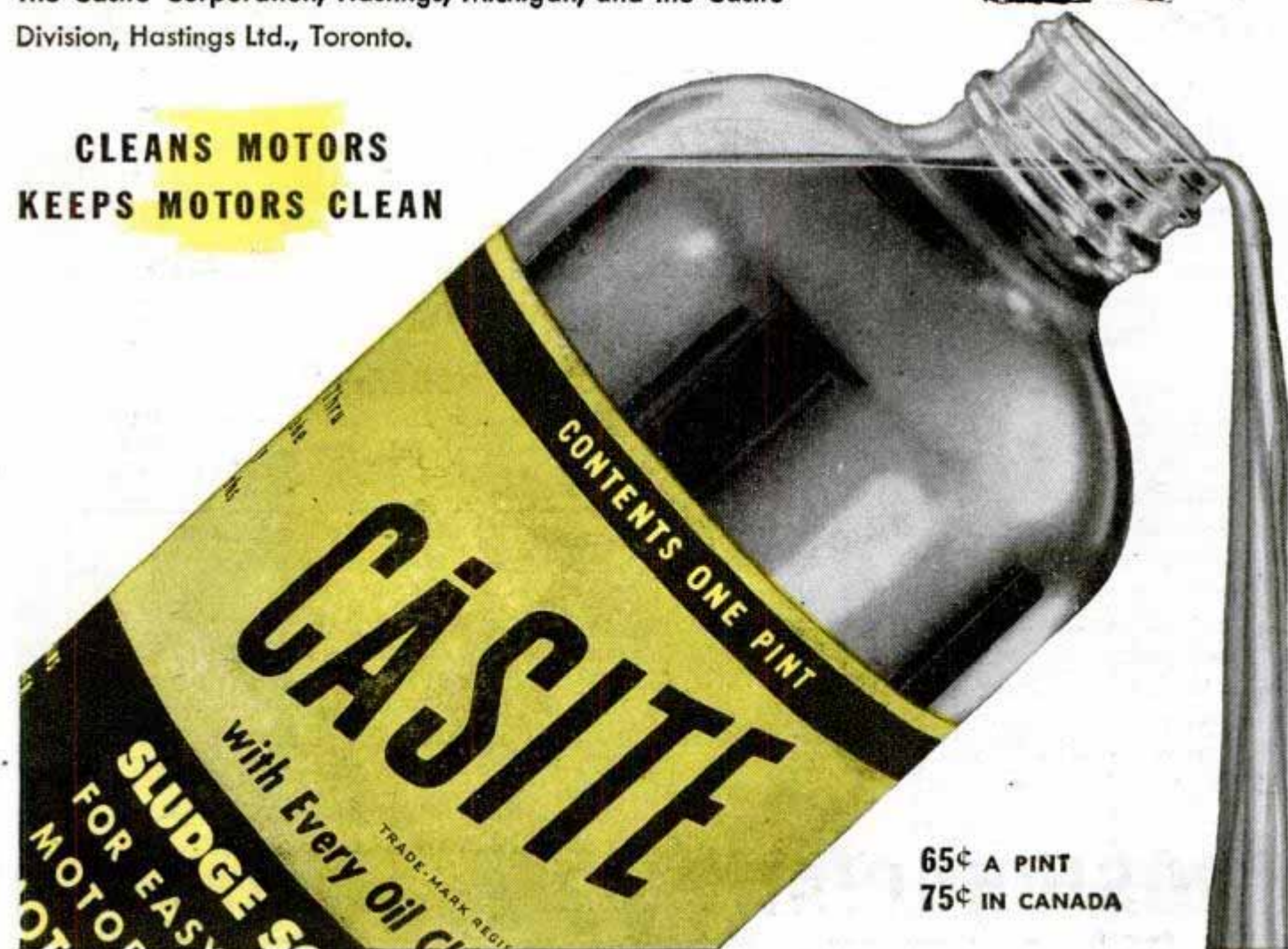

65¢ A PINT  
75¢ IN CANADA



# Thoughts... THAT MOVE MOUNTAINS



## ... IS MIND POWER REAL?

**H**AVE YOU READ volumes on the power of thought? Perhaps you have listened to lengthy theoretical addresses on the forces of mind. You may have wondered if these same writers and lecturers on mind power know how to use it. How many mountains of personal obstacles—everyday trials and tribulations—have *they* moved? What are these subtle principles whereby man can skillfully remove the barriers that impede his progress? How can *you* displace the obstructions and hindrances to *your* goal... the mountains in *your* life? Can practical information about inner power be reduced to mere words... words for public dissemination? Or, is there a secret method especially and uniquely preserved for the worthy seeker... practicable only under ideal circumstances? If so, who has the secret method? Where can it be found?

*The*

**ROSICRUCIANS (AMORC) San Jose, California**

Investigate the Rosicrucians (NOT a religion), the oldest *practical* philosophical fraternity on earth. See if they cannot show you a method for attainment such as you may not have dreamed. Thousands of men and women today are enjoying mental mastery... realization of ideals... the attainment of their objectives. They *know* the secret methods for converting mountains of personal problems into green valleys of achievement.

### ACCEPT THIS OFFER

A FREE book, *The Mastery of Life*, is yours for the asking. It explains how easily you may enter upon the path of attainment. Fill in and send coupon *today!*

SCRIBE V. Z. H.  
THE ROSICRUCIANS (AMORC)  
San Jose, California

Please send me the book, *The Mastery of Life*, which explains how I may learn to use my faculties and powers of mind.

Name \_\_\_\_\_

Address \_\_\_\_\_

City \_\_\_\_\_

Zone Number \_\_\_\_\_ State \_\_\_\_\_



**"What's he got  
that I haven't got?"**

LOOK at the successful men you know. "What have they got" that you haven't?

Very little, probably. In most ways these men are no brighter or naturally more capable than average. Many of them probably have no more formal education or better natural aptitudes than you.

But that little extra they have is important. They have the special knowledge and ability for which business is glad to pay well—they know the what, why and how of business. They have also the confidence and aggressiveness which come from knowing that they know and can apply their knowledge.

You may add that extra—may get that same profitable knowledge and ability—that same confidence and aggressiveness—if you are willing to pay the price in earnest, necessary study. For LaSalle has spent 38 years developing, testing and proving, with over a million student members, spare-time success training in certain specialized business fields. What scores of thousands of men and women—many just like you—have done, you should be able to do.

You need not leave your home or interrupt your job; you need pay comparatively little money. But you must be ambitious and willing to study seriously. And soon after you start training, the results will begin to show up in your own confidence and in your work. For what you learn at home tonight is so practical that often you can apply it on the job tomorrow.

How much do you want success—more money, a promotion or a new job, prestige and responsibility? If you really want it, you will use the coupon below to find out what LaSalle training can do for you. It costs only a postage stamp, but a coupon like it has been the starting point to real success for scores of thousands—and can be for you.



G. I. APPROVED

**LASALLE Extension University**  
*A Correspondence Institution*

Dept. 664-R • 417 S. Dearborn • Chicago 5, Ill.

I want to know how LaSalle can help me win success in the field I have checked below. Please send me your free 48-page booklet about that field and your success training in it.

- |  |  |
|--|--|
| <input type="checkbox"/> Accountancy       | <input type="checkbox"/> Salesmanship                  |
| <input type="checkbox"/> Bookkeeping       | <input type="checkbox"/> Effective Speaking            |
| <input type="checkbox"/> C.P.A. Coaching   | <input type="checkbox"/> Executive Management          |
| <input type="checkbox"/> Business English  | <input type="checkbox"/> Industrial Management         |
| <input type="checkbox"/> Law: LL.B. degree | <input type="checkbox"/> Traffic Management            |
| <input type="checkbox"/> Foremanship       | <input type="checkbox"/> Stenotypy (Machine Shorthand) |

Name.....Age.....

Position.....

Address.....

City, Zone and State.....

**LASALLE EXTENSION UNIVERSITY**  
*Ac* This One



UKPR-FQ6-NC95



# Keep Your Car "feeling good" inside with PYROIL

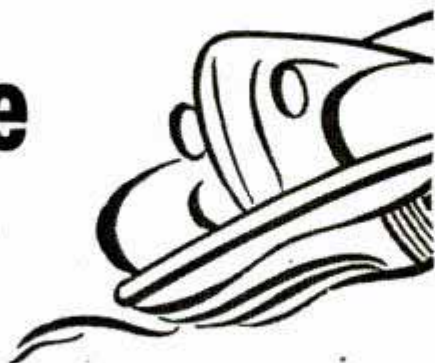

Proper lubrication is a 'round the clock necessity for your car. When standing idle, cylinder walls must be protected from corrosion; when starting, a smooth oil film should prevent friction and wear. Pyroil gives oil the property of adhering to metal surfaces—it reduces wear, it prevents corrosion, it removes carbon and sludge formations.

To add miles to your car, ask your gas station attendant to add PYROIL.

## Pyroil for Aircraft Engines

Use Aircraft Pyroil B for lubricating oil, Aircraft Pyroil A for gasoline.

Manufactured and Guaranteed by Pyroil Company, 68 Pyroil Bldg., La Crosse, Wisconsin.



**PYROIL COMPANY**  
68 Pyroil Bldg., La Crosse, Wisconsin

I want my car to last and run properly. Please tell me more about Pyroil and how it can accomplish this for me.

Name.....

Address.....

City or Town..... State.....



Jerry, the talking dog, is entertaining hospitalized veterans, by courtesy of the PYROIL Company. Picture of Jerry sent on request.

## TABLE OF CONTENTS (Continued)

<b>AUTOMOTIVE</b>	
Safety auto light.....	90
Jet automobile.....	105
Back for garments fits into back seat of car.....	107
Midget car is capable of 60-mile-an-hour speeds.....	127
Midget vacuum sweeper cleans interiors of autos.....	134
Tire chain tightener.....	135
Wire-cord tire is rugged.....	151
<b>AVIATION</b>	
Bomber rides "bicycle" landing gear.....	84
Comfortable seat for pilots.....	95
Model planes dive at transonic speeds.....	96
Pivoting wheels permit cross-wind landings.....	96
British transport.....	98
Verandalike visibility is distinguishing feature of the new Volmer VJ-21.....	107
Underwing fueling saves time.....	107
Crews use bosun's chair to inspect towering tail of the Lockheed Constitution.....	121
Seat jigglers used to test vibrations in airplane seats caused by propeller "blast".....	121
"Refrigerated" bomber.....	135
<b>BOATS</b>	
Silent reel lowers boat anchor.....	91
Lock clamps around boat car.....	91
Cage for boat rudders.....	95
Beached tanker powers city.....	115
Propeller-driven boat.....	166
<b>FARM</b>	
Large conveyor speeds loading of lettuce on trucks.....	107
Precut parts of corncrib bolted together on site.....	114
Adjustable dehorning chute.....	159
<b>FISH AND FISHING</b>	
Double-duty "diving" lure.....	91
Combination fish tape and scale.....	91
Miniature scythe for anglers cuts loose snagged lures.....	114
Quick-change fishing fly.....	134
Float holds live bait for casting.....	139
<b>HOUSE AND HOME</b>	
Small clip-on shelves fit medicine cabinets.....	90
What's new for your home.....	136
"Hypodermic needle" moth sprayer.....	139
Doughnut gun.....	144
Inflatable lounge chair.....	151
<b>INDUSTRY</b>	
Flame projector.....	85
Ball player tests strength of special plate glass.....	121
Machine dumps bags.....	122
Electronic food sterilizer.....	144
Rice-hull bricks.....	150
Trailers tailored for every job.....	152
<b>MEDICAL</b>	
Televising an operation.....	86
Plastic arteries.....	90
New "tool" to fight polio.....	106
What the doctor prescribed.....	115
Swiss transfusion apparatus employs flexible rubber bag.....	134
<b>PHOTOGRAPHY</b>	
Flash-gun shield.....	85
Equipment for photo fans.....	128
Push button selects film from library.....	135
Cameraman is prepared for any assignment.....	154
High-speed camera to snap 800,000 pictures a second.....	166
<b>RADIO AND ELECTRICAL</b>	
Rocket radio installed in test-fired V-2.....	121
Radio treasure hunts.....	122
Electric safety razor.....	129
Electrical flood gauge.....	159
<b>TOOLS</b>	
Giant electromagnet.....	85
Plastic saw handle is miter or square.....	90
Jig holds odd-shaped parts for drilling at any angle.....	114
File guide enables anyone to sharpen handsaws.....	127
Lawn edge trimmer.....	129
Tractor-rigged scoop "bites" 10 cubic feet.....	129
Collapsible ladder.....	143
Auto-jack plasterboard lift.....	143
<b>TOYS AND NOVELTIES</b>	
Toy cars built with plastic kit.....	87
Scoreboard for tasks helps train children.....	139
Rubber elbowed toy sticks.....	143
Model airplane reel control.....	150
<b>MISCELLANEOUS</b>	
Beetles "tagged" with radioactive disk to study their migratory habits.....	84
Electrochemical rod prevents rust.....	87
Plane or locomotive engine.....	87
Puppet circus.....	88
"Double-stroke" electroplating.....	90
Bag puncher.....	105
Sodium makes lake boil.....	106
Safety steel tips on crutches prevent slipping.....	107
"Accordionorgan" weighs more than a ton.....	127
Telescope attachment may determine whether there's life on Mars.....	142
Push-button typewriter.....	144
Plexiglas rivets.....	151
Drilling to music.....	154
Motorcycle bus.....	159
Edible orchids.....	159

## Craftsman and Shop Notes Index

<b>AUTOMOTIVE</b>	
Portable baby crib fits auto.....	183
Valve keepers replaced easily.....	192
Versatile two-in-one auto tool.....	192

(Continued to page 10)



# TIME to SPARE

by I.C.S.



**W**HIGHTIER THAN THE TREES  
CHEMISTS HAVE MADE US INDEPENDENT OF RUBBER, CAMPHOR AND VARNISH TREES.

**M**AKING MILLIONS  
R.G. LETOURNEAU WAS A SCRAPER REPAIR MAN WITH AN OPEN LOT AS BUSINESS LOCATION WHEN HE ENROLLED FOR AN I.C.S. COURSE IN MECHANICAL ENGINEERING.

HE STUDIED AT NIGHT AFTER A HARD DAY'S WORK.  
**SEQUEL:** LAST YEAR THE LETOURNEAU FACTORIES HAD SALES OF \$40,000,000.

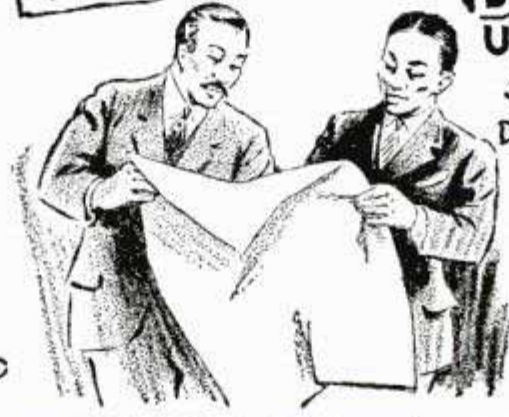

**B**LUEPRINTS ARE A UNIVERSAL LANGUAGE  
SAYS R.G. EVANS, DIRECTOR OF THE I.C.S. DRAFTING SCHOOLS. A CHINESE OR A RUSSIAN READILY CAN READ A U.S. BLUEPRINT.

## INTERNATIONAL CORRESPONDENCE SCHOOLS



BOX 5605-K, SCRANTON 9, PENNA.

Without cost or obligation, please send me full particulars about the course *before* which I have marked X:

- |  |   |   |  |
|--|---|---|--|
| <p><b>Air Conditioning and Plumbing Courses</b></p> <p><input type="checkbox"/> Air Conditioning<br/><input type="checkbox"/> Heating <input type="checkbox"/> Plumbing<br/><input type="checkbox"/> Refrigeration <input type="checkbox"/> Steam Fitting</p> <p><b>Chemistry Courses</b></p> <p><input type="checkbox"/> Chemical Engineering<br/><input type="checkbox"/> Chemistry, Analytical<br/><input type="checkbox"/> Chemistry, Industrial<br/><input type="checkbox"/> Chemistry, Mfg. Iron &amp; Steel<br/><input type="checkbox"/> Petroleum Refining <input type="checkbox"/> Plastics<br/><input type="checkbox"/> Pulp and Paper Making</p> <p><b>Civil Engineering, Architectural and Mining Courses</b></p> <p><input type="checkbox"/> Architectural Drafting<br/><input type="checkbox"/> Architecture<br/><input type="checkbox"/> Bridge and Building Foreman<br/><input type="checkbox"/> Building Estimating<br/><input type="checkbox"/> Civil Engineering<br/><input type="checkbox"/> Coal Mining<br/><input type="checkbox"/> Contracting and Building<br/><input type="checkbox"/> Highway Engineering<br/><input type="checkbox"/> Lumber Dealer<br/><input type="checkbox"/> Reading Structural Blueprints<br/><input type="checkbox"/> Sanitary Engineering<br/><input type="checkbox"/> Structural Drafting</p> | <p><input type="checkbox"/> Structural Engineering<br/><input type="checkbox"/> Surveying and Mapping</p> <p><b>Communications Courses</b></p> <p><input type="checkbox"/> Electronics<br/><input type="checkbox"/> Practical Telephony<br/><input type="checkbox"/> Radio General<br/><input type="checkbox"/> Radio Operating<br/><input type="checkbox"/> Radio Servicing</p> <p><input type="checkbox"/> Telegraph Engineering</p> <p><b>Electrical Courses</b></p> <p><input type="checkbox"/> Electrical Drafting<br/><input type="checkbox"/> Electrical Engineering<br/><input type="checkbox"/> Electric Light and Power<br/><input type="checkbox"/> Lighting Technician<br/><input type="checkbox"/> Practical Electrician</p> <p><b>Internal Combustion Engines Courses</b></p> <p><input type="checkbox"/> Auto Technician <input type="checkbox"/> Aviation<br/><input type="checkbox"/> Diesel-Electric<br/><input type="checkbox"/> Diesel Engines <input type="checkbox"/> Gas Engines</p> <p><b>Mechanical Courses</b></p> <p><input type="checkbox"/> Aeronautical Engineering<br/><input type="checkbox"/> Aircraft Drafting<br/><input type="checkbox"/> Flight Engineer<br/><input type="checkbox"/> Foundry Work<br/><input type="checkbox"/> Heat Treatment of Metals</p> | <p><input type="checkbox"/> Industrial Engineering<br/><input type="checkbox"/> Industrial Metallurgy<br/><input type="checkbox"/> Machine Shop<br/><input type="checkbox"/> Mechanical Drafting<br/><input type="checkbox"/> Mechanical Engineering<br/><input type="checkbox"/> Mold-Loft Work<br/><input type="checkbox"/> Patternmaking—Wood, Metal<br/><input type="checkbox"/> Reading Shop Blueprints<br/><input type="checkbox"/> Sheet-Metal Drafting<br/><input type="checkbox"/> Sheet-Metal Worker<br/><input type="checkbox"/> Ship Drafting <input type="checkbox"/> Ship Fitting<br/><input type="checkbox"/> Tool Designing<br/><input type="checkbox"/> Toolmaking<br/><input type="checkbox"/> Welding—Gas and Electric</p> <p><b>Railroad Courses</b></p> <p><input type="checkbox"/> Air Brake <input type="checkbox"/> Car Inspector<br/><input type="checkbox"/> Diesel Locomotive<br/><input type="checkbox"/> Locomotive Engineer<br/><input type="checkbox"/> Locomotive Fireman<br/><input type="checkbox"/> Railroad Section Foreman</p> <p><b>Steam Engineering Courses</b></p> <p><input type="checkbox"/> Boilermaking<br/><input type="checkbox"/> Combustion Engineering<br/><input type="checkbox"/> Engine Running<br/><input type="checkbox"/> Marine Engineering<br/><input type="checkbox"/> Steam Electric <input type="checkbox"/> Steam Engines</p> | <p><b>Textile Courses</b></p> <p><input type="checkbox"/> Cotton Manufacturing<br/><input type="checkbox"/> Rayon Weaving<br/><input type="checkbox"/> Textile Designing<br/><input type="checkbox"/> Woolen Manufacturing</p> <p><b>Business and Academic Courses</b></p> <p><input type="checkbox"/> Accounting <input type="checkbox"/> Advertising<br/><input type="checkbox"/> Arithmetic <input type="checkbox"/> Bookkeeping<br/><input type="checkbox"/> Business Correspondence<br/><input type="checkbox"/> Business Management<br/><input type="checkbox"/> Certified Public Accounting<br/><input type="checkbox"/> Commercial<br/><input type="checkbox"/> Cost Accounting<br/><input type="checkbox"/> Federal Tax<br/><input type="checkbox"/> First Year College<br/><input type="checkbox"/> Foremanship <input type="checkbox"/> French<br/><input type="checkbox"/> Good English <input type="checkbox"/> High School<br/><input type="checkbox"/> Higher Mathematics<br/><input type="checkbox"/> Illustrating <input type="checkbox"/> Motor Traffic<br/><input type="checkbox"/> Postal Service<br/><input type="checkbox"/> Salesmanship <input type="checkbox"/> Secretarial<br/><input type="checkbox"/> Sign Lettering<br/><input type="checkbox"/> Spanish <input type="checkbox"/> Stenography<br/><input type="checkbox"/> Traffic Management</p> |
|--|---|---|--|

Name \_\_\_\_\_ Address \_\_\_\_\_  
 City \_\_\_\_\_ State \_\_\_\_\_ Present Position \_\_\_\_\_  
 Working Hours \_\_\_\_\_ A.M. to \_\_\_\_\_ P.M. Length of Service in World War II \_\_\_\_\_

Special tuition rates to members of the Armed Forces. Enrollment under the G.I. Bill of Rights approved for War II Veterans. Canadian residents send coupon to International Correspondence Schools Canadian, Ltd., Montreal, Canada.



Name on gas cap prevents theft.....192  
 How to replace oil-pan gaskets.....211  
 Color bands identify oil bottles.....212  
 Marker placed on rubber tube aids in siphoning gas from tank 216

**CAMPING**

Solution rids cabin of insects.....162  
 Refrigerator made from barrel keeps food fresh in camp.....188  
 Jackknife is handy candlestick.....200

**FARM**

Bee smoker for gopher hunters.....200  
 Ridding granary of rats and mice.....210  
 Eggs cleaned quickly by motor-driven buffer.....217  
 Spring-reinforced tractor seat offers smooth ride.....218  
 Wire cutter attached to pitchfork simplifies barnyard chores.....218  
 Six ideas for poultrymen.....219

**HOUSE AND HOME**

Pillows for swing stay at correct height.....174  
 "Mother's aid" hooks to side of crib.....174  
 Safety-razor holder clips on shelf.....174  
 Refinishing upholstered cushions.....188  
 Drop shelf near refrigerator saves many steps.....189  
 Solving home problems.....190  
 Washing machine adapter plug prevents unauthorized use.....196  
 Screen tacked on porch railing makes safe child's play pen.....200  
 Striping around cleaner cord warns apartment tenants.....216

**LAWN AND GARDEN**

Portable spray rig for garden made from wheelbarrow.....182  
 Sprinkling can attached to hose simplifies watering flowers.....182  
 Easily constructed gate latch.....182  
 Hammock has magazine pocket under cushion at head.....184  
 Watering device reaches roots and improves growth.....184  
 How to cut asparagus plants.....184  
 Burlap wrapped around tamper keeps soil from sticking.....188  
 Protecting small trees and vines.....189  
 Wire-mesh baffle keeps leaves from clogging drain.....208  
 Demountable rim serves as foot scraper.....218

**METALWORKING**

Attaching wire to sheet metal.....189  
 Hinges made from metal boxes.....192  
 Hints for grinding soft metals.....218

**OUTDOOR RECREATION**

Guides for bamboo fishing pole.....184  
 Back yard merry-go-round for children.....185  
 Bait carrier fastened to shirt keeps tackle at hand.....196  
 Special hangers prevent swing from damaging tree.....200

**PHOTOGRAPHY**

Developing tank made from battery case.....201  
 Hypo wash tester gives accurate readings.....205  
 Thumbtack stop for paper cutter.....205  
 How to use chipped photo trays.....206  
 Dial thermometer for liquids is held by a clothespin.....206  
 Negatives are kept with prints.....206  
 Snapshots given deckle edge.....206  
 Prints straightened in typewriter.....206

**RADIO AND ELECTRONICS**

Crystal set built into a toy telephone.....221  
 "Wireless" record player transmits music to any set in the house.....222  
 Electronic hints for today.....224

**STORE, SHOP AND OFFICE**

Preventing tape from unrolling.....212  
 Clip board has shoulder strap for ease in carrying.....217  
 Adding-machine tape held erect with sheet-metal guide.....217

**TOOLS**

Pencil clips used as depth gauge.....184  
 Replacement rung for ladder.....188  
 Hose used as sanding block for irregular work.....189  
 Clothespin to drive screw eyes.....192  
 Demountable sawhorse is ideal in basement workshop.....196  
 Two C-clamps used as emergency vise.....200  
 Craft quiz.....207  
 Roller arrangement for bench rig makes sawing long boards easy.....208  
 Twelve-inch disk sander has tilting table.....209  
 Angle iron on ends of scaffold will keep it from slipping.....210  
 Cam-shaped clamp holds work of varied size.....211  
 Strips of cardboard cut quickly with knife-edge disk.....212  
 Sickle blade makes twine cutter.....212  
 Metal trough for welding flux saves time on job.....212  
 Hold-down spring for disk cutter retains waste stock.....216  
 Altered wrench speeds work.....218  
 Bolt at claw end of wrecking bar straightens warped joists.....220  
 Wire bristles on paintbrush handle make dual-purpose tool.....220

**WOODWORKING**

Cutting butt joints that match.....188  
 Ornament bases quickly cut.....208  
 Park bench has reversible back and faces in two directions.....211

**MISCELLANEOUS**

Boat speedometer from old auto parts.....175  
 Paper held securely in envelope.....182  
 Pocket in notebook for papers.....192  
 Plastic decorated with lacquer.....192  
 Ball substitutes for pipe plug.....196  
 Garbage cans are disinfected by spraying on blotter.....196  
 Calibrating marks for ruling pen.....211  
 Strip of metal soldered to pad provides finger holes.....216  
 Extinguisher suspended by spring indicates when it's empty.....220  
 Roofing compound on bolt heads keeps them from rusting.....220  
 Wooden dividers proportion mix carried in wheelbarrow.....220

**IMPORTANT NOTICE**—It is the intention of this magazine to provide its readers with information regarding the latest developments in the mechanical arts. We take no responsibility as to whether the disclosures contained in our articles are covered by patents and advise readers to investigate this subject before making, using, or selling any of the products, machines, or processes described in order to avoid possible liability for patent infringements.

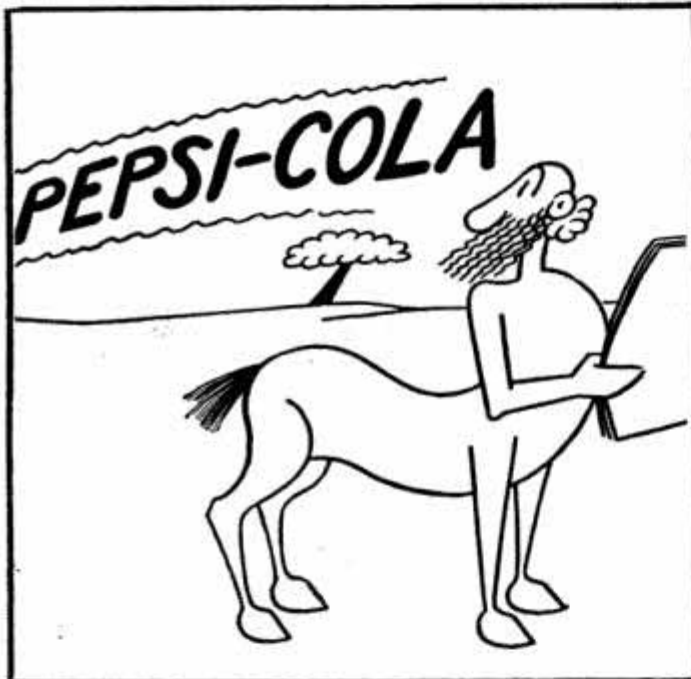



## AUDELS REFRIGERATION & AIR CONDITIONING GUIDE.....\$4

New from Cover to Cover—1280 Pages, Fully Illus. Covering basic principles, servicing, operation & repair of household, commercial & industrial refrigeration & air conditioning. A gold mine of essential important facts for engineers, servicemen, users.

## AUDELS CARPENTERS & BUILDERS GUIDES—4 Vols. ....\$6

A practical illustrated trade assistant on modern construction for carpenters, joiners, builders, mechanics and all woodworkers. 4 vols., 1600 pages, 3700 illustrations, flexible covers. Pocket size. Each volume sold separately \$1.50 a vol.

## AUDELS AUTOMOBILE GUIDE.....\$4

A practical quick ready reference book for auto mechanics, service men, operators & owners. Explains theory, construction & servicing of modern motor cars, trucks, buses & auto type Diesel engines. 1540 pages, fully illustrated. 55 chapters. Indexed. A standard book for mechanics. New fluid drive covered.

## AUDELS DIESEL ENGINE MANUAL.\$2

A practical, concise treatise with questions and answers on the theory, operation and maintenance of modern diesel engines including General Motors 2 cycle Diesel. 384 pages, fully illus., flexible binding, pocket size. All details plainly brought out, this book is of extreme value to engineers, operators & students.

## AUDELS WIRING DIAGRAMS.....\$1

210 Pages. Illustrated. Gives practical facts on wiring of electrical apparatus. It shows clearly how to wire apparatus for practically all fields of electricity. Each diagram is complete & self-explanatory. Highly Endorsed Pocket Companion.

## AUDELS PLUMBERS & STEAMFITTERS GUIDES—4 Vols. ....\$6

A Practical Trade Assistant & Ready Reference. Explains in plain language & by clear illustrations, diagrams, charts, graphs, pictures principles of modern plumbing practice including Marine Pipe Fitting and Air Conditioning. 4 Vols.—1670 Pages—3642 Diagrams. Pocket size. Each Vol. Sold Separately \$1.50 a Vol.

## AUDELS SHEETMETAL WORKERS HANDY BOOK.....\$1

Practical inside information. Fundamentals of Sheet Metal Work. 388 pages. Illustrated. 11 sections. Clearly written. Essential & important facts, figures, pointers in everyday language. Ref. Index.

## AUDELS SHEETMETAL PATTERN LAYOUTS.....\$4

Developed by Experts for Sheet Metal Workers, Layout Men & Mechanics. A Practical Encyclopedia in 10 Sections, size 7 x 10 x 2—1125 Pages—350 Layouts—1600 Illustrations. 1001 Key Facts. Fully indexed for ready reference in answering your layout problems. Covers all phases of sheet metal work including Pattern Cutting, Pattern Development & Shop Procedure.

## AUDELS ANSWERS ON BLUE PRINT READING.....\$2

For Mechanics & Builders. Covers all types of blue print reading including ship & airplane. 376 pages, fully illustrated.

## AUDELS NEW MACHINIST & TOOLMAKERS HANDY BOOK.....\$4

Covers modern machine shop practice in all its branches. 5 practical books in 1. New from cover to cover. Tells how to set up & operate lathes, screw and milling machines, shapers, drill presses and all other machine tools. 1600 pages, fully illustrated, 5 x 8 1/2 x 2. Indexed. 5 sections. 1—Modern Machine Shop Practice. 2—Blue Print Reading & How to Draw. 3—Calculations & Mathematics for Machinists. 4—Shop Physics. 5—How to Use the Slide Rule. 60 chapters. Easy to read and understand. A shop companion that answers your questions.

## AUDELS MATHEMATICS & CALCULATIONS FOR MECHANICS \$2

Mathematics for home study or reference. 700 pages, 550 illus. Practical mathematics from beginning. How to figure correctly. Easy, correct methods covering a complete review. Ill. & Indexed.

## AUDELS HANDY BOOK OF PRACTICAL ELECTRICITY.....\$4

For maintenance engineers, electricians & all electrical workers. 1440 Pages, 2600 illus. Covers important electrical information in handy form—including Marine Wiring, Radio Principles, Welding. Indexed. A Key to a practical understanding of electricity.

## AUDELS RADIOMANS GUIDE.....\$4

A key to the practical understanding of radio including Frequency Modulation, Television, etc., Aircraft & Marine Radio. For radio engineers, servicemen, amateurs. 773 pages. 400 Illustrations & Diagrams. Photos. Review Questions & Answers, Reference Index. Authentic, clear, concise.

## AUDELS ELECTRONIC DEVICES.....\$2

Tells What You Want to Know About Electric Eye. Easily Understood. Covers photo-electric cells & their applications. Amplifiers, illumination, frequencies, voltage, photocell, tubes, Ohm's Law, wiring diagrams, etc.

## AUDELS WELDERS GUIDE.....\$1

A concise, practical text on operation & maintenance of all welding machines for all mechanics. Over 400 pages, illustrated. Covers all methods of electric and acetylene welding including airplane work.



## AN AUDEL GUIDE IS A GOOD FRIEND!

Use the brains and experience of others in these Guides of the Trades. Save time and money with right methods, short cuts, labor saving ideas. CHECK NOW! You can look over any Audel Guide in your home. Start the Easy Payments if satisfied.

# CUT HERE MAIL ORDER

THEO. AUDEL & CO., 49 W. 23 St., New York 10, N.Y.

Please mail me for 7 days' free examination the books marked (X) below. I agree to mail \$1 in 7 days on each book or set ordered, and to further mail \$1 a month on each book or set ordered until I have paid purchase price.

If I am not satisfied with Guides I will return them.

- Audels ELECTRIC MOTOR GUIDE . . . . . \$4.
  - Audels OIL BURNER GUIDE . . . . . 1.
  - Audels REFRIGERATION & Air Conditioning Guide. . . . . 4.
  - Audels POWER PLANT ENGINEERS GUIDE . . . . . 4.
  - Audels PUMPS, HYDRAULICS & AIR COMPRESSORS . . . . . 4.
  - Audels WELDERS GUIDE . . . . . 1.
  - Audels BLUE PRINT READING . . . . . 2.
  - Audels SHEET METAL WORKERS Handy Book . . . . . 1.
  - Audels SHEET METAL PATTERN LAYOUTS . . . . . 4.
  - Audels AIRCRAFT WORKER . . . . . 1.
  - Audels MATHEMATICS and CALCULATIONS . . . . . 2.
  - Audels MACHINISTS & TOOLMAKERS Handy Book . . . . . 4.
  - Audels MECHANICAL Dictionary . . . . . 4.
  - Audels AUTOMOBILE GUIDE . . . . . 4.
  - Audels DIESEL ENGINE MANUAL . . . . . 2.
  - Audels MARINE ENGINEERS Handy Book . . . . . 4.
  - Audels MECHANICAL DRAWING GUIDE . . . . . 1.
  - Rogers MECHANICAL DRAWING and DESIGN . . . . . 2.
  - Audels MILLWRIGHTS and Mechanics Guide . . . . . 4.
  - Audels CARPENTERS and Builders Guides (4 vols.) . . . . . 6.
  - Audels PLUMBERS and Steamfitters Guides (4 vols.) . . . . . 6.
  - Audels MASONS and Builders Guides (4 vols.) . . . . . 6.
  - Master PAINTER and DECORATOR . . . . . 2.
  - Audels GARDENERS & GROWERS GUIDES (4 vols.) . . . . . 6.
  - Audels ENGINEERS & FIREMANS EXAMINATIONS . . . . . 1.
  - Audels ENGINEERS and Mechanics Guides . . . . . 1.
  - Nos. 1, 2, 3, 4, 5, 6, 7 and 8 complete . . . . . 12.
  - Audels Answers on Practical ENGINEERING . . . . . 1.
  - Audels ELECTRICIANS EXAMINATIONS . . . . . 1.
  - Audels WIRING DIAGRAMS . . . . . 1.
  - Audels Handy Book of PRACTICAL ELECTRICITY . . . . . 4.
  - Audels ELECTRICAL POWER CALCULATIONS . . . . . 2.
  - Audels ELECTRONIC DEVICES . . . . . 2.
  - Audels ELECTRIC Dictionary . . . . . 2.
  - Audels RADIOMANS GUIDE . . . . . 4.
  - Audels NEW ELECTRIC LIBRARY at \$1.50 a Volume . . . . . 4.
- Vols. I, II, III, IV, V, VI, VII, VIII, IX, X, XI, XII

Name \_\_\_\_\_

Address \_\_\_\_\_

Occupation \_\_\_\_\_

Employed by \_\_\_\_\_

PM



# LOANS *by* MAIL

\$50 to \$300 *IN A HURRY*

## CONFIDENTIAL

Salaried people, men or women, married or single, loans on your own signature, or your own security. NO personal interview. NO co-signers needed. NO wage assignments. You mail the application to us ... we mail the money to you.

FOR A LOAN OF	YOU CAN REPAY MONTHLY			
	IN 15 PAYMENTS	IN 12 PAYMENTS	IN 9 PAYMENTS	IN 6 PAYMENTS
\$ 50	8.40	\$ 5.03	\$ 6.43	\$ 9.24
100	12.60	10.07	12.87	18.48
150	16.75	15.10	19.30	27.73
200	20.85	20.09	25.68	36.91
250	24.93	25.02	32.02	46.05
300		29.94	38.33	55.17

The above payments made at regular monthly intervals will repay the entire loan and all charges in the time indicated. Charges are based on the monthly rate of three per cent on unpaid principal balances to \$150.00 and two and one-half per cent on that portion of unpaid balances in excess of \$150.00 but not exceeding \$300.00. "Loans by Mail" may be repaid in larger amounts, more frequent payments or repaid in full at further savings to you.

## CONVENIENT

Just write us how much money you need and how you wish to repay ... there's no charge or obligation. Whatever your needs for cash now or in the future, write for your "Loans by Mail" plan, today.

### MERCHANTS INVESTMENT CO.

819-G 1st Nat'l Bldg., Omaha, Nebr.

Without obligation, rush complete details and all papers necessary for a loan of \$\_\_\_\_\_ to be repaid at \$\_\_\_\_\_ on the \_\_\_\_\_ day of each month.

Name \_\_\_\_\_  
Address \_\_\_\_\_  
City \_\_\_\_\_ State \_\_\_\_\_  
Occupation \_\_\_\_\_

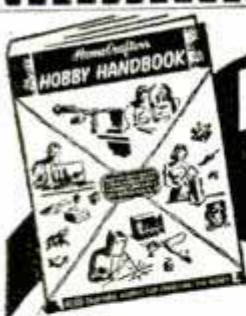

## FREE NEW HOBBY HANDBOOK

A Gold Mine of Information on Newest Equipment, Materials, Tools for HOME CRAFTSMEN AND MECHANICS

IF you work in metals, woods, plastics or glass, you need this Big, FREE Source Book of equipment, tools, parts and materials ... including dozens of hard-to-get items you can't find in stores. Many things you must have for your home hobby or shop. Just loaded with ideas and illustrations.

### A WAREHOUSE OF THINGS YOU WANT

More than 100 items including: Portable Welder; Bench Tools; Plastic Molder; Telephone System; Chemical Sets; Spray Guns; Electroplater; Drills; Grinders; Tool Chests; Model Tools; Key Maker ... everything you need for your hobby or craft. Send for this Big, FREE Book TODAY. Mail postcard or coupon below.

WARNER ELECTRIC CO., 1512 Jarvis, Chicago 26, Dept. M-63

WARNER ELECTRIC CO., 1512 Jarvis, Chicago 26, Dept. M-63

PLEASE SEND BIG, FREE BOOK

NAME \_\_\_\_\_  
ADDRESS \_\_\_\_\_  
CITY \_\_\_\_\_ ZONE \_\_\_\_\_ STATE \_\_\_\_\_

## How to Start YOUR OWN BUSINESS

### Make Flexible Molds, Composition Flooring

NO EXPERIENCE — UNLIMITED MARKET

Start your own business at home in your spare time. Tremendous money-making opportunities for both men and women.

#### FLEXIBLE MOLDS

Make your own FLEXIBLE MOLDS. Cast novelties, statuary, desk sets, book ends, etc. Hundreds of casts made from single mold. Large size mold costs but a few cents. No experience necessary. Steady year-round demand.

#### COMPOSITION FLOORING

Make floors that last a lifetime with amazing COMPOSITION FLOORING! New discovery now enables you to lay artistic floors, in beautiful patterns in most colors and shades. Can be laid over wood, concrete, brick, steel, etc. This composition flooring offers unlimited money-making possibilities.

### Free Catalog!

For FREE information about these and many other profitable business opportunities, WRITE TODAY!

## BING PRODUCTS

Dept. A19, 88 Broad Street BOSTON 10, MASS.

## LEARN AT HOME TO MOUNT BIRDS



Animals, Heads, Fishes, Pets; to TAN. Be a Taxidermist. Profit and FUN.

Hunters, save your valuable TROPHIES.

Mount ducks, squirrels, everything. Learn to TAN for leather and furs. Wonderful HOBBY Have a HOME MUSEUM.—BIG PROFITS mounting for others. INVESTIGATE NOW.

**FREE BOOK** With 100 fine game pictures. NOW absolutely FREE. Write TODAY.

Send Postal TODAY for FREE BOOK. State AGE. N.W. SCHOOL OF TAXIDERMISTRY, Dept. 337A, Omaha, Neb.



## FOR MAGICIANS ONLY

AN AMAZING EFFECT

Spectator selects any card from any deck. It is then made to vanish and appear at will. No sleights or forcing. It will amaze you. Now showing in Detroit and Chicago. Send for this today — Only 50c.

COLETTE PRODUCTS COMPANY

413 Fox Theater Bldg.

Detroit 1, Mich.

## "YOU ARE UNDER ARREST!"



Help Bring Crooks to Justice Through Scientific

### CRIME DETECTION!

I have taught thousands this exciting, profitable, pleasant profession. Let me teach you in your own home. Learn Finger Printing, Firearms Identification, Police Photography, Criminal Investigation thoroughly, quickly, at small cost. 53% of all American Bureaus of Identification employ I. A. S. students or graduates. I can prepare you for this fascinating work, during spare time. Write today, stating age, for "Blue Book of Crime."

Institute of Applied Science, 1920 Sunnyside Ave., Dept. 135-A, Chicago 40, Ill.

## U.S. GOVERNMENT JOBS

START \$1,756 TO \$3,021 YEAR

Men—Women

Prepare NOW for Next Examinations.

FRANKLIN INSTITUTE

Dept. J85, Rochester 4, N. Y.

Sirs: Rush without charge (1) 32-page Civil Service book with list of U. S. Government Jobs. (2) Tell me how to prepare for one.

Vets Get Preference. Mail Coupon today sure.

COUPON  
Name \_\_\_\_\_  
Address \_\_\_\_\_ Vet? \_\_\_\_\_



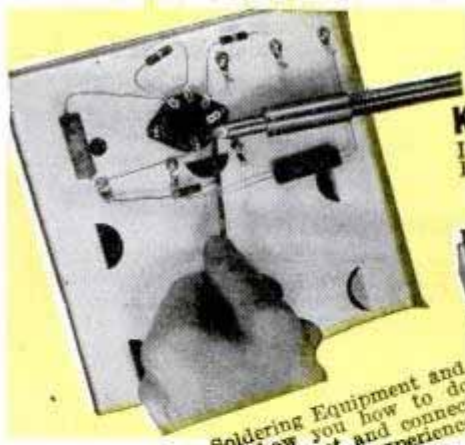

**KIT 1** I send you Soldering Equipment and Radio Parts; show you how to do Radio Soldering; how to mount and connect Radio parts; give you practical experience.



**KIT 2** Early in my course I show you how to build this N.R.I. Tester with parts I send. It soon helps you fix neighborhood Radios and earn EXTRA money in spare time.

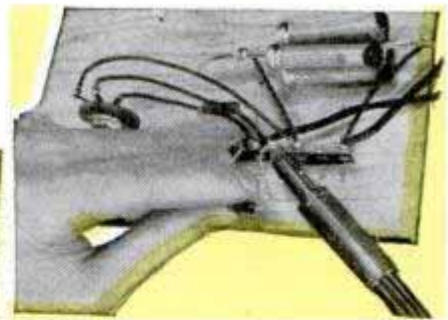

**KIT 3** You get parts to build Radio Circuits; then test them; see how they work; learn how to design special circuits; how to locate and repair circuit defects.

# Learn RADIO by PRACTICING in Spare Time

with **BIG KITS** of **RADIO PARTS** I send you

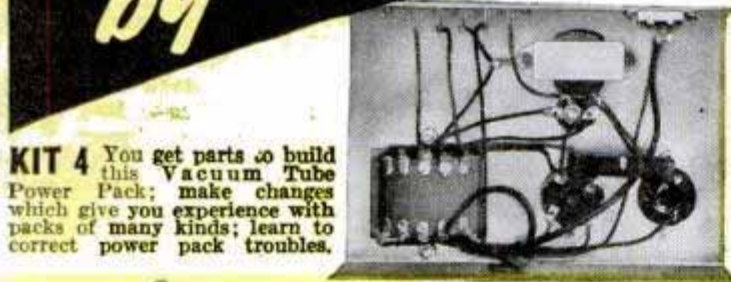

**KIT 4** You get parts to build this Vacuum Tube Power Pack; make changes which give you experience with packs of many kinds; learn to correct power pack troubles.

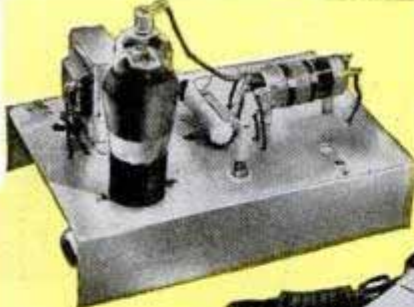

**KIT 5** Building this A.M. Signal Generator gives you more valuable experience. It provides amplitude-modulated signals for many tests and experiments.



**KIT 6** You build this Superheterodyne Receiver which brings in local and distant stations—and gives you more experience to help you win success in Radio.

My Course Includes Training in **TELEVISION • ELECTRONICS**  
Frequency Modulation

Do you want a good-pay job in the fast-growing Radio Industry—or your own Radio Shop? Mail the Coupon for a Sample Lesson and my 64-page book, "How to Be a Success in RADIO—Television, Electronics," both FREE. See how I will train you at home—how you get practical Radio experience building, testing Radio circuits with **BIG KITS OF PARTS** I send!

**Many Beginners Soon Make Extra Money in Spare Time While Learning**

The day you enroll I start sending EXTRA MONEY JOB SHEETS that show how to make EXTRA money fixing neighbors' Radios in spare time while still learning! It's probably easier to get started now than ever before, because the Radio Repair Business is booming. Trained Radio Technicians also find profitable opportunities in Police, Aviation, Marine Radio, Broadcasting, Radio Manufacturing, Public Address work. Think of even greater opportunities as Television, FM, and Electronic devices become available to the public! Send for FREE books now!

**Find Out What NRI Can Do For You**

Mail Coupon for Sample Lesson and my FREE 64-page book. Read the details about the Course; letters from men I trained; see how quickly, easily you can get started. No obligation! Just MAIL COUPON NOW in envelope or paste on penny postal. J. E. SMITH, President, Dept. 7FP, National Radio Institute, Pioneer Home Study Radio School, Washington 9, D. C.

Our 33rd Year of Training Men for Success in Radio



J. E. SMITH, Pres.  
National Radio Institute

**VETERANS**

You can get this training in your home under G. I. Bill. Mail coupon for full details.

Sample Lesson **FREE**  
64 Page Book

Mr. J. E. SMITH, President, Dept. 7FP  
National Radio Institute  
Washington 9, D. C.

Mail me FREE, your sample lesson and 64-page book. (No salesman will call. Please write plainly.)

Name \_\_\_\_\_ Age \_\_\_\_\_  
Address \_\_\_\_\_  
City \_\_\_\_\_ Zone \_\_\_\_\_ State \_\_\_\_\_



Approved for Training under GI Bill



# Now you can get BETTER PICTURES



with less effort!

It's easy when you let the G-E exposure meter guide your camera. Gives you correct exposure in a jiffy.

No tricks to remember—simple to use. Amazingly accurate. Long-lasting life. Good for movies or stills. Gives benefit of ASA exposure-index numbers. Get the G-E meter and make sure of better pictures, especially in color. General Electric, Schenectady 5, N.Y.

Ask your photo dealer for the



**Exposure Meter**

...it's 3 meters in one!



Type DW-58  
**\$26<sup>95</sup>**  
Fed. tax incl.

**NEW ASA HOOD**  
Modernizes Type DW-48 and early DW-58 G-E meters. At photo dealers for only \$5.50, Federal tax included.

**GENERAL ELECTRIC**  
606-196F

## Make Your Decision for a BETTER JOB OR A BUSINESS OF YOUR OWN

AIM high—pick one of these big fields. May never again be such opportunities to get in on ground floor and go up fast. **REFRIGERATION & AIR CONDITIONING** growing fast—frozen foods, commercial installations, many other developments. **ELECTRICITY & INDUSTRIAL ELECTRONICS** offers good pay to trained men. **BODY & FENDER REBUILDING** bringing many big money. **AUTO MECHANICS** in demand. **DIESEL** a rapidly expanding field. Pick one of these fields now—for men who **ACT FAST** things can happen fast. **CONSULTATION AND PLACEMENT SERVICE** whether you are interested in worthwhile job or setting up your own business. **YOU CAN START TRAINING AT HOME IN SPARE TIME AND THEN COME TO BIG TRAINING SHOPS LATER.** A few short weeks can make all the difference.

**VETERANS ENROLLED UNDER "G. I." BILL.** **COMMERCIAL TRADES INSTITUTE**, a nationally known school, only civilian school selected by Army to train service men for refrigeration. **FACTS FREE. MAIL COUPON TODAY. NO OBLIGATION.**



Fill Out, Cut Out, Mail Today

**COMMERCIAL TRADES INSTITUTE, Dept. E26**  
1400 W. Greenleaf, Chicago 26, Ill.

Send **FREE** illustrated Brochures and other information about the field I have checked below.

Refrigeration and Air Conditioning  Auto Mechanics  
 Electricity & Industrial Electronics  Diesel  
 Body & Fender Rebuilding

Name \_\_\_\_\_

Address \_\_\_\_\_

City \_\_\_\_\_ State \_\_\_\_\_

Veteran  Non-Veteran

# STUDY AT HOME

With An Educational Institution

Men with specialized training win higher positions, insure larger earnings, and are bigger successes in business and public life. Opportunities NOW greater than ever before. Send for our Catalog.

## ARTS and SCIENCES

Courses in Philosophy; Education; Letters; Public Health; Medical Jurisprudence; Psychology; Sociology; Physics; Chemistry; Plastics; Geology; Political Science; Theology; Business and Commerce; Accounting; Mathematics; Statistics; Agriculture.

## ENGINEERING

Courses in Electrical, Civil, Mechanical, Drafting, Architectural, Steam, Aeronautical, Radio, Structural, Mining, Industrial, Petroleum, Marine, Chemical, Diesel, Automobile, Refrigeration, and Air Conditioning Engineering.

## LAW

Complete Professional Law Course includes 18 Hornbook Series college grade textbooks. Courses also in Commercial Law, Patent Law and Medical Jurisprudence. **McKinley-Roosevelt Incorporated, 4610-K, Sheridan Rd., Chicago 40, Ill.**

**PLAY GUITAR LIKE THE COWBOYS DO... ONLY 8<sup>1</sup>/<sub>2</sub> A LESSON**

Just out—very latest guaranteed, simple, easy method. Play cowboy songs the Western way in a few minutes by ear. Surprise and amaze your friends. Be in big demand at parties, camps, public entertainments, on the radio, etc. 12 Complete Lessons.

**SEND NO MONEY.** Pay postman only \$1.00 charges, or send \$1.00 and get EXTRA SONGS all postpaid. (Canada, \$1.25 money order only.) Nothing else to buy. Positive money back guarantee. Rush order today.

**WESTERN RANGER STUDIOS, Dept. 156, Hutchinson, Kans.**



## AMAZING HAIR DISCOVERY

TO PREVENT BALDNESS AND HELP GROW HAIR

Men - Women, if you are losing your hair, have dandruff, itchy scalp, dull, drab, lifeless hair or have thin fuzz and want to grow thick, healthy hair, we can help you solve your problems for only a few cents per treatment in the privacy of your own home. Information free, write today.

**SILKLIKE SCIENTIFIC PROCESS CO.**

1007 Bergenline Ave.

Dept. W1

Union City, N. J.



## Your VOICE!

Results GUARANTEED

We build, strengthen the vocal organs—not with singing lessons—but by sound, scientifically correct silent and vocal exercises and absolutely guarantee complete satisfaction with results. Write for Voice Book, FREE. Sent to no one under 17 years old unless signed by parent.

Perfect Voice Studios, Studio 135-A, Kimball Hall Bldg., Chicago 4, Ill.

**RADIO ENGINEERING.** Broadcasting, Television, FM, Servicing, Electronics, Aviation, Marine & Police Radio taught thoroughly. Engineering course equivalent to 3 years' college radio work. Approved Veteran Training. Catalog free. **VALPARAISO TECHNICAL INSTITUTE, Dept. D, Valparaiso, Ind.**

## Get into Good Paying AUTO BODY and FENDER WORK



**BIG DEMAND** in Auto Body and Fender work. Start training now in your spare time at home for good pay work. Practical shop experience included. U.E.I. Training covers metal work, welding, painting, etc. Placement service—or we will show you how to start your own shop. Behind U.E.I. TRAINING is a large national organization founded 1927. Write today for **FREE FACTS**—No obligation.

Approved for Training under G.I. Bill

**AUTO-CRAFTS DIVISION • UTILITIES ENGINEERING INSTITUTE**  
1314 BELDEN AVENUE, DEPT. 167X, CHICAGO 14, ILLINOIS



# INVENTORS

Learn how to protect your invention. The U. S. Patent Laws provide that any new and useful art, machine, article of manufacture, or composition of matter, or any new and useful improvement thereof, may be patented if the act of invention is involved. Therefore, every inventor with a valuable invention should take advantage of the Patent Laws and proceed for patent protection in order to safeguard his rights.

A patent gives the inventor the exclusive right to prevent others from making, using, or selling the invention claimed in the patent for a period of seventeen years.

The Patent Laws were enacted for the benefit of the inventor to give him protection for the features of his invention which are patentable. These features must be properly and concisely set forth and claimed in a formal application for patent, in order to comply with the requirements of the U. S. Patent Office. For that reason, the Patent Office advises the inventor to engage a competent registered patent attorney or agent to prepare his application for patent and represent him before the U. S. Patent Office Examiner.

A specially prepared booklet entitled "Patent Guide for the Inventor", containing detailed information with respect to patent protection and procedure, together with a "Record of Invention" form will be promptly forwarded to you without obligation upon request.

**Patents**  
**Trademarks**  
**Copyrights**

*Registered Patent Attorneys*

**CLARENCE A. O'BRIEN**  
**& HARVEY B. JACOBSON**

71-F District National Building + Washington 5, D. C.

**CLARENCE A. O'BRIEN & HARVEY B. JACOBSON**  
Registered Patent Attorneys

71-F District National Bldg., Washington 5, D. C.

Please send me copy of "Patent Guide for the Inventor" and also "Record of Invention" form. This request does not obligate me.

Name \_\_\_\_\_

Address \_\_\_\_\_

City \_\_\_\_\_ State \_\_\_\_\_

(Please write or print plainly.)





# NOW! An Amazing Opportunity to LEARN RADIO AT HOME

I SEND YOU 8 BIG KITS OF RADIO PARTS

Including a **COMPLETE 6 TUBE SUPER-HETERODYNE RECEIVER**

**I TRAIN YOU RIGHT by PUTTING YOU TO WORK with REAL PROFESSIONAL EQUIPMENT!**

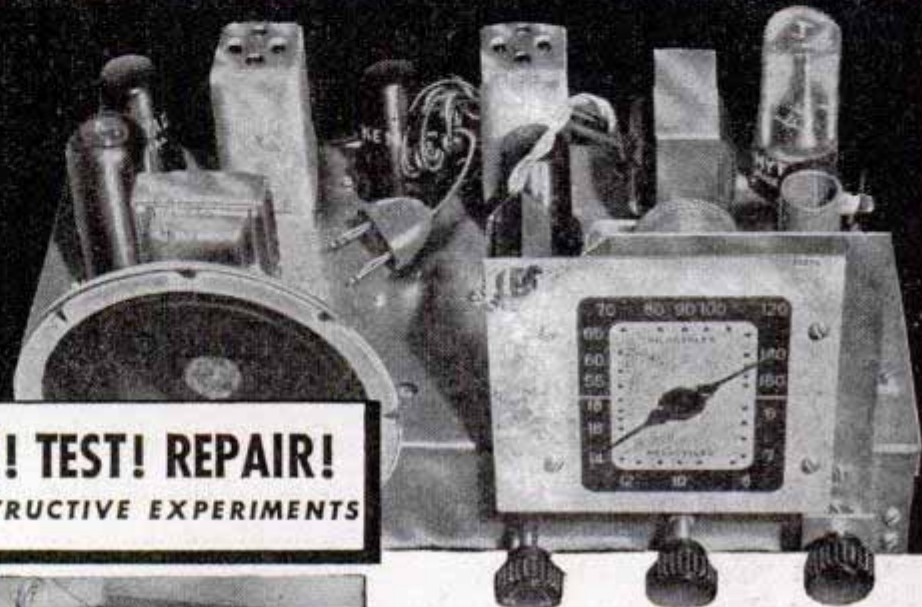

**LEARN HOW TO BUILD CIRCUITS! TEST! REPAIR!**  
YOU DO OVER 175 INSTRUCTIVE EXPERIMENTS

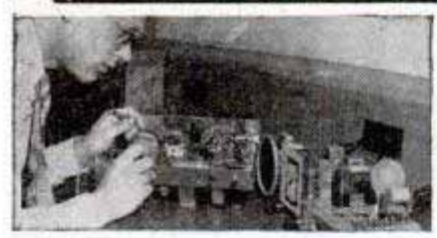

**YOU BUILD THIS USEFUL TEST EQUIPMENT!**



I give you a fine, moving-coil type Meter Instrument on Jewel Bearings — with parts for a complete Analyzer Circuit Continuity Tester. You learn how to check and correct Receiver defects with professional accuracy and speed.

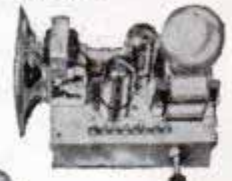

Soldering, wiring, connecting Radio parts . . . building circuits — you can't beat this method of learning. When you construct this Rectifier and Filter, Resistor and Condenser Tester, etc., you get a really practical slant on Radio.

## HERE'S THE EASIEST, MOST PRACTICAL WAY OF ALL TO PREPARE FOR GOOD PAY in RADIO ELECTRONICS and TELEVISION!

I train your mind by putting you to work with your hands on a big 6-Tube Superheterodyne Receiver. And, believe me, when you get busy with real Radio Parts — 8 big Kits of them — you really LEARN Radio and learn it RIGHT! You get the practical stuff you need to be useful in Radio, and that's what it takes to make money. You don't have to worry about what to do with these 8 Kits of Parts. Step by step, I show you how to build circuits, test, experiment, trouble-shoot. And you don't need any previous experience. The Sprayberry Course starts right at the beginning of Radio! You can't get lost! Simplified lessons, coupled with real "Shop" practice, makes every subject plain and easy to understand and remember. Soon after you begin Sprayberry Training, I'll send you my sensational BUSINESS BUILDERS.

A BUSINESS OF YOUR OWN . . . OR A GOOD RADIO JOB  
You'll find out how to get and do neighborhood Radio repair jobs for nice profits and rich experience while learning. This sort of work can easily pave the way for a Radio Service business of your own. But with Sprayberry Training, you're not limited. You can swing into any one of the swiftly expanding branches of Radio-Electronics. INCLUDING Radio, Television, FM, Radar, Industrial Electronics. Be wise! Decide now to become a fully qualified RADIO - ELECTRONICIAN. Get full details about my Training at once! Mail coupon below for my 2 big FREE Books.

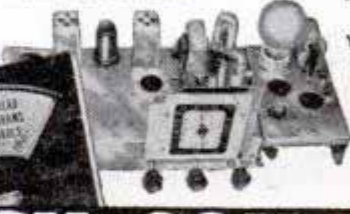

You'll get valuable experience and practice building this Signal Generator and multi-purpose Tester. Makes a breeze out of fixing Radios and you don't have to spend money on outside, ready-made equipment.

**GET THESE VALUABLE FREE BOOKS**

"How to Read Radio Diagrams and Symbols"

Here's a valuable and wonderfully complete new book which explains in simple English how to read and understand any Radio Set Diagram. Includes translation of all Radio symbols. Send for this volume at once. It's free! Along with it, I will send you another Big Free book describing in detail my Radio-Electronic Training.

## RUSH COUPON!

**SPRAYBERRY ACADEMY OF RADIO**  
F. L. Sprayberry, President, Room 1087, Pueblo, Colorado  
Please rush my FREE copies of "How to MAKE MONEY in RADIO, ELECTRONICS and TELEVISION," and "HOW to READ RADIO DIAGRAMS and SYMBOLS."

Name ..... Age .....

Address .....

City ..... State .....

(Mail in envelope or paste on penny postcard)



# Are You Satisfied with

# YOUR BODY?

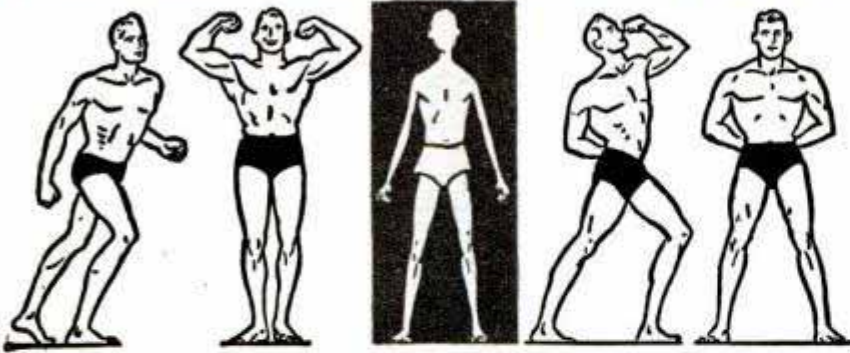

**Let Me PROVE I Can Make You a NEW MAN in Only 15 Minutes a Day!**

HOW do YOU look *stripped*—in locker-room or gym? Skinny, scrawny, sparrow chested, self-conscious, **HALF ALIVE?**

How do you feel when people notice *your* physique? Can you stand their gaze? If you're not satisfied with your present physical development, let me prove I can make you a New Man—in only 15 minutes a day, right in the privacy of your own home! I'll give you biceps like iron and a fine, deep chest. I'll broaden your shoulders, add ridges of solid muscle to your stomach, fill out your arms and legs. If you are fat and flabby, I'll streamline you into a picture of radiant manhood.

## WHAT "Dynamic Tension" CAN DO FOR YOU

"Dynamic Tension" changed me from a flat-chested 97-lb. weakling into the red-blooded HE-MAN that I am today. That's how I'm turning thousands of fellows LIKE YOURSELF into New Men—with husky, handsome body and tireless endurance. I can do the same for YOU! Let me PROVE it!

"Dynamic Tension" is a PRACTICAL and NATURAL method. You use no tiring apparatus, no muscle-straining gadgets. My method is actually FUN! In only 15 minutes a day, you will actually see your muscles increase into powerful bulges of brawn and strength. You'll enjoy new stamina, a glad-to-be-alive feeling. Before you know it, you'll have a rugged, handsome body, a rough-and-ready ambition surging out of you that the world can't lick! I'll show you how it really feels to LIVE!

## SEND FOR FREE BOOK

All I ask is that you mail the coupon NOW for my illustrated FREE book, "Everlasting Health and Strength." It shows actual photos of pupils I've changed from weaklings into remarkable specimens of manhood. If you want a body that men respect and women admire, then get this coupon into the mails as fast as you can. Address me personally: CHARLES ATLAS, Dept. 86, 115 E. 23rd St., New York 10, N. Y.

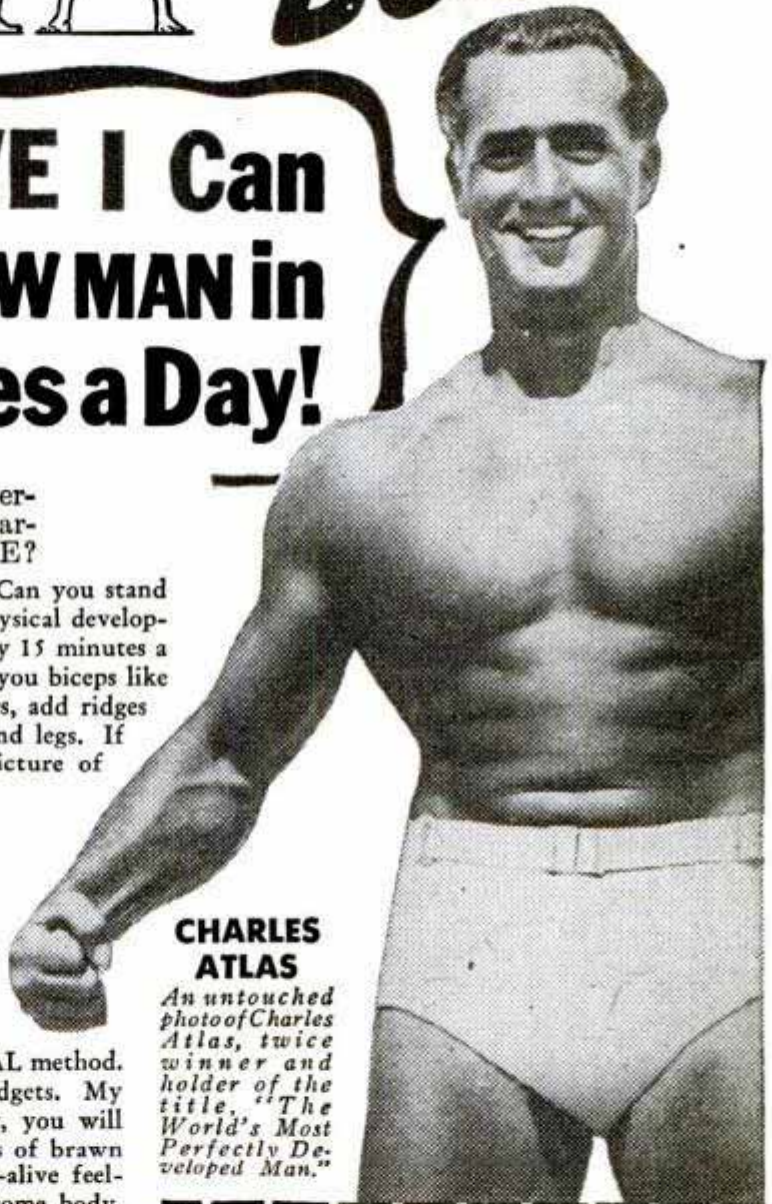

### CHARLES ATLAS

An untouched photo of Charles Atlas, twice winner and holder of the title, "The World's Most Perfectly Developed Man."

**CHARLES ATLAS, Dept. 86,**  
115 East 23rd Street, New York 10, N. Y.

I want the proof that your system of "Dynamic Tension" will help make a New Man of me—give me a healthy, husky body and big muscle development. Send me your free book, "Everlasting Health and Strength."

NAME \_\_\_\_\_ AGE \_\_\_\_\_  
(Please print or write plainly)

ADDRESS \_\_\_\_\_

CITY \_\_\_\_\_ ZONE NO. \_\_\_\_\_ STATE \_\_\_\_\_



# INVENTORS

## Patent Laws Encourage The Development Of Inventions

The Rules of Practice of the U. S. Patent Office advises—unless an inventor is familiar with such matters—that he employ a competent registered attorney, as the value of patents depends largely upon the skillful preparation of the specifications and claims.

The firm of McMorrow, Berman and Davidson is registered to practice before the U. S. Patent Office. Additionally, it maintains a staff of attorneys able to readily understand inventors' disclosures, to advise concerning patentability, and to prepare appropriate specifications and claims for filing with the Patent Office.

If an inventor believes he has an invention, a search of the most pertinent prior U. S. patents should be made and a report obtained relative to its patentability. Where such report indicates that the invention appears patentable, in order to secure protection, diligence should be exercised in making application for a patent.

## McMORROW, BERMAN & DAVIDSON

*Registered Patent Attorneys*

**PATENTS — TRADE MARKS — COPYRIGHTS**

1356 VICTOR BUILDING, WASHINGTON 1, D. C.

### **McMORROW, BERMAN & DAVIDSON**

*Registered Patent Attorneys*

1356 Victor Building, Washington 1, D. C.

Send me further particulars as to patent protection and procedure and "Invention Record" form at once. I understand that this request does not obligate me.

Name.....

Address.....

City..... State.....

(WRITE OR PRINT NAME CLEARLY)



what **I.C.S.** means to

**YOU**

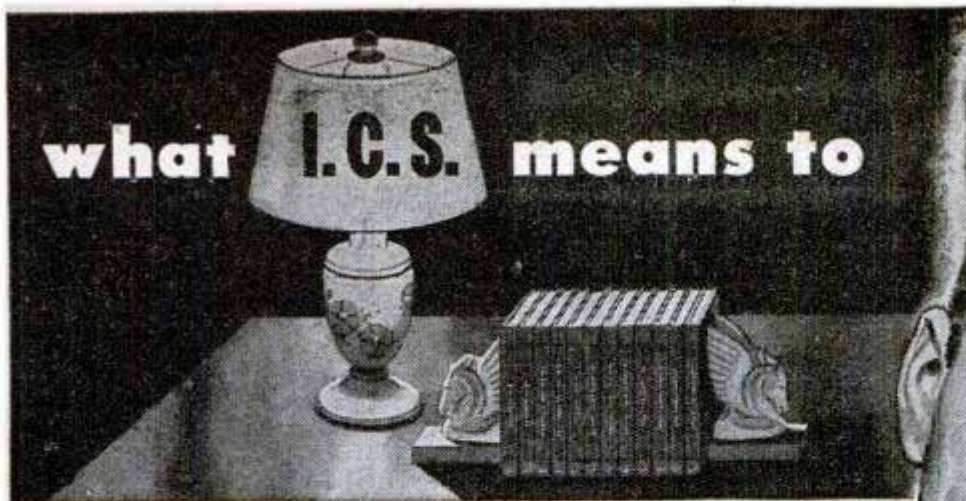

**C**AN you remember when there wasn't an I. C. S.? Not unless you're well over 55 years of age—for that is how long these world-famous schools have been making Training for Success readily available to all.

Before I. C. S., multitudes of potentially able men and women had no place to turn for the knowledge they needed in mastering rewarding careers. Today there's no excuse for any one anywhere to struggle under the handicap imposed by lack of training.

If you are one of the many without time or opportunity to attend traditional schools . . . if it's necessary for you to do your *learning* while you're *earning* . . . I. C. S. is especially designed for you. Whatever your interest, you'll find it covered by one of the 400 I. C. S.

Courses in technical and business subjects. However you're situated, this training can be yours.

The records of thousands of successful students demonstrate that today's I. C. S. student is tomorrow's leader. The same Opportunity they seized is at your door right now. That's what I. C. S. means to you . . . if you are alert, forward-looking, determined to get ahead. You can prove your alertness by mailing the coupon *right now*.

## INTERNATIONAL CORRESPONDENCE SCHOOLS



BOX 5606-K, SCRANTON 9, PENNA.

Without cost or obligation, please send me full particulars about the course *before* which I have marked X:

- Air Conditioning and Plumbing Courses**
- Air Conditioning
- Heating  Plumbing
- Refrigeration  Steam Fitting
- Chemistry Courses**
- Chemical Engineering
- Chemistry, Analytical
- Chemistry, Industrial
- Chemistry, Mfg. Iron & Steel
- Petroleum Refining  Plastics
- Pulp and Paper Making
- Civil Engineering, Architectural and Mining Courses**
- Architectural Drafting
- Architecture
- Bridge and Building Foreman
- Building Estimating
- Civil Engineering
- Coal Mining
- Contracting and Building
- Highway Engineering
- Lumber Dealer
- Reading Structural Blueprints
- Sanitary Engineering
- Structural Drafting

- Structural Engineering
- Surveying and Mapping
- Communications Courses**
- Electronics
- Practical Telephony
- Radio, General
- Radio Operating
- Radio Servicing
- Telegraph Engineering
- Electrical Courses**
- Electrical Drafting
- Electrical Engineering
- Electric Light and Power
- Lighting Technician
- Practical Electrician
- Internal Combustion Engines Courses**
- Auto Technician  Aviation
- Diesel-Electric
- Diesel Engines  Gas Engines
- Mechanical Courses**
- Aeronautical Engineering
- Aircraft Drafting
- Flight Engineer
- Foundry Work
- Heat Treatment of Metals

- Industrial Engineering
- Industrial Metallurgy
- Machine Shop
- Mechanical Drafting
- Mechanical Engineering
- Mold-Loft Work
- Patternmaking—Wood, Metal
- Reading Shop Blueprints
- Sheet-Metal Drafting
- Sheet-Metal Worker
- Ship Drafting  Ship Fitting
- Tool Designing
- Toolmaking
- Welding—Gas and Electric
- Railroad Courses**
- Air Brake  Car Inspector
- Diesel Locomotive
- Locomotive Engineer
- Locomotive Fireman
- Railroad Section Foreman
- Steam Engineering Courses**
- Boilermaking
- Combustion Engineering
- Engine Running
- Marine Engineering
- Steam Electric  Steam Engines

- Textile Courses**
- Cotton Manufacturing
- Rayon Weaving
- Textile Designing
- Woolen Manufacturing
- Business and Academic Courses**
- Accounting  Advertising
- Arithmetic  Bookkeeping
- Business Correspondence
- Business Management
- Certified Public Accounting
- Commercial
- Cost Accounting
- Federal Tax
- First Year College
- Foremanship  French
- Good English  High School
- Higher Mathematics
- Illustrating  Motor Traffic
- Postal Service
- Salesmanship  Secretarial
- Sign Lettering
- Spanish  Stenography
- Traffic Management

Name \_\_\_\_\_ Age \_\_\_\_\_ Address \_\_\_\_\_  
 City \_\_\_\_\_ State \_\_\_\_\_ Present Position \_\_\_\_\_

Working Hours \_\_\_\_\_ A.M. to \_\_\_\_\_ P.M. Length of Service in World War II \_\_\_\_\_

Special tuition rates to members of the Armed Forces. Enrollment under the G.I. Bill of Rights approved for War II Veterans.  
 Canadian residents send coupon to International Correspondence Schools Canadian, Ltd., Montreal, Canada.



# PATENT PROTECTION

for

# INVENTORS

**A PATENT IS A VALUABLE RIGHT**  
 On the basis of a constitutional provision Congress has established a system under which inventors may secure the exclusive right to prevent the unauthorized use, manufacture and sale of their inventions for periods of seventeen years. The inventor secures this protection by obtaining a patent from the United States Patent Office.

*The United States Patent Office*  
**RECOMMENDS**

*We*  
**RECOMMEND**

in its Rules of Practice that "an applicant is advised, unless familiar with such matters to employ a competent registered patent attorney or registered patent agent, as the value of patents depends largely upon the skillful preparation of the specifications and claims."

that you authorize us to conduct a search through the U. S. Patents pertinent to your invention and submit a report setting forth our opinion regarding its patentability.

**VICTOR J. EVANS & CO.** has a staff of experienced registered patent attorneys, available to represent inventors in the preparation and prosecution of their cases before the Patent Office. Detailed information and the steps to be taken in obtaining patent protection will be furnished upon request.

FORM BELOW FOR MAILING CONVENIENCE

**VICTOR J. EVANS & Co.**

*Merlin M. Evans*

REGISTERED PATENT ATTORNEY

230-G Merlin Building, Washington 6, D. C.

Please forward to me detailed information regarding procedure to obtain Patent Protection, together with your convenient "Evidence of Invention" form.

Name.....

Address.....

City and State.....

**PATENTS                      TRADEMARKS                      COPYRIGHTS**



# LEARN EITHER **Electricity OR Radio** IN A FEW WEEKS in the GREAT SHOPS of COYNE

**NOT "Home Study" Courses  
...All Practical Training and  
Necessary Theory Given in  
Our Famous Chicago Shops!**

Why spend years learning Electricity or Radio, when COYNE prepares you for good jobs in either field in a few short weeks? Our training not only saves time; you're ready to step into the better pay that much sooner. You make rapid progress because you work under expert instructors here in our great shops. We do not teach by mail. Select course you prefer and send coupon TODAY!

## **ELECTRICITY**

**Including Industrial  
Electronics**

Big future in Power Plant Work, Motors, Armature Winding, House and Factory Wiring, Industrial Electronics, Home Appliances, Lighting, Auto Electricity, Electrical Maintenance — all covered at COYNE. Here you get "all-around" Electrical training!

**TRAIN ON  
REAL EQUIPMENT**

You use, test, repair full-size apparatus — just like you'll later handle on the job. Previous experience unnecessary.

**FREE ELECTRICAL BOOK**

Send now for big, illustrated book on COYNE Electrical Training. Many large pictures of our shops. Tells about Free Lifetime Employment Service to Coyne graduates. Other vital facts. Check coupon for "ELECTRICITY" and mail today.

## **RADIO** including **SOUND** and **TELEVISION**

If you prefer Radio, COYNE gives quick, practical training in Radio Construction, Testing, Repair; also Public Address, Sound Systems, FM, Television. Many branches of Radio open to you.

**Want to be  
Your Own Boss?**

Hundreds of Coyne graduates have successful Radio shops of their own. We show you how to start, how to build for a lifetime future. No previous experience required to take Coyne Radio Course.

**FREE RADIO BOOK**

Check coupon for "RADIO" to receive our big FREE book of photos and facts about Coyne Training in Radio, Sound and Television. Describes the vast new opportunities in this field, and how we make it easy to get ahead. Rush coupon NOW.



**B. W. COOKE**

### **COYNE HAS BEEN TRAINING MEN SINCE 1899**

For nearly 50 years, the great shops of COYNE have been turning out men and young men trained for better jobs in practical fields. Coyne graduates hold responsible positions in many leading electrical and radio firms.

**NON-VETERANS** who are short of cash can finance their tuition and pay it in easy monthly payments after graduation.

**VETERANS!** Coyne is authorized to accept veterans for G. I. training. Coupon brings bulletin.

**ADDED  
TRAINING  
in  
ELECTRIC  
REFRIG-  
ERATION**  
included with  
either course

**COYNE ELECTRICAL SCHOOL**  
Dept. A7-72H  
500 S. Paulina Street, Chicago 12, Ill.

**CHECK COUPON FOR  
ELECTRICITY OR  
RADIO—MAIL NOW!**

**B. W. COOKE, Director,  
COYNE ELECTRICAL SCHOOL,  
500 S. Paulina St., Dept. A7-72H, Chicago 12.**  
Send me your **BIG FREE BOOK**—for the  
special plans to help me. This does not obligate  
me and no salesman will call.

**ELECTRICITY**       **RADIO**

NAME.....  
ADDRESS.....  
CITY.....STATE.....



# Keep that "TICKING" Car

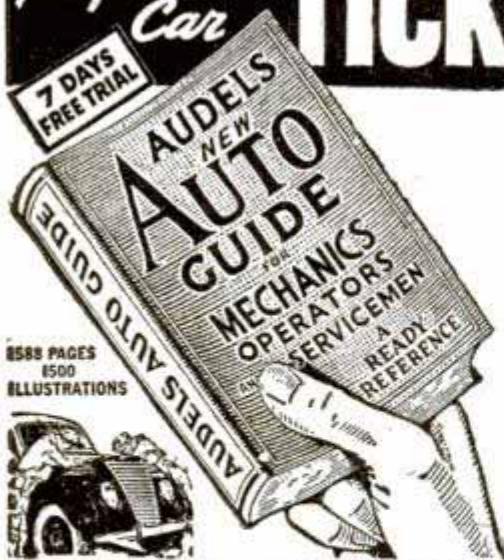

Every operator and mechanic needs AUDELS AUTO GUIDE.

This book saves time, money and worry. Highly endorsed. It presents the whole subject of auto mechanics:

- 1—Basic principles
  - 2—Construction
  - 3—Operation
  - 4—Service
  - 5—Repair
- Handy Size. Easily understood.

## NEW FLUID DRIVE, HYDRAULIC SHIFT AND DIESEL ENGINES FULLY COVERED

Over 1500 pages—1540 illustrations showing inside views of modern cars, trucks and buses with instructions for all service jobs.

**4 COMPLETE • PAY ONLY \$1. A MONTH** ←  
 ASK TO SEE IT!—To Get This Assistance for Yourself Simply Fill in and Mail Coupon Today.

**AUDEL, Publishers, 49 West 23rd St., New York**  
 MAIL AUDELS NEW AUTO GUIDE for free examination. If O. K. I will send you \$1 in 7 days; then remit \$1 monthly until price of \$4 is paid. Otherwise I will return it.

Name.....  
 Address.....  
 Occupation.....  
 Employed by..... PM

# Do you want

- ..to go to College?
- ..or to enter a Profession?
- (Such as Accounting, Architecture, Nursing, Dentistry; Teaching, Social Work, Osteopathy, Beauty Culture, Optometry, Embalming, Chiropody, Law, Medicine, etc.)
- ..or get an Office Position?

To get anywhere, you practically **MUST** finish High School **FIRST**. You can complete our simplified High School Course in **SPARE** time at home, as **FAST** as your time and abilities permit. Equivalent to resident school work—prepares you for college, pre-professional examinations, business, industry. Standard texts furnished. Diploma. Credit for H. S. subjects already completed. Single subjects if desired. Low tuition, easy terms. American School, Chicago, est. 1897—endorsed by educators. Finish your high school education **NOW**, Write **TODAY!**

## High School Course at Home

Many Finish in 2 Years

American School, Dept. H-A45, Drexel Ave. at 58th St., Chicago 37, Ill.

Gentlemen: Send me **FREE** information covering special training in subjects checked below. No obligation on my part.

- |  |  |
|--|--|
| <input type="checkbox"/> High School Course          | <input type="checkbox"/> Diesel Engineering                  |
| <input type="checkbox"/> Architecture and Building   | <input type="checkbox"/> Drafting and Design for Men & Women |
| <input type="checkbox"/> Automotive Engineering      | <input type="checkbox"/> Plastics                            |
| <input type="checkbox"/> Business Management         | <input type="checkbox"/> Private Secretary                   |
| <input type="checkbox"/> Electrical Engineering      | <input type="checkbox"/> Mechanical Engineering              |
| <input type="checkbox"/> Elec. and Gas Refrigeration | <input type="checkbox"/> Aviation                            |
| <input type="checkbox"/> Air Conditioning            | <input type="checkbox"/> Salesmanship                        |
| <input type="checkbox"/> Railway Training            | <input type="checkbox"/> Radio                               |
| <input type="checkbox"/> Electronics, Industrial     |  |

Name.....  
 Address.....

# REPAIRMEN ELEC. APPLIANCES

**MONEY SAVING PRICES — IMMEDIATE DELIVERY**

- RENUALL Iron element. Guar. 1 year. Package of 6.....\$3.12
- Toaster element forms. Clear Mica. Fits most toasters. 10' for... 1.80
- Heating element wire 10 ft. coiled 3/16" O.D. #22..... 1.77
- Christy Electric Heating Element Welding Flux for repairing Flat Irons, toasters, electric stoves, etc. Enough for 50 elements 1.00
- Rubber Grommets—Assorted sizes. Kit of 100..... 1.30
- Motor Insulating varnish. 1 Pint..... 1.00
- Hot plate bricks 5 3/4" diameter. 6 for..... 1.62
- Electricians Drill Bits 1/4", 3/8", 1/2", 3/4" Complete set..... 6.75
- Ribbon element heating wire. Std. size. 100 ft..... .75
- Percolator elements. Universal Flat type. 1 Yr. guar. 2 for.... 1.20
- Element cement. Withstand 3000° F. 1 lb. package..... 1.00
- Lead wire. Asbestos covered heater hook-up wire. 10 ft..... 1.00
- Carbon brush set. Assorted. 104 brushes. 15 springs. Complete. 3.00
- Kerosene to Electric lamp conversion adapters. 5 for only..... 1.00
- Nickle Electroplating Kit. Complete outfit. Ready to use..... 1.50
- Electric Scissor Sharpener. Will handle all sizes. Complete.... 9.75

Here is your opportunity to save on repairing your own appliances and to earn extra money repairing appliances for friends and neighbors.

**CHRISTY SUPPLY COMPANY**  
 2835 N. Central Ave., Dept. T-950 Chicago 34, Illinois

## Be A MASTER PLUMBER

Earn \$15 To \$50 A Day

**DON'T ENVY THE PLUMBER — BE ONE**

Every skilled workman will tell you that Plumbers have the best of it. WINTER and SUMMER the Plumber is busy at top wages. No skilled Plumber is ever out of a job—compare his opportunities with any trade, plus the opportunities of having your own shop.

We teach you Plumbing with **TOOLS** (not books) under Licensed Master PLUMBERS in one of the finest equipped schools in America. We make you a Plumber, every branch is taught thoroughly—Lead Work—Blueprint for plan reading—all other tricks.

## LEARN IN 30 WEEKS WITHOUT PREVIOUS EXPERIENCE

If you like to work with tools you owe it to yourself to investigate. No need to ever work as an apprentice. Get free bulletin. Write now! G.I. APPROVED. Our 24th year.

**UNIVERSAL PLUMBING SCHOOL**  
 815 HOLMES STREET KANSAS CITY, MO.



You can make a good, comfortable living with poultry. For 26 years our course of Home Study training has been helping thousands. With a little study in spare time—you, too, can obtain the "know how" that means extra profits from the start.

Write today for prospectus describing courses, methods, service.

**NATIONAL POULTRY INSTITUTE**  
 Dept. 50 Adams Center, N. Y.

## LEARN MONEY-MAKING CARTOONING

IN SPARE TIME — by Easy Picture Chart Method

Same Simplified Method that has helped train creators of "Terry & Pirates," "Freckles," "Out Our Way," "Win-nie Winkle," "Regular Fellers," "Strange As It Seems," "The Neighbors," and many others. Earn while learning. Send 10c for Picture Chart (to test your ability), and full details. (State age.)

Landon School of Cartooning, Dept. 4706 Philadelphia (1) Pa.



# RUPTURED?

Get Relief This Proven Way

Why try to worry along with trusses that gouge your flesh—press heavily on hips and spine—enlarge opening—fail to hold rupture? You need the Cluthe. No leg-straps or cutting belts. Automatic adjustable pad holds at real opening—follows every body movement with instant increased support in case of strain. Cannot slip whether at work or play. Light. Waterproof. Can be worn in bath. Send for amazing **FREE** book, "Advice To Ruptured," and details of liberal truthful 60-day trial offer. Also endorsements from grateful users in your neighborhood. Write: **CLUTHE SONS, Dept. 31, Bloomfield, New Jersey**



Now IN YOUR OWN HOME Learn

# RADIO ELECTRONICS

The Practical  
"HOME-TESTED"  
Modern "A-B-C" Way



YOU USE ALL OF THESE RADIO PARTS  
TO BUILD AND OPERATE  
**7**  
DIFFERENT RADIO RECEIVING CIRCUITS

WITH THE HELP OF

**A** EIGHT Big Kits of Actual "Learn-by-Doing" Radio Parts and Assemblies with which you make 133 fascinating SHOP METHOD EXPERIMENTS in your own home! Imagine building 7 different Radio Receivers that operate!

**B** A 16 mm Home Movie Projector and Twelve Reels of "Learn-by-Seeing" Home Movie Films . . . for picture-clear, fast understanding of Radio Fundamentals!

**C** Modern, well-illustrated, Loose-leaf Lessons, prepared in clear, simple, understandable language . . . to guide you throughout your training!

**NO PREVIOUS RADIO OR ELECTRICAL EXPERIENCE NECESSARY**

DeForest's Training, Inc. provides every major home study aid to help you learn Radio-Electronics rapidly and thoroughly . . . to give you the experience and confidence needed for a responsible, Good-Pay Job, or to Start a Business of Your Own! Here is a REAL opportunity field for YOU . . . when you are a trained Radio-Electronics man! Just think of the tremendously exciting future ahead of FM Radio, Aviation and Broadcast Radio, Sound Motion Picture Equipment, Servicing and Sales of Radio Equipment, etc. Put yourself in this picture . . . See how you can benefit from a PRACTICAL training in this fascinating work! Think, too, of the coming possibilities ahead of Radar, Facsimile and Television. Send TODAY for the interesting, opportunity-revealing book, "Victory for You!" See how others probably no more talented or ambitious than you, have advanced in earning power after this training . . . how YOU can do it too! Mail the coupon NOW!

INCLUDING:

1. Simple Receiver
2. Two Tube Receiver
3. Tuned Radio-Frequency Receiver
4. Short Wave Receiver
5. Aviation Band Receiver
6. 4-Tube Superheterodyne
7. 5-Tube Superheterodyne with Magic Tuning Eye

... PLUS SCORES OF OTHER FASCINATING, INSTRUCTIVE RADIO-ELECTRONIC EXPERIMENTS

THEN GET THE HELP OF OUR EFFECTIVE EMPLOYMENT SERVICE

**VETERANS!**

Big things are happening at DeForest's Training, Inc. for veterans! See how you can prepare yourself WITHOUT cost for a GOOD JOB or a BUSINESS OF YOUR OWN in the vast Radio-Electronic opportunity field.

YOU USE "LEARN-BY-SEEING" MOVIES

16 MM MOVIE PROJECTOR



DEFOREST'S TRAINING, INC. INCLUDES INSTRUCTION IN MOTION PICTURE SOUND EQUIPMENT, FM RADIO AND TELEVISION . . . RESIDENTIAL TRAINING IN OUR MODERN CHICAGO LABORATORIES ALSO AVAILABLE—ASK US FOR INFORMATION!

**DeFOREST'S TRAINING, INC.** CHICAGO 14, ILLINOIS

E. B. DEVRY, President  
DeFOREST'S TRAINING, INC.  
2535-41 North Ashland Ave., Dept. PM-D6  
Chicago 14, Illinois, U.S.A.

Send FREE "VICTORY FOR YOU!" BOOK, showing how I may make my start in Radio Electronics.

Name \_\_\_\_\_ Age \_\_\_\_\_

Address \_\_\_\_\_ Apt. \_\_\_\_\_

City \_\_\_\_\_ Zone \_\_\_\_\_ State \_\_\_\_\_

If under 16, check here for special information.

If a discharged Veteran of World War II, check here.







**YOUR OWN BUSINESS**

*Learn*

## BE INDEPENDENT

Why work for others at the wages they want to pay you? Learn a good trade and operate your own business and determine just how long you work each day and the amount of money you make. The field of repairing electrical appliances offers any mechanically inclined man the opportunity of a lifetime. There are millions of electrical appliances in this country. Appliances such as refrigerators, irons, sewing machines, vacuum cleaners, heaters, toasters, washing machines, motors, etc. To replace any of these is mighty expensive. In addition, since the end of the war each month brings new inventions in the electrical appliance field and the purchase of each appliance makes another prospect for you if you learn NOW how to repair various types of electrical appliances.

## WHAT YOU NEED

All you need to become a successful electrical appliance business repairman is ambition plus a little training at home in your spare time. If you are mechanically inclined—that is to say—can hold and use tools, our profusely illustrated course written in simple, easy to understand language will prepare you for the years to come. It does not matter if you have not had a great deal of schooling or have had no previous experience along these lines—**WE WILL TEACH YOU.** Age should be no barrier—nor should any minor physical handicap. To repair all types of electrical appliances you do not need expensive tools and equipment or elaborate fixtures. Work as many hours a week as you wish—the home appliance repairman is his own boss. Operate from your garage, basement, kitchen or vacant store, etc.

## WE TEACH YOU

With photographs and simple drawings what troubles to look for and how to make each repair on an electrical appliance. We give you a good sound working knowledge of electricity, and how to do welding, nickel plating, etc. Our course shows you how to build the power tools you need and how to solicit business and keep it coming to you. Not a theory course but an honest to goodness course written by and used by repairmen the country over. Price of course is so low that the savings on your own household appliance repairs will quickly pay for it. Act now! Mail the handy coupon on the next page today.

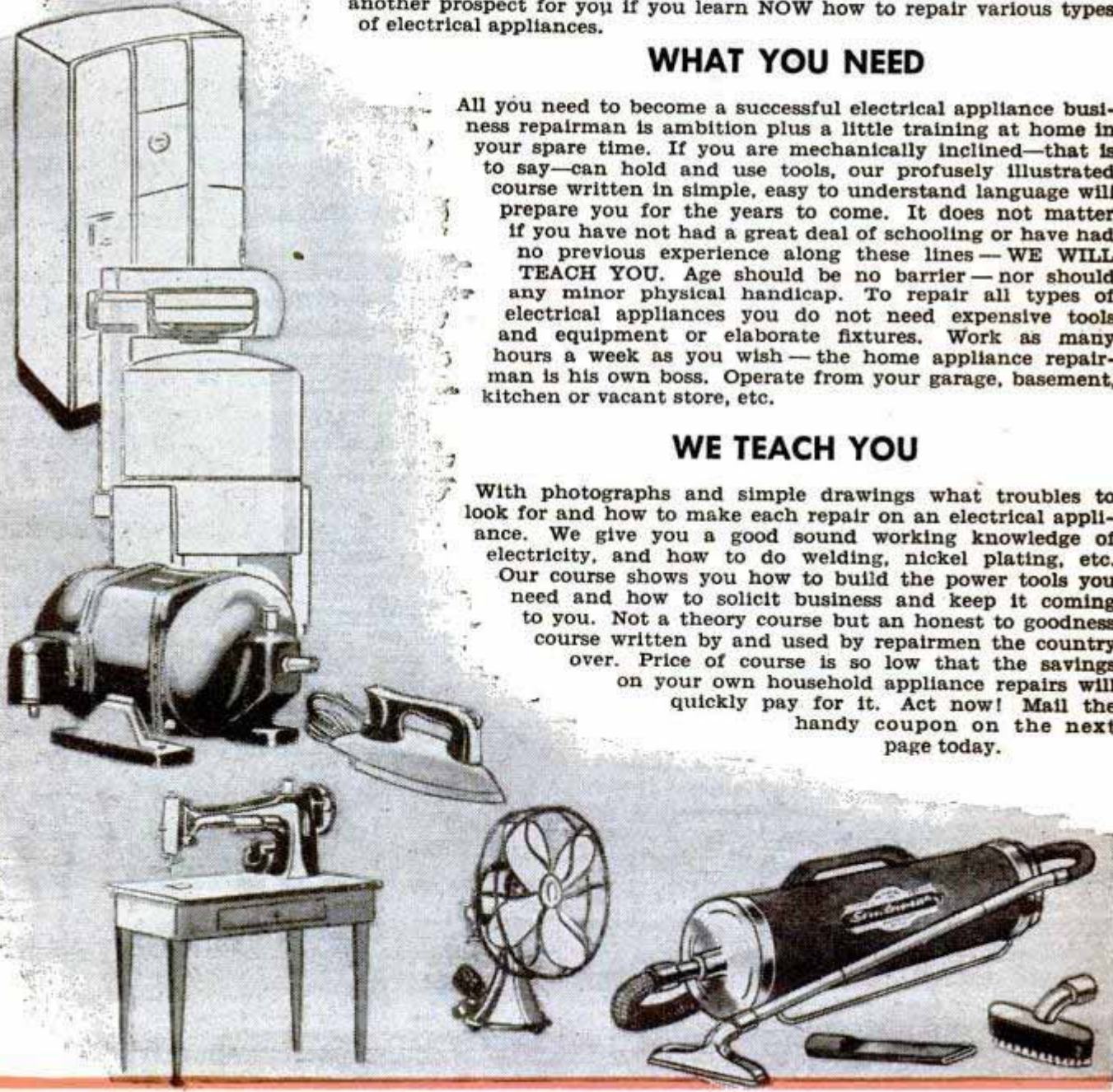



# ELECTRICAL APPLIANCE REPAIRING

## EARN BIG MONEY

The business of repairing electrical appliances for friends, relatives, neighbors and even strangers, offers any ambitious man a real future for it is not at all unusual for appliance repairmen to charge on the basis of \$5.00 to \$6.00 per hour. Then, too, knowing how to repair appliances is often the stepping stone to selling new appliances or parts at a good profit. Don't gamble with your future—learn a trade that will always support you.

## ALWAYS IN DEMAND

Are good appliance repairmen. It is not a war time, prosperity business but a business that provides a real opportunity no matter what the country's general business condition. Ever so many men have written to us of how they prospered after taking our course. Read them for yourself and be convinced.

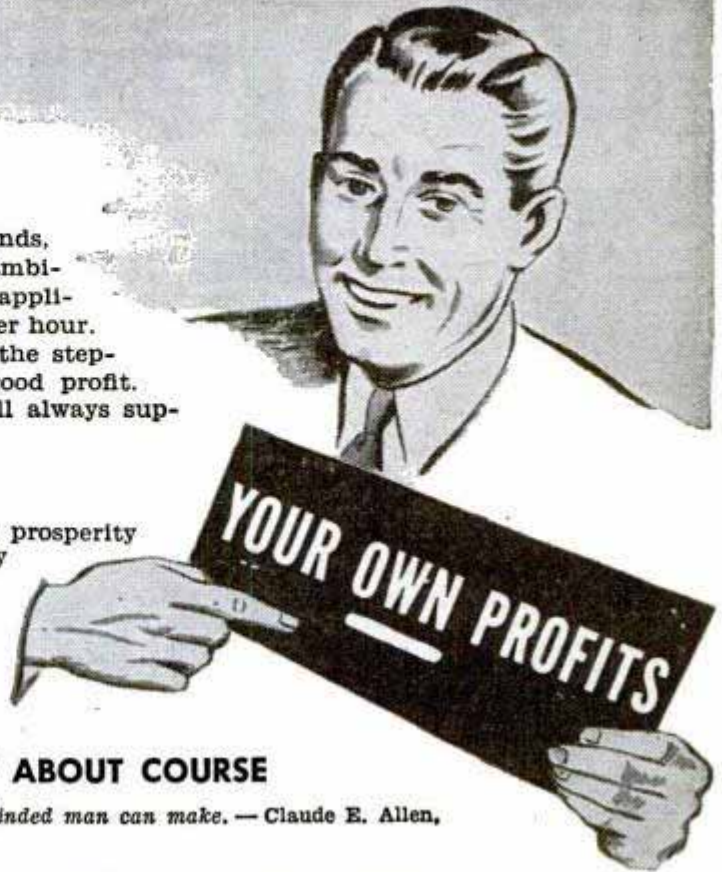

## READ WHAT OUR STUDENTS SAY ABOUT COURSE

*I really believe your course the best investment a mechanically minded man can make. — Claude E. Allen, Indianapolis, Ind.*

*I have received your Course in Appliance Repairing and I must say I am well pleased with same. I am only sorry I did not have said Course some years ago. I have learned so much more through this course I would not part with it. — Charles Schwarz, Hamilton, Ohio.*

*The Course in Appliance Servicing arrived a few days ago. Want to take out a few minutes of my valuable time to let you know that this is just what I have been looking for ever since I opened up my Fix-It shop. I must admit that you told the truth when you said that it contains quite a bit more information than I bargained for. — P. J. Bretl, Sebring, Ohio.*

*I am a mechanic for the Western Union Telegraph Co. Three days after receiving the lessons in refrigeration I earned the exact cost of the course. — Henry S. Lee, Washington, D. C.*

*I work day times at the shipyard and after 4:00 P.M. I operate from my cellar and garage. I average \$10.00 to \$15.00 clear every day. — Walter Hanhy, Brockton, Mass.*



## MAIL COUPON TODAY

**CHRISTY SUPPLY CO.**

**2835 N. Central Ave., Dept. D-4603**

**Chicago 34, Illinois**

Please send me free illustrated literature about America's Fastest Growing Industry—**ELECTRICAL APPLIANCE REPAIRING.**

Name.....

Address.....

City.....State.....

*Assure*



# AVIATION Career

## MAXIMUM TRAINING IN MINIMUM TIME

CAL-AERO TECH TRAINING will add dollars to your pay check all the rest of your life. Specializing in AERONAUTICAL ENGINEERING and MASTER AVIATION MECHANICS since 1929, Cal-Aero Tech training is carefully designed for just one thing—TO MAKE MORE MONEY FOR YOU. An alumni of over 6000 successful graduates proves our career training is unsurpassed.

**VETERANS** —Write us about Aviation Training, as provided under "G.I. Bill of Rights."



**CAL-AERO TECHNICAL INSTITUTE**  
 MAJOR C. C. MOSLEY PRES. SINCE 1929  
 FORMERLY CURTISS-WRIGHT TECHNICAL INSTITUTE  
 GRAND CENTRAL AIR TERMINAL  
 GLENDALE 1, CALIFORNIA  
 LOS ANGELES COUNTY

### MAIL THIS COUPON TODAY!

Cal-Aero Technical Institute, Grand Central Airport, Glendale 1, California  
 Please send full information on Aviation Training FREE—without obligation. Dept. P.M.-6

Name \_\_\_\_\_ Birth Date \_\_\_\_\_  
 Street \_\_\_\_\_  
 City \_\_\_\_\_ State \_\_\_\_\_

## AUDELS Carpenters and Builders Guides 4 vols. \$6

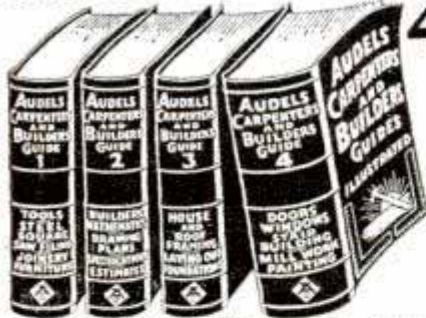

Inside Trade Information for Carpenters, Builders, Joiners, Building Mechanics and all Woodworkers. These Guides give you the short-cut instructions that you want—including new methods, ideas, solutions, plans, systems and money saving suggestions. An easy progressive course for the apprentice and student. A practical daily helper and Quick Reference for the master worker. Carpenters everywhere are using these Guides as a Helping Hand to Easier Work, Better Work and Better Pay. To get this assistance for yourself, simply fill in and mail the FREE COUPON below.

### Inside Trade Information On:

How to use the steel square—How to file and set saws—How to build furniture—How to use a mitre box—How to use the chalk line—How to use rules and scales—How to make joints—Carpenters arithmetic—Solving mensuration problems—Estimating strength of timbers—How to set girders and sills—How to frame houses and roofs—How to estimate costs—How to build houses, barns, garages, bungalows, etc.—How to read and draw plans—Drawing up specifications—How to excavate—How to use settings 12, 13 and 17 on the steel square—How to build hoists and scaffolds—skylights—How to build stairs—How to put on interior trim—How to hang doors—How to lay floor—How to paint



**THEO. AUDEL & CO., 49 W. 23rd St., New York City**

Mail Audels Carpenters and Builders Guides, 4 vols., on 7 days' free trial. If O.K. I will remit \$1 in 7 days, and \$1 monthly until \$6 is paid. Otherwise I will return them. No obligation unless I am satisfied.

Name.....  
 Address.....  
 Occupation.....  
 Reference.....P.M.

## ANALYZE HANDWRITING

Qualify for Certified Grapho Analyst Degree at home, spare time. Credit, Employment, Personnel Managers, Business, Professional men, women use grapho-analysis in their work, earn substantial fees in spare time. Many study solely for personal benefit, no desire to earn money, find it so fascinating they start using it to add to their incomes. Entertainment field pays well, up to \$100 in a week reported. Others establishing profitable practices as Vocational and Family Problem Counselors, Personality Teachers, and lecturers.



### GROWING—UNCROWDED PROFESSION

More and more police use grapho analysis handling suspects and criminals. They understand how criminals think. Their handwriting tells. Men like Hugh Dunlap, university student, Harry Allen, retired preacher, use it in court, win cases, earn fees even before graduation. Only school in world devoted to teaching grapho analysis offers thorough training to earnest, ambitious men and women regardless of where you live, small town, farm or city. Send for GRAPHO ANALYST, illustrated lesson, personal handwriting analysis offer, ALL FREE. Must be 21 or over. Address A. I. G. A. Inc., 120, Noel, Missouri.



## "How to Make Money With Simple Cartoons"

A book everyone who likes to draw should have. It is free; no obligations. Simply address  
**CARTOONISTS' EXCHANGE**

Dept. 96-D

Pleasant Hill, Ohio

## LEARN MOVIE THEATRE MANAGEMENT



The Motion Picture Theatre Business offers big opportunities for trained men. Get into a fascinating field with a post-war future. Train at home in spare time. Free Catalog. Established 18 years.

**THEATRE INSTITUTE, 370 Washington St., Elmira, New York**

## ELECTRICAL TRAINING

Intensive 32 weeks residence course in fundamentals of industrial electrical engineering, including radio, electronics. Prepares for technician, engineering aides. Approved for veteran training. 54th year. Catalog.

**BLISS ELECTRICAL SCHOOL**  
 7634 Takoma Ave., Wash. 12, D.C.



## FREE BOOK SHOWS HOW TO START YOUR OWN BUSINESS

Making statuettes, toy animals, book ends, etc. Instructs you (1) how to make rubber molds (2) how to mold plaster figures (3) how to color and finish. Ideal for convalescent children, "shut-ins", mothers who want extra money. Write today.

**MOLD-ART (Rubber-For-Molds, Inc.)**  
 Dept. 49-H, 6044 N. Avondale, Chicago 31, Ill.

### SAY YOU SAW IT IN POPULAR MECHANICS

**LAW** STUDY AT HOME for PERSONAL SUCCESS and LARGER EARNINGS. 38 years expert instruction—over 108,000 students enrolled. LL.B. Degree awarded. All texts furnished. Easy payments. Send for FREE BOOK—"Law and Executive Guidance."  
**AMERICAN EXTENSION SCHOOL OF LAW**  
 Dept. 78-M, 646 N. Michigan Ave., Chicago 11, Ill.

## INVENTING

**—FOR PROFIT!** If you have an inventive turn of mind, write for free 28-page booklet explaining how the Institute of American Inventors is helping inventors pre-test the profit possibilities of proposed devices to fill today's unprecedented demand for useful new inventions.

**INSTITUTE of AMERICAN INVENTORS**  
 Dept. 4, 1926 Eye St., NW, Washington 6, D. C.



# TRAINING RATES THE GOOD THINGS OF LIFE

**NOW IS THE TIME  
TO PREPARE FOR  
THE EXCITING NEW  
FIELD OF**

**INDUSTRIAL**

**ELECTRONICS**



It's a perfectly natural human desire to want more money, a better job, prestige and all the other good things of life. Who gets them? Look about you. Success, you will see, comes to the man who is trained for his job.

A new world of opportunity is today beckoning to ambitious men. One of the most important and exciting fields is **INDUSTRIAL ELECTRONICS**. It is attracting experienced electrical men as well as younger fellows seeking a way to bigger earnings and a more secure future.

### OPPORTUNITY LIES AHEAD

**Industrial Electronics is not Radio.** It has nothing to do with radio transmitters and receivers. It is a totally new application of electric power, applied to modern production by means of the magic of the vacuum tube. Everywhere industrial electronic devices are replacing the old-time electrical controls, and processes. Industrial Electronics is Modern Industrial Electricity.

"Every electrician should know—must know—Industrial Electronics." That's what many Union leaders are telling their members, today. They know that the use of Industrial Electronics devices is growing by leaps and bounds. They know that to install and service this equipment, even the best of present-day electricians must first have had special training.

### GET READY NOW!

Now is the time to get into Industrial Electronics, while the field is in its infancy . . . and while it is rapidly developing a need for thousands of trained

experts. Tomorrow's leaders are training today.

And here is a School equipped in every way to train you for Industrial Electronics work—one of the largest and most completely equipped, and one of the few of its kind in America—a School that already has trained thousands of men for industrial opportunities.

**LEARN AT HOME OR COME TO OUR SCHOOL.** Learn Industrial Electronics—now, while the time is ripe. You don't need any advanced schooling or previous experience. If you are at all mechanically inclined and have gone to high school for at least one year or have an equivalent education, we can teach you Industrial Electronics.

You can take most of your training at home, in your spare time—or you can come to Chicago and take your entire training in our completely equipped shops and laboratories. Either way you quickly acquire the fine points, practical skill, and broad, technical "know how" that makes the expert Industrial Electronics Technician.

### AUTHORIZED TO ACCEPT VETERANS FOR G.I. TRAINING

**INDUSTRIAL TRAINING INSTITUTE,**  
2150 Lawrence Ave., Dept. P18, Chicago 25, Ill.

Please send me, **FREE**, your "Camera Visit" booklet and information about the opportunity for trained men in **INDUSTRIAL ELECTRONICS**. It is understood that I will be under no obligation.

NAME \_\_\_\_\_

ADDRESS \_\_\_\_\_

CITY \_\_\_\_\_ STATE \_\_\_\_\_

ARE YOU A VETERAN? \_\_\_\_\_

**A GUIDE FOR YOUR FUTURE**—Complete facts about Industrial Electronics. Packed with pictures. Tells all about our successful training plan. Coupon will also bring details about money-making opportunities for trained men and our Life-Time Free Employment Service. No obligation. Mail coupon **TODAY**. Investigation may start you up the ladder of Success.



**SEND FOR  
THIS BOOK  
—IT'S FREE**

**GET THE FACTS ABOUT AMERICA'S FORE-  
MOST SCHOOL OF PRACTICAL TRAINING.**





# Learn this Profitable Profession



**IN 90 DAYS  
AT HOME**

## Money-Making Career Open to Men and Women, 18 to 50

Hundreds of men and women between 18 and 50 make \$10 to \$20 in a single day giving scientific Swedish Massage and Hydro-Therapy treatments. There is big demand from doctors, hospitals, sanatoriums and clubs. Graduates earn large full time incomes from these or in private practice in their own offices. Others make good money from home treatments given in spare time. Learn this interesting, money-making profession in your own home, through our home study course. Same instructors as in our nationally known resident school. You can win independence and prepare for future security by qualifying for your Diploma. Course can be completed in 3 to 4 months. Many earn while they learn. Begin your training at once.



### Anatomy Charts & Booklet FREE

Enroll now and we will include, at no extra cost, many needed supplies. Fit yourself to help meet growing demand for Scientific Swedish Massage. Send the coupon at once for complete details. Anatomy Charts and 32-Page Illustrated Booklet, FREE, postpaid.

THE COLLEGE OF SWEDISH MASSAGE

Dept. 764G, 100 East Ohio St., Chicago 11, Illinois

Please send me FREE and postpaid, Anatomy Charts, 32-page Booklet and complete details on Home Training.

Name

Address

City  State

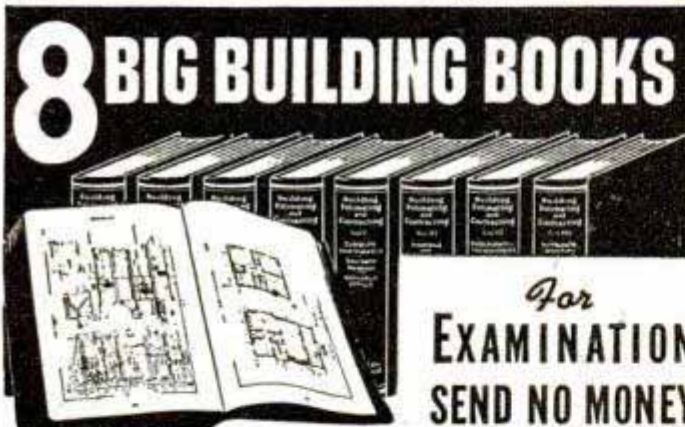

For  
**EXAMINATION  
SEND NO MONEY**

Learn to draw plans, estimate, be a live-wire builder, do remodeling, take contracting jobs. These 8 practical, profusely illustrated books cover subjects that will help you to get more work and make more money. Architectural design and drawing, estimating, steel square, roof framing, construction, painting and decorating, heating, air-conditioning, concrete forms and many other subjects are included.

### BETTER JOBS — BETTER PAY

The postwar building boom is in full swing and trained men are needed. Big opportunities are always for MEN WHO KNOW HOW. These books supply quick, easily understood training and handy, permanent reference information that helps solve building problems.

### UP-TO-DATE EDITION

These books are the most up-to-date and complete we have ever published on these many subjects.

### Coupon Brings Eight Big Books For Examination

AMERICAN TECHNICAL SOCIETY Vocational Publishers since 1899  
Dept. GA19 Drexel at 58th Street Chicago 37, Ill.

You may ship me the Up-to-Date edition of your eight big books, "Building, Estimating and Contracting," without any obligation to buy. I will pay the delivery charges only, and if fully satisfied in ten days, I will send you \$2.00, and after that only \$3.00 a month, until the total price of only \$34.50 is paid. I am not obligated in any way unless I keep the books.

Name

Address

City  State

Please attach a letter stating your age, occupation, employer's name and address, and name and address of at least one business man as a reference. Men in service, also please give home address.

# AVIATION

Aeronautical University Approved Training meets exacting standards of aviation industry, prepares for key positions, big opportunities.

Courses in:

**AERONAUTICAL ENGINEERING.** B.S. degree.  
**AERONAUTICAL ENGINEERING DRAFTING**  
**CERTIFIED ENGINE MECHANICS**  
**ADMINISTRATION**—Including sales

**PRE-ENGINEERING:** Special course for high school graduates and veterans deficient in math and science.

Also refresher courses for Gov't Airplane and Engine Mechanics Licenses for those with aviation experience.

Oldest fully approved aviation school. Outstanding faculty, modern equipment, outside employment, placement service. Day, evening. Approved for Veterans. Send today for FREE catalog "Opportunities in Aviation."

**FOUNDED  
BY  
CURTISS-  
WRIGHT**

**AERONAUTICAL UNIVERSITY**

Dept. 77, 116 S. Michigan Ave., Chicago 3, Ill.

## Command a Substantial Salary BE AN ACCOUNTANT

**FREE  
WRITE  
TODAY**

Hill's, one of America's leading Business Schools, offers you the opportunity to advance yourself to a well paying accountant's job. Our FREE book, "Through Hill's to Success," tells how and where the best positions are found and how you can qualify for them by study at home or in our resident school. We have thousands of successful graduates and maintain nation-wide employment service. G. I. Approved.

**HILL'S EXTENSION SCHOOL**  
and **BUSINESS UNIVERSITY**  
619 W. Main St. • Oklahoma City 2, Okla.

## HORSE MASTERY!

A FINE HOBBY — A GREAT VOCATION!

"The EXPERT HORSEMAN"



**FREE BOOK** — Tells how You can learn to:  
BREAK COLTS, GAIT SHOW HORSES, TRAIN  
RODEO, STOCK and RACE HORSES, BREAK BAD HABITS,  
HANDLE ANY HORSE, TRAIN CIRCUS TRICK HORSES. WRITE TODAY!

**ANIMAL LOVERS ASSOCIATION**  
BOX KA-111 TARZANA, CALIFORNIA

**SUBSCRIBE  
TODAY  
50¢**  
One Year



### AMAZING INVENTION!

**CORRECTS POOR PENMANSHIP** in few days—Big improvement in 3 hrs.—No failures. Now, it's fun to become an expert penman. Complete Outline Free. Write today in your own hand-writing.  
**OZMENT, The Inventor, 34, St. Louis, Mo.**

## SHOP TRAINING for G.I.'s!

Learn Auto, Diesel, Refrigeration or Welding. 7 floors of shops. America's leading school. Established 1902. 45,000 graduates. Free booklet. Specify trade.

### GREER SHOP TRAINING

Dept. 167, 460 S. State St.

Chicago, Ill.

## LEARN WATCH REPAIRING



**AT HOME.** By our modern and original system of instruction you can learn every part of the **WATCH REPAIRING TRADE AT HOME.** Prepare yourself for a well-paying position or start in business after completing our course of instruction. Good watch repairers are in demand and generally earn very good salaries. For particulars apply to the **Wisconsin School of Watch Repairing** 759 North Milwaukee St., Milwaukee 2, Wis.



# GET INTO RADIO

## TELEVISION ELECTRONICS NOW!

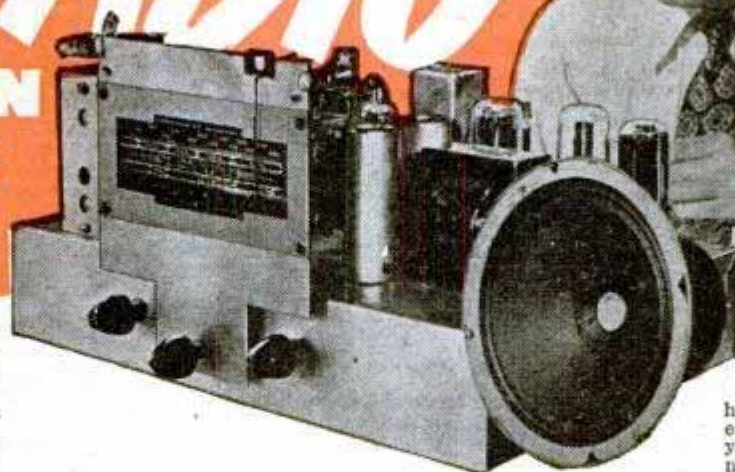

You build this complete, modern super-heterodyne receiver with the equipment that comes with your National Training at no cost.

This practical shop instruction system gives you actual experience with a Home Radio Laboratory—part of the

# SHOP METHOD HOME TRAINING

from one of the world's Oldest and Largest Technical Trade Schools

**FOR YOU—A REAL HOME LABORATORY IN MODERN RADIO**

Send the coupon below immediately. Learn how this improved practical training can fit you for the **GREAT BUSINESS OF RADIO**—for the **NEW AND RAPIDLY EXPANDING FIELD OF FREQUENCY MODULATION (F.M.), TELEVISION AND ELECTRONICS.**

This is the thoroughly proved method used so extensively in wartime training—endorsed by the success of National men everywhere—a system by which you study in spare time—off hours, even minutes right in your home and yet have the **ADVANTAGE OF REAL SHOP EXPERIENCE** behind you.

### Trained Radio Men Wanted

The man who really knows modern Radio is in greater demand today than ever before—not only in Radio proper but in Television and Electronics—in Aviation, Transportation, Manufacturing, Communications. Good jobs

await the trained man, in the production, operation and maintenance of modern electronic equipment—in radio stations, in hundreds of industries—in homes, theatres and studios. Good sound training in this important field is absolutely necessary. And now, National Schools brings such training to you no matter where you live or what you may be doing—not only the fundamental theory but the actual experience that comes with knowing shop practice and working with real equipment—demonstrating each step with first-hand knowledge. This is true "learning by doing"—direct from the great shops and laboratories of National Schools where new developments in methods, equipment and applications are constantly going forward.

National offers you such practical training and National has the facilities. Sample this training yourself. **MAIL THE COUPON FOR A FREE LESSON.**



Your National Training Kits include equipment for over a hundred practical electronic experiments in your own home. You

get standard radio parts for this audio oscillator which you get to understand by building it yourself.

You learn modulation, beat frequencies, signal generation by a actually building this small radio transmitter with your National shop parts.

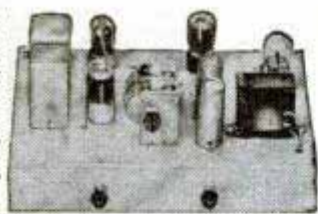

Your training outfits from National are made up of the most modern equipment—much of it just out of the experimental laboratory. You learn new ways of handling equipment by modern methods.

Get the details by mailing the coupon.

### SUCCESS and SECURITY FOR YOU

Radio is a Well-Established Business, Television and allied fields are just on the threshold of limitless expansion. Would you like to profit from these developments? An excellent job or perhaps into a business of your own? Answer these questions by reading the catalog sent you **FREE** from National Schools. Get the facts.

### Check the Job You Now Have With These Opportunities in RADIO

1. Financial Security Radio has grown from \$100 million to \$5 billion in past few years.
  2. Limitless Future predicted by over 1,800 manufacturers of equipment.
  3. Television promises unrealized opportunity.
  4. Electronics opens wide new fields in home and industrial use.
  5. Your Own Business with little capital.
- Get the details. Use the coupon!

## FREE GET THESE 2 BIG BOOKS



## NATIONAL SCHOOLS

LOS ANGELES 37, CALIFORNIA EST. 1905

### MAIL OPPORTUNITY COUPON FOR QUICK ACTION

National Schools, Dept. 6-PM  
4000 South Figueroa Street  
Los Angeles 37, California

(Mail in envelope or paste on penny post card)

Mail me **FREE** the books mentioned in your ad including a sample lesson of your course. I understand no salesman will call on me.

NAME..... AGE.....

ADDRESS.....

CITY..... ZONE..... STATE.....

Check here if veteran of World War II

## NATIONAL TRAINING WINS BIG JOBS

You, too, can share the success of National graduates. Clifford Hannah, Portage La Prairie, Manitoba, Canada, writes: "My training has brought results as I'm in line for another raise, thanks to National's encouragement and thorough training. You can count on me as a real National booster and I am glad I used such good judgment in getting into a live and growing field."

While still a student of National training, I. Wilson of Vallejo, California, writes: "My pay has jumped from \$52.18 a week to \$72.65, and the end is not in sight. I am proud of my National Course."

### VETERANS

If you qualify for training under G.I. Bill, check the coupon for a Special Bulletin.





# AUTO BOOKS ON APPROVAL



## CAN YOU FIX IT?

These wonder books tell step by step HOW to make difficult repairs and adjustments, how to keep a car at maximum efficiency, including latest improvements in car design and operation. Engine troubles and how to correct them well covered.

**6 BIG VOLUMES**  
2800 pages, 2000 illustrations, wiring diagrams, etc., including Diesel engines, Beautiful modernistic, washable cloth binding.

**SEND NO MONEY.** Just mail the coupon for a complete set of Six Big Auto Books, 20th Edition. Whether you are a mechanic or helper, expert or apprentice, auto owner or driver, take immediate advantage of this FREE EXAMINATION OFFER.

### MAKE GOOD MONEY NOW HOLD A PERMANENT JOB

America wants its automobiles kept in good repair. Men with "know how" are in demand, at big pay. These books will help you get and hold an important job, or give you a chance to go into business for yourself now or later. Any man who half tries to improve himself can learn auto servicing and repairing by this quick reference method. Use the JIFFY INDEX to find easily understood answer to any auto problem. These wonder books prepared by eleven of America's great automobile engineers. Many hundreds of valuable illustrations. Send the coupon TODAY.

**[A year's consulting privileges with our engineers now given with these books without extra charge.]**  
*Vocational Publishers Since 1898*

**AMERICAN TECHNICAL SOCIETY, Dept. A-19**  
Drexel Ave. at 58th St., Chicago 37, Ill.

I would like to examine your Six-Volume Set of Auto Books. I will pay the delivery charges only, but if I choose I may return them express collect. If after 10 days' use I prefer to keep them, I will send you \$2 and pay the balance at the rate of only \$3 a month until \$24.50 has been paid. Please include consulting service as offered above.

Name .....

Address .....

City ..... State .....

Please attach letter stating age, occupation, employer's name and address and name and address of at least one business man as reference. Men in service, also please give home address.

# AUDELS ELECTRIC MOTOR GUIDE

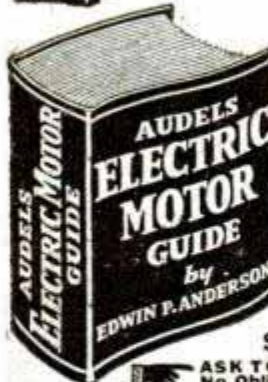

**1000 PAGES OF PRACTICAL MOTOR INFORMATION**

**JUST OUT!** Audels Electric Motor Guide covering the construction, hook-ups, control, maintenance and trouble shooting of all types of motors including armature winding. Explains entire subject in every detail. 31 Chapters, 617 Illustrations and Diagrams. A Handy Guide Fully Indexed for Electricians and all Electrical Workers.

**\$4 COMPLETE • PAY \$1 A MO.**

**ASK TO SEE IT!**—Get This Information for Yourself No Obligation Unless Satisfied.

## MAIL ORDER

**AUDEL, Publishers, 49 W. 23rd St., New York 10, N. Y.**  
MAIL AUDELS ELECTRIC MOTOR GUIDE for free examination. If O. K. I will send you \$1 in 7 days; then remit \$1 monthly until price of \$4 is paid. Otherwise, I will return it.

Name .....

Address .....

Occupation .....

Employed by .....

YOU MAY BE ABLE TO  
**DOUBLE YOUR INCOME**  
IN YOUR  
**SPARE TIME!!**

## LEARN SILK SCREEN PROCESS



**Jealously Guarded Trade Secrets NOW Available to You**

**Develop a Profitable Business of Your Own . . . or a Hobby**

Prepare yourself for an interesting top paying position. Thousands of jobs open. Silk Screen Process signs, displays, Xmas cards, toys, etc., IN GREAT DEMAND THE WORLD OVER. You may make enough the second week to pay for the entire course. EASY TO DO . . . EASY TO LEARN. No education or mechanical knowledge required.

**WRITE FOR FREE COLORFUL INTERESTING ILLUSTRATED CATALOG.**  
**CALIFORNIA SCHOOL OF SCREEN PROCESS**  
Dept. PM-67 3740 Overland Avenue, Los Angeles 34, California

**COURSE INCLUDES A COMPLETE KIT OF SUPPLIES**

## MASTER MACHINIST • MECHANICAL DRAFTING TOOL-DIE DESIGNING • TOOL ENGINEERING

Completely equipped shops and drafting rooms, directed by an accredited staff of engineers and practical instructors. 18 years of successful training of men for industry.

*Days, Evenings • Approved for Veteran Training*

**NEW CLASSES Now Forming • BULLETIN ON REQUEST**

**ALLIED SCHOOL OF MECHANICAL TRADES, INC.**  
42 ALLIED BLDG., 1336 S. MICHIGAN AVE. • CHICAGO 5, ILL.



You can become a good penman right in your own home during spare time by my Simplified Method. Write for my FREE Book, "How to Become an Expert Penman," which shows what others have learned. If desired, send 10c for one of my favorite Pen Points and your name with a beautiful flourished bird written on a card. Write for the Free Book today.  
**T. M. TEVIS, BOX 25K, CHILLICOTHE, MO.**

SAY YOU SAW IT IN POPULAR MECHANICS

## TAXI OWNERS

Send for FREE sample copy of

**TAXICAB OPERATOR**  
National Magazine of the Cab Industry

**TAXICAB OPERATOR**  
1621 N. California Ave. Chicago 47, Ill.

THOUSANDS OF SUFFERERS USE

# BREATHEASY

FOR

# ASTHMA

CARRY IT WITH YOU  
USE IT ANYWHERE

*Sold on Money-Back Guarantee*

*Write To Dept. PM*

**BREATHEASY DISTRIBUTORS, INC.**  
65 CEDAR STREET  
SEATTLE 1 WASHINGTON



LOOK AHEAD to

# ELECTRICITY

CURRENT BUILDING BOOM CREATES BIG DEMAND

PRACTICAL "Learn-by-Doing" TRAINING  
ONLY 19 WEEKS...QUICKLY, THOROUGHLY



NATION'S  
LARGEST  
EXCLUSIVE  
ELECTRICAL  
SCHOOL

Learn a trade with a future bright for years to come . . . *Electricity!* FORECAST: 12 million new homes and apartments to be wired within next 10 years. More Electricians required for House Wiring . . . for Construction and Industrial Maintenance, Armature and Motor Rebuilding, Factory and Office Building Wiring, the Operation, Maintenance and Repair of AC and DC Motors, Generators, Controls, other Power Equipment.

*Learn Electricity . . . Learn by Doing . . .* train on actual equipment . . . graduate in 19 weeks. Learn latest, most advanced methods quickly, easily, thoroughly . . . at Nation's Largest Exclusive Electrical School. Four floors devoted to this one course—individual attention—expert instructors—large auditorium for Electrical Training movies and slide films—day and evening classes, full or part time. We will finance your training. Get more information.

**MICHIGAN TECHNICAL INSTITUTE**

Dept. PM-6 2281 W. Fort St., Detroit 16, Mich.

APPROVED FOR TRAINING UNDER GI BILL

**VETERANS!**

Take this course at no cost to you, and receive \$65 to \$90 a month while training. Complete details furnished. MAIL COUPON TODAY!

MICHIGAN TECHNICAL INSTITUTE Dept. PM-6  
2281 W. Fort St., Detroit 16, Michigan

- Send me catalog and complete information.  
 I am a GI. Send special information.  
 Married.  Single.

NAME \_\_\_\_\_

ADDRESS \_\_\_\_\_

CITY \_\_\_\_\_ STATE \_\_\_\_\_

## LEARN ELECTROPLATING

Highly Paid, Uncrowded, Interesting Business. Part or Full Time, Common School Education Sufficient. Gold, Silver, Nickel, Chromium, etc. Money Making Secrets, Processes. Send postcard for FREE Electroplating Booklet and proof. PLATER HYDE, Dept. M, P. O. Box 176, National City, California.

### "MAGIC VANISHING CARD"

THROW IT INTO THE AIR — It completely disappears. Reproduce it later from spectator's pocket. It amuses and confuses all. Easy to do — 25c with Amazing Catalog of 300 Tricks.

THE MAGICIAN, Dept. 5, 2463 Kensington Ave., Philadelphia 25, Pa.

### APTITUDE TESTS

discover the kind of work or studies best for your success! You get a personal report—a guide for life—more happiness—more prosperity. For men, women, boys and girls. Write for complete facts.

VOCATIONAL COUNSELING INSTITUTE  
956 Maccabees Bldg., Detroit 2, Michigan

### Become a Doctor of PSYCHOLOGY

Win the degree of Ps.D. Teach the secret of contentment, happiness. Solve mental worries. Experience the revelation of truth. Chartered college. Individual help. Write for FREE book. COLLEGE OF UNIVERSAL TRUTH, 5153-B North Clark St., Chicago.

### MONEY for MEN ALL DATA FREE

THE PLASTEX Industry needs manufacturers on small scale and for big production of Lamp and Clock Stands, Art Goods and Novelties in Plastex and Marble imitation. Experience unnecessary. 1/2c material makes regular 10c store sellers. Rubber moulds furnished for speed production. Small investment brings good returns. Big chain store orders now being placed. Ambitious men have chance for real prosperity. Our Free booklet will interest and benefit you.

PLASTEX INDUSTRIES, Dept. P, 1015 Washington Ave., New York, N.Y.

## Learn to Repair ELECTRIC APPLIANCES

**AT HOME** Prepare now for a permanent future, independence and security with a business of your own. Our practical, easy-to-learn home course teaches you, during your spare time, how to repair washing machines, vacuum cleaners, electric ranges, lamps, motors, irons, etc., and do house wiring.

### OPEN YOUR OWN SHOP

Have a Secure Future



**WRITE TODAY for FREE BOOK**

For the man who is handy with tools, and likes to work with his hands as well as his head, there is a **WIDE OPEN OPPORTUNITY** today, in this great growing field. If you own your own shop you can depend on making more money in good times . . . and not losing your job in a depression. You can start a business of your own in your garage or basement with \$20.00 worth of tools. One good repair job can pay for the cost of the entire course. Write today for further information, without obligation.

### PACIFIC TRAINING SCHOOL

7217 So. Broadway, Dept. P-106, Los Angeles 3, Calif.

Dear Sirs: Please send me, without obligation, your free catalog and free details.

Name \_\_\_\_\_

Address \_\_\_\_\_

City \_\_\_\_\_ State \_\_\_\_\_



# GET INTO DIESEL

**AUTOMOTIVE AND ALLIED MECHANICS**

**GET THIS FREE LESSON AND TRY IT. OPPORTUNITY BOOK TOO**

Good jobs, interesting and profitable jobs are available for men who really know the new **MOTORS**—Carburetion, Ignition, Fuel-injection and Motor Tune-up. Train NOW to be an **EXPERT** in power and transportation. Send the coupon below for facts packed with opportunity. Learn Diesel, Automotive and Allied Mechanics with—

**SHOP METHOD HOME TRAINING**  
**BY A REAL ESTABLISHED RESIDENT SCHOOL**  
 Trained Men are constantly needed to keep this pulsating industry moving ahead. If you are mechanically inclined, you too can find your opportunity by knowing Diesel-electric—Internal Combustion Engines, including Diesel, Gasoline and Butane Types, High-octane Fuels—Automotive Drive Systems—developed direct from the Shops and Laboratories of this world-famous training organization, NATIONAL SCHOOLS. Take the first step TODAY! Learn how you may establish yourself successfully in a good job or a business of your own. Get the details. **FREE!**



**MAIL OPPORTUNITY COUPON**

Paste this on a post card or mail in envelope.

**NATIONAL SCHOOLS, Dept. 6-PM**  
 4000 S. Figueroa Street, Los Angeles 37, Calif.

Send me your **DIESEL AND MODERN MOTORS** book together with a sample lesson **FREE**. I understand I may keep and use this information without obligation.

Name \_\_\_\_\_ Age \_\_\_\_\_

Address \_\_\_\_\_

City \_\_\_\_\_ State \_\_\_\_\_

Include your zone number.

**APPROVED FOR TRAINING UNDER GI BILL**

**JUST OUT! NEW FROM COVER TO COVER**

## AUDELS REFRIGERATION and AIR CONDITIONING GUIDE

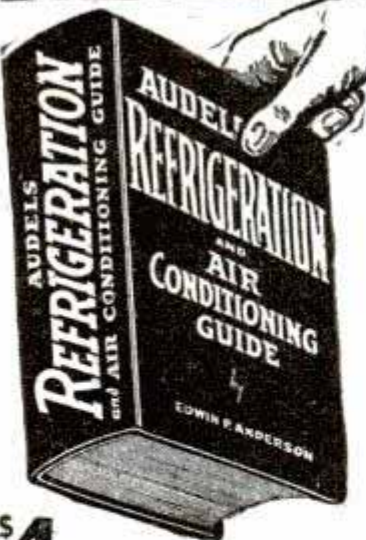

**4 Books in One! Covering:**  
 Basic principles, Servicing, Operation, Repair of  
 1—Household Refrigeration  
 2—Special Refrigeration Units  
 3—Commercial & Industrial Refrigeration  
 4—Air Conditioning Systems  
 Here you have at your fingers' ends a Complete Library in ONE VOLUME, the necessary data you have been looking for on: MODERN UNITS, SYSTEMS & MACHINES, REFRIGERANTS, including Freon, Lockers, Water Coolers, Quick Freezing & Air Conditioning Systems.  
 1280 Pages, 46 chapters all Fully Illustrated & indexed for Ready Reference.

**ANSWERS YOUR QUESTIONS**  
 Get This Information for Yourself. Mail Coupon Today. No Obligation Unless Satisfied. **ASK TO SEE IT.**

**\$4 COMPLETE • PAY ONLY \$1. A MONTH**

**AUDEL, Publishers, 49 W. 23rd St., New York 10, N.Y.**  
 MAIL AUDELS NEW REFRIGERATION GUIDE for free examination. If O. K. I will send you \$1 in 7 days; then remit \$1 monthly until price of \$4 is paid. Otherwise I will return it.

Name \_\_\_\_\_

Address \_\_\_\_\_

Occupation \_\_\_\_\_

Employed by \_\_\_\_\_ PM

## OSWALD RABBIT Cartoon Home Movies! Are ALWAYS Funny!

**3 Monkeys — WALTER LANTZ PRODUCTIONS — Oswald Rabbit**

Show an **OSWALD RABBIT** feature cartoon at your next Home Movie show. Also a **3 MONKEY-MICKEY MOUSE-DONALD DUCK** film for ideal entertainment.



**Oswald Rabbit Features**  
 50ft. 8mm \$1.75 100ft. 16mm \$3.00  
**Dog Team Race**.....1-A  
**Oswald's Ball Game**.....3-A  
**Barnyard Quints**.....7-A  
**Doctor Oswald**.....9-A

Stage a Cartoon Home Movie Show often showing these Cartoon films. See at your Dealers or order direct. For catalog and prices, write to:—

**HOLLYWOOD FILM ENTERPRISES, Inc.**  
 6060 Sunset Blvd. Dept. 115 Hollywood 28, Calif.

## RADIO 10¢ BOOKS

## Get Started in Radio TEN "HOW-TO-DO-IT" BOOKS

Get a solid foundation in radio by means of these 10c timely text books. Each clearly written, profusely illustrated, contains over 15,000 words. You'll be amazed at the wealth of information packed into these handy books. Excellent for reference—ideal for technical library. Your money back if not satisfied.

**5 Books for 50c -- 10 Books for \$1 SENT TO YOU POSTPAID**

- We cannot send less than 5 books
- |  |                                     |
|--|-------------------------------------|
| No. 1—How To Make Four Doerle Short Wave Sets                      | No. 2—All About Aerials             |
| No. 2—How to Make The Most Popular All-Wave 1 and 2 Tube Receivers | No. 3—How To Have Fun With Radio    |
| No. 3—Alternating Current for Beginners                            | No. 4—How To Read Radio Diagrams    |
| No. 4—All About Aerials  | No. 5—Radio for Beginners           |
| No. 5—Beginners' Radio Dictionary                                  | No. 6—Simple Electrical Experiments |
| No. 6—How To Have Fun With Radio                                   | No. 7—Television                    |
| No. 7—How To Read Radio Diagrams                                   |                                     |
| No. 8—Radio for Beginners  |                                     |
| No. 9—Simple Electrical Experiments                                |                                     |
| No. 10—Television  |                                     |
- Remit by check or money order—register letter if you send cash or stamps.  
**RADIO PUBLICATIONS, 23-Z West Broadway, New York (7)**

## SHORTHAND in 6 Weeks at Home

Famous Speedwriting system. No signs or symbols; uses ABC's. Easy to learn; easy to write and transcribe. Fast preparation for a job. Surprisingly low cost, 100,000 taught by mail. Used in leading offices and Civil Service. Write for free booklet.  
**SPEDWRITING, Dept. 1506-7, 55 West 42 St., N. Y. 18**

## Free Book MOUNT BIRDS, ANIMALS, FISH

**MAIL Postal Today**

**Yes FREE.** Explains Taxidermy. Tells how to learn at home by mail to mount birds, animals' heads... to TAN skins and furs. Great for MEN and BOYS. Fun! Also earn money in spare time. **WRITE TODAY—NOW** for free book containing 100 game pictures. State AGE. N.W. School of Taxidermy, Dept. 337A, Omaha, Neb.



Begin today. Write now for our Free Book, "How to Become a Good Penman." It contains specimens and tells how others learned to write in spare time. Enclose 10c for your name beautifully written and a pen point suitable for shaded writing. Write today.  
**THE TAMBLYN SCHOOL OF PENMANSHIP**  
 N-441 Ridge Building, Kansas City, Mo.

## Learn PHOTOGRAPHY at Home

Splendid opportunities. Prepare in spare time. Practical basic training. Long-established school. Send for free book, "Opportunities in Photography." No obligation.  
**American School of Photography, 1315 S. Michigan Ave., Dept. 135A, Chicago 5, Ill.**

## TRI-STATE COLLEGE

B. S. Degree in 27 months in Engineering (7 branches); Bus. Adm., Acc't and Sec. Science. 6th year. School now filled to capacity. No applications can be accepted until further notice.  
 467 College Ave., Angola, Ind.

## LEARN MEAT CUTTING At Home — In Spare Time



Get into the vital meat industry. Concise, practical Home Training based on 25 years proven instruction methods used at National's famous resident school. Prepares you for bigger pay as Meat Cutter, Supervisor, market manager or more money in your own store. Go as rapidly as your spare time permits. Diploma. Start NOW to turn your spare hours into money. Send for FREE bulletin today. No obligation.

**National School of Meat Cutting, Inc., Dept. U-82, Toledo 4, Ohio**



# NEW MIDGET ELECTRIC ARC WELDER



RETAILS ONLY  
**\$3.95**

**Plugs into Light Socket—AC or DC**

It's new! It's handy! It's efficient! Use the Midget Electric Arc Welder for hundreds of light-metal jobs. Does comparable welding work with a 1/16 inch welding rod on thin metal as that of larger and higher priced welders. Operates on 15 ampere fuse, 110 volt 60 cycle A.C. or D.C. current, by use of our special standard-coated 1/16-inch welding rods. Generous supply of rods supplied with machine. Recommended for all light welding like automobile fenders, etc. Take the Midget Arc anywhere to the job. Sturdily built and fully guaranteed. Comes complete—ready to use. Nothing else to buy. No previous welding experience needed to strike an arc. In a short time, anyone mechanically inclined can learn to weld with this machine.

You'll find hundreds of money-saving, time-saving uses for the Midget Arc around your home, garage, or workshop. Also in garages, factories, repair shops, tin shops, mechanics, farmers, inventors, etc. Order a Midget Electric Arc Welder now! **SEND NO MONEY.** We'll rush one to you, complete with rods and helmet (equipped with APPROVED welding glass). Pay postman only \$3.95 plus postage charges. If not satisfied, return Midget Arc in 5 days from receipt and we'll refund your money immediately. **RUSH YOUR ORDER NOW.**  
MIDGET ARC WELDER CO., Strader Ave., Dept. Z-202, Cincinnati 26, Ohio

**PLAY THE GAME THAT IS ENTIRELY NEW AND PACKED WITH ENCHANTING ROMANCE!**

## "THE ENCHANTED KINGDOM"

Twelve characters! Kings! Lords! Knights! Enchanted Castles! Dukes! Forty-eight attractive, colorful cards in all. Just the thing for a party or a quiet evening at home. Order now. Supplies are limited. Full instructions included. . . . . Only **\$2.25**

**KING ARTHUR'S COURT**  
P. O. Box 680 Colorado Springs, Colo.

**THERE'S MONEY IN CARTOONS!**

RAYE BURNS will teach you HOW to CREATE ORIGINAL CARTOONS at home that you may SELL! Course contains 26 lessons and over 600 illustrations. All for Only... **\$2.85**

Send name and address for free details.

RAYE BURNS SCHOOL, Dept. M, Box 3583, CLEVELAND, OHIO

## FIREWORKS

**501-Piece All-Noise Assortment**

includes half gross Cherry Bombs, many Chinese crackers, Lady Crackers, Salutes, Little Red Devils, etc. Shipped by Express same day order is received. Name nearest Express office. No C.O.D. While present supply lasts . . . only **\$3.95!**

**BLUE RAPIDS FIREWORKS BLUE RAPIDS, KANSAS**

## U.S. GOVERNMENT JOBS

**START \$1,756 TO \$3,021 YEAR**

Men—Women

Prepare NOW for Next Examinations.

**FRANKLIN INSTITUTE**  
Dept. J87, Rochester 4, N. Y.

Sirs: Rush without charge (1) 32-page Civil Service book with list of U. S. Government Jobs, (2) Tell me how to prepare for one.

COUPON

Name \_\_\_\_\_

Address \_\_\_\_\_ Vet? \_\_\_\_\_

Vets Get Preference. Mail Coupon today sure.



## Only 8 Hours and You Start Playing by this Amazing Method!

It's true! You learn to play by playing real tunes right from the very first lesson. You start with simple melodies. As you master these you take up more advanced tunes. And sooner than you ever dared hope you're thrilled to find that you can pick up almost any piece of music and play it by note. That's what makes this U. S. School method of learning music a pleasant pastime instead of hard, tedious work.

### Learn At Home Without A Teacher

Yes, here is a way to learn music at home that does away with the old-fashioned drudgery of tiresome scales and exercises . . . cuts the time of learning way down . . . ends the need for a private teacher. No special talent or previous knowledge of music necessary. And you can't go wrong. Everything is right before you in Print and Picture form. First the printed lessons tell you how to play a tune. Then a picture shows you how. Then you play it and hear how it sounds.

### SEND FOR FREE PRINT AND PICTURE SAMPLE

#### Easy as A-B-C



Best of all you can take lessons on any instrument you wish for *only a few cents a day*. So if you want to learn music fast . . . if you want to win new friends and entertain people . . . here's your big chance. Send today for our **FREE 36-page Booklet** and "Print and Picture" Sample. These will prove how amazingly easy it is to learn to play this short-cut, money-saving way. U. S. School of Music, 76 Brunswick Bldg., New York 10, N. Y. (49th Year)

U. S. School of Music, 76 Brunswick Bldg., New York 10, N. Y.

I am interested in music study, particularly in the instrument indicated below. Please send me your free booklet, "How to Learn Music at Home" and your Print and Picture Sample. (Do you have instrument?) \_\_\_\_\_

Piano	Piano Accordion	Reed Organ	Clarinete
Guitar	Saxophone	Tenor Banjo	Trombone
Violin	Trumpet, Cornet	Ukulele	Other Instruments

Name \_\_\_\_\_ (PLEASE PRINT)

Street \_\_\_\_\_

City \_\_\_\_\_ State \_\_\_\_\_

Check here if under 16 years of age.

SAVE 2c—Stick coupon on penny postcard



# NOW! The ONE-UNIT HEARING AID

Thousands Have Waited for

The New ONE-UNIT  
**Beltone**  
MONO-PAC  
HEARING AID

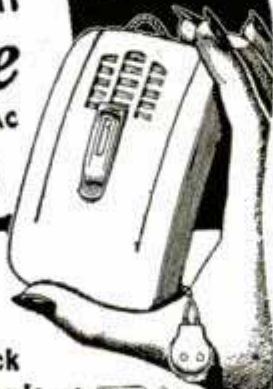

**THIS IS ALL YOU WEAR** →

No Separate Battery Pack  
No Dangling Battery Cords

The tiny new BELTONE Mono-Pac is about 1/2 size and weight of old-style hearing aids, yet so powerful you hear even *whispers!* Get helpful facts about this new "MIRACLE" aid in valuable FREE book about deafness.



**BELTONE HEARING AID CO.**  
1450 W. 19th St., Dept. PM76, Chicago 8, Ill.

**FREE BOOKLET**

Beltone Hearing Aid Co.

Dept. PM76, 1450 W. 19th St., Chicago 8, Ill.

Please send me FREE booklet about deafness and what can be done to overcome it.

Name \_\_\_\_\_

Address \_\_\_\_\_

Town \_\_\_\_\_ Zone \_\_\_\_\_ State \_\_\_\_\_

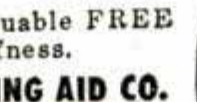

## AIR RIFLES BENJAMIN AIR PISTOLS ARE AVAILABLE

SEND FOR FREE FOLDER OF LATEST MODELS TODAY  
If you want a REAL GUN for PRACTICAL USE inside or outdoors get a SAFE - CLEAN - ECONOMICAL - BENJAMIN with Adjustable Power and Amazing Accuracy. For BEST RESULTS use BENJAMIN H-C PELLETS. WRITE AT ONCE. BENJAMIN AIR RIFLE CO., 812 MARION ST., ST. LOUIS 4, MO.



For the amateur and professional artist and sculptor. Giving detailed study of every part of the body.

### "The Book They're Talking About"

Contains over 300 illustrations, charts and notes

# ART ANATOMY OF THE HUMAN FIGURE

MALE AND FEMALE, POSED AND IN ACTION  
(Sent in plain wrapper.) Outside of U. S. A. Send \$1.25  
MAJOR BOOK CO., Dept. 320-F, Lynbrook, New York

ONLY \$1.00

# REFRIGERATION AND AIR CONDITIONING

**TRAIN FOR YOUR OWN BUSINESS**

Now, not "next week," is the time to start training for a top-pay job in this vital field. A drastic shortage of trained service experts exists. Many thousands more will be needed for the post-war expansion caused by new industrial uses. Train NOW to get your pick of best jobs. We will give you the practical training you need. For 2 years we trained men and women for the Army and Navy only, in fine-precision aircraft instrument work. So our methods must be right. Common schooling is all you need. Our unique system makes everything easy to grasp. You can train at home and in our big Chicago shops. Write for full facts TODAY, without obligation. Dept. PSE.

Approved for Veterans' G.I. Training  
Millions of Old Units Need Expert Service. Big Building Boom Will Create Even More Opportunities.

**INDUSTRIAL TRAINING INSTITUTE**  
2150 Lawrence Avenue, Chicago 25, Illinois



## SEEKING HEALTH? A WINNING PERSONALITY?

Learn my secrets for regaining Health. Overcome weakness, disease, Nature's safe way. Be Strong, Confident, Popular, Poised, Gain Weight, Build POWERFUL Physique. Thousands satisfied. Hurry . . . ACT QUICK!

**FREE**

Beautiful COLOR PHOTOS of MUSCULAR MARVELS. State health problem, enclose stamps.

**DR. FREDERICK TILNEY**

Dept. PM 161, Coral Gables 34, Florida

# ELECTRICIANS' SCHOOL

PRACTICAL RESIDENT TRAINING IN  
HOUSE AND COMMERCIAL WIRING • MOTOR REPAIR AND REWINDING • ELECTRIC REFRIGERATION, COMMERCIAL AND DOMESTIC.

Approved for Veterans Training

**PENNSYLVANIA INSTITUTE SCHOOL OF ELECTRICITY**  
42nd and SPRUCE STS. PHILADELPHIA 4, PENNA.

## WANTED DISTRICT PURCHASING AGENTS

No experience or money required. Exceptional opportunity for those who want to establish themselves in a steady, year 'round, well paying business.

For details: Write

**PURCHASING MANAGER, DEPT. C**  
2719 LAWRENCE AVE. CHICAGO 25, ILL.



**FREE! Large folder on valuable BODY-BUILDING, TRAINING, HEALTH, and STRENGTH books for boys and men. Also free an inspiring picture of a well-developed athlete (Wallet-size, 3"x5", ACTUAL Photograph. Send us your name and address and 10c stamps or coin to cover mailing costs. Write Today to CROSS COMPANY, Box 389, Dept. V-1, Kenosha, Wis.**

## LEARN IMPORT-EXPORT



Represent manufacturers. Study at home. Splendid opportunities. Uncrowded field, big future. ITP trains you in few weeks. Low tuition. Diploma awarded. Folder FREE.

INTERNATIONAL TRADE PROMOTION, 246-P Fifth Ave., New York 1





ACE HOLLYWOOD EXPERTS WILL HELP YOU

MAKE GOOD IN

**RADIO**

**TELEVISION ELECTRONICS**

THROUGH AMAZING EASY HOME TRAINING PLAN!



**LEARN FROM MEN CLOSEST TO RADIO-TELEVISION INDUSTRY!**

Direct from Hollywood, nerve-center of America's broadcasting, Television, Radio and Sound activities, comes this time-proven and tested home training. Here at last is easy-to-learn, advanced home-instruction that quickly qualifies you for steady, good-pay jobs or your own profitable business in Radio, Television and Electronics.

**YOU GET PRACTICAL RADIO SHOP "KNOW HOW"!**

Backed by more than 25 years of practical experience in home training, RADIO TRAINING ASSOCIATION OF AMERICA'S (R.T.A.) professional methods assure quick step-by-step success. R.T.A. is located in Hollywood — "on-the-spot" where new technical developments are introduced. You receive finest shop-type instruction in latest Radio-Television techniques. Every R.T.A. student gets individual guidance and unlimited consultation on any subject pertaining to studies or work — a valuable feature of R.T.A.'s famous service.

**EARN EXTRA MONEY WHILE LEARNING**

When you enroll with R.T.A. you get SPARE TIME JOB SHEETS that show how to earn extra money while still receiving your training direct from Hollywood experts. Never again are there likely to be such opportunities for ambitious men to get ahead quickly. When your friends, neighbors know you are studying Radio-Television, ample repair jobs are practically assured for you. Like many R.T.A. students, you may receive more spare time jobs than you can handle.

**TRAINED MEN NEEDED AS NEVER BEFORE!**

Profitable opportunities are developing daily for Hollywood trained men in Radio Broadcasting, Aviation, Marine and Police, Communications, Public Address Systems, Sales, Service, Manufacturing, Industrial Electronics, Radio Recording and Television.

**SEND FOR FREE BOOK FROM HOLLYWOOD EXPERTS**

telling all about streamlined training plan developed by technicians in heart of vast Radio-Television field. Let R.T.A.'s Hollywood experts show you how to find your place in this great industry. Mail coupon for free book. No obligation. Approved for veterans.

**RTA GRADUATES MAKE GOOD!**

- ★ Thanks to R.T.A. I started my own radio store . . . am making 220 percent more than when I enrolled . . . W. E. Thon, Chicago.
- ★ Truly thankful for the day I enrolled for R.T.A. Course . . . it fitted me splendidly for my present position . . . N. R. Hoffman, Radio Station WCOD, Harrisburg.
- ★ . . . R.T.A. sure opened my eyes to big money . . . thanks for all you have done for me . . . Ernest Lancott, Cleveland.

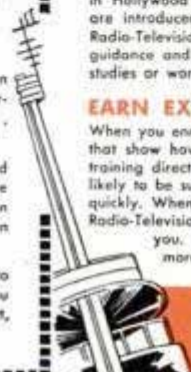

SEND FOR FREE ILLUSTRATED R.T.A. BOOK NOW!!

**RADIO TRAINING ASSOCIATION OF AMERICA**

Send FREE BOOK showing how to make good in Radio-Television through training by Hollywood experts.

NAME \_\_\_\_\_ AGE \_\_\_\_\_

ADDRESS \_\_\_\_\_

CITY \_\_\_\_\_ ZONE \_\_\_\_\_ STATE \_\_\_\_\_

Check box if VETERAN of World War II

5620 HOLLYWOOD BLVD - DEPT. PM 6 - HOLLYWOOD 28, CALIF.



**AROUND THE WORLD FOR 10¢**

**NEW, EXCITING, EDUCATIONAL HOBBY!**

Collect emblems of world famous hotels, air, steamship lines, railroads, major league teams, etc. etc. Send 10¢ with this ad for introductory sample packet, also new catalog and Honorary Membership Card with your name in gold. • VOGUE SPECIALTIES 401 CARNEGIE HALL, DEPT. 51, CLEVELAND 15, OHIO

**LEARN PIANO WITH RECORDS**  
IN ONLY 10 EASY LESSONS

FIRST LESSON STARTS YOU PLAYING SONGS LOW COST! NO RISK! SEND NO MONEY!

Amazing . . . so easy . . . so practical . . . Here is the world's only piano course using this modern perfected method. Hear Your Teacher's Voice Always Beside You . . . Guiding You. You learn faster . . . easier . . . through exclusive teaching records never before available. First lesson starts you playing actual pieces with both hands. Stop Wishing. Start Playing. For complete information Kit FREE, Send your name and address to TRACY INSTITUTE OF MUSIC Dept. P.3., 54 Holmehurst Ave., Baltimore 28, Md.

**U.S. GOVERNMENT JOBS**

START \$1,756 TO \$3,021 YEAR

Men—Women

Prepare NOW for Next Examinations.

FRANKLIN INSTITUTE

Dept. J119, Rochester 4, N. Y.

Sirs: Rush without charge (1) 32-page Civil Service book with list of U. S. Government Jobs. (2) Tell me how to prepare for one.

Name \_\_\_\_\_

Address \_\_\_\_\_ Vet? \_\_\_\_\_

Vets Get Preference. Mail Coupon today sure.

**SURPLUS BARGAINS ASSEMBLE YOUR OWN BINOCULARS!**

Complete Optics! Complete Metal Parts! Save More Than 1/2 Regular Cost

**ARMY'S 7X 50 BINOCULARS**

Here's an unusual opportunity to secure a fine set of Binoculars at a substantial saving of money. Offered here are complete sets of Optics and Metal Parts for the Army's M-16 7X 50 Binoculars. These components are new and all ready for assembly. We supply full instructions.



**METAL PARTS**—Set includes all Metal Parts—completely finished—for assembly of 7X 50 Binoculars. No machining required. Bodies have been factory hinged and covered. A sturdy Binocular Carrying Case is included with each set of Metal Parts.

Stock #824-H 7X 50 Metal Parts . . . . . \$35.00 Postpaid

**OPTICS**—Set includes all Lenses and Prisms you need for assembling 7X 50 Binoculars. These Optics are in excellent condition—perfect or near perfect—and have new low reflection coating.

Stock #5102-H 7X 50 Optics . . . . . \$25.00 Postpaid

NOTICE! Add 20% Federal Excise Tax to above prices if you order both Binocular Optics and Metal Parts.

NEVER HAS THERE BEEN SUCH A SENSATIONAL BARGAIN AS THIS!

**BUBBLE SEXTANT**—Type A-10, used by Army Air Forces. These have just arrived and will be priced so low you'll think we have made a mistake. Send at once for complete descriptive Bulletin 16-H containing pictures, facts and price. If interested, don't wait, because this bargain won't last long.

We have literally millions of war surplus lenses and prisms for sale at bargain prices. Write for Catalog "H" — Sent Free!

Satisfaction Guaranteed Order by Stock No.

**EDMUND SALVAGE COMPANY**

P. O. AUDUBON, NEW JERSEY



It's YOUR future — Make the most of it!



**Start now to earn the bigger pay in electrical repair**

Was there ever such an opportunity to get started in electrical maintenance and repair—and at top-notch wages? Are you ready—with experience and ability—to cash in on it? Others are getting just the sort of background needed—quick! practical!—to handle the great variety of electrical maintenance and repair work TODAY—from this well-known electrical library. You can too!

## THE LIBRARY OF ELECTRICAL MAINTENANCE AND REPAIR

5 vols., 1826 pages, 1724 illustrations

Gives you the "know-how" to tackle any wiring or motor job. Five books show you HOW—to install all types of motor and generator units—to inspect and repair motor starters and generators—to diagnose motor and generator troubles—to figure new windings for old cores—DC and AC windings—to test armature windings—test induction motors, etc., etc. One book is full of trouble-shooting charts that show quickly symptoms, causes, specific remedies, etc.

Take the first step toward improving YOUR future—Mail this coupon TODAY

No money down—special price—easy payments—FREE trial

McGraw-Hill Book Co., 330 W. 42 St., New York 18, N. Y.

Send me for ten days' free examination the Electrical Maintenance and Repair Library. If satisfactory I will send you \$1.50 in 10 days and \$3.00 monthly until the price of \$16.50 is paid. If not wanted I will return books postpaid. (To insure prompt shipment write plainly and fill in all lines.)

Name.....  
 Home Address.....  
 City and State.....  
 Company.....  
 Position..... PM-6-47

# VETERANS Learn WATCHMAKING

## A Lifetime Profession

Regardless of Conditions, Age, Sex, or Physical Limitations  
 Veterans—Civilians!  
 Your Opportunity—  
**LEARN WATCHMAKING**

Lift yourself from a futureless job into a position paying better than your present work. Fit yourself for the job that will permit you to establish your own shop, or be employed in a pleasant environment.

Watch Repairing—Jewelry—Engraving will always be in ever greater demand. Our graduates wanted everywhere. Dignified positions \$50-\$75-\$100 per week. Veterans write today for latest FREE enrollment requirements.

**Kansas City School of Watchmaking**  
 Largest Horological School in America  
 617-621 Wyandotte St. Kansas City 8, Mo.



Approved—  
 G. I. Training

# LEARN WATCH REPAIRING

IN YOUR OWN HOME!



HERE'S BIG MONEY and a secure future for YOU in watch repairing even if you're just a beginner. Be your own boss soon or choose from thousands of available high paying jobs. (There are no age or physical limitations.)

**PRACTICAL SELF-TRAINING & ADJUSTMENT.** This new and complete book is easy to understand. Every step in repair, adjustment, construction, theory, operation. Covers all needed tools and their use. Fully illustrated. Only \$2.95 Post Paid (If C.O.D., plus charges.) **MONEY BACK GUARANTEE**

**WE SUPPLY ALL TOOLS, MATERIALS AND PARTS AT LOWEST COST — PROMPT DELIVERY!**  
 Illustrated catalog, 25 cents, or FREE with order. Complete sets for STUDENTS and WATCHMAKERS.  
**MODERN TECHNICAL BOOK & TOOL CO.**  
 Dept. MMC, 55 W. 42nd Street, New York 18, N. Y.  
 ALL Books on Jewelry, Metalcraft, Homecraft, Etc.

# REFRIGERATION and AIR CONDITIONING

REFRIGERATION TRAINING Since 1927

Mechanical units everywhere need servicing. Be ready with reliable pay-knowledge. Unique home study — actual practice plan. Train now for servicing and installing jobs or business of your own.

Get The Facts FREE Now! Write Today!  
**UTILITIES ENGINEERING INSTITUTE**  
 1314 W. Belden Ave., Dept. 167, Chicago 14, Ill.

**FREE!** Do YOU Want to Build Up Your Body... Gain Strength... Become a Champion Athlete... Gain or Lose Weight?



To inspire and help you: We will send FREE a big 12x19 in. poster of "AMERICA'S BEST DEVELOPED ATHLETE", ALAN STEPHAN—officially recognized by Nat'l A.A.U. Also free information on our valuable body-building, training, and health books for boys and men.



Send us your name and address and 20c stamps or coin to cover part of handling and mailing cost! We do the rest! WRITE TODAY too!  
**CROSS COMPANY, Box 389, Dept. A-1, Kenosha, Wisconsin**

# What Every Mason Wants



We have important Masonic books for Blue Lodge, Chapter, Commandery, Scottish Rite, and Shrine.

Our Rituals Are Used the World Over. Send for free catalog of books and rituals for Masons, Odd Fellows, Knights of Pythias, Knights of Columbus, etc.  
 EZRA A. COOK, Publisher, P. O. Box 796, PJE, Chicago 90, Ill.



**CARTOON TO SUCCESS!**  
 Learn cartooning from a PROFESSIONAL! Let me show you how to create ORIGINAL cartoons and IDEAS. Send for FREE details about course.  
 Also **CARTOONIST'S MAGAZINE**—Lessons, plans and hints. Send 25c coin for copy.  
**CARTOONIST HARTMAN, 2776 California Court, LINCOLN 8, NEB.**



# CODE-SENDING-RECEIVING-SPEED

Learn to send and receive Radio Code with greater speed. Stop nervous tension. Have confidence. Be proficient. Same system used by radiotelegraph specialists. Thousands of operators needed. Rush name for FREE book.  
**CANDLER SYSTEM CO.**  
 Dept. 5-G, Box 928, Denver 1, Colo., U. S. A.



# LEARN PORTRAIT PAINTING AT HOME

Previous art training or talent NOT necessary. This new Stuart System teaches you, in 11 simple, easy-to-follow lessons, to make exact charcoal and oil likenesses. Guidance for your every step. Send for free book today.

**STUART STUDIOS.**  
 121 Monument Circle, Room 66, Indianapolis 9, Ind.  
 Please send me free book and outline of lessons.  
 Name.....  
 Street.....  
 City..... State.....



# Now! NO AUTO REPAIR JOB IS TOO TOUGH FOR YOU!

Let this New Short-Cut Save You Time and Work!

Used by U. S. Army and Navy

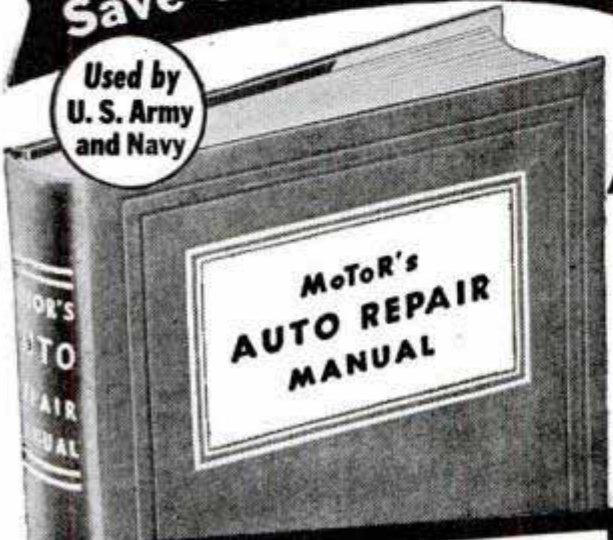

JOB ALL FINISHED IN ONLY HALF THE TIME!



Whether you do auto repairs either as full-time or as part-time work, no service or repair job can "throw" you when you've got MoToR's AUTO REPAIR MANUAL! Just look up make, model, and the job in the streamlined index—and you're ready to lick ANY job from carburetor to rear end, faster, easier, better!

Try it FREE for 7 Days!

## MoToR's AUTO REPAIR MANUAL Shows You How to Service and Repair ANY Part of ANY Car Built Since 1935!

Nearly 200,000 service and repair facts on all 31 makes. 856 big pages; including 50 pages of carburetor text, charts, illustrations, covering all models. Over 500 charts, tables; Tune-up Chart; Valve Measurements; Compression Pressure; Torque Wrench Reading; Starting Motor; Engine Clearances; Generator; Clutch & Brake Specifications; Front End Measurements, etc.; Engines; Electric; Fuel, Cooling, Lubricating Systems; Transmissions; Universals, Front Ends; Wheels; Rear Ends, etc.

### Covers All These Makes!

- |           |           |            |              |
|-----------|-----------|------------|--------------|
| American  | Cord      | La Salle   | Packard      |
| Bantam    | Crosley   | Lincoln    | Pierce Arrow |
| Auburn    | De Soto   | Lincoln    | Plymouth     |
| Austin    | Dodge     | Zephyr     | Pontiac      |
| Buick     | Ford      | Mercury    | Reo          |
| Cadillac  | Graham    | Nash       | Studebaker   |
| Chevrolet | Hudson    | Overland   | Terraplane   |
| Chrysler  | Hupmobile | Oldsmobile | Willys       |
|           | Lafayette |            |              |

Try this great book for 7 days FREE! It's "headquarters" for 200,000 facts about service, repair, adjustment, replacement, and tune-up — on every car built from 1935 through 1946. The engineer-editors of MoToR Magazine built this Manual for YOU, by collecting and organizing all the vital information from 150 official factory shop manuals. Then they put ALL the facts into this ONE amazing workbook.

### More Than 1,000 Pictures!

MoToR's AUTO REPAIR MANUAL not only TELLS you clearly what to do. It SHOWS you, too! — in over 1,000 cut-away photos, diagrams, drawings. 856 BIG pages (8½x11 inches) put the complete "know-how" right at your fingertips! And the fabric binding is strong, built for years of day-in-day-out service!

No wonder it is used by the U. S.

Army, Navy, trade and technical schools, thousands of auto servicemen and handymen everywhere! No wonder we're willing to have YOU try it, FREE, for 7 days! Once you use it—and see for yourself how much valuable time and hard work it saves—you'll never again want to be without it!

## SEND NO MONEY 7-Day Free Examination

Don't send any cash — unless you wish to do so in order to save postage charges! Simply mail coupon NOW. When postman brings your book, pay him nothing. First make the book show you what it does for you! Unless convinced it's the greatest time-saver and work-saver you've ever seen—return book in 7 days, pay nothing. Mail coupon NOW! Address: MoToR Book Dept., Desk 1G, 572 Madison Avenue, New York 22, N. Y.

## Same FREE 7-Day Offer Applies on MoToR's TRUCK REPAIR MANUAL

For mechanics, truck specialists, service stations, fleet owners. Covers EVERY job on EVERY truck made since 1936! 1400 pictures, 952 pages. 300,000 facts. Used by Armed Forces.

All types Gasoline Engines, Diesels, Hesselman, Fuel Systems, Governors, Lubrication Systems, Ignition Systems, Starters, Generators, Clutches, Transmissions, Axles, Torque Dividers, Transfer Cases, Brakes, Steering, etc.

ALSO SERVICES many buses, farm and industrial tractors, tractor and road building equipment, stationary power machinery, etc. (on all parts described in Manual.) Check box in coupon at right.

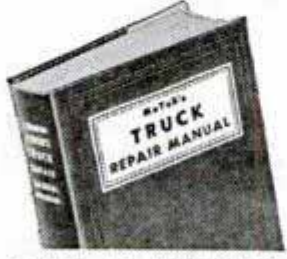

Published by MoToR, The Leading Automotive Business Magazine. MoToR's manuals assure highest standards of repair work.

## MAIL COUPON NOW FOR 7-DAY FREE TRIAL

MoToR Book Dept., Desk 1-G, 572 Madison Ave., New York 22, N.Y. Rush to me at once: (check box opposite book you want).

- MoToR's AUTO REPAIR MANUAL. If O.K. I will remit \$1 in 7 days, (plus 35c delivery charge), then \$2 monthly for 2 months, and a final payment of 95c a month later. (Book's price \$5.95). Otherwise I will return book postpaid in 7 days. (Foreign price, remit \$8 cash with order).
- MoToR's TRUCK REPAIR MANUAL. (Described at left.) If O.K., I will remit \$2 in 7 days, and \$2 monthly for 3 months, plus 35c delivery charges with final payment (\$8.35 in all). Otherwise I will return book postpaid in 7 days. (Foreign price, remit \$10 cash with order).

Print Name..... Age.....

Print Address.....

City..... Zone No. (if any).....

State..... Occupation.....

Save 35c! WE pay postage if you ENCLOSE full payment. (Check, M. O., postal note.) Same 7-day return-refund privilege.



# RADIOMEN! ELECTRICIANS!

Get this Valuable Book

# FREE

for Merely Examining  
Coyne's NEW Pay-Raising

## 3 VOLUME SET APPLIED PRACTICAL RADIO

Here's real news for every man interested in Radio. A sensational new PRACTICAL set of radio books, just off the press! Nothing like it ever before. Gives you the "know how" on everything in Radio today. Basic principles to the newest in Television and FM—how to construct, install, service. 500 illustrations, nearly 1000 pages. To prove how valuable these great books can be to you, Coyne will give you a FREE copy of our new 240-page book "Starting & Operating a Profitable Radio or Electrical Business," just for looking over the 3 Volume Set. For home training or field reference, APPLIED PRACTICAL RADIO is backed by Coyne's 48 years of shop experience to help you to bigger pay, better jobs, greater opportunities in Radio.

**OFFER LIMITED—ACT NOW!** Here's our offer to you—if you act promptly. We will send you the 3 volume set APPLIED PRACTICAL RADIO for 7 days' FREE examination, together with the Business-Starting Book. Look the set over for 7 days. If you like it, you can then pay the low price at easy terms in coupon below. If you don't want the set, return it and you owe NOTHING. In either event, you keep the Business-Starting Book absolutely FREE.

**FREE SEND NO MONEY!**  
BOOK COUPON

Coupon below is just a request to see the books free and get your gift book for doing it. ACT—Send coupon TODAY!



Educational Book Publishing Division,  
COYNE ELECTRICAL & RADIO SCHOOL, Dept. A7-R5  
500 South Paulina St., Chicago 12, Illinois

Send me that 3 volume set APPLIED PRACTICAL RADIO and my FREE gift book "Starting & Operating a Profitable Radio or Electrical Business". I'll either return the set in 7 days and owe nothing, or send you \$3 within 7 days after I receive the books and \$3 a month until \$10.75 is paid. Or I'll pay \$9.75 cash. Whether or not I keep the 3 Volume Set, the Business-Starting Book is mine FREE as a Gift.

NAME \_\_\_\_\_ AGE \_\_\_\_\_  
ADDRESS \_\_\_\_\_  
TOWN \_\_\_\_\_ ZONE \_\_\_\_\_ STATE \_\_\_\_\_

# ELECTROPLATING OUTFIT

BRUSH ON  
SILVER, COPPER

Only  
**\$3.95**  
COMPLETE



**Comes Ready to Use—Nothing Else to Buy!**

Here's the Handy ELECTRO-PLATER outfit for your home-workshop or business! Only \$3.95 complete! Puts a smooth, shining, silver or copper plating on silverware, toys, models, doorknobs, auto accessories, home fixtures . . . everything with a conductive surface! Simple, easy to use! Complete instructions furnished. Just brush on silver or copper plating! Comes complete—ready to use—with liberal jars of silver and copper plating materials, cleaner, two brushes, battery power unit . . . everything you need to start plating at once! Nothing else to buy.

**SEND NO MONEY! GUARANTEED!**

Rush order today—a postcard will do. Electro-Plater shipped direct to you by express. Pay only \$3.95, plus express charges, on delivery—or send \$4.00 with order and we ship prepaid. Use 10 days, if not completely satisfied, return outfit and your money will be refunded. Order now.

**HANDY ELECTRO-PLATER** • Dept. B-413  
259 Strader Avenue Cincinnati 26, Ohio

# BIG MONEY NOW

## In a Profitable Business of Your Own! Full or Spare Time!

We'll tell you how you can easily start a profitable business of your own with our amazing Liquid Imitation Marble, Fibre-Tile Flooring and Flexible Molds. No big investment necessary and you can work right from home. These amazing products have already started many on the road to success and financial independence. No experience necessary. We tell you how!

Today send your name and address and get started along the road to financial success.

## FREE CATALOG AND FULL DETAILS

**Composition Products Co.**

5853 DELMAR BLVD., DEPT. 61, ST. LOUIS 12, MO.

## STAMP COLLECTION FOR SALE!

Collection of 500 Different Postage Stamps From All Over the World. Many Unused! Colorful additions to Your Present Collection. A Wonderful way to Start the World's Most Popular Hobby. The Perfect Gift! Only \$1.

**FREE!** If you Order Now! 500 Peelable Hinges to Mount above in your Album! Also Bargain List of Other Collections from 10c to \$810.00. Send your \$1 today.

NEPTUNE STAMP CO., Dept. C-1, Neptune, New Jersey

## Learn RADIO TELEVISION ELECTRONICS

Train at home, in spare time, for a good pay job or start a business of your own *without capital*—under our *proven* 2-Way method that helps you get into this money-making field of radio *quicker*. You receive Lessons *plus* Home Shop Practice including 9 kits of radio parts to make hundreds of tests. Many students earn money in spare time while learning. Write for **FREE** book "Your Opportunities in Radio" to Hollywood Radio & Television Institute, (Established 1929), Dept. A5, 810 W. 6th St., Los Angeles 14, Calif.

## MAKE MONEY AT HOME

### RUBBER MOLDS

Low as 6¢ EA.



Amazing rubber mold-making outfit makes perfect flexible molds of plaques, ash trays, bookends, etc. Molds cost 6c to 25c each. Each mold makes hundreds of novelties and gifts to sell for \$1.00 apiece and more! No experience necessary. Everything furnished. Quick and easy. Start profitable business in your home—sell to stores, gift shops, friends, resorts, road stands, by mail. Full or spare time. Write for complete **FREE** details and easy instructions.

SO-LO WORKS, Inc., Dept. W-800, Loveland, Ohio

## RAISE CHIN-CHINS



No experience needed. Just a few minutes daily and a few feet of backyard, garage or barn space. Several females and a male starts a large, profitable herd. **WE FURNISH FREE INSTRUCTIONS.** TREMENDOUS DEMAND for breeding and laboratory stock, meat, and world's most beautiful rabbit fur. Brokers, cut off from imported rabbit pelts by world famine, **NEED CHIN-CHIN FURS NOW**, and for years to come! Write for free illustrated catalog today.

WILLOW BROOK FARM • R-36, SELLERSVILLE, PENNA.

## SUIT YOURS AS A BONUS

**AND BIG MONEY IN SPARE TIME, TOO!**

We want you to wear this fine made-to-measure suit! Make it yours by sending a few orders, & earn **BIG CASH PROFITS** in spare time. Your suit will help you get more orders with scores of rich, quality fabrics, tailored-to-measure to newest styles. Also Ladies' Tailored Suits—complete line. Write today for **FREE SAMPLES** NO EXPERIENCE, no money needed. For quick action tell us about yourself.

**J. C. FIELD & SON, INC.**  
Harrison and Throop Sts., Dept. T-1716 Chicago 7, Ill.





# WHICH OF THESE *Opportunities* INTERESTS *You* MOST?

● Today, choose the job you want—and prepare for it. Or if you are already engaged in the work you like best, start training now for quicker promotion. Acquire the knowledge that will help you to get ahead faster, make more money and have greater security.

American School, founded in 1897 as an educational institution *not for profit*, can help you to reach your goal just as it has helped others during the past fifty years. Check the coupon at right, add your name and address and mail it at once. The school will send you details on its training plan and outline of study prepared by specialists. There is no charge, no obligation, so send the coupon immediately.

## CHECK, CLIP AND MAIL COUPON NOW

AMERICAN SCHOOL, Dept. G-A45, Drexel at 58th, Chicago 37, Ill.  
Without obligation, Please send FREE and postpaid, bulletin and details of the Subject checked.

- |  |   |  |
|--|---|--|
| <input type="checkbox"/> PLASTICS ENGR             | <input type="checkbox"/> Accounting                   | <input type="checkbox"/> Drafting and Design for Men and Women |
| <input type="checkbox"/> Refrigeration             | <input type="checkbox"/> Electrical Engr.             | <input type="checkbox"/> Radio                                 |
| <input type="checkbox"/> Architecture and Building | <input type="checkbox"/> Electricity—Pract.           | <input type="checkbox"/> High School                           |
| <input type="checkbox"/> Contracting               | <input type="checkbox"/> Electronics, Industrial      | <input type="checkbox"/> Air Conditioning                      |
| <input type="checkbox"/> Practical Plumbing        | <input type="checkbox"/> Bookkeeping                  | <input type="checkbox"/> Mechanical Eng.                       |
| <input type="checkbox"/> Automotive Engr.          | <input type="checkbox"/> Private Secretary            | <input type="checkbox"/> Shop Management                       |
| <input type="checkbox"/> Aviation Drafting         | <input type="checkbox"/> Diesel Engineering           | <input type="checkbox"/> Tool Making                           |
| <input type="checkbox"/> Aviation                  | <input type="checkbox"/> Sheet Metal Pattern Drafting | <input type="checkbox"/> Better Foremanship                    |
| <input type="checkbox"/> Business Mngmt.           |   | <input type="checkbox"/> Machine Shop Operations               |
| <input type="checkbox"/> Railway Training          |   |  |

NAME \_\_\_\_\_ OCCUPATION \_\_\_\_\_  
ADDRESS \_\_\_\_\_ AGE \_\_\_\_\_  
CITY \_\_\_\_\_ STATE \_\_\_\_\_

### AMERICAN SCHOOL

Dept. G-A45, Drexel at 58th Street, Chicago 37

## MAKE YOUR OWN COSTUME JEWELRY SPLENDID HOBBY OR VOCATION

Sea Shells • Pin Backs • Ear Screws • Screw Eyes  
Plastic Discs • Ear Clips • Floral Stones • Jump Rings  
Chains • Clasps • Wire • Boxes • Bracelets • Paris  
Bow Knots • Catches • Plexiglas • Cements • Dyes

WRITE FOR FREE CATALOGUE • DEPT. B

PHILADELPHIA BADGE CO., 1007 Filbert St., Phila. 7, Pa.



## DRAW for MONEY

### BE AN ARTIST!

**Trained Artists Are Capable of Earning \$50, \$60, \$75 a Week**

Use Your Spare Time to Prepare for a Profitable Art Career! **COMMERCIAL ART, DESIGNING and CARTOONING**—all in ONE complete home study course. No previous Art experience necessary—we teach you step by step—hundreds have profited by our practical method. **TWO ART OUT-FITS FURNISHED.** Full information in colorful, **FREE BOOK, "Art for Pleasure & Profit"**—tells all about our course, service—and commercial opportunities for you in Art.

Approved for training under "G.I." Bill.

**FREE BOOK gives details!**

WASHINGTON SCHOOL OF ART  
Studio 126 H, 1115 15th St., N.W., Wash. 5, D. C.  
Send your booklet and full particulars.

Name \_\_\_\_\_ AGE \_\_\_\_\_  
Street \_\_\_\_\_  
City \_\_\_\_\_ Zone \_\_\_\_\_ State \_\_\_\_\_

## NOW! Build Your Future On DIESEL Opportunities



LOOK around you. See the way tractors, trucks, buses, railroads, ships, power plants and equipment of many kinds are "going Diesel." Every day new opportunities are opening—in industrial and farming communities—for trained men who can install, maintain, operate and repair Diesel engines. Plan now to build your future in this growing field.

### Diesel Knowledge is Earning Power

You don't have to give up your present job. Now, you can begin learning DIESEL in spare time at home. UEI practical training teaches you, step by step, how Diesel engines operate, how fuel systems work, repairs, accessories and auxiliary equipment; a world of Diesel "know how." Includes actual practice on Diesel equipment in our shop under expert guidance. UEI training methods are successful. For 20 years they have helped mechanically inclined men better themselves.

### NOW IT'S UP TO YOU!

Coupon below brings you all the facts without cost or obligation. Get going today! MAIL COUPON NOW.

**UTILITIES ENGINEERING INSTITUTE** *Founded 1927*  
Diesel Division  
1314 W. Belden  
Dept. 167-D,  
Chicago 14, Ill.

Send  
Coupon for  
**FREE  
FACTS**

UTILITIES ENGINEERING INSTITUTE, Diesel Division  
1314 W. Belden Ave., Dept. 167-D, Chicago 14, Ill.  
Please send me Free Facts about Diesel opportunities and training.

NAME \_\_\_\_\_ Age \_\_\_\_\_  
ADDRESS \_\_\_\_\_  
CITY \_\_\_\_\_ Zone or County \_\_\_\_\_ STATE \_\_\_\_\_  
 Check here for special information if you are under 17.  
 Check here if Veteran of World War II.



# Learn **DRAFTING**

I Will Train You at Home Until You Have a **GOOD PAY JOB!**

Engineer Dobe

**Give Yourself a Chance to Make Good in this Big Opportunity Field**

Don't be a fellow who "never had a chance"—for your big chance is right here now—in Drafting. The field for draftsmen is bigger now than ever before, for drafting is the basic profession and all new products start with the draftsman.

Get into Drafting now. I will train you at home, in your spare time and give you actual experience on actual work—the same kind of jobs you will do for the best paying firms. I will train you until you are competent, fully experienced and holding a position that will bring advancement and pay raises as deserved. Write me today!

### WORKING TOOLS INCLUDED

You get drafting instruments, table and other equipment when you start. Nothing for you to buy.

### EXPERIENCE WHILE LEARNING

Don't forget! I train you through practical jobs—I give you experience. And I list this experience as a reference to employers when you are ready to go to work. Lack of starting knowledge or higher education should not hold you back. Low cost—and monthly payments, if desired.

### ACT NOW!

Mail coupon to me today! No salesman will call, but you will get my big book and all details. Give your age to get reply.



### MAIL COUPON FOR VITAL FACTS

Engineer Dobe, Div. 16, Libertyville, Ill.

Send me the Vital Facts on Drafting and Industrial Designing, your Free Book and advertised list of positions for Draftsmen and Designers wanted.

Name..... Age.....  
 Address.....  
 City..... Zone..... State.....

# Now for EVERY WORK SHOP!

## NEW Invention Electroplates by BRUSH



### Easy to Plate CHROMIUM GOLD, SILVER, NICKEL, COPPER . . . For Pleasure and Profit!

If you have a workshop—at home or in business—you need this new Warner Electroplater. At the stroke of an electrified brush, you can electroplate models and projects—you can replating worn articles, faucets, tools, fixtures, silverware, etc. with a durable, sparkling coat of metal . . . Gold, Silver, Chromium, Nickel, Copper or Cadmium. Method is easy, simple, quick. Everything furnished—equipment complete, ready for use. *By doing a bit of work for others, your machine can pay for itself within a week.* So make your shop complete by getting a Warner Electroplater right away. Send today for FREE SAMPLE and illustrated literature. **ACT AT ONCE! Mail Coupon.** **WARNER ELECTRIC CO., DEPT. M-3 1512 Jarvis Avenue, Chicago 26, Ill.**

### FREE Details & Sample!

WARNER ELECTRIC CO., 1512 Jarvis Avenue, Chicago 26, Dept. M-3

Gentlemen: Send Free Sample and Details to:

Name.....  
 Address.....  
 City..... State.....

# MAKE *Extra* MONEY DRAW CARTOONS at HOME!

Learn How! Act NOW! . . . Send only \$1.00

You'll say it's the best dollar you ever invested! Learn how to draw cartoons in 10 EASY lessons . . . learn where and how to SELL them, rates of pay, how to approach big magazines and syndicates. Many other valuable tips. ALL for one dollar! Act NOW! Address . . . EASY CARTOONS, 4305 Crown St., Indianapolis 8, Ind.

## BE A REAL ESTATE BROKER PAYS BIG!

**EASY TO LEARN**—Start and run your own business quickly. Many graduates report making up to \$1000 a month. Course of study covers Sales, Property Management, Appraising, Loans, Mortgages and hundreds of related subjects. Course offered in home study or residential classrooms.

Big new illustrated catalog from this nationally known school. Send Post Card Today. G. I. Approved.

**WEAVER SCHOOL OF REAL ESTATE**  
 Dept. KA-4, 15 E. Pershing Road Kansas City, Mo.

## MAKE MONEY CASTING AT HOME

**FREE FACTS SENT**

Cast thousands of perfect Plaques, Book Ends, Ash Trays, Etc. Plaster, Liquid Marble, Etc. ENORMOUS PROFITS. Start in basement or garage. LITTLE CAPITAL NEEDED. QUICK, EASY, NO PREVIOUS EXPERIENCE NEEDED. Rubber molds for speed production. MAKE YOUR OWN. Sample Kit \$1.00. Canadian \$1.50. Plastic Arts Studio, Route 5, Dept. 29, Muncie, Ind.

## GET INTO REFRIGERATION AND AIR-CONDITIONING

Build your future in fast-growing industry. Prepare for high pay jobs or get into your own business. Dept. M-6 Resident classes only.

Send ad with name and address for information. VETERANS Eligible for training under G. I. Bill, Check here

**BOSTON TECHNICAL INSTITUTE**  
 School of Refrigeration, 4707 Euclid Ave., Cleveland 3, Ohio

## ARTISTS MAKE MONEY

Do you like to draw? Send name, address, age and occupation for FREE ART TEST, to find out your ability.

**ART INSTRUCTION, Inc.**  
 6137 ART INSTRUCTION BLDG., MINNEAPOLIS 15, MINN.

## LEARN CARPENTRY

Get in on the biggest building boom in history. Prepare for a long and profitable career as a big-pay building tradesman. Actual shop training under expert instructors. Write for big free catalog today.

**MIDWEST SCHOOL OF BUILDING TRADES**  
 Dept. C16, 411 N. Center St., Bloomington, Ill.

**VETERANS ASK FOR GI PLAN**

Free FACTS

## U.S. GOVERNMENT JOBS

**START \$1,756 TO \$3,021 YEAR**

Men—Women Prepare NOW for Next Examinations.

**FRANKLIN INSTITUTE**  
 Dept. J120, Rochester 4, N. Y.

First: Rush without charge (1) 32-page Civil Service book with list of U. S. Government Jobs (2) Tell me how to prepare for one.

Name.....  
 Address..... Vet?.....

Vets Get Preference. Mail Coupon today sure.

COUPON



**Mr. America!** would you trade 5 minutes reading time for . . . .

**NEW VIGOR • STRENGTH • VITALITY**

**Alan Stephan**—official winner of the National A.A.U. Title, "Mr. America"\* now offers you all his training secrets.

Alan Stephan, the physical phenomenon of the day, is acclaimed from coast to coast as America's finest male physique. A physical training instructor in the U. S. Navy during the war, he is an unprecedented example of what rigid adherence to sound, logical principles of physical training can do for you.

Solely through his own efforts, Alan Stephan developed from a skinny, underweight weakling into a physical marvel of title-winning proportions. Today, he stands six feet, weighs 205 pounds; his chest is super-impressive, and the muscular development of his arms and back is amazing.

Living proof of what his personally developed training system can accomplish, no man in America today is better qualified to show you how you can attain new vigor—new strength—new vitality.

\*June 8, 1946

**Accept this Special Free Offer from Alan Stephan**

If you act promptly, Alan Stephan will send you a FREE copy of his profusely illustrated book, "Presenting Mr. America . . . Alan Stephan." His book will clearly show you the way to sparkling pep, glowing vitality, vital power. Less than 5-minutes reading will tell you how.



**Act now—Mail this coupon at once!**



Alan Stephan—Post Office Box 1080, Chicago 90, Illinois  
Please send me, FREE and without any obligation, "Presenting Mr. America . . . Alan Stephan." PM-67

Name.....  
(Please print plainly)  
Address.....  
City..... State.....  
Date of Birth.....

**Have an OFFICE of YOUR OWN!**

**LEARN NEW PROFITABLE PROFESSION**  
At Home in 60 Days, Men & Women, 18 to 70!

Earnings of men and women in this profession run as high as \$5,000-\$15,000 yearly. Others make good money in spare time. Little money needed to start. A business where your earnings begin sooner. Easy to learn. No selling or goods to buy. No experience necessary. A depression-proof business. A course of action to guide you step by step as you earn. All 53 lessons sent at once to use as operating manuals. Easy terms. Diploma. Money-back agreement. Write for FREE BULLETIN.

**FRANKLIN CREDIT SCHOOL**  
Dept. 75-F ROANOKE 7, VIRGINIA

Be Your Own Boss and the Boss of Others. Be Respected. Meet Interesting People.



**BY MAIL in Easy Lessons**

**New PERSONAL RADIO... Pocket Size**



This little radio is substantially built and is so constructed that, if dropped, it will not break. It has a beautiful red leatherette case. May be carried in your pocket wherever you go. Reception is guaranteed when used according to instructions.

There is no cost in operating this radio as there are no tubes and no batteries to buy, and no electricity needed. Instead, the new "Crystal diode" rectifier same as used in Army and Navy ultra hi-frequency radar sets is being employed. It is not a toy, but a practical little radio for football or baseball games, news reports, or your favorite program. It is especially good to listen to in bed, or in hospitals, dormitories, barracks, and offices because it is not heard by anyone but yourself.

Send only \$1.00 (check, money order, cash) and pay postman \$3.95 plus delivery fees, or send \$4.95 for postpaid delivery.  
**SHEESS MFG. CO., LAKE GENEVA, WIS.**

Please Mention Popular Mechanics When Answering Ads

**LIQUID MARBLE COLORED POTTERY**

Different! Marvelous! Color-glazed, Brush, spray, mold tiles, table-tops, ornaments! **SANITARY COMPOSITION FLOORING**—Dustless, noiseless; put on like plaster, plain or tile designs; yielding as cork. **RUBBERLASTIC Mold Compound**—For plaster casting, novelties, statuary, toys, plaques, dolls. **TILEX Colored Roofing**. Build Modern **PLASTIC HOMES**. Illustrated literature free. **RAPID MARBLEIZING SERVICE, Dept. 10-A, Edwardsville, Illinois**

**ELECTRICIANS**

Get this Great Book

**FREE**

For Merely Examining  
Coyne's NEW Pay Raising

**7 Volume Set APPLIED ELECTRICITY**

Here's a brand new set of electrical books to give you the "know how" on all branches of electricity from appliance repairing to D. C. and A. C. equipment, electrical refrigeration, etc. 3,000 subjects, 10,000 facts, latest methods all explained in easy to follow instructions. In order to prove how valuable and Practical this set of electrical books is I'm willing to give you a FREE copy of my book "150 Shop Prints and How to Read Them." Just for looking over this set. Written by the Coyne Technical Staff and backed by 47 years' experience, this set has helped many ambitious electrical workers to bigger pay, better jobs & added opportunity.

**OFFER LIMITED • ACT NOW!** Here's my offer to you—If you act promptly, I'll send you the 7 volume set Applied Practical Electricity for 7 days FREE examination . . . together with the 150 Shop Print Book. Look the set over 7 days. If you like it send either \$19.75 cash or send \$3.00 after 7 days and \$3.00 per month until \$21 is paid. If you don't want the set, return it and YOU OWE NOTHING. In either event, however, you keep the 150 Shop Print Book absolutely FREE.

**SEND NO MONEY!** Coupon below is just a request to see the books free and to get my gift book for doing it. ACT—Send coupon Today!

**FREE BOOK Coupon**  
Technical Book Div., COYNE ELECTRICAL SCHOOL, 500 S. Paulina Street, Dept. A7-R6, Chicago 12, Ill.

**COYNE ELECTRICAL SCHOOL, Dept. A7-R6**  
500 SOUTH PAULINA STREET, CHICAGO 12, ILLINOIS

Send me that 7 volume set APPLIED PRACTICAL ELECTRICITY and your FREE gift of a copy of "150 Shop Prints and How to Read Them". I'll either return the set in 7 days and owe nothing or send you either \$3 in 7 days and \$3 a month until \$21 is paid or \$19.75 cash. Regardless of whether or not I keep the 7 Volume Set the 150 Shop Prints is mine FREE as a Gift.

NAME..... AGE.....  
ADDRESS.....  
TOWN..... ZONE..... STATE.....



**MAKE UP TO \$10  
ON EVERY SALE!**

**AIR  
CORPS  
TYPE  
SUN  
GLASSES**



**\$5<sup>00</sup>  
—  
SELLS  
EVERYWHERE  
UP TO \$15 and MORE!**

A Real Fast Money-Maker! Here are genuine 12 Karat gold filled, Air Corps Type SUN GOGGLES complete with "Pearltext" sweat bar, brow rest and rocking pads, scientific ray-absorbent "No Glare" ground and polished sage green lenses, dropped before curving, and self-adjusting comfort cable ear pieces. Handsome crush-proof case included. Will protect eyes from glare, sun, wind, dust and exposure. Wonderful for auto drivers, policemen, golfers, gardeners, farmers and all outdoor workers and sportsmen. Available in Men's and Ladies' sizes. Sold on 10 day no risk trial money-back guarantee. You can easily sell 3 or more pairs a day. Send for your sample pair of these fine Sun Goggles—only \$5.00, postage prepaid. Or send no money. Just deposit \$5.00 with your own postman, plus postage—your money back if not delighted.

**MIDWEST SCIENTIFIC CO.** Dept. 805, 1148-1160 W. Chicago Ave. CHICAGO 22, ILL.

**MAKE MORE  
MONEY**

**APPLYING OR SELLING**

**CORKSTONE  
PLASTIC FLOORING**

**EASY  
TO  
APPLY**

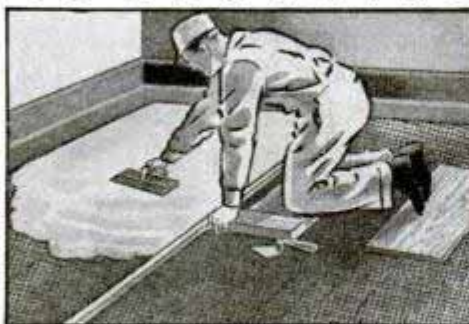

Here's your opportunity to get into business for yourself applying or selling Corkstone, the economical, top-grade plastic flooring. Plenty of profit. Act without delay!

**Dealers & Agents Wanted**

**WRITE FOR DETAILS**

**LASTING PRODUCTS COMPANY  
FRANKLINTOWN ROAD PLANT, BALTIMORE 23, MARYLAND**

**MAKE UP TO \$5<sup>00</sup> AN HOUR  
In Your Own YEAR 'ROUND Business!**

**ONLY A FEW  
DOLLARS  
PUTS YOU IN  
BUSINESS!**

Many Clearing as High as \$20 to \$30 a Day NET Renewing Rugs, Carpets, Upholstery. New Method Now Used for Auto Upholstery. Write for Facts About Quick, Easy Way to Get Started

Here is the chance you've been looking for to step into a pleasant, dignified, big-pay business of your own that offers you a steady, year 'round income. Start on "a shoe-string," full or spare time, right from your own home. Equal opportunities for men and women, young or old, in small towns or big cities. No experience needed. Many making big money with new Americlean System just cleaning auto upholstery. Easy to learn. We send you complete instructions and quick-cleaning supplies so you can start making money the very first day! Quick method cleans upholstery, rugs and carpets like new without taking off floor! Tremendous demand in homes, apartments, hotels, stores, office and public buildings. Steady repeat business. Territories going fast. Write today for full FREE facts. No cost or obligation. Rush letter or postcard now to **AMERICLEAN CO., Inc.; Dept. G-6; 211 North 7 St.; St. Louis 1, Mo.**

**WRITE  
FOR FREE  
DETAILS  
NOW!**

**AIR CONDITION \$1<sup>00</sup>**  
Build Your Own in 2 Days  
OR MAKE FOR RESALE AT GOOD PROFIT

Complete, easy to follow instructions and drawing adaptable for Office, Store or Home. No unusual mechanical skill necessary—no refrigeration system required—inexpensive to make and operates at extremely low cost. Send \$1 at once and beat the heat this summer.

**IMPERIAL AIR CONDITIONING**  
3778-P West Chicago Detroit 6, Mich.

**Learn CARTOONING**

HAVE FUN! MAKE MONEY! Cash in on your sense of humor at HOME—BY MAIL. No experience needed to start. Write today FOR FREE TRIAL LESSON and full particulars.

Meon Gag Cartoon School, Dept. P, Fall Creek, Wis.



**CORRESPONDENCE COURSES IN  
RADIO and ELECTRICAL ENGINEERING**

**Tuition  
\$25**

**ELECTRICAL ENGINEERING.** Get good grasp of wide electrical field. Modern. Very understandable. Theory made easy.  
**RADIO ENGINEERING.** Extra fine course in radio, public address, photo-electric work. Trains you to be super-service man, real vacuum tube technician. Tuition ONLY \$25, either course. Deferred payment plan. Servicemen needed badly.  
**FREE** Write for free copies of school catalogs, student magazines, etc.  
**LINCOLN ENGINEERING SCHOOL, Box 931-P102, Lincoln, Nebr.**

**CHAPMAN CHINCHILLAS**

The originator of the first Chinchilla Farm in the United States. For information on purchasing the finest, selected breeding stock of these aristocratic animals that were virtually trapped to extinction write or visit—

**Established 1919** **Chapman Chinchilla Farm**  
4957 West 104th Street  
Inglewood, California

**do you WORRY?**

Why worry and suffer any longer if we can help you? Try a Brooks Patented Air Cushion. This marvelous appliance for most forms of reducible rupture is **GUARANTEED** to bring YOU heavenly comfort and security—day and night—at work and play—or it costs you **NOTHING**. Thousands happy. Light, neat-fitting. No hard pads or springs. For men, women, and children. Durable, cheap. **Sent on trial** to prove it. Not sold in stores. Beware of imitations. Write for Free Book on Rupture, no-risk trial order plan, and proof of results. All Correspondence Confidential.



**Brooks Company, 359D State St., Marshall, Mich.**





SALES ENGINEER    MOLD DESIGNER    RESEARCHER    FABRICATOR    LAMINATOR    PARTS INSPECTOR    MOLDING TECHNICIAN    YOUR OWN BUSINESS

# WHICH CAREER IN PLASTICS DO YOU WANT?

Plastics is one of the fastest growing industries—offering you unusual opportunities for an interesting, successful career and security in the years ahead. Trained men, with plastics know-how will fill the important, well-paying positions. YOU can be one of them. Mail the coupon below for a big, colorful, free catalog on Plastics and complete de-

tails about Plastics Institute, America's oldest and largest plastics school. Resident School located in beautiful Southern California. Comprehensive Home Training Courses to prepare you in your spare time at home for a career in plastics. You can enroll immediately! Write Plastics Institute, Dept. PM7-6, 1601 S. Western Ave., Los Angeles 6, California.



APPROVED FOR VETERANS

### LEARN BY DOING

To give you practical experience we supply colorful plastics to make useful, attractive creations. You can also make and sell plastics articles to earn while learning.



PLASTICS INSTITUTE in the heart of sunny Los Angeles. Here modern laboratories and shops give Resident School students facilities for practice on the finest of industry-type plastics equipment. Also the headquarters for HOME TRAINING.

## Plastics INDUSTRIES TECHNICAL INSTITUTE

NEW YORK    CHICAGO    LOS ANGELES

Plastics Industries Technical Institute  
Dept. PM7-6, 1601 S. Western Ave., Los Angeles 6, Calif.    Mail in Envelope or paste on penny postcard

Gentlemen: Please send me the booklet "World of Plastics" and information on your Resident School Courses ( ) Home Training Courses. ( ) I understand there is absolutely no obligation.

Name (PRINT).....Occupation.....

Street (PRINT).....Age.....

City.....Zone.....State.....

Important: Please fill out coupon completely. If Veteran, please check. ( ) If in Armed Services now, please check. ( )

FREE BOOKLET

# LAW...

**STUDY AT HOME** Legally trained men win higher positions and bigger success in business and public life. Greater opportunities now than ever before. **More Ability: More Prestige: More Money** We guide you step by step. You can train at home during spare time. Degree of LL.B. We furnish all text material, including 14-volume Law Library. Low cost, easy terms. Get our valuable 48-page "Law Training for Leadership" and "Evidence" books FREE. Send NOW, G. I. APPROVED. LASALLE EXTENSION UNIVERSITY, 417 South Dearborn Street A Correspondence Institution Dept. 664-L Chicago 5, Ill.

## Good Handwriting

HELPS YOU WIN SUCCESS!

It's so important to write a good hand for business and social advancement. Poor illegible penmanship often causes costly errors and marks you for failure. Why write a poor hand? It's so easy to learn at home in spare time. Write for our new free booklet today. If you wish, send 10c for a penpoint suitable for shaded writing and your name beautifully written. THE TAMBLYN SCHOOL OF PENMANSHIP In Business Since 1895 H-441 Ridge Bldg., Kansas City, Mo., U. S. A.

# PHOTOGRAPHY for PLEASURE or PROFIT

**QUALIFY AT HOME!** Learn expert photography as a joy-full hobby, or to qualify for a well-paid position or your own studio. Previous experience unnecessary with N.Y.I.'s success-proved home study training. Details FREE. Also resident courses.

NEW YORK INSTITUTE OF PHOTOGRAPHY, Dept. 49  
10 West 33 St. New York 1, N. Y. (37th Year)

## Store Route Plan PAYS BIG MONEY

### SELL COUNTER CARD PRODUCTS

Build a good-paying business of your own. Call on dealers of all kinds; show nationally-advertised Aspirin, Vitamins, Cosmetics and 200 other necessities. Big 5c and 10c retail packages, high quality. Attractive counter displays sell goods fast. Free book gives amazing facts. Write! World's Products Co., Dept. 10-P, Spencer, Ind.



# No Waiting to LEARN START NOW TO EARN!

This BIG BOOK SHOWS HOW



### IF IT'S RESULTS YOU WANT—GET ACTION QUICKLY WITH THESE PRACTICAL IDEAS

Never before has a more helpful book been printed for those planning a business of their own. Gathered in this large illustrated volume are the formulas, recipes, facts and secrets that have contributed so largely to America's great industrial progress. Capitalize on this information for making most any conceivable product without experience, special equipment or previous knowledge of chemistry or manufacturing.

The experts who compiled this book are authorities, and present this information in simple, understandable language. They also give you wholesale supply sources for needed materials, short cuts and methods for the most profitable results.

### START AT HOME—Expand out of profits.

Hundreds of good paying businesses have been built on a product made from a simple recipe. Choose from any of the 162,000 facts and 10,000 formulas of which the following are only a very few: Adhesives, Alloys, Anti-Freeze Solutions, Cosmetics, Beverages and Liquors, Candy, Gum, Casein, Celluloid, Oils and Ointments, Paints, Paper, Perfumes, Photography, Polishes, Powders, Remedies for Man, Beast or Fowl, Rubber Products, Refrigerants, Soaps, Solder and Soldering, Tooth Cements, Transfers, Transparencies, Varnishes and thousands of others for making all sorts of profitable and practical things.

### ALSO

We include Free —our new book of helpful money-making information: — "The More You Know the More You Can Earn—Easier and Quicker."

### MANY FORTUNES MADE FROM A SINGLE IDEA!

This comprehensive book is an accepted authority by chemists, schools, industry, etc. and is the largest and most comprehensive book of its kind ever issued. Nothing else like it in existence. A single formula has been worth a thousand times this book's small cost to countless owners. Crammed with money-making ideas. Invaluable for reference. Ideal for Factory, Home, Farm, Office or Workshop. As necessary as the dictionary and more useful for manufacturers, chemists and salesmen who put up products for profit.

POSTPAID \$3.98 ANYWHERE IN THE WORLD

\$3.98 U. S. Funds. Postpaid anywhere in the World. (C.O.D. in U. S. A. only) Immediate Shipment. Safe Delivery Guaranteed.

ADAMS BROWN COMPANY BOOKS OF APPLIED SCIENCE  
Dept. 176, Chestnut Hill 67, Massachusetts, U. S. A.





## 7X 50 NAVY BINOCULARS \$135.00

COATED OPTICS!

Mfgd. to U.S. Navy Standards! (Alignment guaranteed to .001") Brand new glasses. Dust proof! Climate proof! Individual eye adjustment. Instant focusing. Coated optics insure sharp, clear images! Ideal for long range hunting, yachting, watching planes, etc. This magnificent 7 power 50 mm. Navy Binocular gives better detail, heightening image contrast. Complete with carrying case only \$135.00 plus 20% Federal tax.



## 6X 30 NAVY BINOCULARS \$62.50

Coated Optics! Brand New

Lightweight Model made to rigid Navy specifications. Ideal for Hunting, sports etc. Made by Universal Camera Corp! Complete with case and straps—Similar to picture \$62.50 plus 20% tax. **WHILE THEY LAST!**

### OTHER BINOCULARS (3 to 16 POWER!)

12x40	Carl Zeiss. Like new	\$200.00
16x45	French Monte Carlo. New	135.00
12x38	French Monte Carlo. New	100.00
10x32	French Monte Carlo. New	79.00
10x50	German Dienstglass. Used	140.00
9x68	Bausch & Lomb. Coated. Like new	150.00
8x34	French Monte Carlo. New	67.00
8x25	French Monte Carlo. New	57.00
8x25	French. Used	52.00
7x50	German Dienstglass. Used	130.00
7x50	Bausch & Lomb. Coated. Like new	135.00
8x30	Carl Zeiss. Used	90.00
6x30	Carl Zeiss. Used	75.00
6x30	Universal. Navy-Lightweight. Used	37.50
6x26	Ross. London. Used	60.00
6x30	Talbot. U. S. Army. Used	37.50
5x40	Nat'l. Field Glass. Coated Optics. New	29.75
5x40	Fee & Sternwedel Field Glass. New	22.00
4x50	Super Eye Field Glass. No case. New	12.00
4x40	Fee & Sternwedel Field Glass. New	20.00
4x40	Wollensaack Field Glass. New	16.25
3x30	Fee & Sternwedel Field Glass. New	4.25
10X-20X-30X-40X	Variable Telescope. New	42.50

Add 20% For Federal Excise Tax. Carrying case and straps included. Supply limited. Give second choice.

### MONEY BACK GUARANTEE!

Use for 20 days at our risk and expense. If not fully satisfied, return for full refund of your money. **ORDER TODAY!** Send \$2.00 deposit and we will ship C.O.D. for balance. Cash orders sent postpaid.

### UNITED PRODUCTS CO.

7941 S. Halsted Dept. ARF-308 Chicago 20, Ill.  
(Reference Dun & Bradstreet)

## Ottawa Self-Propelled Buzz Master

**CLEAR LAND FAST!** Powerful 6-HP motor with friction clutch for safe operation. Cuts down timber, brush and hedge; turn blade vertically and saw logs to length. Can be equipped to fell largest trees. Has clutch pulley for belt work. Is fully guaranteed.



OTTAWA MFG. CO., 627 Brush Ave., Ottawa, Kansas

## Do You STILL CHANGE MOTOR OIL??

If so—you can END this needless waste and expense forever, with "RECLAIMO"

America's Foremost Oil Re-refining Filter. Continuously re-refines crankcase oil through an ingenious use of motor heat while driving!

1. Removes solids by filtration
2. Removes water-fuel dilution by heat and distillation
3. Prevents acid-sludge formation
4. Maintains stable viscosity
5. ELIMINATES ALL OIL CHANGES!

**CAR—TRUCK—TRACTOR and DIESEL OWNERS!** U. S. Bu. of Stds. Bul. 86 states: "Oil Does Not Wear Out Mechanically"—"Reclaimo's" re-refining action has fully confirmed that statement. This great oil-saving feature is indeed important, BUT of far greater importance are the savings resulting from "Reclaimo's" tremendous reduction of costly motor wear! Again available—also to dealers. Complete details in FREE Book "Oil Facts". Write now! RECLAIMO MFG. CO., 5087 Elston Ave., Dept. 49, Chicago 30, Ill.

### GET THE FACTS!



FREE 40 PAGE BOOK

## CONFIDENTIAL LOAN SERVICE

Borrow \$50 to \$300<sup>00</sup>

Need money? No matter where you live you can borrow BY MAIL \$50.00 to \$300.00 this easy quick confidential way.

BY MAIL

IT IS EASY TO  
BORROW  
BY MAIL!  
Completely confidential and private  
CONVENIENT  
MONTHLY  
PAYMENTS

NO ENDORSERS NEEDED  
EMPLOYED MEN and women of good character can solve their money problems quickly and in privacy with loans MADE BY MAIL. No endorsers or co-signers. We do not contact employers, friends or relatives. Convenient monthly payments. Send us your name and address and we will mail application blank and complete details FREE in plain envelope. There is no obligation.

STATE FINANCE CO.  
216 Savings & Loan Bldg., Dept. N-107, Des Moines 8, Iowa



## ARMY COMBAT SHOES

Sizes 7 to 10½  
Plus 25c Postage

\$2.75  
pair

## ARMY SERVICE SHOES

Sizes 7 to 12  
(Plus 15c Postage)

\$1.85  
pair



IN GOOD CONDITION  
NO REPAIRS NEEDED  
Suitable for All Outdoor Wear. If not completely satisfied, return shoes, and money will be promptly refunded.  
Send Check or Money Order; No C. O. D.'s

MAIL ORDER ONLY

Reference—Central National Bank of Delaware

FIRST STATE PATCH CO.

419 Shipley Street

Dept. M.

Wilmington, Del.



## TALK-SING thru your own radio with RADIO MICROPHONE

Be the life of the party. Put on your own broadcasts at home. Talk-Sing make announcements from any room. Wonderful voice practice. Microphone easily attached to any radio. Follow enclosed instructions. SEND NO MONEY—pay postman \$1.98 plus postage. Send Money Order or check and save postage.

EMPIRE RADIO & TELEVISION CO. (Dept. R2) 1521 Bedford Ave. Brooklyn 16, N. Y.



## Learn Public Speaking

Learn theory and fundamentals at home—in spare time. Then acquire actual experience and practice. Send for FREE booklet "Power of Effective Speech."

North American School, Dept. 135A  
1315 S. Michigan Ave., Chicago 5, Illinois

## CRAFT FINISHES SUPPLIES

Materials to produce a professional finish on every type article. Industrial finishes for the home craftsman's use on wood, metal, plastics, plaster, etc. Electroplating and shop supplies, novelty finishes. Catalog free.

CRAFT FINISHES Box M 467 Arlington, Virginia

FEW EXCLUSIVE TERRITORIES AVAILABLE!

DISTRIBUTORS WANTED!

Nationally Advertised Brand  
AUTO ACCESSORIES

\$500 TO  
\$600 SUPPLY  
LASTS ONLY  
WEEK TO 10  
DAYS

Have your own big business in a territory that is exclusively yours. Year around steady demand; national advertising to back you up. Write today for catalog, information and territories available... give age, experience, and complete background in first letter.

KNICKS MEND-RITE CO. 1443-47 Gentry, N. Kan. City, Mo.



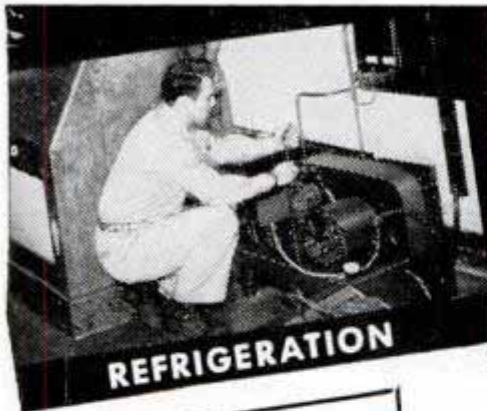

**REFRIGERATION**

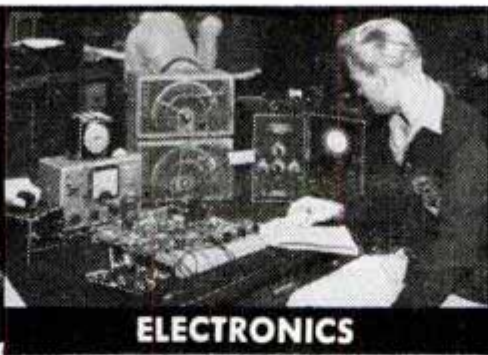

**ELECTRONICS**

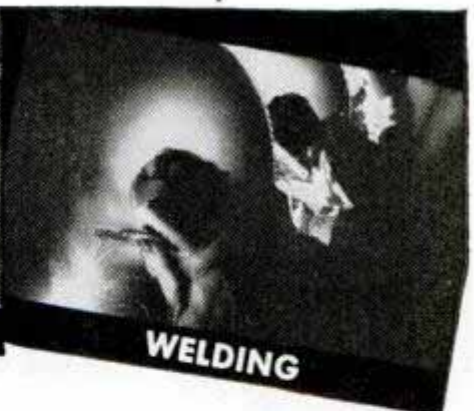

**WELDING**

Specialize In  
6 months to 3 years

**COURSES**

**SERVICE—6 months**

Practical Electricity  
Practical Welding  
Refrigeration Service  
Heating Service

**TECHNICIAN—1 Year**

Electro Technician  
Radio Technician  
Electronics Technician  
Refrigeration, Heating  
and Air Conditioning  
Technician

**PROFESSIONAL—3 Years**

Electrical Engineering  
B. S. Degree—Major in  
Machinery or Electronics

**PRACTICAL TECHNICAL TRAINING**

Our time-tested *CONCENTRIC SYSTEM* enables you to build your career step by step. Each 6-month course is complete in itself. Stay as long as circumstances permit—until you reach your desired occupational objective. For 44 years this school has specialized in technical training. More than 35,000 former students in industries the world over. 1,248 students now enrolled from 46 states and 5 foreign countries. Faculty of 63 specialists. World-wide alumni counselor committee. *Terms start July and September. SEND COUPON TODAY!*

**MILWAUKEE SCHOOL OF ENGINEERING**  
A Technical Institute

Milwaukee School of Engineering, Dept. PM-647  
N. Broadway and E. State, Milwaukee, Wis.

Without obligation, send me free booklet "Career Building" and more details on course in .....

Name ..... Age .....

Address .....

City ..... State .....



**LEARN To Repair and Service**  
Electrical Appliances,  
Sewing machines, mo-  
tors, bicycles, lawn mowers, saw filing,  
cutlery grinding, etc.

Start with \$20.00 and a few common tools!  
Build low cost equipment while earning. Make  
up to \$6.00 an hour! Free details. **\$5.50**  
Complete illustrated course only...

**REPAIRMAN'S SERVICE** 222 4th Ave.,  
Janesville, Wis.



**Bar Bells**

...at Factory Prices

**\$8.95**  
up

WRITE FOR FREE BOOKLET  
AND PRICE LIST

INDEPENDENT IRON WORKS  
2416 East 23rd Street, Dept. P5  
Los Angeles 11, Calif.

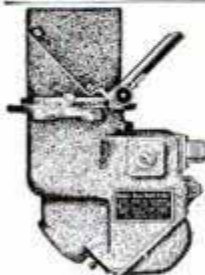

**War Surplus Bargains**

**B-29 AIR FORCE GUN SIGHT**

Contains Double Achromat Lens System  
and Lighting Assembly. Can be used to  
build Slide Projector, Viewer and Colime-  
ter. Many Optical or Photographic Uses.

Rush Check or Money Order  
Postpaid . . . \$5.00

Send 10c for complete surplus list

**PHILLIPS SALVAGE CO., Dept. H**  
8522 Elgin Ave., Detroit 5, Mich.

**NEW HELP FOR  
RUPTURE**

is the amazing Treatise which explains simple, easy, proven way for curbing your rupture permanently. Right at home; without costing you a cent. This proven way has helped thousands of rupture sufferers quickly. So don't let your rupture get worse. Send for **FREE** details today. Mailed to you in plain, sealed envelope. No obligation.

**BRADNER PUBLISHING CO.** (Established 1933)  
Box 332N, Dixon, Ill.

JUNE 1947

SAY YOU SAW IT IN POPULAR MECHANICS

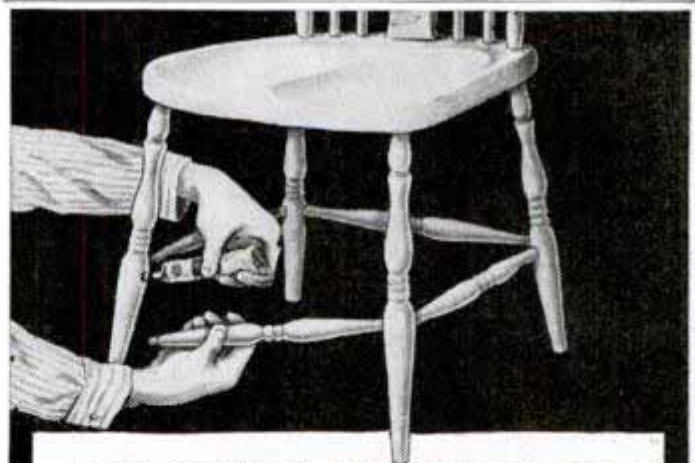

**REPAIRS**

**FURNITURE, LUGGAGE, ETC.**

It's transparent, water-  
proof, flexible  
and durable.



**DUCO CEMENT**

REG. U. S. PAT. OFF.



**IT COST THE NAVY**  
**Hundreds of Dollars—**



You Can Have It  
 for Only  
**\$8.95**  
 The Famous  
**MARK 18 GUN-SIGHT...**  
 The Miracle  
**OPTICAL GYROSCOPE!**

This wonder of the war—The aircraft gunsight that measures and computes automatically! The precision-balanced GYRO UNIT is easily removed with all WIRES. The tiny ball-bearing MOTOR magic GOVERNOR maintains constant speed from 14-22 V. at only 1/10 amp. AC or DC—24 volts. Perfect YOKE and special BEARINGS. The GYRO maintains fixed position in space. The hand-figured SPINNING MIRROR supports a perfect optical image at full speed. Energizing 6 electromagnets with DC will show erection rate, compute lead and deflections. Twin projection systems fuse both images into one. One fixed and one moving variable demonstrate virtual images. 2 SUPERB ACHROMATS in threaded brass cells, cemented doublets. 2" dia. 7 1/2" e.f.l. tested perfect for telescope objectives. 3 Precision first surface PLATS, aluminized. 2 1/2"x4 1/4" REFLECTING GLASS. SUN FILTER. Two 22 V. lamps in door, changeable for another voltage without rewiring. 2 glass-enclosed RECTICLES. Stainless GEARS. PLASTIC GEL CELL DEHYDRATOR with tell-tale colored SILICA GEL. Die cast aluminum case hermetically sealed. 24" CABLE. 10 coded WIRES. Detailed instructions. Detachable recoil shock BASE. 25-leaf spring bronze SLIDE on precision stainless ground RODS, azimuth CLAMP, bolted to wood shipping base. Padded cover. New original package. Send check, money order, or cash. No C.O.D.'s. Express collect.

**GE SELSYN CONTROL TRANSFORMER \$1.95**  
 24 volts. Limited quantity — Only  
**BUFFALO SURPLUS CO.**  
 26 E. NORTH ST.      PHONE GARFIELD 7706  
 BUFFALO 3, N. Y.

**INVENTORS**

The inventor who believes he has a new and useful invention, and finds himself in need of advice, should consult a competent registered patent attorney.

The question as to whether a subject matter is patentable can be substantially determined by a search of the United States Patent records.

Without obligation, write us for information as to what steps an inventor should take to secure a Patent.

**RANDOLPH & BEAVERS**

*Registered Patent Attorneys*

11-D Columbian Bldg., Washington 1, D. C.

**RANDOLPH & BEAVERS**

11-D Columbian Bldg., Washington 1, D. C.

Please send me full information on how to secure Patents & Trademarks.

Name.....  
 Street.....  
 City.....State.....

**FIND UNDERGROUND  
 MINERALS  
 and METALS  
 with M-SCOPE**

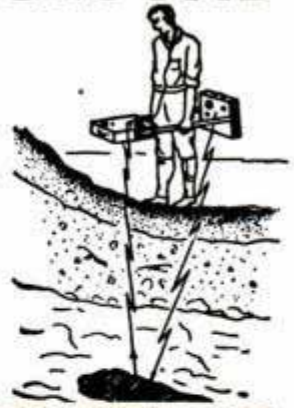

Employs same principle as Army Mine Detector. Unsurpassed in Efficiency. Write for Free 16 page booklet.

**FISHER RESEARCH LABORATORY, INC.**  
 PALO ALTO CALIFORNIA

**BUILDING**



Millions of homes needed. Nation wide call for builders. Big opportunities. Learn now in spare time, — at home. Practical training with blue prints. No books. Send for FREE Trial Lesson and blue print plans.

**CHICAGO TECHNICAL COLLEGE**  
 G-151 Tech. Bldg., 2000 S. Mich. Ave.  
 Chicago 16, Ill.



**GARDEN CUTOUTS**

Giant Assortment—48 patterns in all. Dutch boys, girls, dogs, birds, chickens, parrot, cats, geese, rabbits, squirrel, frog, bird houses, etc., plus toys, games. Beautiful, entirely new. Easy to make. Big Bargain. Novel method allows you to make project any size you desire. Sell these to your friends—make money. Send only \$1.00 today to JACKSON, Dept. 20, 5440 N. Shoreland Ave., Milwaukee 11, Wis.

**\$1.00**

**PATENTS**  
**AND TRADE MARKS**  
**C. A. SNOW & CO.**  
 REGISTERED PATENT ATTORNEYS  
 WRITE FOR INFORMATION TO  
 428 SNOW BUILDING, WASHINGTON 1, D. C.

**PATENTS** "Proof of Invention"  
 Folder mailed without obligation.  
**E. E. VROOMAN, Registered Patent Atty.**  
 871 Woodward Building, Washington 5, D.C.

**GOLD TEETH WANTED**

Dental gold teeth, plates and bridges with metal attached. Any broken pieces of gold jewelry. Immediate payment and free mailing container to you or your friends upon request.  
**LOWES, DEPT PM**      Holland Bldg., St. Louis 1, Mo.

**U.S. GOVERNMENT JOBS**

**START \$1,756 TO \$3,021 YEAR**

Men—Women  
 Prepare NOW for Next Examinations.  
**FRANKLIN INSTITUTE**  
 Dept. J118, Rochester 4, N. Y.  
 Sirs: Rush without charge (1) 32-page Civil Service book with list of U. S. Government Jobs. (2) Tell me how to prepare for one.

**COUPON**  
 Name.....  
 Address..... Vet?.....

Vets Get Preference. Mail Coupon today sure.



# PRESTO! ANYONE CAN MASTER GLAZE

LEAVES HARD GLASS-LIKE FINISH  
EASY TO APPLY  
PROTECTS THE SURFACE  
NO SMEAR OR STREAKS AS WITH WAX  
LASTS SIX MONTHS TO A YEAR



SAVES YOU MONEY

Car Owners! Meet Master Glaze—the sensationally different luster for new and used cars! Not a wax—not an oil polish—not a paint!—nothing that “smears” over the surface.

**MASTER GLAZE** is a unique discovery—a creamy liquid—quick and easy to apply! Gives a hard, glass-like surface. Even gasoline cannot dull it! Lasts six months to a year! Amazing luster—beautiful, sparkling clean and brilliant! Doesn't finger-mark—doesn't smear! A match box full glazes an entire car. Seals the pores—protects! **NOTHING LIKE IT!**

### AGENTS

An unusual opportunity! Quick, flashy demonstrator. Big profits. Good territory. Write today!

### FREE SAMPLE

Just send your name and address to

MASTER GLAZE CO., 7720-604 W. Harwood Ave., Milwaukee, Wis.

One of America's Leading  
Radio and Television Schools

## NEW YORK TECHNICAL INSTITUTE OF NEW JERSEY

158 Market Street, Newark, New Jersey

### Cut Hair at Home! Improved HAIR CLIPPER Pays for Itself First Month!

Real professional barber shop size! Cutting blade special, heat-treated cutlery steel, diamond-edge tested. Full size with wide blade and free easy cutting edge. Rust resisting. Easy to sharpen. Precision made throughout with wrought iron handles. Adjustable and easy to tilt for tapering haircuts. Cuts hair close (equal to shaving) or 1/4 inch long. FREE Book "How to Cut Hair" with every clipper. Order now before present supply is exhausted. Only \$2.99 postpaid or we send C.O.D. plus postage. Rush order today to



NOW ONLY \$2.99 Prepaid ORDER TODAY

**FARMSTON, Inc.** 16th and Junction, Dept. PM Racine, Wisconsin

## GIVE TO FIGHT



AMERICAN CANCER SOCIETY

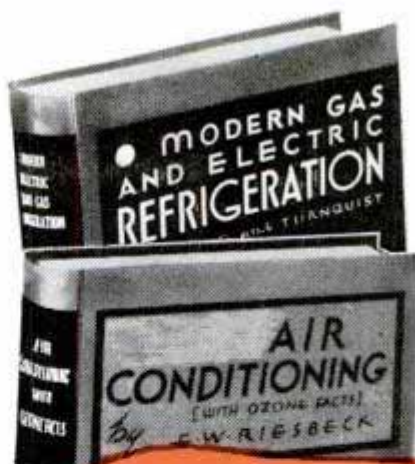

Prepare Now!  
Unusual  
Opportunities  
in these two  
Big Pay  
Fields!  
Mail Coupon

Learn  
**REFRIGERATION  
AIR CONDITIONING**  
This QUICK,  
LOW COST  
EASY Way

### FREE TRIAL in Your Home Use The Handy Coupon Below

Two of the biggest and best money-making fields today are Refrigeration and Air Conditioning with opportunities never before equaled. Men with the know-how are being paid big to service, install, rebuild and maintain household and commercial refrigerators and frozen food equipment. Air Conditioning, delayed by the war, is coming into its own and men with specialized knowledge will be needed in every branch for home and business installation.

**Modern Gas-Electric REFRIGERATION**  
Almost 1000 Pages  
408 Pictures  
17 Color Diagrams  
Thousands of Copies  
Used by U. S. Army for G.I. Training  
Complete Cost  
Only \$5.00

**AIR CONDITIONING With Ozone Facts**  
Over 450 Pages  
232 Pictures  
Complete Cost  
Only \$4.00

### 15 Million Refrigerators Need Service Air Conditioning Growing by Leaps and Bounds

Get ready for a good job or a profitable business of your own. Get your share of the millions to be spent on new equipment and to keep older devices going. Send today for Modern Gas and Electric Refrigeration, by Althouse and Turnquist, and Air Conditioning, by Riesbeck.

### Complete, Practical, Non-Technical — Easy to Read and Understand — Finest Reference Guide

These famous Willcox Books contain the same type material and subject matter included in the best shop courses yet they cost you only a small fraction of what such courses usually cost. Each book is complete and written so you can understand it. Hundreds of pictures make all types of equipment, methods and approved practice plain as day. Each book is a full self-training course prepared especially for men who want to reap the rich rewards these big fields offer. Men already engaged in the work will find the books worth many times their cost for reference use only.

### Used by Thousands of Successful Men

You take no chances. You too must be satisfied. Money refunded if books do not please you after 5 day examination. Order today.

Send No Money  
Mail Coupon

Goodheart-Willcox Co.,  
209 S. Michigan Ave., Dept. 150,  
Chicago, Ill.

Send books checked C.O.D. including charges. If not satisfactory I will return in 5 days and you will refund money paid. (Outside U.S. remit with order.) We pay all postage charges if remittance accompanies order.

Gas & Electric Refrigeration, \$5.00  Air Conditioning \$4.00

Name \_\_\_\_\_

Address \_\_\_\_\_

City \_\_\_\_\_ Zone \_\_\_\_\_ State \_\_\_\_\_

SAY YOU SAW IT IN POPULAR MECHANICS





To the man who wants to enjoy  
**an ACCOUNTANT'S CAREER**

**IF** you're that man, here's something that will interest you.

Not a magic formula—not a get-rich-quick scheme—but something more substantial, more practical.

Of course, you need something more than just the desire to be an accountant. You've got to pay the price—be willing to study earnestly, thoroughly.

Still, wouldn't it be worth your while to sacrifice some of your leisure in favor of interesting home study—over a comparatively brief period in your life? Always provided that the rewards were good—a salary of \$3,000 to \$10,000?

An accountant's duties are interesting, varied and of real worth to his employers. He has *standing!*

Do you feel that such things aren't for you? Well, don't be too sure. Very possibly they *can* be!

Why not, like so many before you, investigate LaSalle's modern Problem Method of training for an accountancy position?

Just suppose you were permitted to work in a large accounting house under the personal supervision of an expert accountant. Suppose, with his aid, you studied accounting principles and solved problems day by day—easy ones at first—then the more difficult ones. If you could do this—and if you could turn to him for advice as the problems became complex—soon you'd master them all.

That's the training you follow in principle under the LaSalle Problem Method.

You cover accountancy from the basic Principles right up through Accountancy Systems and Income Tax Procedure. Then you add C. P. A. Training and prepare for the C. P. A. examinations.

As you go along, you absorb the principles of Auditing, Cost Accounting, Business Law, Statistical Control, Organization, Management and Finance.

Your progress is as speedy as you care to make it—depending on your own eagerness to learn and the time you spend in study.

Will recognition come? The only answer, as you know, is that success *does* come to the man who is really *trained*. It's possible your employers will notice your improvement in a very few weeks or months. Indeed, many LaSalle graduates have paid for their training—with increased earnings—before they have completed it! For accountants, who are trained in organization and management, are the executives of the future.

### Write For This Free Book

For your own good, don't put off investigation of *all* the facts. Write for our free 48-page book, "Accountancy, The Profession That Pays." It'll prove that accountancy offers brilliant futures to those who aren't afraid of serious home study. Send us the coupon *now*.

Over 2300 Certified  
 Public Accountants among  
 LaSalle alumni

**G. I. APPROVED**

## LASALLE EXTENSION UNIVERSITY

### A CORRESPONDENCE INSTITUTION

417 South Dearborn Street, Dept. 664-H, Chicago 5, Illinois

I want to be an accountant. Send me, without cost or obligation, the 48-page book, "Accountancy, The Profession That Pays," and full information about your accountancy training program.

Name.....

Address..... City.....

Position..... Age.....

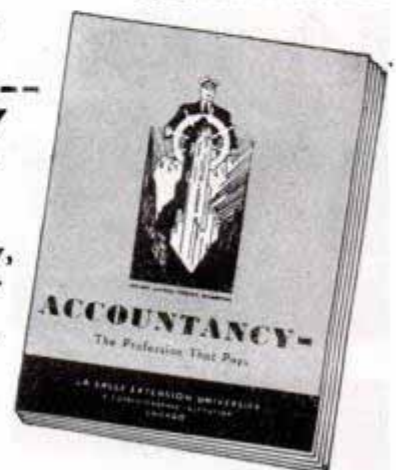



**WORLD'S  
BEST  
WANT AD  
MEDIUM**

# CLASSIFIED Advertisements



Advertisements in this section 60 cents per word, each insertion, minimum 10 words, payable in advance  
To be inserted under proper classification, copy must be in our office the 25th of the  
second month preceding date of issue

F. W. Johnson, Manager, Classified Advertising  
Popular Mechanics Magazine, 200 East Ontario Street, Chicago 11, Illinois

## 1377 CLASSIFIED ADVERTISEMENTS 1377 OPPORTUNITIES FOR YOU

### AUTOMOBILES, MIDGET CARS

**MIDGET** Racer plans, blueprints, parts buying directory 50c. Arthur Sibley, Mendon, Mass.

**SCOOTMOBILE** Roadster! Use scrap parts easily build inexpensive two passenger, three wheeled, small motor runabout. Also two passenger midget "Jeep." Complete plans, specifications for both, \$1.00. Universal, 2671 Algonquin, Toledo 6, Ohio.

**FORD** Rear main bearing oil leaks stopped without overhaul. Complete instructions by licensed instructor of auto mechanics, \$1.50. Martin, 1606 Reynolds, Brunswick, Ga.

**WATER** Injection for your car. More power, smoother performance. Wrench installs in half hour, \$14.65. Give make, model, year of car. Spee-Dee Products, 2409 South 10th St., Tacoma 6, Wash.

**STEERING** Wheels—\$7-\$10.00. Front assemblies, axles, bodies, for midget autos. Send dime for list and sketches. Anderson, Bristol Road, Ivyland, Penna.

**INDIANAPOLIS "500"** Race History Book. 352 large pages, 1100 illustrations. Complete history every race held Indianapolis Speedway since 1909. Tells what happened every race, every hour, every lap. Action photographs, technical details, biographies world-famous drivers. Compiled by Floyd Clymer, this is only complete, authentic book ever published on Speedway. Postpaid \$3.50. In red Fabri-koid with gold leaf lettering, \$5.00. Book on 1946 race only, 32 pages, 85 illustrations, \$1.00. Clymer's complete detailed history 1947 race ready in July. Order now. Postpaid \$1.00. Clymer, Dept. A-60, 2125 W. Pico, Los Angeles 6, Calif.

**SPEED & Mileage** manual—Obtain greater speed, mileage, racing performance from any automobile! Includes simplified methods, speed tuning, gas saving secrets. Instructions on building economizers, speed equipment, duals, mufflers, superchargers, racing fuels, fast conversions, \$1.98. Alquist Engineering, 447 (K) 64th Street, Brooklyn 20.

**AUTO** Racing magazine subscriptions. Pacific Speedway News, \$6.00 yearly. National Speed Sport, \$4.00 yearly. Illustrated Speedway News, \$4.00 yearly. All give complete data midget, big car race results. Sample copy each 50c. Specify publication wanted. Clymer, Dept. A-62, 2125 W. Pico, Los Angeles 6, Calif.

**"CUSTOM-Style"** Manual. Easily make car look Hollywoodized, custom built, ultra-beautiful! New, simplified customizing, restyling, streamlining methods. Instructions, illustrations. Plans for accessories, refinishing, mufflers, model changes, sport, continentals, convertibles, jeeps, etc., \$2.00. Alquist Engineering, 447 (K) 64th Street, Brooklyn 20.

**HENRY** Ford, His Life and Work, by Simonds. Complete book on life of a great American. 384 pages, 75 illustrations. Fabri-koid binding, gold lettering, postpaid \$4.00. Clymer, Dept. A-61, 2125 W. Pico, Los Angeles 6, Calif.

**"STREAMLINED** Roadster"—America's lowest priced car! Small, speedy, two passenger sportster! Amazingly easy to build from inexpensive material, small motor. Complete instructions, drawings, \$1.98. Alquist Engineering, 447 (K) 64th Street, Brooklyn 20.

**SEE** Our ad under Motorscooters for midget car bargains. Midget Motors Directory, Athens, Ohio.

**USED** Cars—New cars risky? Get our checklist-evaluation method (facts, faults and simple tests anyone can perform) and avoid costly mistakes. Money-back guarantee on accuracy. Tested, complete, valuable "know how," \$1.00. Act now! Lee Products Co., Box 67, Bloomfield, N. J.

**RACING** Auto lapel pins. Non-tarnishing, colorful, chromed. Identifies your favorite sport. Specify midget, Indianapolis car, Indian or Harley motorcycle, or Indianapolis souvenir crossed flags, \$1.00 each postpaid. Clymer, Dept. A-63, 2125 W. Pico, Los Angeles 6, Calif.

**INDIANAPOLIS** 500 Mile race! New packet 4 1/2 x 6 1/2 inch pictures cars and drivers! Latest shots Mays, Hepburn, Horn, Robson, 21 other winners. Send \$1. Tower Photographers, 5454 East Washington, Indianapolis 19.

**USED-CAR** Handbook, "Judging the Used Car." Dealers' tricks exposed, comprehensive simple tests, photographs. Postpaid \$1. Truvalu, Box 723-E, Arcadia, California.

**CLYMER'S** Historical Motor Scrapbook No. 4. Ready June. Latest Clymer book old cars and motorcycles. Postpaid, deluxe edition, \$2.50. Clymer, Dept. A-68, 2125 W. Pico, Los Angeles 6, Calif.

**R & R** Mfg. Co., marine and auto division, Anderson, Indiana, Robert M. Roof. \$1.00 for our new 1947 speed and power equipment catalogue with price sheet—showing racing cars, midgets, speed boats with recommendations how to rebuild your motors for racing. Dual ignition racing cylinder heads for V-60-100 and Mercury Ford engines. Dual intake manifolds, racing pistons, camshafts, compound valve springs, Lynite flywheels, quick change gear boxes and numerous other supplies.

**DUALTONE** Crystalline packed mufflers. Single or twin mufflers for all cars. Duals priced complete V8's \$23.00, six cylinders \$33.00, eight cylinders \$36.00. Large chromed tailpipe extensions \$3.30. Polished carburetor velocity stacks \$1.30. Chromed Station Wagon stacks \$15.00. Request catalogue. Dualtone Mufflers, 2636C India Street, San Diego 1, California.

**CLYMERTONE**, Twin muffler sets, beautiful sound, complete with necessary welded pipes, E-Z installation. Ford V-8, \$20.00. Chevrolet set with split manifold, \$37.50. Specify car model. Clymer, Dept. A-64, 2125 W. Pico, Los Angeles 6, Calif.

**RACING** Car performance for all cars. Complete specifications, \$1.00. Increase power, speed. Special "custom-built" equipment. Free literature. Write Lee Motorcraft, 1412-A Great Northern Bldg., Chicago 4, Illinois.

**BUILD** Speedy midget track racer from castoff parts! Plans, specifications, construction information, \$1.00. Motor Supply, Box CS-1682, Toledo, Ohio.

**AUTOMOBILE** Racing book, fifth edition, well illustrated. Instructions on building bodies, frames, engines. Ford A and B conversions. Plans. AAA rules, specifications. Roadster racing, Indianapolis cars. \$1.00 postpaid, \$1.30 C.O.D. Ray Kuns, Dept. 47, Madisonville, Cincinnati 27, Ohio.

**MAKE** Your Ford fast! Complete details, photographs. How to construct 120 m.p.h. Hotrod. \$1 postpaid. California Bill, Box L-1, Eaglerock, Los Angeles 41, Calif.

**CUSTOMIZE** Your automobile. Illustrated, new restyling ideas, instructions, suggestions, specific model changes by simple methods. Postpaid \$1. Speedwheel, Box 723-E, Arcadia, California.

**PROFESSIONAL** Midget racer, motor-scooter, midget roadster, and midget motorcycle. Plans, specifications for all four contained in illustrated handbook, 25c. Big list bargain priced used motors, motorscooters, servicycles, etc., included free Midwest, 3839 Drummond, Toledo, Ohio.

### AUTO SUPPLIES AND EQUIPMENT

**BATTERY** Cable clamp—Apply with fingers. Simple and practical lever action. Address Stanley S. Wyman, 159 Crescent St., Willimantic, Conn.

**TIRES** (Brand new) cut rate, famous brands, 600x16 \$11.95, 650x16 \$14.45. Limited quantities. Money orders, f.o.b. Chicago. Chief Motor Products, Rm. 909, 160 N. LaSalle, Chicago, Ill.

**SEAT** Covers to 1933. Save \$10. Good plaid fiber. Leatherette trim. Full sets \$10.45. Fronts \$6.95 COD, postpaid, immediately. Lubbock Cover Co., 1911-N, Lubbock, Texas.

**TIRES**, (New) popular brands. Real bargain prices. No tricks. Popular Tire Service, 52 Factory Square, Southington, Conn.

**BATTERY** Repairmen! "Send for a connector strap drill that leaves a post." \$2.50 postpaid, guaranteed. Batteryman, Grand Junction, Colorado.

**1947 SUPERIGNITIONER** \$5.50. Special \$5.00. Atomic starting, pep, mileage, 8 improvements cars, trucks, 50c. EG Mfg., 355-A East 149th, New York 55.

**GASOLINE** Saving vacuum supercharger, uses gasoline motor's waste, more power, speed, smoother motor, reported savings high as 25%. Price \$12.85. Self addressed stamped envelope for pamphlet showing this great patented invention, McDowell Co., 2000 NE. Union, Portland 12, Oregon.

**BURN** Water in your car. Costs less than gas. More power, cleaner motor. Mail card for data on \$17.50 octa-gane water injecting carburetor. Ralph A. Shade, 563 Lake Road, Webster, N. Y.

**TWIN-TONE** Mufflers for V-8 and Mercurys 35 to 47 models. Gives more mileage, without back pressure. Mufflers are straight through-type and produce deep mellow tone, \$20.00 a set. Single through-type mufflers for all cars \$6.50 ea. Chrome tail pipe extension 2 1/2" dia. \$2.50 ea. Satisfaction guaranteed. Twin-Tone Mufflers, 139 East Manchester Ave., Los Angeles 3, Calif.

**MAGIC** Motor tune-up, tunes your motor instantly. Extra miles per gallon. Only \$1.00. United Sales Co., Aberdeen, So. Dak.

**MERCURY** Automobiles. Walert Company, 3429 North Tenth St., Milwaukee 6, Wisconsin.

**SAVE** Up to 50% on auto accessories, parts, home supplies. Catalog for stamp. Main Supply, Fairfield, Ill.

**HOT-ROD** Manual; plans, photos, instructions, fast Fords, \$1.50 p.p. Racing parts list, 10c p.p. Hollywood Hot-Rod, Box 9626P, Los Feliz Sta., Hollywood 27, Calif.

**STOP** Automatic choke troubles. A new invention, The Redex Hand Choke Adapter quickly changes these carburetors to a reliable hand choke operation. Oldsmc Pontiac, Hudson and others. State and year. \$3.00 postpaid. Money guarantee. Agents wanted. Redex M. Rochester 13, New York.



**NEED Auto parts?** We have them. New and rebuilt. Prompt shipment. Write requirements. Save money. Buy direct. (See our display advertisement page 249). Factory warehouse. Mechanics Auto Parts, 3807-PM-5 North Ashland, Chicago 13.

**NEED Moving parts?** Truck & Auto Parts Center, Box 123, Bergenfield, N. J.

**USE Anti-Glare** against wild headlights. Stops road, sky and hood glare too day-time. Place anywhere on windshield. Fits any car. Set of two \$1.00. Gabe's Shop, Box 615-S, North Hollywood, Calif.

**PEP-UP Your car** with C. A. Bombs. Rust and corrosion preventive. Send 25c to M. Van Horn Dists., J-1 1128 S. 13th St., Philadelphia 47, Penna.

**OIL Pumping motors**—brought back to normal without ring job. Send address on postcard for free details. Mullner Co., Box 3102, St. Paul 1, Minn.

**HAVING Car trouble?** New, used, guaranteed auto, truck parts, save money. Transmission specialists. Describe needs; immediate reply. Victory, 2930 1/2 Northwestern, Chicago 18.

**AUTO Parts** for all autos and trucks. Trans., motors, differentials, fenders, carburetors. Also body parts. Security Auto and Truck Parts, 1941 BJ Eddy, Chicago 13.

**PLATING Outfits** for auto parts. Connect to a battery. No tanks used. Free particulars and proofs. Gunmetal Co., Ave. J, Decatur, Ill.

**AUTO TRAILERS**

**CATALOGUE**, Trailer building plans, parts, accessories, for house, boat, camp, etc., sent with booklet "Trailer Building." Send \$1.00. Trailer Mart, Buffalo 7, N. Y.

**COMPLETE Foundation** for your trailer home. Chassis frames, Tor-Q-Les axle, spring and wheel assemblies, hitches, tires and tubes. Order a complete unit or specify items desired. Literature on request. General Trailer Company, 705 S. 3rd Ave., Wausau, Wis.

**TRAILER**, 14 Foot Vagabond has everything. Manual drawings, instructions, parts list \$1.00. Tandem 24 foot, 3 room trailer. Large 24x36" six views floor plans, principal dimensions \$1.00. Circulars illustrate 14 to 24 ft., three room designs, 20c. Craftsmann Books, Box 1153 P3, Milwaukee 1, Wis.

**YOU Can build a sturdy 500-lb. capacity one-wheel utility trailer**, with pneumatic caster wheel, complete for less than \$50. Illustrated circular free. K & M Trailer Sales, 52 So. State, Elgin, Ill.

**SOFT Tire indicators** for trailers. Inquire. Laidlaw Mfg. Co., Box 1108, Pasadena 20, Calif.

**BUILD Your own trailer!** Save money! Have every feature you want! Plans for house, sport, camp and utility trailers. Catalog describing 9 models 10c. 15c in Canada and overseas. Jim Dandy, Box 125-A, Wausau, Wisconsin.

**MOTORCYCLES, BICYCLES, MOTOR-SCOOTERS AND SUPPLIES**

**MOTOR Scooters**, 1947 models. Immediate delivery. Free catalogue. American Cycle Company, 1105 Avenue M, Brooklyn 30, New York.

**BEAUTIFUL New bicycles**, all makes, \$34.95. Free catalog. Century Cycle, 3447 Lawrence, Chicago 25, Ill.

**MOTORCYCLES**, Parts, new and used. Harley, Indian, Henderson, Super-X. List 10c. Ballak, 811 N. 9th, St. Louis 1, Mo.

**MOTORCYCLE News**—monthly. Yearly subscription \$1.00. Sample copy 10c. Motorcycle News, 5424-A Sawyer, Chicago 25.

**CLYMER'S Motorcycle Books**. Speedway Motorcycle Racing, \$2.00. Motorcycle Speedway Annual, \$1.00. How to Manage Motorcycles, \$1.50. Motorcycling Manual, \$2.00. How to Obtain Speed, \$1.50. Motor Scooter Plans, \$2.00. Books on Ariel, BSA, Norton, Triumph, Villiers, \$1.50 each. English Motorcycle Magazine, 50c. All postpaid. See our ad automobile section. Catalog free. Clymer, Dept. A-66, 2125 W. Pico, Los Angeles 6, Calif.

**DISC Wheels**, metal. Bicycle supplies, wholesale, retail. Universal, 4713 Virginia, St. Louis, Mo.

**BICYCLES**—Brand new Schwinn or Roadmaster, full-size 26" balloon, equipped with electric light, horn, kickstand and chain guard, boys' or girls', only \$34.95. Send check or money order, immediate delivery. Send for free bargain price list on bicycles, parts and accessories. Holterman's Bicycle Store, 308 East Walnut, Kalamazoo, Michigan.

**MOTOR Scooters**, bicycle engines. 120 miles gallon. Dime for catalog. Clymer, Desk A-65, 2125 W. Pico, Los Angeles 6, Calif.

**"BICYCLE Repair Manual"**, illustrated, explains bicycle repairing thoroughly, 65c. Robert Klausner, Shelbyville, Illinois. Information on powerful bicycle motors free with each order.

**MOTORCYCLE (Miniature) lapel pins**. Exact duplicates favorite 1947 model. Chromed, colorful, non-tarnishing. Specify Harley, Indian, BSA, Norton, Triumph or Ariel, or Daytona race souvenir crossed flags. \$1.00 each, postpaid. Midget or Indianapolis racer same price. Any above emblems on attractive tie-clasp, \$1.25; tie-holder, \$1.75 postpaid. Clymer, Dept. A-67, 2125 W. Pico, Los Angeles 6, Calif.

**MOTORS For bicycles and motorscooters** \$3 up; motorscooter frames less motors \$5 up; factory built motorscooters as low as \$35, complete; motorcycles \$25 up; plenty of new 2 h.p. motors in original factory crates. Brand new motorscooters and midget cars ready for delivery now. Over 6000 balloon tires for motorscooters and midget cars \$1 up. Mailorder only. Send 25c for big war-bargain catalogue Number 19, just out, listing the above and hundreds of other bargains in new and used motors, motorscooters, midget cars, racers, etc. (35c by first class mail.) Midget Motors Directory, Athens, Ohio.

**MIDGET Car axles**, etc. Write Behnke's Auto Supplies, 5721 Leland Ave., Chicago 30, Ill.

**WHEELS**—Steel disc, rubber tired, sizes 5"-6"-7"-8"-10". Available. United Wheels Mfg. Co., 11727 La Fayette Ave., Chicago 28, Ill.

**HARLEY-DAVIDSON Parts**, accessories, batteries, tires, and repair work. 24 hour service. Authorized factory dealer. Philadelphia Harley-Davidson Company, 857 North Broad Street, Philadelphia 23, Penna.

**TIRES**, Inner tubes, wheels, for small trucks, wheelbarrows, power scooters, midget cars, farm equipment, carts, etc. Sizes 8" to 18" o.d. in 2, 4 and 6 ply first-line quality tires, with removable inner tubes and heavy duty demountable wheels. Also caster forks, straight or swivel types. Free circular and prices. Jahant Co., 626 East Exchange Street, Akron 6, Ohio.

**CUSHMAN Motorscooter** \$20 (includes motor and extra tires), midget racer \$15! Send 25c for big summer catalog #938, just printed, listing these and scores of other sensational bargains in motors, wheels, motorscooters, motorbikes, Servicycles, tires, etc. Associated, Box CS-1764, Toledo, Ohio.

**MODERN Motorcycle Mechanics manual**, 560 pages, 300 illustrations, covers Harley, Indian and English makes. The most complete motorcycle book published. \$3.15 postpaid. Nicholson Brothers, Motorcycle Engineers, Saskatoon, Sask., Canada.

**CUSHMAN Motorscooter** \$15, Shaw bicycle motor \$15, Harley-Davidson motorcycle \$35! Send 25c for bargain catalog #8, just off the press, packed with money saving buys in motorscooters, motorbikes, midget cars, motors, wheels, tires and parts. Gail and Company, 538 Erie, Toledo, Ohio.

**WHEELS!** Build wagons, scooters, mowers, trailers, wheelbarrows, grocery carts, baby carts, play pens, baby carriages. 4" to 16". Free list. Trulsen Mfg. Co., 811 E. 31. Kansas City, Mo.

**BICYCLE Book**, how to buy, rebuild, sell used bicycles 50c. John Collett, Handley, Texas.

**TIRES And industrial wheels**, suitable for scooters, wheelbarrows, farm equipment, etc. All sizes. Bicycles and accessories. Largest assortment in America. Send dime for list. Cycle Transport Company, 1241 So. Michigan Ave., Chicago 5, Illinois.

**BUILD America's lowest priced motor-scooter speedster!** Complete plans, specifications, \$1.00. Big list bargain priced used motors, etc., included free! Motor Supply, Box 1682-CS, Toledo, Ohio.

**LARGE Stock Indian parts**. Expert motor rebuilding. New and rebuilt Chief motorcycle, motors only. Indian Motorcycle Sales, Kansas City 1, Mo.

**HARLEY-DAVIDSON** — New and used 45" motors, service, parts, accessories, tires. Send \$2.25 for army motorcycle manual, 10c for bulletins. Knuth's (Harley-Davidson factory dealer), 2491 Fondulac, Milwaukee, Wis.

**LITTLE Library of Useful Information**. 102 different books. Catalog free. Popular Mechanics Press, 200 E. Ontario St., Chicago 11, Ill.

**LEARN Aviation**. 300 page illustrated course \$1.50. Craig Dare, 140 W. 42nd, N. Y. 18.

**AIRCRAFT Engines**. Cont 65hp. Fits Cubs, Aerona, etc. Complete with Carb Mags. Guaranteed running condition, \$200. Alexander Aviation, 97 Rutgers St., Jersey City, N. J.

**PROPELLERS**—We specialize in ice-snow sleds and boats. 2 or 3 blade. Illustrated literature. Standard Aerocraft, Ft. Worth, Texas.

**PROPELLERS For ice-snow sleds**, air boats. Catalog 10c. Banks Propellers, R.F.D. 12, Ft. Worth, Texas.

**CAREER Counselor**. Guidance for beginners. 23 years aviation experience. George Miller, 1333 18th Street, Santa Monica, California.

**VETERANS: Flight training** under the G.I. Bill. Private, commercial and flight instructor ratings. Write for information. Gottschalk School of Aeronautics, Adrian, Michigan.

**NEW Catalog!** Rush name. Experiment-er Supply, Tipp City 6, Ohio.

**B-29 COMPUTERS**, Dynamotors, amplidyne, auto pilots, amplidyne servo amplifiers, compressors, gun chargers, turret drives, generators, starters, Plexiglas domes, sighting stations, etc. Free list. Ercco, 1006 Hewitt, Everett 1, Washington.

**CUBS**, Wacos, Taylorcrafts, Aerona. Big catalog, 25c. Lists these and thousands of other sensational airplane bargains. Some are "easy to repair" crackups. National, Box 1682-CS, Toledo, Ohio.

**BATTERIES, GENERATORS**

**NEW Exide aircraft storage batteries**, dry-charged, 12 volts, 17 amp., \$7.95. Small, light, shielded. Ideal for 'Ham' radios, toy motors, etc. Conner Sales, 917 South Main, Forth Worth, Texas.

**ELECTRIC Generator**. Plans for simple, home-made hand generator, three volts. 50 electric stunts included. \$1 postpaid. Reiss, 3017 Ocean Parkway, Brooklyn 24, N. Y.

**EDISON Non-acid lifetime storage batteries** for home lighting, motors, radios, etc. Free complete interesting literature. T. Hawley Smith Company, Croton Falls, N. Y.

**ELECTRICAL SUPPLIES, EQUIPMENT**

**FLUORESCENT Service manual**. Proper care and maintenance of fluorescent lighting. Compact reference book. Proper ballast wiring diagrams. Symptoms and remedies for trouble shooting. Mailed postpaid, \$1.00. C. DeForest Derrick, 1009A Benito Street, Alhambra, California.

**ELEMENTS**—Irons, toasters, 55 cents each. Claudio, 67 West 101 Street, New York 25, N. Y.

**BUILD Your own lamps**. Save half. Be different. Write for free photos, also lamp parts. Buddy Products Mfg. Co., 1123 W. Belmont, Chicago, Ill.

**ELECTRIC Meters**, prompt shipments, any quantity, all sizes. D.C. or A.C. New and used. Ditto Pyrometers, Thermocouples. Service on all types. Write Cleveland Electric Laboratories, 1988 E. 66 St., Cleveland 3, Ohio.

**LAMPS**—If you build or repair, had trouble finding parts, your search is ended. Chrome push sockets 25c, harps, pipes, switches, vase caps, clusters, etc. Illustrated catalog 10c. Gyro Lamps, 5416 Clark, Chicago 40.

**FLUORESCENT Fixtures**. Factory prices. Free catalogue. Naturalite, 1520 Ardmore, Chicago 26.

**EXPERIMENTS**—Re-light burned 2-40W fluorescent with 5 volts, \$1.00. Pamats, 227 Woodbine, Brooklyn, N. Y.

**NEW Model Wind-O-Vent fans**; adjustable to fit windows 24" to 36", mounted on steel panel. 10" blade powered by 110v. 60c. a.c. motor protected with husky guard, cord and plug. Quiet but effective. Delivered postpaid, \$22.95. Supply limited. Order today. Roy's Electric Co., 7015 Manchester Ave., St. Louis 17, Missouri.

**MAGNET Wire**—No. 20 Formvar. Ideal for motor winding. 750 ft., \$4.75 post paid. A.C. motor windings designed. J. I. Weeks, 919 Neland, Grand Rapids 7, Mich.

**ELECTRIC Pencil**: Writes, engraves all metals. \$1.00 postpaid. Beyer Mfg., 229-H Dixon Blvd., Uniontown, Penna.

**ELECTRIC Fan assemblies**. Assemble your own. Ted Riseaman, 207 North Fifth, Springfield, Illinois.



**CONTROL** Garage doors from dashboard. "Build yourself" plans \$1.00, refundable. Vital parts available. Kaytor Laboratories, Lynwood, California.

**ELECTRIC Pencil**—writes, engraves all metals. Battery model \$1.00—110 volt model, \$2.00 postpaid. Guaranteed 5 years. C.O.D.s accepted. Reb Industries, Dept. 265-X, Elmhurst, Illinois.

**WASHING** Machines. Parts all makes. Northeast Burner, 1358 H St., Washington 2, D. C.

**MAGNETS**—Alnico. Postcard brings 1947 list. Terry Sales Company, 3726 South Detroit Avenue, Toledo 9, Ohio.

**B-29 FIRE-CONTROL** Computers GE2-CH1C1. Single parallax. New \$75.00. Free list. Ereco, 1006 Hewitt, Everett 1, Washington.

**1000 AMPERE** Starter solenoid relays. \$2.45. New. Specify coil voltage desired. Free list. Ereco, 1006 Hewitt, Everett 1, Wash.

**PRACTICAL** Winding of a.c. motors. A course of instruction on winding, connecting, and testing single, two, and three phase motors. Clearly written in everyday non-technical language. Illustrated throughout. This book is recommended for beginners interested in learning motor re-winding and repair. Satisfaction guaranteed or remittance refunded. \$2.00 prepaid. Educational Advancement Co., Dept. Y, Lakewood, New York.

### WELDING, SOLDERING, PLATING

**BUILD** A combination electric brazer, solderer, and arc welder for less than \$1.50. Instructions 50c. Roman Girard, Forest Lake, Minnesota.

**NEW Model** electric welder 110 volt a.c.-d.c.; will weld all metals; easy to use; full directions. Complete with power unit, flame and metallic arc attachments, carbons, fluxes, rods, mask; all for \$19.95. Used by the navy. Magic Welder Mfg. Co., 239 MP6 Canal St., New York City.

**SENSATIONAL** Offer—acetylene welding outfit. Torch, tips, regulators, hose, goggles, etc. Guaranteed. Lowest price. Investigate this amazing value. Standard Welder's Equipment Co., 11 Kilmer Road, Hingham, Mass.

**WELDERS** (Acetylene), double present earnings welding white metal (pot) using your own rod made from scrap. La Combe, Oakland 6, Calif.

**YOU** Can make a lot of extra money using Mendall Metal for quick, permanent repairs on motor blocks, cylinder heads, water jackets, radiators, plumbing, kitchen utensils, etc. Easy to use with blowtorch flame. Try it at our risk. Send \$5.00 now for shop size six bar package prepaid. Moneyback guarantee. Four A Manufacturing Co., Dept. 11, Littleton, Colorado.

**SOLDER** Cast iron or rough dirty steel easily and permanently. Formula for inexpensive flux \$1.50. Gingerich, 237 Fulton St., Redwood City, Calif.

**ACETYLENE** Welding generator, popular, safe, 15 lbs. carbide, portable. Make it, save \$90.00. Print and layout \$5.00. Haywood Generator Co., Box 1325, Brownsville, Texas.

**NEW Aircraft** generators, model R. 2, volts 12 to 30 (adjustable), 300 amp. d.c. shipping weight, 69 lbs.; size 16"x7", price each, \$39.50; air cooled. Cost about \$250.00 each. Immediate shipment; check with order. Greer Co., 460 S. State St., Chicago 5, Illinois.

**A.C. Welders**, 110 v., welds 1/2" steel, \$29. Money back guarantee. Paul Morris, 1850 State St., Schenectady 4, N. Y.

**ACETYLENE** Generator. Easy to build—plans, instructions \$2.00. Weldox, R. 2, Box 264, Phoenix, Arizona.

**ELECTRO** Plating outfit including solutions for jewelry, fishing spoons, etc. Plugs into lighting outlet. Instruction booklet tells how to plate baby shoes. \$19.50. Free folder. Hoover & Strong, Inc., 113 W. Tupper St., Buffalo 1, N. Y.

**WELD**, cut, braze with gasoline! Amazing new discovery shatters costs. Boosts profits. Important! Write Matthews Mfg. Co., Calgary 21, Canada.

**WELDING**, Cutting, aircraft welding and soldering equipment. Electric arc welders. Superior Oxy-Acetylene Co., Hamilton, Ohio.

**FREE—"Amazing New Book"**—"Profits From Classified Advertising." Tells how and what to advertise. Be sure to read this book before you invest one cent in advertising. Remember—it's free! Write for your copy now. F. W. Johnson, Classified Advertising Manager, 200 East Ontario Street, Chicago 11, Illinois.

### MACHINERY, TOOLS AND SUPPLIES

**BUILD** Quickchange gear box without castings for \$10.00. Craftsman, Atlas, adaptable other lathes. Complete drawings \$3.75. Stevens, 2604 Military, Los Angeles 34.

**TEEHO-TOOL**. Handsaw filing guide. Gets teeth uniform, 25c. Satisfaction guaranteed. 316 North 2, Maywood, Illinois.

**25 ASSORTED** 1" Felt buffs, \$1.00. Discs, 6136 Northwest Highway, Chicago 31.

**HOME** Shop owners attention.—Send for actual photograph and sample of the work our attachments will do. The photograph and sample speak for themselves. Have fun in your home shop. Cut gears, sprockets, ratchets, lay out holes accurately, cut keyways, build complete clocks and other interesting jobs. Build these attachments yourself from our reasonably priced blue prints. Don't limit your lathe to round work only. The Home Shop, 415 Raymond Avenue, Glendale 1, California.

**ALUMINUM** Handles. For socket screw keys. Wittle Manufacturing, 1043 Lititz Avenue, Lancaster, Penna.

**MAGNETIC** Dial indicator bases—\$3.45! Write, Eyrich, Box 849, Milwaukee 1.

**HOBBYISTS!** You can equip your workshop at a fraction usual cost by building your own mill, shaper, drillpress and other shop tools for metal and woodworking from Lewis castings, materials and blueprints. Easy to complete, and ideal for home use. Send 10c to cover cost of mailing latest catalog describing 21 items. Lewis Machine Tool Co., 3217 Union Pacific Ave., Dept. M, Los Angeles 23, Calif.

**UNIVERSAL** Mechanics tools, dandy 8 piece set: Ceetee pliers, waterpump pliers, master-ratchet pipe wrench, needlenose pliers, crescent wrench, diagonal cutters, claw or pain hammer, plastic screw-driver, \$14.85. New catalog free! Remit today! Universal Tool Company Has It, 1527 Grand PM, Kansas City, Missouri.

**BENCH** Saws \$19.00, compressors, drills, welders, sanders, drills, motors, etc. Circulars 5c stamps. Sunshine, Berkshire Heights, Penna.

**VARIABLE** Speed transmissions. Fractional to 5 hp. Wide speed ranges, use standard V belts. Priced from \$16.50. Free folder. Standard, 3401 Verdugo Rd., Los Angeles 41.

**NEW** Glass drill. Free literature. Box R188B, Seal Beach, Calif.

**AIR** Compressors, electric, 3-stage. Value over \$200.00. New 27-volt AC-DC. Convert easily with transformer. Weight 28 lbs., wrapped in Plofilm and boxed. Instructions free. A real buy \$15.00. Immediate delivery. Write for quantity prices. General Surplus Stores, Dept. CM6, 1439 Grand Ave., Kansas City, Missouri.

**GEARS** For inventors, experimenters, model makers, schools, work shops, laboratories, etc. Government surplus made of brass, bronze, dural steel and stainless steel. 12 matched pairs; 24 gears, bevel, spur and ratchet. List price \$12.00, our price \$2.50. 25 matched pairs; 50 gears, includes larger gears, also sets of worm gears. List price \$30.00, our price \$5.00. Limited quantity. Order now. Write for our bulletins on ball bearings, rectifiers, relays, selsyns, horns and government surplus materials. Met Exchange, 323 Canal Street, New York.

**1000 NEW** 3/8" Torrington needle bearings with press-in flange housing, 35c each. H. A. Komulaine, 1423 So. Spruce Ave., Montebello, Calif.

**WATCHMAKERS'** Lathes, millers, chucks, headstocks, compounds. Machine Service, Newfane 2, Vermont.

**HANDY** Spring assortment—over 200 springs, \$1.00 postpaid. Harold Products, 6115 N. Washtenaw, Chicago 45, Illinois.

**ELECTRIC** Drills: 1/4 in. Chicago pneumatic, heavy duty, used, good condition, \$14.50, check or money order. Kleinschmidt Store, Corder, Missouri.

**CEMENT** Machines, mixers, moulds, \$20 up. Cheap plaster insulation, dandy floors, with Insulmix, Blue, Excelsior, Minnesota.

**TRANSFORMERS**, New—Convert General Electric and Corneliu aircraft compressors, 27-volt, 20-amp., a.c.-d.c. to 110-volt. Immediate delivery. \$14.50 each f.o.b. General Surplus Stores, Dept. MPI, 1439 Grand Ave., Kansas City 6, Mo.

**CORONA** 7" Shaper attachment fits all lathes, does any job a small shaper will do, \$18.62. Also other attachments. Free circular. Corona Tool Co., Dept. M, 107-15 51st Avenue, Corona, N. Y.

**BALL-BEARINGS**. One-fourth list price. Free list. Burgess, Box 168, Ferguson, Mo.

**V-BLOCKS** At low prices. 10 sizes for all purposes. Free literature. Miles Products, 2532 Wabash, Chicago 16.

**MACHINE** Shop tools released for private industry; 14" loose change lathes \$150; 16"—\$180; vertical miller \$260; 12" quick change lathe \$390; 16"—\$440; Gould & Eberhart gear cutter \$430; small hand miller \$130; larger millers \$180; new drill chucks, 1/4"—\$5; 1/2"—\$7; 3/4" swivel bend vise \$14; Warney & Swarey turret lathe \$320. Conversion Parts Co., 278 Adams Street, Boston 22, Mass.

**ANGLE** Plate 4"x3"x3", ribbed. Precision ground 6 sides \$3.00. Casting 75c. Catalog 3c. Model Tool Service, Rock Falls, Ill.

**DRILL** Grinder for twist drills \$2.95. See ad on page 243.

**HOBBY** Dealers let us supply you with woodworkers power tools, electric motors, hand tools and many profitable new hobby items. Free monthly bulletins. Hobby Distributors' Alliance, 647 Main Street, Hartford 3, Conn.

**TAPS** And dies. Buy direct from manufacturer at small cost. Send postage stamp for price list "D." King Tap & Tool Co., Inc., North Attleboro, Mass.

**HOISTS**, surplus Spur Gear Hand Hoist will lift 500 pounds 20 feet. Made by famous manufacturer to lift bombs into aircraft. Easy to install and operate. New, unused. Shipped postpaid anywhere in U.S.A. for \$10.00, or write for illustrated details and dozen uses. Hurry! Ireland and Vice, 48 Chedele Place, Auburn, N. Y.

**WAR** Surplus in small tools for machine shop—Send 15c for bulletin. Travers Tool Company, Dept. P, 5 Court Square, Long Island City, N. Y.

**DRILLS-TAPS**—Reconditioned high speed, up to seventy-five percent off list. Send for free circulars. Perry Screw and Bolt Corporation, 4250 Grand River, Detroit 8, Michigan.

**CONCRETE** Building block machines and molds. Catalog free. Concrete Machine Co., 5129 South Compton Ave., St. Louis 11, Mo.

**BARGAINS** in machinist tools. Write Precision Tool Service, 55 E. Washington St., Chicago 2, Illinois.

**DRILL** Grinder—Grinds drills to factory accuracy. Callipers with direct reading scales, Circle cutters, New Tool grinder. Lowest prices. Free literature. Factory, 811-B East 31st, Kansas City 3, Mo.

**SHEBEL** Saw filer \$7.50. Files all saws. Circular. Free trial. Shebel, 730B S. 2nd St., Milwaukee 4, Wis.

### BOATS, OUTBOARD MOTORS, ETC.

**ANCHORS**. Time tested navy type, sizes 5-10-15-20-25-30 lb., semi-steel, aluminum finish. Recommended size, 1 lb. per ft. Price 20c lb. f.o.b. Wilson Patterns, Coffeyville, Kansas, U. S. A. Discount to dealers. No c.o.d.

**CATALOGUE** Over 50 plywood plans—Kyacks to Cruisers—sent with William Deed's book "Plywood Building," send \$1.00. Marine Mart, Buffalo 7, N. Y.

**NEW**, Used, rebuilt marine motors. Marine conversions, fittings. Free catalog. Stokes Marine Supply, Dept. 24, Coldwater, Michigan.

**ALL** Weatherproof brass push and pull switch for boats, \$1.00 postpaid. Lefte, 621 Fourth Avenue, San Diego, Calif.

**BEAUTIFUL** Plywood kyack. Complete large blueprints. Send \$1.00. Marine Mart, Buffalo 7, N. Y.

**"MIL-DU-CHEK"**—(Dry process) kills mildew, protects sailcloth, canvas. Absolutely safe. Large box 75c postpaid. Regatta, 1606 Zeraga Ave., Bronx 61, N. Y.

**SPORTSMEN**—You can build the famous folding Foldkraft Kayak, 10 1/2' or 15' plans \$1.00 postpaid. F. J. Leary, 15 Park Row, Suite 1216, New York City 7.

**WHY** Lug your outboard motor? New carrier \$8.75. Catalog free. Sportspal, 102 Eighth, Tahoe Valley 6, Calif.

**BOOK**—20 Complete plywood boat plans, with building guide. Send \$1.00. Marine Mart, Buffalo 7, N. Y.

**BUILD** Your own boat! All top grade solid cedar and oak. Completely prefabricated 12 footer. Simple to assemble with Monel fastenings. Will carry large outboard motor. \$64.50 f.o.b. includes everything. Fire Island Boat Works, 160 Fulton St., Brooklyn, N. Y.

**MARINE** Catalogue, over 5,000 items, pictured, priced, deliverable. Send \$1.00. Marine Mart, Buffalo 7, N. Y.

**ARMY** Surplus rubber rafts, big (21'x6'x2') Govt. price \$487.00. Complete for only \$40.00. Many uses. Money orders, f.o.b. Chicago. Franklin-Weber Motors, 6111 N. Clark St., Chicago, Ill.



**CATALOGUE** Moulded weldwood and plywood boat kits sent with Deed's book "Plywood Building." Send \$1.00. Marine Mart, Buffalo 7, N. Y.

**PLYWOOD Boat kits!** Complete materials for building "Deltacraft," "Junior Dinghy," "Tadpole Skiff." Mahogany marine plywood and oak construction! Send 10c today for illustrated folder featuring these boat kits and other marine materials and supplies. Carmen-Bronson, Marine Department, Mount Vernon, N. Y.

**PROPELLERS**—Use airpulsion. 2 or 3 blade. Illustrated literature. Standard Aircraft, Ft. Worth, Texas.

**SAILKITS** 100 Square feet \$21.50, yacht, canoe sails, etc. Canvas—all widths, airplane dope, cement, marine paints, hardware, Manila, linen rope. Marine flags. Boat covers. Plastic cushion covering. Catalogue. Alan-Clarke Co., 96 Chambers, New York City.

**SPORTSMEN!** Build kayak from easy-construction kit! Literature. Kay-yacks, Dedham, Mass.

**MARINE Plywood.** Phenol resin glued, made to U. S. Navy specifications for PT boats, 1/4" thick, 3 ply, mahogany on two sides, some with mahogany centers, 3' x 8', 3' x 6' sheets. 34 cents square foot, f.o.b. Chicago. Beck Plywood and Lumber Company, Inc., 611 West Division Street, Chicago, Illinois.

**MARINE Power**—Easily convert any Ford and Jeep motor (domestic and foreign) with Osco parts and kits. Complete catalogue 25c (coin). Osco Motors Corp., 2020 E. Orleans St., Philadelphia 34, Penna.

**PRACTICAL,** Light, folding Kayak. Specify 10 1/2' or 15'. Rush \$1.00 for plans. Hoosier House, Dept. B-1, P.O. Box 1264, Indianapolis 6, Indiana.

**PISTON Rings** for all outboards. One man rubber life rafts \$15.00. Wilson Marine, 170 Terrace, Buffalo, N. Y.

**REBUILT Tachometers** 0-5000 and 0-8000 r.p.m. \$10.00 each, specify rotation. Also new tachometers and adapters. Zakarian Engineering, Box 416, East San Diego, Calif.

**KAYAK Blueprints,** deluxe models—catalogue 10c. Viking Canoes, Merrick, N. Y.

**OUTBOARD Motor parts,** new and used, for all makes. New pistons, standard and oversize. Cylinders rebored. Outboard Motor Mart, Inc., 309 Atlantic Ave., Boston 10, Mass.

**ALL Copper water jacketed exhaust manifolds** for marine conversions of automobile and aviation engines and marine engine replacements; any make, model or age. Joseph Van Blerck & Son, 391 Woodcleft Ave., Freeport, N. Y.

**PROPELLERS:** New army surplus, Michigan, 3 blade bronze, 12"x10"RH; 3/8" hub bore. Made for Johnson 22 h.p. outboard. Modify for other engines. Only \$5.65 each postpaid (with order). We will increase pitch to 11", 12" or 13" at \$1.00 additional per each propeller. Baker Bros. Supplies, Box 301-C, Palatine, Ill.

**MARINE Conversions** for Ford and Jeep engines. Catalog 10c. Lehman Manufacturing Company, Department D, Newark 2, New Jersey.

**USED Outboard motor parts.** Outboard Exchange, 1194 Remsen Ave., Brooklyn 12, N. Y.

**KAYAKS.** Rowboats, weldwood ready cut kits, booklet. E. J. Croot Co., #103-D, Basking Ridge, N. J.

**BOATS** And all about them. How to select, build, repair and operate. For 40 years the leading practical boating magazine. Half price trial subscription. 12 issues for \$1.00. Motor Boat, 62 Gold Street, New York 7.

**TWENTY Plywood boat plans** \$1.00. Catalog boat building plans 10c. The Rudder, 15 Murray Street, New York.

**BOAT Designers** are highly paid professionals. Complete course by mail. Catalog. Westlawn, Montville, N. J.

## ENGINES, MOTORS, DYNAMOS

**DEALERS**—Sell electric motors, gas engines, light plants, a.c. and d.c. generators, fans and ventilating equipment. Catalogue 10c. CMCO, 514 Van Buren, Chicago 7.

**150 AMPERE Generators** for welding \$47.50; extra flexible cable, 6 ft. lengths, \$2.75. Other bargains. Butler Electric Company, 1885 Milwaukee, Chicago 47.

**SELSYN Motors.** Bendix 3 1/2"x5 1/2" heavy duty 115 volts, 60 cycles, \$10.25 per pair. J. A. Weber, 150E Maple, Hershey, Penna.

**SIMPLEX Water motors**—1/20 h.p. and up; also specials for any purpose. Duplex motors 1/4 h.p. and up; for water, oil, air, or steam, for any pressures up to 250 lbs. Specials built to order. Universal motors built in multiple jet drives for special jobs. Gasoline miniature engines for model builders 1/10 h.p. and up. Mechanical and electrical specialties built to order. Wood and metal patterns to order. Duplex Motors, Burlington, Iowa.

**NEW Aircraft generators,** Model R. 2, volts 12 to 30 (adjustable), 300 amp. d.c. shipping weight, 69 lbs.; size 16"x7", price each, \$39.50; air cooled. Cost about \$250.00 each. Immediate shipment; check with order. Greer Co., 460 S. State St., Chicago 5, Illinois.

**400 CYCLE Dynamotors.** GE5D21N3A. 27VDC to 110VAC. 485 watts, shaft extension. Will operate 60 cycle radio equipment. \$12.50. Free list. Ercco, 1006 Hewitt, Everett 1, Washington.

**WINDING Data,** listing 225 motors, single and three phase, \$1.00. Motor Data Co., Box 7631, Kansas City 3, Mo.

**"BUILD Your Own"** gas drive arc welder easily with Hobart Generator. Save \$300 to \$500, and need only add used auto engine and chassis to build portable gas drive welder that goes everywhere after profitable construction and repair jobs. Write for free instruction book, further details. Hobart Brothers Co., Box M-1066, Troy, Ohio.

**AMPLIDYNE Motor-generators.** GE5A-M31N3A. Input 27VDC, output 60-0-60 VDC. 530 watts. Shaft extension. New \$15.00. Free list. Ercco, 1006 Hewitt, Everett 1, Washington.

## ATHLETIC EQUIPMENT, BODY-BUILDING COURSES

**DEADLY Judo**—Fiercest fighting technique. Trick knockouts. (200 photographs—plus illustrations). Expert instructions. Three volumes. Complete \$2.25. Variety House, Box 46-BS, Wall Station, New York 5.

**MASSIVE Proportions,** strength. Personal Barbell Course, \$3.00. EG, Elmsford, New York 1.

**HEALTH**—Build perfectly developed body. World's greatest system. Literature free. James Todd, Springfield, Mass.

**BARBELLS!** Catalog! Bur Barbell Co., 319 Orient Way, Lyndhurst, N. J.

**BARBELLS.** Exercise and weight lifting types, world's finest. Stamp for folders. Jackson Barbells, Springfield, N. J.

**BARBELLS.** Exercise equipment. Courses. Free booklet. Good Barbell Co., Reading, Penna.

## SPORTING GOODS, GUNS, FISHING TACKLE, ARCHERY, TRAPPING

**SEND 10c** For list 100 used guns. Prayseth's, Willmar, Minnesota.

**SPORTING Goods,** Catalog free. Craig Dare, 140 West 42, New York 18.

**FISH** At night with Johnstone Electric lighted Bobber \$1.00 prepaid. Circular on request. Dealers wanted. Johnstone Bobber Co., Aurora, Ind.

**LIQUID Type compass** 2 1/4 inches diameter. Luminous dial. Brand new. Postpaid anywhere two dollars each. Meyers Company, 820 Dryades, New Orleans, La.

**BAIT Casting plug** for bass and pickerel, proven. Send \$1.10, no c.o.d. please. D. C. Tackle, 605 Bedford St., Stamford, Conn.

**AUTOMATIC Lure**—Positively weedless. Greatest invention in ages. Nothing like it. Circular free. Babcock Reel Co., Oak Harbor, Ohio.

**SPORTSMEN!** Build kayak from easy construction kit! Literature, Ka-yacks, Dedham, Mass.

**NYLON Line:** 50 yard spool, 45 pound test, finest quality, \$2.25 prepaid. Fishing canes: all kinds, native canes, bamboos. 3-piece native cane, \$2.50. Ferrules, all sizes. Many other fishing accessories. 10c for list. Dealers' discounts, too. Bob Pace, Combs, Ark.

**GET Fishworms** with electricity. \$1.00 for drawing of worm getter and instructions. Colby, 419 Center St., Waukegan, Ill.

**REEL Seats:** The very finest. Surf size, \$2.25. Casting or fly, \$1.85. Fishing poles, canes and bamboos, creels, gaffs, electric bobbers, leaders, reels, baseball bats. List 10c. Dealers' discounts. Bob Pace, Combs, Ark.

**"1001 FISHING Secrets";** baits; lures; chums; worm surfer. Everything. Rush \$2.00. Details free. Modern Angler, Covington, Ky.

**RAISE Field crickets.** Most effective fish bait. Raise throughout year for p.o.st, hobby or own use. Inexpensive. Let Jr. make money. Details photos \$1.00. J. S. Hughes, P.O. Box 8156, Sulphur Springs, Fla.

**BOWS-Arrows.** Write headquarters for archery equipment. Quality products. Popular prices. Catalog 10c. Large illustrated hand book instructions, making and shooting. 50c. Archery, 617-B So. State, Chicago 5.

**SWIZZLE Water "Magic Liquid"** gets fishworms. No digging. \$1. 8 oz. bottle makes 50 gallon. Free catalog. Robt. Kochenrath, 1446-P Bardstown, Louisville 4, Ky.

**GUNSMITHS**—Now available, complete polishing kit for refinishing your guns. Long experience in refinishing guns qualifies us to furnish you at low cost proper wheels correctly shaped and sized to repolish guns at your plant or in your home. Write for complete information. Middletown Metal Finishing Co., Inc., River Road, Middletown, Connecticut.

**NOW Available** a complete Du-Lite installation for finishing guns and other small metal parts for \$150.00. Use it in your home or garage. Good money-making proposition. Further particulars from Middletown Metal Finishing Company, 45 River Road, Middletown, Connecticut.

**HUNTERS, Sportsmen:** Here is what you have been looking for. A four piece steel cleaning rod with aluminum handle. Can be dismantled when not in use. Fits all shotguns and large caliber rifles. Only \$1.00 prepaid anywhere in U.S.A. Order now. Don't be disappointed later as supply is limited. Irving Goodman, Box 1998, Fargo, N. D.

**3000 BARGAINS.** Firearms, binoculars, war relics. Catalog 40c. Smith Firearms, Runnemede, New Jersey.

**AMMUNITION**—New and used shotguns, rifles, handarms, fishing tackle. List 10c. Rudolph's, Atchison, Kansas.

## FIELD GLASSES, TELESCOPES, MICROSCOPES, MAGNIFIERS

**REFLECTING Telescope kit,** complete optical parts, fully finished 3" diameter 39" F.L. mirror and diagonal, both hard aluminized, plus 3 lenses for high power eyepieces. (Never again a bargain like this.) All postpaid \$6.00. Ross, C68 West Broadway, New York 7, N. Y.

**WORLD War II 6x30 binoculars** \$45.00, 7x50 \$90.00, tax incl. Excellent condition. New leather cases, fit most 6x30 binoculars, tan leather, 5 1/2" high, 2 1/2"x6" wide, \$3.50 each. Send for free list on other bargains. Optical Instrument Co., 4534 E. Thompson St., Philadelphia 37, Penna.

**GENUINE Polaroid** mounted in optical glass. 3" (72 mm.) discs, perfect for every use in photography, physics, petrology, chemistry, etc., \$1.25 each or 2 for \$2.00 postpaid. Also 1" (25 mm.) diameter 60c each or 2 for \$1.00. Ross, C68 West Broadway, New York, N. Y.

**TELESCOPES, Microscopes, binoculars, barometers, books;** buy, sell, repair. We guarantee. Lists 10c. Rasmussen & Reece, Amsterdam, N. Y.

**50 POWER Microscope** and microscience kit, \$2.98. Guaranteed. Free literature W. Wardell, 2509-A Clarendon Road, Brooklyn 26, N. Y.

**GIANT Astronomical telescope.** 100 diameters magnification. (10,000 area magnification). Metal main tube. Wood tripod 6 ft. tall. Equatorial mounting. Full power, clear vision guaranteed. \$12.50. Instructions and specifications for making it yourself. 10c. Carl Jamer, Manorville, N. Y.

**INFRA-RED filters** glass 1 1/4" (40 mil) diameter, mounted. Snap on binocular or camera. \$1.00 per set. Ross, C68 West Broadway, New York, N. Y.

**60 POWER Telescope,** \$2.95. 250 power microscope, \$2.45. Send for free catalog of telescopes, binoculars and microscopes. Brownscope Company, 24 West 45th Street, New York.

**REFLECTING Telescopes,** complete. 3 1/2" diameter, equatorially mounted. View planets, stars. \$19.75. Write Sky-scope Company, 475-P 5th Ave., New York.

**BINOCULARS, Telescopes, watches.** Buy, sell, trade. Paul Schweer, Donnellson, Iowa.

## DOGS, PETS, BIRDS, RABBITS

**CAN** Furnish puppies most any breed. Ahn's Kennels, Pau Pau, Ill.

**RAISE Golden hamsters.** Thousands needed by laboratories. Delightful pets. Literature 10c. Hamstery, 1519 Basil, Mobile, Ala.



**EXCELLENT Opportunity** raising guaranteed giant chinchilla rabbits for food, fur and breeding stock. Waters Rabbit Farm, Glennville, Ga.

**\$250.00 MONTHLY** Raising angora rabbits. Particulars free. White's Rabbitry, Newark, Ohio.

**ST. BERNARD Pups:** Champion sired beauties. Franklin Young, R4, Riverhead, Long Island, New York.

**REAL Giant Chinchilla rabbits.** Offered by their originator. Free details. Stahl, Pearl River 3, N. Y.

**BRASS Dog tags** stamped with your name, address, phone, 25c; 5 for \$1.00; 12 for \$2.00. Links free! Agents wanted. Arco, Dept. 300-F, P.O. Box 1594, St. Louis, Mo.

**RAISE Diamond Seal rabbits.** We pay \$30-\$60 each. Small investment. No experience needed. Illustrated literature 25c, with hutch plans, \$1. Prefabricated hutches, \$7.90. Automatic cleaning, feeding, watering. Hansen's Rabbit Institute, 1347 Miller Ave., Salt Lake City 6, Utah.

**SUPERIOR Chinchilla Giants—Other varieties.** Breeding stock supplied credit terms. Beautiful picturesque catalogue. Complete instructions, 25c. Behrens Farms, Pearl River 4, New York.

**BEAUTIFUL.** Useful collie-shepherds, pups \$14.00. Paul Schuitetus, New Liberty, Illinois.

**ANGORAS, Chinchillas, giant rabbits—finest, pedigreed!** Catalogue free. Book "Profitable Rabbit Raising" tells everything \$1.00; scientific self-cleaning hutch plans \$1.00; automatic feeder plans \$1.00. All three \$2.50. Grinsteads, Dept. 15-E, Edwardsville, Illinois.

**70 VARIETIES—Pigeons, rabbits, pheasant, peafowls.** Catalogue 10c. Jim Houck, Tiffin, Ohio.

**ANGORA Wool spinners, shearing tables, breeding stock.** House of Angora, Springfield, Illinois.

**INCREASE Your income** by raising domestic rabbits. Small space needed. Ready market for delicious meat, fur and wool. Largest magazine in the industry tells you how. \$1 per year. Send dime for sample. No stamps. Small Stock Magazine, Lamoni 50, Iowa.

**STANDARD Rabbit Journal, Milton, Pa.** 3 years \$1.00, sample dime.

**\$2000 PER Year** raising Angora rabbits. We buy your output. Contract particulars free. Wilsons, 1065 Shryer, St. Paul 8, Minn.

**GUARANTEED Chin-Chin giant Chinchilla rabbits.** Greatest amount of delicious meat. Largest, finest, most valuable furs. Tremendous demand for breeding stock. We buy youngsters. Contact world's largest breeder. Willow Brook Farm, R15, Sellersville, Penna.

**ZOOLOGICAL** And pet animals for sale. Illustrated catalogue, literature, 25c. Trails End Zoo-5, St. Stephen, S. C.

**RAISING Rabbits, Cavies, Hamsters, Chinchillas** is a growing and profitable industry. Magazine 10c. Descriptive book and magazine 25c. Book and magazine (monthly) one year \$1.00. Address Small Stock Farmer, Pearl River 15, N. Y.

### FARMS, FARM LANDS, REAL ESTATE

**THERE'S A farm** in your future—and you may find it in the exciting pages of United's new free Summer catalog of up-to-the-minute bargains! Farms, ranches, orchards, summer homes, water frontage, business opportunities—over 100 pages with many photographs, from the northern dairy section to the famous Ozarks, from the midwest corn belt to glamorous California, 18 states. Write today for your free copy! United Farm Agency, 220 South State St., Chicago 4, Ill.

**CHEAP Lands, Illinois, Missouri, Florida, free list.** Williams Realty, Mt. Vernon, Illinois.

**WANT A farm** of your own? Good ones are available in Canada at comparatively low prices. Favorable terms. Why not write for information today? Indicate the kind and size of farm, and the province in which you are interested. Address inquiry to H. S. Cresswell, Canadian Pacific, Montreal.

**GOVERNMENT Lands** \$2.00 acre up. Information all states twenty-five cents. National Tax Service, 834-A Majestic Bldg., Detroit.

**\$5.00 MONTHLY** Buys 40 acres near town; price \$200.00. Free list. Box 425-P, Carthage, Mo.

**WEST'S 1947 Catalogue.** Over 1000 farm and business bargains. Free copy write West's Farm Agency, Inc., HE-6, Pittsburgh 17, Penna.

**STROUT'S Green farm catalog.** Over 2500 bargains, money makers, 32 states, coast to coast. Mailed free. Tell us what you want. When? Where? Price? Terms? We will try to save you time and money. Strout Realty, 255-4th Ave., New York 10, N. Y.; 20 W. 9th St., Kansas City 6, Mo.; 453 S. Spring, Los Angeles 13, Calif.

**"100,000 SQUARE Miles Free!"** Interesting illustrated booklet describing fertile South-American lands obtainable free, 25c. Vallesp, 395-MX Broadway, New York 13.

**HOMESITES \$450—Convenient payments.** California's finest garden section. On Morro Bay's scenic shores. Wonderful fishing, hunting, boating, bathing. Fertile soil, softest water, temperate climate, congenial community. Free literature. Richard Motto, 6560 Hollywood Blvd., Hollywood 28, California.

**GOOD Farms—Ranches.** Washington, Minnesota, Montana, Idaho, Oregon, North Dakota. Dependable crops, favorable climate. Write for literature, lists describing typical postwar farm opportunities. Specify which state. J. W. Haw, 119 Northern Pacific Ry., St. Paul 1, Minn.

**OZARK Lands** for all purposes. Actual river frontages, 5 acres \$90.00 and upwards. Free list and literature. Hubbard, 424-I, Minnesota Ave., Kansas City 4, Kansas.

**FARMS, Ranches.** All kinds, sizes. Reasonable prices, terms. Wide variety locations, climates, recreational facilities. Free descriptive folders, price lists. Milwaukee Railroad territory; Washington, Idaho, Montana, the Dakotas, Minnesota, Iowa, Missouri, Indiana, Illinois, Wisconsin, Upper Michigan. R. W. Reynolds, 914, Union Station, Chicago 6, Illinois.

### POULTRY, FARM SUPPLIES

**KNOW How** to raise poultry for profit. Read Northeastern Poultryman. Every issue packed with helpful hints and practical suggestions. Latest articles on breeding, feeding and management. Subscribe now. 1 year \$1.00. Northeastern Poultryman, Dept. P.M., 376 Boylston St., Boston 16, Mass.

**POULTRY Pays!** Learn how. Postcard brings free booklet, "Seven Keys to Poultry Profits." Informative, factual. Poultry Guild, 1046 So. Olive St., Los Angeles 15, California.

**BUILD Your own poultry picking machine.** We will furnish you blueprints, specifications, and "fingers." For full information write: E. J. Willard, Box 1754, Long Beach, California.

**RAISE Turkeys** the new way. Write for free information explaining how to make up to \$3000 in your own backyard. Address National Turkey Institute, Dept. 3, Columbus, Kans.

**BUILD Your own Poultry Houses.** Save money. Carpenter experience not needed. Our plans are simple. Also make electric and kerosene heated brooders, incubators. All this in our Plan Book for only 25c. Ask for Booklet No. 108. Popular Mechanics Press, 200 East Ontario St., Chicago 11, Illinois.

### PROFITABLE OCCUPATIONS

**CANADA.** Land of business opportunities and glorious holiday. Detailed information of your desired vocation or vacation, \$1.00. Dominion Business and Travel Service, Box 55 Terminal "A", Toronto, Ont., Canada.

**TATTOOING Machines.** World's finest, supplies. Free catalogue. Jensen, 120 West 83rd Street, Los Angeles 3.

**"THERE'S Big money** in junk," and repairing batteries. Write, Batteryman, Grand Junction 5, Colorado.

**PERMANENT Molds** for metal novelty casting. Fritz Foundry & Supply, 622 N. Fulton, Allentown, Penna.

**AT Home—Your own manufacturing business** making popular \$1.00 novelties. Cost you 3c to 15c. Everything supplied. Write So-Lo Works, Dept. U-600, Loveland, Ohio.

**HOW To set up** and run a mirror shop! Resilver mirrors. For price write, John Sprinkle V50, Marion, Indiana.

**NOVELTY Manufacturing,** the casting of book ends, plaques, etc., is today's best bet to start a profitable business on little money. No expensive equipment or molds to buy. Use garage or basement, successful manufacturer shows how. Plastex Products, 711 Laguna St., San Francisco 2.

**"EASIEST Way** To Writing Success," \$1. Box 689, Athens, Ga.

**MAKE Money** at home. Write Jackson, Box 111, Newberg, Oregon.

**YOU Can sit in the boss' seat!** Keep your job; start your own factory in your spare time. We provide 15 valuable tested trade secrets. You need no plant, very little money. See page 254 for details. Chemical Research Co., 130 W. 42 St., New York.

**SEWING Machine** repairing. Step-by-step instructions on repairing, rebuilding and converting all types home sewing machines, \$5.00. Hubbard, 293 Magnolia, Cranston 10, R. I.

**MONEY** And fun playing Hawaiian guitar. Play songs first lesson. Guitar given. Free booklet. National Studios, Exchange Building, Spokane 8, Wash.

**\$5000, UPWARDS.** Annually operating dignified private "employment agency." Easily learned. Free details. Hunt, Box 308, Burlingame 1, Calif.

**"MAKE Money** With Duplicator." Free folio. Tells how. Rucker, 2836-P Slevin, Louisville 12, Kentucky.

**START Back yard, perennial plant business.** Much more profitable than Ginseng. Instructions \$1.00. Richland Gardens, Martin, Tennessee.

**MAKE Beautiful mirrors** from window glass cheaply. Formulas and silvering data \$1.00. Metallize baby shoes for profit. Several methods \$1.00. Tes-Co., Box 189-ME, Wilkes Barre, Penna.

**"ALASKA—The Last Frontier"** offers excellent opportunities! \$1 brings official government map and 1947 copyrighted report describing potential opportunities in commercial fishing, mining, fur farming, prospecting, aviation, timber, agriculture, live stock raising, business enterprises, government homestead lands. Alaska Opportunist, 6417 Homewood Ave., Dept. PM, Hollywood 28, Calif.

**MEDICAL Laboratory technicians** in great demand. We train you in your spare time, in your own home. You can practice while studying. Write for free catalogue. Imperial Technical Institute, Box 973-T, Austin, Texas.

**START Big profit vendor business.** Cost small. Free details. Factory Silver King Corp., 622 Diversey Pkwy., Chicago 14, Ill.

**MAKE Flexible molds.** Few cents each! Cast plaques, novelties, bookends! Free sample! H. Tooker, Hamilton 9, Ohio.

**MAKE Beautiful costume jewelry** at home for large profits, hobby or therapy. Free illustrated wholesale catalogue of sea shell, metal and plastic parts contains detailed instructions. Florida Supply House, Bradenton, Florida.

**LEATHERCRAFT Supplies.** Catalog 10c. Art Craft Supply Company, 1205 Throckmorton, Fort Worth, Texas.

**INTERESTED In Latin American** and foreign employment? \$1 brings 1947 Foreign Service Directory listing oil, aviation, mining, transportation, manufacturing, construction concerns with foreign interests and tips for immediate application. Global Reports, 6417 Homewood Ave., Dept. PM, Hollywood 28, Calif.

**WOULD You pay 3¢—first \$350 made?** Color-illustrated book "505 Odd, Successful Enterprises" free! Some offer occasional "day off." Work home. Expect something odd! Pacific, San Clemente, Calif.

**LOCKSMITHING—Profitable business** or hobby! New course teaches you lock secrets, how to fit keys, de-code, masterkey, etc. Easy self-instruction lessons. Bargain price. Fascinating 100-page illustrated catalog free! Write Nelson Company, Dept. 2-02, Chicago 5.

**MUSHROOMS Grown.** Boxes, Barrels. Illustrated instructions 50c, Spawn \$1.00. Gordons, 553 William, Winnipeg, Manitoba.

**TYPEWRITER Repairing instructions,** standard typewriters. Webers', Box 1008, Canton, Ohio.

**\$40.00 WEEKLY** Made growing mushrooms, fresh, dried. Dominion patent 331583. Free spawn. North American, 169P Yonge, Toronto, Canada.

**TYPEWRITER Repairmen** urgently needed. Earn \$40 to \$50 weekly spare time. Our easy to learn home study course teaches how to repair typewriters. Write for free information. Houston Typewriter Repair Service, P.O. Box 5357A, Houston 12, Texas.

**WELDING—Electric arc.** Learn profitable trade quickly through actual practice. Individual welder instructions at bare cost of materials. Full particulars free. Valuable welding lessons book 50c. Hobart Welding School, Box M-1064, Troy, Ohio.



**ELECTRIC** Clocks are every where you go, buildings, homes, parking lots, factories. Repairs increasing. Our easy to learn course with pictures and drawings teach you how to repair these clocks. Electronic Supply Co., P.O. Box 2350A, Houston 1, Texas.

### BOOKS, PERIODICALS, PICTURES, POSTCARDS

SEND 25c For Alaska's attractive, pictureful magazine. The Alaska Sportsman, Box PM-118, Ketchikan, Alaska.

WHAT Every Mason wants. We have Masonic books for Blue Lodge, Chapter, Commandery, Scottish Rite and Shrine. Our rituals are used the world over. Send for free catalog of books and rituals for Masons, Odd Fellows, Knights of Columbus, etc. Ezra A. Cook, Publisher, P.O. Box 796-PJE, Chicago 90, Ill.

MAKE Money raising fur and trapping. 16 page descriptive booklet free. Fur Trade Journal, 588 Mt. Pleasant Road, Toronto, Ontario.

OUTDOOR. In your home or workshop. Brilliantly-colored outdoor pictures 25 cts. 7-51. Persil, 436 N. Y. Ave., Brooklyn 25, N. Y. (Dealers wanted).

PRETEND Visiting Heart-o-Texas! Three postcards 25c. Address, return for remailing. Letters mailed 25c. The Store, Box D, Richland Springs, Texas.

HOW To accumulate money. Free details. Stanley, 544 East Jersey Street, Elizabeth 1, N. J.

ATOM Bombed Nagasaki. 15 photos, \$1.00. 12 Aleutian photos \$1.00. Makins Pictures, 1005 Parkside, Bremerton, Wash.

10 VOLUME Sets Kipling or Stevenson, \$20.00 value for \$10.00. Send \$1.00 (returnable) for descriptive folder. Mileson Company, 1818 Tyler Pkwy., Louisville, Ky.

LIST Of postcard collectors, 25c. United Card Collectors, Park and Eighth, Mt. Vernon, Ill.

"CARRIER War"—Chronological story with 200 action pictures, many colored. Pacific sea and air battles. Postage prepaid, only 50c. 319 Hyde Bldg., Spokane 8, Wash.

BACK-DATE Magazines, books. Specific issues, years. Arkel's, Tarzana, Calif.

"BOOK Of Rafter Lengths"—How to cut common or hip rafters. Useful, needed by carpenters, lumber dealers, contractors, builders. Copy 50c, three copies \$1.00 postpaid. Maywood News, Maywood, Ill.

ART Anatomy of The Human Body, \$1.00. Art of Drawing Women, \$1.00. Free catalogue of unusual books included. A. Fuller Company, 201 Dewey Street, Newark 8, New Jersey.

MAGAZINES—Business, vocational, diversion. Current single copies. Choice over 850 periodicals. All fields. Free price-list. Commercial Engraving Publishing Co., 34C North Ritter, Indianapolis 19, Indiana.

BACK Issue magazines. Priced catalogue for \$1.00. Credited on first order. Kovach, 712 So. Hoover, Los Angeles 5, Calif.

GOOD Books by mail. Free catalog PM. H. H. Evans, 1157 Sutter, San Francisco 9, California.

\$1.00 BRINGS 20 Beautiful, large 8x10 size, colored art pictures of scenes, etc. Marvelous, Box 2343, New Orleans 16, La.

YES! We are again accepting agents to handle magazine subscriptions, books, greeting cards, complete details 25c (refunded). Cassell Publishers Service, Westfield, New Jersey.

BOOKS! (Out-of-print, scarce): Quickly supplied. Send wants. Spotlight, 141 Broadway, New York 6.

BOOK Catalog free—Drop post card in mail today for interesting catalogue. Milwaukee Book Mart, Dept. C, 620 W. Center St., Milwaukee 12, Wisconsin.

GOOD "Used" self-instruction educational books on all subjects bought, sold, rented, exchanged. Satisfaction guaranteed. Complete information and 100-page illustrated bargain catalog free! Write—Nelson Company, Chicago 5.

SELF-EXPLAINING Bible; Illustrated circular free, Box 446-P, Minneapolis, Minn.

BIG Profits taking subscriptions for all magazines. Agents' confidential catalog listing over 2500 periodicals and complete starting supplies free. Pines Subscription Agency, Flushing, New York.

NATIONAL Geographic Magazine, 1888-1945, any issue. Periodical Service, Dept. PM, Swarthmore, Penna.

BOOKFINDERS! (Scarce, out-of-print unusual books.) Quickly supplied. Send wants. Clifton, Box 1377PM, Beverly Hills, Calif.

MAGAZINES (Back dated)—foreign, domestic, arts. Books, booklets, subscriptions, etc. Catalog 10c (refunded). Cicero's, 863 First Ave., New York 17, N. Y.

### GAMES AND ENTERTAINMENT

MAGIC? No! Skill? No! What is it that makes people wonder how it is done? Any one who can read and add simple sums can be the wonder of the party. Two samples 25c. John Duchow, 5304 Park Ave., Montreal, Canada.

PLAY Pool professionally. Complete course \$2.00. Pamphlet sent free. Box 268, Hindsboro, Ill.

PHONOGRAPH Records cheap. Catalogue. Paramount, MD-313 East Market, Wilkes-Barre, Penna.

### MAGIC TRICKS, PUZZLES, JOKER NOVELTIES

SPECTACULAR Chinese ring illusion and super magic catalog, yours for 10c. Also details about our startling introductory offer of free professional type tricks. Magic Shoppe, 19 N. Springfield Ave., Newark 2, N. J.

BEWILDERING Hindu mystic trick, catalogue 10c! Postways, Box 5325-D, Philadelphia 42.

TRUE Secret of ventriloquism. Send for booklet. Quackenbus, Big Flats, N. Y.

50c MAGIC Frame and lists. 25c. Prit-Trix, 642 Madison, Evansville 13, Indiana.

DOLLAR Magic set free with mammoth catalog, 25c. Mysto, 4462-A, Germantown, Philadelphia.

"VENTRILLO," Professional voice-throwing instrument and catalog, 25c. Box 971-PM, Philadelphia.

COIN Disappearing trick, magic safety pin trick, disappearing card trick; all three for \$1.00. Mystic, 1241 Quebec Road, Cincinnati, 5, Ohio.

CHANGE Water to wine, (vice versa). Secret professional trick, 50c coin. Worth \$10.00 to any magician. Walker, Box 394, Union, New Jersey.

TWELVE "Catchy" tricks; ten side-show tricks; magic catalog, 10c. Lee's, 2231-M McKinley, Berkeley 3, Calif.

SNEEZING, Itching powders, eighteen other tricks, free with catalog, 25c. Factory, 2404-N Fifteenth, Philadelphia.

MAGICIAN'S Pin, ghost illusion, Houdini escapes, giant catalogue. Everything, complete 25c. Magic Wand-M, 9W Colorado, Pasadena, California.

PERFORM Astounding stunts with Alnico. Defy gravity. Mystify your friends. Two bar magnets (4 oz.), instructions, 60c postpaid. Ross, C68 West Broadway, New York, N. Y.

FREE Catalogue magic, puzzles, tricks, Schetz's, 98-N Branch, Sellersville, Penna.

AMAZE And mystify your friends with highest quality magic. New catalogue 25c coin. Mazda Magic Co., 1135 Westgate Ave., Oak Park, Ill.

BE A magician. Large professional magic catalog of latest tricks, 25c. Ireland, C-109 North Dearborn, Chicago 2.

GUARANTEED Magic tricks! High quality, low prices and fast service! Big illustrated catalog and five good tricks explained, only 25c. Satisfaction guaranteed! Bargain! Act now! Newton Magic Co., 121-A Main, Bonham, Texas.

LAUGH Kit of 10 tricks and jokes for \$1.00 postpaid (retail value \$2.50). Halo Novelty Co., 2015 North 6th St., Harrisburg, Penna.

VENTRILLOQUISM Taught, 3c stamp bring particulars. Smith, 801 Bigelow, Peoria 5, Ill.

WHOLESALE Jokers' novelties. 50c. Samples, catalogue—25c. Box 526, Jamaica, N. Y.

VENTRILLOQUISM. Complete course only \$1. LeSueur, 77 Wellesley, Toronto, Canada.

VANISHING Half dollar trick and catalog 25c. Sterling Magic Co., Royal Oak, Mich.

WORLD'S Largest professional magic shop, keeps you in touch with latest tricks. To receive mailings, send 35c for new catalog. Holden's, M220 West 42nd St., New York.

200 ELECTRIC Stunts, 110 volts, \$1. Kutting Sons, Campbell, Calif.

500 TRICKS! New 1946-7 edition Douglas famous catalog now ready, only 10c. Brand new magic for pocket, parlor, club, stage, professional, amateur. America's fastest service to magicians everywhere for over 25 years. Send 10c today. Douglas Magicland, Dept. 1, Dallas, Texas.

EARN Money in any crowd. Call names of strangers, tell unspoken questions. Professional course mind reading, faked spiritualism, etc. \$1. Henderson, Box 341, San Bernardino, Calif.

LARGE Illustrated professional catalog 10c. Williams, 900 Plymouth, Ellwood City, Penna.

FREE! Large catalog of magical apparatus if you remit 25c for "Magic Is Fun" magazine. Robbins Co., 152-F West 42nd Street, New York.

ENTERTAIN! Mystify! New, bigger magic catalog and 4 secret tricks 25c. Herbert, P-192 N. Clark, Chicago 1.

MAGIC Tricks, puzzles, books, cards, punch boards. Catalog 10c. Specialty, Box 671, St. Louis 1, Mo.

### COINS, TOKENS, CURRENCY

UNUSUAL Worldwide collection twelve different foreign coins and bills only 25c. Webb, Box 473, San Bruno, Calif.

COMMEMORATIVE \$½, Oregon, Texas, Kentucky, Cleveland, Long Island, \$2.00 ea. Illustrated catalogue 25c. Norman Shultz, Salt Lake 9, Utah.

WILL Pay \$10.00 each for certain Lincoln pennies. Indianheads \$50.00; dimes \$1,000.00. Catalogue 10c. Federal Coin Exchange, 8-PM, Columbus, Ohio.

INDIAN Head penny with list 10c. Charles Banker, Salina, Kansas.

OLD Money wanted. Will pay \$100.00 for 1894 dime, S. mint, \$50.00 for 1913 Liberty head nickel (not buffalo). Big premiums paid for all rare coins. Send 4c for large coin folder. May mean much profit to you. Numismatic Co., Dept. 20, Fort Worth, Texas.

30 DIFFERENT Coins \$1.00. 30 different bills \$1.00. Oddehon, Box 482, St. Louis, Mo.

LINCOLN Cent bargains—1909-SVDB \$10.00, 1909-S 60c, 1914-D \$2.25, 1922-P \$1.75, 1922-D broken D, 75c, 1931-S 65c. Other Lincolns, any 10 different \$1.00, 20 different Indian cents \$1.00, 3-legged buffalo nickel \$1.25. Whitman folders 25c, handbook 50c, guide book \$1.50. Minimum order \$1.00. Fast service. Large retail catalogue 10c. Bebee Coin Company, 1180 East 63rd, Chicago 37, Illinois.

JAPANESE Invasion currency, five different 15c. Calzi, 6162 North 17th, Philadelphia 41, Penna.

HANDBOOK U. S. coins \$1.00. Indian heads, 10 different, \$1.00. Foreigns, 10 different, \$1.00. Coin Exchange, Box 92, Fairfield, Ohio.

CHINESE \$10. Bill, 10c each, 20 for \$1.00. 10 Japanese yens, coins, \$1.00. S. Sabatino, 27 Spring St., Elizabeth 4, N.J.

WE Pay \$2 to \$200 each for hundreds of old or odd coins, Indianhead, Lincoln and foreign coins wanted. You may have valuable coins. Keep all until posted. Send 20 cts. for new Ill's Coin Value Book, 4x6. Buying and selling prices, 40 years in business. Coin Exchange, (7), LeRoy, N. Y.

FOR Sale: 1893 Columbian World's Fair half dollar, 75c; U. S. 2-cent pieces or 3-cent pieces, 25c each; 50 assorted Indian head cents, \$1.25; large 50 page U.S. coin catalog, listing thousands of coins for sale at reasonable prices, 25c; Giant 72 page foreign copper-silver-gold catalog listing over 10,000 coins for sale, 25c. Ben's Coin Company, 72 West Washington, Chicago 2, Illinois.

WORLD Coins—25 different \$1.00. Harry Elsholz, Box 9014, Pittsburgh 24, Penna.

GET Profit and pleasure in collecting old coins. Send 10c for 56 page illustrated coin catalog. You'll be delighted with it. Send for it now. B. Max Mehl, 370 Mehl Bldg., Fort Worth, Texas. Largest rare coin establishment in U.S. Established 47 years.

FREE! Foreign coin, banknote and coin collectors illustrated catalog to approval service applicants. Send 3c postage. Tatham Coinco, Springfield-125, Mass.

FREE—"Amazing New Book"—"Profits From Classified Advertising." Tells how and what to advertise. Be sure to read this book before you invest one cent in advertising. Remember—it's free! Write for your copy now. F. W. Johnson, Classified Advertising Manager, 200 East Ontario Street, Chicago 11, Illinois.



## STAMP COLLECTING

**MANCHUKUO** Railway set complete including a beautiful map stamp, high value Canadian, large Peru, "El Chasqui" Indian post runner, two large Ceylon pictorials, French and British Colonials, and many others. Only 10c to approval applicants. J. L. Meagher, 2040 Spencer St., Philadelphia 38, Penna. Dept. A.

**FREE!** Complete Balkan aviation set with approvals. Beaman, Elliston, Virginia.

**FREE!** Tiny Chinese "midget" war set. Approvals. Seminole, Elliston, Virginia.

**ALL** Different, 200 Denmark \$2.25; 200 Finland \$3.50; 200 Norway \$3.50; 200 Sweden \$2.25; 200 Iceland \$6.00. Hoffer, Vanlose, Denmark.

**600 MIXED** 10c! Australia, China, Ecuador. Fine bank mixtures for many lands. (One to a customer) approvals included. Limited supply so write today! L. Brady, Cheswick, Penna.

**COOK** Island: mixed \$1.00. No approvals. Krueger, Tirohia, Paeroa, New Zealand.

**FREE:** Ten different British Colonies and coupon proposition how you can get more stamps free. Stampdean, Box 202, Wilmette, Illinois.

**112 DIFFERENT** World-wide, from 20 different countries, 10 cents to approval applicants. Daniel W. Menge, 827 North Lime Street, Lancaster, Penna.

**25 DIFFERENT** World stamps to approval applicants for only 10c. We cater to beginners. Chemcity Stamps, 1508 Jackson, Charleston, West Virginia.

**AROUND** The world—30 different countries; Basutoland, Nyassaland, Tangier, Cyprus, St. Helena, 10c with approvals. Excello Stamps, P.O. Box #95, Hackensack, N. J.

**ROOSEVELT** Issue, Cuba, mint, 5c with approvals. Miami Stamp Company, Box 2437, Miami 14, Florida.

**FREE—French** Coat of Arms. Hitler heads, airmails, Vatican, with approvals. Gulfstream, Drawer 71, Miami 1, Florida.

**SWASTIKA!** Most hated symbol in the world! To serious applicants of our deluxe approvals, we offer 5 different mint swastika blocks, cataloging \$1.08, for only 10c. Philatelic Corner, 175 Stratford Rd., Buffalo 16, N. Y.

**FREE** German price list, 900 varieties, 50 different German 25c. 500 different German \$4.40. Cut Rate, Blue Springs 11, Missouri.

**31 DIFFERENT** With George Washington stamps from Brazil and Ecuador; Pirate Island; victory issue; medical set; others—all 4c with approvals. Grayson Company, Sherman, Texas.

**OFFER** Juvenile stamps, 35 different, canceled, against remittance of \$1.00 in banknotes. E. Krausz, Box 578, St. Gallen, Switzerland.

**FREE.** 35 Stamps with approvals. Hohnski, 305 Philadelphia Block, Canonsburg, Penna.

**MASSIVE** Values: 20 different Hong Kong 25c. 20 different Panama 45c. 50 different Bohemia; Moravia 50c. 50 different Egypt 70c. 100 different Czechoslovakia 75c. 50 different French Morocco 75c. 100 different Chile 85c. 40 different Philippines 85c. 50 different Algeria 95c. 50 different Lithuania \$1.50. 100 different Guatemala \$1.50. 50 different Manchukuo \$1.50. 1000 different French Colonies \$8.50. Mission Mart, Washington 17, D. C.

**COLLECTORS!** Credit terms, beautiful collections, superb packets, sets, rarities, new issues. Send for free list. Sharp, Box 454, San Bruno, California.

**WORLDS'** 2 Smallest countries. Vatican & San-Marino. 15 beautiful unused stamps only 10c with approvals. Hugo Madsen, Box 72 Station B, Brooklyn, New York.

**FREE.** San Marino airmail set, 3 values, to new approval applicants. Wesken Stamp Co., Box 66M, Queens Village, N. Y.

**MEXICO** Mixture, plenty airmails, commemoratives, 400-\$1.00. Biehl, Apartado 2887, Mexico City.

**WHAT** Have you to offer? A collection? A "shoe box" accumulation? Anything in stamps. We urgently need them. Spot cash paid. Cosmopolitan Stamp Co., 1457 Broadway, Dept. 6-E, New York.

**VICTORY** Packet free—Includes stamps from Tanganyika, British Cayman Islands, animal, scarce babyhead, Coronation, early Victorian, airmail, map stamps. Including big illustrated catalogue. Send 5c for postage. Gray Stamp Company, Dept. PM, Toronto, Canada.

**POSITIVELY** Greatest free offer—Latest Scott's International \$6.00 stamp album, covering entire world, contains 36,000 illustrated descriptive spaces; Scott's 1947 Standard \$6.00 catalogues "Philately's Encyclopedia"—absolutely free to applicants for foreign approvals becoming customers. Plymouth Specialty Company, Dept. A-9, Bell, California.

**FREE—New** souvenir sheet commemorating 100th anniversary of our country's stamps. Free to applicants for our outstanding United States and foreign approvals. Send 25c which you will deduct from your purchase. S. C. Engel, 38 Park Row, New York.

**VATICAN** City! Four varieties of Vatican City (world's smallest country) including portrait of Pope Pius! Also stamps from Afghanistan, Cape Juby, Libya, Macao, Palestine, Syria, Liechtenstein, San Marino, and many other interesting countries. All together 48 different stamps, total catalog price over \$2.50!—only 10c to approval applicants! Methuen Stamp Service, Inc., Dept. 211, Methuen, Mass.

**UNITED** States bargain. Here's an offer so stupendous that it is almost unbelievable: 50 different U. S. stamps ranging in age as far back as over sixty years and in face value as high as the dollar value composed entirely of face different postage, airmail and commemorative stamps, nothing else. In addition, we include 2 Japanese stamps of the Philippines. We will send all these for only 10c, but only for sincere approval applicants. In asking for approvals, please state whether you are interested in United States or foreign stamps or both. Approval Headquarters, Globus Stamp Company, 268 Fourth Ave., New York City 10, Dept. 201A.

**50 DIFFERENT** French stamps and our price list, one silver dime. Stamp Sales, Box 1649P, Oakland 4, California.

**FREE!** 20 Different India! With swell approvals. Eric Kardell, 1175-3 Clay, San Francisco 8, California.

**120 DIFFERENT** Stamps, 3c to approval applicants. Appelman, Ida, Mich.

**24c** PRESIDENT Harrison. This scarce stamp only 5c with approvals. Willett Stamps, Box 507, Port Chester, N. Y.

**GENUINE** "Goya Nude" set 10c to approval applicants. Royal Stamp Company, Tamaqua, Penna.

**AMERICA'S** Friendliest stamp magazine! Chock-full information, news, bargain offers! Trial subscription, 25c! "Stamp Post," Station A, Pasadena, Calif.

**FREE!** 20 Mint recent Hungary to approval applicants. Quality Stamp Company, Box 202, Sta. F, Buffalo, N. Y.

**AGENTS** Wanted, sell stamps, no investment. William Waugh, 2140 N. N.W., Washington 7, D. C.

**STORES—**Stamps on consignment. Inquire letterhead. Also bargain lists for collectors. Hammond Co., Auburndale, Mass.

**PROGRESSIVE** United States approvals. Adult applicants only. Panther Company, Dorchester 24, Mass.

**GRAND** Value packet with five foreign sets, free with approvals. Stoll Stamp Service, 2630B West Burnett, Louisville 10, Kentucky.

**ROOSEVELT,** Churchill, Stalin, Hitler, Vatican city stamps free, to approval applicants. Flamingo Stamps, Box 517, Miami Beach, Florida.

**FREE!** Cuba Roosevelt stamp! Approvals. Keating, 637 Bergen, Jersey City, N. J.

**SENSATIONAL!** Over 125 different including Abyssinia, Albania, Rhodesia, etc. Everything 10c with approvals. Brody, 264 Dwight St. Ext., Springfield, Mass.

**FIRST** See them, then buy them. United States approvals plus unique premiums. Jarr, Box 217-J Madison Square, New York 10.

**BECOME** Successful stamp dealer. Details free. Postage please. Sample book \$7 with trade stimulators. Bing Co., Minneapolis 9, Minn.

**KISHENGARH,** Antigua, Patiala, Ceymans, dime, Bargain list. No approvals. Roth, 25 Maple, Bloomfield, N. J.

**5000 UNPICKED** U. S. \$2.00. Satisfaction guaranteed. Kuhn, 3315 80th, Jackson Heights, N. Y.

**GALA-GROUP** Free! U. S. commemoratives, Camerons, French Equatorial Africa, Madagascar, New Caledonia, Oceania, St. Pierre and Miquelon, with approvals. Hill Stamps, Box 732, Woodmere, N. Y.

**GENUINE** Magnifying glass, plastic handle—only 10c! To approval applicants. Elliott, Box 51-X, Miami Beach 39, Fla.

**TEN** Beautiful mints free with grade A approvals, fast service. Cornell, Box 4259B, Miami 26, Fla.

**300** COMMEMORATIVES, pictorials, etc., plus surprise packet, \$1.00. Schneider, Box 1012, Chicago 90.

**FREE** Cuba "Roosevelt." Request approvals. Suburban Stamp Sales, St. Louis 14, Mo.

**FREE—Beautiful** and unusual Italian Social Republic set, commemorating Bandiera brothers, with introductory approvals. Home Hobby-Craft, 3322 Decatur, Philadelphia 36, Penna.

**BRAZIL** Diamond shaped set, 10c with approvals. Vargo Stamps, 6044 South Fairfield, Chicago 29, Illinois.

**FREE** Beautiful new issues, six countries, including San Marino airmail, to approval applicants. Green and Company, Norwood 12, Ohio.

**30 BEAUTIFUL** Airmails 10c, selected approvals. Louis Morrison, Milmont Park, Penna.

**FLAG** Stamp free with U. S. approvals. Wenigman, 929 Oakdale, Chicago.

**1/2c** UP. Popular approvals. Small Stamp Dealers, 2616 Cortez, Chicago 22.

**NUDE** Duchess set (two values) 5c to approval applicants. Masters, Clifton, Kernan, Baltimore 7, Maryland.

**U. S.** Used #376, #378, #413, #410, #509, Mint #582, #603. Only 50c. Approvals accompany. Whiton-Stamps, Westport 4, Connecticut.

**GIANT** Roosevelt stamp free with approvals. Granada, 4891 Southwest 5th Street, Miami 34, Florida.

**PROTECT** And beautify your stamps, blocks, covers, etc., with Crystal-Mount. Write for free samples. Harris & Co., 202 Transit Bldg., Boston 17, Mass.

**VALUABLE** Catalogs, 10c each: (1) "United States and British N. America" complete with 1000 illustrations; (2) "Airmail Stamps"; (3) "British Empire"; (4) "Modern Europe"; (5) "Annual Catalog" of albums, supplies, packets, advice to beginners, etc. Each catalog 128 or more pages, profusely illustrated, wonderfully informative! Harris & Co., 202 Transit Bldg., Boston 17, Mass.

**SAN** Marino—16 values mint (4 sets), commemoratives and airmails. All for only 15c to approval applicants. Wm. Thiem, Cape Vincent, New York.

**\$10.00** FOR \$1.00. Box full stamps valued Scott's \$10.00 and stamp album. Everything \$1.00. Longacre Shop, 108k West 42nd, New York City 18.

**2,000** UNUSED Stamps from over 150 countries at face value. Postcard brings full information. Comet, G.P.O. Box 517-P, Brooklyn, N. Y.

**COLLECTIONS** For sale! See our ad page 38. Neptune Stamps.

**UNITED** States collection, thirty-seven fine unused commemoratives before 1943, including Columbians, bicentennials, parks. Price \$1.03, approval applicants only. Fort Orange Stamps, Albany 3, New York.

**SCARCE** U. S. stamps nearly 100 years old, 1893 commemorative, \$5-\$10 stamps, Armed services pictorials complete, Roosevelt set, large allegorical figure of Commerce, old revenues, everything 5c to serious approval applicants. Metropolitan, 140 Nassau, New York 7.

**EGYPT—**15 Different, 5c to approval applicants. Bohemia Stamp Service—1, Bohemia, N. Y.

**UNITED** States approval—Largest varieties. America's lowest selling prices. Stamp Company, Albany 7, N. Y.

**AIRMAILS** Only on approval. Mint and used. References required. Gerspacher, 159 Irving Terrace, Kenmore, N. Y.

**FREE!** 33 Transjordan, Trinidad, Haiti, others. Approvals. Robert Keating, Box 267M, Forest Hills, New York.

**PENNY** Approvals. Henry Jay Service, 15 Park Row, New York City.

**ICELAND** Packet free to approval applicants. Don't delay, write now to "Everglades," Box 3222, Station F, Atlanta, Ga.

**ILLUSTRATED** Stamp Magazine, 26 weeks 25c. Stamp Journal, Kalamazoo, Michigan.

**ZANZIBAR,** Palestine, Manchukuo, Azerbaijan, Haiti, Iraq, Siam, Victoria, Hitler stamp 5c. Approvals. Postzegel, Windham, New York.

**CANADA—**75 Diff. 25c. Approvals, Lists. Victoria Stamp Co., London 4, Canada.

**BET** You haven't these! South Georgia, South Orkneys, Grahamland, South Shetlands. Shortlived Falkland Dependencies. Everything 3c with approvals. Viking, 130ZZ Clinton St., Brooklyn, N. Y.



**FINE Approvals, freshly mounted. Past, personal service. Tell me what countries you prefer and I'll send their stamps. Skinner, 438 Locust, Long Beach 12, Calif.**

**WORLDWIDE, Different 200—25c; 500—60c; 1000—\$1.50. Beacon Sales, Maynard 2, Mass.**

**FREE! Airmail packet with approvals, Deane Stamps, Box 87, Miami 35, Florida.**

**COSTA Rican triangle and diamond stamps free to approval applicants. Jay-Dee Sales, 49 Chalmers, Youngstown, Ohio.**

**FREE! The Stamp Finder! Send today for the big new edition, fully illustrated, enabling you instantly to identify all difficult stamps! Also fine packet strange, fascinating stamps from Bosnia-Herzegovina, Monaco, Patiala, Cyprus, etc., including maps, ships, animals and strange scenes. All free to approval applicants enclosing 3c postage. Garcelon Stamp Company, Box 900, Calais, Maine.**

**200 DIFFERENT Stamps, 6c, to approval service applicants. Tatham Stamp Company, Springfield 30, Mass.**

**PORTUGAL—30 Different 10c. Approvals on request. Stamp Chest, Box 748-A, Jamestown, New York.**

**BRITISH, Spanish and French Colonies, Vatican, Hitler heads, and airmail packet, free with approvals. Pan-American Stamp-co, Box 145, New York 33, N. Y.**

**OVER 100,000 sold; 100 different Latin America only 33c; 100 different Greece 85c. Carlton's, 10243 Silvertown, Tujunga, Calif.**

**EXOTIC Pictorial collection: Tahiti spearfishing, Melanesian idol, Ingavi battle, Reunion, Madagascar, St. Pierre Miquelon, Djibouti, Wurttemberg, Dutch Indies, Newfoundland, many others. This outstanding offer only 5c. Imperial, Box 1491, Tampa, Florida.**

**SIXTY-SIX Different stamps 3c. Approvals. Cornetta, 228 West 25th, New York 1.**

**15 U. S. Commemoratives 10c, approvals. Roger Stamp Mart, P.O. Box 316, New York 8, N. Y.**

**FREE—Famous Americans set, plus Flag Set, plus the National Parks Set, plus the Presidential Set to the \$5. A total of 90 stamps absolutely free to customers for our unsurpassed United States or foreign selections. Send 3c postage for 15 of the above mentioned stamps and full particulars. Triboro Stamp Company, 145 Nassau St., Dept. 103, New York.**

**CHINA 20 Colorful historical stamps 10c with approvals. Collins', 71 Coleridge, San Francisco 10, Calif.**

**\$2,000 IN Stamps free to contest winners. Particulars, entry blank, to approval applicants enclosing only 10c for scarce Roosevelt Mourning stamps from Nicaragua, Greece and Argentina, plus photograph of "Roosevelt Collecting Stamps." National Stamp Sales, 276A West 43rd Street, New York 18, N. Y.**

**DANDY U. S. approvals; write immediately. Sullivan, Endicott Building, St. Paul, Minnesota.**

**CUBA'S Retirement set shows aged couple receiving pension check. This set sent to approval applicants for only 5c. Bryson Stamp Company, Drawer F-2, Rossford, Ohio.**

**ROUND The world colonies—British, Dutch, French, Portuguese; strange little known countries, primitives, cannibals etc. All for 3c to approval buyers. Dixie Stamp Company, Dept. 10, Milwaukee 1, Wis.**

**118 DIFFERENT Stamps including commemoratives, charities, airmail, surcharges, sets, etc. Only 3c to approval buyers. Badger Stamp Company, Dept. M, Milwaukee 3, Wis.**

**SMOKY Mountain souvenir commemorative sheet and 30 different U. S. stamps, including commemoratives, airmail, etc. (catalog value exceeds 65c) for 10c to approval applicants. Curhan Stamp Company, Dept. H, Gloucester, Mass.**

**BERLIN Bears, complete set of eight and 100 different stamps only 10c to approval applicants. Reich Stamp Co., 4647 Kenmore, Chicago 40, Ill. Dept. M11.**

**FIVE Vatican City stamps free to approval applicants. Florida Stamp Company, Box 807, Miami 5, Florida.**

**20,000 VARIETIES 1c-5c each! Gordon Davison, Box 1019B, Manchester, N. H.**

**STAMP Collections wanted. Complete collections, duplicate lots, surplus stock, mint and used. Prefer trade for printing or other items, buy outright if priced right. What have you, what's wanted? Vanroy Shirk, Lebanon, Penna.**

**U. S. Price list. Send postage. State Stamp Service, 1225 Park Building, Pittsburgh 22, Penna.**

**WOW! \$10.00 Worth of fun only 10c. What a treasure hunt! Big package 500 foreign stamps—just as received from foreign missions—other sources. Includes stamps from Africa, South America, Philippines, Free French, Cape Juby, Palestine, etc., including airmails, commemoratives, and stamps worth up to 50c and 75c. This amazing offer is given for 10c to serious approval applicants only. One to a customer, money back if not more than delighted. Jamestown Stamp Co., Dept. 22, Jamestown, New York.**

**YOUR Money's worth! Seychelles, Djibouti, Angola, Chinese hunger stamps and over 100 different other stamps. Everything 10c to approval applicants. Atlas Stamps, 4220 West 16th, Dep't L, Little Rock, Ark.**

**FREE—Abyssinia, Cayman Islands, Tuna triangle, Indochine, Syria, Ivoire, Philippines (Jap "shame" issue), Turkish harem, Damascus, Cambodia, African "beauty," Pirate Islands, Colonials, others—All free for 3c postage with approvals. Belmont Stamps, Washington 10, D. C.**

**1000 MIXED U. S. old and new—25c; 2 lb. \$1.25. Weatherby, Medina, Ohio.**

**OLD Scarce U. S. seconds on approval. Slightly defective, nice appearance, bargain prices. Hernfield, 551 Clinton, Newark 8, N. J.**

**U. S. Price list. Send postage. Stanley Gibbons, 38-P Park Row, New York.**

**PENNY Approvals, that satisfy. Neil Gronberg, Box 5441-P, Philadelphia 43, Penna.**

**ZOWIE-E! A barrel of fun for only a dime. 500 United States stamps—absolutely unpicked and unsorted—just as received from church missions. Many varieties, including large commemoratives, airmails, high denominations up to \$5.00! Stampdom's biggest package of fun—and you might find something really valuable! Price only 10c to serious approval service applicants. Money back if not delighted. Illustrated bargain lists with each order. Mystic Stamp Company, Dept. 80, Camden, New York.**

**50 DIFFERENT United States, 10c. Price-list free. Seidenberg, Cassopolis, Mich.**

**FREE! Negro Triangle; Turks Islands "Cactus"; Dakar; Guinea; Palestine; "Fairy Tale," Pirate Chart, Map, Ship, Sea Lion and Snake stamps; French, British, Portuguese Colonies, etc. Free for 3c postage. Approvals. Potomac Stamps, Washington 10, D. C.**

**UNITED States approvals complete coverage, fine quality, attractive prices. Seminoles Stamps, Box 378, Coconut Grove, Florida.**

**50 DIFFERENT Including scarce diamond-shaped airmail 3c to approval service applicants. Avalon Stamp Co., Dept. M, Springfield 8, Mass.**

**1000 GRABAGS 15c Each. Super bags 25c. Zandy, 630 Bingham, Reading, Pa.**

**FREE U. S. price list. Postage 3c. Mark Hanna, 335 - 5th Avenue, Pittsburgh 22, Penna.**

**FREE! Canadian sets, royal visit, George VI, George V, coronation, jubilee, others, to approval applicants. Ensign, Box 118-M, South Orange, N. J.**

**WORLD'S Largest diamond and triangle stamps, free stamp magazine, stamps from fighting Free French, 20 stamps from 20 different countries, pictorials, airmails, big bargain 5c with approvals. Capital Stamps, Dept. 2, Little Rock, Ark.**

**DEALERS—Wholesale list. Postage 3c. Frank, 5031 Queensberry, Baltimore 15, Md.**

**25 DIFFERENT Swiss 10c—with ¼, ½, 1c approvals. Carroll's, 4357A S. Hoover, Los Angeles 37, Calif.**

#### ANTIQUES, RELICS, INDIAN GOODS, CURIOS

**FIFTY Thousand arrows, spears, rainbow variations. Don McKillop, Regina, Sask.**

**SWORDS, Rapiers, daggers, pistols, armor. Illustrated catalog 50c. Robert Abels, 860-A Lexington Ave., New York.**

**4 FINE Ancient arrowheads \$1.00. Stone tomahawk \$1.00. List free. Lear's, Box 569, Galveston, Texas.**

#### HOBBIES AND COLLECTIONS

**MAKE Money with hobbies. Fun and profit at the same time. Literature free. F. W. Kimball, Woodhaven, New London, N. H.**

**HOBBY Fans. Monthly magazine. Features many hobbies. \$1 year. Everyday Hobbies, Box 104PM Highland Station, Los Angeles 42, California.**

**KLONDIKE! For hobby jewelry makers! Novelty jewelry findings swept from tables of large manufacturers—parts for bracelets, pins, earrings, etc.—unfinished. Chains, rings, pins, stones, clips, beads—many other items. 1 lb. bags, \$2.00 per bag in 5 bag lots. Sample bag \$3.00. Prepaid only. Mdse. Distributing Co., 19 E. 16 St., New York 3.**

**FREE Catalog pocket tricks, magic. Schetz's, 98-S Branch, Sellersville, Penna.**

**INSIGNIA Collectors, our bargain assortment ten army patches. Send fifty cents. Box 228, New York 10, N. Y.**

**MONTREAL, Canada, matchbox covers. Exchange with everyone. Marc Jette, 2311 Girouard St., St. Hyacinthe, Que., Canada.**

**UNUSED Match book covers. 100 all different \$1.00. 35 Royal Flash covers \$1.00. Free catalog. Charles Edelman, 1311C East 84, Cleveland 3, Ohio.**

**EXCHANGE Your duplicate stamps, match covers, or any hobby with collectors everywhere! Directory listing swappers, 10c. (Mention hobby). World Hobby House, Box 721-A, Olympia, Wash.**

**WANTED: Old bitters bottles. Write Bob Halter, Bucks County, Newtown, Penna.**

**WANTED: Old cigarette cards. Write Charles Bray, East Bangor, Penna.**

**INTRODUCTORY Offers—10 officers insignias 25c; 22 different American or 15 different foreign, \$1.00; 10 different metal collar insignias our choice—\$1.00. Illustrated catalog 10c. Hobbyguild, 35P West 32nd St., New York.**

**CAMPAIGN Ribbons—Beginner's package. Introductory price 50c. Contains 15 assorted ribbons. L.H.G. Company, 19 E. 16 St., New York 3.**

**GEM Making—Fascinating! Profitable! Free equipment catalog, or send 25c for complete instruction book. Lapidary Company, 1545 West 49th, Seattle 7, Wash.**

**COLLECTING Hobbyists! Exchange duplicates. "Hobbyswap Contacts" directory 10c. C. Bishop, Route 8, Kalamazoo 88, Michigan.**

**296 COLORED Illustrations, new book "Foreign Medal Ribbons." \$1.00. Foreign campaign bars, insignia, lists, samples, 20c. Packets \$1.00. Insigniacrafts, 236-28th Ave. N.W., Calgary, Canada.**

**INVENTING Can be an interesting and profitable hobby. Write for complete particulars. Institute of American Inventors, Dept. 40-E, 1926-Eye St. N. W., Washington 6, D. C.**

**COLLECT Colorful Army patches. Pictures, prices and sample patch only 10c. Insignia Mart, 703 Broadway, N. Y.**

#### PRECIOUS STONES, MINERALS

**GENUINE Mexican gem minerals. \$5.00 brings our valuable assortment. C. Biehl, Apartado 2887, Mexico City.**

**OVER 50 Identified mineral specimens mounted in 6x9 box \$2.50, postpaid. Tharp's Gem Shop, 506 Bellevue Place, Austin, Texas.**

**"GENUINE" Arizona rubies (garnets). Send quarter for packet. Mineral Specimens Company, Box 2651, Phoenix, Arizona.**

**METAL Detectors. The very latest circuit. Free literature. Hedden Metal Detectors, 538 North Homewood Avenue, Pittsburgh 8, Penna.**

**JEWELRY Stones removed from rings, etc. 100 assorted \$2.40. 50 large ones \$2.40. B. Lowe, Holland Building, St. Louis 1, Mo.**

**MINERALS—Gems, Cutting, specimen. Low prices. Free list. Plummer's, 5068 Brighton, San Diego 7, Calif.**

#### CAMERAS AND PHOTO SUPPLIES

**SPEED-O-COPY Ground-glass focusing attachment for Leica, Contax, Argus C-2 and C-3. Send for literature. D. Paul Shull, Dept. PM 6, 240 S. Union, Los Angeles, California.**

**COLOR Photographs in oil. Beginners' simplified instructions. Details free. Goynes Skills, Lock Drawer 1784-A, Orange, Texas.**

**35MM. 36 Exposure reloaded cartridges, 4 for \$1.00. Allan's, 16516 Detroit Ave., Lakewood 7, Ohio.**

**BARGAINS Galore. Buy, sell, trade. Sample copy 25c. Used Camera Beacon (M), 1214 NW 30, Oklahoma City 6, Oklahoma.**

**ATTENTION Photographers. For largest assortment of photo mounts, frames, albums and mailers, quickest service. Lowest prices, request catalogue. International Sales Co., 414 E. Baltimore St., Baltimore 2, Md.**



**SPECIAL Offer** ending June 30. 2 rolls 127 film and sunshade included with each Clix-O-Flex reflex camera at only \$5.95 complete. Carrying case additional \$1.00. Clix-O-Flex awarded Certificate of Merit by New York Museum of Science & Industry. No focusing, no adjusting, bakelite body, neckstrap. Takes 16 pictures 1 1/4 x 1 3/8" on each roll. Also new Beacon miniature camera with telescopic viewfinder. Takes 16 pictures 1 1/4 x 1 3/8" on 127 film; plastic and chrome body, \$9.95. Case \$2.50. Special DeJur 5A-5B photoelectric exposure meter. Was \$17.40, now \$12.95. Order with safety on guaranteed 10-day money back trial from Conway Camera Co., 34 N. Clark St., Chicago 2, Ill.

**BENSEN Light**—Fits on all movie and still cameras. Uses reflector photofoods. Eliminates clamps. At dealers or send money order, \$9.45. (Includes tax. Less bulbs.) Free booklet. A. L. Bensen & Co., Staten Island 2, N. Y.

**LENSES**, Camera, binocular, etc., duplicated, resurfaced, recemented. Prompt service. Workmanship guaranteed. Send lenses for estimates. Gould Lens Service, 26 Franklin Ave., Binghamton, N. Y.

**KEEP Posted** on hundreds of "buys" in choice war surplus equipment, lenses, film, etc.; read the "Surplus News Letter," no charge, from Sterling-Howard, Dept. PM5, 1900 Monterey Avenue, New York City 57.

**BASS Says!** At the sign of the old "Horse Trader," 37th year. Thousands of satisfied customers everywhere! Finest brands including Kodak, Bell & Howell, Argus, Zeiss, Leitz, etc. Satisfaction always guaranteed, or your money back! Bass buys 'em, sells 'em, trades 'em. Write or wire. Bass Camera Company, Dept. AG, 179 W. Madison St., Chicago 2.

**INFRA-RED Filters** glass 1 1/4" (40 mil) diameter, mounted. Snap on camera or binocular, \$1.00 per set. Ross, C68 West Broadway, New York, N. Y.

**PHOTOGRAPHIC Equipment**. Terms. Catalogs. Film rentals. Dayton Film, 2227 Hepburn, Dayton, Ohio.

**PHOTOGRAPHY** For pleasure or profit. Learn at home. Practical basic training. Long established school. Write for booklet. American School of Photography, 1315 Michigan, Dept. 3431, Chicago 5.

**OIL Coloring** photographs can be a fascinating hobby or profitable sideline for those with artistic talent. Learn at home. Easy simplified method. Send for free booklet. National Photo Coloring School, 1315 Michigan, Dept. 3431, Chicago 5, Ill.

**USED Camera Directory**, Box 1031-M, Canton, Ohio—lists hundreds of war-bargain used cameras—35mm., Speed Graphics, Kodaks, Rolleiflex—many others. Send 25c for latest issue.

**HAVE You a camera?** Improve your hobby of photography and learn how to make better pictures. Write today for our latest book catalog and sample copy of American Photography, containing articles and pictures by the world's foremost writers and photographers. Camera House, 601, 353 Newbury St., Boston 15, Mass.

### PHOTO FINISHING

**ENLARGEMENTS**—(Beautiful hand oil colored) from your favorite negatives. 5x7 -45c, 8x10-85c. Black and white double-weight enlargements—5x7-20c, 8x10-40c. From pictures or proofs, send 35c extra for each enclosed. Send cash or money orders only. No c.o.d.'s. Snapshots Co., Dept. D, General P.O. Box 979, Newark, N. J.

**2c—VELOX Reprints**. Roll developed 16 prints 25c. Photographer, Lake Geneva, Wis.

**16 FOR 25c**—Velox decked prints with roll developed. Velox reprints 2c. Deckle-tone, Lake Geneva, Wis.

**SPECIALIZING 35MM.** fine grain developed, 36 big 3 1/2 x 5 hi-gloss enlargements, \$1.50. Photoshop, Linton 3, Indiana.

**NEW Process** prints photos from any negative on anything, handkerchiefs, etc. Outfit, supplies, instructions \$2.00. Holm Sales, Box 12A, Oaklandon, Indiana.

**ENLARGEMENTS**—5x7, 10c; 8x10, 25c; from your negatives. National Film Service, 3111 West Tuscarawas, Canton 3, Ohio.

**8 PRINTS** All enlarged to nearly post-card size from your roll or negatives 25c; 16-50c. (Trial offer). Willard Studios, Box 3535A, Cleveland, Ohio.

**FREE Snapshots!** Free album! Mail this ad and two negatives for free snapshots complete in album! When you see these free samples you'll want more! Only one free offer to a customer. Artisto, Dept. 131, Drawer 220, Regina, Sask.

**THREE Prints** each, 8 exposure roll 40c. Two each 35c. One each 25c. Reprints 3c. Fred D. Eastman, Bode, Iowa.

**ENLARGEMENTS** From your favorite negatives. 5x7, 25c; 8x10, 50c. E. R. Howell, Box 8338, Pittsburgh 18, Penna.

**BEAUTIFUL 5x7 Enlargement** 25c; 8x10 50c. Expert oil coloring 75c additional. McCreary Photo Laboratories, Dept. 57, 4402 Barker, Omaha, Nebr.

**MAMMOTH 8x6 Mirrotone** enlargement, two sets sparkling Lifetone prints, roll developed, 30c! Films wholesale! Lifetone Studios, Dept. 670, Des Moines, Iowa.

**1 HAND Colored** enlargement and 1 black and white enlargement, 5x7, only \$1.00 postpaid. Bus' Photo Enlarging Studio, 57 W. Burton Pl., Chicago 10, Ill.

**8x10 ENLARGEMENT** Made from your picture or negative, \$1.00. C.O.D. orders accepted. Daniels Studio, Route 3, Box 70-C, Meridian, Miss.

**PRINTS** Enlarged 3 1/4 x 4 1/2—35mm. (36 exposures) \$1.00; 16 exp. 60c; 16 exp. split 50c; 8 exp. 30c; reprints 3 1/2c. Holly Finishers, Box 625 B, Succasunna, N. J.

**MOVIE Film 8-16mm.**— Tremendous savings! Eastman Kodak Super X, Weston 32, from government stock. Tested, unconditionally guaranteed! 16mm., 100 ft. roll, \$1.95; 50 ft. 98c; 50 ft. magazine, \$1.35. 8mm., 25 ft. double-8, 75c. Processing: 50 ft., 75c; 100 ft., \$1.00; 8mm. 25 ft., 75c. Finest quality, fast service! Photo Surplus Sales, Dept. PM5, 12 Duane Street, New York City.

**EVERY Picture** an enlargement. Bigger and better snapshots than you have ever seen before! New electronic developments give you improved lifetime deckled-edge enlargements at our same low prices. Any 8 exposure roll developed and printed enlarge size 25c; reprints 3c each. Fast, accurate service guaranteed! Send for free mailers, today! Enlarge Photo Service, Box 791D, Boston, Mass.

**MOEN Finished** finer photos, 8 exposure roll developed and attractive Moen-Tone enlargement each good negative, 35c. Superior quality since 1898. Moen Photo Service, Drawer Z, LaCrosse, Wis.

**LARGA-PIC**—We have only one offer, but it's an outstanding one! Your roll developed and 8 prints made into brilliant Larga-Pic photos for 30c. Reprints from your negatives 4c each. Write for free mailers. Larga-Pic, Box Z2, Brookline 46, Mass.

**TWO Beautiful** prints from each picture on roll 25c. Twenty-six years of satisfied customers. Quick service. Lens Photos, Dept. J4, Janesville, Wis.

**PHOTO Copied**, 25 reprints, \$1. Suburban, 1410-M Bond, Rockford, Illinois.

**16 VELOX** Deckledge prints with roll developed 25c. Studio, River Grove, Ill.

**BEAUTIFUL** Enlargement from each picture on roll 25c. Cut Rate Photos, Dept. B4, Janesville, Wis.

**NEW Color** process makes full color prints from black and white film or negatives. Send dime for sample. We have films. Midwest Photo, Janesville 26, Wis.

**ROLL** Developed, two prints each exposure 25c. Additional reprints 3c each. Skrudland, 6444Z Diversey, Chicago.

**8 BEAUTIFUL** Double size pictures and roll developed 30c. 8 hour service. Free mailers. Pacific Photo Service, Box 666, San Francisco, Calif.

**BIGGEST \$1.00 Value** in 35mm. finishing today. 36 exposure fine grain 3 1/4 x 4 1/2 enlargements; deckled, embossed margin and date. Eighteen exposures 75c; 16 exposure splits 55c; 36 exposure reloads 50c. Special: return this ad with \$2.00 and we will send five 36 exposure reloads. Free mailers. 8 exposure rolls in beautiful, deckled contact finish with embossed wide margin, 25c. Mailbag Film Service, Box 5440A, Chicago 80.

**PHOTOGRAPHY** For pleasure or profit. Learn at home. Practical basic training. Long established school. Write for booklet. American School of Photography, 1315 Michigan, Dept. 3452, Chicago 5.

**ROLL** Developed and 8 prints 30c. Overnight service. Free mailers. Tri-Plex Photo Service, Box 375, San Francisco, Calif.

**8 HOUR Service**. Your 8 exposure roll printed jumbo or regular size, 25c; 12 exposures, 35c; 16 exposures, 50c; 36 exposures, \$1.00. Reprints jumbo or regular, 3c. Regular prints deckled. Fine grain developing. Send for free mailers. Quality Photo Service, Box 468, San Francisco 1, Calif.

**2 BEAUTIFUL** Hi-Gloss prints each good negative and enlarging coupon with each 6 or 8 exposure roll developed 28c. Owlphoto Co., Weatherford, Oklahoma.

**GLOSS Finish** enlargements, 4 5x7 from negative 50c. 3 5x7 from photo 50c. Robert Renshaw, Jr., P.O. Box 478, Chester, Penna.

### MOTION PICTURES AND SOUND EQUIPMENT

**TALKIES**: Convert your silent 16mm. projector into sound with our guaranteed parts kit. Plays all 16mm. sound films. Quickly assembled at home. Special introductory offer. Send this ad now with \$25.00, check or money order, and we will include sound test film, instruction manual and full information on how to use with your radio. Kit includes photocell, exciter lamp, optic, which makes a sound head complete. Or send \$1.50 for complete blueprints showing how to make adapter yourself. Apex Video, Box 3071P, Hollywood 28, California.

**TITLES** Of quality. Technicians, 3964 Ames St. N. E., Washington 19, D. C.

**16-35MM.** Silent-sound films, projectors. Bedner, 5300 So. Talman, Chicago.

**FREE Booklet** "Ten Simple Rules Making Titles." Westwood Company, 635 Victoria St., San Francisco, Calif.

**16MM.** Motor driven projectors, \$16.00 up. Selco Products, Danvers, Massachusetts.

**FILM Movetone** is back. It's Weston 12 nonhalation. Free processing 100 ft. 16mm. \$3.25, 25 ft. double 8mm. \$1.50. Bulk film without processing, 100 ft. 16mm. \$2.25, double 8mm. \$2.45. We have new Revere cameras and projectors. Will take your old machine in trade. Free circulars. Fromader Genera, Davenport 4, Iowa.

**SOUND Projectors**, films, close out. "Cameramen," 542-5th Ave., New York 19.

**FINEST** Movie screens, inexpensive, make them yourself. Free literature. Snow White Screen Company, Danville, Illinois.

**SOUND Screens**, used, good condition, 6'x6', \$12.95, 5'x4', \$9.95, 39"x50", \$5.95. Films, sales, exchanges, details free. Simons & Hunt Film Exchange Club, Oak Park, Box 166, Flint 5, Michigan.

**PROJECTORS**—35 mm.-16 mm. sound-silent. Nusslock, 4614 Green Tree, Milwaukee 9, Wis.

**400 FT. 16MM.** motor projectors \$17.50. Send stamp for 8mm., 16mm. lists. Sterling's, 679 Northampton, Easton, Penna.

**FILM Titles** for home movies. Head line copy for stills. Newest type faces. Do a professional job. 25c for complete information. Alfa Products, 30 W. Washington St., Chicago.

**JOIN** World's largest cinematographic society. Details free. International Cinematographers Society, Suite 118, 6770 Hollywood Blvd., Hollywood 28, Calif.

**BASS Says!** 37 years of leadership means satisfaction to you! Finest equipment, 8 and 16 mm., sound cameras, sound projectors. Bass buys 'em, sells 'em, trades 'em. Satisfaction always guaranteed, or your money back! Bass Camera Company, Dept. A, 179 W. Madison St., Chicago 2.

**MOVIE** Camera films 100' 16mm. \$2.25, 3 rolls \$6.00, 100' high speed \$2.75, 25' double eight \$1.25. Ambassador, 479-A Quincy Street, Brooklyn 21, N. Y.

**HOME** Movies since 1929. No-Wat-Ka, 257 Main Ave., Passaic, N. J.

**DEVELOPING** Units for movie film with instructions. Literature. Duro Movie Products, 1519 Eggert, Eggertsville 21, N. Y.

**8MM., 16MM.** Features. Lists. Sams Electric Shop, Passaic, New Jersey.

**UNUSUAL** 8mm.-16mm. movies. Catalogue free. Fine Arts, Box 2084-X, San Antonio 6, Tex.

**BEAUTIFUL** Kodachrome slide and lists 25c. Slide Supply Service, 3111 West Tuscarawas, Canton, Ohio.

**MOVIE** Equipment. Terms. Catalogs. Film rentals. Dayton Film, 2227 Hepburn, Dayton, Ohio.

**35MM.** Sound features, westerns. C. Rogers, Box 26, East Atlanta, Ga.

**LEARN** Professional motion picture technique at home. Approved for veteran training under G.I. Bill. Free catalog. Motion Picture Institute, Birmingham 4, Mich.

**MAKE \$8** to \$10 net profit daily with your 8mm. or 16mm. projector. Details free. Metcalf, 10806 Glenroy Ave., Chicago 43, Ill.

**GUARANTEED** Fresh anti-halo outdoor movie film! Weston 12! Daylight loading! Processing free! Three spools double 8mm. \$3.45! Six single 8mm. for Univex, \$4.60! Postpaid! Catalog. Eso-S, 828-B West 39th, Kansas City 2, Missouri.



"THE World's Greatest Passion Play," all sizes sound and silent. Write Hemenway Film, 33-F Melrose St., Boston 16, Mass.

I BUY, Exchange, swap movie films. Harvey Iris, Box 539, Brockton, Mass.

UNUSUAL Home movies: Travel, adventure, sports, comedies. Silent-Sound. Many film bargains. Big illustrated 1947 catalog, sample—dime. Audet, Box 6520BG, Philadelphia 38, Penna.

8-16MM. Silent-sound films. Complete rental library. All latest subjects. Free catalogue (sample film 10c). Garden Film, 317 W. 50th, New York 19.

EXCITING Films — bullfights, movie stunts. Unusual subjects. Send only dime for sample film and special list. Exciting Films, 1071-F El Centro, Hollywood, Calif.

MOVIE Camera films, 100' 16mm. \$2.50. 25' double 8mm. \$1.25. Free developing. Better Films, 742 New Lots, Brooklyn 7, N. Y.

LEARN Movie projection, management. Free catalog. Theatre Institute, Elmira, N. Y.

## MUSIC AND MUSICAL INSTRUMENTS

HARMONICAS—Swiss imported. Deluxe finish. Genuine brass reeds. \$2.98 postpaid. Includes self-instruction booklet. Franklin Sales, 1142 Greenacre, Hollywood, California.

PIANO—Play by ear. Easy. Bodine, 10353 Peoria, Chicago, Ill.

ERNEST Tubb, Jimmie Rodgers, other records bought, sold. Evans, 1209-A 14th, Lubbock, Texas.

GUITARS, Mandolins, violins, accordions, banjos, amplifiers, pickups. Catalogs free. Wack Sales, 3131-W North, Milwaukee, Wisconsin.

ACCORDIONS, Wholesale prices. Request circular. New streamline accordions. All sizes and makes. Metro Accordion Co., 44 N. Albany Ave., Chicago, Ill.

ATTENTION: Fine harmonicas \$2.00, \$2.90; double row \$3.00, \$5.00, \$7.75, \$9.75; Chromatics \$5.50. Accordions, drums, guitars, sold reasonably. Bugles \$8.75. Instruments repaired. Catalogs 25 cts. Musician's Shop, 2 E. Centre Street, Baltimore 2, Md.

NEW Italian accordions, all sizes. Wholesale prices. Free catalog. American Accordion Center, 39 So. Kedzie Ave., Chicago 12, Illinois.

GUITARIST Complete album and explanation of guitar chords. Gives name, notes, diagram, fingering. Sensational, play outstanding. \$2.00. Poole, 115 E. 11th St., Salisbury, N. C.

LATE Used phonograph records, 10 for \$2.00, assorted. B & F, 300 W. 75th, Chicago 21.

CHORD Chart (364 popular, standard and modern professional chords) 25c. Calculator, Box 1-PM, Station A, Brooklyn 6, N. Y.

CATCHY Song melodies written. Beautiful manuscripts. Sholl, 2217 Penn St., Harrisburg, Penna.

MUSICAL Instruments and accessories. Hundreds rebuilt like new. 5 day trial, money back guarantee. High trade or cash allowance for your old instrument. Write for free bargain list. Specify instrument in which interested. Meyer's Musical Exchange Co., Dept. J, 454 Michigan, Detroit 26, Michigan.

AMPLIFY Your accordion with our new Del Principe pickup. \$22.50. Install it yourself in one minute. Makes any accordion sound like an organ. Works with any amplifier. Special Del Principe amplifier and pickup only \$72.50. Write for details. Del Principe, 307 So. Wabash Ave., Chicago.

PHONOGRAPH Records cheap. Catalogue. Paramount, ME-313 East Market, Wilkes-Barre, Penna.

ARE You writing a song? Let us help you prepare it for publication. Free examination. Ace Songwriters, 27 Spring St., Elizabeth, N. J.

FREE Accordion pickup with each accordion purchased. New or used accordions for sale. Cash or terms, wholesale or retail. Write for bargain list. Del Principe, 307 So. Wabash, Chicago.

MUSIC Arranged. Songs printed. Frank Wildt, Music Publisher, Lancaster, Penna.

PIANISTS Popular music chord chart: Shows names; symbols; readings; enharmonics; notation; 648 treble, 180 bass positions. Sensational! Desirable! Practicable! Only \$1.00. Carol Music Chart Co., Box 21 PM-Lefferts, Brooklyn 25, N. Y.

POEMS Wanted to be set to music. Free examination. Send poems. McNeil, Master of Music, 510-PM S. Alexandria, Los Angeles, California.

SONGWRITERS—Protect your songs. Get the facts first. Free booklet, attractive offer. Song Service, 331-C West 46th, New York.

SONGWRITERS! Outstanding ethical offer. Hibbler, C5, 2157 N. Avers, Chicago.

BEFORE Sending your poem to be set to music, know your composer. Free folder. Al. Moquin, 5333 La Cresta Court, Hollywood 38, Calif.

POEMS Wanted for new songs. Send poem for free examination. Eliot Wright, Master Composer, 207 Rivoli Theater Building, Portland, Oregon.

POEMS Wanted for musical setting. Send poem for immediate consideration. Five Star Music Masters, 630 Beacon Building, Boston.

SONGWRITERS: Send poems for free examination and outstanding offer. United Music Service, 150, Salem, Indiana.

PIANISTS Acquire professional technique in quickest possible time. Most unique course ever put out. Low cost. Get literature. Wehner, 25 Fulda, Roxbury 19, Mass.

WRITE Songs. Big money and reputation. Write for information. J. Gordon Pub Co., 201 N. Hoyne Ave., Chicago.

SONG Writer's attention! The amazing demand for phonograph records, accelerated by more than 300,000 juke boxes and the hits popularized warrants your immediate consideration. We are offering song-poem writers the rare opportunity of having established composers collaborate on appealing material received this month. Recola Records, Box 987P, Hollywood 28, Calif.

POEMS Wanted for musical setting. Send poem for immediate consideration and free rhyming dictionary. Richard Brothers, 24 Woods Building, Chicago.

## RADIOS, SUPPLIES, INSTRUCTIONS

RADIOMEN, Servicemen, beginners—make more money, easily. \$250 weekly possible. We show you. Information free. Merit, 216-32A 132nd Avenue, Springfield Gardens 13, New York, N. Y.

CRYSTALS—Sylvania 1N34 fixed. Best crystal ever developed for crystal sets, \$1.60. Stanley, 1418 West 50th Street, Norfolk 8, Virginia.

SUPER Reception! Fixed radar crystal. \$1.00 postpaid. White Sales, 5011 Linwood, Kansas City 3, Mo.

RADIO Tubes. New. Mailed anywhere, prepaid. What do you need? Beacon Radio Center, 649 Anderson, Cliffside, New Jersey.

1947 REVISED "Plans 18 Long Distance Crystal Sets," catalog, "Radiobuilder"—25c. 3 issues "Radiobuilder", 25c. Laboratories, Box I-c, San Carlos, California.

BUILD "Simplest" one tube a.c. radio. Instructions, 25c. Loudest crystal set instructions and crystals, 25c. Amorose, Route Four, Richmond, Virginia.

MIKE Jr. at reduced price. Works on any radio. \$1.59 postpaid. Dave Soper, Alpha, Ill.

LOUD Crystal radio, also one tube radio, new design. Illustrated plans for both, 25c postpaid. Radio Leader, Box 391-C, Claremont, California.

FREE New radio catalog is ready! Radionic's catalog lists radios, hard-to-get radio parts, books, amateur, test, and P.A. equipment. All available for immediate delivery. Send today to: Radionic Equipment Co., Dept. 206, 170 Nassau St., New York 7, N. Y.

FREE Illustrated catalog of radio-electronics books. Servicing, home study, U.H.F., radio math, electricity, operating, television, etc. D. B. Nephews Publishing Company, Dept. M6, 300 Pacific Street, Brooklyn 2, N. Y.

FOUR Tube kit including tubes, \$10.95. Details, Knight Radio, 9418 Avenue A, Brooklyn 12, N. Y.

STOP That radio hum and blasting. Apply "Voicool," solution for dry, brittle cores and cones. Guaranteed for years. Try it. 25c postpaid. Radio Research Products, 6417 Harper Ave., 37 Chicago, Ill.

MONEY Making business and manufacturing opportunities in radio, electronics, and electricity. Free details, Huffman Research, Box 251-D, Orange, Texas.

WESTERN Electric "sound powered" phones \$1.77 pair; 15-ohm potentiometers with switch, 8 for \$1.00. Lectronic Research, 5832 Hegerman, Philadelphia.

RADAR Crystals. Supersensitive. Free details. Hayes, Box 636-F, Santa Barbara, California.

25 YEARS Experience in radio repairing at your fingertips for \$1.00. I've repaired 45,000 radios and have perfected system you can follow step by step. My methods are far simpler than any other course published. Requires no calculations. Total price \$1.00 postpaid or c.o.d. Moneyback guarantee. Ross Radio Company, 14615-A Grandriver, Detroit 27, Mich.

RADIOS, Record players, tubes. Send for free list of bargain prices. Hallmark, 592 Communipaw, Jersey City, New Jersey.

BUILD Your own radio, save money. Complete kit for 5 tube, cabinet style radio with 5 inch speaker sent on guarantee of satisfaction. Get free facts and trial offer. Write Coronet, 704 Land Bank Bldg., Kansas City, Mo.

AMERICA'S Best buys. Radio tubes 29c up. Free bargain lists. Potter, 1314-F McGee, Kansas City 6, Mo.

BUILD Simple crystal radios. Crystal and illustrated plan 25c. United Products, Box 114 Crosstown Station, Memphis, Tennessee.

WRITE Dept. RC10 for wholesale radio and parts bulletin free. R. C. Radio Parts & Distg. Co., Kansas City 6, Kansas.

COMPLETELY Assembled crystal radio plus 100 foot antenna. Postpaid \$1.00. Jack Kennedy, Box 653, Boston, Mass.

BUILD Radio, phonograph, combination, complete kits: catalog. Radion, 6922 D 21st Ave., Brooklyn 4, N. Y.

RADIO Service men and experimenters send stamp for our giant radio catalogue. Save dollars. United Radio Co., (1000-V) Newark 1, N. J.

MAKE Simple, tubeless, batteryless, distance-getting crystal radios. Crystal and illustrated instructions 25c postpaid. Allen, 427-P, Clinton, Missouri.

RADIO Technician and radio service courses. Training for federal licenses. American Radio Institute, 101 W. 63 St., New York City. Approved under G. I. Bill of Rights.

## BUSINESS OPPORTUNITIES

MONEY Makers: Get exclusive mail and supply sources for big profits. 25c brings "Advance Magazine." Frederick Zenker, 8890 Cloverlawn, Detroit, Michigan.

PREPARE For security. Own home business. Write Cottage Industries, Omaha 12, Nebr.

MAKE, Sell over 100 fast repeating products under your name without machinery. Guernsey Mail Service, 518-M South Ninth Street, Cambridge, Ohio.

OPERATE Profitable mail order business. Splendid opportunity. For details write D. E. Brown, 108 W. Ridley Ave., Ridley Park, Penna.

MONEY By mail, free book, "How to Be a Successful Mail Dealer." Write J. A. McKittrick, P.O. Box 58-M, Mt. Vernon, Ill.

SKILLED Workers attention! Large construction contracts in Philippines, Hawaii, Alaska, South America, Arabia, United States. \$1.00 for latest list contractors. Personnel Service, Box 949-B, Knoxville, Tenn.

EXCLUSIVE Manufacturing franchise offered by large corporation. Own your own business. Manufacture patented concrete slabs in your city. For low cost homes, floors, walls. Roof and farm buildings, concrete silos and billboards. Slabs bolt together. No expensive equipment required. All you need is a concrete mixer, vibrating table and our steel forms, and a building with yard space. Responsible persons and companies are invited to investigate this valuable and exclusive franchise rights in your city. Don't miss this opportunity. Investigate this profitable business. Wire or write for free folder. Fire Proof Construction, Inc., 880 West 3rd Avenue, Columbus 8, Ohio.

COMPOSITION Flooring—made in most colors. Lifelong, soundproof, resilient. Flexible molds. Cast novelties, plaques, statuary. Big money—your own business. Catalog free. Write, Bing Products, 88A3A, Broad Street, Boston 10, Mass.

ABALONE Pearl ladies' rings. Sterling silver \$6.75 dozen. \$9.00, \$12.00 dozen. Abalone earrings and necklace. Dealers only. Joseph Fleischman, 1535 Broadway, Tampa, Florida.

SMALL Capital. Start your own advertising agency at home in spare time. Complete operation revealed. No stock or equipment. Large earnings and permanent income. Free folder and proof. P. Snyder, Box 4907-A, Philadelphia 19, Penna.

AGENTS Or exclusive distributor for cigarette lighter mfg. MacGregor, 802 89th, Tahoe Valley 16, Calif.



**FREE Home-manufacture formulae!** Send stamp. Gamble, 1155-M Pondview, Akron 5, Ohio.

**OPERATE Profitable mail order business.** Splendid opportunity. For details write, Fred Wolf, Box 362, Cuero, Texas.

**\$100.00 A Week possible.** Your own mail order business. Newest mail-order and agency proposition. Write today. Norman S. Rorick, 3514 Columbia Parkway, Cincinnati 26, Ohio.

**TELEVISION Radio repair has expanding future.** Establish business. Mail \$1. Radionics, P.O. 625 G.C.T., New York 17, N. Y.

**GOODYEAR—Has rubber for molds,** self vulcanizing, air curing. Quart \$3.00, gal. \$10.50. Instruction free. Goodyear, Lake Geneva, Wis.

**BABY Shoe formula,** for preparing non-metallic materials for solid metal process, \$1.00. Schoettle, Friendship, Ohio.

**RED Latex for making molds!** Cast plaques, novelties, bookends! Free sample! H. Tooker, Hamilton 35, Ohio.

**WHOLESALE Items, business plans and opportunities,** 10c. Holm Sales, Box 12A, Oaklandon, Indiana.

**BIG Profits in carded merchandise,** combs, blades, etc. Write for wholesale prices. Buford's, Box 54, Dallas, Texas.

**MAKE Extra money: start home business** spare time. Splendid opportunity, free literature. Wolf's, 3240 Glenview St., Philadelphia 24, Penna.

**"HOW To Make Money With Hobbies."** Big profits! Send 3c stamp for free details. Business Service, 1101 Kings Highway, Shreveport 49, Louisiana.

**FREE Models; Pinkie pig bank model** with quart "Rubbercoat" aircure mold making liquid \$2.95, directions. Rubbercoat, 3873-A California Street, San Diego 1, California.

**\$6000 YEARLY Possible at home.** Make your own rubber molds with Prestolax liquid rubber, \$1.25 pint, \$2.00 quart. Make plaques, statues which glow in the dark with Prestoluminous paint, kit \$1.00. Instruction free. Order now. Money back guaranteed. Presto Company, 1012 N. Marshfield, Chicago 22F, Illinois.

**BUYERS Wanted for plaster novelties.** Painted—unpainted. Retail—wholesale. Write today for free information. Bing Products, 88-XA Broad, Boston 10, Mass.

**DOLLARS Daily! Cleared \$1900 in two** months. Details. Loeb, 7201-A6 Montgomery, Cincinnati.

**AT Home—Your own manufacturing** business making popular \$1.00 novelties. Cost you 3c to 15c. Everything supplied. Write So-Lo Works, Dept. U-6001, Loveland, Ohio.

**EARN Good money at home as I do.** Send stamp for details. Lollar, 678 Emmett, Battle Creek, Mich.

**HOW To set up and run a mirror shop!** Resilver mirrors. For price write—John Sprinkle V60, Marion, Indiana.

**SENSATIONAL Proposition.** Extra money spare time. No selling. Absolutely different. You can do it. Particulars free. Business Plan Institute, 349 Third Ave., Mansfield, Ohio.

**WHY Job worry? Learn electroplating.** Highly paid, uncrowded, interesting business. Gold, silver, nickel, chromium, etc. Send postcard for free booklet and proof. Plater Hyde, Dept. MC, P.O. Box 176, National City, Calif.

**MONEY In worms.** Start hatchery and make money. Mail \$1.00 for booklet. Earthworm Farms Enterprises, Lamoni, Iowa.

**GIANT Opportunity mail-useful gift** 25c. VMS., 4631C Lake Park (PM), Chicago 15.

**GET Started in legal coin-operated** amusement machine business. Small investment required. Terrific money maker. Write for full details. Skill Games Corp., 1145 DeKalb Ave., Brooklyn 21, N. Y.

**MAKE Plaster novelties.** Special molding rubber. Free sample. Quart \$3.00, gallon \$10.50. Free instructions. Universal Sales, Box 1076-A, Peoria, Ill.

**PROFITABLE Home business selling** names. Proof free. W. Kimball, Wood Haven, New London, N. H.

**ANY Business requires study.** Book, "Doing Business by Mail," \$1.00 postpaid. Mid-West Agencies, 114 Highland Ave., Marion, Ind.

**ELECTRIC Mousetrap electrocutes many** mice at one setting. Interested? Write, Leo Brandinger, 1326 Fulton Avenue, Bronx 56, N. Y.

**SUPER X liquid molding rubber.** Sample jar 25c, quart \$3.00, gallon \$10.00. Free sample. W. Wooley, 115-A Donald, Peoria, Ill.

**CARPENTERS—Handymen, everyone.** Build furniture, upholster. Book \$2.15 prepaid. Educational Service, Box 385-A3, Lombard, Illinois.

**LEARN To make sea shell jewelry,** pins, earrings, hair ornaments, novelties. Book of instructions and designs free with \$2.00 and \$5.00 kits, postpaid. Catalogue 10c. Herbert Diamond Co., Box 4619, Miami 31, Florida.

**SOLIDIFY: Baby shoes.** Complete instructions \$10.00. Sensational method. Poole, 115 E. 11th St., Salisbury, N. C.

**FINANCIAL Success in your own business** or profession—the art of knowing how. Lanzafame, Hotel Rowe, Grand Rapids, Michigan.

**LEARN Appliance, sewing machine, bicycle,** lawn mower repairing. \$20.00 capital! Repairman's Service, Janesville, Wis.

**INFORMATION—Locating articles and** products (wholesale) etc. Mention requirements. National, 3537C So. Hoyne, Chicago 9.

**OPERATE Profitable mail order business.** Write Gallagher Publications, Box 691C, Kingsport, Tenn.

**START Your own business; metalizing** baby shoes. Complete instructions \$3.00. Technical Aid & Supply, P.O. Box 668-P, Los Angeles 53, Calif.

**BABY Shoes preserved.** Formulas, instructions \$1.00. Novelty Bronzing, Box 56, Hyde Park 36, Mass.

**\$100 WEEKLY Possible repairing, servicing,** installing fluorescent lights. No capital needed. Make beautiful household fixtures for 50c each, and less. Amaze friends. Build gadget that relights burnt-out lamps bright, indefinitely. Rush \$3.00 for amazing illustrated instructions covering everything. Plus sample materials. Literature 10c (refundable.) Willis Service, Box 6, New York City #35.

**BECOME 1947's Successful publisher of** profitable weekly newspaper. "Know How" explains all. Free literature. Success Publications, Dept. A, 15870 Wisconsin, Detroit 21, Michigan.

**RUBBER Latex for flexible molds.** Simple instructions 50c. Advanced \$1.00. Apex Plastic Products, 1915 Lunt, Chicago 26.

**EARN Easy money, spare time.** No experience. Lane, 548-B 61st Street, West New York, New Jersey.

**INVESTIGATE Mail order or home business.** 140 new ideas. Write Marshall, Box 655, Centralia 11, Washington.

**SYNTHETIC Latex with Neoprene base** for making flexible molds! Quick drying! Safe! For home, classroom, or industry! Quart \$2.00. Gallon \$5.95. Full instructions. Beginners' booklet on molding and plaster casting, 25c. Plastercraft Supply Company, 1406 East 43rd Street, Cleveland 3, Ohio.

**FINANCIAL Independence.** Own your own business. Hinson new way of cleaning and rejuvenating rugs, carpets (all kinds) and upholstery. Cleaning ready for use within two to four hours. All work done in the home. Also mothproofing done with latest equipment. Year around business earnings \$50 per day and up. Exclusive territory. \$875 to \$1000 required for merchandise and equipment. We can show you many ways to secure business in your territory. Write Hinson & Company, Inc., M-1, Richmond, Indiana.

**LIQUID Marble, plastics, marblite,** plasters, make your own. Universal Sales, Box 1076-A, Peoria, Ill.

**START Mail order business, home, office,** spare-time, limited capital. Succeed. Rush 25c for "how" booklet and valuable descriptive literature or send dime for complete details. Whittier Service Bureau, 17½ No. Lewis, Tulsa 4, Oklahoma.

**SELL Books by mail.** Large profits! Free! Literature. Cline-Porter, Box 6346 PB, Pittsburgh 12, Penna.

**"MAIL Order Counsel Book"—Reveals** powerful plans. Tells "what" to do. Answers problems. New, authentic, a powerful force for mail order profit. 136 pages, \$2. Money back guarantee. Research Press, Ossining, New York.

**OPERATE Profitable mail order business.** Splendid opportunity. For details write H. Fall, Box 211, Massillon, Ohio.

**REMNANTS—Amazing values.** Housewives buy on sight. Good profit. Write B & M Textiles, 415 East 26th Street, Paterson 4, N. J.

**RUBBER Molds—Make big money duplicating** hundreds of items. Own your own business. Start in spare time. Make your own genuine rubber production molds, duplicate expensive molds for only a few dollars cost. Latest shop and factory methods. Also molds made to order. Get our prices. Information free. Write The Shop Technician, 1832 E-9th Street, Kansas City 1, Mo.

**MFG. At home—earnings unlimited.** 10,000 formulas, tested, approved. Experience unnecessary. Write Argyle, 1412-A Great Northern Bldg., Chicago 4.

**OWN A mail-order paper products business.** Sell envelopes, tags, bags, boxes, by mail, wholesale. Tremendous demand. Steady profits. No capital necessary. Write Omaha Envelope Service, Dept. 210, 4721 California, Omaha 3, Nebraska.

**RELIABLE Distributors wanted.** Make money helping us. Distributors, Box 67, Sebastopol, Calif.

**50 MAIL Order opportunities; knocking!** Write: F. L. Dupont, 1916 Kenneth, Arnold, Penna.

**UP To \$1500 yearly selling by mail** in spare time interest you? New ideas and plans every month. Details free. Idea of Month Club, 3023-H Greenmount, Baltimore 18, Md.

**YOU Can make \$2000.00 in few months** with "Souvenir of World War II of your Locality." Our copyrighted plan shows you how. Free details. Weekly News, Dept. C, Lansdale, Penna.

**COMPLETE Mail order course!** Information you cannot afford to be without. Limited supply! Reasonable. Stamp. Versatile Enterprises, Westfield, New York.

**GOT \$24,500 Using "schemes" from** "Schemer" magazine, Alliance, Ohio, 49th year, \$1.00. Three samples 25c.

**PACKAGE.** Sell products by mail, local. Linnell Company, Box 1720A, Cleveland, Ohio.

**MAIL Order business at home.** Large profits. Interesting work. Write today for free details. G. R. Remson, 158-10 Sanford Ave., Flushing, N. Y.

**A SUCCESSFUL Future for yourself** operating a typing service. In your home or office. Little or no capital required. For free information write Superior Typing Service, Dept. C, 4444 W. Madison St., Chicago 24, Illinois.

**WHOLESALE Directory, send quarter.** Hurry. Iowa Auction Enterprises, Des Moines 1, Iowa.

**BRONZED Baby shoe mountings and** supplies. All metal bookends, ash trays, picture frames, etc. Wholesale only. Hollywood Bronze Supply, 1770 North Vermont, Hollywood 27, Calif.

**INVESTIGATE Mail selling! What's the** one best thing to sell, happily, honestly, profitably? We know! Get free particulars, free samples. What-To-Do Shop, Box 1082, Tacoma, Washington.

**START Home manufacturing business** making Cleaning Compounds, Soaps, Insecticides, Cosmetics, Polishes. No machinery. Literature free. Kemix, Park Ridge, Ill.

**JUST Out; nothing like it.** Combination horse race and 5c almond vender. Legal everywhere. Big business stimulator for bars and taverns. Cost \$25 each. Some machines netting operators \$3.50 per night. Many locations support several machines. Small investment with big income possibilities. Full particulars by air mail. Address Spin-It, 8200 Beverly Blvd., Los Angeles 36, Calif.

**HOMEWORKERS—Mold wood plastic** bookends, ashtrays, statuettes; 12 assorted samples with big list models. \$1.00. Artercraft Products, 1416-R Fletcher, Chicago.

**FORGE Ahead: establish yourself in** most profitable division of mail order. New arrangement with special setup; guarantee of sales; open to sincere persons. Moderate investment required. Enterprises, 5345-B Harper, Chicago 15.

**MAIL Order businesses bought and sold.** All types successfully handled through national brokers. List your business now, or tell us what you want to buy. Current bulletin of opportunities \$1.00. Turnipseed, Inc., Box 681, St. Louis, Mo.

**HAVE Your own business.** No investment required. We permanize baby shoes in beautiful plastic, metallic finishes. Low cost to agents. Gould, 220 Suydam St., New Brunswick, N. J.

**A Grand little business of your own.** For details write Lilless Specialties, Box 151, Athens, Penna.



**RAISING** Canaries pays good profits. Valuable bird book—"Its Care, Breeding and Training." Price \$1.00. American Canary, 2839 N. Halsted, Chicago.

**X-RAY** Mirrors used by hotels, night-clubs, police. Process using window glass, common chemicals, \$1.00. Modern Devices, Hartford Terrace, Boston 25, Massachusetts.

**BIG** Profit local business supplying domestic service needed everywhere. Permanent. We start you, furnishing everything. Write Textile, Inc., 11106-A So. Longwood, Chicago.

**CURRENT** Names homeworkers, 200-\$1.00. Johnson, Box 203-P, Brookport, Ill.

**MAKE** Liquid marble, flexible molds, statuary, art goods, novelties, artificial marble flooring. Literature free. Kemico, Park Ridge 50, Ill.

**OPERATE** Employment agency. Complete instructions with forms used by former agency operator, Charles, 12AF, Norwood, Ohio.

**OPERATE** Profitable mail order business. Write Walter Service, 4159-A East 112th, Cleveland 5, Ohio.

**JUST** Out. New. Tops them all. "Queen of queens" plan and product mail order business. It's old and beginner's grand opportunity. Saccani, Box 3825-M, Cleveland 10, Ohio.

**EARN** Up to \$480 month part or full time keeping books for small firms. Simplified system. Write Tax-Saver System, Dept. N, Ft. Worth, Texas.

**START** Home business. Collection profitable plans. Free particulars. Twin Parks Z, Box 4696, Dallas.

**METALLIZE** Baby shoes! Learn this money making business from nationally recognized consultant. Get "know how" from outstanding authority! See Kushner ad, page 250.

**OWN** Your own factory! Start on a shoestring, hold your job. Start at home, in your kitchen or basement, with very little money. See page 254 for details of 15 valuable tested trade secrets that will lead you to success and freedom. Chemical Research Co., 130 W. 42 St., New York.

**AMAZING!** The million dollar mail order plan! Guaranteed puller! Immediate profits! Complete plan \$1.00, literature free. Newell & Co., 1006 Michigan Bank Bldg., 600 Woodward, Detroit 26, Mich.

**1947** GIGANTIC Directory of opportunities, advertisers, supplies sources, trade information, mail order ideas, products, wholesalers, valuable tips. Just published. Descriptive literature free. Wilkin & Co., Hillsboro 3, Ohio.

**START** Home business making statuary, plaques, novelties, garden furniture, artificial marble flooring, liquid marble. Make your own flexible molds. Amazing profits. Folder free. Creative Publishers, Box 236-L, Winnetka, Illinois.

**MEN—Women** be your own boss start a home business with our collection of 137 plans. Send for particulars. Simon Waldman, Dept. P-1, 4444 Richmond St., Philadelphia 37, Penna.

**GET**, Use, sell Scheall's \$1.25 guaranteed fire extinguishers. Scheall, Box 263, Duluth, Minnesota.

**OUTSTANDING** Opportunity in electric appliance business. Start now with small capital. Special instructions, help, supply sources, contacts. Write Soltz, Box 303, Silverton, Oregon.

**IF** You'd like to make \$5,000-\$10,000 yearly in the collection-credit agency business, write us at once. Outstanding opportunity. Cole Associates, Syracuse 2, N. Y.

**\$2000.00** CLEAR Profit in three months. Exclusive in your county. Reference required. You handle your own money. Details free. C. J. Maguire, Cannon Ave., Lansdale, Penna.

**FREE** Literature describing fifty amazing plans for mail order business at home. J. Scott, 282 West 117th Street, New York 26, N. Y.

**MAKE** Money making shell jewelry and novelties. Instruction book 75c. Kit \$5.00. Catalogue free. Palm Shellcraft Co., 220 W. 9th St., Sarasota, Fla.

**METALLIZE** Baby shoes. Excellent profits. New system insures success. Free details. "Treasures Forever," Metallizers, 89 Henry Ave., Lynn, Mass.

**OPERATE** America's most popular low priced precision penny vending machine. Big profits. Be independent. Write for bulletin and prices. Stock shipments, Field Mfg. Co., Desk 547PM, Jackson, Michigan.

**OPERATE** Profitable mail order business. Splendid opportunity. For details write J. F. Ward, Box 531, Muskegon, Michigan.

**THE** Mail Order News (54th year) shows you money making opportunities in every issue. Sample copy 25c. Veterans Business Publications, Charleston 1, Ill.

**VENDING** Machines. Be independent. Own a big money business operating coin machines. Earn as high as \$7.00 weekly on machine costing as low as \$11.75 each. Car and experience unnecessary. Routes can be operated either in your spare or full time. Act quickly. Write for details and catalogue showing our amusement games, postage machines, candy-gum-nut vendor and scales. Parkway Machine Corp., 623 W. North Ave., Dept. P, Baltimore 17, Md.

**\$46** FROM Square foot plywood. Jigsaw necessary. Write, Woodarts, X-36, Bridgewater, Mass.

**EXTRA** Dollars, or a good living, with your typewriter. New, exclusive opportunity. Never before offered. Get details now. Schroder, 221 E. Bush, Covington, Ky.

**MAIL** Order Beginners! "Business Development Plan," "Profitable Mail Selling Idea," "Pointers Along the Mail Order Trail." Noted mail sales specialist's, three-in-one, 10,000-word treatise shows "how" at home, spare time, small capital. From idea to mailbag, 25c postpaid. Satisfaction guaranteed. Maupin & Maupin, Lafayette 3, Indiana.

**MAKE** Strange plastic—1c pound. Makes durable, attractive floors, walls. Build with waste. Save half. Bays Laboratory, Oklahoma City 9.

**PROFITABLE** Business of your own, local or mail order. Tes-Co, Box 189-MF, Wilkes Barre, Pa.

**YOUR** Own lifetime business at home. Preserve real live flowers in all their beautiful coloring and fragile beauty. Demand year around. Amazing new simple discovery. Child can do work. No equipment needed. Large profits. Full instructions, enough raw material to preserve \$100 worth of flowers sent for \$2.98. E. Morrison, Box 9312-N Station S, Los Angeles 5, Calif.

**EARN** \$20-\$30 Daily "Textra-Cleaning" upholstery, rugs; demand everywhere. We start you, furnishing everything. Booklet free. Textile Cleaners, Inc., 11106-A So. Longwood, Chicago.

**SIGNS** Made easily. Instructions and ten sets modern alphabets, numerals, patterns. Sizes up to eight inches. All for \$1.00. Co-operative Business, 7 West Madison, Chicago, (2).

**RUBBER** Molds, liquid rubber, statuary plaster, kits for beginners. Free "Plastercraft" instructions. Blue Rapids Supply. Blue Rapids, Kansas.

**INCORPORATE** Your business. Delaware laws. Many advantages, free details. Tax Research Bureau, Inc., Delaware Trust Building, Wilmington, Delaware.

**LIQUID** Marble—Colorful, glazed! Molded, brushed, sprayed! Composition floors. Rubberlastic molds. Particulars free. Marbleizing Service, Edwardsville, Ill.

**RECAST** Old batteries into new. Latest achievements. Battery Laboratories, Minneapolis.

**BIG** Mail income. Free particulars. Murray's, 196 Circle, Forestville, Conn.

**PLASTIC** Homes—Build yourself! Resurface old buildings! Wonderful building material. Particulars free. Marbleizing Service, Edwardsville, Illinois.

**PARATOL**—Amazing new rubber latex moulding compound for perfect detail castings of all kinds tested and approved in long service. No worries—easy to apply, quick drying, maximum strength and long life. Why pay more—buy direct! Quarts—\$1.60, 1 gal.—\$4.90, 5 gals. \$4.45 gal. 4 oz. samples on request. Send 25c to cover mailing and handling charges. Full instructions sent with each order. Testworth Laboratories, Inc., Manufacturers of coating and adhesive products of all kinds, 407 S. Dearborn Street, Chicago 5, Illinois.

**OPERATE** Profitable mail order business at home. Postal brings details. Ellsworth Klein, 731 Northampton, Buffalo, New York.

**BEST** Tested moneymakers—68 page book 25c (coin) postpaid. Business secrets, mail order plans, formulas. Wholesale supply sources. Money back guarantee. Frank R. Carpenter, Boyes Hot Springs, Calif.

**YOUR** Own business. Bronze baby shoes. Make bronze castings, novelty castings, liquid marble, flexible molds. New methods, easier, quicker, more profitable. Productive Arts Co., Dept. M-7, Box 221, Seattle 11, Wash.

**OUR** Unique service will help sell your idea or invention. Literature free. Ellis Martz, Representative, Muncy, Penna.

**SELL** Pin earring sets, novelty jewelry, \$2.50, \$5 sellers. Order assortment \$15 dozen. Manufacturers, 264 5th Ave., New York.

**GROW** Bean sprouts in dark room for market. Pays well. Free information. Mrs. Nickell, Rt. 1, Box 456, Bend, Ore.

**START** A home business in spare time. Make extra money. Experience unnecessary. Literature free. Ellmar Services, Muncy, Penna.

**A** FACTORY In your home garage! Mfg. and sales rights, mechanics' waterless hand cleaner. \$500-\$800 monthly. No special equipment necessary. Western Aircraft Co., Los Angeles 6, California.

**YOUR** Own plastic business at home. Produce costume jewelry, novelties, statuettes. Liquid plastic, liquid marble. Flexible molds. Write for free book. American Trades, Box 1016-A, Peoria, Illinois.

**POPCORN** Machines, peanut roasters, caramelpopcorn equipment, vending machines, new, used. Northside Sales, Indianola, Iowa.

**BIG** Money in vending machines. Smallest capital start brings immediate profits that build permanent profitable business. Starting instructions free. Becker Vendors, 105-A Dewey, Brillion, Wisconsin.

**MAKE** Perfumes. Profitable business. Free book tells how. Walter Lawson, 21 Joiner, St. Augustine, Florida.

**BELTS!** Make 'em and make money. No tools! Sample 50c. Artinc Leather, 411 Joseph Ave., Rochester 5, N. Y.

**BECOME** Independent! Rent New York office under your own name, and sell what you have to offer through New York Metropolitan area, world's greatest business center. Rates \$7.30 and \$14.60 yearly. Co-Operative Offices, 126 Lexington Avenue, New York 16.

**WINDSHIELD** Wiper and fuel pump rebuilding bring big profits. Free particulars. H. & H. Products, P.O. Box 430, East Akron Station, Akron 1, Ohio.

**MAIL** Order opportunities. Full or spare time. Hundreds of chances. No charge. Postal brings copy. Blackstone Press, Somerville, New Jersey.

**GREAT** Opportunities and profits in mail order business at home. Free literature. F. Webster, Box 1972C, Hollywood, Calif.

**LEARN** Piano tuning, repairing, at home. Tremendous field! Piano parts, tools furnished. Established 1935. Empire School of Piano Tuning, 606-B East University Ave., Champaign, Ill.

**MEN—Women—"Everybody** likes candy." Learn to manufacture professionally at home. (Our 36th year). Ragsdale Candies, Dept. 4, East Orange, N. J.

**HANDYMEN—Earn** money home operating Community "Fix-It" Shop. Write Stafford, 708 Rawlings, Carbondale, Ill.

**DO** It with sea shells. Big profits. Werts, 1429 - 56th Avenue, Oakland 3, Calif.

**WOULD** You pay 3%—first \$350 made? Color-illustrated book "505 Odd, Successful Enterprises" free! Some offer occasional "day off." Work home. Expect something odd! Pacific, San Clemente, Calif.

**BOOKKEEPERS—Operate** your own simplified "Dollar-A-Week" bookkeeping and tax service. Full or spare time. Details free. Ellis, Box 200, Cedar Grove, North Carolina.

**MAIL** Order business course shows you how to make money, spare or fulltime. Teaches professional mail order technique—not penny-snatching schemes. Fascinating 100-page illustrated success-catalog free! Write, Nelson Company, Dept. 4-02, Chicago 5.

**PLASTIC** Discs, shapes, metal findings, wholesale, free catalog. "Secors," Bradenton Beach, Florida.

**ELITE** Collection contains 137 practical money-making plans; local and mail order. New edition. Particulars free. Elite Co., 220 Grand St., New York 13.

**137** WAYS To make money, in home or office, business of your own. Full particulars free. Elite Co., 220 Grand St., New York 13.

**OPERATE** Profitable home business. Levine's, Box 15-X, Boulevard Station, New York 59, N. Y.

**BRONZING** And metallizing baby shoes! Gold, silver, copper, nickel, bronze, pearl, ivory, and "luminous glow" colors! Big profits! New field! Details free! Write R. O. Morgan, Box 349, Long Beach 2, Calif.

**ANYONE** Can learn. Tune pianos by my system. \$1 2 lessons and chart. Oscar Fylling, 841 Robinson, Oroville, Calif.



**LEARN** Shell jewelry manufacturing. No tools or experience needed. Learn-earn within a week! Complete home instruction course, beautifully photographed, shows how to make 75 styles of pins, earrings, brooches, hair ornaments, dress clips, necklaces, bracelets, candy dishes, wall plaques, ash trays, candle sticks, etc. Includes pearlizing, gilding, dyeing, luminous methods. Illustrates 55 species of sea shells. Lists hundreds of raw materials with wholesale prices. Complete course \$1.00, postpaid. Beginner's kit, \$3.00. (\$3.50 in Canada). House of Gifts, Box 4550-RF, Coral Gables, Fla.

**QUICK Money!** "Repairing car batteries." At home! Easy too! Write. Batteryman, Grand Junction 5, Colorado.

**SELL** By mail!—Books and novelties! 35 different items! Large profits! Catalog free! Elfco, 432 N. Wells, Chicago 10.

**OPERATE** Profitable home business selling merchandise by mail. Fast sellers. Large profits. Powell Service, 5713 Euclid, Cleveland 3, Ohio.

**COLOR** Concrete with chemicals. Make Hollywood style pottery; home or shop. Marbling, water-paints. 10c brings sample, pictures. Hollywood Cementcraft, 8527 Wonderland, Hollywood 46, Calif.

**INTERESTED** In immediate mail order cash? Read "Advance"—Voice of mail order. Offers money-making opportunities. Personal guidance and benefits to all. Sample copy 25c. American Mail Trade Association, 313 East 21st Street, Dept. 400, New York 10, N. Y.

**COPUBLISH** Leading m.o. paper. Latest copy Mail Sale Advertiser and proposition, commemorative stamp. Vanroy Shirk, Lebanon, Penna.

**START** Profitable mail order business. PMT lists new propositions available; products, sources, accurate methods. Covers ad writing, letter logic, trade information. Send 10c for copy and get free instruction folio offer. Progressive Magazine, Sheboygan, Wisconsin.

**HOW** And where to obtain capital. Fully explained. Particulars free. Star Service, Wapakoneta, Ohio.

**LIQUID** Rubber, for making flexible molds, literature and sample free. H. Chaney, 1130 E. 16th St., Jacksonville 6, Fla.

**BIG** Paying jobs in welding. Complete welding lessons and reference books, 516 pages, 41 lessons, \$3.00 copy. Money-back guarantee. Hobartweld, Box M-1065, Troy, Ohio.

**START** A clock shop. Fascinating, easily learned profitable business requiring little capital. We teach you how to repair all kinds of clocks. Information free. Houston Clock Shop, P.O. Box 5086A, Houston 12, Texas.

**SPECIALTY** Manufacturing, the big money business that can be operated anywhere, start on a very small capital; we supply dependable formulas and complete instructions; get interesting free booklet, "Money-making Opportunities in Specialty Manufacturing." Howard Robinson, Ph.G., 1300-A South Ohio Street, Sedalia, Mo.

**COLORGLAZED** Concrete pottery made without molds. New, low cost, patented method. Cemetery products, novelties, tiles, floors, etc. Basement leaksealing. Other moneymaking projects. Booklet, details free. Men only. National Pottery Company, Fergus Falls, Minnesota.

**START** Mailorder bookshop—Everything furnished; publisher cooperation. 25c brings booklet, exclusive setup, samples, exciting ideas. General Publications, Ossining, N. Y.

**\$25 WEEKLY** Working two hours daily. No canvassing. No manufacturing. Lycke, Box 2471, Cleveland 12, Ohio.

**BRUSH** Plating outfits connect to a battery. No tanks necessary. Good paying business at home plating autoparts, bathroom fixtures, bicycles, reflectors, silvering mirrors. No shop or experience required. Outfits furnished. Free booklet. Gunmetal Co., Ave. H. Decatur, Ill.

#### MONEYMAKING OPPORTUNITIES

**500 MONEY-MAKING** Propositions, offers, ideas. Details free. American Success Aids, Dept. E, Bellmore, N. Y.

**SENSATIONAL** Money making opportunities. Details free. The Evergro Service, 131 West 42nd Street, New York 18, N. Y.

**"HOW To Market Your Own Product."** Step by step procedure from idea to orders. Get free publicity—avoid costly mistakes. Mail \$1.00 today to: Standard, 3403 Verdugo Rd., Los Angeles 41.

**MOULDS** For lead toys. Sample mould and catalog \$1.00. Catalog 10c. Dandridge, 1557 Essex St., Rahway, N. J.

**MEN—Women.** Start own business in home or office, you need no peddling. Little or no investment. Start in spare time if you wish. Our collection plans describe over 100 home business enterprises. Send for free booklet describing this large collection of plans fully. Send today. Setney Enterprises, 26596 Alger, Royal Oak, Mich.

**1001 MONEYMAKING** Ideas! Free details. Neuway Institute, Box 5463-M, Chicago 80.

**START** Your own business! Big money manufacturing novelties, plaques, statuary. Free catalog. Write Bing Products, 88-A3B Broad Street, Boston 10, Mass.

**MAKE** Money six ways. Get orders by mail \$1.00 to \$20.00. Keep half. Complete guaranteed plan, 25c. Franklin, 22219M Telegraph, Detroit 19, Michigan.

**SELL** By mail! Illustrated merchandise catalog furnished. Details 10c. Harold Edlund, 577 Kensington, Los Angeles 26, California.

**NEW** Penetrating oil. Best on the market. Formula \$1.00. Act now. Wm. A. Farnsworth, 801 West Main St., Bellevue, Ohio.

**SUCCEED** Anywhere! "Outstanding Opportunities Magazine" shows how! Sample 25c. Box 2501-PM, Los Angeles.

**WIN** Money on contests advertised in magazines and on radio. General Contest Bulletin, published monthly, gives hundreds of tips. Lists current contests and rules. Sample 25c. General Contests, 1609 1/2 East 5th, Duluth, Minn.

**HAIR** And scalp liquor. Grand-dad's old time recipe. Easy to bottle and label. Formula \$1.00. Stafford Laboratories, Summit, New Jersey.

**RUBBER** Molds for ash trays, lamps, etc. Vallance Art Products, 1873 E. 70 St., Cleveland, Ohio.

**METALLIZE** Baby shoes. Further information free. Metal Crafts, 5501 Swayne, Tampa, Fla.

**SEWING** Machine repairs make big money lifetime. Start neighborhood shop. Complete repair manual, covering all makes, \$1.98 postpaid. Money back guarantee. Sewmachine Serviceman, Hamilton 9-B, Ohio.

**HOW** To sell by mail. Details. Forest Kimball, New London, N. H.

**LADIES,** Want independent income? Write for particulars about The Very Thing to do. No selling. Spare time work. West Agency, Box 2115-P, Pueblo, Colo.

**POSTCARD** Mailing very profitable. National Mailers, 1395 Yosemite, San Jose 11, California.

**MEN—Women!** Sell "Aroma of Flowers" sachets! In demand everywhere! Over 200% profit! Details free. Mountain Specialties, Box 72, Westcliffe, Colo.

**MAKE** Big money. Build your own lamps and sell. Write for free factory photos. Buddy Products Mfg. Co., 1123 West Belmont, Chicago, Ill.

**AGENTS**—Solution re-brightens auto bumpers, black grilles. Used car dealers buying gallons. Free sample. Fast seller. Good profit. Pellis Products, 476 S. Park Ave., Buffalo 4, N. Y.

**INFORMATION**—Locating articles and products (wholesale) etc. Mention requirements. National, 3537D So. Hoynes, Chicago 9.

**PEARLS,** Lovely colors, big selling summer item. List 10c. Doremby Co., Chisholm, Maine.

**LEARN** Mail order, dime magazine. Diehl's, 168 Clinton, Buffalo, New York.

**DEPENDABLE,** Substantial, mailorder information, new ideas, profitable spare-time time moneymaking opportunities galore in our magazine. Copy 25c. John Hillstrom, 6411P Hollywood Blvd., Hollywood 28, Calif.

**"TIMELY** Tips magazine," Paulding, Ohio, includes moneymaking plans, ideas, business opportunities. Monthly, 10c. 19th year, \$1.00. Trial six months, 50c.

**THE** Knack of making money in any job, business or profession. Postal brings details. L. R. Schulz, 216 W. Jackson, Chicago 6.

**SUCCESS** In the mail order field can only be had by knowing all the facts! You must know what sells, who buys, how to mail. We tell you the "who, what and how!" Particulars free! Wilson's Service, R.R. 4, Martinsville, Indiana.

**EMBOSS,** Beautifully, stationery, cards. New, amazing inks, gold, silver, easily applied. Free literature. Crawford, 174P Nichols, Bridgeport 8, Conn.

**MAIL** Order magazine, dime. Acme, Fifty Bristol, Buffalo, New York.

**MAGAZINE** Of ideas, schemes, plans—25c. "The Circuit," Woodbine, Maryland.

**SELL** Ball pens. Dollar for sample pen, two units, details. Thomas Pens, Box 3 Station W. Brooklyn 11.

**WHOLESALE** Anything imaginable. New guaranteed list 25c. Refundable. Lasalle Novelties, Box 2188, Waterloo, Iowa.

**MAKE** And sell simple home fire extinguishers. Big market, every home. 100% profit. Details, 25c. D. Schneider, Box 201, Copiague, L. I., N. Y.

**RECEIVE** Moneymaking opportunities, mails, samples, catalogs, magazines. Your name in thousand mailing lists, 25c. Glassmine, 1654-MP Amsterdam Avenue, New York 31.

**THOUSANDS** Articles wholesale. "Supply Source Directory" 10c. Ideal Service, Park Ridge 40, Illinois.

**NO** Peddling. No capital. Work home. Spare time. Charles, 12AG, Norwood, Ohio.

**SELL** By mail! Increase your income with your own mail order business. Write now—today! Bricker, 115-3 North 5th St., Emmaus, Penna.

**BIG** Money silvering mirrors. Learn how, special process, formula \$1.00. Zanol-P, Box 2266, Cleveland, Ohio.

**MAKE** Money! Collection 137 plans. Booklet free. Twin Parks Z, Box 4696, Dallas, Texas.

**A** Business of your own! Go into business for yourself. Start at home in your spare time. We can help you! Details free. Rennolet, 1022-A 9th Street, Rock Island, Ill.

**MAKE** More money in your own factory! Start at home in spare time, work hard, and others will be punching your time-clock! See page 254 for details of 15 valuable tested trade secrets, easy to make, easy to sell. Chemical Research Co., 130 W. 42 St., New York.

**500%-1000% PROFIT** And up. Your own interesting service business. Tremendous demand everywhere. Experience unnecessary. We teach, help, supply everything. Practically no capital needed. Resistal, Inc., 1757-B Sunnyside, Chicago 40.

**EXCELLENT** Profits raising mink. Details furnished. Franklin Young, Riverhead, New York.

**FREE** Literature describing 20 money-making plans. Dalles Ruth, Wheelersburg, Ohio.

**MANUFACTURE** Costume jewelry at home for profit, hobby, therapy. Free wholesale supply catalogue. Instructions. Florida Supply House, Bradenton, Florida.

**SHELLCRAFT** Instructions free! Make beautiful seashell jewelry! Wholesale catalogue of complete line shells! Plastic discs! Animal shapes! Pinbacks! Earrings! Cameos! Etc. (Buy direct.) Pace's, Box 279, Bradenton, Florida.

**BIG** Mail including mail order magazines 10c. Mallo, 767-PM Leith, Flint 5, Mich.

**I MAKE** Big money in the mail-order business. You can do the same at home with my copyrighted system. Write me. I'll tell you how. P. Little, Box 8, Glenshaw, Penna.

**\$25 WEEKLY** Working two hours daily. No canvassing or manufacturing. Lycke, Box 2471, Cleveland 12, Ohio.

**WOULD** You pay 3%—first \$350 made? Color-illustrated book "505 Odd Successful Enterprises" free! Proven! Work at home, office. Expect something odd! Pacific, San Clemente, Calif.

**THERE'S** Big money in junk," and repairing batteries. Write, Batteryman, Grand Junction 5, Colorado.

**\$246.50 MAKING** Unusual secret device without skill, machinery, from former war material costing \$1.50! Simple, baffling invention, unbelievably profitable! Illustrated proofs free. Rolls Enterprises, 115-D West 16th, New York 11.

**EARN** Money at home—steady income. Write Successful Income Builders, 508-A, Hollywood 28, California.

**200 MONEY** Making deals, plans, rare formulas. Schemes, Folio free. Formico-Eng., Box 572, Dayton, Ohio.

**FORTIFY** The future! Start own business; home, office. Booklet describing "Collection of 137 Tested Plans" free. Elite Co., 220-A Grand St., New York 13.

**PUBLISH** Your own magazine. Hand-some 52 page format, well edited, illustrated. Cost low as \$1.00 month. Brings you prestige, profits. 25c brings sample, details. National, Ord. Nebr.



## FORMULAS, PLANS, ETC.

**MANUFACTURE** Cleaners, soaps, polishes, flavors, cosmetics. Literature free. Kemico, Park Ridge 16, Illinois.

**FREE** Shave cream and lotion formulas list. Moon, Broadway, Fulton, N. Y.

**ANY** Formula \$1.00 each. All tested and workable. Williams Co., Box 385, Galesburg, Ill.

**PERFUMED** Bubble bath formula for sale. Complete information. Neu Laboratories, Box 608, Painesville, Ohio.

**SPECIALIZING** In auto. chemical formulas. All guaranteed. Free literature. Write Karen Chemical Co., P. O. Box 242, Pasadena 17, Calif.

**FORMULAS** For profit. A book of over a thousand formulas and trade secrets for home, factory, workshop, school and laboratory. Size 8 1/2 x 6 1/2 inches and 638 pages. Price \$3.95. Campbell Mail Service, P.O. Box 3, Beaver Falls, Penna.

**"CONTEMPLATING** manufacturing frozen custards?" One dollar brings full instructions. Years of experience. B. C. Stroud, Tallmadge, Ohio.

**50 SINGLE**-Ingredient formulas, \$1.00. Kay, Box 13, Sta. W, Brooklyn, N. Y.

**FREE**, Descriptive circular on toy plans. Production Engineering, 403-C City Hall Bldg., Rockford, Ill.

**GIANT** Formula book—now only \$3.50. 10,000 secrets, recipes, formulas, latest edition, free literature. Argyle, 1412-B Great Northern Bldg., Chicago 4.

**COLD** Kream shampoo, coal saver. Each formula 50c. Cy Bibbs, 2233 Eastern Ave., Indianapolis, Ind.

**"LUMINOUS** Paint." Resilvering Mirror formulas 25c each. Ideal Service, 300, Park Ridge, Ill.

**15 TRADE** Secrets that cost millions to develop and test—yours at low cost. You start your own business in spare time at home. Easy to make, easy to sell. See page 254 for details. Chemical Research Co., 130 W. 42 St., New York.

**NEW** Formula, plant food. Enclose dollar. Lester Dudley, Mapleton, Maine.

**NEED** Chemists? Products duplicated? Formulas? Analyses? Consulting Scientific Company, Swarthmore, Pennsylvania.

**100 SINGLE** Ingredient formulas 25c. Tes-Co, Box 189-MG, Wilkes-Barre, Penna.

**10,000 FORMULAS** And trade secrets. Free literature. Stillman, 555 Kingston Ave., Brooklyn 3, N. Y.

**FIREWORKS**. Twenty formulas, one dollar. Pyrotechnics, 215 West Haskell, Tulsa, Oklahoma.

**REAL** Manufacturing formulas. Lists free. Cummings, Chemist, Gordon Ave., Syracuse 4, N. Y.

**FORMULAS**—Latest, best. Analysis. Giant formula catalog and chemical instruction sheet 10c. Refunded first order. Belfort, Engineering Building, Chicago 6.

## PLASTICS

**FIVE** Plastic projects in one kit. Plans, instructions, extra plastic. Send \$2.00. Plastikit, Box 214, Charleston, Illinois.

**NEW** Liquid plastic. Clear, colors. Cast without heat. Embed flowers, insects, coins. Saw, drill, carve. Manual tells how. Send \$3.35 for complete 20 project kit including one pound liquid Castolite. Castolite, Dept. G-21, Box 211, Kenilworth, Ill.

**PLASTICS**, Sheets, rods, tubes. Free list. Swiss music units \$3.50. Plastic Supply Co., Dept. PM61, 2618 St. Louis Ave., St. Louis 6, Mo.

**CATALIN** Plastic shapes. Free price list. National Plastic Products Co., 5 W. Larned St., Detroit 26, Michigan.

**GOLD** Imprinter \$3.25. Samples 10c. G. E., 8 Walden, Cambridge 40, Mass.

**PLASTICS** And supplies. Excellent book on plastics, \$1.50 value \$1.00. Exceptional kits \$3.00-\$5.00. Internal carving drills 95c. Prices f.o.b. St. Louis. Free list. Plas-met Sales and Engineering, 4648 Shirley Pl., St. Louis 15, Mo.

**LUCITE** Catalog dime. Refunded. Special offer. Midwest Plastic Supply, 1717 No. 66, Omaha 4, Nebr.

**SLASHED**—Our Plexiglas prices. For June only. Send for free listings. Novaltic Plastic, Box 106-SL, Brooklyn 19, N. Y.

**LUSTROUS** Formalin, quick-setting liquid plastics. Complete line casting supplies. Literature free. Sample kit \$3.00 f.o.b. Formalin Works, Box 199, Romeo, Michigan.

**LEARN** Internal carving in plastics for pleasure and profit. No special skills or long training required. It's easy, exciting. Complete instruction folder shows how to carve flowers, animals, landscapes of colorful, thrilling beauty in solid Plexiglas plaques and cubes. Explains dyeing, gilding. Illustrates power tool, drills, materials needed. Complete information plus price list, catalog of metal findings and jewels, only 10c. Plastic Parts & Sales, 1157 S. Kingshighway, Dept. H-26, St. Louis 10, Mo.

**MAKE** Thirty beautiful Plexiglas household gadgets. Kosto Plexikit number one contains new materials cut to size; seventy-two page brand new fully illustrated handbook—All other materials to finish fifteen crystal clear and colorful projects. Rush order today, \$5.00 in U. S. Kosto, Washington 7, D. C., Dept. M5.

**PLASTIC** Injection machines, three sizes, toy, industrial, commercial. Full line jewelry findings. New low prices. Plexiglas, dyes and supplies. Tenite, Polystyrene rods, kits, etc. G. Baker Company, River Edge, New Jersey.

**MAKE** Money assembling our pre-fabricated plastic kits. Sample kit 50c. Catalog free. Fabros, Box 156, Station F-1, Buffalo 12, N. Y.

**PLASTICS**—7 Colors sheets and rods. Send stamp for price list. Hanson Plastics, 7625 South Parkway, Chicago 19.

**LUCITE** Sheets, rods, dyes, cements, cheap. Free price list. Thomas Cavaliere, 2141 So. Beechwood St., Philadelphia 45, Penna.

**KITS**: \$1.50 Each. Plexiglas tie-rack 18", 5"x7" picture frame or bud vase. Send for free price list. Free gift with each kit. Heah Mfg. Co., 5115 N. Neenah Ave., Chicago 31, Ill.

**PLEXIGLAS** Masked sheets 12"x12"—1/16"—\$1.00, 1/8"—\$1.25, 3/16"—\$1.55; 1/4"—\$1.85. Include 10% postage. Dyes, rods, cements, shells, buffing compounds, jewelry findings, tools. Free listings. Craft Plastics, Box 129-P, Somerville, New Jersey.

## CHEMISTRY

**SPECTROSCOPE** For quick chemical analysis \$3.00. Cutting Co., Box 457, Campbell 1, Calif.

**THE** House of Winn, home of supplies for amateur chemists. See Winn's New Idea chemical kits and apparatus outfits for home experimenting. Send 10c for retail catalog. Established 1931. John H. Winn, Dept. 506, 124 West 23rd St., New York 11, N. Y.

**NU PROCESS** Products Laboratories, Dept. 301, Aurora, Illinois, have some choice distributorships open. Exclusive territory franchise. Big profits. Wholesale and retail. Age no barrier. Men and women eligible. Cash profits start first hour. Two products (1) Silver Plating Liquid (NuSilver Trademark Patent No. 245,336 and Re-Plate-O Trademark Patent No. 367,355), and (2) Lectrik Silver Kleaner Plate for quick de-tarnishing of silverware. Full details free. Write them today.

**TRI** Sodium phosphate nitrated. Wonder cleaner and soap saver, now available. 100 pounds \$8.95 f.o.b. Send 25c for carton and sample. Thoro Company, 14831 Bessemer, Van Nuys, California.

**FREE** Scientific catalog. Fourteen hundred exceptional items. Tracey Laboratories, 1907 Harrison Street, Evanston, Ill.

**LABORATORY** Supplies at wholesale prices. Chemistry, biology, physics, geology. Catalogue 10c. National Scientific Company, Established 1908, 2204 W. North Ave., Chicago 47, Ill.

**SOMETHING** New! Student chemists send 5c for catalog and free copy of N-1 "Know Your Chemicals" series. Met & Co., Dept. 10, 160 Hillside Avenue, Nutley, New Jersey.

**NEW** Laboratory supply catalog of chemicals and apparatus, contains over 5000 items with illustrations, 212 pages. Send 50c. Standard Science Supply Co., 1232 No. Paulina Street, Chicago 22, Ill.

**CHEMICALS**—LAB. Supplies. New catalog 10c. Mel-Glo Chemical Co., 258 Fourth Avenue, Brooklyn 15, N. Y.

**HANDBOOK** For chemical experimenters, illustrated, hundreds of experiments, 50c. Experiment booklet 15c. Supply catalog 5c. Reading Scientific Company, Reading, Penna.

**CHEMICALS** And apparatus for industrial, analytical, and private laboratories. Complete supply service for correspondence school students. Send 3c for catalog. Dept. M-43, Biological Supply Co., 1176 Mt. Hope Ave., Rochester 7, New York.

**APPARATUS**, Chemicals, ounce quantities, catalog 5c. Fleischer's Laboratories, Everett 49, Mass.

## HELP WANTED

**WOOD** Finishers beginners contact Satin Wood Products Co., 42 LaBelle St., Dayton 3, Ohio. Information free.

**MAKE** More money selling individualized buckles, belts, tie holders, cap badges. Choice of 2000 emblems. Quick profits—repeats. Special outfit offer, write Hook-Fast Products, Dept. A, Columbus 6, Ohio.

## AGENTS WANTED

**ECUADOR** Native handwork brings 500% profit. Sample collection \$2. Money-back guarantee. Estrella, Box 537, Quito, Ecuador, S. A.

**VETERANS**, The honorable service emblem in shining yellow on a chromium-plated ring, to be worn with honor and pleasure. No changing from one coat to another; no hiding under an overcoat. Agents and dealers wanted. Mail \$1.00 for sample, postage paid. Retail \$2.00. Special discounts for quantity orders. Fuller & Co., 517 E. 44th St., Indianapolis, Ind.

**DISTRIBUTORS** Wanted to call on taverns, roadstands, etc. with complete line of five and ten cent nut meats, also five cent boneless herring card. Write Royal Nut and Candy Co., Inc., 1015 Grand Street, Hoboken, New Jersey.

**IT'S** New! Every auto owner will want one or two. Opportunity to really make money. Over 100% profit for you. Send \$1 for sample, details. Peerless Sales, 913-Q Main, Kansas City, Mo.

**FOOT-MASTER** Tablets. Amazing seller to those afflicted with foot trouble. Proven seller 45 years. Good profit. Repeats fast. Write Master Products Co., 6 East Oak Avenue, Moorestown, New Jersey.

**\$1 STARTS** You in business. Sell DeLux ties, 100% wool interlining. Costs you only \$7 per dozen, you make \$5.00 dozen. Send \$1.00 for special introductory offer two DeLux ties. Catalog complete line free. Philip's Neckwear, 20 West 22nd St., Dept. K-12, New York 10.

**A NATURAL!** Make good money with fast-selling, new line plastic tablecloths and women's aprons! Also novel, embroidered cotton pillow cases! Write for interesting details. Royalty Sales, Box 748-A, Passaic, New Jersey.

**BIG** Profits with products that sell like an atomic blast. You can't beat our offer. Write us at once. KaBe Bros. Inc., 4823 Denison Ave., Cleveland 9, Ohio.

**PROFITABLE** Business! Demonstrating sensational water saver nozzle in your own community or traveling. When hose is dropped flow is stopped. Car washers, service stations, homes, farms, factories, greenhouses, nurseries, gardeners, golf courses buy on sight. Send postcard. Water-master, 19465-P Ward, Detroit 21, Mich.

**MAKE** a bigger profit! Let us tell you where to buy 800,000 articles direct from 1200 factories. Details free. Glass Publishing Co., Ellwood City 11, Penna.

**TAKE** Orders for solid brass nameplates. Immediate commissions. We deliver. Metro Engraving Co., 362 Cross Street, Malden, Mass.

**MILLIONS** Want foot comfort! Amazing daily profits. Sensational new arch support body-balancer for men, women selling like hotcakes. Experience unnecessary. Complete outfit free. Special deal to distributors, crew managers. Write: Colt Shoe Company, 244-D6 Purchase, Boston 10, Mass.

**PLASTIC** Tablecloth covers, curtains, drapes, baby pants, bowl covers and other plastic articles selling like wildfire! Make big money now! Free details. Write Plastics, Dept. 58-F, 206 N. Fourth, St. Louis, Mo.

**WHOLESALE** Ball point pens to stores. Price list free. Sample pen \$1.00. Friendly, 17 South Penn Avenue, Philadelphia 11, Penna.

**SELL** Guaranteed refrigerator deodorizer 65c. Cost \$4.00 dozen, sample 35c. Borland, Box 9699, Station S, Los Angeles 5, Calif.

**AT** Home—Your own business making, selling, popular \$1.00 novelties. Cost you 3c to 15c. Everything supplied. Write So-Lo Works, Dept. U-6003, Loveland, Ohio.

**HOUSE** Numbers that glow in the dark. Luminous pictures, etc. Large mfr. wants factory representative. Wonderful new product. Fast seller. Free samples. Madison Mills, 303 4th Ave., New York City.



**AMAZING** Daily profits. Big repeat business. Sell top-quality, lowest-priced men's, women's hosiery, full, part-time. Experience unnecessary. Take orders. We deliver. Complete outfit free. Write Colt Shoe Company, 242-D6 Purchase, Boston 10, Mass.

**BIBLES**, Size of postage stamp, samples 25c, 100 \$6.00. Everybody buys. RB Co., 542 Fifth Ave., New York 19.

**AMAZING** New rust remover! Whirlwind seller. Agents make 100% profit. Free details. Arch Macdonald, Box 21, Winnetka, Illinois.

**MEXICAN** Feather pictures. Unusual novelty. \$1.00 (stamps) brings \$2.00 worth samples, details. Refunded if unsatisfied. Aztec Art-P, Apartado 762, Mexico City.

**LADIES'** Genuine alligator handbags, 12"x9", \$24.95 postpaid. \$204 dozen. Moises Rodriguez, Apartado 2497, Havana, Cuba.

**BIG Demand**—power mowers. Drop shipments. Catalog free. Rotacut, M2005, Excelsior Springs, Mo.

**MAKE** Quick clean-up selling perfume beads, sachets, incense. Mission Factory, 2328 W. Pico, Los Angeles 6, Calif.

**WHOLESALE**—New item for women. Free particulars. Renee, 8 Cumberland St., Boston, Mass.

**FINGER** Nail clips. Tool steel cutting edges stay sharp. Bright nickel. Retail 50c, sample 15c. Twelve on display card, \$1.80 dozen plus postage. Fast seller. Kearney, 180 Seventh Avenue, New York 11, New York.

**100% PROFIT!** Prospects everywhere! Skram protects shrubbery from "dog nuisance." Suau, Wenonah, New Jersey.

**BIG** Money selling large rubber and wool sponges. Inman and Inman, 135 So. Second St., Highland Park, Ill.

**AGENTS**, Dealers, distributors. We have the fastest-selling item on the market today. 100% profit. Steady repeater. No competition. Rush \$2.98 for complete set-up, or write for details now! Morrison, Box 9312, Station S, Dept. 12, Los Angeles 5, Calif.

**WANT** To be a successful salesman? Get our practical sales formula and plan. It tells you how. \$1.00. Steinbraker, 1910 Newport, Chicago 13.

**WHY** Need money! Our product offers excellent profits with thousands of prospects. Free information. Atlas Products Company, Dept. 17, Box 388, Oklahoma City, Oklahoma.

**JOKERS** Novelties and tricks. Agents earn quick return. Request details. Delrose Magic Products, 536 Sixth Avenue, New York City 11.

**GREETING** Cards: Easy money, quick. Free literature tells all! Evers, Elmhurst, N. Y.

**BIG** Profits with plastic floor finish good for linoleum, wood, asphalt tile. Small investment in stock. Credit arranged. Thrifty Products, 1650 Ocean Ave., Brooklyn, N. Y.

**IMMEDIATE** Profits! Collection 137 business plans. Booklet free. Twin Parks Z, Box 4696, Dallas.

**AGENTS**: All ages, earn \$30 to \$50 weekly selling for yourself, fibre brooms, mops, and floor dusters, start now. Write Burtz Fibre Broom Co., Columbia, Penna., Dept. A.

**EXCELLENT** Sideline for printing and advertising salesmen. Decalcomania name plates in small quantities. Great demand. Also, make money with our line of automobile initials and sign letters. Free samples. "Ralco" XL-Roxbury, Boston 19, Mass.

**EARNING** Less than \$200 weekly? Boost income quickly. Fast selling celluloid price tags, metal molding, menu covers. Every store, restaurant buys. Pricing Press, Dept. PX, 124 White Street, New York.

**WARCO** Polishing Paper. Cleans and polishes automobiles, furniture, glass, etc. A profitable fast seller. 25c brings regular package and wholesale prices. Warco Supply, 255 S. Meridian, Indianapolis, Ind.

**AGENTS**. Substantial profits. Repeat order products. Not mere "job" but opportunity establish steady income. Additive lubricant. Limitless field. Factories, autoists, service stations, fleet owners buy big. Write Kidder Oil Company, LaCrosse 1, Wisconsin.

**WONDER** Cleaner, free sample! Other producers: unusual bubble bath—Glas-Klean. Sell homes, stores. Circulars furnished. Courier, 3829-I Delmore, Cleveland Heights 21, Ohio.

**REFLECTING** Signs, lawn and house numbers. Carl Sign Co., Wooster, Ohio.

**SELL** Personal Initialed individualized belts, buckles, cap badges, tie holders. 2,000 emblems to choose. Fast profits. Repeats. Write today special outfit offer. Hookfast Specialties, Box 1425, PM, Providence, Rhode Island.

**AMAZING** Discovery. Miracle glaze puts brilliant glass-like surface on cars. Free sample, information. Big profits. Miracle Glaze Company, 9714 S. Austin Ave., Oaklawn, Illinois.

**AGENTS**—Distributors \$28.00—\$140.00 daily. Flo-Glo plastic linoleum finish. Write, Acme, Box 404, Mount Vernon, N. Y.

**JUST** Out! History of World War II. Huge volume. Popular price. Authentic text. Official photographs. Big profits. Riverside Book Company, Iowa Falls, Iowa.

**MAKE** Money in your spare time! Helps furnished. Easy sales. Voluntary repeat orders. Liberal commissions. Write for free wholesale price list today! McGregor Magazine Agency, Dept. P.M.-7, Mount Morris, Illinois.

**MAGIC** Cleaner—Hotter than a fire-cracker. Saves soap—Big profits—Sample free. Bestco, 5007 Irving Park, Chicago.

**BIG** Bargains for big profits. Over 100 sensational values. Men's used suits \$2.00, pants 35c, topcoats \$1.25, overcoats \$2.00, shoes 20c. Experience unnecessary. Free wholesale catalog. Superior, 1250-B Jefferson, Chicago 7.

**GREETING** Card agents, "line up" with "Pines" for bigger, better, quicker profits. Rush name, address on postcard today. Box 32, Flushing 5, New York.

**90c PROFIT** Each \$1 sale. Sell positive mothproofing solution to housewives, stores, agents. Experience unnecessary. Postal brings details. Kinford, Wayne 3, Penna.

**AGENTS**: Stamping names on pocket-key protectors. Sample check with your name, address, 25c. Stamping outfits. Emblem checks, check-fobs, name plates. Hart Mfg. Co., 303 Degraw St., Brooklyn, N. Y.

**137 COMPLETE** Plans for starting own business: local—mail order. Particulars free. Elite Co., 220 Grand St., New York 13.

**AGENTS**—300 % Profit selling genuine gold window letters; stores and offices. Free samples. Metallic Letter Co., 438-B North Clark, Chicago.

**200 MONEY** Making deals. Plans, rare formulas. Schemes. Polio free. Formico Service, Box 572, Dayton, Ohio.

**\$3 FIRE** Extinguisher; quick sales, wholesale or direct; liberal profits. "Fire-Killer," 109 N. Franklin, Syracuse 1, N. Y.

**PLATING** Outfits for autoparts, reflectors. Connect to a battery. No tanks necessary. Free booklet and particulars. Gunmetal Co., Ave. N. Decatur, Ill.

**FREE** Water and our concentrates, makes flavors, lotions, shampoos. 72 products, labels, bottles furnished. Qualco, E-20030 Russell, Detroit.

**GOLD** Lacquered window sign letters. Large sizes penny each. New foils. Absolutely beautiful. Free samples. Atlas, 544 W. 79th, Chicago 20.

**SELL** Personalized soap. Name on every cake. Ideal for gifts. Get sample offer. Dunbar Soap, New Brunswick, N. J.

**AGENTS**—Big line including food products. Fast selling premium and bargain deals. Low prices. Send card for big profit offer with gift. Ho-Ro-Co, 2796 Dodier, St. Louis 7, Mo.

### HIGH GRADE SALESMEN

**SALESMEN** Calling on stores. No investment. Give experience. Ponto, Station S, Box 9551, Los Angeles.

**DISTRIBUTORS**, Salesmen — Patented cigarette case holder for automobiles, trucks. Fine seller. New. 200% profit. Samples \$3.00 per doz. Literature free. Little Giant Holder Company, 919 South Vermont, Los Angeles 6, California.

**12 FANCY** Boxes pure Vermont maple sugar postpaid \$6.60. Retail \$1 each! Eulalia Turner, Poultney, Vermont.

**AMAZING** New zipper shoe sells on sight. Big profits for salesmen. Leads line 200 splendid styles. Territories open. Get free sample outfit. Write, Consolidated Shoe, Dept. S-773, Chippewa Falls, Wis.

**POCKET** Pal: The all-purpose cutting tool. Wagon jobbers-salesmen. Sell to retailers and jobbers. 50c seller. Steady repeat item. Exceptional profit. Sample 25c. Nelson Mfg. Co., 222 West Kellogg, St. Paul 2, Minn.

**FREE** Samples new spun glass wick and flints. Save 35%, buy direct from "Packers." Glasser Products, 1738 Union Street, Brooklyn 13, N. Y.

**STATE** Distributors to sell simplified bookkeeping system small stores and public accountants. Sells \$13.50. Your commission \$8.50. Exclusive franchise. Send \$5.50 for sample set. Hawthorne Sales Co., Decatur, Ala.

**HOW** To become a successful salesman. Double your income. Send \$1.00 today. "Successful Selling." P.O. Box 6351, Los Angeles 53, California.

**ADVERTISING** Book matches—World's largest direct selling manufacturer of advertising book matches offers opportunity for profitable year 'round selling; every business a prospect. No experience needed to start; full or part time. Factory service. Low prices for high quality; repeats; sales kit furnished. Match Corp. of America, 3433-43 West 48th Place, Dept. E-8, Chicago 32, Illinois.

**START** Your own business on our capital. Always your own boss. Hundreds average \$6,000 to \$25,000 annual sales. We supply stocks, equipment on credit. 200 home necessities. Selling experience unnecessary to start. Wonderful opportunity to own pleasant, profitable business backed by world-wide industry. Write Rawleigh's, Dept. F-U-PPM, Freeport, Ill.

**ADVERTISING** Book matches—Cash in on political campaigns—sell Union Label matches. Cuts for all businesses and political parties. Free powerhouse selling kit, low prices. Protection guaranteed on repeat orders. Cash commissions. Superior Match Co., Dept. M67, 7530 Greenwood, Chicago.

**SALESMEN**, Experienced, to sell and distribute high-grade furniture polish, polishing oils, etc. Exclusive territory to producers. F. W. Boyde & Co., 731 No. 24th St., Philadelphia 30, Penna.

**AMAZING** Daily profits, steady repeat business selling Colt's famous Foot-Balance Shoes direct. Exclusive features make selling easy. 216 styles! Experience unnecessary. Patented Foot-O-Graph assures accurate fitting. Free selling outfit. Colt Shoes, 601-06 Atlantic, Boston 10, Mass.

**FREE**—New 42-page book entitled—"How To Become a Successful Direct Salesman," written by salesmen for those who want to become salesmen and earn up to \$100 and more weekly. Send penny postcard. Specialty Salesman Magazine, Dept. PM-2, 307 N. Michigan, Chicago 1, Ill.

**SELL** Most comfortable belt buckle and belt ever invented. Every man a prospect. Hand Tooled Leather Co., 114 N. Winnebago St., Rockford, Ill.

**EXPERIENCED** Advertising specialty representative. Thermometers, yardsticks, calendars, plastics, metals, leathers. Resume, references essential. Commission. Bonus to 50%. Eric Howlett, Huntington, New York.

**10c NOISEMAKER** Balloons \$3.90 gross! Balloons with stix \$3.35 gross. Super 42" balloons \$1.80 dozen. Fast big profits in our balloon business. Ellswood Balloon Headquarters, La Junta, Colorado.

**PRESSURE** Cookers. Now available. Selling like wildfire. Amazing profits. Write quickly. Morris Mandell, Inc., 131-P W. 14th St., New York 11, N. Y.

**PRINTING** Salesmen: Get our free sales kit of complete line and start earning real money. Big commission, 100% cooperation. Barker's Service, Elizabethtown, Ky.

**"KING-PIN"** Air feed valve for automobiles guarantees greater mileage, power plus, less carbon, smoother performance. Buyers become boosters, gold mine for hustlers. No-Co-Ro, Oakland 6, Calif.

**MANAGEMENT** Engineering franchise available. Supervise salesmen, make surveys. Valuable training given. Sims & Associates, 120-PA S. La Salle, Chicago 3.

**STORES**, Salesmen, individuals: handle handmade plastic belts, suspenders. Fast sellers. Large profit. Acme Plastics, State-san, Wis.

**WANTED** Salesmen, county and state distributors: men with cars to sell automatic electric water heaters. First class job. Crane Electric, Eugene 4, Oregon.

**SELL** Tires—make money. Standard makes, first quality. No investment or experience required. Direct Tire Co., 962 E. 129 St., Cleveland, Ohio.

**SELL** Filling stations, sales tested specialties. Good profits. General Sales Co., 915 Brooklyn, St. Louis 6, Mo.

**SELL** Calendars full or part time—every business house a prospect—also wholesale to printers—calendars, novelties, sheet pictures. Fleming Calendar Company, 6535 Cottage Grove Avenue, Chicago 37, Ill.



**ORANGE** Concentrate direct from our Florida groves. One quart bottle makes six quarts delicious natural orange drink simply by mixing with five parts cold water. Groceries, foodmarts, hotels, restaurants, taverns, roadstands, soda fountains, hospitals, resorts, camps, farmers, big buyers. Money-back guarantee. No investment. Protected territory. Salesmen earn \$100.00 to \$200.00 repeat commission weekly. Sunset Valley, 3357 N. Clifton, Chicago 13, Ill.

**QUICK** Profits selling full or part time, individualized buckles, belts, cap badges, tie holders, uniform shirts, caps, ties. Choice of thousand emblems. Sure repeat orders. Easy-selling outfit offer. Write Hook-Fast Company, Dept. 12, Roanoke, Virginia.

**WAGON** Salesman—Fast moving carded goods and 10c line. Long profit. Free facts. Peerless. 2717 Dodier, St. Louis 7, Mo.

**FREE!** Latest issue Opportunity Magazine. Salesman's Guide. Inspiring, constructive. Shows how to earn money selling for others or in your own business. Hundreds postwar opportunities. Send name and describe what you have sold or are selling. Illustrated copy sent free. Opportunity Magazine, 620 N. Michigan, Dept. 17, Chicago 11, Ill.

#### AGENCIES WANTED

**SURE** Success! Appoint William Finau Store, Nukualofa, Friendly Island, Oceania, your distributor, annual sales: \$20,000. Bankers: Bank of New Zealand, Auckland. Interesting lists gratis.

#### EDUCATIONAL AND INSTRUCTION

15 **BEAUTIFUL**, Romantic, copyrighted California, Arizona poems on picture post cards, also plain comics, 25c postpaid. Ponto, Station S., Box 9551, Los Angeles.

**"HOW To Break and Train Horses"**—a book every farmer and horseman should have. It is free; no obligation. Simply address Beery School of Horsemanship, Dept. 1106, Pleasant Hill, Ohio.

**HAVE** An office. Many earn up to \$5,000-\$15,000 annually. Learn credit-collection agency business by home study course. Write for free bulletin. Franklin Credit School, Dept. 202-D, Roanoke 7, Virginia.

**PLASTICS**—Get into nation's fastest growing industry. Exceptional opportunities. Enroll now for June class. Veterans approved. Free catalog. Kansas City School of Plastics, 3827-A Main St., Kansas City, Mo.

**RESORT** Hotel business offers permanent career, travel, beautiful surroundings. Write for booklet. Lee Hotel Institute, 12A South Market St., Boston, Mass.

**PHOTOGRAPHY!** Let us train you for this dignified, well-paying profession. Residence courses only. Fully G.I. approved. Write for information. Southwest Photo-Arts Institute, 1709 Forest Ave., Dallas 15, Texas.

**CALENDAR** 1753 To 2152. 35c postpaid. Tracy Newton, Decatur, Georgia.

**LEARN** Secret of being irresistible, the key to success. Capitalize your hidden powers. "Winning Personality" shows how. \$1 copy. A. Doherty, Box 171, Station W., New York 24.

3800 **USED** Correspondence courses cat. (25c). EG Mfg., Elmsford, New York 1.

**AMAZING** Discovery. Review touch typewriting, develop terrific typewriting speed. 50c coin. Walker, Box 394, Union, New Jersey.

**JOB-HUNTERS!** Quit standing in line for jobs. Copyrighted manual tells how to prepare scientifically designed letter and resume guaranteed to attract employers and produce interviews; \$1.00 postpaid. Vocational Guidance Service, 622 Penfield Bldg., 1328 Chestnut Street, Philadelphia 7, Penna.

**HOME** Study course for beginners—oil painting. For the person who desires to paint but has been unable to receive the necessary instruction. You pay by the lesson. Write for information. Carlos Art Academy, Correspondence Division, 330 Brainard St., Watertown, N. Y.

**GOVT.** Jobs: 200 coaching questions and answers. Start yourself toward security and good pay now! New manual tells how. Only \$1.00 complete! Ellis, 915 Shreve Bldg., San Francisco, Calif.

**SLIDE** Rule circular and instruction booklet \$2.50 C.O.D. GFB Associates, 1328 Chestnut, 622P, Philadelphia, Penna.

**TRAIN** For aviation mechanics high salaries. This famous school approved for veterans. Immediate enrollment. For information write California Flyers, Inglewood, California.

**HERBALISM**—Complete course in two volumes. 1000 recipes. Home Service, Forestville 2, Va.

**CHIROPODY**, Masso-Physio-Therapy. Evans natural therapeutics home study courses. Foot correction, adjustments, massage, arch supports, etc. All massage movements, diet, baths, etc. P.O. Box 1195, San Antonio 6, Texas.

**HOME** Study courses. 300 subjects. Tuition \$4.98. Free bulletin. DeVoto School, 35 Vicente, San Francisco 16, Calif.

**LEARN** Paint. Estimating, blue print reading at home. Approved easy system, prepared by expert. Write for interesting facts. Fred T. Schuttler, 5017 No. Wolcott, Chicago 40, Ill.

**LEARN** Trigonometry better than others. Master method instructions \$1. Guaranteed. J. Ziemba, 6123 Orchard, Dearborn, Mich.

**PREPARE** For Civil Service Examination. Pay for course after securing position. Write Free School, Dept. PM4, Kokomo, Indiana.

**USED** Correspondence courses and educational books bought, sold, rented, catalog free. Educational Exchange, Henagar, Ala.

**GOOD** "Used" self-instruction educational books on all subjects bought, sold, rented, exchanged. Satisfaction guaranteed. Complete information and 100-page illustrated bargain catalog free! Write—Nelson Company, Chicago 5.

**USED** Educational books on all subjects sold, rented, also bought and exchanged. Moneyback guarantee. Write today for free catalog and details. Lee Mountain, Pisgah, Alabama.

**INVESTIGATOR** Training. Phillips Secret Service, 1917B North Kenneth, Chicago 39, Ill.

**BIG** Money rebuilding shoes. Help needed everywhere or start big-income business of your own. Learn practical, sure, easy way in 3 months. Anyone from 18-60 years can learn easily. Approved for GI training. Rush postcard today. Modern Shoe Rebuilding School, Est. 1927, 2935 Belmont, Chicago 18, Illinois.

**29 LANGUAGES** By Linguaphone. Russian, Spanish, Portuguese—Direct conversational method for mastering any language quickly, easily, correctly at home. Available under G.I. Bill of Rights. Send for free book. Linguaphone Institute, 83 RCA Bldg., New York 20.

**LEARN** Photo-engraving at home or in oldest, largest school in America. Work for newspaper or establish own profitable business. New Tasope' Photo-Engraving equipment available soon. Write for information. Veterans ask about G.I. training. The Aurora School of Photo-Engraving, Tasope' Bldg., Aurora, Mo.

**MODERN** Welding school gives thorough training for one of industry's best paid jobs. Experienced instructors. Individual attention. Non-profit institution. Qualified under G.I. Bill. Write for literature and details. Hobart Brothers Co., Box M-1067, Troy, Ohio.

**SECRET** Investigation. Experience unnecessary. Investigators particulars free. George Wagner, M 125 West 86th, New York.

**MEDICAL** Laboratory technicians in great demand. We train you in your spare time, in your own home. You can practice while studying. Write for free catalogue. Imperial Technical Institute, Box 973-E, Austin, Texas.

**BOOKS**—All Kinds—Homcraft, Radio, Plastics, Boat Building, Photography, Model Building. Catalog free. Popular Mechanics Press, 200 E. Ontario St., Chicago 11, Ill.

#### PLAYS, STORIES, MANUSCRIPTS

**NEW** Writers needed. Nonfiction material demand is booming. Many magazine editors buy features and "fillers" from new writers. Our earn as you learn lessons prepare you to meet their requirements. Experience unnecessary. Reasonable price, unexcelled service. Details, sample lesson free on request. Use postcard. No obligation. Comfort Writer's Service, 200-PN S. 7th St., St. Louis 2, Mo.

**I WANT** New writers to cash hundreds of checks for \$1 to \$100, offered each month. The easiest way to write for pay. No previous experience necessary. Send for free details. No obligation. Saunders M. Cummings, 467-M Independence Bldg., Colorado Springs, Colo.

#### BUSINESS SERVICE

**WHERE** To find it? Our specialized service provides you with source of supply on any article or material made in the United States. We save you time, money and effort. Reliable information on any single item only \$1. For ten different articles, \$5. Send no money! Pay on approval of information sent you. Tell us what you want to locate. Donald Kelly, 9544-A Whitcomb Ave., Detroit 27, Mich.

**MANUFACTURERS**, Any article. Two names 25c; 15, \$1.00. Pittshire, Box 90, Pittsfield, Mass.

**BUSINESS** Representation, world's principal cities. Associates wanted. Universal-PA Butler Building, Chicago 1.

**CHICAGO** Mail address. Suite 665-P, 120 S. La Salle, Chicago 3.

**ENJOY** Big mail sales. Your ads, letters, folders, etc. that sell! Written by Faultless Advertisers, P-3439 Michigan, Chicago 16.

**ATTENTION** American and Canadian manufacturers: Representatives of several leading firms in Portugal, will be interested to receive full information concerning all articles of your manufacture, to be introduced in the Portuguese and Colonial market. Send details to A. Feio, Apartado 202, Lisbon, Portugal.

**TO** Whom it may concern: We will represent you in all principal cities of the world. Personal or business assignments \$1 per hour. James W. Farley, Citizens Bldg., Cleveland 14, Ohio. Note: Would appreciate hearing from someone who wishes to enter this business in your city. Will send you assignments immediately. References exchanged. State qualifications.

#### SPECIAL SERVICES

**WE'LL** Represent you in Boston \$2.00 hour, business, social. J. McDonnell, 8 Cumberland St., Boston, Mass.

**CONCRETE**—Expert advice on concrete, concrete products, masonry, waterproofing. Uses and manufacture of cement. Up to four specific questions answered—\$5.00. "We have nothing to sell but knowledge." San Antonio Laboratories, Dept. M, Box 6764, Cleveland, Ohio.

**YOUR** Helper. Architectural, machine design, drafting. Calculations. The Straightway Eng. Co., Box 342, Cambridge, Mass.

**INCREASE** Business—Boston address \$2.00 monthly, \$10.00 yearly. Mail forwarded daily. McDonnell Enterprises, Box 99, Boston, Mass.

**PROFESSIONAL** Buying service from Chicago. Mail list of needs to Joseph Torres, Suite 507, 479 Broadway, Gary, Ind.

**WANT** To make a big impression? We'll write your poetry with discretion! Time to Rhyme, 2002 Myrtle, Davenport, Iowa.

**NEW** York address. Your mail received and forwarded. Confidential. Free details. Arlington, 131-H West 42nd, New York 18.

**LETTERHEAD** Designing; artwork; 200 attractive stationery designs, \$1.25; folder free. Jacobson's, 3510 Palmer, Chicago 47.

**ALASKA**. Letters stamped, forwarded, 25c coin. Tolovana Traders, Tolovana, Alaska.

**AMAZE** Your friends by having mailed, ornamental saving bank as souvenir from Michigan, 50c. Novelty Shop, 3013 Hess, Saginaw, Michigan.

\$2.00 **MONTHLY** Maintains Washington, D. C., business, personal mail address. Letters reforwarded daily. "Hawkins," 1300-H Taylor.

**SAN FRANCISCO**—Reno, Nevada, 3 souvenir postcards 25c. You address, write message, we mail. Letters remailed 25c each. Free particulars. Ira Smith, Box 4685, San Francisco.

**GOOD** "Used" self-instructional books on all subjects bought, sold, rented, exchanged. Satisfaction guaranteed. Complete information and 100-page illustrated bargain catalog free! Write—Nelson Company, Chicago 5.

#### CARTOONING, COMMERCIAL ART, SHOWCARD WRITING, SIGN PAINTING

**TALENT** Test free. American School Commercial Art, Box 8066, Dallas 5, Texas.

**MAKE** Signs. 9 complete alphabet pattern sets. 3 complete numeral pattern sets and catalog \$1.00. Sign Letter Distributors, P.O. Box 101, Mineola, N. Y.

**"HOW To Make Money With Simple Cartoons"**—a book everyone who likes to draw should have. It is free; no obligation. Simply address Cartoonists' Exchange, Dept. 96-C, Pleasant Hill, Ohio.



**ALWAYS** Make extra money painting signs easily, quickly. Includes "How to Make" brush paints, bronzes, pen inks, cardboards. Correct pens, brushes, layouts, spacings, balance. Overcome fear of lettering. Finger, hand exercises, limbers up muscles. \$1.00. Jantzen, Box 252, West New York, New Jersey.

**LEARN** Showcard writing in spare time. Fascinating, lifetime business of your own. No special skill needed. Free information. Sherwood Publishing Co., Dept. 108, Irvington 11, New Jersey.

**FREE** Catalog of cartoon markets, cartooning courses, artists' books and materials. Write now. Lawrence Publications, Box 22-A, New York 23, N. Y.

**WANT** Independence? Learn sign painting! Signways, 4933 Erie Street, Chicago 44.

**DRAWING** Board. Carry anywhere. Plexiglas straight edge parallel attachment. Accurate sturdy construction. 10x12, \$2.00 postpd. Guaranteed. Mech-Kemic Co., York, Penna.

**EARN** Big money. Become a skilled sign painter with our 112 lesson course. Results guaranteed. Write for details. Stewart Sign Co., Box 1329, Glendale, Calif.

**SIGN** Painting taught at home by an old master. Ben Kerns, Box 812, Greenville, S. C.

**CHALK** Talks. Laugh producing program. \$1.00. Catalog 10c. Balda The Cartoonist, Oshkosh, Wisconsin.

### ADVERTISING AGENCIES, LETTER WRITERS, FOR ADVERTISERS

**CASH** Buyers' names, unworked, remitting 25c to \$1.00 from national advertising in past 30 days. New customers for you. 200-25c. 1000-\$1.00. Martin's Service, Box 295P, Bassett, Va.

**SELL** The veterans' market. List of 1200 vets World War 2 living in Iowa. "the mail order paradise," \$3.00. Vets Advertising Service, Box 621, Des Moines, Iowa.

**17 WORDS**, 66,000 Readers, 3 months \$3.00. Renick, Holland 4, New York.

**FRESH** Mailing list. 500 names, \$3.00. Lester Kotthaus, Statesan, Wisconsin.

**NEW** Names. 1000, \$5; 500, \$3. Ross Advertising Service, Cartersburg, Ind.

**ADVERTISERS:** We specialize in a highly personalized service to mail order accounts, large and small. Complete staff expert artists, copywriters, etc. We are a legitimate advertising agency that can produce results for you. No extra costs to deal with us. Legitimate businesses solicited. Larson Advertising, Dept. PM, 315 N. 7th St., St. Louis, Mo.

**ADVERTISE:** 24 Words, 40 newspapers \$3.50. Lists free. Advertising Bureau, 229-C Dixon Blvd., Uniontown, Penna.

**NEW** Names! Just completed white, negro school teachers, automobile owners, births, etc. \$7.00 1000. Trial 300 \$1.00. Business Service, 1101 Kings Highway, Shreveport, Louisiana.

**FREE!** 1947 Advertisers Rate and Data Directory. 52 pages! E. H. Brown Advertising Agency, 20 N. Wacker, Chicago 6.

**ADVERTISERS:** Mail order ad covering United States—2,000,000 circulation—\$21.00 inch. Classified ad, 24 words, 20 metropolitan Sunday newspapers—\$25. Magazine, newspaper, mailing-list ratebook, adwriting assistance—free. Chicago Advertising Agency, 20-PM West Jackson, Chicago 4.

**ADS** Placed in out of town newspapers and magazines. Low rates. Catalogue free. Ideas that pay. Baker Advertising Agency, Successors Ankrum Agency, 189 W. Madison, Chicago 2.

**INCH** Display advertisement Mallorder World, year \$24. Wood's Popular Services, Atlantic City, New Jersey.

**ADVERTISING** Service, art work. C. Sanford, 5029 Maple, St. Louis, Mo.

**MAILING** Lists, certified, productive, inexpensive, \$5.00 1000. Homeworkers, agents, buyers, etc. Write Dixie Service, King, N. C.

**24 WORDS** in 64 weeklies \$4.96. H. J. Darnell, 730 Hays, Jackson, Tenn.

### TYPEWRITERS, DUPLICATORS, OFFICE DEVICES

**"PRINTOMATIC"** Selffeeding post card stencil printing duplicators \$9.50 up. Office size duplicators. Speedprints. Hilcos. Excellographs \$33.41 up. Literature free. Pittsburgh Typewriter Supply, 336-WK Fourth Avenue, Pittsburgh 22, Penna.

**CONDITIONED** Typewriters, mimeograph, multigraph printing devices, appliances, supplies. Catalog. Dixiegraph Service, King, N. Carolina.

### RUBBER STAMPS AND OFFICE SUPPLIES

**NAME-Address**, 70c, pad, 40c, both \$1. Saunders, Tipton, Mich.

**RUBBER** Stamps. Send for catalog. Excello, Box 500, Shreveport, Louisiana.

**KNOB** Handle, 1 line 35c; 3-55c. Stamp Works, Centerport, N. Y.

**RUBBER** Stamps. Buy direct from manufacturer. Literature free. Lee-Vall Press, Box 1242, Indianapolis 6, Indiana.

### PRINTING, MULTIGRAPHING, MIMEOGRAPHING, GUMMED LABELS

**QUALITY** Printing at reasonable prices. Write for latest price list. Bagby Printing Company, Georgetown, Ohio.

**250 LETTERHEADS**, envelopes \$2.95. Multigraphing, samples, estimates. Valley Print Shop, St. Elmo, Tennessee.

**250 LETTERHEADS**, 250 Envelopes, parchment rag bond, \$3. Pilgrim Service, Box 194B, Springfield, Mass.

**PHOTO-OFFSET**, Printing, multigraphing. Samples free. Mango Printing Company, 555-A, South 20th, Newark 3, N. J.

**MIMEOGRAPHING** Specialists — any copy. Reasonable. Mailers Service, Box 606-A, Chicago 90, Ill.

**STATIONERY** Printing, 250 letterheads, 250 size 6 3/4 envelopes, and 250 size 10 envelopes, \$7.75. 500 of each \$11.00. Fast service. Bagby Printing Company, Georgetown, Ohio.

**100 GOVERNMENT** Size post cards neatly printed with name and address \$1.00. 200 business cards \$1.00. 1M business cards \$1.95. M. Kerman Press, 40 W. 17th St., New York City.

**QUALITY** Printing: Business, personal stationery. Prepaid delivery. Samples free. Mero Products, 100 Morrison, Punxsutawney, Penna.

**100-8 1/2x11 HAMMERMILL** Letterheads \$1.00 postpaid. Envelopes same. Race Printing, Hudson, New York.

**QUALITY** Offset printing at low prices. Speedy, dependable service. Free samples. ABC Press, 1041-J Eighteenth Ave., Newark 6, New Jersey.

**PRINTED** Envelopes, letterheads, statements, business cards. Maloney Sales, 36 PM St. Paul, Rochester 4, N. Y.

**PRINTING** Multigraphing. Type for multigraph users. Ace Printing, Brentwood, Maryland.

**SUPERIOR** Printing. Free samples. Cline Printing Service, 615 Birchwood, Davenport, Iowa.

**PRINTING**, Complete line and price range. Free samples. D'Yarmett Printing, Newark, Ohio.

**ENVELOPES**, 6 3/4" Printed, \$3 thousand in 5000 lots. Michel, Box 76F, New York 16.

**250 GUMMED** Mailing labels, 2 1/2x3 1/2, with your name and address, \$1.75. Many other sizes. Envelopes, letterheads. Ad-Man, 305 1/2 Liberty Bldg., Indianapolis, Indiana.

**1000 BUSINESS** Cards \$2.45; 1000 6 3/4 envelopes \$4.95; 1000 8 1/2x11 letterheads \$4.95; 5000 2x1 1/4 gummed stickers \$4.95 (postpaid). Dept. PM, Madison Printing Service, Madison, Ohio.

**YOU** Will like our quality! Samples. Mail Printing, M93, Danvers, Mass.

**\$1 FOR** 1,000 Assorted gummed labels 1 1/2x3 1/2. Glass, fragile, c.o.d., rush, etc. Useful to any business. Stock Labels, F. E. Point, South Amboy, N. J.

**FIFTY** Sheets, fifty envelopes, printed your name, address, 75c postpaid. Atlantic, Box 653-H, Rock Hill, S. C.

**1000 HIGH** Quality business cards, \$2.95. Up to 25 words carefully and correctly printed. Satisfaction assured. Prepaid. Cash or c.o.d. Walker's, Box 1298, Amarillo, Texas.

**250 LETTERHEADS** \$1.75. Envelopes same. Mallo, 767 Leith, Flint 5, Mich.

**COMBINATION** Mimeographed letterhead and letter, 100-\$1.35. Samples free. Martin Mimeo, 3212 Harper, St. Louis 7, Missouri.

**STATIONERY**, Laundry—gas station lists, garage repair order, etc. Free estimates. Southern Standard Publishing Co., Dept. M, Panama City, Florida.

**1000 FOUR** Line stickers, \$1.00. Printing, mimeographing, best and cheapest in the country. Imprint, Emporia, Kansas.

**500 3/4x2 1/4 FOUR** Line gummed stickers, 35c. Moritz Printery, Saginaw, Mich.

**1000 BUSINESS** Cards \$2.50. prepaid. Reliable Print Shop, 901 E. Jefferson, Louisville 6, Ky.

**MIMEOGRAPHING**. Highest quality. Reasonable. Letter Service, Box 1849, Chicago 90, Illinois.

**SEND** 10c Now, for our 36-page 1947 pricelist—refunded first order. McCall Press, 1326 South 27th, Omaha, Nebraska.

**BETTER** Grade printing reasonable. Estimates on anything. Economic Press, Leonia, N. J.

**MIMEOGRAPHING**—Letters, pricelists, formulas, instructions. Lowest prices. Lem's Letter Shop, 5710 Stanton, Detroit 8.

### PRINTING OUTFITS AND SUPPLIES

**CUTS**—Make real halftones, line cuts yourself! Samples 25c. Particulars free. Rapid Chemical Service, Edwardsville, Ill.

**PRINT** At home—Send 10c for catalogue—presses, type, supplies. Barnhard Co., 6 Columbia St., Newark 5, N. J.

**PRINTING** Equipment, type and supplies. Send stamp for details or dime for complete illustrated supply book. Kelsey Inc., X-11, Meriden, Conn.

**PRINTERS**, Make a quick-etch etcher for cuts, halftones. Details. Charles Medlock, Box 256C, Goodland, Indiana.

**HOME-MADE** Presses. Proofs free. Riegel, 1111 Harrison, Phila. (24), Penna.

**INEXPENSIVE** Home-made printing press. Details free. Novelty Shop, Downsville, Louisiana.

### PATENT ATTORNEYS

**INVENTORS**—Patent laws encourage the development of inventions. The Rules of Practice of the U. S. Patent Office advises—unless an inventor is familiar with such matters—that he employ a competent registered attorney, as the value of patents depends largely upon the skillful preparation of the specifications and claims. Write for further particulars as to patent protection and procedure and "Invention Record" form at once. No obligation. McMorror, Berman & Davidson, Registered Patent Attorneys, 134-L Victor Building, Washington 6, D. C.

**PATENT** Protection—The U. S. Patent Office recommends—"an applicant is advised, unless familiar with such matters, to employ a competent registered Patent Attorney, as the value of patents depends largely upon the skillful preparation of the specifications and claims." Steps to be taken in obtaining patent protection will be sent upon request. Victor J. Evans & Co., 231-G Merlim Building, Washington 6, D. C.

**INVENTORS:** Learn how to protect your invention. The patent laws afford the inventor protection for the patentable features of his invention. The United States Patent Office advises the inventor to engage a competent, registered patent attorney to represent him. We offer inventors experienced, confidential service. Specially prepared booklet containing detailed information concerning patent protection and procedure with "Record of Invention" form will be forwarded to you upon request—without obligation. Clarence A. O'Brien & Harvey Jacobson, Registered Patent Attorneys, 71B-D District National Building, Washington, D. C.

**C. A. SNOW** & Co., M-427 Snow Bldg., Washington 1, D. C. Registered patent attorneys. Literature mailed on request.

**INVENTORS**. For "Record of Invention" form, contact Carl Miller, Registered Patent Attorney, Woolworth Building, New York.

**"INVENTOR'S** Guide" free on request. Frank Ledermann, Registered Patent Attorney, 154 Nassau St., New York 7, N. Y.

**PATENTS**. "Proof of Invention" folder mailed without obligation. E. E. Vrooman, Registered Patent Attorney, 871 Woodward Building, Washington 5, D. C.

**INVENTORS:** Without obligation, write us for information as to what steps an inventor should take to secure a patent. Randolph & Beavers, Registered Patent Attorneys, 21-C Columbian Bldg., Washington 1, D. C.

**INVENTORS:** Write for free brochure "Evidence of Invention." Labiner, World Building, New York 7.

**PATENTS**—Trade marks. Irving L. McCathran, 315 McLachlen Bldg., Washington 1, D. C. Registered Patent Attorney.

**PATENT** And Trade-Mark Practice before U. S. Patent Office. Validity and infringement investigations and opinions. Booklet and form "Evidence of Conception" forwarded upon request. Lancaster, Allwine & Rommel, Registered Patent Attorneys, Suite 411, 815-15th Street, N.W., Washington 5, D. C.



## FOR INVENTORS

**ATTENTION Inventors!** List your patented, patent pending, unpatented invention with me for immediate action. Hundreds of manufacturers have requested my assistance in locating marketable new inventions. Leslie Buford Stratton, Patent Promoter and Broker, Chicago Stock Exchange Building, 120 South La Salle Street, Chicago, Illinois.

**HIGHEST Royalties and cash for your inventions when we market them.** Free particulars without obligation. Universal Marketing Co., 126 Lexington Ave., New York 16, N. Y.

**INVENTORS—Patent laws encourage the development of inventions.** The Rules of Practice of the U.S. Patent Office advises—unless an inventor is familiar with such matters—that he employ a competent registered attorney, as the value of patents depends largely upon the skillful preparation of the specifications and claims. Write for further particulars as to patent protection and procedure and "Invention Record" form at once. No obligation. McMorrow, Berman & Davidson, Registered Patent Attorneys, 134-K Victor Building, Washington 1, D. C.

**PATENT Protection—The U. S. Patent Office recommends—"an applicant is advised, unless familiar with such matters, to employ a competent registered patent attorney . . . as the value of patents depends largely upon the skillful preparation of the specifications and claims."** Preliminary steps to take to obtain patent protection will be sent upon request. Victor J. Evans & Co., 232-G Merlin Building, Washington 6, D. C.

**INVENTORS: Learn how to protect your invention.** The patent laws afford the inventor protection for the patentable features of his invention. The United States Patent Office advises the inventor to engage a competent, registered patent attorney to represent him. We offer inventors experienced, confidential service. Specially prepared booklet containing detailed information concerning patent protection and procedure with "Record of Invention" form will be forwarded to you upon request—without obligation. Clarence A. O'Brien & Harvey Jacobson, Registered Patent Attorneys, 71A-D District National Building, Washington, D. C.

**INVENTORS—There is absolutely no legal way to protect your invention without a patent.** Learn how to protect and put your unpatented invention into money-making form and receive my selling assistance. Buyers waiting. I save you considerable in patent application cost. Easy terms. My Washington registered patent attorney, a former Patent Office examiner, represents you and prosecutes your case. Patent search with copies, \$6.00. Invention record free. Charles R. Morton, Patent Broker, Established 1919, Dept. 62, 11 West 42nd Street, New York.

**INVENTORS—Want good ideas? New booklet "100 Needed Inventions" \$1.** John Kline, Lititz, Penna.

**MARKET Your ideas and inventions through our "Product Study Brochure"** plan for quick responses and known results. Spartan Sales, 600 Woodward Ave., Dept. 1006, Detroit 26, Michigan.

**INVENTIONS Wanted—Patented, unpatented. Cash waiting!** Financial assistance, those forming company. Suite 665-PA, 120 S. La Salle, Chicago 3.

**DON'T let us, nor anyone else, see them!** Protect your unpatented ideas, inventions, formulas. Send stamped, self-addressed envelope for details. P.O. Box 723-A, Chicago 90.

**INVENTORS—Sell your invention.** Patented or unpatented. Or finance it yourself. Write—Director White, 3439 Michigan, Chicago 16.

**PROVING Invention date, your problem? Use ironclad Aaberly routine.** Out-ranks registered letters, "invention copyrights," other dangerous makeshifts. Special form, 25c. No comparison whatsoever with free "evidence" forms. For dependability, guaranteed next to Patent Pending! No disclosure to me or other strangers! Drawings, other services, including preliminary searches, the careful kind! Rely on 31 years "know how." N. R. Aaberly, Patent Engineer, 303 Woodward Building, Washington.

**DRAWINGS Of your ideas engineered to modern practices by experienced designers.** Absolutely confidential. Free estimate of drawing charges by return mail. Machine Design Service, 416 Madison Avenue, Rahway, New Jersey.

**PATENTED, Unpatented inventions promoted.** M. Joyce Humphries, 1424 Land-tite, Philadelphia 10, Penna.

**WANTED By live manufacturer.** Home work shop and hobby gadgets—devices, ideas for tools. We manufacture and sell. Do not send models. Simply send description and illustrations of what you have. Warner Electric Co., 1512 Jarvis Ave., Chicago 28, Ill.

**INVENTORS: You save up to 300% when dealing with your patent searcher direct.** Complete search with patent copies \$6.00. Reports mailed in 5 days. Invention protection forms free. Write Raymond L. Smith, Patent Searcher, 703-M Albee Building, Washington 5, D. C.

**INVENTORS: Avoid unnecessary expense.** Write for free booklet explaining how our consulting and advisory service can assist you in deriving greatest profit from inventing. Institute of American Inventors, Dept. 40-A, 1926-Eye St. N.W., Washington 6, D. C.

**"INVENTOR'S Guide" free on request.** Frank Ledermann, Registered Patent Attorney, 154 Nassau St., New York 7, N. Y.

**THE Inventor who believes he has a new and useful invention, and needs advice, should consult a competent registered patent attorney.** Without obligation, write for full information on how to secure patents and trademarks. Randolph & Beavers, Registered Patent Attorneys, 11-E-Columbian Bldg., Washington 1, D. C.

**I SELL Patents.** Established in 1900. Charles A. Scott, 773PM Garson Ave., Rochester, N. Y.

## INVENTIONS WANTED

**INVENTORS! Have you good, patentable ideas? Write Patent Agent Metzler, 11 West 42nd, New York.**

**HAVE Capital for manufacture and distribution practical inventions.** M. Garten, 1122 Market Street, San Francisco 2, Calif.

**WANTED—Practical inventions of all classes by manufacturers.** John D. & Son, Dept. PM-6, Box 3213, 285 Howard Ave., Bridgeport 5, Conn.

**MANUFACTURERS Want patented or pending inventions!** Send patent copy or complete details. "Universal Guaranty Company, Lakewood, New York.

**CASH For your idea.** 280 manufacturers need inventions, patented or unpatented. List free. Invention Bureau, 208 Clinton, Oak Park, Illinois.

**WANTED: Practical inventions suitable for sale through 5c-\$1.00 stores, drug-stores, cigar stores; also sportsmen's items of all kinds.** Write Matt, 1412-P, Great Northern Bldg., Chicago 4.

**INVENTIONS Wanted.** Patented or pending. Inventors Exchange, Dept. B, Hartford 1, Connecticut.

**INVENTORS: Hundreds of manufacturers have requested our assistance in locating marketable new products.** Complete information, free. Institute of American Inventors, Dept. 40-D, 1926-Eye St. N.W., Washington 6, D. C.

## MANUFACTURING

**ENGINEERING, Designing, tooling.** Complete engineering service. Porsberg, Northfield, Ohio.

**MANUFACTURE Paints.** Your garage a factory. Free information. Industrial Chemist, 1826 60th, Kenosha, Wisconsin.

**EXPERIMENTAL Work, models.** Reasonable. Nelson Manufacturing, 948 First, Woodburn, Oregon.

**MODELS—Small lot manufacturing.** Metals, plastics, etc. Milburn, Burlington, Kentucky.

**A BRAND New inventor's service.** Write for information. J and M Company, Burlington, Kentucky.

**MODELS Developed and built.** Small run manufacturing. The Thompson Engineering Co., 206-C Winchester Bldg., Grand Rapids 2, Michigan.

## PATENTS FOR SALE

**INVENTION For sale.** Patent protected U. S. Government. G. S. Kolassar, Rosignol West Coast, Berbice, British Guiana.

**PAT. No. 2,296,455, improvement on crayon wrappers.** Very practical and novel. W. E. Schroeder, 919 Wheeler Ave., Scranton, Penna.

**TWELVE Million neckties sold yearly.** Patent just issued (non-slip tie), available for development. For information address Romme, 109 Atlantic St., Stamford, Conn.

**INVENTORS: Test the commercial value of your patented or unpatented inventions, quickly and inexpensively.** Write for free information. Institute of American Inventors, Dept. 40-B, 1926-Eye St. N.W., Washington 6, D. C.

## MODELS AND MODEL SUPPLIES

**SPEED King steam engine for boats and other models.** Engines, casting kits, water tube boilers. Literature 5c. H & P Machine Co., 1617 Fulton St., Kalamazoo 25, Mich.

**GAS Modelers! Powerful midget ignition coil weighs only 2/3 ounce.** Write for particulars. Electric Miniatures, 1607 S. Western, Los Angeles 6, Calif.

**SHIP Model kits and fittings, most complete stock in New England.** Boucher, Fisher, Marine Model and Model Shipways fittings, blueprints and model yacht equipment at standard prices. Send 25c for new illustrated 1947 catalog and price list. Dept. M, James Bliss & Co., Inc., 220 State Street, Boston, Mass.

**STEAM Boiler for model engines, withstands 500 lb. pressure.** Complete with pressure gauge and all fittings. Uses one or two Sterno cans for fuel. Postpaid \$22.50. Ross, C68 West Broadway, New York, N. Y.

**MODEL Airplane motors \$12.75 inc.** spinner and propeller, catalog 5 cents. Ridgway Model Hobbies, P.O. 7637 Sta. D, Kansas City, Mo.

**POWER Models—Steam and gasoline engines, steam traction engine, metals, tools.** Catalog 35c. Chas. Cole, Ventura, Calif.

**WIZZ Electric motor: Flashlight cell operates.** Each kit attractively boxed, complete with instructions, 50c at hobby dealers or stationers, or send direct. Eltro Company, Deer Park, N. Y. (Dealers discounts.) Please write.

**RAILWAY Models, complete informative catalog HO and O gauge.** 128 pages, 35c. Walthers, 247 Erie, Milwaukee, Wisconsin.

**STEAM Engine, precision made to scale from brass and bronze.** A practical working model that performs like its full size brother. Complete, fully assembled—ready for steam. Overall size 6" by 3"; weight 2 1/4 lb. \$17.50 postpaid. Ross, C68 West Broadway, New York, N. Y.

**PATENT Models built to your specifications.** Wood, metal, plastic. Expert workmanship. Rogay Models, 3818 Beecher St. N.W., Washington 7, D. C.

**FUN Building models—Airplanes, trains, ships.** Everything furnished. Giant catalog 10c. Ben's Hobby Shop, 72 West Washington, Chicago 2, Illinois.

**BALSA Wood, Generous supply \$1.00.** Price list free. Sanlader, Manitowoc, Wis.

**MIDGET Permog motors, 12-27VDC.** 80-250RPM. Reversible. \$2.35, new. Free list. Eresco, 1006 Hewitt, Everett 1, Wash.

**SHIP Models and yacht supplies complete.** Large 64 page catalogue 30c. Bill Wild's, 510 East 11 St., New York City 9.

**LANDLOCKED Sailors! Here's a beautiful, richly illustrated, fully descriptive catalogue of famous model ships—whalers, slavers, corvettes, etc., authentic in every detail.** Send for it today. Only 10c. Halesite Yacht Service, Inc., Halesite, Huntington, N. Y.

**SHIP and Yacht model fittings; blueprints.** Send 25c for illustrated catalog No. 20—listing hundreds of items. A. J. Fisher, 1002-1 Etowah Ave., Royal Oak, Mich.

**BRASS Gears and model supplies for the inventors.** Send 10c for catalog. Pierce Model Works, Tinley Park, Ill.

**BIG Illustrated model engine catalog 10c.** Active Products & Supply Co., 53 W. Jackson, Chicago 4.

**MINIATURE Steam locomotives, 1/4" 1 1/2", 3/4" scales.** Castings, parts, rail! Thorough drawings with instructions. Catalog 25c. Little Engines, Wilmington, Cal.

## HOME CRAFTSMEN

**SHELLCRAFT Beginner's kit with instruction book \$3.00.** Price list free. Stelle Shellcraft Industries, Route 1, Box 69X, Orlando, Florida.

**GENUINE Leather scraps for leathercraft items, assorted colors, 6 pounds, \$2.00.** Send 10c for sample. International Cushion Co., 515 No. Halsted, Chicago 22, Illinois.

**JIG Saw blades, professional.** Artistic fast turning. Wood, plastics, 60c dozen. Charles DeMee, 108 E. Walnut, Milwaukee 12, Wisconsin.

**35 PATTERNS Of action pull trucks, carts, toy furniture, etc.** Continental Homecrafters, 907 Birch, Claire 3, Wisconsin.



**ATTRACTIVE** Pieces of good quality leatherette, assorted colors, suitable for many handicraft items, 8 lbs., \$2.00. Send 10c for sample. International Cushion Co., 515 No. Halsted, Chicago 22, Illinois.

**YOUR** Dollar brings shellcraft supplies for spray, necklace, comb, brooch. Kits, dollar up. Catalogue free. Dixie Shell Service, Lakeland, Fla.

**LEATHERCRAFTERS!** Send for free catalog listing leathers, tools, supplies. Kit Kraft, 1607 S. Western, Los Angeles 6, Calif.

**FILING** Operations with jig saw. Fast! Accurate! Blueprint and instructions, \$1.00. R. LaBarre, 12683 Terry, Detroit 27, Michigan.

**12 NEW** Original full size what-not patterns \$1. Albright Service, M6901 Railroad Ave., Omaha 7, Nebr.

**LUMINOUS** Paint (shines at night), bottle, 25c. Arthur Sibley, Mendon, Mass.

**JEWELRY**, Made in your own home, economically. We supply findings, imitation gems, small Lucite and Plexiglas squares, chemicals, ideas. Send for the big illustrated Craftsman's catalog, only 25c (refunded on first order). Pittshire, Box 90, Pittsfield, Mass.

**\$46 FROM** Square foot plywood. Jigsaws necessary. Write, Woodarts, Bridgewater, Mass.

**SHELLS**, Findings, for making shell jewelry. Free catalogue. Tamiami Gift Shop, P.O. Box 507, Bradenton, Fla.

**EXOTIC** Woods—Tigerwood, lacewood, zebra wood, ayodire, rosewood, aromatic red cedar, walnut. Sedio Company, P.O. Box 7161, New Orleans 19, La.

**CACTUS** Covered-wagon lamp. Beautiful desert wood. Ready to assemble. Polished cholla cactus body, wheels; electric parts; lamp shade parchment, rings, lacing; directions. Satisfaction guaranteed. Postpaid \$3.00. Cactus Craft, 2050 Oracle, Tucson, Arizona.

**UNFINISHED** Leather, plastic kits. Twenty minutes to finish. Sample plastic belt, \$1.25. Wholesale Leathercraft, State-san, Wisconsin.

**MAKE** Beautiful cameo sea shell brooch, earrings, easily. Complete kit \$1. Instruction booklet 35c. Wholesale supplies. Shell-art, 3027 1/2 6th St., South, St. Petersburg, Florida.

**LEATHERCRAFTERS!** Belt kits, projects, leather, supplies. Write for catalog. Art Leather, 411 Joseph Ave., Rochester 5, N. Y.

**COSTUME** Jewelry. Make 12 pieces. Shellcraft \$2.00. Plastic \$2.00. Both \$3.00. Craft Co-op, 3928 Dumaine, New Orleans 19, La.

**SHELLCRAFT** Supplies. Complete line. For illustrated instruction-book-catalogue send 10c. Shell-Art Novelty Company, 5th and Moore Sts., Philadelphia, Penna.

**KITS** \$2.00 Each—beautiful plastic candlestick holder. All materials ready cut. Instructions furnished. A. F. Sobol, Route 96A, Romulus, N. Y.

**861 PAPER** Patterns of projects for the home crafter. Pattern Mart, 5735 Wintrop Avenue, Cincinnati 24, Ohio.

**LEATHERWORKER'S** Bible. Every leatherworker should own this completely illustrated catalogue combined with valuable instructions and information. Largest in this field. Actual leather samples. \$1.00 postpaid. Satisfaction guaranteed. Art-craft Leather of California, 271C Twelfth Street, Oakland 7, California.

**CHOLLA** Cactus wood—12 inches 50c. 10 cactus plants, all different. Instructions, \$2.25 postpaid. Natural Desert Displays, Box 876, Coolidge, Arizona.

**MAPLE** Walnut, rosewood blocks, 4"x4" up. Maple cribbage board blanks, 25 lbs. \$3.50. Express charges collect. DeMuro, 540 Jackson, Muskegon, Mich.

**MAKE** Your own genuine leather billfold! Complete kit and simple instructions \$1.00! A. Glassman, 3633 Pinegrove, Chicago 13, Illinois.

**WHAT-NOT** Clever original designs, 5 full size. Will add beauty to any home, \$1.00. D. A. Wallace, 637-E Amelia, Orlando, Florida.

**MAKE** Your own jewelry! Findings in metal and plastics; earwires, pinbacks, cameos, stones, beads, clasps, sprays, combs, hairbars, plastic and metal chains. Hobby Art Corp., Dept. 7, P.O.B. 276, New York 18, N. Y.

**KNOCKDOWN** Cedar chest lumber veneers. Free price list. Giles-Kendall, Huntsville, Ala.

**SHELLCRAFT** Instruction free! 450 rare Caribbean shells including findings making \$6 shell jewelry. \$1. Satisfaction guaranteed. Shell Company, Miami 36, Florida.

**MASONTIE** Mill ends, 10# \$1.00, plus postage. Carl Sign Co., Wooster, Ohio.

**LEATHER** Designs on plastic eliminate tracing. Introductory offer \$1.00. Sample 10c. Lampkin Artcrafts, Box 641-M, Culver City, Calif.

**LEATHER** Designs. Fifty belts, \$1.00. Twenty billfolds, \$1.00. Ten handbags, \$1.00. Lampkin Artcrafts, Box 641-M, Culver City, Calif.

**SEA** Shells, supplies. Wholesale catalogue. Tropical Shell Company, P.O. Box 1509, Sarasota, Florida.

**FREE** Instructions, shell jewelry. Werts, 1429-56th Avenue, Oakland 3, Calif.

**SHELLS**, Plastics, findings. Lowest prices. Free catalog. Frances Jones, Box 251, Sarasota, Fla.

**CERAMIC** Jewelry supplies, bar pins, ear screws, for ceramic and woodworkers; also glass and seashell assemblers. Free catalog. Philadelphia Badge Co., Dept. B-1, 1007 Filbert St., Philadelphia, Penna.

**EXPERIMENTERS!** Interested in electrical, mechanical devices from war surplus? List free. F. Siefke, Box 18, Station E, Buffalo 11, N. Y.

**MAKE** Shell jewelry—for gifts, as a hobby or start a business. Free catalogue and price list. Complete illustrated book of instructions 75c. Florida Shellcraft Company, Box 1840, Sarasota, Florida.

**SHELL** Jewelry supplies. Wholesale only. McFarland Plastic Co., Sarasota, Fla.

**BOOKS**—All Kinds—Homecraft, Radio, Plastics, Boat Building, Photography, Model Building. Catalog free. Popular Mechanics Press, 200 E. Ontario St., Chicago 11, Ill.

### MAKE IT YOURSELF

**MAKE** Brooches, earrings from sea-shells. Instruction book 35c. Supply catalog free. Whyteson, 5726 1st St. So., Arlington, Va.

**DELICIOUS** Wieners in 2 minutes! Build amazing electric roaster from scrap materials. Plans 50c. Emco Sales, Box 116, Cambridge 38, Mass.

**NEW** Electric signal trap for fishing. Efficient. Inexpensive. Instructions, \$1.00. Paul Kayholm, 137 Central Ave., Hackensack, New Jersey.

**STEAM** Or air engine, 3/4 lb. brass and steel. No castings. Blueprints \$1.50. Engine complete \$3.98. O. Warner Machine Works, 18833 Pacific Hwy So., Seattle, Washington.

**MAKE** Popular novelties, statues, at home—3c to 15c each. Sell at big profit. Everything supplied. Write So-Lo Works, Dept. U-6004, Loveland, Ohio.

**"BUILD** Your House as a Hobby." Save 50%. No mortgage. No rent. 24 page booklet: drawings, instructions on how to build. \$1.00. H. C. Lightfoot, Civil Engineer, Buck County, Richboro 1, Penna.

**SQUARE** Holes, boring bars, key ways, etc. Easy to make with a broach which you can easily make with cheap material and no special equipment. This kink is good. Details \$1. Bills Shop, Box 28, Klamath, Calif.

**HOT** Water free—from sunlight. System efficient any locality year 'round. Standard materials—easily built—low cost. Facts free. Solar Water Co., Box 175, Dept. X, Coral Gables, Florida.

**SHELLS** And all supplies for making shell jewelry, wholesale prices. Russ Renaud Novelty, Little River, Florida.

**"CONCRETE** Block Homes." 24 page booklet: drawings, instructions on how to build. \$1.00. H. C. Lightfoot, Civil Engineer, Richboro 1, Penna.

**BUILD** Own low cost sheet metal, brake, roller, and shear. 3 plans \$1. Home Workshop Engineering, 6359 S. Yale Ave., Chicago 21, Ill.

**BUILD** Your own dishwasher that washes, dries dishes sparkling clean. Easy, inexpensive for anyone with simple tools. Complete plans \$1.00. Inventor, Box 355-e, Leesburg, Fla.

**BUILD** Concrete block machine. 2 blocks per minute. Build concrete mixer. Easy, inexpensive. Details free. Horne, 206 West Wilder, Tampa 3, Florida.

**BUILD** Concrete block machine. Vibrator or hand. Easy. Economical. 150 blocks per hour. Build house, shop, garage, or other buildings. Save half. Sell blocks. Make money. Free details. Clyde Lee, Mountain View, Dept. A, Oklahoma.

### PLANS AND BLUEPRINTS

**PLANS** For everything located through Craft and Shop Index, 25c issue, \$1.00 year—free sample. 4534 Woodlawn, Chicago.

### WATCHES. OLD GOLD. JEWELRY

**20 WATCH** Movements broken for student practice work, \$10.00. 3 pounds broken costume jewelry, \$8.00. 1000 costume jewelry stones, \$3.50. Lowe's, Dept. PM 611, Holland Bldg., St. Louis 1, Mo.

**WATCH** Band, beautifully styled. Expands, fits any wrist comfortably. Stainless steel, will not rust or tarnish. Durable, fully guaranteed. If not completely satisfied return for full refund. Remarkably priced at only \$1.00, postpaid. The Hollywood Mart, Box #2232, Los Angeles.

**OLD** Gold: Top price paid. Mail old or broken jewelry, rings, watches, gold teeth, silverware, diamonds. Receive cash immediately. 100% satisfaction or articles returned. Information free. Old Gold Specialist Robert Wyndham, 1035 East 'A' Street, Ontario 1, California.

**JADE** Or picture agate 10K gold ring, \$15. State size. Handicapped Veterans Gem Shop, 277, Mills, Wyoming.

**WATCH** Repairing. Done by expert watchmaker. Have your watch recased and made to look like new. 30 years experience fine watch making. All work guaranteed. Kane Watch Co., 104 Canal St., Dept. M-1, New York 2, N. Y.

**LEARN** Watchmaking, special home course, free information. Perfect Time School, 1112 West 79th St., Chicago, Ill.

**SEND** Your discarded jewelry, watches, crowns, bridges, spectacles, silver, etc., for cash offer. Goods returned promptly if offer unsatisfactory. Old State Metal Co., P.O. Box 1054, Houston, Texas.

**HIGHEST** Cash paid for old gold teeth, diamonds, jewelry, watches, rings. Satisfaction guaranteed. Information free. Fern Jewelry Co., 170 Broadway, New York 7, N. Y.

**JEWELRY** Findings, lowest prices. George Sassen, 154 Nassau Street, New York 7.

**WATCH** And Clockmakers Handbook—Britten \$5.79. Most complete on the subject. Free catalog. Engineers' Book Service, 19 W. 44th St., New York City 18.

**LEARN** Watchmaking. Complete instruction book and tool catalogue \$3.50. Stewarts, 727 Market Street, St. Louis, Mo.

**WATCHES**—Broken or usable: All kinds. Highest prices paid for jewelry, rings, spectacles, gold teeth, diamonds, sterling silver, etc. Cash mailed promptly. Write for free shipping container. Lowe's, Holland Building, St. Louis, Missouri.

**BALL** Point pen, for home, school, or office. Makes carbon copies. Beautifully designed and balanced. Writes smoother than a pencil. Famous long lasting ink cartridge. Money back guarantee. Priced sensibly at only \$2.00 postpaid. The Hollywood Mart, Box 2232, Los Angeles.

**GOLD** \$35.00 Ounce—Mail old gold teeth, diamonds, jewelry, watches—receive cash by return mail. Satisfaction guaranteed. Free information. Dr. Weisberg's Gold Refining Company, 1500-Q Hennepin, Minneapolis, Minn.

**GEMS**, Precious and semi-precious, all genuine, from world wide sources. Deal direct, no overhead, save money. Catalog 10c. Hill Co., Route 7, Salem, Oregon.

**CASH** For old, broken jewelry. Highest prices paid immediately. Mail gold teeth, watches, rings, silverware, diamonds, spectacles. Satisfaction guaranteed. Information free. Rose Smelting Co., 29-A East Madison, Chicago.

**WATCH** And clock repairing—Complete practical course in modern horology. 66 illustrated self-instruction lessons. Just out! Low price. Fascinating 100-page illustrated catalog free! Write—Nelson Company, Dent 3-02, Chicago 5.

**WATCH** Repairing easy learned by our home study course. Watch repairers are in demand and are among the highest paid craftsmen today. Write for free information. Houston Chronometer & Watch Co., P.O. Box 1140A, Houston 1, Texas.

### TOBACCO, SMOKERS' SUPPLIES

**CIGARETTES**—Popular brands \$1.49 carton postpaid. Send check or money order. Holly Products Company, 4815 Holly, Kansas City 2, Missouri.

**PIPES**—Factory rejects and kits. Literature free. Carvape, 2829-E Dixie, Hamilton, Ohio.

**MONTHLY** Pipe magazine! Pictures, articles, gadgets, ideas. Write Pipe Lovers, 532P Pine, Long Beach 12, California.

**CIGARS**—Imported. 50 Coronas \$3.60 postpaid. Grebne Distributors, 1410 Ardmore, Grand Rapids 7, Mich.



## SURVEYING INSTRUMENTS

**GUARANTEED** Factory rebuilt transits and levels for sale (cash or terms) or rent (with purchase option). We will repair, trade, or buy old instruments. Ship prepaid for estimate and valuation. For complete information, write for list M-36, Warren-Knight Co., (Manufacturers of Transits and Levels), 136 N. 12th St., Philadelphia 7, Penna.

## FOR SALE OR EXCHANGE

**DRAIN** Tile and block machinery. Flower pot, love seat, block and brick molds. Aluminum lawn furniture. Data free. Concrete Machinery Company, Hickory 6, N. C.

## FOR THE HOME

**STOP** Wasting money through heat loss. Our plans tell how. Free details. A. Claber Co., Box 491, Grandville, Michigan.

**INSULATE** Your home yourself. Complete plans, illustrations, instructions, \$1.00. Moneyback guarantee. Details free. Fuel Savings Service, P.O. Box 741-F, Canton, Ohio.

**SPECIAL** Discounts. Household products. Gifts. Free information. Hazel Gardiner, 36 Hillside Ave., Providence 6, R. I.

**MANY** Unsuspected benefits common household articles. Save money, time, energy. Free details. Goynes Skills, Lock Drawer 1784-HA, Orange, Texas.

**SAVE** Time, money. List of 109 prefabricated homes manufacturers \$1.00. Fabrication Service, Box 804, Battle Creek, Mich.

**"GAUGE-IT"**—Tells contents 55 gallon household oil drums. Fits in fill-hole. \$1.35, postpaid. Moneyback guarantee. Hare Products, Whitinsville, Mass.

## FOR SALE—MISCELLANEOUS

**GOVERNMENT** surplus wooden tripods with adjustable metal legs. Used by government for engineers' levels. 5½ foot extension. Very strong. Can be used for holding telescopes, cameras, etc. Value \$24.50, special \$4.95 postpaid. Public Sport Shops, 13 S. 16th Street, Philadelphia, Penna.

**MECHANICAL** Drawing instruments—Veeco, 4 piece, compact, precision set, brand new in lined case, value \$12.50, special \$7.25. Hull automobile compass, for accurate road direction, brand new, \$2.50. Prisms for 6x30 or 8x30 binoculars, brand new, \$1.50 each. Offset prisms to be attached to 7x50 B. & L. binoculars gives double the field of the ordinary 7x50 binocular. Cost \$98.00, special \$25.00. Green sunshades for binoculars size 6x30 and 7x50, snap on type, value \$7.50, special \$1.25 per pair. Forward money order. No c.o.d. shipments. Public Sport Shops, 13 S. 16th St., Philadelphia, Penna.

**LARGE** Size aluminum waffle molds and recipes, \$1.50. Free information. Mowrey's, 450 E. 9 St., Ashland, Ohio.

**BASEBALL** Bat cigaret lighter, gold plated, 3½ inches long, \$3.00 including federal tax. Check or money order. The Jonlyn Company, P.O. Box 97, Brooklyn 9, N. Y.

**WAR** Surplus fire fighting asbestos helmets \$1.95, collapsible canvas basins 35c, headphones \$1.75 without bands, \$2.75 with; spot light assemblies 35c, pilots safety belts \$1.95, navy signal lights \$6.95, boot powder 15c, assortment six lenses 50c, chromium belt buckles 15c. Minimum order \$2.00. Send check or money order. Nico Supply Co., 1700 Walnut, Philadelphia 3, Penna.

**REYNOLDS** Rocket Ball Pen \$1.00 postpaid, \$1.25 c.o.d. Writes years, no refilling. Peerless, 2726 Sturtevant, Detroit 6, Mich.

**WALTHAM** Compasses \$1.25, hunting knives \$1.95, Air Corps sun glasses \$3.95, Navy fishing kits \$3.25, one man rubber lifeboats \$14.95, two man nylon mountain tents \$14.95, nylon jungle hammocks \$4.95. Slightly used Army chino pants and shirts \$1.85 each. "Rays" Army & Navy Store, 607 Vanderbilt Ave., Brooklyn 17, New York.

## WANTED MISCELLANEOUS

**WANTED:** Anything in unusual bulbs, plants or seeds. Also any saleable novelties, for florist or gardener, also any gadgets for the farm or garden. Will act as manufacturer's agent or will buy outright. Jo-Bee Company, 1023 Fox Bldg., Detroit 1, Michigan.

**PROMPT** Cash for machinists' squares, rules, micrometers, indicators, gages, etc. Satisfaction guaranteed. Wm. Gruer, 460 Ryerson Ave., Elgin, Illinois.

**MERCURY** (Quicksilver). Write for quotation stating quantity. Metallurgical Products Co., 35th and Moore Sts., Philadelphia, Penna.

**WANTED:** Miniature creation such as a village, garden or circus, etc., suitable for a travel exhibition. State whether for sale or lease. Jo-Bee Co., 1023 Fox Bldg., Detroit 1, Mich.

## PERSONAL

**FREE** Catalog. Abdominal, Sacro-Iliac, rupture belts. Custom made. Reasonable. Earles Company, Flint, Michigan.

**POSTCARD** Collectors! Three cards from Peoria or Bloomington, Illinois, 25c. Address, return, I remail. Box 11, Congerville, Illinois.

**STAMMER?** Let me help you. Details free. Sauers, Box 139-K, Mars, Penna.

**RUPTURED?** Beltless, bulbless, strapless truss. Brandon, North Quincy, Clinton, Illinois.

**NATIONAL** Buying agency. List your wants. Spada Enterprises, 10 Lexington, Wethersfield 9, Conn.

**15** SHAVES Every blade, through chemistry. Instructions 25c. Lusbough, Angwin, Calif.

**FEET** Hurt? Wear soft resilient Airflow adjustable Arch Ezurs, two dollars pair, any size. Stemmons Mfg. Company, 300 East 51 Street, Kansas City, Mo.

**FALLING** Hair, its cause and prevention, fully explained in an informative and educational pamphlet entitled "How To Keep Your Hair Till Ninety." Price 25c. James Hilton, 4819 Fourth Ave., Brooklyn 20, N. Y.

**ATLANTIC** City by mail, 3 postcard views, 20c. Address, return, I remail. Letters mailed, 15c. Famous salt water taffy, \$1.00 lb. postpaid. Muriel Koler, 1111 Atlantic Ave., Atlantic City, N. J.

**FALSE** Teeth wearers. Avoid loose plates, possible dangerous complications. Name on postcard brings free literature. Dental Technicians, 1649 Grant, San Francisco 11, California.

**BORROW** By mail. Loans \$50.00 to \$300.00 to employed men and women. Easy, quick. Completely private, confidential. No endorsers. Repay in convenient monthly payments. Details free in plain envelope. Write State Finance Company, 216 Savings and Loan Bldg., Dept. N-20, Des Moines, Iowa.

**HOLLYWOOD** picture cards mailed in your handwriting from So. California, 3-35c. Box 6081, Metro Sta., Los Angeles, Calif.

**PRETEND** Visiting Wisconsin's vacationland—3 scenic cards 25c, address, return, I remail. E. R. Miller, 1008 S. Minnesota Ave., Stevens Point, Wis.

**"PLANNED** And profitable" mail order selling. New, different work-book of ideas and instruction for beginners, aspirants, established dealers. Send quarter for copy of leading mail order trade magazine and details. Special year's subscription \$3. National Publishing Co., 356 So. Broadway, Suite 706-PM, Los Angeles 13, Calif.

**STUTTER?** Stammer? Literature sent free. Frank Teurfs, 25 E. Jackson, Chicago, Illinois.

**MAINTAIN** Mexican mailing address. Letters forwarded. Mystify friends. Scenic postcards 15c. You address, return, I remail. Tillotson, Apartado 1405, Guadalajara, Jalisco, Mexico.

**SWAPPERS!** Traders!—Free information. "Swappers" Gazette," 2836-PM Slevin, Louisville 12, Kentucky.

**RUPTURED?** Positive comfort, no understraps, no steel, no elastic. Write Smith Manufacturing Company, Preston, Ontario.

**HAIR** Falling? Dandruff? Write Trichologist, 137 Lewis St., Phillipsburg, N. J.

**HOW** You can find out! Information discreetly developed, any matter, person, problem, anywhere. Personal-business assignments, representations, undertaken. Nation-wide. Officially licensed and bonded service established 1922. Reasonable. All inquiries confidential. William Herman, 170 Broadway, New York.

## MISCELLANEOUS

**GIGANTIC** Mail regularly, samples, catalogs, seed books, bargains, special offers, etc., listing your name in our big mail column, for only 25c. Six times for \$1.00 with free gift. Martin's Service, Box 295P, Bassett, Va.

**PERMANENT** Wave—pin curl, new book, showing every step. Package Wave set free with details. Write; Aljen Books, Dept. PM, Charlotte, Mich.

**LARGE** Detailed maps—Every county in Washington, Oregon, Idaho and California. Write "Metsker Maps," Tacoma, Wash. for price list.

**SEPTIC** Tank booklet—Details complete systems 50c. Bruvoid, Hebron, North Dakota.

**MAIL,** Business or personal letters, forwarded or mailed 25c each. Box 3093, Jacksonville, Florida.

**MAILS** Galore, magazines, catalogs, samples. Name listed. 10c. American Directory, 1420 Mistina, Corpus Christi, Texas.

**WHOLESALE** Radio service. Any radio repaired. Ship via express. Satisfaction guaranteed. Elkins Radio, Elkins, W. Va.

**YES,** Men's shoes in sizes 11½ to 16. Widths AA to EEE. Finest quality, moderate price. Free circulars. Write King-size 174, Brockton, Mass.

**PANNING** Gold—learn how. Instructions in free illustrated booklet—catalogue, mining books, supplies. Old Prospector, A-81, Dutch Flat, Calif.

**THE** Lord's coming! Get free proofs. Time is short. International Evangelism, Box 263, Duluth, Minnesota.

**BEAUTIFUL,** "Real engraved" name plate, 3¼"x3¼"—silver letters on black. Only \$1.00, 3 for \$2.00. Cash or c.o.d. Satisfaction guaranteed! Rush names wanted. Monroe Engravers, 681-P Redondo, Long Beach 4, California.

**SWISS** Musical movements \$4.25. Music boxes, Lucite wedding-baby albums, frames, Novelties of Distinction, 131 W. 42nd, New York City.

**HOW** To set up and run a mirror shop! Resilver mirrors. For price write, John Sprinkle V65, Marion, Indiana.

**INVENTORS,** Experimenters, hams! Counters, new Veeder-Root, 3 places reset counters, \$7.00 value, \$1.00. Limited quantity. R. J. Penner Company, 1334 Lake, Chicago 7, Illinois.

**AT** Home—Your own manufacturing business; making popular \$1.00 novelties. Cost you 3c to 15c. Everything supplied. Write So-Lo Works, Dept. U-6002, Loveland, Ohio.

**MEXICAN** Jumping beans. July to December delivery. Order now. Dozen 25c; hundred \$1.00; thousand \$5.00. Mexican Products, 126 N. Main, Tulsa, Oklahoma.

**STAZ-KLEEN,** Plastic wallpaper coating. Permanent protection from grease, dirt. Particulars and sample-proof free. Manson Chemical Company, Room 622, 1328 Chestnut Street, Philadelphia 7, Pennsylvania.

**NAME** Plates; hand made, useful, attractive, durable, 59c each, two for \$1.00, postpaid, Sauers, 1317 North Pearl, Compton, Calif.

**LAY** Brick! Build it yourself and save money. New invention assures good job. Requires no previous experience. Send for information. Bricklayer, Box 260C R. 7, Dayton 9, Ohio.

**POWER** Lawn mowers now available. Light weight, all aluminum. Cuts grass 3 feet high. Literature free. Johnson Motor Sales, Milford, Ind.

**CLOTHESPINs,** Stainless steel, new invention. Sold on money back guarantee. Send one dollar for twenty. Ritex Corporation, Attleboro, Mass.

**ARISTOLITE** Illuminated house number and steplight. Easy to install. Send \$4.85 to Camp & Bradley, Box 109, Chagrin Falls, Ohio.

**"RACKETS** That Get Your Money." Large 5½"x8½" book exposing "rackets," "swindles" and "crooked schemes." Protect yourself by reading "Rackets That Get Your Money." Prepaid, \$1.00. Morris, Box 626, Cortland, N. Y.

**RECEIVE** Giant mails, magazines, samples. Name in thousand mailing lists, 20c. Lawson, Box 1302-P6, Detroit 31.

**GIGANTIC** Mails, magazines, catalogs, listing 10c, three times 25c. Waddell's Directory, 341 East 76th, New York 21.

**BASEBALL** Fans—for \$3.00 make a new pitching device. Practice batting in back yard. Duplicates curves. Delivers regulation baseball every 5 seconds. No fielding. Plans \$1.00. A. Rankin, Route 4, Hagerstown, Md.

**LUCKY** Coin—Lord's Prayer, Ten Commandments, or Crucifixion on penny. 25c each—50c for all three. Peerless, 2726-B Sturtevant, Detroit 6, Mich.

**"RECEIVE** Mail." Moneymaking offers, opportunities, catalogs. Name listed 10c. Ideal Service, 100, Park Ridge, Ill.



**TRADE Secret discovered!** Mysterious "lookout glass" mirrors made by cheap, simple processing of ordinary glass. Mirror on one side; see right through from other side. Huge profits being made supplying these strange mirrors to eager buyers everywhere. You can make them rapidly and cheaply at home, any size, any thickness. No technical skill, electricity, or elaborate equipment required, only several chemicals available everywhere. Complete, detailed instructions, fully exposing this jealously guarded secret process, mailed under sealed cover. Guaranteed. Request "Process #103," \$1.00. Kinetic Research Co., Dept. A647, Box 33, Boulder, Colorado.

**FREE!** Samples, magazines, catalogs, literature, moneymaking opportunities! Receive lots of mail from everywhere! Mails galore! Your name listed in over 15,000 "surefire" mailing directories. One year, \$1.00. 5000 listings three months, 50c; 2000 listings one month, 25c. Here's your chance to receive plenty of interesting mail! Act now! Stanford, 6220-M 16th Street, Philadelphia 41, Penna.

**BOYS Athletic Club**—Any boy who likes sports can join our club, wear an emblem and enter athletic contests. Captains will be selected from the first to answer. Write now for details. Please enclose self-addressed stamped envelope. Coach's Club, 55 Main Street, Warsaw, New York.

**SELF-DEVELOPMENT** Home-study plan details and lecture free. No obligation. Dare to be a bigger personality. School of Psychology, 10th Floor, Washington Bldg., Louisville 2, Ky.

**THE Sensational mystery drinking bird,** only \$2.25. Specialty House, Box 542, Danville, Illinois.

**20TH Century soot removing method.** Saves time, money, work. Nothing to buy. No work to do, 20c. Coal saver formula, 10c. Nantco, 157-A West Noble, Nanticoke, Penna.

**STUTTER? Stammer? Literature sent free.** Teurfs Studios, 25 E. Jackson, Chicago, Illinois.

**8 ALNICO Magnets plus 100 experiments,** \$2.00. War surplus, extra powerful 1" disc Alnicov magnets—fascinating; pair \$2.00. G. E. midget precision switches, 110V, 10A—2 circuit; each \$1.00; six \$5.00. Eljay, Box 891, Newark 1, N. J.

**GOOD "Used" self-instruction educational books** on all subjects bought, sold, rented, exchanged. Satisfaction guaranteed. Complete information and 100-page illustrated bargain catalog free! Write—Nelson Company, Chicago 5.

**BOOKFINDERS!** (Scarce, out-of-print unusual books.) Quickly supplied. Send wants. Clifton, Box 1377PMM, Beverly Hills, Calif.

**PURE Vermont maple sugar postpaid in \$1, \$2 and \$5 lots.** Eulalia Turner, Poultney, Vermont.

**70 BIBLE Lessons, 25c.** Bulletin, Box 87, Station H, New York 25.

**TATTOOING Outfits—engraving outfits,** Circulars free. Write, Zeis Studio, 728 Lesley, Rockford, Illinois.

**MEDICAL Laboratory technicians in great demand.** We train you in your spare time, in your own home. You can practice while studying. Write for free catalogue. Imperial Technical Institute, Box 973-J, Austin, Texas.

**M-SCOPE Metal, mineral locators latest 1947 electronic type** ready for immediate shipment. Fisher Research Laboratory, Inc. manufactured some of the finest metal-locators for the U. S. army. Experience gained is yours in the most efficient metal, mineral locator. Free 16-page booklet upon request. Credit plan available. Fisher Research Laboratory, Inc., Palo Alto, California.

**FREE—"Amazing New Book"—"Profits From Classified Advertising."** Tells how and what to advertise. Be sure to read this book before you invest one cent in advertising. Remember—it's free! Write for your copy now. F. W. Johnson, Classified Advertising Manager, 200 East Ontario Street, Chicago 11, Illinois.

## A NEW ANGLE

on quickly figuring rafter and other angle problems:

### SLIDE SQUARE

A brand new, all aluminum, unique, patented tool for every work shop! Gives plumb line and notch cut angles for all rafter types! Protractor arm adjusts to form handy "T" square! Send \$2.50 today, postpaid.

**CORWELD SUPPLY CO.**  
4125 S. HOOVER ST., LOS ANGELES 37, CALIF.



\$2.50 SAVES TIME

DEALERS! BIG DEMAND!  
Write for our PLAN!

## INVENTORS

If you wish to protect your invention, you should take steps to protect it by a U. S. Patent. Write me for "Record of Invention" Form.

**CARL MILLER**  
REGISTERED PATENT ATTORNEY

Woolworth Bldg., 35th Floor, Dept. 67A, New York City  
Please send me "Record of Invention" form.

NAME \_\_\_\_\_

ADDRESS \_\_\_\_\_

## THIS HANDBOOK

is crammed from cover to cover with countless ideas to add more fun and greater success to your days afield . . . full of up-to-the-minute information on Hunting—Fishing—Camping—Boating—Dog Training, etc. . . . tells you all about Duck Shooting, Deer Hunting, Upland Game, guns and rifles, sights, ballistics, fly, bait and surf fishing, and hundreds of informative and interesting facts. Over 100 pages and scores of helpful illustrations.

## FREE--IF YOU ACT NOW!

This invaluable Handbook WON'T COST YOU A PENNY—if you act today! We want you to join our gang of real sportsmen who read Hunting & Fishing every month. Hunting & Fishing is published for and by its thousands of readers, who send in stories, items and pictures of actual experience—true-to-life, red-blooded accounts of their good times and adventures with rod, dog, rifle and gun. That's why Hunting & Fishing is the favorite magazine of true sportsmen everywhere!

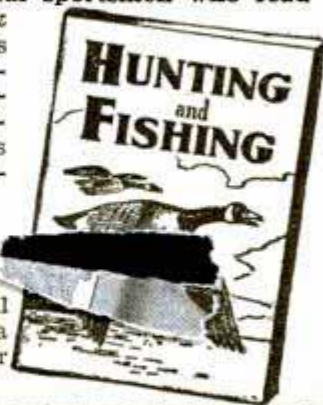

## SPECIAL OFFER

Just fill in the coupon below and send it along with a little \$1.00 bill, and we will send you Hunting & Fishing Magazine for a whole year—12 big issues—PLUS a free copy of the Hunting & Fishing Handbook! Send the coupon and your dollar today!

**HUNTING & FISHING MAGAZINE, 251 Sportsman's Building, Boston, Mass.**

Name \_\_\_\_\_

Address \_\_\_\_\_

City \_\_\_\_\_ State \_\_\_\_\_



# STUDY CARPENTRY AT HOME!



**complete set prepaid \$7.50**

Simplified Stair layout (57 pgs.) \$1.50  
 Interior and Exterior Trim (264 pgs.) \$2.00  
 Use of Hand Tools & Portable Machinery (192 pgs.) \$1.50  
 Concrete Form Construction (106 pgs.) \$1.25  
 Framing, Sheathing, Insulation (237 pgs.) \$1.75

For the first time! A clearly written, easily understood, practical series of five large, well-illustrated texts for carpentry students, apprentices, craftsmen, construction foremen, teachers, home owners and hobbyists! Material is prepared by skilled craftsmen and teachers in the order that fundamental carpentry operations are performed. Used by trade and vocational schools in the U.S. and overseas, this series is perfect for home study to supplement apprentice training programs. Save money! Order complete series! We'll refund your money if you're not satisfied.

PASTE COUPON ON PENNY POSTCARD

DELMAR PUBLISHERS, INC., Dept. A., Broadway & Orange St., Albany 7, New York  
 Please rush postpaid, books checked, for which I enclose money order \$  
 check (\$ ). If not satisfied, I'll return books, postpaid, at end of 5 days and  
 my money will be refunded. 1. Complete Series at \$7.50 ( ) 2. Simplified Stair layout ( )  
 3. Concrete Form Construction ( ) 4. Interior & Exterior Trim ( ) 5. Framing, Sheathing,  
 Insulation ( ) 6. Use of Hand Tools & Portable Machinery ( )

NAME \_\_\_\_\_  
 ADDRESS \_\_\_\_\_  
 CITY \_\_\_\_\_ STATE \_\_\_\_\_

# RUNNING HOT WATER INSTANTLY!

From Your Cold Water Faucet



## with ROKEY Instant Hot Water Heater

Here's one of the greatest household inventions of all time . . . back again for the first time in many years. Now you can actually have all the hot water you need the instant you need it . . . FROM YOUR COLD WATER FAUCET! This new postwar type heater quickly attaches to any cold water faucet . . . in the basement for extra hot laundry work . . . in the bathroom for bathing needs . . . in the kitchen for dishes, cooking and cleaning. You regulate the temperature and quantity with your faucet handle. Just plug the cord in any electric outlet (AC or DC 110-120 volts), turn the faucet and PRESTO—Hot Water, anytime of day or night, as much and as hot as you want. Easy to install, complete with 6-foot extension cord. Order one or more TODAY.

Hot water as fast as it flows from your cold water faucet.

**\$8.49**

**SEND NO MONEY**

Just write today . . . order your Rokey electric Water Heater and pay the postman \$8.49 plus postage when delivered, or send \$8.49 and we will pay the postage. Try for 5 days and if not completely satisfied return to us and we will gladly refund full purchase price. No C.O.D.'s outside U. S. A.

ROLEY SALES CO., INC., Dept. FF-72, 15 Spruce St., New York 7, N. Y.

Name \_\_\_\_\_  
 Address \_\_\_\_\_  
 City & Zone \_\_\_\_\_



# MAGI-KLIPS KIT

## TEACH YOURSELF RADIO & ELECTRONICS BUILD 18 EXPERIMENTS WITHOUT TOOLS!

You've read about this radically new kit designed by former Navy radar engineers. Pre-wired chassis enables you to build 18 different circuits — radio receiver, code oscillator, home broadcaster, photoelectric relay, etc.—by "clipping in" basic components as directed in simply-diagrammed manual. 110 v. AC or DC. Kit's 58 parts alone would cost double this low price. Order your Magi-Klips Kit today and learn electronics quickly at home. Send for illustrated folder to show \$29.75 friends interested in learning electronics this complete easy way!

DEER & TAYLOR COMPANY Dept. K, 1340 Milvia St. Berkeley 9, California

# GOOD LUCK

Remarkable disclosure reveals how Happiness, Good Fortune and Success may easily be yours by applying a few simple, though little known rules that lead to the MASTERY OF LIFE! Good Luck Key included free! Both sent postpaid for \$1.00. Money back if not satisfied. Belle Haven, P. O. Box 996-C, Redwood City, California

# MAKE YOUR OWN MUSIC BOX

Home craftsman can have fun and make money creating music boxes. For gifts, toys, or boxes we supply Swiss Musical Movements. Large variety of tunes available including beautiful waltzes, operas or classical tunes. Easily installed and unconditionally guaranteed . . . only **\$3.50** POSTPAID  
 12 or more . . . . . \$3.00 each

SEND CHECK OR M. O. 2942 W. 2 ST. BROOKLYN 24, N. Y.  
 McKAY IMPORT CO., Dept. M



## HOW TO CREATE SOUND EFFECTS FOR HOME RECORDINGS

by ED. LUDES, Head of Sound Effects for the NATIONAL BROADCASTING COMPANY in Hollywood

Tells how YOU can make hundreds of the sound effects you hear on your radio  
 ORDER TODAY—Send \$1.50 Money Order or C.O.D.

NATIONAL HOLLYWOOD, 1475 EL MIRADOR DRIVE, PASADENA 2, CALIFORNIA

# LAW

STUDY AT HOME FOR PERSONAL SUCCESS and LARGER EARNINGS. 38 years expert instruction—over 108,000 students enrolled. LL. B. Degree awarded. All texts furnished. Easy payments. Send for FREE BOOK—"Law and Executive Guidance."  
**AMERICAN EXTENSION SCHOOL OF LAW**  
 Dept. 78-M, 646 N. Michigan Ave., Chicago 11, Ill.



## Thrilling Work COLORING PHOTOS

Fascinating vocation learned at home by those with aptitude. Thrilling pastime. National method brings out life-like colors. Free booklet.  
**NATIONAL PHOTO COLORING SCHOOL**  
 1315 S. Michigan, Dept. 135A, Chicago 5

# U.S. GOVERNMENT JOBS

## START \$1,756 TO \$3,021 YEAR

Men—Women  
 Prepare NOW for Next Examinations.  
**FRANKLIN INSTITUTE**  
 Dept. J86, Rochester 4, N. Y.  
 Sirs: Rush without charge (1) 32-page Civil Service book with list of U. S. Government Jobs. (2) Tell me how to prepare for one.  
 Name \_\_\_\_\_  
 Address \_\_\_\_\_  
 City \_\_\_\_\_

Vets Get Preference. Mail Coupon

COUPON



# ONE-MAN SAWMILL

**EASY TO TURN TREES INTO MONEY... BELSAW**

**MODELS** in 10 to 24 foot sawing lengths. **MECHANICAL FEED**, accurate set works and positive dogs. Use tractor or old auto engine for **Makes lumber, ties, shingles, crates, lath, studing, siding.**



**LESS THAN \$200<sup>00</sup>**  
low cost power. Thousands used for commercial sawing. Pays for itself quickly. *Mr. Nettleton of California reports, "Have sawed over five million feet of lumber since I got my BELSAW selling it at \$35 per M.B.M." Send a postcard today for FREE booklet, "HOW TO MAKE LUMBER"—and Catalog of Woodworking Equipment.*

**BELSAW MACHINERY CO., 2811 MS Field Bldg. 315 Westport Road, Kansas City 2, Missouri**

## BUILD YOUR OWN Battery Driven ELECTRIC LAWN MOWER.. PLANS ONLY



This ultra-modern rotary-blade mower can be made from inexpensive parts and an old auto generator. Plans complete, easily followed. Mower cuts forward, backward, tall or short grass, weeds.

**35¢**  
WRITE TODAY

**LEJAY MFG. CO.**  
247 Lejay Bldg., Minneapolis 8, Minn.

## AGENTS 300% Profit SIGN LETTERS

For Store Fronts and Office Windows. Anyone can put them on. Free Samples. Liberal Offer to General Agents.

**METALLIC LETTER CO., 430 N. Clark, Chicago 10**

## INVENTIONS WANTED Pat'd or Unpatented

**FREE** List of 280 buyers who want many hundreds of ideas sent on request. Or mail us your drawings for fast action—cash or royalty.

**INVENTORS SALES & ENGINEERING BUREAU, 208 Clinton, Oak Park, Ill.**

### Handy Mail Order List

#### Little Library of Useful INFORMATION

**5 for \$1<sup>00</sup>**  
**12 for \$2<sup>00</sup>**  
**25¢ Each**

Here at amazingly low cost is the practical help and information you have always wanted. Articles in previous issues of Popular Mechanics have been classified according to subject and are now available in these handy reprint booklets.

- How to Use Measuring Tools—Micrometers, Calipers, etc.—106.
- Power Driven Saws—74.
- Drill Presses, Grinders, Etc.—79.
- Wood, Metal Turning—Lathes—81.
- Filing Machine, Hacksaw, Cutoff Wheel, Shaper—82.
- Lathe Tools You Can Make—101.
- Workbenches—Tool Cabinets—47
- Spray Painting—94.
- From Pattern to Casting—91.
- Tool and Saw Sharpening—92.
- Sharpening Drills, Wood Bits—90.
- Successful Wood Turning—32.
- How to Read Blueprint—71.
- Metal Turning Lathe Kinks—99.
- Operating a Metal Lathe—100.
- Heat Treating, Hardening—102.
- Working With Glass—103.
- Servicing Elec. Motors—75.
- Electromagnets & Solenoids—44.
- Transformer Construction—41.
- The Boy Electrician—43.
- Soldering and Brazing—17
- Arc and Spot Welders—5.
- Electroplating With Nickel, Chromium, Cadmium, Etc.—86.
- Plating Leather, Wood, etc.—87.
- Lower Your Fuel Costs—31.
- Curing Leaky Basements—45.
- Fitting Home Game Room—55.
- Indoor & Outdoor Fireplaces—88.
- Backyard Gardening—39.
- Lawn and Garden Novelties—72.
- Trellises, Pergolas, Fences—76.
- Lawn and Garden Furniture—77.
- Playground Equipment—73.
- Concrete Garden Furniture—8.
- Making Serving Trays—53.
- Sanders—80.
- House Wiring—89.
- Treasure Finders—13.
- Hanging Wallpaper—38.
- Built-in Fixtures—78.
- Bird Houses—7.
- Magazine Racks—49.
- Clock Cases—50.

- Knots and Ropework—105.
- Working With Plastics—61
- Simple Home Improvements—104
- Ridding Home of Insect Pests—107
- Children's Room Furniture—51.
- Jigsawed Novelties—57.
- Doll House & Doll Furniture—60.
- 25 Shelves You Can Make—64.
- Novelties Turned on Lathe—62.
- Inlay Pictures—Veneering—63.
- Wood, Soap Carving—65.
- Windmills & Weather-vanes—66.
- Lamps from Wood, Metal—69.
- Rustic Furniture—18.
- Wood Finishing—40.
- Boats—14 ft. Outboard—2.
- Boats—14 ft. Sail Dinghy—26.
- Boats—21 ft. Sloop—46.
- Rowboats, Small Dinghy—83.
- Small Sail Boats—84.
- Two Outboard Runabouts—85.
- Build Own Canoe, Kayak—30.
- Build Class-E Ice Yacht—22.
- Auto Kinks, Shortcuts—10.
- Building Trailers—27.
- Motor-Driven Midget Cars—34.
- Stop Auto Elect. Troubles—95.
- Photo Printers and Dryers—25.
- Photo Darkroom Equipment—96.
- Trick and Table Top Photos—97.
- Cosmetic Formulas—12.
- Poultry Houses—108.
- Guns and Decoys—109.
- Re-Silvering Mirrors—70.
- Chemical Experiments—93.
- Log Cabins, Tourist Houses—14.
- Trapping Small Animals—33.
- Farm and Garden Tractors—8.
- Building Extra Attic Rooms—23.
- Attractive Basement Rooms—24.
- Small Looms—37.
- Gem Cutting—42.
- Photo Enlargers—1.
- Photo Kinks—98.
- Cleaning Formulas—11.
- Taxidermy—9.
- Magic—29.
- Training Dogs—35.
- Small Furnaces—36.

Check Titles Wanted, Clip, Mail with Remittance to **POPULAR MECHANICS PRESS, Dept. 635, 200 E. Ontario, Chicago 11**

# MAKE MORE MONEY IN AUTO BODY and FENDER REPAIRS

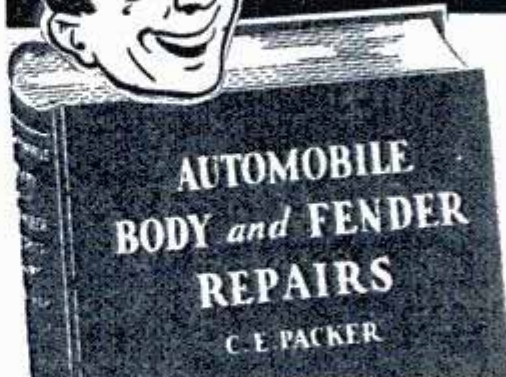

Get This Famous Book Today  
**FREE TRIAL** in Your Home MAIL COUPON

**QUICK, EASY, LOW COST!**  
**THE 'HELP YOU NEED!'**

Do it now! Get yourself a share of the big money car owners are spending to keep their older cars looking good. Get this famous and practical book that will put you right into this profitable business. No previous experience needed. Get a good job or start a business of your own with little or no capital.

### Covers Methods, Tools, Equipment! Tells How to Get Business — How to Run a Shop and Make Money

Thousands of copies in use. A winner everywhere. Written by a man who knows the business thoroughly. Easy to use and easy to understand. Covers the use of tools and equipment, gives approved methods; describes materials and shows you how to actually do a professional job, operate a shop, etc. The very latest information and pictures on all interior and exterior body work and fender repairs—the kind of work people everywhere want and will pay big for when you can do it. Ideal for shop owners and every man who wants to get in on the millions being spent to make old cars look newer. Mail coupon today.

### OTHER FAMOUS AUTO BOOKS

**DYKE'S AUTO ENCYCLOPEDIA.** New 20th edition of world's best known book on auto construction, repair, adjustment, testing and remedies. Over half-million have been sold. 1483 pages. 4600 illustrations and diagrams. Weighs 6 pounds—equal to 4 ordinary books. \$7.00.

**DYKE'S CARBURETOR BOOK.** The standard guide on auto carburetor work for a generation. Has helped thousands make money. New edition covers engine tune-up, compression, ignition, carburetion, fuel pump, valves. Use this book to specialize in this big field. 244 pages. 549 illustrations. \$3.50.

### GET STARTED NOW

To make money, get into body and fender work now—or any other branch of this big business that appeals to you. Select the book or books you need and order now.

**Send No Money • Mail Coupon Today**

**Goodheart-Willcox Co.**  
2009 S. Michigan Ave., Dept. 16, Chicago 16, Ill.

Send books checked C.O.D. including charges. If not satisfactory I will return in 5 days and you will refund money paid. (Outside U.S. remit with order). We will pay all postage charges if remittance accompanies order.

- Body and Fender Repair \$3.50       Dyke's Carburetor Book \$3.50

Name \_\_\_\_\_

Address \_\_\_\_\_

City \_\_\_\_\_ Zone \_\_\_\_\_ State \_\_\_\_\_



# This is a STICK-UP!

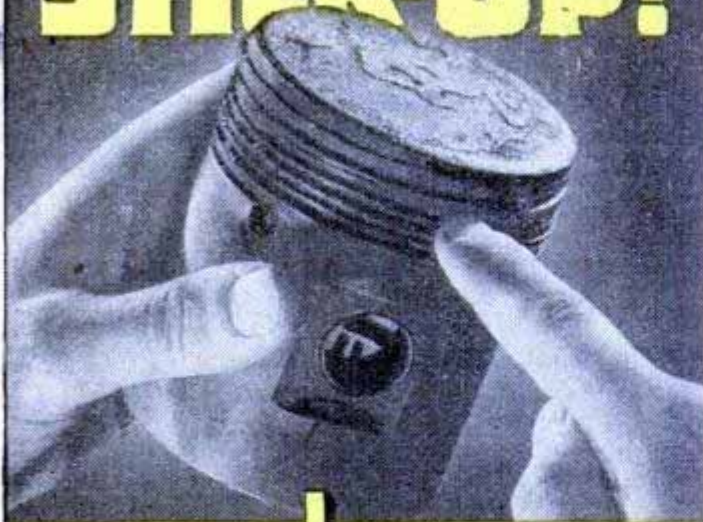

It's a "stick-up"—and you're the loser—when dirty oil circulates through your engine. Have your oil tested—*free*—by the AC method. If your oil contains grit, dirt or carbon, it stands out clearly on the clean white AC Test Pad.

Dirty oil clogs piston rings and slots—makes valves stick—wears out moving parts—wastes fuel and oil—robs engines of power.

You can prevent that "highway robbery" by installing an AC Oil Filter or Element. Why not do it today?

Free oil tests with AC Test Pads, as well as AC Oil Filters and Elements, are available at any AC Oil Filter Service Station.



AC SPARK PLUG DIVISION • GENERAL MOTORS CORPORATION

Please Mention Popular Mechanics When Answering Ads

## WAR SURPLUS Close Outs

- ARMY TRUNKS: Used, made of durable Plywood with extra tray, real value. . . . . \$3.99
- METAL BOXES: Used, extra heavy gauge, well built 14x17x23". Fine for tool box, storage, etc. . . . . \$1.99
- METAL CHEST: (new) 12 1/2 x 18 1/2 x 9 1/2", with 4 liftout trays perfect as strong box for valuable papers, jewelry, etc. \$12.00 value . . . . . \$5.99
- WHEEL CHAIRS: New, genuine GENDRON, bargain. \$24.50
- ROPE: New 1/2" Government specifications, (longer lengths available) 100 feet . . . . . \$2.75
- SCREW JACKS: Bell Bottom, 12 ton capacity (used). . . \$5.49
- GRINDERS AND BUFFERS—Bench Size (New) 1/2" shaft less wheels, \$2.20 value. . . . . \$1.69
- ELEC. DRILLS: (used) with 1/4" Jacobs Chuck, tested, in excellent working condition, \$40.00 value. . . . . \$17.99
- WIRE BUFFING WHEELS: Genuine Osbornes 10" (used) good condition. State shaft size desired, \$2.20 value. . \$1.19
- WHEELS: Ball bearing with tire and tube, 10" High (used like new) . . . . . Each \$4.50
- STEEL WHEELS: Used, ball bearing, 10" high. . . . . Each \$1.99
- DRILL BITS: Hi-Speed, (used—good condition) assortment up to 1/4"—\$2.98 doz., 1/4 to 3/8" . . . . . \$3.98 doz.
- TAPE: (Mystik-Adhesive cloth back). For all purposes, 60 yd. rolls, 4" wide, per roll. . . . . \$1.19

### AIR or LIQUID TANKS

Airplane oxygen tanks (used) good condition, holds up to 400 lbs. pressure; non-rusting stainless steel, weighs 1 lb., 10 1/2 gal. capacity, 24" long x 12" diam., \$4.98. Same specifications 24" long x 6" diam., weighs 5 lbs., 3 gal. capacity, \$2.98. Ends tapped for 3/8" standard pipe thread. Air check-valve to fit tanks, \$5.00 value, 98c. Ideal for compressed air tanks, any bottled gas, or liquids, water supply for house trailers, compressors, floating rafts, buoys, net floats, air horns, air brakes, etc.

Prices FOB, Kansas City—No COD orders

### MIDWEST BUY ANYTHING CO.

1520 Locust St.

Kansas City, Mo.

## BRASS NAME TAGS

STAMPED WITH YOUR NAME, STREET, CITY & PHONE!



High Quality Brass tags, for luggage, keys, tool box, fishing tackle, identification. Free links for attaching, 25c each, 5 for \$1, 12 for \$2. (All same or different), AGENTS WANTED!

ARTCO Dept. 100-F, P.O. Box 1594 St. Louis 1, Mo.

25c  
5 for \$1  
12 for \$2

## New Designs in

### FRANZITE GRIPS



Modernize Your Gun! Improve Your Score!

Most durable grips made. Positively unbreakable! For Colt, Smith & Wesson, Hi-Standard, Ortgies, Luger & Mausers in a wide choice of beautiful designs in ivory, pearl, walnut, onyx, etc. Low prices. FREE CATALOG. Dealers Wanted.

SPORTS, INC., (Mfrs.) 5501 Broadway, Dept. P-6, Chicago 40, Ill.

## HOW TO CUT RAFTERS

New vest pocket book gives lengths, Side cuts, Plumb cuts, Deductions. For all rafters for any building from one inch to forty feet wide. Gives numbers to cut on square. Also degrees for some cuts for Radial Saws. All standard pitches from 1/8 to 5/8. Just open book to pitch page and there are your lengths, side cuts, etc. Anyone who knows what a jack rafter is can frame a roof if he has this great book. Price one dollar pre-paid. BUILDERS' TOPICS, Dept. M, Lock Box 828, Seattle, Washington. Original teachers of the square in five easy lessons by mail. SEND FOR FREE LIST OF TECHNICAL BOOKS. Learn to read blueprints etc.

## MAGIC LIQUID CASTS

# PLASTICS

THE GREATEST THING IN PLASTICS! A NEW LIQUID PLASTIC! Just pour PLASTICAST into any kind of mold or container and it hardens in a few minutes to a solid, smooth, clear as glass plastic. No machinery or tools required. PLASTICAST has UNLIMITED POSSIBILITIES . . . novelties, toys, jewelry, knick-knacks, fascinating brilliant, sparkling clear or colored plastic articles . . . an endless variety of useful things. Being transparent it is ideal for imbedding flowers, coins, photos, souvenirs, charms, etc. Can also be cast into rods, sheets, blocks, any shape. Make PLASTICASTING A THRILLING NEW HOBBY OR A PROFITABLE BUSINESS! No experience required. Start casting 10 minutes after you receive your outfit. Full instructions and accessories provided.

COMPLETE MASTER OUTFIT, will make over 200 articles, \$3.00 ppd. FREE PLASTICS MANUAL & HOBBY CATALOG. How to cast plastics, make molds, dies, valuable data on ALL types of plastics. Sent free for 3c stamp.

PLASTICAST CO., Dept. C (Send order to nearest office)

5961 Madison St., Chicago, Ill. P.O. Box 987, Palo Alto, Calif.

POPULAR MECHANICS



**FOR**  
Homes  
Gardens  
Schools  
Churches  
Factories  
Ships  
Tennis  
Golf Dr.  
Ranges  
Lawn Parties  
Parking  
Areas  
Driveways

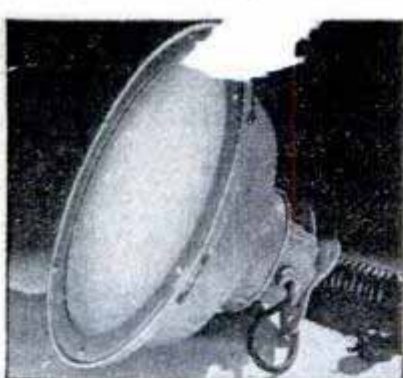

**ONLY \$15**  
**BRAND NEW**  
This Price Below Former OPA Ceiling Only Fraction of What It Cost Government

**GIANT FLOOD LIGHT AS MADE FOR U. S. NAVY ILLUMINATES LARGE AREA**

Easily installed. Base plate on lamp bored for quick mounting. Weather-proofed. Has 14 feet of heavy rubber cord; takes AC or DC current; frosted heavy convex lens; rugged construction; made to Navy specifications.

**Protect Your Home Against Burglars and Prowlers**

**GIANT:** 14 inches in diameter; includes 150-watt standard bulb; weight 8 lbs. .... **\$15**

**SUPER GIANT:** 17 inches in diameter; includes 300-watt standard bulb; weight 15 lbs. .... **\$25**

**JUMBO:** 17" in diameter; adjustable to any position; standard 500-watt bulb. **\$35**  
1000-watts ..... **\$40.00**  
1500-watts ..... **\$42.50**

**MONEY BACK GUARANTEE.** Terms: Cash With Order. Mail order today with money order or check. Shipped Express Charges Collect.

**CARNEY'S, 29 Central Ave., Dept. MM-2, Tarrytown, N. Y.**

**BURN WATER IN YOUR CAR**

**COSTS LESS THAN GAS**  
More Power, Cleaner Motor.  
Mail card for data on \$17.50  
Water-injecting Carburetor.  
**OCTA-GANE**  
2425 E. 57TH ST. • LOS ANGELES 11, CAL.



**INDIANAPOLIS "500" RACE HISTORY BOOK**  
352 pages, 1100 illustrations. Covers every race since 1909. Postpaid \$3.50; cloth-bound \$5.00. 32-page book on 1946 race only, \$1.00. Book on 1947 race (ready in July) \$1.00. **CLYMER, Dept. A-6, 2125 W. Pico, Los Angeles 6, Calif.**

**Learn LANDSCAPE GARDENING**

A thorough, interesting, home study course for those who wish to become LANDSCAPERS, GARDENERS, DESIGNERS, etc., for profit or pleasure. Write today for **FREE BOOK** to  
**NATIONAL LANDSCAPE INSTITUTE**  
Dept. P-6, 310 So. Robertson, Los Angeles 36.

**LEARN-WATCH REPAIRING at HOME**  
FREE information write—American Institute of Specialized Watch Repair—P.O. Box 117, Dept. 1, Grand Rapids 1, Michigan.

**BRUSH PLATING OUTFITS**

for re-plating articles in the home and shop. No tanks necessary. Free particulars.  
**GUNMETAL CO., AVE. M, DECATUR, ILLINOIS**  
SAY YOU SAW IT IN POPULAR MECHANICS

**WATCH & CLOCK REPAIRING**  
LEARN AT HOME IN YOUR SPARE TIME! ... Prepare for a happy future, with security—and qualify for a good job NOW. A fascinating and thorough self-instruction training in American and Swiss watches and clocks. Special section on alarm clock repairs. Fast-growing field. Satisfaction is guaranteed. Success-Catalog Free. **NELSON CO., 1139 S. Wabash, Dept. FO2, Chicago 5, Ill.**

**REFRIGERATION**

Repair, adjust all refrigerators. New large manual tells how. Charts and pictures to help you. Price only \$1. postpaid. Money back guarantee.  
**Supreme Publications, 9 S. Kedzie Ave., Chicago 12, Illinois**

**INDIANA TECHNICAL COLLEGE**  
Engineering B. degree in 27 m. s. aeronautical, Chemical, Civil, Electrical, Mechanical and Radio Engineering, 2-yr. diploma, Air Conditioning and Refrigeration; Drafting, 1-yr. Gov't approved for G.I.'s. Low rate. F.H. board. Large industrial center. Demand for graduates. Enter J.P. Sept., Dec., March. Catalogue. 567 E. Washington Blvd., Ft. Wayne 2, Ind.

**BUILD THIS HOUSE Yourself**



**The Famous Popular Mechanics House**

The picture below is from an actual photograph of the Build-It-Yourself House with breezeway and garage, as built by Jack Brownson, 23-year-old veteran, in Aurora, Illinois.

Designed by Popular Mechanics and Famous Architects. Every Detail Simplified and Explained. No Previous Experience Needed!

Can you use everyday tools as well as the average Popular Mechanics reader? Then you, too, can easily build this modern house in any of its five designs, doing every part of the job yourself. The new Popular Mechanics Book, "Your Home—How to Build it Yourself" will show you how.

**Space for Living and Family Growth**

This beautiful, modern house is 1½ stories, with basement, living room, kitchen, dining nook, two bedrooms, bath, plenty of closets and space for two additional bedrooms on second floor. The house itself is 35' 9"x28' 11"; breezeway 20' 10"x8'; garage 20' 10"x12'.

**The House That Has Everything**

Designed for easy construction and the most living space for the least cost, the Build-It-Yourself House is also most attractive and suitable for any community and most income groups. The basic plan is adaptable to four other exterior designs.

**Get Book and Plans Now—Build When You Can**

You may never have thought about actually building a house yourself, but now that building restrictions have been lifted, it is easier than you think. So order book and plans today. Even if you engage a contractor to build for you, you will need the plans. And you certainly will want the book which can easily save you hundreds of dollars, whether you build this or any other house.

**Mail Coupon for New Book and Plans!**  
Build It Yourself or Have It Built—Save Hundreds of Dollars!

**PLANS YOU CAN READ AND FOLLOW**

Plans consist of eight working-size blueprints—floor plans, elevations, construction notes, framing, joints, lumber and mill list, specifications, plumbing and wiring diagrams. Every measurement is marked—every detail made clear as ABC. Book has 100 pages—three-fifths are photographs and drawings. Some sections in color, showing just how your house will look when finished.

**BIG BOOK 8½x11 inches**



**MAIL COUPON FOR BOOK AND PLANS**

**POPULAR MECHANICS PRESS**  
200 E. Ontario St., Chicago 11  
I enclose \$\_\_\_\_\_ Send me the items checked at once.  
 Your Home and How to Build it Yourself..... \$ 3.00  
 Complete set of plans for Popular Mechanics Home.. 12.50  
 Book and plans at reduced price..... 14.00  
 Duplicate set of plans..... 5.00

Name \_\_\_\_\_  
Address \_\_\_\_\_  
City \_\_\_\_\_ Zone \_\_\_\_\_ State \_\_\_\_\_



**MAGIC**



**The Baron**

**"MAGIC AS A HOBBY!"  
LEARN OVER 100 MAGIC TRICKS**

- Easy To Do . . .
- Make Magic Your Hobby
- Amaze Your Friends

**\$1.00** post paid brings illustrated book showing how to do these tricks.

**"THE BARON"**

P.O. BOX 109

PRESCOTT, ARIZONA

**SHOP TRAINING  
and  
for G.I.'s CIVILIANS**

**APPROVED FOR G. I. AND  
CIVILIAN TRAINING**

*Not correspondence courses*

**Practical Shop Training  
America's Leading School  
7 Floors of Fully Equipped Shops  
Established 1902  
Over 45,000 Graduates  
Expert Individual Instruction  
Learn by Doing**

*You hear it everywhere:  
"GREER SHOP TRAINING IS THE BEST"*

**MAIL COUPON!**

Erwin Greer, President  
Dept. 267, 460 S. State St., Chicago, Ill.  
Please send "Shop Training Facts" on trades checked below:

- Diesel Mechanics       Refrigeration  
 Welding                       Auto Mechanics

Name \_\_\_\_\_

Address \_\_\_\_\_ Age \_\_\_\_\_

City \_\_\_\_\_ State \_\_\_\_\_

- Out of town men:  Check here if a veteran.  
 Check here if a civilian

Call, write, telegraph or phone me personally.  
—Erwin Greer

**SPORTSMAN'S BARGAINS!**

... EXCELLENT WAR SURPLUS EQUIPMENT

**NEW RUBBER LIFE RAFTS**

2-man, with oars, sail, anchor, pump, inflating tank. A water sport "must." Shpd. frt. chgs. coll. **\$29.50**

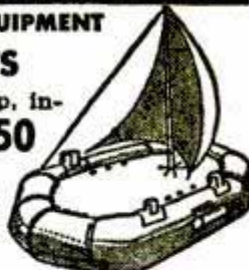

Polar Green Sun Goggles, shatter-proof, dustproof; 2 spare lenses, cowhide case, new **98c**

**MOUNTAIN TENTS (2-MAN)**



Reversible, sewed-in floor, mosquito net; poles and stakes. Shp. wt., 12 lbs., **\$9.95**

new .....  
Used ..... **\$7.45**

**SLEEPING BAGS**

Blanket-wool liner, zippered, water-repellent cover. Shp. wt., 8 lbs., **\$6.95**  
new.....  
Used, excellent ..... **\$3.95**



New Canvas Folding Cots, with mosquito net tent.... **\$7.95**  
Used, excellent ..... **\$4.45**  
Shpd. frt. coll. Send check for indicated price.

Blankets, used, OD all-wool, shp. wt., 6 lbs..... **\$3.33**  
Foul Weather Rain Suits, 2-pc., hooded, shp. wt., 5 lbs., new ..... **\$4.95**  
Compass, an outdoor necessity..... postpaid, **\$1.00**  
Combat Jackets, water repellent OD poplin; exc. cond., shp. wt., 4 lbs..... **\$3.45**

**FREE COMPASS** on request with orders for two or more items.  
**SEND AMOUNT PLUS POSTAGE**

**MIDWEST WAR SURPLUS DIVISION**

54-A South 3rd Street

Minneapolis 1, Minn.

**MAKE YOUR OWN SPARKLERS**

Harmless Chemical Set—Everything-complete including instructions for making your 4th of July Sparklers. Order Now—Supply Limited.



**ONLY \$1.50** Per Set Postpaid

C. C. Groff, 116 S. Broad St., Lancaster, Pa.

**Raise GOLDEN HAMSTERS**

The new wonder animals. Look like toy bears. Delightful pets. Everybody wants them. Thousands needed by laboratories. Make money, get started now. Send 10c for illustrated literature, or send \$5 for a pair of hamsters and literature.



**GULF HAMSTERY, 1536 BASIL ST., MOBILE 17, ALA.**

**YOUR OWN BUSINESS!**



MAKE MONEY in your own home, spare room, basement, garage! Manufacture popular "Plastex" plaques and figurines. Everything furnished! 5c material makes \$1.00 seller! Start spare time. Full cooperation given. Pleasant business; small capital; BIG PROFITS! Write for FREE literature.

**GENMERC, BOX 142, DORCHESTER CENTER, MASS.**

**GUITARISTS Now Ready by HARRY VOLPE**

Twelve Swing Choruses..... **\$1.00**  
(contains 12 swing versions of the Classics for the hot guitarists)  
Volpe's Guitar Journal No. 1..... **\$1.00**  
(contains 11 solos, originals, and arrangements with text and explanations for each solo)

**VOLPE MUSIC CO. 32-18 88th. St., Dept. M-6, Jackson Heights, N. Y.**

**"AGE-CAKE ANY PIPE"**

IN ONLY THREE SMOKINGS "KAKE-IT" gently breaks in and sweet-cakes the most stubborn of pipes, leaving a perfectly set bowl cake. Simple and easy to use, "KAKE-IT" performs, almost overnight, what formerly required weeks of time and work, makes any pipe a better smoke. **DOLLAR SIZE BOTTLE ENOUGH FOR SEVERAL PIPES.**

**KAKE-IT BOX 524 STUDIO CITY, CALIFORNIA**

**Learn BAKING At Home**

Baking is one of America's high industries in wage. Nearly depression-proof. Thorough basic home course lays sound foundation. If you have aptitude, write for **FREE BOOKLET.** Opportunities in Commercial Baking. **National Baking School, 1315 Mich. Ave., Dept. 135A, Chicago**





**BIG MONEY and YOUR OWN BUSINESS**

**LIQUID IVORY**



**FREE INFORMATION ON A GREAT NEW MONEY-MAKING OPPORTUNITY**

Regardless of your age, sex, previous experience, we will send you astonishing free facts about the unlimited possibilities—in your own business—with amazing LIQUID REPLICATED IVORY. To secure this information, absolutely free, fill in coupon below or send a letter or postcard. No salesman will call on you now or ever. Write TODAY! Offer limited!

LIQUID IVORY is one of the most marvelous synthetics developed in years. With it you can easily and simply produce a wide variety of wonderful items that almost defy detection from genuine ivory. No expensive equipment is needed. You can work in a corner of your basement or garage with a few hours of work producing handsome profits. Here is unexcelled opportunity for all ambitious people that want a profitable business of their own.

**Greatest Opportunities NOW!**

Stop being a slave to a time clock! Stop worrying about lay-offs and depressions stealing your livelihood. NOW is the time to line up your own money-making business. We offer this great opportunity to aggressive people. Get into your own profitable business with LIQUID IVORY. Get the FREE FACTS today!

**EMPIRE TRADES and HANDICRAFTS**  
Box 1340 -PM St. Louis, Mo.

**SEND FOR FREE DETAILS**

**A MONEY-MAKING BUSINESS FOR THE LITTLE MAN! NO EXTENSIVE CAPITAL NEEDED!**  
Forget big investment worries. We tell you how to get your own fast-moving business going with very little money. We feature only one sound business course. You will never find us confusing this successful vocation with other diverting business ideas. We tell you all about one great business and how you can make money in it exclusively. Write for full FREE information today!

**FREE INFORMATION COUPON**

**EMPIRE TRADES & HANDICRAFTS, BOX 1340-PM, ST. LOUIS, MO.**

Please send me free details about your BIG money making LIQUID IVORY. I am anxious to get started in a profitable business of my own. Please rush!

Name .....  
Address .....  
City ..... State .....

**Made To U. S. Army Specifications!**

**15 JEWEL ELGIN \$18.95**



Sturdy 15 Jewel ELGIN men's wrist watches. Waterproofed. Sweep second hand. Stainless Steel case. Unbreakable crystal. QUALITY! American made. Fully reconditioned with ONE YEAR GUARANTEE! Made for the U. S. Army Air Corps, they HAD to be good. SEND NO MONEY. Simply pay postman \$18.95 plus 10% tax and postage on delivery. Cash orders sent postpaid. Limited Supply.

**UNITED PRODUCTS CO.**

7941 S. Halsted St. Chicago 20, Ill. Dept. WES-109

**BECOME A MANUFACTURER'S AGENT**

Be your own boss and earn big profits with little or no capital investment. Send today for the VIMAR PLAN which provides you in detail with soundly-tested methods on how to become a representative for prominent manufacturers. Learn how to contact concerns, select products and build a successful business for yourself. \$2.00 postpaid.

**VIMAR CO. 210 LOEB ARCADE, Dept. A-12 MINNEAPOLIS 2, MINN.**

**STAMMER?**

This new 128-page book, "Stammering, Its Cause and Correction," describes the Bogue Unit Method for scientific correction of stammering and stuttering—successful for 46 years. Benj. N. Bogue, Dept. 1849, Circle Tower, Indianapolis 4, Ind.



**FIREWORKS OH-BOY!**

Banner has always been right there with the newest and best in fireworks. Now we offer you sensational new creations you never heard of before. Thrills galore. You'll be the envy of your friends and neighbors when you start celebrating with BANNER FIREWORKS... always rock bottom in price.

**BIG SPECIAL DEAL—ONLY \$4.95**

Big giant assortment of over 150 pieces including Salutes, Roman Candles, Sky Screamers, Chinese Firecrackers, Sparklers, Vesuvius Fountains, Aerial Bombs and many others... regular \$10.05, retail value for only \$4.95. Rush your order. Supply limited, Catalog FREE.

**BANNER FIREWORKS MFG. CO., INC., DEPT. 242**  
446 Capistrano Toledo 12, Ohio

SAY YOU SAW IT IN POPULAR MECHANICS

**NEW PLASTICS Fabricating MANUAL**

**HOW TO USE Plastic AT HOME**  
NOW ONLY 25c

Make beautiful objects of Plexiglas, Lucite, Catalin, Polystyrene at home. Jewelry, novelties, accessories. Send for new 10,000 word manual on how to fabricate, weld and form latest plastic materials in home workshop. Hundreds of practical suggestions. Written by leading plastics engineer. Price prepaid 25c (stamps or coin). Or get FREE information and price list covering transparent plastic sheets, rods, tubing cut to your size. Write today: **HOUSE BEAUTIFUL PLASTICS**, Dept. G3, 5534 W. Harrison St., Chicago 44, Ill.

PROFESSIONAL TRAINING IN A MINIMUM OF TIME

**RADIO-ELECTRONICS TELEVISION • BROADCAST ENGINEERING**

An Accredited Technical Institute nationally recognized for high calibre training. Prepares high school graduates for technical careers. Classes start every Monday. Comprehensive courses in Radio-Electronics Engineering, Broadcast and Television Engineering, Broadcast and Television Servicing; 2,100 hours classroom and laboratory study. Write today for free informative booklet, "Radio Engineering as a Career."

**CAPITOL RADIO ENGINEERING INSTITUTE**  
DEPT. P-6, 16th STREET & PARK ROAD, N. W. • WASHINGTON 10, D. C.







Make more money  
arc welding  
with the new  
**HOBART** welders



Gasoline Drive  
Arc Welder



"Build Your  
Own" Generator



A.C. Arc Welder



**Hobart**

"One of the World's Largest Builders of Arc Welders."

Check through these money-making features: **THEY'RE SIMPLIFIED** . . . sturdy and compactly built from finest materials, gives you outstanding performance. Has convenient controls.

**SMALL INVESTMENT** . . . when compared with the bigger profits and superior quality welds you get with a HOBART "behind the arc."

**IMMEDIATE RETURNS** . . . from profitable welding jobs in the field, in production and on maintenance work. Multi-Range Dual Control and Remote Control save time, cut costs.

**"BUILD YOUR OWN" ROAD TYPE WELDER** . . . HOBART shows you how to save from \$300 to \$500 by building your own welder, using a HOBART Generator only, a reconditioned auto engine and chassis. Booklet on request, tells you how.

**HOBART A.C. WELDER FOR SINGLE PHASE** . . . Specially designed to bring improved alternating current welding performance to shops having only single phase 220 volt power.

**BECOME AN EXPERT . . . ENROLL IN HOBART SCHOOL** . . . The best of training at low cost, use latest up-to-date equipment. Learn in a modern building with complete equipment and experienced teachers.

**HOBART BROTHERS CO.,**  
Box M-67, Troy, Ohio, U.S.A.

**Free!**

Literature  
and details.  
**CHECK.**

**HOBART BROS. CO., Box M-67, Troy, O.**

Send me information on items checked, no obligation.

- Gas Drive Welder  "Build Your Own"  
 HOBART A.C.  Electric Drive

NAME \_\_\_\_\_

ADDRESS \_\_\_\_\_

FOR YOUR COLLECTION . . .

**FREE METEORITE**

READY TO MAIL! Rare, valuable, genuine METEORITE from Arizona's famous meteor crater. Makes important addition to any collection. Mounted on card containing complete description.



Given With Order for Sample Copy of  
**America's Newest Geology Magazine**

Features the scientific and human interest side of geology. Packed with absorbing articles, photos, maps, etc. Contains most complete information about sources of minerals, fossils and supplies. Invaluable to students, teachers, collectors, hobbyists, gem cutters. Used in Geology Dept. of leading universities. Fascinating. Issued monthly.

WRITE for big Sample Copy. Get FREE Meteorite. Send name and only 25c for packing and mailing. Supply limited. **ORDER YOURS NOW!**

**THE EARTH SCIENCE DIGEST, Box P-57, Omaha 3, Nebr.**

**V-8  
DUALS  
& SINGLES**



**MUFFLERS**  
**STEELS and ALUMINUMS**  
with a motorboat tone

SINGLES, Chev, V-8, Plymouth, Steels \$5.50, Aluminum \$6.50. Chry., Olds., Buicks, etc., Steels \$7.50, Aluminum \$8.50. V-8 and MERCURY DUALS, Steel \$17.50, Aluminum \$20.00. Aluminums are guaranteed for life of your car.

**DEALERS WANTED**

**SANDEE MUFFLER CO.**  
7523 S. WESTERN AVE., LOS ANGELES 44, CALIF.

**ENSHRINE THEIR MEMORIES WITH**



**U. S. MONUMENTS**

There is none better. Our free catalog is ready for you. Write today. A-18 U. S. Marble & Granite Co., Oneco, Fla.

**\$14. UP**  
Freight Paid

## HERE'S WHY SKIN TROUBLES DON'T HEAL!

**PIMPLES, ITCHY TORMENT  
SCABIES, RING WORM, ETC.**

## ATHLETE'S FOOT

are so often externally caused by germs deeply imbedded in the skin. (Staphylococcus pimple festering, tinea, fungi, etc.) You can try everything under the sun that acts on the surface only, and still have your trouble—until you try Clinically Proven RIDD, the flesh-tinted powder, that penetrates to kill these germs deep under the skin. Then normal healing can quickly result at last! For instance **ATHLETE'S FOOT** relief actually starts in 5 to 20 minutes with RIDD! So if you still have these common externally germ caused skin troubles **YOU HAVEN'T TRIED RIDD!**

**RIGHT NOW CLIP THIS AD. TAKE IT TO YOUR DRUGGIST!** If he is not stocked with RIDD, he will quickly obtain it for you on request. Otherwise we will supply you direct, postpaid, on receipt of \$1.00, providing you include in confidence name and address of your druggist. Full refund by makers on return of bottle if not positively overjoyed at results!

**RIDD LABORATORIES, INC., Box 266, Dept. 5**  
Edmonds, Wash. (Suburban Seattle)



# UP TO **SAVE 85%** in **WAR SURPLUS**

SENSATIONAL VALUES  
at **GADGETEER'S HEAVEN**  
IN MANY ITEMS WE HAVE THE WORLD'S LARGEST SUPPLY

### New Hydraulic Cylinders

VALVES, PUMPS, FITTINGS, HOSE & TANKS

The World's Largest Supply. 1001 Labor Saving Adaptations for pulling, pushing, lifting operations.

Finest precision workmanship and materials. Liquid and/or air operation, developing terrific power.

**15% OF GOVERNMENT COST!**  
Write for Catalogue



### A Real Buy!

#### A 1001 USES! WINCH HOIST

Capacity 2500 lbs. Controlled worm gear drive winch with 19 ft. 1/4" diam. alloyed steel cable. Ideal for garages, truck loading, machine shops, boat building, etc.

#100 Without handle..... \$10.75  
#100 With handle..... \$12.50



### Dry Cell BATTERIES

NEW! FULL STRENGTH

For portable Radios, Signal Lamps, Boats, Electric Trains, etc.

#516 9 Volt 8 1/2 x 6 x 4 in. 3 run, 24 Volt Motor ..... 79c  
#515 90 & 1 1/2 Volt ..... 69c  
#517 67 1/2 & 1 1/2 Volt Battery ..... 69c



### PNEUMATIC RIVET

#180 Goose-neck  
#181 Pistol

### GUNS

Pistol & Gooseneck Type  
1001 Uses - Chipping Hammer - Beating Carpet - Chicago Pneumatic, Cleco, Ingersoll Rand Makes.

E3, E2, 3X, 2X, OY  
\$55 Value  
**\$8.95**

#186 Squeezer  
PNEUMATIC ALLIGATOR SQUEEZER  
\$80 Value  
**\$15.95**



### MESS TRAY

6 COMPARTMENTS  
Rustless, Stainless Steel.

Can be used for cooking as well ideal for restaurants. The perfect companion for that vacation trip, barbecue picnic. Saves dishwashing.

#311 ..... 69c ea.



### PLEXIGLASS DOMES

15"x19 1/4"x6" deep, 1/4" thick.

Can be used for home hot-house, fish bowl, washbowl, ornamental light. Can be flattened in oven and will make flat sheet. 15"x19 1/4" x 1/4". Weight 3 1/4 lbs.

#700 ..... \$1.69

Also 200,000 lbs. of other plexiglass sizes and shapes.



### NEW Amplidyne Motor-Generator

With 24 volt current, it gives 80 volt output. This unit has been adapted to independent and stand lighting power.

Welding and many other uses.  
Weight 29 lbs.  
Gov't. Cost Approximately \$237.00

#511

A Steal at **\$8.95**



### AIR DRILLS

CLEVELAND THOR CHICAGO

Straight Angle Drill  
#196  
Straight **\$17.95**  
Angle Drill **\$19.50**



### WINDSHIELD WIPER KIT

1/6 H. P., 24 volt, D. C. series wound motor, with 30" flexible shaft, switch circuit breaker, 10,000 forward or 5,000 reverse R. P. M.

Wiper & wiper bracket, arm blade & switch.

only **\$7.95**



### Electric GYRO PILOT

Assembly Part 2 solenoids for reverse and forward motor control. 2 solenoids throw clutch to engage drive. With brake assembly. Can be used as boat rudder control, converted for lath tapping and slow speed motor tool, wt. 29 lbs. Finest precision workmanship

Cost Gov't. Thousandd  
Your Cost **\$8.95**

#513



### OPTICAL GYROSCOPE!

MARK 18 GYRO-SIGHT

An engineering marvel worth hundreds of dollars - Our Price **\$8.35**

Airforces Gun-Sight, #103 N8A, with polarizing variable density \$2.95  
L3 Type, #102, Triple Lense \$1.95

#150



### ELECTRIC DRILLS

CLARK and THOR

110 V. A.C. 50/60 cycle, 1/2 drill bit & JCB Chuck. Both side and trigger handle. High Speed. For commercial or home use. The best there is. Gov't. Cost Approx. \$60.00

**A TERRIFIC VALUE \$17.95**

#197

### PRESSURE TANKS

Stainless steel, shatter proof, 400 lbs. /sq. in. G-1 2100 cu. in. 26 x 12 in. #105 **\$4.75**  
D-2 500 cu. #104 **\$2.25**



### COMPASSES

#151 Marching, lens-less, with luminous dial ..... \$1.69  
#152 Matchbox, both jewel & liquid floating dial ..... 39c  
#153 Jeweled Pocket Watch Compass ..... \$1.19  
#154 Wrist strap Compass ..... 69c



### COMPARE THESE PRICES

#301 CANTEEN, 1 qt. alum., plastic top ..... 29c  
#302 MESS KITS, 2 pc. alum. .... 39c  
#304 FISHING KITS - Excellent fishing knife, hook & line, mackerel & feather jig, pork rind bait, abrasive stone, hooks, triple hook jig, dip net, sm. harpoon \$3.95  
#400 WORK HELMET, Alum., 12 oz. 59c  
#510 & 511 Amp. & Volt Meters ea. \$2.50  
#303 SLEEPING BAGS, New, 100% wool Mummy type, heavy 30" zipper Water Repellent Cover \$1.60 Extra. \$4.95  
#305 GOGGLES, New colored flexible lens. Shatterproof. Sponge Rubber Frame ..... 59c

Air Corp Fleece Lined Leather Jacket, used... \$8.95

#106 HOBBYISTS - LOOK! GADGET MIX Rivets, spacers, nuts, clamps, bolts, gears, Radio parts, etc. A gold mine ..... 5 lbs. **\$1.19**



### 1/3 to 1/5 Gov't. Cost (approx.)

#### Air Corp Fleece-lined LEATHER JACKET

To keep you warm in the coldest wind.

- Made to last practically a lifetime.
- Full angora felt
- Fleece-lined collar.
- Leather taped seams
- Full length zipper.
- 2 zippered, deep, slash pockets.
- Adjustable strap & buckle at throat.
- Type D-1. Styled for easy, hand-free action.
- Soft, pliant, "aviation tan" leather.

Made to U. S. gov't. specifications - "and seed"

Sizes: #401, small; #402, medium; #403, large. You've never seen them at **\$10.95**

Used (best cond) **\$8.95** WHILE THEY LAST!



### Valuable GEARS Bargain!

8 to 1 ratio, splined drive ..... \$112 \$2.99  
4 to 1 with screw shaft ..... \$111 \$4.95

45 to 1 (can be used for radio antennas, etc.) ..... \$112 \$3.95  
2 to 1, Box gear type ..... \$113 \$4.95  
1 to 1 ..... \$114 \$3.95  
Flexible gear shaft with and drives 30" ..... \$115 1.00



### All Purpose H A M M E R

As a hammer combination for wood & metal work. 3 1/2 lbs. 14 1/2" hardwood handle, hand steel cutting edge. 69c

Compound METAL SNIPS Action Hard steel blades. Expansion spring. Locking device. Now **\$2.59**



### SPRING MIX

Torsion, compression and tension springs. Assorted. A shelf treasure for emergencies! - 2 lbs. **89c**

#206



### ELECTRIC SOLDERING IRON

#198 200 WATT 'SOLDER MASTER' **\$3.95**  
105, 110, 120 Volt Nut-Sed

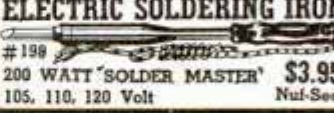

### RUBBER GOODS

RUBBER PAD 28 x 26 in. 1/4" thick, \$1.95 Soft & springy. Ideal fastener for workbenches. Stand on their feet - Chisels, Draw-staves, machinists, etc.

NEOPRENE SHEET RUBBER

Thick.	Price per sq. ft.
1/32	\$1.25
1/16	\$1.50
1/8	\$1.75
3/16	\$2.00
1/4	\$2.25
5/16	\$2.50
3/8	\$2.75
1/2	\$3.00



### COMPRESSOR

complete with tank and fittings. G. E. 2-stage, A.C. or D.C. 1/3 h. p. 1000 lbs./sq. in. Spraying, laboratory use, inflating. NOW #506 ..... \$17.95

Compressor and 24 volt motors can be adapted to 110 A.C. with transformers or 4 1000 heating elements. We stock both.

ELECTRIC MOTORS  
New 1/2 H. P. 27 Volt D. C. 24 Volt A. C. #500 \$5.45  
Used 1/2 H. P. 27 Volt D. C. 24 Volt A. C. #502 \$3.95

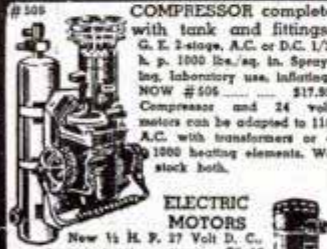

### BOAT FENDER

21 in. long 5 in. diam. Protection against docks for small boats. **\$6.50 VALUE A STEAL AT \$1.95**

#313

3/16" JUTE ROPE  
3 Thread Strand, Right Lay 50 Ft. ..... 79c  
1/8" SISAL ROPE  
50 Ft. ..... \$3.59  
5 lb. Ball 3/16" Hemp Twine Traveled ..... \$1.49 #314

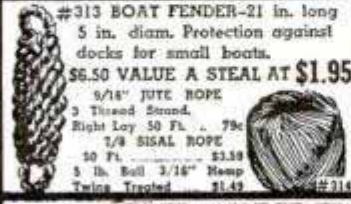

### Fire Extinguishers

KIDDIE LUX CO2 TYPE  
Built to Government Specifications. 4 lb Trigger Control with horn. Fully recharged. \$30.00 Value ..... \$10.75

2 LB. CO2 TYPE  
Value \$22.50 ..... \$8.75  
15 lb. Ueche, Nozzle Control Value \$70.00 ..... \$7.50

Indispensable for small or large planes, trucks, auto. home, factories, etc.

#601 NEVER AGAIN A BUY LIKE THIS!



### LEATHER FLEECE-LINED BOOT INSERTS

For hunting or around house as slipper. sizes: medium, large

\$7.00 Value  
**\$1.89 pr.**

#312



**ORDER DIRECT FROM THIS AD**  
All sales final. Make remittances by money-order, bank draft or personal check. Purchase orders acceptable from D & B firms. All quotations F.O.B. Los Angeles. BIG ILLUSTRATED CATALOGUE AVAILABLE Also Aircraft Supply Catalogue

### TRANSFORMERS

For Remote Control G. E. Model 27.1G.1 57.5 volts, 400 cycle #514

COST \$60.00  
OUR PRICE **\$3.95** Each



# PALLEY SUPPLY CO.

THE LARGEST FIRM OF ITS TYPE IN THE WORLD

DEPT. P. M. 67 - 6321 SAN FERNANDO RD.  
GLENDALE 1, CALIFORNIA  
GREATER LOS ANGELES COUNTY



It's smoother sailing  
when you've got P.A.\*

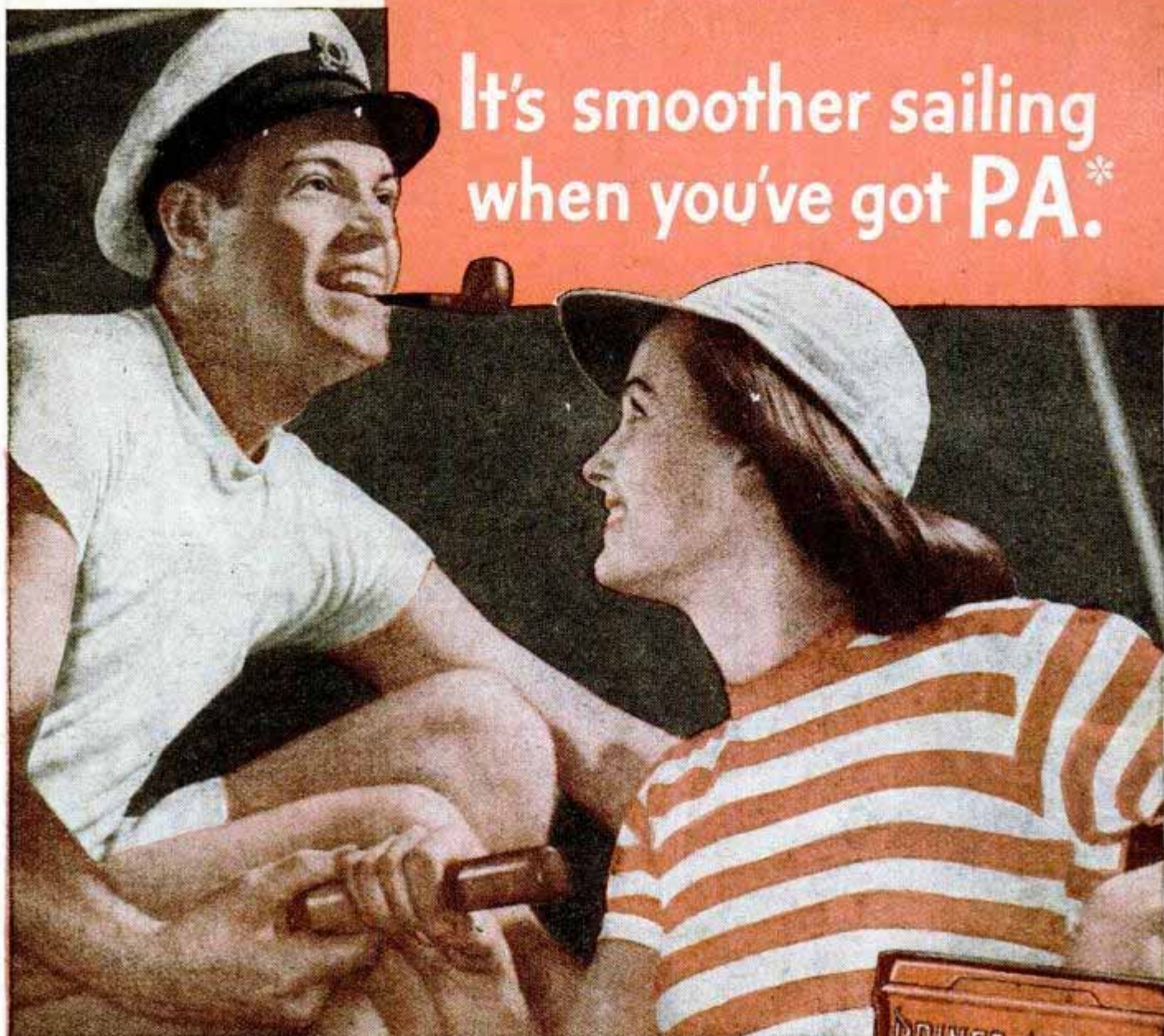

**P.A.\*** means **Pipe Appeal**

When a man smokes a pipe, he has a masculine attractiveness that women find appealing! And, when he smokes Prince Albert, he has a rich-tasting smoke that's easy on the tongue!

**P.A.\*** means **Prince Albert**

Try Prince Albert and you'll agree—it's a great tobacco! P.A. is *crimp cut*—packs and cakes just right in your pipe . . . smokes cool and even right down to the bottom of the bowl.

R. J. Reynolds Tobacco Co., Winston-Salem, N. C.



**The National Joy Smoke**

A GREAT CIGARETTE TOBACCO TOO.  
NOTHING LIKE P.A. FOR FAST, EASY  
ROLLING AND TASTY SMOKING!

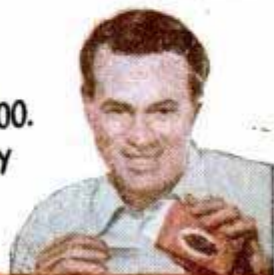



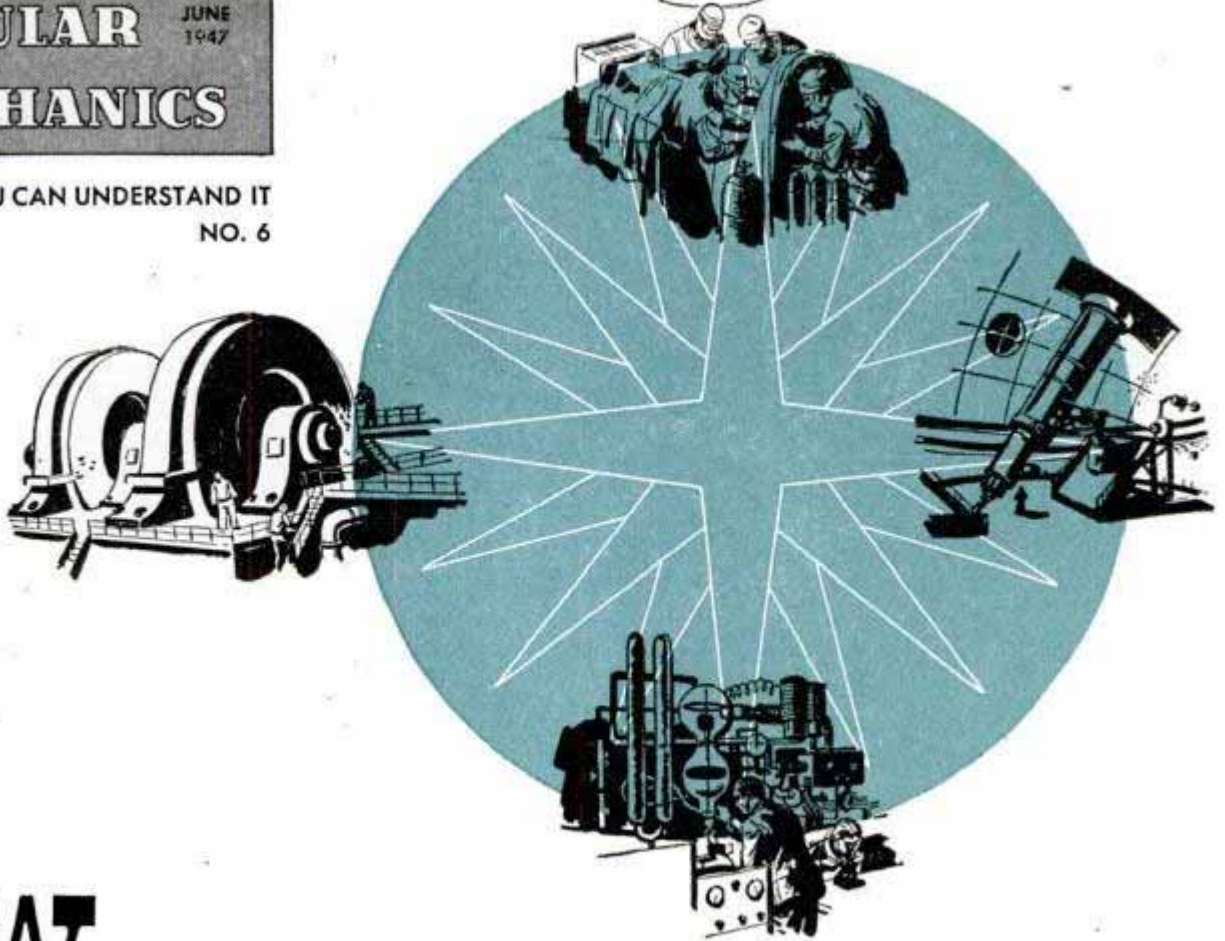

# Where are our **new** frontiers?

**C**RYSTAL gazing is a fascinating but perilous business—and especially so when we are dealing with a rapidly changing technology. If it were really possible for us to foresee tomorrow's inventions and discoveries, we would not need to wait for tomorrow—we would start using them today. But even admitting our inability to predict specific developments, it may still be possible to determine something about our probable future course by recognizing such trends as are already available to us.

Since 1860 there have been four broad eras of industrial development in the United States. Each has covered a span of roughly twenty years. The first, from 1860 to 1880, might be called the Railroad Era—a period of great geographical expansion, of bridges, tunnels and other mammoth civil engineering works.

From 1880 to 1900 was an Electrical Era: the period of the telephone, the electric light, the polyphase AC system, and countless developments in electrical machinery. It was the period of the electrical engineer.

From 1900 to 1920 was, by and large, a Mechanical Era. The automobile and the airplane were its dominant developments.

From 1920 to 1940 was, I believe, largely a Chemical Era. High-octane fuels, plastics, synthetic fibers, chemical agriculture and other chemical developments were among outstanding products.

What shall we say of the period from 1940 to 1960—the period in which we are now engaged?

The first thing we should notice about this period is that it is an era of expanding research. According to figures recently published by the National Research Council, the number of scientific personnel in industrial research laboratories has nearly doubled since 1940. It is interesting to observe that the greatest increase has been in the number of industrial biologists and bacteriologists, although these are still a relatively small group compared with the enormous number of chemists, engineers and physicists employed

by  
*Charles F. Kettering*  
Vice-President,  
General Motors Corporation  
General Manager,  
GM Research Laboratories Division





in industrial research. Chemists, engineers and physicists have also increased to a considerable extent. Metallurgists have increased only slightly over 1940.

Since industrial research laboratories are the "cradle" of most new technological developments, these figures on the relative growth of various professional groups engaged in industrial prospecting have a special significance for any "look ahead" at probable future developments.

Of equal significance to the scientific crystal gazer is a knowledge of the trends of present-day research. New developments are always evolutionary rather than revolutionary. A hundred years of steam development preceded James Watt's invention of the successful steam engine. Still another hundred years were required to bring the internal combustion engine to a state of relatively high perfection. The airplane was "in the air" for some forty years before the Wright brothers finally achieved mechanical flight. Always new developments take shape progressively, step by step. Never do they make their first appearance in their final form. Consequently, if we know which fields are advancing most rapidly today, we may gain an insight into what the future holds for us.

Probably the most dramatic and active field of scientific research today is the release of energy by atomic fission. The same tremendous energy that was so devastating as a weapon promises to have valuable applications in our normal peacetime endeavors. This is such a new field that one would be reckless indeed to make dogmatic predictions regarding it. There is still a great deal to be learned about controlling and utilizing atomic power. Some of these factors are being investigated in the government's atomic power pilot plant at Oak Ridge, Tenn. Whatever the outcome of these investigations, we may be sure they will have an important bearing on tomorrow's developments.

Another field which is developing with great rapidity is petroleum refining. A few years ago refining involved only two relatively simple processes—distillation and thermal cracking. Then, as a result of in-



industrial research, it was discovered that differences in molecular structure have an important effect on the knock quality of automotive and aviation fuels. The refining processes which had served the petroleum industry for so many years would no longer do—they produced gasolines containing the wrong kind of molecules. Consequently, one of the main efforts of petroleum research during the last decade has been to develop new processes which would yield special molecules of the proper shape and size. As a result, the old processes have been largely superseded by these new processes—hydrogenation, catalytic cracking, isomerization, polymerization, alkylation, hydroforming, and so on—insofar as the production of high-octane fuels is concerned. The petroleum industry is still spending millions of dollars annually on this kind of research.

Despite a background of development extending back even to prehistoric times, metallurgy is still one of the most active fields of industrial research. It is likely to continue so, because our requirements from metals are growing ever more critical. Loads are becoming heavier and heavier, speeds are increasing, service conditions generally are becoming more severe. At the same time, we expect metals to satisfy a growing multitude of conditions with respect to machining, drawing and working in mass-production processes. These facts, coupled with the equally important fact that we are only now beginning to acquire a real understanding of the complex structure of iron-carbon-alloy solutions, point to a very promising future.

As yet man has not been able to satisfy his appetite for speed—nor is it likely that he ever shall. Among the main efforts of the present-day aeronautical research is the raising of aircraft speeds into the supersonic range, that is, in excess of the speed of sound (about 760 miles per hour). One of the difficulties inherent in such extremely high speeds is the rapid increase in drag, due to the compressibility of air, as moving objects approach sonic speed. This difficulty has been overcome to the extent that





aircraft have recently been clocked at over 600 miles per hour; further increases may be expected as a result of continuing improvements in airfoils and power plant. Whatever we learn about aircraft performance and characteristics when we finally penetrate the so-called "sonic barrier," and it appears likely that this may be accomplished in the near future, we may be sure



that it will have a profound effect on the whole future of aviation.

There is a great deal of confusion in the mind of the average person regarding the place of synthetic resins, or plastics, in the hierarchy of present

day materials. Plastics, like all other materials, have their advantages and their limitations. While it is not likely that we shall have all-plastic automobiles, or similar visionary products such as so often have been predicted, we shall undoubtedly see an increasing use of plastics in those applications for which plastics are uniquely adapted. There are certain jobs that plastics can do better than any other widely available material; one of the first large-scale uses of plastics, ignition apparatus for automobiles, is a typical example. Another more recent example is the use of silicone resin, a new plastic possessing resistance to temperatures ranging as low as  $-75$  degrees Fahrenheit and as high as 500 degrees Fahrenheit,



in gaskets for turbosuperchargers and in conjunction with Fiberglas as insulation for electric motors.

In any "look ahead" at our new frontiers, we should not overlook television. Since the first electronic scanning device for modulating a carrier wave with video signals was developed in 1923, television has made rapid strides toward commercialization. Authority to begin television broadcasting was, in fact, granted by the Federal Communications Commission on July 1, 1941, but American participation in the war prevented its fulfillment at that time. Now we should see a tremendous expansion of this potentially important industry.

Electronics has made tremendous strides in recent years, particularly in the ultra-short-wave regions. One of the most spectacular recent applications of electronics

is the electron microscope, a development certain to have an enormously stimulating effect on many fields of industrial research. Making possible visual magnifications as great as 30,000 diameters, compared with 2000 diameters for the optical microscope and 3000 diameters for the ultraviolet microscope, the electron microscope makes it possible to "see" large



molecules. The usefulness of this new research tool in the study of viruses, colloids, catalyzers, surface chemistry, pigments, ceramics, plastics and many other fields will be immeasurable.

There is one field of development which probably merits our attention and encouragement more than any other—that is man's fight against disease. Sulfa drugs, penicillin and synthetic antimalarials are only a few of the outstanding new pharmaceuticals which have been brought to clinical usefulness during the last decade or so. There is no reason to believe that we have yet scratched the surface of the ultimate full usefulness of these new materials. While there are, for example, five well-known sulfa drugs at present, there are actually some 2000 possible compounds of this type, many of which are under active investigation. In the case of penicillin, a product of the green mold *penicillium notatum*, we have recently discovered the existence of four distinct



active principles—penicillins F, G, X, and K—but there are undoubtedly many others among the 50,000 or more known molds and fungi. In the case of synthetic antimalarials, over 14,000 different compounds were investigated during the war, leading to several new and important drugs for the treatment of malaria, and yet our conquest of this disease has only begun. This is an important field—one which will keep doctors, bacteriologists, biologists and chemists busy for many years.

These are only a few representative examples of our new frontiers. There are dozens more which could be mentioned if space permitted. But incomplete though the list may be, it should give us assurance that we have by no means reached the end of our progress—we have only begun to explore the limitless frontiers before us.



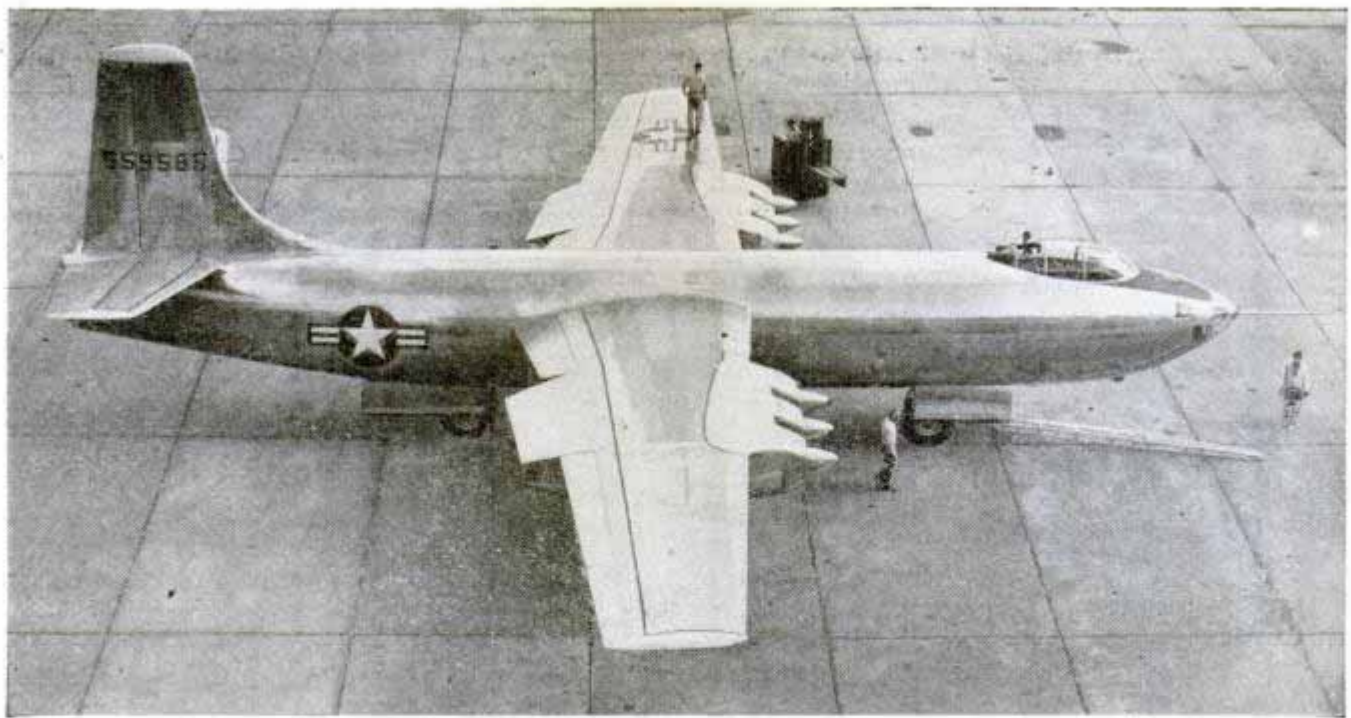

Martin Aircraft photos

First trials of the bicycle-type landing gear developed for the jet XB-48 were made on a Martin Marauder

## BOMBER RIDES "BICYCLE" LANDING GEAR

Wings too thin to house conventional landing gear have made it necessary to develop a new bicycle-type gear for a six-jet AAF bomber. The XB-48's wheels, one behind the other, are drawn up into the fuselage instead of into the wings or engine nacelles. One is far forward and the other is aft of the bomb bay. Two smaller and thinner wheels mounted near each

wing tip prevent the plane from tipping when it taxis or halts. Martin engineers ran lengthy tests of the gear on a Marauder before installing it on the high-speed long-range bomber. The XB-48 has a wing span of 108 feet 4 inches, length of 85 feet 9 inches and is 27 feet 6 inches high. Three General Electric gas turbine engines are grouped in each wing.

## Beetles "Tagged" With Radioactive Disks to Study Their Migratory Habits

Migratory habits of beetles are studied in England with the aid of a Geiger-Muller counter, the radiation-detecting instrument used in atom-smashing experiments. Seeking new ways to combat crop pests, British scientists glue tiny disks of radioactive ma-

terial to the wings of captured beetles which are then turned loose. A Geiger-Muller counter, carried a few inches above the ground, makes a ticking noise when it comes close to a "tagged" beetle. It even spots beetles four inches underground.



## Flame Projector

Engineers, using a flame projector, are studying the private lives of different types of flame as an aid in improving the design of jet engines for aircraft. The actual flame is reflected by a series of lenses and the magnified image is thrown on a screen. By measuring the cone in the center of the flame Westinghouse engineers can determine the speed at which fuel is converted into heat. This information is vital in the design of aviation and turbine engines.

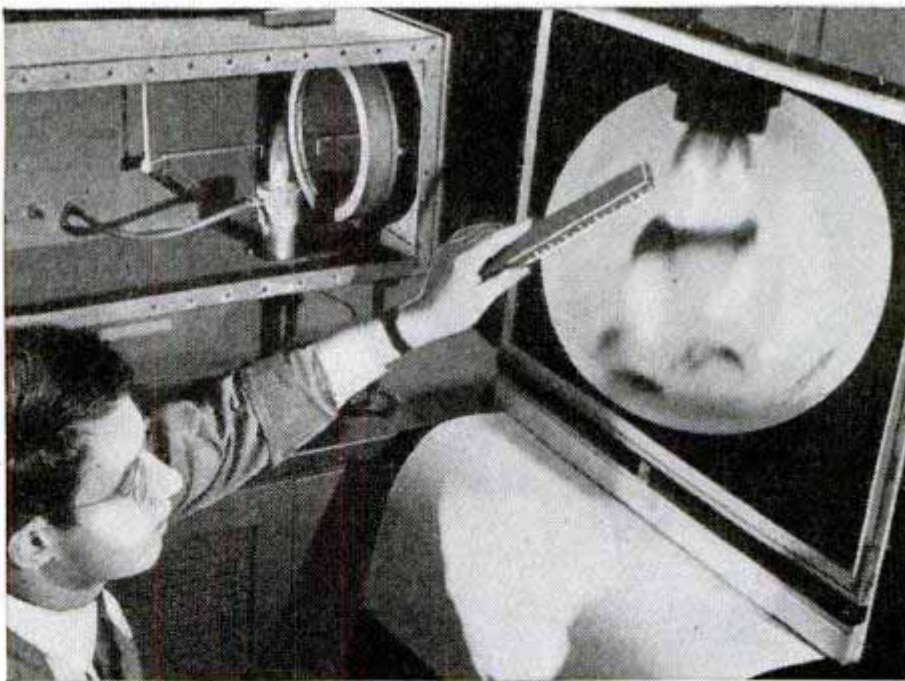

## Flash-Gun Shield

With a light-diffusing shield for flash guns that swings up out of the way it is not necessary to remove the shield to insert new bulbs. Use of the shield helps to prevent "burned out" and "chalk-white" pictures. The shield is a spring-tension hoop attached to the flash-gun reflector. The spun-glass diffuser disk is held in the hoop and is easily replaced if broken. Heat of the flash bulbs will not discolor the disk.

## Giant Electromagnet

More than 200 tons of steel went into a giant electromagnet built for Carnegie Institution's new atom-smashing cyclotron. The powerful magnet was cast in six pieces of flawless steel, then machined.

Popular Mechanics is always ready to supply further information to readers about various products described in any issue. Just write to Bureau of Information, Popular Mechanics Magazine, 200 East Ontario Street, Chicago 11, Ill., for a prompt reply

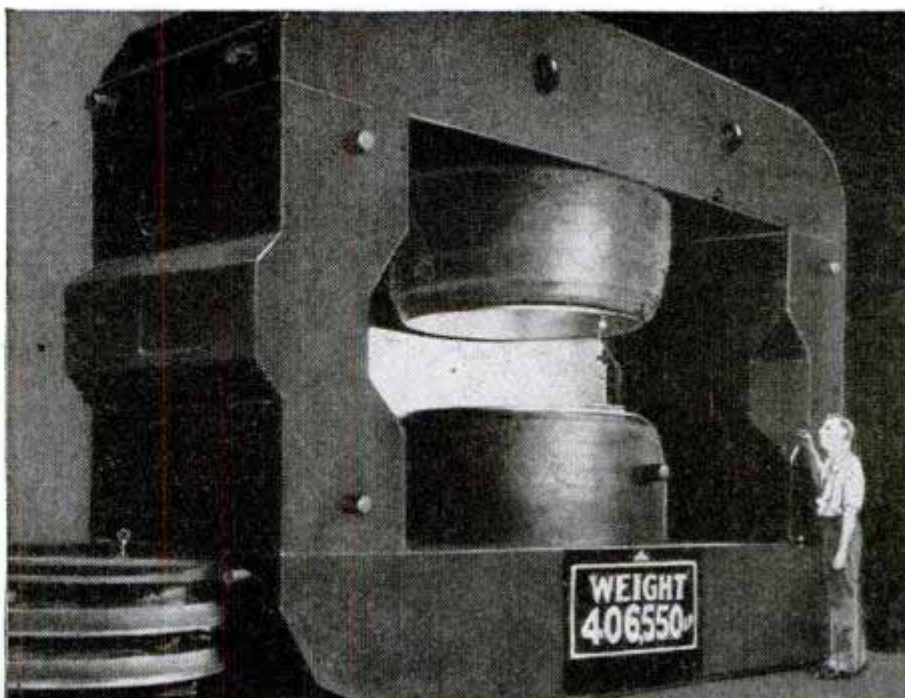





Photos by Sy Friedman, NBC

Television camera (above) records an actual operation at Johns Hopkins Hospital and transmits the action pictures to receivers viewed by medical students (below). Upper right, control units

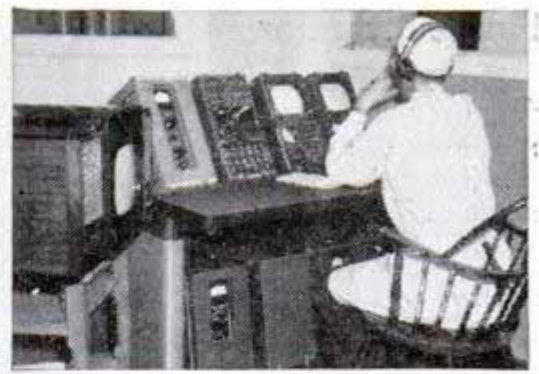

## Televising an Operation

Five surgical operations were televised recently by Johns Hopkins University and Hospital and RCA to test television as a means of teaching medical students. Two supersensitive cameras were used. One was mounted on a light fixture 4½ feet directly above the operating table. The second camera, equipped with telephoto lens, was set up in the gallery of the operating room. The camera over the operating table was preset and controlled automatically. A microphone above the table carried the surgeon's voice as he commented on the operation. Ten receivers permitted the operations to be viewed by 300 doctors. Television lifts the physical limitations of operating room amphitheatres which restrict the visibility of medical students.





## Electrochemical Rod Prevents Rust

To prevent rust from forming in hot-water tanks, a rodlike attachment made of special alloy can be installed in the hot-water outlet. Made in one-inch and  $\frac{7}{8}$ -inch-diameter sizes, the rod produces an electrochemical reaction that inhibits the formation of rust.

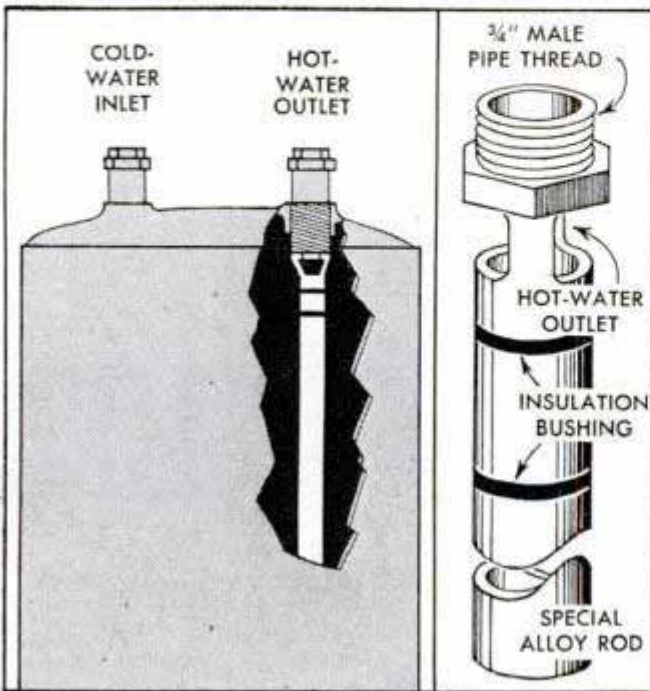

## Toy Cars Are Built With Plastic Kit

Young automotive engineers can build a roadster, coupe or sedan with a Lumarith plastic car-building kit. Changing the superstructure on the 10-inch chassis produces the different models. A geared, spring-wound motor drives the car. The kit includes separate metal axles, wheels, hub caps, exhaust stacks and bumpers.

## Plane or Locomotive Engine

Hailed as a possible power plant for aircraft, high-speed locomotives, trucks or ships, a Northrop-Hendy "turbodyne" gas turbine is undergoing extensive tests. Developed for the B-35 Flying Wing, the turbodyne differs from ordinary jet engines in that virtually all of its power is used to drive the built-in turbine. It is designed to operate conventional propellers through gear trains instead of serving as a jet-type power plant. Paralleling aircraft experiments, the engine is being installed in the chassis of a Union Pacific Diesel-electric locomotive from which the original power plant was removed. By operating at slightly less than top speed it is expected to obtain about 10,000 hours of operation between overhauls. Present models can be operated for only about 500 hours. The relatively cool exhaust is to be dissipated through the locomotive roof. Pulverized coal will be used in the locomotive installation and liquid fuels for the other tests.

View of compressor blades; turbine at end

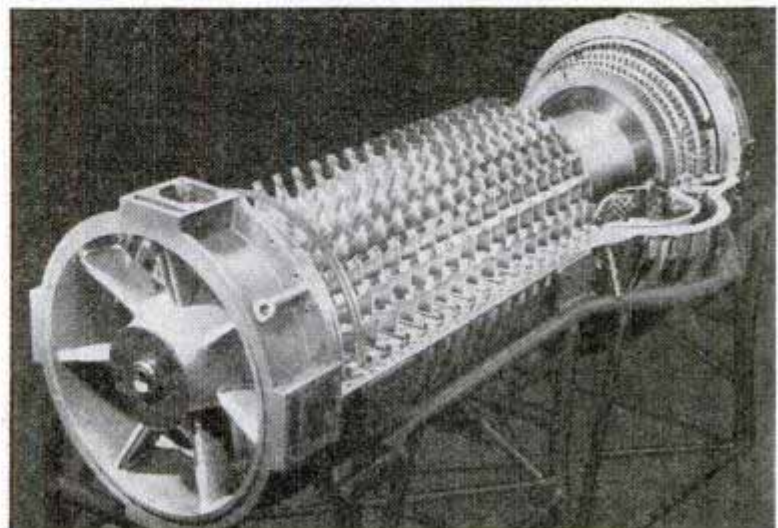
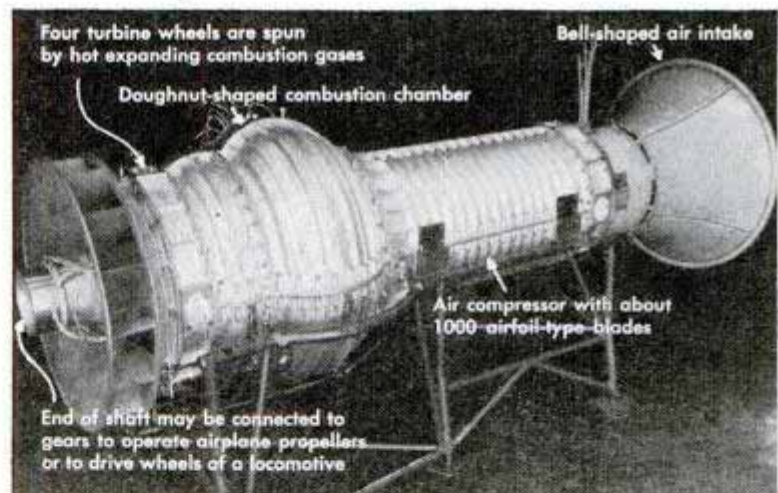



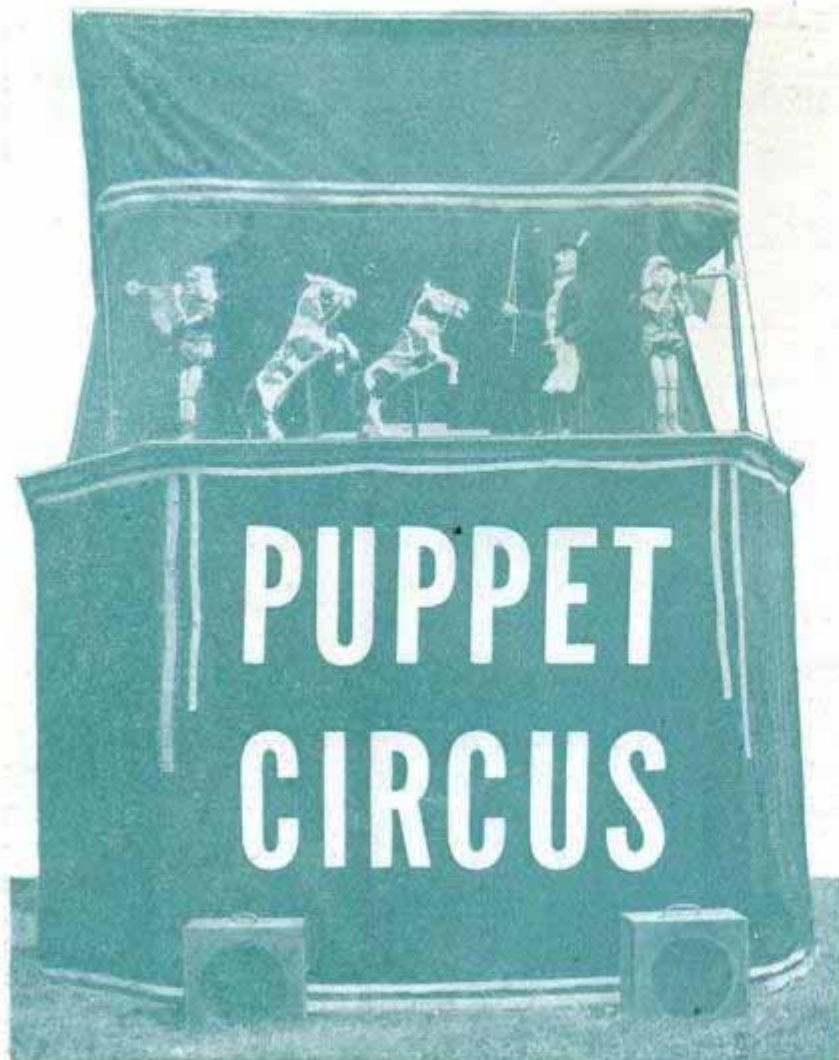

All photos copyrighted by British Combine

Three dozen two-foot-high characters perform with sound effects in an English puppet circus. Archie the Accordionist, above, is a yodeler. His "voice" comes over speakers in front of stage

↓ Trick cyclist is balanced on the tightrope by a long rod which the operator manipulates from underneath the stage

↓ It takes a lot of skill to keep Leslie the Acrobat from getting all tangled up in his act





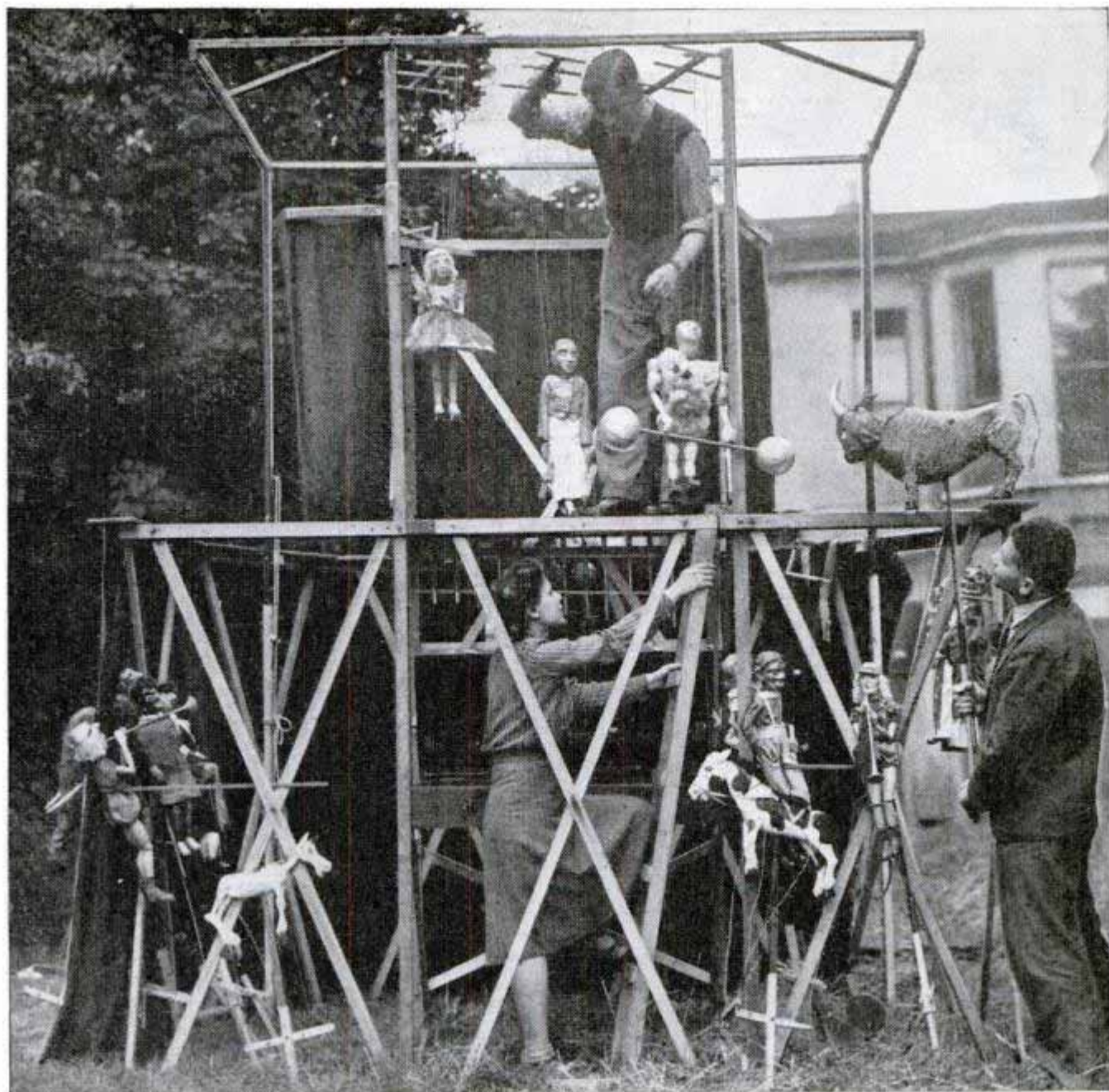

All performers and props must be placed carefully in advance so the show can keep moving at a fast pace. The folding stage is designed so that it can be set up or packed quickly for hauling to the next circus lot

Wire ribs are wound around a wooden skeleton to form body of the puppet



The show's comics are Tim Turnover the Clown and Walter the Wonder Horse. Both of them "talk" over the circus loudspeaker system





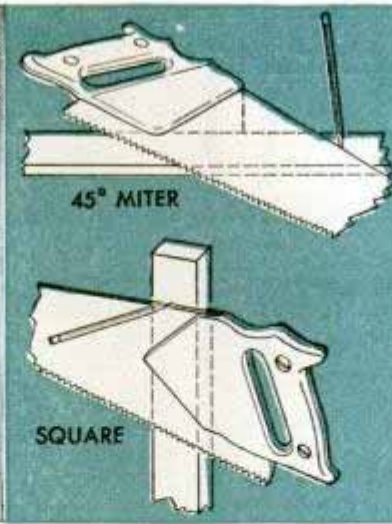

## Plastic Saw Handle Is Miter or Square

Three functions are performed by a plastic handle designed for use with straight-back saws. Besides serving as a handle, it can be used as a 45-degree miter or as a square. To attach, the square half of the handle is drilled and secured to the saw. Then the other half of the handle is fastened to the square half.

## Safety Auto Light

Emergency auto lights are protected against breakage by a durable Plexiglas hood which covers the bulb. The hood minimizes the possibility of fire caused by sparks from a bulb shattering near gasoline or alcohol fumes. The hood also provides a flood of light instead of a focused beam. The light is plugged into the cigarette lighter outlet.

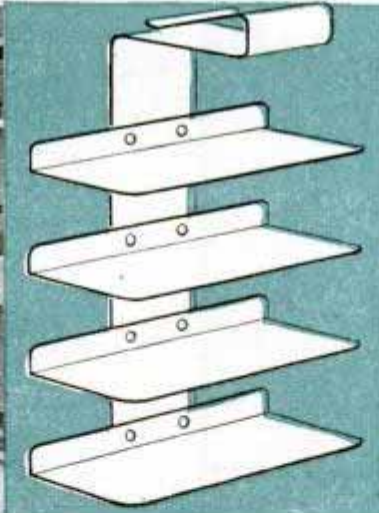
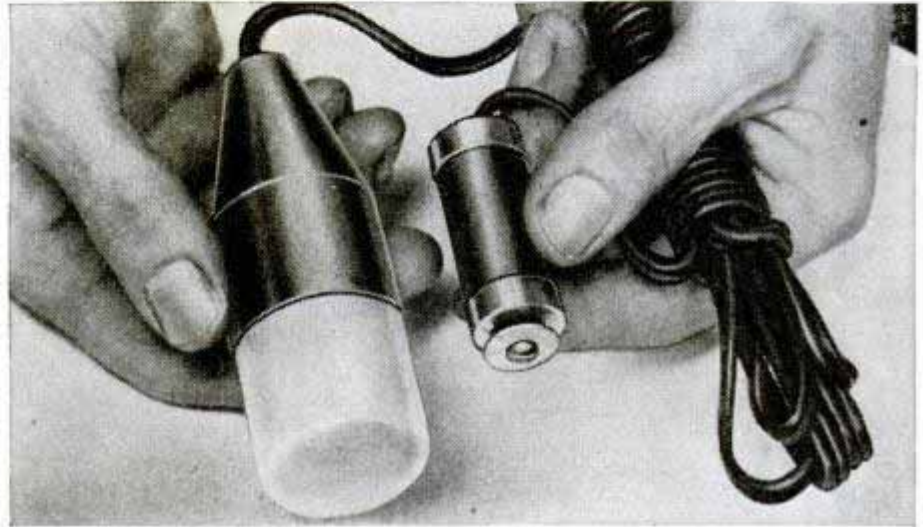

## Small Clip-On Shelves Fit Medicine Cabinets

Extra space in medicine cabinets is provided by four small shelves attached to a metal arm which clips onto a regular cabinet shelf. The clip-on shelves are suitable for holding shaving brush and cream, tooth paste, lipstick and other small articles. The shelves are finished in ivory enamel and are easily cleaned.

## "Double-Stroke" Electroplating

Like a painter moving his brush back and forth, a new electroplating process flows plating onto an object in one direction and removes surplus metal with an electrical "backstroke." Developed by Westinghouse, this method eliminates the need for polishing away excess metal coating piled on by conventional one-direction electroplating. In two-direction plating, current is reversed periodically in the plating tank by low-voltage contactors.

## Plastic Tubes Replace Arteries

Lucite plastic tubes an inch long have been used successfully to replace segments of the aorta (big artery) in animals. In reporting his experiments to the American College of Surgeons, Dr. C. A. Hufnagel of Boston said the tubes were held in place by stitches of specially braided silk. The artery with its plastic tube section functioned satisfactorily in carrying blood; no drugs, such as heparin or dicoumarin, were needed to prevent blood clotting.



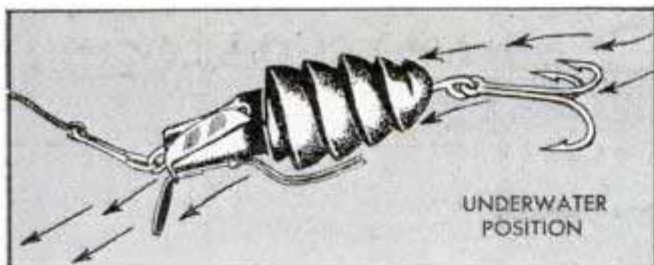

UNDERWATER POSITION

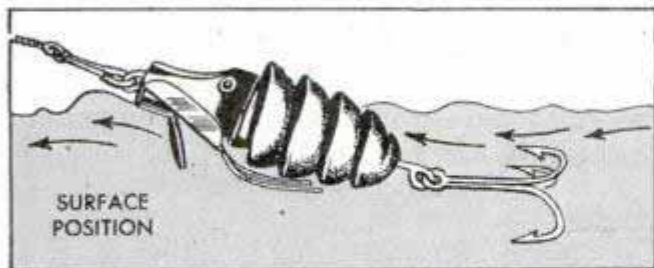

SURFACE POSITION

### Double-Duty "Diving" Lure

By adjusting the diving fins on a fishing lure the angler can use the same plug for both deep-water fishing and surface bait casting. For underwater fishing the darting fin is forward and the diving fins slant down, pushing the lure deep into the water. To convert the plug to a surface bait the darting fin is rotated so that it slants to the rear and the forward edges of the diving fins are pushed upward.

### Combination Fish Tape and Scale

Fish can be weighed and measured by a combination 24-inch tape and scale which handles up to eight-pounders. The instrument weighs only 2½ ounces and folds to fit a fisherman's tackle box or pocket. The manufacturer calls it a fisherman's "deliar."



JUNE 1947



### Silent Reel Lowers Boat Anchor

Lowering anchor from a small fishing boat is accomplished silently and easily by a reel within reach of a seated fisherman. An outside control lever releases the anchor at low speed, with no spinning of the handle to frighten fish away. The anchor is brought up by turning the handle. If the handle is released, the anchor automatically is locked at that level.

### Lock Clamps Around Oar

Oarlocks that clamp around the oars eliminate the need for drilling holes and thereby weakening the oar. The clamp is a steel spiral through which the oar is inserted. A bolt on the top of the clamp tightens the spiral to hold the oar firmly in place.

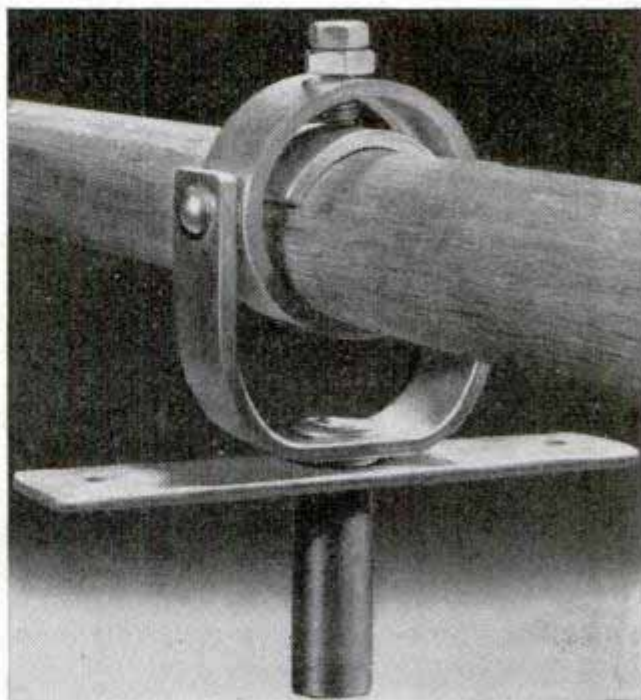



# GERMS PUT THE SQUEEZE ON OIL

Latest wonder of the petroleum industry is the use of bacteria to free droplets of oil from sand, shale and limestone

By Andrew Hamilton

**A** NEW PROCESS for boosting oil production has hard-headed petroleum engineers and oil executives talking to themselves. It may increase the production of exhausted wells by as much as 35 percent. It may unlock vast reserves of oil from tar sands and oily shales in which production is now too costly.

The new process was developed by Dr. Claude E. ZoBell, associate professor of microbiology and expert on bacteria at the University of California's Scripps Institution of Oceanography. Oil wells and oil sands are inoculated with microscopic bacteria  $\frac{1}{5000}$  inch long. These tiny organisms migrate through oil-bearing sediments in all directions and free droplets of oil from sand, shale and limestone.

At a time when the world's resources of oil are said to be running low, the process offers a new way to squeeze petroleum out of the earth's crust. This is big news in a nation that consumes oil at the rate of 5,000,000 barrels a day.

The ZoBell process is by no means the

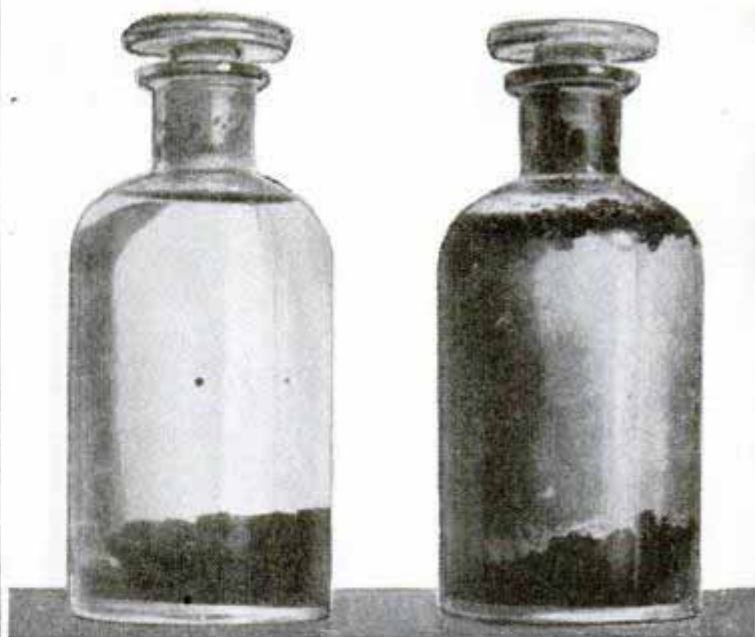

Dr. Claude E. ZoBell checks water sampler he designed. The bottle at right, above, shows oil scum from bacteria; bottle at left contains oil shale, no bacteria



first time that science has put bacteria, and their cousins, the molds, to work for mankind. These microscopic organisms, more like plants than animals, are used in the making of cheese and pickles, the manufacture of certain plastics and explosives, the preparation of penicillin and streptomycin and the production of many other food, industrial and medicinal products.

The particular bacteria used in inoculating oil wells are new ones, discovered several years ago by Dr. ZoBell. They are types of sulphate-reducing bacteria and bear the jaw-cracking name of *desulphovibrio halohydrocarbonoclasticus*. They are about medium sized as bacteria go and it would take 5000 of them, stretched end to end, to cover one inch. In general, they are shaped like miniature bananas. Often two or more are linked together to produce a corkscrewlike shape.

In March 1943, Dr. ZoBell was working in his laboratory at the Scripps Institution of Oceanography at La Jolla, Calif., investigating the bacteria of sea bottom muds and the ways in which they may turn organic matter into hydrocarbons of oil. This project was a study sponsored by the American Petroleum Institute.

One day he placed cultures of the new bacteria in a chunk of oil sand, dropped the whole thing in a test tube and filled it with water. In a few days he noticed a scum of oil on top of the water and gas bubbles slithering up from the sand below. In three or four weeks the sand had been pretty well cleaned of oil. He recorded this fact in his laboratory journal as an interesting phenomenon of considerable scientific significance—but didn't think of it in terms of producing oil in the field.

The following month Dr. ZoBell reported his findings to the committee on the occurrence and recovery of petroleum of the American Petroleum Institute during a meeting of the Association of American Petroleum Geologists in Dallas, Tex. The oil men immediately saw the practical value of the experiment.

A flood of questions came from the committee members: "How are the bacteria produced?" "Is it possible to produce them in 5-gallon lots?" "How much will it cost?" "How much oil will be liberated?"

An official of one company was so impressed by what he heard that he offered Dr. ZoBell \$100,000 outright for the complete report of his experiments and exclusive rights to develop it. Another promised the bacteria expert a \$10,000-a-year job for life if he would work on the process exclusively for his organization.

But Dr. ZoBell turned down all offers and returned to his University of California laboratory on the shores of the Pacific

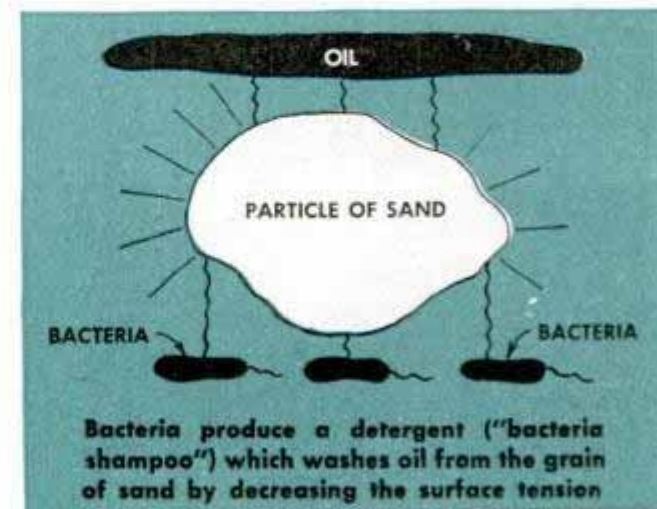
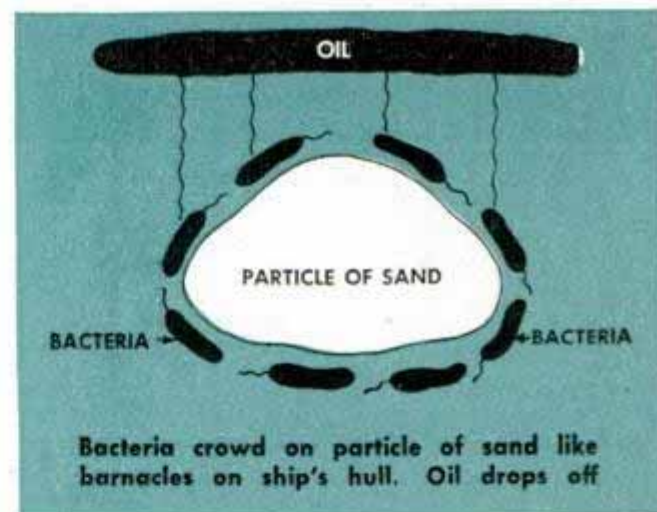
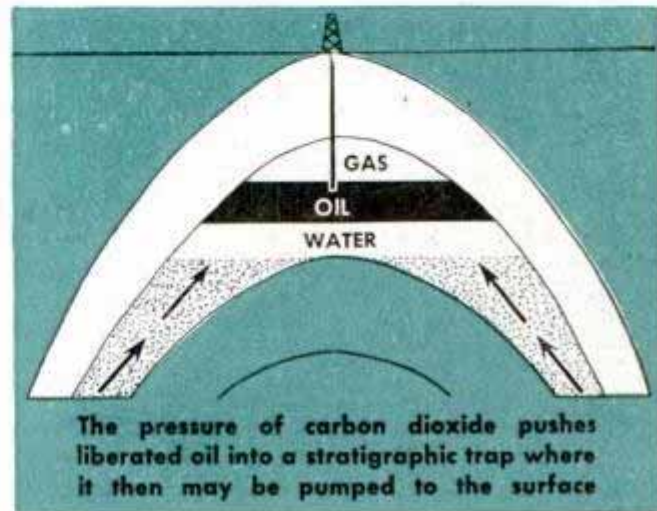
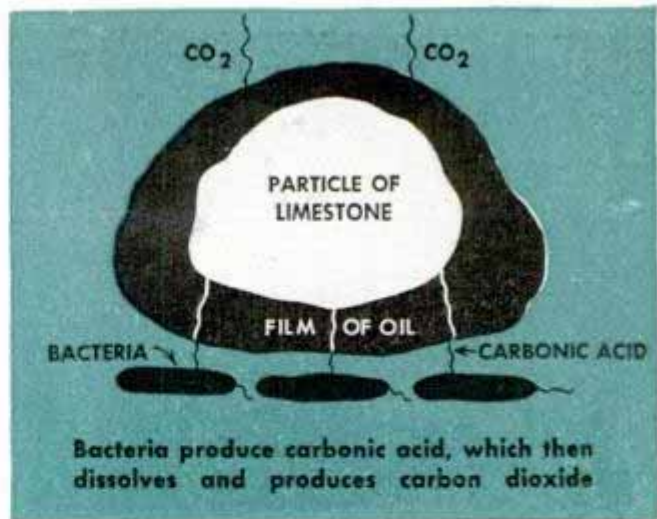



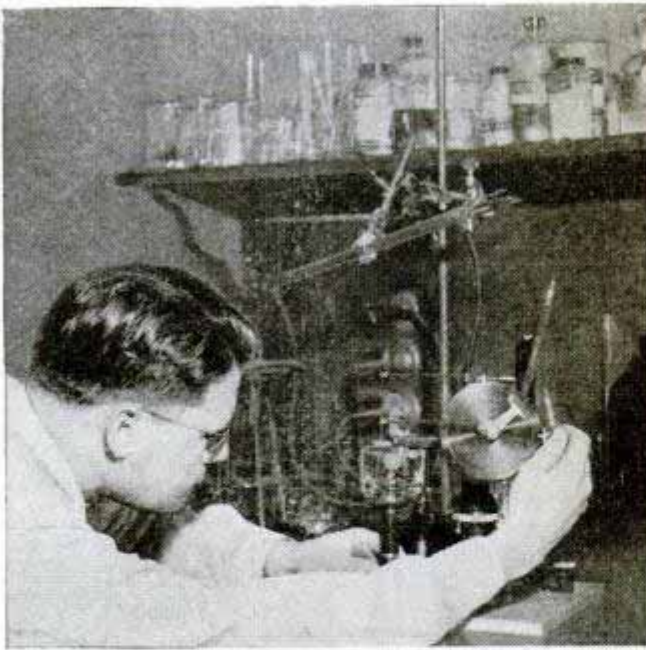

Pennsylvania Grade Crude Oil Assoc. photos

Laboratory "surface tension" test reveals new bacteria dissolve shale without destroying valuable oil. Below, released oil rises to top of bottle in test



Tubular object (below) is diamond-cut core from an oil-producing sand encased in Lucite. Bacteria will be forced through core to release oil locked in sand



to find the answers to many questions that had been raised by the initial discovery.

In three years of experimenting he learned that the new bacteria release droplets of oil from sedimentary materials in four different ways:

(1) They produce carbonic and other organic acids which dissolve particles of limestone and other calcareous (containing calcium carbonate or carbonate of lime) material. When this material is dissolved, the oil that was attached to the particle becomes free to move around.

(2) Respiring bacteria produce carbon dioxide. Carbon dioxide is also produced when calcareous materials are dissolved by acids. This gas makes oil flow more readily and its pressure pushes oil into areas where it can form pools. In such stratigraphic pockets, oil can be pumped to the surface more easily.

(3) The bacteria have a physical attraction for grains of sand or sediments. They fasten themselves to a particle like barnacles on the bottom of a ship—thus crowding off the oil. The bacteria will settle on almost any surface unless it is coated with some poisonous substance such as copper or arsenate. This action occurs in about four hours' time in the ocean, about two hours in the laboratory.

(4) Bacteria produce a detergent (similar to the substance in soapless shampoos). This decreases the surface tension of oil and allows it to slip off the grains of sand. Because this substance is produced in such minute quantities, scientists have not been able to determine its chemical composition. They do know that such "bacterial shampoo" exists and removes oil in somewhat the same manner that you wash grease off your hands.

Dr. ZoBell says that one or all four of these actions may be going on at all times to create greater concentrations of oil. In fact, there is reason to believe that desulphovibrio halohydrocarbonoclasticus bacteria or some of its near relatives may have contributed to the formation of the world's great pools of oil in California, Texas, Pennsylvania, the Near East, Venezuela and other areas.

Because of the tremendous implications of this discovery, Dr. ZoBell decided to take out a patent on the process. It is a basic principle of the University of California and the American Petroleum Institute that all information resulting from its sponsored research projects shall be made available to the public without charge. Patenting the process, and making it obtainable to all, prevents the wildcatter and get-rich-quick promoter from exploiting it.

If you are interested in the patent, don't

(Continued to page 236)





Caterpillar Tractor Co. photos

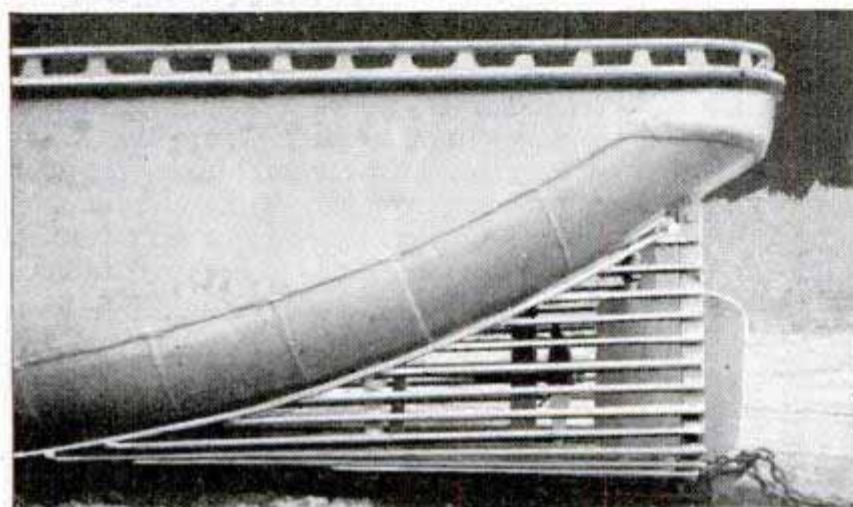

### CAGE FOR RUDDERS

To reduce hazards to tugs working in streams filled with floating logs, propellers and rudders are placed inside a steel cage welded to the hull. Steel skids, molded to the bottom of the craft, permit skidding the boats across logs or even across land. The boats were designed by Price Bros., Ltd., a Canadian company that uses the tugs for logging and paper-mill operations.

### "Breathing" Seat

Pilot fatigue on long flights is lessened by a "pulsating" rubber cushion and a pad for the lower part of the back now being tested by the Army Air Forces. The cushion and pad consist of multiple-celled rubber bladders sandwiched between two layers of foam rubber. These cells are connected with a "breathing" apparatus so that air passes from one to another to create a pulsating or massaging action which fights fatigue. "Lung power" for the seat and back pad is provided by an 11-ounce pneumatic motor drawing pressure from the plane engine's vacuum pump. It was first tried on the 5051-mile Honolulu to New York flight.

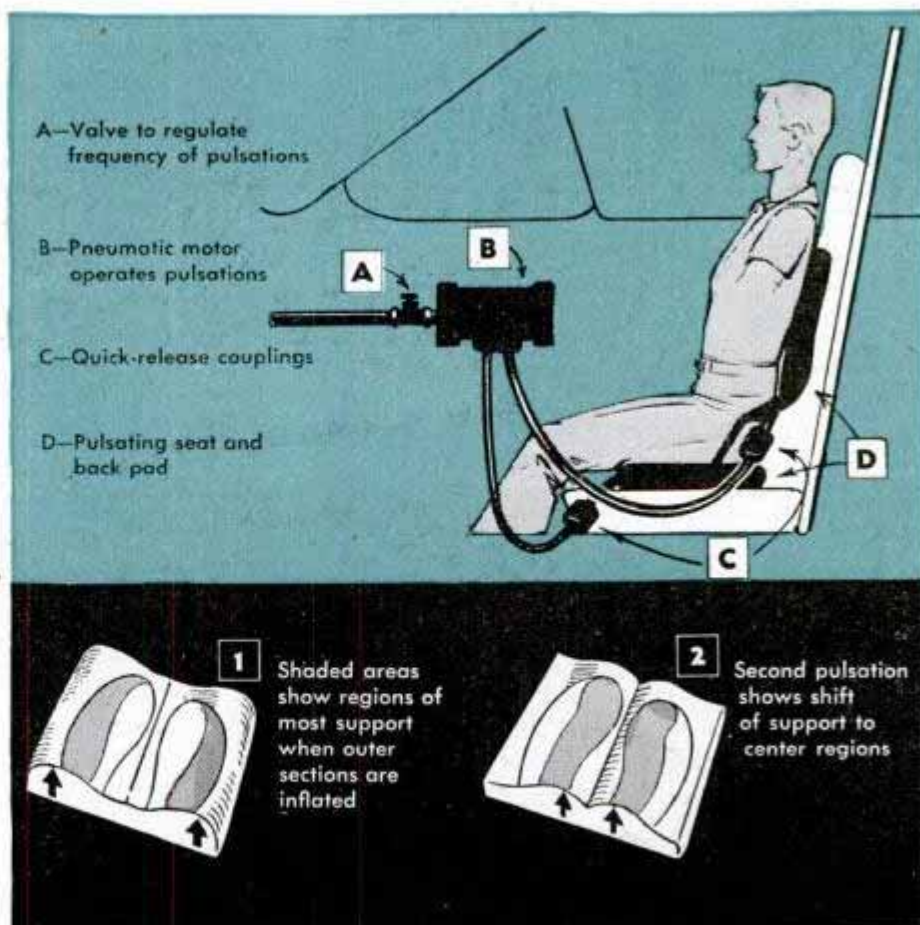



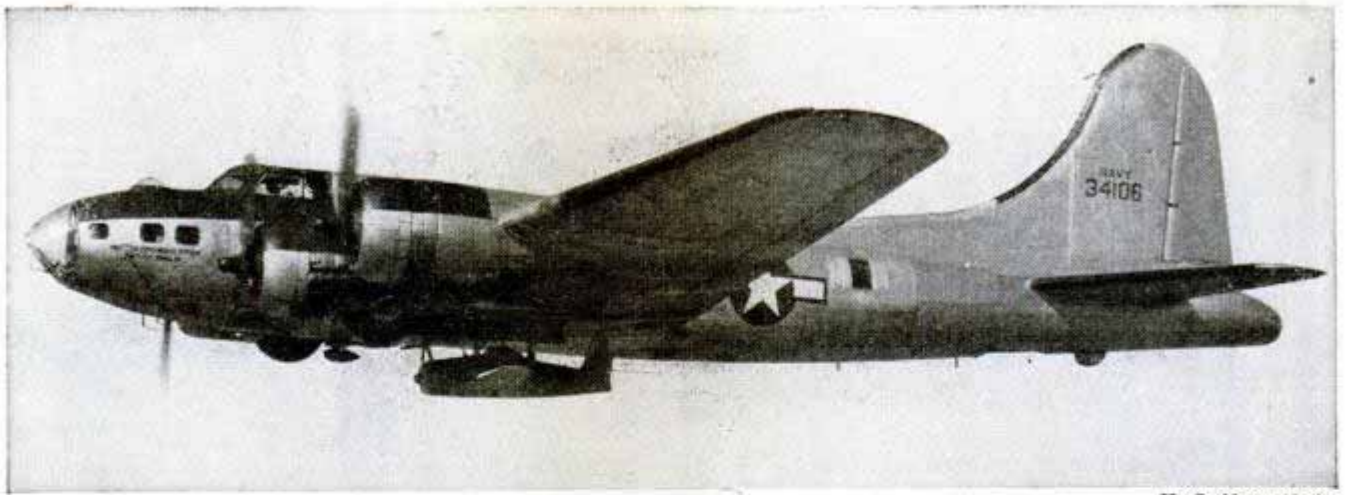

U. S. Navy photo

## MODEL PLANES DIVE AT TRANSSONIC SPEEDS

Wooden models, which fall from bomb racks at speeds over 600 miles an hour, are used by the Navy to obtain transsonic flight data. They have no propulsive unit, but carry 500 pounds of lead in the nose and attain speed solely by diving. Automatic controls within the model pull it out of the dive, parachuting it down for recovery and reuse. Radio telemetering equipment in the forward section sends information to ground receiving stations during

the dive and pull-out. Radar tracking traces the trajectory and automatic radio transmission permits evaluation of behavior in flight. Only  $\frac{1}{10}$  full size, the models are replicas of F8F Bearcat fighters and are dropped at high altitudes from the Navy version of B-17s. The technique makes possible transsonic speed tests without the correction of data necessary in wind tunnel experiments, due to the "blocking" effects in a tunnel at extremely high speeds.

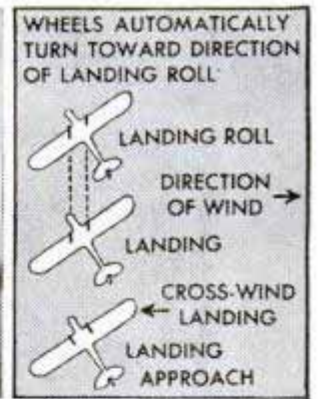

Goodyear Aircraft photos

## PIVOTING WHEELS PERMIT CROSS-WIND LANDINGS

All the castoring action is built directly into the wheels of a gear developed for cross-wind landings. It will permit the plane a yaw of 25 degrees to either side and still maintain a straight-ahead landing or

take-off roll. The pivoting action comes from a kingpin, placed at a 30-degree angle to the ground, in the wheel assembly. It may be applied to any standard airplane landing gear without adding much weight.



British Official photo

## British Transport

England's 40-passenger Airspeed Ambassador is being built for medium-distance operations between the islands and Europe. It will have a cruising speed of 280 miles an hour and a range of over 1000 miles. Except for a high wing, it closely resembles the larger Lockheed Constellation.



# DRESS PARADE ON RAILS

By Clifford B. Hicks

You're zipping across the country on a streamlined train making 80 miles an hour. You want to reserve a hotel room at your destination so you pick up a phone and call a number a thousand miles away while you gaze out the window at the flashing scenery.

After you've hung up the phone you decide you need a haircut. You walk through a couple of cars to the barber-beauty shop. While in the chair you ask the barber what movie is to be shown that night in the theater car.

That's a rough idea of the rail travel just around the bend. More than 100 new streamliners soon will roll between the nation's cities. Many are on daily schedules already. They're more than just superfast trains—

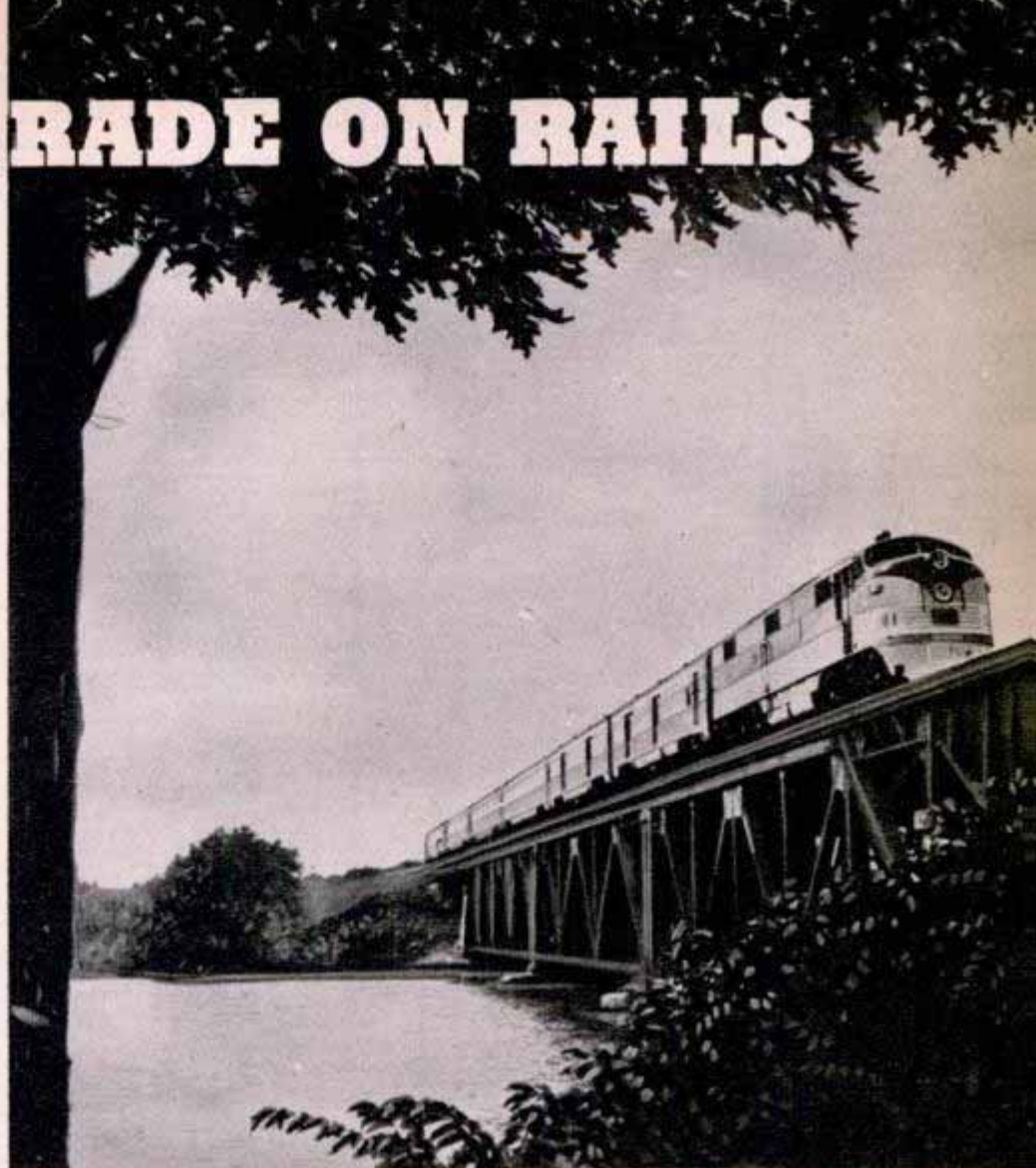

↑ Luxury-packed Pere Marquettes whisk passengers between Detroit and Grand Rapids thrice daily, making the 152-mile run in 160 minutes

↓ Individual fluorescent lights in many new coaches ease eyestrain of reading while riding. This coach also has a public address system

New York Central photo







↑ Modernized by streamlined jacket, Chesapeake and Ohio locomotive actually began service in 1926. Drawing at right, reproduced from our cover, shows sky-view observation car of Milwaukee Road's Olympian Hiawatha

they're luxury liners on rails. Since the end of the war, 3285 luxury cars have been ordered, cars that are eye-openers.

There are double-deck "Vista Dome" cars with glassed-in tops. On some trains you may flip a switch to turn on an individual radio built into the cushion of your

seat; your neighbor won't mind because he won't be able to hear it. You'll borrow books from the train library and pick up the latest news on a ticker tape.

You won't find all these luxuries on any one train. But the \$7,000,000 fleet of Empire Builders offers a preview of streamliners that will be rolling the rails within a few months. The five trains, operated by Great Northern and Burlington, will run a daily 45-hour schedule between Chicago and Seattle, clipping 13½ hours from the old time over the northern route.

Coach passengers can tip back their seats, fold down an upholstered leg rest from the seat ahead, and relax on a chaise longue that's almost as comfortable as a bed. If you want to look at the scenery, you can turn your entire seat around until you are gazing out the huge picture window.

Venetian blinds control the glare when the sun's on your side and you have an individual reading lamp that spreads a cone of light just to the edge of your seat. If you want a quick snack instead of a dinner there's a coffee shop where you can get a sandwich and malted milk. Sleeping-car passengers have a wide choice of accommo-



↑ Engineer's fingertips control 6000 horsepower in this new locomotive. Below, Diesel-electric engine can be geared for heavy freight or fast passenger run

General Motors Electro-Motive Division photo







Postwar Empire Builders are pulled by two-unit 4000-horsepower locomotives with twin cabs

dations including duplex roomettes—private rooms at a price barely above the cost of a lower berth.

Luxury is the keynote on all the new trains and the railroads have good reason for emphasizing it. Much of their equipment was recalled from retirement to roll up their unbelievable war record and a great deal of it made a final run with discharged troops and headed for the pasture. Air lines are competing for the travelers who want to get from here to there in a hurry. Automobile production has been boosted so there'll be an increasing number of motor tourists. The railroads are building new trains by the score, depending on luxury and comfort to sell tickets.

Last January, Baltimore & Ohio's Cincinnati cut the time between Cincinnati and Washington to 11½ hours. Just a few of the special features of this 100-mile-per-hour top speed train are fluorescent lamps, a loud-speaker and radio in every car, nonfogging windows and an intercommunicating telephone system. The

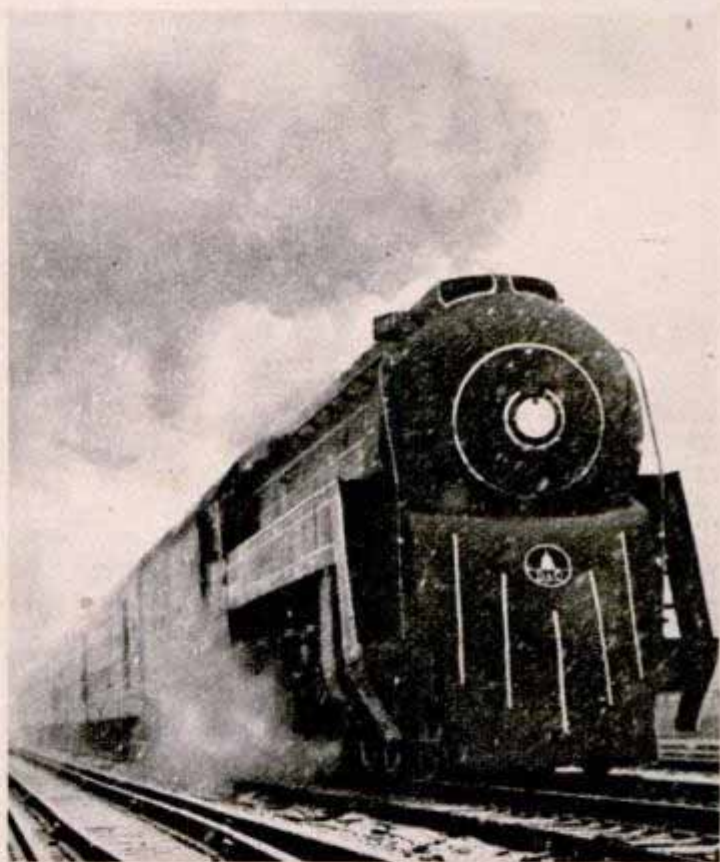

Speedy Cincinnati roars through a snowstorm on its trial run to Washington, D. C. Below, new Humming Bird between Cincinnati and New Orleans clicks across Biloxi Bay

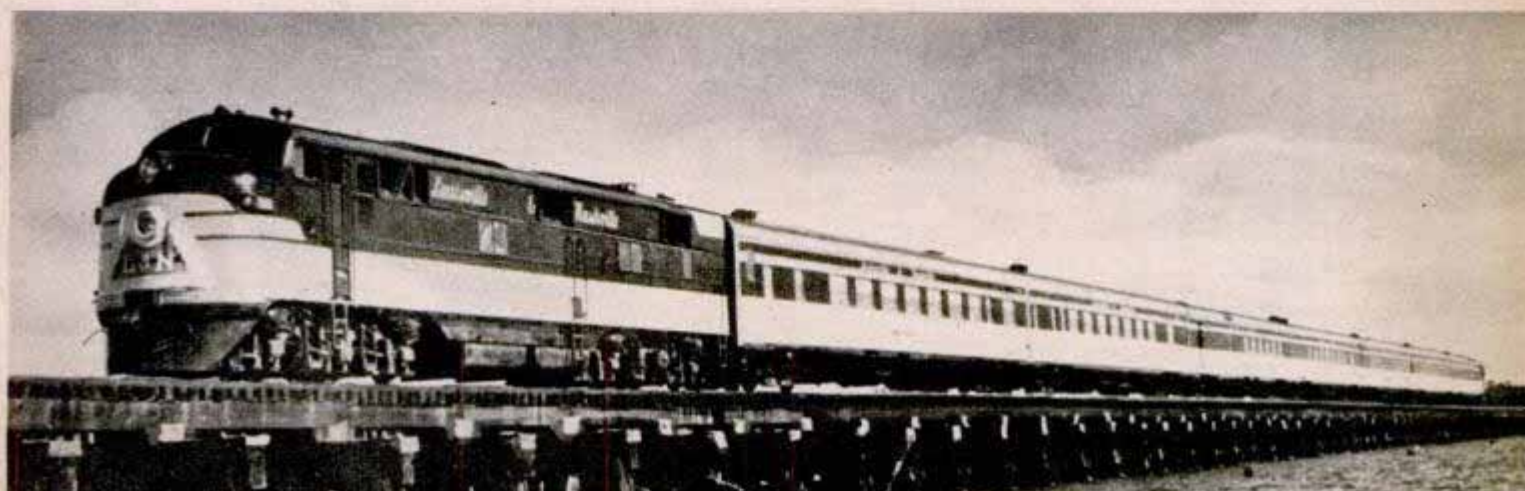





Chesapeake and Ohio photo

stewardess-nurse's room has a sofa-bed, heating equipment for baby bottles and walls that are soundproof to baby wailing. Of a total of 244 seats on the train only 176 are sold, leaving ample room for relaxation in any of the combination cars. It's not an extra fare train—you can ride it at regular coach rates.

The Humming Birds, Louisville & Nashville's new streamliners on a fast day run between Cincinnati and New Orleans, emphasize the trend toward combination cars. There's a tavern-lounge and a coach-lounge on each train. Other features include in-

Coach passengers sink into tilt-back seats, flick down the soft leg rests and relax on a chaise longue

Great Northern photo

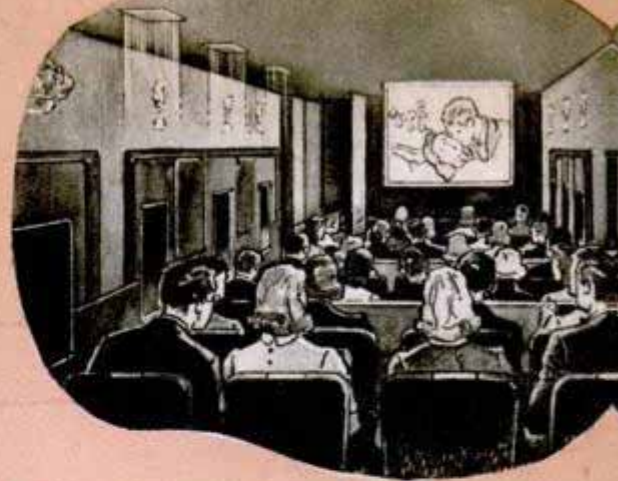

↑ In some new diners, tables fold into walls, screen is dropped and regular movies shown.  
← Spacious lounges with extra seats provide plenty of room for relaxation and amusement

dividual heating units, folding arm rests between the double seats, and a self-emptying ash tray for each seat. Incidentally, several of the new streamliners have efficient air-conditioning systems that permit smoking throughout the train.

Chesapeake and Ohio's fleet of Pere Marquette shuttles three times daily between Detroit and Grand Rapids, making the 152-mile run in 160 minutes. Dining facilities are spotlighted on these streamliners. The tables are rectangular and triangular in shape and fit diagonally into the wall so each passenger has a complete side to himself. No more bruised shins, either; the tables are supported by wall brackets instead of legs. Attractive waitresses have replaced the traditional waiters, and the railroad emphatically discourages tipping.

Other dining car features soon to come

Coffee shop of North Western's 400 offers sandwiches and soft drinks for travelers who want only a snack

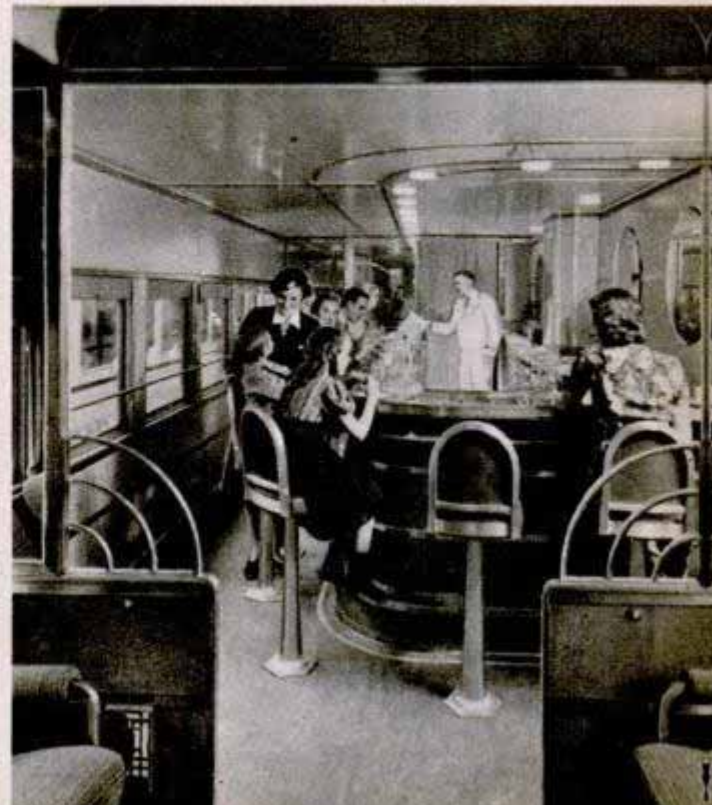



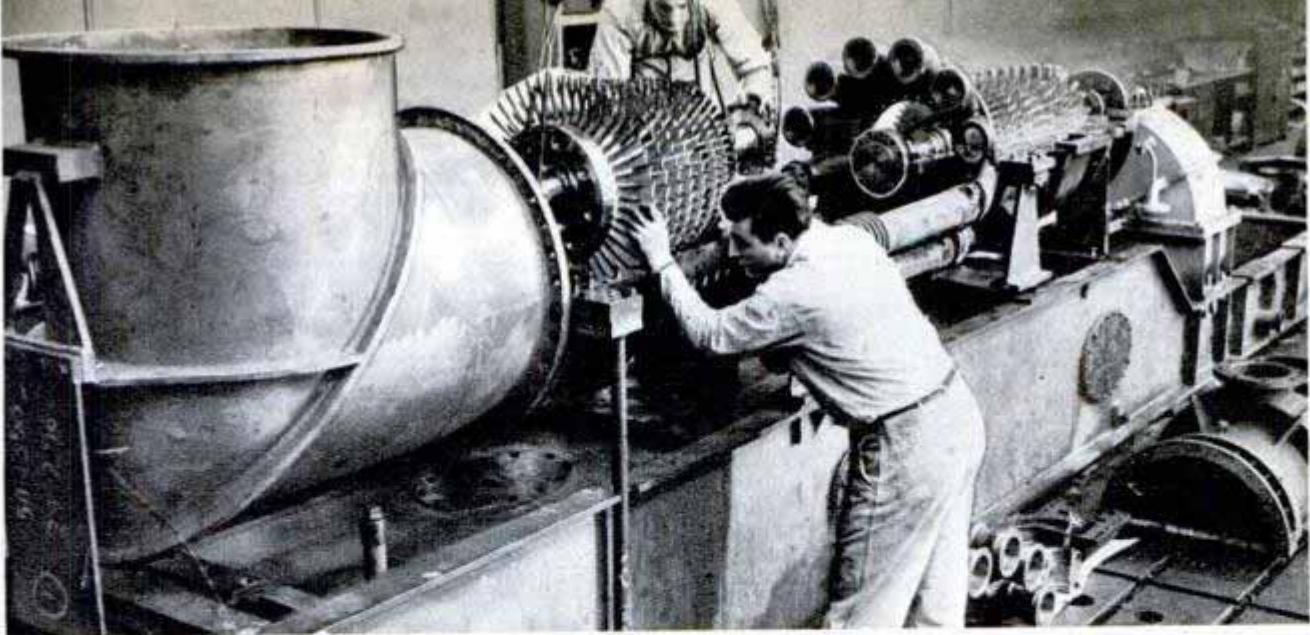

Westinghouse photo

Workmen fit blade-bristling rotor into gas turbine that will burn low-cost fuel oil to compete economically with coal-burning engines. Unit is so compact that four can be fitted into a locomotive half the length of comparable Diesel-electric. Right, artist's sketch shows how turbines probably will be installed in a locomotive for testing

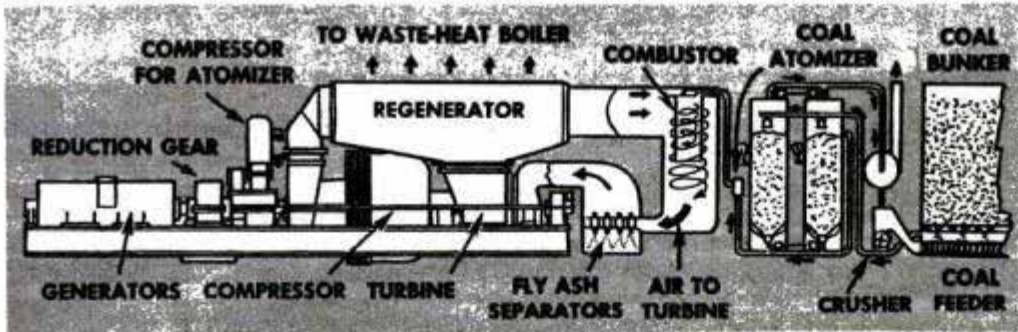
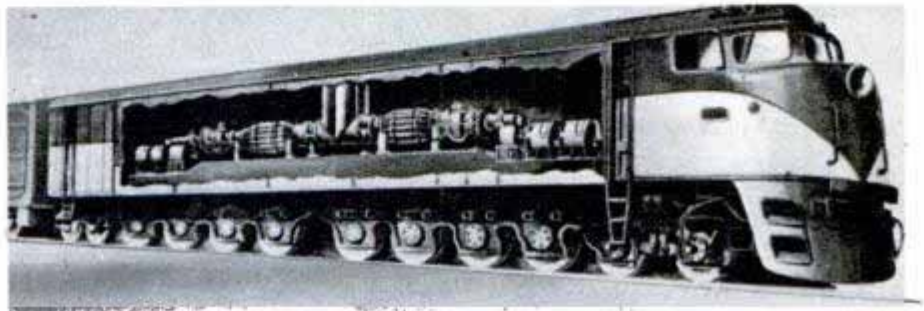

← Diagram of the revolutionary new coal-burning gas turbine. Coal is atomized, then "exploded" in combustor to provide expanding gases which turn rotor blades. Sketch below shows how turbines could be fitted into the engine

Bituminous Coal Research drawing

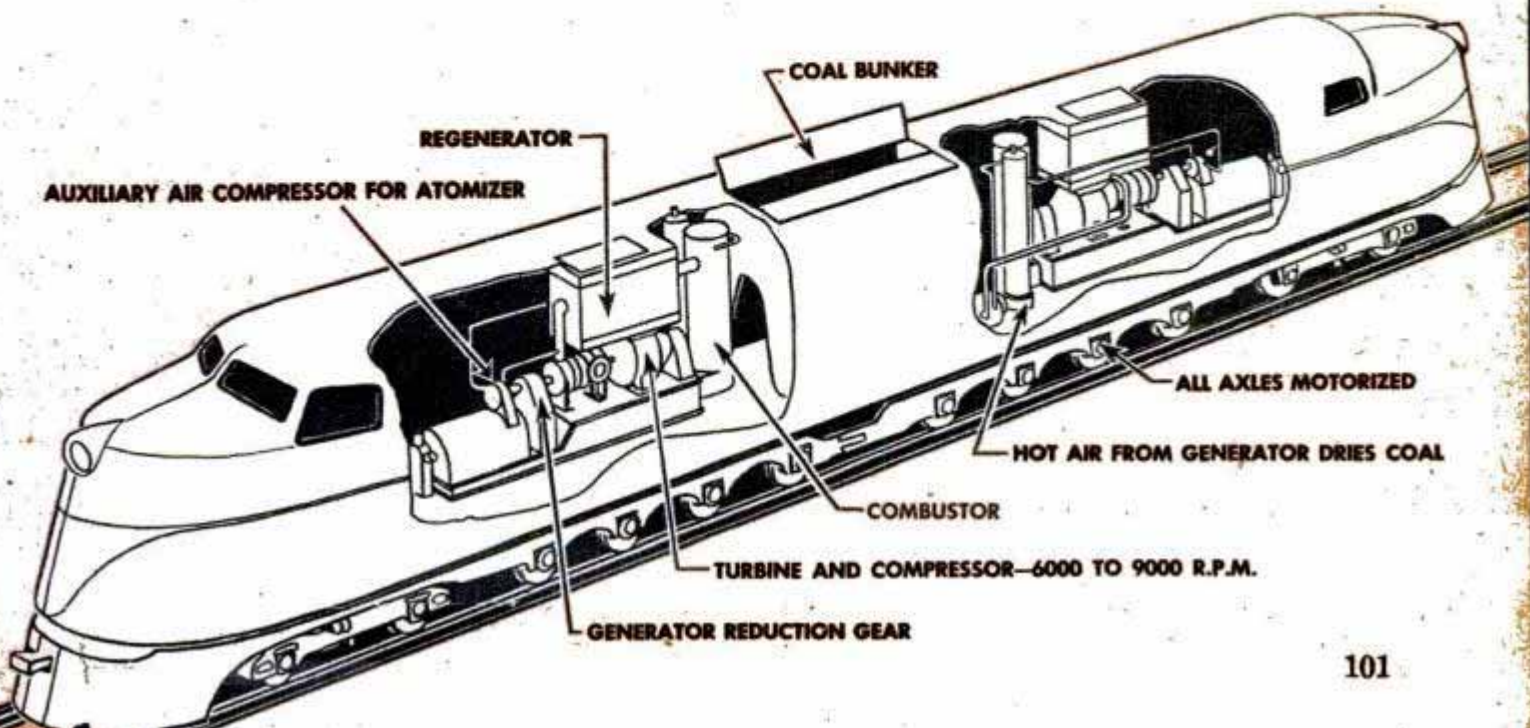





**Pere Marquette's diagonal table arrangement gives each passenger a side of the table to himself. Waitresses replace waiters and railroad discourages tipping. Diagram shows how dining sections are separated by kitchen**

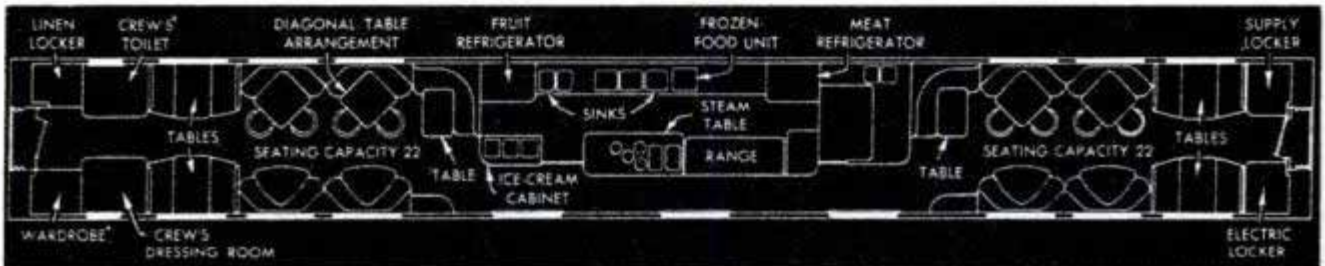

will spike most of the complaints about eating aboard train. The Southern Pacific Shasta Daylights will have a diner-kitchen-coffee shop arrangement built into three cars. And Pullman-Standard has designed a cafeteria that may eliminate the long wait for a meal.

Most of the seats on these trains are cush-

ioned with foam rubber; some have leg rests that pull out from beneath your seat, others from the seat ahead of you. Overnight coaches are designed for maximum sleeping comfort with reclining chairs and several inches more leg room—many of the cars have only 44 chairs compared to 56 in older coaches. On the rear of some seats

**Three-high berths in new Pullman give three passengers privacy of an individual room with lavatory. There is plenty of space during the day, too. Berths fold away to make room for an arm-rest seat for each occupant**

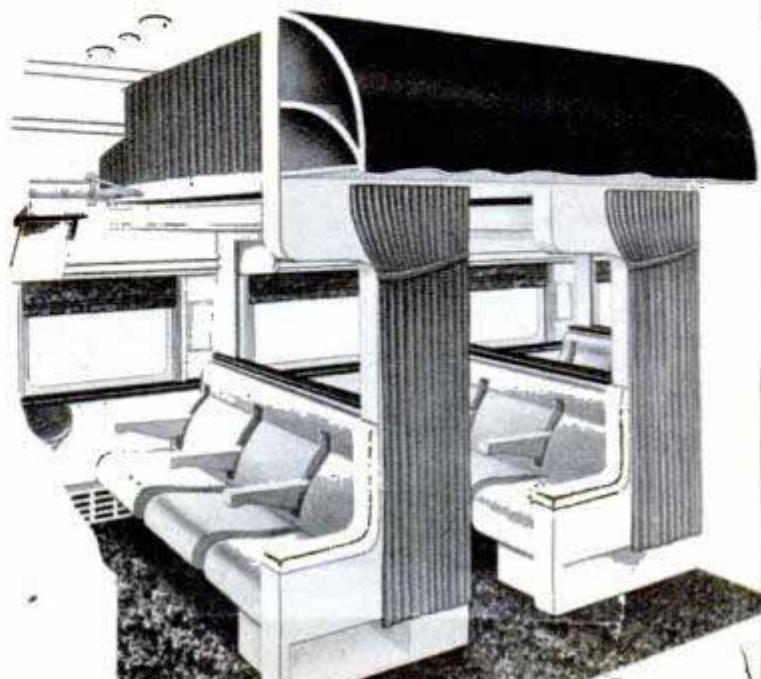
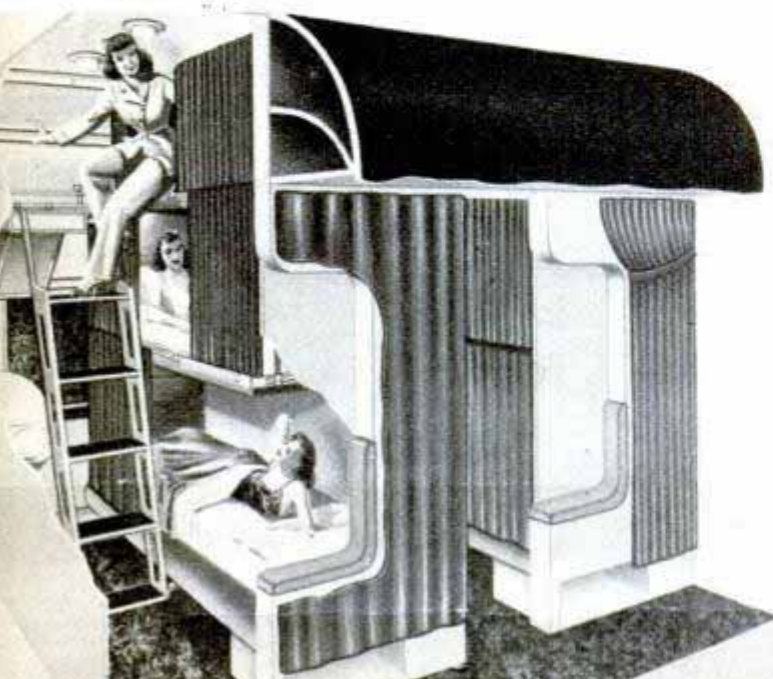





One luxury car will have an illuminated goldfish bowl stretching to the ceiling

are coat hangers with elastic bands at the bottom to prevent your clothes from swinging with the motion of the train.

You were measured for many of these new seats; at least someone your size was consulted. The Harvard Department of Anthropology measured the sitting postures of exactly 3867 people—male and female, tall, short and medium. The seat was designed to fit the hypothetical average person discovered from the measurements. Don't worry, though, if you're tall, short, fat or lean—the same seat is much more comfortable for anyone than the older type.

Chesapeake and Ohio soon will introduce a temperature control system with thermostats outside the skin of the car. These robots "feel"  $\frac{1}{10}$ -degree temperature change in the outside air, reporting their discoveries to a team inside the car that reacts instantly to provide the necessary change. Budd has developed an electronic device that draws the finest particles of



Travelers find that a radio, what-not shelf, draperies and growing plants give Panama Limited's observation car a homey air

dust, pollen and cigarette smoke from the coach. An electrical charge ionizes the particles, making them adhere to the filter.

Wrestling with heavy doors can be crossed off your list of complaints. A metal bar runs completely across the automatic doors of the new Pennsylvania coaches. Whenever a passenger touches any part of the bar the door opens for five seconds, then closes automatically. Under light tension the door can be held open as long as desired.

Pullman-Standard's new wrinkle in overnight accommodations is a sleeper stacking the passengers three high, an arrangement that gives the passenger more privacy. The berths run crosswise with a car-length aisle along one side. This, in ef-

Left, designers have budgeted every inch of space in a single room that costs little more than an open section berth. Right, double-deck Vista Dome cars have glassed-in tops to give travelers a broad view of the scenery

Budd Company photo

Burlington photo







↑ Air conditioning-heating outlet is in the ceiling of Pennsylvania coach. After air is circulated it returns through tiny perforations in baggage rack. Right, door swings open automatically as soon as bar is touched

fect, makes each stack of berths a small compartment with the passenger's privacy shared by only two others. You won't have to plod the length of the car in the middle of the night to get Junior a drink, either, as there's a lavatory built into each section.

The traditional argument over uppers and lowers soon may be a thing of the past. The Budgette costs little more than today's lower berths, yet it gives the traveler a small room to himself. Through an arrangement of rooms cleverly staggered on two levels the car can carry a lot of passengers and rates are kept correspondingly low.

Most of the more expensive rooms have

private radios. Many of the sleepers have premade beds that swing down when the traveler pushes an electric button. A few are even piped for shower stalls.

In the near future the most revolutionary changes will be in locomotive power. Of the approximately 200 streamliners now in service or on order, 178 are to be pulled by Diesel-electric power. Diesels are coming to the front in passenger travel now, but other types of locomotion may give them the squeeze play soon.

The new coal-burning gas turbine under development by Bituminous Coal Re-

(Continued to page 252)

Pullman-Standard has plans ready for a casino car with stewardess' quarters and small play-rooms that can be used individually or in pairs

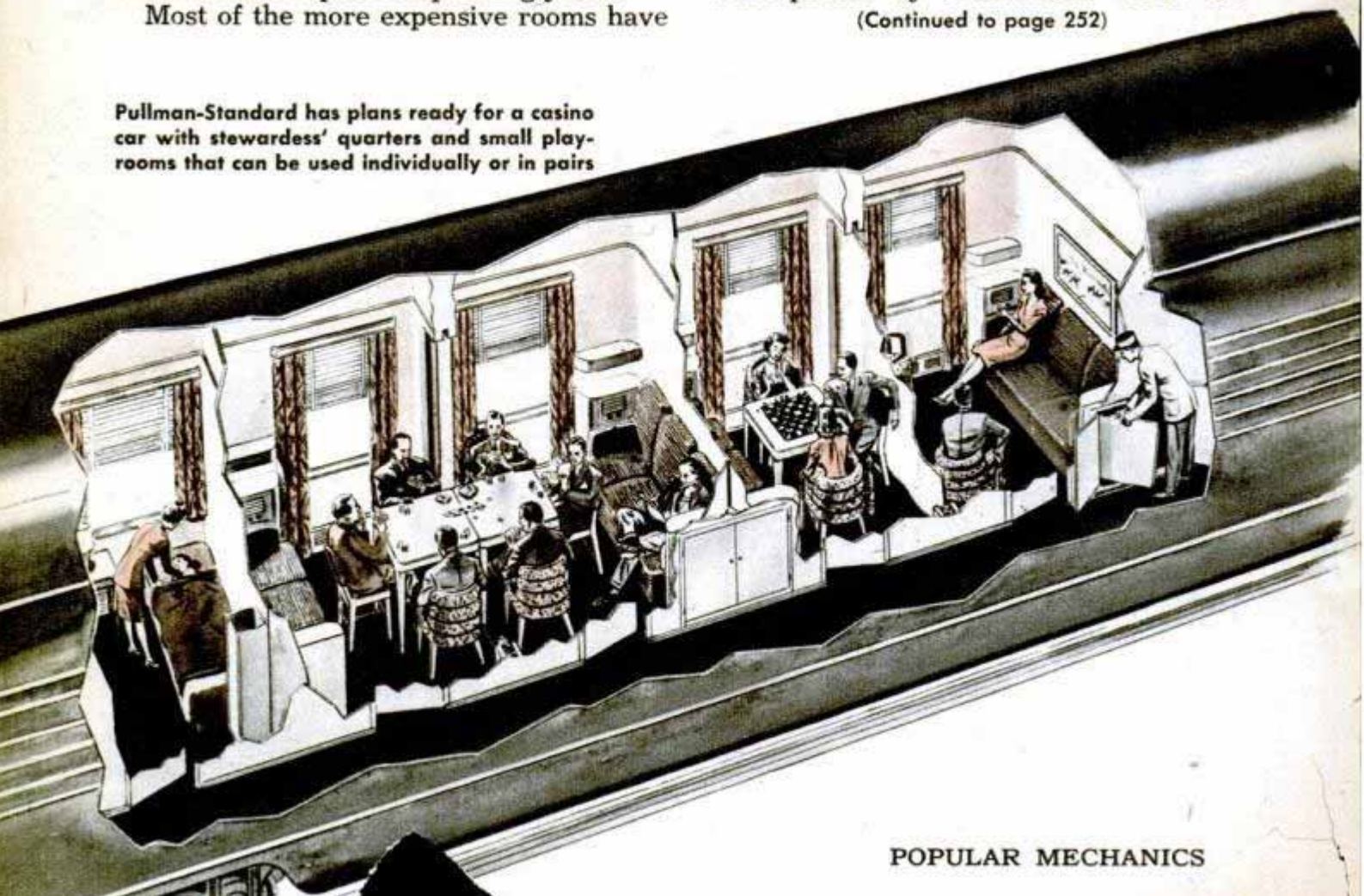



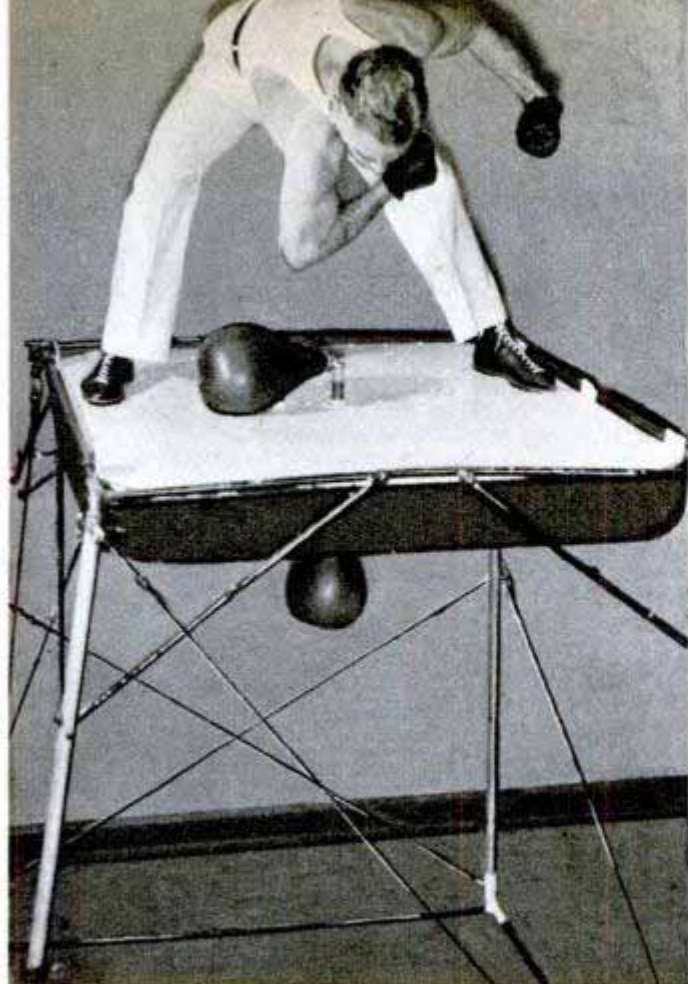

Two rhythmic fists earn a living for 54-year-old Labe Safro of Minneapolis whose profession is beating punching bags. He performs before theater, night club and sporting event audiences and recently received a bid from the USO for a tour of Japan. Safro can punch a bag while standing, sitting, or lying flat on his

## BAG PUNCHER

back and using his forehead as a third fist. He does part of his act blindfolded. An electric timer once counted Safro's two gloved fists hitting the bag eight times a second. Safro has a collapsible steel-legged stage to which he attaches the bag. The former amateur fighter took up bag punching for exercise.

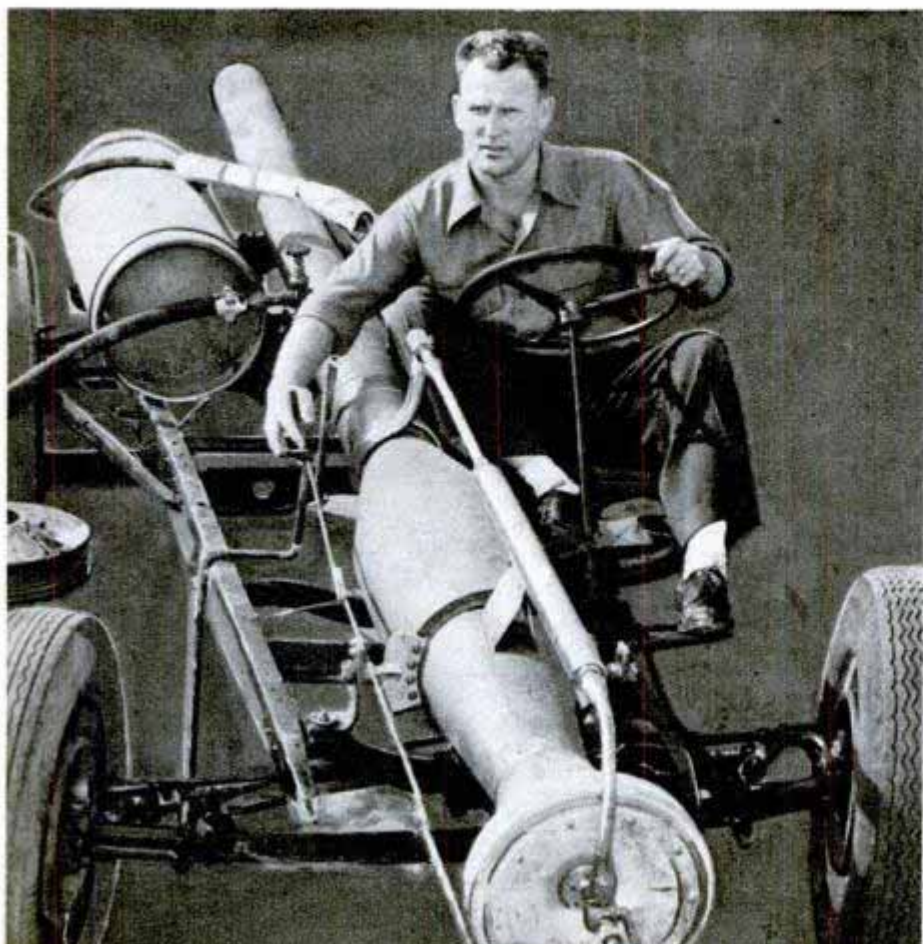

## Jet Automobile

Under test at Rosamond, Calif., Dry Lake, is America's first jet-propelled automobile, built by Bob Yeakel of Los Angeles. The jet engine operates on propane fuel. While driving the car Yeakel wears an asbestos suit and sits sideways because of the heat generated in the jet tube.



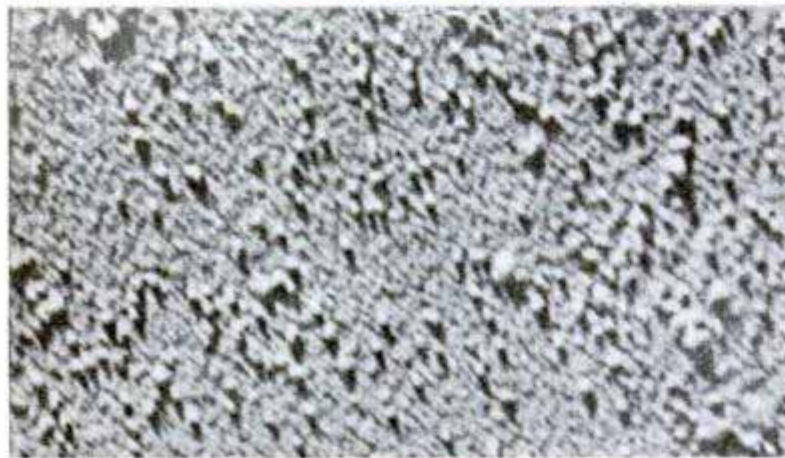
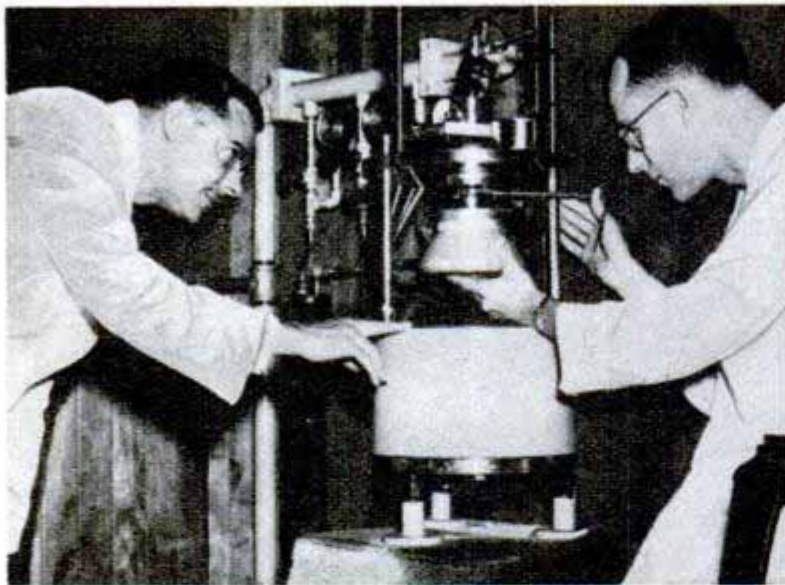

## New "Tool" to Fight Polio

After years of effort science has succeeded in producing nearly pure polio virus, an important step in what up to now has been a futile laboratory struggle to produce a vaccine effective against infantile paralysis. Dr. Hubert S. Loring and Dr. C. E. Schwerdt of Stanford University are responsible for this latest development. Laboratory tests, including photographs taken through an electron microscope, indicate that the virus isolated by the two scientists is 80 percent (or more) pure. With a relatively pure virus available, Dr. Loring points out, the scientific door is open to render this virus noninfectious by chemical or physical treatment to produce a concentrated vaccine free of the impurities which have plagued previous polio vaccine experimenters. Much more research work is necessary, the scientist cautions, before an effective vaccine can be produced.

Drs. Loring (top left) and Schwerdt at the centrifuge used to isolate nearly pure polio virus, magnified 30,000 times at left

## Sodium Makes Lake Boil

Great clouds of water vapor boiled from Lake Lenore in Washington when 10 tons of war-surplus metallic sodium were dumped. The violent reaction of the sodium and water added 17 tons of lye to the lake and decomposed nearly eight tons of the water, releasing oxygen and hydrogen. The burning hydrogen joined with oxygen in the air to create more than seven tons of water vapor which formed heavy clouds that mushroomed hundreds of feet into the air and were visible for miles. The metallic sodium was dumped because it could not be shipped to industrial consumers.

Every day new products for homes and workshops are appearing on the nation's markets, and every month you'll find them described in *Popular Mechanics*. For additional information about these products, write to Bureau of Information, *Popular Mechanics*, 200 East Ontario Street, Chicago 11, Illinois

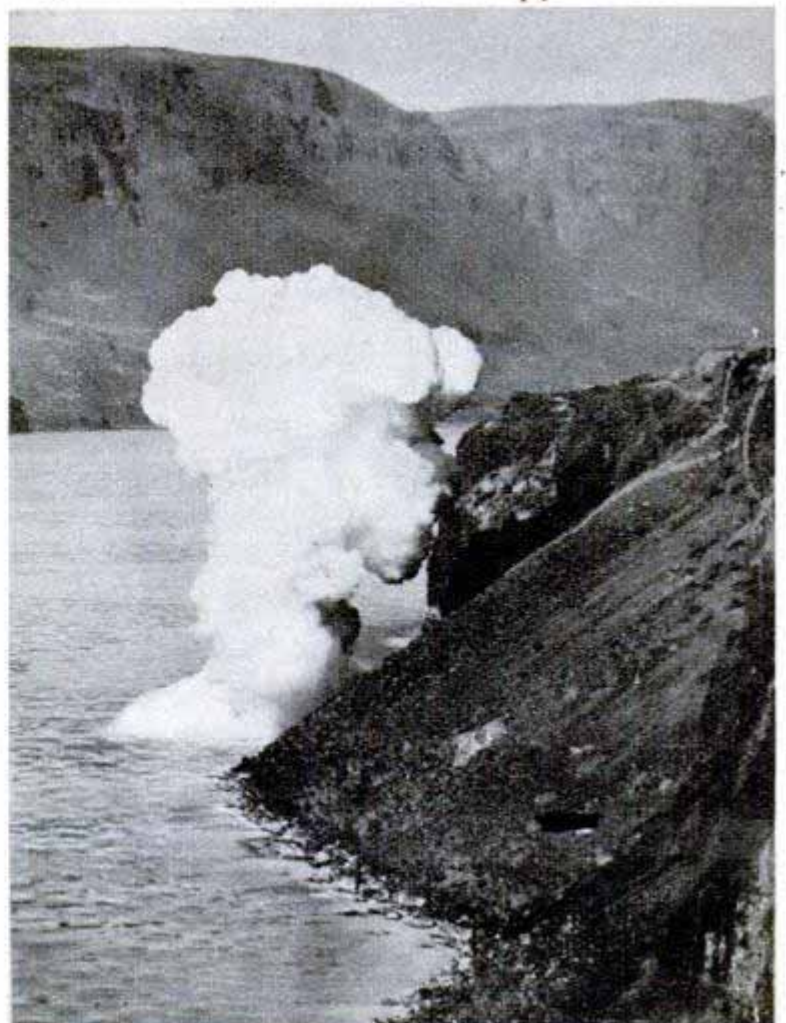



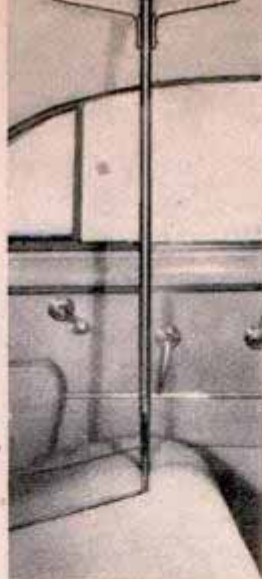

Automobile travelers can carry as many as 16 extra garments without wrinkling by hanging them on a rack that fits into the back seat. Two arms slip under the cushion of the rear seat to hold the device upright



Verandalike visibility is a distinguishing feature of the new Volmer VJ-21. The three-place pusher has a top speed of 120 miles an hour and a 500-mile range. A low, auto-style door permits easy entry to the cabin



Designed to prevent slipping, feared by all crutch users, is a safety steel tip that can be quickly adjusted for use or nonuse by a simple quarter turn



Shell Oil Company photo

Its originators claim underwing fueling is three to four times faster than the present wing top method. In test a plane took on 14,000 gallons in 15 minutes

To speed highly perishable lettuce to market, a 40-foot conveyor has been designed that loads heads directly on waiting trucks. The vehicle has a tread of 82 inches, which allows the wheels to travel between rows of lettuce

Chevrolet photo

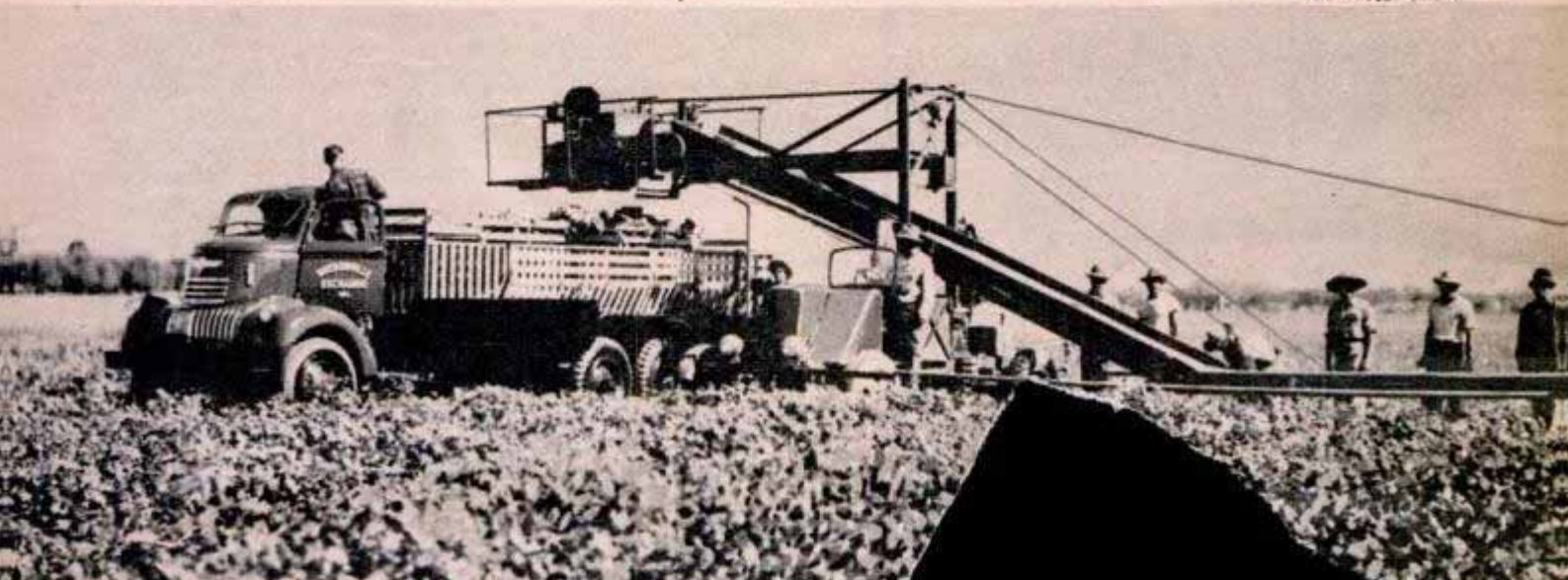



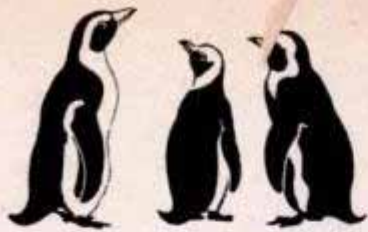

# REPORT from ANTARCTICA

## PART III

By Tom Henry

(Correspondent with the Byrd expedition)

**O**N BOARD the USS Mount Olympus (By Navy Radio)—The greatest naval antarctic problem is ice navigation. Most of the continent is surrounded by a ring of open water a few miles wide. North of this ring is a belt of pack ice from 50 to 400 miles across, almost reaching the Antarctic Circle. The open water ring is created by heavy winds from the pole that push ice floats northward.

Even in midsummer, when partially disintegrated with numerous pools, this pack forms an impassable barrier to most ships. Naval craft are in constant danger of having their hulls punctured or crushed by blizzard-driven ice fields containing bergs weighing millions of tons, propelled by the inexorable force of deep undercurrents.

The most obvious answer is to break paths with the new type 6000-ton icebreakers that have a 10,000-horsepower push. These "toughest" ships in the world cut

**Snow clearance was a constant problem for Byrd's party. Blinding swirls can cover an air landing strip again within five minutes after it has been cleared off**

U. S. Navy photos



their way easily through ice packs 10 feet thick. For experimental purposes this year's pack was the worst ever recorded in the Antarctic, extending nearly 700 miles into the Ross Sea.

The voyage of three thin-hulled ships, led by a Coast Guard icebreaker, from near the Antarctic Circle into the Bay of Whales was an epic of modern navigation. It established principles on which ice travel science of the future may be based. Ships arrived battered but intact in two weeks, after several tight squeezes. Ice navigation requires an ability to judge varying thickness of the pack by observations from a helicopter at about 100 feet altitude and 10 to 25 miles ahead of the ships. Much also depends on the ability of skippers to read the horizon where ice formations are reflected in fantastic designs. Ross Sea is like a gigantic hall of mirrors for even experienced ice sailors, of whom there are very few extant, and it is the easiest path to the continent. Its summer pack is usually looser and thinner than anywhere else, due to favorable prevailing winds. It brings ships within about 800 miles of the pole and is the best known section of Antarctica, with the excep-





Robot recording units were vital in collecting first accurate data in "world's weather factory"

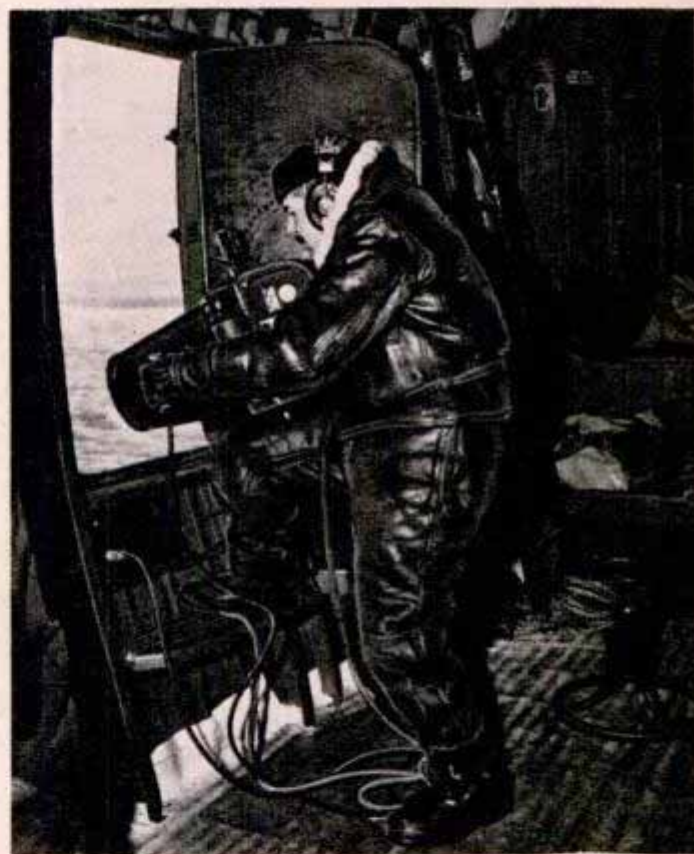

Aerial cameras mapped thousands of square miles of virgin territory. Below, pads were devised to protect the dogs' feet during training runs

tion of far northern Palmer Peninsula. In most other places the pack is too thick even for icebreakers alone.

Despite snow and ice transport means developed in the war, such as the weasel, tractored counterpart of the jeep, antarctic land exploration is still exceedingly hazardous, requiring almost superhuman effort. A relatively short path from the end of the Bay of Whales to the pole is blocked in several areas and so deeply crevassed that it is impenetrable for anything but dog sleds. Further knowledge of the interior of this mysterious continent depends almost entirely on air observation. Sea and carrier-based aircraft are able to get only a few hundred miles beyond the continental shores, due to the many miles of ice pack which they must cross. Admittedly, land-based planes, preferably with wheeled landing gear, are essential for systematic long flights across the South Pole from different angles.

Successful use of these requires adequate landing fields. Building an experimental air strip on neve, a curious sand-like snow that covers everything, was







Land travel was slow without tractors, like this one assigned to the photographers

the second major military objective of the expedition. Naval engineers are testing several methods of laying down such a strip—a problem akin to landing planes on the finest and deepest beach sand imaginable. Landings can also be made on skis, but details of these methods are military secrets.

Surface transport has been the nemesis of south polar exploration in the past and only dog teams have proved entirely reliable. This is the most far-reaching experiment ever made with motorized vehicles on antarctic ice. They were very unsatisfactory on previous expeditions led by Admiral Byrd and, even while hundreds of tons of supplies were hauled over a 60-foot-high slope to barrier ice from the Bay of Whales, weaknesses developed.

The greatest difficulty is that neve does not pack down, become hard and develop

a hard surface like ordinary snow. It degenerates into "sand" in which tracks sink deeper with every turn. Motorized vehicles have proved too heavy to cross deep crevasses in the ice, sometimes a thousand feet deep, which have been bridged over and hidden by wind-blown snow with a thin crust on the surface. Dogs and men can often cross such bridges with little risk, but heavy equipment breaks through. This is the great drawback in all proposals for a motor convoy to the South Pole.

However, great advances have been made over past expeditions. Heavy tractors have been equipped with "snowshoes" and the most important vehicles are light motorized cargo carriers with surface pressure less than two pounds per square inch.

Calculations before the expedition started showed that any such transport must

Metal airstrips devised in wartime facilitated landings and take-offs of heavy planes with wheeled gear





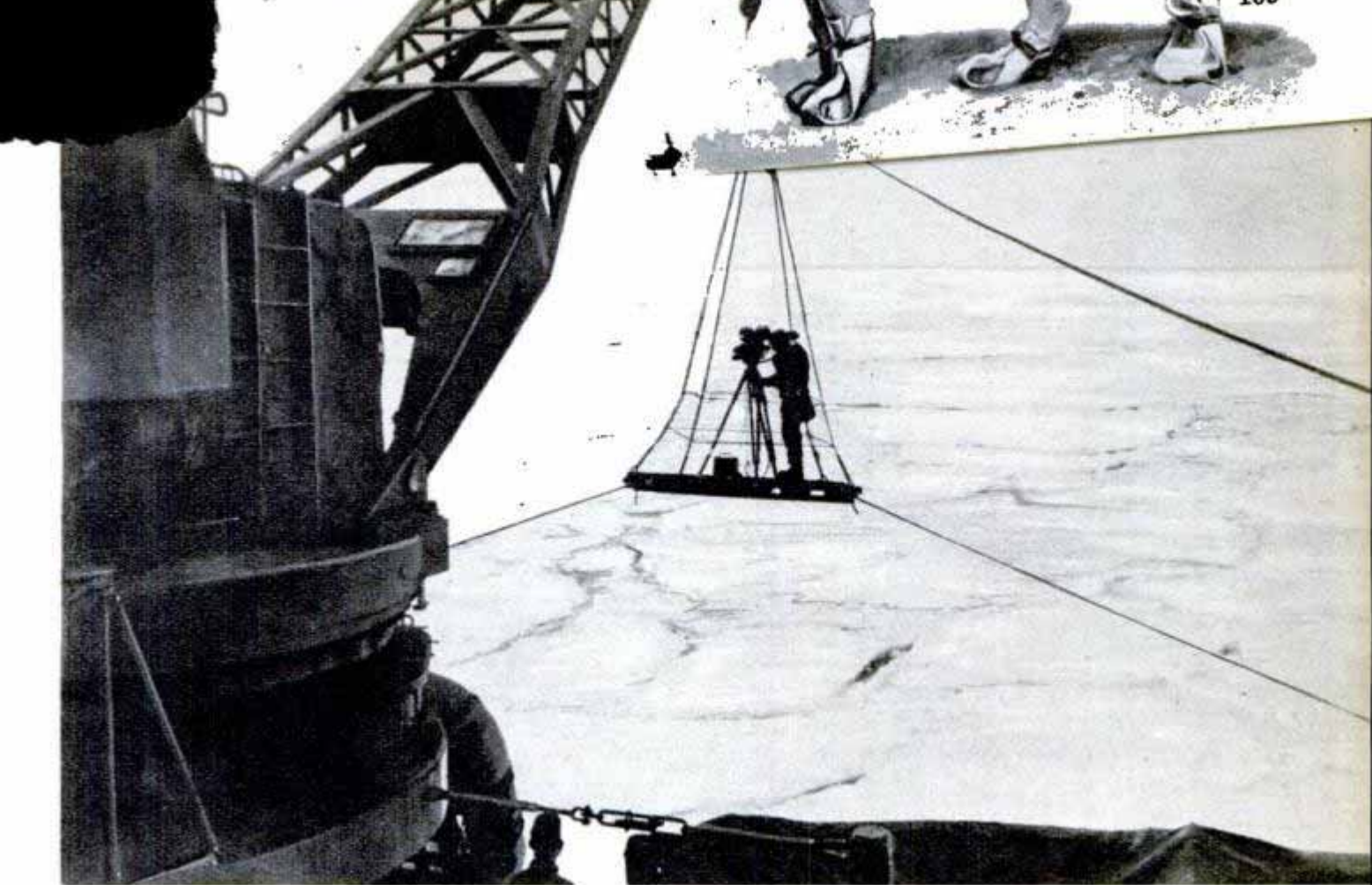

Working from a precarious perch slung over the side of the USS Burton Island, a photographer shoots motion pictures of the slow transit through the ice pack

have a pressure on surface of less than four pounds per square inch. This was practically impossible to attain with vehicles large and sturdy enough to be of much value. Less than half this pressure was attained with the war-developed weasel, greatly improved for last winter's Canadian Musk Ox maneuvers in the Arctic.

With large tractors needed for transporting heavy supplies, the construction problem seemed unsolvable until Marine Corps

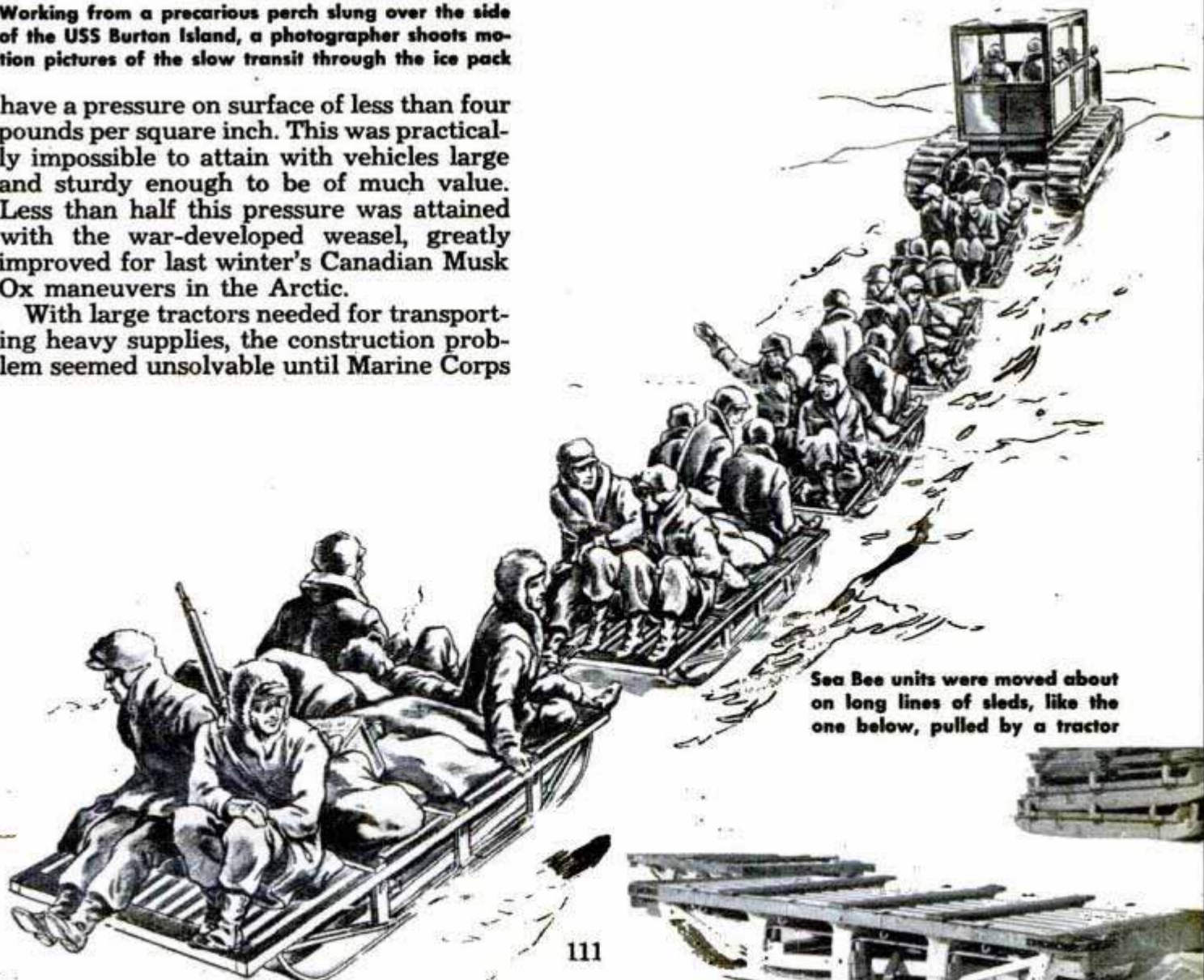

Sea Bee units were moved about on long lines of sleds, like the one below, pulled by a tractor



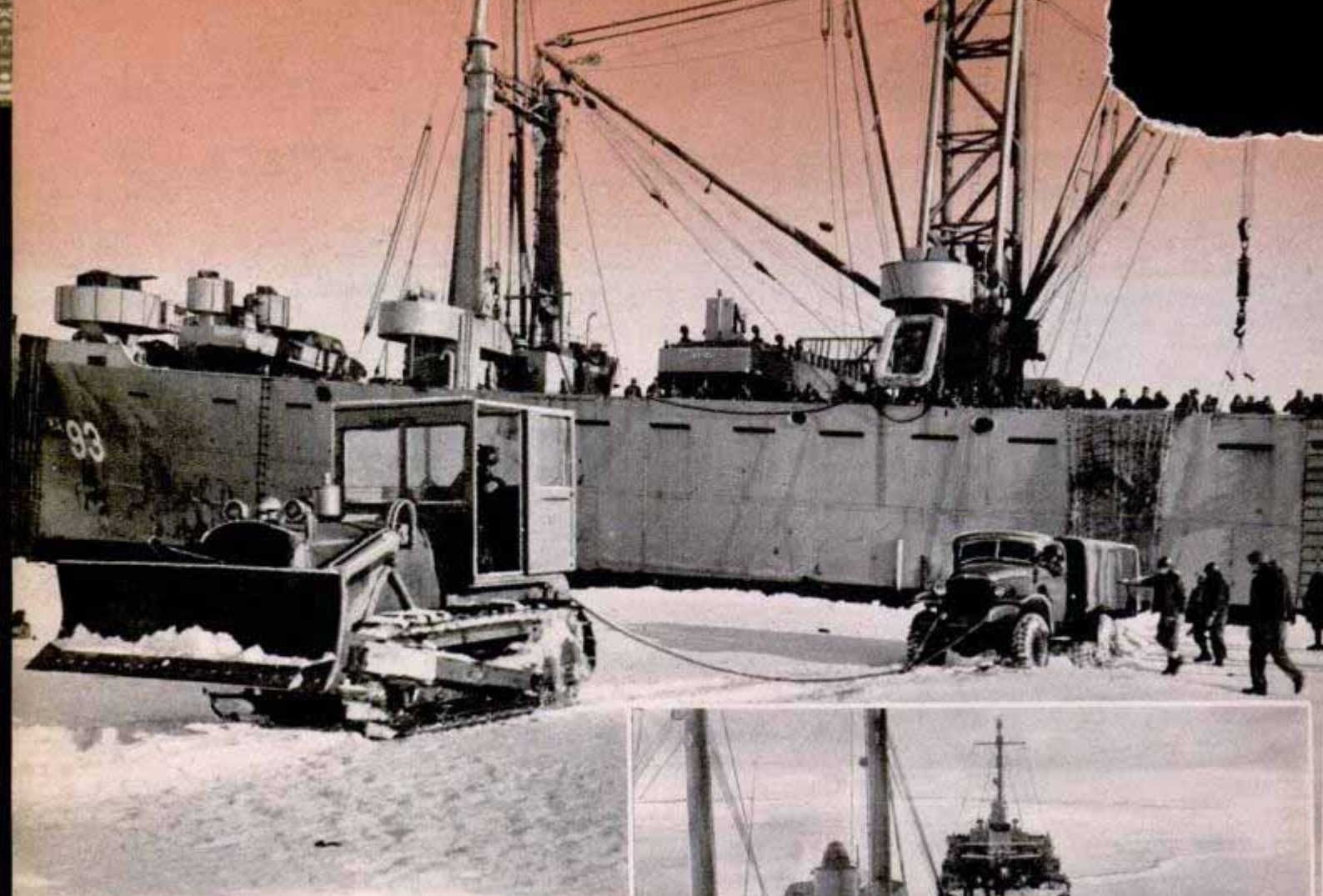

Wheeled trucks had their troubles. Here a tractor tows a 6 by 6 stuck in the ice. Right, breaking a path through the Ross Sea. One theory advanced by the exploration is that Antarctica's peaks are missing links in a chain, bottom, that once ringed the Pacific



Captain Vernon Boyd evolved his snowshoe idea. Such a tractor ordinarily has a pressure of about nine pounds per square inch. This is greatly reduced by attaching oak planks to the cleats on both sides. These planks distribute the pressure over a much wider area.

What use to anybody—except for weather stations and as a possible training ground for polar warfare—is a continent that will not support life? The answer lies with the expedition's geologists, who roped themselves together in exploring parties to traverse some of the most dangerous areas of the world. Last fall there were persistent rumors that the chief motive of the five expeditions from five nations into the "white desert" this year was to prospect for large uranium deposits. This idea is silly. Even if uranium is here, as it quite probably is, there is no way of locating or mining it. Ice

(Continued to page 260)





U. S. Navy photos

Modified for aerial mapping, a Navy R4D transport gets take-off boost from jato. Below, with a ground pulse navigation radar unit it was possible to keep track of all aircraft in 30-mile range



U. S. Navy photos

In icy tests only long underwear was worn under one-piece rubber swim suits. Right, huskies slept in blizzards with only noses visible. Note deep crevasse, below, in shelf ice at Bay of Whales





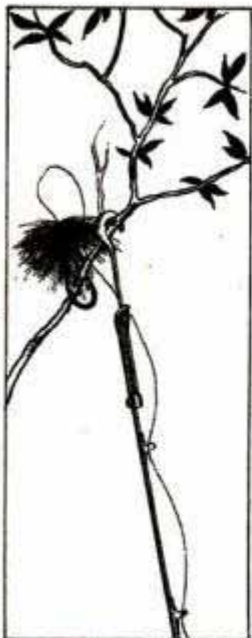

## Miniature Scythe for Anglers Cuts Loose Snagged Lures

Attached to the tip of a fishing rod, a curved knife resembling a miniature scythe aids the fisherman in retrieving a lure that has become hooked in a tree. The knife slides through the line guide at the tip of the rod and is fastened securely to the rod with a spring clamp. The fisherman uses the extension knife to cut the twig or branch holding the snagged lure. The knife may be attached or removed quickly.

## Jig Holds Odd-Shaped Parts For Drilling at Any Angle

Accurate holes can be drilled at any angle with a drill jig which will accommodate such diverse shapes as flat stock, balls, cubes, hexagonal nuts, gears and rods. It is possible, for example, to drill directly into one corner of a rectangular metal part. The part to be drilled is placed between the jaws of the jig and clamped in position by tightening a screw. Construction of the jaws prevents springing or binding. The jig takes stock up to two inches in diameter and will accommodate drills up to  $\frac{1}{2}$  inch in diameter. Drilling may be done from either side. Bushings are quickly interchanged in the jig jaw. The jig including six bushings and two wrenches fits into a rustproof metal box.

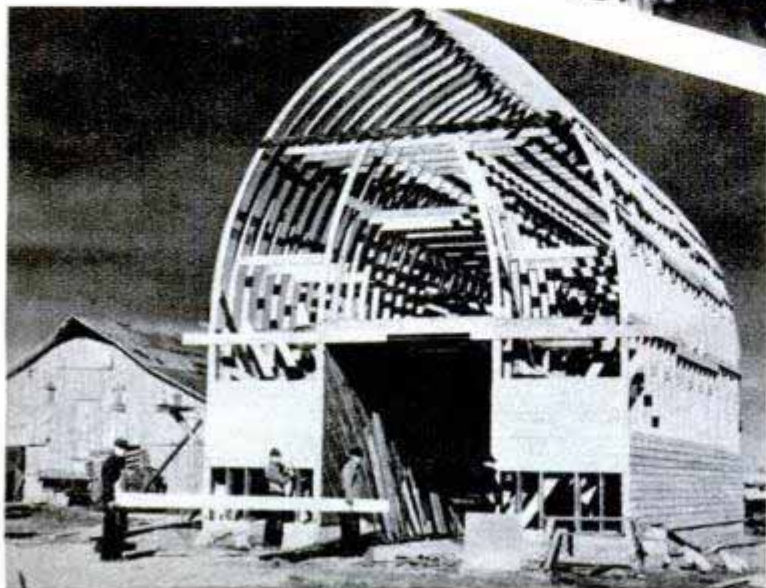
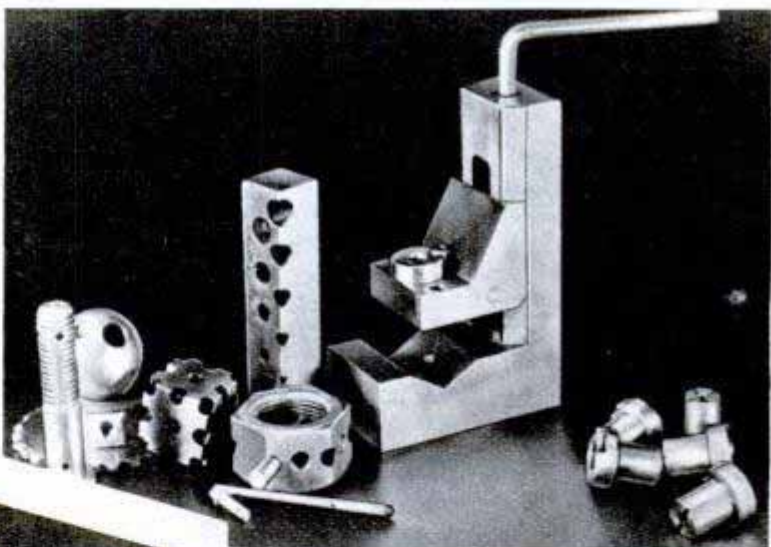
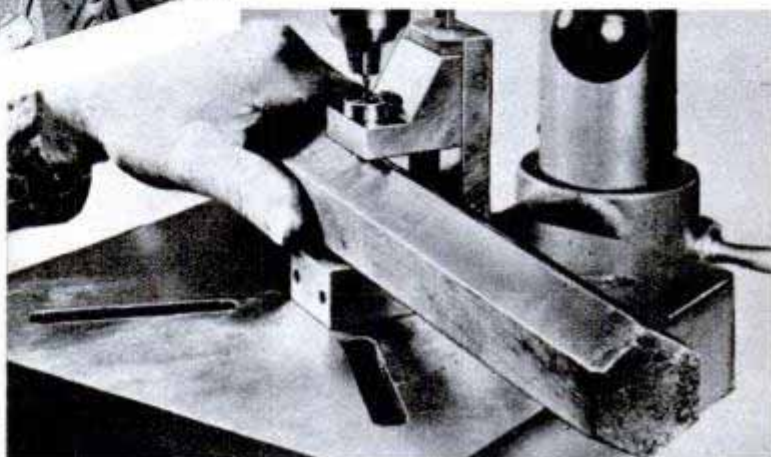

## Precut Parts of Corncrib Bolted Together on Site

Precut parts were quickly assembled into a corncrib that looks like a small aircraft hangar on a farm near Macon, Ill. Parts of the framework were ready to be bolted together upon delivery. The walls were not assembled but individual pieces were cut to the proper length and easily joined. The streamlined crib has a capacity of 5500 bushels of ear corn plus 2700 bushels of small grain.





Elephants suffer from complicated ailments, too. The contraption wrapped around the bewildered animal's trunk is an electrotherapy unit put there to treat "fibrositis" of the trunk. Six performing elephants in an English circus were affected by the disease, two so badly they couldn't flex their trunks to eat. After two treatments the animals improved greatly.



Three times daily Patient X in a London hospital is "strung up" and left to hang in mid-air. This is the unconventional treatment devised to cure him of partial paralysis in one arm and side, which was brought on by a displaced neck cartilage. When suspended by the chin, with his feet dangling nine inches from the floor, the patient says he feels fine, despite his awkward position.



Pending completion of a new generating plant, Eureka, Calif., draws part of its electric power from the 6700-horsepower steam-electric turbine engine of a beached former Russian tanker. The engine is in the stern half of the SS Donbass III, which cracked

### Beached Tanker Powers City

apart in February 1946. The Pacific Gas and Electric Company bought the stern half of the ship from the U. S. Maritime Commission for \$125,000. Transformers installed on the dock alongside the ship feed the power directly into the transmission line.



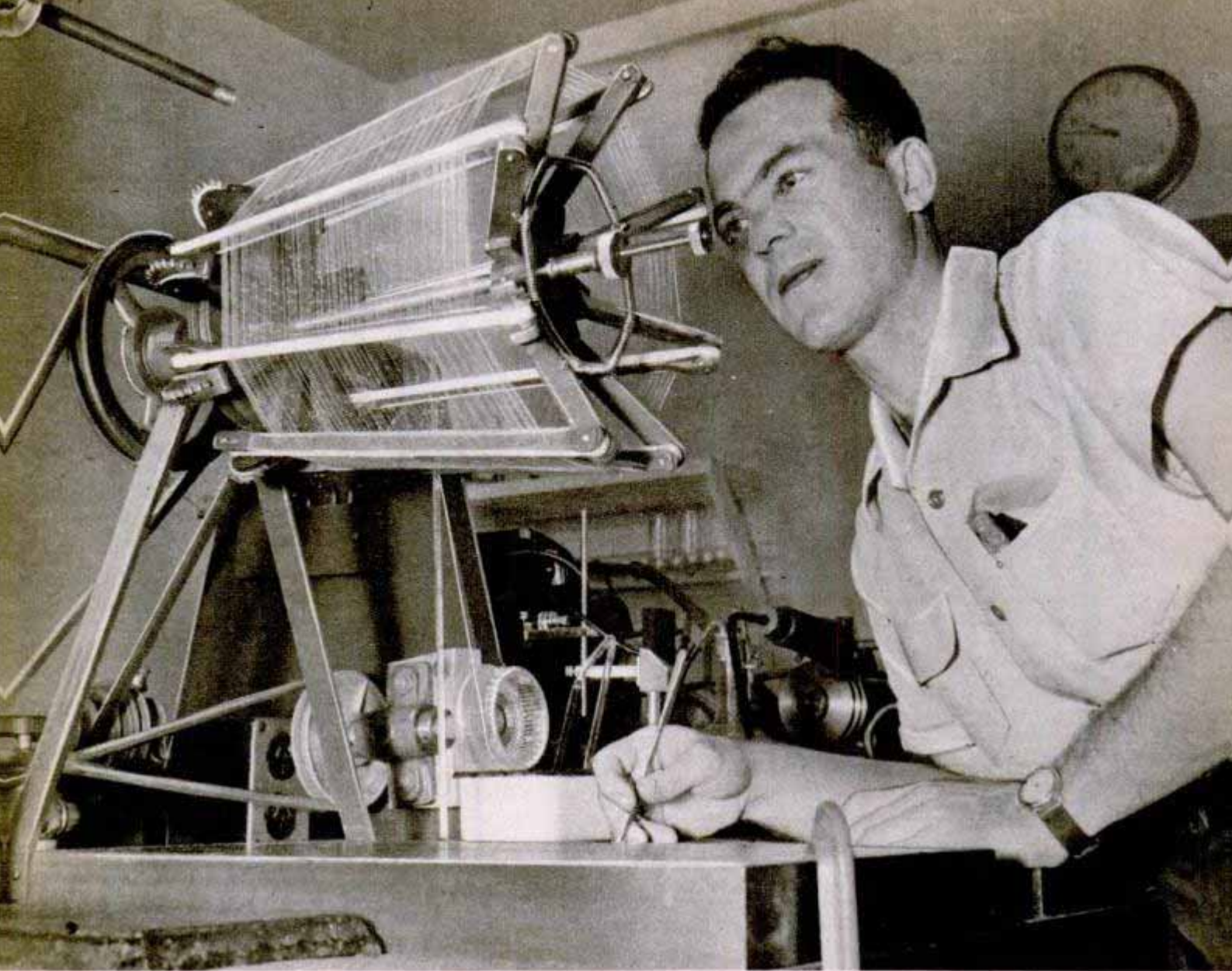

## *New Wealth from Waste*

**By John R. Kinsey**

Fibers from chicken feathers are collected on automatic reel. Below, mannequin wigs made from feather fibers  
Western Regional Research Laboratory photos

Paintbrushes from skim milk, medicines from asparagus butts and buckwheat, wigs from chicken feathers, motor fuel and engine cleaning material from corn cobs.

Strange things are being made from farm products, particularly residues. New markets are bidding for the farmer's wares.

The research work of a thousand U. S. Department of Agriculture scientists is beginning to show results. These chemists, industrial engineers and fermentologists started searching seven years ago for new industrial uses for farm products.

They went to work in four huge new laboratories equipped with the latest research tools and pilot-plant facilities to develop and test new materials for industrial uses. The laboratories are at Peoria, Ill., New Orleans, Philadelphia, and Albany, Calif.





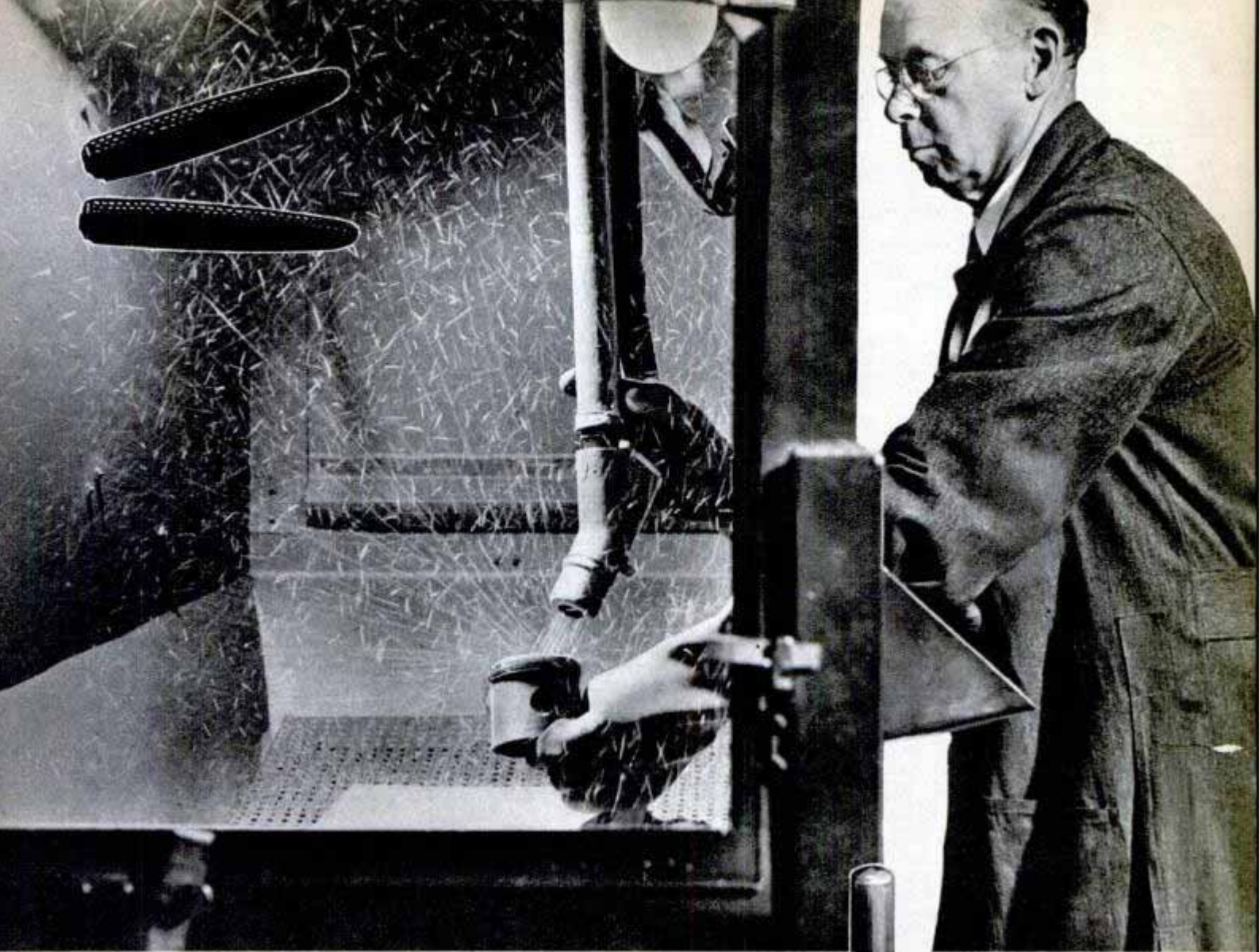

Dr. E. C. Lathrop, Northern Regional Research Laboratory, uses mixture of ground corncobs and whole rice hulls to blast-clean a piston. Right, valve assembly after half is cleaned by ground corncobs shown below

At Philadelphia they found a method to make tough, durable bristles from waste skim milk. The bristles resist oils and organic solvents and make excellent paintbrushes. One company has been manufacturing them since last November.

Casein from skim milk is mixed with water, heated, then drawn or extruded in the form of long fibers. Chemical treatment transforms the fibers into stiff, black bristles similar to horsehair or pig bristles. Research on casein bristles began when the war cut off our supply of high-quality imported pig bristles.

Casein bristle paintbrushes are attractive and have good painting qualities. The bristles can be made in any diameter or length and may be used for hairbrushes, buffers and clothesbrushes.

Another accomplishment by chemists at the Eastern Regional Research Laboratory (Philadelphia) was the discovery that buckwheat contains rutin. This is a yellow pigment used in medicine for treatment of

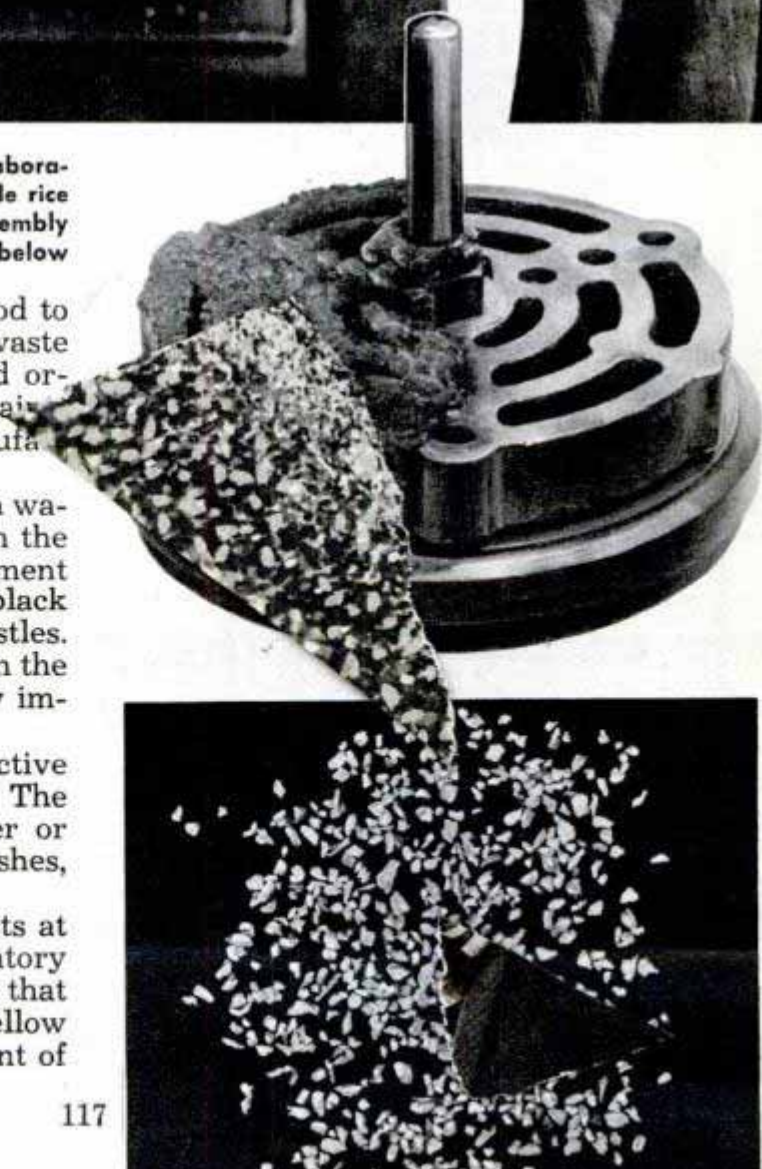





Extruding textile fiber from skim milk casein. Casein is mixed with water, heated, then extruded or drawn into long fibers

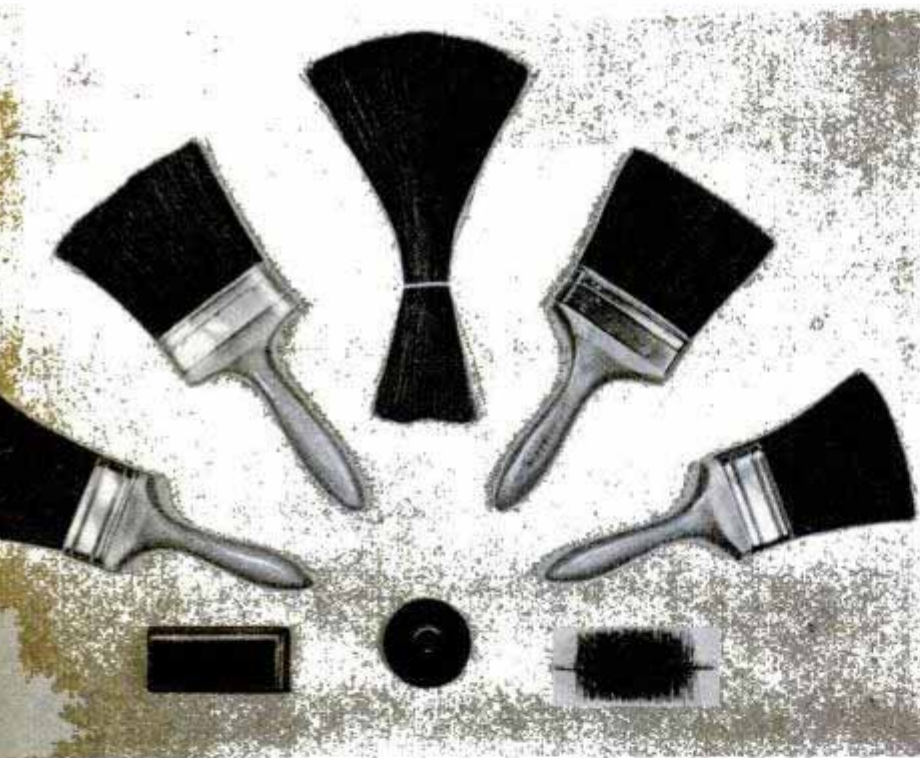

U. S. D. A. photos by M. C. Audsley

Paintbrushes and other types of brushes are fashioned from the stiff bristles produced by chemically treating casein fibers. Below, samples of fabrics, fibers and plastics made from skim milk



high blood pressure and apoplexy. Rutin reduces the tendency of capillary blood vessels to rupture and cause hemorrhages.

Prior to the discovery that buckwheat contains rutin, tobacco plants were the only source and the yield was quite small. The effectiveness of rutin led to a search for an extended supply. Buckwheat leaves and flowers offer a plentiful supply, containing about four percent. Several large drug companies now rely on buckwheat as their sole source of the drug.

At the Western Regional Research Laboratory (Albany, Calif.), chemists discovered a medical use for the tons of asparagus butts thrown away by canneries. Experiments revealed that the juice from asparagus butts is a good culture medium for growing subtilin, a drug that shows promise in the treatment of farm animal and plant diseases.

Juice is squeezed from asparagus butts in a hydraulic press, then heated to 122 degrees Fahrenheit and filtered. This process produces a soupy solution with high nitrogen content, which is essential to growing subtilin.

One of the strangest farm research developments which may have a medical application is the starch sponge. It is being used as an absorbable surgical dressing in experiments on animals.

Cornstarch is transformed into a soft, pliable, spongelike material by freezing it, letting it thaw, and squeezing out the excess water.

Starch sponges have one characteristic in particular which interests medical men studying new types of surgical dressings. Starch is converted by body enzymes into simple sugars which are absorbed by the body. Consequently, a med-





U. S. D. A. photos by M. C. Audsley

Cutting buckwheat to extract from it a yellow pigment called rutin, which is used to treat high blood pressure and apoplexy. Rutin crystals are pictured at right

icine-soaked starch sponge in a wound or incision would not have to be removed.

Chemists at the Northern Regional Research Laboratory (Peoria) point out that anyone can make a starch sponge in a home refrigerator. Detailed instructions are listed at the end of this article.

Working alongside the Peoria chemists who developed the starch sponge process is a group of fermentologists who had a lot to do with increasing the production of penicillin during the war.

They developed improved strains of the molds that produce penicillin and perfected the culture medium in which the molds grow. They discovered that yields of the drug were greatly increased by adding corn steep liquor (by-product of corn starch manufacture) and lactose (milk sugar) to the culture medium.

From penicillin to wigs is quite a jump, from a research or any other standpoint. But farm products are used in the production of both—corn for penicillin and chicken feathers for a new type of wig.

Noreseal, substitute for cork, is made from cornstalks, peanut shells or sugar cane bagasse. Mixture is heated, beaten to incorporate air, and a setting agent added



The Department of Agriculture figured that new uses should be found for the 75,000,000 pounds of chicken feathers that farmers throw away every year. So far, chemists at the Albany, Calif., laboratory have found that chicken feathers can be converted into dyed hair wigs for manne-

During the war cork shortage, Noreseal was used experimentally to line caps for beverage bottles. Liners are stamped from flat sheets or cut from rod stock

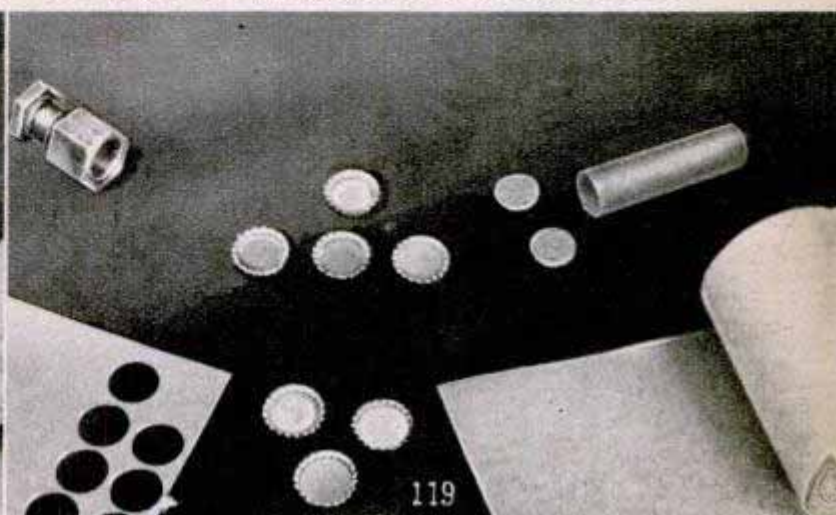



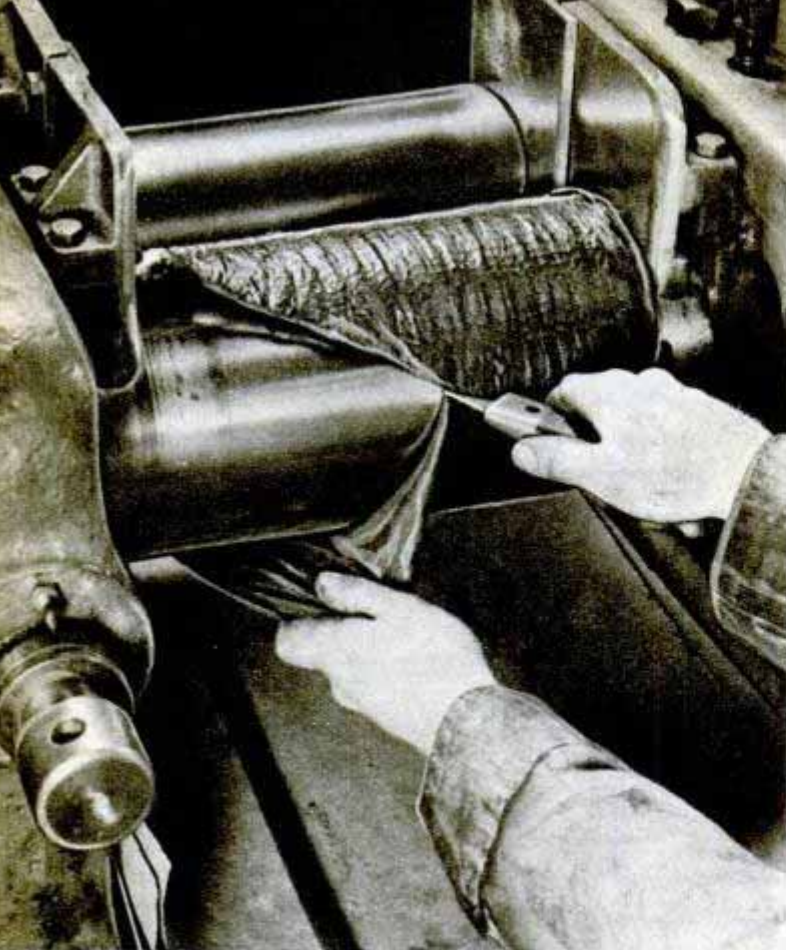

Lactoprene, a synthetic rubber made from whey, is cut from compounding rollers at Philadelphia laboratory

quins and theatrical use, paintbrush bristles, plastic ash trays, carpets, absorption pads and coatings to resist certain chemicals.

Like chicken feathers, the corncob is another farm residue that used to be considered useless. Now, thanks to science's never-ending search for things unknown,

the corncob has a number of important uses. It is effective as a soft-grit blasting material to remove hard carbon deposits from cylinders and pistons of aircraft and automobile engines. Engineers at the Northern Regional Research Laboratory found that ground corncobs, mixed with rice hulls, can be used in standard sandblasting machines to remove rust, paint, grease and dirt from metals.

The corncobs are ground in an attrition mill, air-sifted to get rid of dust, then screened to produce the right size of pellets. Ground cobs remove carbon without scratching or marring metal surfaces and without causing any dimensional changes in the parts being cleaned.

The glass and rubber industries use ground corncobs for air-blasting to clean molds; automobile repair shops use the material to clean engine parts; foundries use it for cleaning mold cores and boxes; tire recappers use it to clean carbon from aluminum matrices without the corroding action caused by strong acids.

The lowly corncob can even be converted into motor fuel to run automobiles. This fuel is being produced daily in a plant adjoining the Peoria laboratory where conversion processes are studied in an attempt to lower the production costs. No figures on production costs are available at present.

Chopped corncobs are fed through a long tank while dilute sulphuric acid is forced through in the opposite direction. The acid converts part of the cob to xylose sugars which are fermented to form butanol, acetone and ethyl

(Continued to page 244)

Diagrammatic flow sheet shows the process which converts corncobs into motor fuel

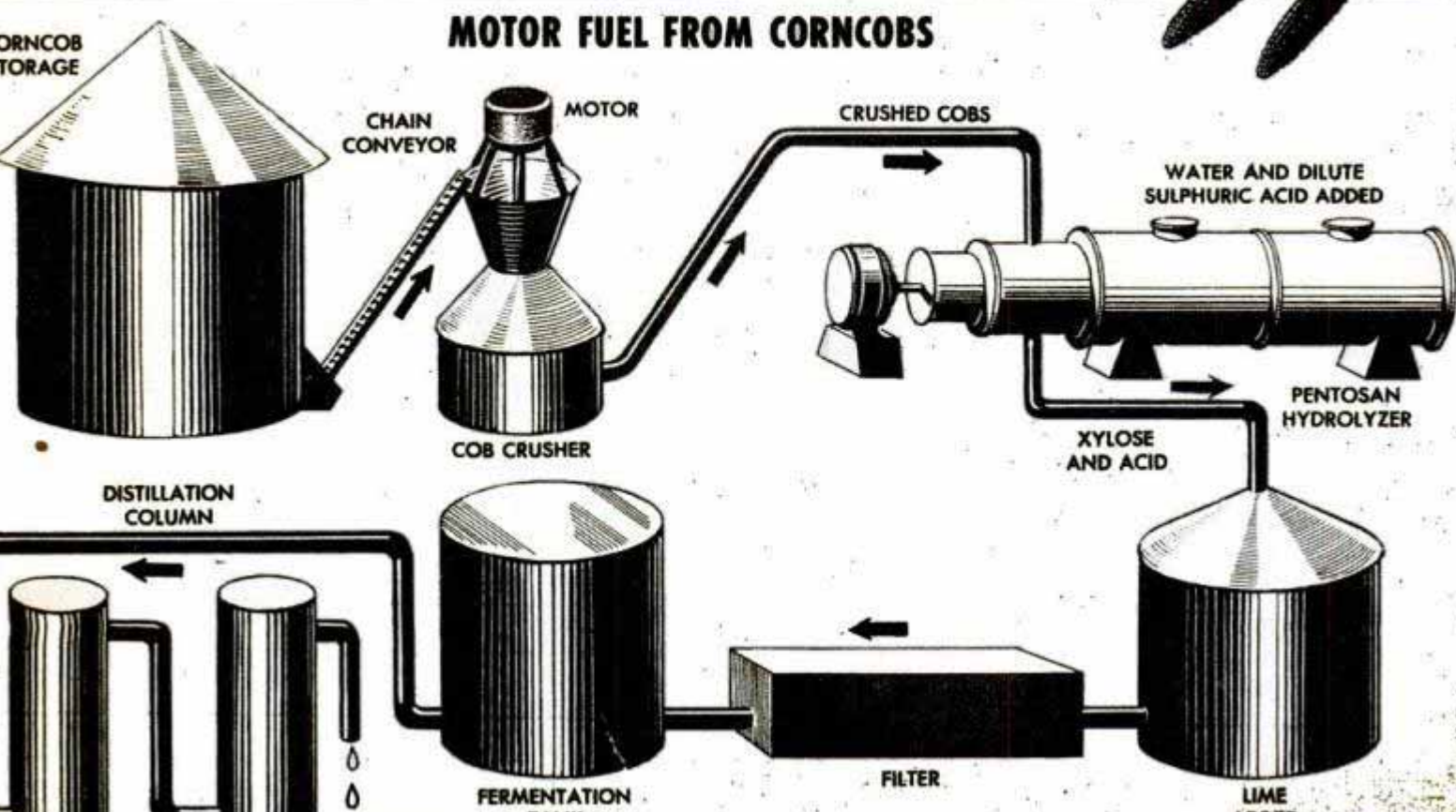









Courtesy of Admiral Corporation







**TOWERING TAIL** of the Lockheed Constitution being built for the Navy is so high that crews must use a bosun's chair for inspections of the rudder

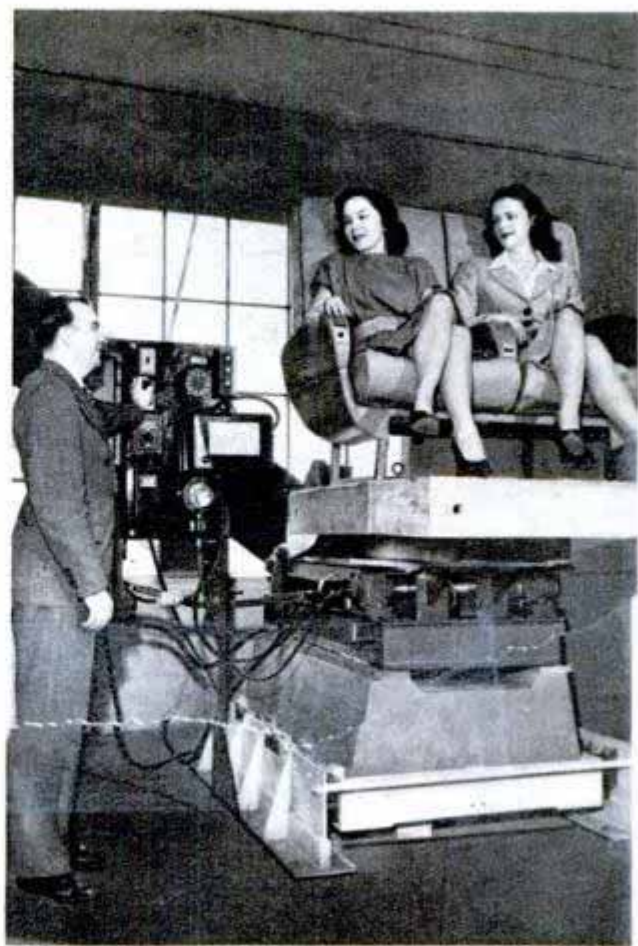

**SEAT JIGGLER** used by Boeing to test the vibrations in airplane seats caused by propeller "blast" led to development of chair mounted on live rubber

**ROCKET RADIO** installed in test-fired V-2 transmits 28 separate items of information each 1/35 second  
General Electric photo

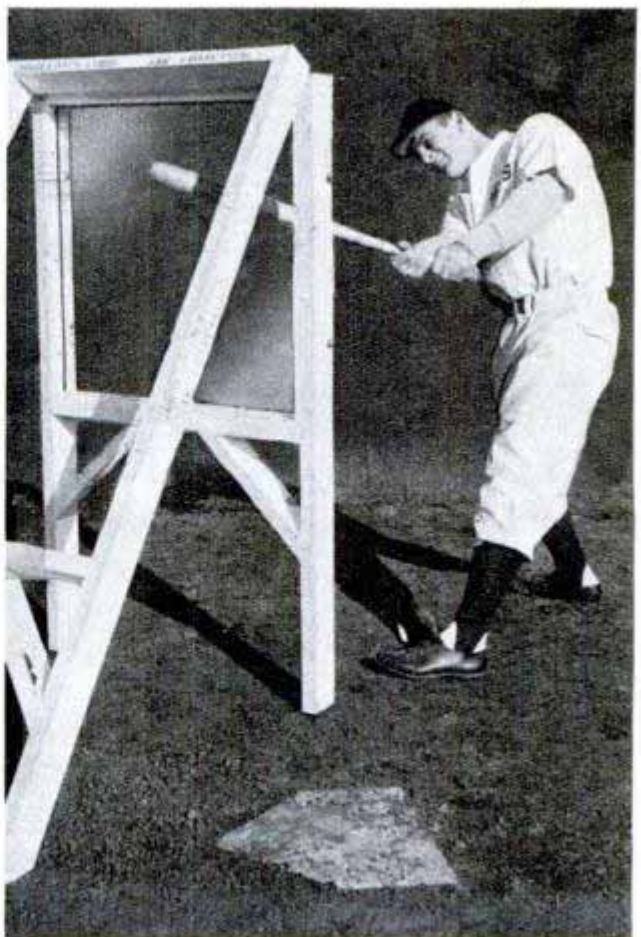

**BATTER UP!** A sheet of special plate glass withstood healthy cuts by a ball player in recent tests





Courtesy of Admiral Corporation

## Radio Treasure Hunts

Amateur radio operators in the Chicago area have developed a new twist to treasure hunts. The contestants—riding in autos equipped with radio direction-finders—search for a hidden radio transmitter. Three men in a car make up a team, with one driving, a second operating the direction-finder, and the third keeping bearings on a road map. All teams start at a central point, and at a specified time the transmitter starts sending code. For participants not familiar with radio code, a simple series of Rs is also sent at intervals. The first team to arrive at the transmitter—location of which is unknown to the contestants—wins. The automobiles are equipped with special antennas, receivers, remote control boxes and tuning controls to help the radio sleuths track down the hidden transmitter. In a recent hunt, two transmitters were used, the second going on the air as soon as the first one was located.

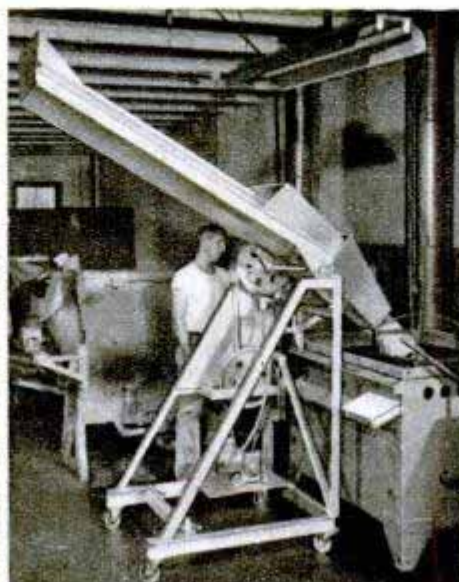
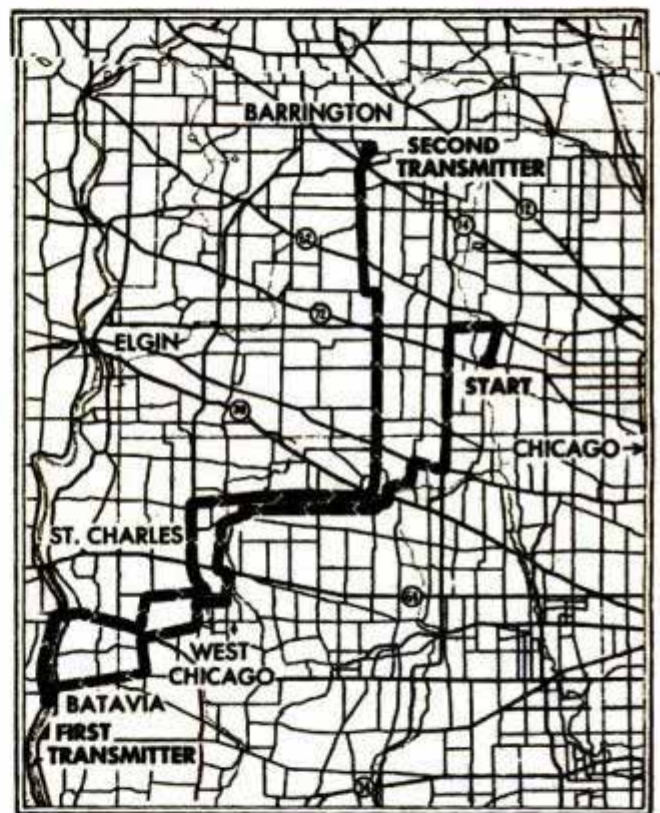

## Machine Dumps Bags

Lifting and emptying sacks—an arduous hand job—is accomplished easily by a small power machine which does both jobs. Bags up to 300 pounds can be handled by the dumper. Two removable spikes puncture the bag and a pin holds it open for emptying. A pouring funnel prevents waste. The entire unit is mounted on wheels and is suitable for emptying any free-flowing materials.



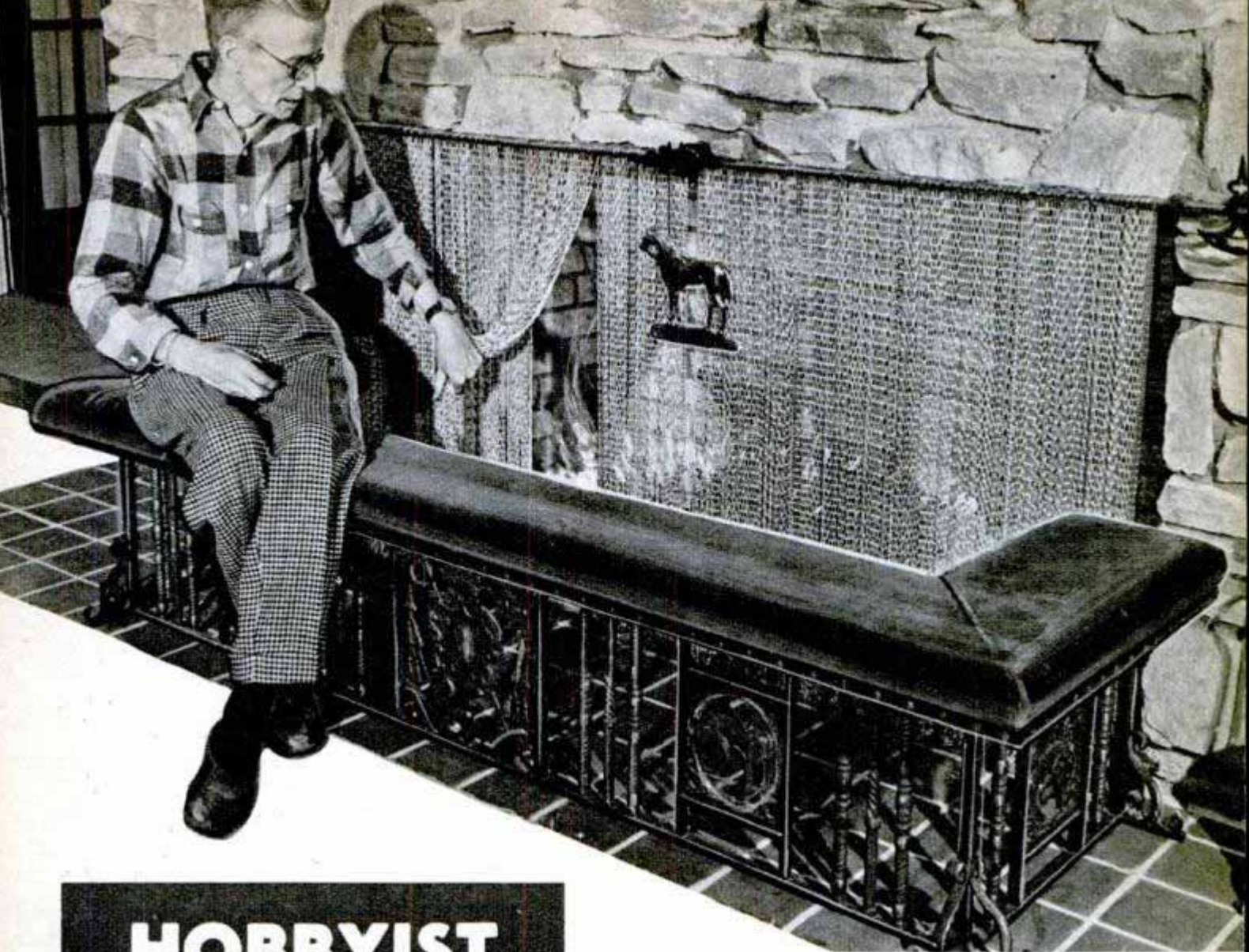

## HOBBYIST OF THE MONTH

*Tom Howard*

By Bill Reiche

Though other stars of show business may find fun and relaxation in night clubs, Tom Howard, veteran trouper and radio comedian, has a design for living that keeps him away from the bright lights.

When Howard is not rehearsing or broadcasting his nonsensical half-hour CBS program, "It Pays to Be Ignorant," you'll probably find him in his large, well-equipped workshop at his fine new home in Red Bank, N. J.

Here he turns his back to a lifetime of show business, and his raucous voice—known to millions via radio, vaudeville, musical comedy and the movies—yields to the whirr of the drill, the rasp of the grinder and the whine of the power saw.

Amid a mass of fine and varied tools he

Veteran of stage, screen and radio, Howard spends leisure hours in his workshop where he turned out this fireplace screen made of 1000 feet of polished chain. Below, he mixes his own tobacco in flour sifter after cutting it in coffee grinder shown on bench

and his son, Tom, Jr., a musician, composer and arranger, frequently put in almost a 40-hour week of making, mending and just "messing around." Tom, Sr., devotes his time to making useful objects, sound and functional, while his son leans toward decorative and entertaining projects.

As the owner of a new house, Howard







Howard drills a pipe bowl with his new drill press

finds plenty of opportunity to put his shop-work to good use. When a cabinet is needed to fill an odd corner, or some shelves need alteration, these demands get priority.

But given a free hand to do just what he wants, Howard will turn out pipes of his own design. He and his son are habitual pipe smokers, and if any of their men friends are not, it isn't the Howards' fault; they've made scores of pipes and given practically all of them away.

Howard buys briar roots by the bag and rubber bits the same way—in quantity and of assorted sizes. Out of this large assortment he makes pipes of various shapes, sizes, weights and style of decoration.

He can turn out a finished pipe in three or four hours. First he cuts the hunk of briar into a rough approximation of the shape of the pipe's bowl and stem. Then the briar is turned and shaped before the bowl is drilled.

This last step is performed with the greatest of satisfaction by Howard, who gets a thrill from using his shining new drill press. From the press the embryo pipe returns to the shaping and turning machine for its semifinal contouring. Then if any rough spots remain they are removed with a hand file after the briar has been placed carefully in a vise and protected with aluminum shields. After sanding and polishing, the briar is ready to be joined to the rubber bit.

Any pipe smoker will note at once that Howard's pipes are devoid of filters, goo

traps, cleaners and all other devices calculated and alleged to produce a cooler, sweeter smoke or a drier, sweeter pipe. Howard has no use for such gadgets and considers them a direct affront to the dignity of an honest pipe.

"There should never be any plumbing in pipes," he growls. "It just doesn't work."

He has shown a fine flair for inventiveness in his favorite field of craftsmanship.

In 1939 he built a pipe through which a pipe cleaner could be drawn from mouth-piece to base of bowl, thereby providing a more thorough cleaning through the entire length of the smoke channel. The hole in the bowl was neatly plugged with a plastic or metal screw. Howard also devised a pipe that had an orthodox flint and wick lighter in the leading edge of the bowl. After removing the lighter's cap and flicking the wheel the smoker holds the pipe stem up; the flame flows over the bowl and ignites the tobacco.

But there is another lighter-pipe that he considers more practical, and this, too, is a Howard idea. A metal "match" with steel striking surface and fuel supply is snugly assembled under the bowl—providing a constant source of fire for the often matchless pipe fiend. The match also enables the



↑ Cleaner is drawn all way through one of his pipes

↓ "Metal match" lighter fits compactly under the bowl to provide fire for proverbially matchless pipe smokers.





smoker to light a partially filled pipe, which the lighter-on-the-rim does not.

Howard's first successful workshop project was a cabinet for a home recorder. This proved to be a serviceable object, as he recently sold it after using it almost 10 years.

His workshop boasts 22 motors in stationary, installed tools alone and a good many more in portable tools. Around its walls and on an "island" workbench in the middle of the floor are a drill press, three cloth buffers, two wire buffers, a grinding wheel, wood lathe, metal lathe, disk and belt sander, bandsaw, jigsaw, small belt sander, jointer, power hacksaw and a bench circular saw.

He is quick to adapt machines to his special needs. Following through on his pipe-making, he mixes his own blend of tobacco. To reduce the coarser tobaccos to smoking size he rigged an electric motor to an old-fashioned coffee grinder. To mix the final blend thoroughly he uses an old flour sifter.

Shortly after moving into his magnificent new home—a converted barn and carriage house—he saw a fireplace screen made of hundreds of strands of dangling chain. Upon pricing it he found that the screen cost \$150 and he was sure he could make one for less than that.



↑ One of Howard's ingenious pipes has a conventional flint lighter fitted to the rim of the bowl. Below, in his hands he holds the biggest pipe he ever made

CBS photos





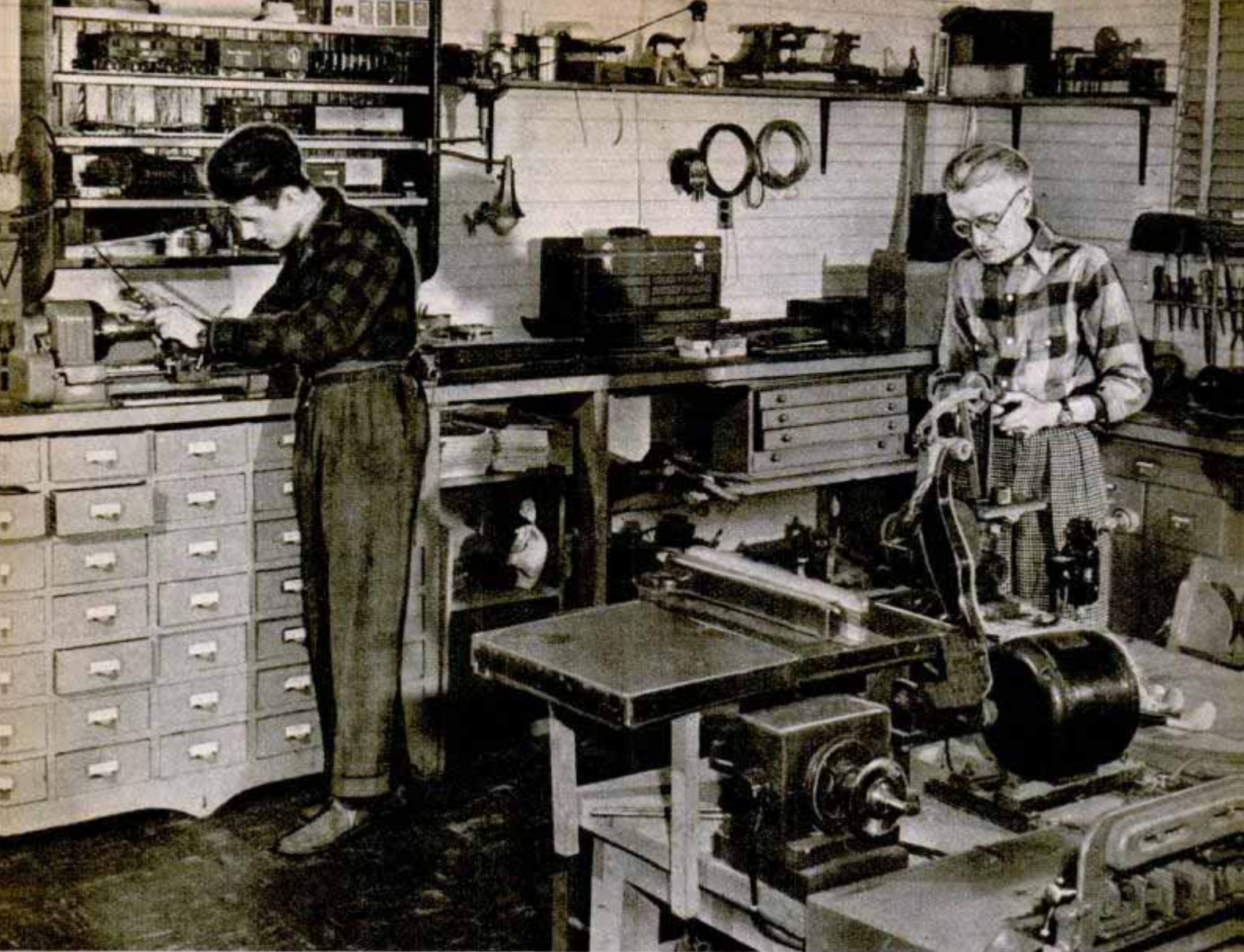

CBS photos

Father and son work together in this shop; Tom, Jr., specializes in boats, planes and cars like models below

For his fireplace he needed 1000 feet of chain, which he finally obtained for three cents a foot. He bought brass pipe from a plumber, cut the threads in his shop, found a decorative metal horse and the spears for the ends of the pipe in his "junk box" and Eureka! he had a screen. Net saving: about \$115.

A coffee table was needed for one end of his enormous living room. So large was the area among the chairs that any ordinary

table would have looked like doll's furniture. He found an old-fashioned mahogany circular dinner table, cut off the center shaft to bring it down to good ash tray height and a most practical and handsome coffee table was the result.

Tom, Jr., specializes in model boats, trains, brass cannon and other decorative pieces. Some day he hopes to have enough room to set up a complete division of a mid-western railroad, entirely built to scale, but even the Howards' outsize home isn't big enough to accommodate that.

Since the day in 1937 when the senior Howard saw a display of shop tools in a department store—and received many of them from his wife for Christmas—it's been pretty clear what his hobby is.

The song says "There's No Business Like Show Business," but to Tom Howard there's no work like shopwork.

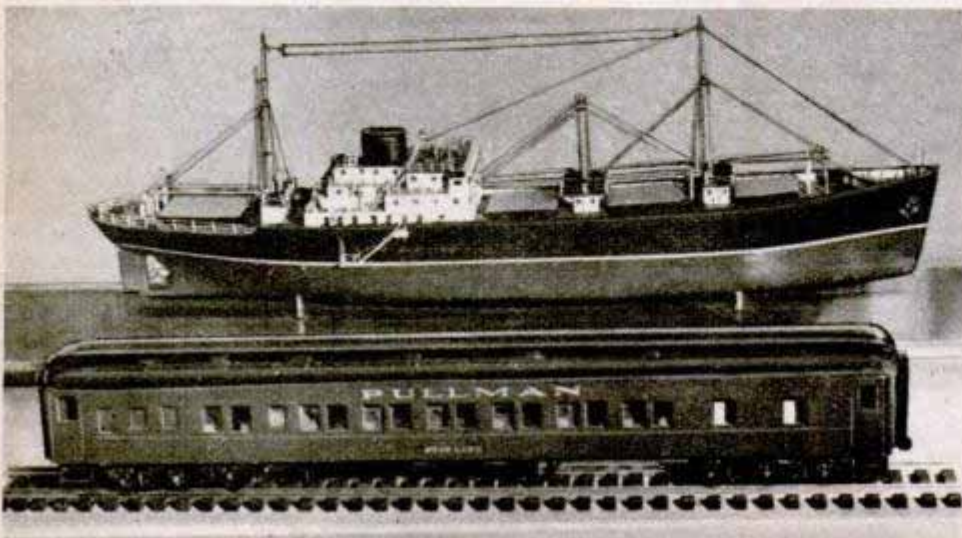



**Midget car** called the "Playboy", now in production, will go 35 to 45 miles on a gallon of gas in city driving, according to the manufacturer. The little car has a streamlined body with full-length fenders and a convertible top. Running boards have been eliminated from the midget, which has a chrome-plated grille, full-width bumpers and built-in headlights. Small-size tires are used on the wheels. The manufacturer hopes to mass-produce the little vehicle soon.

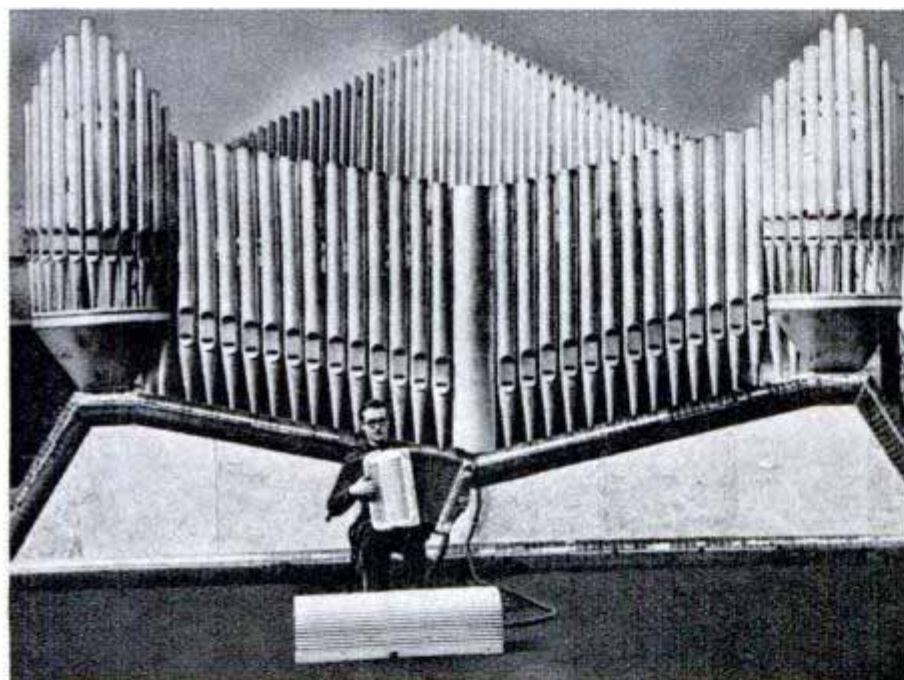

**"Accordionorgan"** can be played by anyone who can play a conventional accordion, but it's not so easy to carry the new instrument to concerts. It weighs more than a ton and is so big it must be hauled in a truck. To play it, the musician presses the keys of a regular accordion held in his lap. Electric wires connect the keys with the pipes of a large organ, which are actuated as the accordion is played. The young French inventor now is giving concerts on the instrument in Paris.

**File guide** holds metal files at the proper pitch and angle, enabling anyone to sharpen handsaws. The tool, which clamps over the saw blade, has a double arm through which the file guide slides. By adjusting the arm to the correct pitch and angle, the operator can sharpen the teeth of any handsaw with precision.

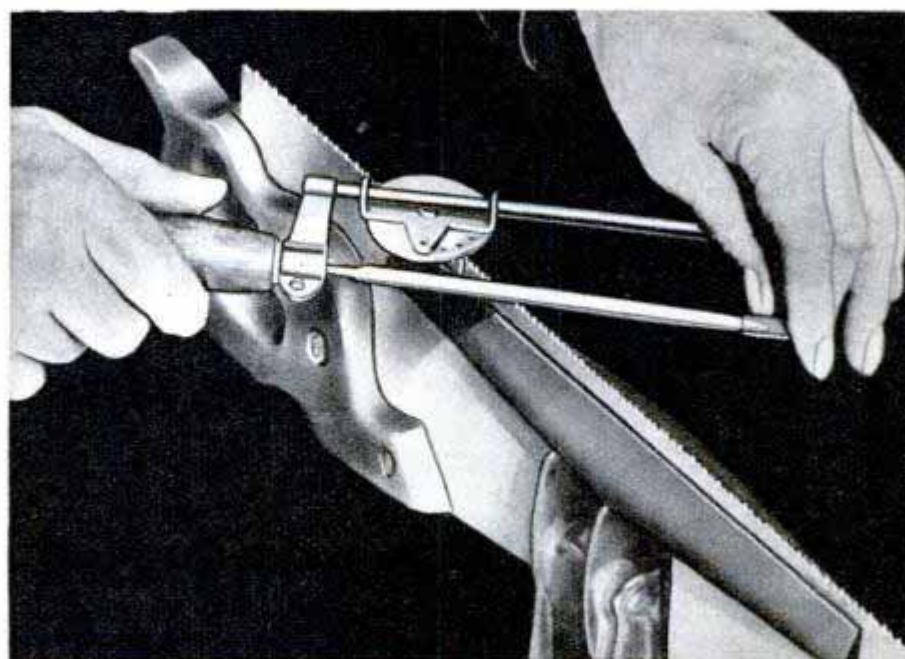

☐ America's rarest waterfowl, the trumpeter swan, increased its U.S. population last year by 60 birds to reach a new total of 361 for the flock.



## FOR PHOTO FANS



**HARNESS LIGHTS** invented by this newsreel cameraman move as he directs his camera, freeing both hands for taking the pictures



**ELECTRONIC FLASH UNIT** developed by Navy completely stopped motion in photo above. Attached to camera below, it fires 4000 flashes on same battery, 10,000 flashes on single repeating bulb



**PLASTIC SLIDE MOUNTS** hold 35-mm. transparencies firmly without cement. Film is slipped into groove, is replaced easily

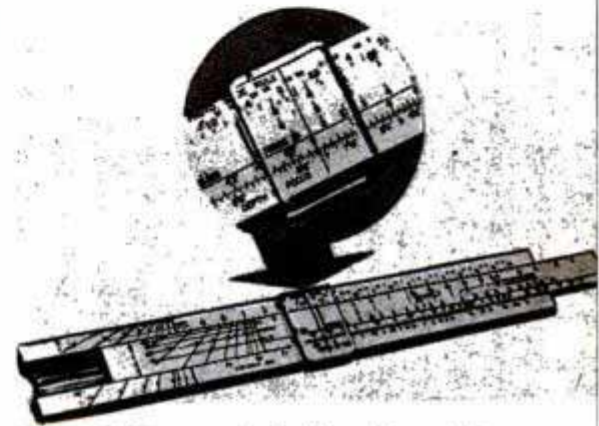

**SLIDE RULE** automatically solves photographic problems including exposure, lens equations and depth of focus for taking pictures under any type of illumination

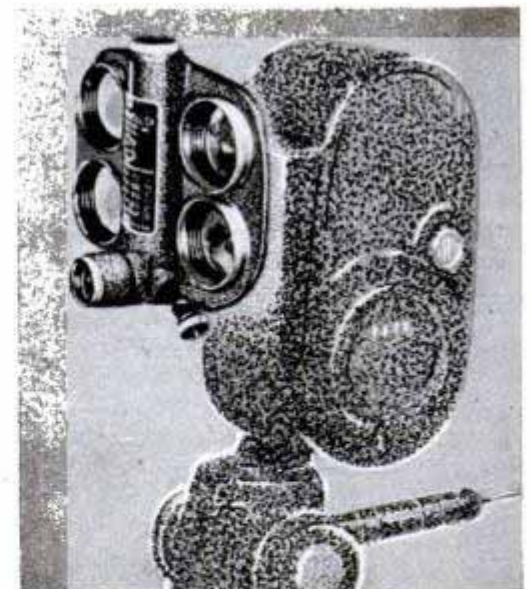

**FRAMING ATTACHMENT** for 8 and 16-mm. movie cameras shows exact field of view as close as six inches from the subject. Fastened to the camera lens, the attachment is equipped with an auxiliary lens and compensating view finder. Additional lenses are available for use in camera-to-subject distances up to 36 inches. It can be used in title making as well as close-ups



## Electric Safety Razor

Standard razor blades are used in an electric shaver that gives the blade 120 straight, edge-wise movements per second. This crosscutting action is said to duplicate the smooth shaving of a straightedge razor. The head of the electric shaver is patterned after a standard safety razor and the blades may be changed in the same way. The razor operates on 110-120-volt current, but it can be used as a regular safety razor if electricity is not available.

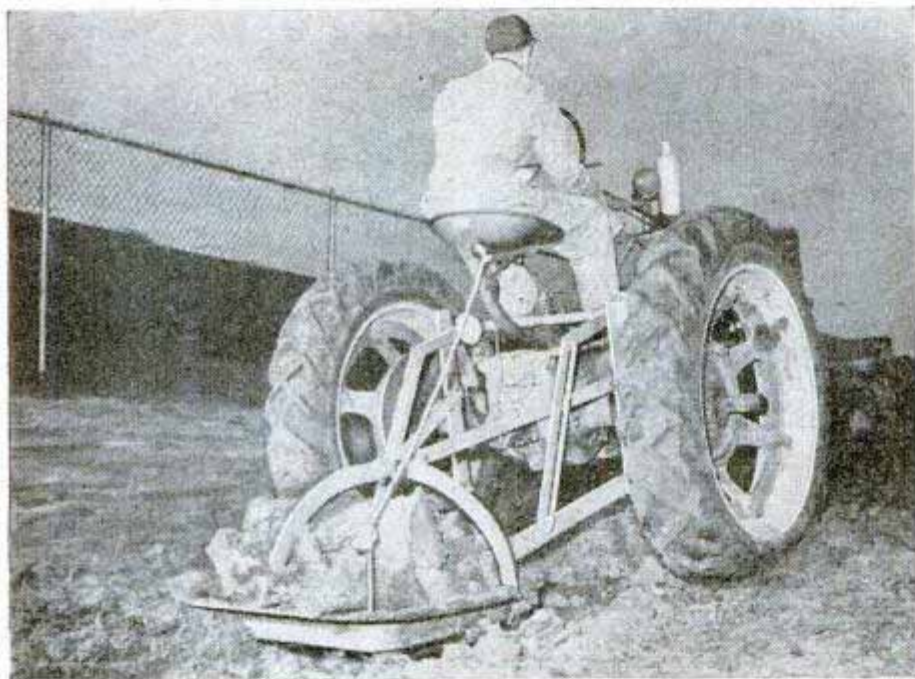
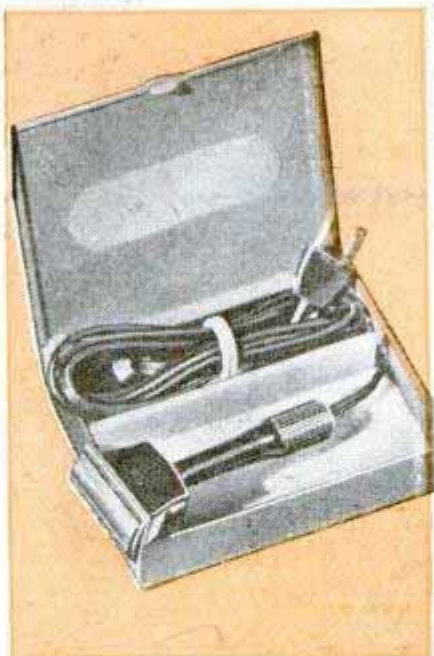

## Tractor-Rigged Scoop "Bites" 10 Cubic Feet

Excavating, ditching and leveling jobs are performed by an earthmoving scoop attached to the hydraulic lift of a tractor. A basement 20 feet by 30 feet can be excavated to a depth of six feet in less than a day. The scoop is raised and lowered by the hydraulic lift and is tripped and dumped by an easy one-hand movement. In less than 15 seconds it will scoop up a load of 10 cubic feet of dirt.

## Lawn Edge Trimmer

Lawn borders along sidewalks can be trimmed quickly and easily with a long-handled edging tool. The operator stands and inserts the tool in the turf alongside the walk. A foot lever operates the cutting blade which trims scraggly grass or shrubbery. The tool is also useful for work around trees or flowers as it will cut around irregular shapes.

☛ A blood bank for horses, cows and dogs is operated at the State College of Washington.

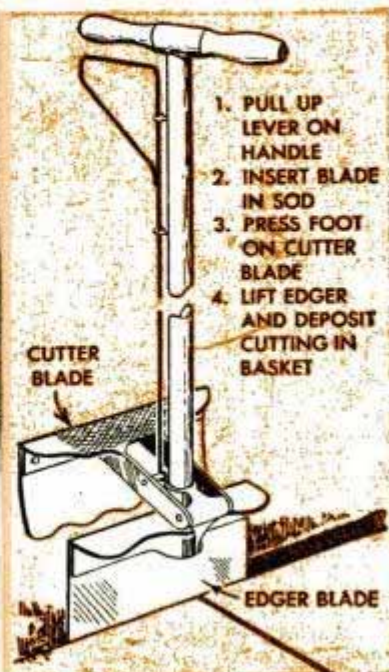



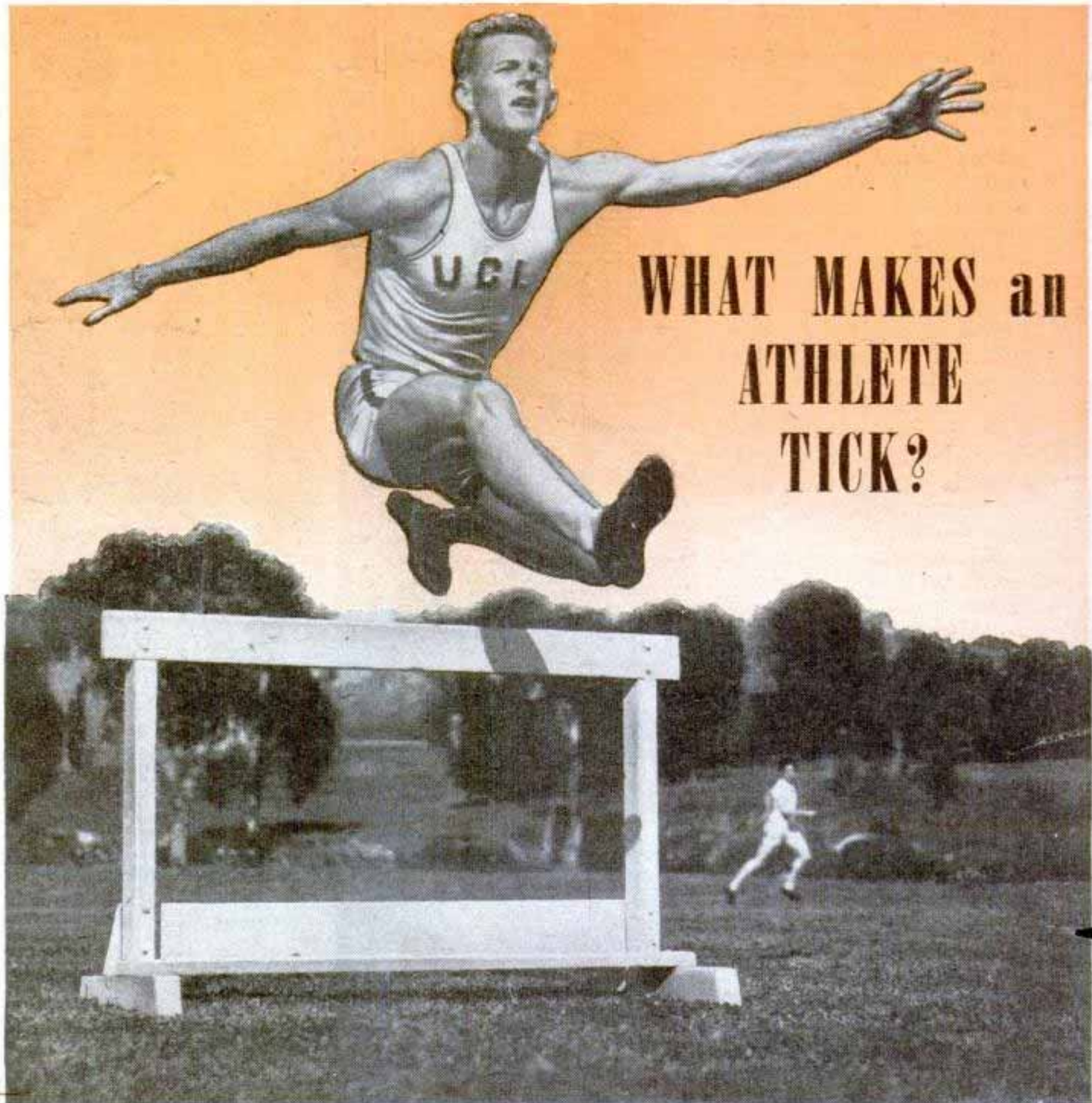

## WHAT MAKES an ATHLETE TICK?



Dr. Henry designs special apparatus to test the condition and potentialities of athletes

By Dr. Franklin Henry  
*University of California, Berkeley*

As told to Andrew Hamilton

**T**HOUGHTS of the sports world this summer are turning toward the 1948 Olympic Games and such questions as these naturally arise:

Can a man run the 100-yard dash in nine seconds? Can a pole vaulter top 16 feet? Will the four-minute mile ever be achieved? Will some future high jumper clear a seven-foot bar?

The answer seems to be, "Yes, with the help of science and smart coaching." Perhaps not this year, perhaps not next, but before long.



With increasing regularity, new world's records in track and field events have been hung up almost every year. In other competitive sports — football, basketball, baseball, ice hockey, tennis and skiing — individuals and teams are getting better and better.

Why? Probably because, as medical statistics indicate, the population of the United States is growing larger, stronger and healthier. And, more important, because better coaching has brought about more skillful individual and team performances.

No longer does a track coach rely upon hearsay, superstition or "hunch" in training his men. When he tells a sprinter to leave the blocks in a certain manner, it's because exhaustive tests in the laboratory and on the running track have proved a certain technique to be most efficient for launching a man into motion from a crouching start.

Research in medicine, biology, physiology, psychology, chemistry and physics are giving us a better understanding of how the human machine works. The more a coach knows about the human body and the individual traits of the men under his direction, the better results he'll achieve.

Much work has been done by America's scientists on how an average group of persons will react in a given situation. However, in the Department of Physical Education at the University of California, we are interested in how an individual will act. In addition to scientific facts about body functions we learn which physical and psychological traits spell the difference between a world's champion and an

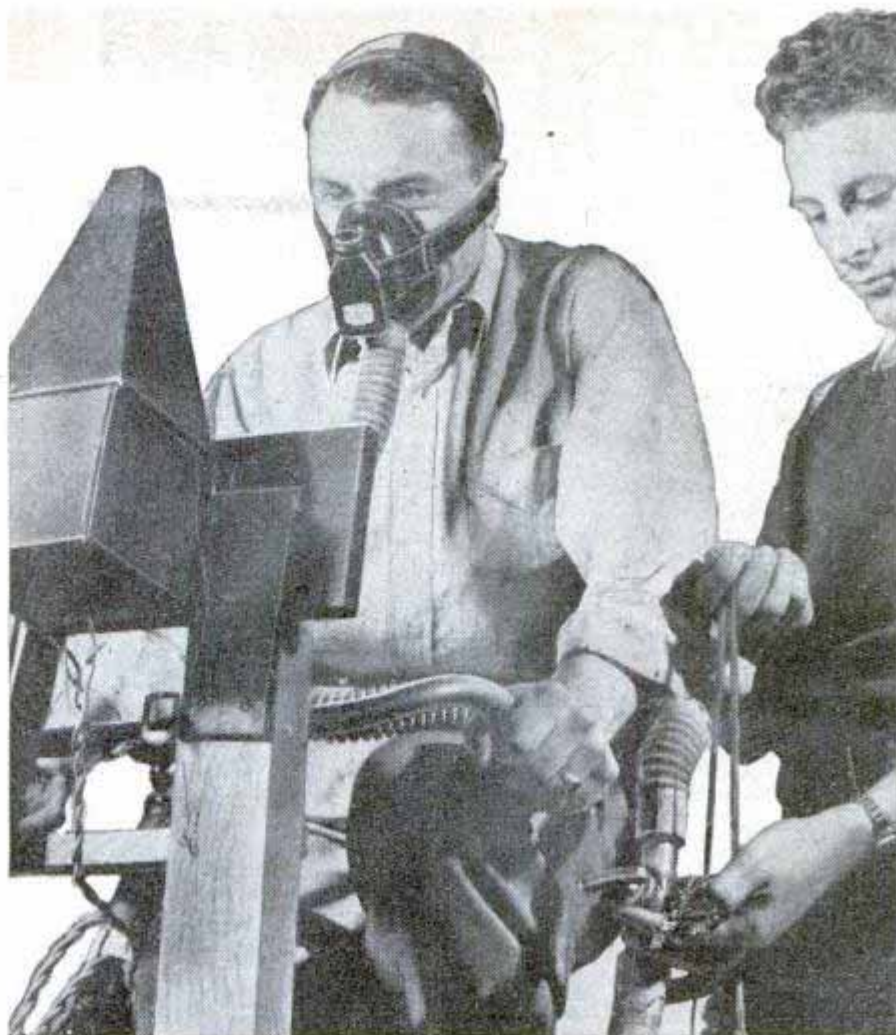

Rigged up like a man from Mars, a physical education student takes a metabolism test. As he pedals a stationary bicycle, his exhaled breath is collected in the mask and tubed to a meter. Below, tests of this type demonstrated that smoking impedes a person's steadiness. After inhaling a few puffs, students found it difficult to hold a pencil in the center of a hole

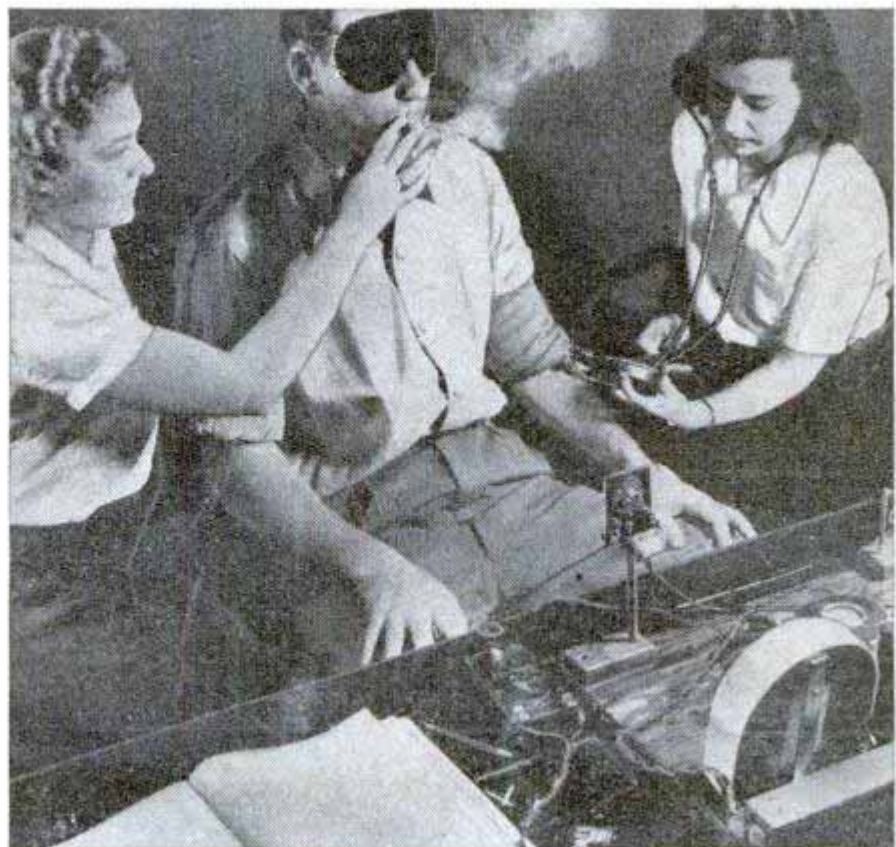



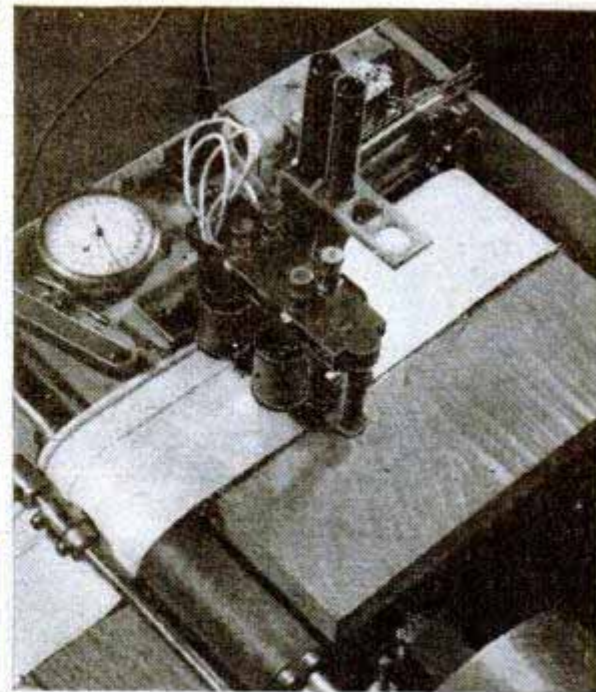
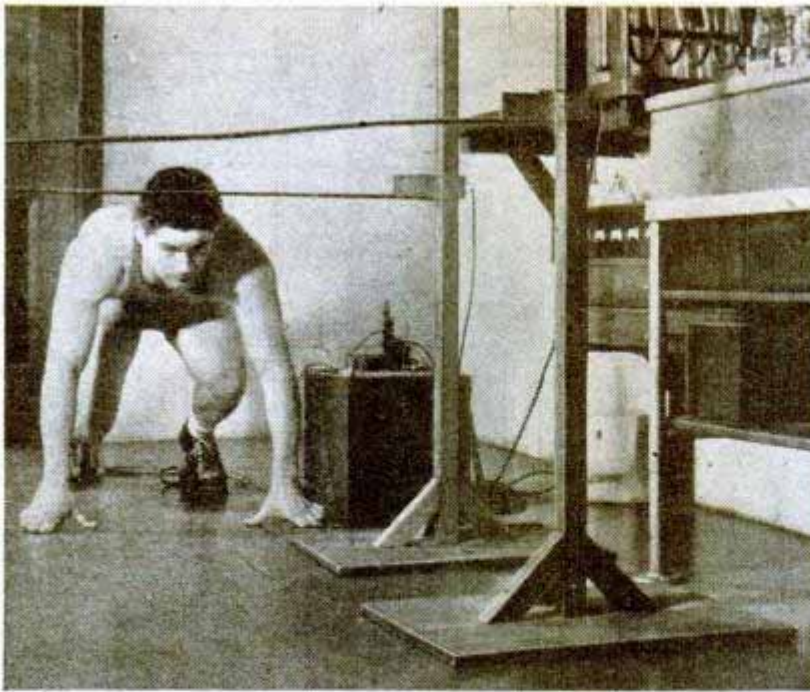

Starting speed is measured by chronograph (right) which is set in motion electrically by bamboo gates (above) when struck by runner's chest. Drawing below demonstrates how apparatus works

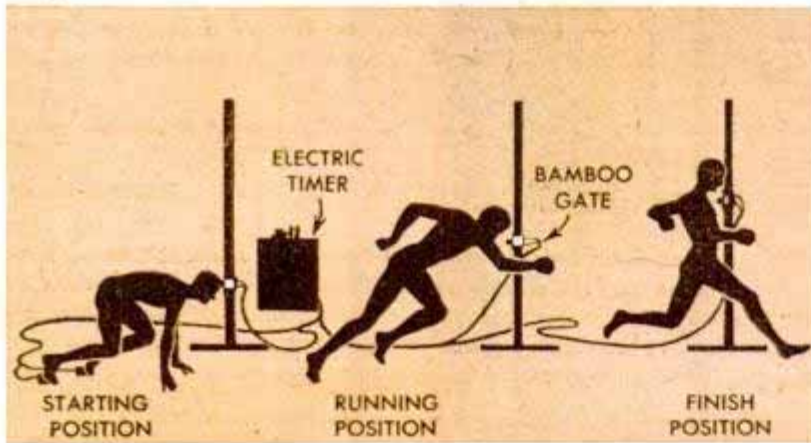
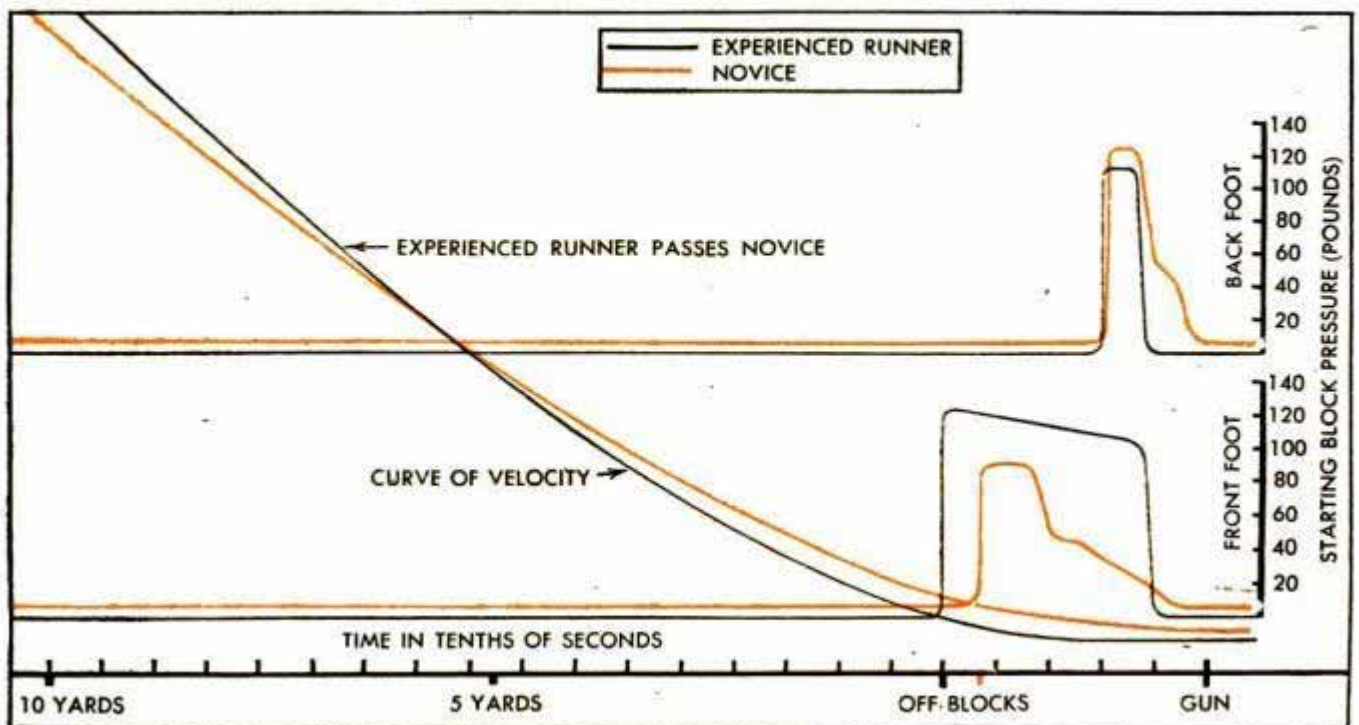

Diagram below shows that novice starts like a flash but soon is overtaken by veteran who runs 50 yards 1.1 seconds faster than opponent

ordinary competitor. If a lad with championship potentialities can be discovered at an early age and trained properly, he's the one who is going to set new records.

In this sort of human engineering, we explored many new paths. We built our own measuring devices. Our laboratory in the men's gymnasium is cluttered with equipment used to test athletes. In one corner of the room stands a model-maker's shop in which future devices will be constructed.

Much time has been devoted to studying the reactions of runners. Individual ability may







**Athlete takes centrifugal tilt test. If he "blacks out" he is given exercises to strengthen abdominal muscles**

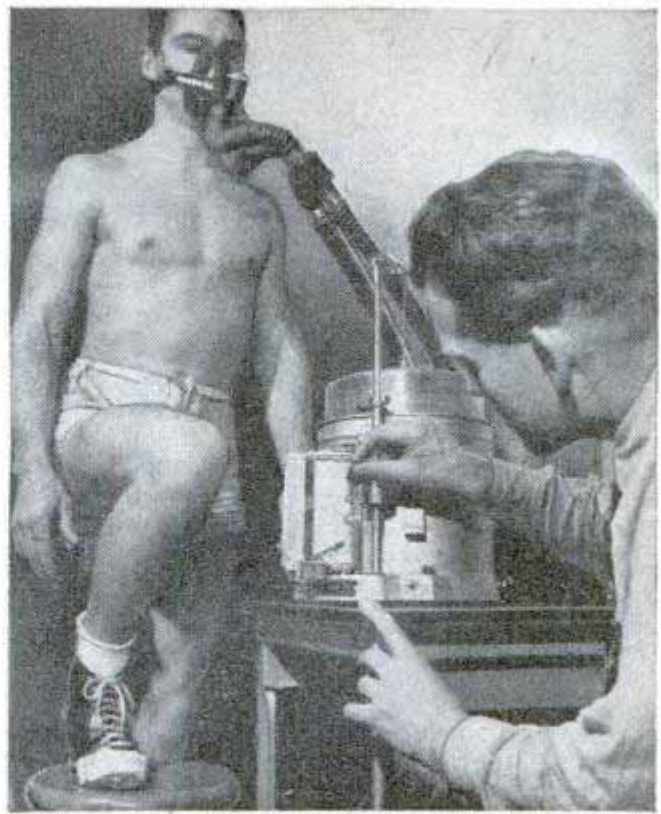

**Measuring oxygen output as student steps up and down from stool tests endurance of long-distance runners**

indicate whether a man is best suited to run the 100-yard dash, half mile or cross-country steeplechase. It may also furnish the basis for selecting football players, tennis players or crew men.

To measure the dynamics of sprint running, a complicated device electrically records a runner's speed over short distances. It includes (1) starting blocks connected to a mechanism that records time and the force exerted, (2) light bamboo gates at intervals along the runner's path that automatically record when they swing open, (3) an electric timer which registers on ticker tape the speed of the runner. The mechanism is put into operation by the starter's gun. As a runner pounds down the track, with the light bamboo gates hitting his chest and swinging open, progress is recorded on the ticker tape. The results are interpreted to show how pressure was exerted by the feet, whether there was any variation in the speed of the runner and what his total time was at any point along the path.

A number of sprinters were clocked at full speed through the lane of timing gates. Curiously enough, those who took more time in leaving the starting blocks would usually overcome the handicap within the first 10 yards. This contradicts the generally accepted notion that the first man away wins a sprint race.

A smart coach would use this information by telling his dash men: "Get a good, fast start, yes, but be sure that your form

in leaving the starting blocks is as good as possible."

Endurance tests also are valuable. In the past, endurance was measured by determining how long a specific task could be performed efficiently—such as lifting a 50-pound weight or jumping up and down on one foot. Since this method measured endurance in only one type of exercise, a test of a more general nature was sought.

Extensive research had shown that the response of the heart to exertion was, to a certain extent, a reflection of a person's physical condition. The time required for the heart rate to return to normal is affected by fatigue, diet, smoking, etc. To test the predictive value of this fact, an endurance index was established by considering the time it took a man to run 220 yards, as compared to his time for 50 yards. A person in good physical condition is able to cover the longer distance at a speed more nearly proportionate to the time for the short sprint.

Through cooperation with California track coach Brutus Hamilton, 28 men of varied condition and training were enlisted for the first experiment. The runners were timed at intervals, and their index of endurance computed. This was compared with measures of their heart and circulation, which had been obtained by registering heart rates while the subjects mounted and dismounted from a footstool. These tests, when conducted again after a short

(Continued to page 228)





## Midget Vacuum Sweeper Cleans Interiors of Autos

Resembling a flashlight in size and shape, a vacuum cleaner for automobile interiors gets its suction from the windshield-wiper hose. The connection is made through a valve installed in the glove compartment. Equipped with a 12-foot nonkinking hose, the cleaner picks up dirt and dust while the car's engine runs at idling speed. The slender nozzle, which is designed to reach into crannies inaccessible to a whisk broom, unscrews from the plastic tube to permit emptying the canvas bag inside which catches the dust. The entire unit can be cleaned by wiping it with a damp cloth. After being used, the cleaner and its tube can be stored in the glove compartment.

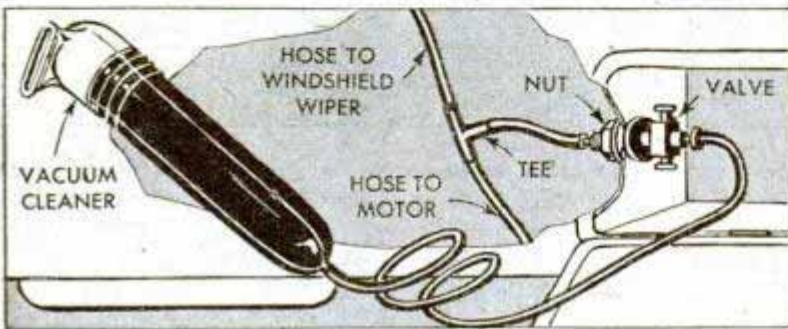

## Swiss Transfusion Apparatus Employs Flexible Rubber Bag

Instead of the usual inverted bottle to hold blood, a Swiss apparatus for blood transfusion employs a flexible rubber bag to contain whole blood or plasma. In addition to gravity, which controls the flow of blood from an inverted bottle, pressure can be applied to the rubber bag to increase the flow. This pressure is applied by squeezing a bulb to inflate a balloon inside the bag.

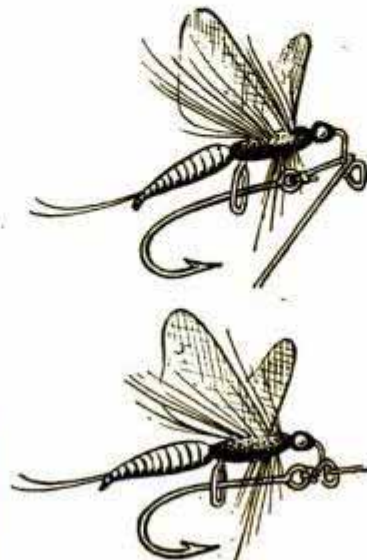
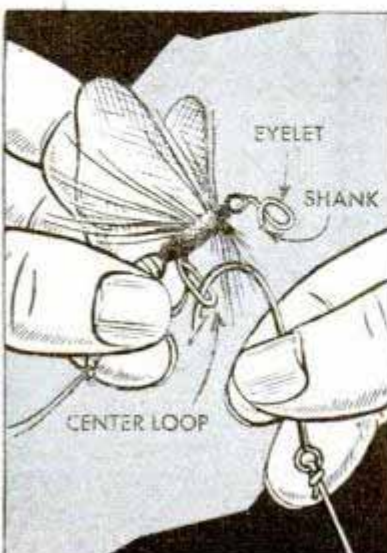

## Quick-Change Fishing Fly

Fishing flies which attach directly to a hook instead of the leader enable an angler to change flies in four seconds or less if he's having no luck. To attach, the hook is inserted through a loop at the bottom of the detachable fly and the leader is secured to an eyelet at the head. This fly also is available with one hook attached, making a double-hook bait possible when it rides pickaback on a hook tied directly to the leader. It can be attached or detached with the same speed.



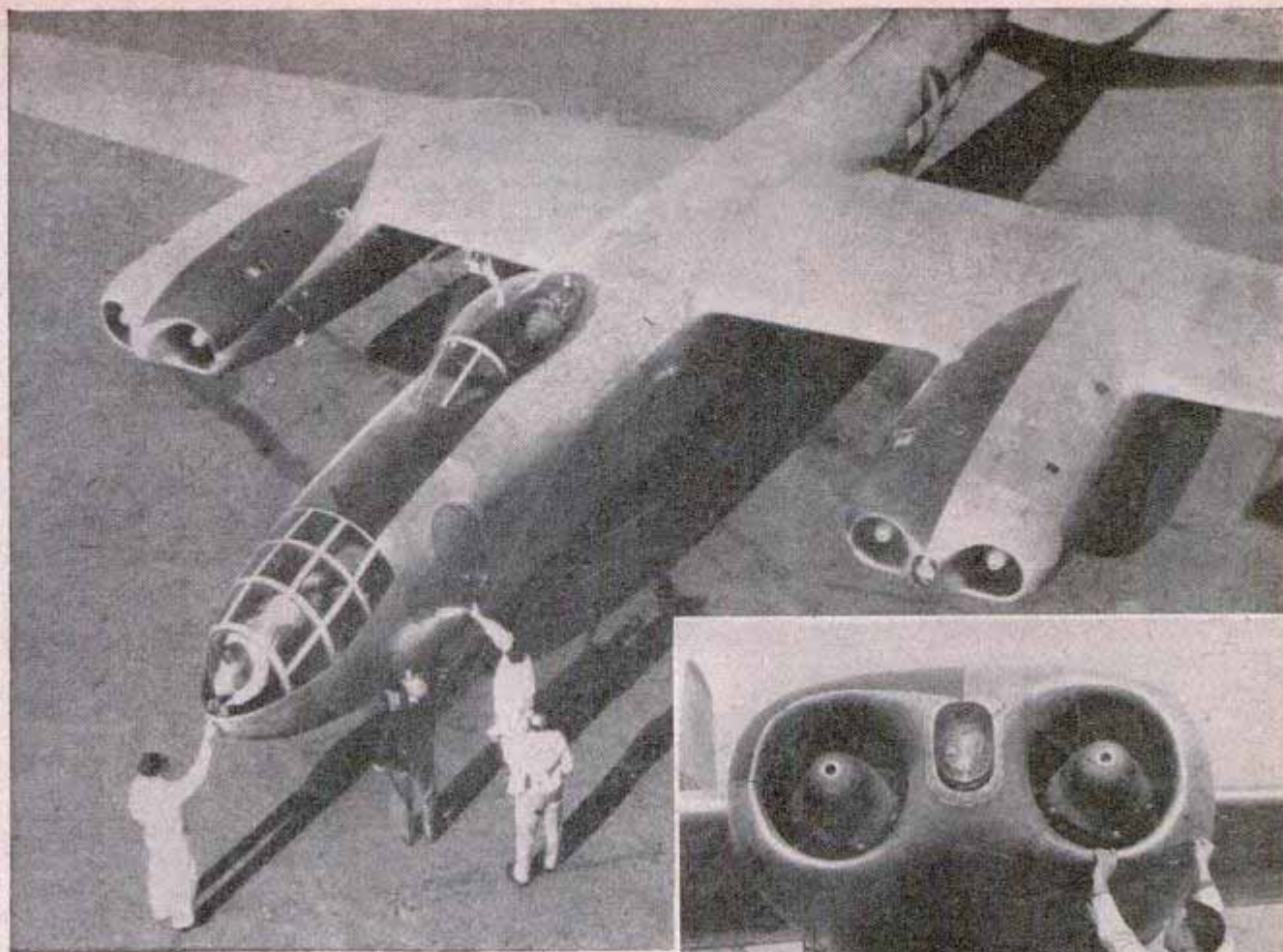

## "REFRIGERATED" BOMBER

Four turbojet engines are paired in single nacelles in the XB-45, described by the AAF as an "exceedingly high-speed" medium bomber. Among its innovations are an absence of external gun turrets and a refrigerating unit that lowers the temperature as much as 30 degrees below outside temperature when flying at low altitudes. The high-pressure tires have a very narrow tread to allow the landing gear to retract into the thin wings. It carries a



North American Aviation photo

four-man crew, has an 89½-foot wing span and is 74 feet long. Pilot and copilot sit tandem fashion beneath a plastic bubble forward of the leading edge of the wing.

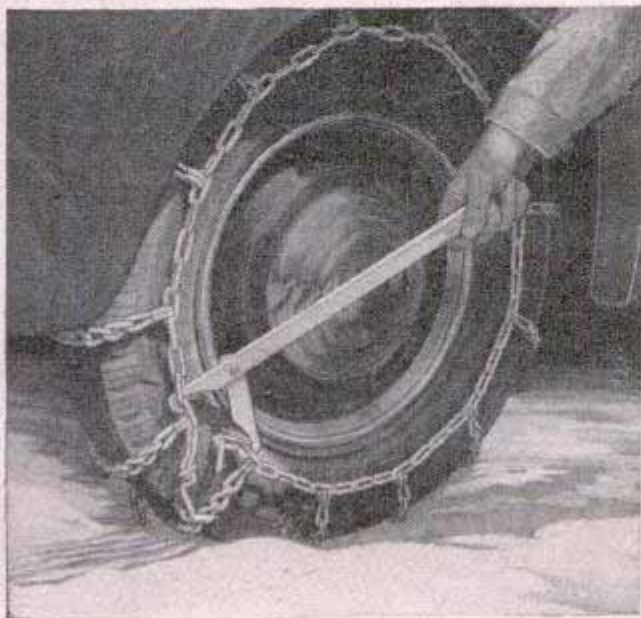

## Tire Chain Tightener

No pulling or tugging is necessary to tighten tire chains when a double-hook tool is used. The motorist puts the hooks through two chain links and pulls up on the lever. The chain pulls together instantly, assuring a snug fit on the tire when the hooks are secured.

## Push Button Selects Film From Library

Push-button control simplifies removal of 8 and 16-millimeter film rolls from a film library chest. When a button is pushed, the selected roll of film is moved forward within easy reach. The door of the all-metal welded chest opens downward. Rolls are held in position inside by a self-aligning stacking system.





Midget water softening unit contains enough chemical to treat 50 gallons of water. To regenerate, two tablespoons of salt are added

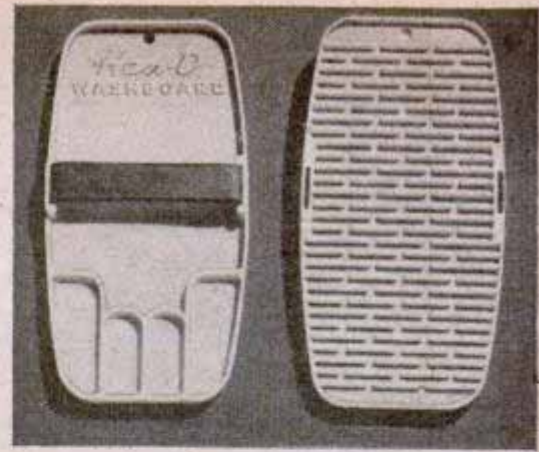

† Plastic scrubbing board, designed for travelers, is held to user's hand by elastic band

## WHAT'S NEW *For Your Home*

Wire basket with spray-head cover, right, cleans fruit and vegetables quickly and thoroughly. Below, kernels are removed from ears of corn by four-bladed cutter operated by a plunger







Ironing machine can be kept in kitchen, since it folds into cabinet 36 by 18 by 25 inches. Has fingertip and knee controls. Left, razor blade holder serves as paint scraper and cutting tool. Below, swing chair for porch or garden use has a nontip safety stop and posture control from upright to full reclining position



Can opener requires only slight touch to shear the lid from a can. It folds against wall when not being used

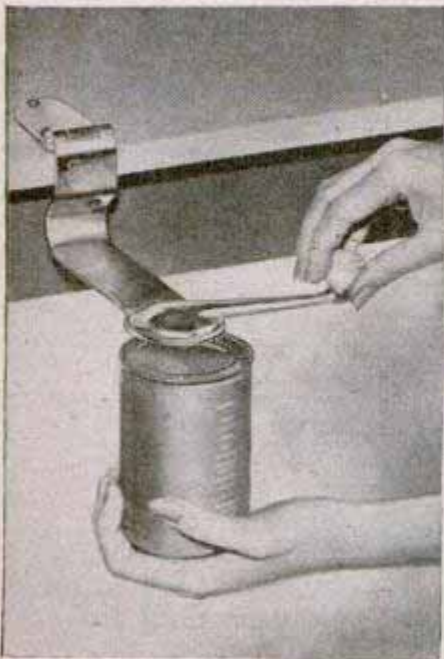



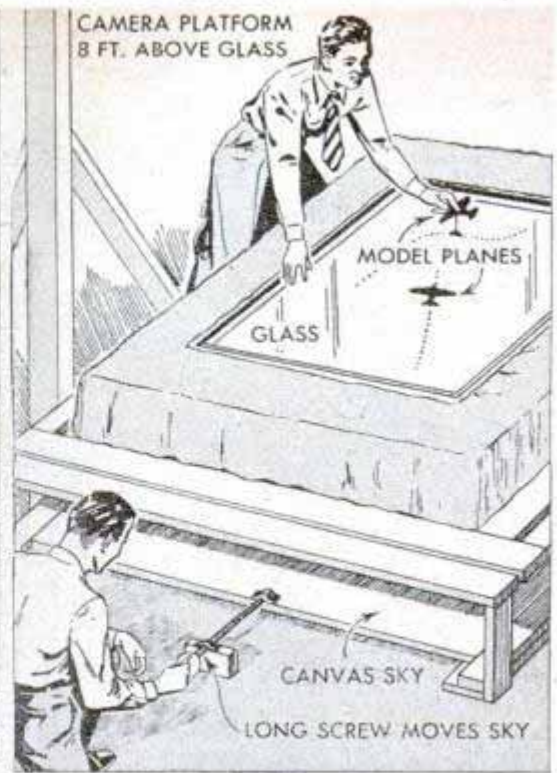
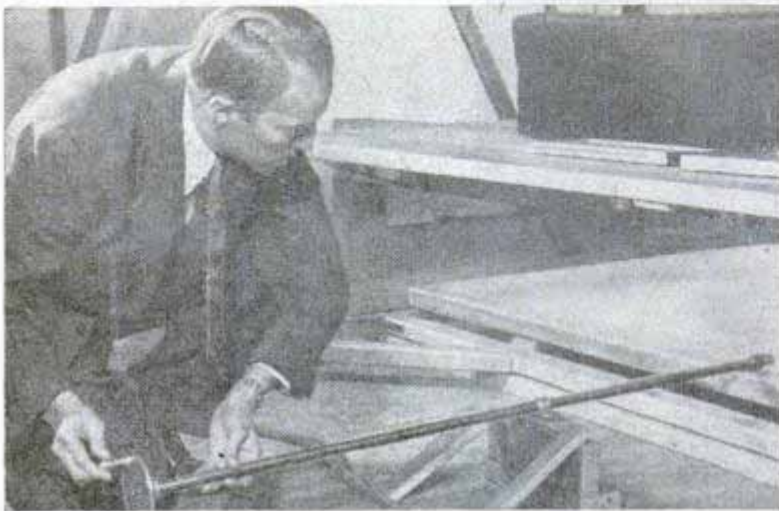

## AIR BATTLE "FOUGHT" ON GLASS

Tiny planes mounted on clear glass over a canvas sky give those seeing "The Secret Life of Walter Mitty" a realistic version of an aerial dogfight. The technique, devised by special effects director John Fulton, uses the stop camera method of filming animated cartoons. The planes are moved by hand a fraction of an inch after each frame is shot, follow-

ing a pinpoint path laid out in advance. Although shot upside down from eight feet above the glass set, the camera appears to be shooting upward because the planes are silhouetted against clouds which are painted on a lighted, blue canvas sky mounted two feet below the glass. The sky is moved slightly after each shot to complete the illusion. Tilting the wings makes it appear as if the planes were doing snap rolls, banks and other maneuvers. The planes' mountings are narrow and completely hidden under the fuselage when photographed from above the set.



## Dog Stalls in Store

Shoppers in San Carlos, Calif., forbidden by law from taking their dogs inside stores, can park them in a row of stalls outside one of the markets. The stalls keep hostile canines a safe distance apart. There's even a special fountain where the dogs can get a drink.

Red-filtered lights in cockpits enable a night-flying pilot to glance from his instruments to the outside without waiting for his eyes to adjust themselves, according to United Air Lines.



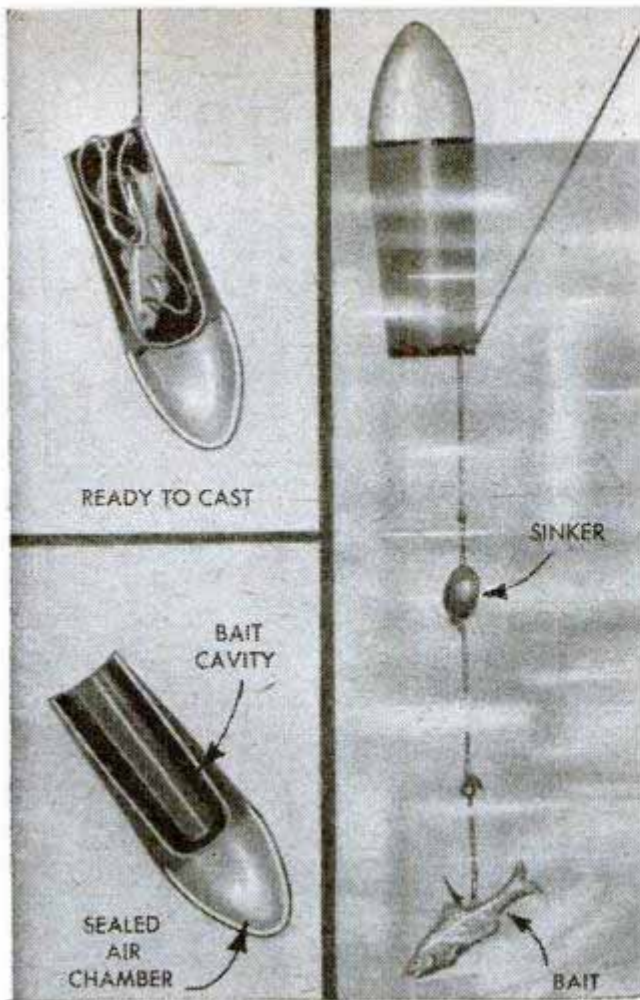

### Float Holds Live Bait for Casting

Fishermen cast live minnows without losing them with a special casting float. The float is a bullet-shaped plastic case with an air pocket in one end and a cavity for the bait in the other. The fisherman drops his minnow, hook and sinker into the cavity and casts as though he were using a plug. As the float strikes the water the sinker pulls the minnow to the desired depth.

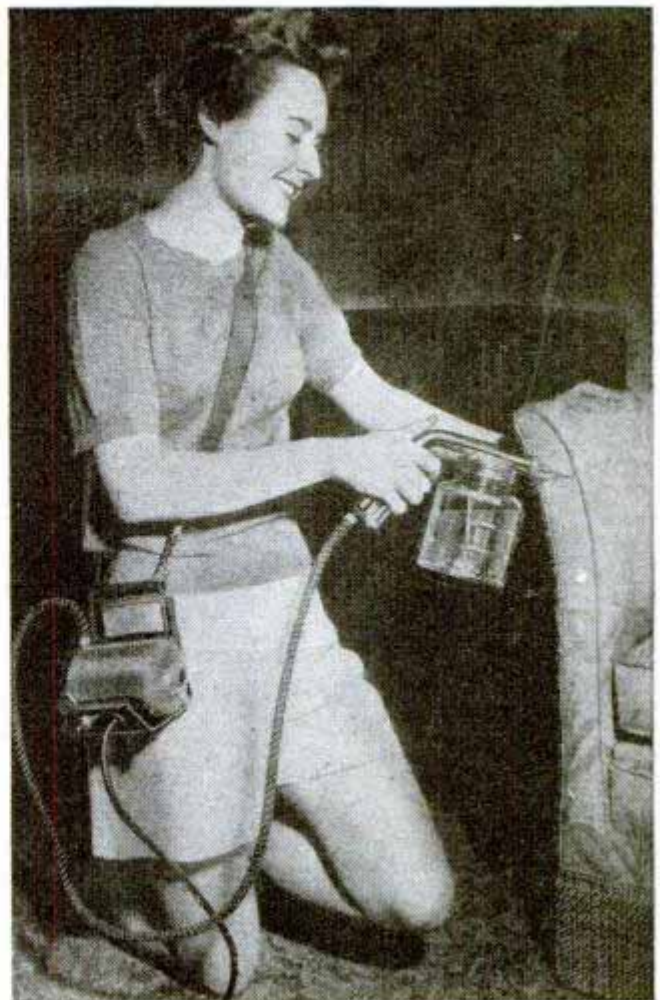

### "Hypodermic Needle" Moth Sprayer

Overstuffed chairs and sofas are protected against moths by an electric sprayer with a "hypodermic needle." By inserting the needle at the seams of furniture covering, spray is distributed beneath the surface. The sprayer is equipped with an electric motor, 10 feet of cord and a shoulder strap. It also has a saturating nozzle for spraying garments, rugs and other articles.

### Scoreboard for Tasks Helps Train Children

To teach her children the value of money with relation to daily tasks, Mrs. Inez Cole Curtis of Akron, Ohio, designed a scoreboard to determine weekly allowances. Under days of the week are listed such things as washing hands and face, eating everything on the plate, and helping with the dishes. For every task performed, a peg is inserted in the board. The pegs are in different colors to represent from one to ten cents.

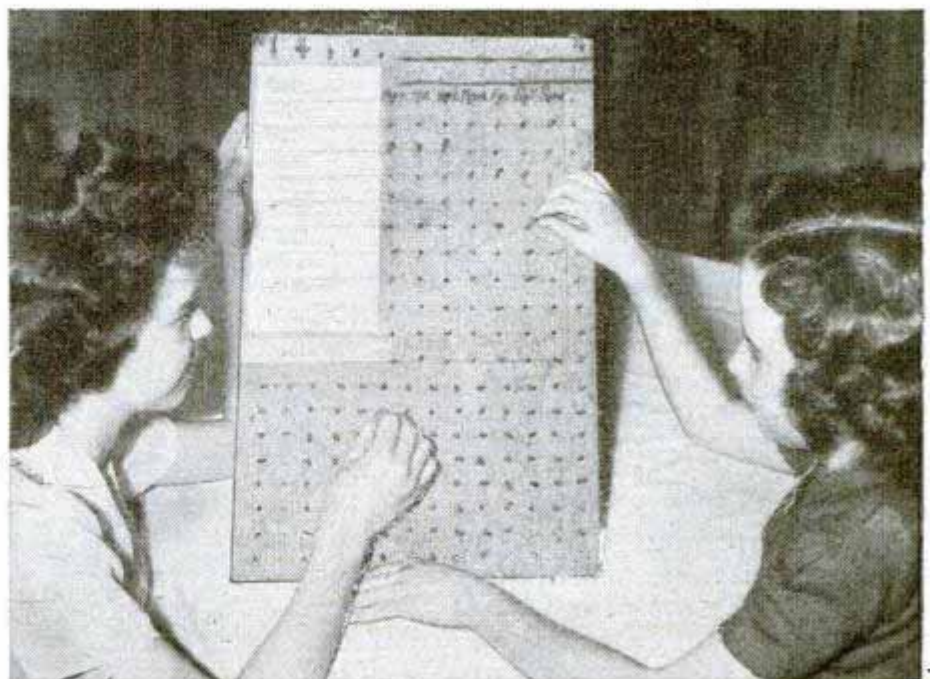



# BAKING BISCUITS by REFLECTION

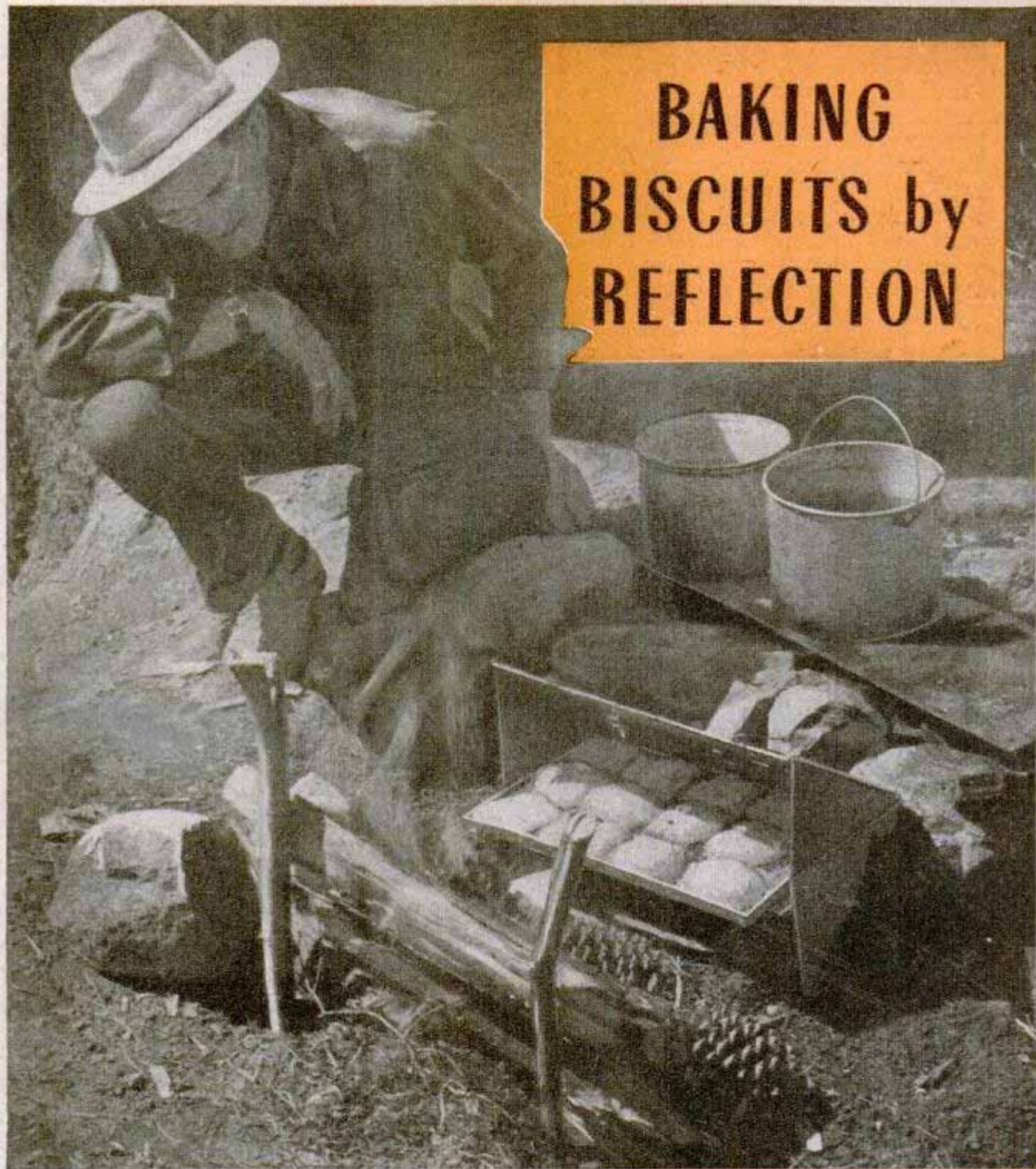

By Claude M. Kreider

Photos by Ray Chapin

**I**F YOU'RE planning a camping trip this summer you may be puzzling over one age-old problem in preparing your grub. What can you do to provide good bread?

Bakery bread soon dries out and it's difficult to carry. Crackers and hardtack are a poor supplement to a piping hot camp dinner.

Take a tip from the old-timers and bake your own biscuits, easily and quickly, with a reflecting campfire baker. In this lightweight "oven" you can turn out biscuits and corn bread—always the delight of hun-

Heat from a quick blaze raises the biscuits, which are browned by a slow fire

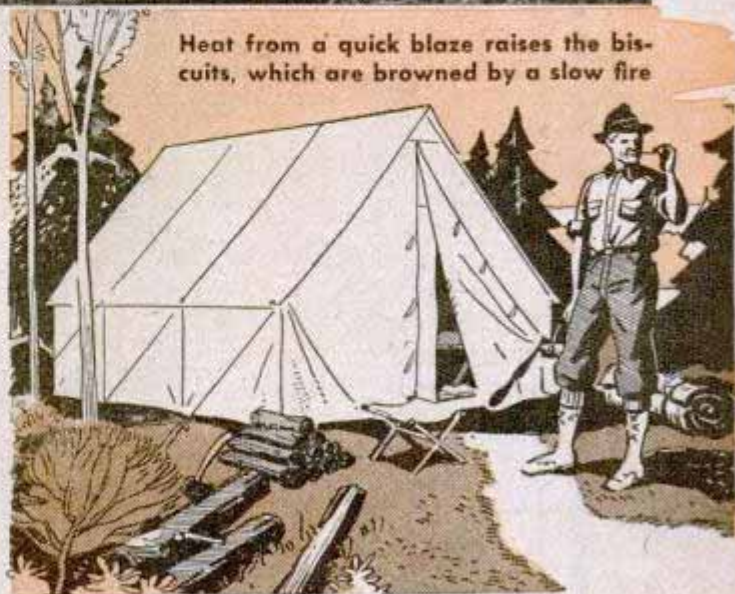





Careful campers clear ground before building a fire

gry outdoorsmen. You can whip up simple camp cakes and pies for your companions.

You'll find the campfire bakers in sporting goods stores in a variety of sizes and materials. The baker shown here is a "four-man" size that will turn out a dozen large satisfying biscuits at a time. Made of medium-gauge aluminum alloy, it's only one inch thick and measures 11 by 17 inches when folded with the bread pan.

Heat from the fire is reflected evenly on the biscuits by the upper and lower surfaces. To raise the biscuits you'll need a high blaze from a stack of quick-burning wood. Then, as the wood burns down, a golden brown color will creep across the biscuits.

The ingredients? Light biscuits are easy to make from prepared biscuit flours which contain the necessary ingredients and need only to be mixed with water. Breadboards, rolling pins and other kitchen utensils can be left at home and the biscuits prepared "cowboy" style.

For a change you can have delicious corn bread made from another of the prepared



No fancy ingredients are needed—just mix prepared biscuit flour with water in a pan to make the dough



↑ Biscuits are patted flat on the pan "cowboy" style

↓ In about 15 minutes they bake to a golden brown

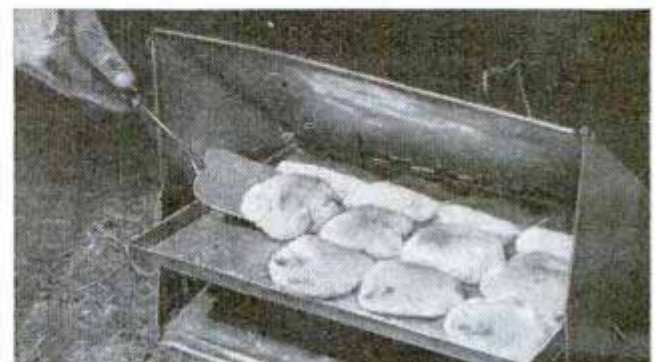





mixes. And if you like to experiment, surprise your companions with a simple camp cake. Just add a handful of raisins, an egg, canned milk and a bit of extra shortening to the biscuit dough and put the batter in a well-greased pan.

To make pies you need only white flour, shortening, water and salt for the crust, and canned fruit or fresh berries for the filling. With a little ingenuity on your part the reflecting baker will turn out any number of delicious baked goods.

← Delicious biscuits from reflector pass the test of an old-timer

↓ Folding reflector packed with bread pan is only an inch thick

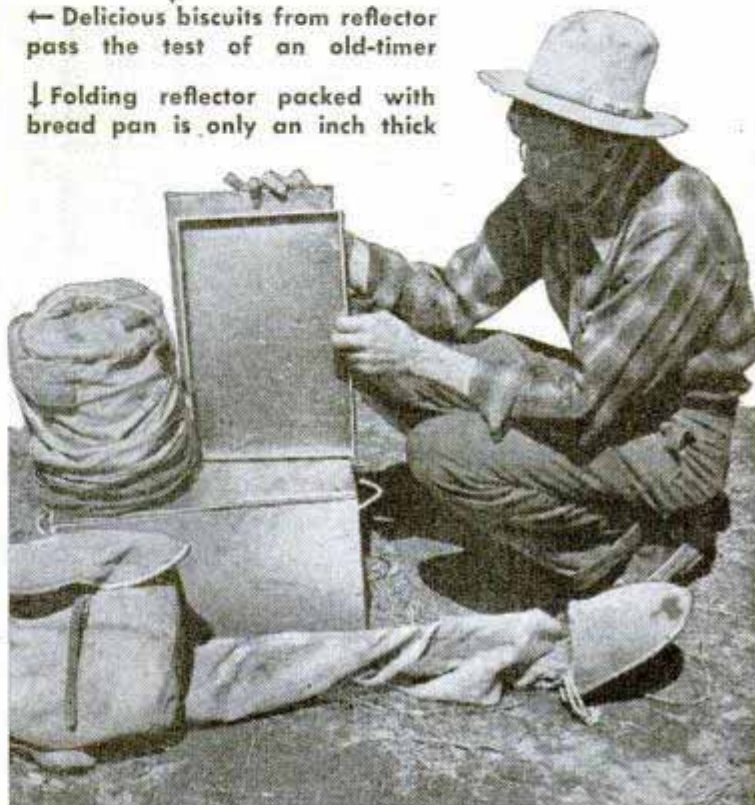

## Telescope Attachment May Determine Whether There's Life on Mars

With the aid of a telescope attachment astronomers soon may discover whether there is life on Mars. The attachment, called a spectral recorder, is activated by invisible infrared rays. These rays emanate from stars and penetrate clouds of "star dust," or particles of matter, through which ordinary light cannot pass. In the telescope

the rays are interrupted 1080 times a second by a rotating toothed wheel and the "chopped" light passes through glass prisms and is spread into a spectrum. A photoelectric cell in the instrument separates the infrared rays from the spectrum, translating them into an electrical current which varies with their intensity. An electronic circuit amplifies this current 10,000,000 times and the variations are recorded on a paper graph to give an accurate picture of the infrared emanations. Many astronomers have speculated that green spots on Mars may be vegetation, and the recorder will enable them to measure the intensity of infrared radiations from the spots. Scientists then can compare the rays with the infrared light reflected from plants. If the two recordings are identical it will be strong evidence that the spots are living vegetation. The recorder was developed by Professor Robert J. Cashman and Wallace R. Wilson of Northwestern University.

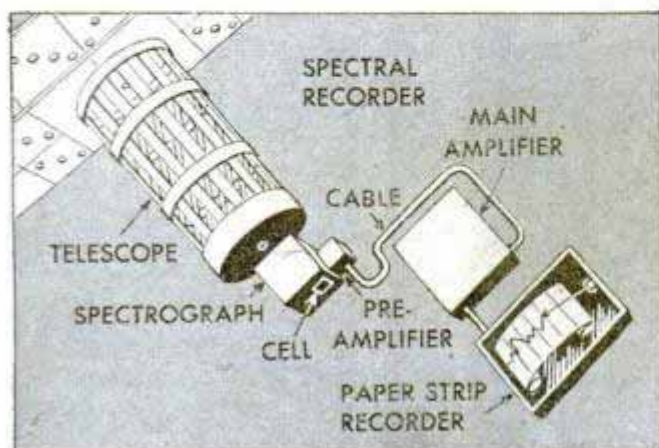



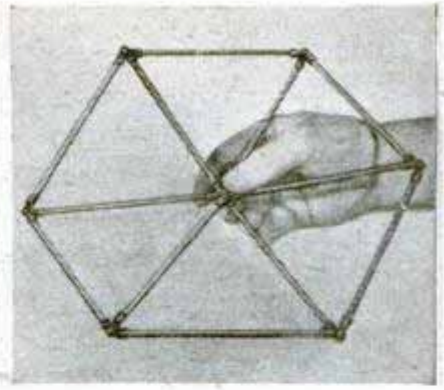
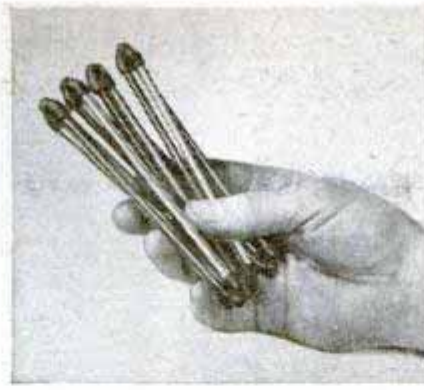
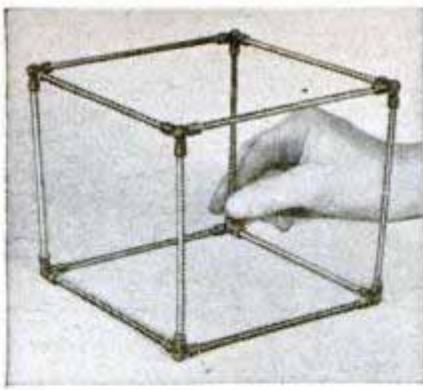

Efforts of a physics teacher to demonstrate the three-dimensional form of crystals led to the development of a flexible toy consisting of 12 sticks about 5½ inches long. Joined by rubber elbows, the sticks form a cube that can be transformed in shape to

### RUBBER ELBOWED TOY STICKS

resemble letters of the alphabet, numerals,

and crystal and geometric shapes. The stick cube can even be used by children in various games. For example, the sticks can be formed into a flat, six-sided figure to be tossed at a hook mounted on the wall.

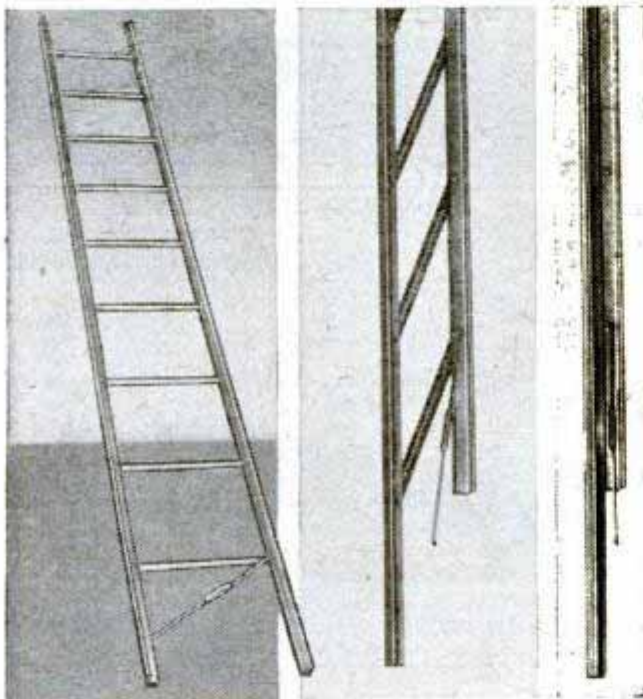

### Collapsible Ladder

Weighing 40 percent less than conventional wood ladders, a collapsible ladder has rungs made of metal tubing and side rails made of extruded aluminum sections. When the ladder is not in use the side rails can be pivoted on the rungs and folded together with the rungs inside. The collapsed ladder requires less storage space than a two-by-four timber of comparable length. The ladder is locked in open position by a folding arm.

### Auto-Jack Plasterboard Lift →

Plasterboard is lifted and held in place for ceiling installations by metal arms mounted on a steel shaft which is raised by an automobile friction jack. By means of this device, which has 11-foot elevation capacity, one man can cover a ceiling with plasterboard. The boards are nailed in place while the lift holds them against the ceiling. The mechanism weighs 35 pounds and consists of a three-piece assembly which can be set up in a few seconds.



Many of the products described in this issue are already available or are ready to be marketed. For additional information on these products, including the name and address of the manufacturer or distributor, simply write to Bureau of Information, Popular Mechanics Magazine, 200 E. Ontario St., Chicago 11, Ill., for a prompt reply





## Push-Button Typewriter

Automatic typewriters, operating like a player piano from a paper record roll, write "personalized" letters made up of standard paragraphs to business correspondents. Messages written are not the usual form letters but can be varied to include any of 160 different paragraphs. The machine is used for typing answers to inquiries on products, typing credit and collection forms, bills and invoices, subscription and renewal correspondence and other standard subjects. "Stops" on the machine permit manual typing of names, addresses or other personalized material. The form paragraphs are written and cut into the record roll. Pushing control buttons causes the roll to move to certain sequences. Compressed air, escaping through slots in the roll, drives the keys.

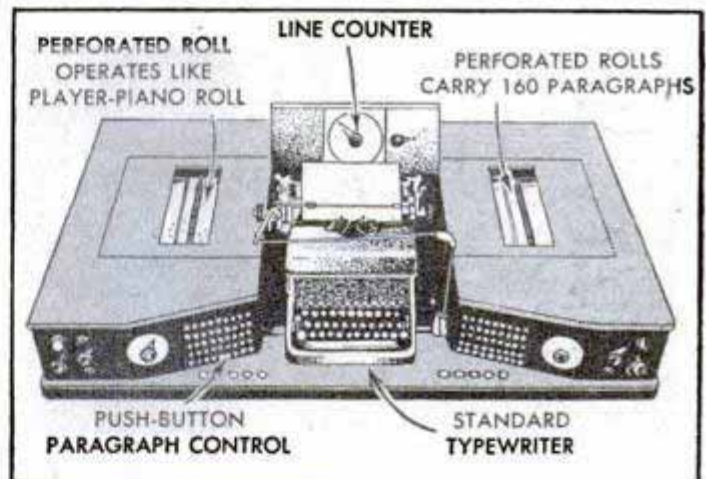

## Doughnut Gun

Almost as fast as you can count, perfectly shaped doughnuts ready for frying pop out of the barrel of a doughnut gun. Squeezing a side handle ejects the sinkers. The gun holds batter enough to make 22 to 24 doughnuts and turns them out at the rate of one per second. It can be taken apart for easy cleaning.

## Electronic Food Sterilizer

Food, medicines, whole blood and blood plasma are sterilized and preserved by an electronic instrument called a Capacitron. The preserving effect is produced by checking enzyme action with electrons released at millionth-of-a-second frequency at an intensity of 30,000 to 50,000 amperes.



Steel ingot 45 inches thick is sliced by a modern oxyacetylene blowpipe. The "air saw" makes the 30-inch cut in 15 minutes

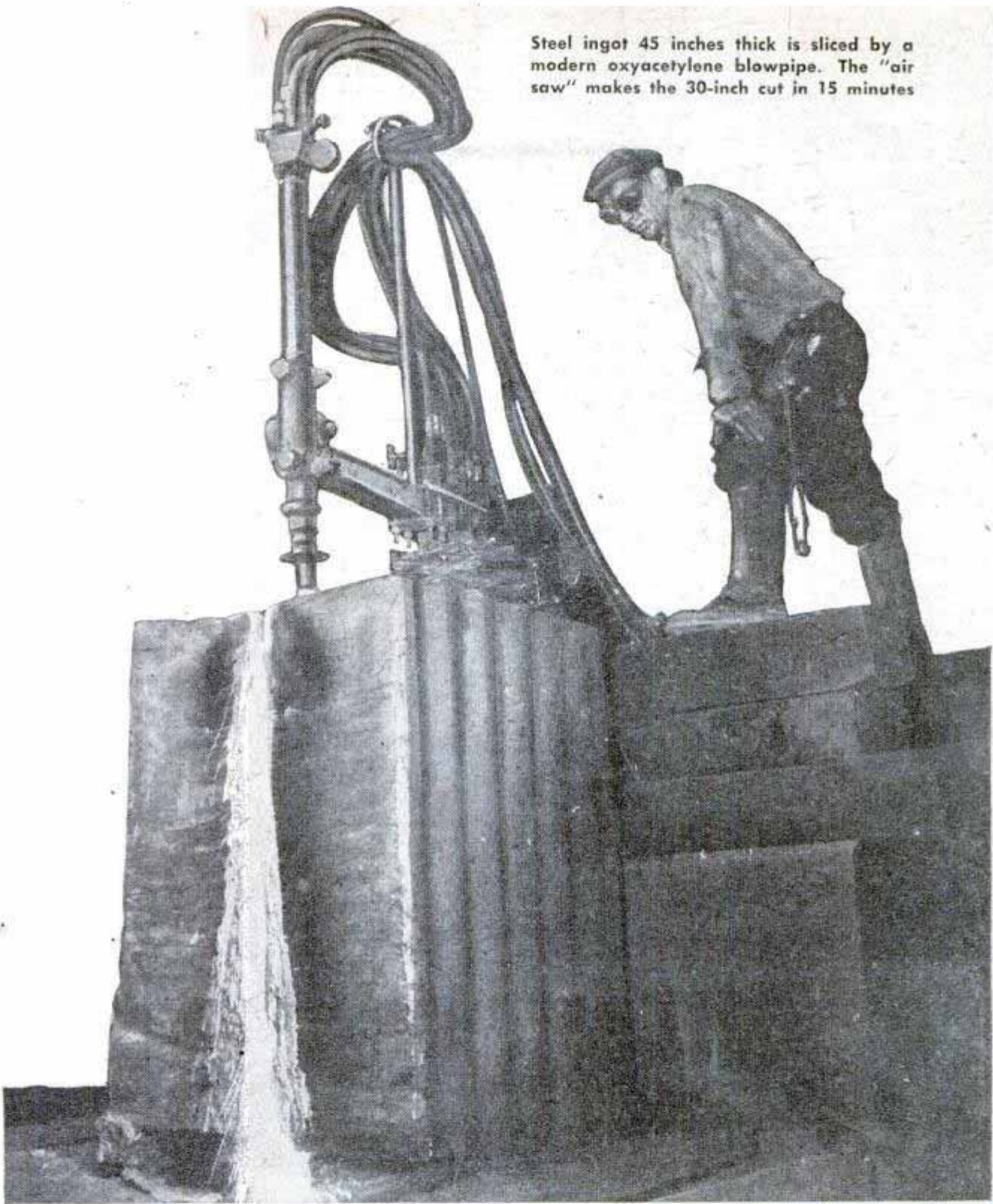

## *Industry Also Breathes Oxygen*

**A** MERICAN industry inhales more than 90,000,000 cubic feet of oxygen a day. It's sucked through open hearth furnaces and welding torches, through metal-cutting machines and airplane cabins.

Each year we use 22,000,000,000 cubic feet just to breathe life into our metal-

**By Eugene W. Nelson**

processing machines. If you could put each cubic foot into a metal container you'd have enough building blocks to construct a wall 20 feet wide and 70 feet high across the United States.

Separating and using almost pure oxygen is a fairly new industrial process.



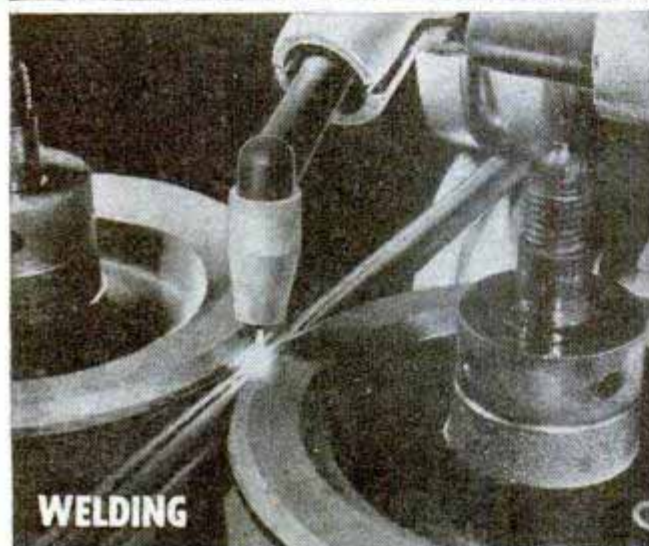

Here's a raw material that is available in huge amounts. The envelope of air around the earth contains millions of tons of oxygen. It's always been there. Yet pure oxygen wasn't discovered until Joseph Priestley, the English scientist, stumbled across it before the American Revolution.

Today oxygen is taken from the air in vast quantities. Air is compressed, then cooled in heat exchangers. Rapid expansion of the air after compression and cooling changes the gas into a liquid. This liquid air is then "cooked" at a carefully controlled rate. Each gas that forms a part of what we call air—nitrogen, oxygen, helium and others—boils away from the parent mass at a different, definite temperature. The trick is to catch each gas while the liquid is held steady at a particular temperature. Oxygen, for example, comes off at  $-297.2$  degrees F. under normal pressure.

Oxygen "manufacturers" have boosted the demand for oxygen and created new uses for the stuff by improving their methods of separation and passing the savings along to their customers. In 1921 only a little more than a billion cubic feet of the work-horse gas was used. Today, 22 times that amount flows through our machines.

The secret behind the demand for oxygen is that anything that burns will burn a lot hotter in pure oxygen. An oxyacetylene torch produces a flame tip that's hot enough to burn through metal. Recently the same torch has been overhauled and streamlined. Now it will make a 30-inch cut through a steel ingot 45 inches high in only 15 minutes, which is a few years faster than you can do it with a hacksaw.

Several uses for the oxyacetylene torch have become standard in industry. One is the slashing of large sections of scrap steel into pieces small enough to feed into open hearth furnaces. Obsolete ships, bridges,





skyscraper frameworks—all kinds of metal structures—are now sliced apart quickly with cutting “lances” to make the scrap from which shining new products come.

Slag-pot “skulls” once gave industry a costly headache. They are huge semi-spherical chunks left in the ladles from which metal is poured, so heavy they can be moved only with great difficulty. Blasting them apart means moving them to a safe area. Burying them is too wasteful. Today oxygen lances slice them into small pieces rapidly, and the skulls have become a profitable source of scrap metal.

Oxygen is hard at work in other tools besides the lance for cutting metals. For example, industry now has a machine that trims and bevels the edges of metal plates before they are welded together. The edges can be beveled at several angles simultaneously with an accuracy as great as that obtained with machine tools. Foundries use flame cutters to remove “gates” and “risers,” unwanted projections on castings.

Still another machine that breathes oxygen gouges metal in almost any pattern. In this process a “gouging nozzle” combined with hand-cutting blowpipes cuts a controlled groove in the surface without damaging the rest of the metal.

One of the greatest contributions of oxygen to the steel industry is in “scarfing” or “deseaming” steel bars and slabs. In processing steel, surface defects formerly were removed by laborious hand chipping or grinding. Now with a deseaming blowpipe a worker can remove all defects from a slab five times faster than it can be done by hand. “Scarfig” machines have been perfected that clean up all four sides of a slab of steel simultaneously. They’re so foolproof they ignore all sound metal.

Perhaps the newest of the flame-cutting



Air Materiel Command photo

Lifesaver for pilots who are forced to bail out at extreme altitudes is this emergency oxygen cylinder assembly developed for the Army. Bottle in flyer’s pocket holds enough oxygen for a parachute descent

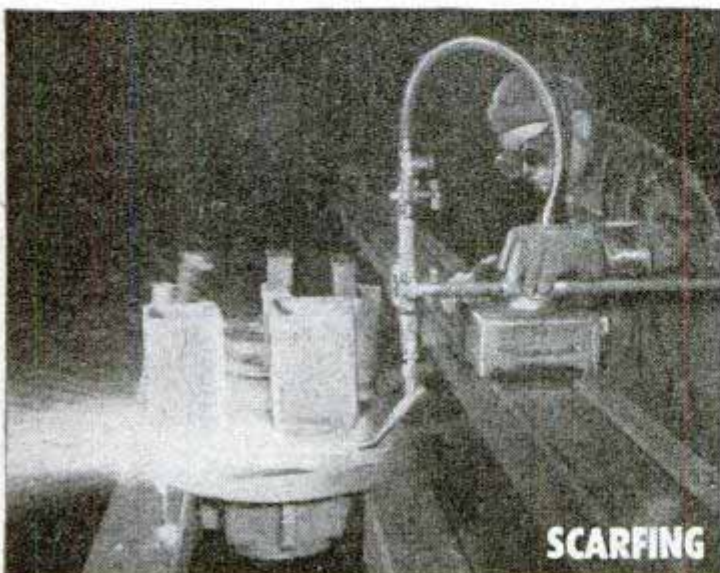

SCARFING



HARDENING



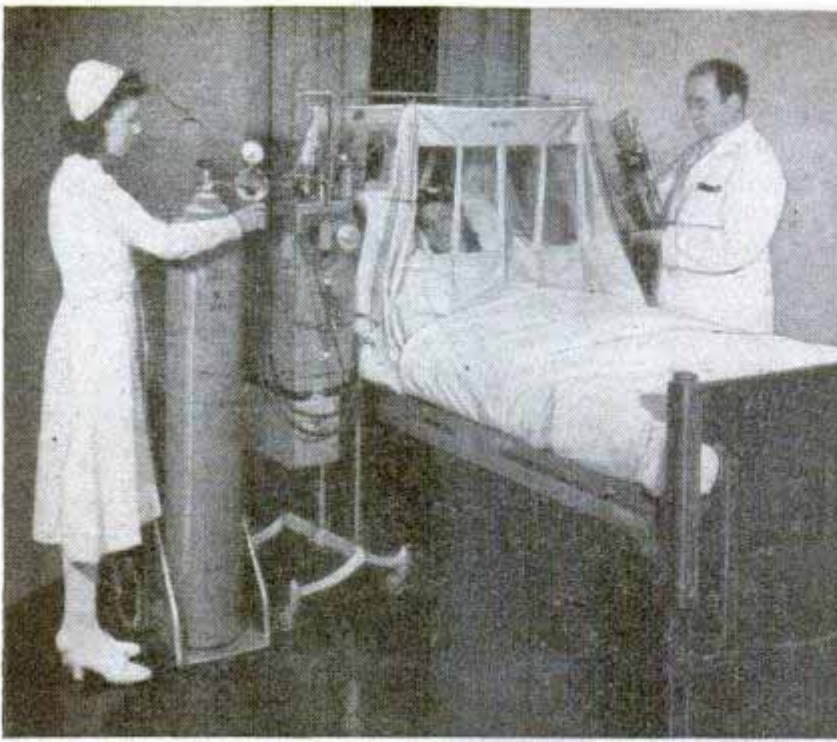

Air Reduction Sales Co. photo

**No modern hospital is complete without oxygen tents. The lifesaving gas is an essential aid in the treatment of many respiratory ailments**

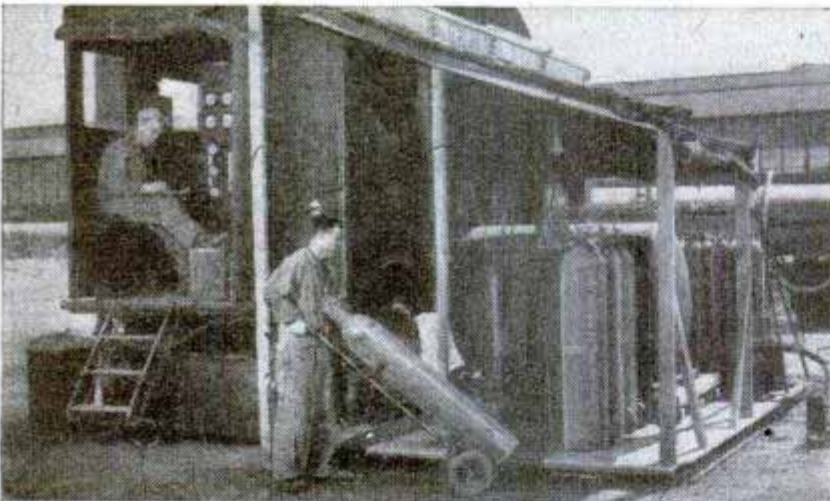

Air Materiel Command photo

**↑ Army's mobile generator produces 1000 cubic feet of oxygen an hour**

**↓ Maze of pipe lines threading through welding section of industrial plant carries oxygen and other gases from central source to benches**



techniques is "powder scarfing." Stainless steels are made by adding other elements to ordinary steel. Formerly it was almost impossible to flame cut stainless steels because the flame would form oxides upon contact with the oxygen. The oxides spread like a film over the metal and prevented further cutting.

Today powdered flux is fed from a hopper into the oxygen stream. When the powder burns it melts and carries away the oxides as fast as they form, paving the way for ordinary flame cutting of stainless steel.

New machines cut patterns in thick or thin metal the same way a jigsaw cuts through a slab of plywood. By hooking several of the machines together, the same pattern can be cut from a good many pieces of metal at once.

Cutting metals isn't even half the story. Oxygen turns around and joins the metal.

Oxyacetylene welding by hand is an old method. A newer process is "pressure welding." Heat and pressure are applied at the same time. Oxygen controls the heat so precisely that the metal becomes plastic but doesn't melt. Such welds can be heat-treated to become as strong as the base metal itself.

Still more recent machines permit high-speed automatic welding. All the operator does is set the controls.

Hard, wear-resistant surfaces can be put on localized sections of metal parts without changing the "core" metal. "Flame cleaning" is the quickest way to remove rust and scale from steel surfaces before painting. Still another new process is "flame spinning." Steel containers and tubes are spun and heat applied to close their ends.

But oxygen's uses aren't confined to plants and mills. The gas gives a lift to the health of thousands every year. Oxygen is an aid to recovery for many types of respiratory ailments and may be prescribed in treating serious



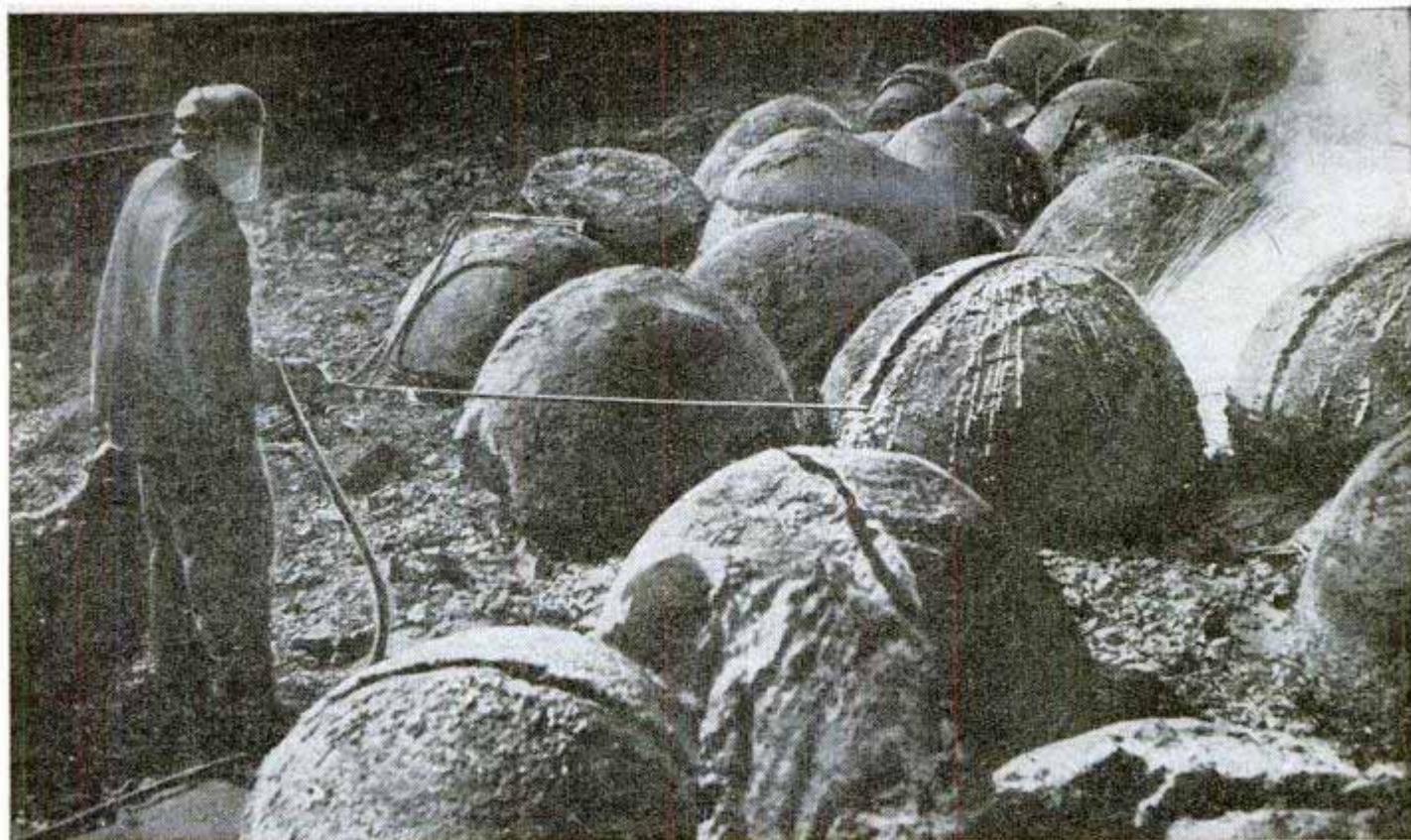

Linde Air Products photo

**Metal in slag-pot "skulls" was formerly wasted. Now the skulls are cut into small pieces with oxygen lances**

illnesses. The oxygen tent is standard equipment in every modern hospital.

The gas saves lives in the clouds as well as on the ground. During the war a "bail-out" cylinder was devised that fitted into the stratosphere flyer's suit. If he was forced to bail out several miles up it kept him alive until he could breathe normally.

A mobile oxygen generator also was developed that produced 1000 cubic feet of oxygen per hour. The generator proved oxygen can be manufactured inexpensively anywhere it's needed.

Experiments are under way that will find widespread new uses for the hard-working gas. A \$15,000,000 plant in Brownsville, Texas, will be finished next year. Every day it will mix together 40,000,000 cubic

feet of oxygen and 64,000,000 cubic feet of natural gas. Engineers are confident the daily result will be 5800 barrels of high-grade gasoline, 1200 barrels of Diesel oil and 150,000 pounds of chemicals. The manufacturing cost of the gasoline is expected to be 2½ cents less than the wholesale price of the gas you're now burning in your car.

Another proposal is to turn coal into heating and cooking gas. It's even been suggested that coal be burned underground to provide the cheapest possible gas. In either case oxygen would be required.

Ethyl alcohol burns with liquid oxygen to produce the tremendous power generated by all sorts of rocket motors.

The gas that became industry's man Friday is seeking and finding new fields.

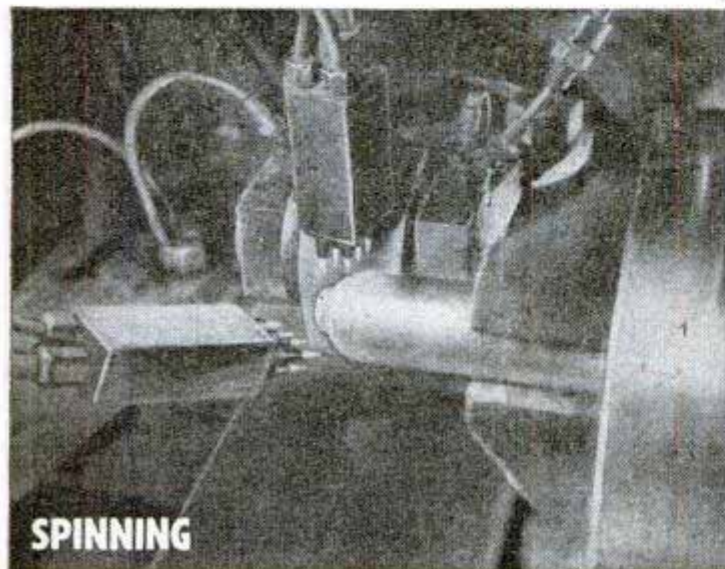

**SPINNING**



**FLAME CLEANING**



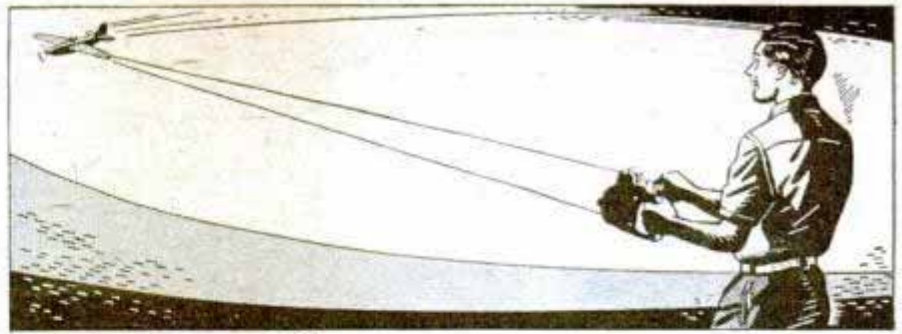

Electric impulse from battery inside reel trips a relay to control model airplane

## MODEL AIRPLANE REEL CONTROL

Gas engine powered model airplanes can be controlled in flight for dogfighting, formation flying, hedgehopping and other

stunts with a "B" battery powered reel control. The electric current is transmitted through the reel to a relay in the model plane. When a button on the control handle is pressed, the current trips the relay. This slows down or speeds up the engine for landings, take-offs or aerial maneuvers. The reel control and relay also can be used to operate flaps, retract or lower landing gear and to drop bombs or parachutes. Made of molded plastic, the reel has a pistol grip for one-hand operation.



## RICE-HULL BRICKS

Waste rice hulls, which formerly created a disposal problem, are now being used for building materials. Building blocks made with the hulls look like concrete but weigh much less and will support heavy loads. Rice-hull fence posts may be nailed or

sawed like wood. Made from a mixture of cement, hulls and hull ash, the material is highly fire-resistant. It can be used also as an insulating material since the hull, one of nature's most perfect packages, is moisture and decayproof. Rice farmers have used small quantities of the hulls in the past to insulate icehouses.



## Wire-Cord Tire Is Rugged

Steel wire replaces cotton and rayon cord in pneumatic tires said to be the most rugged ever built. Tests indicate they last up to 50 percent longer, run cooler under heavy loads at high speeds and recap more easily, and they have never been known to blow out. The cord consists of several strands of wire slightly larger than a human hair and is only .036 inch thick. Other than for the original ply preparation, the same machinery and building techniques are used for the new tires. Because of the wire cord's greater strength, fewer plies are required than with cotton or rayon. A test tire has already run 103,000 miles.

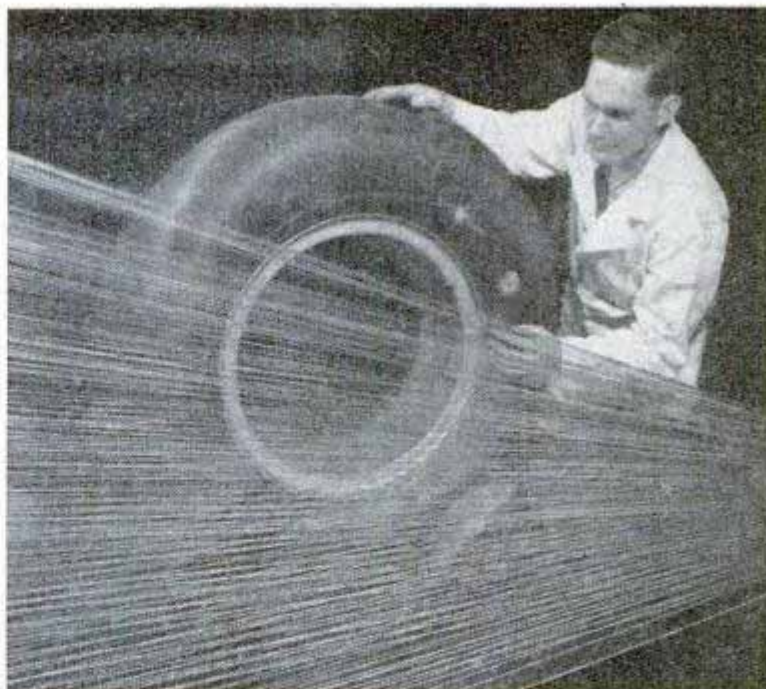

Firestone Tire and Rubber Co. photo

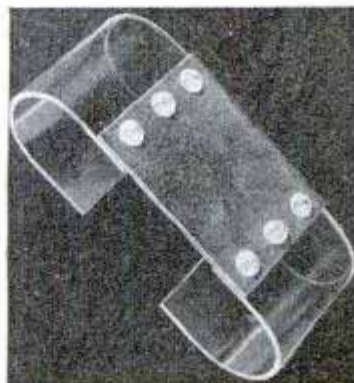

## Plexiglas Rivets

Plexiglas rivets have been developed for fastening light metals, leather, rubber, cardboard, upholstery and various plastics. They are inserted in fragile materials without shock by an air gun that heats and expands them. This also permits use of the rivets as "blind" fasteners. Exposed parts of the rivet can be fashioned into decorative effects by further heat application.



## Inflatable Lounge Chair

Air pumped into the seat and back of an inflatable easy chair forms comfortable cushions for complete relaxation. A tubular metal frame provides the support. When deflated, the chair can be packed into a zipper bag. The entire unit, manufactured by a Cardiff, Wales, firm, weighs only four pounds.

One mystery of plant growth has been solved—how chlorophyll in plants holds light energy from the sun long enough for it to be stored in plants as sugar, starch and other substances. Tests by University of California chemists demonstrated that chlorophyll has a phosphorescent quality which "captures" energy from the sun.

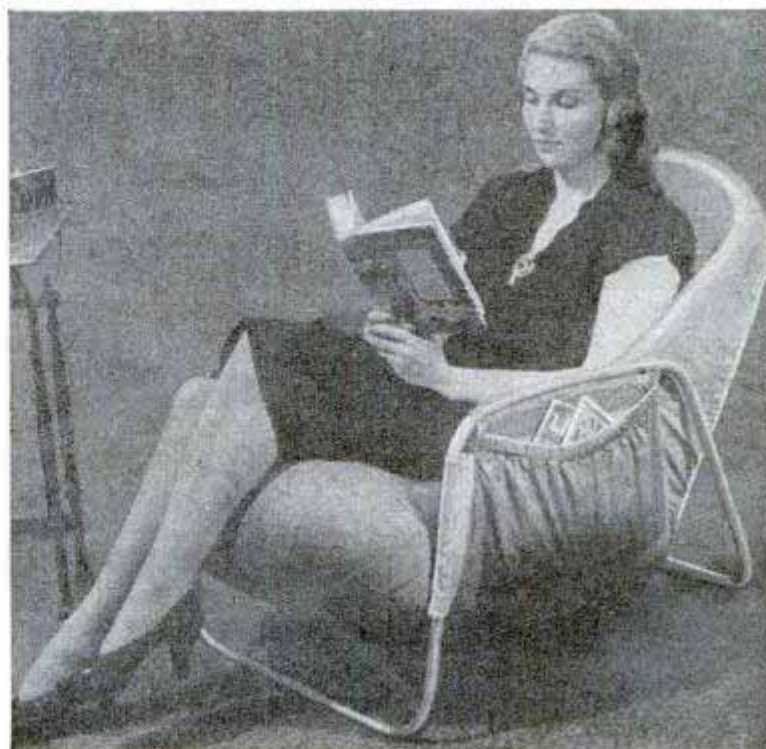

British Combine photo



# TRAILERS TAILORED for EVERY JOB

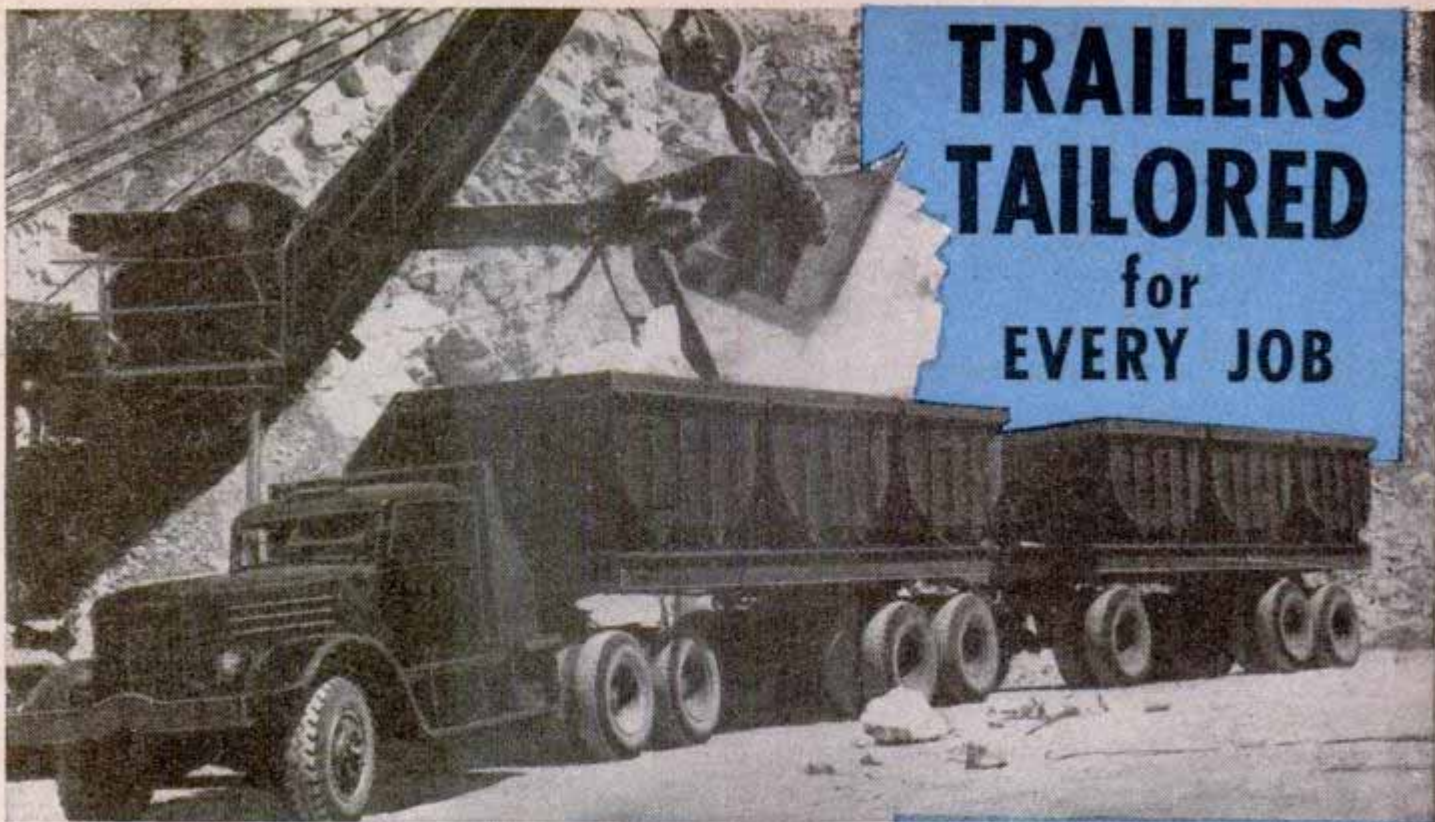

Mountains of limestone in the sizzling Mojave desert are moved by trailer to cement factories operated by Southwestern Portland Cement Company

The driver pulls a lever and tons of stone are dumped automatically from a heavily laden trailer onto a railcar waiting to haul the material away

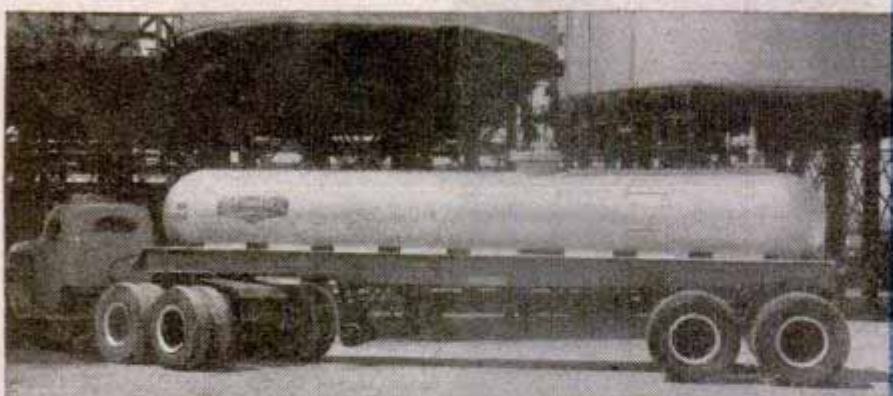

Twenty-ton rubber-lined acid tank is transported by 18-wheel trailer to 50 industrial plants in the Los Angeles area to supply their acid requirements

Portable-derrick drills and services oil wells. It weighs 30 tons, is 89 feet long, can be erected in two hours, compared with two days for steel towers

All photos courtesy Fruehauf Trailer Company







Butane gas for cooking and heating is transported by semitrailer to 2000 farm customers in the San Diego area. Center platform is for portable tanks

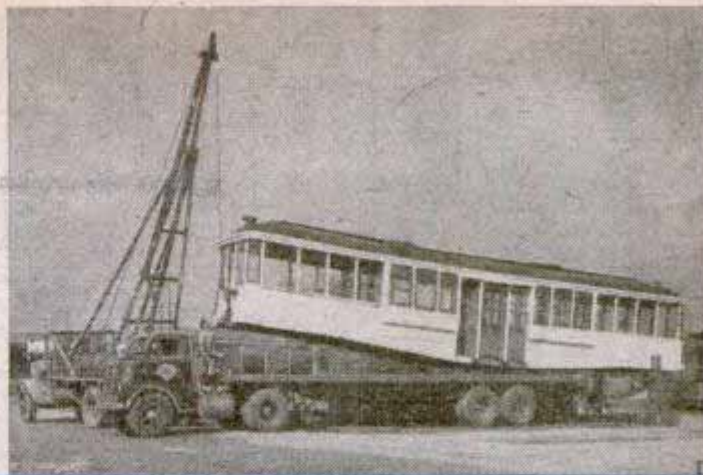

Old streetcars, moved by 35-foot trailers, are solving the housing shortage for some families. The trolleys also serve as hot dog stands and cabins



Huge redwood logs—some containing 15,000 board feet of Washington fir—are hauled by truck and trailer from almost inaccessible regions. Below, dump trailer in Idaho Falls unloads volcanic cinders used in building blocks for homes and big structures



Animal bones are moved from slaughterhouse in San Francisco to be processed into tallow, dog food and livestock medicine

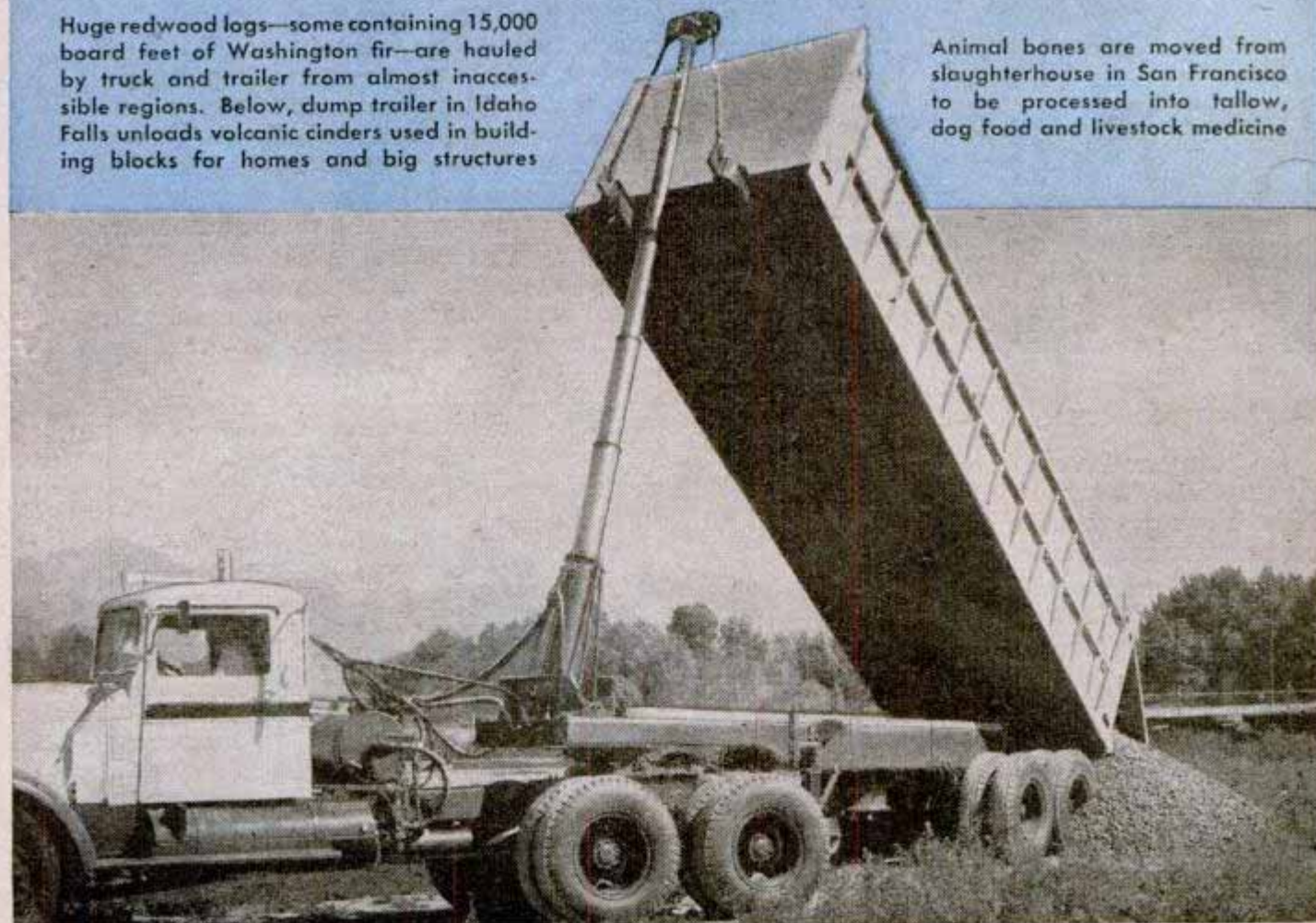





† Two cameras with all attachments are the photographer's tools. Right, he carries complete camping equipment and emergency rations in his car. Below, between shots he brews a cup of coffee on his stove

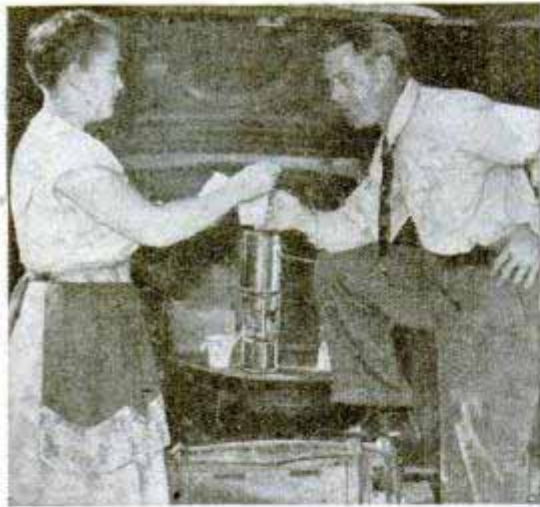

### 'Be Prepared' Is Cameraman's Motto

When Paul Calvert, staff photographer for a Los Angeles newspaper, receives an assignment, he's prepared to go anywhere in any kind of weather and stay for days to snap the pictures. His paraphernalia includes an aviation-type helmet for cold weather, knitted helmet, heavy gloves, overshoes, leather boots, flashlight, binoculars, pistol, complete change of clothing, Coleman stove, coffee, canned cream and sugar; condensed Army rations, mess kit, collapsible bucket, heavy overcoat with hood, sleeping bag, raincoat and hat, two knapsacks, a canteen with belt, tire chains—oh, yes, and two cameras.

### Drilling to Music

Soothing music calms nervous patients of Dr. Herbert Weinstock, a New York dentist. He has installed earphones, connected to the office radio, in the headrest on his dental chair. The patient can adjust the volume by a control on the armrest, bringing in music loud enough to drown the awesome whirr of the burrs and drills.

☐ First commercial passenger plane certified by CAA for take-off with gross weight above 100,000 pounds is the Lockheed Constellation.







## Electric Orchestra

Metal strings, aluminum tubes and amplifiers team up to produce strange new musical tones

By Vera and Henry Bradshaw

Photography by Ken Wright Studios

**E**LECTRICITY has invaded the field of music. Of course, the warm strains of the electric organ and the unusual tones of electric guitars are no longer wonders. But electronic music does not stop there! Awaiting public approval are electronic violins, cellos, violas and bass viols.

These instruments are bare skeletons of the originals. Void of a sound box, each instrument is merely a slender metal tube, over which rest the fingerboard and metal strings. The "big" bass viol has been diminished to a long aluminum tube barely four inches wide! A volume-control foot pedal and individual amplifiers complete these strange instruments.

Built around the idea that actual vibration of the strings, and not sound boxes, should be the source of tone, the instruments produce three-dimensional sounds. The secret of the inner workings of electronic instruments is this: metallic vibra-

tions of the strings, set up in a magnetic field, are transformed into electrical oscillations which are made audible by amplification through loud-speakers. The conversion is accomplished exactly as in the electric phonograph or radio receiver.

Although termed electronic, actually they are semielectronic and not mechanical in any way. They still require the skilled fingers of the artist to bring them to life. It is the amplification that electricity gives to hitherto unheard tones, the new power of holding notes longer than ever before, the unusual range and the fantastic blending of tone which bring about the amazing musical qualities of these instruments.

Not only can the electronic violinist get a tone as big and round as that of a wooden cello, or as thin as that of the violin, but he also brings to the audience eerie sounds, seemingly from far away. In electronic music, the listener hears the lowest notes.





**Adele Parrish, using a conventional wooden violin, blends her music with the tones Bert Lynn produces on his electronic violin. Below, Lynn uses a screwdriver to adjust his instrument. Note aluminum finger guide**



The frequencies of these low notes, ordinarily unheard, are amplified to the point of human ear detection.

The inventor of electronic instruments is Bert Lynn, who introduced his electronic "vibrolynn" to the public in 1935 in Earl Carroll's Vanities. The only instrument of its kind in the world, it mimics air raids, recites "Mary Had a Little Lamb," and produces remarkable tones and volume.

Lynn points out that these odd-looking electronic instruments can render either stringed music, a la Hawaii, or music which will blend symphonically with brass. Tone color can be controlled to such an extent that they sound like gut-stringed instruments at one moment, metal-stringed instruments at another, and something new and fantastic at the next.

The blending of extremely high and low tones can easily be accomplished with electronic instruments. The volume of high tones is cut down and that of low tones magnified. Lynn explains that with a wooden violin the high notes are loud and carrying. When the musician drops to the "G" string, though, the small sound box reduces this carrying quality. With the electronic violin, the player can increase the low-note



volume by automatically stepping up tone frequencies.

Let us imagine a bass viol 12 feet high with one player standing on a ladder to finger it while another bows it. This is the size a wooden bass would have to be, Lynn asserts, to create the depth, tone and color possible with an electronic viol. Also, an electronic bass player, with either a rubber hammer or a conventional bow, can achieve a kettledrum effect.

"With amplification," Lynn explains, "a deaf man can hear. With amplification a person with normal hearing can hear more notes. We get a better blend of sounds."

Tone volume is controlled by foot pedals. As the player bows or plucks, he also uses the volume-control foot pedal, pressing it down to create depth and a big, round tone, adding intensity when he hits the "G" string, releasing it as he plays up the scale because higher notes are heard anyway.

"The wooden-instrument violinist," Lynn says, "wants to play a soft note. It is very difficult. The scratch of rosin and the scratch of the bow being pulled over the strings can be heard. With an electronic violin, a mere reduction of pressure on the foot pedal is all that is necessary."

To eliminate the scratching, the wooden violin must be muted (which, in the midst of an orchestration, takes time), whereas an electronic instrument can be shifted from mute to open tone instantly.

The leader of an electronic orchestra faces a radiolike box equipped with knobs or dials. By turning a knob, he can change the tone color of his string section. He can bring out the high, sweet tones of the violins or he can make the string sections comparable to the brass so the listener can hear both.

Lynn believes that nothing will ever replace the beautiful, mellow tone of the wooden violin for the concert stage. But he thinks electronic instruments will replace wooden instruments for orchestra use, and possibly symphony, with the exception of the soloist.

He also predicts that the electronic or semielectronic principle will be applied to the brass section of an orchestra by means of an automatic vibrato, similar to that in an electric organ.



Lynn, the inventor of electronic instruments, plays his favorite, the vibrolynn, which mimics air raids and recites "Mary Had a Little Lamb." Below, foot control regulates volume by stepping up tone frequencies





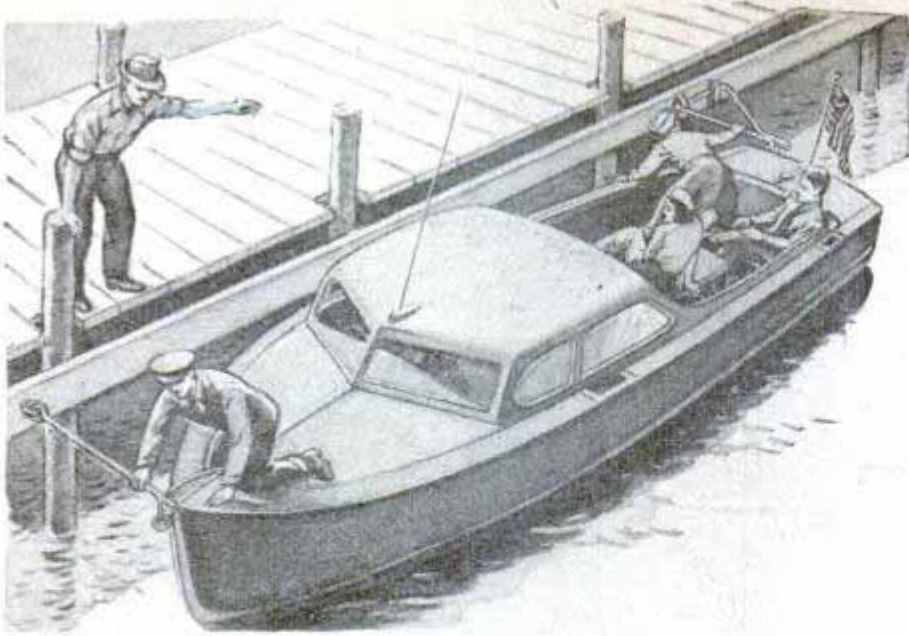

## Nonrub Boat Moor

Small boats can't rub against the pier when moored with a double fastening system that holds them several inches from the edge of the pier. Two eyebolts are installed in the boat, one on the stem and the other on the stern. A bracket working on a swivel is bolted to the pier to hold the prow of the boat and a triangular bracket that turns in a sleeve holds the stern. Each bracket has a pin that fits into the corresponding eyebolt to lock the boat in place. Wave action lifts the boat up and down without pushing it against the pier and damaging it. The brackets are made of  $\frac{7}{16}$ -inch cadmium-plated steel rods with welded joints.

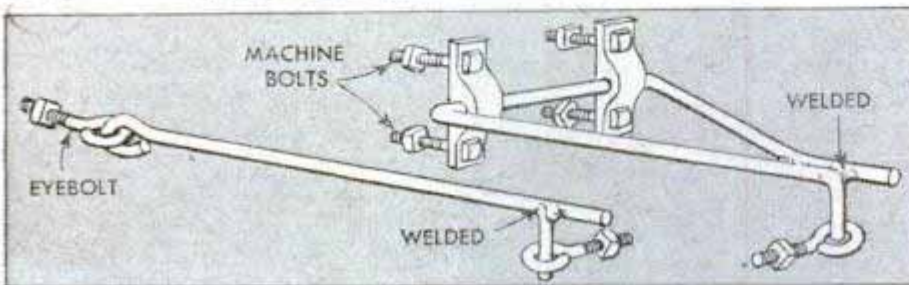

## Bit Has Changeable Boring Heads

Holes of different sizes can be bored with a single auger bit by changing the boring head instead of the entire bit. The lead screw is part of the bit itself, and the boring heads, available in sizes from  $\frac{5}{8}$  inch to  $1\frac{1}{4}$  inches, are fastened with a setscrew.

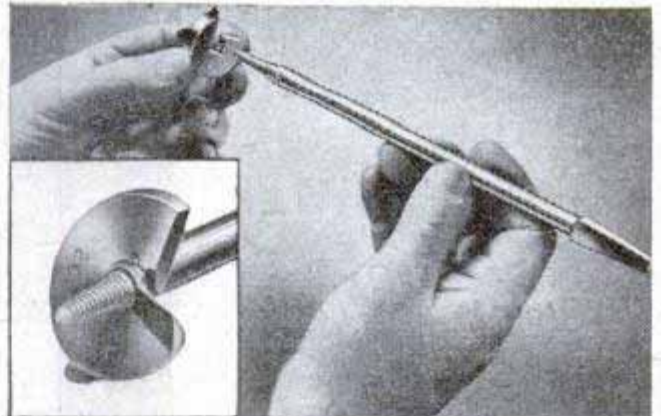

## Car's Vacuum Secures Boat Rack to Top

Boats or luggage can be hauled on top of an automobile with a vacuum-cup carrier. Unlike other suction cups, these are held tightly in place by a vacuum created by the car engine. The carrier is said to have a holding power of 640 pounds and cannot be pulled loose by rough roads or bumps.

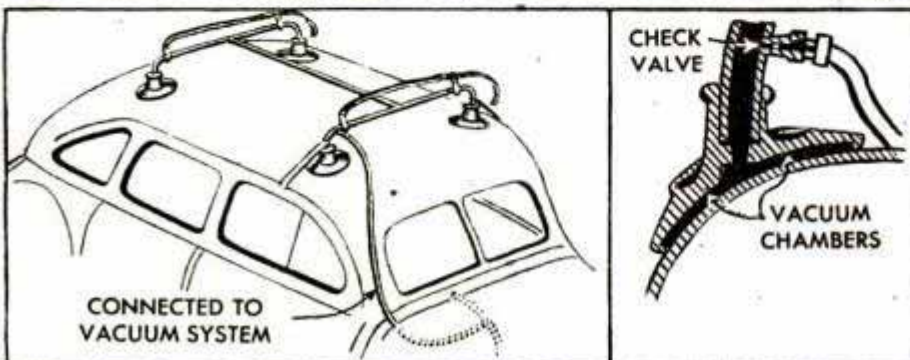

Ⓞ Fifty-seven 130-gallon water tanks were carried instead of sandbags or pig iron in cargo test flights of the 92-ton Lockheed Constitution.



## Adjustable Dehorning Chute

Animals are protected from injury during branding or dehorning by an adjustable dehorning chute. The animal's head is held stationary by a stanchion and one side of the chute is moved in to prevent the animal from jumping around and injuring itself. After the branding or dehorning, a side door is opened to release the prisoner. The chute can be operated by one man. It is made of steel and is portable.

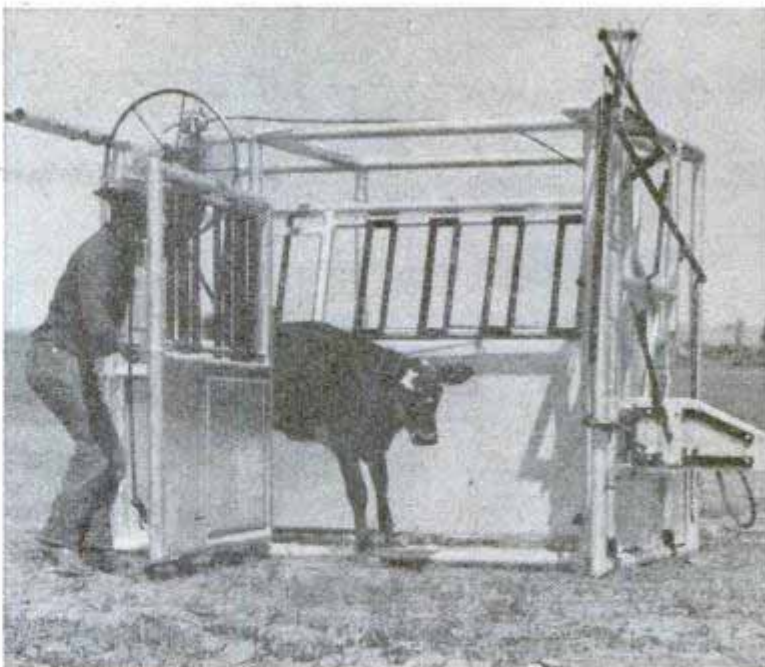

## Electrical Flood Gauge

Flood movements of rivers can be calculated a thousand times faster with an electrical computer built at Ohio State University. In the test model, electrical circuit elements represent the friction of the river bed and the channel's water storage capacity. After setting up "flood conditions" by introducing current, the flood crest's movement down the "channel" is observed and measured directly on an oscilloscope. Calculations are generally complicated by the rapidly changing effects of rainfall, tributaries, dams, reservoirs and channel variations.

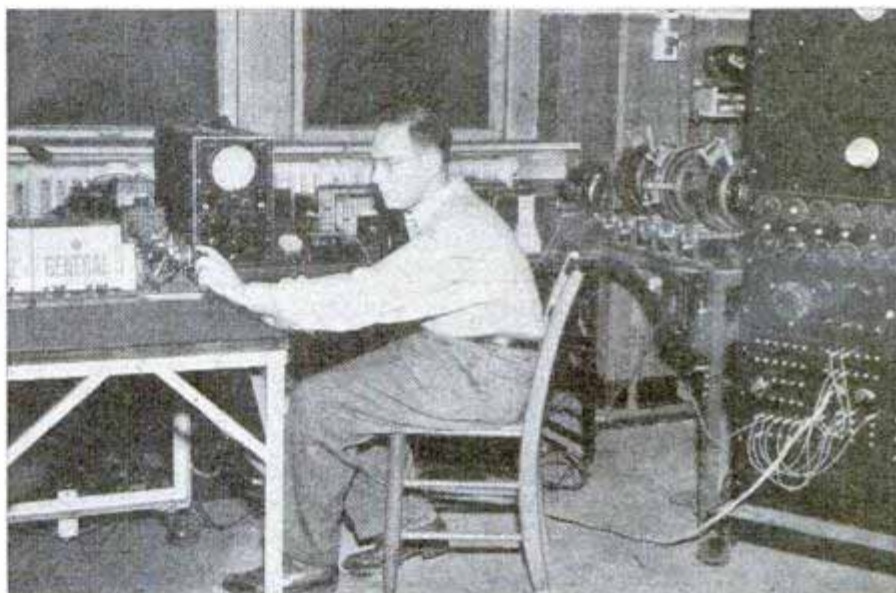

## Motorcycle Bus

Improvised from a motorcycle chassis, an open-air three-wheel bus hauls passengers in Rome, Italy. With gasoline strictly rationed, the more-miles-per-gallon economy of the two-cylinder motorcycle engine provides public transportation at low cost.

## Edible Orchids

Orchids that can be eaten may be grown in American gardens of the future. The edible orchids are among 11,000 plants and ferns brought back to the New York Botanical Garden by an expedition into Nyasaland in East Africa. Unlike the ornamental species that are found on trees, they grow in the ground like ordinary plants. The natives dig up their tubers and eat them with cornmeal.



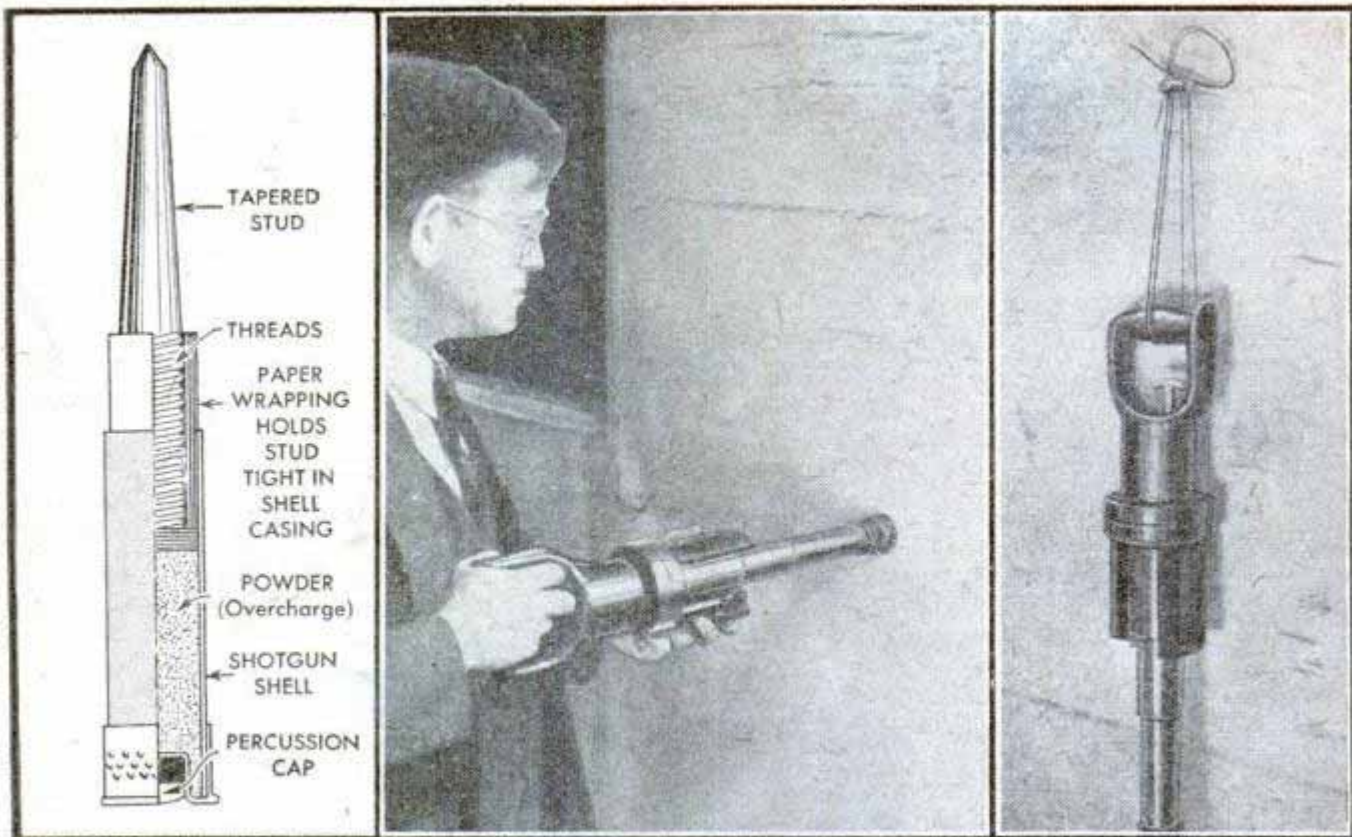

## CONCRETE BOLT GUN

Bolts or studs can be placed permanently in concrete, brick or other rocklike material by firing them with a new high-velocity bolt gun. Driven by an explosive charge similar to a .410-gauge shotgun shell, the metal bolt is forced into the concrete and becomes securely embedded. The inventors claim that from one to two tons of force are needed to extract the bolt, several times the pull that will remove bolts



that are cast into the material or planted by expansion devices. Secret of the gun is a design that allows air to escape from the barrel ahead of the projectile plus a gas escape that prevents recoil. This permits placement of the gun in direct contact with the material to be entered and prevents fracturing of the surface. An adjustable footplate at the end of the barrel allows placing bolts at almost any desired angle. A typical projectile has a heat-treated point, is 3 inches long, with the outer inch being threaded and of  $\frac{5}{16}$ -inch diameter. The projectile embeds itself 2 inches deep in concrete, leaving the threaded portion projecting and ready for use.

## Tripod Head for Panning and Tilting

Home movie makers can pan or tilt their "takes" with a new tripod head that fits all standard tripods and all still or movie cameras. The attachment permits panning without tilting, or tilting without panning. A knob on the handle locks or releases the panning action, while the handle itself regulates the tilting action. Ball-bearing construction permits 360-degree panning and the camera can be tilted in a 180-degree arc. A plug in the attachment screws into the base of the camera.

☞ When the Army sought experienced aid in devising body armor to protect airmen against flak, they acted on a Scotland Yard tip and contacted a British firm that had made bulletproof vests for U. S. gangsters.



# TRICKS OF THE GREEN MEN

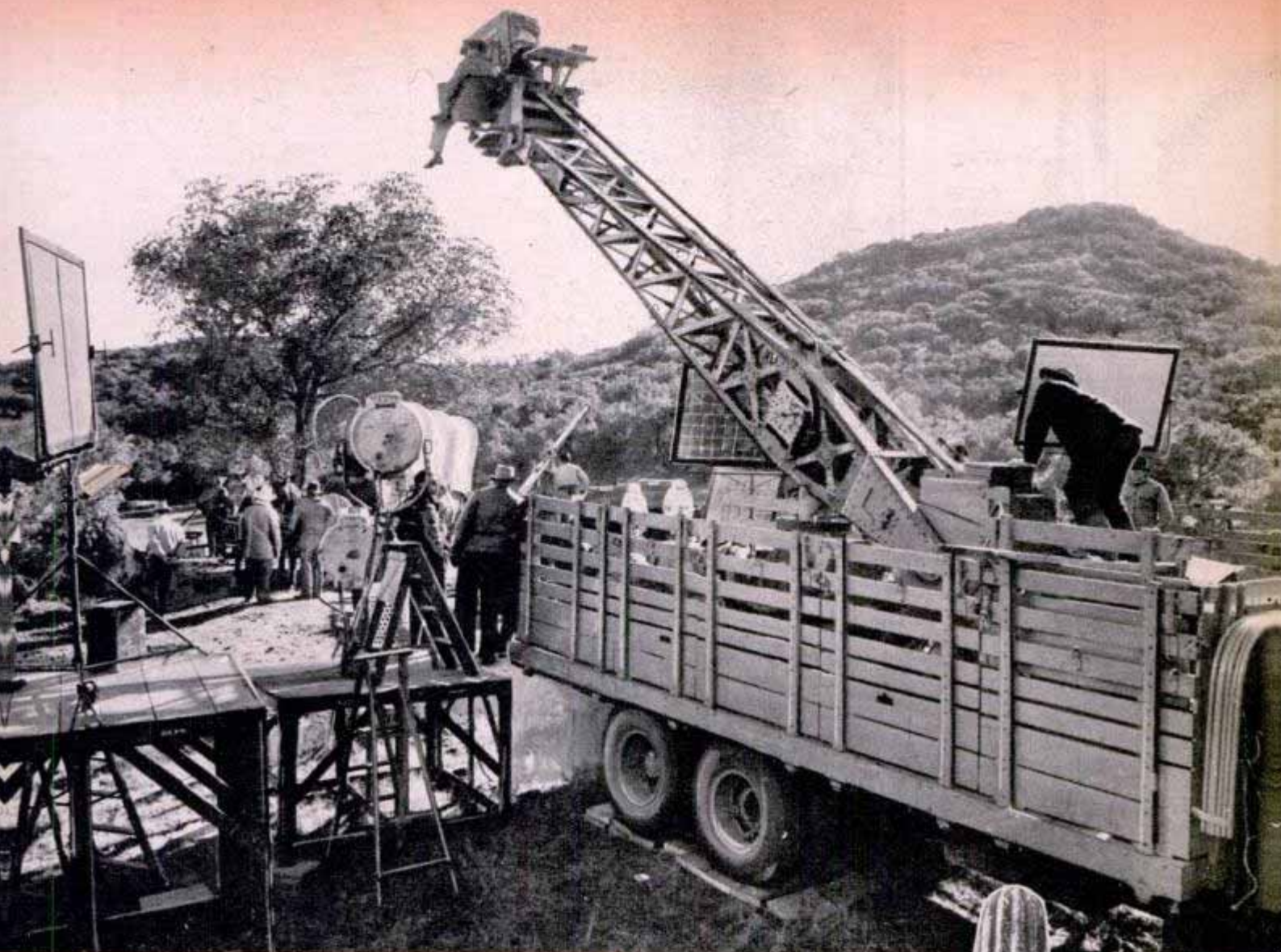

Under a built-to-order tree, movie actors perform before a studio camera. Below, nonsticking soft grass "spikes" are inserted in plaster cactus plant for a scene

By Thomas E. Stimson, Jr.

**O**UT on location Nick Kalten was studying the tree under which a movie sequence was to be filmed the next day.

"The director just decided that he wants an apple tree in bloom here instead of this oak," he told his crew. "The tree is the wrong shape for an apple, so prune it back and fill in with eucalyptus branches to give it the right appearance. We'll use sumac leaves for foliage since we can't get apple leaves this time of year. I'll pick up a couple thousand artificial blossoms to wire on."

Not even an arboriculturist would have guessed on seeing the finished movie that the apple tree had been put together on the spot. Even the oak's rough bark had been smoothed with plaster and spray-painted to conform to its new species.





For picture purposes the tree was perfect.

Nature can't keep up with Hollywood studios. Tropical jungles, Iowa farms at harvest time and New England winter scenery may be needed on adjacent sound stages or on the lot during the same week. Each background must be authentic to fronded palms in jungles and stalks of wheat on farms.

Studio "green men" use natural trees and shrubs whenever they can. They use ingenious substitutes when the needed greenery is out of season or unavailable. Once Nick Kalten, head of the greenery department at Twentieth Century-Fox, was told that he had eight days to produce a Costa Rica coffee field that would stand close scrutiny on the screen. He filled the order although there were no coffee plants in Hollywood. To imitate coffee berries he bought thousands of half-grown dates from a desert date orchardist, painted them red and attached them to the stems of a native California bush that has pointed leaves similar to those of the coffee plant. Thinned out, trimmed to shape, and planted in dirt spread over a sound-stage floor, the composite bushes couldn't be distinguished from the real article.

On occasion Kalten has reproduced a cotton plantation by using black-eyed Susan plants when cotton plants were unobtainable, tying tufts of cotton on paper pods that were wired to the stems.

Manufacturing trees is a standard job with the studio green men. At Twentieth Century-Fox, Kalten maintains a "skeleton park" of basic trees that have been used in

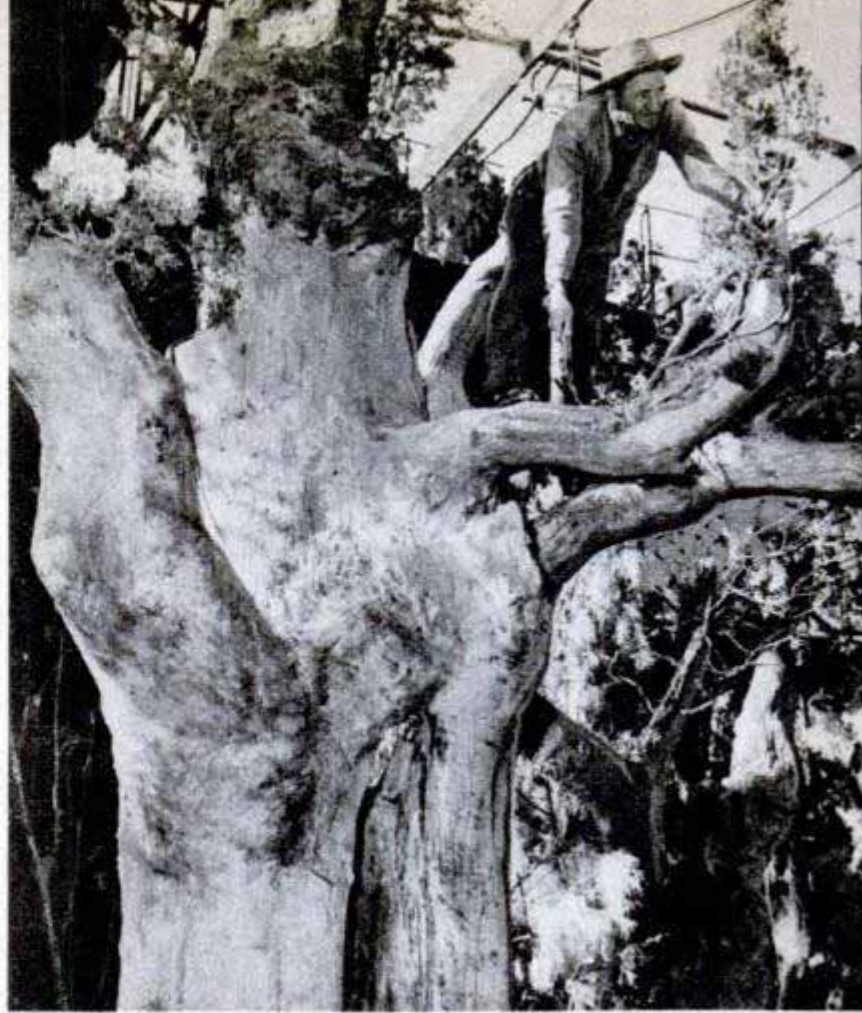

Foliage is added to natural-and-plaster tree by movie "green man"

scores of pictures. Each skeleton consists of the trunk and major branches of a particular species, chosen for size and shape. Mounted on a wheeled platform, each skeleton is decked out with additional branches and foliage when it is needed in front of a camera. The bark may be natural or may be plaster casts of bark from similar trees. Plaster is used to smooth over the joints where new branches are nailed to the stub limbs of the skeleton. "Dressing" the tree for a picture includes concealing its wooden base with grass or weeds. If portions of the roots are to appear

Palm trunks on portable stands and artificial flowers and leaves are made to order and stockpiled for scenes





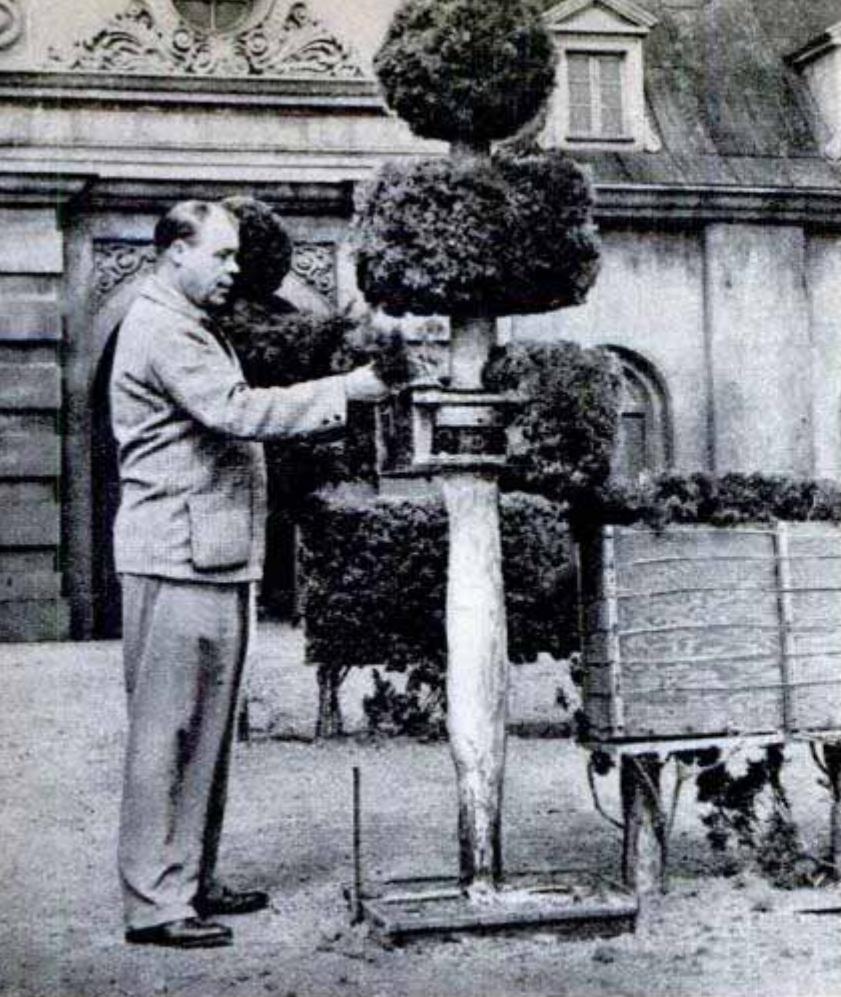

Formal hedges are of greenery added to wood and plaster trunks

they will be built from plaster and painted.

Kalten keeps hundreds of other stock trees on hand. Sycamore, mountain oak and live oak are good base trees for all except tropical backgrounds. Magnolia, pepper, weeping eucalyptus and palm trees are used when a tropical or semitropical background is specified. For close-ups, authentic foliage is used; for middle-distance shots, foliage of sycamore, elm, oak or eucalyptus substitutes well for many species.

When one of his natural tree trunks won't do for a certain scene Kalten builds his own tree, often of barrels or kegs. Mi-

nus their tops and bottoms, the barrels are strung on a tall pole and nailed to it. Then sheets of artificial bark are stretched around the barrels and nailed in place. The bark consists of thin plaster casts attached to burlap backing. Wrapping the burlap around the barrels cracks the plaster, of course, but the cracks occur along the natural crack-lines of the bark and so are not visible. To this artificial trunk Kalten adds plaster roots, natural limbs and foliage.

Towering palms of several varieties are easily fabricated by wrapping plaster casts of palm bark around a tall eucalyptus pole from which all the branches are removed, or around built-up skeletons of two by four timbers. Old blueprint paper is used to represent shaggy bits of bark partly detached from the trunk. The fronded tops of the palm trees are created by tying to an iron framework at the top of the trunk a number of real palm branches.

One greenery assignment called for a giant redwood tree inside a sound stage, realistic enough for a

couple of lumberjacks to cut with axes. An actual redwood, of course, towers hundreds of feet in the air. Even a 30-foot section of such a tree, 15 feet in diameter, would cost a prohibitive amount for transportation alone.

Kalten knew that only one side of the tree would appear and that only about 15 feet of its height would be visible. He obtained enough redwood bark to build up that much of the trunk. At the point where the lumberjacks were to cut into the tree he built in a solid backing of timber, closely joined and with vertical grain. That was

Branches are nailed to artificial tree after the trunk and limbs are moved by hoist truck to the film setting





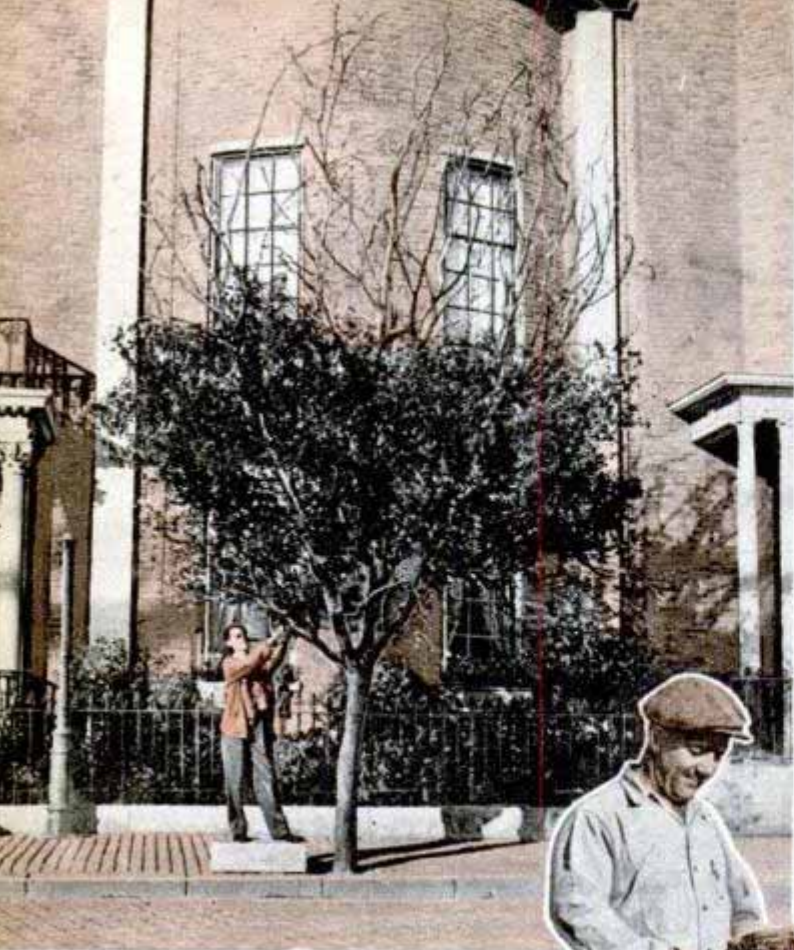

Only the lower half of this tree has foliage since camera will take in only that portion



Gnarled manzanita limbs serve as dwarfed trees for film with Siam setting. Bases and wire platforms will be concealed by leaves. Below, bleak bushes covered with artificial snow are "planted" for winter scene



all that was needed and movie audiences saw what appeared to be an actual tree-cutting operation in the forest.

Gnarled manzanita trunks and branches are ideal bases upon which to build up weird trees and shrubs such as are found in some foreign areas. For one mystery picture Kalten was called upon to create a "beautiful and sinister" plant unlike any living shrub. He got just the effect the director wanted by combining large artificial oleander flowers with natural oleander leaves that were attached to the twisted branches of a manzanita.

There is a four-acre nursery of live trees and shrubs on the Twentieth Century-Fox lot, together with hothouses in which tropical plants are grown for close-up scenes. When fresh vegetables are needed in a picture or when growing vegetable plants are required, they usually are bought from truck gardeners in the Hollywood area and transplanted just before the scene is filmed.

Grass is always in great demand and some Hollywood nurseries specialize in growing acres of different varieties for use by the studios. Cut as sod several inches deep, the grass is laid on the wooden floor of a sound stage to serve as lawns and parkings. Even under the heat of the lamps it stands up for several days. Live grass is augmented with thousands of mats of artificial grass when large areas are required. The artificial grass consists of raffia sewn on burlap and treated with glycerin and calcium chloride. These chemicals keep the grass pliable and make it fire-

proof. Similar treatment is given to most other artificial greenery used inside the sound stages.

Always on hand are hundreds of feet of stock hedges of various shapes and from one to 18 feet tall. Each hedge comes in units three or four feet long for easy handling. The units are mounted on flat boards that are buried under the dirt. A few men can "transplant" an imposing looking hedge in a few minutes so that it appears to have been growing in its location for years. Natural stalks of bushes are used in building a hedge, the upper portions of which consist of wood and wire framework into which juniper or other evergreen foliage is placed, trimmed to shape, and spray-painted.

Another handy device that Kalten uses





is the "traveling forest." This consists of a low trailer on which a scaffolding 25 feet long and 16 feet high is mounted. Decked with foliage, it is wheeled into the background of an out-of-doors scene. To the camera it looks like a distant clump of trees or brush. It is used chiefly to conceal buildings in the distance or skylines that would not be in keeping with the picture being filmed. If a story of early Mexico is being filmed, with tall buildings of Beverly Hills visible in the distance, a few units of traveling forest are spotted in the background to conceal the office buildings.

Kalten estimates that he has turned out almost half a million trees in the last 30 years in addition to uncounted acres of artificial bushes, shrubs and plants. Making a tree, he decided long ago, is a lot easier than trying to imitate one. That was a job that he had only once, early in the days of Hollywood, when a director decided that a flooded river scene needed a small tree, partly submerged, in the middle distance to indicate the height of the flood. There was no way to anchor a tree in the water so Kalten stood there, holding the branches and foliage of a tree in front of him, while the actors ran through the scene.

Exotic tree is created by attaching clumps of wild growth to limbs fashioned from wood and coated with plaster. Below, abandoned telephone pole is used to test the appearance effect of plaster "palm bark"

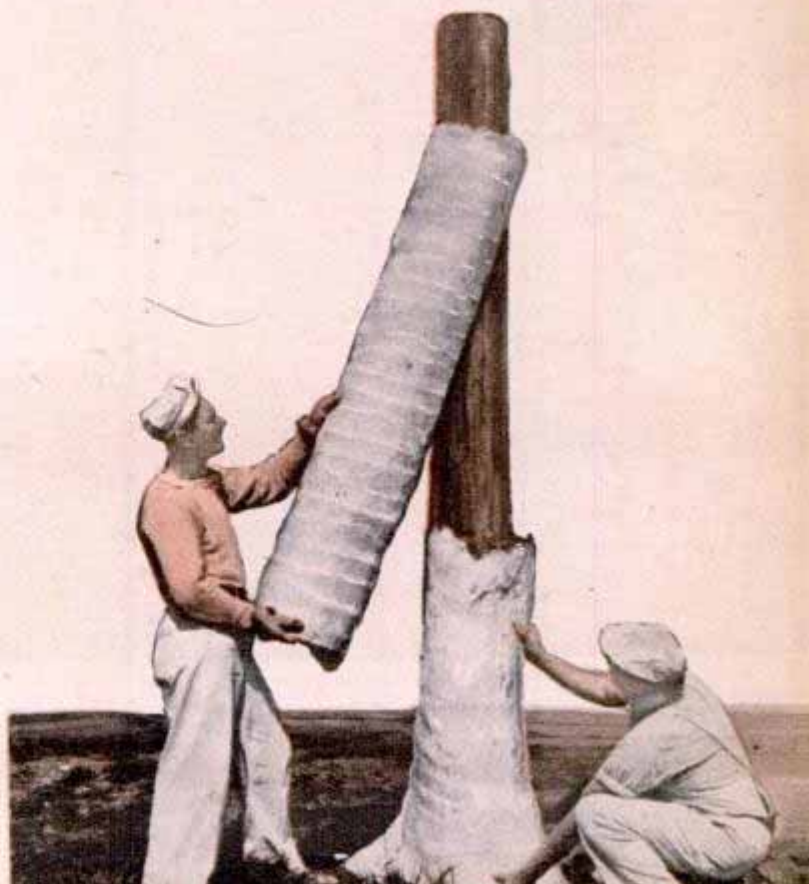



## HIGH-SPEED CAMERA TO SNAP 800,000 PICTURES A SECOND

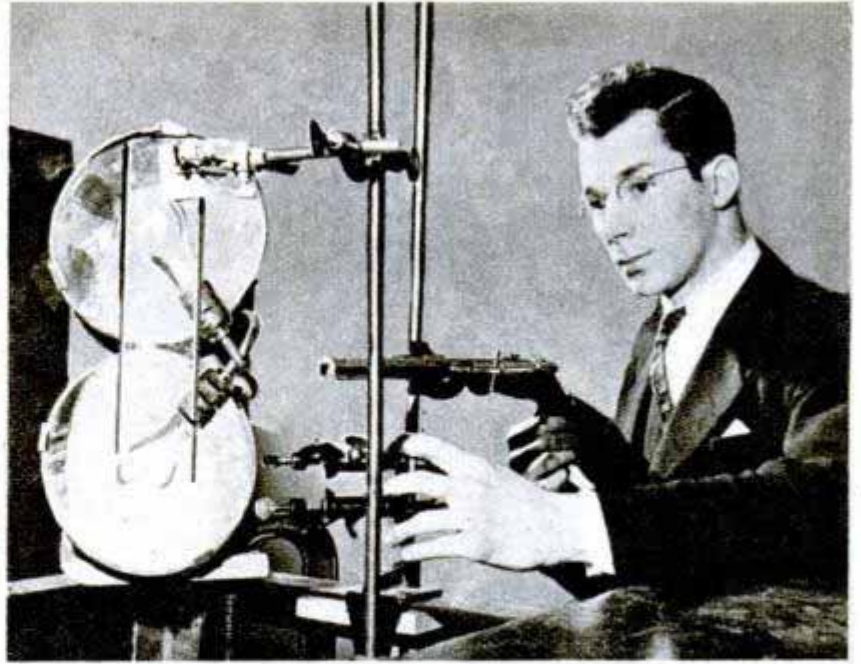

Top, a battery of small lenses snaps pictures. Top right, rifle is aimed preparatory to photographing bullet. Model above takes 70,000 pictures a second

Sights too quick for the human eye will be recorded by an ultra-high-speed camera nearing completion in Canada. The camera is designed to shoot 800,000 exposures a second. An experimental model built by physicist Kenneth Baird will take 70,000 clear pictures a second and modifications are expected to make the new camera the fastest one in existence. Photographs of the split-second impact of a bullet will last two minutes when shown at the normal screening rate of a 16-mm. projector. Film for the camera is wound on a revolving drum. A spinning metal disk with slots placed around the circumference acts as a shutter. Multiple lenses, producing images in rows of five across the film, take pictures five times as fast as a single lens with the film moving at the same speed. Baird expects to replace the five lens series with as many as 40 smaller lenses to boost the speed even further. To minimize blurring, a set of revolving prisms reflects the images to the film. Ordinary flash bulbs provide light for the pictures. The camera will be used to study the reaction of explosives and electricity and to solve high-speed problems of engineering.

### Propeller-Driven Boat

In preliminary trials at Rio de Janeiro, Brazil, a boat driven by an airplane propeller has attained speeds of 40 miles per hour. The craft is designed for use in coastal waters. Cabin, engine and propeller are mounted in one unit on the hull.

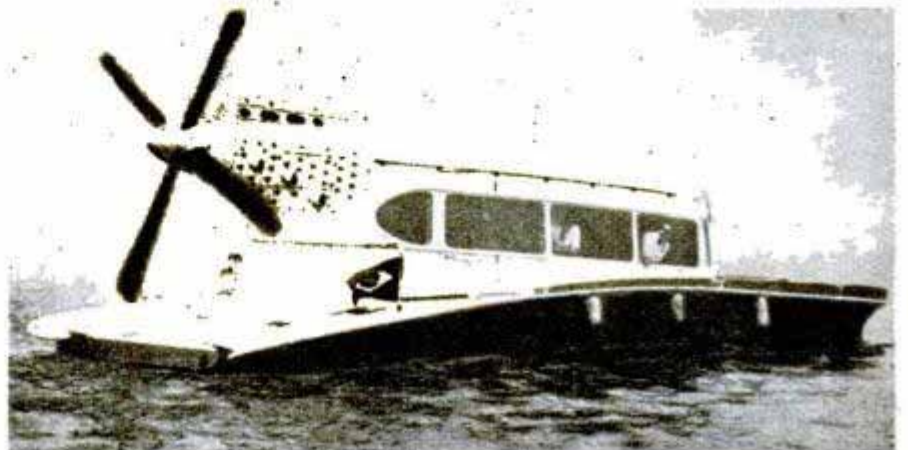



# The CRAFTSMAN

★ Botching a piece of critical work in the shop is not always due to a lack of skill—often it's simply the end result of poor lighting. Light where you want it at the bench or over a machine usually calls for portable lighting units and that's just what the article on page 213 details and describes. You'll be especially taken with the spotlight mounted on a boom. It puts light right at your fingertips where it's needed most.

★ Not only is a disk sander simple to put together but it does work almost impossible to produce in like quality and finish by hand methods. After you go over the story on page 209 you'll want one in your shop.

★ A long auto trip and a few-months-old baby—that combination can add up to a lot of discomfort for everybody unless you plan ahead and build the auto baby crib described on page 183.

★ You'll probably wish you had had it yourself when you were a youngster—that merry-go-round for your own back yard described on page 185. Its aim in life is to keep the children happy in their own yard for hours at a time.



PORTABLE SHOP LIGHTS

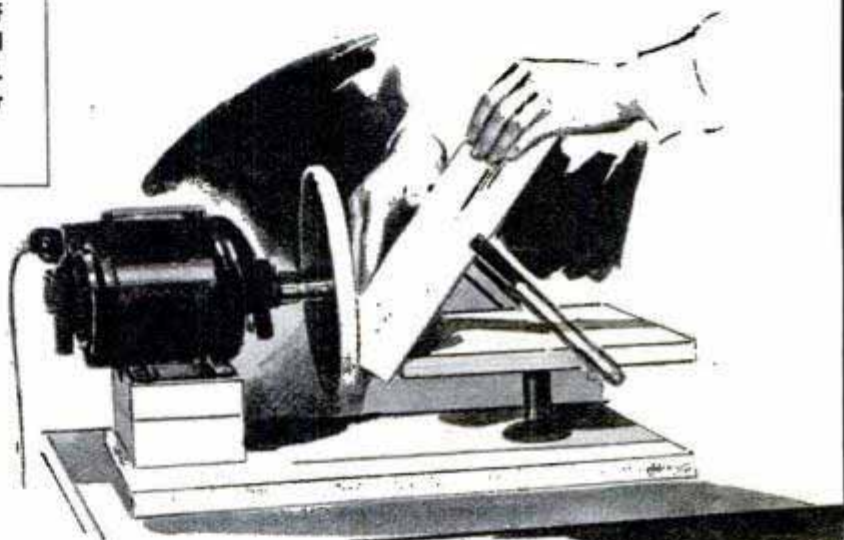

DISK SANDER



AUTO BABY BED

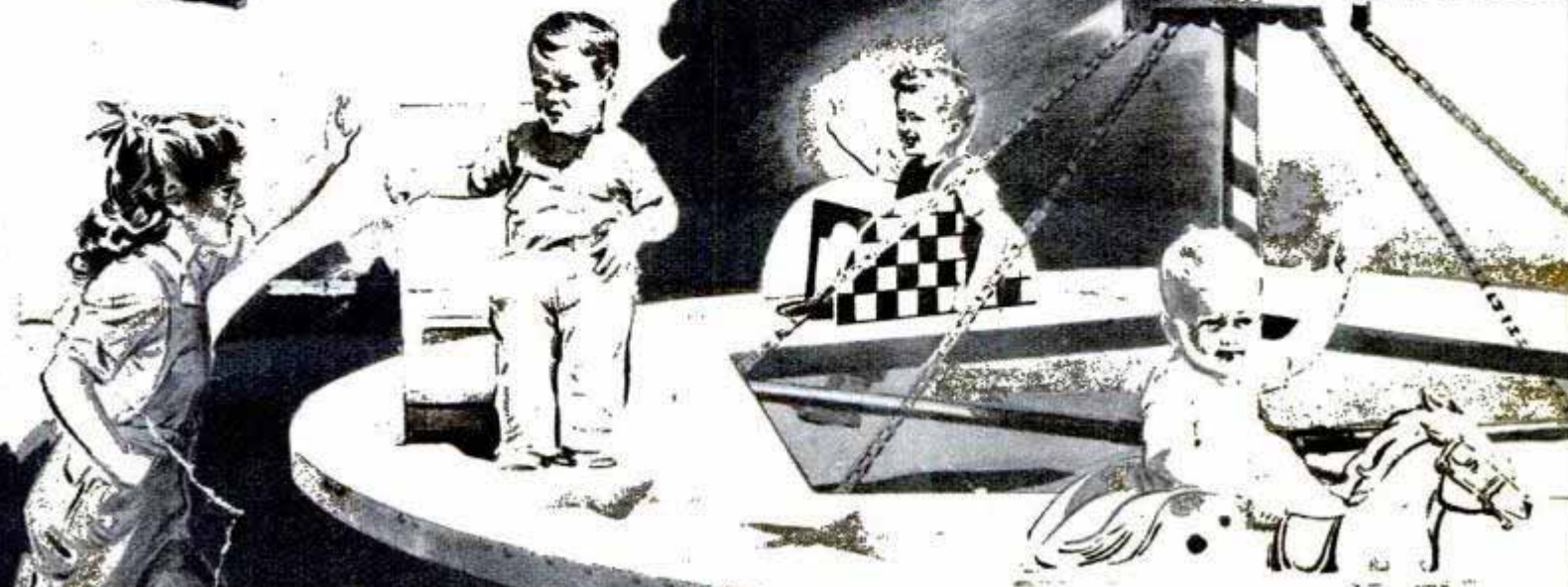

MERRY-GO-ROUND



THE POPULAR MECHANICS

*Build-It-Yourself*

**HOUSE**

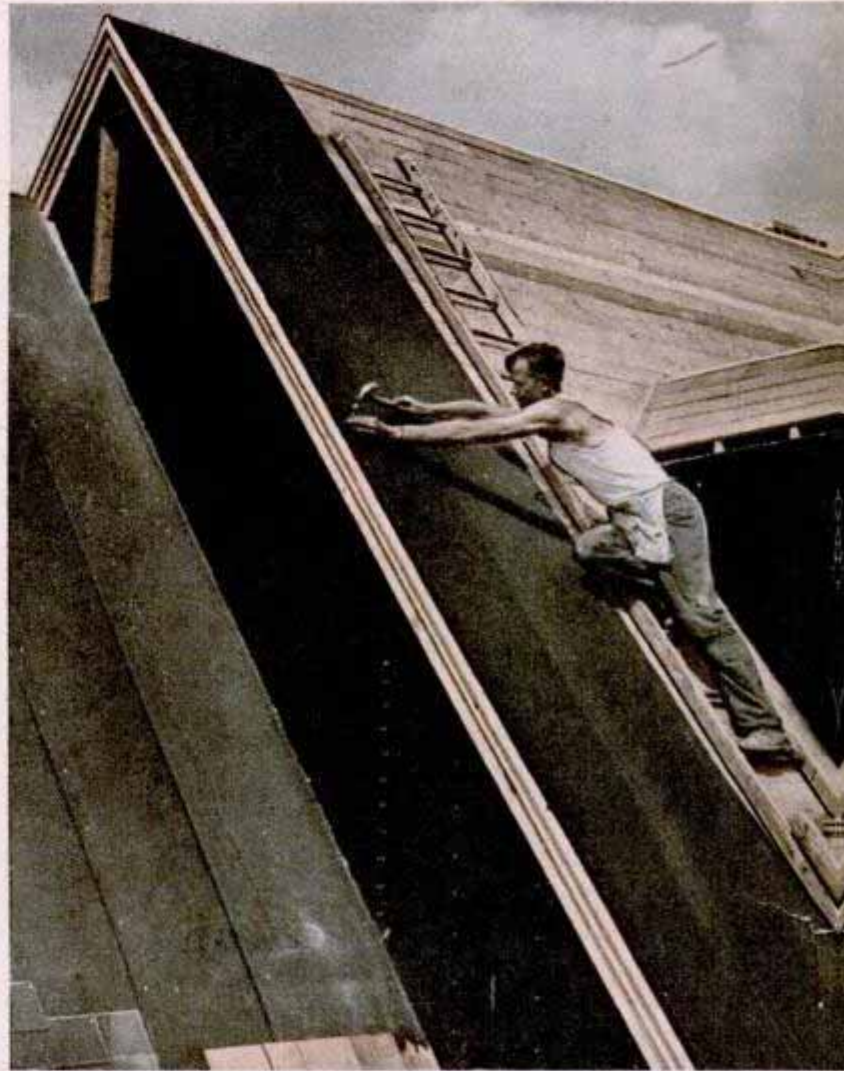

After laying the roof boards and sawing off the ends straight, the cornice is applied. The edge of this is flush with the roof boards as shown in the photo

Below, the house is completed except for some paint touch-up here and there. Note simple yet effective arrangement of both high and low-growing evergreens

Although not absolutely necessary, a layer of roofing felt under the shingles will be well worth-while. Use the heavy black type of felt and spot-tack it lightly

The photo below shows how the wide siding is laid over the insulating-type sheathing to make a long-lasting, weatherproof wall that is neat and sturdy





In this, the concluding installment, we tell you briefly how Jacques Brownson laid the roof, put on the siding, installed the doors and windows and completed the interior of his home, ready for occupancy

### PART III

By James R. Ward

**I**N LAST MONTH'S installment of *The House That Jacques Built*, we went through construction up to where the roofing material was ready to be laid. This can be of your own choice, but should be of high quality, since no house is better than its roof. Although not absolutely necessary, the roof boards should first be covered with heavy black roofing felt, lightly tacked into place. This provides a smooth surface for the shingles.

Since it is desirable to close in the house as soon as possible, especially if you are not working full time on it, put in the windows and exterior doors next and then apply the siding. Use a carpenter's level to plumb the window and door frames. Give all exposed wood a priming coat of paint as soon as it is put in place. This protects it from moisture and helps prevent warping. In fact, you should give the exterior of the house a couple of coats of paint as soon as it is completed.

If you have been a little pressed for time to work on the house, you can take it easier from here on as the house cannot be damaged by the weather. The first job inside is to put up the rest of the partitions and install the plumbing and electrical wiring. If you are building the house in a town or city, check with the officials as to whether or not plumbing and wiring have to be done by a licensed workman. If you are in a

Here the boys are framing the open ends of the breezeway; 2 by 6s are used for this purpose to make a framework that will withstand high winds



When setting in the window frames, make sure that they are plumb. Check them with a carpenter's level



If you pour the sidewalk at the side of the house before applying the siding, the latter will be clean



Framing the projecting portion of the dining nook comes next. All the window and door frames, as well as other framing, are done before applying the siding





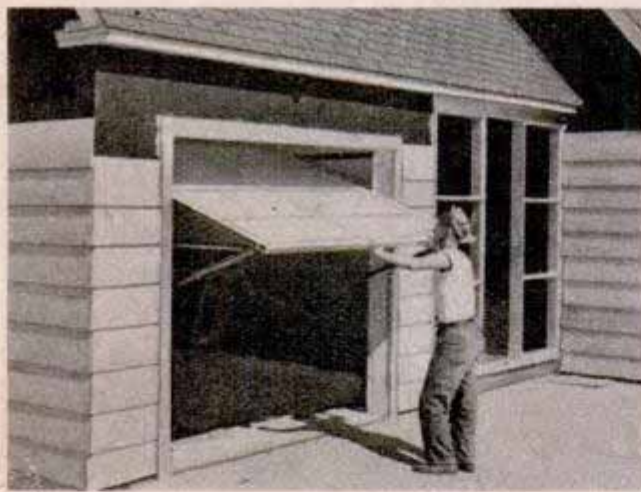
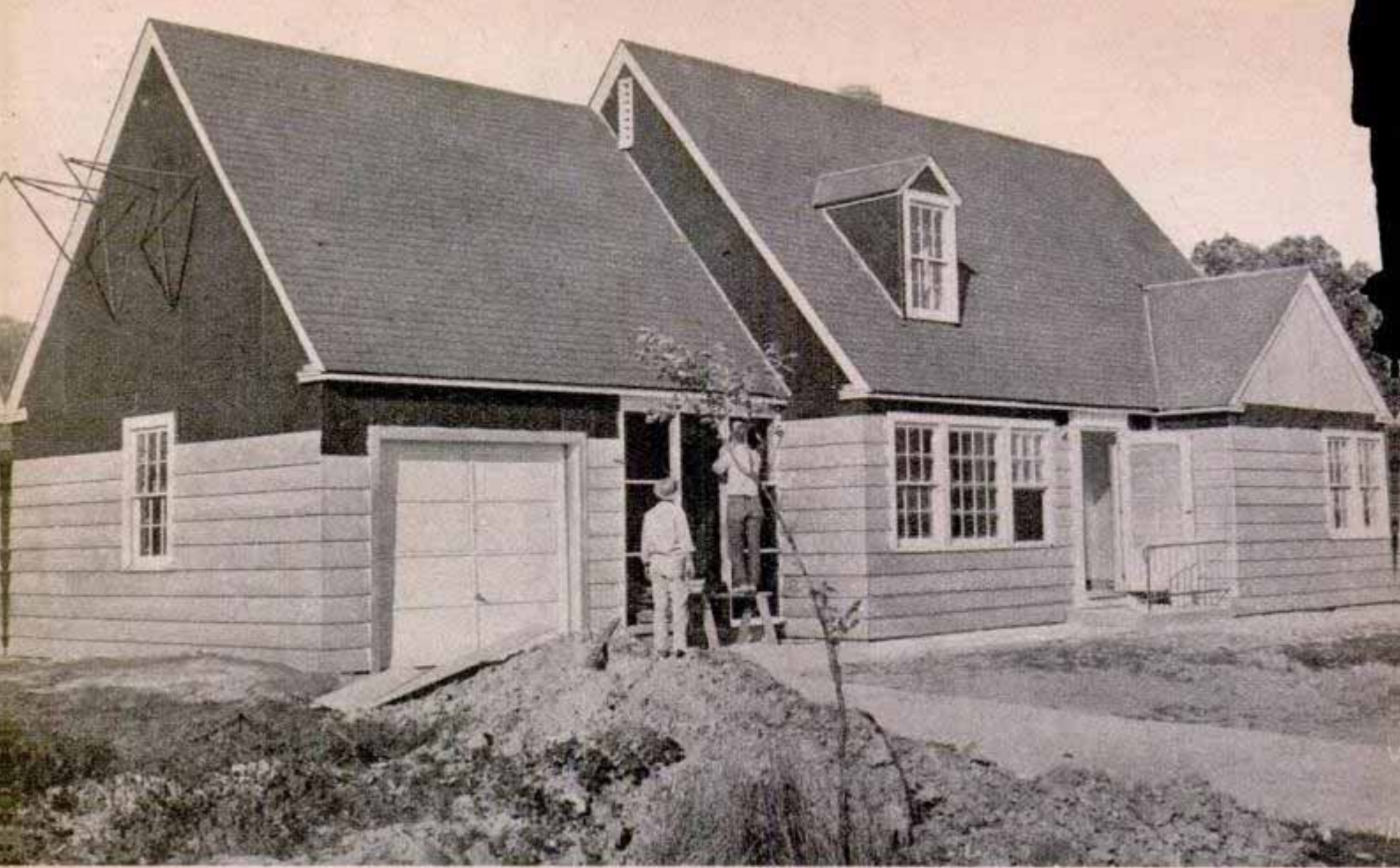

After installing the overhead type of garage door, it is tested to make sure that it closes correctly

rural area, contact your local utility company as to their requirements for wiring.

After the wiring and plumbing have been put in, it is a good idea to complete the concrete work, such as the basement floor, stoops, walks and driveway, and also the garage floor. You should put a drain in the garage floor, or, as we did, slope the floor toward the entrance so that it will drain down the driveway to the street. While we are on the subject of drainage, don't forget to lay a tile line around the outside of the foundation at the footings. Lay the tiles with open joints and run the line into the sewer. Place a small piece of tarred roofing paper over the top of each joint. Then cover the tile to a depth of a foot or so with



Here Jacques is cutting a stair stringer with an electric saw. A saw of this type will save much time

coarse gravel or crushed stone and complete the fill with dirt. Also, tile each window well into this line. If this tiling is not done, water, during heavy rains, will seep into the basement and also collect in the window wells, from where it may flow into the basement, or at least cause the window sash and casings to rot quickly.

Now, with the house closed in against the weather, and partitions, wiring and plumbing in and concrete laid, you are ready to complete the interior. If the outside walls are to be insulated, do that next. Use a blanket type of insulation and place it between the studs, taking care to fill all spaces around windows and doors. If rooms are to be finished on the second floor immediate-



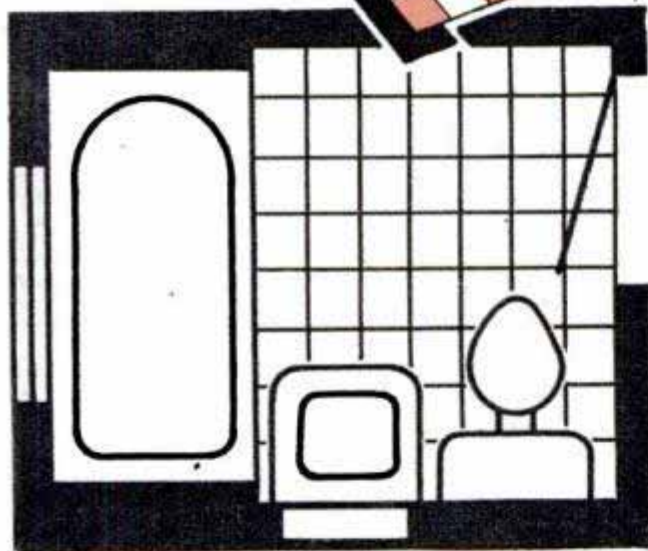

Note arrangement of the spacious kitchen cabinets, top, for step saving between stove, refrigerator, sink and dining nook. Bathroom layout is indicated above

construction is the same regardless of the size or style, the information contained in our book on building this house will enable you to change it almost any way you wish, or even build one of your own design.

In conclusion, there are several things that every prospective homeowner should check thoroughly before a lot is purchased or construction started. Since many of us spend the better part of a lifetime acquiring a home, we want to be sure that the location is desirable in every way. To name but a few things, be sure the location is everything you think it is. Are the sewers already in and adequate, and are other utilities sufficient? What are the prospects for future heavy assessments? How about the zoning laws of the town? Are they sufficient to protect you against heavy manufacturing plants being located nearby? Are schools and public transportation convenient and adequate? Are taxes satisfactory? What are the future plans of the town that might be likely to raise taxes excessively? Is the town or neighborhood in which you propose to build likely to build up and improve so your property will continue to gain in value? What will your location be like 10, 15 or 20 years from now? And, last but not least, what kind of people will you have for neighbors, and will your children have the environment you desire? Satisfactory answers to these questions and many others before you build may save you much disappointment and hundreds of dollars in the future.

THE END



As a service to our many readers, we have prepared blueprints and a book, **Your Home and How to Build It Yourself**, which gives complete step-by-step instructions for building this house in five styles. Plans and book are available by writing to Popular

Mechanics Press, 200 East Ontario Street, Chicago 11, Illinois.

THE BOOK .....	\$ 3.00
COMPLETE SET OF BLUEPRINTS.....	12.50
BOOK AND BLUEPRINTS.....	14.00
DUPLICATE SET OF BLUEPRINTS.....	5.00



## Pillows for Swing Stay At Correct Height

Held in position by a wide band of canvas, porch-swing pillows can be adjusted to a height most comfortable to the occupants of the swing. The band must be long enough to fit around the back of the swing, and one section is made of elastic to provide the necessary "stretch." Snaps fasten the ends. Ordinary porchswing pillows are used with straps sewed on the backs for the band to pass through.

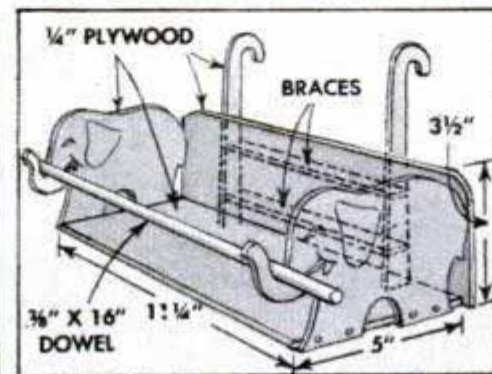

## "Mother's Aid" Hooks To Side of Crib

By using this convenient tray, the young mother will find that time can be saved by keeping such necessities as swabs, cleansing tissue, powder and rubbing oil at hand. Because of the hooks on the back, it's an easy matter to transfer the tray from the back of a chair to the crib or any other location. Materials for the tray and the method of assembly are indicated in the upper right-hand detail.—John L. St. Lawrence, Tiverton, R. I.

## Safety-Razor Holder Clips on Shelf

When clipped to a shelf in the medicine cabinet, this holder for a safety razor and blades provides a handy place to keep these articles. Both the case and the drawer should be made of lightweight sheet brass if this metal is available as it will not rust. The dimensions given in the right-hand detail are for a holder that will fit most makes of razors on the market. All joints should be soldered together.—R. W. Madden, Palatine, Ill.

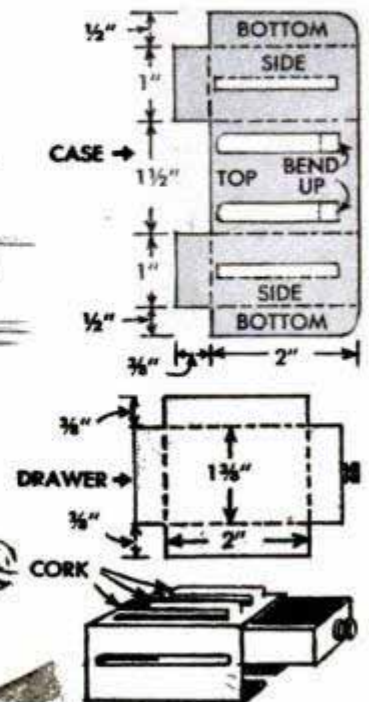
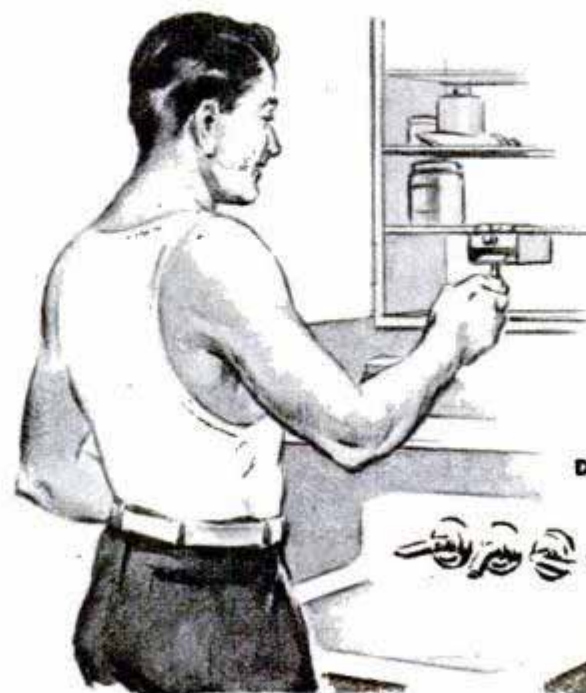



# from used auto parts

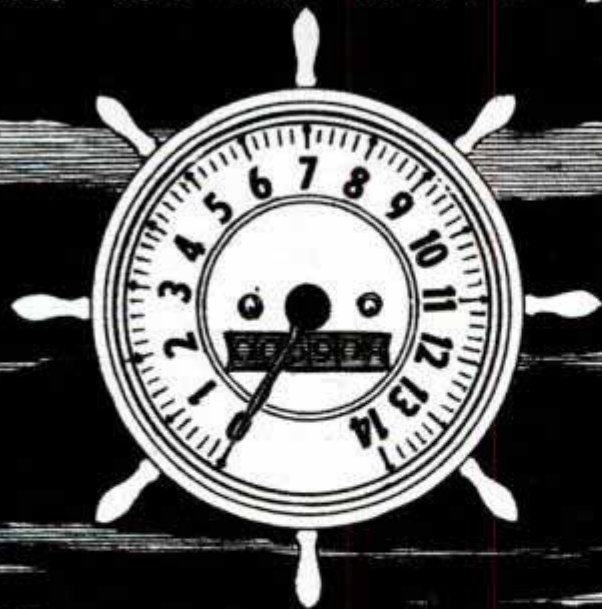

FOR the boating enthusiast who likes to know how far he's traveled and how fast he got there, here's a speedometer made from a few auto parts that indicates both total mileage and speed with fairly close accuracy. A used speedometer and cable are purchased and most of the remaining parts are made and assembled in the home workshop. The heart of the unit is a small propeller mounted on the keel which turns the speedometer cable to record the speed and total mileage on the speedometer. Certain details of the assembly will vary with the type of boat that is used, but the individual parts that make up the unit will remain the same.

Fig. 1 gives the dimensions for the propeller shaft, propeller-shaft bearing and the packing plate. The propeller and propeller-shaft bearing bracket are detailed in Fig. 3 and the general assembly in Fig. 4. The dimensions of all parts given here are for a 1941 Chevrolet speedometer and cable and it may be necessary to alter some of these to fit units of other manufacture. Part of the propeller-shaft bearing assembly, detail A of Fig. 1, is a  $\frac{1}{8}$ -in. standard brass nipple. Detail B consists of a male to female coupling threaded on one end for the nipple and on the other to fit  $\frac{1}{4}$ -in. outside dia. brass tubing, complete with sleeve and nut. The brass rod, detail D, is drilled, reamed and tapped as shown. Detail C gives the dimensions for the shaft and this part is made of brass rod also. The .105-in. dimension for the square hole in the end of the shaft may have to be altered to fit the speedometer cable that you are using, but, in any case, make the hole .004 in. larger than the cable. By using the drill press as an arbor press, the broaching tool, upper detail in Fig. 1 can be used to square the .125-in.

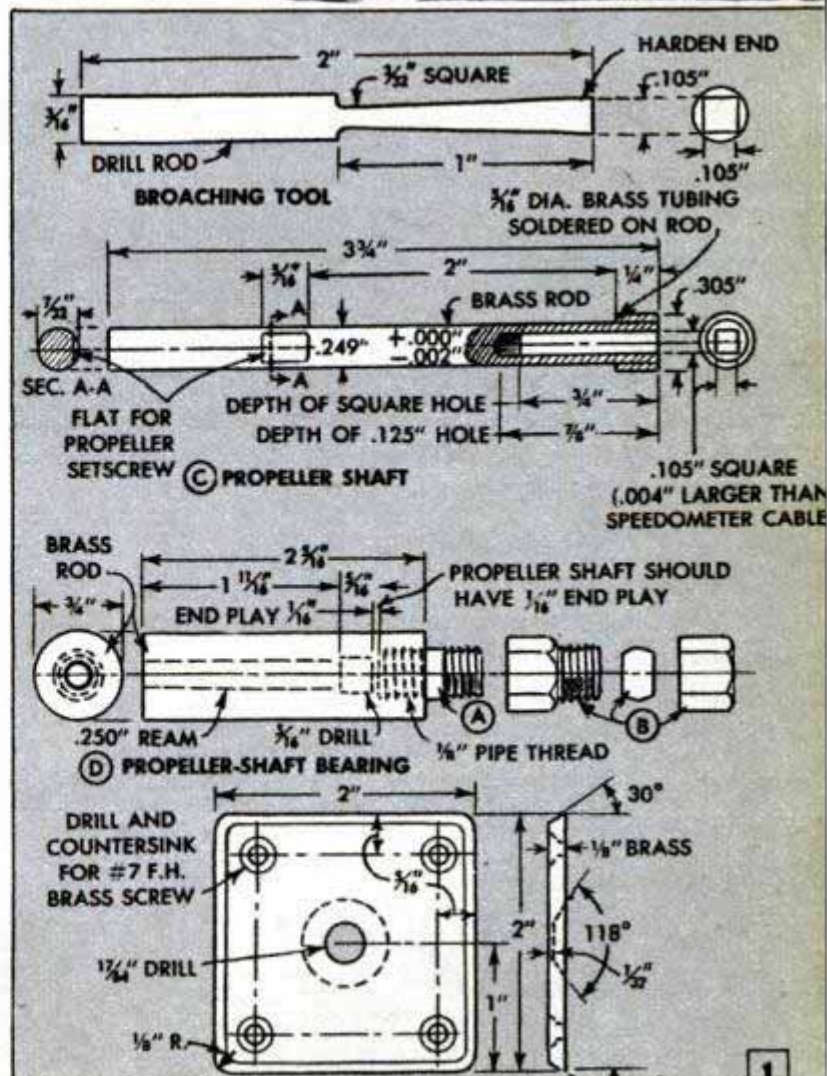







# RODS, REELS and LURES

*Just knowing where they are isn't enough — knowing the right lure, the proper rod and reel, and how to handle these bait-casting "tools" — that's the combination it takes to catch 'em*

By Robert Page Lincoln

TIME was when bait casting was done with a "multiplying" reel and a short steel rod measuring only 3 or 4 ft. in length. But the refinements of experience in plug throwing soon brought a demand for a longer, more pliant rod plus that certain nameless quality in a rod which a fisherman calls "life." Nowadays, and only after ideas got a lot of kicking around, the seamless tubular steel rod about 5½ ft. in length gets the okay from most bait casters, although somewhat longer rods are used by some with good success. Others still use the shorter rod for such specialized work as salt-water fishing from piers, bridges, or causeways where the short rod is more or less a necessity. Good steel rods of a tapering square or triangular section also are finding considerable favor, especially when handling the heavy spoon lures or the large plugs. These rods, being stiffer, generally have somewhat more initial "drive," an aid in getting a heavy lure away on a long cast. Bamboo bait rods also are preferred by many fishermen for throwing live baits, heavy lures and for other special purposes. They like the stamina and "backbone" of the bamboo rod. An offset handle on a bait-casting rod, Fig. 1, has some advantages over the straight handle. In the former the reel position puts the thumb in a natural, unstrained contact with the





# TYPES of LURES

reel spool and gives a more delicate and positive control of the running line. Bait-casting reels of the 100-yd. line capacity are perhaps the standard. Actual capacity is usually between 80 and 100 yds. Line sizes used in bait casting range up to 24-lb. test. Hard-braided lines are quite generally favored.

A bait-casting reel, Fig. 1, should have the level-winding feature, which aids in laying the line on the spool. Some reels have large-diameter cork arbors which prevent slippage and bring the line up high on the reel spool. On other reel spools with small arbors many fishermen fill the spool partly with old line, then attach sufficient new line to fill the spool to within  $\frac{1}{4}$  in. or so of the spacer bars. A full reel gives better control of the line at the start of the cast and aids in thumbing the line when casting and also in playing the fish.

Lures for bait casting, Figs. 2 to 6 inclusive, come in various types: the floating or

top-water lure, the combined top-water and underwater or diving lure, the sinking-plug lure, and the various metal lures, also of the sinking type. Then there are the baby or lightweight plugs, most of which work 6 to 12 in. under the surface. Floating plugs are usually jerked or "popped" on the surface to simulate live bait. Effective stand-bys, these, and they can be used successfully in most waters where the black bass is found. Some lures in this class are so designed that they give the necessary animation when merely reeled in steadily. In the second class named are the lures which float when at rest, but when reeled dive underwater and have a snaky, undulating "crawl" that is very effective. The typical red-head wobbler, with a scoop indentation at the head, is a popular number. Most of these lures have specially shaped metal mouthpieces that cause them to wriggle through the water.

The third class, called sinking lures, will sink slowly if not reeled in promptly. Many have propellerlike spinners fore and aft which give them animation. Others, such as the deep runner, can be trolled deep. The latter, and also some other types, can be used for under-surface trolling in the summer when the bass lie deep.

## FLOATING LURES

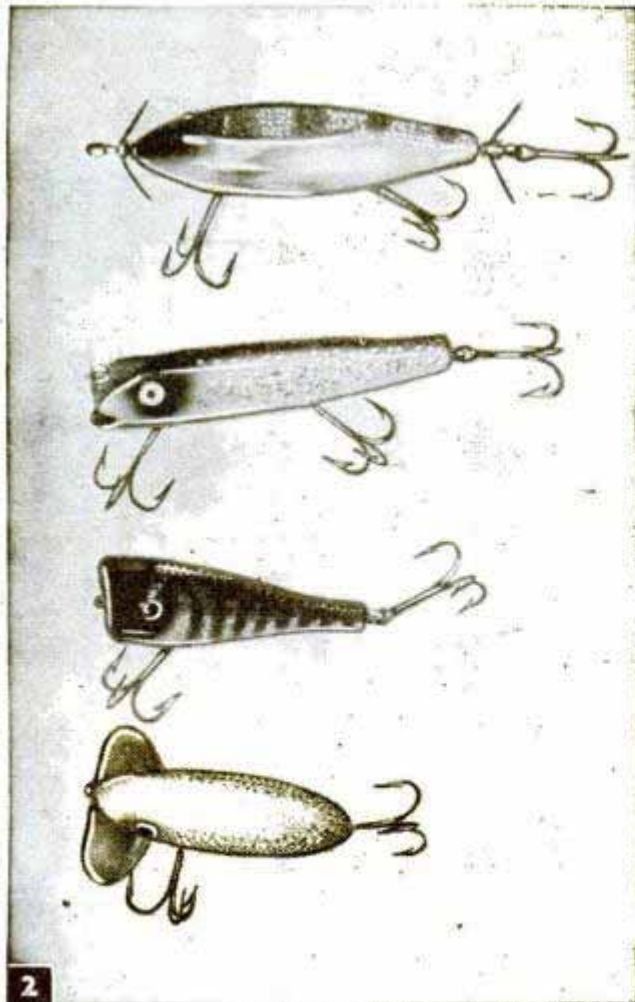

## DIVING LURES

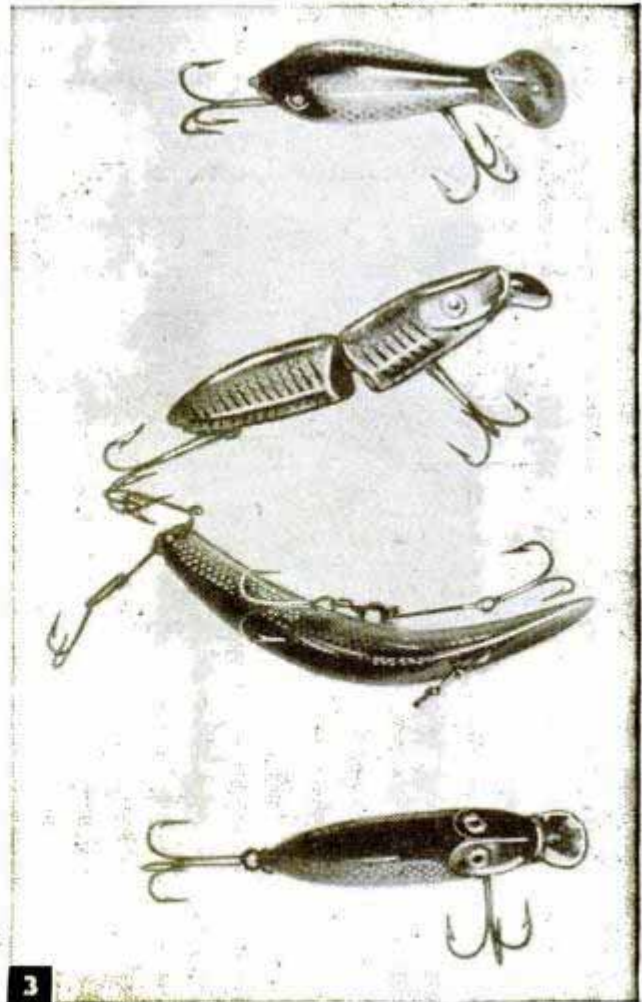



## Lightweight or Baby Lures

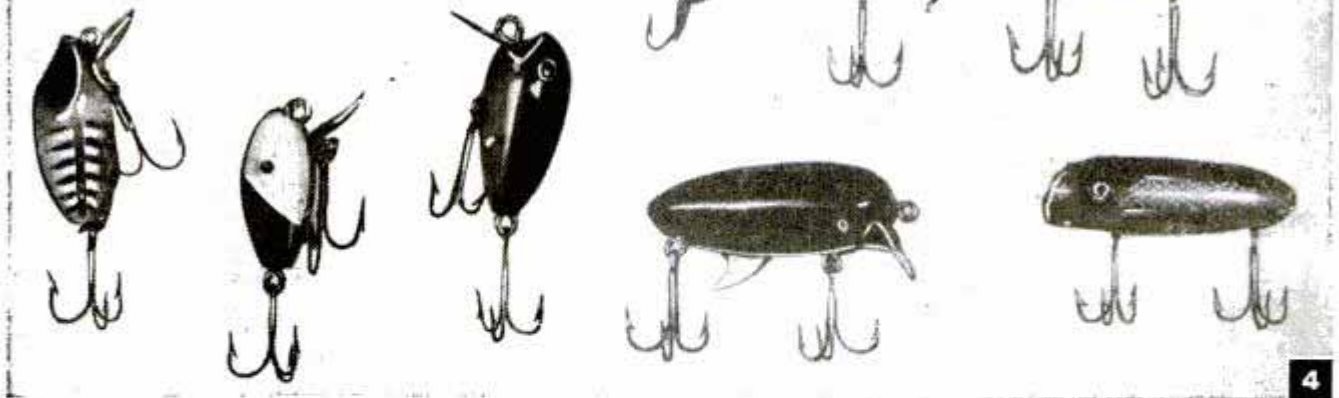

4

Metal, or weedless, lures should be included in the tackle box for often they will take fish when the plug lures fail to make connections. The skirted weedless lures may be cast into the lily pads or other vegetation and then reeled in without snagging. The same is generally true of pork-rind lures which come in both plastic and metal construction. Bass lures range from  $\frac{1}{2}$  to 1 oz. in weight with the in-between  $\frac{3}{4}$ -oz. weight about the most popular. Lures lighter than  $\frac{1}{2}$  oz. belong in the baby bass-plug class.

Often these baby plugs are miniature duplicates of larger lures. Others are original in design but most of them belong to the wiggler type of lure. Of course, nearly all plugs are considered most effective when used in fairly clear water. The lightweight items are particularly useful when fishing near banks and around logs. Use 9 to 12-lb. test lines when throwing the light plugs.

There are two generally accepted methods of bait casting, the overhead cast and

## SINKING LURES

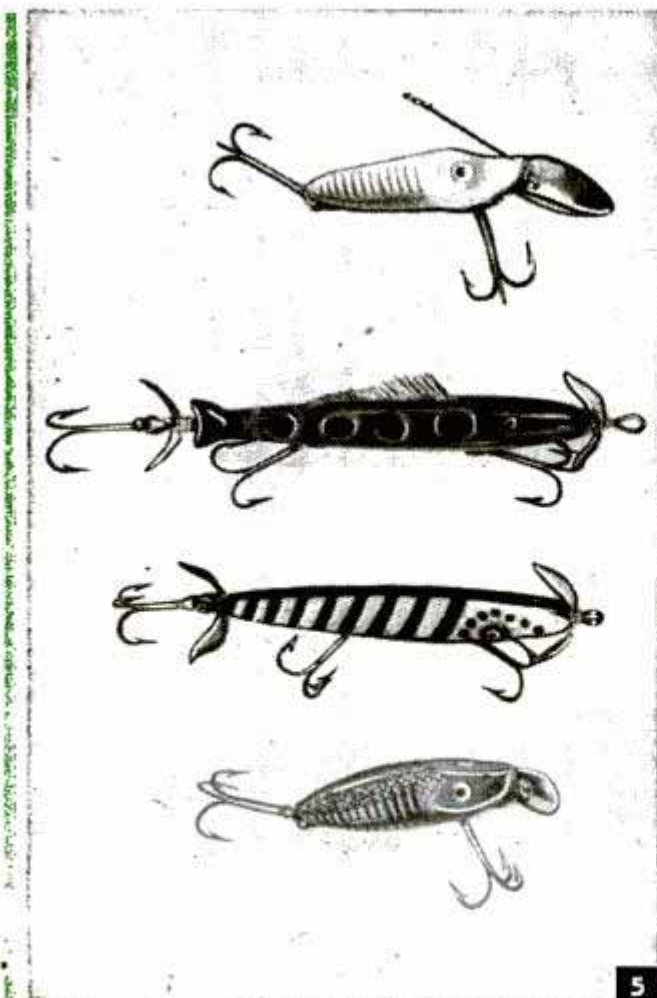

5

## WEEDLESS LURES

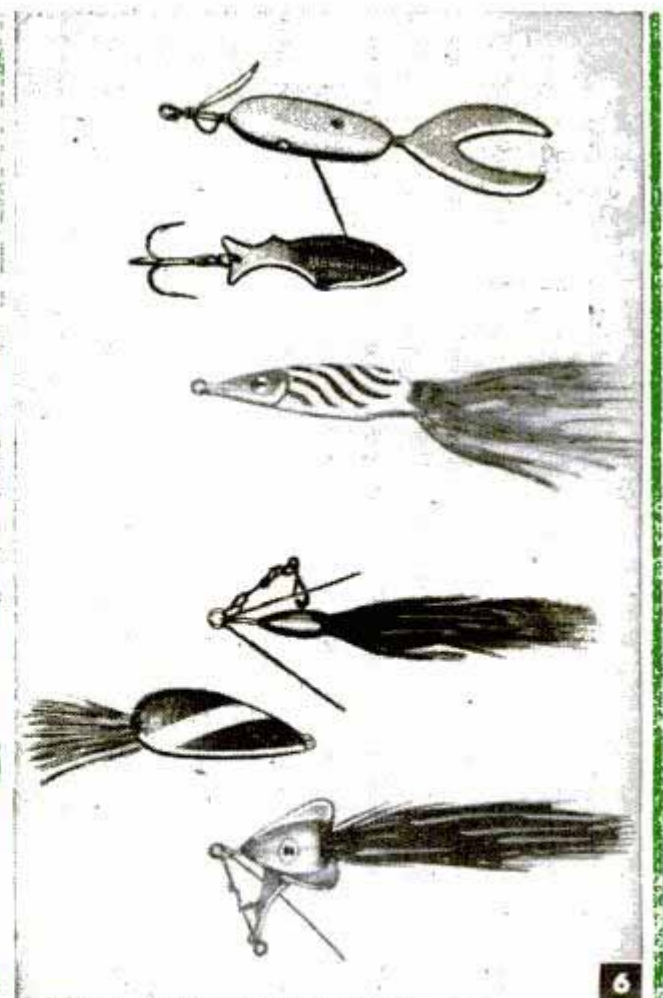

6



## THE OVERHEAD CAST

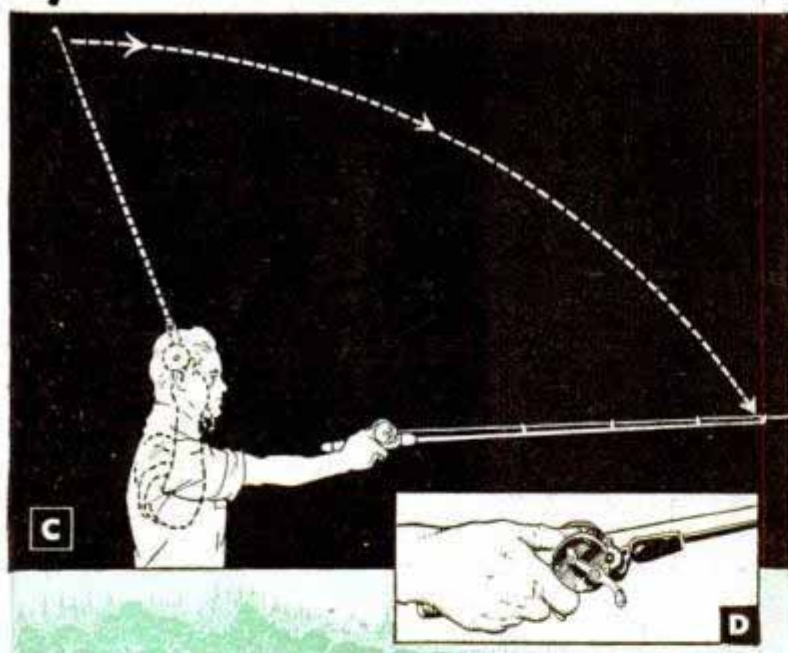
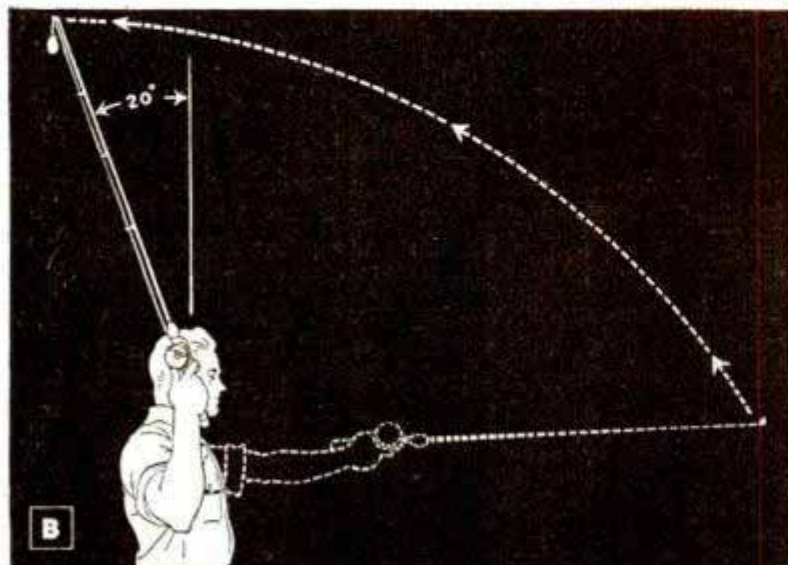

the side cast, the latter also known as the underhand cast. Overhead casting is the usual method used over open water but some good fishermen favor the side cast for all conditions, and all use the side cast where it is necessary to work close to shore or under overhanging trees. The mechanics of the overhead cast are quite simple. The trick in making this cast is holding the rod tip toward the spot where you wish to place your lure, Fig. 7, A. The rod is then carried straight up over the right shoulder, Fig. 7, B, so that it assumes a backward slant of about 20 deg. There is only a slight pause between the back cast and the start of the forward cast. It's a combined wrist and arm motion. As the lure goes forward some casters stop the rod at approximately a 45-deg. angle. Others drop the rod almost to the horizontal position, Fig. 7, C. One trick in preventing backlash is simply tipping or turning the rod one quarter turn to the left as the lure goes forward. This movement also helps to slow the reel spool.

Skillful thumbing of the line, Fig. 7, D, is a trick one must master by practice. The main purpose, of course, is to prevent the line going slack behind the plug. Thumbing starts when carrying the rod over the shoulder preparatory to the forward cast. The thumb is then pressed firmly on the reel spool. But as the forward cast is made the tip of the thumb is lifted slightly so that the line can feed out. The idea is to feed just enough slack into the line so that it "keeps up with the plug," so to speak, without retarding forward movement of the lure. Then, as the cast nears its end, you can drop the lure where you want it by light thumb pressure. The underhand or side cast, Fig. 8, A, B and C, is simply the overhead cast made with the rod swinging in a horizontal plane. Here the rod is carried back to the same 20-deg. angle as in the overhead cast and the forearm is brought into play as before. A snappy wrist action is imperative. It takes practice to master the side cast, more especially because you can't "aim" the plug as you do in the overhead cast. When the rod move-



ment is finished the tip points at the spot toward which you're aiming the lure. The movement of the rod throughout is altogether in the horizontal plane, not up or down. The reel remains more or less horizontal throughout the cast, the spool of the reel facing up. Leaning the body to the right and bringing the head down in line with the horizontal position of the rod aids some casters in making accurate casts by this method. Many casters use the side cast exclusively when fishing from a boat. And when you have to get under trees and overhanging branches the side cast must be used from any position. Some casters find it easier to let the wrist take a natural twist in the backward and forward movements, Fig. 8, A, B and C. This twisting motion tends to give more freedom of movement and a snappier wrist action. At the start, A in Fig. 8, the reel is in the vertical position. From the start to the finish of the back cast, B in Fig. 8, the rod and reel are turned about 90 deg. Then, as the rod is brought forward, Fig. 8, C, the reel and rod come back to the vertical position again. Of course, the equipment must be in good condition. Worn guides, a loose, shaky reel spool or a frayed line—any one of these defects will cut down accuracy and shorten the distance of the cast. Rough, badly worn guides are especially troublesome. They slow down a running line and may snag it and break the coating. It's difficult to keep a worn reel lubricated so that it runs free. Most reels can be made as good as new by replacing worn parts.

A bait-casting leader of synthetic gut or raw silk is generally best as it forms a more or less invisible connection between the line and lure. Also, the leader gives a better action to the reeled lure. Gut leaders for bait casting are usually fitted with snaps, thus making a change from one lure to another only a matter of seconds. Medium-sized snaps are used for average-sized lures. The fly-leader type snaps generally are best for light lures. Even though no gut leader is used, snaps should be used. They are tied directly to the line.

## THE SIDECAST

8

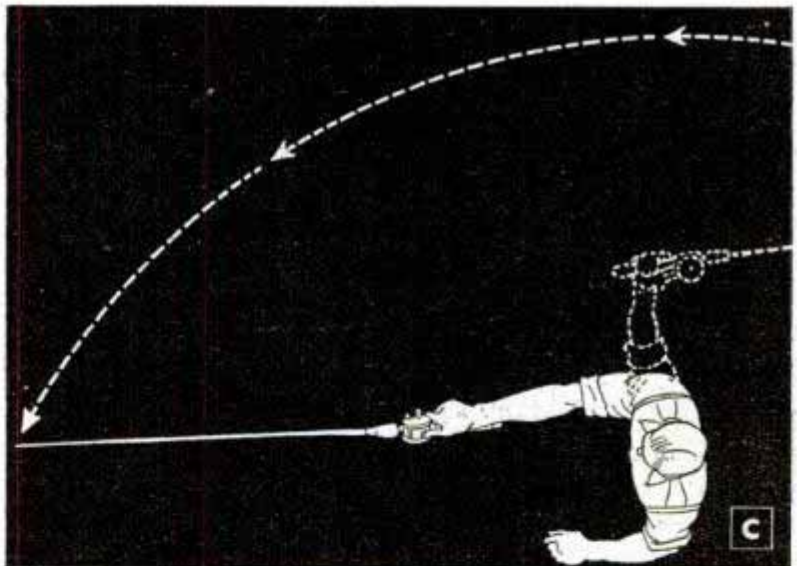
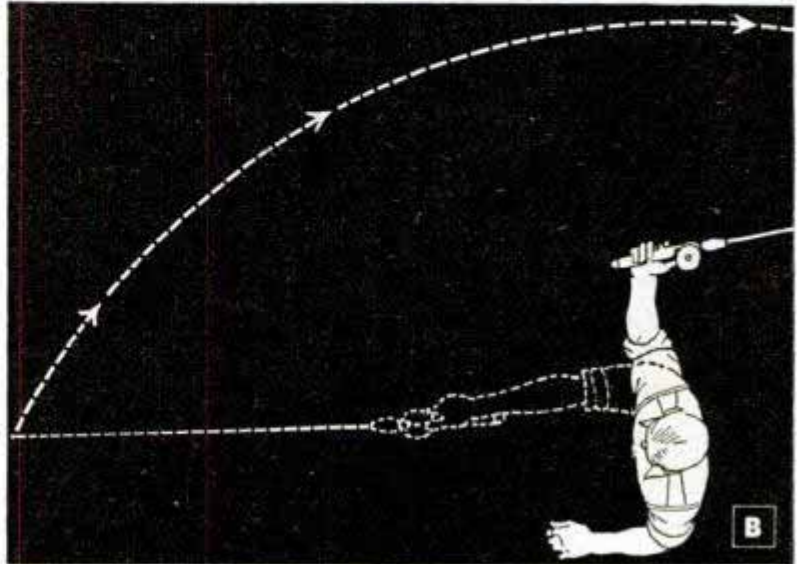
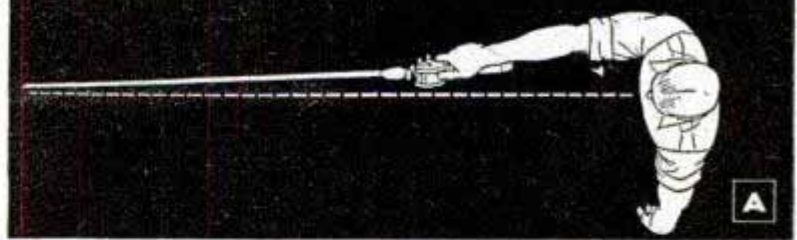



## Portable Spray Rig for Garden Made From Wheelbarrow



Using a wheelbarrow, an old hot-water tank and the necessary spray pump, you can make a portable spray rig that has a large capacity. Cut the tank in half and rivet a clip on the side to hold it in the barrow. It will be necessary to cut a hole in the bottom of the wheelbarrow so the tank will set in it. A standard spray pump is bolted to the inside of the tank in such a position that the handle can be worked easily. When not in use as a sprayer, the pump unit is removed and the hole in the wheelbarrow is covered with a piece of metal.

F. E. Averill, Jr., Santa Ysabel, Calif.

## Sprinkling Can Attached to Hose Simplifies Watering Flowers

Attach a sprinkling can to the hose and you'll find it a lot easier to water your flower beds. A length of copper tubing having approximately the same inside diam-

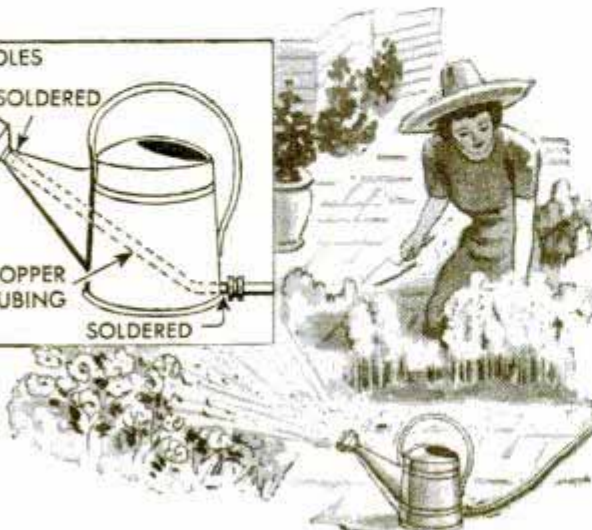
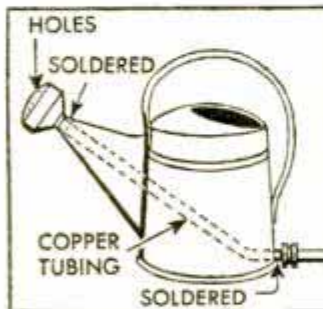

eter as the hose is soldered into the neck of the can and into a hole cut near the base. A female connection to fit the hose is soldered here also. The can is moved about without having to turn off the water, as is the case with some sprinklers.

A. F. Cox, Chicago.

## Paper Held Securely in Envelope

To secure a folded paper containing a coin, or to hold a letter in place, cut a U-shaped flap in the center of the envelope flap and stick this to the paper inside the envelope. Then fasten the flap in the regular manner. The U-shaped piece is cut to include some of the adhesive material on the flap of the envelope.

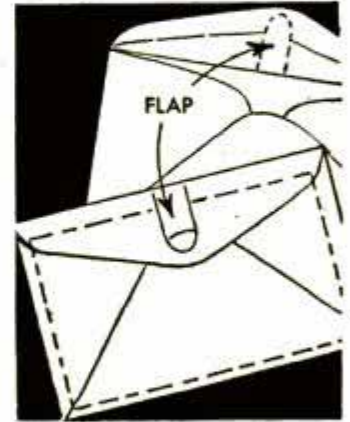

Nels S. Ekberg, Sioux Falls, S. Dak.

## Solution Rids Cabin of Insects

If you want to rid a cabin of flies and other insects, burn a small amount of a mixture of turpentine and menthol crystals inside the building. Place a teaspoonful of the crystals in a can cover, add a few drops of turpentine and ignite the mixture. The fumes, while not unpleasant to humans, are offensive to most insects.

## Easily Constructed Gate Latch

Only a ring and two door handles or short lengths of rod and flat iron are required to make this simple but effective gate latch. If door handles are used, a ring is slipped over one which is screwed to the fence post. One end of the other handle is cut off and fastened to the gate with the open end up. To close the gate, slip the ring over the open end of the handle. If rod and flat iron are used to make the latch, form the pieces in the manner indicated in the circular detail.

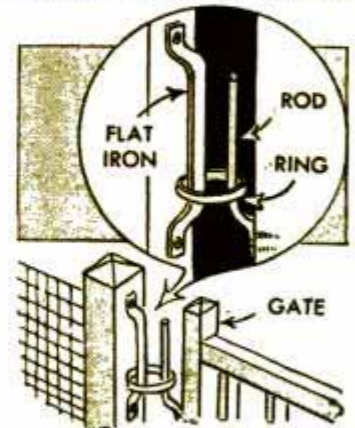

Keep a small magnet with your pins and needles so that when you need to pick up a number of them your magnet will do the work quickly and easily.



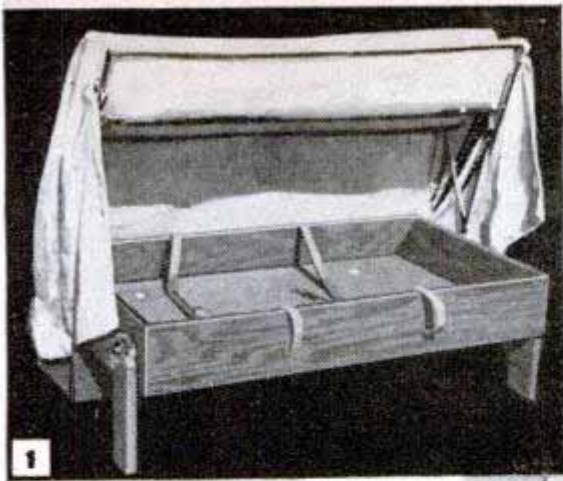

# PORTABLE BABY CRIB

By M. L. Bobing

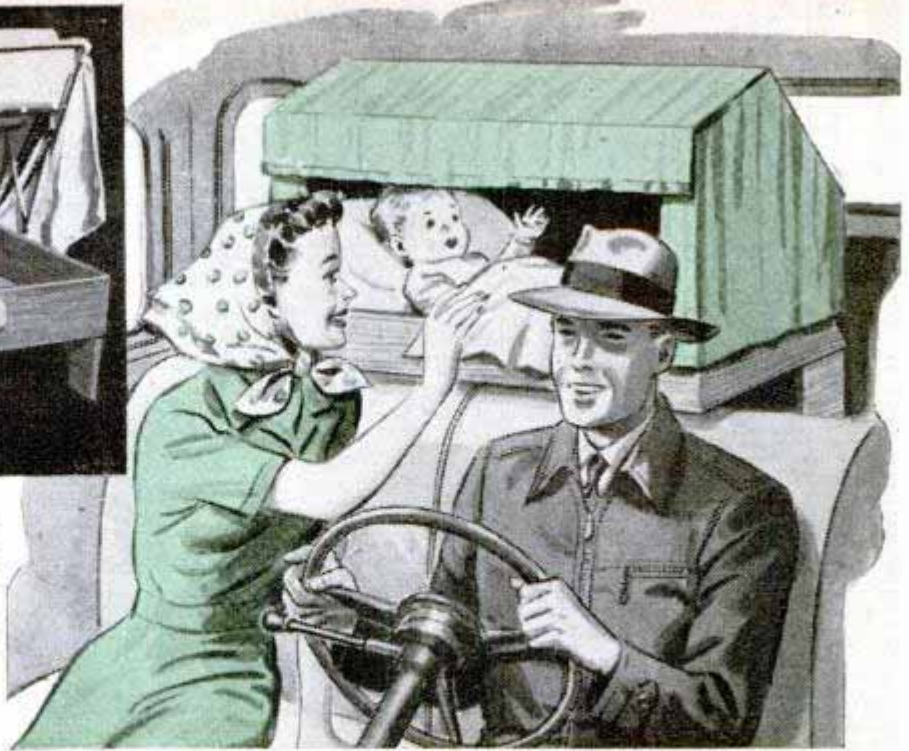

Babies just don't fit in auto seats even on comparatively short trips, and taking a few-months-old youngster on a long trip poses a real problem. This portable crib or bed is the solution, for it keeps everyone comfortable and able to enjoy themselves. The crib pictured in Fig. 1 and detailed in Fig. 2 is designed to be placed on the ledge back of the single seat in a coupe, but by adding a suitable hanger bracket and folding legs it will fit equally well on the back

of the front seat in a sedan. With the crib in either position you will probably need to install a separate rear-view mirror, either on the fender or door frame, as the crib canopy obscures the field of the inside mirror. Essential details of construction will be found in Fig. 2. The straps, Figs. 1 and 2, are fastened to the frame with screws and are buckled loosely over the child's blankets. Adjust the legs so that the crib stands level when in place.

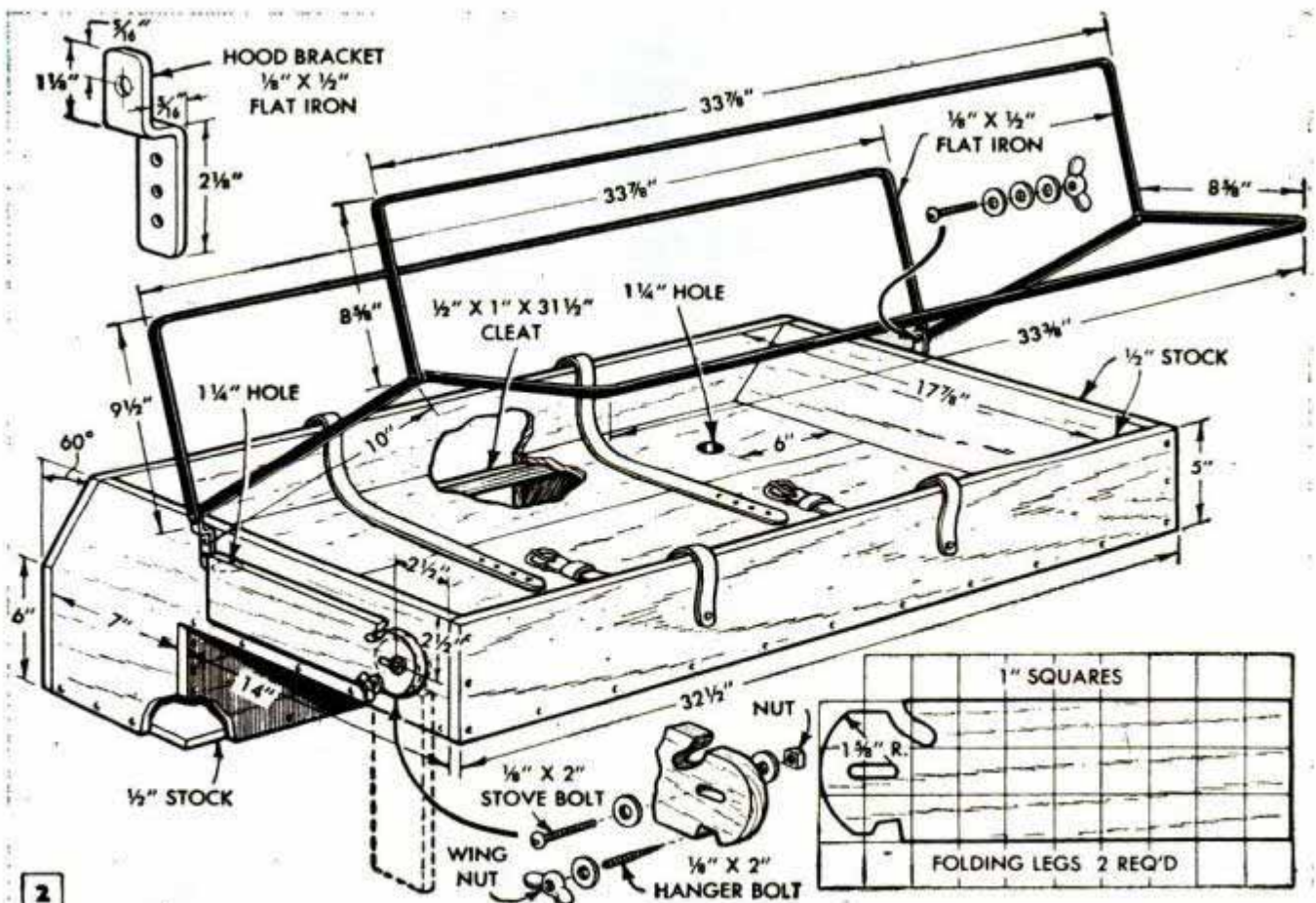



## Hammock Has Magazine Pocket Under Cushion at Head



Papers and magazines are always at hand when kept in a pocket sewed beneath the head of a hammock. Canvas is used to make the pocket and it is fastened on with carpet thread. Allow enough "bulge" so that several magazines and papers will fit.

## Watering Device Reaches Roots And Improves Growth

If you have some special plants that you want to give the best possible care, this watering device can be used to get moisture down around the roots where it will do the most good. A cone-shaped reservoir made of sheet metal is used to hold the wa-

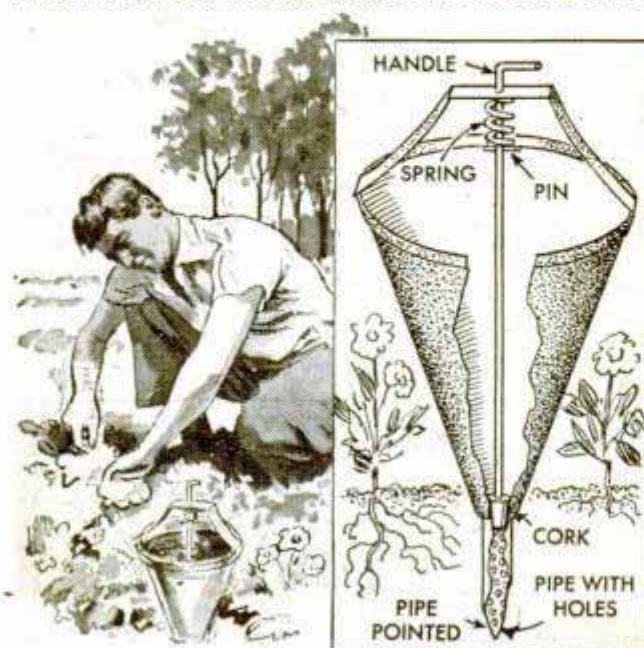

ter. Attached to the narrow end is a pointed piece of pipe in which numerous tiny holes are drilled. There is a bracket across the open end which is drilled for a rod. One end of the rod is fitted with a cork and the other is bent and fitted with a compression spring and pin. The spring serves to keep the cork in place. To use the device, press the pipe into the soil and lift the handle, allowing the water to seep into the ground and thoroughly saturate the root system.

## How to Cut Asparagus Plants

According to one truck gardener, cutting asparagus stalks above ground may cause the stump to bleed and wither or dry out. He recommends making the cut at a slant just below the surface of the bed. Then the cut will heal and produce better. The type of knife that produces a clean cut is illustrated and should have a sharp edge.

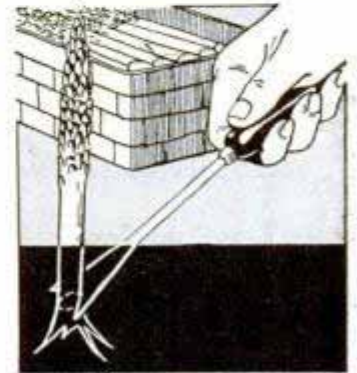

## Guides for Bamboo Fishing Pole

Guides for a bamboo fishing pole can be made from safety pins of assorted sizes, using the largest pins at the butt and graduating with smaller sizes toward the tip. To make the guides, cut off the catch leaving two prongs and the eye at the other end. Then wrap the prongs around the pole and bring the ends together on the underside, twisting them to fasten in place. Fine wire or tape can be wrapped around the guides and the pole so that the fastenings will not slip or twist.

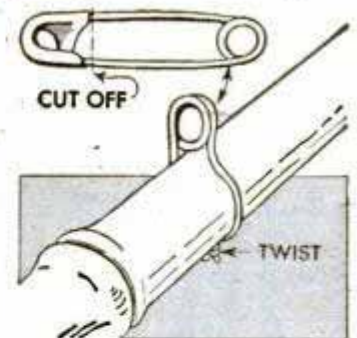

## Pencil Clip Used as Depth Gauge

When a depth gauge isn't available, a pencil and sliding pencil clip can be used to take fairly accurate readings. For example, if the depth of a blind hole is to be measured, place the pencil point in the bottom of the hole and set the clip so that it is flush with the top. The distance from the point to the clip is the depth of the hole. This method will not work where the measurement must be exact, but for emergency use it will serve.

Paul Criton, Jr., Kayville, Sask., Can.



# Back Yard Merry-Go-Round for Children

Safe and sturdy, this back yard merry-go-round provides ideal amusement for children too small to play the rougher games of older children. Details of construction given here need not be followed exactly since they will depend upon the materials that can be obtained. The pedestal and spindle assembly on which the merry-go-round turns is the rear axle and housing from a car, cut down and bolted to a concrete base as shown in the upper right-hand detail. The same detail indicates the mounting for the rear-wheel drum. After completing this part of the assembly, weld a 36-in. length of 3-in. pipe to the top of the drum and screw on a pipe cap. Then weld the flagpole socket to the cap. The lengths of pipe that serve as struts to connect the pedestal to the wooden platform are cut and assembled as shown in the center and lower right-hand details. Finally, attach

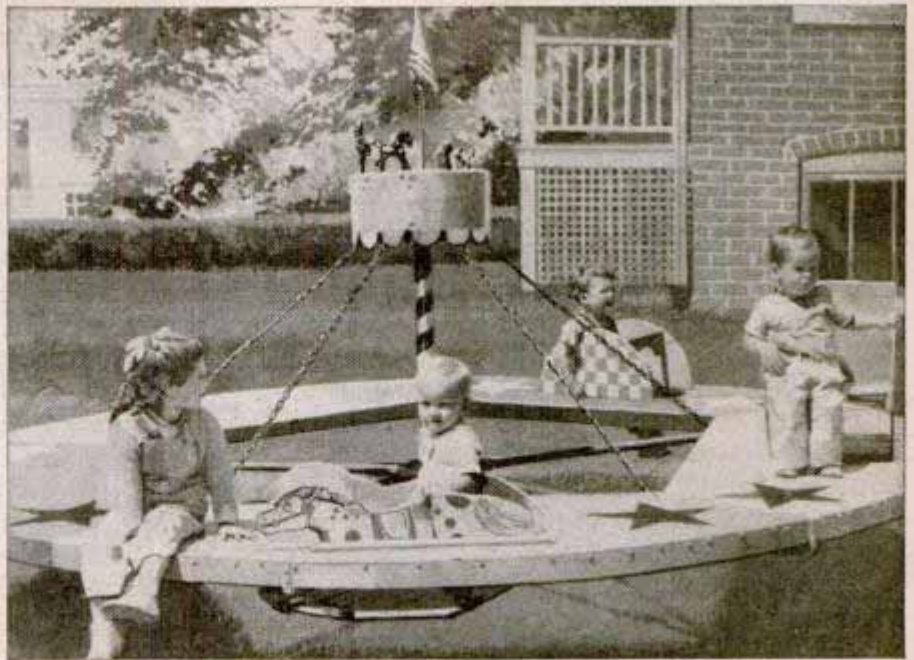

chain braces to the struts and pipe cap, and weld the sheet-metal canopy in place. Seats for the merry-go-round can be of a size and design to suit the age of the children. A pattern for a pinto pony is given in the upper left-hand detail, and the top photograph suggests a few other types. Finish the ride with gaily colored enamels.

William W. Fears, Vallejo, Calif.

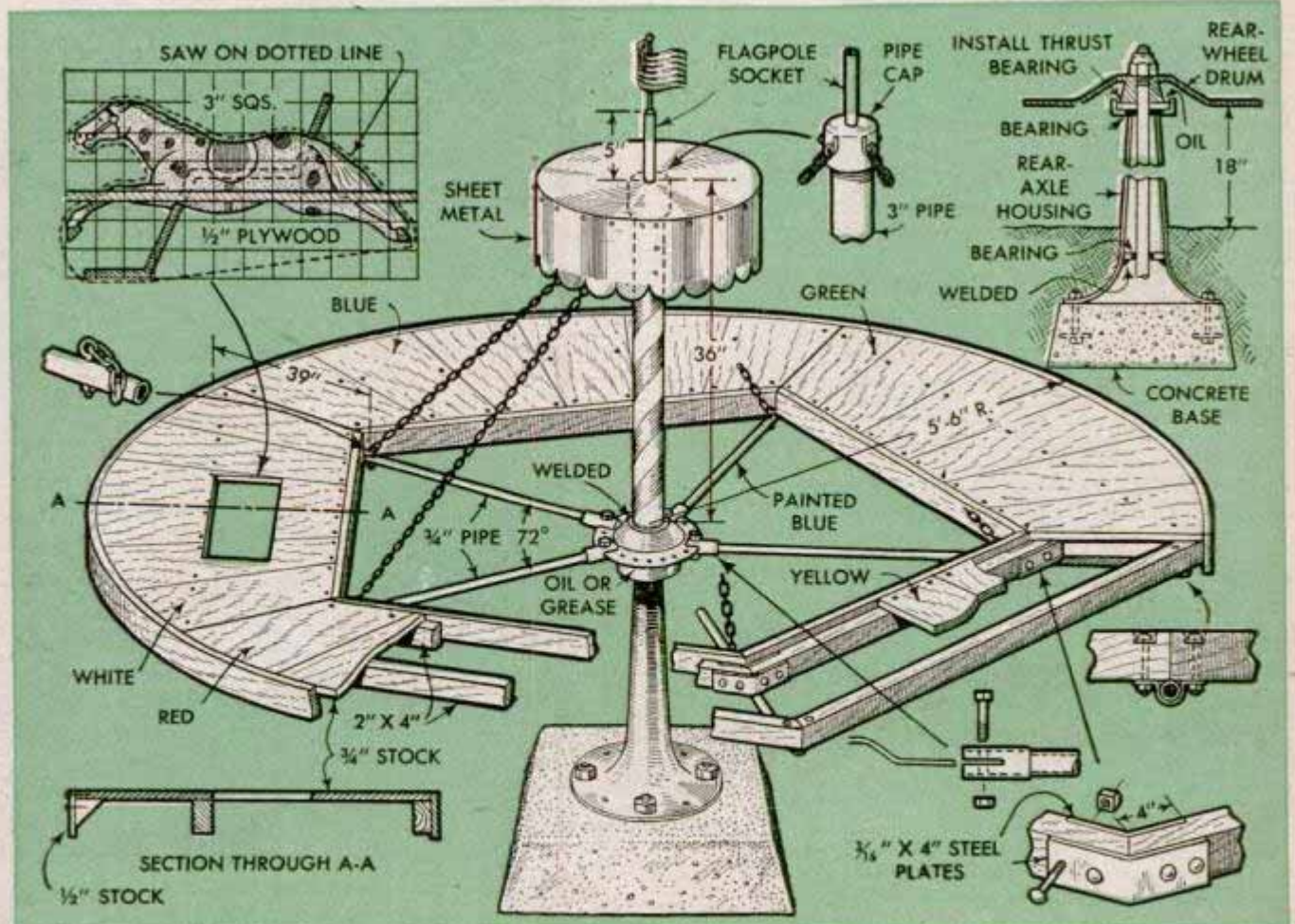



# Make Your Fence A VERTICAL

**T**URN your rock garden on edge—it's just as simple as that. Moreover, there's no trampling of the blooms, and you get more plants in less than half the space and a better all-season exhibit of flowers than you see in most horizontal gardens. Fig. 4 lets you in on the secret of construction. As you can see, a vertical garden is nothing more than an orderly pile of rocks—stones, if you'd rather—laid up to a height of 6 or 7 ft. with rich, black earth used as mortar. The sectional drawing in Fig. 4 has been purposely exaggerated to show the general idea to better advantage. Obviously, you couldn't follow this literally and expect to have the rocks stay in place. Some builders lay up a vertical course of stones on one side in regular mortar, then on the opposite side lay only irregular sections of the wall in mortar, just enough to give the wall form and also support against tipping. Then the spaces between the mortared sections are filled in with loose stones and black soil to make a sloping face as in Fig. 4. The

**Gardeners with a flair for the unusual will appreciate the novelty and practical advantages of vertical flower plantings**

loose stones are laid up in irregular pattern and fitted together loosely so that there are sizeable spaces for earth fill. Stonework should be arranged so that there is room for a quantity of soil on top of the wall as many plants thrive in this elevated position where there is plenty of air and sunlight. On a new wall, newly planted, the soil will quickly wash away unless there is some means provided for retaining it until the root systems of the plantings spread enough to hold the earth in place. Builders usually cover the vertical plantings with coarse burlap or an open-mesh cloth made especially for holding soil on terraces. Where the location is suitable, such as that against a hillside, the earth can be cut away to a vertical face and soil and stones laid against this in such





# GARDEN

a way as to form a rock-and-earth facing which slopes inward slightly.

Many rock-garden plants, except those producing bulbs, are suitable for wall plantings, Figs. 1, 2 and 3. Plants should be selected with some thought for pattern of the blooms, suitability for the location, and time of blooming. A number of varieties which bloom at different times will give you an all-season series of flowerings. Some of those which bloom continuously can be planted alternately along the wall.

Suggestions could include a great variety of suitable plants, but of course the gardener's choice will vary. Sweet alyssum, and the variety known as "golden tuft," are especially adaptable. Both are spring-flowering perennials, but the former is quite commonly grown as an annual, the seed being started indoors. Aubrietia, also known as false or purple rock cress, goes well with the alyssums, or when grown in masses. One species of phlox, known as "phlox subulata" or "moss pink," and several varieties of the succulents lend a colorful variety to any wall planting. The succulents are more particularly effective as individual plantings rather than in large groups. They will thrive best near the top of the wall where the soil is drier.



When you build your rock garden on edge you get more plants in less space and a better all-season exhibit of blooms than in the usual horizontal plantings



Above, varieties planted alternately to produce masses of bloom make attractive color patterns. Below, certain succulents are suitable for vertical gardens. Regular watering is essential in hot, dry weather

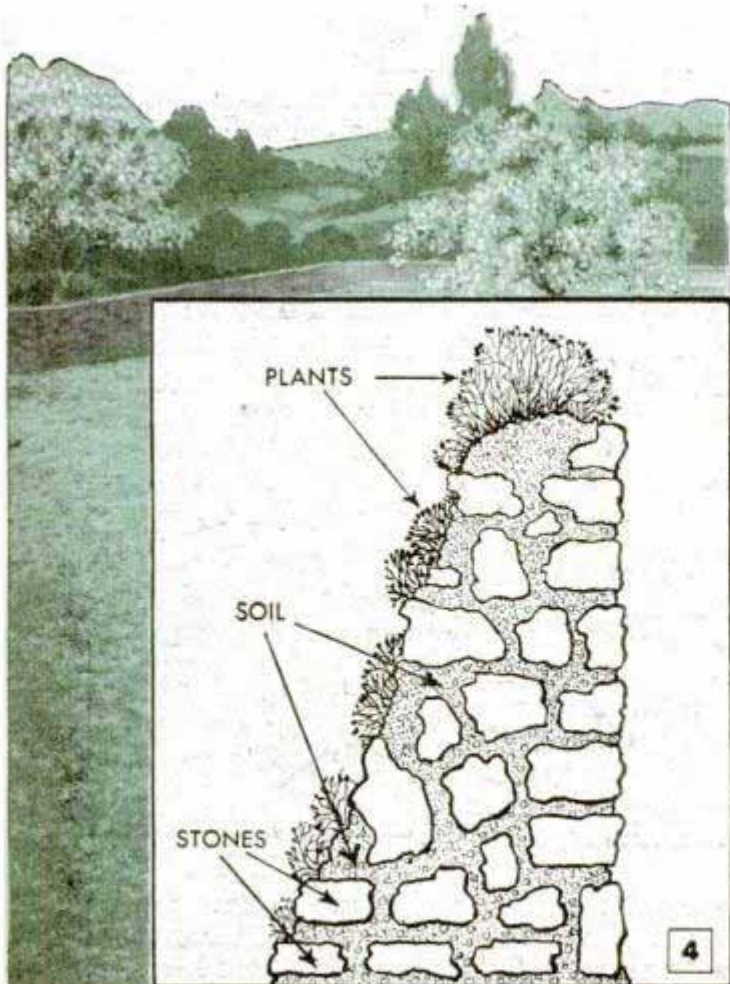



## Burlap Wrapped Around Tamper Keeps Soil From Sticking

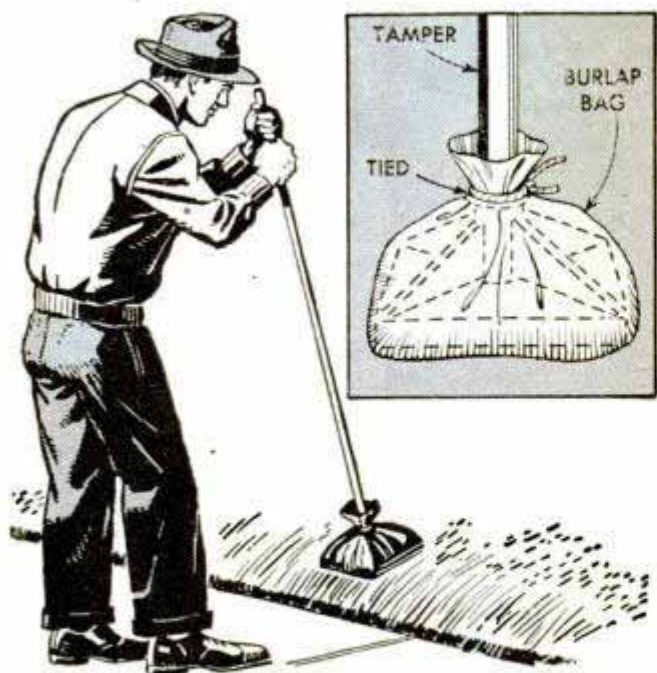

Burlap wrapped over the head of a tamper when working on wet soil will keep mud from sticking to the tool. From time to time it may be necessary to remove the cloth and clean it. However, a neater job of tamping will result and the work will not be so tiring.

## Refrigerator Made From Barrel Keeps Food Fresh in Camp

With this barrel refrigerator, you won't have to worry about keeping food fresh in camp. To make the refrigerator, cut an opening in the side of the barrel and fit it with hinges, a hasp and a lock. This provides access to the inside. Shelves are fastened into the barrel so that food is easy to get at. To provide stability in the water, the side boards are added. Turtles can

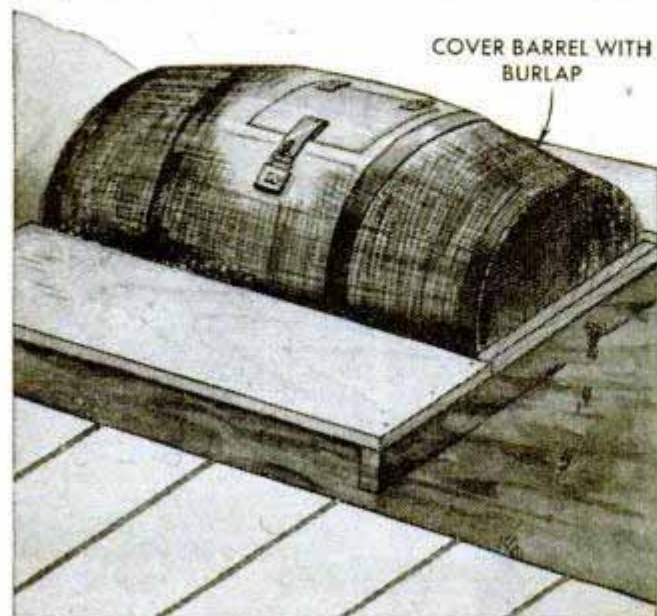

be kept off these boards by driving nails through from the bottom. Burlap is thrown over the barrel with the ends trailing in the water to provide evaporative cooling. Anchor the refrigerator to a float or dock.

## Replacement Rung for Ladder

Here's a quick way to replace the broken rung in a ladder. First saw off the broken ends so they are flush with the inside of the rails, and cut two blocks as shown in the circular detail.

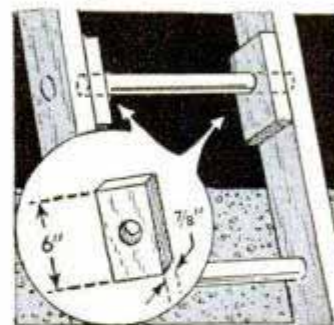

These blocks are drilled to take the ends of the new rung. Slip the rung into the blocks and nail the latter in place.

## Refinishing Upholstered Cushions

For a very small outlay, you can refinish upholstered davenport cushions and do a workman-like job. First open one of the seams at the back and remove the filling and the nest of springs. If the latter are in good condition, all that will be needed is a 3 lb. roll of cotton batting, 80 by 90 in. However, if the springs are too worn, a new set should be obtained. Ask for a set with an overall dimension of 15 by 18 in. as this is the size for most davenport cushions. Wrap the cotton lengthwise and crosswise around the springs, securing and lacing it in place with ordinary string. Then slip the springs and batting into the cover, sewing the latter shut to complete the job.

Francis W. Henry, Pottsville, Pa.

## Cutting Butt Joints That Match

If a miter box isn't handy, here's a way to cut butt joints that will match perfectly. One piece is laid on top of the other, allowing enough overlap, and the two are fastened together with small nails. Then the cut is made at an angle and the pieces are separated. Either nails or fasteners can be used when the butting ends are joined in place. — Floyd Crain, Carterville, Ill.

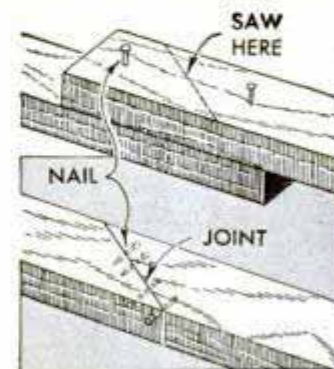

Plastic chessmen that are hollow can be made easier to play with by filling them with plaster of paris to make them heavier.



# Drop Shelf Near Refrigerator Saves Many Steps

A drop shelf near the refrigerator will come in handy when taking out foods. Many different items can be taken out at one time, which eliminates opening and closing the door repeatedly. For example, if milk, eggs, butter, meat and salad dressing are needed, this usually means two or three trips to the refrigerator, but with this shelf all can be handled at one time. The shelf is made 18 in. wide so that the supports can be screwed into studding. The manner in which the brace fits into the cleat is indicated in the circular detail. The shelf can be painted white and decorated with decals.—Hi Sibley, Nuevo, Calif.

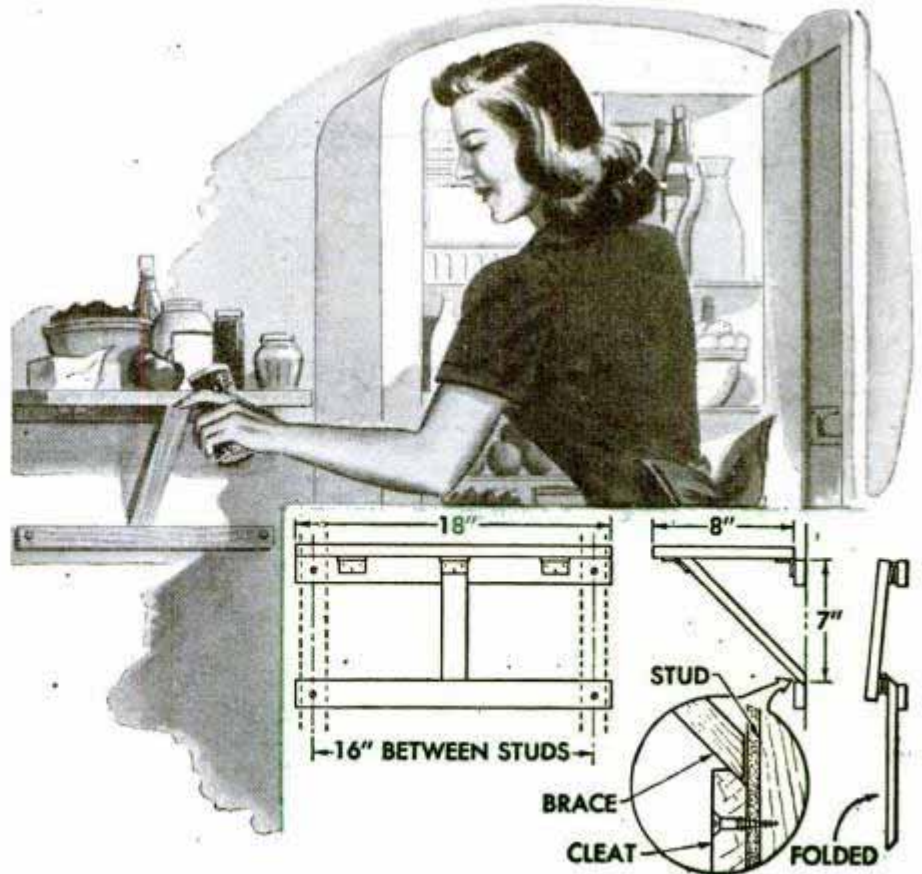

## Attaching Wire to Sheet Metal

To make good electrical contact between a wire and sheet metal, cut the metal lengthwise a short distance and wrap the ends around the wire in opposite directions, as indicated in detail A. For larger sheets, make a slit in one corner and bend the metal down and over the wire, detail B. If the wire is insulated, the insulation should be removed.

Richard C. Hare, Grafton, Mass.

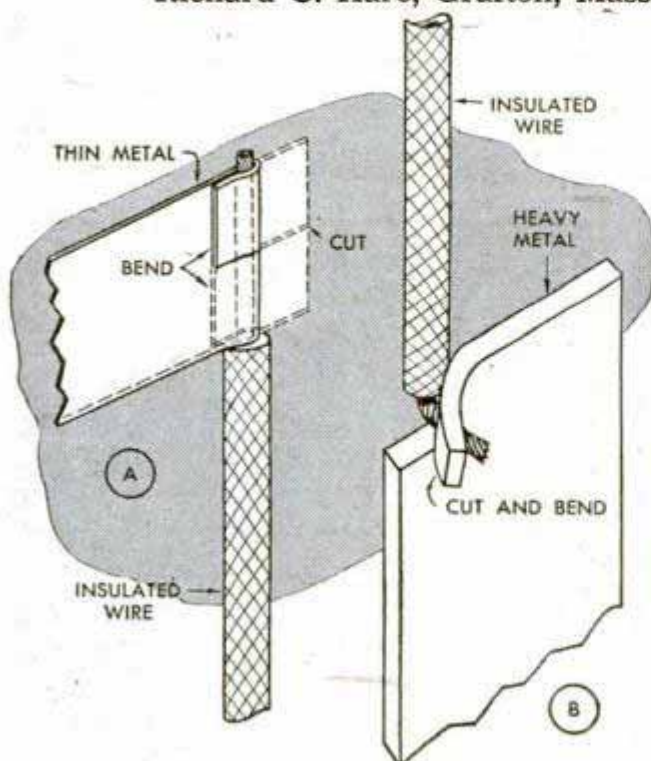

## Hose Used as Sanding Block For Irregular Work

For sandpapering in crevices, slots and other out-of-the-way places, use a sandpaper holder that has the paper stapled around a piece of automobile radiator hose of the proper length. Because of the flexibility of the hose, it may be squeezed into almost any shape that is required to do a difficult sanding job.

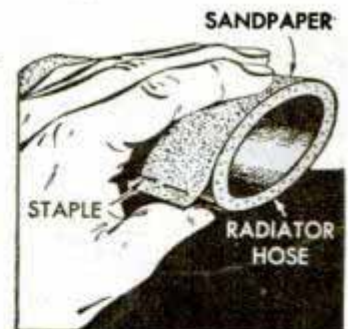

## Protecting Small Trees and Vines

As protection for small trees, bushes and vines from rabbits, tie a loose cloth sack of moth balls to the trunk a few inches above the ground. Damage to trees caused by deer can be prevented by tying several sacks of the moth balls to the lower limbs.—R. A. Jenkins, St. Louis, Mo.

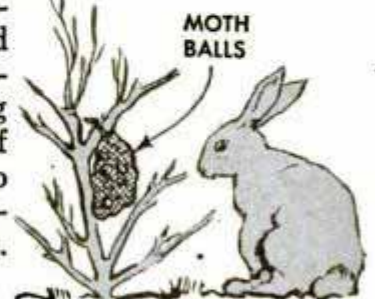

☞ To clean artificial flowers, place them in a bag, pour in a cup of salt and shake.



# Solving HOME



1. Attached to the back of a lawn or garden chair, a folded square of oilcloth will serve as a headrest and also as a cover or pouch for a dustcloth. If kept here, it's not necessary to make a trip inside to get a cloth when you're dusting

2. Screwed to the front of a wooden coat hanger, a coat hook serves as an ideal place on which to hang a hat and keep it and your coat together. If the closet is a small one without a shelf, this will be an especially convenient arrangement

3. When recovering an old chair or other piece of upholstered furniture, try painting the heads of the upholstery tacks with colored fingernail polish so that they will either match or blend with the particular fabric and trimming being used

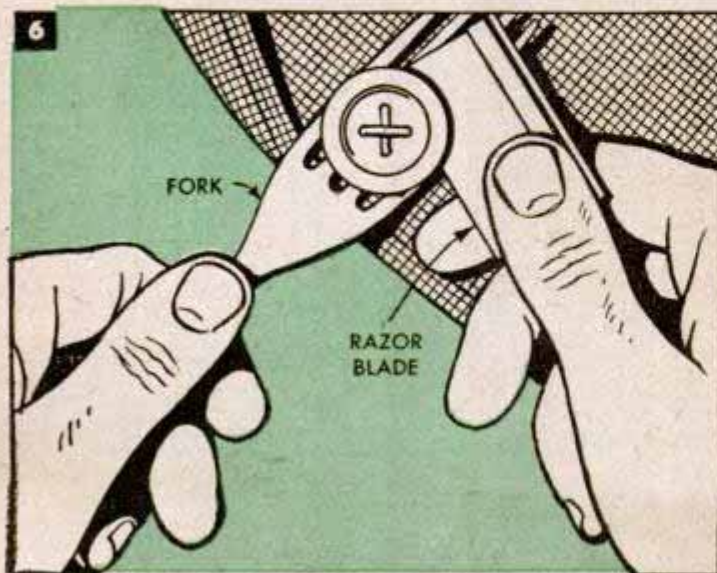



# PROBLEMS

4. Two ordinary clothespins will provide a neat holder for a dustpan. Screw the clothespins to the inside of a utility closet door or to a wall at some convenient location. The dustpan will slide into place between the two halves of the pins

5. Use a rubber band as a warning signal for young and not-so-young refrigerator raiders. The contents of any container on which a band is found should not be touched so that the food will be on hand when needed to prepare the family meals

6. If you're removing a button with a razor blade, knife, scissors or other sharp instrument, slip a fork under the button, as shown, to prevent cutting the cloth. The tines act as a guard to keep the blade from coming in contact with the material



2

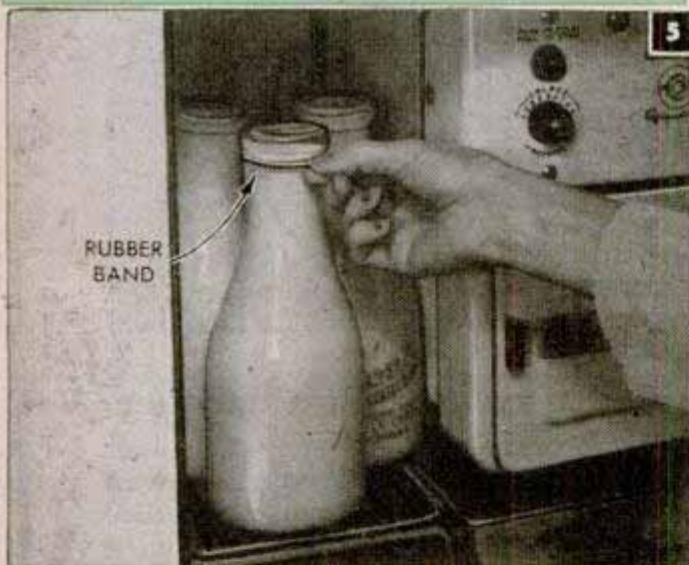

7. In an emergency, when the regular opener for a screw-type jar isn't handy, a piece of sandpaper will serve. Wrap the paper over the lid with the grit side down and twist it

8. To save cleaning up time when preparing food in a chopper, tie a paper bag over the mouth. After grinding, remove the bag and empty the contents into a mixing bowl or dish

9. Should a recipe call for half a lemon, the other half can be covered with a small, plastic bowl cover and stored in the refrigerator. Then it will not dry out so quickly

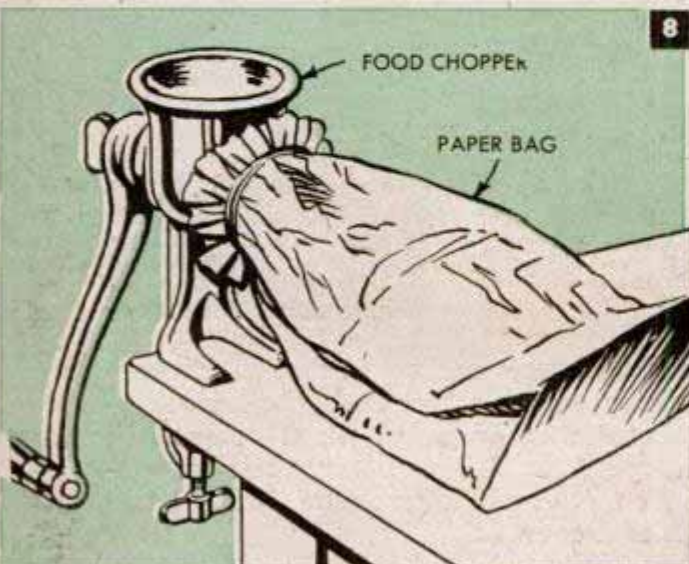



## Clothespin to Drive Screw Eyes

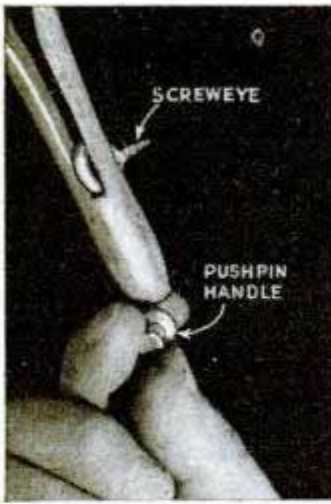

When you have a number of small screw eyes to drive, strain can be avoided by using an ordinary clothespin to drive them. Attach a pushpin to the head of the clothespin to serve as a handle. With this "tool" the screws can be driven in a short time.

## Pocket in Notebook for Papers

A handy pocket for loose papers can be made by doubling the last page in a notebook and fastening the top and bottom edges to the cover with cellulose tape. The sheet should be fastened loosely to take as many papers as possible. Should the pocket wear out, it can be replaced easily with another page from the notebook. — Beatrice E. Reese, St. Petersburg, Fla.

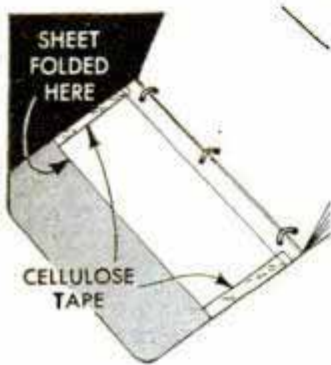

## Hinges Made From Metal Boxes

Small hinges that can be used on novelties and gift boxes or for other small work can be made from lightweight metal boxes that contain aspirin or other medicines. Cut out the portions of the box where indicated by the dotted lines and then punch holes in each half for the screws or nails that are used to fasten the hinge. — Wm. E. Danne-man, Chicago.

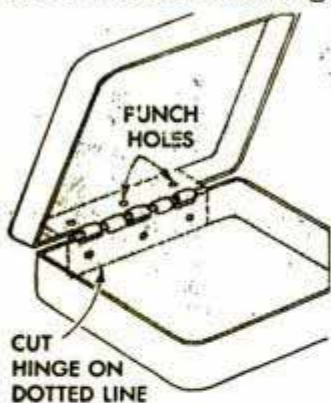

## Valve Keepers Replaced Easily

One of the quickest and easiest ways to install valve keepers on an auto motor is to use a long-blade magnetized screwdriver. The inside of the keeper is coated with heavy grease and then placed on the tip of the screwdriver, against the flat side. This is pressed onto the stem. When both

keepers are in place, ease the valve spring down with the lifter, making sure each half remains in place.

D. W. Brentlinger, Richmond, Calif.

## Versatile Two-in-One Auto Tool

Here's a two-in-one auto tool that will be a welcome addition to any motorist's kit. It's made by welding the shank of a screwdriver to the handle of a tire wrench in such a manner that several inches of the tip end project. When removing a wheel, the screwdriver is used to pry the hub cap off, and then the wrench is used in the usual manner.

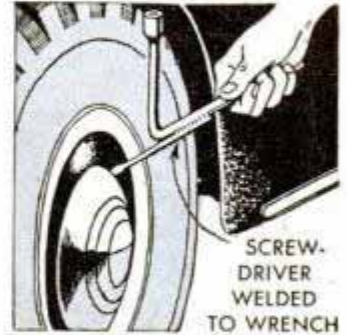

## Name on Gas Cap Prevents Theft

If the owner's name is written or printed on the gas cap of an automobile, it is not likely to be taken, and if lost, the finder will know where to return it. There are several ways to mark the cap; the name and address can be scribed with a sharp-pointed tool and then lacquered. Or the name may be stamped with marking dies if available.



## Plastic Decorated With Lacquer

Desk stands and similarly shaped articles made of transparent plastic can be given a decorative treatment that will harmonize with most color schemes. Just coat the inside of the object with lacquer or enamel. More than one color may be used to make a multicolored pattern. If it is desired to remove the finish, wipe it with a bit of absorbent cotton that has been moistened with lacquer thinner.

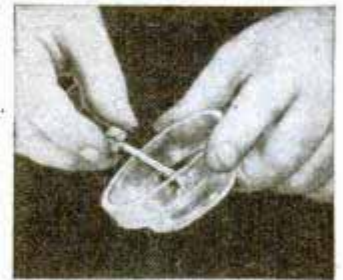

Next time you use a paintbrush for varnishing, prepare it by placing it in a mixture consisting of equal parts of varnish and turpentine. This is better than turpentine alone, which may make the bristles rough and coarse.



# SWEEPING IS NOT ENOUGH

Solvent cleaners supplement the work of the vacuum cleaner and broom and keep your rug looking bright and clean

*By Mildred Anderson*

**D**URABILITY of your wool-pile carpet or rug is largely dependent on the day-to-day, month-to-month care you give it while it's serving its purpose right on the floor. Under special conditions and exceptionally severe usage, periodic professional cleaning is necessary to supplement home care. This is emphasized further when one gives some thought to how a wool-pile carpet is constructed and how the different types of dirt affect the pile structure. The term "wool pile" describes the tufts of woolen yarn held together by a backing of lengthwise and crosswise yarns.

Usually these backing yarns are made of cotton or jute, sometimes of other materials. Weaves differ. In some, the pile yarn is looped around the backing yarn. In others it is not. Generally the backing is sized to give it body and firmness.

To most homemakers dirt is simply dirt—something to be gotten up off the floor and out of the house with as little fuss and labor as possible. But people who peer at dirt through powerful mi-



Photos courtesy Von Schrader Mfg. Co.

croscopes have discovered that there are three kinds responsible for wear and discoloration of your rugs. Surface litter is lint, hair, threads and other items which collect on the surface of the pile. It is easily removed. The second is light, clinging dirt. Much is deposited on the pile by air currents and gradually is worked part way down into the pile tufts by foot traffic. This type of dirt also is easily removed with a vacuum



(A) NORMAL—TUFTS INCLINE IN SAME DIRECTION



(B) SHADING—TUFTS INCLINE IN OPPOSITE DIRECTIONS

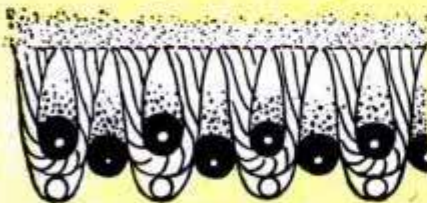

(C) BEFORE CLEANING WOOL-PILE RUG. NOTE EMBEDDED DIRT

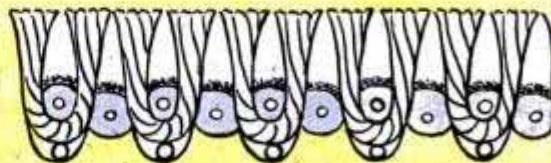

(D) AFTER CLEANING WITH VACUUM CLEANER SOME DIRT REMAINS

(2)



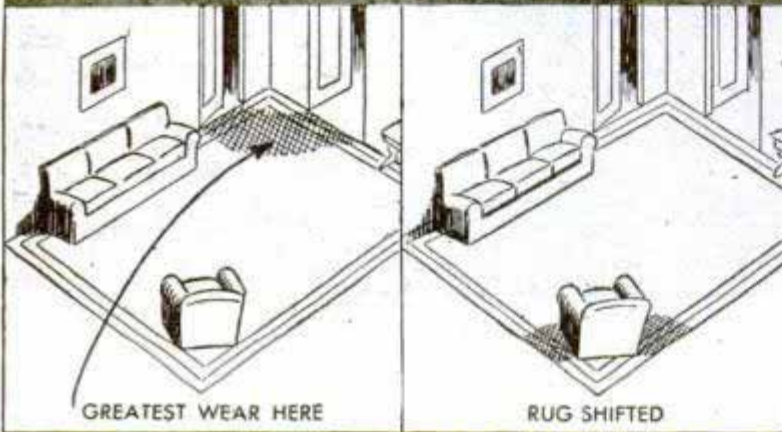

④ Shifting a rug has the effect of rerouting foot traffic and equalizing wear. Sometimes moving furniture will do it

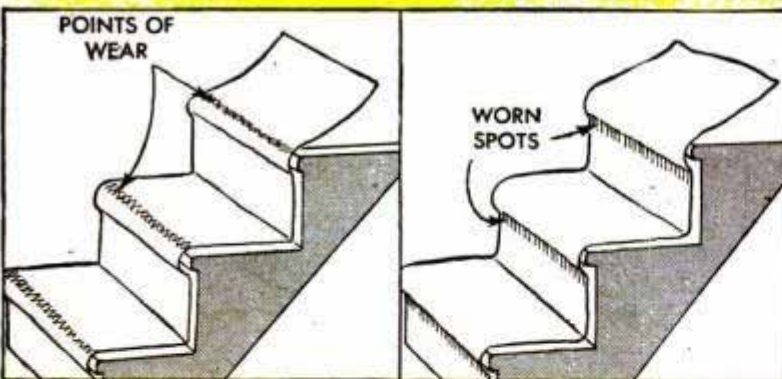

⑤ Stair rugs get the greatest wear at the front edge of the stair tread. Shift the rug as shown to hide wear streaks

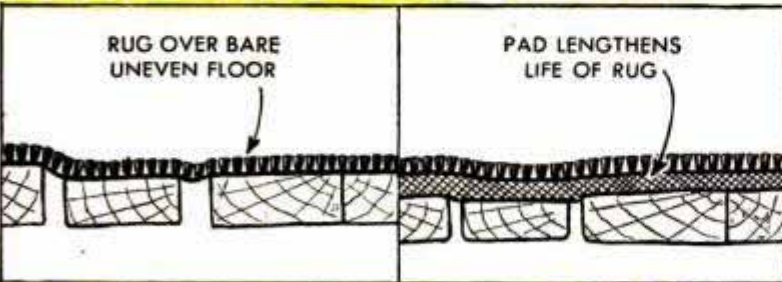

⑥ Unsightly wear streaks quickly show on a rug laid over an uneven floor. A pad lessens breaking strain on rug fibers

cleaner. The third variety is very much heavier than the other two. It has a powdery consistency and is bound together by certain sticky substances. It is not so easy to remove because it is heavy enough to work itself gradually down to the base of the pile tufts and over a longer period becomes embedded in the yarns of the backing, Fig. 2, C.

When the sharp abrasive particles contained in this heavy dirt are rubbed against the wool-pile tufts by action of foot travel, they cut the tufts near the backing yarns. The grease in the dirt causes it to cling to the pile and mat it, producing the condition known as "shading," Fig 2, B. Often the colors of the rug are dulled and may even change noticeably as the tufts flatten or incline in several directions, Fig. 2, A and B. For example, delicate rose colors will become a neutral taupe shade as the rug becomes soiled. No household vacuum cleaner can remove all of this type of embedded dirt, Fig. 2, C and D. If the cleaner were made sufficiently powerful to do so it would ruin the rug in a short time. But regular cleaning holds this deposit to a minimum. The schedule of maintenance should include both the daily and weekly care plus periodic special care. Rug manufacturers often recommend that a vacuum cleaner be used daily for a short time on each rug and carpet in your home. Shaking and beating of rugs is not advised. In time it may break the backing yarns and loosen the pile tufts. The vacuum cleaner may be used without any ill effects from the moment your new rug arrives. Every new rug will fluff to a certain extent because of the number of short fibers left in the pile. After several times over with the cleaner this usually clears up.

Most rug manufacturers do not recommend home shampooing, the chief reason being that the average home does not have facilities for adequate rinsing, which is essential to success. Quick drying is another problem of shampooing at home. Wet cotton and jute backing yarns, which do not dry quickly, may cause mildew or rotting. However, should floor shampooing at home be impera-





Solvent cleaner sprinkled on the rug, then brushed in with stiff-bristle brush and later removed with vacuum cleaner, picks up much of the embedded dirt, cleans and straightens the tufts and brightens the colors

tive for some practical reason—as in the case of wall-to-wall carpeting—one can use a specially prepared nonalkaline detergent. Nevertheless, in most cases it's best to take the carpeting up and send it to a reputable professional rug-cleaning service.

For periodic care in the home, carpet manufacturers often recommend use of prepared cleaners which consist of absorbent powders mixed with a cleaning solvent. These are worked into the rug pile with a hand brush, Figs. 1 and 7, or a machine. After the solvent evaporates, the powder is removed with a vacuum cleaner, Fig. 3. Although this process cannot be expected to equal a professional shampooing, it will greatly improve appearance by brightening the colors and lifting the pile, and at the same time it will get a lot of the deeply embedded dirt as well. These ready-prepared cleaners are particularly effective on hard-twist or frieze carpets as they do not affect the texture.

When removal of spots is called for, there are several general precautions to follow. First, try to catch the spot quickly before it sets into the pile. Blot up liquids as soon as possible with a clean, absorbent cloth or white blotting paper. Remove excess semisolid materials with a dull knife or

spatula. If the carpet has been wet through, raise it to let the back dry. On frieze or twist-pile carpets, solvent cleaners are preferred. Many spots will yield to treatment with carbon tetrachloride or to a cleaning solution which has this chemical as its base. Use a small quantity of the solvent and work from the outer edge of the spot inward. Keep the room well ventilated.

One general rule to follow with all types of rugs and carpets is to save the manufacturer's label and follow the cleaning instructions given. Wool frieze or hard-twist rugs, luster type white rugs, rayon rugs and cotton rugs should not receive run-of-the-mill treatment. Instructions should be followed with care and attention to every detail. You also can prolong the life of a rug and equalize the wear by shifting it on the floor as in Fig. 4. Sometimes it is possible to reroute the foot traffic merely by shifting the furniture. Stair rugs get a lot of wear at the points indicated in Fig. 5. A slight shift slips the worn streaks out of sight in the corner where the riser meets the tread. Even the best rug will soon show pronounced wear streaks if you lay it over an uneven floor as in Fig. 6. Of course a pad will help but it's best to level the floor or cover it with plywood before laying the rug.



## Bait Carrier Fastened to Shirt Keeps Tackle at Hand

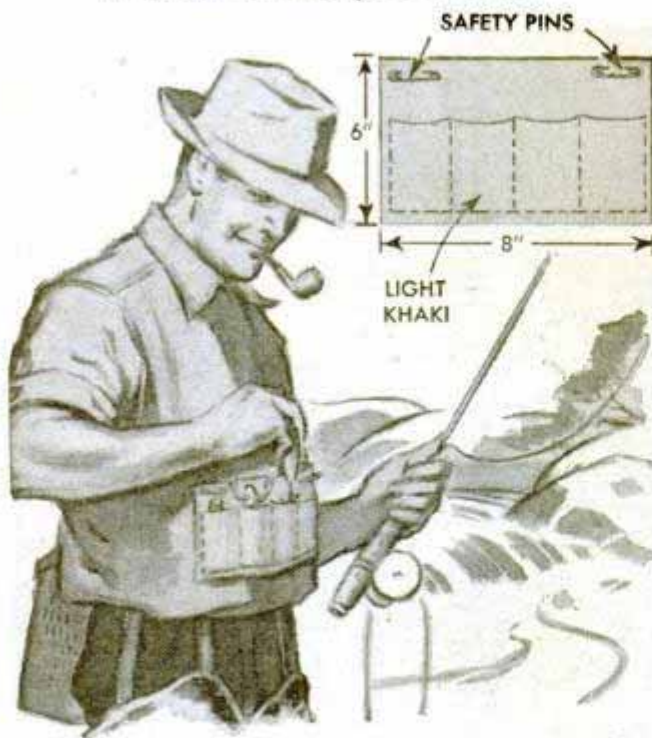

When wading in midstream or fishing along the shore, it's difficult to carry a tackle box with a supply of extra baits. However, with this canvas carrier, three or four lures can be carried with no inconvenience. The carrier is made of light khaki cloth and each pocket is about 2 by 4 in., the number of pockets being determined by the number of lures you wish to carry.

## Garbage Cans Are Disinfected By Spraying on Blotter

To disinfect his garbage can, one householder secured a large square of blotting paper to the underside of the can lid. Then

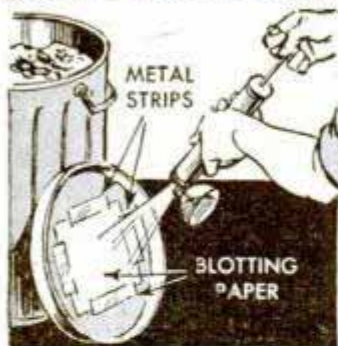

at regular intervals the blotter was sprayed with disinfectant. Because of the absorbent nature of the paper, it retains the spray longer than would the metal surface of the can lid.

## Washing Machine Adapter Plug Prevents Unauthorized Use

Having to keep a washing machine in an apartment-house basement, one owner found that by reversing the plug arrangement and using an adapter piece, unauthorized people were discouraged from using the machine. Instead of the usual male plug on the machine cord, a female plug

was used, and the adapter, consisting of a 4 or 5-in. length of cord, was fitted with a male plug on each end. With this arrangement, the washing machine cord was plugged into the adapter, and the adapter connected to the wall receptacle. The machine cannot be plugged into a wall outlet without the special cord which, of course, was not left with the machine.

George A. Austin, Syracuse, N. Y.

## Ball Substitutes for Pipe Plug

Where the water pressures are low enough, a sponge-rubber ball can be substituted for a pipe plug or cap if the latter is not available or if the pipe has not been threaded. The ball should just fit inside the pipe. Punch a small hole through the ball and insert a bolt, using washers on both ends, through the ball. After the ball is placed in the pipe, several turns of a wing nut will squeeze it tightly against the sides of the pipe to hold it in place.

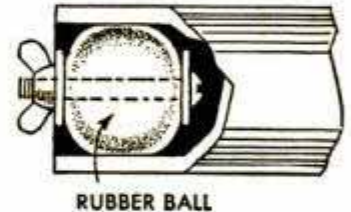

## Demountable Sawhorse Is Ideal In Basement Workshop

If you are cramped for space in your basement, these demountable sawhorses will come in handy because they require little storage space when taken apart. Cleats are nailed to the cross bar, forming a slot that fits between the legs. The top and bottom braces for the legs are screwed to them, and the top ends of the legs are rounded.

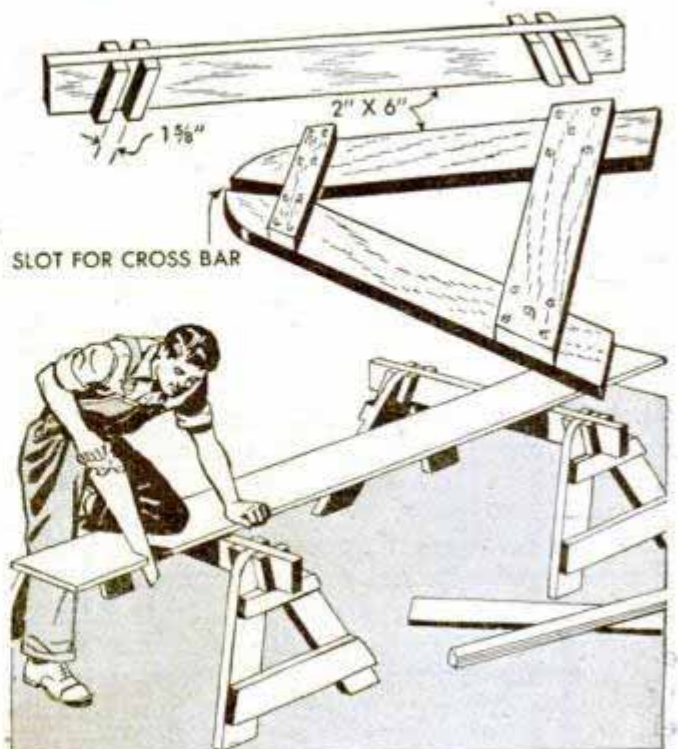



# "DETECTIVES" SPOT GOOD DRIVERS

These simple devices will help beginners learn how to handle a car safely—and taking the tests might surprise some oldtimers behind the wheel who learned their driving the hard way

BY ERIC DEVINE

Auto accidents don't always just happen. Accidents on the highway usually "develop" and then happen. Fatal crashes occur even when driving conditions seem to the casual observer to be ideal—good visibility, a straight road, a dry pavement. Cars sometimes crash through the gates and into trains standing still on a highway or street crossing; they run off the pavement, off the road shoulder into the ditch, crash into poles and trees and bridge abutments in broad daylight.

Generally the causes or reasons are more or less obscure. Frequently the reports state laconically that "the driver lost control" or "the car went out of control." But, perhaps just as frequently, examination of the wrecked car—if there was enough of it left intact to determine—revealed no mechanical fault which could be the direct cause of the crash.

Whenever there are a number of cars on the highway in close proximity, all traveling at varying speeds and some in opposite directions, circumstances and conditions of traffic may combine, in a split second, to produce the cause or causes of a fatal crash or one that results in serious injury to several persons. Only the ability of the drivers to "see it coming," and to act instantly in the emergency, will avert the danger.

In selecting recruits for the efficient and safe operation of motor vehicles, the U. S. Army put drivers-to-be through a series of tests designed to expose the nature and extent or degree of physical defects which could handicap the prospective driver and of which he himself might not be fully aware. One of these, the field-of-vision test, Fig. 1, determines just how far to the right or left an object must be before it passes out of the driver's field of vision when he is looking straight ahead. This test quickly reveals the eye defect commonly known as "tunnel" or "barrel" vision. Such an eye deficiency may seriously handicap a driver unless he learns to compensate for it by exercising the greatest caution when ap-

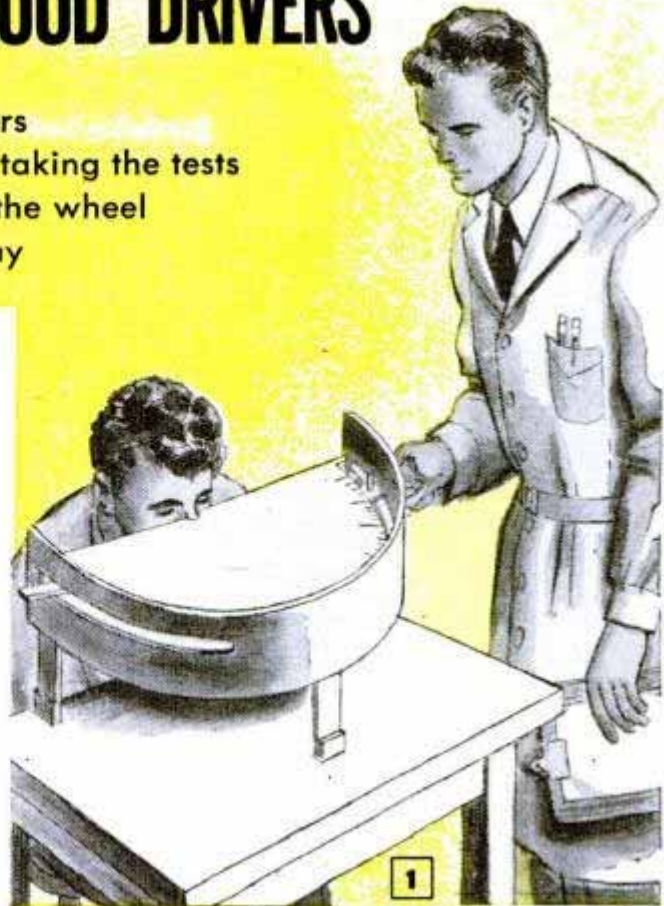

**1** FIELD OF VISION TEST

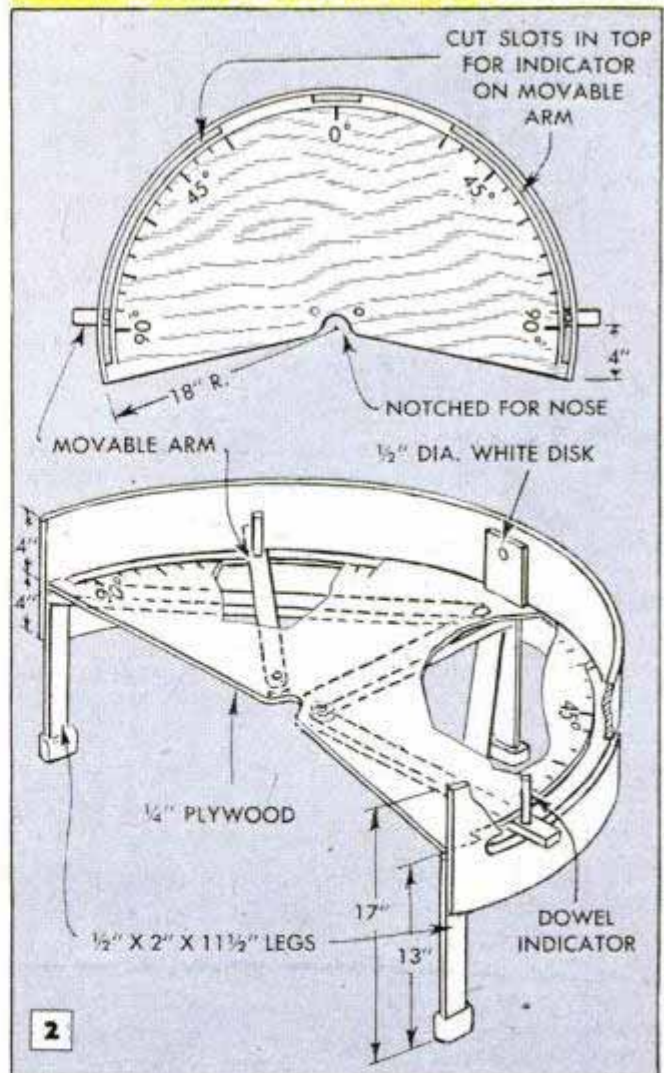







# HAND STEADINESS TEST

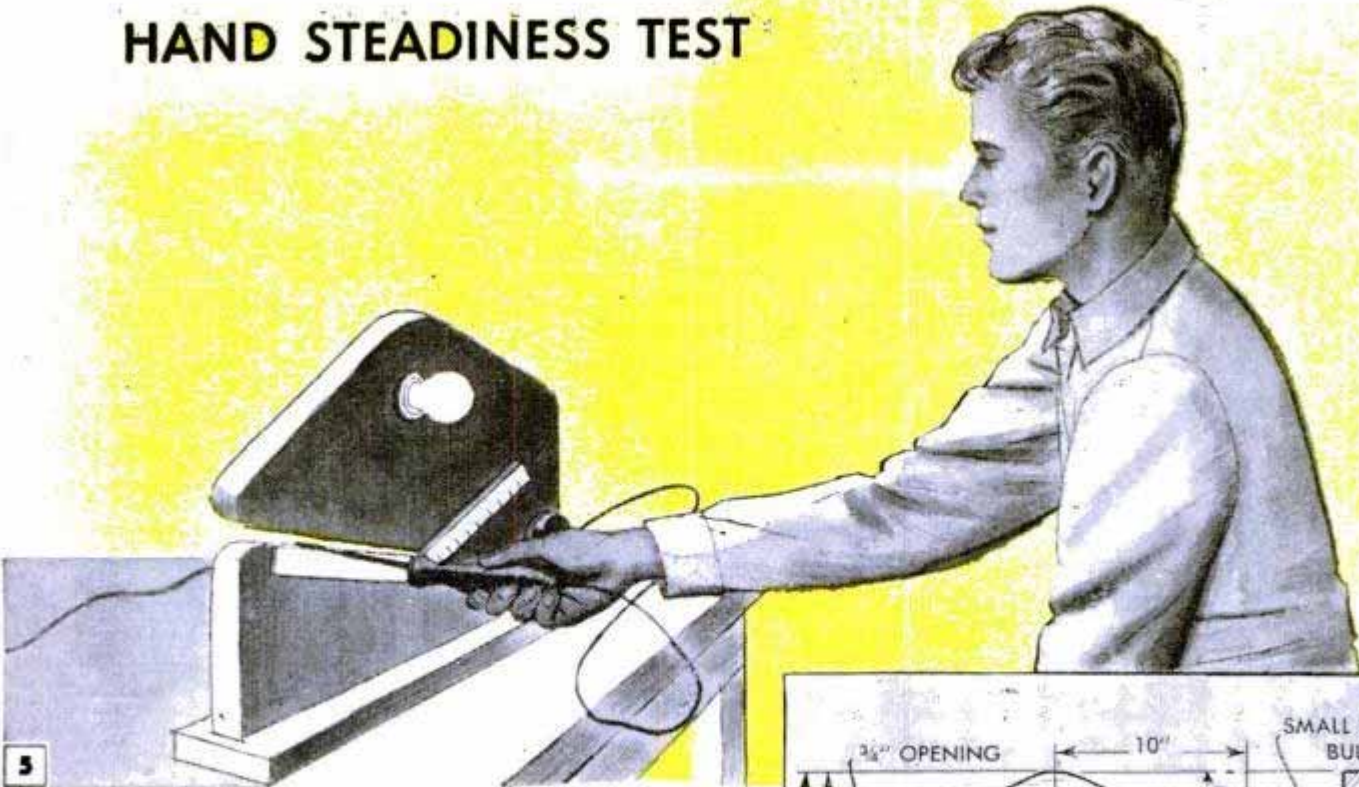

movable rod to a point exactly opposite the stationary one. The subject makes five trials, a separate reading being taken for each and then an average value is determined as a result.

If, in any of the trials, the movable rod is stopped more than 1 in. from the fixed rod, a deficiency in judgment is indicated which should be regarded by the prospective driver as a warning rather than any direct reflection on his ability. It also should be remembered that there are variable factors, both in the taking of the tests and out on the road where the man at the wheel must meet varying conditions of traffic, visibility, etc. It should be kept in mind that the tests are not necessarily designed to be conclusive one way or another, but rather to develop in the subject an appreciation of the dangers of a handicap.

The hand-steadiness test is interesting just by itself, without any application to driving ability. It is often used merely as one test in the total measurement of a driver. It is not at present regarded as being in any sense conclusive in determining qualifications. Figs. 5 and 6 are self-explanatory. In operation the operator passes the stylus down the gap. If unsteadiness of hand causes the stylus to touch the copper rods the light flashes on and a reading is taken. The procedure is repeated three times. All three of these devices are similar to those used by the U. S. Army and also the National Conservation Bureau in driver-training programs although of course in regular training schedules the tests are supplemented with extended instruction courses.

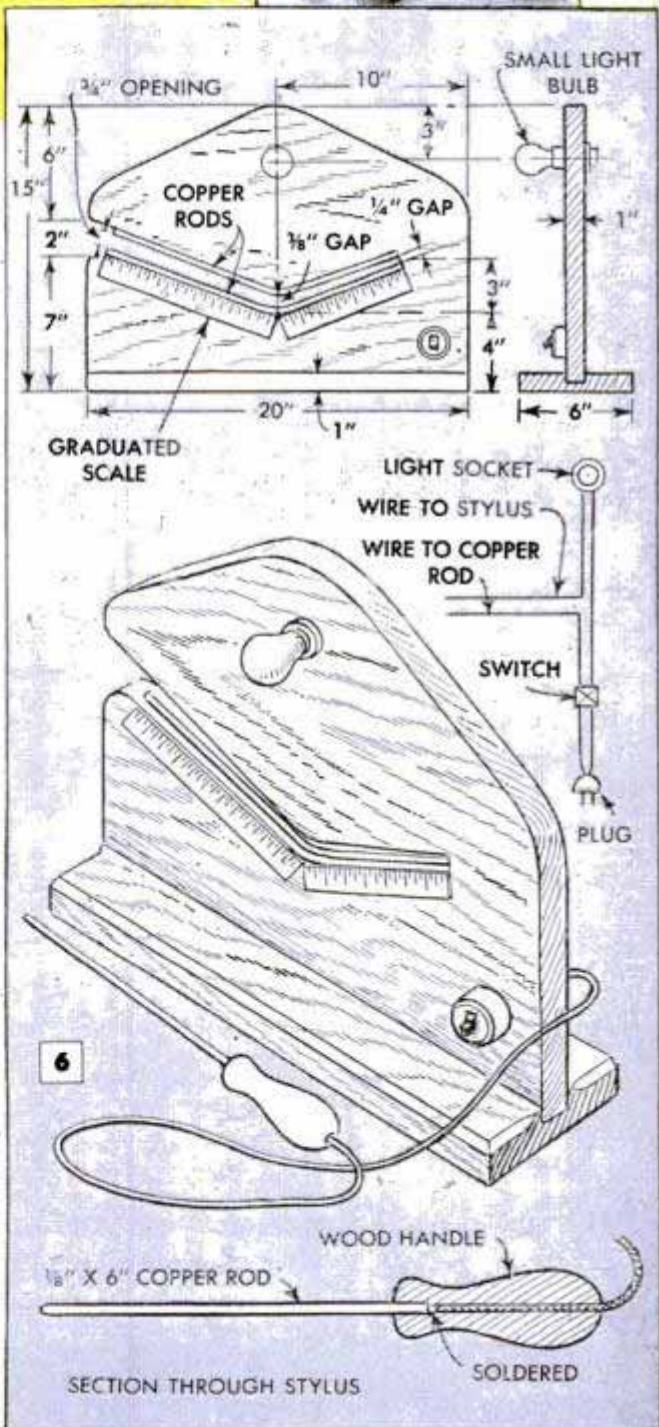



## Screen Tacked on Porch Railing Makes Safe Child's Play Pen



If screen wire is tacked to the inside of a porch railing, very young children will have a safe place in which to play. With the screen covering the rails, it is not possible for the child to do any dangerous climbing or to push toys off the porch. If the screen extends to the floor, balls and other round objects will not roll under the railing beyond the youngster's reach.

## Special Hangers Prevent Swing From Damaging Tree

Made so there is no rubbing where it is fastened to the branch of a tree, this swing is sturdy enough for almost any child. The hangers are two lengths of flat iron that

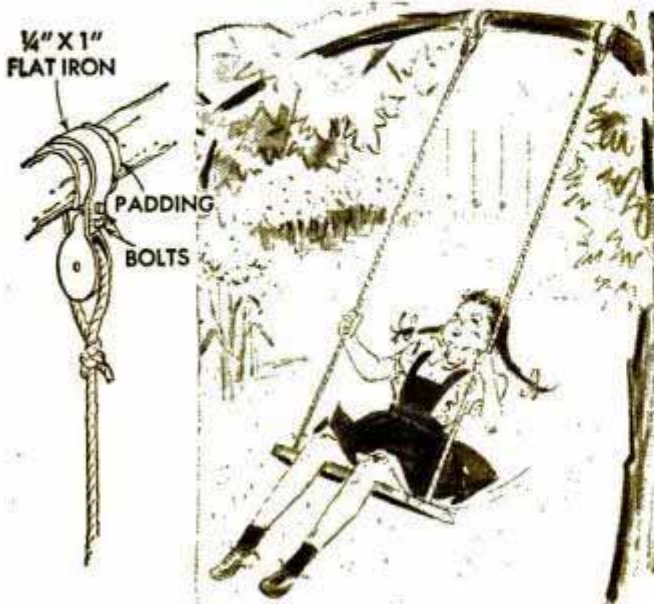

are bolted around the limb with pulleys attached to the hangers. The ropes are run through the sheaves and tied. There should be padding between the flat iron and the branch.—R. E. Murray, Fremont, Ohio.

## Two C-Clamps as Emergency Vise

Here's a quickly rigged vise for the home modelmaker that requires only two C-clamps and a small block of wood. The wood that acts as a base is notched to fit the back of one of the clamps and the other clamp serves

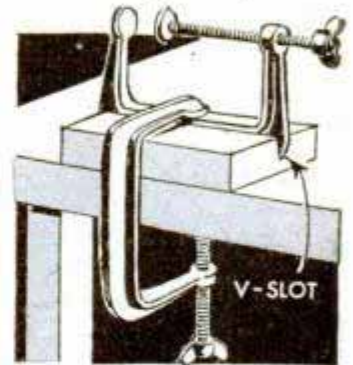

to hold it and the wood in place. The vise can be used for light and small work only.

Harold M. Winz, Republican City, Nebr.

## Bee Smoker for Gopher Hunters

Farmers and others who wish to rid their property of gophers will find that they can be "smoked out" of their holes quickly by using a bee smoker.

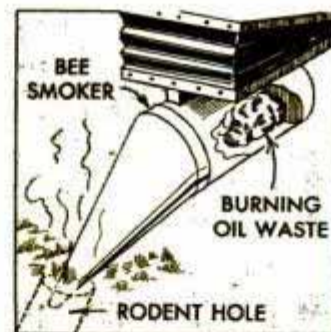

Fill the smoker tube with oily cotton or waste, ignite it and insert the spout in the burrow opening. Usually a few strokes will fill the burrow with smoke and drive the animal to the surface in a very short time.

## Jackknife Is Handy Candlestick

Safe and convenient, this candlestick holder will come in handy at camp, or in some dark corner of the basement where there isn't sufficient light. The large blade of the knife is stuck into a wall or tent post and the small blade, which is opened at right angles to the handle, holds the candle. With this arrangement, the flame is at some distance from the wall or tent post.—E. Handleman, Syracuse, N. Y.

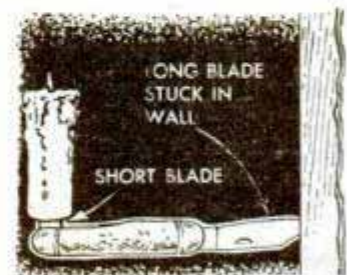

☐ Linen handkerchiefs won't need ironing if stretched and pressed flat against a mirror until dry. This idea is especially handy when traveling.



# FROM BATTERY CASE TO DEVELOPING TANK

*Here's a small three-in-one tank that's ideal for developing, rinsing and fixing cut film*

By William Riederich

FOR the photographer who has occasion to develop small batches of cut film up to 5 by 7 in. in size, this compact unit, Fig. 1, will do the entire job; it requires little storage space and is easy to drain, Fig. 3. The tank proper is made from a 3-cell storage-battery case of 15 or 17-plate size, sound and free from cracks. After thoroughly cleansing the case with a soda and water solution, cut a shoulder around the outside top edges of one end cell to permit a light-tight fit for the cover, Fig. 4. Remove about  $\frac{1}{16}$  in. Then cut notches in the top of each cell for the number of film holders you will require and make a slit for the lip of the cover that fits against the compartment dividing the center and end cell. The cover is dimensioned to fit, making sure that it will not leak light. Finish it with several coats of acid-resisting paint. Holes are drilled in each cell and through the bottom ribs to insure complete drainage. Force rubber inserts into each outside hole and attach lengths of rubber tubing to these, holding the tubing in place with clips screwed to the side of the case. Finally, it will be necessary to shorten the arms of the film holders to fit the tank, Fig. 2. In use, the cell with the lid is for the developer; the center cell is for the rinse and the uncovered end cell for the fixing solution.

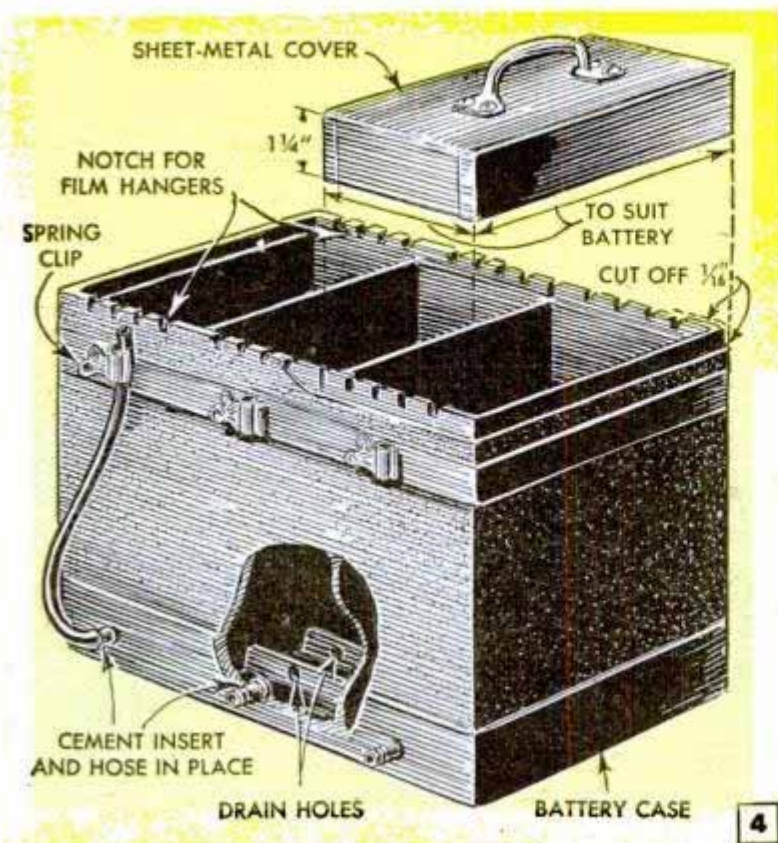
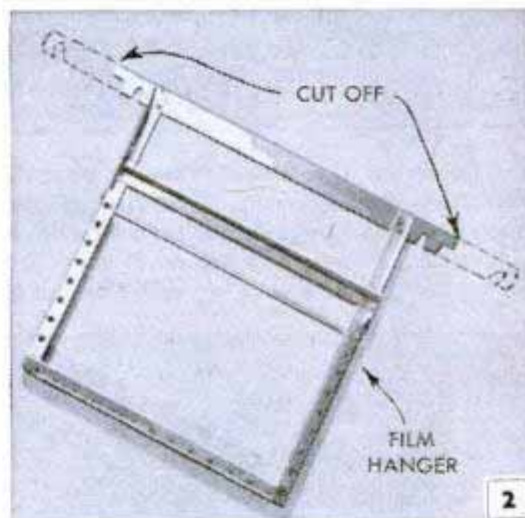
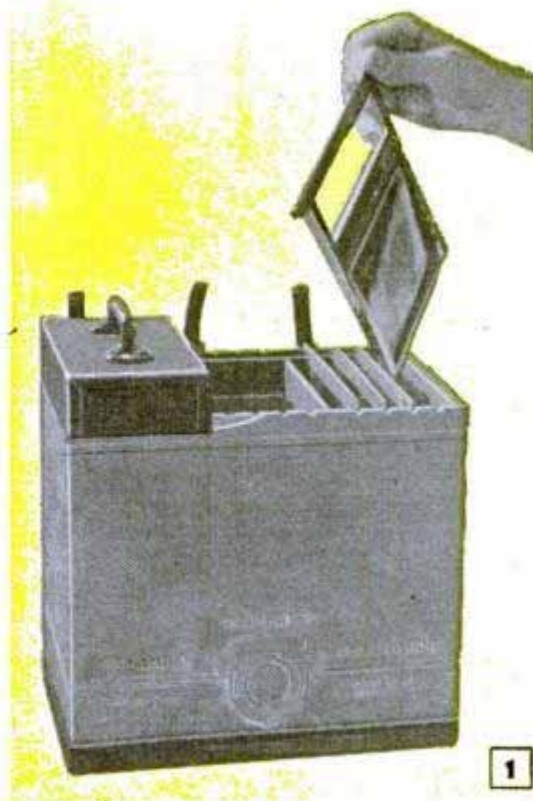





The lowering sky, the lighthouse and the angular detail introduced by the weathered driftwood in the picture above suggest symbolically the dangers of shipwreck. Below, who wouldn't spark with interest at the thought of a real log cabin on the lake shore?



At first glance you think of a sentinel rock but actually it's a pillar of earth with the surrounding area washed away. Farm editors like such shots as this

# Profits

## IN ROADSIDE PICTURES

By Paul Hadley

Old millstones are good bets for the roving photographer. Here they are serving as an "atmosphere" exhibit near the entrance to a large antique shop







Once proud sailing vessels, these old hulks now lie partially sunken and listing, favorite studies for artists and photographers. Don't miss such a shot

**T**HERE are salable roadside photos hidden along every mile you travel by auto. The ability to "see a picture," to recognize instantly the elements of good photo material, is one of those sixth senses the traveling photographer must acquire. When you're speeding swiftly through the countryside, the essentials of a good picture have a way of momentarily falling into place, giving you a fleeting glimpse, and then disappearing just as suddenly. Other pictures often "develop" along the way. You may pass a given spot—a dam, an old mill, a lighthouse or a cabin—several times and see nothing to excite a photographer's interest. But if you watch these spots there will come a day when the natural lighting, the cloud formations and the tonal values are just right.

Then there is what might be called the seasonal picture; that is, it develops as a result of the change in season. Many landscapes, street or roadside scenes, and close-ups of detail frequently offer little of photographic value unless covered with a mantle of snow or locked in the winter ice. Often you will see picture possibilities then where none appeared before. Likewise

This odd passenger depot is located at the top of Lookout Mountain near Chattanooga, Tenn., and it is a terminal of one of the world's steepest railways



JUNE 1947



Pictorial shots such as this one of a mountain home are always good to have in your photo file. Notice how the cloud formation enhances the pictorial values

winter scenes more or less lacking in appeal may develop into interesting and dramatic shots during the spring, summer or autumn season.

You don't search exclusively for the unusual, the novel or the unique in roadside views. Very often the commonplace holds even more interesting possibilities for the observing free-lance photographer. Frequently one will have the experience of studying a view from one spot without seeing anything attractive in the composition. Move a little from your point of vantage, right, left, forward or back. Sometimes just a few steps one way or another will have the effect of changing the composition of the scene before you into something with definite and perhaps striking photographic values.

Point of interest and a composition which stimulates thought on the part of the reader—these generally top the features editors look for in a photoprint. Study the accompanying photographs and see how, in various ways, they fill this order. Who, for example, wouldn't spark with interest at the prospect of owning a real log cabin by the lake shore, and who wouldn't like to know

Even a box camera is capable of good photos when in the hands of an expert. Note the sharp reflection of the wagon and the horses in the still water





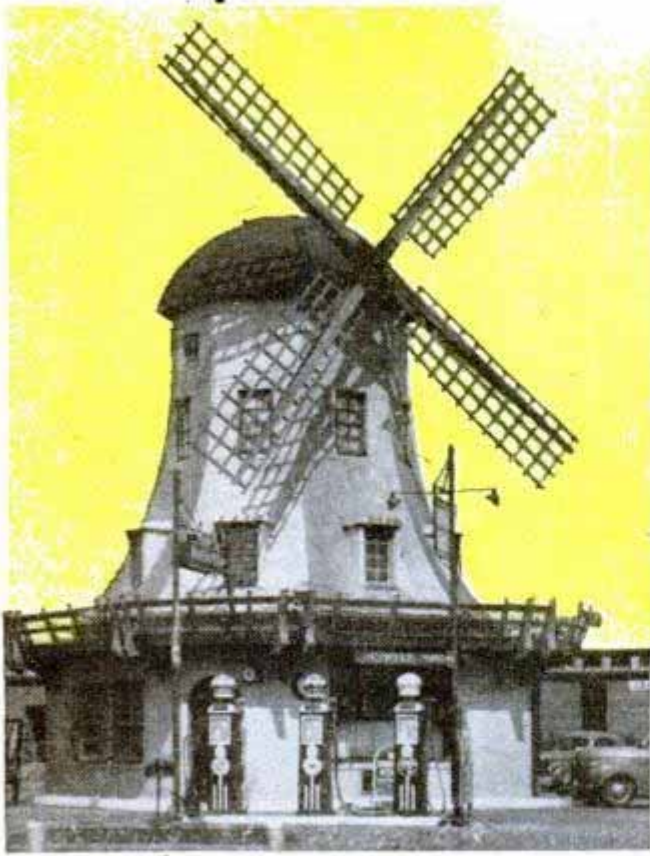

Trade journals are usually customers for such photos as the one above of the combination coffee shop and filling station with the Dutch windmill motif, and, below, the woods photo of a newly felled big tree

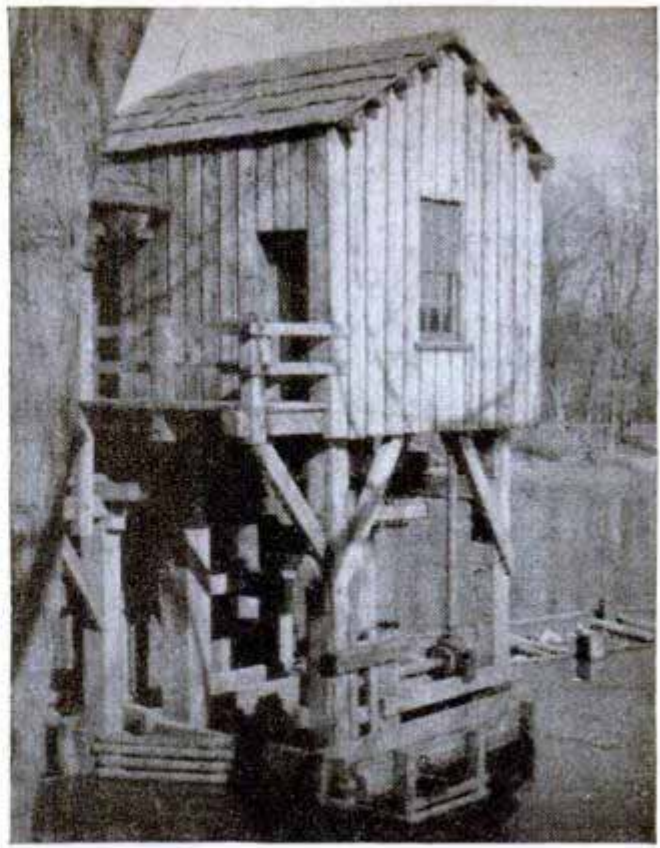

Never pass up a water mill. It's a natural with most editors. This one is a very famous restoration—a part of the Abraham Lincoln Memorial at New Salem, Ill.



Below, carefully composed photos of home grounds, spacious lawns, flower gardens and trained shrubbery are used by publications devoted to homeowners

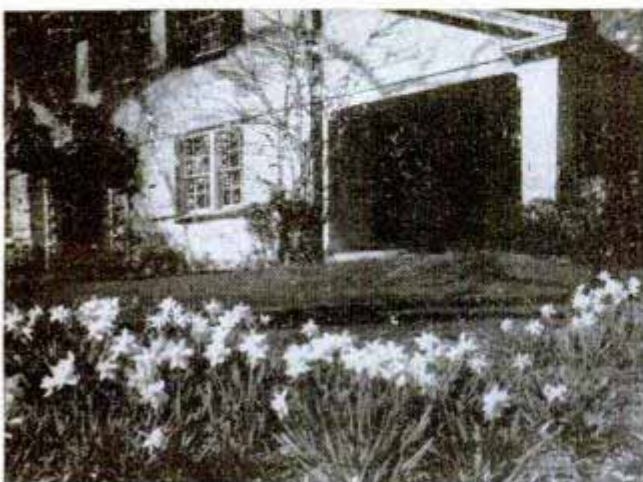

the real story of the old millstones? The shot of the lighthouse towering against a lowering sky and framed by a piece of weathered driftwood gives one an inescapable feeling of stark reality.

Trade journals, farm and garden publications, and magazines featuring articles of interest to the homeowner are markets for good photos such as that of the combination gas station and coffee shop with the Dutch windmill motif. Well-composed photos of home gardens and flower arrangements are always good bets for the roadside photographer. Photos of famous historical buildings, monuments or restorations are good prints to have in your file.

The camera used for this work is a matter of individual choice. Some photographers prefer a view camera taking a large film size so that they can make salable contact prints direct from the negative. Photo-prints in the 4 by 5-in. size are quite generally acceptable to photo editors but the 8 by 10-in. size nearly always gets a better rating. With many photographers experienced in outdoor work the reflex camera gets the nod of approval because it gives all the advantages of ground-glass focusing in a smaller, lighter package than the view camera. Moreover, in the reflex camera you see the image right side up while focusing. Negatives smaller than 4 by 5 in. should be "blown up" in an enlarger to 4 by 5, 5 by 7 or 8 by 10-in. size.



# Hypo Wash Tester Gives Accurate Readings

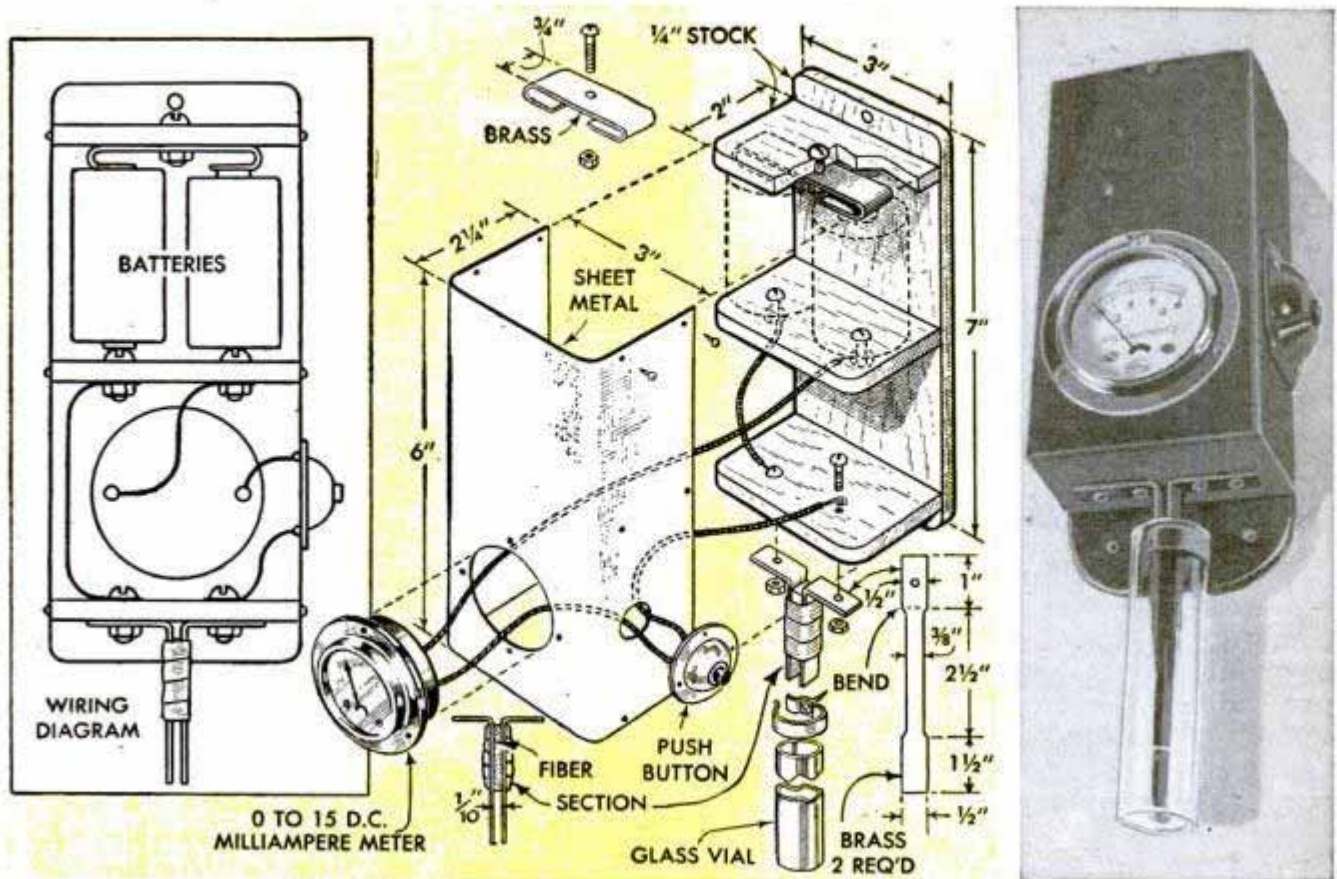

Photoprints that are to be toned or kept for permanent records—any prints that are to last—must be thoroughly washed. Although there are several ways of testing the wash chemically, this electric tester is built up around the principle that concentrations of salts in water have a resistance to the passage of electric current that can be measured. Simplifying the taking of a series of readings, or checks, will speed up the job of washing. A d.c. milliamperemeter or milliammeter giving a reading of 0 to 15 will do very well, although others having a slightly different range will serve. The details tell the story of the construction of the tester. A push-button switch that cuts off the current makes it possible to reduce battery drain, which ordinarily begins as soon as solution touches the brass

blades and would continue as long as solution remained on the blades. The closed-end glass tube is held in place with a spring clip. File or grind a fill mark as indicated in the right-hand photo. Make sure the bottom of the tube touches the ends of the test blades. Then see that the batteries are inserted as shown in the left-hand detail—one right side up and the other upside down—and check the positive and negative connections to the meter to be sure they are correct. Take a reading from the tester with the tube filled to the mark with plain water. Then, to use, drip the hypo wash directly into the tube. As long as the meter reads above the check reading with plain water, washing of the prints or negatives should continue. Always test with the same amount.—John Steinke, Cleveland, Ohio.

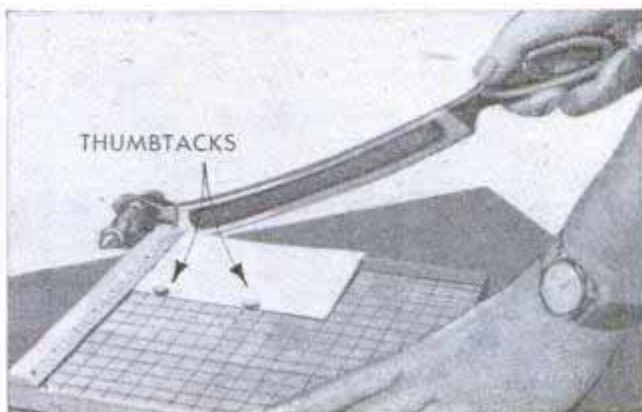

## Thumbtack Stop for Paper Cutter

Because it is often difficult to see the graduations on a paper-cutter board in the dim light of a darkroom, use a couple of thumbtacks to serve as a work stop. By hooking the sheet under the heads of the tacks, it is possible to hold the paper more steadily than when pressed against the ruler only. For extra large sheets, it may be necessary to use three or four tacks to keep the paper properly lined up and prevent its slipping on the board.



## How to Use Chipped Photo Trays



Until a badly-chipped photo tray can be repaired or replaced, avoid using it in that condition because iron stains on negatives or prints might result. Instead, line the tray with a sheet of waxed paper which will mold itself in position when the processing solution is poured into it. This will serve as a temporary waterproof liner.

## Dial Thermometer for Liquids Is Held by a Clothespin

When using a dial-type thermometer in the darkroom to determine the temperature of liquids, slip the shank through the coil of a spring clothespin and the thermometer can be attached anywhere. It can be clipped to the side of a tray or tank to register the temperature, or when not in use, it can be fastened to a nearby shelf support.

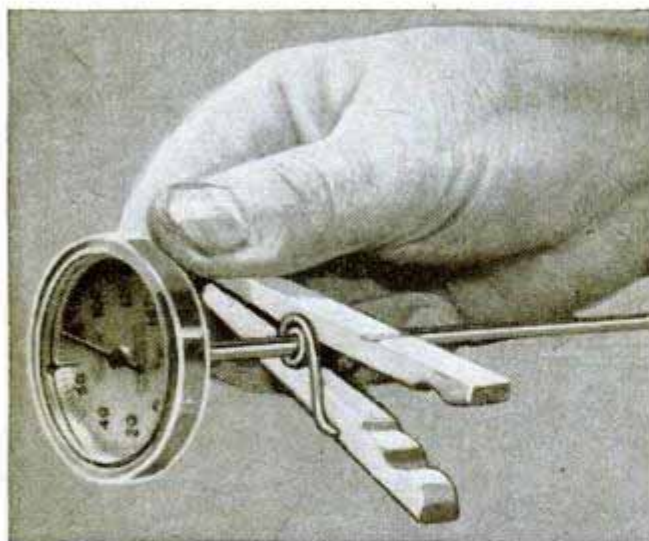

## Negatives Are Kept With Prints

If you use art corners to fasten snapshots in an album, it's an easy matter to slip the negative behind the print when mounting pictures. This serves as protection for the

negative and helps to identify it. In addition, you know where to find the negative in case additional prints are required.

Margaret Tatroe, Edmonton, Alta., Can.

## Print Straightened in Typewriter

One of the simplest and quickest ways to straighten a curved glossy print when you don't have a regular print straightener is to run it through the typewriter. The curved side should be away from you as

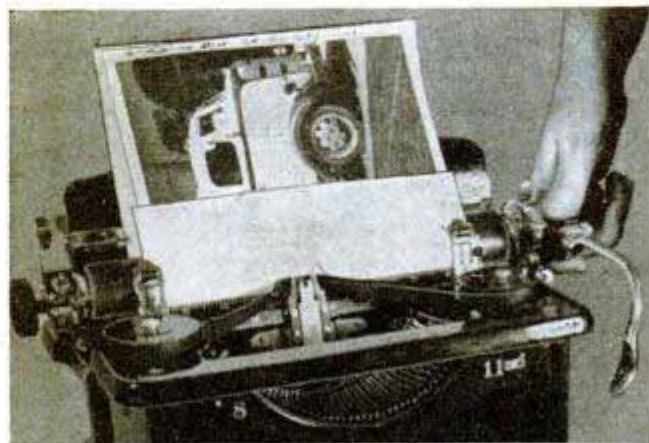

you feed it into the machine. A piece of paper laid over the surface of the picture will protect it from scratches. Most pictures will be flat after passing through the typewriter once, but in some cases, when heavier weight papers are used, it may be necessary to repeat the treatment.

Bob Hurst, Chicago.

## Snapshots Given Deckle Edge

Glossy photographs and snapshots on single-weight paper can be given a deckle edge with the serrated cutter on a box of waxed paper. Merely slip one edge of the print underneath the cutter, hold the latter down firmly and pull the photo up, being careful when making the tear. Allow sufficient margin for the deckle edge when trimming the print in the paper cutter.

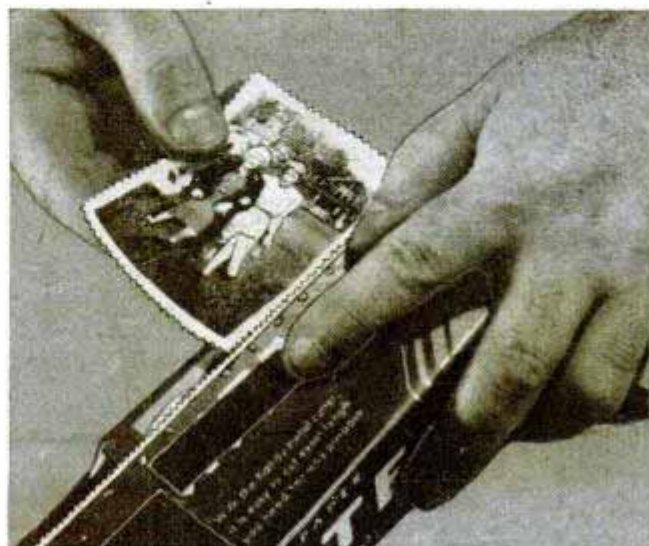



# CRAFT QUIZ



1. Best window screen material is—  
 (a) Bronze (c) Aluminized zinc  
 (b) Black (d) Galvanized



2. Orange shellac is thinned with—  
 (a) Turpentine (c) Naphtha  
 (b) Orano (d) Alcohol

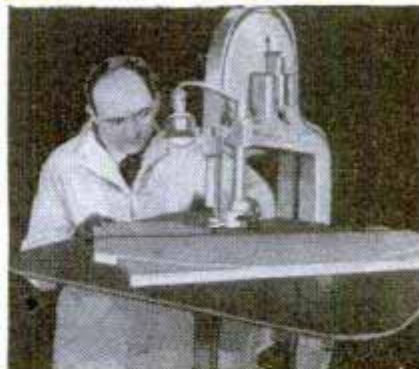

3. First bandsaw was invented in—  
 (a) 1798 (c) 1850  
 (b) 1808 (d) 1892



4. Hammering copper makes it—  
 (a) Ductile (c) Soft  
 (b) Brittle (d) Flexible

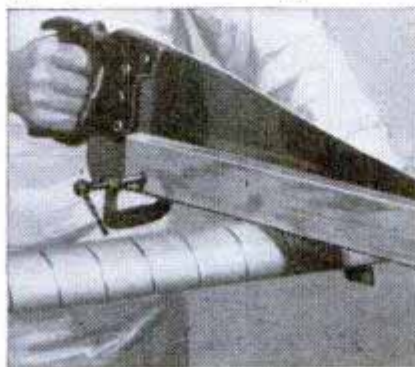

5. His next operation will be—  
 (a) Sanding (c) Spinning  
 (b) Filing (d) Turning



6. He is repairing the—  
 (a) Flashing (c) Thimble  
 (b) Culvert (d) Flue

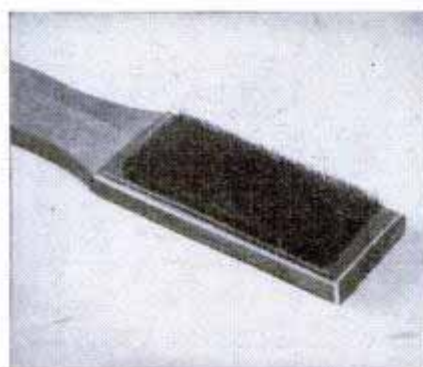

7. This gadget goes with—  
 (a) Files (c) Metal cleaning  
 (b) Lathe (d) Soldering



8. This house roof is—  
 (a)  $\frac{1}{2}$  pitch (c)  $\frac{1}{4}$  pitch  
 (b)  $\frac{1}{3}$  pitch (d)  $\frac{3}{4}$  pitch



9. Copper silhouette cutout is—  
 (a) 2 diopters (c) 3 ohms  
 (b) 22 gauge (d) 15 mils

**ANSWERS:** 1—a; 2—d; 3—b (however, not in general use until about 1850); 4—b; 5—b (spiral turning is cut by hand filing); 6—a; 7—a (file card, for cleaning); 8—b (vertical height or "rise" is  $\frac{1}{3}$  the horizontal distance between eaves); 9—b; 10—a; 11—c



10. This style chair looks best in—  
 (a) Maple (c) Whitewood  
 (b) Walnut (d) Fir

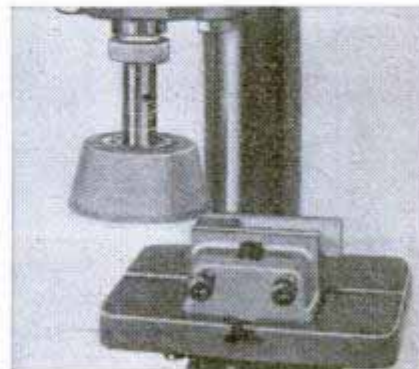

11. Shape of grinding wheel is—  
 (a) Saucer (c) Cup  
 (b) Dish (d) Straight



## Roller Arrangement for Bench Rig Makes Sawing Long Boards Easy

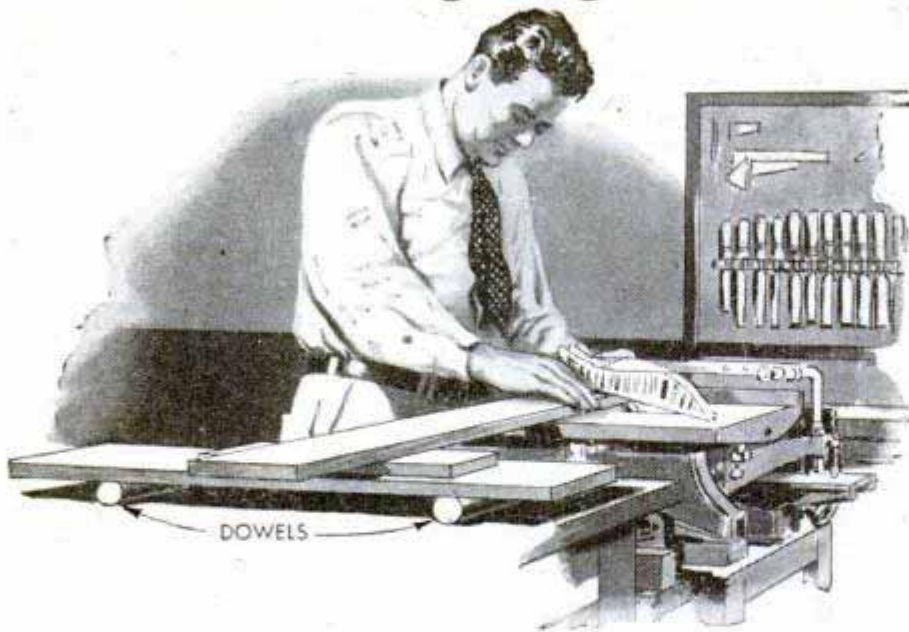

Users of bench saws often find it difficult to cut long boards because the ends project over the saw table and are hard to handle. If two or three large dowels or rollers and some supporting boards are used as a carriage, the job is easy and the cut will be clean. The supporting board, or boards, should be several feet long, and the rollers large enough to make up the difference in height between the workbench and the saw table. Dowels, short pieces of pipe or tin cans are used as rollers.—James V. Oldham, Park Ridge, Ill.

## Ornament Bases Cut Quickly

Bases for ornaments such as flag stands and candlesticks can be produced in quantity by the method outlined: Select a suitable piece of stock and drill pilot holes for the centers; then cut the outlines of the bases with a fly cutter. Finally, plane and sand the four sides and saw the bases from the stock, as indicated.—Thomas G. Sutherland, Chicago.

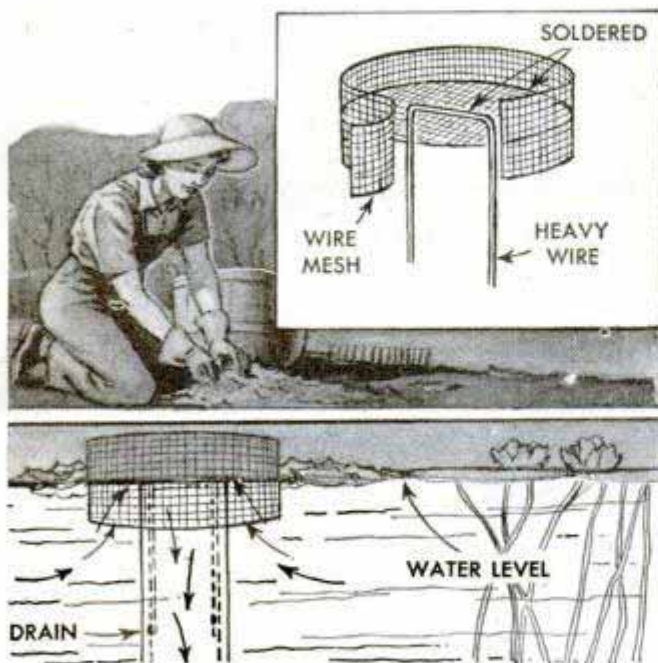
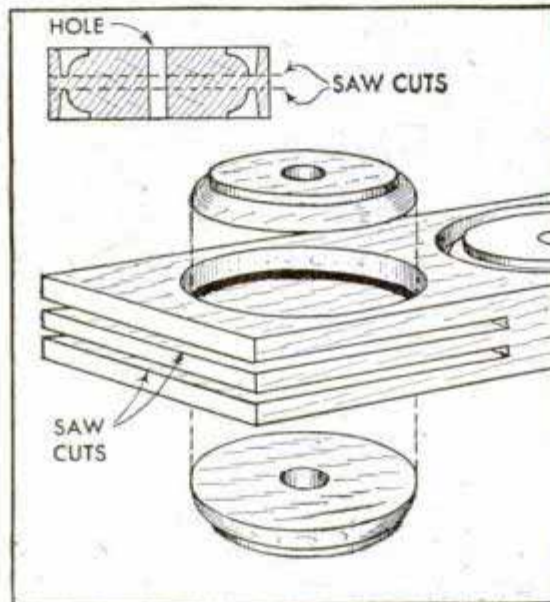

## Wire-Mesh Baffle Keeps Leaves From Clogging Pool Drain

Leaves and other debris floating on a garden pool soon collect around the overflow outlet and prevent the water from draining. The wire-mesh baffle shown here will prevent this. Cut a circular piece about 2 in. larger than the outlet and solder a 3-in. strip around the edge, as indicated. Then bend a length of heavy wire in a U-shape and solder this to the underside of the baffle. The projecting lengths of wire should be a snug fit inside the drain and extend downward for some distance.

Edward H. Stutz, Cleveland, Ohio.

☐ A round oatmeal container covered with attractive wallpaper will provide a serviceable hat stand that will add to the appearance of your closet.



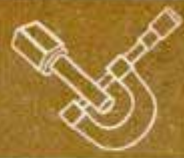

## 12-inch DISK SANDER has tilting table

By Paul F. Sass, Jr.

**S**QUARING UP small, rough-sawed parts, smoothing end grain and finishing the edges on plywood—these are quick, easy jobs for a disk sander, and at the same time are among the most difficult and tedious to do by hand. Exclusive of the motor, which can be  $\frac{1}{4}$  to  $\frac{1}{2}$ -hp., 1725-r.p.m. capacity, the sander is made from odds and ends that are found around most workshops, and only hand tools are needed for its construction.

Dimensions for the motor-mounting block are omitted because they will vary with the motor that is used. As far as height is concerned, the center line of the motor should be 1 in. above the tilt-table top, or  $6\frac{1}{2}$  in. above the base, and, lengthwise of course, it centers on the base. Bolt the motor to the block and countersink holes for the nuts and washers, Fig. 1. The base is slotted to provide for adjustment of the motor, and these slots are countersunk also, Fig. 3, so the block mounting nuts and washers can be recessed. Make the slots a little wider than the diameter of the bolts to provide adjustment sideways. The table and tilt top are screwed to a pipe-and-flange pedestal that is  $3\frac{1}{2}$  in. from the end of the base opposite the motor. Dimensions for

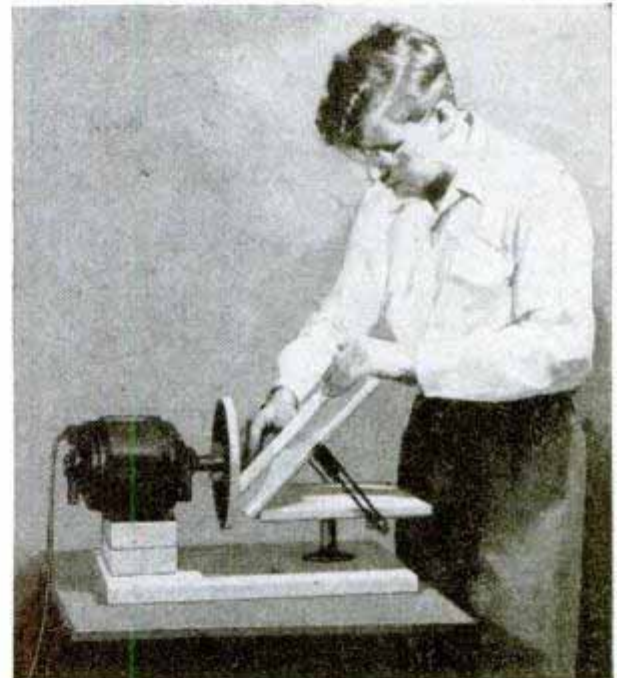
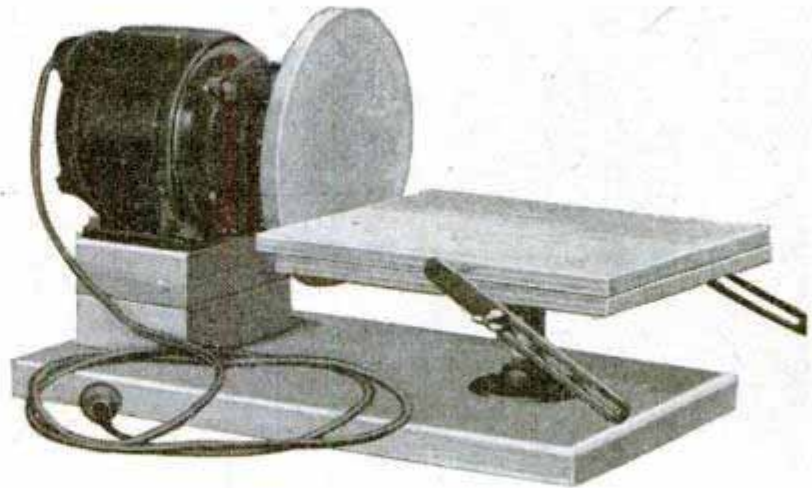

Sanding surfaces at any desired angle is not difficult because the tilting table is adjustable

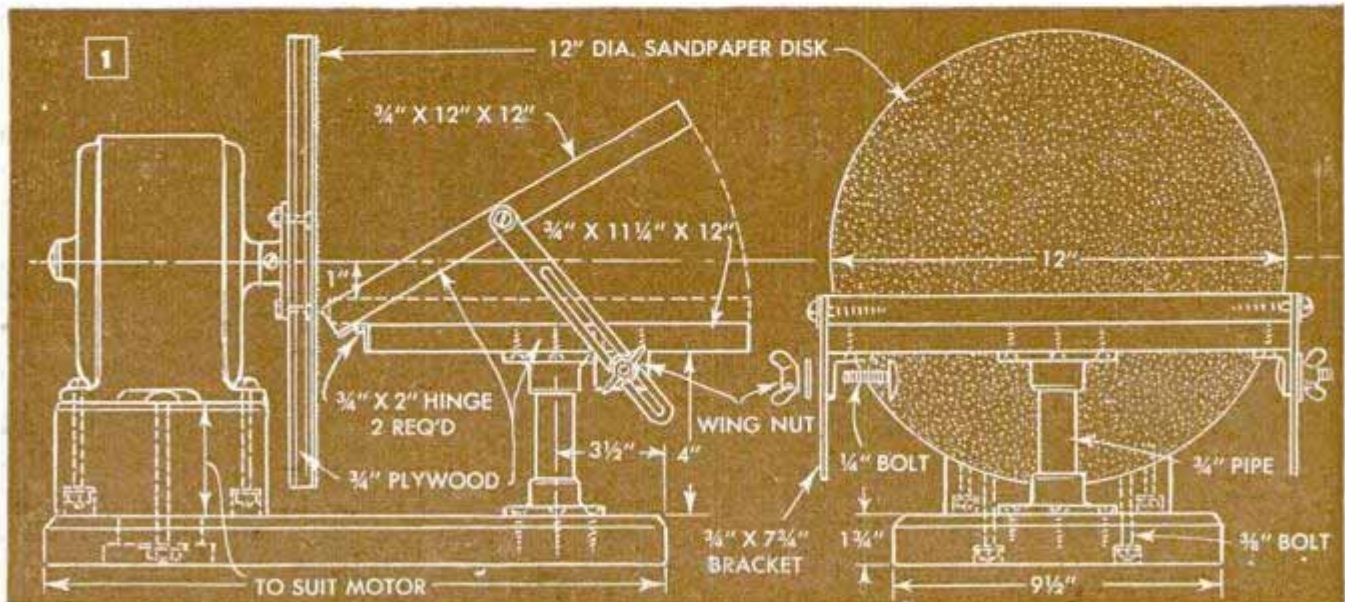



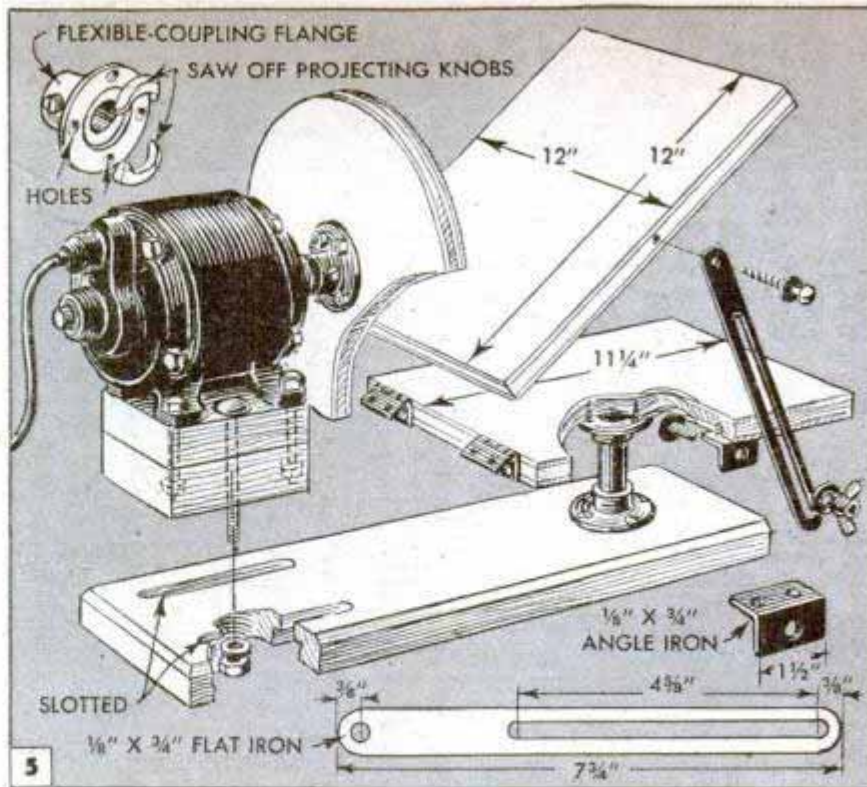
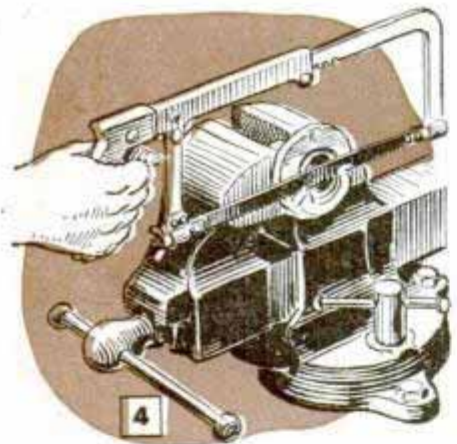
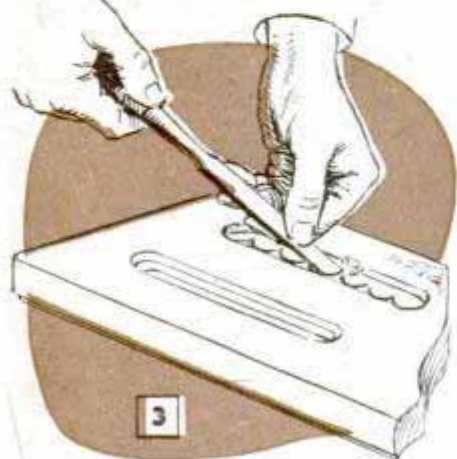
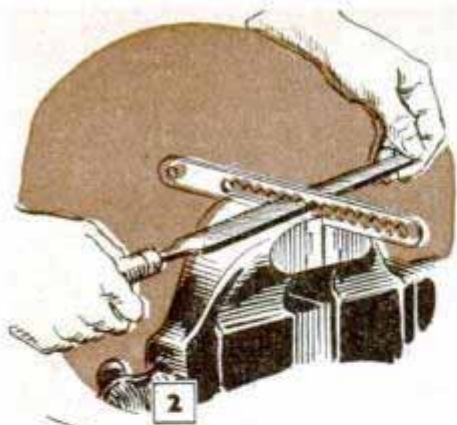

the table and tilt top, which are  $\frac{3}{4}$ -in. plywood, are given in Fig. 5, as are the details of the adjusting brackets. The slots for the brackets are drilled and filed as indicated in Fig. 2. Two butt hinges are used to secure the tilt top to the table, allowing the former to overlap the latter as shown in the left-hand detail of Fig. 1. A flexible-coupling flange is used as a mounting for the sanding disk. The face is cut off flush with a hacksaw, Fig. 4; or, to insure a disk that will run true, it can be faced in a lathe if the latter is available. To complete the sander, cut a  $\frac{3}{4}$ -in. plywood disk 12 in. in diameter and bolt it to the flange with flat-head screws, countersinking the holes so the heads will be a little below the surface of the disk. Glue on the sandpaper and finish the unit with gray or black paint. For convenience in operation, a toggle switch can be mounted on the base or block to control the operation of the motor instead of using a switch in the line or on the wall.

## Angle Iron on Ends of Scaffold Will Keep It From Slipping

Safety for those who work on scaffolds is increased by screwing angle irons to the ends so the scaffold cannot slip off the supporting members. One leg of the angle should be flush with the end of the scaffold. If the scaffold is of the expanding type, the iron should be attached to the stationary pieces only.

## Ridding Granary of Rats and Mice

When killing rats and mice in a granary, a "club," made by nailing a 24-in. length of garden hose to a short wooden stick, will come in handy. The stick serves as a handle. With this device you can get into difficult corners not accessible with a heavy stick, and, when a blow is struck, the club doesn't "sting" your hands.

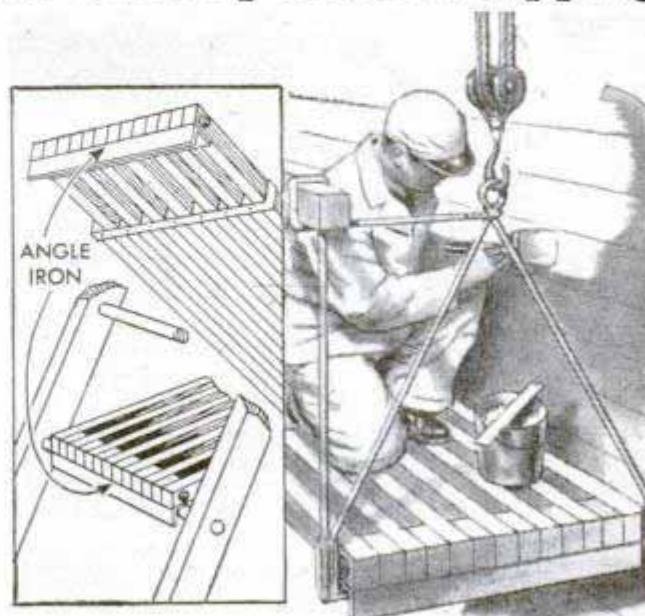



# Cam-Shaped Clamp Holds Work of Varied Size

Necessity being the mother of invention, one craftsman devised this clamp to glue wooden letters on a book when he had no suitable clamping device on hand that would cover a large enough area. The dimensions given in the lower detail need not be followed necessarily, but they represent an average size for this particular kind of work. The upper left-hand photograph shows the book being placed in the clamp with a board over the letters to equalize the pressure. Because the lever is cam shaped, work of varying thickness can be clamped in short order, the amount of pressure being regulated by the turnbuckle. Hardwood was used throughout in the construction of the clamp.

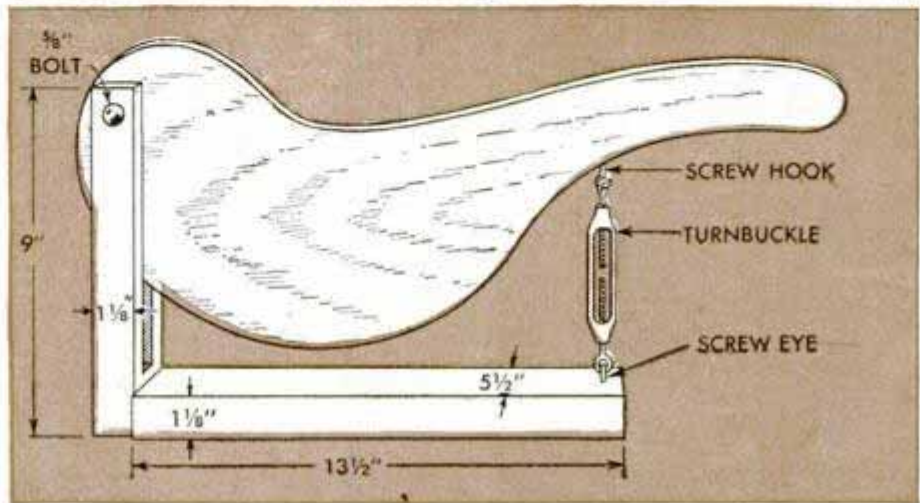
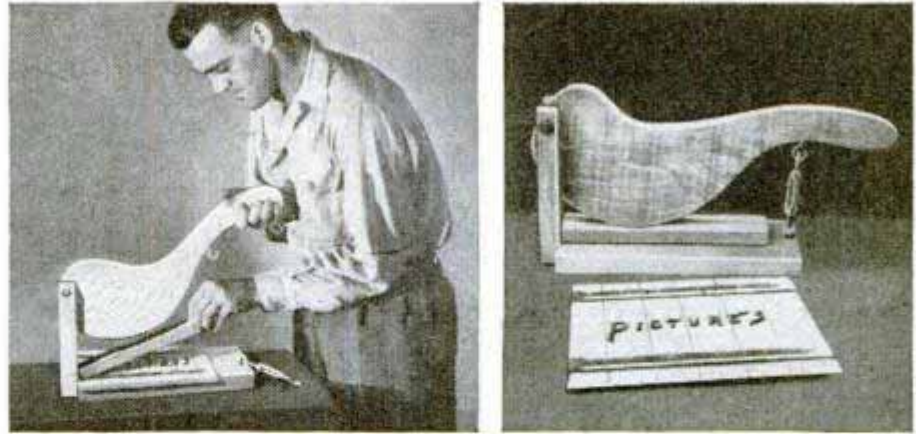

## Calibrating Marks for Ruling Pen

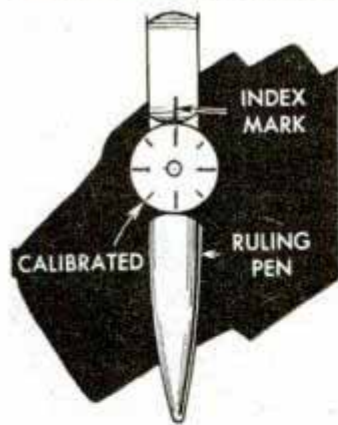

If calibrating marks and an index mark are made on a ruling pen, it's easy to set it and duplicate the width of lines previously drawn. The nut is divided into eighths and an indexing mark is made on the pen above the nut.

## How to Replace Oil-Pan Gaskets

When replacing an oil-pan gasket on your car, instead of shellacking it to the pan use string to hold it in place. It's only necessary to tie it through every other hole. When the pan is pulled up, the string sets into the gasket. Secured in this manner, it will be easier to remove the gasket for replacement.

W. V. Atharas, Ashland, Ore.

❏ Never put the ivory handles of knives or forks into hot water as it causes them to crack and discolor. Instead, hold the handles while washing the blades or prongs.

## Park Bench Has Reversible Back And Faces in Two Directions

Taking a tip from the manufacturers of railway coach seats which have reversible backs, one carpenter applied the same principle when making park benches. The back is pivoted to the legs and the users can face in one of two directions merely by changing the position of the back. Occupants of the benches can always enjoy the sun in clear weather.

Paul Hadley, Philadelphia, Pa.





## Strips of Cardboard Cut Quickly With Knife-Edge Disk

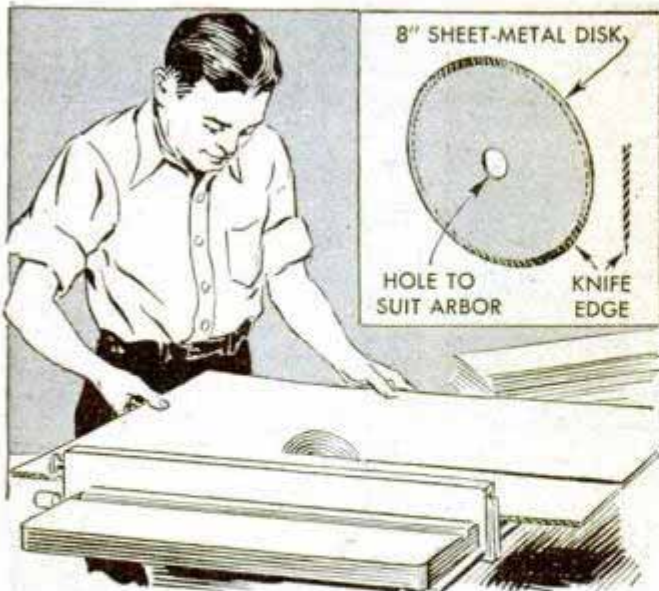

Where strips of corrugated cardboard were used to pack glassware in a manufacturing plant, difficulty was encountered because the cardboard was too thick to cut with a knife and sawing left rough edges. The solution was accomplished by making a disk of metal about as thick as stovepipe and sharpening it to a knife edge. When mounted on a saw, the disk cut the cardboard with ease.—Everett Goddard, Sidney, Vancouver Island, B.C., Can.

## Preventing Tape From Unrolling



In a shipping department where gummed tape is used to seal packages, it was found that without a holder the tape unrolled and was difficult to use. One clerk overcame this trouble by coating both sides of the roll with rubber cement. Not only does this prevent the tape from unrolling, but also seals the sides against moisture.—Kenneth Murray, Colon, Mich.

## Color Bands Identify Oil Bottles



By painting the spouts of oil bottles with different colors and numbers of bands, one filling station is able to identify any grade or viscosity at a glance. This saves consid-

erable time and means that the customer can be served quicker. The bottles are filled during off periods when the attendant is not busy with customers.

Opie Read, Jr., Chicago.

## Sickle Blade Makes Twine Cutter

With an old sickle section and a scrap piece of hardwood, a safe and efficient twine cutter can be made in short order. The wood is cut square and the four corners are trimmed. Then a slot ending in a drilled hole is made. Mount the cutter so that one of the cutting edges partially covers the hole in the block. When the section becomes dull, it can be reversed. Fasten the unit to a post or at any other convenient place.

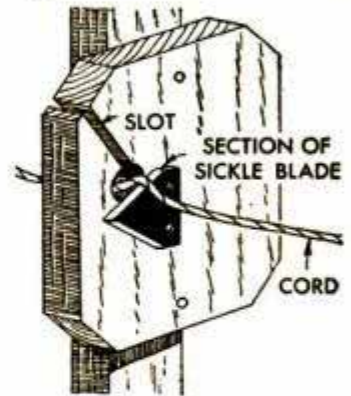

## Metal Trough for Welding Flux Saves Time on the Job

When using rods that are dipped in flux, a welder can save much time if the flux is poured into a trough so that more of the rod can be covered at a time. The trough, which is about 1 ft. long, is made of angle iron with one end closed and the other supported by a shorter angle. Be sure to pour the flux back into the can and seal it after finishing a job.

Andrew Vena, Philadelphia, Pa.

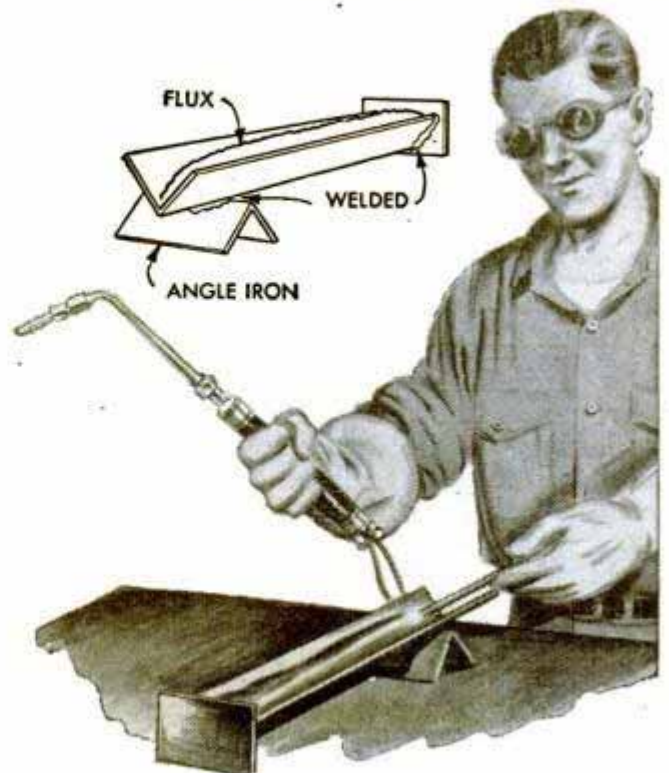



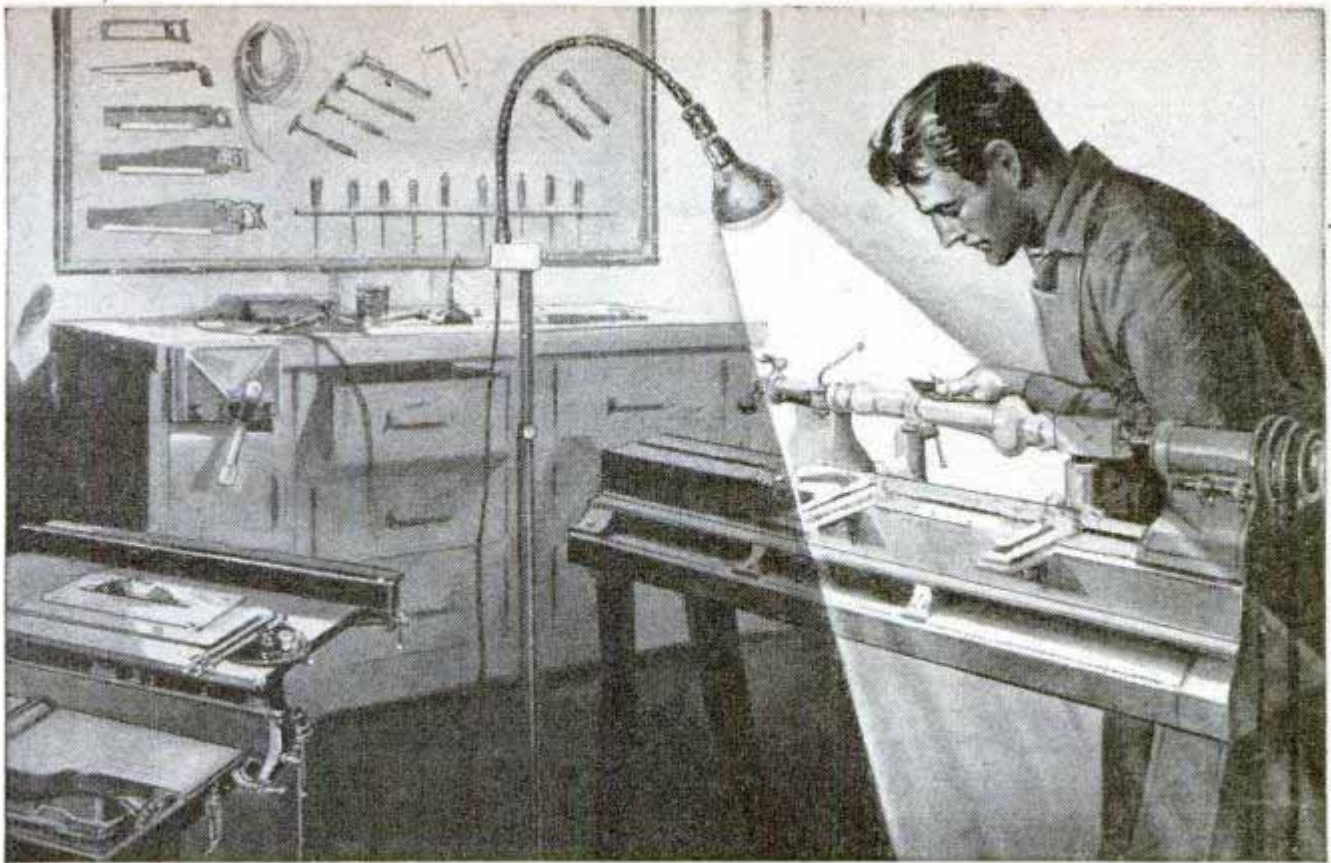

## SHOP "FLOOR LAMPS" By A. Maxwell

ALTHOUGH the human eye is adaptable to varying light conditions, it's better to provide a good source of illumination when working in a shop or around machinery where accuracy and precision are essential. The two shop floor lamps described here are designed to give the kind of light that will avoid eyestrain and to direct it where needed. In addition, by using special bulbs now on the market, the lamp shown in Fig. 1 will do multiple duty by serving as a source of infrared, ultraviolet and photographic light. The baby spotlight, Fig. 2, also performs well in the photographic studio.

Of the two lamps, the one with the gooseneck adjustment is easier to make because it requires fewer parts, and in some respects it is more versatile, due to the fact that many different types of bulbs can be used with it. The base should be heavy and compact. The cast-iron standard or base taken from an old floor lamp will serve—the heavier the better. Probably it will be necessary to bore and tap the hole in the base to fit the threads on the  $\frac{1}{2}$ -in. pipe that serves as the lower half of the upright. The upper half, which serves as the sliding member, is a length of  $\frac{3}{16}$ -in. rod approximately 36 in. long, as is the pipe. The diameters of these two pieces do not have to be held exactly, but they should be sufficiently rigid and not fit together too loosely. Drill and tap the pipe for the thumbscrew that adjusts the height of the lamp.

A metal block that serves as a swiveling member for the gooseneck fits on top of the rod and is locked in position with a headless setscrew. First, machine the outside dimensions and then drill and

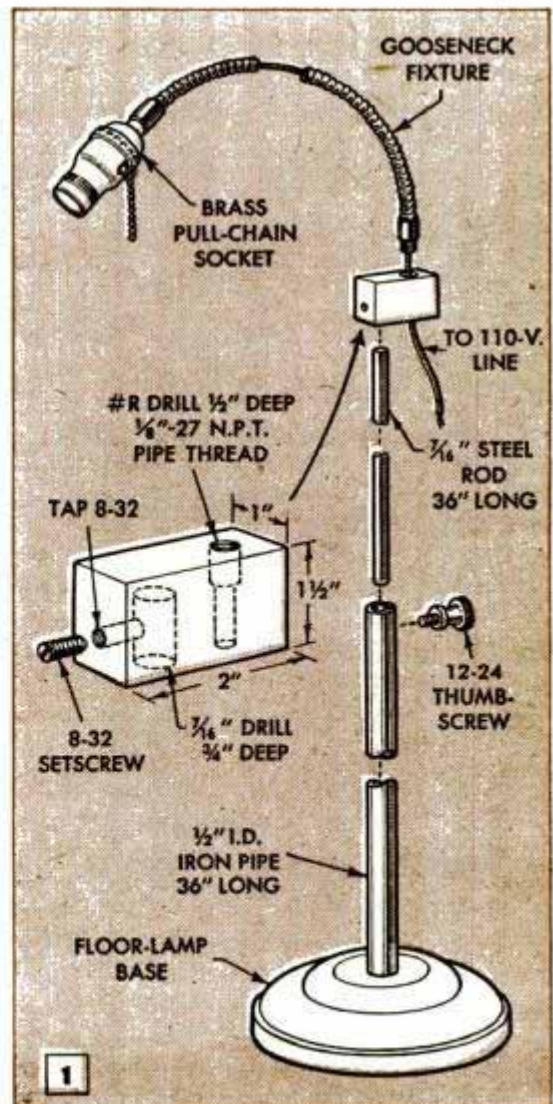



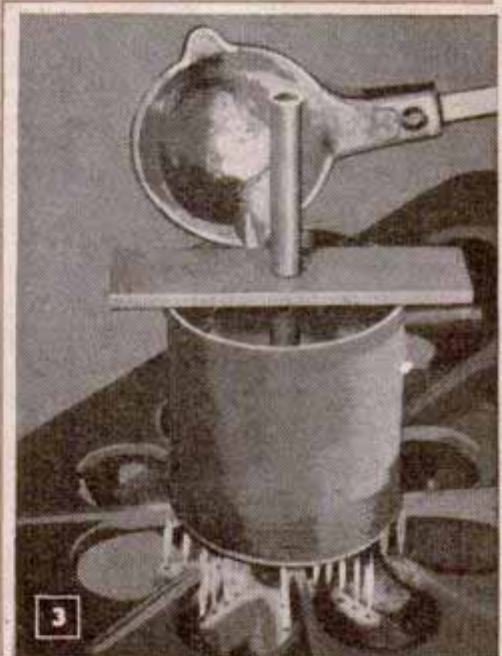
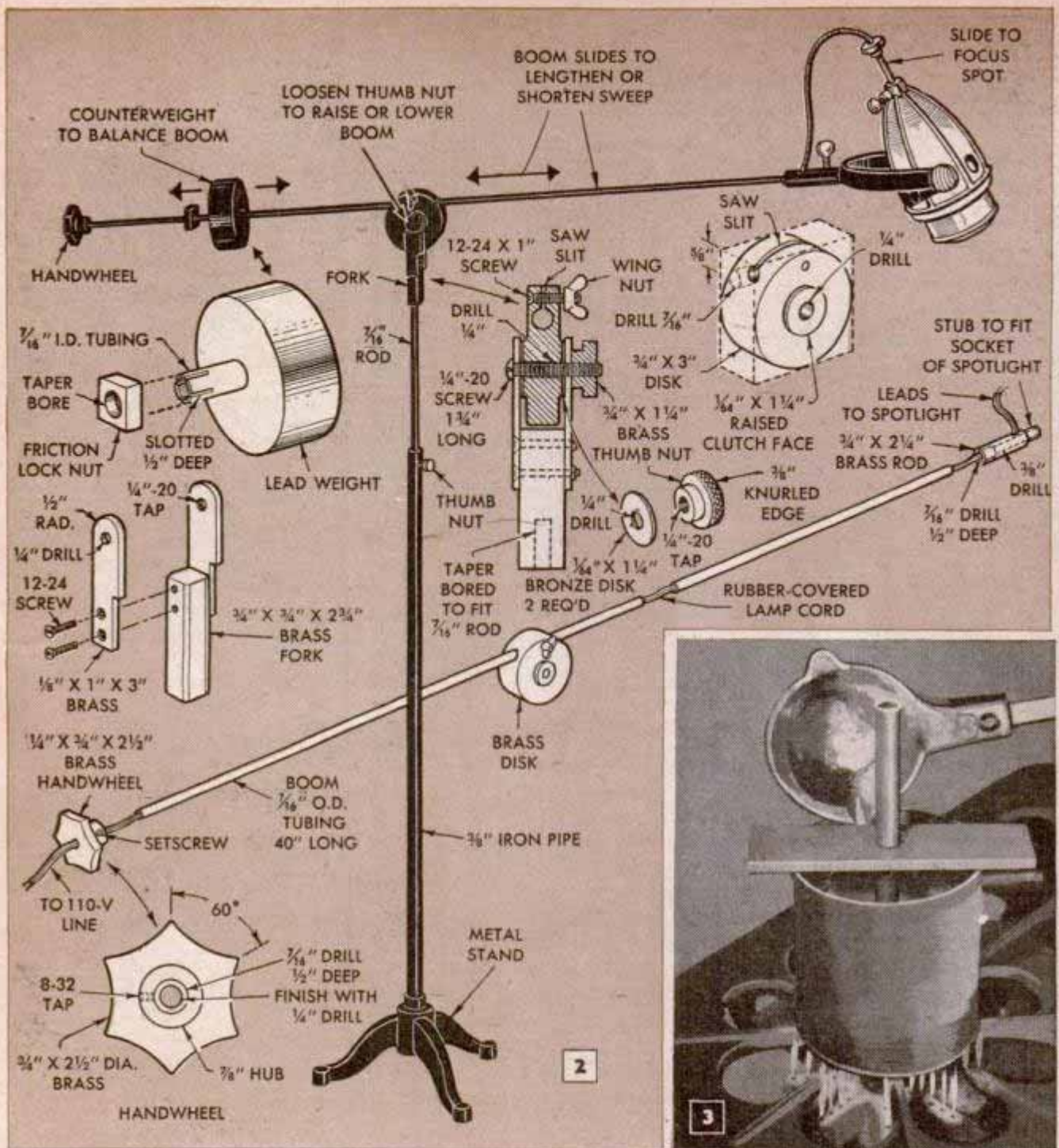

tap the holes as indicated in the center left-hand detail of Fig. 1. The tolerance between the rod and the block should be small so that any vibration transmitted from machinery will not affect the lamp. When selecting a gooseneck fixture for the lamp, be sure to get one that is long enough to provide the range of adjustment that you want. It should be possible to set the lamp near a machine and direct the light almost on the work. A brass pull-chain socket is used because it's easy to reach the chain when turning the light on and off. However, any type of socket that has a built-in switch will serve equally well. No reflector is needed for this lamp since the bulbs that are used have an inside coating that serves this purpose. For ordinary service in the shop, a 200-watt flood or spotlight, as com-

monly used for photographic work, will fulfill most requirements. For specialized purposes, such as drying paint in a hurry, an infrared bulb is used. And, of course, with an ultraviolet light in the socket, you have a health-giving sun lamp.

The second lamp, the focusing baby spot, Fig. 4, has a smooth, universal manipulation that is obtained by careful workmanship and fitting of each part. It has a large range of adjustment and is especially handy for reaching hard-to-get-at places where the lamp must be set at some distance from the work. Also, the focusing feature makes it possible to cover a wide area or to concentrate the light in one spot, whichever is required. The effectiveness of the lamp is indicated by Figs. 5 and 6. In Fig. 5 the mechanic is outside the beam of



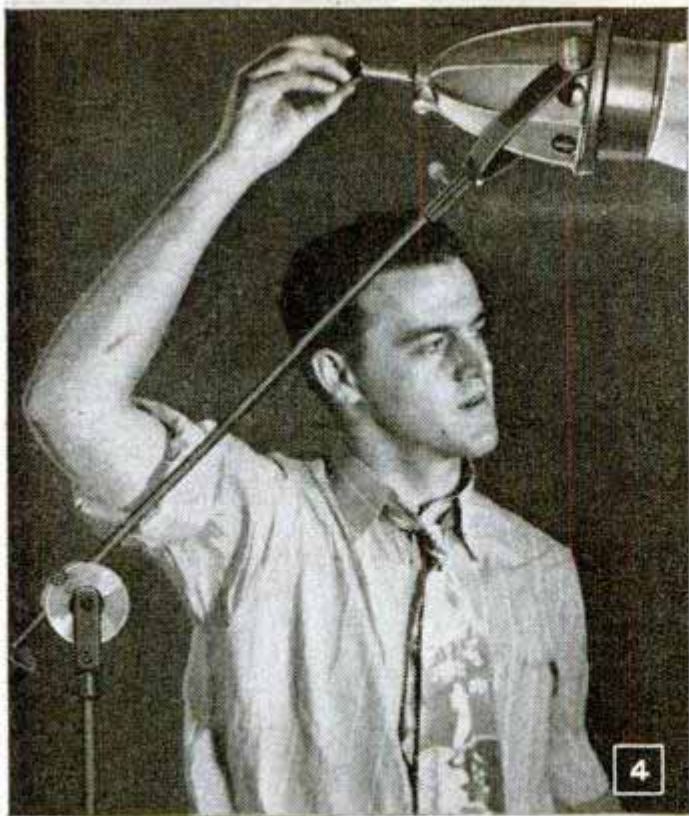

light, which spreads an even illumination over the motor, while in Fig. 6 an ordinary bulb is suspended from the hood, directing its light into the mechanic's eyes as well as on the work.

The spotlight and mounting fork are purchased as an integral unit and, if obtainable, should be made of aluminum because of its light weight. The lighter the holder, the smaller the counterweight and the greater the ease with which the lamp can be manipulated. A heavier stand is needed than that shown in Fig. 1, and the three-legged type illustrated in Fig. 2 is recommended. Construction of the two upright members is similar to that given for the first lamp and they can be made of materials at hand if sufficiently sturdy. The boom is made of  $\frac{7}{16}$ -in. outside dia. tubing instead of rod and is about 40 in. long.

With the exception of the counterweight, the remaining parts, which control the adjustments, can be turned in a lathe. The counterweight is made of lead and should weigh about one third more than the spot. Casting it requires the use of a tin can in which the guide sleeve,  $\frac{7}{16}$ -in. inside dia. tubing, is carefully centered. To prepare the tin can for pouring, bore a press-fit hole in the bottom and steady the sleeve with a wooden brace, Fig. 3. Unless you have a large ladle, it will be necessary to pour the metal in batches. To prevent chilling between pourings, set the can over a low flame but be careful not to melt the bottom. After the lead has set, remove as much of the can as is possible with tin snips; mount the weight in a lathe and true it up. Then shorten and slot the sleeve,



fitting it with a friction lock nut as indicated in the upper left-hand detail, Fig. 2. The fork and disk that serve as the pivoting member for the boom are dimensioned in the upper right-hand and center left-hand details. Construction of the handwheel is shown in the lower left-hand detail. The spotlight may come equipped with a fork that will not fit the boom, and in this case it will be necessary to add a brass-rod bushing, as shown in the lower boom detail. When assembling the unit, run the light cord from the spot through the boom tubing and out the handwheel.



## Marker Placed on Rubber Tube Aids in Siphoning Gas From Tank

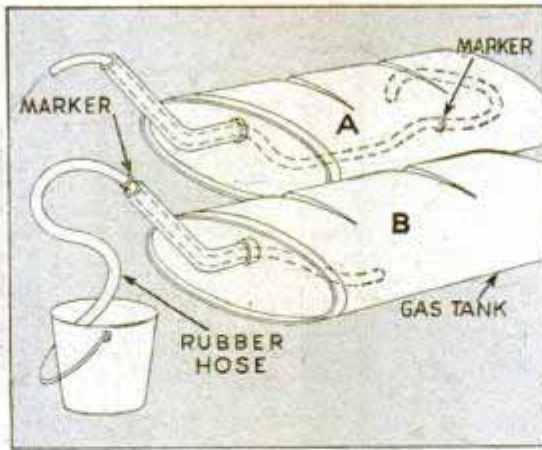

Simple and quick, this method of siphoning gasoline requires only a length of rubber hose or tube. Mark the tube to indicate how far it can be withdrawn and still allow the end in the tank to be near the bottom. To use, insert the tubing, detail A; then close the open end with the thumb and withdraw until the marker shows. Hold the hose as indicated in detail B and let the gas flow into a container.

## Hold-Down Spring for Disk Cutter Retains Waste Stock

Because a drill-press disk cutter has to run at relatively high speeds to produce a smooth cut, there is a tendency for the disk to spring up, and in some cases, damage the point of the cutter bit. To avoid this trouble, slip a length of coil spring over a pilot drill so that it is held between the chuck and the work. The spring should be a fairly stiff one and about as long as your drill to provide the proper tension and hold the disk against the drill-press table.—Albert M. Lindner, Jr., Cold Spring, N. Y.

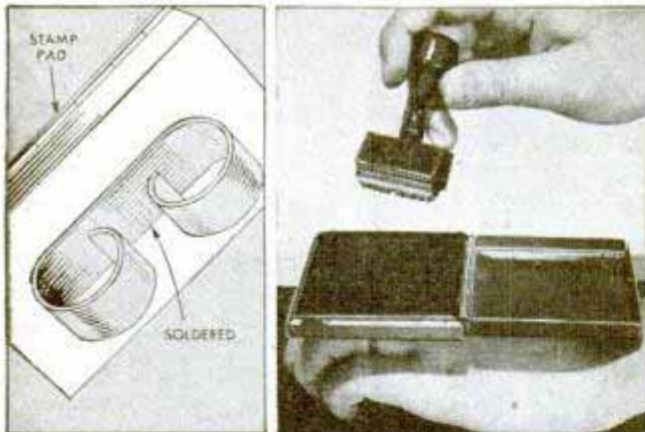
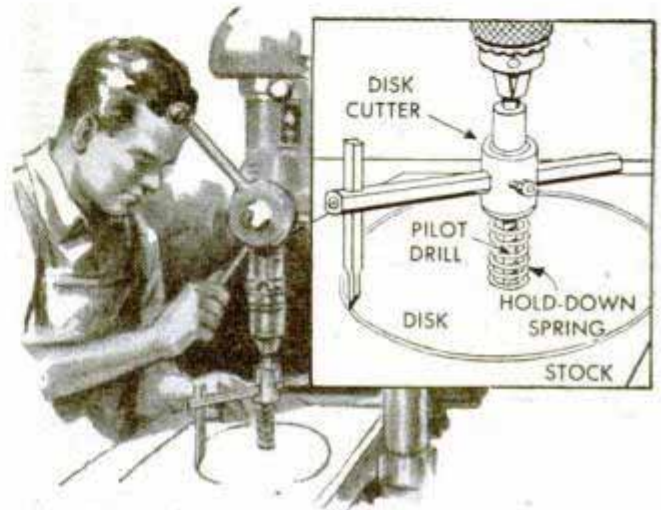

## Strip of Metal Soldered to Pad Provides Finger Holes

Inspectors on assembly lines often have to carry a stamp pad and rubber stamp to mark finished products. To make it easy to carry the pad, one inspector soldered a metal band to the underside of the pad and bent the ends to form finger holes. Thus the pad could be slipped over two fingers and be ready for use. This is handy when stamping products where size of the item requires the inspector to move about.

## Striping Around Cleaner Cord Warns Apartment Tenants

When the hallways in apartment buildings are not too well lighted, it's easy for tenants of the building to trip over the vacuum-cleaner cord when the janitor is cleaning the hall or stairs. To prevent such accidents, cut a number of short lengths of hose or tubing that will fit snugly over the cord and paint spiral stripes on them. The pieces of tubing should not be more than 3 ft. apart on the cord.

☞ Rubber bands wrapped around the handle of a bath brush will assure a firm grip.

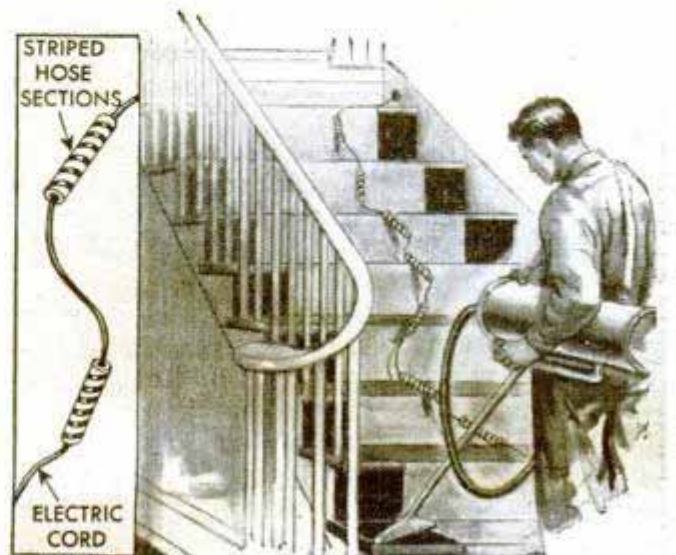



# Eggs Cleaned Quickly by Motor-Driven Buffer

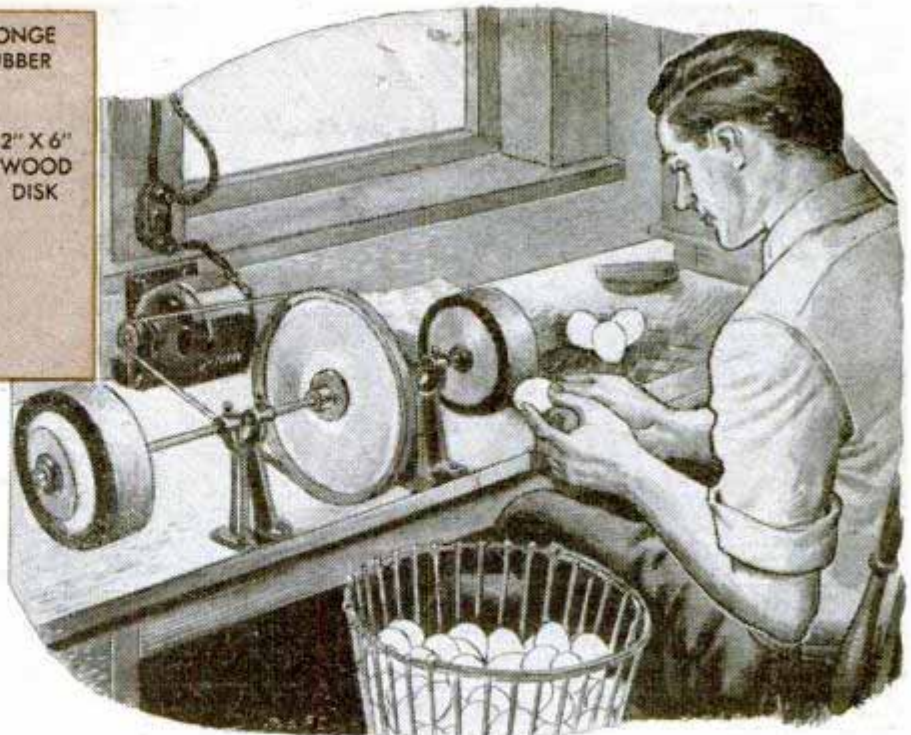
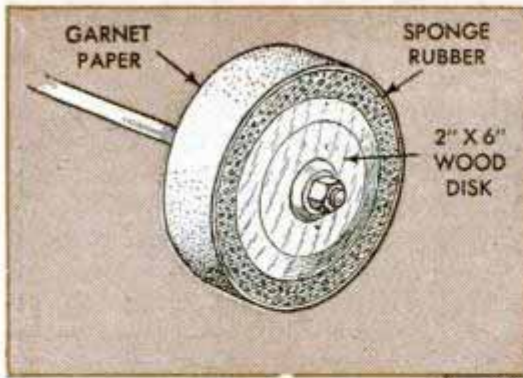

Time consumed in cleaning eggs on a poultry farm can be halved through the use of this motor-driven buffer. It's provided with two wheels so that several persons can clean eggs at the same time. Construction of the wheels is shown in the upper left-hand detail. A 2 by 6-in. hardwood disk is used for the center with a fairly thick strip of sponge rubber wrapped and glued around it. Then garnet paper is glued to the rubber to provide an abrasive surface. The wheels are overhung on a common shaft supported by

two pedestals and bearings that have the driven pulley mounted between them. The motor can be bolted to the wall or bench, depending upon the space that is available. To clean eggs quickly and give them a fine sheen, run the wheels at about 250 r.p.m.

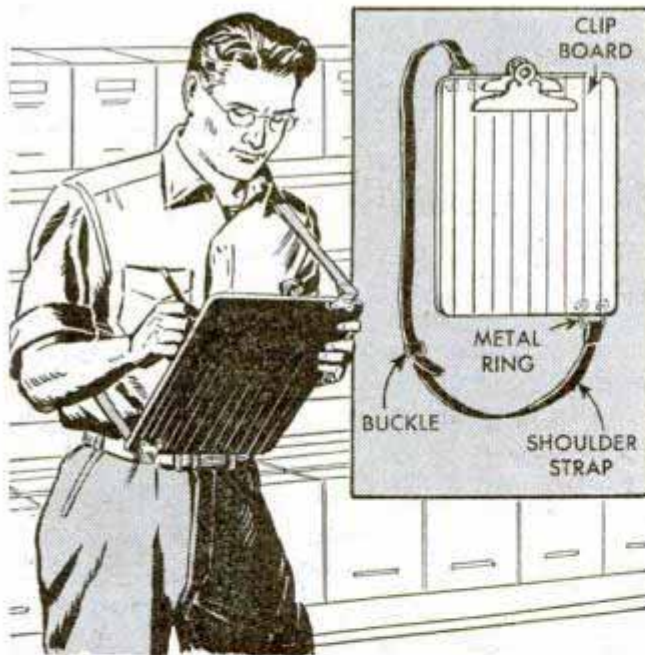

## Clip Board Has Shoulder Strap For Ease in Carrying

Clerks and others who have to keep papers on a clip board when working around the shop or office will find that a shoulder strap for carrying the board eases the work considerably. The strap is attached to the top and bottom corners, diagonally, with metal rings. A buckle provides adjustment.

## Adding-Machine Tape Held Erect With Sheet-Metal Guide

Fashioned from a strip of light sheet metal, this guide will hold an adding-machine tape upright so a whole column of figures is visible. Two channels guide the tape, which is fed from the bottom. The two feet holding the guide are fastened to the machine with self-tapping screws. When necessary, the guide can be removed.





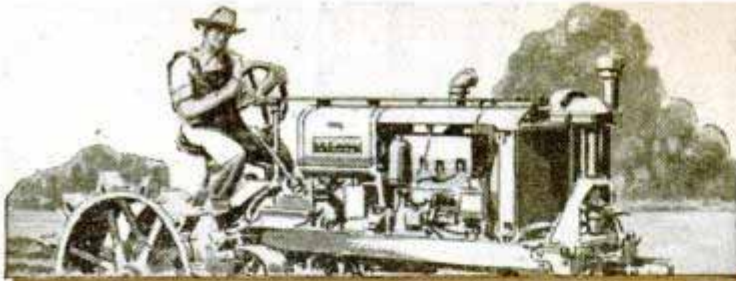

## Spring-Reinforced Seat Offers Smooth Ride

To make his tractor smoother riding, one farmer removed a part of the spring-leaf support for the seat and reinforced it with a discarded auto spring to provide a "knee-action" ride. This was done by replacing leaf B, top detail, with a steel bar, bottom detail. The latter served as a support for the spring which is held between it and leaf A. A bolt is fastened to the seat and passes through the spring and bar, being held in place with locked nuts. Although the details of this arrangement are for one particular make of tractor, it could be adapted to most makes by modifying the support for the spring.—Carl W. Willman, Jr., Moberly, Mo.

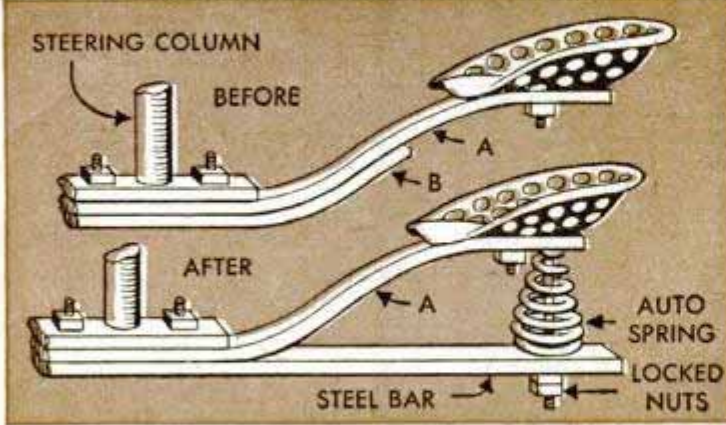

## Wire Cutter Attached to Pitchfork Simplifies Barnyard Chores

One of the most used tools on a farm or ranch, the pitchfork is generally at hand, but wire cutters to open a bale of hay or straw are often hard to locate. Many steps and much time can be saved if a cutter is attached to the pitchfork handle. The cutter is made from an old file that has been annealed by heating to a bright red color and then allowed to cool slowly. A 3 or 4-in. section of the file is ground to form the hook and then bolted to the handle. In use, the hook is slipped under the wire and the fork is braced against the bale of hay. A sharp pull on the handle will cut the wire.



## Altered Wrench Speeds Work

Grinding the edges of open-end wrenches to a slight bevel will speed work because the wrenches will slip over the heads of bolts and nuts more quickly. The bevel must not be too wide as this would weaken the grip of the wrench.

Wm. P. Houser, Organ, N. Mex.

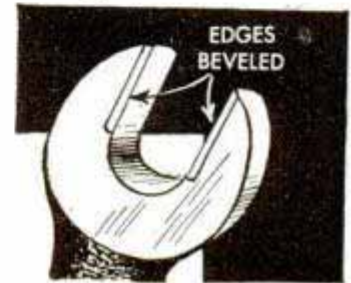

## Demountable Rim as Foot Scraper

Useful on the farm or in outlying filling stations and stores on muddy roads, this foot scraper is made from odds and ends that are easy to find. The scraper itself is a demountable automobile rim having four rods welded vertically to it to serve as legs. Discarded brake rods will serve for this purpose.

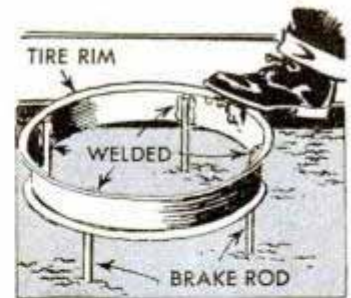

## Hints for Grinding Soft Metals

When using a sanding machine, soft metals such as aluminum can be finished well if the belt, grade 180, is filled first with chalk. The chalk prevents the belt from becoming clogged with the metal. Never press too hard if the belt does not have the proper grinding action as it may be that a new one is required.



# Six Ideas for Poultrymen



One poultryman has found that sliding doors like these give good control of sunlight and ventilation in the laying house. Doors are seldom completely closed except in stormy weather or when it is very cold

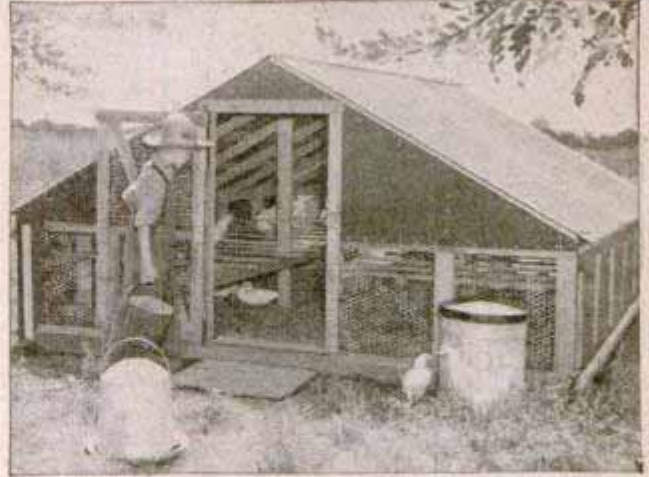

Floor of this poultry range shelter is simply a fine-mesh poultry netting. Has a center boardwalk and the gable ends and roof are covered with a waterproofed soft-pressed board nailed to a wood framework

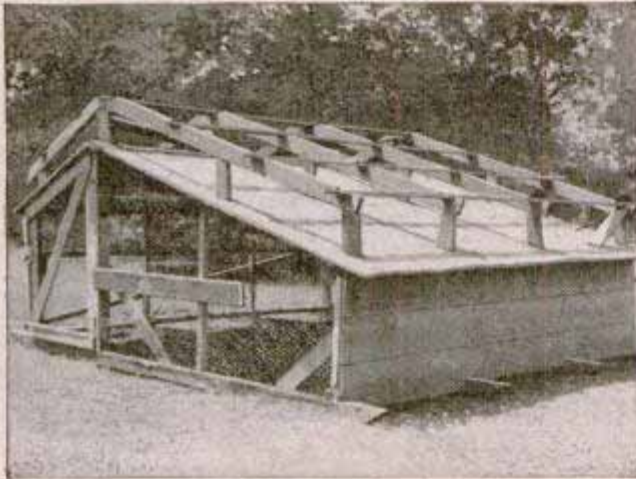

Cleanliness and portability are the features of this range roost and shelter combination for turkeys. Shelters the tender poults from stormy weather and provides an open-air roost for the birds later on

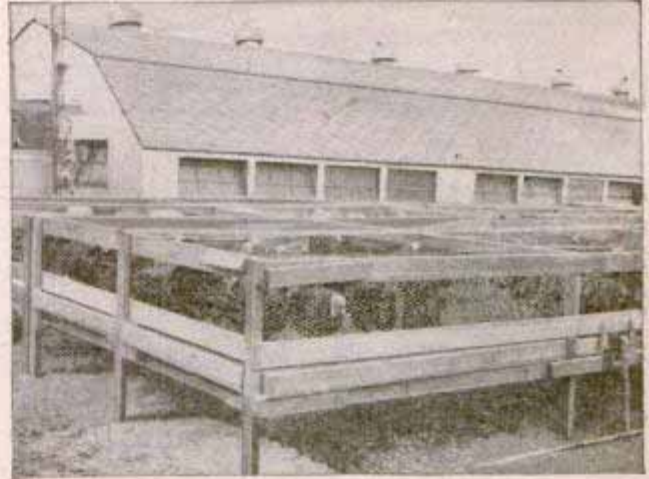

Either chicks or turkey poults can be raised to maturity in these wire-floored sun porches attached to conventional brooder houses. Detachable feed and water pans along the sides provide for easy feeding

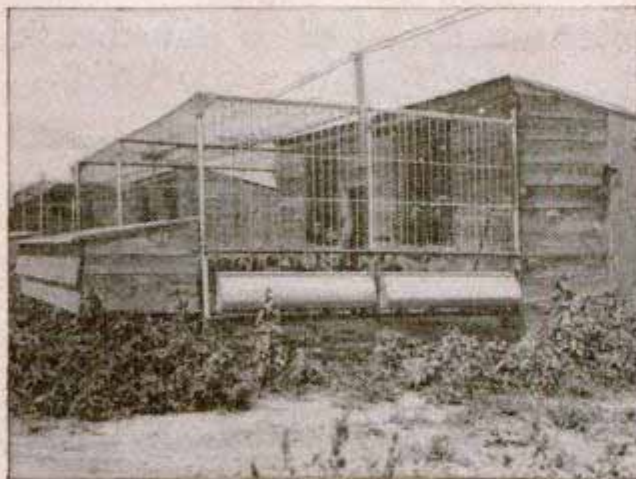

Another type of sun porch developed especially for brooding turkey hens. The shed-roofed nests are attached to the porch at the left. After hatching, the hens are removed and the young poults take over

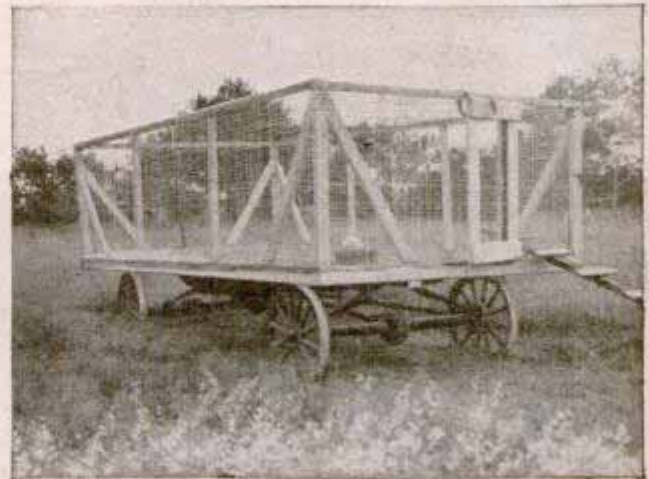

A portable wire floor and roosting pen for turkeys or chickens. Protects young birds at night when first moved to the range. Chickens are sheltered by covering one end of wire enclosure with a tarpaulin



## Bolt at Claw End of Wrecking Bar Straightens Warped Joists



Welded to the inside curve of a wrecking bar near the claw end, a section of a bolt or stud will provide a point of leverage to pry warped joists in place when repairing flooring or doing other maintenance work. The bar could be used also to force loose flooring boards in place when sprung.

## Wooden Dividers Proportion Mix Carried in Wheelbarrow

In order to save time on the job, one builder made wooden dividers that would fit into wheelbarrows and proportion the space correctly for the different kinds of concrete mixes. This is especially handy



when only small batches of concrete are to be made. A handle is attached to one of the separator boards so the divider can be removed and placed in the barrow easily.

## Roofing Compound on Bolt Heads Keeps Them From Rusting

If asphalt roofing compound is applied to the exposed heads, nuts and threads of bolts, it will keep them from rusting. This is valuable especially for farm machinery and equipment which is exposed to severe weather. The compound is applied with a brush. Such a protective coating does not require frequent renewal.



## Extinguisher Suspended by Spring Indicates When It's Empty

To make sure that fire extinguishers would not be overlooked when they were empty, one store manager conceived the idea of hanging them from the supporting hooks by means of springs.

Lines were painted on the wall to indicate the position of the full and empty containers. When full, the extinguisher is at the lower mark; when empty, at the higher one.

G. E. Hendrickson, Argyle, Wis.

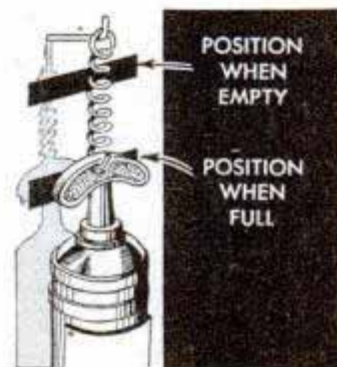

## Bristles Attached to Paintbrush Make Dual-Purpose Tool

Fasten a section from a stiff wire brush to the handle of a paintbrush, as shown in the detail. This will be handy to use when scraping scale and rust from surfaces to be painted.

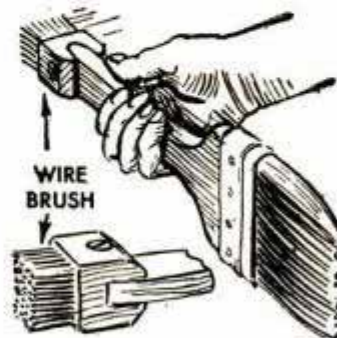

□ A small bottle that has a dropper in the cap provides a handy container in which to keep light oil for use on small motors and machines around the house.





## CRYSTAL SET BUILT INTO TOY TELEPHONE

**D**ADDY really made a hit with this youngster when he converted his plastic toy telephone into a modern crystal receiver. The set is concealed in the base of the make-believe telephone and a tiny earphone is installed inside the handset unit so that the youngster hears the pre-tuned local station when he holds the phone to his ear.

The set employs a type 1N34 Sylvania germanium crystal and a permeability-tuned coil. Any small earphone may be used; the one shown was a war surplus unit catalogued as a "hearing aid type." It has very low impedance, which made a speaker matching transformer necessary, selecting the taps that gave the loudest signal. Photos B, C and D show views of the completed receiver on the fiber base plate. The circuit diagram appears in Fig. 1. A knife is used to take the caps off the plastic handset so that the earphone can be mounted. Wires run to the earphone through the hollow body of the handset; holes are made through the body spacers with a heated copper wire. The earphone is spaced from the plastic cap by means of a cardboard washer cemented to the cap with china cement; this washer must clear the diaphragm. Cement is used to replace caps on the handset; when completed, set is connected to antenna and ground.

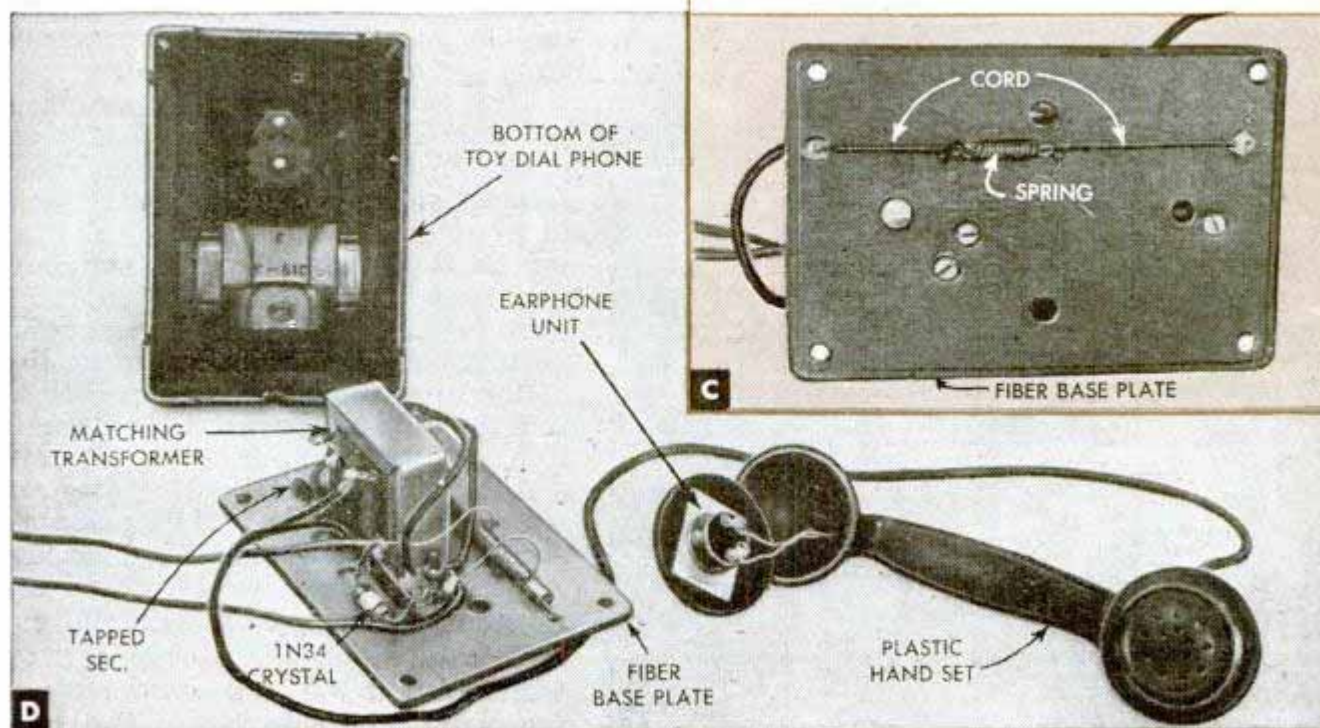
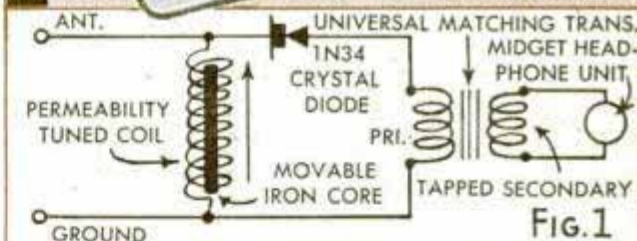
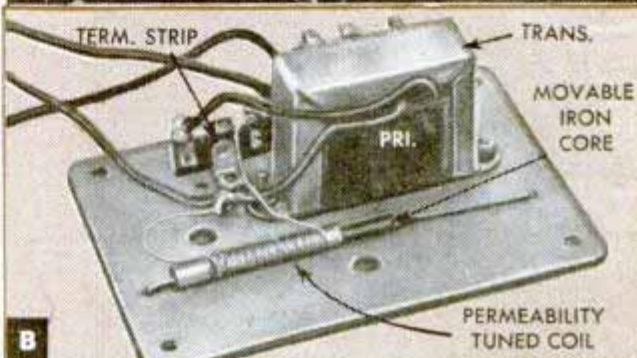



# "Wireless" Record Player Transmits

By Arthur I. Rattray

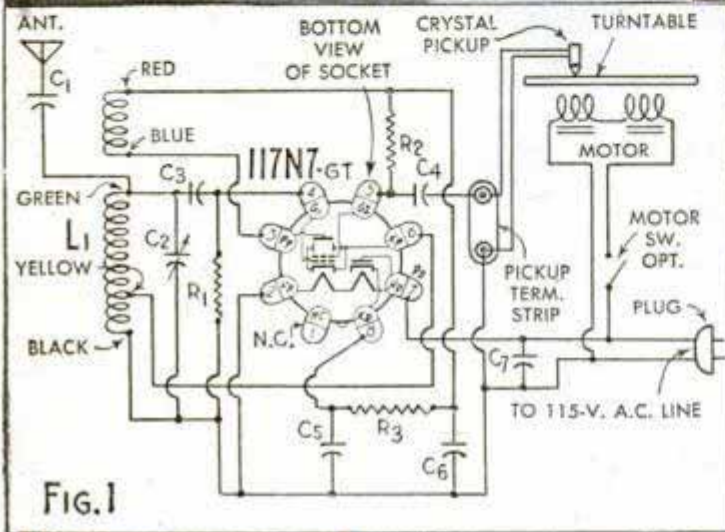
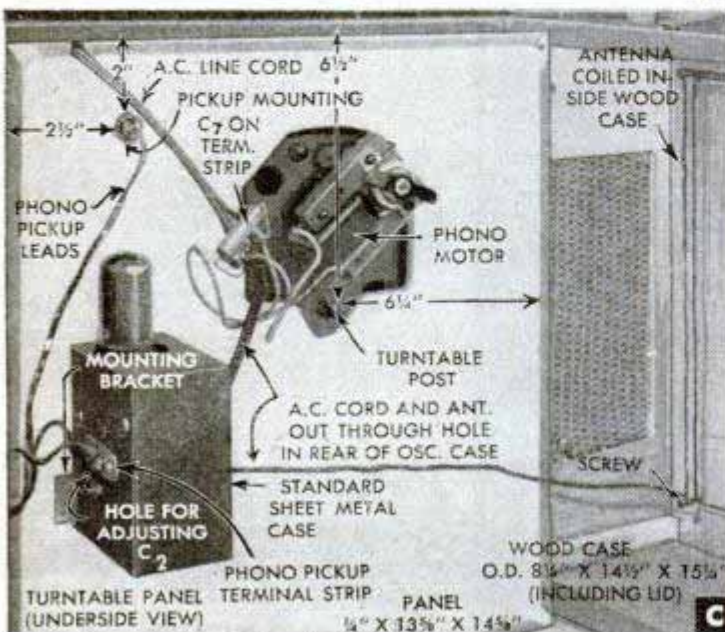
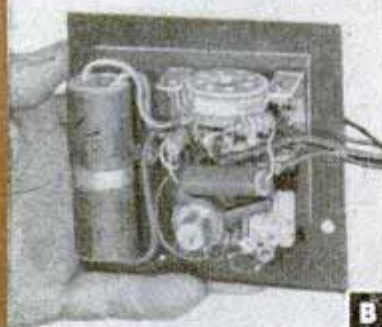

FIG. 1

- L1—Unshielded adjustable oscillator coil (adjustable from 175 to 520 kilocycles)
- R1—47,000-ohm 1/2-watt carbon resistor
- R2—390,000-ohm 1/2-watt carbon resistor
- R3—10,000-ohm 1/2-watt carbon resistor



ONLY one tube is used in this portable "mystery" record player which supplies sufficient modulated power to play records through radio receivers at full volume in other rooms in the home without wired connections. The circuit design of the phono-oscillator is a combination Hartley oscillator with additional feed-back being provided by the plate circuit. This oscillator is modulated by applying the output of the phono-graph pickup to the screen grid of the type 117N7-GT tube. One section of this dual-purpose tube is a diode and the other a pentode. The diode section is used for rectification and the pentode section is employed for the R.F. power oscillator circuit.

Housed in a small standard metal case 4 in. square and 2 in. deep, this tiny phono-oscillator is fastened to the underside of the turntable panel board near the edge by means of small angle brackets as indicated in photo C. The frequency of the oscillator is variable between 1350 to 1700 kilocycles by means of the screwdriver adjustment illustrated in photo A. Holes are drilled in the wood carrying case and the small metal case so that the screwdriver may be inserted in the adjusting screw of the 36-mmfd. ceramic-type trimmer condenser C2. This enables the operator to select a quiet spot on the dial of the broadcast receivers where the recorded music may be tuned in without interference from any broadcasting station.

The schematic circuit diagram is given in Fig. 1. Please note that all parts for the oscillator are mounted directly on the back of the small metal front panel inside a guide line as indicated in photo B. This standard metal case, available from all radio parts houses, has removable front and back panels. A hole is cut in the top of the case above the tube socket so that the tube can be inserted externally, thus making a very compact unit.

A detailed pictorial wiring diagram appears in Fig. 2; the various parts are separated to show the wiring clearly. Actually the parts are mounted close together on the panel, with the exception of the a.c. line terminal strip which is mounted on the underside of the wood turntable panel. The two-



# Music to Any Set in the House

section electrolytic condenser is strapped to one of the pickup terminal strip mounting screws; the oscillator coil has its own mounting screw. The fixed condensers and resistors are self-supported by their stiff wire pigtailed leads. Solder all connections carefully with rosin-core wire solder, and use insulated hookup wire for the circuit. Photos C and D show all assembly details clearly.

The antenna for the phono oscillator is 8 ft. long and can be either strung out or coiled in a loop around screws in the bottom of the wooden case. This carrying case is a standard leatherette-covered type used to house portable phono-radios; any similar case may be employed. The phono-motor used is a 78-r.p.m. constant-speed motor, providing rim drive on the turntable. A crystal pickup with an output of between 1 and 1.5 volts should be used; the tube may be either a type 117N7-GT or a 117P7-GT, which are interchangeable. The motor switch, indicated in Fig. 1, was not used in the original model but may be added if desired; the switch can be a single-pole, single-throw toggle type mounted on the turntable panel. Detailed student material list R-356 is available from Popular Mechanics Radio and Electronics department upon receipt of ordinary letter postage.

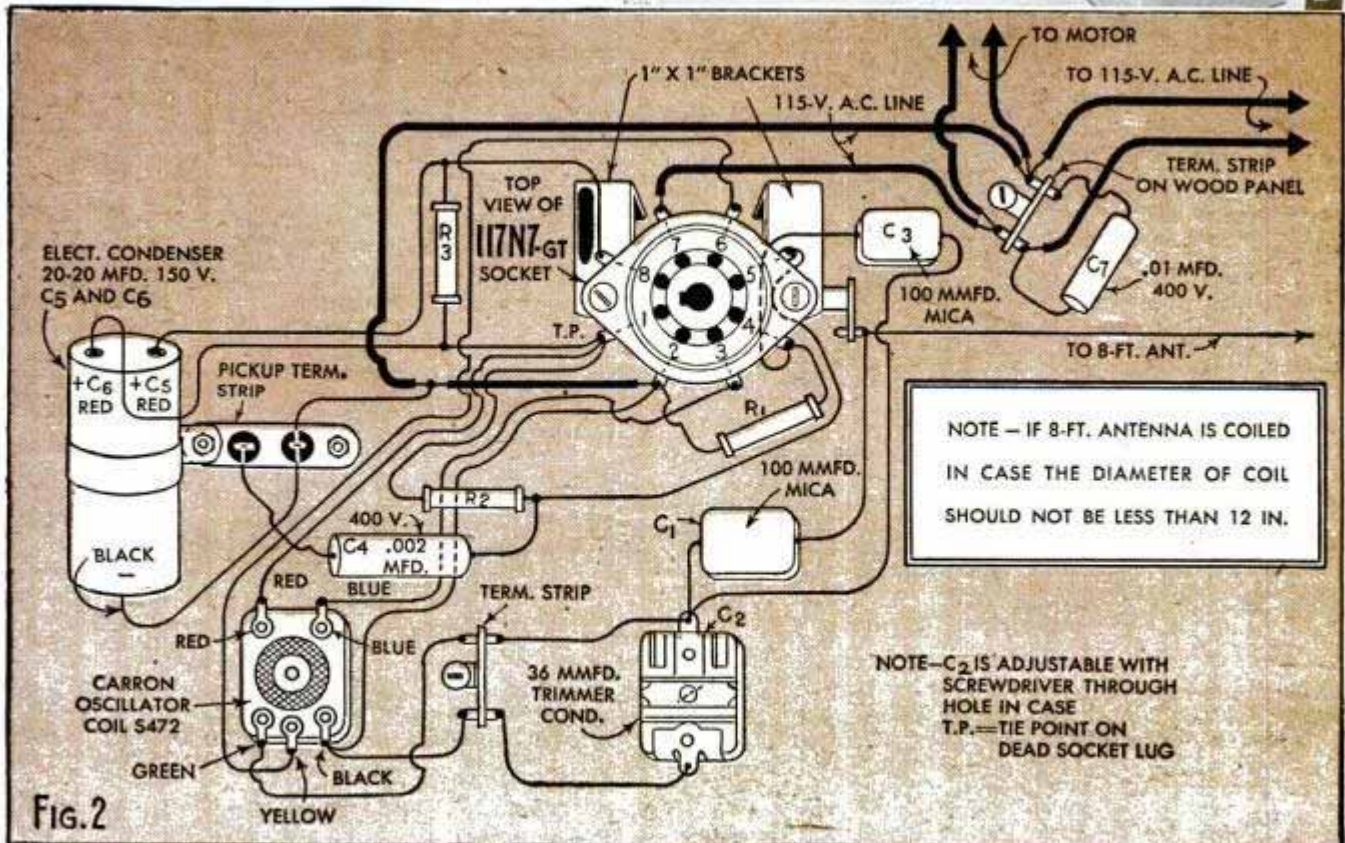
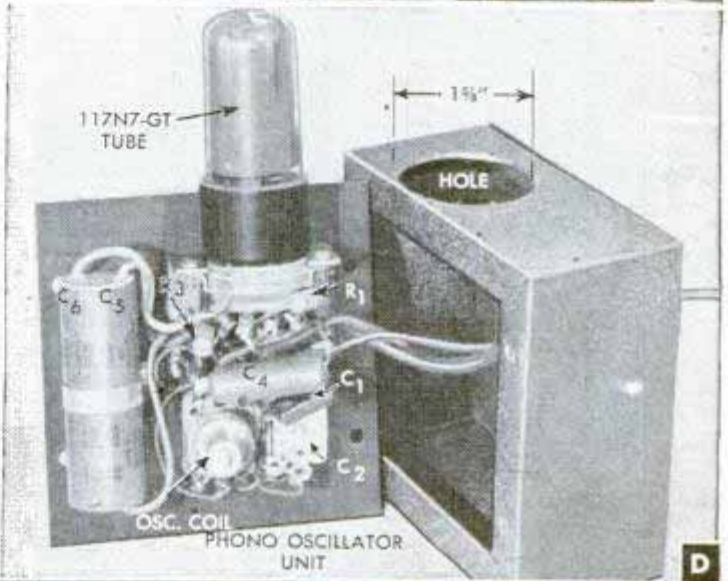

FIG. 2



# Electronic Hints for Today



**A**



(A) Unidirectional crystal microphone stops feedback and features "cardax" dual-frequency adjustable response selector for flat or rising needs; also includes a built-in switch

(B) Electronic photo-timer provides split-second timing from 1/25 second to 40 seconds. Two long-life vacuum tubes are employed

(C) "Hat box" a.c. record player has 3-tube built-in amplifier, 5-in. speaker, crystal pickup and employs a permanent sapphire needle

(D) Hand microphone equipped with a "metal-seal" crystal is claimed to withstand unusual humidity conditions for paging and call uses



**B**

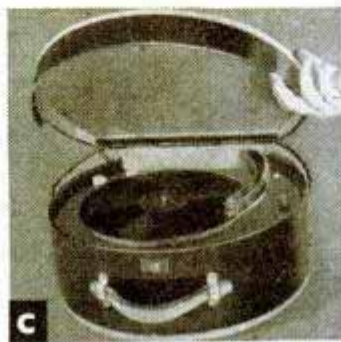

**C**

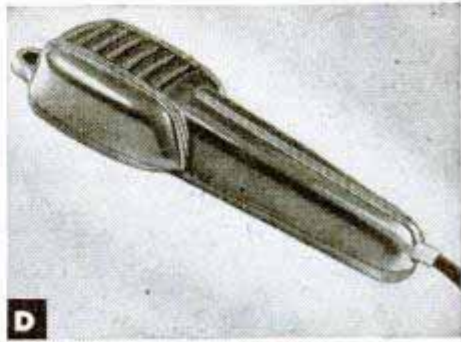

**D**



**E**

(E) Two-coin operated radio receiver for hotel guests provides 30 minute operation for 10 cents, 90 minutes for 25 cents. A.c.-d.c. set with 5 tubes

(F) "Add-a-unit" amplifier in separate portable sections provides unusual flexibility. Beginning with a basic 15-watt or 30-watt unit the power can be increased to 90 watts if required

(G) Wire recorder, radio and phonograph in table model for \$169.50 with 1 spool of wire. It is claimed to record both speech and music with high fidelity

(H) When R. J. Leichter and wife visit the Browns on the third floor, a remote speaker and a long wire to an amplifier-speaker unit solve the baby sitter problem in their first-floor apartment

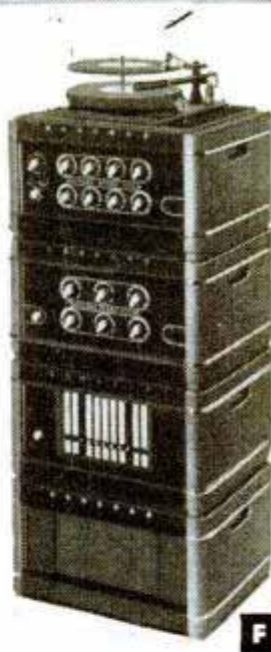

**F**

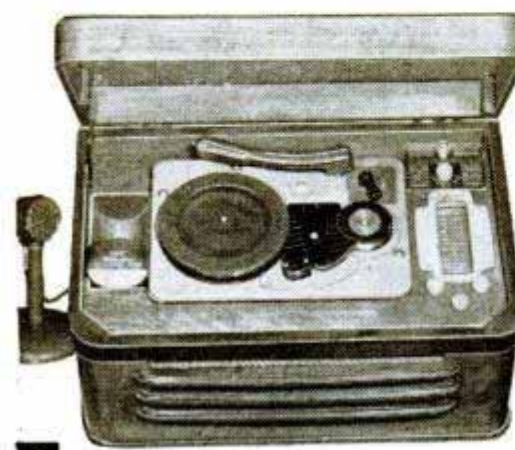

**G**



UPSTAIRS **H**



DOWNSTAIRS



# FOR SUPERB COLOR SHOWS...

## Kodak Still Projection Equipment

Set up your trim, efficient Kodaslide Projector; load as many as 46 slides in the Kodaslide Changer . . . and you're off to a brilliant showing.

For the slick professional touch, use two Kodaslide Projectors, with the Kodak Dissolve Control Outfit . . . one slide fades out as the next fades in. Consult your Kodak dealer about this equipment . . . EASTMAN KODAK COMPANY, ROCHESTER 4, N. Y.

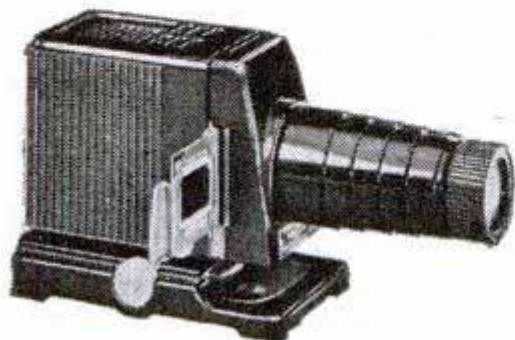

**Kodaslide Projector, Model 2A,  
with 5-inch f/3.5 lens**

Shows your Kodachrome transparencies brilliantly. Lenses and entire optical system *Lumenized*—ultrahard coated. Result: approximately 50% more illumination delivered to your screen . . . Accessory 7½-inch f/4 lens also available.

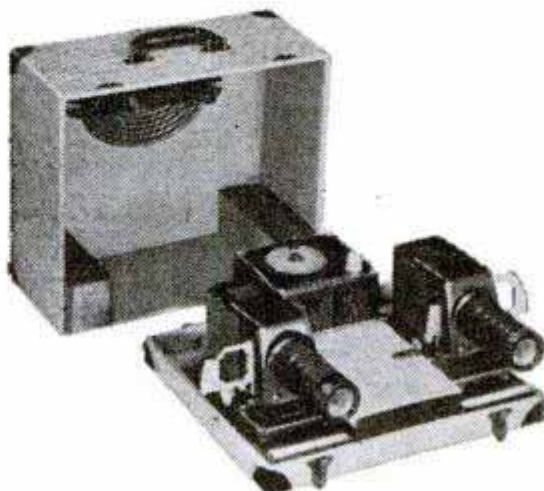

**Kodaslide Dissolve Control Outfit**

One image appears on screen as other fades out. No awkward pauses, no "break." Outfit consists of case, electrical control unit, two projector platforms, storage space for lens barrels and slide files. (Projectors not supplied with unit.)

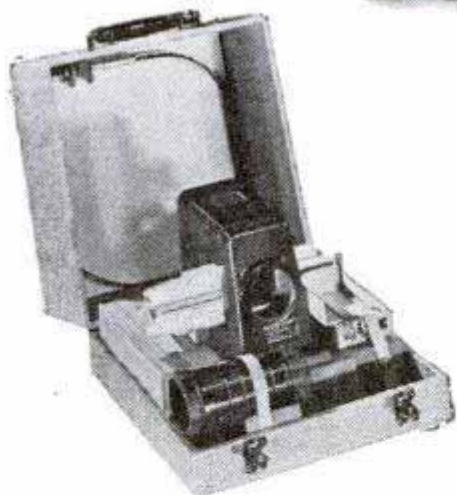

**Combination Case**

Provides space for Kodaslide Projector, Model 2A, spare lamps, the lens, a Kodaslide Changer, and two Kodaslide Sequence Files. Removable cover contains matte screen for trial projections.

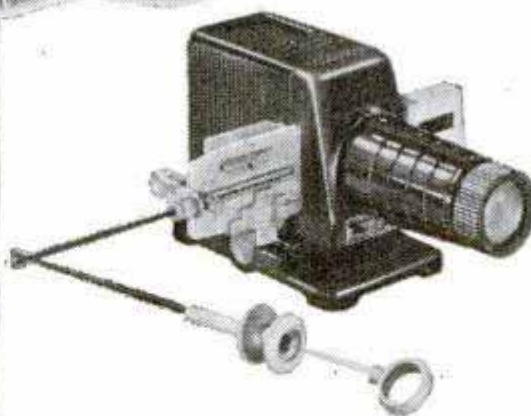

**Kodaslide Changer (shown  
here on Model 2A Projector)**

Hand-operated plunger (30" cable) automatically changes up to 46 Kodaslides. Fits Kodaslide Projectors, Models 1, 2, 2A.

**Kodak**



NOW AVAILABLE

FAMOUS *Marlin* "36"

HIGH-POWER RIFLES

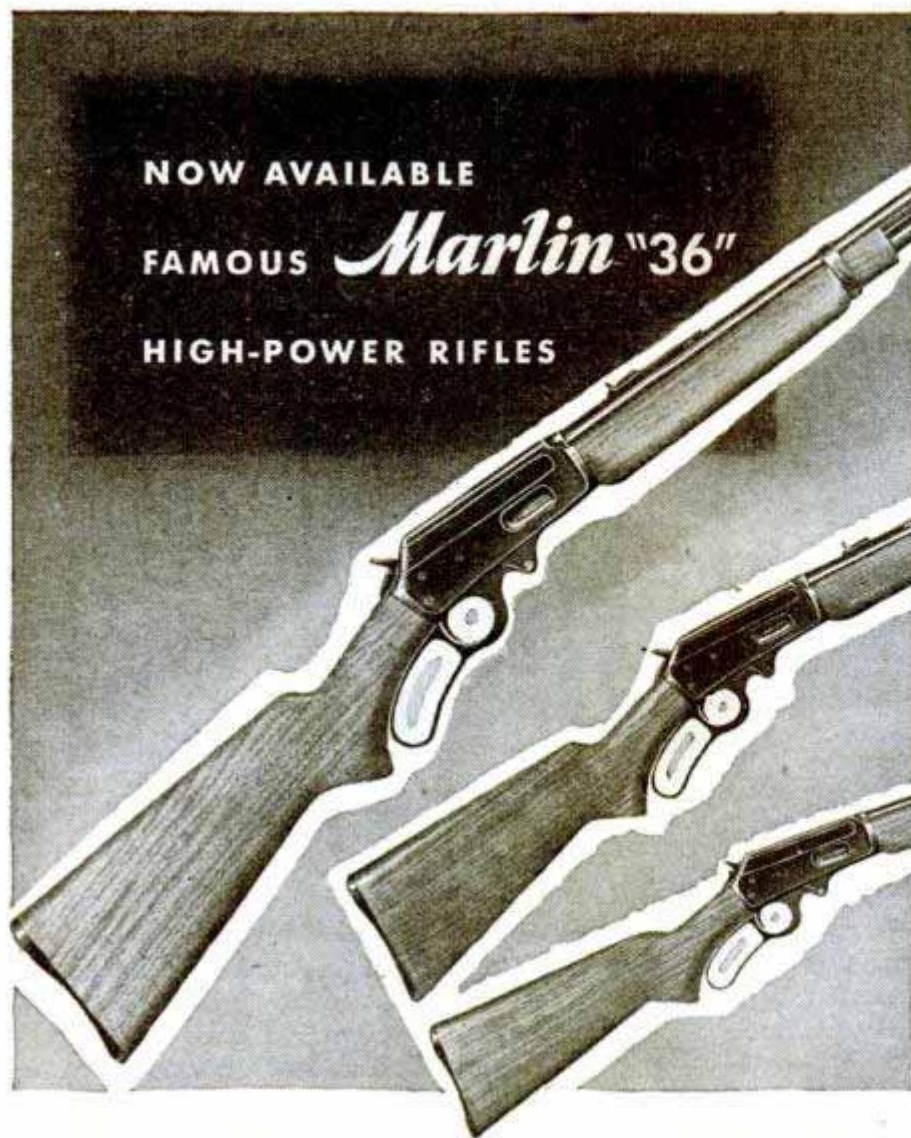

MARLIN 36 CARBINE  
Barrel Length 20"

MARLIN 36 SPORTING CARBINE  
Barrel Length 20"

MARLIN 36-A RIFLE  
Barrel Length 24"



MODEL 36 CARBINE, with full magazine of 7 shots and 20" barrel, is ideal for fast shooting in brush and from horseback \$55.60\*

● Here's a tip if you plan to buy a Marlin Model 36 Rifle this year: *give your dealer the order now*. It takes time and skilled manpower to turn out fine sporting guns. 1947 production, while increased, will not last long. We suggest you order now—to be sure of your Marlin 36 for the Fall hunting season. It will give you a lifetime of sport.

#### OUTSTANDING FEATURES OF MARLIN 36 RIFLES:

Rugged construction; dependability; accuracy; long life. Solid top, non-glare receiver, allowing *low* telescope mounting; drilled and tapped for Lyman 56 and other receiver sights as well as tang peep sight. Powerful extraction of shells, ejection at the *side* for safety—deep-cut, Ballard type rifling—fast lever action—tapered barrel of special smokeless steel—unbreakable coil and trigger springs—selected American walnut stock and forearm. All Marlin High-Power Rifles are targeted and proof tested (JM) before shipment.



MODEL 36 SPORTING CARBINE—6 shots, 20" barrel—has the balance and feel of a longer rifle, yet handles fast in thick cover. \$55.60\*



MODEL 36-A RIFLE—6 shots, 24" barrel—is preferred in open country and on long shots. With telescope sight, gives high accuracy at long range. \$65.50\*

## *Marlin 36*

Famous High-Power Rifles 30/30 and .32 Special Calibers

\*Prices slightly higher west of the Rockies.

THE MARLIN FIREARMS CO., NEW HAVEN, CONN. • Fine Guns Since 1870



# "Dave ought to know better than that"



**AL:** Yeah, I wouldn't take that set of drills if they gave it to me.

**PHIL:** Just junk — that's all they are. And Dave's bragging about the bargain he got.

**AL:** You'd think he'd know by this time that you can't save money buying "no-name" tools.

**PHIL:** Sure, it's plain as day that when a well-known manufacturer puts his name on tools, those tools have got to be good. And when you buy tools *without* known brand names, you're just throwing money

away.

**AL:** Well, I guess we all have to learn it the hard way.

**PHIL:** Yeah. I made some bad buys before I got wise. Now I stay away from bargain counters and do all my tool buying at the hardware store.

**AL:** Same here—and the first thing I look for is the brand name.

Your **HARDWARE DEALER** sells **QUALITY tools**  
and hardware... Buy from HIM



## POPULAR MECHANICS



# ANCO RAIN-MASTER

*"Dead-Locker"*  
WINDSHIELD WIPER  
ARMS and BLADES

BLADE SNAPS ON...  
STAYS PUT

FINGER-  
TIP  
RELEASE

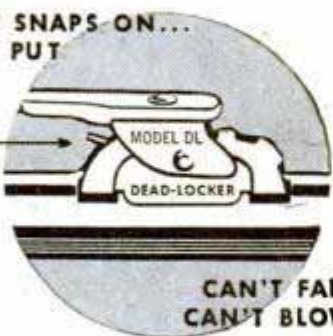

CAN'T FALL OFF  
CAN'T BLOW OFF

(A war-born invention—by ANCO—first)  
for military aircraft—now for your car.)

## DON'T SHOOT YOUR GAS-PUMP MAN!

He's doing the best he can. Sure, he knows how dangerous it is for you to drive your car... in stormy weather... with your dull old windshield wipers that smear and smear. He'd gladly put on for you quickly a pair of keen new ANCO RAIN-MASTER Wiper Blades and Arms. He has them—Newest Models! But he forgets to remind you? Too busy? You can't shoot him for that!



After all, it's *your* car to protect. So *you* remind *him*. Get RAIN-MASTERS... patented features... original equipment on many makes of high grade cars and trucks... used in war—on our fighting tanks and trucks and ships and bombers too... because ANCO RAIN-MASTERS clean quicker, clean cleaner... last longer. May save you a costly smashup.

Ask for RAIN-MASTER Windshield Wiper Arms and Blades next time you buy gas.

THE ANDERSON COMPANY  
Established 1918  
GARY, INDIANA

## What Makes an Athlete Tick?

(Continued from page 133)

rest period, showed that the variations in the response of the heart caused by differences in physical condition were definitely correlated with the subject's powers of endurance. Thus the endurance of an athlete could to a certain degree be determined from the responses of the heart to a simple stool-stepping test.

Other tests conducted on a new group of 25 distance runners showed that changes in pulse rate accelerations during exercise reflected changes in condition. The men were first tested in the spring when all were preparing for competition, and later in the year when most had relaxed their observance of training rules. Still more variations were introduced by testing men after an all-night party, or after recovering from an illness. All confirmed the accuracy of the method.

Archie Williams, whose heart showed the best response and whose endurance score was highest, later developed Olympic potentialities. Lesser laurels also came to numbers two, three and four—Del Fishback, Bill Dougherty and Les Vorhees, names well remembered by Pacific Coast fans. Only one good athlete developed from the poorest half of the group and this man achieved some fame as a wrestler.

To record heartbeats an electric tachometer was designed which weighs 30 pounds and is portable. An attachment makes the device valuable to hospitals. It can be used to keep constant check on a patient's heartbeat, and when slight variation in the pulse rate occurs it sounds or flashes a warning. The principle is similar to that of automobile speedometers which glow red when certain speeds are reached.

Another method to determine whether an athlete is in condition is the flarimeter test. The person tested blows into a tube in an effort to maintain a 10-inch column of water at a constant level. After a short period he again blows into the flarimeter. The difference in his endurance indicates his physical condition. The inability of a person to hold the water at a certain pressure for a long period of time is not due to lack of air in his lungs, but to an interference with circulation caused by the exertion.

During the study of physical condition, scientific data on the effects of the common cold on physiological responses to exercise were tabulated. Although medical authorities have declared that individuals suffering from a cold should not engage in exercise there was no definite proof that

(Continued to page 232)



Dependable

# CHAMPION

AMERICA'S FAVORITE SPARK PLUG



When one make of spark plug consistently stands out above all others in open competition, you may be certain that it will consistently outperform all others in your car. Champion's unequalled record in record-breaking events is constantly being augmented by such exceptional examples as their use in "Miss Great

Lakes," owned by Al Fallon of Detroit, which was driven by Dan Foster at record-breaking speeds to win all three heats in the President's Cup Race. Champion is America's Favorite Spark Plug, on land, water or in the air, because it is always dependable for every engine. Champion Spark Plug Company, Toledo 1, Ohio.

**FOLLOW THE EXPERTS**—DEMAND DEPENDABLE CHAMPIONS FOR YOUR CAR

Listen to the CHAMPION ROLL CALL, Harry Wismer's fast sportscast every Friday night, 9:55 EDST over the ABC network



# WORKSHOP WISDOM

Quick, easy way to make curved parts for furniture, boats, and skis—without using nails, bolts, drifts, or steam

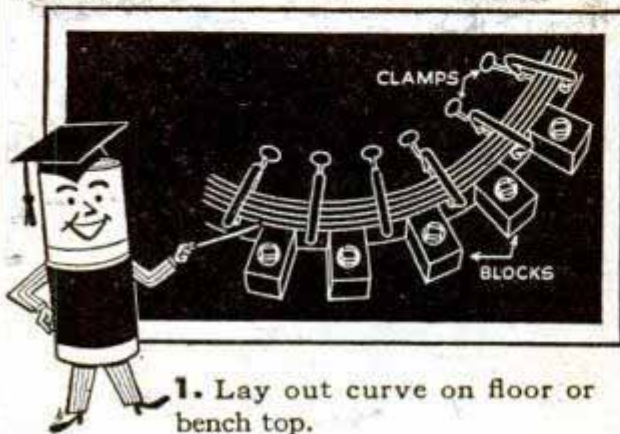

1. Lay out curve on floor or bench top.
2. Fasten down series of blocks around desired curve.
3. Screw wood or metal band to blocks to make a "form."
4. Spread thin pieces of wood with glue and clamp to form as shown above. When glue sets you'll have a laminated section four to eight times stronger than a pieced or bolted section.

## Make sure you use Cascophen Glue on outdoor projects!

Cascophen is completely heatproof, waterproof, moldproof, and fungusproof.

It bonds at moderate pressure, cures at 70 degrees F. or warmer, keeps indefinitely in storage. It is the only durable waterproof glue available to craftsmen.

See your hardware, building-supply, marine, or paint dealer today. He has Cascophen in ¼-pint, pint, quart, and larger sizes.

For Indoor Projects use Casco or Cascamite  
**FREE GLUING CHART.** Address: Dept. PM67, Casein Co. of America, 350 Madison Ave., New York 17, N. Y.



CASCO



CASCAMITE



CASCOPHEN

SAY YOU SAW IT IN POPULAR MECHANICS



## SCREENS LOOSE?



## Fix it with Mortite a household friend

Fills cracks around screens, casements, sinks, baseboards, etc. Fine for caulking; keeps out dirt, dust, insects. Stops rattles. Ideal weather-stripping. Easy to apply, just press into place. Roll covers about 80 ft. At Hardware, Paint, Dept. Stores and Lumberyards.

Write for booklet.

**\$1.25** Higher West of Rockies and Canada

**J. W. MORTELL CO.**  
 522 Burch St. Kankakee, Ill.



## CUTS INTRICATE DESIGNS never before possible



Sharp spiral blade saws in any direction. Cuts wood, plastics, or light metals without binding or breaking. Sturdy steel frame, with new lever adjustment, keeps tension right. Complete saw with 3 extra blades, 95¢. Blades only, 3 for 25¢. Get yours—today. AT YOUR NEAREST HARDWARE STORE, or send \$1 direct for sample to

**TYLER MANUFACTURING COMPANY**  
 938 Pico Boulevard — Santa Monica, California



ENLARGED SECTION OF BLADE

## FLUID PUMP

At last, a dependable, low priced coolant pump for machine tools. Fully guaranteed by old, reliable manufacturer.

Constructed of non-corrosive materials. Plastic screen quickly removed for cleaning. With this pump and small pan for fluid you obtain same results as with expensive equipment.

May be used for Evaporative Coolers, Fountains, Displays, etc.

DEPT. M **\$19.50** POSTPAID

JOBBER AND DEALER INQUIRIES INVITED

**AMERICAN METAL PRODUCTS CO.**  
 FORT WORTH 9, TEXAS





# NEW EVEREADY

TRADE-MARK

# FLASHLIGHT BATTERIES

*Now last 93% longer!\**

**Packs Enough Energy for 3 400-lb. Bar Bell Lifts!**

Can YOU raise 400 pounds 7 feet in the air? A few champion strong men can . . . But the energy of *one* tiny "Eveready" flashlight cell, properly expended, could perform this back-breaking feat 3 times! Think of this kind of energy when you buy flashlight cells . . . ask for "Eveready" batteries every time. *Still 10¢ each.*

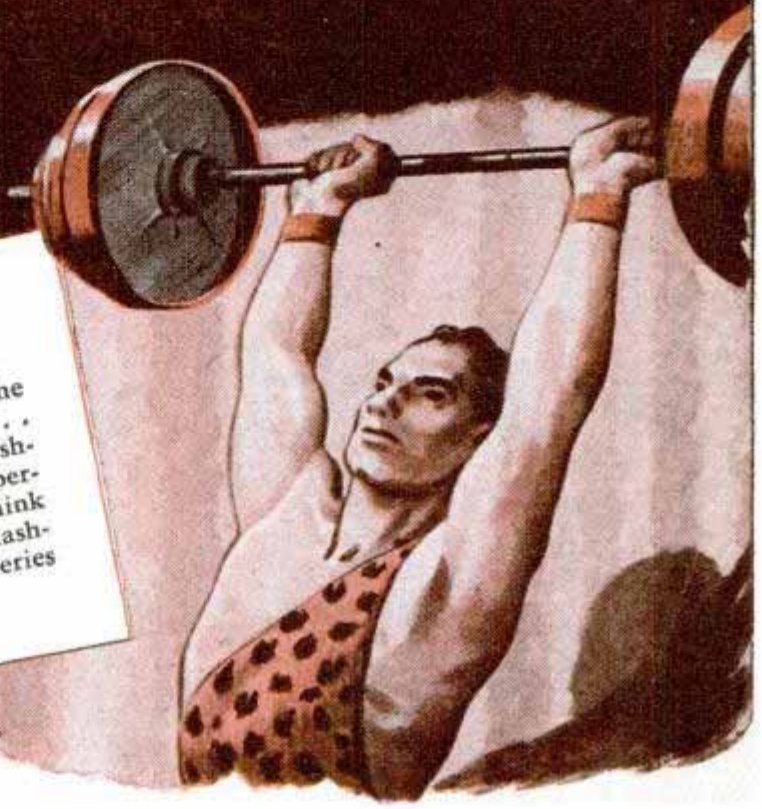

● You've got a "pipe line to the powerhouse" when your flashlight contains these great new "Eveready" cells. For they give you nearly double the energy that pre-war "Eveready" batteries gave you. No wonder these are the largest-selling flashlight batteries in the world! No wonder it can be said, "Get 'Eveready' brand flashlight batteries . . . and you get the best!"

The registered trade-mark "Eveready" distinguishes products of  
**NATIONAL CARBON COMPANY, INC.**  
 30 East 42nd Street, New York 17, N. Y.  
 Unit of Union Carbide and Carbon Corporation



**NOW**  
 1941  
**93% MORE ENERGY**

\* Nearly twice the electric energy. That's today's high-energy "Eveready" battery, as proved by the "Light Industrial Flashlight" test devised by the American Standards Assn.



*High Energy*  
**MEANS BRIGHTER LIGHT,  
 LONGER LIFE**





**SPEED WASH  
FOUNTAIN BRUSH**  
*Cuts Wash Time*

**USED** on thousands of truck fleets, buses and trains. Also for floors, vats, walls, etc. Clean water is constantly fed through five foot handle and 11" brush. Each stroke soaks, scrubs and rinses. Nylon mixture tufts are hand-stitched into block. Brush back and handle are steel. Handle connects with standard size hose. Guaranteed to cut washing time in half. Mail order today. Include **\$11.75!** check for postpaid shipment.

**MILWAUKEE DUSTLESS  
BRUSH COMPANY**

**M D** MILWAUKEE DUSTLESS BRUSH CO.  
525 N. 22nd St., Milwaukee 3, Wis.

Please ship.....Speed Wash Brush(es). If not satisfactory we understand Brushes can be returned within 30 days for full refund.

Name .....

Address .....

City ..... State .....

this was so. Many athletes believed that exercise was actually good for a cold. University students in the third-day stage of an uncomplicated cold underwent the stool climbing exercise while their heart and breathing rates were recorded. Such tests give a practically complete picture of a person's physiological responses through a series of ink graphs on a long strip of paper. Blood pressures were also taken, as well as a flarimeter blow test.

Similar figures were obtained after the patients had recovered from colds. Significant differences between the results led to this conclusion: a person suffering from a cold is under handicap and will suffer 12 to 18 percent greater strain from exercise.

Although the no-smoking rule is almost universally enforced by coaches, there is still some controversy as to the actual physical effects of tobacco. Students were blindfolded, given a cigarette to smoke and then told to hold a metal pencil in a small hole. Any wavering of the hand was recorded electrically. The tests showed that a person's steadiness, as well as his pulse rate, is affected by smoking, but they did not indicate whether this is physically harmful.

Tests with large groups of athletes and nonathletes are showing a definite relationship between athletic ability and psychological attitudes. For example, college men who are above average in general athletic ability almost always say they would have attended high school physical education classes voluntarily. Among those that are below average, 17 percent attended physical education classes because they were forced to go. Although there may be little or no difference in the general personalities of the two groups, athletes tend to be less neurotic, less introverted, and lower in hypochondriac tendencies. Whether this is a cause or result of participation in sports has not been determined, but there is reason to believe that athletes are a better-adjusted class of students.

On the basis of our present knowledge, individual differences in running ability are divided as follows: 20 percent psychological, 20 percent skill, 40 percent physiological (including such factors as muscle viscosity and efficiency of blood circulation), and 20 percent unknown factors. Any of the four factors may be important when applied to a particular athlete.

What makes an athlete tick is a subject that requires much more experimentation before a definite and comprehensive answer can be given. The psychologists and the physiologists are doing the "pure" research. It is up to the coaches to find the practical application for such studies.





*Radiator rusted-  
Vacation busted*

*Clean out rust with*

### **DU PONT Cooling System CLEANSER**

Before your engine is ruined by overheating, clean out rust and scum in the radiator. Just pour in a can of DU PONT COOLING SYSTEM CLEANSER, run the engine 30 minutes or more, then drain. No reverse flushing is necessary. It dissolves rust—cleans thoroughly, quickly, and safely.



*Then keep out rust with*

### **DU PONT Acid and Rust INHIBITOR**

After cleaning out the radiator, you can keep it free from rust all season by pouring in a can of DU PONT ACID AND RUST INHIBITOR. This neutralizes the acid and prevents damaging rust from forming.



*Avoid radiator leaks with*

### **DU PONT Cooling System SEALER**

You can stop leaks quickly and securely—and make the cooling system LEAK-PROOF—by pouring in DU PONT COOLING SYSTEM SEALER. It will not clog the radiator or harm hose or metal parts.



**DU PONT**

REG. U.S. PAT. OFF.

BETTER THINGS FOR BETTER LIVING  
... THROUGH CHEMISTRY





**"It's the Wonder Drill"**

**Craftsmen say so  
Hobbyists say so  
You'll say so, too**

**PRICE  
\$4.95**

Chuck size . 1/4"  
Length . . . 10"  
Weight . . 22 oz.

JOIC can even drill around a corner. Here's why. It's adjustable, the only hand drill with swivel chuck and handle.

JOIC is a handy tool for easy drilling in tight places. For example, you can drill any number of holes at exactly the same height. (See top illustration at right.) JOIC will be a must, once you get your hands on it.

JOIC Hand Drill is all metal construction, rust proofed, and enameled. The removable end cap of the handle is convenient for storing drills.

This wonder drill is available almost everywhere. If your dealer's stock is exhausted, or does not include JOIC, kindly send us his name so we can make sure you are promptly supplied.



Drill's flat side holds bit parallel to surface.



Handle's 180-degree range locked by thumb screw.



Turret locks chuck in seven different positions.

**JO MANUFACTURING COMPANY**  
8442 OTIS STREET • SOUTH GATE, CALIF

**Electrically Welded Endless**

**Paramount**

**BAND  
SAW  
BLADES**



Made in widths from 1/8" to 1-3/4"

Make your band saw do more work for you. The proper width of blade will extend the scope of this important machine. Burrill's Paramount Blades are made from tough Nickel Alloy Steel properly tempered. Teeth accurately set and filed, and all saws carefully straightened. Send order and check today. Delivery will be made as promptly as conditions permit, from a few days to a week or two. You can obtain these saws at the following prices:

1/4"-3/16"-1/4"-3/8" wide, 5'6" long.....\$ .90 each  
3/8"-3/16"-1/4"-3/8" wide, 6'6" long..... .95 each  
3/8"-3/16"-1/4"-3/8" wide, 7'6" long..... 1.10 each

Other sizes at proportional prices

**NO C.O.D. SHIPMENTS ACCEPTED**  
State Make of Machine

Your satisfaction is guaranteed

**BURRILL SAW & TOOL WORKS**  
407 E. Main St., Ilion, N.Y.



**OFFICIAL U. S. GOV.**

**COMPASS**

Hunting Case, Watch  
Type, All Metal,  
Jeweled Waltham  
\$3.50 Value

**\$1.95**

**WHEATSTONE BRIDGES** Used, in excellent condition. Mfg. by Thompson Lever Mfg. Co., Philadelphia. Value \$150.00.. **SPECIAL \$49.50**

Engineers All Metal Army Type Hand-Sighting

**LEVELS**

**\$2.00** PRECISION QUALITY



**PUBLIC SPORT SHOPS**

13 S. 16th St., Phila. 2, Pa.

No COD's



**FURNACES GAS OIL** Floor furnaces, Range burners, Gas burners, Gas burners for natural, mixed and liquid petroleum gases. Gun Type oil burners with controls. Pre-Cast fire boxes. Blowers, blower wheels and bearings, etc. Evaporative coolers, Cooling coils. Exhaust fans. Sell and install. Peerless Sales, 4818 Sheridan Blvd., Lincoln 6, Nebr.

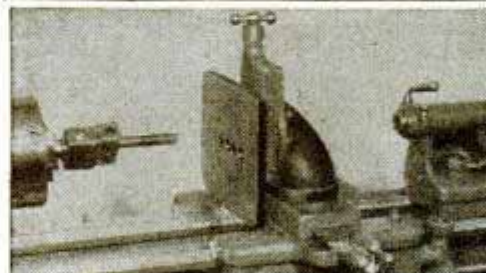

Two parts ready for use. Easy to set up and disassemble. Horizontal, vertical and angle adjustments. Holds work rigid for precision milling, drilling, boring, counterboring, spottfacing,

**NEW  
LOW COST  
ADAPTOR  
CONVERTS  
LATHES  
FOR  
MILLING  
AND  
BORING!**

**\$12.75** — SPECIFY LATHE MAKE

**QUALIFIED GAGE CO., BERKLEY, MICHIGAN**



# BIG YANK Shirts and Pants

## Give You 9 "Help the Job" benefits

RECOMMENDED BY A STAFF OF WOMEN  
 ★  
 Guaranteed by  
 Good Housekeeping  
 IF NOT AS ADVERTISED THEREIN

Read over the 9 points below. You'll say: "Just the features I want in work clothes!" Yes, BIG YANK gives you benefits that make the job easier—make you look neater—help you get ahead. Real comfort, too—long wear, and so economical. Choice of popular fabrics and colors.

- ✓ Large Pockets with Flaps
- ✓ Danger-Check Safety Cuffs\*
- ✓ Elbow-Action Sleeves\*
- ✓ Sanforized (shrinkage less than 1%)
- ✓ Dress Shirt Styling
- ✓ Wet-Resistant Cigarette and Non-Jab Pencil Pocket\*
- ✓ Reliance Strainproof Yoke\*
- ✓ Full-Cut Roominess
- ✓ Reinforced Crotch

\*Patented



Reliance  
 Manufacturing Co.,  
 212 W. Monroe St.,  
 Chicago 6

# BIG YANK

SHIRTS PANTS

At good  
 stores  
 everywhere

**\$12.85 List**



**GENUINE TURNER MICROPHONE**

**MODEL 20X**

Record at home, parties, etc. Get high quality results with new Turner crystal type hand microphone. Improved circuit. Light weight. Convenient. Low cost. Use with any high impedance recorder. Ask your dealer or write for bulletin. Free literature on all Turner Microphones.

**THE TURNER COMPANY**  
 921 17th Street N. E., Cedar Rapids, Iowa

## RECLAIM LUMBER

with this

*Amazing New Tool!*



**BORD-PRI**  
 TRADE MARK

Pat.  
 Pend.

**SALVAGE ROOFING, FLOORING, FORMS SIDING WITHOUT SPLITS OR BREAKS**

You'll like the speed, ease, and economy of BORD-PRI. This new kind of lever-action tool gives damage-free results on all types of board-removal jobs. It lifts off lumber ready for re-use. BORD-PRI has many uses in home and workshop. Get yours today.

**Reversible Handle • Flat Plates • Free Pivot**

*Saves many times its cost* **\$9.60**

SEE YOUR DEALER OR WRITE

**THE MACO CORPORATION**

1420 Henry St., Huntington, Ind.

Best for Reels..



..for Guns

## LUBRIPLATE

The universal white lubricant reduces friction and wear • Waterproof • Prevents rust • Stays put • Lasts longer

**20c** at your dealers

in U. S. A.

Ideal for the HOME WORKSHOP



USE AC's FOR  
**UTMOST  
RELIABILITY**

Dairies and milk producers use factory-recommended AC Spark Plugs to assure utmost reliability in milk delivery. Your AC dealer can supply you with factory-recommended AC's for your car, truck or tractor, designed for today's fuels and driving conditions.

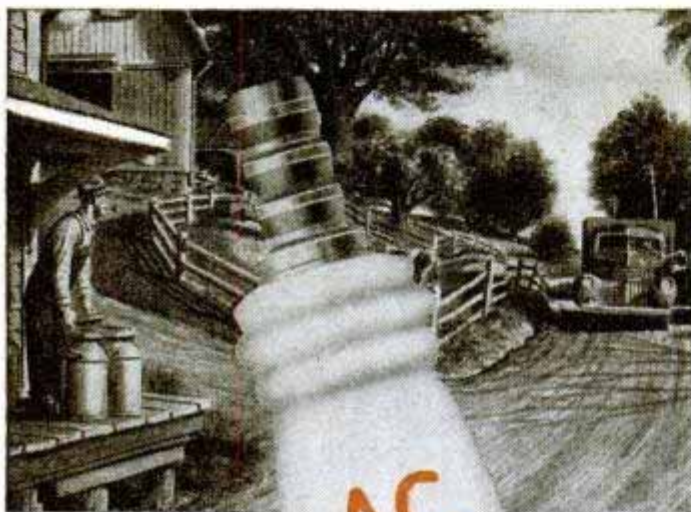

Look for this sign



Spark Plugs cleaned and adjusted "By the AC Method" may save as much gas as 1 gallon in 10

**AC  
SPARK PLUGS**

AC SPARK PLUG DIVISION • GENERAL MOTORS CORPORATION

## Germes Put the Squeeze on Oil

(Continued from page 94)

write to Dr. ZoBell about it. He has no bacteria cultures for sale, is up to his ears in further research work and cannot answer individual queries. You can get the patent and a complete explanation of how the oil bacteria work by writing to the U. S. Patent Office, Washington, D. C., asking for Patent No. 2,413,278 and enclosing 25 cents to cover printing and mailing.

When the laboratory work was done, then came the problem of trying out the new discovery under field conditions. Several oil companies were eager to inoculate their exhausted wells. But it was decided finally to let the Pennsylvania Grade Crude Oil Association work out the practical aspects. This is a nonprofit organization and is in an area whose wells have become pretty well depleted.

For example, the Bradford field in northwestern Pennsylvania for many years had produced a high-grade 100 percent paraffin-base petroleum, highly prized as a lubricant. In an area of 78,000 acres some 25,000 wells had been drilled. Since the early 1870s, when drilling was first started, about 600,000,000 barrels of oil were pumped out of that one field. Water-flooding the wells has made it possible to produce another 500,000,000 barrels. Water under high pressure was pumped into the oil-bearing strata, forcing the oil to producing wells from which it is pumped to the surface. It is estimated that another 550,000,000 barrels of oil are left in the sands—about 35 percent of the original oil. Will the bacterial method make it possible to recover this oil, which now sells for about \$350 per barrel?

Exactly how the wells are inoculated, and how much oil the bacteria will produce, the Pennsylvania Grade Crude Oil Association is not prepared to say at the moment. Preliminary experiments have proved encouraging and further tests now in progress are expected to give a definite answer.

It is known, however, that the bacteria spread in all directions—like a creeping fire—at the rate of about two inches a day. The bacteria can move by stringlike appendages called flagella, and spread also by multiplying. The wells already are drilled, the pipes are in place and the pumping machinery is ready to operate. If wells that are producing a barrel or two a day are stepped up to 10 or 12 barrels, it will mean greater production for the oil companies and cheaper gasoline and lubricants for the average motorist.

(Continued to page 240)



# Quick change artist in action!

How Johnson's Carnu,\*  
famous liquid-type car polish,  
makes a quick job of car shining  
... cleans and polishes  
in one application

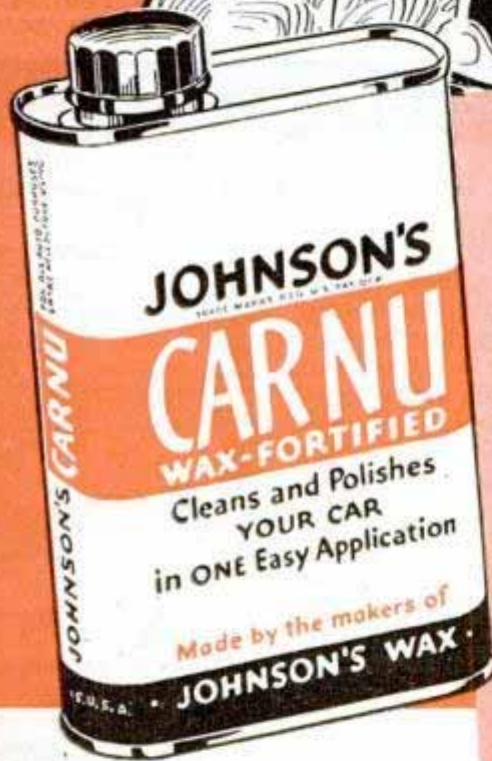

## What Carnu does

**Before Carnu:** Dirt and oxidized paint make car finish rough, lusterless.

**After Carnu:** "Showroom shine" is restored. Finish is bright and beautiful, and so smooth that future dust and dirt may be wiped off easily!

## How Carnu does it

**Apply Carnu . . .** It's easy — just rub hard enough to loosen the grime, then let Carnu dry completely to a white powder.

**Wipe Carnu off . . .** Nothing to it — just wipe off the powder. Dirt comes with it, leaving the finish shining like new.



## Keep your car shining with this extra protection!

A tough, preservative coat of Johnson's Auto Wax does these things:



1. Maintains the "Carnu" shine.

2. Protects the finish.

3. Helps preserve the color.

If you're the type who wants that "little bit extra," and are willing to spend a little time to get it, Johnson's Auto Wax is just what you're looking for.

This special, easy-buffing car wax gives your car a tough, protective coat of wax, protects it against sun, heat, and moisture. Auto Wax makes it easy to keep your car clean and shining because dirt can't get a foothold on the smooth, hard, waxed surface. Your auto supply store, filling station, or regular Johnson's Wax dealer has Johnson's Auto Wax. Try it!



© Trademarks Reg. U. S. Pat. Off.

© S. G. Johnson & Son, Inc., Racine, Wisconsin, 1947

S. C. JOHNSON & SON, INC. RACINE, WISCONSIN





*the right files for  
the Home Workshop*

**MODEL MAKING . . . woodworking . . . metal work . . . whatever your hobby, it's bound to give you more satisfaction when the tools you use are tops in quality and right for the job. In files, that means Nicholson or Black Diamond.**

Use small size, single cut standard files and X.F. Swiss Pattern Files on delicate metal parts. Rasps and double cuts for woodworking. Milled Tooth and Super Shear Files for soft metals and plastics. Mill Files for sharpening and smooth finishing.

Shapes and sizes for most any job are obtainable through the better hardware stores and industrial supply houses.

**FREE BOOK — "FILE PHILOSOPHY"**

**NICHOLSON**  
U.S.A.

**NICHOLSON FILE CO.**  
22 Acorn St., Providence 1, R. I.  
(In Canada, Port Hope, Ont.)



**NICHOLSON**  
**FILES** FOR EVERY PURPOSE

## McAleer

**SIDE CAR CARRIERS**

THOUSANDS NOW IN USE

**\$4.50**



Slips on or off  
any car in a jiffy

Will carry anything  
too big for the  
inside of your car

**PER PAIR  
COMPLETE**

● Indispensable for carpenters, painters, plumbers, farmers, window washers, gardeners, campers, hunters, fishermen, home owners, salesmen, etc. Carries tent poles, lumber, pipe, oars, ladders, garden tools, fish poles, skis, etc., securely and conveniently. Guaranteed not to damage car finish. Instantly removable. Fully patented. Exclusive design.



Shipped prepaid on receipt of check, money order . . . or C.O.D.  
Or at your nearest dealer. Write Dept. 9.

**SOLD ON 5 DAY MONEY BACK GUARANTEE**

**Makers of McAleer Automotive Cleaners, Polishes,  
Home Buffing Compounds, Waxes, Rust Removers**

**McALEER MFG. CO.**

**Rochester,  
Michigan**

**Save Time and Money  
with this Press**

Ten-ton press, ideal for all kinds of pressing, separating, straightening, and bending jobs. Ample capacity for home shops. Easily adjustable table takes work up to 18 inches wide and 11½ inches high. Roller-bearing ram for long life. Send for free bulletin showing press and wide variety of accessories.

**UT-10A Press f.o.b. factory \$28.25**



**DAKE ENGINE COMPANY**

**624 Seventh Street, Grand Haven, Michigan**

**BOILING HOT WATER IN A JIFFY!!**



Place the Jiffy Electric Water Heater into the water and insert the plug in the nearest electric wall or light plug. You will have hot water in less than five minutes for baby's bath, your washing, shaving and a great many other uses in the home, camping, business, and on the farm. Mailed complete, including six feet of rubber covered wires and plug. One year guarantee. **JIFFY ELECTRIC COMPANY, Dept. PM3, 21321 Stephenson Highway, Hazel Park, Mich.**

**\$2.95**  
plus twenty five cents for postage

**MACHINE SHOP EQUIPMENT**

Just off the press!—Every man who owns a workshop should have a copy of the new, up-to-the-minute, 200 page catalog of Machine Shop Equipment—the latest tools made by the biggest manufacturers in the U. S. Replete with illustrations, descriptions, prices. Prompt delivery on most tools listed in this book. Available at cost of printing—50c a copy—get yours today! **Price of Catalog Refunded on First Order over \$5.00.** Send check or Money Order to

**CENTER TOOL CO., 153 Centre St., Dept. C, New York 13**



When you look for quality features in an outboard motor, look for them in the line where they were originated, developed and perfected.



**FREE  
HANDY  
CHART**

These are outboard motoring's big features. All are *Johnson* developments.

- Alternate Firing
- Rewind Starter
- Full Pivot Reverse
- Rotary Valve
- Dual Carburetion
- Shock Absorber Drive

—and Others!

Write for Sea-Horse Handy Chart of motor sizes and specifications. 5 great models. Consult your Johnson dealer about delivery. Look for his name under "Outboard Motors" in your classified phone book.

JOHNSON MOTORS, 400 Pershing Road, Waukegan, Ill.  
*Johnson Motors of Canada, Peterboro, Canada*

# JOHNSON SEA-HORSES

*FOR DEPENDABILITY*

## Here's the OUTDOOR FIREPLACE YOU CAN BUILD YOURSELF!

only \$29.50\*



The Grill King is a barbecue beauty, a self-contained unit ready for masonry... easy to build and sure to make a hit with your picnic crowd! All you have to do is add stonework or bricks in the design you like best.

Outdoor cooking's a real treat with the Grill King. Made of sturdy steel plate, it has adjustable grids for use with any solid fuel. Grate size is 13½" x 24". Complete assembly instructions and design suggestions are sent with each grill.

Get set for your outdoor parties now—order a Grill King today. Satisfaction guaranteed. Send check or money order to...

**GRILL KING** \*E. O. B. Youngstown

BOX B, WEST SIDE • YOUNGSTOWN 9, OHIO

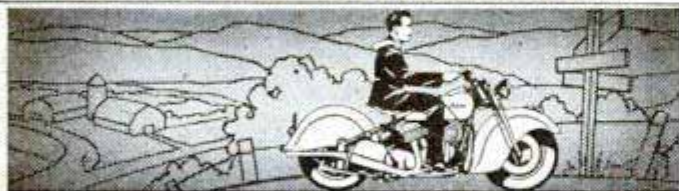

**Indian**  
WORLD'S FINEST  
MOTORCYCLE  
SPRINGFIELD, MASSACHUSETTS

## NEW POST-WAR INVENTION!

# DAVOS FAUCET RESEATER

STOPS LEAKY FAUCETS

SAVES WATER BILLS!

The only tool at this amazing low price

**\$1.00** complete with brass replacement seat

that actually inserts **A NEW SEAT!** IN YOUR FAUCET!



1. Remove bonnet and stem of faucet



2. Insert DAVOS Faucet Reseater, turn handle till new seat opening is topped.

3. Insert new DAVOS seat with handy reseater.



Economical! Easy! Effective! Gets at the heart of the trouble—doesn't grind metal away—but adds a new seat! Re-seats most standard faucets quickly and easily. Its self-centering, tool-steel tap forms a new seat opening into which the DAVOS replacement seat fits snugly and securely. Cannot damage faucet, assures 100% water-flow.

Additional brass seats may be obtained at a charge of 10c each.

Ask your local hardware dealer for DAVOS Faucet Reseater or send \$1.00 for Reseater complete with brass replacement seat to

**DAVOS PRODUCTS CO.**  
3042 West Montrose, Dept. A • Chicago 18, Illinois





## Simoniz Gives Your Car Lasting Glamour

First step before vacation travel—SIMONIZ! It starts you off with a car more beautiful than ever . . . and keeps it that way mile after mile. The finish is protected against ultra violet rays, corrosive airborne chemicals and road grit that dull and destroy. Then, at the trip's end, dust and dirt are whisked away with a dry cloth . . . and the finish sparkles brighter than ever. Insist on SIMONIZ—your car deserves it!

**TO RESTORE NEW BEAUTY** to dull finishes . . . use the Simoniz Kleeners—liquid when it's in average condition . . . paste when the finish is exceptionally dull. Then apply SIMONIZ to make that sparkling finish last years longer. Sold everywhere.

THE SIMONIZ COMPANY, Chicago 16, Ill.

"SIMONIZ" . . . Trade Mark Reg.  
U. S. Pat. Off. and Foreign Countries



Motorists Wise  
**SIMONIZ**

The implications of this experiment are tremendous. In addition to reviving "dry" wells, there are many petroleum-rich oily shales and sands where oil exists, locked in the sediments in such a way that it is too costly to remove—up to \$5 and \$6 a barrel by present methods. One of these areas is the Santa Maria oily shales of California. Another is the Athabaska sands of Alberta, Canada. Millions of barrels of oil lie attached in microscopic films or as tiny droplets to grains of sand and shale in these areas—waiting to be liberated.

Use of bacteria for boosting production of oil wells is a technique that calls for the services of an expert. If not, it can be as dangerous as a sharp knife in the hands of a three-year old. You've got to be certain that the bacteria you introduce into your oil-bearing formations are the right strain of the new desulphovibrio halohydrocarbonoclasticus. Some bacteria, points out Dr. ZoBell, actually chew up the hydrocarbons of oil. It is thought, for example, that certain areas of the world which exhibit all the geological characteristics of rich oil fields, but which are barren, may have been invaded in ages past by oil-eating bacteria.

The petroleum industry has considered some odd and unorthodox methods of getting oil out of stubborn geologic formations. They've heard and investigated proposals for using detergents, acids, chemicals, water, superheated steam and natural gas pumped in under pressure. The use of bacteria, strange as it may appear, also offers promise and the suggestion is being backed up by solid, scientific experimentation.

Dr. ZoBell's "oil bugs" may yet prove that the slogan, "good to the last drop," is almost as applicable to oil production as it is to coffee.

### Source of Atomic Energy

Atomic ovens have produced a new chemical isotope which can be split to release atomic energy, according to Dr. Glenn T. Seaborg of the University of California. The new substance is neptunium 237, a chemical twin of neptunium 239 which is used in making the atomic bomb. The number of atoms in a given quantity of the chemical which will split and thereby release energy is so low that the isotope could not be used in a bomb, Dr. Seaborg reports. A small quantity of the chemical has been produced for special studies.

☛Tons of cracked apricot pits are used by Trans World Airline as an abrasive in blasting the carbon out of engine cylinder heads.





## Worn piston rings don't show, but they're more serious

**W**ORN pants are harmless, but worn piston rings can cause real damage in your car. As soon as you notice excessive oil consumption, ask your Sealed Power franchise dealer to install a set of Sealed Power Individually Engineered Piston Rings. They save gas, save oil, lengthen engine life, restore original power.

Whatever the make, model or degree of cylinder wear in your engine, there is a Sealed Power Ring Set specifically engineered to do the best possible job for you. Sealed Power workers are proud of their product and its 36-year record of preference by leading car, truck and engine builders. See your Sealed Power Franchise Dealer. Send a postal for illustrated, informative new booklet on 7 ways to save oil. It's free and may save you lots of money. Sealed Power Corporation, Dept. G6, Muskegon, Mich. In Canada: Stratford, Ont.

**KEEP YOUR WAR BONDS! GET \$4 FOR \$3**

### For better results 26 Basic Ring Designs

No one piston ring design can meet all replacement needs. Sealed Power Individually Engineered Ring Sets are made up from twenty-six (26) basic ring designs, which permit each set to be specifically engineered to do the best possible job in a particular make of engine.

These ring sets are engineered to save oil without sacrifice of gas economy, to save oil without inducing friction and cylinder wear. Each set gives balanced performance in a particular engine.

*Piston Rings*  
*Pistons*  
*Cylinder Sleeves*  
*Valves*  
*Water Pumps*  
*Chassis Parts*



©1947,  
Sealed Power Corp.

# SEALED POWER PISTON RINGS

**BEST IN NEW CARS! ★ BEST IN OLD CARS!**



# AMERICA'S FAVORITE

**Luther**  
HAND AND POWER GRINDERS

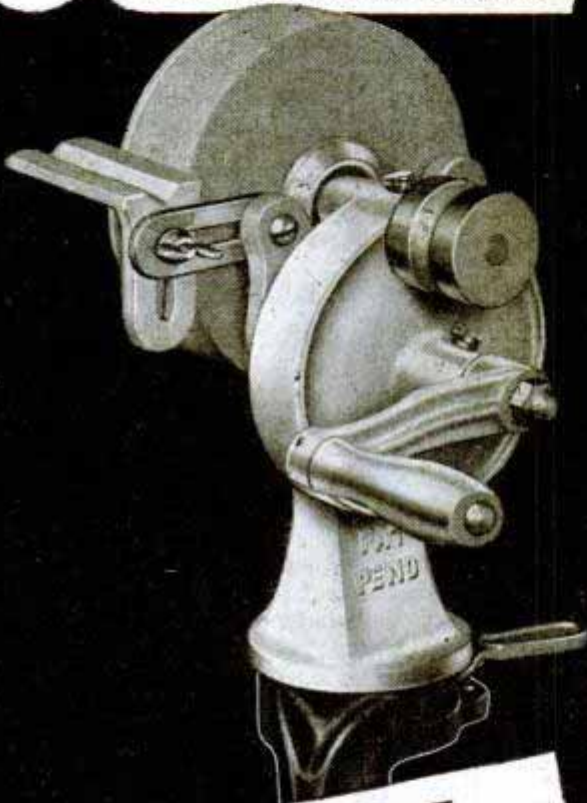

## DEPENDABLE

Here's a name in grinders that has been famous for 50 years—Luther Grinders are manufactured to the most exact specifications—You will find a dependable Luther hand or power grinder for your purpose. See Your Hardware Dealer

**LUTHER  
GRINDER & TOOL CO.**

ESTABLISHED 1896

**SHEBOYGAN, WISCONSIN**

EASY with one hand  
and a

**"YANKEE"**

Quick-Return Spiral  
Screw Driver

Got to drive screws where it's hard to use both hands? Easy with a "Yankee" 130A Spiral Driver. "Quick-return" spring in handle keeps bit in slot, returns handle after each push.

Write for the "Yankee" Tool Book.

YANKEE TOOLS NOW A PART OF

**STANLEY**

THE TOOL BOX OF THE WORLD

**NORTH BROS. MFG. CO.**

Philadelphia 33, Pa.



## Snap-On-Lawnmower Barrow

**\$6.95** Free Wheeling  
Fits all Lawnmowers

Convert your lawnmower into a wheelbarrow in one minute. Simply invert mower snap on. Strong, durable, will carry 250# loads. Barrow is 6" deep with two sturdy legs. Painted red and green with attractive flower designs on panel.

Dealers Write

IMMEDIATE SHIPMENT CHECK OR M.O. WITH ORDER

**INDIANA APPLIANCE CO.**

20 East Sycamore

Dept. LM-20

Evansville 9, Ind.



## SAVE TIME—AVOID SPOILAGE WITH A TAPER-MASTER

Cuts tapers of any pitch up to 2 1/4" per foot with micrometer accuracy and a minimum of make-ready time. Fits any standard 6 - 9 and 12" swing lathes. Easy to set up and adjust. Square thread lead-screw with bronze nut, and especially treated center assure life-long accuracy. Write for literature today. Factory representatives wanted.

**L. M. & S. MACHINE CO., South Milwaukee, Wis.**



Also 50c 4-oz. tube.  
Pts., qts., gals. for  
industrial use.

**THE UNIVERSAL  
AMBROID LIQUID CEMENT**

The "Mr. Fix-it"  
for "a million things"

Tops in quality for 37 years. Uses unlimited . . . sticks and mends permanently. Waterproof . . . quick drying. Keep a tube on hand always. Extra quality . . . extra strength. Ready to use. LOOK! Get acquainted with Ambroid quality. At your dealers or send 25c for big 2-oz. tube postpaid (U.S.A. only). Money back guarantee. **25c**

**AMBROID CO.**

303 Franklin St., Boston 10, Mass.



# It's NEW

and just what you've been wanting! It's the

## BEST VALUE ON THE MARKET

### L-W Model SD

# 6 1/2" UNIVERSAL DIVIDING HEAD Only \$95

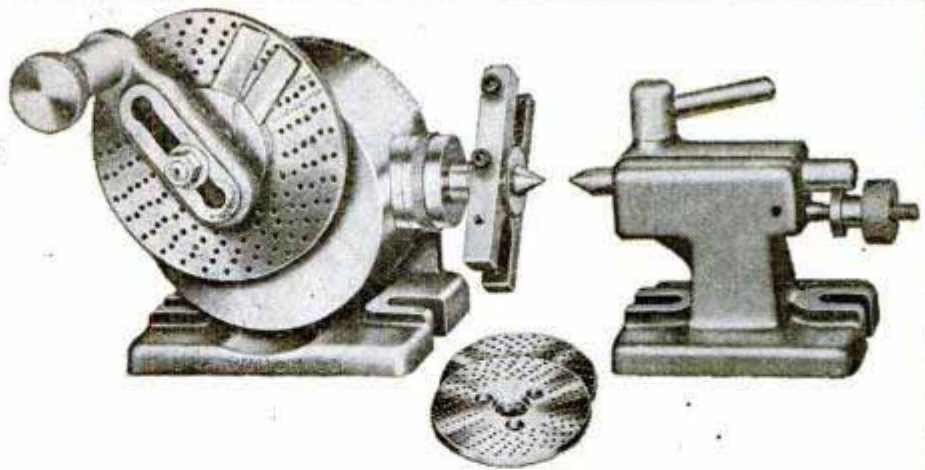

Well built for hard usage on smaller milling machines. Rugged head and tailstock. Alloy steel spindle has a tapered bearing. Bored for #9 B & S taper threaded spindle nose. Head tilts to 90°+ in vertical position. Special alloy steel worm and bronze worm wheel cut to close limits for accuracy. End thrust is taken out by bronze bearings. Complete with three index plates

for dividing all numbers to 50, and even numbers to 100, with the exception of 96 T. Index chart shows all divisions obtainable to 380.

ORDER TODAY or write for complete catalog on the high quality, low cost line of L-W LATHE CHUCKS • UNIVERSAL CHUCKS • MILLING MACHINE VISES • POWER HACK SAWS • DIVIDING HEADS • MAGNETIC CHUCKS • RECTIFIERS • DEMAGNETIZERS • DEMAGNETIZING SWITCHES.

## L-W CHUCK COMPANY

31 SO. ST. CLAIR ST.

TOLEDO 4, OHIO

### SUPER DRILL GRINDER



Sharpens round shank drills from 3/32" to 1-1/16" diameter. Grinds Old Drills like new in 4 different drill point angles. Grinds Short, Medium and Long Twist Drills from 1 1/2" up to 11" long, for hand or power grinding wheels.

200,000 IN USE!

Grinds your drills like factory in 25 seconds. Gives perfect center and clearance. Saves drills, time and money. No shop should be without the Super Drill Grinder. Guaranteed to do the work or money back. The Grinder that gives a rounded point!

Only \$2<sup>95</sup>

At Your Dealer's or Postpaid  
**CRANDALL MFG. CO.**

1512 West Slauson, Dept. FA-18

Los Angeles 44, Calif.

\$2<sup>95</sup>

## TORNADO GAS TORCH

*The Modern Way of Soldering*

Ideal for hard and soft soldering. Will heat quickly; solder will flow freely and smoothly. No compressed air required. Nothing to pump. Self-adjusting. Safe. Economical. Can be used for annealing small parts and bending metal parts. Generates a heat of 1700° Fahrenheit. Simply connect to any illuminating (manufactured) gas jet with a

rubber hose and operate. Tornado Torch No. 119 comes with three (3) tips, (1/8", 1/4", 3/8" blast).

The Tornado Gas Torch No. 119, complete with three tips, is \$2.95. See your dealer or order direct. Send check or money order—post paid.

Robco Corporation, 202 E. 44th Street, New York 17, N. Y.



Paratroop  
HUNTING  
BOOTS  
in Waterproof Elk  
Finish

ONLY

\$9<sup>87</sup>  
plus  
postage

All sizes from 4 to 13 1/2  
All widths from AA to EEE

Newest thing in comfortable, serviceable boots. Ideal for hunting, fishing, hiking and all kinds of outdoor use. Made in soft, pliable, heavy-oiled waterproof leather. Same design, construction and high quality standards as famous boots worn by Paratroopers during war. Write to our Dept. PM-6. Specify size and width. Enclose check or money order for \$9.87. Boots sent immediately, postage C. O. D. Money back if you are not entirely satisfied on receiving boots.

**CORCORAN INC., STOUGHTON, MASS.**





## VACATION TOURS TOPS FOR FUN

When you own a  
**HARLEY-DAVIDSON**

Visit your country's historic places, natural wonders and famous fun spots the Harley-Davidson way! Go anytime — stop where and when you please — no timetables to follow. Your Harley-Davidson turns every evening, holiday and weekend into *extra vacation time* — as you join other riders on pleasure trips. Take in gypsy tours, race meets, hillclimbs and other thrill-packed motorcycling events. See your Harley-Davidson dealer NOW — and mail coupon today!

**HARLEY-DAVIDSON**  
*Motorcycles*



Harley-Davidson Motor Co., Dept. P, Milwaukee 1, Wis.

Please send at once free copy of 24-page "ENTHUSIAST" Magazine, filled with thrilling motorcycle action pictures and stories.

Name.....

Address.....

City..... State.....

## New Wealth From Waste

(Continued from page 120)

alcohol. Xylose sugar also can be treated with heat to produce furfural, an oily liquid employed in petroleum refining. The cobs then are ground into a fine powder and treated with a stronger acid which breaks down the cellulose structure into a solution of glucose sugar, from which ethyl alcohol is made.

The Peoria plant is capable of handling 3.3 tons of corncobs in eight hours. From this, 1600 pounds of xylose and a ton of corn sugar can be produced, both of which can then be fermented to make liquid motor fuels. These materials and the lignin residue will yield 90 to 95 gallons of motor fuel from a ton of cobs, and about half of it will be in the form of ethyl alcohol.

Agricultural experts estimate that 200,000,000 tons of farm residues are produced annually, and that perhaps half of this amount might be available for industrial uses. The remainder is needed by farmers for livestock and soil improvement.

Although many of these residues can be turned into motor fuels, experimentation in this field is at present confined to corncobs. Other residues, such as the hulls of oats, rice and cottonseed, the shells of nuts, peanut pith, flax shives and cereal straws, are being used in a number of products ranging from cigarette paper to fiberboard and as an extender for plastics.

Not only cobs but corn itself is assuming many new roles. In one chemical process, a purified protein called zein is extracted from corn. Zein, which is odorless, is used as a coating for paper and wood, particularly for food packaging. It has been used as a replacement for shellac to provide a scuff-resistant material for phonograph records.

The properties of zein make it a useful component of ink for high-speed printing. Several magazines and printing ink manufacturers are experimenting with it for this purpose.

Textile fibers can be produced from zein and woven into dresses, sweaters and neckties. Dr. A. K. Smith of the Peoria laboratory says zein fibers have a dry strength equal to wool and a wet strength two thirds that of wool. Cost is between one half and three fourths the price of wool.

Another new use for corn is in the manufacture of phenolic resin plywood glue. Corn gluten or soybean meal can be substituted for about 40 percent of the phenolic resin. This lowers the cost without reducing the quality of the glue.

Three or more sheets of wood veneer are

(Continued to page 248)



# AUTO-LITE "Plug Tips"

## AVOID WASTE, Check Spark Plugs Regularly

The right type of spark plug will save you time and money. Plugs which are faulty and mis-fire waste as high as 10 per cent of your fuel, according to experts. And hard-to-start engines can lose valuable time.

Check all your spark plugs regularly to make sure you have the right plugs for your engines.

This Auto-Lite "Plug-Chek" Kit quickly helps you find spark plugs that are causing trouble. All you do is match plugs with pictures on the "Plug-Chek" Indicator — each example refers to a page in the "Plug-Chek" Data Book that shows you what to do.



\* Because these illustrations are not in full color, they do not accurately reproduce the actual firing tip appearance. For accurate, full color reproduction, mail the coupon.



**Too Hot\***  
If spark plug firing tips are fused or blistered, plugs are operating too hot and may be causing loss of power.



**Normal\***  
If spark plugs look like this, they are of correct heat range. Get your Auto-Lite "Plug-Chek" Kit right now.



**Too Cold\***  
If spark plug firing tips show deposits of carbon or are wet with oil, plugs are too cold, may waste dollars in costly gas.

Send for your Auto-Lite "Plug-Chek" kit...only 10¢!

Switch to  
**AUTO-LITE**  
SPARK PLUGS

### THE ELECTRIC AUTO-LITE COMPANY

Department PM3, Toledo 1, Ohio

Enclosed find ten cents for the Auto-Lite "Plug-Chek" Kit that includes both the "Plug-Chek" Indicator and Data Book.

Name \_\_\_\_\_

Address \_\_\_\_\_

City \_\_\_\_\_



# COMPLETE SOLDERING KIT \$1.00



## SOLDERING MADE EASY

YOU can now make clean, smooth soldered joints or repairs with this amazing new kit that contains all of the necessary Solder, Flux, Cleaners and detailed instructions.

**EACH KIT CONTAINS**

- Generous supply of SOLDER
- A tube of PROTECTIVE PASTE
- One bottle of FLUX FLUID
- One tube of FLUX PASTE
- A SAL AMMONIAC BRICK
- and a BRUSH

**COMPLETE INSTRUCTIONS.** Experienced mechanics as well as the beginner will want, and keep, these unique, simple, concise directions. Anyone can now easily make clean soldered joints and repairs to Cast Iron, Steel, Brass, Bronze and many other alloys.

**ORDER BY MAIL.** Order this complete Soldering Kit by mail. Send \$1.00 and the kit will be sent postpaid.

**Satisfaction Guaranteed or Money Refunded**  
NO C.O.D. ORDERS PLEASE

Dept. P-2, UNIT SALES CO., Box 86, Montville, N. J.

# 75 MILES Per Gallon



**Cushman**  
MOTOR SCOOTER

The two wheel Cushman Motor Scooter, when equipped with tandem seat, will safely and comfortably carry two people. When equipped with SIDE KAR a third person or a 200 lb. payload can also be carried. Side Kar quickly and easily detachable.

FOR WORK OR PLAY

For City or Highway — factory, farm or commercial use!

DEALERS from Coast to Coast. Write today for name of your dealer and **FREE FOLDER** describing our two and three wheel models. **CUSHMAN MOTOR WORKS, INC., Dept. M-600, Lincoln, Nebr.**

## WHITE-GRIP AUTOMATIC BENCH STOP

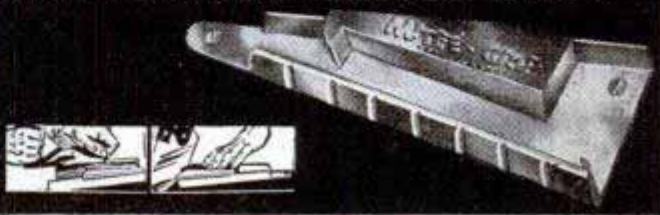

### FOR YOUR WORKSHOP

A fast firm grip on any work-piece • Finger-flip release. No vise marks • \$2.50 Post Paid • Prompt Delivery • Money Order or Check or C.O.D.

## ELROY PRODUCTS CO.

527 S. 7th St., Minneapolis 15, Minnesota

## NU-WAY Lawn Mower

Write for  
Free Circular

PRICE  
**12.50**

## BUILD YOUR OWN ROTARY TYPE LAWN MOWER

We Supply Cutting Unit  
Complete  
**No Increase in Price**



Tractor-Lite Mfg. Co.  
Spirit Lake, Iowa

WHY PAY MORE?

## WHEELS FOR JUVENILE AND INDUSTRIAL USE

MANUFACTURER'S AND DEALER'S INQUIRIES INVITED  
CIRCLE METAL MFG. CO., 4272 E. Pacific Way, Los Angeles 23, Cal.

## Thompson BEATS the World on BOATS



### Better Built Lower Prices



**Safe Boats With Full Length Spray Rails**  
Keep passengers perfectly dry—even at high speeds. Catalog also shows two new models of "Take-Along" Boats. Two big factories—save you freight.

**CATALOG FREE**  
Write for your copy. State kind of boat in which you are interested.  
**THOMPSON BROS. BOAT MFG. CO. (161)**  
213 Ann St. PESHTIGO, Wis. (Write to either place)

Light Boat for Auto  
**113 Elm St. CORTLAND, N.Y.**

# A DOZEN ERRANDS FOR JUST ONE CENT

RIDE ONE AND YOU'LL BUY ONE!

Shopping, errands, commuting, are so thrifty, so much fun with a dependable WHIZZER Motor on your bike! 125 miles to the gallon! 5 to 35 m.p.h.! Fits any man's balloon tire bike! If no local dealer yet, mail coupon today!

ONLY  
**\$97<sup>55</sup>**  
PLUS TAX  
F.O.B. PONTIAC

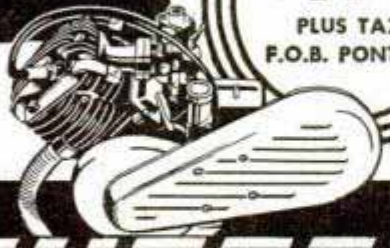

ON A

# WHIZZER

Whizzer Motor Company, Dept. 526, Pontiac, Michigan.  
I enclose \$99.97, which includes \$2.42 Federal Excise Tax ( ) check or ( ) money order. Send me one Whizzer Motor complete, ready for installation. If descriptive literature only is desired, check here ( ).

Name \_\_\_\_\_ City \_\_\_\_\_  
Street \_\_\_\_\_ State \_\_\_\_\_



# Mows and Trims Lawns



In One Simple  
Easy Operation

8 1/4 Lbs.

Save Time  
and Labor with a  
**MONTAMOWER**

New model. New type metal handle has special device to adjust cutting height. Drive shaft now mounted on free rolling, factory lubricated, and sealed ball bearings. No tired backs or aching arms. 8 1/4 lbs. of live precision made mechanism that first gathers, then cuts smoothly a clean 16" swath through grass, dandelions, spike grass and weeds. No noise or clatter. As modern and efficient as your electric razor. Cuts right up to walls, fences, trees or posts; leaves no fringes to be trimmed by hand. Cutters are self-sharpening. Built to last many years. Many thousands in use. Sold direct from factory. Costs little. Write at once for guarantee information and literature.

**MONTAMOWER DISTRIBUTING CO.**

822 Keeler Bldg.

GRAND RAPIDS 2, MICHIGAN

## G & E CRAFTSMEN'S BARGAINS!

**Hi-Power ELECTRIC DRILL**  
 • Heavy duty 1/4" drill. Light weight. Three jaw keyless chuck. Oil bronze bearings. 6 ft. flexible rubber cord with plug. 900 rpm at full load. Operates at 110 V. AC or DC. **\$17.95**  
 No. 6202..... Each

**A TREASURE CHEST OF RADIO PARTS**  
 • Contains transformers, condensers, dial controls, insulators, terminal connectors, coils, practically all types of switches. Many more useful items. **\$4.50**  
 No. 6508..... 15 lb. Kit for only  
 • Send check or money order, including postage. No C.O.D.'s. Write for new free parts catalog.

## G & E EQUIPMENT SUPPLY CO.

Dept. PM-18 400 N. SANGAMON ST., CHICAGO 22, ILL.

Sand Casting—Forging—Heat Treating—Case Hardening

# BRONZE FOUNDRY



is again available in limited quantity without priority. Orders filled in sequence as received. **INVENTORS—SCHOOLS—CRAFTSMEN** use **FOUNDRYETTE** for making castings quickly for new inventions, for instruction, and general purpose. Order now for early delivery. Three sizes are available capable of making bronze castings of 1 1/2, 3, and 6 pounds weight, aluminum, copper, brass, etc. Domestic gas supply and 110 volt AC or DC energy required for operation.

Write for circular.

**KANSAS CITY SPECIALTIES CO.**

Box 6022, Dept. P-79

Kansas City, Mo.

# CATCH 'EM ALIVE AND UNHURT!

Amazing new trap can't harm children, pets, birds or poultry. Simple to set. Rustproof. No springs. Send 10c today for 24 page booklet on trapping with free price list. Write

**HAVAHART,**  
479 Water Street  
Ossining, N. Y.

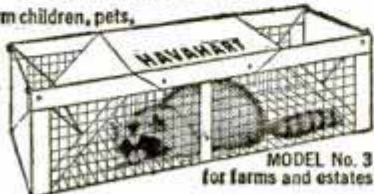

MODEL No. 3  
for farms and estates

"I belong in every home in America..."

#402

**BECAUSE I DO SO MANY JOBS BETTER"**

There's no other pair of pliers in the world like the Parallel-Action BERNARD. And here's why they're so handy for you.

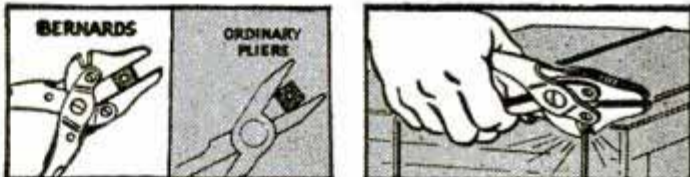

Jaws close parallel—like a vise. Fit snug and flat. Won't slip or mar the nut.

Powerful cutters on the outside of the head, easy and convenient to use. They'll cut an 8-penny nail!

Hundreds of thousands of BERNARD's went to war in Yank machine gun kits, but, once again, they're available to you at your local hardware store.

Look for the name "BERNARD" BERNARD Parallel-Action PLIERS are one item in a line of fine hand tools—hedge clippers, pruners, paper and leather punches, etc.—known for quality for 75 years. Free catalog on request.

QUALITY TOOLS SINCE 1870

**BERNARD**  
TRADE MARK REGISTERED

**WM. SCHOLLHORN CO.**  
7506 Chapel Street, New Haven 9, Conn.



*Logan*.. A NAME TO REMEMBER  
WHEN YOU THINK OF BETTER

LATHES AND SHAPERS

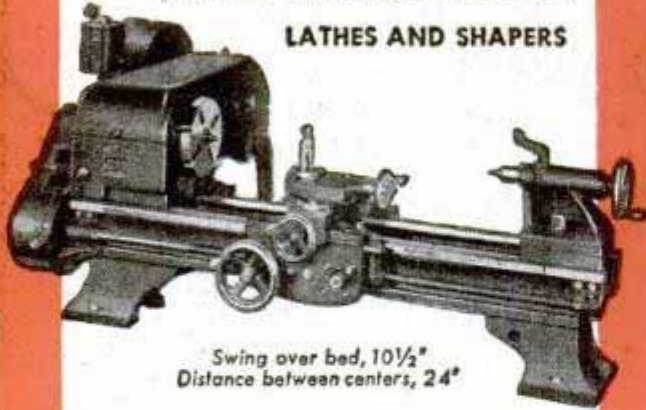

Swing over bed, 10½"  
Distance between centers, 24"

**LASTING  
ACCURACY**

Another reason for  
choosing a LOGAN Lathe

The ability of the Logan Lathe to hold to closest tolerances after years of usage results from advanced design and precise construction methods. Logan lathe bed ways are within .0005" of parallelism. The front bearing seat on the Logan ball bearing mounted spindle can vary no more than .0002". Total spindle run-out 12 inches from the bearing is less than .0008". Rugged, massive construction is combined with these precision standards, and vital points of the lathe are protected by self-lubricating bronze bearings. These are a few of many reasons why it pays to choose a Logan Lathe for the small shop as well as for industrial use.

**WRITE FOR THE LOGAN CATALOG...** complete information on Logan Lathes, Shapers and Accessories.

## 9 REASONS why LOGAN Lathes are BETTER lathes

- 1 **BALL BEARING HEADSTOCK**  
for sustained accuracy.
- 2 **RUGGED, ACCURATE BED**  
within .0005" of parallelism.
- 3 **SELF-LUBRICATING BEARINGS**  
at vital points lengthen life.
- 4 **BACK GEARS ENCLOSED IN HEADSTOCK**  
with shifter rack safely and conveniently  
at your finger-tips.
- 5 **RUBBER CUSHIONED COUNTERSHAFT**  
for smoothness and accuracy in working area.
- 6 **THREE POINT SUPPORT**  
Steadies the countershaft, prevents rocking.
- 7 **ENCLOSED BELTS, GEARS, PULLEYS**  
Prevents accidents. Keeps lathe clean.
- 8 **AUTOMATIC BELT TENSION RELEASE**  
Makes belt changing easy and safe.
- 9 **PRECISION BUILT THROUGHOUT**  
For tool room accuracy in your shop.

### DISTRICT OFFICES

Woolworth Bldg.  
New York 7, N. Y.  
Cortland 7-8024

550 W. Washington Blvd.  
Chicago 6, Illinois  
Central 1246

1672 Mission Street  
San Francisco, Calif.  
Underhill 6682

**LOGAN ENGINEERING CO.,**  
DEPT. B-6, 4901 LAWRENCE AVE., CHICAGO 30, ILL.

glued together to form plywood, and the glue is so strong that the wood tears apart before the glued sections give way. Plywood glued together with this glue was used in Liberty ships, airplanes and PT boats during the war.

War-born shortages of cork led to the development of a substitute for cork made from the pith of peanut shells. It is called Noreseal, named for the Northern Regional Research Laboratory, plus SEAL. Noreseal has been tested and found satisfactory for liners in bottle caps for beverages, fruit juices and extracts. It also can be made from cornstalks and sugar cane.

The cork substitute is made by grinding and screening out the pith from peanut shells, mixing with glue, glucose and various chemicals, then heating the mixture and beating it to admit air. The material is formed in sheets or poured into individual bottle cap liners.

The list of new uses for farm products is almost endless. One synthetic rubber (called Lactoprene) is made from whey; a cigarette moistening agent from apples; mineral-rich poultry feed from vegetable wastes (leaves and stems).

Farm crops are the nation's income, and by using that income as a basis for industry, the United States can follow a course that will conserve its capital (petroleum, coal and ore) and extend its industrial life.

**How to make a starch sponge at home.**—The ingredients for making a starch sponge in your home refrigerator are 6½ tablespoons of powdered cornstarch and 2⅔ cups of cold water.

Slowly add ¼ cup of water to the starch while stirring. Continue stirring until a smooth paste is formed. Add the rest of the water while stirring. Cook for 15 minutes in a double boiler over vigorously boiling water, stirring constantly for the first five minutes, then occasionally to keep the starch from sticking to the pan.

The cooked paste should be smooth, thick and creamy, like cornstarch pudding. Pour the hot paste into a refrigerator ice-cube tray from which the partitions have been removed. Place the tray on the upper shelf in the freezing unit. Have the refrigerator set at "normal." Leave the paste in the freezing unit until completely frozen. This will require at least 24 hours.

Then remove the tray from the freezing unit. Allow the paste to thaw. Cold or barely lukewarm water can be used to hasten thawing, but not hot water. Do not direct a strong stream of water onto the frozen paste, because this will break it up.

(Continued to page 252)



# Larson

## "MAKE YOUR OWN" PICNIC TABLE

### AND LAWN BENCHES

Another new  
**LARSON**  
Construction  
set



Hook together for table

Copyrighted instruction sheet for easy assembly. Illustration shows how table is constructed and ease with which it is converted into a pair of lawn benches. Quickly taken apart for storage. Set of hardware only. Lumber not included.



Used as Benches

**PREPAID \$3.30**

**CHAS. O. LARSON CO., BOX 358, STERLING, ILLINOIS**

## ● POWER LAWN MOWER

### BUILD ONE YOURSELF FROM YOUR OLD MOWER

We supply complete attachments that fit any make or size of mower, with or without 1 1/2 H.P. gas engine. Easy to install in less than an hour. No more back breaking mower pushing. Immediate delivery, at low prices.

**MONEY BACK GUARANTEE**

You'll be delighted! Complete satisfaction or your money back. Write for

**FREE FOLDER**

Dealers Wanted.

**ROYAL OAK LAWN MOWER SHOP**

Box 48 Royal Oak, Mich.



**SALESMEN! DISTRIBUTORS! AGENTS!  
MAKE REAL MONEY WITH REAL FUR, STUFFED TOYS**

Cash in on one of the fastest-moving lines in the business! Send for demonstration sample of French Poodle (illustrated) \$5.00 or complete catalog for 25c.

**ACE TOY MFG. CO., 122 W. 27th St., Suite 701, N.Y. 1**

## Now You Can GET THOSE

### MOTOR-CLUTCH- TRANSMISSION AND AXLE PARTS in stock

Why worry about parts when we have them . . . All you want, at a **BIG SAVING** . . . We ship within 48 hours . . . We also have **REBUILT UNITS** for **EXCHANGE** at **Bargain Prices**: **CARBURETORS — FUEL PUMPS —**

## ● NEW ● AUTO PARTS

and  
**SAVE  
MONEY**

Get Our  
**BARGAIN**



# You needn't get

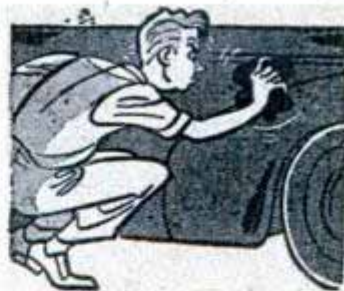

## A "charley-horse"



## For ease and speed



## Use this of course



Removes dull traffic film—restores the original color and lustre—quickly, easily and safely.

# DU PONT





# 'QUICK-CHANGE' GEAR BOX

CUT THREADS — 4 TO 224 PER INCH

Approximately .003 feed, for fine turning.  
 New reverse furnished with box for Atlas.  
 Bronze bearings throughout entire unit.  
 Aluminum casting — All steel gears.  
 Maintained accuracy.  
 Speeds up production.  
 Easy to install.  
 Simple to set.  
 Immediate delivery.

Only **\$75<sup>00</sup>**

F.O.B. Chicago  
 Guaranteed

**FOR-** Atlas, Logan, Craftsman  
 and Power-Kraft Lathes

Write for information or order direct. Full instructions with shipment.  
**O'BRIEN MACHINE CO., Sales Dept. PM, 1620 Highland Ave., Chicago, Ill.**

Fill Holes, cracks, dents, gouges...

## These **BETTER FILLERS**

- HARDEN FASTER
- SHRINK LESS
- STAY IN!

FILLS HOLES  
 IN ONLY  
 1 APPLICATION



FILLS DENTS  
 AND SCRATCHES

SAND OR  
 POLISH IT

WEATHERPROOF  
 WATERPROOF

TAKES HIGH FINISH

CRACKS ARE  
 EASILY FILLED

Duratite Wood Dough will fill rough or irregular cavities in wood, metal, plastic or plaster in one application. (Duratite Surfacing Putty for shallow cavities). Can be sawed, cut, milled, sanded; are waterproof, fire resistant. Seven wood colors, in tubes or cans, at Hardware and Paint stores. Made by Manufacturers of famous Arrowhead Cement.

LARGE TUBE  
 25c Postpaid

### WEBB PRODUCTS CO.

228 South G Street, San Bernardino, California  
 or Webb Company - Dept. M - Norcross, Georgia.



# DURATITE

**WOOD DOUGH AND SURFACING PUTTY**



## BRASS

For Home Work Shops

Free Cutting Brass Rods  
 Round, Hexagon, Square,  
 1/2-Oval.

Naval Brass Rods  
 Round and Hexagon.  
 Brass and Copper Tubing.  
 Brass Sheet.

Please send 10c  
 for Catalog No. 101  
**MEIER BRASS & COPPER CO.**  
 1155 Bellevue, Detroit 7, Mich.

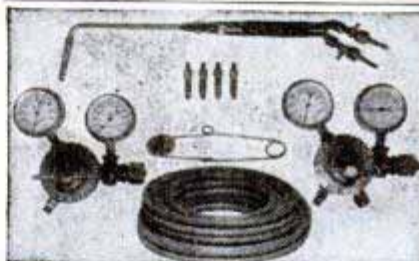

## New Welding Outfit

Complete like picture  
**\$54.50**

Electric Welding Outfits  
 from \$39.00 up. (Weld-  
 ers Manual \$1.75) 400  
 pages.

**EAGLE WELDING  
 EQUIP. CO.**  
 Dept. 40  
 5085 Broadway, Chicago

## METALLIZE BABY SHOES

Learn this easy, money making business from nationally recognized consultant. Small investment; perpetual market. For free details write Joseph B. Kushner, B.S. Ch.E., Metal Finishing Consultant, Stroudsburg, Pennsylvania, RD3H.

## Don't Spoil it ...KROIL it!



Don't ruin valuable equipment merely because some part is rusted tight. KROIL, the new chemical lubricant, creeps into millionth inch spaces, dissolves rust and loosens frozen parts, faster than any penetrating oil known. 5000 industrial plants still use KROIL to keep production going. Try it on money back basis. AT YOUR DEALER or send \$1 for two 8 oz. spout cans, postpaid. Send dealer's name.

**KANO LABS, 3023 Lincoln Tower, Chicago 1, Ill.**

## WRITE FOR YOUR **FREE** COPY OF THE NEW **KRW HYDRAULIC PRESS BOOK**

Describes all manner of Production and Shop Work on KRW Hydraulic and Bench Type Arbor Presses. 32 pages illustrating the new KRW Hand-operated, Electric-operated and Air-operated Hydraulic Presses.

Write for your copy today.



**K. R. WILSON, DEPT. 17, 215 MAIN ST., BUFFALO 3, N. Y.**

Builders of Shop Equipment for Ford Dealers Since 1916

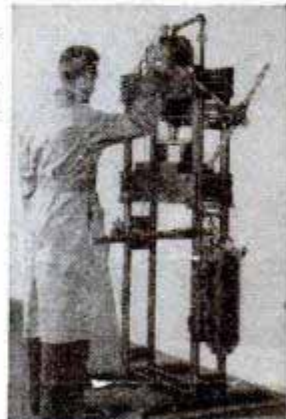



# MORE PROFITS

with

## MODERN LAWN MOWER SHARPENER



**SHARPEN ANY LAWN MOWER** from 5-inch Edger to 36-inch Power Mower in ten to twenty minutes with a **MODERN LAWN MOWER SHARPENER** because dismantling is unnecessary—neither handle, roller, wheels nor motor need be removed when sharpening any mower. . . . the **MODERN SHARPENER** eliminates all hand filing; it precision grinds to the extreme ends of both left or right reel blades. Bottom knife is held in same brackets for sharpening. **NO EXTRA ATTACHMENTS!** Order today! Price \$241.50 (less motor) f.o.b. Pasadena. (1/2 or 3/4 H.P. single phase motor recommended.)

Modern Mfg. Co., 156 N. Fair Oaks, Pasadena 1, Calif.

## WOODWORKERS ... Get this

**CONSTANTINE MASTER MANUAL**

**Get the Most Fun From Your Hobby** indispensable to woodworkers. Newest, biggest edition, more pages, more color, helpful how-to-do-it articles, pre-war and new items, more bargains. Send 25c today and we will include **FREE! FULL YRS. SUBSCRIPTION** to Chips and Chats, published bi-monthly. Keeps you up-to-date on everything in woodworking, offers big money-saving bargains. Send now.

ALBERT CONSTANTINE & SON, Inc.  
791-F 135th Street, New York 54, N. Y.



• • • **INSTALL YOUR OWN LAWN SPRINKLERS—UNDERGROUND \$1.49 each**  
with **AQUA-SPRAY HEADS**  
6 HEADS SPRAY UP TO 800 SQUARE FEET  
Easily installed—fully adjustable to any shape lawn—full instructions—money-back guarantee. Send check or money order to

## AQUA-SPRAY LAWN SPRINKLER CO.

439 EAST FORT STREET, DETROIT 26, MICH.

SAY YOU SAW IT IN POPULAR MECHANICS

## THE NEW MODERN MOWER

For either gas or electric power. You furnish the engine or motor, we furnish the rest. Shipped completely assembled with adjustable mounting brackets to fit any conventional engine or motor.

For Details Write  
**AIR-ELECTRIC MOWER**  
LOHRVILLE, IOWA

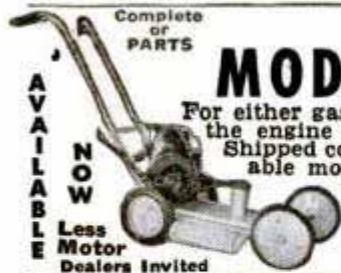

AVAILABLE NOW  
Less Motor  
Dealers Invited

What marks a box,  
a can, a jar  
So all may know  
what contents are?

# Dennison

## GUMMED LABELS

At Stationery Departments Everywhere

Radio's Greatest  
Buying Guide!

**FREE**



## ALLIED'S NEW RADIO CATALOG

Send for this Big  
Value Book NOW!

Send for your **FREE** copy of the leading Buying Guide for Everything in Radio! Here's the handiest catalog for Servicemen, Dealers, Soundmen, Amateurs, Builders and Experimenters. Features the world's largest and most complete stocks of quality radio and electronic supplies—all at lowest prices! Get the equipment, the speedy service, the expert help you want, from **ALLIED—Radio's Largest Supply House!**

**164 PAGES — RADIO'S BIGGEST!**



**HUGE STOCKS—MORE THAN 10,000 ITEMS**

Everything for every radio use: new model home radios, phono-radios, communications receivers, Ham kits and gear, radio parts, tubes, tools, test instruments, public address equipment, low-cost easy-to-build radio kits, diagrams, instructive radio books, radio's most complete stocks—all at lowest prices!

## HELPFUL RADIO BOOKS!

- Radio Formulas & Data No. 37-752 . . . 10c
- Dictionary of Radio Terms No. 37-751 . . . 15c
- Radio Circuit Handbook No. 37-753 . . . 25c
- Radio Builders' Handbook No. 37-750 . . . 15c
- Simplified Radio Servicing No. 37-755 . . . 10c
- Radio Data Handbook No. 37-754 . . . 25c
- ALL 6 BOOKS above No. 37-799 . . . \$1.00
- Parallel-Resistance and Series Capacitance Calculator. No. 37-960 . . . 25c
- R-F Resonance and Coil Winding Calculator. No. 37-955 . . . 25c

## ALLIED RADIO

**ALLIED RADIO CORP.**  
833 W. Jackson Blvd., Dept. 5-F-7  
Chicago 7, Illinois

**FREE CATALOG**

- Rush **FREE** 1947 Catalog
  - Send 6 Books No. 37-799
  - Send Books checked above
  - Send Calculators checked above
- } \$.....enclosed

Name.....

Address.....

City..... Zone..... State.....



# PAUL BUNYAN



... always got the big ones!  
So do Paul Bunyan Baits



PAUL BUNYAN

LADY BUG DIVER

When you retrieve the Lady Bug, she dives down into the deep water, where the 'lunkers' like to lie in wait for a big dinner. And how they go for the Lady Bug! Those moss-backed Pike, Muskies and Bass can't resist a Paul Bunyan Lady Bug Diver. Treble tail hooks. Choice of colors. Two sizes, 2½ inches, \$1.10; 3¼ inches, \$1.25.

PAUL BUNYAN  
TRANSPARENT  
DODGER



Darts, wobbles, dodges and dives with the action of a crippled minnow. Irresistible to all game fish, for all game fish go for minnows—particularly one that acts injured! Transparent Tenite, ribs and spine give a skeleton-like appearance. Six colors. \$1.25.



"Made by the Waters  
of Minnetonka"

**PAUL BUNYAN  
BAITS**

**PAUL BUNYAN BAIT COMPANY**  
Department PM67, Minneapolis 5, Minn.

If your dealer can't supply you, write us.

Remove most of the water from the thawed starch sponge by pressing slowly and gently, preferably between sheets of screening or on a perforated tray so that the water can easily be drained away. If the water is not allowed to flow away, it will be reabsorbed by the sponge as soon as the pressure is released. A good sponge springs back into its original size and shape when the pressure is released.

To make a dried sponge, cut the damp pressed sponge into pieces of the desired size and shape before drying. Then place the pieces of damp pressed sponge in front of a fan and allow to dry at room temperature until firm and tough. Crisp the starch sponge by final drying in an oven at a temperature below 200 degrees.

## Dress Parade on Rails

(Continued from page 104)

search, Inc., in cooperation with several railroads may outmode all other types of locomotion. It's the biggest threat to oil power, and railroads may throw the switch back to coal if it's successful.

Coal is a difficult fuel to handle inside a turbine, but in this engine unprepared coal is atomized finer than face powder by "exploding" the air inside it. Delivered to the combustors, it burns under 70 pounds pressure per square inch. The resulting gases enter the turbine at 1300 degrees Fahrenheit to turn the turbine blades and air compressor. The turbine turns electric generators which drive the locomotive.

Economy is the biggest advantage of the coal burner. Its proponents expect the coal-burning gas turbine to operate at a cost of about 26 cents a mile compared with 56 to 60 cents a mile for the Diesel-electric. Furthermore, the colder the outside temperature the more efficiently the turbine operates, and there's no smoke.

Another locomotive just around the bend is a Westinghouse gas turbine which burns a low-cost fuel oil. This puts it in economic competition with conventional rail prime movers. Its chief advantage is its small size, about half that of a Diesel-electric engine.

The railroads are catering to you with many new services, too. For example, a number of the new coach trains have reserved seats throughout at regular fares. You can phone in a reservation and pick it up on the train without waiting in line. A group of 34 railroads is establishing a credit system; anyone with references who does a lot of traveling can obtain a credit card and sign for all expenses, paying his bill at the end of the month. The card takes

(Continued to page 256)





## CROSMAN *Silent* RIFLE

Most Amazing Gun Ever Invented for Target and Small Game Shooting

The ideal rifle for year 'round shooting indoors or out. Shoots low-cost SUPER PELLETS without noise, odor or recoil. Requires no cleaning.

Adjustable power—rifled barrel for accuracy. .177 and .22 caliber models.

CROSMAN ARMS CO., INC.  
3 HENRIETTA ST., ROCHESTER 7, N. Y.

### Shoot CROSMAN *SuperPells*

The BETTER Ammunition for ALL .177 and .22 caliber Air Pistols and Rifles.

.177 cal. . . \$2.50 per M

.22 cal. . . \$3.00 per M

POSTAGE PREPAID

At your dealer or order direct

CROSMAN ARMS CO. HENRIETTA ST., ROCHESTER 7, N. Y.

FOR  
GREATER  
ACCURACY  
MAXIMUM  
POWER

## NEW! METAL FORMING TOOLS

**VISE IRON BENDER.** Easily bends 1/2" square or round; 1/4" up to 2" wide. Makes hooks, rings, brackets, eyelets, etc. Screw adjustment for accurate work. All steel. Price \$10.00 PP. Immediate delivery.

**VISE FORMING TOOL.** Makes cylinders, ovals, cones hoops and round corners in sheet metal, wire and 1/4x2 steel strap, 2" to 60" in dia., 18" wide. \$8.50 PP.

**12" BRAKE.** Fits in vise, or bolts to bench. Forms angles, channels, boxes and crimps in sheet metal and thin strap iron. \$14.50 PP.

**12" VISE PRESS-BRAKE.** Forms channels in sheet metal, 1/8" to 1/2" wide, up to 4 ft. long. \$8.50 PP.

Order direct, or send for details. Sheet metal and wire forming booklet, 50c.

VISE BRAKE MFG. CO., Dept. P.M., 1318 So. 30th Ave., Omaha 5, Nebr.



## NO TEDIOUS HAND TURNING!



Revolves Three Times a Minute

Sturdy, adjustable, it's equipped with 50 feet of cord; 110 V. AC. Useful indoors too. At better stores or write for literature. \$39.50 each.

**KASSON**

## Electric Bar-B-Q

GENERAL DIE AND STAMPING CORPORATION  
270 Mott St. Dept. MP New York 12, N. Y.

## NEW TOOL READY

QUICKLY SHAPES, SANDS, CARVES, PROFILES, BANDSANDER  
GRINDS, BEVELS, SMOOTHS, POLISHES, CLEANS!

Industry's most versatile machine—THE MEAD BANDSANDER—now available to hobbyists, craftsmen, model makers, pattern makers, home workshops—cuts fast and clean on wood, metal, plastics! Works equally well on inside cut-out openings or irregular outside edges, on intricate scrolls, curves. Saves hours of tiresome hard work—does better job. Nothing else like it. **IDEAL TO GIVE OR GET FOR WORKSHOP!** Sold on 5 Day's Trial, money back GUARANTEE.

### FREE!

Write for free, lavishly illustrated Circular describing how Bandsander—the machine that amazed the experts—saves time, money, trouble. Write now—a post card will do!

MEAD SPECIALTIES CO.  
4114 N. Knox Ave., Dept. 167, Chicago 41, Ill.



# WALTHAM STOP WATCH

BRAND NEW! **\$9.95**  
only 9.95

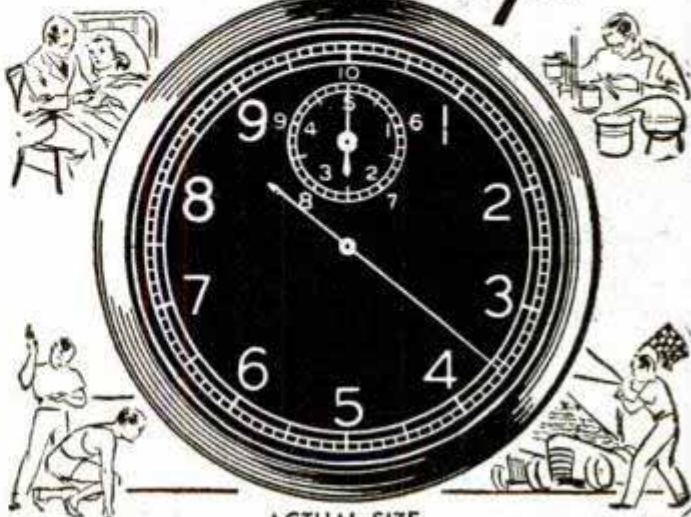

ACTUAL SIZE

**GUARANTEED!** If not satisfied, return within 10 days for money back. But you'll keep and treasure this beautiful 9-jewel, 1/10 second pocket stop watch. Shockproof, water-resistant. Handsome non-corrosive, chromium-plated metal case. Unbreakable crystal. Sweep second hand. Precision-made by WALTHAM craftsmen to rigid specifications for U. S. Army.

## BULOVA • WALTHAM ELGIN



YOUR CHOICE ONLY **\$22.50**

(PLUS 10% TAX)

U. S. GOV'T. SURPLUS  
16-JEWEL

## WRIST WATCHES

CANNOT BE DUPLICATED  
AT DOUBLE THIS PRICE!

- Sweep Second Hand • Shockproof
- Moistureproof • Non-Magnetic
- Fully Guaranteed

Order one or both of these amazing watch values today! A fortunate quantity purchase makes this amazing offer possible. Send check, cash or money order for prompt postpaid shipment. C.O.D.'s accepted, but you pay postage.

**ARCH SALES COMPANY**  
43 N. 11th STREET • PHILA. 7, PA.



# X-acto

HANDICRAFT  
KNIVES & TOOLS



Choice of experts in every art and craft field. Singly and in sets, 25c to \$45.00.

Buy where you see this sign —  
At hobby, hardware and gift shops.

X-acto Crescent Products Co., Inc., N. Y.  
In Canada, Handicraft Tools, Ltd., Toronto  
\*Reg. U.S. Pat. Off.

## SUCCEED

Start Now In Spare Time!

Be A Manufacturer  
Hold Your Job! Work At Home!

15  
TRADE  
SECRETS

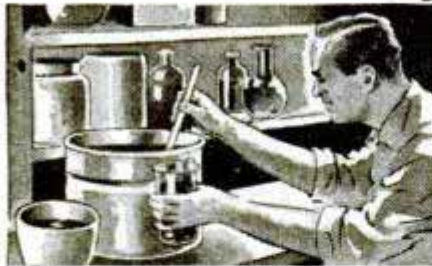

Starting in your kitchen or basement, in spare time, you can build a profitable manufacturing business of your own. We provide 15 valuable processes, developed and perfected in America's largest laboratories at the cost of millions of dollars. You make products which are in great demand—for example, "Thermo-Sol", a new inexpensive fireproofing that has no competition; "Chem-Stone", a new plastic liquid that makes concrete as hard as stone; "Water Seal", the secret sealer for leaky walls and ceilings, and 12 other easy-to-make, easy-to-sell products. We supply everything you need. Get started now!



Own Your Own Factory! Write Today  
For Complete Free Information!

CHEMICAL RESEARCH CO.  
130 WEST 42nd ST. NEW YORK-18, N. Y.

## ELECTRICITY *Anywhere*

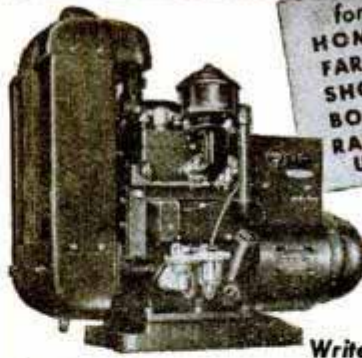

for  
HOMES  
FARMS  
SHOPS  
BOATS  
RADIO  
USE

Onan gasoline engine-driven Electric Plants supply reliable, economical electric service for any use. Portable, stationary or standby models. Water or air-cooled, compact and rugged.

A.C.: 350 to 35,000 watts in all standard voltages and frequencies. D.C.: 600 to 10,000 watts, 115 and 230 volts. BATTERY CHARGERS: 500 to 3,500 watts; 6, 12, 24, 32 volts.

Write for folder

D. W. ONAN & SONS INC.  
2530 Royalston Ave., Minneapolis 5, Minn.



## New THOR "B" ENGINE—\$6.95

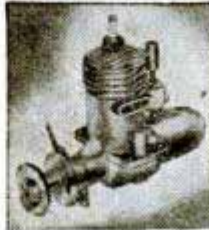

The new THOR "B"—Sensational miniature gasoline engine that really works. Super-power performance. Smooth, velveted power that roars into action with a "twist of the wrist." Over 20,000 already sold. 1/6 H.P. Complete with coil, condenser, and fully illustrated instructions, ready to run, only \$9.95. In KIT form, fully machined, 5 minutes to assemble, \$8.95, without coil and condenser. Powers all models. Send \$1.00—shipped collect same day C.O.D. Free. Send for 24-page illustrated hobby catalog.

AMERICA'S HOBBY CENTER, INC.  
DEPT. B67, 156 WEST 22ND STREET, NEW YORK 11, NEW YORK

## NEW PANTAGRAPH PORTABLE ADDING MACHINE

Add, subtract, multiply. \$999,999.99 cap. Easy fingertip operation. Nothing complicated about this practical new type machine. Ruggedly constructed. Lightning fast. For business, farmers, professional men. Use it a week on our money back guarantee. Return for refund if not satisfied. \$14.50 C. O. D. plus postage. Cash orders prepaid. This company is 100 years old. Established 1846. Clip this.

PANTAGRAPH BUSINESS MACHINES  
DEPT. 44 BLOOMINGTON, ILL.

"SAWZIT"—A Tool of 1000 Uses. Handles Like Knife. Cuts Like a Hack Saw

A versatile tool for the mechanic, electrician, carpenter, modelmaker, handyman. Reaches places no other saw can get. Uses broken or new hack saw blades. Comes with 1 blade. Additional blades, 6 for 25c. Postpaid ALGONQUIN PARTS DARIEN, CONNECTICUT

SAY YOU SAW IT IN POPULAR MECHANICS

## MAKE BIG MONEY AT HOME

Preserving baby shoes in metal, pearl, gold, silver, bronze. No experience necessary. 500%-1000% profit. Your own business.  
KIKTAVI CO., 8620 So. Ruthelen, Los Angeles 44, Calif.

## DIE-LESS DUPLICATING

Many small parts can be formed without dies, to duplicated accuracy of .001" with DI-ACRO Precision Machines. — Benders, Brakes, Shears. Save die expense and time delay. Ideal for experimental and research work, making samples, models, etc., as well as regular production runs. Write for descriptive literature.

O'Neil-Irwin Mfg. Company  
341 8th Ave.  
Lake City, Minnesota



SHEAR

BENDER

BRAKE





# MOTO-TOOL ★ THE "POCKET-SIZE" MACHINE SHOP

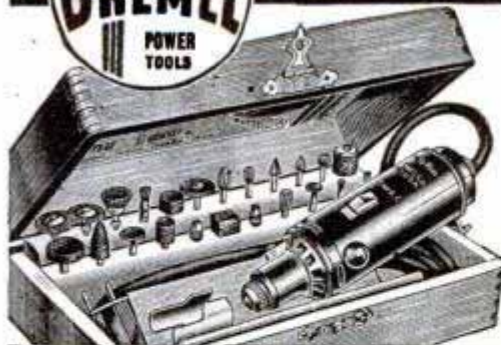

**"MAN . . . WHAT A POWERHOUSE!"**

**A TOOL THAT PACKS YEARS OF PLEASURE**

Here's a tool to please a man's heart . . . one that holds promise of endless creative hours. Dremel Moto-Tool is a "war veteran" . . . used by all branches of the armed forces in far-flung repair bases . . . helped set production records at General Electric, Westinghouse, Remington Arms, Ford and others. Hobbyist or expert craftsman, first choice is Model 2 Moto-Tool Kit with its handsome felt-lined, highly finished wood case with rows of tools begging to be put to work. Write for FREE catalog of Moto-Tool attachments and accessories.

**MOTO-TOOL FEATURES:**

Oil-less, sealed bearings • Patented automatic chuck lock pin • Over-size armature shaft, hardened, ground, polished • 110 Volt, AC-DC motor • Sliding snap-type switch • Cord protector • Shockproof bakelite housing • Dust-filtered, air-cooling system • Weighs only 13 oz. • Dynamically balanced for vibrationless operation.

**MONEY BACK GUARANTEE:** Buy Dremel Moto-Tool and Accessories from your dealer. If he cannot supply you, order direct from factory on 10 day trial. Shipped postpaid for cash in full; or for \$2.00 sent C.O.D. for balance plus postage.

**DREMEL MFG. CO.,** Dept. 117-F, Racine, Wisconsin



Approx. 27,000 R.P.M.

- Burring
- Grinding
- Routing
- Polishing
- Engraving
- Sharpening
- Drilling
- Inlaying
- Sawing
- Sanding
- Carving
- Cutting

**Moto-Tool Kit No. 2**, with 23 accessories (high speed steel cutters, grinding wheels, polishing accessories) and heavy-duty professional Model 2 Moto-Tool in natural-  
**finish, hardwood case . . . \$23.50.** (Items purchased separately would cost about \$30.00; you save \$6.50.)  
**Moto-Tool No. 1** with one emery wheel point . . . \$16.50.  
**Moto-Tool Kit No. 1** with 34 accessories and Model 1 Moto-Tool in wood case . . . \$17.50.  
**Model 1 Moto-Tool** with one emery wheel point . . . \$9.85.

## FOR DAD, SAFER DRIVING



A Hull Streamline Automobile Compass for Father's Day means no more lost directions, treacherous driving on wrong roads for Dad. Insist on the original Hull for accuracy, dependability. At your dealer's. Write for circular. Price \$3.95.

**HULL MFG. CO.,** P. O. Box 246-D5, Warren, Ohio



## KUT RITE lawn mower sharpener

Patented. 3 popular sizes; retail prices: 14", \$1.40; 16", \$1.50; 18", \$1.60

Send Check or Money Order  
Postage for mailing twenty cents.

**ACCURATE SHARPENER MFG. CO.**  
2230-A N. Hubbard Street,  
Dept. P.M. 1, Milwaukee 12, Wis.



Pat. No. 2250764

## PULVEX "DDT" FLEA POWDER



Kills the fleas *Quickly!*  
Keeps others off for Days.



Pulvex also comes with ROTENONE, the original formula. BEST FOR CATS.

Either Kind 25¢ & 50¢

# STOP LEAKS!

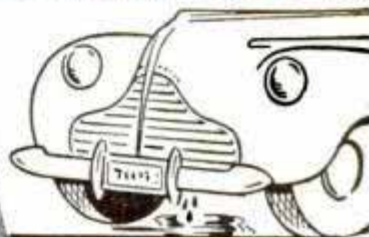

**Cooling Systems Made Leak-Proof QUICKLY**

**WARNER LIQUID SOLDER—Non-Metallic—Deposits Tiny Fibers to Repair Leaks Anywhere in Cooling Systems. Simply pour in! Finds and REPAIRS every crack or hole. Do it yourself—or see your service man.**

**Warner-Patterson Co., 920 S. Michigan Ave., Chicago 5**



**MACHINISTS — TOOLMAKERS**  
Better construction of Gerstner Tool Chests, makes them better values. Free Catalog.

**GERSTNER TOOL CHESTS**  
447 Columbia St., Dayton 7, Ohio

# TRAILER AXLES • HUBS • WHEELS AND SPRINGS

Axles are strong construction and can be supplied with or without our new coil spring suspension. Straight axle has standard 58" tread. Drop axle has 58 1/2" tread. Spring centers 46" on both axles. Load capacity 1500 pounds. Write for Descriptive Literature.

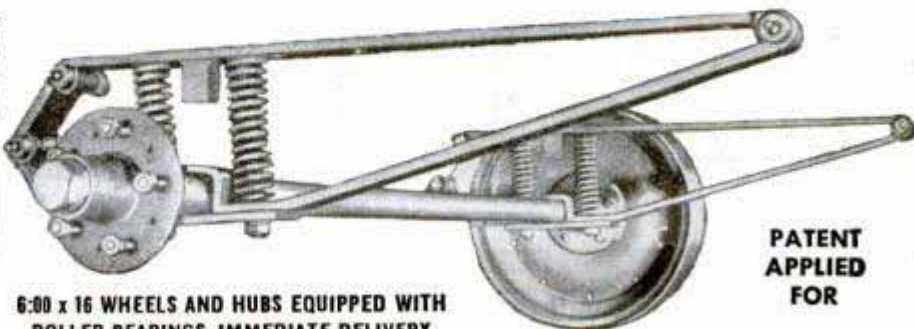

Remittance with order	Axle Only	Axle with Springs
—No C.O.D.		
Straight Axle, Std. Tread	\$ 6.75	\$24.75
Drop Axle, Std. Tread	12.00	30.00
Wider tread axles available at additional cost		
PRICES F.O.B. FENTON, MICH.		

6:00 x 16 WHEELS AND HUBS EQUIPPED WITH ROLLER BEARINGS. IMMEDIATE DELIVERY

PATENT APPLIED FOR

**MANUFACTURERS AND DEALERS WRITE FOR QUANTITY LOT PRICES**

**200 S. LEROY ST. INDUSTRIAL MACHINE TOOL CO., INC. FENTON, MICHIGAN**



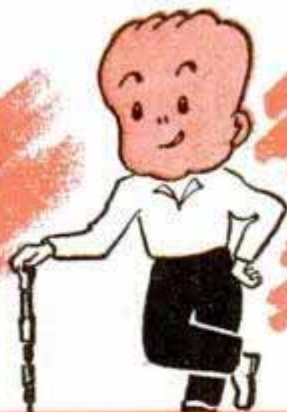

**Save Time  
on Routine Jobs**

## with an **AUTOMATIC SCREW DRIVER**

Whether it's light production assembling or a routine home workshop job, you can save a lot of time with a Millers Falls Automatic Screw Driver. This unique spiral ratchet tool can handle any screw driving job quicker and easier. By simply shifting the knurled control sleeve and the spiral lock nut, it can be used either as a regular rigid screw driver, a right or left hand ratchet, or as a complete automatic. Made with or without quick return.

Smooth, powerful action and tested dependability are built right into Millers Falls Automatic Screw Drivers. You can depend on them for long-lasting satisfaction. Ask to see one at your dealers today.

**One thing in common—Quality**



**MILLERS FALLS COMPANY  
GREENFIELD • MASSACHUSETTS**



care of all costs including tickets, berths, meals and other services. Some of the Santa Fe trains will have a sick room in the club-lounge car. If anyone must be removed by stretcher a special hinged wall opens out of the room and the patient can be transferred directly to an ambulance.

Chesapeake and Ohio started the first theater-on-rails last January on the George Washington between Washington and Cincinnati, and other railroads will follow suit soon. Twin-unit dining cars of the George Washington were rebuilt into a theater with 50 seats that fold into the wall. There's no charge for the 16-mm. pictures shown twice nightly on a four-by-five foot screen.

Car manufacturers have designed some unique specialty cars that are still future promises. When the demand for basic equipment has been filled you'll probably find night clubs with dance floors, playrooms with slides and teeters for the kids, and casino cars for the card players.

Over a year ago an advertisement appeared in the newspapers that drew a lot of chuckles but pointed out an obvious shortcoming in rail service. It was inserted by Robert R. Young of Chesapeake and Ohio, who leveled an accusing finger at the railroads because a hog could cross the country without changing trains but humans couldn't.

Today coast-to-coast sleeper service is a reality and you can step into your compartment in Washington or New York and never open the door until you arrive at Los Angeles, San Francisco, El Paso or San Antonio. You can even travel from Mexico City to New York without leaving the car!

Travelers will have a choice of many spanking new streamliners within a year. North Western will add an overnight sleeping car train this summer to its fleet of 400s running from Chicago to the Twin Cities. The Milwaukee Road will have six new fast trains costing \$1,500,000 apiece in daily service between Tacoma-Seattle and Chicago within a few months. Twin coach streamliners, the Shasta Daylights, are scheduled by Southern Pacific for the end of '47 for runs on the scenic route between San Francisco and Portland. Rock Island and Southern Pacific plan triweekly de luxe trains between Chicago and Los Angeles this summer on a 39 $\frac{3}{4}$ -hour schedule.

Illinois Central's new City of New Orleans is running between that city and Chicago in 16 hours. North Coast Limiteds of the Northern Pacific will make the run between Chicago and the North Pacific coast in 45 hours. Burlington has ordered Vista Dome cars for its California Zephyrs to op-

(Continued to page 260)



# There's a "Four" for YOU—



ZEPHYR

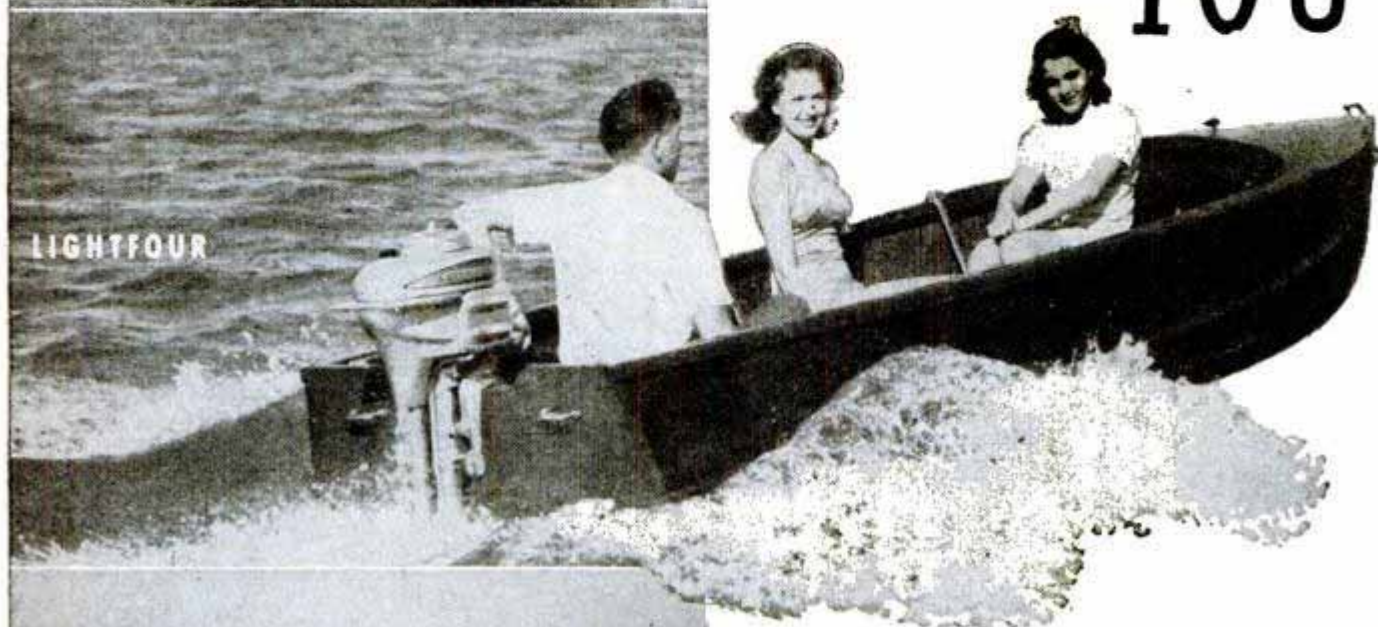

LIGHTFOUR

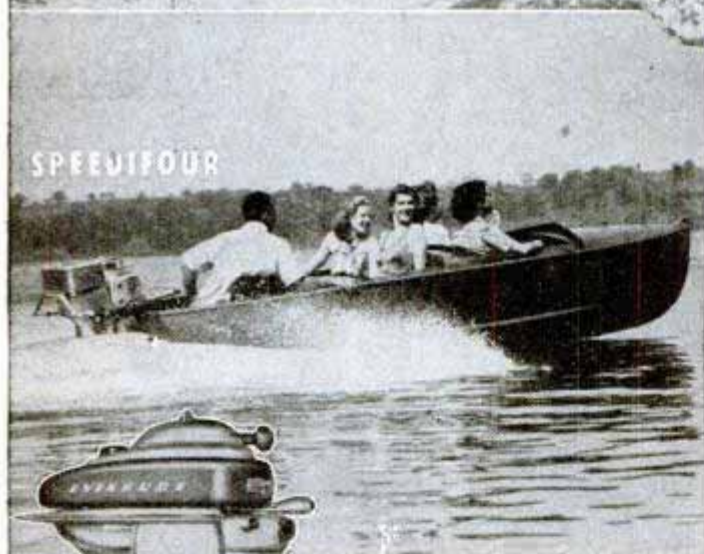

SPEEDIFOUR

—just right in size, power, performance . . . in Evinrude's complete line of 3 thrilling four-cylinder models!

If you want a motor developing 5 horsepower or more — why not enjoy the *extra* smoothness — the *extra* thrill of performance — that are yours with an Evinrude "four"?

There's nothing like them — for any boat, or any kind of service! No other type of outboard motor to match their velvety surge of power, their responsiveness and flashing get away!

See your Evinrude dealer — look for his name under "Outboard Motors" in your classified telephone directory. Catalog of the complete Evinrude line of 7 models sent on request. Write for it today—address, EVINRUDE MOTORS, 5561 North 27th Street, Milwaukee 9, Wis.

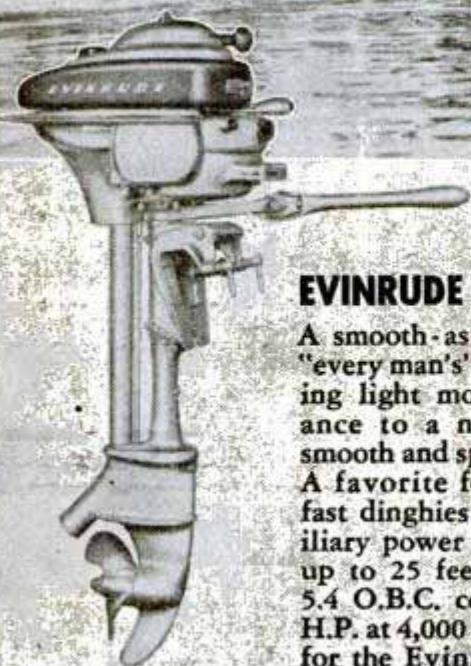

## EVINRUDE "ZEPHYR"

A smooth-as-silk four in "every man's" size—bringing light motor performance to a new level of smooth and spirited action. A favorite for powering fast dinghies and for auxiliary power on sail boats up to 25 feet. Develops 5.4 O.B.C. certified brake H.P. at 4,000 R.P.M. Write for the Evinrude catalog.

# EVINRUDE

FIRST IN OUTBOARDS • 38TH YEAR

In Canada: Evinrude Motors, Peterboro, Ontario.



Now you get  
**2 PIPES IN 1**

NO EXTRA COST

# Thoro-Kleen

AIR COOLED ALUMINUM PIPE WITH INNER AND OUTER BOWLS OF GENUINE IMPORTED BRIAR

Ask Your Dealer for the Genuine Thoro-Kleen



**\$2.50**  
COMPLETE

NATIONALLY FAIR TRADED

2 INTERCHANGEABLE SCREW-ON BOWLS  
FEATHERLIGHT • ALL PARTS REPLACEABLE  
INSIDE FILTERS • SPIC AND SPAN CLEAN  
VULCANITE RUBBER BIT BEVELLED FOR COMFORT

## GREENWICH HOUSE CORP.

939-M 8th AVENUE, N. Y. 19, N. Y.

Territories Open. Jobber Inquiry Invited.

## BUILD YOUR OWN RADIO

### 3-TUBE AC-DC KIT



It's great fun to build and hear this fine 3 tube set. Gets all stations from 550 to 1500 kc. For 110 volts AC or DC. Uses 2-6J5 and 1-6SJ7 Tubes. Complete kit, less tubes, wire, solder, and phones, only **\$6.15**

Kit of 3 Tubes.....\$2.40 — Set of Phones.....\$1.95

### 5-TUBE AC-DC MODEL



A full-sized 5 Tube SuperHet Kit with Automatic Volume Control, Built-in Antenna, PM Dynamic Speaker, Brown Plastic Cabinet. Uses 12SA7, 12SK7, 12SQ7, 50L6, 35Z5 Tubes. For 110 volt AC or DC. Complete, less tubes..... **\$12.75**

Complete Kit of Tubes (as above).....\$4.08

### PHONO Oscillator 2-Tube Kit



Build this fine Phono Oscillator with complete kit and instructions. Mounts anywhere. 110 volts AC or DC. Including two tubes Only..... **\$5.33**

Order from New York or Chicago  
Enclose postage with order

### PHONO AMPLIFIER 2-Tube Model

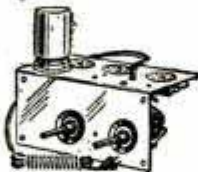

Compact, mts. any position. Tone, volume controls. 35Z5, 50L6, 110 V. AC-DC. Wired, ready to operate, less tubes..... **\$2.95**  
2 tubes for above.....\$1.62  
3-Tube Model — Similar, uses 35Z5, 12SK7, 50L6. **\$4.45**  
Less tubes.....  
3 Tubes for above.....\$2.54

NEW YORK  
Offices & Warehouse  
242 W. 55th St., N.Y. 19

**NEWARK**  
ELECTRIC COMPANY, INC.

CHICAGO  
323 W. Madison St.  
Chicago 6, Ill.

New York City Stores: 115-17 W. 45th St. & 212 Fulton St.

# WAR SURPLUS

Cost Gov't approx. \$100 to \$500

## NEW RUBBER LIFE BOATS

Complete with compressed Air Cylinder, Paddles and Miscellaneous standard equipment.

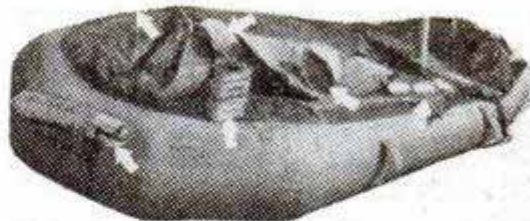

Guaranteed. Can be inflated in less than 5 minutes. Portable, folds up in case. Can be carried underarm.

1 MAN RAFTS ..... **\$15.75** 5 Man Rafts.....\$34.75  
7 Man Rafts.....\$49.75

Immediate shipment. Sent postpaid.

## ROKO COMPANY

729 BALTIMORE

KANSAS CITY, MO.

## Redecorating?

A single coat of Luminall paint, in the rich, new colors, will work wonders in your home. Use over wallpaper ... dries in 40 minutes. There's a dealer near you.

Luminall Paints, Chicago 9.



**Use Luminall**  
for brighter interiors



AMAZING NEW *Star* SCIENTIFIC GAS BURNER

Automatic, Self-Acting • Needs No Adjustments • Jet Type • Cannot Backfire • Powerful in Performance  
Natural, Manufactured or Butane Gas

DEALER'S QUANTITY DISCOUNT

BIG PROFITS • ORDER NOW

DIRECT FACTORY TO YOU • MONEY BACK GUARANTEE

**STAR HEATER COMPANY**

1012-14 POWHATTAN • DALLAS 2, TEXAS

- \* STOVES
- \* KETTLES
- \* TUBS
- \* GRIDDLES
- \* HOT PLATES
- \* STEAM TABLES
- \* WATER HEATERS

EASY ASSEMBLY IN LARGE UNITS WITH STANDARD PIPE FITTINGS

\$2.00 POSTPAID

PROMPT DELIVERY AVAILABLE

## Say You Saw It in POPULAR MECHANICS



## CORROSION and FRICTION

Use Fiendoil on tools, electrical appliances, household devices. It actively

Lubricates • Cleans • Prevents Rust

3-oz. Spout Can  
**40c**

## FIENDOIL

"The Enemy of Corrosion and Friction"



## HOME-PLANNERS • BUILDERS

IN 10 SECONDS!! All 11 lengths and angles of rafters for any size and shape of simple or hip roof. Struggle no more with tables. Just set dial to "pitch" and "run" and the measurements show up in windows. Save time and materials. The RAFTER DIAL: \$1 95

E. Weyer, Dept B, P.O. Box 153, Planetarium Station, New York 24, N. Y.

POPULAR MECHANICS



# CRESCENT

TRADEMARK OF A

*Master Craftsman*

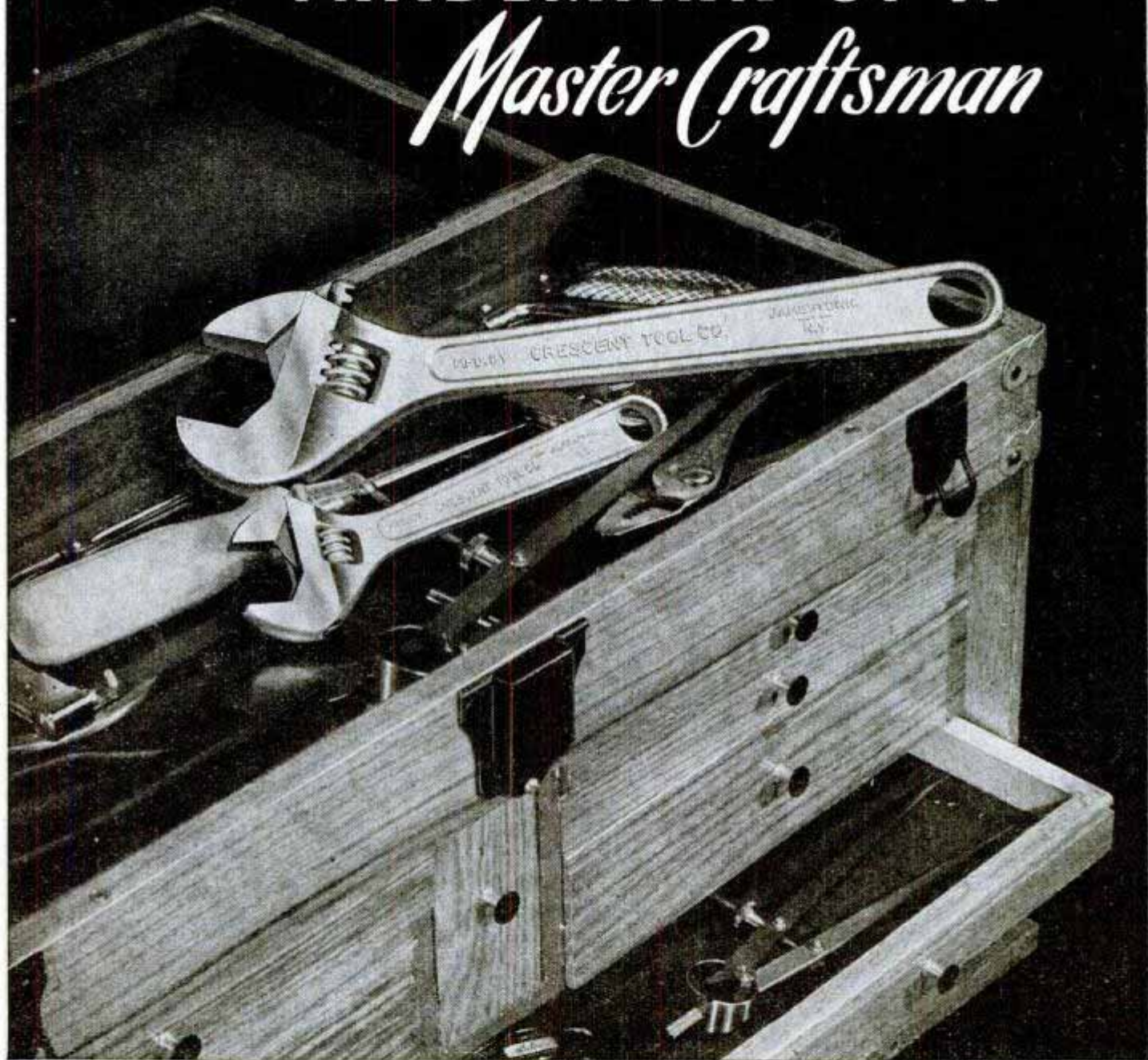

**\*CRESCENT TOOLS**

*Give Wings to Work*

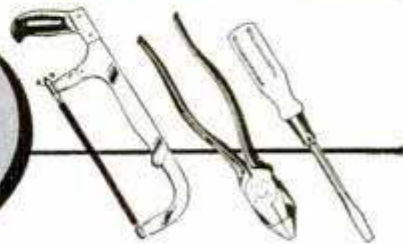

\* "CRESCENT" is our trade mark registered in the United States and foreign countries for wrenches and other tools. "Crescent" tools are made only by Crescent Tool Company of Jamestown, N. Y., and are sold by leading distributors everywhere.



# SMASHING PRICE CUT ON THE HUDSON TURBO GRINDER



Here is one of the most sensational price reductions you've ever read. The Hudson Turbo Grinder is now reduced in price to only \$4.95. The Hudson Turbo Grinder was a great value at \$8.95. Now it's a twice-as-good value at \$4.95.

## HERE'S WHY WE'RE REDUCING THE PRICE

This amazing Hudson Turbo Grinder has caught on. Thousands have ordered it and the tremendous volume of orders has permitted us to set up large quantity production runs at substantial price savings. Now everyone who works with tools can afford to own a Hudson Turbo Grinder.

The Hudson Turbo Grinder is a top quality product—super-hard silicon carbide grinding wheel, stainless steel shaft, oilite bearings, gleaming chrome housing, colorful vinylite tubing.

Simple to operate—just attach to your faucet, turn on the water and the Hudson Turbo Grinder spins at 3000 to 10,000 RPM depending on water pressure.

Sharpens knives, scissors, wood planes, chisels and all edged tools. Buffs and polishes silverware and metals. If you are a handyman, hobbyist, housewife, or mechanic, if you want sharp tools, join the thousands who are now getting sharp edges, quickly and easily, with the Hudson Turbo Grinder.



## FULL MONEY BACK GUARANTEE

Available thru any progressive dealer, or send money direct.

### THE HUDSON PRODUCTS CO., Inc.

4400 St. Aubin Ave. Room 206 Detroit 7, Mich.

erate between Chicago and San Francisco. The Twentieth Century Limited has cut running time between Chicago and New York to 15½ hours.

Packed into these trains are frills and luxuries designed to attract vacation as well as business travelers. The railroads say your vacation shouldn't wait until you've reached your destination, but should start as soon as the conductor calls "All Aboard!"

## Report From Antarctica

(Continued from page 112)

several thousand feet thick acts as an effective shield against emanations which could affect detecting devices, such as Geiger counters.

The fact remains that resources of the continent, as large as the United States and Canada combined, the accumulation of a billion years, are locked under an ice cap. Most of this time the land was clear of ice and, at some time, densely forested, as evidenced by already discovered coal resources sufficient to supply all American demands for a half century. It is probable that there are oil reserves buried under the ice and it is difficult to imagine any mineral not there to some extent. It is not beyond possibility that there is an unknown region in the interior of east Antarctica where there are ice-free stretches, perhaps with some vegetation which has survived in regions of hot springs. Such open stretches in the ice are known in the Arctic.

Geologically speaking, expedition experts say, parts of the continent were forested not long ago. In Palmer Land there is fossil sequoia, similar to that of the California species, dating back not more than 20,000,000 years. The land apparently was abundantly forested in the days of dinosaurs but certainly was ice covered during all the age of man on earth.

Ideas of a Shangri-La among the ice mountains are beyond remotest possibility. Geologists are not concerned now primarily with the continent's resources, although these may become important in the next century. The greatest interests now are theoretical.

Among lofty peaks of the continent's interior, which project like islands out of the ice, they hope to find the missing arc in a ring of ancient mountains completely encircling the Pacific, providing a link between the southern Andes and the New Zealand mountains and thence an ancient land bridge between South America and Asia. Countless millenniums ago some ti-

(Continued to page 264)



## FOR AMAZING PRECISION WORK AT HOME OR IN THE PLANT!

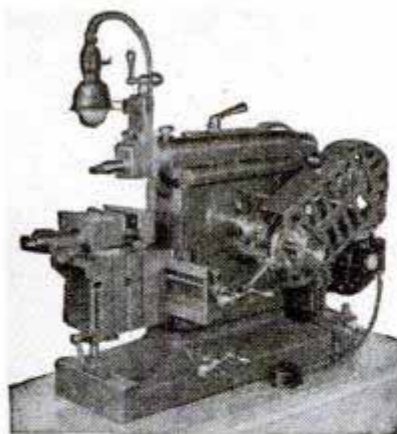

### LOW PRICED AMMCO 7" SHAPER

You'll be amazed at the wide variety of jobs this AMMCO 7" SHAPER can handle quickly, accurately, economically. It does the precision work of a larger machine... has many features found only in the big expensive shapers.

Compactly designed for home and plant use, sturdily constructed for long life—it comes in bench or portable models. At its new low price, you now can afford this Shaper of a "thousand uses".

Address Dept. PM-67 for specifications and prices.

## AMMCO TOOLS, INC.

COMMONWEALTH  
AVENUE



NORTH CHICAGO  
ILLINOIS

SKILL IS BUILT INTO EVERY AMMCO PRODUCT

## WILLEY'S MASONRY DRILLS

DRILL CEMENT, TILE, PLASTER, MARBLE,  
BRICK, SLATE, LIMESTONE, WALLBOARD

Tipped with Willey's Metal, almost as hard as a diamond, these famous drills are needed by every electrician, plumber, mechanic and home workman. Use with hand brace, portable electric drill or drill press. Give accurate holes, no chipping. Fast. Easy to use. Outlast dozens of ordinary drills. Stay sharp longer. Satisfaction guaranteed. Sizes from 3/16" to 2" dia. Sold individually. SPECIAL UTILITY KIT—Six drills, 3/16", 1/4", 5/16", 3/8", 1/2" and 5/8" complete with strong canvas case, only \$13.40 at your dealers, or mailed postpaid.

Write for Literature

WILLEY'S CARBIDE TOOL CO.

1340 W. Vernor

Detroit 1, Mich.

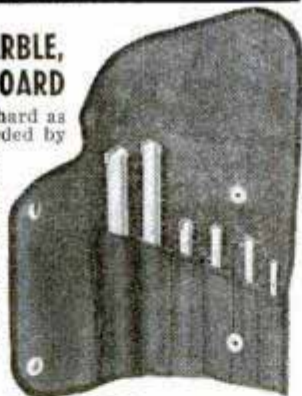

### NUMBERALL Rotary Stamp (Patented)

1 Tool Instead of 12

For stamping figures and letters on metal, etc. One stamp does away with 12 individual hand stamps. Changes of characters are quickly made merely by rotating the indexed wheel. Wheel is made of finest tool-steel. Sizes 1/16" to 3/16" figures can be furnished at \$5.00 each in pouch. Larger sizes and alphabet at higher prices. Write for Catalog.

NUMBERALL STAMP & TOOL CO.  
HUGUENOT PARK STATEN ISLAND 12, N. Y.

Performance  
goes up  
in smoke...



when worn  
connecting rod bearings  
cause oil pumping

Smoky exhaust means engine trouble, caused by worn bearings. Through them, excess oil reaches combustion chambers to burn and carbon-foul pistons, rings, valves and spark plugs, destroying pep, pick-up, power. Stop oil pumping, restore pep, power and economy. Replace in sets with Federal-Mogul Oil-Control Bearings. Ask your mechanic!

### FEDERAL-MOGUL SERVICE

DIVISION OF FEDERAL-MOGUL CORPORATION  
COLDWATER, MICHIGAN



Replace in sets with Genuine  
**FEDERAL-MOGUL**  
Oil-Control Bearings



# BRAND NEW WAR SURPLUS AT BARGAIN PRICES!

## PORTABLE CHARCOAL GRILL

For Outdoor camping, picnics and home yard. Made of heavy gauge steel. Beautifully finished in enamel. Size folded, 18 x 12 x 3 1/4 inches.

**\$5.95**

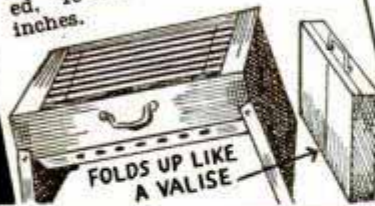

## U. S. AIR FORCE RUBBER LIFE BOAT \$16.50

1 or 2 Man — Complete with 2 Hand Paddles. Size inflated 3 1/4 feet wide by 5 1/2 feet long. When deflated, it fits into a waterproof case 15 x 15 x 4 inches.

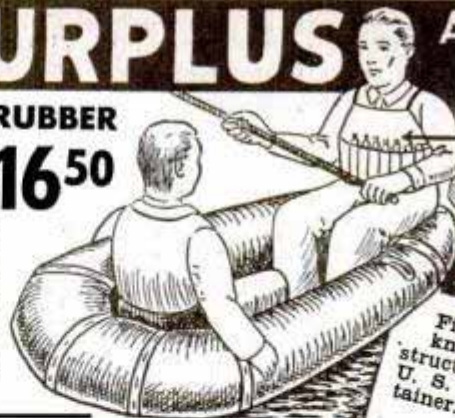

## EMERGENCY FISHING KIT

A durable apron with numerous pockets filled with the following: 1 Fishing Net • 1 pair flannel gloves • Flies • Hooks, Sinkers • 7 varieties of Bait • 1 Fish U. S. Navy airtight metal container. Only \$4.95.

Mail check or money order. We pay postage. Write for catalog.

## EDWARD LAWRENCE CO., Inc.

396 Broadway, Depf. 18, New York 13, N. Y.

## YOURS, TOO, FOR GOOD HITTING

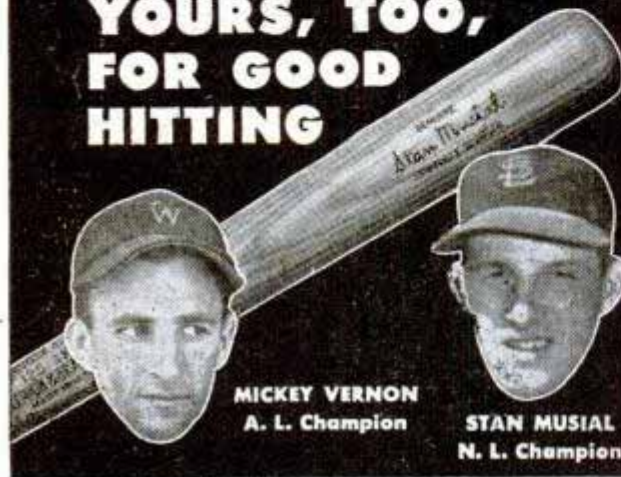

**MICKY VERNON**  
A. L. Champion

**STAN MUSIAL**  
N. L. Champion

The 1946 Champions swung to the top with their personally autographed Louisville Sluggers. Duplicates of their bats and other famous hitters are included in the 1947 Slugger line-up.

1947 Famous Slugger Yearbook  
Ask your dealer or send 5c direct to  
Dept. P-31, Hillerich & Bradsby Co.,  
Louisville 2, Ky.



## Louisville SLUGGER BATS

FOR BASEBALL & SOFTBALL

NOW *Sounded* FOR YOUR SILENT PROJECTOR Economically

**\$59.95**

Convert your 16mm silent projector to sound (regardless of make) with Apex sound head & radiofilm adapter. Guaranteed excellent performance. Write today for free information.

APEX VIDEO • Box 3071-B • Hollywood 28, Calif.

## HY-SCORE AIR PISTOL

for ACCURATE SHOOTING

No pumping. Fast. Powerful. Finest made. Single shot. 30 1/2 oz. 10 1/4" long. \$25.00 with pellets. Extra pellets per 1000 \$2.50 for cal. .177, \$3 for cal. .22.

SEE YOUR DEALER OR ORDER DIRECT  
Send 10c for circular to Dept. M-6

HY-SCORE ARMS Corp. BROOKLYN, I. N. Y.

SHOOTS CAL. 177 or .22 HEAD PELLETS

● AMAZING NEW WOOD PRESERVATIVE ●  
**DOUBLES LIFE OF LUMBER AND MILLWORK**

**COP-R-NAP** offers a simple, easy and inexpensive method of preserving, protecting and greatly increasing the life of all types of lumber... porch flooring, fencing, sills, joists, sash and millwork, rope, sails, tarpaulins, boat planking and framing. Prevents decay, kills fungi, mildew and "blue stain". Easy to apply by dip, spray or brush methods. 1 Gal. treats 400 sq. ft. of wood. Paint right over it, makes paint last longer. Order a trial gallon for only \$3.00 post paid anywhere in U. S. Big discounts on larger quantities. Osomose Wood Preserving Co., Dept. M., 1437 Bailey Ave., Buffalo 12, N. Y.

## MARCOT KEY MACHINE

Immediate Delivery

Marcot No. 8 Key Machine Mounted on Cabinet..... \$ 82.50  
Book on Modern Locksmithing..... 3.95  
Auto Code Book and Auto Depth Keys ..... 12.50  
162 Doz. Popular Key Blanks.. 77.76  
Set Key Files, Tools, Pins, Springs, Thimble ..... 10.50

**\$187.21**

A. J. MARCOTTE CO., 1200 N. KEDZIE AVE., DEPT. PM, CHICAGO 51, ILL.



## A VEST POCKET SIZE MOTOR

Actually so small it will fit in your vest pocket. Much smaller than a pack of cigarettes. Streamlined, durable, attractive, black plastic housing completely enclosed, as shown in this actual photograph. It is completely self-contained ready to use. No special equipment or transformers needed. Just wire to ordinary 1 1/2 Volt flashlight battery and see the power of this mighty LITTLE GIANT. No plug-ins to worry about. Safe and harmless for that youngster to use in running his model boat, auto, and erector set, etc.

### GUARANTEED TO WORK

Just send \$2.95 and you will receive your LITTLE GIANT MOTOR by return mail. Use it for five days. If you don't agree that this is the best miniature motor you ever owned, just return it to us and your money will be cheerfully refunded. Don't delay! Hurry! Order yours today. Shortages may limit future production, so order now for early delivery.

UTILITY STORES, 117 S. WABASH AVE., DEPT. 55-4, CHICAGO, ILL.



**NOW!**

**THE WIRELESS MICROPHONE FOR USE WITH ANY RADIO**

**ULTRA-MIKE**

Simply set up ULTRA-MIKE, throw a tiny switch, and your radio is within approximately 75 feet, can be tuned in to it. Self-contained extra long-life batteries make ULTRA-MIKE independent of power lines—can be used anywhere.

**NO HOOK-UPS  
NO CONNECTIONS  
RETAIL PRICE \$18.00**



**SPECIAL PRICE TO  
RADIOMEN  
HOBBYISTS  
EXPERIMENTERS**

**\$10.58**

**THE ONLY COMPLETELY WIRELESS MICROPHONE.**

**NATIONAL SUPPLY CO.**  
1115 W. WASHINGTON BLVD.  
CHICAGO 7, ILLINOIS

**New "THERMO-SAW" (CUTS WITH HEAT)**

**MAKE THINGS FOR THE HOME or FOR SALE**

**• Any Child Can Use It!**

- NO NOISE
- NO VIBRATION
- NO SAWDUST

CUTS RAPIDLY AND CLEANLY THROUGH WOOD AND OTHER MATERIALS... AN IDEAL GIFT! Difficult patterns are made QUICK and EASY... No turning of work... Cuts in every direction... Cuts plywood 1/8" or 1/4"... Cuts 14"x36" board... Special Transformer produces high frequency current in a tough steel wire "blade" from ordinary Alternating (AC) current. No radio interference. IMMEDIATE DELIVERY!



NOTE: Operates on 110 volt Alternating Current: 50 to 60 cycle. NO C.O.D.'s

Machine Measures 11x4x3 1/2" High. Throat 7" ONLY \$4.50 Deep. PATTERN FREE. Postpaid COMPLETE SAW outfit as illustrated with transformer and 12 spare blades. READY TO USE.

ORDER \$4.75 in Canada and TODAY Mexico. \$5 Elsewhere.

**BOISSELIER MFG. CO., Dept. P-6, GLEN ELLYN, ILL.**

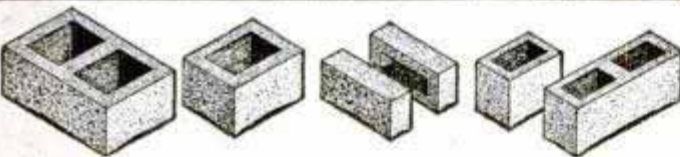

**Profit by the Building Boom!**

Start your own business manufacturing concrete building block and brick. Use Economy hand moulds. Make true, straight, easy-to-lay units which will pass any building code. Small investment, high production, big profits. One \$30.00 mould will make 1,000 5"x8"x12" blocks per day. Letters and repeat orders tell how pleased our customers are. Post card brings free folder.

**Economy Manufacturing Company**  
Dept. P Stone Mountain, Georgia

**LAW** STUDY AT HOME for PERSONAL SUCCESS and LARGER EARNINGS. 38 years expert instruction—over 108,000 students enrolled. LL.B. Degree awarded. All texts furnished. Easy payments. Send for FREE BOOK—"Law and Executive Guidance."  
**AMERICAN EXTENSION SCHOOL OF LAW**  
Dept. 78-M, 646 N. Michigan Ave., Chicago 11, Ill.

**Makes 1 RAZOR BLADE DO THE WORK OF 10**

**EASY... stops blade in 12 seconds**

You'd never go back if a barber shaved you without stopping his razor. Why expect a blade, even new, to be really sharp without stopping... a distinct, hand operation, but easy for you to do. 12 seconds a day takes the pull out of shaving, and keeps blade tuned up so it lasts 10 times as long. You save money. Thousands say the Twinplex Stroppler pays for itself over and over. For double-edge Gillette type blades. Ask for it where blades are sold.



**\$2** Where blades are sold or postpaid direct

**Twinplex STROPPER**

**TWINPLEX MANUFACTURING CO.**  
1807 Roscoe St. Chicago 13, Ill.

**SAY YOU SAW IT IN POPULAR MECHANICS**

**AUTOMATIC SAW SET AUTOMATIC RETOOTHER**

**HAND AND BAND SAWS**

Set saw teeth automatically. Perfect hammer and anvil action sets teeth uniformly and tensions metal. No tooth breakage. No fatigue. Sets 400 teeth per minute.

**Makes New Profits**

Cuts teeth in 50 seconds! Any size tooth 4 to 16 points. Old teeth fall off as chips. Simple to operate. A perfect job.

**Immediate Delivery**

**FOR HAND SAWS**

**With Motor**

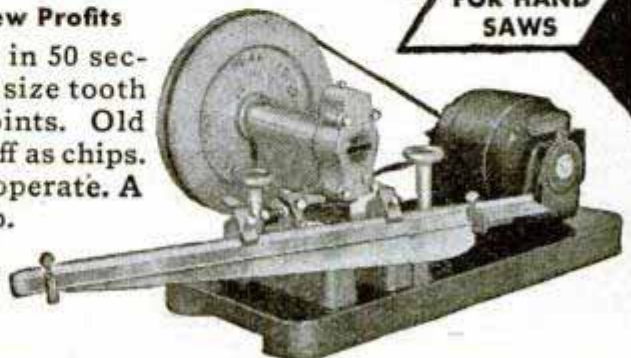
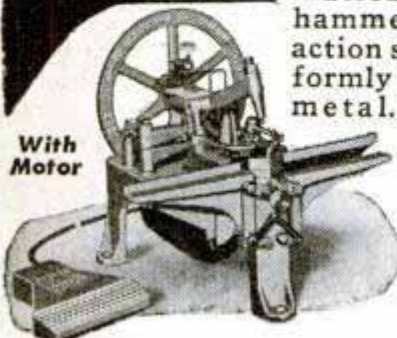

**WRITE TODAY**  
Saw Shops Need These Machines For Greater Profit

**BURR MFG. COMPANY** 8933-E Venice Blvd. Los Angeles 34, Calif.



*Any way you figure -*  
**TOOL VALUES ARE UP!**

WRENCHES - PLIERS  
 PUNCHES - CHISELS  
 SCREWDRIVERS  
 SPECIAL TOOLS  
 SOCKETS &  
 HANDLES  
 PULLERS  
 TOOL  
 BOXES

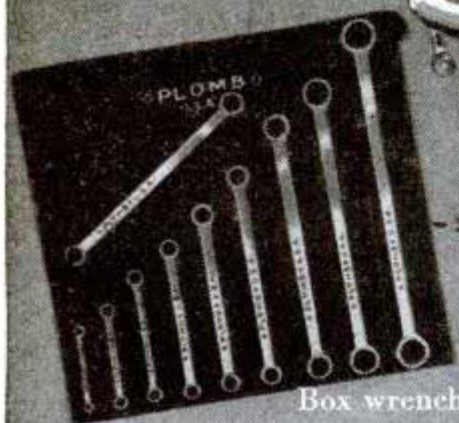

Box wrench set, with openings from  $\frac{5}{16}$ " to  $1\frac{1}{8}$ "

Today Plomb tools offer you greater value than ever before. Large volume keeps prices low - for higher-quality tools. Don't delay new tool purchases. Get the ones you need for making your set complete from your Plomb dealer, *now!* Write for catalog to Plomb Tool Company, 2255F Santa Fe Ave., Los Angeles 54, Calif.

4763

**PLUMB**  
*streamlined*  
**TOOLS**

tan force pushed outward from the Pacific depths in all directions, piling and folding rocks in front of it into mountain ranges with abysmal depths at their bases. Links in the practically continuous chain are the Aleutians, the mountains of Alaska and the Rockies, the Andes, and the mountains of New Zealand, Formosa and Japan. If the interior antarctic peaks prove to be of the same folded structure, the Pacific ring theory will be considered completely proved.

This in turn will lead to significant deductions on the structure of the earth itself and the mysterious forces which have produced its present form. Of greater interest is the light these studies will throw on the process of mountain building everywhere. Here are telescoped into years processes which elsewhere require millenniums. Ice is like rock, with structure and behavior similar to basalt or granite. Great areas of shelf ice here are subjected to enormous pressures from the continental ice behind it and from continuous accretions to its own weight from winter snowstorms. Sheets of ice are folded over each other in much the same pattern seen in the Grand Canyon walls. In this way mountains have been built up all over the world, but ice mountains are piled up in a few years whereas a rock mountain requires millions of years. Specimens of antarctic ice are being brought back to Washington for preservation with rock types in the government's geological museum.

Near the Bay of Whales base is one small ice range which, geologists say, seems almost an exact small scale model of Switzerland's Jura Mountains. Most of the geological work was concentrated in the canyons of this formation. Since fossil search is possible only on long trips inland, where mountain tops are exposed above the ice, this seems impossible during the short summer season.

THE END

### Battery-Powered Flash Welder

Powered by storage batteries, a new flash welder handles heavy sections of aluminum in locations where the conventional power supply is limited. The batteries are renewed by ordinary battery chargers. Special gears enable the machine to operate under the extremely high accelerating and decelerating forces required when flash welding aluminum. Another machine made by the same company dispatches spot welding current to as many as 100 guns, each adjusted to its proper welding pressure. Welding rates up to 900 spots a minute are possible with the control unit.





*RCA Communications' new world-wide automatic tape relay radio system speeds Radiograms.*

## ***New wings for words around the world!***

Radiograms "Via RCA" to and from overseas points now are processed by automatic machines which speed your messages through such gateway cities as New York, London, San Francisco and Manila, without delay.

This advanced technique in international radiotelegraphy is the result of wartime research and development. It gives to private messages the same speed, accuracy and dependability which were attained through its use by the U. S. Army Communications Service during the war.

RCA Laboratories—one of the

world's foremost centers of radio and electronic research—is continually pioneering and advancing radio communications in service to the Nation and the public.

When you buy an RCA Victor radio or television receiver, Victrola radio-phonograph, or phonograph record, you are getting, thanks to RCA research and engineering, one of the finest products of its kind science has achieved.

"Victrola" T. M. Reg. U. S. Pat. Off.

*Radio Corporation of America, RCA Building, Radio City, New York 20. Listen to the RCA Victor Show, Sundays, 2:00 P. M., Eastern Daylight Saving Time, over NBC.*



At RCA Communications, "Package Sets" contain an automatic sending and receiving unit for a foreign gateway city. Messages in tape form and received through these machines, are ready for delivery or immediate transmission to any part of the world.



**RADIO CORPORATION of AMERICA**





# A Better Bit Brace

## WILL HELP YOU DO BETTER WORK

Every craftsman knows that better tools produce better work. And that's what a Stanley Bit Brace does. It puts skill in your hands and it represents the ultimate in material, design and performance.

Look at Stanley Bit Brace No. 923 - head of fine tropical hardwood, steel clad-bronze bushing in head to minimize wear, with end thrust carried against ball bearings - heavy steel rod - chuck with steel shell and hardened, forged jaws to hold bit or drill securely for true boring.

A word to the wise craftsman is - buy Stanley.



Trade Mark

**HARDWARE · HAND TOOLS · ELECTRIC TOOLS**

### Here are two books well worth owning

The first book is free... "The Joy of Accomplishment", a brief introduction to tools and their uses. The second is the famous textbook... "How to Work with Tools and Wood", recently revised, fully illustrated. The cost is only \$1.

Stanley Tools, 167 Elm St., New Britain, Conn.

Please send by return mail

- FREE booklet: "The Joy of Accomplishment."
- 188-page book: "How to Work with Tools and Wood." \$1.00 enclosed.

(In Canada: Send order to Stanley Tool Co. of Canada, Ltd., Roxton Pond, Quebec.)

Name.....

Address.....

City..... State.....

# actual TESTS prove MIN-O-LIFE

Positively Keeps

## MINNOWS

Alive and Lively

## HOURS LONGER

Transport live minnows in standard bait buckets for long distances in your car with Min-O-Life. Simple valve attachment agitates and aerates water.

Connect Min-O-Life with rubber hose to vacuum line beneath auto dashboard. Fresh air is drawn into jar by system of intakes and outlets.



You can probably get your Min-O-Life at your Hardware or Sporting Goods Dealer; if not, order direct.

LEE SALES CO., 608 Main, Dallas, Texas

### KAYAKS

**AQUA V-18**

*Easy to Build*

**OUTBOARDS ROWBOATS**

### BOATS for Home Assembly

**"U-MAK-IT"**

KAYAKS, ROWBOATS, DINGHIES, INBOARDS, OUTBOARDS, RUNABOUTS

Cut-To-Fit for Quick Assembly. Everything Complete plus Illustrated Instructions. No Experience Necessary. Simple as A. B. C.

SEND 25c POSTAGE (COIN) TODAY FOR 3 MONEY SAVING ILLUS. CATALOGS Showing all '47 Models (marine plywood) and construction details.

**25¢ COIN FOR ALL THREE**

### AQUAMOBILE V-18

Designed for Auto Engines. Open or with cab. Length 18 ft.

Fast VEE Bottom Hull

KAYAK BOAT CO., 154P EAST 129th ST., NEW YORK 35, N. Y.

## WORK BENCH

Ideal for hobbyist or shop worker, this sturdy, useful bench makes home handwork a joy! Heavy top, 2 large drawers, Tool rack, strong shelf, bins for nails and bolts. 59" long-23" wide -36" high. Shipped unassembled, easily set up (from instructions). F.O.B. Phila. factory. Check or money order. Money back if not satisfied.



QUALITY CRAFTSMEN, INC., Dept. M, 3431 Market St., Philadelphia 4, Pa.

## WHEELS

AT BARGAIN PRICES

... 4" wheel & tire, 5/16" sleeve bearing & hub cap	50.45 ea.
... 5" wheel 5/8" solid tire 5/16" shaft hole	0.65 ea.
... 6" wheel 5/8" solid tire 5/16" shaft hole	0.75 ea.
... 7" wheel 3/4" solid tire 3/8" shaft hole	0.85 ea.
... 8" wheel 1" solid tire 1/2" sleeve bearing	1.25 ea.
... 8x2" wheel, semi-pneumatic tire 7/16" ball bearing	2.50 ea.
... 10x1.75 wheel semi-pneumatic tire 7/16" ball bearing	3.25 ea.
... 12x1.75 wheel semi-pneumatic tire 1/2" bronze bearing	4.00 ea.
... 10x2.50 wheel semi-pneumatic 1/2" ball bearing	5.50 ea.
... 6x2" wheel 5/8" ball bearing, solid tires	3.95 ea.

**BUILD YOUR OWN** - Wagons - Scooters - Soap Box Racers - Welding Carts - Baby Pens - Etc.

To order above wheels write number wheels wanted in space provided, tear out and mail this ad with check or money order and your name and address. If other sizes are wanted write for FREE LIST.

**TRULSON MFG. CO., 811 E. 31 St., Dept. M3, Kansas City, Mo.**



# "Blow-by" gets the "go-by" from Ford's 4<sup>th</sup> piston ring!

**Here's what** that extra ring in every Ford piston does for you. It gives you power you never dreamed of, by reducing compression loss or "blow-by" to an absolute minimum. In addition, you also get better control of oil film on cylinder walls. This cuts down the amount of oil reaching combustion chambers. And that means oil savings!

With features like these, no wonder Ford engines—both SIX and V-8—are far "out front" in their field.

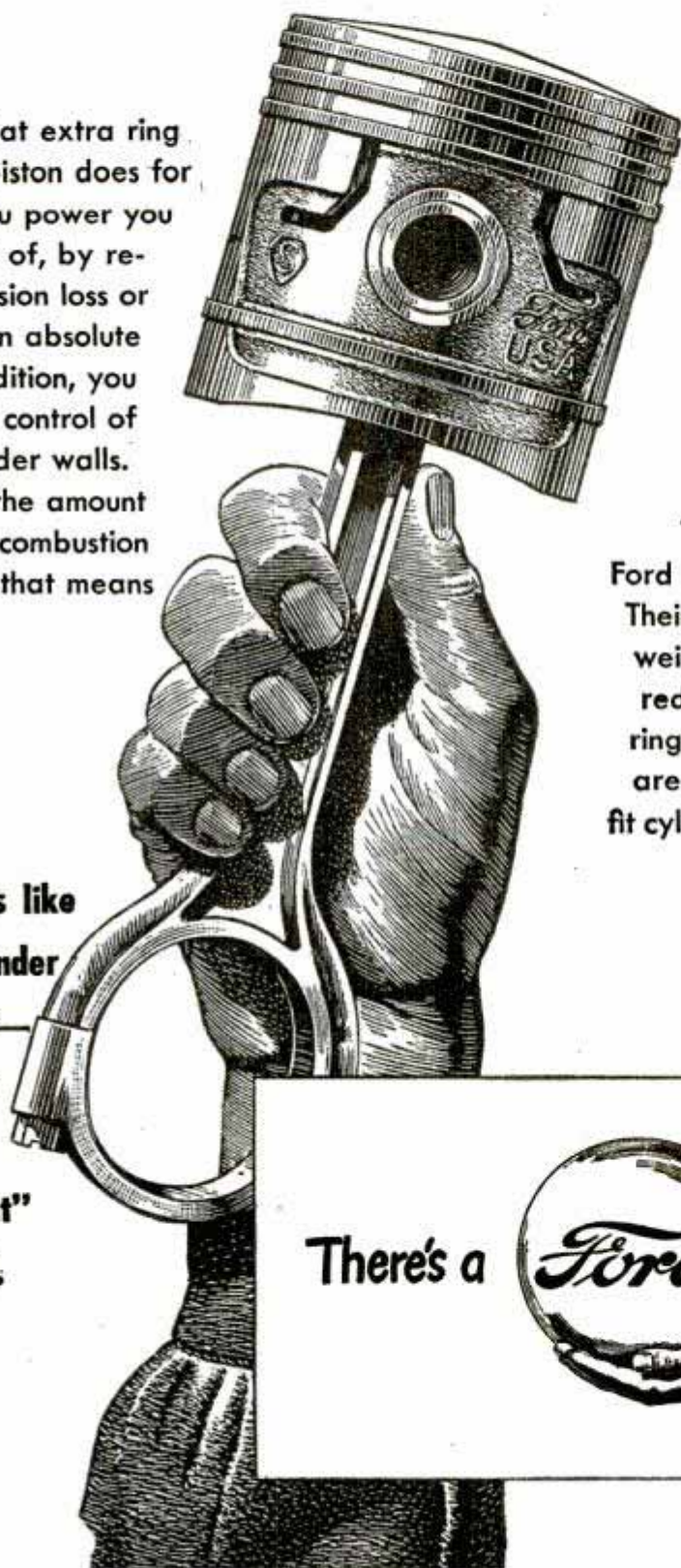

The ring in the bottom of the skirt removes most of the oil. The upper oil control ring allows just the right amount of oil to pass to lubricate the compression rings and prevent scuffing.

Teamed with this 4-ring feature, Ford gives you aluminum alloy pistons. Their double advantage of lighter weight and higher heat conductivity reduces bearing loads and keeps rings from sticking. And Ford pistons are slotted and cam-ground to best fit cylinders for slap-free oil economy.

There's a  in your future



# TireX INFLATES FLAT TIRES INSTANTLY



## She Won't Be Late. Thanks to TireX!

In 60 seconds that flat tire will be inflated and ready to go. TireX contains enough compressed CO<sub>2</sub> to fill 3 flat tires. Just attach it to the tire as you would an air hose, turn the handle and up comes the tire without any effort whatever.

## TireX—A Wonderful Fire Extinguisher, Too!

CO<sub>2</sub> is ideal for smothering any fire likely to occur in an automobile. It works fast. The CO<sub>2</sub> "snow" evaporates immediately without a trace. It can't damage the car finish, engine, or upholstery.

If your dealer can't supply, send check (or M.O.) for \$4.95 and your TireX will be sent prepaid. Money-back guarantee. Refillable for life-time use.

## BREAKSTONE & CO.

2155 West Harrison St. • Chicago 12, Illinois

### SO EASY TO HANDLE!

the **STURDY,**  
**VERSATILE, EFFICIENT**



**Garden-All**  
LAWN and GARDEN TRACTOR

Instant Tool Attachment!

Exclusive Tool Control!

A Tool for Every Need!

Write for Booklet

A boy can handle it with ease . . . yet it does a man's job in all its operations; and does each job with thoroughness and efficiency! GARDEN-ALL is sturdy, efficient . . . so extremely versatile. It plows, it discs, it cultivates, it cuts grass. And the GARDEN-ALL snow plow doubles as a junior bull-dozer for grading jobs. Uses little gas. See the GARDEN-ALL Tractor before you buy any power lawn or garden equipment. There's nothing at all like GARDEN-ALL!

## GARDEN-ALL TRACTOR, INC.

Dept. P, 100 W. UNION STREET, LIBERTY, INDIANA

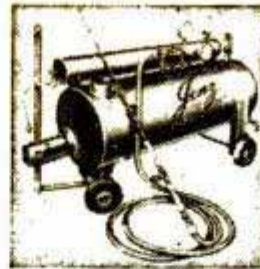

## Jenz Super Chief Steam Cleaner

Portable—No moving parts—Cleans anything—Motors—Chassis—Machinery—Floors—Hatchery Buildings—Dairy & Creamery—Oil Rigs etc. Oil fired—Economical—fully tested and warranted. 75# Steam in less than 10 min. Complete as illustrated.  
**\$249.50** Check or M.O. freight prepaid to any place in U.S.A. Cleaning compound 25¢ pails \$5.25 prepaid when ordered with steamer. C.O.D. 25% with order frt. collect. Immediate delivery.

## CHAMPION BLUE RIBBON OUTBOARD MOTORS



Dual Rotary Valves—Needle Bearings—Trolls Perfectly—Cannot be flooded—Positive Lubrication—Positive Cooling—Quiet Under water Exhaust.

### Tops in Outboard Motors!

Standard Single 4.2 H.P.

**\$127<sup>00</sup>**

(West of Rockies \$129.00)

Check or M.O. Frt. prepaid to any place in U.S.A.

C.O.D. 25% with order frt. collect. Immediate delivery.

## HI-PURE LABORATORIES

20 E. Sycamore St.

Evansville, Ind.

## A SEAMAN TILLER is Your Best Crop Insurance . . .

Because this farm-size Rotary Tiller pulverizes the soil thoroughly; mixes fertilizer and humus into the growing area of the seed-bed; conserves moisture; aerates soil; promotes earlier and more complete germination of seed; helps to destroy many crop pests; provides effective weed control . . . all with ONE machine!

Write for "Questions and Answers" booklet that tells you all about it! There is no obligation.



Motorized models . . . 4 to 6-ft tillage widths.



Power Take-Off Models . . . 3 to 5-ft. tillage widths.



## SEAMAN MOTORS, Inc.

364 No. 25th Street, Milwaukee, Wis.

### SAY YOU SAW IT IN POPULAR MECHANICS

**BE YOUR OWN BOSS** Men and women make up to \$100.00 or more a week! Design and fit corrective arch supports by the time-tested Stephenson Method. A profitable, full or part-time, profession. Train at home; pay as you go. No costly equipment to buy. No capital needed. Send for **FREE** booklet today.  
**STEPHENSON METHOD, 12-28 South Market St., Boston, Mass.**

## GET THE BEST IN MUFFLERS V-8 DUALS & SINGLES

Finest Norman custom-built muffler sets—steel pack—torpedo type—heavy, perforated steel cores—chrome enamel finish—mellow, deep tone (improves with use)—designed to fit—all ways superior—double economy.

DUALS . . . . . \$17.50 SINGLES . . . . . \$7.50

V-8 Ford-Mercury Buick, Olds., Chrys.

SINGLES . . . . . \$5.50 ORDER TODAY! Will outlast

Chev., Ford, Plym. three ordinary mufflers.

Dealers—Write Today for Full Details

## NORMAN'S MUSICAL MUFFLERS

Dept. PM-5, 1216 W. Slauson Ave., Los Angeles 44, Calif.



# free CONCORD Radio Catalog



Radio Parts • Radio Sets • Record  
Changers-Players • Kits • Ham Gear • Amplifiers • Testers

It's here! The big, new 1947 Concord Catalog with a vast, complete selection of everything in Radio and Electronics for building, experimenting, testing, repair and maintenance. Thousands of items—hundreds now available for first time—latest 1947 prices. Now LOWER prices on Radio Sets, Receivers, Kits, Record Changers, Players, Portables, Amplifiers. Latest listing standard items. Complete stocks—IMMEDIATE SHIPMENT. Write for FREE COPY—please address Dept. P-67.

## CONCORD RADIO CORP.

LAFAYETTE RADIO CORPORATION

CHICAGO 7

ATLANTA 3

901 W. Jackson Blvd.

265 Peachtree Street



## AMAZING NEW MAGNETIC JIG SAW!

READY!

Ready for Delivery!

SYNCRIO . . . new, remarkable, patented, magnetic jig saw . . . needs no belts . . . no motor . . . no gears . . . no oiling! Just plug into any 60 cycle A.C. 110-130 volt outlet—and saw! Portable . . . world's safest saw! Cuts clean, smooth . . . no sanding necessary. Perfect for models, displays, inlays, etc. Cuts intricate designs on 3/4" soft wood, 1/2" plywood and thinner hardwoods, metals, plastics . . . NOT for ordinary lumber. Leaves NO ragged undersides on plywood or heavy cardboard. Special magnetic safety stroke features! Nothing else like it! Sold on 10 days Moneyback Trial! Prompt delivery guaranteed. Rush name, address on postcard for FREE details, Trial Offer. Hurry!

SYNCRIO SAW CORP., Dept. A-67, Rochester, Mich.

\$24.95  
Full Set

## MICROMETERS

Six piece set, in velvet lined leather case. Special price, only \$24.95.

Precision machined in one thousandths, up to 4" outside and 3 3/4" inside measurements. Guaranteed accurate, easy to read and adjust. Satisfaction guaranteed or money back. Also indicators and gauges. Shipped prepaid on receipt of remittance. On C.O.D. shipments, send deposit of \$2.00.

FREE  
FOLDER

MICRO PRODUCTS, 8655 E. Jefferson, Detroit 14, Mich.



BE FAIR  
TO YOUR  
Hair

**WAKE UP YOUR SCALP** Want better looking hair? Embarrassed by falling dandruff, itching scalp? Then try VITABRUSH, new electric driven scalp brush that gives your scalp a vigorous and invigorating "workout" in just three minutes of fun. Cleans scalp. Stimulates blood supply. Restful. Pleasant. Write today for complete information and satisfaction-guaranteed offer. Hershey Mfg. Co., 3717 Field Bldg., Chicago 3

O. A. SUTTON CORPORATION  
WICHITA, KANSAS

*This is it!*



For the finest  
in Air Circulation



To behold in operation—with its smooth, murmurless currents of fresh air swirling 'round you—this is a thrill you'll relive again and again as you use a Vornadofan. Draftless, gentle billows, powerfully driven by a new principle in air circulation, cool as they refresh as they soothe. You simply must see it all in a demonstration to understand how and why. Ask your dealer and he'll be as thrilled to show you as you will be to see.

### REASONS FOR Vornadofan SUPREMACY

<p>1 Compressed air is thrust through cones in greater volume.</p>	<p>2 High-pitched propeller blade "bites" off and circulates more air.</p>	<p>3 A special, patented cone construction absorbs air noises.</p>
<p>4 Mounted in rubber, motor is noiseless, chatter is eliminated.</p>	<p>5 Air is put into a spiralling motion that bates through space.</p>	<p>6 All moving parts are enclosed for safety and silence.</p>

Convincing proof to men who know mechanics

*Vornadofan*  
World's Finest Air Circulators



Say you saw it in *Popular Mechanics!*



**FUN TO USE**—this fast, easy-to-handle powerful tool for use in home or shop

# THE Bantam GRINDER



Polishing  
Grinding  
Carving  
Drilling  
Buffing  
Plastic  
Glass  
Metal  
Wood  
Bone

You'll be surprised how many interesting, money-saving jobs you can do with the Bantam Grinder. Balanced for easy handling. Precision-built of quality materials for years of dependable service. Plenty of power—operates on 110-115 Volt AC-DC. Speed approx. 20,000 R.P.M. Internal ventilating fan. Finger-tip switch. Weight only 15 oz. 8-ft. cord and plug. 23 useful accessories. Attractive gift box. Get the Bantam now for faster, finer work, for more pleasure in your work shop.



At your dealers—or order from us today **\$25**  
—immediate shipment—postpaid—only

## SMALL MOTORS Inc.

Dept. 80, 2076 Elston Avenue, Chicago 14



## NEW LOW-PRICED LINCOLN WELDER

### Simplifies Repair and Construction

**A**RC WELDING is easy with the new Lincoln "Fleet-Arc Jr." A.C. Welder because of its exclusive "Arc Booster". This device prevents electrode sticking, makes arc-striking as simple as striking a match on a hot stove.

Welding of light and heavy metals and alloys, hard-facing general repair and construction work are all easy with the "Fleet-Arc Jr." Range 20 to 180 amps. Smooth, continuous "dial tuning" control—no plugs to shift. Low-priced. For complete details, write for free Bulletin 365.

*NEW MANUAL explains how to weld all types of joints and hard-face. 32 pages, 88 illustrations. Price 25c postpaid.*

**THE LINCOLN ELECTRIC COMPANY**  
Dept. 513 • Cleveland 1, Ohio

Largest Manufacturer of Arc Welding Equipment in the World



## MODEL PUMPS



GEAR TYPE

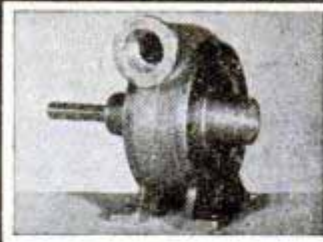

CENTRIFUGAL

Build your own real working model pumps from our complete kits which include all necessary castings, shaft and bearing materials, impeller or gears, machine screws, blueprints and detailed instructions.

Either kit complete . . . \$5.00 postpaid  
Blueprints & instructions . . . \$1.50  
Send 10c in coin for illustrated folder.

**American Equipment Company**  
P.O. BOX 7103 NEW ORLEANS, LA.

## AUTO ENGINE SPEED CONTROL GOVERNORS



\$21.75

Give constant or changeable speed to any auto or truck engine, when used for power. Guaranteed Instructions. Oil ring bearing, \$14.25. Ball bearing, \$21.75.

No. 18-7 Heavy Duty for Engines to 300 HP: \$29.75

Agents Wanted: Parts Dealers, Garages, Wreckers, Implement Dealers. General Merchants, etc. Free circulars.

Also additional carburetor butterflies. Sold in Montreal: 7546 Wiseman St.; In Skaneateles, N. Y., Horle Welding Supply.

CANDEE, Dept. PM6, 2641 S. Hill, Los Angeles 7, Calif.

## \$1.00 SURPLUS SPECIALS

- 1 Pair Heavy Faced Asbestos Mittens.....\$1.00
- 1 Pair Solid Brass and Steel Aviation Turnbuckles.....\$1.00
- 2 Rotary Brushes (White Tampico Fibre).....\$1.00
- 4 Flush type Door Handles (Stanley).....\$1.00
- 8 Cadmium plated Harness Snaps (beauties).....\$1.00
- 12 Cadmium plated 3 oz. Fish Line Sinkers.....\$1.00
- 1 Rotary Nylon Brush 7".....\$2.00

Or send \$5.00 for any \$6.00 worth. Postpaid.

INTERSTATE SALES COMPANY • RIVERSIDE, ILLINOIS



### 8x2" TIRE & WHEEL - COMPLETE

Here is the Wheel you will want for your Wagon, Scooter, etc. Will never RUST! No painting needed—hub of cast aluminum—nuts & bolts cadmium plated. ARGUTO OILLESS bearing—7/16" bore. Never need be oiled "Clipper" semi-pneumatic tire. Use as is—polished hub very attractive.

(Dealers & Manufacturers write for quantity discounts)

\$2.60 each ★ A set of 4 Wheels \$10.00

C. L. WALKER, P. O. Box 1023, Plant City, Fla.

## Say You Saw It in POPULAR MECHANICS



### BUILD YOUR OWN ZEOLITE WATER SOFTENER

Save up to 50%. Pays for itself. Fun to build. Only a wrench required. All materials available. Send \$1.00 check or money order for simple and complete plans and operating instructions.

BOX 2732-P LAR MFG. CO. MINNEAPOLIS 7, MINN.

POPULAR MECHANICS



# WELLER SOLDERING GUN

## For Faster Soldering

**5-SECOND HEATING**  
Ready to solder in 5 seconds.

**LESS TIP RETINNING**  
Heats only when needed.

**FAST COOLING**  
Ideal for service calls.

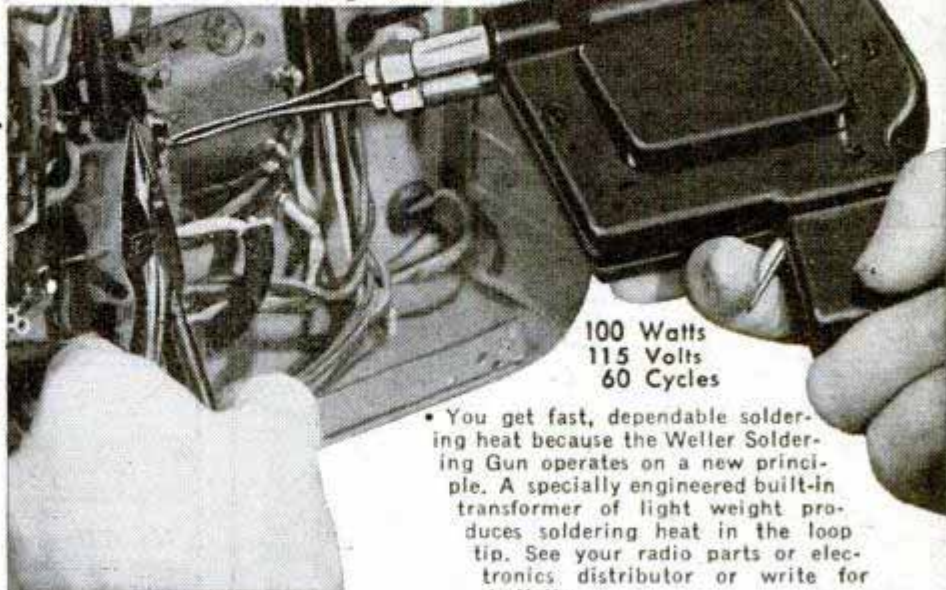

100 Watts  
115 Volts  
60 Cycles

You get fast, dependable soldering heat because the Weller Soldering Gun operates on a new principle. A specially engineered built-in transformer of light weight produces soldering heat in the loop tip. See your radio parts or electronics distributor or write for bulletin.

**WELLER MFG. CO.**

**816 Packer St., Easton, Pa.**

In Canada: Atlas Radio Corp., Ltd., 560 King St., N. W., Toronto, Ont.  
Export Dept: 25 Warren St., New York 7, N. Y.

## The SPEED SAW FILER

Saves You Time, Money

Now you can do expert saw filing at home. Lifetime tool makes precision filing easy for even the most inexperienced. Two simple adjustments make it fit any type hand saw. Keep your saws extra sharp and true-cutting with a Speed Saw Filer. Complete with file, ready to use. Money back guarantee. Cash with order, prepaid (C.O.D. postage extra.)

THE SPEED CO., Dept. PM  
2025 N.E. Sandy, Portland 12, Ore.

**Now FILE Your OWN SAWS**

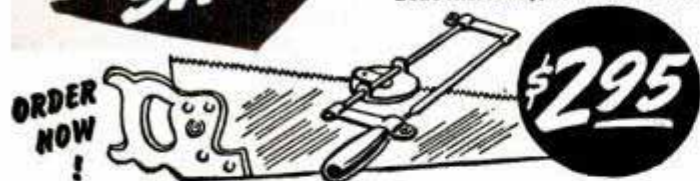

## AMAZING NEW TOOL!

**CARBIDE TIP TURNING CHISEL**

Turns metals free hand such as brass, bronze, aluminum, magnesium, copper, nickel, silver, and harder metals such as cold rolled steel, as easily as it turns plastic, fibre and wood. Turn your own projects such as earrings, charm bracelet novelties, drawer knobs, cigarette holders, candle sticks, brass finials, and many hundreds of others.

• **CHECK THESE FEATURES**—This new tool features a tungsten carbide tip suitable for high-speed cutting, an easy grip handle, cadmium plated rust-proof blade requires little or no sharpening, and does the work of many tools. The chisels are available in four sizes— $\frac{1}{8}$ " square nose;  $\frac{1}{8}$ " round nose;  $\frac{1}{4}$ " square nose;  $\frac{1}{4}$ " round nose.

• Order a set of two or a more complete set of four today. EACH Postpaid **\$465**

**MARTIN INCORPORATED**  
548 West Rock Place Milwaukee 12, Wisconsin



## 56 piece U.S. Navy Fishing Kits



THE HANDIEST AND MOST COMPLETE OUTFIT FOR FISHING.

Gives you eight complete fishing lines with all equipment, including two large red-eye feather jigs, mackerel lure, harpoon, fishing knife, hook sharpening stone, fishing gloves, extra leads, more than ten hooks, dip net, three prong grapple for snagging fish, 12 Bass size dehydrated pork rind baits, more than 700 foot of line, and many other items including a full set of fishing instructions prepared for the U. S. NAVY, all wrapped in a neat pocketed carrying case that serves as a fishing apron.



**COMPLETE FISHING OUTFIT**  
BRAND NEW

These kits are all brand new and have never been opened or taken from the original vacuum sealed can. They were prepared for the U. S. Navy by fishing experts.

IMMEDIATE DELIVERY

Your order will be filled on the day it is received. Satisfaction guaranteed or money refunded. Rush your order while they last. SEND CHECK OR MONEY ORDER

**3.50**  
Postpaid  
4 for \$12.50

**ROYAL SUNDRIES CORP.**

275 CANAL STREET · NEW YORK 13, N. Y.



**STOP  
GROPING  
FOR THAT  
SCREW  
HEAD**

**LENGTH—9" OVERALL**



**\$1.95 Postpaid**

**Graham FLASHLIGHT-SCREWDRIVER**

**LIGHT WHERE AND WHEN YOU NEED IT—WITH ONE HAND FREE**

One hand holds screwdriver and focuses light directly on the point of work. Other hand free! No other light necessary. End all fumbling and groping in dark places. Save time and effort. Hundreds of uses around your home, farm, car or shop.

Remove blade and you have a FLASHLIGHT.  
GRAHAM MFG. CO. • 4781 WEST FORT ST. • DETROIT 9, MICHIGAN

Battery and bulb encased in shock-proof torque-tested plastic handle. Removable blade of tempered alloy steel. A quality product ruggedly constructed. A lifetime tool—a lifetime gift. \$1.95 complete with bulb and battery. See your dealer or mail check or money order to Sales Dept.

**A "MUST"  
FOR EVERY  
MECHANIC  
HOBBYIST  
FARMER  
MOTORIST**



**Just plain Careless**

Visiting on the phone — left the iron on. A Pyrene\* Fire Extinguisher would have stopped that fire before it spread.



That little item cost \$1,625,000 last year. By using appliances properly, 9 out of 10 of the 70,000 electric fires a year could be prevented, saving \$40 million. Careless or careful, you need Pyrene home fire protection.

Invest in yours at your home and auto supply dealer today.

Keep a Pyrene refill handy. \*T. M. Reg. U. S. Pat. Off.

**Pyrene Manufacturing Company**

NEWARK 8 • NEW JERSEY

Affiliated with C-O-Two Fire Equipment Company



**JET PROPULSION**



**GAS TURBINE Model Engine**

★ ★ Be one of the first to build a real Turbo-Jet Model Engine. Single-stage centrifugal compressor and turbine. This is a real engine, easily made with ordinary home workshop equipment. Complete plans for construction . . . design formulas and curves for checking performance and testing.

**\$2.00 Post paid**

THE ROTOJET CO. Department 11 • BOX 757 • LOS ANGELES 25 • CALIFORNIA

**12 lbs. SURPLUS RADIO PARTS \$2.00**

A gold mine of parts for repairmen, amateurs, and experimenters . . . sockets, condensers, resistors, transformers, coils, hardware, wire, etc. An outstanding bargain in usable parts! Send \$2.00 cash, check or M.O. today! (Pay small express charges on receipt.)

ELECTRONIC PARTS, Inc. Dept. M6 622 W. Randolph St., Chicago 6, Ill.

**PLEXIGLAS**

New Low Prices, new masked prime stock, clear

Thicknesses, per square foot; 1/16" @ \$1.00; 1/8" @ \$1.30; 3/16" @ \$1.60; 1/4" @ \$1.85; 3/8" @ \$2.75; 1/2" @ \$3.60; 3/4" @ \$5.50; 1" @ \$7.40. Sheet sizes 6" x 12"; 6" x 24"; 12" x 12"; 12" x 24" and 12" x 36". Add 10% for packing and postage any place in U.S.A. Minimum order \$5.00. Send money order for prompt shipment. Dept. PM60.

PLASTIC SUPPLY CO., 2618 St. Louis Ave., St. Louis 6, Mo.

**EXHAUST BLOWERS • PEDESTAL FANS**

PHOTOGRAPHERS • HOSPITALS • LABORATORIES • WORK SHOPS • LAUNDRIES  
OFFICES • RESTAURANTS • PRINTERS • PLAYROOMS  
SOLVE ANY VENTILATION PROBLEM WITH THESE 2 AIR CONDITIONERS

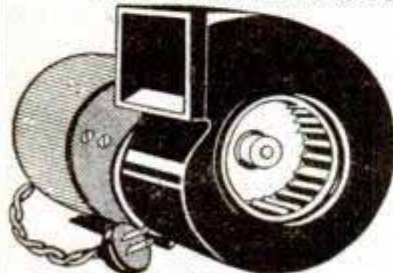

At last! A real post war fan to banish summer heat. Far superior to any pre-war product. Made of the finest materials to give perfect service indefinitely.

- 18" Fan Blades • 4 1/2 ft. Stand • Aluminum Blades
- Chromium Slide Bar • Chromium Guard.

Continuous duty Ball Bearing Motor guarantees long, trouble free operation. 110 Volts, A.C., 50-60 cycles.

SEND CHECK OR MONEY ORDER FOR \$65  
This RUGGED BLOWER & EXHAUST DELIVERS 100 CU. FT. AIR PER MINUTE. Quick and simple to install. Anyone can do it with ordinary household tools.

Continuous duty BALL BEARING MOTOR assures quiet, trouble free operation. Tough housing insures long life. 110 Volts, A.C., 50-60 cycles.

**ONLY \$65.00**

FOB Yonkers



**WORTH \$50**

**Only \$15.85**

Send check, money order. No C.O.D.'s. West of Mississippi add \$1.00 for mailing, handling.

**UNIVERSAL YONKERS CORP. (Dept. M-6)**

**41 Locust St., Yonkers 2, N.Y.**



# Test-O-Lite the MODERN TROUBLE SHOOTER



## THE NEON GLOW

... LOCATES TROUBLE INSTANTLY in electric circuits, fuses, cut-outs, motors, radios, appliances. Tests everything electrical from 100 to 550 volts. Indicates hot or grounded wires. Tells AC from DC. Engineers prefer it because it has patented safety features.

## PUTS "FINGER" ON THE TROUBLE SPOT -- QUICKLY

Far superior to ordinary clumsy test bulb. Saves precious time. Indispensable in shop or home. Vest pocket size. Lifetime guarantee. (Pat. No. 1,778,883) Purchase through regular electrical dealers.

**L. S. BRACH MFG. CORP.**

200 Central Ave. Newark, N. J.

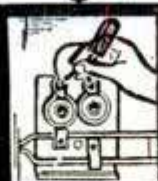

FUSES



MOTORS

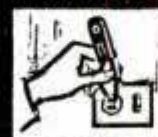

OUTLETS

# HOW TO MAKE LOOSE FIXTURES STAY TIGHT

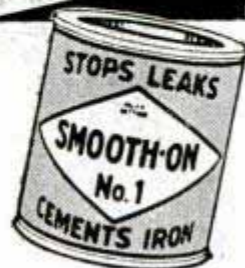
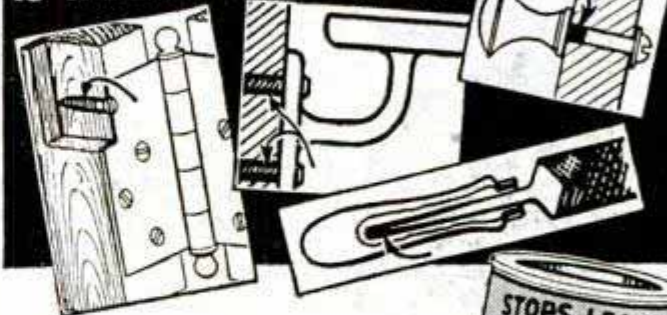

Hinges, door handles, coat hooks, drawer pulls, knobs, casters, bathroom fixtures, tool and cutlery handles, set in Smooth-On No. 1 Iron Cement, do not work loose.

Mix the cement with water, apply it to the hole in which the screw, bolt, tang or other part fits, and insert the part. Smooth-On hardens quickly and holds the part firmly in place.

Smooth-On No. 1 has been a repair standby for over fifty years, sealing cracks, stopping leaks, tightening loose parts and fixtures. Get it in inexpensive 1 3/4-oz., 7-oz. or larger size at your hardware store. If they haven't it, write us.

## FREE REPAIR HANDBOOK

40 pages. 170 diagrams. Simple instructions. Tested, short-cut repairs on home, garage and shop equipment. Pocket size. Send coupon for YOUR free copy today.

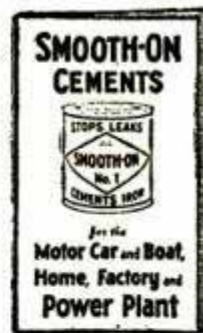

### Sign and Send Now

Smooth-On Mfg. Co., Dept. 37F,  
570 Communipaw Ave., Jersey City 4, N. J.  
Please send me a Smooth-On Handbook!

Name.....  
Address.....  
6-47.....

# Do it with SMOOTH-ON IRON CEMENT

## MAKE BIG MONEY BUY OLD GOLD

### FRIENDS, RELATIVES, EVERYONE A "GOLD-MINE" FOR YOU

Make extra money full or part time. We pay highest cash prices for watches, jewelry, rings, spectacles, gold teeth, diamonds, sterling silver, etc. regardless of condition. Send to us and receive cash promptly. Write for a supply of free shipping containers. Start making money immediately.

**LOWE'S** Dept. PM51  
Holland Bldg. St. Louis, Mo.

## THE SCOUT SENIOR

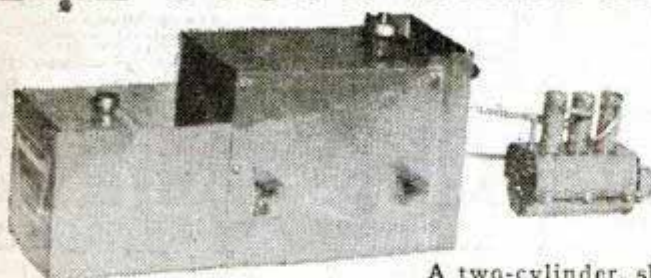

A two-cylinder, slide valve engine for boats 18" long and larger. 7/16" bore by 5/8" stroke. Aluminum pistons. High-pressure, brazed boiler. Drives a 2 1/4", two-bladed prop of 3" pitch at 2000 r.p.m. for almost 20 minutes. Burns alcohol. Price postpaid, complete ready to run with 70-lb. safety valve and prop rig. **\$950**

PHILIP STEVENSON CO.

Box 162, Station D Cincinnati 6, Ohio

## SHAW GARDEN TRACTORS and MOWERS



### Get FREE FOLDER NOW!

Get details on 1 to 9 H. P. walking and riding tractors. Do 1000 jobs on small farms, estates, orchards, gardens. Low-priced. Send postcard today!

4506 Front Street, Galesburg, Kans.  
668G North 4th St., Columbus, Ohio

SHAW MFG. CO.



## NOW—COMPLETELY NEW MITER-BOX

- FITS ANY SIZE BOARD!
- ALL STEEL CONSTRUCTION
- ALLOWS SAWING AT ANY ANGLE
- WEIGHS 1¾ LBS.

## SAW-KUT GUIDE

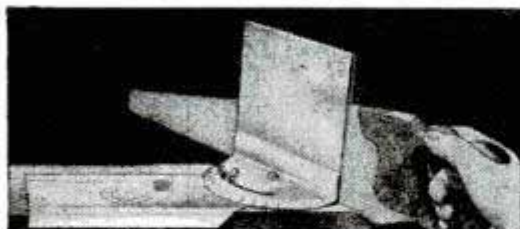

An innovation in miter boxes! Lighter in weight, handier than old type. Designed to accommodate any saw. Precision built of cold rolled steel.

Miter gauge has complete mobility. Simple one-quarter turn of wing-nut locks gauge at selected angle. Guide flange on base places SAW-KUT GUIDE firmly against board aligning saw perpendicular to axis of board. Enables framing of windows and doors without pre-cutting boards.

**\$3.50**

POSTPAID  
Anywhere in U.S.

### THE BONAIRE CO.

58 GLENWOOD • MINNEAPOLIS 3, MINN.

The Bonaire Company, Dept. M  
58 Glenwood Avenue, Minneapolis 3, Minn.

Enclosed please find check or money order for \_\_\_\_\_  
Please send me \_\_\_\_\_ SAW-KUT GUIDES.

NAME \_\_\_\_\_  
ADDRESS \_\_\_\_\_  
CITY \_\_\_\_\_ STATE \_\_\_\_\_  
NAME OF DEALER \_\_\_\_\_

IF YOUR DEALER  
CAN'T SUPPLY  
YOU SEND  
COUPON TODAY!

DEALERS!  
WRITE FOR  
NAME OF  
NEAREST  
JOBBER.

SAY YOU SAW IT IN POPULAR MECHANICS

## DON'T THROW IT AWAY • FIX IT! with this complete ELECTRIC SOLDERING SET

Set No. 207 includes:

- Underwriters Approved Pencil Iron
- 8-page Folder Soldering Instructions
- Two sizes of Copper Tips
- Flux & Brush
- Core Solder
- Emery Cloth



**\$2.25**  
POSTPAID

HEATING UNIT  
Guaranteed  
Forever!

COMPLETE  
No Extras Needed

For soldering tin, brass, copper, etc. A necessity for every home workshop. Ideal for general repair, model, hobby, electronic, radio work, and other hard-to-reach jobs requiring exactness and speed. New 20-watt design gives 100-watt performance.

**10-DAY MONEY-BACK GUARANTEE**

See your dealer or send \$2.25 direct to

## UNGAR Electric Tools

Box 2255-M, Terminal Annex, Los Angeles 54, Calif

## BARGAIN 3X ARMY TELESCOPE

Original Cost \$150.00



ALL COATED LENSES — BRAND NEW

An ideal gift for viewing objects, landscapes, seashores, etc. The high resolving power of the six coated lenses, five of them achromats will bring out great details. For the experimenter it can be dismantled and used for hundreds of projects. Length 22½ inches. 38° Field. Postpaid \$7.50.

**500,000 Lenses and Prisms.** Send 3c stamp for "Bargain" List

A. JAEGER

123-26P ROCKAWAY BLVD., SO. OZONE PARK 20, N. Y.

AT YOUR  
DEALERS!

JOBBER  
DISTRIBUTORS  
Write today  
for open territories

GENIE INDUSTRIES  
2600 WEST OLIVE AVE.  
BURBANK, CALIF.

## GENIE TOOLS

- for hobbyist
  - model maker
  - precision worker
- DOES MORE • DOES IT  
**BETTER!**

IT CARVES



IT NOTCHES! CUTS HOLES! IT CHISELS! CUTS RAZOR-THIN! IT SAWS!

A PENNY POSTCARD MAY  
CHANGE YOUR FUTURE . . .

Get full information on the coin-operated vending machine industry. Start with a few machines and build to a wonderful future. We'll give you complete advantage of our "know-how." Send For Free Booklet Today—No Routes Sold!

### PIONEER VENDING SERVICE

Address all mail to Dept. PM

461 SACKMAN ST. • BROOKLYN 12, N. Y.

## GASOLINE ENGINES

Briggs-Stratton or Wisconsin Air cooled **\$99.50**  
6 H.P. . . . .

LIGHT PLANTS

3,000 watts — 110 volts . . . . . \$149.50  
Above items (used—Government Surplus) guaranteed in good Mechanical and operating condition.

Write for illustrated circulars.

MIDWEST SURPLUS SALES

1520 Locust St.

Kansas City, Mo.

(Pat. Pend.)

SAVES TIME, EFFORT, MONEY IN

## APPLIANCE REPAIRING!

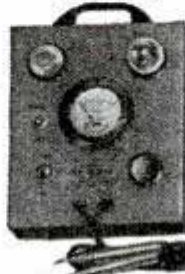

AC ammeter range 0-10 Amp. Serves as wattmeter with conversion chart range 55 to 1100 watts. High sensitivity neon tube for high-resistance tests. Tells AC from DC. Tests continuity, shorts, grounds, live and dead circuits, automatic irons, vacuum cleaners, motors, etc. Checks thermostats under working conditions. Tells instant it cuts in and out. Also controls heat on soldering irons. Operates on 110 V. AC, 50-60 cycles. ONLY \$14.50 complete, postpaid. MONEY BACK GUARANTEE.

Appliance Tester

**FREE** with each tester. New, Complete Practical Course in electrical appliance repairing. Write for circular.

HANLAN CO., 1419-A, West Jefferson Blvd., Los Angeles 7, Calif.

POPULAR MECHANICS



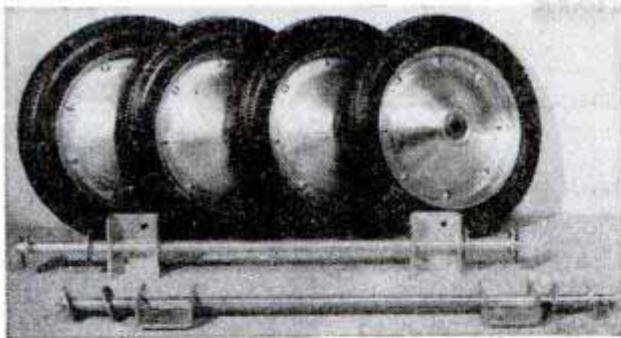

# LARGE 12 x 2 1/2 & 10 x 1 3/4 Ball Bearing WHEELS

**BUDD STEEL WHEELS** with GATES,  
MADE TO OUTWEAR ANY  
OTHER TYPE WHEELS . . . **GOODYEAR,  
and OSBORN**

**NOTE: Not the  
toy tires used  
by most wheel  
manufacturers.**

**Semi-Pneumatic Puncture-  
Proof Deep Tread Tires**

## BUDD HEAVY STEEL WHEELS

Bright Zinc Plated . . . With Arguto Lifetime Oilless Bearings or Killian Ball Bearings. **4 FOR \$10.00**  
For 1/2" or 5/8" Axles. . . . .  
10.00 x 1.75 (our regular) 1/2" Ball Bearing or 1/2" and 5/8" in Arguto Lifetime Oilless Bearings. Note: for 5/8" Ball Bearing add 25c per wheel.

With 2 . . . 1/2" dia. Axles 20" long hangers. **\$13.50**  
washers, cotter pins, Ready To Use. . . **ONLY**

### Here It Is . . . Combination V Belt Pulley Drive First Again— . . . and Brake Drum



Securely Held To Wheel . . . **READY TO USE.** Smart Design in Sturdy Pure Cast Aluminum . . . Precision Machined.  
One Combination Drive and 10" x 1.75 Wheel Assembled. . . . . **PRICE \$5.50**  
One Combination Drive Wheel and three without (set of 4). **PRICE \$13.00**  
Same as above with 2-20" x 1/2" axles, 4 hangers, washers, cotter pins. **READY FOR USE. . . . . PRICE \$16.50**

Same as above with 24" long x 5/8" dia. axles, 4 hangers, washers and cotter pins. **READY FOR USE . . . . . PRICE \$19.00**

Combination V Pulley Drive and Brake Drum, without wheel. . . . . **PRICE \$3.50**

F.O.B. Doylestown, or, add 10% for Prepaid Shipment anywhere in U.S.A.

### INDUSTRIAL HEAVY STEEL WHEELS

—with 5/8" Ball Bearings and Gates 10.00"x2.50" Heavy Duty Semi-Pneumatic 250 lb. Load Tire—  
**ONLY \$6.00 EACH PREPAID**

## SPECIAL: Electric Drive WHEEL CHAIR

All Hand Controlled FOR ANY AGE  
24" wide x 42" long. Speed—Steering and Brake all hand controlled. Intended for level driving only; inside or outdoors . . . **PREPAID \$275.00**  
less battery. **IN U.S.A.**

### OSBORN WHEEL COMPANY

115 So. Main St., Dept. P-6, DOYLESTOWN, PENN.

65 inches Long  
24 inches Wide  
Weight  
Approx. 55 Pounds



**Model "A" RACER CHASSIS  
for POWER or PUSH  
with 4 — 12x2.50 SUPER  
Sturdy Built ALL-PURPOSE Chassis. Miles of Pleasure for any age. The two rear wheels have the Combination V Belt Pulley Drive and Brake Drum (not against tires as shown above). Engineered for Electric, Gasoline or Push Power. Equipped with Genuine Arguto OIL-LESS LIFETIME BEARINGS or Killian Ball Bearings. Ready to roll and steer. COMPLETE AS ABOVE. F.O.B. Doylestown, or, add 15% for Prepaid Shipment in U.S.A.**

**RUSH ORDER TODAY**



**ONLY \$56.00**

### Here It Is: Electric Motor for REAL POWER DRIVE

12 Volt Electric Motor With 3 Speed Control . . . Easy to Install.  
**ONLY \$33.50**  
Write For Free Circular

**Super DeLux  
12x2 1/2" Wheels  
for 1/2" or 5/8" Axles  
Wheels Complete With Tires  
1 ONLY . . . . . \$ 5.50  
2 ONLY . . . . . \$10.00  
4 ONLY . . . . . \$18.00  
Plus 10% for  
Prepaid Shipment**

## RUBBER MOLDS!

Make your own rubber molds! Cost only a few cents each! Cast plaques, novelties, bookends, lamps, clock cases, ash trays, etc. We supply everything! Also make pottery, vases, window boxes, sundials, bird baths, garden furniture. Send a post card for **FREE SAMPLE!**

H. TOOKER 630 N. CHESTNUT ST. HAMILTON, OHIO.

## CHANITE SELF-WELDING FLUX

REPAIRS ALL ELECTRIC HEATING ELEMENTS  
So simple anyone can make repairs in your broken or burnt-out electrical appliances—irons, toasters, stoves, etc. Guaranteed nothing like it. From our mines to your appliances. \$1.00 per package. \$7.50 per doz. Stick form 25c. \$2.00 per doz.  
**CHANITE SALES COMPANY, 914 So. Main, Fort Worth 4, Texas**

# Genuine BENDIX HYDROVAC

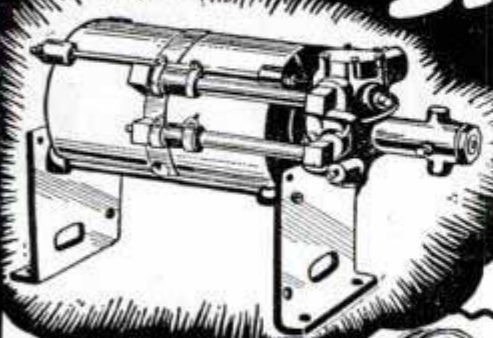

**MORE WAR SURPLUS BUYS**

**Newest Thing In POWER BRAKES**  
**EASILY ATTACHED TO MOST 1 1/2 To 3 Ton TRUCKS & BUSES**  
**Increases Your Hydraulic Brake Power To Maximum**  
**NOW STANDARD EQUIPMENT ON MOST NEW TRUCKS—CHEV.—DODGE—FORD—INT'L.—ETC.**

Unit is easily attached anywhere on Truck, Truck-Tractor or Bus hydraulic brake system to amazingly increase brake power to MAXIMUM. Hydraulic-Vacuum action! Your Master Cylinder controls and activates the Unit! Supplied complete with Installation Parts Kit for most trucks . . . includes supply Wagner Brake Fluid. List price complete packaged Unit and Kit, \$84.00!  
**War Surplus Buy!**  
**OUR PRICE \$28.50**  
Including Parts Kit  
(Quantity Discount To Dealers)

SEND FULL REMITTANCE OR 25% DEPOSIT WITH BALANCE C.O.D.

20,000 LB. CAPACITY TRAILER AXLE ASSEMBLY \$158 Complete (Less Wheels). New, with Double Cyl. Hydraulic Brakes, 6-Hole Budd Hubs, Etc.  
20 x 7 - 6 HOLE BUDD WHEELS TO FIT ABOVE ASSEMBLY \$6.75 EACH.  
10,000 LB. CAPACITY 16 in. DUAL WHEEL ASSEMBLY \$109 Complete (Less Wheels). New, with Hydraulic Brakes, 5-Hole Hubs, Etc. For 15 in. to 20 in. Single or Duals.  
16 x 7.50 - 5 HOLE BUDD WHEELS TO FIT ABOVE ASSEMBLY \$12.50 EACH.

## NORTHWESTERN AUTO PARTS CO. (DEPT. 7 - 834 NO. 7th St. MINNEAPOLIS II, MINN.)

AMERICA'S LARGEST MAIL ORDER DISTRIBUTOR OF ITS KIND - Est. 1918 - "29th Year" • SEND FOR CATALOG • Specify Items You're Interested In!



# HYDRAULIC POWER

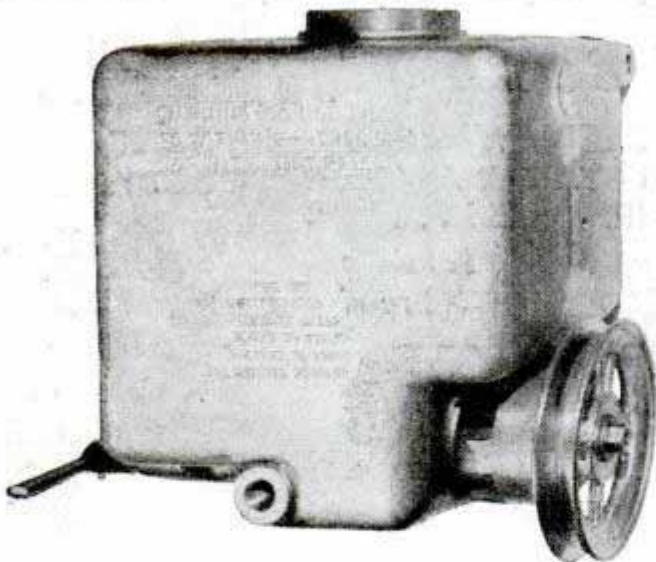

This complete "POWER PACK" has pump, operating valve and reservoir in one unit. It is ready for installation on any engine, tractor, electric motor, special machines or on any power driven equipment.

The "POWER PACK" will operate hydraulic lift attached to loaders, bulldozers, shovels, plows, cranes, jacks, rams, presses, etc.

Precision Built For Long Service.

Immediate Delivery.

Surprisingly Low Price.

**HYDRAULIC RESEARCH & MFG. CO.**  
1500 W. VERDUGO BUREAU, CALIF.

Send for Circular.

Order by Mail NOW!



All Brand New

DELCO New Motor, 6 to 30 Volt D.C., 1/30 H.P., Shunt type, 2.4 Amp., 3600 R.P.M. Durable wrinkle finish. Measures 7 1/2" long, 2 1/2" high. Ideal for running trains, movable toys, etc., etc.

\$3.95 EA.

## MINI-MOTOR BARGAINS

DELCO New type Alnico field, 6 to 30 volts D.C., 60 to 250 R.P.M. Powerful Torque. REVERSIBLE. You'll find 100 handy uses for it around the house!



\$2.95 EA.

R. S. SURPLUS CO.  
428 Erie Blvd., Syracuse, N.Y.

Please Send Me at Once:

..... Delco Motors @ \$2.95 Post Paid

..... Delco Motors @ \$3.95 Post Paid

Name..... City.....

Street..... State.....

## The PRECISION Lawn Mower Sharpener

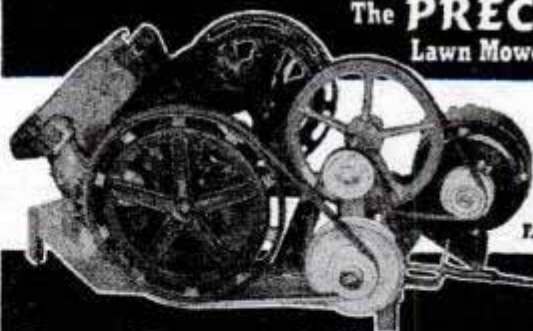

Only \$37.50  
Less Motor  
F.O.B. Rock Island

## EXTRA DOLLARS IN YOUR SPARE TIME...

Looking for an extra income sideline? Install a Precision Lawn Mower Sharpener in your workshop and turn your spare time into dollars. Sturdily constructed - Easy to operate.

QUAD-CITY PRODUCTS CO. - P.O. Box 42, Rock Island, Ill.

## WAR SURPLUS SPECIAL

### BRAND NEW ARMY FATIGUE TROUSERS

Here is the trouser you'll want for work, sports, general wear. The low price for such fine quality makes them an outstanding SURPLUS value. Heavy 8 oz. Herringbone Twill material; dark olive drab color; two large side pockets; made to Gov't. specifications; plain bottoms; double stitched for strength; washable; fit good, look good, wear, wear, wear. Our supply is limited. Order now to insure delivery. Sizes: 30-32-34-36-38 waist; 33 length only. Shipping Wt. 4 Lb.

2 Pr. for \$4.38

PAY POSTMAN ON DELIVERY. SATISFACTION GUARANTEED OR MONEY REFUNDED PROMPTLY.

FREE Illustrated circular of SURPLUS and civilian clothing sent with order, or free on request. Send for your copy today.

ADDISON UNIFORM CO., Dept. PM-6, Cambridge, Ohio

## NEW SCIENTIFIC LUCKY BIRD WEATHER FORECASTER

This NEW Scientific Weather Bird accurately predicts the weather 8 to 24 hours in advance and as well gives you accurate temperature readings with a thermometer encased in the Lucky Weather Bird's Neck, 7" High. Be your own weatherman. Not an expensive barometer yet scientifically accurate. Not Just A Toy!... A Real Weatherman Tail Changes Triple tested to U. S. Government Color & Standards, it registers temperature within 1 degree of accuracy. Wonderful for the home, office, factory, store, school & farm. MAIL YOUR ORDER NOW. Write For Free Catalogue. Special Prices For Dealers. Bernard Fine Co., 501 Sixth Ave., New York 11, N. Y., Dept. WV-1.



Out-guesses the Weather Man

\$1.98 Post paid

## USE Fine Walton Wheels to Make Your Own WAGONS—SHOPPING CARTS and RACERS



65¢

Each in Sets of 2 or 4 — plus 10¢ ea. for postage. 4 1/2-inch with 3/8-in. bushing

Coaster wagons, scooters, shopping carts, bike trailers, golf bag carriers, etc., are easy to make. Use fine Walton Deluxe Wheels! They're strong welded pressed steel construction. Ideal for making many things for use and play. Solid rubber tires. Red enameled. Send check or money order. No C.O.D.'s. Dealers and manufacturers write.

WALTON WHEEL COMPANY, Dept. J-4  
Plankinton Bldg. Milwaukee 3, Wis.

## BUILD YOUR OWN ARC WELDER

For Light or Heavy Work  
No rewinding necessary—use coils taken from old auto generators. Works on 110 or 220 A.C. Has 20 different heats. Complete plans and BIG Catalog 35¢. LEJAY MFG. CO. 3347 LeJay Bldg. Minneapolis, Minn.

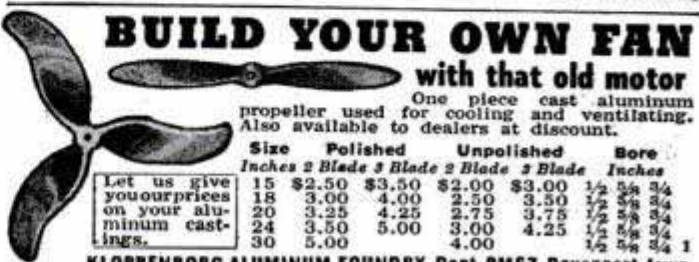

## BUILD YOUR OWN FAN with that old motor

One piece cast aluminum propeller used for cooling and ventilating. Also available to dealers at discount.

Size Inches	2 Blade	3 Blade	2 Blade	3 Blade	Bore Inches
15	\$2.50	\$3.50	\$2.00	\$3.00	1/2 5/8 3/4
18	3.00	4.00	2.50	3.50	1/2 5/8 3/4
20	3.25	4.25	2.75	3.75	1/2 5/8 3/4
24	3.50	5.00	3.00	4.25	1/2 5/8 3/4
30	5.00		4.00		1 1/2 5/8 3/4 1

Let us give you our prices on your aluminum castings.

KLOPPENBORG ALUMINUM FOUNDRY, Dept. PM67, Davenport, Iowa



## ARMY RADIO PHONES



**They're Weather — Water  
and Shock Proof**

When we say they are made to Army specifications, that's enough assurance they must be of best quality. These Army Radio Phones are perfect and were O.K.'d by Signal Corps Inspectors. These Dynamic Mikes and Receivers, were used on aircraft and tank inter communication systems. Use them for recording, for battery-less phone, for pocket size set loud speaker or talk through your radio set. We bought a good many of these Radio Phones, they are brand new, and cost a great deal more than you can get them for. A complete dynamic hand mike, 2 earphones, headband, cord set. A wonderful buy for only...

**\$3.45**

Send check or Money Order, FOB warehouse

**LEEDS RADIO CO.**

75 Vesey St.

Dept. PM4

New York City 7

## GET A NEW THRILL IN NIGHT FISHING



with the New

### BITE LITE BOBBER

**When the Fish Bites  
The Bobber Lights**

Have more fun! Catch more fish! Beautiful, streamlined colored plastic case. Has exclusive line locking Depth Control Device. Good for day fishing, too. Long life battery flashes only when fish bites. New batteries only a few cents anywhere. Individually boxed, complete with battery, only \$1.50 at your dealer. Legal in all states.

If your dealer cannot supply you we ship direct, postage paid. Write for literature on other outstanding fishing accessories.

**GLO LITE BOBBERS INCORPORATED**  
912 FRANCIS PALMS BLDG. • DETROIT 1, MICHIGAN

### Special Castolite Kit

Hobbyists, craftsmen: Get new CASTO-KIT containing everything to make useful objects with CASTOLITE, the new "magic" liquid casting plastic that pours without heat or pressure. Use crystal clear or color brilliantly. Make beautiful articles very first day—lamp bases, bookends, novelty jewelry. Also embed flowers, butterflies, photos, coins. Carve, saw or drill. Kit includes 1 lb. Liquid CASTOLITE, hardener, buffing compound, measuring dropper, abrasives, molding vial, flowers for embedding. Instruction Manual with easy step-by-step method. Big profit opportunities between now and Xmas. Send \$3.35 for kit prepaid or order C.O.D. The Illustrated Manual alone is 25c.

**THE CASTOLITE COMPANY**  
Dept. G-1, Box 211 Kenilworth, Ill.

**NEW  
Liquid  
Plastic**

**20-Project  
KIT  
\$3.35**

### ★ ★ PRICE REDUCTIONS ★ ★ EXPANDED STOCKS

Aluminum flats to 4", squares, rounds, hexagons, angles, tubing. Drill rod in rounds, squares, flats and octagons. Plastic in sheets, rods and tubing, clear and color. Also Decorative Panels. Many other items. Listing (A47) on above 5c. Catalog 1046-E and Listing A47 which lists tools, supplies, equipment, etc. 15c.

**METPLAS SUPPLY COMPANY, 1420 S. 16TH, MAYWOOD, ILLINOIS**



### MINIATURE ENGINES

**Gasoline—Steam  
Air—Locomotive**



**THE WORLD'S  
MOST FASCINATING HOBBY**

**Build them yourself — In your own shop**

**With your own tools**



Send 10 cents for my illustrated catalogue listing the world's largest selection of miniature engine castings and drawings.

**McADED MODELS**  
1313 S. TALMAN AVE.  
CHICAGO 8, ILLINOIS

# A TOOLSHOP IN YOUR HAND!

- GRIND • DRILL • ROUT
- POLISH • ENGRAVE
- CUT • SAND • SAW, etc.

Make Things From  
Wood—Plastics—Metals—Glass—Linoleum—Leather—Alloys—Horn—Stone—Bone, etc.

**HANDEE TOOL OF 1001 USES**

Smooth, steady power at your fingertips! Perform precision operations not possible with any other portable tool! With a Handee you can turn out professional looking projects for pleasure or profit—ship, plane and train models, costume jewelry, wood carvings, puppets, initialed tumblers, etc. AC or DC. 25,000 r.p.m. Wt. 12 oz.

**USE THE RIGHT ACCESSORIES!** Choose them from the most complete line . . . more than 500 made right in the Handee plant.

### GET A GOOD START GET THE HANDEE KIT

HANDEE Tool and 40 most popular accessories packed in compact steel carrying case. You'll be amazed at what you can accomplish! Complete, **postpaid, \$27.50**

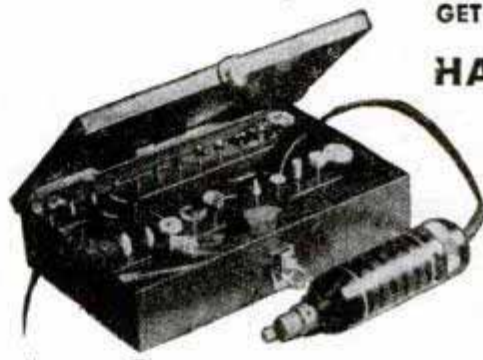

Handee only, with 7 accessories, \$20.50

**FOR YOURSELF OR A FRIEND...  
THE GIFT OF A LIFETIME!**

### NEW PRECISION ATTACHMENTS

Fit Handee only; enable novice or craftsman to do perfect work. Magically, easily, your offhand carving, routing, shaping will be exact as to depth of cut, accuracy of line. Set of 6 attachments with instructions, **postpaid, \$7.95**



**ORDER NOW. SATISFACTION GUARANTEED!**

**FREE! NEW 52-PAGE MANUAL**

**CHICAGO WHEEL & MFG. CO.**

1101 W. Monroe St., Dept. PM, Chicago 7, Ill.

Send  Handee Kit  Handee Tool  Precision Attachments  
 C.O.D.  Remittance enclosed  Send Manual

Name.....

Address.....



**It Pays to Buy an  
AIRCOOLED  
DIESEL POWERED  
Generating Set**

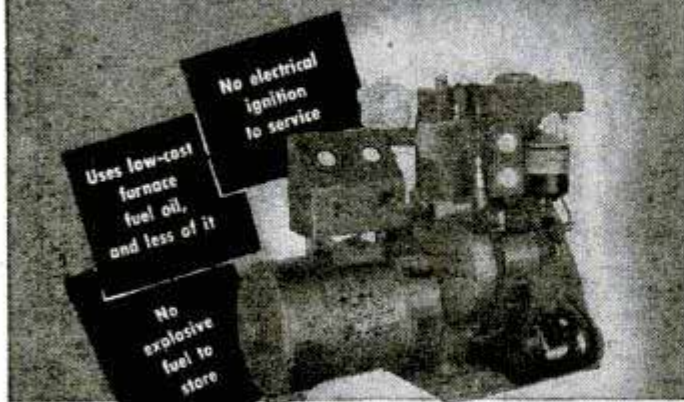

Uses low-cost  
furnace  
fuel oil,  
and less of it

No electrical  
ignition  
to service

No  
explosive  
fuel to  
store

Steady voltage  
power... free  
from outside  
interference

Literature containing complete information is available. Just mail a post card today.

**R. H. SHEPPARD CO., INC.**  
48 Middle St., Hanover, Pa.

DIESEL'S THE POWER...

*Sheppard's the Diesel*

**USE THESE FAMOUS INDUSTRIAL  
DRILLS IN YOUR HOME WORKSHOP**

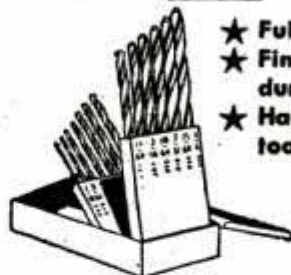

- ★ Full Length—Long Flutes
- ★ Finest H. S. Steel—Keen, durable
- ★ Handy case for pocket or tool kit

**SPECIAL!**

only **\$5.75** post paid

Michigan orders add 3% sales tax.

**"Quarterpak"** SEND CHECK, MONEY ORDER OR C. O. D.

13 DRILLS, 1/16" TO 1/4" BY 64THS IN HUOT CASE

**LARGER SETS**

No. 21—1/16" to 3/8" by 64ths, \$14.25

No. 15—1/16" to 1/2" by 32nds, \$15.50

No. 29—1/16" to 1/2" by 64ths, \$28.25

IF YOUR DEALER CAN'T SUPPLY YOU, WRITE DIRECT

**ACE DRILL CORPORATION**  
DEPT. M • DETROIT 27, MICHIGAN

**PLASTICS!**

Fabricating plastics offers you a fascinating hobby or a profitable business. New Carmen-Bronson Plastics Handbook tells you how; gives construction plans. New Carmen-Bronson Catalog lists all needed materials—Plexiglas, Lucite, Bakelite, Lignolite, Tenite II, Lumarith in sheets, rods, tubes, special shapes—clear and glowing colors. Also plastics dyes, cements, accessories and supplies. 25c (refundable with first order), brings you both catalog and handbook. Send for them today.

**CARMEN-BRONSON COMPANY**  
165 EAST 3RD STREET, DEPT. 6-B, MOUNT VERNON, N. Y.

**STAR LIVE CENTERS**



**\$14.65**

Nos. 1 & 2 Morse Taper. Same general dimensions as standard dead center, accuracy to .0002", thrust to 300 lbs. Satisfaction or your money back. Send check or M.O. for \$14.65, we pay postage in USA.

**STAR TOOL CO.** DEPT. M542 W WASHINGTON ST. CHICAGO, ILL.

FOR TRAILER - TRUCK - WAGON  
**HUB AND WHEEL ASSY.**  
6.16 WHEEL STUB AXLE  
TIMKEN BEARING EQUIPPED  
PAIR COMPLETE \$28.75 F. O. B. OMAHA  
**HUSKER MFG. CO.**  
OMAHA, NEBRASKA

**Cut NEW TEETH in 3 Min.**

With **FOLEY RETOOTHER**

For All  
**HAND SAWS**

No need to grind off old teeth—cut new ones over them. Fast, accurate, no eye-strain. Cuts filing time in half.

Cuts 20 sizes of teeth from 4 to 16 points per inch. Immediate delivery



**FOLEY MFG. CO.**  
690-7 Foley Bldg., Minneapolis 13, Minn.  
Send full details on Foley Retoother.

Name.....  
Address.....

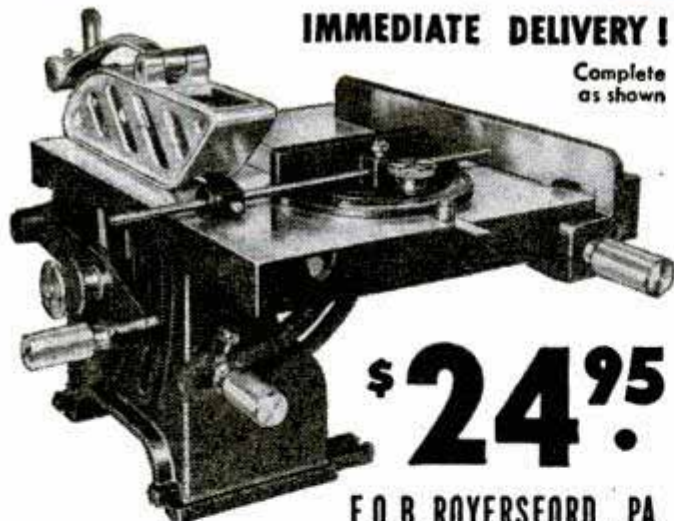

**IMMEDIATE DELIVERY!**  
Complete as shown

**\$24.95**

F.O.B. ROYERSFORD, PA.

**QUALITY 8" BENCH SAW**  
CUTS THROUGH 2 5/16"

**UNCONDITIONALLY GUARANTEED ONE YEAR**  
(Write for Free Booklet and Guarantee Bond)

Comes complete with Floating motor mount—miter gauge with adjustable stop—aluminum guard—soft aluminum insert—spring steel splitter—heavy gray iron fence—(no motor—no blade). Table 12" x 14". Tilts to 45°—Oilite bearings. Shipping Wt. 50 lbs.

**AMERICAN MACHINE & TOOL CO. Inc.**  
DEPT. 100 ROYERSFORD, PA.



INDOOR or OUTDOOR! DAY or NIGHT!  
RAIN or SHINE! *Perfect Pictures!*

Univex  
**UNIFLASH**  
ONLY \$8.75

FED. TAX INCLUDED

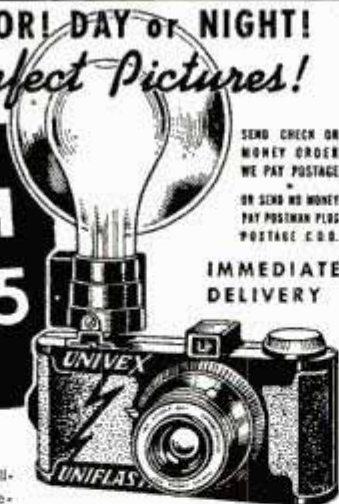

SEND CHECK OR MONEY ORDER  
WE PAY POSTAGE  
OR SEND NO MONEY  
PAY POSTMAN PLUS  
POSTAGE C.O.D.

IMMEDIATE DELIVERY

Just aim and shoot with this sensational all-purpose camera. Get perfect pictures regardless of weather... regardless of where you shoot. New coated lens. Accurate flash timing. Automatic bulb ejector. Magni-Field view finder. A great value... a great camera! Immediate delivery. Order today!



UNIVEX FILM 15c A ROLL

KENT JEWELRY CO., 13933 E. Jefferson, Detroit 15, Mich.

BRAND NEW SOLID BRASS 12 FT. PORTABLE

## RADIO ANTENNAS

Real \$15 Value Now Only \$4.95 Postpaid  
FOR HOMES, BOATS or AUTOS

**JUST OUT!** Gov't surplus used on Army tanks. These telescopic rustproof antennas have tremendous pickup eliminate dangerous wiring. Solid Brass throughout practically insuring **NOISE FREE RECEPTION.**

**12**  
Exceptionally Rugged Sections compress into 1 ft. 4 in. Handy for Camping Trips, also Useful for Transmitting, FM & Television sets. Each antenna comes with clamps, nut, lug, and wire. Easy to install anywhere.

QUANTITY LIMITED

ORDER TODAY. A real \$15 value for only \$4.95 Postpaid. Mail check or money order now or sent C.O.D. plus postage. Money back in 10 days if not satisfied.

RADIO HOSPITAL 1113 Lexington Ave., Dept. A6  
New York 21, N. Y.

## Amazing Low Cost Aladdin's Tool DOES ALL TYPES WOOD SHAPING

ROUTING, TONGUE and GROOVE, FLUTING NOTCHING, INLAY, ANY TYPE OF JOINT



Comes with 2 ground blades and 4 blank blades for grinding to shape needed for any particular job. These 6 blades will make 12 different cuts. Send \$5.95 check, cash or money order for prepaid shipment, or name and address on 1c postcard for C.O.D. shipment.

DESIGN CO 2016 East 31st St. Dept. P16 Kansas City, Mo.



If your dealer does not stock this item order direct giving his name address so we may credit him.

\$5.95 COMPLETE

## SELL ULTRA-BLUE STOCK SIGNS



To General Stores over 1000 Different Slogans and Sayings. Fine Line of Religious Ultra-Blue Signs for Homes and General Display. Make Money on these Fast Selling Signs. 35c Sellers. 15—Sample Ultra-Blue Store Stock Signs—7x11, \$1.00 postpd. 15—Sample Ultra-Blue Religious Signs—7x11, \$1.00 postpd. 100—Ultra-Blue Stock Signs—7x11, \$5.00, No C.O.D.'s.

L. LOWY, 8 WEST BROADWAY, NEW YORK 7, N. Y.—DEPARTMENT 318

## Big Money for Workers In Home or Shop



Licensed Concrete Specialists wanted. No experience needed. Make *Colorglazed* concrete pottery without molds. New, low cost, patented method. Cemetery products, novelties, tiles, etc. Basement leaksealing. Other big pay projects. Booklet, details free. Men only.

NATIONAL POTTERIES COMPANY  
542 Lincoln Avenue Fergus Falls, Minnesota

# NEW!



\$25.50 COMPLETE

THE **FIRST** COMPLETE  
ELECTRIC DRILL KIT!

## CENTURY Cub

1/4" CAPACITY, A.C.-D.C....LIGHT DUTY

HOME CRAFTSMEN, FARMERS, HOBBYISTS, REPAIRMEN... here's a complete drill kit for handy use at-the-bench or on-the-job

KIT INCLUDES... 1/4" CAPACITY ELECTRIC DRILL



A light duty drill, engineered with balance and "feel." Makes drilling easier, more accurate. Research proves men prefer saw grip handle. Factory guaranteed 1 year.

PLUS... 13 HIGH SPEED DRILLS AND DRILL RACK



The finest drills in the world—made of High Speed Tungsten-Molybdenum Steel to withstand temperatures of 1200°F. Sizes every 64th from 1/16" to 1/4" in indexed rack.

ALL IN ONE COMPACT, STEEL CARRYING CASE



Sturdy, baked enameled steel case, only 10 3/4" x 5 3/4" x 3 1/4". Weighs only 5 lbs. complete. Tucks under arm or in corner of standard tool box.

ON SALE AT LEADING HARDWARE, AUTO SUPPLY AND DEPARTMENT STORES EVERYWHERE OR MAIL COUPON DIRECT TO

CENTURY TWIST DRILL WORKS  
96 Lafayette St., New York 13, New York

Send me one complete Century Cub Electric Drill Kit  
 Enclosed is my check ( ) money order ( ) for \$25.50  
 Please ship C.O.D. plus postage and insurance.

Name \_\_\_\_\_

Street/Route \_\_\_\_\_

City/Town \_\_\_\_\_ State \_\_\_\_\_



# WAR SURPLUS

For the Sportsmen — Young or Old  
All Year 'Round Use



Perfect all wool  
Olive Drab  
**SLEEPING BAG**

Comes in handy for fishing trips, hunting, camping, boating, just roughing it or use as auto robe and many other purposes. Has warmth of 2 blankets; zipper slide fastener; tie-strap on bottom; approx. Gov't cost \$12.90, our price, Ea.... **\$3.95**  
Outside Cover for Sleeping Bag—Water repellent.....\$1.89

**ARMY PUP TENTS** Perfect Without Pole..... **\$2.95**

BLANKETS—Wool O. D., excellent condition.....\$4.85  
Perfect CANTEENS—used. 65c SPURS—Cavalry, New....95c  
Perfect MESSKITS—used. 65c CANTEEN CUPS .....40c  
RAIN PONCHOS (used) Good condition.....\$2.25  
FLASHLIGHTS Angle Head—clip-on—New.....\$1.00  
WATER PURIFIER—"Sunstill", New. Used by Air Forces and Navy to distill salt water into FRESH DRINKING WATER. Original Gov't cost, approx. \$70.00. **\$9.95**  
Our price.....

**PUMP TYPE GARDEN AND TREE SPRAY**  
Slightly used, perfect condition. Can be used also as fire extinguisher, white wash spray, etc. **\$3.95**  
4 gal. capacity.....

## NEW GOGGLES

For skiers, fliers, campers, hunters, fishing, beachwear, safety-wear, motorcycling, bicycling, boating and many other uses. Set comes complete (boxed) with 9 extra interchangeable shatter-proof, flexible, cellulose acetate lenses. Amber, Green and white colors. A rubber flexible chamois lined goggle frame. Back adjustment head strap. Made for A. A. F. Cost Gov't approx. **\$1.59**  
**\$4.50.** Our Price—EACH.....



## NEW AIR CORPS SUNGLASSES

Manufactured by Bausch & Lomb for U. S. Air Corps. Quality and Style with Bone Nose Cross Bar, individual case. Priced at big savings which INCLUDES postage..... **\$8.95**  
White Mattress Covers, 81x31", Excellent condition.....\$1.49  
Knitted SHORTS—White, New, Men's size 32 to 46—3 for \$1.00  
MACKINAW (used) — Water repellent, excellent condition, blanket lined, high collar with belt. Perfect as hunting, fishing coat, etc. Small, medium and large sizes... **\$4.95**  
RAIN COATS (used)—Good condition. Small, medium and large sizes..... **\$2.49**  
Add 10% for postage — No COD — Send check or money order.  
Dept. P. M., 5th & Broadway  
Kansas City, Mo.

**AMERICAN SUPPLY CO.**

SAY YOU SAW IT IN POPULAR MECHANICS

# WORLD'S LOWEST PRICED ADDING MACHINE

VEST POCKET SIZE  
IDEAL FOR BUSINESS OR PERSONAL USE

FREE TRIAL  
ONLY **\$2.50**  
TOTAL COST  
SEND NO MONEY

Each Baby Calculator in Beautiful, rich-looking Leatherette case — at no extra cost. **FREE!!**



Fits vest pocket or purse. Guaranteed accurate. Operated as easily, and as reliable, as machines costing many times as much. Not a toy. Substantially made of 28-gauge steel—guaranteed for life against defects in construction. You positively can't buy a calculator of equal quality for as little money. **ACCEPTED AS THE FINEST LOW PRICED CALCULATOR FOR OVER 30 YEARS!** Operates with a flick of your finger. Adds, subtracts, multiplies, divides—counts up to ten million. Pays for itself over and over in mistakes avoided, and time saved. **MAKES IDEAL GIFT.**

Sold on a positive money back guarantee. Send only \$2.50, Calculator sent postpaid, or send name and address and pay postman \$2.50 plus postage. **MONEY BACK IN 10 DAYS IF NOT DELIGHTED!** (If outside U. S., send \$3.00.)

AGENTS WANTED.

**CALCULATOR MACHINE CO. (Mfrs.)**  
Dept. 191, P. O. Box 248, Glenview, Illinois

# FINE TOOLS NEED FINE OIL!



• Lubricates



• Prevents Rust

• Cleans • Polishes

SOLD EVERYWHERE

## 3-IN-ONE Oil

## THE NEW IMPROVED ARMY TYPE HAND SIGHTING LEVEL \$2

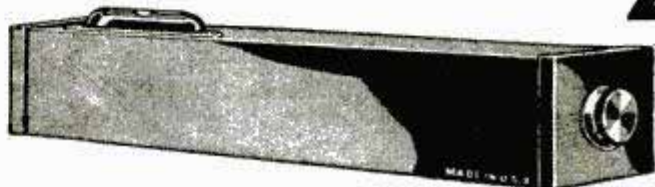

May be held in the hand or mounted. Only 5" long. For engineers, contractors, surveyors, gardeners, Boy Scouts, carpenters, farmers, etc. Widely used as a level, as a sighting and surveying instrument for laying drains, ditches, foundations, roads, etc., as a stadia range finder for judging distances, as a height finder for gauging the height of trees, buildings, hills, etc. Hundreds of uses. Directions included. Moneyback guarantee. Only \$2.00. We pay the postage.

**BROWSCOPE CO., Dept. 6M, 24 W. 45th St., N. Y. 19, N. Y.**

## PLASTICS

Get started now in a profitable business or fascinating hobby. Write today for FREE list complete plastic supplies for fabricating and casting, plastic kits, complete plans for plastic projects and plastic accessories.

**CENTURY ENTERPRISE**

Box 56-PM, Station A Los Angeles 31, Calif.

## DUAL TAIL PIPE EXTENSION FOR YOUR CAR. \$2.95

DEEP TONE,  
PRODUCED BY 2 1/2 IN. OUTLETS  
Chrome Plated -- Fits All Cars  
Postage Free on Money Order, Check or Cash  
PAT. PEND. LYONS PRODUCTS Co. 2319 Ridgeley Dr. Los Angeles 16, Cal.

## BUILD YOUR OWN TILTING TABLE SAW!

Performance of \$60 Saw at 1/6 the Cost!



- 21x27 in. table tilts to 45°.
- 8 in. blade cuts from 0 to 2 1/2 in.

- Ball bearing mandrel
- Self-aligning and indexed rip fence and mitre gauge

- Sturdy wood, steel, and aluminum construction
- No machining—build easily with hand tools
- Ability to read blueprints not necessary
- Operate with any 1/4 to 1/2 H.P. motor

Send \$1.00 NOW for easy step-by-step Plans!

**GIL-BILT, P. O. Box 1-E, Lambert Field, St. Louis 21, Mo.**

SAVE  
**\$50**  
OR MORE

COMPLETE  
PLANS  
only  
**\$1.00**



# PERFECT DOWELS

... easily made



## ON YOUR LATHE OR DRILL PRESS

Use a SPEE-DOWL and you can work wonders with wood. Quickly and easily you'll make dowels of any wood... perfect burnished dowels for furniture, toys and thousands of other projects. You merely push SPEE-DOWL on wood—the lathe or drill press does the

work! Cast body, tool steel blade. SIZES: 2, 3, 4, 5, 6, 7 and 8/16" (illustrated at left). Only \$1 ea. Special—any 4 of above for \$3.50; complete set of 7 for \$6. Also individual sizes 9 to 20/16" (illustrated at right) \$2.65 each. SPEE-DOWL is Unconditionally Guaranteed. Send postal note or check—we pay postage in North America. FREE Literature.

JOHNS MFG. CORP., DEPT. C-9  
DUNELLEN, N. J.

## NEW INVENTION Controls Radio Commercials, Loud Music, Etc.

Enjoy your radio more! Plug this Earsaver remote volume control into your radio; from anywhere in room, fade down or out singing commercials, loud music, etc. Only \$4.95, complete with 15-ft. cord. Sold on 10-day trial. Send \$1 bal. C.O.D. Give make and model number of your radio. Circular free.

EARSAVER 1725 Bonita, Dept. 7,  
Burbank, Cal.

## Assemble KING MIDGET

Practical highway racer runabout. New model. We supply all parts. Just bolt together. Low cost. Ready for delivery NOW. One or two cylinder, 40 m.p.h., up to 100 miles per gallon. Send 25c for complete new literature with large picture, 4-view drawings, price of parts, or send \$1 (refunded with first order) for the above, plus 24 page booklet showing complete assembly with 30 photographs and drawings.

MIDGET MOTORS, Athens, Ohio

## PAINERS' STRIPING TOOL

A TOOL... NOT A BRUSH

### NEW, IMPROVED

Modern—streamlined—fits the hand like a fountain pen! Easy to use as a pencil. Draws parallel lines—straight, curve or circular. Does expert job on autos, furniture, toys, bikes, model planes, signs, bulletins, linoleum. (Makes wall board look like tile.) Every painter and craftsman needs one! Type "M" MASTER Painters' Striping Tool complete with tip for 1/16" stripe, \$1.00. Extra tips 1/64", 1/32", 3/64", 1/16", 5/64", 3/32", 1/8"—75c each. Tool with complete set of 7 tips \$5.00. (C.O.D. orders 25c extra.) Paint dealers, write!

EASY AS  
USING A  
PENCIL!

\$1.00  
POST  
PAID

WENDELL MFG. CO.  
4234-B Lincoln Ave., Chicago 18, Illinois

# LOW PRICED

FOR THE FIRST TIME IN YEARS!

DOES ALL  
THESE JOBS  
EASIER, BETTER



SANDING



POLISHING



CARVING



ROUTING



GRINDING



DRILLING



ENGRAVING



SHARPENING



CLEANING



Real  
fractional  
horsepower  
AC-DC  
Electric  
Motor

## FAMOUS CASCO POWER WORKSHOP

New portable all-purpose Electr-O-Tool Kit  
FOR MECHANICS,  
HOBBYISTS, HOME CRAFTSMEN

Speed your work on wood, metal, glass, plastics, leather with this professional all-purpose tool. More exclusive features than any other tool on the market. Long life, powerful 20,000 RPM motor in unbreakable plastic case, oil-less bearings, air-cooled. Exclusive built-in finger grip for perfect control in fine detail work. Weighs only 12 1/2 oz. Fully guaranteed. Complete with 20 precision-made accessories in fitted chest. Hobby or professional work is easier with this whole shop full of tools in one. Do hundreds of jobs by simply changing the versatile accessories.

Buy at your dealer's today. If he cannot supply, write direct to factory giving dealer's name. Free descriptive literature on request.

### SPECIAL LOW PRICE OFFER

Price of power tool alone . . . . . \$14.95  
20 accessories and valuable Project Book . . . . . 8.50  
Total Value . . . . . \$23.45

ALL 21 PIECES FOR ONLY \$14.95

ANOTHER  
BIG VALUE!  
CASCO  
ELECTRI-CRAFT  
POWER TOOL KIT  
complete with  
36 accessories in  
fitted steel chest  
\$32.95 value  
for only \$22.50



# CASCO

CASCO PRODUCTS CORPORATION • BRIDGEPORT 2, CONN.



# Use Fine Tools

In Wrenches — use Billings Quality drop forged Wrenches. Made from Billings Vitalloy Steel with a heavy chrome plate over a nickel plated copper base, openings exact to size, light in weight and scientifically designed to balance, "feel" and strength. Every Billings Wrench guaranteed. You'll like to use them — they fit better, last longer and are fine tools! . . . Check the sizes you need, your Hardware Store has many styles and sizes for all nuts, bolts and cap screws . . . Say "Billings" when buying Wrenches.

**YOUR HARDWARE STORE**  
displays Billings Wrenches. Look for the attractively wood panels.

**Billings**  
DROPPED FORGED  
**WRENCHES**  
for FARM-HOME-INDUSTRY

TOOL CRAFTSMEN SINCE 1849  
THE BILLINGS & SPENCER CO. HARTFORD 1, CONN.

# MAKE MORE MONEY—EASIER!

## The IDEAL MIXER for CEMENT MORTAR FEED FERTILIZER GERMINATION

**Large 3½ cu. ft. Capacity — Shipped Complete with 1½ HP Gasoline Engine**

Save money by doing your own mixing, and make extra cash by doing contract mixing for your friends and neighbors. The portable "TRANSCO" Model 350P assures fast, thorough mixing. Cast iron mixing bowl, electro-welded steel cone. Sturdy frame, extremely portable. Complete with powerful 1½ HP gasoline engine. Weighs 310 lbs.

**10 DAYS DELIVERY — READY FOR USE**  
Mail in this ad today giving your name and address for complete literature and prices.

**TRANS-CONTINENT SUPPLY CO.**  
BOX 1057 WICHITA, KANSAS

# HOT WATER Quickly

## PORTABLE ELECTRIC WATER HEATER

Will furnish hot water on short notice. Useful in every home—hot water supplied in seconds. Perfectly safe and simple—just plug it in and its ready to go . . . only . . . plus 5% excise tax. **\$4.95**

## ELECTRIC UTILITY PAIL

A pail for many uses, where you need it and when you need it whether on the farm, in the home, or for the office building. Heats any liquid in a short time. Comes complete with a sealed Chromalux unit. Will operate on AC or DC . . . plus 5% excise tax **\$9.90**

SEND CHECK OR M.O. FOR IMMEDIATE DELIVERY

**LARNAY SALES CO.**  
50 FULTON STREET DEPARTMENT PM NEW YORK 7, N. Y.

## Start a NEW BUSINESS

# Sharpen Dull Pipe Wrenches

Or Add to Your Present Repair Business

Write for information.

**J. C. MOORE INDUSTRIES** P. O. Drawer 276 FREDONIA, PA.

## THE HANDY PICK-UP TOOL

LOTS OF USES **ADCO MECHANICAL FINGER—12" Reach**

MAIL ORDER TODAY

One of the HANDIEST SMALL TOOLS for office, home, garage, cottage, airplane, radio, farm. Spring handle, two jaws, cadmium plated. Picks up round stock 3/4" dia.; small objects under beds, around motors, behind radiators. Holds abrasive cloth, steel wool, cloth for cleaning bottles, venetian blinds, small guns. Starts machine screws, square nuts, cotter pins. Pulls pans from ovens, wire thru tubing. Hundreds of uses!

Each Postpaid **\$1.00**

PATENTED THE AMERICAN DISPLAY CO., Dayton, Ohio

## "LITTLE WONDER" Crystal Radio

NO ELECTRIC—NO BATTERIES—NO TUBES

One of the smallest genuine crystal radio sets in the world. Slider-contact tuning, banding posts for aerial and ground. Extra long range. SEND NO MONEY. Just send your name and address and when your "Little Wonder" arrives simply pay the postman \$1.99 plus a few cents postage. Sent prepaid if you inclose check or money order with your order.

MART DISTRIBUTORS, Dept. P-12, P.O. Box 6, Evanston, Ill.

## THE GEM MAKER

Amateurs or professionals . . . hobbyists or jewelers . . . Polish your own gems with a B&I Gem Maker. You will find this a profitable adventure. All necessary lapidary equipment is furnished, including a super-charged diamond blade for sawing, and all wheels for grinding, shaping and polishing, also complete instructions. The complete equipment as shown, less motor and belt, for only \$29.50, f.o.b., Burlington, Wis. Write today for information and literature on the Gem Maker and accessories.

**B&I MFG. CO., Dept. S, Burlington, Wis.**

## LAWN ORNAMENT-NOVELTY PATTERNS

28 Lawn Ornament Patterns, 25c. Other patterns; 15-20" high; Dutch Girl, Dutch Boy, Pirate, Bull Terrier, Mexican Girl, Mexican Boy, Dwarf, Penguin, Flower Girl, 10c each. 25 Novelty Patterns, 30c. All 62 Full Size Patterns, \$1.00 Postpaid. Strother Pattern Service, Dept. W-8, Box 383, Belington, W. Va.

## MASTER CHAMPION LAWN MOWER SHARPENER

Also Mfg., Saw Sharpening & Key Machines

**FRANK'S MFG. CO.**  
Dept. PM9  
2501 E. Imperial Highway  
Los Angeles 2, Calif.



**ONLY \$65\***

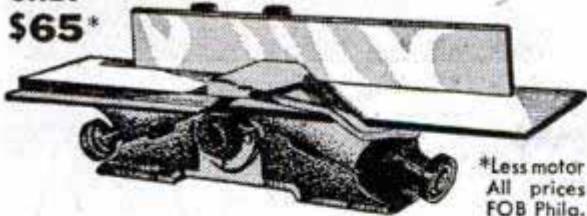

\*Less motor  
All prices  
FOB Phila.

**FOR WORKSHOP or HOBBY SHOP  
4" JOINTER**

A joy to use. Planes on a bevel, 1/2" rabbeting lip, 32" bed, dustproof ball bearings. Heavy construction. Ready for immediate delivery. Good gift idea. Send check or money order.

Popular Wood Jig Saws . . . 16", \$12.95\*, 26", \$16.95\*  
Belt and Disc Comb. Bench Sanders . . . . . \$28.00\*

**WM. H. SHELLINGTON** 2055 Hunting Park Ave.  
MACHINERY SALES & SERVICE Phila. 40, Pa., Dept. PM

**AIRCRAFT SUPERCHARGER  
LUBE PUMP**

Designed for Pumping Liquids Up to 3 G.P.M.

A gear type impeller pump with two pumping units in one housing. Precision built of aluminum, cast iron, bronze and steel. Compact construction—only 3 1/2" Dia. x 8 1/2" long.

- Vacuum, 29 1/2 inches of mercury.
- 1/2" Dia. Threaded and keyed shaft.
- Brand new! Sealed in Pliofilm.
- With Test Sheet and Instructions.

Immediate delivery. Order now! Post paid anywhere in U.S.A. upon receipt of check or M.O. C.O.D. orders include postage and extra fees.



Pressures up to 200 lbs. per Sq. In.

From 1 to 3900 R.P.M.

Originally cost \$24.00. Now only **\$3.95**

**FISCHER LABS** 1731 N. MOBILE, CHICAGO, 39, ILL.

**MUFFLERS**

**STEELS and ALUMINUMS with a motorboat tone**

SINGLES, Chev, V-8, Plymouth, Steels \$5.50, Aluminum \$6.50. Chry., Olds., Buicks, etc., Steels \$7.50, Aluminum \$8.50. V-8 and MERCURY DUALS, Steel \$17.50, Aluminum \$20.00. Aluminum are guaranteed for life of your car.

**DEALERS WANTED**

**V-8  
DUALS  
& SINGLES**



**SANDEE MUFFLER CO.**  
7523 S. WESTERN AVE., LOS ANGELES 44, CALIF.

**Luxury Living  
ANYWHERE IN A SCHULT**

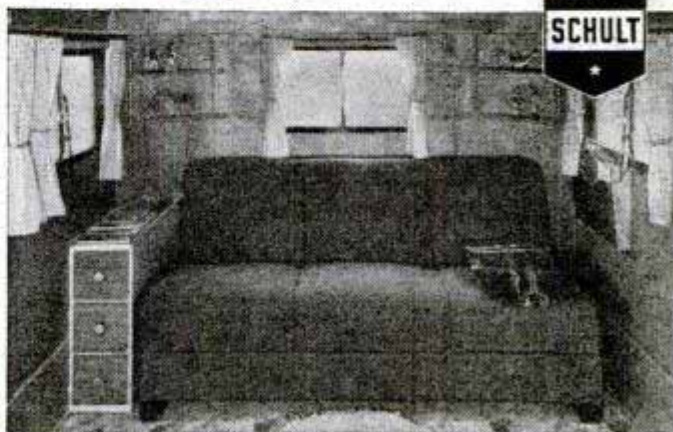
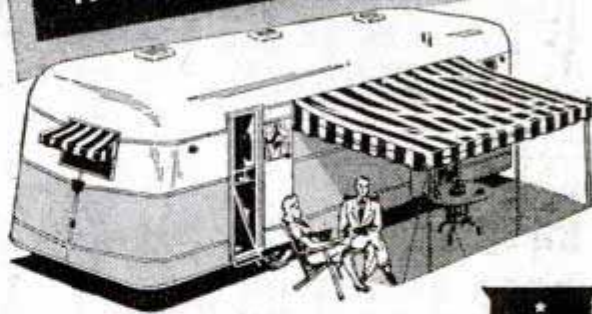

**... AND SO ECONOMICAL!**

• Here's every facility of a well-insulated furnished home that you can take where you need it. . . . A QUALITY product that offers full value in years of satisfying service for a modest investment. Two sizes to suit purse and purpose. Write today for catalog.

**26-FT. 3-ROOM LUXURY**

The famous Luxury Liner, "tops" in living comfort. Three separate rooms, including living room shown above. Designed for maximum comfort on long stays.

**21-FT. TRAVEL LUXURY**

The Deluxe Commodore, a lighter yet amazingly spacious travel coach. Every real utility of "big" coaches. Accommodates four adults in comfort on extended trips.



**SCHULT CORP., Dept. 3206, ELKHART, IND.**

In Canada: John Inglis Co., Ltd., Toronto

**SCHULT** Trailer Coaches

**SEND US ANY OLD WATCH... AND GET THIS \$49.75  
17 JEWEL 2-BUTTON CHRONOGRAPH**

FOR ONLY **\$37.50**  
YOU MAY BUY THIS WATCH WITH OR WITHOUT TRADE-IN GREAT VALUE EITHER WAY!  
FED. TAX INCLUDED

You know this watch by name. It's nationally advertised and recognized for its dependability! Now on sale at \$49.75 or just \$37.50 if you trade in any old watch. Here's the instrument you've always wanted . . . a fine Chronograph. Get it now . . . SAVE!

**IT'S THE WATCH FOR MEN WHO DO THINGS!  
An Amazing Instrument!**

- ★ PERFECT TIMEKEEPER
- ★ IT'S A STOP WATCH
- ★ MEASURES SOUND DISTANCES
- ★ MEASURES SPEED OF RACES TRAINS, PLANES, CARS, ETC.
- ★ MEASURES M. P. H.
- ★ RADIUM DIAL
- ★ SWEEP SECOND HAND
- ★ STAINLESS CASE



SEND CHECK OR MONEY ORDER WE PAY POSTAGE OR SEND NO MONEY PAY POSTMAN PLUS POSTAGE C.O.D.

**5 DAY MONEY BACK GUARANTEE!**

MECHANICS! DOCTORS! FLYERS! BOATMEN! SPORTSMEN! CHEMISTS! ENGINEERS! TIME STUDY MEN! TECHNICIANS... ALL NEED... ALL WANT A FINE CHRONOGRAPH!

**KENT JEWELRY CO.**  
13933 E. JEFFERSON, DETROIT 15, MICH.



# Stop This!



with original

## HaCAR Safety Locks 2 DOOR SAFETY ON 4 DOOR CARS

Perfect safety for every rear seat occupant. Ideal theft protection, too. Simple, concealed HaCAR installation makes it impossible for the rear doors to be opened accidentally.

Easily installed by any garage. From your dealer or write for complete descriptive literature.

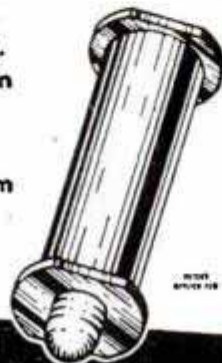

**Consolidated Sales Co., Inc.**

4525 12TH STREET  
DETROIT 8, MICHIGAN

SAY YOU SAW IT IN POPULAR MECHANICS

**MORE POWER!**

**MORE CAPACITY!**

**MORE FLEXIBILITY!**



## ... than any other homeshop handgrinder



Now you can have the handgrinder you've always wanted for your workshop! Its full 1/14 HP motor has the extra power for "heavy" jobs. Its extra-capacity chuck takes all 3 tool sizes — 1/4", 1/8", 3/32". Attachments convert it instantly for bench, lathe, and flexible-shaft work!

Think what you can do with the extra power, capacity, and versatility of the Duplex. Work in wood, metal, and plastics is faster, easier—and twice the fun!

Tear out this coupon and mail today!

- The Dumore Company, Dept. F-51, Racine, Wisconsin
- Please send complete information on Duplex Grinder
  - Send me Deluxe Duplex Kit (27 accessories), \$27.50 enclosed
  - Send me Standard Duplex Kit (9 accessories), \$19.75 enclosed
- Shipping charges C.O.D.

Name.....

Address.....

City.....(.....) State.....

**Make Your Car or Truck  
A PORTABLE POWER PLANT  
This Easy, Economical Way!**

ASPEN DRIVE-ALL gives power when you want it . . . where you want it! Just line up with rear wheel, drive on to unit, and you're set for work! No jacking up or de-mounting! Use the rugged DRIVE-ALL for all belt-driven operations requiring up to ten h.p.!

**LOW-COST  
ACCESSORIES—  
Generator; Grinder  
Centrifugal Pump.**

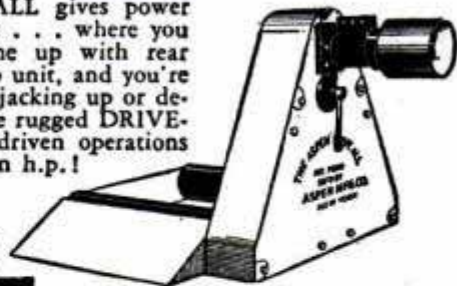

**Aspen  
DRIVE-ALL**

**FREE!** Write today for illustrated folder and full information to: Aspegren Mfg. Co., Inc., 1612-A Webster Avenue, Bronx 57, N. Y.

## GET SET FOR LIFE

This is not a doorbell ringing job—but an outstanding opportunity for a responsible man to set himself up in a permanent business. You invest little, yet you control steadily increasing repeat business. Your profits are limited only by your efforts. (1) You call on retailers to stock our quick-selling "Plastikpli" Liquid Plastic Paint, (2) you can open your own "Plastikpli" store; or (3) you can sell in volume for maintenance painting. This new-type plasticized paint spreads uniformly without brush marks. Extremely hard, yet elastic surface avoids chipping, cracking and withstands ravages of sun and frost to outlast ordinary high-priced paints and save constant re-painting. Non-porous surface prevents penetration of dirt so that it can wash clean and bright. For interiors and exteriors. If you want "A REAL BUSINESS" write us for the details.

Plastikpli is sold direct to user where we do not have distribution. Write for color-chart and prices.

**PLASTIKPLI LABORATORIES, Dept. S**

169 W. Wacker Drive

Chicago 1, Ill.

**NEW**



EACH \$1<sup>00</sup>  
POSTPAID  
ONE DOZ. \$8<sup>00</sup>  
POSTPAID

*The Handy* "SCREW GRIPPER"

Starts screws in hard-to-get-at places. Saves time and temper. Dealers, jobbers, salesmen wanted.

SCREW GRIPPER CO. MUSCATINE, IOWA

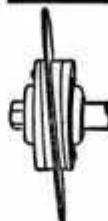

## ADJUSTABLE WEDGES FOR SAW GROOVING

SAW OWNERS! SOMETHING NEW! With these Wedges you can cut up to 3/8" width with 10" blade! Can be used on any saw from 6" to 12". No Dado head needed. If your Dealer can't supply you, write direct. Sent any place in USA for \$3.95 postpaid. Specify 1/2"; 5/8"; 3/4" shaft. (Dealers write for discounts.)

H. W. LEINENWEBER • Woodruff St. • Pittsburgh 11, Pa.

## Catch ALL Your Fish With JUST ONE Minnow!

**MINNO-MAGIC**  
(By Bel-Dart)

KEEPS MINNOW ALIVE. Minnow fits into transparent plastic case with hooks. Fins and tail stick out—produce live action. Minnow stays put. Sensation at sports shows—none like it. Large catches recorded.

\$1.25 postpaid check cash or M.O. 3% sales tax if in Ohio.  
MERIT Ltd. Dept. 21 P. O. Box 9 Toledo 12, O.

\$13<sup>50</sup> Value for Only \$2.49

8000 ohm impedance Head Phones, produced to Air and Signal Corps specs. Extremely sensitive, lightweight (only 9 oz.). With 5 1/2 ft. cord, plug, jack and ear cushions. Every One BRAND NEW.

No. 17A37, Special Per Pair.....\$2.49  
Plus 25c each for Postage.



Burstein-Applebee Co. 1012 McGee, Kansas City 6, Mo.

POPULAR MECHANICS



**\* BOYS, MOTHERS, FATHERS, LOOK! \***  
**This Sensational 4<sup>th</sup> of July Offer! \***

**POPULAR  
SAFE  
SANE**

# FIREWORKS

**102  
PIECES  
\$2.98**

**AT AMAZING BARGAIN PRICE**

Make this 4th celebration the most thrilling you've ever had! Big, generous assortment consists of 102 pieces... each one a "knock out"! Gorgeous, colorful displays... lots of intricate and artistic effects! All merchandise brand new! Included in this special offer are 30 Magic Indian Snakes, 24 Flitters, 6 Jeep Wheels and many other after-dark thrillers!

**HAVE AN EXCITING BUT SAFE AND SANE 4th!**

Every item in this wonderful assortment has been designed along the lines of safety as recommended by numerous Fire Marshals and officials throughout the United States.

**MAIL COUPON — FREE CATALOG!**

STARS & STRIPES FIREWORKS COMPANY  
 BOX 6206, DEPT. G-1, FT. WORTH, TEXAS  
 Gentlemen: Please send me  
 F.O.B. Ft. Worth, fireworks as-  
 sortments checked below:

No.	Description	Price
—	\$2.98 Assortment	—
—	\$4.98 Assortment	—
—	\$7.98 Assortment	—
—	\$12.98 Assortment	—
(No C.O.D. Sales)		Total

I enclose Money Order, Bank Draft or  
 Certified Check to amount of \$.....

Please send me big, free catalog

Name.....

Address.....

Express Office.....  
 (Fireworks cannot be mailed)

**OTHER WONDERFUL  
BARGAIN ASSORTMENTS!**

**\$4.98 Assortment.** Lots of  
 Noise and Beauty! Actual  
 retail value **\$9.95!** Save  
 50%!

**\$7.98 Assortment.** Over 400  
 pieces! Plenty of "Bang"  
 for daytime... beautiful  
 displays at nite! Actual re-  
 tail value **\$15.65**

**\$12.98 Assortment.** GIANT  
 selection. 565 pieces! Salute  
 bombs... color displays!  
 Combination Noise plus  
 Beauty! Retail value **\$23.50!**

**STARS AND STRIPES FIREWORKS COMPANY • BOX 6206 • FT. WORTH, TEXAS**

## SAVE MONEY

build your own  
**SMITH COMPRESSOR**

Now, use the world-famous Smith Air Com-  
 pressor to operate rock drills, paving breakers,  
 spray guns, sandblasting, etc., at low cost!  
 Just order the Smith Compressor Head and  
 Accessories with complete instructions for as-  
 sembling. All you need is a Ford Motor and  
 shop facilities. Capacity 60 cu. ft.—ample  
 power for most compressor jobs. Pressure up  
 to 100 lbs. per square inch. Head equipped  
 with high speed compressor valves; auto-  
 matic unloading and idling.

WRITE **GORDON SMITH & CO., Inc.**  
 TODAY! 410 College Street Bowling Green, Ky.

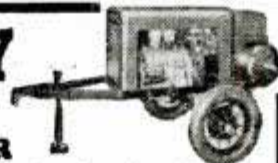

## BUILD YOUR OWN TRAILER

Get these Modern  
 Complete Plans

Select just the model you want—for hunting—travel—camping—or as a  
 home. Each plan is complete with simple, step-by-step instructions and a  
 bill of materials. Easy to follow. Three models!

STOCK No. H27 NATIONAL MODEL 27. A sleek 27-foot  
 trailer with 3 rooms, lavatory, etc. Sleeps six. complete plan **\$1.00**

STOCK No. H20 NATIONAL MODEL 20. A good-looking,  
 easily-built 20-ft. trailer. 3 rooms, sleeps four. complete plan **\$1.00**

STOCK No. H10 NATIONAL CAMPER. A compact unit for trav-  
 eling, camping, hunting, fishing. Sleeps two. Complete plan **.50**

Special—Order all 3 of above plans.....**\$2.00**

**FREE!** Big parts catalog with any order

**NATIONAL TRAILER STORES**

Dept. 10 Box 2353 Terminal Annex - Los Angeles 54, Calif.

**Time & Date  
AT A GLANCE**

**BELL  
GUARANTEED  
CALENDAR  
WATCH**

Tells time, name of day and date.  
 Day name changes automatically.

No. XD382 — Calendar watch, 17 jewels  
 waterproof, shockproof, anti-magnetic, ra-  
 dium dial and hands, stainless steel back. **\$49.75**

**OTHER SPORTS WATCHES WATERPROOF  
SHOCKPROOF**

**NOW AT RECORD  
LOW PRICES**

Precision tested, guaranteed.  
 17 jewels, anti-magnetic,  
 radium dial and hands,  
 unbreakable crystal, sweep  
 second hand.

No. XD196 — Stainless Steel Back..... **\$24.75**

No. XD220 — ALL STAINLESS STEEL CASE... **\$29.95**

**ORDER BY MAIL:** Send check, money order or pay  
 postman C.O.D. Prices Incl. Fed. Tax and Postage.

Write for **FREE Booklet "XD"**  
**REPAIR SERVICE:** All types and makes of quality  
 watches. **FREE** estimate on request.

**BELL WATCH COMPANY, INC.**

Time and Life Bldg., Rockefeller Center, New York 20, N. Y.

**SAY YOU SAW IT IN POPULAR MECHANICS**





**NO MORE BATTERIES FOR ME!**

**BRILLIANT LIGHT AT ALL RIDING SPEEDS—AND BULBS WON'T BLOW!  
GOOD LIGHT EVEN AT A WALK—NO DIM-OUTS!**

# MAKE-A-LITE

## BIKE LIGHT Generator

It's a knockout! Generates brilliant light for head and tail lamps. No more battery bother. Make-A-Lite's automatic voltage control generator prevents blowing of bulbs at high speeds . . . gives sure, bright light at snail's pace.

See the new MAKE-A-LITE head and tail lamps. Rich new finish makes your bike look like a million!



Now at your bicycle, sporting goods, hardware or automotive store

**MAKE-A-LITE DIVISION**  
Chefford Master Mfg. Co., Inc. • Fairfield, Illinois

# 5 POWER TOOLS IN 1

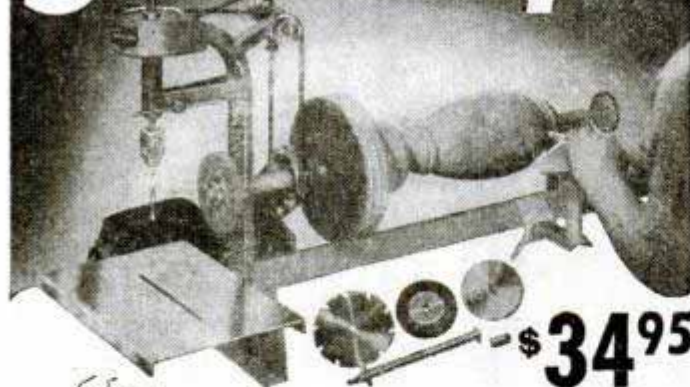

**\$34.95**

## COMPLETE HOME WORKSHOP

Here is power tool pleasure and profit in a ruggedly built, HEAVY steel unit—the Emrick Universal Woodworker. Handles big work. Drill press pulls  $\frac{1}{2}$ " drill in steel. Saw takes 6" to 8" blade. Lathe 10" swing, 30" centers, spindle dia.  $\frac{3}{4}$ ". Takes all standard accessories. Sander 8" dia. Emery wheel 5". Bronze bearings, replaceable throughout. Price does not include motor and saw blade. Order today.

**10 DAY TRIAL**

1736 CLINTON STREET  
**EMRICK, Inc. KALAMAZOO 24, MICH.**

Ship on 10 Days Trial. I am enclosing \$17.50, balance C.O.D.  Send free literature.

Name \_\_\_\_\_  
Address \_\_\_\_\_ City \_\_\_\_\_



# MOTORS

**110 VOLT — 60 CYCLE  
HEAVY DUTY  
CONSTRUCTION**

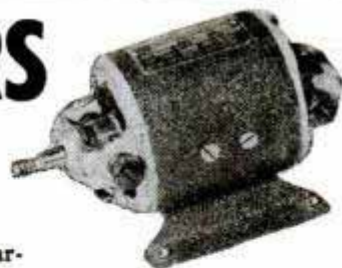

Fractional H.P. ball bearing—brand new. Ideal for power tools, fans, models—100 other uses. \$15.00 value.  
**IN LOTS OF 10 . . . \$3.95**

Your price with 6' approved line cord . . . . .

**\$4.95**

ALL PRICES F.O.B. N. Y. CITY  
REMIT 20%—BALANCE C.O.D.

**MANUEL KLEIN** 74 CORTLANDT ST.  
NEW YORK 7, N. Y.

EXTRA! **JUST OUT** EXTRA!  
**INSTANT NICKEL**  
U. S. PATENT PEND. NO. 702581  
NO CURRENT OR BATTERIES USED

Iron, Steel, Aluminum, Brass, Bronze, Copper and practically all Industrial metals (except Zinc) can now be HEAVILY nickelplated without EQUIPMENT, VESSELS, ELECTRICITY OR PREVIOUS COPPER PLATING, a blessing to Hobbyists, Doctors, Hospitals, Restaurants, bar and Beauty shop owners. Recommended for Auto, bicycle and Machinery parts and accessories, Surgical and Musical Instruments, Electrical appliances, Coffee Urns, and practically anything made of metal. THERE IS NO TRICKS CONNECTED WITH THIS MARVELOUS NEW INVENTION, the principles of the battery and electroplating have been harnessed into this compound, so when it is applied with a wet applicator on a clean metallic object, a bright nickelplate instantly appears, the thickness of plating is regulated by amount of applications given. **JUMBO SHOP SIZE** (Covers 50 Sq. Ft.) \$6.75 P.Pd. Sample Trial Offer \$2.00 P.Pd. **INSTANT PLATING PRODUCTS**, 3439 Michigan Ave., Chicago 16, Ill. (Applicator sent free.) C.O.D.'s few cents extra for postage.

**COMPLETE \$2 POST PAID Covers 10 Ft.**

AGENTS WANTED

## 5 PLASTIC PROJECTS

**\$1.00**



Kit contains Plexiglas, cement, full-size plan sheets, sand paper, pin backs and instructions to make 5 beautiful plastic projects—projects that you would pay \$5.00 for at any retail store. Projects include: candy dish, 2 initial lapel pins, letter opener and tie clip. Easy to make. An excellent way to try this new hobby of plastics. Act now. Send only \$1.00 for your big introductory kit. Mail today.

JACKSON, 5440 N. Shoreland Ave., Dept. 19, Milwaukee 11, Wis.

## Opportunity Knocks

With **TRADIO** . . . the radio FUNCTIONALLY DESIGNED for coin operation in Hotels, Motels, Stopovers, Clubs, Hospitals, Stations, Etc. Big Earnings . . . Steady Income . . . No Clock To Punch . . . Full Or Part Time!

● **QUANTITY DELIVERIES DAILY . . . ONLY SMALL INVESTMENT** Grow With A Young Industry! Get In On The Ground Floor and Be Independent For Life. It's Easy! Send for Complete Information Today . . . No Routes Sold

Write To **TRADIO, INC.** Dep't. M, Asbury Park, N. J. **RIGHT NOW!**

# IF GLUE WILL FIX IT

## FRANKLIN LIQUID HIDE GLUE

will do it better, faster, easier!

Ready-to-use Franklin makes joints stronger than the wood itself. Saves time — no mixing, no heating. Banish unpleasant odors, avoid chilled joints with Franklin Liquid Hide Glue.



The FRANKLIN GLUE CO., COLUMBUS 15, O

AT YOUR HARDWARE DEALER



# Make HAND OPERATED LATHES AUTOMATIC

## For Greater Profits from Turret Lathes and Hand Screw Machines

One man can operate three machines equipped with Newton Automats. Makes small run jobs profitable. Saves 50 minutes out of every hour for other profitable activities. Speeds production. Easy to install—no drilling or tapping of lathe. Use present power source. Fits Logan, Atlas or Craftsman Lathes.

A REAL  
MONEY-MAKER!

WRITE FOR  
FOLDER TODAY!

A.K. TOOL COMPANY  
2029A Blake Avenue  
Los Angeles 26, Calif.

# PROTECT YOUR EYES AND GLASSES



The SAF-I-SHIELD GOGGLE of "Optilite," the new optical plastic, weighs less than one ounce, yet, it will withstand the impact of a sharp piece of metal traveling at 240 miles per hour. Gives full protection . . . allows full vision . . . one size fits everyone . . . smart in appearance and comfortable . . . worn by workers in hundreds of the largest plants in the country. Protect your eyes from flying particles, dust, chemicals and eye hazards in all kinds of work. Made of all crystal clear plastic (#202) for inside work and all anti-glare green plastic (#222) for outside work and sportswear. If your dealer can't supply you, order by number. Send money order, cash or check. No C.O.D. Offer good in U.S.A. only. . . . . Postpaid **\$1.50**

UNITED STATES SAFETY SERVICE COMPANY  
1215 McGee Street Kansas City 6, Missouri

## HUOT DRILL INDEX No. 29 '3

KEEP YOUR TWIST DRILLS  
CONVENIENT AND SAFE.

HUOT'S ALL STEEL DRILL INDEX No. 29 holds twist drills from 1/16" to 5/8" by 64ths. ORDER YOURS TODAY. Huot makes a Drill Index for every need. Eleven Sizes. Write for details or see your dealer. Get No. 29 today—Send \$3.

HUOT MFG. CO. 555 North Wheeler  
ST. PAUL 4, MINN.

# BUILD YOUR OWN FAST FREEZER

PLANS  
\$1.00



5 sizes  
8 to 40 cu. ft.

It's easy to build this household appliance and profitable to use. Save up to 75%. Operates on 110 or 32 volts. Plans show 5 sizes and are easy to follow. ENJOY MAKING ONE OF these freezers from new or used parts. No expert knowledge needed. Mail \$1.00 bill or check for complete plans and catalog. LE JAY MFG., 447 LeJay Bldg., Minneapolis 8, Minn.

# WORK APRONS

On the job—On your hobby—Protect your clothes. Heavy white cotton drill—3 pockets—full length. Send \$1.00 money order. Prompt delivery. Postpaid. Quantity prices on request.

H. F. MONTGOMERY 101 PALM STREET NEWARK 6, N. J.

# HOT WATER INSTANTLY

with this fast working  
electric Hot Water Heater

Banish the discomforts of Cold Water with this improved, economical, efficient and handy portable heater. Works on A.C. or D.C. current. Just plug into any light socket, starts to heat immediately. Take it with you wherever you go. Only \$3.95, or get 3 for \$11.00 and save. ORDER NOW. SEND NO MONEY. Pay postman plus postage. Cash orders shipped postpaid.

JAXON PRODUCTS, 4730 Sheridan, Desk 17, Chicago 40, Ill.



\$3.95  
3 for \$11

# Webster says:

"Pocket knife"

...pōk'ēt nīf



but it will pay YOU to say

# CAMILLUS

Kā-MILL-us

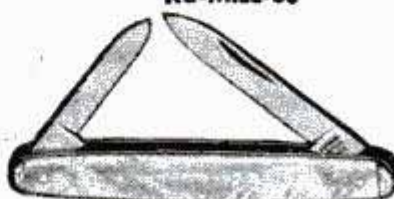

No. 42  
Size 3 1/2"

For CAMILLUS means a knife of finest value. Hand honed blades of custom made steel.

Say "CAMILLUS" to your good neighbor, the local hardware or sporting goods dealer. We're doing our best to keep him supplied.



CAMILLUS CUTLERY COMPANY, New York 17, N. Y.  
Established 1876 . . . . Factory at Camillus, N. Y.

## Govt. Surplus Guaranteed

# PHOTOGRAPHIC SUPPLY BARGAINS

Dark room ventilator w/spun glass filters built-in; cost Uncle Sam \$18.00 each. Cost you only.. **\$5.25**

### OUTDATED OF COURSE BUT GOOD AS GOLD

16MM 50 ft. magazine film, super X or XX processing not inc.. \$1.75  
35MM 100 ft. rolls panatomic X or Plus X..... 2.79  
4x5 Anseo Super Pan Press Film Packs, each ('46 dated).... 1.74  
8x10 Eastman Kodagraph process Pan cut film, per 2 doz..... 3.83  
8x10 Anseo Super Pan Portrait Cut Film; per 2 doz..... 7.30  
7" x 18" Super XX 1946 dated Kodacolor per roll..... 4.55

### SURPLUS PAPER — GUARANTEED

4 1/4" x 825' roll Kodabromide A4, light weight..... 2.83  
7" x 125' roll Aero Bromide, water resistant in sealed tins.  
S.W. (similar to Kodabromide Grade N)..... 3.83  
8x10 A20 S.W. glossy, 1, 2, and 3, per gross..... 2.53  
10x20 Anseo Convira, S.W. glossy, 2, 4, 5, per gross..... 4.87

We reserve the right to return your money  
if any of the items you select is sold out

## NATIONAL PHOTOGRAPHIC SUPPLY CO.

272 Fremont St.

San Francisco 5, Calif.



Every home needs one

**HOLLOWELL "HOME" KIT**

the tool you need is in  
the hollow handle



A boon to the harried tool hunter is this new Home Kit which contains seven interchangeable tool bits made of finest alloy steel. Bright red hollow plastic handle holds a gimlet, instrument and 1/4" screwdriver, a Phillips bit, tack

lifter, knife blade and a 3/16" chisel. Kit is compact—only 4 1/4" long.

Modern, useful gift for any occasion.

At your local Hardware Dealer or Industrial Distributor. Descriptive Literature free.

Kits: Pat's. Pend.

Over 44 Years in Business

**STANDARD PRESSED STEEL CO.**

JENKINTOWN, PA. BOX 802

BOSTON • CHICAGO • DETROIT • INDIANAPOLIS • ST. LOUIS • SAN FRANCISCO

**WAR SURPLUS BARGAIN SPECIAL**

**BRAND NEW!  
VACUUM-AIR  
HYDRAULIC  
FUEL  
PUMP**

Original Cost

\$45.00

Now Only

**\$9.95**

Postpaid in U.S.A.

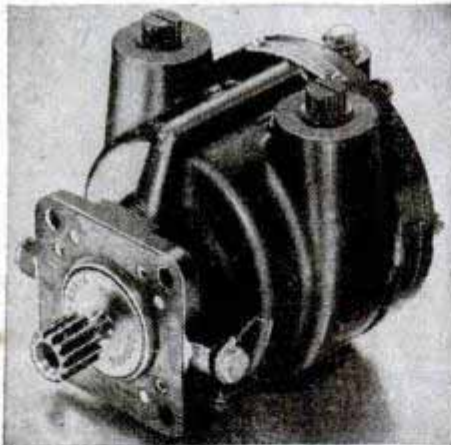

**WORTH MANY TIMES THIS LOW SALE PRICE**

**USE THEM FOR  
OIL BURNERS**

**SPRAYING  
MACHINES**

**MILKING  
MACHINES**

**COMPRESSORS**

**VACUUM PUMPS**

**HYDRAULIC  
SYSTEMS**

**MANURE  
LOADERS**

**PRESSES, etc.**

Originally cost \$45.00. Used by the Air Corps to drive bomber de-icer boots, gyroscopes, automatic pilots, etc. May be used as air or fluid pump—for pressure or vacuum. Standard 3/8 inch pipe thread with interchangeable ports. Will pump 7 1/2 gal. SAE 30 oil per minute at 300 RPM. Builds air pressure of 30 lbs. per sq. in. at 1000 RPM. Vacuum will draw 26 inches of mercury at 1750 RPM. Develops up to 120 lbs. per sq. inch of hydraulic pressure, which in conjunction with a 3 inch hydraulic cylinder, will lift 840 lbs. minimum. Runs forward or reverse. Self aligning shaft. Die cast aluminum housing 6x4x4 inches. Has stainless alloy steel vanes and impeller. Made by Bendix Avia. Corp. Spline terminal for direct drive—readily replaced with a pulley. Recommend a 1/4 H.P. or stronger electric motor as source of power. Rated capacity 1500 RPM with high overload factor. Special price for quantity users. Complete illustrated report and instruction booklet FREE with every pump. Send check or money order today. Postpaid in U.S.A.

**\$9.95**

**GROBAN SUPPLY CO.** 1522 So. Michigan Avenue  
Dept. PM6 Chicago 5, Ill.

New IMPROVED Electric  
**MOTO-SAW**

Only  
**\$5.85**  
Postpaid



**SAFE AS A HAND SAW  
JUST GUIDE IT!**

More like magic than any tool you ever saw. Imagine an electric scroll saw only slightly heavier than a hand coping saw... a tool that takes no effort to run, no pressure to feed. Works at any angle—on big assembly jobs or on the tiniest piece you can hold in your fingers. Runs 7200 strokes a minute... so fast the blade seems to stand still. Sturdily built... only two moving parts... never needs oiling. Easily cuts intricate designs—so smooth it eliminates sanding. A thrill awaits you when you get a Moto-Saw in your hand. Thousands of satisfied users.



No Limit To Length Of Stock It Will Cut. Saws To Center Of 19" Widths

It's fast... cuts on an average of 1 ft. per minute up to 3/4" medium hard wood. Operates on 110-120 V. 50 or 60 cycle alternating current. If your dealer does not yet have Moto-Saw, send \$5.85... we'll pay postage. Or send \$1. pay postman halinates sanding. MONEY when you get a Moto-Saw in your BACK if not delighted after 5 days trial.

U. S. Patent 223862  
Other Patents Pending

**DREMEL MFG. CO., Dept. S117-F, Racine, Wisconsin**

**WIGGINS QUICK WATER HOSE COUPLING**

**SNAP - it's on! PULL - it's off!** Easy, fast! Wiggins coupling is guaranteed leakproof! Saves water, time. No bruised fingers or twisted hose. Precision made of solid aluminum bar stock. Lifetime use. For the best in water hose couplings, buy Wiggins! On sale at better stores \$1.35 complete.



**E. B. WIGGINS OIL TOOL CO., INC.**

3424 E. OLYMPIC BLVD., LOS ANGELES 23

**ATTENTION: GOLFERS!  
BRAND NEW GOLFING ACCESSORY!**

Amazing New "CADDY-STAND" holds golf bag upright anywhere on turf. Simplifies bag handling, eliminates throwing it on ground. Protects clubs, bag and clothes. Quickly attached to any bag, hardly noticeable. Sturdy, yet weighs only 14 ozs. Tested by leading golfers. ONLY \$3.00 POSTPAID. If not satisfied return within 10 days for full refund. Send M.O. or Check to...

**NORTHERN SALES COMPANY**

1555 DEVON AVE., CHICAGO 26, ILLINOIS

**SAVING'S ELECTRONIC  
FUN WITH JUKE BOX BANK**

The kids will love to save, and you'll thrill when this Electronic Juke Box glistens colorfully and lights on coin insertion. Here is the perfect gift for children and adults alike. Built of sturdy plastic and metal construction, this Electronic Bank makes friends of the entire family, and adds up to "money in the bank." Special Price to Dealers. Mail your order today.

ONLY

**\$1.69**

1/6 actual size



**BERNARD FINE CO.** 501 Sixth Avenue  
N. Y. 17, N. Y. Dept. 58-1

**144  
PAGE  
FREE  
CATALOG**

**BUILD A RADIO!**

Fellows—anybody can buy a radio! The real fun is in building it yourself! Doesn't cost much either. Especially when you get this FREE 144-page catalog which lists everything you need—even the tools, at well savings. Send for FREE catalog today.

**LAFAYETTE RADIO Dept. LF-7**  
100 6th Ave., New York 13, N.Y.

**Now CHEAP OIL BURNER**  
FOR HEATING AND COOKING STOVES - FURNACES

**HEAT YOUR HOME, COOK YOUR MEALS  
WITH CHEAP FURNACE OIL**

**NO MORE SHOVELING COAL**

**OR ASHES.** Sensational Fuelizer

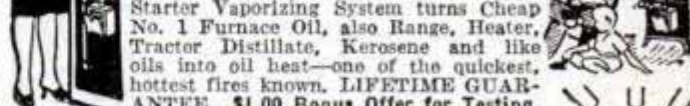

Starter Vaporizing System turns Cheap No. 1 Furnace Oil, also Range, Heater, Tractor Distillate, Kerosene and like oils into oil heat—one of the quickest, hottest fires known. **LIFETIME GUARANTEE.** \$1.00 Bonus Offer for Testing. We will let you try it in your own stove or furnace for one month. Get yours for introducing. Big profits QUICK. Be first. Send in your name today for details and cash in on the tremendous demand for this Amazing Invention.

**NORTHWEST MFG. CO., 608-G, Mitchell, S. Dak.**



## Look what this Amazing New Tool does for You!

You can now use your electric drill to sand, polish and grind. Do better work in half the time.

Here's the new "Wonder Tool" you won't want to be without. Fits on any electric drill, 3/4" or larger. Snap abrasive Disc on or off in few seconds. New Discs cost only few cents. Ready instantly to sand, grind, buff, or polish. Works equally well on wood, metal or plastic. A "must" for every home work bench and small shop. Does better work in fraction of time formerly required. Now offered at about 1/2 regular price while limited supply lasts. Rush order with \$1.98 or

**SEND NO MONEY** and pay postman \$1.98 plus postage and few cents C.O.D. fee. **MONEY BACK IF NOT DELIGHTED.** Mail order today.

(Jobbers: Write for Special Introductory offer.)  
**QUINN SUPPLY CO.** 712 W. 69th St., Dept. 12, Chicago, Ill.



Only \$1.98 Postpaid

**SAVE \$30 to \$40**  
**Build it yourself**



**LANE CARD & GAME TABLE—Send \$1 today**

for photographs and bill of material showing how to build this clever new model card and game table . . . to . . .

**GEORGE H. LANE, Edgewood 1, Md.**

## Sterling Silver HORSEMAN'S Rodeo RING



Truly a ring of distinction! Authentic western design. Handsomely formed from solid Sterling Silver. Oxidized, hand-buffed, finish. A "knock-out!" Sent on approval.

**SEND NO MONEY!** Just clip ad, and mail with name, address and ring size. Pay postman only \$4.95 (includes tax) plus postage. Wear for 10 days. If not delighted, return for full refund.

**WESTERN CRAFTSMEN** Dept. 872 206 So. 19 St. OMAHA 2, NEBR.

## 3 WAR SURPLUS ITEMS

**Save Money At Our Prices**

**RUBBERIZED CLOTHING BAG . . . . . \$1.00**  
 Waterproof, dustproof, rubberized lining, vulcanized seam stitches, holds 30-35 lbs. of clothing — thousands of uses.

**MUSETTE BAG . . . . . \$1.00**  
 Handy for hikers, fishermen, cyclists — for lunches, etc.

**WATER REPELLENT SPORT PANTS . . . . \$2.95**  
 For hunters, fishermen, farmers, gas station men, milkmen, etc. Large size only.

**ORDER NOW**—State quantity of each item desired and enclose full amount with order for postpaid delivery. Sorry. No C.O.D.'s.

**A & T SALES CO.,** 2476 Lincoln Avenue Dept. PM-1, Chicago 14, Ill.



## 2 BIG OUTFITS WILL FIT ALL ELECTRIC HAND GRINDERS

**#1 COMPLETE KIT**  
 102 Grinding, Cutting and Polishing WHEELS PLUS 150 ass't items for Home or Shop

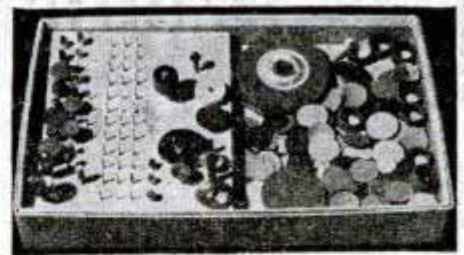

- 2 Grinding Wheels 3" and 2" dia.
- 2 Rotary Files, High Speed Steel.
- 6 Rotary Cutters 1/8" Shank.
- 3 Rotary Cutters 3/32" Shank.
- 6 Mounted Grinding Wheels 1/4" Shank.
- 4 Mounted Grinding Wheels 3/32" Shank.
- 4 Speed Drills 3/32" Shank.
- 36 Rotary Cutting Burs 3/32" Shank.
- 2 Mandrels 3/32" Shank.
- 1 Mandrel 1/8" Shank.
- 1 Screw Type Mandrel 3/32" Shank.
- 3 Rotary Bristle Brushes 3/32" Shank.
- 1 Rotary Wire Brush 3/32" Shank.
- 1 Circular Saw 1 1/2" dia.
- 1 Mandrel for Circular Saw 1/4" Shank.
- 1 Rubber Cylinder Mandrel 3/32" Shank.
- 1 Rotary Drum Sander 1/8" Shank.
- 10 Bands for Rotary Drum Sander.
- 15 Rotary Felt Wheels 1" dia.

Total Value \$45 if bought separately

**FINEST ROTARY TOOLS EVER SOLD BY MAIL**

**ONLY \$9.75**

Postpaid in U. S. A.

**#2 COMPLETE ASSORTMENT**  
 Carborundum Grinding Wheels, NORTON, Etc.  
 222 Grinding Wheels, Sharpening Stones, Rotary Cutters, Etc.  
 PLUS 200 ass't items for Home or Shop



- 12 Grinding Wheels 3" to 10" dia.
- 12 Ass't Abrasive Cloth Sanding Belts.
- 12 Sheets Abrasive Paper wet or dry.
- 5 Cut Off Wheels 1" to 6".
- 1 Rotary File.
- 2 Mounted Wheels 1/4" Shank.
- 150 Sanding Discs and Butterflies Ass't Sizes and Grits.
- 1 Abrasive Met Cloth Roll 50 Yds. Long.
- 2 Sharpening Stones.
- 1 Drum Sander.
- 20 Bands for Sander.
- 3 Muslin Polishing Buffs 3" to 6".
- 1 Scraper High S.S.

\$60 Value ONLY \$9.75

Postpaid in U.S.A.

We Require \$1 Deposit on C.O.D. Orders

**D. SCHUPACK • Rush Your Order**  
 2256 E. 75th St., Dept. P-6, CHICAGO 49

## EARN MORE MONEY GRINDING LAWN MOWERS "THE UNIVERSAL WAY"

**FULL or SPARE TIME**

Build a Business of Your Own in Your basement or garage and earn \$135 a month. Mr. Felber of Ind., writes, "My UNIVERSAL GRINDER is faster and more accurate than any other grinder. Its efficiency enabled me to sharpen 150 mowers in 4 1/2 months. More than paid for itself the first month. Every customer satisfied." Mr. Hardy of Mississippi writes, "Received my Universal Grinder the first part of May and by August 18 had sharpened over 1000 mowers." Mr. Bacon of California writes, "The lawn mower business, with the use of my Universal Grinder, has been a gold mine these last two years."

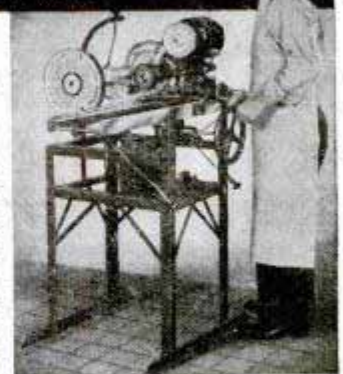

Only on the UNIVERSAL GRINDER can the inside face and edge of the stationary blade, as well as the reel blades, be ground to proper clearance

**ALL IN ONE SET-UP**

WITHOUT REMOVING ANY BLADE FROM MOWER  
 Tool Grinding Rest Included  
 Write for Free Folder

**Rogers Mfg. Co., Dept. 67-M, Lindsey, Ohio.**



Our Finest Precision REBUILT  
**MOTOR BLOCK**  
 ASSEMBLIES



**Sold Outright or Exchange**

Rebuilt by skilled mechanics. Assembly has Rebores Block with New Pistons, Pins, Rings, Re-ground Crankshaft, and all New Bearings. Guaranteed 90 Days.

**Allowance on Old Motor**

We ship at outright price. Send your motor prepaid, must be suitable for rebuilding. Send in notarized bill of sale showing title number if any. We refund difference when we receive your motor.

\$5.00  
Crating  
Charge

**For 1928-41 FORDS and 39-41 MERCURY**

Year	Out'rt.	Exch.	Year	Out'rt.	Exch.
1928-31	98.00	73.00	1938, 24 Stud 85	149.00	99.00
1932-34, V8	149.00	99.00	39-41, 24 Stud 85	149.00	99.00
1935-36, V8	149.00	99.00	39-41, 95 H.P.	149.00	99.00
37-38, 21 Stud 85	149.00	99.00	1939-41 Mercury	149.00	99.00

**For 1934-42 CHEVROLET Cars and Trucks**

Year	Out'rt.	Exch.	Year	Out'rt.	Exch.
1934 Mstr.	117.50	87.50	1940 All	107.50	87.50
1935 All	117.50	87.50	1941-42	107.50	87.50
1936 All	127.50	87.50	41-42, Hi-Torq.	117.50	97.50

**For 1935-42 DODGE Cars and Trucks, 3 1/4" Bore**

Year	Out'rt.	Exch.	Year	Out'rt.	Exch.
1935-39	139.00	109.00	1941	125.00	95.00
1940	139.00	109.00	1942	125.00	95.00

**For 1935-42 PLYMOUTHS**

Year	Out'rt.	Exch.	Year	Out'rt.	Exch.
1935-39	139.00	109.00	1940-41	125.00	95.00
			1942	125.00	95.00

SEND 25% CASH WITH ORDER, BALANCE C.O.D.

**J.C. WHITNEY & Co.**  
 1917 Archer Ave. Chicago 16, Ill.

**Portable Paint Sprayers**

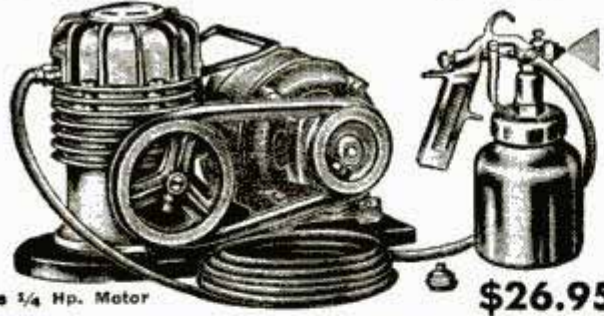

Uses 1/4 Hp. Motor

**\$26.95**

Complete as illustrated, less motor. Sprays all kind of paint, lacquer, varnish and etc. Oil-less ball bearing compressor. 2 cu. ft. air per minute. 15 to 50# pressure. Sprays paint 5 times faster than hand brushing.

**No. 890**—Outfit complete as shown, with "V" belt, motor pulley, 15 ft. high test air hose and No. 112 gun, but without motor. **\$26.95**

**No. 444**—Outfit, twin cyl. 4 cu. ft., production type gun, 15 ft. air hose, reg. and gauge, V belt and motor pulley. Complete less motor, **\$47.50**. Uses 1/2 hp. motor.

**Spray Guns—Low Pressure**  
 Operate on 15 to 50# pressure

#112—1 qt. cup	\$6.50
#121—Production type	7.95
#125—External mix	9.50
Regulator & Gauge 0 to 160#	4.95
Air Filters	1.85
Air Hose—15 ft.	1.75
Air Hose—25 ft.	2.75
3 Gal. Paint tanks, with hose, reg. and gauge	24.95
Less reg. and gauge	16.50

**NEW BLACK & DECKER DRILLS**  
 110V AC-DC

1/4" 2250 rpm.	\$16.95
1/2" 375 rpm.	31.95
1/4" Drill Stand	9.95
1/2" Drill Stand	14.95

**Super-Air Auto Engine Pump**  
 Pumps 100# pressure. For inflating tires, spray painting and etc. Complete with hose, pump, gauge, and spark plug adaptors **\$4.75**  
 Less gauge **\$3.75**  
 20c additional west of Rockies

**AIR COMPRESSORS — PAINT SPRAYING SUPPLIES**  
**GAS ENGINES — 1/2 TO 1 1/2 HP. 37.95 UP**  
 Immediate delivery—check or M.O. shipped prepaid, cod's plus chgs.  
**INDIANA APPLIANCE CO.**  
 20 East Sycamore Dept. PM-15 Evansville, Ind.

**NAVY STANDARD BATTERY (Brand New)**

Made by Gould Storage Battery Corp. 6 volt 15 amp. hour. Excellent for motors, motorcycles, amateurs, experimenters, radio servicemen, etc. Shipped dry, with complete instructions for charging. 4 3/4" wide, 4 3/4" deep, 6 3/4" high. Shipping weight 12 lbs. **\$4.95**  
 While they last....



**French Type PHONE TS-13C Hand Set**



With butterfly switch on handle. When the switch is pressed, the microphone is connected into the circuit and an additional set of contacts are closed, to operate a change over relay. Has a 6 ft. length of cord, with a PL 55 plug for earphone and PL 68 for microphone and switch. Impedance of earphone approx. 2500 Ohm; impedance of microphone approx. 250 Ohm (carbon); connected with batteries it can be used for inter-communication system. They are brand new and the original cost is many times what we are offering them to you... while they last.

**\$3.95**

**MICHAEL STAHL, Inc.**  
 39 Vesey St., Dept. PM6 New York 7, N. Y.

Spotwelded Heavy Gauge Steel

**WHEELS**



5", 3/8" solid tire, 3/8" bushing. **\$.50 ea.**  
 8" 1" solid tire, 1/2" and 3/4" bearing **.99 ea.**  
 8" same as above with hubcap. **1.11 ea.**  
 10", 10x1.75 semipneumatic tire, cast bronze hub, 1/2" hole **2.19 ea.**  
 5" cast alum. 1 1/4" wide, 1/2" hole **.69 ea.**  
**BOYS' EXPRESS CART KIT**—includes 4-8" rubber tire wheels, axles, hangers, braces, steering assembly, instructions for 15"x34" wagon **\$5.98**  
 ADD 10% to all prices for parcel post. Check, moneyorder only. Satisfaction guaranteed.  
**C. W. YOUNG MFG. CORP.**  
 200 Burnet Ave. Syracuse, N. Y.



**WING NUTS**

Top quality wing nuts. Manufactured of zinc alloy with a plain bright tumbled finish. Thread sizes: #8-32, #8-32, #10-32, #12-24, 3/16"-24, 1/4"-20. Box of 100 nuts of one size for only **\$1.00** post-paid. Send check or M.O. and specify size desired.  
**WM. BLOCK HARDWARE CO.**  
 110 West 47th St. New York 19, N. Y.

**EDGE YOUR LAWN in 15 minutes For Only 4c**



Yes, with the new Perfection Power Lawn Edger, you can edge an average size lawn in 15 minutes and at an average cost of only 4c.

**Weights Only 28 Pounds**

Designed to take the drudgery out of lawn trimming, it is so light and easy to handle that a girl can operate it.

**Free Literature**

Ask your dealer. Or write today for free folder, describing this amazing invention that will save you time and money in caring for your lawn.

**LAWN EQUIPMENT MANUFACTURING CO.**  
 2030 Westheimer Houston 6, Texas



Save 75%-90%  
of Set-Up Time  
in CENTERLESS  
GRINDING...

## Porter-Cable Centerless BELT GRINDER

*Eliminates truing,  
balancing... and continued wheel dressing*

Since the Contact Roll is behind the endless abrasive cutting belt, it is not subject to wear. Therefore, it always has a flat, smooth, true-running surface and square edge. Does not nick, round or chip. Furthermore, its *resiliency* eliminates chatter... compensates for irregularities of stock.

For different size stock, simply advance or retract the Regulating Wheel Assembly to or from the abrasive belt. It's simple, fast, *true set-up* in just a few minutes!

This Porter-Cable Model L-4 handles a wider range of operations. Takes stock  $\frac{3}{8}$ " to  $2\frac{1}{4}$ " in diameter, in lengths from  $\frac{3}{4}$ " to 2' in one fixture. (Adaptable to longer lengths also).

**SAVE MONEY!**  
Read what the L-4 will do for YOU! Write today for information.

The L-4 is now available at a revolutionary low price! Any shop can afford it!

PORTER-CABLE MACHINE CO.  
2050-6 N. Salina St. Syracuse 8, N. Y.

## SELF-CONTAINED - COMPLETE SPRAYING OUTFIT

No hose or elec. cords; no pumping  
Completely self-contained, portable spray gun—fully guaranteed. Sprays paints, enamels, insecticides. For home, workshop, garden, farm. For pressure uses a CO2 Cartridge available at all drug stores at 10c or less. One cartridge will spray one quart. Complete, ready for use; with one cartridge.

Price, postpaid ..... \$18.50

SULLIVAN-BECKER 6705 14th Ave.  
Kenosha, Wisconsin



## \$2.50 POCKET WATCH BUY



An American beauty — here again. Genuine New Haven timepiece: accurate movement, modern dial, engraved back, polished metal case. Factory guaranteed. Limited quantity. Order fast. Send cash remittance, including 10% tax, we pay postage. Or pay postman C.O.D. plus 10% tax and few cents postage.

Plus Tax R. W. SUMMERS, LTD. 516 FIFTH AVE., N. Y. 18

## GET THIS NEW Amazing Car-Washer

Slip on like a mitt, washes cars perfectly. Made of fine fur quality it's the best article you can get for car washing.

**Get it now, only \$1.00**

Special price for garages and stores.  
Write for price list today to

VAL-COE'S, 2079 Dorchester West, Montreal, Canada

## START A BATTERY FACTORY

—at home; the latest achievement; re-cast junk batteries into new. Complete instructions. We supply everything. Big Profits!

**THE BATTERY LABORATORIES**  
Dept. PM Minneapolis 13, Minn.



**You Now Can  
BE YOUR OWN BOSS**  
Start a business with this new modern invention. With a small investment you can, without exaggerating, make from \$75.00 to \$250.00 per week. No experience necessary. Write for FREE literature.  
**Precision Key Mfg. Co.**  
657 Columbia Street Dept. 5  
San Diego 1, California

# Complete Auto Engine Power Sprayer Set

Reg. \$10 Value

# 6.95

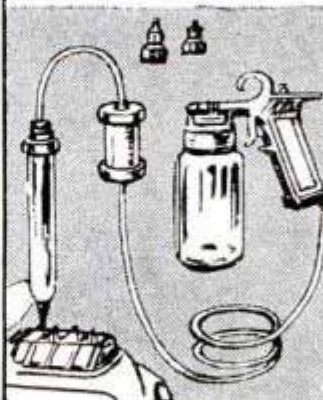

Operates from spark plug opening of any gas engine of 4 or more cylinders. Has paint jar, adapters, compression tank, trigger controlled sprayer, spark plug air check valve, 10-ft. hose. For paint, varnish, enamel, insecticide.



Phone and  
Mail Orders  
Accepted. Call  
WABash 9800  
Shopping Service  
Switchboard  
Open Daily  
9 A.M.

### Mail Order Coupon

Goldblatt Bros.,  
State, Jackson & Van Buren Sts.,  
Chicago 4, Illinois  
Please send me.....Auto Engine Sprayers  
at 6.95 Complete set  
Name.....  
Address.....  
City.....Zone.....State.....  
Cash ( ) Charge Acct. No.....C.O.D. ( )  
Illinois residents add 2% Retail Occupational Tax. Extra charge for mailing outside our regular delivery zone.

**GOLDBLATT'S**  
STATE STREET AND NEIGHBORHOOD STORES

## ZIG THE NEW WAY TO APPLY SHAVE CREAM

Product of  
Navesink  
Industries



special  
introductory  
price... only

# \$3.00

ZIG's air foam rubber roller is the result of scientific research on how to get a clean, fast, comfortable shave every time, with any cream, soap or brushless. Thousands of tiny vacuum-action cells in the ZIG roller force penetrating lather to the base of your beard... where lather really counts!

These vacuum-action cells massage your skin, as you roll up beard-softening lather, stimulating your complexion to a new, healthful glow, conditioning it for the next shave. ZIG gives you modern efficiency, real economy... and the best shaves you've ever enjoyed!

Right now, ZIG can be yours for the low introductory price of only \$3.00... complete with 2 extra rollers. MONEY BACK GUARANTEE! Use ZIG, then if not more than satisfied, return within five days for a full refund of your money.

Mail This Coupon with Your Check or Money Order for \$3. We'll send you ZIG, the best shaving investment you ever made! (We pay postage.)

\* Reg. Trade Mark  
Pat. Pend.

ZIG  
P. O. Box 948, Fairhaven, N. J.  
Gentlemen: Send ZIG. I enclose \$3.00 which you guarantee to return if I'm not pleased.  
Name.....  
Address.....  
City.....State.....





"I have maintained that America needs a fine light car--Crosley sales prove I was right!"



**Powell Crosley, Jr.**  
PRESIDENT, CROSLLEY MOTORS, INC.

Consider what you get in a new fine CROSLLEY—a really modern-looking fine car with ample room for 4 six-footers, plus baggage. Lightning pick-up, "parks on a dime", big-car comfort, amazing driving ease. And a 4-cylinder, valve-in-head steel engine that weighs less than 150 lbs., yet delivers speeds up to 60-plus! This CROSLLEY COBRA (COPPER BRAZED) is the most talked-of internal combustion engine in 40 years; gives 35-50 miles per gallon on ordinary gasoline! If genuine economy means anything, you should drive the new fine CROSLLEY before you buy any car!

**CHECK THESE FEATURES!** ALL STEEL construction. low center of gravity means greater safety. MODERN Streamlining, the "aircraft flavor." WEIGHS only 1150 lbs., curbside, perfectly balanced. weight-to-power; instant pick-up; oversize shock absorbers.

For information and literature write:  
Crosley Motors, 2532-HA Spring Grove Av., Cin'ti 14, O.

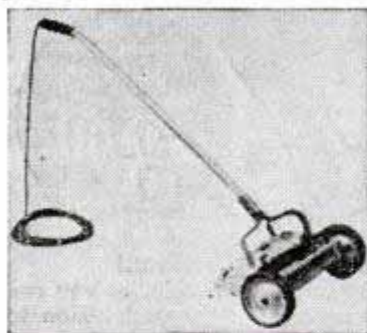

## A Completely New Electric Lawn Mower

The mower thousands have waited for. A light weight (20 lbs.) one hand operated, 14 inch electric

lawn mower complete with 75 feet of cord and plug, handle switch, thumb screw adjustment for cutting height, built in motor and mower into a high quality standard mower blade assembly, is equipped with ball bearing throughout grease packed, requires no oiling. Made for 110 volt current, complete in every detail. This mower is so easy to operate a child of six can operate this machine without fatigue. Is patented in United States and foreign.

Due to a limited supply of raw material these mowers are being sold direct from factory to users for \$69.95. Mail check or money order today for the wonder mower of the century with the understanding that if not satisfied you may return it for full refund. Shipping weight 28 pounds.

If you wish further details write for folder. Sold only by

**REMONTE MFG. CO.**

BOX 837

CORSICANA, TEXAS

## HANG THAT DOOR THE PROFESSIONAL WAY!

USE THE TIME SAVING  
—LABOR SAVING . . .

## E-Z Mark Butt Gauge

YOU DO THIS



You get a clean cut deeply etched profile. Removes chips. Repeat this operation on the jamb and hang the door. THAT'S ALL—NO MORE!

AND GET THIS

- Hang more doors better.
- No adjustments • No errors.
- Used and approved by Master mechanics.
- Comes in 3 1/2" and 4" (standard) sizes.
- Precision made.

Cost ONLY \$1.75 each or \$3.00 a set at your hardware store. If your Dealer can't supply you send only \$1.00 with order and pay Postman balance, plus postage C.O.D.

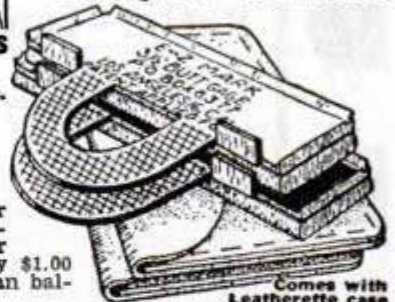

Comes with Leatherette case

**E-Z MARK TOOLS • P. O. BOX 8377 • LOS ANGELES 16, CALIF.**

## PLANS FOR 5 PROJECTS

that are fun to build

— only  
**\$1.00**

postpaid

Special combination offer includes easy-to-read

- plans for: 1. Folding Lawn Chair  
2. Child's Teeter Tottler 3. Child's Glider Swing  
4. 24-room Swallow House 5. Bird Feeder  
Mail your dollar bill today! Ask for Package "Z".

**DELTA MANUFACTURING DIVISION**

Rockwell Manufacturing Co.

680F E. Vienna Ave., Milwaukee 1, Wis.

## Deltacraft®

H-50



For safety, service, strength . . . order this

## NEW MODEL HYDRAULIC 20 TON ARBOR PRESS

All steel, welded construction; 5 ft. high, 2 ft. wide; right side hand pump gives operator full control. Only 99.50 f.o.b.—20% of list price must accompany C.O.D. orders.  
**R & H TOOL CO. — NEW MILFORD — N. J.**

## D. C. MOTORS

Good deliveries on 1/4, 1/3, and 1/2 hp Motors. Available at special D.C. Voltages. Manufacturers of A.C. Generators, Rotary Converters, Lighting Plants, Frequency Changers and high Frequency Generators.

**KATO ENGINEERING COMPANY**  
1401 First Ave., Mankato, Minn.



## WATCHES WANTED

BROKEN OR USABLE

All kinds. Highest Prices paid for jewelry, rings, spectacles, gold teeth, diamonds, Sterling Silver, etc. Cash mailed promptly. Write for free shipping container.

**LOWE'S, Dept. PM, Holland Bldg., St. Louis 1, Missouri**



## BELT SANDER EASY SPEEDY

Save time and effort . . . use American Portable Sanderplane! Handles more work and is many times faster than a hand plane—well balanced, powerful, efficient. Write for details.

## AMERICAN

FLOOR SURFACING MACHINE COMPANY  
535 So. St. Clair St. Toledo 3, Ohio



# BACK AGAIN: All You Want

## BEARINGS ALL TYPES ALL SIZES

INDUSTRIAL • AUTOMOBILE • TRACTOR •

### WE HAVE THEM NOW

We can furnish you with exactly the kind of bearings you want and in the quantities you need.

- AUTO BEARINGS
- BALL BEARINGS
- ROLLER BEARINGS
- THRUST BEARINGS
- BEARING PILLOW BLOCKS
- BRONZE BEARINGS
- V-BELT DRIVES
- OIL SEALS

Special Prices to Large Users

Let Us Know Your Requirements

Write For Prices

**AUTO-INDUSTRIAL BEARINGS CO.**

Dept. P.B.8

3811 No. Ashland Ave., CHICAGO 13



## A GREAT SURPLUS BARGAIN REDUCING GAUGE

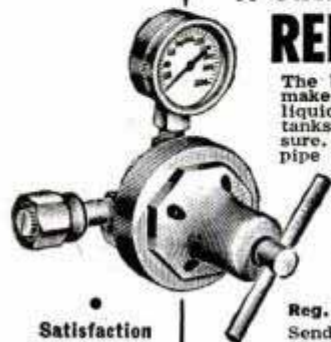

The buy of a lifetime in a standard make air pressure regulator. Used on liquid carbonic tanks and air pressure tanks of all kinds to regulate the pressure. Fitted with standard 1/2 inch pipe thread. Dial calibrated 0 to 200 lbs. Made by U.S. Gauge Air Reduction Co., Walter Kidde — all famous makers. Used by artists for air brush work, sign painters, retouchers, etc. Used by soda fountains and taverns. All in new condition. Satisfaction guaranteed.

Reg. \$15.00 Value  
Send check or money order. Ship same day.

# \$5.95

Postpaid in U.S.A.

**GROBAN SUPPLY CO.**

1522 S. Michigan Ave., Dept. PM6, Chicago, Ill.

Satisfaction Guaranteed

## Quick Shipment on TAPER ATTACHMENTS

FOR ALL LATHES OLD OR NEW—

10" to 24" swing  
\$49.50 to \$125.00

Write for bulletin

**MASTER-TAPER COMPANY**

126 N. Clinton St. Chicago 6, Ill.

Exclusive Mfrs. of Taper Attachments



## TELEPHOLA HIGH GRADE RADIOS

Highest quality — written guarantee: Five tubes, plastic walnut finish, \$17.95; Six tubes, \$20.95 — Ivory finish, \$1.90 extra. Portables, \$28.95 — batteries, \$3.75 extra. Electric phonograph, luggage-style case, \$28.95. Twenty models to choose from. Send for FREE illustrated circular. Cash with order or 25% cash balance C.O.D.



Telephola Radio Div., Horn Electronic Co.  
Main P. O. Box 177-P Dearborn, Mich.

5-tube, smart-looking leatherette case — \$16.95

## HIGH SPEED BORING BITS 125

5/16" square shank. Centrifugally cast with high Tungsten content and Chrome & Vanadium hardened to 64 Rockwell. Cutting Bit widths 3/16", 5/16" & 3/8". Set of three for \$3.25. Send check, M.O. or cash for exact amount, we pay postage in USA. Satisfaction or your money back.

**STAR TOOL CO. DEPT. 542 W. WASHINGTON ST. CHICAGO 6, ILL.**

## NEW! LOW COST! RESPIRATOR

Wear when sanding, grinding, paint spraying, sweeping, dusting, furnace cleaning, etc. Handy as a pair of glasses. Just keep mouth closed and breathe through nose is all you do to operate. Protects against nuisance dusts, lint, coal, cement, grain dusts, HAY FEVER pollen! Weighs 1 oz. Has 9 sq. in. filter.



**JERRY BRYANT PRODUCTS**  
Dept. PM, 919 N. Michigan Ave., Chicago 11, Ill.

Order Today \$1.00 POST PAID

# MASTER DRAFTING MACHINE

Mounted on 20"x24" Masonite

for Beginners • for Professionals

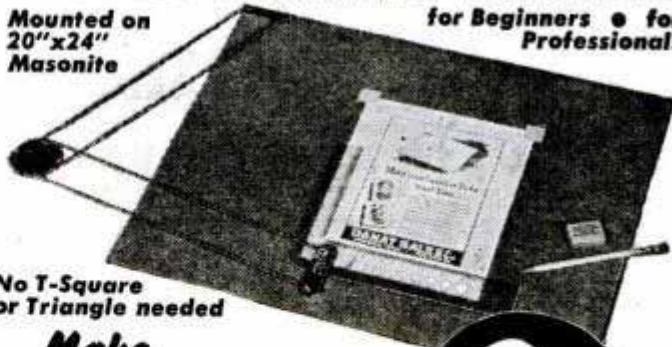

No T-Square or Triangle needed

Make

## FASTER-BETTER

### Drawings - Layouts!

# \$2.95

Tear off and Mail this Handy Order Form



Yes! — the Master Drawing Machine not only is an advanced aid for Faster and Better mechanical drawing — it is a Time Saver. Professional users praise its dual-purpose features which eliminate countless unnecessary movements.

Advertising men have found the Master Drawing Machine to be a short cut to quicker results and better work. This mechanical drawing board adds Speed to valuable time.

The unique, fixed mechanical guide operates with finger-tip ease. Its swivel action allows diagonal paneling at any angle.

**DANAT COMPANY, 624 S. Michigan Ave., Chicago 5, Ill.**

Please ship Quantity \_\_\_\_\_ Master Drafting Machine @ \$2.95 ea. \$ \_\_\_\_\_

Name \_\_\_\_\_

Address \_\_\_\_\_

City \_\_\_\_\_ State \_\_\_\_\_

Send check or Money Order

**Danat Company, 624 S. Michigan Ave., Chicago 5, Ill.**

SAY YOU SAW IT IN POPULAR MECHANICS

# YOU CAN NOW BECOME A PROSPECTOR!

HERE IS ONE OF THE WAR'S TOP SECRETS  
**BRAND (NEW) ARMY MINE DETECTORS!**

Portable: Will Detect METALLIC and NON-METALLIC objects; Very Sensitive; using 955 Tube in detecting head; two tube amplifier using two 1N5gt; headset; or microphone; also 150 micro meter; Power supply: 3-45v.; one 6-v.; or 2 3-v. batteries. Complete with instr. Less Batteries; packed in original cases; shpg. wgt. 108 Lbs.



FOB. From N. Y. Special

# \$17.50

No C.O.D.'s With Batteries \$26.40 F.O.B. N. Y.

Send order to

**COLUMBO TRADING CO., INC.**  
304 CANAL ST. DEPT. M NEW YORK 13, N. Y.

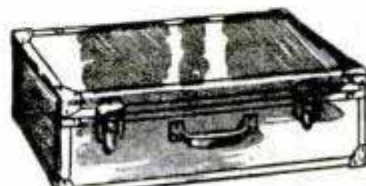

CARRYING CASE CT-21/PRS-1



# ★ PAINT NEWS ★

## War Brings Sensational NEW PAINT Discovery!



### For Any Surface, Anywhere

Now a new wonder paint, made from resins developed by Army and Navy during the war, is available to paint users. Made of finest resins and chinawood oil. Good for indoor and outdoor painting. Dries quickly; leaves no brush marks; gives hard high-gloss finish. Available in colors. Withstands salt air, salt water, rain, sleet, snow, sun, alcohol and road tar.

**SPECIAL SAVINGS.** If the dealer in your town has not yet stocked RESINITE, order direct from our factory at only \$2.95 per qt. F.O.B. Chicago. For a limited time we will allow you a 25c reduction on each quart of RESINITE if, with your order, you also send us the name and address of your paint dealer and the store manager's name. Get RESINITE at your dealer's or order direct from Factory—today. RESINITE CHEMICAL CORPORATION, Dept. G-2, 322 S. Mich. Ave., Chicago 4, Ill.

DEALERS write for prices and literature.

only PER  
\$2.95 QT.



## More Fun Fishing with BOB-ER-LITE



Fish Bites  
Bobber  
Lites

\$1.98

Now, with Bob-er-Lite, you can fish at night from boat or pier, safely, comfortably, without eye strain—add many extra hours to your days sport. When fish bites, bobber lites. Nothing to adjust, nothing to get out of order, guaranteed performance. Thousands are already in use. Bulb and battery are standard—readily replaced when worn out. Enjoy this extra thrill yourself. At better stores—or use the convenient order coupon.



Patents applied for

Enclosed is M. O. or check for Bob-er-Lites at \$1.98 each

Name \_\_\_\_\_  
Address \_\_\_\_\_

Send to **Pasch Bros.** 229 N. WATER ST. Dept. 18 MILWAUKEE 2, WIS.

# PALMGREN

## ROTARY TABLE

WITH  
DOUBLE CROSS-FEED

A Rotary Table with full 360° movement and 4" cross-feed travel. Has 8" Circular Table provided with free moving adjusting wheels and dials graduated in degrees.



Cross-feed adjusting screws have acme threads and are provided with adjustable dials graduated in thousands. Base has four convenient bolt slots and key slots for bolting to machine table.

Palmgren No. 83—  
Rotary 8" Table ..... **\$49.50**  
Prompt Delivery

Order from your dealer. If he cannot supply you, write, wire or telephone factory:

**CHICAGO TOOL AND ENGINEERING CO.**  
8365 South Chicago Avenue Chicago 17, Illinois  
Telephone — Saginaw 9675

## BUILD YOUR OWN MACHINE TOOLS!

Blueprints \$1.00-Catalog FREE

Detail construction Blueprints on 6 Lewis metal and wood-working tools postpaid for \$1.00. Includes prints for Lewis 10" Shaper, Milling Machine, Drill Press, Vise, 8" Circular Saw, 6" Jointer. Castings for these tools save up to 80% of comparable new tool cost.

Illustrated 32-page Catalog—sent free with Blueprint Order—describes 21 Lewis tools. WRITE TODAY!

LEWIS MACHINE TOOL CO.  
P. O. Box 7446, Sta. L, Dept. M, Los Angeles 23, Calif.



## with CARVED BALSA HULLS

MEGOW  
SHIP  
MODEL  
KITS

Beautifully smooth, carved hulls and complete accessories. Many models—the greatest names in sea history. See your dealer or write for details.

OCEAN CITY NOVELTY CO.  
14th & HAVEN AVE., OCEAN CITY, N. J.

TORPEDO DIRECTOR SIGHT . . . . . \$4.50

Rack & Pinion assembly, achromatic lens, polaroid filter, packed in plywood carrying case.

K-3 COMPUTING GUN SIGHT . . . . . \$12.50

110 precision bearings; 200 gears and drives, motor, lens, etc.

SIGHTING STATION . . . . . \$49.50

B & L & Eastman. 30 coated lenses, prisms, selsyns, pump, etc. Orig. cost \$9,854.00

Everything Brand New  
ASSOCIATED SURPLUS CO.

10838 Ventura Blvd. North Hollywood, California

# WOOD WORKERS

LUMBER—PLYWOOD AVAILABLE

Harold Hunt wants to send new No. 15 catalog. Over 148 pages of woodworking ideas. UNEQUALLED BARGAINS in imported and American woods, supplies, hard-to-find hardware. Send only 15c to cover postage and handling.

CRAFTSMAN WOOD SERVICE CO.  
2729 S. Mary St., Dept. A-82, Chicago 8, Ill.

only  
15¢







### Build Your Power Tools With OUR BALL BEARING ARBORS

New Departure  
Self Lubricating  
Bearings

10,000  
R.P.M.



(No extra charge for left hand threads) C5—5/8 Pictured

B33—\$4.95 P.P.  
5/8 x 4 1/2 Spindle  
B15 Plain Spindle  
\$3.50

Shaper Arbors C4, C6, D8, 3 inches between collars, add \$6.00.  
Plain Spindle models less threads and collars C4—\$8.00, C5—\$8.00,  
C6—\$9.00, D8—\$16.00 all P.P.



### BUILD YOUR DISC SANDER WITH OUR ARBOR, DISC AND PLANS

8" x 5/8 Tru-disc ..... \$3.50  
B15 x 5/8 B.B. Arbor ..... 3.50  
2" x 3/8 pulley ..... 0.35  
35" V Belt ..... 1.15  
Plans ..... 0.10  
Total ..... 8.60  
Special Offer ..... \$7.60 P.P.

Make the above Disc Sander with our B15 Ball Bearing Arbor and 8" or 10" Tru-disc. See special offer.

10" disc instead of 8" add \$1.50 to Special Offer. 8" disc \$3.50 P.P., 10" disc \$5.00 P.P. Center hole 1/2, 5/8 or 3/4. Complete stock V belts and pulleys. Courtesy to Dealers.

POLY PRODUCTS, 406 S. Chester, Ct. 1a, Pasadena 5, Calif.

### FREE TRAILER PARTS CATALOG

"Safety Engineered"



BULL DOG Hitches & Parking Jacks.  
TORQ-LESS Axles,  
Drop a card to Box 115

HAMMER BLOW TOOL CO., WAUSAU, WIS.

**SIGNS AND SHOWCARDS** EASILY AND EXPERTLY PAINTED WITH LETTER PATTERNS. MANY SIZES & STYLES. WRITE FOR FOLDER! JOHN F. RAHN 1330-31 N. Central Ave. CHICAGO 51, ILL.

Lasting Beauty for Your Home or Summer Cottage!

Brand New!

**FEDERAL "Lifetime" SEAT**

\$9.75

Fits All Standard Bowls

A HANDSOME fixture in your bathroom that will give a world of wear! Of acid-resistant plastic, this "Lifetime" Seat is guaranteed not to chip or peel. It's feather-light, yet strong as steel! Easier to clean, too . . . and more sanitary. All fittings are brass, chrome-plated. Your choice of smartly marbled black or white. SEE YOUR HARDWARE DEALER OR DEPARTMENT STORE if your dealer can't supply you, send dealer's name with check or money order for \$9.75 — and we'll ship postpaid.

FEDERAL SEAT CORP., 601 W. 26th St., New York 1

## Keep Brushes like New

**BEFORE** **AFTER**

5c  
10c  
25c

**DICA DOO PAINT BRUSH BATH**

Clean and Restore PAINT BRUSHES

At Paint, Hardware, Dept., and 5 & 10c Stores  
Patent Cereals Co. Geneva, N. Y.

## Vacation Bargains

All prices postpaid except for items marked with asterisk (\*). See instructions below.

**AAF PNEUMATIC RUBBER BOATS\***  
New! One-man (illustrated). Complete with CO2 tank, mast and sail. Can be used with or without sail. \$15.95  
5' 6"x3'..... \$15.95  
New! Five-man. With oars, CO2 tank, hand pump, carrying case and other items. \$37.50  
Five-man. Slightly used but good condition, with hand pump and oars. \$29.50

**PUP TENTS.** Used, excellent condition ..... \$3.75  
Very Minor repairs needed \$2.50

**TARPAULINS\***—NEW! Rubber or rubberized. 14x20. Either \$11.95

**MAE WEST LIFE PRESERVERS**  
With inflating device . . . \$1.65

**AAF GABARDINE COVERALLS**  
New! With zipper. Sizes 34 to 48 ..... \$6.95

**COMPASSES**  
Watch-type, by Longine. Luminous face . . . \$1.50. Lenticular, for sighting and surveying \$1.95  
Hull, for automobile or boat \$2.95

**PARACHUTE CANOPIES**  
Over 50 yds. Suitable for all kinds of garments. White nylon ..... \$15.95  
Green camouflage nylon. \$11.95

**AAF SLEEPING BAGS**  
New! Down-filled. Double zipper on one side and both ends. Complete with lightweight tarpaulin. \$31.50  
Same bag, slightly used but sterilized, without tarpaulin. \$19.50  
Mummy-type. Down-filled. Zipper closure, water repellent case. Used but sterilized. Perfect condition. \$12.95  
Mummy-type, with wool-blanket liner and water-repellent case. New \$6.95. Used, excellent condition. \$4.50.

**AAF C-1 VESTS**  
New! 15 pockets and gun holster. Perfect for hunters and fishermen. \$2.95

**RUCK SACKS**  
Slightly used, excellent condition ..... \$3.25

Write for FREE WAR SURPLUS CATALOG

\*These items will be shipped transportation charges collect. Send remittance for advertised price.

Mail Check, Currency or Money Order **Pacific Fur & Wool Co.**  
War Surplus Dept., Box 926-PM, Sacramento, Calif.



# Start a SAW REPAIR BUSINESS!

**MAKE A GOOD LIVING IN YOUR OWN BUSINESS**  
—sharpening saws with the Foley Automatic Saw Filer. It makes old saws cut like new again. All hand saws, also band saws and cross-cut circular saws can be filed on this ONE machine.

**THERE ARE HUNDREDS OF SAWS TO BE FILED** in your own neighborhood, used by farmers, carpenters, homes, schools, factories, etc. W. L. Tarrant writes: "I left my old job last September and in 10 months have filed 2,159 saws. We have a lovely business worked up and cannot keep up with the work."

**SEND FOR FREE PLAN**—Shows how to start this steady cash business. No experience needed, no eyestrain, no canvassing. Send coupon today.



## FOLEY Automatic SAW FILER

**FOLEY MANUFACTURING CO.**

616-7 Foley Bldg., Minneapolis 13, Minnesota

Send Free Plan on Saw Filing business, no obligation

Name \_\_\_\_\_

Address \_\_\_\_\_



SAY YOU SAW IT IN POPULAR MECHANICS

# WILTON VISE

5  
YEAR  
GUARANTEE

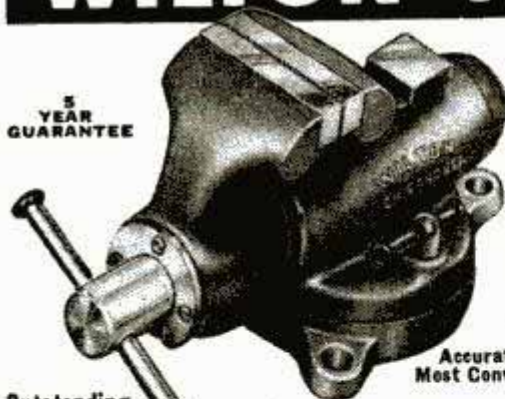

"The Best Vise  
Money Can Buy"

FOR—  
Jewelers  
Model Makers  
Radio Repair  
and  
Home Workshops  
**SWIVEL BASE**

Accurately Holds Work in  
Most Convenient Position

Outstanding  
Features

Jaw Face Precisely  
Milled.  
Body Bored and  
Reamed.  
Unbreakable Horizontal  
Nut.  
Entire Base Surface  
and Movable Jaw  
Lathe Turned.  
Keyway Broached.  
Ground Anvil.

Jaws are always truly parallel—no shifting or wobbling. Just what you need for precision work. Jaw inserts are reversible and interchangeable. Streamlined patented enclosed design prevents dust and filings from entering and wearing internal parts. Extra rugged because head and nut are made from malleable alloy—53,000 lbs. tensile strength.

When ordering state if you want soft or hard steel jaws—with smooth or serrated faces. We recommend ordering an extra set of brass or copper jaws for special work. The Wilton Vise is a Precision Tool made for the man who likes to do precision work.

Satisfaction Guaranteed — We Pay Delivery Charges

SIZE	WITHOUT SWIVEL BASE	WITH SWIVEL BASE	EXTRA COPPER OR BRASS JAWS (INDICATE CHOICE)
2"	\$ 9.85	\$11.20	\$2.34
2 1/2"	11.45	14.05	2.46
3"	12.30	14.95	2.57

Wilton Vises are also available in industrial sizes including combination pipe jaw types.

For catalog sheet describing larger industrial sizes, write Dept. A-6.

**SHEFFIELD INDUSTRIAL SUPPLY CO.**

7616 N. SHEFFIELD AVENUE CHICAGO 14, ILLINOIS

# GET INTO YOUR OWN PROFITABLE BUSINESS!

**BIG PROFITS IN  
CONCRETE CINDER  
BLOCKS**

Capture Your Share of  
the Big Building Boom.  
Supply the Great Demand  
for Quality Blocks Needed  
Everywhere for Every Kind  
of Construction Work.

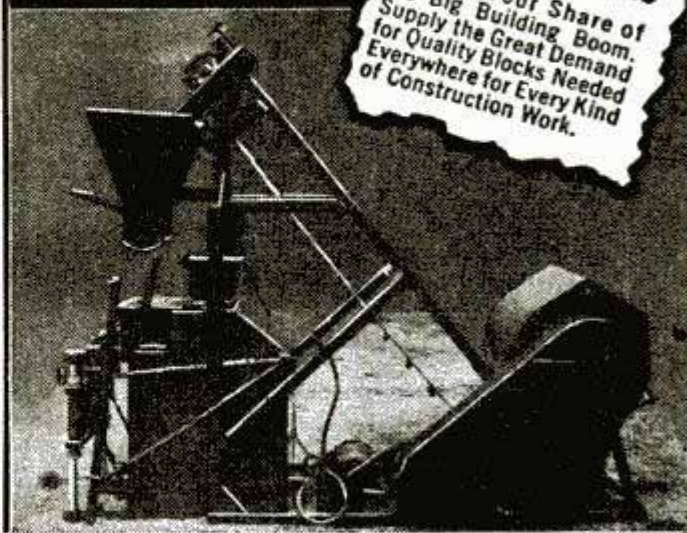

Here's an OPPORTUNITY Never Before Equalled  
**PAYS FOR ITSELF IN A FEW MONTHS—**

and then you have a real profitable business of your own. One user, (Concrete Products Co. of Junction City, Kansas) says: "Easy to maintain production ONE HUNDRED CONCRETE BLOCKS PER HOUR PER MACHINE." Quick delivery now to get these operating in many different localities at once.

**WRITE** for MONEY MAKING FACTS for men of vision and modest capital. Write today—a 1c postcard will do.  
**CONCRETE BLOCK EQUIPMENT CO. INC.**  
920 Central Dept. 414 Kansas City 6, Mo.

# Ball-Bearing —SPEED WHEELS—



**Juvenile Wheels — Solid Tire**  
(no bearings)

7" wheel .....60c  
6" wheel .....50c  
4" wheel .....30c

**Semi-pneumatic Tired Wheels**  
12" x 1.75" wheel.....\$3.25  
10" x 1.75" wheel.....\$2.75  
8" x 2" wheel.....\$2.00

**Industrial Wheels**  
10" x 2.75" .....\$6.75  
8" x 1" .....\$4.90  
6" x 2" .....\$2.80

**ORDER NOW FOR  
PROMPT DELIVERY**  
**10% REQUIRED  
WITH C.O.D.'S**

**JIM BROWN TOY COMPANY**  
1097 Home Ave. Akron 10, Ohio

**NAILS** Over 1000 nails in assorted sizes \$1.00. Shipping weight 8 lbs. or Bargain Assortment 3 times as large \$2.00. Ship Wt. 26 lbs. Include shipping charges with currency or M.O. remittance. No C.O.D.

**PRAIRIE NAIL & SUPPLY CO.**  
Dept. A-1 1327 W. Randolph St. Chicago 7, Ill.



**Build An Advanced 1948 Pedal Car Chassis**  
**BE THE FIRST TO HAVE GEARED  
STEERING AND BICYCLE DRIVE**

Use this smart, strong 9" Metal Steering Wheel (pictured) Black lacquered rim with nickel plated spokes and hub for a 3/8" shaft, for only \$2.87 postpaid USA. You can buy the essential parts, i.e., gear reduction steering unit, and ball bearing pedal drive assembly, to use on your present car, or build one complete, using our axles, wheels, frames, etc. Write for free sketched price list.

**\$2.87 Postpaid USA**  
**NELSON-PRICE MFG. CO., P. O. Box 25, Rockville Centre, N. Y.**



# 45,000 MOTORISTS SAY - "MORE POWER-PICK-UP PEP"

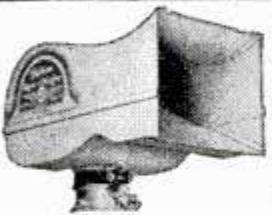

Amazing TYPHOON SUPER-CHARGER is back again, ready to put new life into old motors, add to power, pickup, pep. 45,000 users find gasoline economy, you will, too. Motor knock vanishes . . . Grease bath air cleaning

keeps dust out. Takes 5 minutes to install with screw driver, fits on carburetor. Order today, mention make and car model. Only \$5.95. Ohio orders add 3% tax, west of Rockies add 10%.

**10 DAY  
MONEY-BACK  
GUARANTEE**

**TYPHOON PRODUCTS CO.**

509-K Engineers Bldg., Cleveland 14, Ohio

## COLOR CONCRETE WITH CHEMICALS

Get into business on small capital working at home, or shop. There is real money in making Hollywood style pottery and bird-baths without moulds. Our instructions cover a large variety of designs. Washing-wells, benches, garden light-houses, stucco-rock imitation marble, cement water-paints and many more. 10c brings sample, details and pictures.

**HOLLYWOOD CEMENTCRAFT**  
8529 Wonderland Ave., Hollywood 46, Calif.

## OTTAWA LOG SAW Write For FREE BOOK



SAWS 10 to 20 CORDS A DAY - FALLS TREES - SAWS LIMBS

Put this OTTAWA to work for you. MAKE MONEY! Wood is bringing highest prices ever known. Ottawa does more than 10 men. Easily operated. Falls trees - saws limbs. Use 6-hp. engine for other work.

**OTTAWA MFG. CO., 627 Wood St., Ottawa, Kans.**



## COMB-A-TRIM The New Quick Trimmer

Something New! Trim your hair without any experience. It's easy! The excess hair comes off smoothly and easily by just pulling trimmer through hair like an ordinary comb. Save on hair-cut bills. . . . Trim your own hair or the whole family's. Send 59c and your Comb-A-Trim will be sent at once, postpaid.

**SPECIAL OFFER** Send \$1.00 for 2 Comb-A-Trims. Save 18c **2 for \$1** 5 Extra Blades (Year's Supply) **25c**

**COMB-A-TRIM CO., CAREW TOWER, Dept. R-20, Cincinnati, Ohio**



**Fascinating**  
GENUINE CRYSTAL RADIO \$1.99

Midget radio small enough to carry in a pocket. Gets regular programs thru a sensitive crystal. Extra long range. Very clear tone.

On C.O.D. orders pay postman \$1.99 plus C.O.D. fees and postage (C.O.D.'s in U.S.A. only). We pay all costs if you send \$1.99 in check, cash or money order. Write to

**MANSE RADIO SALES, Dept. P, Box 81, Ravinia, Illinois**

**NO TUBES, BATTERIES OR ELECTRICITY**

# GOVERNMENT PAID \$15,000 FOR COMPLETE UNIT . . . . . Portable Power Plant BRAND NEW! AND ONLY

**\$695**  
EACH  
Lots of 3  
\$650 Each

**Complete with FOUR 600x16 Tires**

**Completely Enclosed Self Contained Unit**

Standard JXD Hercules Gas Engine 4-in. Bore

G. E. Generator GT-1508-B1 100 to 115 Volt D. C. Up to 300 Amp.

Individual 2-Wheel Brakes

Standard Ford Axles

Mobile Unit is Adaptable for Trailer Hitch

Hundreds of uses for this efficient power plant which you can haul to the spot needed. Now at a fraction of the cost the government paid. Ideal for welders and industrial uses. Quantities limited. Hurry! Order now!

**880 Million Candle Power SEARCHLIGHTS**  
Complete with Remote Control Station

**\$300 EA. IN LOTS OF 3 \$349 EA.**

Send 25% with order, balance C.O.D.

Ideal for carnivals, outdoor games, advertising purposes. Hundreds of other uses.

Mobile Unit Has FOUR 6.00x16 Tires Performs Perfectly with Power Plant

## CHICAGO SURPLUS CO.

**THE MOTOR TRUCK BROKER**  
4545 W. Madison St., Chicago 24, Ill.  
Dept. PM6

**VAC-V-GRIP CAR TOP CARRIER**  
DELUXE BOAT CARRIER, TUBULAR STEEL FRAME WITH LOAD CARRYING BOARDS 5 FT. LONG. STRAPS, RUBBER PADS.

**MOTOR VACUUM POWER PREVENTS SLIPPING**  
Catalog FREE

**VAC-V-GRIP COMPANY 2025 DETROIT AVE. TOLEDO, 6 OHIO.**

## SANBORN Dog Whistle No. 1

Natural Alternating Two Tone Dog Call, Also Human Hailing Call

**FACTORY TESTED AT 1 MILE**—Pitched just below insect interference tones—a scientific precision-made instrument turned from a special aluminum alloy. Dogs respond without special training. All calls personalized by blower. See your dealer or order direct.

**SANBORN PRODUCTS CO. BOX 132-O MENTOR, OHIO**

\$2.00



# Announcing THE BARRON DRUM SANDER FOR DRILL PRESS USE

● Another new Barron development. Will fit any 1/2" drill press chuck, collet chuck, adapter or 1/2" I.D., Spindle. Has 1/2" ground steel shank, rubber cylinder, compression cups, light steel cylinder and full length arbor. Extra light in weight, runs smooth as a top. A fine, precision sander, complete with 5 sanding sleeves 2 1/2" dia. x 3" long. The first drum sander of its size and design ever offered at so low a price! Try it on our 10 day money back guarantee.



\$3.95

COMPLETE



\$7.50 COMPLETE

### MULTI-PURPOSE DRILL PRESS PLANER

The greatest all-purpose drill press tool on the market. Planes, parallels, rabbets, routs, panels, beads, tenons, grooves, etc. NO EXTRA BLADES TO BUY! It's complete, ready to use. Does any or all operations without a single blade change or adjustment. Harmless to drill press. Safe, accurate, perfectly balanced. Over 75,000 now in use!

### OTHER DRILL PRESS ACCESSORIES

4" ROTARY SURFACE SANDER \$5.95      1/2" DOVETAIL CUTTER \$1.85  
ALL-METAL AUXILIARY DRILL PRESS PLANING AND SHAPER TABLE \$9.85  
TAPERED AND THREADED SPINDLE ADAPTERS  
ROUTER AND ROUND END MORTISING BITS 1/8" TO 1/2" SET OF 6 \$9.50

Liberal 10 Day Money Back Guarantee

Workshop Guide FREE

BARRON TOOL CO.

569 Architects Bldg., Detroit 1, Mich.



## BARRON PRECISION WORK SHOP TOOLS

# ATOMIC SPEED BOAT



SOUNDS LIKE  
A REAL SPEEDBOAT

- All Metal  
No Moving  
Parts
- Fuel Supply  
Included  
Free
- No Springs  
or Gears  
to Break

One of the novelty sensations of the atomic age. Beautifully enameled in bright, durable colors. Runs half an hour on a small piece of fuel. (Fuel included FREE.) Sounds like a roaring 2-cylinder speedboat. Simple to operate. Hours of fun for all adults and children. A wonderful and different gift idea. Order several. Fully guaranteed.

\$1 Complete  
Postpaid

Mail Orders Direct To

L. C. J. SALES CO.

2625 Lucas Ave.

Dept. PM-6

St. Louis, Mo.

# WALKIE-TALKIES!

## Complete Army Sets Ready to Operate



Portable radio telephone sends and receives 10 to 15 miles! Used by the Army with great success. Ideal for amateurs, police, explorers, airports, utilities, boat owners, Government services, etc. Operates anywhere in the 28 to 52 MC band. Renewed by the Government and guaranteed. Shipped, ready to operate, complete with tubes, microphone, telescope antenna and new batteries. Price—only \$45.00 each.

\$45.00

F.O.B. Chicago

Extra batteries (80 hours continuous service) ..... \$4.75 each

## Radio-Telegraph Sending Keys

Real S-37 Signal Corps keys for your radio or telegraph set or for code practice. They have coin silver contacts and full adjustments. Valued at 3 times our low price. Send \$1.00 plus 20c for postage anywhere in U. S. Guaranteed.



320 N. La Salle St., Dept. P-6  
Chicago 10, Illinois

## FOR IMMEDIATE DELIVERY ELECTRIC HAIR CLIPPERS

for BARBER SHOP USE  
FARM USE  
KENNEL USE

WRITE FOR COMPLETE ELECTRICAL APPLIANCE  
CATALOG, DEPT M.P.

WILLIAM MARVY CO.

479 ST. PETER ST.

ST. PAUL 2, MINN.

# LIVE STEAMERS!!

All Castings and prints for Southern Pacific Atlantic A-6 in one inch scale now available. Also completed Locomotive. Lists for Dime.

DOC FIXIT, 665 1/2 Ivy, Junction City, Oregon

## LAW

STUDY AT HOME for PERSONAL SUCCESS and LARGER EARNINGS. 38 years expert instruction—over 108,000 students enrolled. LL.B. Degree awarded. All texts furnished. Easy payments. Send for FREE BOOK—"Law and Executive Guidance."  
AMERICAN EXTENSION SCHOOL OF LAW  
Dept. 78-M, 646 N. Michigan Ave., Chicago 11, Ill.

## AT LAST! A HOBBY THAT OFFERS YOU PROFIT AS WELL AS PLEASURE!

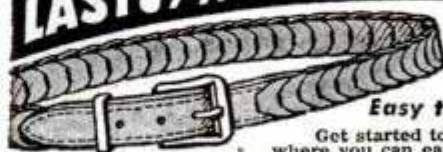

GENUINE LEATHER  
Hand Crafted  
LINK BELT

Easy to Make - Easy to Sell

Get started today on a fascinating hobby where you can earn up to \$10 or \$15 a week in spare time! Send for your complete profit-producing Handicraft Kit with all the material needed to make 6 genuine leather link belts. Sell all you make at \$2 each to people expecting to pay far more for genuine hand-made belts. Kit for 6 belts costs you only \$3.50—can easily be sold for \$12—leaving you a profit of \$8.50. Send \$3.50 for your Kit today, or mail only a dollar for sample Kit! Or C.O.D., you pay postage. Money back if not delighted.

FREE  
WITH YOUR  
ORDER

... IF YOU ACT NOW!

Beautiful Plastic Card Case, value 25c, free with \$1 Kit. Yours to keep, even if you return belt kit. Also, on request, big new 40-page CRAFT CATALOG FREE with or without order.

DWINNELL CRAFT SHOP, Dept. P-76, Elm Grove, Wheeling, W. Va.



# SURPLUS DISTRIBUTORS . . . Shop by Mail!



**3X GUN SIGHT**  
Precision optical instrument; powerful achromatic color corrected lens; waterproof, dustproof, shockproof. All bronze and brass body; a find for bird and nature study, long distance observation. 22 1/2" long. Gov't cost approx. \$175.00. Shpg. wgt. 7 lbs.  
**No. 2A . . . \$4.95 Each**



**6-POWER PANORAMIC SCOPE**  
Revolving head telescope; finest prisms and lenses. Contains 90 prism in worm E) gear mounting 11/16 sq. by 3" Dove Prism in worm E) gear mount. Head revolves 360 on double bevel gears. Achromatic objective and Kellner eye-piece, 90 Amic (Roof) Prism. Adjustments controlled and protected. Water, dust and shock-proof. A real buy. Shpg. wgt. 5 lbs.  
**No. 3A . . . \$7.95**



**10-MAN RUBBER BOATS**  
Brand new manually-inflated; cost Govt. over \$800. Fine for life raft, swimming raft, fishing, boating. Includes 2 paddles, 3 pumps, repair kits, tools, motor mount, etc. Shpg. wgt. Approx. 500 lbs.  
**No. 9B . . . \$75.00**

- O.D. Leggings (renovated) . . . \$ .29
- Glider Covers (canvas) . . . 6.95
- Foot Lockers (used) . . . 5.95
- Hunting Knives (new) . . . 1.98
- Flying Helmets (new) . . . .49
- Wooden Shower Clogs (new) . . . .79



**HAMMOCK**  
Ideal for camping, home or resort use. Waterproof roof, mosquito-proof, nylon netting sides. Designed for U. S. Army. Just the thing for outdoor sleeping. Shp. wgt. 7 lbs.  
**No. 4B . . . \$7.95**



**100% WOOL SLEEPING BAG**  
Ideal for vacations, camping. Blanket-type with 30-in. Talon zipper. Renovated—AA1 like new. Shp. wgt. 4 lbs.  
**No. 7A . . . \$2.95**



**FLIGHT PANTS**  
Govt. surplus like new Air Corps flight pants; fine for outdoor work, truck drivers, sports. Alpaca-lined, waterproof shell; fits 36" to 40" waists. Shpg. wgt. 4 lbs.  
**No. 10A . \$3.98 Pair**

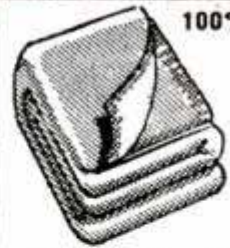

**100% Wool Army Blankets**  
Full size renovated U. S. Army blankets, made for service, priced to sell. Shp. wgt. 4 lbs.  
**No. 5B . . . \$3.95**  
**AUSTRALIAN WOOL**  
**No. 5A . . . \$5.95**



**Combat Boots — Brand New**  
Famous tough; long-wearing combat boots; comfortable, ideal for hunting, camping. Comp. sole, rubber heels. Sizes 9A, 9 1/2A, 9B, 9 1/2B, 10B, 10 1/2B, 11A, 11B. Shp. wgt. 5 lbs.  
**No. 6A . \$5.95 Pr.**



**SKIFF OR CANOE PADDLES**  
5-ft. length, matched woods, sturdy construction. A much-wanted War Surplus item. Shp. wgt. 3 lbs.  
**No. 11A \$2.95 Each**  
**No. 11B 6-FT. \$3.95**



**INSECT REPELLENT**  
Used by armed forces to keep away all insect pests —to Govt. specifications —easy to apply for complete comfort, protection. Available in 2-oz. bottles. Shp. wgt. 5 lbs.  
**No. 12A \$6.95 ctn. of 36**

## SURPLUS DISTRIBUTORS

924-B N. Plankinton Ave.  
Milwaukee 3, Wisconsin

All orders shipped FOB Milwaukee, postage collect. Send money order or check. On C.O.D. orders, enclose 25% deposit, balance plus postage on arrival. Money cheerfully refunded if not satisfied.



## NOW! Electroply

1 PLIER DOES 3 JOBS—Cuts—Strips—Forms!

Send today! C.O.D. \$1.95 plus postage — or send \$2.00 and we pay postage. Send today! Agents! Write for proposition!

Patented nose forms connections, loops, bends! Cutting edges snip wire up to 1/4"—stripping edges strip insulation! Makes amateur work professional; professional work faster, neater! Rubber handles, drop forged, heat treated, polished! Send for yours today!

Electroplier Company, Dept. P  
State Bank Bldg., Palatine, Illinois

## AMAZING • NEW ELECTRIC MOTOR

New Fractional A.C. H.P. Motors for the Amateur or Pro



A compact factory-built power unit to meet numerous small motor requirements, ideal for home appliances, toys, fans, movie projectors, small grinders and many other useful applications. Develops up to 1/100 H.P. under continuous load. 110 volt A.C., 60 cycle, no load speed 3300 R.P.M. Special price \$1.75 each.

ONLY \$1.75 POSTPAID — No C.O.D.  
Dept. 506  
THE ROTOR CORPORATION  
Miamisburg, Ohio

## FOR LOW COST BOATING PLEASURES



## THE MOTOR TROLLER

Pat. Pend.

NOW! The Motor Troller specially designed for use with your small gasoline engine (1/2 to 1 1/2 H.P.) such as used on lawn mowers, washing machines and numerous other devices, gives you a power driven boat for only \$28.50. Clamps on any row boat, operates in shallow water. Aluminum castings and bronze fittings used. Ideal for boat liveries, fishing and duck hunting.

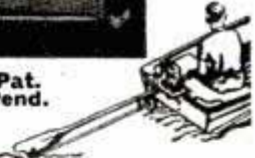

**\$28.50**  
F.O.B.

SATISFACTION GUARANTEED

Send check or money order. Sorry no C.O.D.s.  
Free pamphlet on request.

THE MOTOR TROLLER CO., Dept. P

292 RIVERSIDE AVE.

WESTPORT, CONN.

SAY YOU SAW IT IN POPULAR MECHANICS

# Now a DYNAMIC Super-charged WELDER

IDEAL FOR AUTO • HOME APPLIANCE • FARM REPAIRS



DESIGNED TO DO HIGH GRADE WELDING INEXPENSIVELY!

Maintenance Men; Farmers; Mechanics; Machine Shops; Foundries; Auto, General Repair and Job Welding Shops; all using the DYNAMIC find it so indispensable and useful that they cannot afford to be without it. If inexperienced you can easily learn to do a variety of high grade welding jobs by following the practical, simplified operating and welding instructions furnished. Once you see a DYNAMIC in operation, you won't want to be without it. Its simplicity will amaze you. In a year the DYNAMIC only costs you about 6c a day. Helmet, rods, cables, holder and operating instructions, etc., furnished.

**SAVES YOU VALUABLE TIME AND MONEY!**

This portable industrial transformer type DYNAMIC WELDER easily carried right to the job, can be operated from any convenient, properly wired 110 Volt, 60 Cycle Line — has 8 metallic and carbon arc welding heat stages — does work you would think only possible with a larger more expensive machine. Can also be supplied for 220 volt, 60 cycle operation and other voltages and cycles at slight additional cost. Works on Iron, Steel, Brass, Bronze & other metals.  
**DYNAMIC WELDER CO., 13 East 23rd St., RE, Chicago 16, Ill.**

**ONLY \$28.50 COMPLETE**  
Available Now  
IMMEDIATE DELIVERIES

Write Today for Particulars  
GET DETAILS on our 10 day Trial Offer.  
Member Chicago Association of Commerce



# DUAL-PURPOSE BAND SAW

## IMMEDIATE DELIVERY!

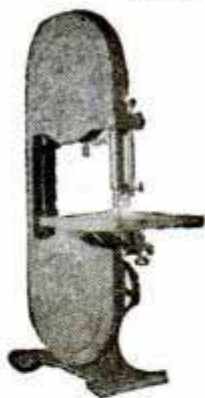

IDEAL FOR FACTORY  
OR HOME WORKSHOP

This 14" precision-built saw is expertly constructed of finest materials and designed for use on wood or metal. Frame of durable heat-treated cast iron with aluminum guard. Bronze Oil-lite bearings throughout; hardened blade guides and inserts, ground tilting table surface, 14 tooth all-purpose blade .....

**\$79<sup>50</sup>**

### COMBINATION BELT AND DISC SANDER

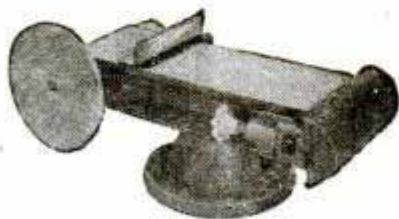

This sander is precision built and has a sturdy cast iron, heat-treated frame. All rotating parts dynamically balanced and set in ball bearings. Has a 6"x14" working surface, 8" disc. Can be adjusted quickly—easily! Here's the ideal sander to complete your shop equipment.....

**\$49<sup>50</sup>**

Shipped Freight Collect — 25% Deposit on COD's  
Mail Orders Promptly Filled

**MINNEAPOLIS OUTLET STORE**  
54 SOUTH 3RD STREET MINNEAPOLIS 1, MINN.

For **BEGINNERS**  
(4 yrs. and up)

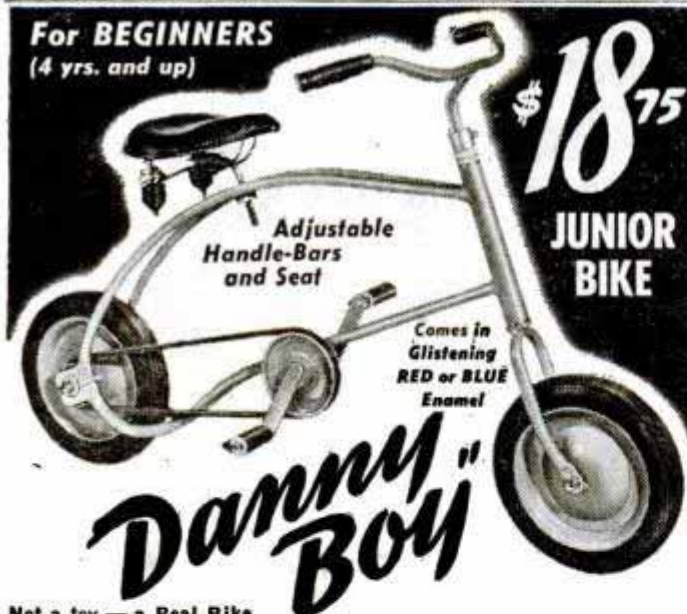

**\$18<sup>75</sup>**

**JUNIOR  
BIKE**

Adjustable  
Handle-Bars  
and Seat

Comes in  
Glistening  
RED or BLUE  
Enamel

**Danny  
Boy**

Not a toy — a Real Bike

**STURDY ENOUGH — EVEN FOR DAD**

- Double Bar—Steel Tubing
- Disc Wheels with Ball Bearings
- Wheel Base 32 Inches
- Sturdy Fork — Bronze Bushings
- Adjustable High Grade Seat
- Adjustable Handle Bars, Rubber Grips
- Danny-Boy bikes have the adjustable take-up feature on the rear wheel to take up any slack which might appear in the belt drive.
- Welded Frame
- Large Semi-pneumatic Rubber Tires
- V-Belt Drive—Safe—Quiet
- Full Bearing Pedal Crank
- Rubber Pedals—Streamlined
- Baked Enamel Finish

Specify Color when ordering — Shipped Express Collect — Send Check or M.O.

**Prompt Shipment Guaranteed**

**Danat Company, 624 S. Michigan Ave., Chicago 5, Ill.**

# Sensational New SAVES TIME AND EFFORT Tool

A New Revolutionary Hand Tool that INSTANTLY MEETS WITH THE APPROVAL OF ALL MECHANICS... Just what they have wanted to make their work easier and faster... GRIPS SECURELY and RATCHETS AUTOMATICALLY.



PAT. PEND.

## Marvelous Invention!

COMPOUND LEVERAGE  
& DOUBLE BROACHED  
—JAW

These features make The LOGAN the outstanding wrench on the market today... Important to any mechanic.

### A Ratchet WRENCH FOR Tough Nuts—

CAN'T SLIP—CAN'T SPREAD GRIP  
JUST SLIP IT ON TO THE NUT

The LOGAN Ratchet Wrench slips readily onto the nut from the side or top... engaging nut securely. The ratchet construction makes it unnecessary to remove wrench until tightening or loosening is done... A new experience for all mechanics... Saves knuckles and temper.

#### Mechanics Enthusiastic

An indispensable tool for Mechanics and Auto Owners also for the home mechanic.

IF YOUR DEALER CANNOT  
SUPPLY YOU ORDER DIRECT

LOGAN TOOLS, INC., Dept. P, LAMBERTVILLE, NEW JERSEY

### LOGAN Ratchet WRENCH

Note These Features

- IT RATCHETS
- DOUBLE ACTION LEVERAGE
- SHORT HANDLE MOVEMENT
- POSITIVE GRIP on ROUNDED-OFF NUTS
- DROP FORGED CHROME VANADIUM

AVAILABLE SIZE 5/8  
START YOUR SET NOW

**ONLY \$2<sup>50</sup>**

Postpaid in U.S.A.  
IF YOU REMIT WITH ORDER or WE SHIP C.O.D. PLUS POSTAGE.

## Emergency Bottled Power!

*New*  
**DOUBLE-PURPOSE AIR-O-FLATER**

**FIRE EXTINGUISHER  
TIRE INFLATER**

*New*  
**LOW PRICE \$5<sup>45</sup>**  
Complete with mounting bracket

**Distributors WANTED**

**A "MUST" FOR CAR OWNERS!**

Puts out gas, oil and electrical fires—contains the new CO2 fire-fighting gas, under high pressure. Safe and easy to operate, non-injurious and quick-acting. Also inflates tires "in a jiffy"—simply attach hose connection to valve stem and turn lever of AIR-O-FLATER—tire is inflated in about 3 seconds.

See your dealer, or mail check (or M.O.) for \$5.45 — satisfaction guaranteed or money refunded. Refill — 75c.

**GENERAL AIR PRODUCTS CORP.**  
3318 MONTROSE AVE. CHICAGO 18, ILL.



### HAND MICROPHONE



Top quality hand microphone with control button in handle. Highly sensitive. Has rubber covered cord and tel. plug. Fine for use on home recorders, public address systems, etc. Brand new—perfect. Shp. wgt. 2 lbs. Stock No. 170. Each... **\$1.95**

### MESS KITS

Regulation two-piece Army Mess Kits with folding handle. Used but perfect. Weight 2 lbs. No. 69c. A116—Ea. **69c**



### CANTEENS

Reg. U. S. Issue canteens. Plastic screw top chained to body. Slightly used but perfect. Wgt. 1 lb. 117—Metal **69c** 118—Plastic—Ea. **69c**



### CANTEEN CUPS

All metal. Folding handle. Wgt. 1 lb. No. A120—Each... **25c**

### CANTEEN COVERS

Heavy canvas. Button fastener. New No. 530—Each... **69c** Used No. 119—Each... **35c**

### ARMY BANDOLIERS

Of fine heavy khaki. Big roomy pockets with snap button fasteners. Fine for hunters, campers, boy scouts, etc., also for shop work in carrying small parts, etc. Material alone is worth this price. Shp. wt. 1 lb. 11 Pocket Type No. 129 Each **49c** 5 Pocket Type No. 128 Each **29c**



### WOOL BLANKET

Full size and 100% wool. Used but renovated for reuse. Use for camping, etc. Shp. wgt. 3 lbs. No. 233—Each... **\$4.89**



### BAYONET BLADE

Fine forged steel. Ground but not polished. May be made into throwing or hunting knife or spear. Blade 6 3/4 x 3/8 inches, 1 1/2 inches overall. Will take and hold a fine edge. Shp. wgt. 1 lb. No. 664-R—Each... **49c**



### PROF. TELEGRAPH KEY

Purchased from the gov't. Finest design and construction. Base measures 3 3/4 x 3 inches. Original value \$2.50. All parts of instrument brass. Adjustable. A-147. Each... **98c**



### LIFE PRESERVER BELTS

Right from the invasion beaches. Consists of two air chambers. May be inflated automatically with "sparklet" cartridges or manually by attached hose. Adjustable in waist size. One air chamber guaranteed air tight—other may need a tire patch. All belts are used and slightly soiled but a bargain at this low price. No. 1261—Each... **\$1.00**



### SPARKLET CARTRIDGES

May be used with above belts. In boxes of 10. Stock No. 254. Per Box... **50c**

# WAR SURPLUS AND HUNDREDS OF OTHER BARGAINS

### POPULAR RECORD ASSORTMENT



Fifty records of modern dance, race, blues and hillbilly selections. No two alike. Famous name bands and artists included. Used in juke boxes, but guar. perfect. Shipped exp. collect only—no exchanges or refunds. Wgt. 28 lbs. No. A303—50 records... **\$9.64**

No. A300—25 Records. All Dance. Wgt. 14 lbs. **\$4.88**

No. A301—25 Records. Hillbilly, Race and Blues. Wgt. 14 lbs. Set... **\$4.88**

No. 302—25 Records. All Hillbilly numbers. Wgt. 14 lbs. Set... **\$4.88**

### TELESCOPING BAIT AND FLY ROD

Combination 4 piece telescoping bait and fly casting rod. Screw locking reel seat. Cork grip. Snake guides. Extends to 9 feet, telescopes to 38 inches. Shp. wgt. 1 lb. No. F411—Each... **\$3.65**

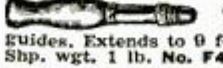

### SATCHEL POUCH

Heavy canvas pouch. Ideal for totting lunches, shopping, books, etc. Has 11x12 inch pocket. Brand new, guaranteed perfect. Has oversize flap with single strap fasteners. A113—Each... **\$1.69**



### RADIO HEADPHONES

Extremely sensitive with 4000 ohms resistance. Brand new and fully guaranteed. With moisture-proof cord and phone plug. A splendid value for the radio serviceman and experimenter. A106—PAIR... **\$2.95** New supersensitive phones. A108—Pair... **\$5.95**



### BINOCULAR CASE

Heavy cowhide, hand sewn. Die cut top for compass. Will fit 8x30 Bausch & Lomb or similar binocular. Wgt. 2 lbs. No. A191, Each... **\$2.95**



### CAVALRY SPURS

Genuine wishbone type cavalry spurs. Nickered brass. A102, Pair... **98c** A103 Spur straps per set of four... **50c**



### SHERRILL COMPASS

A finely balanced liquid immersion accurately calibrated compass with mtg. bracket. Measures 5x3 inches. Compensating adjustments. Worth much more. Shp. wgt. 5 lbs. No. A122, Each... **\$9.85**



### WOOL SLEEPING BAG

G.I. Type 100% wool with 30 inch Talon zipper. Used but renovated for reuse. Shp. wgt. 3 lbs. No. 165, Each... **\$3.95**



### 7 LB. EXPERIMENTER PARTS ASSORT. KIT



A "gold mine" for the radio serviceman. Hundreds of valuable radio parts, new radar and electronic parts and subassemblies, coils, resistors, trimming condensers—worth many times this low price. A130R—7 lbs... **\$1.79**

### LEVEL WIND ANTI BACK LASH

Highest quality with chrome plated frame: 3 piece take down design, 4x 5/8" S & F S. Bronzed bearings and jeweled spool caps. Spool diameter 1 1/2 inch; pillar length 1 1/2 inch. Capacity 100 yard line. Onyx head ring. Shp. wgt. 1 lb. No. 450F—Each only... **\$8.55**



### RAIN SUITS

New 2 piece rain suits. Of durable wear resisting water and wind repellent OD fabric. Bib style pants, zipper fly. Jacket has parka attached. Guaranteed 100% weatherproof. Small, medium and large sizes. Shp. wgt. 3 lbs. No. R549. Ea. **\$4.95**



### 2 Man Mountain Tent

Regulation Army type two man mountain tent, complete with poles, guy ropes, etc. Of durable nylon with reinforced seams. Ideal for outdoorsmen, campers, etc. Shp. wgt. 10 lbs. A splendid value. Stock No. 202—Each... **\$9.95**



### PUP TENTS

Regulation Army Pup Tents of durable, brown canvas. Used, but in good condition. Fine for campers, outdoorsmen, boy scouts, etc. Wgt. 8 lbs. A100—Tent only **\$3.95** A110—Tent, new... **\$7.95** A101—Ropes, wooden poles and stakes for above. Per set **\$1.00**



### 27 LENSES, ALL NEW, PERFECT.

For experimental work in optics. Consists of 27 precision ground and polished prisms and lens elements in assorted diameters and focal lengths. Big variety, positive, negatives, etc. Actual value over \$100.00. A519—27 PIECES... **\$7.95**



### 50 LENSES SEMI-FINISHED

Lenses similar to above but not polished. All are blanked and formed ready for polishing. Negatives, positives and prisms in Crown and Flint glass. Worth many times this low price. A520—50... **\$1.95**



### ONE MAN RUBBER BOAT

Similar to above but smaller. Designed for one man use. Each boat complete with oxygen tank—packed in a special parachute bag. Wgt. 15 lbs. No. 526—Each... **\$17.95**

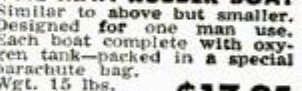

### METAL TOOL CHEST

All metal welded construction 16x 8 1/2 x 11 overall. Has 5 roomy, easy sliding drawers. Hinged drop front. Metal top and end handles. Use it for tools, small parts, etc. Shp. wgt. 48 lbs. Stock No. 282, Each... **\$9.75**



### CAMERA TRIPOD

Purchased from Gov't. Used but perfect. For cameras up to 8x10 inches. Folds to 32 inches, extends to 58 inches. Needs adapter to mount camera. Wgt. 5 lbs. Stock No. 190, Ea. **\$4.95**



### ORDER DIRECT FROM THIS AD

Values galore! Hundreds of hard-to-find items for home, shop and outdoors. Make remittances by money order, bank draft or personal check. Send 25% deposit on C.O.D. orders. No C.O.D.'s on orders for less than \$5.00. Include sufficient postage on parcel-post orders—any overage will be promptly refunded. All quotations F.O.B. Chicago. Used items and materials are guaranteed serviceable and as described. Your money back if not more than satisfied.

**Big Illustrated Catalog Free**  
WRITE FOR YOUR COPY TODAY

# STARK'S

Dept. PM647  
509 So. State St.  
CHICAGO 5, ILL.



# UTILITY CABINET

36 ROOMY COMPARTMENTS  
4 - 7" Drawers  
With Removable  
Partitions

A Thousand Uses For  
**HOBBYISTS  
MECHANICS  
DRAFTSMEN  
TECHNICIANS**



For home workshop, factory,  
laboratory, garage, outdoors,  
fishing and hunting.



Made of heavy gauge aluminum. Strong  
airplane construction. Sag proof—  
Rust proof.

**Cabinet \$2.98 (plus postage)**  
**SINGLE TRAY WITH COVER 60c**  
**Two trays \$1 (postage prepaid)**

— Cut out this coupon and send with money —

NAME \_\_\_\_\_

ADDRESS \_\_\_\_\_

CITY \_\_\_\_\_ STATE \_\_\_\_\_

Enclosed find check or money order for \$ \_\_\_\_\_

Cabinet \$2.98  Single Tray 60c  Two Trays \$1.00

**THE KNICKERBOCKER CORP. MANTENO, ILL.**

THE *Natural* WAY  
TO LIGHT A PIPE

- Windproof
- Lightweight
- Large Flame



DOWN-DRAFT CHIMNEY-ACTION



**\$3.50**

AT YOUR  
DEALER

Unconditionally Guaranteed

**Nimrod  
PIPELITER**

If your dealer is unable to supply you, send \$3.50 direct.

WARD-NIMROD COMPANY

Dept. 35-C, 2968 Jessamine St., Cinti. 25, Ohio

Make Up To **\$600**  
An Hour!



Operate Your OWN Home-  
Weaving Business With **AMAZING**  
New **DEEN Power Loom!**

Make yourself financially independent! Start a steady business  
of your own . . . right in your home! Earn **BIG PROFITS** by  
weaving thousands of different designs of rugs on the new easily  
operated Deen Power Loom. Machine will automatically weave  
ten yards of beautiful intricate designs every hour.

**DEEN LOOM TAKES UP LITTLE SPACE.** You can put this  
marvelous weaving machine in a corner of your living room,  
basement, garage, or spare bedroom. Then later on, as your busi-  
ness expands, you can move into regular business establishment.

**IDEAL BUSINESS FOR HANDICAPPED PEOPLE** such as  
veterans and persons handicapped by loss of sight or limbs, and  
those unable to do strenuous labor. Loom is simple to operate  
. . . a child can run it. Any rug design you wish can be woven  
by merely changing paper guide pattern.

**ORIGINAL INVESTMENT CAN BE RETURNED IN  
THIRTY DAYS.** A small investment gets you started in your  
own business right away. Deen Loom has capacity of from  
eighty to one-hundred yards a day . . . in only one month it is  
possible to get back your original investment. Demand for home-  
woven rugs is **GREATEST IN HISTORY. DON'T DELAY**—  
start making plans for your own business NOW. Write today for  
free descriptive booklet and full information. Address Dept. 31,  
DEEN LOOM DIVISION.

**THE GIBSON CO., World Herald Bldg., Omaha, Neb.**

"Makers of DEEN Looms — FAMOUS Since 1895"

Remarkable Invention  
**QUICKLY  
INFLATES TIRES**



**SIMPLE!  
AUTOMATIC!  
CLEAN!**

Lightweight!  
Handy!  
Carry It  
In Your Car!

Don't put yourself on the spot with tire trouble! It's not funny  
to be caught with flats, small punctures, or a slow leak when  
help is out of sight and you're in a hurry.

**Now! Be Prepared . . .**

with the new, modern on-the-road emergency aid. Carry a handy,  
lightweight Diamond Emergency Unit in your car—the miniature-size  
steel cylinder containing compressed CO<sub>2</sub> that inflates tires instan-  
tly, automatically. Nothing to it! No pumping, towing, or struggling  
with dirty tools. Simply attach and open valve. In less than three  
minutes you can be on your way. Safe, odorless, stainless carbon di-  
oxide even helps preserve tires.

**PUT OUT FIRES, TOO!**

(No car or truck engine is fire proof.) Crowds out oxygen in split sec-  
ond—smothers oil, gas, and electrical fires. Without even raising the  
hood—you can extinguish engine fires! Size—12 3/4" x 1 3/4". Weight—2  
lbs., 6 oz. Get Diamond Emergency Unit NOW—only \$6.45.

**SEND NO MONEY** Simply mail name and address. On delivery,  
pay postman \$6.45 plus C.O.D. charges. Order  
today or write for details.

**THE AKRON LAMP & MFG. CO. 106 HIGH STREET  
AKRON 11, OHIO**



# MILLIONS of War Surplus "GADGETS"

The following seven carefully selected surplus items are all components of the A-5 Sperry auto-pilot, used to guide bombers throughout the world! Original cost of these items totaled many thousands of dollars; we offer them now at little more than 1% of original cost! Weights shown are packaged weights.

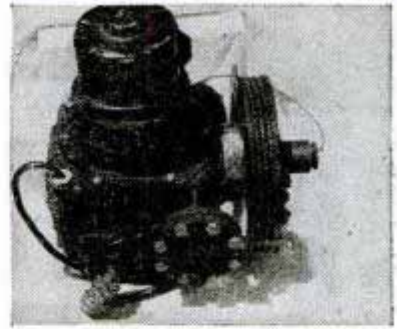

**1. SERVO UNIT**, a combination hydraulic cylinder and electric type actuating unit. Includes Holtzer-Cabot 1/10 hp 24 volt DC motor (6000 rpm), gears, shafts and many other valuable items. **NEW! Weight 23 lbs. . . . . \$8.95**

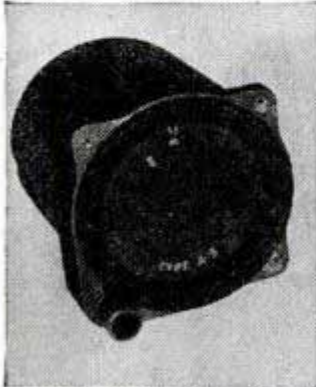

**2. INDICATOR**, Pilot Director, Sperry. Includes autosyn motor, indicator face, etc. **NEW! Weight 2 lbs. \$1.95**



**3. AMPLIFIER**, for rudder servo. Includes 4 tubes: two 1632, one 1633, one 1634; condensers, transformers, switches, resistors, terminals, tube sockets, chassis, etc. Ideal for radio hams, etc. **NEW! Weight 5 lbs. . . . . \$2.95**

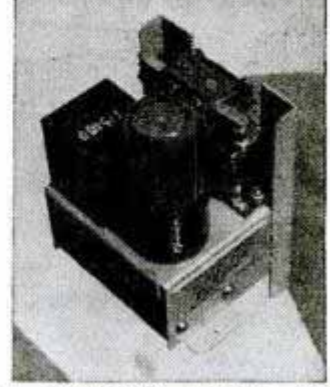

**4. AMPLIFIER**, erection type. Contains one 1633 tube, transformer, relay, condensers, registers, socket, chassis, etc. **NEW! 2 1/2 lbs. . . . . \$1.45**



**5. GYROSCOPE**, Directional. Has a fine precision electric 110 volt AC gyro mounted in brackets, one autosyn transmitter generator, one 110 volt AC motor (small) 3 phase, 11 electro-magnets, bearings, gears, slip rings, plugs, etc. A beautifully built expensive unit chuck full of gadgets! **NEW! Weight 14 1/2 lbs. . . . . \$9.95**



**6. CONTROL UNIT AND PANEL**, Sperry. This is the unit that controls the units that fly the huge bomber by electronics! **SIZE 7 1/2"x8"x4 1/2"**. A gold mine! Includes 6 toggle switches (retail price \$2.55 each), two three way switches, 3 indicators (can be used as amp, or volt meters using own calibrations), plugs, resistors, etc., etc. **Weight 6 1/2 lbs. . . . . \$5.95**

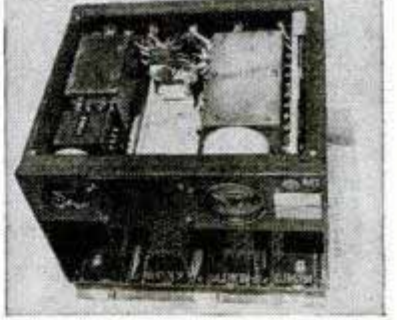

**7. AMPLIFIER RACK, ASSEMBLY**, Auto-Pilot A-5, Sperry. This assembly is the electronic device that the servo amplifiers were used. Is not merely a rack but a complicated assembly that is filled with many many valuable items to gadgeteers. **Size of assembly is 14"x10"x12"**. As pictured, it includes the 2 1/4" dial type AC volt meter, 0 to 120; Frequency meter 350 to 450 dial size 3 1/4"; many fine relays; capacitors, resistors, condensers, plugs, screws, nuts, etc. **Weight 25 lbs. . . . . \$8.95**

**AUTOMATIC PILOT LOT:** The above seven assemblies may be purchased in one single lot **\$34.95** for only . . . . .

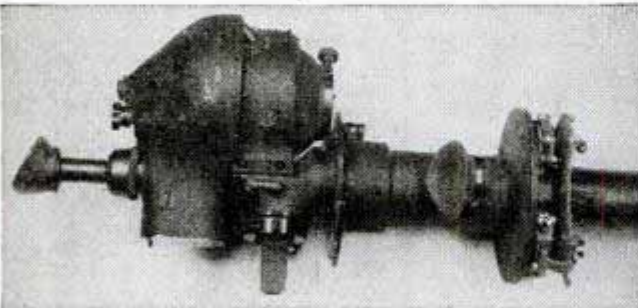

**8. AIRFORCE DRIFT METER, TYPE B-3.** Built to close precision tolerance by Bendix for Bombers. Overall length 47". Net weight 24 lbs. Contains many valuable unreplaceable items such as precision lenses, eyepieces, switches, electric gyroscope, filters, prisms, scales, etc. Invaluable to the experimenter. Used to determine drift of aircraft in flight. Cost many hundreds of dollars! Shipping weight app. 40 lbs. Slightly used. A bargain at only **\$19.95**

**9. TRIPLE OUTPUT DYNAMOTOR.** Input voltage 24 volts, output is 300, 150 and 14.5 DC; rpm 6000, cont. duty, temp. rise 50C. Has voltage regulator, fan, etc. **Weight 20 lbs. Less than 1% original cost, used condition. . . \$6.95**

**10. AIRCRAFT MACHINE SCREW AND RIVET ASSORTMENT.** All new, ten sizes and types of screws as well as alum. rivets. Not mixed but in separate boxes. Including a metal tool box. **Weight 27 lbs. All this for. . . \$9.95**

**11. ULTRA-HIGH FREQUENCY RECEIVER,** Aircraft marker beacon receiver, 75 megacycles, can be used on either 12 or 24 volts, uses two tubes, etc. Circuits furnished. Slightly used. **Weight 4 lbs. \$9.95**

**12. DUAL CYLINDER HEAD TEMP. GAGE,** 0 to 350 deg. C, when properly wired can be used to record temperature of water, oil, cylinder heads, etc. (Wires not furnished). Has two sensitive micro-amp jeweled movements. **NEW, Weight 2 lbs. . . . . \$6.95**

**13. INTERPHONE AMPLIFIERS TYPE RL-7.** Includes tubes, coils, condensers, phone plugs, mike plugs, fuse holders, receptacles, switches, 24 volt dynamotor (250 volts output), as well as many more fine parts. **Weight 8 lbs. . . . . \$9.95**

**14. RADIO HEADPHONES AAF TYPE,** used good condition, **weight 1 lb. . . . . \$1.10**

**15. RADIO THROAT MIKE AAF TYPE,** used good condition, **weight 1 lb. . . . . \$1.00**

**16. MALLORY RADIONOISE FILTER;** For cutting noise between radio and motor, etc. **NEW! Weight 2 lbs. . . . . \$1.29**

**17. STAINLESS STEEL AIR TANK.** Used by AAF for oxygen, 24" long, 6" diameter. High pressure range up to 400 lbs: 500 cu. in. volume. Pipe fittings each end. Can be used for air pressure, air horns, boat buoys, markers, etc. **Stainless steel, Weight 5 lbs. . . . . \$3.95**

**IMPORTANT:** We pay no shipping charges! Include adequate on cash orders to pay charges or we will ship collect charges. No orders accepted for less than \$2.00. No C.O.D. shipped unless 20% deposit made in advance. App. shipping weight of each item is listed.

**AERO INSTRUMENT COMPANY** MUNICIPAL AIRPORT HOUSTON 12, TEXAS



# SOUTH BEND LATHES

**FOR PRECISION WORK**

Built for precision machining, South Bend Lathes are ideal for all kinds of fine work. Their dependability has been proved in every type of shop—from the smallest to the big toolrooms, laboratories, and production lines of large industries.

They give you the best of everything. Accuracy that is more than adequate for exacting jobs. A versatility for efficient machining on all types of operations. And the ease of operation and rugged durability that have made South Bend Lathes favorites of craftsmen everywhere.

Prices are only slightly higher than pre-war—and improvements developed to meet exacting war production requirements give you greater dollar value. Write for catalog, stating size of lathe in which you are interested: 9", 10", 13", 14½", or 16" swing.



**SOUTH BEND LATHE WORKS**  
BUILDING BETTER LATHES SINCE 1906  
455 EAST MADISON STREET • SOUTH BEND 22, INDIANA

## COLLET ATTACHMENT

One of more than 60 attachments and tools available for South Bend Lathes that provide greater versatility. Write for Catalog 77 which illustrates and describes all of them in detail.

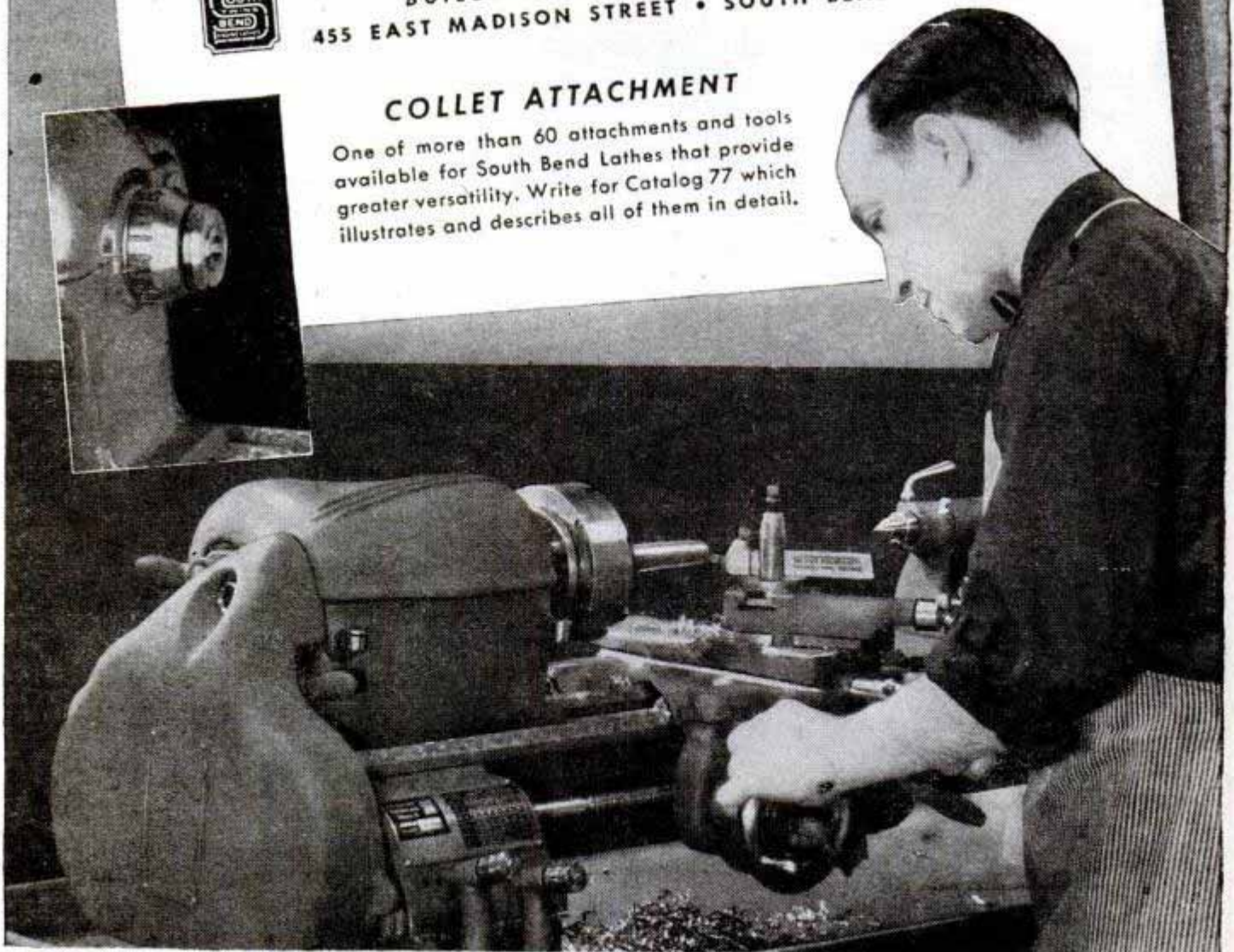



# SPEAKING OF RECORDS by FRANK WILLIAMS

HOLDER OF EVERY OFFICIAL  
WORLD'S BACKSTROKE RECORD FOR MEN—

## ADOLPH (SONNY) KIEFER

...BEATS MOST FREE-STYLERS  
SWIMMING ON HIS BACK!

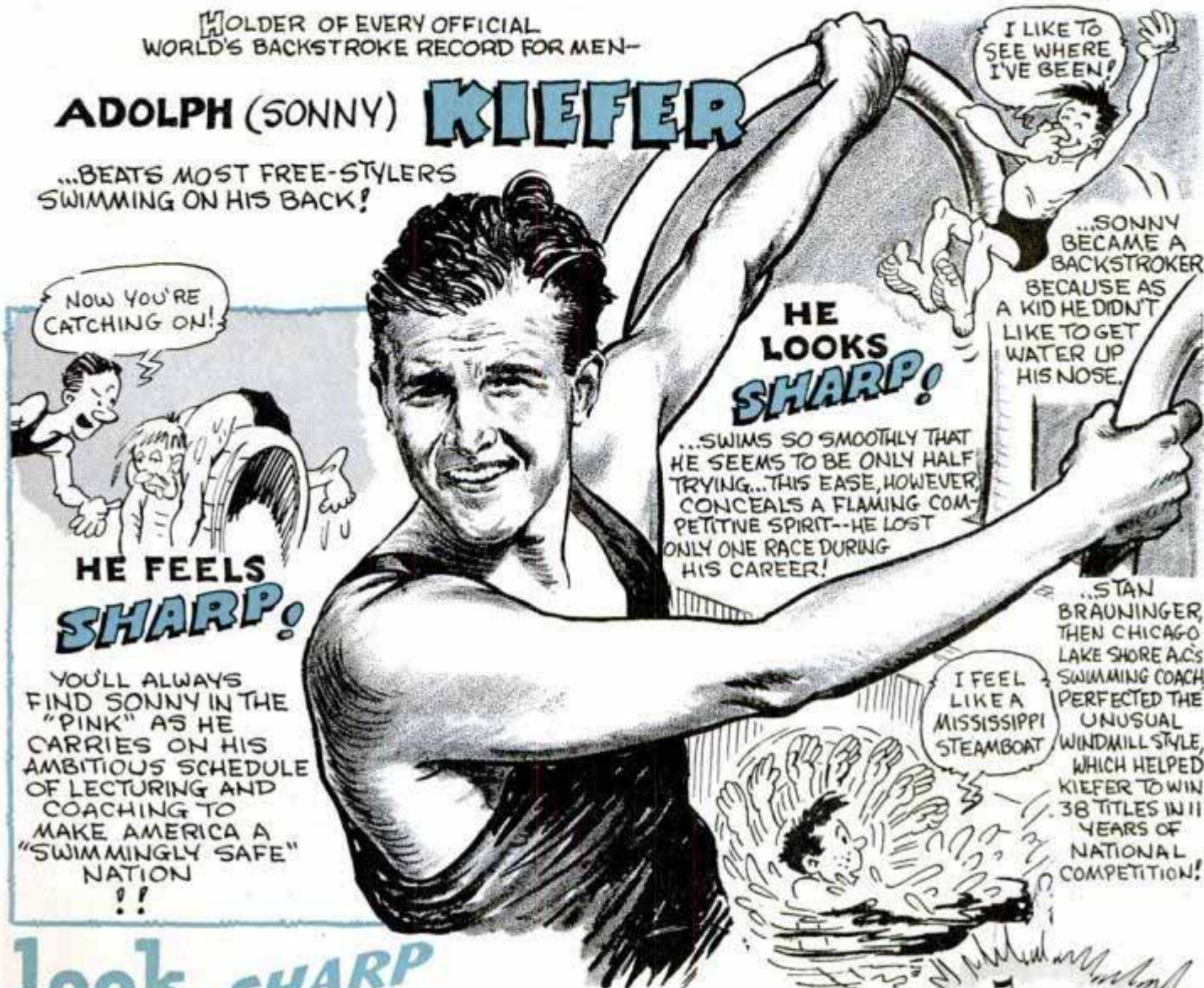

NOW YOU'RE  
CATCHING ON!

I LIKE TO  
SEE WHERE  
I'VE BEEN!

HE  
LOOKS  
**SHARP!**

...SONNY  
BECAME A  
BACKSTROKER  
BECAUSE AS  
A KID HE DIDN'T  
LIKE TO GET  
WATER UP  
HIS NOSE.

...SWIMS SO SMOOTHLY THAT  
HE SEEMS TO BE ONLY HALF  
TRYING...THIS EASE, HOWEVER,  
CONCEALS A FLAMING COM-  
PETITIVE SPIRIT--HE LOST  
ONLY ONE RACE DURING  
HIS CAREER!

HE FEELS  
**SHARP!**

YOU'LL ALWAYS  
FIND SONNY IN THE  
"PINK" AS HE  
CARRIES ON HIS  
AMBITIOUS SCHEDULE  
OF LECTURING AND  
COACHING TO  
MAKE AMERICA A  
"SWIMMINGLY SAFE"  
NATION  
!!

I FEEL  
LIKE A  
MISSISSIPPI  
STEAMBOAT

...STAN  
BRAUNINGER,  
THEN CHICAGO  
LAKE SHORE A.C.'S  
SWIMMING COACH  
PERFECTED THE  
UNUSUAL  
WINDMILL STYLE,  
WHICH HELPED  
KIEFER TO WIN  
38 TITLES IN 11  
YEARS OF  
NATIONAL  
COMPETITION!

look **SHARP**  
feel **SHARP**  
be **SHARP**

use  
**Gillette**  
**Blue Blades**  
with the **SHARPEST** edges  
ever honed!

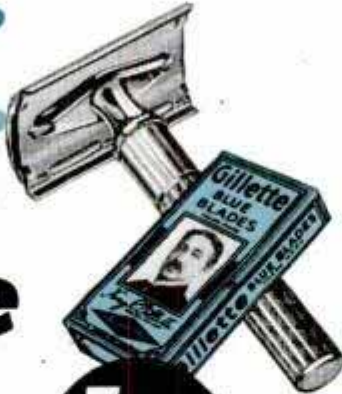

5 for  
25¢

HE IS **SHARP!**

YES SIR, SONNY KIEFER ALWAYS USES  
**GILLETTE BLUE BLADES**  
WITH THE SHARPEST EDGES EVER HONED.  
THAT'S BECAUSE THEY GIVE HIM  
THE SLICKEST, MOST REFRESHING  
SHAVES MONEY CAN BUY.  
ALSO-- HE KNOWS THAT  
**DOUBLE EDGES MEAN  
DOUBLE ECONOMY!**

● You *look* sharp for you enjoy the swellest shaves ever. You *feel* sharp because they're refreshing and give you a lift. You *are* sharp for you get far more shaves per blade and save money. Ask for Gillette Blue Blades.

ENJOY BOXING  
EVERY FRIDAY NIGHT  
OVER ABC NETWORK. GILLETTE'S CAVALCADE OF SPORTS  
ALSO AIRS THE ALL-STAR BASEBALL GAME, JULY 8, AND  
OTHER CLASSICS YEAR 'ROUND.

**Gillette Safety Razor Company, Boston 6, Mass.**

Copyright, 1947, by Gillette Safety Razor Company



FOR *Dependable* BALL TIP WRITING



Color photograph by John Paul Pennebaker

# SHEAFFER'S *Stratowriter*

- QUICK NOTES AND CASUAL WRITING
- MAKING MULTIPLE CARBONS AND STENCILS
- ADDRESSING PACKAGES
- MEMOS WHILE TELEPHONING
- WRITING ORDERS
- WRITING ON ALMOST ANY SURFACE
- WRITING AT ANY ALTITUDE IN ANY CLIMATE

SHEAFFER'S STRATOWRITER is the *dependable* ball-tip writing instrument! Its factory-installed supply of Strato-Ink—Red, Blue or Green—is thoroughly permanent. It writes a smooth, even line several miles long. When re-filling does become necessary, the internal unit, including point, will be exchanged at reasonable cost by your Sheaffer dealer. Gold-filled, jewelry-fine, sleek and trim—Stratowriter is the finest instrument of its type—as any comparison, any test, will speedily convince you! \$15.00, tax included.

W. A. Sheaffer Pen Company, Fort Madison, Iowa, U.S.A.

Listen Every Sunday to SHEAFFER'S  
PARADE with Carmen Cavallaro—  
NBC Complete Network:  
2 P.M. E.S.T.; 3 P.M. E.D.T.

## SHEAFFER'S

Listen Every Saturday to  
SHEAFFER'S ADVENTURERS CLUB—  
CBS Complete Network:  
10:30 A.M. E.S.T.; 11:30 A.M. E.D.T.

Copyright 1947, W. A. Sheaffer Pen Co.