

MAY 1947



POPULAR MECHANICS

MAGAZINE

WRITTEN SO YOU CAN UNDERSTAND IT

REG. U.S. PAT. OFF. TRADE MARK GREAT BRITAIN NO. 40325



CHANNEL-WING PLANE
PAGE 81

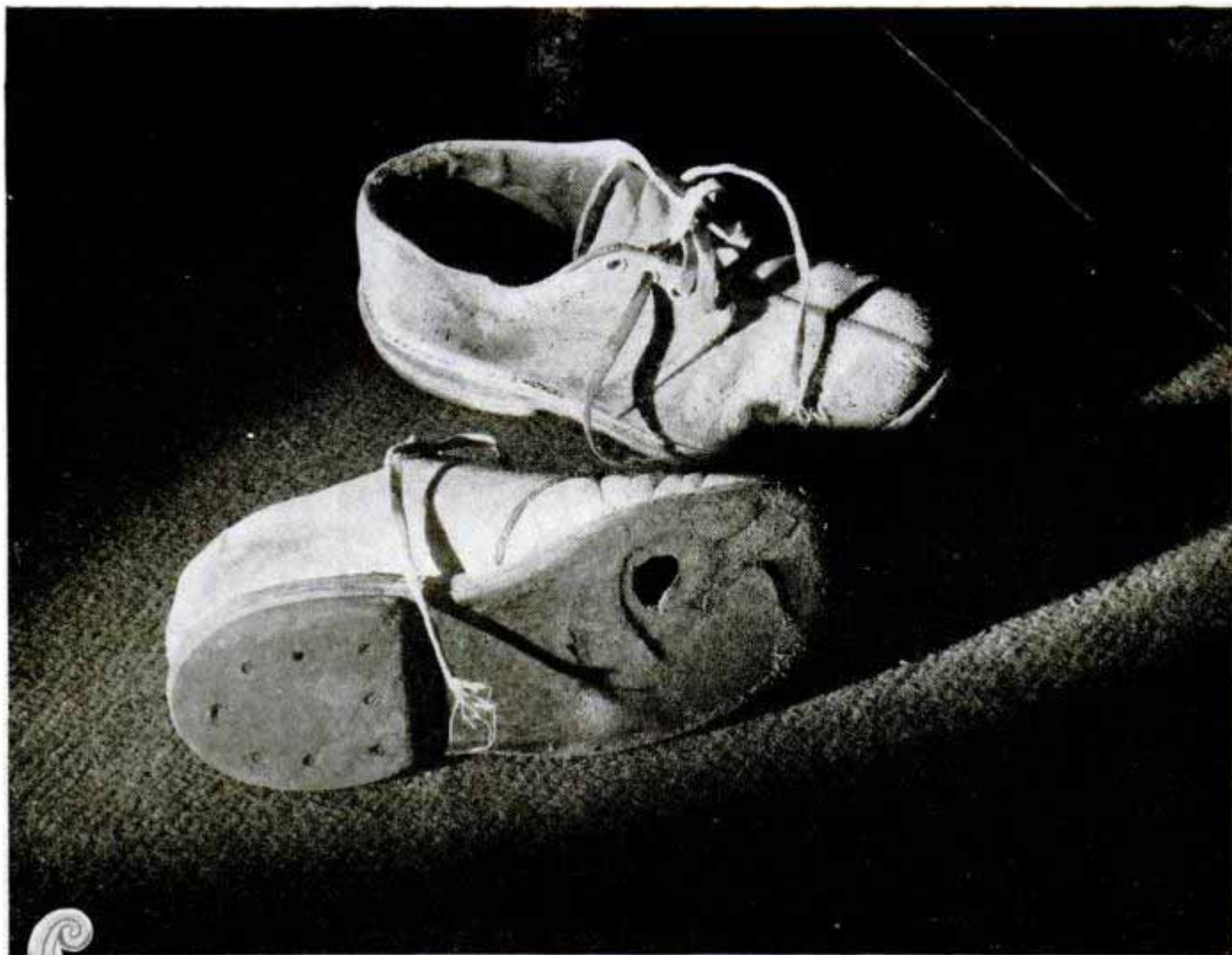

Piston Rings wear out, too

Piston rings are *replacement* parts . . . they're made to "take" the wear . . . to protect your engine . . . to be replaced again and again. And the sooner you replace worn-out rings, the longer your engine will last . . . the better and more economical it will run.

When smoke, excessive oil-consumption and half-hearted engine performance first warn that you need new piston rings, play safe—install Hastings rings, at once.

They *stop* oil-pumping and *check* cylinder wear . . . they *restore* engine performance and *prolong* engine life.

Remember that name—Hastings Piston Rings—the best money you can spend on your car.

HASTINGS MANUFACTURING COMPANY, HASTINGS, MICH.
Hastings Ltd., Toronto



HASTINGS

STEEL-VENT PISTON RINGS

TOUGH on Oil-pumping
GENTLE on Cylinder Walls

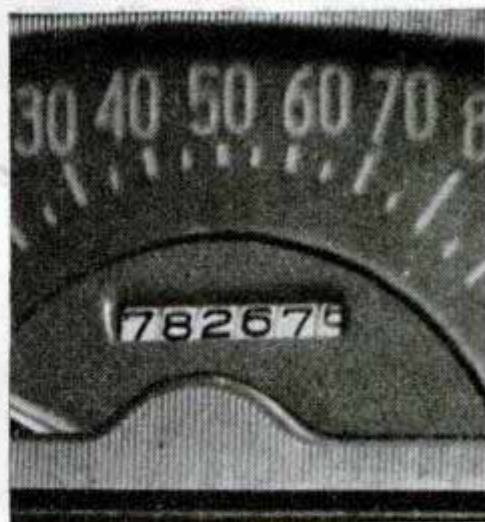

TYPICAL EXAMPLE: THE B. F. GOODRICH TIRE THAT OUTWEARS PREWAR TIRES

THE B. F. GOODRICH tires on the cab shown above had already gone over forty thousand miles when these pictures were taken and were still in good shape to be recapped.

Reporting on these tires, L. R. Lane, Jr., of the Yellow Cab Company, Marion, Ohio, says:

"As you know, in taxi service, it is necessary to operate our cars on all types of streets and roads in all kinds of weather. In addition, we believe the tire has been subjected to an abnormal number of starts and stops.

"Based on our experience with the new B. F. Goodrich passenger

car tire, we believe that it will outwear prewar tires even in adverse conditions.

"Speedometer reading at time tires were put on was 35,062. Photos were taken at 78,267. Mileage on tires is now 43,205, and as you see, they are about ready for recapping."

One reason you get more mileage out of a B. F. Goodrich tire is that it carries a broader, flatter tread—puts more rubber on the road, spreads wear over a greater area. Because B. F. Goodrich engineers found that this wider, longer-lasting tread requires extra strength in the sidewalls,

B. F. Goodrich tires today are being made with a new, stronger body. It is this body-tread combination which makes possible a tire that *outwears prewar tires*.

Most people who need tires can now get the new B. F. Goodrich Silvertowns! Some sizes are still scarce, of course, but most dealers have a fair assortment right in stock. Talk to your B. F. Goodrich dealer—you may not have to wait at all. *The B. F. Goodrich Company, Akron, Ohio.*

B.F. Goodrich
FIRST IN RUBBER



*Bing
Leatherman
Ed, Sasser
Dennis
Allison
H. L. Bailey
Pineville, La.*

"Hawaiian Wigglers Are Tops!"

Dear Fred:

"I always look for your advertisements in the outdoor magazines just to see the pictures of the big ones the other fellows are catching in other parts of the country.

"Enclosed are pictures of one morning's catch in central Louisiana waters. My three friends and I were all using your shallow running No. 2 Hawaiian Wigglers. With us Hawaiian Wigglers are tops and our favorite bait." — Ed L. Sasser, Pineville, La.



No. 2 Hawaiian Wiggler
Shallow Running

\$1.10 ea.

Write For Free Catalog

It is beautifully illustrated in colors and has many photographs of record catches made with my Hawaiian Wigglers, Jitterbugs, and Hula Dancers.

Colored Movies Available

We have several reels of colored movies taken of bass fishing in Canada, Michigan and Florida. These are available without cost for showing to clubs.

FRED ARBOGAST & CO., 1605 North St., Akron 3, Ohio

Popular Mechanics Magazine

Registered in U. S. Patent Office and Canada

H. H. WINDSOR, Founder

H. H. WINDSOR, Jr., Editor and Publisher

Next Month

WHERE do we go from here, scientifically speaking? Charles F. Kettering, research genius of General Motors Corporation, brings you the answer to this question in a June article: "Where Are Our New Frontiers?"

PART II of the story of *Popular Mechanics'* Build-It-Yourself House appears in the Craftsman section of this issue. Coming next month is a blow-by-blow account of how the roof and siding were applied. Then you step indoors to watch war veteran Jacques Brownson and his wife erecting and plastering partitions, hanging doors, laying floors and installing fixtures.

HOP aboard one of the new super-trains described in "Dress Parade on Rails," a June feature. While whizzing across the country at 100 miles an hour you can make a phone call, have your hair cut or see a movie.

NOW that fishin' time is here, sportsmen will turn to next month's Craftsman section for a lesson in bait casting.

HUMAN engineering has joined the coaching staff to create better athletes. Dr. Franklin Henry of the University of California tells "What Makes an Athlete Tick," an especially timely article as America's Olympic challengers go into training for '48.

WANT to find out how good a driver you are? A feature in the June Craftsman section describes a number of easy-to-build devices for testing the individual's ability behind the wheel.

YOU can play records through any radio set in your home with the one-tube "wireless" record player described in the Radio and Electronics pages next month.

Volume 87 MAY 1947 Number 5

Managing Editor.....Roderick M. Grant
Assistant Managing Editor.....Wayne Whittaker
Shop Notes and Crafts Editor.....James R. Ward
Radio and Electronics Editor.....Frank L. Brittin
Aviation Editor.....Aubrey O. Cookman, Jr.
Associate Editor.....John R. Kinsey
Eastern Editor.....Bill Reiche
Western Editor.....Thomas E. Stimson, Jr.
Art Director.....Frank Beatty

Assistant Editors

Donald R. Brooks Clifford B. Hicks Virgil T. Swanson

Assistant Editors, Shop Notes and Crafts

W. Clyde Lamme Wayne C. Lecky John F. Shrock A. E. Youngquist

In This Issue

The Wing That Fooled the Experts	81
The Mechanics of Batting	91
Shoot From the Sidelines	97
Report From Antarctica	108
New Engines From Old	114
Fencing In the Waterways	122
Brazil's One-Man Boom	129
They Tailor Their Own Cars	139
Silver Sheds the Overalls	146
Get Ready for Camp	156
Ultrasonics—Magic Energy	161

For the Craftsman

The Build-It-Yourself House	168
A Home of 1000 Addresses	178
Motor-Driven Paddle Board	193
Color-Photo Processing Unit	200
Rotary Lawn Mower	209
Cutting Heavy Metal With a Jigsaw	217
Radio and Electronics	221

[Table of Contents Continued on Page 8](#)

Published monthly by POPULAR MECHANICS COMPANY, 200 East Ontario Street, Chicago 11, Ill. H. H. Windsor, Jr., president; Paul H. Dunakin, vice president and general manager; D. F. Windsor, vice president and secretary-treasurer; William Harrison Petridge, vice president and assistant to the publisher; Clover L. Perkins, advertising manager; Alan M. Deyoe, circulation manager. Single copy in the United States and Canada, 25 cents; subscription rates in United States and possessions, Canada, and countries of the Pan-American Postal Union, 1 year, \$2.50; 2 years, \$4.50; 3 years, \$6.00. To all other countries add \$1.00 a year over United States prices for overseas postage. If you plan to move, notify us at least 60 days in advance so you will not miss an issue. Give both old and new addresses. Entered as Second Class Matter, September 15, 1903, at the Post Office at Chicago, Illinois, under Act of March 3, 1879. Entered as Second Class Matter at Post Office Dept., Canada, Copyright 1947, by Popular Mechanics Company, Copyright under International Copyright Union, Copyright in France. All rights reserved under Pan-American Copyright Union. Printed in the United States of America.

Ingenious New Technical Methods

To Help You
Simplify Production

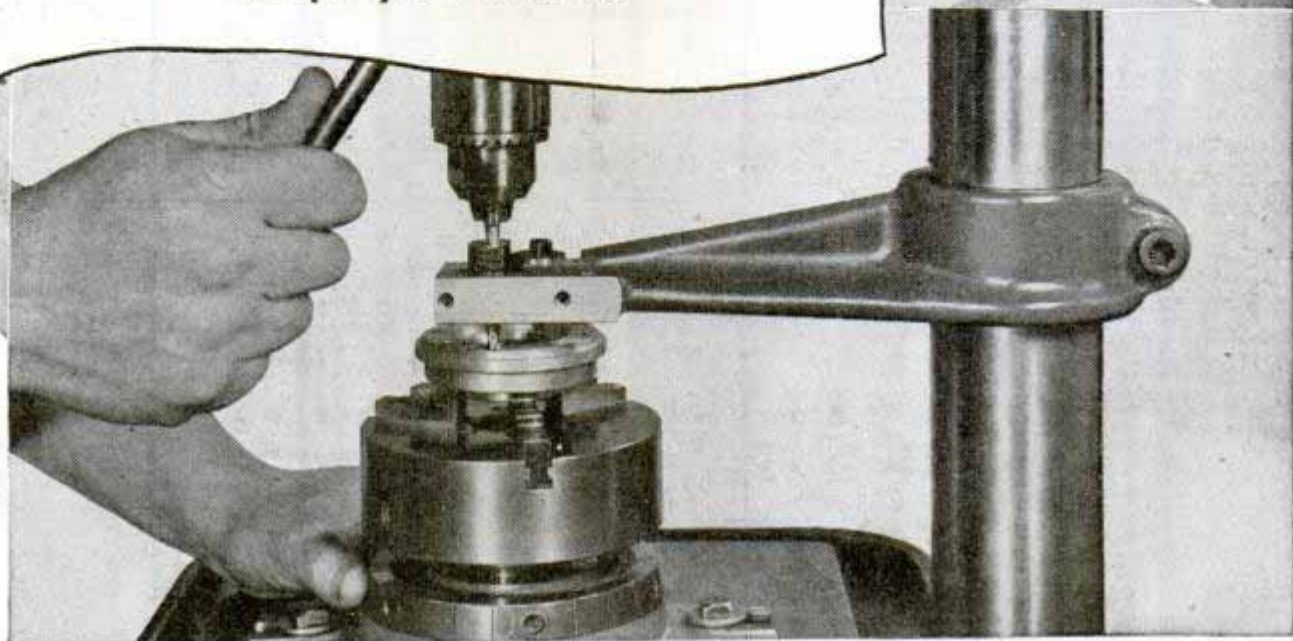

Precision Adapter for Drill Presses Perfects Alignment, Prevents Drift!

The new **Aetna Adapter**, of aluminum alloy, fits the columns of most small drill presses—assures accurate milling and deep hole drilling—without a drill jig. It firmly and accurately holds interchangeable drill bushings close to work.

Precision Alignment is accomplished through an eccentric aligning bushing, which once set needs no further adjustment. Filler bushings cover the entire bushing range up to $\frac{1}{2}$ ". Stops to locate the piece to be drilled, are attached to the press table or directly to the adapter. Milling chatter is avoided. Chip interference is eliminated. Overlapping holes can be drilled without punch marks, or indication of run-out, with drills as small as $\frac{1}{32}$ " diameter. $\frac{1}{4}$ " holes can be drilled more than 6" deep with as little as .006" drift.

Accuracy in work is achieved best by alert workers. That's why many plant owners make chewing gum available to all. The chewing action helps relieve monotony—helps keep workers alert, aiding them to do a better job with more ease and safety. And they can chew Wrigley's Spearmint Gum right on the job—even when hands are busy.

You can get complete information from
Aetna Mfg. Co., 250 Chicago Ave., Oak Park, Ill.

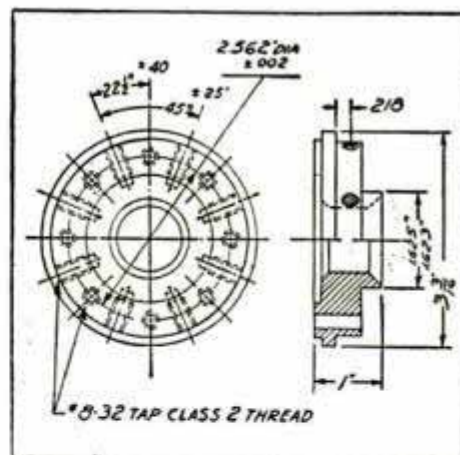

Example of piece drilled with Aetna Adapter



AB-63

**NO BREAKING IN
NO BITE
NO BITTER TASTE**

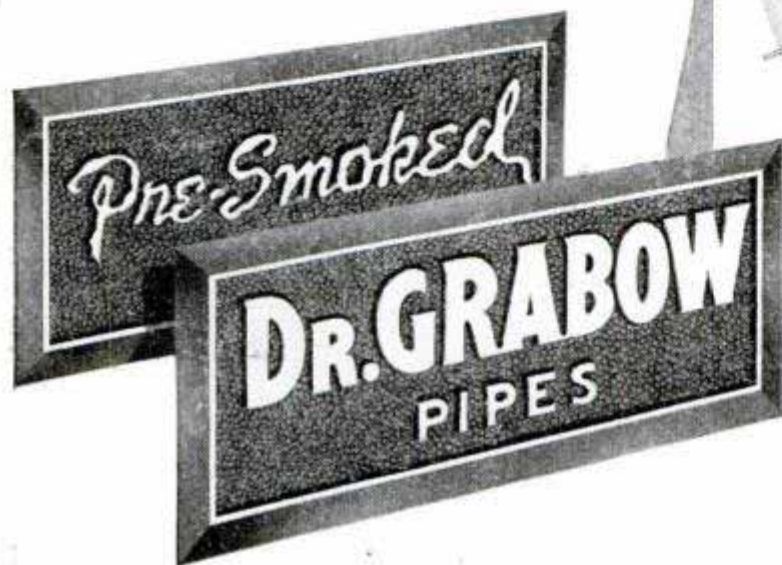

"Take a gander at the bowl, sir,—you can see that only a Dr. Grabow pipe is scientifically Pre-Smoked!"

Ripe'n' Ready for Smokin' Steady

SEE...

It's Pre-Smoked



Illustrated
DR. GRABOW
Tru-Grain...\$3.50

The DR. GRABOW Pre-Smoked Line

- SELECT GRAIN...\$5.00
- TRU-GRAIN...\$3.50
- SUPREME...\$2.00
- DELUXE...\$1.50

Fashioned by Linkman
DR. GRABOW PIPE COMPANY, INC.
Chicago 14, Ill.



You taste the fragrance of real tobacco from the very first puff of your new Dr. Grabow . . . *No Breaking In . . . No Bite . . . No Bitter Taste!*

The only correct way to break in a new pipe is to smoke it. Every Dr. Grabow is Pre-Smoked at the factory . . . actually under fire . . . with fine tobacco (Edgeworth) on Linkman's exclusive pipe smoking machine . . . duplicating the slow, deliberate puffing of an experienced smoker. Here is the most important advancement in pipe smoking history . . . ripe and ready for smoking steady.

Ask your dealer for Dr. Grabow Pre-Smoked Pipes . . . all equipped with special aluminum fittings.



**KNOWLEDGE
THAT HAS
ENDURED WITH THE
PYRAMIDS**

A SECRET METHOD FOR THE MASTERY OF LIFE

WHENCE came the knowledge that built the Pyramids and the mighty Temples of the Pharaohs? Civilization began in the Nile Valley centuries ago. Where did its first builders acquire their astounding wisdom that started man on his upward climb? Beginning with naught they overcame nature's forces and gave the world its first sciences and arts. Did their knowledge come from a race now submerged beneath the sea, or were they touched with Infinite inspiration? From what concealed source came the wisdom that produced such characters as Amenhotep IV, Leonardo da Vinci, Isaac Newton, and a host of others? Today it is known that they discovered and learned to interpret certain *Secret Methods* for the development of their inner power of mind. They learned to command the inner forces within their own beings, and to master life. This secret art of living has been preserved and handed down throughout the ages. Today it is extended to those who dare to use its profound principles to meet and solve the problems of life in these complex times.

This Sealed Book—FREE

Has life brought you that personal satisfaction, the sense of achievement and happiness that you desire? If not, it is your duty to yourself to learn about this rational method of applying natural laws for the mastery of life. To the thoughtful person it is obvious that every one cannot be entrusted with an intimate knowledge of the mysteries of life, for everyone is not capable of properly using it. But if you are one of those possessed of a true desire to forge ahead and wish to make use of the subtle influences of life, the Rosicrucians (not a religious organization) will send you A Sealed Book of explanation without obligation. This Sealed Book tells how you, in the privacy of your own home, without interference with your personal affairs or manner of living, may receive these secret teachings. Not weird or strange practices, but a rational application of the basic laws of life. Use the coupon, and obtain your complimentary copy.

The ROSICRUCIANS

SAN JOSE

(AMORC)

CALIFORNIA



**AMENHOTEP IV,
Founder of Egypt's
Mystery Schools**

*Use this
coupon for
FREE
copy of book*

SCRIBE K.K.V.
The Rosicrucians (AMORC)
San Jose, California

Please send free copy of Sealed Book,
which I shall read as directed.

NAME _____

ADDRESS _____

CITY _____

What keeps YOU from making more MONEY?



Just what is the matter—why aren't you making more money? Look around you. Probably many of the people you know are doing a lot better than you are.

What's the reason?

Your own native ability is probably just as good as theirs—probably nothing wrong with your personality and appearance.

But—they have something you lack. The fact that they have a better job and more money proves that. Success in business today is measured by the dollar sign.

The secret is this—the man who prepares himself for the job ahead—is the one who gets advancement and more money. He doesn't need "pull." The man who really has something on the ball—"push" enables him to get what he wants.

Ambitious men and women have found in LaSalle the way to get ahead in business. This has been going on for 38 years. Hundreds of thousands of students have enrolled—our files are full of grateful letters from people who have bettered their earnings and position through LaSalle.

Perhaps we can help you. You should at least find out. The coupon below will bring full information. Just check the field of your choice and we'll send you full information, without obligation—the money making possibilities in that field, and how you can prepare in your spare time at moderate cost.

For a brighter future in the business world—more money and a better job—send the coupon today. Tomorrow you might forget.
G. I. APPROVED.

LA SALLE Extension University a Correspondence Institution Dept. 564-R Chicago, Ill.

I want to better my position—make more money. Send me your free booklet on the field I have checked

<input type="checkbox"/> Higher Accountancy	<input type="checkbox"/> Expert Bookkeeping
<input type="checkbox"/> Foremanship	<input type="checkbox"/> Industrial Management
<input type="checkbox"/> Executive Management	<input type="checkbox"/> Traffic Management
<input type="checkbox"/> Law: I.L.B. Degree	<input type="checkbox"/> Salesmanship
<input type="checkbox"/> Stenotypy (Machine Shorthand)	

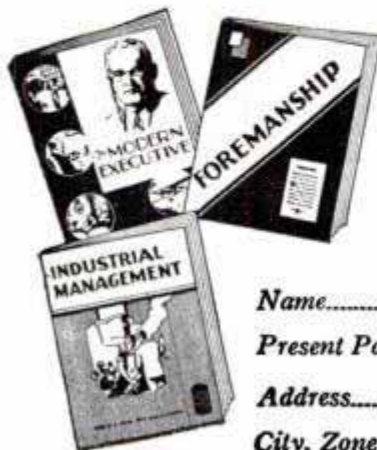

Name..... Age.....
 Present Position.....
 Address.....
 City, Zone and State.....

This One



LBTQ-OKZ-899E

Subtract
wear, corrosion
carbon, sludge...

Add
PYROIL
Add
MILES



The thoughtful thing to say when you drive up for gasoline or oil is "add Pyroil." Pyroil gives oil the property of adhering to cylinder walls, providing an ever-ready film of lubrication for easy, low friction starting. The protective film also prevents corrosion. The thoughtful—the economical thing to say is "add Pyroil."

Pyroil for Aircraft Engines

Use Aircraft Pyroil B for lubricating oil, Aircraft Pyroil A for gasoline.

Manufactured and Guaranteed by Pyroil Company, 67 Pyroil Bldg., La Crosse, Wisconsin.



PYROIL COMPANY

67 Pyroil Bldg., La Crosse, Wisconsin

I want my car to last and run properly. Please tell me more about Pyroil and how it can accomplish this for me.

Name.....

Address.....

City or Town..... State.....



Jerry, the talking dog, is entertaining hospitalized veterans, by courtesy of the PYROIL Company. Picture of Jerry, sent on request.

TABLE OF CONTENTS (Continued)

AUTOMOTIVE

Air conditioning adaptable to autos..... 84
Auto hoist lifts and turns cars..... 85
Magnetic emergency auto light..... 88
Huge trucks test pulling power of U.S. Army's biggest tanks..... 107
Oxygen tank for high-altitude flyers will inflate five auto tires..... 107
Adjustable wheel chock keeps car from rolling off jack..... 130
Hydraulic jack can be installed without stooping..... 135
Current tester indicates current flow or a good spark plug..... 135

AVIATION

Plane locates tuna for fishing clipper..... 106
Tail fan stabilizes helicopter..... 113
Automatic flight recorder..... 113
Superforts are wrapped in plastic cocoons for storage..... 121
Cargo "canoe" fastens to belly of transport plane..... 134
Pressure chamber designed for Winston Churchill's flights..... 135
Door ramps being tested by Southwest Airways..... 159
Transport loading principles taught with plywood profile of plane..... 155
AAF plane to carry 400 troops..... 160

BOATS

Jet-driven Blue Bird II..... 86
Ship's stabilizing fins may prevent seasickness..... 89
Normandie on wheels..... 118
Rubber boat designed for special needs of sportsmen..... 144
"Siamese twin" steel boat driven by outboard..... 151

FARM

Aircraft engine throws spray to cover 100-foot tree..... 106
Wheel-mounted burner uses either gasoline or kerosene to kill weeds..... 128
New farm machine does work of both disk and harrow..... 128

HOUSE AND HOME

Waxlike chemical sticks remove spots from fabrics..... 113
Glamorized kitchen..... 133
Chair legs tightened with liquid wood sweller..... 134
Home air cleaner picks up most of dust entering house..... 135
Down-fired heater burns powder coal..... 145
Heating unit uses turbine to turn forced-air fan..... 151
What's new for your home..... 152
Memo holder under phone base keeps pad out of sight..... 154

INDUSTRY

Fire-resistant cotton batts protect walls of building..... 106
Folding sawmill rides trailer..... 144
Portable telephone picks up messages 15 miles away..... 150

MODELS

Midget engine for model planes has frontal area of one square inch..... 113
Hobbyist of the month—Gene Kettering..... 136
Hobbyist's tiny guns shoot blanks..... 145

OUTDOOR RECREATION

Rubber wading pool..... 84
"Volcano" camp stove..... 85
Outboard-motor weed guard..... 85
Plastic putter resists changes in moisture and temperature..... 135
Golf scorekeeper tabulates strokes for each hole..... 135
Extra seat attaches to bike frame..... 166

RADIO AND ELECTRICAL

Wire recorder..... 95
Portable time control unit..... 96
Transmitter-receiver fits coat pocket..... 104
U. S. Navy's "sky hook"..... 120
Radio waves from electronic candle separate good eggs from bad..... 149
Electric movie "reviewers" record reaction to film..... 149

TOOLS

Flywheel tool..... 95
Portable electric saw..... 96
Power drive cuts speeds of fractional horsepower motors..... 128
Rivets are spread by "fluid" hammer..... 151
Midget carbide grinders cut metals or plastics..... 154
"Sculpture" tool for wood carver duplicates by depth-control..... 154

TOYS AND NOVELTIES

Jar rings aid African courtships..... 104
Painting with pebbles..... 105
Stovepipes made from German artillery and antiaircraft shells..... 150
Superpipe includes drain with tiny bucket on the bottom..... 150
Slingshot launcher controls flight of toy glider..... 166

MISCELLANEOUS

Torrid belt 30 miles from earth..... 84
Camera develops and prints own pictures..... 88
Book-vending machine..... 90
Miniature British bus..... 90
Battery-operated lawn mower..... 90
Pencil-size microscope..... 96
Signs pop out of subway grilles—latest advertising technique..... 104
Pencils in sections eliminate stubs..... 104
Uranium and aluminum discovered in Swedish oil shale deposits..... 121
Heated sidewalk eliminates snow shoveling..... 134
Biological specimens preserved in plastic blocks..... 138
Steel columns of England's new House of Commons rise on "bloom base"..... 150
Airborne germ "clouds" concentrated in chamber for study..... 155
Indoor driving practice possible with a ball anchored to sliding rod..... 155
Blood-typing of newborn babies may help avoid hospital mix-ups..... 160
Drop-center axle lowers trailer..... 166
Glow meter detects vitamin in liquid..... 166

(Continued to page 10)

Arthur Godfrey says:

"I.C.S. made the impossible—easy!"

You've often heard Arthur Godfrey, famed "Huck Finn of Radio," now winning new renown with his coast-to-coast "Talent Scouts" and other CBS programs. But this is the first time you've heard the star on the subject of I. C. S.:

"I had to quit high school before the end of my second year. Later in life, at the U. S. Naval Materiel School at Bellevue, D. C., I had to master a working knowledge of math, all the way from simple decimals and fractions through trigonometry, in the first six weeks or be dropped from the course. So I took an I. C. S. Course and finished at the head of the class! I. C. S. made the impossible—easy!"

As usual, the former Navy radio operator and present Lt. Commander in the U. S. Naval Reserve knows what he's talking about. As an I. C. S. graduate, Mr. Godfrey is in the best of all positions to tell you about the educational system that's served so long as talent scout for American industry.

Study his statement. Then mark your interest on the coupon and mail it today for full information on what I. C. S. can do for you!



INTERNATIONAL CORRESPONDENCE SCHOOLS



BOX 5603-K, SCRANTON 9, PENNA.

Without cost or obligation, please send me full particulars about the course *before* which I have marked X:

- | | | | |
|---|--|---|--|
| <p>Air Conditioning and Plumbing Courses</p> <ul style="list-style-type: none"> <input type="checkbox"/> Air Conditioning <input type="checkbox"/> Heating <input type="checkbox"/> Plumbing <input type="checkbox"/> Refrigeration <input type="checkbox"/> Steam Fitting <p>Chemistry Courses</p> <ul style="list-style-type: none"> <input type="checkbox"/> Chemical Engineering <input type="checkbox"/> Chemistry, Analytical <input type="checkbox"/> Chemistry, Industrial <input type="checkbox"/> Chemistry, Mfg. Iron & Steel <input type="checkbox"/> Petroleum Refining <input type="checkbox"/> Plastics <input type="checkbox"/> Pulp and Paper Making <p>Civil Engineering, Architectural and Mining Courses</p> <ul style="list-style-type: none"> <input type="checkbox"/> Architectural Drafting <input type="checkbox"/> Architecture <input type="checkbox"/> Bridge and Building Foreman <input type="checkbox"/> Building Estimating <input type="checkbox"/> Civil Engineering <input type="checkbox"/> Coal Mining <input type="checkbox"/> Contracting and Building <input type="checkbox"/> Highway Engineering <input type="checkbox"/> Lumber Dealer <input type="checkbox"/> Reading Structural Blueprints <input type="checkbox"/> Sanitary Engineering <input type="checkbox"/> Structural Drafting | <ul style="list-style-type: none"> <input type="checkbox"/> Structural Engineering <input type="checkbox"/> Surveying and Mapping <p>Communications Courses</p> <ul style="list-style-type: none"> <input type="checkbox"/> Electronics <input type="checkbox"/> Practical Telephony <input type="checkbox"/> Radio, General <input type="checkbox"/> Radio Operating <input type="checkbox"/> Radio Servicing <input type="checkbox"/> Telegraph Engineering <p>Electrical Courses</p> <ul style="list-style-type: none"> <input type="checkbox"/> Electrical Drafting <input type="checkbox"/> Electrical Engineering <input type="checkbox"/> Electric Light and Power <input type="checkbox"/> Lighting Technician <input type="checkbox"/> Practical Electrician <p>Internal Combustion Engines Courses</p> <ul style="list-style-type: none"> <input type="checkbox"/> Auto Technician <input type="checkbox"/> Aviation <input type="checkbox"/> Diesel-Electric <input type="checkbox"/> Diesel Engines <input type="checkbox"/> Gas Engines <p>Mechanical Courses</p> <ul style="list-style-type: none"> <input type="checkbox"/> Aeronautical Engineering <input type="checkbox"/> Aircraft Drafting <input type="checkbox"/> Flight Engineer <input type="checkbox"/> Foundry Work <input type="checkbox"/> Heat Treatment of Metals | <ul style="list-style-type: none"> <input type="checkbox"/> Industrial Engineering <input type="checkbox"/> Industrial Metallurgy <input type="checkbox"/> Machine Shop <input type="checkbox"/> Mechanical Drafting <input type="checkbox"/> Mechanical Engineering <input type="checkbox"/> Mold-Loft Work <input type="checkbox"/> Patternmaking—Wood, Metal <input type="checkbox"/> Reading Shop Blueprints <input type="checkbox"/> Sheet-Metal Drafting <input type="checkbox"/> Sheet-Metal Worker <input type="checkbox"/> Ship Drafting <input type="checkbox"/> Ship Fitting <input type="checkbox"/> Tool Designing <input type="checkbox"/> Toolmaking <input type="checkbox"/> Welding—Gas and Electric <p>Railroad Courses</p> <ul style="list-style-type: none"> <input type="checkbox"/> Air Brake <input type="checkbox"/> Car Inspector <input type="checkbox"/> Diesel Locomotive <input type="checkbox"/> Locomotive Engineer <input type="checkbox"/> Locomotive Fireman <input type="checkbox"/> Railroad Section Foreman <p>Steam Engineering Courses</p> <ul style="list-style-type: none"> <input type="checkbox"/> Boilermaking <input type="checkbox"/> Combustion Engineering <input type="checkbox"/> Engine Running <input type="checkbox"/> Marine Engineering <input type="checkbox"/> Steam Electric <input type="checkbox"/> Steam Engines | <p>Textile Courses</p> <ul style="list-style-type: none"> <input type="checkbox"/> Cotton Manufacturing <input type="checkbox"/> Rayon Weaving <input type="checkbox"/> Textile Designing <input type="checkbox"/> Woolen Manufacturing <p>Business and Academic Courses</p> <ul style="list-style-type: none"> <input type="checkbox"/> Accounting <input type="checkbox"/> Advertising <input type="checkbox"/> Arithmetic <input type="checkbox"/> Bookkeeping <input type="checkbox"/> Business Correspondence <input type="checkbox"/> Business Management <input type="checkbox"/> Certified Public Accounting <input type="checkbox"/> Commercial <input type="checkbox"/> Cost Accounting <input type="checkbox"/> Federal Tax <input type="checkbox"/> First Year College <input type="checkbox"/> Foremanship <input type="checkbox"/> French <input type="checkbox"/> Good English <input type="checkbox"/> High School <input type="checkbox"/> Higher Mathematics <input type="checkbox"/> Illustrating <input type="checkbox"/> Motor Traffic <input type="checkbox"/> Postal Service <input type="checkbox"/> Salesmanship <input type="checkbox"/> Secretarial <input type="checkbox"/> Sign Lettering <input type="checkbox"/> Spanish <input type="checkbox"/> Stenography <input type="checkbox"/> Traffic Management |
|---|--|---|--|

Name _____ Age _____ Address _____
 City _____ State _____ Present Position _____

Working Hours _____ A.M. to _____ P.M. Length of Service in World War II _____

Special tuition rates to members of the Armed Forces. Enrollment under the G.I. Bill of Rights approved for War II Veterans.
 Canadian residents send coupon to International Correspondence Schools Canadian, Ltd., Montreal, Canada.

Radio's Greatest
Buying Guide!

FREE

ALLIED'S NEW RADIO CATALOG

Send for this Big
Value Book NOW!

Send for your FREE copy of the leading Buying Guide for Everything in Radio! Here's the handiest catalog for Servicemen, Dealers, Soundmen, Amateurs, Builders and Experimenters. Features the world's largest and most complete stocks of quality radio and electronic supplies—all at lowest prices! Get the equipment, the speedy service, the expert help you want, from ALLIED—Radio's Largest Supply House!



HUGE STOCKS—MORE THAN 10,000 ITEMS

Everything for every radio use: new model home radios, phono-radios, communications receivers, Ham kits and gear, radio parts, tubes, tools, test instruments, public address equipment, low-cost easy-to-build radio kits, diagrams, instructive radio books, radio's most complete stocks—all at lowest prices!

HELPFUL RADIO BOOKS!

- Radio Formulas & Data No. 37-752 . . . 10c
- Dictionary of Radio Terms No. 37-751 . . . 15c
- Radio Circuit Handbook No. 37-753 . . . 25c
- Radio Builders' Handbook No. 37-750 . . . 15c
- Simplified Radio Servicing No. 37-755 . . . 10c
- Radio Data Handbook No. 37-754 . . . 25c
- ALL 6 BOOKS above No. 37-799 . . . \$1.00
- Parallel-Resistance and Series Capacitance Calculator. No. 37-960 . . . 25c
- R-F Resonance and Coil Winding Calculator. No. 37-955 . . . 25c

ALLIED RADIO

ALLIED RADIO CORP.
833 W. Jackson Blvd., Dept. 5-E-7
Chicago 7, Illinois

- Rush FREE 1947 Catalog
 - Send 6 Books No. 37-799
 - Send Books checked above
 - Send Calculators checked above
- \$.....enclosed

Name.....

Address.....

City..... Zone..... State.....

FREE
CATALOG

(Continued from page 8)

Craftsman and Shop Notes Index

AUTOMOTIVE

- Weather seal on auto starter.....186
- Hacksaw blade with hooked end retrieves broken keys.....214
- Heavy pencil line on cardboard used to test auto spark.....214
- Nonslip surface for step plate increases driver's safety.....214
- Tire pressure printed on body of truck avoids mistakes.....220

CAMP AND CAMPING

- Water for summer camp lifted by using lever and bucket....186
- Campfire irons made with rod.....188
- Candid-camera film cans used to make salt shakers.....192

FARM

- Fuel tank should be drained if tractor is stored.....198
- Building a chopped-hay drier.....212
- Tarpaulin stored in barn is suspended from rafter.....214
- Tractor and washtub are used when coiling electric fence.....216
- Way to preserve fence posts.....216
- Auto tire around stake keeps rope untangled.....220
- Feed bags hung over iron pipe as protection against mice...220

FISH AND FISHING

- Bell sinker snapped onto line frees snagged fishing lure....188
- Raffia used to repair creel makes permanent patch.....208
- Fishhook embedded in float cork adjusts line automatically..208

HOUSE AND HOME

- Vertical handrail at corner of stair adds safety and convenience.....175
- Concrete stoop base uses cement blocks.....175
- Fold-away table for the kitchen.....176
- How to reverse window shades.....184
- Arrow shows position of latch.....188
- Solving home problems.....190
- Corner brackets decorate shelves of plain wood cabinet.....198
- Bracket used as lamp support.....198
- Bolt lock for basement window.....208
- Decalcomanias removed easily.....211

LAWN AND GARDEN

- Cigarette papers keep cutworms from damaging tomatoes...186
- Cast-concrete birdbath repaired with cement and screen wire.192
- Sifter-mixer for garden soil.....199

PHOTOGRAPHY

- Measuring cup used in darkroom to make up solutions.....206
- Small film will fit large holder.....206
- Burning-title effect for movies.....206
- Tape marks position on trimmer.....206
- Quickly improvised lens shade.....206

RADIO AND ELECTRONICS

- Special purpose voice recorders.....221
- Beginner's four-tube progressive receiver—set No. 2.....222
- Kit for radio and electronic experimenters.....224

RECREATION

- Archery tackle box.....187
- Eliminating squeak from oarlock.....192
- Numerals for children's games cut from calendar.....198

STORE AND SHOP

- Adjusting screws under bench serve to level it.....186
- Mailing tube holds small parts for easy dispensing.....189
- Mirror on clothier's mannequin shows how suit looks.....211

TOOLS

- Improvised sawbuck for wood lot can be set up easily.....184
- Roller attached to paste brush aids in mounting clippings....188
- Slotted work will protect gauge.....192
- C-clamp aids in cutting mortise.....192
- Craft quiz.....207
- Hinge serves as bending brake.....208
- Rotary weed cutter.....209
- Copper lining held in vise jaws.....211
- Grinding jig for tool bits.....215
- Installing springs in typewriters.....216
- How to stop drill from slipping.....220

TOYS AND NOVELTIES

- Seesaws need not all be alike.....177
- Youngster's coaster wagon is hand-propelled.....184
- Novel weather vanes.....185
- Sidewalk skis furnish year 'round fun.....189

MISCELLANEOUS

- Pitch of sloping roof easy to figure.....175
- Sheets of sandpaper stored in discarded record album.....184
- Letters printed with writing pen.....186
- Walnut is darkened by using lye.....188
- Coins are mailed conveniently in gummed-paper envelopes..198
- Blackboard eraser holds chalk.....208
- Modified heater tank will carry tools.....211
- Numbered tacks mark zones for delivery routes.....211
- Chain link made of metal plate.....214
- Racks hold lengths of molding so they can be tied.....216
- Safety for pedestrians insured by painting elevator doors...220

IMPORTANT NOTICE—It is the intention of this magazine to provide its readers with information regarding the latest developments in the mechanical arts. We take no responsibility as to whether the disclosures contained in our articles are covered by patents and advise readers to investigate this subject before making, using, or selling any of the products, machines, or processes described in order to avoid possible liability for patent infringements.

AUDELS REFRIGERATION & AIR CONDITIONING GUIDE....\$4

New from Cover to Cover—1280 Pages, Fully Illus. Covering basic principles, servicing, operation & repair of household, commercial & industrial refrigeration & air conditioning. A gold mine of essential important facts for engineers, servicemen, users.

AUDELS CARPENTERS & BUILDERS GUIDES—4 Vols.\$6

A practical illustrated trade assistant on modern construction for carpenters, joiners, builders, mechanics and all woodworkers. 4 vols., 1600 pages, 3700 illustrations, flexible covers. Pocket size. Each volume sold separately \$1.50 a vol.

AUDELS AUTOMOBILE GUIDE....\$4

A practical quick ready reference book for auto mechanics, service men, operators & owners. Explains theory, construction & servicing of modern motor cars, trucks, buses & auto type Diesel engines. 1540 pages, fully illustrated, 55 chapters. Indexed. A standard book for mechanics. New fluid drive covered.

AUDELS DIESEL ENGINE MANUAL.\$2

A practical, concise treatise with questions and answers on the theory, operation and maintenance of modern diesel engines including General Motors 2 cycle Diesel. 384 pages, fully illus., flexible binding, pocket size. All details plainly brought out, this book is of extreme value to engineers, operators & students.

AUDELS WIRING DIAGRAMS.....\$1

210 Pages. Illustrated. Gives practical facts on wiring of electrical apparatus. It shows clearly how to wire apparatus for practically all fields of electricity. Each diagram is complete & self-explanatory. Highly Endorsed Pocket Companion.

AUDELS PLUMBERS & STEAMFITTERS GUIDES—4 Vols.\$6

A Practical Trade Assistant & Ready Reference. Explains in plain language & by clear illustrations, diagrams, charts, graphs, pictures principles of modern plumbing practice including Marine Pipe Fitting and Air Conditioning. 4 Vols.—1670 Pages—3642 Diagrams. Pocket size. Each Vol. Sold Separately \$1.50 a Vol.

AUDELS SHEETMETAL WORKERS HANDY BOOK.....\$1

Practical inside information. Fundamentals of Sheet Metal Work. 388 pages. Illustrated. 11 sections. Clearly written. Essential & important facts, figures, pointers in everyday language, Ref. Index.

AUDELS SHEETMETAL PATTERN LAYOUTS.....\$4

Developed by Experts for Sheet Metal Workers, Layout Men & Mechanics. A Practical Encyclopedia in 10 Sections, size 7 x 10 x 2—1125 Pages—350 Layouts—1600 Illustrations. 1001 Key Facts. Fully indexed for ready reference in answering your layout problems. Covers all phases of sheet metal work including Pattern Cutting, Pattern Development & Shop Procedure.

AUDELS ANSWERS ON BLUE PRINT READING.....\$2

For Mechanics & Builders. Covers all types of blue print reading including ship & airplane. 376 pages, fully illustrated.

AUDELS NEW MACHINIST & TOOLMAKERS HANDY BOOK...\$4

Covers modern machine shop practice in all its branches. 5 practical books in 1. New from cover to cover. Tells how to set up & operate lathes, screw and milling machines, shapers, drill presses and all other machine tools. 1600 pages, fully illustrated, 5 x 6 1/2 x 2. Indexed. 5 sections. 1—Modern Machine Shop Practice. 2—Blue Print Reading & How to Draw. 3—Calculations & Mathematics for Machinists. 4—Shop Physics. 5—How to Use the Slide Rule. 60 chapters. Easy to read and understand. A shop companion that answers your questions.

AUDELS MATHEMATICS & CALCULATIONS FOR MECHANICS \$2

Mathematics for home study or reference. 700 pages, 550 illus. Practical mathematics from beginning. How to figure correctly. Easy, correct methods covering a complete review. Ill. & Indexed.

AUDELS HANDY BOOK OF PRACTICAL ELECTRICITY.....\$4

For maintenance engineers, electricians & all electrical workers. 1440 Pages, 2600 Illus. Covers important electrical information in handy form—including Marine Wiring, Radio Principles, Welding. Indexed. A Key to a practical understanding of electricity.

AUDELS RADIOMANS GUIDE.....\$4

A key to the practical understanding of radio including Frequency Modulation, Television, etc., Aircraft & Marine Radio. For radio engineers, servicemen, amateurs. 772 pages. 400 Illustrations & Diagrams. Photos. Review Questions & Answers, Reference Index. Authentic, clear, concise.

AUDELS ELECTRONIC DEVICES...\$2

Tells What You Want to Know About Electric Eye. Easily Understood. Covers photo-electric cells & their applications. Amplifiers, illumination, frequencies, voltage, photocell, tubes, Ohm's Law, wiring diagrams, etc.

AUDELS WELDERS GUIDE.....\$1

A concise, practical text on operation & maintenance of all welding machines for all mechanics. Over 400 pages, illustrated. Covers all methods of electric and acetylene welding including airplane work.

AUDELS, Publishers, 49 W. 23 St., N. Y. 10

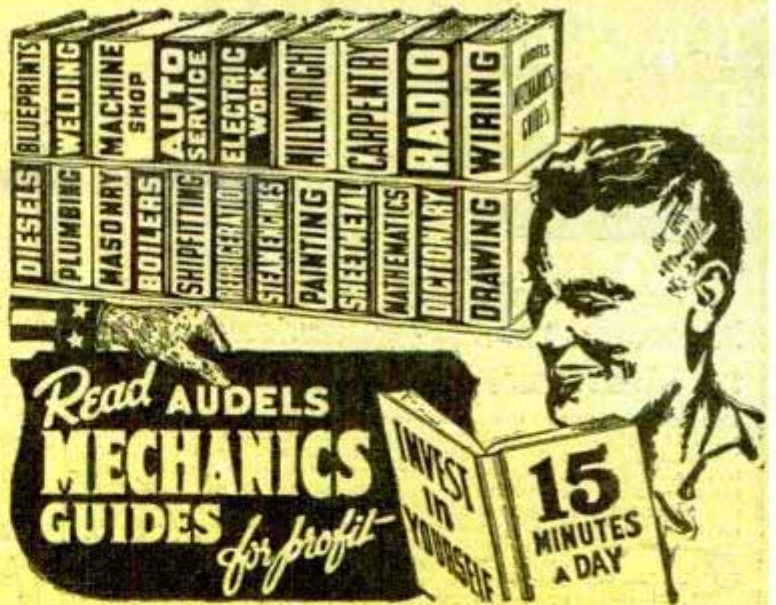

AN AUDEL GUIDE IS A GOOD FRIEND!

Use the brains and experience of others in these Guides of the Trades. Save time and money with right methods, short cuts, labor saving ideas. CHECK NOW! You can look over any Audel Guide in your home. Start the Easy Payments if satisfied.

CUT HERE MAIL ORDER

THEO. AUDEL & CO., 49 W. 23 St., New York 10, N.Y.

Please mail me for 7 days' free examination the books marked (X) below. I agree to mail \$1 in 7 days on each book or set ordered, and to further mail \$1 a month on each book or set ordered until I have paid purchase price.

If I am not satisfied with Guides I will return them.

- Audels OIL BURNER GUIDE \$1.
- Audels REFRIGERATION & Air Conditioning Guide. 4.
- Audels POWER PLANT ENGINEERS GUIDE 4.
- Audels PUMPS, HYDRAULICS & AIR COMPRESSORS 4.
- Audels WELDERS GUIDE 1.
- Audels BLUE PRINT READING 2.
- Audels SHEET METAL WORKERS Handy Book 1.
- Audels SHEET METAL PATTERN LAYOUTS 4.
- Audels AIRCRAFT WORKER 1.
- Audels MATHEMATICS and CALCULATIONS 2.
- Audels MACHINISTS & TOOLMAKERS Handy Book 4.
- Audels MECHANICAL Dictionary 4.
- Audels AUTOMOBILE GUIDE 4.
- Audels DIESEL ENGINE MANUAL 2.
- Audels MARINE ENGINEERS Handy Book 4.
- Audels SHIPFITTERS Handy Book 1.
- Gueths MECHANICAL DRAWING COURSE 1.
- Rogers DRAWING and DESIGN 2.
- Audels MILLWRIGHTS and Mechanics Guide 4.
- Audels CARPENTERS and Builders Guides (4 vols.) 6.
- Audels PLUMBERS and Steamfitters Guides (4 vols.) 6.
- Audels MASONS and Builders Guides (4 vols.) 6.
- Master PAINTER and DECORATOR 2.
- Audels GARDENERS & GROWERS GUIDES (4 vols.) 6.
- Audels ENGINEERS & FIREMANS EXAMINATIONS 1.
- Audels ENGINEERS and Mechanics Guides 12.
- Nos. 1, 2, 3, 4, 5, 6, 7 and 8 complete 12.
- Audels Answers on Practical ENGINEERING 1.
- Audels ELECTRICIANS EXAMINATIONS 1.
- Audels WIRING DIAGRAMS 1.
- Audels Handy Book of PRACTICAL ELECTRICITY 4.
- Audels ELECTRICAL POWER CALCULATIONS 2.
- Audels ELECTRONIC DEVICES 2.
- Audels ELECTRIC Dictionary 2.
- Audels RADIOMANS GUIDE 4.
- Audels NEW ELECTRIC LIBRARY at \$1.50 a Volume 4.

Name _____

Address _____

Occupation _____

Employed by _____ PM

Learn this Profitable Profession



**IN 90 DAYS
AT HOME**

Money-Making Career Open to Men and Women, 18 to 50

Hundreds of men and women between 18 and 50 make \$10 to \$20 in a single day giving scientific Swedish Massage and Hydro-Therapy treatments. There is big demand from doctors, hospitals, sanatoriums and clubs. Graduates earn large full time incomes from these or in private practice in their own offices. Others make good money from home treatments given in spare time. Learn this interesting, money-making profession in your own home, through our home study course. Same instructors as in our nationally known resident school. You can win independence and prepare for future security by qualifying for your Diploma. Course can be completed in 3 to 4 months. Many earn while they learn. Begin your training at once.



Anatomy Charts & Booklet FREE

Enroll now and we will include, at no extra cost, many needed supplies. Fit yourself to help meet growing demand for Scientific Swedish Massage. Send the coupon at once for complete details. Anatomy Charts and 32-Page Illustrated Booklet, FREE, postpaid.

THE COLLEGE OF SWEDISH MASSAGE

Dept. 764E, 100 East Ohio St., Chicago 11, Illinois

Please send me FREE and postpaid, Anatomy Charts, 32-page Booklet and complete details on Home Training.

Name.....

Address.....

City..... State.....

AUDELS Carpenters and Builders Guides 4 vols. \$6

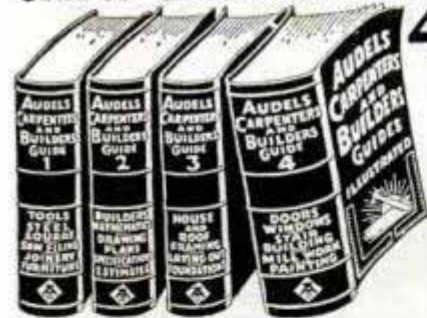

Inside Trade Information for Carpenters, Builders, Joiners, Building Mechanics and all Woodworkers. These Guides give you the short-cut instructions that you want—including new methods, ideas, solutions, plans, systems and money saving suggestions. An easy progressive course for the apprentice and student. A practical daily helper and Quick Reference for the master worker. Carpenters everywhere are using these Guides as a Helping Hand to Easier Work, Better Work and Better Pay. To get this assistance for yourself, simply fill in and mail the FREE COUPON below.

Inside Trade Information On:

How to use the steel square—How to file and set saws—How to build furniture—How to use a mitre box—How to use the chalk line—How to use rules and scales—How to make joints—Carpenters arithmetic—Solving mensuration problems—Estimating strength of timbers—How to set girders and sills—How to frame houses and roofs—How to estimate costs—How to build houses, barns, garages, bungalows, etc.—How to read and draw plans—Drawing up specifications—How to excavate—How to use settings 12, 13 and 17 on the steel square—How to build hoists and scaffolds—skylights—How to build stairs—How to put on interior trim—How to hang doors—How to lay floor—How to paint



THEO. AUDEL & CO., 49 W. 23rd St., New York City

Mail Audels Carpenters and Builders Guides, 4 vols., on 7 days' free trial. If O.K. I will remit \$1 in 7 days, and \$1 monthly until \$6 is paid. Otherwise I will return them. No obligation unless I am satisfied.

Name.....

Address.....

Occupation.....

Reference.....PM

"The Supreme Authority"

in courts, schools, homes, newspapers and Government offices

The Merriam-

WEBSTER

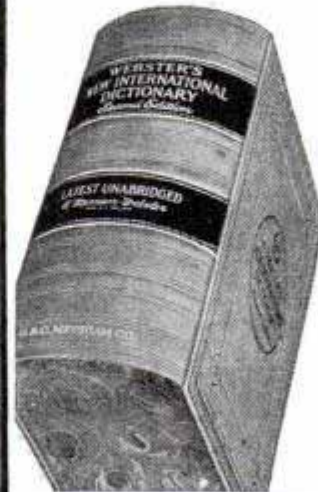

YOU may have had to wait for a copy of WEBSTER'S NEW INTERNATIONAL DICTIONARY, Second Edition. However, more and more copies are reaching your dealer. See him now. The MERRIAM-Webster contains 3,350 pages, illustrations for 12,000 terms, and a total of 600,000 entries—122,000 more than any other dictionary. It is the only unabridged dictionary completely revised and rewritten in three decades. G. & C. Merriam Co., Springfield 2, Mass.

1847 A CENTURY OF PUBLISHING 1947
MERRIAM-WEBSTERS

WEBSTER'S NEW INTERNATIONAL DICTIONARY - Second Edition



Acquiring a superior VOCABULARY is basic training for a top position in any profession, trade or business. To get in the upper brackets financially and socially, develop a masterful VOCABULARY through the fascinating, entertaining and profitable new science of LEXIPOWER. You are judged and rated by every sentence you utter. Executive ability and professional capacity are demonstrated by what you say—not by what your hands do. More POWER to you through LEXIPOWER. Benefit at once! You start using the POWER of LEXIPOWER after the first Lesson. Write NOW for FREE details about LEXIPOWER Dime-a-Day LESSON CLUB.

LEXIPOWER LESSON CLUB

517-G W. Deming Place

Chicago 14, Ill.

Be A Writer

Short Stories, Mysteries, Novels, Articles—at home in spare time

THE demand for writers is creating great new opportunities for people with an urge to write. It's not as hard to succeed as you may imagine. Most famous authors come from ordinary walks of life. At home, you too may learn fiction writing, the best basis for all fields—short stories, novels, features, articles, radio scripts. Palmer Institute's Home Study Training (Established 1917) is endorsed by Rupert Hughes, Ruth Comfort Mitchell, Gertrude Atherton, Katharine Newlin Burt and other famous authors and by scores of successful graduates. Complete instruction material and professional coaching to develop your own style. FREE book explains how you may enjoy an ideal part time or full time career. Write today (no salesman will call).

PALMER INSTITUTE OF AUTHORSHIP, Desk T-57
Palmer Building, Hollywood 28, Calif.



I Will Show You How to Learn RADIO by Practicing in Spare Time

I Send You Big Kits of Radio Parts



KIT 1
I send you Soldering Equipment and Radio Parts; show you how to do Radio soldering; how to mount and connect Radio parts; give you practical experience.



KIT 2
Early in my course I show you how to build this N.R.I. Tester with parts I send. It soon helps you fix neighborhood Radios and earn EXTRA money in spare time.

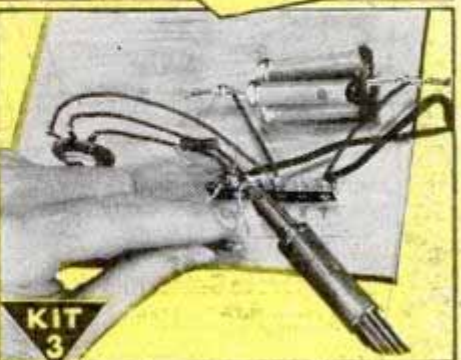

KIT 3
You get parts to build Radio Circuits; then test them; see how they work; learn how to design special circuits; how to locate and repair circuit defects.

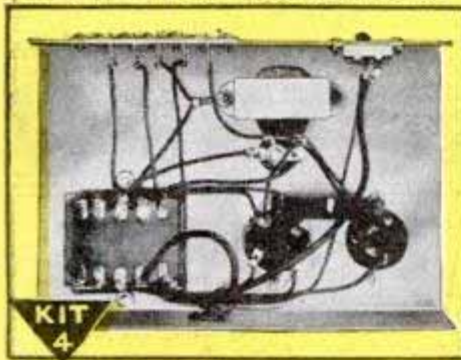

KIT 4
You get parts to build this Vacuum Tube Power Pack; make changes which give you experience with packs of many kinds; learn to correct power pack troubles.

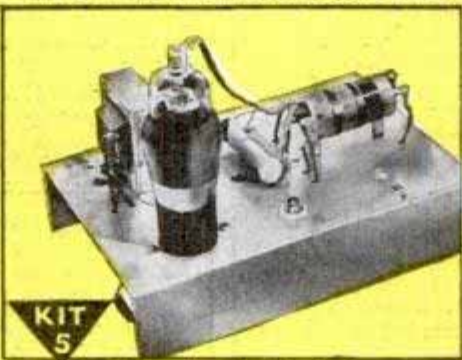

KIT 5
Building this A. M. Signal Generator gives you more valuable experience. It provides amplitude-modulated signals for many tests and experiments.



KIT 6
You build this Superheterodyne Receiver which brings in local and distant stations—and gives you more experience to help you win success in Radio.

KNOW RADIO - Win Success I Will Train You at Home - SAMPLE LESSON FREE

Do you want a good-pay job in the fast-growing Radio Industry—or your own Radio Shop? Mail the Coupon for a Sample Lesson and my 64-page book, "How to Be a Success in RADIO—Television, Electronics," both FREE. See how I will train you at home—how you get practical Radio experience building, testing Radio circuits with BIG KITS OF PARTS I send!

Many Beginners Soon Make Extra Money in Spare Time While Learning

The day you enroll I start sending EXTRA MONEY JOB SHEETS that show how to make EXTRA money fixing neighbors' Radios in spare time while still learning! It's probably easier

to get started now than ever before, because the Radio Repair Business is booming. Trained Radio Technicians also find profitable opportunities in Police, Aviation, Marine Radio, Broadcasting, Radio Manufacturing, Public Address work. Think of even greater opportunities as Television, FM, and Electronic devices become available to the public! Send for FREE books now!

Find Out What NRI Can Do For You
Mail Coupon for Sample Lesson and my FREE 64-page book. Read the details about my Course; letters from men I trained; see how quickly, easily you can get started. No obligation! Just MAIL COUPON NOW in envelope or paste on penny postal. J. E. SMITH, President, Dept. 7EP, National Radio Institute, Pioneer Home Study Radio School, Washington 9, D. C.

Approved for Training under GI Bill

Good for Both - FREE

Mr. J. E. SMITH, President, Dept. 7EP, National Radio Institute, Washington 9, D.C. Mail me FREE, your sample lesson and 64-page book. (No salesman will call. Please write plainly.)

Name _____ Age _____
Address _____
City _____ Zone _____ State _____



VETERANS
You can get this training right in your own home under G. I. Bill. Mail coupon for full details.

**NOW! The ONE-UNIT
HEARING AID**
Thousands Have Waited for

The New ONE-UNIT
Beltone
MONO-PAC
HEARING AID



**THIS IS ALL
YOU WEAR** →

No Separate Battery Pack
No Dangling Battery Cords

The tiny new BELTONE Mono-Pac is about 1/2 size and weight of old-style hearing aids, yet so powerful you hear even *whispers!* Get helpful facts about this new "MIRACLE" aid in valuable FREE book about deafness.



BELTONE HEARING AID CO.
1450 W. 19th St., Dept. PM75, Chicago 8, Ill.

FREE BOOKLET

Beltone Hearing Aid Co.
Dept. PM75, 1450 W. 19th St., Chicago 8, Ill.

Please send me FREE booklet about deafness and what can be done to overcome it.

Name _____

Address _____

Town _____ Zone _____ State _____

STUDY AT HOME

With An Educational Institution

Men with specialized training win higher positions, insure larger earnings, and are bigger successes in business and public life. Opportunities NOW greater than ever before. Send for our Catalog.

ARTS and SCIENCES

Courses in Philosophy; Education; Letters; Public Health; Medical Jurisprudence; Psychology; Sociology; Physics; Chemistry; Plastics; Geology; Political Science; Theology; Business and Commerce; Accounting; Mathematics; Statistics; Agriculture.

ENGINEERING

Courses in Electrical, Civil, Mechanical, Drafting, Architectural, Steam, Aeronautical, Radio, Structural, Mining, Industrial, Petroleum, Marine, Chemical, Diesel, Automobile, Refrigeration, and Air Conditioning Engineering.

LAW

Complete Professional Law Course includes 18 Hornbook Series college grade textbooks. Courses also in Commercial Law, Patent Law and Medical Jurisprudence.
McKinley-Roosevelt Incorporated, 4610-K, Sheridan Rd., Chicago 40, Ill.

LEARN AT HOME TO MOUNT BIRDS



Animals, Heads, Fishes, Pets; to TAN. Be a Taxidermist. Profit and FUN.

Hunters, save your valuable TROPHIES. Mount ducks, squirrels, everything. Learn to TAN for leather and furs. Wonderful HOBBY Have a HOME MUSEUM.—BIG PROFITS mounting for others. INVESTIGATE NOW.

FREE BOOK With 100 fine game pictures. NOW absolutely FREE. Write TODAY.

Send Postal TODAY for FREE BOOK. State AGE. N.W. SCHOOL OF TAXIDERMY, Dept. 3375, Omaha, Neb.



CODE SPEED SHORT CUT

Be an expert. Learn to be a Telegraph or Radio Operator. Thousands of men needed. Intensely interesting work—good pay. Learn at home or wherever you are, quickly, easily with the famous Candler Speed System. Book of particulars Free. **CANDLER SYSTEM CO.**, Dept. 5-E, Box 928, Denver 1, Colo. U.S.A.



You can become a good penman right in your own home during spare time by my Simplified Method. Write for my FREE Book, "How to Become an Expert Penman," which shows what others have learned. If desired, send 10c for one of my favorite Pen Points and your name with a beautiful flourished bird written on a card. Write for the Free Book today.
T. M. TEVIS, BOX 25K, CHILLICOTHE, MO.

LAW STUDY AT HOME for PERSONAL SUCCESS and LARGER EARNINGS. 38 years expert instruction—over 108,000 students enrolled. LL.B. Degree awarded. All texts furnished. Easy payments. Send for FREE BOOK—"Law and Executive Guidance."
AMERICAN EXTENSION SCHOOL OF LAW
Dept. 77-M, 646 N. Michigan Ave., Chicago 11, Ill.

WANT \$1,756 TO \$3,021 A YEAR?

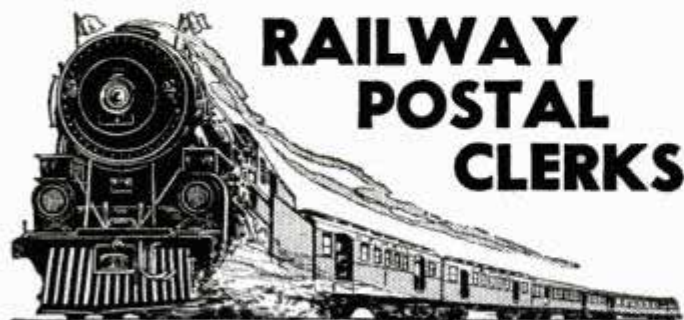

**RAILWAY
POSTAL
CLERKS**

City and Rural Carriers—Postoffice Clerks—
Inspectors—Accountants—Clerks at Washington
—Many other Government Jobs

TRAVEL FOR "UNCLE SAM"

Prepare Now for Many Coming Examinations
Veterans Get Special Preference

FRANKLIN INSTITUTE, Dept. H85, Rochester 4, N. Y.

Sirs: Rush to me, without charge, copy of 32-page book, "How to get a U. S. Government Job," list of positions, and full particulars telling how to prepare for them.

Name.....

Address..... Vet?.....

INVENTORS

The patent laws provide that any new and useful art, machine, article of manufacture, composition of matter, or design, or any new and useful improvement thereof, may be patented if the act of invention is involved. Therefore, every inventor with a valuable invention should take advantage of the patent laws and proceed for patent protection in order to safeguard his rights.

A patent gives the inventor the exclusive right to prevent others from making, using, or selling the invention claimed in the patent for a period of 17 years.

The patent laws were enacted for the benefit of the inventor to give him protection for the features of his invention which are patentable. These features must be properly and concisely set forth and claimed in a formal application for patent in order to comply with the requirements of the U. S. Patent Office. For that reason, the Patent Office advises the inventor to engage a competent registered patent attorney to prepare his application for patent and represent him before the U. S. Patent Office Examiner.

A specially prepared booklet containing detailed information with respect to patent protection and procedure will be forwarded to you without obligation upon request.

Patents
Trademarks
Copyrights

Registered Patent Attorneys

CLARENCE A. O'BRIEN
& HARVEY B. JACOBSON

71-E District National Building + Washington 5, D. C.

CLARENCE A. O'BRIEN & HARVEY B. JACOBSON
Registered Patent Attorneys
71-E District National Bldg., Washington 5, D. C.

Please send me booklet containing information regarding patent protection and procedure, and also "Record of Invention" form. This request does not obligate me.

Name _____

Address _____

City _____ State _____

(Please write or print plainly.)



NOW! An Amazing Opportunity to LEARN RADIO AT HOME

I SEND YOU 8 BIG KITS OF RADIO PARTS

Including a **COMPLETE 6 TUBE SUPER-HETERODYNE RECEIVER**

I TRAIN YOU RIGHT by PUTTING YOU TO WORK with REAL PROFESSIONAL EQUIPMENT!

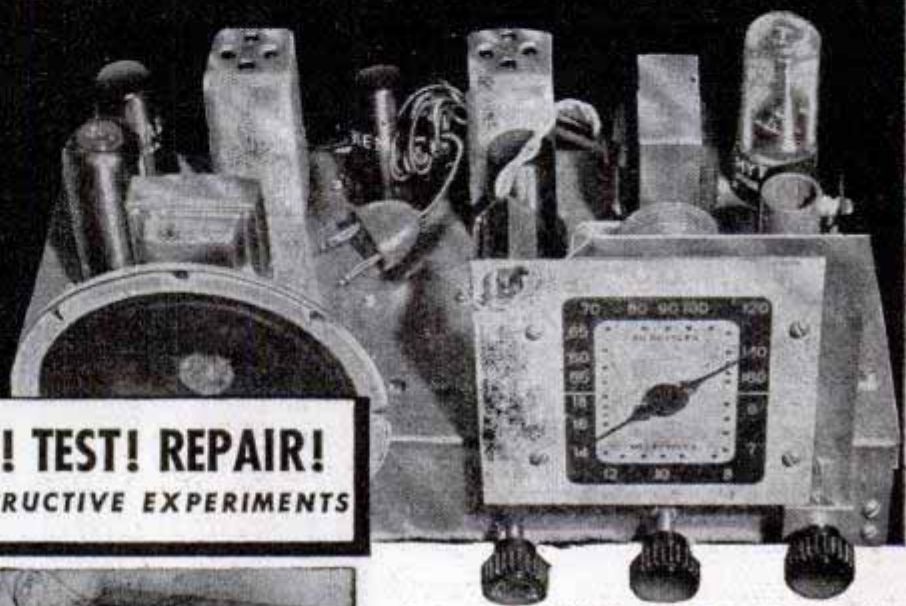

LEARN HOW TO BUILD CIRCUITS! TEST! REPAIR!
YOU DO OVER 175 INSTRUCTIVE EXPERIMENTS



YOU BUILD THIS USEFUL TEST-EQUIPMENT!

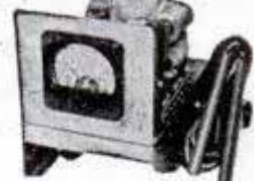

I give you a fine, moving-coil type Meter Instrument on Jewel Bearings—with parts for a complete Analyzer Circuit Continuity Tester. You learn how to check and correct Receiver defects with professional accuracy and speed.

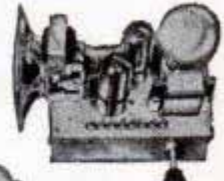

Soldering, wiring, connecting Radio parts . . . building circuits—you can't beat this method of learning. When you construct this Rectifier and Filter, Resistor and Capacitor Tester, etc., you get a really practical slant on Radio.

HERE'S THE EASIEST, MOST PRACTICAL WAY OF ALL TO PREPARE FOR GOOD PAY in RADIO ELECTRONICS and TELEVISION!

I train your mind by putting you to work with your hands on a big 6-Tube Superheterodyne Receiver. And, believe me, when you get busy with real Radio Parts—8 big Kits of them—you really LEARN Radio and learn it RIGHT! You get the practical stuff you need to be useful in Radio, and that's what it takes to make money. You don't have to worry about what to do with these 8 Kits of Parts. Step by step, I show you how to build circuits, test, experiment, trouble-shoot. And you don't need any previous experience. The Sprayberry Course starts right at the beginning of Radio! You can't get lost! Simplified lessons, coupled with real "Shop" practice, makes every subject plain and easy to understand and remember. Soon after you begin Sprayberry Training, I'll send you my sensational BUSINESS BUILDERS.

A BUSINESS OF YOUR OWN . . . OR A GOOD RADIO JOB
You'll find out how to get and do neighborhood Radio repair jobs for nice profits and rich experience while learning. This sort of work can easily pave the way for a Radio Service business of your own. But with Sprayberry Training, you're not limited. You can swing into any one of the swiftly expanding branches of Radio-Electronics INCLUDING Radio, Television, FM, Radar, Industrial Electronics. Be wise! Decide now to become a fully qualified RADIO-ELECTRONICIAN. Get full details about my Training at once! Mail coupon below for my 2 big FREE Books.

GET THESE VALUABLE FREE BOOKS

"How to Read Radio Diagrams and Symbols"

Here's a valuable and wonderfully complete new book which explains in simple English how to read and understand any Radio Set Diagram. Includes translation of all Radio symbols. Send for this volume at once. It's free! Along with it, I will send you another Big Free book describing in detail my Radio-Electronic Training.



You'll get valuable experience and practice building this Signal Generator and Multi-purpose Tester. Makes a breeze out of fixing Radios and you don't have to spend money on outside, ready-made equipment.

RUSH COUPON!

SPRAYBERRY ACADEMY OF RADIO
F. L. Sprayberry, President, Room 1057, Pueblo, Colorado
Please rush my FREE copies of "How to MAKE MONEY in RADIO, ELECTRONICS and TELEVISION," and "HOW to READ RADIO DIAGRAMS and SYMBOLS."

Name Age

Address

City State

(Mail in envelope or paste on penny postcard)



GEE what a build!
Didn't it take a long
time to get those muscles?

SHOWER

No SIR! - ATLAS
Makes Muscles Grow
Fast!

Will You Let Me PROVE I Can Make YOU a *New Man?*



LET ME START SHOWING YOU RESULTS LIKE THESE

<p>5 inches of new Muscle</p> <p>"My arms increased 1 1/2", chest 2 1/2", forearm 7/8". - C. S., W. Va.</p>	<p>What a difference!</p> <p>"Have put 3 1/2" on chest (normal) and 2 1/2" expanded." - F. S., N. Y.</p>
<p>Here's what ATLAS did for ME!</p> <p>John Jacobs BEFORE John Jacobs AFTER</p>	<p>For quick results I recommend CHARLES ATLAS</p> <p>"Am sending snapshot showing wonderful progress." - W. G., N. J.</p> <p>GAINED 29 POUNDS</p> <p>"When I started, weighed only 141. Now 170." - T. K., N. Y.</p>

CHARLES ATLAS

Awarded the title of "The World's Most Perfectly Developed Man" in international contest - in competition with ALL men who would consent to appear against him.

This photo of Charles Atlas is not a studio picture but an actual untouched snapshot.

Here's What Only 15 Minutes a Day Can Do For You

I DON'T care how old or young you are, or how ashamed of your present physical condition you may be. If you can simply raise your arm and flex it I can add SOLID MUSCLE to your biceps—yes, on each arm—in double-quick time! Only 15 minutes a day—right in your own home—is all the time I ask of you! And there's no cost if I fail.

I can broaden your shoulders, strengthen your back, develop your whole muscular system INSIDE and OUTSIDE! I can add inches to your chest, give you a vise-like grip, make those legs of yours lithe and powerful. I can shoot new strength into your old backbone, exercise those inner organs, help you cram your body so full of pep, vigor and red-blooded vitality that you won't feel there's even "standing room" left for weakness and that lazy feeling! Before I get through with you I'll have your whole frame "measured" to a nice, new beautiful suit of muscle!

What's My Secret?

"Dynamic Tension!" That's the ticket! The identical natural method that I myself developed to change my body from the scrawny, skinny-chested weakling I was at 17 to my present super-man physique! Thousands of other fellows are becoming marvelous physical specimens—my way. I give you no gadgets or contraptions to fool

with. When you have learned to develop your Strength through "Dynamic Tension" you can laugh at artificial muscle-makers. You simply utilize the DORMANT muscle-power in your own God-given body—watch it increase and multiply double-quick into real solid MUSCLE.

My method—"Dynamic Tension"—will turn the trick for you. No theory—every exercise is practical. And, man, so easy! Spend only 15 minutes a day in your own home. From the very start you'll be using my method of "Dynamic Tension" almost unconsciously every minute of the day—walking, bending over, etc.—to BUILD MUSCLE and VITALITY.

FREE BOOK "Everlasting Health and Strength"

In it I talk to you in straight-from-the-shoulder language. Packed with inspirational pictures of myself and pupils—fellows who became NEW MEN in strength, my way. Let me show you what I helped THEM do. See what I can do for YOU! For a real thrill, send for this book today. AT ONCE, CHARLES ATLAS, Dept. 85, 115 East 23rd St., New York 10, N. Y.

**CHARLES ATLAS, Dept. 85,
115 East 23rd St., New York 10, N. Y.**

I want the proof that your system of "Dynamic Tension" will help make a New Man of me—give me a healthy, husky body and big muscular development. Send me your free book, "Everlasting Health and Strength."

Name.....Age.....
(Please print or write plainly)

Address.....

City.....State.....



INVENTORS

Patent Laws Encourage The Development Of Inventions

The Rules of Practice of the U. S. Patent Office advises—unless an inventor is familiar with such matters—that he employ a competent registered attorney, as the value of patents depends largely upon the skillful preparation of the specifications and claims.

The firm of McMorrow, Berman and Davidson is registered to practice before the U. S. Patent Office. Additionally, it maintains a staff of attorneys able to readily understand inventors' disclosures, to advise concerning patentability, and to prepare appropriate specifications and claims for filing with the Patent Office.

If an inventor believes he has an invention, a search of the most pertinent prior U. S. patents should be made and a report obtained relative to its patentability. Where such report indicates that the invention appears patentable, in order to secure protection, diligence should be exercised in making application for a patent.

McMORROW, BERMAN & DAVIDSON

Registered Patent Attorneys

PATENTS — TRADE MARKS — COPYRIGHTS

1355 VICTOR BUILDING, WASHINGTON 1, D. C.

McMORROW, BERMAN & DAVIDSON

Registered Patent Attorneys

1355 Victor Building, Washington 1, D. C.

Send me further particulars as to patent protection and procedure and "Invention Record" form at once. I understand that this request does not obligate me.

Name.....

Address.....

City..... State.....

(WRITE OR PRINT NAME CLEARLY)

R. R. President never lets up!

AN I. C. S. TRUE STORY

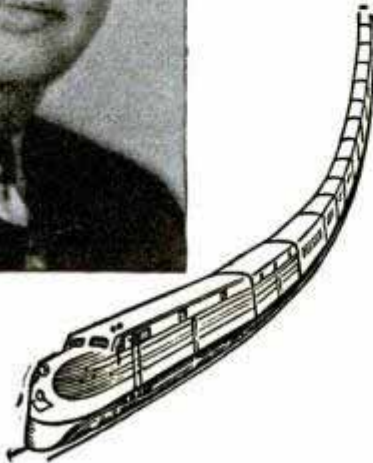

WAYNE A. JOHNSTON at 47 is president of the Illinois Central—one of the nation's largest railroads. He got there by setting a definite goal for himself and never letting up in his efforts to reach it.

On graduation from college, Mr. Johnston started as an accountant with the Illinois Central. That's when a man of less industry and imagination would have let up on his studies. But Wayne A. Johnston enrolled for a course with International Correspondence Schools.

His progress to the top since then has followed that same pattern . . . never letting up . . . always asking "What else can I do?" Now, as one of the youngest presidents of a major railroad, he's still working and studying . . . to increase the efficiency of the Illinois Central, to modernize equipment even more, to keep on moving forward.

If you are asking "What else can I do?" you, too, may be destined for business leadership. The coupon gives you some idea of the more than 400 business and technical subjects I. C. S. can help you to master. Mark and mail it *today* for full information on the course in which you're interested.

"Following my graduation from the University of Illinois, I subscribed for and took a course with International Correspondence Schools. I thought then, as I do now, that the course was excellent. It is my opinion that adult education is real education."

W. A. JOHNSTON, PRESIDENT
Illinois Central System

INTERNATIONAL CORRESPONDENCE SCHOOLS



BOX 5604-K, SCRANTON 9, PENNA.

Without cost or obligation, please send me full particulars about the course *before* which I have marked X:

- | | | | |
|---|--|---|---|
| <p>Business and Academic Courses</p> <ul style="list-style-type: none"> <input type="checkbox"/> Accounting <input type="checkbox"/> Arithmetic <input type="checkbox"/> Business Correspondence <input type="checkbox"/> Business Management <input type="checkbox"/> Certified Public Accounting <input type="checkbox"/> Commercial <input type="checkbox"/> Cost Accounting <input type="checkbox"/> Federal Tax <input type="checkbox"/> First Year College <input type="checkbox"/> Foremanship <input type="checkbox"/> Good English <input type="checkbox"/> Higher Mathematics <input type="checkbox"/> Illustrating <input type="checkbox"/> Postal Service <input type="checkbox"/> Salesmanship <input type="checkbox"/> Sign Lettering <input type="checkbox"/> Spanish <input type="checkbox"/> Traffic Management <p>Air Conditioning and Plumbing Courses</p> <ul style="list-style-type: none"> <input type="checkbox"/> Air Conditioning <input type="checkbox"/> Heating <input type="checkbox"/> Refrigeration | <p>Chemistry Courses</p> <ul style="list-style-type: none"> <input type="checkbox"/> Chemical Engineering <input type="checkbox"/> Chemistry, Analytical <input type="checkbox"/> Chemistry, Industrial <input type="checkbox"/> Chemistry, Mfg. Iron & Steel <input type="checkbox"/> Petroleum Refining <input type="checkbox"/> Pulp and Paper Making <p>Civil Engineering, Architectural and Mining Courses</p> <ul style="list-style-type: none"> <input type="checkbox"/> Architectural Drafting <input type="checkbox"/> Architecture <input type="checkbox"/> Building Estimating <input type="checkbox"/> Civil Engineering <input type="checkbox"/> Contracting and Building <input type="checkbox"/> Highway Engineering <input type="checkbox"/> Lumber Dealer <input type="checkbox"/> Reading Structural Blueprints <input type="checkbox"/> Sanitary Engineering <input type="checkbox"/> Structural Drafting <input type="checkbox"/> Structural Engineering <input type="checkbox"/> Surveying and Mapping <p>Communications Courses</p> <ul style="list-style-type: none"> <input type="checkbox"/> Electronics <input type="checkbox"/> Practical Telephony <input type="checkbox"/> Radio, General <input type="checkbox"/> Radio Operating | <ul style="list-style-type: none"> <input type="checkbox"/> Radio Servicing <input type="checkbox"/> Telegraph Engineering <p>Electrical Courses</p> <ul style="list-style-type: none"> <input type="checkbox"/> Electrical Drafting <input type="checkbox"/> Electrical Engineering <input type="checkbox"/> Electric Light and Power <input type="checkbox"/> Lighting Technician <input type="checkbox"/> Practical Electrician <input type="checkbox"/> Power House Electric <input type="checkbox"/> Ship Electrician <p>Internal Combustion Engines Courses</p> <ul style="list-style-type: none"> <input type="checkbox"/> Auto Technician <input type="checkbox"/> Diesel-Electric <input type="checkbox"/> Diesel Engines <p>Mechanical Courses</p> <ul style="list-style-type: none"> <input type="checkbox"/> Aeronautical Engineering <input type="checkbox"/> Aircraft Drafting <input type="checkbox"/> Flight Engineer <input type="checkbox"/> Forging <input type="checkbox"/> Foundry Work <input type="checkbox"/> Heat Treatment of Metals <input type="checkbox"/> Industrial Engineering <input type="checkbox"/> Industrial Metallurgy <input type="checkbox"/> Machine Shop <input type="checkbox"/> Machine Shop Inspection | <ul style="list-style-type: none"> <input type="checkbox"/> Mechanical Drafting <input type="checkbox"/> Mechanical Engineering <input type="checkbox"/> Mold-Loft Work <input type="checkbox"/> Patternmaking—Wood, Metal <input type="checkbox"/> Reading Shop Blueprints <input type="checkbox"/> Sheet-Metal Drafting <input type="checkbox"/> Sheet-Metal Worker <input type="checkbox"/> Ship Drafting <input type="checkbox"/> Tool Designing <input type="checkbox"/> Welding—Gas and Electric <p>Railroad Courses</p> <ul style="list-style-type: none"> <input type="checkbox"/> Air Brake <input type="checkbox"/> Diesel Locomotive <input type="checkbox"/> Locomotive Engineer <input type="checkbox"/> Locomotive Fireman <input type="checkbox"/> Railroad Section Foreman <input type="checkbox"/> Steam Engineering Courses <input type="checkbox"/> Boilermaking <input type="checkbox"/> Combustion Engineering <input type="checkbox"/> Engine Running <input type="checkbox"/> Marine Engineering <input type="checkbox"/> Steam Electric <p>Textile Courses</p> <ul style="list-style-type: none"> <input type="checkbox"/> Cotton Manufacturing <input type="checkbox"/> Rayon Weav'g <input type="checkbox"/> Woolen Manufacturing |
|---|--|---|---|

Name _____ Age _____ Address _____

City _____ State _____ Present Position _____

Working Hours _____ A.M. to _____ P.M. Length of Service in World War II _____

Special tuition rates to members of the Armed Forces. Enrollment under the G.I. Bill of Rights approved for War II Veterans. Canadian residents send coupon to International Correspondence Schools Canadian, Ltd., Montreal, Canada.

ADVICE for the INVENTOR

The United States Patent Office advises the inventor, unless he is familiar with such matters, to employ a competent, registered patent attorney since the value of a patent depends largely upon the skillful preparation of the specifications and claims set forth in his application.

PRELIMINARY STEPS *toward* PATENT PROTECTION

The Evidence of Invention form mentioned below is offered as a convenience to the inventor in making his disclosure of invention. The inventor should date and sign his disclosure and have it witnessed by two or more persons who are capable of understanding his invention. The disclosure should then be mailed together with the inventor's authorization to conduct a pre-

liminary search at the U. S. Patent Office among previously granted U. S. Patents for similar types of invention. A report is then prepared on the probable patentability of his invention and a recommendation made as to the further course he should take in regard to his invention, provided that the patentability report indicates possible patentability.

Victor J. Evans & Co., has a staff of experienced, registered patent attorneys available to represent inventors in the preparation and prosecution of their cases before the Patent Office.

The **COUPON BELOW** is suggested as a convenience to the inventor in starting action on his invention.

**VICTOR J.
EVANS & Co.**

Merlin M. Evans

REGISTERED PATENT ATTORNEY

230-E Merlin Building, Washington 6, D. C.

PLEASE SEND DETAILED PATENT INFORMATION TOGETHER WITH CONVENIENT "EVIDENCE OF INVENTION" FORM.

Name.....

Address.....

City and State.....

Choose one of these **2 GREAT FIELDS**

- Get Ready **QUICK** at **COYNE!**

ELECTRICITY OR **RADIO-ELECTRONICS TELEVISION**



This big fire-proof building is occupied entirely by Coyne. Established 1899.

Prepare for Success in a few short weeks... in the

GREAT SHOPS OF COYNE

Conditions today are different. Many "one-operation" jobs that pay well will not last. Plan for steady pay and advancement by training NOW. Come to the great shops of COYNE in Chicago, for "all-around" training in Electricity or Radio—the 2 great opportunity fields.

NOT A "HOME-STUDY" COURSE

Our famous "Learn-by-Doing" method gives you practical experience on full-size equipment. Not by correspondence, but actual shop work plus necessary theory. You are trained right here in the great Coyne shops that has been training men and young men for over 48 years.

ELECTRICITY RADIO ELECTRONICS TELEVISION

INCLUDING INDUSTRIAL ELECTRONICS

Big future in Power Plant Work, Motors, Armature Winding, Home and Factory Wiring, Appliances, Refrigeration, Maintenance, Illumination, etc. Electricians are in demand everywhere—lifetime job service. Send for BIG FREE BOOK.

A great field now, even greater growth ahead. Here at COYNE you're trained for Construction, Testing, Trouble-Shooting on Radio, Public Address, Sound Picture Units, Training includes FM, Photo-cells, Television, etc. Our training is quick, easy, practical. Many Coyne trained men own well-paying radio businesses of their own.



ELECTRIC REFRIGERATION

Added training in Electric Refrigeration now included with either our Electrical or Radio Course—no extra tuition cost.

Any Man With a Physical Disability whether a Veteran or not may qualify for Coyne training at no cost to them for tuition or subsistence. Check coupon.

VETERANS
COYNE is authorized to train those who qualify for training under G. I. Bill of Rights. Check coupon for our Special G. I. Bulletin.

Non-veterans who are short of cash can finance most of their tuition and pay it in easy monthly payments after graduation.

PICK FIELD YOU LIKE—SEND FOR BIG BOOK

FREE

—MAIL COUPON



B. W. Cooke

Whether you prefer Electricity, or Radio, train in a few short weeks at Coyne. We have a big, fully illustrated book on each course, and we'll send you the one you want, without obligation. Mail coupon — TODAY.



B. W. COOKE, Director
COYNE ELECTRICAL SCHOOL
500 S. Paulina St., Dept. 57-72H, Chicago 12, Ill.

Send me your BIG FREE BOOK — for the course checked below, also details of your "Student Finance" plan. This does not obligate me.

- ELECTRICITY RADIO
 Send special G.I. Bulletin y disability

NAME.....

ADDRESS.....

CITY.....STATE.....

B. W. COOKE, Director
COYNE ELECTRICAL SCHOOL

500 So. Paulina Street, Dept. 57-72H, Chicago 12, Ill.

"I'll show YOU how to make yourself COMMANDO-TOUGH

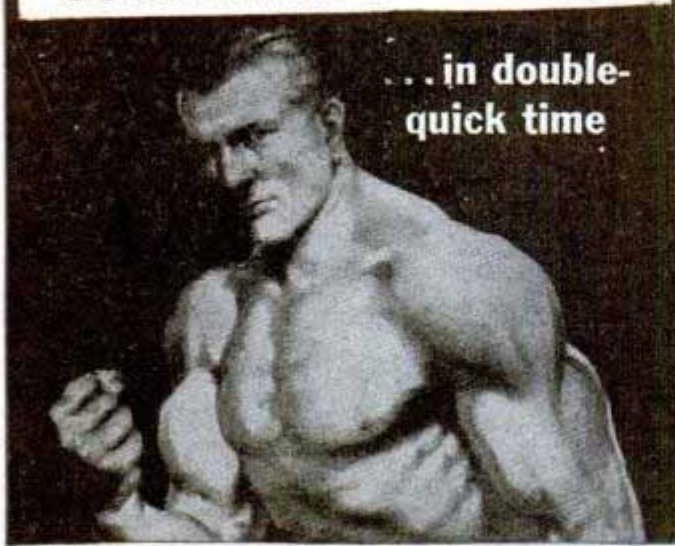

...in double-quick time

...OR IT WON'T COST YOU A CENT!"

says *George F. Jowett*

WORLD'S GREATEST BODY BUILDER

Let me prove to YOU that you can put inches of dynamic muscles on your arms! Add inches to your chest! Broaden your shoulders and power-pack the rest of your body. I can do for you what I've done for thousands the world over, including many officers and men now in the U. S. and British Armed Forces.

**GIVE ME 10 MINUTES A DAY!
I'll Show You My Secrets Of Body Building**

I'll help you learn the "Progressive Power Method" through which I rebuilt myself from a physical wreck to the holder of more strength records than any other living athlete or teacher! No matter how skinny or flabby you are, you can learn my methods right in your own home. Through my proved secrets I show you how to develop your power, inside and out, until YOU are fully satisfied that you are the man you want to be. "The Jowett System," says R. F. Kelly, Atlantic City, Physical Director, "is the greatest in the world!"

**PROVE TO YOURSELF
IN ONE NIGHT!**

Send only 25c for test Course, "Molding a Mighty Arm." Read it the evening it arrives—learn from experience the thrill you can give your muscles!

**SEND FOR THESE FIVE FAMOUS
COURSES IN BOOK FORM
ONLY 25c EACH
or ALL 5 for \$1.00**

If you want a physique that will inspire respect from men, and admiration from women... ACT LIKE A HE-MAN! Decide at once! The famous book, "Nerves of Steel—Muscles Like Iron" will be included FREE! Priceless for the strength fan! Full of photos of marvelous power-bodied men who will show you what Jowett has done for them and how he can do the same for you. Reach out... Grasp this Special Offer today!

Jowett Institute, Dept. PM-75
230 Fifth Ave., New York 1, N.Y.

QUICK ACTION BRINGS

**THIS
BOOK
FREE!**



PHOTO BOOK OF FAMOUS STRONG MEN FREE



Jowett Institute of Physical Culture DEPT. PM-75
230 Fifth Avenue, New York 1, N. Y.

George F. Jowett: Your proposition looks good to me. Send by return mail, prepaid, the courses checked below, for which I enclose (). Include FREE book of PHOTOS.

George F. Jowett
Champion of Champions

- | | |
|--|---|
| <input type="checkbox"/> All 5 courses for.... \$1 | <input type="checkbox"/> Molding Mighty Legs 25c |
| <input type="checkbox"/> Molding a Mighty Arm 25c | <input type="checkbox"/> Molding a Mighty Grip 25c |
| <input type="checkbox"/> Molding a Mighty Back 25c | <input type="checkbox"/> Molding a Mighty Chest 25c |
| <input type="checkbox"/> Send all 5 C.O.D. (\$1 plus postage.) No orders less than \$1 sent C.O.D. | |

NAME..... Age.....
(Please print plainly. Include zone number.)

ADDRESS.....

REFRIGERATION AND AIR CONDITIONING

**BECOME A
SERVICE
EXPERT**

Now, not "next week," is the time to start training for a top-pay job in this vital field. A drastic shortage of trained service experts exists. Many thousands more will be needed for big post-war expansion caused by new industrial uses. Train NOW to get your pick of best jobs. We will give you the practical training you need. For 2 years we trained men and women for the Army and Navy only, in fine-precision aircraft instrument work. So our methods must be right. Common schooling is all you need. Our unique system makes everything easy to grasp. You can train at home and in our big Chicago shops. Write for full facts TODAY, without obligation. Dept. P8c.

Approved for Veterans' G.I. Training

Millions of Old Units
Need Expert Service.
Big Building Boom
Will Create Even
More Opportunities.

INDUSTRIAL TRAINING INSTITUTE

2150 Lawrence Avenue

Chicago 25, Illinois



MAIL CLERKS

\$2,300 A YEAR, TO COMMENCE!

Railway Mail Clerks, Mail Carriers—Clerks, Storekeeper, Gauger, etc. \$1,756 to \$3,021 first year. Write IMMEDIATELY for list of jobs and pointers on how to get one.

FRANKLIN INSTITUTE, Dept. H87, Rochester 4, N. Y.



AMAZING DISCOVERY!

CORRECTS POOR PENMANSHIP in few days—Big improvement in 3 hrs.—No failures. Now, it's fun to become an expert penman. Complete Outline Free. Write today.
O.Z.M.E.N.T., The Inventor, 34, St. Louis, Mo.

LAW...

STUDY AT HOME Legally trained men win higher positions and bigger success in business and public life. Greater opportunities now than ever before. **More Ability: More Prestige: More Money** We guide you step by step. You can train at home during spare time. Degree of LL.B. We furnish all text material, including 14-volume Law Library. Low cost, easy terms. Get our valuable 48-page "Law Training for Leadership" and "Evidence" books FREE. Send NOW, G. I. APPROVED, LASALLE EXTENSION UNIVERSITY, 417 South Dearborn Street A Correspondence Institution Dept. 564-L Chicago 5, Ill.

LEARN MONEY-MAKING CARTOONING

IN SPARE TIME — by Easy Picture Chart Method

Same Simplified Method that has helped train creators of "Terry & Pirates," "Freckles," "Out Our Way," "Winnie Winkle," "Reg'lar Fellers," "Strange As It Seems," "The Neighbors," and many others. Earn while learning. Send 10c for Picture Chart (to test your ability), and full details. (State age.)

Landon School of Cartooning, Dpt. 4705 Philadelphia (1) Pa.



BIG MONEY MAKING SIGNS

New streamlined course revolutionizes learning sign painting. Interesting, easily understood. Decide now for independent and profitable future. Write today for FREE Circular "B."

SUPREME SIGN SCHOOL, 252 W. 67th St., Chicago 21, Ill.



makes False Teeth TIGHT

Makes loose dental plates fit snugly and comfortably.
LASTS for MONTHS!

Simply squeeze on dental plate and put it in your mouth. Hardens and becomes part of plate. Money-back guarantee.

FREE Generous package of Dental Plate Cleanser with each order. Send \$1.00 or mailed parcel post collect.

Fit-Rite Co., 1557 Milwaukee Ave.
Dept. 5-PM, Chicago, Ill.



RADIO ELECTRONICS

DeFOREST'S
TRAINING, INC.
 CHICAGO, ILLINOIS

IT IS THE **WELL TRAINED** MAN **WHO WINS**

In the prize ring, as in the bigger contest of making a livelihood for ourselves and families, *training* makes the champion... brings the real PAY OFF!

You can prepare for bigger winnings, too, by training for one of America's great championship fields—**RADIO** and **ELECTRONICS**—the billion dollar opportunity-packed industry that is on the march.

Mail coupon below right now, for late facts about the exciting events in F.M. Radio, Broadcast Radio, Motion Picture Sound, Electronics, Sound Recording, the future developments in Television, Radar and other branches. See, too, how you may score a *knockout* against low pay, uninteresting work, an uneventful future.

You don't have to know a thing about Radio and Electronics at present. Over a period of 15 years, DeFOREST'S TRAINING, INC. has perfected a championship method of home training that **GETS RESULTS QUICKLY!**

We provide you, for use in your own home, with a **BIG FOUR** training method that includes:

- (1) commercial type Radio-Electronic parts and assemblies for valuable "LEARN-BY-DOING" experience,
- (2) a 16 mm. Motion Picture Projector and 12 reels of action-packed "LEARN-BY-SEEING" instructive movies to speed your understanding of important principles,
- (3) many easy-to-read loose-leaf lessons illustrated with handy fold-out diagrams, and
- (4) an effective **FREE EMPLOYMENT SERVICE** to help you get started toward a good Radio Job when trained—or to assist you in starting your own Radio Business where you can be your own boss.

This championship method has started many men toward Real Pay, Fascinating Work, and a Grand Future—see HOW it may do the same for you. Mail coupon today for big free book that shows you the way.

**YOU CAN BUILD 133
 FASCINATING EXPERIMENTS**

You use 8 Big Kits of Radio-Electronic parts and assemblies. Build and operate SEVEN different Radio Receiver Circuits, Electric Eye Devices, Radio Telephone, Wireless Microphone and dozens of other fascinating projects.

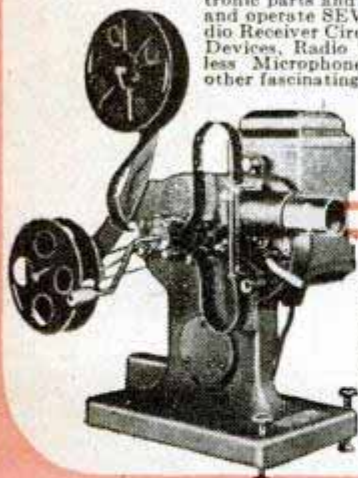

YOU USE A 16 MM. MOTION PICTURE PROJECTOR with 12 reels of instructive movies to help you grasp important fundamentals faster, easier. You enjoy one of today's most modern, effective training aids, **right in your own home.**



LEARN FASTER AT HOME WITH MOVIES

Without obligation, send for our valuable, information-packed book, "VICTORY FOR YOU"
MAIL COUPON TODAY!



DeFOREST'S TRAINING, INC.
 2533-41 N. Ashland Ave., Dept. P.M.-D5
 Chicago 14, Illinois, U. S. A.

Send me both your big book "VICTORY FOR YOU" and Kit Supplement, showing how I may make my start in Radio-Electronics with your modern home training plan. No obligation.

Name..... Age.....
 Address..... Apt.....
 City..... Zone..... State.....
 If under 16, check here for special information.
 If a discharged veteran of World War II, check here.

VETERANS!!!

Both the Home Study and Chicago Laboratory courses of DeForest's Training, Inc. are approved for your training. If you qualify under the "G. I. Law", you can obtain this training without cost.



Start

YOUR OWN BUSINESS

Learn

BE INDEPENDENT

Why work for others at the wages they want to pay you? Learn a good trade and operate your own business and determine just how long you work each day and the amount of money you make. The field of repairing electrical appliances offers any mechanically inclined man the opportunity of a lifetime. There are millions of electrical appliances in this country. Appliances such as refrigerators, irons, sewing machines, vacuum cleaners, heaters, toasters, washing machines, motors, etc. To replace any of these is mighty expensive. In

addition, since the end of the war each month brings new inventions in the electrical appliance field and the purchase of each appliance makes another prospect for you if you learn NOW how to repair various types of electrical appliances.

WHAT YOU NEED

All you need to become a successful electrical appliance business repairman is ambition plus a little training at home in your spare time. If you are mechanically inclined—that is to say—can hold and use tools, our profusely illustrated course written in simple, easy to understand language will prepare you for the years to come. It does not matter if you have not had a great deal of schooling or have had no previous experience along these lines—**WE WILL TEACH YOU.** Age should be no barrier—nor should any minor physical handicap. To repair all types of electrical appliances you do not need expensive tools and equipment or elaborate fixtures. Work as many hours a week as you wish—the home appliance repairman is his own boss. Operate from your garage, basement, kitchen or vacant store, etc.

WE TEACH YOU

With photographs and simple drawings what troubles to look for and how to make each repair on an electrical appliance. We give you a good sound working knowledge of electricity, and how to do welding, nickel plating, etc. Our course shows you how to build the power tools you need and how to solicit business and keep it coming to you. Not a theory course but an honest to goodness course written by and used by repairmen the country over. Price of course is so low that the savings on your own household appliance repairs will quickly pay for it. Act now! Mail the handy coupon on the next page today.

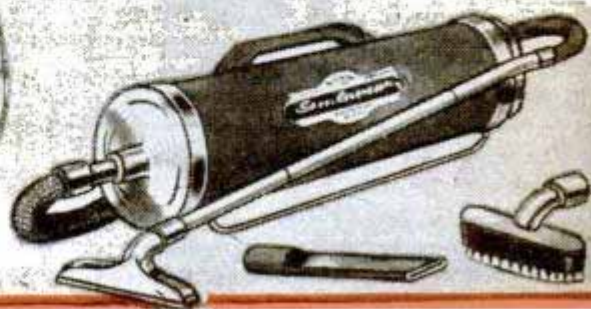
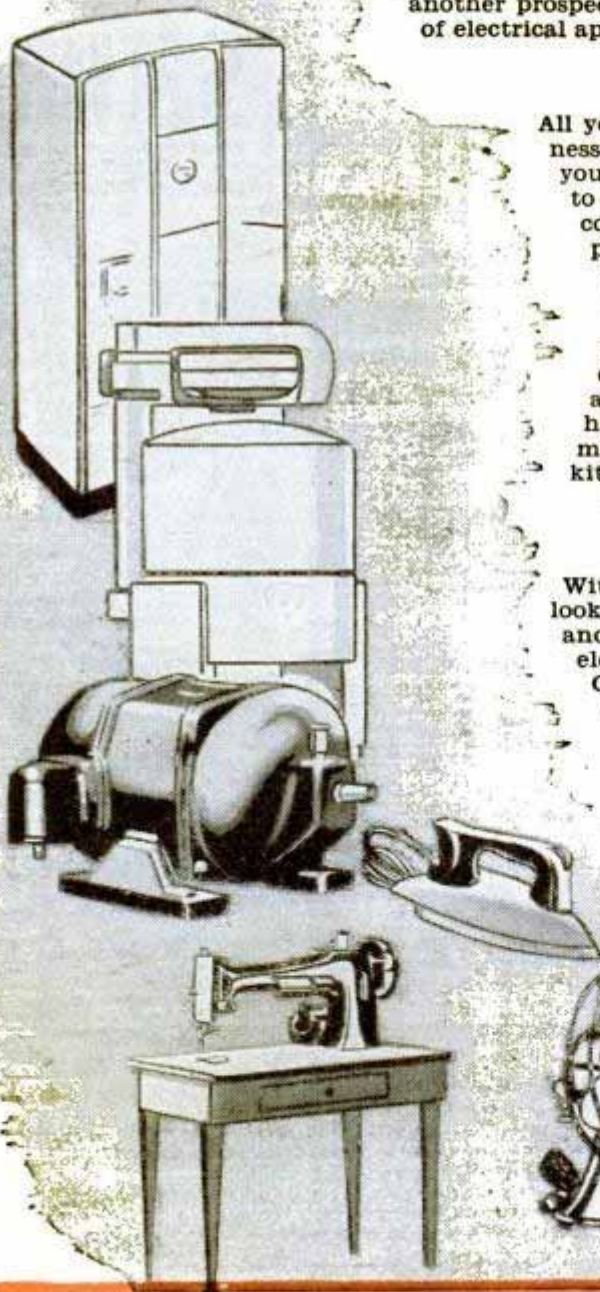

ELECTRICAL APPLIANCE REPAIRING

EARN BIG MONEY

The business of repairing electrical appliances for friends, relatives, neighbors and even strangers, offers any ambitious man a real future for it is not at all unusual for appliance repairmen to charge on the basis of \$5.00 to \$6.00 per hour. Then, too, knowing how to repair appliances is often the stepping stone to selling new appliances or parts at a good profit. Don't gamble with your future—learn a trade that will always support you.

ALWAYS IN DEMAND

Are good appliance repairmen. It is not a war time, prosperity business but a business that provides a real opportunity no matter what the country's general business condition. Ever so many men have written to us of how they prospered after taking our course. Read them for yourself and be convinced.

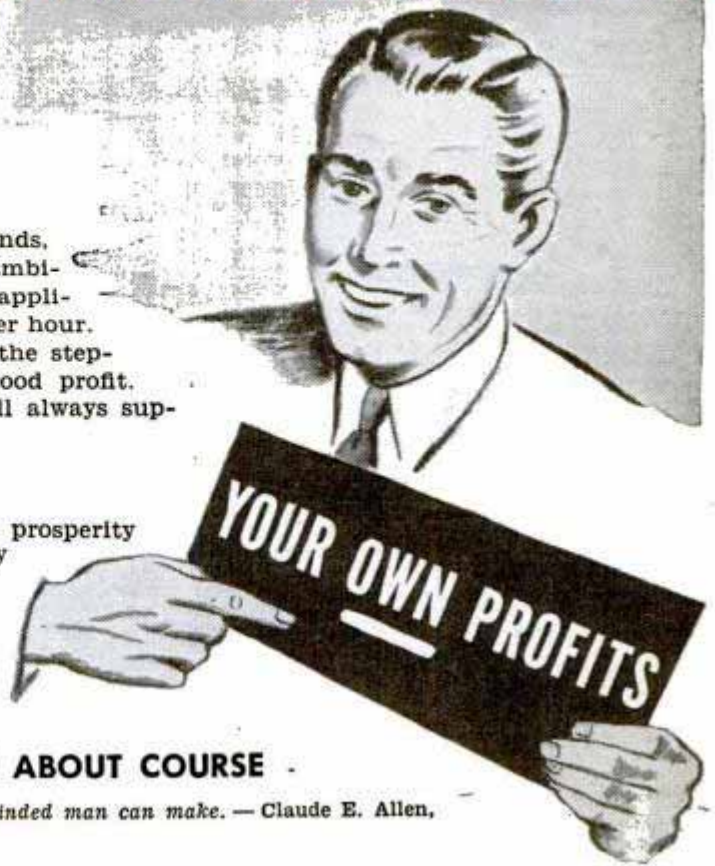

READ WHAT OUR STUDENTS SAY ABOUT COURSE

I really believe your course the best investment a mechanically minded man can make. — Claude E. Allen, Indianapolis, Ind.

I have received your Course in Appliance Repairing and I must say I am well pleased with same. I am only sorry I did not have said Course some years ago. I have learned so much more through this course I would not part with it. — Charles Schwarz, Hamilton, Ohio.

The Course in Appliance Servicing arrived a few days ago. Want to take out a few minutes of my valuable time to let you know that this is just what I have been looking for ever since I opened up my Fix-It shop. I must admit that you told the truth when you said that it contains quite a bit more information than I bargained for. — P. J. Bretl, Sebring, Ohio.

I am a mechanic for the Western Union Telegraph Co. Three days after receiving the lessons in refrigeration I earned the exact cost of the course. — Henry S. Lee, Washington, D. C.

I work day times at the shipyard and after 4:00 P.M. I operate from my cellar and garage. I average \$10.00 to \$15.00 clear every day. — Walter Hanhy, Brockton, Mass.



MAIL COUPON TODAY

CHRISTY SUPPLY CO.

2835 N. Central Ave., Dept. D-4503

Chicago 34, Illinois

Please send me free illustrated literature about America's Fastest Growing Industry—**ELECTRICAL APPLIANCE REPAIRING.**

Name.....

Address.....

City..... State.....

Assure

8 BIG BUILDING BOOKS



For
EXAMINATION
SEND NO MONEY

Learn to draw plans, estimate, be a live-wire builder, do remodeling, take contracting jobs. These 8 practical, profusely illustrated books cover subjects that will help you to get more work and make more money. Architectural design and drawing, estimating, steel square, roof framing, construction, painting and decorating, heating, air-conditioning, concrete forms and many other subjects are included.

BETTER JOBS — BETTER PAY

The postwar building boom is in full swing and trained men are needed. Big opportunities are always for MEN WHO KNOW HOW. These books supply quick, easily understood training and handy, permanent reference information that helps solve building problems.

UP-TO-DATE EDITION

These books are the most up-to-date and complete we have ever published on these many subjects.

Coupon Brings Eight Big Books For Examination

AMERICAN TECHNICAL SOCIETY Vocational Publishers since 1898
Dept. G519 Drexel at 58th Street Chicago 37, Ill.

You may ship me the Up-to-Date edition of your eight big books, "Building, Estimating and Contracting," without any obligation to buy. I will pay the delivery charges only, and if fully satisfied in ten days, I will send you \$2.00, and after that only \$3.00 a month, until the total price of only \$34.80 is paid. I am not obligated in any way unless I keep the books.

Name

Address

City.....State.....

Please attach a letter stating your age, occupation, employer's name and address, and name and address of at least one business man as a reference. Men in service, also please give home address.

AUDELS ELECTRIC MOTOR GUIDE

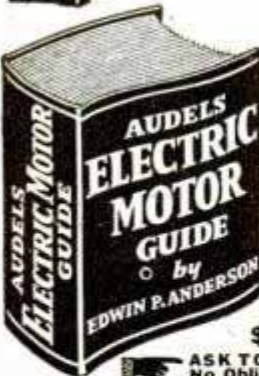

1000 PAGES OF PRACTICAL MOTOR INFORMATION

JUST OUT! Audels Electric Motor Guide covering the construction, hook-ups, control, maintenance and trouble shooting of all types of motors including armature winding. Explains entire subject in every detail. 31 Chapters, 617 Illustrations and Diagrams. A Handy Guide Fully Indexed for Electricians and all Electrical Workers.

\$4 COMPLETE • PAY \$1 A MO.

ASK TO SEE IT!—Get This Information for Yourself No Obligation Unless Satisfied.

MAIL ORDER

AUDEL, Publishers, 49 W. 23rd St., New York 10, N. Y.
MAIL AUDELS ELECTRIC MOTOR GUIDE for free examination. If O. K. I will send you \$1 in 7 days; then remit \$1 monthly until price of \$4 is paid. Otherwise, I will return it.

Name.....

Address.....

Occupation.....

Employed by.....

AVIATION

Aeronautical University Approved Training meets exacting standards of aviation industry, prepares for key positions, big opportunities.

Courses in:

AERONAUTICAL ENGINEERING. B.S. degree.
AERONAUTICAL ENGINEERING DRAFTING
CERTIFIED ENGINE MECHANICS
ADMINISTRATION—including sales

PRE-ENGINEERING: Special course for high school graduates and veterans deficient in math and science.

Also refresher courses for Gov't Airplane and Engine Mechanics Licenses for those with aviation experience.

Oldest fully approved aviation school. Outstanding faculty, modern equipment, outside employment, placement service. Day, evening. Approved for Veterans. Send today for FREE catalog "Opportunities in Aviation."

AERONAUTICAL UNIVERSITY

Dept. 77, 116 S. Michigan Ave., Chicago 3, Ill.

FOUNDED
BY
CURTISS-
WRIGHT

Be A MASTER PLUMBER

Earn \$15 To \$50 A Day

DON'T ENVY THE PLUMBER — BE ONE

Every skilled workman will tell you that Plumbers have the best of it. WINTER and SUMMER the Plumber is busy at top wages. No skilled Plumber is ever out of a job—compare his opportunities with any trade, plus the opportunities of having your own shop. We teach you Plumbing with TOOLS (not books) under Licensed Master PLUMBERS in one of the finest equipped schools in America. We make you a Plumber, every branch is taught thoroughly—Lead Work—Blueprint for plan reading—all other tricks.

LEARN IN 30 WEEKS WITHOUT PREVIOUS EXPERIENCE

If you like to work with tools you owe it to yourself to investigate. No need to ever work as an apprentice. Get free bulletin. Write now! G.I. APPROVED. Our 24th year.

UNIVERSAL PLUMBING SCHOOL

815 HOLMES STREET

KANSAS CITY, MO.

"How to Make Money With Simple Cartoons"

A book everyone who likes to draw should have. It is free; no obligations. Simply address

CARTOONISTS' EXCHANGE

Dept. 95-D

Pleasant Hill, Ohio

TRAIN

Your VOICE!

Results GUARANTEED

We build, strengthen the vocal organs—not with singing lessons—but by sound, scientifically correct silent and vocal exercises and absolutely guarantee complete satisfaction with results. Write for Voice Book, FREE. Sent to no one under 17 years old unless signed by parent.

Perfect Voice Studios, Studio 1355, Kimball Hall Bldg., Chicago 4, Ill.

BUILDING HUMAN STATURE

"I grew 6 inches during a year I followed instructions given in 'BUILDING HUMAN STATURE,'" says the younger man at left. "Now I am a head taller than my father."

If you wonder why you are short send for FREE outline of this remarkable book loaded with practical information.

CARILLON BOOKS, Dept. 103, Boerne, Tex.

INVENTING

—FOR PROFIT! If you have an inventive turn of mind, write for free 28-page booklet explaining how the Institute of American Inventors is helping inventors pre-test the profit possibilities of proposed devices to fill today's unprecedented demand for useful new inventions.

INSTITUTE of AMERICAN INVENTORS

Dept. 4, 1926 Eye St., NW, Washington 6, D. C.

Learn REFRIGERATION AND AIR CONDITIONING FROM THE INDUSTRIAL TRAINING INSTITUTE

America's Foremost School of **PRACTICAL TRAINING!**



ADMINISTRATION BUILDING



DEMONSTRATION LABORATORY



ELECTRONICS LABORATORY



REFRIGERATION LABORATORY



EXPERIMENTAL HOME

*Industrial
Training
Institute*

Here is an industry that offers every opportunity you could ask for. Good jobs—security—plenty of chance for advancement—a business of your own.

And here is a school equipped in every way to train you for Refrigeration and Air Conditioning work—one of the largest and most completely equipped schools of its kind in America—a school that already has trained thousands of men for just such opportunities.

GET READY NOW!

Learn Refrigeration and Air Conditioning—now, while the time is ripe. You don't need any advanced schooling or previous experience. If you are at all mechanically inclined and have gone to high school for at least one year or have an equivalent education, we can teach you Refrigeration and Air Conditioning.

**LEARN AT HOME
OR COME TO OUR SCHOOL**

You can take most of your training at home, in your spare time—or you can come to Chicago and take your entire training in our completely equipped shops and laboratories. Either way you quickly acquire the fine points, practical skill, and broad, tech-

nical "know how" that makes the expert Refrigeration and Air Conditioning Technician.

**FACTS ABOUT THE
INDUSTRIAL TRAINING INSTITUTE**

Founded in 1916. Has trained more than 400,000 men for practical work in industrial fields. From 1942 through 1945 trained specialized technicians, exclusively, for the Army, Navy and Marine Corps. Now training thousands of veterans under the G.I. Bill, both in its Residence Schools and by home-study. Occupies five buildings of its own. Has over \$500,000 invested in training facilities, with an instruction staff of more than 100 men. Known everywhere as America's foremost school of practical training for industry.

Get all of the facts about the opportunities in this interesting field of work, and about the I.T.I. system of training that has helped so many men into key jobs in this industry. Fill out the information coupon below and mail it TODAY. You will be under no obligation whatsoever.

**AUTHORIZED TO ACCEPT
VETERANS FOR G. I. TRAINING**

**REGISTRAR PIR
INDUSTRIAL TRAINING INSTITUTE
2150 Lawrence Ave., • Chicago, 25, ILL.**

Please send me, FREE, your "Camera Visit" booklet and information about the opportunities for trained men in Refrigeration and Air Conditioning. It is understood that I will be under no obligation.

Name.....
Address.....
City.....State.....
Are you a veteran?.....



**GET THE FACTS MAIL THIS
COUPON
TODAY**



For Men Who are Trained in AUTO BODY & FENDER WORK

Men 18 to 60. Want a future with good pay, perhaps a business of your own later? If you are mechanically inclined, start now to learn to become an auto body mechanic and fender repair man. This fast growing field has great possibilities for trained men with experience. U. E. I. spare time, home-study training combined with actual shop practice gives you sound, basic knowledge of latest, best methods so you may get the experience which may bring you big pay. Capable instructors supervise your studies and actual practice. Course includes acetylene welding, spray painting, use of hand and power tools, etc.

THOROUGH, RELIABLE TRAINING

U. E. I. has trained men for new opportunity fields since 1927 and many students are now making good. Auto body and fender repairing is one of the best profit-makers in any garage or service station. Little capital required. . . . placement service, or we will show you how to start your own shop. Get the facts FREE, without obligation. Write today.

Training approved under G. I. Bill

UTILITIES ENGINEERING INSTITUTE

AUTO-CRAFTS DIVISION

1314 Belden Avenue, Dept. 157-X, Chicago 14, Ill.

Gentlemen: -- YES! I want to get into profitable Auto Body and Fender Repair Work. Please send me FREE FACTS at once.

Name _____ Age _____

Address _____

City _____ Zone or County _____ State _____

If veteran of World War II check here
 Check here for Special Information if under 17.

AVIATION

Career

MAXIMUM TRAINING IN MINIMUM TIME

CAL-AERO TECH TRAINING will add dollars to your pay check all the rest of your life. Specializing in AERONAUTICAL ENGINEERING and MASTER AVIATION MECHANICS since 1929, Cal-Aero Tech training is carefully designed for just one thing -- TO MAKE MORE MONEY FOR YOU. An alumni of over 6000 successful graduates proves our career training is unsurpassed.

VETERANS -- Write us about Aviation Training, as provided under "G.I. Bill of Rights."



CAL-AERO TECHNICAL INSTITUTE
 MAJOR C. C. MOSELEY PRES. SINCE 1929
 FORMERLY CALIFORNIA TECHNICAL INSTITUTE

GRAND CENTRAL AIR TERMINAL
 GLENDALE 1, CALIFORNIA
 LOS ANGELES COUNTY

MAIL THIS COUPON TODAY!

Cal-Aero Technical Institute, Grand Central Airport, Glendale 1, California
 Please send full information on Aviation Training FREE -- without obligation. Dept. P25-5

Name _____ Birth Date _____

Street _____

City _____ State _____

ANALYZE HANDWRITING

Qualify for Certified Grapho Analyst Degree at home, spare time. Credit, Employment, Personnel Managers, Business, Professional men, women use grapho-analysis in their work, earn substantial fees in spare time. Many study solely for personal benefit, no desire to earn money, find it so fascinating they start using it to add to their incomes. Entertainment field pays well, up to \$100 in a week reported. Others establishing profitable practices as Vocational and Family Problem Counselors, Personality Teachers, and lecturers.



GROWING -- UNCROWDED PROFESSION

More and more police use grapho analysis handling suspects and criminals. They understand how criminals think. Their handwriting tells. Men like Hugh Dunlap, university student, Harry Allen, retired preacher, use it in court, win cases, earn fees even before graduation. Only school in world devoted to teaching grapho analysis offers thorough training to earnest, ambitious men and women regardless of where you live, small town, farm or city. Send for GRAPHO ANALYST, illustrated lesson, personal handwriting analysis offer, ALL FREE. Must be 21 or over. Address A. I. G. A. Inc., 120, Noel, Missouri.



Command a Substantial Salary BE AN ACCOUNTANT



Hill's, one of America's leading Business Schools, offers you the opportunity to advance yourself to a well paying accountant's job. Our FREE book, "Through Hill's to Success," tells how and where the best positions are found and how you can qualify for them by study at home or in our resident school. We have thousands of successful graduates and maintain nation-wide employment service. G. I. Approved.

HILL'S EXTENSION SCHOOL
 and BUSINESS UNIVERSITY
 619 W. Main St. • Oklahoma City 2, Okla.

LEARN ELECTROPLATING

Highly Paid, Uncrowded, Interesting Business. Part or Full Time, Common School Education Sufficient. Gold, Silver, Nickel, Chromium, etc. Money Making Secrets, Processes. Send postcard for FREE Electroplating Booklet and proof. **PLATER HYDE**, Dept. M, P. O. Box 176, National City, California.

MASTER MACHINIST • MECHANICAL DRAFTING TOOL-DIE DESIGNING • TOOL ENGINEERING

Completely equipped shops and drafting rooms, directed by an accredited staff of engineers and practical instructors. 18 years of successful training of men for industry.

Days, Evenings • Approved for Veteran Training

NEW CLASSES Now Forming • BULLETIN ON REQUEST

ALLIED SCHOOL OF MECHANICAL TRADES, INC.
 42 ALLIED BLDG., 1336 S. MICHIGAN AVE. • CHICAGO 5, ILL.

THERE'S MONEY IN CARTOONS!

RAYE BURNS will teach you HOW to CREATE ORIGINAL CARTOONS at home that you may SELL! Course contains 26 lessons and over 600 illustrations. All for Only... **\$2.85**

Send name and address for free details.

RAYE BURNS SCHOOL, Dept. M, Box 3583, CLEVELAND, OHIO

LEARN WATCH REPAIRING



AT HOME. By our modern and original system of instruction you can learn every part of the **WATCH REPAIRING TRADE AT HOME.** Prepare yourself for a well-paying position or start in business after completing our course of instruction. Good watch repairers are in demand and generally earn very good salaries. For particulars apply to the **Wisconsin School of Watch Repairing** 759 North Milwaukee St., Milwaukee 2, Wis.

GET INTO RADIO ELECTRONICS & TELEVISION

for Success and Security!

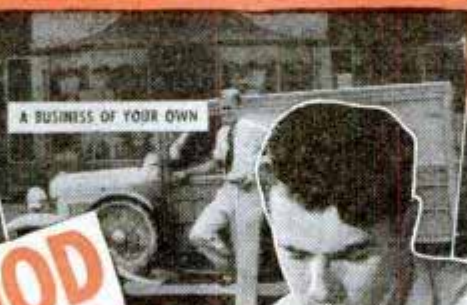
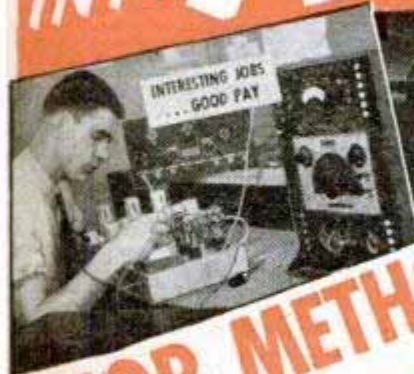

SHOP METHOD HOME TRAINING

BY A REAL ESTABLISHED RESIDENT SCHOOL

In the Classrooms, Shops and Laboratories of this Established School, improved training methods have been designed for practical Home Study instruction in the great field of Radio—in the rapidly expanding branches of Television and Electronics. National graduates everywhere have qualified, through spare time study, for well-paying jobs, success and security. Here is training created BY Practical men FOR Practical men.



You build this powerful super-heterodyne receiver.

are constantly absorbing trained men. If you like mechanics—like to work with your hands as well as your head, you too can find your opportunity in industry or in a business of your own.

LEARN BY DOING RIGHT AT HOME

The secret of success of this practical training method is the EXPERIENCE OF WORKING WITH ACTUAL FULL SIZE, STANDARD EQUIPMENT DURING YOUR TRAINING. Here's a fully tested and approved method—thorough, complete and easy to put into PRACTICE! As you go along, you check PROGRESS right on your own equipment! You can see advancement from the start. It will only take a moment to fill out and send the coupon for a sample lesson. PROVE TO YOURSELF HOW MUCH YOU CAN ACCOMPLISH WITH NATIONAL TRAINING SHOP METHODS.

BECOME A RADIO EXPERT IN YOUR SPARE TIME

The Radio, Television and Electronics industries are demanding more and more trained, experienced men as service men, operators and technicians. It is a field with a proved future. Untold Radio sets are in use—they need maintenance or repair. Radio service organizations, broadcasting, marine and police Radio, public address, and other specialized phases

BIG KITS OF EXPERIMENTAL EQUIPMENT ARE INCLUDED WITH YOUR TRAINING

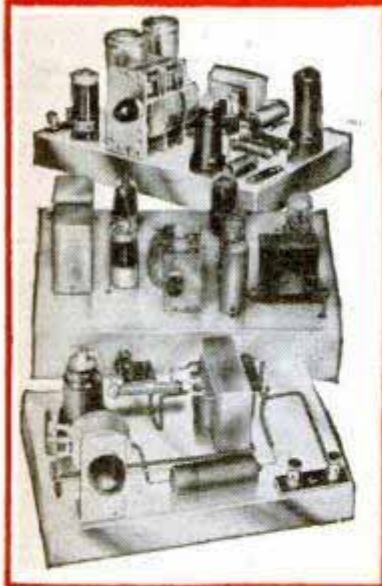

Here are a few of the units of Standard Radio equipment supplied. Build a big, long distance receiver, an audio oscillator, a signal generator and conduct many other experiments.

BIG OPPORTUNITY BOOK AND SAMPLE LESSON Free

Learn how National trains you for good-paying jobs—a business of your own. Get this valuable "Modern Radio Servicing" manual without obligation. Send coupon NOW!



VETERANS

If you qualify for training under G. I. Bill, check the coupon for a Special Bulletin.

NATIONAL SCHOOLS
LOS ANGELES 37, CALIFORNIA EST. 1905

MAIL OPPORTUNITY COUPON FOR QUICK ACTION

National Schools, Dept. 5-PM
4000 South Figueroa Street
Los Angeles 37, California

(Mail in envelope or paste on penny post card.)

Mail me FREE the books mentioned in your ad including a sample lesson of your course. I understand no salesman will call on me.

NAME.....AGE.....

ADDRESS.....

CITY.....ZONE.....STATE.....

Check here if veteran of World War II



AUTO BOOKS ON APPROVAL



CAN YOU FIX IT?

These wonder books tell step by step HOW to make difficult repairs and adjustments, how to keep a car at maximum efficiency, including latest improvements in car design and operation. Engine troubles and how to correct them well covered.

6 BIG VOLUMES
2800 pages, 2000 illustrations, wiring diagrams, etc., including Diesel engines, beautiful modernistic, washable cloth binding.

SEND NO MONEY. Just mail the coupon for a complete set of Six Big Auto Books. 20th Edition. Whether you are a mechanic or helper, expert or apprentice, auto owner or driver, take immediate advantage of this FREE EXAMINATION OFFER.

MAKE GOOD MONEY NOW HOLD A PERMANENT JOB
America wants its automobiles kept in good repair. Men with "know how" are in demand, at big pay. These books will help you get and hold an important job, or give you a chance to go into business for yourself now or later. Any man who half tries to improve himself can learn auto servicing and repairing by this quick reference method. Use the JIFFY INDEX to find easily understood answer to any auto problem. These wonder books prepared by eleven of America's great automobile engineers. Many hundreds of valuable illustrations. Send the coupon TODAY.

A year's consulting privileges with our engineers now given with these books without extra charge.
Vocational Publishers Since 1898

AMERICAN TECHNICAL SOCIETY, Dept. A519
Drexel Ave. at 58th St., Chicago 37, Ill.

I would like to examine your Six-Volume Set of Auto Books. I will pay the delivery charges only, but if I choose I may return them express collect. If after 10 days' use I prefer to keep them, I will send you \$2 and pay the balance at the rate of only \$3 a month until \$24.80 has been paid. Please include consulting service as offered above.

Name
Address

City State

Please attach letter stating age, occupation, employer's name and address and name and address of at least one business man as reference. Men in service, also please give home address.

JUST OUT! NEW FROM COVER TO COVER

AUDELS REFRIGERATION and AIR CONDITIONING GUIDE

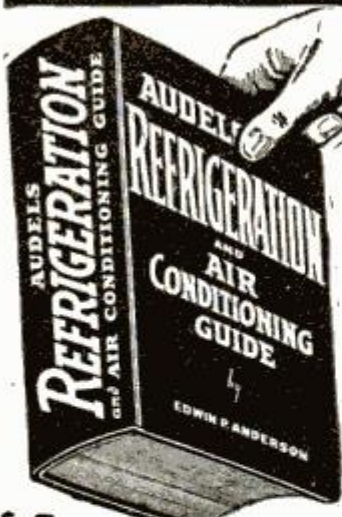

4 Books in One! Covering:
Basic principles, Servicing, Operation, Repair of
1—Household Refrigeration
2—Special Refrigeration Units
3—Commercial & Industrial Refrigeration
4—Air Conditioning Systems
A gold mine of essential important facts for ENGINEERS, SERVICEMEN & USERS.

A Good Book is a Good Friend!
Here you have at your fingers' ends a Complete Library in ONE VOLUME, the necessary data you have been looking for on: MODERN UNITS, SYSTEMS & MACHINES, REFRIGERANTS, including Freon, Lockers, Water Coolers, Quick Freezing & Air Conditioning Systems.
1280 Pages, 46 chapters all Fully Illustrated & indexed for Ready Reference.

ANSWERS YOUR QUESTIONS
Get This Information for Yourself. Mail Coupon Today. No Obligation Unless Satisfied. ASK TO SEE IT.

\$4 COMPLETE • PAY ONLY \$1. A MONTH

AUDEL, Publishers, 49 W. 23rd St., New York 10, N.Y.
MAIL AUDELS NEW REFRIGERATION GUIDE for free examination. If O. K. I will send you \$1 in 7 days; then remit \$1 monthly until price of \$4 is paid. Otherwise I will return it.

Name
Address

Occupation
Employed by PM

RADIO 10¢ BOOKS

Get Started in Radio
TEN "HOW-TO-DO-IT" BOOKS
Get a solid foundation in radio by means of these 10c timely text books. Each clearly written, profusely illustrated, contains over 15,000 words. You'll be amazed at the wealth of information packed into these handy books. Excellent for reference—ideal for technical library. Your money back if not satisfied.
5 Books for 50¢ -- 10 Books for \$1
SENT TO YOU POSTPAID
We cannot send less than 5 books

- | | |
|---|-----------------------------------|
| No. 1—How To Make Four Doerle Short Wave Sets | No. 4—All About Aerials |
| No. 2—How to Make The Most Popular All-Wave 1 and 2 Tube Receiver | No. 5—Beginners' Radio Dictionary |
| No. 3—Alternating Current for Beginners | No. 6—How To Have Fun With Radio |
| No. 7—How To Read Radio Diagrams | No. 8—Radio for Beginners |
| No. 9—Simple Electrical Experiments | No. 10—Television |
- Remit by check or money order—register letter if you send cash or stamps.
RADIO PUBLICATIONS, 23-X West Broadway, New York (7)

PHOTOGRAPHY

for Today's—and Tomorrow's Better Opportunities

Ever-increasing demand for trained photographers in advertising, industry, science, publishing. N. Y. I.'s success-proved home study training qualifies you. Previous experience unnecessary. Details FREE! Also resident courses.
New York Institute of Photography, Dept. 49, 10 West 33 St., New York 1, N.Y.

AIR CONDITION \$1.00

Build Your Own in 2 Days
OR MAKE FOR RESALE AT GOOD PROFIT

Complete, easy to follow instructions and drawing adaptable for Office, Store or Home. No unusual mechanical skill necessary—no refrigeration system required— inexpensive to make and operates at extremely low cost. Send \$1 at once and beat the heat this summer.
IMPERIAL AIR CONDITION
3778-P W. Chicago Detroit 6, Mich.

INDIANA TECHNICAL COLLEGE

Engineering B.S. degree in 27 mos. Aeronautical, Chemical, Civil, Electrical, Mechanical and Radio Engineering, 2-yr. diploma, Air Conditioning and Refrigeration; Drafting, 1-yr. Gov't approved for G.I.'s. Low rate. Earn board. Large industrial center. Demand for graduates. Enter June, Sept., Dec., March. Catalogue, 557 E. Washington Blvd., Ft. Wayne 2, Ind.

LAW

STUDY AT HOME for PERSONAL SUCCESS and LARGER EARNINGS. 38 years expert instruction—over 108,000 students enrolled. LL.B. Degree awarded. All texts furnished. Easy payments. Send for FREE BOOK—"Law and Executive Guidance."
AMERICAN EXTENSION SCHOOL OF LAW
Dept. 77-M, 646 N. Michigan Ave., Chicago 11, Ill.

APTITUDE TESTS

discover the kind of work or studies best for your success! You get a personal report—a guide for life—more happiness—more prosperity. For men, women, boys and girls. Write for complete facts.
VOCATIONAL COUNSELING INSTITUTE
956 Maccabees Bldg., Detroit 2, Michigan

STAMMER? GET THIS FREE BOOK!

This new 128-page book, "Stammering, Its Cause and Correction," describes the Bogue Unit Method for scientific correction of stammering and stuttering—successful for 46 years. Benj. N. Bogue, Dept. 1848, Circle Tower, Indianapolis 4, Ind.

LEARN-WATCH REPAIRING at HOME

FREE information write—American Institute of Specialized Watch Repair—P.O. Box 117, Dept. 1, Grand Rapids 1, Michigan.

Learn PHOTOGRAPHY at Home

Splendid opportunities. Prepare in spare time. Practical basic training. Long-established school. Send for free book, "Opportunities in Photography." No obligation.
American School of Photography, 1315 S. Michigan Ave., Dept. 1355, Chicago 5, Ill.

RAISE CHIN-CHINS

No experience needed. Just a few minutes daily and a few feet of backyard, garage or barn space. Several females and a male starts a large, profitable herd. WE FURNISH FREE INSTRUCTIONS. TREMENDOUS DEMAND for breeding and laboratory stock, meat, and world's most beautiful rabbit fur. Brokers, cut off from imported rabbit pets by world famous, **NEED CHIN-CHIN FURS NOW!** and for years to come! Write for free illustrated catalog today.
WILLOW BROOK FARM • R-36, SELLERSVILLE, PENNA.

If you can lick a  you can learn

How to equal the PHENOMENAL PHYSIQUE of...

ALAN STEPHAN

Official Mr. America!

Body Measurements of ALAN STEPHAN—"MR. AMERICA"



Trade 5 Minutes Reading Time

For **NEW** VIGOR STRENGTH VITALITY

ALAN STEPHAN—official winner of the National A.A.U. Title, "Mr. America"—has received thousands of letters from all parts of the world, asking for the secrets of his phenomenal physical development. His new course in Physical Perfection is his answer to those who are not satisfied with existing, ordinary systems of physical culture.

70 Additional Pounds of Muscle the First Year!

In early youth, Alan Stephan was just a skinny, gangling kid of less than average weight. Determined to surpass the rugged physiques of his playground companions, he studied and trained until he perfected a training system which—in the very first year—added *seventy pounds of muscle* to his rapidly developing physique. His progress was so rapid he was selected im-

mediately as a physical training instructor when he enlisted in the United States Navy early in the war. Today Alan Stephan is officially recognized as America's Best Developed Athlete. The training system *perfected and practiced by himself*, has earned for Alan Stephan, by unanimous decision of the qualified judges, the National A.A.U. Title—"Mr. America."

Not a Sectional or Local Title

There is nothing synthetic or imaginary about Alan Stephan's title of "Mr. America." He competed on a *national basis* against outstanding athletes, physical trainers and strong men from all parts of the country. Only through his

own efforts—and by applying himself to the revolutionary new training system he personally perfected—did Alan Stephan attain his title-winning physique. He now offers you every secret of his easy-to-follow training system.

Send for Profusely Illustrated Book by Mr. America

FREE

Act promptly and Alan Stephan will send you a FREE COPY of his illustrated book, "Presenting Mr. America . . . Alan Stephan," giving you complete facts about his title-winning training system.

MAIL THIS COUPON NOW

Alan Stephan, Post Office Box 1080, Chicago 90, Illinois
Please send me—FREE and without any obligation—a copy of your book, "Presenting Mr. America . . . Alan Stephan." PM 47

NAME..... (Please Print Plainly)

ADDRESS.....

CITY.....STATE.....

DATE OF BIRTH.....

- Height: 6 feet
- Weight: 205 lbs.
- Neck: 17 in.
- Biceps: 18½ in.
- Chest Normal: 48½ in.
- Forearm: 15 in.
- Waist: 30½ in.
- Wrist: 7½ in.
- Thigh: 26 in.
- Calf: 17 in.

Compare these measurements with those of any other physical training teacher! The comparison will speak for itself, as does this original, unretouched recent photograph by Constantine of Hollywood.

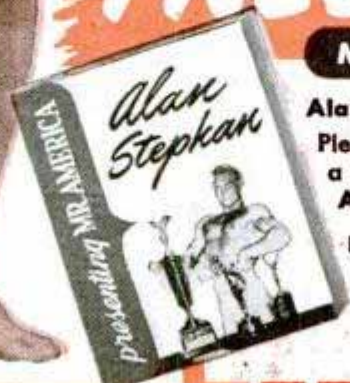

START YOUR OWN REFRIGERATOR REPAIR SHOP!



Learn at Home In Your Spare Time

Our practical, shop-tested home-training teaches you quickly and easily how to repair and install all types of REFRIGERATION and AIR-CONDITIONING. No experience is needed. A grade school education is enough. You may either take a well-paid job or start your own shop with as little as \$50 worth of tools. The opportunities are endless in this huge, well-paid, expanding field. Let us tell you all about it with no obligation. Mail coupon now.

WRITE FOR OUR FREE BOOK



MECHANICS TRAINING SCHOOL

7217 So. Broadway, Dept. P-105, Los Angeles 3, Calif.

Dear Sirs: Please send me without obligation, your free book giving full details about your training.

Name.....
 Address.....
 City.....State.....



WANT A GOVERNMENT JOB?

START
\$1,756 to \$3,021 Year

Prepare NOW For Next Examinations

VETERANS GET SPECIAL PREFERENCE

Railway Postal Clerks
 City Mail Carriers
 City Postoffice Clerks
 Postmasters
 Stenographers-Typists
 Messengers, Etc.

32-Page Civil Service Book FREE

Mail Coupon today—SURE

FRANKLIN INSTITUTE

Dept. H86
 Rochester 4, N. Y.

Rush to me, entirely free of charge, 32 page book with:
 (1) A full description of U. S. Government jobs; (2) A list of U. S. Government jobs; (3) Tell me how to prepare for a job.

COUPON

Name.....
 Address.....
Vet?.....

No Waiting to LEARN

START NOW TO EARN!

This BIG BOOK SHOWS HOW



IF IT'S RESULTS YOU WANT—GET ACTION QUICKLY WITH THESE PRACTICAL IDEAS

Never before has a more helpful book been printed for those planning a business of their own. Gathered in this large illustrated volume are the formulas, recipes, facts and secrets that have contributed so largely to America's great industrial progress. Capitalize on this information for making most any conceivable product without experience, special equipment or previous knowledge of chemistry or manufacturing.

The experts who compiled this book are authorities, and present this information in simple, understandable language. They also give you wholesale supply sources for needed materials, short cuts and methods for the most profitable results.

START AT HOME—EXPAND OUT OF PROFITS

Hundreds of good paying businesses have been built on a product made from a simple recipe. Choose from any of the 162,000 facts and 10,000 formulas of which the following are only a very few: Adhesives, Alloys, Anti-Freeze Solutions, Cosmetics, Beverages and Liquors, Candy, Gum, Casein, Celluloid, Ceramics, Cheese, Cleaning Preparations, Concrete, Copper, Cotton, Dentifrices, Depilatories, Dyes, Embalming Fluids, Enameling, Glass, Glazes, Household Formulas, Inks, Insecticides, Iron, Jewelers' Formulas, Lacquers, Laundry Preparations, Leather, Linoleum, Lubricants, Manicure Preparations, Marble (artificial), Metals, Mirrors,

ALSO

We include Free—our new book of helpful money-making information:—
 "The More You Know the More You Can Earn—Easier and Quicker."

Photography, Polishes, Powders, Remedies for Man, Beast or Fowl, Rubber Products, Refrigerants, Soaps, Solder and Soldering, Tooth Cements, Transfers, Transparencies, Varnishes and Thousands of others for making all sorts of profitable and practical things.

MANY FORTUNES MADE FROM A SINGLE IDEA!

This comprehensive book is an accepted authority by chemists, schools, industry, etc. and is the largest and most comprehensive book of its kind ever issued. Nothing else like it in existence. A single formula has been worth a thousand times this book's small cost to countless owners. Crammed with money-making ideas. Invaluable for reference. Ideal for Factory, Home, Farm, Office or Workshop. As necessary as the dictionary and more useful for manufacturers, chemists and salesmen who put up products for profit.

\$3.98 U. S. Funds. Postpaid anywhere in the World. (C.O.D. in U. S. A. only) Immediate Shipment. Safe Delivery Guaranteed.

ADAMS BROWN COMPANY BOOKS OF APPLIED SCIENCE
 Dept. 175, Chestnut Hill 67, Massachusetts, U. S. A.

POSTPAID
\$3.98
 ANYWHERE IN THE WORLD

CORRESPONDENCE COURSES IN RADIO and ELECTRICAL ENGINEERING

Tuition \$25

ELECTRICAL ENGINEERING. Get good grasp of wide electrical field. Modern. Very understandable. Theory made easy.
RADIO ENGINEERING. Extra line course in radio, public address, photo-electric work. Trains you to be super-service man, real vacuum tube technician. Tuition ONLY \$25, either course. Deferred payment plan. Servicemen needed badly.
 Write for free copies of school catalogs, student magazines, etc.
FREE LINCOLN ENGINEERING SCHOOL, Box 931-P101, Lincoln, Nebr.

WATCHES WANTED Broken or Usable

All kinds. Highest Prices paid for jewelry, rings, spectacles, gold teeth, diamonds, Sterling Silver, etc. Cash mailed promptly. Write for free shipping container.
LOWE'S, Dept. PM, Holland Bldg., St. Louis 1, Mo.

PEPSI-COLA ... Tops For Quality



COMB-A-TRIM THE NEW QUICK TRIMMER

Something New! Trim your hair without any experience. It's easy! The excess hair comes off smoothly and easily by just pulling trimmer through hair like an ordinary comb. Also removes hair from legs—armpits. Save on hair-cut bills... Trim your own hair or the whole family's. Send 59c and your Comb-A-Trim will be sent at once.

SPECIAL OFFER
 Send \$1.00 for 2 Comb-A-Trims and save 18c. **2 for \$1**

5 Extra Blades (Year's Supply) 25c
COMB-A-TRIM CO.
 Cincinnati, O.

1734 Carew Tower

Dept. R-19

Cincinnati, O.

Now Any AUTO REPAIR JOB Can Be a "Push-Over" for You!

**IN LESS TIME—
WITH LESS WORK—
AND MORE PROFITS!**

MoToR's new AUTO REPAIR MANUAL shows you how to service and repair ANY part of ANY car! Now you can lick even the toughest jobs when you have this amazing Manual to make your work easier!

Every job on every car built since 1935 is explained as simply as A-B-C. Clear, illustrated instructions lead you step by step. NOW you can tackle ANY job from carburetor to rear end—and do it quick, easy, right, the FIRST time! Just look up make, model, and the job in the quick index to MoToR's AUTO REPAIR MANUAL—and go to work!

ONLY Manual of Its Kind

No wonder this manual is used by the U. S. Army, Navy, trade and technical schools everywhere, and thousands of successful auto servicemen!

To make this great book possible, the engineer-editors of MoToR Magazine condensed all the meat from 150 official factory manuals for you. They dug out all the information you need; made sure every word is crystal-clear; and put "the whole works" into this one great, handy book!

MoToR's AUTO REPAIR MANUAL is a big book: 856 large pages, 8½ x 11 inches, bound in sturdy covers. Nearly 200,000 serv-

ice, repair, adjustment, replacement, tune-up facts on every car built from 1935 through 1947!

Over 1,000 Pictures!

More than 1,000 cutaway photos, diagrams, drawings, charts, SHOW you what the clear text TELLS you! No wonder thousands of men call this amazing book their Auto Repair "Bible"! No wonder it will save YOU countless hours of work—and help you make MORE MONEY from auto repairs!

See for yourself—without cost!—what a work-saver, time-saver, and "life-saver" MoToR's AUTO REPAIR MANUAL will be for you! TRY it FREE—for 7 days. Learn first-hand how it can pay for itself the first few times you use it!



Clear, Pictured Facts on Every Job on Every Car Built Since 1935!

Nearly 200,000 service and repair facts on all these makes:

American	Crosley	La Salle	Packard
Bantam	De Soto	Lincoln	Pierce
Auburn	Dodge	Lincoln	Arrow
Austin	Ford	Zephyr	Plymouth
Buick	Graham	Mercury	Pontiac
Cadillac	Hudson	Nash	Reo
Chevrolet	Hupmobile	Oldsmobile	Studebaker
Chrysler	Lafayette	Overland	Terraplane
Cord			Willys

856 big pages; including 50 pages of carburetor text, charts, illustrations covering all models. Over 500 charts, tables: Tune-up Chart; Valve Measurements; Compression Pressure; Torque Wrench Reading; Starting Motor; Engine Clearances; Generator; Clutch & Brake Specifications; Front End Measurements, etc.; Engines; Electric, Fuel, Cooling, Lubricating Systems; Transmissions; Universals; Front Ends; Wheels; Rear Ends, etc.

**FREE
7-DAY OFFER
SEND NO MONEY**

Just mail coupon below—without money! When the postman brings your book, examine it thoroughly. Make it show you what it's got! Unless you agree this is the greatest time-saver and work-saver you've ever seen—return book in 7 days and pay nothing. Mail coupon today! Address: MoToR Book Department, Desk 1-E, 572 Madison Ave., New York 22, New York.



Same FREE 7-Day Offer Applies on MoToR's Truck Repair Manual

For mechanics, truck specialists, service stations, fleet owners. Covers EVERY job on EVERY truck made since 1936! 1400 pictures, 952 pages, 300,000 facts. Used by Armed Forces. Warranted to contain every essential fact you need to know. Strong binding, size 8½x11.

Covers all types Gasoline Engines; Diesels and Hesselmans. Fuel Systems, Governors, Lubrication Systems, Ignition Systems, Starters, Generators, Clutches, Transmissions, Axles, Torque Dividers, Transfer Cases.

Brakes, Steering, etc., etc. Also services buses, farm and industrial tractors, contractor and road building equipment, stationary power machinery, etc. (on all parts described in Manual.)

Offered on same FREE 7-Day examination as Auto Repair Manual. Check box in coupon at right.



Published by MoToR, The Leading Automotive Business Magazine. MoToR's manuals assure high standards of repair work.



Used by
U.S. Army
and Navy

MoToR Book Dept., Desk 1-E, 572 Madison Ave., N. Y. 22

Rush to me at once: (Check box opposite book you want)

MoToR's AUTO REPAIR MANUAL. If O.K. I will remit \$1 in 7 days, plus 35c delivery charges; \$2 monthly for 2 months and a final payment of 95c a month later (Price \$5.95). Otherwise I will return book postpaid in 7 days. (Foreign price, remit \$8 cash with order.)

MoToR's TRUCK REPAIR MANUAL. (Described at left.) If O.K. I will remit \$2 in 7 days, and \$2 monthly for 3 months, plus 35c delivery charge with final payment (\$8.35 in all). Otherwise I will return book postpaid in 7 days. (Foreign price, remit \$10 cash with order.)

Print Name..... Age.....

Print Address.....

City..... Zone No. (if any).....

State..... Occupation.....

SAVE 35c SHIPPING CHARGE! ENCLOSE full payment (check, money order, or postal note) and we pay postage. Same 7-day return-refund privilege.

**Big
News!**

America's Famous 150 Openings for

Many Thousands of Dollars Worth of New Equipment Enables Us to Increase Our Enrollment Quota—Personal Instruction by Expert Teachers on Big, Modern Television Equipment—Students May Keep the Television Receivers They Build.

Students are here checking alignment of television sets they are building.

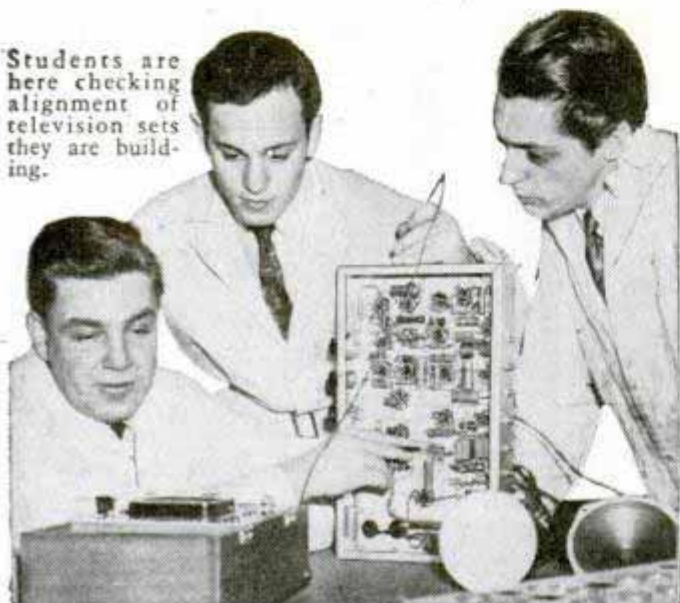

The latest test equipment is available in volume to all students at N.Y.T.I. of N.J. Just learning how to use the latest types of television test equipment is an important part of your training.

IF YOU are interested in a big-money career in TELEVISION—here is good news! We have just purchased more thousands of dollars of up-to-the-minute television equipment. This enables us to accept 150 additional students in May, June and July. *New classes begin every 2 weeks.*

Television is a highly technical subject. You can't expect to make the best progress unless you get expert, PERSONAL instruction and study with the *right apparatus*. You've actually got to *handle* the big, technical equipment YOURSELF. You've got to be in daily PERSONAL contact with your teachers. You've actually got to BUILD television receivers to understand them—and don't let anybody tell you differently!

Here's The Best Way To Learn Television

At the New York Technical Institute of New Jersey—one of America's great technical schools—you can do all that. The school is located in Newark,



Here you see one of the television laboratories in full swing. The class is building television receivers, using many advanced types of test devices.

Television School Will Have May, June & July

N. J.—right smack in the heart of the television industry. It is lavishly equipped with the very latest television test equipment. It maintains a large staff of expert instructors—many of whom are also actively associated with the television industry.

Here you "live" right WITH these experts. They are all regular fellows who have come up "through the mill." They know your problems and they also *know* Television. Working with these men makes it easier to understand even the most technical side of Television. They help you with the 77 different electronic experiments which each student must complete before he starts to build his very own television receiver—which he may keep as his own property—if he chooses.

School Approved for G.I. Training

N.Y.T.I. of N.J. is approved for training under the G.I. Bill of Rights. The government pays up to \$500 a year for a veteran's educational expenses and pays \$90 a month to veterans with dependents and \$65 a month to those without dependents for their living expenses. (Of course, you *don't* have to be a veteran to attend the school.)

We Will Teach You the Mathematics You Need

N.Y.T.I. of N.J. is ideally located for Television Training—right in Newark, in the heart of the country's great radio and electronics industry, just 20 minutes from N. Y. City. The school is near such leading television, radio and electronics man-

**APPROVED
For G.I.
Training**

Eight of these latest RCA High-Frequency Sweep Generators are in almost constant use by students in Advanced Television.

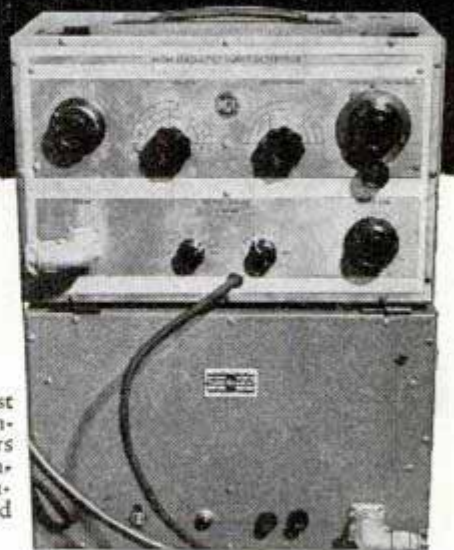

ufacturers as R.C.A., Western Electric, General Electric, DuMont, Federal, Westinghouse and Edison. It is also near some of the biggest television transmitting stations.

Here at the N.Y.T.I. of N.J.—you can really start from scratch and become a television expert. No high school diploma is required. All you need is a grammar school education and a sincere desire to learn, plus a willingness to make an all-out effort. If you are rusty in mathematics, we can teach you the radio and television math you will need.

Send for our Special FREE Bulletin

The school issues a Special Bulletin, which describes and illustrates its facilities and equipment. The FREE Bulletin also describes classes which may be attended, housing conditions, costs, hours, etc. You can have it by mailing the coupon below to—*New York Technical Institute of New Jersey, (Dept. 25) 158 Market Street, Newark, N. J.*

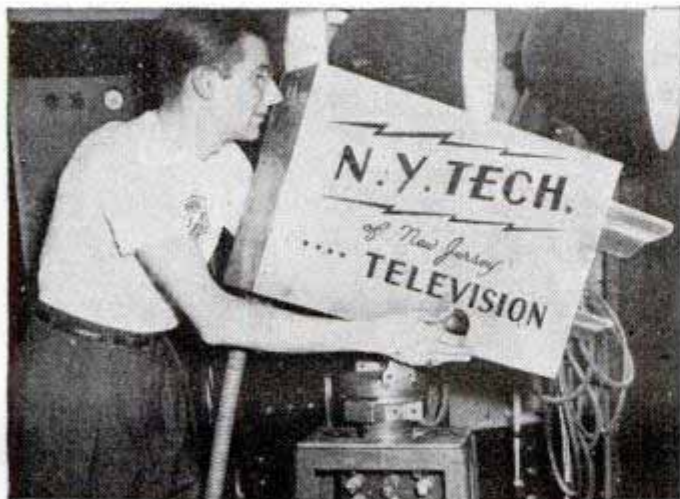

Here an Ex-G.I. is shown taking pictures with N.Y. Tech's Iconoscope Television Camera. When it comes to television—you can't beat N.Y.T.I. of N. J.

**New York Technical Institute of N. J., Dept. 25
158 Market Street, Newark, New Jersey**

Please send me your FREE Bulletin describing the famous Resident School of the New York Technical Institute of New Jersey located in Newark, N. J.—including its facilities, equipment, courses offered, costs, hours, etc.

Check here if you are a Veteran of World War II.

Name.....Age.....

Address.....

City.....Zone
(if any).....State.....

(N.Y.T.I. of N.J. employs no salesmen to call.)

Keep that "TICKING"
Car

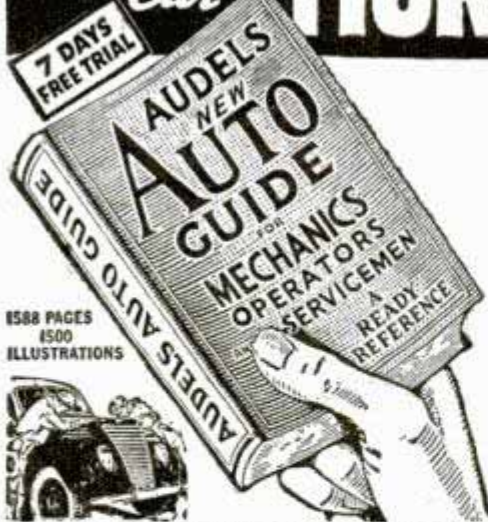

Every operator and mechanic needs AUDELS AUTO GUIDE.

This book saves time, money and worry. Highly endorsed. It presents the whole subject of auto mechanics:

- 1—Basic principles
 - 2—Construction
 - 3—Operation
 - 4—Service
 - 5—Repair
- Handy Size, Easily understood.

NEW FLUID DRIVE, HYDRAULIC SHIFT AND DIESEL ENGINES FULLY COVERED

Over 1500 pages—1540 illustrations showing inside views of modern cars, trucks and buses with instructions for all service jobs.

4 COMPLETE • PAY ONLY \$1. A MONTH

ASK TO SEE IT!—To Get This Assistance for Yourself Simply Fill in and Mail Coupon Today.

AUDEL, Publishers, 49 West 23rd St., New York

MAIL AUDELS NEW AUTO GUIDE for free examination. If O.K. I will send you \$1 in 7 days; then remit \$1 monthly until price of \$4 is paid. Otherwise I will return it.

Name.....
Address.....
Occupation.....
Employed by..... PM

Do you want

- ..to go to College?
- ..or to enter a Profession?
- ..or get an Office Position?

(Such as Accounting, Architecture, Nursing, Dentistry; Teaching, Social Work, Osteopathy, Beauty Culture, Optometry, Embalming, Chiropody, Law, Medicine, etc.)

To get anywhere, you practically **MUST** finish High School FIRST. You can complete our simplified High School Course in SPARE time at home, as FAST as your time and abilities permit. Equivalent to resident school work—prepares you for college, pre-professional examinations, business, industry. Standard texts furnished. Diploma. Credit for H. S. subjects already completed. Single subjects if desired. Low tuition, easy terms. American School, Chicago, est. 1897—endorsed by educators. Finish your high school education NOW, Write TODAY!

High School Course at Home Many Finish in 2 Years

American School, Dept. H-545, Drexel Ave. at 58th St., Chicago 37, Ill.

Gentlemen: Send me FREE information covering special training in subjects checked below. No obligation on my part.

- | | |
|--|--|
| <input type="checkbox"/> High School Course | <input type="checkbox"/> Diesel Engineering |
| <input type="checkbox"/> Architecture and Building | <input type="checkbox"/> Drafting and Design for Men & Women |
| <input type="checkbox"/> Automotive Engineering | <input type="checkbox"/> Plastics |
| <input type="checkbox"/> Business Management | <input type="checkbox"/> Private Secretary |
| <input type="checkbox"/> Electrical Engineering | <input type="checkbox"/> Mechanical Engineering |
| <input type="checkbox"/> Elec. and Gas Refrigeration | <input type="checkbox"/> Aviation |
| <input type="checkbox"/> Air Conditioning | <input type="checkbox"/> Salesmanship |
| <input type="checkbox"/> Railway Training | <input type="checkbox"/> Radio |
| <input type="checkbox"/> Electronics, Industrial | |

Name.....
Address.....

SAY YOU SAW IT IN POPULAR MECHANICS

CAUGHT BY THEIR FINGER PRINTS



During the past 30 years the I. A. S. has trained hundreds of men at home to fill positions of responsibility and steady pay as finger print experts. This fascinating, profitable profession can be learned at home during spare time. More than 800 American Identification Bureaus employ I. A. S. graduates or students. Write today for complete list of these Bureaus.

YOU Can Become a **CRIMINAL INVESTIGATION and FINGER PRINT EXPERT AT HOME!**

Send Now for "BLUE BOOK of CRIME" Thrilling, inspiring, helpful. Be sure to state your age when sending for book. **FREE!** **INSTITUTE OF APPLIED SCIENCE** Dept. 1355, 1920 Sunnyside Ave., Chicago 40, Ill.

SUCCEED IN THE POULTRY BUSINESS!



You can make a good, comfortable living with poultry. For 26 years our course of Home Study training has been helping thousands. With a little study in spare time—you, too, can obtain the "know how" that means extra profits from the start.

Write today for prospectus describing courses, methods, service.

Dept. 50 **NATIONAL POULTRY INSTITUTE** Adams Center, N. Y.

LEARN MOVIE PROJECTION THEATRE MANAGEMENT

The Motion Picture Theatre Business offers big opportunities for trained men. Get into a fascinating field with a post-war future. Train at home in spare time. Free Catalog. Established 18 years.

THEATRE INSTITUTE, 370 Washington St., Elmira, New York

ELECTRICAL TRAINING

Intensive 32 weeks residence course in fundamentals of industrial electrical engineering, including radio, electronics. Prepares for technician, engineering aides. Approved for veteran training. 54th year. Catalog.

BLISS ELECTRICAL SCHOOL 7632 Takoma Ave., Wash. 12, D.C.

LEARN MEAT CUTTING At Home—In Spare Time

Get into the vital meat industry. Concise, practical Home Training based on 25 years proven instruction methods used at National's famous resident school. Prepares you for bigger pay as Meat Cutter, Supervisor, market manager or more money in your own store. Go as rapidly as your spare time permits. Diploma. Start NOW to turn your spare hours into money. Send for FREE bulletin today. No obligation.

National School of Meat Cutting, Inc., Dept. U-81, Toledo 4, Ohio

REFRIGERATION and AIR CONDITIONING

Mechanical units everywhere need servicing. Be ready with reliable pay-knowledge. Unique home study—actual practice plan. Train now for servicing and installing jobs or business of your own. **Get The Facts FREE Now! Write Today!** **UTILITIES ENGINEERING INSTITUTE** 1314 W. Bolden Ave., Dept. 157, Chicago 14, Ill.

Approved under G. I. Bill

POPULAR MECHANICS

**WANT TO
EARN
More
MONEY?**

**Prepare at Home--
in Spare Time**

Start Your Own RADIO

**Business With Little Capital
or Qualify for a Good Pay Job**

Find out about the many money-making opportunities Radio offers you. Learn how you can qualify for a good-pay job or start a business of your own without capital. Send coupon below for my big FREE book, "Your Opportunities in Radio and Television," which tells of radio's vast opportunities and how HOLLYWOOD RADIO & TELEVISION INSTITUTE has been training men for success in Radio through home study, for over 17 years, in over 40 countries, through its proven 2-WAY METHOD—
LESSONS PLUS HOME SHOP PRACTICE!

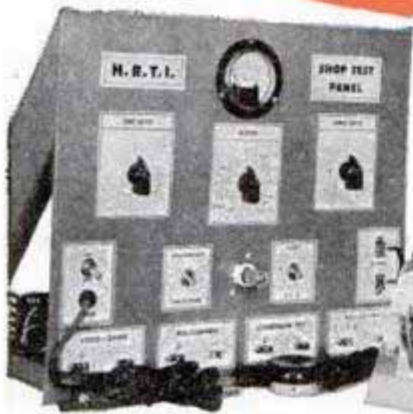

ABOVE — You build this Multi-purpose Shop Test Panel. 5 Test instruments in one.



My 2-Way Method (Lessons plus practical experience) helps you get into Radio Quicker.

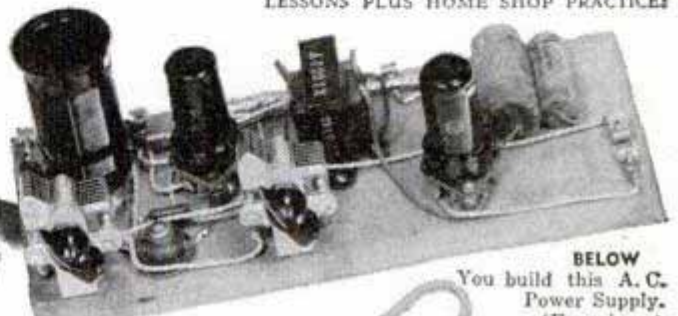

ABOVE — You build transformer coupled audio stage. (Experiment No. 260)



LEFT—You build this tuned radio stage, regenerative detector and audio amplifier. (Experiment No. 329)

BELOW You build this A.C. Power Supply. (Experiment No. 155)

**You Get 9 KITS OF RADIO PARTS * You Learn By Doing
You Do Over 300 Fascinating Tests * You Keep All Kits!**

My regular course shows you the "Whys" of radio. My Home Work Shop Experimental Course shows you the "Hows" of radio, first hand—by doing. Thus you learn more thoroughly—quicker.

HOLLYWOOD IS A WORLD CENTER

of radio broadcasting and manufacture-television-motion picture production. Thus, H. R. T. I. is in an excellent location to bring you modern, up-to-the-minute instruction. Before you decide on any course you owe it to your future to find out about H. R. T. I. training. Read what graduates in 40 different countries say about this famous course.

BIG BOOK FREE

Just paste coupon on a postcard or send in envelope for free big fully illustrated book "Your Opportunities in Radio, Television and Electronics" and explaining the advantages of HRTI training. No salesman will call.



MANY H.R.T.I. STUDENTS EARN MONEY IN SPARE TIME WHILE LEARNING

From the very start, through special "Spare Time Work Sheets," I show you how to earn money in spare time by doing good-pay radio jobs that abound in nearly every neighborhood. Many students earn \$5, \$10, and more a week while learning. A mighty good way to lay the foundation for a future radio business of your own.

Now is the time to start preparing for your career in this fast-growing industry. Take the first step—send coupon for my big FREE Book today.

MAIL COUPON NOW

C. H. Mansfield, President, Dept. A4
HOLLYWOOD RADIO & TELEVISION INSTITUTE
810 WEST 6TH ST., LOS ANGELES 14, CALIF.

Send me your FREE book, "Your Opportunities in Radio, Television and Electronics" which explains your 2-way home study training method. (No salesman will call.)

Name _____ Age _____

Address _____

City _____ Zone _____ State _____

Air Mail Reaches Me Overnight

HOLLYWOOD RADIO & TELEVISION INSTITUTE
810 West 6th Street, Los Angeles 14, California

NEW peacetime production plans mean



BIGGER PAY FOR MACHINISTS

Master shop work quickly with these books

This big home-study and reference course gives you the practical facts on machines and methods you need to advance in machine shop work. Take advantage of the other man's experience as found in books, to solve your problems, increase your efficiency, with

The AMERICAN MACHINISTS' LIBRARY

6 volumes—2368 pages—2516 illustrations
(A combined home-study course and reference library)

This library of machine shop practice was written for practical men. It gives you the best methods for every kind of machine shop work. It fully explains lathes, drills, and other machine tools and their operation, automatic screw machines, speeds and feeds, gear design and production, jigs and fixtures, punch and die work, metal surfacing, etc., etc. Plainly written—completely illustrated—the best kind of help to the machine shop man who wants to advance himself.

No money down—special price—easy payments.

EXAMINATION COUPON

McGRAW-HILL BOOK CO., 330 W. 42nd St., N. Y. 18

Send me for ten days' examination the American Machinists' Library. If satisfactory I will send you \$4.00 in 10 days and \$4.00 monthly until the price of \$20.00 is paid. If not wanted, I will return the books postpaid. (To insure prompt shipment write plainly and fill in all lines.)

Name.....
Home Address.....
City and State.....
Company.....
Position..... PM-5-47

NOW! Build Your Future On



DIESEL Opportunities

LOOK around you. See the way tractors, trucks, buses, railroads, ships, power plants and equipment of many kinds are "going Diesel." Every day new opportunities are opening—in industrial and farming communities—for trained men who can install, maintain, operate and repair Diesel engines. Plan now to build your future in this growing field.

Diesel Knowledge is Earning Power

You don't have to give up your present job. Now, you can begin learning DIESEL in spare time at home. UEI practical training teaches you, step by step, how Diesel engines operate, how fuel systems work, repairs, accessories and auxiliary equipment; a world of Diesel "know how." Includes actual practice on Diesel equipment in our shop under expert guidance. UEI training methods are successful. For 20 years they have helped mechanically inclined men better themselves.

NOW IT'S UP TO YOU!

Coupon below brings you all the facts without cost or obligation. Get going today! MAIL COUPON NOW.

UTILITIES ENGINEERING INSTITUTE
Diesel Division
1314 W. Belden
Dept. 157-D,
Chicago 14, Ill.



Send Coupon for FREE FACTS

UTILITIES ENGINEERING INSTITUTE, Diesel Division
1314 W. Belden Ave., Dept. 157-D, Chicago 14, Ill.
Please send me Free Facts about Diesel opportunities and training.

NAME..... Age.....
ADDRESS.....
CITY..... Zone or County..... STATE.....
 Check here for special information if you are under 17.
 Check here if Veteran of World War II.

Mickey Mouse Cartoon Home Movies

Always Packed with Laughs



- 100 Ft. 8mm.....\$3.00
- 200 Ft. 16mm..... 6.00
- Six Shooter.....1413-B
- Air Raid.....1414-B
- High Speed.....1415-B
- Dog Catcher.....1416-B

Show also a Donald Duck film and Walter Lantz's 3 Monkeys and Oswald Rabbit Cartoons for complete Home Movie entertainment.

At your Photo Dealer or order direct.

For complete lists and prices, write—

HOLLYWOOD FILM ENTERPRISES, Inc.

6060 Sunset Blvd. Dept. 115 Hollywood 28, Calif.

What Every Mason Wants



We have important Masonic books for Blue Lodge, Chapter, Commandery, Scottish Rite, and Shrine.

Our Rituals Are Used the World Over. Send for free catalog of books and rituals for Masons, Odd Fellows, Knights of Pythias, Knights of Columbus, etc.

EZRA A. COOK, Publisher, P. O. Box 796, PMY, Chicago 90, Ill.

BUILDING



Millions of homes needed. Nation wide call for builders. Big opportunities. Learn now in spare time.—at home. Practical training with blue prints. No books. Send for FREE Trial Lesson and blue print plans.

CHICAGO TECHNICAL COLLEGE
E-151 Tech. Bldg., 2000 S. Mich. Ave.
Chicago 16, Ill.

HORSE MASTERY!

A FINE HOBBY—A GREAT VOCATION!

"The EXPERT HORSEMAN"

SUBSCRIBE TODAY
50¢
One Year



FREE BOOK—Tells how you can learn to: BREAK COLTS, GAIT SHOW HORSES, TRAIN RODEO, STOCK and RACE HORSES, BREAK BAD HABITS, HANDLE ANY HORSE, TRAIN CIRCUS TRICK HORSES. WRITE TODAY!

ANIMAL LOVERS ASSOCIATION
BOX KA-111 TARZANA, CALIFORNIA

TRI-STATE COLLEGE

B. S. Degree in 27 months in Engineering (7 branches); Bus. Admin., Acc't and Sec. Science. 64th year. School now filled to capacity. No applications can be accepted until further notice.

457 College Ave., Angola, Ind.

HOME STUDY OR SHOP TRAINING

Learn Plastics, Refrigeration or Diesel. Study at home, shop work later. Also shop courses in Body and Fender, Tool and Die, Auto, Diesel, Refrigeration. 45,000 graduates. Established 1902. Free booklet. Specify trade. **GREER SHOP TRAINING**, Dept. 157, 460 S. State St., Chicago.

Learn Public Speaking

Learn theory and fundamentals at home—in spare time. Then acquire actual experience and practice. Send for FREE booklet "Power of Effective Speech."

North American School, Dept. 1355
1315 S. Michigan Ave., Chicago 5, Illinois



LEARN PORTRAIT PAINTING AT HOME

• Previous art training or talent NOT necessary. This new Stuart System teaches you, in 11 simple, easy-to-follow lessons, to make exact charcoal and oil likenesses. Guidance for your every step. Send for free book today.

STUART STUDIOS.

121 Monument Circle, Room 65, Indianapolis 9, Ind.
Please send me free book and outline of lessons.

Name.....
Street.....
City..... State.....

STEADY JOB! GOOD PAY! CLEAN WORK!

ELECTRICITY

**NATION'S
LARGEST
EXCLUSIVE
ELECTRICAL
SCHOOL**

**LEARN QUICKLY AND THOROUGHLY
LATEST, MOST ADVANCED METHODS**

Learn Electricity Fast . . . at nation's largest exclusive electrical school . . . in only 19 weeks! Learn Electricity Right . . . topflight instructors help you learn easily, quickly, thoroughly . . . on-the-job, up-to-the-minute methods of training. Qualify yourself for Construction and Industrial Maintenance . . . Operation, Maintenance and Repair of AC and DC Motors, Generators, Controls, other Power Equipment . . . House and Factory Wiring . . . Armature and Motor Rebuilding. Entire building—4 floors devoted exclusively to this one course. Individual attention to students. Living quarters arranged for if desired.

Pay after you graduate . . . Lack of money need not hold you back. We will finance your training. Pay later in small monthly payments.

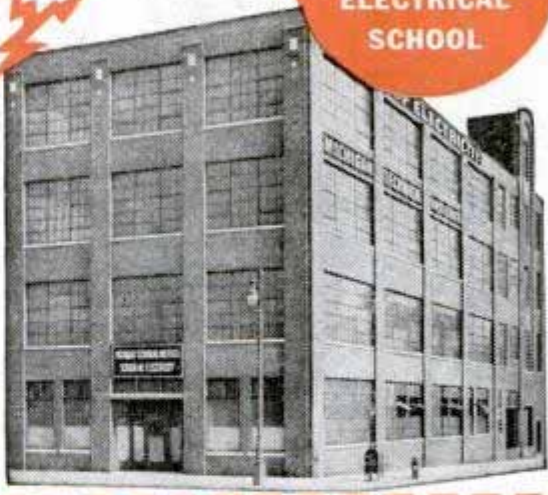

MICHIGAN TECHNICAL INSTITUTE

Dept. PM-5, 2281 W. Fort St., Detroit 16, Mich.

MICHIGAN TECHNICAL INSTITUTE Dept. PM-5
2281 W. Fort St., Detroit 16, Michigan

- Send me catalog and complete information.
- I am a GI. Send special information.

NAME _____
ADDRESS _____
CITY _____ STATE _____

APPROVED FOR TRAINING UNDER GI BILL

VETERANS!

Take this course at no cost to you, and receive \$65 to \$90 a month while training. Complete details furnished.
MAIL COUPON TODAY!

**MAKE MONEY CASTING AT HOME
FREE FACTS SENT..**



Cast thousands of perfect Plaques, Book Ends, Ash Trays, Etc. Plaster, Liquid Marble, Etc. ENORMOUS PROFITS. Start in basement or garage. LITTLE CAPITAL NEEDED. QUICK, EASY, NO PREVIOUS EXPERIENCE NEEDED. Rubber molds for speed production. MAKE YOUR OWN. SAMPLE KIT \$1.00.
Plastic Arts Studio, Route 5, Dept. 29, Muncie, Ind.

START YOUR OWN PHOTO COPY BUSINESS!

SMALL investment . . . BIG profits. No darkroom needed. EASY work. Write immediately for FREE 4 page folder and price list.
GENERAL PHOTO PRODUCTS COMPANY
15 Summit Avenue Dept. PM Chatham, New Jersey

ELECTRICIANS SCHOOL

PRACTICAL TRAINING IN
HOUSE AND COMMERCIAL WIRING
MOTOR REPAIR AND REWINDING
ELECTRIC REFRIGERATION
Approved for Veterans Training

PENNSYLVANIA INSTITUTE SCHOOL OF ELECTRICITY
42nd & SPRUCE STS. CATALOG PHILADELPHIA 4, Pa.

Learn to MOUNT BIRDS



Tan SKINS, make up FURS
Be a Taxidermist. Double your hunting fun. We teach you at Home. Mount Birds, Animals, Fish, Heads, common specimens. Fun and profits. Decorate home and den MAKE MONEY. Mount game, tan for others. Big profits in spare time. WRITE TODAY.
100 game pictures in FREE BOOK
Hunters, get your copy. It's Now Free. Send post card. State your AGE.
NORTHWESTERN SCHOOL OF TAXIDERMY
Dept. 3375 Omaha, Nebraska

FREE BOOK



MY DOBE TRAINING WAS ALL PRACTICAL EXPERIENCE!

I WILL TRAIN YOU AT HOME UNTIL YOU GET A GOOD PAY JOB!

Get Started NOW in DRAFTING

EXPERIENCE WHILE LEARNING

Your training will be experience because I give you practical jobs to do. And I list your experience and send it to employers as a reference when you are ready. All Dobe trained men start out with experience. You will too, because I will train you until you get a good pay job in drafting.

Take the first step now and step into Drafting—the big opportunity field—as an experienced, well paid draftsman. Act now for a better job, better pay and better working conditions. The field for draftsmen is bigger now than ever before for all new products, machines, construction start with the draftsman. Get into drafting now. I will train you at home in your spare time, and give you actual experience on actual work—the same kind of jobs you will do with the best paying firms. I will train you until you are competent, fully experienced, and holding a position that will bring advancement and pay raises. Write me today.

WORKING TOOLS SENT WHEN YOU START
All drafting instruments and table and other needed equipment sent when you start. Nothing to buy. Act today. Mail coupon to me now and be sure to give age.



MAIL COUPON FOR VITAL FACTS

Engineer Dobe, Div. 15, Libertyville, Ill.

Send me the Vital Facts on Drafting and Industrial Designing, your Free Book and advertised list of positions for Draftsmen and Designers wanted.
Name _____ Age _____
Address _____
City _____ Zone _____ State _____

Now LEARN ELECTRIC MOTOR REPAIR!



**Easily, Quickly
AT HOME \$5
for ONLY \$5**

Based on what you can learn at home from this big book—FOR ONLY \$5 complete—you can train to profitably trouble-shoot, repair and rewind all types of electric motors. Every home, every office, every business and factory is a prospect for electric motor repair work. The field is tremendous, the pay good. Up to now, there has been no easy, practical way to learn the work in spare time study. The opportunity is "wide open"—and **ELECTRIC MOTOR REPAIR**, the big 580-page book by Robert Rosenberg, helps you cash in on it within a few short weeks!

TRAIN FOR GOOD PAY IN A FIELD THAT ISN'T CROWDED

You learn fast! You learn right. **ELECTRIC MOTOR REPAIR** covers alternating-current motors, direct-current motors and synchronous motors and generators. ALSO, it covers BOTH mechanical and electrical motor control systems. Quick-reference guides show exactly how to handle specific jobs. Every subject is not only written understandably, but further explained VISUALLY by more than 900 clean-cut drawings. Invaluable for beginners or for bench use in busy shops. Book divides into two sections, enabling BOTH text and related illustrations to be seen AT THE SAME TIME. Lies open flat while you work!

"BORROW" IT FOR 5 FULL DAYS!

Send coupon now. Practice from **ELECTRIC MOTOR REPAIR** for 5 full days. If not more than satisfied with book, return it. Every cent of your money will be cheerfully refunded and absolutely no questions asked. What could be fairer?

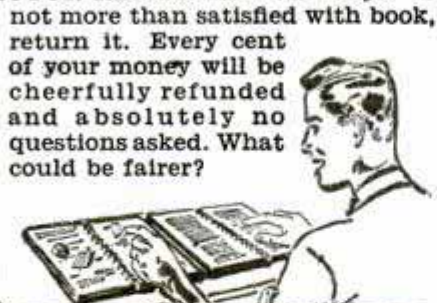

FREE!

Check coupon for free literature on famous **GHIRARDI RADIO-ELECTRONIC Training Books**

NO RISK COUPON mail today

Dept. PM-57, Murray Hill Books, Inc.,
232 Madison Ave., New York 16, N. Y.

Enclosed find \$5 (\$5.50 foreign) for my copy of the big **ELECTRIC MOTOR REPAIR** book; or send C.O.D. (no foreign C.O.D.'s) for this amount plus postage. In either event, if book is unsatisfactory for any reason, I may return it in 5 days and have my money refunded.

CHECK HERE for free literature on Ghirardi **RADIO-ELECTRONIC** books.

Name.....

Address.....

City & Zone..... State.....

YOU MAY BE ABLE TO
DOUBLE YOUR INCOME
IN YOUR
SPARE TIME!!

LEARN SILK SCREEN PROCESS

Jealously Guarded Trade Secrets NOW Available to You

Develop a Profitable Business of Your Own... or a Hobby

Prepare yourself for an interesting top paying position. Thousands of jobs open. Silk Screen Process signs, displays, Xmas cards, toys, etc., IN GREAT DEMAND THE WORLD OVER. You may make enough the second week to pay for the entire course. EASY TO DO... EASY TO LEARN. No education or mechanical knowledge required. WRITE FOR FREE COLORFUL INTERESTING ILLUSTRATED CATALOG.

CALIFORNIA SCHOOL OF SCREEN PROCESS
Dept. PM-57 3740 Overland Avenue, Los Angeles 34, California



COURSE INCLUDES A COMPLETE KIT OF SUPPLIES

CONTACT NEW POWERS FOR PERSONAL SUCCESS

Back your better self with inspired action! Unleash new hidden powers by daring to attack hindrances and wrongs. Come out of your corner fighting and stop being pushed around.

Whether it's worry, fears, nerves or a feeling of inferiority and poor health beyond the doctor's remedies, do something about it. Don't just sit down and let misfortune have a picnic at your expense. Gain the advantages of Personal Know-How with our Home-Study Self-Development Plan. We offer you sincere help with a money-back guarantee of results in your case. Write today for FREE LECTURE and full details. No obligation.

SCHOOL OF PERSONAL PSYCHOLOGY

(Chartered Non-profit Correspondence Education)

1008-1009 Washington Bldg., Louisville 2, Ky.

BE A REAL ESTATE BROKER PAYS BIG!

EASY TO LEARN—Start and run your own business quickly. Many graduates report making up to \$1000 a month. Course of study covers Sales, Property Management, Appraising, Loans, Mortgages and hundreds of related subjects. Course offered in home study or residential classrooms.

FREE Big new illustrated catalog from this nationally known school. Send Post Card Today.

WEAVER SCHOOL OF REAL ESTATE
Dept. KA-3, 15 E. Pershing Road Kansas City, Mo.



ARTISTS MAKE MONEY

Do you like to draw? Send name, address, age and occupation for **FREE ART TEST**, to find out your ability.

ART INSTRUCTION, Inc.

5137 ART INSTRUCTION BLDG., MINNEAPOLIS 15, MINN.



Begin today. Write now for our Free Book, "How to Become a Good Penman." It contains specimens and tells how others learned to write in spare time. Enclose 10c for your name beautifully written and a pen point suitable for shaded writing. Write today.

THE TAMBLYN SCHOOL OF PENMANSHIP
N-441 Ridge Building, Kansas City, Mo.

AGENTS... Be First With Newest Products

It means quick easy sales and large profits. Our monthly **NEW PRODUCTS BULLETIN SERVICE** lists 100 **NEWEST** products, where to buy them, long before they appear on the market. Sample Bulletin \$1.00. **FREE** information. **HURRY—BE FIRST—BEAT COMPETITION.** EDUCATIONAL BOOK CO., 2907 Berwick Ave., Baltimore 14, Md.

MONEY for MEN ALL FREE

THE **PLASTEX** Industry needs manufacturers on small scale and for big production of Lamp and Clock Stands, Art Goods and Novelties in Plastex and Marble imitation. Experience unnecessary. 12c material makes regular 10c store sellers. Rubber moulds furnished for speed production. Small investment brings good returns. Big chain store orders now being placed. Ambitious men have chance for real prosperity. Our Free booklet will interest and benefit you.

PLASTEX INDUSTRIES, Dept. P, 1025 Washington Ave., New York, N.Y.



IT'S FUN! BE YOUR OWN MUSIC TEACHER!

YES, it's a great pastime learning music this short-cut, Print and Picture way, right at home. You learn to play by playing real tunes by note with the very first lesson.

No boresome exercises. No lengthy, baffling explanations. Instead of hard work, learning to play becomes a genuine pleasure. You start with simple melodies. As you improve, you take up more difficult pieces. And soon you're amazed to find that you can pick up many popular tunes and play them right off.

And that's not all. You can take up any instrument this easy, home-study way for only a few cents a day. Surprise your friends—win new popularity—by learning your favorite instrument at home. 49th Successful Year.

If interested, send for our Free Booklet and Print and Picture Sample which explain all. U. S. School of Music, 75 Brunswick Bldg., New York 10, N. Y.

*Actual name on request. Picture by professional model.



It's easy as A-B-C!

Yet it's from that stirring favorite of the South, "Dixie"



PLAYS ON RADIO . . .

"As a proud student I can't keep from telling you that as a result of my course I have a good position playing from KTHS every morning."

*J. S. Heavener, Okla.

Diagrams like this explain everything

Follow the dotted lines from the notes to the piano keyboard and before you know it you're playing the famous "Dixie." A remarkable invention, the "Note-Finder" tells you just where each note is located on the keyboard.

FREE! Print and Picture Sample

U. S. School of Music, 75 Brunswick Bldg., N. Y. 10, N. Y. I am interested in music study, particularly in the instrument indicated below. Please send me your free booklet "How to Learn Music at Home" and your Print and Picture Sample. (Do you have instrument.....)

Piano Piano Accordion Reed Organ Clarinet
Guitar Saxophone Tenor Banjo Trombone
Violin Trumpet, Cornet Ukulele Other Instruments

Name.....

PLEASE PRINT

Street.....

City..... State.....

Check here if under 16 years of age.

SAVE 2c—Stick coupon on penny postcard

MAKE MONEY AT HOME

RUBBER MOLDS

Low as 6¢ EA.

Amazing rubber mold-making outfit makes perfect flexible molds of plaques, ash trays, bookends, etc. Molds cost 6c to 25c each. Each mold makes hundreds of novelties and gifts to sell for \$1.00 apiece and more! No experience necessary. Everything furnished. Quick and easy. Start profitable business in your home—sell to stores, gift shops, friends, resorts, road stands, by mail. Full or spare time. Write for complete FREE details and easy instructions.

SO-LO WORKS, Inc., Dept. U-800, Loveland, Ohio

REFRIGERATION

Repair, adjust all refrigerators. New large manual tells how. Charts and pictures to help you. Price only \$1.00, postpaid. Money back guarantee. Supreme Publications, 9 S. Kedzie Ave., Chicago 12, Illinois.

SENSATIONAL BARGAIN OFFER! SAFE SANE FIREWORKS

OH BOY! Giant assortment of 102 safe and sane fireworks for gorgeous, colorful night displays! Latest artistic and intricate effects! Included in this amazing offer are 30 Magic Indian Snakes, 24 Flitters, 6 Jeep Wheels and many other pieces!

ACTUAL RETAIL VALUE \$5.50! **FREE CATALOG**
Amazing bargain! You can save money by taking advantage of this SPECIAL offer today! Many other wonderful assortments!

F. O. B. FT. WORTH. NO C. O. D. SALES. Send for catalog today!
STARS AND STRIPES FIREWORKS CO. Box 6206 Ft. Worth, Texas

102 PIECES \$2.98

VETERANS Learn WATCHMAKING

A Lifetime Profession

Regardless of Conditions, Age, Sex, or Physical Limitations

Veterans—Civilians!
Your Opportunity—
LEARN WATCHMAKING

Lift yourself from a futureless job into a position paying better than your present work. Fit yourself for the job that will permit you to establish your own shop, or be employed in a pleasant environment.

Watch Repairing—Jewelry—Engraving will always be in ever greater demand. Our graduates wanted everywhere. Dignified positions \$50-\$75-\$100 per week. Veterans write today for latest FREE enrollment requirements.

Kansas City School of Watchmaking
Largest Horological School in America
617-621 Wyandotte St. Kansas City 6, Mo.



Approved G. I. Training

WAR BARGAINS in LENSES and PRISMS

ASSEMBLE YOUR OWN BINOCULARS!

Complete Optics! Complete Metal Parts!
Save More Than 1/2 Regular Cost

ARMY'S 7X 50 BINOCULARS



Here's an unusual opportunity to secure a fine set of Binoculars at a substantial saving of money. Offered here are complete sets of Optics and Metal Parts for the Army's M-16 7X 50 Binoculars (M-16 is not the waterproof model). These components are new and all ready for assembly. We supply full instructions. Limit—1 set of Metal Parts and 1 set of Optics to a customer.

METAL PARTS—Set includes all Metal Parts—completely finished—for assembly of 7X 50 Binoculars. No machining required. Bodies have been factory hinged and covered. A sturdy Binocular Carrying Case is included with each set of Metal Parts.

Stock #824-H 7X 50 Metal Parts.....\$35.00 Postpaid

OPTICS—Set includes all Lenses and Prisms you need for assembling 7X 50 Binoculars. These Optics are in excellent condition—perfect or near perfect—and have new low reflection coating.

Stock #5102-H 7X 50 Optics.....\$25.00 Postpaid

NOTICE! If you buy both the Binocular Optics and the Binocular Metal Parts, your purchase becomes subject to 20% Federal Excise Tax. Be sure to add amount covering tax to your remittance or your order cannot be filled.

ARMY'S 6X 30 BINOCULARS

COMPLETE OPTICS & METAL PARTS—Model M-13A1 (Waterproof Model). 6X 30 Binoculars. Everything you need—ready for assembly. When finished will look like a regular factory job costing \$102 to \$120. The Optics are new, in perfect or near-perfect condition. Have new low reflection coating. Metal Parts are new and perfect, all completely finished. No machining required. Bodies factory hinged and covered. Complete assembly instructions included.

Stock #830-H.....\$40.00 Postpaid, plus \$8.00 tax—Total—\$48.00

METAL PARTS ONLY—Model M-13A1, 6X 30 Binoculars. No Optics. Same Metal Parts as described for Stock #830-H.

Stock #832-H 6X 30 Metal Parts.....\$25.00 Postpaid

OPTICS FOR 6X 30 BINOCULARS (No Metal Parts) Slight Seconds. Cemented and coated.

Stock #5124-H.....\$12.75 Postpaid

If you buy both the Binocular Optics and the Binocular Metal Parts, your purchase becomes subject to 20% Federal Excise Tax. Be sure to add amount covering tax to your remittance or your order cannot be filled.

Optics and Metal Parts are Available for Monoculars (1/2 a Binocular). For Complete Details, Write for Bulletin #14-H.

BATTERY COMMANDER'S PERISCOPE

With Tripod—6 Power Instrument. Excellent condition. Length 27 1/2 inches—diam. 1 1/2 inches. Cost U. S. Gov't. approximately \$175.00.

Stock #717-H.....\$20.00 F.O.B. Audubon

MOUNTED KELLNER TELESCOPE EYE PIECE—Perfect, coated, in Ordnance sealed boxes. F.L. 1 3/4 inches. Outside dia. of steel mount 40 mm.

Stock #6198-H.....\$3.15 Postpaid

35 MM. KODACHROME PROJECTING LENS SET—Consists of Achromatic Lens for projecting, plus a Condensing Lens and piece of Heat Absorbing Glass with directions.

Stock #4025-H.....\$1.95 Postpaid

SCHMIDT OPTICAL SYSTEM. Black plastic body, size 3-15/16" by 5 1/2". F.L. 2.4" with amazing speed of F.0.9. Used in Navy's Infra-Red Sniperscope and Signaling Units. Gov't cost \$134.00. Limit—1 to a customer.

Stock #720-H.....\$6.00 Postpaid

MOUNTED PROJECTING LENS SYSTEM. F.L. 91.44 mm. (just right for 35 mm. Projectors). Speed of F 1.9. Outside dia. of mount at one end 60 mm. Length of mount 64 mm.

Stock #4033-H.....\$3.00 Postpaid

MOUNT FOR ABOVE PROJECTING LENS SYSTEM.

Stock #715-H.....\$1.50 Postpaid

CONDENSING LENSES for 35 mm. Projectors and Enlargers. Consists of set of 2 Lenses—diam. 2 3/8", F.L. 3" each.

Stock #1077-H.....\$2.00 Postpaid

We have literally millions of war surplus lenses and prisms for sale at bargain prices. Write for Catalog "H" — Sent Free!

Satisfaction Guaranteed

Order by Stock No.

EDMUND SALVAGE COMPANY

P. O. AUDUBON, NEW JERSEY



OH BOY! FIREWORKS!

Rich Bros' All-American Pre-war Quality ASSORTMENT. Over 172 pieces including 100-2" Salutes, 20 Cherry Flash Bombs, 25 Flitter Crackers, Comet, 2-shot Repeaters, Whistle Bomb, Red & Green Fire Cones, Whistle Devil, Humdinger, Gyro Flyer, Vesuvius Fountain, Flower Pot, Roman Candles, Aerial Bombs, Sparklers, 6 packages Chinese Firecrackers, FREE PUNK!

RETAIL VALUE \$8.55. **YOURS FOR ONLY \$4.95**

RICH BROS' FIREWORKS CO.

Dept. M Box 514 Sioux Falls, S. D.
Shipped Ry. Express Only. None sent C.O.D.
Enclose Money Order or Check.
Name nearest Express Office.

Many other assortments and displays. Send for FREE CATALOG. FREE CAP and Cap Pistol circular.

CONFIDENTIAL LOAN SERVICE

Borrow \$50 to \$300⁰⁰

Need money? No matter where you live you can borrow **BY MAIL** \$50.00 to \$300.00 this easy quick confidential way.

IT IS EASY TO BORROW BY MAIL!

Completely confidential and private

CONVENIENT MONTHLY PAYMENTS

NO ENDORSERS NEEDED

EMPLOYED MEN and women of good character can solve their money problems quickly and in privacy with loans **MADE BY MAIL.** No endorsers or co-signers. We do not contact employers, friends or relatives. Convenient monthly payments. Send us your name and address and we will mail application blank and complete details **FREE** in plain envelope. There is no obligation.

STATE FINANCE CO.
Southern Surety Bldg., Dept. M-107, Des Moines 8, Ia.

STERLING SILVER

LADY LUCK HORSE SHOE Ring



Stylusque Horse's head, horse shoe and 4-Leaf Clover design. Handsomely formed from solid Sterling Silver. Oxidized, hand-buffed finish.

Styled for men or women.

SEND NO MONEY! Just clip ad and mail with name, address and ring size. Pay postman only \$3.98 (tax included) plus postage. Wear for 5 days. If not delighted, return for full refund.

Dept. 972
ARIZONA CRAFTSMEN 205 So. 19th St., Omaha, Nebr.

SELL ULTRA-BLUE STOCK SIGNS



THANK YOU CALL AGAIN

To General Stores over 1000 Different Slogans and Sayings. Fine Line of Religious Ultra-Blue Signs for Homes and General Display. Make Money on these Fast Selling Signs, 35c Sellers, 15—Sample Ultra-Blue Store Stock Signs—7x11, \$1.00 postpd. 15—Sample Ultra-Blue Religious Signs—7x11, \$1.00 postpaid, 100—Ultra-Blue Stock Signs—7x11, 86.00, No C.O.D.'s.

L. LOWY, 8 WEST BROADWAY, NEW YORK 7, N. Y. — DEPARTMENT 309

Quick Help for RUPTURE!

FILLED WITH AIR



Sent on Trial!
Made-to-measure and sent on no-risk actual wearing test. Act NOW.

Learn About This Perfected Invention

Light, cool, comfortable. Durable, cheap. **GUARANTEED** instant relief for reducible ruptures in men, women and children. Not sold in stores. No agents. You deal direct! Correspondence confidential.

Ordered by 18,278 Doctors!

Send Postcard for FREE Rupture Book
BROOKS CO., 359-C State St., Marshall, Mich.

You Can Grow With PLASTICS!

Plastics is one of the fastest growing industries—offering you unusual opportunities for an interesting, successful career and security in the years ahead. Trained men, with plastics know-how will fill the important, well-paying positions. YOU can be one of them. Mail the coupon below for a big, colorful, free catalog on Plastics and complete details

about Plastics Institute, America's oldest and largest plastics school. Resident School located in beautiful Southern California. Comprehensive Home Training Courses to prepare you in your spare time at home for a career in plastics. You can enroll immediately! Write Plastics Institute, Dept. PM7-5, 1601 S. Western Ave., Los Angeles 6, Calif.

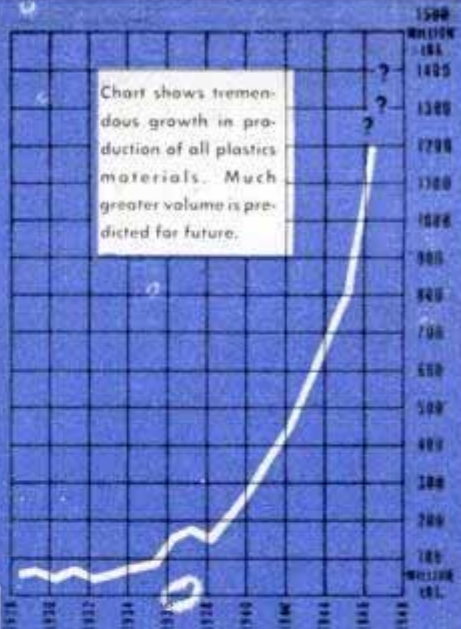

APPROVED FOR VETERANS

LEARN BY DOING

To give you practical experience we supply colorful plastics to make useful, attractive creations. You can also make and sell plastics articles to earn while learning.

Plastics INDUSTRIES TECHNICAL INSTITUTE

NEW YORK CHICAGO LOS ANGELES



PLASTICS INSTITUTE in the heart of sunny Los Angeles. Here modern laboratories and shops give Resident School students facilities for practice on the finest of industry-type plastics equipment. Also the headquarters for HOME TRAINING.

FREE BOOKLET

Plastics Industries Technical Institute
Dept. PM 7-5, 1601 S. Western Ave., Los Angeles 6, Calif. Mail in Envelope or paste on penny postcard

Gentlemen: Please send me the booklet "World of Plastics" and information on your Resident School Courses () Home Training Courses. () I understand there is absolutely no obligation.

Name (PRINT)..... Occupation.....

Street (PRINT)..... Age.....

City..... Zone..... State.....

Important: Please fill out coupon completely. If Veteran, please check. () If in Armed Services now, please check. ()

LEARN IMPORT-EXPORT

Represent manufacturers. Study at home. Splendid opportunities. Uncrowded field, big future. ITP trains you in few weeks. Low tuition. Diploma awarded. Folder FREE.

INTERNATIONAL TRADE PROMOTION, 246-P Fifth Ave., New York 1

SAY YOU SAW IT IN POPULAR MECHANICS

\$5, \$10, \$15 FOR ONE DRAWING

Be an ARTIST!

Learn at home in your spare time

Prepare now for a fascinating and profitable Art career. Our practical method has trained men and women since 1914. COMMERCIAL ART, CARTOONING, and DESIGNING all in one complete course. Trained Artists are capable of earning \$50, \$60, \$75 a week. No previous Art experience necessary. FREE BOOK, "Art for Pleasure and Profit" describes course, commercial opportunities, and TWO ART OUTFITS included with training. VETERANS! Course G.I. Approved.

FREE BOOK gives details!

Washington School of Art, Studio 125H
1115—15th St., N.W., Washington 5, D. C.

Please send me full information and your Free Book, "Art for Pleasure and Profit."

Name..... AGE.....

Street.....

City..... Zone..... State.....

Learn WATCH REPAIRING

From An Approved School
The Largest of Its Kind



EARN WHILE LEARNING

Spare Time Home Training Prepares You For Big Pay

FREE WATCH working tools and watch included as part of our Watch Repairing Course

The demand for skilled watch repairers—men and women—is increasing with the step-up in the manufacture of watches. Now is the time to prepare yourself in this fascinating profession with the aid of our highly practical HOME TRAINING COURSE—in your spare time at home. Start your own business or accept a big pay position.

WRITE TODAY FOR FREE DETAILS

Earn while you learn with an "approved" school. Get the facts—then judge.

ILLINOIS SCHOOL OF WATCH REPAIRING
6312 Huntington Street, Dept. PM-5, Chicago 30, Illinois

Learn to Repair ELECTRIC APPLIANCES

**AT
HOME
in your
SPARE
TIME**

Prepare now for a permanent future, independence and security with a business of your own. Our practical, easy-to-learn home course teaches you, during your spare time, how to repair washing machines, vacuum cleaners, electric ranges, lamps, motors, irons, etc., and do house wiring.



**WRITE
TODAY
for
FREE
BOOK**

OPEN YOUR OWN SHOP Have a Secure Future

For the man who is handy with tools, and likes to work with his hands as well as his head, there is a **WIDE OPEN OPPORTUNITY** today, in this great growing field. If you own your own shop you can depend on making more money in good times . . . and not losing your job in a depression. You can start a business of your own in your garage or basement with \$20.00 worth of tools. One good repair job can pay for the cost of the entire course. Write today for further information, without obligation.

PACIFIC TRAINING SCHOOL 7217 So. Broadway, Dept. P-105, Los Angeles 3, Calif.

Dear Sirs: Please send me, without obligation, your free catalog and free details.

Name _____
Address _____
City _____ State _____

INVENTORS

The inventor who believes he has a new and useful invention, and finds himself in need of advice, should consult a competent registered patent attorney.

The question as to whether a subject matter is patentable can be substantially determined by a search of the United States Patent records.

Without obligation, write us for information as to what steps an inventor should take to secure a Patent.

RANDOLPH & BEAVERS

Registered Patent Attorneys

11-D Columbian Bldg., Washington 1, D. C.

RANDOLPH & BEAVERS

11-D Columbian Bldg., Washington 1, D. C.

Please send me full information on how to secure Patents & Trademarks.

Name.....
Street.....
City..... State.....

Electric Heating Element FLUX

Repair burned out electric elements of coffee urns, electric stoves, flat irons, toasters, and other electrical appliances. Simply apply Christy Electric Heating Element Flux to the break, turn on the current and PRESTO the job is done and your appliance is ready again for years of satisfactory service. Generous size package (enough to repair 50 elements) sent postpaid for only \$1.00.

ELECTRICAL APPLIANCE REPAIR PARTS

Renual Iron element. Guar. 1 year. Package of 6.....\$3.12
Toaster element forms. Clear Mica. Fits most toasters. 10 for.. 1.80
Heating element wire. 10 ft. coiled 3/4" O.D. #20..... 2.55
Heating element wire. 10 ft. coiled 3/16" O.D. #22..... 1.77
Hot Plate bricks 5 3/4" diameter, 6 for..... 1.62
Appliance cord. Rubber covered. 20 ft. \$1.00; 100 ft..... 4.50
Electricians Drill Bits. 1/4", 3/8", 1/2", 3/4". Complete set..... 6.75
Ribbon element heating wire. Std. size 100 ft..... .75
Percolator elements. Universal. Flat type. 1 yr. guar. 2 for.. 1.20
Element cement. Withstand 3000° F. 1 lb. pkg. \$1.00. 5 lb. pkg. 3.50
Lead wire. Asbestos covered heater hook-up wire. 10 ft..... 1.00
Iron Cord Sets with complete plug attachments. 10 for..... 5.00
Carbon brush set. Assorted. 104 brushes. 15 springs. Complete set 3.00
Kerosene to Electric lamp conversion adapters. 5 for only..... 1.00
Nickel Electroplating Kit. Complete outfit. Ready to use..... 1.50
Electric Scissor Sharpener. Will handle all sizes. Complete.... 9.75
Here is your opportunity to save on repairing your own appliances and to earn extra money repairing appliances for friends and neighbors.

CHRISTY SUPPLY COMPANY

2835 N. Central Ave. Dept. T-850 Chicago 34, Ill.

Thrilling Work COLORING PHOTOS
Fascinating vocation learned at home by those with aptitude. Thrilling pastime. National method brings out life-like colors. Free booklet.
NATIONAL PHOTO COLORING SCHOOL
1315 S. Michigan, Dept. 1355, Chicago 5

FIREWORKS

501-Piece All-Noise Assortment

includes half gross Cherry Bombs, many Chinese crackers, Lady Crackers, Salutes, Little Red Devils, etc. Shipped by Express same day order is received. Name nearest Express office. No C.O.D.
While present supply lasts . . . only \$3.95!

BLUE RAPIDS FIREWORKS BLUE RAPIDS, KANSAS

PATENTS "Proof of Invention"
Folder mailed without obligation.
E. E. VROOMAN, Registered Patent Atty.
871 Woodward Building, Washington 5, D.C.

PATENTS AND TRADE MARKS
C. A. SNOW & CO.
REGISTERED PATENT ATTORNEYS
WRITE FOR INFORMATION TO
428 SNOW BUILDING, WASHINGTON 1, D. C.

INVENTORS

If you wish to protect your invention, you should take steps to protect it by a U. S. Patent. Write me for "Record of Invention" Form.

CARL MILLER REGISTERED PATENT ATTORNEY

Woolworth Bldg., 35th Floor, Dept. 57A, New York City
Please send me "Record of Invention" form.

NAME _____
ADDRESS _____

WHICH OF THESE *Opportunities* INTERESTS *You* MOST?

● Today, choose the job you want—and prepare for it. Or if you are already engaged in the work you like best, start training now for quicker promotion. Acquire the knowledge that will help you to get ahead faster, make more money and have greater security.

American School, founded in 1897 as an educational institution not for profit, can help you to reach your goal just as it has helped others during the past fifty years. Check the coupon at right, add your name and address and mail it at once. The school will send you details on its training plan and outline of study prepared by specialists. There is no charge, no obligation, so send the coupon immediately.

CHECK, CLIP AND MAIL COUPON NOW

AMERICAN SCHOOL, Dept. G545, Drexel at 58th, Chicago 37, Ill.
Without obligation. Please send FREE and postpaid, bulletin and details of the Subject checked.

- | | | |
|--|---|--|
| <input type="checkbox"/> PLASTICS ENG'R | <input type="checkbox"/> Accounting | <input type="checkbox"/> Drafting and Design for Men and Women |
| <input type="checkbox"/> Refrigeration | <input type="checkbox"/> Electrical Engr. | <input type="checkbox"/> Radio |
| <input type="checkbox"/> Architecture and Building | <input type="checkbox"/> Electricity—Pract. | <input type="checkbox"/> High School |
| <input type="checkbox"/> Contracting | <input type="checkbox"/> Electronics, Industrial | <input type="checkbox"/> Air Conditioning |
| <input type="checkbox"/> Practical Plumbing | <input type="checkbox"/> Bookkeeping | <input type="checkbox"/> Mechanical Eng. |
| <input type="checkbox"/> Automotive Engr. | <input type="checkbox"/> Private Secretary | <input type="checkbox"/> Shop Management |
| <input type="checkbox"/> Aviation Drafting | <input type="checkbox"/> Diesel Engineering | <input type="checkbox"/> Tool Making |
| <input type="checkbox"/> Aviation | <input type="checkbox"/> Sheet Metal Pattern Drafting | <input type="checkbox"/> Better Foremanship |
| <input type="checkbox"/> Business Mngment. | | <input type="checkbox"/> Machine Shop Operations |
| <input type="checkbox"/> Railway Training | | |

NAME _____ OCCUPATION _____
ADDRESS _____ AGE _____
CITY _____ STATE _____

AMERICAN SCHOOL

Dept. G545, Drexel at 58th Street, Chicago 37

REAL RELIEF FOR RUPTURE



Thousands of wearers tell of real relief. Scientifically shaped, made of strong washable materials, gives the RIGHT support WHERE NEEDED. Satisfaction GUARANTEED. Write for FREE literature NOW.

The WEB Truss Co. Dept. M-18, Hagerstown, Md.

FREE 5 INCH GENUINE LEATHER Jolly Rogers Patch



Join the JOLLY ROGERS CLUB of INSIGNIA COLLECTORS. Send only \$1.00 and get this Genuine Leather Jolly Roger Breast Patch Free with 25 all different Air Force Wings and Officers Collar Insignia. (List Price \$5.00.) Colored insignia book FREE with order.
THE INSIGNIA MART DEPT. KK
703 Broadway New York 3, N. Y.



LEARN MEAT CUTTING EASILY-QUICKLY At Home - In Spare Time



The steady, dependable trade of Meat Cutting taught easily, quickly by improved HOME METHOD. National School, established over 25 years, has organized its famous "Learn By Doing" Classroom, Cutting room and Retail Market training system into sound, practical HOME STUDY form.

Now, by the miracle of this EXTENSION TRAINING you can prepare in Your Spare Time At Home, for a better job, bigger responsibilities or success and security in a store of your own. Remember, PEOPLE MUST EAT!

Buying, cutting, percentage, pricing, advertising, selling—a complete meat education. For beginner or men with ex-

perience. Thousands of successful graduates. Send coupon for FREE Bulletin NOW!

MAIL THIS COUPON TODAY FOR FREE BULLETIN

National School of Meat Cutting Dept. PM10, Toledo 4, Ohio

Send me your FREE Bulletin on Meat Cutting and Meat Merchandising. No obligation. No Salesman will call.

Name _____

Street _____

City _____ State _____

LOANS *by* MAIL

\$50 to \$300 *IN A HURRY*

CONFIDENTIAL

Salaried people, men or women, married or single, loans on your own signature, or your own security. NO personal interview. NO co-signers needed. NO wage assignments. You mail the application to us... we mail the money to you.

FOR A LOAN OF	YOU CAN REPAY MONTHLY			
	IN 15 PAYMENTS	IN 12 PAYMENTS	IN 9 PAYMENTS	IN 6 PAYMENTS
\$ 50	—	\$ 5.03	\$ 6.43	\$ 9.24
100	8.40	10.07	12.87	18.48
150	12.60	15.10	19.30	27.73
200	16.75	20.09	25.68	36.91
250	20.85	25.02	32.02	46.05
300	24.93	29.94	38.33	55.17

The above payments made at regular monthly intervals will repay the entire loan and all charges in the time indicated. Charges are based on the monthly rate of three per cent on unpaid principal balances to \$150.00 and two and one-half per cent on that portion of unpaid balances in excess of \$150.00 but not exceeding \$300.00. "Loans by Mail" may be repaid in larger amounts, more frequent payments or repaid in full at further savings to you.

CONVENIENT

Just write us how much money you need and how you wish to repay... there's no charge or obligation. Whatever your needs for cash now or in the future, write for your "Loans by Mail" plan, today.

MERCHANTS INVESTMENT CO. 819-G 1st Nat'l Bldg., Omaha, Nebr.

Without obligation, rush complete details and all papers necessary for a loan of \$_____ to be repaid at \$_____ on the _____ day of each month.

Name _____

Address _____

City _____ State _____

Occupation _____

MAKE YOUR OWN COSTUME JEWELRY SPLENDID HOBBY OR VOCATION

Sea Shells • Pin Backs • Ear Screws • Screw Eyes
Plastic Discs • Ear Clips • Floral Stones • Jump Rings
Chains • Clasps • Wire • Boxes • Bracelets • Parts
Bow Knots • Catches • Plexiglas • Cements • Dyes

WRITE FOR FREE CATALOGUE • DEPT. B

PHILADELPHIA BADGE CO., 1007 Filbert St., Phila. 7, Pa.

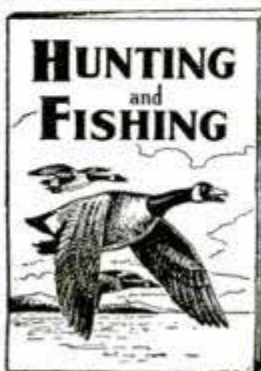

Subscribe NOW to HUNTING and FISHING

America's foremost Sportsmen's Magazine, with down to earth facts and stories about hunting, fishing, camping, dogs, boats etc.

FREE — ACT NOW!

Send \$1 for full year's subscription to HUNTING & FISHING, and we will include absolutely free the HUNTING AND FISHING HANDBOOK, 100 pages crammed full of valuable information about every phase of outdoor activity.

HUNTING & FISHING

251A Sportsmen's Bldg., Boston, Mass.

THOUSANDS OF SUFFERERS USE
BREATH EASY
FOR
ASTHMA
CARRY IT WITH YOU
USE IT ANYWHERE
Sold on Money-Back Guarantee

Write To Dept. PM

BREATH EASY DISTRIBUTORS, INC.
65 CEDAR STREET
SEATTLE 1 WASHINGTON

"MAGIC VANISHING CARD"

THROW IT INTO THE AIR — It completely disappears. Reproduce it later from spectator's pocket. It amuses and confuses all. Easy to do — 25c with Amazing Catalog of 300 Tricks.

THE MAGICIAN, Dept. 5, 2463 Kensington Ave., Philadelphia 25, Pa.

Store Route Plan PAYS BIG MONEY

SELL COUNTER CARD PRODUCTS
Build a good-paying business of your own. Call on dealers of all kinds; show nationally-advertised Aspirin, Vitamins, Cosmetics and 200 other necessities. Big 5c and 10c retail packages, high quality. Attractive counter displays sell goods fast. Free book gives amazing facts. Write!

World's Products Co., Dept. 10-N, Spencer, Ind.



CARTOON TO SUCCESS!
Learn cartooning from a PROFESSIONAL! Let me show you how to create ORIGINAL cartoons and IDEAS. Send for FREE details about course.

Also CARTOONIST'S MAGAZINE—Lessons, plans and hints. Send 25c coin for copy.
CARTOONIST HARTMAN, 2776 California Court, LINCOLN 8, NEB.

SUIT YOURS AS A BONUS

AND BIG MONEY IN SPARE TIME, TOO!

We want you to wear this fine made-to-measure suit! Make it yours by sending a few orders, & earn BIG CASH PROFITS in spare time. Your suit will help you get more orders with scores of rich, quality fabrics, tailored-to-measure to newest styles. Also Ladies' Tailored Suits—complete line. Write today for FREE SAMPLES. NO EXPERIENCE, no money needed. For quick action tell us about yourself.

J. C. FIELD & SON, INC.
Harrison and Throop Sts., Dept. S-1716 Chicago 7, Ill.



RUPTURED?

Get Relief This Proven Way

Why try to worry along with trusses that gouge your flesh—press heavily on hips and spine—enlarge opening—fail to hold rupture? You need the Cluthe. No leg-straps or cutting belts. Automatic adjustable pad holds at real opening—follows every body movement with instant increased support in case of strain. Cannot slip whether at work or play. Light. Waterproof. Can be worn in bath. Send for amazing FREE book, "Advice To Ruptured," and details of liberal truthful 60-day trial offer. Also endorsements from grateful users in your neighborhood. Write: CLUTHE SONS, Dept. 31, Bloomfield, New Jersey

DO ANY JOB.. EASIER.. QUICKER
MAKE MORE MONEY in the
BIG OPPORTUNITY
FIELDS

SEND NO MONEY
 Select the Books
YOU Need Now!
 We Ship **C.O.D.**
 Anywhere in U. S.
 and Will Refund
 Amount Paid if
 Not Satisfactory.

AIR CONDITIONING

Big air conditioning boom interrupted by war will be bigger than ever. It's ready to GO now! Get this non-technical book by international authority and be ready for your share of millions to be spent. Covers whole field. 450 pages. Illustrated. \$4.00.

AIRPLANE WELDING

All metal airplane building offers big peacetime opportunities
 New 2nd edition of this famous book by J. B. Johnson, Materials Division, Wright Field. The authoritative and practical book on Airplane welding and materials brought right up to date. 420 pages, 193 pictures. \$3.50.

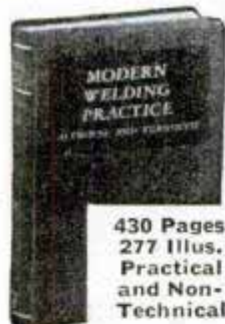

MODERN WELDING PRACTICE

Newest book on all types of welding and heat treatment of metals. Written by recognized specialists in training men for production jobs. Practical and Non-Technical.

430 Pages
 277 illus.
 Practical and Non-Technical

Covers everything you need to know. Prepare for best pay jobs now. Price \$4.00.



REFRIGERATION—Book of the Hour!
Biggest Opportunity in Many Years!

NEW PRINTING—ALMOST 1000 PAGES
 408 Pictures—17 Diagrams in Colors Makes All Refrigerator Service Maintenance, Repairs Simple as A. B. C.

Thousands of Refrigerators need repairs! Owners will pay big for competent service which will be needed more and more. Get MODERN GAS AND ELECTRIC REFRIGERATION, the non-technical guide to all types of refrigerators and get your share of this new profit. Get a job or start your own service business. This book will help you make money anywhere. Price \$5.00.

BODY & FENDER REPAIR

Owners will spend big money to keep their good older cars looking like the new ones coming out. This is a practical money-making guide, ideal for shop owners and every man who wants a share of the millions to be spent in keeping old cars looking new. Tells how to get a good job or start business of your own with small capital. 325 pages, 232 illustrations. \$3.50.



DYKE'S FAMOUS CARBURETOR BOOK

This famous book has been the standard guide in the best paying auto work for a generation. It has helped thousands of men make money. New edition covers engine tune-up, compression, ignition, carburetion, fuel pump valves, etc. Use this book to specialize in this big field. 244 pages, 549 illustrations. \$3.50.

HOUSE WIRING NEW EDITION

Get this new sixth edition of this standard and practical electrical wiring book. It gives complete practical instruction on every phase of house wiring in one handy volume. Goes further than most books on subject. Hand-book style. Gives National Electric Code. 400 pages, 669 illustrations. Electrical work will reach a new high with millions of new homes to be built. Get started now. \$3.00.

15 Million Refrigerators Need Service and Repairs

Here's the Help You Need For Best Paying Jobs Right NOW!

FREE TRIAL IN YOUR OWN HOME

Used by Army, Navy, Other Government Depts., 200 Schools and Industrial Firms.



NEW 20th EDITION
Leading Auto Book for Over 32 Years

World's Greatest AUTO BOOK

New Material on Transmissions, Trucks, Tractors, Diesels, Aircraft and Auto Engines

Now with millions of cars needing repairs and thousands of men needed to do the work, you need the famous DYKE Auto Book more than ever before. Brand new 20th Edition covers all principles, construction, repair, adjustments, testing, troubles and remedies of all cars. Over a half million copies of 20 editions of Dyke's have been sold. Gives specifications of old and newer cars. World's biggest book value. \$7.00. This big book, a complete auto library in one volume, has 1483 pages—4600 illustrations and diagrams—weighs 6 lbs.—equal to 4 ordinary books.

ENGINEERS HANDBOOK

World famous Bailey's handbook of universal questions and answers for Stationary, Marine and DIESEL engineers and firemen. Prepares for any license examination. This is the one book that men should have if they want to reach the top in installation, maintenance and operation of Diesel and steam plants. Pocket size, \$2.00.

Goodheart-Willcox Co., Inc.
 2009 S. Michigan Ave., Dept. 15, Chicago 16, Ill.

SEND NO MONEY! Mail Coupon

GOODHEART-WILCOX CO.,

2009 S. Michigan Ave., Dept. 15, Chicago 16, Ill.

Send books checked. C.O.D. I will pay postman, plus few cents charges. If not satisfactory I will return books in 5 days and you will refund money paid. (Outside U.S. or possessions remit with order.)

- | | |
|--|--|
| <input type="checkbox"/> Gas & Electric Refrigeration \$5.00 | <input type="checkbox"/> Air Conditioning \$4.00 |
| <input type="checkbox"/> Dyke's Auto Book \$7.00 | <input type="checkbox"/> Engineers Handbook . . . \$2.00 |
| <input type="checkbox"/> Dyke's Carburetor Book . \$3.50 | <input type="checkbox"/> Body and Fender Repair . \$3.50 |
| <input type="checkbox"/> Modern Welding \$4.00 | <input type="checkbox"/> House Wiring \$3.00 |
| <input type="checkbox"/> Airplane Welding \$3.50 | <input type="checkbox"/> Shop Math. (2 vols.) . . \$3.00 |
| <input type="checkbox"/> Sheet Metal Layout . . . \$3.50 | <input type="checkbox"/> A.C. Power Wiring . . . \$4.00 |
| | <input type="checkbox"/> D.C. Power Wiring . . . \$4.00 |

If remittance accompanies order we will pay all postage charges under same return privilege.

Name
 Address
 City State

Become an EXPERT ACCOUNTANT through LASALLE'S PROBLEM METHOD

WHAT is the LaSalle Problem Method of acquiring Higher Accountancy Training?

Certainly not the dull routine associated with ordinary study—not “book-learning” in the theoretical sense.

Under the Problem Method each week you are given an important accounting principle—then shown how the principle is applied. You are given a problem and its solution. After you fully understand the principle and its application, you are then given a problem which you work out for yourself and send in to LaSalle. Your solution is returned to you with comments. If it has not been properly solved you are shown your error and the correct method.

The entire procedure is practically first-hand personal experience gained by you direct from capable accountancy instructors. These men take an interest in you, check your individual needs and work with you step by step as you progress.

You study and learn under a tested, proven plan built around the Problem Method. You continuously learn by actually handling important accountancy problems, analyzing, working them out and thinking out your own decisions.

Thus you are coached in the practical solving of the very problems you face in a higher accountancy position. Step by step you work mat-



More Money—A Better Position

ters out for yourself. At the end of your training, you have real ability and practical experience—the kind which fits you for positions that business is glad to reward with real money.

Don't confuse Accountancy with bookkeeping. The Accountant is the executive, the man who makes the big money—the bookkeeper does only the detail routine jobs at low pay.

You can become an expert accountant through the LaSalle Problem Method without any preliminary knowledge of bookkeeping.

You will be given whatever basic training, instruction or review on the subject of bookkeeping you need. Mail the coupon now for full information.

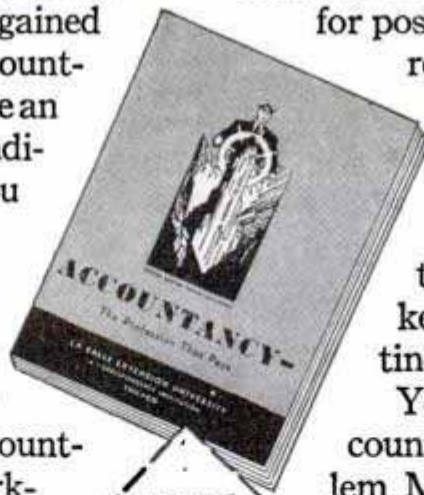

FREE ACCOUNTING BOOKLET

Send me, without obligation, your 48-page booklet “Accountancy, the Profession that Pays.”

NAME.....

POSITION.....AGE.....

ADDRESS.....ZONE.....

LASALLE EXTENSION UNIVERSITY Dept. 564-H
A Correspondence Institution Chicago 5, Ill.

G. I. APPROVED

Send for the Facts TODAY!

**WORLD'S
BEST
WANT AD
MEDIUM**

CLASSIFIED Advertisements



Advertisements in this section 60 cents per word, each insertion, minimum 10 words, payable in advance
To be inserted under proper classification, copy must be in our office the 25th of the
second month preceding date of issue

F. W. Johnson, Manager, Classified Advertising
Popular Mechanics Magazine, 200 East Ontario Street, Chicago 11, Illinois

1442 CLASSIFIED ADVERTISEMENTS 1442 OPPORTUNITIES FOR YOU

AUTOMOBILES, MIDGET CARS

CHROME Tailpipe extensions for all cars. Very latest style. Good heavy chrome. The finest available. 2 1/2" diam. \$3.00—3" diam. \$4.00. Sandee Muffler Company, 7523 South Western Avenue, Los Angeles 44, Calif.

INDIANAPOLIS 500 Mile race! New packet 4 1/2 x 6 1/2 inch pictures cars and drivers! Latest shots Mays, Hepburn, Horn, Robson, 21 other winners. Send \$1. Tower Photographers, 5454 East Washington, Indianapolis 19.

USED-CAR Handbook, "Judging the Used Car." Dealers' tricks exposed, comprehensive simple tests, photographs. Postpaid \$1. Truvalu, Box 723-E, Arcadia, California.

SCOOTMOBILE Runabout! Two passenger, three wheeled, motorized, speedy. Simple construction from available second hand parts. Detailed plans \$1.00. Midget "Jeep" plans included free. Universal, 2671 Algonquin, Toledo 6, Ohio.

46-47 BUICK Hood ornament repaired easily. Instructions 50c coin. Starling, 8004 Eastern Drive, Silver Spring, Maryland.

MIDGET Racer plans, blueprints, buying guide 50c. Sibley, 133, Mendon, Mass.

"CUSTOM-STYLING" manual—Easily make car look Hollywoodized, custom built, ultra-beautiful! New, simplified customizing—restyling—streamlining methods. Instructions, illustrations. Plans for accessories, refinishing, mufflers—model changes for new and old cars. \$2.00. Almqvist Engineering, 447 (H) 64 Street, Brooklyn 20.

CLYMER'S Motor Scrapbooks (old automobiles) Editions 1, 2, 3, each different. \$1.50 each. Motor History of America, \$3.00. Fastest on Earth, racing book, \$2.00. Motor Racing With Mercedes-Benz, \$2.00. Book Steam Automobiles, \$2.00. Power & Speed, \$2.50. Henry Ford, His Life & Work, \$3.00. Midget Automobile Racing Book, \$1.10. Indianapolis "500" Race History book 1909-1946, \$3.50; 1946 only, \$1.00. All postpaid. Catalog free. See ad motorcycle section. Clymer, Dept. A53, 2125 W. Pico, Los Angeles 6, Calif.

MOTORACES. New book Grand Prix auto racing. Includes 100 photos famous foreign cars, drivers. \$2.00 postpaid. Clymer, Dept. A-51, 2125 W. Pico, Los Angeles 6, Calif.

HOUSE-TRAILER. Complete housekeeping facilities built into this beautiful trailer. Size 7 1/2 x 17 by 6 ft. 4" inside measurements. Sleeps 4 comfortably. All steel chassis. Our plans make it easy to build. Complete plans \$1.50. Popular Mechanics Press, 200 East Ontario St., Chicago 11, Ill.

MAKE Your Ford fast! Complete details, photographs. How to construct 120 m.p.h. Hotrod. \$1 postpaid. California Bill, Box L-1, Eaglerock, Los Angeles 41, Calif.

MORE Profits from Ernie Automatic Tire Inflator (16 ft.) retails \$1.95. Sells itself. State distributors wanted. Sample \$1.00 (refundable). Details free. Kramer Industries, Box 3505-P, Cleveland 18, Ohio.

AUTO Racing magazine subscriptions. Pacific Speedway News, \$6.00 yearly. National Speed Sport, \$4.00 yearly. Illustrated Speedway News, \$4.00 yearly. All give complete data midget, big car race results. Sample copy each 50c. Specify publication wanted. Clymer, Dept. A50, 2125 W. Pico, Los Angeles 6, Calif.

INDIANAPOLIS Official 1946 Race Program, 102 pages. Photos, results. Limited supply. 60c each postpaid. Clymer, Dept. A57, 2125 W. Pico, Los Angeles 6, Calif.

SPEED & Mileage manual—Obtain greater speed, mileage, racing performance from any automobile! Includes simplified methods, speed tuning, gas saving secrets. Instructions on building economizers, speed equipment, duals, mufflers, superchargers, racing fuels, fast conversions. \$1.98. Almqvist Engineering, 447 (H) 64 Street, Brooklyn 20.

RACING Auto lapel pins. Non-tarnishing, colorful chromed. Identifies your favorite sport. Specify Midget, Indianapolis car, Indian or Harley motorcycle, or Indianapolis souvenir crossed flags. \$1.00 each postpaid. Clymer, Dept. A58, 2125 W. Pico, Los Angeles 6, Calif.

"STREAMLINED Roadster"—America's lowest priced car! Small, speedy two passenger sportster! Amazingly easy to build from inexpensive material, small motor. Complete instructions, drawings \$1.98. Almqvist Engineering, 447 (H) 64 Street, Brooklyn 20.

HISTORY Of Buick, city of Flint book, now available. Illustrations early, late Buick. Beautiful binding. \$3.00 postpaid. Clymer, Dept. A56, 2125 W. Pico, Los Angeles 6, Calif.

R & R Mfg. Co., marine and auto division, Anderson, Indiana, Robert M. Roof. \$1.00 for our new 1947 speed and power equipment catalogue with price sheet—showing racing cars, midgets, speed boats with recommendations how to rebuild your motor for racing. Dual ignition racing cylinder heads for V-60-100 and Mercury Ford engines. Dual intake manifolds, racing pistons, camshafts, compound valve springs, Lynite flywheels, quick change gear boxes and numerous other supplies.

SEE Our ad under Motorcycles for midget racer bargains. Midget Motors Directory, Athens, Ohio.

DUALTONE Chrystalline packed mufflers. Single or twin mufflers for all cars. Duals priced complete V8's \$23.00, six cylinders \$33.00, eight cylinders \$36.00. Large chromed tailpipe extensions \$3.30. Polished carburetor velocity stacks \$1.30. Chromed Station Wagon stacks \$15.00. Request catalogue. Dualtone Mufflers, 2636C India Street, San Diego 1, California.

JEEP Station wagon, body, safety glass, etc. Large how to build blueprints, instruction, parts list, etc., \$2.00. Circular illustrating before and after building, dime. Craftsman Books, Box 1153-FJ, Milwaukee 1, Wis.

RACING Car performance for all cars. Complete specifications, \$1.00. Increase power, speed. Special "custom-built" equipment. Free literature. Write Lee Motorcraft, 1412-A Great Northern Bldg., Chicago 4, Illinois.

LITTLE Library of Useful Information. 102 different books. Catalog free. Popular Mechanics Press, 200 E. Ontario St., Chicago 11, Ill.

BUILD Speedy midget track racer from castoff parts! Plans, specifications, construction information, \$1.00. Motor Supply, Box CS-1682, Toledo, Ohio.

AUTOMOBILE Racing book, fifth edition, well illustrated. Instructions on building bodies, frames, engines. Ford A and B conversions. Plans, AAA rules, specifications. Roadster racing, Indianapolis cars. \$1.00 postpaid, \$1.30 C.O.D. Ray Kuns, Dept. 47, Madisonville, Cincinnati 27, Ohio.

CUSTOMIZE Your automobile. Illustrated, new restyling ideas, instructions, suggestions, specific model changes by simple methods. Postpaid \$1. Speedwheel, Box 723-E, Arcadia, California.

MUFFLER Manual. Convert easily to Hollywood, Laguna, Westwood, duals, etc. Includes construction details, regulations, diagrams. Postpaid \$1. Mellotone, Box 723E, Arcadia, California.

PROFESSIONAL Midget racer, motor-scooter, midget roadster, and midget motorcycle. Plans, specifications for all four contained in illustrated handbook, 25c. Big list bargain priced used motors, motorscooters, servicycles, etc., included free Midwest, 3839 Drummond, Toledo, Ohio.

AUTO SUPPLIES AND EQUIPMENT

POLISH Your car twice—50c! Guaranteed! New concentrated, quick, easy-to-use powder. Just mix with water. Gives durable lustre. Postpaid 50c. Write for other products. 3 Star Products, 3800 Genessee, Kansas City 2, Missouri.

MANIFOLD Whistle—Imitates "wolf whistle," siren, barking dog, etc. Connects to any car manifold. Complete installing instructions. Send \$6.00 to Protecturo Company, 4033 Windsor, Youngstown 7, Ohio.

GASOLINE Vaporizer, 27 miles per gallon. Mercury automobiles. Walert Company, 3429 North Tenth St., Milwaukee 6, Wisconsin.

CALIFORNIA'S Sandee and Dualtone mufflers for every make. With that motorboat tone. Singles \$5.50 to \$9.00. V-8 duals \$17.50 to \$22.50. Shipped immediately. Von Esser, 2840 No. Kedzie Ave., Chicago, Illinois.

BATTERY Repairmen! "Send for a connector strap drill that leaves a post." \$2.50 postpaid, guaranteed. Batteryman, Grand Junction, Colorado.

NEED Moving parts? Truck & Auto Parts Center, Box 123, Bergenfield, N. J.

BURN Water in your car with the Vandervoel water injecting carburetor. More power, faster pickup, cleaner, cooler, smoother motor. \$22.25 complete with tank and fittings. State make and year of car. Ralph A. Shade, 563 Lake Road, Webster, N. Y.

USE Anti-Glare against wild headlights. Stops road, sky and hood glare too daytime. Place anywhere on windshield. Fits any car. Set of two \$1.00. Gabe's Shop, Box 615-S, North Hollywood, Calif.

USED Jeep motors complete, less transmission, ready to run. Seventy-five dollars each. Meyers, 820 Dryades St., New Orleans, La.

RACING Equipment. Cylinder heads with single or dual ignition, camshaft grinding, camshaft duplicated, dual manifolds, 180 degree 60V8 crankshafts, wheels, etc. Knepper Manufacturing Co., 504 S. Allegheny, Tulsa 4, Okla.

STOP Automatic choke troubles. A new invention, The Redex Hand Choke Adapter quickly changes these carburetors to good reliable hand choke operation. Oldsmobile, Pontiac, Hudson and others. State make and year. \$3.00 postpaid. Money back guarantee. Agents wanted. Redex Machine, Rochester 13, N. Y.

MIDGET Car axles, etc. Write Behnke's Auto Supplies, 5721 Leland Ave., Chicago 30, Ill.

SPEEDY Piston ringer, amazing new tool. Instantly removes, replaces any size ring. Saves time, eliminates breakage. \$3.00 postpaid. Clymer, Dept. A-511, 2125 W. Pico, Los Angeles 6, Calif.

PEP-UP Your car with C. A. Bombs. Rust and corrosion preventive. Send 25c to M. Van Horn Distrib., J-1 1128 S. 13th St., Philadelphia 47, Penna.

TIRES, (Brand new) cut rate, standard brands 6.00x16 \$13.25, 6.50x16 \$15.75, all sizes, limited quantities, money order. R & R Trading Co., 1930 East 34th St., Brooklyn, N. Y.

CLYMERTONE Twin muffler sets, beautiful sound, complete with necessary welded pipes, E-Z installation. Ford V-8, \$20.00. Chevrolet set with split exhaust manifolds, \$37.50. Specify car model. Clymer, Dept. A-52, 2125 W. Pico, Los Angeles 6, Calif.

OIL Pumping motors—brought back to normal without ring job. Send address on postcard for free details. Mullner Co., Box 3102, St. Paul 1, Minn.

GAS Station men—Hot motors, overheating due to rust and sediment in radiators and blocks cured, pictures show you how, money back on first job, you guarantee work. Price \$3.00, money order. R & R Trading Co., 1930 East 34th St., Brooklyn, N. Y.

NEED Auto parts? We have them. New and rebuilt. Prompt shipment. Write requirements. Save money. Buy direct, (see our display advertisement page 258). Factory warehouse. Mechanics Auto Parts, 3807-PM-5 North Ashland, Chicago 13.

1947 **SUPERIGNITION** \$5.50. Atomic starting, pep, mileage. EG Mfg., 355A East 149th, New York 55.

DE-SO-LIZER Use diesel and stove oil in your car save 70%. Install it your self. Free literature. Box R188B, Seal Beach, Calif.

BUY Wholesale 50% off auto accessories, parts, home supplies. Make money selling from truck, store, garage. Free price list. Main Supply, Fairfield, Ill.

HAVING Car trouble? New, used, guaranteed auto, truck parts save money. Transmission specialists. Describe needs; immediate reply. Victory, 2930½ North-western, Chicago 18.

AUTO Parts for all autos and trucks. Trans., motors, differentials, fenders, carburetors. Also body parts. Security Auto and Truck Parts, 1941 BJ Eddy, Chicago 13.

PLATING Outfits for auto parts. Connect to a battery. No tanks used. Free particulars and proofs. Gunmetal Co., Ave. J, Decatur, Ill.

AUTO TRAILERS

AUTO-TRAILER Travel, monthly magazine, \$1 year. Magazine Mart, Plant City 8, Fla.

TRAILER Manual. Construction blueprints. New circular, illustrates 14 to 24 ft. three room designs. 10c. Manual 17 ft. Streamliner has everything. \$1.00 includes circular. Craftsmann Books, Box 1153 P3, Milwaukee 1, Wis.

SOFT Tire indicators for trailers. Inquire. Laidlaw Mfg. Co., Box 1108, Pasadena 20, Calif.

BUILD Your own trailer! Save money! Have every feature you want! Plans for house, sport, camp and utility trailers. Catalog describing 9 models 10c. 15c in Canada and overseas. Jim Dandy, Box 125-A, Wausau, Wisconsin.

MOTORCYCLES, BICYCLES, MOTOR-SCOOTERS AND SUPPLIES

CHROME Plating on motorcycle and all other parts. Silver, gold, brass, bronze and tin plating on all metals. Send parts or description for prices. Master Silverplaters, 2031 Caniff, Detroit 12, Mich.

BIKES \$42.50 Delivered, rebuilds like new \$32.50. Wheels, parts, tricycles. Hillman Cycle Co., 142 Wilson St., Havre De Grace, Maryland.

HARLEY-DAVIDSON Parts, accessories, batteries, tires, and repair work. 24 hour service. Authorized factory dealer. Philadelphia Harley-Davidson Company, 857 North Broad Street, Philadelphia 23, Penna.

BICYCLE Sale! Finest American made brand new 1947 boys or girls full size 26" balloon bicycle, only \$36.85 send money order or check to Holtermans's Bicycle Store, 308 East Walnut, Kalamazoo, Michigan.

CUSHMAN Motorscooter \$30 (includes motor and extra tires), midget racer \$15! Send 25c for big summer catalog #938, just printed, listing these and scores of other sensational bargains in motors, wheels, motorscooters, motorbikes, Servicycles, tires, etc. Associated, Box CG-1764, Toledo, Ohio.

MODERN Motorcycle Mechanics manual, 560 pages, 300 illustrations, covers Harley, Indian and English makes. The most complete motorcycle book published. \$3.15 postpaid. Nicholson Brothers, Motorcycle Engineers, Saskatoon, Sask., Canada.

MOTORCRAFT Manual complete motorbike, motorscooter, midget car plans, instructions, other information. 75c. Details free. Reed Motorcraft Company, 215 No. First Avenue, Maywood, Illinois.

CLYMER'S Motorcycle books. Speedway Motorcycle Racing, \$2.00. Motorcycle Speedway Annual, \$1.00. How to Manage Motorcycles, \$1.50. Motorcycling Manual, \$2.00. How to Obtain Speed, \$1.50. Motor Scooter Plans, \$2.00. Books on Ariel, BSA, Norton, Triumph, Villiers, \$1.50 each. English Motorcycle Magazine, 50c. All postpaid. See our ad automobile section. Catalog free. Clymer, Dept. A-54, 2125 W. Pico, Los Angeles 6, Calif.

V-BELT Clutch for scooters. 3¼" built-in pulley, 3" long. No friction plates, \$11.75. V-Belt Clutch Co., 3759 Wilshire, Los Angeles 5, Calif.

MOTORCYCLE (Miniature) lapel pins. Exact duplicates favorite 1947 model. Chromed, colorful, non-tarnishing. Specify Harley, Indian, BSA, Norton, Triumph or Ariel, or Daytona race souvenir crossed flags. \$1.00 each, postpaid. Midget or Indianapolis racer same price. Any above pins on attractive tie-clasp. \$1.25; tie-holder, \$1.75. Postpaid. Clymer, Dept. A-59, 2125 W. Pico, Los Angeles 6, Calif.

BEAUTIFUL New bicycles, also tricycles all makes, all sizes. Reduced price list free. Atlas Cycle Co., 3002 SS Broadway, Chicago 14, Ill.

1947 **MOTORCYCLE** Catalog, 10c. Indian and Harley parts. Pistons, chains, sprockets, carburetor and motor rebuilding, batteries, tires, chrome accessories. Bootz, 622 East Grand, Des Moines 9, Iowa.

MOTOR Scooters, bicycle engines. 120 miles gallon. Dime for catalog. Clymer, Desk A-55, 2125 W. Pico, Los Angeles 6, Calif.

CUSHMAN Motorscooter \$15. Shaw bicycle motor \$15. Harley-Davidson motorcycle \$35! Send 25c for bargain catalog #8, just off the press, packed with money saving buys in motorscooters, motorbikes, midget cars, motors, wheels, tires and parts. Gail and Company, 538 Erie, Toledo, Ohio.

WHEELS! Build wagons, scooters, mowers, trailers, wheelbarrows, grocery carts, baby carts, play pens, baby carriages. 4" to 16". Free list. Trulsen Mfg. Co., 811 E. 31, Kansas City, Mo.

MOTORCYCLE Cams ground for speed and power, carburetion. For information write Harold Schaller, 247 West Main, Turlock, Calif.

BICYCLE Book, how to buy, rebuild, sell used bicycles 50c. John Collett, Handley, Texas.

TIRES And industrial wheels, suitable for scooters, wheelbarrows, farm equipment, etc. All sizes. Bicycles and accessories. Largest assortment in America. Send dime for list. Cycle Transport Company, 1241 So. Michigan Ave., Chicago 5, Illinois.

BUILD America's lowest priced motor-scooter speedster! Complete plans, specifications, \$1.00. Big list bargain priced used motors, etc., included free! Motor Supply, Box 1882-CS, Toledo, Ohio.

LARGE Stock Indian parts. Expert motor rebuilding. New and rebuilt Chief motorcycle, motors only, Indian Motorcycle Sales, Kansas City 1, Mo.

HARLEY Single motorcycle \$50. Harley twin \$65, complete. Motorscooters \$9 up, midget cars \$10 up, motorcycle \$25, less motors. Used motors \$3 up. Plenty of brand new 2 horsepower motors never taken from factory crates. Over 5000 balloon tires for motorscooters and small cars \$1 up, mailorder only. Send 25c for Big War-Bargain catalogue Number 18, just out listing the above and hundreds of other bargains in new and used motors, motorscooters, midget cars, racers, etc. (35c by first class mail.) Midget Motors Directory, Athens, Ohio.

HARLEY-DAVIDSON — New and used 45" motors, service, parts, accessories, tires. Send \$2.25 for army motorcycle manual, 10c for bulletins. Knuth's (Harley-Davidson factory dealer), 2491 Fond-dulac, Milwaukee, Wis.

TIRES, Inner tubes, wheels, for small trucks, wheelbarrows, power scooters, midget cars, farm equipment, carts, etc. Sizes 8" to 18" o.d. in 2, 4 and 6 ply first-line quality tires, with removable inner tubes and heavy duty demountable wheels. Also caster forks, straight or swivel types. Free circular and prices. Jahant Co., 626 East Exchange Street, Akron 6, Ohio.

"**BICYCLE** Repair Manual." Illustrated booklet, tells how to repair bicycles. 66c. Robert Klausner, Shelbyville, Ill.

BICYCLES, Schwinn's, Monarks, mens, ladies', \$37.50. Send dime for accessory list. Century Cycle, 3447 Lawrence, Chicago 25, Illinois.

AVIATION

CAREER Counselor. Guidance for beginners. 23 years aviation experience. George Miller, 1333 18th Street, Santa Monica, California.

PROPELLERS — Especially designed, Airliner 3 blade for ice-snow sleds, boats. Also 2 blade. Aluminum castings Ford A aircooled conversion. Free literature. Standard Aero Craft, Ft. Worth, Texas.

VETERANS: Flight training under the G.I. Bill. Private, commercial and flight instructor ratings. Write for information. Gottschalk School of Aeronautics, Adrian, Michigan.

NEW Catalog! Rush name. Experiment-er Supply, Tipp City 6, Ohio.

B-29 COMPUTERS, Dynamotors, amplidyne, auto pilots, amplidyne servo amplifiers, compressors, gun chargers, turret drives, generators, starters, Plexiglas domes, sighting stations, etc. Free list. Erec, 1006 Hewitt, Everett 1, Washington.

CUBS, Wacos, Taylorcrafts, Aeronca. Big catalog, 25c, lists these and thousands of other sensational airplane bargains. Some are "easy to repair" crackups. National, Box 1682-CS, Toledo, Ohio.

BATTERIES, GENERATORS

BATTERIES—Safely, permanently desulphated. Complete treatment \$1.25. Gordon, 1503 Benton, St. Louis, Mo.

EDISON Non-acid lifetime storage batteries for home lighting, motors, radios, etc. Free complete interesting literature. T. Hawley Smith Company, Croton Falls, N. Y.

ELECTRICAL SUPPLIES, EQUIPMENT

ELECTRIC Razor sharpener. Easy, quick, guaranteed. 25c postpaid. Arnold, 621 E. 31st, Kansas City 3, Missouri.

LAMPS—All parts to build or repair. Harps, sockets, vase caps, bases, etc. Illustrated catalog 10c. Gyro Lamps, 5416 Clark, Chicago 40.

RUGGED Circuit and fuse tester. 110-440 volts, ac or dc. Positive indications, unlike neon testers, \$4.50 plus postage. V. Peterson, 7621 S. Park, Chicago 19.

ELECTRIC Shaver—Remington Rand's Foursome. Twin head. Nationally advertised. C.O.D. \$19.50. Cash less 6%. A. Kramer Distributing Agency, McDonald, Penna.

ELECTRIC Pencil: Writes, engraves all metals. \$1.00 postpaid. Beyer Mfg., 229-H Dixon Blvd., Uniontown, Penna.

CONTROL Garage doors from dashboard. "Build yourself" plans \$1.00, refundable. Vital parts available. Kaytor Laboratories, Lynwood, California.

ELECTRIC Fan assemblies. Assemble your own. Ted Riseman, 207 North Fifth, Springfield, Illinois.

CLOCKS, Radios, fans, irons, motors, toasters, etc. Jeannette Electric, 159 West 23rd Street, New York City 11, N. Y.

MAKE Powerful demagnetizer by using our ready made coils. \$4.25 postpaid. Heavy formvar magnet wire #20—750 ft., ideal for motorwinding, chokes, transformers, etc. \$4.75 postpaid. A.C. motor windings designed for all voltages, phases and speeds. Send for free data card. J. I. Weeks, 919 Neland, Grand Rapids 7, Mich.

ELECTRIC Pencil—writes, engraves all metals. Battery model \$1.00—110 volt model, \$2.00 postpaid. Guaranteed 5 years. C.O.D.s accepted. Reb Industries, Dept. 265-X, Elmhurst, Illinois.

WASHING Machines. Parts all makes. Northeast Burner, 1358 H St., Washington 2, D. C.

ELECTRICAL Supplies bought, sold and traded, agents wanted. Estes, Box 155, St. Matthews, Louisville 7, Ky.

MAGNETS — Alnico. Postcard brings 1947 list. Terry Sales Company, 3726 South Detroit Avenue, Toledo 9, Ohio.

LAMP Sockets, brass shell. Also Mogul sockets. Three way switches, cord sets, electrical repair parts, lamp parts, wires, etc. Catalog 10c. The Gearon Company, 4348 Broadway, Chicago.

B-29 FIRE-CONTROL Computers GEZ-CH1CL. Single parallax. New \$78.00. Free list. Erecos, 1006 Hewitt, Everett 1, Washington.

1000 AMPERE Starter solenoid relays. \$2.45. New. Specify coil voltage desired. Free list. Erecos, 1006 Hewitt, Everett 1, Wash.

PRACTICAL Winding of a.c. motors. A course of instruction on winding, connecting, and testing single, two, and three phase motors. Clearly written in everyday non-technical language. Illustrated throughout. This book is recommended for beginners interested in learning motor re-winding and repair. Satisfaction guaranteed or remittance refunded. \$2.00 prepaid. Educational Advancement Co., Dept. Y, Lakewood, New York.

WELDING, SOLDERING, PLATING

"MENDALL-METAL." Permanent repairs for leaks, cracks, splits, holes, in all pipe and fittings, right through rust, corrosion, paint. Also motors, cylinder heads, water gaskets, etc. Easy to use with blowtorch flame. Fuses with any metal at only 250 degrees of heat—less than red heat. Contains own flux. Permanently mends in ten minutes. Any part accessible to blowtorch can be mended in place. Money back guarantee. Used nationally for 30 years. Send \$5.00 for 6-bar package, prepaid to you. Immediate delivery. 4 A Manufacturing Co., Dept. 11, Littleton, Colorado.

MAKE Your own 20-200 amp. welder, using auto storage batts. Instructions \$1.50. One 5 KW 100,000 volt transformer cheap. Battweldco, Santa Barbara, Calif.

HOME-MADE Arc welder. Details free. International, Incorporated, 6347 Parnell-P, Chicago 21, Illinois.

A.C. Welders, 110 v., welds 1/2" steel, \$29. Money back guarantee. Paul Morris, 1850 State St., Schenectady 4, N. Y.

ACETYLENE Generator. Easy to build—plans, instructions \$2.00. Weldox, R. 2, Box 264, Phoenix, Arizona.

ACETYLENE Welding outfits, new, consisting of 2 gauge regulators, torch, 3 tips, hose, connections, clamps, lighter, \$54.50. Eagle Welding, Dept. PM, 5085 Broadway, Chicago 40, Ill.

SILICON Steel strips 30"x2"-5", Ernest Noyes, 32328 Brush, Royal Oak, Mich.

JOHNSON Jiffy-Kit, portable welding and cutting outfit complete with cylinders and carrying case designed especially for hobby shops, small repair shops, refrigeration and electrical service men. You own the cylinders! No rental charges! Free literature! A-A Welding Supply Co., E-9228 S. Ada St., Chicago 20, Illinois.

NEW Model electric welder 110 volt a.c.-d.c.; will weld all metals; easy to use; full directions. Complete with power unit, flame and metallic arc attachments, carbons, fluxes, rods, mask; all for \$19.95. Used by the navy. Magic Welder Mfg. Co., 239 MP5 Canal St., New York City.

PLANS To make welder of P1 aircraft generator \$1.00. Hoffman, 3136 W. 7th, Ft. Worth 7, Tex.

ELECTRO Plating outfit including solutions for jewelry, fishing spoons, etc. Plugs into lighting outlet. Instruction booklet tells how to plate baby shoes. \$19.50. Free folder. Hoover & Strong, Inc., 113 W. Tupper St., Buffalo 1, N. Y.

"THUNDERBOLT"—Transformer welder, dial-control, 3 heats, 60 amps., 110 volts—a.c., carrying case, accessories, instructions. \$39.50. Also "Super-Welder," 110 volts, a.c.-d.c. \$19.95. Save 2%, send check. Or order c.o.d. Dealers wanted, liberal proposition. Super-Welder Mfg. Co., 23 E. 20th St., New York 3, N. Y.

WELD, cut, braze with gasoline! Amazing new discovery shatters costs. Boosts profits. Important! Write Matthews Mfg. Co., Calgary 21, Canada.

WELDING, Cutting, aircraft welding and soldering equipment. Electric arc welders. Superior Oxy-Acetylene Co., Hamilton, Ohio.

MACHINERY, TOOLS AND SUPPLIES

PILLOW Block bearing, bronze bushing, self aligning, large enclosed oil reservoir, steel construction, sizes 1/2", 3/8", 3/4", \$1.10 each postpaid, 95c lots six. Further information Ideal Products, 63 West Nevada, Oshkosh, Wis.

HOBBY Dealers let us supply you with woodworkers power tools, electric motors, hand tools and many profitable new hobby items. Free monthly bulletins. Hobby Distributors' Alliance, 647 Main Street, Hartford 3, Conn.

GEARS For inventors, experimenters, model makers, schools, work shops, laboratories, etc. Government surplus made of brass, bronze, dural steel and stainless steel. 12 matched pairs; 24 gears, bevel, spur and ratchet. List price \$12.00, our price \$2.50. 25 matched pairs; 50 gears, includes larger gears, also sets of worm gears. List price \$30.00, our price \$5.00. Limited quantity. Order now. Write for our bulletins on ball bearings, rectifiers, relays, selsyns, horns and government surplus materials. MET Exchange, 323 Canal Street, New York.

EQUIP Your home workshop quickly, efficiently, economically by building your own mill, shaper, drillpress, vise, jointer or other metal and woodworking tools. Lewis castings and materials are ready to finish, detailed blueprints show how. Send 10c to cover cost of mailing new catalog describing 23 items. Lewis Machine Tool Co., P.O. Box 116, Station A, Dept. M, Los Angeles 31, California.

JOINTER Head for wood shaper, 2" wide, 2" cutting circle. Replaceable tool steel blades. State arbor diameter. \$4.75 postpaid. Hurley, 14 Lone Oak, Bethesda 14, Md.

BALL-BEARINGS, One-fourth list price. Free list. Burgess, Box 168, Ferguson, Mo.

20-1/4"x1" HARD Felt handgrinder buffs and 50 emery cloth discs, \$1.00 postpaid. Disco, 6136 Northwest Hwy., Chicago 31.

SINE Bars, Simplified, accurate. Instructions included, \$8.75. Capanna, 552 Morgan, Akron 11, Ohio.

MAGNETIC Dial indicator bases—\$3.45! Write—Eyrich, Box 849-B, Milwaukee, 1.

TEEH Saw filing tool. Gets teeth uniform. 25c. 316 North 2, Maywood, Illinois.

BENCH Milling machine, 12" table travel, power feed. Rough or semi-finished castings with blueprint. Fry, 2229 McGee Ave., Berkeley 3, California. Write for information.

LAY Cement block faster, more accurately! Kingsley Bonder guarantees uniform joints by providing adjustable slot for mortar. Place Bonder on top of block, trowel mortar into slot, sweep clean, remove Bonder. Neat, accurate bond remains, without waste of material. \$2.00 postpaid. Kingsley Shop, Inc., P.O. Box 1832, Atlanta, Georgia.

LAWNMOWER Sharpening machines renew edges factory like. Write M. C. Hardies, 4148 Cornwell, Berkley, Mich.

LABEL Your cigar boxes for tools, hardware, screws, nuts, bolts, washers, electrical parts, machine parts, etc. Send postcard for complete details. Hinds Mfg. Co., 223 Second, Niagara Falls 1, N. Y.

V-BLOCKS At low prices, 10 sizes for all purposes. Free literature. Miles Products, 2532 Wabash, Chicago 16.

BENCH And jig saws, post drills, com-pressors, mandrels, block machines, sanders, etc. Circulars 5c. Sunshine, Berkshire Heights, Penna.

UNIVERSAL Mechanics tools: Dandy 10-piece set: Rldgid pipe-wrench, Channel-grip pliers, adjustable wrench, Cetee pliers, diagonal cutters, ballpeen hammer, plastic screwdriver, waterpump pliers, hacksaw and blade, cold chisel, \$19.85. Remit today. New catalog free. Universal Tool Company Has It, 1527 Grand, 10C, Kansas City, Missouri.

TEMPERING And case hardening made easy. The know how and formulas supplied for 50c. Melwill Enterprises, 200 Center Avenue, Pittsburgh 29, Penna.

SANDER, Guaranteed, colored plastic, fifty cents. Dollar includes assorted grits. Pegmar Products, 111 Sutter, Room 1031, San Francisco 4, California.

TAPS And dies. Buy direct from manufacturer at small cost. Send postage stamp for price list "D." King Tap & Tool Co., Inc., North Attleboro, Mass.

STRAIGHT Edge precision ground with name and address, to 12" \$1.50, 12" to 18" \$2.00. Send power hack saw blade, plus postage. (remove teeth). Tool castings etc. Model Tool Service, Rock Falls, Ill.

HOISTS, surplus Spur Gear Hand Hoist will lift 500 pounds 20 feet. Made by famous manufacturer to lift bombs into aircraft. Easy to install and operate. New, unused. Shipped postpaid anywhere in U.S.A. for \$10.00, or write for illustrated details and dozen uses. Hurry! Ireland and Vice, 48 Chedeles Place, Auburn, N. Y.

DRILL Grinder for twist drills \$2.95. See ad on page 258.

WAR Surplus in small tools for machine shop—Send 15c for bulletin. Travers Tool Company, Dept. P, 5 Court Square, Long Island City, N. Y.

NEW Glass drill. Free literature. Box R188B, Seal Beach, Calif.

DRILLS-TAPS — Reconditioned high speed, up to seventy-five percent off list. Send for free circulars. Perry Screw and Bolt Corporation, 4250 Grand River, Detroit 8, Michigan.

CONCRETE Building block machines and molds. Catalog free. Concrete Machine Co., 5129 South Compton Ave., St. Louis 11, Mo.

MAKE Cement bricks, Tri-Brik, the wonder brick maker, \$19.90 f.o.b. Richmond, Va. Write Welding Service, Sect. A, PO Box 6014, Richmond, Va.

BARGAINS in machinist tools. Write Precision Tool Service, 55 E. Washington St., Chicago 2, Illinois.

INDEX Head for sale. Sixty-two divisions. Used on lathes up to twenty inch swing, drill-presses, milling machines, etc. Make gears, hobbs, cutters, etc. Very accurate and durable used by shops, factories and machinists. Write for free folder. Long's Index Head, 2117 East B Street, Torrington, Wyoming.

DRILL Grinder—Grinds drills to factory accuracy. Calipers with direct reading scales. Circle cutters. New Tool grinder. Lowest prices. Free literature. Factory, 811-B East 31st, Kansas City 3, Mo.

BLOCK Machines—Concrete, 200 to 240 hour, 2 blocks one time. Also other machines. 45 to 100 per hour. Power or hand brick machines. Batch mixers. Any size. Madison Equipment Co., Madison, Tenn.

SHEBEL Saw trial \$7.50. Files all saws. Circular. Free trial. Shebel, 730B S. 2nd St., Milwaukee 4, Wis.

BOATS, OUTBOARD MOTORS, ETC.

SAILS For yachts-canoes. Canvas for recovering boats, trailers. Wing dope, canvas cement. Marine paints, hardware. Sailcloth. Manila, linen rope. Marine flags. Outboard motors, rowboats. Alan-Clarke, 96 Chambers, New York City.

RUBBER Boats—Hold 1 to 5 men; weigh 5 to 40 lbs. Ideal for fisherman, duckhunters, yachtsmen, seashores. Made to rigid government specifications. Price \$14.81 to \$69.75 depending upon size and condition. Write for circular. Karl Ort, Dept. PM-2, York, Penna.

ANCHORS Navy type, sizes 10-15-20-25-30 lb. semi-steel, aluminum finish. Recommended size, 1 lb. per ft. Price 20c lb. f.o.b. Wilson Patterns, Coffeyville, Kansas. U.S.A. Discount to dealers.

PROPELLERS—Use Airpulsion, Airliner 3 blade, 2 blade aluminum castings, Ford A aircooled conversion. Standard Aero Craft, Ft. Worth, Texas.

PRACTICAL, Light, folding Kayak. Specify 10 1/2' or 15'. Rush \$1.00 for plans. Hoosier House, P.O. Box 1264, Indianapolis 6, Indiana.

PISTON Rings for all outboards. One man rubber life rafts \$15.00. Wilson Marine, 170 Terrace, Buffalo, N. Y.

MARINE Plywood boat—Complete kit includes all necessary material to build nine foot dinghy. Send for free circular. Marine Division, Box 51, Chautauqua, N. Y.

USED Jeep motors complete. Less transmission. Ready to run. Seventy-five dollars each. Meyers, 820 Dryades St., New Orleans, La.

WHY Lug your outboard motor? New easy carrier \$8.75. Catalog free. Sportsman's Pal, Tahoe Valley 6, Calif.

REBUILT Tachometers 0-5000 and 0-8000 r.p.m. \$10.00 each, specify rotation. Also new tachometers and adapters. Zakarian Engineering, Box 416, East San Diego, Calif.

SPORTSMEN—You can build the famous folding Foidkraft Kayak, 10 1/2' or 15'. Plans \$1.00 postpaid. F. J. Leary, 15 Park Row, Suite 1216, New York City 7.

KAYAK Blueprints, deluxe models—cat-alogue 10c. Viking Canoes, Merrick, N. Y.

ATTENTION Sportsmen! Go kayaking! Build yours from complete easy-construction kits. Literature. Play-yacks, Dedham, Mass.

OUTBOARD Motor parts, new and used, for all makes. New pistons, standard and oversize. Cylinders rebored. Outboard Motor Mart, Inc., 309 Atlantic Ave., Boston 10, Mass.

ALL Copper water jacketed exhaust manifolds for marine conversions of automobile and aviation engines and marine engine replacements; any make, model or age. Joseph Van Blerck & Son, 391 Woodcleft Ave., Freeport, N. Y.

PROPELLERS: New army surplus, Michigan, 3 blade bronze, 12"x10"RH; 7/8" hub bore. Made for Johnson 22 h.p. outboard. Modify for other engines. Only \$5.65 each postpaid (with order). We will increase pitch to 11", 12" or 13" at \$1.00 additional per each propeller. Baker Bros. Supplies, Box 301-C, Palatine, Ill.

ROWBOAT Dry indefinitely, years. Inexpensive, copyrighted, \$1.00. Crsa, Box 8, Nanticoke, Penna.

MARINE Conversions for Ford and Jeep engines. Catalog 10c. Lehman Manufacturing Company, Department D, Newark 2, New Jersey.

USED Outboard motor parts. Outboard Exchange, 1194 Remsen Ave., Brooklyn 12, N. Y.

KAYAKS. Rowboats, weldwood ready cut kits, booklet. E. J. Croot Co., #103-D, Basking Ridge, N. J.

BOATS And all about them. How to select, build, repair and operate. For 40 years the leading practical boating magazine. Half price trial subscription. 12 issues for \$1.00. Motor Boat, 62 Gold Street, New York 7.

TWENTY Plywood boat plans \$1.00. Catalog boat building plans 10c. The Rudder, 15 Murray Street, New York.

BOAT Designers are highly paid professionals. Complete course by mail. Catalog. Westlawn, Montville, N. J.

USED Marine motors, propellers, marine fittings, conversion manifolds. Stokes Marine Supply, Coldwater, Michigan.

ENGINES, MOTORS, DYNAMOS

SPEEDY 1" Motor runs atop flashlight cell! Parts, instructions, 35c. Fonskov, 655-G Amboy, Perth Amboy, N. J.

SELSYN Motors, Bendix 3 1/2"x5 1/2" heavy duty 115 volts, 60 cycles, \$10.25 per pair. J. A. Weber, 150E Maple, Hershey, Penna.

MOTORS! 1/2 HP.—All new—High speed 110 volt, 25 or 60 cycle, d.c. converted to a.c. ball-bearing motors with forward and reverse switches. Countless uses for home mechanics. Actual cost about \$100.00. Now \$19.50, three for \$50.00. Order today while they last! No c.o.d. orders. "Bachman's is Amazing," 23 Herman St., Rochester 5, N. Y.

150 AMPERE Generators for welding \$47.50. Extra flexible cable, 6 ft. lengths \$2.75. Other bargains. Butler Electric Company, 1885 Milwaukee, Chicago 47.

NEW Amplidyne motor generators, 27 VDC input, 530 W, 60 VDC output. \$9.50. Government paid \$105.00. Surplex, 2409 La Salle, Chicago 16, Ill.

MIDGET Magnetic motor. Small flashlight cell operates. Parts plus instructions 30c. Eltro, Deer Park, N. Y.

MOTOR Winding tester, indicates burned out or partly shorted coils in single or three-phase motors, indispensable for repairmen. Send for bulletin. Motor Industries, Quincy, Illinois.

400 CYCLE Dynamotors. GE5D21N3JA. 27VDC to 110VAC. 485 watts, shaft extension. Will operate 60 cycle radio equipment. \$12.50. Free list. Erecos, 1006 Hewitt, Everett 1, Washington.

WINDING Data, listing 225 motors, single and three phase, \$1.00. Motor Data Co., Box 7631, Kansas City 3, Mo.

"BUILD Your Own" gas drive arc welder easily with Hobart Generator. Save \$300 to \$500, and need only add used auto engine and chassis to build portable gas drive welder that goes everywhere after profitable construction and repair jobs. Write for free instruction book, further details. Hobart Brothers Co., Box M-1066, Troy, Ohio.

AMPLIDYNE Motor-generators. GE5A-M31N9A. Input 27VDC, output 60-0-60 VDC. 530 watts. Shaft extension. New \$15.00. Free list. Erecos, 1006 Hewitt, Everett 1, Washington.

ATHLETIC EQUIPMENT, BODYBUILDING COURSES

BUILD Strength and health with bar bells, dumbbells. Six complete, illustrated courses \$1.00. Mail prepaid. Paramount System, 2440 East 23rd Street, Los Angeles 11, California.

HEALTH. Perfect body, personality fast! World's greatest system! Guaranteed! Free literature! James Todd, Springfield, Mass.

DEADLY Judo—Piercest fighting technique. Trick knockouts. (200 photographs—plus illustrations). Expert instructions. Three volumes. Complete \$2.25. Variety House, Box 46-BR, Wall Station, New York 5.

BARBELLS. Exercise and weight lifting types, world's finest. Stamp for folders. Jackson Barbells, Springfield, N. J.

BARGAIN Sales. Barbell equipment, muscle courses. Free strongmen physique circular. Write Sid's System, (CPM10) 8421 1/2 Evergreen, South Gate, California.

200 LB. Adjustable Barbells—Personal course \$29.00. EG, Elmsford, New York 1.

BARBELLS. Exercise equipment. Courses. Free booklet. Good Barbell Co., Reading, Penna.

SPORTING GOODS, GUNS, FISHING TACKLE, ARCHERY, TRAPPING

JUST Out—The new Day Lite Bobber in green and red plastic, with balancing fins and automatic depth control for only 50c, postpaid. Glo Lite Bobbers, 2111 Woodward Avenue, Detroit 1, Michigan.

AUTOMATIC Lure—Positively weedless. Greatest invention in ages. Nothing like it. Circular free. Babcock Reel Co., Oak Harbor, Ohio.

BOWS-Arrows. Write headquarters for archery equipment. Quality products. Popular prices. Catalog 10c. Large illustrated hand book instructions, making and shooting, 50c. Archery, 617-B So. State, Chicago 5.

FISHERMAN—Try your luck with the sensational Bite Lite Bobber—when the fish bites, the bobber lights. Only \$1.50 postpaid. Glo Lite Bobbers, 2111 Woodward Avenue, Detroit 1, Michigan.

SWIZZLE Water "Magic Liquid" gets fishworms. No digging. \$1. 8 oz. bottle makes 50 gallon. Free catalog. Robt. Kochenrath, 1446-P Bardstown, Louisville 4, Ky.

FISHERMEN Want lots of worms, worms galore. Write Century Lab, Box 532, Hannibal, Mo.

FIREARMS: Blued or browned. Proven formulas, satisfaction guaranteed. Earn extra cash coloring steel and iron. Remit 50c. Melwill Enterprises, 200 Center Avenue, Pittsburgh 29, Penna.

GUNSMITHS—Now available, complete polishing kit for refinishing your guns. Long experience in refinishing guns qualifies us to furnish you at low cost proper wheels correctly shaped and sized to repolish guns at your plant or in your home. Write for complete information. Middletown Metal Finishing Co., Inc., River Road, Middletown, Connecticut.

SEND 10c For list 100 new and used guns. Frayseth's, Willmar, Minnesota.

NOW Available a complete Du-Lite installation for finishing guns and other small metal parts for \$150.00. Use it in your home or garage. Good money-making proposition. Further particulars from Middletown Metal Finishing Company, 45 River Road, Middletown, Connecticut.

FISHING Poles, ferrules, guides, tips, clamps, etc., native canes, bamboos, tonkins. 1-piece all-purpose rod, guides, top, reel-seat, butt, varnished, \$6.60. 3-piece native cane, painted, \$2.50. 2-piece steel rod, guides, tip, hardwood handle \$2.50. Dealers write. Bob Pace, Combs, Ark.

HUNTERS. Sportsmen: Here is what you have been looking for. A four piece steel cleaning rod with aluminum handle. Can be dismantled when not in use. Fits all shotguns and large caliber rifles. Only \$1.00 prepaid anywhere in U.S.A. Order now. Don't be disappointed later as supply is limited. Irving Goodman, Box 1998, Fargo, N. D.

CONVERT Your 22 cal. single shot rifle into a target pistol. State make and model. Send \$1.00 for plans, easy for anyone with simple tools. The Gunshop, Lovelaceville, Ky.

3000 BARGAINS. Firearms, binoculars, war relics. Catalog 40c. Smith Firearms, Runnemede, New Jersey.

ALLEN-DALE Sporting Goods, Inc., Box P187, Bayonne, New Jersey, offers complete catalog, fishing tackle, pocket knives, hunting, hardware, other useful sports items. Send 25c coin cover mailing. Deduct from first order.

AMMUNITION—New and used shotguns, rifles, handarms, fishing tackle. List 10c. Rudolph's, Atchison, Kansas.

MAKE Your own decoys. It's fun—and easy too with our plans. Our booklet also gives information on gun care. All included for only 25c. Ask for Booklet No. 109. Popular Mechanics Press, 200 East Ontario St., Chicago 11, Illinois.

FIELD GLASSES, TELESCOPES MICROSCOPES, MAGNIFIERS

INFRA-RED filters glass 1 1/4" (40 mil) diameter, mounted. Snap on binocular or camera, \$1.00 per set. Ross, C68 West Broadway, New York, N. Y.

GENUINE Polaroid glass—2 3/8" (72 mil) diameter. \$1.25 each, 2 for \$2.00. Ross, C68 West Broadway, New York, N. Y.

MAKE Your own powerful, efficient astronomical telescope. Lenses and instructions 100x \$2.50. 200x \$3.50. 400x \$5.50. Instructions alone 10c. Carl Jamer, Manorville, N. Y.

MAKE High power reflecting telescope, complete kit of precision optical parts, fully finished: 3" diameter, 44" focal length, mirror and diagonal both hard aluminized, plus 3 lenses for high power eyepieces. The buy of the year. All \$6.00. Ross, C68 West Broadway, New York 7, N. Y.

7x50 BINOCULAR Prisms (perfect). 60 cents ea. Also other elements. Iesco Products, 46 N. Penn St., Indianapolis, Ind.

LENS Grinding machine. Manufacture microscopic, telescope lenses, etc. Precision outfit easily constructed for \$5.00 less motor. Plans 50c. S. James & Co., Box 704, Saskatoon, Sask., Canada.

50 POWER Microscope and microscience kit, \$2.98. Guaranteed. Free literature. W. Wardell, 2509-A Clarendon Road, Brooklyn 26, N. Y.

MAKE Your own efficient compound microscope. Lenses and instructions 50x \$1.00. 200x \$2.00. 400x \$3.00. Instructions alone 10c. Carl Jamer, Manorville, N. Y.

BUILD Reflecting telescope. Catalog free. Instructions 10c. Maylor, Katonah, N. Y.

TELESCOPES, Microscopes, binoculars, barometers, books, photographic equipment. Buy, sell, repair. Lists 10c. Rasmussen & Reece, Amsterdam, N. Y.

60 POWER Telescope, \$2.95. 250 power microscope, \$2.45. Send for free catalog of telescopes, binoculars and microscopes. Brownscope Company, 24 West 45th Street, New York.

REFLECTING Telescopes, complete. 3 1/2" diameter, equatorially mounted. View planets, stars. \$19.75. Write Sky-scope Company, 475-P 5th Ave., New York.

BINOCULARS, Telescopes, watches. Buy, sell, trade. Paul Schweer, Donnellson, Iowa.

DOGS, PETS, BIRDS, RABBITS

SUPERIOR Chinchilla Giants—Other varieties. Breeding stock supplied credit terms. Beautiful picturesque catalogue. Complete instructions, 25c. Behrens Farms, Pearl River 4, New York.

RAISE Guinea Pigs. Make money at home. Big demand. Booklet free. Taylor, Box 426A, Hapeville, Georgia.

RAISE Angora wool rabbits, very profitable, wool \$14 a pound, shear four times a year. Also good for meat, easy to raise, we teach you in 20 lessons. Details free. International Angora Institute, 200 Burrell Building, San Jose, California.

POLICE Puppies—Black, white, cream. Ansonia Kennels, Mose, N. Dak.

BEAUTIFUL. Useful collie-shepherds, pups \$14.00. Paul Schultetus, New Liberty, Illinois.

ANGORAS. Chinchillas, giant rabbits—finest, pedigreed! Catalogue free. Book "Profitable Rabbit Raising" tells everything \$1.00; scientific self-cleaning hutch plans \$1.00; automatic feeder plans \$1.00. All three \$2.50. Grinsteads, Dept. 15-E, Edwardsville, Illinois.

\$250 MONTHLY. Raising Angora rabbits. Particulars free. White's Rabbitry, Lawrence, Kansas.

70 VARIETIES—Pigeons, rabbits, pheasant, peafowls. Catalogue 10c. Jim Houck, Tiffin, Ohio.

REAL Giant Chinchilla rabbits. Offered by their originator. Free details. Stahl, Pearl River 7, N. Y.

\$50.00 WEEKLY Raising Angoras for us. Free literature. Angoraville, 1215-34th Northeast, Cedar Rapids, Iowa.

ANGORA Wool spinners, shearing tables, breeding stock. House of Angora, Springfield, Illinois.

INCREASE Your income by raising domestic rabbits. Small space needed. Ready market for delicious meat, fur and wool. Largest magazine in the industry tells you how. \$1 per year. Send dime for sample. No stamps. Small Stock Magazine, Lamoni 50, Iowa.

STANDARD Rabbit Journal, Milton, Pa. 3 years \$1.00, sample dime.

\$2000 PER Year raising Angora rabbits. We buy your output. Contract particulars free. Wilsons, 1065 Shryer, St. Paul 8, Minn.

GUARANTEED Chin-Chin giant Chin-chilla rabbits. Greatest amount of delicious meat. Largest, finest, most valuable furs. Tremendous demand for breeding stock. We buy youngsters. Contact world's largest breeder. Willow Brook Farm, R15, Sellersville, Penna.

ZOOLOGICAL And pet animals for sale. Illustrated catalogue, literature, 25c. Trails End Zoo-5, St. Stephen, S. C.

RAISING Rabbits, Cavies, Hamsters, Chinchillas is a growing and profitable industry. Magazine 10c. Descriptive book and magazine 25c. Book and magazine (monthly) one year \$1.00. Address Small Stock Farmer, Pearl River 15, N. Y.

RAISE Guinea pigs. Profitable, low-cost feeding, small space required, small investment. Complete details 25c. Guinea Pig Farms, 3456 West 116th St., Chicago 43.

FARMS, FARM LANDS, REAL ESTATE

CHICKEN-FARM In Canada! Low-priced land and good markets make this an opportunity worth investigating. Farms available in most parts of the Dominion. Don't delay, write today for information (state province in which you are interested). Address H. S. Cresswell, Canadian Pacific, Montreal.

IT'S Spring again—in the exciting pages of United's new free spring catalog of up-to-the-minute bargains! Farms, ranches, orchards, summer homes, water frontage, business opportunities—over 100 pages with many photographs, from the northern dairy section to the famous Ozarks, from the midwest corn belt to glamorous California, 18 states. Write today for your free copy! United Farm Agency, 220 S. State St., Chicago 4, Ill.

FLORIDA—660 Acres, 15 miles from Tampa, 10 acre tracts or more, \$25.00 per acre. W. H. Hamiter, 104 N. Rome Avenue, Tampa, Florida.

\$5.00 MONTHLY Buys 40 acres near town; price \$200.00. Free list. Box 425-P, Carthage, Mo.

STROUT'S Green farm catalog—Over 2500 bargains, money-makers. 32 States, coast to coast. Mailed free. Tell us what you want—where? Price? Terms? We can save you time and money. Strout Realty, 255-P 4th Ave., New York 10, N. Y. 20 W. 9th St., Kansas City 6, Mo., 453 S. Spring, Los Angeles 13, Calif.

WEST'S 1947 Catalogue: Over 1000 farm and business bargains; Free copy write West's Farm Agency, HE-5, Pittsburgh 16, Penna.

GOVERNMENT Lands \$1.00 acre up. Information all states 25 cents. National Tax Service Bureau, 834A Majestic Building, Detroit.

MY 10TH and greatest year of giving the greatest land buys ever offered. 40 acres of real virgin land only \$155. Low terms. Free information. J. T. Armstrong, Shook, Mo.

HOMESITES \$450—Convenient payments. California's finest garden section. On Morro Bay's scenic shores. Wonderful fishing, hunting, boating, bathing. Fertile soil, softest water, temperate climate, congenial community. Free literature. Richard Motto, 6580 Hollywood Blvd., Hollywood 28, California.

GOOD Farms—Ranches. Washington, Minnesota, Montana, Idaho, Oregon, North Dakota. Dependable crops, favorable climate. Write for literature, lists describing typical postwar farm opportunities. Specify which state. J. W. Haw, 119 Northern Pacific Ry., St. Paul 1, Minn.

OZARK Lands for all purposes. Actual river frontages. 5 acres \$90.00 and upwards. Free list and literature. Hubbard, 424-I, Minnesota Ave., Kansas City 4, Kansas.

FARMS, Ranches. All kinds, sizes. Reasonable prices, terms. Wide variety locations, climates, recreational facilities. Free descriptive folders, price lists. Milwaukee Railroad territory: Washington, Idaho, Montana, the Dakotas, Minnesota, Iowa, Missouri, Indiana, Illinois, Wisconsin, Upper Michigan. R. W. Reynolds, 914, Union Station, Chicago 6, Illinois.

POULTRY, FARM SUPPLIES

POULTRY Pays! Learn how. Postcard brings free booklet. "Seven Keys to Poultry Profits." Informative, factual. Poultry Guild, 1046-K So. Olive St., Los Angeles 15, California.

BUILD Your own Poultry Picking Machine. We will furnish you blueprints, specifications, and "fingers." For full information write: E. J. Willard, 1744 Gaviota Avenue, Long Beach, California.

RAISE Turkeys the new way. Write for free information explaining how to make up to \$3000 in your own backyard. Address National Turkey Institute, Dept. 3, Columbus, Kans.

BABY Chicks, champion mated. 52 varieties, 6 Hybrids, licensed inspected, blood-tested. Rush postal, large colored book free, low prices. Berry's Farm, Route 12, Clarinda, Iowa.

PROFITABLE OCCUPATIONS

MONEY From wood scraps. Details stamp. Woodcraft, Lovers Lane, Gainesville, Texas.

"MAKE Money With Duplicator." Free folio. Tells how. Rucker, 2836-P Slevin, Louisville 12, Kentucky.

SEVERAL Worthwhile selling propositions 25c. Parcell, 2701 Main, Elkhart, Ind.

RAISE Earthworms. Complete instructions \$1.00. Huffman, 391 Pleasant Lake, Rives Junction, Mich.

START Back yard, perennial plant business. Much more profitable than Ginseng. Instructions \$1.00. Richland Gardens, Martin, Tennessee.

STORY Writing simplified by Simple Segment System. Circular free. Box 834, Spokane, Wash.

OPERATE Your own floor mat factory, use discarded auto tires. Large profits, huge market. Particulars 10c. Alvin Mfg. Co., 3704 Gordon Ave., Ft. Worth 4, Tex.

PRESERVE Live flowers, fascinating, profitable. Information furnished. "Beck," Semmes 3, Ala.

BE A novelty manufacturer, fascinating, interesting work. Exceptional profits. No expensive equipment needed. Quickly learned. Use garage or basement, successful manufacturer shows you how to start on limited capital. Plastex Products, 711 Laguna, San Francisco 2, California.

MECHANICALLY Inclined men—Own and operate general appliance repair shop. Complete, illustrated course shows you how. Welding, refrigeration, motor repair, how to get business, etc., all phases covered. Free literature. Christy Supply, Dept. 476, 2935 N. Central Ave., Chicago.

EARN More than average. Send card for information about very lucrative trade. Lidemark, 226 Potomac Ave., Buffalo, N. Y.

MAKE Beautiful mirrors from window glass cheaply. Formulas and silvering data \$1.00. Metallize baby shoes for profit. Several methods \$1.00. Tes-Co., Box 189-ME, Wilkes Barre, Penna.

SMALL Capital builds independent-prosperous business. Results amazing. Details free. Peisert, R-4, St. Paul 4, Minn.

SHELL Jewelry—easy to make. Instructions and materials for making six colorful pin and earring sets, sent postpaid, only \$3. Price list free. Don-Dee Shellcraft Industries, Box 1183B, Orlando, Florida.

AT Home—Your own manufacturing business making popular \$1.00 novelties. Cost you 3c to 15c. Everything supplied. Write So-Lo Works, Dept. T-600, Loveland, Ohio.

YOU Can sit in the boss' seat! Keep your job; start your own factory in your spare time. We provide 15 valuable tested trade secrets. You need no plant, very little money. See page 258 for details. Chemical Research Co., 130 W. 42 St., New York.

"ALASKA—The Last Frontier" offers excellent opportunities! \$1 brings official government map and 1947 copyrighted report describing potential opportunities in commercial fishing, mining, fur farming, prospecting, aviation, timber, agriculture, live stock raising, business enterprises, government homestead lands. Alaska Opportunist, 6417 Homewood Ave., Dept. PM, Hollywood 26, Calif.

SCRAP Metal costing 5c pound brings dollars in finished castings. Lifetime profits. Information, Fritz Foundry & Supply, 622 N. Fulton, Allentown, Penna.

MEDICAL Laboratory technicians in great demand. We train you in your spare time, in your own home. You can practice while studying. Write for free catalogue. Imperial Technical Institute, Box 973-T, Austin, Texas.

START Big profit vendor business. Cost small. Free details. Factory Silver King Corp., 623 Diversey Pkwy., Chicago 14, Ill.

MAKE Flexible molds. Few cents each! Cast plaques, novelties, bookends! Free sampler! H. Tooker, Hamilton 9, Ohio.

MAKE Beautiful costume jewelry at home for large profits, hobby or therapy. Free illustrated wholesale catalogue of sea shell, metal and plastic parts contains detailed instructions. Florida Supply House, Bradenton, Florida.

OWN A mirror shop! Resilver mirrors. Write for information. John Sprinkle, V50, Marion, Indiana.

LEATHERCRAFT Supplies. Catalog 10c. Art Craft Supply Company, 1206 Throckmorton, Fort Worth, Texas.

TRADES That often pay \$50.00 daily completely described and illustrated. "Flagpole Painting and Repairing"—\$2.00. "Smokestack Painting and Repairing"—\$2.00. The Skyline Co., Box 1601B, Uniontown, Penna.

INTERESTED In Latin American and foreign employment? \$1 brings 1947 Foreign Service Directory listing oil, aviation, mining, transportation, manufacturing, construction concerns with foreign interests and tips for immediate application. Global Reports, 6417 Homewood Ave., Dept. PM, Hollywood 28, Calif.

WOULD You pay 3%—first \$350 made? Color-illustrated book "505 Odd, Successful Enterprises" free! Some offer occasional "day off." Work home. Expect something odd! Pacific, San Clemente, Calif.

LOCKSMITHING—Profitable business or hobby! New course teaches you lock secrets, how to fit keys, de-code, masterkey, etc. Easy self-instruction lessons. Bargain price. Fascinating 100-page illustrated catalog free! Write Nelson Company, Dept. 2-02, Chicago 5.

QUICK Money! "Repairing car batteries" At home! Easy too! Write Batteryman, Grand Junction 6, Colorado.

MUSHROOMS Grown. Boxes, Barrels. Illustrated instructions 50c. Spawn \$1.00. Gordons, 553 William, Winnipeg, Manitoba.

TYPEWRITER Repairing instructions, standard typewriters. Webers', Box 1008, Canton, Ohio.

\$40.00 WEEKLY Made growing mushrooms, fresh, dried. Dominion patent 331583. Free spawn. North American, 169P Yonge, Toronto, Canada.

TYPEWRITER Repairmen urgently needed. Earn \$40 to \$50 weekly spare time. Our easy to learn home study course teaches how to repair typewriters. Write for free information. Houston Typewriter Repair Service, P.O. Box 5357A, Houston 12, Texas.

TADPOLES Make frogs, tremendous demand. Both make you money. 25c brings tell-how information. Chariton Corporation, Century Building, Chicago 4.

WELDING—Electric arc. Learn profitable trade quickly through actual practice. Individual welder instructions at bare cost of materials. Full particulars free. Valuable welding lessons book 50c. Hobart Welding School, Box M-1064, Troy, Ohio.

ELECTRIC Clocks are every where you go, buildings, homes, parking lots, factories. Repairs increasing. Our easy to learn course with pictures and drawings teach you how to repair these clocks. Electronic Supply Co., P.O. Box 2350A, Houston 1, Texas.

BOOKS, PERIODICALS, PICTURES, POSTCARDS

MAGAZINES—Business, vocational, diversion; Current single copies. Choice over 850 periodicals. All fields. Free price-list. Commercial Engraving Publishing Co., 34C North Ritter, Indianapolis 19, Indiana.

CHINA Veterans—50 prints (4x5) of China \$5, 100 for \$10, postpaid. George Clayton, 8469½ Cypress Ave., South Gate, Calif.

BACK-DATE Magazines, books. Specific issues—years. Arkell's, Tarzana, Calif.

POSTCARDS Beautiful colored western states, 90 delivered \$1.00. Hall, 50 Patton, San Francisco.

INTERESTING And unusual books, catalogue free. Paller Company, 201 Dewey Street, Newark 8, New Jersey.

SELL Your old books by mail. Write for details about our service. Logan Specialty Company, Department J, Kenilworth, Illinois.

BACK Issue magazines. Priced catalogue for \$1.00. Credited on first order. Kovach, 712 So. Hoover, Los Angeles 5, Calif.

DIRECTORY 2500 World newspapers addresses. \$1. Hiralal, Vakilpura, Delhi, India.

SPECIALS For service men, women and veterans of World War Two. New or renewal. Life \$4.25, Time \$4.50, Fortune \$6.00. Send serial number. Free catalog. Miss Frances C. Winn, Box 87, Clinton, S. C.

GOOD Books by mail. Free catalog PM. H. H. Evans, 1157 Sutter, San Francisco 9, California.

\$1.00 BRINGS 20 Beautiful, large 8x10 size, colored art pictures of scenes, etc. Marvelous, Box 2343, New Orleans 16, La.

FREE Photo of your favorite radio, recording, or movie star. Famous Fotos, 1990 Como, St. Paul 8, Minn.

AMAZING New book gives instant solutions to 100,000 practical problems. Details free. Columbia Graphs, Columbia, Connecticut.

WHAT Every Mason wants. We have Masonic books for Blue Lodge, Chapter, Commandery, Scottish Rite and Shrine. Our rituals are used the world over. Send for free catalog of books and rituals for Masons, Odd Fellows, Knights of Columbus, etc. Ezra A. Cook, Publisher, P.O. Box 796-PMY, Chicago 90, Ill.

VETERANS! Be financially independent. Changes in Loan Guaranty not generally known offer amazing opportunities for financial success. Write today. H. B. Smith, Box 747, Dept. M, Youngstown, Ohio.

OCCUPATIONAL Success Chart. How to Study Guide, free. Prepared by college authorities. Learn how to make your own practical home study course of every text in big educational catalogue. Send for free chart and guide today. Central Educational Service, Dept. B-24, 6009 Belmont Avenue, Chicago, Illinois.

ANY Back number magazines quickly supplied. Books, all subjects. American Book Mart, 20 West Jackson, Chicago 4, Illinois.

MAGAZINE Subscriptions, technical books, if it's printed we have it! Catalog 10c. Cassell Publishers, Westfield, New Jersey.

YES! We are again accepting agents to handle magazine subscriptions, books, greeting cards, complete details 25c (refunded). Cassell Publishers Service, Westfield, New Jersey.

BOOKS! (Out-of-print, scarce): Quickly supplied. Send wants. Spotlight, 141 Broadway, New York 6.

CANDID Snapshots glamorous Hollywood stars, 10 different \$1.00. Frederick Forman, 868 Lorimer, Brooklyn 22, N. Y.

BOOK Catalog free—Drop post card in mail today for interesting catalogue. Milwaukee Book Mart, Dept. C, 620 W. Center St., Milwaukee 12, Wisconsin.

GOOD "Used" self-instruction educational books on all subjects bought, sold, rented, exchanged. Satisfaction guaranteed. Complete information and 100-page illustrated bargain catalog free! Write—Nelson Company, Chicago 5.

SELF-EXPLAINING Bible: Illustrated circular free. Box 446-P, Minneapolis, Minn.

NATIONAL Geographic Magazine, 1888-1945, any issue. Periodical Service, Dept. PM, Swarthmore, Penna.

MAGAZINE Export Sales Company, 2084 First Avenue, New York 29, N. Y. U. S. A. Over-issue popular American magazines and pocket-size novels. Comics, fashions, pictorials, romances, screens, pulps, many others. Export only.

BOOKFINDERS! (Scarce, out-of-print unusual books.) Quickly supplied. Send wants. Clifton, Box 1377PM, Beverly Hills, Calif.

BIG Profits taking subscriptions for all magazines. Agents' confidential catalog listing over 2500 periodicals and complete starting supplies free. Pines Subscription Agency, Flushing, New York.

MAGAZINES (Back dated)—foreign, domestic, arts. Books, booklets, subscriptions, etc. Catalog 10c (refunded). Clear-one's, 863 First Ave., New York 17, N. Y.

GAMES AND ENTERTAINMENT

FIREWORKS! Luminous bombs, colored sparklers, fountains, flares. Big new assortment. Safe, inexpensive, easily made. Complete illustrated instructions 25c coin. Presto Products, 407-409 Springdale Avenue, East Orange, New Jersey.

NOVEL Racing game rules 15c. Van Dyke, 6012 B Middleton, Huntington Park, Calif.

1,000 JOKES, Cartoons, tricks, \$1.00! Hirsch's, Spring Valley, N. Y.

MAGIC TRICKS, PUZZLES, JOKER NOVELTIES

"SPOTS (Change!) Before Your Eyes." Magical sensation! Durable plastic paddles have spots which vanish, reappear, multiply as you watch! Perform repeatedly—no skill. 3 magic paddles, instructions, super catalog, 25c. Magic Shoppe, 19 M Springfield Ave., Newark, New Jersey.

DOLLAR Magic set free with gigantic catalog 25c. Mysto, 4462-B Germantown, Philadelphia.

PERFORM Astounding stunts with Alnico. Defy gravity. Mystify your friends. Two bar magnets (4 oz.), instructions, 60c postpaid. Ross, C68 West Broadway, New York, N. Y.

"VENTRILLO," Professional voice-throwing instrument and catalog 25c. 4462-W Germantown, Philadelphia.

VENTRILLOQUIAL Figures lesson course. Turner, 1284 S. Cochran, Los Angeles.

FREE Catalogue magic, puzzles, tricks. Scheetz's, 98-N Branch, Sellersville, Penna.

STARTLING, Bewildering Hindu mystic trick 10c! Postways, Box 5325-C, Philadelphia 42.

INSTRUCTIONS—279 Tricks (illustrated)—50c. Steiner's, Rockwell Road, Danbury, Conn.

SNEEZING Powder, itching powder, eighteen other tricks, free with Joker's Catalog 25c. Factory, 2404-N, Fifteenth, Philadelphia.

AMAZE and mystify your friends with highest quality magic. New catalogue 25c coin. Mazda Magic Co., 1135 Westgate Ave., Oak Park, Ill.

SLICK Tricks, jokers' fun items, puzzles. Catalog 10c. Novelty fun package included. Magic, Box A35, Irvington 11, New Jersey.

BE A magician. Large professional magic catalog of latest tricks, 25c. Ireland, C-109 North Dearborn, Chicago 2.

GUARANTEED Magic tricks! High quality, low prices and fast service! Big illustrated catalog and five good tricks explained, only 25c. Satisfaction guaranteed! Bargain! Act now! Newton Magic Co., 121-A Main, Bonham, Texas.

"MAGIC" Mirrors—See others through "one-way" mirror. They see only their reflection! 4 in. x 4 in. plate glass mirror, send \$1.10 to Trans-Flect "C," Box 236, Prospect Heights, Illinois.

LAUGH Kit of 10 tricks and jokes for \$1.00 postpaid (retail value \$2.50). Halo Novelty Co., 2015 North 6th St., Harrisburg, Penna.

NOVELTIES, Tricks, jokes. Free list. Mann, 113A South Third, St. Joseph 5, Mo.

VENTRILLOQUISM Taught. 3c stamp bring particulars. Smith, 801 Bigelow, Peoria 5, Ill.

FIVE Card tricks; magic race game; rubber dollar; hot pepper gum; also price list on unusual tricks. All for 25c. Betsy's Magic, 110 N. Eighth, Klamath Falls, Ore.

WHOLESALE Jokers' novelties. 50c. Samples, catalogue—25c. Box 526, Jamaica, N. Y.

VENTRILLOQUISM, Complete course only \$1. LeSueur, 77 Wellesley, Toronto, Canada.

TRUE Secret of ventriloquism. First time published. Free booklet. Quackenbus, Big Flats, N. Y.

VANISHING Half dollar trick and catalog 25c. Sterling Magic Co., Royal Oak, Mich.

WORLD'S Largest professional magic shop, keeps you in touch with latest tricks. To receive mailings, send 35c for new catalog. Holden's, M220 West 42nd St., New York.

"MAGIC Vanishing card." Throw it into air, it completely disappears, reproduce it later from spectators pocket. Easy to do. Complete, 25c with magic catalog. The Magician, 2463-C Kensington Ave., Philadelphia 25, Penna.

200 ELECTRIC Stunts, 110 volts, \$1. Kutting Sons, Campbell, Calif.

500 TRICKS! New 1946-7 edition Douglas famous catalog now ready, only 10c. Brand new magic for pocket, parlor, club, stage, professional, amateur. America's fastest service to magicians everywhere for over 25 years. Send 10c today. Douglas Magician, Dept. 1, Dallas, Texas.

EARN Money in any crowd. Call names of strangers, tell unspoken questions. Professional course mind reading, faked spiritualism, etc., \$1. Henderson, Box 341, San Bernardino, Calif.

LARGE Illustrated professional catalog 10c. Williams, 900 Plymouth, Ellwood City, Penna.

FREE! Large catalog of magical apparatus if you remit 25c for "Magic Is Fun" magazine. Robbins Co., 152-F West 42nd Street, New York.

ENTERTAIN! Mystify! New, bigger magic catalog and 4 secret tricks 25c. Herbert, P-192 N. Clark, Chicago 1.

MAGIC: Big 160 page Illustrated Catalog Latest Magic Goods, 25c. For over 1/3 century we have supplied Professional as well as Beginner. Chicago Magic Co., 2300 N. Mason, Chicago 39.

MAGIC Tricks, puzzles, books, cards, punch boards. Catalog 10c. Specialty, Box 671, St. Louis 1, Mo.

COINS, TOKENS, CURRENCY

WE Pay \$2 to \$200 each for hundreds of old or odd coins. Indianhead, Lincoln and foreign coins wanted. You may have valuable coins. Keep all until posted. Send 20 cts. for new Ill's Coin Value Book, 4x8. Buying and selling prices. 40 years in business. Coin Exchange, (7), LeRoy, N. Y.

WILL Pay \$10.00 each for certain Lincoln pennies! Indianheads \$50.00; dimes \$1,000.00. Catalogue 10c. Federal Coin Exchange, 5-PM, Columbus, Ohio.

FOREIGN Coins on approval on request. Del Monte, 40 W. 18, New York 11.

30 FOREIGN Coins \$1.00, 100 coins \$3.25, 3 coins 10c. Oddehon, Box 482, St. Louis, Mo.

FREE Foreign coin, bill and catalog to approval applicants. Nassau Hobby Center, Freeport, New York.

U. S. Coins bought—sold. Send now new list. Coins, Box 77, Alameda, Calif.

SCARCE Japanese invasion of America bills. Free list. Glenn Godwin, 5 Mildred Ave., Binghamton, New York.

BOOK Of all U. S. coins, values, \$1.00 Will pay 50c for 1909s pennies. Coin Exchange, Box 92, Fairfield, Ohio.

5,000,000 DRACHMA Greek banknote 40c. Bargain list 10c; foreign coin free. Whitman folders 30c; eight \$2.00. Olson, 434 North Menard, Chicago 44.

NEW Half dollars—Iowa \$3.50; Booker T. Washington set (3) \$4.00; Stone Mountain Memorial \$1.25. Lincoln cent bargains, 1909-SVDB \$10.00; 1914-D \$2.25; 1909-S 60c; 1922-P \$1.75; 1931-S 65c. Other Lincolns, 10 different \$1.00. Whitman folders 25c. Minimum order \$1.00. Bebee Coin Company, 1180 East 63rd, Chicago 37, Illinois.

OLD Money wanted. Do you know that coin collectors pay up to \$100.00 for certain U. S. cents? And high premiums for all rare coins? We buy all kinds. Send 4c for large coin folder. May mean much profit to you. Numismatic Co., Dept. 20, Fort Worth, Texas.

FREE! Stamp and Coin Collector's Catalogue. Box 418, Beverly Hills, Calif.

COINS And currency, 57 all different, many countries. Bargain \$2.00. Reynolds, 1118 Mathews, Flint 3, Michigan.

FOR Sale: 1893 Columbian World's Fair half dollar, 75c; U. S. 2-cent pieces or 3-cent pieces, 25c each; 50 assorted Indian head cents, \$1.25; large 50 page U.S. coin catalog, listing thousands of coins for sale at reasonable prices, 25c; Giant 72 page foreign copper-silver-gold catalog listing over 10,000 coins for sale, 25c. Ben's Coin Company, 72 West Washington, Chicago 2, Illinois.

WORLD Coins—25 different \$1.00. Harry Elsholz, Box 9014, Pittsburgh 24, Penna.

GET Profit and pleasure in collecting old coins. Send 10c for 56 page illustrated coin catalog. You'll be delighted with it. Send for it now. B. Max Mehl, 370 Mehl Bldg., Fort Worth, Texas. Largest rare coin establishment in U.S. Established 47 years.

FREE! Foreign coin, banknote and coin collectors illustrated catalog to approval service applicants. Send 3c postage. Tatham Coinco, Springfield-125, Mass.

FREE—"Amazing New Book"—"Profits From Classified Advertising." Tells how and what to advertise. Be sure to read this book before you invest one cent in advertising. Remember—it's free! Write for your copy now. F. W. Johnson, Classified Advertising Manager, 300 East Ontario Street, Chicago 11, Illinois.

STAMP COLLECTING

UNITED States collection, thirty-seven fine unused commemoratives before 1943, including Columbians, bicentennials, parks. Price \$1.03, approval applicants only. Fort Orange Stamps, Albany 3, New York.

BIG Packets all different stamps 10c each (11 for \$1.00). 30 Asia; 30 Belgium; 50 British Colonies; 50 Denmark; 50 France; 40 Hungary; 30 India; 50 Italy; 25 Norway; 25 Portugal; 30 South America; 25 Spain; 30 Sweden; 25 Uruguay. Longacre Shop, 108 West 42nd, New York City 18.

NEW Giant packets: 100 different Portuguese Colonies 50c. 25 different Saar 75c. 100 different India native states 85c. 25 different Straits Settlements 90c. 100 different Great Britain \$1.00. 100 different Peru \$1.25. 50 different Latvia \$1.35. 100 different airmails \$1.50. 50 different Haiti \$1.65. 100 different Bolivia \$2.25. 100 different Dutch Indies \$3.25. 1000 different British Colonies \$9.50. Mission Mart, Washington 17, D. C.

SCARCE U. S. stamps nearly 100 years old, 1893 commemorative, \$5-\$10 stamps, Armed services pictorials complete, Roosevelt set, large allegorical figure of Commerce, old revenues, everything 5c to serious approval applicants. Metropolitan, 140 Nassau, New York 7.

GIVEN! Miniature collection with free premium approvals. Verne, 916-D Fallowfield, Charleroi, Penna.

U. S. FIRST Day of issue stamp covers add beauty and value to your collection. Send \$2 and receive big package of 20 different (pre-war). Fred Coops, Box 215, Fontana, California.

PROFIT In stamps. Cover every angle with the new book "How To Gain Pleasure and Profit from Stamp Collecting." \$2.75. Funk & Wagnalls, Dept. PM, New York 10.

JAPANESE Invasion money and 100 different foreign stamps, 10 cents. Nagle, 1101 Marion, Reading, Penna.

\$2.00 HARDING. (Presidential). General approvals. 15c. O. Burgett, Lima 2, Ohio.

EGYPT—15 Different, 5c to approval applicants. Bohemia Stamp Service—1, Bohemia, N. Y.

UNITED States approval—Largest varieties. America's lowest selling prices. Stamp Company, Albany 7, N. Y.

100 DIFFERENT—Commemoratives, airmails, triangles, diamonds, 10c. Approvals. Kostillo, Bellaire, Ohio.

200 U. S. Commemorative \$1.00. Wants filed. John Winn, Bolivar, Mo.

MINT. French coat-of-arms, Vatican, Hitler heads, airmails, free with approvals. Gulfstream, Drawer 71, Miami, Fla.

BRITISH Colonies peace issue. 92 stamps, mint \$6.00. Clarkson, Ridgewood, New Jersey.

AIRMAILS Only on approval. Mint and used. References required. Gerspacher, 159 Irving Terrace, Kenmore, N. Y.

JOIN: International Stamps Exchange Club, 280, Kandana, Ceylon. Membership year \$1.00.

BARGAIN! All different, some mint, from Seychelles, Cyprus, Libia, Uruguay, Norway, etc. Only 10c with approvals. Wollaston Stamps, Wollaston 70, Mass.

"GOYA Nude" set 10c to approval applicants. Royal Stamp Company, Tamaqua, Penna.

300 COMMEMORATIVES. Pictorials, etc., plus surprise packet \$1.00. Schneider, Box 1012, Chicago 90.

USED 1938 Presidentials 5c, 10c, 15c, 18c, 19c, 20c, 25c, 50c, \$1. Given to approval applicants. R. B. Rossom, 218 West 59th St., Chicago 21, Ill.

UNITED States. #302, #303, #304, #305, #306, #307, #367. Only 50c. Approvals accompany. Whiton-Stamps, Westport 4, Connecticut.

EXCHANGE 100-200 Any country. Send today. Godbey's, Box 77, Alameda, Calif.

FREE! 33 Transjordanian, Trinidad, Haiti, others. Approvals. Robert Keating, Box 267M, Forest Hills, New York.

U. S. 200 Different \$1.00—95 different 25c. Guaranteed. Victor Logsdon, Hyndman, Pennsylvania.

100 COMMEMORATIVES. Etc. 20c, 300—50c. Kellermann, Box 457, Newark 1, New Jersey.

\$27.00 CHINESE Airmail and 50 others 10c to approval applicants. Burmaster, Box 1910-C, Los Angeles 53.

GIVEN—Tanganyika! Sudan! Rhodesia! Thuringia! Approvals. Keating, 637 Bergen, Jersey City, New Jersey.

REMOVING Stamps? Do it in only 10% the normal time; clean and sterilize without fading or bleaching and insure flat drying; good for many thousand removals. Send \$1.00 for Phesol to F. M. Simpson, 466B West Superior, Chicago 10, Illinois.

PENNY Approvals, Henry Jay Service, 15 Park Row, New York City.

FREE Nicaragua bicolored diamond stamps with approvals. Myles Payne, West Cheshire, Conn.

ICELAND Packet free to approval applicants. Don't delay, write now to "Everglades," Box 3222, Station F, Atlanta, Ga.

NEW Advanced collectors exchange duplicates credited on Scott 47 basis. 3c for prospectus. L & M Exchange, Statesan, Wisconsin.

MAGNIFIER \$9.35. Five power magnifier with self-contained battery illumination. Prepaid to you \$3.95. Warshal's Sporting Goods, 1002 First Avenue, Seattle 4, Washington.

SHIPS, Birds, famous men, animals, strange cities. Request approvals. Get free gift packet. Skiarew, 74 Bank, New York 14.

UNPICKED: 5000 U. S. \$2.00; 3000 foreign \$2.00. 1000 different \$2.00. Satisfaction guaranteed. Kuhn, 3315 80th, Jackson Heights, N. Y.

VATICAN City. 10 beautiful pictorials to approval applicant 10c. G. A. Hegenbarth, 1545 Ardmore Ave., Chicago 26, Ill.

PICTORIAL Stamps, mostly British Colonials, on approval. Barrington Smith Company, Halfwaytree, Jamaica, B. W. I. (Postage 5c).

HINDENBURG Zeppelin set 5c. Approvals. Thode, 14302B 119 Avenue, Jamaica, New York.

MONTENEGRO Colorful pictorial set. 10c with approvals. Vargo Stamps, 6044 South Fairfield, Chicago 29, Illinois.

FIRST See them, then buy them. United States approvals plus unique premiums. Jarr, Box 217-H, Madison Square, New York 10.

ILLUSTRATED Stamp Magazine, 26 weeks 25c. Stamp Journal, Kalamazoo, Michigan.

ZANZIBAR, Palestine, Manchukuo, Azerbaijan, Haiti, Iraq, Siam, Victoria, Hitler stamp 5c. Approvals. Postzegel, Windham, New York.

FREE! British Empire packet. Postage 3c. Williams, 606 Archer, Bay City, Mich.

FREE! Western Hemisphere packet. Postage 3c. Owens, 806 Welsh, Bay City, Michigan.

FREE! Pony Express set (facsimiles). Postage 3c. Roberts, 406 Building, Bay City, Michigan.

FOLD-O-HINGES Free. Regular 10c package to approval applicants who enclose 3c postage. Baker Stamps, Evansdale Street, Lake Mary, Fla.

RICH Man's approvals, poor man's prices. Grand value packet containing five foreign sets, free with approvals. Stoll Stamp Service, 2630B West Burnett, Louisville 10, Kentucky.

POSITIVELY Greatest free offer—Latest Scott's International \$6.00 Stamp album, covering entire world, contains 36,000 illustrated descriptive spaces; Scott's 1947 Standard \$6.00 catalogues "Philately's Encyclopedia"—absolutely free to applicants for foreign approvals becoming customers. Bargain Stamp Service, Santa Ana, California.

EXCHANGE Stamps universe. Particulars free. "Exchangers," Bry 126, Seine, France.

PICTORIAL Packet! Philippines, Panama, Palestine, Paraguay, Portugal, Porto Rico, Poland, Peru, Persia, free to approval applicants. Eliot Stamps, 86-31 Eliot Avenue, Rego Park, N. Y.

WHAT A bargain! 10 Vatican including Cardinals, 10 San Marino and beautiful large Italy Polish Corp. All 10c with approvals. Aldee, Tremont Station, Box 38, Bronx 57, N. Y.

FREE Beautiful new issues, six countries, including new Istria, to approval applicants. Green and Company, Norwood 12, Ohio.

MISSION Mixtures. Worldwide accumulations 1,500 \$1.00. Missions Outlet, Reverend Marshall, Paterson 1, N. J.

WHAT Have you to offer? A collection? A "shoe box" accumulation? Anything in stamps. We urgently need them. Spot cash paid. Cosmopolitan Stamp Co., 1457 Broadway, Dept. 5-E, New York.

100 ONLY Canada CE3 with error 75c each with approvals. London Stamp House, London, Canada.

VATICAN City! Four varieties of Vatican City (world's smallest country) including portrait of Pope Pius! Also stamps from Afghanistan, Cape Juby, Libya, Macao, Palestine, Syria, Liechtenstein, San Marino, and many other interesting countries. All together 48 different stamps, total catalog price over \$2.50!—only 10c to approval applicants! Methuen Stamp Service, Inc., Dept. 211, Lawrence, Mass.

FREE! 20 Diff. foreign with approvals. Box 3735, Portland, Oregon.

MEMBERSHIP Throughout the world. Stamps, postcards, etc. \$1 per year. Tui Exchange Club, Box 96, Symonds St., Auckland, New Zealand.

FREE San Marino airmail set, 3 values, to new approval applicants. Wesken Stamp Co., Box 66M, Queens Village, N. Y.

ROGUES Gallery packet—Hitler, Petain portraits, Norway "Quisling" traitor, Jap-Philippines issue. Beautiful Seychelles "palm tree." Yours for 3c postage. Approvals. Premium, Hartland, Maine.

FREE Philippine Rizal issue with foreign approvals. 20th Century, P.O.B. 3413, Philadelphia 22, Penna.

GIBRALTAR Packet free—Nice collection Gibraltar, New Zealand Centennial, British Uganda, French Colonials, early British Colonial, West Indies, South American, war stamps plus Philatopic Monthly Magazine. All for 5c postage. Empire Stamp Company, Dept. PM, Toronto 5, Canada.

CANADA—75 Diff. 25c. Approvals. Lists. Victoria Stamp Co., London 4, Canada.

BET You haven't these! South Georgia, South Orkneys, Grahamland, South Shetlands. Shortlived Falkland Dependencies. Everything 3c with approvals. Viking, 130ZZ Clinton St., Brooklyn, N. Y.

FINE Approvals, freshly mounted. Fast, personal service. Tell me what countries you prefer and I'll send their stamps. Skinner, 438 Locust, Long Beach 12, Calif.

MEXICO Mixture—Plenty of pictorials, 400 for \$1.00. Biehl, Apartado 2887, Mexico City.

UNEQUALLED Bargain. Stamps from over 25 countries including Fiji, Swaziland, Pitcairn, Tonga, Trinidad, etc. Everything 10c to approval applicants. Bennett's, Box 252, Terminal 'A', Toronto, Canada.

PACKET Of "Free-French" stamps given with approvals. Hill Stamps, Box 732, Woodmere, N. Y.

PROTECT Your stamps with Crystal-Mount. Send for free samples. Harris & Co., 202 Transit Bldg., Boston 17, Mass.

MAGNIFYING Glass with plastic handle, 10c! To foreign or United States approval applicants only. Elliott Stamp Company, Box 51x, Miami Beach 39, Florida.

WORLDWIDE, Different 200—25c; 500—60c; 1000—\$1.50. Beacon Sales, Maynard 2, Mass.

FREE! Airmail packet with approvals. Deane Stamps, Box 87, Miami 35, Florida.

BREAKING Up large foreign collection. Approvals by countries. Lion, 200 W. 81 Street, New York 24.

COSTA Rican triangle and diamond stamps free to approval applicants. Jay-Dee Sales, 49 Chalmers, Youngstown, Ohio.

GORGEOUS New Nicaragua diamond, Roosevelt commemorative, San Marino airmail, 50 different 3c with approvals. Chesapeake Stamps, 748 Overbrook, Baltimore 12, Maryland.

VALUABLE Catalogs 10c each: (1) "United States, possession and Brit. N. America" complete with 1000 illustrations; (2) "Airmail stamps"; (3) "British Empire"; (4) "Modern Europe." Each catalog 128 or more pages, profusely illustrated, wonderfully informative, economical prices. H. E. Harris & Co., 202 Transit Bldg., Boston 17, Mass.

FREE! The Stamp Finder! Send today for the big new edition, fully illustrated, enabling you instantly to identify all difficult stamps! Also fine packet strange, fascinating stamps from Bosnia-Herzegovina, Monaco, Patiala, Cyprus, etc., including maps, ships, animals and strange scenes. All free to approval applicants inclosing 3c postage. Garcelon Stamp Company, Box 900, Calais, Maine.

200 DIFFERENT Stamps, 6c, to approval service applicants. Tatham Stamp Company, Springfield 30, Mass.

PORTUGAL—30 Different 10c. Approvals on request. Stamp Chest, Box 748-A, Jamestown, New York.

FIVE Large mint French Colonies free with approvals. Cornell Stamps, Box 4259, Miami 26, Florida.

ABSOLUTELY Free! Scarce airport stamp (guaranteed genuine—Catalog price 50c) and illustrated "Get-Acquainted Folder" describing other free stamps given with our valuable publications. H. E. Harris & Co., 202 Transit Bldg., Boston 17, Mass.

BEGINNERS! My progressive U. S. approvals, postage or precancel, are intended for you! Send a postal today! Cole, 43 Binewalt, Williamsville, N. Y.

BOLIVIA Music set, Greek occupation of Albania, airmail packet. Free to approval applicants. Middleton Stamp Co., 78-14 Woodside Ave., Elmhurst, N. Y.

BIGGER, Better, pleasingly priced foreign approvals. Inter-Continental Stamps, Englewood 2, Florida.

HITLER, Vatican, airmails, free with approvals. Granada Stamps, 4891 S.W. 5th Street, Miami, Florida.

BRITISH, Spanish and French Colonies, Vatican, Hitler heads, and airmail packet, free with approvals. Pan-American Stamp Co., Box 145, New York 33, N. Y.

OVER 100,000 sold; 100 different Latin America only 33c; 100 different Greece 85c. Carlton's, 10243 Silverton, Tujunga, Calif.

EXOTIC Pictorial collection: Tahiti spearfishing, Melanesian idol, Ingavi battle, Reunion, Madagascar, St. Pierre Miquelon, Djibouti, Wurttemberg, Dutch Indies, Newfoundland, many others. This outstanding offer only 5c. Imperial, Box 1491, Tampa, Florida.

FREE! 25 Different foreign, mostly pictorials. Approvals. Streiner, 898 East 75, Cleveland 3, Ohio.

SIXTY-SIX Different stamps 3c. Approvals. Cornetta, 228 West 25th, New York 1.

FREE—Pick 25c worth of stamps from our first U. S. approval selection. Special illustrated lists included. S. C. Engel Co., 38 Park Row, New York City.

U. S. Price list, send postage. Steger, 1165 Downing, Denver 3, Colorado.

15 U. S. Commemoratives 10c, approvals. Roger Stamp Mart, P.O. Box 316, New York 8, N. Y.

BRITISH Colonies and South America on approval. Theo. Stevens, Box 3705, Kercheval Station, Detroit 15, Mich.

FREE—Famous Americans set, plus Flag Set, plus the National Parks Set, plus the Presidential Set to the \$5. A total of 90 stamps absolutely free to customers for our unsurpassed United States or foreign selections. Send 3c postage for 15 of the above mentioned stamps and full particulars. Triboro Stamp Company, 145 Nassau St., Dept. 103, New York.

CHINA 20 Colorful historical stamps 10c with approvals. Collins', 71 Coleridge, San Francisco 10, Calif.

\$2,000 IN Stamps free to contest winners. Particulars, entry blank, to approval applicants enclosing only 10c for scarce Roosevelt Mourning stamps from Nicaragua, Greece and Argentina, plus photograph of "Roosevelt Collecting Stamps." National Stamp Sales, 276A West 43rd Street, New York 18, N. Y.

DANDY U. S. approvals; write immediately. Sullivan, Endicott Building, St. Paul, Minnesota.

CUBA'S Retirement set shows aged couple receiving pension check. This set sent to approval applicants for only 5c. Bryson Stamp Company, Drawer F-2, Rossford, Ohio.

ROUND The world colonies—British, Dutch, French, Portuguese; strange little known countries, primitives, cannibals etc. All for 3c to approval buyers. Dixie Stamp Company, Dept. 10, Milwaukee 1, Wis.

118 DIFFERENT Stamps including commemoratives, charities, airmail, surcharges, sets, etc. Only 3c to approval buyers. Badger Stamp Company, Dept. M, Milwaukee 3, Wis.

SMOKY Mountain souvenir commemorative sheet and 30 different U. S. stamps, including commemoratives, airmail, etc. (catalog value exceeds 65c) for 10c to approval applicants. Curhan Stamp Company, Dept. H, Gloucester, Mass.

BERLIN Bears, complete set of eight and 100 different stamps only 10c to approval applicants. Reich Stamp Co., 4647 Kenmore, Chicago 40, Ill. Dept. M11.

FREE. Irish commemorative collection, including dramatic Easter Rebellion issue with approvals. Raymax, 123-Z William St., New York City.

FIVE Vatican City stamps free to approval applicants. Florida Stamp Company, Box 807, Miami 5, Florida.

WOW! \$10.00 Worth of fun only 10c. What a treasure hunt! Big package 500 foreign stamps—just as received from foreign missions other sources. Includes stamps from Africa, South America, Philippines, Free French, Cape Juby, Palestine, etc., including airmails, commemoratives, and stamps worth up to 50c and 75c. This amazing offer is given for 10c to serious approval applicants only. One to a customer, money back if not more than delighted. Jamestown Stamp Co., Dept. 22, Jamestown, New York.

20,000 VARIETIES 1c-5c each! Gordon Davison, Box 1019B, Manchester, N. H.

STAMP Collections wanted. Complete collections, duplicate lots, surplus stock, mint and used. Prefer trade for printing or other items, buy outright if priced right. What have you, what's wanted? Vanroy Shirk, Lebanon, Penna.

1000 MIXED U. S. old and new—25c; 2 lb. \$1.25. Weatherby, Medina, Ohio.

YOUR Money's worth! Seychelles, Djibouti, Angola, Chinese hunger stamps and over 100 different other stamps. Everything 10c to approval applicants. Atlas Stamps, 4220 West 16th, Dep't L, Little Rock, Ark.

FREE—Abyssinia, Cayman Islands, Tuna triangle, Indochina, Syria, Ivoire, Philippines (Jap "shame" issue), Turkish harem, Damascus, Cambodia, African "beauty," Pirate Islands, Colonials, others—All free for 3c postage with approvals. Belmont Stamps, Washington 10, D. C.

PORTUGUESE Colonies. 25 different 5c with approvals. Lorane Brown, Marion, Michigan.

U. S. Price list. Send postage. State Stamp Service, 1225 Park Building, Pittsburgh 22, Penna.

OLD Scarce U. S. seconds on approval. Slightly defective, nice appearance, bargain prices. Hearnfield, 551 Clinton, Newark 8, N. J.

U. S. Price list. Send postage. Stanley Gibbons, 38-P Park Row, New York.

PENNY Approvals, that satisfy. Neil Gronberg, Box 5441-P, Philadelphia 43, Penna.

MINT Pictorials free to approval applicants. Surf Stamp Co., Box 2296, Miami Beach 40, Florida.

ZOWIE-E! A barrel of fun for only a dime. 500 United States stamps—absolutely unpicked and unsorted—just as received from church missions. Many varieties, including large commemoratives, airmails, high denominations up to \$5.00! Stampdom's biggest package of fun—and you might find something really valuable! Price only 10c to serious approval service applicants. Money back if not delighted. Illustrated bargain lists with each order. Mystic Stamp Company, Dept. 80, Camden, New York.

50 DIFFERENT United States, 10c. Price-list free. Seidenberg, Cassopolis, Mich.

FREE! Negro Triangle; Turks Islands "Cactus"; Dakar; Guinea; Palestine; "Fairy Tale," Pirate Chart, Map, Ship, Sea Lion and Snake stamps; French, British, Portuguese Colonies, etc. Free for 3c postage. Approvals. Potomac Stamps, Washington 10, D. C.

UNITED States approvals complete coverage, fine quality, attractive prices. Seminole Stamps, Box 378, Coconut Grove, Florida.

50 DIFFERENT Including scarce diamond-shaped airmail 3c to approval service applicants. Avalon Stamp Co., Dept. M, Springfield 8, Mass.

1000 GRABAGS 15c Each. Super bags 25c. Zandy, 630 Bingaman, Reading, Pa.

FREE U. S. price list. Postage 3c. Mark Hanna, 335 - 5th Avenue, Pittsburgh 22, Penna.

FREE! Canadian sets, royal visit, George VI, George V. coronation, jubilee, others, to approval applicants. Ensign, Box 118-M, South Orange, N. J.

WORLD'S Largest diamond and triangle stamps, free stamp magazine, stamps from fighting Free French, 20 stamps from 20 different countries, pictorials, airmails, big bargain 5c with approvals. Capital Stamps, Dept. 2, Little Rock, Ark.

DEALERS—Wholesale list. Postage 3c. Frank, 5031 Queensberry, Baltimore 15, Md.

25 DIFFERENT Swiss 10c—with ¼, ½, 1c approvals. Carroll's, 4357A S. Hoover, Los Angeles 37, Calif.

STAMPS wanted by thousands of our readers. Your ad in this space will bring you some nice orders. One advertiser sold 150,000 stamps. Write for positive proof. F. W. Johnson, Classified Advertising Manager, Room 301, 200 East Ontario St., Chicago 11.

HOBBIES AND COLLECTIONS

UNUSED Match book covers, 100 all different \$1.00. 35 Royal Flash covers \$1.00. Free catalog. Charles Edelman, 1311C East 84, Cleveland 3, Ohio.

WORLDWIDE Hobby Magazine, twelve issues \$1.00; sample 10c. Klings', Blue Island, Illinois.

EXCHANGE Your duplicate stamps, match covers, or any hobby with collectors everywhere! Directory listing swappers, 10c. (Mention hobby). World Hobby House, Box 721-A, Olympia, Wash.

WANTED: Old bitters bottles. Write Bob Halter, Bucks County, Newtown, Penna.

WANTED: Old cigarette cards. Write Charles Bray, East Bangor, Penna.

PRIZE Contests again booming. Contest Magazine lets you in on how to win. Send \$1.00 today for four issues, you'll be surprised at the wealth of information. Contest Magazine, Drawer 259, Upland, Indiana.

INTRODUCTORY Offers—10 officers insignias 25c; 22 different American or 15 different foreign, \$1.00; 10 different metal collar insignias our choice—\$1.00. Illustrated catalog 10c. Hobbyguild, 35P West 32nd St., New York.

MILITARY Insignia; metal regimental crests; 12 assorted officer insignia \$1; 1001 collectors items. Send 25c for sample crest, catalogue. Bon-Lee Company, 5801—15th Ave., Brooklyn 19, N. Y.

CAMPAIGN Ribbons—Beginner's package. Introductory price 50c. Contains 15 assorted ribbons. L.H.G. Company, 19 E. 16 St., New York 3.

KLONDIKE! For hobby jewelry makers! Novelty jewelry findings from tables of large manufacturers—parts for bracelets, pins, earrings, etc.—unfinished. Chains, rings, pins, stones, clips, beads—many other items. 1 lb. bags, \$2.00 per bag in 5 bag lots. Sample bag \$3.00. Prepaid only. Mdse. Distributing Co., 19 E. 16 St., New York 3.

GEM Making—Fascinating! Profitable! Free equipment catalog, or send 25c for complete instruction book. Lapidary Company, 1545 West 49th, Seattle 7, Wash.

SWAPPER? Collector? Send 25c for sample copy "Hobbyswap Contacts." 1328 South 27th, Omaha, Nebraska.

COLLECTING Hobbyists! Exchange duplicates. "Hobbyswap Contacts" directory 10c. C. Bishop, Route 8, Kalamazoo 88, Michigan.

296 COLORED Illustrations, new book "Foreign Medal Ribbons." \$1.00. Foreign campaign bars, insignia, lists, samples, 20c. Packets \$1.00. Insigniacrafts, 236-28th Ave. N.W., Calgary, Canada.

INVENTING Can be an interesting and profitable hobby. Write for complete particulars. Institute of American Inventors, Dept. 40-E, 1926-Eye St. N. W., Washington 6, D. C.

COLLECT Colorful Army patches, Pictures, prices and sample patch only 10c. Insignia Mart, 703 Broadway, N. Y.

ANTIQUES, RELICS, INDIAN GOODS, CURIOS

4 FINE Ancient arrowheads \$1.00. Stone tomahawk \$1.00. List free. Lear's, Box 569, Galveston, Texas.

SWORDS, Rapiers, daggers, pistols, armor. Illustrated catalog 50c. Robert Abels, 860-A Lexington Ave., New York.

PRECIOUS STONES, MINERALS

GENUINE Siamese zircons. Perfect for engagement rings, birthdays, graduations. Fire and sparkle resembles diamonds. Fast selling. Wholesale \$1.50 per carat. Sample \$2.00. Two for \$3.00. Huse, North Sutton, N. H.

MINERAL And Fossil Collectors; Read "The Earth Science Digest." Subscription \$2.00. Sample 25c. Dept. PM, Box 57, Omaha 3, Nebr.

PETRIFIED Wood. Rare. Beautifully grained. Six cubic inches \$1.00 postpaid. Jesse Teer, Roosevelt 2, Oklahoma.

OVER 50 Identified mineral specimens mounted in 6x9 box. \$2.50 postpaid. Thorp's Gem Shop, 506 Bellevue Place, Austin, Texas.

METAL Detectors. The very latest circuit. Free literature. Hedden Metal Detectors, 538 North Homewood Avenue, Pittsburgh 8, Penna.

OBSIDIAN Small stones 50c, large \$1.00, red and black \$1.00 per pound plus postage. Charles S. Richards, Box 556, Jackson, Wyoming.

MINERALS—Gems, Cutting, specimen. Low prices. Free list. Plummer's, 5068 Brighton, San Diego 7, Calif.

FOOL'S Gold from famous gold camp 10c per sample. Gold \$1. Others, Martin's, 506 Harrison, Leadville, Colorado.

CAMERAS AND PHOTO SUPPLIES

ANSCO-COLOR daylight, 35mm., 18 exposures, in new cartridges; 6 rolls, \$5.00 postpaid. Get your copy of the "Surplus News Letter" for photographic "plus values." No charge—from Sterling-Howard, Dept. PM4, 1900 Monterey Avenue, New York City 57.

IMMEDIATE Delivery on Eastman, Ansco, Gevaert, film. Send for price list. Allan's, 16516 Detroit Ave., Lakewood 7, Ohio.

ELIMINATE Middleman. Surplus directory 25c. "Camera," 126-M Lexington Avenue, New York 16.

INFRA-RED Filters glass 1 1/4" (40 mil) diameter, mounted. Snap on camera or binocular, \$1.00 per set. Ross, C68 West Broadway, New York, N. Y.

SPEED-O-COPY Ground-glass focusing attachment for Leica, Contax, Argus C-2 and C-3. Send for literature. D. Paul Shull, Dept. PM-5, 240 S. Union, Los Angeles, Calif.

CONCORD Camera (formerly Lafayette Camera) pays top dollars for used cameras and all type photographic equipment. Write Concord Camera, Dept. CE-10, 901 West Jackson Blvd., Chicago 7, Ill.

PRINT Your own pictures, kit \$1.00. Spada Enterprises, 10 Lexington, Wethersfield 9, Conn.

CANDID #127 Camera \$3.95. "35" color camera \$82.50. Speed Graphics \$125-\$225 complete. Leica, Contax cameras \$95-\$375. Enlargers \$18.75-\$750. Darkroom supplies. Trades accepted, bought, Mogull's, 68 West 48 St., (Radio City) New York.

200 POWER Telephoto camera easily made. Objects miles away photograph close up. Telephoto lens and instructions alone 10c. Carl Jamer, Manorsville, N. Y.

BARGAINS Galore. Buy, sell, trade. Sample copy 25c. Used Camera Beacon—(M), 1214 N.W. 30, Oklahoma City 6, Okla.

CAMERAS, Enlargers, projectors. Lowest prices. Free catalog. Cavalier Camera, 1822 Center, Pittsburgh 19, Penna.

MICRO 16. New sensational pocket precision camera. 2 1/2 x 3 1/4 prints. Smaller than package cigarettes. \$29.95 postpaid. Clymer Motors, Dept. A-522, 2125 W. Pico, Los Angeles 6, Calif.

ENLARGEMENTS—(Beautiful hand oil colored) from your favorite negatives. 5x7—45c, 8x10—85c. Black and white double-weight enlargements—5x7—20c, 8x10—40c. From pictures or proofs, send 35c extra for each enclosed. Send cash or money orders only. No c.o.d.'s. Snapshots Co., General P.O. Box 979, Newark, N. J.

PHOTOGRAPHIC Equipment. Terms. Catalogs. Film rentals. Dayton Film, 2227 Heppburn, Dayton, Ohio.

PHOTOGRAPHY For pleasure or profit. Learn at home. Practical basic training. Long established school. Write for booklet. American School of Photography, 1315 Michigan, Dept. 3431, Chicago 5.

OIL Coloring photographs can be a fascinating hobby or profitable sideline for those with artistic talent. Learn at home. Easy simplified method. Send for free booklet. National Photo Coloring School, 1315 Michigan, Dept. 3431, Chicago 5, Ill.

CASH! Spot cash for cameras, lenses, binoculars, movie and still equipment. Send full description for prompt cash offer. Over 36 years of dependability. Bass Camera Company, Dept. AG, 179 W. Madison St., Chicago 2.

BASS Says: Trade cameras? For 36 years Bass has satisfied thousands everywhere! Finest equipment available. Always satisfaction guaranteed or your money back! Bass buys 'em, sells 'em, trades 'em. Bass Camera Company, Dept. AG, 179 W. Madison St., Chicago 2.

USED Camera Directory. Box 1031-M, Canton, Ohio—lists hundreds of war-bargain used cameras—35mm., Speed Graphics, Kodaks, Rolleiflex—many others. Send 25c for latest issue.

HAVE You a camera? Improve your hobby of photography and learn how to make better pictures. Write today for our latest book catalog and sample copy of American Photography, containing articles and pictures by the world's foremost writers and photographers. Camera House, 601, 363 Newbury St., Boston 15, Mass.

PHOTO FINISHING

EVERY Picture an enlargement. Bigger and better snapshots than you have ever seen before! New electronic developments give you improved lifetime deckled-edge enlargements at our same low prices. Any 8 exposure roll developed and printed enlarge size 25c; reprints 3c each. Fast, accurate service guaranteed! Send for free mailers, today! Enlarge Photo Service, Box 791D, Boston, Mass.

MOEN Finished finer photos. 8 exposure roll developed and attractive Moen-Tone enlargement each good negative, 35c. Superior quality since 1898. Moen Photo Service, Drawer Z, LaCrosse, Wis.

LARGA-PIC—We have only one offer, but it's an outstanding one! Your roll developed and 8 prints made into brilliant Larga-Pic photos for 30c. Reprints from your negatives 4c each. Write for free mailers. Larga-Pic, Box Z2, Brookline 46, Mass.

5x7 OIL Colored enlargement, from negative \$1.00. McCreary Photo Lab., 4402 Barker, Omaha 5, Nebr.

TWO Beautiful prints from each picture on roll 25c. Twenty-six years of satisfied customers. Quick service. Lens Photos, Dept. J4, Janesville, Wis.

PHOTO Copied, 25 reprints, \$1. Suburban, 1410-M Bond, Rockford, Illinois.

16 VELOX Deckledge prints with roll developed 25c. Studio, River Grove, Ill.

8 EXPOSURE Roll developed and printed; 1-5"x7" enlargement 30c. Ba-Dur Photo Service, 3219 Guilford Ave., Baltimore 18, Md.

GORGEOUS Color prints from your transparencies. 4x5, \$1.00; 5x7, \$1.98; 8x10, \$2.98. Broad Camera, 953 Broad St., Newark, N. J.

BEAUTIFUL Enlargement from each picture on roll 25c. Cut Rate Photos, Dept. B4, Janesville, Wis.

NEW Process prints photos from any negative on paper, cloth or anything including handkerchiefs and greeting cards. Outfit with supplies instructions \$2.00. Holm Sales, Box 12A, Oaklandon, Indiana.

8"x10" HAND Colored framed enlargement from negative or photograph \$1.50. Promenade Photos, Cooper Station, Box 198-V, New York 3.

ENLARGEMENTS, Professional, double weight paper. Quick service. 2 5x7 25c. 2 8x10 50c. E. R. Howell, Box 8338, Pittsburgh 18, Penna.

PHOTO Finishing. Photos reproduced on 'kerchiefs \$2.50 postpaid. Cowling, 533 Somerset, San Francisco 24.

SPECIAL Offer! Your 8 exposure roll developed, 8 oversize prints, 8 deckle-edge dated prints in handsome pocket album, one 5"x7" enlargement and one roll of guaranteed fresh film—all for only \$1. Strictly high quality work. Andre Photo Shop, 573a Fifth, Parkersburg, W. Va.

CENTURY Delivers work and service that can't be beat. Sixteen famous Century-Tone prints each 8-exp. roll 30c. Free mailers. Century Photo Service, LaCrosse, Wis.

BIGGER Prints—better pictures. Roll of 6 or 8 developed 35c. Reprints 4c. (Western folks have liked our work for 30 years). Old Timer Photo-Lab. 610 W. Roma, Albuquerque, New Mexico.

SENSATIONAL Introductory offer! Send snapshot or negative, this ad and 3c. We'll send you a beautiful 7x5" enlargement! Or, Kodak roll developed and printed (with free coupon) only 25c; or 8 giant prints from roll, 30c. Reprints from negatives, any quantity, regular size, 3c; Giant size, 4c. Candid rolls—36 exp. 35mm. developed, vaporated, enlarged to 3x4, \$1.00, 18 exp. 50c. Free mailers. Free premium offers sent on request. American Studios, Dept. 364, Lacrosse, Wisconsin.

UNIVEX Mercury film fine grain developed, beautifully enlarged 3 1/4 x 4 1/2 glossy, 65 exposure roll \$2.58, 32 exposure roll \$1.31. Fresh 65 exposure film 45c, accessories stocked. Spiratone, Dept. (ME), 49 W. 27 St., New York City.

ENLARGEMENTS—5x7—10c; 8x10—25c. National Film Service, 3111 West Tuscarawas, Canton, Ohio.

NEW Color process makes full color prints from black and white film or negatives. Send dime for sample. We have films. Midwest Photo, Janesville 26, Wis.

ROLL Developed, two prints each exposure 25c. Additional reprints 3c each. Skrudland, 6444Z Diversey, Chicago.

8 BEAUTIFUL Double size pictures and roll developed 30c. 8 hour service. Free mailers. Pacific Photo Service, Box 666, San Francisco, Calif.

BIGGEST \$1.00 Value in 35mm. finishing today. 36 exposure fine grain 3 1/4 x 4 1/2 enlargements; deckled, embossed margin and date. Eighteen exposures 75c; 16 exposure splits 55c; 36 exposure reloads 50c. Special: return this ad with \$2.00 and we will send five 36 exposure reloads. Free mailers. 8 exposure rolls in beautiful, deckled contact finish with embossed wide margin, 25c. Mailbag Film Service, Box 5440A, Chicago 80.

PHOTOGRAPHY For pleasure or profit. Learn at home. Practical basic training. Long established school. Write for booklet. American School of Photography, 1315 Michigan, Dept. 3452, Chicago 5.

ROLL Developed and 8 prints 30c. Overnight service. Free mailers. Tri-Plex Photo Service, Box 375, San Francisco, Calif.

8 EXPOSURE Rolls developed. 1 print each and one enlargement coupon 25c. Two each and coupon 35c. 3 each and coupon 40c. Reprints 3c. Fred D. Eastman, Bode, Iowa.

8 HOUR Service. Your 8 exposure roll printed jumbo or regular size, 25c; 12 exposures, 35c; 16 exposures, 50c; 36 exposures, \$1.00. Reprints jumbo or regular, 3c. Regular prints deckled. Fine grain developing. Send for free mailers. Quality Photo Service, Box 468, San Francisco 1, Calif.

FREE Price list on quality developing, printing, enlarging. Write for it today. Roy Photo Service, G.P.O. Box 644, New York (1), N. Y., Dept. M.

SPECIALIZING 35MM. fine grain developed. 36 big 3x4 enlargements, \$1.25. Photoshop, Linton, Indiana.

ROLL Developed, 8 brilliant fadeproof Velox prints and two professional enlargements 25c. Overnight service. Young Photo Service, 405-C, Albany 2, N. Y.

8 PRINTS, All enlarged to nearly postcard size, from your roll or negative, 25c. Willard Studios, Box 3535A, Cleveland 18, Ohio.

2 BEAUTIFUL Hi-Gloss prints each good negative and enlarging coupon with each 6 or 8 exposure roll developed 28c. Owlphoto Co., Weatherford, Oklahoma.

GLOSS Finish enlargements. 4 5x7 from negative 50c. 3 5x7 from photo 50c. Robert Renshaw, Jr., P.O. Box 478, Chester, Penna.

MOTION PICTURES AND SOUND EQUIPMENT

LATEST Subject including the sensational hit of the year "The Anniversary Waltz," complete 16mm. sound only. Approximately 400'. Immediate delivery, \$17.50. "Parade of Stars," approximately 400' Kodachrome sound, \$67.50. Garden Film Service, 317 West 50, New York 19.

FILM—Free processing 100 ft. 16mm. Weston 12 \$3.25, Weston 24 \$4.90, Weston 64 \$4.95, 25 ft. double 8mm. Weston 13 \$1.50, Weston 24 \$1.89, Weston 64 \$1.99. Free circulars. Fromader Genera, Davenport 4, Iowa.

16 35MM. Silent sound films, projectors. Bedner, 5300 So. Talman, Chicago.

HOME Movies since 1929. No-Wat-Ka, 257 Main Ave., Passaic, N. J.

READY Made movie titles 15c. 100' 16mm. \$2.25. 3 rolls \$6.00. 25' double 8mm. \$1.25. Ambassador, 479-A Quincy Street, Brooklyn, N. Y.

DEVELOPING Units for movie film with instructions. Literature. Duro Movie Products. 1519 Eggert, Eggertsville 21, N. Y.

300-WATT, 8MM. motor projectors \$32.50. Send stamp for 8mm., 16mm. lists. Sterling's, 679 Northampton, Easton, Pa.

8MM., 16MM. Features. Lists. Sams Electric Shop, Passaic, New Jersey.

UNUSUAL 8mm.-16mm. movies. Catalogue free. Fine Arts, Box 2084-X, San Antonio 6, Tex.

FREE, Catalog, movies; sample film 10c. Cameras, projectors. Goodwill Company, Jackson, Tennessee.

BEAUTIFUL Kodachrome slide and lists 25c. Slide Supply Service, 3111 West Tuscarawas, Canton, Ohio.

PANCHROMATIC Movie film, indoor-outdoor. Top quality—not surplus! Extra speed—Weston 32. Fine grain. Anti halo. Spooled, ready for camera. Daltite loading. Processing included! 25 ft. double 8—\$1.65. 100 ft. 16mm.—\$3.95. Fast service! Postpaid! Order now! Satisfaction guaranteed or money back. Chromex Films, Dept. D, Rutherford, New Jersey.

RARE 8-16MM. silent-sound films. International, 2120 Strauss, Brooklyn, N. Y.

RECONDITIONED 16MM. sound complete projectors, immediate delivery. Ampro \$335, Bell Howell \$388, RCA \$279, Victor \$295, DeVry \$395. Also new ones slightly higher. New 8mm. Bell Howell \$177.25, Ampro \$150, 500 watt Universal \$63.50, Univex \$29.85, DeJur 1000 watt \$171, Zeiss 110-220 volt 16 mm. silent projectors \$110, Bell Howell \$147.50, Excel Deluxe \$36.50, Kodascope \$65, Keystone \$79.85. Splicers, editors, every make movie film for cameras, projectors, large catalogues; film library 15,000 subjects. 35mm. silent DeVry projectors \$39.75, Holmes \$75, Acme \$65, DeVry 1000 ft. sound \$265, 2000 ft. \$375 with amplifier and speaker, RCA 1000 ft. \$545, 2000 ft. \$745 complete, Acme Simplex 2-2000 ft. projectors, amplifier, speaker, \$825. 8-16-35mm. cameras, large assortment, cutting, lab. equipment. Trades accepted, bought, Mogull's, 68 West 48 St., (Radio City) New York.

MOVIE Equipment. Terms. Catalogs. Film rentals. Dayton Film, 2227 Hepburn, Dayton, Ohio.

35MM. Sound features, westerns. C. Rogers, Box 26, East Atlanta, Ga.

MOVIE Cameras and projectors. Film available. Selco Products, Danvers, Mass.

FREE Movie titles. Dime brings details, samples, etc. Peerless Service, 6411 Hollywood Blvd., Suite 118, Hollywood 28, Calif.

LEARN Professional motion picture technique at home. Approved for veteran training under G.I. Bill. Free catalog. Motion Picture Institute, Birmingham 4, Mich.

MAKE \$8 to \$10 net profit daily with your 8mm. or 16mm. projector. Details free. Metcalf, 10806 Glenroy Ave., Chicago 43, Ill.

GUARANTEED Fresh anti-hale outdoor movie film! Weston 12! Daylight loading! Processing free! Three spools double 8mm. \$3.45! Six single 8mm. for Univex, \$4.60! Postpaid! Catalog. Eso-S, 828-B West 39th, Kansas City 2, Missouri.

UNUSUAL Home movies. Free list. Loja, Box 74B, Station B, Brooklyn.

"THE World's Greatest Passion Play" all sizes sound and silent. Write Hemenway Film, 33-F Melrose St., Boston 16, Mass.

I BUY. Exchange, swap movie films. Harvey Iris, Box 539, Brockton, Mass.

UNUSUAL Home movies: Travel, adventure, sports, comedies, Silent-Sound. Many film bargains. Big illustrated 1947 catalog, sample—dime. Audet, Box 6520BG, Philadelphia 38, Penna.

8-16MM. Silent-sound films. Complete rental library. All latest subjects. Free catalogue (sample film 10c). Garden Film, 317 W. 50th, New York 19.

EXCITING Films — bullfights, movie stunts. Unusual subjects. Send only dime for sample film and special list. Exciting Films, 1071-F El Centro, Hollywood, Calif.

HOME Movies. Rent, buy, swap 8mm.-16mm. silent and sound at money-saving rates. Details for a dime Midland, Box 429, Oak Park 4, Ill.

COMPLETE Stocks always of Castle, Official, Pictorial films, 8mm., 16mm., sound. Musicals, soundies, free catalogs. We exchange your films and equipment, or buy them for cash. Frank Lane, 5 Little Bldg., Boston, Mass.

MOVIE Camera films, 100' 16mm. \$2.50. 25' double 8mm. \$1.25. Free developing. Better Films, 742 New Lots, Brooklyn 7, N. Y.

BASS Says: 36 years of leadership in the motion picture equipment field. Sound projectors, 8 and 16mm. equipment, finest accessories. Bass buys 'em, sells 'em, trades 'em. Always satisfaction guaranteed or money refunded! Bass Camera Company, Dept. A, 179 W. Madison St., Chicago 2.

LEARN Movie projection, management. Free catalog. Theatre Institute, Elmira, N. Y.

TALKIES: Convert your silent 16mm. projector into sound with our guaranteed parts kit. Plays all 16mm. sound films. Quickly assembled at home. Special introductory offer: Send this ad now with \$19.95, check or money order, and we will include sound test film, instruction manual and full information on how to use with your radio. Kit includes photocell, exciter lamp, optic, which makes a sound head complete. Or send \$1.50 for complete blue prints showing how to make adapter yourself. Sound Tech, Box 3071, Hollywood 28, California.

MUSIC AND MUSICAL INSTRUMENTS

WHOLESALE Used mixed jukebox records, \$12.00 per 100. You sell for 25c. No catalogs. Olin Milner, 335 McDaniel, Atlanta, Ga.

MUSIC Arranged. Songs printed. Frank Wildt, Music Publisher, Lancaster, Penna.

POEMS Wanted for musical setting. Send poem for immediate consideration. Five Star Music Masters, 630 Beacon Building, Boston.

RECORD Collectors: Send me your 'want-list' today. Olin Milner, 335 McDaniel St., Atlanta, Ga.

SONGWRITERS: Free prizes each month for best song! Two prominent Hollywood composer-arrangers offer a complete song service to qualified authors of song poems. Write today for generous offer and free booklet! Hollywood Melodies, Box 2168, Dept. Z-3, Hollywood 28, Calif.

YOUR Songs, poems, compositions on phonograph records. Free information. Peerless Recorders, 2726 Sturtevant, Detroit 6, Mich.

MUSIC Composed to your song poems—send poems for free examination. Songs written by us were featured by leading screen and radio personalities. Mayflower Music Co., Atlas Bldg., Dept. 6, Washington, D. C.

GUITAR Microphone \$1.00. Use your radio as an amplifier. Complete hookup instructions included. Radio-Cycle Labs., Dalton, N. Y.

CHORD Chart: (364 popular, including modern chords) 25c. Calculator, Box 1-PM, Station A, Brooklyn 6, N. Y.

SONGWRITERS—Something new! Complete harmony for any note. Just turn the "Wonder Wheel" Jiffy Composer. Details, J. Barnes, Publisher, Box 490, Times Sq. Station, New York 18, N. Y.

POEMS Wanted to be set to music. Free examination. Send poems. McNeil, Master of Music, 510-PM S. Alexandria, Los Angeles, California.

PHONOGRAPH Records cheap. Catalogue. Paramount, MC-313 East Market, Wilkes-Barre, Penna.

SONGWRITERS—Protect your songs. Get the facts first. Free booklet, attractive offer. Song Service, 331-C West 46th, New York.

SONG Poems wanted. Melodies set to your song poem, \$6.00. Thomas Raso, 90 Main St., Warren, R. I.

PIANISTS Popular music chord chart: Shows names; symbols; readings; enharmonics; notation; 648 treble, 180 bass positions. Sensational! Desirable! Practicable! Only \$1.00. Carol Music Chart Co., Box 21 PM-Lefferts, Brooklyn 25, N. Y.

LEARN Guitar accompaniment, Spanish or Hawaiian, from diagram-chords. Full course, three dimes. Franks Musicians Supply, Box 103, San Diego 8, California.

POEMS Wanted for musical setting! Send poem for immediate consideration. Hamann Service, 614 Manhattan Building, Milwaukee, Wisconsin.

SONGWRITERS! Outstanding ethical offer. Hibbler, C5, 2157 N. Avers, Chicago.

BEFORE Sending your poem to be set to music, know your composer. Free folder. Al. Moquin, 5333 La Cresta Court, Hollywood 38, Calif.

SWISS Musical units, install powder. Cigarette boxes, Lloyd Kelley, Hanover, Mass.

POEMS Wanted for new songs. Send poem for free examination. Elliot Wright, Master Composer, 207 Rivoli Theater Building, Portland, Oregon.

POEMS Wanted for musical setting. Send poem for immediate consideration. Five Star Music Masters, 630 Beacon Building, Boston.

SONGWRITERS: Send poems for free examination and outstanding offer. United Music Service, 150, Salem, Indiana.

PIANISTS Acquire professional technique in quickest possible time. Most unique course ever put out. Low cost. Get literature. Wehner, 25 Fulda, Roxbury 19, Mass.

DUO-FLEX Reeds, for clarinets and saxophones. Eliminate your reed troubles. Circular free. Duo-Flex Reeds, 1204 First Ave., Evansville, Ind.

ACCORDIONS, Wholesale prices. Request circular. New streamline accordions. All sizes and makes. Monarch Accordion Co., 44 N. Albany Ave., Chicago, Ill.

WRITE Songs. Big money and reputation. Write for information. J. Gordon Pub Co., 201 N. Hoyle Ave., Chicago.

SONG Writer's attention! The amazing demand for phonograph records, accelerated by more than 300,000 juke boxes and the hits popularized warrants your immediate consideration. We are offering song-poem writers the rare opportunity of having established composers collaborate on appealing material received this month. Recola Records, Box 987F, Hollywood 28, Calif.

POEMS Wanted for musical setting. Send poem for immediate consideration and free rhyming dictionary. Richard Brothers, 24 Woods Building, Chicago.

RADIOS, SUPPLIES, INSTRUCTIONS

RADIO Tubes wholesale. Send for list. S & S Radio Co., 140 Derby St., Salem, Mass.

1947 REVISED "Plans 18 Long Distance Crystal Sets," catalog, "Radiobuilder"—25c. 3 issues "Radiobuilder"—25c. Laboratories, Box Eye-c, San Carlos, California.

BUILD Simplest one-tube a.c. radio. Instructions, 25c. "Loudest" crystal set instructions and crystal, 25c. "All About Crystal Sets" booklet, 50c. Amorose Radio, Route Four, Richmond, Virginia.

FREE New Radio catalog is ready! Radionic's catalog lists hard-to-get radio parts, books, amateur, test, and P. A. equipment. All available for immediate delivery. Send today to: Radionic Equipment Co., Dept. P-12, 170 Nassau St., New York 7, N. Y.

NEVADIUM Crystals now 50 cents. Three for dollar. Box 764, Elko, Nev.

RADAR Crystals. Supersensitive. Free details. Hayes, Box 636-D, Santa Barbara, California.

RADIO Crystal detector kit. Easily assembled and ready to get reception with your headphones and aerial. Complete with crystal, parts, base, illustrated instructions, 40-page radio beginners booklet, extra crystal and crystal set building diagram, all for only \$1.00. Al's Radio Service, Box 1285-P, Sioux City 7, Iowa.

RADAR Crystal radios, distance reception. Free information. Pierce Radio, McAlester, Okla.

WIRELESS Record changers, code oscillators. Factory direct. 5 in. PM speakers \$1.29. Phono. oscillator kits \$3.50. Crystal pickups \$2.25. Myles, 3433 So. Maple Ave., Berwyn, Illinois.

START Home manufacturing business making radio, electrical or electronic products. Details free. Huffman Research, Box 251-C, Orange, Texas.

25 YEARS Experience in radio repairing at your fingertips for \$1.00. I've repaired 45,000 radios and have perfected system you can follow step by step. My methods are far simpler than any other course published. Requires no calculations. Total price \$1.00 postpaid or c.o.d. Moneyback guarantee. Ross Radio Company, 14615-A Grand River, Detroit 27, Michigan.

BICYCLE Radios. Build them for pleasure and profit. Plans for crystal and battery sets, especially designed for bicycles, \$1.00. Radio-Cycle Labs., Dalton, N. Y.

COMPLETELY Assembled crystal radio plus 100 foot antenna. Postpaid \$1.00. Jack Kennedy, Box 653, Boston, Mass.

WESTERN Electric fixed crystal, no adjusting, loud, steady signal. Government release. Cost originally over five dollars, prepaid 99c. Excellent for crystal sets. List 5. Radio City Lab., 30 Church Street, New York 7, New York.

KITS, Phones, surplus items. "E" list free. John Barron, Box 128, Ft. Hamilton Sta., Brooklyn 9, N. Y.

RADIO Tubes 29c up. Free bargain lists. Potter, 1314 McGee, Kansas City 6, Mo.

CRYSTAL Set kits complete with phone, wire, solder. All you need is screwdriver and iron. \$3.95 postpaid. Antenna Kits \$1.50. Western Radio, Brady, Texas.

BUILD Radio, phonograph, combination, complete kits: catalog. Radion, 6922 D 21st Ave., Brooklyn 4, N. Y.

RADIOMEN, Servicemen, beginners—make big money, easily. \$250 weekly reached. We show you how. More information free. Merit, 216-32P 132nd Avenue, Springfield Gardens 13, New York, N. Y.

NAVY Surplus bargain "Operators Control Box." Eighty useful parts. Only one dollar postpaid. Van Sickle Radio Supply, Indianapolis 6, Ind.

RADIO Men. Lowest prices in America. Big stock. Write for latest catalogue. McGee Radio, 1330 Broadway, Denver, Colorado.

RADIO Service men and experimenters send stamp for our giant radio catalogue. Save dollars. United Radio Co., (1000-V) Newark 1, N. J.

MAKE Simple, tubeless, batteryless, distance-getting crystal radios. Crystal and illustrated instructions 25c postpaid. Allen, 437-P, Clinton, Missouri.

RADIO Technician and radio service courses. Training for federal licenses. American Radio Institute, 101 W. 63 St., New York City. Approved under G. I. Bill of Rights.

RADIO tubes, parts, wholesale, retail large stock. Radio Mail Order Company, 46-13 188th St., Flushing, N. Y.

BUSINESS OPPORTUNITIES

START Home business making statuary, plaques, novelties, garden furniture, artificial marble flooring, liquid marble. Make your own flexible molds. Amazing profits. Folder free. Creative Publishers, Box 236-L, Winnetka, Illinois.

WHOLESALE Distributor. Amazing screw holding screw drivers! Removes, holds, inserts screws hard-to-get places! Stores, mechanics, factories buy quantities. Counter displays furnished. Also staple driver for all wiring purposes! Fast sales, big profits, repeats, tremendous domestic and foreign market. Refundable trial offer! Millen Mfg., 518 Miller Bldg., Boston, Mass.

"KEMO-PLASTIK"—Amazing new rubber molding liquid. Dries quickly. Easy to apply. Quart \$3.00. Gallon \$6.95. Mold-making instruction included free. B. Belfort, Engineering Bldg., Chicago.

REPAIR Appliances, motors, bicycles, etc. \$20.00 capital! Illustrated instructions, \$5.50. Repair Service, Janesville, Wis.

OPERATORS, The hottest deal in years. Useful, irresistible novelty. Free brochures. Economy Distributing Co., 308 W. Superior, Cleveland 13, Ohio.

START Profitable mail order business. Tremendous profits. Patrick Service, 2026 E. 107, Cleveland 6, Ohio.

MAKE Money at home. Write, Jackson, Box 111, Newberg, Ore.

MEN—Women be your own boss start a home business with our collection of 137 plans. Send for particulars. Simon Waldman, Dept. P-1, 4444 Richmond St., Philadelphia 37, Penna.

GET Use, sell Scheall's \$1.25 guaranteed fire extinguishers. Scheall, Box 263, Duluth, Minnesota.

START Home manufacturing business making Cleaning Compounds, Soaps, Insecticides (DDT), Cosmetics, Polishes. No machinery. Literature free. Kemix, Park Ridge, Ill.

OUTSTANDING Opportunity in electric appliance business. Start now with small capital. Special instructions, help, supply sources, contacts. Write Soltz, Box 303, Silverton, Oregon.

SOAPMAKING. Learn at home. No machinery needed. Posera, AP-4545 Bartlett, Milwaukee 11, Wisconsin.

START Selling costume jewelry. \$1-\$5 sellers. Order assortment. \$12.00 dozen. Double your money. A. & S. Jewelry, 31-49 12th St., Astoria, N. Y., Dept. M1.

MAIL-ORDER Opportunity—Hollywood fortune telling dolls. No toy. We drop ship. Original. Details free. Sample \$1.00. Howard of Hollywood, 1437 Lake Shore, Los Angeles 26.

METALIZE Baby shoes. Learn new modern business or hobby, details free. Schoettle, Friendship, Ohio.

COIN-OPERATED Radios for hotels, motels. Finest quality at lowest prices. Secure best locations now or someone else will. Details free. Johnstone Co., M-1, 5007 Duval, Austin, Texas.

OPERATE Home mailorder business. Full or spare time. Fascinating. Profitable. Learn how. Literature free. Dalles Ruth, Wheelersburg, Ohio.

UP To \$1500 yearly selling by mail in spare time interest you? New ideas and plans every month. Details free. Idea of Month Club, 3023-C Greenmount, Baltimore 18, Md.

MAKE Money by mail—20 home operated small capital opportunities now open to you. Details free. Shook's Mail Mart, 1330 N. Main, Follansbee, W. Va.

"SELL-BY-MAIL" Plan \$1.00. Details free. Fowl Printing, Muncie, Indiana.

MAKE New batteries from old. Send card for details. L. Wertz, Pekin, Illinois.

OPPORTUNITIES! Let the Mail Order News, \$4 year old trade magazine show you. \$1.50 year. Sample copy 25c. Silvercrest, 3040-P North Ave., Chicago 47.

OPERATE Profitable mail order business from home. For details write, Anthonn Gioia, 447 Stockholm Street, Brooklyn, New York 27.

PUBLISH Community newspaper. Share big profits, prestige. "Know-how" will help you launch, operate, fascinating business. Reveals practical methods of newspaperman whose popular weekly grossed \$41,000 advertising in 18 months. Illustrated. Free literature. Success Publications (Dept. A.) 15870 Wisconsin, Detroit 21, Michigan.

BUY Wholesale 50% off auto accessories, parts, home supplies. Make money selling from truck, store, garage. Price list for stamp. Main Supply, Fairfield, Illinois.

EXCLUSIVE Plans, supply sources, benefits 25c. Spada Enterprises, 10 Lexington, Wethersfield 9, Conn.

DISTRIBUTORS—Insecticide spraying equipment. Vital Sales Company, 408 Walton Building, Atlanta, Georgia.

OPPORTUNITY. The key to unlock the door to a happy prosperous future for you. Albert Pearson, Box 1182, Milwaukee 1, Wisconsin. Free literature.

PLASTER Novelty makers. Sell the big buyers. Write Perry Rudd, Sylacauga, Alabama.

RUBBER Molds. Make your own. Air-cure mold making liquid. 22 ounces \$2.00; quart \$2.95; gallon \$7.50. Directions. Rubbercoat, 3873 A. California, San Diego.

OPERATE Profitable mail order business. Write Walter Service, 4159-A East 112th, Cleveland 5, Ohio.

COMPOSITION Flooring—made in most colors. Lifelong, soundproof, resilient. Flexible molds. Cast novelties, plaques, statuary. Big money—your own business. Catalog free. Write, Bing Products, 88 Broad Street, Boston 10, Mass.

IF You'd like to make \$5,000-\$10,000 yearly in the collection-credit agency business, write us at once. Outstanding opportunity. Cole Associates, Syracuse 2, N. Y.

AMAZING Plan that produced thousands for its originator. Complete plan \$1.00. Cy Bibbs, 2233 Eastern Ave., Indianapolis, Ind.

\$2000.00 CLEAR Profit in three months. Exclusive in your county. Reference required. You handle your own money. Details free. C. J. Maguire, Cannon Ave., Lansdale, Penna.

MAIL Order offers increased income, independence, unlimited possibilities. Free literature. Manhattan House, 126-L, Lexington, New York 16.

FREE Literature describing fifty amazing plans for mail order business at home. J. Scott, 282 West 117th Street, New York 26, N. Y.

MAKE Money making shell jewelry and novelties. Instruction book 75c. Kit \$5.00. Catalogue free. Palm Shellcraft Co., 220 W. 9th St., Sarasota, Fla.

OWN A mail-order paper products business. Sell envelopes, tags, bags, boxes, by mail, wholesale. Tremendous demand. Steady profits. No capital necessary. Write Omaha Envelope Service, Dept. 206, 4721 California, Omaha 3, Nebraska.

METALLIZE Baby shoes. Excellent profits. New system insures success. Free details. "Treasures Forever," Metallizers, 89 Henry Ave., Lynn, Mass.

WHOLESALE Sources mail order literature free. Essex Service, Box 208, Boston 12, Mass.

UNPAINTED Plaster plaques and statuettes. Free illustrated catalog. Edison, 710 Weiser, Reading, Penna.

DISTRIBUTOR: Take exclusive franchise, fast selling hose preservative, unusual opportunity. Lyle A Products, 5 E. Spaulding, Willoughby, Ohio.

BOOKKEEPERS: General ledger and tax report experience operate permanent, profitable accounting service for the smaller business. Part or full time. Simplified method. Write now! L. A. Bell, 1404 West 25th Street, Cleveland 13, Ohio.

OPERATE Profitable mail order business. Splendid opportunity. For details write J. P. Ward, Box 531, Muskegon, Michigan.

MAILORDERS' Fastest dollar puller! You keep dollars. Orders filled free! Details 10c coin. Jay Peterson, Box 752, Minneapolis 1, Minnesota.

THE Mail Order News (54th year) shows you money making opportunities in every issue. Sample copy 25c. Veterans Business Publications, Charleston 1, Ill.

METALLIZE Baby shoes, gloves, etc. Complete instructions \$1.00. Don Brady, 1618 Sage St., Topeka, Kan.

A FACTORY In your own home or garage. Manufacture and sales rights mechanics waterless hand cleaner. \$500-\$1000 monthly. No special equipment necessary. Schaffner Laboratories, Pittsburgh 2, Pa.

BARGAINS, Wholesale items, business plans and opportunities. 10c. Holm Sales, Box 12A, Oaklandon, Indiana.

OPERATE America's most popular low priced precision penny vending machine. Big profits. Be independent. Write for bulletin and prices. Stock shipments. Field Mfg. Co., Desk 547PM, Jackson, Michigan.

AGENT Or exclusive distributor for cigarette-lighter mfg. MacGregor, Tahoe Valley 16, Calif.

LIQUID Marble, plastics, marblite, plasters, make your own. Universal Sales, Box 1076-A, Peoria, Ill.

PENNA. Dutch designs for decorating furniture, pottery and gifts. Free literature. Edison, 710 Weiser, Reading, Penna.

START Profitable small store. Details dime. Lyle, Box 385-A2, Lombard, Illinois.

300% PROFIT! Novel idea. Leather items. Fascinating. Send \$1.00 complete outfit. Yale Leather, P.O. Box 1938P, New Haven 9, Conn.

VENDING Machines. Be independent. Own a big money business operating coin machines. Earn as high as \$7.00 weekly on machine costing as low as \$11.75 each. Car and experience unnecessary. Routes can be operated either in your spare or full time. Act quickly. Write for details and catalogue showing our amusement games, postage machines, candy-gum-nut vendor and scales. Parkway Machine Corp., 623 W. North Ave., Dept. P, Baltimore 17, Md.

CONCRETE Drain tile machines \$295. Biggest money maker yet. Fast and easy to operate. Data free. Concrete Machinery Company, Hickory 1, North Carolina.

PACKAGE, Sell products under your name. Samples. Linnell, Box 1720A, Cleveland, Ohio.

\$46 FROM Square foot plywood. Jigsaw necessary. Write, Woodarts, X-36, Bridgewater, Mass.

MECHANICALLY Inclined men — Own and operate general appliance repair shop. Complete, illustrated course shows you how. Welding, refrigeration, motor repair, how to get business, etc., all phases covered. Free literature. Christy Supply, Dept. 176, 2835 N. Central Ave., Chicago.

SUPER X Liquid molding rubber. Sample jar 25c. Quart \$3.00. Gallon \$10.00. Free instructions. W. Wooley, 115-B, Donald, Peoria, Ill.

EXTRA Dollars, or a good living, with your typewriter. New, exclusive opportunity. Never before offered. Get details now. Schroeder, 221 E. Bush, Covington, Ky.

ASSEMBLE Handmade jewelry for fun and profit. Dollar starts you! Hughes, 712 Kimball, Danville 3, Illinois.

EARN Extra money, home business or mail order. Over 100 ways. Write Marshall, Box 655, Centralia, Washington.

TREMENDOUS Profits mailing literature. Dealers information 3c. General-print, East Orange, New Jersey.

METALIZE Baby shoes. Correct modern method. Information free. Universal, Box 1076-B, Peoria, Ill.

LIQUID Latex for flexible molds. Instructions. Simple 50c. Advanced \$1.00. Apex Plastic Products, 1915 Lunt, Chicago 26.

OPERATE Profitable mail order business \$5 capital. Write, Crafts' Pursuit, Davison 1, Mich.

THERE Is money in raising domesticated earthworms. New fast growing business. Write for literature. Earthworm Farms Enterprises, Lamoni, Iowa.

MANUFACTURE Modern overhead garage doors. Big demand. You can start with little capital; few tools. We furnish hardware; plans. Gardo Engineering, Dept. 2A, 3819 Riviera Drive, San Diego 9, Calif.

IDEAL Business stamping metal key protectors, social security plates. Information upon request. General Products, 11 No. Pearl (M), Albany, N. Y.

SUCCEED With Oxiun. Sell garages, shops, factories everywhere. Make it yourself. Small investment. Free literature. Weinman, Box 442, Elkhart, Indiana.

MANUFACTURE Beautiful plaster novelties, strong flexible molds, working instructions 35c. Bowman, A2837 Central, Chicago 34.

OPERATE Profitable mail order business. Splendid opportunity. For details write R. Hollenbeck, Box 655, Station A, St. Petersburg, Florida.

MAIL Order Beginners! "Business Development Plan," "Profitable Mail Selling Idea," "Pointers Along the Mail Order Trail." Noted mail sales specialist's, three-in-one, 10,000-word treatise shows "how" at home, spare time, small capital. From idea to mailbag. 25c postpaid. Satisfaction guaranteed. Maupin & Maupin, Lafayette 3, Indiana.

MAKE Strange plastic—1c pound. Makes durable, attractive floors, walls. Build with waste. Save half. Bays Laboratory, Oklahoma City 9.

BRONZED Baby shoe mountings. Beautiful all-metal bookends, onyx plaques, etc. Wholesale only. Write for list. Hollywood Bronze Supply, 177Q No. Vermont, Hollywood 27, Calif.

PROFITABLE Business of your own, local or mail order. Tes-Co, Box 189-MF, Wilkes Barre, Pa.

YOUR Own lifetime business at home. Preserve real live flowers in all their beautiful coloring and fragile beauty. Demand year around. Amazing new simple discovery. Child can do work. No equipment needed. Large profits. Full instructions, enough raw material to preserve \$100 worth of flowers sent for \$2.98. E. Morrison, Box 9312-N Station S, Los Angeles 5, Calif.

1001 MONEY-MAKING Ideas for everybody. Write for details. Neuway Institute, Box 5463-M, Chicago 80, Ill.

SCIENTIFIC Beekeeping. Establish a profitable home industry. Utilize thermodynamics. New, revolutionary beekeeping method. Send postcard for our valuable free bulletin, "The Beemaster." Earthmaster Publications, Dept. 7, Box 547, Roscoe, Calif.

\$5 COMMISSION On booked distant moving jobs you recommend. United, 243 W. 60 St., New York, N. Y.

OLD Gold—Buy, sell. Big money. Capital unnecessary. Instructions 25c. Charles, 12 AC, Norwood, Ohio.

AMAZING New course in shellcraft just off the press. Can not be duplicated. Make beautiful jewelry and novelties. Covers all phases. Complete with materials only \$5.00. Order c.o.d. or cash. Guaranteed. You must be satisfied or your money back. Brace Mail Shop, Dept. 5A, 528 White Bldg., Buffalo 2, N. Y.

MAKE Money at home, like I do. Write immediately. Duffy, Covington, Ky.

GO Into business for yourself. Make \$50-\$100 weekly. Others doing it. Be independent! Small capital starts you. We furnish everything. Send \$1.00 for samples, and full information. Universal Service, 209 W. 125th Street, New York 27, N. Y.

OPERATE Profitable mail order business. Splendid opportunity. For details write Eastern Sales Service, 46 Violet Ave., Floral Park, N. Y.

EARN \$20-\$30 Daily "Textra-Cleaning" upholstery, rugs; demand everywhere. We start you, furnishing everything. Booklet free. Textile Cleaners, Inc., 11106-A So. Longwood, Chicago.

FREE—Secured income plan. Write. Studio, Box 339, Lake Orion, Mich.

OPERATE Your "own typing service." Requires no starting capital. Complete details \$5.00. Cash or money order. Postpaid. Superior Typing Service, Dept. C, 4444 W. Madison St., Chicago 24, Ill.

AT Home—Your own manufacturing business making popular \$1.00 novelties. Cost you 3c to 15c. Everything supplied. Write So-Lo Works, Dept. T-6001, Loveland, Ohio.

UNPAINTED Wall plaques, statues. Variety of designs, free list. ArBo Products, A 195 E. 7th, St. Paul, Minn.

\$6000 YEARLY Possible at home with Prestolax Rubber Molds which cost as low as 5c each. Make plaques, statues, etc., which glow in the dark. For free sample write today. Presto Company, 1012 N. Marshfield, Chicago 22E, Illinois.

RU-BEE Twists delicious snack. Exclusive territory available. Send \$1.00 for large sample. Ru-Bee Twists, P.O. Box 310, Binghamton, New York.

\$50.00 STARTS Brand new idea mail business. It sells, it repeats. Write Beeman, Route 42, Box 240, El Paso, Texas.

INTERESTED In mail order business? Send time for details to Opportunities Through Mail, 3540 West 49th Street, Cleveland 2, Ohio.

BIG Money-making opportunity manufacturing and selling exterior house paints. I will send you 17 thoroughly tested and approved formulas with instructions for only \$1.00. R. Palmer, P. O. Box 3976, Portland 8, Oregon.

DOLLARS Daily! Cleared \$1900 in two months. Details, Loeb, 7201-A5 Montgomery, Cincinnati.

ADDRESSES 100,000 Items wholesale! Interesting money-making literature 10c. Wilborn, 706-P Judson Rives Bldg., Los Angeles 13.

PLASTIC—Wood-cast bookends, ashtrays, statuettes. 12 assorted samples with big list models \$1.00. Plastic Artcraft Products, 3151-3, Southport, Chicago.

LOS Angeles area—Our brochure gives latest employment demands by trades; housing possibilities; present and future industrial expansion. Postpaid \$1.00. H. R. Brown, Box 1315, Santa Ana, Calif.

FINANCIAL Independence in your own locality. Full time business. \$875 for merchandise and equipment gets you started to big profits. Protected territory. Sure repeats. Hinson and Company, Inc., Department 246-A, Richmond, Indiana.

\$100.00 WEEKLY Possible. Your own mailorder business. Newest propositions. Rorick, 3514 Columbia Parkway, Cincinnati, 26, Ohio.

NYLON Wholesale. 45 gauge fullfashioned perfects \$12.50 dozen. 51 gauge fullfashioned perfects \$15.75 dozen. Sample box 3 pair \$4.25 postpaid. Martin Co., Box 298, Wernersville, Penna.

OWN Your own factory! Start on a shoestring, hold your job. Start at home, in your kitchen or basement, with very little money. See page 258 for details of 15 valuable tested trade secrets that will lead you to success and freedom. Chemical Research Co., 130 W. 42 St., New York.

SMALL Business courses—Thousands delighted. Novel variety. Details free. "LaPlant," Menominee, Michigan.

UNPAINTED Bookends; plaques, statues, figurines. List. Haverly Products, 1219 8th Ave., Altoona, Penna.

SIGNS Made easily. Instructions and ten sets modern alphabets, numerals, patterns. Sizes up to eight inches. All for \$1.00. Co-operative Business, 7 West Madison, Chicago, (2).

RUBBER Molds, liquid rubber, statuary plaster, kits for beginners. Free "Plastercraft" instructions. Blue Rapids Supply, Blue Rapids, Kansas.

INCORPORATE Your business. Delaware laws. Many advantages, free details. Tax Research Bureau, Inc., Delaware Trust Building, Wilmington, Delaware.

SHELL Jewelry kits, all materials furnished with instructions. \$2.60 and \$1.00 postpaid. Most distinctive and complete kits ever offered. Order today, earn while you learn. Catalogue free. Shell-O-Craft Co., Box 365 Station A, St. Petersburg, Fla.

LIQUID Marble—Colorful, glazed! Molded, brushed, sprayed! Composition floors. Rubberlastic molds. Particulars free. Marbleizing Service, Edwardsville, Ill.

SMALL Capital. Start your own advertising agency at home in spare time. Complete operation revealed. No stock or equipment. Large earnings and permanent income. Free folder and proof. P. Snyder, Box 4907-A, Philadelphia 19, Penna.

RECAST Old batteries into new. Latest achievements. Battery Laboratories, Minneapolis.

BIG Mail income. Free particulars. Murray's, 196 Circle, Forestville, Conn.

PLASTIC Homes—Build yourself! Resurface old buildings! Wonderful building material. Particulars free. Marbleizing Service, Edwardsville, Illinois.

PARATOL—Amazing new rubber latex moulding compound for perfect detail castings of all kinds tested and approved in long service. No worries—easy to apply, quick drying, maximum strength and long life. Why pay more—buy direct! Quarts—\$1.60, 1 gal.—\$4.90, 5 gals. \$4.45 gal. 4 oz. samples on request. Send 25c to cover mailing and handling charges. Full instructions sent with each order. Testworth Laboratories, Inc., Manufacturers of coating and adhesive products of all kinds. 407 S. Dearborn Street, Chicago 5, Illinois.

FORTUNES In formulas and trade secrets. Stillman, 555 Kingston Ave., Brooklyn 3, N. Y.

RED Latex for making molds! Cast plaques, novelties, bookends! Free sample! H. Tooker, Hamilton 35, Ohio.

MAKE Flexible molds! Few cents each! Cast plaques, novelties, bookends! Free sample! H. Tooker, Hamilton 44, Ohio.

OPERATE Profitable mail order business at home. Postal brings details. Ellsworth Klein, 731 Northampton, Buffalo, New York.

MAKE Liquid marble, flexible molds, statuary, art goods, novelties, artificial marble flooring. Literature free. Kemico, Park Ridge 50, Ill.

BEST Tested money-makers—68 page book 25c (coin) postpaid. Business secrets, mail order plans, formulas. Wholesale supply sources. Money back guarantee. Frank R. Carpenter, Boyes Hot Springs, Calif.

OUR Unique service will help sell your idea or invention. Literature free. Ellis Martz, Representative, Muncy, Penna.

YOUR Own business. Bronze baby shoes. Make bronze castings, novelty castings, liquid marble, flexible molds. New methods, easier, quicker, more profitable. Productive Arts Co., Dept. M-7, Box 221, Seattle 11, Wash.

OPERATE Profitable mail order business. Splendid opportunity. For details write George Radatovich, Box 142, Fairmont, W. Va.

BECOME A locomotive engineer or railroad conductor, information 50c. The Student Railroad, Box A53, Elmhurst, Ill.

SELL Pin earring sets, novelty jewelry, \$2.50, \$5 sellers. Order assortment \$15 dozen. Manufacturers, 264 5th Ave., New York.

NOVELTY Advertising card. Sample, quarter. Manson, 1306 Rhodes St., Jackson, Michigan.

GROW Bean sprouts in dark room for market. Pays well. Free information. Mrs. Nickell, Rt. 1, Box 456, Bend, Ore.

BABY Shoes preserved. Instructions, formulas, \$1.00. Novelty Bronzing, Box 56, Hyde Park 36, Mass.

START A home business in spare time. Make extra money. Experience unnecessary. Literature free. Ellmar Services, Muncy, Penna.

RAISING Canaries pays good profits. Valuable bird books. "Its Care, Breeding & Training," "Mating for Color Breeding." Both \$5.00. American Canary, 2839P N. Halsted, Chicago 14.

MAKE Your living selling by mail. Start small with few dollars—Build from profits. Send stamp for eye-opening literature today, begin business quickly. W. Otis, Aurora 21, Missouri.

A FACTORY In your home garage! Mfg. and sales rights, mechanics' waterless hand cleaner. \$500-\$800 monthly. No special equipment necessary. Western Aircraft Co., Los Angeles 6, California.

YOUR Own plastic business at home. Produce costume jewelry, novelties, statuettes. Liquid plastic; liquid marble. Flexible molds. Write for free book. American Trades, Box 1016-A, Peoria, Illinois.

POPCORN Machines, peanut roasters, caramelpopcorn equipment, vending machines, new, used. Northside Sales, Indianapolis, Iowa.

BIG Money in vending machines. Smallest capital start brings immediate profits that build permanent profitable business. Starting instructions free. Becker Vendors, 105-A Dewey, Brillion, Wisconsin.

OWN A mirror shop! Resilver mirrors. Write for information. John Sprinkle, V60, Marion, Indiana.

MAKE Perfumes. Profitable business. Free book tells how. Walter Lawson, 21 Joiner, St. Augustine, Florida.

BECOME A finance man. Particulars free. George Lenhoff, Lincoln 8, Nebr.

WANTED Unused U. S. postage stamps, small discount. Advance Stamp Company, 24 East 23rd Street, New York.

BELTS! Make 'em and make money. No tools! Sample 50c. Artnic Leather, 411 Joseph Ave., Rochester 5, N. Y.

BUILD Your home or build your business with concrete brick. Minimum equipment expenditure for production machines and mixers. Reed Corporation, P.O. Box 237A, Three Rivers, Michigan.

BECOME Independent! Rent New York office under your own name, and sell what you have to offer through New York Metropolitan area, world's greatest business center. Rates \$7.30 and \$14.60 yearly. Co-operative Offices, 126 Lexington Avenue, New York 16.

MANUFACTURE Beautiful name-plates, house-numbers, signs. Crabtree, Box 221, Newport News 6, Virginia.

WINDSHIELD Wiper and fuel pump rebuilding bring big profits. Free particulars. H. & H. Products, P.O. Box 430, East Akron Station, Akron 1, Ohio.

MAIL Order opportunities. Full or spare time. Hundreds of chances. No charge. Postal brings copy. Blackstone Press, Somerville, New Jersey.

TRAIN Yourself in crime detection and finger printing. Literature free. Perkins Publications, 300-B Brandeis Theatre Bldg., Omaha, Nebraska.

GREAT Opportunities and profits in mail order business at home. Free literature. F. Webster, Box 1972C, Hollywood, Calif.

LEARN Piano tuning, repairing, at home. Tremendous field! Piano parts, tools furnished. Established 1935. Empire School of Piano Tuning, 606-B East University Ave., Champaign, Ill.

MEN—Women—“Everybody likes candy.” Learn to manufacture professionally at home. (Our 36th year). Ragsdale Candies, Dept. 4, East Orange, N. J.

HANDYMEN—Earn money home operating Community “Fix-It” Shop. Write Stafford, 708 Rawlins, Carbondale, Ill.

DO It with sea shells. Big profits. Werts, 1429 - 56th Avenue, Oakland 3, Calif.

START Home plaster novelty business. Amazing course tells how. Literature free. W. Belfort, Engineering Building, Chicago 6.

MAIL Order business—Your opportunity. Start small—Grow big. Literature free. O-Belfort, Engineering Building, Chicago 6.

YOUR Town is ripe for a profitable Collection Agency. \$5,000 first year easily possible. We train you, coach you, get you started and help develop your business. Send \$1.00 for Starter Course, or ask for facts. American Collection Associates, 226 State Street, Schenectady 5, New York.

WOULD You pay 3%—first \$350 made? Color-illustrated book “505 Odd, Successful Enterprises” free! Some offer occasional “day off.” Work home. Expect something odd! Pacific, San Clemente, Calif.

BOOKKEEPERS—Operate your own simplified “Dollar-A-Week” bookkeeping and tax service. Full or spare time. Details free. Ellis, Box 200, Cedar Grove, North Carolina.

MAIL Order business course shows you how to make money, spare or fulltime. Teaches professional mail order technique—not penny-snatching schemes. Fascinating 100-page illustrated success-catalog free! Write, Nelson Company, Dept. 4-02, Chicago 5.

PLASTIC Discs, shapes, metal findings, wholesale, free catalog. “Secors,” Bradenton Beach, Florida.

ELITE Collection contains 137 practical money-making plans; local and mail order. New edition. Particulars free. Elite Co., 220 Grand St., New York 13.

SELL Lamswool lined slippers, men's, women's and children's. Sensational profits. Sell from illustrated catalog or samples. Write for full details today. Shepherd Products Company, Worcester, Massachusetts.

137 WAYS To make money, in home or office, business of your own. Full particulars free. Elite Co., 220 Grand St., New York 13.

OPERATE Profitable home business. Levine's, Box 15-X, Boulevard Station, New York 59, N. Y.

BRONZING And metallizing baby shoes! Gold, silver, copper, nickel, bronze, pearl, ivory, and “luminous glow” colors! Big profits! New field! Details free! Write R. O. Morgan, Box 349, Long Beach 2, Calif.

ANYONE Can learn. Tune pianos by my system. \$1 2 lessons and chart. Oscar Fylling, 841 Robinson, Oroville, Calif.

LEARN Shell jewelry manufacturing. No tools or experience needed. Learn—earn within a week! Complete home instruction course, beautifully photographed, shows how to make 75 styles of pins, earrings, brooches, hair ornaments, dress clips, necklaces, bracelets, candy dishes, wall plaques, ash trays, candle sticks, etc. Includes pearlizing, golding, dyeing, luminous methods. Illustrates 55 species of sea shells. Lists hundreds of raw materials with wholesale prices. Complete course \$1.00, postpaid. Beginner's kit, \$3.00. (\$3.50 in Canada). House of Gifts, Box 4550-RP, Coral Gables, Fla.

QUICK Money! “Repairing car batteries.” At home! Easy too! Write. Batteryman, Grand Junction 5, Colorado.

“HOW To Make Simple Molds and Plaster Plaques.” Profitable business or hobby! Instructive booklet 25c. Plastercraft Supply Company, 1406 East 43rd Street, Cleveland 3, Ohio.

SELL By mail!—Books and novelties! 35 different items! Large profits! Catalog free! Eifco, 432 N. Wells, Chicago 10.

ORGANIZE Wholesale—retail—popcorn, potato chip shops. We sell beginner's outfits. Long-Eakins, 4760 Hi St., Springfield, Ohio.

MAKE Extra money now. Build to financial independence. Sell office supplies by mail from your home. I tell you how. Jo Troutwine, 8654 S.W. Ninth, Portland 1, Oregon.

OPERATE Profitable home business selling merchandise by mail. Fast sellers. Large profits. Powell Service, 5713 Euclid, Cleveland 3, Ohio.

COLOR Concrete with chemicals. Make Hollywood style pottery; home or shop. Marbling, water-paints. 10c brings sample, pictures. Hollywood Cementcraft, 8527 Wonderland, Hollywood 46, Calif.

INTERESTED In immediate mail order cash? Read “Advance”—Voice of mail order. Offers money-making opportunities. Personal guidance and benefits to all. Sample copy 25c. American Mail Trade Association, 313 East 21st Street, Dept. 400, New York 10, N. Y.

COPUBLISH Leading m.o. paper. Latest copy Mail Sale Advertiser and proposition, commemorative stamp. Vanroy Shirk, Lebanon, Penna.

START Profitable mail order business. PMT lists new propositions available; products, sources, accurate methods. Covers ad writing, letter logic, trade information. Send 10c for copy and get free instruction folio offer. Progressive Magazine, Sheboygan, Wisconsin.

HOW And where to obtain capital. Fully explained. Particulars free. Star Service, Wapakoneta, Ohio.

LIQUID Rubber, for making flexible molds, literature and sample free. H. Chaney, 1130 E. 16th St., Jacksonville 6, Fla.

BIG Paying jobs in welding. Complete welding lessons and reference books, 516 pages, 41 lessons, \$2.00 copy. Money-back guarantee. Hobartweid, Box M-1065, Troy, Ohio.

START A clock shop. Fascinating, easily learned profitable business requiring little capital. We teach you how to repair all kinds of clocks. Information free. Houston Clock Shop, P.O. Box 5086A, Houston 12, Texas.

SYNTHETIC Latex with Neoprene base for making flexible molds! Quick drying! Safe! For home, classroom, or industry. Quart \$2.00. Gallon \$5.95. Full instructions. Plastercraft Supply Company, 1406 East 43rd Street, Cleveland 3, Ohio.

200 MONEY Making deals, Plans, Rare formulas. Schemes, Folio free. Formico Mart, Box 572, Dayton, Ohio.

SPECIALTY Manufacturing, the big money business that can be operated anywhere, start on a very small capital; we supply dependable formulas and complete instructions; get interesting free booklet, “Money-making Opportunities in Specialty Manufacturing.” Howard Robinson, Ph.G., 1300-A South Ohio Street, Sedalia, Mo.

TADPOLES Make frogs, tremendous demand. Both make you money. 25c brings tell-how information. Chariton Corporation, Century Building, Chicago 4.

COLORGLAZED Concrete pottery made without molds. New, low cost, patented method. Cemetery products, novelties, tiles, floors, etc. Basement leaksealing. Other money-making projects. Booklet, details free. Men only. National Potteries Company, Fergus Falls, Minnesota.

START Mailorder bookshop—Everything furnished; publisher cooperation. 25c brings booklet, exclusive setup, samples, exciting ideas. General Publications, Ossining, N. Y.

\$25 WEEKLY Working two hours daily. No canvassing. No manufacturing. Lycke, Box 2471, Cleveland 12, Ohio.

BRUSH Plating outfits connect to a battery. No tanks necessary. Good paying business at home plating autoparts, bathroom fixtures, bicycles, reflectors, silvering mirrors. No shop or experience required. Outfits furnished. Free booklet. Gunmetal Co., Ave. H. Decatur, Ill.

MONEYMAKING OPPORTUNITIES

500%-1000% PROFIT And up. Your own interesting service business. Tremendous demand everywhere. Experience unnecessary. We teach, help, supply everything. Practically no capital needed. Resistal, Inc., 1757-B Sunnyside, Chicago 40.

BUILD Neon signs and neon lighting. Easy to learn. Very small capital required. McMaster Sign Co., 730 State St., Bellingham, Wash.

START Your own business! Big money manufacturing novelties, plaques, statuary. Free catalog. Write Bing Products, 88-A2K Broad Street, Boston 10, Mass.

MANUFACTURE Perfumes easily. Little capital. Good profits. Rosa, 907 Adams, Brownsville, Texas.

WHOLESALE Catalogue free; retail 10c. Fast selling Mexican and biological curios; feather pictures. Investigate! Quivira Specialties, Topeka, Kansas.

EARN Money spare time, mailing circulars for mail dealers. Pioneer, P-404, Yonkers 1, N. Y.

AMAZING Money-making plans. Work from home, 25c. Schneider, 1038 Holland, Schenectady 3, N. Y.

RUBBER Molds made to order. Stock molds. Vallance Art Products, 1873 E. 79 St., Cleveland, Ohio.

GIRLS! Everybody! Earn premiums. Write postal. Renschler's, Carrollton 6, Kentucky.

WIN Money on contests advertised in every magazine and on radio. General Contest Magazine, published monthly, gives hundreds of tips. Lists current contests and rules. Sample 25c. General Contests, 1609 1/2 East 5th, Duluth, Minn.

THOUSANDS Articles wholesale—Directory, magazine, hundreds money-making opportunities, big mail; 25c coin. National, 378G Hooper Street, Brooklyn 11, New York.

AMAZING Profits in home operated distinctive exclusive, art-gifts specialty business. Write for starting ideas. Valvick, Warba, Minnesota.

EARN While you learn clock repairing. With our method your income can start immediately. Write Akron Clock Clinic, 964 Wye Dr., Akron 3, Ohio.

“MAIL Dealer” Magazine, 1420 Mistina, Corpus Christi, Texas. Brightest, best. Cashable plans. Year \$1.00. Three copies 25c.

CO-PUBLISH Magazine. Many profits. 16-page booklet 10c (refundable). Gold-enberg, 5209-DD Lindsay, Houston 3, Tex.

DEPENDABLE Substantial mailorder information, new ideas, profitable spare-time moneymaking opportunities galore in our magazine. Copy 25c. John Hillstrom, 6411P Hollywood Blvd., Hollywood 28, Calif.

“BIG Time” mail order business. Free details. 10c brings copy Progressive Mail Trade, Kerk's Service, Box 454-A Wellston Station, St. Louis, Missouri.

EXCELLENT Profits raising mink. Details furnished. Franklin Young, Riverhead, New York.

\$100.00 WEEKLY Easy, as our agent. Rush \$2.50 for sample, information. Valley Sales Company, Weslaco, Texas.

QUICK Profitable business, unfinished useful novelties, interesting personalized gifts. Easily finished. Write—Wilhites, 927-C Palm Dr., Colton, Calif.

NEW Iron holder, nothing like it. Every housewife a prospect. Send \$1.25 for sample, information. Household Appliance Sales Co., P. O. Box 372, Sewickley, Penna.

HOW To start a mail order business, with little money. Details free. Useful Service, A3702 West Austin, Seattle 6, Washington.

BECOME Independent selling by mail. Write Success, Box 513, Berkeley, Calif.

SURPRISINGLY Unusual, moneymaking books. Free lists. Ralph Underhill, Beebe, Arkansas.

\$-DOLLARS In your mail—\$. Unlimited possibilities. Write Logan, Box 131-A, Lakeland, Florida.

MORE Money? Spare, fulltime. No manufacturing. No merchandise to sell. Particulars free. Williams, 5514 Speedway Dr., Indianapolis, Ind.

SAWDUST—Turn it into cash. Home. Spare time. No capital. Instructions 25c. Charles, 12 AD, Norwood, Ohio.

SHELLCRAFT Sells! Have fun making genuine marine shell jewelry. Make money selling to stores and friends. Save money buying direct from wholesaler. Large kit \$1.00. Instructions free. Eastern Shellcraft, 985 Myrtle Ave., Brooklyn 6, N. Y.

SEWING Machine repairs men make big money lifetime. Start neighborhood shop. Complete repair manual, covering all makes, \$1.98 postpaid. Money back guarantee. Sewing Machine Serviceman, Hamilton 9-A, Ohio.

WHERE To buy 25 money-making items. F. L. Dupont's Mail Service, 1916 Kenneth, Arnold 5, Penna.

NEW! Money making shellcraft kits! Chatelaine gardenias \$1. Violet corsage \$1. Cameo brooch, earrings \$1. Instruction booklet 35c. Wholesale supplies. Shelart, 3027 1/2 6th St. South, St. Petersburg, Florida.

A BUSINESS Of your own! Go into business for yourself. Start at home in your spare time. We can help you! Details free. Rennolet, 1022-A 9th Street, Rock Island, Illinois.

WHOLESALE Anything imaginable. New guaranteed list 25c. Refundable. Lasalle Novelties, Box 2172, Waterloo, Iowa.

MAKE More money in your own factory! Start at home in spare time, work hard, and others will be punching your time-clock! See page 258 for details of 15 valuable tested trade secrets, easy to make, easy to sell. Chemical Research Co., 130 W. 42 St., New York.

EARN Money sparetime. 10 mail order magazines, circulars 25c. R. L. Tipton, 229 Overton Place, Knoxville, Tenn.

MAKE Dollars. Working new mailorder plan. Details 3c. J. W. Arthur, Box 4, Montgomery, W. Va.

SELL By mail! Full or part time. No stock to carry—big profits! Write today. E. L. Bricker, Box K, Emmaus, Penna.

EARNINGS Unlimited, brand new field, work at home, no selling, copyrighted material, instructions, \$2.00 refundable. Keirstead, 3541 North Meridian, Indianapolis, Indiana.

MAKE Flexible molds! Few cents each! Cast plaques, novelties, bookends! Free sample! H. Tooker, Hamilton 15, Ohio.

THOUSANDS Articles wholesale. "Supply Source Directory" 10c. Ideal Service, Park Ridge 40, Illinois.

FREE Literature describing 20 money-making plans. Dalles Ruth, Wheelersburg, Ohio.

GET Dollar orders by mail! You keep 90c profit! Easy, pleasant, home operated business. Just \$5.00 capital starts you! Complete plan, only \$1.00. Interesting details free. Send today! William Redmond, 1216-A Park Row Building, New York 7, N. Y.

"TIMELY Tips Magazine." Paulding, Ohio contains promotional plans, ideas, opportunities. Monthly 10c. 19th Year, \$1.00. Trial four months, 25c.

SUCCEED With Oxium. Sell garages, shops, factories everywhere. Make it yourself. Small investment. Free literature. Weinman, Box 442, Elkhart, Indiana.

YOUR Own business metalizing baby shoes. Complete instructions. Write. Technical Aid and Supply Co., P.O. Box 668, Los Angeles 53, Calif.

WHOLESALE Catalog, directory 10c. Stafford Sales, Box 5211, Indianapolis 1, Ind.

"HOW To Build Your Own Mail Order Business" book 25c prepaid. Packed with ideas. Supply limited. Box 63, Station H, Dept. M12, Buffalo 14, N. Y.

MANUFACTURE Costume jewelry at home for profit, hobby, therapy. Free wholesale supply catalogue. Instructions. Florida Supply House, Bradenton, Florida.

INVESTIGATE Mail selling! What's the one best thing to sell, happily, honestly, profitably? We know! Get free particulars, free samples. What-To-Do Shop, Box 1082, Tacoma, Wash.

"LUMINOUS Paint." Resilvering Mirror formulas 25c each. "Soap Substitute Formulas" \$1.00. Ideal Service, 300, Park Ridge, Ill.

SHELLCRAFT Instructions free! Make beautiful seashell jewelry! Wholesale catalogue of complete line shells! Plastic discs! Animal shapes! Pinbacks! Earrings! Cameos! Etc. (Buy direct.) Pace's, Box 279, Bradenton, Florida.

BIG Mail including mail order magazines 10c. Mallo, 767-PM Leith, Flint 5, Mich.

OWN A mirror shop! Resilver mirrors. Write for information. John Sprinkle, V55, Marion, Indiana.

"FIFTY PLANS" for profitable, home-operated mail business. Details free. Lakeside Publishers, Detroit 15, Mich.

I MAKE Big money in the mail-order business. You can do the same at home with my copyrighted system. Write me. I'll tell you how. F. Little, Box 8, Glenshaw, Penna.

\$25 WEEKLY Working two hours daily. No canvassing or manufacturing. Lycke, Box 2471, Cleveland 12, Ohio.

WOULD You pay 3%—first \$350 made? Color-illustrated book "505 Odd Successful Enterprises" free! Proven! Work at home, office. Expect something odd! Pacific, San Clemente, Calif.

THERE'S Big money in junk," and repairing batteries. Write, Batteryman, Grand Junction 5, Colorado.

\$246.50 MAKING Unusual secret device without skill, machinery, from former war material costing \$1.50! Simple, baffling invention, unbelievably profitable! Illustrated proofs free. Rolls Enterprises, 115-D West 16th, New York 11.

LEARN Battery repairing, rebuilding. Engineer offers money making methods. Battery Bureau, 2225 North 44th St., Milwaukee, Wis.

EARN Money at home—steady income. Write Successful Income Builders, 508-A, Hollywood 28, California.

200 MONEY Making deals, plans, rare formulas. Schemes. Folio free. Formico-Eng., Box 572, Dayton, Ohio.

FORTIFY The future! Start own business; home, office. Booklet describing "Collection of 137 Tested Plans" free. Elite Co., 230-A Grand St., New York 13.

PUBLISH Your own magazine. Hand-some 52 page format, well edited, illustrated. Cost low as \$1.00 month. Brings you prestige, profits. 25c brings sample, details. National, Ord. Nebr.

FORMULAS, PLANS, ETC.

NEED Chemists? Products duplicated? Formulas? Analyses? Consulting Scientific Company, Swarthmore, Pennsylvania.

MAKE Money at home, 127 formulas \$2.00. Huffman, 391 Pleasant Lake, Rives Junction, Mich.

SLAVERY? Self hair cutting. POM. order \$1.00. Agent wanted. Engineering, Box 342, Cambridge 39, Mass.

FREE. New shave and furniture cream formulas. Moon, Broadway, Fulton, N. Y.

"HANDBOOK Of Formulas," 10,000 trade secrets for home, farm, and workshop. Unknown to general public. Make money—save money. Cloth, \$3.50. Foreign, \$4.00. The Audubon Book Service, 415 Lincoln Avenue, Brooklyn 8, N. Y.

MAKE Products yourself. Free formula catalogue. Schaffner's Lab., Emsworth, Penna.

FORMULAS—High quality, fast selling products. We furnish electrotypes for flashy three color labels. Literature. Weinman, Box 442, Elkhart, Indiana.

100 SINGLE Ingredient formulas 25c. Tes-Co, Box 189-MG, Wilkes-Barre, Penna.

LATEST Formula lists; wholesale supply sources 100,000 items (chemicals, equipment) 10c. Wilborn, 706-P Judson Rives Bldg., Los Angeles 13.

15 TRADE Secrets that cost millions to develop and test—yours at low cost. You start your own business in spare time at home. Easy to make, easy to sell. See page 258 for details. Chemical Research Co., 130 W. 42 St., New York.

10,000 FORMULAS And trade secrets. Free literature. Stillman, 555 Kingston Ave., Brooklyn 3, N. Y.

ROOFING 100% Fireproof, low cost, lasts like slate. Insulates better. Apply like plaster. Formula \$1. Rav Roofing, 3 Box 98, New Hyde Park, New York.

MANUFACTURE Cleaners, soaps, polishes, flavors, cosmetics. Literature free. Kemico, Park Ridge 16, Illinois.

FIREWORKS. Twenty formulas, one dollar. Pyrotechnics, 215 West Haskell, Tulsa, Oklahoma.

REAL Manufacturing formulas. Lists free. Cummings, Chemist, Gordon Ave., Syracuse 4, N. Y.

FORMULAS—Latest, best. Analysis. Giant formula catalog and chemical instruction sheet 10c. Refunded first order. Belfort, Engineering Building, Chicago 6.

PLASTICS

NEW Liquid plastic. Clear, colors. Cast without heat. Embed flowers, insects, coins. Saw, drill, carve. Manual tells how. Send \$3.35 for complete 20 project kit including one pound liquid Castolite. Castolite, Dept. E-21, Box 211, Kenilworth, Ill.

2 LB. Plexiglas first grade, size 6" x 6" or larger \$2.50. 2 lb. clear scrap 70 ct. 5/32", 3/16", 1/4", 5/16", 3/8", 1/2", 1". Schick Mfg. Co., 257 William St., New York City.

PLASTIC Injection machines, three sizes, toy, industrial, commercial. Full line jewelry findings. New low prices. Plexiglas, dyes and supplies. Tenite. Polystyrene rods, kits, etc. G. Baker Company, River Edge, New Jersey.

HOME Training through "Working With Plastics," covering every step, every material, \$1.25. Plastic hobby kit: 2 lbs. Lucite, Plexiglas, bottle cement, 2 bottles plastic dye (red, green) \$3.25 postpaid. (Includes instructions.) Modern Technical Book Co., Dept. MMC, 55 West 42nd Street, New York 18, N. Y.

LUCITE—Catalog dime. Refunded first order. Special offer. Midwest Plastic, 1717 No. 66th, Omaha 4, Nebr.

PLEXIGLAS—Dyes, cement, jewelry findings. Free listings. Novalte Plastic, P.O. Box 106-M, Brooklyn 19, N. Y.

PROJECTS. Ten marvelous plastic, guaranteed, \$1. Plasticplan Co., Box 181, Cincinnati 1, Ohio.

HOME Crafters! Plastic formula-moulding instructions \$1.00. Box 84, Station K, Toronto, Canada.

FORMALIN. Lustrous, quick setting liquid plastics. Casting supplies. Free literature. Kit \$3.00 F.O.B. Formalin Works, Box 199, Romeo, Michigan.

INJECTION Molded plastic parts for 4" baby ball, gyro singing top, three compartment tray. Red, blue, ivory, and pink colors. Tenite and Polystyrene materials. Easy to assemble. Complete kit \$1.00 postpaid. Quantity prices included. Economy Precision Products Co., 10 Main Street, Germantown, Wis.

PLASTICOR Injection molding machine molds toys, games, novelties. Economical. Easy to use. Precision built for professional accuracy. Each machine equipped with five molds and sufficient Tenite pellets for 250 moldings. Uses 110V a.c.-d.c. current. Regularly \$32.95, our price \$19.95 f.o.b. St. Louis. Also, send 10c for catalog, price list on plastics, accessories, etc. Plastic Parts & Sales, 1157 S. Kingshighway, St. Louis 10, Mo.

MONEY In plastics! Lucite plastic hobby kit. 2 pounds Lucite material, coloring dye, cement. Instructions. Send \$2.50 (plus 40c express charges). Also Swiss music movements, \$3.50 each. Plastic Specialty Co., (Dept. M), 127 East 28th St., New York City.

MAKE Money assembling our pre-fabricated plastic kits. Sample kit 50c. Catalog free. Fabros, Box 156, Station F-1, Buffalo 12, N. Y.

PLASTICS And supplies; book on plastics \$1.50; kits \$3.00-\$5.00. Special internal carving drill \$1.30 f.o.b. St. Louis. List. Plas-met Sales and Engineering, 4648 Shirley Pl., St. Louis 15, Mo.

PLASTICS. Sheets, rods, tubes. Free list. Swiss music units \$3.50. Plastic Supply Co., Dept. PM52, 2618 St. Louis Ave., St. Louis 6, Mo.

GOODYEAR—Has rubber for molds, self vulcanizing, air curing rubber. Quart \$3.00, gal. \$10.50. Instruction free. Goodyear, Lake Geneva, Wis.

HOME Crafters! Plastic formula and instructions \$1.00. Box 84, Station K, Toronto, Canada.

PLASTICS—7 Colors sheets and rods. Send stamp for price list. Hanson Plastics, 7625 South Parkway, Chicago 19.

LUCITE Sheets, rods, dyes, cements, cheap. Free price list. Thomas Cavaliere, 2141 So. Beechwood St., Philadelphia 45, Penna.

KITS: \$1.50 Each. Plexiglas tie-rack 18", 5"x7" picture frame or bud vase. Send for free price list. Free gift with each kit. Heah Mfg. Co., 5115 N. Neenah Ave., Chicago 31, Ill.

LATEST Postwar rage. Start business making gifts, useful articles from Lucite Plastic. "Easy Home Outfit," complete supplies, directions \$10. 20th Century Plastic, 1288 Mission, San Francisco.

PLEXIGLAS Masked sheets 12"x12"—1/16"—\$1.00, 1/8"—\$1.25, 3/16"—\$1.55; 1/4"—\$1.85. Include 10% postage. Dyes, rods, cements, smells, buffing compounds, jewelry findings, tools. Free listings. Craft Plastics, Box 129-P, Somerville, New Jersey.

FREE—"Amazing New Book"—"Profits From Classified Advertising." Tells how and what to advertise. Be sure to read this book before you invest one cent in advertising. Remember—it's free! Write for your copy now. F. W. Johnson, Classified Advertising Manager, 200 East Ontario Street, Chicago 11, Illinois.

CHEMISTRY

RUBBER Tubing, aprons, gloves, buckets, dippers, funnels, sheet. Free price list. Bucey Supplies, 19465 Ward, Detroit 21, Michigan.

THE House of Winn, home of supplies for amateur chemists. See Winn's New Idea chemical kits and apparatus outfits for home experimenting. Send 10c for retail catalog. Established 1931. John H. Winn, Dept. 505, 124 West 23rd St., New York 11, N. Y.

NEW Laboratory supply catalog of chemicals and apparatus, contains over 5000 items with illustrations, 212 pages. Send 50c. Standard Science Supply Co., 1232 No. Paulina Street, Chicago 22, Ill.

CHEMICALS—LAB. Supplies. New catalog 10c. Mel-Glo Chemical Co., 258 Fourth Avenue, Brooklyn 15, N. Y.

HANDBOOK For chemical experimenters, illustrated, hundreds of experiments, 50c. Experiment booklet 15c. Supply catalog 5c. Reading Scientific Company, Reading, Penna.

APPARATUS, Chemicals, ounce quantities, catalog 5c. Fleischer's Laboratories, Everett 49, Mass.

CHEMICALS And apparatus for industrial, analytical, and private laboratories. Complete supply service for correspondence school students. Send 3c for catalog. Dept. M-43, Biological Supply Co., 1176 Mt. Hope Ave., Rochester 7, New York.

FREE Catalog. Chemistry, mineralogy, biology, optics. Tracey Laboratories, Evanston, Illinois.

HELP WANTED

WOOD Finishers beginners contact Satin Wood Products Co., 42 LaBelle St., Dayton 3, Ohio. Information free.

RELIABLE Man with car wanted to call on farmers. Wonderful opportunity now \$15-\$20 in a day. No experience or capital required. Permanent. Write today. McNess Co., Dept. 25, Freeport, Illinois.

MAKE More money selling individualized buckles, belts, tie holders, cap badges. Choice of 2000 emblems. Quick profits—repeats. Special outfit offer, write Hook-Fast Products, Dept. A, Columbus 6, Ohio.

AGENTS WANTED

CASH In on easy-selling Riteheat in your spare time. The automatic room temperature regulator needed by every owner of a wood or coal stove in your neighborhood. Backed by national advertising campaign. Others are getting liberal commissions now. You can do the same with very little effort. No obligation. Riteheat Regulator Division of Caloric Stove Corporation, Widener Bldg., Philadelphia 7, Penna.

EXCLUSIVE Protected territories to men calling on grocery stores or hardware, paint, drug, department stores, etc. Sell Wonder Plastic Linoleum Finish and the new Wonder Plastic "Wood Finish." Huge profits. Write Wonder Plastic Products Co., 2608 So. Kedvale Avenue, Chicago 23, Illinois.

EASY Sales—big profits. Hand painted, genuine leather, all around zipper wallets sell for \$3.00. Sample \$1.50. Quantity prices. Request wholesale catalog of exceptional wallets, belts, novelties. Golden Novelty Co., 648 Broadway, Dept. P-1, New York 12, N. Y.

WONDERFUL Year 'round cash profits showing folks everyday, birthday, get well, gift wrappings, comic, correspondence note boxes. Quickly, easily make up 100% profit. Special offers. Experience unnecessary. Write immediately for details. Request sparkling 14 card \$1 everyday box on approval. Pascale Greeting Card Service, 94 Campfield St., Dept. 300, Irvington 11, N. J.

RUBBER Wall plaques, colored fruits. Stick any where. Sample dozen \$1.00. Profit \$2.00. Liberty Sales, 2624 South Central Park Ave., Chicago.

LIQUID Shampoos available in bulk. Retail sales. Fast sellers. Details free. Delfa Co., 3958 Avondale, Chicago 41.

100% PROFIT Or more. No investment. Unusually steady business. Handle photo stamps. Amazing stamp size gummed-back glossy photographs, 100 retail for only \$3.00. Free samples and information. American Photo Stamp Co., 103 East 125th St., Dept. (301), New York 35, N. Y.

COSTS 20c. Sells \$1.00. Millions prospects. \$20 daily. Samples free. Burns Company, Johnstown, Penna.

NYLONS! Dozen, \$13.20. Delicious candy, \$10.80. Renschler's, Carrollton 7, Ky.

EXCELLENT Sideline for printing and advertising salesmen. Decalcomania name plates in small quantities. Great demand. Also, make money with our line of automobile initials and sign letters. Free samples. "Ralco" XL-Roxbury, Boston 19, Mass.

EARNING Less than \$200 weekly? Boost income quickly. Fast selling celluloid price tags, metal molding, menu covers. Every store, restaurant buys. Pricing Press, Dept. PX, 124 White Street, New York.

NU PROCESS Products Laboratories, Dept. 296, Aurora, Illinois, have some choice distributorships open. Exclusive territory franchise. Big profits. Wholesale and retail. Age no barrier. Men and women eligible. Cash profits start first hour. Two products (1) Silver Plating Liquid (NuSilver Trademark Patent No. 245,336 and Re-Plate-O Trademark Patent No. 367,355), and (2) Lectrik Silver Kleener Plate for quick de-tarnishing of silverware. Full details free. Write them today.

VICTORY Ornamental. Practical shakers. Provable. Patented. Box 5024, So. Norfolk, Va.

DOUBLE-DUTY Shopping bag. Zips open. Instantly changes from small to large size. Lightning seller. Samples sent on trial. Kristee 135, Akron, Ohio.

WANTED Agents for house to house selling of plastic products including table cloth covers. Write for free details, sample \$1.00. House of Schiller, Dept. P, 180 N. Wacker Drive, Chicago 6, Ill.

GREETING Card money makers. Birthday, relations, everyday. Catalog free. Greenport Art Company, Dept. 508P, Brooklyn 15, New York.

BIG Money selling new hose nozzle. Shuts off automatically when dropped. Saves water. Sells on sight. Garages, service stations, homes, wash racks, gardeners, greenhouses. Free particulars. Watermaster, 19465 Ward, Detroit 21, Mich.

SELL Glass mail boxes, bonderized metal covers. \$13.20 dozen. 50 lbs. Circulars optional. Perfection, 637 E. 71st, Chicago, 19.

DISTRIBUTORS Wanted highly salable cosmetics. Amazingly lucrative. Full co-operation sales promotion. Stephanie Limited, 1280 Ontario, Cleveland, Ohio.

MAKE Big profits selling everyday greeting card box assortments. Fast sellers. Low wholesale prices. Write today. Bluebell Art Co., 1059 Avenue C, Bayonne, New Jersey.

BECOME Our costume jewelry jobber! Modern Fifth Avenue jewelry sells fast. Every woman a buyer! Big profits! Catalogue and literature free. Edward J. Paseka, 505 Fifth Avenue, New York 17.

AGENTS: All ages, earn \$30 to \$50 weekly selling for yourself, fibre brooms, mops, and floor dusters, start now. Write Burts Fibre Broom Co., Columbia, Penna., Dept. A.

EXTERMINATING Products harmless to humans, animals, food, etc. Nationally acclaimed. In demand by municipalities, industries, stores, homes everywhere. Offering lucrative proposition. Biocerta, 303 Fifth Ave., New York, N. Y.

DRIVER Salesmen—Men, women agents to sell aluminum giftware to homes. Fast sales. Regent Mfg. Co., 1477 York Ave., New York City.

SELL Ball point pen wholesale. Sample one dollar. Free details. Friendly, 17 South Penn Ave., Philadelphia 11, Penna.

AGENTS. Fastest selling, large profit pencil deal #25: 25 assorted pencils for every possible need, business, home or workshop; black, blue, red, etc. Indelible, drawing and carpenter pencils; free, with each deal, 5 stainless steel gold plated fountain pen points; that formerly sold 25c each. Pencils sold at 5c, 10c and 15c each. Bought singly deal would cost about \$3.00. Deal #25, costs you only 95c each in dozen lots; 89c each in gross lots. Deal can easily be resold at \$2.00 each. Deal packed individually. Sample deal one dollar. Money back. No c.o.d.'s. Foreign price \$1.50 per deal. S. Auctioneers, Box 434, Times Square, New York 18.

HOUSE To house salesmen—pleasant outdoor work applying "Tree Gum" to trees. No competition. \$3.50 investment brings in over \$30.00. Free particulars. Ross Industries, Box 5480, Philadelphia 43, Penna.

WARCO Polishing Paper. Cleans and polishes automobiles, furniture, glass, etc. A profitable fast seller. 25c brings regular package and wholesale prices. Warco Supply, 255 S. Meridian, Indianapolis, Ind.

WHERE To buy 800,000 articles direct from manufacturers; save middleman's profit; folder free. Glass Pub. Co., Ellwood City 4, Penna.

AGENTS—Dealers sell home entertainment radio microphones. Good profit. Century Lab., Box 532, Hannibal, Mo.

AGENTS. Substantial profits. Repeat order products. Not mere "job" but opportunity establish steady income. Additive lubricant. Limitless field. Factories, auto-lubricants, service stations, fleet owners buy big. Write Kidder Oil Company, LaCrosse 1, Wisconsin.

NEW Patented invisible belt, keeps shirttail in. Men, women, unlimited earnings. Sell easily. Millions prospects. Free particulars. Invisibelt, PM2, Box 26, Elmwood Station, Omaha 6, Nebraska.

\$1 STARTS You in business. Sell deluxe ties, 100% wool interlining. Costs you only \$7 per dozen, you make \$5.00 dozen. Send \$1.00 for special introductory offer two deluxe ties. Catalog complete line free. Phillip's Neckwear, 20 West 22nd St., Dept. K-11, New York 10.

WONDER Cleaner, free sample! Other producers: unusual bubble bath—Glassklean. Sell homes, stores. Circulars furnished. Courier, 3829-I Delmore, Cleveland Heights 21, Ohio.

SELL Standard brand spark plugs. Completely rebuilt, neatly boxed. Guaranteed 10,000 miles. Sample 15c. Carl's Supply Co., 7927 Paseo, Kansas City, Mo.

SELL Blankets. Commission bonus. Zephyr Woolen Company, Oakland 1, California.

MEN And women to sell beautiful new deodorant tea-rose. Sell 4 out of 5 prospects. National Sales & Service, Dept. P, Main St., Greenville, Penna.

BE First with newest items—New Products Bulletin Service brings listing 100 newest products. Tells where to get them long before they're on open market. Sample bulletin only \$1.00, details free. American Enterprises, Box 595-P, Grand Central Station, New York 17.

PLASTIC Tablecloth covers, curtains, drapes, baby pants, bowl covers and other plastic articles selling like wildfire! Make big money now! Free details. Write Plastics, Dept. 58-E, 206 N. Fourth, St. Louis, Mo.

SELL Personal Initialed individualized belts, buckles, cap badges, tie holders. 2,000 emblems to choose. Fast profits. Repeats. Write today special outfit offer. Hookfast Specialties, Box 1425, PM, Providence, Rhode Island.

MILLIONS Want foot comfort! Amazing daily profits. Sensational new arch support body-balancer for men, women selling like hotcakes. Experience unnecessary. Complete outfit free. Special deal to distributors, crew managers. Write: Colt Shoe Company, 244-D5 Purchase, Boston 10, Mass.

PLASTONE: Amazing new polishes for floor, furniture, autos. Beautifully packaged. Low priced. Whirlwind seller to stores, gas stations, homes. Fast repeater. Big profits. Unconditional moneyback guarantee. Write for "free sample offer" now. Plastone Company, 2267 PM5 West Chicago Ave., Chicago 22, Ill.

POWER Lawn mowers. Live dealers—agents. Rotacut, M-2004, Ex. Springs, Mo.

ELECTRIC Appliances—toasters, automatic irons, clocks, etc. At wholesale prices. "Hard-to-get" items. Develop profitable house to house trade. General Products, 131-0, 621 Courtlandt, Bronx 51, N. Y.

NEED Money? Start your own business. 137 different detailed plans. Sparetime, home, office. Small investment, immediate returns. Free booklet. Twin Parks Co., Box 4696, Dallas, Texas.

AMAZING Daily profits. Big repeat business. Sell top-quality, lowest-priced men's, women's hosiery, full, part-time. Experience unnecessary. Take orders. We deliver. Complete outfit free. Write Colt Shoe Company, 242-D5 Purchase, Boston 10, Mass.

AGENTS Make big money with quick selling Utility Garment Hanger. Retail for 50c, your profit 25c. Send 30c for post-paid sample. House of Schiller, Dept. P, 180 N. Wacker Dr., Chicago 6, Ill.

AT Home—Your own business making, selling, popular \$1.00 novelties. Cost you 3c to 15c. Everything supplied. Write So-Lo Works, Dept. T-6003, Loveland, Ohio.

REFLECTING Signs, lawn and house numbers. Carl Sign Co., Wooster, Ohio.

FACTORY Agents—dealers. Power lawn mowers. Shipments prepaid. Rotacut, M-2004, Excelsior Springs, Mo.

AMAZING Discovery. Miracle glaze puts brilliant glass-like surface on cars. Free sample, information. Big profits. Miracle Glaze Company, 9714 S. Austin Ave., Oak-lawn, Illinois.

AGENTS—Distributors \$28.00—\$140.00 daily. Flo-Glo plastic linoleum finish. Write, Acme, Box 404, Mount Vernon, N.Y.

SALESMEN, Saleswomen, Agents—Establish your own all year round business. Tremendous demand sweeping country for glass animals and brass miniatures. Sells on sight everywhere—homes, offices, stores, shops; everyone a prospect. Exceptional earning opportunity, large profits, quick turnover. Write for convincing details. P Box No. 531, Roosevelt Park Station, Detroit 32, Michigan.

JUST Out! History of World War II. Huge volume. Popular price. Authentic text. Official photographs. Big profits. Riverside Book Company, Iowa Falls, Iowa.

SELL Electric razors for \$5.00. Your cost only \$4.00 postpaid. Henderson, 1333 Santa Fe Ave., Los Angeles 21, Calif.

MAKE Flexible molds! Few cents each! Cast plaques, novelties, bookends! Free sample! H. Tooker, Hamilton 2, Ohio.

QUICK Money! Men! Women! "You'll love this!" Free details! Battery Shop, Grand Junction, Colo.

MAKE Money in your spare time! Helps furnished. Easy sales. Voluntary repeat orders. Liberal commissions. Write for free wholesale price list today! McGregor Magazine Agency, Dept. P.M.-7, Mount Morris, Illinois.

MAGIC Cleaner—Hotter than a fire-cracker. Saves soap—Big profits—Sample free. Bestco, 5007 Irving Park, Chicago.

BIG Bargains for big profits. Over 100 sensational values. Men's used suits \$2.00, pants 35c, topcoats \$1.25, overcoats \$2.00, shoes 20c. Experience unnecessary. Free wholesale catalog. Superior, 1250-B Jefferson, Chicago 7.

GREETING Card agents, "line up" with "Pines" for bigger, better, quicker profits. Rush name, address on postcard today. Box 32, Flushing 5, New York.

90c PROFIT Each \$1 sale. Sell positive mothproofing solution to housewives, stores, agents. Experience unnecessary. Postal brings details. Kinford, Wayne 3, Penna.

AGENTS: Stamping names on pocket-key protectors. Sample check with your name, address, 25c. Stamping outfits. Emblem checks, check-fobs, name plates. Hart Mfg. Co., 303 Degraw St., Brooklyn, N. Y.

137 COMPLETE Plans for starting own business: local—mail order. Particulars free. Elite Co., 220 Grand St., New York 13.

COLLEGE Students! 100% profits selling costume jewelry. Wm. Morris, Maywood, New Jersey.

AGENTS—Big line including food products. Fast selling premium and bargain deals. Low prices. Send card for big profit offer with gift. Ho-Ro-Co, 2796 Dodier, St. Louis 7, Mo.

AGENTS—300 % Profit selling genuine gold window letters; stores and offices. Free samples. Metallic Letter Co., 438-B North Clark, Chicago.

200 MONEY Making deals. Plans, rare formulas. Schemes. Polio free. Formico Service, Box 572, Dayton, Ohio.

\$3 FIRE Extinguisher; quick sales, wholesale or direct; liberal profits. "Fire-Killer." 109 N. Franklin, Syracuse 1, N. Y.

PLATING Outfits for autoparts, reflectors. Connect to a battery. No tanks necessary. Free booklet and particulars. Gunmetal Co., Ave. N. Decatur, Ill.

FREE Water and our concentrates, makes flavors, lotions, shampoos, 72 products, labels, bottles furnished. Qualco, E-20030 Russell, Detroit.

GOLD Lacquered window sign letters. Large sizes penny each. New foils. Absolutely beautiful. Free samples. Atlas, 544 W. 79th, Chicago 20.

SELL Personalized soap. Name on every cake. Ideal for gifts. Get sample offer. Dunbar Soap, New Brunswick, N. J.

EXCELLENT Sideline for printing and advertising salesmen. Decalcomania name plates in small quantities. Great demand. Also make money applying initials on automobiles. Free samples. "Ralco" XL-Roxbury, Boston 19, Mass.

LITTLE Library of Useful Information. 102 different books. Catalog free. Popular Mechanics Press, 200 E. Ontario St., Chicago 11, Ill.

HIGH-GRADE SALESMEN

ORANGE Concentrate direct from our Florida groves. One quart bottle makes six quarts delicious natural orange drink simply by mixing with five parts cold water. Groceries, foodmarkets, hotels, restaurants, taverns, roadstands, sodafountains, hospitals, resorts, camps, farmers, big buyers. Money-back guarantee. No investment. Protected territory. Salesmen earn \$100.00 to \$200.00 repeat commission weekly. Sunset Valley, 3357 N. Clifton, Chicago 13, Ill.

SELL Delicious candies, nuts, gum. Immediate delivery. Write Casterline, 2031-A Sunnyside, Chicago 25, Illinois.

STARTLING New line. Artistic waitress checks and daily menu sheets. Standard Printed Products, Box 29, Santa Ana, Calif.

SELL Filling stations, sales tested specialties. Good profits. General Sales Co., 915 Brooklyn, St. Louis 6, Mo.

BALLOONS, Fireworks, rubber novelties. Our salesmen make money. Write for territory. Ellswood Distributors, LaJunta, Colorado.

PATENTED Suction cup resilient arm; giant holding power; uses: advertising matter, stores, automobiles, homes, hospital, etc. \$1.00 per dozen. One sale to right company—fortune. L. G. H., 919 South Vermont, Los Angeles 6, Calif.

SALESMAN To sell coin-operated radios in every city. Liberal commissions. Johnstone Co., M-2, 5007 Duval, Austin, Texas.

BIG Profits for wagon-jobbers! Ballpoint pens (\$2.98 retail), leather work gloves, blades, lighters, films, hundreds fast sellers. Free details. Salesmanager, Box 27, Atlanta, Georgia.

AMAZING Daily profits, steady repeat business selling Colt's famous Foot-Balance Shoes direct. Exclusive features make selling easy. 216 styles! Experience unnecessary. Patented Foot-O-Graph assures accurate fitting. Free selling outfit. Colt Shoes, 601-D5 Atlantic, Boston 10, Mass.

\$70.00 WEEKLY Selling twenty boxes greeting cards daily. Eighteen money makers. One earned \$160.00 weekly. Samples on approval. Details. Carleton Distributors, 25-A W. 17th, Bayonne, N. J.

QUICK Profits selling full or part time, individualized buckles, belts, cap badges, tie holders, uniform shirts, caps, ties. Choice of thousand emblems. Sure repeat orders. Easy-selling outfit offer. Write Hook-Past Company, Dept. 12, Roanoke, Virginia.

ADVERTISING Book matches—Cash in on political campaigns—sell Union Label matches. Cuts for all businesses and political parties. Free powerhouse selling kit, low prices. Protection guaranteed on repeat orders. Cash commissions. Superior Match Co., Dept. M57, 7530 Greenwood, Chicago.

AMAZING New zipper shoe sells on sight. Big profits for salesmen. Leads line 200 splendid styles. Territories open. Get free sample outfit. Write, Consolidated Shoe, Dept. S-757, Chippewa Falls, Wis.

START Your own business on our capital. Always your own boss. Hundreds average \$6,000 to \$25,000 annual sales. We supply stocks, equipment on credit. 200 home necessities. Selling experience unnecessary to start. Wonderful opportunity to own pleasant, profitable business backed by world-wide industry. Write Rawleigh's, Dept. E-U-PPM, Freeport, Ill.

AMAZING Discovery. Master Glaze, puts brilliant glass-like surface on cars. Free sample, information. Big commissions. Master Glaze, Dept. 593, 7720 Harwood, Milwaukee, Wis.

POCKET Pal: The all-purpose cutting tool. Wagon jobbers-salesmen. Sell to retailers and jobbers. 50c seller. Steady repeat item. Exceptional profit. Sample 25c. Nelson Manufacturing Company, 222 West Kellogg, St. Paul 2, Minn.

DISTRIBUTORS, Salesmen—Patented cigarette case holder for automobiles, trucks. Fine seller. New. 200% profit. Samples \$3.00 per doz. Literature free. Little Giant Holder Company, 919 South Vermont, Los Angeles 6, California.

STATE Distributors to sell simplified bookkeeping system small stores and public accountants. Sells \$13.50, your commission \$8.00. Exclusive franchise. Write Hawthorne Sales Co., Decatur, Ala.

SELL Calendars full or part time—every business house a prospect—also wholesale to printers—calendars, novelties, sheet pictures. Fleming Calendar Company, 6535 Cottage Grove Avenue, Chicago 37, Ill.

WAGON Salesman—Fast moving carded goods and 10c line. Long profit. Free facts. Peckers, 2717 Dodier, St. Louis 7, Mo.

FREE! Latest Issue Opportunity Maga-zine. Salesman's Guide. Inspiring, constructive. Shows how to earn money selling for others or in your own business. Hundreds postwar opportunities. Send name and describe what you have sold or are selling. Illustrated copy sent free. Opportunity Magazine, 620 N. Michigan, Dept. 17, Chicago 11, Ill.

EDUCATIONAL AND INSTRUCTION

LEARN To "speak in public." Banish fear. Speak fluently with confidence. Easy simplified method. Absolutely guaranteed. Surprisingly low price! Send for free folder. Trissel-Heymann, Publishers, Mason City 1, Iowa.

BIG Pay for you in show business. Learn how to become a theatre manager. Complete course by a manager of big New York theatres for 20 years. Send \$1.00 now to Guide to Show Business, 635 Main St., Hartford, Conn.

TRAIN For aviation mechanics high salaries. This famous school approved for veterans. Immediate enrollment. For information write California Flyers, Inglewood, California.

LEARN Piano tuning. Approved system for beginners. Six simplified lessons. Complete treatise \$5.00. Music Mart, 711 West Greene, Carlsbad, New Mexico.

SLIDE Rule circular and instruction booklet \$2.50 C.O.D. GPB Associates, 1328 Chestnut, 622P, Philadelphia, Penna.

TUTORING Courses in practical mathe- matics and mechanics. \$10.00 either course. Send postcard for details. Math Tutor, Box 1214-B, Indianapolis 6, Ind.

LEARN Foot correction. Six weeks course. Low tuition. Tunis Corrective Foot System, 3041 S. Double Dr., Temple City, Calif.

WANTED: Publication rights on trade, occupation and business training courses. Purchase or royalty basis. Box 1058, Omaha, Nebraska.

ANALYZE Handwriting for profit! Complete outfit \$1.00. 4462-R Germantown, Philadelphia.

"UNCLE Sam" jobs! \$1756-\$3021 year. Men—women. Prepare for next examinations. Veterans get preference. 32 page booklet on Civil Service free. Write Franklin Institute, Dept. H-24, Rochester, N. Y.

TYPING Made easy! Modern course \$1.00 Write: Box 1052, Steubenville, Ohio.

NEW Courses. Self-advancement. Self- improvement. Self-promotion type. Send 25c for "Check-Chart." Mention occupation. Professor. Martin, 406 Panama Bldg., Portland 4, Oregon.

HERBALISM—Complete course in two volumes. 1000 recipes. Home Service, Forestville 2, Va.

CHIROPODY, Masso-Physio-Therapy. Evans natural therapeutics home study courses. Foot correction, adjustments, massage, arch supports, etc. All massage movements, diet, baths, etc. P.O. Box 1195, San Antonio 6, Texas.

HOME Study courses. 300 subjects. Tui- tion \$4.98. Free bulletin. DeVoto School, 35 Vicente, San Francisco 16, Calif.

LEARN Paint, Estimating, blue print reading at home. Approved easy system, prepared by expert. Write for interesting facts. Fred T. Schuttler, 5017 No. Wolcott, Chicago 40, Ill.

LEARN Photo-Retouching. One of the most profitable fields of commercial art. Positions always open. Experts earn \$5000 year. Practical and easily mastered course. Personal instructions. No special ability required. Write at once for full particulars. School of Commercial Illustrating, 3720 N. Penn St., #40, Indianapolis, Ind.

BECOME A Doctor of Psychology or Metaphysics. Teach secret of contentment, happiness. Win degree of Ps.D. or Ms.D. Solve mental worries. Free book. College of Universal Truth, 5153-B North Clark, Chicago.

OPERATE Commercial employment agency. Many more needed nationally. Earn \$5000 upwards annually. Experienced director has low-cost full instruction course. Information free. Hunt, Box 308, Burlingame 21, Calif.

I WANT Your name and address. You want information about lucrative trade. Lidemark, 226 Potomac Ave., Buffalo 13, N. Y.

EDUCATIONAL. Unusual books bought, sold, rented. Bargain catalogue free. Baker, 5509-C Winthrop, Chicago 40.

"HOW To Break and Train Horses"—a book every farmer and horseman should have. It is free; no obligation. Simply address Beery School of Horsemanship, Dept. 1105, Pleasant Hill, Ohio.

HAVE An office. Many earn up to \$5,000-\$15,000 annually. Learn credit-collection agency business by home study course. Write for free bulletin. Franklin Credit School, Dept. 202-F, Roanoke 7, Virginia.

ELEMENTS—Irons, toasters, 55 cents each. Claudio, 67 West 101 Street, New York 25, N. Y.

AMAZING Discovery: teaches you touch typewriting in two weeks. Postpaid \$2.00. Typewriting Review and Speed Builder, \$1.00. Walker, Box 394, Union, N. J.

LEARN Trigonometry better than others. Master method in instructions \$1. Guaranteed. J. Ziemba, 6123 Orchard, Dearborn, Mich.

PREPARE For Civil Service Examination. Pay for course after securing position. Write Free School, Dept. PM4, Kokomo, Indiana.

FACTS, Figures, faces, stick like burrs! New improved Supermemory course. Write Thor Books, ZC-3, Box 1210, Chicago.

3800 USED Correspondence courses. Cat. 25c. EG Mfg., Elmsford 1, N. Y.

USED Correspondence courses and educational books bought, sold, rented, catalog free. Educational Exchange, Henagar, Ala.

HOME Study course, drugless therapy. Free literature. Institute of Drugless Therapy, Tama, Iowa.

AMAZE Others. Add faster than adding machine. Free details. Math Institute, Box 638, Mobile 4, Ala.

GOOD "Used" self-instruction educational books on all subjects bought, sold, rented, exchanged. Satisfaction guaranteed. Complete information and 100-page illustrated-bargain catalog free! Write—Nelson Company, Chicago 5.

USED Educational books on all subjects sold, rented, also bought and exchanged. Moneyback guarantee. Write today for free catalog and details. Lee Mountain, Pisgah, Alabama.

INVESTIGATOR Training. Phillips Secret Service, 1917B North Kenneth, Chicago 39, Ill.

BIG Money rebuilding shoes. Help needed everywhere or start big-income business of your own. Learn practical, sure, easy way in 3 months. Anyone from 18-60 years can learn easily. Approved for GI training. Rush postcard today. Modern Shoe Rebuilding School, Est. 1927, 2935 Belmont, Chicago 18, Illinois.

29 LANGUAGES By Linguaphone. Russian, Spanish, Portuguese—Direct conversational method for mastering any language quickly, easily, correctly at home. Available under G.I. Bill of Rights. Send for free book. Linguaphone Institute, 83 RCA Bldg., New York 20.

LEARN Photo-engraving at home or in oldest, largest school in America. Work for newspaper or establish own profitable business. New Tasope' Photo-Engraving equipment available soon. Write for information. Veterans ask about G.I. training. The Aurora School of Photo-Engraving, Tasope' Bldg., Aurora, Mo.

MODERN Welding school gives thorough training for one of industry's best paid jobs. Experienced instructors. Individual attention. Non-profit institution. Qualified under G.I. Bill. Write for literature and details. Hobart Brothers Co., Box M-1067, Troy, Ohio.

SECRET Investigation. Experience unnecessary. Investigators particulars free. George Wagner, M 125 West 86th, New York.

MEDICAL Laboratory technicians in great demand. We train you in your spare time, in your own home. You can practice while studying. Write for free catalogue. Imperial Technical Institute, Box 973-E, Austin, Texas.

PLAYS, STORIES, MANUSCRIPTS

NEW Writers needed. Nonfiction material demand is booming. Many magazine editors buy features and "fillers" from new writers. Our earn as you learn lessons prepare you to meet their requirements. Experience unnecessary. Reasonable price, unexcelled service. Details, sample lesson free on request. Use postcard. No obligation. Comfort Writer's Service, 200-P S. 7th St., St. Louis 2, Mo.

WIN Fame, success, security writing short stories, newspaper features. New, easy plan shows you how. Write today for exclusive details. Writer's Institute, 4-M So. 15th St., Philadelphia 2, Penna.

POEMS Wanted for publication consideration, details free. J. Barnes, Publisher, Box 490 Times Sq. Station, New York 18, N. Y.

I WANT New writers to cash hundreds of checks for \$1 to \$100, offered each month. The easiest way to write for pay. No previous experience necessary. Send for free details. No obligation. Saunders M. Cummings, 467-M Independence Bldg., Colorado Springs, Colo.

BUSINESS SERVICE

CHICAGO Address. Your personal mail received and forwarded. \$1 monthly. Mail Organization, 3439-P Michigan, Chicago 16.

5000 GUMMED Labels, 2"x1 3/4", postpaid \$5.50. J. Barnes, Publisher, Box 490 Times Sq. Station, New York 18, N. Y.

NEW York mail-address. Receiving, forwarding, Confidential. Free details. Arlington, 131-H West 42nd Street, New York 18, N. Y.

SAVE—Buy direct from manufacturer. Any article. Guaranteed lists. Pittshire Research, Box 90, Pittsfield, Massachusetts.

TO Whom it may concern: We will represent you in all principal cities of the world. Personal or business assignments \$1 per hour. James W. Farley, Citizens Bldg., Cleveland 14, Ohio. Note: Would appreciate hearing from someone who wishes to enter this business in your city. Will send you assignments immediately. References exchanged. State qualifications.

SPECIAL SERVICES

PERSONAL Poetry is now being offered the public. Written under your instructions by outstanding literary artist. Inquire: Hillscript Studios, 6427 Begole, Detroit 10.

CURRENT Information on any city in California only \$1.00. Box 8436, Los Angeles 16, California.

THAT "Hard-to-find item"—we'll help you locate it! Send 25c coin for supplier's name-address. Wyterce Co., Dept. PM15, 366 Madison Ave., New York 17.

SEND Me \$2.00, and I will photostat and return two copies of any valuable paper. 24 hour service. Wilbur E. Christman, Greenwood Lake, N. Y.

\$2.00 MONTHLY Maintains Washington D.C. business, personal mail address. Letters reforwarded daily. Hawkins, 1300-G Taylor.

LETTERHEAD Designing. Highest quality artwork. 200 attractive designs \$1.25. Samples free. Jacobson, 3510 Palmer, Chicago 47.

GOOD "Used" self-instructional books on all subjects bought, sold, rented, exchanged. Satisfaction guaranteed. Complete information and 100-page illustrated bargain catalog free! Write—Nelson Company, Chicago 5.

CARTOONING, COMMERCIAL ART, SHOWCARD WRITING, SIGN PAINTING

PROFITABLE New art-advertising business. Information free. Fogerty, 49 Longview, Fairfield, Conn.

CARTOONIST'S, Gagster's, "Cyclopedia," 3c, Kleinman, 25-31-B 30th Road, Astoria 2, N. Y.

EARN Money evenings, copying and duplicating comic cartoons for advertisers. Adservice, Argyle (1-B), Wisconsin.

HOW To draw animated cartoons. New, self-instruction home study course. 335 illustrations! 69 problems! Learn how to build animation board; make human and animal figures walk, run, fly; animate expressions; backgrounds. Tricks and secrets never disclosed before. Basic career book in animation art for movies and television. Send cash, money order or check for \$2.50 complete, postpaid. Personally autographed by author. Alvin Epstein, 405 Atlantic Bldg., Washington, D. C.

LEARN Showcard writing at home in spare time. Fascinating, lifetime business of your own. No special skill needed. Free information. Sherwood Publishing Co., Dept. 106, Irvington 11, N. J.

KU-KUL-O-GRAPH—Amazing new device. Draw beautiful designs, patterns without art knowledge or experience. Children as well as adults just wild over this invention. Sample designs and literature free. Nelson Manufacturing, 948B First, Woodburn, Oregon.

MAKE Extra money painting signs. Easily, quickly. \$1.00. Jantzen, 252 West New York, New Jersey.

"HOW To Make Money With Simple Cartoons"—a book everyone who likes to draw should have. It is free; no obligation. Simply address Cartoonists' Exchange, Dept. 95-C, Pleasant Hill, Ohio.

CREATE Original pictures; don't copy. New painting method for everyone shows how. Colorful details free. Weidner, 1321 Wellesley, Los Angeles 25, California.

ART Students—Write for commercial art talent test. Art Institute, Box 8066, Dallas 5, Texas.

SIGN Painting taught at home by an old master. Ben Kerns, Box 812, Greenville, S. C.

CHALK Talks. Laugh producing program. \$1.00. Catalog 10c. Balda The Cartoonist, Oshkosh, Wisconsin.

ADVERTISING AGENCIES, LETTER WRITERS, FOR ADVERTISERS

ADVERTISE: 24 Words, 40 newspapers \$3.50. Lists free. Advertising Bureau, 229-C Dixon Blvd., Uniontown, Penna.

NEW Mailing lists of all medical (M.D.) specialties. \$5.00 per 1,000. State your needs. Cole, Room 213, 3937 Main Street, Kansas City 2, Missouri.

SEND For prices of mailing lists, 1412-13 Great Northern Building, Chicago 4, Illinois.

MAIL Order "Monitor," leading mail trade magazine for mail order business operators, beginners. Read it regularly with profit. Copy 25c, none free. No stamps. "Monitor," 10029 85th Ave., Edmonton, Alberta, Canada.

NEW Names! Just completed white, negro school teachers, automobile owners, births, etc. \$7.00 1000. Trial 300 \$1.00. Business Service, 1101 Kings Highway, Shreveport, Louisiana.

ENJOY Big mail sales. Your ads, letters, folders, etc. that sell! Written by Faultless Advertisers, P-3439 Michigan, Chicago 16.

FREE! 1947 Advertisers Rate and Data Directory. 52 pages! E. H. Brown Advertising Agency, 20 N. Wacker, Chicago 6.

ADVERTISERS: Mail order ad covering United States—2,000,000 circulation—\$21.00 inch. Classified ad, 24 words, 20 metropolitan Sunday newspapers—\$25. Magazine, newspaper, mailing-list ratebook, adwriting assistance—free. Chicago Advertising Agency, 20-PM West Jackson, Chicago 4.

ADS Placed in out of town newspapers and magazines. Low rates. Catalogue free. Ideas that pay. Baker Advertising Agency, Successors Ankrum Agency, 189 W. Madison, Chicago 2.

INCH Display advertisement Mailorder World, year \$24. Wood's Popular Services, Atlantic City, New Jersey.

ADVERTISING Service, art work, C. Sanford, 5029 Maple, St. Louis, Mo.

ADVERTISERS! Reach nearly 18,000,000 readers. 25 Sunday national key newspapers, 18 words, \$42.25. "Terrific pullers." 20 popular newspapers, \$8.50. "Free booklet." Special—One inch display 2,600,000 circulation. \$32.90. Newmark's Advertising Agency, (Established 1893) 217-7th Ave., New York 11.

MAILING Lists, certified, productive, inexpensive, \$5.00 1000. Homeworkers, agents, buyers, etc. Write Dixie Service, King, N. C.

24 WORDS in 64 weeklies \$4.96. H. J. Darnell, 730 Hays, Jackson, Tenn.

RUBBER STAMPS AND OFFICE SUPPLIES

3 LINES 40c; Pads 35c; signatures \$2. Stamprite, Wauwatosa, Wis.

PROMPT Service. 1 line 40c, 3 lines 60c. Guaranteed. Stampcraft, 1707 Virginia Street, Gary, Indiana.

KNOB Handle, 1 line 35c, 2—45c, 3—55c. Stamp Works, Centerport, N. Y.

RUBBER Stamps. Buy direct from manufacturer. Literature free. Lee-Vall Press, Box 1242, Indianapolis 6, Indiana.

TYPEWRITERS, DUPLICATORS, OFFICE DEVICES

MAKE Inexpensive home duplicator. Write. Wilhites, 927-D Palm Dr., Colton, Calif.

TYPEWRITERS Now available. Standard makes—Remingtons, Royals, Smiths and Underwoods, \$59.50. Factory rebuilt and guaranteed. Pruitt Office Machines, Inc., 307 W. Monroe Street, Chicago 6, Illinois.

"PRINTOMATIC" Selffeeding post card stencil printing duplicators \$9.50 up. Office size duplicators. Speedoprints, Hilcos, Excellographs \$33.41 up. Literature free. Pittsburgh Typewriter Supply, 336-WK Fourth Avenue, Pittsburgh 22, Penna.

RECONDITIONED Typewriters, mimeograph, multigraph printing devices, appliances, supplies. Catalog. Dixiegraph Service, King, N. Carolina.

PRINTING, MULTIGRAPHING, MIMEOGRAPHING, GUMMED LABELS

100 GOVERNMENT Sized post cards, \$1.00. Name-address printed, 200 business cards \$1.00, free card case. Kerman Press, Dept. M, 40 W. 17th St., New York City.

100 TWO-COLOR Letterheads \$1.25. Samples. D'Yarmett Printing, Newark, Ohio.

FIFTY Sheets, fifty envelopes, printed your name, address, 75c postpaid. Atlantic, Box 653-H, Rock Hill, S. C.

250 8 1/2 x 11 LETTERHEADS And 6 3/4 envelopes \$2.75. Advance, Strasburg, Ohio.

MIMEO. Multigraphing, specializing in sales letters. Write for details. Acme Duplicating, Columbus 6, Indiana.

200 8 1/2 x 11 RIPPLE Finish letterheads \$2.00. Shults, 1703 Kaley, South Bend 16, Ind.

GOOD Printing any amount. Estimates free. O'Reilly, 31037 Detroit, Pittsfield 3, Maine.

1000 HIGH Quality business cards, \$2.95. Up to 25 words carefully and correctly printed. Satisfaction assured. Prepaid. Cash or c.o.d. Walker's, Box 1298, Amarillo, Texas.

150 HAMMERMILL Letterheads \$1.00. Envelopes same. Race Printing, Hudson, New York.

MAY Special, 500 8 1/2 x 11 letterheads, 500 6 3/4 envelopes, printed, \$4.00. H. J. Vrazel, Yoakum 1, Texas.

1,000-3 1/4 x 4 1/4 GUMMED Labels, \$3.75 postpaid. 75 word limit. Schultheis, Box 449, Irwin, Penna.

250 LETTERHEADS \$1.75. Envelopes same. Mallo, 767 Leith, Flint 5, Mich.

COMBINATION Mimeographed letterhead and letter, 100-11.35. Samples free. Martin Mimeo, 3212 Harper, St. Louis 7, Missouri.

QUALITY Printing: Business, personal stationery. Prepaid delivery. Samples free. Mero Products, 100 Morrison, Punxsutawney, Penna.

STATIONERY. Laundry—gas station lists, garage repair order, etc. Free estimates. Southern Standard Publishing Co., Dept. M, Panama City, Florida.

NEW. Used, rebuilt presses, type, supplies. List 3c. Buffalo Press Co., 656 Smith, Buffalo, N. Y.

QUALITY Offset printing at low prices. Speedy dependable service. Free samples. ABC Press, 1041 Eighteenth Avenue, Newark 6, N. J.

FINE Printing for every use. Samples. Treaster Printing, Milroy, Pennsylvania.

PHOTO-OFFSET. Printing, multigraphing. Samples free. Mango, 555-A, South 20th, Newark 3, N. J.

BUSINESS Cards to booklets. Correctly printed. Ace Printing, Brentwood, Md.

1000 FOUR Line stickers, \$1.00. Printing, mimeographing, best and cheapest in the country. Imprint, Emporia, Kansas.

500 3/4 x 2 1/4 FOUR Line gummed stickers, 35c. Moritz Printery, Saginaw, Mich.

1000 BUSINESS Cards \$2.50. prepaid. Reliable Print Shop, 901 E. Jefferson, Louisville 6, Ky.

MIMEOGRAPHING. Highest quality. Reasonable. Letter Service, Box 1849, Chicago 90, Illinois.

SEND 10c Now, for our 36-page 1947 pricelist—refunded first order. McCall Press, 1326 South 27th, Omaha, Nebraska.

BETTER Grade printing reasonable. Estimates on anything. Economic Press, Leonia, N. J.

MIMEOGRAPHING—Letters, pricelists, formulas, instructions. Lowest prices. Lem's Letter Shop, 5710 Stanton, Detroit 8.

PRINTING OUTFITS AND SUPPLIES

"PRACTICAL Printers"—The printers handbook, 50c. Steiner's, 32 Rockwell Road, Danbury, Connecticut.

PRINTING Press complete, assembled, guaranteed to print \$1.00. Samples of work, details dime. Berry's, Box 482, Pleasantville, N. J.

PRINTERS Galley—quarterly magazine. Subscription, 25c. Steiner's, 31 Rockwell Road, Danbury, Connecticut.

BARGAINS—Presses, type, supplies. Send stamp, 8 Walden, Cambridge, Mass.

MAKE Your own plastoplate printing cuts. Simple, easy process. Plastoservice, Argyle (1-A), Wisconsin.

"BABY Calculator" vest pocket, metal adding machine. Adds, subtracts, multiplies, divides. \$2.50. Afco Products Company, Lexington 73, Mass.

HAND Presses, cutters, cabinets, equipment. Your needs? Box 918, New York 8.

CUTS—Make real halftones, line cuts yourself! Samples 25c. Particulars free. Rapid Chemical Service, Edwardsville, Ill.

PRINT At home—Send 10c for catalogue—presses, type, supplies. Barnhard Co., 6 Columbia St., Newark 5, N. J.

PRINTING Equipment, type and supplies. Send stamp for details or dime for complete illustrated supply book. Kelsey Inc., X-11, Meriden, Conn.

PRINTERS. Make a quick-etch etcher for cuts, halftones. Details. Charles Medlock, Box 256C, Goodland, Indiana.

HOME-MADE Presses. Proofs free. Riegel, 1111 Harrison, Phila. (24), Penna.

INEXPENSIVE Home-made printing press. Details free. Novelty Shop, Downsville, Louisiana.

PATENT ATTORNEYS

INVENTORS—Patent laws encourage the development of inventions. The Rules of Practice of the U. S. Patent Office advises—unless an inventor is familiar with such matters—that he employ a competent registered attorney, as the value of patents depends largely upon the skillful preparation of the specifications and claims. Write for further particulars as to patent protection and procedure and "Invention Record" form at once. No obligation. McMorror, Berman & Davidson, Registered Patent Attorneys, 134-G Victor Building, Washington 6, D. C.

PATENT Protection—The U. S. Patent Office recommends—"an applicant is advised, unless familiar with such matters, to employ a competent registered Patent Attorney, as the value of patents depends largely upon the skillful preparation of the specifications and claims." Steps to be taken in obtaining patent protection will be sent upon request. Victor J. Evans & Co., 231-E Merlin Building, Washington 6, D. C.

INVENTORS. For "Record of Invention" form, contact Carl Miller, Registered Patent Attorney, Woolworth Building, New York.

"INVENTOR'S Guide" free on request. Frank Ledermann, Registered Patent Attorney, 154 Nassau St., New York 7, N. Y.

PATENTS. "Proof of Invention" folder mailed without obligation. E. E. Vrooman, Registered Patent Attorney, 871 Woodward Building, Washington 5, D. C.

INVENTORS: Without obligation, write us for information as to what steps an inventor should take to secure a patent. Randolph & Beavers, Registered Patent Attorneys, 21-C Columbian Bldg., Washington 1, D. C.

INVENTORS: Write for free brochure "Evidence of Invention." Labiner, World Building, New York 7.

C. A. SNOW & Co., M-427 Snow Bldg., Washington 1, D. C. Registered patent attorneys. Established 1875. Literature mailed on request.

PATENTS—Trade marks. Irving L. McCathran, 315 McLachlen Bldg., Washington 1, D. C. Registered Patent Attorney.

PATENT And Trade-Mark Practice before U. S. Patent Office. Validity and infringement investigations and opinions. Booklet and form "Evidence of Conception" forwarded upon request. Lancaster, Allwine & Rommel, Registered Patent Attorneys, Suite 411, 815-15th Street, N.W., Washington 5, D. C.

FOR INVENTORS

INVENTORS—Victor J. Evans and Co., established 1898, has a staff of registered patent attorneys, available to represent inventors in the preparation and prosecution of their cases before the Patent Office. Detailed information and the steps to be taken to obtain patent protection will be furnished upon request. Victor J. Evans & Co., 232-E Merlin Building, Washington 6, D. C.

DRAWINGS Of your ideas engineered to modern practices by experienced designers. Absolutely confidential. Free estimate of drawing charges by return mail. Machine Design Service, 416 Madison Avenue, Rahway, New Jersey.

FOR Men with hobbies—2000 booster assemblies for aircraft turrets manufactured by General Electric, original cost \$131.65, available now at \$1.00 each. Buffalo Housewrecking and Salvage Company, 489 Walden Avenue, Buffalo 11, New York.

INVENTORS! Have you good, patentable ideas? Write Patent Agent Metzler, 11 W. 42nd, New York.

INVENTORS—Patent laws encourage the development of inventions. The Rules of Practice of the U. S. Patent Office advises—unless an inventor is familiar with such matters—that he employ a competent registered attorney, as the value of patents depends largely upon the skillful preparation of the specifications and claims. Write for further particulars as to patent protection and procedure and "Invention Record" form at once. No obligation. McMorror, Berman & Davidson, Registered Patent Attorneys, 134-G Victor Building, Washington 1, D. C.

PATENTED. Unpatented inventions promoted. M. Joyce Humphries, 1424 Landtitle, Philadelphia 10, Penna.

IF 5,000 People in America can use or benefit from your idea, I guarantee its sale at your price in less than sixty days. Don't show your idea to me or anyone else. Write for free information. George Pearce, 47G Bartholomew Street, Peabody, Mass.

HIGHEST Royalties and cash for your inventions when we market them. Free particulars without obligation. Universal Marketing Co., Dept. 5M, 126 Lexington Ave., New York 16, N. Y.

INVENTORS; Jigborer layouts, holes, lines, angles, centers. Flat or three dimensions. Sensible prices. Mitrasonic, Torrington, Connecticut.

WANTED By live manufacturer. Home work shop and hobby gadgets—devices, ideas for tools. We manufacture and sell. Do not send models. Simply send description and illustrations of what you have. Warner Electric Co., 1512 Jarvis Ave., Chicago 26, Ill.

THERE is absolutely no legal way to protect an invention without a patent. Learn how to protect yours and receive selling help. Buyers waiting. I save you considerable in patent application cost. Invention record free. Charles Morton, Patent Broker, 11 West 42nd Street, New York.

SCALE Models, Inc. Consultant engineers. Development and construction of mechanical, electrical, electronic and decorative models for inventors and industry. 104 Penn Street, Brooklyn 11, N. Y.

PROVING Invention date, your problem? Use ironclad Aabberly Routine. Out-ranks registered letters, "copyrights," other dangerous makeshifts. 25c for the special copyrighted form. No comparison at all with free invention forms. For dependability guaranteed next to Patent Pending! No disclosure to me or other strangers! Preliminary searches, drawings, other services. Rely on 31 years "know how." Aabberly, Patent Engineer, 301 Woodward Building, Washington.

IF You have an idea, invention, patent, consult us! Ideas developed, products designed and engineered, drafting, model making, patent searches, market tests, disposing of your inventions. Request our pamphlet. Consultation without charge. Eio Developing Company, 29-28 41th Avenue, Long Island City 1, New York.

LITTLE Library of Useful Information, 102 different books, Catalog free. Popular Mechanics Press, 200 E. Ontario St., Chicago 11, Ill.

INVENTORS And manufacturers. Save 75% on special and regular gears. You provide easily made blanks. We cut the teeth. Folder free. Write. Gorrell & Gorrell, Haworth, N. J.

YOUR Ideas developed. Send sketch, write for information. Confidential. Edwards, 1210 Griggs St., S.E., Grand Rapids 7, Michigan.

HOW I made gadget inventing pay. Detail booklet \$1.00. W. C. DeWeese, Del Rio, Texas.

INVENTORS: You save up to 300% when dealing with your patent searcher direct. Complete search with patent copies \$6.00. Reports mailed in 5 days. Invention protection forms free. Write Raymond L. Smith, Patent Searcher, 703-M Albee Building, Washington 5, D. C.

INVENTORS: Avoid unnecessary expense. Write for free booklet explaining how our consulting and advisory service can assist you in deriving greatest profit from inventing. Institute of American Inventors, Dept. 40-A, 1926-Eye St. N.W., Washington 6, D. C.

"INVENTOR'S Guide" free on request. Frank Ledermann, Registered Patent Attorney, 154 Nassau St., New York 7, N. Y.

THE Inventor who believes he has a new and useful invention, and needs advice, should consult a competent registered patent attorney. Without obligation, write for full information on how to secure patents and trademarks. Randolph & Beavers, Registered Patent Attorneys, 11-E-Columbian Bldg., Washington 1, D. C.

I SELL Patents. Established in 1900. Charles A. Scott, 773PM Garson Ave., Rochester, N. Y.

INVENTIONS WANTED

CASH For your ideas. Free booklet. William Barker, Elizabethtown, Kentucky.

TOY Manufacturer seeks patents, inventions, ideas. Kurt J. Stein, 1525 West 11 Street, Brooklyn 4, New York.

WANTED—Practical inventions of all classes by manufacturers. John D. & Son, Dept. PM-5, Box 3213, 285 Howard Ave., Bridgeport 5, Conn.

EARN Up to \$2,000 year, inventing simple items for special cash markets, ideas only. No patents. Hendrickson, Argyle (7-B), Wisconsin.

FREE Legal forms! Send \$1.00 for directory listing names, addresses, specifying inventions manufacturers will buy. Invention Research, 342-PME Madison Avenue, New York 17.

WANTED Patentable ideas. Write A. Rehkop, Box 4805, San Francisco 1, Calif.

WANTED: Practical inventions suitable for sale through 5c-\$1.00 stores, drugstores, cigar stores; also sportsmen's items of all kinds. Write Matt, 1412-P, Great Northern Bldg., Chicago 4.

PATENTS—Wanted by manufacturers. Write Universal Guaranty Company, Lakewood, New York.

INVENTIONS Wanted. Patented or pending. Inventors Exchange, Dept. B, Hartford 1, Connecticut.

INVENTORS: Hundreds of manufacturers have requested our assistance in locating marketable new products. Complete information, free. Institute of American Inventors, Dept. 40-D, 1926-Eye St. N.W., Washington 6, D. C.

PATENTS FOR SALE

PATENTED New adjustable electric soldering iron, hobby craft type, single hand operation. C. O. Barstad, 530 McKnight Bldg., Minneapolis.

INTERCHANGEABLE Auto battery cells connect automatically. John Anderson, 4929 Henderson, Chicago, Ill.

INVENTORS: Test the commercial value of your patented or unpatented inventions, quickly and inexpensively. Write for free information. Institute of American Inventors, Dept. 40-B, 1926-Eye St. N.W., Washington 6, D. C.

MANUFACTURING

EXPERIMENTAL Work, models. Reasonable. Nelson Manufacturing, 948 First, Woodburn, Oregon.

MACHINES. Machine parts, inventions, designed, built. Louis, 86 Walther Ave., Ridgewood, N. J.

MACHINING—Models, tooling, production. Eastside Mfg., Box 1585, Rockford, Illinois.

WANTED: Manufacturing or assembly of small products, light press and bench work, drilling, milling, etc., on job basis or cost plus. Jewel Industries, P.O. Box 889, Canton, Ohio.

MODELS—Small lot manufacturing. Metals, plastics, etc. Milburn, Burlington, Kentucky.

A BRAND New inventor's service. Write for information. J and M Company, Burlington, Kentucky.

MODELS Developed and built. Small run manufacturing. The Thompson Engineering Co., 206-C Winchester Bldg., Grand Rapids 2, Michigan.

MODELS AND MODEL SUPPLIES

MODELS. Mock-ups, architectural, process and plant layout, sales, advertising and visual training aids. Howland, 28 North Walnut, Troy, Ohio.

STEAM Boiler for model engines, withstands 500 lb. pressure. Complete with pressure gauge and all fittings. Postpaid \$22.50. Ross, C68 West Broadway, New York, N. Y.

BUILD. Sail for fun, profit! Authentic 2½' 3 masted schooner. Easy, inexpensive. \$1.00 brings complete illustrated instructions. Milton Sailing Models, Dept. D-5, Box 466, Rye, N. Y.

RAILWAY Models, complete informative catalog HO and O gauge. 128 pages. 35c. Walthers, 247 Erie, Milwaukee, Wisconsin.

PLASTIC Miniature city, three kits \$1. Johnson, 366 Freeman, Long Beach, Calif.

STEAM Engine, precision made to scale from brass and bronze. A practical working model that performs like its full size brother. Complete, fully assembled—ready for steam. Overall size 6" by 3"; weight 2¼ lb. \$17.50 postpaid. Ross, C68 West Broadway, New York, N. Y.

PATENT Models built to your specifications. Wood, metal, plastic. Expert workmanship. Rogay Models, 3818 Beecher St. N.W., Washington 7, D.C.

PHIZZ Powered model race cars, \$1.50 postpaid. Other models. Ridgway Model Hobbies, Box 7637 Sta. D, Kansas City, Mo.

MOTORS—Kits (Aeroplanes, racing cars, boats, model R.R.)—Tools. Everything for the hobbyist. Catalog 15c. Westchester Hobbies, Inc., 259 Mamaroneck Ave., White Plains, N. Y.

GAS Modelers! Powerful midget ignition coil weighs only 2/3 ounce. \$2.00. Electric Miniatures, 1607 S. Western, Los Angeles 6, Calif.

SHIPS In bottles, easy to build. Instructions. 25c. Steiner's, R.F.D. 5, Danbury, Connecticut.

FUN Building models—Airplanes, trains, ships. Everything furnished. Giant catalog 10c. Ben's Hobby Shop, 72 West Washington, Chicago 2, Illinois.

BALSA Wood. Generous supply \$1.00. Price list free. Sanlader, Manitowoc, Wis.

MIDGET Permag motors. 12-27VDC. 80-250RPM. Reversible. \$2.35, new. Free list. Erec, 1006 Hewitt, Everett 1, Wash.

SHIP Models and yacht supplies complete. Large 64 page catalogue 30c. Bill Wild's, 510 East 11 St., New York City 9.

LANDLOCKED Sailors! Here's a beautiful, richly illustrated, fully descriptive catalogue of famous model ships—whalers, slavers, corvettes, etc., authentic in every detail. Send for it today. Only 10c. Halesite Yacht Service, Inc., Halesite, Huntington, N. Y.

SHIP and Yacht model fittings; blueprints. Send 25c for illustrated catalog No. 20—listing hundreds of items. A. J. Fisher, 1002-1 Etowah Ave., Royal Oak, Mich.

BRASS Gears and model supplies for the inventors. Send 10c for catalog. Pierce Model Works, Tinley Park, Ill.

BIG Illustrated model engine catalog 10c. Active Products & Supply Co., 53 W. Jackson, Chicago 4.

MINIATURE Steam locomotives, ¼", ½", ¾" scales. Castings, parts, rail thorough drawings with instructions. Catalog 25c. Little Engines, Wilmington, Cal.

HEMOCRAFTSMEN

JAGERMIX Water Plastic is the all around repair material you have been looking for. Has hundreds of uses around home, hobby, cabinet and fixit shops. Repairs wood work. Excellent for casting, modeling, pattern making. 5 lbs. only \$2 postpaid in U.S. L. A. Jagerson Co., 1201 Loma Long Beach 4, Calif.

CUSTOM-MADE Jewelry. Profitable hobby or business. Copyrighted laboratory manual starts you working with precious metals. Designing, pattern making, casting by proven methods using simple equipment. \$1.00 refundable in seven days if dissatisfied. Hobby Craft Research Bureau, Suite 312-A Guaranty Bldg., 6331 Hollywood Blvd., Hollywood 28, Calif.

MAKE Your own jewelry! Findings in metal and plastics; earwires, pinbacks, cameos, stones, beads, clasps, sprays, combs, hairbars, plastic and metal chains. Hobby Art Corp., Dept. 7, P.O.B. 276, New York 18, N. Y.

ELECTROPLATING Service; chrome, silver, gold, bronze, brass and tin plating on all metals. Send article or description; we will quote prices. Master Silverplaters, 2031 Caniff, Detroit 12, Michigan.

SEA Shells and all parts for making pins, earrings, novelties. Instructions free with \$2.00 kit. Free catalogue. Herbert Diamond Co., Box 4619, Miami 28, Fla.

KNOCKDOWN Cedar chest lumber veneers. Free price list. Giles-Kendall, Huntsville, Ala.

35 PATTERNS Of action pull toys, trucks, carts, toy furniture, etc., \$1.00. Continental Homocrafters, 907 Birch, Eau Claire, Wisconsin.

12 ORIGINAL Full size what-not patterns \$1. Albright Service, 6901 Railroad Ave., Omaha 7, Nebr.

CANADIAN Hobbycraft Magazine. New! Different! Sample 25c. 22 Woodlawn East, Toronto, Canada.

LEATHERCRAFTERS! Send for free catalog listing leathers, tools, supplies. Kit Kraft, 1607 S. Western, Los Angeles 6, Calif.

LAWN Chairs—Enjoy their cool comfort. Plans of 5 styles, \$1.00; 10, \$2.00. Summer-craft Studio, 42 Vernon St., Newton 58, Mass.

WOODMISER Makes money from plywood scraps, actual patterns. Quit buying circulars. Winkler, 2822 Harney, Omaha, Nebraska.

PIANO Hinge. 1½" width extruded aluminum. Two twelve inch lengths \$1.00 postpaid. Thayercraft, 3925 Tuller Ave., Culver City, Calif.

MOCCASINS—Elkskin. Easily assembled kits. Mens', boys', womens'. Popular colors and sizes. Postcard brings details. Kit Kraft, Dept. MM, 1607 S. Western, Los Angeles 6, Calif.

HERE Is something new. Gracefully curved birds made out of cowhorn. Complete instructions with drawings 50c cash or stamps. H. Harrison, 14303 Strathmore, East Cleveland 12, Ohio.

LEATHERWORKER'S Bible. Every leatherworker should own this completely illustrated catalogue combined with valuable instructions and information. Largest in this field. Actual leather samples. \$1.00 postpaid. Satisfaction guaranteed. Artcraft Leather of California, 271 Twelfth St., Oakland 7, California.

SHELLCRAFT Instruction free! 450 rare Caribbean shells including findings making \$6 shell jewelry. \$1. Satisfaction guaranteed. Shell Company, Miami 36, Florida.

BIG Money selling leather goods. Lace yourself. Sample \$1. Free catalogue. Donald Saugstad, Statesan, Wisconsin.

EXOTIC Veneers—Burls of cherry, walnut. Crotches of mahogany, walnut. List available. Sedle Company, P.O. Box 7161, New Orleans, La.

JIG Saw patterns. Full size, ready to use. Artistic Gothic wall shelf 20" high; corner shelf 17". Both for 10c. Jig Saw Guild, 117-JM Worth Street, New York 13.

55 PLANS, Projects, craft, Wood, plastic, shellcraft, etc. \$1.00. Craft Co-op., 3928 Dumaine St., New Orleans 19, La.

"HOMECRAFTSMEN"—Dime brings National Bulletin. Timely, instructive. Crossville 151, Tennessee.

CRAFTSMEN. Investigate this money maker. Be first in town. New sensational fascinating aquarium. Sells on sight, big profit. Plans \$1.00 cash or money order. Box 465, Studio City, Calif.

LEATHERCRAFTSMEN, valuable information for bigger profits. Also where to obtain all materials. 35c. Donlee, Statesan, Wis.

HARDEN Steels expertly, safely. Durable ingredients with instructions \$1. Roman Nejski, Box 185, PHSM57, Ft. Wayne 1, Indiana.

BIRDHOUSES—Ready to assemble. Wren \$1.50. Bluebird \$2.00. Patterns 25c. Jepson, 95 Liberty Ave., Belleville 9, N. J.

MASONITE Mill ends. 10# \$1.00, plus postage. Carl Sign Co., Wooster, Ohio.

JOIN Dixie shell club. Year's membership, shells, instruction book, dollar. Kits, dollar up. Catalogue free. Dixie Shell Service, Lakeland, Fla.

LEATHERCRAFTERS: Ready made leather projects simple to complete are fully illustrated in our 1947 catalog of projects, tools, hides and accessories. Write for free catalog. Ester Leather Company, 145 St. Paul St., Rochester 4, N. Y.

INSTALL Inexpensive domestic fire alarm. Details free. McVeigh, Box 3724, Kerchevale Station, Detroit 15, Mich.

STAMPED Steel wheels for small toys, models, etc. Priced as low as 5 cents each. Send for list. Also small stampings made to your specifications. Richard C. Judson, 4554 Eastway, Toledo 12, Ohio.

LEATHER Designs on plastic eliminate tracing. Introductory offer \$1.00. Sample 10c. Lampkin Artcrafts, Box 641-M, Culver City, Calif.

JEWELRY Findings, imitation gems, Lucite, Plexiglas, all types of chemicals, ideas, for pleasure or profit. All in the big illustrated Craftsman's Catalog. Everything for the jewelry and plastics hobbyist, at a cost that everyone appreciates. You can't do without this catalog long. Send 25c now, today. (Refunded on first order.) Pittshure Plastics, Box 90, Pittsfield, Massachusetts.

LEATHER Designs. Fifty belts, \$1.00. Twenty billfolds, \$1.00. Ten handbags, \$1.00. Lampkin Artcrafts, Box 641-M, Culver City, Calif.

MAGNESIUM Dowmetal for lightweight construction available miniature structural shapes and .005 to .064 sheet. Dowmetal can be joined with our special adhesive. See your dealer or write for size and prices to Sims & Associates, Dept. M, 464 Neff Road, Grosse Pointe, Michigan.

SEA Shells, supplies. Wholesale catalogue. Tropical Shell Company, P.O. Box 1509, Sarasota, Florida.

PLYWOOD Cabinet kitchen plans 25c. Playne Cabinets, 4617 Johnson Avenue, Western Springs, Illinois.

SPECIAL Offer: 70 full size toy, novelty, and lawn ornament patterns only \$1.00. Lynds, Medway, Mass.

70 PATTERNS Lawn ornaments and novelties. \$1.00. Modern Woodcraft, Saginaw, Michigan.

FREE Instructions, shell jewelry. Werts, 1429-56th Avenue, Oakland 3, Calif.

SHELLS, Plastics, findings. Lowest prices. Free catalog. Frances Jones, Box 251, Sarasota, Fla.

CERAMIC Jewelry supplies, bar pins, ear screws, for ceramic and woodworkers; also glass and seashell assemblers. Free catalog. Philadelphia Badge Co., Dept. B-1, 1007 Filbert St., Philadelphia, Penna.

EXPERIMENTERS! Interested in electrical, mechanical devices from war surplus? List free. F. Siefke, Box 18, Station E, Buffalo 11, N. Y.

MAKE Shell jewelry—for gifts, as a hobby or start a business. Free catalogue and price list. Complete illustrated book of instructions 75c. Florida Shellcraft Company, Box 1840, Sarasota, Florida.

SHELL Jewelry supplies. Wholesale only. McFarland Plastic Co., Sarasota, Fla.

MAKE IT YOURSELF

PACK Film camera. Anyone can build. Nontechnical, illustrated instructions \$1.00. Free information. Harry Frahm, San Ysidro, Calif.

STEAM Or air engine. 3/4 lb. brass and steel. No castings. Blueprints \$1.50. Engine complete \$3.98. O. Warner Machine Works, 18833 Pacific Hwy So., Seattle 88, Wash.

BUILD Concrete block machine. 2 blocks per minute. Build concrete mixer. Easy, inexpensive. Details free. Horne, 206 West Wilder, Tampa 3, Florida.

MAKE Novel, 2-purpose bookends. 9 prints 25c. Frank's Print Shop, 1111 Center, Joliet, Ill.

HOT Water free—from sunlight. System efficient any locality year 'round. Standard materials, easily built, low cost. Facts free. Solar Water Co., Box 175, Dept. L, Coral Gables, Florida.

BUILD Your own modern overhead garage door of weatherproof plywood. We furnish hardware; plans, inexpensive. Gardo Engineering, Dept. 1A, 3819 Riviera Drive, San Diego 9, Calif.

BUILD, Twice as good, and for half price. Plans \$1.00. Details free. W. Denham, Box 265, Murray, Ky.

BUILD Your own home-freezer unit. Simple, easy to understand plans. Reaches 30-degree-below temperature. Freezing compartment size 10x16x28". Storage compartment 24x28x36". Complete plans 50c. Popular Mechanics Press, 200 E. Ontario St., Chicago 11, Ill.

AIRPLANE Jettison tanks—Streamlined, 10 1/2 foot, tear drop shaped, 165 gallon. Of light weight lead coated steel, weighs 75 pounds. Floats over 1200 pounds. Ideal for making trim, inexpensive boats, canoes, kayaks, dinghys, duck boats, powered catamarans and runabouts. Prices \$12.50 complete. \$9.75 each for three or more. U. S. freight prepaid. General Sales, 205 Market, Grand Rapids 3, Michigan.

"CONCRETE Block Homes." 24 page booklet: drawings, instructions on how to build. \$1.00. H. C. Lightfoot, Civil Engineer, Richboro, Penna.

PLANS For building kitchen cabinets, concrete blocks, lathe, toys, garden furniture, etc. Free list. Masterprint Company, White Building, Buffalo 2, N. Y.

MAKE Popular novelties, statues, at home—3c to 15c each. Sell at big profit. Everything supplied. Write So-Lo Works, Dept. T-6004, Loveland, Ohio.

BUILD Real heavy duty machines, using our production tested plans. 30" band-saw, 12" lathe, dowel machine, portable sawmill, planer, concrete block machines, mixers, 70 machines for shop, farm, home. Catalog—handbook free. Nichols Equipment Co., Dept. PM, Purvis, Miss.

"BUILD Your House as a Hobby." Save 50%. No mortgage. No rent. 24 page booklet: drawings, instructions on how to build. \$1.00. H. C. Lightfoot, Civil Engineer, Richboro, Penna.

AIR Conditioning. Low cost material available. Complete plans show procedure. \$1.50 postpaid. Shopcraft, Box 332, Salt Lake City, Utah.

FREEZER Plans and complete instructions. Description upon postcard request. H. Gordon Anderson, Lakeshore Drive, Rome, Georgia.

MAKE Simple home-made electric generator for flashlights, door-bells, etc. Plans \$1 postpaid. Free: 50 electric stunts. Reiss, 3017 Ocean Parkway, Brooklyn 24, N. Y.

BUILD Concrete block machine. Vibrator or hand. Easy. Economical. 150 blocks per hour. Build house, shop, garage, or other buildings. Save half. Sell blocks. Make money. Free details. Clyde Lee, Mountain View, Dept. A, Oklahoma.

LANE Oak table. Fun for all, felt side cards, wall side dice. Easy made. Patented instructions. \$1.00. Geo. H. Lane, 162, Edgewood, Md.

FLUORESCENT Lights. How to make your own 20 watt lights for less than \$1.00 each. Materials available. Complete, guaranteed, detailed instructions. \$1.00 cash or money order. Checks \$1.10. Specialty Sales, Box 1086, Muncie, Indiana.

PLANS AND BLUEPRINTS

FOOD Cooler without ice, electricity. Plans 25c. Fogwood Company, King, Ontario, Canada.

WATCHES, OLD GOLD, JEWELRY

WATCH Band, beautifully styled. Expands, fits any wrist comfortably. Stainless steel, will not rust or tarnish. Durable, fully guaranteed. If not completely satisfied return for full refund. Remarkably priced at only \$1.00, postpaid. The Hollywood Mart, Box #2232, Los Angeles.

OLD Gold: Top price paid. Mail old or broken jewelry, rings, watches, gold teeth, silverware, diamonds. Receive cash immediately. 100% satisfaction or articles returned. Information free. Old Gold Specialist, Robert Wyndham, 1035 East 'A' Street, Ontario 1, California.

WATCHES—Broken or usable: All kinds. Highest prices paid for jewelry, rings, spectacles, gold teeth, diamonds, sterling silver, etc. Cash mailed promptly. Write for free shipping container. Lowe's, Holland Building, St. Louis, Missouri.

WATCH Repairing: Complete course. Every part of watch fully explained. Many large pictures and drawings. Tools, material. Where to buy. \$2.75 money back guarantee. Park Place Supply Co., P.O. Box 1983, Houston 1, Texas.

GENUINE Mexican gem minerals. \$5.00 brings our valuable assortment. C. Biehl, Apartado 2887, Mexico City.

WATCHES Repaired. Send by insured mail for free estimate. Prompt service. Reasonable. Hammond, 1112 Mahantongo, Pottsville, Pennsylvania.

JEWELRY Findings, lowest prices. George Sassen, 154 Nassau Street, New York City.

BALL Point pen, for home, school, or office. Makes carbon copies. Beautifully designed and balanced. Writes smoother than a pencil. Famous long lasting ink cartridge. Money back guarantee. Priced sensibly at only \$2.00 postpaid. The Hollywood Mart, Box 2232, Los Angeles.

MODERNIZE Your watch with a new case, dial and strap. We supply chromium or yellow case and dial to fit any movement. Cord bracelet with ladies watch, strap with gents, all for \$6.00. Repairing extra. Petite Jewelry, 110 Nassau St., New York 7.

CASH For old, broken jewelry. Highest prices paid immediately. Mail gold teeth, watches, rings, silverware, diamonds, spectacles. Satisfaction guaranteed. Information free. Rose Smelting Co., 29-A East Madison, Chicago.

WATCH And clock repairing—Complete practical course in modern horology. 66 illustrated self-instruction lessons. Just out! Low price. Fascinating 100-page illustrated catalog free! Write—Nelson Company, Dept. 3-02, Chicago 5.

WATCH Repairing easy learned by our home study course. Watch repairers are in demand and are among the highest paid craftsmen today. Write for free information. Houston Chronometer & Watch Co., P.O. Box 1140A, Houston 1, Texas.

GEMS, Precious and semi-precious, all genuine, from world wide sources. Deal direct, no overhead, save money. Catalog 10c. Hill Co., Route 7, Salem, Oregon.

GOLD \$35.00 Ounce—Mail old gold teeth, diamonds, jewelry, watches—receive cash by return mail. Satisfaction guaranteed. Free information. Dr. Weisberg's Gold Refining Company, 1500-Q Hennepin, Minneapolis, Minn.

TOBACCO, SMOKERS' SUPPLIES

CIGARS, Seidenberg's 50's postpaid \$4.50. Money-saving price list of standard brands sent. Mapleton Mail Specialties, 2159 71st Street, Brooklyn, New York.

CIGARS—Popular brands. Save by mail. Andrew Tapia, 1903 Nebraska, Tampa 3, Florida.

CIGAR Smokers—Free trial offer. S. Kelley, 2302 Ontario St., Ft. Wayne 6, Ind.

MONTHLY Pipe magazine! Pictures, articles, gadgets, ideas. Write Pipe Lovers, 532P Pine, Long Beach 12, California.

CIGARS—Imported. 50 Coronas \$3.60 postpaid. Grebne Distributors, 1410 Ardmore, Grand Rapids 7, Mich.

CIGARETTES—Introducing to smokers a popular priced brand of cigarettes \$1.45 carton. One windproof cigarette lighter \$1.00 value free with order of 4 cartons. Send \$1.00 with order—balance C.O.D. (Limit 1 deal to a customer.) Seneca Wholesale Co., Seneca, Kansas.

FOR THE HOME

"GAUGE-IT"—Tells contents 55 gallon household oil drums. Fits in fill-hole. \$1.35, postpaid. Moneyback guarantee. Hare Products, Whitinsville, Mass.

LUMINOUS House numbers mounted on artistic background \$1.00. W. Thompson, Box 125, Perrysburg, Ohio.

FIRE Alarm systems for the home. Essential. Inexpensive. Send postcard for details. Regent Electric, 70 Rockland St., Boston 19, Mass.

TAKE Down, put up. Conventional storm sash. No ladder, any floor. Instructions \$1.00. Reed, 9506 Winchester, Chicago 43.

STORM-WINDOWS Outmoded! New method. Do yourself. 25c. Teeho, 316 North 2, Maywood, Illinois.

HEATING Bills cut as much as one third. Our treatise tells how. Details free. Write A. Claber Co., Box 491, Grandville, Mich.

FOR SALE—MISCELLANEOUS

MECHANICAL Drawing Instruments—Veeco, 4 piece, compact, precision set, brand new in lined case, value \$12.50, special \$7.25. Hull automobile compass, for accurate road direction, brand new, \$2.50. Prisms for 6x30 or 8x30 binoculars, brand new, \$1.50 each. Offset prisms to be attached to 7x50 B. & L. binoculars gives double the field of the ordinary 7x50 binocular. Cost \$98.00, special \$25.00. Green sunshades for binoculars size 6x30 and 7x50 snap on type, value \$7.50, special \$1.25 per pair. Forward money order. No c.o.d. shipments. Public Sport Shops, 13 S. 16th St., Philadelphia, Penna.

GOVERNMENT Surplus wooden tripods with adjustable metal legs. Used by government for engineers levels. 5 1/2 foot extension. Very strong. Can be used for holding telescopes, cameras, etc. Value \$24.50. Special \$5.95 postpaid. Public Sport Shops, 13 S. 16th Street, Philadelphia, Penna.

DICTAPHONE Recorders and amplifiers. War surplus 75% discount. Bulletin free. Offenbach-Reimus, 372 Ellis, San Francisco 2, Calif.

WAR Surplus fire fighting asbestos helmets \$1.95, collapsible canvas basins 35c, headphones \$1.75 without bands, \$2.75 with; spot light assemblies 35c, pilots safety belts \$1.95, navy signal lights \$6.95, foot powder 15c, assortment six lenses 50c, chromium belt buckles 15c. Minimum order \$2.00. Send check or money order. Nico Supply Co., 1700 Walnut, Philadelphia 3, Penna.

WANTED MISCELLANEOUS

SELL Us your old Singer sewing machine. We pay \$15.00 to \$35.00 for almost all models. Send for circular. Essex Shop, 172 Washington St., Newark 2, N. J.

PROMPT Cash for machinists' squares, rules, micrometers, indicators, gages, etc. Satisfaction guaranteed. Wm. Gruer, 460 Ryerson Ave., Elgin, Illinois.

MERCURY (Quicksilver). Write for quotation stating quantity. Metallurgical Products Co., 35th and Moore Sts., Philadelphia, Penna.

PERSONAL

NEW York buying service, list your wants. Wioch, C4 St. James, Elmhurst, New York.

ATLANTIC City—visit by mail. Dozen scenic postals for \$1.00. Address, stamp and return for forwarding. Letters forwarded 25c. Wm. Berry, Box 482, Pleasantville, N. J.

DRINKING Glasses personalized in gold, 3-\$1.00. Larsen Kilns, Wellsville, Ohio.

LETTERS, Cards, forwarded, 25c. 3 giant 7"x10" colored postcards, for mailing or framing, and large fishing information map \$1.00. No stamps. Photo Service, Box 446, Wadena, Minn.

QUEBEC, Canada—3 postcards 25c. We remain free. Letters 25c each. Free information. H. Injob, 86 Salaberry, Quebec, Canada.

STUTTER? Stammer? Literature sent free. Frank Teurfs, 25 E. Jackson, Chicago, Illinois.

MEXICAN Law. General practice atty. J. Cenicerros, 1203 Arizona St., El Paso, Texas.

BORROW By mail! Loans \$50.00 to \$1,000.00 to employed men and women. Easy, quick. Completely private, confidential. No endorsers. Repay in convenient monthly payments. Details free in plain envelope. Write First Loan Co., World Herald Bldg., Dept. M-20, Omaha, Neb.

MAINTAIN Mexican mailing address. Letters forwarded. Mystify friends. Scenic postcards 15c. You address, return, I remail. Tillotson, Apartado 1405, Guadalajara, Jalisco, Mexico.

"BROOKLYN" Remail service. Mystify your friends. 3 postcards 25c. You address, return. I remail free. Letters forwarded 25c. Box 8, Station P, Brooklyn, N. Y.

STAMMER? Maybe I can help. Sauers, Box 139-J, Mars, Penna.

PERSONAL Stationery—110 white wove 8 1/2 envelopes with your name and address printed on the flap sent anywhere in America postpaid for \$1.00. Blair Correspondence Club Printery, 4554PM Broadway, Chicago 40, Illinois.

RECEIVE Moneymaking opportunities, mails, samples, catalogs, magazines. Your name in thousand mailing lists, 25c. Glassmine, 1654-MP Amsterdam Avenue, New York 31.

LET US make a pencil portrait from your photo. Free information. Presto Method, Box 805, Dept. A, Rockford, Ill.

SWAPPERS! Traders!—Free information. "Swappers' Gazette," 2836-PM Slevin, Louisville 12, Kentucky.

RUPTURED? Positive comfort, no understraps, no steel, no elastic. Write Smith Manufacturing Company, Preston, Ontario.

HAIR Falling? Dandruff? Write Trichologist, 137 Lewis St., Phillipsburg, N. J.

HOW You can find out! Information discreetly developed, any matter, person, problem, anywhere. Personal-business assignments, representations, undertaken. Nation-wide. Officially licensed and bonded service established 1922. Reasonable. All inquiries confidential. William Herman, 170 Broadway, New York.

MISCELLANEOUS

ARMY Blankets—all wool, used, minor defects, special, \$3.33 postpaid. Send 3c stamp for circular. Midwest War Surplus Division, 54-L South 3rd Street, Minneapolis, Minn.

YES, Men's shoes in sizes 11 1/2 to 16. Widths AA to EEE. Finest quality, moderate price. Free circulars. Write King-size 137, Brockton, Mass.

JADE Hearts. Carved from beautiful Wyoming Jade, approximately 25x25 m. m. Unpolished \$1.25, polished \$2.00. Wyoming Jade Co., 1712 Capitol Ave., Cheyenne, Wyoming.

GENUINE Leather book marks 10c each. Smith, 828 Lafayette Ave., Brooklyn 21, N. Y.

GRAVE Markers—reasonable. Artistic Bronze Co., Box 3162-A, Bridgeport 5, Conn.

PLASTIC Ball point pen, writes years without refilling. You will be delighted or money back. \$1.50 postpaid. Pensworth Co., 1181 Walton Ave., New York 52.

LUCKY Coin—Lord's Prayer, Ten Commandments, or Crucifixion on penny. 25c each—50c for all three. Peerless, 2726-A Sturtevant, Detroit 6, Mich.

RECEIVE Big mails, literatures. Name in thousands lists 25c. Liberty, Box 1187, Trenton, New Jersey.

FREE! Samples, magazines, catalogs, literature, moneymaking opportunities! Receive lots of mail from everywhere! Mails galore! Your name listed in over 15,000 "surefire" mailing directories, \$1.00, 5000 listings, 50c; 2000, 25c. Here's your chance to receive plenty of interesting mail! Act now! Stanford, 6220-M 16th Street, Philadelphia 41, Penna.

EMBOSSING Ink kits \$1.00 postpaid. Feole, Box 708, Huntington Park, Calif.

GET Plenty of mail steadily, samples, catalogs, seed books, masses of real bargains and opportunities. Every day a big mail day, when your name is listed in our big mail column. Only 25c. 6 months \$1.00, with free gift. Martin's Service, Box 295F, Bassett, Va.

SAWS \$1.50, Scissors 50c, sharpened, reconditioned. Overland's Saw Service, 501, Independence, Iowa.

PANNING Gold—Learn now. \$60 ounce possible soon. Free illustrated booklet. How To Get Started, Catalog, mining books, supplies. Old Prospector, A-70, Dutch Flat, Calif.

SPOTOLITES Shine forever in the dark. Sample 10c. Dial Service, 13601 Blenheim Rd., Cleveland, Ohio.

MANUFACTURERS Attention, let us represent you as jobbers in northwest. Electrical items preferred. A-1 Electrical Supplies Company, P.O. Box 2225, Portland 14, Oregon.

DENTAL Plates loose? New method restores fit. Guaranteed. Free folder. Dental Technicians, 1649 Grant Avenue, San Francisco 11, California.

20TH Century soot removing method. Saves time, money, work. Nothing to buy. No work to do. 20c. Coal saver formula, 10c. Nantco, 157-A West Noble, Nanticoke, Penna.

SELL The veterans market. List 1200 vets World War 2 living in Iowa \$3.00. Vets Advertising Service, Box 621, Des Moines, Iowa.

"CUSTOM-BILT" Desk name plates. Your name in gleaming plastic mounted on 14"x3" stand of walnut or cedar \$2.50. Catalog free. Veterans Advertising Service, Box 621, Des Moines, Iowa.

HOUSES OF Earth. The ground you stand on is your best building material. Easy to build—insulated against heat and cold. Ratproof, sound, termite and fireproof. Dr. Lyman J. Briggs (in 1941 Director National Bureau of Standards—U. S. Govt.) approved this type of structure. Low building and upkeep costs. Send today for "Houses of Earth" containing complete building instruction and 18 illustrations mailed upon receipt of \$1.00. A. B. Lee, Box 171, Washington, D. C.

SEPTIC Tank problems solved. "What to do." A booklet compiled from years of experience. Order now! \$1.00 per copy. Reuben Selfridge, Septic Tank Engineer, Dept. M, Clymer, N. Y.

PERFUME Oils—Pound Jasmine Synth. \$1.70; Musk Synth. \$3.75; Bergamot Synth. \$4.95; add postage. Samples all above oils 25c. Price list, stamp. G & W Supply Co., 217 E. State St., Trenton 10, N. J.

RECEIVE Big mails, opportunities, magazines, samples. Listing 10c. Three times 25c. Lawson, Box 1302-P5, Detroit 31.

WAR Surplus—Self contained oil transmissions, input up to 2 hp. @ 4000 r.p.m. Output infinitely variable either direction. Suitable for motor scooters, machine drives, etc. \$25.00 prepaid. C. J. Cartwright, Box 583, Keego Harbor, Michigan.

FREE Details—Cash in your spare time. Charles, 12 AE, Norwood, Ohio.

STUTTER? Stammer? Literature sent free. Teurfs Studios, 25 E. Jackson, Chicago, Illinois.

PERSONALIZED Pencils—Individual or firm name. Dozen 60c, 2 dozen \$1.00, gross \$4.80. Cash delivered. Pencil Market, 611 15th St., Knoxville 16, Tenn.

HAND-Painted billfolds of finest calfskin, 100% leather lacing. Ladies style \$10, mens \$8. Western designs. Western Art Leathercraft, 2915 Sacramento St., El Paso, Texas.

AT Home—Your own manufacturing business; making popular \$1.00 novelties. Cost you 3c to 15c. Everything supplied. Write So-Lo Works, Dept. T-6002, Loveland, Ohio.

BALLOONS. Army targets inflate 3 1/2 feet in diameter. Flies better than a kite. 29c postpaid. Harry Freedman, Box 68B Revere, Massachusetts.

SWISS Musical movements \$4.25. Lucite photo albums, frames. Musical boxes. Novelties of Distinction, 131 W. 42nd, New York 18, New York.

8 ALNICO Magnets plus 100 experiments. \$2.00. War surplus, extra powerful 1" disc Alnicov magnets—fascinating; pair \$2.00. G. E. midget precision switches, 110V, 10A—2 circuit; each \$1.00; six \$5.00. Eljay, Box 891, Newark 1, N. J.

PEANUTS—Raw, roasted, blanched, Spanish. \$1 or \$2 bags, shelled, delicious. Postpaid. Louis Johnson, Brundidge, Alabama.

SURPRISE Friends. Letters forwarded Los Angeles, Hollywood 25c, 3 for 50c. Box 607, Los Angeles 43.

PAINT Crackles forming designs. Samples 15c, 25c. Circular free. Mapco, Hasbrouck Heights, N. J.

WANTED—1000 Foot sufferers to test Custom Made Research Foot Balancers at our risk. Amazing foot relief awaits you. Rush name and address for free trial offer. Kindschi Foot Appliances, Dept. A4, 321 W. Jefferson, Dallas 8, Texas.

SENSATIONAL Genuine ball point pen only 50c and stamp. Thomas Pens, Box 3, Station W, Brooklyn 11.

BIGGEST Money in tattooing now! No experience required. Complete instructions with outfit. Send for free literature. Tatuco, 651M South State, Chicago.

"RECEIVE Mail." Moneymaking offers, opportunities, catalogs. Name listed 10c. Ideal Service, 100, Park Ridge, Ill.

INDIAN River citrus fruits, Florida's juiciest. Basket-packed fresh from trees. Send stamp for price-list. Schuyler Jackson, Wabasso, Fla.

RARE Garden, field and tree seeds. Mexican Products Co., 126 N. Main, Tulsa 3, Okla.

GOOD "Used" self-instruction educational books on all subjects bought, sold, rented, exchanged. Satisfaction guaranteed. Complete information and 100-page illustrated bargain catalog free! Write—Nelson Company, Chicago 5.

PURE Vermont maple sugar postpaid in \$1, \$2 and \$5 lots. Eulalia Turner, Poultney, Vermont.

BOOKFINDERS! (Scarce, out-of-print unusual books.) Quickly supplied. Send wants. Clifton, Box 1377PMM, Beverly Hills, Calif.

TATTOOING Outfits—engraving outfits. Circulars free. Write, Zeis Studio, 728 Lesley, Rockford, Illinois.

MEDICAL Laboratory technicians in great demand. We train you in your spare time, in your own home. You can practice while studying. Write for free catalogue. Imperial Technical Institute, Box 973-J, Austin, Texas.

CALENDAR 1753 To 2152. Shows actual calendar for each month. Accurate, simple and durable. 35 cents postpaid. Tracy Newton, Decatur, Georgia.

70 BIBLE Lessons, 25c. Bulletin, Box 87, Station H, New York 25.

M-SCOPE Metal, mineral locators latest 1947 electronic type ready for immediate shipment. Fisher Research Laboratory, Inc. manufactured some of the finest metal-locators for the U. S. army. Experience gained is yours in the most efficient metal, mineral locator. Free 16-page booklet upon request. Credit plan available. Fisher Research Laboratory, Inc., Palo Alto, California.

PROFESSIONAL TRAINING IN A MINIMUM OF TIME

RADIO-ELECTRONICS TELEVISION • BROADCAST ENGINEERING

An Accredited Technical Institute nationally recognized for high calibre training. Prepares high school graduates for technical careers. Classes start every Monday. Comprehensive courses in Radio-Electronics Engineering, Broadcast and Television Engineering, Broadcast and Television Servicing; 2,100 hours classroom and laboratory study. Write today for free informative booklet, "Radio Engineering as a Career."

CAPITOL RADIO ENGINEERING INSTITUTE

DEPT. P-5, 16TH STREET & PARK ROAD, N. W. • WASHINGTON 10, D. C.



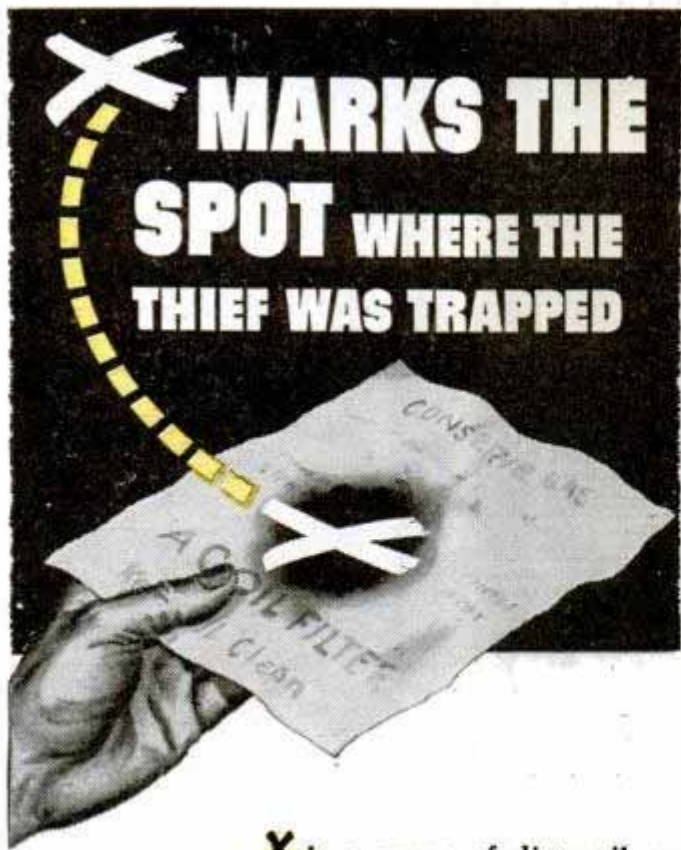

X MARKS THE SPOT WHERE THE THIEF WAS TRAPPED

X is a smear of dirty oil on an AC Oil Test Pad—oil from a car whose owner didn't know he needed an oil filter. The evidence shows clearly on the white pad.

You can get this oil test FREE—and in a jiffy—at any official AC Oil Filter Service Station. The attendant simply wipes the dipstick on the Pad, instead of a rag, and you can see for yourself whether your oil is safe to use.

Dirty oil is a power thief. It clogs piston rings and slots—makes valves stick—hastens engine wear—wastes fuel and oil—steals more and more power as the days go by.

Every engine needs an oil filter. The AC oil test will show you why. And the AC Oil Filter Service Station will show you why the AC Oil Filter gives you tops in protection—and why the AC Replacement Element is the one you should use in your present filter. AC makes quality replacement elements for nearly all filters.

So see your AC Official Oil Filter Service Station today and trap the thief that's stealing your power.



AC OIL FILTERS

AC SPARK PLUG DIVISION—GENERAL MOTORS CORPORATION

PROUD PROFESSION... BE A SURVEYORS INSTRUMENT MAN



Learn this skilled and fascinating profession at home—quickly and easily. No high school education necessary. Many choice positions open, both at home and in South America, China, Alaska and the Philippines. Start today, prepare for a highly paid profession. This 10 lesson course is completely illustrated and fully detailed. Only \$5.98—Send Check or Money Order, or send \$1.00, balance C.O.D. WE PAY POSTAGE. We reserve the right to limit number of applicants. FREE-Folder.

TECHNICAL PUBLICATIONS
P.O. Box 85 White Plains, New York



Learn modern watch and clock repairing

At home, spare time. Good field now... security and contentment in future. Start part-time business and **EARN while you learn.** Horology is precision instrument work... a great and growing field, sensational opportunities. Easy self-instruction course. Low price. **Money-back guarantee.** Write today for **FREE Success-Catalog!**
NELSON CO., 1139 S. Wabash Ave. Dept. E02 Chicago 5, Illinois



CARTOONS PAY BIG!

Learn quickly to draw cartoon figures. My **NEW Simplified** home study course starts you drawing with the first lesson. No experience necessary! New technique, based on years of successful professional cartooning, assures **fast training.** Send for this practical illustrated course now!

ROLAND GLENN, Dept. H
1300 THORNDALE AVE., Chicago 40, Ill.

Complete **ONLY \$2.00** CASH OR MONEY ORDER NO C.O.D. PLEASE!



Bar Bells

...at Factory Prices

WRITE FOR FREE BOOKLET AND PRICE LIST

\$8.95 up

INDEPENDENT IRON WORKS
2416 East 23rd Street, Dept. P5
Los Angeles 11, Calif.

TAXI OWNERS

Send for **FREE** sample copy of

TAXICAB OPERATOR

National Magazine of the Cab Industry

TAXICAB OPERATOR

1621 N. California Ave.

Chicago 47, Ill.

SAY YOU SAW IT IN POPULAR MECHANICS

MAGIC LIQUID MAKES PHOTOS APPEAR

Amazing discovery permits you to print pictures from any of your snapshot negatives on wood, cloth, leather or paper. Like magic your pictures will show on ties, handkerchiefs, purses, cards and letterheads. Takes only a few minutes in broad daylight. Won't rub off or harm negative. An attractive set with enough material for over 100 pictures. **ORDER TODAY.** Send \$2.49 postpaid, C.O.D. pay postman a few cents more in addition. (Foreign \$2.60 money order only.)

STYLE-ARTS, Inc.

Dept. I-D

4649 Broadway

Chicago 40, Ill.

GET THIS FINE SUIT NO MONEY TO PAY!



BIG CASH EARNINGS, TOO!

Big news! This fine tailored suit yours without paying one cent—and big cash earnings, too! It's easy! Just take a few orders. Earn up to \$10 a day and get your own suit as **extra bonus.** Dozens of rich new fabrics, superbly tailored in latest styles, at low prices produce orders on sight. **Money-back guarantee.** **FREE SAMPLES!** Write today giving name, address, age, etc. for big complete outfit of actual samples and details of amazing new **BONUS SUIT** and money-making plan—**All Sent Free!** No experience. **SEND NO MONEY!** W. Z. GIBSON, Inc. 500 S. Throop, Dept. 5-516, Chicago 7, Ill.

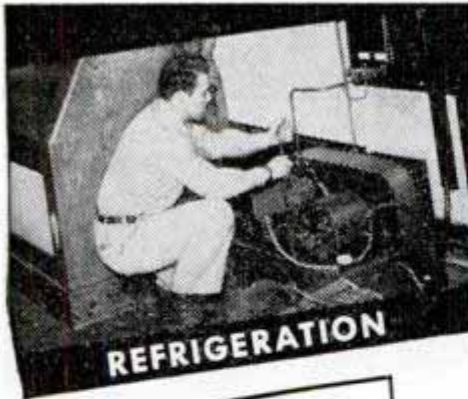

REFRIGERATION



ELECTRONICS



WELDING

Specialize in
6 months to 3 years

COURSES

SERVICE—6 months

- Practical Electricity
- Practical Welding
- Refrigeration Service
- Heating Service

TECHNICIAN—1 Year

- Electro Technician
- Radio Technician
- Electronics Technician
- Refrigeration, Heating and Air Conditioning Technician

PROFESSIONAL—3 Years

- Electrical Engineering
- B. S. Degree—Major in Machinery or Electronics

PRACTICAL TECHNICAL TRAINING

Our time-tested *CONCENTRIC SYSTEM* enables you to build your career step by step. Each 6-month course is complete in itself. Stay as long as circumstances permit—until you reach your desired occupational objective. For 44 years this school has specialized in technical training. More than 35,000 former students in industries the world over. 1,248 students now enrolled from 46 states and 5 foreign countries. Faculty of 63 specialists. World-wide alumni counselor committee. *Terms start July, September, January.* **SEND COUPON TODAY!**

MILWAUKEE SCHOOL OF ENGINEERING
A Technical Institute

Milwaukee School of Engineering, Dept. PM-547
N. Broadway and E. State, Milwaukee, Wis.

Without obligation, send me free booklet "Career Building" and more details on course in

Name Age
Address
City State

**V-8
DUALS
& SINGLES**

MUFFLERS
STEELS and ALUMINUMS
with a motorboat tone

SINGLES, Chev, V-8, Plymouth, Steels \$5.50, Aluminum \$6.50. Chry., Olds., Buicks, etc., Steels \$7.50, Aluminum \$8.50. V-8 and MERCURY DUALS, Steel \$17.50, Aluminum \$20.00. Aluminums are guaranteed for life of your car.

DEALERS WANTED

SANDEE MUFFLER CO.
7523 S. WESTERN AVE., LOS ANGELES 44, CALIF.

FLOYD CLYMER'S POPULAR MOTOR BOOKS

Midget Race Book, \$1.10. Indianapolis 352-page Race History, \$3.50. Mercedes-Benz Book, \$2.00. Catalog free. Chromed, enameled lapel pins—specify Midget Car, Race Car, Harley or Indian. \$1.00 ea., postpaid.

CLYMER, Dept. A-5, 2125 W. Pico, Los Angeles 6, Calif.

QUICK! "REPAIRING CAR BATTERIES" MONEY! At Home! Easy Too!

Write, **BATTERYMAN, Dept. 5, Grand Junction, Colorado**

Learn NOVELTY MANUFACTURING!!

Today's best bet for a business of your own starting with little money is the Casting of Wall Plaques, Book Ends and other Novelties. Large orders and profits waiting. Start in garage or basement, quickly learned. **NO EXPENSIVE MOLDS TO BUY.** Our system has started many on the road to a splendid financial future. Write today for free particulars.

PLASTEX PRODUCTS, 711 Laguna St. San Francisco 2, Calif.

HOW TO CREATE SOUND EFFECTS FOR HOME RECORDINGS

by ED. LUCAS, Head of Sound Effects for the NATIONAL BROADCASTING COMPANY in Hollywood

Tells how YOU can make hundreds of the sound effects you hear on your radio

ORDER TODAY—Send \$1.50 Money Order or C.O.D.

NATIONAL HOLLYWOOD, 1475 EL MIRADOR DRIVE, PASADENA 2, CALIFORNIA

BOY'S! GIRL'S! WIN THRILLING PRIZES

1st Prize \$50 Bicycle
2nd Prize Temple Radio
100 Other Prizes

All you do is get Stenso Lettering Guides and make up any Poster, Booklet or other designs using your Stenso easy aids to attractive art and lettering. Remember, Stenso Guides make perfect lettering easy for anyone, talented or not! Stenso Lettering Guides are a wonderful help in school, at work, in recreation, for making attractive scrap-books, bulletins, signs, etc.

Widely used. Approved by experts! Lasts for years yet costs only 10c to 20c—each. At stationery or Department Stores, neighborhood stores, 5 & 10c stores.

New contest every 4 months. 100 new prize winners selected each July 1, Nov. 1, March 1 Anyone can win. Originality and age will be considered. Winners will be notified by mail. Don't delay! To enter contest make up and send us your poster, design or map. You may use pencil, crayon, ink, or water colors with

STENSO GUIDES

If your dealer doesn't have Stenso, he can order it for you. Otherwise, you may order direct from us. For best results, we suggest our new Giant Kit of 8 Stenso Lettering Guides in all size letters 1/2" to 1 1/2", and U S. map, shipped prepaid complete for only \$1.00.

STENSO LETTERING CO. Dept. I 2510 Elsinor Ave., Baltimore 16, Md.

How the French learn French

Frenchmen learn their language as you learnt English; not by studying it, but by living with and using it. That is nature's way. The Linguaphone Method is so successful because it employs that natural, effortless method. Instead of formally "studying" the language, you hear it spoken by the voices of expert native teachers. You follow their conversation in the text book, you listen and understand. Soon you yourself begin to speak and then to write the language easily and fluently. Thousands of people who thought they had no gift for languages have learned to speak Spanish, French, German, Russian, or any of 25 other languages, by this simple method in an amazingly short time. So can you.

Send for the **FREE Linguaphone Book** which reveals many little-known facts about mastering a language in your own home.

LINGUAPHONE INSTITUTE
98 RCA Building, New York 20, N.Y.
Without cost or obligation, send me the illustrated Linguaphone Book.

Name

Address

City..... Zone....

Language you want to speak.....

Are you a Veteran?.....

If you are a veteran, you can take a Linguaphone Course under the G.I. Bill of Rights.

Say You Saw It in
POPULAR MECHANICS

How to Start
YOUR OWN BUSINESS

**Make Flexible Molds,
Composition Flooring**

NO EXPERIENCE — UNLIMITED MARKET

Start your own business at home in your spare time. Tremendous money-making opportunities for both men and women.

FLEXIBLE MOLDS

Make your own FLEXIBLE MOLDS. Cast novelties, statuary, desk sets, book ends, etc. Hundreds of casts made from single mold. Large size mold costs but a few cents. No experience necessary. Steady year-round demand.

COMPOSITION FLOORING

Make floors that last a lifetime with amazing COMPOSITION FLOORING! New discovery now enables you to lay artistic floors, in beautiful patterns in most colors and shades. Can be laid over wood, concrete, brick, steel, etc. This composition flooring offers unlimited money-making possibilities.

Free Catalog!

For FREE information about these and many other profitable business opportunities, WRITE TODAY!

BING PRODUCTS

Dept. A18, 88 Broad Street BOSTON 10, MASS.

NEW MIDGET ELECTRIC ARC WELDER

RETAILS ONLY \$3.95

FULLY GUARANTEED

Plugs into Light Socket—AC or DC

It's new! It's handy! It's efficient! Use the Midget Electric Arc Welder for hundreds of light-metal jobs. Does comparable welding work with a 1/16 inch welding rod on thin metal as that of larger and higher priced welders. Operates on 15 ampere fuse, 110 volt 60 cycle A.C. or D.C. current, by use of our special standard-coated 1/16-inch welding rods. Generous supply of rods supplied with machine. Recommended for all light welding like automobile fenders, etc. Take the Midget Arc anywhere to the job. Sturdily built and fully guaranteed. Comes complete—ready to use. Nothing else to buy. No previous welding experience needed to strike an arc. In a short time, anyone mechanically inclined can learn to weld with this machine.



You'll find hundreds of money-saving, time-saving uses for the Midget Arc around your home, garage, or workshop. Also in garages, factories, repair shops, tin shops, mechanics, farmers, inventors, etc. Order a Midget Electric Arc Welder now! **SEND NO MONEY.** We'll rush one to you complete with rods and helmet (equipped with APPROVED welding glass). Pay postman only \$3.95 plus postage charges. If not satisfied, return Midget Arc in 5 days from receipt and we'll refund your money immediately. **RUSH YOUR ORDER NOW.**

MIDGET ARC WELDER CO., Strader Ave., Dept. X-202, Cincinnati 26, Ohio

LEARN CARPENTRY

Get in on the biggest building boom in history. Prepare for a long and profitable career as a big-pay building tradesman. Actual shop training under expert instructors. Write for big free catalog today!

MIDWEST SCHOOL OF BUILDING TRADES
Dept. C15, 411 N. Center St., Bloomington, Ill.

VETERANS ASK FOR GI PLAN

**Free
FACTS**

MIKE Jr.

NOW ONLY \$1.69

SING—TALK—AMUSE YOUR FRIENDS—
through your own radio set. Practice to become an announcer. Simple to install—Not a Toy.
SEND NO MONEY—WRITE TODAY
Just send your name and address and when your MIKE Jr. arrives, pay postman \$1.69 plus few cents postage. Sent postpaid if check or money order accompanies your order. No stamps.



MART DISTRIBUTORS, Dept. P-11, P.O. Box 6, Evanston, Ill.

Raise GOLDEN HAMSTERS

The new wonder animals. Look like toy bears. Delightful pets. Everybody wants them. Thousands needed by laboratories. Make money, get started now. Send 10c for illustrated literature, or send \$5 for a pair of hamsters and literature.

GULF HAMSTERY, 1536 BASIL ST., MOBILE 17, ALA.



Do Your Own Welding & Save!

See our ad Page 275
DYNAMIC WELDER CO. 13 E. 23rd St., RW, CHICAGO 16, ILL.

HERE IT IS

**EVERYTHING YOU NEED TO DO YOUR OWN
SILK SCREENING**

THE IDEAL WAY TO PRINT EXCLUSIVE GREETING CARDS & POSTERS—TO DECORATE TOYS & NOVELTIES IN ALL COLORS. Simple & Complete Instructions With Every Kit. Send Your Name & Address To:
ISSEROFF BROS., DAVIDSON AVE., BOUND BROOK, N. J.
Pay Postman \$3.98 Plus Postage When You Receive Your Complete Outfit.
MONEY BACK GUARANTEED WITH EVERY KIT.

\$5,000,000 CASH PRIZES FOR INVENTIONS



WORLD INVENTORS' EXPOSITION
PAN PACIFIC AUDITORIUM
LOS ANGELES, CALIF.
TEN DAYS ONLY!
JULY 11-20, 1947

Sponsored by United Inventors and Scientists of America. The Greatest Inventors Show on Earth!

- ★ Grand total of \$5,000 cash prizes will be awarded for best inventions.
- ★ Judges will be nationally-known scientists and industrialists.
- ★ No restrictions on the type of inventions — radio, plastics, home appliances, etc.
- ★ Models, drawings, plans, copies of patents or printed matter may be submitted.
- ★ Your invention will be fully protected — no invention or Model will be loaned to anyone without your express permission. Whether you attend in person or not, your rights will be protected — guards on duty at all times.
- ★ Manufacturers also are invited to show their new products — Buyers, Exporters and their representatives will be present.
- ★ It's the greatest World Inventors' Exposition in history. The first get-together between inventors and manufacturers, in the world's largest 1-floor auditorium space!

★ You may win one of these big cash prizes!

1st prize	\$1,000 cash
2nd prize	\$700 cash
3rd prize	\$300 cash
4th through 13th ...	\$100 each
14th through 33rd ...	\$50 each
34th through 73rd ...	\$25 each

Grand total ... 73 prizes \$5,000

★ Your invention will be seen by thousands of manufacturers, jobbers, distributors. You may sell or lease your invention, patent or idea — make permanently useful contacts.

Get your model ready now! Write for details TODAY!

CLIP AND MAIL THIS COUPON TODAY!

WORLD INVENTORS' EXPOSITION
 2712-1/2 West Seventh Street, Los Angeles 5, Calif.

Please send me full information, without obligation, on how to get my invention in the Exposition.

(NAME OF INVENTOR — PLEASE PRINT)

(STREET ADDRESS)

(CITY OR TOWN — ZONE NO., IF ANY) (STATE)



BIG MONEY FOR YOU IN PLASTICS

SEND **10¢** Offer includes 2 books: New Fabrication Manual & Giant Catalog, listing the most complete stock of Plastic Materials, Accessories, Tools.

BERTON PLASTICS, INC.
 19 W. 21st St., N. Y. 10, N. Y.

RADIO ENGINEERING, Broadcasting, Servicing, Electronics, Aviation, Marine & Police Radio taught thoroughly. 48 weeks' Engineering course equivalent to 3 years' college radio work. Approved Veteran Training. Co-educational. Catalog free.

VALPARAISO TECHNICAL INSTITUTE, Dept. D, Valparaiso, Ind.

LEARN MYOPATHY

— modernized, improved massage. Revolutionary methods start you right for big earnings in a growing profession. Many former students earning \$300 a mo. up.

Granger School of Myopathy, 3906 Belle, St. Louis 8, Mo.

Learn BAKING At Home

Baking is one of America's high industries in wages. Nearly depression-proof. Thorough basic home course lays sound foundation. If you have aptitude, write for FREE BOOKLET, "Opportunities in Commercial Baking."

National Baking School, 1315 Mich. Ave., Dept. 1355, Chicago 5

MAKE MONEY IN YOUR OWN SILK SCREEN PRINTING BUSINESS

Print 100, 50¢ signs an hour! Build your own press. Start with only \$50, sparetime at home! We tell you HOW! Write today!

W. E. WOLFF CO., 817 HIGH ST., ANDERSON, INDIANA

CARTOONING

HAVE FUN! MAKE MONEY! Cash in on your sense of humor AT HOME—BY MAIL. No experience needed to start. Write today FOR FREE TRIAL LESSON and full particulars.

MeoN Gag Cartoon School, Dept. B, Fall Creek, Wis.

Make Your Decision for a BETTER JOB OR A BUSINESS OF YOUR OWN

AIM high—pick one of these big fields. May never again be such opportunities to get in on ground floor and go up fast. **REFRIGERATION & AIR CONDITIONING** growing fast—frozen foods, commercial installations, many other developments. **ELECTRICITY & INDUSTRIAL ELECTRONICS** offers good pay to trained men. **BODY & FENDER REBUILDING** bringing many big money. **AUTO MECHANICS** in demand. **DIESEL** a rapidly expanding field. Pick one of these fields now—for men who ACT FAST things can happen fast. **CONSULTATION AND PLACEMENT SERVICE** whether you are interested in worthwhile job or setting up your own business. **YOU CAN START TRAINING AT HOME IN SPARE TIME AND THEN COME TO BIG TRAINING SHOPS LATER.** A few short weeks can make all the difference. **VETERANS ENROLLED UNDER "G. I." BILL. COMMERCIAL TRADES INSTITUTE**, a nationally known school, only civilian school selected by Army to train service men for refrigeration. **FACTS FREE. MAIL COUPON TODAY. NO OBLIGATION.**



Fill Out, Cut Out, Mail Today

COMMERCIAL TRADES INSTITUTE, Dept. E25
 1400 W. Greenleaf, Chicago 26, Ill.

Send FREE Illustrated Brochures and other information about the field I have checked below.

<input type="checkbox"/> Refrigeration and Air Conditioning	<input type="checkbox"/> Auto Mechanics
<input type="checkbox"/> Electricity & Industrial Electronics	<input type="checkbox"/> Diesel
<input type="checkbox"/> Body & Fender Rebuilding	

Name _____

Address _____

City _____ State _____

Veteran Non-Veteran

ELECTRICIANS! RADIO MEN!

Valuable BOOK

**150
Wiring
Diagrams**

FREE

It's My Gift
to Help You Get
Ahead



B.W. COOKE, Dir.

HERE'S one of the greatest "get acquainted" offers ever made. This new book of 150 selected Electrical Shop Prints and Wiring Diagrams is YOURS — absolutely FREE.

This book is 'chuckfull' of valuable charts, diagrams, wiring methods and instructions for reading and using wiring shop prints. All the shop prints are full size 8 1/2" x 11" with full explanatory information. Here's all you have to do to get this free book:

150 Diagram Book Free FOR MERELY EXAMINING COYNE'S NEW 7 Volume Set

To get your FREE copy of this Shop Print Book, all you have to do is to let me send you my complete new 7 volume set of electrical books — COYNE APPLIED PRACTICAL ELECTRICITY for 7 days' FREE examination. Here's a set of books written for the "beginner" or "old-timer" in electrical work who is anxious to get ahead.

This 7 volume set contains thousands of "show how" methods and photos—the latest information in "easy-to-understand language." Electricity from "A" to "Z" presented in new, practical, modern methods of explanation. A leader in electricity today must "know his stuff." To succeed from now on you must know many branches.

SEND NO MONEY You have to see this new 7 volume set to really appreciate how much it can mean to you and your future. I'll send you the complete set of 7 volumes (pictured below) at my risk, postpaid for 7 days' FREE Examination. I'll also send you the New Coyne Book of 150 Shop Prints and Motor Diagrams as my FREE gift to you TO KEEP REGARDLESS OF WHETHER OR NOT YOU DECIDE TO KEEP THE 7 VOLUME SET COYNE PRACTICAL APPLIED ELECTRICITY.

5 to 1 Satisfaction GUARANTEE

I personally guarantee that at the end of 1 year from the date you receive these books that they must have earned 5 times their cost or you may return them and I'll refund every cent you paid.

7 AMAZING VOLUMES
Covers everything from home wiring to D.C. AC Motors and Equipment. Over 8000 subjects — 2000 illustrations — 5000 facts.

Coupon is Not an Order
Just a Request to See the Books FREE
YOU ARE NOT BUYING THE 7 VOLUME SET WHEN YOU SEND THIS COUPON. You are merely asking to see the books free for 7 days. The coupon only becomes an order if you decide to keep the 7 volume set after 7-Day Free Examination. OFFER IS LIMITED—Don't delay! Fill in and Mail FREE BOOK Coupon Now!



FREE BOOK COUPON

B. W. Cooke, Dir., COYNE ELECTRICAL SCHOOL, Dept. 57-R6
500 S. PAULINA ST., CHICAGO 12, ILLINOIS

Send me the NEW 7 Volume COYNE APPLIED PRACTICAL ELECTRICITY. Also send the Bound Volume of 150 Shop Prints and Diagrams which I am to keep FREE whether I keep the 7 Book Set or not. I'll either return the 7 Book Set in 7 days and owe you nothing or pay \$3 within 7 days and \$3.00 a month until \$21 is paid, or I'll send the cash price of \$19.75. You also include FREE one full year of Consultation service and technical bulletins.

NAME _____ Age _____

ADDRESS _____

TOWN _____ Zone _____ STATE _____

Check here if you want to pay postman cash price of \$19.75 (you save \$1.25) delivered. Same 7 day examination privilege and Money-Back Guarantee.

LEARN WATCH REPAIRING

IN YOUR OWN HOME!



THERE'S BIG MONEY and a secure future for YOU in watch repairing even if you're just a beginner. Be your own boss soon or choose from thousands of available high paying jobs. (There are no age or physical limitations.) Get through our "PRACTICAL SELF-TRAINING" course in "MODERN WATCH REPAIRING & ADJUSTMENT." This new and complete book is easy to understand by beginners and watchmakers. Every step in repairs, adjustment, construction, Theory, operation. Covers all needed tools and their use. Fully illustrated. Only \$2.95 Post Paid (if C.O.D., plus charges.) MONEY BACK GUARANTEE

WE SUPPLY ALL TOOLS, MATERIALS AND PARTS AT LOWEST COST — PROMPT DELIVERY!

Complete sets for STUDENTS and Practical Repairmen. FREE price list.

MODERN TECHNICAL BOOK & TOOL CO.
Dept. MMC, 55 W. 42nd Street, New York 18, N. Y.

FREE — JOIN NEW TECHNICAL BOOK CLUB — FREE

ALL books on Technics, Chemistry, Plastics, Refrigeration, Building, Radio, Automotives, Mathematics, Homecraft, Farming, Sports, etc. FREE literature. SPECIFY SUBJECT.



48 PLANS

48 complete plans of toys, ash trays, garden ornaments, Dutch boys and girls, what-not shelves, and many other interesting projects. Finest selection available. Novel method allows you to make finished project any size desired. PLUS FREE DeLuxe Plan of Martin House. Send only \$1 to Jackson, Dept. 17-5440 N. Shoreland Ave., Milwaukee 11, Wis.

\$100



Voice Training at HOME!

EASY PROGRESSIVE LESSONS — POPULAR, OPERATIC SINGING
Write for Particulars

MODERN METHOD VOICE STUDIO

1216 Park Row Building — Dept. M-10
New York City 7, N. Y.

Auto Repair & Fix-It Shops Extra Profits for You!

See our ad Page 275

DYNAMIC WELDER CO. 13 E. 23rd St., RX, CHICAGO 16, ILL.

BRUSH PLATING OUTFITS

for re-plating articles in the home and shop. No tanks necessary. Free particulars,
GUNMETAL CO., AVE. M, DECATUR, ILLINOIS

BOWS & ARROWS

Write for 94 page Illustrated Instruction Hand Book 50c; 20 page catalog 5c; stamps or coin.
LE STEMMER CO. QUEENS VILLAGE, N.Y.

FIBRE ARMS AND LEGS!
Light, correctly fitted, strong and comfortable. Natural appearance. Braces for all deformities. Scientific design. Fair Terms.
BUCHSTEIN-MEDCALF 223 S. 6th St., Minneapolis, Minn.

12 lbs. SURPLUS RADIO PARTS \$2.00

A gold mine of parts for repairmen, amateurs, and experimenters . . . sockets, condensers, resistors, transformers, coils, hardware, wire, etc. An outstanding bargain in usable parts! Send \$2.00 cash, check or M.O. today! (Pay small express charges on receipt.)

ELECTRONIC PARTS, Inc. Dept. M5 622 W. Randolph St., Chicago 6, Ill.

Now Your
Dream Home
Comes True!

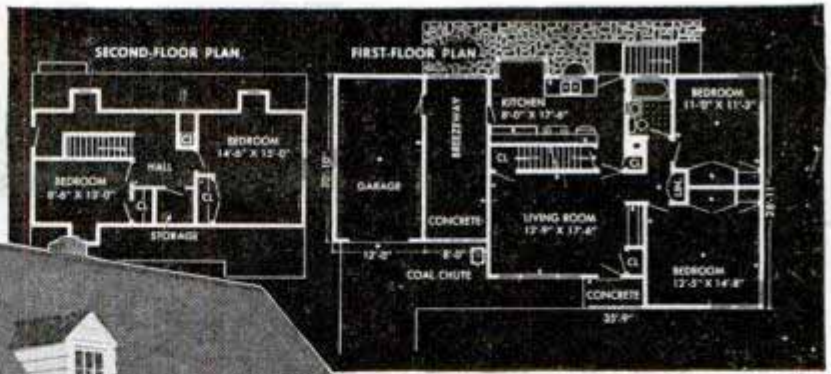

**The House That
Jack Built**

From actual photograph of Build-It-Yourself House with breezeway and garage as built by Jack Brownson, Aurora, Illinois, a twenty-three-year-old veteran.

**YOU CAN BUILD
THIS HOUSE
YOURSELF!**

**MAIL COUPON FOR BIG NEW BOOK
AND PLANS • BUILD IT YOURSELF
OR HAVE IT BUILT AT A BIG SAVING!**

Can you use a hammer—saw a board straight—use common, everyday tools as well as the average *Popular Mechanics* reader? Then, startling as it may at first seem, you too, can build this modern house in any of its five designs, and do it easily and quickly, at a tremendous saving. *Popular Mechanics* and a famous firm of architects have designed it and worked out every detail so you can do every part of the job yourself, even though you have no experience whatever.

**SPACE FOR LIVING AND
FAMILY GROWTH**

Illustrated is the *Popular Mechanics* "build-it-yourself" house Jack Brownson built from our plans, in Aurora, Illinois, with one inexperienced helper. This beautiful, modern house is 1½ stories, with basement, living room, kitchen, dining nook, two bedrooms, bath, plenty of closets and space for 2 additional bedrooms on the second floor. The house itself is 35'-9" x 28'-11"; breezeway 20'-10" x 8"; garage 20'-10" x 12 feet.

**THE HOUSE THAT HAS
EVERYTHING**

The big, basic idea behind the design is ease of construction and the most living space and the most useful space, at the least cost, considering attractiveness and suitability for any neighborhood and most income groups. On top of this is its adaptability to other types of architecture, such as modified Dutch Colonial, modified Cape Cod, plain gable roof house without dormer windows, or the house as pictured, but without garage and breezeway.

**USE CONVENIENT ORDER
COUPON**

You may never have thought about actually building your own house, but you can do it. And now that building restrictions have been lifted, it's easier than you think. So send for the big new book—Your Home and How to Build It Yourself, and set of construction plans, today. Even if you engage a contractor or builder to build this house for you, you will need the plans. Then too, you will certainly want the book, which can easily save you countless hundreds of dollars whether you build this house or any other house of your choosing.

**100 Pages
52 in Color
60% illus.
8½"x11"**

**GET THE BOOK NOW!
STUDY THE PLANS NOW!**

Start Building When You Can

You can get "Your Home and How to Build It Yourself" and complete plans by mailing the coupon below. Book is plastic bound and contains 100 pages, size 8½ x 11 inches. Three-fifths of the book consists of photographs and drawings. Several sections are printed in extra colors and a four-page, four-color insert shows just how your own house will look in actual colors. Every detail of the house and its construction are discussed in this book with minute details of Build-It-Yourself instruction that will guide you in every step.

**PLANS YOU CAN READ
AND FOLLOW**

Plans consist of eight working size blueprints, giving floor plans, elevations, notes on construction, framing, lumber list, millwork list, specifications, plumbing and wiring diagrams. Every measurement is marked, every detail made as clear as A-B-C. With the book to guide you and the plans to follow, any handyman who can use simple tools can build this remarkable house and enjoy every minute of the work while saving thousands of dollars.



MAIL COUPON FOR BOOK AND PLANS

Popular Mechanics Press,
200 E. Ontario Street, Chicago 11.

I enclose \$_____ Send me the items checked at once.

- Your Home and How to Build It Yourself \$ 3.00
- Complete set of plans for Popular Mechanics Home 12.50
- Book and Plans at reduced price 14.00
- Duplicate set of plans 5.00

Name _____

Address _____ Zone _____

City _____ State _____



WORK WHERE YOU WANT TO, IN PLASTICS

Plastics is here now! Most big industries have own plastics division. All need trained men. Live and work where you please in Plastics!

BE WELL PAID

All Plastics industries want completely trained men, and pay good money too. We train you in the shortest possible time at our Cleveland resident school, then you can demand good pay for the rest of your life.

TRAIN UNDER G. I. BILL

Veterans, when you train with us the Govt. pays the complete cost.

TRAINING IS EASY

Because Plastics Technicians get big salaries, you think training hard. But we can teach with average intelligence and 2 Yrs. High Sch. for a successful career. BE SMART. GET THE REAL FACTS, on PLASTICS TRAINING AND WORK. INQUIRE NOW. COMPLETE FACTS SENT FREE. NO OBLIGATION.

WHICH JOB DO YOU WANT

- PLASTICS DESIGNER
- YOUR OWN SHOP
- SALES TECHNICIAN
- PRODUCTION TECHNICIAN
- LABORATORY TECHNICIAN

MAIL IMMEDIATELY

NAME AGE

STREET

CITY, STATE VETERAN?
check

Dept. M-5 PLASTICS TECH. SCHOOL OF AMERICA, INC.
5200 Euclid Ave. — Cleveland 3, Ohio

FOOLS Everybody The **MYSTERY KNIFE**

HOW DOES IT OPEN? HOW DOES IT CLOSE?

Mystify your friends with this trick pocket knife. Secret locking device fools everybody. A fine quality knife. Pearl handle. Carbon steel blade. Nickel-silver bolsters and caps. Only \$1.00 postpaid. Every knife collector should have this specimen. Cash or money order. No Stamps.

SPECIALITY SERVICE CO.
Box 5924 Kansas City 2, Mo.

PRESTO! ANYONE CAN MASTER GLAZE

LEAVES HARD GLASS-LIKE FINISH

EASY TO APPLY

PROTECTS THE SURFACE

NO SMEAR OR STREAKS AS WITH WAX

LASTS SIX MONTHS TO A YEAR

SEALS THE PORES OF THE SURFACE

WILL NOT FINGER-MARK

NO OILY FILM AS WITH POLISH

SAVES YOU MONEY

Car Owners! Meet Master Glaze—the sensationally different luster for new and used cars! Not a wax—not an oil polish—not a paint!—nothing that “smears” over the surface.

MASTER GLAZE is a unique discovery—a creamy liquid—quick and easy to apply! Gives a hard, glass-like surface. Even gasoline cannot dull it! Lasts six months to a year! Amazing luster—beautiful, sparkling clean and brilliant! Doesn't finger-mark—doesn't smear! A match box full glazes an entire car. Seals the pores—protects! NOTHING LIKE IT!

AGENTS
An unusual opportunity! Quick, flashy demonstrator. Big profits. Good territory. Write today!

FREE SAMPLE
Just send your name and address to
MASTER GLAZE CO., 7720-592 W. Harwood Ave., Milwaukee, Wis.

3 NEW PLASTICS MANUALS

FABRICATING • CARVING • CASTING PLASTICS



Make gorgeous gift and novelty objects of Plexiglas, Lucite, Polystyrene, Catalin and Castolite at home. Jewelry, ornaments, lamp bases, picture frames, other accessories. Have fascinating hobby and build very profitable spare time or full time business. Send for new Manuals on Fabricating, Carving and Casting. Show you how to weld, form, fabricate, carve and cast latest plastic materials in home work shop. See HOW—then we can supply all kinds of latest plastics materials (including special new liquid plastic) and kit of famous HANDEE grinding tools. These new Manuals include hundreds of practical suggestions, ideas and facts showing how to succeed. Price for all three manuals prepaid, \$1.00. Or get circular and price list Free. Write today! **HOUSE BEAUTIFUL PLASTICS**, Dept. E3, 5534 W. Harrison St., Chicago 44, Ill.

Now Only \$1.00

ARMY & NAVY BARGAINS



- New Gov't All Weather HAMMOCK—Waterproof Roof—Zipper enclosed Nylon Netting, Value \$30.00 \$4.98
- PUP TENT New \$5.95—Slightly Used \$3.95
- U.S. ARMY PISTOL BELT Slightly Used 59c
- New Gov't Watch Type JEWELLED COMPASS Longines Waltham98c
- New HUNTING KNIFE & SHEATH 6" Polished Blade \$1.98

Send Check or Money Order — Include 50c for postage

THOUSANDS OF SATISFIED CUSTOMERS
Write for Illustrated Free Price List

NATIONAL SURPLUS SALES
184 Flatbush Ave. (dept 5) Brooklyn 17, N.Y.

OUR 25th YEAR

BECOME A MANUFACTURER'S AGENT

Be your own boss and earn big profits with little or no capital investment. Send today for the **VIMAR PLAN** which provides you in detail with soundly-tested methods on how to become a representative for prominent manufacturers. Learn how to contact concerns, select products and build a successful business for yourself. \$2.00 postpaid.

VIMAR CO. 210 LOEB ARCADE, Dept. A-11 MINNEAPOLIS 2, MINN.

What Type of Work Do You Want . . .

Design-Engineering Parts Jobber

We Can Help You! *Get The Job You Want!*

REFRIGERATION and AIR-CONDITIONING

There aren't enough trained men in this industry. Greater opportunity for you — get your training now. Big profits, steady employment, lifetime security, a dignified career. Choose from a variety of jobs.

Inquire Now — All Details FREE — Mail This Coupon

NAME AGE

STREET

CITY STATE

ARE YOU A VETERAN?

Dept. M-4, Boston Tech Inst.,
4707 Euclid Ave., Cleveland 3, Ohio

TRAIN THIS EASIER, FASTER WAY

The Govt. pays all your expenses, and we train you in less than half the average time required in apprenticeship! Train in modern Labs., under expert instructors. Upon completion our Service Dept. helps find the job you want. Our men have the jump on their competitors.

Take Under G. I. Bill! *Make More Money!*

Service Work Your Own Business

in Refrigeration-Air Conditioning

MAKE UP TO \$5⁰⁰ AN HOUR In Your Own YEAR 'ROUND Business!

ONLY A FEW DOLLARS PUTS YOU IN BUSINESS!

Many Clearing as High as \$20 to \$30 a Day **NET** Renewing Rugs, Carpets, Upholstery. New Method Now Used for Auto Upholstery. Write for Facts About Quick, Easy Way to Get Started

Here is the chance you've been looking for to step into a pleasant, dignified, big-pay business of your own that offers you a steady, year 'round income. Start on "a shoe-string," full or spare time, right from your own home. Equal opportunities for men and women, young or old, in small towns or big cities. No experience needed. Many making big money with new Americlean System just cleaning auto upholstery. Easy to learn. We send you complete instructions and quick-cleaning supplies so you can start making money the very first day! Quick method cleans upholstery, rugs and carpets like new without taking off floor! Tremendous demand in homes, apartments, hotels, stores, office and public buildings. Steady repeat business. Territories going fast. Write today for full FREE facts. No cost or obligation. Rush letter or postcard now to **AMERICLEAN CO., Inc.; Dept. G-5; 211 North 7 St.; St. Louis 1, Mo.**

WRITE FOR FREE DETAILS NOW!



Beautiful brass Social Security plates (illustrated 1/2 actual size), priced at only 50c. Please print your name & number plainly.

ACME Stamping Service
Box 836
Davenport, Iowa

Learn LANDSCAPE GARDENING

A thorough, interesting, home study course for those who wish to become LANDSCAPERS, GARDENERS, DESIGNERS, etc., for profit or pleasure. Write today for FREE BOOK to

APPROVED FOR VETERANS NATIONAL LANDSCAPE INSTITUTE
Dept. P-5, 310 So. Robertson, Los Angeles 36.

There's MONEY in MAGIC!

Entertain For Profit or Fun! Earn money doing magic at parties, clubs, hotels, etc. Rush 25c for "MAGIC IS FUN" magazine. Teaches HOW to be a magician. FREE, with order, large catalog of magic apparatus.
D. Robbins & Co., Dept. M-93, 152 W. 42 St., N.Y. 18, N.Y.

The GLENWOOD MEMORIAL
Freight Paid Anywhere in U.S.A.

In all its beauty and durability is pictured in our free catalog of genuine Marble and Granite. Write for yours today.
U. S. MARBLE & GRANITE CO., A-18, Oneco, Fla.

Say You Saw It in POPULAR MECHANICS

Do You STILL CHANGE MOTOR OIL??

GET THE FACTS!

OIL FACTS

RECLAIMO
The Famous Filter-Refiner
ALL SORTS OF OILS

FREE 40 PAGE BOOK

If so—you can END this needless waste and expense forever, with "RECLAIMO"

America's Foremost Oil Re-Refining Filter. Continuously re-refines crankcase oil through an ingenious use of motor heat while driving!

1. Removes solids by filtration
2. Removes water-fuel dilution by heat and distillation
3. Prevents acid-sludge formation
4. Maintains stable viscosity
5. ELIMINATES ALL OIL CHANGES!

CAR—TRUCK—TRACTOR and DIESEL OWNERS!
U. S. Bu. of Stds. Bul. 86 states: "Oil Does Not Wear Out Mechanically"—"Reclaimo's" re-refining action has fully confirmed that statement. This great oil-saving feature is indeed important, BUT of far greater importance are the savings resulting from "Reclaimo's" tremendous reduction of costly motor wear! Again available—also to dealers. Complete details in FREE Book "Oil Facts". Write now! **RECLAIMO MFG. CO., 5087 Elston Ave., Dept. 44, Chicago 30, Ill.**

LEARN SPRAY PAINTING BIG PAY—

JOBS AWAIT YOU!



This new book covers fundamentals of spray painting—explains fully all phases—industrial spray-gun work—commercial studio and sign work—interior and exterior decorating. Simply written—easy to understand. Over 125 pages, fully illust. Only \$1.50 (Check No. 1 on coupon).

ALSO NOTE THESE OTHER VALUABLE DRAKE BOOKS

- No. 2. House Painting Methods—with Brush and Spray Gun. 400 pages, over 150 illust. and color chart. Only \$2.50.
- No. 3. Wood Finishing. Plain and Decorative. 360 pages, only \$2.50.
- No. 4. Cyclopedia of Painting and Decorating. 350 pages, 288 illust. Only \$3.50.

Drake's Books: Are Sold on a Money-Back Guarantee

USE THE COUPON — NOW

Fred'k. J. Drake & Co., Dept. A-6
600 W. Van Buren St., Chicago 7, Ill.

Please send me the books checked below. If not satisfied I will return them in 5 days and money will be refunded.

1 2 3 4 (Circle numbers wanted)

Check or money order enclosed \$_____ Send books postpaid.
 Send C. O. D. plus postage.

Name _____
Address _____
City _____ State _____

Drake books sold by leading booksellers



at Chicago's First Glass School

Fully approved for training under GI Bill of Rights
All phases of neon processing including GLASS LETTER BENDING . . . NEON COLOR GASSING and BOMBARDING.

Small weekly payments
Evening classes enable you to learn this interesting trade while you work during the day. Length of course is only 500 hours, approximately 13 weeks. No home studies—no course books—all work done in the shop under the watchful eye of skilled technicians. There is now a tremendous need for trained neon technicians all over the country.

COUPON

Send me additional information about your school:

Name _____
Address _____
City _____ State _____ Dept. P-57

ACME NEON INSTITUTE, Ltd.
1648 West Van Buren St. Chicago 12, Ill.

Make
big money...

— start a business
of your own with a

HOBART
multi-range arc
welder



Electric Stationary



"Build Your Own"



It from repair and construction work to be found everywhere.

"Build Your Own"

Save hundreds of dollars, build your own gasoline drive Hobart Arc Welder. Need only a Hobart generator, used auto engine and chassis. Free booklet tells you how. Write for details.

The Hobart Welding School

It's a modern trade school in which students learn by doing. Expert instructors give individual attention. Each student has own welding booth and welder. Fully accredited under G. I. Bill. Send coupon for details.

HOBART BROTHERS COMPANY
Box M57, Troy, Ohio

Electric
Portable

Hobart

"One of the World's Largest Builders of arc welders"



HOBART BROTHERS CO., Box M57, TROY, OHIO

I'm interested in the profit making possibilities of Hobart Arc Welders. Send me details on items checked.

- "Build Your Own" Gas Engine Drive
 Electric Drive A. C. Welder
 Hobart Welding School

NAME _____

ADDRESS _____

PAY RAISING—EXTRA MONEY BOOKS

Use these books to prepare for a better job—bigger pay—to start a profitable spare time or full time business of your own, improve your home, start a hobby. Popular Mechanics specializes in

supplying outstanding self-help books on many subjects. Send for our FREE catalog.

- Shop Notes for 1947
Now ready. For every man who uses tools 60c
- Shop Notes Library
5 Vols.—1946, 45, 44, 42, 41 (No Dup. Mat.) \$3.00
- Painting, Furniture Finishing and Repairing \$1.50
- Rewinding and Servicing Electric Motors (No. 75) 25c
- Elementary School Subjects for Home Study
Covers high points of grammar, spelling, arithmetic, history, science, geography, etc. 635 pages, \$1.89
- High School Self Taught
Covers 25 subjects with study guide and self-testing quizzes. Completely revised and enlarged edition, 1280 pages, 300 illustrations, ... \$3.95
- Garden Book
Build own trellises, lawn furniture, fireplaces, ornaments, etc. \$1.00
- Diving, Cutting and Welding in Underwater Salvage Operations
Only book of its kind .. \$2.00
- Picture Framing
Modern methods for making and painting picture frames. Fully illustrated, \$2.75
- Frog Industry
Breeding, feeding, dressing and marketing \$1.00
- New Fields for the Writer
Television, radio, film, drama \$1.00
- Making Amateur Photography Pay
How and where to sell your pictures \$1.00
- 20 Careers of Tomorrow
Covers plastics, metallurgy, textiles, radio, electronics, television, transportation, chemistry, etc. \$2.50
- Breaking Into Advertising
\$1.00
- Into the Freezer and Out
A complete handbook on the home freezing of foods. \$2.50
- Concrete Handbook
New book on using concrete around home, garden, farm \$1.50
- The Vegetable Growing Business \$3.50
- This Way Up
The successful philosophy of practical business men \$2.00
- Welding, Brazing and Soldering
How to build own equipment and how to use it effectively \$1.25
- Modern Refrigeration
Electric, Gas. Be service expert \$5.00
- Dyke's Auto Ency. (includes Diesels, airplane engines) New 20th Ed. World's greatest book for mechanics \$7.00
- Household Mechanics
The "fix-it" book to end all "fix-it" books. Covers electric appliances, painting, carpentry, etc. \$2.75
- Oil Burner Handbook \$2.50
- Build Your Own Boat
Describes 17 popular boats—rowboats, sailboats, plywood outboard, etc. 192 pages \$1.50
- House Wiring (No. 89) ... 25c
- Turn Scrap Into Money
Convert old auto generators into motors, welders, etc. \$1.00
- Woodworking for Everybody
The first complete book on this subject. Considers tools, explains cutting and shaping of wood, and has 46 useful projects \$2.75

- Sheet Metal Work \$3.00
- Tool and Saw Sharpening (No. 92) 25c
- Forging Practice \$1.50
- Action Toys (No. 66)
Plans for 21 easy-to-make toys 25c
- Foundry Work \$2.25
- Pattern Making
Wood, metal \$2.25
- Forty Power Tools
Build own saw, drill, lathe, sander, etc., from scraps—save money \$1.25
- Carpentry \$2.50
- The Young Craftsman
Over 450 things boys can make \$1.50
- Five Acres and Independence
How to make money on small farm \$2.50
- Your Home and How to Build It Yourself
Step by step construction of the famous POPULAR MECHANICS house. Wonderfully illustrated \$3.00
- Photo Guide
Construct own equipment, gadgets. Make better photos \$1.50
- Knots, Ties and Splices
For everyone who uses rope \$1.25
- Plastics
Latest information on manufacture and use \$5.00
- LeJay Manual of Homemade Electric Equipment
How to construct 100 items that are scarce and valuable \$1.50
- How to Estimate for the Building Trades: Material and labor costs for masonry, plumbing, electricity, carpentry, heating, hardware, painting, etc. 629 pp \$5.50
- A Small Store and Independence
Guide to successful retailing \$2.50
- Rabbits for Food and Fur \$2.50
- Tool Making \$4.00
- Tool Design \$4.50
- Plumbing Installation & Repair
Ropp's Calculator \$2.00
- Ropp's Calculator
Figuring made easy .. 50c
- Slide Rule Simplified ... \$2.75
- Drake's Refrigeration Service Manual \$2.00
- Primer for Home Builders
All the information you need to know in building a house \$2.50
- How to Remodel A House
Nothing is omitted \$5.00
- Toys You Can Make of Wood \$2.50
- A.B.C. of Poultry Raising \$2.50
- Ice Cream for Small Plants
Some technical formulas for ice cream, ices and frozen desserts on a commercial scale \$2.50
- Furniture Joinery \$2.50
- Essentials of Upholstery \$3.25
- Radio Physics Course
A thorough training in radio fundamentals \$5.00
- Science Digest Reader
Fascinating articles on astronomy, atomic energy, psychology, medicine, etc. \$3.00



MAIL THIS COUPON TODAY

Check the books you want, write your name and address below, and mail this advertisement with money order or check. Outside U. S. A. include 15% additional for shipping charges.

Books selected will be mailed promptly on our "money back if you're not entirely satisfied" guarantee.

Name _____

Address _____

City _____ State _____

Mail to **POPULAR MECHANICS PRESS**
Dept. 650—200 East Ontario St., Chicago 11, Ill.



GRANDSON- OF-A-GUN

THAT cavernous muzzle staring at you is the business end of the Army Ground Forces' new 75-mm. recoilless rifle. It fires a 14-pound projectile—with sniper accuracy—at targets four miles away. Two infantrymen can carry it. One can fire it.

This weapon is a grandson of the old 75-mm. Field Artillery piece, mainstay of World War I, which weighed over 3000 pounds and required a crew of six to nine men.

The 75-mm. recoilless rifle, by contrast, weighs 110 pounds, and its tripod is the same used for the Army's caliber .30 machine gun!

Increasing firepower per man is only one among hundreds of new, pace-setting developments now under way in Army laboratories all over the country. The job of keeping our Ground Forces ahead in equipment and training calls for the efforts of thousands of high-caliber, conscientious young men.

• Listen to "Sound Off," "Warriors of Peace," "Voice of the Army" and "Proudly We Hall" on your radio.

Your new Regular Army is advancing the frontiers of science, and many of its projects, now in the exploratory stage, will find their way into vital peacetime uses. There's a place here for inventive genius and mechanical skill.

Today, many of America's finest young men are launching interesting and useful careers with the Regular Army. If you can measure up to high enlistment standards, you become a part of an organization that offers the best available training in a wide range of trades and skills. New pay increases enable you to begin your service at \$75 a month, with food, clothing, housing and other expenses paid. Get full details at your nearest U. S. Army Recruiting Station.

A GOOD JOB FOR YOU
U. S. Army
 CHOOSE THIS
 FINE PROFESSION NOW!

You're really
 "Solid"-when you've got
 P.A.*



R. J. Reynolds Tobacco Co.
 Winston-Salem, N. C.

P.A.* means **P**ipe **A**ppeal

Pipe Appeal is that "something extra" that has a real appeal to women. It's the distinctly masculine look of men who smoke pipes!

P.A. means **P**rince **A**lbert



CRIMP CUT P.A. IS
 GREAT FOR 'MAKIN'S'
 CIGARETTES. ROLLS
 EASY—PACKS JUST RIGHT

—that rich-tasting tobacco that's mild and mellow—easy on the tongue. P.A. is specially treated to insure against tongue bite—to give you real smoking joy and comfort. More pipes smoke Prince Albert than any other tobacco. Try it—and see why!



The National Joy Smoke

WITH stubby wings like half barrels flanking its fuselage, it resembles nothing you've ever seen in the air before—but it flies! Some experts who've seen it still can't understand why.

And before you recover from the shock of watching this strange craft perform in the sky, its inventor, Willard R. Custer, has many more surprising claims to make.

He says planes of this design can: take off and land at 15 miles an hour in 50 feet of space, lift twice the pay load of present transports using the same power, and either hover overhead or pierce the supersonic speed zone. And he supports his

Inventor Custer points to the channel wing design he says makes possible safe 15-mile-an-hour take-offs and landings and doubles planes' lifting capacity. Test version, below, has flown more than 100 hours

THE WING THAT FOOLED THE EXPERTS

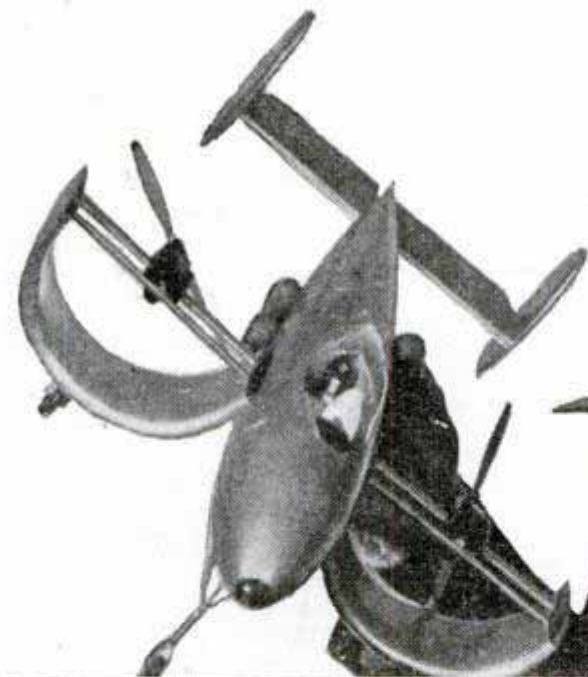

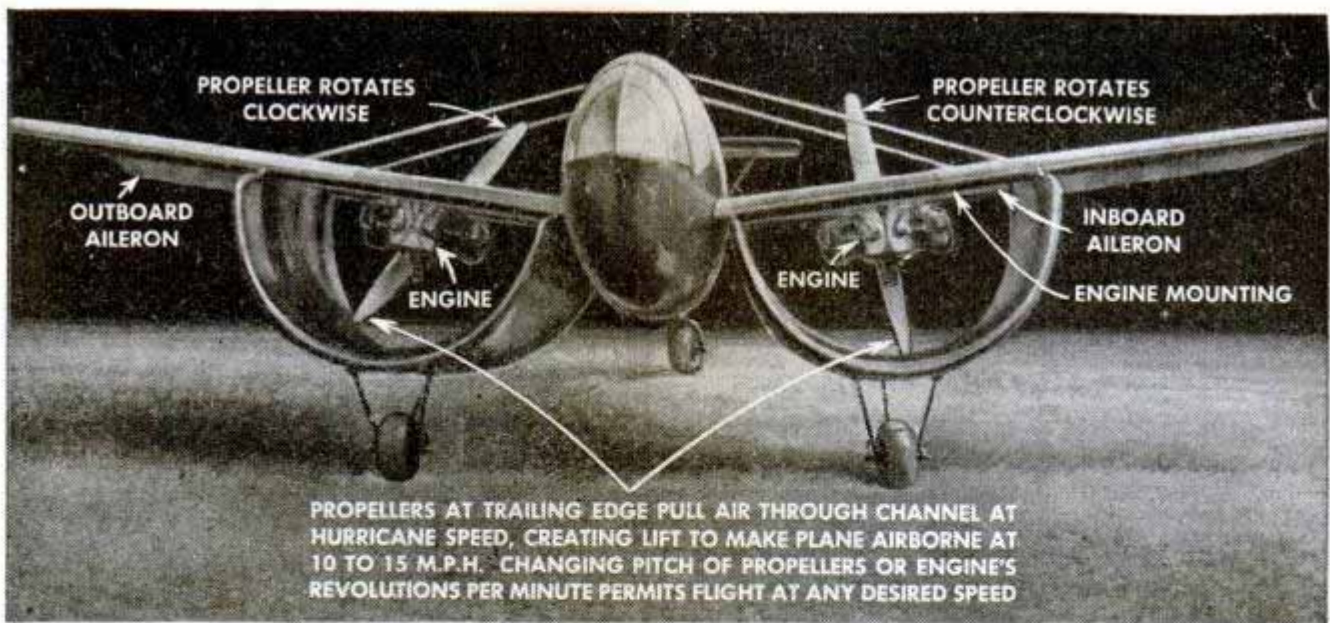

PROPELLERS AT TRAILING EDGE PULL AIR THROUGH CHANNEL AT HURRICANE SPEED, CREATING LIFT TO MAKE PLANE AIRBORNE AT 10 TO 15 M.P.H. CHANGING PITCH OF PROPELLERS OR ENGINE'S REVOLUTIONS PER MINUTE PERMITS FLIGHT AT ANY DESIRED SPEED

Front view of experimental plane with 75-horsepower engines. It made take-offs and landings in less than 100 feet—upwind, downwind, crosswind

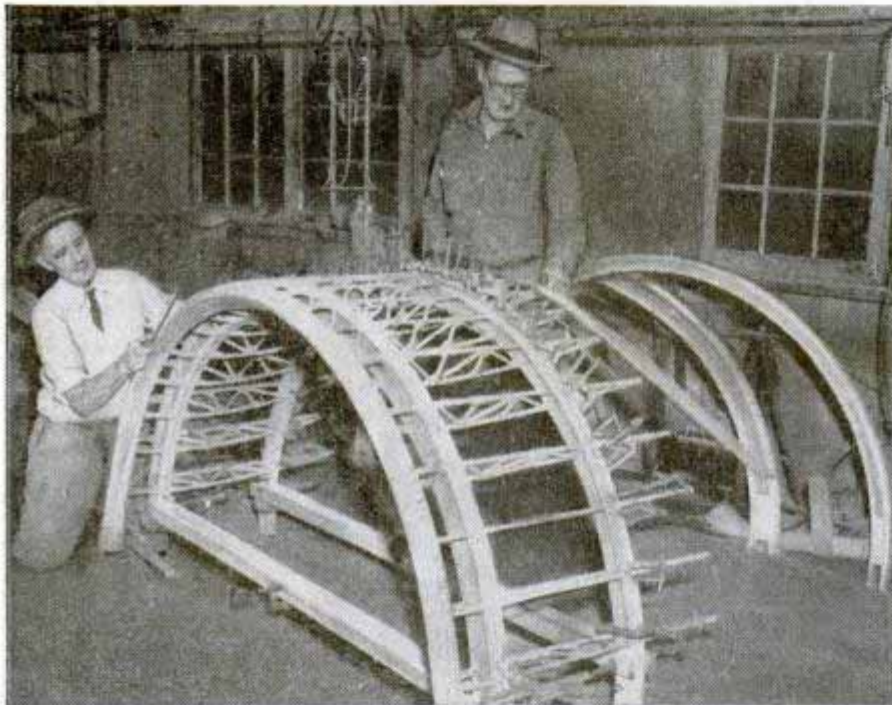

Readying six-foot channel for plywood skin prior to full-scale laboratory trials to determine lift, drag, thrust and pitching moment. Below, rear view of test model flown during Maryland trials. Despite its unusual appearance, the plane's controls are conventional and it is easy to fly



claims with results from Army and privately conducted tests.

Heart of this remarkable performance is the Custer Channel Wing, adaptable to any type aircraft, and to piston, jet or rocket power. In contrast to a conventional airfoil, it is shaped like the lower half of a tube and has an adjustable-pitch propeller at the rear. The propeller's tips sweep almost the entire trailing edge.

Simply stated, an ordinary wing is fashioned so that air pressure—or lift—is built up beneath it and decreased above it, as the plane speeds along the runway, until a slight difference between the two makes the plane fly. Atmospheric pressure on all sides of the wing is a constant 14.7 pounds per square inch at sea level when the plane is standing perfectly still. Modern transports like United Air Lines' DC-6s reach 125 miles an hour and use over 3800 feet to get off the ground, and they touch down at 100 miles an hour, using more than 1800 feet to stop.

Custer's method is to relieve the pressure above the wing by the propeller's sucking action at the rear of the

channel, and let the undisturbed pressure of nearly a ton per square foot below the wing lift the plane off the ground. Instead of moving the plane to achieve lift he gains it by moving air masses through the channel. To better control the lower-pressure air thus created within the wing, he has built up its sides above the propeller's center and slightly constricted the forward portion.

This funnels more air to the propeller, increasing its efficiency so much that the pitch has to be adjusted to absorb unused horsepower, Custer says. In contrast to this concentrated lift, a conventional wing's efficiency varies along its entire length. Since the channel will lift 75 percent of the plane's weight without forward motion, very little movement is needed to add the 25 percent that makes the craft airborne.

His unorthodox attack on the problem of finding more efficient ways to fly can probably be laid to the fact that Custer is an auto mechanic by trade, not an aeronautical engineer. So he cut a simple and unique path to his solution. He uses familiar objects instead of complex technical formulas to illustrate his arguments.

Although the invention has many important potentialities if completely successful, Custer prefers to stress the safety features that will further popularize flying. With it, he points out, planes can sink slowly to earth through the worst weather, onto deep snow or any other kind of unprepared ground, at landing speeds slower than a man runs. The crash hazards of blind approaches and landings at high speeds are

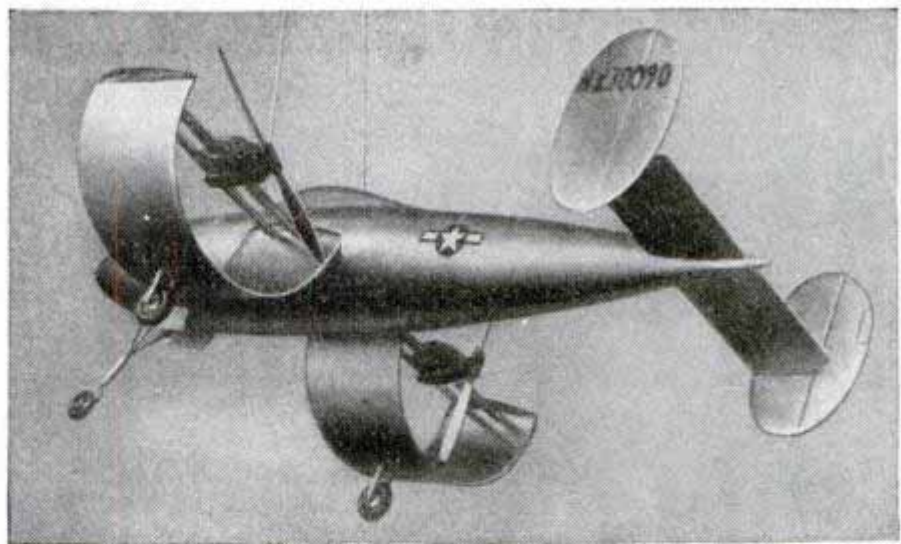

Supersonic speeds are expected from the channel wing on fighter aircraft

eliminated. Another important item is that all the controls of the channel wing plane are conventional and it is easy to fly.

While most experiments with the wing have been in wind tunnels and laboratories, a test ship flew more than 100 hours over a government field at Beltsville, Md., using 75-horsepower engines. The engines and propellers were mounted on metal supports extending across the upper rear section of each channel.

During those first test flights the plane, weighing only 1785 pounds with pilot, was held to a top speed of 60 miles an hour. Take-offs and landings were made under 100 feet, upwind, downwind and crosswind.

Two series of nonflying tests were later made by the Air Materiel Command at Wright Field. One fact established during trials was that the wing's lift increased even when its chord, the distance from front to rear, was reduced by half. Frank D. Kelley, president of the National Aircraft Corporation, said that a second flying model using a short channel wing will be ready for flight tests this fall at Hagerstown, Md.

Inventor's rough sketches showing adaptations of channel wing. One has large propeller sweeping rear of channel formed by section joining twin-fuselage fighter. Transport design uses double channels on both sides

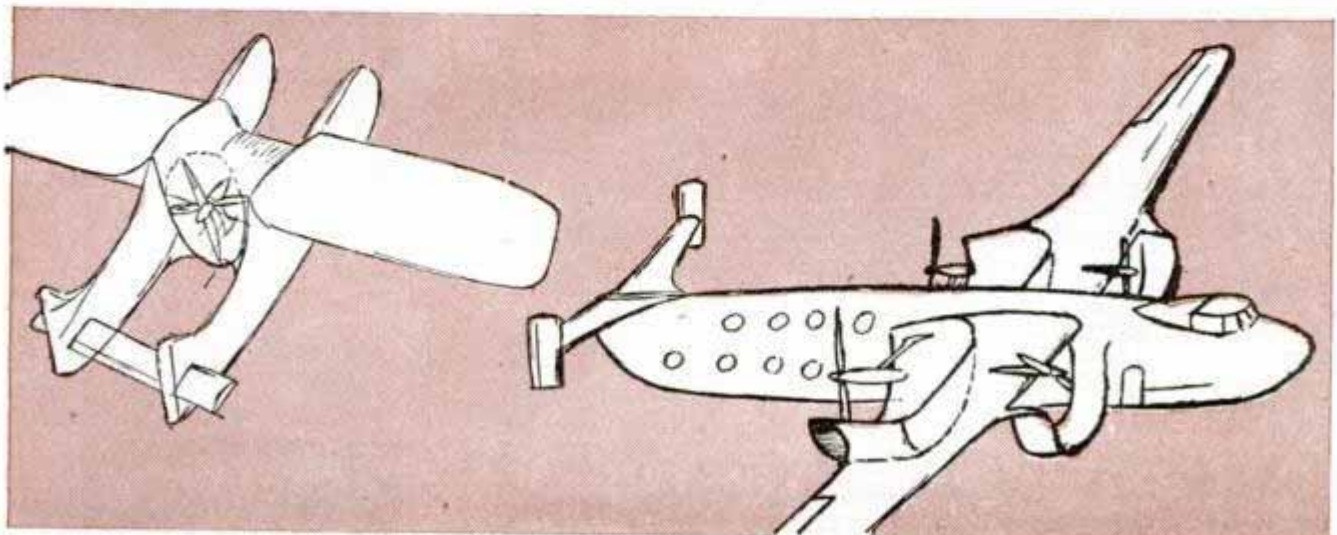



Rubber Raft Wading Pool

There's fun for the whole family in an inflated rubber wading pool. By turning it bottom side up, adults can use it as a beach raft or float. Because there are no rigid parts to fall against, children can play in the pool safely. The inflated unit is six feet four inches in diameter. It is made of heavy duck canvas, double-coated with synthetic rubber, and it folds into a package 12 by 22 by 8 inches. It is equipped with a tire pump adapter which makes it easy to inflate. The portable pool can be set up or repacked by one person in a few minutes and is compact enough to stow in a small space in a car.

☐ Vending machines to dispense hosiery are being developed.

Torrid Belt 30 Miles From Earth

Like the filling in a three-decker sandwich, temperature zones are stacked in contrasting layers in the upper atmosphere seven to 70 miles above the earth. Until recently, weathermen believed that above seven miles the temperature remained constant at 67 degrees below zero. Thermometers carried by V-2 rockets exploded this theory when they returned to earth with evidence that just the opposite actually exists. From seven to 30 miles the temperature is 67 below. From 30 to 40 miles the temperature jumps to 170 degrees above zero. In the next 10 miles it drops back to 80 below. Above 50 miles it climbs to 212 degrees, equivalent to the boiling point of water. The hot and cold layers exist because of the changing composition of the air itself. This new information, according to the National Advisory Committee for Aeronautics, will be helpful in designing rocket aircraft to operate in the upper atmosphere.

Air Conditioning Adaptable to Autos

Automobiles can be air conditioned like transport planes by circulating air and heat through hollow walls. The same system would also make possible fogproof windows and draftless ventilation. Another development is a hot water heating system for motor coaches which, used in combination with air-circulating fans and thermostats, gets heat from the engine and from additional booster units in extreme weather. Air is taken in just above the windshield, heated, and discharged through slots above windows on both sides of the coach.

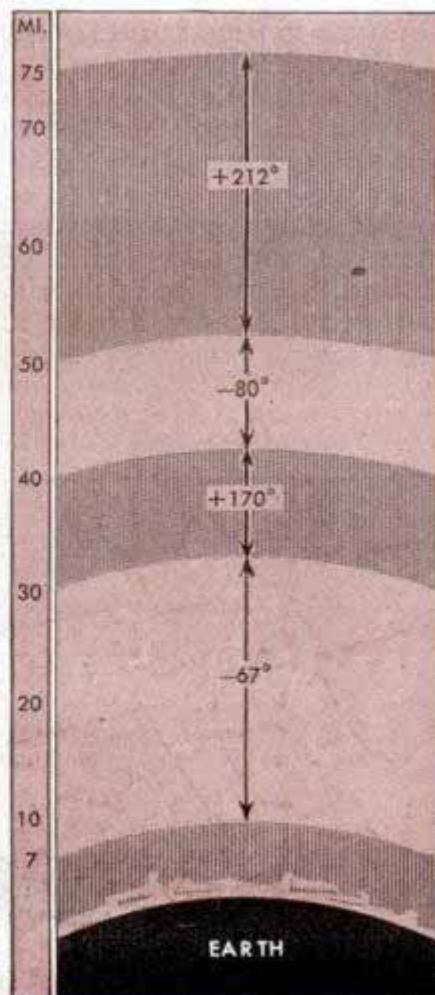

"Volcano" Stove For Campers

Within five minutes a new aluminum camp stove will bring a half gallon of liquid to boil, using only sticks, twigs and dry leaves as fuel. The stove utilizes almost all the heat of the fire by surrounding the flame with the liquid to be boiled. The grate is placed on the ground, and the unit, which has a circular opening through the center, is placed on top of it. A lid with a hole in it covers the unit. The flame burns through the center of the stove to heat the liquid. A pan support on top of the lid permits cooking of other food at the same time.

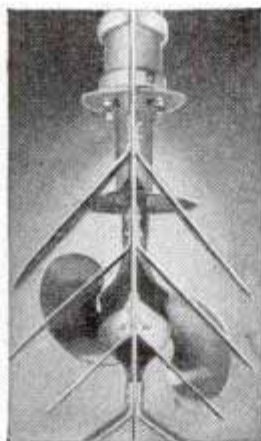
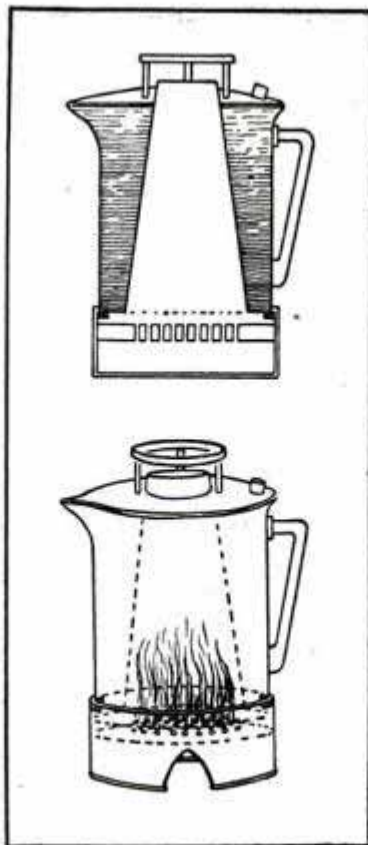

Outboard-Motor Weed Guard

A guard for outboard-motor propellers protects the spinning blades against weeds, floating moss, submerged rocks and snags. Made of aluminum alloy, the guard weighs less than two pounds and has eight fins which shield the propeller. The fins are shaped so as to offer little resistance to forward motion through water. To attach the guard to an outboard motor, two holes are drilled through the lower fin of the vertical member. The unit is then firmly anchored with two screws and a clamp.

Automobile Hoist Lifts and Turns Cars

Automobiles are not only lifted by a tilting hoist but also turned sideways so mechanics can stand comfortably while working on the undercarriage. The hoist can be mounted on either a stationary hydraulic or portable mechanical lift. It was designed by Carlyle Hall, retired dairy products manufacturer, of Seattle, Wash., to "take the auto off the mechanic and put the mechanic on top of the auto." The hoist makes it possible for two or more mechanics to work on a car at once.

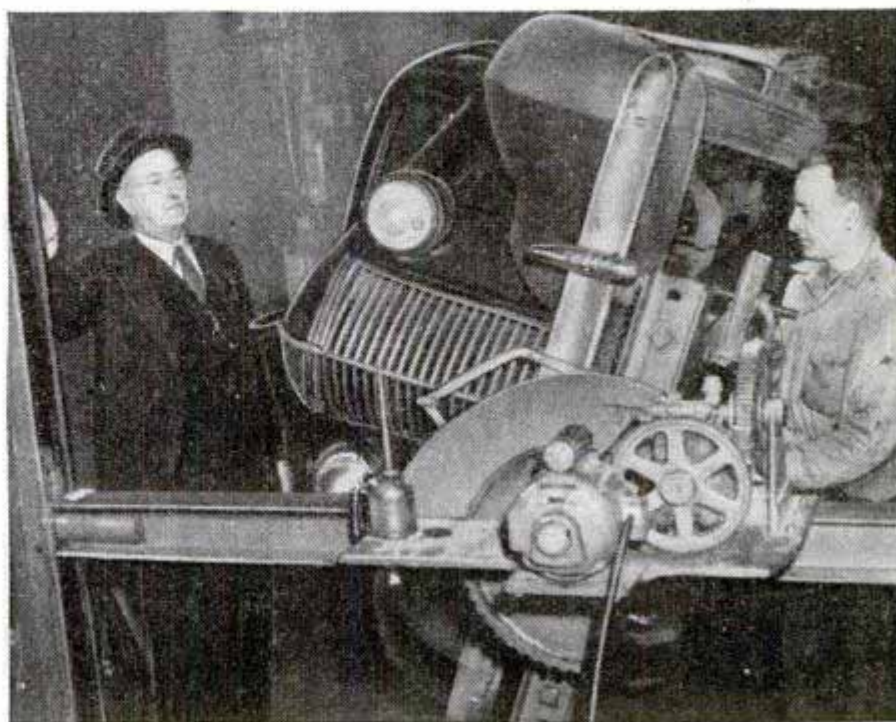

APPROXIMATE POSITION TAKEN BY BLUEBIRD II AT FULL SPEED

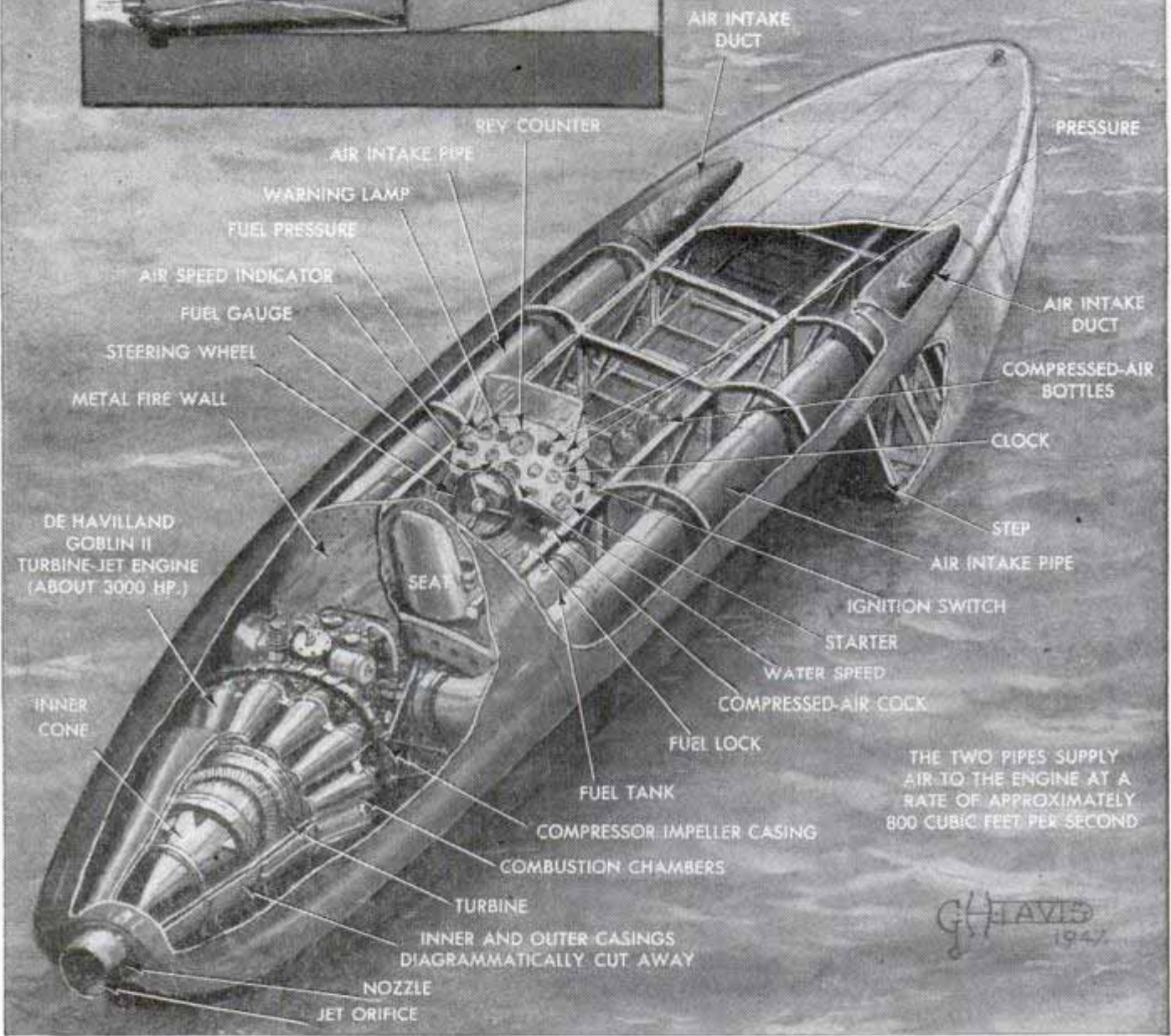
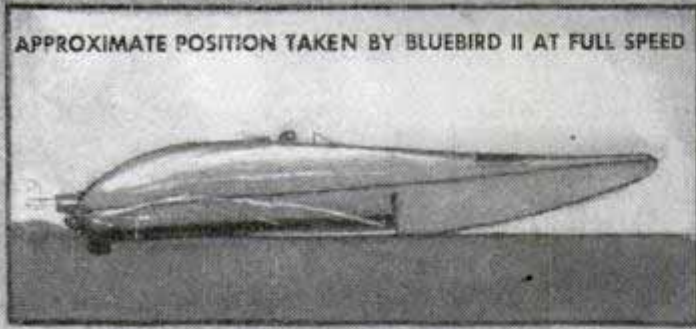

JET-DRIVEN BLUE BIRD II

The 3000-horsepower turbine-jet engine of this British speedboat may push the craft to a new world record—better than 141.7 miles per hour. Sir Malcolm Campbell will find out soon

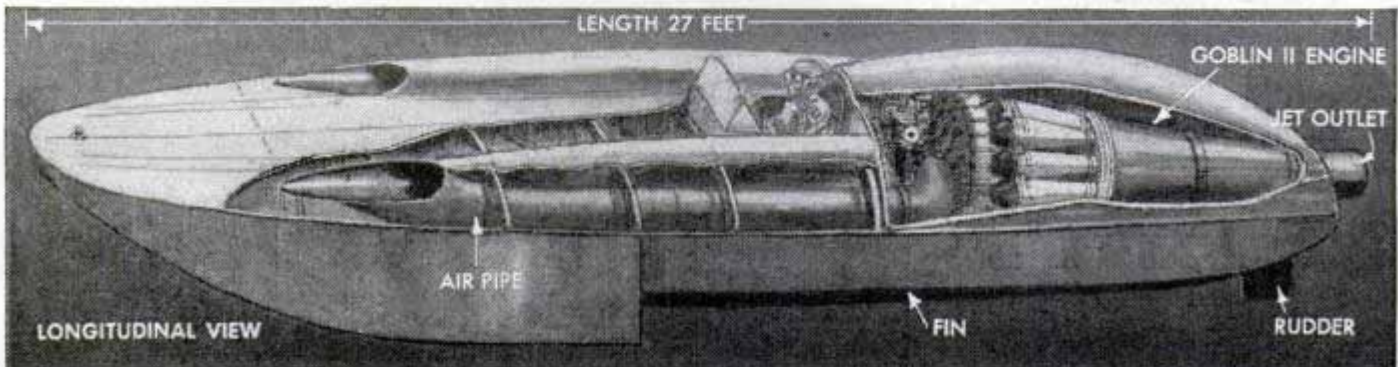

BBRITAIN'S Sir Malcolm Campbell is ready to resume his war-interrupted quest for new speedboat records. Holder of the world mark (141.74 miles per hour), he plans an attempt this month to set a new high on Lake Coniston in his reconstructed Blue Bird II, powered by a 3000-horsepower turbine-jet engine.

The lower hull is the same used in the original Blue Bird which carried Sir Malcolm to the present record August 19, 1939, on Lake Coniston. But the upper portion of the jet boat has been completely redesigned by Commandér Peter du Cane, managing director of Vospers, Ltd., British boatbuilders.

The propeller and shafting have been removed and in place of the former piston engine a De Havilland jet engine, similar to those used in British Vampire fighter planes, has been installed. It burns a refined kerosene. From the orifice in the stern, 1000-mile-an-hour jets will issue.

Sir Malcolm will not venture to forecast the speed he will attain. The jet engine in a Vampire develops 9330 horsepower when the plane hits 600 miles an hour. It uses 20 times as much air as a 2000-horsepower piston engine.

Some of England's top engineers have worked for more than a year in developing Blue Bird II. First there were tests with scale models in a special water tank. Then M. S. Hooper and other aerodynamic experts at Fairey Aviation Company conducted wind tunnel tests.

In the early days of speedboat runs, efforts were made to design a craft whose nose would rise out of the water to reduce water drag. But at the speed Sir Malcolm expects to reach, this rising out of the water could become dangerous. His boat might lift so much it would turn over. One of Hooper's toughest jobs was to modify the upper design of the old Blue Bird so that the dangerous angle of lift will not be reached at high speeds.

When the speed king climbs into Blue Bird II for a new record try, he will not engage in any long-drawn-out preliminary runs. Sir Malcolm believes that the behavior of the boat at moderate speeds would not necessarily indicate how the boat will act at top speeds.

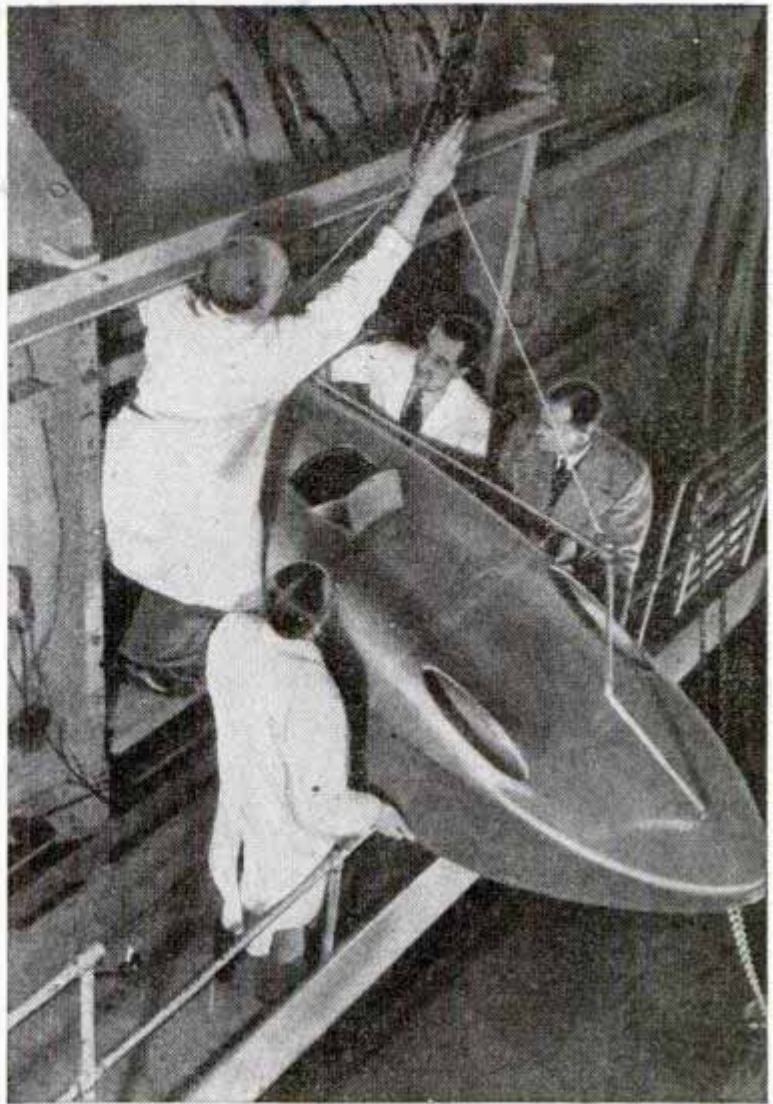

Sir Malcolm watches as model of jet boat is placed in a wind tunnel for tests. Below, making design measurements in wind tunnel

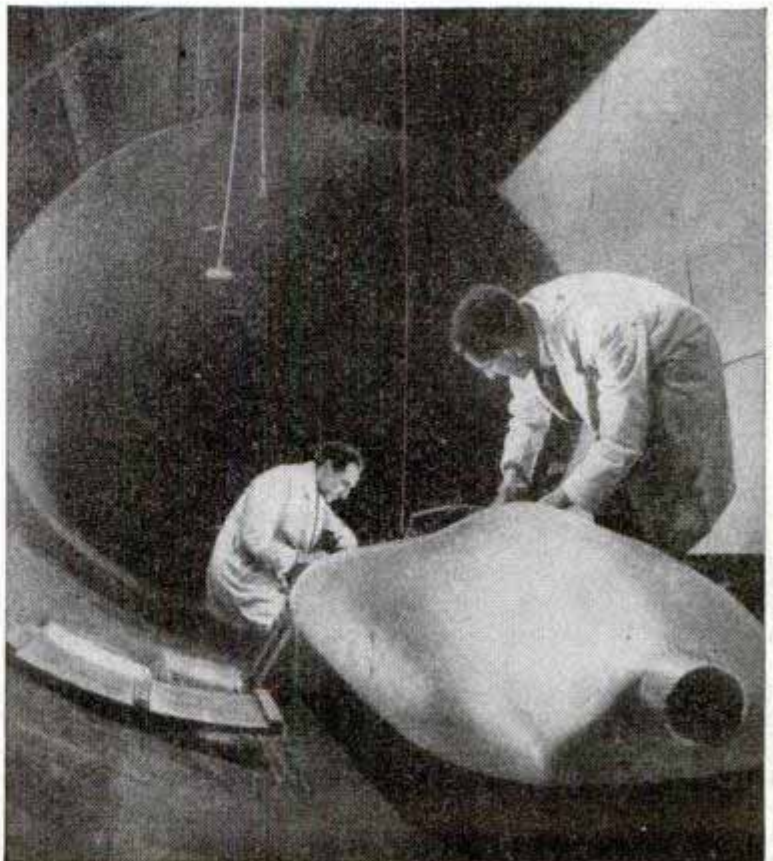

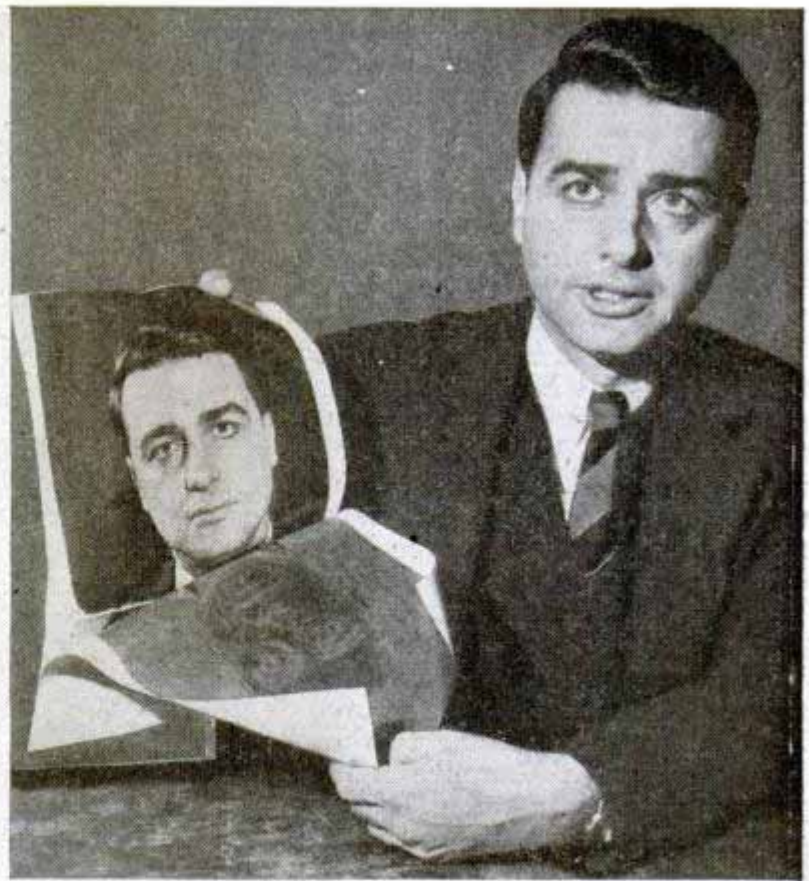
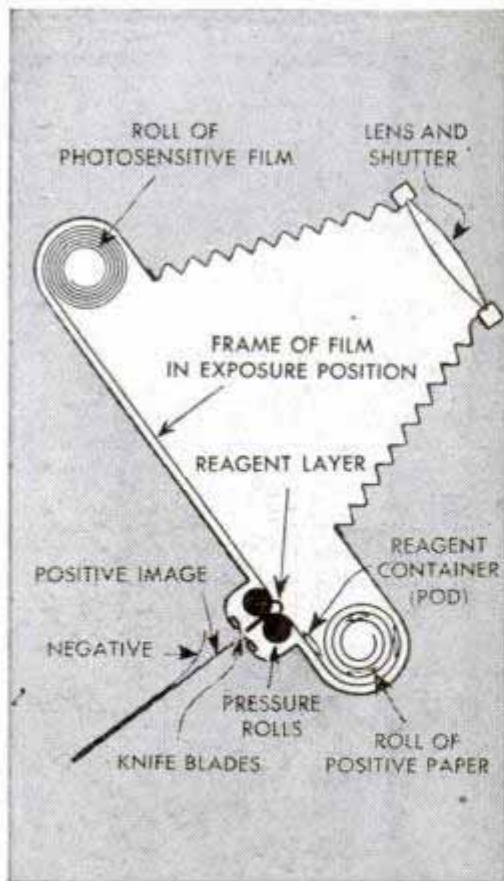

Camera Develops and Prints Pictures in One Minute

Finished pictures are produced by a revolutionary new camera one minute after its shutter is snapped. The camera has two rollers, one carrying the film and the other carrying a roll of special sensitized paper. After a picture is snapped, a knob is turned to advance the film and paper through the rollers. Pressure of the rollers breaks a small vial containing developer and hypo

taped between the film and paper. The chemical develops and fixes the negative and makes the positive print during the minute the film and paper are in contact. In the final step, the film and paper "sandwich" is pulled apart, leaving a positive print on the paper. The camera was developed by Edwin H. Land, president and director of research of Polaroid Corporation.



Magnetic Emergency Light

Electromagnetism holds an emergency automobile light securely against fenders, bumpers, hoods, engine blocks and other metallic parts. This action eliminates the trouble of looking for a place to rest the light, enabling a motorist to have both hands free to change a tire or fix his engine. The light, said to provide as much illumination as an automobile headlight, becomes electromagnetized as soon as it is plugged in. It comes in three types for plugging into a jack or cigarette lighter on an automobile dash, or for clamping onto a battery terminal.

Every day new products for homes and workshops, farms and factories, are appearing on the nation's markets, and every month you'll find them described in Popular Mechanics. For additional information about these products, write to Bureau of Information, Popular Mechanics Magazine, 200 East Ontario Street, Chicago 11, Illinois.

Ship's Stabilizing Fins May Prevent Seasickness

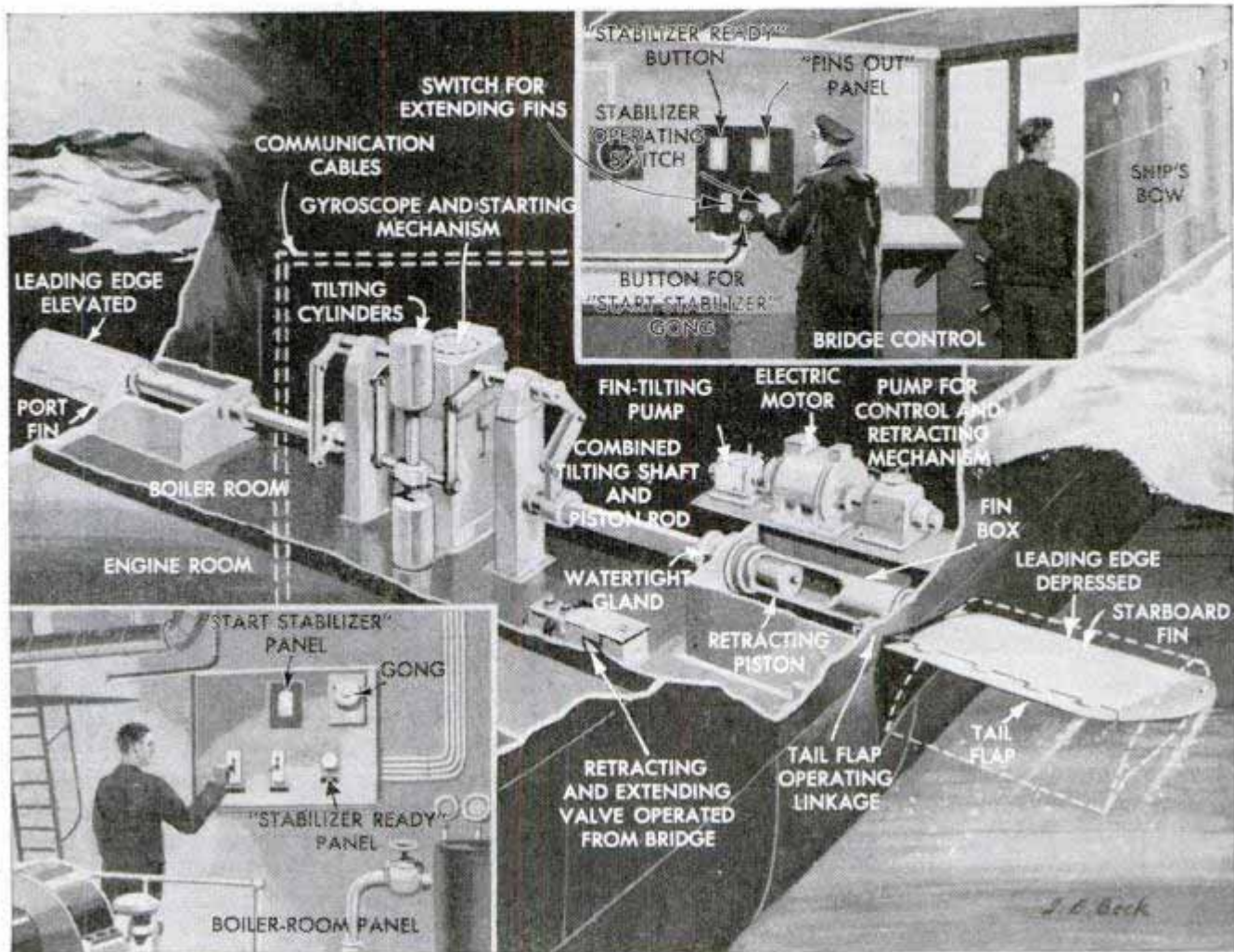

Tomorrow's ships may eliminate seasickness with underwater "wings" that reduce the pitch and roll of the hull in heavy seas. The retractable wings are part of a new stabilizing system for seagoing vessels described in British news releases. Two fins are installed amidships below the water line and project from the sides of the hull. They are connected by shafts to a gyroscope and a power unit. When the ship begins to roll, hydroelectric power is applied automatically, elevating one fin while depressing the other at high speed. The stabilizing effect is the same as that performed by the ailerons of an airplane, tending to counteract the natural roll of the ship. The stabilizer is operated from a control panel in the boiler room, which is connected by communication cables with the ship's bridge. The system was developed during the war to make naval gunnery more accurate. Stabilizers now are being fitted on new ships, it is reported.

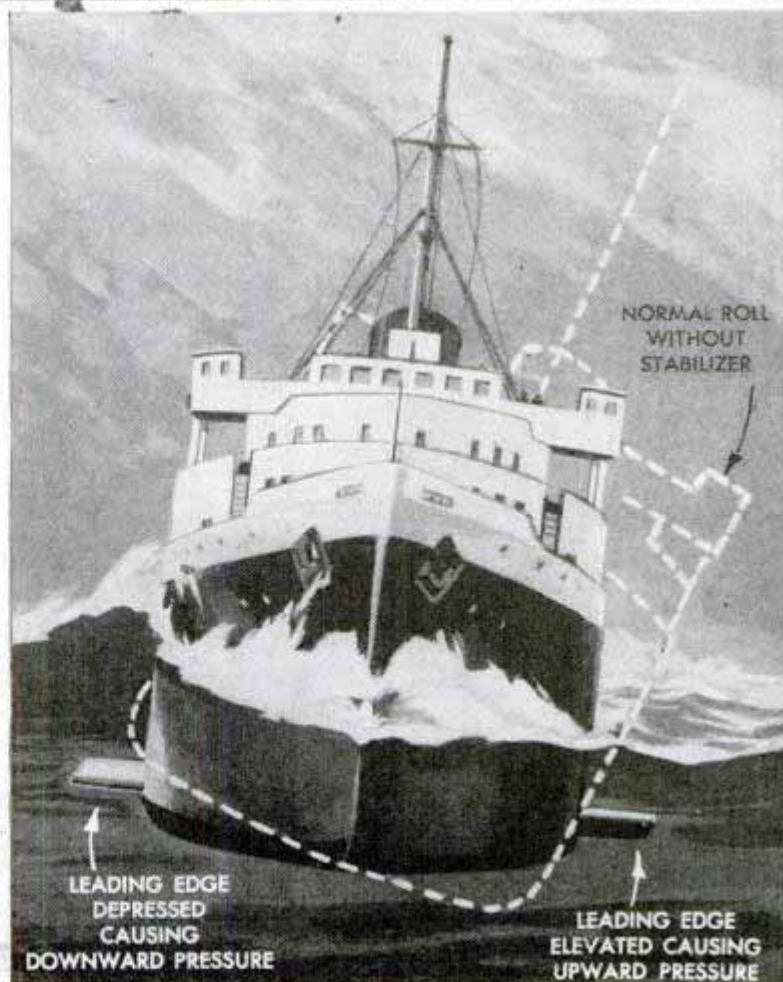



Book-Vending Machine

Pocket-size books are dispensed by a vending machine which offers a selection of 15 for 25 cents each. Manually operated, the machine holds 96 books and was designed for installation in hospitals, bus and railroad terminals and stores.



Miniature British Bus

In London, F. Renshaw got tired of waiting at street corners for overcrowded buses. He solved his personal transportation problem by building a small replica of a big bus. Renshaw's model is foot-pedal powered and gets through heavy traffic with ease.

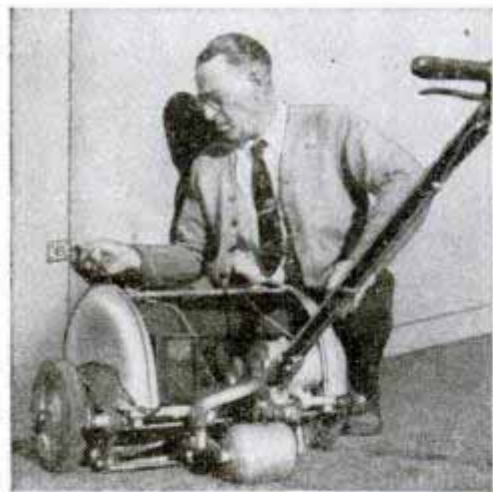

Battery-Operated Lawn Mower

Battery-operated lawn mowers make grass cutting an easy job. One model carries the battery, charger and electric motor in a streamlined housing above the cutting blades. It runs two to three hours before the battery needs recharging. This is done by plugging a cord into a 110-volt outlet. Both the cutting reel and the wheels are power-driven. Two controls in the handle simplify the operation. One starts and stops the mower while the other disengages the wheels to move around trees and obstructions.

There are 411 separate lights on the double-decked Boeing Stratocruiser and 82 are warning or indicator lights, all in the cockpit.

The MECHANICS of BATTING

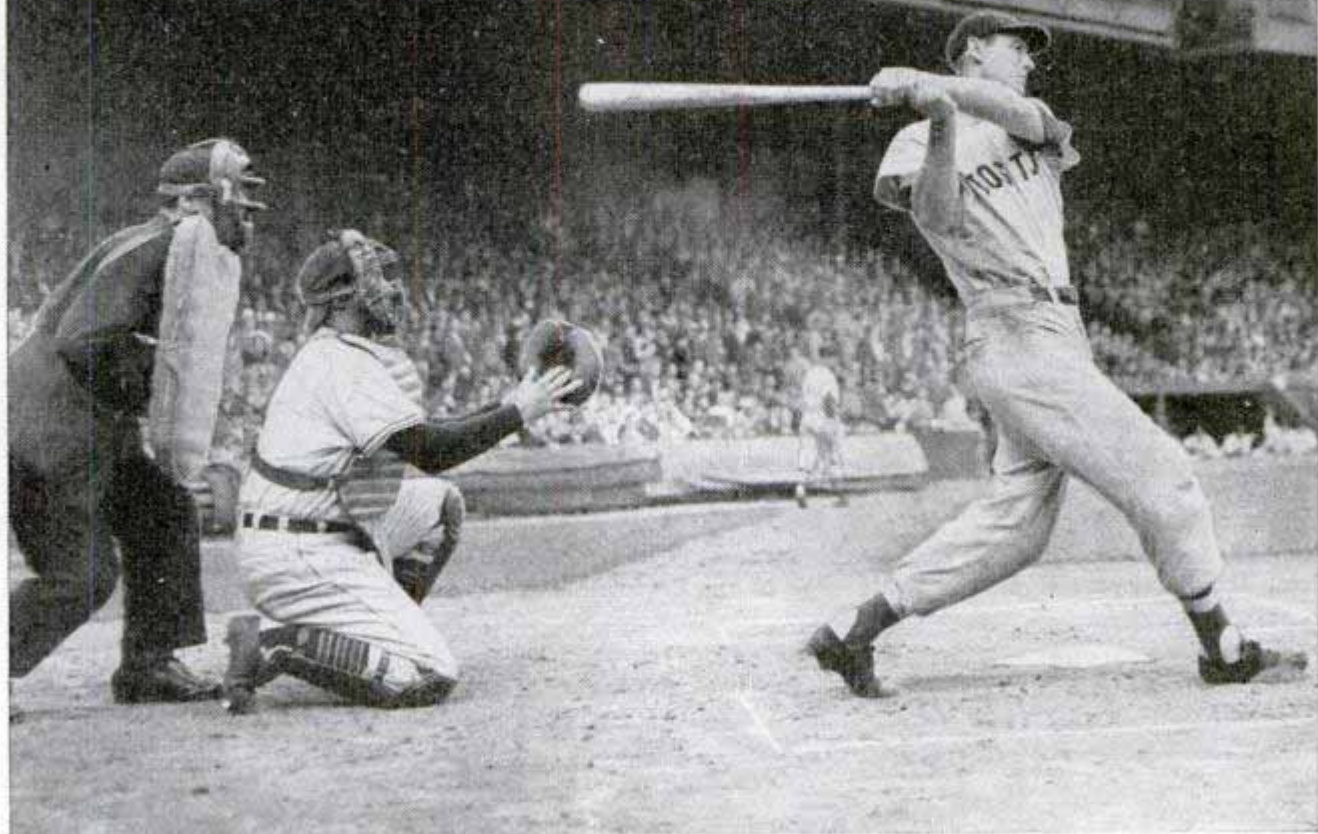

By
Aubrey O. Cookman, Jr.

WANT to be a good hitter? Then keep that bat off your shoulder and stop waggling it as you await the pitch.

Rogers Hornsby, baseball's foremost batting coach, says those are the two most common faults of rookies, and he's worked with thousands during his 33 years in the game. This spring he was given the special assignment of injecting long-sought hitting skill into the Cleveland Indians.

Few are better qualified to teach the subject. Called by many the most dangerous right-hand batter of all time, "the Rajah" led the National League for six straight years, with a .396 average for that time. In one season, 1924, he finished with a .424 mark that still stands as the highest in modern baseball. During his active big league years he rapped out more than 300 home runs and managed the St. Louis Cardinals to their first world's title. He has been elected to baseball's official Hall of Fame at Cooperstown, N. Y.

Wham! Power and good form in action as Ted Williams smashes a long one. Boston's "Splendid Splinter" may break Ruth's record. Below, two baseball immortals, Tris Speaker at left and Rogers Hornsby, right, give the author tips on holding bat for bunting

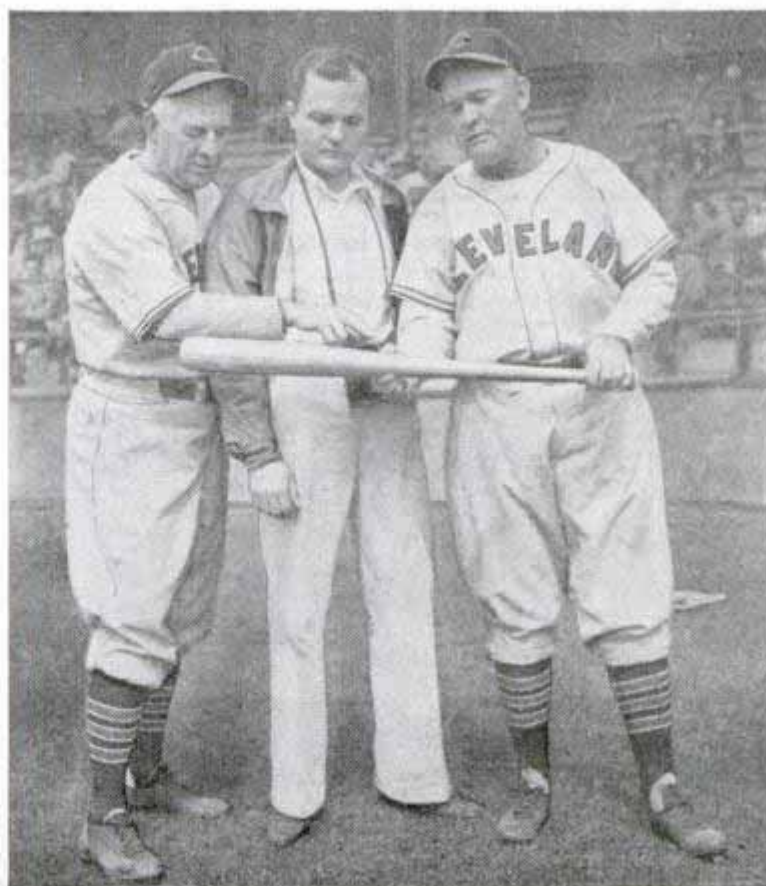

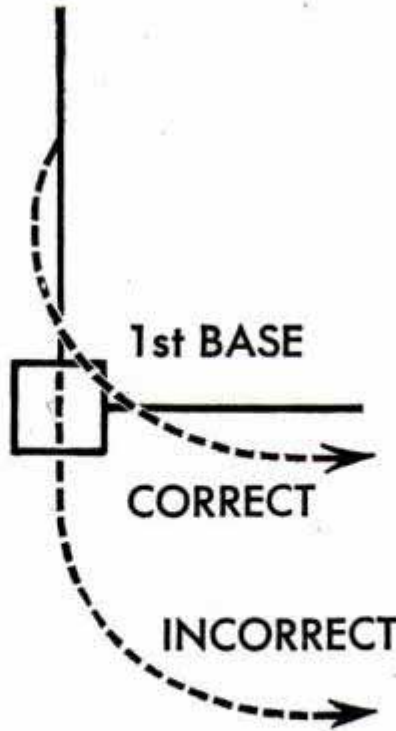

Manager Lou Boudreau shows the correct (left) and incorrect (right) ways to come into first on a hit to outfield. It is important to hit the inside edge of the bag with the left foot in making the pivot for second

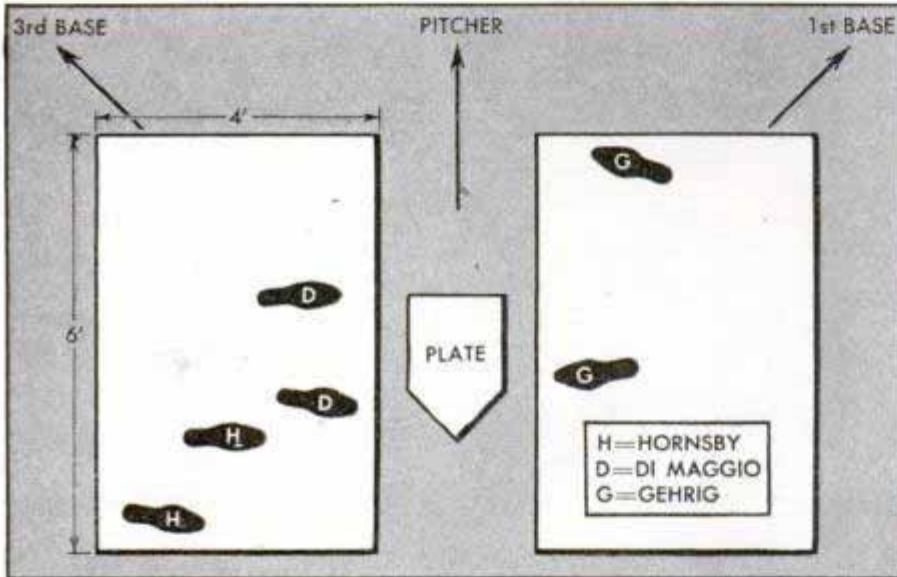

Indicating there's a wide choice, here's how some of the stars stood at the plate. Below, "the Rajah" takes positions for sacrifice bunt (left) and offensive bunt (right). Hold bat loosely to deaden impact with ball

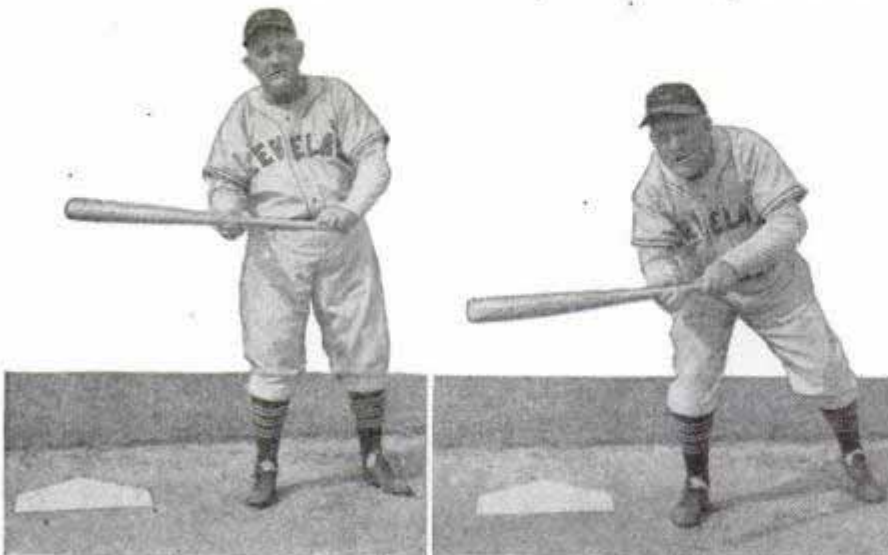

Hornsby says that most young ball players lose precious seconds, that mean the difference between hits and outs, simply by not being ready to hit. With pitchers like Bobby Feller firing the ball at you 100 miles an hour from a little more than 60 feet away, there's no time for hesitation or waste motion. There's just a split second to decide what to do, and do it!

He first teaches his charges to take a comfortable stance in the box. Surprisingly, Hornsby insists there's no "correct place" to stand within that area, four feet wide and six feet long. He just makes sure his pupils are relaxed—but ready. The stance's only purpose is to get the batter in his best natural position for the pitch, and solutions to that vary with individuals. What's perfect for a long, lean player might be awkward and uncomfortable for a squatty teammate.

Some star batsmen, imitating the late Lou Gehrig's style, crowd well forward in the box; others, in the manner of Tris

Speaker and Joe Di Maggio, straddle the midway mark, about opposite the plate. Hornsby planted himself at the farthest rear corner of the box. But all meet the ball squarely when it gets up to the plate, which is the most important thing. Hornsby doesn't recommend his own stance for others, only urging that they find one that's natural and comfortable, even if it means much experimenting.

Although favoring an erect waiting position in the box, the Rajah allows for personal preference here, too. Some very effective lead-off men, like Eddie Stanky of the Brooklyn Dodgers, get good results from a crouched stance. Some stand leaning forward slightly, and one long-time major leaguer, George Burns of Cleveland, kept both feet close together.

But before you get up to the plate, remember in selecting a bat to get one that feels free and easy, one that can be swung around easily on an inside fast ball. Don't pick a club that drags you. While most big leaguers use a stick around 34 or 35 inches long and weighing about an ounce an inch, there's no agreed best size.

Hillerich & Bradsby, batmakers for most of the game's stars, get requests that run from 33 ounces for Stan Musial to 36 ounces and over for Dixie Walker, Johnny Mize and Joe Di Maggio. Weight alone doesn't push the ball over the fence. Hard hitters like Hank Greenberg and Ted Williams use models weighing only 34 ounces, and Hank's isn't much larger than a softball bat in size.

Early in Babe Ruth's career he toted a tremendous 54-ounce bludgeon, but in later years dropped to 46 ounces and less. Another slugger of his era, Ken Williams of the Browns, was also in the 54-ounce class, and Hornsby picked his between 36 and 42 ounces. Many stars swing bats as light as 32 ounces.

Al Simmons is generally credited with wielding the longest bat, a 38-incher; and "Wee Willie"

Joe Gordon breaking fast for first. Most runners are thrown out by a step

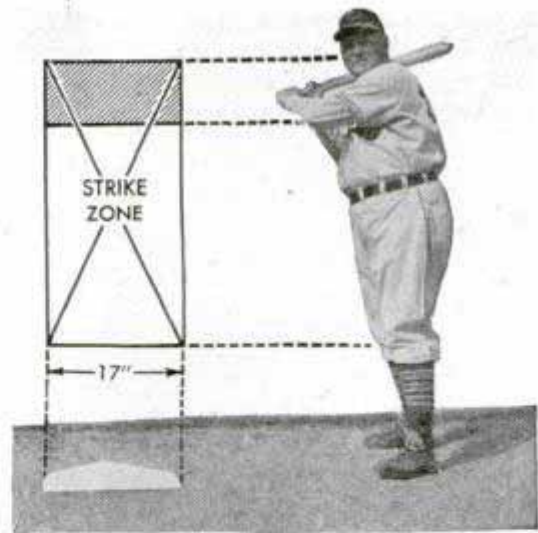
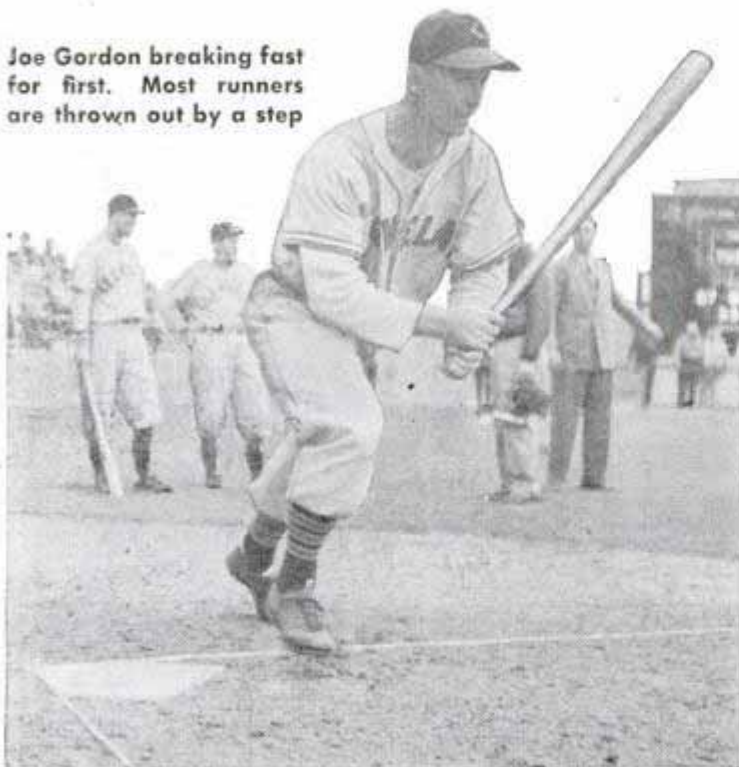

Photos by Sam Levitz

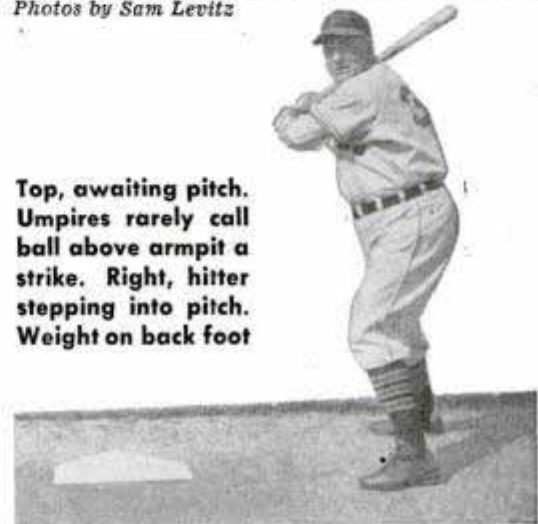

Top, awaiting pitch. Umpires rarely call ball above armpit a strike. Right, hitter stepping into pitch. Weight on back foot

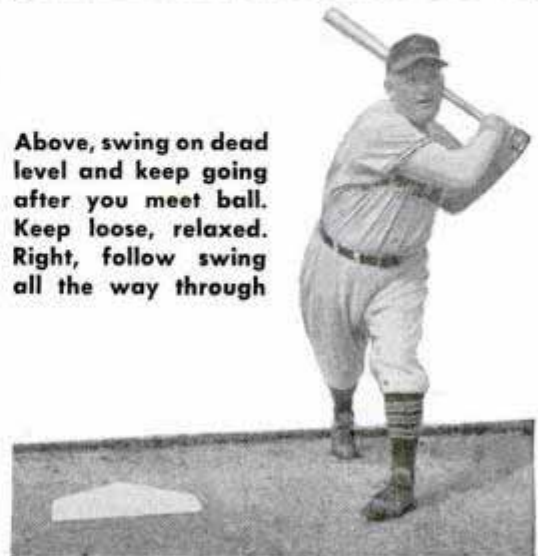

Above, swing on dead level and keep going after you meet ball. Keep loose, relaxed. Right, follow swing all the way through

He who hesitates is lost. Bob Feller's fast one gets to the plate in under a half second!

Cleveland Baseball Club photo

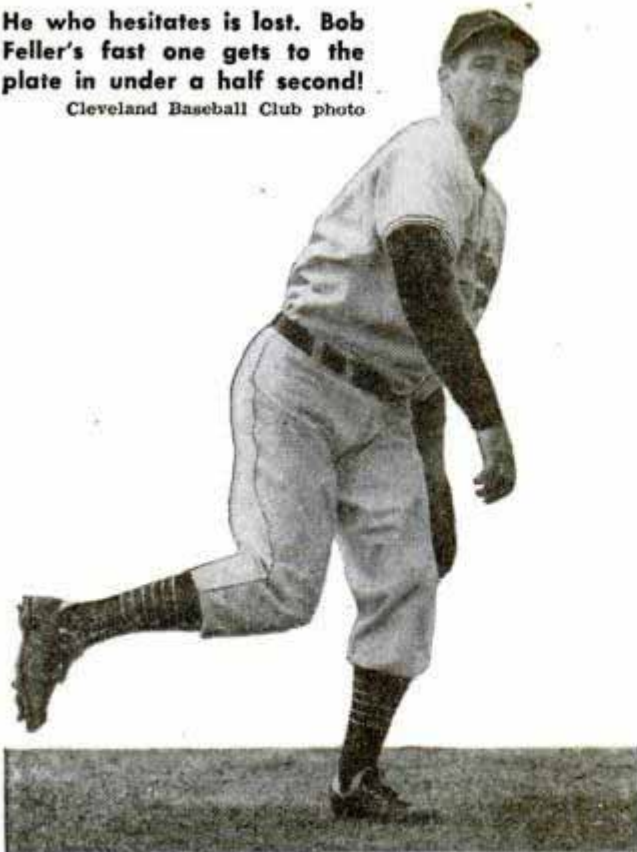

Keeler, famed place hitter, the shortest, 30½ inches.

Incidentally, manufacturers say expert batters have the least trouble with breakage. They don't catch the ball way out on the end, against the grain or up on the handle, like less proficient players who go for the "bad ones."

Once you take that comfortable stance and the pitcher moves up on the rubber, get the bat well back and away from your

shoulder. And keep elbows and arms away from the body. If they're down close to you it's an added time-wasting motion to shove them away before starting the swing forward. The same advice applies to the fault of having the bat rest on your shoulder, then jerked up and back in those last split seconds as the ball whirls to the plate.

Hornsby has spent countless hours ironing out nervous, long-practiced habits of waving the bat back and forth as the pitcher gets set to throw. To the spectator it may seem a gesture of defiance toward the pitcher, but it is usually a tip-off that the batter is overly tense, and it's always ineffectual. Once the bat is back, hold it there until it is swept forward at the ball.

Don't grip that bat too tightly; just make sure it's under control for the swing. Squeezing the handle tightens the forearm muscles and spoils the rhythm of the swing. And while you're waiting for the pitch, remember the strike zone the man with the ball is shooting for. Although it is the 17-inch width of the plate, from the knees to the shoulders, Hornsby and many others claim umpires rarely call strikes on pitches above the armpits.

Watch the ball from the moment it leaves the pitcher's hand and swing at any good one. Don't wait out your favorite pitch; if your opponent is smart it'll never come. And don't attempt to outguess the pitcher, anticipating what he'll throw and getting set for that particular pitch. The odds are all in his favor in that kind of a guessing contest and four out of five times you'll be off balance for the ball that does come.

Hornsby demonstrates position of hands and grip on bat at three stages of swing. Inset 2 is just after impact with ball, moving into follow-through. Don't hold the bat too tightly, he cautions



1



2



3



It doesn't pay to be a first-ball hitter at all times; wait it out until you get one in the strike zone. If the pitcher knows you always swing at the first ball he'll be certain to serve up a bad one. Occasionally, of course, it's good strategy to offer at the first pitch, but not as a general practice.

Now when you stride forward into the pitch remember that the rear leg holds the full weight and the front one is only a pivoting guide. The power is going to come from the balance you get on that rear leg, and the full weight of your body moving forward on it.

Generally a stride of about six inches or less is enough, but that'll vary with the batter's type of build and his timing. Some take practically no step and a few remain flat-footed throughout. One of the latter type, Joe Sewell of the Cleveland Indians, went through several seasons with just a couple of strike-outs each year. The flat-footed stance apparently gave him a needed extra fraction of a second to distinguish between strikes and balls that a "strider" loses by moving in earlier to meet the ball. Although a really great batter, Mel Ott of the Giants is noted for the odd manner in which he lifts his front leg high in the air in striding forward, instead of taking a low step in the pitcher's direction.

Al Simmons is a good illustration of the front leg's minor importance. A notorious "foot in the bucket" offender, pulling his front leg to the side instead of forward as the pitch came in, the Athletics' star was a leading American League slugger for years. Disobedience of a general practice never bothered his fat batting average.

In swinging, move the bat straight through on the same long level plane you plan to meet the ball, neither uppercutting nor chopping, and follow all the way through. Don't press or strain—it'll ruin your timing. Swinging too hard is just a form of bad timing, not a distance getter. And check carefully to eliminate any fancy "hitches" that prevent your swing from being straight and level.

Try meeting the ball at the top of the swing, putting into the impact the wrist snap that produces extra bases. Until then the bat is angled backward from your hands and the snap pulls it out quickly to a perpendicular from the body. It's the rhythmic action of strong wrists, not brawn, that gives a star like Williams added power.

See if you can direct your hit according to where the ball comes into the strike zone. If you're a right-hander and it's outside, a curve, fast ball or change of pace, aim for right or right center. When it's inside, shoot for left field. When one comes down the middle, use the pitcher as a target

(Continued to page 268)



Wire Recorder Home recordings are made on stainless steel wire with a new unit combining a wire recorder, radio and phonograph. Each 3½-inch spool of wire records a program lasting one hour. Radio programs, "albums" of children's voices and copies of conventional disk records can be recorded. Recordings no longer desired can be wiped off the wire by a system of electrical erasure, making it possible to use the same wire several times. The combination also has a turntable for playing disk records.

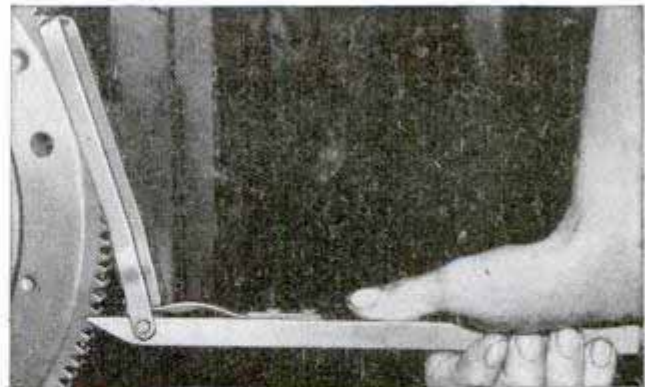

Flywheel Tool Skinned knuckles or frayed tempers are avoided on engine repair jobs with a handy flywheel turning tool. The handle of the tool is long enough to give leverage so precise adjustments of flywheel and crankshaft can be made. Once in place, spring tension holds it, leaving the mechanic's hands free for other work. It can be used on any make of car, truck or tractor engine.

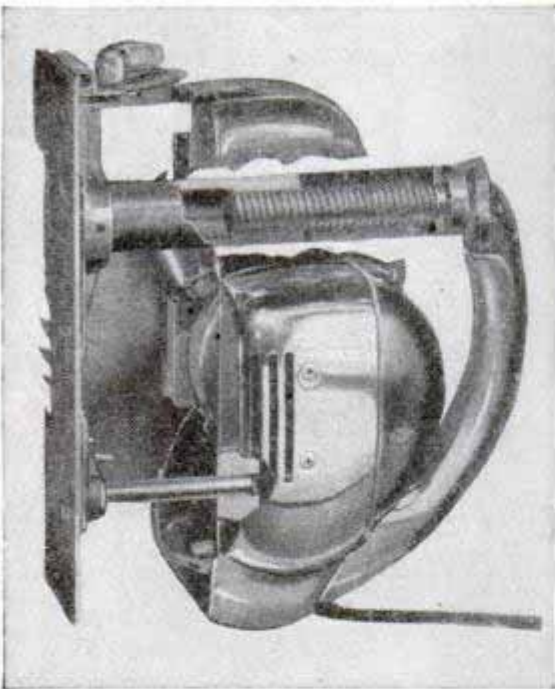

Portable Electric Saw Elevating and pointing mechanisms used in machine guns have been adapted for regulating the depth of cut made by a portable electric saw. The triple-lead thread used in the saw is similar in principle to the gun mechanism. It provides rapid, positive depth control. To make a depth adjustment, a knob is turned, causing a sleeve to move the relative distance of three thread spaces.

Pencil-Size Microscope



Grains of salt examined through a tubular microscope are magnified 25 times, appearing almost like pebbles

Pencil-size microscopes with 25-power magnification have been developed for inspection work and as an aid to students of chemistry and other sciences. To focus the instrument, the user holds the bottom section while rotating the upper part. In viewing tiny objects, the slanted cutoff at the bottom is faced toward a good source of light to provide maximum illumination.

Portable Time Control Unit

Radios, coffee brewers, roasters and lights are automatically turned on and off at predetermined times by a portable time control unit. One electric outlet of the unit is plugged into a wall socket and a second outlet is plugged into the appliance. Then the "on" and "off" settings are made. Bed-side radios can be set to turn off at midnight—in case the listener falls asleep—and to turn on at 7 a.m. to awaken him. When people are away on vacation, they can use the robot for burglar protection by setting it to turn the house lights on at dusk and turn them off at a later hour. On hot summer nights, fans can be attached to the time control unit and regulated to turn off later.

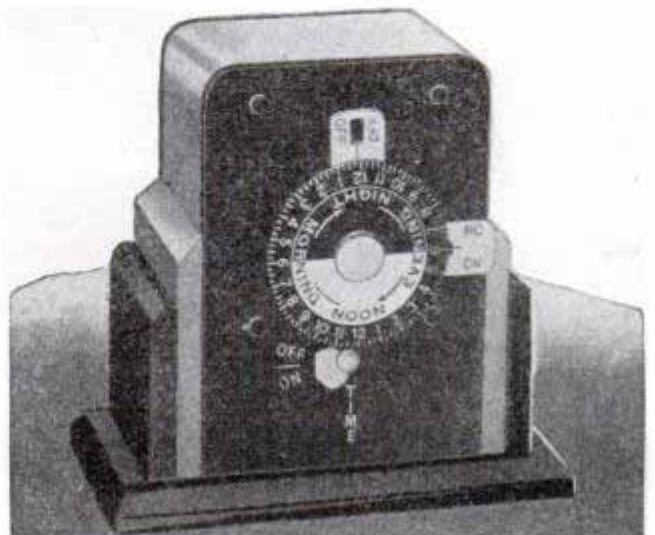



SHOOT FROM THE SIDELINES



Steeplechase's swift lateral action calls for highest shutter speeds. Below, elevation helps if you want a shot showing the field

By Richard W. Emery

AT BIG sporting events, amateur photographers have made such determined raids that now the managements and the professionals have drawn up rules and regulations for sideline shooting. To get a good spot for action close-ups, you have to show more credentials than a speckled hound has spots.

And that's a pesky situation, if you happen to be one of the amateurs.

A few years ago, when fast shutters began to appear on cameras priced under the stratosphere, hopeful sports-photo fans poured into the sidelines at big games. They got in, somehow, and they had a field day.

They got in front of the coaches or judges or umpires or referees. They bounced up in front of players. They trespassed upon the field of play. At critical moments they stood to their full height in front of pay customers to shoot pictures, despite wrathful yells. They put the whole photographic fraternity in a bad way with

the management. So the professionals, who have to get back to the office with a picture or else, drew up a truce with the management. All over the country it's the same, now, and you can get the terms from the Press Photographers Association in your home city.

The rules are specific, but they aim at broad targets:

You must have an airtight reason for taking pictures.

You mustn't heckle the players, the officials, the bigwigs or the cash customers.

But all the games aren't big games—and all the good sports pictures aren't close-ups. There are pictures—good ones!—to be made from the bleachers. You can pick your spot at many a lesser game, fight or tournament, close enough to get pictorial action rather than record shots of plays.

Many of the best action pictures of individual players are shot by the news photographers not in the touchy moments of actual play, but at practice games or warm-ups. When you can get rid of guesswork and take ex-



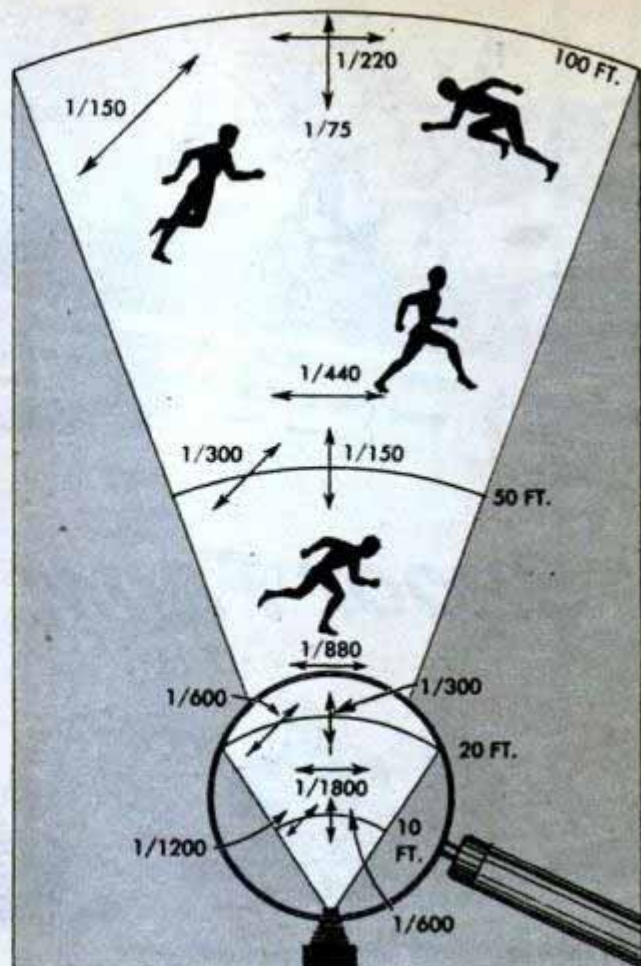

Even the fastest shutter in ordinary use won't stop a golf club. Based on minimum shutter speeds for action with five-inch lens, the diagram above shows that halving the distance to the subject requires doubling the shutter speed. Action at 45-degree angle to the camera can be shot at half the speed of broadsides at the same angle

tra care with focusing, composing the picture and shooting at the best moment, you gain much in pictorial quality, sharpness and clearness. Those important things often are sacrificed to news interest when you shoot actual play.

Knowing and liking the game helps you to get good pictures, whether you're shooting football or baseball or any other sport. It's not luck alone that puts you within range of where action will happen; it's

the ability to anticipate what may happen.

If you're going to try for good sports pictures, study up on the game itself, study the pictures of it in newspapers and sports magazines, and look for new ideas and new angles. That isn't the approach of a beginner, but rather of a professional. Even seasoned and expert sports photographers keep watch on what the other guy is doing.

Sports pictures include such a wide range of subject matter and photographic limita-

To put telephoto lens on Speed Graphic first remove the lens board, left, then place mounted lens in camera and lock it in position, center. The next step is to mask off the view finder, right, to fit the smaller field

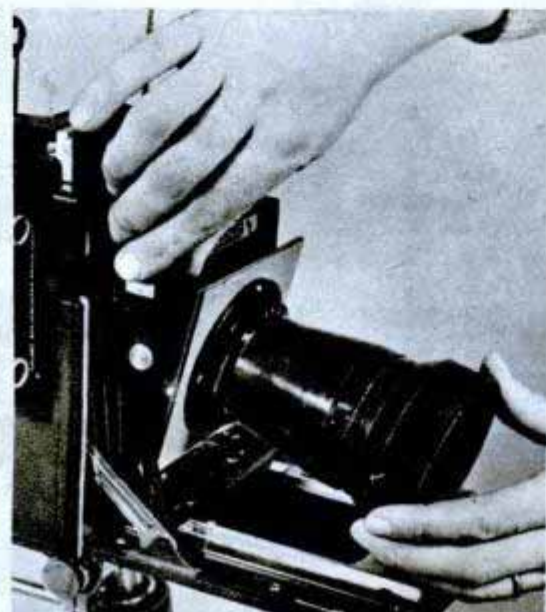



Try for shots like this one at scrimmage. Shoot from low angle and use all the shutter speed you can muster

tions that no one set of rules would hold for all sports photos. Here are several suggestions from Hal Jensen, California sports photographer, winner of many state and national press sports-photo honors:

1. Shoot with the sun to your advantage. You'll see cameras shooting the other way, into the sun, but pictures shot that way won't stack up against competition from the other side of the field.

2. Set the shutter for the maximum speed you believe necessary to stop action in the sport you are photographing. Then let the diaphragm determine the amount of

light necessary for proper exposure. The reasoning here is that the speed of action in the sport won't change, but the light will; by opening the diaphragm you lose depth of field but keep sharpness of rapidly moving subject matter within the shallower depth of field.

3. Where your shutter speed is limited, pan with the action. Pick up the subject and follow it with the camera, shooting while you're still panning. If you time your swing with the subject, you can stop fast lateral action with half the shutter speed otherwise necessary.

Left, inking boundaries of telephoto area so smaller rectangle frames field, as shown on ground glass. Margins are masked off as indicated in center photo. The proper way to hold camera to avoid movement is shown at right

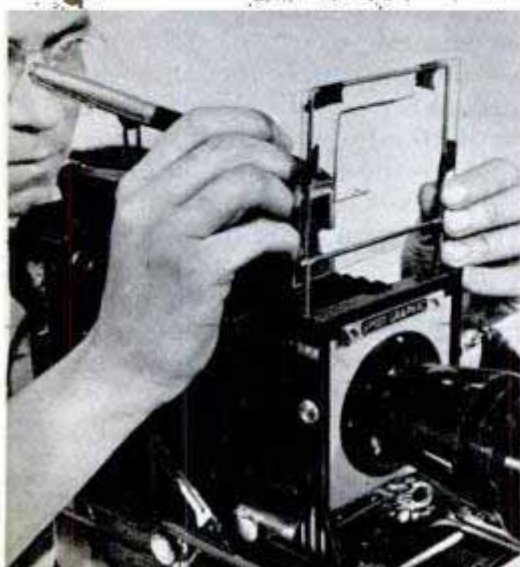



Photos by
Hal Jensen

4. Be sure that action comes within a reasonable focus range for your camera before shooting. A picture of distant action lacks punch. If you enlarge the picture tremendously and crop it down to the action, the picture loses technical quality—a hard thing to get in action sports pictures even under favorable conditions.

(For a Speed Graphic with five-inch lens, Jensen sets that "reasonable range" at 50 feet or less. When he covers football he carries two cameras. One is a Graphic with five-inch lens. The other is a Graflex with 14½-inch telephoto.)

5. Before you try for pictures at a major sports event, find out the management's rules and stick to them. Operators of sports arenas know that they can get publicity through good amateur photographs. Your chances for good pictures are better when you go with the management rather than against it.

6. Remember that development of the exposed film is very important and that it can be controlled. If you know that your negatives should have extra-long development to improve their contrast you can make the best of what you brought back. And, knowing that you will be able to develop your negatives fully, you can hang on to your high shutter speed to the bitter end of the fourth quarter—maybe!

If you shoot roll film, don't start off to the game with a half-shot roll in the camera. Suppose the pictures already shot were made with excellent lighting and you want to save them? Those negatives should have no more than normal development.

What kind of camera should you have? There are almost as many answers as there are sports photographers. A logical way to decide is to work back from the particular game or sport you want to shoot. Choose a camera you can use at the place you can get into. If you'll be squeezed into tight quarters with a crowd around you, a fist-sized 35-mm. may be the answer. If you'll have lots of elbow room and elevation, maybe you can set up a big camera with a tripod and telephoto rig.

A telephoto is good for diagrammatic shots showing a whole play. High shutter speed is essential. Your depth of field with a telephoto is very shallow and width of field is greatly reduced. You can mask down the view finder of your camera to match the reduced field of the telephoto. With a reflex-type camera you see on the ground glass what the telephoto sees.

Because the shallow depth of field of a telephoto lens makes quick focusing difficult and limits sharpness to a small area, a short lens is better for working on close action. The shorter the lens, the wider the field. And short lenses have the advantage of giving a greater depth of field. Your picture has a fighting chance to be sharp even if you are a bit sloppy in your focusing.

If your camera has a top shutter speed of only 1/200 or so, don't let that discourage you from tackling action pictures. The boys with 1/1000 are sitting pretty—if they can get enough light to use that 1/1000. You



Because the bases "stay put," baseball gives sideline shooters a chance to focus for action at a given spot

can do good work at much slower shutter speed if you watch for "peaks of action" where, for a fleeting moment, violent action hesitates. You can find those peaks of action in every sport.

You also can cut the necessity for high shutter speed by placing yourself where action will take a sharp angle toward the

camera, or away from the camera, instead of crossing the camera field broadside. Panning with action helps, at sacrifice of background—and often the background adds little or nothing to pictorial effect.

If it comforts you to know that even the $\frac{1}{1000}$ boys can't stop everything, consider the fact that a broadside view of a golf club



Put a lens shade on your camera, but check carefully to see that it doesn't cut into the camera's field



Use a light meter. For fast sports action you want as high shutter speed as light conditions will permit



Hold camera firmly against face with both hands and squeeze, don't jerk, trigger to avoid movement. Below, for long shots of action on known area use a tripod



swung by a hard-swinging pro blurs six inches at the head of the club—even at $\frac{1}{1000}$. If you want to freeze every part of a fast moving sports subject, try stroboscopic lighting. Some of the new portable stroboscopic rigs are being tried on action sports close-ups.

A few years ago, stroboscopic light was a laboratory exhibit, big and heavy and expensive. Portable rigs are on the market now at prices comparable to the price of a good camera or a good telescopic lens.

Here are some suggestions on getting sports pictures:

Choose a camera with high-speed shutter and fast lens.

Use fast film.

Put a lens shade on the camera.

If you can't use a tripod where you will be shooting, brace the camera against movement.

Shoot from a low angle to dramatize close-up action.

When the light goes bad, sacrifice depth of field before you reduce shutter speed; open up, don't slow down.

If you shoot roll films, try to standardize exposure on each roll so that you can develop for known light conditions.

Unless you're a human photoelectric cell, get a light meter and use it.

Don't be an outlaw and get the other photographers in bad—find out the rules of the field or arena, abide by them and do the best you can.



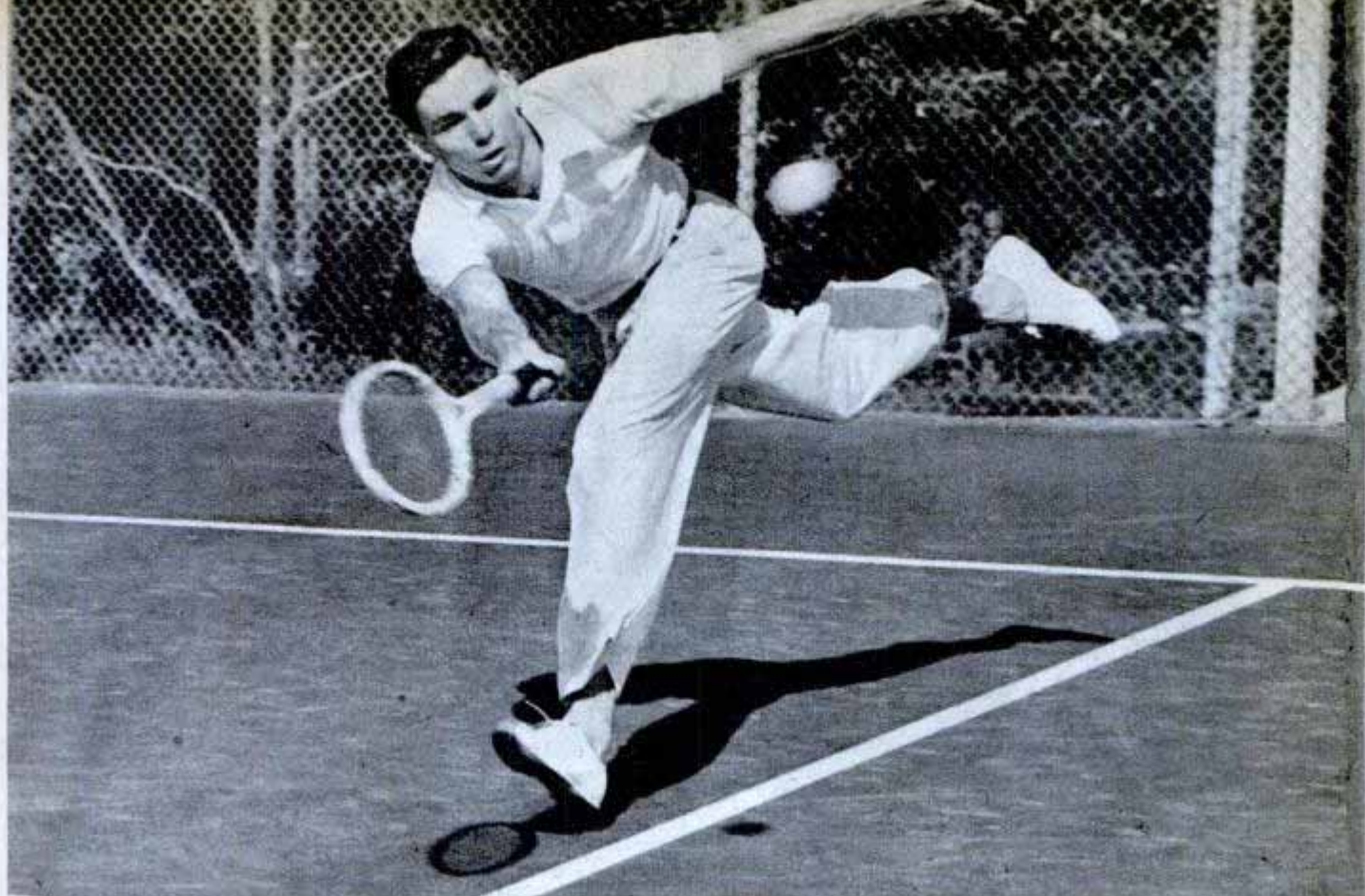

Tennis is a good subject if you focus where action is likely to happen, and then wait. Even 1/1000 probably won't freeze all the motion. Pools offer another natural but remember that splashes move faster than swimmers





Copyright Central Press Photo, Ltd.

Transmitter-Receiver Fits Coat Pocket To Broadcast Over 1/2-Mile Radius

Small enough to fit into a coat pocket, a miniature radio developed in England transmits and receives messages over a half-mile radius. The receiver hooks over the ear and the microphone can be concealed beneath the lapel of a coat. In operation the radio receives continuously unless a button is pushed to change the set to transmission. More powerful batteries are proposed to add to the range of the radio. One of the suggested uses is to enable ushers to handle crowds more effectively.

Signs Pop Out of Subway Grilles—Latest Advertising Technique

You may be seeing pretty girls in the subway ventilator grilles in New York City soon. A method of painting designs on the vertical sides of the gratings enables pedestrians to read a sign or see a picture as they approach. By leasing the ventilators as advertising billboards, the city may collect as much as \$4,000,000 a year.

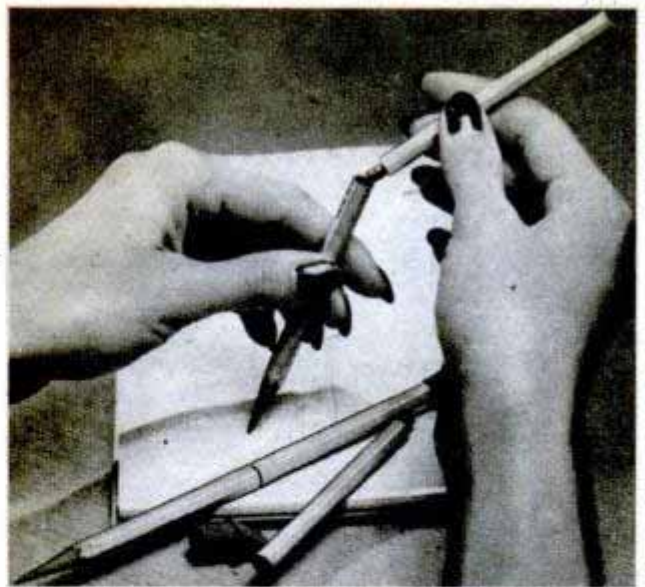

Pencils in Sections Eliminate Stubs

Pencils made in sections eliminate the waste of thrown-away stubs as a new section can be added when necessary. A dowel on one end of each new section fits into a socket on the unused end of the old. The dowel is coated with a glue that holds the two sections together when moistened.

Jar Rings Aid African Courtships

When a South African swain wants to impress a native belle he adorns his wrists and ankles with red and black rubber jar rings. A shortage of brass wire, which the natives formerly twisted into bracelets, caused the costume jewelry switch. During the last year, style-conscious natives used more than 500,000 rubber rings. But American canners need not worry. The U.S. Rubber Company says production will meet both canning and courting demands.





PAINTING WITH PEBBLES

In a New York studio Max Spivak fashions exquisite mosaics from pebbles, glass beads, steel washers, brass screws and bits of colored glass.

He turned to these materials—picked up at seashores and junk piles or bought in hardware stores—when the war cut off his supply of costly mosaic stones from Italy. The results were so satisfactory for unusual wall decorations that he continued to use the “pickup” substitutes.

Spivak draws a design on paper and pastes the colored stones onto the design. Next he transfers the pebbled figure, face down, to a concrete base. Water is used to wash off the paper and paste, leaving the design embedded in the concrete in reverse. When dry, the mosaic is cleaned with kerosene.

The artist uses few tools, mainly his fingers, a stone cutter and a chisel.

First step in making a pebble mosaic is drawing the design on paper. Spivak draws humorous-looking fish and strange faces and figures. Below, holding small pieces of colored materials with tweezers, he dips them in paste and fills in the outline of his drawing



A full-length mosaic figure often requires several thousand tiny pebbles, glass beads, brass screws and steel washers. Spivak finds materials in odd places



Strips of colored glass from a hardware store are placed on a support and broken into desired sizes. Below, cleaning a mosaic embedded in its concrete base

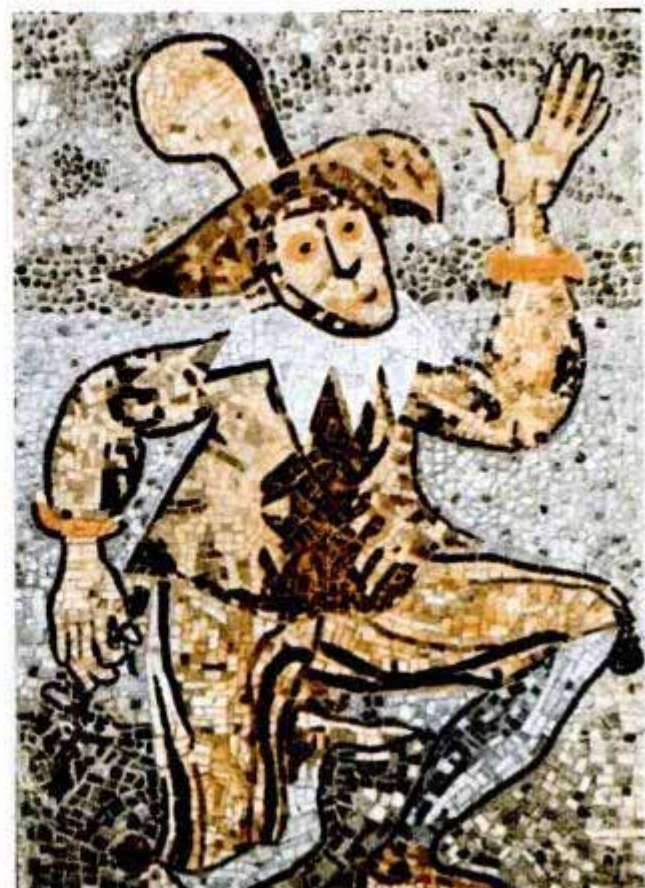

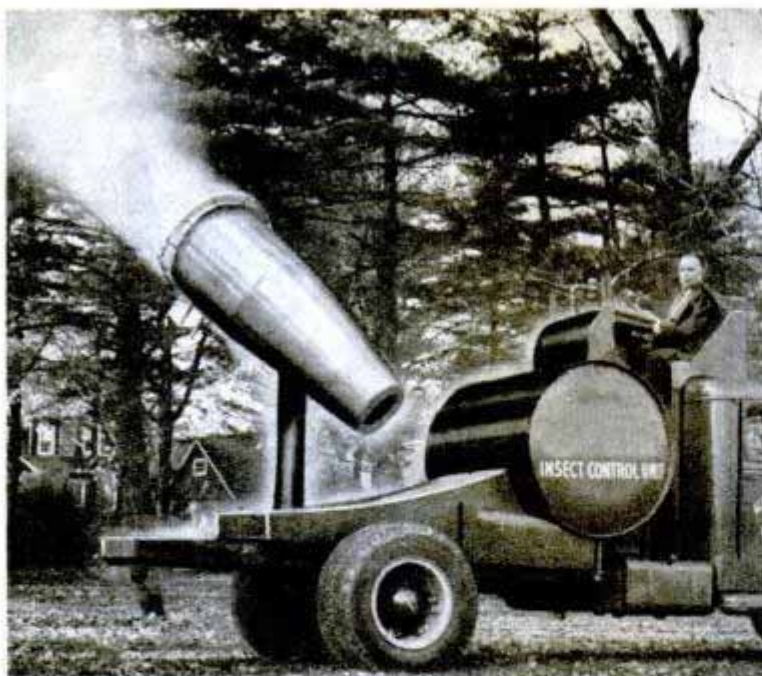

Aircraft Engine Throws Spray To Cover 100-Foot Tree

Insecticide is sprayed quickly over large areas by a truck-mounted insect control unit that is equal in power to airborne spray equipment. The apparatus sprays individual trees or can be operated while moving through tree-lined streets, swamps and parks. A 100-horsepower aircraft engine turns a four-blade propeller that can be aimed in any direction. A large tank holds the spray compound, which is fed through the propeller arc and blown across the area to be treated. The unit can spray a 100-foot tree in less than three minutes, using only three gallons of concentrated insecticide.

Plane Locates Tuna For Fishing Clipper

One Southern California fishing clipper now carries a hydroplane and pilot to spot schools of tuna within a radius of 100 miles. The plane is equipped with two-way radio and carries enough fuel for three hours flying at 120 miles an hour. The clipper's cargo boom lowers and raises the plane to and from the water, and when not in use the craft is lashed securely to the top section of the fishing clipper's bait tank.

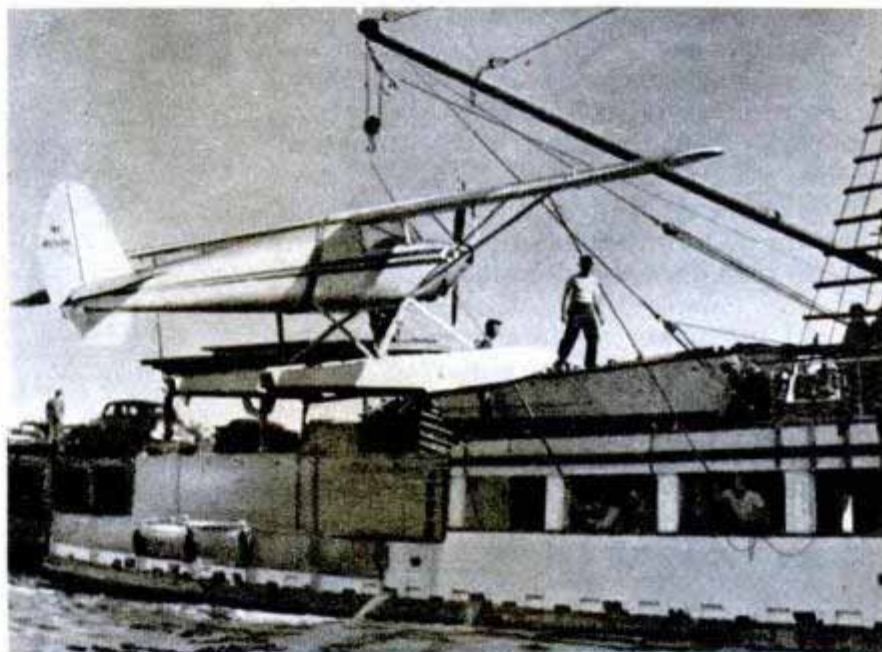

Fire-Resistant Cotton Batts Protect Walls of Building

Fire-resistant cotton batting is now in use as building insulation material. Lighter than rock wool, the chemically treated cotton is reported to withstand high temperatures. The processing formula was worked out by cotton goods manufacturers and consultants of the Department of Agriculture in seeking uses for low-grade cotton.

Information, including manufacturers' names, concerning products described in this issue may be obtained by writing Bureau of Information, Popular Mechanics, 200 E. Ontario St., Chicago 11

Oxygen Tank for High-Altitude Flyers Will Inflate Five Auto Tires

Portable tanks holding air under pressure permit the inflation of automobile tires on the road. The tanks, originally used as oxygen containers for pilots of high-altitude planes, fit easily into an automobile trunk. They weigh 21 pounds, hold enough air to inflate five auto tires and can be refilled from any service station air line. Garages and service stations find the tanks useful in inflating tires without moving cars from gasoline pumps and for service calls to repair flats. A short hose and a valve are provided with each tank.



Huge Trucks Test the Pulling Power of U. S. Army's Biggest Tanks

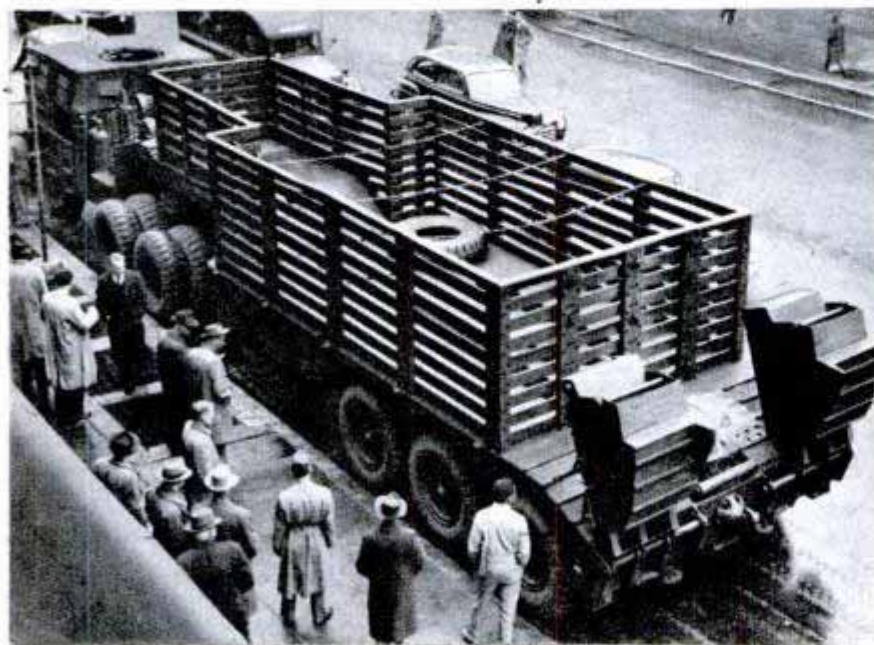
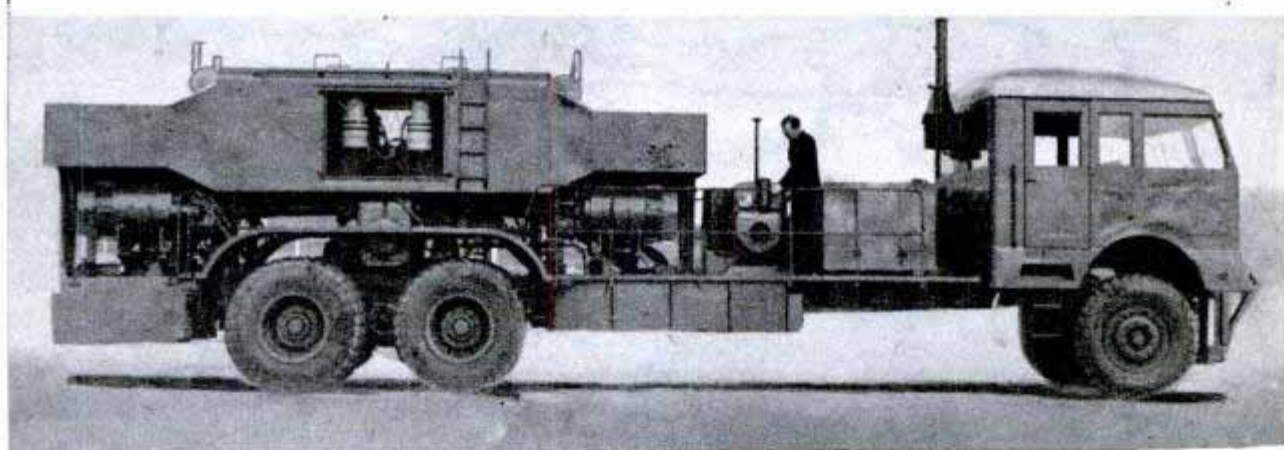

Two huge trucks, recently put to work by the Army at Aberdeen Proving Grounds, will test and service the Army's biggest tanks. One, a dynamometer truck, is a combination gasoline-electric vehicle. It is used to test the pulling power and rolling resistance of tanks and heavy artillery pieces. It is 40 feet long, weighs 50 tons and develops 1000 horsepower. The other, said to be the largest ever built, is a 22-wheel tractor-trailer model. It is 50 feet long and can carry a 60-ton tank.



REPORT from ANTARCTICA

By Tom Henry

(Correspondent with the Byrd expedition)

PART II

ON BOARD the USS Mount Olympus (By Navy Radio)—The great continental mass stretching a thousand miles in every direction from the South Pole is a complete blank on all weather maps, yet it is the original homeland of tempests. Northward over the polar plateau to the three oceans, enormous masses of cold wind sweep almost constantly at velocities as great as 150 miles an hour. They largely create the weather of all South America, Africa and Asia below the equator, and this weather, in turn, has great effect on northern weather. What happens at the South Pole today may change Chicago's temperature a month hence. Reliable long-range forecasting with any of the present established methods requires daily reports from a land where it is impossible to maintain observers. One of the major objectives of the Byrd expedition is to find out if there is a way to keep track of South Pole storms from the continent's periphery, where



Weddell seal and pup. At 90 degrees below zero the big, friendly mammals huddle comfortably in sides of deep, inland ice crevasses. Fish is their only food



← Running interference, Coast Guard's USS Northwind cuts safe path through the ice pack. Above, a crab-eater seal that soon became sealburgers and dog food

there are habitable islands. Meanwhile, Weather Bureau observers are seizing the opportunity to study numerous unique atmospheric phenomena during the brief polar summer, such as snowstorms that start from clouds about the level of a man's eyes, showers of ice crystal feathers and visibility in clear weather that makes objects hundreds of miles away seem near.

Antarctica in winter is a continent that is stratosphere high. Its mountain peaks extend thousands of feet into this layer of the earth's atmosphere, which is at least six or seven miles high over most of the United States, and in which temperature no longer declines with altitude but remains constant or increases slightly. In summer the bottom of this stratum remains steadily at about 23,000 feet altitude, where temperature is 60 below zero Fahrenheit. In the next mile of altitude the temperature rises to minus 55. But, with the start of the long southern night, the stratosphere drops down to about 3000 feet altitude, which is less than the average height above sea level of the continent itself. This low stratosphere constitutes one of the major problems of antarctic aviation. Most problems

of high-altitude flying in middle latitudes are encountered here near the surface.

The air has a curious exhilarating effect which may be partly psychological but which has some physical basis. It is the purest air in the world and has a composition of gases slightly different from atmosphere elsewhere, samples have shown. Analysis of air collected on previous expeditions indicates it is about two percent richer in nitrogen, probably because of the absence of plant life. It is also slightly richer in oxygen and the rare gas argon. The greatest difference is in the water vapor, which constitutes almost three percent of air at the equator and less than one percent here. The atmosphere here also has a slightly greater carbon dioxide content, an unexplained paradox because of the scarcity of living organisms producing this gas. This expedition has bottled air directly from the South Pole for analysis at the Bureau of Standards in Washington. The expedition will carry back special vacuum bottles filled with wind blown northward across at least a thousand miles of white desert at 6000 feet altitude. The pole is the remotest spot on earth from any possibility of atmospheric contamination with dust pollen, grains, germs or other microorganisms. Antarctica is the healthiest place on earth—as far as contagious or infectious diseases are concerned.

One of the most curious atmospheric effects found here is the "inversion layer."



Helicopter based on the USS Northwind returns from an observation flight to scout new routes through ice pack

Daily air soundings near the Bay of Whales show a fairly constant layer about 300 feet thick and 2000 feet above the earth in which the temperature is 8 to 10 degrees higher than it is at ground level. One day a sounding showed 18 degrees difference. This same phenomenon is found in the middle latitudes but it is usually much less pronounced there and present only in the early morning. Here it lasts during 24 hours of continuous morning daylight. After this layer is crossed the thermometer declines steadily to 60 degrees below zero at the bottom of the stratosphere.

Weather Bureau representatives brought into the antarctic for the first time special devices to study winds to an altitude of about six miles over the low cloud cover of the continent. Such studies are made by means of balloons dragging a target which can be followed by radar, a method de-

veloped by the Air Forces during the war. They also studied conditions to 12,000 feet by means of radiosondes, which automatically record and report the temperatures and humidity by radio.

Although the antarctic has long been recognized as a world weather factory, the only weather reports ever obtained came spasmodically from expeditions and whaling ships, so no systematic study was possible. Among the experiments this expedition is conducting is the establishment of robot weather observatories to record automatically and transmit observations by radio several times daily. Eventually there may be a chain of these observatories around the continent, as is also planned for the north polar basin where conditions are much easier. The present robots are expected to function for three months.

Weather prediction difficulties previous-

Sea leopard, left, antarctic's most vicious animal, can outrun man over ice fields. Right, surface thermometer



ly were the major handicap to antarctic exploration. Sudden changes in a few hours have meant the difference between life and death, as in the case of the 1912 Scott and Amundsen expeditions, both of which reached the pole the same month. Due to weather difference in a period of a few days the latter group returned without incident and the other band perished.

Curious atmospheric conditions not found elsewhere on earth make Antarctica a land of strange mirages. They are seen almost daily, especially over the ice pack when warm air strata over pools and lanes of open water cause irregularities in the surface of the ice that are projected against the sky as spires, pinnacles, skylines of cities and other equally strong pictures.

Double and triple halos are often seen around the sun. Most striking of the phenomena are prismatic sunrises and sunsets. These appear as high arches with the colors of the spectrum extending from the top of the arch to the horizon in the sky opposite the sun. Solar and lunar halos are produced by reflection and refraction through and from ice crystals. A common phenomenon in the Ross Sea area is a white rainbow caused by the refraction of light by the water particles in fog. Colors differ with the size of droplets; the smaller the drops the lighter the colors and the more violet at the end of the spectrum. Hence fog bows appear as broad bands of shimmering white across blue sky.

Also very striking are iridescent clouds which appear as a deep blue central tract with banded margins of vivid purple, orange and green. There are also dark blue



Inspecting huge pressure ridge broken in cross sections at Bay of Whales

ATMOSPHERIC CONDITIONS AT THE SOUTH POLE

AIR 2% RICHER IN NITROGEN THAN ORDINARY AIR, AND RICHER IN OXYGEN, ARGON AND CARBON DIOXIDE.
1% WATER VAPOR IN ANTARCTIC AIR
3% WATER VAPOR IN AIR AT EQUATOR
NO DUST POLLEN, GRAINS, GERMS OR OTHER MICROORGANISMS

(Temperature rises from 60° below 0° to 55° below 0° first mile up in stratosphere)
LOWEST PART OF STRATOSPHERE IS 23,000 FEET

"INVERSION LAYER"
APPROX. 300 FEET THICK AT 2000 FEET ELEVATION

LOWEST PART OF STRATOSPHERE IS 3000 FEET. TEMPERATURE REMAINS CONSTANT OR INCREASES SLIGHTLY



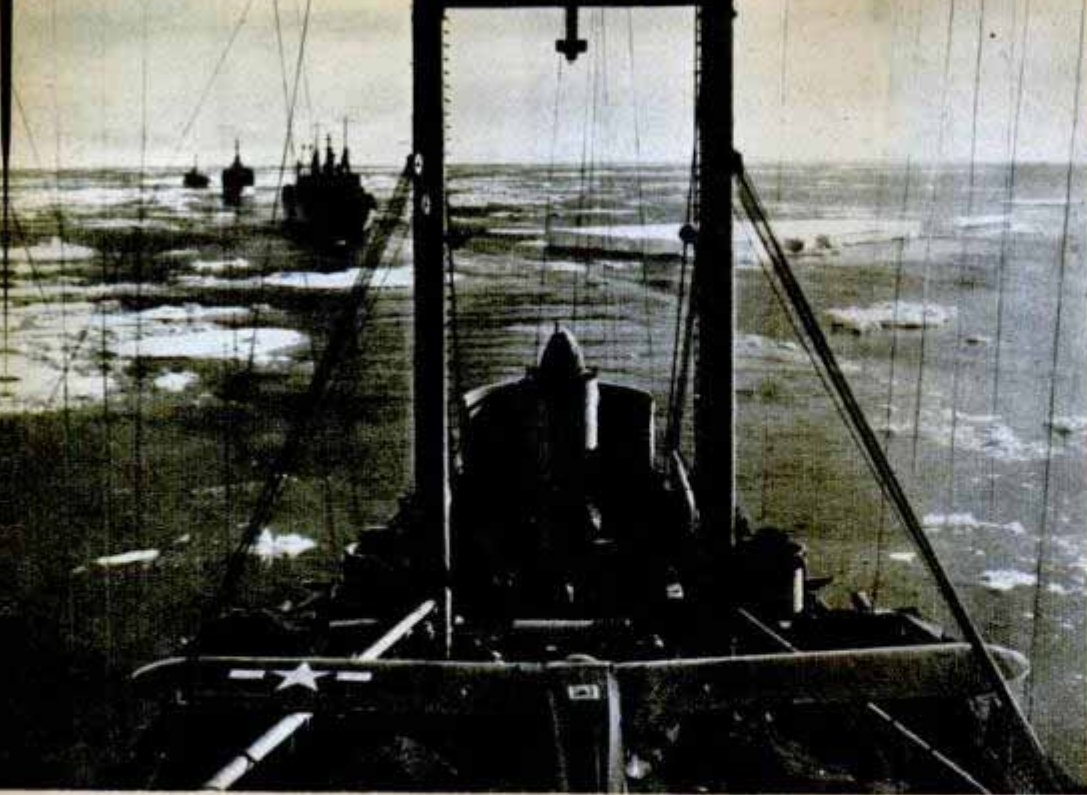

Task force ships push way through stubborn ice pack off Ross Sea. From left, vessels in order are: Northwind, Merrick, Yancey and the flagship Mt. Olympus

bands projected into the sky, believed to be shadows of mountain peaks against clouds.

Complete radio blackouts are even more common here than in the arctic, supposedly due to the aurora australis, southern counterpart of the northern lights. Among the scientific objectives of the expedition is a thorough study of these blackout phenomena, which become very serious in ground control of planes flying over the continent. Radio, for example, was a complete failure in efforts to locate the crew of a plane which crashed on the ice, although the marooned men retained one set undamaged. The expedition expects to map a circular belt where the disturbances are most likely to occur.

The antarctic continent's edges are the extreme frontier of life on earth. This life

has taken extreme forms and differs radically from anything else on the planet. Here is a combination of Eden and Hades. The bloodthirstiest and gentlest animals live together, apparently without fear. Even the fiercest show no alarm at approach of the strange intruder, man. The southernmost living animal is the vulturelike skua, found within 200 miles of the South Pole. It is called the most voracious of all birds. Scavenger of the antarctic, cannibalistic and attacking mercilessly any weak or maimed creature, nevertheless skuas look and act much like the pigeons who gather about Sunday strollers in an American city park. They will cluster curiously about men on the ice and the flock will not move when disturbed. The fierce marauder has a downy head and the innocent eyes of a newly hatched chick.

The best known antarctic creatures are the penguins, who display only friendly curiosity without the slightest alarm at human approach. Here in the Bay of Whales an emperor penguin almost four feet high and with comically human appearance tags constantly at the heels of sailors and tries ludicrously to imitate their movements as they play ball on the ice. Near the spot where ships of the central group are at anchor is the largest colony of southernmost mammals—big, friendly, sleepy Weddell seals—who live the year around among grotesquely shaped pressure ridges in the

Emperor penguins during courtship. Giants of family, they are 3½ feet tall



ice. Biologists of the expedition are making observations of their strange ways of life. They live about eight miles from the water's edge in a great ice canyon where there are deep crevasses through which they dive for fish, their only food. When the crevasses freeze over they saw holes through the ice with their long teeth. In winter they actually live under ice, apparently huddled on ledges in sides of crevasses where they remain warm with temperatures

(Continued to page 260)

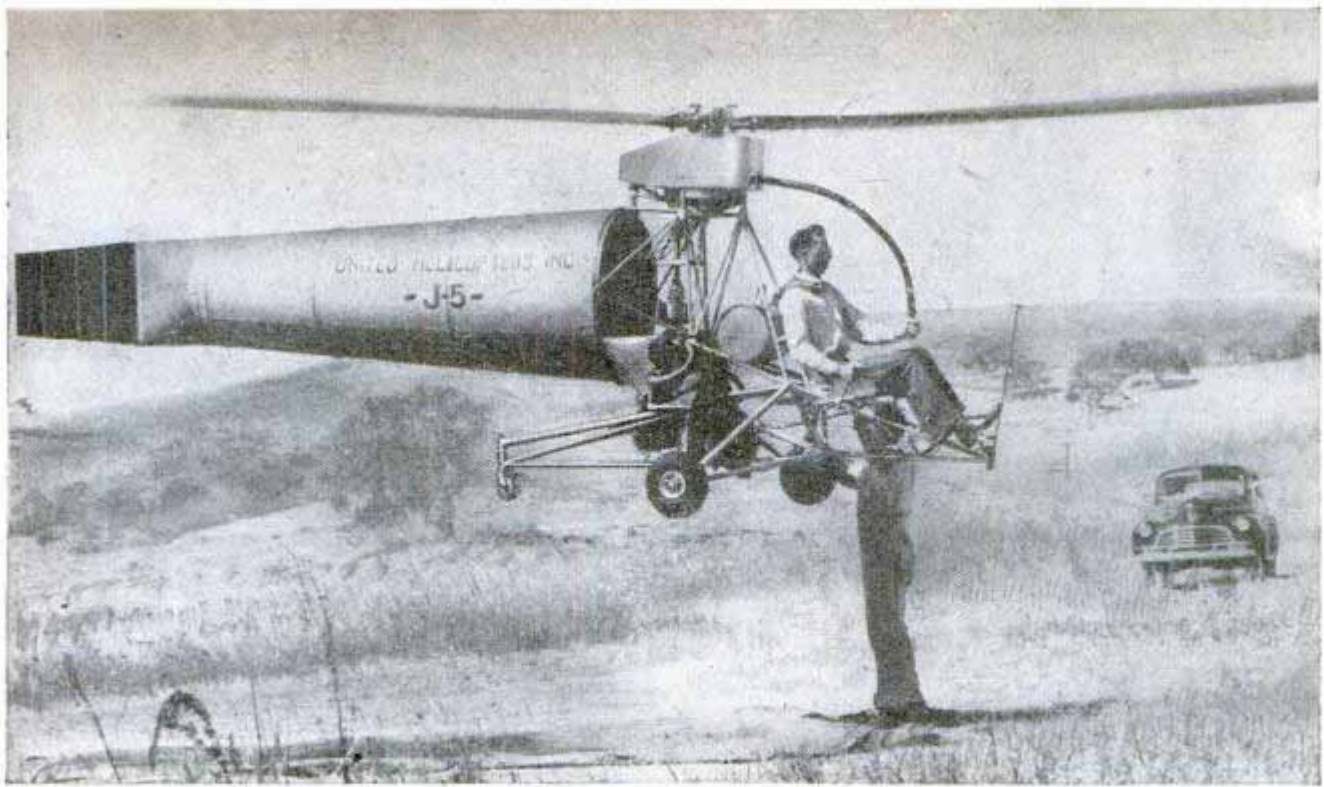

Rotor torque is counteracted in a new "stovepipe" helicopter by a compressor fan that forces air under high pressure through one side of the fuselage tail. Helicopter designers always have been plagued by a tendency of the helicopter to twist in the air because of the one-way thrust of the rotor. In the new craft the fan, mounted immediately behind the engine and forward of the tail, forces air under pressure

Tail Fan Stabilizes Helicopter

through the fuselage to vanes in the tail, which deflect the air stream to counteract the side thrust of the rotor. Part of the air may be drawn off through an opening on the opposite side of the fuselage to "trim" the helicopter. Before passing through the fuselage the air stream flows over the engine, eliminating the need for a separate cooling fan. The new craft is an experimental model not yet on production lines.

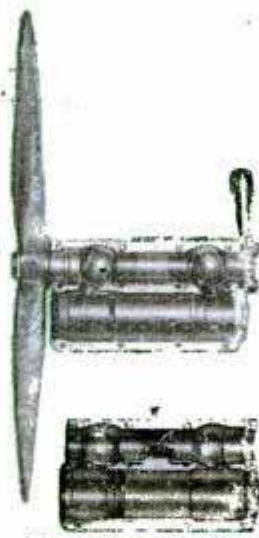
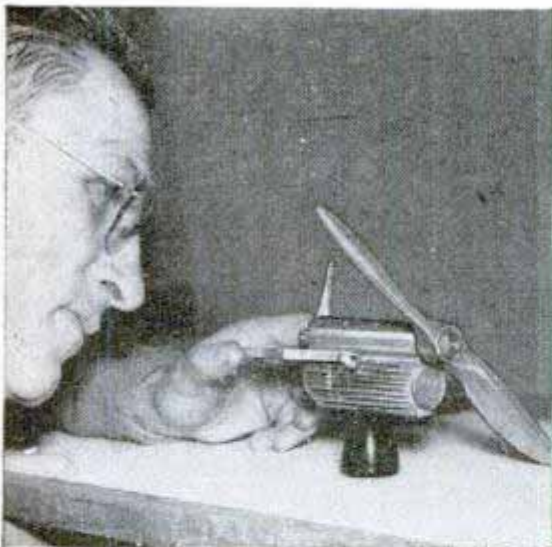

Midget engine for gasoline-powered model planes has a frontal area of only one square inch yet develops one full horsepower at 12,000 r.p.m. The engine has two opposed pistons that slide back and forth inside a horizontal cylinder, transmitting motion through wobble-plate mechanisms to a straight propeller shaft mounted parallel with the cylinder. The engine, weighing 13 ounces, is 5 inches long.

Stain-removing sticks made of waxlike chemicals remove spots from fabrics caused by tea, coffee, ink, grass and other substances. First, the fabric is laid on a clean undercloth and sponged. The first, or acidic, stick is daubed on until no more stain appears on the undercloth. Then the fabric is rinsed and the second, or reducing, stick is applied and the spot disappears.

Automatic flight recorder which registers dangerous airplane and pilot tendencies may reduce aircraft crashes. It also makes it possible to determine the cause of an air accident. Electric signaling devices transmit all variations in instrument readings to the recorder. Checking the record gives a picture of the flight. The recorder was developed by General Electric.

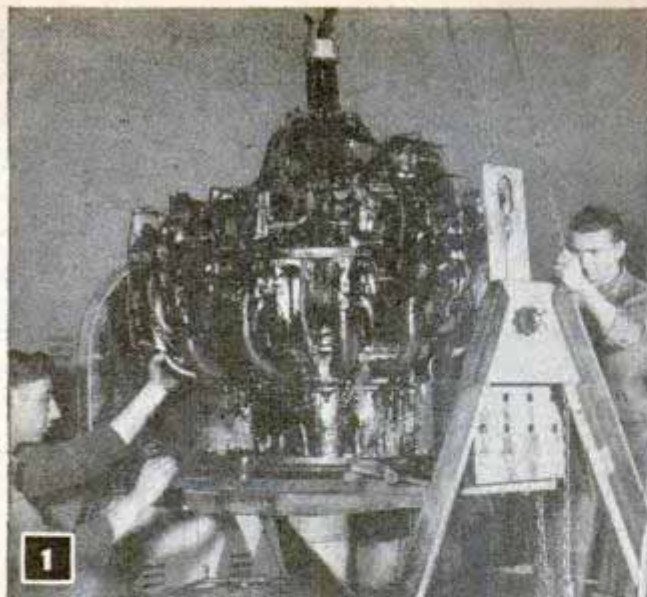

1
Installing aircraft engine on wheel-mounted disassembly rack where it will stay until entirely torn down

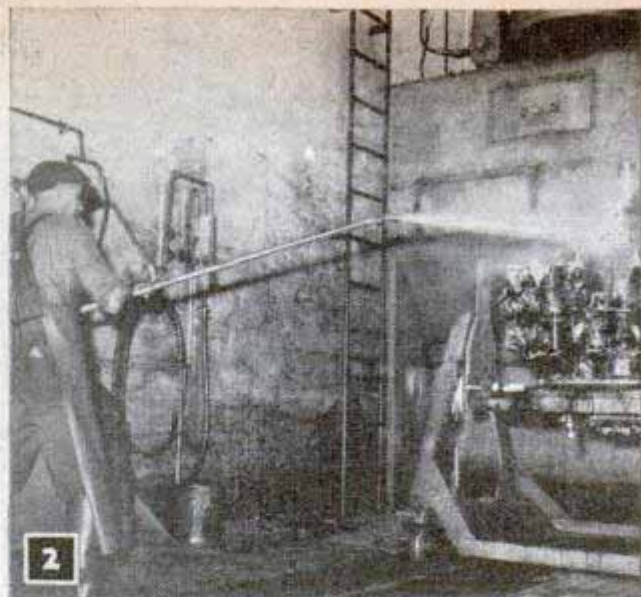

2
Pictures taken for *Popular Mechanics* by George Bankston, Naval Air Station, Alameda, Calif.
High-pressure spray treatment removes coatings of dirt and grease from airplane engines before disassembly

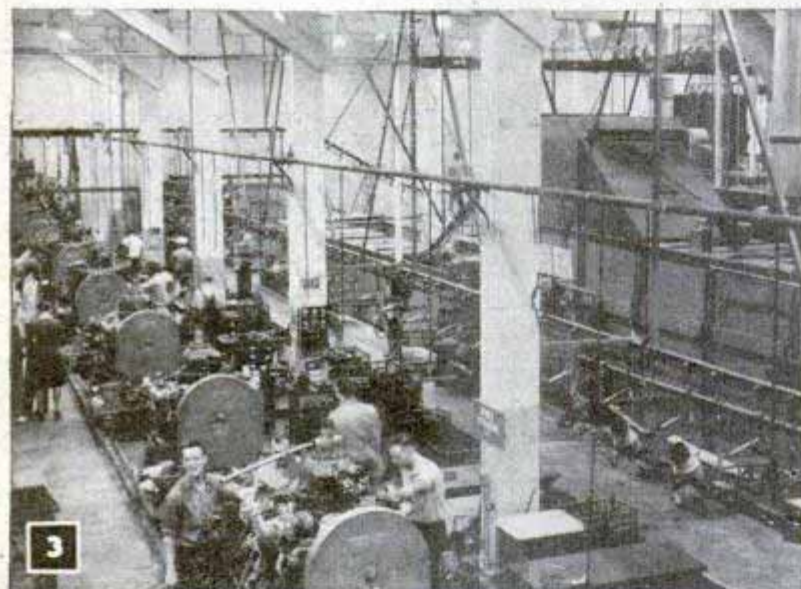

3
View of disassembly section where engines are taken apart. Conveyor baskets carry parts to other shop departments. Below, mechanics tear down power section

**NEW
ENGINES
for
OLD**

A second cleaning often is required to remove heavy preservatives from an engine part before its trouble is diagnosed. A solvent spray is being used here

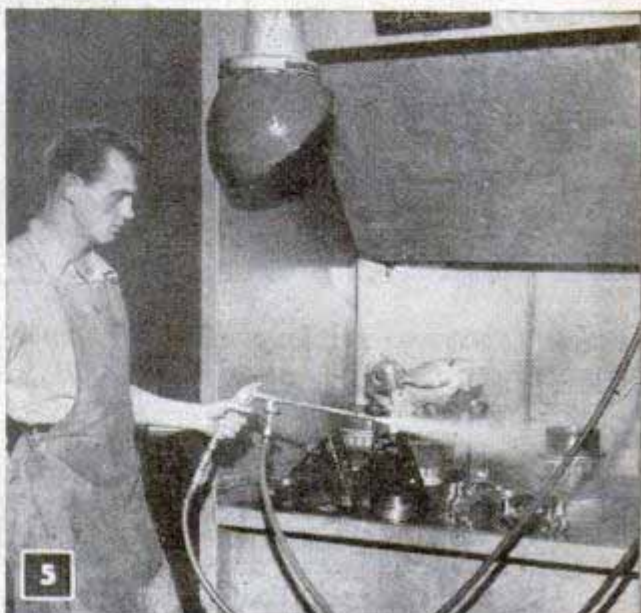
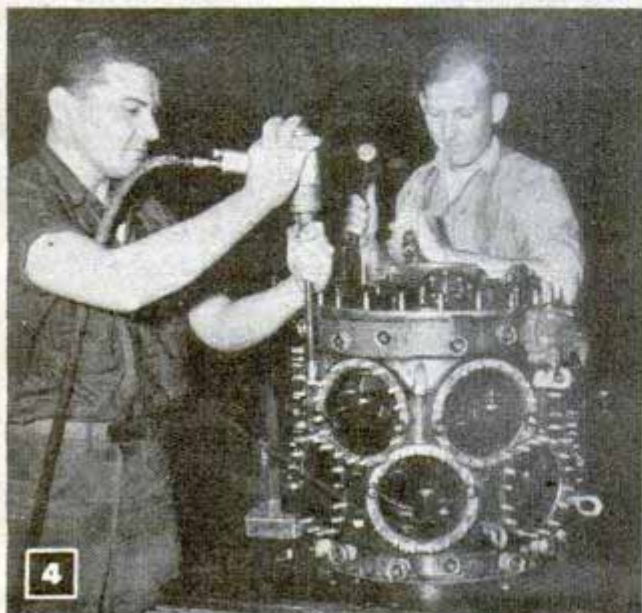

By James Corcoran

THE Naval Air Station at Alameda, Calif., makes new engines from old. It disassembles, repairs, manufactures and reassembles the engines of seven widely different aircraft ranging from combat planes to four-engined transports.

This is not a casual motor teardown. Every part of the engine is removed, each part inspected, rated for rework or replacement, then 100 percent finish-inspected before reassembly. The aim is to give the pilot engines that are even better than those produced by the original manufacturer.

The bulk of the work in this department is the general overhaul after a maximum number of flight hours. These engines may come to Alameda from overseas, from the planes of carriers resting at Alameda between cruises, or from aircraft based in the Alameda service area. Or they may be engines that have failed in service from cracked cylinders, thrown rods or faulty ignition.

Engines covered with heavy preserva-

Hand-washing other engine parts in a cleaning solvent



7



6

Worker uses a hot air blast method for drying the solvent-cleaned parts

tives or pulled off a plane, dripping grease and dirt, are mounted on four-wheeled work stands that run on rails through the shop. After a thorough high-pressure spray treatment, the cleaned engine passes from

High-speed buffing helps recondition a connecting rod



8

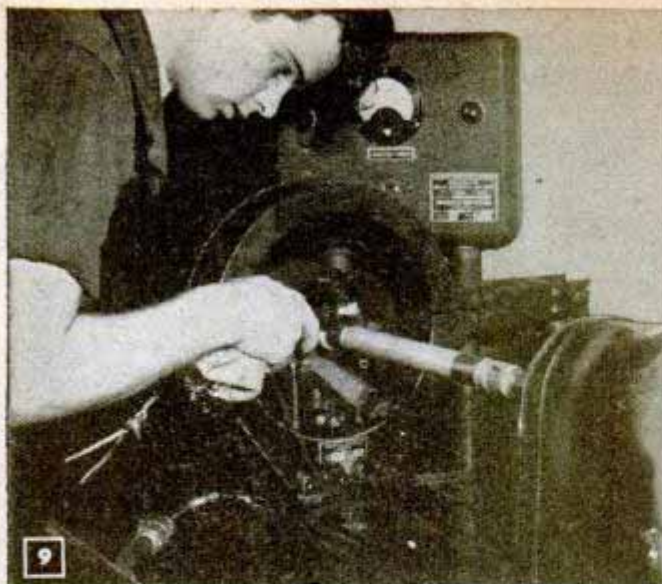

Cracks and other flaws in steel parts are detected by Magnaflux inspection which shows results on meter



Sandblasting cylinders. Worker at left puts hands into rubber gloves and sleeves to handle the parts

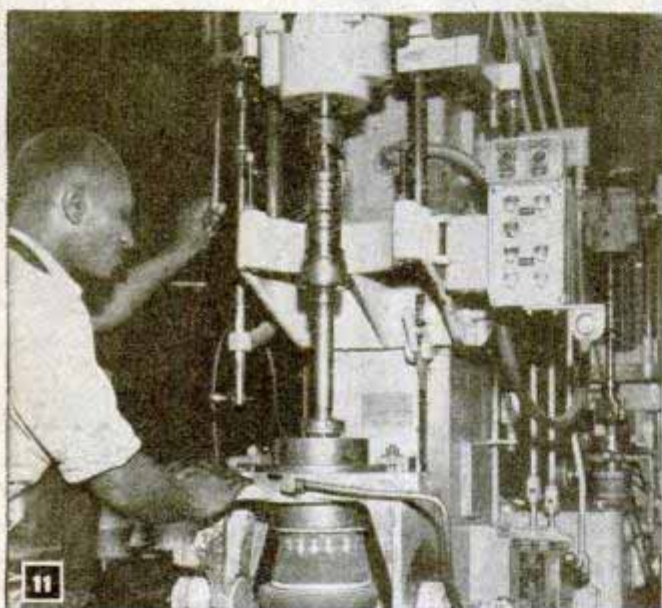

Aircraft cylinders are honed on this precision machine



Valves from hard-driven engines are ground here

Enamel applied to reconditioned parts is baked in an infrared drying oven. Parts move on a chain conveyer

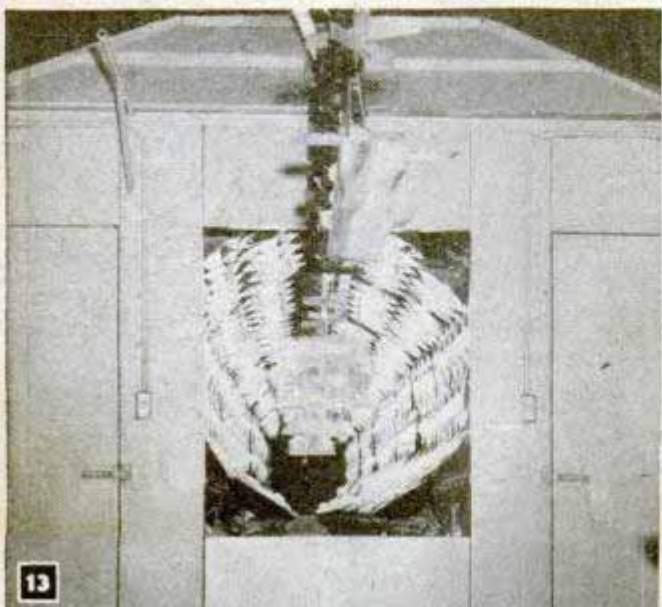

13



14

one disassembly station to another, losing its electrical equipment, prop shaft, gears, lines, pipes, power section, blower and clutch.

Each disassembled part is placed in a wire basket and carried to its own department for inspection, rework or replacement. Eleven such baskets hold the parts and, unless every compartment of each of the eleven baskets is filled, that engine cannot be reassembled.

Meanwhile, all steel parts have been Magnaflux-inspected for flaws; cylinders, valves and pistons have been resurfaced and reconditioned; on subassembly lines, the power, blower and prop sections have begun to take shape. In the final assembly the work stands receive the various sections at proper points and the engines progress to completion.

Then, in great test chambers, the engines are placed on stationary mounts and tested. Various flight conditions are simulated and a full range of fuel and air mixtures is fed each engine. Temperature changes to duplicate flight conditions are regulated by remote control. When inspectors pronounce an engine OK, it is installed and put back to work.

This department is but one of the air station sections under the direction of Captain Selden B. Spangler, assembly and repair division officer and long prominent in naval aviation. He was detailed in 1940 to report on jet propulsion, and his report could be accepted today with little change. He aided in the design of the Grumman F8F Bearcat, considered at Alameda as the combat plane with the highest performance in the world.

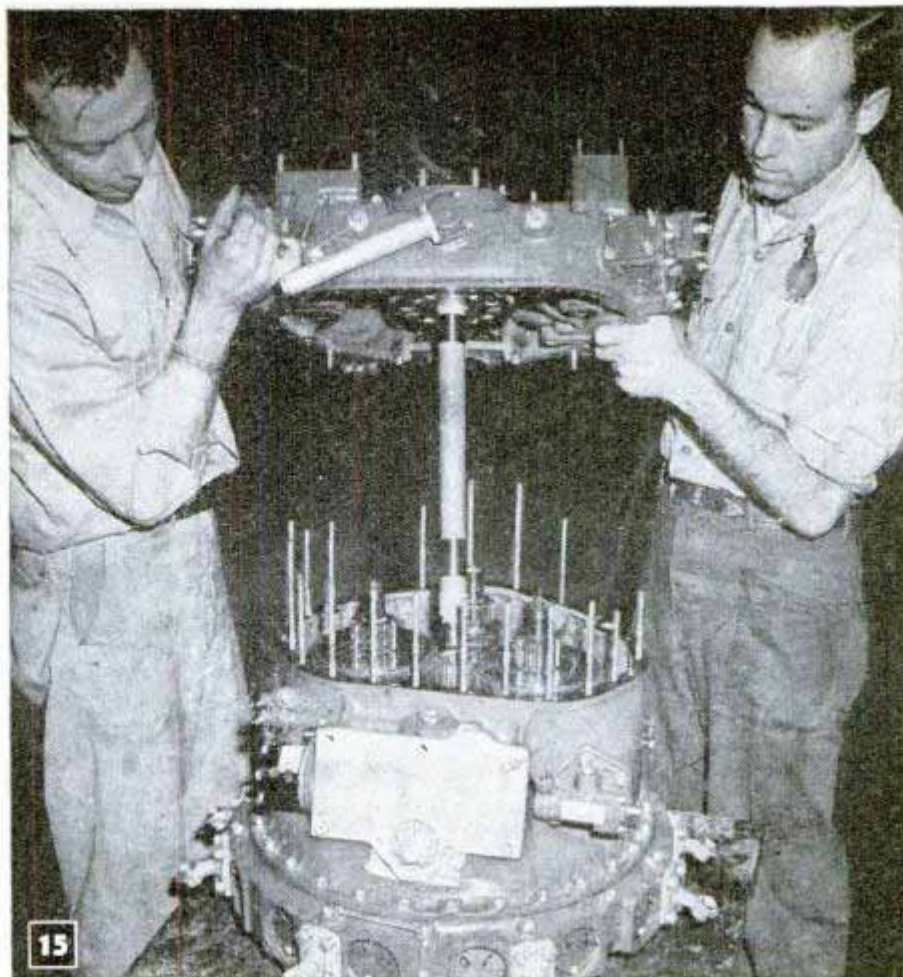

Nearing the end of the overhaul, two mechanics cautiously lower propeller gear into place. Below, inspector makes final check on sparkling new engine which was old and worn when it arrived at the Naval Air Station

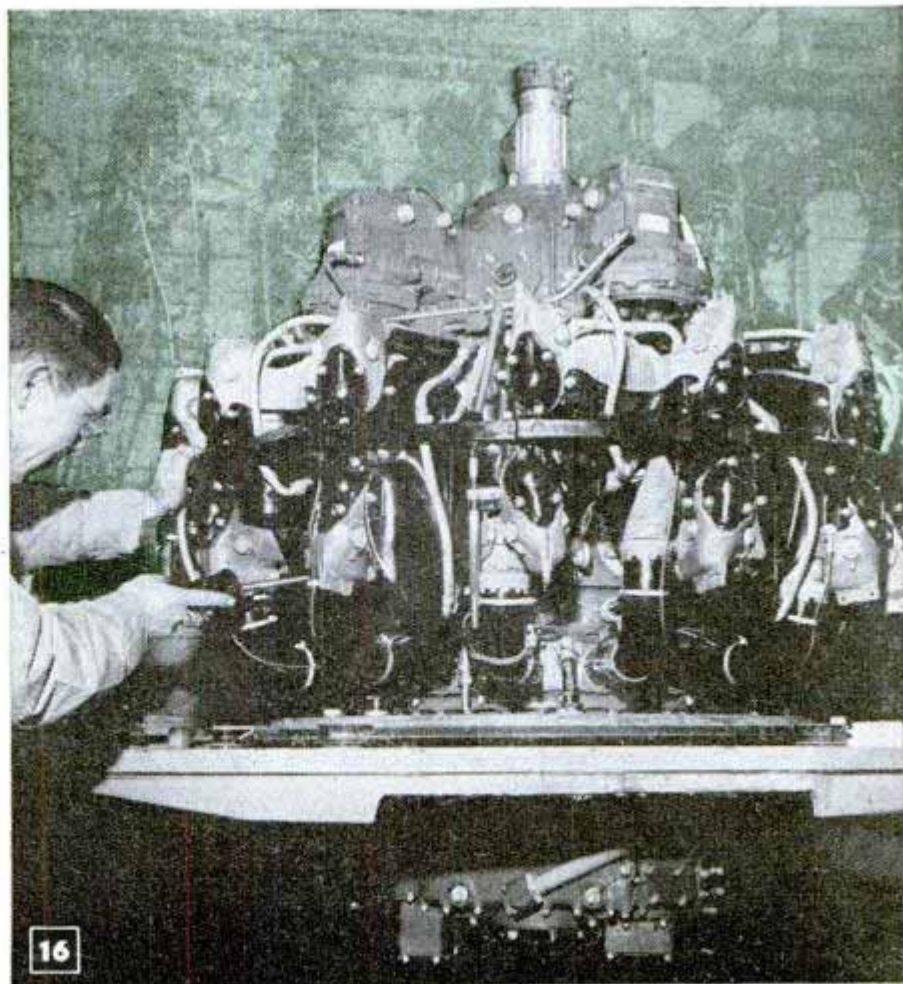

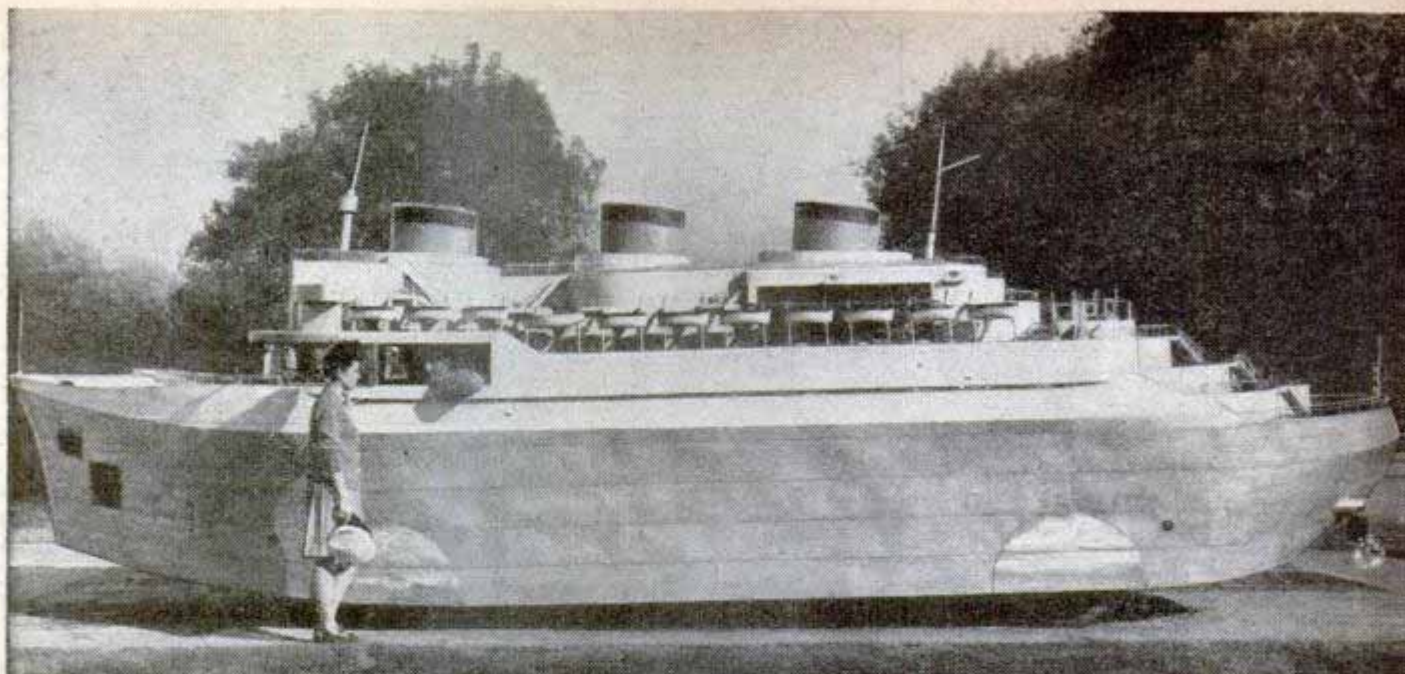

NORMANDIE ON WHEELS

A "LAND LINER" patterned after the SS Normandie contains comfortable living quarters for two and can be driven almost anywhere that a truck or automobile can go.

Three years of work by three Los Angeles men went into the construction of the land-going ship. It is constructed principally of riveted aluminum sheeting and welded steel shapes. The ship has three funnels

Door leads to the living quarters with full headroom



Highway is "sea" for this ship-shaped vehicle which has complete trailer accommodations for two persons

that serve as ventilators for the living space below, and six decks above the main deck with railings and stairs for each. Twenty-two miniature life boats, complete with covers, are rigged on their davits. The ship has its own air whistle and navigation lights in addition to standard highway lamps. Retracted during the day, the ship's head-

"Liner" tips scales at 4300 lbs., so license costs \$11

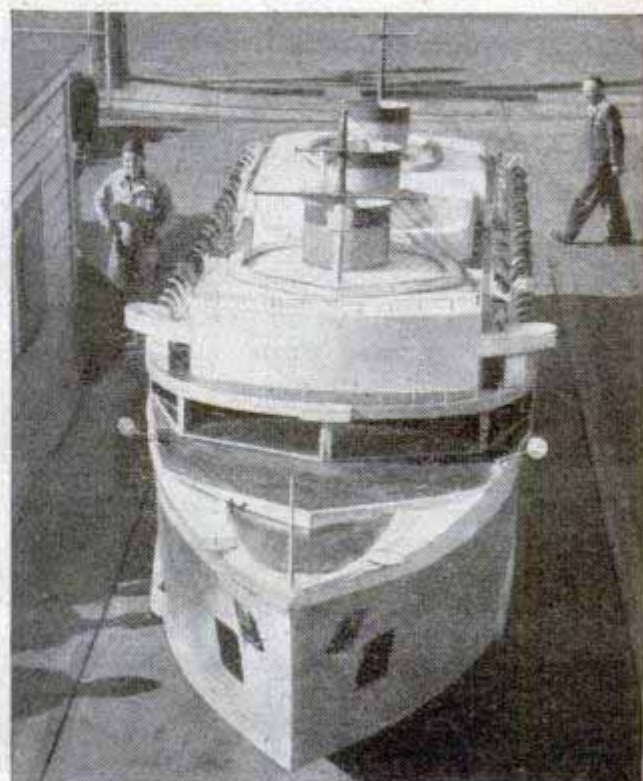

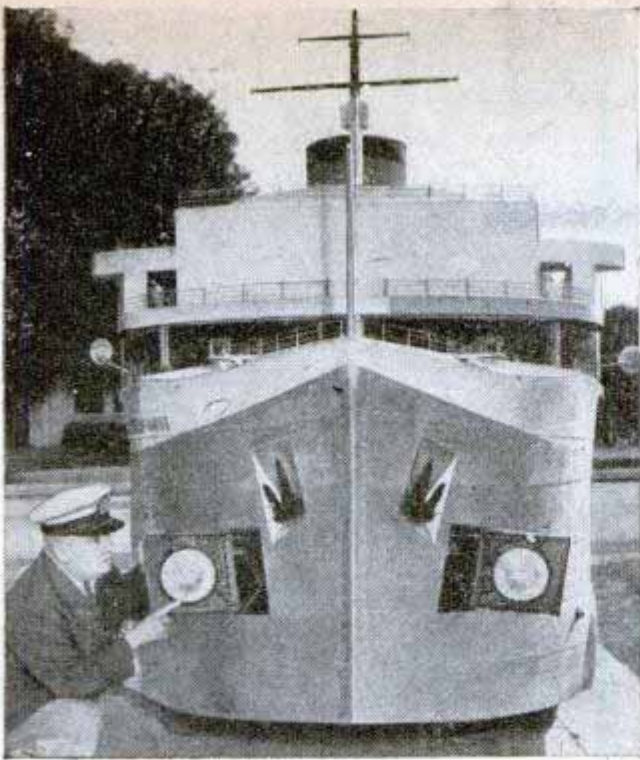

lights swing out through ports that open in the bow under the miniature anchors.

The land liner is powered with a stock six-cylinder automobile engine. Its chassis is made up of stock parts, extended and strengthened to support the exterior hull. Total weight is 4300 pounds. It is 28 feet long, 6 feet 4 inches wide and 9 feet tall.

The interior, with full headroom, has accommodations comparable to a good house trailer. It is furnished in marine style. Besides cruising western highways the owners plan to lease it to advertisers.

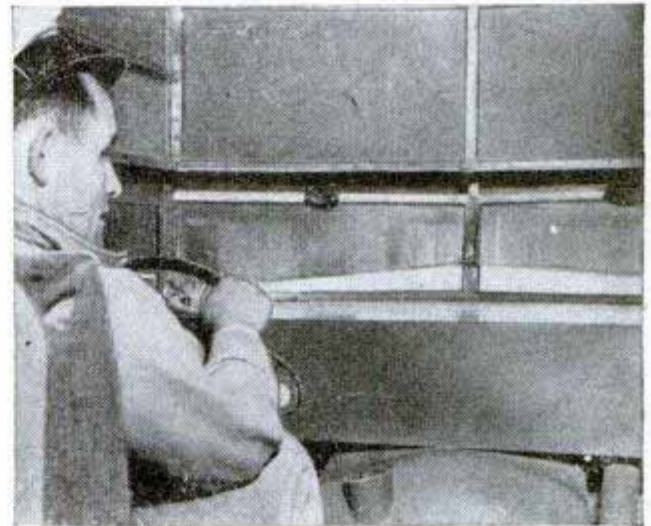

Front and rear views show retractable headlights and glassed-in promenade decks. Right, driver has 180-degree vision. Drawing shows interior arrangement

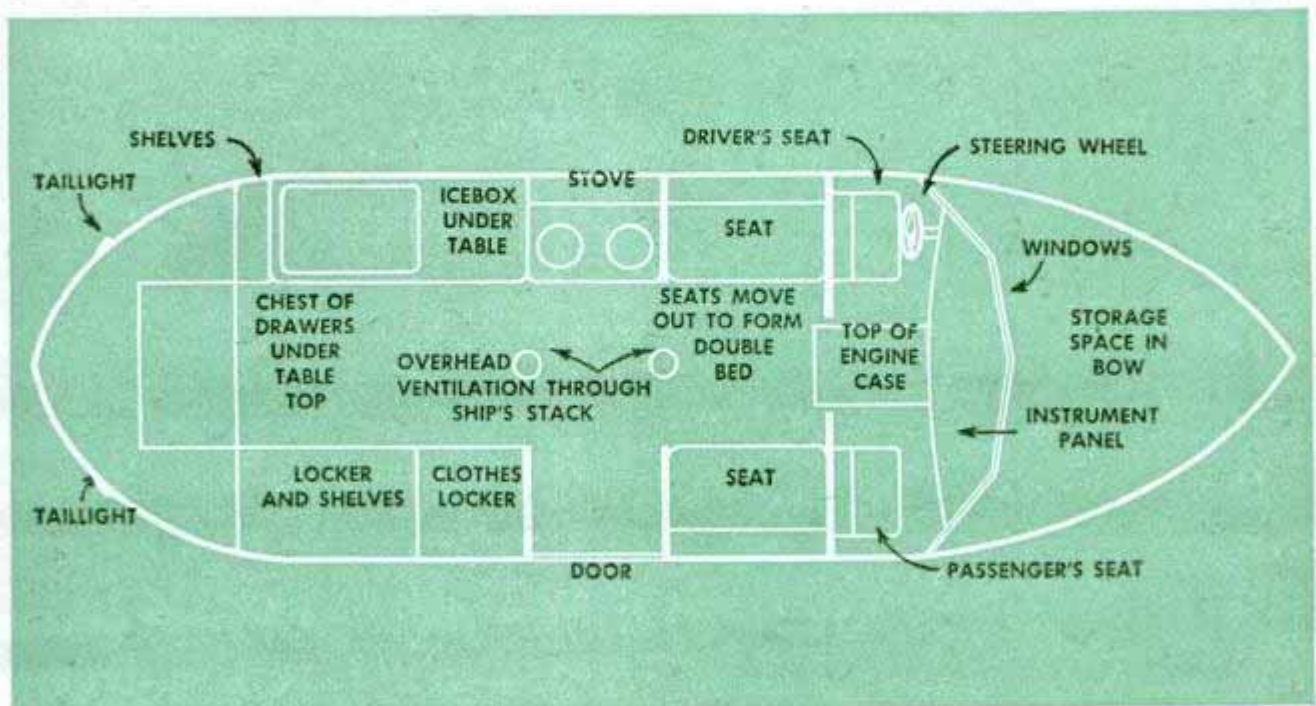



Universal Helicopters photos

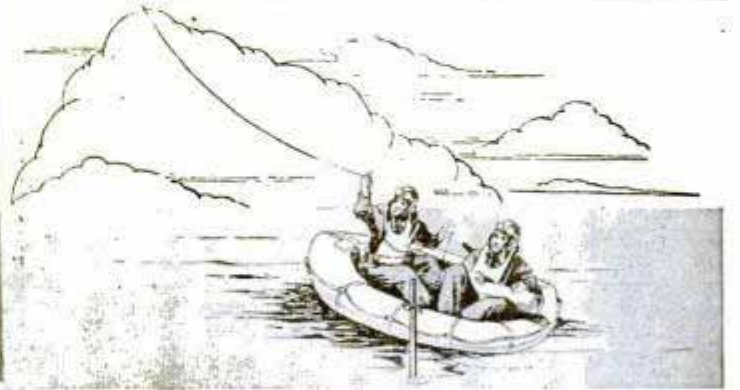
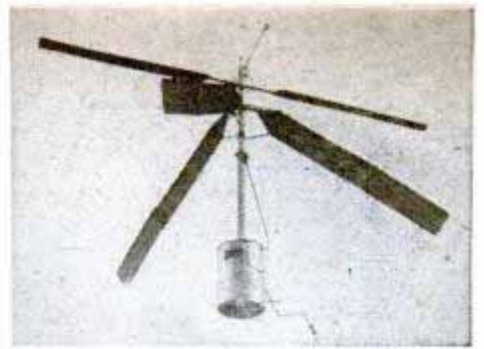

"SKY HOOK"

Electronic distress signals carry beyond the horizon when sent from transmitters hitched to the U. S. Navy's "sky hook." The "hook" is a coaxial rotor with a small motor operated by current traveling through control wires from batteries in a raft or lifeboat. It replaces kites, which are useless without wind, and balloons, which are blown into the sea by strong winds. Without elevation the transmitter impulses have "line of sight" characteristics and head into space at the horizon

Adjustable Wheel Chock Keeps Car From Rolling Off Jack

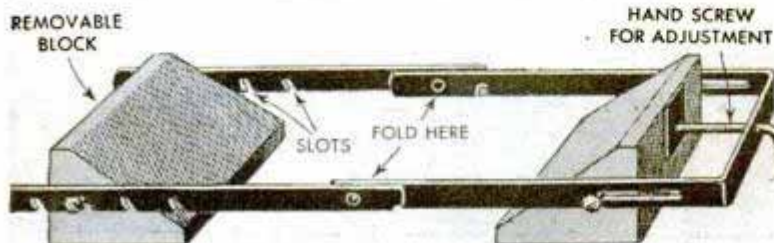

Automobiles jacked up for repairs can't slip off the jack when held in place by a double chock that prevents one wheel from moving in either direction. The wheel is wedged between two triangular blocks that grip the surface even on ice or snow. Turning a hand screw on one end of the chock adjusts the blocks to fit automobile tires of any size. A larger chock is available for trucks. The metal bars that hold the two blocks in place are pivoted in the middle so the chock can be folded to occupy little space when stored in the tool or luggage compartment.

You may wish to obtain some additional information about the new products described each month in *Popular Mechanics*. If you want to know the name and address of the manufacturer or distributor, just write to Bureau of Information, *Popular Mechanics Magazine*, 200 East Ontario Street, Chicago 11, Illinois

Superforts Are Wrapped in Plastic Cocoons for Storage



Hollingshead Corp. photos

Plastic cocoons are being spun with spray guns around 1500 Army B-29s to preserve them for possible future use. Because of a shortage of storage space the Boeing bombers will remain in the open subjected to all kinds of weather. The airtight cases, said to be seven times stronger than rawhide, are expected to prevent deterioration for 10 years. Five different-colored coats of a special plastic are applied so that workers know when the plane is completely sealed. This eliminates the possibility of leaks. The fourth coat has an asphalt base to keep out moisture and the fifth is aluminum colored to reflect the sun's rays and keep interiors at a more even temperature. Engines and all movable equipment are stripped and separately treated for storage.

All rough edges are covered and tape provides supports for the webbing coat. To check storage conditions, the cocoons have windows through which humidity indicators can be seen. Below, bomber getting final coat

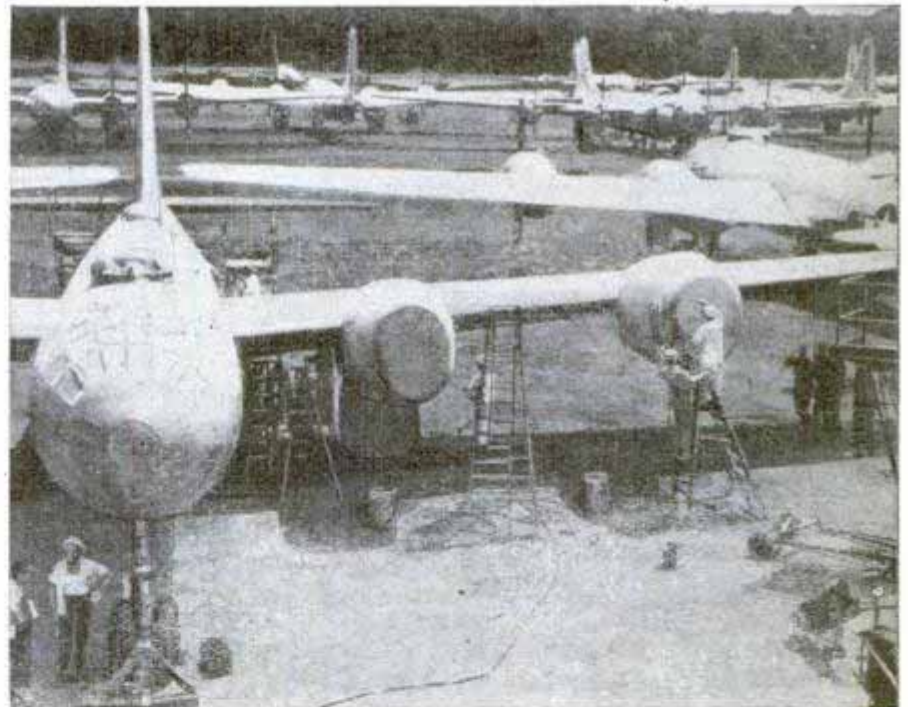

Open spaces, such as ports, are bridged with synthetic cobwebs which are in turn sprayed with a solid coat of plastic.

Uranium and Aluminum Discovered in Swedish Oil Shale Deposits

New sources of uranium have been discovered in Sweden through the development of a large shale oil industry to offset coal and petroleum shortages. Uranium oxide, the compound used in generating atom-

ic energy, is one of several by-products obtained in producing oil from shale. The shale is radioactive and contains about half a pound of uranium oxide per ton, plus aluminum, vanadium and molybdenum.



The mighty Mississippi River is reproduced in miniature in model studies of flood control for Cairo, Ill. Below, testing model of New Jersey canal and locks

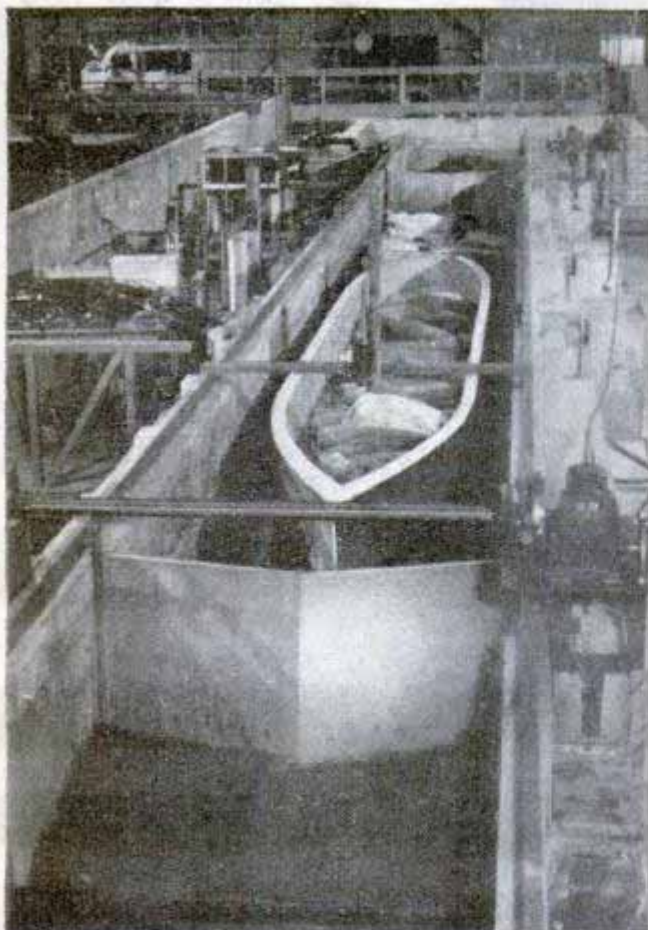

FENCING IN THE WATERWAYS

When typhoons menace ships in Guam Harbor or Old Man River goes on a tear, engineers turn to miniature models of the waterways to learn how rampaging Nature can be curbed

WHAT PROTECTION from the 30-foot waves of a Pacific typhoon can be given to shipping in Apra Harbor, Guam?

That's typical of the multimillion-dollar questions handed to the engineers who build Tom Thumb harbors and ports and then create miniature editions of ocean storms to batter their models.

Many problems that involve tides, currents and waves are too complex to be solved by mathematics. The best way to determine the value of a breakwater, for instance, is to construct the breakwater in miniature and study what happens.

When Prof. Robert T. Knapp and Dr. Warren Wagner of California Institute of Technology were asked by the Navy's Bureau of Yards and Docks to recommend a design for breakwater and other protective

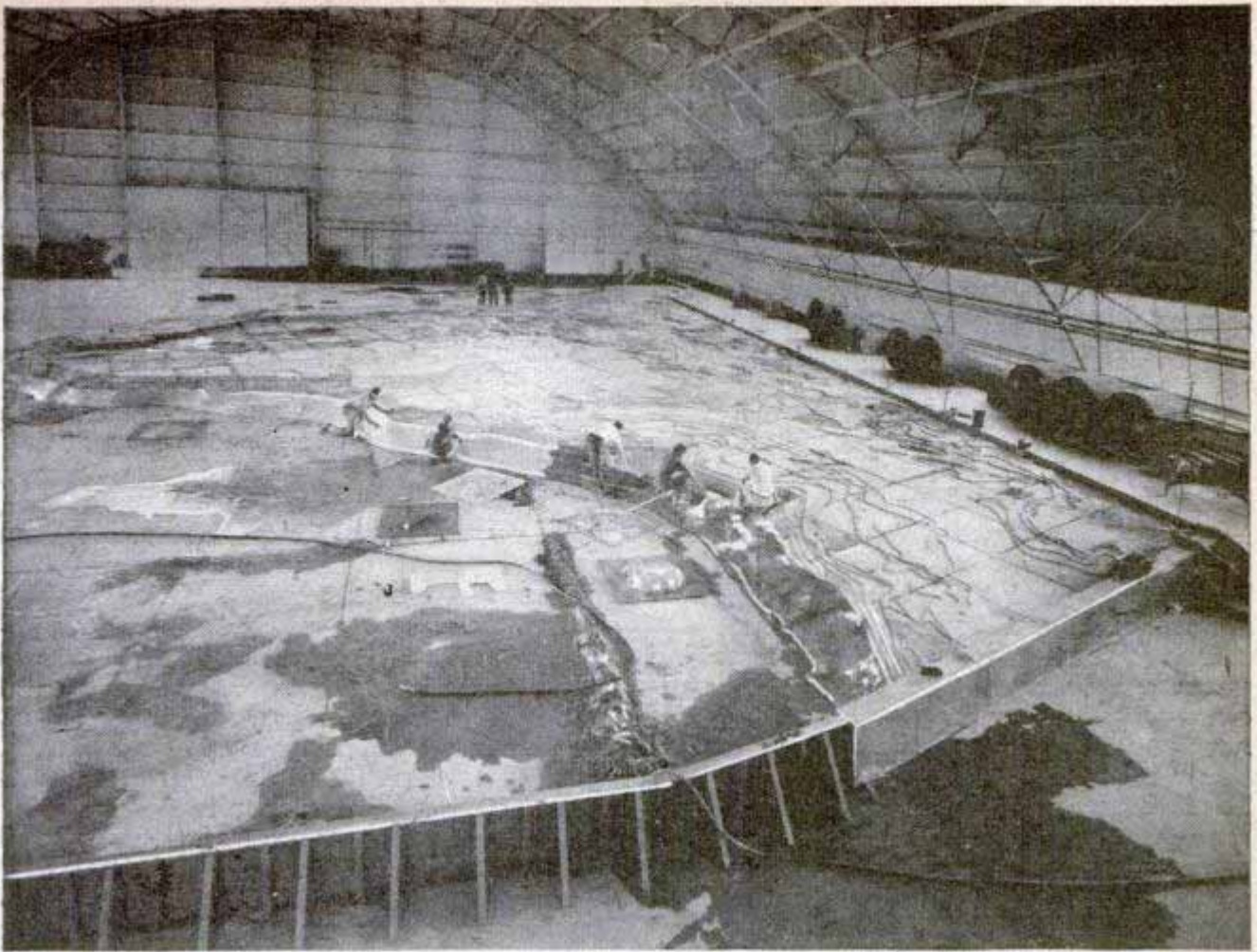

works for Apra Harbor, the two engineers and their staff erected a big aircraft hangar at Azusa, Calif., and built a shallow, steel-walled, 120-foot-square pool on the floor of the hangar.

Inside the pool they assembled a concrete model that represents seven square miles of the Apra Harbor area. Built to a scale of 1 to 360, the model is accurate to $\frac{1}{1000}$ foot. Terrain features, shore lines, harbor depths, coral heads, and the ocean bottom down to 550 feet below sea level are duplicated in miniature. It was unnecessary to model the sea floor to greater depths and, besides, since Guam is actually the tip of a tall submarine pinnacle, a true scale model of the island would rise 80 feet above the floor of the hangar. Wave machines were installed along the sides of the pool, plus pumps and water gates, so that scaled-down imitations of tides, currents, surges and wave actions could be duplicated.

To operate their miniature harbor, the engineers place a breakwater model at the entrance and turn valves and switches to start the water. Tides sweep in and out of the entrance, eddies and currents are set up, and tiny combers, product of a 100-mile-per-hour wind, pound the diminutive breakwater.

From 57 feet overhead, equivalent to an actual altitude of 20,000 feet, a cameraman

Scale model of Guam was built in aircraft hangar at Azusa, Calif., to design breakwater for Apra Harbor. Below, action of waves in harbor with no breakwater

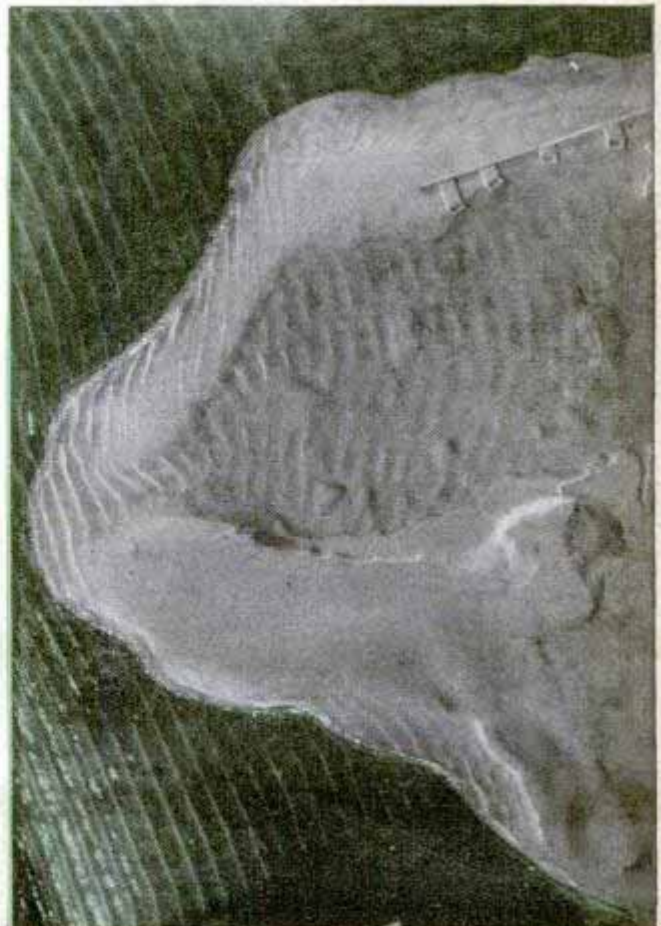

makes still and motion pictures of the incoming waves and their action against the breakwater. Submerged oscillograph elements measure the rise and fall of the water at strategic points and transmit this information to recording machines.

After-dark studies are made of currents created by storm conditions. Tiny buttons with reflectors that sparkle under lights are placed on the water and their floating movements are photographed by time exposures, revealing directions and speeds of their travel.

One after another, breakwaters of different shapes, lengths and heights are studied. The effects of interior moles and other protective works are determined. When completed some time this year the tests will provide an accurate picture of currents and wave heights inside the harbor under all anticipated conditions.

One of the auxiliary questions is to find out whether Apra Harbor will be self-cleaning after its breakwater is built. If normal tidal action doesn't clean the harbor of industrial wastes and sewage, it may be necessary to excavate a canal across the rear of a headland to provide the needed sweep of water. Studies with the model will determine the course and size of the canal if it is needed.

The Navy is spending \$275,000 on this miniature and on a smaller one of the same harbor that California Institute of Tech-

nology used for preliminary studies. About \$400,000,000 is to be spent in converting Apra into a huge, modern naval base. Model studies will help prevent design mistakes and save time and money.

During the war Cal Tech hydraulic engineers used models to solve a mysterious condition that was plaguing shipping at Los Angeles Harbor. On some days the ships berthed in one part of the harbor seemed to be jitterbugging. They would smash against their piers, charge back and forth to the extent of their mooring lines and pitch their bows and sterns into the air, all without any apparent reason. They behaved as if they were in a heavy storm and yet usually the weather was calm with little or no wave action. Sometimes the ships damaged themselves or the piers.

Oceanographers suspected that the trouble was caused by an invisible water action or surge that was intermediate in size between waves and tides. Apparently the phenomena had been aggravated by recent additions to the port's main breakwater.

At Cal Tech the engineers subjected a scale model of the harbor to normal tide, current and wave action and then measured the mysterious surge. Their remedy, tested on the model, included narrower entrances through the main breakwater, plus an inner mole. These improvements were made and the harbor trouble stopped.

A year ago the hydraulics research group

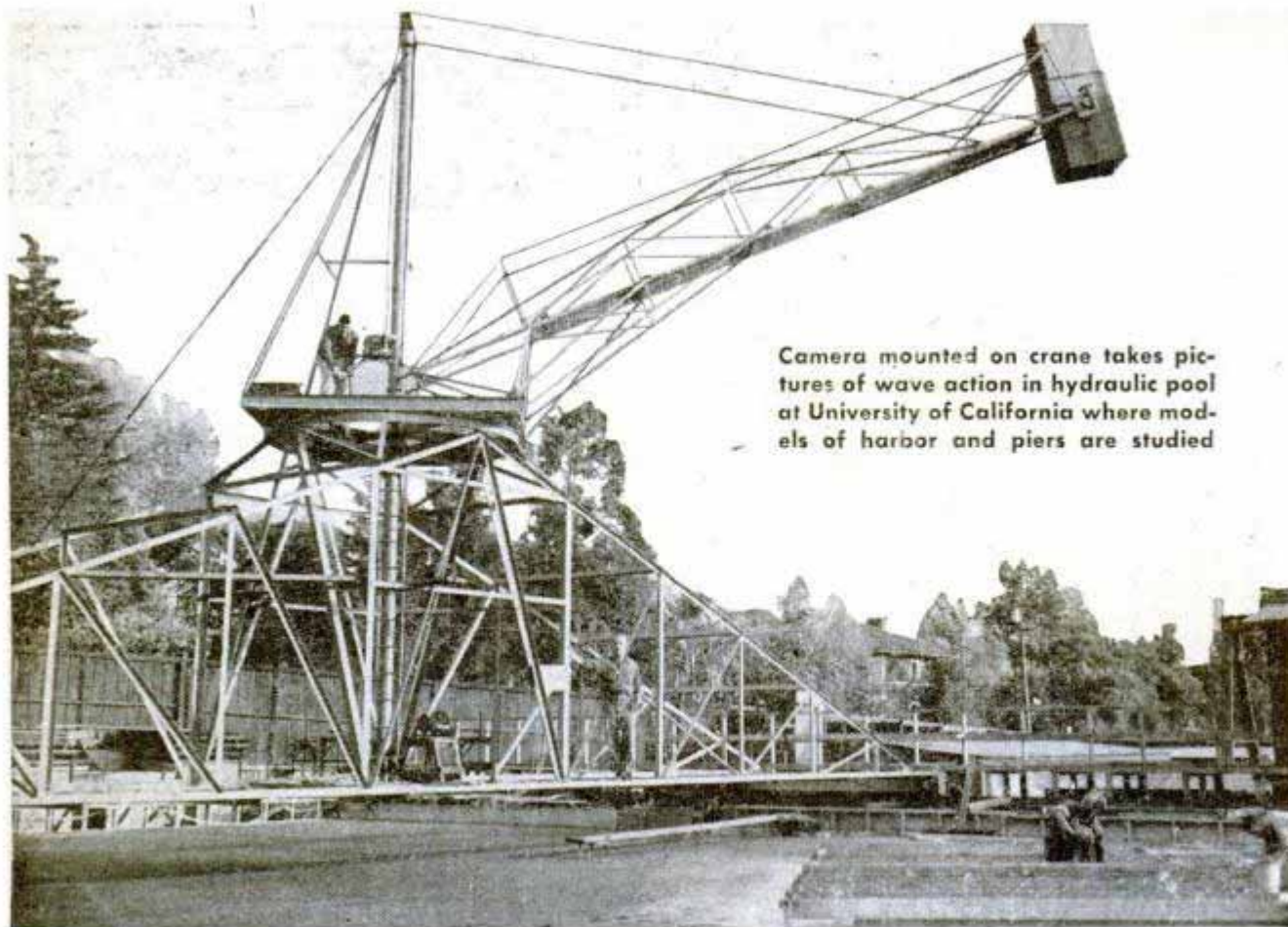

Camera mounted on crane takes pictures of wave action in hydraulic pool at University of California where models of harbor and piers are studied

at the Berkeley campus of the University of California was asked: Will the underwater atomic bomb explosion at Bikini create waves that will sweep entirely across Bikini atoll? To find out, Dr. Joseph Johnson and his technicians had to simulate the actual bomb explosion before anyone had any idea of what the explosion would be like.

They succeeded so well that months before the Baker Day blast was touched off they had photographs of miniature upheavals of water that compared closely with photographs that were made later of the explosion itself.

They produced their effect by suspending an iron weight above a small model of the atoll and its lagoon. When the suspension rope was burned away the weight fell and created a miniature eruption of water. The waves spread and crashed against the surrounding beaches. Objects of varying weights and shapes were dropped from different heights in making the full run of tests.

Part of the same problem was to determine the time that radioactive materials would remain in different parts of the lagoon after the bomb was exploded. For this a larger model was built in a 60 by 93-foot tank and water gates were manipulated to create the effects of tides and currents. Colored dye was released in the lagoon at the intended point of the explosion and then the movements and persistence of the dye were recorded during a large number of tidal cycles. Some areas were swept free of contamination almost at once; at other points, contamination remained heavy for considerable periods. This

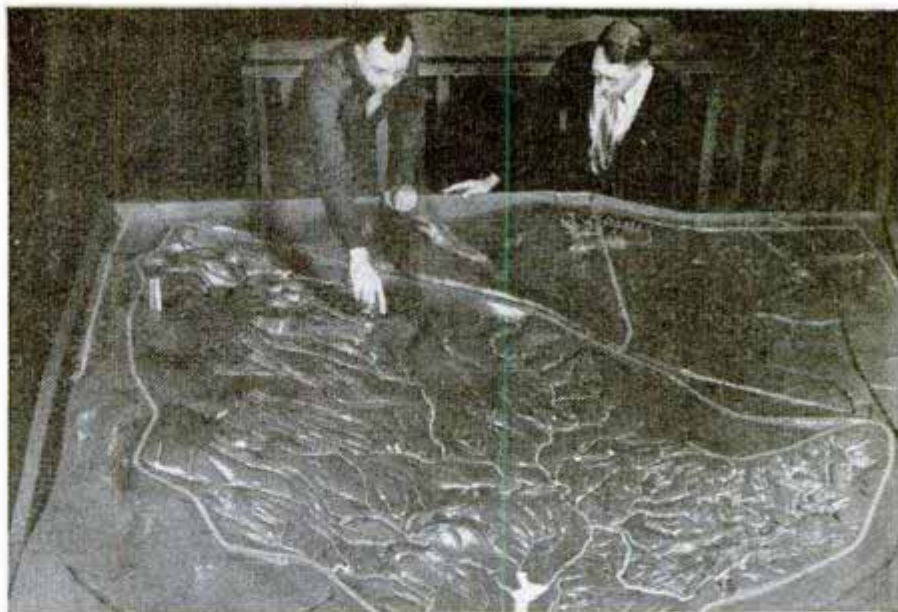

Engineers examine table model of 200-acre working model of Mississippi basin under construction near Clinton, Miss. Large model represents 31 states

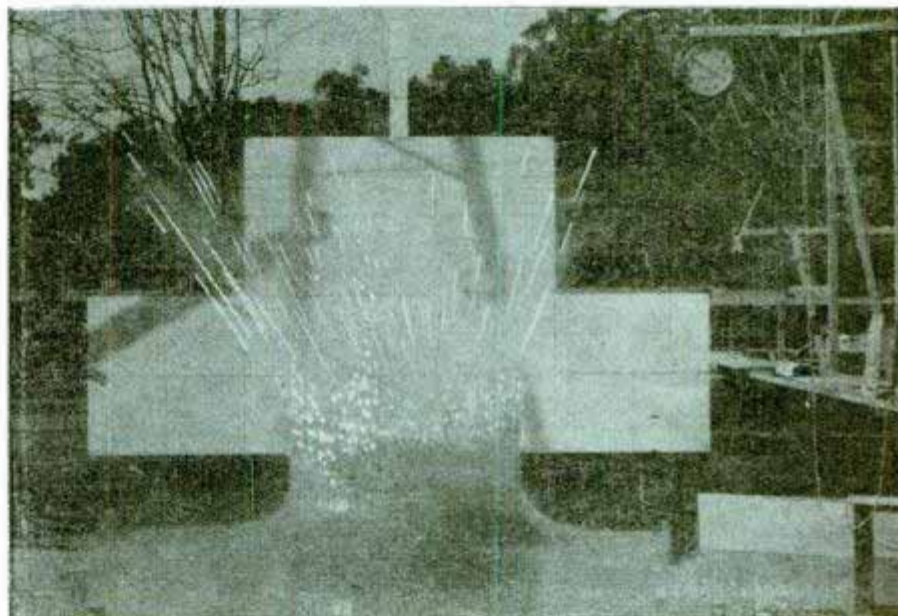

Weight dropped in pool at University of California simulated underwater atom bomb explosion before Bikini blast to test whether waves would pass over Bikini atoll. Below, skeleton of control structure for model at U. S. Waterways Experiment Station to test proposed Morganza floodway (Louisiana)

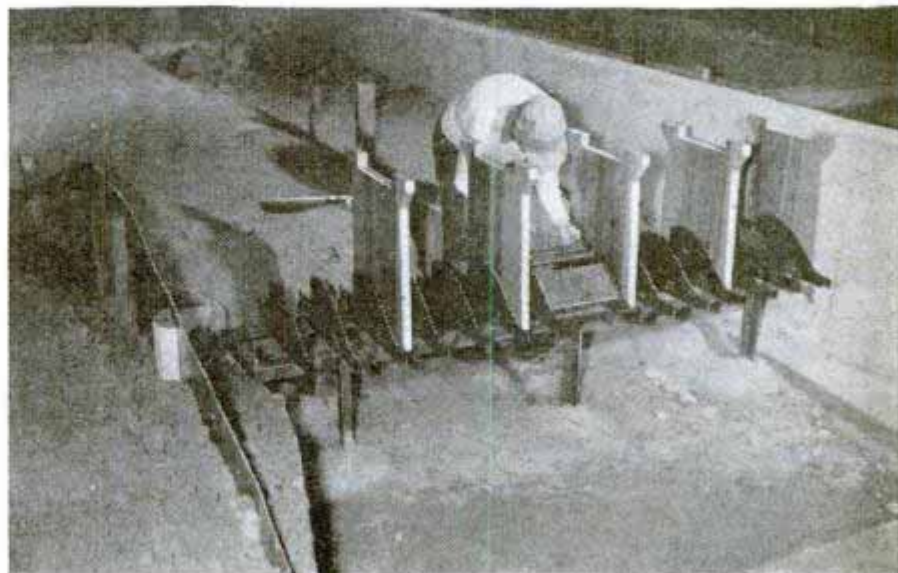

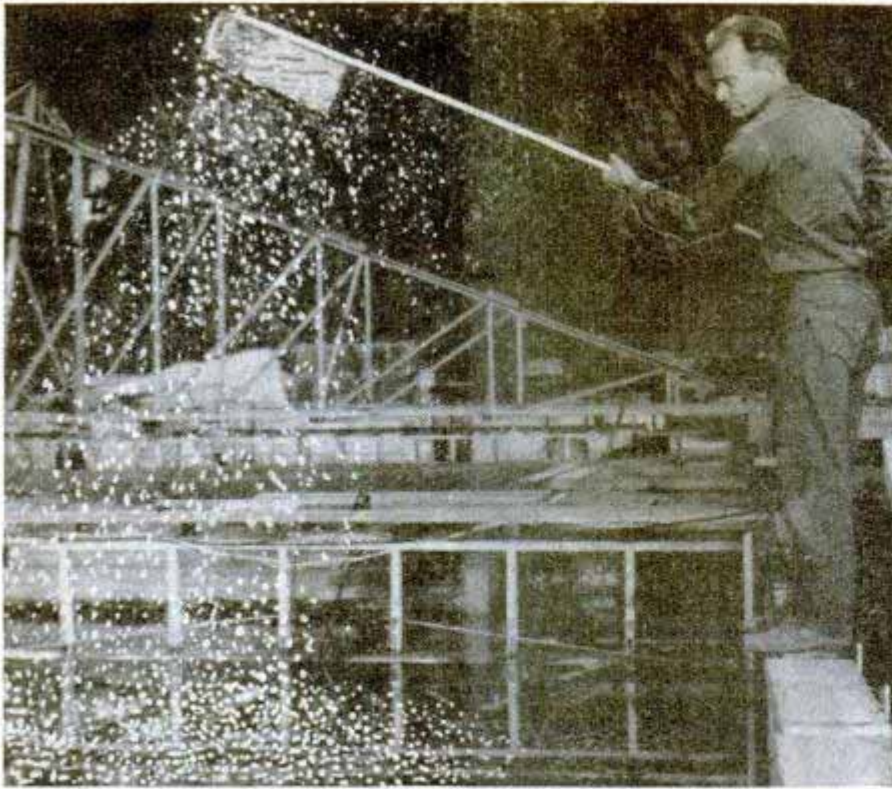

Sprinkling confetti on water so photographs will reveal directions and speeds of swirling streams in model harbors and canals. Below, six-second time exposure of confetti swept along by water in a model of St. Johns River in Florida. To create color contrast for photos, the water is tinted dark

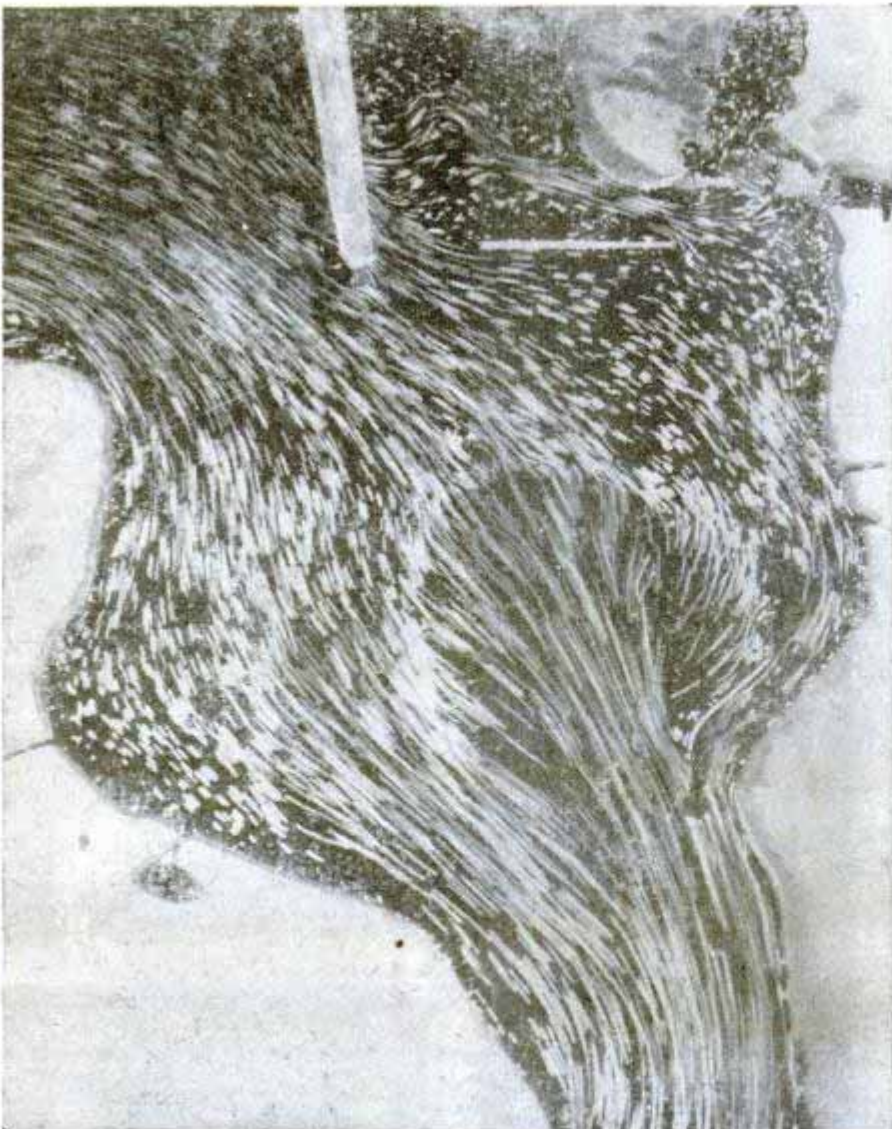

information later was put to use at Bikini.

Largest of all hydraulics research laboratories is the U.S. Waterways Experiment Station near Vicksburg, Miss. Most of the flood control and other improvements made to the Mississippi River since 1930 were first tried out on practical working models at the laboratory.

Each task at the waterways experiment station is different. During the war, Colonel C. T. Newton, director, and his staff made final tests on new designs of pontoon bridges. They worked in a secret, covered laboratory to test different designs of caissons in stopping wave actions typical of the English channel. The study provided basic data for the design of the artificial harbors that were used in the invasion of Europe.

Right now the station is seeking practical answers to questions such as these: how to increase the depth of the ship channel leading to Jacksonville, Fla., without increasing river velocity and tidal heights, and without increasing the river's salt content; the best designs for spillways, outlet conduits and other works for a proposed dam on the North Santiam River, Ore.; the best alignment for a breakwater extension to protect Anaheim Bay, Calif.; and the value of proposed flood control improvements at Cumberland, Md., and Cairo, Ill.

Always concerned with the control of the Mississippi, the experiment station is now building a model of that river which will be the largest practical model ever built. Covering a 200-acre area near Clinton, Miss., the model will duplicate in

(Continued to page 244)

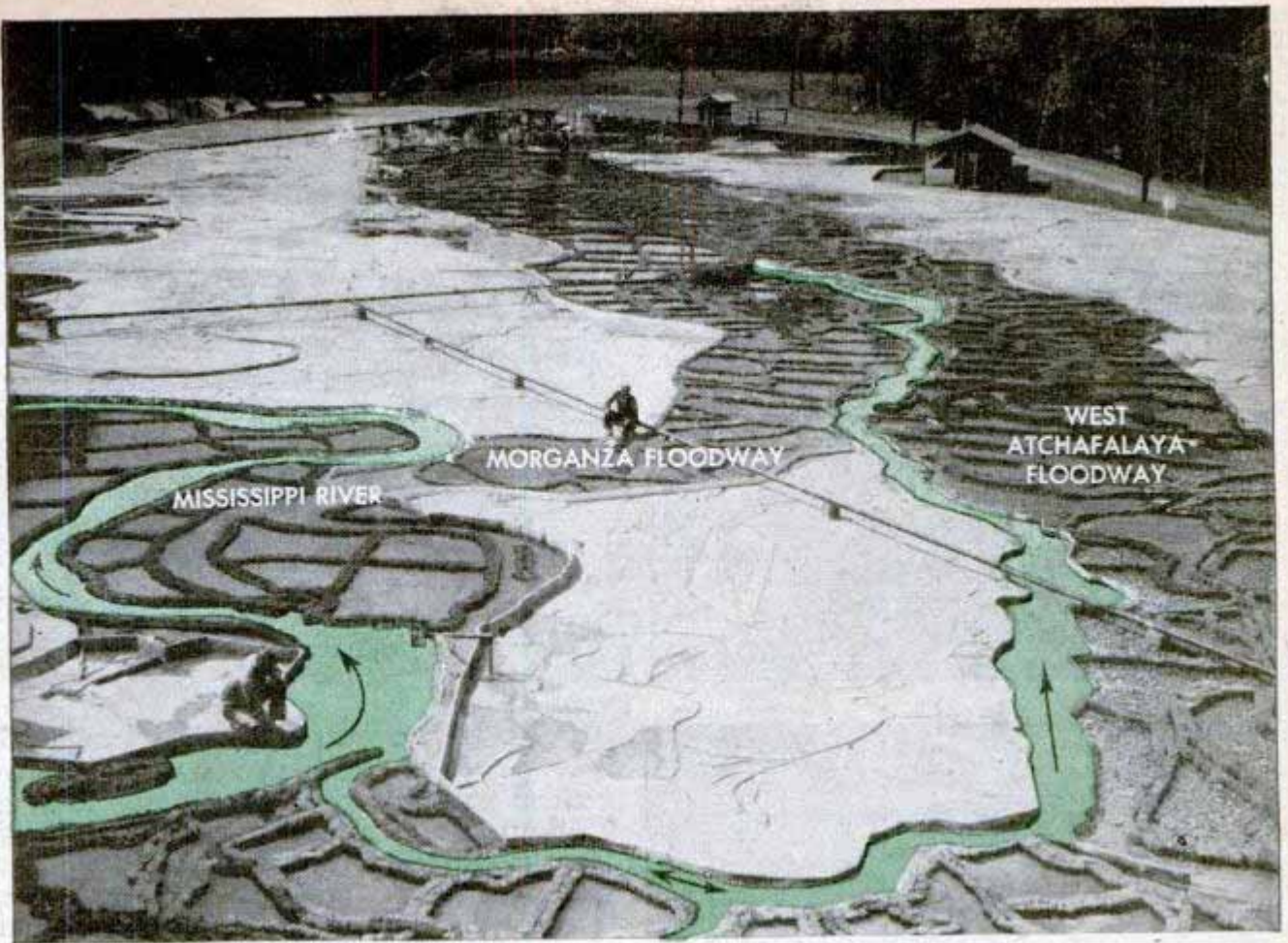

Dwarfed by the size of the model, government hydraulic engineers measure the flow of water through the lower section of the Mississippi River flood control model. Below, control mechanism (at extreme right) for automatic tide-producing machine operates the tides that pour in and out of this scale model of Savannah Harbor. The United States Waterways Experiment Station at Vicksburg, Miss., uses this equipment in channel silting tests

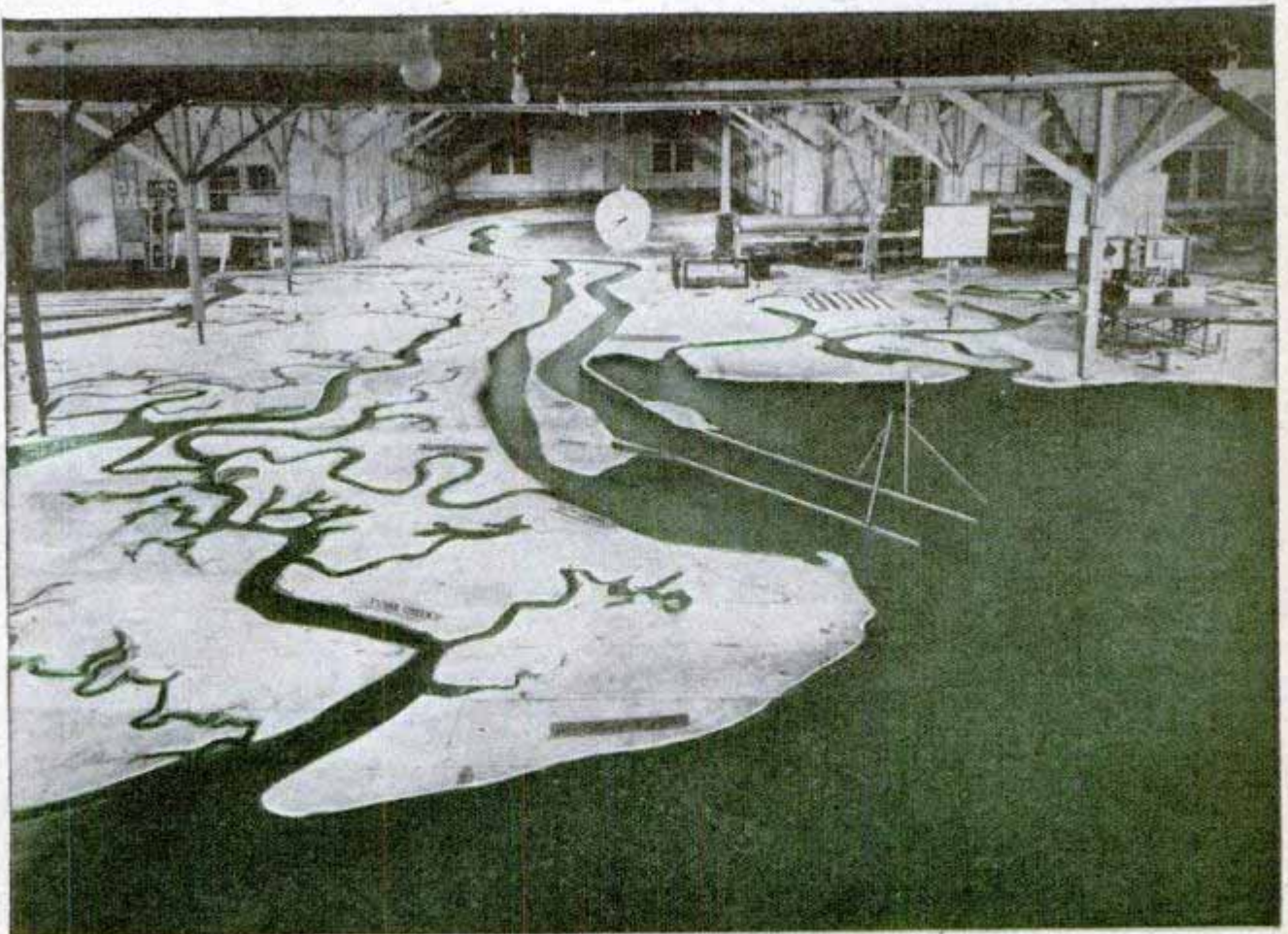

Wheel-mounted burner

that uses either gasoline or kerosene fuel kills weeds and unwanted grass instantly. The burner is attached to a boom which extends several feet in front of a tank containing a three-hour supply of fuel. The boom can be raised or moved sideways at a 45-degree angle.

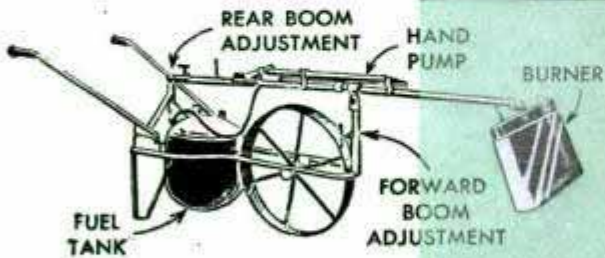

Power drive cuts speeds of fractional horsepower motors to as low as four revolutions per minute. When attached to a 1725-r.p.m. motor the drive has a range of 20 to 750 r.p.m., and with an auxiliary shaft the speed can be cut further to four r.p.m. The drive has a universal coupling and an adapter that fits round, square, triangular and tapered threaded shafts up to $1\frac{1}{8}$ inches in size. The motor can be mounted right or left of the base to take care of shaft rotation in either direction. The base and housing are made of aluminum and the entire unit weighs only 12 pounds.

Whirling spikes on a new farm machine pulverize the soil to do the work of both disk and harrow. The rotary harrow, invented by John Rittenhouse of Washington, Iowa, has a long cylindrical shaft driven by tractor power at a rate of 450 revolutions per minute. Fastened to the shaft are four rows of spikes that rotate through the soil, leaving a strip of pulverized earth. The machine, which weighs less than one ton, pulls up weeds by the roots, according to the inventor.

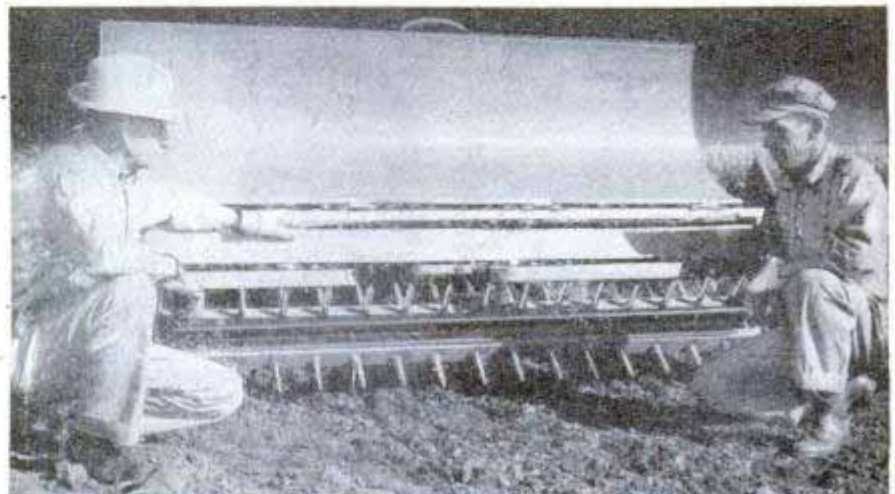

❏ Synthetic resin cast in thin foils was used by the Germans as a wartime substitute for mica insulation in high-frequency electrical equipment.

BRAZIL'S ONE-MAN BOOM



Introducing Francisco Pignatari, a young wizard who is waving a magic wand over industry in Brazil

By Bill Reiche

SAO PAULO, BRAZIL—Brazil is on the march. Our great neighbor to the south, larger than this country by the area of Texas, is arming herself, not against an enemy, but industrially against an economic lethargy that has long kept her from assuming her place in the sun.

For 400 years Brazil has suffered from being too rich for her own good.

A large black and white photograph showing a worker in a foundry. The worker is wearing a dark, protective suit and a large, dark, rectangular face mask. He is leaning over a large, glowing furnace, using a long-handled ladle to pour molten metal into a mold. The scene is filled with heat and light from the furnace.

Molten metal in the booming Pignatari foundry in Sao Paulo is pouring new life into Brazil industry



↑ Air view shows aluminum plant that transforms bauxite into ingots to be made into pots and pans. Right, training plane designed by Pignatari's engineers is becoming popular. Below, 600-ton press stamps out finned basins

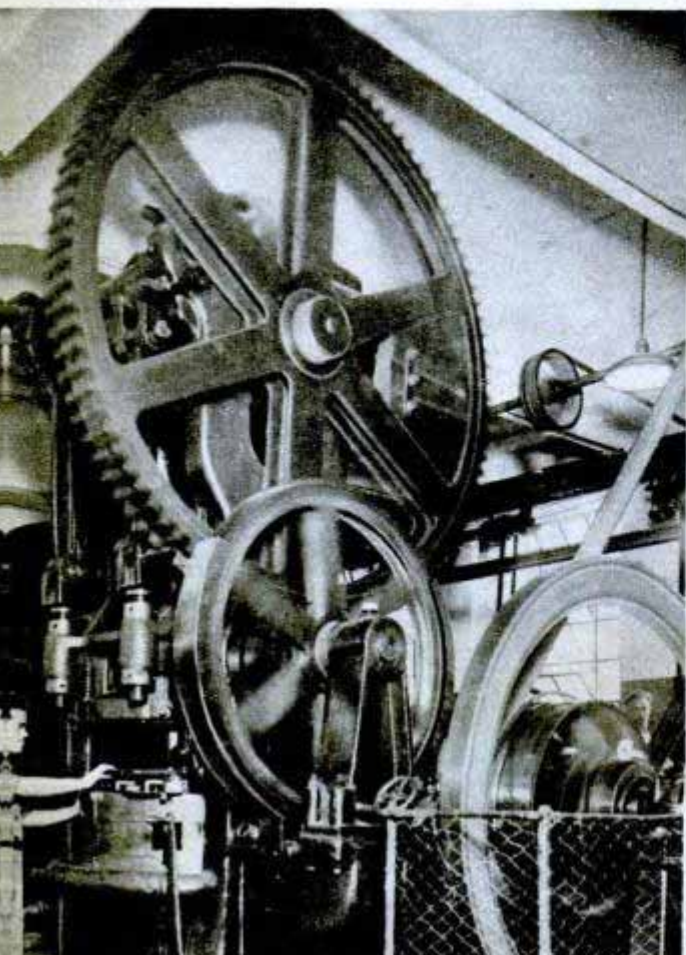

She hasn't had to work because of her wealth of natural and agricultural resources. Selling one commodity at a time to the world, she maintained enough foreign credit to supply herself with finished goods—until the crash came. First it was gold, until Africa took away that market; sugar was the meal ticket until Cuba took over; rubber paid the freight until the market was lost to the Orient; and finally overproduction of coffee brought on a market collapse in the late '20s.

Cotton became a major crop in the '30s, but in recent years a more important seed has been planted. Industries, stimulated by heavy Allied demands for products and raw materials, are springing up as never before. They promise to rescue the nation from the economic improvidence of the one-crop system.

Industrialization, for which Brazil has a firm foundation of vast natural resources of almost every type, is important not only to American industrialists but to everyone in the 48 states.

Contrary to what we might think, the greater commercial and technological progress a foreign nation makes, the better customer it becomes for our production machinery, finished products, li-



Aluminum from plant at left is processed into modern kitchen utensils to meet Brazil's growing demand

censes to manufacture, and engineering and technical know-how.

Hard-headed American business men realize this. William E. Knox, president of the Westinghouse Electric International Company, states that "we know from experience that industrialized nations make the best customers for our own industrial economy—and the best friends."

In the first half of 1946 Brazil imported \$186,000,000 worth of goods from this country—exactly two thirds of her total foreign purchases. During the same period we paid out dollars for 44 percent of her exports.

It was World War II and the Allies' scarcity of almost everything that shifted Brazil's industry into high gear. The nation's total industrial production in 1939 came to only \$750,000,000, but by 1945—the last year for which complete figures are avail-

All kinds of table service from tinned iron to gold-plated sterling are manufactured by the Wolff division

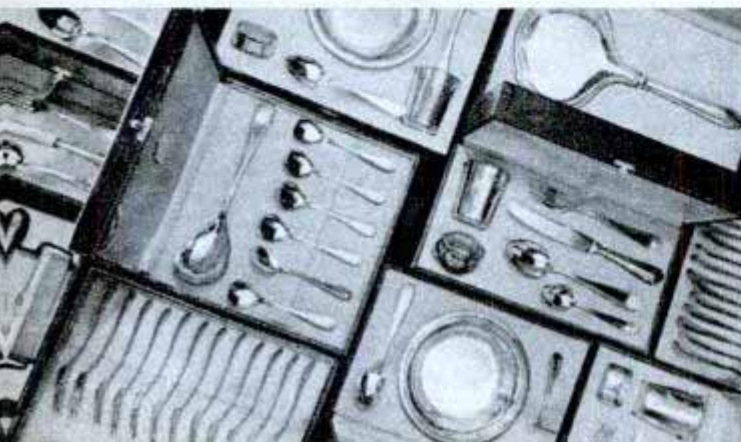

Exquisite pitchers and candlesticks are wrought from silver. Millions of units are manufactured each year

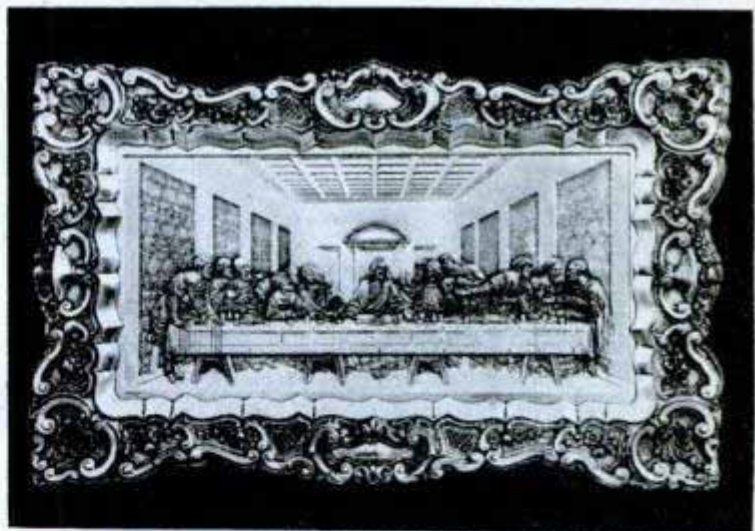

Silver tray depicts the Last Supper in fine detail. Such items may be exported to the United States soon

Master craftsman engraves a metal die for table service. Brazil needs workers with technical "know-how"

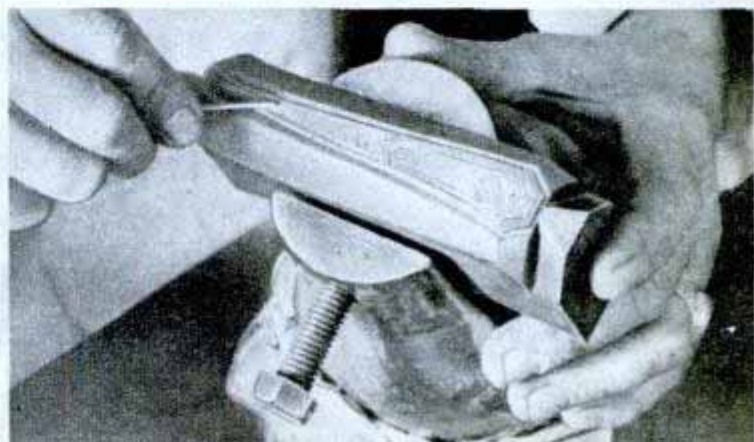

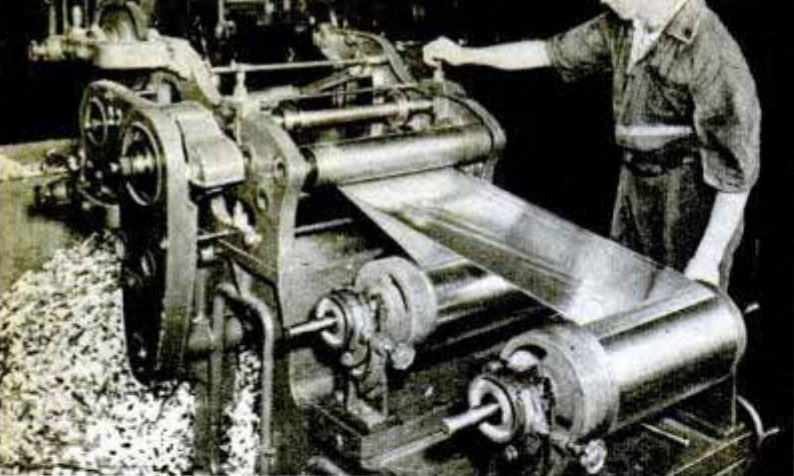

From machines like this roll thousands of yards of aluminum foil each year. Pignatari's lieutenants adopted a method of finishing the foil in any color



↑ Steam boiler parts are welded in a modern factory. The industrial combine also makes gas and oil tanks.

↓ During the war one subsidiary turned out shell fuses

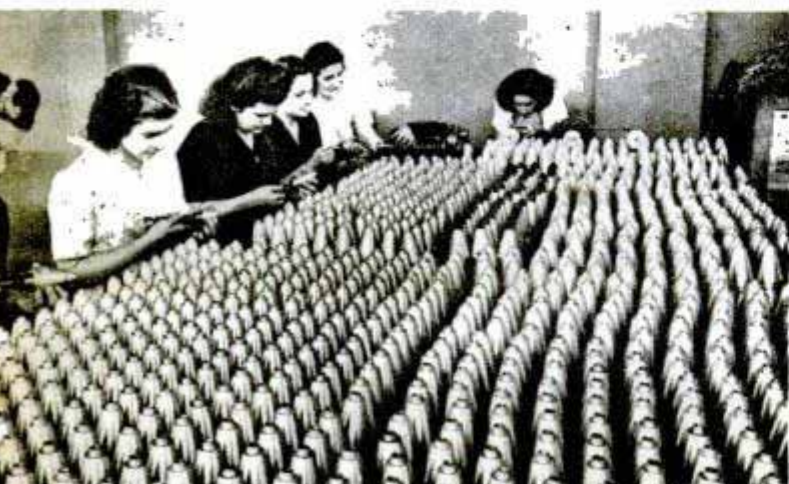

able—production totaled more than \$2,800,000,000, an increase of almost 300 percent.

But the groundwork for the new day was laid in the '30s, which also saw the founding of one of the most modern industrial organizations in South America. In 1933 Dr. Julio Pignatari formed a small company in Sao Paulo, "the Chicago of South America," to manufacture aluminum foil for packaging, and bronze and aluminum powders for painting and lithography. The following year he embarked on the production and fabrication of nonferrous metals, forming a new company—Laminacao Nacional de Metais. This was a real accomplishment, since there wasn't a rolling mill in the country—and never had been—and no skilled labor. Mills were imported from Germany and Switzerland and labor was trained. A dynasty was in the making.

In 1936 Dr. Pignatari died and his 19-year-old son, Francisco, became director of the business. Until that time the son had been known chiefly as a playboy, with little or no business experience and displaying little indication that he would, within a few years, cause a splash which would be felt by the whole continent.

Young Pignatari was and is completely out of sympathy with the widespread Brazilian practice of making an exorbitant profit on limited production. He prefers the Yankee method of realizing a small unit profit on a large volume of production.

By 1941 annual production of Laminacao was up to 3364 tons and sales were more than \$3,000,000. Last year the company produced more than 8500 tons of plates, sheets, tubings, extruded shapes and wire of aluminum, brass, bronze, copper and nickel silver. Its sales exceeded \$9,000,000. During the war it manufactured shell fuses and is now producing machine guns for the army.

Compared to a hundred U. S. companies these figures are piddling. But a business is something like a projectile—it isn't so much where it is at the moment, but where it is going and how fast. This company is the major source of nonferrous metal fabrications in Brazil; it exported part of its output before the war and will export again when production exceeds internal demand. Its plant in a suburb of Sao Paulo covers an area of more than 14,000,000 square feet.

The Companhia Brasileira de Artefactos de Metais takes care of Brazilians' needs for pots and pans and table service. The Wolff division manufactures tableware, ranging from tinned iron to gold-plated sterling, in millions of units. It also makes a fairly complete line of kerosene lamps and stoves. Its sales have mushroomed from a little over \$500,000 in 1940 to approximately \$3,000,000 last year.

(Continued to page 228)

Glamorized Kitchen

New paint and wallpaper, modern kitchen appliances and a big dose of ingenuity have transformed the old-fashioned, inefficient kitchen in the home of Bernard S. Molay in Chicago. Now it is a cheery, comfortable work-room which eliminates, as completely as possible, stooping, bending or lifting.

The remodeling job was done by Molay and a friend, with advice from Mrs. Molay. It has several unique features. A new ceiling of acoustical tile absorbs noise and a ventilator changes the air in the room every two minutes. Curtains, which picked up dust and stopped part of the light coming through the two windows, have been replaced by a wire framework made from shrubbery fencing and laced with three-inch red ribbon. A mirror behind the electric stove creates an illusion of greater depth while adding visibility and light. The divider between stove and dinette was sawed from a piece of 3/4-inch plywood. Three legs of an office table were removed and it was installed as a dinette table and enameled blue. Behind the sink and table-top work cabinets runs a plate-glass splashboard. It is 13 1/2 inches high and 9 feet long. The colorful figures behind it were cut from the patterned wallpaper and covered by plate glass. Shallow bric-a-brac shelves link the wall cabinets. A trap in the kickboard under the work cabinets has a hinged door and serves as a convenient trash receptacle.

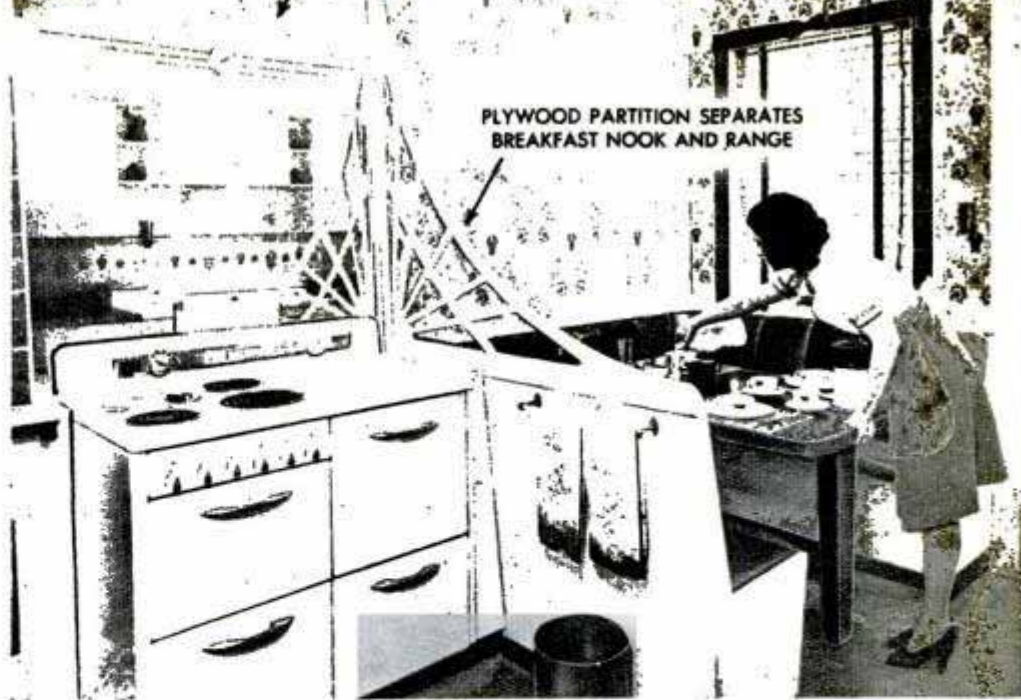

PLYWOOD PARTITION SEPARATES BREAKFAST NOOK AND RANGE

Mirror behind stove gives room greater depth. Trap under kickboard, below, eliminates stooping and makes disposal of floor sweepings easy



FLOOR SWEEPINGS DROP THROUGH OPENING TO TRAP IN BASEMENT

Wire frame and ribbons eliminate dusty window curtains; glass splash panel above sink can be wiped clean



WINDOW DECORATIONS WIRE FENCING INTERWOVEN WITH RIBBON

COFFEE DISPENSER

RADIO

MAGAZINE RACK BUILT INTO END OF RADIATOR GRILLE

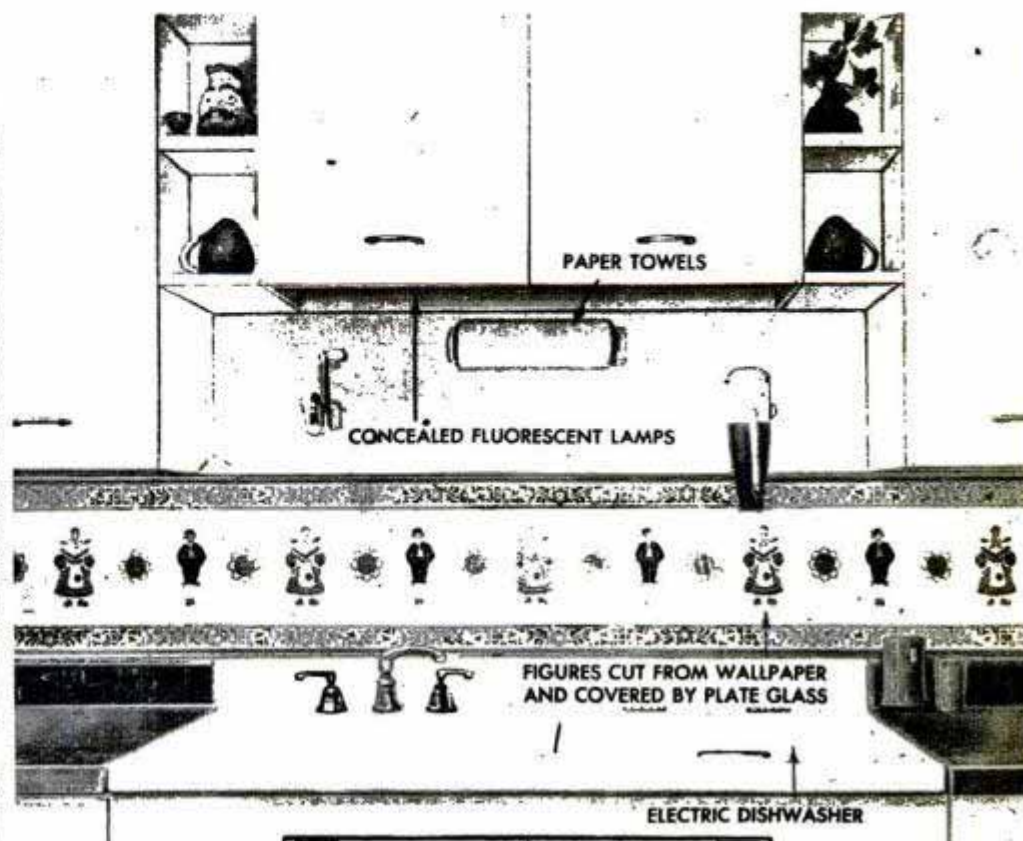

PAPER TOWELS

CONCEALED FLUORESCENT LAMPS

FIGURES CUT FROM WALLPAPER AND COVERED BY PLATE GLASS

ELECTRIC DISHWASHER

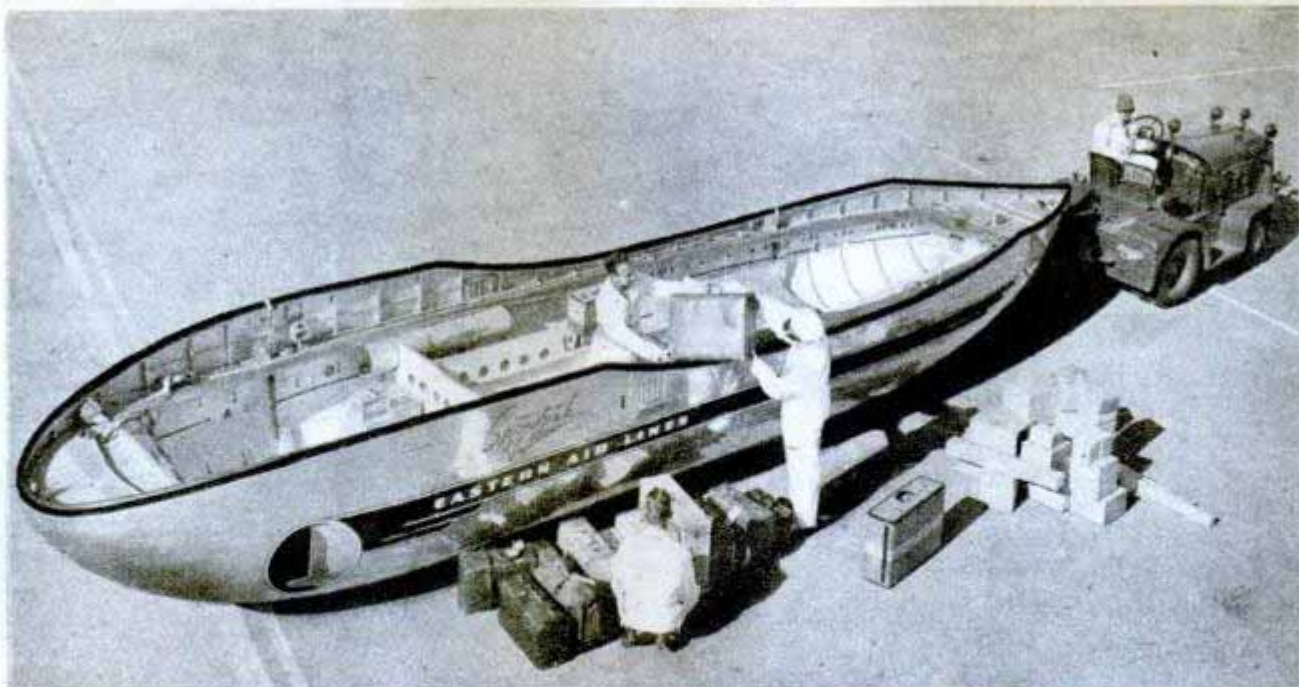

Eastern Air Lines photo

Cargo "canoe," a metal container that fastens to the belly of a transport plane, permits rapid handling of air travelers' baggage. The container is 33 feet long, seven feet wide, three feet deep and weighs 1700 pounds empty. Its 400 cubic feet of space can be packed with about 8000 pounds of cargo. A built-in electric hoist raises and

lowers the wheeled container. All of the compartments designed for intermediate stops can be removed and replaced as a unit. Single pieces of baggage can be loaded or unloaded en route through a small door. The units have their own heating and fire protection systems which can be connected to indicators in the pilot's cockpit.

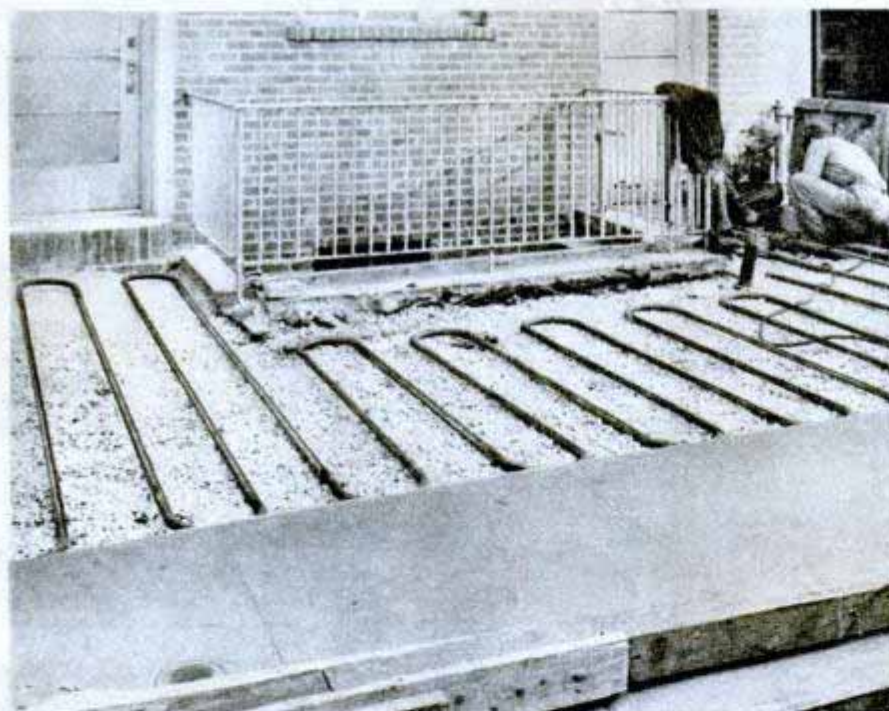

Heated sidewalk under construction in front of a New York apartment building will eliminate snow shoveling. Hot water, with a quantity of antifreeze added, will be forced through a melting system of wrought-iron pipe coils embedded in the concrete. This will keep the temperature above freezing and the walk clear of ice and snow. The pipe, laid in a bed of gravel beneath the sidewalk, is set in strips about a foot apart to cover the entire area in front of the remodeled apartment building.



Wood sweller, a liquid which causes wood fibers to expand, quickly tightens loose chair legs, tool handles or stair treads. Applied either with an eye dropper or dauber, the liquid is said to effect a firm and lasting fit in 15 minutes. It is not a glue but a complex chemical solution which penetrates the wood and causes joints to swell tight. The new liquid has greater lasting powers than brittle glue, according to the manufacturer.

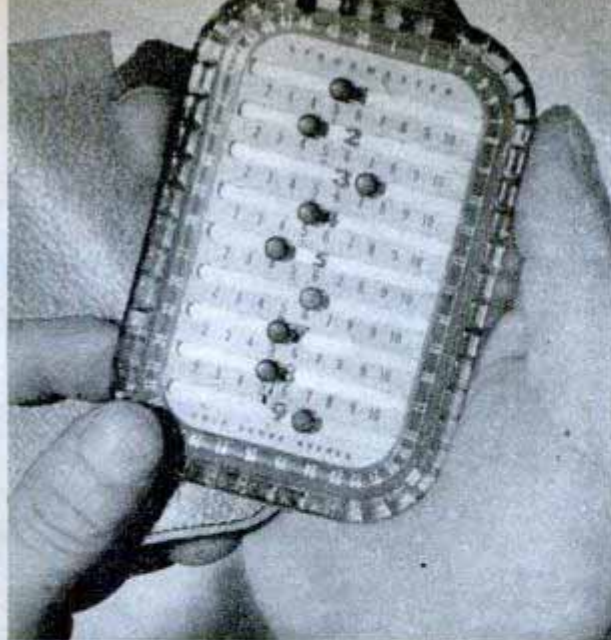

GOLF SCOREKEEPER'S movable buttons tabulate strokes for each hole and for course



PRESSURE CHAMBER, designed on doctor's orders for Winston Churchill's flights, has a couch, telephone, ash tray, shelf



PLASTIC PUTTER resists changes in moisture and temperature. The club has a steel shaft



HOME AIR CLEANER picks up 85 percent of dust entering house. Dust is electrically charged, then attracted to metal plate

CURRENT TESTER has neon bulb that glows, indicating current flow or a good spark plug

HYDRAULIC JACK fastens to bumper, can be installed without stooping. Handle is on top and requires only slight pressure

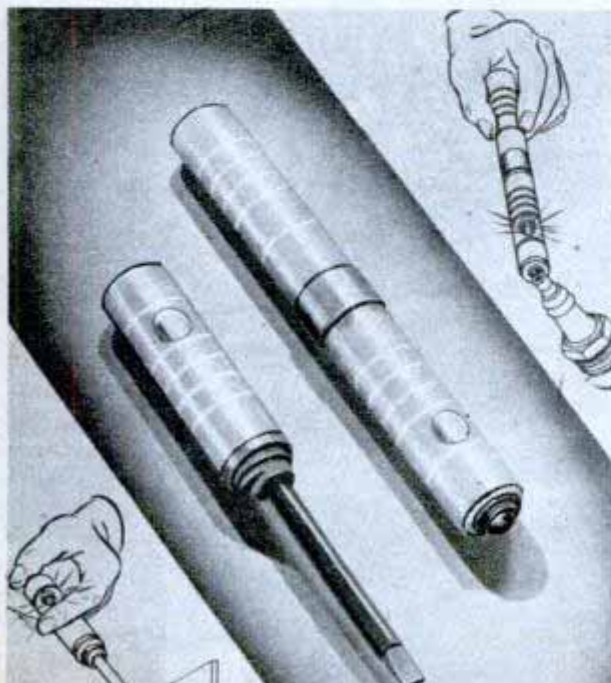

Kettering holds model of the Navy's trimotored NC-4. In 1919 the original made the first transatlantic crossing

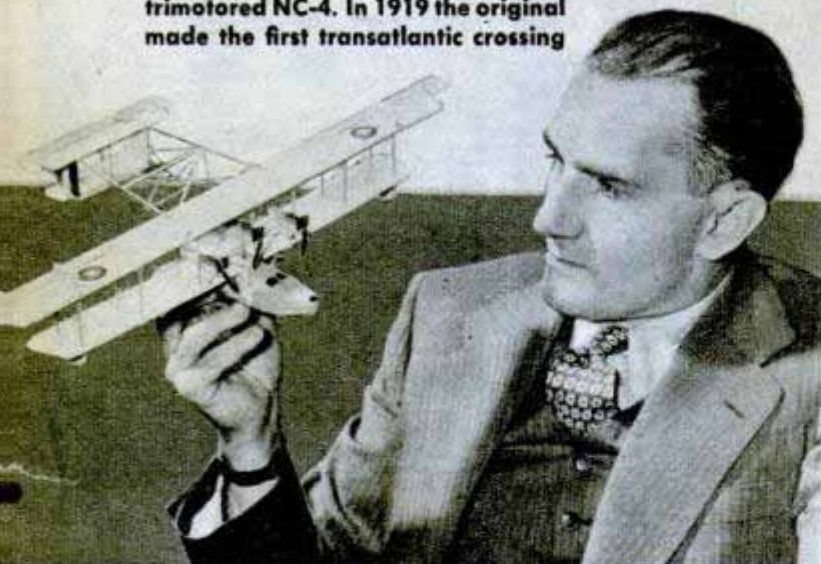

HOBBYIST OF THE MONTH

Eugene W. Kettering

GENE KETTERING'S business is designing powerful Diesel locomotives. But after office hours his interest wings homeward to his pride and joy, the world's largest collection of model airplanes.

Built to an exact scale of four millimeters to a foot, an ever-growing array of over 450 models fills lighted wall cabinets in the library of his Hinsdale, Ill., home. All are made of balsa wood, the largest weighing almost four ounces and having a wing span of 32 inches. The smallest tips the scale under a quarter of an ounce and spans less than an inch.

Beginning with a Wright brothers' mod-

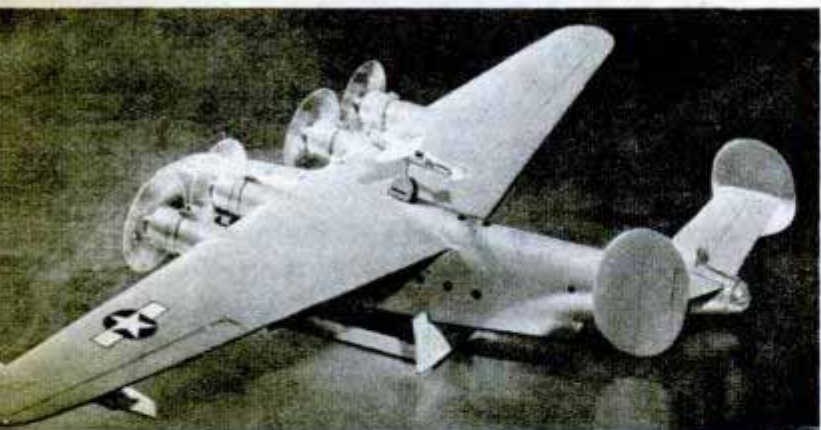

Each built to scale, the winner of the 1937 Thompson Trophy race perches atop the Martin Mars. Below, the collector touches up blister on a modern flying boat

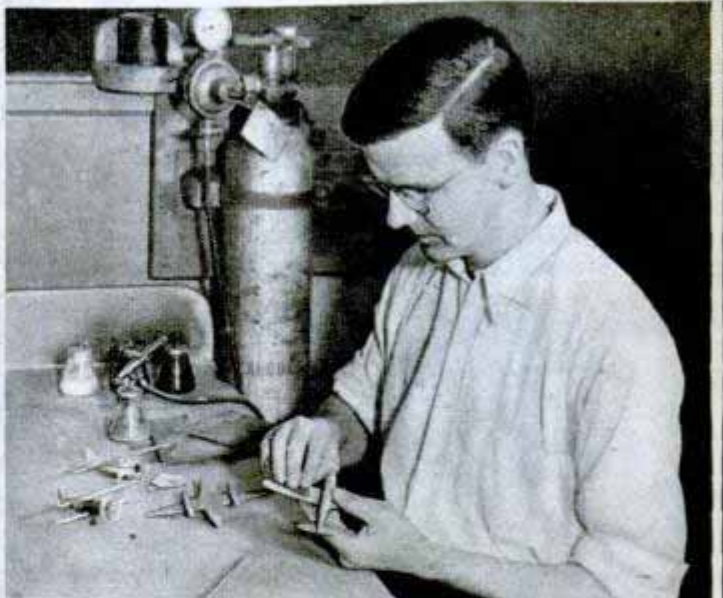

In front of modelmaker Chaffee, sanding Jap "Tony," are an ME-262, Stinson and PT-13. Below, Wright plane on Mars wing was speed champ—at 50 m.p.h.!





Enough planes for a small air force fill specially built and lighted cabinets along walls of the collector's library

el, the collection is a visual history of aviation. Among its divisions are commercial, Army, Navy, foreign and racing planes, gliders and ships participating in famous flights, such as the Spirit of St. Louis and the Winnie Mae. On display are the winners in such notable speed classics, past and present, as the Bennett, Pulitzer, Bendix, Thompson and Schneider Trophy races. And running your eye along one of the shelves you can quickly trace the evolution of warplanes from the early crates to today's sleek speedsters.

Every detail is perfect, even to guy wires and the supercharger on a Liberty engine. They're painted their actual colors with regular aircraft pigmented dope, using an artist's airbrush, after the priming filler coat has been carefully sanded. Blisters and canopies are made by heating celluloid and pulling it over a form while still in a plastic state. A tiny, lifelike figure of Orville Wright at the controls of an early ship is carved out of soap.

Like many hobbyists, Kettering isn't
(Continued to page 260)

On the lowest shelf are winners of famous trophy races. Just above are early-day air liners and mail planes

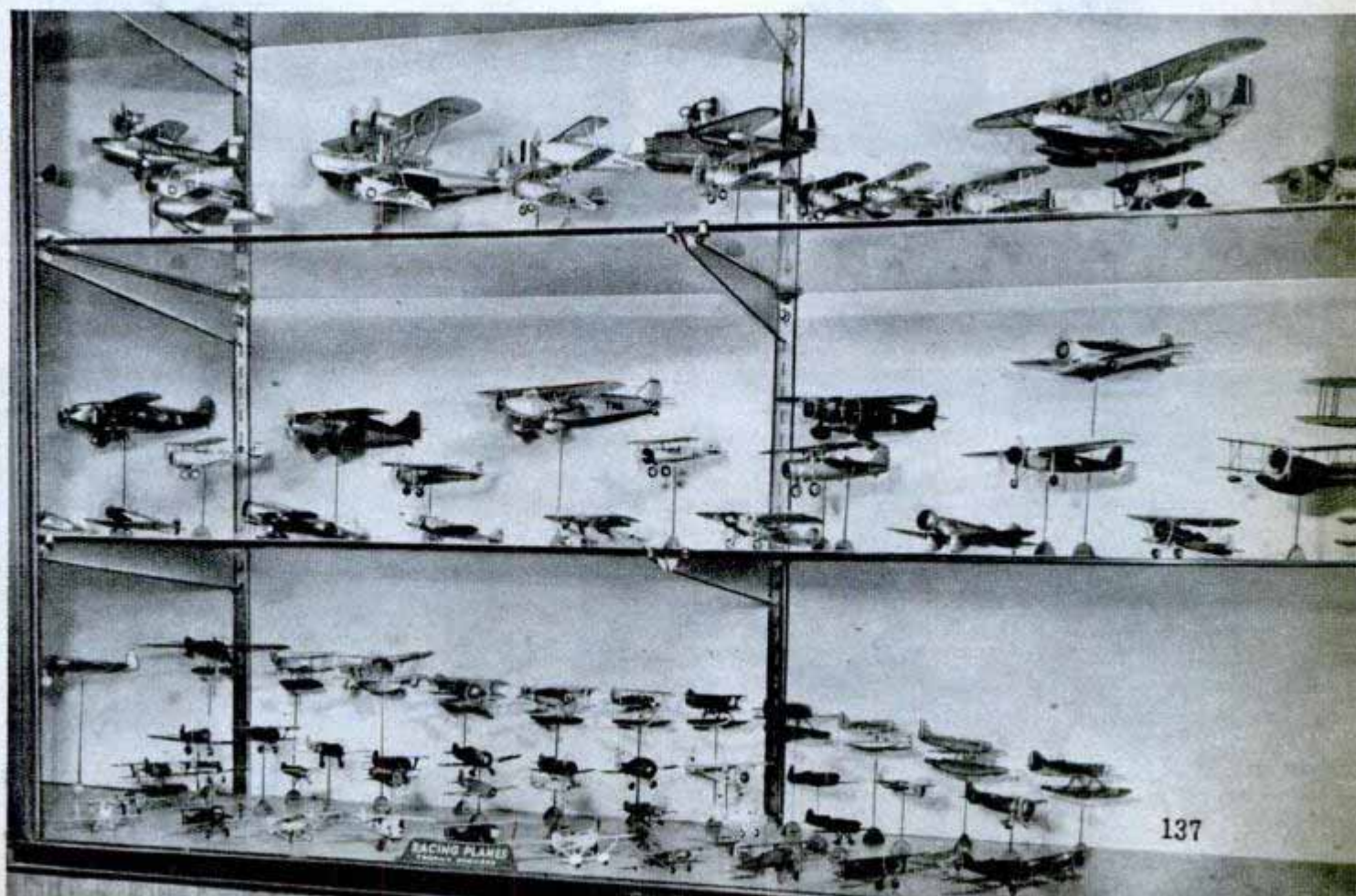

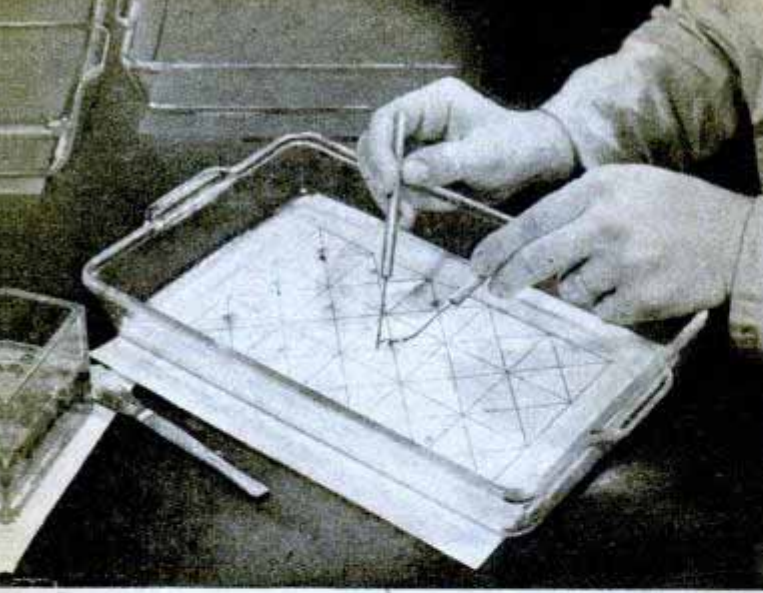

Biological specimens are preserved in plastic blocks. Above, placing chick embryos on layer of plastic



Next step in the process, developed by Ward's Natural Science Establishment, is adding a second layer of plastic



MOUNTING SPECIMENS in PLASTIC

When dishes of plastic have "jelled," they are placed in oven for heat curing. Heat starts at 100 degrees Fahrenheit and goes up to 250 degrees

Final polishing is performed with high-speed buffer to prepare specimens for lab use or classes

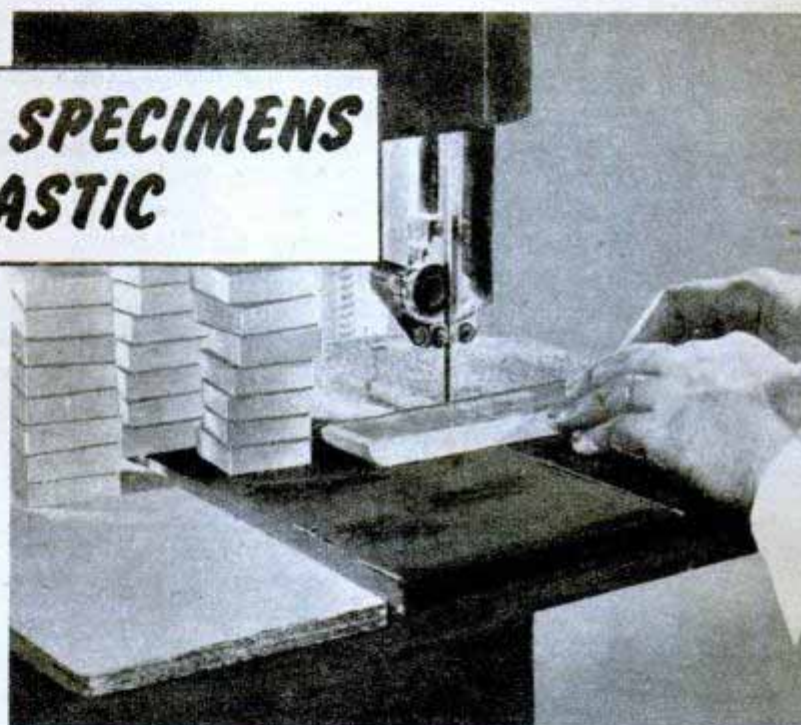

Following heat treatment, cakes of plastic are sawed into blocks. Each block contains one specimen as a result of installing them in accordance with block pattern

Plastic mounting for the delicate embryo of a pig is compared with a glass microscope slide mounting (top)

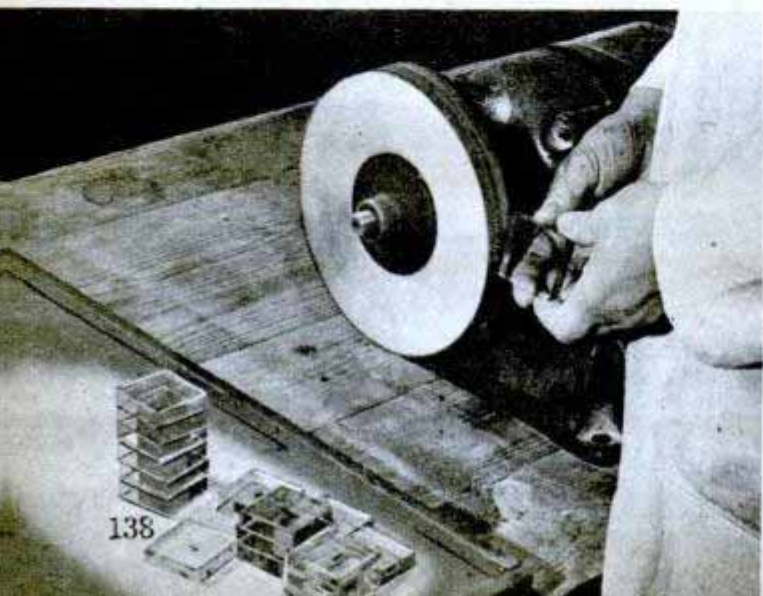

THEY TAILOR THEIR OWN CARS

By Thomas E. Stimson, Jr.

EVER hear of the Kurtis car? Or the Summers automobile? Or the Smith or the Jones or the Brown makes? These and hundreds of others, each one different, are rolling along the highways today.

The Summers is a low-slung convertible engineered for roadability and ease of handling. Its taillights and rear license plate are built into the rear bumper. The luggage compartment has no handle and is unlatched from inside the car.

A typical Smith coupe has a high-powered engine, a one-piece body, and no locks or handles on its doors. The owner opens a door by pressing a foot lever concealed beneath the body.

The Jones may be a convertible with a low windshield and a semisolid cloth top that is removed from the car as a unit in good weather. The car has no dashboard and its instruments are grouped on a small panel in front of the steering wheel. Its

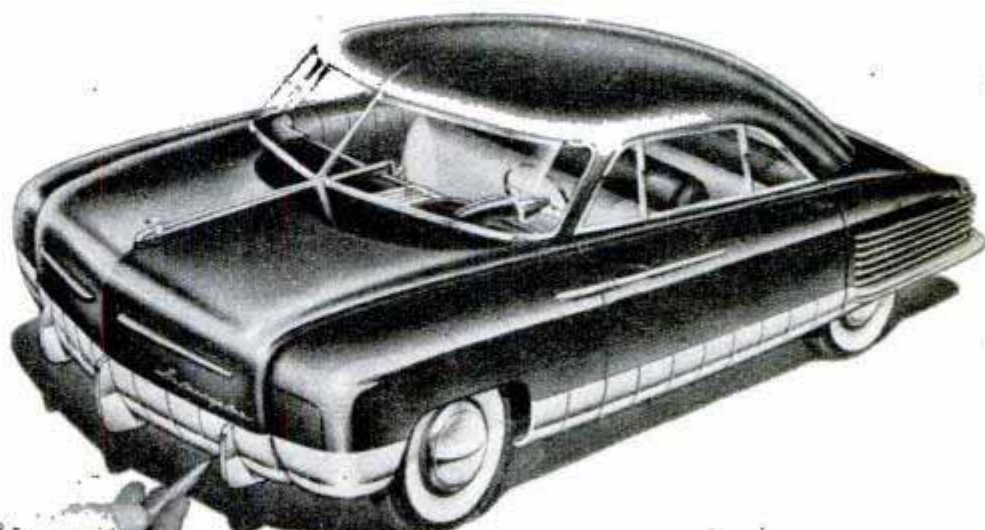
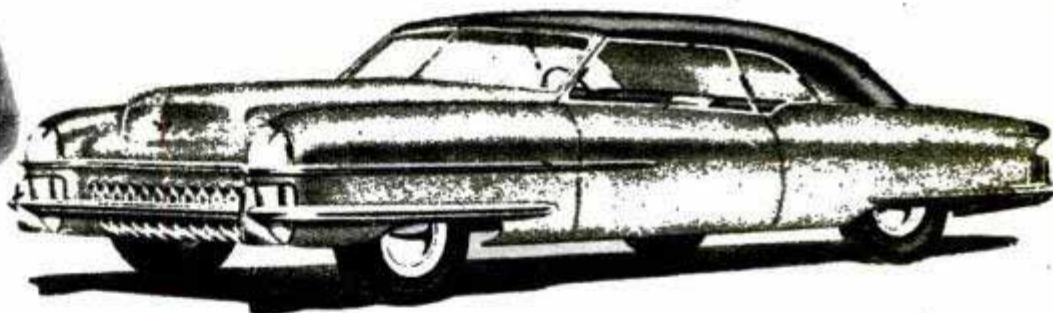

Industrial designer steps up auto styling. Rhys Miller works on a car with flush bumpers and a rear engine. Note "pontoon" fenders of top design

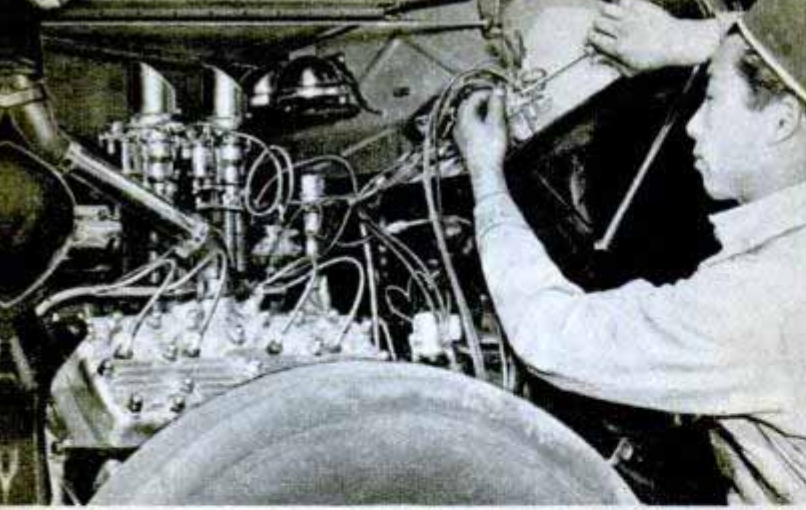

Proud owner has eliminated chrome from exterior but chrome-plated almost every part of his smooth engine



↑ Cloth is tacked to welded frame to complete a hand-tailored convertible top that will eliminate drafts

↓ Frame for semipermanent top is fitted to a cut-down car. Covered with cloth, it can be removed as a unit



rear license plate is mounted inside the body and is visible through a glass window.

All of these, actually, are stock cars that have been modified by their owners. Dissatisfied with the "peas in a pod" appearance of their cars or the conventional power plants, many owners redesign their factory-built automobiles. New cars as well as jalopies eight or ten years old are reworked. Some owners spend several times the original cost of the car for custom work by specialists. Others do much of it in their own garages in spare time.

Most of the modified cars are several inches lower than the stock models and have practically no chrome brightwork or gingerbread. Usually the engine has a high-compression head to deliver more power and is fitted with special mufflers. Often the entire engine is chrome-plated. Most owners are so proud of their tailored cars that they keep even the engine compartments meticulously clean.

Large chrome "ripple disk" hub caps and a chromed radiator grille are the only brightwork that most owners want. Chrome molding strips and other ornamentation are removed and the holes and slots by which they were attached to the body are filled in with body solder or welding metal. This spot work is filed smooth and painted.

The smooth streamlining of aircraft is simulated by filling in the sharp angles where fender and body lines meet. The fabric beading that serves to prevent fender squeaks is removed and the whole angle filled with body solder or welding metal.



Finished Summers car has been lowered 8½ inches, running boards removed, and new radiator grille installed

↓ Instruments are grouped at left of wood-paneled dash

Solder is easier to use but is more apt to work loose. Welding does the best job though the high heat of the operation usually ripples the body metal. These bumps must be hammered out. The whole fillet of added metal is filed to a smooth curve. The changes are concealed under a new coat of paint and the car has the rich appearance of a custom-built automobile.

Some owners alter the appearance of front ends by installing a radiator from another make of car or by designing their own. They cut or reshape the nose of the body to fit the new grille.

Special tools are needed for much of this work and few owners have the skill to do a good job. A new shape of fender, for example, must be hammered out, using a large leather-covered sandbag as an anvil. The hammer dents then are beaten out with a high-speed pneumatic hammer and the final imperfections are filed smooth. The finished fender looks as perfect as if it had been stamped out by a huge press.

Numerous small shops specialize in different kinds of work. In southern California where modified bodies are an expensive fad, engine shops, top shops, spring shops and body shops have more work than they can handle. Changes sometimes total a thousand dollars or more per car.

Jimmy Summers of Hollywood special-



↓ Jimmy Summers' restyled 1940 Mercury has special bumper holding license, flanked by tail and stop lights

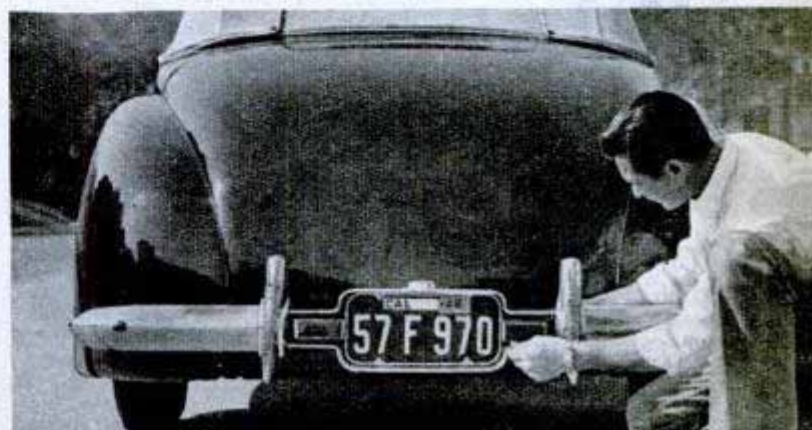

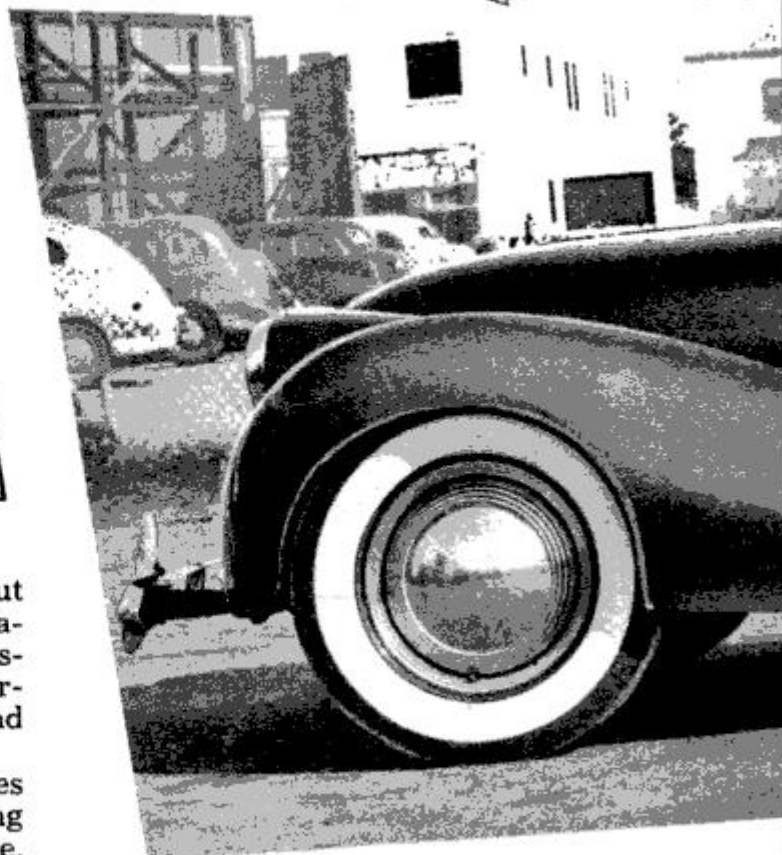
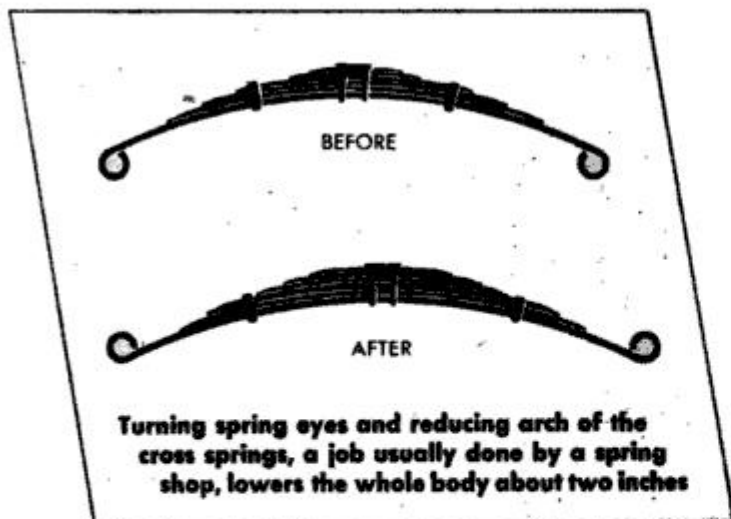

izes in custom work, hand-tailoring about one car per week to an owner's specifications. Many of the orders come from customers who have seen his redesigned personal car, which has been inspected and praised by Detroit factory officials.

The car, a 1940 Mercury, is 8½ inches lower than it was when he started working on it, yet it has standard headroom inside. It hugs the road like a heavy car and is easy to handle in traffic. The car is valued and insured at \$6200.

Summers lowered the entire body six inches on its frame but left the fenders at their original height, reshaping them to fit the altered body. He built a special radiator grille and redesigned the front end to fit it. The running boards were removed, the hood latch placed inside, and the handle of the luggage compartment door taken off. A control unlatches the door from the driver's seat. Front and rear bumpers were built from his own designs. The height of the windshield was reduced 2½ inches and a special semipermanent Carson top was installed. Instruments are grouped in front of the steering wheel and the balance of the dashboard is paneled in wood. The top is

finished inside with dark broadcloth and the seats covered with top-grain steerhide.

The paint job consists of 60 separate coats of maroon lacquer sprayed on one after the other. Then the finish was sanded with extra-fine sandpaper and a final coat of lacquer thinned out 80 percent sprayed on. This was rubbed down with a fine cleaner, burnished with a dry sheepskin mounted on a high-speed power disk, and waxed.

Designing brand-new bodies as well as modification of existing bodies is quite a hobby in itself. Rex Burnette, a young Douglas aircraft engineer, designed a bubble top roadster which a couple of his friends are building. He's now finishing plans for a rear-engine station wagon that

Sheet metal shaped into a special panel to add to the length of a fender is smoothed with a file

Unfinished panel is tested for size on the car, a Chevrolet, before the final rounding, cutting and painting

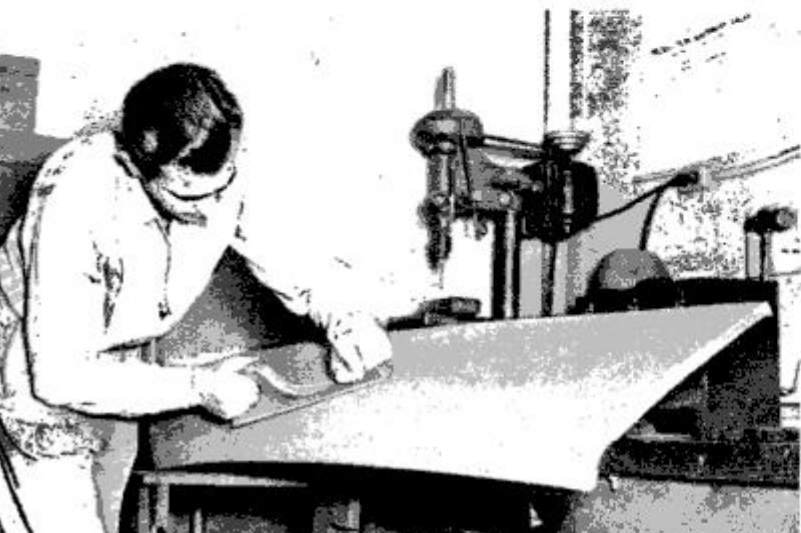

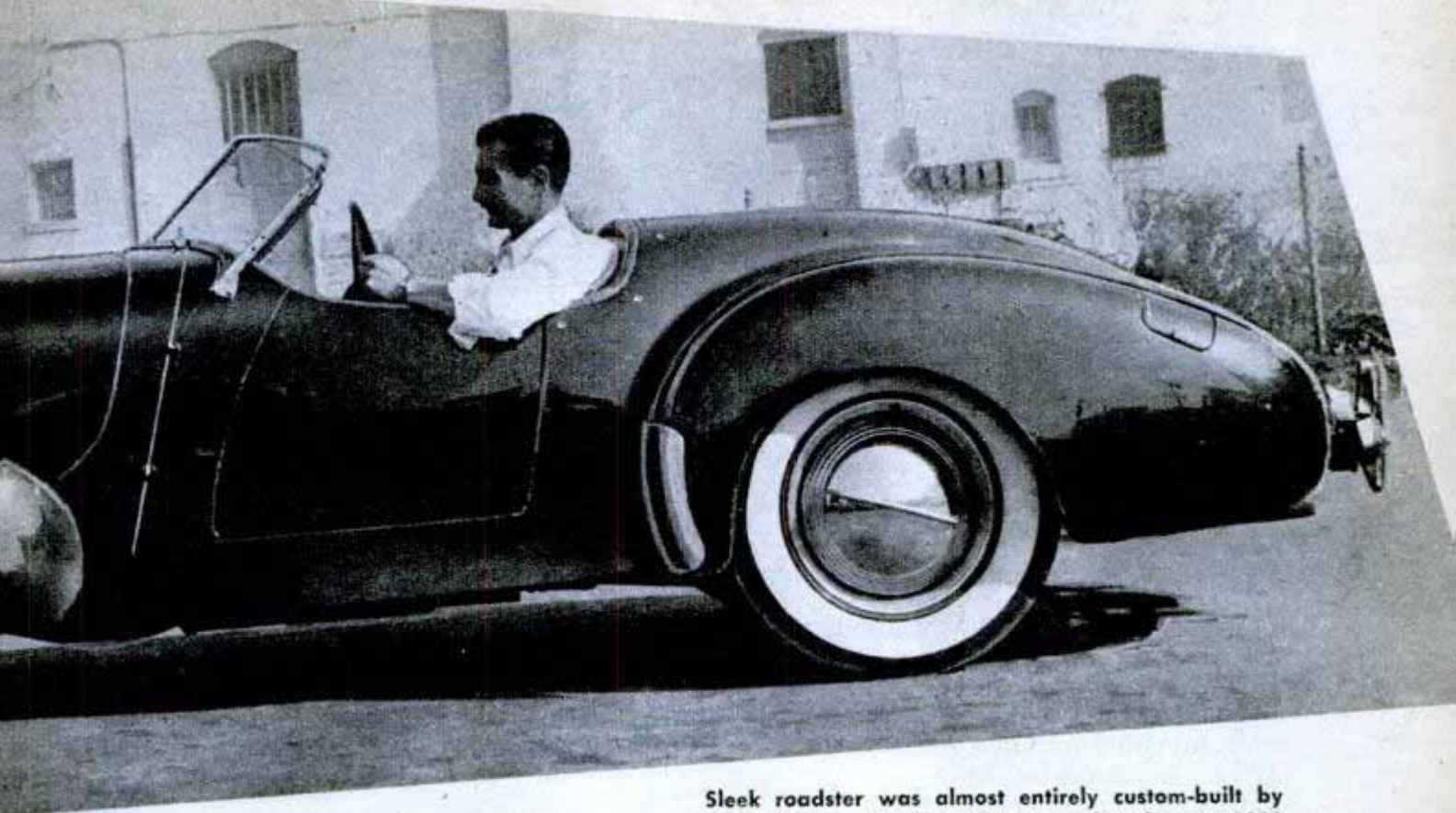

Sleek roadster was almost entirely custom-built by Frank Kurtis. Only the fenders, taken from a 1939 Chevrolet, and the engine were remade from old parts

features a forward storage compartment covered with wood paneling, air intakes built into the leading edges of the rear fenders for carburetor and cooling air, and a single horizontal high-intensity fluorescent tube headlight across the front of the car. Some of his other designs stress low radiator grilles that extend across the front of the car, plus semicircular lounge-type rear seats built to fit the curve of the body.

Rhys Miller, young Hollywood industrial engineer, has plans for a light 100-inch wheel base two-door car that has many attractive features, including a rear engine, flush-type bumpers mounted independent of the body, a curved windshield and extra-

(Continued to page 240)

Electric jack that formerly raised top of a convertible is installed in luggage compartment to lift lid

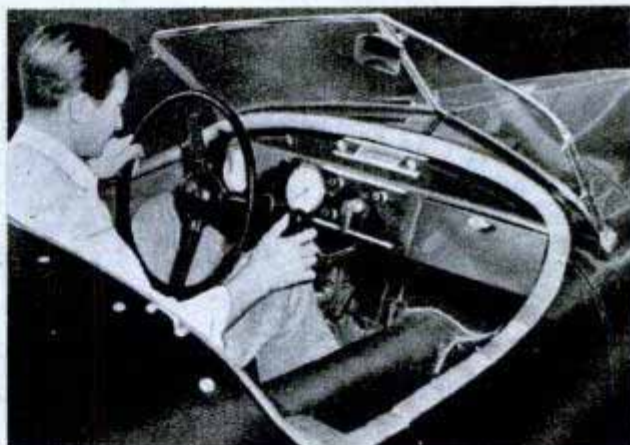

Gearshift lever runs straight through the dashboard
 ↓ Altered fenders of the roadster give it a racy appearance. The car is powered by a Mercury engine

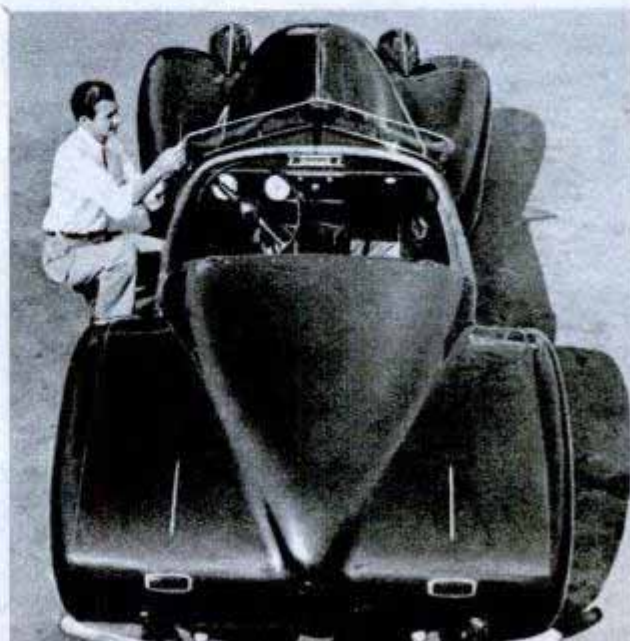

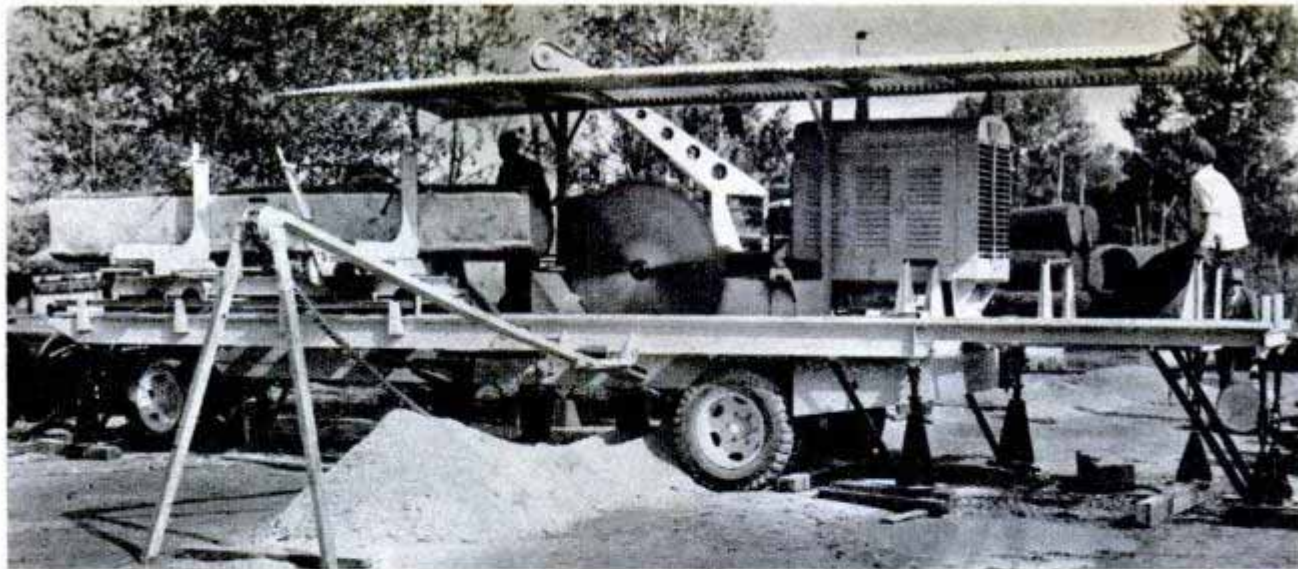

Folding Sawmill Rides Trailer

Waste timber and small stands of wood can be cut profitably by a mobile sawmill that "folds" into a compact unit when it is moved from one site to another. The mobile mill, invented by Glen Johnson of Tenino, Wash., is supported by a sturdy 28-foot trailer mounted on six tires. At the site it unfolds to a length of 36 feet and is steadied by 11 screw-type platform jacks. A chain-driven sawdust conveyer pivots out from one side while another conveyer unfolds from the opposite side to carry the logs to the trailer and hoist them into position. The 60-inch blade, driven by a six-cylinder Diesel engine, handles logs 16 feet long and

30 inches in diameter. The inventor claims the mill will turn out about 14,000 board feet of lumber a day, opening to loggers vast areas of lumber that are now wasted. Eight of the mills are already in operation by ten-man crews, which include loggers and haulers.



Rubber boat designed for the special needs of sportsmen is stable enough to permit a fisherman to stand up while casting. Four separate air compartments and an inflated bottom insure buoyancy. It can be propelled by oars or a two-horsepower outboard motor. The motor fits a rigid wooden mount attached to the aft air cell. All sections are made of tan cord canvas, double coated with Neoprene and vulcanized together. If a leak develops, it can be repaired by a hot or cold patch. The boat comes equipped with two wooden seats, two telescoping aluminum oars, an aluminum air pump and a canvas carrying case.

Planes 12 miles away were spotted by the Germans during the war with special infra-red-ray equipment that detected the heat from engine exhausts.



Hobbyist's Tiny Guns Shoot Blanks

Midget guns that shoot and carpenter's tools that cut wood are built to scale by Jose Tristhan of Mexico City. He uses a jeweler's lathe to turn out the parts. The miniatures are one eighth actual size and are finished to a .001-inch tolerance without the aid of a magnifying glass. Most of Tristhan's little guns fire tiny blank cartridges that he furnishes with the weapons. The smallest of the guns, 1 1/8-inch-long, watch-charm miniatures of Army service revolvers, can't be fired but their cylinders rotate and they can be taken apart. Tristhan's monkey wrenches have ivory handles and tiny thread adjustments. Among the other working models in his 15 sets of miniatures are barber's scissors and hair clippers, butcher's implements, shoe-

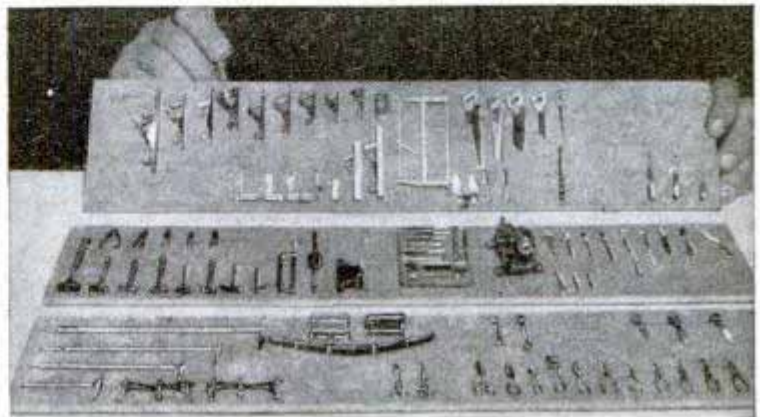

maker's tools and plumber's kits which include miniature blowtorches that throw pencil-point flames.

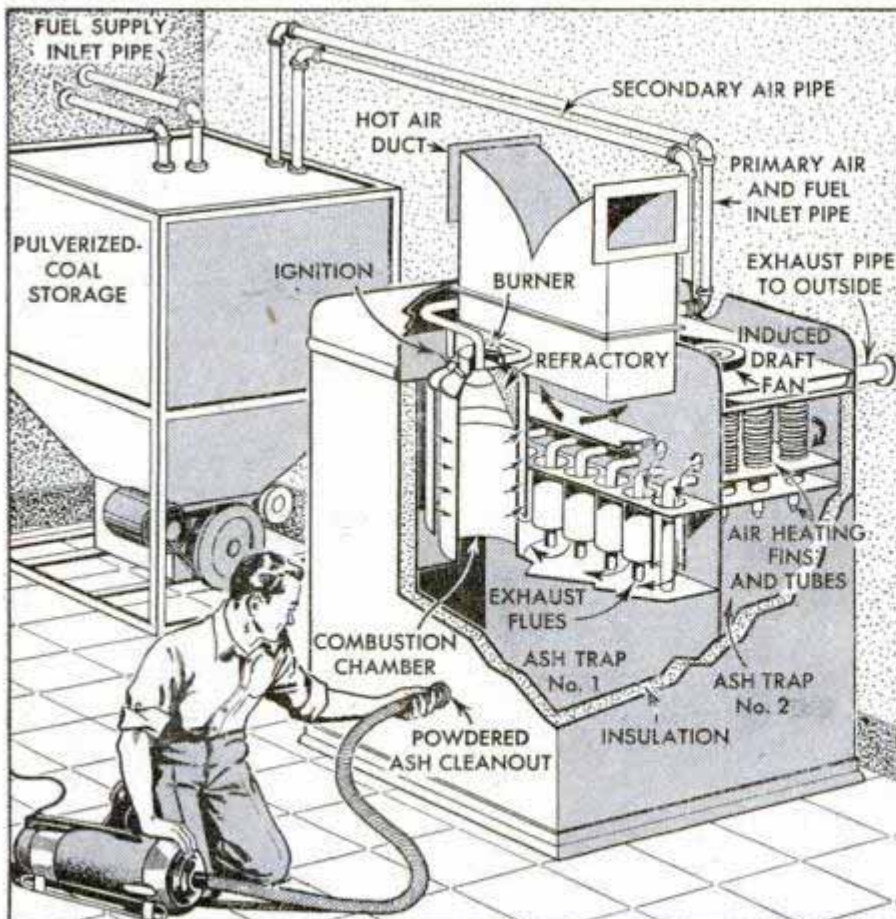

Down-Fired Heater Burns Powder Coal

Built for low-cost operation, an automatic home furnace burns pulverized coal piped into a basement hopper like fuel oil. The furnace is a vertical sheet-metal cylinder lined with fire-resistant material. It is down-fired from a top-mounted burner after ignition by a gas pilot and spark plug. A screw conveyer at the bottom of the hopper moves the powdered coal to a blower for carburetion with the air going to the burner. The fire chamber gets added combustion air through a small take-off line from the blower. About 90 percent of the fly ash is separated from the flue gases and dropped in a trap, where it can be removed.

SILVER SHEDS THE OVERALLS

By John W. Snyder
Secretary of the Treasury

THE NATION'S silver resources are not diverted to bus bar manufacture, as a rule. Silver is more familiar as the raw material for coins, knives and forks, candlesticks and compotes, or as an occupant of treasury vaults. Bus bars normally are made from less aristocratic stuff.

It should be recorded, then, that half a billion dollars' worth of silver, enough to load 300 freight cars, is returning to the treasury from a tour of wartime bus bar

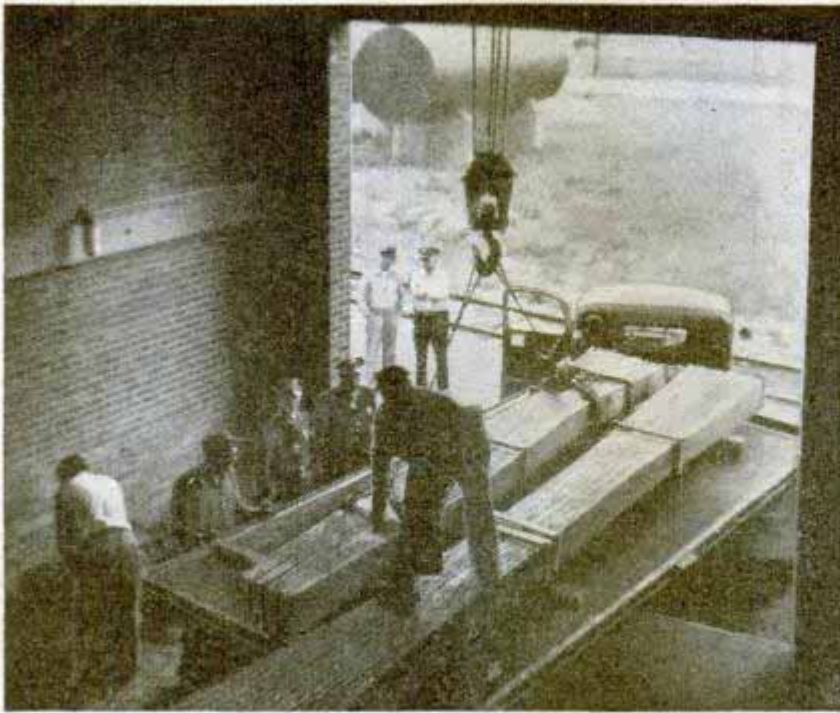

Silver bus bars head back to U. S. Treasury after wartime use in power lines at Marysville, Mich., magnesium plant. Below, after being cut into small bars the silver is returned to the West Point depository

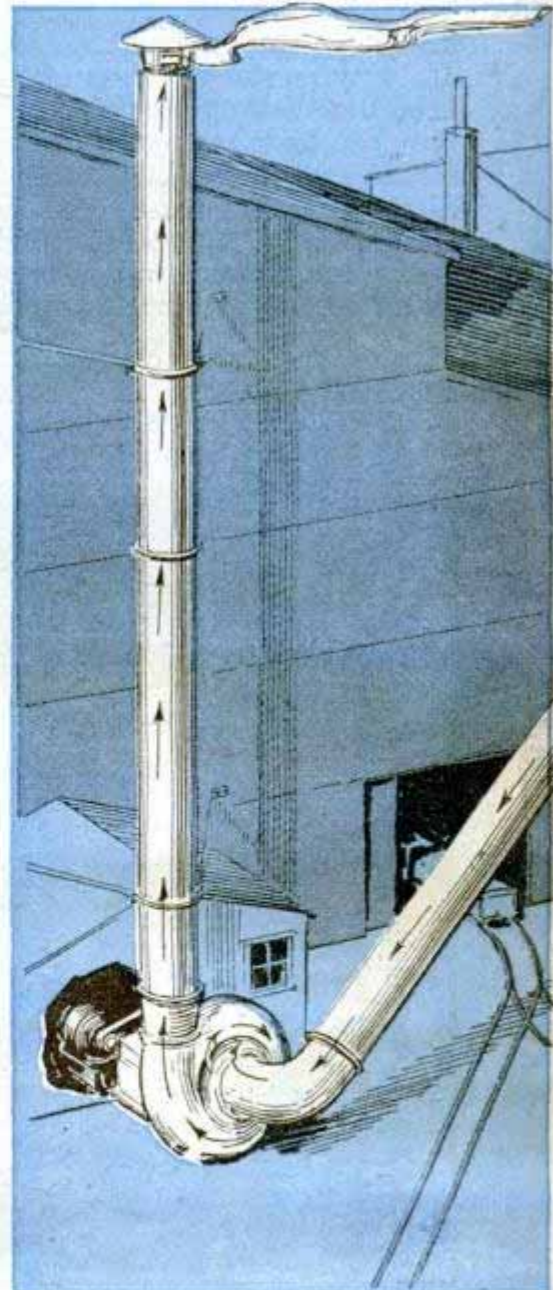

duty. The duty was discharged in Reconstruction Finance Corporation war plants engaged in producing light metals such as aluminum and magnesium.

It was "free" silver, meaning that it had no immediate monetary responsibilities, when the treasury first released it for the bus bar assignment. But through a complexity of war exigencies and altered legal distinctions, most of it came to be "monetized" silver before the assignment was ended. This meant that for a time the silver was doing two jobs at once—serving the nation's needs on the war production front, while also serving as security for a lot of outstanding United States currency.

Bus bars are slabs of metal used as heavy-duty conductors of electricity. The slabs are built into lines in and around industrial plants which use large amounts of electrical current. Silver bus bars installed in 13 RFC war plants conveyed enough

electricity to light New York City for years.

The electrical current did no damage to the silver. The properties of silver are such that it gets along with electricity very well. The metal suffered somewhat in other ways, however. A hundred pounds of silver melted from a bus bar line in the aluminum plant near Spokane, Wash., when a molten mixture of aluminum oxide and cryolite overflowed from an electrolytic pot which the bus bar encircled. When the mess cooled, all but half a pound of the silver was recovered.

The silver bus bars helped produce much more magnesium and aluminum than ever had been produced in this country before. Upon this production our wartime air power was built, for the light metals went primarily into airplane construction.

The National Research Council, the War Production Board and the RFC were interested in saving copper, the material from

Special equipment recovered silver worth \$250,000 from fumes at New Jersey refinery which processed bus bars

Courtesy Northern Blower Co.

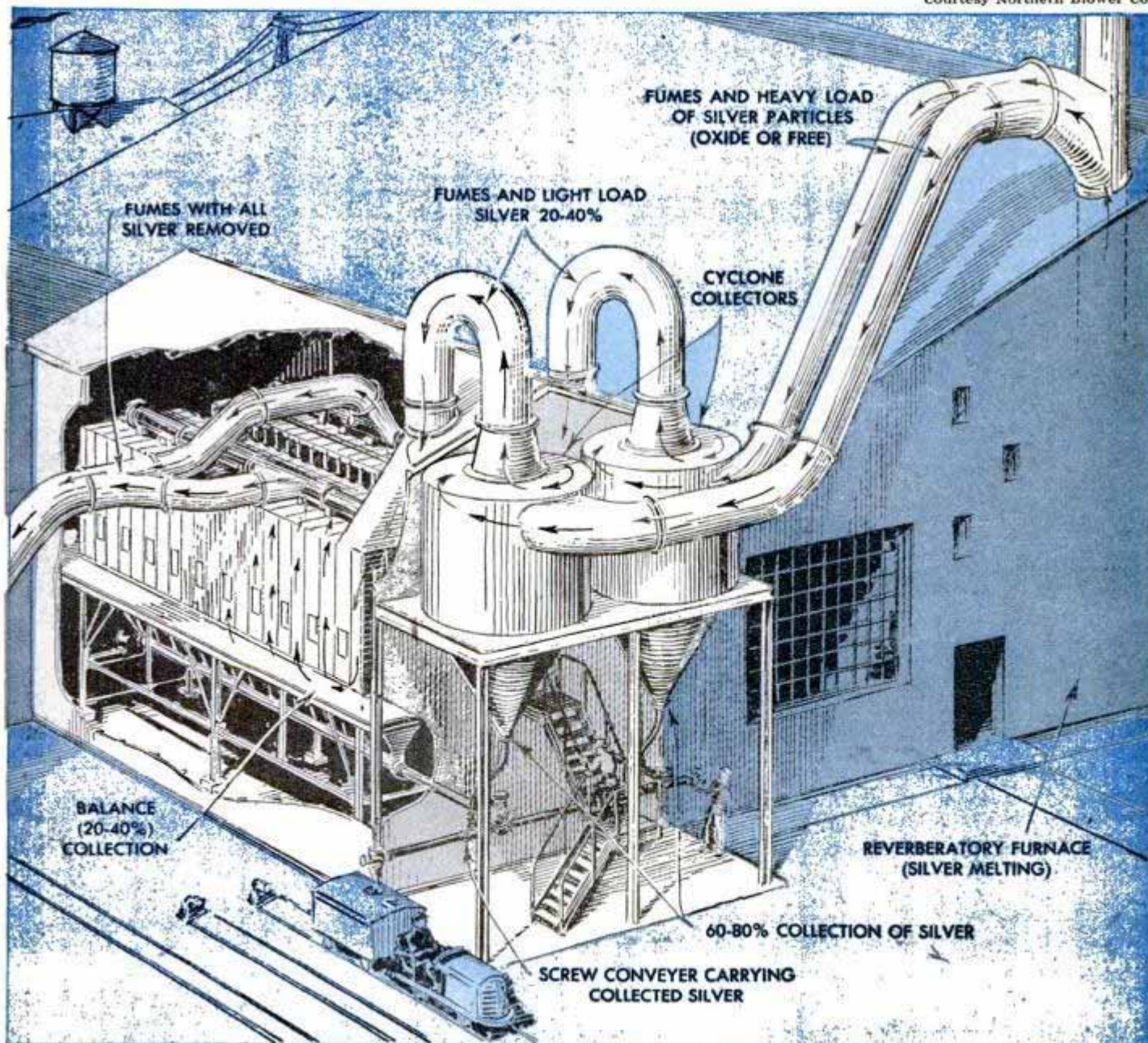



At Basic Magnesium Plant, Las Vegas, Nev., bus bars (background) connect to electrolytic cells (foreground) where magnesium was "cooked"

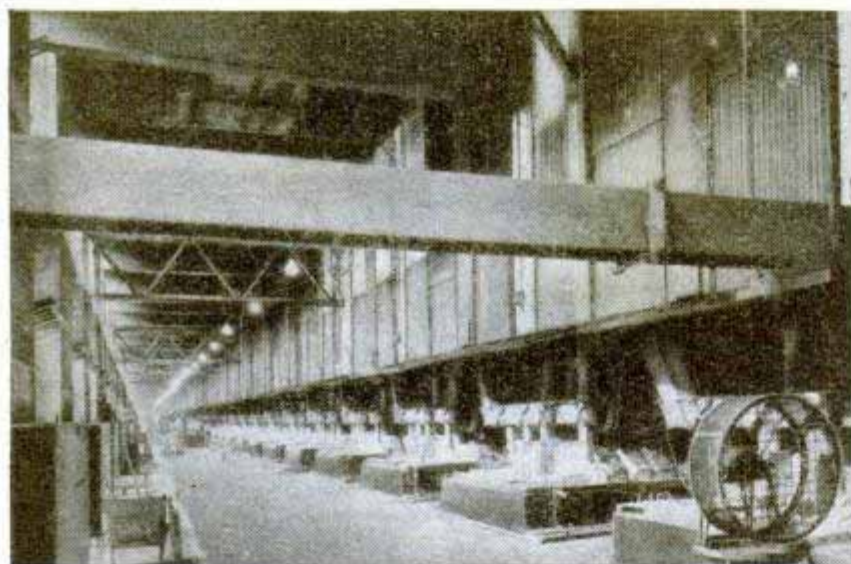

A lot of dimes could be made from this nine by nine-inch silver bus bar which served a Marysville, Mich., magnesium plant. Below, in a New York warehouse, officers guard 5000 tons of cut-up silver bus bars



which bus bars usually are made. Copper was scarce and getting scarcer in 1941 and 1942, when the RFC aluminum and magnesium plants were being built. Dr. Zay Jeffries, metals expert, reported to the National Research Council on September 6, 1941, that the electrical conductivity of silver is similar to that of copper. He noted that the government had a lot of silver in storage, that silver bus bar installations in war plants would be reasonably safe "because the lines would nearly always be hot," and asked: "May not the government's excess silver as well be working to conduct useful electricity as lying idle in a vault?"

Negotiations between the RFC's Defense Plant Corporation and the treasury began early in 1942, and an agreement by the treasury to lend the corporation up to a billion fine ounces of silver was signed May 6, 1942. To whatever extent silver was used in the war plants, an equivalent amount of copper was released for other vital wartime requirements.

Silver deliveries to 13 war plants in 11 states totaled 474,194,634 fine troy ounces, or about 16,300 tons. The treasury charged nothing for its use; the RFC agreed to return it within five years, a provision later amended to read "within six months after the formal ending of hostilities."

It was evident at the start of the project that guarding the silver would constitute a many-sided problem. The Army first was asked to take over the guarding responsibility, but it declined, and the RFC then formed its own guard units.

The silver was in commercial bars weighing about 1000 troy ounces each as it was turned over to the RFC at the West Point depository. Since these were not large enough for bus bar rolling operations, the bars were

(Continued to page 252)



SUPERPIPE, a gift to Richard Kartheiser of Milwaukee, has whistle, fire extinguisher, a filter coil, ashpit door and a drain with a tiny bucket on the bottom



STOVEPIPES are made from German artillery and anti-aircraft shells by Wilhelm Kersten, a blacksmith who converts Nazi war scrap into essential products

STEEL COLUMNS of England's new House of Commons rise on "bloom base" resting on concrete raft built in 1840 to support old House, destroyed by bombs

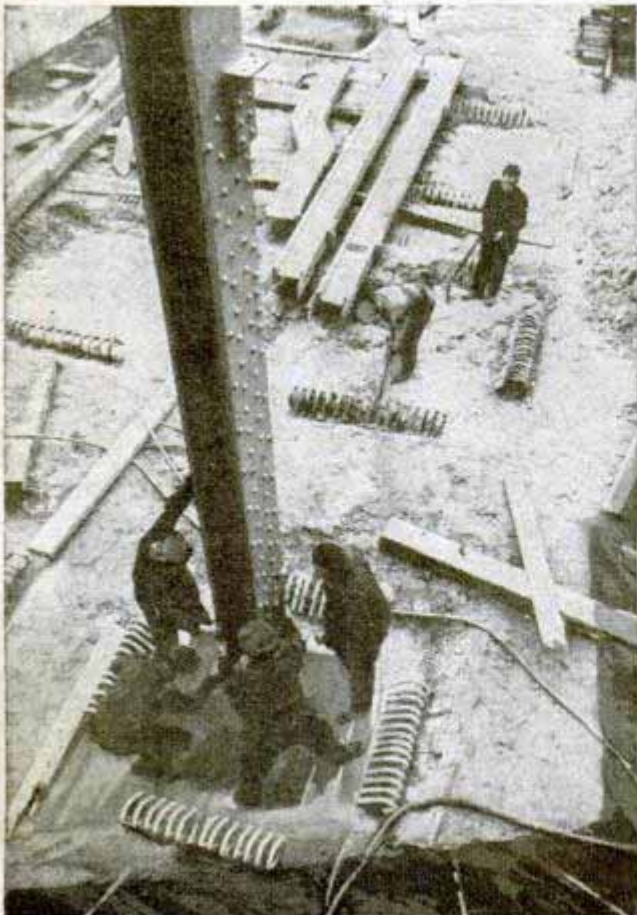

PORTABLE TELEPHONE for Pennsylvania Railroad picks up messages 15 miles away, receiving through air by induction with tracks as communication channels

Rivets Are Spread By 'Fluid' Hammer

When a rubber riveting hammer smashes a cold steel rivet there isn't any noise but the rivet is flattened just the same. Hydraulic fluid, encased in a synthetic rubber hose, does the job. The hose carries fluid under enough pressure to flatten a rivet with one stroke. The riveter looks like a huge C-clamp which slips over the parts to be joined. It is used in factories where the work can be carried to the big machine.

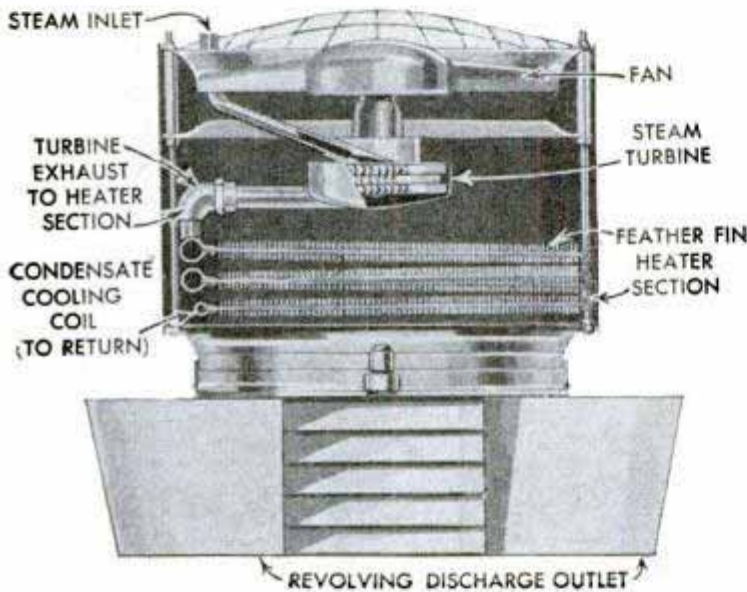
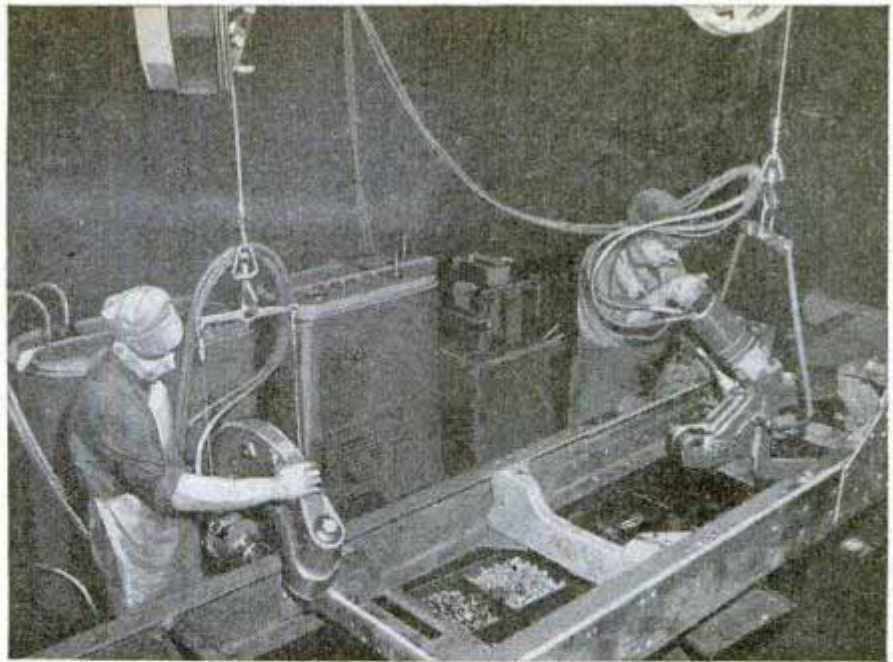

Heating Unit Uses Turbine To Turn Forced-Air Fan

Power for turning the fan in a new forced-air heating unit is supplied by a miniature steam turbine that is connected with the steam heating pipe. The unit, requiring no electric power, is designed for ceiling installation in commercial establishments. The steam passes through an inlet into the heater, turns the turbine and then is exhausted into the heater section where it heats the air that is blown into the room by the fan. After the steam is condensed it is returned to the heater's boiler through an open return system.

"Siamese Twin" Steel Boat Driven by Outboard

Twin boats linked by steel catwalks form one side-by-side pleasure craft powered by an outboard motor. Radically different from standard boat designs, the craft will carry heavy loads and cannot be capsized in ordinary use. Seams and joints are welded. The craft is 11 feet 4 inches long with a four-foot eight-inch beam. It weighs about 220 pounds.

⌈Admitting quantities of warmed air into a room without drafts has been recommended as the best way to achieve odor control, a home heating problem created by tightly built houses and greater numbers of cigar and cigarette smokers.



WHAT'S NEW *For Your Home*

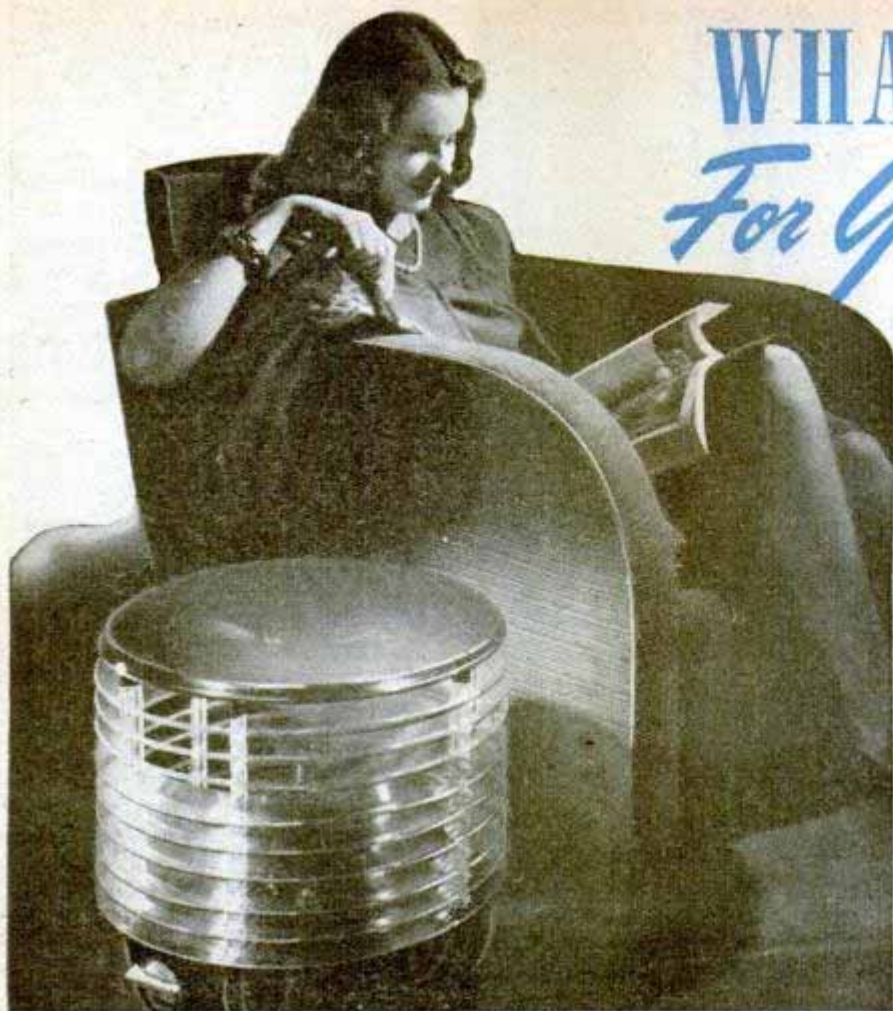

GLEAMING FAN adds eye appeal to a room while it circulates air into far corners. Made of Bakelite, it eliminates sudden gusts of cool air



Tennessee Eastman Corporation photo
ADJUSTABLE PLASTIC CAPS for furniture legs eliminate wobble



FIRE-SMOTHERING WASTEBASKET'S double lid catches carbon dioxide from flame, depleting oxygen in basket

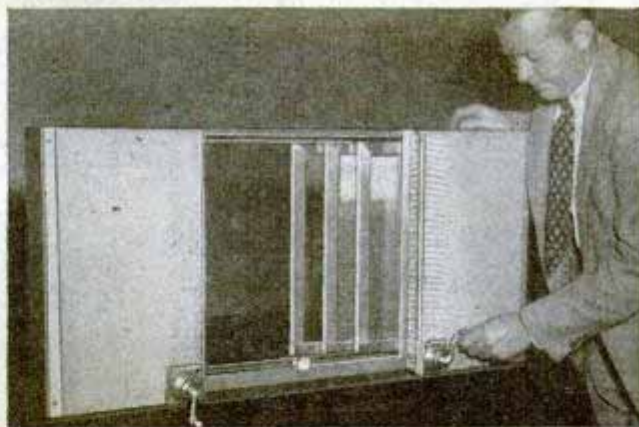

THREE-IN-ONE CASEMENT for new homes combines ordinary window, storm window, aluminum screen

↓ **KNIFE SHARPENER** holds the blade at proper angle



↓ **RAZOR STROP GUIDE** doubles as knife-blade handle



(2) LARRY L. STEWART & ASSOC.
8731 S. WABASH - CHICAGO 19

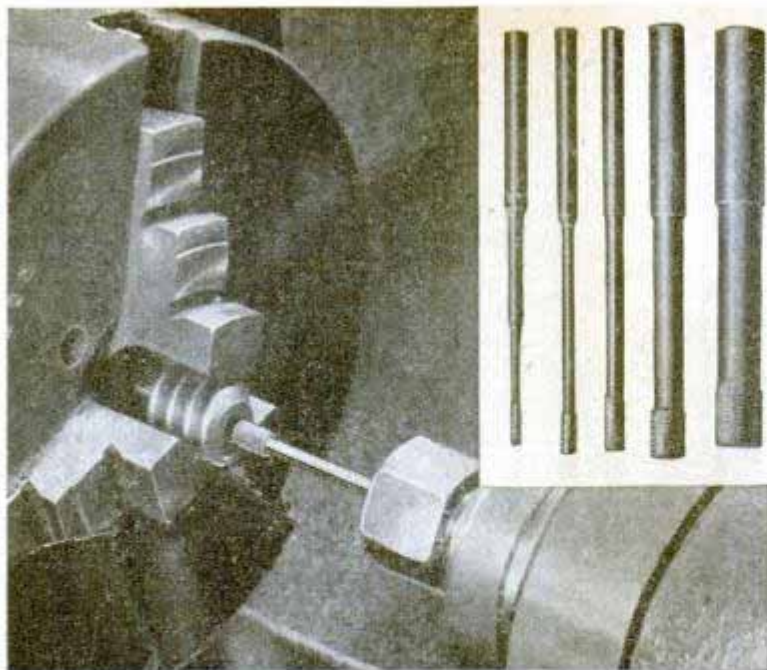

Midget Carbide Grinders Cut Metals or Plastics

Midget burrs and grinding wheels made of superhard solid tungsten carbide are speeding the production of such articles as steel dies and aircraft engine parts. Used as drills or grinders, the carbide wheels are reported to last 500 times longer and cut through metal much faster than other abrasive points. The midget grinding tools are made in sizes ranging from .03 to .25 inch. Because of their extreme hardness, the carbide tools will hold a sharp edge and cut through metal of any hardness. They are also useful in cutting soft but tough plastics which dull steel tools.

Memo Holder Under Phone Base Keeps Pad Out of Sight →

Memo paper and a pencil are stored inside a small stand that fits beneath a telephone. A slide inside the stand pulls out to reveal the paper pad and pencil. It will not mar polished surfaces because it remains rigid when extended. The stand will not fall off when the telephone is lifted. A separate base is made for different types of telephones.

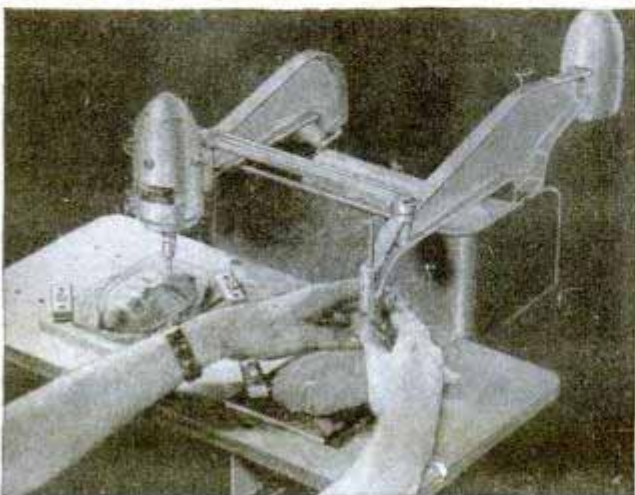
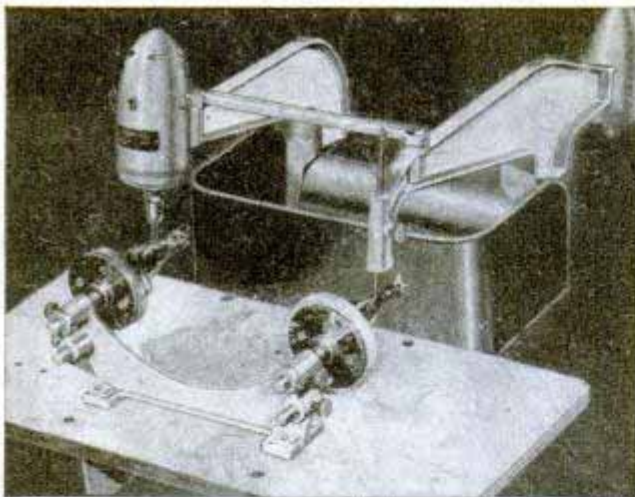

'Sculpture' Tool for Wood Carver Duplicates by Depth Control

← Cutting-depth controls on a power tool for home workshops make it easy to carve wood reproductions of plaques, costume jewelry, ash trays or art figures. The tool consists of a pair of arms yoked together and moving in unison. The cutting arm carries a motor-driven router blade. Both the model and the block to be carved are clamped to the work table. As the tracer arm is guided over the raised contours of the model, the router carves a duplicate in the work piece. The tool, which cuts ebony and mahogany, can also be used for the free-hand carving of special paneling or molding.

You may wish to obtain additional information about the new products that are described each month in Popular Mechanics. If you want to know the name and address of the manufacturer or the distributor, just write to Bureau of Information, Popular Mechanics, 200 East Ontario Street, Chicago 11, Ill. Your letter will be answered promptly.

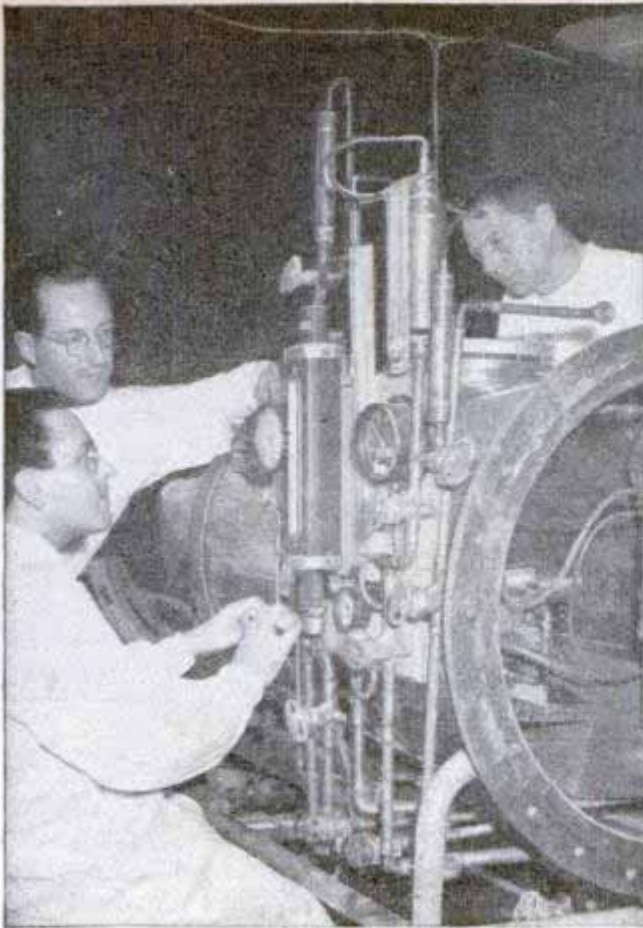

AIRBORNE GERM "CLOUDS" are concentrated in this chamber for study at the University of California. Laboratory instruments used inside are manipulated through airtight opening in the top of the chamber

INDOOR DRIVING practice is possible with a ball anchored to a sliding rod so that it can't damage furniture. Distance is gauged by a target set a foot away for every 50 yards of the user's average drive



MAY 1947



DOOR RAMPS are being tested by Southwest Airways to save time, labor and ground equipment at airports. They hinge at the bottom, have built-in steps to the ground and open from either the inside or outside

TRANSPORT LOADING principles are taught Navy trainees with small lead weights and a plywood cut-away profile of a PB4Y-2. A load adjuster slide rule checks results worked out mechanically on the model

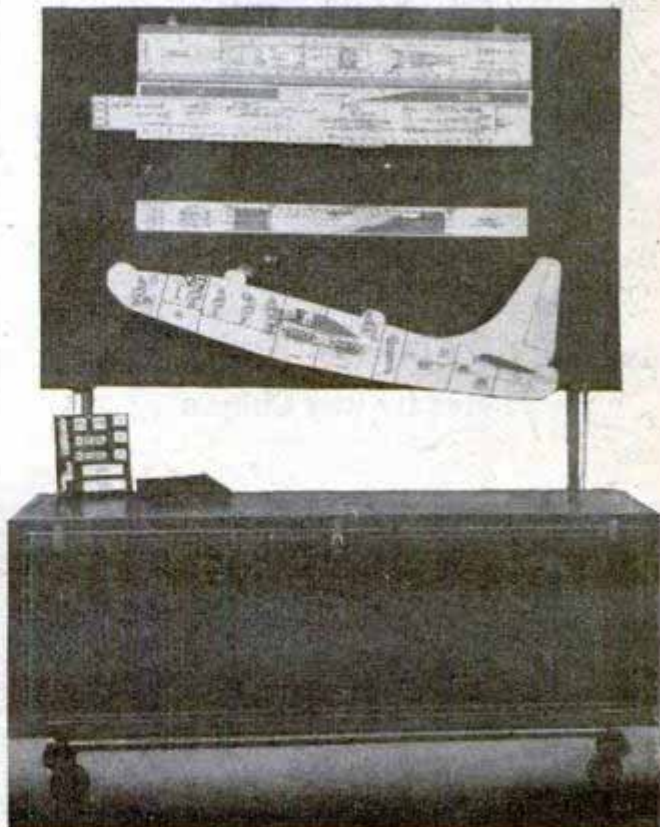



Wise campers assemble and inspect their gear long before they leave home, allowing time for repairs

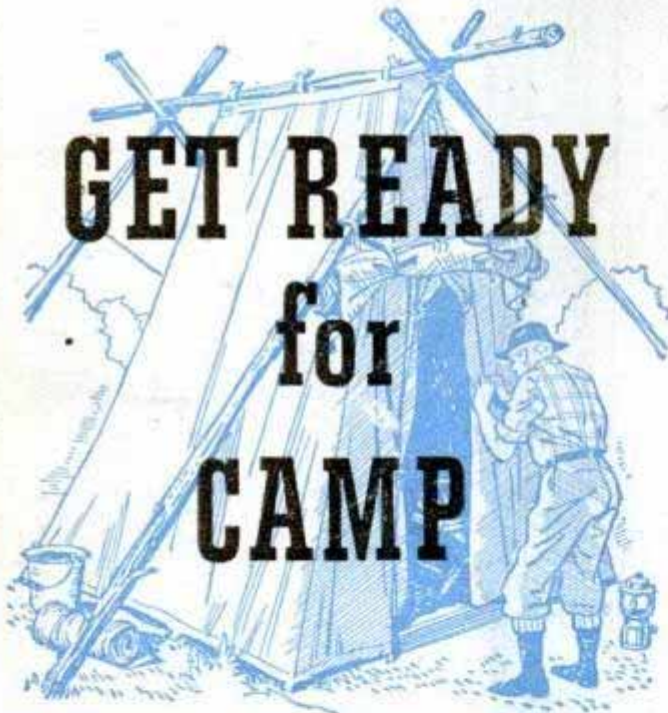

By Claude M. Kreider

Photos by Ray Chapin

WITH vacation season just around the corner, it's time to check and test each item of your camping equipment, particularly if you belong to that increasing clan of real outdoor lovers who want to be entirely on their own. A camping outfit need not be elaborate, but it must be complete, for your pleasure, comfort—and even health—will depend on the forethought given the individual items.

It is best to list first everything that will be needed under three headings—shelter, bed, cooking equipment. Then assemble the whole, piece by piece, for a thorough inspection, with special attention to items that have been stacked up in the attic since last year. You'll find forgotten wear and tear that will need attention.

The tent—Erect your tent in the back yard for a close inspection. First determine whether it is really waterproof. A new one may be guaranteed to be water-resistant, which does not mean it will shed a hard rain. Fasten down the door and window flaps and turn a hose stream on the roof and sides. If even a fine mist penetrates the fabric a real waterproofing job is in order. The same test may be applied to the



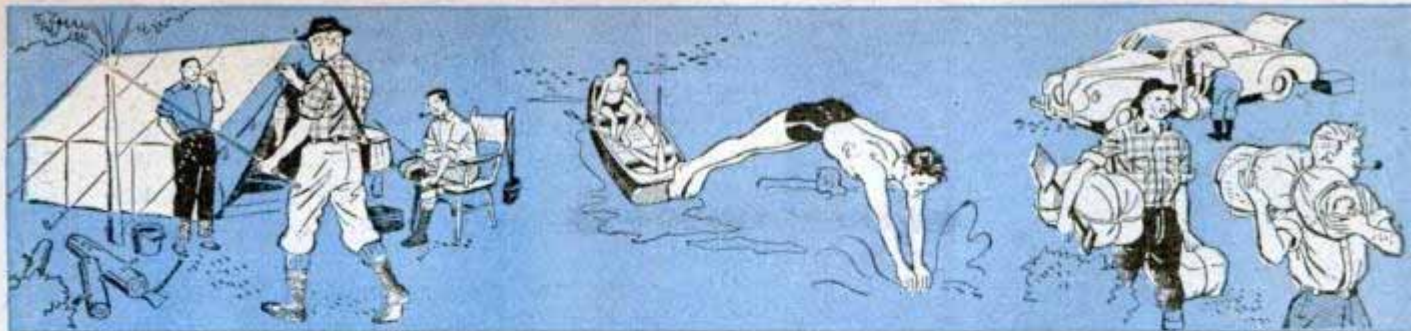

older tent, which may leak due to age and wear. There are many good waterproofing products on the market, most of them easy to apply.

The tent fabric should be inspected for holes, and patched wherever necessary. The peg loops may need repairing or replacing and the pegs—at least 12 for secure erection of the tent—should be straightened and scoured free of rust. Those made of light angle iron, with strong, welded half hooks, are best.

The tent pole and stretcher will need a brief inspection. Often the clamp, which

slides on the pole, will need new bolts or nuts and the pole itself may have swelled or become splintery. In this case sandpaper it smooth, then add a coat or two of boiled linseed oil, rubbing it well into the wood.

And finally, be sure that the mosquito curtain over door and window is intact and that it fits snugly at all points. Just one night of discomfort in a mosquito country can spoil a trip.

The bed—Most experienced campers use sleeping bags, which retain one's body heat to give maximum warmth with min-

An old-timer flips his flapjacks from the skillet of a nesting cook kit that's ideal for the camp kitchen





**Air mattresses should be inspected or you may be in for a big letdown. Repair the leaks with a tire kit
↓ Bubbles from mattress immersed in water show leaks**



Nesting utensils of aluminum are light and compact. Table implements and a dishpan complete the kitchen



imum weight. The bag also offers protection to the bedding in transit and is ready to crawl into after a tiring day. Placed on an air mattress it will give maximum comfort, although many people prefer to use the bag on a canvas cot. In that case additional bedding may be needed underneath it.

A comfortable sleeping bag for one or two persons can be made at home by folding blankets or quilts inside a section of heavy canvas 6 by 12 feet in size. This is turned up to cover the bedding and fastened with large safety pins along the sides, simulating the cowpuncher's famous tarpaulin bed.

Estimate the weather likely to be encountered and apportion the amount of bedding accordingly. Remember, too, that wool blankets are warmer than cotton comforters and take less space. The air mattress—even if new—should be fully inflated and tested in a tub of water for possible pinhole leaks which, if not discovered, will surely let you down to the hard ground before morning. Leaks can be repaired easily with ordinary tire patching material that requires a heavy coat of cement, which will fill the rough surface of the material and insure a tight patch. Inspect your hip boots or waders for possible leaks at the same time and patch them with the same material if necessary.

The cook kit—Carefully chosen utensils from the kitchen serve adequately if proper consideration is given the number of persons in the party, the type of cooking to be done and the bulk that can be carried. Often saucepans and kettles with bails—not handles—may be arranged to nest compactly, with the coffee pot, holding the cups, inside the assembly. A compact, nesting aluminum kit will give many years of service if the material is heavy gauge and de-

Gasoline stoves and lanterns stored in attic dust may develop trouble if they aren't cleaned before the trip





Good shelter means comfort to the camper. Pitch the tent and test it with heavy "rainstorm" from the hose

signed for hard use. One popular kit has two cast aluminum frying pans with detachable "cold" handles, fitting neatly over the largest of the kettles. The two-quart coffee pot with straight sides holds the cups. These should be of graniteware, as aluminum ones will burn the lips even while their contents are cooling because the metal is a good heat conductor. For this reason plates of aluminum are an advantage in outdoor cooking.

It's wise to have a cloth roll for all the table and cooking implements with a loop for each item. In addition to knives, forks, teaspoons and stirring spoons, a spatula

(Continued to page 248)



Large paintbrush makes waterproofing an easy job. † Canvas bag is an ideal container for your bedding

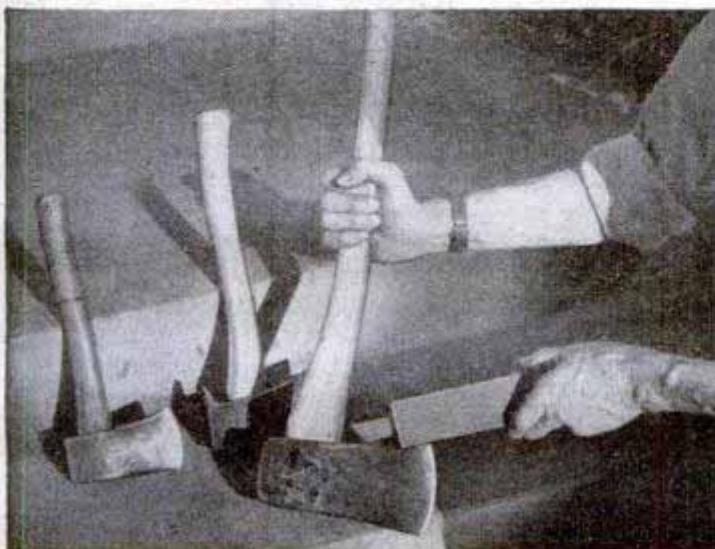

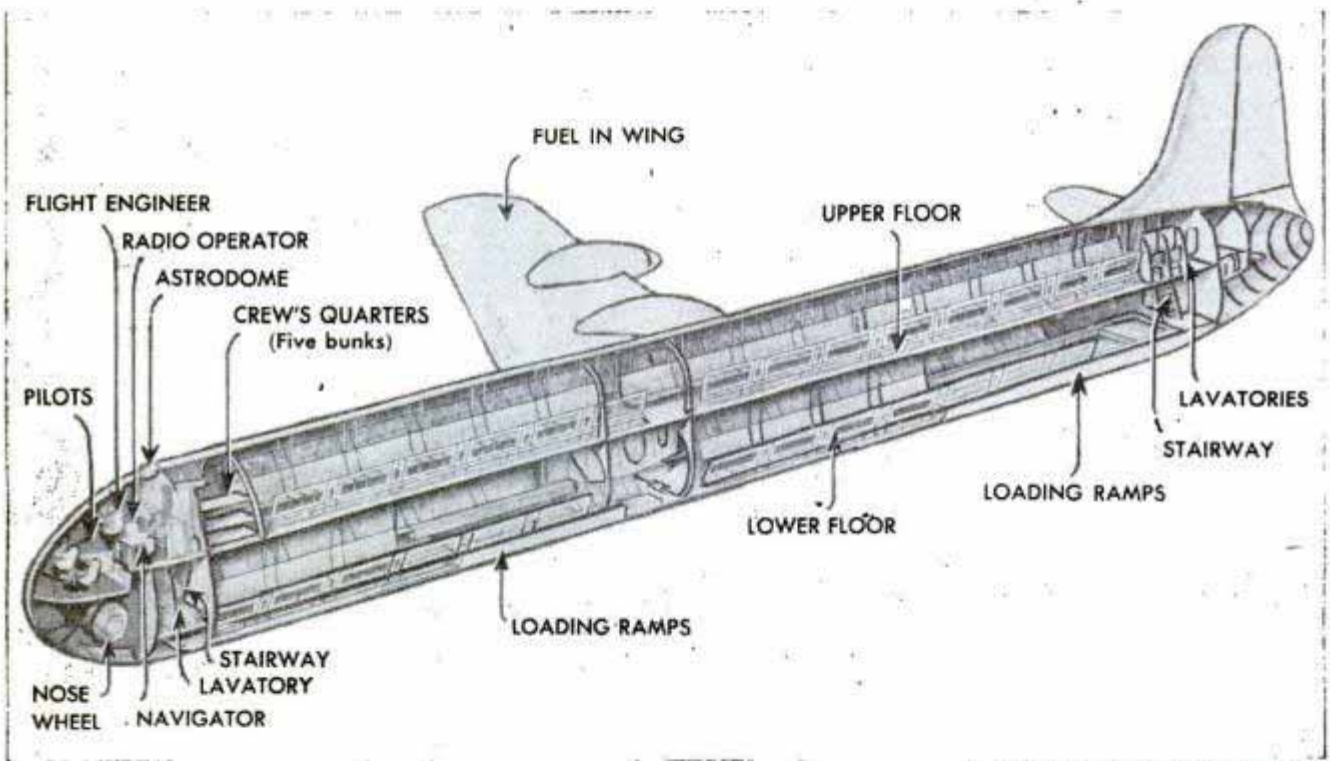
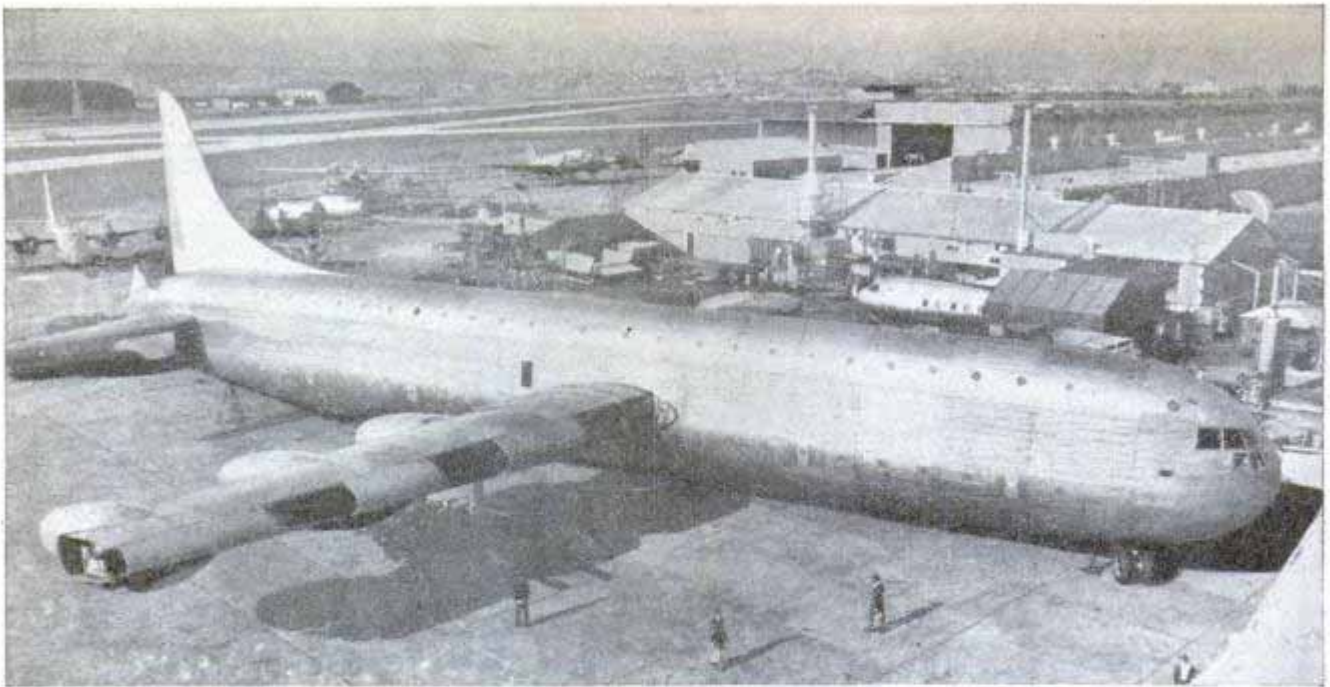

Consolidated-Vultee photo and sketch

AAF Plane to Carry 400 Troops

No building is big enough at the Consolidated plant to house the nearly completed XC-99 troop transport, world's largest land-based plane. An extensive ground testing program will start as soon as land-

ing wheels, wing sections and engines are installed. The double-deck version of the B-36 bomber will carry 400 troops, 335 liter patients or 100,000 pounds of cargo. It will have a range of more than 8000 miles.

Blood-Typing of Newborn Babies May Help Avoid Hospital Mix-Ups

Newborn babies should be blood-typed instead of footprinted in hospitals to avoid mix-ups in identification, according to Dr. Malcolm A. Hyman of the Jewish Hospital of Brooklyn. A total of 360 different types of human blood can be identified through varying factors in blood composition. Dr. Hyman advocates taking a sample of blood

from the baby immediately after birth and attaching this to the mother. Later if there is any doubt as to the child's identity another sample can be taken and compared with the first. Dr. Hyman points out that footprints change completely within a month after birth but that the chemical pattern of blood is unchanging.

ULTRASONICS - MAGIC ENERGY

H. D. Von Jenef, chief engineer of Tele-viso Products Co., regulates vibration frequency of an ultrasonic generator



By John R. Kinsey

SOUND that can't be heard is science's newest "wonder tool."

It pierces tin and steel, sterilizing and preserving uncooked foods without marring their taste. It kills insects, offering the farmer a possible new attack on crop pests. It disperses smoke and soot and may help keep cities clean. It transforms fog into rain so pilots can see well enough to land planes.

These unheard sounds are known as ultrasonics.

U. S. Bureau of Mines photos

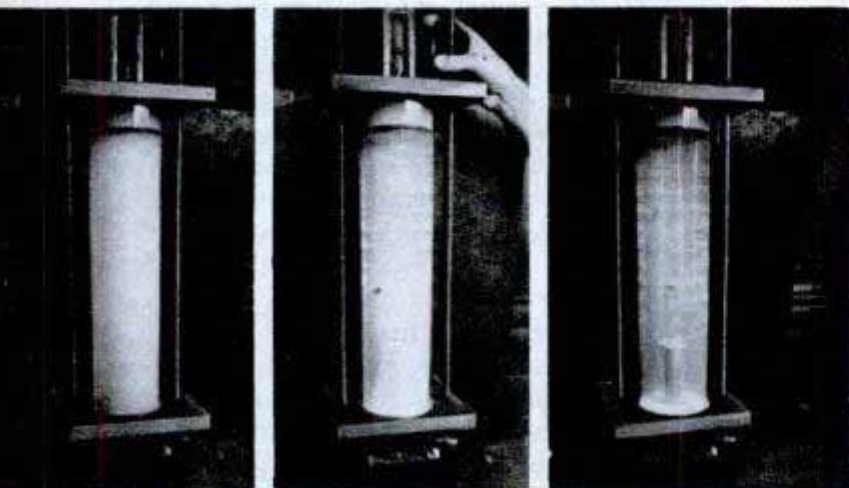

Simulated chimney smoke is blotted out by ultrasonic power. Tube (left) filled with ammonium chloride fumes receives charge (center) which precipitates deposits (right). Drawing shows crystal holder which creates the high-frequency sound waves

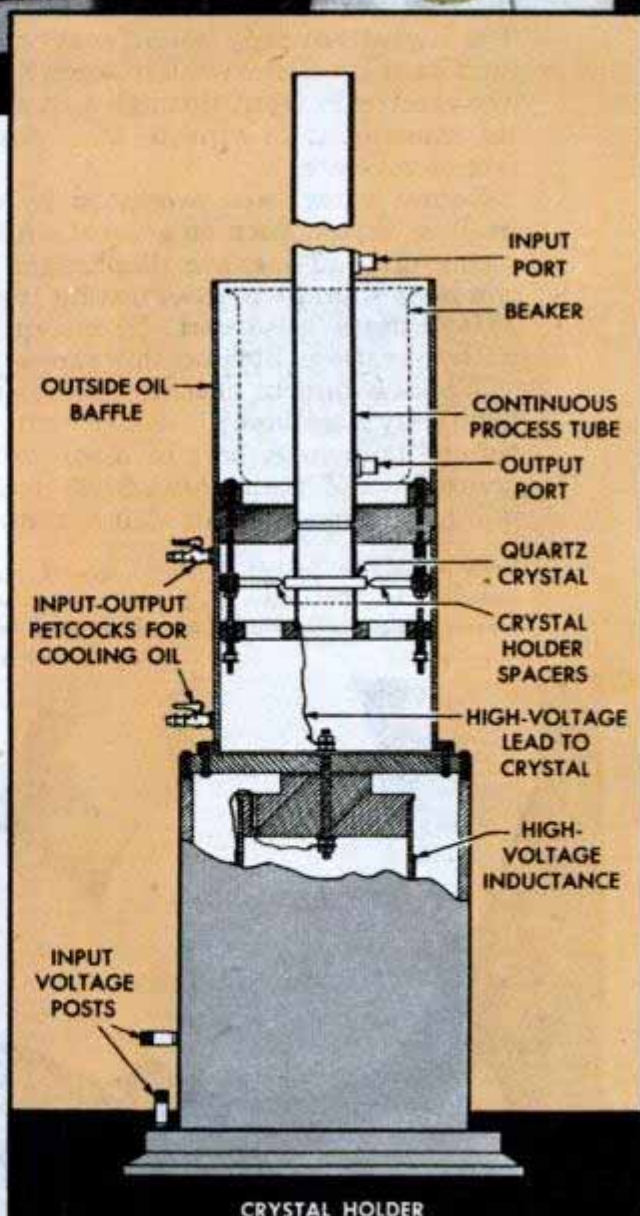

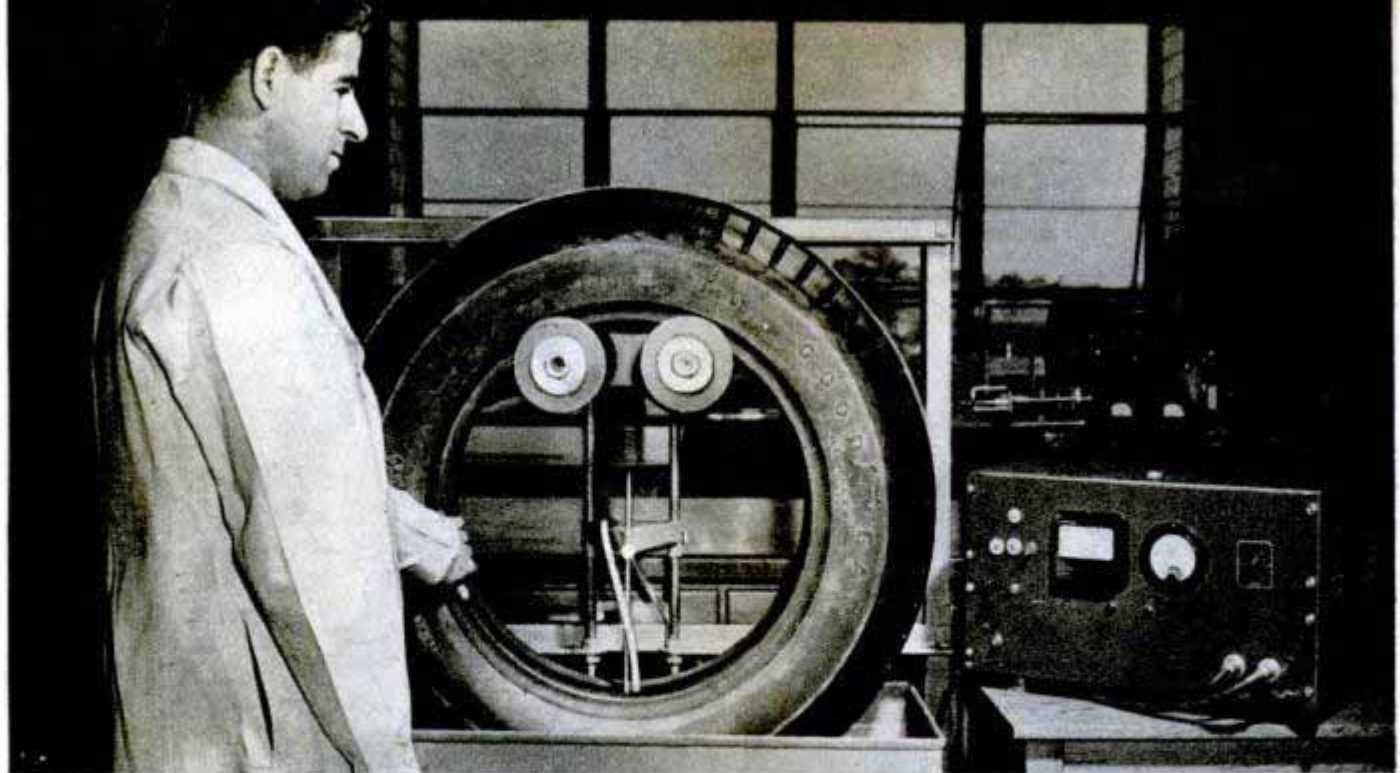

High-frequency sound waves test used tires at Goodyear Tire Company to determine if recapping is feasible

They are sound waves beyond the scope of human hearing, vibrating at 20,000 to 100,000,000 cycles per second and traveling through air, water, metal, earth and rock. The high-frequency sound waves are created by a generator which sends high-voltage electric current through a quartz crystal, causing it to vibrate at a designated frequency rate.

Sound waves are produced by any vibrating object, such as a vocal cord, violin string or loud-speaker diaphragm. People can hear sound waves vibrating from 20 to 20,000 times a second. Ultrasonics deals with vibrations beyond this range.

When a quartz crystal is forced to vibrate, say a million times a second, strange things happen. A sort of magic energy is created which many industries—food, steel, paint, pharmaceutical, dairy, automotive,

aviation—are studying as a possible aid in making better products.

Tobacco growers are experimenting with ultrasonics to kill insects that infest tobacco during its curing. Flour mills may use it to exterminate weevils in wheat, and germs which sometimes mature in flour after it is processed. Producers of grape juice and wines are testing sound wave machines to kill acetic acid bacteria.

Sound waves kill germs by producing and rupturing microscopic air bubbles inside a microbe cell, according to H. D. Von Jenef, chief engineer of Televiso Products Company of Chicago. Von Jenef directs the ultrasonic research which guides his company's manufacture of high-frequency sound wave generators.

"Possible uses for ultrasonics are almost unlimited," Von Jenef declares. For one thing, he points out that ultrasonics knocks the truth out of the old saying that oil and water won't mix. Oil and water mix when treated with intense ultrasonic waves, and they stay mixed. So do water and mercury. Even paraffin and water can be mixed.

This mixing ability opens the way to many applications. Bombarding photographic emulsion with sound waves increases its resolving power, sensitivity and stability. Ultrasonics also may be the long-sought way of mixing all the constituents of paint.

In the field of medicine, Von Jenef says it is entirely pos-

Forty-millimeter (about 1½-inch) quartz disk (note metric ruler) is installed in ultrasonic oscillator to set up high-frequency sound waves which are utilized to mix liquids in production of penicillin

Courtesy North American Phillips Company, Inc.



sible that ultrasonics may make it unnecessary to put a "Shake Well Before Using" label on a bottle. A sound wave machine will stir the medicine so vigorously it will remain mixed permanently. Production of serums is speeded by sound waves. Treating a culture fluid with ultrasonics and then spinning the liquid in a centrifuge and filtering it destroys bacteria and creates antibodies for serums.

Sulfathiazole treatment is improved by ultrasonics. The coarse crystals are smashed by sound vibrations and placed in a salt solution to form a creamy emulsion which can be injected into a patient through fine hypodermic needles, a procedure previously impossible, according to Von Jenef.

The dairy industry is testing ultrasonics to emulsify cream cheese mixes and pasteurize milk at low temperature. The Raytheon Manufacturing Company makes a sonic oscillator which homogenizes milk; as the liquid passes over a vibrating steel diaphragm, milk particles are made microscopically fine, producing a soft-curd milk suitable for stringent dietetic requirements.

The use of ultrasonic equipment to eliminate sooty smoke is being investigated by the U.S. Bureau of Mines. Sound waves, traveling through a column of smoke, cause dirt particles to collect and fall to the bottom of a tube.

Airports may be equipped with sonic generators to dissipate fog. At the Naval Landing Aids Experiment Station at Arcata, Calif., sound waves turned heavy fog into rain, clearing the field sufficiently for planes to land.

Steel and rubber companies test their products with ultrasonic equipment. The manner in which a material absorbs or "sheds" sound waves reveals hardness, cracks, pits and other characteristics.

During the war the Navy used an ultrasonic radar trainer to teach pilots and bom-

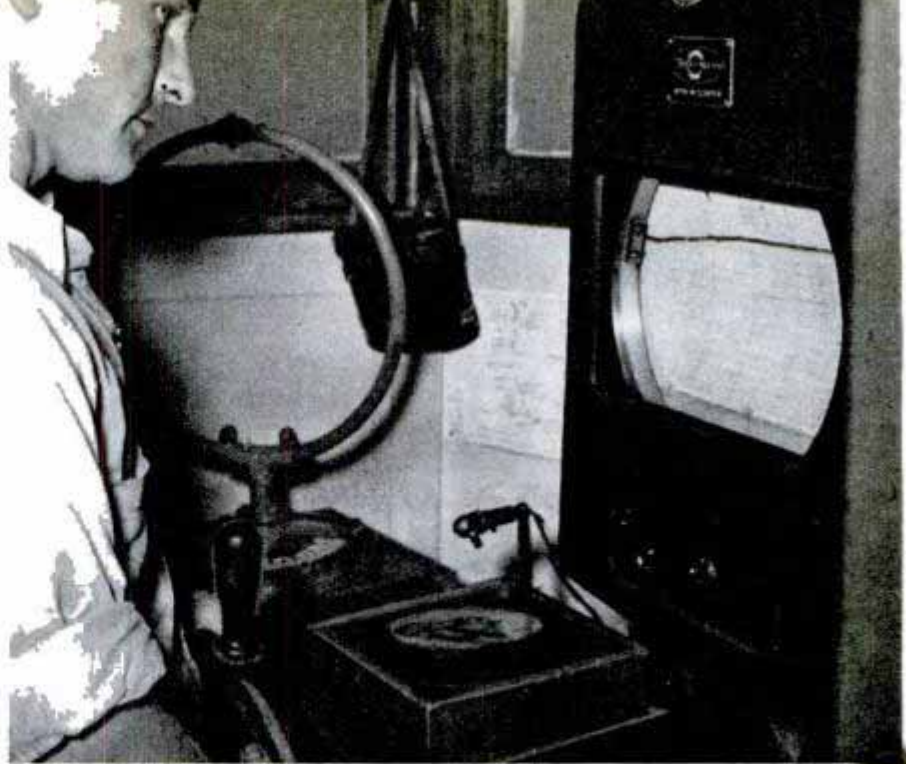

Captain Lloyd Lindwall, Santa Barbara commercial fisherman, studies chart made by Bendix depth recorder which locates school of fish

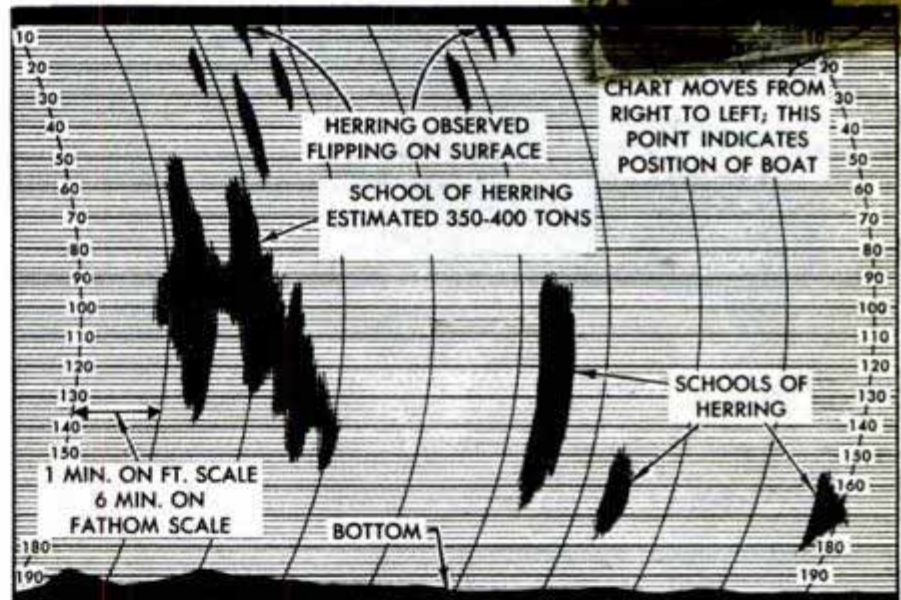

Depth recorder chart not only spots schools of fish and estimates their tonnage, but also warns of underwater hazards and records ocean bottom profile. Below, Captain Lindwall's 45-foot fishing craft, Linda





Bell & Howell Company photos

Ultrasonic machines simulate radar to teach Navy flyers how to aim bombs from high-altitude bombers

ardiers how to use radar equipment. Developed by the Bell & Howell Company, the trainer simulated the use of radar to aim bombs from planes. Ultrasonic waves, projected through water on a relief map, produced the same relative "echo" as radar.

Bendix Aviation Corporation manufactures a supersonic depth recorder which aids commercial fishermen in locating schools of fish and spotting underwater navigation hazards. The Navy equipped ships and submarines with ultrasonic sonar sets during the war to locate enemy craft.

Two types of ultrasonic generators are

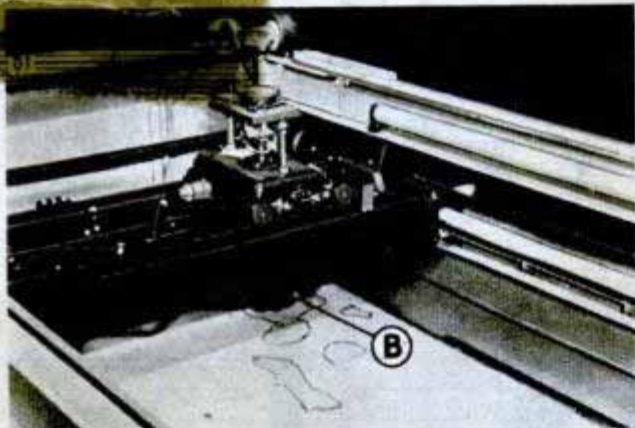

Inside view of tank of ultrasonic radar trainer, showing submerged relief map with trolley above it. Below, simplified drawing shows how trainer works

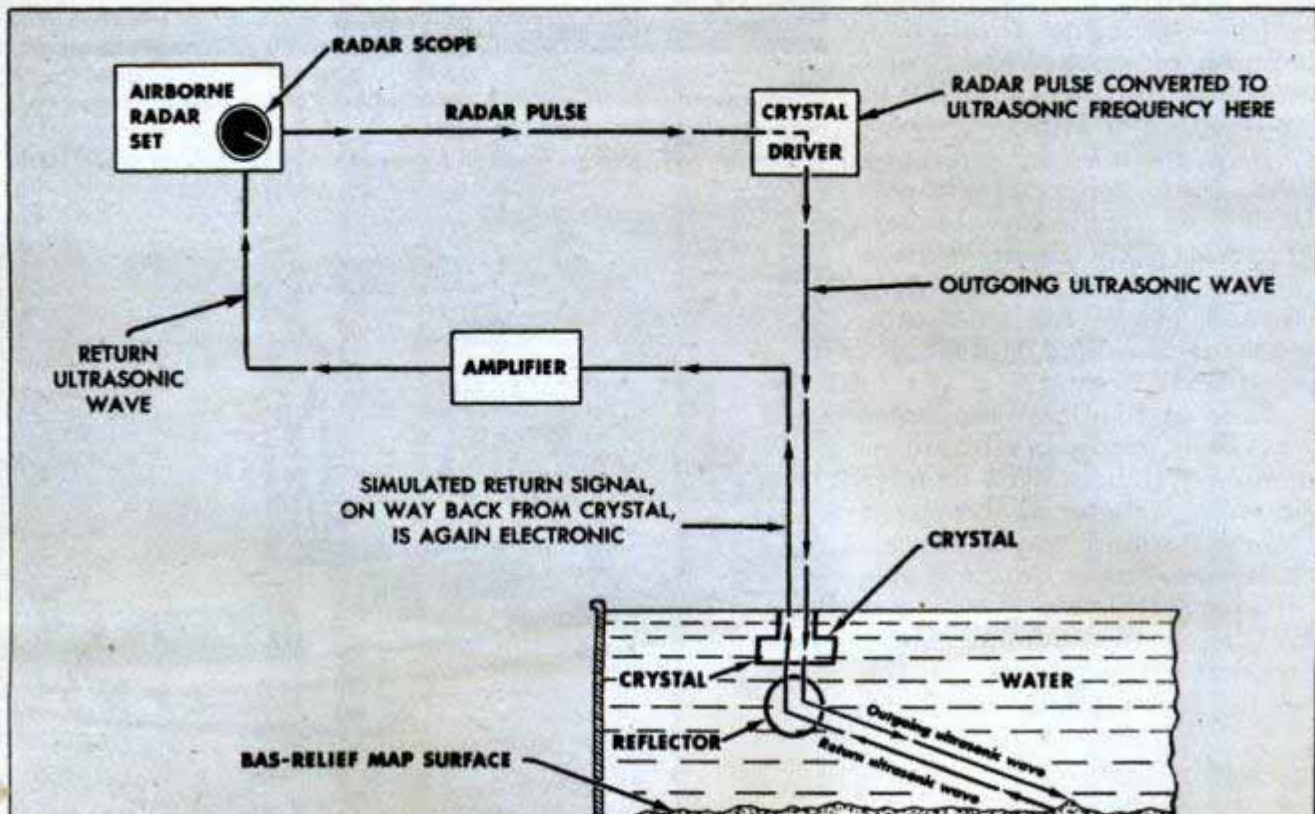

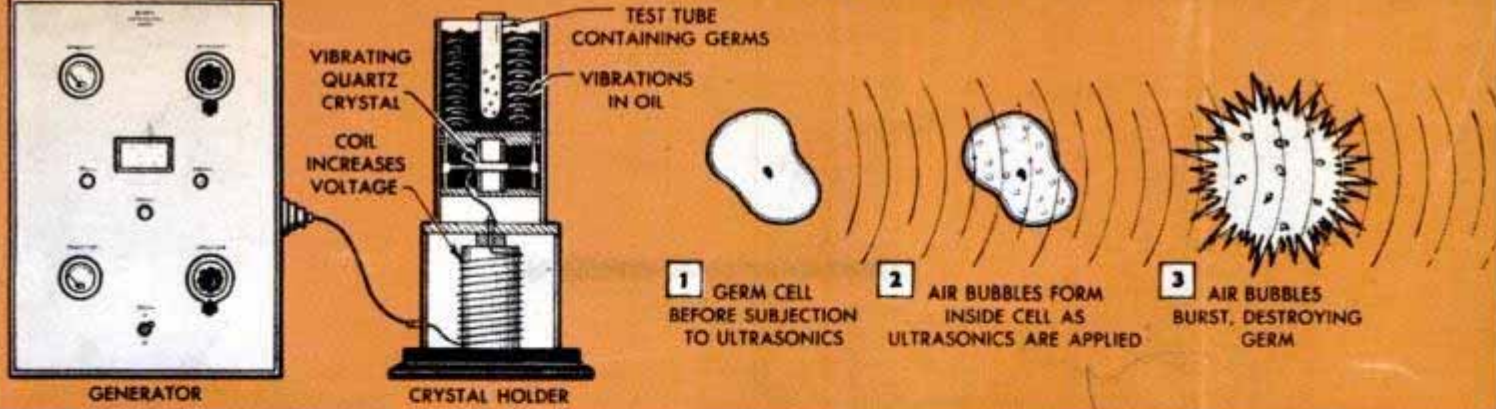

ULTRASONICS IN INDUSTRY AND SCIENCE

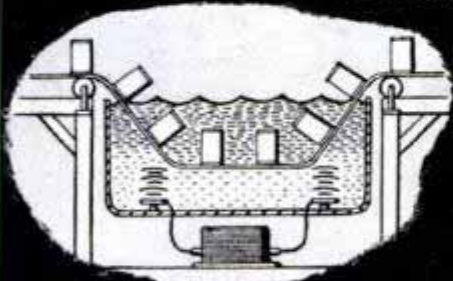

DESTROYS BACTERIA IN CANNED FOOD WITHOUT COOKING

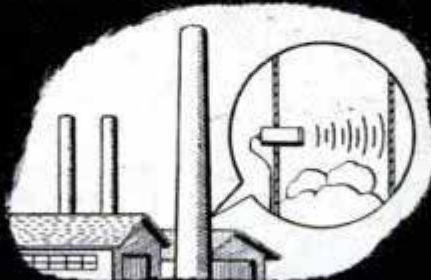

DISSIPATES SMOKE AND GASES IN FACTORY AREAS



USED IN LABORATORIES TO MIX AND SEPARATE CHEMICALS

Artist's drawing (top) of ultrasonic equipment and method employed to destroy germ cells. Sketches show applications of high-frequency sound waves for industrial and laboratory purposes

manufactured: one for research work, the other for production processes such as sterilizing food and mixing pharmaceuticals.

Manufacturers of ultrasonic equipment are swamped with weird requests. Tele-viso received a letter from a Chicago official asking if a sound wave machine could be built to kill pigeons that perch on window sills and electric lines. An Oklahoma farmer wanted "some kind of sound wave gun to kill pesky birds in my orchard."

As a matter of fact, ultrasonics offers so many possibilities that scientists hesitate

to say anything is impossible. Von Jenef already has harnessed ultrasonic power to an experimental dental drill which he says will take most of the pain out of tooth drilling. "The ultrasonic drill," he explains, "does not revolve, as do conventional dental drills. Instead, it jabs, moving back and forth so swiftly that very little pain-causing heat develops within a tooth."

And, without batting an eye, Von Jenef says it would be easy to design an ultrasonic "death ray" gun that would kill a rabbit or dog at 60 feet.

Milk particles which pass over vibrating steel diaphragm, right, are made microscopically fine, producing soft-curd milk that is easy to digest. Left, after receiving sonic treatment milk is piped from oscillator to bottles

Courtesy of Raytheon Manufacturing Company

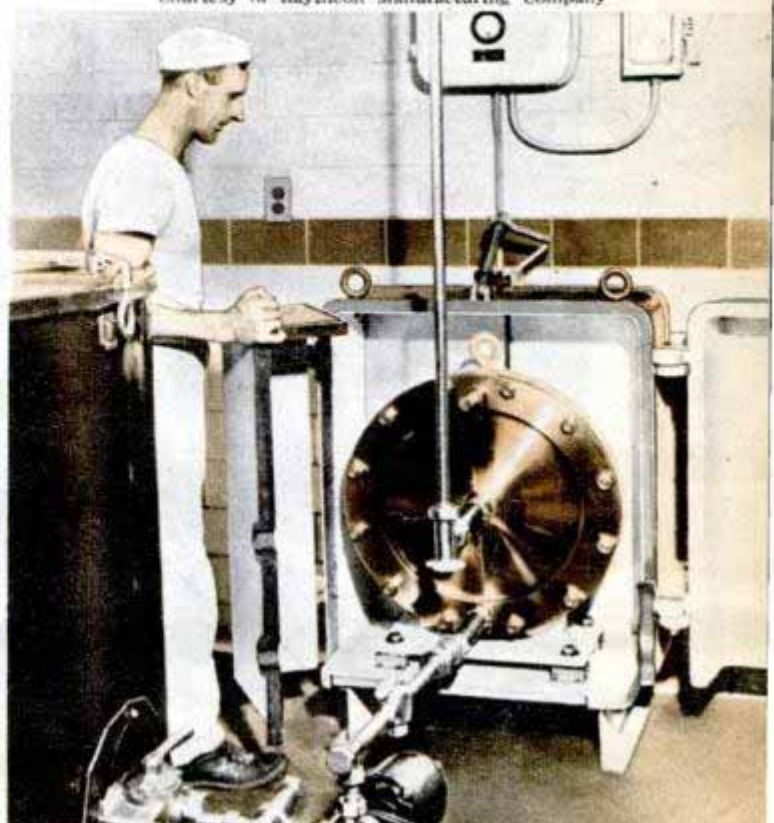
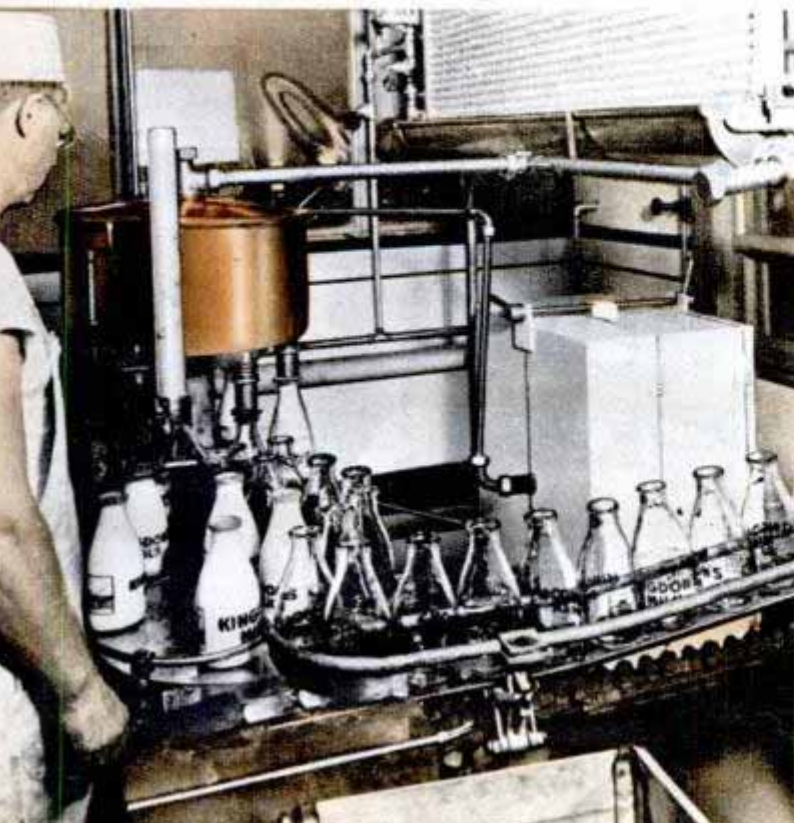



Extra Seat Attaches to Bike Frame

Carrying an extra passenger is easier and safer with an auxiliary seat mounted on a bicycle frame. The seat, made of wood and leather trimmed with plastic, can be attached with a screwdriver. Two clamps hold it in place so that it cannot slip and spill the extra rider. It is especially useful for carrying a small child.

Drop-Center Axle Lowers Trailer

Trailer owners can have either high or low road clearance for their vehicles by turning a new drop-center axle up or down. The steel axle supports 2000 pounds and fits most automobile front hubs. Having wheels the same size as those on the car makes it necessary to carry only one spare tire. The axles are built in standard and custom widths of 72 and 84 inches. Added use of an adjustable hanger permits mounting the spring to either the top or underside of the axle.

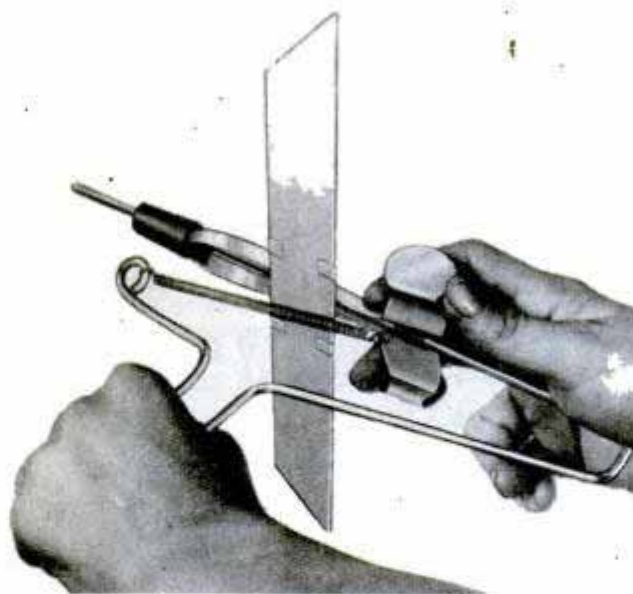
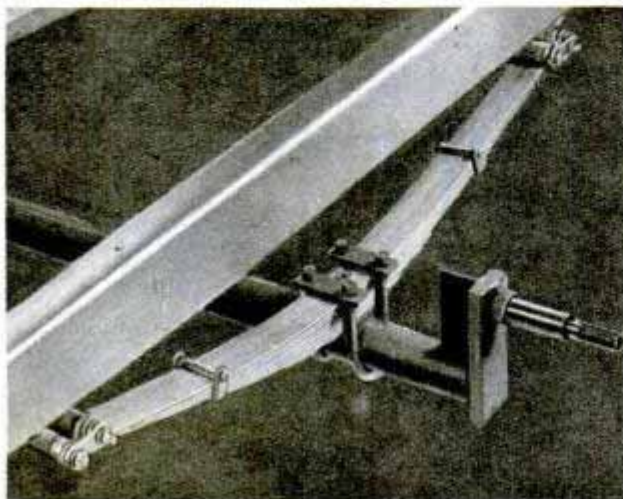

Slingshot Launcher Controls Flight

Each flight of a toy glider can be controlled by adjusting the position of the spring slingshot mechanism which launches it. The glider slides over the round steel rod of the launching device for the take-off. Constructed of aluminum, it has a balsa wing and a rubber nose to prevent damage to furniture or windows if used indoors.

Glow Meter Detects Vitamin in Liquid

Minute amounts of vitamins and other light-emitting substances are detected instantly in liquids and body tissues by an electronic instrument which measures the amount of fluorescence, or light, thrown off by the material under study. Developed by Dr. Theodore E. Friedemann, associate professor of physiology at Northwestern University's Medical School, and George S. Liebeck of the American Telephone and Telegraph Company, the "glow measurer" is expected to aid chemical research, particularly in the field of human nutrition.



The CRAFTSMAN



ROTARY MOWER

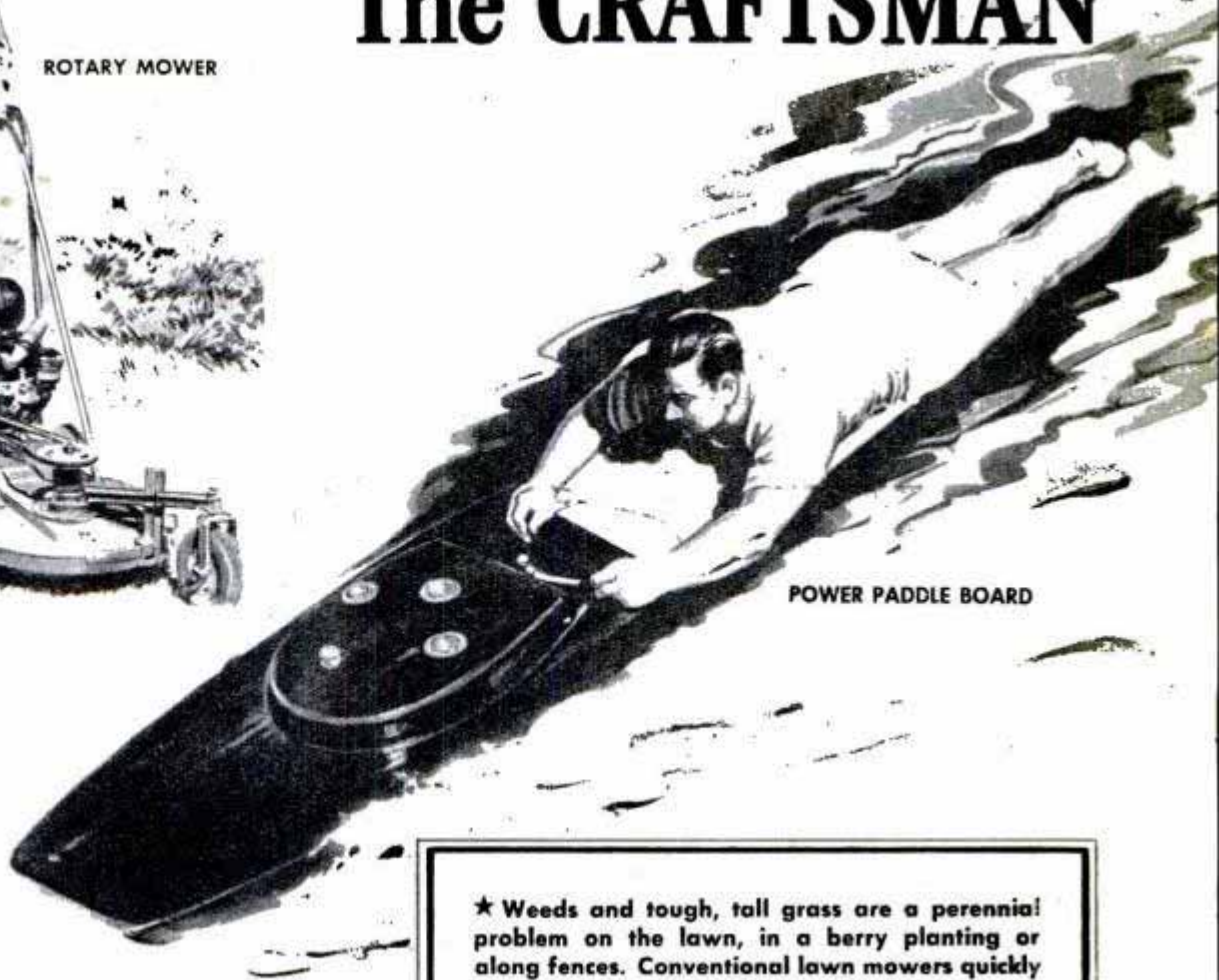

POWER PADDLE BOARD



WEATHERVANES



COLOR-PROCESSING UNIT



★ Weeds and tough, tall grass are a perennial problem on the lawn, in a berry planting or along fences. Conventional lawn mowers quickly bog down in the thick growth. But a rotary mower really mows 'em down. Clips the lawn neatly, too. Details on page 209.

★ You'll be in time for the water sports season if you start building a power paddle board right away. It's built just like a hand-powered paddle board but is driven by an outboard motor. That's the angle. Construction plans on page 193.

★ At last it's come to pass — a complete unit for processing color film! A darkroom in a suitcase, that's what it amounts to when you get it together. As you'll see from the story beginning on page 200 it's very simple to make.

★ Two other features, one on metal weather-vanes, page 185, and another on metal cutting with a jigsaw, page 217, will be of interest to the craftsman who likes metalworking.

METAL CUTTING WITH JIGSAW

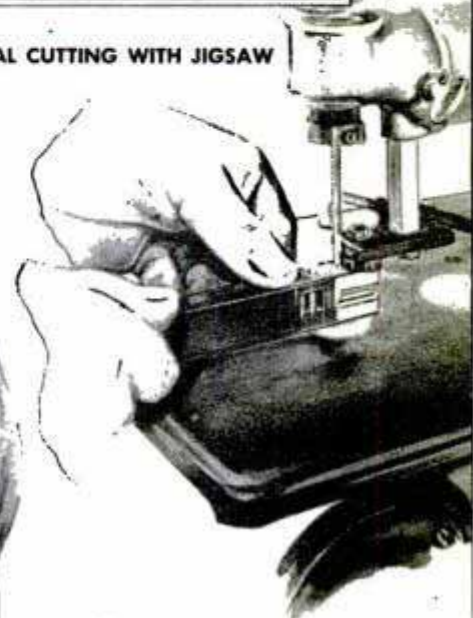

Build-It-Yourself HOUSE

PART II

By James R. Ward

Interior views and construction photos show you how cozy this home is and how easily anyone with mechanical flair can build it



BREEZEWAY is one of the outstanding features of the house. Can be used winter or summer if it is heated. Glass panes replaceable with screens



KITCHEN has all the modern facilities to save work. Dining nook at one end is close to stove and sink



ALCOVE in living room lends itself to many arrangements: a built-in bookcase, desk or a small piano



Furnishings by Simons Furniture and Rug Co., Aurora, Ill.

LIVING ROOM is spacious and a wide three-window unit helps to make the interior light and cheerful

AFTER last month's description of the *Popular Mechanics* BUILD-IT-YOURSELF HOUSE, telling how it was conceived by our editors and built by Jacques Brownson, you will want to know more about the interior. Photos on this and the opposite page will give an idea of the cozy atmosphere and honest-to-goodness living the house provides. The kitchen, for example, is designed for step saving. It's narrow and long with a dining nook at one end close to cabinets, stove, refrigerator and sink. Glazed doors and large windows provide a bright, cheery interior.

An alcove in the living room adjoins the guest closet at the entrance door and may be used as pictured, or for a built-in bookcase or desk, or as a place to house a spinet or other small piano. A shelf with drawers

BEDROOMS have simulated corner windows, which admit plenty of light without breaking walls to hinder furniture arrangement. Spacious wardrobes and built-in chests are hidden by beautiful flush-type doors

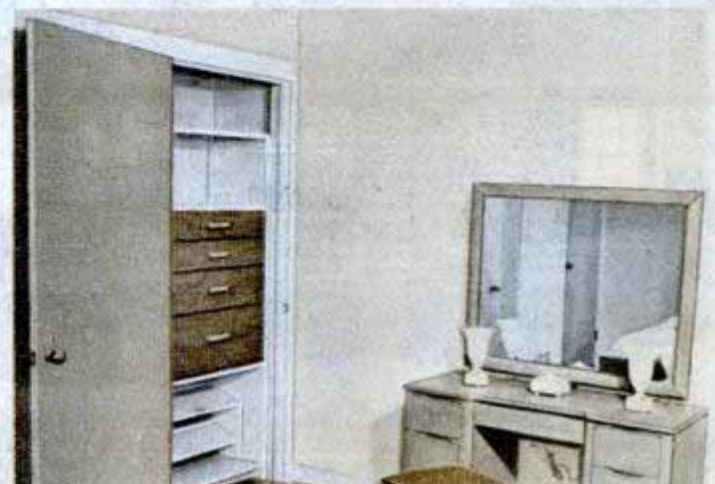



FRONT ELEVATION



RIGHT SIDE ELEVATION



LEFT SIDE ELEVATION

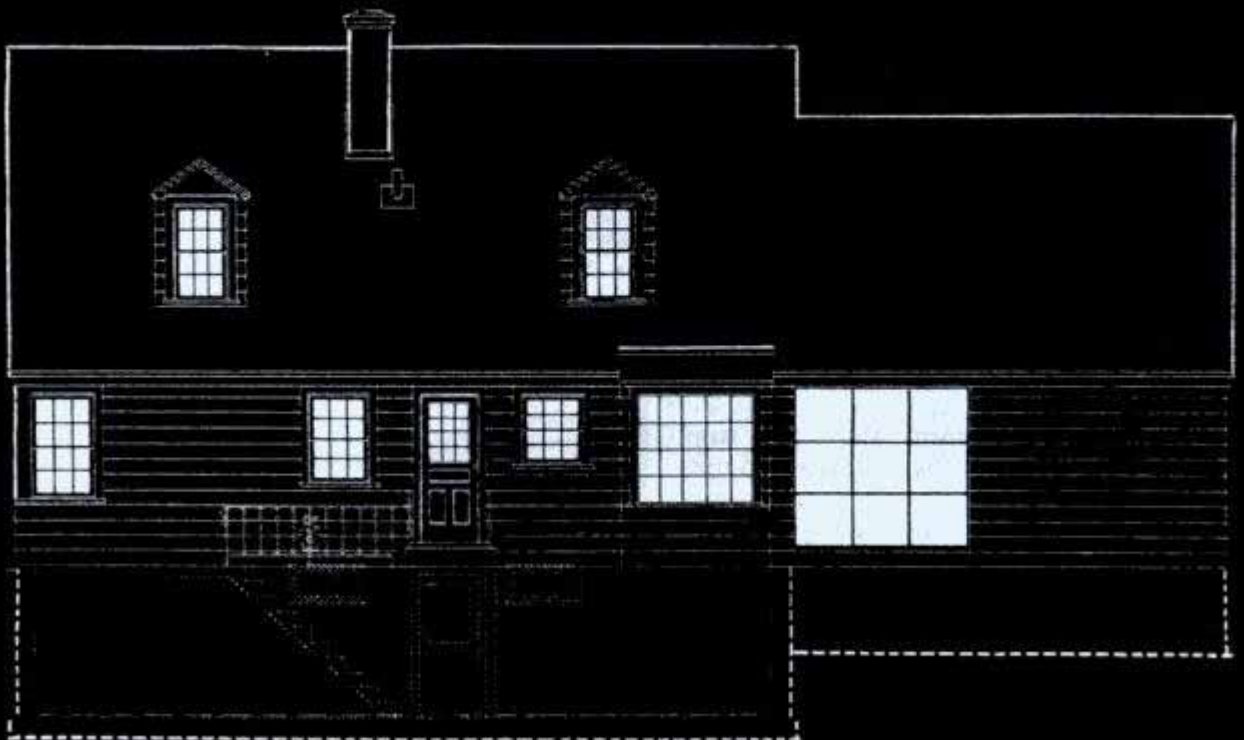

REAR ELEVATION

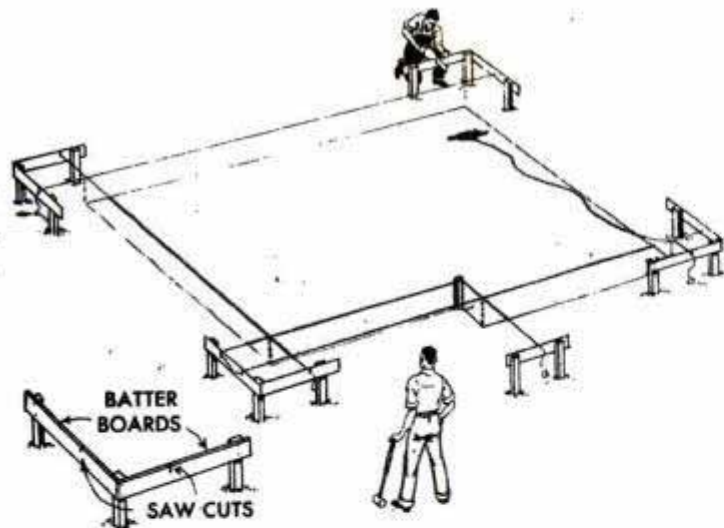

The first step in starting construction is to lay out the excavation. The diagram above shows how this can be done to assure accuracy, which is necessary

underneath also would be ideal. Entrance to the breezeway is from the kitchen. This was done for convenience to the kitchen when dining in the breezeway. A door could be put in the wall of the living room instead of the kitchen if you desire, or you could have two entrances.

The two bedrooms are similar except the front one is larger. Simulated corner windows provide abundant illumination without broken wall space to hinder furniture arrangement. The second floor is unfinished, but a closed stairway off the living room is installed for future use, and now serves as a spare closet. Above the garage and breezeway is a large room that can be made into a playroom, a spare bedroom, or to provide storage for screens, storm windows and other articles that accumulate.

If your family is one of the many who want a fireplace and you don't mind the extra expense, one can be built in the living room next to the breezeway. In fact, a double type of fireplace could be made here to serve both the living room and the breezeway. Other interior rearrangements can be incorporated to suit your particular desires. As mentioned in last month's installment, the exterior design of the house can be altered by leaving off the garage and breezeway and merely changing the roof, and in some cases relocating the windows. If your lot is a maximum of 50 ft. in width, one of the latter designs would be necessary since the house as built is 55 ft. in length and would have to be set lengthwise of the lot, which is what we did on a 50-ft. corner lot.

Magazine space does not permit us to give you blueprints and step-by-step instructions, but we have prepared a 100-page book and blueprints that show and explain every step, every joint and every dimension in drawings and photographs so that anyone can go right ahead and put up



A mechanical scoop makes quick work of digging the excavation. You will have to do some shovel work, of course, to square up the sides before the forms are set



Plywood panels stiffened with 2 by 4s make good forms, and later can be used as a subfloor. The excavation walls serve as the forms on the outside. Bracing the forms as below makes it unnecessary to cut the stock and thus ruin it for use in the house

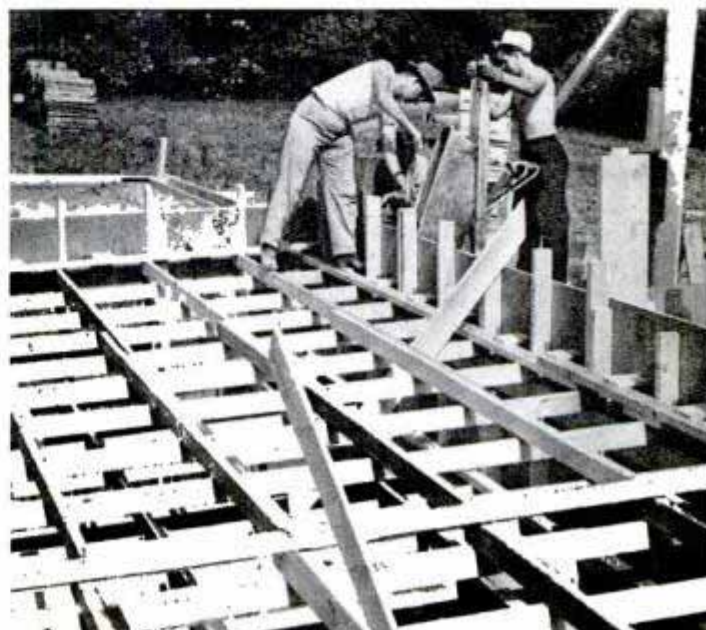

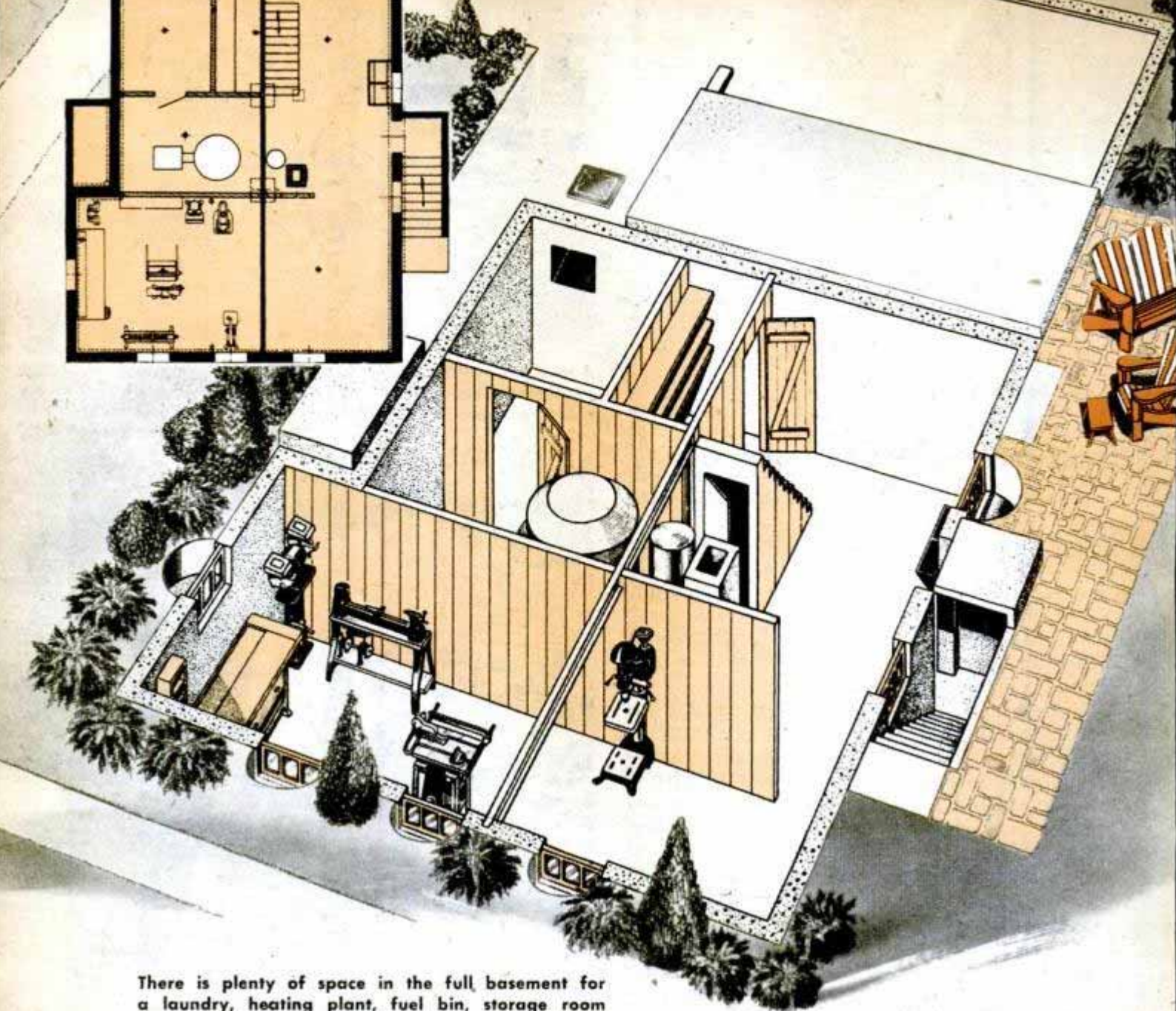

There is plenty of space in the full basement for a laundry, heating plant, fuel bin, storage room and a large room for your workshop or rumpus room

the house without trouble. If you are not planning to build a house, the information in the book will enable you to repair the one you have, add a dormer or a room upstairs, build on a wing or put in a playroom. Also, it will show you how to install or repair plumbing or wiring, put in or relocate doors and windows, etc.

To remove any doubt of your ability to build your own house, and to prove our statement that "anyone who can drive a nail and saw a board straight can build a house," let's analyze a house. I once overheard an old carpenter remark, "A house is a hole in the ground lined with stones on which 2 by 4s are set to support a roof and to hold boards which shed wind and rain." Let's refer to the photos and briefly go through the construction to see if he is correct. After laying out the excavation and removing the dirt, the footings are poured and forms set for the concrete walls.

If the ground isn't so sandy that it will cave in, use the walls of the excavation as one side of the forms. You will have to square them accurately with a shovel, but this method saves material and labor. Plywood panels stiffened with 2 by 4s provide good forms and can be used later as a subfloor. Bracing the forms can be done in several ways. We used the method shown to avoid ruining the material for later use.

After the concrete has been poured and allowed to set, forms are removed, pillars for the center posts are poured and the center supporting beam put in, in this case a steel I-beam as pictured in the upper photo of page 173. When pouring the walls, bolts are set in the concrete for attaching a sill. Next is laying the floor joists and bracing them. Nothing so very difficult so far. Now, the plywood used for the concrete forms is cleaned and laid over the joists and nailed down for a subfloor. Following this,

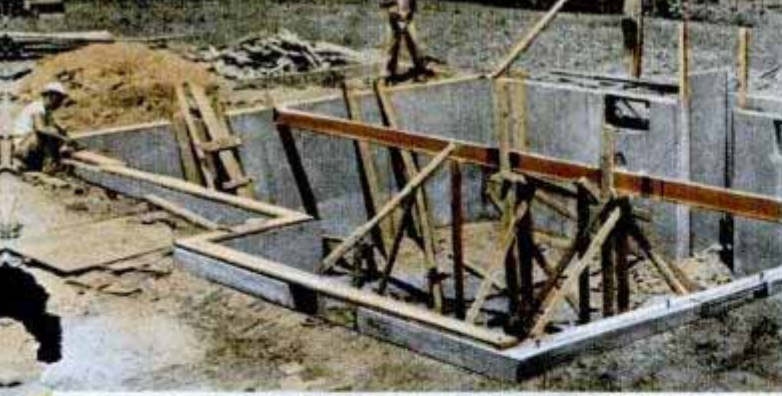

The center supporting member and posts are put in after the concrete has been poured and the forms removed. Posts are placed on concrete pillars



After erecting the studs for the main part of the house, put up those for the garage and bridge across the breezeway to support ceiling joists



Floor joists are next. These meet and overlap at the center member. They are laid on a wide sill which is bolted to the concrete foundation wall

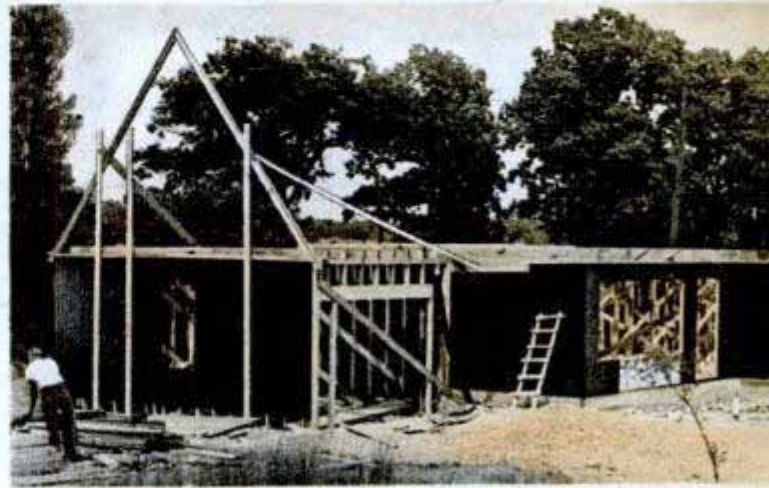

Studs for the main supporting partition go in next, followed by the insulating-type sheathing and the ceiling joists, ready to install the rafters

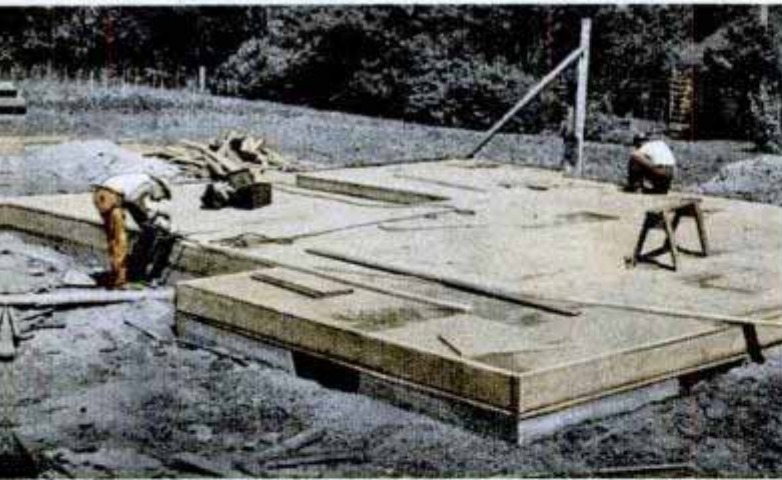

Plywood used in the concrete forms is laid on the joists for the subfloor, and then the wall studding is put up. The studs are assembled in panels on the ground and then erected. Triple studs should be used at all the corners for strength

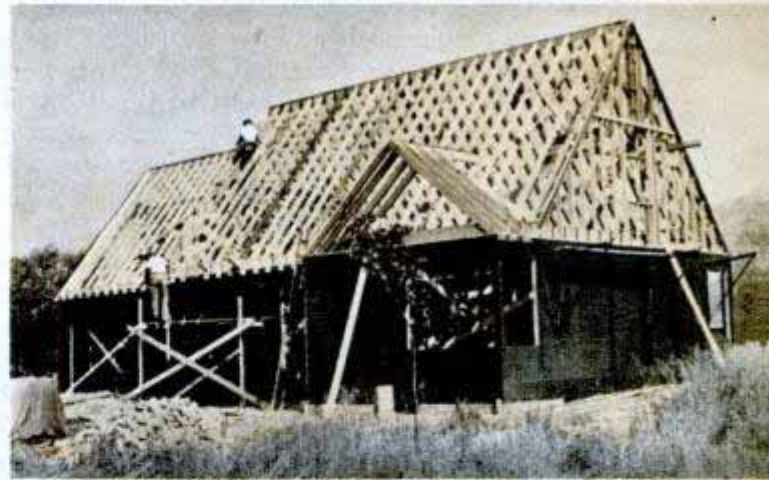

When the rafters and gable and studs are all up apply the rest of the sheathing and then put on the roof boards. Nail them close together and let the ends project. When installed, saw all of them off at one time to get a straight roof edge





The photo above will give you some idea of how the small front gable is framed into the roof section. It is unnecessary to cut out the roof rafters for this. The other photo shows the gable end being trimmed.

the wall studs are erected. These are 2 by 4s all cut the same length, spaced 16 in. on centers and nailed to 2 by 4s across the ends, openings for windows and doors being cut out later. Usually, the studs are assembled in panels on the ground and then raised into position. This simplifies the job. It will be necessary to brace the panels temporarily to hold them in position. The main supporting partition comes next and is merely a repetition of the outside walls. Cross partitions are put in later. When walls and partition are completed, ceiling joists are laid. This work is similar to the floor joists. The frame or square of your house begins to take on strength, which is furthered by nailing on the sheathing; in this case an insulating type made especially for this purpose was used. The door and window openings are left open. You still haven't run into anything very difficult. It's been just a matter of measuring, sawing and nailing according to the plans.

You are now ready for the roof rafters. Those where the dormers will be installed are full length and later cut away to frame the dormers. Gable-end studs go up after completing the rafters. Follow with the small gable rafters and studs, and then frame in the dormers. The structure looks more like a house now.

Roof boards are next. Lay them close. It's unnecessary to cut them to fit; just let the ends extend over the roof edge if they are too long. They are all sawed off at once later to produce a straight edge. You will find this a good place to use up odds and ends of material that have accumulated in construction so far. After the roof boards have been sawed off, sheathing is applied to the gable ends and the cornice boards and part of the exterior trim are applied.

Many prospective home builders make up a cardboard model before starting construction. This shows in miniature just what your house will look like when completed so that you can make minor changes before it is too late. You are now over the worst hurdles in constructing the house and have gained confidence in your ability as a carpenter. Of course, it has required work — any worth-while accomplishment does—but you have saved money and experienced the pleasure of seeing something take shape under your own hands. In the concluding installment next month we will take up the roof, siding, doors, windows and interior.

(To be continued)



Here is the book that gives complete step-by-step instructions and diagrams for building the Popular Mechanics House. Whether you build this house or any other house it will prove to be an invaluable aid.

Concrete Stoop Base Uses Cement Blocks

Proper preparation of a stoop before pouring the concrete can result in a saving of material and insure a base that is solid. Instead of using a wooden core, as is often done, one can be formed of concrete blocks and sand, or any other suitable filler. Broken blocks are used for the sides and smaller pieces are mixed with the filler. The outside form is made of wood and should be spaced so as to obtain the desired thickness of concrete.

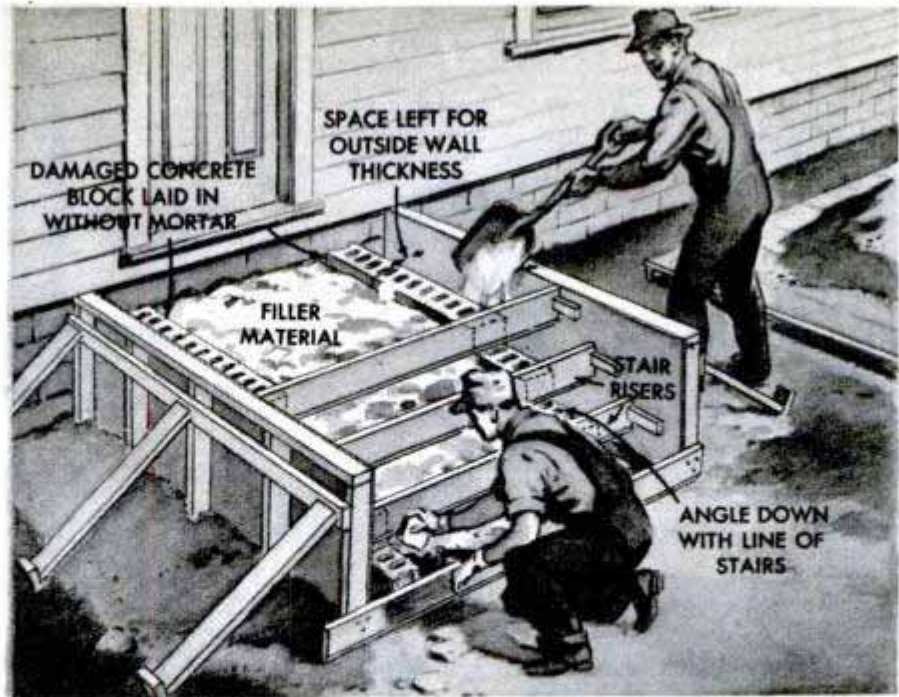

Vertical Handrail at Corner of Stair Adds Safety and Convenience

Fastened to the corner of the wall where there are winding stairs, a vertical handrail will add to the safety and convenience of users, especially when there are youngsters or elderly people. The rail is located at a convenient height so that it can be reached easily and should be long enough for people of different heights to grasp it while ascending or descending steps where the tread is narrower than usual. The same fittings that are used to fasten the regular handrail to the wall can be used for this section also. However, instead of the usual rail, it would be better to use a smaller piece that affords a firmer grip.

Michael Ligocki, Gary, Ind.

Pitch of Sloping Roof Easy to Figure

To determine the pitch, or rise, of a roof or other sloping surface in inches per foot, use a carpenter's square and a level. Lay the longer leg of the square on the roof with the shorter leg extending upward. Then place one end of the level at the 12-in. mark, as shown, and hold it so the bubble is exactly in the center of the glass. Pitch of the roof in inches is read from the scale on the short leg at a point where the level crosses it.



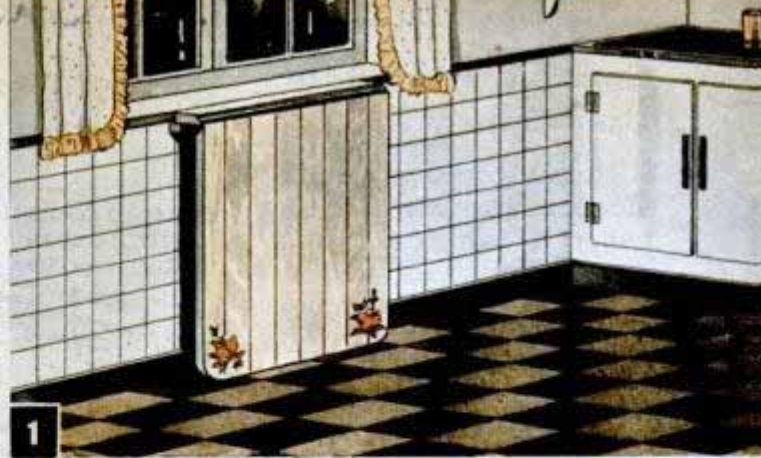

Fold-Away Table

FOR THE SMALL KITCHEN

By Wallace W. Buffmire

NOWADAYS breakfast in the kitchen, also late-hour snacks and even informal parties are a regular practice in most homes. In small kitchens without breakfast nooks or other provision for seating space, the conventional table is a No. 1 problem. Here's a good solution: A look at Figs. 1 and 2 and you have it. The fold-away table

serves every purpose from breadboard to party top but when folded it takes only about 4 in. or so of room space, Fig. 3, A. In Fig. 1 you see it attached to the window sill; in Fig. 2 it's fastened to the kitchen door.

Fig. 3 gives construction details and suggests dimensions of the top. In this case the top is $32\frac{1}{4}$ in. square over all, but of course you can vary this to suit the location and space available. Table tops are usually 30 in. from the floor, but height, too, can be varied. Use hardwood for the top—birch is excellent—and join several narrow pieces with doweled joints and glue to give the necessary width. You can join the table top to the two-piece wall bracket with a rule joint and special hinges as indicated in Fig. 3, or with a plain hinged joint. Sand all parts thoroughly and wipe off the dust with a painter's tack rag. Finish with enamel or with clear brushing lacquer and wax.

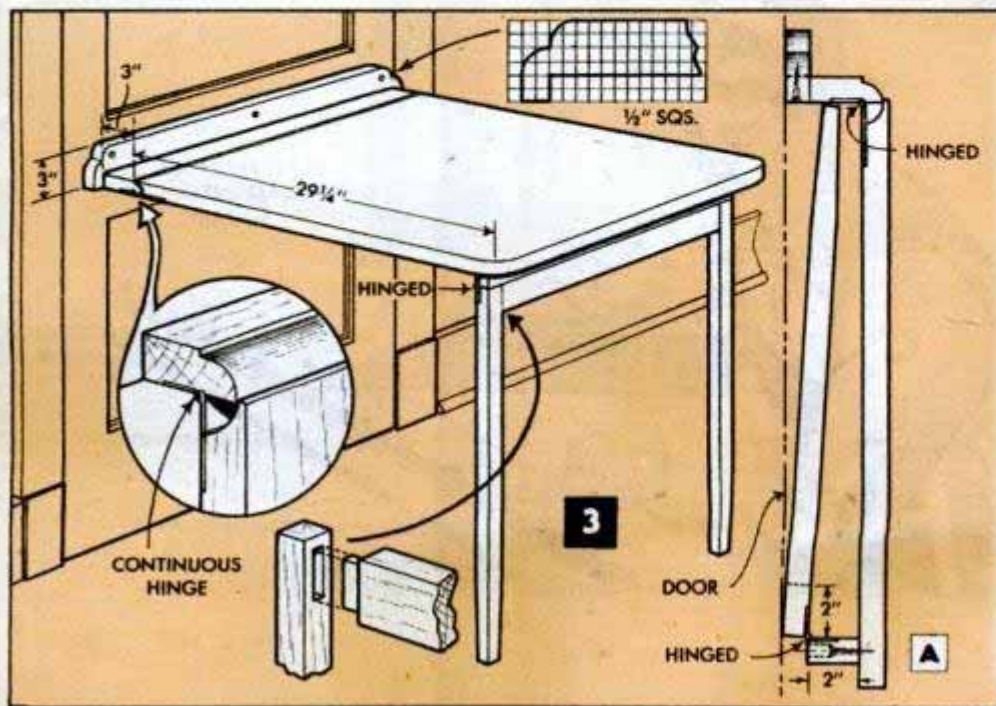

SEESAWS NEED NOT ALL BE ALIKE

AERIAL

That's right. They needn't all be alike. They can have considerable variety. Here, for example, are four types, plus as many different kinds of fun. The first one, right, swings on a universal joint, that is, it can go up and down and around at the same time. One lad and a companion each grab an end. The lightweight really gets a ride 'round and 'round and up, too

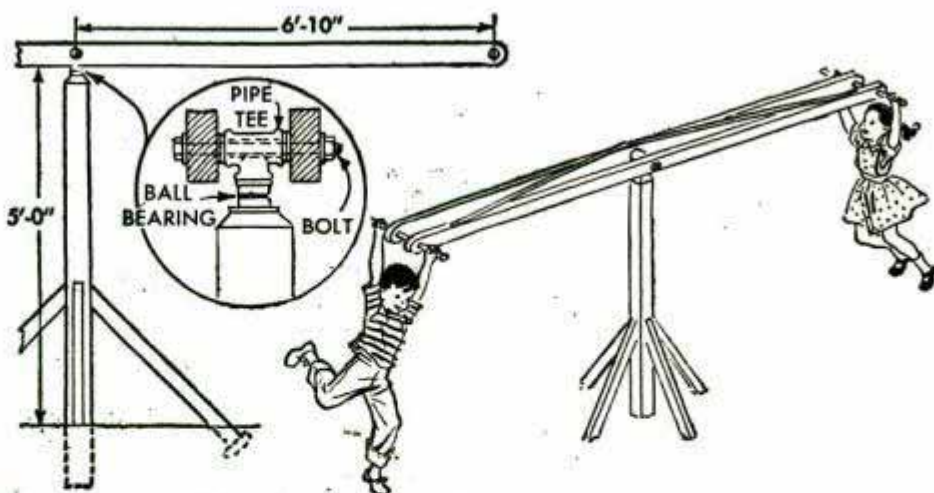

HIGH-LIFT

Then there's this version. The upgoing passenger may feel as if he's about to take off from a springboard but that's okay. If he hangs onto the sturdy handles provided he'll come down again. So will the other fellow when his turn comes. Detail drawing shows how it's made, in a sort of cantilever style. Posts should be anchored firmly in solid ground or concrete

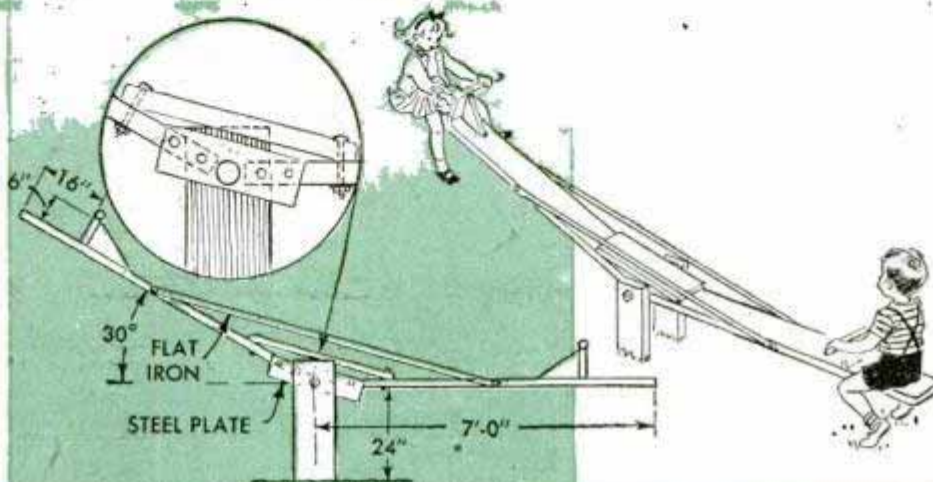

SOLO

These two are designed exclusively for solo flights. On one the dummy passenger is a box of sand. Find the right spot on the long end of the board where nice balance is attained and away you go. The other number, shown in the detail, performs much like a springboard. Strong coil springs give the bounce necessary to keep things lively. Parts should be amply strong

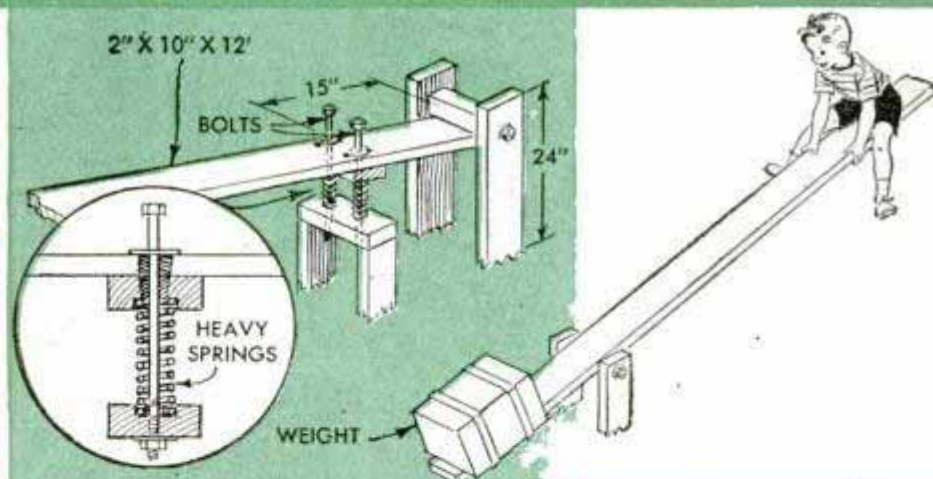

LAZY LOUIE

This one's still different. Arms instead of legs supply the motive power. Riders about equally matched in weight sit in bucket seats and make with the hand levers. Sections cut from old tire casings and attached to the plank keep the bumps safe and satisfying. Operating this one by hand actually takes a lot more energy, but the riders never know the difference

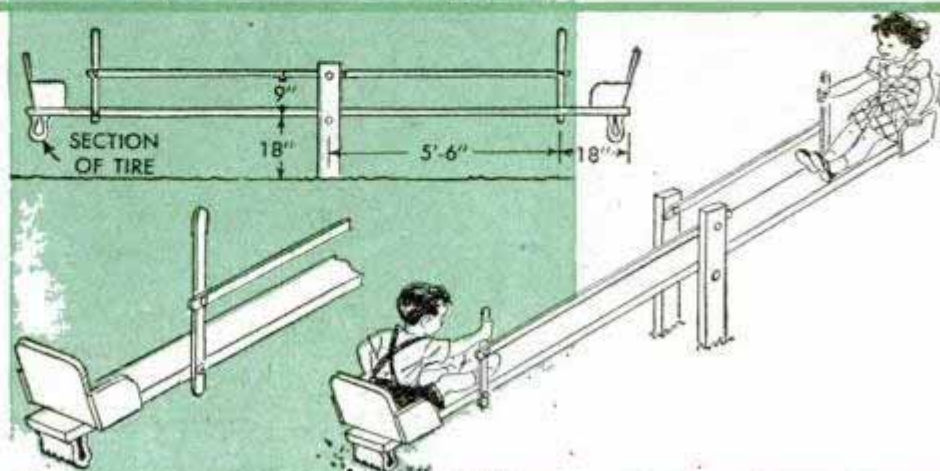

A Home of 1000

Numerous built-in features to make this trailer livable include a stove, a kitchenette with sink, icebox and wall cabinets, and a wardrobe and toilet. A dining nook at the front folds into a bed for two and a studio couch at the rear serves as a settee and sleeps two comfortably

AFTER completing the trailer proper, you are ready for the various built-in features which make it livable. Arrangements are shown in the floor plan, Fig. 22, and Fig. 2 of the March issue, the forward end serving as a dining room, and the rear end as a bedroom with a studio couch that folds out to make a double bed. In between, on the right side, are a toilet and wardrobe, and on the left side a kitchenette complete with four-burner bottled-gas range, a sink with cabinets below and cupboards above, and an icebox under the forward end.

The gas tank is mounted on the frame extension forward, outside the living quarters. Under no circumstances is it permissible to locate the tank inside, and in installing the gas line great care should be taken so that the copper tubing is not kinked with the hazard of cracking, and as few connections made as possible. Use the proper type of regulator for the tank you select and run as much of the gas line as possible under

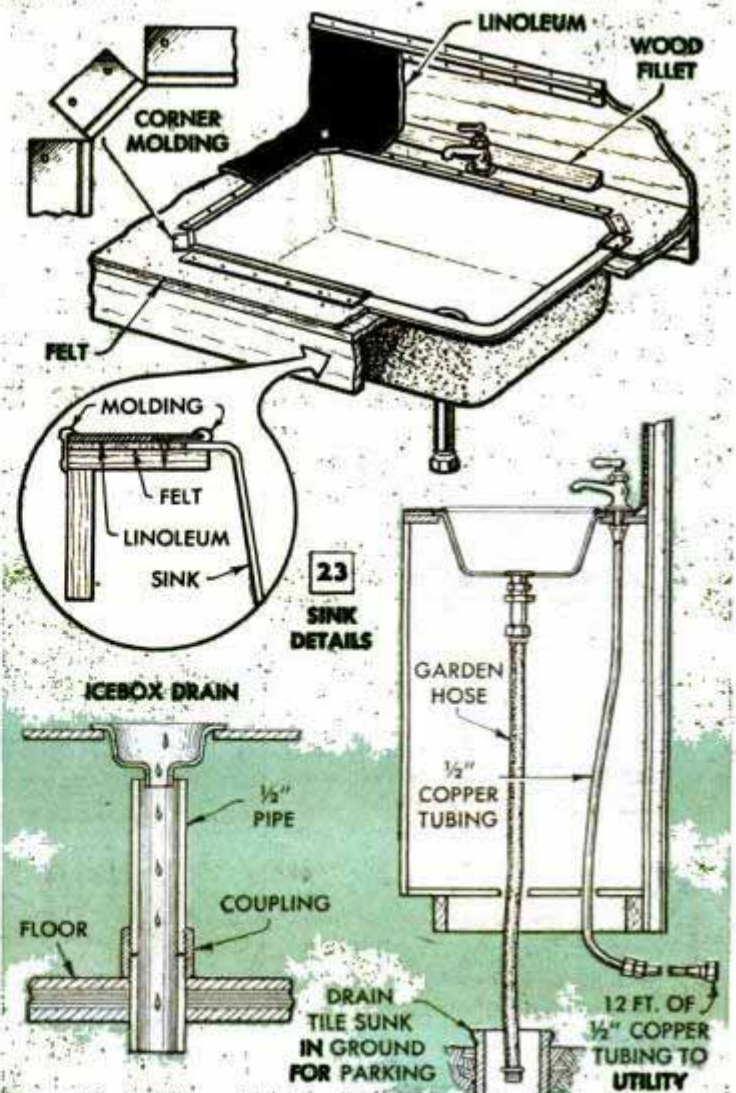
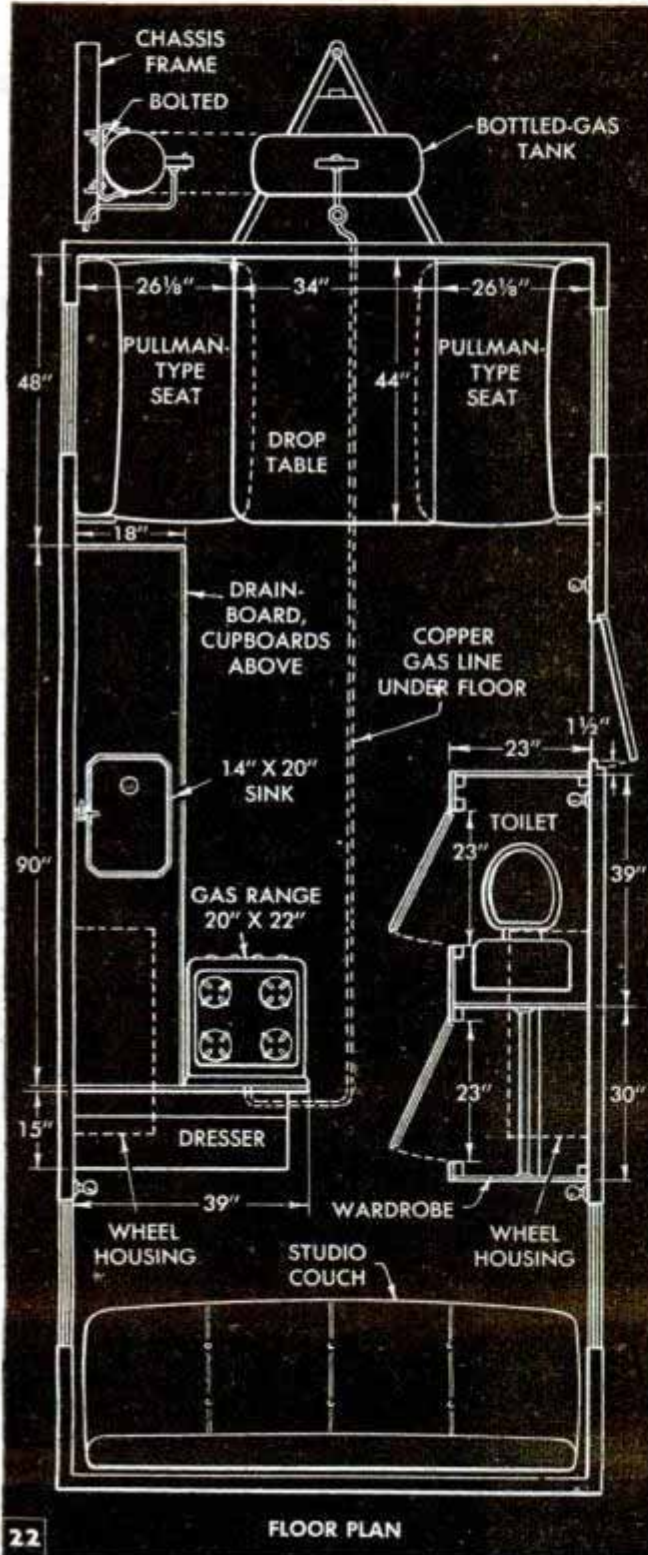

Addresses

PART III

By Hi Sibley

the floor. Installation of the tank used in the original trailer is shown in Fig. 22, the legs being bolted to the angles across the V of the frame extension.

General layout of the left side of the trailer is shown in Fig. 27 with the kitchenette dimensions given in full. Further construction details on the kitchenette are given in Fig. 24. An exceptionally long drainboard is provided and, with the range at one side at the end, this will be found more convenient than in the average house trailer. Throughout, the kitchenette unit has been built and finished



with exceptional care. Cupboard doors, being built of two panels of plywood glued together, will not warp, and the back wall is cleaned easily, being of imitation tile. This attractive material is secured to the plywood by daubing on tile cement every four inches and pressing the tileboard against it. The same type of stainless-steel

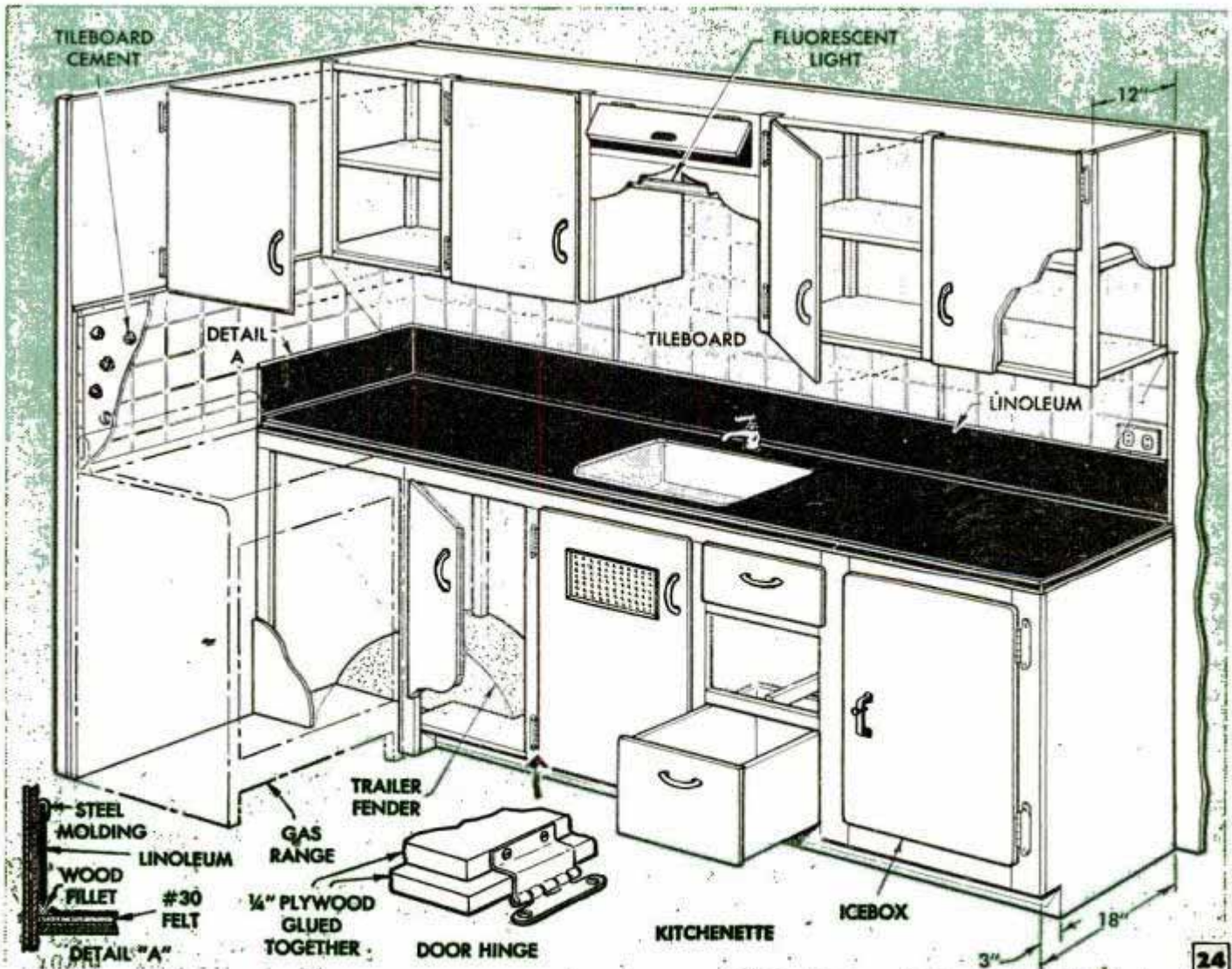



25



26

Above, fine styling plus an icebox and three large drawers make this unit appealing. Special drainboard linoleum is laid over felt as at the left. Note wood fillet in the corner and the stainless-steel molding above

molding as used on the vertical joints outside is used on joints of the tileboard.

A fluorescent-light unit is installed just above the sink to cast a pleasing glow over the entire work surface. The latter is covered with 30-lb. felt, Fig. 25, and special drainboard linoleum, Fig. 26, and bound with stainless-steel molding. A narrow strip of the linoleum is installed along the front and end of the drainboard, and bordered with molding.

Details of sink installation are given in Fig. 23. First the sink is set in the opening cut in the plywood top and the felt laid up to the edges of it in cement. Next a stainless-steel strip with rolled edge is lapped over the rim of the sink and nailed in place. The corners are cut at 45 deg. Then the linoleum is cut to fit right up to the roll of the metal strip and cemented to the felt, after which edges are bound with stainless-steel molding. Note that the rolled-edge molding is laid in mastic to render a watertight joint. For drainboard use, select a linoleum that does not have a burlap backing. Such

material is undesirable because if any water seeps under it, each burlap strand serves as a wick to carry the moisture all through the fabric by capillary attraction.

The water system is illustrated in Fig. 23, and is connected to the local supply through copper tubing. The builder carries extra tubing for this purpose. It can be disconnected when on the road. The drainage is carried out through garden hose, and when parked for an extended time a hole is dug in the ground and a drain tile set in it for a miniature cesspool. Arrangement of the icebox drain is also given, the small amount of waste water merely dripping onto the ground below the trailer.

Arrangement of the right-hand side of the trailer is shown in Figs. 31 and 32. Much of the partition work can be built of 1/4-in. plywood left over from paneling the inside, and reinforced with battens at top and bottom and in corners. In this case 3/4 by 1 1/4-in. pieces were used, with quarter-round molding on the floor and ceiling. Incidentally, joints of plywood on interior

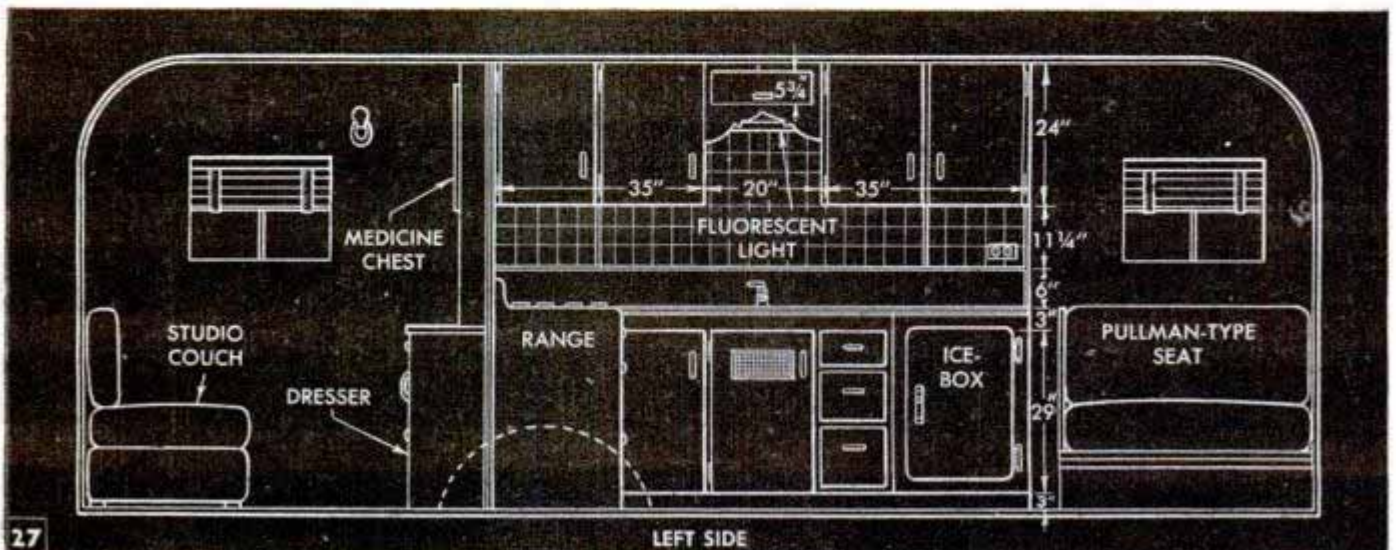

27

LEFT SIDE

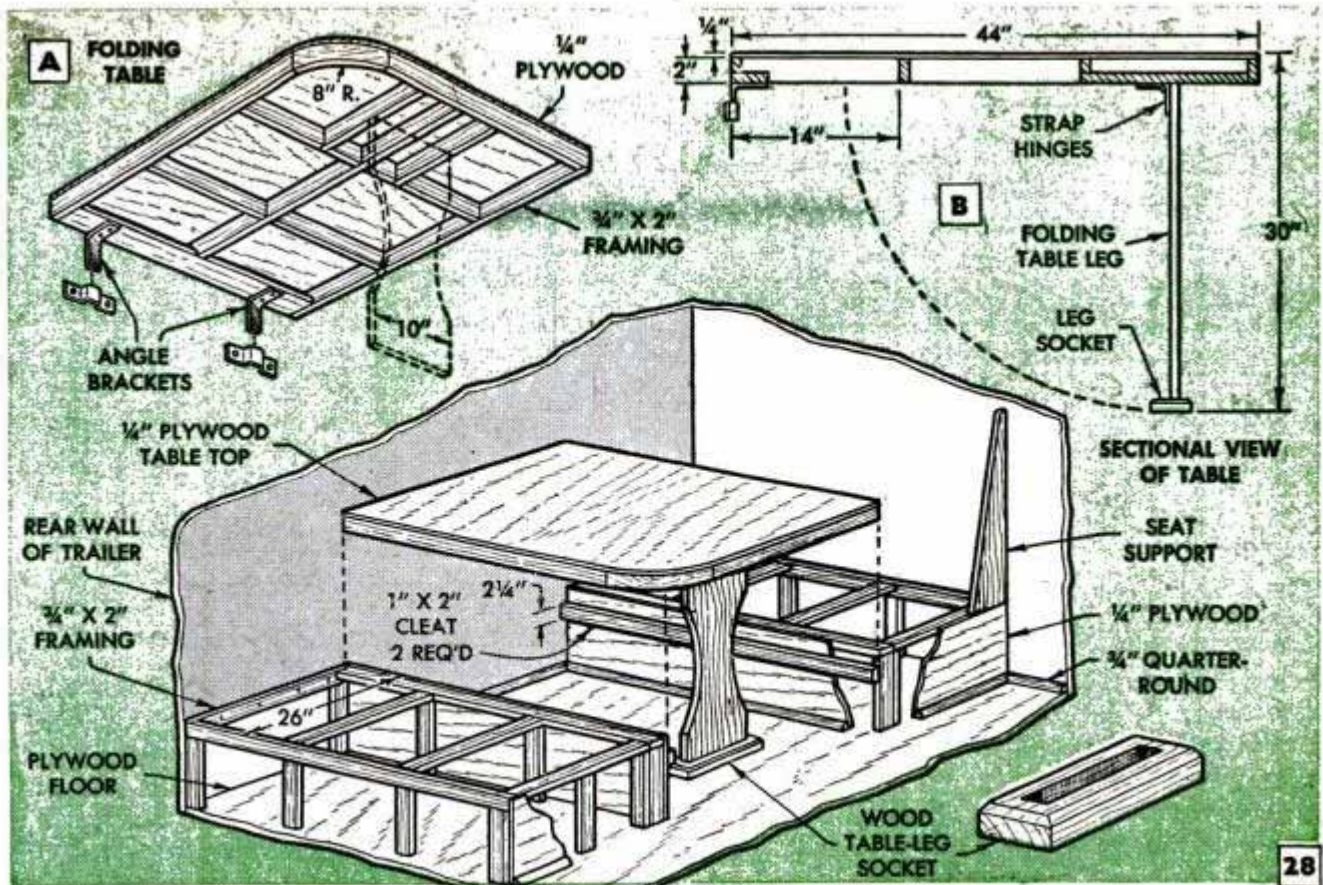
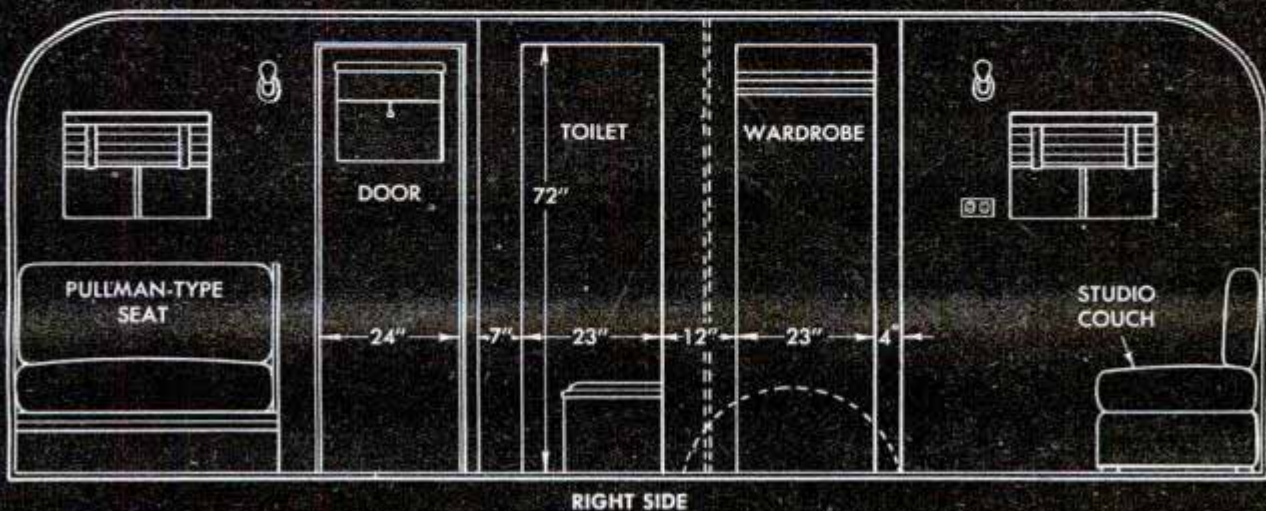

Photo above shows the dining nook made up into a comfortable bed that will sleep two. At right, table and seats are quickly made up so that four can dine without crowding



walls are concealed with $\frac{1}{4}$ by 1-in. strips.

The chemical toilet is a trim enameled one with a "tank" for charcoal to absorb odors, and sets over one end of the wheel housing. It requires no installation beyond screwing to the floor.

A shelf and clothes pole are provided for the wardrobe adjoining the toilet. Note that the wardrobe is built over most of the wheel housing, which does not interfere with garments hung there.

Wardrobe and toilet doors are identical, except that the latter has a handle on each side. Both are equipped with friction catches. The doors are made from a single panel of $\frac{3}{8}$ -in. plywood with battens of scrap $\frac{1}{4}$ -in. plywood on the inside, secured with casein glue and small screws, Fig. 32. They are hung on offset hinges.

The folding table with Pullman-type seats, Fig. 30, will comfortably accommodate four adults and is within easy serving distance of the kitchenette. Framing of the seats is built as indicated in Fig. 28. The folding table is made to drop down between the Pullman seats, the cushions of which are laid over it to form an extra bed, Fig. 29. The top is built of $\frac{1}{4}$ -in. plywood over a frame of $\frac{3}{4}$ by 2-in. material. The corner near the icebox, detail A, is rounded to per-

mit easier access to the seat. The under frame around the curve is scrollsawed. Two angle brackets in sockets support the table on the forward wall, and a folding leg is provided at the other end, fitting in a floor socket or slot, detail B. To make a bed, the top is simply lifted out of the end supports and the leg folded under and then placed on cleats on the fronts of the Pullman seats.

A dresser, Fig. 33, is built against the wall just back of the stove. At the right a panel door opens into a shallow compartment for general storage, and also gives access to the gas line into the stove. On the left are two drawers and a door hinged at the bottom for a soiled laundry compartment. This is deeper than the right-side compartment, extending back under the sink drainboard and over one end of the wheel housing.

Drawers are made in the conventional manner and are fitted with plastic handles, as are all other drawers and doors inside the trailer.

The medicine chest is a standard item with glass shelves and a mirror on the door. It is installed flush with the wall, and is flanked with small shelves as illustrated.

In the final finishing of the interior, see

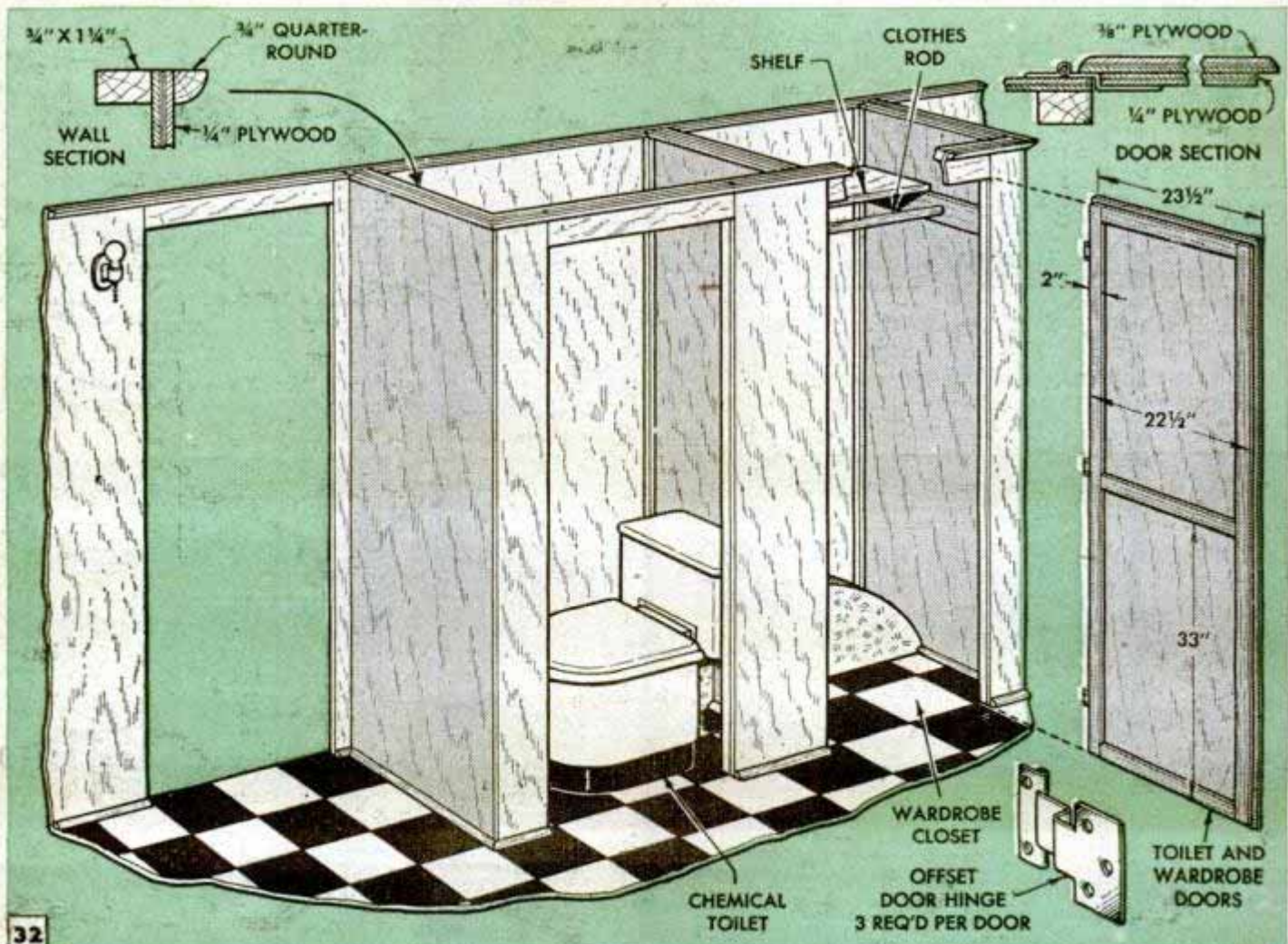

that all joints are covered with battens. In the original, $\frac{1}{4}$ by 1-in. strips were used, and in the upper curved corners $\frac{1}{4}$ -in. plywood with the exposed grain crosswise was used, allowing bending to that radius. Standard venetian blinds manufactured for trailer use are hung over all the windows and, with the natural finish of the wood, give a very pleasing effect. A manufactured doorstep is a convenience, as it folds up and slides back under the body when traveling.

Many owners provide their trailers with pressure water systems independent of any outside source in a camp, thus enabling them to have water available regardless of where they park. Usually, this is done by installing a tank either under the trailer or someplace inside it and then providing fittings so it can be filled from outside the trailer and pressure applied with a tire pump or an air hose. Connections can be provided at the sink to use either the tank or an outside source of water supply.

For sake of safety, obtain the best hitch possible and acquaint yourself with and obey all laws pertaining to trailers in states in which you intend to use yours. Construction blueprints to aid you in constructing this trailer are available.

(THE END)



A built-in dresser base topped by an ordinary medicine chest with side shelves provides facilities for shaving, dressing, etc. Base has compartment for soiled laundry and two large drawers for other storage

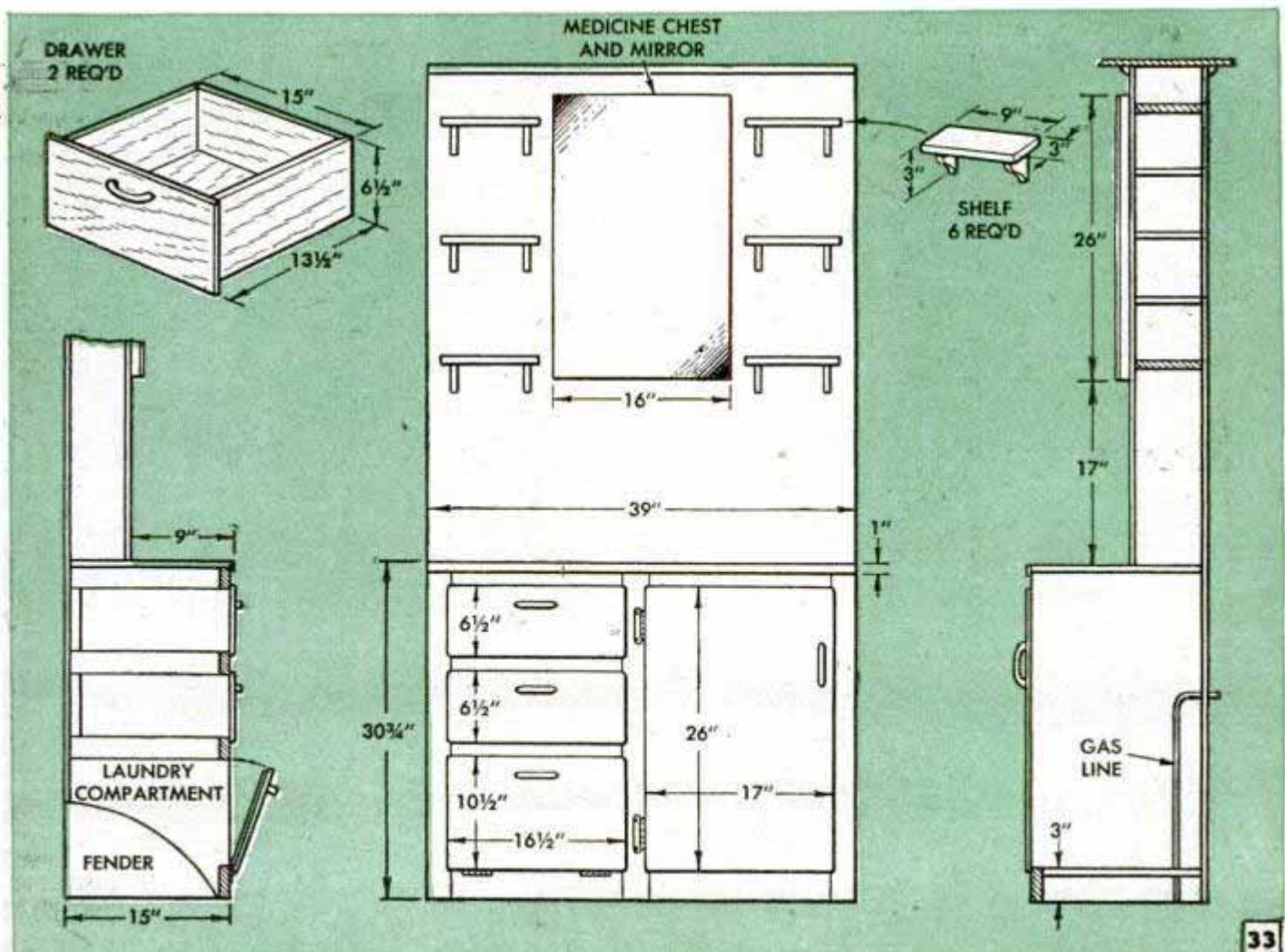

Youngster's Coaster Wagon Is Hand-Propelled

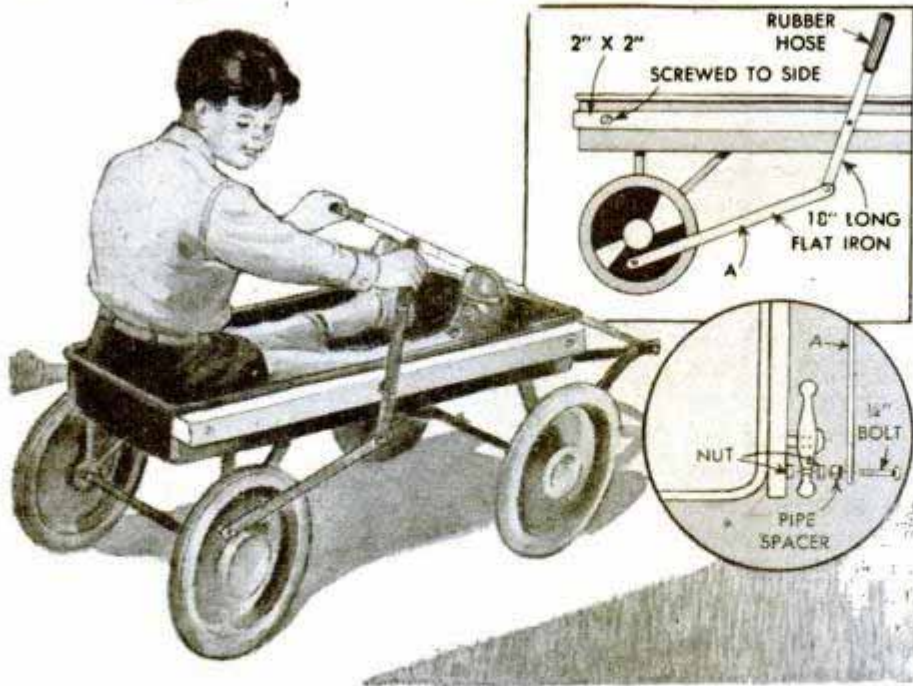

It doesn't take much in the way of material or labor to convert an ordinary coaster wagon into a hand-propelled vehicle. Two flat-iron levers with the necessary bolts and nuts for linkages are about all that's required. The length of the levers depends upon the size of the wagon. A 2 by 2-in. spacer strip is bolted to the side, and the lever, with a rubber-hose grip that serves as a handle, is fastened to this. Connections for the driving lever are shown in the circular detail. — David Heggie, Whittier, Calif.

Improvised Sawbuck for Wood Lot Can Be Set Up Easily

For heavy work in the wood lot, this improvised sawbuck can be set up in a few minutes and it will hold fairly large logs. Four medium-size saplings sharpened at one end are driven into the ground at an angle on opposite sides of a log as indicated and then tied where they cross.

Hi Sibley, Nuevo, Calif.

How to Reverse Window Shades

Reversing and cleaning window shades can be done in a few simple operations, and the result is well worth the effort. Begin by removing the tacks that fasten the shade to the end of the roller. Cut away any damaged material and square this end of the shade. Next remove the stick from the other end and rip out the stitching. Reverse the ends, stitching a seam for the stick on what was the roller end. Then square the shade and attach it to the roller.

Louis G. Barkley, Glendale, Calif.



Sheets of Sandpaper Stored in Discarded Phonograph Record Album

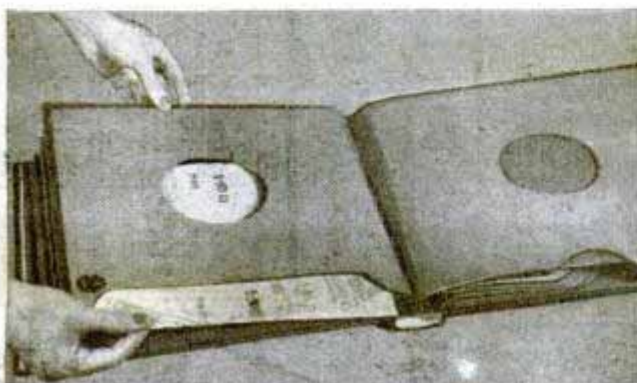

An old phonograph record album is an excellent container for various grades of sandpaper. When inserted in the pockets—a different grade for each—the number of the grit is read through the hole in the center of the pocket. Index tabs may be attached.—Benj. Nielsen, Aurora, Nebr.

☞ Before storing overshoes, wash them in warm water to remove oil and grease spots. Then stuff them with crumpled newspapers and keep them in a dark, cool, dry place.

WEATHER VANES

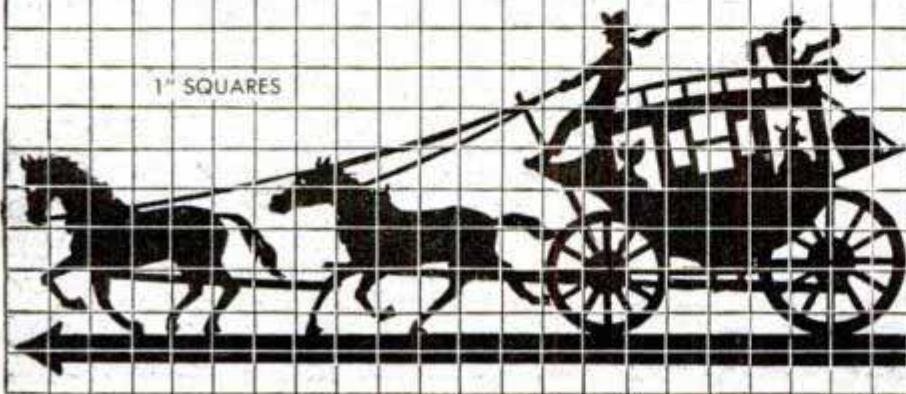
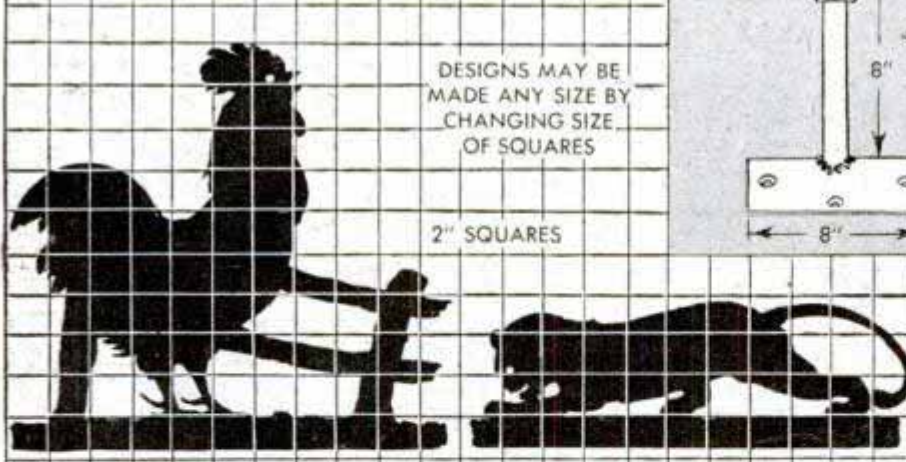
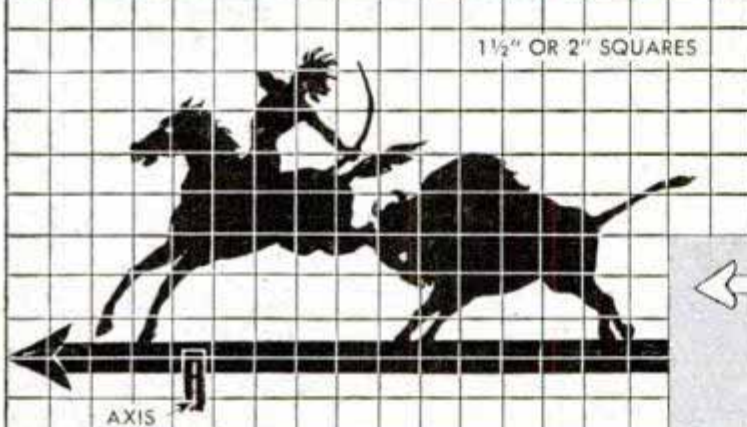
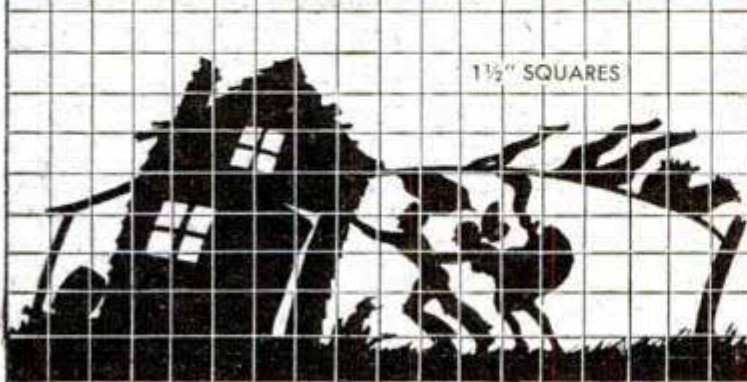

In fair weather or foul, any of these vanes will tell you faithfully which direction the wind is blowing. The silhouettes are cut from outdoor plywood or sheet metal and finished in black so they can be seen clearly against the sky. If sheet metal is used, it should be fairly heavy to stand the buffeting of the wind. A suggested method of assembling and mounting the parts of the unit is given in the lower right-hand detail. Also note that the standard, which carries the arrow and silhouette, rides in a sealed bath of oil

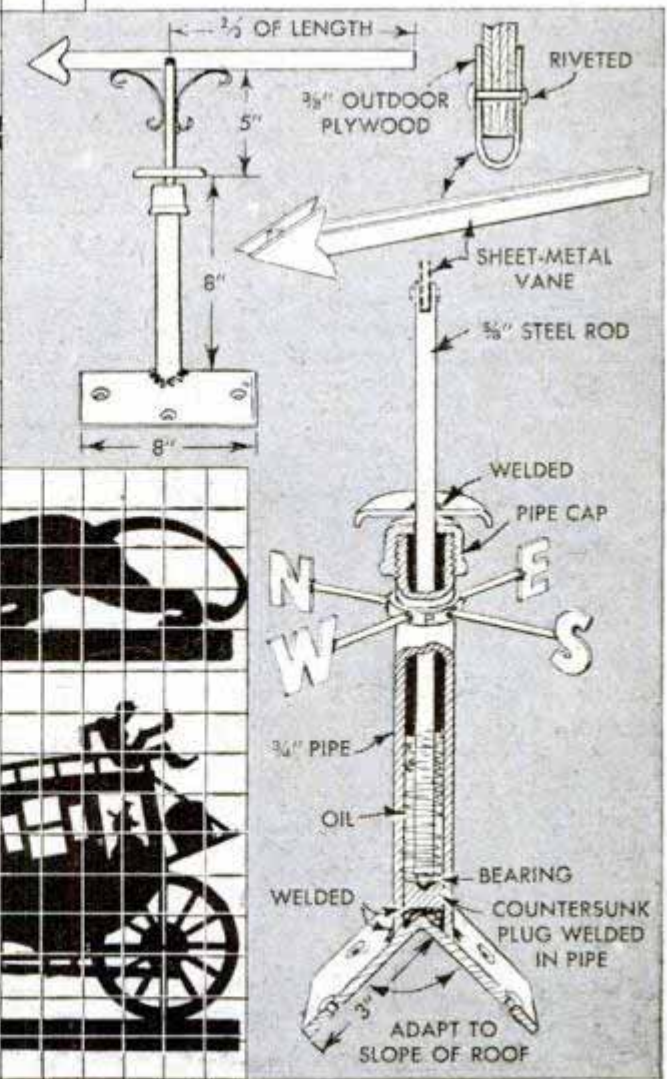

Adjusting Screws Under Bench Serve to Level It



When your workbench rests on an uneven floor, or if one or more of the legs are of unequal length, you can avoid propping the legs to make the bench level and steady by the use of lag screws. These are turned into the lower end of the leg, as shown in the detail, until the bench is properly adjusted. Care should be taken not to use screws that are too large as they may split the wood. A hole for the screw is drilled first.—Wm. A. Novak, Maywood, Calif.

Water for Summer Camp Lifted By Using Lever and Bucket

If you are camping by a river or lake where steep or muddy banks make it difficult to dip up water, use a simple water lift that can be operated from the top of

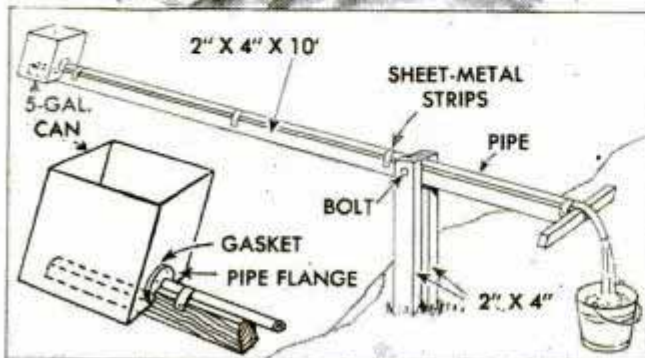

the bank. The lever illustrated is about 10 ft. long, although this dimension will be governed by the height of the bank above the water. A 5-gal. can with the top removed serves as a bucket to catch the water, which drains out through a pipe along the lever into a container at the handle end. Two uprights and a bolt provide the fulcrum on which the lever pivots.

C. L. Meehan, Lakeview, Ont., Can.

Cigarette Papers Keep Cutworms From Damaging Tomatoes

You can protect newly set tomato plants against cutworm damage by wrapping the stalks with cigarette paper or strips of newspaper. The paper should be twisted to hold it in place, and should project at least $\frac{1}{2}$ in. above and below the ground. By the time the paper has rotted away, the plants will not be liable to cutworm damage.

G. E. Hendrickson, Argyle, Wis.

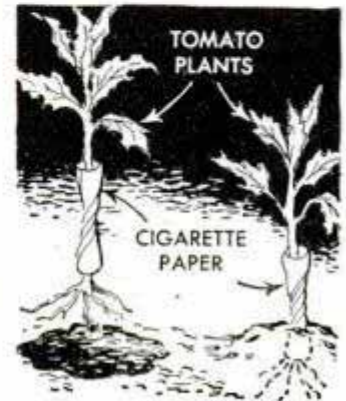

Letters Printed With Writing Pen

An ordinary pen point can be converted to a lettering pen suitable for printing fairly large letters by grinding or filing the point until the nib is the width desired for the letter. When grinding, hold the pen with a pair of pliers, and when finished, smooth the nib with a whetstone. Do not use too much ink on the pen.

William B. Eagan, Charleston, W. Va.

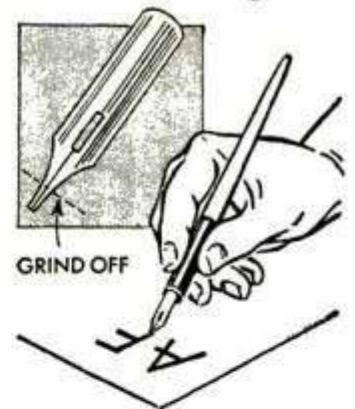

Weather Seal on Auto Starter

Many automobiles have starters that are fitted with a rubber "skirt" which acts as a weather seal on the floorboard and also keeps gases and noise from coming into the interior of the car. After a time these skirts wear out and often are difficult to replace. If there is a boot from the master cylinder of a hydraulic brake system on hand, this may serve as a substitute.

D. W. Brentlinger, Richmond, Calif.

Archery Tackle Box

Compact and easy to carry, this archery tackle box has space for almost everything that's needed in the field. Compartments can be arranged to suit your convenience

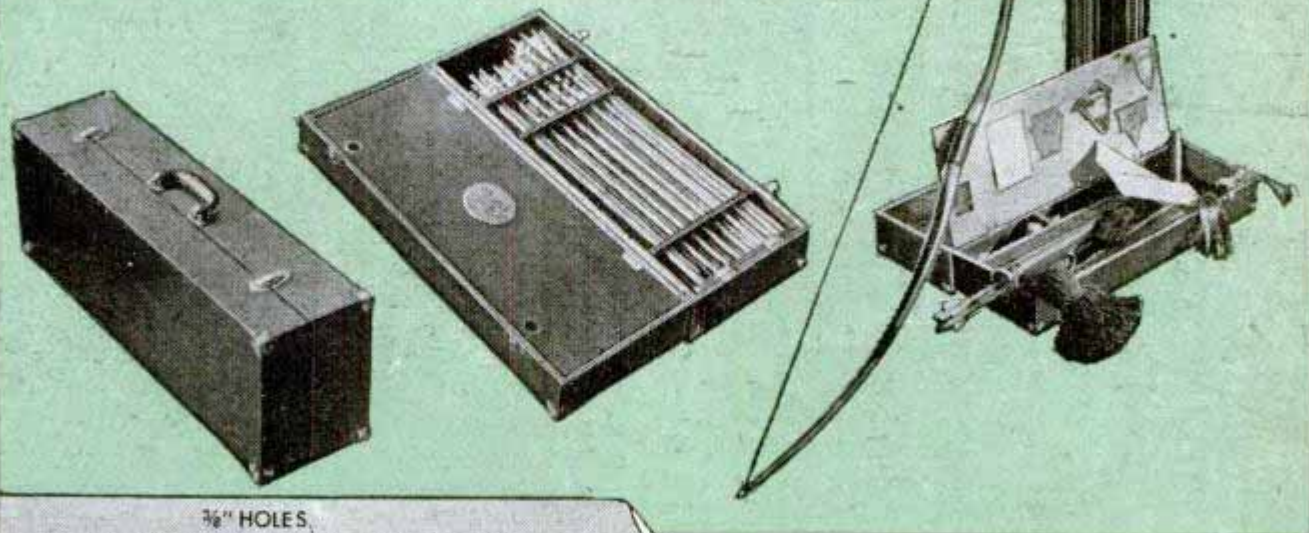

By Kenneth B. Wikel

IF THE over-all dimensions shown on the drawing are followed, one half of this archery tackle box will have space enough for 36 arrows and the other half can be divided into compartments to carry such necessities as arm guards, gloves, string wax, repair thread and other items that are a part of every archer's kit. The corners are dovetailed and the two sidepieces are rabbeted for a close fit. Arrangement of the compartments is made to suit your own requirements. The dividing section fits into the half that contains the compartments and has a finger hole reinforced with a metal grommet. Construction of the rack for the arrows is shown in the upper and right-center details. Notice that the metal arrow-rack support is fitted after the rack is completed and hinged to the box. After the two halves of the box are joined with a continuous or piano-type hinge, all corners are rounded and fitted with metal reinforcements. The handle and latches are of the type used for trunks.

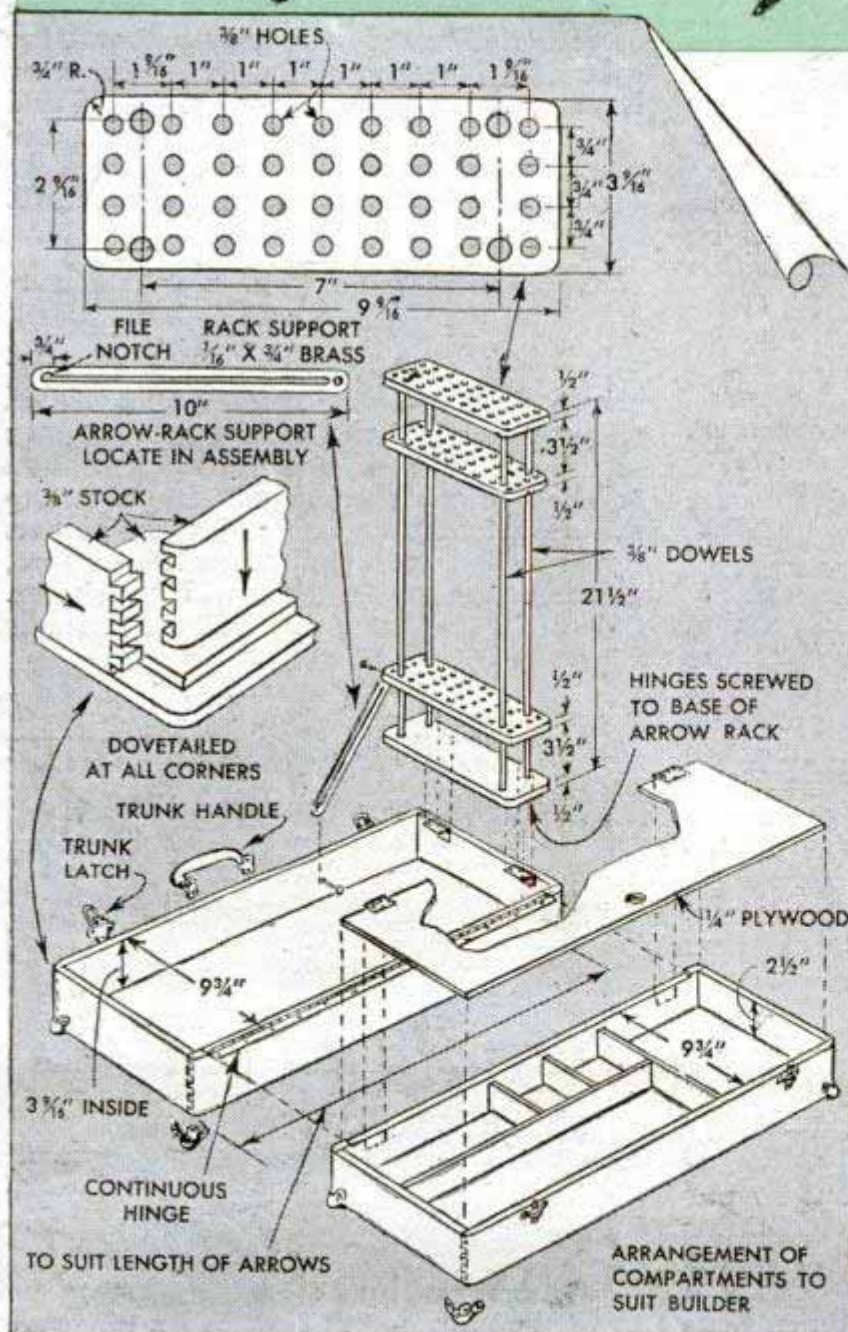

Roller Attached to Paste Brush Aids in Mounting Clippings



Clippings, photographs and other items that are pasted in scrapbooks can be mounted more easily with this combination roller-brush. An ordinary paste-jar brush is used with the roller attached to the end opposite the brush by means of a wire handle. The roller itself is a dowel covered with a length of smooth rubber tubing. Tubular rivets are driven into the dowel to serve as bearings for the handle.

Arrow Shows Position of Latch

To indicate the open and closed position of the latches on kitchen cabinets, one householder painted arrows on the knobs. Each arrow is parallel with, and points to,

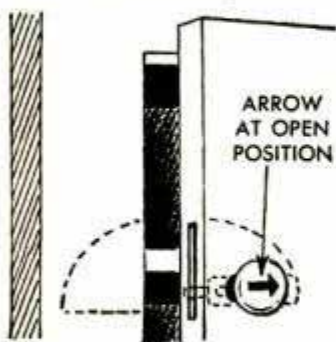

the free end of the latch. When the head of the arrow is toward the hinges on the door, the latch is open. Fingernail polish will make a suitable "paint." — David Streby, Lancaster, Pa.

Walnut Is Darkened by Using Lye

If there's a piece of black walnut in your stock that isn't quite dark enough, paint it with a 10 percent solution of lye to get the proper effect. The best way to do this is to work the wood to the desired dimensions

first and then wash or paint on the solution. After drying, the piece is polished with fine sandpaper. Care must be taken not to make the lye solution too strong.

Erik Sollid, Denver, Colo.

Campfire Irons Made With Rod

Why carry a heavy grill when lightweight campfire irons will serve the same purpose? The ones shown here are made of $\frac{3}{8}$ -in. cold-rolled rod 24 in. long. They are bent at right angles about 6 in. from each end, and the ends are pointed



so they can be driven into the ground easily. When setting up the irons, drive two of the ends fairly close together and the others farther apart. Utensils with narrow bases are set where the rods are close and larger utensils, such as frying pans, are placed at the other end.

D. E. Horn, River Forest, Ill.

Bell Sinker Snapped Onto Line Frees Snagged Fishing Lure

By using a fairly large bell-type sinker rigged with a treble hook, and a swivel snap to attach it to the fishing line, plugs or spoons that have become snagged often can be worked free. A chalk line is tied to the swivel snap to manipulate the sinker, upper right-hand detail. To release a lure, get above the snag and bob with the sinker.

Francis C. Zuiker, Chicago.

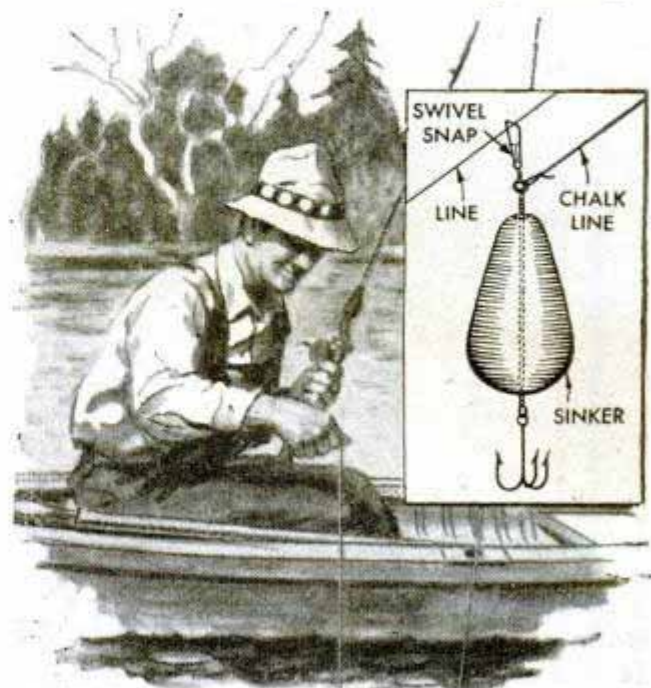

These Sidewalk Skis Furnish Year 'Round Fun

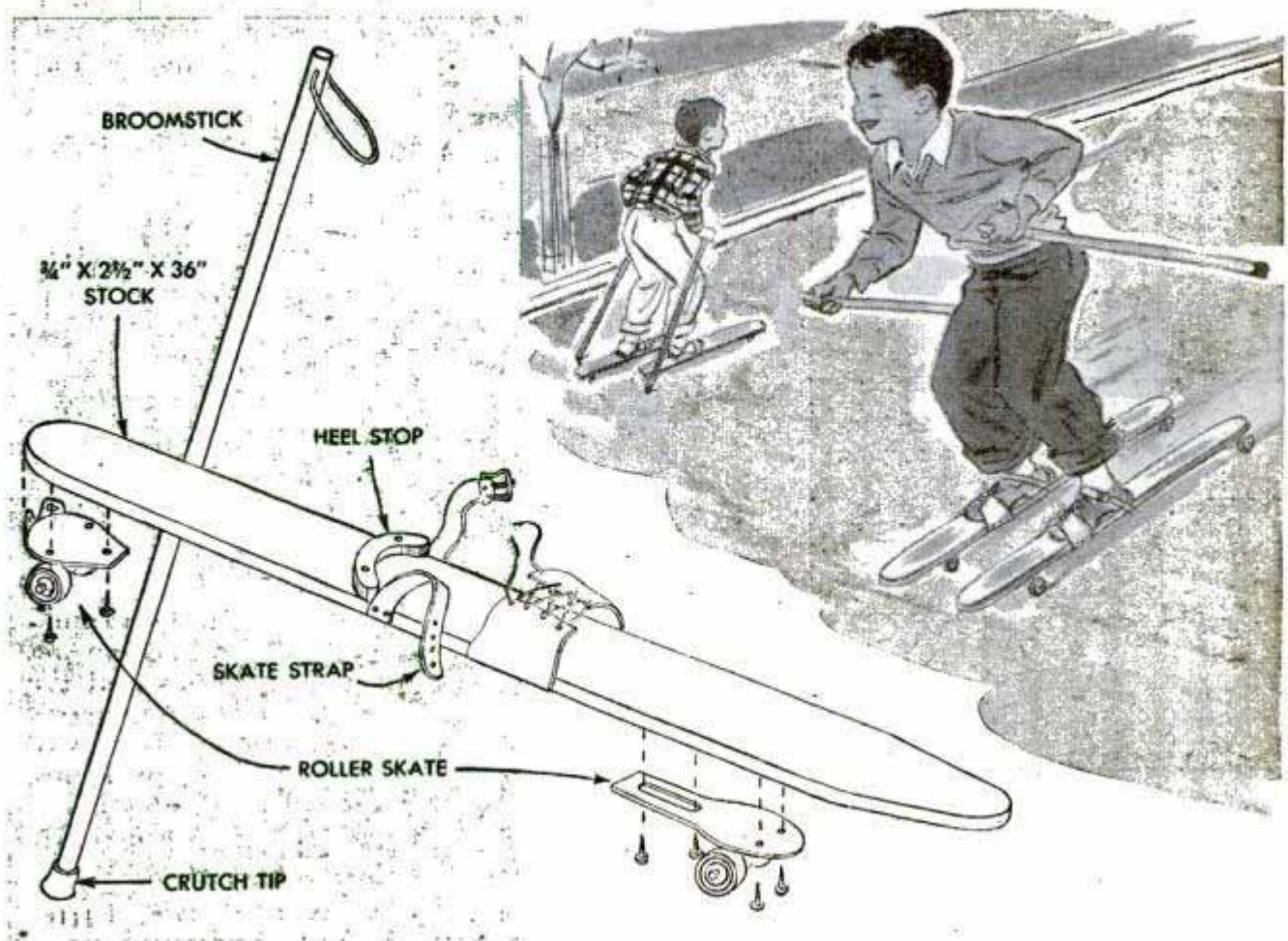

"Ski-skates" would be another good name for such novel funmakers as these. One pair of roller skates, in reasonably good condition, and two 3-ft. lengths of $\frac{3}{4}$ -in. hardwood will make a pair of sidewalk skis. Cut off the "heel" of each roller-skate frame as indicated, shape the ends of the boards and smooth with fine sandpaper and

then screw the two parts of each roller skate in place as shown in the detail. Finish with leather ankle and toe straps and screw a curved heel stop to each ski. Suitable poles can be cut from discarded broom handles. Each is fitted with a wrist loop of strong cord and a crutch tip to prevent slipping.—Harold Gluck, Bronx, N. Y.

Mailing Tube Holds Small Parts for Easy Dispensing

Plugged at both ends with wooden disks and having an access opening cut into the side, a mailing tube makes an ideal dispenser for nails, tacks, screws and other small parts found around the workshop. The upper left-hand detail shows how a baffle plate is fastened inside the tube to control the flow of parts. The reservoir space above the baffle permits the storage of large quantities.

☞ When sending a cake or cookies through the mails you can be sure the pastry will arrive fresh if you pack marshmallows around it. These not only act as humidors to retain moisture, but are an additional treat to the recipient.

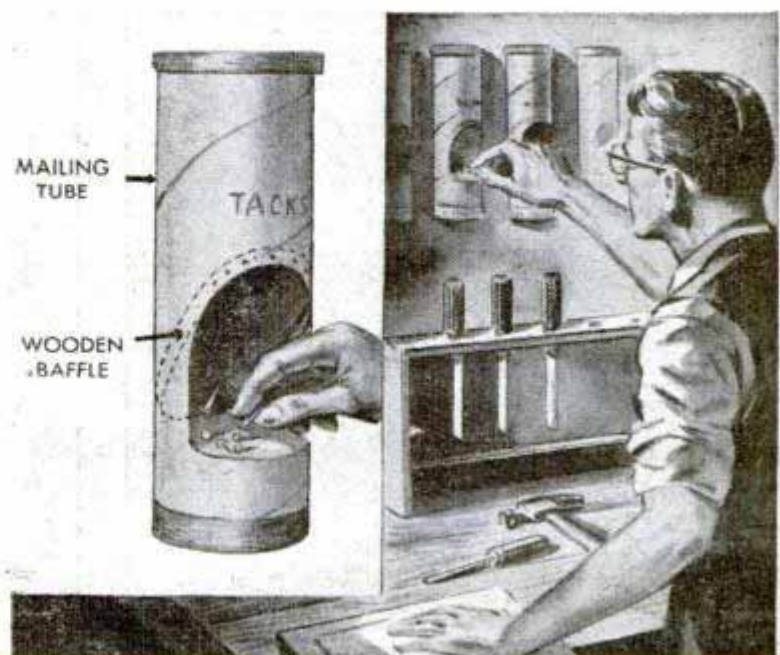

Cover chipped spots on pottery with colored nail polish mixed with vegetable dye to secure an exact match



Caster cups under the legs of an ironing board will prevent its slipping



Keep your sewing machine bobbins handy by placing them on spool racks



Your hat won't fall off the coat-closet hook if a sponge-rubber ball is slipped over the hook. Balls that are gaily colored will add a decorative touch

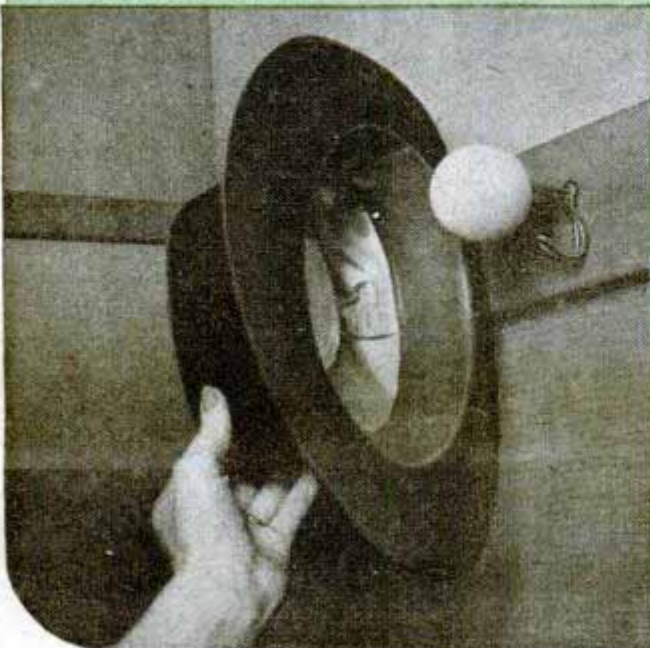

Wooden coat hangers can be made to do double duty by using them as skirt hangers. Fasten screw hooks to the hangers and slip the loops on the skirt over the hooks

Solving HOME

Always at hand when needed, this board is kept beneath the breadbox where it is not in the way. The board slides in two sheet-metal channels which are formed by hand and soldered to the bottom of the box

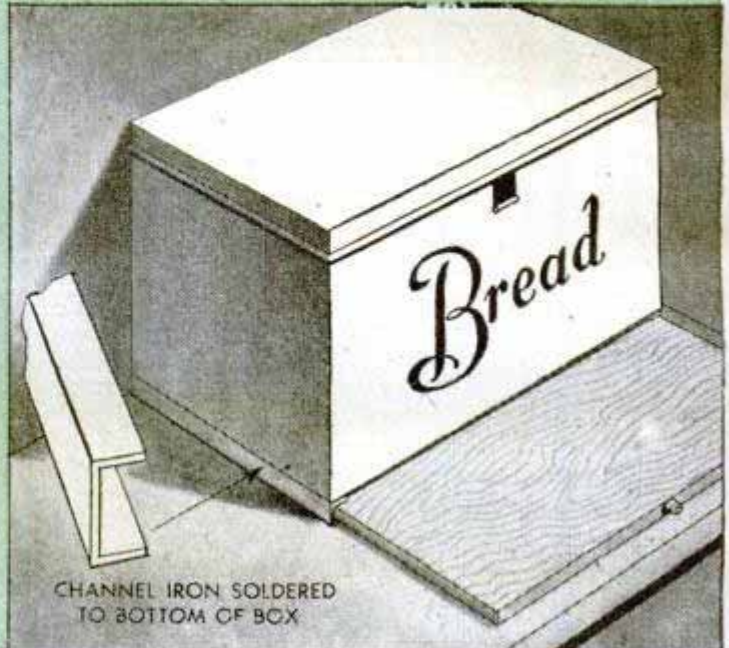

CHANNEL IRON SOLDERED TO BOTTOM OF BOX

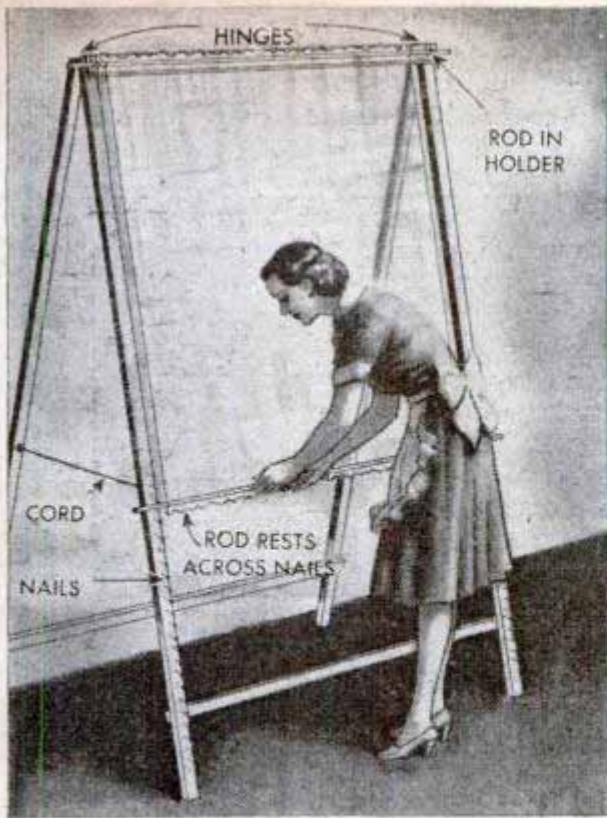

If you want to dry curtains in a hurry, this stretcher will do the job. Sides of the easel must be far enough apart for the widest curtain and the length is adjusted by means of the bottom rod

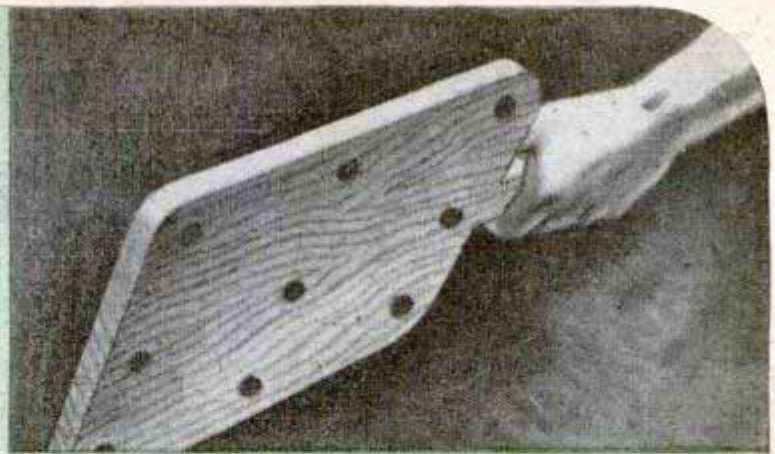

When a number of rubber tacks are fastened to the bottom of a meat or bread board, they will keep it from sliding



Take the work out of waxing and polishing flat surfaces, such as end-table tops, by using a thick, soft, shoe buffer

PROBLEMS

Screw-top jars will make ideal places to conceal valuables around the house. Two possible locations are shown at the side or bottom of a chest of drawers

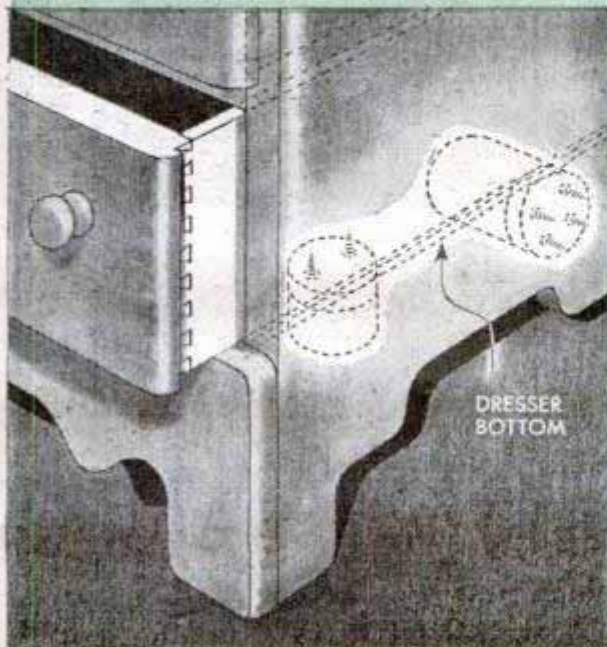

Small particles of food clinging to a waffle iron are removed by using steel wool wrapped around the end of a dowel

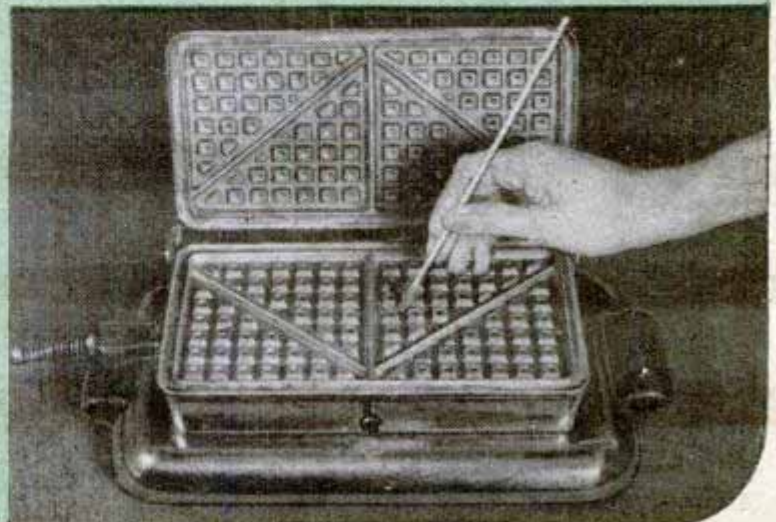

Cast-Concrete Birdbath Repaired With Cement and Screen Wire



If a sizable piece of concrete has been broken from a birdbath, it need not be discarded. Soak the broken piece or pieces and then fit them in place. Cut a piece of screen wire to cover the area and pour a mixture of cement and fine sand over it. This should be a thin layer. As soon as it has set somewhat, smooth and brush the surface. Let the repaired bath harden, propping the broken pieces in place. Finally, when the repair has hardened, sand the rough areas.

Franz J. Serdahely, Philadelphia, Pa.

Candid-Camera Film Cans Used To Make Salt Shakers

Cans that 35-mm. photographic film is packed in may be used as salt and pepper shakers for the picnic basket. It is neces-



sary only to punch holes of the proper size in the tops, which are unscrewed for filling. The shakers can be used in the kitchen also.
Herman Klein, Pittsburgh, Pa.

Eliminating Squeak From Oarlock

After two holes have been drilled into the wooden base of an oarlock at an angle as shown in the circular detail, they can be used to lubricate the oarlock and eliminate the squeak caused by a dry condition. To obtain best results, insert wicks in the holes. Wicks should be kept lubricated.



Slotted Cork Will Protect Gauge

Accidental breakage of the glass gauge in a level can be prevented by slipping a cork guard over the glass when it is not being used. The slot in the cork should be a snug fit over the glass and the cork should be a tight fit in the mounting hole. Cut the cork so it does not project from either side of the level.—Stanley B. Nichols, Cold Spring Harbor, N. Y.

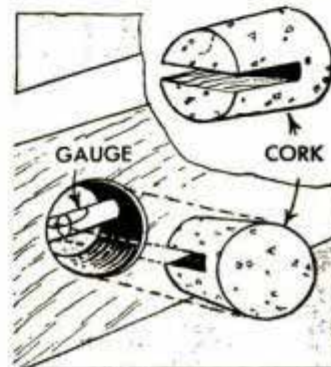

C-Clamp Aids in Cutting Mortise

When cutting a mortise with hand tools for the lock in a door, or doing similar cabinet work, clamp a block of wood on each side of the door where the cut is to be made. These will prevent splitting the door when working close to the edges. The bridge of the clamp is turned so that it will not be in the way.

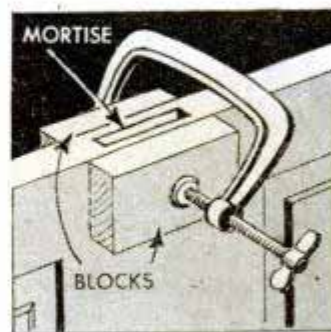

Should you have odds and ends, such as artificial flowers and bits of dry goods, that need cleaning, put them in a fruit jar containing nonflammable cleaning fluid and shake thoroughly. Then rinse with clean fluid and the job is done.

LLB, 139

diag
p. 1



Skim the Waves in this motor-driven paddle board

HERE'S something new in water-sports equipment—a motor-driven paddle board. It combines the common characteristics and seaworthiness of the surfboard and paddle board, but, more than that, it's power driven by a conventional outboard motor. That's the new angle. Smooth, sweeping "hull" lines, crowned deck and low motor hatch make this the sleekest, trimmest little craft you ever looked at. Light enough to be easily launched by one person, it rides rough water like a cork.

The hull, or board, itself is constructed just like the nonpower jobs, except that it is 5½ in. deep instead of the usual 3 in. or so on the conventional surfboard and paddle board. Deck and outboard plan views shown in Fig. 3 give the general over-all dimensions. Note that the motor hatch is placed well forward, giving ample room for a tall man to lie full length aft of it. Con-

trols consist of tiller and speed lever, and a plastic-glass transom permits a view inside the "engine room" from the rear. This, together with a midget headlight, could be lighted from a small storage battery for night cruising. General arrangement of the hull is shown in Fig. 1. Note that three of the bulkheads are only about half the width of the others and serve as deck beams. In the engine compartment is another half-bulkhead on the bottom, and the only one that is not spaced 12 in. on centers. The location of this is determined by the particular outboard motor you select.

In laying out the board, follow the dimensions given in the station layout, Fig. 1, which shows the stations all spaced 12 in. apart. To achieve a true curve, use a 7/8-in.-square spruce or pine batten, and, by bringing pressure at the ends, let it take a natural bend. Drive nails into the plywood

bottom $\frac{1}{8}$ in. outside the station dimensions so that nails will not mar the panel, and at the same time leave material for trimming. The mark should be on the inside of the batten. The deck only is completely streamlined, the bottom having extensions aft which act as planes.

Details of construction are shown in Fig. 1. Side members of mahogany are notched into both nose and stern blocks after bulkheads have been installed. The latter are of soft pine, $\frac{3}{4}$ in. thick, with lower corners cut away for limber holes to permit any bilge water seeping in to flow from one compartment to another. Drain holes plugged with roundhead brass screws are located just forward of bulkhead No. 3 and aft of No. 5. When necessary these screws are removed and the hull tipped to drain.

In assembling, apply casein glue to all edges of the bulkheads and on edges of the side members. Where these parts contact nose and stern blocks, use marine glue. Brass or galvanized flathead screws, 2-in., No. 8 size, are used to fasten parts to bulkheads and to nose and stern blocks. The bottom, which is installed before the deck, is fastened with $\frac{3}{4}$ -in. No. 6 screws spaced 3 in. apart.

Extensions of the bottom serve as planing surfaces and are reinforced with $\frac{3}{4}$ -in. soft-pine stock glued to extensions of the $\frac{1}{4}$ -in. plywood bottom piece. Holes are cut in the full-size bulkheads for the steering cables, as indicated, and should be the same distance apart in each, in this case 11 in., or the width of the cable arms. An opening in the bottom for the propeller unit and various pipe fittings is cut later on. Steering is

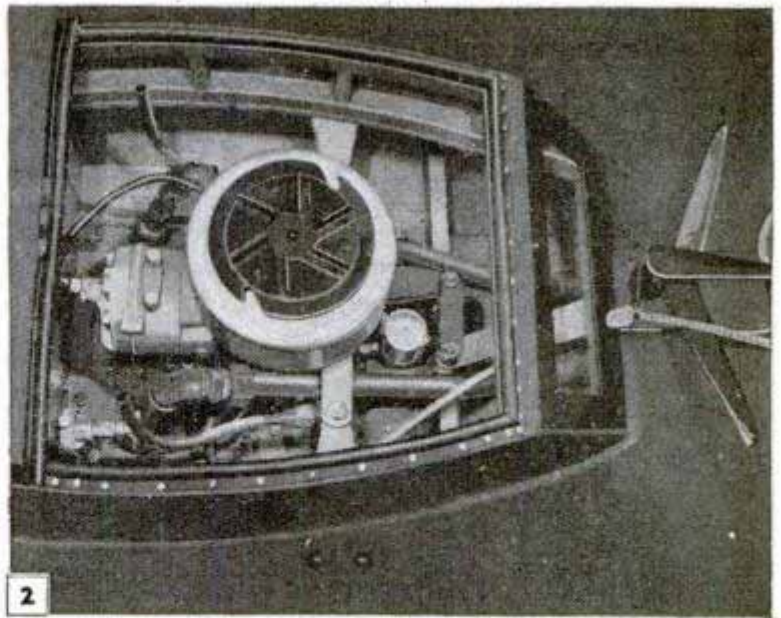

Down view into engine hatch showing all fittings and flywheel fan in place. Note safety cord which attaches to the rider's wrist

opposite that of a bicycle. Pulling the right end of the tiller back causes the board to turn left and vice versa. If one prefers the bicycle arrangement, cross the cables, cutting holes in the bulkheads accordingly.

The deck is cut from $\frac{1}{4}$ -in. waterproof plywood, the same material as is used for the bottom. There are two openings in the deck piece, one for the engine hatch and a circular hole at the stern for steering gear inspection, to be covered with plastic glass and a brass plate secured with roundhead brass screws. Aluminum bent around a scrollsawed framework forms the wall of the superstructure, with a plastic-glass panel in the after end covered with a brass frame and waterproofed with aquarium cement. At the juncture of wall and deck a fillet is made of wood putty, Fig. 1. The forward top is stationary, with a hole for the gas tank filler cap. The rear end is hinged, and both are neatly rounded. Three

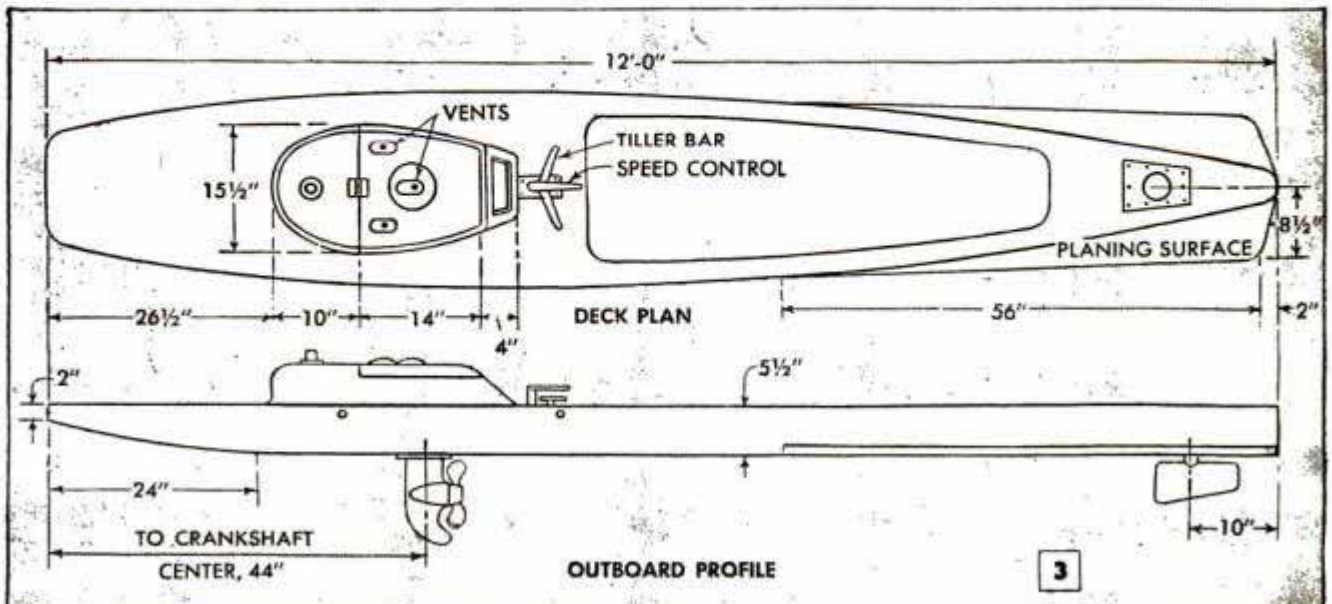

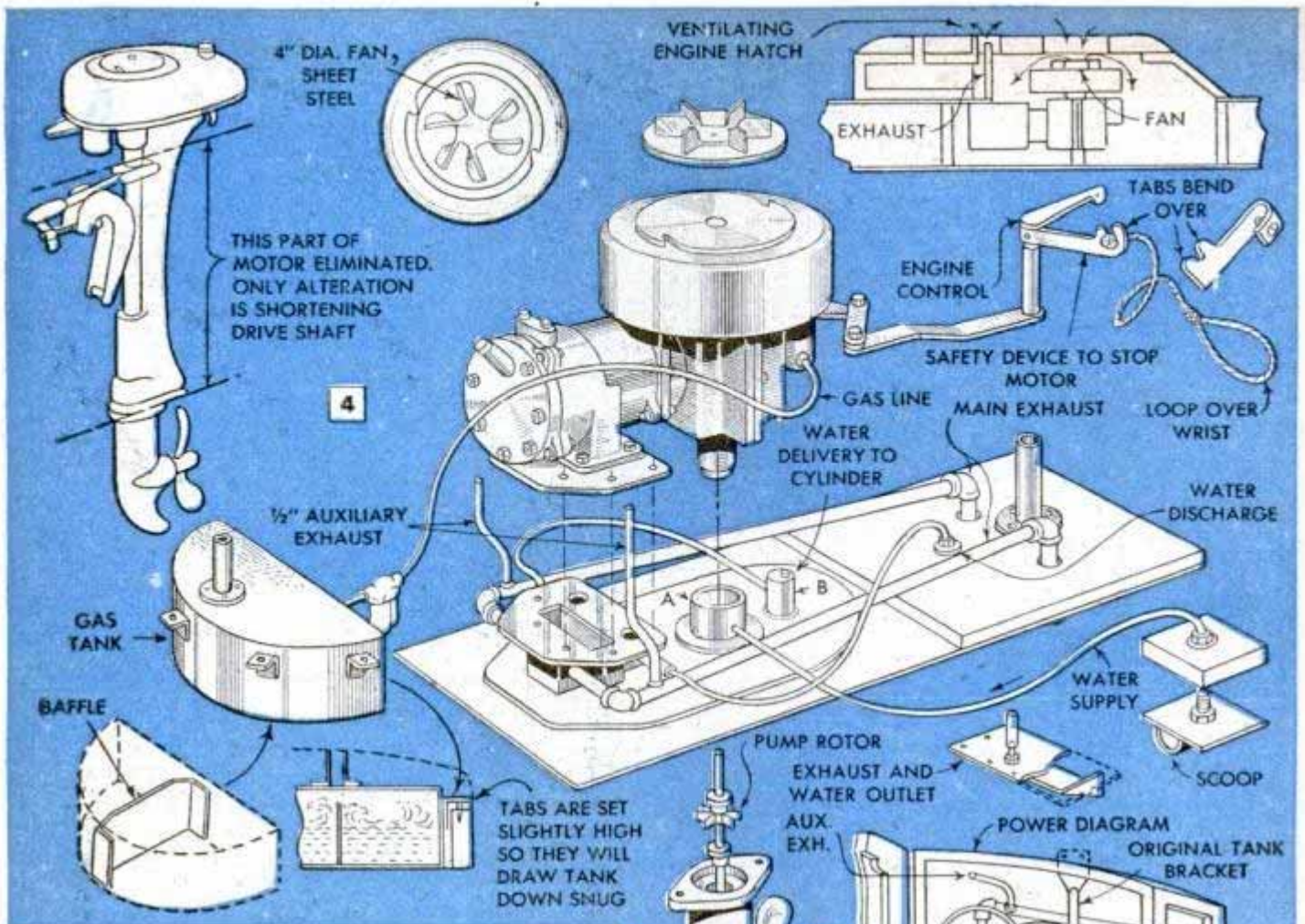

vents are provided in the hinged section and covered with standard scoop strainers obtainable from a marine hardware dealer. Top edge of the open section is fitted with a rubber door seal, making the compartment watertight when closed. A latch is installed at the rear end.

Any small outboard motor is suitable for this craft. In the original a 3½-hp., single-cylinder, 2-cycle motor was used. No alterations were required except removing the parts shown in Fig. 4 and cutting off the drive shaft and filing the end square. A 4-in.-dia. fan bent from sheet steel is bolted to the top of the starting disk on the fly-wheel to ventilate the engine hatch. The engine control unit is fitted with a safety device consisting of a notched arm to which the starting cord is attached. A loop of the cord is put over the wrist. If the rider slips overboard the tug on the cord automatically shuts off the power.

The semicircular gas tank is made of sheet brass, with four tabs, Fig. 4, located so that they will draw the tank down snugly on the deck. A baffle is installed with corners cut away. The filler cap is simply a pipe with a flange brazed to the top. Ventilation by the fan is aided by exhaust from two auxiliary pipes discharging through two forward openings as in the upper right-hand detail, Fig. 4.

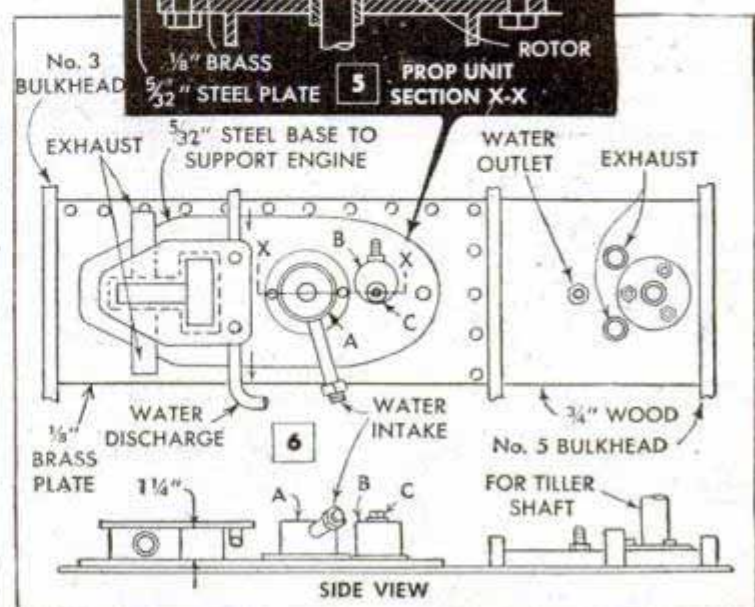
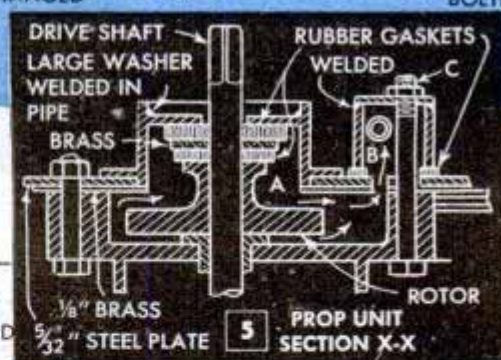
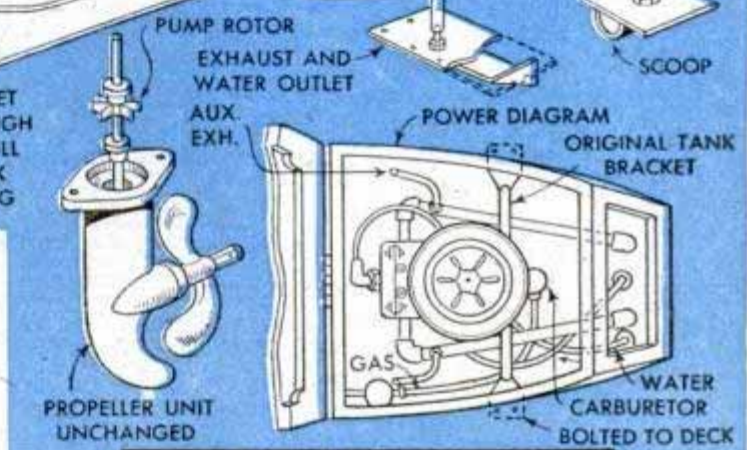

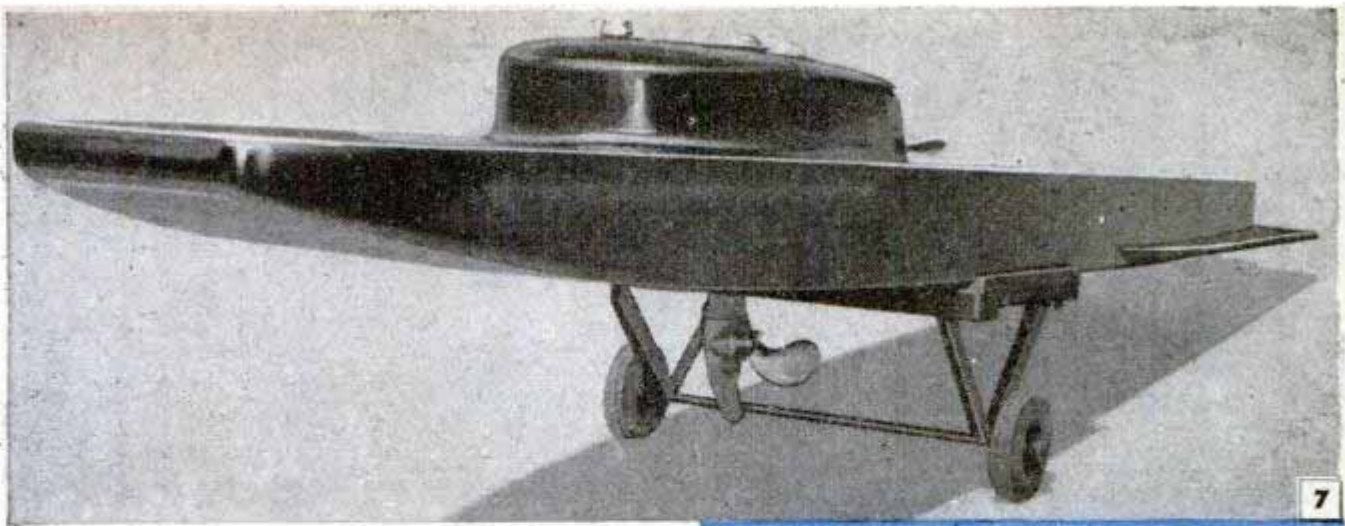

Because of the propeller-shaft extension a launching dolly is necessary. This is designed to fit the hull snugly and makes the craft easily portable on dry land

In order to keep the engine as low as possible, a special base is made upon which to mount it, incorporating connections for water and exhaust, Fig. 7. This is a welding job on $\frac{3}{8}$ -in. steel plate and makes a very compact unit to which the engine is bolted. It rests upon a brass plate bolted to the bottom. A similar plate has the exhaust and water outlets brazed in. Assembly of connections on these two units is shown in Fig. 4. Exhaust pipes are installed as indicated, with an auxiliary exhaust of $\frac{1}{2}$ -in. copper tubing in each adding to the power of the motor by relieving back pressure of the underwater exhaust. The underwater outlets are covered by a reverse scoop into which the cooling water also discharges. The scoop is bolted through the plywood bottom, the brass plate upon which the outlets are brazed, and also through a board on top. This assembly is just forward of bulkhead No. 5.

Water is drawn into part A, Fig. 4, from the intake scoop through copper tubing, delivered from B, Fig. 5, into the engine base, then up around the cylinder and out again to the outlet between the exhaust pipes. All brass-tube fittings are silver-soldered. The housing of the crankshaft bearing fits down in part A and the pump rotor is directly under it in the flange of the propeller unit, Fig. 5. The plywood bottom is cut away to receive this streamlined flange, and is bolted through the brass plate and steel engine base. The rear bolt C, Fig. 5, also passes through part B. The latter consists of a section of pipe with the top welded on and a nut also welded to it. This is offset to allow for the water opening at the bottom, Figs. 5 and 6. Part B is drawn down on a synthetic-rubber gasket. This material is impervious to oil. Washers of this same material are used around the drive shaft above and below a brass wash-

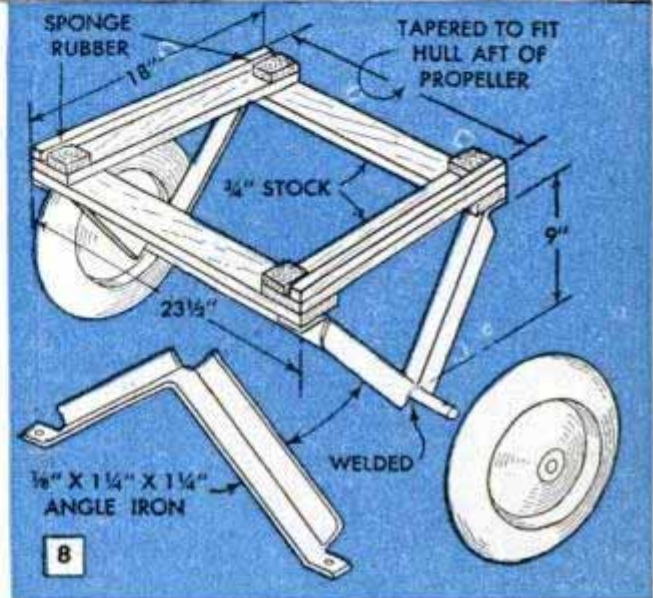

er, part A, forming a watertight joint. Part A is a section of pipe with a washer welded just below the top, forming a cup for the accommodation of the crankshaft bearing hub. Another sectional view of part B is shown in Fig. 5, indicating where the welds are made.

A down view of the power plant is shown in Figs. 2 and 4, indicating how the engine is braced crosswise by extensions on the original tank bracket bolted to the deck.

The tiller consists of a handle bar of heavy sheet metal bent as in Fig. 1 and welded to a collar which in turn is bolted to a $\frac{5}{8}$ -in. shaft. Below deck is another collar with a spring above it. The latter holds the tiller down against a rubber washer, making a watertight joint. The tube for the engine control shaft is high enough above the deck to keep water out.

A simple but sturdy dolly for launching is built as in Figs. 7 and 8 and mounted on balloon-tired wheels for running over sand. The axle is welded to the angle-bar brackets, which in turn are bolted to the cradle. The latter tapers to fit the hull just aft of the propeller, and balances the craft nicely so that it is very easy to handle. Finish hull with two coats of enamel and then wax.

Corner Brackets Decorate Shelves Of Plain Wood Cabinet

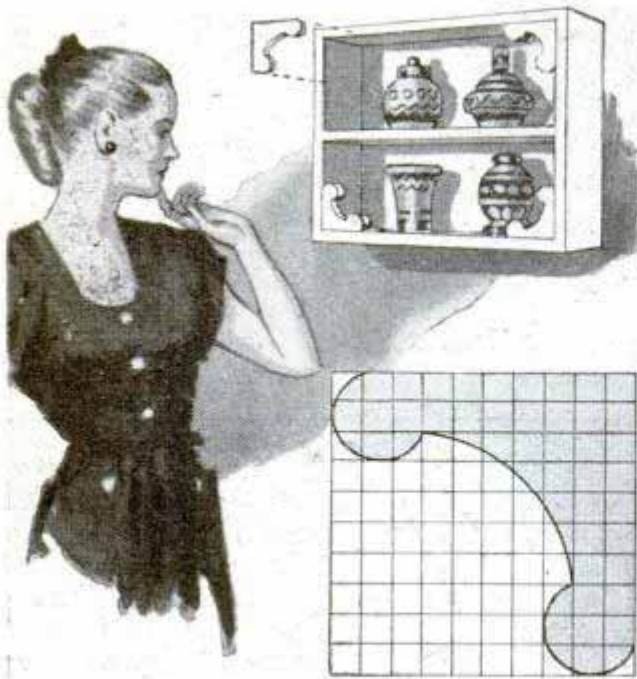

If you have a small cabinet with plain shelves, ornamental brackets like these will add to its appearance. The brackets are scrollsawed from $\frac{1}{4}$ -in. plywood or similar stock and are attached with nails or screws. It is best to draw the design on a piece of cardboard first, then use this as a template for tracing the pattern onto the wood so that all brackets will be the same. They are painted in a contrasting color.

I. M. Fenn, Chicago.

Numerals for Children's Games Cut From Calendar

When constructing games that require numerals, such as dart games, bean-bag boards, etc., use numerals cut from a large-



size calendar. After they are pasted in place, a coat of shellac will make them more durable.—Ronald Eyrich, Milwaukee, Wis.

Coins Are Mailed Conveniently In Gummed-Paper Envelopes

Convenient and safe, these envelopes for mailing coins are made from a 4 by 6-in. filing card and three $3\frac{1}{2}$ -in. strips of gummed tape 2 in. wide. Cut the filing card into three 2-in. strips and fold 1 in. from both ends to the center. Overlap the tape $\frac{1}{4}$ in. at the bottom and seal the open side of the card. This will allow about $\frac{3}{4}$ in. for the flap. Three envelopes are made from one card, each capable of holding up to a 50-cent piece in size.—R. A. Jenkins, St. Louis, Mo.

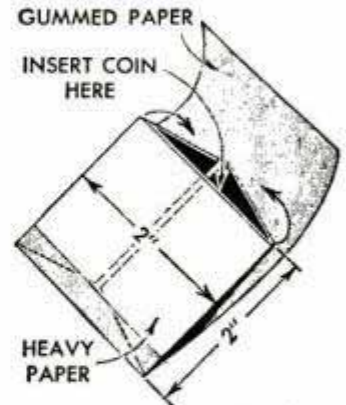

Fuel Tank Should Be Drained If Tractor Is Stored

Should you find it necessary to put a tractor in storage or keep it idle for an extended period of time, it's best to drain the carburetor and fuel strainer of gasoline. Otherwise there is a gumlike substance that will deposit on these parts as the gasoline evaporates and this will impair the operation of the motor. To compare different gasolines and determine which contains the most gum, place several kinds in shallow dishes and let them evaporate. Then compare the deposits that are left.

Bracket Used as Lamp Support

As a substitute for a side-wall lamp, use a shelf bracket and an ordinary drop-fixture socket. The end hole in one of the legs of the bracket will probably have to be enlarged to fit the threaded extension at the base of the socket. In the case of this particular lamp, an ornamental fitting from a chandelier was used to fasten the socket to the bracket, although any fitting with a male thread that fits will do. The cord is attached to a baseboard outlet.—Mabel-Ruth Jackson, San Bernardino, Calif.

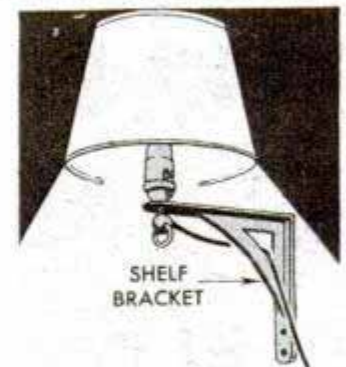

SIFTER-MIXER for garden soil

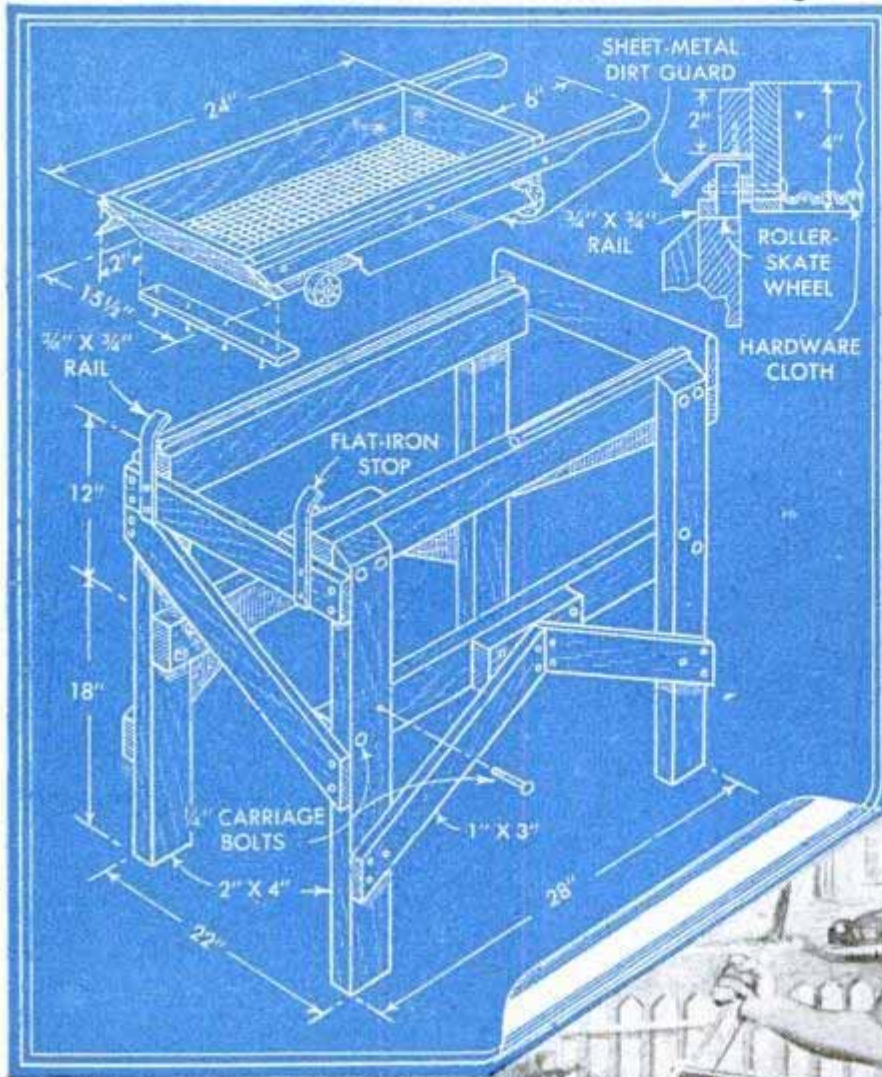

Where a quantity of soil, leaf mold, fertilizer, etc., is to be prepared for special planting it's worth while to build this efficient sifter-mixer. Frame can be mounted on four legs set into the ground and diagonally braced. The screen frame rides on four roller-skate wheels and the track is protected by a sheet-metal guard. After the good soil has passed through the screen the siftings are dumped in the manner indicated. Flat-iron stops prevent the skate wheels running off the end of the track.

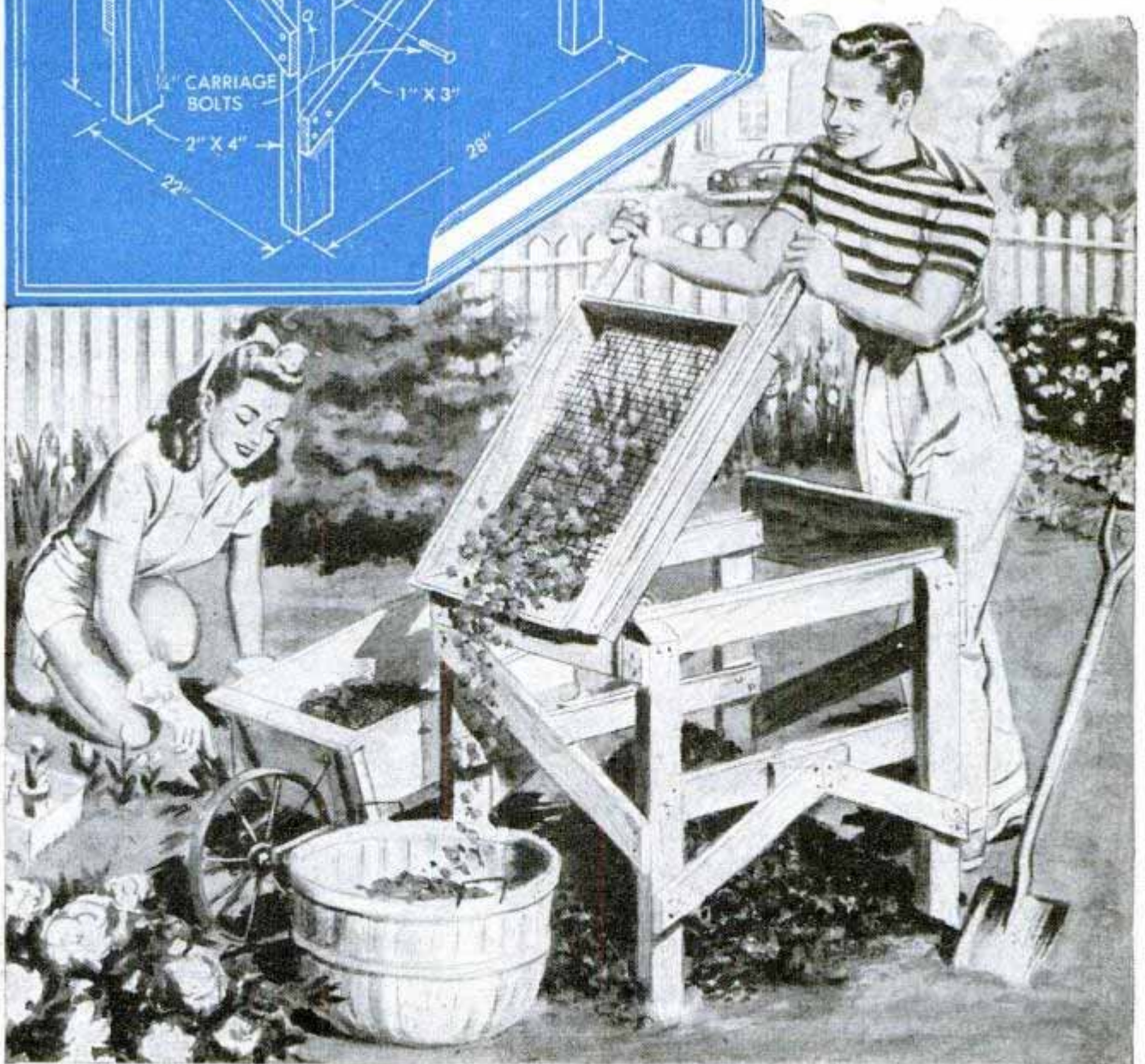

COLOR PROCESSING

for transparencies or prints

UNTIL recently color processing transparencies and prints was one of those things no amateur even talked about doing for himself. But now he can process his own color work. More than that, he can set aside a few evenings and build this processing unit in his own workshop.

The completed unit is shown in Fig. 1, and the tank, which is the principal part of the assembly, is detailed in Fig. 8. It can be cut from a 28 by 34-in. piece of 24-ga. galvanized sheet steel. When cutting the metal allow $\frac{1}{2}$ in. for lap joints at the corners. All joints are soldered and should be tested to be sure that they are leakproof.

Water inlet, as well as the main tank outlet, is made from 2 ft. of $\frac{3}{8}$ -in. copper tubing. A short piece of $\frac{1}{2}$ -in. copper tubing also is required for the wash tank outlet. Obtain a tire valve and cut off enough of the threaded end to expose the release pin so that the valve may be opened by pressing on the pin. To make the necessary bend in copper tubing, plug one end and partially fill with solder which then is melted with a torch. When the solder is cold the tubing can be bent without flattening. After shaping the tubing, melt out the solder, then solder the valve stem to the tubing as in Fig. 8-A. Two $\frac{1}{16}$ -in. holes, Fig. 8-A, drilled

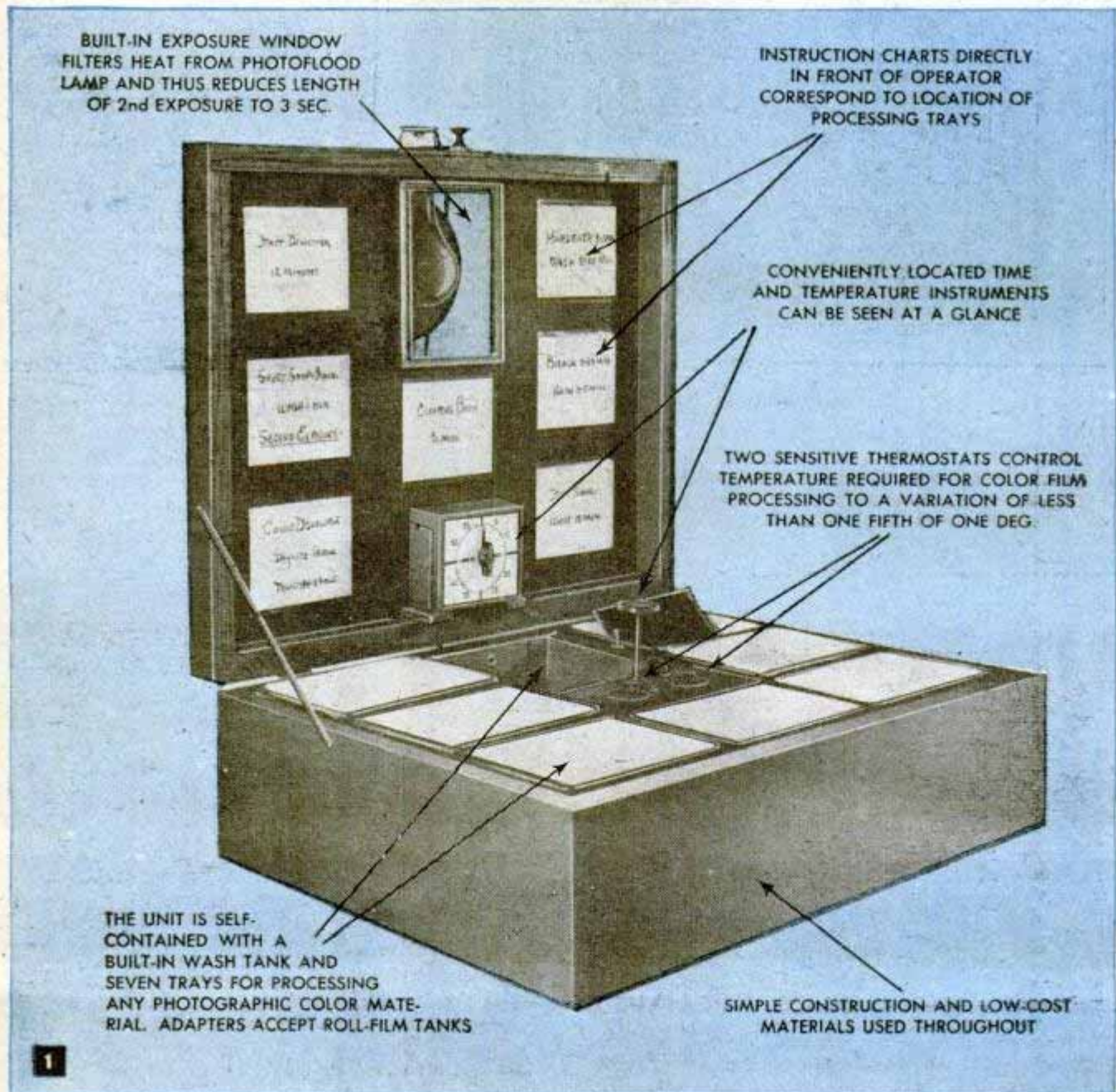

UNIT

By Kenneth Murray

in the side of the inlet pipe where it passes through the wash tank, have a combined opening somewhat less than that of the inlet opening. When connected to a faucet part of the water passes through the valve into the larger tank where it is utilized for cooling purposes. Temperature is controlled by sensitive thermostats. The two holes in the tube keep the wash water in rapid circulation and constantly replenish it with fresh water.

Wash tank, Figs. 4 and 8, has a double wall, the space between the two walls being filled with insulating material. Where the water inlet tube passes through at the bottom of the walls, measure off and carefully prick-punch centers for the $\frac{3}{8}$ -in. holes. With the inlet tube loosely in place, solder the inner wall from the inside, the outer wall from the outside, Fig. 4. Solder the inlet tube in place last, making sure that it is exactly located, with the top of the valve stem $2\frac{7}{8}$ -in. above the tank bottom. Drill holes for the two tubes that serve as an outlet for the wash tank and an overflow for the main tank, using center distances indicated in the detail, Fig. 8, and solder them in place. Control-panel supports are $\frac{3}{4}$ -in. angle pieces bent from strips of scrap 24 or 22-ga. galvanized sheet steel. Bend the ends over as shown and solder in place as indicated in Fig. 5.

Frame for the tank is detailed in Fig. 8 and consists of a wood frame to support the tank so that it can be effectively insulated against heat and cold. The frame sections are mitered and the corner pieces are rabbeted $\frac{1}{4}$ in. to provide a seat for the tank. In assembling, squareness is achieved by the method illustrated in Fig. 6. Corner pieces are braced as in detail B, Fig. 8. A waterproof wallboard bottom is tacked to the frame. Cover the bottom of the frame with a layer of fire-retardant insulation and then place the preheater element on top, as in Fig. 9, so that it will be in contact with the bottom of the tank when the latter is in position. The element is of the type used as an incubator heater, rated at 100 watts.

Control panel, Fig. 7, is the heart of the unit. Two thermostats are controlled with micrometer accuracy by a knob and dial on the control panel. One thermostat applies pressure to the stud projecting from the cold-water inlet valve. The other operates a snap-acting Micro switch in a self-contained "heat well," turning on 15 watts of electric heat to keep the



2 Second exposure requires only a few seconds because light from photoflood lamp is heat-filtered by absorbing glass in window

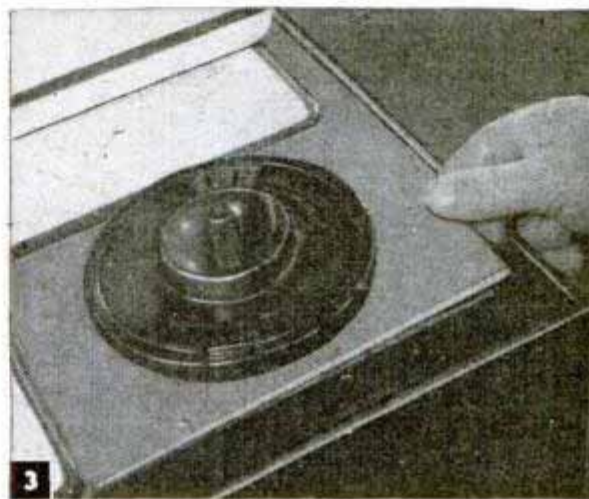

3 Above, by use of adapters roll and cut-film processing tanks fit neatly into the unit. Below, soldering wash tank and insulation retainer in place

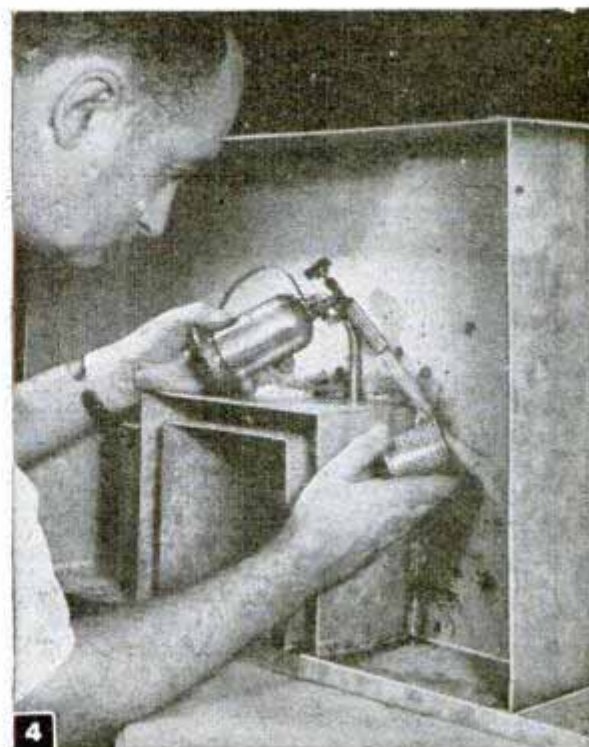

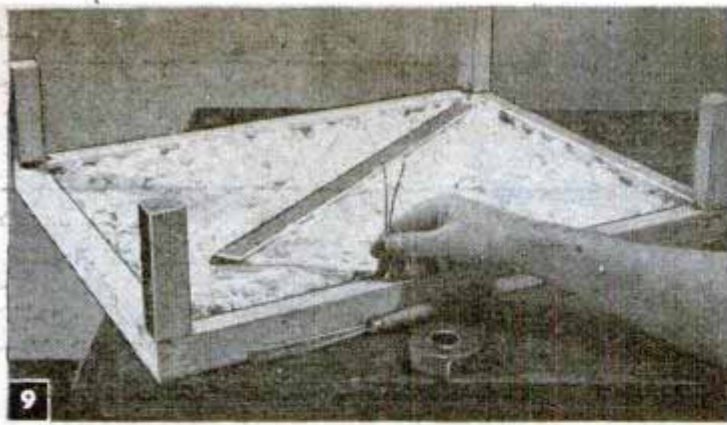

9 Preheating unit is laid directly on top of insulating material with which frame is packed. Protect leads with rubber tape

temperature up to the required degree. The preheater also is wired into this circuit. After the preheater has brought the tank up to temperature, it is shut off by the snap or toggle switch and the heat well takes over. The latter dissipates its energy quickly, responds immediately to the thermostat and therefore is extremely sensitive. The heat well is a short tin can of 3 $\frac{3}{8}$ -in. diameter. Either a Micro or Mu switch is stamped to indicate contacts for normally open or closed circuits. Connections should be made so that the switch is normally closed.

Radio angle brackets having double angles serve as supports for the brass thermostat control bolts. The latter, $\frac{3}{16}$ dia. and threaded to fit the thermostats, should be at least 2 in. long. Two brass nuts are required for each. Solder them on either side of one end of each angle bracket, using the bolt to keep the threads in line. Rivet the brackets to the control panel as in Fig. 10. Details of the assembly are shown in Fig. 7. Radio dial plates are likewise riveted to the face of the panel, Fig. 18.

Heaters are two 7 $\frac{1}{2}$ -watt candelabra lamps. Sockets are mounted on either side of the right-hand angle bracket and are wired in parallel and coated with heat-resisting black paint to avoid light leakage, Fig. 17. A bracket bent from sheet brass supports the Mu switch inside the heat well, Figs. 7 and 11. It is sweat-soldered to the inside wall of the can as shown. Exact distance of the hanger from the bottom of the can is measured with the thermostat in place. The activating stud of the switch should be centered exactly over the pressure plate of the thermostat when the latter is at normal distension, or at a temperature of around 68 deg. F. It will be noticed that a single-angle bracket is bolted tightly over the back of the switch, so as to be under the activating stud. The bracket serves as a pressure plate for the end of the control bolt.

Thermostat and pressure plate are shown in Fig. 12. As the thermostat is of smaller diameter than the can, a wood embroidery hoop, Fig. 12, is split and cut down to make a spacer. Thermostat should not fit tightly. Extra sensitivity is accomplished by covering the thermostat to the top of the bellows with heavy lubricating oil

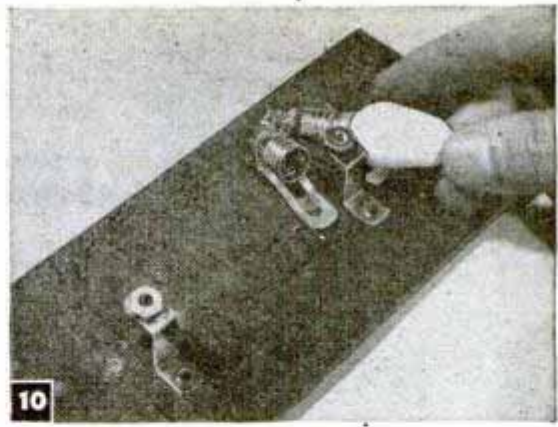

10 Before riveting sockets tightly, test with lamps. Afterward lamp bulbs are enameled flat black

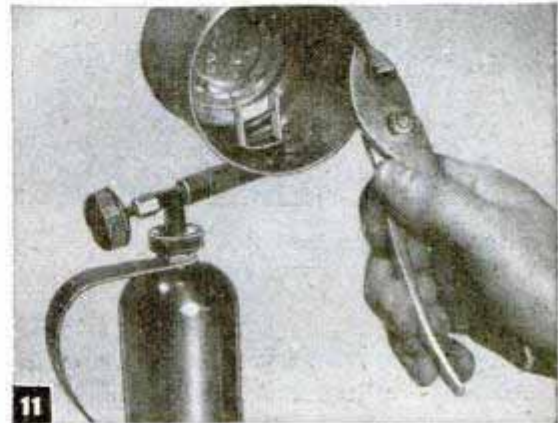

11 Soldering switch bracket inside heat well. Be sure it is properly located above the bottom



12 Section of embroidery hoop serves as a fitting for thermostat, which is covered with heavy oil

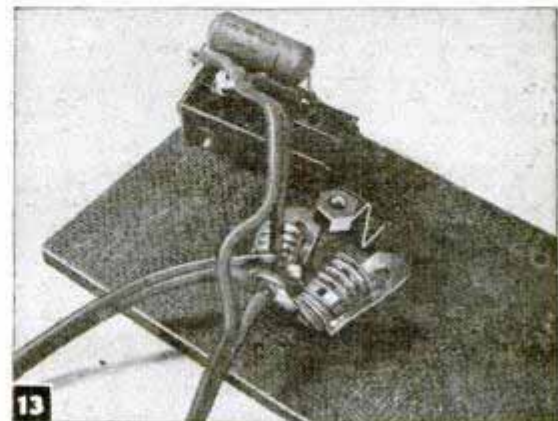

13 Switch and candelabra sockets are wired in series as in Fig. 15 and the preheater connection is made across socket contacts, or lugs



Packing insulating material between walls of unit. Insulation is covered with strips of hard-pressed board

after the control panel is finished. When wiring as in Fig. 15, a .1 mfd. tubular condenser is wired across the Mu switch to eliminate radio interference. Switch is wired in series with the two lamps, and the preheater leads, Fig. 13, are cut in on each side of the pair of lamps. A single-pole snap or toggle switch, Fig. 16, cuts the preheater circuit in and out, but is under thermostatic control at all times and cannot overheat. All connections should be soldered and taped. Completed assembly can be seen in Fig. 17. Heads of the 2-in. control bolts are cut off so that small radio knobs can be fitted as in Fig. 18. Cooling thermostat is screwed onto the lower end of the other control bolt, and the latter is screwed down until the thermostat comes directly over the valve stem of the cold-water inlet as you see in Fig. 19.

Paint the tank with an acid and alkali-proof plastic paint. Apply primer first, then two or three coats of the plastic paint. Do the painting with the tank on edge, Fig. 20. For covering over the outer frame use $\frac{3}{16}$ -in. black hard-pressed board. Fit the tank inside the frame and attach the cover pieces with screws as in Fig. 8. Note that the sides are $\frac{3}{16}$ in. higher than the frame so that there will be space for finishing strips which retain the insulating material.

Figs. 8 and 14 show how the tank is insulated. Attach rubber feet to the bottom of the unit. The hinged cover, Fig. 8, is fitted with a window covered with a $\frac{1}{4}$ -in.-thick sheet of heat-absorbing glass. This means that the film can be held closer to the light source than is ordinarily done. In processing, color films require a second exposure,

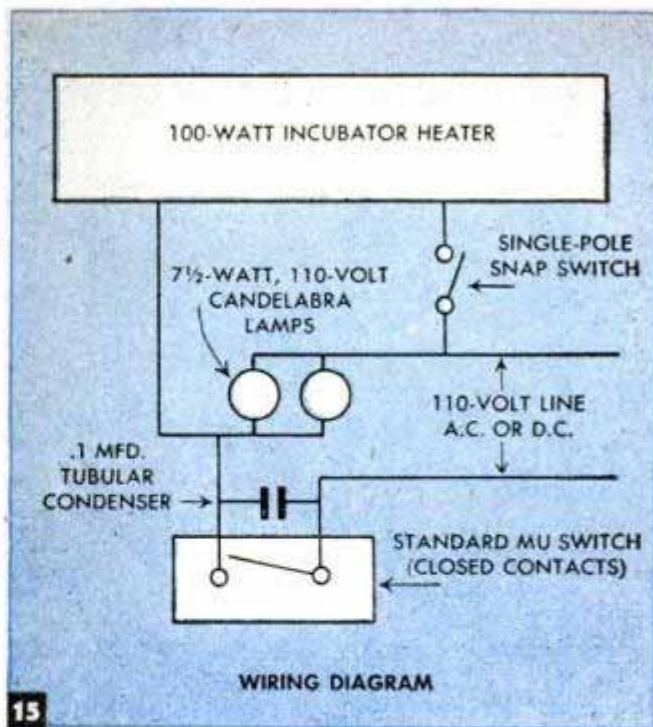
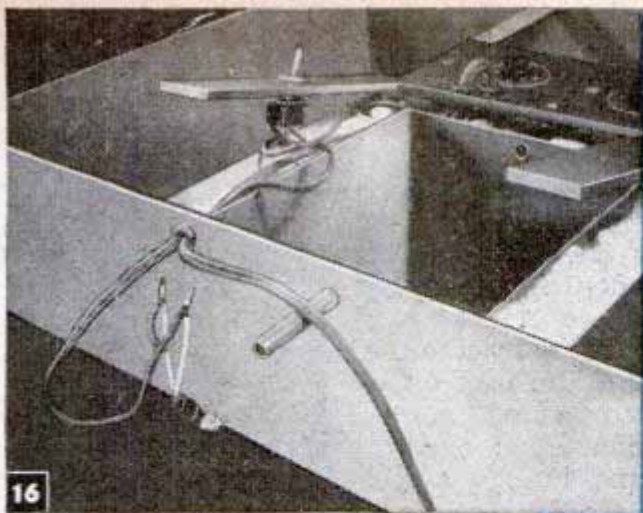
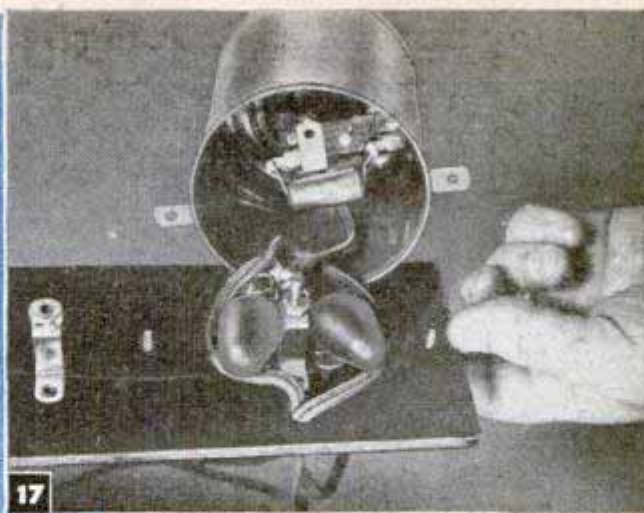

Fig. 2, and with this unit the exposure time is reduced to about 3 seconds by using a powerful photoflood lamp, mounted as in Fig. 21. As the lamp is directly back of the window, illumination will spread in a wide angle. However, when processing roll film, the second exposure will require that the strip be held at a distance sufficient for the entire length to be illuminated, or it will be necessary to move the strip so that the ends receive exposure equal to that at the center. The fixture is detailed in Fig. 8, and consists of a piece of hard-pressed board, a porcelain sign socket and an old photoflash reflector. A No. 2 photoflood lamp is used. As shown in Fig. 21, the fixture is held in place on the cover by an ordinary screw-type drawer knob which provides adjustment for locating the lamp.

Regular equipment consists of seven 4x6-in. porcelain enameled trays which fit on the tank. Processing is done from left to right and, to make it easier to keep proper sequence, instruction sheets are attached to the inside of the cover, Fig. 1. These occupy the same relative position as the trays and information on them pertains to the corresponding tray. On each card, letter or type the necessary data, such as description and time, for that step. Number them if you wish. Use a stiff cardboard and cover the face with Cellophane to prevent soiling. If you use more than one kind of color material have an alternate file of data cards for each. Use art corners to hold the cards in place on the cover. A set of roll-film tanks can be substituted for the trays by the use of adapters, detailed in Fig. 8-C and also in Fig. 3. To set up the unit for processing, connect the inlet tube to a water tap with a length of rubber hose. Attach another to



16



17

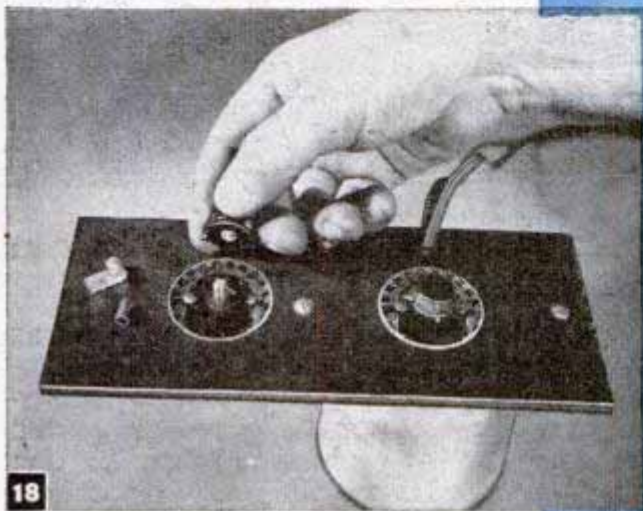

18

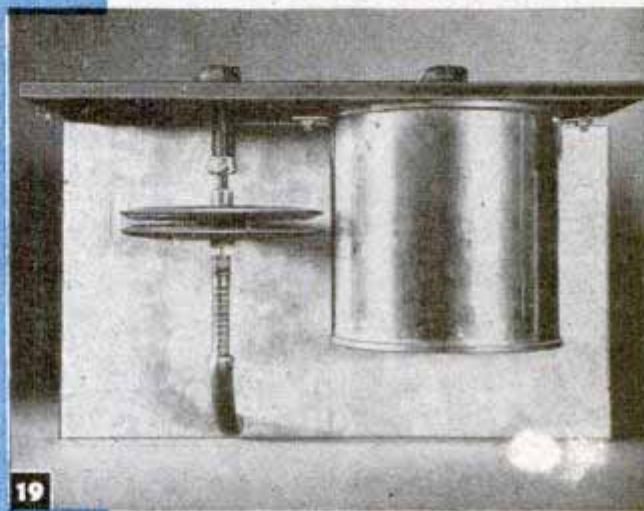

19

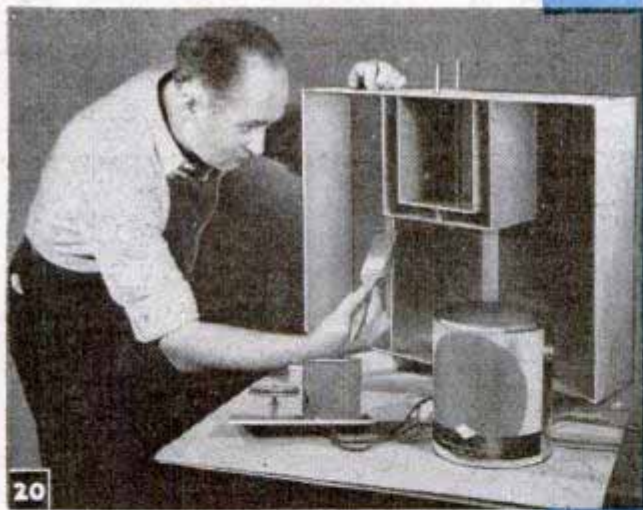

20

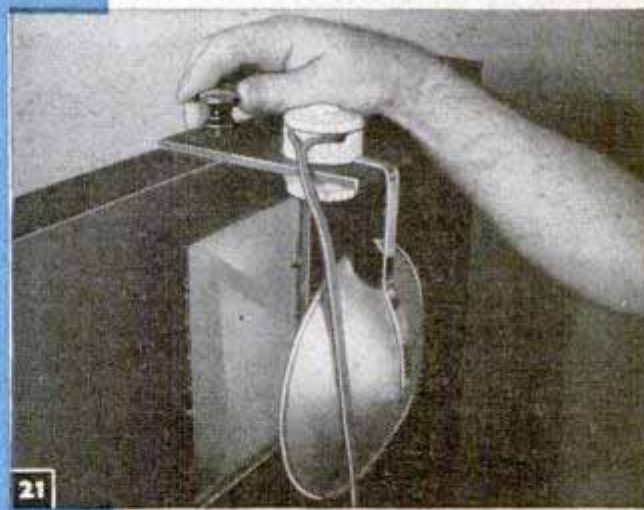

21

the outlet pipe and lead it to a drain. A third piece of hose is useful for filling the tanks for the first time. After the tanks have been filled, open the cold-water faucet just enough to circulate water rapidly in the wash tank. Insert dial thermometer through opening in the control panel and note temperature. If it reads above 68 deg. F., adjust the cooling thermostat, on the left side of the panel, by turning the knob to the right. Adjust to the desired 68 deg. Then loosen the locking screw of the knob and set it at the 68-deg. position on the dial plate. If the thermometer should read be-

low 68 deg. F. in the first test, switch on the preheater until water is warmed to that temperature. Turn off the preheater and adjust the heat-well knob. When you turn the knob to the right until there is an audible "click," it indicates that the switch is open. On turning the knob to the left there will be another click and the current will be on. Leave the knob in the "on" position until the thermometer registers exactly 68 deg. Now turn the knob to the right until you hear the click, then stop. This is the correct setting. Loosen the lock screw and position the knob.

Quickly Improvised Lens Shade

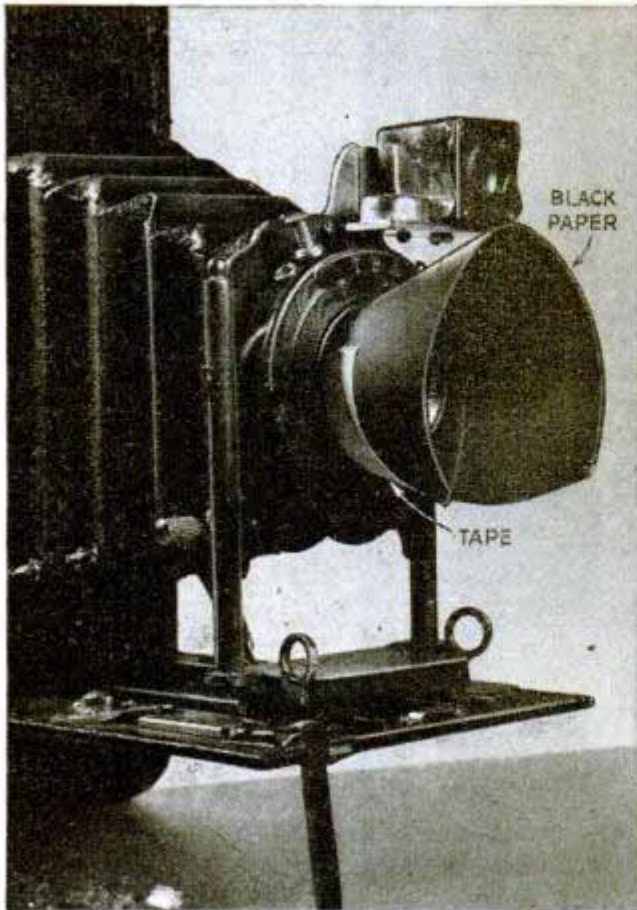

If you're taking pictures outside and find you have no lens shade at hand, one can be improvised by using black paper. Roll it into a cone that will slip over the lens and attach it with tape.

Kenneth Murray, Colon, Mich.

Tape Marks Position on Trimmer

When it's necessary to trim photographic paper under a dim light, make the work easier by marking off the distances on the trimmer with adhesive tape.

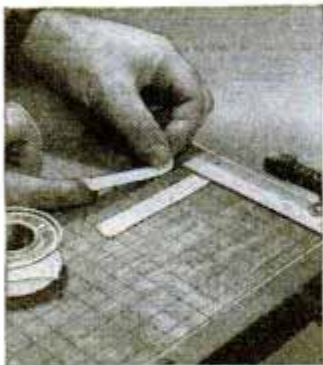

trimmer with adhesive tape. This can be done ahead of time and the marks will stand out in a dim light. If working in total darkness, the strips can be located by touch. The tape is easy to remove.

Burning-Title Effect for Movies

For the movie maker who likes titles that are unusual, this burning title will furnish variety. Paint the wording on a sheet of clear Cellophane with colored nail polish. Then paste stiff cardboard at each end of the sheet so it will slide into the title holder. Place the holder in front of a scenic view

or enlarged photograph to serve as a background. After taking a few frames, light the bottom of the Cellophane evenly and continue photographing as the title burns.

Small Film Will Fit Large Holder

Small sizes of sheet film can be used in larger holders by mounting the film on a sheet of cardboard, as shown, and inserting this in the holder. Mark off the area of the smaller negative on the ground glass to guide in composing the picture.

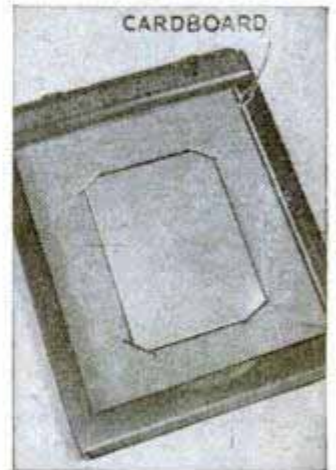

Measuring Cup Used in Darkroom To Make Up Solutions

An ordinary glass measuring cup, such as is used in kitchens, makes an ideal darkroom graduate to make up photographic solutions. These cups usually are graduated in ounces and may be used when diluting developers and fixers. They can be obtained in half-pint, pint and quart sizes to cover a variety of needs. The pouring lip avoids spilling and the handle allows such cups to be used without staining the fingers.

Bob Hurst, Chicago.



CRAFT QUIZ



1. A square of roofing covers—
 (a) 10 sq. ft. (c) 1 sq. ft.
 (b) 100 sq. ft. (d) 5 sq. yds.

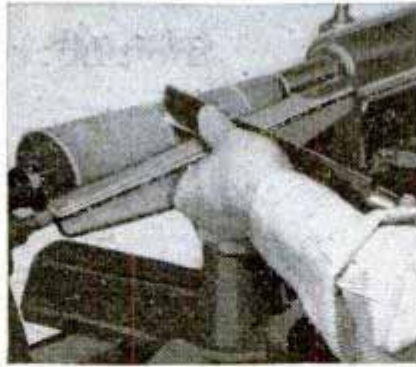

2. Wrong in turning taper is—
 (a) Kind of chisel (c) Hand position
 (b) Turning direction (d) Tool rest



3. This is a—
 (a) Circular saw (c) Dado saw
 (b) Hole saw (d) Keyhole saw

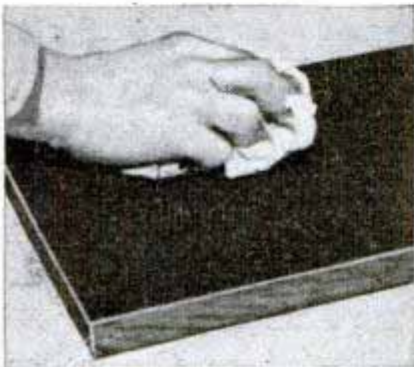

4. Staining with—
 (a) Oil stain (c) Water stain
 (b) Spirit stain (d) NGR stain



5. She is leaning on the—
 (a) Baluster (c) Riser
 (b) Newel (d) Corner post

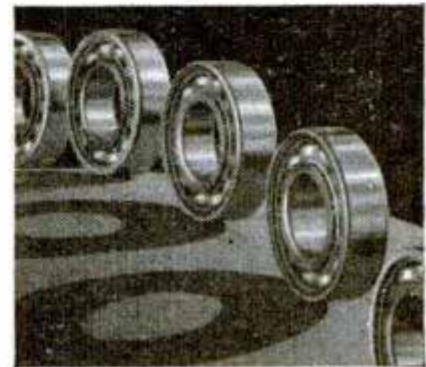

6. In wood lathe these might be—
 (a) No. 3 bore (c) No. 16 bore
 (b) No. 10 bore (d) No. 22 bore



7. This wood grain is—
 (a) Mottle (c) Crotch
 (b) Burl (d) Feather



8. He is mixing—
 (a) Purple (c) Orange
 (b) Green (d) Tartrazine

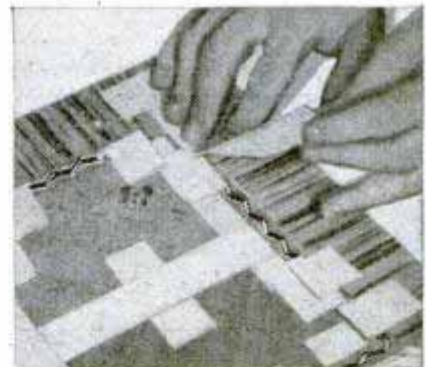

9. This kind of work is—
 (a) Inlaying (c) Veneering
 (b) Parquetry (d) Herringbone

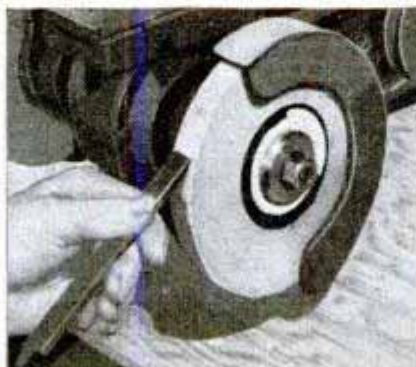

10. Best wheel for tools—
 (a) Aluminum oxide (c) Silicon carbide
 (b) Emery (Turkish) (d) Green grit

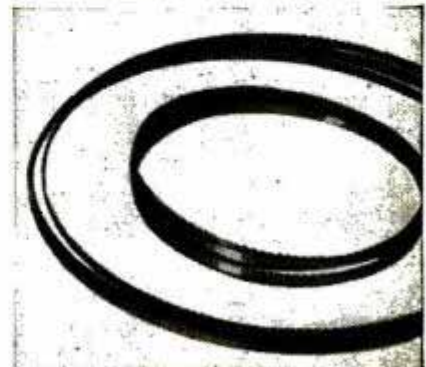

11. Bandsaw folded in—
 (a) 4 loops (c) 2 loops
 (b) 5 loops (d) 6 loops

ANSWERS: 1—b; 2—b (taper should be turned downhill to prevent digging-in); 3—b; 4—c (others are not wiped); 5—b; 6—a (approx. 1 1/16" dia. hole); 7—b; 8—b; 9—c; 10—c; 11—b (either 3 or 5 loops as shown but not 2, 4 or 6)

Raffia Used to Repair Creel Makes Permanent Patch



When the fibers in a fishing creel break, or when it starts to fray and pull loose around the edges, repairs can be made with raffia, which is obtained at most florists' shops. Place the raffia in a pan of warm water for a few minutes, then remove and stretch it slightly. The repair can be made more easily if the raffia is threaded through a bent sailmaker's needle. Shrinkage of the material will make the patch more secure.

Blackboard Eraser Holds Chalk

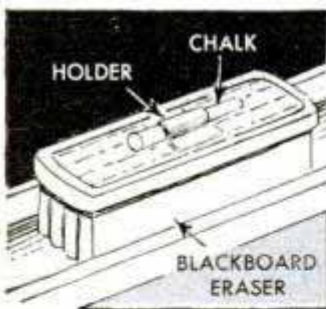

As a convenience, one teacher attached a holder for a piece of chalk to the back of a blackboard eraser. Then, when moving from one board to another, the chalk, as well as the eraser, was always at hand. The holder is made of inner-tube rubber and should fit the chalk tightly.

Hinge Serves as Bending Brake

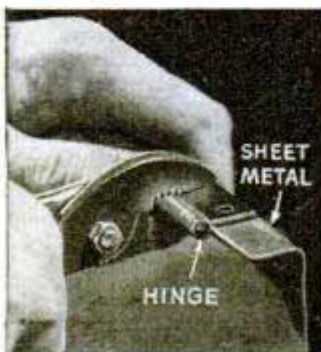

If you want to shape a small piece of light sheet metal, a butt hinge makes a good bending brake. Using pliers alone may produce a bend that is uneven, but if a hinge is held in the pli-

ers, sufficient area is covered to obtain satisfactory results. For most jobs the hinge should be about 3 in. long.

A. H. Waychoff, Phoenix, Ariz.

Bolt Lock for Basement Window

Hidden from outside access, even if the window is broken, this lock will foil the efforts of intruders to get into a house through a basement window. It is made from a bolt-action lock. A

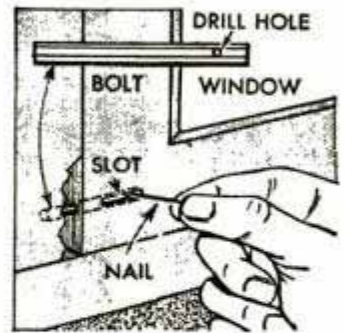

hole is drilled into the lower corner of the sash and frame so the bolt can slide completely into the sash to open the window or slide partially into the frame to lock the window. A slot is cut into the bolt hole on the sash side and a hole drilled in the bolt will permit using a nail to slide the bolt into the open or closed position.

Fishhook Embedded in Float Cork Adjusts Line Automatically

Fishermen who like to fish with a float or bobber attached to the line will find this rig handy because it will automatically adjust the bait to the varying depths of a lake or stream by permitting the line to slide through the eye in the hook. As the right-hand detail indicates, the cork is slit and the barb embedded in the top so that the eye extends out from the bottom. The line is threaded through the eye. By keeping the line fairly taut, the hook will be suspended off the bottom and not snag easily.

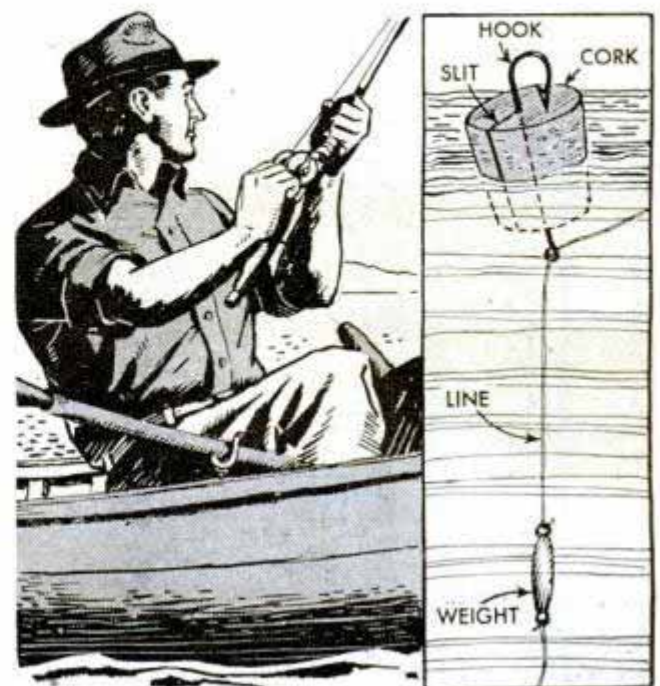

Shop Notes

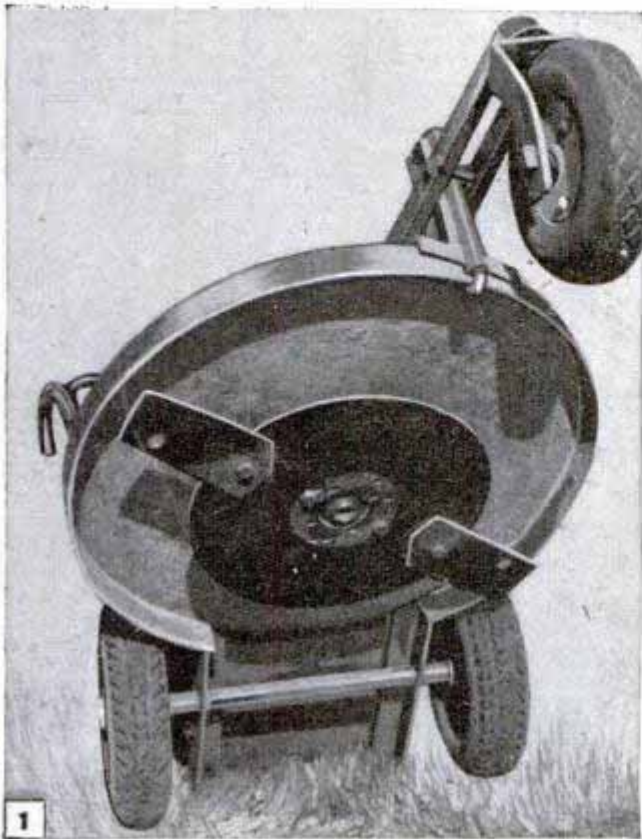

MOW'EM DOWN WITH THIS ROTARY CUTTER

By Benj. Nielsen

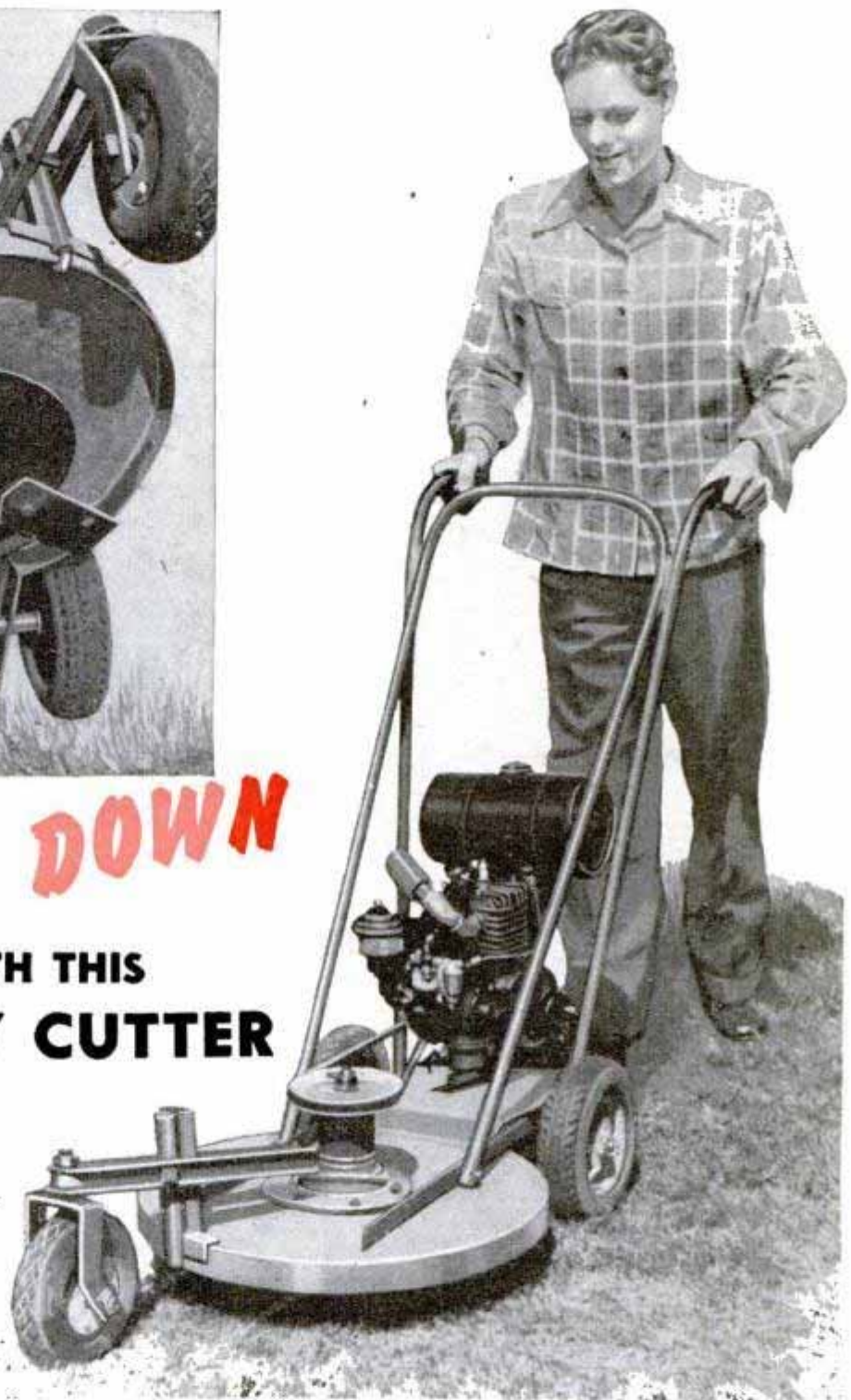

POWERED by a 1½-hp. air-cooled engine, the rotating blades on this powerful mower cut everything from dandelions to the tallest and toughest weeds. An outstanding feature of this machine is that the front wheel may be set to either side of the cutting path to avoid rolling down uncut grass. This insures clean cutting with no ridges left standing. Also note that the center of gravity of the engine is well back

of the rear wheels to secure a nice balance.

The engine platform and guard for the cutter blades are cut and bent from a piece of No. 10-ga. sheet steel to the dimensions given in the upper right-hand detail of Fig. 2. Then a band of flat iron is welded around the edge of the guard. Two lengths of 1½ by 1½-in. angle iron are welded to the top of the guard and the bottom of the platform to give additional strength and

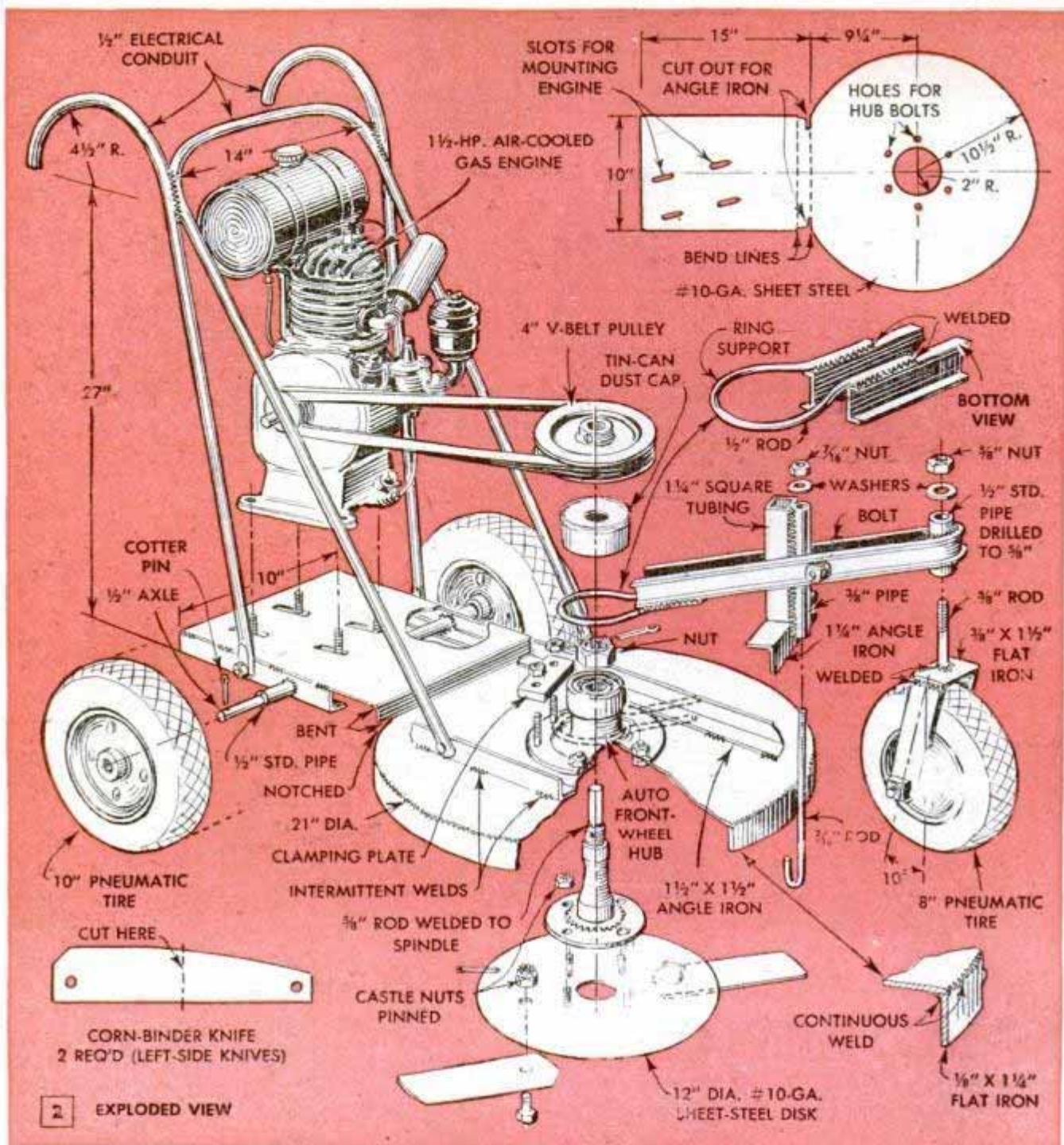

furnish mounting surfaces for the handle and the rear-wheel sleeve bearing. The cutter assembly consists of a cut-down spindle and hub from the front wheel of an auto. A short piece of rod is welded to the spindle and threaded for a castle nut. This rod also serves as a shaft for the driven pulley, center detail. As shown in the lower left-hand detail, the cutter blades are made from two corn-binder knives and are bolted to a 12-in. disk of No. 10-ga. sheet metal. After these parts are completed, the disk is bolted to the spindle, the hub is bolted to the guard and a V-belt pulley and tin-can dust cap are fitted for a trial assembly. The parts should turn freely and be in line, Fig. 1.

The front-wheel assembly, which consists of an adjustable arm, a clamping plate

that bolts to the auto hub, and a fork, are illustrated in the right-hand center detail of Fig. 2. The height of the arm, and consequently the height of the cutting blades from the grass, is adjusted by means of a J-bolt and sleeve that fit between the two sides of the arm. In addition, the arm furnishes a means of lateral adjustment so the wheel can be set to either side of the cutting path. The rear wheels ride on an axle that turns in a pipe-sleeve bearing welded to the platform angle iron. When slotting holes for the engine mounting, notice that these holes are off center and at an angle so the centers on the driving and driven pulleys will line up correctly. To complete the mower, form the handle and brace of 1/2-in. rigid electrical conduit.

Modified Heater Tank Will Carry Tools

Pipe fitters, plumbers and others who carry a large number of tools on a job will find this box, which is made from a domestic hot-water tank, a convenient carryall for everything from a can of white lead to a 36-in. Stillson wrench. The tank is cut in two lengthwise, the top part that serves as a lid being smaller than the lower portion, which is the box proper. Hinges and a hasp are welded in place. When cutting and welding galvanized metal, always work outdoors or, if inside, be sure there is sufficient ventilation. Otherwise the fumes will be obnoxious. Flat-iron braces to support the box are bolted to the side of the truck, using lock washers to hold the nuts securely.

W. S. Head, Miami, Fla.

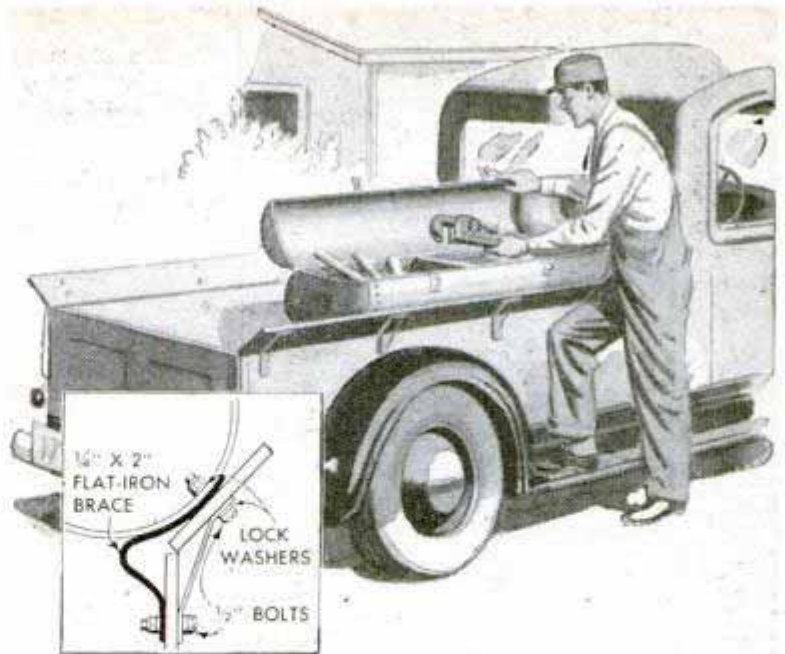

Numbered Tacks Mark Zones For Delivery Routes



Numbered tacks of the type used to mark windows and screens make good zone markers when laying out delivery routes. The zones are laid out on a map of the city and the number

assigned to any delivery truck is placed on the territory to which the truck is assigned.—Opie Read, Jr., Chicago.

Copper Lining Held in Vise Jaws

It's a common practice to insert strips of sheet copper between the jaws to avoid damaging the work when clamping soft metals in a vise. However, the copper sheets have a habit of dropping from between the jaws, resulting in lost motion and time in picking them up. To avoid this, one metalworker notched the ends of the

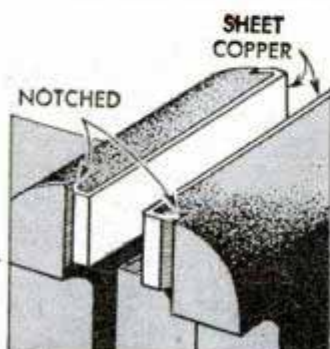

jaws and slipped the ends of the strips into the notches. Although the strips are easy to remove, when fastened in place they will not drop out easily.—Clarence Klumb, Rockfield, Wis.

Decalcomanias Removed Easily

When redecorating furniture, walls or other painted surfaces, it is often necessary to remove decalcomanias. Ordinary scraping is tedious, but if acetone, which usually is used as a nail-polish remover, is applied to the decalcomania it can be lifted off with ease.

Charles H. Hardy, Los Angeles, Calif.

Mirror on Clothier's Mannequin Shows How Suit Looks

To show a customer how a suit will look on him, without his having to change clothes, one clothier placed mirrors on mannequins or clothing forms in such a manner that a customer facing the form would see his reflection in the mirror as though wearing the suit. If several mannequins are fitted with mirrors, a customer can "try on" a number of suits in a short time.

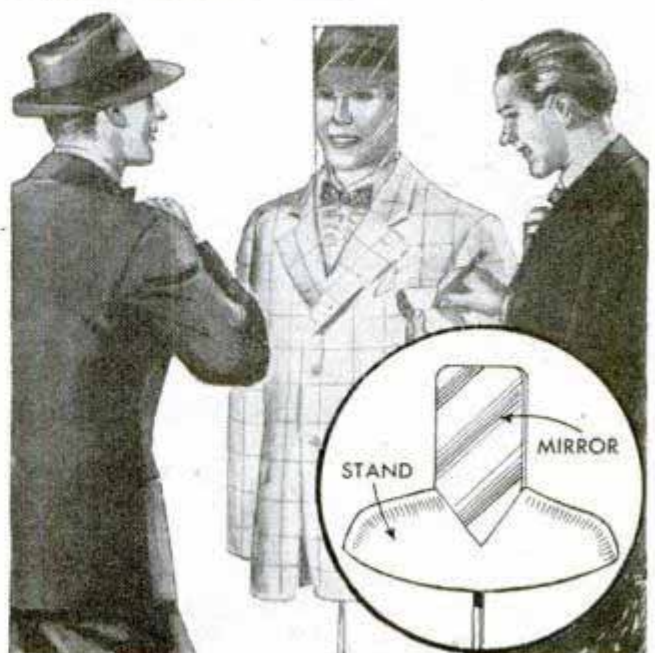

6 REASONS FOR



Here's a typical installation with telescoping ducts leading from a wind tunnel built across one end of the mow

IT'S possible to put haymaking on a 4-hour schedule when you use the new methods of field processing and cure the hay in the barn with this electric drying unit. From the mower to the drier the whole process practically eliminates the hazards of field curing and results in a roughage of far better feeding quality. Loss of the valuable leaves, one of the most nutritive parts of the plant, is reduced to the minimum as the material is handled while still green. Figs. 1 to 5 inclusive detail a typical installation using a propeller-type fan, Fig. 2. The centrifugal, or blower-type, fan also can be used in this same installation. As you can see from Figs. 1 and 5 the unit consists of a wind tunnel, usually built across one end of the haymow, and a series of lateral air ducts extending across the mow floor at right angles. The wind tunnel is constructed of plywood nailed to a rigid framing and is made as nearly airtight as possible. Doors are fitted at both ends, one allowing access to the interior of the tunnel, the other opening and closing the air inlet. Ducts are open at the bottom and cleats raise them $1\frac{1}{4}$ in. from the floor to allow air circulation. As you see in Fig. 4, the ducts are made in two parts so that they telescope. The opening into each duct from the wind tunnel is provided with a sliding door, Fig. 3. That's all there is to it, except to say that the usual practice is to distribute the chopped hay over the mow floor to a uniform depth of about 9 in. Also, a movable wall, Fig. 5, can be provided to keep the material within a given area.

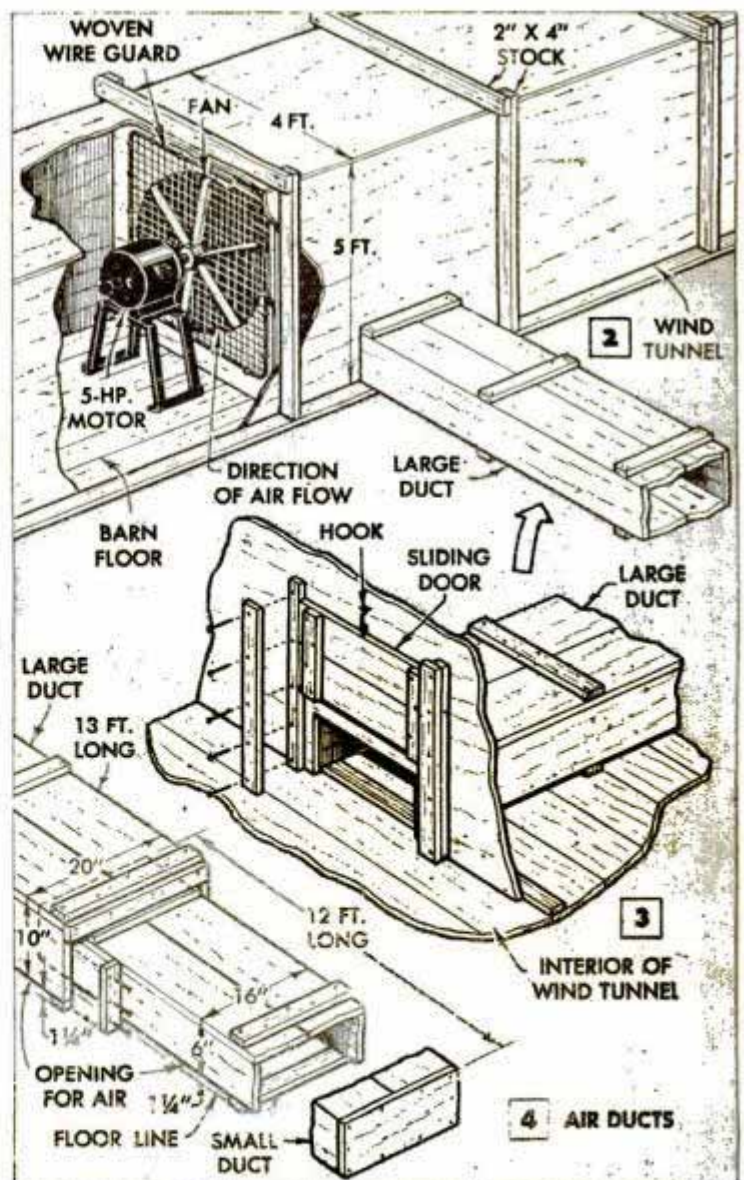

BUILDING A CHOPPED-HAY DRIER

- 1** Cuts field curing time from days to hours. Saves crop from discoloration and spoilage due to rain and heavy dew
- 2** Prevents waste due to handling. Makes it possible to save the leaves, which are the most nutritive part of the plant
- 3** Saves harvesting labor and time. In good weather crop can be chopped and stored in about 4 hours after mowing
- 4** Crop can be stored in much less space and with far less labor than is required to mow away loose hay in the barn
- 5** Cost of electric power is more than offset by savings in labor, time and crop nutrients which otherwise are lost
- 6** Greater economies in feeding, less waste, higher beef and milk production are advantages of this new curing

By
A. E. Holden

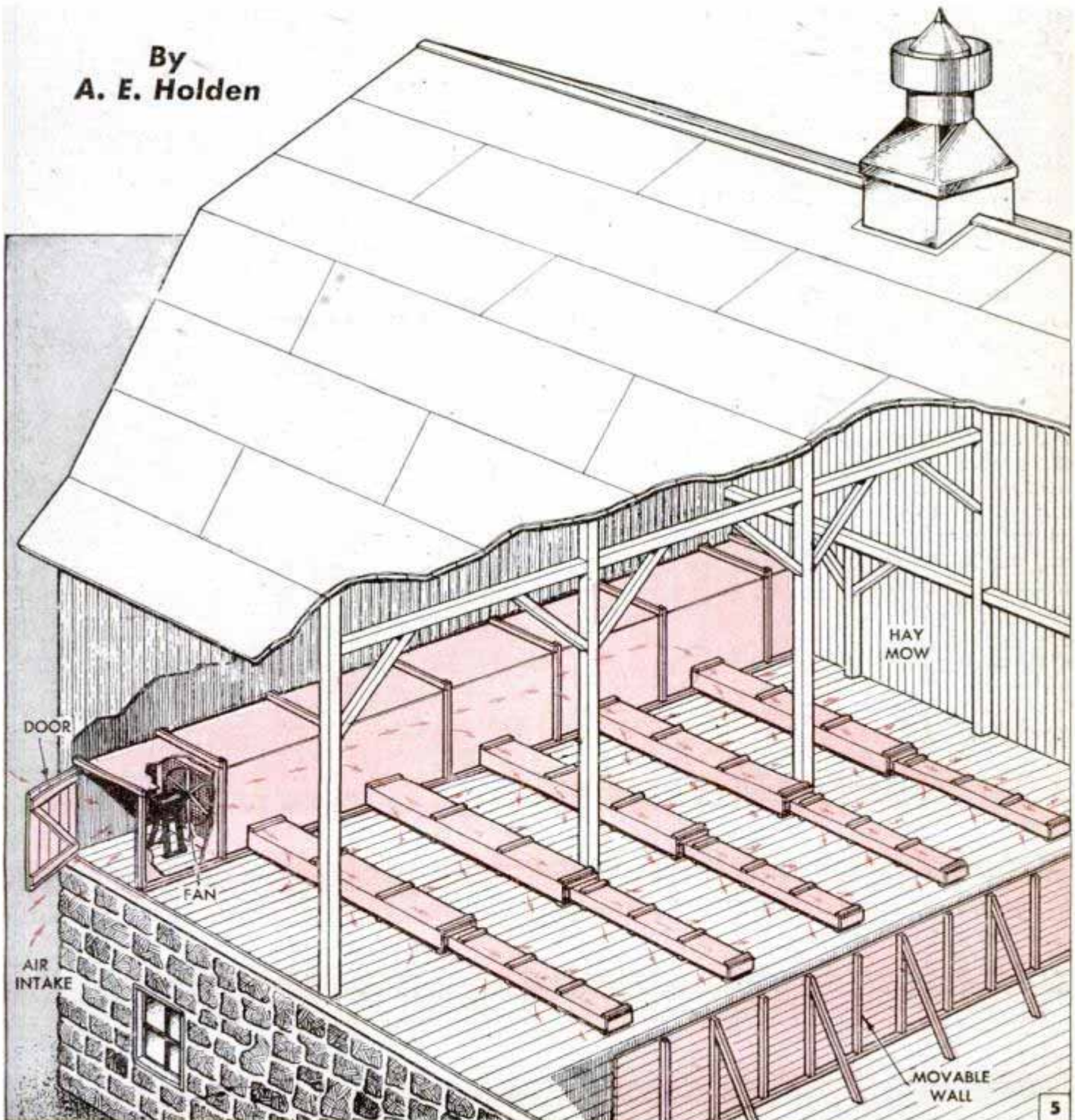

Hacksaw Blade With Hooked End Retrieves Broken Keys

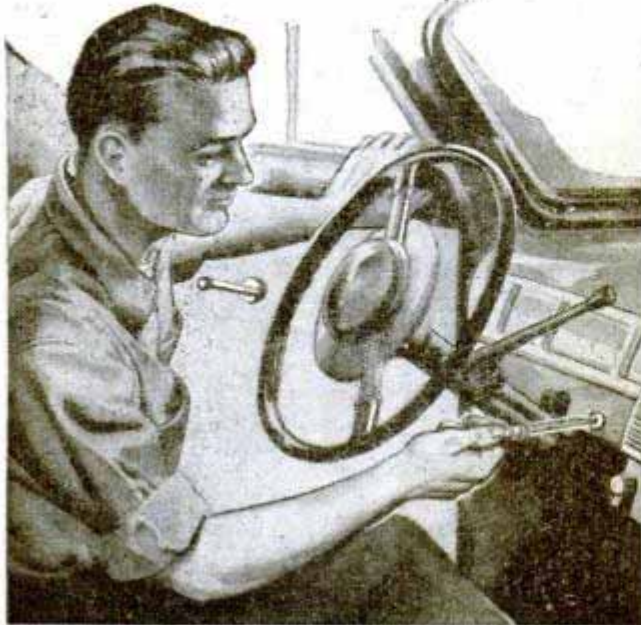
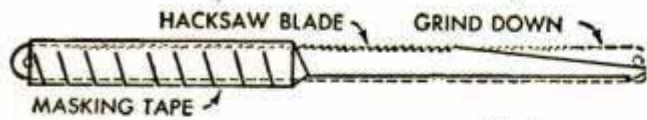

An old hacksaw blade may be converted into a handy tool for extracting keys that have been broken off in auto locks. Grind the blade down to a tapering point, leaving a hook on the end which can be worked into the lock behind the broken key. The other end is wound with tape to provide a comfortable handle. After a bit of practice it will be found that sections of broken keys can be removed from locks with ease.

Canvas Tarpaulin Stored in Barn Is Suspended From Rafter

To keep that good canvas tarpaulin from being damaged by rats and mice, suspend it from a barn rafter by using a barrel hoop as a holder. A metal hoop should be used.

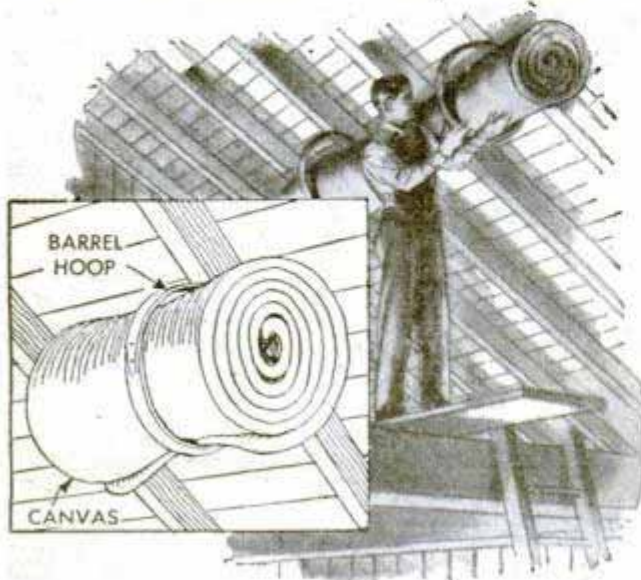

Be sure that there are no leaks in the roof that would permit water to drip on the canvas and possibly cause mildew. The hoop should be nailed as near the peak of the roof as is practical.

Heavy Pencil Line on Cardboard Used to Test Auto Spark

When a suitable testing instrument is not available, strength of the ignition spark on your car can be tested by means of a heavy pencil line drawn with a soft pencil across a strip of light cardboard which must be wide enough to reach from the top of the spark plug to the motor block. Test as shown, and if a hot spark travels the length of the line, the current should be adequate.

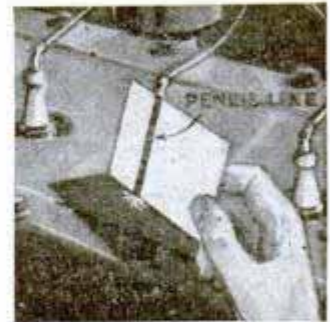

Chain Link Made of Metal Plate

If a chain breaks when you're out logging in the woods, or you need a quick repair for any chain, for that matter, two pieces of metal plate and two bolts will provide a substitute link. The plates are drilled at both ends for bolts, which should fit snugly in the links of the chain. It's a good idea to carry such a spare "link" whenever you are using chains.

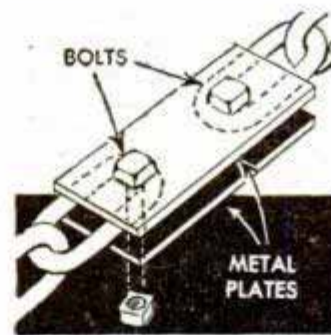

Nonslip Surface for Step Plate Increases Driver's Safety

Although the step plate on most trucktractors has a raised pattern designed to provide a safe surface, during muddy or snowy weather the surface of the plate is apt to become slippery. To provide a safe surface, cut a piece of expanded metal lath approximately the size of the step and weld it in place. In addition to providing a better surface, the lath will do double duty as a foot scraper.

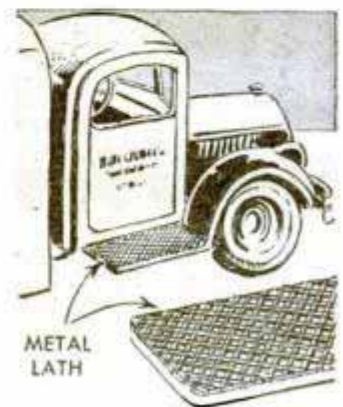

Tractor and Washtub Are Used When Coiling Electric Fence

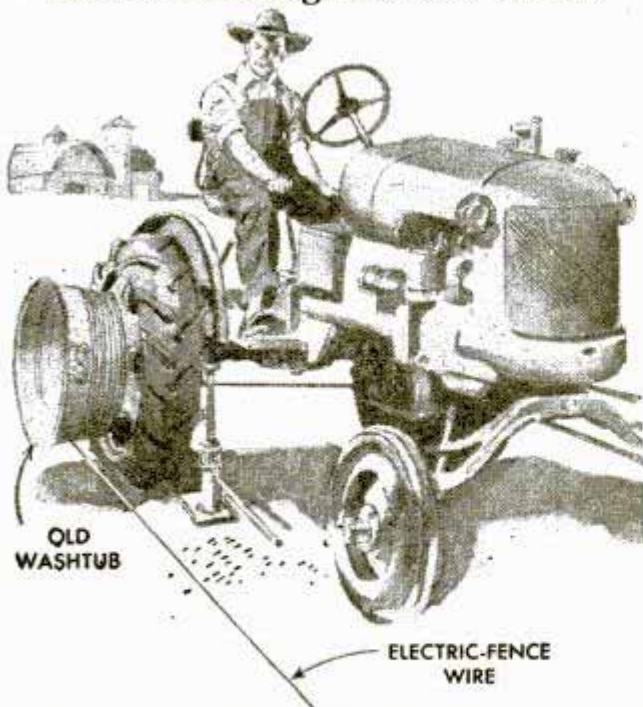

Not wanting to waste a lot of time coiling electric-fence wire by hand, one farmer developed an ingenious way to do this by using his tractor. A rear wheel is jacked up and a washtub or other suitable drum is bolted to the wheel. Then the tractor is put in low gear and the wire wound on the tub. After it is completely wound, the tub is removed from the wheel and the wire is slipped off. Of course, it's necessary that someone guide the wire while it is being wound onto the washtub.

Way to Preserve Fence Posts

If you want to keep fence posts and poles from rotting, an inexpensive salt-solution treatment may be the answer to your problem. It's best to use round posts of green wood. The bark is left on the portion that will be underground but is peeled from the rest. Holes about 2 in. deep and $\frac{3}{4}$ in. in dia. are drilled in the posts 6 in. above the ground line. One hole should be sufficient for a post 4 to 6 in. in dia., two holes for posts 7 to 9 in. in dia., and three holes for 10 to 12-in. posts. Freshly cut green

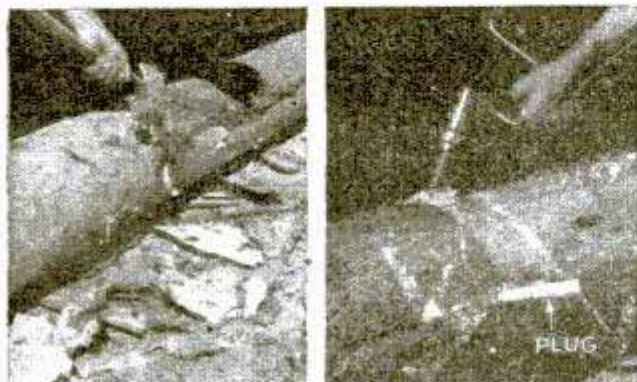

wood is used because the solution is carried through the fibers by moisture in the wood plus that which is absorbed from the ground. For the solution use equal parts, by weight, of white arsenic, corrosive sublimate and common salt. One tablespoon of the solution is poured into each hole in the post or pole. After the holes have been filled, the openings should be well plugged so that cattle cannot lick the mixture.

A. M. Morgan, Lafayette, Calif.

Racks Hold Lengths of Molding So They Can Be Tied

One annoying task, that of tying lengths of molding or other narrow strips of lumber, was eliminated by one dealer through the use of racks that held the wood while being tied. The upper part of the rack is U-shaped and the lower part is made like a pedestal with four feet. The exact dimensions need not be followed, but can be varied to suit the individual's own require-

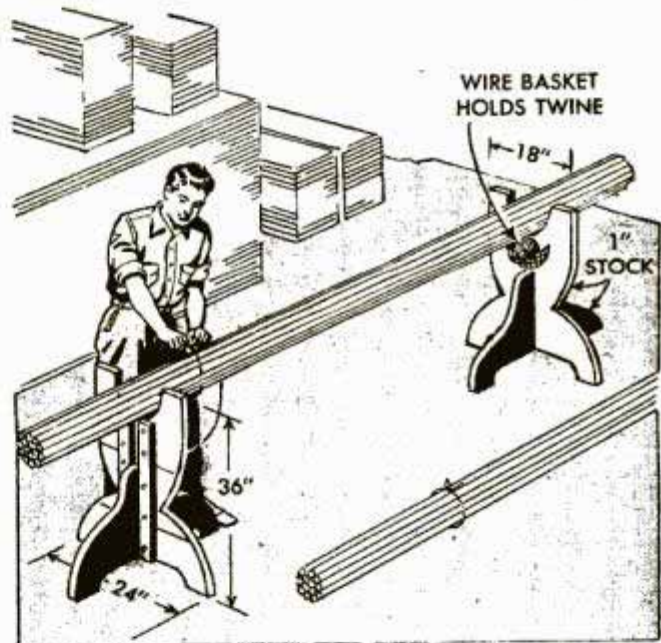

ments. Each rack has a wire basket nailed to it that holds twine for tying the bundles. The racks should not be fastened to the floor as it will be necessary to move them farther apart or closer together in order to accommodate different lengths of wood.

Installing Springs in Typewriters

To install a small spring in an inaccessible place, such as is found in many typewriters, use a length of fairly stiff wire. Bend it to fit the opening in which you are working; run it through the center of the spring and attach with a small piece of adhesive tape. Slip the end loop of the spring over the proper fitting on the typewriter and release the wire with a slight tug.

Val Bruce Galbreath, Hollywood, Calif.

CUTTING HEAVY METAL WITH YOUR JIGSAW

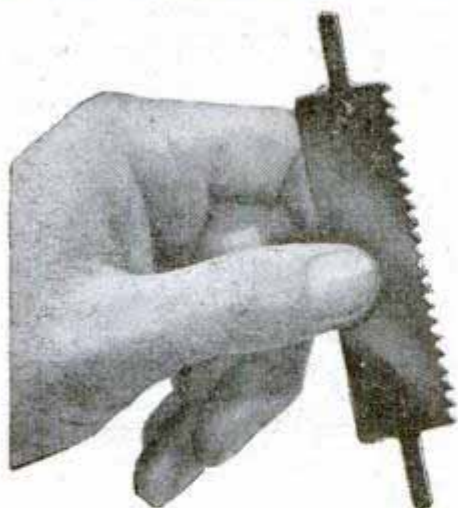

By Alexander Maxwell

BANDSAW blades capable of cutting tough steels and other hard materials at high speeds now are available in narrow and wide widths. Cut into short lengths, they also make the best jigsaw blades available for heavy work in the hard-to-cut materials. The toothed edge of the blade is hardened by an electrical process which makes the points of the teeth almost as hard as diamonds and at the same time leaves them pin-point sharp. The balance of the blade retains all the pliability and toughness of the original steel. You can cut this portion of it with ordinary tin snips, but not the teeth. This part must be broken by bending back on itself several times. Then you grind the ends down to fit the jigsaw-blade chucks or holders and you're ready for sawing anything from wood to tough alloy steels.

The usual narrow width of ordinary jigsaw blades makes the cutting of thick wood a problem due to the blade bending and cutting on an arc. With the substantial backing of a 1-in. blade made from these new bandsaw blades, the heaviest and hardest lumber can be handled at high speed, Fig. 1. A special roller guide, Fig. 9, must be made to accommodate the wide blade. Aluminum and brass can be cut at a top speed of 1725 cutting strokes a minute. Steel goes more slowly because the teeth tend to skid instead of biting, especially at the higher speeds. With steel, a low speed and considerable pressure give best results. To get these low speeds a countershaft and step-down pulleys are used. It also is advisable to lubricate the blade with graphite grease and use cutting oil on materials requiring it.

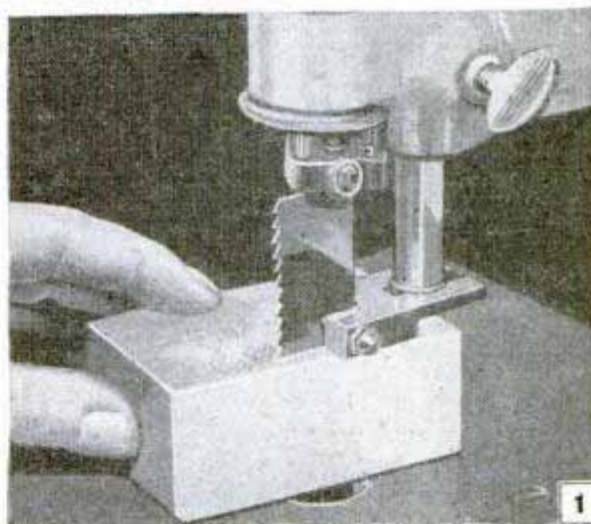

Above, wide blades work effectively in heavy cuts as they are stiffer. Below, measure the teeth with a gauge to make sure of proper blade selection

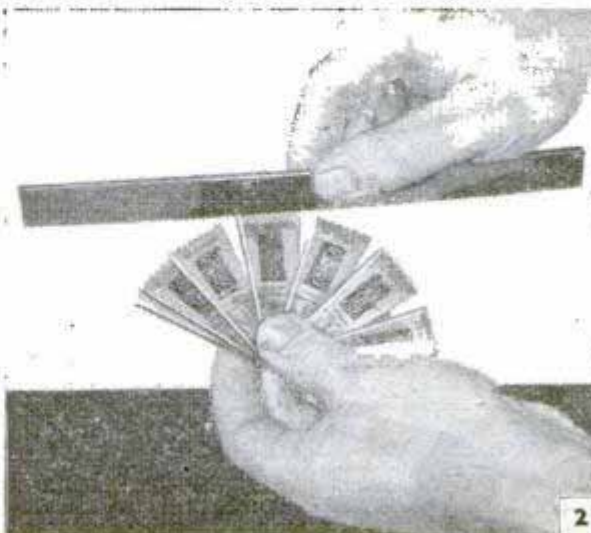

(3) GUIDE FOR PROPER SELECTION OF JIGSAW BLADES

MATERIAL	SAW PITCH				STROKES PER MINUTE			
	Work Thickness				Work Thickness			
	1/8"	1/4"	1"	More	1/8"	1/4"	1"	More
Carbon Steel	24	14	10	6	500	500	250	150
Free Machining	18	14	10	6	500	500	250	150
Chrome Vanadium	18	14	12	8	250	175	100	90
Silicon Manganese	18	14	10	6	200	100	50	
Armor Plate	18	12	10	8	175	90		
High Speed	24	14	12	8	100			
Stainless Steel 18-8	24	14	10	8	90			
Rolled Shapes	24	14	10	8	175	100	90	
Thin Wall Tubing	32	14			250	100		
Cast Iron	18	14	10	6	500	250	100	90
Aluminum	18	10	6	6	1725	1725	1300	650
Babbitt-Lead	14	8	6	6	1725	1725	1725	1725
Soft Brass	18	14	8	6	1725	1300	1100	650
Phosphor Bronze	18	14	10	6	1100	650	250	90
Tobin Bronze	18	12	10	6	650	500	250	90
Copper	18	10	6	6	1300	1100	650	500
Magnesium	14	10	6	4	1725	1725	1725	1725
Monel	18	12	10	6	250	200	90	90
Nickel	14	8	6	6	200	100	90	90
Nickel Silver	18	14	10	6	650	500	250	90
Silver	24	18	14	8	650	500	250	90
Asbestos	24	14	6	4B	1725	1725	1725	1300
Bakelite	10	8	6	4B	1725	1725	1725	1725
Wall Board	14	10	6	4B	1725	1300	1100	650
Cork	10	8	6	6	1725	1725	1725	1300
Fibre	14	10	6	6	650	500	250	100
Pressed Wood	24	18	6	4B	1725	1725	1300	650
Plastics	14	10	6	4B	1725	1725	1725	1725
Porcelain	24	18			500	100		
Hard Rubber	24	18	6	4B	1725	1725	1725	1725
Transite	32	18	14	8	1300	1100	90	90
Paper	10	8	6	4B	1725	1300	1100	675
Hard Wood	18	10	6B	4B	1725	1725	1725	1725
Soft Wood	14	6	4B	3B	1725	1725	1300	1100

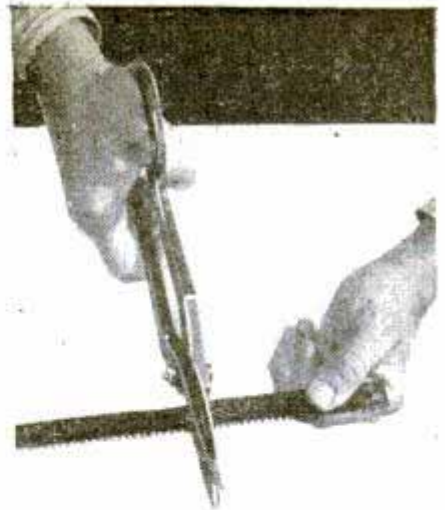

5

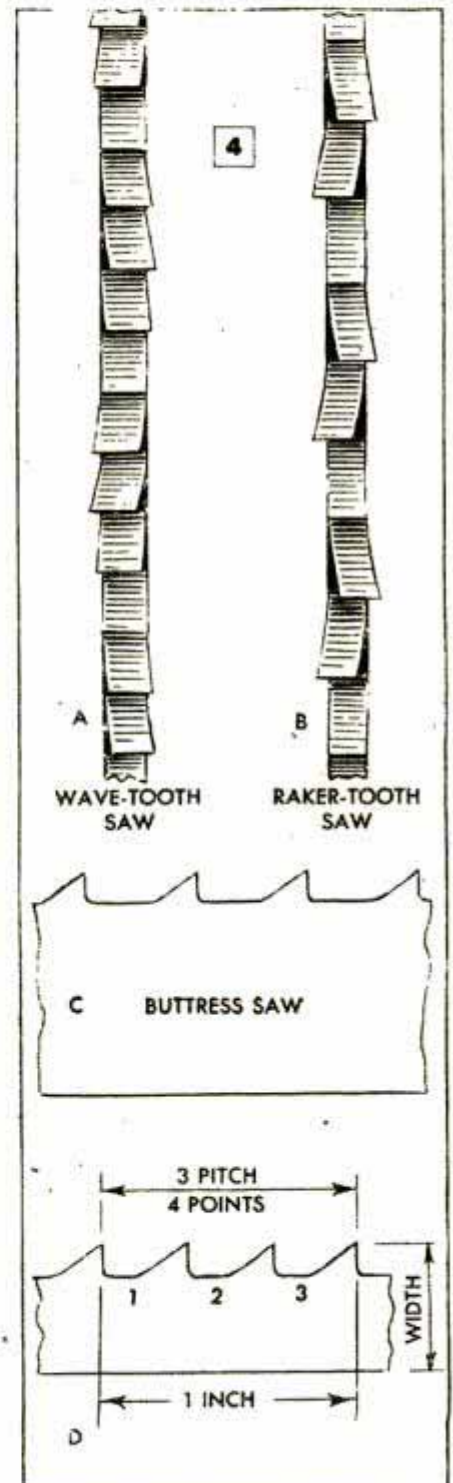

There is no such thing as an all-purpose blade, so to handle a wide range of materials a selection of blades is required. Tooth pitch and speed are of the utmost importance. The table, Fig. 3, gives a list of the materials most likely to be cut and the proper blade to do the job. Using the wrong size blade as well as running it too fast or too slow will result in poor work and short blade life. Check with a gauge, Fig. 2, and count the teeth, Fig. 4, D, to make the proper blade selection.

Although these blades sometimes are sold cut to length and ready to use, they are now readily available as mill ends. It is more economical to purchase a yard or so of blade and cut it up yourself as in Fig. 5. Grind down the ends, Fig. 7, and if the blade is too thick to enter the chuck, grind down the ends to the required thickness. Also it's generally best to grind away the teeth for 1 in. or so at each end of the blade.

Blades are commonly made with three types of teeth. The wave tooth, Fig. 4, A, comes only in 32 pitch and is used for tubing and thin sheet metal. The raker tooth, Fig. 4, B, has teeth set alternately to the right and left with one straight tooth between pairs to clear away the chip. The buttress tooth, Fig. 4, C, has every other tooth missing and is used on work where there is a tendency to clog. It is specified as 3B or 4B in the table. All types cut both wood and metal. The point to remember is to use the pitch and speed best suited for the material.

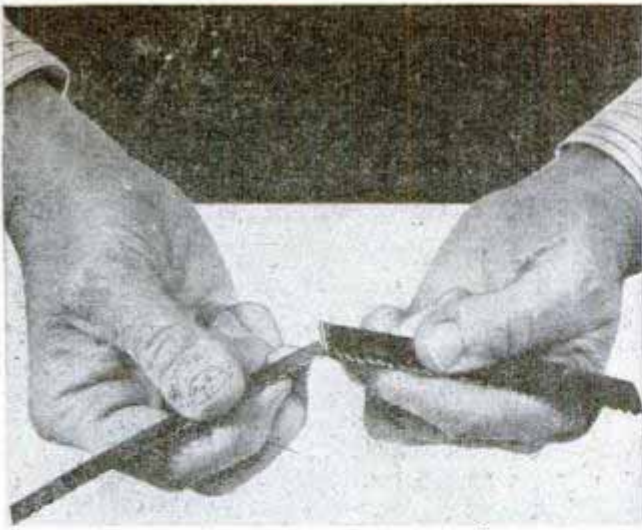

6

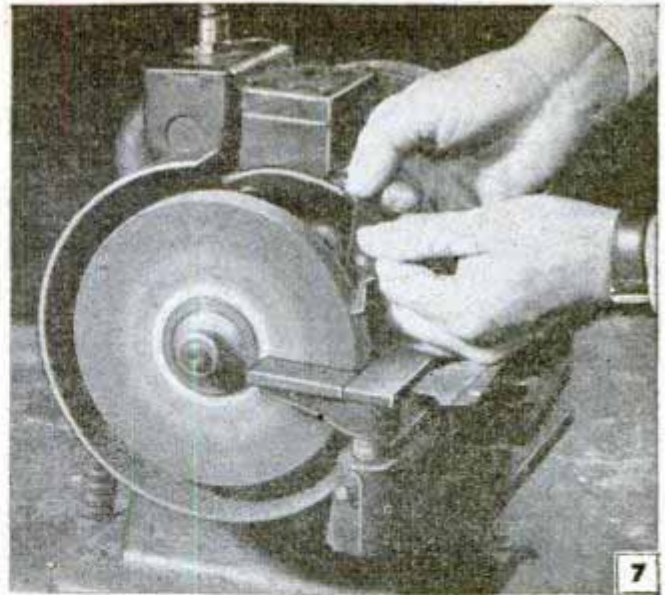

7

Blade life is comparatively short on the harder materials, as the upward drag tends to dull the teeth. From 6 to 12 in. in medium steel is about all you can expect from one blade. On the jigsaw a blade lasts much less time than it does on a bandsaw and cuts less rapidly. Always use the widest blade possible. This is governed by the arc of the minimum circle to be cut. The average minimum radius of various blades is shown in Fig. 8.

Jigsaw guides are not all alike. If your saw does not have a roller guide capable of handling the heavier blades, one should be made as in Fig. 9. Select a bar of $\frac{3}{8}$ "x1"

cold-rolled steel stock and lay out a guide which will fit your saw. The type of guide detailed in Fig. 9 fits a popular model, now superseded. Other blade guides are different in minor details. Use a hacksaw to cut the body of the guide to the required shape, then finish by filing. It is advisable to leave a considerable "handle" on the stock, so that you can hold it easily in the vise. Saw off the handle when no longer needed. Drill holes before making cuts, to assure alignment. Harden the shaft and roller of the guide after fitting. The two guide screws are adjusted each time a blade is changed and any wear can be taken up quickly.

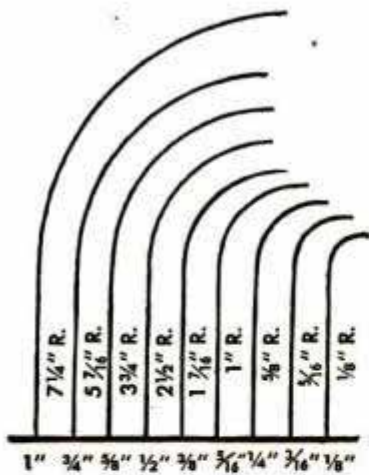

SAW WIDTH
FOR 1" WORK THICKNESS
ALWAYS USE THE WIDEST
SAW POSSIBLE

8

Above you have charted approximately full size the average minimum radius cuts for blades of various widths. When turning a radius in either wood or metal, the trick in getting a smooth-edged cut is to keep the blade cutting uniformly while in the curve. If you stop the work or move it irregularly you will get "flats" along the sawed edge

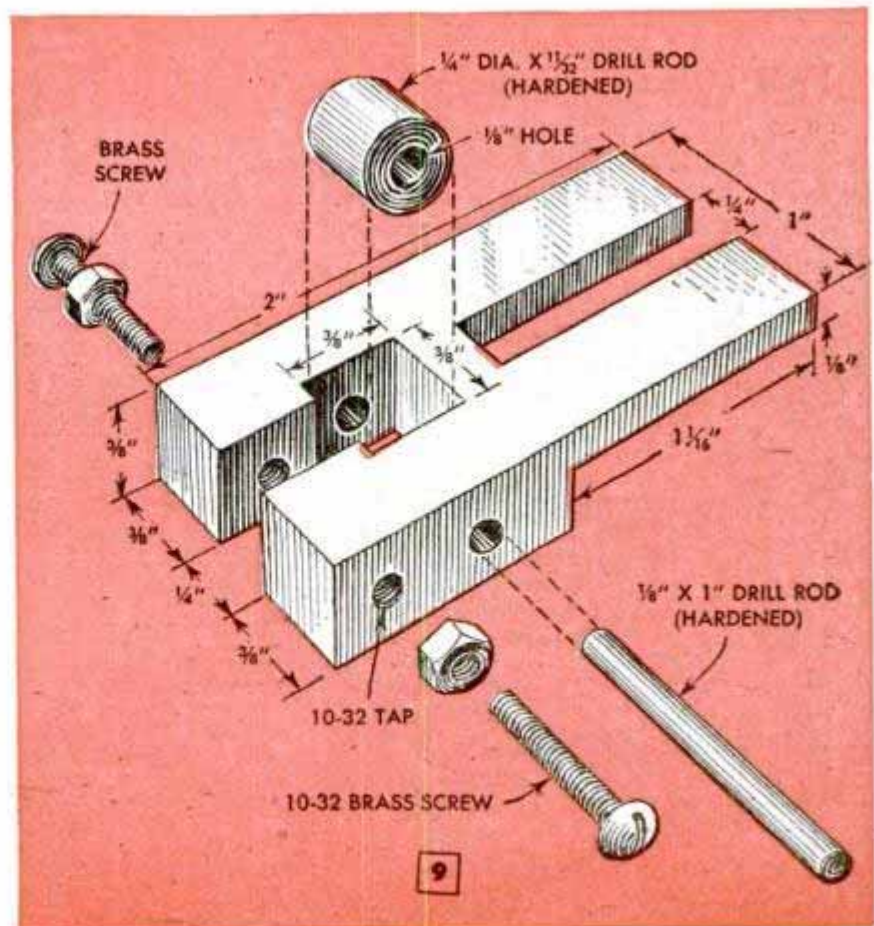

9

Feed Bags Hung Over Iron Pipe As Protection Against Mice



To keep empty feed sacks from being damaged by mice or rats, take a piece of iron pipe slightly longer than the width of the sacks and suspend it from the ceiling with two lengths of wire. Mice and rats are unable to get down the wire to the sacks.

Jerry Pokorny, Kewanna, Ind.

Safety for Pedestrians Insured By Painting Elevator Doors

Often sidewalk elevators are not equipped with warning bells, and since the elevator doors do not stand out too clearly from the sidewalk, there is danger that pedestrians will walk into the opening or

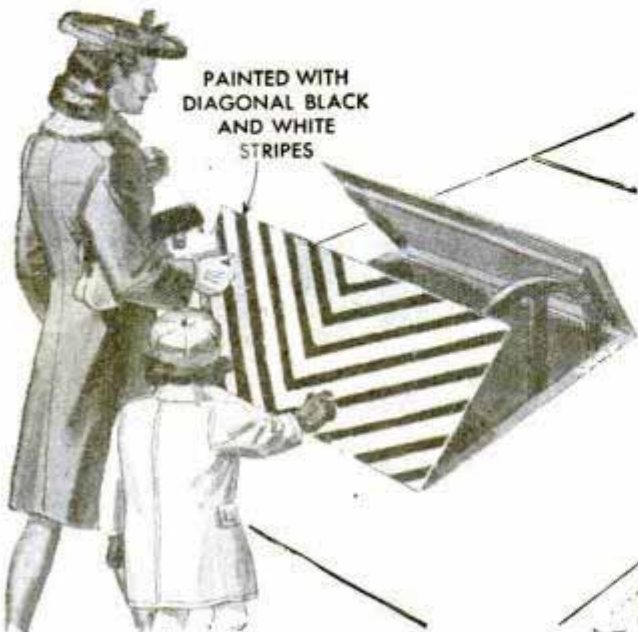

stand on the doors when the elevator is coming up. To serve as a warning, diagonal stripes of black and white can be painted on the doors to attract attention.

How to Stop Drill From Slipping

If the shank of a drill is scored, or if the jaws of the chuck are weak, frequently the drill will slip in the chuck. To prevent this, grind or file three flat surfaces on the shank 120 deg. apart. Then clamp the jaws of the chuck directly on these flat surfaces and the drill will hold.

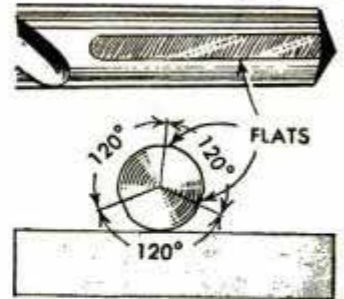

Earl R. Goddard, Denver, Colo.

Automobile Tire Around Stake Keeps Rope Untangled

Instead of tying a tether directly to the stake, fasten it to an old auto-tire casing and then drop this over the stake. The lat-



ter, of course, should be much higher than ordinarily so the animal will not pull the tire off the stake. This keeps cattle from winding the tether around the stake.

Tire Pressure Printed on Body Of Truck Avoids Mistakes

In order that he might be sure the tires in his fleet of trucks were always properly inflated, one operator had the correct pressure stenciled on the side of the truck, directly above the tire. This eliminated considerable confusion that had existed previously, especially when drivers used different trucks or trailers.

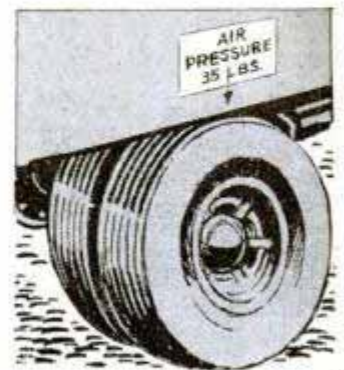



Special Purpose Voice Recorders

NOW you can mail your voice instead of writing a letter. The Brush magnetic recording unit, illustrated in the sketch and photo A, records your words and plays them back—with every personal meaning you gave them. These magnetic recordings are made on paper disks that may be folded and inserted in ordinary envelopes for mailing. The electronic recordings play back just as you recorded them, and the folds do no harm as there are no grooves to break or scratch. Each recording holds three minutes of your voice and costs only a few pennies. The small paper disks may be erased and used over, or they may be filed for permanent records.

Designed for recording lengthy conferences, examinations or court proceedings where a continuous record must be made, a new Miles portable tape recorder, photo B, employs an endless loop of film for uninterrupted recording and playback up to three hours. Starting on track No. 1, it automatically moves over to track No. 2 and continues until 100 tracks are indented across the width of the film.

Although the Peirce magnetic wire recorder shown in photo C has a wide range of uses, this improved model is a heavy-duty business unit that includes all the dictating, transcription and playback features and accessories demanded by businessmen and educators. Remote control permits dictation to the recorder from distances up to 100 feet. In transcribing, the secretary or typist controls the instrument by a button attached to the typewriter, or by a foot pedal, leaving her hands free for typing.



MAGNETIC VOICE RECORDER

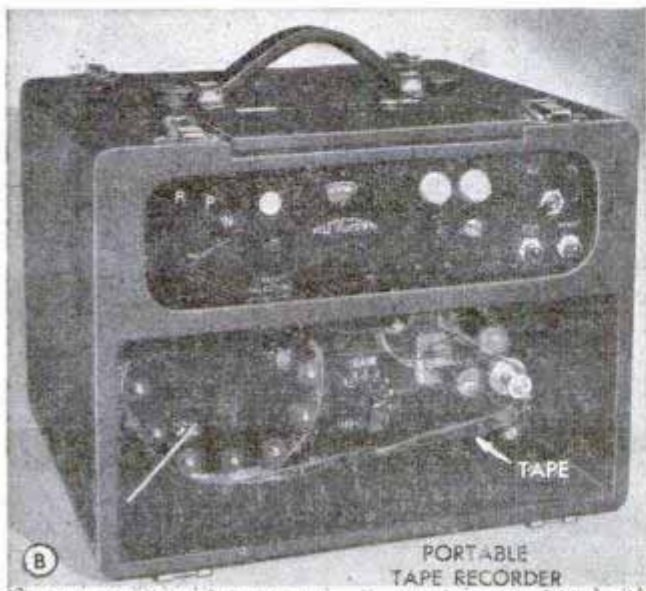

PORTABLE TAPE RECORDER



OFFICE DICTATION WIRE RECORDER

BEGINNER'S FOUR-TUBE

By S. A. Johnson

ALTHOUGH primarily designed for beginners, this second low-cost unit in the series that began in the April issue is not intended to be easy. It is an entirely different receiver and employs 3 plug-in coils that tune from 550 to 18 meters, or, in other words, from about 545 to 16,670 kilocycles. All of the parts used in the 1-tube set are again specified, with the exception of the coil. The chassis base and panel details are exactly the same. Therefore, those who built set No. 1 will need only the additional tubes, audio transformer, speaker, plug-in coil forms and small parts.

Self-powered by using a 6J5 as a rectifier tube, no B-battery is required and the set has sufficient sensitivity and audio output to operate a loud-speaker. On the short-wave bands it is an excellent performer, bringing in stations at surprising distances. Placement of parts is not critical but, in or-

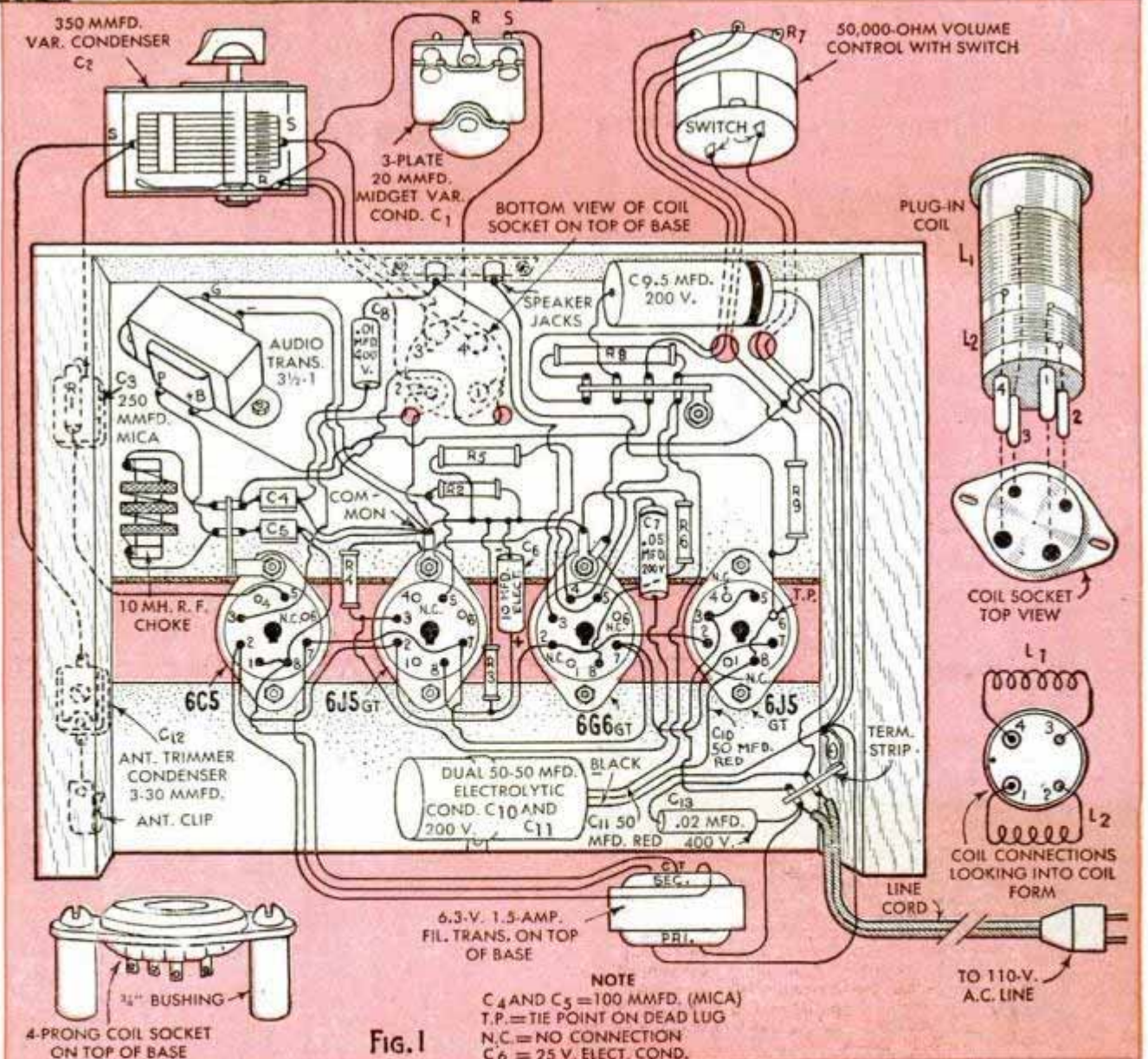
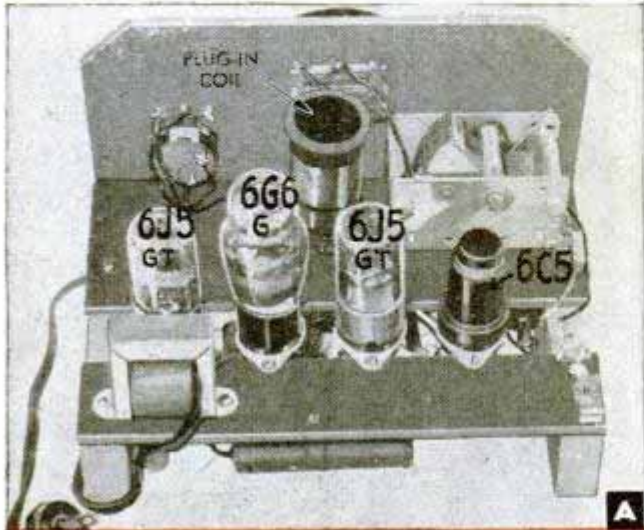
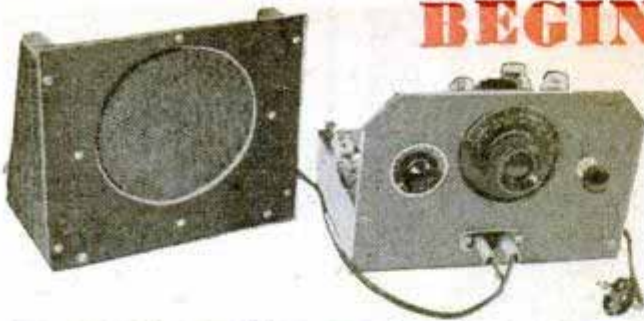

Fig. 1

PROGRESSIVE RECEIVER--SET No.2

der to prevent confusion in wiring, the builders of the 1-tube receiver are advised to remove all of the No. 1 set wiring and make a fresh start. The 350-mmfd. variable condenser, volume control and 6.3-volt filament transformer remain in the same positions.

In order to keep the audio transformer as far as possible from the a.c. leads it is mounted close to the front of the pressed-wood chassis on the underside in the position shown in the bottom view, pictorial wiring diagram Fig. 1. This is necessary to prevent hum pickup. Photos A, B and E show various views of the completed receiver. The separate speaker unit appears in photo D; it is a 6-in. permanent-magnet dynamic type and a universal output transformer is mounted directly on the speaker. The voice coil connections are made on transformer taps Nos. 1 and 4. Dimensions are given for the speaker baffle and frame.

When wiring the set, check each lead with the schematic circuit diagram, Fig. 2.

(Continued to page 236)

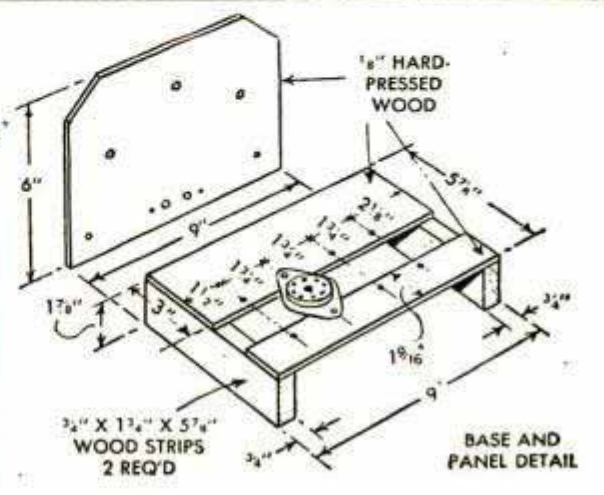
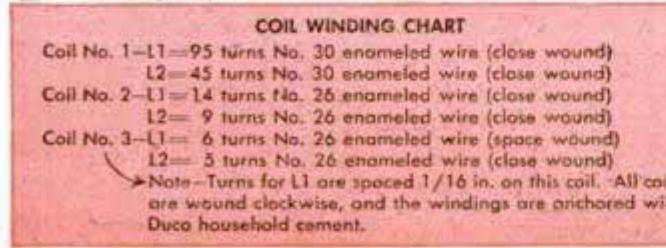
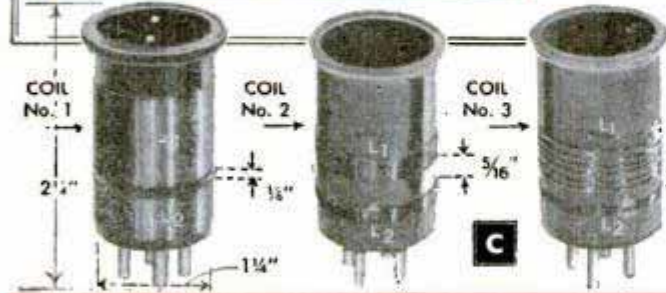
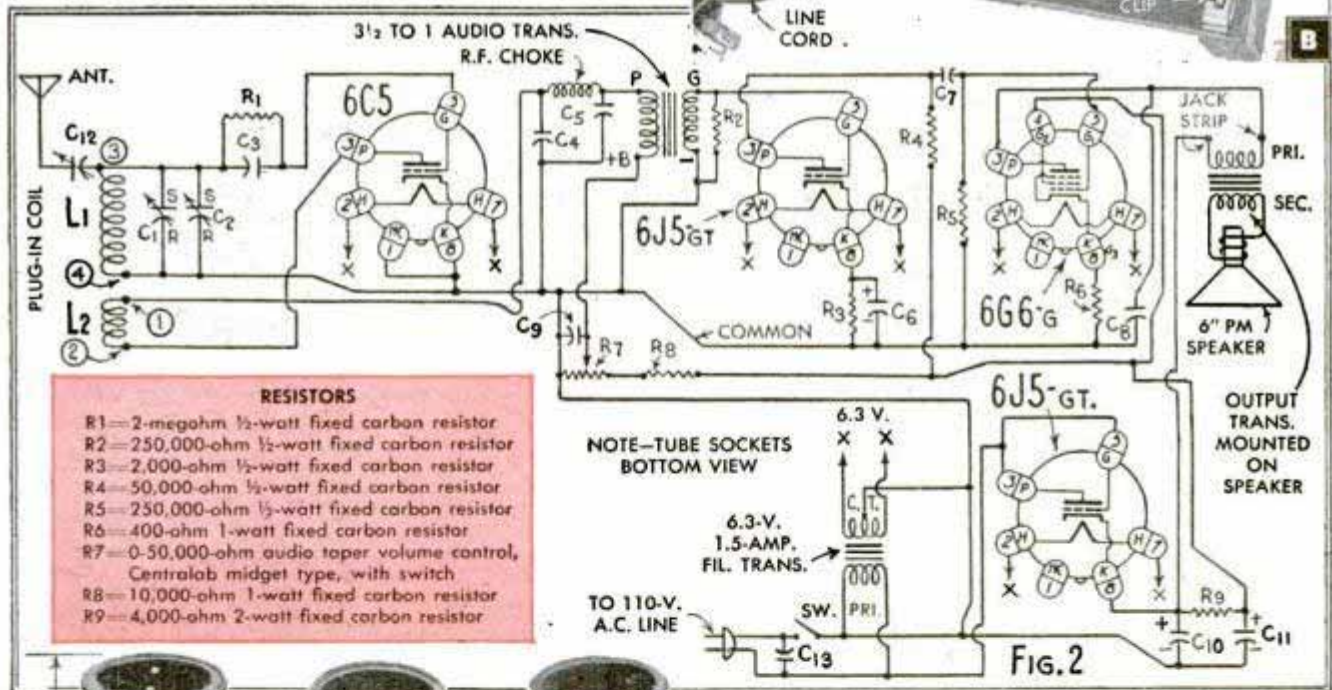
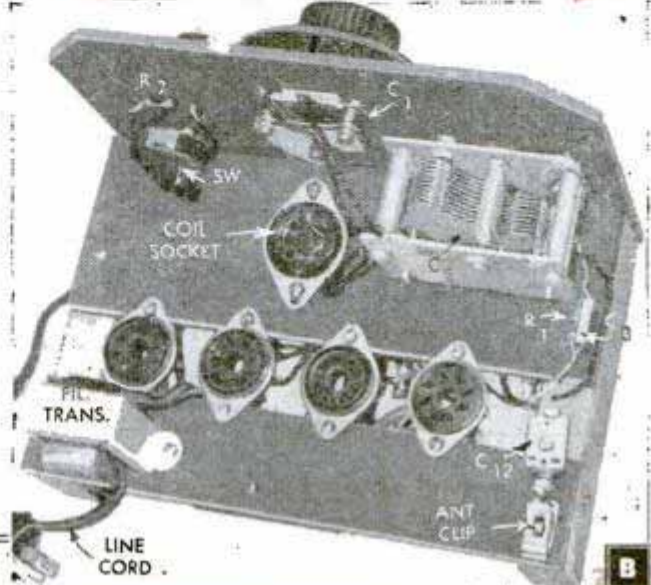



Kodak Combination Lens Attachments increase scope and picture-taking ability

More Power to your Camera

You add dash to a scene when you darken the sky with a K-2 Wratten Filter. You picture a world of fantasy on Kodak Infrared Film plus a Wratten A Filter.

You'll make gentler, softer landscapes with a Kodak Pictorial Diffusion Disk. You cut through mountain haze with a Kodachrome Haze Filter . . . clear away glare with a Pola-Screen.

For fine close-ups of people, flowers, pets . . . add one of the three Portra Lenses.

Interchangeable, inexpensive, easy to use. See your Kodak dealer. EASTMAN KODAK COMPANY, Rochester 4, N. Y.

NEW KODAK COMBINATION FILTER CASE carries Adapter Ring, a Lens Hood, and four filters.

Kodak

What's your choice of these

Marlin .22's?

Marlin Model 39-A—25-shot Lever Action Repeating Rifle. \$50.45*



Marlin Model 81-DL—25-shot Tubular Magazine Repeating Rifle. \$25.55*



Marlin Model 80-DL—8-shot Clip Magazine Repeating Rifle. \$20.05*



**Prices slightly higher west of the Rockies*

Be sure to see these three fine Marlin '47 models at your dealer's soon! Each is an outstanding rifle in its class.

● Here you have three great rifles for small game and all around sport. Marlin's 39-A is the only lever action .22 repeater made...a favorite in hunting circles the world over since 1892. As a practical weapon for vermin and small game, the 81-DL is a wise selection. It carries a full day's ammunition, and its light weight is a great asset in the field. The loaded clip of the 80-DL provides extra shots for fast-running game...and allows use as a single loader for target work. All three are rugged, man-sized Marlins, famous for accuracy and dependability. All shoot .22 short, long and long rifle cartridges—regular or high speed—without adjustment. Whichever you choose, you'll buy years and years of trouble-free sport!



Often called the "world's best all around .22," Marlin's 39-A is a light rifle of remarkable accuracy and versatility. Only lever action .22 made. Extra fast for snap and exhibition shooting.



A full day's hunting is provided by the large 25-shot capacity of the Marlin 81-DL. Removable bolt assembly; Off and On safety...a fine "learning gun."



With eight shots to the clip, Marlin's 80-DL gives you a rapid fire load for fast-running small game and vermin. Also handy as a single loader on the firing line.

Marlin .22 Rifles

Outstanding for accuracy, dependability, long life

THE MARLIN FIREARMS CO., NEW HAVEN, CONN. • Fine Guns Since 1870

IT'S A GRAND FEELING

TO BUILD A MODEL SHIP

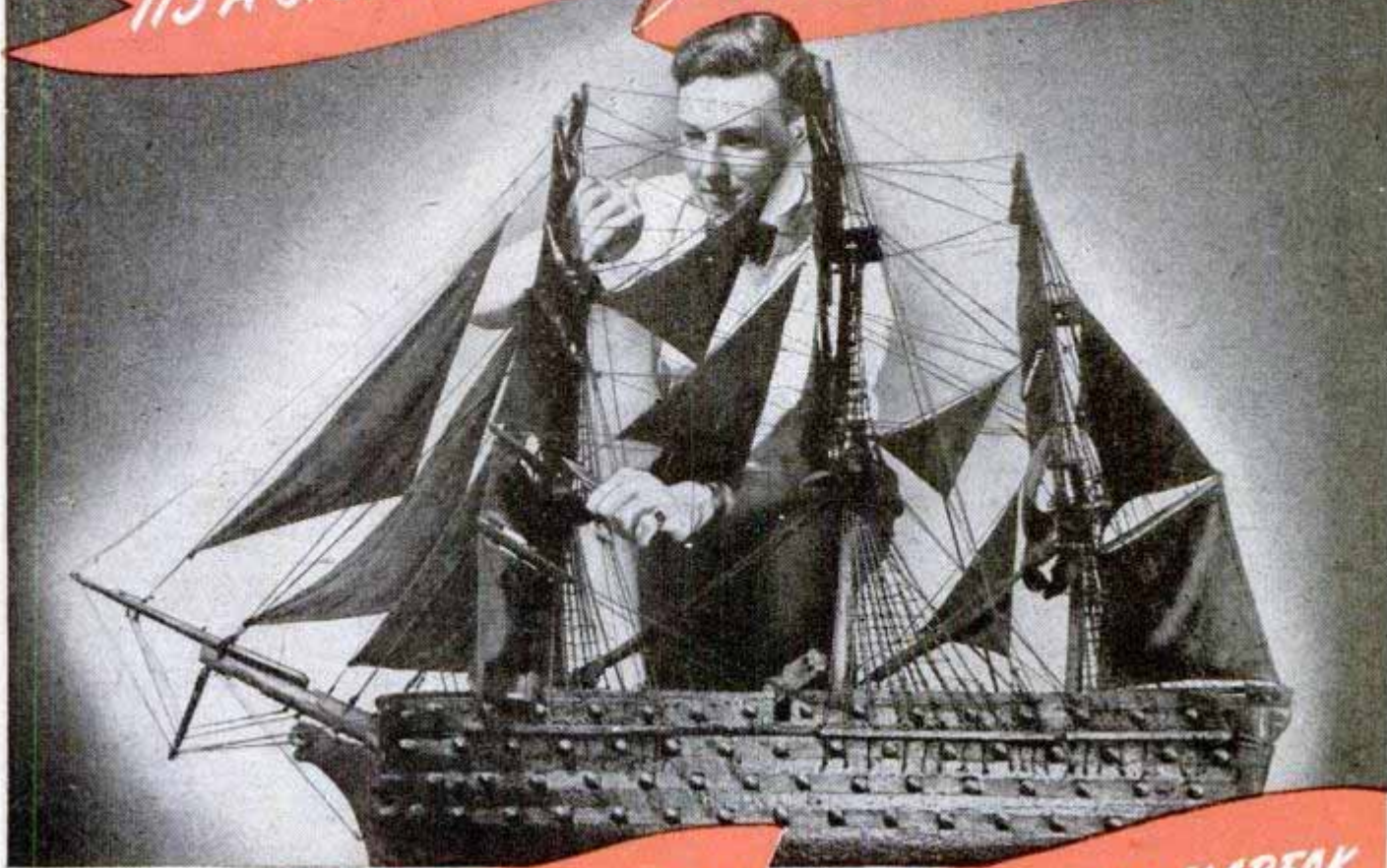

IT'S A GRAND FEELING, TOO,
WHEN YOUR CAR IS

CUSHIONED WITH MARFAK
CHASSIS LUBRICATION

THAT CUSHIONY FEELING LASTS LONGER WITH MARFAK!

It's a grand feeling to build a model sailing ship . . . the same grand feeling you get from your smooth riding, *Marfak* lubricated car.

Marfak is scientifically designed to cling to bearing surfaces, resist wash-out, jar-out and squeeze-out and stick to the job for a thousand miles and more. See your Texaco Man today, and get that grand feeling with a *Marfak* lubrication job.



THE TEXAS COMPANY

TEXACO DEALERS IN ALL 48 STATES

Tune in: TEXACO STAR THEATRE presents the new TONY MARTIN show every Sunday night. See newspaper for time and station.

ANCO RAIN-MASTER

"Dead-Locker"
WINDSHIELD WIPER
ARMS and BLADES

BLADE SNAPS ON...
STAYS PUT

FINGER-
TIP
RELEASE



CAN'T FALL OFF
CAN'T BLOW OFF

(A war-born invention—by ANCO—first)
for military aircraft—now for your car.)

DON'T SHOOT YOUR GAS-PUMP MAN!

He's doing the best he can. Sure, he knows how dangerous it is for you to drive your car... in stormy weather... with your dull old windshield wipers that smear and smear. He'd gladly put on for you quickly a pair of keen new ANCO RAIN-MASTER Wiper Blades and Arms. He has them—Newest Models! But he forgets to remind you? Too busy? You can't shoot him for that!



After all, it's *your* car to protect. So *you* remind *him*. Get RAIN-MASTERS... patented features... original equipment on many makes of high grade cars and trucks... used in war—on our fighting tanks and trucks and ships and bombers too... because ANCO RAIN-MASTERS clean quicker, clean cleaner... last longer. May save you a costly smashup.

Ask for RAIN-MASTER Windshield Wiper Arms and Blades next time you buy gas.

THE ANDERSON COMPANY
Established 1918
GARY, INDIANA

Brazil's One-Man Boom

(Continued from page 132)

The Rochedo division produces aluminum cooking utensils—and at a remarkable rate of acceleration. Its total business was in the vicinity of \$1,750,000 last year—10 times its sales in 1940. Both divisions are far behind in filling orders and there is no apparent limit to the table and kitchenware which the country can absorb.

Other of Pignatari's bright young men—many of his leading engineers and executives are about 30—have evolved a process for the production of colored aluminum sheets. This process, based on a Canadian patent, is done by electropolishing and anodizing. All colors are possible, although of varying degrees of permanence, and the sheets may find wide use in such applications as tiles for interior decoration and as an outside finish for planes and automobiles.

Another component of the Pignatari enterprises makes slide fasteners. Eight million feet of fasteners were turned out in the first six months of last year—a third more than was produced in the whole of 1944. Brazil is rapidly becoming a nation of "zip-pers" instead of buttoners. The company also exports fasteners to the U. S., Europe and Africa.

The Companhia Aeronautica Paulista, another subsidiary, is one of the leading producers of planes in Latin America with a planned 1947 output of more than 50 two-seat and four-seat planes a month. The model, which somewhat resembles a \$2500 Piper Cub, sells for about \$3000. Except for the engines—imported from the United States—the planes have been designed and built by Brazilian engineers and workers, and certain important developments in the use of tubular fuselage members are claimed for the plane.

Brazil is a fertile field for the sale of planes, being a nation of vast distances and inadequate rail and motor road facilities.

(Continued to page 232)

Model Builders Attention!

	V	V-2	V-3
Hex	1/2"	3/8"	5/16"
Thread	3/8"-24	1/4"-32	1/4"-32
Thread Length	7/32	7/32	5/32
Weight, Grams	8	3 1/2	2 1/2

Actual Size V-Plug

Champion spark plugs for model gas engines give the same dependable performance as regular Champions. Sillment sealed. Sillimanite insulator. Alloy needlepoint electrodes for easy starting. One piece construction.

CHAMPION

SPARK PLUG COMPANY • TOLEDO 1, OHIO

Dependable

CHAMPION

AMERICA'S FAVORITE SPARK PLUG

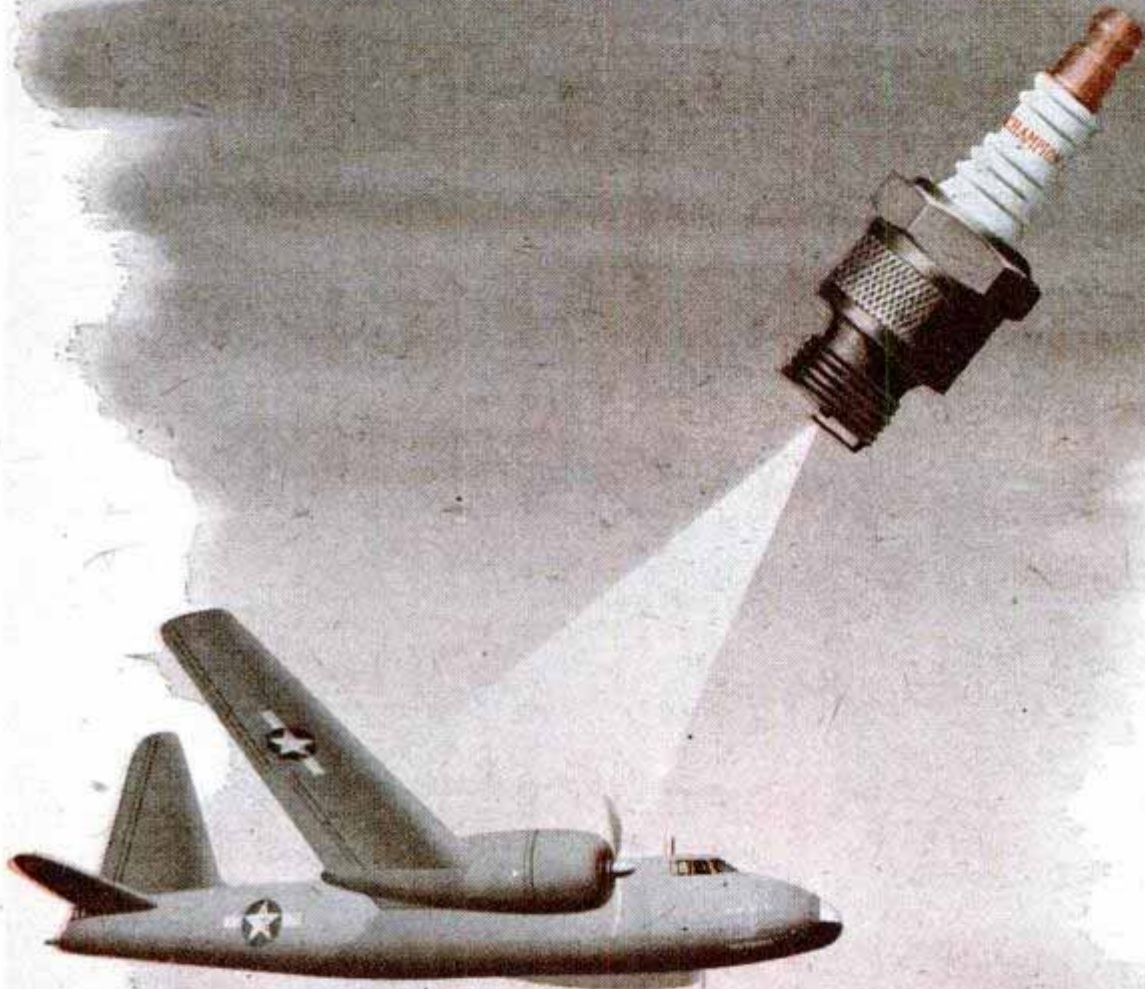

When the Navy's Patrol bomber "Truculent Turtle" set a world's non-stop long distance record in a flight of over 11,000 miles, it was equipped with Champion Spark Plugs. This flight from Perth, Australia, to Columbus, Ohio, provided another exceptional example of the outstanding dependability of Champion Spark Plugs. The name Champion and the word "dependable" are synonymous, a fact that has made it America's Favorite Spark Plug — for every engine. Champion Spark Plug Company, Toledo 1, Ohio.

FOLLOW THE EXPERTS

DEMAND DEPENDABLE

CHAMPIONS FOR YOUR CAR

Listen to the CHAMPION ROLL CALL, Harry Wismer's fast sportscast every Friday night, 9:55 EST over the ABC network

Big, Delicious Meals Wherever You Go!

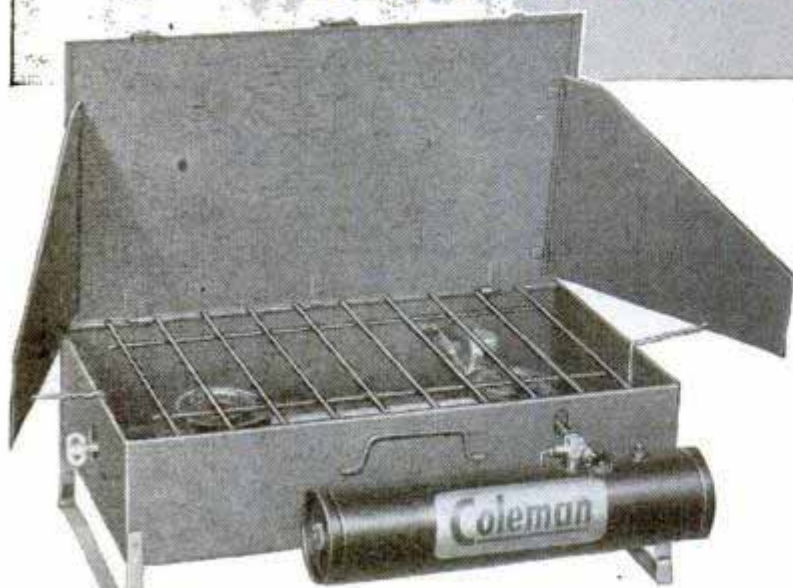

Coleman

Folding CAMP STOVE

The Smooth Way to Rough it

Easy meals... more fun... less work... better eats... anywhere with a Coleman Camp Stove. It's the speedy answer to outdoor appetites — ready at the touch of a match and the turn of a valve. Cooks like a gas range. Bakes, boils, roasts, fries, broils, toasts.

Sets up or knocks down in a jiffy. Folds up with everything inside.

The Coleman makes and burns its own gas from gasoline. Instant lighting. Two wind-proof burners; instantly regulated to any desired cooking heat. See the Coleman Camp Stove at your dealer's. Ask him for free demonstration.

FREE! Write for illustrated book telling about these and other Coleman Appliances. Address nearest office.

THE COLEMAN COMPANY, INC. Dept. 204-PM, Wichita 1, Kans.; 401 N. Broad St., Philadelphia 8, Pa.; Los Angeles 54, Calif.; Honolulu, T. H.; Toronto, Canada.

You'll Want This Amazing



Coleman

POCKET STOVE

3 lbs.; 8½ in. high; take it anywhere, for cooking, making hot drinks, boiling water. Burns any kind of gasoline—white or leaded. Aluminum case makes two handy cooking utensils. Ask your dealer.

And This Powerful

Coleman

FLOODLIGHT LANTERN

Floodlights 100-ft. area so bright you can read a newspaper 50 feet away. A 105-mile gale can't put it out. Safe—can't spill fuel even if tipped over. Ask your dealer.



HAVE THE RIGHT SIZE WRENCHES HANDY WHEN NEEDED

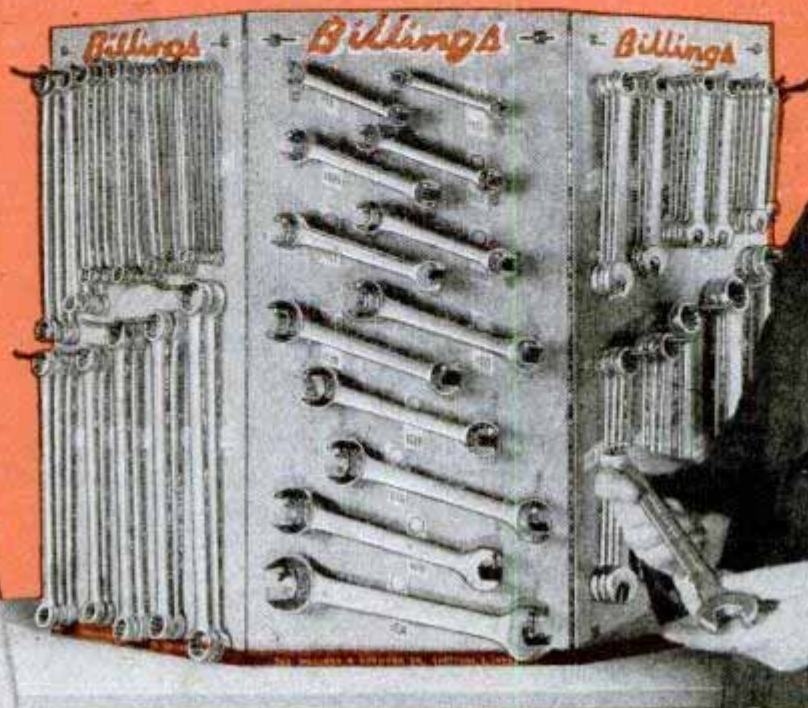
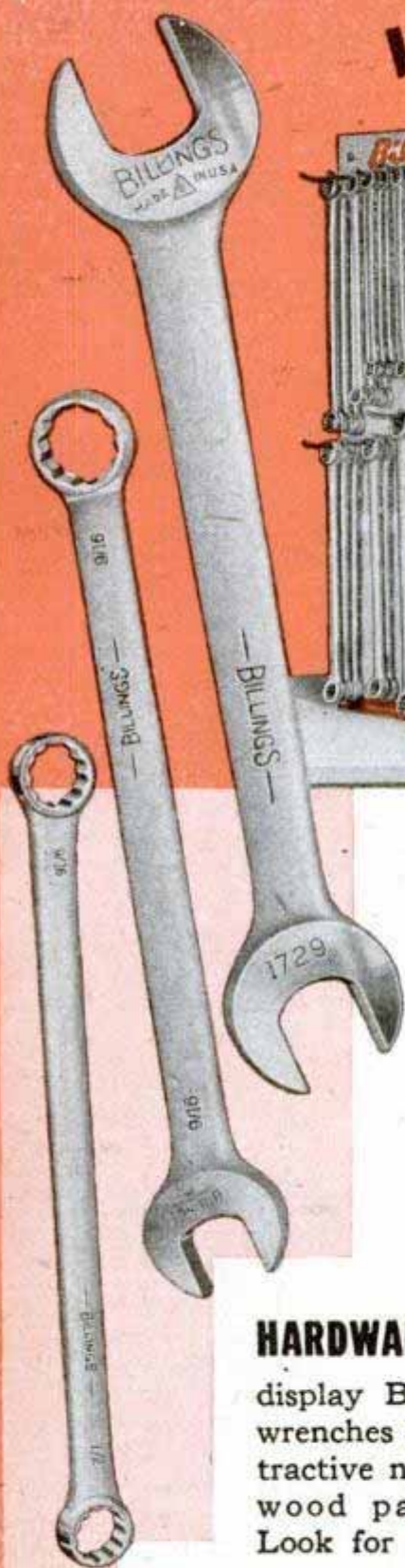

You'll like the "feel" of Billings quality wrenches — they're scientifically designed to give balance, proper leverage without strain and to fit all popular size nuts, bolts and cap screws . . . Have the right size handy when needed . . . Billings *Vitalloy wrenches are drop forged from special analysis steel with a heavy chrome plate over a nickel plated copper base — light weight — laboratory tested for strength — openings accurate to size — polished heads with size stamped on each wrench . . . You can buy Billings in sets, too!

HARDWARE STORES

display Billings wrenches on attractive natural wood panels. Look for them!

. . . Say "BILLINGS" when buying wrenches



TOOL CRAFTSMEN SINCE 1869
THE BILLINGS & SPENCER CO. HARTFORD 1, CONN.



For New-Car Pep, Economy Say, Burd "Graf-Flox" Piston Rings

● No, Burd doesn't advocate breaking speed-laws, but you don't have to confess that the old bus hasn't the pick-up she used to have. Install Burd "Graf-Flox" Piston Rings, and "hang onto your hat!" No kidding, the right Burd Combination Set in your engine will really work wonders . . . will give it surprising new power and snap . . . will cut fuel and oil bills. Yes, you'll get new-found pleasure in driving. Ask your service man about Burd Piston Rings . . . they are "Engineered for Results." Two free booklets, packed with handy information for the car-owner, are available *free*. Mail the coupon tonight!

BURD PISTON RING CO.

Dept. PM • Rockford, Ill.



THIS COUPON BRINGS FREE BOOKS

BURD PISTON RING CO., DEPT. PM
Rockford, Illinois

Gentlemen:

I'd like copies of your "Servicemen's Handy Handbook," which tells how to keep my car in good working order, and the booklet "No Job For A Dub."

Name

Address

City State



Pignatari had learned to fly at 19 and last December received the Diploma d'Honneur of the Ligue Internationale des Aviateurs. He covers his widely separated plants by plane and uses his own transports on his frequent trips to the United States.

Other plants manufacture electrolytic zinc, sulphuric acid, copper and zinc sulphate, steam boilers and oil and gasoline tanks. At Saramenha an aluminum plant with an annual capacity of 10,000 tons transforms the bauxite of the rich Pignatari mines in Minas Gerais into ingots for Laminacao's sheets. Eventually it becomes pots and pans.

During the war Pignatari took over a barely started modern plane factory at Lagoa Santa in the wilderness north of Rio de Janeiro. The plant, which produced advanced trainers for the Brazilian air force, was placed in this out-of-the-way spot as a move in the decentralization of industry during wartime.

Material had to be brought 500 miles from Sao Paulo, labor had to be imported and local workers trained, materials for manufacturing the planes had to be brought by truck from the nearest railroad—10 miles away. Despite these prodigious handicaps the plant was completed and planes were built. But Pignatari, surveying the costs of production and the small government purchase guarantee, now wonders whether he didn't pay a rather stiff price.

His industries cannot compare to their American counterparts in efficiency or rate of production, but this young man expects to catch up with us in a hurry. He needs tools, equipment and men to teach his engineers and supervisors the North American way of manufacturing.

Pignatari asks no financial assistance and makes it clear that he will permit no one to invest in his enterprises. He prefers complete independence.

The young man scoffs at those who tell him that an already booming inflation and the inevitable depression which will follow will ruin his over-expanded empire. The threat of communism in a land where there is great poverty doesn't frighten him. He says that, come good times or bad, there will be more than enough demand for everything his industries can produce.

Brazil is fantastically rich in natural resources; no man knows just how rich. Approximately 40 percent of her great area has never been explored by white men—or by anyone else interested in its resources, for that matter.

According to conservative estimates she has 13 billion tons of iron ore—22 percent

(Continued to page 240)

Closeup of a shining success!

How Johnson's Carnu,* the efficient, liquid type car polish, brings out your car's original "showroom shine"!



BEFORE CARNU:

Dirt and oxidized paint make your car's finish rough and dingy. Dirt sticks in crevices... won't wipe off readily.



AFTER CARNU:

Your car shines like new again, because Carnu both cleans and polishes in *one* application. The finish is lustrous and bright—the surface so smooth that future dust and dirt will wipe right off.



Just follow these simple directions



1. RUB CARNU ON!

It's easy... rub just hard enough to loosen the grime, then let Carnu dry completely to a white powder.



2. WIPE CARNU OFF!

Nothing to it!... just wipe off the powder. You'll find the dirt comes with it, leaving the finish shining like a brand new car. Yes, Johnson's Carnu cleans *and* polishes in one application.

Extra protection for the man who demands "perfection"

A tough, preservative coat of Johnson's Auto Wax does all these things:

1. Maintains the "Carnu" shine



2. Protects the finish



3. Helps preserve the color

This special car wax gives the finish a tough, protective film, protects it against sun, heat and moisture. Auto Wax also makes it easy to keep your car clean and shining because dirt can't get a foothold on the smooth, hard, waxed surface. Your auto supply store, filling station, or regular Johnson's Wax dealer has Johnson's Auto Wax. Try it!



© S. C. JOHNSON & SON, INC. • Racine, Wisc., 1947

*Trademark Reg. U. S. Pat. Off.

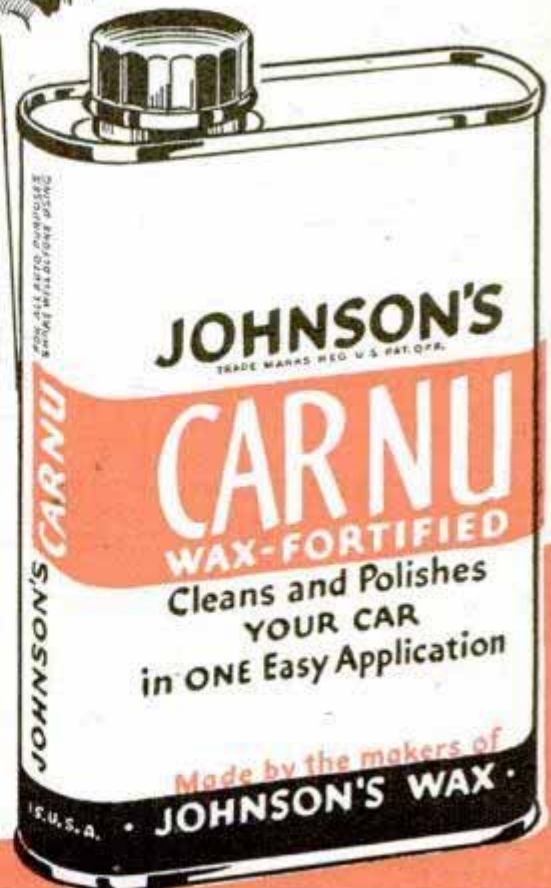

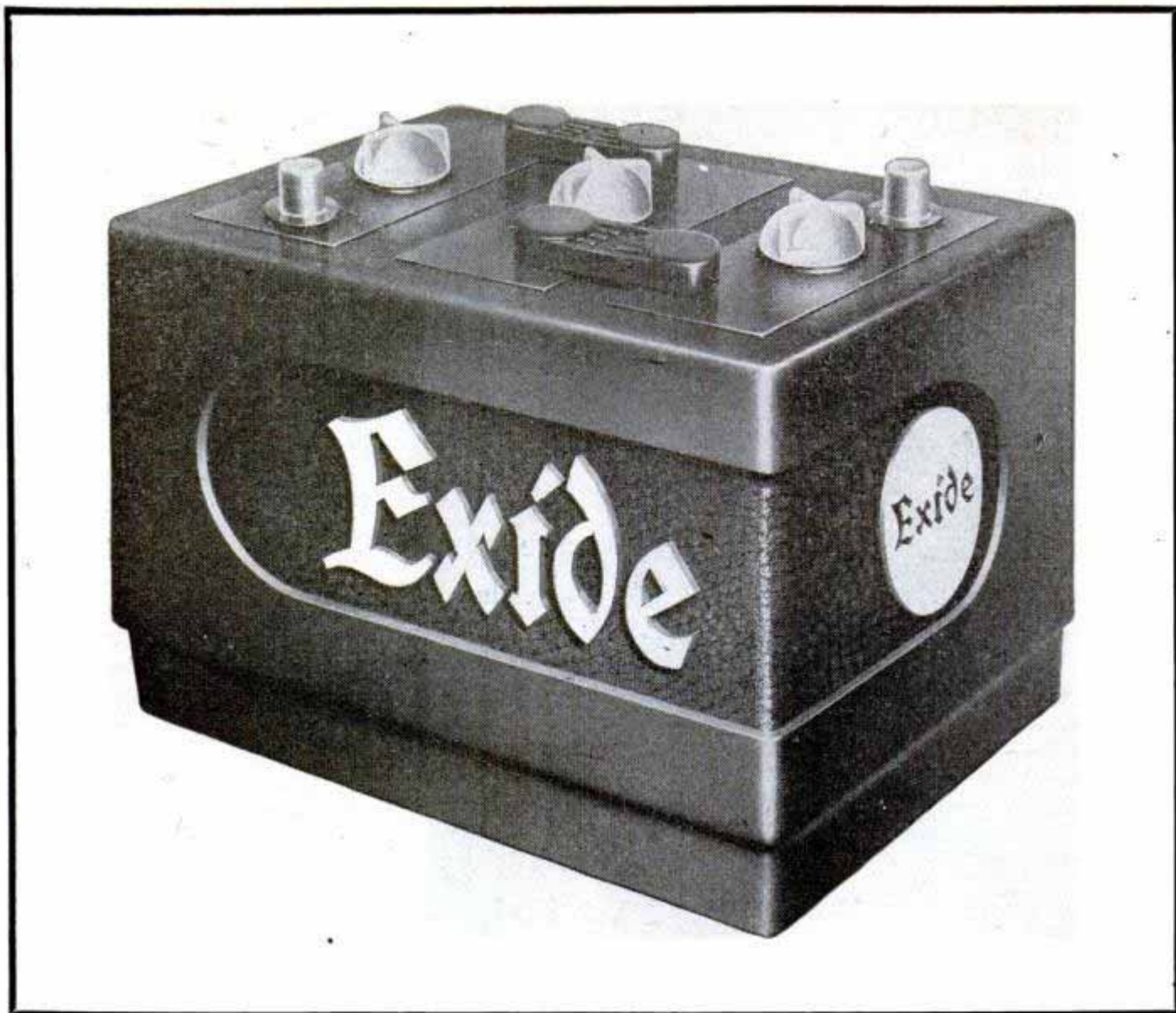

Announcing the New Exide Batteries

In design, construction, performance . . . the NEW Exide BATTERIES excel even Exide's best efforts of the past. A natural result, for with this valuable past experience is combined the new scientific, and technical knowledge gained from modern research and severe, wartime service in all climates of the world.

There are many noteworthy improvements and added features:

- Extra-duty capacity—for greater power.
- Heavy, over-size plates—for longer life.
- Double insulation between plates.
- Dirt-proof, non-spitting vent plugs.
- "Bull's-Eye" electrolyte leveling device.
- Heavy, over-size inter-cell connectors.

THE ELECTRIC STORAGE BATTERY COMPANY, Philadelphia 32

Exide Batteries of Canada, Limited, Toronto

"That brand name means plenty, Mister"



JONES: Sure it does—to you hardware dealers. Tools with advertised names get you higher prices. But how about me? I want the most I can get for my money.

DEALER: Well, sir, let me ask you this. Do you think you get more for your money when you buy unknown tools at bargain counter prices?

JONES: Not necessarily. But I know this much—you can't change a poor tool into a good one just by putting a well-known name on it.

DEALER: Of course not. But don't forget that when a reliable manufacturer puts his advertised brand name on a tool—or

any other piece of hardware—it's got to be good.

JONES: How do you figure that?

DEALER: The manufacturer has a reputation to protect. Thousands of men *believe* in that brand name... *depend* on it... and he can't afford to let them down. It's the same way with me and my hardware store. I've got to keep *my* reputation for quality merchandise or I couldn't even stay in business.

Your **HARDWARE DEALER** sells **QUALITY** tools
and hardware... Buy from HIM



POPULAR MECHANICS

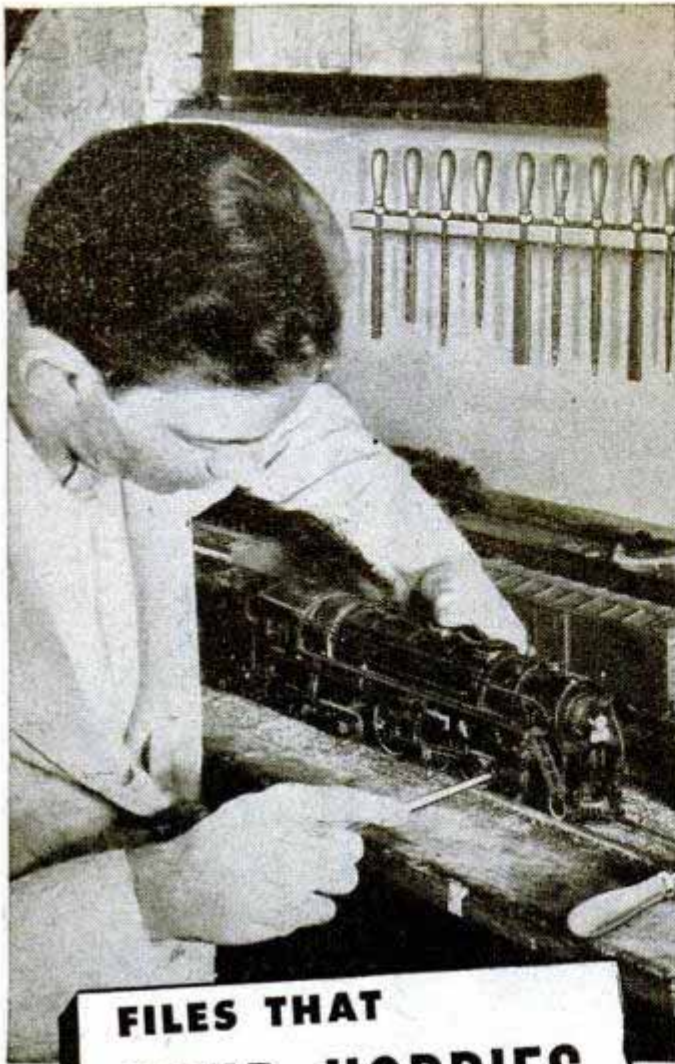

**FILES THAT
SPUR HOBBIES**

LET A MAN—or a boy—get his hands on a few fine tools and he's sure to feel that instinctive urge "to make something."

That's the way it is with Nicholson or Black Diamond files. Just the feel of them—their perfect balance and sure, keen bite—is enough to start you looking for something to sharpen, or to smooth, or to create.

You'll take pride in owning a versatile assortment of these high-quality files. Then, whether you work in metal, wood or plastic—tinker with delicate models or turn out full-scale projects—you'll be able to reach for *The right file for the job.*

Your hardware dealer offers Nicholson or Black Diamond files in a wide selection of shapes, cuts and sizes.



NICHOLSON FILE CO.
22 Acorn St., Providence 1, R. I.
(In Canada, Port Hope, Ont.)



**NICHOLSON
FILES** FOR EVERY PURPOSE

Beginner's Four-Tube Progressive Receiver—Set No. 2

(Continued from page 223)

and carefully solder each connection with rosin-core wire solder. The 3 coils are wound on standard 4-prong coil forms and overlap to cover the broadcast and short-

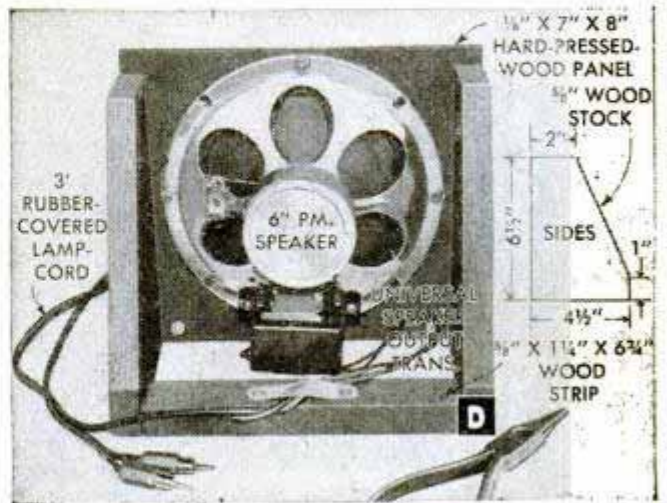

wave bands. Coil connection details are given in Fig. 1, and the winding chart appears under coil photo C.

For receiving local broadcasting stations, a 10-ft. indoor antenna will give best selectivity. A good outdoor antenna is best for distant stations. To tune the receiver, plug it into your 110-volt a.c. line and rotate the large condenser C_2 for the broadcast band. It is also employed as a "band set" condenser for the short-wave bands.

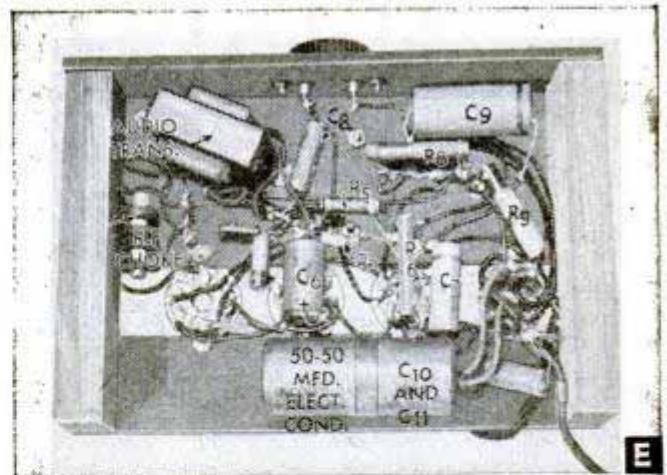

For short waves it is set for the approximate frequency of the stations to be received, and then all fine tuning is done with the small band-spread condenser C_1 . This condenser spreads small segments of the band across the dial, making short-wave tuning easier. No external ground should be used. Detailed student material list R-355 is available from Popular Mechanics Radio and Electronics department upon receipt of ordinary letter postage.



My dentist looked down in the mouth!

I see my dentist twice a year, regular. But does he see me—his Doctor of Motors—regular? He does not!

"Look," I told him a few days ago, "cars, like teeth, need good care: You expect good service from your car every day, yet you never think to take care of it."

Boy, he certainly looked down in the mouth. But after I had ground the valves and put in new gaskets and a set of Perfect Circle Piston Rings, she stopped pumping oil, gave him more power and

drove like a dream. He was one happy Doc as he drove away.

A Doctor of Motors, like a dentist, can spot trouble before it happens and keep little troubles from becoming big ones. Just that regular care can save plenty in worry and money.

NOTICE TO CAR OWNERS

Perfect Circles are available at any automotive repair shop. Your favorite mechanic — your Doctor of Motors — recommends them.

Listen to the Indianapolis 500-Mile Race — Mutual Network, May 30

See Your Newspaper for Time and Station (4 Broadcast Periods). Sponsored by Perfect Circle Corporation—Dedicated to the Doctor of Motors.

Your Doctor of Motors
restores power . . . saves gas
. . . saves oil with . . .

PERFECT CIRCLE

PISTON RINGS

Craftsman's Aid
IN COMBATING
RUST AND MILDEW

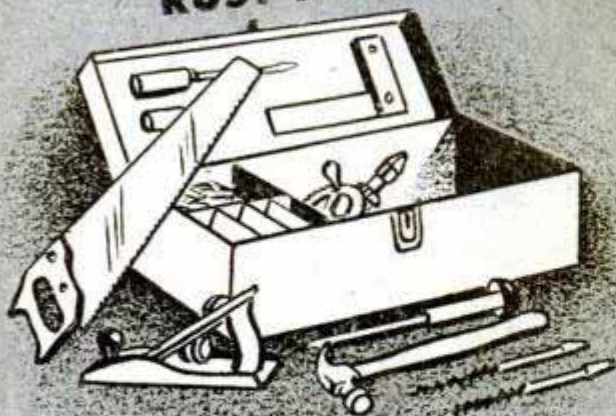

*Absorbs Moisture
IN THE AIR!*

Rust and Mildew are a constant worry, trouble and expense to every craftsman who prides himself on having bright, gleaming tools—in safe, smooth working order. And how often such damage occurs from exposure to damp air, even though you take ordinary precautions . . . even though you keep your tools and sports equipment in closed, tight-fitting boxes!

Damp air simply seeps in and, in time, does damage to metals that rust and leather that mildews. That's why you need Tamms MIDGET DRI-AIR unit—filled with the kind of crystals used extensively by U. S. Armed Forces during the war—the *thirsty* crystals that protect your prized possessions as they absorb moisture in the air!

HOW IT WORKS . . . LONG LASTING!

Just set the shallow, round Tamms MIDGET DRI-AIR unit in with the equipment you want to protect. In the window of the perforated, aluminum case you'll see *blue colored* crystals—the sign that they are *dry*, ready to absorb harmful dampness. When they have absorbed enough moisture to require reactivating, the crystals turn *pink*. Then—no dripping, no bother or expense with refills—simply place the Tamms unit in a hot oven 'til the crystals return to their *dry*, blue color. Then, the MIDGET DRI-AIR is ready to resume its dehumidifying service at top efficiency.

THIS EXTRA SAFEGUARD—ONLY 69¢!

Don't take unnecessary risks with rust and mildew. Do something about it. Buy Tamms MIDGET DRI-AIR from your hardware or sports dealer—*right away!*

TAMMS SILICA CO. Chicago 1, Illinois

Stop This!



with original

HaCAR Safety Locks 2 DOOR SAFETY ON 4 DOOR CARS

Perfect safety for every rear seat occupant. Ideal theft protection, too. Simple, concealed HaCAR installation makes it impossible for the rear doors to be opened accidentally.

Easily installed by any garage. From your dealer or write for complete descriptive literature.

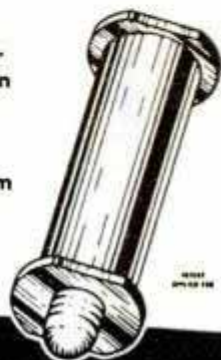

**Consolidated
Sales Co., Inc.**

4525 12TH STREET
DETROIT 8, MICHIGAN



CROSMAN Silent RIFLE

**POWER
without POWDER**

You'll like a Crosman because there is no recoil to spoil your aim . . . no noise . . . no odor . . . no cleaning! Rifled barrel for greater accuracy . . . adjustable power, too, for short or long range shooting indoors or out. Available in .177 and .22 cal. models.

WRITE FOR COMPLETE INFORMATION

CROSMAN ARMS CO., INC.

3 HENRIETTA ST., ROCHESTER 7, N. Y.

Shoot CROSMAN SuperPells

The BETTER Ammunition for ALL .177 and .22 caliber Air Pistols and Rifles.



.177 cal. . . \$2.50 per M
.22 cal. . . \$3.00 per M

POSTAGE PREPAID

At your dealer or order direct

FOR
GREATER
ACCURACY
MAXIMUM
POWER

CROSMAN ARMS CO. HENRIETTA ST., ROCHESTER 7, N. Y.

Sand Casting — Forging — Heat Treating — Case Hardening

BRONZE FOUNDRY



is again available in limited quantity without priority. Orders filled in sequence as received. INVENTORS—SCHOOLS—CRAFTSMEN use FOUNDRYETTE for making castings quickly for new inventions, for instruction, and general purpose. Order now for early delivery. Three sizes are available capable of making bronze castings of 1½, 3, and 6 pounds weight, aluminum, copper, brass, etc. Domestic gas supply and 110 volt AC or DC energy required for operation.

Write for circular.

Box 6022, Dept. P-78

KANSAS CITY SPECIALTIES CO.

Kansas City, Mo.



AUTO-LITE "Plug Tips"

Are your plugs wasting time and money?

The right type of spark plug will save you time and money. Plugs which are faulty and mis-fire waste as high as 10 per cent of your fuel, according to experts. And hard-to-start engines can lose valuable time. Check all your spark plugs regularly to make sure you have the right plugs for your engines.

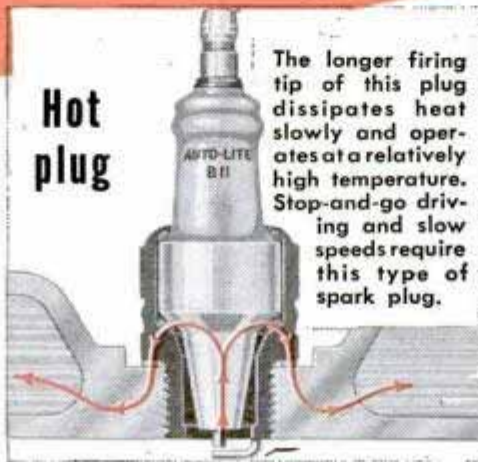

Hot plug

The longer firing tip of this plug dissipates heat slowly and operates at a relatively high temperature. Stop-and-go driving and slow speeds require this type of spark plug.

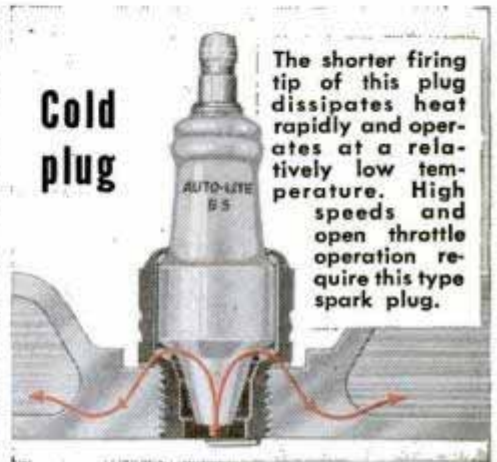

Cold plug

The shorter firing tip of this plug dissipates heat rapidly and operates at a relatively low temperature. High speeds and open throttle operation require this type spark plug.

Send for Auto-Lite "Plug-Chek" kit...only 10¢!



Too Hot *

If spark plug firing tips are fused or blistered, plugs are operating too hot and may be causing loss of power and damaging spark knock.



Normal *

If spark plugs look like this, they are of correct heat range. Get your Auto-Lite "Plug-Chek" Kit right now and check your spark plugs.



Too Cold *

If spark plug firing tips show deposits of carbon or are wet with oil, plugs are too cold, may cause poor starting and waste dollars in costly gas.

This Auto-Lite "Plug-Chek" Kit quickly helps you find spark plugs that are causing trouble. All you do is match plugs with pictures on the "Plug-Chek" Indicator—each example refers to a page in the "Plug-Chek" Data Book that shows you what to do.



* Because these illustrations are not in full color, they do not accurately reproduce the actual firing tip appearance. For accurate, full color reproduction, mail the coupon.

Switch to
AUTO-LITE
SPARK PLUGS

THE ELECTRIC AUTO-LITE COMPANY
Department PM2, Toledo 1, Ohio

Enclosed find ten cents for the Auto-Lite "Plug-Chek" Kit that includes both the "Plug-Chek" Indicator and Data Book.

Name _____
Address _____
City _____

USE AC's FOR
**UTMOST
RELIABILITY**

"The mail must go through"—and does, with the help of today's AC's in thousands of mail cars and trucks. You can enjoy utmost reliability in spark plug performance by having your spark plugs checked to be sure they are right for today's driving and fuels.



Look for this sign



Spark Plugs cleaned and adjusted "By the AC Method" may save as much gas as 1 gallon in 10



AC
SPARK PLUGS

AC SPARK PLUG DIVISION • GENERAL MOTORS CORPORATION

of the world total; 120 billion tons of manganese; 150 million tons of bauxite, a billion tons of coal and very considerable quantities of cement.

Brazil, in the opinion of qualified economists, is headed for a boom and eventually for a place in the front rank of industrial powers. To the United States she will be a good customer as well as a good neighbor—perhaps our best customer. To enterprising young men and young women she will be a new frontier.

A few years ago President Roosevelt said: "If I were a young man, I would go to Brazil. Some day this will be the most important area of development in the world. The whole history of our own West will be repeated."

They Tailor Their Own Cars

(Continued from page 143)

wide doors. Steering wheel and instrument board are similar to those of an airplane.

An easy way to lower the body of a stock automobile equipped with cross springs is to use longer spring shackles. But this is not recommended because it may impair riding and steering qualities. The best way, which should be done by a spring shop, is to reduce the arch of the springs and turn the spring eyes. This drops the car about two inches; it also lowers the center of gravity.

Elliptic springs are lowered by placing a two to three-inch hardwood or steel block between the axle housing and the spring assembly and using longer U-bolts. Coil springs of knee-action units are cut to reduce the height of the coils. The car may pound on rough ground after this change but it rides well on pavement. Care must be taken not to lower the body so much that the tires rub on the fenders. On most makes the shock absorbers can be repositioned to provide normal stroke.

Windshields are lowered by cutting 2½ to four inches from the sides of the frames, then cutting the glass to match. Convertible tops must be cut down to fit the new height of the windshield.

Lowering the hard top of a coupe is more difficult. Usually the entire top is sliced off across the center of the rear window. Two or three inches of metal are trimmed away all around, leaving comfortable head-room inside. The windshield, rear window frames and glass are cut to fit. The roof now must be lengthened to match the rest of the body. This is done by cutting the roof in half, crosswise, and fitting the front and rear sections in place. The gap is filled by carefully welding in a strip of metal. The

(Continued to page 244)

Here's your "FOUR" - for more fun
fishing

EVINRUDE

Zephyr

FOUR CYLINDERS

One top choice! . . . if you want the kind of motor that just naturally seems to do all things better! It's a pedigreed Evinrude "Four" for the smoothest, sweetest outboard power you've ever dreamed! It's an Evinrude "Four" for hair-trigger starting ease and sureness. It's an Evinrude "Four" for utmost flexibility, for thrilling responsiveness.

In the 5.4 horsepower Zephyr it's all yours . . . all the glorious performance of a "Four" packed into a motor of the most popular size for average service. Try it—ride with it—learn what 38 years of know-how have contributed to fine outboard performance!*

See your Evinrude Dealer! Look for his name in your classified phone directory under "Outboard Motors". Evinrude Catalog FREE. Write today for catalog of the complete Evinrude line. Address, EVINRUDE MOTORS, 5532 N. 27th Street, Milwaukee 9, Wis.

*In Canada: Evinrude Motors,
Peterboro, Ontario.*

**5.4 O.B.C. certified brake H.P.
at 4000 R. P. M.*



FIRST IN OUTBOARDS
— 38TH YEAR

EVINRUDE



**SPEED WASH
FOUNTAIN BRUSH**
Cuts Wash Time

USED on thousands of truck fleets, buses and trains. Also for floors, vats, walls, etc. Clean water is constantly fed through five foot handle and 11" brush. Each stroke soaks, scrubs and rinses. Nylon mixture tufts are hand-stitched into block. Brush back and handle are steel. Handle connects with standard size hose. Guaranteed to cut washing time in half. Mail order today. Include check for postpaid shipment. **\$11.75**

**MILWAUKEE DUSTLESS
BRUSH COMPANY**

M D MILWAUKEE DUSTLESS BRUSH CO.
525 N. 22nd St., Milwaukee 3, Wis.

Please ship.....Speed Wash Brush(es). If not satisfactory we understand Brushes can be returned within 30 days for full refund.

Name

Address

City State.....

new . . . for wood, linoleum, plastics, etc.



**NO. 77 X-ACTO
WOODCARVING SET**

Contains: 6 different chisel and gouge blades, scalpel-sharp, high carbon surgical steel. Flat, "U" and "V" shapes.
4 assorted regular X-acto blades.
2 3-inch blades.
1 specially designed X-acto handle.
Gouge and chisel blades are designed with architectural rib, for rigidity and control in cutting. At hobby, hardware and gift shops. **Only \$3.00**

Other X-acto Knives, Blades & Tools, 25c to \$45.00

X-ACTO CRESCENT PRODUCTS CO., INC.

440 Fourth Ave., New York 16, N. Y.

In Canada: Handicraft Tools, Ltd., Hermant Bldg., Toronto

ROTO-ETTE
Reg. U. S. Pat. Off.
**THE ALL-PURPOSE
POWER GARDENER**

*Does Most
Outdoor
Chores*



**1947 MODEL
ROTARY
TILLAGE
PLUS!**

Changes back-aching jobs into healthy enjoyment. For men, women — home owners or small acreage growers.



ROTO-ETTE, in a few minutes, can be easily converted to prepare seed bed, seed, cultivate, mow, rake, haul, plow snow, spray, pump water. Built to exacting automobile standards by oldest manufacturer of rotary tillage equipment in U.S. Seventeen years experience — thousands of enthusiastic users. You will enjoy a dependable ROTO-ETTE.

Write Dept. N for Folder

ROTOTILLER, INC. TROY, N.Y.



OWN A HARLEY-DAVIDSON

and make the entire country your vacation land

Enjoy the most thrilling vacation of your life this year — on a Harley-Davidson. It brings most of the country's historic places, natural wonders and famous fun spots within easy range. Go whenever you get the urge — stop where and when you choose — with no timetables to follow. What's more, motor-

cycling turns every evening, holiday or weekend into extra "vacation-time" — as you zoom along with other fun-loving riders on pleasure jaunts and club runs — or take in race-meets, hillclimbs and other thrill-packed motorcycling events. See your Harley-Davidson dealer NOW — and mail coupon today!

HARLEY-DAVIDSON *Motorcycles*

HARLEY-DAVIDSON MOTOR CO., Dept. P, Milwaukee 1, Wisconsin
Please send at once free copy of 24-page "ENTHUSIAST" Magazine, filled with thrilling motorcycle action pictures and stories.

Name.....
Address.....
City..... State.....



RUB ON

Let dry a minute

WIPE OFF



*Clean 'em up
Shine 'em up*

The
**Quick
ZECOL
Way**

ZECOL's popularity with car owners is due to its Quality, its Quickness and Ease of Application.

ZECOL adds a brilliant lustre to all types and colors of lacquers and enamels.

Keep your car looking shiny and new. It's so easy with ZECOL.

If your car has an accumulated road film, use ZECOL Scum Remover before applying ZECOL Wax.

Ask for ZECOL—at service stations and garages. Pints 75c, quarts \$1.25, in U.S.A.



ZECOL Cooling System Conditioner

Easy to use. Rust and corrosion inhibitor. No draining or flushing. Add to radiator—clean up rusty water while you drive. Lubricate water pump, bearings and seals. Stop water pump squeaks. At service stations and garages. Price \$1.00 in U.S.A.

ZECOL INC., Dept. 3
Milwaukee 1, Wis.

CAR OWNERS . . .

For smooth engine performance—pep and power—for stepped up lubrication—to free sticky valves—keep rings and valves free. At service stations and garages. LUBAID-T 12 oz. 60c. LUBAID pt. 75c, qt. \$1.00 in U.S.A.

LUBAID CO., Dept. 3
Milwaukee 1, Wis.

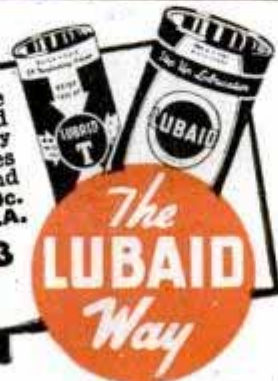

The
**LUBAID
Way**

entire top then is welded back onto the car.

Various methods are used for unlatching the luggage compartment by remote control. One way is to reverse the positions of the lock and its catch, attaching the lock to the body and the catch to the deck lid. A flexible cable is installed to pull open the lock from the driver's seat. The lid handle is removed and the hole is welded over and painted. Two small coil springs inside the lid may be installed to spring open the lid when the catch is pulled.

An entire extra door-locking mechanism is used when a door handle is removed and the control pedal is mounted below the body. The extra lock is mounted in the body, facing the existing lock in the door. The bolts of the two locks are modified so that the door opens when either bolt is withdrawn. The lock mechanism in the body then is connected to a foot treadle under the side of the car by a metal rod. Car doors also may be opened electrically from inside the car by using a concealed push button to operate a solenoid that withdraws the bolt. In all such cases the standard door handle outside the car is removed and its installation hole is welded over.

Back in the '20s many automobile owners spent their spare cash on extras and accessories that they added to their cars to improve the performance or comfort of their vehicles. Gradually the factories adopted many of these extras as stock equipment. Perhaps today some of the car owners who are modifying the designs of their automobiles are pointing the way to future factory changes in our stock cars.

Fencing In the Waterways

(Continued from page 126)

miniature the entire watershed of the Mississippi. The model will be 4500 feet long and 3900 feet wide, of sod and concrete, and will represent the terrain of all or parts of 31 states from the Appalachians to the Rockies and from Canada to the Gulf. About 41 percent of the total area of the United States will be reproduced.

The channels of the Ohio, Tennessee, Arkansas and Red Rivers and their principal tributaries will be included as well as the Mississippi itself. Mile-high mountain ranges are being scaled down to hills 50 feet tall. Some 15,000 miles of river channels are being compressed to a length of eight miles. All existing and proposed flood control measures, including levees, dikes and approximately 200 reservoirs, will be installed.

When completed in two to four years, the

(Continued to page 248)

WORK BETTER—LOOK BETTER IN **BIG YANK**

MATCHED SHIRTS AND PANTS



*Patented

Watch fellow workers take a second look—boss and public say: "There's a fellow going places," when you wear handsome **BIG YANK** work clothes. Your choice of popular fabrics and colors. Besides, they have

9 "HELP-THE-JOB" FEATURES!

- ✓ Large Pockets with Flaps
- ✓ Danger-Check Safety Cuffs*
- ✓ Sanforized (shrinkage less than 1%)
- ✓ Elbow-Action Sleeves*
- ✓ Dress Shirt Styling
- ✓ Wet-Resistant Cigarette and Non-Jab Pencil Pocket*
- ✓ Full-Cut Roominess
- ✓ Non-Rip Seams
- ✓ Reinforced Crotch

At good stores everywhere



BIG YANK

SHIRTS PANTS

Reliance Manufacturing Co., 212 W. Monroe St., Chicago 6

LOW PRICED AMMCO 7" PRECISION SHAPER

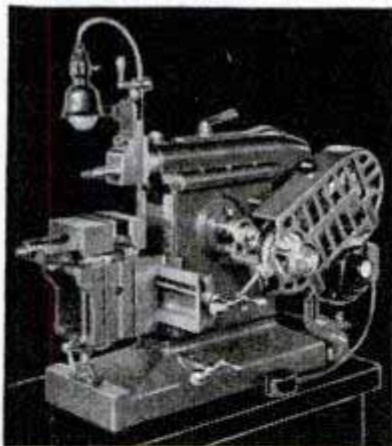

SMALL, COMPACT... for HOME or PLANT

You'll be amazed at the wide variety of jobs this AMMCO 7" SHAPER can handle quickly, accurately, economically. It does the precision work of a larger machine... has many features found only in the big expensive shapers.

Compactly designed for home and small plant use, sturdily constructed for long life—it comes in bench or portable models. At its new low price, you now can afford this Shaper of a "thousand uses".

Address Dept. PM-57 for specifications and prices.

AMMCO TOOLS, INC.

COMMONWEALTH
AVENUE



NORTH CHICAGO
ILLINOIS

(Formerly Automotive Maintenance Machinery Co.)

THE SKILL IS BUILT INTO AMMCO MACHINES



Gives 1 Hand
a TON-GRIP

WISE-GRIP
WRENCH
REG. U.S. PAT. OFF.

Does more jobs easier, quicker. For "impossible" jobs, where other tools fail, VISE-GRIP is invaluable. Gripping power easily exceeds a ton. Locks to the work with hands removed. Holds anything, any shape. Superplier action. Ask for genuine VISE-GRIP, the original toggle-wrench—strongest made, never equaled. Wider range of jaw adjustment than any other type. Built of fine alloy steel. Nickel plated. Two sizes: still only \$1.65 and \$1.95.

Sold thru Tool Jobbers and Dealers

Invented, Developed and Made World-Famous by

PETERSEN MFG. CO., Dept. 29, DeWitt, Nebr.

SO MANY THOUSANDS SAY:

"America's Great Fishing Motor"

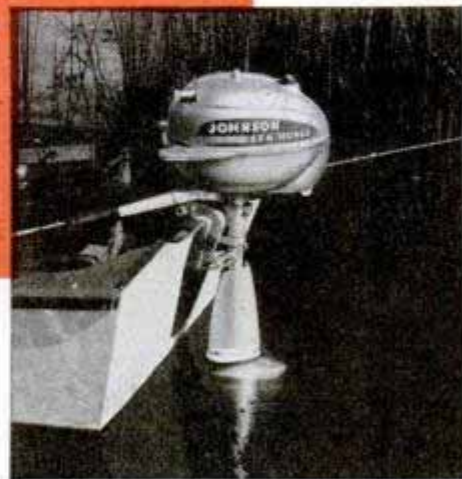

Ask your experienced fishin' friends what outboard motor they recommend for sweetest performance, easiest handling and all around dependability. Such a big percentage of America's fishermen own Johnsons that we are sure of the answer you will get. Expert fishermen know outboards from experience. And there is no substitute for experience!

FREE HANDY CHART: Full details on all Johnson Sea-Horses. Write, JOHNSON MOTORS, 400 PERSHING ROAD, WAUKEGAN, ILLINOIS
Johnson Motors of Canada, Peterboro, Canada

FAMOUS FOR DEPENDABILITY

See your Johnson Dealer about delivery. Look for his name under "Outboard Motors" in your classified phone book.

JOHNSON SEA-HORSE

Larson

"MAKE YOUR OWN" PICNIC TABLE

AND
LAWN
BENCHES

Another new
LARSON
Construction
set



Hook together for table

Copyrighted instruction sheet for easy assembly. Illustration shows how table is constructed and ease with which it is converted into a pair of lawn benches. Quickly taken apart for storage. Set of hardware only. Lumber not included.



Used as Benches

PREPAID \$3.30

CHAS. O. LARSON CO., BOX 358, STERLING, ILLINOIS

FLUID PUMP

At last, a dependable, low priced coolant pump for machine tools. Fully guaranteed by old, reliable manufacturer.

Constructed of non-corrosive materials. Plastic screen quickly removed for cleaning. With this pump and small pan for fluid you obtain same results as with expensive equipment.

May be used for Evaporative Coolers, Fountains, Displays, etc.

DEPT. M **\$19.50** POSTPAID

JOBBER AND DEALER INQUIRIES INVITED

AMERICAN
METAL PRODUCTS CO.
FORT WORTH 9, TEXAS



HOLD-E-ZEE

Automatic Grip

SCREWDRIVERS

... not only tools of finest quality, with chrome-vanadium blades, hand-ground bits, insulating, unbreakable handles ... but possessing the exclusive Gripper which holds, starts, and sets up screws in unhandy places. At leading dealers everywhere. Upson Bros., Inc., 86 Exchange St., Rochester, N.Y.



QUALITY UNSURPASSED • CONVENIENCE UNEQUALLED

Keep Brushes like New

BEFORE

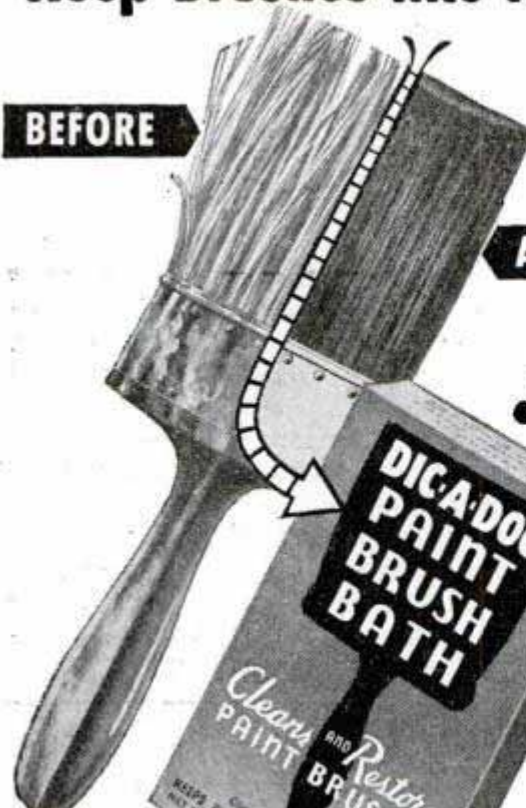

AFTER



• 5c
• 10c
• 25c

**DICA'DOO
PAINT
BRUSH
BATH**

*Clean and Restore
PAINT BRUSHES*

At Paint, Hardware, Dept., and 5 & 10c Stores
Patent Cereals Co. Geneva, N. Y.

GET A GENUINE DELTA REDDYLITE ELECTRIC LANTERN

6-volt. Shoots beam 800-ft. Light revolves in a circle—"stays put" at any angle you set. Dozens of uses. Buy at hardware, sport, and electrical stores.

\$2.69
battery



Delta ELECTRIC CO.
Marion, Indiana

UTICA TOOLS

**PLIERS FOR
EVERY NEED**

Ask Your Dealer

UTICA DROP FORGE & TOOL CORP.
UTICA 4, NEW YORK

THE METEOR

(It's a UNIVERSAL)



... and only **\$15.00!**

Here it is, Universal's smart new, low-priced camera with twelve (count 'em - 12) high-cost, "professional" features. It's the perfect camera for photo-eager folks who want to start on the streamlined path to a great photo-future!

STREAMLINED DESIGN! All-metal construction - satin-finish aluminum - with smart pebble-grained cover.

COATED LENS! For clear, sharp pictures every time!

ADJUSTABLE DIAPHRAGM! For better pictures under any light conditions!

COLLAPSIBLE LENS MOUNT! Ready for action at the twist of the wrist!

ROTARY-FOCUSING MOUNT! No special attachments necessary for close-ups, landscapes, etc.

BUILT-IN LENS SHADE! Protects pictures from glare!

BUILT-IN EXPOSURE METER, CALCULATOR! Makes it easy to get proper exposures every time!

BUILT-IN SYNCHRONIZED FLASH! Get those "professional" indoor shots!

OPTICAL VIEW FINDER! See what you're getting before you shoot!

CHAMBER LOADING! Takes standard 620 film in a unique chamber-loading device.

TRIPOD SOCKET!

SQUARE PICTURES! 2 1/4 x 2 1/4 exposures mean no gymnastics - camera never needs to be re-oriented!

See the **METEOR** at your dealer's



**MERCURY
FLASH UNIT**
-for use
with built-in
synchronizer
\$7.30



Sturdy,
ever-
ready
carrying
case
\$5.00

UNIVERSAL CAMERA CORPORATION

NEW YORK

CHICAGO

HOLLYWOOD

Manufacturers of Cinémaster and Mercury Cameras
and other Photographic Equipment

SAY YOU SAW IT IN POPULAR MECHANICS



TUNE UP WITH MOTOR RYTHM!

Pour a pint of MOTOR RYTHM through your carburetor and make your motor zing with new power and pep! MOTOR RYTHM cleans out carbon and other harmful, power-wasting deposits the modern, chemical, safe way. It makes motors run better . . . helps them travel farther on less gasoline. Ask for MOTOR RYTHM at your garage or service station. *R. M. Hollingshead Corporation, Camden, New Jersey; Toronto, Canada.*

Here's a WHIZ item that belongs in every garage and home workshop—Loosen-All. A few drops quickly frees stubborn bolts and nuts, or any other part seized by rust, scale, corrosion, paint, shellac, red or white lead.



PRODUCTS OF



Hollingshead
LEADER IN MAINTENANCE CHEMICALS

colossal model will permit engineers to work out the best technique for over-all river operation. How to operate the scores of reservoirs in the system most efficiently, for instance, is a major problem in itself.

Approximately 1000 gallons of water per minute can be pumped into the model to duplicate any combination of storms. A major storm near the headwaters of the Red River, sustained but gentle precipitation along the upper reaches of the Mississippi, and a sharp flash flood pouring down the Ohio can be created simultaneously. The course and effects of each flood will be measured by gauges at 1500 strategic points on the model, each connected to electrical recorders that will make permanent records of water heights.

Already the experiment station uses a 2½-acre model of the lower Mississippi for flood control studies. Huge as it is, this model will be dwarfed by the vast watershed model that is now being built.

Get Ready for Camp

(Continued from page 159)

and cake turner should be included. Don't forget a sharp butcher knife and a can opener. For cleaning dishes and taming the stickiest of frying pans include a can of powdered cleanser and plenty of steel wool. A dish mop and plenty of dishcloths rolled up with the implements will complete the "kitchen." A large square of white oilcloth makes an ideal tablecloth for use on the ground or camp table.

The gasoline stove and lantern—These modern servants go far to take the curse from camping, but they are efficient only if given proper care. The stove tank should be drained of old fuel and refilled, and the burners brushed clean and lighted. If the air pressure drops quickly it indicates that the packing glands need tightening. If the pump leather is dry add a few drops of neat's-foot oil to give it a good, tight seal. If the stove has had much service a new generating unit may be advisable, for old ones become clogged with carbon.

The lantern should be emptied, refilled, carefully tested, and the same measures applied as to the stove. If the generator gives the least sign of trouble by all means replace it, for the tiny hole in the generator tube is difficult to clean out and rarely works well after it has been cleaned. A supply of extra mantles should be carried in a compact metal box to prevent damage.

Finally—and most important—have a good, tight gasoline can painted red for safety. Fill it at home with white gasoline,

(Continued to page 252)

**SAY, LOOK AT THIS!
A WHOLE BOOK OF
SWELL SHOP-PLANNING
IDEAS!**



**New, big Delta*
book gives you
page after page
of useful ideas**

**32 pages of the best ideas
of dyed-in-the-wool
woodworking enthusiasts**

Delta's new book, "21 Home Workshop Floor Plans," is a reliable guide to more fun from your wood-working hobby.

If you're a beginner, there's useful material here that's a great help in building your first workshop.

If you're an old hand at wood-working, there are ideas to give you new inspiration for modernizing your present set-up.

A Variety of Information!

Here's a collection of the ingenious ideas of experienced woodworking hobbyists — the "top-notchers" selected from thousands of wood-working shop plans gathered by Delta.

You get floor plans for almost any size shop — to fit almost any size budget!

You get scale drawings of the

base dimensions of Delta HOME-CRAFT® Power Tools — helpful in estimating the floor space you need.

You get practical suggestions on the arrangement of tools, storage of lumber, etc.!

You get idea upon idea for convenience, economy, and safety!

You get pictures of the interesting workshops of other hobbyists!

Get This Book Today!

With all this help — plus your own ideas — think of what a great shop you can design and build. It's bound to be an attractive place you're proud to show to friends — a pleasant retreat where you are close to your family as you all share in the fun.

The sooner you order your copy of Delta's book, "21 Home Workshop Floor Plans," the quicker you can enjoy your planning fun. So don't delay — attach your check, money order, or dollar bill to the coupon below and mail it now!

\$1
Postpaid

**A fine woodworking shop
calls for fine tools**

To get the most from your investment in power tools, it pays to go to the store near you that handles Delta HOME-CRAFT® Power Tools. They are popular tools with a reputation for dependable, safe, economical performance. Your Delta dealer is listed under "Tools" in the classified section of your telephone directory. Get to know him — he's glad to give you helpful advice on planning and equipping your shop.



*Trade Mark Reg. U.S. Pat. Off.

**Tear out
coupon and
mail today!**

DELTA MANUFACTURING DIVISION
Rockwell Manufacturing Company
680E E. Vienna Ave. Milwaukee 1, Wisconsin.

Enclosed is one dollar cash check money order } as payment

in full for the new Delta book, "21 Home Workshop Floor Plans."

Name.....
Address.....
City..... (.....) State.....

GET IT
AS YOU
SEE IT—
IN COLOR!



Master II

WESTON EXPOSURE METER

Colors will be true and life-like if your exposure is correct. That's why photographers everywhere rely on the WESTON Exposure Meter. Ask your dealer for a demonstration today. Weston Electrical Instrument Corporation, 671 Frelinghuysen Ave., Newark 5, N. J.

The meter most photographers use!

SAY YOU SAW IT IN POPULAR MECHANICS



WRITE FOR YOUR **FREE** COPY OF THE NEW
KRW HYDRAULIC PRESS BOOK

Describes all manner of Production and Shop Work on KRW Hydraulic and Bench Type Arbor Presses. 32 pages illustrating the new KRW Hand-operated, Electric-operated and Air-operated Hydraulic Presses.
Write for your copy today.



K. R. WILSON, DEPT. 17, 215 MAIN ST., BUFFALO 3, N. Y.
Builders of Shop Equipment for Ford Dealers Since 1916



OFFICIAL U. S. GOV.
COMPASS
Hunting Case, Watch
Type, All Metal,
Jeweled Waltham
\$1.95
\$3.50 Value

WHEATSTONE BRIDGES Used in excellent condition. Mfg. by Thompson Lever Mfg. Co., Philadelphia. Value \$150.00. **SPECIAL \$49.50**

Engineers All Metal Army Type Hand-Sighting

LEVELS

\$2.00 **PRECISION
QUALITY**



PUBLIC SPORT SHOPS

13 S. 16th St., Phila. 2, Pa.

No COD's

Today's Best
PLANER VALUE

\$119.⁵⁰

A Life-Time Tool
at Low Cost



THE "YAGER" —Thickness Planer—not a jointer, for homecraftsmen, or auxiliary tool in large shops. A marvel of efficiency, precision performance — at an amazingly low cost. Dependable for constant, uninterrupted, trouble-free service. Works any stock from soft balsa to hard ebony. Produces smooth, polished surfaces. Takes stock up to 10 in. wide, 2 3/4 in. thick or down to a thinness of 1/16 in. Handles light work with 1/3 H.P. motor and hand crank feed or heavy cuts up to 1/8 in. with 3/4 H.P. Sealed ball bearing arbor requires no lubricant. Feed gears packed in oil seldom need repacking. Now ready for immediate delivery. Write for prices and starting facts.

THE KNEISLEY ELECTRIC COMPANY

497 S. St. Clair St., Dept. 57

Toledo 3, Ohio



The Modern PLASTIC
for lasting Home Repairs

PERMANENTLY mends cracks or holes in wood, tile, stone or plaster. Sticks and stays put—Does not chip, shrink or fall out. Easy to use. Economical. Mold it, chisel it, polish or paint it. If unobtainable from your lumber, paint or hardware dealer, the big 4-lb. can will be sent you post-paid (in U.S.) for only \$1. Full money-back guarantee, order now.

DONALD DURHAM CO.
Box 804-E, Des Moines, Iowa

BACK AGAIN: All You Want BEARINGS

ALL TYPES
ALL SIZES
INDUSTRIAL • AUTOMOBILE • TRACTOR •

WE HAVE THEM NOW

We can furnish you with exactly the kind of bearings you want and in the quantities you need.

- AUTO BEARINGS
- BALL BEARINGS
- ROLLER BEARINGS
- THRUST BEARINGS
- BEARING PILLOW BLOCKS
- BRONZE BEARINGS
- V-BELT DRIVES
- OIL SEALS

Special
Prices
to Large
Users

Let Us
Know
Your
Require-
ments

Write For Prices

AUTO-INDUSTRIAL BEARINGS CO.

Dept. PB-5
3811 No. Ashland Ave., CHICAGO 13



GET THE BEST IN MUFFLERS V-8 DUALS & SINGLES



Finest Norman custom-built muffler sets - steel pack - torpedo type - heavy, perforated steel cores - chrome enamel finish - mellow, deep tone (improves with use) - designed to fit - all ways superior - double economy.

DUALS.....\$17.50 SINGLES.....\$7.50

V-8 Ford-Mercury Buick, Olds., Chrys.
SINGLES.....\$5.50 ORDER TODAY! Will outlast
Chev., Ford, Plym. three ordinary mufflers.

Dealers—Write Today for Full Details

NORMAN'S MUSICAL MUFFLERS

Dept. PM-5, 1216 W. Slauson Ave., Los Angeles 44, Calif.

\$2.95

TORNADO

GAS TORCH

The Modern Way of Soldering

Ideal for hard and soft soldering. Will heat quickly; solder will flow freely and smoothly. No compressed air required. Nothing to pump. Self-adjusting. Safe. Economical. Can be used for annealing small parts and bending metal parts. Generates a heat of 1700° Fahrenheit. Simply connect to any illuminating gas jet with a rubber hose and operate. Tornado Torch No. 119 comes with three (3) tips, (1/8", 1/4", 3/8" blast).

The Tornado Gas Torch No. 119, complete with three tips, is \$2.95. See your dealer or order direct. Send check or money order—post paid.

Robco Corporation, 202 E. 44th Street, New York 17, N. Y.

operate. Tornado Torch No. 119 comes with three (3) tips, (1/8", 1/4", 3/8" blast).
The Tornado Gas Torch No. 119, complete with three tips, is \$2.95. See your dealer or order direct. Send check or money order—post paid.
Robco Corporation, 202 E. 44th Street, New York 17, N. Y.

Thompson BEATS the World on BOATS



Better Built
Lower Prices

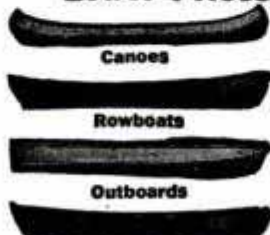

Safe Boats With Full Length Spray Rails
Keep passengers perfectly dry—even at high speeds. Catalog also shows two new models of "Take-Along" Boats. Two big factories—save you freight.

CATALOG FREE
Write for your copy. State kind of boat in which you are interested.
THOMPSON BROS. BOAT MFG. CO. (151)
213 Ann St. Write to 113 Elm St.
PESHIGO, WIS. (either place) CORTLAND, N.Y.

A TOOLSHOP IN YOUR HAND!

- GRIND • DRILL • ROUT
- POLISH • ENGRAVE
- CUT • SAND • SAW, etc.

Make Things From
Wood—Plastics—Metals—Glass—Linoleum—Leather—Alloys—Horn—Stone—Bone, etc.

HANDEE
TOOL OF 1001 USES

Smooth, steady power at your fingertips! Perform precision operations not possible with any other portable tool! With a Handee you can turn out professional looking projects for pleasure or profit—ship, plane and train models, costume jewelry, wood carvings, puppets, initialed tumblers, etc. AC or DC. 25,000 r.p.m. Wt. 12 oz.

USE THE RIGHT ACCESSORIES! Choose them from the most complete line . . . more than 500 made right in the Handee plant.

GET A GOOD START GET THE HANDEE KIT

HANDEE Tool and 40 most popular accessories packed in compact steel carrying case. You'll be amazed at what you can accomplish! Complete, postpaid, \$27.50

Handee only, with 7 accessories, \$20.50

FOR YOURSELF OR A FRIEND...
THE GIFT OF A LIFETIME!

NEW PRECISION ATTACHMENTS

Fit Handee only; enable novice or craftsman to do perfect work. Magically, easily, your offhand carving, routing, shaping will be exact as to depth of cut, accuracy of line. Set of 6 attachments with instructions, postpaid, \$7.95



ORDER NOW. SATISFACTION GUARANTEED!

FREE! NEW 52-PAGE MANUAL

CHICAGO WHEEL & MFG. CO.

1101 W. Monroe St., Dept. PM, Chicago 7, Ill.

Send Handee Kit Handee Tool Precision Attachments
 C.O.D. Remittance enclosed Send Manual

Name.....

Address.....

*It will LAST
a LIFETIME*

—Because It's a PLUMB

A Plumb hand tool is made for permanence. The scientifically tempered head is built for years and years of service. The second growth hickory handle is shaped for a comfort grip and tested for strength. For almost a century master craftsmen have been combining these exclusive Plumb features into perfectly balanced tools. You can be certain it will last a lifetime—because it's a Plumb. Fayette R. Plumb, Inc. Phila. 37, Pa.



Quality Comes **FIRST**
'PLUMB'
is **FIRST** in Quality

PLUMB

HAMMERS • HATCHETS • AXES • SLEDGES

since neither the stove nor lantern will handle colored automobile fuel properly. The white, untreated gasoline is sometimes difficult to find when you are on the road.

A good ax of full or three-quarter size is always useful and may be a necessity in woods country where an evening campfire is wanted. It is required, along with a shovel, in national forest camps throughout the country. Sharpen the ax to a keen edge at home, using a good two-grit oilstone, and carry the stone along for later treatment of the ax and butcher knife.

Final tips—Include a simple first-aid kit, with the necessary antiseptics and bandages for minor wounds. Remember what pests mosquitoes can be and carry a bottle of proven "dope" to apply to the face and hands. Your druggist will know of several formulas that he can prepare. And last, take two supplies of matches with at least one supply in a waterproof can for use in emergencies.

Silver Sheds the Overalls

(Continued from page 148)

sent to a commercial plant in New Jersey and recast into heavier ones. These heavier bars were shipped to other plants in Baltimore and Detroit to be turned into bus bars of varying shapes and sizes. Finally, the bus bars were distributed to the 13 plants in which they were to be installed.

Guards were on hand at all times during all of these procedures. They kept watch over 171 shipments by freight, up to 14 carloads each, and 1660 shipments by motor truck, and over stacks of silver bars spread over acres of space, indoors or out.

The war plants were scenes of feverish activity during the construction rush. The chances were that nobody would pay any attention to one more or one less truckload of silver, worth perhaps \$300,000, being hauled around the grounds or unloaded at a building entrance. Installing the silver bars was, for the skilled workmen employed, just another task such as putting sections of fabricated steel together—a lifting, fitting, bolting, clamping job. But guards' eyes always were present.

Completed and in operation, the plants presented the circumstance that, in the average case, value of the silver bus bar circuits far exceeded the cost of everything else—site, plant, equipment. Guards patrolled the bus bar lines at regular intervals, reported meticulously any damage done to the silver, checked records daily to be sure that the 10 or 20 or 75-million dollar investment in bus bars still was intact.

(Continued to page 256)

REAMING TAPER CUTTING TURNING THREADING

Logan

A NAME TO REMEMBER WHEN YOU THINK OF BETTER LATHES

AND SHAPERS

TURNING FACING THREADING DRILLING BORING

REAMING THREADING TAPER CUTTING

TURNING REAMING DRILLING

FACING CUTTING

TURNING FACING THREADING DRILLING BORING

steel • cast iron • non-ferrous metals • plastics

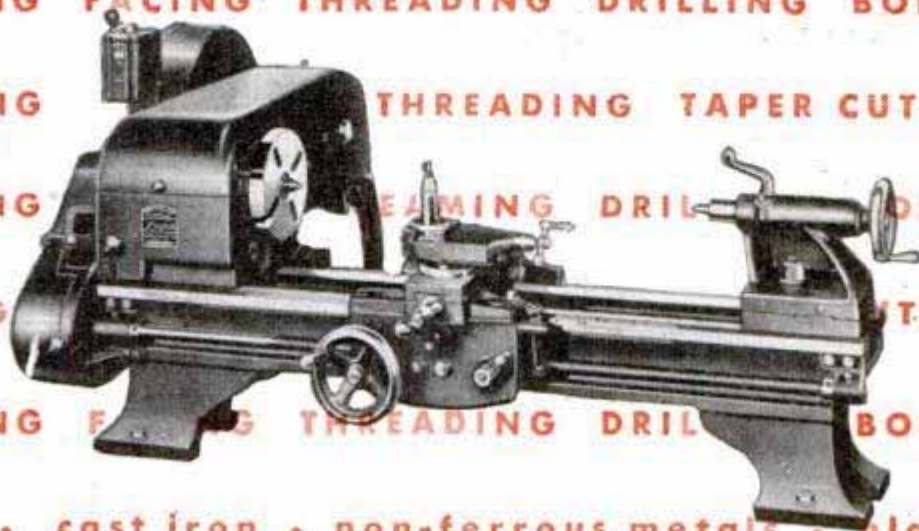

**the right lathe
for small shops**

**9 reasons why LOGAN
Lathes are BETTER lathes**

- 1 BALL BEARING HEADSTOCK**
for sustained accuracy.
- 2 RUGGED, ACCURATE BED**
within .0005" of parallelism.
- 3 SELF-LUBRICATING BEARINGS**
at vital points lengthen life.
- 4 BACK GEARS ENCLOSED
IN HEADSTOCK**
with shifter rack safely and conveniently
at your finger-tips.
- 5 RUBBER CUSHIONED COUNTERSHAFT**
for smoothness and accuracy in working
area.
- 6 THREE POINT SUPPORT**
Steadies the countershaft, prevents
rocking.
- 7 ENCLOSED BELTS, GEARS, PULLEYS**
Prevents accidents. Keeps lathe clean.
- 8 AUTOMATIC BELT TENSION RELEASE**
Makes belt changing easy and safe.
- 9 PRECISION BUILT THROUGHOUT**
For tool room accuracy in your shop.

**compact Logan Lathe
performs variety of work with
speed, ease and accuracy**

The qualities which make the Logan Lathe a successful industrial tool are equally effective in the small shop. The wide variety of operations which can be handled on one Logan Lathe is an important advantage to the small shop owner. Designed for compactness as well as for efficiency, the Logan Lathe occupies a minimum of floor or bench space. The ball bearing mounted spindle requires no adjustment from 30 to 1450 rpm and permits use of high speed carbide cutting tools. Conveniently located levers and hand wheels enable the operator to work in safety and comfort and without fatigue. Rugged construction throughout, and self lubricating bronze bearings at vital points insure lasting accuracy and low maintenance.

WRITE FOR THE LOGAN CATALOG ...complete illustrated descriptions of Logan Lathes, Shapers and Accessories.

DISTRICT OFFICES

Woolworth Bldg.
New York 7, N. Y.
Cortland 7-8024

550 W. Washington Blvd.
Chicago 6, Illinois
Central 1246

1672 Mission Street
San Francisco, Calif.
Underhill 6682

LOGAN ENGINEERING CO., DEPT. B-5, 4901 LAWRENCE AVE., CHICAGO 30, ILL.



No time for tears

• I'm not crying, folks. I'm as brave as the next guy—but I've got worms, and watery eyes are a symptom.

The tears will go if you treat me with Sergeant's SURE SHOT Capsules. They're safe, thorough, gentle on my system, and they kill worms fast!

Sergeant's Puppy Capsules give pups, and small dogs weighing less than 10 pounds, the same sure relief from worms.

Sergeant's 73 years of research and kennel-testing have developed 19 dependable dog care products. Each one helps you to give your dog the care he deserves.



• Watery eyes are only one of the symptoms for worms. Keep a careful check on your dog's health with Sergeant's new FREE Dog Book. Ask for it at drug or pet stores, or write Sergeant's, Richmond 20, Va.

Sergeant's

DOG CARE PRODUCTS

Do a Better Job WITH ONE OF THESE EMPIRE LEVELS

Smallest, most handy and accurate Level made. "Cigar-shaped"—no sharp corners to tear pocket. Aluminum stock. Only 3 oz. wt. 9" long. Has Level, Plumb, 45° Vials.

EMPIRE TORPEDO LEVEL



No. 26\$1.75



ALUMINUM LEVEL — No. 151

Cast and Machined, a Beautiful Tool, with Patented, Removable Level and Vial.

With 2 Plumb, 2 Levels, 2 — 45° Vials. 18"\$6.00
24"\$6.50 28"\$7.00

Order EMPIRE LEVELS from your local dealer.
Write direct for literature.

EMPIRE LEVEL MFG. CO.

717 S. 6th St. Dept. P-246 Milwaukee 4, Wis.

FIND UNDERGROUND MINERALS and METALS with M-SCOPE



Employs same principle as Army Mine Detector. Unsurpassed in Efficiency. Write for Free 16 page booklet.

FISHER RESEARCH LABORATORY
PALO ALTO CALIFORNIA

WALKER-TURNER

DRILL PRESSES

BENCH MODEL

\$66⁵⁰

LESS MOTOR AND GUARD
IMMEDIATE DELIVERY

Write for Free Catalogue

CARPENTERS MACHINERY CO.
213 N. 11th ST., PHILADELPHIA 7, PA.



"I'LL TAKE THE WHITE ONE EVERY TIME!"



WYTEFACE
TRADE MARK
STEEL MEASURING TAPES



KEUFFEL & ESSER CO.

Aladdin's Tool

THE "GENI" OF
A THOUSAND AND ONE USES !!!

all types of
WOOD SHAPING

Routing
Tongue & Groove
Fluting
Notching
Inlay
cuts any type of joint

\$5.95



use in any standard type chuck
HIGHEST QUALITY HIGH SPEED TOOL STEEL
6 blades will make 12 different cuts

IF YOUR DEALER DOES
NOT STOCK THIS ITEM
SEND \$5.95 IN CHECK
OR MONEY ORDER
FOR PREPAID SHIPMENT
OR C.O.D.

DEALERS WRITE
FOR INFORMATION

DESIGN CO.
326 LAW BUILDING
KANSAS CITY 6, MO.

IT COST THE NAVY
Hundreds of Dollars—



You Can Have It
for Only

\$8.95

The Famous
MARK 18 GUN-SIGHT...

The Miracle
OPTICAL GYROSCOPE!

This wonder of the war—The aircraft gunsight that measures and computes automatically! The precision-balanced GYRO UNIT is easily removed with all WIRES. The tiny ball-bearing MOTOR magic GOVERNOR maintains constant speed from 14-22 V. at only 1/10 amp. AC or DC—24 volts. Perfect YOKE and special BEARINGS. The GYRO maintains fixed position in space. The hand-figured SPINNING MIRROR supports a perfect optical image at full speed. Energizing 6 electro-magnets with DC will show erection rate, compute lead and deflections. Twin projection systems fuse both images into one. One fixed and one moving variable demonstrate virtual images. 2 SUPERB ACHROMATS in threaded brass cells, cemented doublets. 2" dia. 7 1/2" c.f.l. tested perfect for telescope objectives. 3 Precision first surface FLATS, aluminized. 2 1/2"x4 1/4" REFLECTING GLASS. SUN FILTER. Two 22 V. lamps in door, changeable for another voltage without rewiring. 2 glass-enclosed RECTICLES. Stainless GEARS. PLASTIC GEL CELL DEHYDRATOR with tell-tale colored SILICA GEL. Die cast aluminum case hermetically sealed. 24" CABLE. 10 coded WIRES. Detailed instructions. Detachable recoil shock BASE. 25-leaf spring bronze SLIDE on precision stainless ground RODS, azimuth CLAMP, bolted to wood shipping base. Padded cover. New original package. Send check, money order, or cash. No C.O.D.'s. Express collect.

GE SELSYN CONTROL TRANSFORMER \$1.95
24 volts. Limited quantity — Only

BUFFALO SURPLUS CO.

26 E. NORTH ST. PHONE GARFIELD 7706
BUFFALO 3, N. Y.

Performance goes up in smoke...

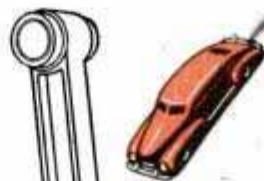

when worn
connecting rod bearings
cause oil pumping

Heavy exhaust smoke behind your car means engine trouble ahead! It's a sign that worn engine bearings are letting excess oil carbon-foul pistons, rings, valves and spark plugs. THAT means sluggish operation, no pep or pick-up. Worn bearings can cause costly crankshaft damage, too. Restore power, pep and economy—replace with Federal-Mogul Oil-Control Bearings. They are engineered for the job—ask your mechanic!

FEDERAL-MOGUL SERVICE
DIVISION OF FEDERAL-MOGUL CORPORATION
COLDWATER, MICHIGAN

Replace in sets with Genuine
FEDERAL-MOGUL
Oil-Control Bearings



miracle stove

OF A THOUSAND USES!

Now Available
to Sportsmen!

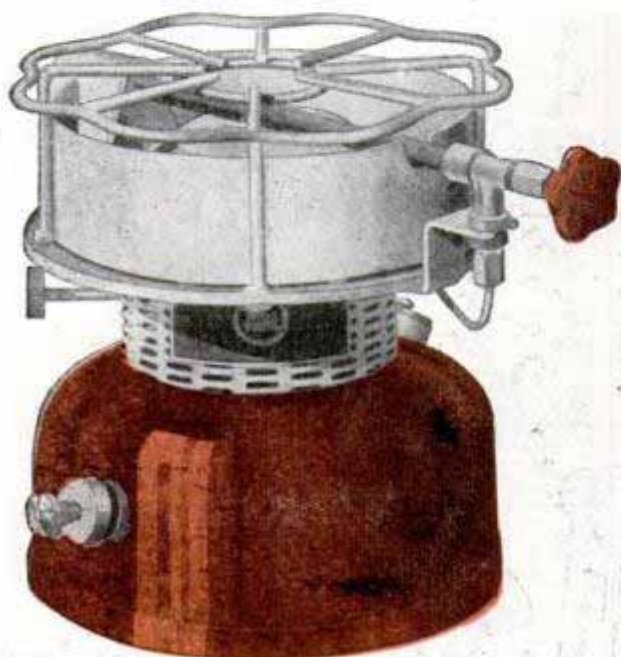

Speedikook

- Hotter flame than city gas.
- Small, compact, easy to carry.

At last—a practical sportsman's portable stove! The new Speedikook lights instantly—ready to fry those fish, make coffee—yet takes so little space you don't know it's in the duffel.

Speedikook holds sufficient gasoline for 9 to 10 hours cooking. Only 7 inches high, weighs only 5 pounds. Non-rusting finish throughout. Every sportsman needs one! Ask your dealer for the genuine AGM product—Speedikook.

KAMPKOLD . . .

Perfect portable refrigerator. 10 pounds of ice lasts 20 hours with outside temperatures of 80!



READY-LITE—Camper's necessity! 8 to 10 hours brilliant lantern light on one filling. Can't blow out! One and two mantle models.

PRODUCTS OF

AMERICAN GAS MACHINE COMPANY
Albert Lea, Minnesota



"Equipment Most Sportsmen Like Best!"

Lieutenant Martin Clair, head of the RFC guards at a plant where 54,000 slabs of silver were used in building the bus bar circuits, took the plant's employees into his confidence. He made a speech to them over a public address system, told all about the silver—emphasizing that it was .999 percent pure—and warned that, since it belonged to the government, trying to steal any of it would be ridiculous because the thief would be "followed to the ends of the earth."

Clair had only one suspect to deal with thereafter, and had to follow this one only to a plant locker room. There the suspect disgorged from his pocket a chunk of silver weighing two or three ounces. A traveling crane knocked it from a bus bar and he picked it up, he said. He intended to turn it over to the guards, but had forgotten.

The man was found to have been in and out of the plant several times since acquiring the silver. That he still had the metal in his pocket argued against any evil intentions. Nevertheless, the case went to the Attorney General of the United States for a decision as to whether the man should be prosecuted. He wasn't.

Not until all the borrowed silver has been returned to the treasury, recast into coinage ingots or commercial bars, and tested for quality and fineness, will it be known how much of the metal was lost in the war project. Preliminary examination has indicated that at most plants damage to the bars amounted only to slight oxidation.

The pains taken to guard against unnecessary silver losses and damage while the metal was in RFC custody were of wide variety. At the New Jersey refinery where the silver had its first processing for RFC use, dust discharged through the flues of a furnace used for melting the silver was trapped in cloth bags, and from accumulations of the dust silver worth \$250,000 was recovered. Sweepings from freight cars and trucks in which silver was shipped were similarly processed. During installation of the bus bar lines in the war plants, bits of silver scrap were carefully saved. In lifting heavy bus bar sections with a derrick, lengths of rubber hose rather than metal chains were used to bind the slabs of silver together and fasten them to the lifting blocks. Slabs of silver stacked for storage were separated by wooden laths.

When bus bar lines in a magnesium plant near Marysville, Mich., were dismantled and the slabs of silver sheared into short lengths for storage, a small aluminum trough was mounted under the cutting edge of the shearing machine. After each cut, a workman armed with a brush and tin can salvaged the silver dust from the trough.

Build YOUR OWN ELECTRIC CLOCK

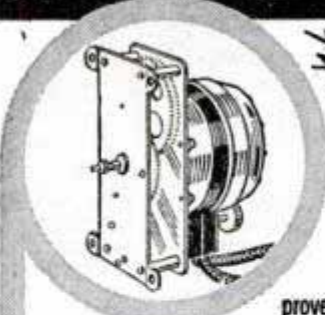

ELECTRIFY
Your
OLD CLOCK!

Design and build the clock of your dreams with this dependable Hansen Synchron movement, 25 years time proved, self-starting, self-lubricating. Solid steel pinions, perfectly matched brass gears insure quiet operation. Heavy steel protecting cover ready to mount. Only \$4.95 prepaid. Set of hand blanks can be filed to your own design and sweep second hand, 50c. Order now.



\$4.95

Harley's Clock Shop
Altman Bldg. Kansas City 6, Mo.

New "THERMO-SAW" (CUTS WITH HEAT) MAKE THINGS FOR THE HOME or FOR SALE

• Any Child Can Use It!

- NO NOISE
- NO VIBRATION
- NO SAWDUST

CUTS RAPIDLY AND CLEANLY THROUGH WOOD AND OTHER MATERIALS... AN IDEAL GIFT! Difficult patterns are made QUICK and EASY... No turning of work... Cuts in every direction... Cuts plywood 3/8" or 1/4"... Cuts 14"x36" board... Special Transformer produces high frequency current in a tough steel wire "blade" from ordinary Alternating (AC) current. No radio interference. IMMEDIATE DELIVERY!

NOTE:
Operates on 110 volt Alternating Current: 50 to 60 cycle. NO C.O.D.'s



Machine Measures 11x4x 3 1/2" High. Throat 7" Deep. PATTERN FREE. Postpaid ONLY \$4.50. COMPLETE SAW outfit as illustrated with transformer and 12 spare blades. READY TO USE.

ORDER \$4.75 in Canada and TODAY Mexico. \$5 Elsewhere.

BOISSELIER MFG. CO., Dept. P-5, GLEN ELLYN, ILL.

Save up to 75%

On NEW HEATERS War Surplus Stewart Warner South Wind Heaters (aircraft type) works on autos, trucks, tractors

Regular Value \$40.00

Now \$7.45 p.p.

25% Deposit on C. O. D. Orders

All Sales Final

Fenwal Thermostats... 400° Max. Range \$1.95 p.p.
Stewart Warner Fan Motor... 24 volts 2.45 p.p.
Micro Switches .75 p.p.

A. KOSIN 6041 LIME AVENUE, LONG BEACH 5, CALIFORNIA
PHONE 2-4447

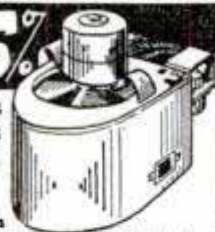

NU-WAY Lawn Mower

Write for Free Circular

PRICE

12.50

WHY PAY MORE?



BUILD YOUR OWN ROTARY TYPE LAWN MOWER

We Supply Cutting Unit Complete

No Increase in Price

Tractor-Lite Mfg. Co.
Spirit Lake, Iowa

NUMBER 1

POST-WAR RADIO

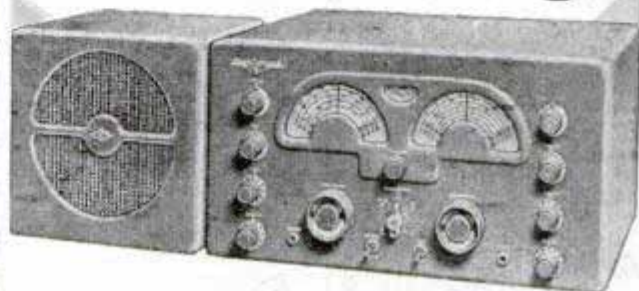

Really new, really post-war, National's NC-173 brings you the latest engineering developments contributed by four years of production-for-war, plus a solid year of peacetime research. Here's incomparable versatility... local and worldwide all-weather reception operating with marvelous clarity, pin-point selectivity. Yet National's NC-173 costs so little more.

- 12 tubes and rectifier, super-heterodyne circuit
- Standard, short-wave and amateur bands. 540 to 31,000, and 48,000 to 56,000 KC
- AM reception, phone and code
- AC powered. Also operates on battery for portable or emergency use—110/120 or 220/240 volts, 50/60 cycles
- Distinctive streamlined styling

Write for the name of your nearest dealer today

NATIONAL

COMPANY, INCORPORATED

MALDEN, MASS.

National



EST 1914

MAKERS OF LIFETIME RADIO PRODUCTS

SUCCESS Can Be Yours!

starting Now at Home,
in your spare time, you can become
a successful manufacturer
with these

15 VALUABLE TRADE SECRETS

In America's largest laboratories millions of dollars were spent to develop and perfect these 15 processes. Now you can get started at home, in your kitchen or basement. You need no technical training, you invest very little money. To assure success manufacture such large-demand products as "Chem-Stone," a new plastic that makes concrete hard as stone and eliminates dusting; "Thermo-Sol," a new inexpensive fireproofing that has no competition; "Water-Seal," the secret sealer for leaking walls and ceilings, and 12 other easy-to-make, easy-to-sell products. We supply everything you need.



Own Your Own Factory! Write Today
for Complete, Free Information!

CHEMICAL RESEARCH CO.
130 WEST 42nd ST., NEW YORK-18, N. Y.

**Paratroop
HUNTING
BOOTS**
in Waterproof Elk
Finish



All sizes from 4 to 13 1/2
All widths from AA to EEE

Newest thing in comfortable, serviceable boots. Ideal for hunting, fishing, hiking and all kinds of outdoor use. Made in soft, pliable, heavy-oiled waterproof leather. Same design, construction and high quality standards as famous boots worn by Paratroopers during war. Write to our Dept. PM-5. Specify size and width. Enclose check or money order for \$9.87. Boots sent immediately, postage C. O. D. Money back if you are not entirely satisfied on receiving boots.

CORCORAN INC., STOUGHTON, MASS.

ONLY
\$9.87
plus
postage

Now You Can GET THOSE MOTOR-CLUTCH- TRANSMISSION AND AXLE PARTS in stock

Why worry about parts when we have them . . . All you want, at a BIG SAVING . . . We ship within 48 hours . . . We also have REBUILT UNITS for EXCHANGE at Bargain Prices: CARBURETORS — FUEL PUMPS — GENERATORS — STARTERS — SHOCKS AND KNEES . . . It will pay you to GET OUR PRICES or RUSH YOUR ORDERS.

and
**SAVE
MONEY**

Get Our
**BARGAIN
PRICE
LIST**
for parts
you want

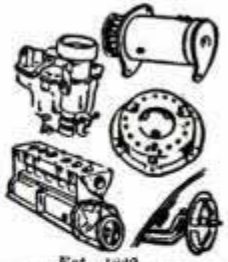

Send Your Orders NOW! IMMEDIATE SHIPMENT

MECHANICS AUTO PARTS. Factory Warehouse
3807 No. Ashland Ave., Dept. PM-5 CHICAGO 13

SUPER DRILL GRINDER

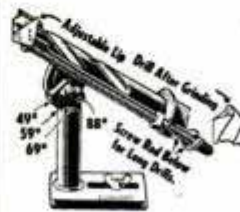

Sharpens round shank drills from 3/32" to 1-1/16" diameter. Grinds Old Drills like new in 4 different drill point angles. Grinds Short, Medium and Long Twist Drills from 1 1/2" up to 11" long, for hand or power grinding wheels.

200,000 IN USE!

Grinds your drills like factory in 25 seconds. Gives perfect center and clearance. Saves drills, time and money. No shop should be without the Super Drill Grinder. Guaranteed to do the work or money back. The Grinder that gives a rounded point!

At Your Dealer's or Postpaid
CRANDALL MFG. CO.

1512 West Slauson, Dept. FA-17

Los Angeles 44, Calif.

SMART—SNAPPY—STURDY FULL FASHION MEN'S RAINCOATS



MADE OF FINE QUALITY GABARDINE. RUBBERIZED FOR EXTRA WATERPROOFING. DOUBLE BREASTED WITH FULL BELT. SLASH POCKETS. LIGHT TAN.

Sizes 34 to 46 **\$7.95** Include
Send your coat 25c
size when ordering for parcel post

ORDER NOW

EDWARD LAWRENCE CO., 396 Broadway
New York 13, N. Y.

EXTRA! **JUST OUT** EXTRA!

INSTANT NICKEL

U. S. PATENT PEND. NO. 702581
NO CURRENT OR BATTERIES USED

Iron, Steel, Aluminum, Brass, Bronze, Copper and practically all Industrial metals (except Zinc) can now be HEAVILY nickelplated without EQUIPMENT, VESSELS, ELECTRICITY OR PREVIOUS COPPER PLATING, a blessing to Hobbyists, Doctors, Hospitals, Restaurants, bar and Beauty shop owners. Recommended for Auto, bicycle and Machinery parts and accessories, Surgical and Musical Instruments, Electrical appliances, Coffee Urns, and practically anything made of metal. THERE IS NO TRICKS CONNECTED WITH THIS MARVELOUS NEW INVENTION, the principles of the battery and electroplating have been harnessed into this compound, so when it is applied with a wet applicator on a clean metallic object, a bright nickelplate instantly appears, the thickness of plating is regulated by amount of applications given. JUMBO SHOP SIZE (Covers 50 Sq. Ft.) \$6.75 P.Pd. Sample Trial Offer \$2.00 P.Pd. **INSTANT PLATING PRODUCTS.** 3439 Michigan Ave., Chicago 16, Ill. (Applicator sent free.) C.O.D.'s few cents extra for postage.

**COMPLETE
\$2 POST
PAID**
Covers 10 Ft.

AGENTS WANTED

Something New That You've Been Needing

for Easier, Quicker, More Accurate Work

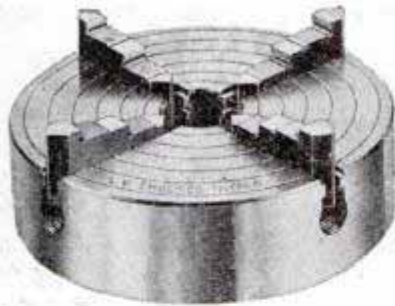

L-W Medium Duty 4-JAW INDEPENDENT CHUCKS for Small Lathes

Semi-steel cast bodies. Face and outer edge surfaces ground. Steel jaws. Hardened and ground steps. Heat-treated steel screws. Complete with wrench.

RUGGED 8" MEDIUM DUTY \$21
Completely finished, ready to mount adapter back plates, 1 1/2"-8 thread \$3.60. Rough adapter back plate casting, \$1.50.

6" HEAVY DUTY \$16.95
Completely finished, ready to mount adapter back plate, 1 1/2"-8 thread \$3.00. Rough adapter back plate casting, \$1.25.

Finished adapter back plates are suitable for some models of Atlas, Clausing, South Bend and Logan lathes.

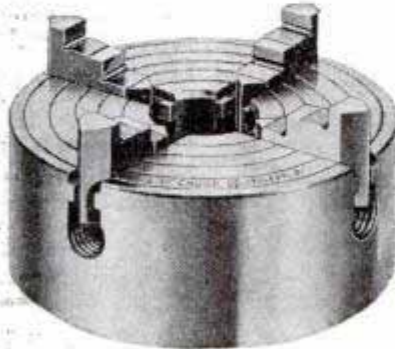

ORDER TODAY

or write for complete catalog on the high quality, low cost line of L-W LATHE CHUCKS • UNIVERSAL CHUCKS • MILLING MACHINE VISES • POWER HACK SAWS • DIVIDING HEADS • MAGNETIC CHUCKS • RECTIFIERS • DEMAGNETIZERS • DEMAGNETIZING SWITCHES.

L-W CHUCK COMPANY, 31 So. St. Clair St., Toledo 4, Ohio

WILLEYS MASONRY DRILLS

DRILL CEMENT, TILE, PLASTER, MARBLE, BRICK, SLATE, LIMESTONE, WALLBOARD

Tipped with Willey's Metal, almost as hard as a diamond, these famous drills are needed by every electrician, plumber, mechanic and home workman. Use with hand brace, portable electric drill or drill press. Give accurate holes, no chipping. Fast. Easy to use. Outlast dozens of ordinary drills. Stay sharp longer. Satisfaction guaranteed. Sizes from 3/16" to 2" dia. Sold individually. SPECIAL UTILITY KIT—Six drills, 3/16", 1/4", 5/16", 3/8", 1/2" and 5/8" complete with strong canvas case, only \$13.40 at your dealers, or mailed postpaid.

Write for Literature

WILLEY'S CARBIDE TOOL CO.

1340 W. Vernor

Detroit 1, Mich.

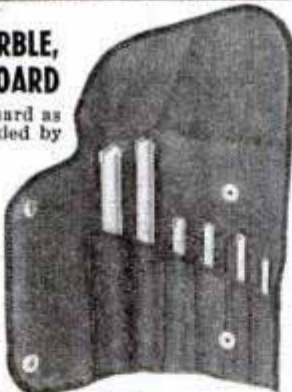

At last...

an Amazing NEW TOOL

that reclaims

all types of lumber

SPLIT-FREE

BORD-PRI
TRADE MARK

FASTER • EASIER

Reversible
Handle
Flat Plates
Free Pivot

**SIMPLY LIFTS OFF
FLOORING, ROOFING, SIDING,
FORMS—READY FOR RE-USE**

You can save time, work, and wood on dozens of home and workshop jobs with handy, lever-action BORD-PRI.

Gives many times its cost **\$9.60**

SEE YOUR DEALER OR WRITE

THE MACO CORP., Huntington, Ind.



Patent Pending



NUMBERALL Rotary Stamp (Patented)

1 Tool Instead of 12

For stamping figures and letters on metal, etc. One stamp does away with 12 individual hand stamps. Changes of characters are quickly made merely by rotating the indexed wheel. Wheel is made of finest tool steel. Sizes 1/16" to 3/16" figures can be furnished at \$5.00 each in pouch. Larger sizes and alphabet at higher prices. Write for Catalog.

**NUMBERALL STAMP & TOOL CO.
HUGUENOT PARK STATEN ISLAND 12, N. Y.**

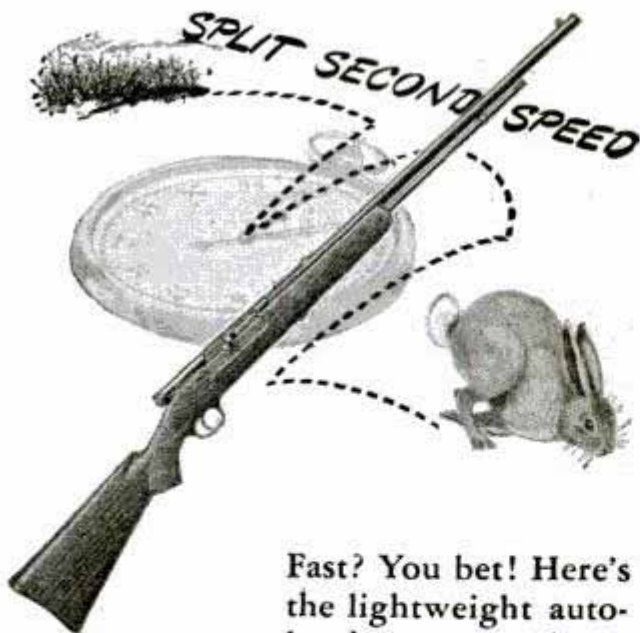

Savage Model 6—.22 (L.R.) caliber Automatic Rifle. "15 shots as fast as you can pull the trigger." Also, instantly adjustable as a repeater or single shot—shooting .22 L.R., .22 L. or .22 S.

Fast? You bet! Here's the lightweight auto-loader you've been waiting for. It opens up a whole new field of "22" rifle thrills, including the exciting sport of speed shooting at small running

game . . . rapid fire target work . . . plain and fancy "plinking," etc. See this "22" Automatic—and other rifles and shotguns in the complete Savage-Stevens-Springfield-Fox line—at your dealer's.

SAVAGE ARMS CORPORATION
Firearms Division
CHICOPEE FALLS, MASS.



Savage Model 29—.22 caliber Slide Action Hammerless Repeating Rifle. Extra long, "man's size" checked fore-end for fast action and steady holding.

Savage Model 4—.22 caliber Bolt Action. Clip Magazine Repeating Rifle. Fast handling, accurate, dependable. For small game hunting and "plinking."



**MANUFACTURER OF SAVAGE-STEVENSON-
SPRINGFIELD-FOX RIFLES & SHOTGUNS**

Hobbyist of the Month

(Continued from page 137)

content with a single extracurricular interest. A complete model railroad takes over a good share of his home basement and he also collects finely made cameras. Probably much of his interest in things mechanical is inherited. His father is Charles F. Kettering of General Motors, chairman of the National Inventors Council and the inventor of automotive starting, lighting and ignition systems.

Making models the caliber of Kettering's is almost a full-time job. He's been able to build only about 60 himself since starting the collection in 1930. Most of the others have been made for him by a young man named Bill Chaffee at Northville, Mich.

Chaffee says the toughest to build were old Navy flying boats like the NC-4, which were so burdened with rigging, wires and struts that alignment, the hallmark of good modeling, was quite a problem. All surfaces have to be true and square with each other or the whole miniature effect is spoiled. And it takes skilled fingers to get trailing edges razor sharp and contour lines exact.

Report From Antarctica

(Continued from page 112)

falling to 90 degrees below zero. These creatures have apparently chosen the southernmost home in the world because of their laziness. They have no enemies except an occasional sea leopard, a fierce, solitary seal and the most vicious antarctic animal, which can outrun a man across ice fields and is the most dangerous creature encountered here on land. The country of Weddel seals is so dangerous that scientists enter three at a time, roped together.

Creatures basking beside water holes are only mildly annoyed when prodded with ski poles. They open their eyes and look curiously at intruders, then fall asleep again. The reason for their lack of fear is that all animals here are conditioned for generations to expect complete safety on shore, with danger only in water where a fierce struggle for life goes on. For example, the favorite sea leopard food is penguin, but only a very hungry creature bothers to chase a bird across the ice. The sea leopard hunts entirely in cold water among the ice floes, where penguins must come for fish. Great seals, in turn, are fearless on ice because the only enemy they know is the fierce, voracious and formidable orca, or killer whale.

Among the expedition's jobs has been

(Continued to page 264)

When you're glad
you have a
Snap-on

Snap-on's Blue-Point **VALVE COMPRESSORS** remove the stiffest valve springs easily . . . safely

Here is one of the most practical lifters on the market today. Universal in its scope, this valve spring compressor works efficiently on many different makes of cars.

Check these important features: It's fast and easy to use because the handle is in the most convenient place for simple, downward lever action . . . it's light in weight . . . and it has stronger, slimmer, channel-formed, adjustable jaws for all types of springs. In addition, the handle locks at any position by use of the sliding ring on the lower part of the frame.

Available through Snap-on's nationwide direct-to-user tool service.

SNAP-ON TOOLS CORPORATION
8062-E 28th AVE. KENOSHA, WIS.



MARGIE

RATTLE!

SCREENS LOOSE?

Fix it with **Mortite**
a household friend

Fills cracks around screens, casements, sinks, baseboards, etc. Fine for caulking; keeps out dirt, dust, insects. Stops rattles. Ideal weather-stripping. Easy to apply, just press into place. Roll covers about 80 ft. At Hardware, Paint, Dept. Stores and Lumberyards. Write for booklet.

\$1.25 Higher West of Rockies and Canada

J. W. MORTELL CO.
522 Burch St. Kankakee, Ill.

This is the way to Make Money!

MACHINE SAW FILING with the Foley Automatic Saw Filer is the modern way to recondition saws. Anyone can do the work—no experience needed—no eye-strain. Start in spare time—Foley-filed saws cut so smooth and fast, they will advertise for you, bring you new customers and a steady repeat cash business.

The Foley is the **ONLY** machine that files all hand saws, also band and cross-cut circular saws—enables you to handle work from schools, shops and factories as well as farmers, carpenters, etc.

Send for FREE PLAN

Shows how to start—no canvassing. Send coupon today.

FOLEY Automatic SAW FILER

FOLEY MANUFACTURING CO.
516-7 Foley Bldg., Minneapolis 13, Minnesota
Send Free Plan on Saw Filing business, no obligation

Name _____
Address _____

"I bought a Foley Saw Filer, one year later had all debts paid and also \$400 on a new home. Many days I earn as much as \$16," says J. H. Kellogg.

W. L. Tarrant writes: "I left my old job last September and in 10 months have filed 2,159 saws. We have a lovely business worked up and cannot keep up with the work."

Thor Neuhof, Iowa, says: "I have filed 550 saws, made \$350. As I'm a carpenter, I just file saws in spare time—have more than I can take care of."

BIG PROFITS

THE PRESS-EVER TROUSERS HANGER & CREASER

PANTS & SLACKS

Here is the quick and simple way of keeping men's trousers and women's slacks neat and pressed. Just insert the "PRESS-EVER" hanger into the cuffs of the garment and release the spring. Holds fast and keeps the press.

USERS PRONOUNCE IT THE BEST YET.

Retail Price 60c AGENTS MAKE 100% PROFIT

Canvassers sell from 10 to 18 gross per month.
EVERY MAN AND WOMAN A POTENTIAL BUYER.
Order sample and get our wholesale prices

FROHOCK-STEWART CO.
20 Harris Court Worcester 8, Mass.

French Type PHONE
TS-13C Hand Set

With butterfly switch on handle. When the switch is pressed, the microphone is connected into the circuit and an additional set of contacts are closed, to operate a change over relay. Has a 6 ft. length of cord, with a PL 55 plug for earphone and PL 68 for microphone and switch. Impedance of earphone approx. 2500 Ohm; impedance of microphone approx. 250 Ohm (carbon); connected with batteries it can be used for inter-communication system. They are brand new and the original cost is many times what we are offering them to you . . . while they last.

\$3.95

MICHAEL STAHL, Inc.
39 Vesey St., Dept. PM4 New York 7, N. Y.

PLASTIC HOMES New Building Material! Resurface old homes; build new ones. Colorful, Beautiful! **LIQUID MARBLE—**Color-grazed! Molded, brushed, sprayed. **SANITARY COMPOSITION FLOORING—**Dustless, noiseless; put on like plaster; resilient—yielding as cork; lasts like stone; plain or marked in tile design. **RUBBERLASTIC Mold Compound—**Mold novelties, statuary, toys, gifts, plaques, plaster animals. **COLORS POTTERY—**Birdbaths, garden furniture, vases. **TILEX** colored roofing. Illustrated literature **FREE.** **RAPID MARBLEIZING SERVICE, Dept. 10-B, Edwardsville, Illinois**

EXTRA WIDE **SHOES FOR MEN**
EE-EEEE SIZES 5 to 15

"MY LOW PRICE \$8.95 A PAIR" POSTPAID

"Old Comfort" is back. The easiest and most comfortable shoe you ever wore. Lightweight. Blucher style. Very dressy. High or low. Leather soles. Rubber heels. Simply send size and width you are wearing, and drawing of left foot. Money-back guarantee. A charge of \$2.50 extra for sizes 13-14-15.

EDWARDS SHOE CO., Dept. P-5, Jamaica Plain 30, Mass.

Name _____
Address _____
City _____ State _____
Size _____ Width _____

NEW

POLYVOLTESTER

NOW AVAILABLE

ONE COMPACT
TESTER TELLS
ELECTRIC VOLTS
110/220/440 A. C.
AND ALSO D. C.

TELLS 3 PHASE
FROM 1 PHASE

TELLS A. C. FROM D. C.

TELLS PHASE ROTATION
ON 110/220/440

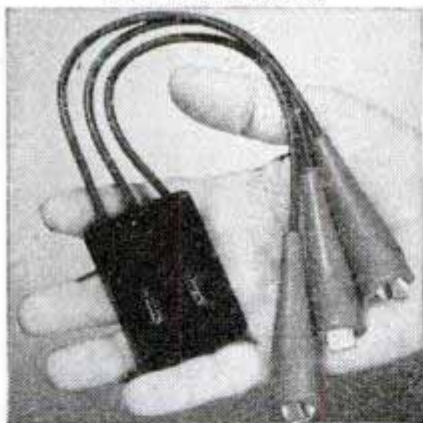

TESTS FUSES, APPLIANCES, SHORTS, ETC.
A laboratory in the palm of your hand!

Furnished with informative instruction sheet,
\$6.50 at your dealers, or send \$6.50 to

THE FOX VALLEY INSTRUMENT CO., INGLESIDE, ILLINOIS

U. S. GOVERNMENT SURPLUS

New Westinghouse Generator

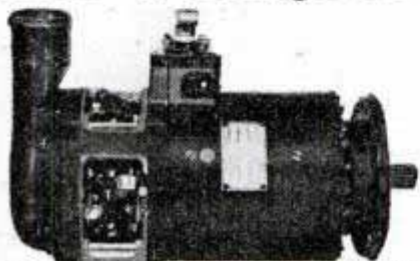

200 AMPS.
5700 WATTS
28 VOLTS

\$49⁷⁵

F.O.B. CHICAGO

Can be converted for use as Welder, Electro-Plater,
Fast Battery Charger, Auxillary Power Unit, Etc. Gov-
ernment approved. New, in original case. Weight 58 lbs.

Also Bracket for use with this outfit to be driven
by 3 "B" "V" Belts \$19.95

Surplus Distributors, 1721 No. Hoyne Ave., Chicago 47, Ill.

POWER LAWN MOWER

**BUILD ONE YOURSELF
FROM YOUR OLD MOWER**



We supply complete attachments that
fit any make or size of mower, with or
without 1 1/2 H.P. gas engine. Easy to
install in less than an hour. No more
back breaking mower pushing. Im-
mediate delivery, at low prices.

MONEY BACK GUARANTEE

You'll be delighted! Complete satis-
faction or your money back. Write for

FREE FOLDER
Dealers Wanted.

ROYAL OAK LAWN MOWER SHOP
Box 48 Royal Oak, Mich.

LUMINALL PAINT



**makes furnishings
look their best**



Redecorate your interiors with Luminall
for better lighting and purer color.
See the lovely colors at your dealer's.

LUMINALL PAINTS, Chicago 9, Illinois

COMPLETE HOME WORKSHOP

5 POWER TOOLS IN 1



LATHE 10" swing, 30" between cen-
ters, 3/4" spindle, face plate,
spur center, tool rest.

\$34⁹⁵

SAW

Takes 6" to 8"
blade. Arbor
handles scratch
brush, grinder,
buffer. Saw
blade not
included.

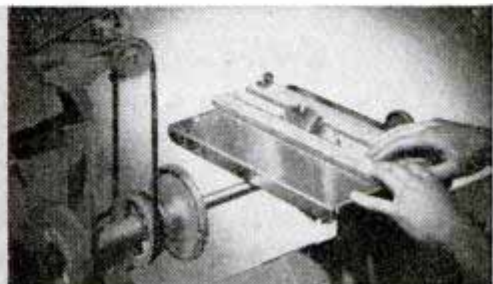

**DRILL
PRESS**

Takes drills to
1/2". 2" travel,
1/2" spindle.
Drills to center
of 12" circle.

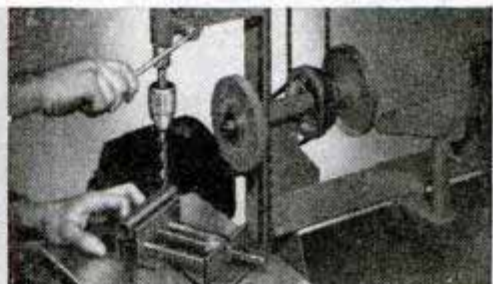

GRINDER

5" Emery wheel
furnished. 4 step
cone pulley.
Spindles moun-
ted in replace-
able bronze
bearings.

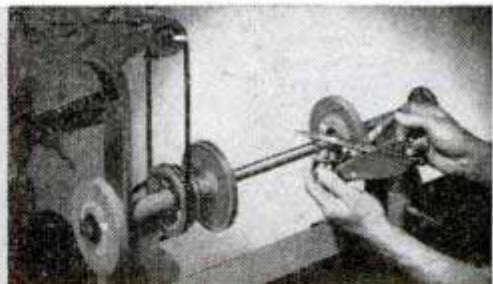

SANDER

8" diameter
disc takes any
type abrasive.
Heavy con-
struction lasts
for years.
Motor not in-
cluded in price.

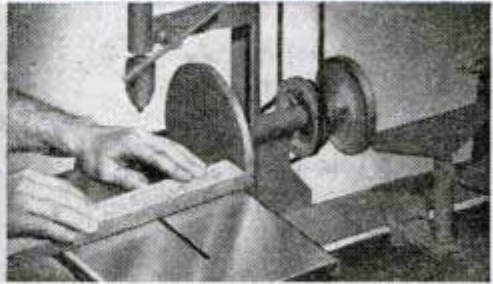

**10
DAY
TRIAL**

EMRICK, Inc., 1735 Clinton St., Kalamazoo 24, Mich.

Ship on 10 Days Trial. I am enclosing \$17.50, balance
C.O.D. Send Free Literature Send Free Tool List

NAME _____

ADDRESS _____ CITY _____

"Paint-it-Yourself"

\$345

**PAINTS YOUR
ENTIRE CAR WITH**

ONE COAT COVERS

NU-ENAMEL

TRADE MARK REG. U. S. PAT. OFFICE

NO BRUSH MARKS

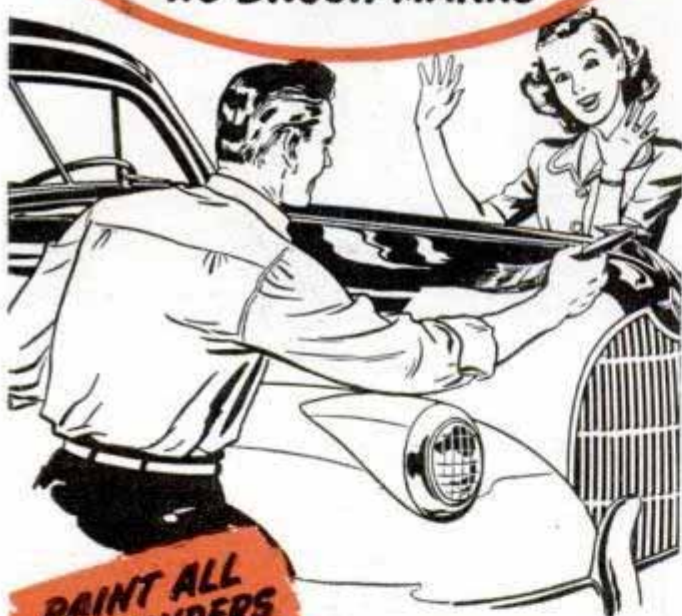

**PAINT ALL
YOUR FENDERS
FOR ONLY \$195**

ASK YOUR
NU-ENAMEL
DEALER FOR THIS
INSTRUCTION FOLDER

Contains the step-by-step story of how you can Paint-It-Yourself with Nu-Enamel and get a professional looking job.



It's EASY! - It's FUN!

the making of a partial census of whales throughout the area by a sampling count from the air.

Annual bird migrations are of particular interest and a special job has been to band on these shores the arctic tern, which makes a 25,000-mile pilgrimage almost from pole to pole every year. The tern nests and breeds in the arctic summer within a few miles of the North Pole. The first arctic sunset stirs some weird impulse that starts it southward over Europe and Africa, speeding madly through brief intervals of darkness, until it reaches another nightless habitat on the antarctic continent's shores. In early February the tern is ready to start for the North Pole again, this time over North and South America.

Although all this is generally accepted by biologists, it is based on very few observations, say agents of the Fish and Wildlife Service on the expedition. The northern route along American coasts, the time required to reach the arctic, and the migration reasons are unknown. One theory is that millions of years ago its ancestors were glacier birds, following the edges of moving glaciers for debris left behind, and it has been unable to break the habit. The tern must have ice and light, and eight months each year are spent in flight to find them together.

Another bird-banding experiment was planned but abandoned due to the protests of sailors. This was to capture and mark several wandering albatrosses. The belief that any injury to these birds means disaster is one of the oldest superstitions of seafarers, far antedating Coleridge's "Ancient Mariner." Next to the arctic tern the albatross is one of the earth's greatest wanderers. A single bird follows the ship for days, presumably for debris cast overboard. Even modern sailors believe an albatross is attached to the ship as a guiding spirit. When it leaves, it is a sign land is near. Such a superstition outweighs scientific interest.

Through the ice packs the ships passed a great field of lemon yellow ice, which microscopic examination showed contained colonies of countless quadrillions of microscopic diatoms, apparently the only living things able to survive and multiply while frozen solid in an ice cake. These diatoms are not in hibernation; they live in tiny air holes between ice crystals. Although in the plant kingdom, these diatoms are free-moving with a unique jet-propulsion mechanism. They are the chief food of tiny crustaceans which support whales and fish.

All antarctic life depends on the sea, where food is abundant. The continent is

(Continued to page 268)

Does More Grinding Operations

FASTER!

because it's an
Abrasive Belt
Grinder **CN-2**
by
PORTER-CABLE

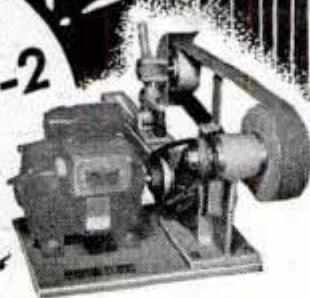

The CN-2 increases output over ordinary bench grinder by 200%... because it eliminates wheel loading, wheel digging, wheel dressing. Cutting element—the abrasive belt—keeps sharper longer. Reduces operator fatigue. Maintains high production all day.

Grinds on contact wheel, platen or free belt. Use the CN-2 for deburring, bevelling, chamfering, clean-up, knocking-off corners... and for many other operations in assembling and machining departments, tool rooms, job shops, service stations, home shops.

Easily adjusted for vertical or horizontal use within 90° arc. Weighs only 15 lbs. Furnished with or without motor. Write today for full information. Ask for demonstration by local Porter-Cable distributor.

PORTER-CABLE MACHINE CO.
2050-5 N. Salina Street Syracuse 8, N. Y.

The **SPEED SAW FILER**

Saves You Time, Money

Now you can do expert saw filing at home. Lifetime tool makes precision filing easy for even the most inexperienced. Two simple adjustments make it fit any type hand saw. Keep your saws extra sharp and true-cutting with a Speed Saw Filer. Complete with file, ready to use. Money back guarantee. Cash with order, prepaid (C.O.D. postage extra.)

THE SPEED CO., Dept. PM
2025 N.E. Sandy, Portland 12, Ore.

Now FILE YOUR OWN SAWS

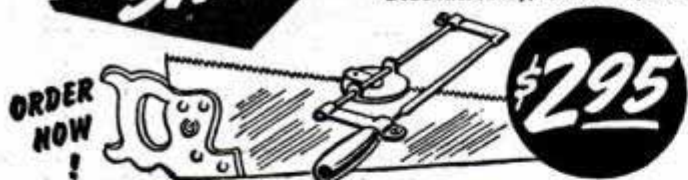

ORDER NOW!

HOW TO CUT RAFTERS

New vest pocket book gives lengths, Side cuts, Plumb cuts, Deductions. For all rafters for any building from one inch to forty feet wide. Gives numbers to cut on square. Also degrees for same cuts for Radial Saws. All standard pitches from 1/8 to 2 1/2. Just open book to pitch page and there are your lengths, side cuts, etc. Anyone who knows what a jack rafter is can frame a roof if he has this great book. Price one dollar prepaid. **BUILDERS' TOPICS**, Dept. M, Lock Box 828, Seattle, Washington. Original teachers of the square in five easy lessons by mail. **SEND FOR FREE LIST OF TECHNICAL BOOKS.** Learn to read blueprints etc.

MAKE THESE SCARCE BUILDING MATERIALS

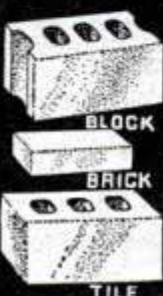

Today's huge demand for blocks and other masonry products makes opportunity for local manufacturing. Buy modern, cost-cutting machinery direct from large factory—national headquarters for 40 years. Complete line. Sold on 15 days' trial. Liberal terms. Free manufacturing instructions. Write for new catalog with all prices plainly marked. Early delivery.

CONCRETE EQUIPMENT COMPANY
512 Ottawa Avenue Holland, Michigan

Don't slink away



And live with Rover



Use this and soon



You'll be in clover



Removes dull traffic film—restores the original color and lustre—quickly, easily and safely.



No. 7 POLISH

SAY YOU SAW IT IN POPULAR MECHANICS

**AL'S A BETTER WORKER SINCE HE GOT
A WESTERN ELECTRIC HEARING AID!**



There is a difference in Hearing Aids

• That difference can mean better hearing for you, too. Western Electric Hearing Aids are made by the nation's largest producer of communications and electronic equipment. They are the *only* hearing aids designed by Bell Telephone Laboratories, designers of your Bell telephone.

Mail the coupon today for free hearing helps and details on the new Model 64 Hearing Aid.

Western Electric

Dept. 380-PM5. 195 Broadway, New York 7, N. Y.

Please send your free guides to better hearing and information about Model 64.

Name _____

Address _____

City _____ Zone _____ State _____

Distributed in Canada through Northern Electric Co., Ltd.

SAY YOU SAW IT IN POPULAR MECHANICS

Quick, Easy, Lasting REPAIRS!



Cracks, holes, dents in wood, plaster, concrete, metal, etc. — loose handles, rungs, knobs, screws — mistakes in carpentry, etc. — fix them *all* with Savogran Crack Filler (hard as stone) or Savogran Wood Putty (easily tooled). Just mix with water, press into place. Stays put, hardens quickly, will not shrink! Can be painted, pre-colored. Ideal for models, inlays, etc. Patented! Big 1-lb. can only 30c at hardware and paint stores.

FREE CIRCULAR

Describes these and other Savogran Products: Heavy Duty Cleaner, Remover & Bleacher (renews floors), Paint Brush Cleaner, Stryp-eeze (removes all finishes), Coldfoam Soapless Soap Powder.

THE SAVOGRAN CO.
Dept. 44, Boston 10, Mass.



SAVOGRAN

CRACK FILLER • WOOD PUTTY

IN EVERY WELL-EQUIPPED HOME WORKSHOP

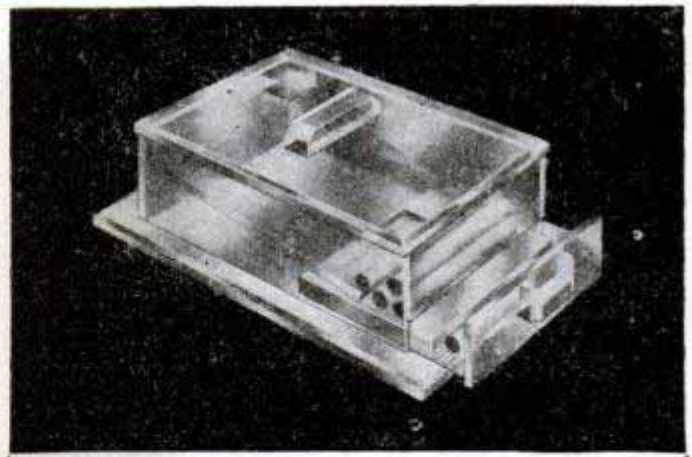

Automatic Cigarette Dispenser

Made of Lucite the jewel of plastics and ready to assemble into a beautiful and practical container holding 31 cigarettes. Ideal gift or saleable article to stores, individuals, etc. Home-crafters will find this a fascinating hobby or a profitable business. Complete illustrated instructions, polishing compound, brushes, and jig come with the kit. Actual size 4x6 inch. Sent prepaid if cash with order. Otherwise C.O.D. Only \$3.95. Any color 10% extra. Special price dozen lots. Free descriptive folder upon request.

CENTURY ENTERPRISES

P. O. Box 56 Station A Los Angeles, Cal.

BARGAIN

Original Cost \$150.00



3X Army Telescope

ALL COATED LENSES — BRAND NEW

An ideal gift for viewing objects, landscapes, seashores, etc. The high resolving power of the six coated lenses, five of them achromats will bring out great details. For the experimenter it can be dismantled and used for hundreds of projects. Length 22 1/2 inches. 36° Field. Postpaid \$7.50.

500,000 Lenses and Prisms. Send 3c stamp for "Bargain" List
A. JAEGER, BOX 84P, SO. OZONE PARK 20, N. Y.

RADIO PARTS GRAB BAG!

\$25 value assortment of Coils, Condensers, Transformers, Resistors, Controls, etc. An experimenter's dream. Order today! Only.....

\$3.98

MARKO SUPPLY, Dept. PM-5
2924 Logan Blvd. Chicago 47, Ill.

AUTO ENGINE SPEED CONTROL GOVERNORS



Give constant or changeable speed to any auto or truck engine, when used for power. Guaranteed Instructions. Oil ring bearing, \$14.25. Ball bearing, \$21.75.

\$21.75

No. 18-7 Heavy Duty for Engines to 300 HP: \$29.75

Agents Wanted: Parts Dealers, Garages, Wreckers, Implement Dealers, General Merchants, etc. Free circulars.

Also additional carburetor butterflies. Sold in Montreal: 7546 Wiseman St.; In Skaneateles, N. Y., Horle Welding Supply.

CANDEE, Dept. PM5, 2641 S. Hill, Los Angeles 7, Calif.

75 MILES Per Gallon

FOR WORK
OR PLAY



Cushman
MOTOR SCOOTER

The two wheel Cushman Motor Scooter, when equipped with tandem seat, will safely and comfortably carry two people. When equipped with SIDE KAR a third person or a 200 lb. payload can also be carried. Side Kar quickly and easily detachable.

For City or Highway — factory, farm or commercial use!

DEALERS from Coast to Coast. Write today for name of your dealer and **FREE FOLDER** describing our two and three wheel models. **CUSHMAN MOTOR WORKS, INC., Dept. M-500, Lincoln, Nebr.**

New 4-in-1 Screwdriver

BRASS and STEEL
Made to Last a
Lifetime!

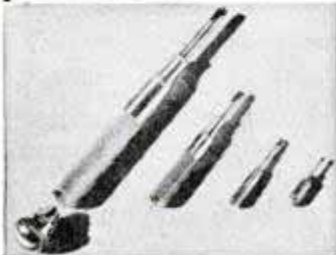

It's no ordinary screwdriver you see pictured here but actually four screwdrivers in one! Handle made of solid brass with screwdriver blade made of finest tool steel in four different sizes! Here's a lifetime tool you'll be proud to own or offer as a worthwhile gift. Sold under full money-back guarantee. Don't miss this. Order today before Present supply is snapped up.

Only 95c

POSTPAID. Send Check or Money Order TODAY to

F & K SALES CO.

Dept. PM, 1111 S. Washtenaw Ave. Chicago, Ill.

MAKE YOUR OWN DISC SANDER



Mount this 8" cast aluminum sanding disc on any 1/2", 5/8" or 3/4" spindle. Sturdy ribbed design. Order direct — \$2.00 postpaid. Threaded bore 25c extra. Abrasive paper discs, 8" — 1 doz. asst. grits \$1.25.

1726 Clinton Street
EMRICK INC. KALAMAZOO, MICH.

WRITE FOR FREE TOOL LIST.

ADJUSTABLE WEDGES FOR SAW GROOVING



SAW OWNERS! SOMETHING NEW! With these Wedges you can cut up to 3/8" width with 10" blade! Can be used on any saw from 6" to 12". No Dado head needed. If your Dealer can't supply you, write direct. Sent any place in USA for \$3.95 postpaid. Specify 1/4"; 5/8"; 3/4" shaft. (Dealers write for discounts.)

Pat. Pending
H. W. LEINENWEBER • Woodruff St. • Pittsburgh 11, Pa.

FIREWORKS
OH-BOY!

Banner has always been right there with the newest and best in fireworks. Now we offer you sensational new creations you never heard of before. Thrills galore. You'll be the envy of your friends and neighbors when you start celebrating with **BANNER FIREWORKS**. . . always rock bottom in price.

BIG SPECIAL DEAL — ONLY \$4.95

Big giant assortment of over 150 pieces including Salutes, Roman Candles, Sky Screamers, Chinese Firecrackers, Sparklers, Vesuvius Fountains, Aerial Bombs and many others. . . regular \$10.05, retail value for only \$4.95. Rush your order. Supply limited. Catalog FREE.

BANNER FIREWORKS MFG. CO., INC., DEPT. 241
446 Capistrano Toledo 12, Ohio

How to **TIGHTEN**
THAT LOOSE HANDLE
TO STAY



Use this quick, sure remedy for loosened tool and cutlery handles, metal door knobs and fixtures, casters, bolts, nuts, screws, rivets, etc. Fill screw hole or handle hole with a soft putty of Smooth-On No. 1. Insert screw or handle, turn it up tight and allow the Smooth-On to harden. The loose part will stay tight, because Smooth-On No. 1 expands slightly in hardening and holds screw or handle in place. You'll find Smooth-On No. 1 also a time-saver and money-saver for sealing cracks and stopping leaks in piping, boilers, radiators, tanks, etc. Buy it in inexpensive 1 3/4-oz. or 7-oz. size at your hardware store. If they haven't it, write us.

FREE HANDY REPAIR HANDBOOK

40 pages. Pocket size. Clear, practical, short-cut directions for dozens of repair jobs in the home, on the car, etc. 170 diagrams. Send coupon for YOUR free copy today.



— — — **Sign and Send NOW** — — —
Smooth-On Mfg. Co., Dept. 37E
570 Communipaw Ave., Jersey City 4, N. J.

Please send me my Smooth-On Handbook.

Name.....
Address.....
5-47

Do it with **SMOOTH-ON**
Iron Cement of 1000 Uses

OUTBOARD MOTOR OWNERS!

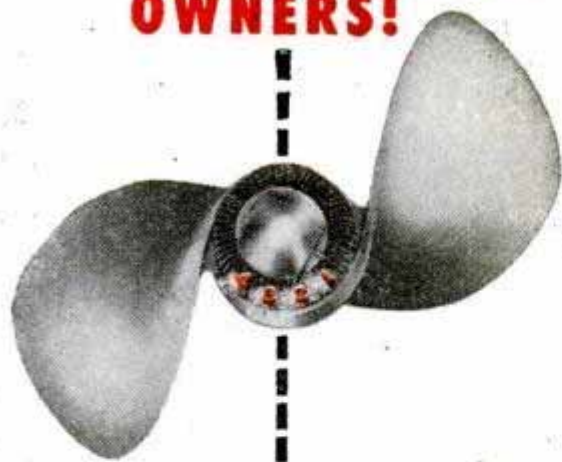

Paul Bunyan's New Vari-Pitch PROPELLER GIVES YOU

4 speeds!
1. Low 3. High
2. Intermediate 4. Overdrive

all from one propeller permanently installed on your motor!

Now you can troll as slowly as you wish, without plates or special devices. Merely set the pitch of a Paul Bunyan Vari-Pitch propeller at low and you barely move. To speed up, change the pitch, just as you would shift gears in a car. For extra fast speed, use pitch 2, 3 or 4, depending on load. Adjustment is simple, self-locking, fool proof, can't come loose.

Now, for the first time, sportsmen can have *four motors in one*, by installing the Vari-Pitch propeller, which becomes a permanent part of your motor.

NOW AVAILABLE for the following motors:

TYPE "D" Johnson 5 H.P. 1941 to present.
TYPE "DZ" Johnson 4.5 H.P. up to 1940 inclusive.
TYPE "C" Evinrude Zephyr 5.5 H.P. All years.

Above Models \$10.00. On these adjusting ring is in front of propeller as illustrated.

TYPE "A" For Champion singles 1938 serial number 3000 and over, to and including 1942. Also Firestone 1946 10-A-4 and 10-A-1A.

TYPE "B" Champion singles up to 1938 serial number 3000. (Note: some of the older motors have replacement lower units which take type "A" propellers.)

TYPE "F" Champion singles 1946 to present.

Above Models \$8.00. On these adjusting ring is inside hub.

NOTE: If you have difficulty obtaining Paul Bunyan Vari-Pitch propeller, write us, giving type desired. Enclose check or money order and your propeller will be sent to you through one of our many dealers.

PAUL BUNYAN BAIT CO.
Department PPM57
Minneapolis 5, Minn.



**PAUL
BUNYAN**

VARI-PITCH PROPELLER

almost as barren as the moon. It has no plant life except a low order of mosses and lichens found on sheltered rock faces. There is no food for animal life except in the extreme northern Palmer Peninsula, which is very different from all other parts of the south polar land. But antarctic shore life is abundant. Single rookeries contain millions of penguins. A question for future biologist-explorers is the origin of life here. Doctor Paul Siple, chief scientific adviser of this expedition, believes most forms may be remnants from 20,000,000 years ago, when much of Antarctica apparently had a temperate climate.

(Concluded next month)

The Mechanics of Batting

(Continued from page 95)

and smash it right back at him. There's more safe hitting space through the center of the diamond, Hornsby points out, than any place else.

When you've hit and finished your follow-through, drop the bat quickly and break fast, on your toes, for first base. Don't hesitate to watch where the ball goes and run all the way at top speed. Coaches claim that 8 out of 10 runners are thrown out at first base by a single step. A moment's "loafing" at the plate or on the base line costs that step.

Speed also has psychological value in making the opposition's infielders "edgy" and inclined to hurry their throws. Ty Cobb used to streak for first so fast that he not only got on base a good share of the time, but also forced errors that brought extra bases.

If the ball is hit through the infield or to the outfield you'll know it well before getting to first. When you do, swing a step or two to the right of the baseline about 10 to 20 feet short of first, gauging the remaining distance so you'll hit the inside edge of the bag with your left foot.

Coming into the base at this slight angle, pivoting on the inside foot, you're already turning and set to continue for second without wasting steps if a fielder bobbles the ball. Costly seconds are lost if you charge into the bag on a straightahead run, striking it on the outside foot, if a chance comes to go on to second. Sheer momentum will send you veering yards wide of the 90-foot interval between bases.

An important phase of hitting that's often slighted is bunting. There are two kinds: a sacrifice, intended primarily to advance runners already on base, and a "drag" or "push" bunt to get the batsman on first.

(Continued to page 272)

IF **GLUE** WILL FIX IT

FRANKLIN LIQUID HIDE GLUE

will do it better, faster, easier!

Ready-to-use Franklin makes joints stronger than the wood itself. Saves time — no mixing, no heating. Banish unpleasant odors, avoid chilled joints with Franklin Liquid Hide Glue.

The FRANKLIN GLUE CO., COLUMBUS 15, O

AT YOUR HARDWARE DEALER



SELL FLUORESCENT FIXTURES

SEND FOR BIG FREE MONEY MAKING KIT

FULL OR PART TIME

NO EXPERIENCE NECESSARY—We Show You How!



National Lighting Products offers you an opportunity to become affiliated with one of America's fastest growing and most profitable industries. Modern fluorescent lighting is ideal for everyone and sells quickly. It is easily installed. Perfect for stores, theatres and hotel lobbies as well as professional reception rooms—display rooms—hospitals—churches—farms and homes. It is a "Sales Getter." National Lighting Products backed by extensive advertising including brochures magazine ads, mailing pieces. No samples to buy or other strings. Investigate today by writing to

NATIONAL LIGHTING PRODUCTS, INC.
4217 West Harrison St. Chicago 24, Ill.

Make your own **LAWN! FURNITURE!**

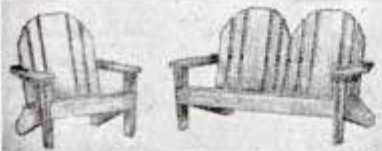

It's easy to build these handsome, sturdy pieces of lawn furniture from our full size plan (printed in ink). Actual size transfer plan prints make patterns unnecessary. Wood finishing instructions included. Send \$1.00, cash, check or M.O. for Plan No. S-57.

SEND 25c for catalog of patterns

CRAFTSMAN DESIGN SERVICE
823 Eckart St. Dept. G Ft. Wayne 5, Ind.

SAY YOU SAW IT IN POPULAR MECHANICS

FINE Cabinet WOODS

For immediate delivery! Thousands of feet in sizes and grades to exactly meet your homecraft or wood-shop needs. Bargains in Turning Blocks, Mouldings, Plywoods.

CATALOG OFFER: (U.S.A.)

Complete Hobbywoods catalog with periodic helpful supplements sent along with a twenty-five cent can of Waterproof Veriply (urea resin) Glue—Both prepaid for 25c.

Hobbywoods

Eastern Ave. and Cedar
Baltimore 3, Md.

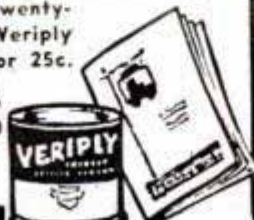

make your **TALLEST**

wish come true

instantly in

ELEVATORS

TRADE MARK
HEIGHT-INCREASING SHOES
"YOUR PERSONAL PEDESTAL"

*TRADE MARK OF STONE-TARLOW CO., INC.

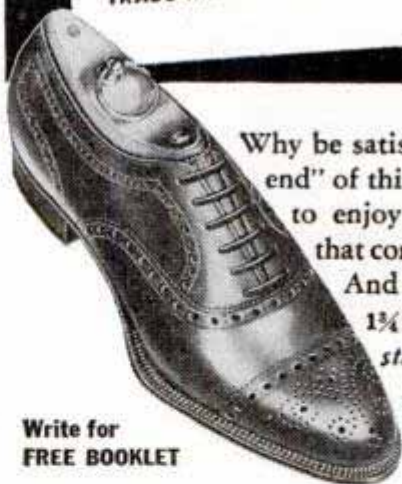

Why be satisfied with the "short end" of things when it's so easy to enjoy all the advantages that come from being taller. And you can be almost 1 3/4 inches TALLER the instant you step into a pair of "ELEVATORS". Secretly, too, for the heels are no higher.

Write for FREE BOOKLET

STONE-TARLOW CO., Inc. Dept. PM5-47
Brockton 68, Mass.

Please send me Free Booklet and name of nearest dealer.

Name _____ (Please Print)

Address _____

City _____ State _____

The Original and Genuine "ELEVATORS"
Manufactured Exclusively by Stone-Tarlow Co., Inc.

SKAN
YOUR WAY TO
BETTER PICTURES



Get more from your camera. Precision-engineered SKAN gives you correct exposure under all light conditions... enables you to get that better picture every time.

For free literature write: G-M Laboratories Inc., 4290 N. Knox Ave., Chicago 41, Illinois

Sold at camera counters everywhere.

\$14.95
with case,
including tax
on meter

SKAN PHOTOELECTRIC
EXPOSURE METER

SAY YOU SAW IT IN POPULAR MECHANICS

NO TEDIOUS HAND TURNING!

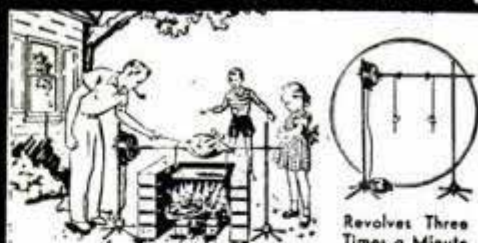

Revolves Three Times a Minute

Sturdy, adjustable, it's equipped with 50 feet of cord; 110 V. AC. Useful indoors too. At better stores or write for literature. \$39.50 each.

KASSON

Electric Bar-B-Q

GENERAL DIE AND STAMPING CORPORATION
270 Mott St. Dept. MP New York 12, N. Y.

BUILD YOUR OWN TRAILER

NEW AXLE AND WHEELS



IMMEDIATE DELIVERY

10% With Order—Bal. C.O.D.

- TIMKEN BEARINGS
- USES 6.00 x 16 TIRES
- 59" TREAD — DEMOUNTABLE WHEELS
- AXLE TESTED 4,000 POUNDS

\$26.35

Without Tires or Tubes

\$56.35

With New Implement Tires and Tubes

STANDARD EQUIPMENT CO.

999 SECOND AVE. S.W. CEDAR RAPIDS, IOWA



ELECTRIC WELDER

AC or DC 110 Volts

Pre-war type—All metal—No chemical—5 year written guarantee. Welds 1/4" thick metal or money back. Repairs tanks, tools, fenders, machine parts, etc. Comes complete with rods, unit directions and eye shield. We also manufacture a set you can

learn with for only \$3.95 complete. On C.O.D. mailing charges extra.

ESSAY MFG. CO., INC., Dept. P.M., Quincy 69, Mass.

\$6.45

Complete

KUT RITE
lawn mower sharpener

Patented. 3 popular sizes; retail prices: 14", \$1.40; 16", \$1.50; 18", \$1.60

Send Check or Money Order
Postage for mailing twenty cents.

ACCURATE SHARPENER MFG. CO.

2230-A N. Hubbard Street,
Dept. P.M. 1, Milwaukee 12, Wis.



115 Volt A.C. Portable Lighting Plant

Especially suitable for field use or for permanent installation in cottage, farm, trailer, boat, etc. Built to rigid Army requirements by D. W. Onan & Sons. Check these outstanding features:

- Supplies 115 volts, 60 cycle A.C. at 350 watts. (Enough for a radio and several lights.)
- Supplies 12 volts D.C. for charging batteries.
- 1 H.P. 4 cycle gasoline engine with silencer.
- Automatic push-button starting (if used with 12V storage battery).
- Runs 4 hours on 1 gallon of fuel.
- Fuel tank holds 3/4 gallon (larger tank can be used).
- Steel carrying cart with pneumatic aircraft tires. (Cart may be unbolted for permanent installation.)
- Shipped new in original crate complete with instruction book, tools, starting rope, battery table (without battery) and full guarantee.

Priced at a fraction of original cost — only \$149.50 F.O.B. Chicago. Shipping wt. 275 lbs. Net wt. 150 lbs. 25% deposit required with C.O.D. orders.

WELLS SALES, INC., 320 N. LaSalle St., Dept. P-5, Chicago 10, Ill.

New Sensational RADIO

Special
Bargain

ONLY \$7.98

COMPLETE with Earphone



SLIDE RULE DIAL

Developed by Army Radar Branch

At last, the sensational post-war midget radio, known as RADARADIO. Small, superbly superior in quality. Recent radar developments make this set unique. Enjoy your favorite radio broadcasts without disturbing others. Smart streamlined design. Cabinet made of durable, colorful plastic. Comes complete with earphone for individual reception.

SEND NO MONEY - LIMITED SUPPLY

Order today. Limited number available at special low price of only \$7.98, postpaid, complete with earphone. SEND NO MONEY. Upon delivery pay postman only \$7.98 plus postage. C.O.D. charges. Or send \$7.98 with order for postpaid delivery. Return in 10 days (untampered) for refund if not delighted. RUSH order NOW!

AMERICAN MERCHANDISING CO., Inc.
Dept. PM-R

12 Adams Avenue Montgomery 4, Alabama



FEATURES

Conventional slide rule dial. USES NO electricity, battery, tubes. Perfect lifetime pleasure. GUARANTEED reception when used as directed. Nothing to assemble - comes ready to use! Order now!

New THOR "B" ENGINE - \$6.95

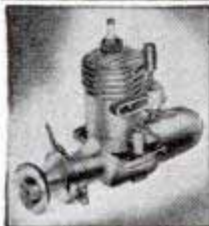

The new THOR "B"—Sensational miniature gasoline engine that really works. Super-power performance. Smooth, velvety power that roars into action with a "twist of the wrist." Over 20,000 already sold. 1/8 H.P. Complete with coil and condenser. Ready to run, only \$9.95. In KIT form, fully machined, 5 minutes to assemble, \$6.95, without coil and condenser. Powers all models. Fully illustrated instructions. Send \$1.00—shipped collect same day C.O.D. FREE—Send for 24-page illustrated hobby catalog.

AMERICA'S HOBBY CENTER

Dept. B57 156 West 22nd Street New York 11, New York

ATTENTION AUTO OWNERS!

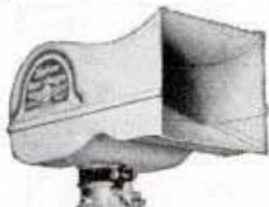

New Power, Pickup, Pep!

Amazing TYPHOON SUPERCHARGER is back again, ready to put new life into old motors, add to power, pickup, pep! 41,000 users find gas economy, you will, too. Motor knock vanishes, grease bath air cleaning keeps harmful dust out. Takes 5 minutes to install with screw driver on carburetor, replacing old air cleaner. Order today, mention make and model of car. Only \$5.95.

(Ohio orders add 3% sales tax, West of Rockies, add 10%)
10 Day Money Back Guarantee!

TYPHOON PRODUCTS CO. 509-F Engineers Bldg.
Cleveland 14, Ohio



AMAZING NEW Star SCIENTIFIC GAS BURNER

Automatic, Self-Acting • Needs No Adjustments • Jet Type • Cannot Backfire • Powerful in Performance
Natural, Manufactured or Butane Gas

\$2.00
POSTPAID

DEALER'S QUANTITY DISCOUNT
BIG PROFITS - ORDER NOW
DIRECT FACTORY TO YOU - MONEY BACK GUARANTEE
STAR HEATER COMPANY
1812-14 POWHATTAN • DALLAS 2, TEXAS

PROMPT DELIVERY AVAILABLE

HANDYMAN'S Steel-Cutting



SHEAR

Cuts flat steel up to 1/8" thick, with ease. Can be mounted in vise or bolted to bench. Built for hard use by maker of famous "Handnib" Machine Shop tools. EXTRA: Has built-in die for cutting rods up to 5/16" dia. Shipped express prepaid for cash with order.

ONLY \$2750

National Machine Tool Co., Dept. 157-E, Racine, Wis.

MACHINE TOOL

BARGAINS

LIKE THIS



Schauer Speed Lathe
Model NA1B with 1/2 hp Motor

\$53

1103-1

25% OR MORE Below Used Market Price

- Hundreds of models
- No priorities needed
- Price lists give details

For copies, write or call the nearest WAA office below. Do it today.

OFFICE OF GENERAL DISPOSITION

WAR ASSETS

ADMINISTRATION



Offices located at: Atlanta • Birmingham
Boston • Charlotte • Chicago
Cincinnati • Cleveland • Denver • Detroit • Grand
Prairie, Tex. • Helena • Houston • Jacksonville • Kansas City, Mo.
Los Angeles • Louisville • Minneapolis • Nashville • New Orleans
New York • Omaha • Philadelphia • Portland, Ore. • Richmond • St. Louis
Salt Lake City • San Antonio • San Francisco • Seattle • Spokane • Tulsa

**AMAZING
NEW
JET IMPELLED
SPEED
GRINDER**

FOR ONLY \$8.95

Another Quality Product from the House of Hudson

The HUDSON TURBO GRINDER

SHARPENS Everything for Home and Shop

Simplest operation possible. Just attach to any ordinary faucet, turn on the water and the sensational patented Hudson turbo-jet impeller spins the wheel at more than 3,000 revolutions per minute — almost twice the speed of a standard electric motor. Adjustable to 10,000 RPM, depending on water pressure. Ideal for the handy man, housewife, hobbyist, mechanic, farmer. Precision built, quality throughout. Super-hard silicon carbide wheel. Stainless steel shaft. Chrysler Oilite bearings (never need oiling). All metal parts gleaming chrome. Colorful vinylite tubing.

Sharpens knives, scissors, skates, lawn mowers, wood planes, bits, chisels, axes, hatchets and all edged tools.

FULL MONEY BACK GUARANTEE
See Your Hardware Dealer

HUDSON PRODUCTS CO.
4400 ST. AUBIN AVENUE
DETROIT 7, MICHIGAN

HUDSON PRODUCTS CO. Room 201
4400 St. Aubin Ave., Detroit 7, Michigan

Enclosed is a \$8.95 () check, () money order for which rush to me, postpaid, one Hudson Turbo Grinder with full instructions for use. I understand the Grinder carries a full, money back guarantee.

Name

Address

City..... State

Name of Hardware Dealer.....

Address



**IF YOUR DEALER DOESN'T
HAVE THE HUDSON TURBO
GRINDER SEND COUPON
TODAY**

For a sacrifice bunt the batter moves forward, facing the pitcher, the instant the ball is being delivered. A right-hand batter slides his right hand about a foot up the handle and keeps the other near the tip end. The bat is brought to a level about six inches ahead of the plate and held loosely to deaden impact so the ball won't travel too far toward the pitcher or infielders.

There's no swing and the bat is held stationary to block, not hit, the ball. Because the sacrifice bunt is generally brought into play under conditions the opposition anticipates, it is especially important that it be well placed to advance the runners.

On a drag bunt the hands are closer together and the bat meets the ball with a shoving motion, generally pushing it between the pitcher and first sacker. Hitting it there normally forces the latter to field the ball and throw to the pitcher covering first base, which requires perfect timing for success and gives the runner a good chance to get on safely. Unlike straight-away hitting, the weight for offensive bunts is on the front foot.

Good bunting is an ace in the hole against weak fielding pitchers or infielders and in tight games where one run will win. Two present-day stars who can expertly plague their foes with well-placed bunts are "Red" Schoendienst of the Cardinals and Johnny Pesky of the Red Sox.

Last of all, don't believe that good hitters are "born" and you're fated to be good or bad at the plate. A puny .232 hitter his first season in baseball, Hornsby thinks any player can become a good hitter by studying the fundamentals and constantly practicing. As a rookie his main weakness was an inability to hit slow curves on the outside corner. But after endless sessions with practice pitchers throwing to that weakness, at his request, Hornsby was able to correct that shortcoming and go on to be a champion hitter.

Cloud Meter for Icing Conditions

Water content of clouds is measured automatically by a tiny cuplike instrument mounted atop high mountains. The device gives meteorologists a new "tool" to predict rain and to determine the intensity of icing conditions that planes may encounter. Developed by the General Electric Research Laboratory, the cloud meter is a midget porous cup mounted on the end of a tube. It collects liquid cloud particles so minute that 100 million of them are required to form one drop of water. The meter is expected to be an important instrument for flying weather stations.

McAleer

SIDE CAR CARRIERS

THOUSANDS NOW IN USE

\$4.50

PER PAIR COMPLETE



Slips on or off any car in a jiffy

Will carry anything too big for the inside of your car

● Indispensable for carpenters, painters, plumbers, farmers, window washers, gardeners, campers, hunters, fishermen, home owners, salesmen, etc. Carries tent poles, lumber, pipe, oars, ladders, garden tools, fish poles, skis, etc., securely and conveniently. Guaranteed not to damage car finish. Instantly removable. Fully patented. Exclusive design.

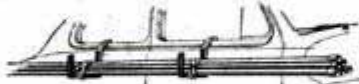

Shipped prepaid on receipt of check, money order . . . or C.O.D. Or at your nearest dealer. Write Dept. 9.

SOLD ON 5 DAY MONEY BACK GUARANTEE

Makers of McAleer Automotive Cleaners, Polishes, Home Buffing Compounds, Waxes, Rust Removers

McALEER MFG. CO. Rochester, Michigan



AMAZING NEW

MAGNETIC JIG SAW!

Ready for Delivery!

SYNCRO . . . new, remarkable, patented, magnetic jig saw . . . needs no belts . . . no motor . . . no gears . . . no oiling! Just plug into any 60 cycle A.C. 110-130 volt outlet—and saw! Portable . . . world's safest saw! Cuts clean, smooth . . . no sanding necessary! Ideal for hobbyists, craftsmen, light production. Perfect for models, displays, inlays, etc. Cuts intricate designs on 3/4" soft wood, 1/2" plywood and thinner hardwoods, metals, plastics . . . NOT for ordinary lumber. Leaves NO ragged undersides on plywood or heavy cardboard. Special magnetic safety stroke features! Nothing else like it! Sold on 10 days Moneyback Trial! Prompt delivery guaranteed. Rush name, address on postcard for FREE details, Trial Offer. Hurry!

WRITE FOR FREE CIRCULAR

SYNCRO SAW CORP., Dept. A-57, Rochester, Mich.

BUILD THESE PROJECTS

For garden or lawn. Easy to build. Easy to sell. Detailed Blueprints Model B-25 Dutch Windmill 50c; Model OM-60 Old Mill, 85c. Lawn Figure Patterns—Sunbonnet Girl, Dutch Boy, Tulip Girl, Holland Pair, 35c each, all 4—\$1. Catalog illustrating many models, send 10c. today.

CRAFTSMAN'S MODEL CO., Dept. P-103, 2030 N. 41st St., Milwaukee, Wis.

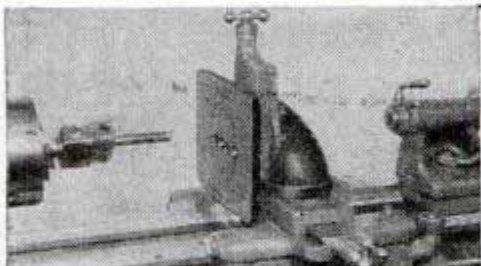

Two parts ready for use. Easy to set up and disassemble. Horizontal, vertical and angle adjustments. Holds work rigid for precision milling, drilling, boring, counterboring, spotfacing,

\$12.75 — SPECIFY LATHE MAKE

QUALIFIED GAGE CO., BERKLEY, MICHIGAN

NEW
LOW COST
ADAPTOR
CONVERTS
LATHES
FOR
MILLING
AND
BORING!

AT LAST!

An Amazing New

ADDING MACHINE

Everyone Can Afford!

Professional Appearance

Figure-Magnifying Plastic Lens

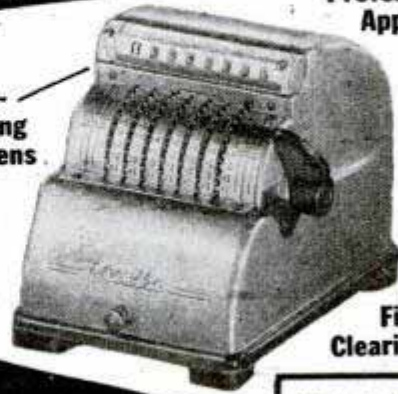

Figure Clearing Lever

NOT A POCKET TOY OR GADGET
A *Real* BUSINESS-LIKE ADDING MACHINE

Easy to Use
Guaranteed Accurate

Lowest Price Ever Asked for a REAL ADDING MACHINE

This substantial, professional looking GUARANTEED machine gives you lifelong, accurate figuring service at an amazingly low price! Pays for itself in errors avoided and time saved. The new "Precise" adds, subtracts, multiplies — with easy stylus operation. **No paper tape to bother with.** Totals come up on the Polystyrene magnifier instantly, automatically, accurately! Counts up to 99,999.99. Professionally built with internal construction of steel, bronze and brass throughout; Zamac cast metal case, in handsome, two-tone baked spray lacquer finish; number plate is solid bronze, with etched red and black figures for easy visibility. 7" x 5" x 4 3/4". With complete instructions. Portable, fool-proof, rugged. A real adding machine at a fraction of the usual cost!

**ADDS!
SUBTRACTS!
MULTIPLIES!**

For Everyone:

Homes
Stores
Offices
Factories
Teachers
Students

10 DAY TRIAL Full Money-Back Guarantee!

YOU RISK NOTHING. Use the "Precise" Adding Machine for 10 days. If you're not completely satisfied, return it for full refund. Every machine is covered by a full year's guarantee for materials and workmanship; free repair during guarantee period. Order today—we'll ship C.O.D., or postpaid on paid orders.

ONLY
\$21.95
COMPLETE
(Postpaid on paid orders)

FREE TRIAL!

TAM PRODUCTS
3814 Wrightwood Ave.
Chicago 47, Illinois, Dept. A-6

Ship me one "Precise" Adding Machine
 \$21.95 enclosed. Ship C. O. D.

ORDER TODAY!

Name.....
Address.....
City..... Zone..... State.....

SOLID SENDERS!



Stan Musial
1946 National League
Batting Champion

Ripky Vernon
1946 American League
Batting Champion

Again Louisville Slugger Bats shared the Nation's top batting honors with the 1946 Champions of both major leagues. They know as do tens of thousands of ball players throughout the world, "It pays to play with the finest."

FREE AT YOUR DEALERS!

1947 FAMOUS SLUGGER YEAR BOOK and OFFICIAL SOFTBALL RULE BOOK. Or send 5¢ for Year Book and 10¢ for Softball Rule Book direct to Dept. P-31, Hillerich & Bradsby Co.



Louisville 2, Ky.

Louisville SLUGGER BATS
FOR BASEBALL & SOFTBALL

MARINE SPECIALTIES

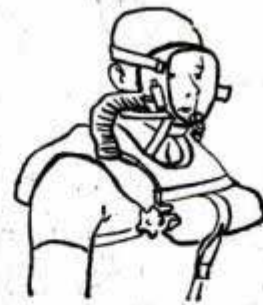

THOUSANDS of satisfied customers are telling their friends about M & E "Marine Specialties." The reason: substantial savings, prompt service, guaranteed satisfaction. May we send you information on any of the following, or just tell us what you need.

OUTBOARD MOTORS—Immediate Delivery on New 10 HP Neptunes \$228. Also 50-55 HP Evinrude Storm Motors with extras.

RUBBER BOATS—1-2 man, 5-7 man—\$11.95 up.

LIGHT PLANTS—500 W. 1500 W. new-reasonable.

DIVING EQUIPMENT—New self-contained "Frog Man" underwater lung. No surface connections, many uses—professionals and sportsmen. Also Navy Shallow Water Rigs plus inexpensive underwater masks and spear fishing equipment. Deep Water Diving Accessories.

SEXTANTS, Chronometers, Compasses, Bells, Life Jackets, Stainless Anchors, Fire Extinguishers, etc.



M & E MARINE SUPPLY CO.

Box 601 Camden, New Jersey

NEW! METAL FORMING TOOLS



WISE IRON BENDER. Easily bends 1/4" square or round; 1/4" up to 2" wide. Makes hooks, rings, hoops, eyelets, etc. Screw adjustment for accurate work. All steel. Price \$8.50 PP. Immediate delivery.

WISE FORMING TOOL. Makes cylinders, ovals, cones and round corners in sheet metal, wire and 1/4x2 steel strap, 2" to 60" in dia., 18" wide. \$8.50 PP.

12" BRAKE. Fits in vise, or bolts to bench. Forms angles, channels, boxes and crimps in sheet metal and strap iron. \$14.50 PP.

SHEET METAL PLIERS. Forms any length, angles. Jaws 2 1/2" wide. Price \$2.50. All items guaranteed. Instruction book, 50c.



WISE BRAKE MFG. CO., 1318 So. 30th Ave., Omaha 5, Nebr.

10¢ FOR THIS PLAN (and four others!) STANLEY

PLAN SET No. 14



• FIVE EASY WAYS to improve your grounds and have fun . . . artistic bird houses, trellis and garden seat. 5 complete plans for just 10c. Drawings fully detailed, step by step. Send for Set No. 19 and free list of Plan Sets. STANLEY TOOLS, 157 Elm St., New Britain, Conn.

TALK-SING thru your own radio with RADIO MICROPHONE

Be the life of the party. Put on your own broadcasts at home. Talk-Sing make announcements from any room. Wonderful voice practice. Microphone easily attached to any radio. Follow enclosed instructions. SEND NO MONEY—pay postman \$1.98 plus postage. Send Money Order or check and save postage.

EMPIRE RADIO & TELEVISION CO. (Dept. R2) 1521 Bedford Ave. Brooklyn 16, N. Y.

Every Youngster WANTS THIS

BOYS and GIRLS are enthusiastic over this **SPEEDY RACER** . . . It runs like a streak . . . Fully Streamlined . . . Heavy Cast Unbreakable Aluminum 9 1/2 inches long with 4 1/4 inch Axles . . . Fully mounted with smooth running Rubber Tire Wheels; that can't come off . . . Beautiful High Lustre Finish . . . Wins the admiration of all youngsters . . . Worth much more than our **LOW PRICE** . . . Therefore do not delay ordering. We can make **IMMEDIATE SHIPMENT NOW**.

SPEEDY RACER

NOTE: Looks Like Models Selling Up to \$13.00

ORDER YOURS TODAY Dept. P-5, CHICAGO 21



Start a Racer Club Now

Send ONLY \$2.79 Postpaid in U.S.A.

Dealers Wanted Everywhere

Now A DYNAMIC Super-charged WELDER

IDEAL FOR AUTO • HOME APPLIANCE • FARM REPAIRS

ONLY
\$28.50
COMPLETE

Available Now
IMMEDIATE
DELIVERIES

Write Today for
Particulars

GET DETAILS
on our 10 day
Trial Offer.

Member Chicago
Association of
Commerce.

DESIGNED TO DO HIGH GRADE WELDING INEXPENSIVELY!

Maintenance Men; Farmers; Mechanics; Machine Shops; Foundries; Auto, General Repair and Job Welding Shops; all using the DYNAMIC find it so indispensable and useful that they cannot afford to be without it. If inexperienced you can easily learn to do a variety of high grade welding jobs by following the practical, simplified operating and welding instructions furnished. Once you see a DYNAMIC in operation, you won't want to be without it. Its simplicity will amaze you. In a year the DYNAMIC only costs you about 6c a day. Helmet, rods, cables, holder and operating instructions, etc., furnished.

SAVES YOU VALUABLE TIME AND MONEY!

This portable industrial transformer type DYNAMIC WELDER easily carried right to the job, can be operated from any convenient, properly wired 110 Volt, 60 Cycle Line—has 8 metallic and carbon arc welding heat stages—does work you would think only possible with a larger more expensive machine. Can also be supplied for 220 volt, 60 cycle operation and other voltages and cycles at slight additional cost. Works on Iron, Steel, Brass, Bronze and other metals.

DYNAMIC WELDER CO., 13 East 23rd St., RC, Chicago 16, Ill.



FARM
IMPLEMENTS

BICYCLE
REPAIRS

SHOP
WORK

HOME
APPLIANCES

AUTOMOBILE REPAIRS



MAIL COUPON FOR FREE DETAILS 10-DAY TRIAL OFFER

DYNAMIC WELDER CO.
13 East 23rd Street RC, CHICAGO 16, ILL.

Send me free details of your 10-DAY trial offer.

Name _____

Address _____

City _____

Zone _____

State _____

PULVEX
"DDT"
FLEA POWDER

RECOMMENDED BY A DIVISION OF WORLD
Guaranteed by
Good Housekeeping
AS DIRECTIVE OF
NOT AS ADVERTISED THEREIN

Kills the fleas
Quickly!
Keeps others off
for Days.



Pulvex also comes with ROTENONE,
the original formula. BEST FOR CATS.

Either Kind
25c & 50c

BOYS!
Fly your own plane
**REAL
GAS ENGINE**
Complete with
**MODEL
AIRPLANE KIT**

ONLY \$11.95



All ready to build and fly
... and anyone can do it!

More than a toy — a real gas-powered model plane that you'll get a kick out of building and flying. This little beauty will really perform in the sky! You'll be the envy of your pals! Fully detailed instructions provided. Complete outfit, including: 1/6 H.P. engine, coil and condenser; beautiful trim airplane; propeller, wheels, etc.

SEND ONLY \$1 We'll ship C.O.D. for balance. Don't delay, order NOW and be the first fellow in your neighborhood to fly this swell plane! Have you our FREE catalog? Send for it!

AMERICA'S HOBBY CENTER, Inc.

DEPT. BN 57, 156 WEST 22ND STREET, NEW YORK 11, N. Y.

Blu-Ray



IF YOU DRIVE AT NIGHT, you'll like driving with BLU-RAY! It makes night driving more relaxing, enjoyable and safer, too. Attached to any car in a jiffy, BLU-RAY directs a downward "V" of restful blueness upon your windshield. New anti-glare principle, reduces eye-strain and fatigue of headlight glare. Goes on with lights, does not affect visibility. Try it for 10 days! See what a difference BLU-RAY makes! Many users say they wouldn't drive at night without it. Inconspicuous, quality-made. Complete with 4-ft. cord, bulbs, simple instructions and 10-day money back guarantee. Order today.



ONLY \$4.75

Postpaid

M & M DIST. CO., Dept. P-5
3659 N. Avers Ave., Chicago 18, Ill.

I enclose \$4.75. Rush BLU-RAY postpaid on 10-day Guarantee.

Name _____

Address _____

A MECHANICAL MARVEL!

This little tractor
will amaze you!

Garden-All
LAWN and GARDEN TRACTOR



- ★ STURDY
- ★ VERSATILE
- ★ EFFICIENT

See Garden-All before buying any power lawn or garden equipment.

Write for
Booklet

For men who like things mechanical . . . this is IT! Because GARDEN-ALL does so many jobs so speedily and so thoroughly! Powered by the popular 1½ to 2 h.p. Clinton Engine, the GARDEN-ALL Model S plows, discs, cultivates and cuts grass. And the GARDEN-ALL snow plow doubles as a junior bull-dozer for grading jobs. GARDEN-ALL has everything . . . instant tool attachment, exclusive tool control, a tool for every need.

GARDEN-ALL TRACTOR, INC.
100 W. UNION STREET, LIBERTY, INDIANA

THE CHAMP

by Medana

An accurate, shock-proof, water-resistant wrist watch, with radiolite hands, numerals, and sweep second hand. Fitted with handsome leather strap. A written and signed guarantee with each watch. If matching stainless steel expansion band is desired, add \$1.00 to your remittance. Comes to you Postage Prepaid. Send check or Money Order.



ONLY
\$18.65

Includes Federal Tax

REPAIRS: Jewelry and watch repairs and pearl restringing done promptly at reasonable prices.

ANTIN'S JEWELERS—GIFT COUNSELORS

Dept. 7, 114 Baronne St.

New Orleans 12, La.

Please send me The CHAMP (with) (without) the stainless steel expansion band.

Name _____

Address _____

City _____

Zone _____

State _____

STOP SWEARING AT DULL BLADES



Allegro

HONES as well as strops

Stropping alone won't put a new edge on a razor blade. First you have to do what a barber does—hone it. Allegro both hones and strops single- or double-edge blades. You simply slip the blade into the holder and stroke it a few times on the honing stone, then on the stropping device. It takes but 30 seconds. The blade cuts your beard with new ease, because it has a truly professional edge. You enjoy a smooth shave, free from irritation.

\$6.50 at leading cutlery stores. If not available locally, we send postpaid on receipt of \$6.50. State name of blade used.

Voss Cutlery Co., Inc., 258 Broadway, New York 7, N.Y., Dept. 15



New FILING ATTACHMENT

CONVERTS YOUR LATHE INTO FILING—SAWING MACHINE!

Only
\$11.50
postpaid



Think of it! Attach this super accessory to your present lathe and you own a handy filing and vertical sawing machine. You'll make dies, jigs, fixtures and tools. You'll do art metal and scroll work. You'll work wood, metals, hard rubber, fibres and plastics with beautiful results! Installed quickly on any lathe. No screws, no clamps. Easily detached. Takes ¼ shank files or hack saw blades. Used in any position. Self-lubricating bronze bushings. Sold by reliable dealers or direct from factory at the same low price. Immediate delivery if you order now! DEALER INQUIRIES INVITED.

CAREY-ANSLINGER MFG. CO.
Dept. AA,
1129 E. Bourbonnais St. Kankakee, Ill.

New, SCIENTIFIC DRINKING BIRD



"TOP HAT BOBBY" complete with COLORED HIGH HAT, ATTRACTIVE LUCITE STAND & GLASS.

only **\$2.95** Top Hat Bobby is a new screw-ball drinking bird that will fascinate young and old with his antics. Perched on his LUCITE STAND he will drink and drink for hours at a time. NO SPRINGS, NO MOTOR, NO ELECTRICITY. He is new, novel, different. Wonderful as a gift, or for the home.

MAIL YOUR ORDER TODAY
BERNARD FINE CO.
Dept. PM3
501 SIXTH AVE. N. Y. 11, N. Y.

SAY YOU SAW IT IN POPULAR MECHANICS

DRILL PRESS OWNERS



Here Is Your Utility Tray— one which can be attached or removed in just 2 SECONDS. Excellent for holding tools and parts at your finger tips to avoid wasted time and energy while drilling. Used in Home Workshops and Factories to speed production. Trays made of heavy gauge steel with welded corners, size 10"x10". Attachment arm made of aluminum. IT'S BUILT TO LAST! Money back guarantee. ORDER NOW and specify column diameter of your drill press. Prompt delivery. Free literature. Shipped Postpaid in U. S. A. \$7.95.

LORENZEN INDUSTRIES
East Lake Street Niles 5, Michigan



**FASTER, EASIER
WOOD-BORING WITH THIS
BRUNO
AUGER BIT SET**

Complete with 6 boring heads (1/4" to 1 1/4") in plastic case, \$3.95 (11 boring heads, as illustrated, \$5.95). Now you can bore many different size holes with one auger bit... exclusive Bruno Quick-Change Boring Heads cut tool costs in half! Boring Heads of finest high carbon tool steel have special extra long cutting edge... require no forward pressure, turn easily in toughest woods. No flutes to bind or clog, bores all the way without cleaning. **MONEY BACK GUARANTEE.**

**SEE YOUR
DEALER**

SET NO.	SHAPE	BORING HEADS	CUTTING DIAMETER	LENGTH	PRICE
340-B	Square	10, 12, 14,	5/8" to 1-1/4"	8-1/16"	\$3.95
340	3/8" straight	16, 18, 20,	inc. by 8ths	8-1/16"	\$3.95
350-B	Square	10, 11, 12, 13,	5/8" to 1-1/4"	8-1/16"	\$5.95
350	1/2" straight	14, 15, 16, 17,	inc. by 16ths	8-1/16"	\$5.95



The BIG BUY in TOOLS

BRUNO TOOLS BEVERLY HILLS, CALIF.

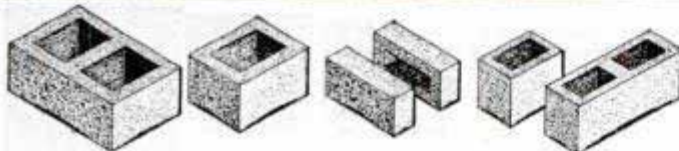

Profit by the Building Boom!

Start your own business manufacturing concrete building block and brick. Use Economy hand moulds. Make true, straight, easy-to-lay units which will pass any building code. Small investment, high production, big profits. One \$30.00 mould will make 1,000 5"x8"x12" blocks per day. Letters and repeat orders tell how pleased our customers are. Post card brings free folder.

**Economy Manufacturing Company
Dept. P Stone Mountain, Georgia**

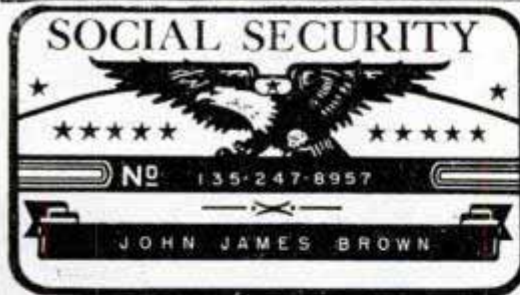

**WANTED
SALESMEN
to Sell
SOCIAL
SECURITY
CARDS
EARN
\$100.00
WEEKLY**
Write to

METAL SOCIAL SECURITY CARDS

P. O. Box 212

Akron, Ohio



WAKE UP YOUR SCALP Want better looking hair? Embarrassed by falling dandruff, itching scalp? Then try VITABRUSH, new electric driven scalp brush that gives your scalp a vigorous and invigorating "workout" in just three minutes of fun. Cleans scalp. Stimulates blood supply. Restful. Pleasant. Write today for complete information and satisfaction-guaranteed offer. Hershey Mfg. Co., 157 S. La Salle St., Chicago 3.

**Mandel Brothers
Chicago**



Originally Army Surplus!

the same multi-purpose hammock tents we sold by the thousands last fall for 9.95!

JUNGLE HAMMOCKS

\$3.99 complete with roof

You couldn't buy the materials alone for 3.99! Yet here's a complete bed with roof and lower canopy that's out of this world for comfort and fun. Zip yourself in, the way the soldiers did in the jungle, completely safe from insects. Pitch it as a tent or hang it as a hammock in the backyard for the kiddies. Fold it up into a small, 6 1/2-pound package and take it to camp on fishing or hunting trips. The heavy, pliable cloth is mildew-proof, waterproof, non-toxic. The roof is synthetically resin-coated and waterproof. The hammock has insect-proof marquisette netting covering the two sides and the head end, a 43-inch zipper slide opening and hanging ropes. Built to rigid Army specifications. Mail coupon today!

•••••

• **MANDEL BROTHERS**

• State and Madison, Chicago 2, Ill.

• Please send me.....Jungle Hammocks at \$3.99 each.*

• Name.....

• Address.....

• City.....Zone.....State.....

• *Illinois residents add 2% on account of Illinois Retailers' Occupational Tax*

• *Plus Postage Charges

•••••



**NO MORE
BATTERIES
FOR ME!**

**BRILLIANT LIGHT AT ALL
RIDING SPEEDS—AND
BULBS WON'T BLOW!
GOOD LIGHT EVEN AT A
WALK—NO DIM-OUTS!**

MAKE-A-LITE

BIKE LIGHT Generator

It's a knockout! Generates brilliant light for head and tail lamps. No more battery bother. Make-A-Lite's automatic voltage control generator prevents blowing of bulbs at high speeds . . . gives sure, bright light at snail's pace.

See the new MAKE-A-LITE head and tail lamps. Rich new finish makes your bike look like a million!



Now at your bicycle, sporting goods, hardware or automotive store

MAKE-A-LITE DIVISION
Chefford Master Mfg. Co., Inc. • Fairfield, Illinois

Inflates Tires Instantly!



SENSATIONAL NEW AUTO ACCESSORY

Enjoy new freedom from driving worries. Carry a Tirex in your car. Soft or flat tires are inflated in 5 seconds. Just attach the convenient steel bottle to your tire valve, turn the handle and the tire is filled instantly! No pumping. Avoids most roadside tire changing. Ideal for areas where air pressure is not available. Enough pressure for 3 tires. Completely safe.

Tirex Puts Out Fires, Too!

The Tirex is filled with carbon dioxide under pressure. It is the perfect fire extinguisher for small gasoline or electrical fires. It smothers the flames without harming the car. Tirex gives you double protection—pressure for tires—safety from fires. A lifetime accessory, Tirex may be refilled for 75c. Send check (or M.O.) for \$4.95. Money refunded if not satisfied. Distributor Inquiries Invited

\$4.95

POSTPAID
IN U.S.

BREAKSTONE & CO.

2155 W. Harrison St. Chicago 12, Illinois

MORE PROFITS

with

MODERN LAWN MOWER SHARPENER



SHARPEN ANY LAWN MOWER from 5-inch Edger to 36-inch Power Mower in ten to twenty minutes with a **MODERN LAWN MOWER SHARPENER** because dismantling is unnecessary—neither handle, roller, wheels nor motor need be removed when sharpening any mower. . . . the **MODERN SHARPENER** eliminates all hand filing; it precision grinds to the extreme ends of both left or right reel blades. Bottom knife is held in same brackets for sharpening. **NO EXTRA ATTACHMENTS!** Order today! Price \$241.50 (less motor) f.o.b. Pasadena. (1/3 or 1/4 H.P. single phase motor recommended.)

Modern Mfg. Co., 156 N. Fair Oaks, Pasadena 1, Calif.

WOODWORKERS . . . Get this

CONSTANTINE MASTER MANUAL

Get the Most Fun From Your Hobby Indispensable to woodworkers. Newest, biggest edition, more pages, more color, helpful how-to-do-it articles, pre-war and new items, more bargains. Send 25c today and we will include **FREE! FULL YRS. SUBSCRIPTION** to Chips and Chats, published bi-monthly. Keeps you up-to-date on everything in woodworking, offers big money-saving bargains. Send now.

ALBERT CONSTANTINE & SON, Inc.
791-E 135th Street, New York 54, N. Y.



WALKIE SIREN

Formerly \$15.00 - Now Only \$3.95

GOV'T SURPLUS. A precision instrument. Easy turn of crank produces CLEAR, FULL SIREN TONE. Can be heard for great distance. Ideal for Boats, Autos, Schools, Sporting Events, etc. Dimensions 7" x 8" x 5". Wt. 4 1/2 lbs. Price includes shoulder strap and waterproof cover; **SEND NO MONEY.** Just name and address. We'll ship C.O.D. for \$3.95 plus postage, or send money in advance, we'll ship prepaid. Canadian price \$4.50. **ILLINOIS MERCHANTISE MART, Dept. 400-A, 1227 Loyola Ave., Chicago 26, Ill.**

CRESCENT TOOLS

Give Wings to Work

ASK YOUR
HARDWARE
DEALER

LAW

STUDY AT HOME for **PERSONAL SUCCESS** and **LARGER EARNINGS.** 38 years expert instruction—over 108,000 students enrolled. LL.B. Degree awarded. All texts furnished. Easy payments. Send for **FREE BOOK**—"Law and Executive Guidance."

AMERICAN EXTENSION SCHOOL OF LAW
Dept. 77-M, 646 N. Michigan Ave., Chicago 11, Ill.

FEW EXCLUSIVE TERRITORIES AVAILABLE! DISTRIBUTORS WANTED!

Nationally Advertised Brand AUTO ACCESSORIES

**\$500 TO
\$600 SUPPLY
LASTS ONLY
WEEK TO 10
DAYS**

Have your own big business in a territory that is exclusively yours. Year around steady demand; national advertising to back you up. Write today for catalog, information and territories available . . . give age, experience, and complete background in first letter.

KNICKS MEND-RITE CO. 1443-47 Gentry, N. Kan. City, Mo.

Ball-Bearing —SPEED WHEELS—



with semi-pneumatic Tires

12" x 1.75" wheel.....\$3.25
10" x 1.75" wheel.....\$2.75
8" x 2" wheel.....\$2.00
Low Price Derby Steering Wheel
Write Us

— AXLES —

24" Steel axle.....75c

—Solid Tire WHEELS—

(no bearings)

7" wheel60c
6" wheel50c
4" wheel30c

ORDER NOW FOR
PROMPT DELIVERY
10% REQUIRED
WITH C.O.D.'S

JIM BROWN TOY COMPANY

1097 Home Ave. Akron 10, Ohio

THE SCOUT SENIOR

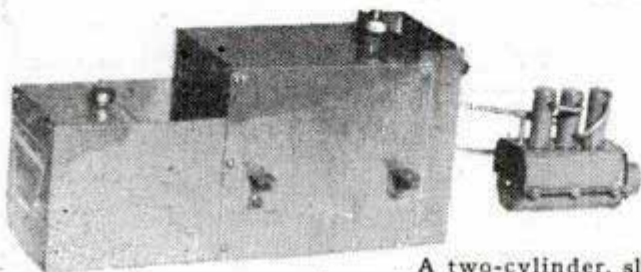

A two-cylinder, slide valve engine for boats 18" long and larger. 7/16" bore by 5/8" stroke. Aluminum pistons. High-pressure, brazed boiler. Drives a 2 1/4", two-bladed prop of 3" pitch at 2000 r.p.m. for almost 20 minutes. Burns alcohol. Price postpaid, complete ready to run with 70-lb. safety valve and prop rig. **\$950**

PHILIP STEVENSON CO.

Box 162, Station D Cincinnati 6, Ohio

JET PROPULSION



GAS TURBINE Model Engine

★ ★ Be one of the first to build a real Turbo-Jet Model Engine. Single-stage centrifugal compressor and turbine. This is a real engine, easily made with ordinary home workshop equipment. Complete plans for construction . . . design formulas and curves for checking performance and testing.

\$2.00
Post paid

THE ROTOJET CO. Department 11
BOX 757 • LOS ANGELES 25 • CALIFORNIA

MUFFLERS

STEELS and ALUMINUMS
with a motorboat tone

SINGLES, Chev, V-8, Plymouth, Steels \$5.50, Aluminum \$6.50. Chry., Olds., Buicks, etc., Steels \$7.50, Aluminum \$8.50. V-8 and MERCURY DUALS, Steel \$17.50, Aluminum \$20.00. Aluminums are guaranteed for life of your car.

DEALERS WANTED



SANDEE MUFFLER CO.
7523 S. WESTERN AVE., LOS ANGELES 44, CALIF.

Atlas LATHES

SPEED AUTO SERVICING

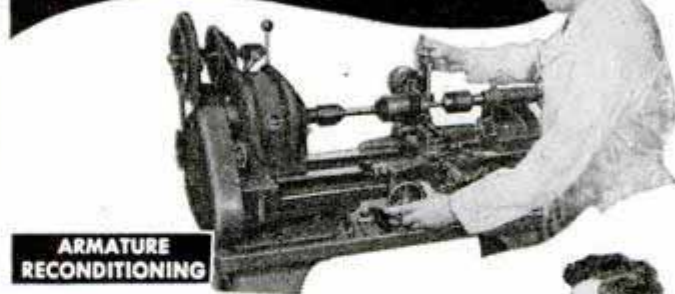

ARMATURE RECONDITIONING

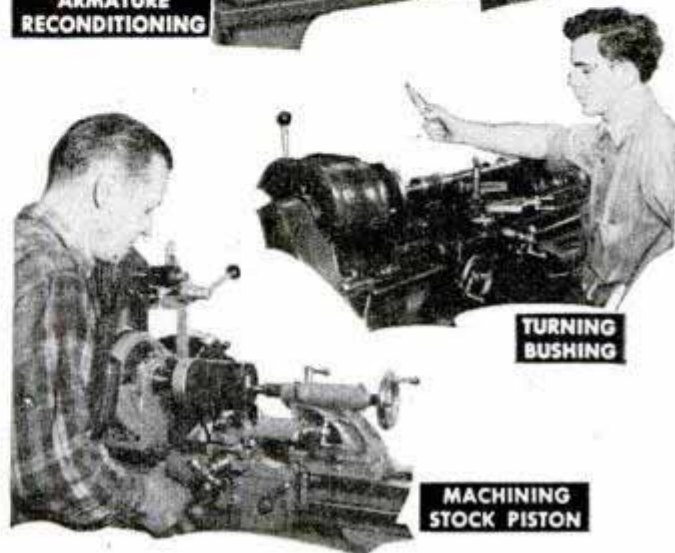

TURNING BUSHING

MACHINING STOCK PISTON

Automotive shops all over the nation are rapidly equipping with Atlas lathes. It's a profit suggestion to consider if you operate or work in a garage—something to remember as a valuable use for an Atlas in your home shop.

There are more than 44 profitable servicing jobs you can handle on an Atlas lathe with accessories. Atlas lathes are preferred for automotive work because they are: (1) ruggedly built for years of precision service (2) easy to set-up and operate (3) extremely versatile (4) compactly engineered for minimum space (5) available at low cost. Send for latest catalog.



ATLAS PRESS CO.

543 N. PITCHER ST.
KALAMAZOO 13, MICHIGAN



6"-10" Lathes



Milling Machines



Shapers



Drill Presses

ATLAS 4 TOOL TEAM

SAY YOU SAW IT IN POPULAR MECHANICS

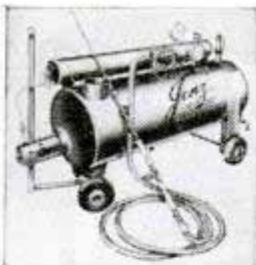

Jenz Super Chief Steam Cleaner

Portable—No moving parts—Cleans anything—Motors—Chassis—Machinery—Floors—Bathery Buildings—Dairy & Creamery—Oil Rigs etc. Oil fired—Economical—fully tested and warranted. 75# Steam in less than 10 min. Complete as illustrated.
\$249.50 Check or M.O. freight prepaid to any place in U.S.A. Cleaning compound 25¢ pails \$5.25 prepaid when ordered with steamer. C.O.D. 25% with order frt. collect. Immediate delivery.

CHAMPION BLUE RIBBON OUTBOARD MOTORS



Dual Rotary Valves—Needle Bearings—Trolls Perfectly—Cannot be flooded—Positive Lubrication—Positive Cooling—Quiet Under water Exhaust.

Tops in Outboard Motors!

Standard Single 4.2 H.P.

\$127⁰⁰

(West of Rockies \$129.00)

Check or M.O. Frt. prepaid to any place in U.S.A. C.O.D. 25% with order frt. collect. Immediate delivery.



ALL-PURPOSE Fluorescent Fixture

Just plug in and light. No extra wiring or equipment. Saves up to 1/2 on light bills.

20 WATT LAMPS
White or daylight .75
Soft white .85
Immediate shipment—Check or M.O. with order—Postage prepaid
C.O.D. 25% with order postage collect.

BAKED WHITE ENAMEL FINISH
2-LAMP FIXTURE, \$7.95
20 watt, without lamps
3-LAMP FIXTURE \$9.95
20 watt, without lamps

HI-PURE LABORATORIES

20 E. Sycamore St.

Evansville, Ind.

SAY YOU SAW IT IN POPULAR MECHANICS

A NEW SHELDON

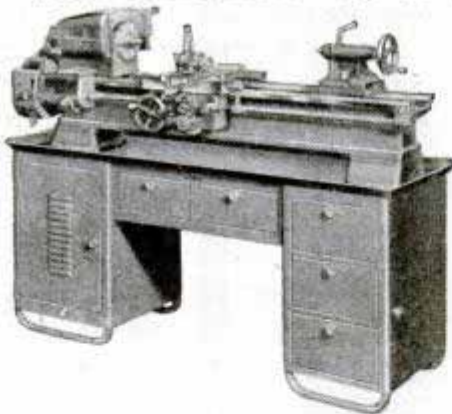

TRB-S56

For the home craftsman who can afford the best, or for those who use lathes in their business, the new SHELDON TRB-S56 is today's most sensational lathe value.

With 11 1/4" swing, 1" collet capacity and a 56" bed, it has capacity. With "Zero Precision" Taper Roller bearings (heretofore available on large and costly lathes) it has extreme accuracy. Mounted on a modern 5-drawer steel bench with enclosed 8 spindle speed, double V-belt underneath motor drive it has convenience, extra power and speeds for both today's and tomorrow's machining, and, frankly, class, not found in ordinary shops.

\$1000.00, as illustrated, less motor f.o.b. Chicago.

Write for TRB-S56 Bulletin

SHELDON MACHINE CO. Inc.

Manufacturers of Sheldon Precision Lathes • Milling Machines • Shapers
4266 N. KNOX AVENUE • CHICAGO 41, ILLINOIS, U.S.A.

ARMY RADIO PHONES



**They're Weather—Water
and Shock Proof**

When we say they are made to Army specifications, that's enough assurance they must be of best quality. These Army Radio Phones are perfect and were O.K.'d by Signal Corps Inspectors. These Dynamic Mikes and Receivers, were used on aircraft and tank inter communication systems. Use them for recording, for battery-less phone, for pocket size set loud speaker or talk through your radio set. We bought a good many of these Radio Phones, they are brand new, and cost a great deal more than you can get them for. A complete dynamic hand mike, 2 earphones, headband, cord set. A wonderful buy for only... **\$345**

Send check or Money Order. FOB warehouse

LEEDS RADIO CO.

75 Vesey St.

Dept. PM4

New York City 7

Amazing New Marking Tool

for Home and
Workshop



Cado FLO-MASTER LEAKPROOF POCKET FOUNTNBRUSH

• Use Flo-Master for marking on glass, china, wood, cloth; make layouts and patterns on metal and paper; mark tools, etc. for identification; label tins, jars; scores of other uses. Fine, medium, or broad lines as desired.

All-aluminum. Gives years of service with Cado Inks—Black and 7 colors. They're waterproof, fadeproof. Ask for Flo-Master and Cado Inks at your dealer's or order direct. Only \$3.00 with ink (\$3.25 Denver and West).

CUSHMAN & DENISON MFG. CO.

135PM West 23rd Street

New York 11, N. Y.

CECO WHIZZ!!

10" All-Purpose Wheel



Double Radial Ball Bearings give this wheel speed plus! Puncture proof balloon—10" x 1 3/4". Heavy duty wheels — for racers, 4 wheel trucks, wagons, market carriers, golf bag carriers, scooters, garden and porch furniture, etc., etc.

Ceco "Whizz" wheels are completely assembled; ready for immediate use. They're smooth, quiet, stream-lined, STURDY. (We have axles and other parts; ask for prices.)

Money order or check with order. No C.O.D. Supply limited; order today!

\$2⁷⁵ COMPLETE
Including Tire
and Bearings
EACH Set of 4—\$10.80

Dealers—Write for Quantity Prices.

CECO SALES CO.

507 Fifth Ave., New York 17, N. Y.

SAVE up to 85% on NEW HYDRAULIC CYLINDERS

VALVES, PUMPS, FITTINGS,
HOSE, TANKS

The World's Largest Supply, 1001 labor saving adaptations for pulling, pushing, lifting operations. Finest precision workmanship and materials. Liquid and/or air operation.
15% GOVERNMENT COST

PNEUMATIC RIVET GUNS #181
CHICAGO, CLECO AND ALL MAJOR MAKES

Used but in Swell Condition.

Send for Free War Surplus Catalogue

\$8⁹⁵

PALLEY SUPPLY CO.

6321 San Fernando Rd.
Dept. PM-57
GLENDALE, CAL.

EASY-TO-ASSEMBLE

10½ Foot KAYAK

Complete Pre-Fabricated Kit

● Here's a rugged, full-sized 10½' boat just made to order for vacation fun on the water. Easy to follow illustrated instructions and pre-cut, numbered parts. Can be assembled in a few enjoyable evenings. Designed for stability and safety. Ample supplies of paint, canvas, nails, glue etc. Kit is absolutely complete including paddle. New low price. Send postcard for free illustrated literature.



KAYAK KIT COMPANY

Department 5, Bloomfield, N. J.

ELECTRICITY *Anywhere*

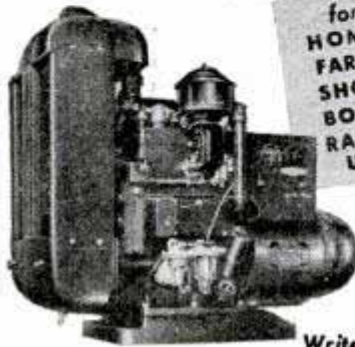

for
HOMES
FARMS
SHOPS
BOATS
RADIO
USE

● Onan gasoline-engine-driven Electric Plants supply reliable, economical electric service for any use. Portable, stationary or stand-by models. Water or air-cooled, compact and rugged.

A.C.: 350 to 35,000 watts in all standard voltages and frequencies. D.C.: 600 to 10,000 watts, 115 and 230 volts. BATTERY CHARGERS: 500 to 3,500 watts; 6, 12, 24, 32 volts.

Write for folder



D. W. ONAN & SONS INC.
2529 Royalston Ave., Minneapolis 5, Minn.

Send for Free List of Leading Books and Catalog of Tools For Watch and Clock Repairing—Engraving, Aircraft Instruments Etc. Address Dept. 12. Use Letterhead.

HENRY PAULSON & CO.
37 SO. WABASH AVE., CHICAGO 3, ILL.

Catch ALL Your Fish With JUST ONE Minnow!

MINNO-MAGIC
(By Bol-Dart)

KEEPS MINNOW ALIVE. Minnow fits into transparent plastic case with hooks. Fins and tail stick out—produce live action. Minnow stays put. Sensation at sports shows—none like it. Large catches.

es recorded. \$1.25 postpaid check cash or M.O. 3% sales tax if in Ohio.
MERIT Ltd. Dept. 21 P. O. Box 9 Toledo 12, O.

FREE RADIO CATALOG

Lafayette—world's largest radio supply house—presents the world's greatest radio catalog. 144 value-packed pages. Over 10,000 items. Everything handsomely illustrated—fully described—economy priced. Send for FREE copy AT ONCE.

LAFAYETTE RADIO
100 SIXTH AVE., NEW YORK 13
110 Federal St., Boston 10 • 24 Central Ave., Newark 2, N.J.

LAFAYETTE RADIO, Dept. LE-7, 100 Sixth Avenue, N. Y. 13, N. Y.
RUSH new Lafayette Catalog to:

Name.....
Address.....
City..... Zone..... State.....

MAIL COUPON NOW

Now you can own ACTUAL WORKING MODELS



Not
A KIT
Not
A TOY
Completely
Assembled

3.7 A. A. GUN—

FIRES REAL PROJECTILES

These finely made working models look and operate just like the real thing. They're beauties—and they'll do everything their larger counterparts did in actual use.

The 3.7 gun shown above is the finest example of its kind in existence. 9" barrel. Incorporates all features of a real gun. Projectiles are fired by means of standard caps loaded in shell case.

Price complete with shell case and projectiles. . . . \$12.50



FORT GUN

Shoots projectiles up to 60 feet. Quick loading. Ideal for use with miniature soldiers. Height 2½".

Complete with shell case and projectiles. \$2.20



LONG RANGE SEARCHLIGHT

Here is a magnificent, carefully-constructed model of the latest type anti-aircraft searchlight. Throws tremendous beam. Works off batteries in operating platform. Diameter of lens, 4". \$9.50



ANTI-TANK GUN

Finely-machined model of Mobile Anti-Tank Gun. Twin rubber-tired wheels. Fires projectiles up to 20 yards by means of caps. Length 7".

Complete with shell case and projectiles. \$3.50



ANTI-AIRCRAFT GUN

The smallest working model of this gun. Uses standard caps to fire projectiles. Height 6¼". Length of barrel 5".

Complete with shell case and projectiles. \$2.70



ROUND-BASE SEARCHLIGHT

A detailed model of one of the most popular military searchlights. Throws penetrating beam a great distance. Height 3¼".

Complete with operating gear \$4.00

ORDER DIRECT FROM THIS AD.

INQUIRIES FROM AGENTS AND DEALERS INVITED.

BRITISH INDUSTRIES CORP. (Astra Toy Division)

315 Broadway, New York 7, N. Y.

I am enclosing \$..... for which send me items checked below. Send C.O.D. (C.O.D. orders must include 25% deposit with order.)

- 3.7 A. A. Gun. Long Range Searchlight.
 Anti-Tank Gun. Round-Base Searchlight.
 Anti-Aircraft Gun. Fort Gun.

Name.....
Address.....
City..... Zone..... State.....

New SOLDERING KIT

for **\$1.00**

SIMPLE FOOLPROOF SOLDERING



You can now have this new and revolutionary all-purpose Soldering Kit which contains all the FLUX and cleaners necessary to give smooth, clean cut joints and repairs.

A generous supply of SOLDER, tubes of FLUX PASTE and PROTECTIVE PASTE, a BRUSH, a bottle of FLUX FLUID and a SAL AMMONIAC BRICK.

COMPLETE INSTRUCTIONS

Both the experienced and novice will want these unique, simple, concise directions. Anyone can now easily make clean soldered joints and repairs to Cast Iron, Steel, Brass, Bronze and many other alloys.

ORDER BY MAIL. Order this complete soldering kit by mail. Send \$1.00 and the kit will be sent postpaid.

No C.O.D. orders please—Satisfaction guaranteed or money refunded.

Dept. P-1, UNIT SALES CO., Box #86, Montville, N. J.

PULL COTTERPINS QUICK with the "KOTTER PULLER"

• Gets out the most stubborn cotterpins, quick and easy. For auto and aviation mechanics, garage men, shop men, farmers, hobbyists and anyone who works with tools.

DEALERS WANTED

Send Check or Money Order Today

The DORRHONS Co.

3131 WEST 30th STREET • DEPT. 1
CLEVELAND 9, OHIO



NEW—WAR SURPLUS JUNGLE HAMMOCKS

For the home, yard, farm, camping, scouting and many other uses. Can also be used for Pup tents.



Made of high grade Poplin for the U. S. Army. Complete with ropes and canopy for protection against mosquitoes and other insects. Comes individually packed. Ready for immediate shipment. Order yours today. Add 10% for **\$4.95** postage

Special quantity discounts

RoKo Company

729 Baltimore

Kansas City, Mo.

Start a NEW BUSINESS

Sharpen Dull Pipe Wrenches

Industries save hundreds of dollars. Some "wrench shops" make \$50 a day.

Write for information.

J. C. MOORE INDUSTRIES P. O. Drawer 276
FREDONIA, PA.



COLOR CONCRETE WITH CHEMICALS

Get into business on small capital working at home, or shop. There is real money in making Hollywood style pottery and bird-baths without moulds. Our instructions cover a large variety of designs. Washing-wells, benches, garden light-houses, stucco-rock, imitation marble, cement water-paints and many more. 10c brings sample, details and pictures.

HOLLYWOOD CEMENTCRAFT
8529 Wonderland Ave., Hollywood 46, Calif.

BUILD YOUR OWN POWER LAWN MOWER

WHY BREAK YOUR BACK MOWING FIELD OR LAWN?

WRITE FOR
FREE
LITERATURE
The Rite-Way
Mower
Attachment
Ball Bearing

SAVE MONEY
SAVE TIME

Now anyone can save time and effort mowing field or lawn by building their own whirl type power mower. Build according to your own ideas and needs at small cost. Cut close to fences, walks, buildings, etc. Build in short time with parts and instructions we furnish. Save hours of time and back breaking labor. Write today for FREE information.



IT'S FUN TO BUILD

Write today for FREE information.

T & H MFG. CO., Dept. PM3
811 E. 31, Kan. City 3, Mo.

FOR STEADY-VOLTAGE POWER...
FREE FROM OUTSIDE INTERFERENCE

DIESEL'S THE POWER...

Sheppard's the Diesel

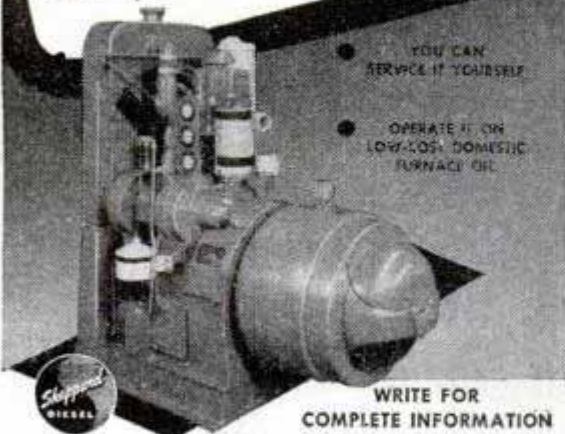

YOU CAN
SERVICE IT YOURSELF

OPERATE IT ON
LOW-COST DOMESTIC
FURNACE OIL

WRITE FOR
COMPLETE INFORMATION

Generating Sets... 2,000 to 36,000 Watts
Power Units... 3/4 to 56 continuous H. P.
Marine Engines... 3/4 to 62 continuous H. P.

R. H. SHEPPARD COMPANY, INC., 48 Middle St., Hanover, Pa.

TELA-WEATHER*

tells you tomorrow's weather TODAY!

Plan picnics, fishing trips, planting, outdoor cleaning... know what to wear, where to go... use TELA-WEATHER!

\$1.00
Complete

Tela-Weather incorporates the latest techniques of weather forecasting; designed by former Air Force meteorologists!

Greatest accuracy possible in weather forecasting is yours with this easy-to-use, scientific instrument that makes complicated meteorological calculations for you.

Copyright, 1947, C. K. Reynolds, Jr.

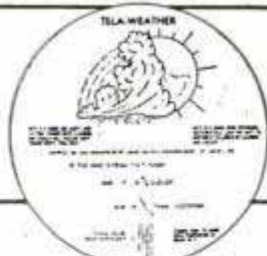

Please send me

_____ TELA-WEATHERS today!

Name _____

Address _____

City _____

State _____

I enclose check money order cash for _____

(\$1.00 each includes tax, postage, etc.)

Weathercasts of St. Louis

Railway Exchange Bldg., St. Louis 1, Mo.

EXHAUST BLOWERS

WORTH \$50

\$15.85



FOR PHOTOGRAPHERS
HOSPITALS • LABORATORIES • WORK SHOPS
LAUNDRIES • OFFICES
RESTAURANTS • PRINTERS
PLAYROOMS

100 CU. FT. FRESH AIR EVERY MINUTE!

Solve your ventilation problems with this NEW rugged, built-for-service blower and exhaust. Quick and simple to install. Anyone can do it with ordinary household tools.

110 Volt, A.C., 50-60 cycles. Continuous duty. BALL BEARING motor assures quiet, trouble free operation. Durable Housing Insures Long Life. Send Check, Money Order. No C.O.D.'s. West of Mississippi add \$1.00 for mailing, handling. Immediate delivery.

UNIVERSAL YONKERS CORP. (Dept. M-5) 41 Locust St., Yonkers 2, N. Y.

\$12.85 List

GENUINE TURNER MICROPHONE

MODEL 20X

Record at home, parties, etc. Get high quality results with new Turner crystal type hand microphone. Improved circuit. Light weight. Convenient. Low cost. Use with any high impedance recorder. Ask your dealer or write for bulletin. Free literature on all Turner Microphones.

THE TURNER COMPANY

921 17th Street N. E., Cedar Rapids, Iowa

WHEELS FOR JUVENILE AND INDUSTRIAL USE

MANUFACTURER'S AND DEALER'S INQUIRIES INVITED
CIRCLE METAL MFG. CO., 4272 E. Pacific Way, Los Angeles 23, Cal.

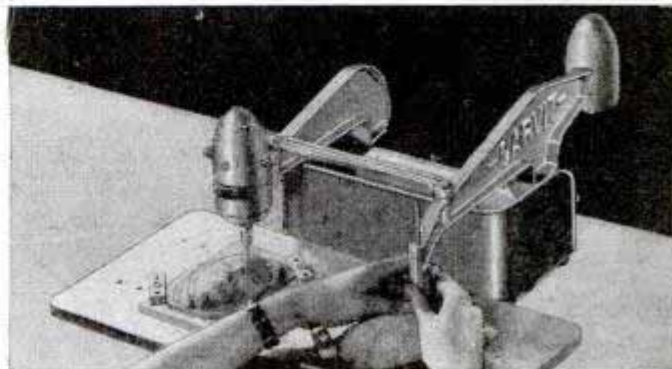

New! Sensational! Carvit makes you a skilled wood carver in 20 minutes!



H-3

Here's a fascinating new hobby — complete in one tool! The unbelievable perfection of your first carving amazes your friends! Experienced craftsmen use the Carvit to give their projects that professional touch.

With the Carvit, you make beautiful replicas of inexpensive objects you can find in any dime store or gift shop — in mahogany, walnut, and other fine woods: useful ornaments for your home, distinctive gifts for your friends — fine carvings that *sell!*

TEAR OUT THIS COUPON AND MAIL TODAY!

The Dumore Company, Dept. E-51, Racine, Wis.

Please send complete information on the Carvit.

Please send one Carvit. \$48.50 enclosed. Shipping charges C.O.D.

Name _____

Address _____

City _____

State _____

SAY YOU SAW IT IN POPULAR MECHANICS

Now a 10-inch WEATHERPROOF BRUNING All-Plastic Slide Rule



PRICE
\$8.25

Here's the slide rule you've been wanting—an all-plastic precision instrument! This rule operates smoothly and accurately under any atmospheric conditions. Precision graduations are not affected by weather or temperature changes. Backed by the famous name Bruning, this new rule has numerals and graduations of the CI scale in RED to provide easier reading. A, B, CI, C, D, K, S, L and T scales provide widest possible range of service. Beveled edges of rule are graduated in inches and centimeters. Glass indicator is enclosed in a stainless steel frame that holds it firmly in place — tension of slide easily adjusted by four screws on back of rule. Instruction manual furnished with each rule at no extra cost.

Includes sturdy leatherette case and instruction manual. Price with genuine leather case and manual, \$10.50.

No C. O. D. Orders

Charles Bruning Co., Inc.
4722-30 Montrose Avenue, Chicago 41, Illinois

Please send me (show number desired) _____ Bruning 10-Inch Slide Rule(s) _____ with leatherette case \$8.25 each _____ with genuine leather case \$10.50 each. I enclose \$ _____

Name _____

Address _____

City _____

State _____

New 8-Power Prismatic ELBOW TELESCOPE

US ARMY
SURPLUS

WITH 4 BUILT-IN FILTERS



\$175
Value!

Now only . . .

\$35

The same precision Elbow Telescope used by the United States Army. Very highly corrected lenses. Field of view 6 degrees; has four element filter; clear, neutral, red and amber; etched hairlines with illuminating electric light; body of cast aluminum alloy; overall size objective end 12" long x 2.4"; eye-piece end 7.5" long x 2.5". Has 50 mm objective lens. Use it for target spotting, for mountain vacations, for seashore vacations, in airport towers, boats, harbors and for use as finder-scope by astronomers.

PREPAID

Checks or
Money Orders
Accepted

TENDLER'S

913 D ST N.W. ME. 9339
WASHINGTON 4, D. C.

SAY YOU SAW IT IN POPULAR MECHANICS



MENDS

DISHES, TOYS, ETC.

It's clear, water-proof, flexible, durable.



DUOCO CEMENT

REG. U. S. PAT. OFF.

Mows and Trims Lawns



In One Simple
Easy Operation

8 1/4 Lbs.



Save Time
and Labor with a

MONTAMOWER

New model. New type metal handle has special device to adjust cutting height. Drive shaft now mounted on free rolling, factory lubricated, and sealed ball bearings. No tired backs or aching arms. 8 1/4 lbs. of live precision made mechanism that first gathers, then cuts smoothly a clean 16" swath through grass, dandelions, spike grass and weeds. No noise or clatter. As modern and efficient as your electric razor. Cuts right up to walls, fences, trees or posts; leaves no fringes to be trimmed by hand. Cutters are self-sharpening. Built to last many years. Many thousands in use. Sold direct from factory. Costs little. Write at once for guaranteed information and literature.

MONTAMOWER DISTRIBUTING CO
821 Keeler Bldg. GRAND RAPIDS 2, MICHIGAN

TRU-BORE

The newest and most practical lathe tool. Speedy, accurate boring, internal threading and outside finishing. Three standard lathe sizes complete with boring bars and tool bits. Immediate delivery. Write for literature.

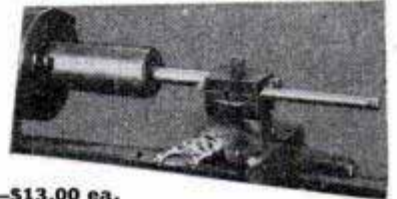

No. 1-46 (9-12" Lathe)—\$13.00 ea.
No. 1-41 (12-16" Lathe)—\$36.00 ea.
No. 2-41 (18-36" Lathe)—\$54.00 ea.

ACCURATE! SPEEDY!
PROFITABLE!

MILES PRODUCTS

2532 S. Wabash Ave., Chicago 16, Ill.

BUILD YOUR OWN FAN

with that old motor

One piece cast aluminum propeller used for cooling and ventilating. Also available to dealers at discount.

Size	Polished	Unpolished	Bore
15	\$2.50	\$3.50	\$2.00
18	3.00	4.00	2.50
20	3.25	4.25	2.75
24	3.50	5.00	3.00
30	5.00		4.00

KLOPPENBORG ALUMINUM FOUNDRY, Dept. PM57, Davenport, Iowa



MASTER CHAMPION LAWN MOWER SHARPENER

Also Mfg., Saw Sharpening
& Key Machines

FRANK'S MFG. CO.

Dept. PM9
2501 E. Imperial Highway
Los Angeles 2, Calif.



POWERFUL BINOCULARS

only \$6⁹⁵

All metal type with adjustable focusing wheel. Enjoy indoor, outdoor shows, sporting events, etc. Plated draw tubes extend for sharp instant focusing on distant objects. Low price includes handsome Carrying Case and long adjustable Shoulder Strap. SEND NO MONEY. Clip ad and mail. We'll ship COD for \$6.95 plus tax and postage charges. Address:

ILLINOIS MERCHANDISE MART Dept. 2216, 1227 Loyola Ave. Chicago 26, Ill.

POPULAR MECHANICS

Roper DIGS TWO HOLES A MINUTE



BUY DIRECT SAVE UP TO 50%

A speedy digger with ALL features. Installed by one man in less than 5 minutes. No belts, chains, cables. No stripping down tractor. Operated from seat. Digs up to 18" dia. hole, 30" deep even through shale, 3" sand stone. Adjustable to dig straight on rolling land. Steel encased double end bearing shaft cannot bend. Easily replaceable safety shear pin. (Available for Ford Tractors with Ferguson System only.)

\$125.00
F.O.B. FACTORY

FOR DETAILS WRITE **ROPER MFG. CO.**
210 WALNUT DRIVE ZANESVILLE, OHIO

OVER 40 M. P. H. WITH THIS AMAZING NEW JET RACER ONLY **\$3.00**



Kit includes everything needed to build 8" racer and jet unit. Additional fuel at any drug store. Speed guaranteed or money back. Send cash, money order, or C.O.D. to

DEATRICK'S MODEL SHOP
Bendersville, Penna.

New HULL Beaconlite ILLUMINATED AUTOMOBILE COMPASS



Keeping you on the right road day or night, and giving constant reassurance that you're right, is the peak of motoring convenience offered by the new Hull Beaconlite. Casts a non-glare reddish glow at night for perfect dial visibility. Works without light in daytime. Latest luxury design in ebony or brown, accurate, easy to install. At your dealer's or write us for circular. Price \$5.95.

HULL MFG. CO.
P.O. Box 246-D4 Warren, Ohio

FINE TOOLS NEED FINE OIL!



- Lubricates
- Prevents Rust
- Cleans • Polishes

SOLD EVERYWHERE

3-IN-ONE Oil

BREEZE

THROUGH YOUR HEDGE WITH THE GREATEST OF EASE



Keen, tough blades and a deft, "handy" balance! With BERNARD's it's easy to have the neatest hedge in town.

Mighty handy, too, for trimming bushes, small trees and for making all your foliage look its smoothest, shapely best.

Blades of hard forged steel set deep in tough hickory handles and anchored there with sturdy pinions. Lock washer at the joint keeps blade tension just right.

You'll find BERNARD Hedge Clippers at your hardware store. Ask for them by name.

BERNARD Hedge Clippers are one item in a line of fine hand tools—pruners, pliers, cutters, etc.—known for QUALITY for 75 years. Free catalog on request.



Quality Tools Since 1870

BERNARD

TRADE MARK REGISTERED

WM. SCHOLLHORN COMPANY
7505 Chapel St., New Haven 9, Conn.

a big nickel's worth

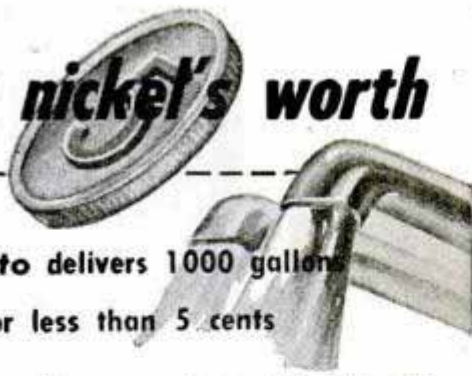

Myers Ejecto delivers 1000 gallons of water for less than 5 cents

Why pump and carry water when this efficient Myers Ejecto will deliver 1000 gallons, fast and fresh and where you want it, for less than 5 cents' worth of electricity? Specially designed pump with precision-cut impeller (the only moving part) enables this system to pump large quantities of water economically in all horsepower sizes. Free 3-color water system booklet shows cutaway views, explains Ejecto principle of operation, illustrates the complete Myers line. Mail the coupon.

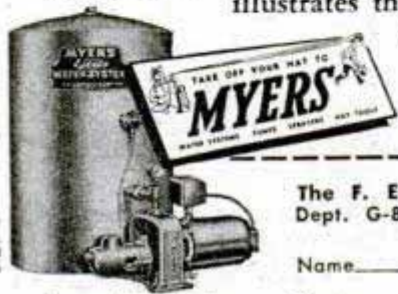

Myers "H" Series Ejecto, for shallow and deep wells

The F. E. Myers & Bro. Co.
Dept. G-85, Ashland, Ohio

Name _____
Town _____
State _____ County _____

Go Places For Pennies!



Put a WHIZZER Motor on your bike, and go places! The thriftiest power on wheels! Six miles for one penny! 5 to 35 m.p.h.! Fits any man's balloon tire bike!

If no local dealer yet, mail coupon, today.

RIDE ONE AND YOU'LL BUY ONE



ON A WHIZZER

Whizzer Motor Company, Dept. 525, Pontiac, Michigan. I enclose \$99.97, which includes \$2.42 Federal Excise Tax () check or () money order. Send me one WHIZZER Motor complete, ready for installation. If descriptive literature only is desired, check here ().

Name _____ City _____
Street _____ State _____

A TOOL... NOT A BRUSH

\$1.00 POST PAID

PAINTERS' STRIPING TOOL

NOW! PAINT STRIPING MADE EASY!

Easy to use as a pencil! Draws parallel lines, straights, curves, circles with paint, enamel, lacquer, etc. Do your own striping on autos, furniture, toys, bikes, model planes, signs, linoleum... make wall board look like tile. Painters—craftsmen, order today! Type "M" Master Painters' Striping Tool complete with tip for 1/16" stripe, \$1.00. Extra tips 1/64", 1/32", 3/64", 1/16", 5/64", 3/32", 1/8"—75c each. Tool with complete set of 7 tips \$5.00. (C.O.D. orders 25c extra.) Dealers write!

WENDELL MFG. CO.
4234-B Lincoln Ave., Chicago 18, Illinois

TRIANGLE Cribbage Board

Three beautiful Walnut boards held in place by a peg in each corner. An ideal Gift.

\$3 Postpaid

M.P. MANUFACTURING CO.
Maple Plain, Minn.

SHAW 'DU-ALL' GARDEN TRACTORS and MOWERS

Get FREE FOLDER NOW!

Get details on 1 to 9 H. P. walking and riding tractors. Do 1000 jobs on small farms, estates, orchards, gardens. Low-priced. Send postcard today!

SHAW MFG. CO. 4505 Front Street, Galesburg, Kans.
668G North 4th St., Columbus, Ohio

USE Fine Walton Wheels to Make Your Own WAGONS—SHOPPING CARTS and RACERS

65¢

Each in Sets of 2 or 4—plus 10c ea. for postage. 4 1/2-inch—with 3/8-in. bushing

Coaster wagons, scooters, shopping carts, bike trailers, golf bag carriers, etc., are easy to make. Use fine Walton DeLuxe Wheels! They're strong welded pressed steel construction. Ideal for making many things for use and play. Solid rubber tires. Red enameled. Send check or money order. No C.O.D.'s. Dealers and manufacturers write.

WALTON WHEEL COMPANY, Dept. J-4
Plankinton Bldg. Milwaukee 3, Wis.

NEW The Handy "SCREW GRIPPER"

EACH POSTPAID \$1.00
ONE DOZ. POSTPAID \$8.00

Starts screws in hard-to-get-at places. Saves time and temper. Dealers, jobbers, salesmen wanted.

SCREW GRIPPER CO. MUSCATINE, IOWA

SAY YOU SAW IT IN POPULAR MECHANICS

NEW CHEAP OIL BURNER

FOR COOKING & HEATING STOVES-FURNACES
HEAT YOUR HOME, COOK YOUR MEALS WITH CHEAP FURNACE OIL

NO MORE SHOVELING COAL OR ASHES. A New Fuelizer Starter Vaporizing System turns Cheap 130 Flash Furnace Oil, Distillate, Kerosene etc. into Oil Gas heat without clogging up. LIFETIME GUARANTEE against defects. \$1.00 Bonus Offer for Testing. We will let you try it in your own stove or furnace for one month. Get yours for introducing. Big Profits QUICK. Be first. Send in your name TODAY.

NORTHWEST MFG. CO., 567-E 5th, Mitchell, So. Dakota

An Easier, Quicker Way to CUT GRASS and WEEDS

Get a MOW-MASTER... the Rotary Mower built to do a hard job the easy way. Plenty of power from famous air-cooled, 2 H. P. gasoline motor with muffler. Easily adjustable rotary blade.

LOW PRICED

Modern methods of volume production make MOW MASTER low priced.

SEE YOUR DEALER or write us for FreeFolder.



Adjustable handle, handle-bar control, precision built of quality materials.

Lightweight - a woman can run it. Cuts thru high grass and weeds. Keeps lawn velvety smooth.

The PROPULSION ENGINE CORP. Dept. 201

7th and White Eagle Rd. Kansas City, Kansas

POWERED BY 2 H. P. POWER-PAK GASOLINE ENGINE with MUFFLER.

MOW-MASTER Rotary Mower

CUTS INTRICATE DESIGNS never before possible



Sharp spiral blade saws in any direction. Cuts wood, plastics, or light metals without binding or breaking. Sturdy steel frame, with new lever adjustment, keeps tension right. Complete saw with 3 extra blades, 95¢. Blades only, 3 for 25¢. Get yours - today. AT YOUR NEAREST HARDWARE STORE, or send \$1 direct for sample to

TYLER MANUFACTURING COMPANY
938 Pico Boulevard - Santa Monica, California



ENLARGED SECTION OF BLADE

Giffy ELECTRIC HEATER

HOT WATER IN FIVE MINUTES

For baby's bath, your washing, shaving and many other uses in the home, camping, business or on the farm.

One Year Guarantee

See your local Dealer or order direct...

AMBORY CORPORATION
Dept. PM2 Hazel Park, Michigan

ONLY \$6.50

PLASTIC DIAL TOP SHOWS MEASURE!

Better Features

- HEAVY STEEL CASE
- BUILT-IN SCRIBE
- SELF-OILING TAPE
- CHROMED INSIDE AND OUT
- FULL VIEW WINDOW
- ACCURATE TO 1/32"
- 72 VISIBLE INCHES
- METEDED MEASUREMENT



DART

The NEW DIAL-FACE RULE Gives You an Extra Hand!

FAST—ACCURATE—DEPENDABLE—NO GUESSING WITH "DART"

THIS IS THE ITEM SHOWN ON PAGE 99, APRIL ISSUE POPULAR MECHANICS

Here's good news—The new Dart Scribe Rule—Full view—Accurate dial reading—No fumbling for pencils—The built-in, protected scribe marks with a slight pressure—You don't need that "third" hand. Built to last a lifetime, the heavy chrome-

plated steel case can be easily taken apart for cleaning—Oiled felt keeps tape in perfect condition—Tape retracts at slightest pressure.

At your Hardware Dealer **\$3.35** ... or write to Dept. 10 PM.



For inside dimensions DART is easier to use and far more accurate.

DART MANUFACTURING CO., MASON, MICHIGAN

Luxury Living ANYWHERE IN A SCHULT

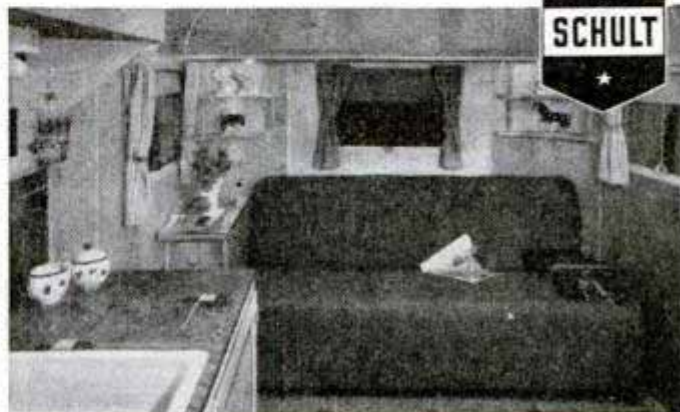

Imagine having your own complete, comfortable accommodations... ready to take wherever you want, for living or travel.

Three separate rooms for utmost privacy. Every facility for luxurious and gracious living.

THE DELUXE COMMODORE

Schult Trailer Coaches, in two handsome models, are available right now. Both models sleep four adults comfortably, have ample closet and storage space, are tastefully decorated, and have complete kitchens with refrigerators and oven ranges.

21-foot marvel of compact completeness. (Living room illustrated.) Amazing in drawer, locker and other storage space. For those who want every facility for comfort, in a lighter, more economical coach.

THE LUXURY LINER
26-foot tandem model for maximum living comfort.

SEE BOTH models at your Schult dealer's. Write TODAY for his name; we will include latest catalog.



SCHULT CORP., Dept. 3205, ELKHART, IND.
Canada: John Inglis Co., Ltd., Toronto

SCHULT Trailer Coaches

SAY YOU SAW IT IN POPULAR MECHANICS



For A Perfect Day

P
K

AMAZIN' MAIZIE

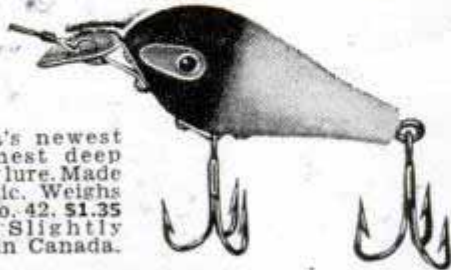

America's newest and finest deep running lure. Made of Plastic. Weighs 3/8 oz. No. 42. \$1.35 each. Slightly higher in Canada.

"Adventures in Fishing" 48 pages in four colors; pictures, fishing stories, secret hints, etc., with regular 10c package of Raparound, invisible ribbon sinker, both for only 10c. Send your dime today. Offer good only in U. S.

P & K INCORPORATED

(PACHNER & KOLLER, INC.)
3428 Archer Avenue Chicago 8, Illinois
Canadian Distributors: Central Purchasing Agency, Ltd., Toronto, Ontario

TESTED AND PROVED LURES AND FISHING ACCESSORIES

At last! A *Custom-built* motor to power your construction set!

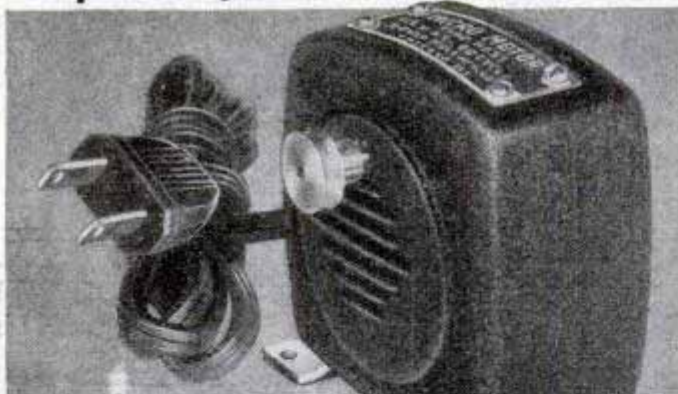

FULLY CASED IN ALUMINUM WITH BEAUTIFUL BAKED BLACK WRINKLE FINISH...HANDSOMELY LOUVRED FRONT AND BACK!

- ★ High torque 115 V.A.C. 60 cycle AC
- ★ Plug in DIRECT to electrical outlet
- ★ 1/8" stainless steel shaft—graphite bronze bearings
- ★ No exposed windings or connections
- ★ Motor can be stalled indefinitely

GUARANTEED UNCONDITIONALLY FOR ONE YEAR!
JOBBER AND DEALER INQUIRIES INVITED

ONLY \$5.95 POST PAID COMPLETE READY TO PLUG IN!

BOXAR TOOL & MFG. CO.
Dept. 3-2240 W. Ogden Ave., Chicago 12, Ill.
Yes! Send me at once _____ motors at \$5.95 each.
\$ _____ enclosed (money order or check)

NAME _____
ADDRESS _____
CITY _____ TOWN _____ STATE _____

NEW TRUCK - TRAILER AXLE ASSEMBLY

• War Surplus Buy!

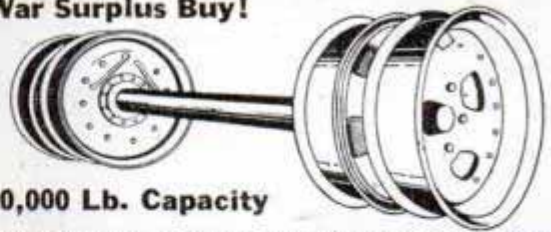

• 20,000 Lb. Capacity

EQUIPPED WITH THE LATEST TYPE DOUBLE CYLINDER HYDRAULIC BRAKES, 6 HOLE BUDD HUBS, ETC. . . .

\$158 COMPLETE (Less Wheels) Standard width with heavy type 4 in. tubular steel axle and 16 in. brake drum diameter.

6 HOLE - 20x7 BUDD WHEELS To Fit Axle \$6.75 Each

NEW 16 in. CAR TYPE TRAILER WHEELS

Ford - Chev. - Plym. - Model "T" and Universal **\$6.45 EACH**
Double disc, drop center, heavy type to fit any above pass. car hubs. Specify make and model!

"WELD-IN" WHEEL CENTER DISCS \$1.95 Each
For 16 in. drop center rims, fit same 5 types as wheels above. Perfect fit! Specify make and model!

Send Full Remittance or 25% Deposit and Balance C. O. D.

NORTHWESTERN AUTO PARTS CO.

834 No. 7th St. • Dept. 7 • Minneapolis 11, Minn.

KAYAKS
AQUA VIR
Easy to Build

BOATS for Home Assembly
"U-MAK-IT"
KAYAKS, ROWBOATS, DINGHIES, INBOARDS, OUTBOARDS, RUNABOUTS
Cut-To-Fit for Quick Assembly. Everything Complete plus Illustrated Instructions. No Experience Necessary. Simple as A. B. C.
25¢ COIN FOR ALL THREE
SEND 25c POSTAGE (COIN) TODAY FOR 3 MONEY SAVING ILLUS. CATALOGS Showing all '47 Models (marine plywood) and construction details.

AQUAMOBILE V-18
Designed for Auto Engines. Open or with cab. Length 18 ft.
Fast VEE Bottom Hull
KAYAK BOAT CO., 154P EAST 129th ST., NEW YORK 35, N. Y.

PROTECT YOUR EYES AND GLASSES

The SAF-I-SHIELD GOGGLE of "Optilite," the new optical plastic, weighs less than one ounce, yet, it will withstand the impact of a sharp piece of metal traveling at 240 miles per hour. Gives full protection . . . allows full vision . . . one size fits everyone . . . smart in appearance and comfortable . . . worn by workers in hundreds of the largest plants in the country. Protect your eyes from flying particles, dust, chemicals and eye hazards in all kinds of work. Made of all crystal clear plastic (#202) for inside work and all antiglare green plastic (#A222) for outside work and sportswear. If your dealer can't supply you, order by number. Send money order, cash or check. No C.O.D. . . . Postpaid **\$1.50**

UNITED STATES SAFETY SERVICE COMPANY
1215 McGee Street Kansas City 6, Missouri

Big Money for Workers In Home or Shop

Licensed Concrete Specialists wanted. No experience needed. Make Colorglazed concrete pottery without molds. New, low cost, patented method. Cemetery products, novelties, tiles, etc. Basement leaksealing. Other big pay projects. Booklet, details free. Men only.
NATIONAL POTTERIES COMPANY
542 Lincoln Avenue Fergus Falls, Minnesota

SPECIAL—METERS

SURPLUS — NEW — GUARANTEED — GOV'T. INSPECTED



A.C. VOLTMETER, Triplett Model 331-J.P., 3½", round flush bakelite case, 0-150 Volts A.C., white scale. (See illustration.)

A.C. AMMETER, Triplett Model 331-J.P., 3½", round flush bakelite case, 0-30 Amperes A.C., white scale.

D.C. AMMETER, Triplett, 3½", round flush bakelite case, 0-15 Amperes D.C., white scale.

SPECIAL OFFER ALL 3 METERS \$9.95

Postage Prepaid
Anywhere in U. S.
or Canada

MARITIME SWITCHBOARD

Dept. PM9 336 Canal Street N. Y. 13, N. Y.

Save Filing Time With FOLEY RETOOTHER

Cuts **NEW TEETH**
all Hand Saws
in 2 to 3 Minutes

Saves half of filing time on old saws with irregular teeth. Cuts 20 sizes of teeth from 4 to 16 points per inch. Quick, easy, no eye-strain. "The Foley Retoother paid for itself in file savings alone"—says one user.



Write for circular to

LEY MFG. CO. 590-7 Foley Bldg., Minneapolis 13, Minn.

MACHINE SHOP EQUIPMENT



Just off the press!—Every man who owns a workshop should have a copy of the new, up-to-the-minute, 200 page catalog of Machine Shop Equipment—the latest tools made by the biggest manufacturers in the U. S. Replete with illustrations, descriptions, prices. Prompt delivery on most tools listed in this book. Available at cost of printing—50c a copy—get yours today! **Price of Catalog Refunded on First Order over \$5.00.** Send check or Money Order to

CENTER TOOL CO., 153 Centre St., Dept. C, New York 13

OTTAWA LOG SAW Write For FREE BOOK

Put this **OTTAWA** to work for you. **MAKE MONEY!** Wood is bringing highest prices ever known. Ottawa does more than 10 men. Easily operated. Falls trees—saws limbs. Use 6-hp. engine for other work.

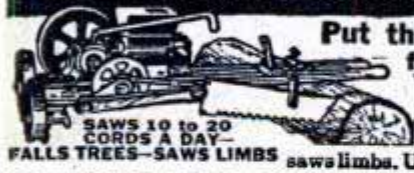

OTTAWA MFG. CO., 527 Wood St., Ottawa, Kans.

Say You Saw It in
POPULAR MECHANICS

Get Acquainted With— LUCITE "The Gem of Plastics"

Write now for your copy of the illustrated booklet which gives step-by-step fabricating instructions, chemistry & properties of Lucite, wholesale and retail price list on **CLEAR & COLORED** sheets, rods, tubes, dyes, supplies. Booklet & Lucite sample 35c, postpaid; booklet only 10c **GEM-O'-LITE**, P.O. Box 686D, North Hollywood, Calif.

FREE

get

ALLIED'S NEW RADIO CATALOG

SEND FOR IT
NOW



FOR
EVERYTHING
IN RADIO!



NEW HOME RADIOS



**SERVICE SUPPLIES
BUILDERS' SUPPLIES**



AMATEUR GEAR



SOUND SYSTEMS

164 Value-Packed Pages

Send for your **FREE** copy of the most complete Buying Guide for Everything in Radio! Here's the Catalog for Servicemen, Dealers, Soundmen, Amateurs, Builders and Experimenters. Features the world's largest and most complete stocks of radio and electronic supplies—quality equipment at lowest prices! Get the speedy service and expert help you want from **ALLIED—Radio's Largest Supply House.** Depend on **ALLIED!**

MORE THAN 10,000 ITEMS

Get everything for every radio use: New 1947 home model radios, phono-radios, recorders, communications receivers, Ham kits, and gear, code apparatus, radio parts, tubes, tools, test instruments, public address equipment, low-cost easy-to-build radio kits, diagrams and matched parts lists, largest selection of instructive radio books—all at lowest prices!

ALLIED RADIO

ALLIED RADIO CORP.

833 W. Jackson Blvd., Dept. 5-EE-7
Chicago 7, Illinois

**FREE
CATALOG**

Rush new **FREE** 1947 Catalog

Name.....

Address.....

City.....Zone.....State.....

BRAND NEW

SPERRY
AUTOMATIC "PILOT"
VERTICAL GYRO UNIT

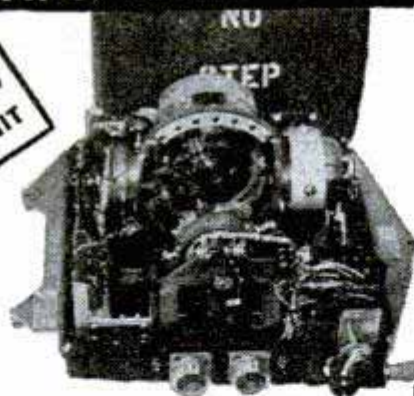

**ARMY PAID
\$2885.00**

DESIGNED FOR B-29 SUPERFORT
BROUGHT TO YOU . . . BECAUSE OF A "FORTUNATE" BUY

YOU PAY ONLY \$19.50
less than 1 cent on \$
of original cost

HERE IS PART OF WHAT YOU GET!

- 1 400-CYC, 115 V, 3 PH. Motor propelled gyroscope
- 2 24 V DC Shunt-wound motors; variable-pitch gear train
- A precision ball-bearing worm sector
- 2 electronic relays (type 1633 vac. tubes)
- 3 ball bearing pendulums, 2 solenoid pick-off motors
- Auto transformer, resistor bank
- Numerous miniature ball-bearing races, condensers, mechanical movements and hundreds of other parts all housed in original aluminum casing.

Size 15" X 14" X 9"
26 lbs. in weight . . . you pay shipping cost.

Send check or money order to:

SURPLEX RETAIL SALES, INC.
2409 S. LaSalle St. Chicago 16, Illinois
Chicago Buyers Att'n Phone CALumet 9130

Time & Date
AT A GLANCE



BELL
GUARANTEED
CALENDAR WATCH

Tells time, name of day and date.
Day name changes automatically.

No. DY382 — Calendar watch, 17 jewels waterproof, shockproof, anti-magnetic, radium dial and hands, stainless steel back. **\$49.75**

OTHER SPORTS WATCHES WATERPROOF SHOCKPROOF
Precision tested, guaranteed. 17 jewels, anti-magnetic, radium dial and hands, unbreakable crystal, sweep second hand.

NOW AT RECORD LOW PRICES

No. DY196 — Stainless Steel Back **\$24.75**
No. DY220 — ALL STAINLESS STEEL CASE . . . **\$29.95**
ORDER BY MAIL: Send check, money order or pay postman C.O.D. Prices incl. Fed. Tax and Postage. Write for FREE Booklet "DY"
REPAIR SERVICE: All types and makes of quality watches. FREE estimate on request.

BELL WATCH COMPANY, INC.
Time and Life Bldg., Rockefeller Center, New York 20, N. Y.

NEW TOOL READY

QUICKLY SHAPES, SANDS CARVES, PROFILES, BANDSANDER
GRINDS, BEVELS, SMOOTHS, POLISHES, CLEANS!

War industry's most versatile machine—now available to hobbyists, craftsmen, model makers, pattern makers, home workshops—cuts fast and clean on wood, metal, plastics! Works equally well on inside cut-out openings or irregular outside edges, on intricate scrolls, curves. Saves hours of tiresome hard work—does better job. Nothing else like it. IDEAL TO GIVE OR GET FOR WORKSHOP! Sold on 5 Day's Trial, money back GUARANTEE.



FREE!

Write for free, lavishly illustrated Circular describing how Bandsander—the machine that amazed the experts—saves time, money, trouble. Write now—a post card will do!

MEAD SPECIALTIES CO.
4114 N. Knox Ave., Dept. 157, Chicago 41, Ill.

NOW *Sound* FOR YOUR SILENT PROJECTOR Economically

\$5995

Convert your 16mm silent projector to sound (regardless of make) with Apex sound head radiofilm adapter. Guarantee excellent performance. Write today for free information.

APEX VIDEO • Box 3071-B • Hollywood 28, Calif.

THE GEM MAKER

Amateurs or professionals . . . hobbyists or jewellers . . . Polish your own gems with a B&I Gem Maker. You will find this a profitable adventure. All necessary lapidary equipment is furnished, including super-charged diamond blade for sawing, wheels for grinding, shaping and polishing, also complete instructions. Complete equipment as shown, less \$10.00, for only \$29.50, f.o.b., Bufile 101. Write today for information and literature on the Gem Maker and a list of dealers.

B&I MFG. CO., Dept. S, Burlington, Vt.

ELECTRIFY your LAWNMOWER

Battery Operated . . .

SELF-CONTAINED • SELF-PROPELLED

We show you how to convert your own lawn mower for use with a car battery. Save energy, labor and time with this self-propelled unit. Our simplified plans make it easy.

LEJAY MFG. CO. 247 LeJay Bldg. Minneapolis



PLEXIGLAS

New Low Prices, new masked prime stock, clear

Thicknesses, per square foot: 1/16" @ \$1.00; 1/8" @ \$1.30; 3/16" @ \$1.60; 1/4" @ \$1.85; 3/8" @ \$2.75; 1/2" @ \$3.60; 3/4" @ \$5.50; 1" @ \$7.40. Sheet sizes 6" x 12"; 6" x 24"; 12" x 12"; 12" x 24" and 12" x 36". Add 10% for packing and postage any place in U.S.A. Minimum order \$5.00. Send money order for prompt shipment. Dept. PM51.

PLASTIC SUPPLY CO., 2618 St. Louis Ave., St. Louis 6, Mo.

START A BATTERY FACTORY

—at home; the latest achievement; re-cast junk batteries into new. Complete instructions. We supply everything. Big Profits!

THE BATTERY LABORATORIES
Dept. PM Minneapolis 13, Minn.

Ottawa Self-Propelled Buzz Master

CLEAR LAND FAST! Powerful 6-HP motor with friction clutch for safe operation. Cuts down timber, brush and hedge; turn blade vertically and saw logs to length. Can be equipped to fell largest trees. Has clutch pulley for belt work. Is fully guaranteed.

OTTAWA MFG. CO., 527 Brush Ave., Ottawa, Kansas



IT'S NEW! It's Revolutionary
IT'S MIN-O-LIFE
FOR MINNOWS

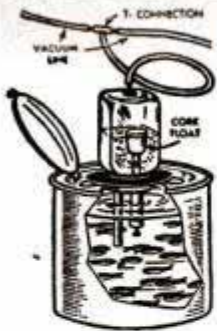

Hook MIN-O-LIFE to any standard auto windshield vacuum line. Powerful action creates a vacuum inside jar, forcing agitated and aerated water into circulation. Actual tests prove minnows stay alive for hours.

Now, transport big, live, healthy minnows overland to your favorite fishing spot, full of life and pep on arrival.

MIN-O-LIFE fits all standard size minnow buckets and comes complete, ready for connecting.

Ask your hardware or sporting goods dealer today for MIN-O-LIFE. If he doesn't have them in stock, order direct.

37.5

Postpaid.

LEE SALES CO., 608 Main St., Dallas, Texas

NEW
Liquid
Plastic

Special Castolite Kit

Hobbyists, craftsmen: Get new CASTO-KIT containing everything to make useful objects with CASTOLITE, the new "magic" liquid casting plastic that pours without heat or pressure. Use crystal clear or color brilliantly. Make beautiful articles very first day—lamp bases, bookends, novelty jewelry. Also embed flowers, butterflies, photos, coins. Carve, saw or drill. Kit includes 1 lb. Liquid CASTOLITE, hardener, buffing compound, measuring dropper, abrasives, molding vial, flowers for embedding. Instruction Manual with easy step-by-step method. Big profit opportunities between now and Xmas. Send \$3.35 for kit prepaid or order C.O.D. The Illustrated Manual alone is 25c.

THE CASTOLITE COMPANY
 Dept. E-1, Box 211 Kenilworth, Ill.

20-Project
KIT
\$3.35



BRASS RODS
For Home Work Shops

Free Cutting Rods
 3/32 - 3" Round & Hex
 Naval Brass Rods
 1/8 - 2 1/4" Round
 Brass & Copper Tubing
 1/4 - 3/4" Outside Diam.

Please send 10c
 for Catalog No. 101

MEIER BRASS & COPPER CO.
 1155 Bellevue, Detroit 7, Mich.

SAY YOU SAW IT IN POPULAR MECHANICS

Assemble KING MIDGET



Practical highway racer runabout. We supply all parts. Just bolt together. Low Cost. Ready for delivery NOW. One or two cylinder, 40 m.p.h., up to 100 miles per gallon. Send 25c for complete literature with large picture, 3-view drawings, price of parts, or send \$1 for the above plus 4 actual photographs, plans for snow and ice conversions, catalogue of new and used motors, motorscooters, transmissions, clutches, other offerings, etc.

MIDGET MOTORS, Athens, Ohio

IT'S EASY PICKING
FROM A HUOT DRILL INDEX

A handy container for indexing and filing twist drills. All steel—ten sizes. Correct drill always at your fingertips.

SEND \$1 for No. 13 holds drills from 1/16" to 1/4" by 64s. (Or see dealer) Order Today.

HUOT MFG. CO.

Foot, Schultz Bldg., St. Paul 1, Minn.



"Soft Pedal Stops
are yours with
Grizzly"

"Like my new hat, Joe?" she asks. "The boy friend says it gives me that angel look."

"Humph," I snort.

"Why the gloom, sour-puss?" she asks. "Indigestion?"

"No," I shoot back. "It's just I'm thinkin' if you don't reline those brakes, you may really look like an angel."

"Oh," she says casually, "I can still stop can't I?"

"Not quick enough or easy enough," I reply.

"Well, it does take a lot of pressure to stop this old bus," she admits grudgingly. "Will new lining make it easier to stop?"

"My Grizzly Brake Lining will," I tell her. "Plus giving you greater stopping safety, Grizzly also permits you to slow down and stop with a 'soft' pedal. That's why Grizzly is the perfect lining for both men and women drivers and—"

"Whoa," she laughs, "that's enough. Reline 'er with Grizzly, Joe, and I'll drive relaxed!"



BIG FOOT . . . LITTLE FOOT
 Grizzly Brake Lining is designed to give sure, smooth stops to both. Demand Grizzly—a leading brand of brake lining for over 30 years! Grizzly Manufacturing Company, Paulding, Ohio.

"Bear in Mind" . . . ask for

GRIZZLY
REG. U.S. PAT. OFF.
BRAKE LINING

WHEREVER BRAKES ARE SERVICED

NEW RAZOR SIMPLIFIES SHAVING

*World's Newest Razor Gives
Swifter, Smoother, Safer Shaves*

Mystic, Conn., May 5, 1947.
There's a new razor out, simpler by far than any that has ever been made.

The new Enders Razor is all one piece, no moving parts, no extra gadgets. All you do is click the blade in and shave. And what a shave! The razor doesn't clog; it's easy to clean and keep clean. Its modern plastic handle is curved to fit your hand. Its shaving angle is so well set to your face that it reaches easily all the hard-to-get-at spots—around chin, ears, nose.

If your dealer doesn't have the new Enders Razor yet, order direct from Durham-Enders Razor Corp., Dept. 103, Mystic, Conn.

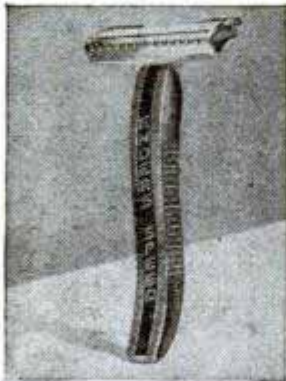

SPECIAL OFFER...

RAZOR AND 5 BLADES... 49¢

Durham-Enders Razor Corp., Dept. 103, Mystic, Conn.

SpeedWay

**No. 209
Drill Stand
(less drill)
\$1295**

**No. 229
Drill Stand
(Less Drill)
\$525**

**No. 89 1/2" DRILL
\$2995**

Why tote around a heavy "production type" drill (designed to run continuously at full capacity on some production line), when you can get a light weight handy SpeedWay Drill that makes all ordinary drilling easier and gives you years of service. Regardless of what you pay, you cannot get a better 1/2" drill for general use, than the SpeedWay No. 89. With its No. 209 drill stand it doubles as a capable drill press at savings that will go a long way in paying for other equipment. You'll find the same sensible economy in the little SpeedWay No. 89 Drill and its No. 229 drill stand. This low cost pistol grip drill will drill straight holes up to 3/4" diameter in steel.

No. 69 \$1180
1/4" Drill

SPEEDWAY MANUFACTURING CO.
1863 S. 52nd Ave., Cicero, Ill

PERFECT DOWELS

... easily made



ON YOUR LATHE OR DRILL PRESS

Use a SPEE-DOWL and you can work wonders with wood. Quickly and easily you'll make dowels of any wood... perfect burnished dowels for furniture, toys and thousands of other projects. You merely push SPEE-DOWL on wood—the lathe or drill press does the work! Cast body, tool steel blade. SIZES: 2, 3, 4, 5, 6, 7 and 8/16" (illustrated at left). Only \$1 ea. Special—any 4 of above for \$3.50; complete set of 7 for \$6. Also individual sizes 9 to 20/16" (illustrated at right) \$2.65 each. SPEE-DOWL is Unconditionally Guaranteed. Send postal note or check—we pay postage in North America. FREE Literature.

**JOHNS MFG. CORP., DEPT. C-8
DUNELLEN, N. J.**

U. S. ARMY SURPLUS

FIREMAN'S UTILITY COAT

Used by All Big City Fire Departments
In Summer and Winter
Has Removable Wool Lining

Made of heavy olive drab mountain cloth, fully waterproofed with solid rust proof buckles for hard wear. Sizes medium and large. Worth \$25.00.

\$14⁹⁵

Send Money Order and Your Coat Size

EDWARD LAWRENCE CO., INC.
396 Broadway New York 13, N.Y.

MARCOT KEY MACHINE

Immediate Delivery



Marcot No. 8 Key Machine	Mounted on Cabinet.....	\$ 82.50
Book on Modern Locksmithing.		3.95
Auto Code Book and Auto Depth		
Keys		12.50
162 Doz. Popular Key Blanks..		77.76
Set Key Files, Tools, Pins,		
Springs, Thimble		10.50
		\$187.21

A. J. MARCOTTE CO., DEPT. PM, CHICAGO 51, ILL.

SAY YOU SAW IT IN POPULAR MECHANICS

ONE-MAN SAWMILL

● EASY TO TURN TREES INTO MONEY... BELSAW MODELS in 10 to 24 foot sawing lengths. MECHANICAL FEED, accurate set works and positive

LESS THAN
\$200⁰⁰

Makes lumber, ties, shingles, crates, lath, studing, siding.

dogs. Use tractor or old auto engine for low cost power. Thousands used for commercial sawing. Pays for itself quickly. Send a postcard today for FREE booklet, HOW TO MAKE LUMBER"—and

Catalog of Woodworking Equipment.

**BELSAW MACHINERY CO., 2811LS Field Bldg.
315 Westport Road, Kansas City 2, Missouri**

SMALL EFFICIENT SPEED REDUCER

Just the thing for the Home Work Shop, Hobby Shop, Bench Work, Animated Displays, Light Production work. Used daily in thousands of homes and shops. Sturdy, compact, (see dimensions). Case of heat treated aluminum. Gears, SAE 65 (British) Gear Bronze. Worm of case hardened steel. Timken Bearings throughout. Torque capacity 100 inch pounds. Available in 4 different assemblies (shown below) and in these standard ratios:

4-1	25-1	64-1	200-1
8-1	30-1	75-1	300-1
10-1	40-1	80-1	400-1
16-1	50-1	100-1	600-1
20-1	60-1	150-1	800-1

When ordering be sure to specify assembly and ratio required. Shipping weight in carton, 8 lbs. Full money back guarantee. Prompt deliveries.

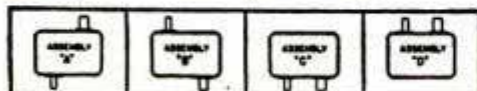

THE OHIO GEAR CO.

1404 EAST 179th ST. - CLEVELAND 10, OHIO



\$18.56

NET - POSTPAID

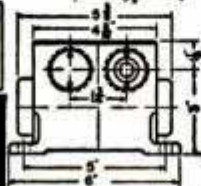
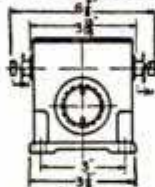

\$2250
POST-PAID



A REAL POWER STEAM BOILER NOT A TOY

Withstands 500 lb. pressure. Cast bronze ends silver soldered to brass tubing. Enclosed in sheet iron housing. Fittings include: Safety valve, pressure gauge, throttle, copper connecting steam pipe with oiler, and wrenches. Exceptional value.

HARRY ROSS C 68 West Broadway N. Y. 7, N. Y.

Opportunity Knocks

With **TRADIO** . . . the radio FUNCTIONALLY DESIGNED for coin operation in Hotels, Motels, Stopovers, Clubs, Hospitals, Stations, Etc. Big Earnings . . . Steady Income . . . No Clock To Punch . . . Full Or Part Time!

● QUANTITY DELIVERIES DAILY . . . ONLY SMALL INVESTMENT Grow With A Young Industry! Get In On The Ground Floor and Be Independent For Life. It's Easy! Send for Complete Information Today . . . No Routes Sold

Write To **TRADIO, INC.** Dep't. M, RIGHT NOW!
Asbury Park, N. J.

PRECISION JEWELERS SCREW DRIVERS

Complete Set of 8 for Every "Hobbyist"

At last—a complete set of precision screw drivers to meet the needs of every model builder. Not a miniature but the same type set used by U. S. Navy for precision instruments and watches during the war. Brass knurled handles, hexagon heads, finest tempered steel blades. Sizes 2-9. Never before a set of this quality and precision at such a low price. Your money back if not satisfied. C.O.D. \$2.00 plus postage or send \$2.00 and we pay postage. **PINE WATCH CO., Rm. 24, 29 Eldridge St., New York 2, N.Y.**

BUILD YOUR OWN TILTING TABLE SAW!

Performance of \$60 Saw at 1/6 the Cost!

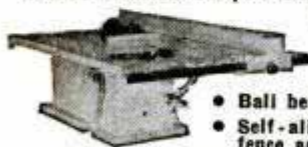

- 21x27 in. table tilts to 45°.
- 8 in. blade cuts from 0 to 2 1/2 in.

- Ball bearing mandrel
- Self-aligning and indexed rip fence and mitre gauge

- Sturdy wood, steel, and aluminum construction
- No machining—build easily with hand tools
- Ability to read blueprints not necessary
- Operate with any 1/4 to 1/2 H.P. motor

Send \$1.00 NOW for easy step-by-step Plans!

GIL-BILT, P. O. Box 1-E, Lambert Field, St. Louis 21, Mo.

SAVE
\$50
OR MORE

COMPLETE
PLANS
only
\$1.00

"Here's achievement of my ambition to build a fine, light car comfortable for my 6'4"."



Powell Crosley, Jr.

PRESIDENT, CROSLLEY MOTORS, INC.



Smarter-looking, smarter-to-buy, the new, fine CROSLLEY Convertible is really economical! Priced for lower, costs only about half as much to operate as the cumbersome, 3-times-as-heavy cars advertised as "low priced"! Yet plenty of room for 4 husky men—plus baggage!

Notice particularly the 4-cylinder, valve-in-head CROSLLEY COBRA (Copper BRazed) engine! It's made of steel, weighs only 59 lbs. and is the most talked-of internal combustion engine in 40 years! On ordinary gasoline it delivers 35-50 miles per gallon; speeds to 60-plus! Check, inspect, compare the stunning new CROSLLEY Convertible before you buy any "sports" car!

COMPARE THESE FEATURES:

ALL STEEL construction, low center of gravity, great safety factors, MODERN Streamlining, the "aircraft flavor," WEIGHS only 1150 lbs., EASY DRIVING, virtual-

ly "parks on a dime"; oversized shock absorbers, MORE MANEUVERABLE, instant pick-up; 20 inches narrower than most cars. "JIFFY-RIG" beige weather-proof top folds out-of-sight.

For information and literature write: Crosley Motors, 2537-Y Spring Grove Ave., Cin'ti 14, O.

SAY YOU SAW IT IN POPULAR MECHANICS



STOP LEAKS!

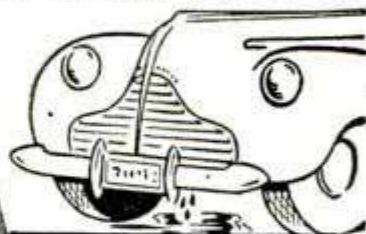

Cooling Systems
Made Leak-Proof QUICKLY

WARNER LIQUID SOLDER—Non-Metallic—Deposits Tiny Fibers to Repair Leaks Anywhere in Cooling Systems. Simply pour in! Finds and REPAIRS every crack or hole. Do it yourself—or see your service man.

Warner-Patterson Co., 920 S. Michigan Ave., Chicago 5

Amazing Novelty



Mystery Thirsty Bird

- Drinks and drinks and drinks.
- Nearest thing to perpetual motion.
- No machinery -- nothing to wind.
- Perfect gift -- will amaze and amuse all.
- Only \$2.50 postpaid. No C.O.D.'s.

Bowman Products

915 West Erie Avenue, Phila. 40, Pa.

MAIL THIS COUPON NOW!

Gentlemen: Please send me at once, postpaid, _____ (quantity)

Mystery Thirsty Birds. Enclosed find \$ _____
 in check money order

NAME _____

ADDRESS _____

CITY AND STATE _____

Money Back Guarantee

Power Tool Pedestal!

Something New
For Your Power Tools!

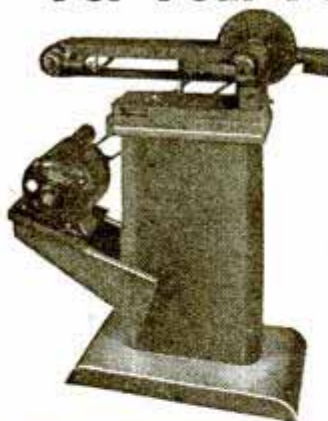

... a streamlined, metal base which permits individual mounting of your power tools.

- CONSERVES SPACE
- INCREASES WORKABILITY
- FITS ANY AVERAGE POWER TOOL
- IMPROVES APPEARANCE
- LOW COST

Now you can mount each power tool on a handsome metal base which permits handy, convenient placement in your workshop. You get more pleasure and better results from your work. The pedestal has a broad base, strong supporting column, and a bracket and platform for mounting the motor. Constant belt tension is assured. The price is only \$14.85 including motor mount. Write at once for descriptive folder. Inquiries from dealers and distributors are invited.

THE PICKWICK COMPANY

285 - 3rd St. N.E.

Cedar Rapids, Iowa

BIG MONEY NOW

In a Profitable Business of Your Own! Full or Spare Time!

We'll tell you how you can easily start a profitable business of your own with our amazing Liquid Marble, Fibre-Tile Flooring and Flexible Molds. No big investment necessary and you can work right from home. These amazing products have already started many on the road to success and financial independence. No experience necessary. We tell you how!

FREE CATALOG AND FULL DETAILS

Today send your name and address and get started along the road to financial success.

Composition Products Co.

BOX CC, DEPT. 51 RICHMOND HEIGHTS, MO.

Have Us PLATE YOUR

MOTORCYCLE PARTS SPORTING GOODS AUTOMOBILE PARTS REFRIGERATOR TRAYS AND HARDWARE

NO JOB TOO LARGE OR TOO SMALL—QUICK DELIVERY

MARINE PARTS

FIREPLACE FIXTURES

SILVERWARE

PLUMBING FIXTURES

JEWELRY

HOUSEHOLD ARTICLES

PLATING any Metal or Finish
GOLD SILVER CHROME BRASS BRONZE COPPER TIN

Here's your opportunity to have these articles beautifully plated—and at a reasonable cost. Send them in—prices quoted before work is started. If not satisfactory, articles returned at no obligation.

Don't Delay—Ship Today

MASTER SILVERPLATERS

2729 S. Mary St., Dept. A-81, Chicago 8, Ill.

WOOD WORKERS

LUMBER—PLYWOOD AVAILABLE

Harold Hunt wants to send new No. 15 catalog. Over 148 pages of woodworking ideas. UNEQUALED BARGAINS in imported and American woods, supplies, hard-to-find hardware. Send only 15c to cover postage and handling.

CRAFTSMAN WOOD SERVICE CO.
2729 S. Mary St., Dept. A-81, Chicago 8, Ill.

only 15¢

Air Liquid STORAGE TANKS

Airplane Oxygen tanks; non-rusting, stainless steel, (used). Good condition. Tested for 400 lbs. safe pressure. 9 gallons capacity, 12x24 inches, weighs 16 lbs., both ends tapped 3/8" standard pipe thread, \$4.98. 24x6 inch, 2 1/4 gal. size \$2.98. Ideal for compressed air, any liquids, bottled gas, house trailers, buoys, floating rafts and other uses. Limited quantity. Order now. No C O D orders, send money orders or cashiers checks for faster delivery.

MIDWEST BUY ANYTHING CO.

1520 Locust St.

Kansas City, Mo.

MAKE BIG MONEY!

Be a floor surfacing contractor and sand both new and old floors. Sanders are easy to operate and better still, you're your own boss. Write for latest "sell-all" booklet entitled "Opportunities in Floor Surfacing", enclosing 25 cents in coin or stamps to cover handling.



AMERICAN

FLOOR SURFACING MACHINE CO.
525 So. St. Clair Street • Toledo 2, Ohio



MOTO-TOOL ★ THE "POCKET-SIZE" MACHINE SHOP

"MAN . . . WHAT A POWERHOUSE!"

A TOOL THAT PACKS YEARS OF PLEASURE

Here's a tool to please a man's heart . . . one that holds promise of endless creative hours. Dremel Moto-Tool is a "war veteran" . . . used by all branches of the armed forces in far-flung repair bases . . . helped set production records at General Electric, Westinghouse, Remington Arms, Ford and others. Hobbyist or expert craftsman, first choice is Model 2 Moto-Tool Kit with its handsome felt-lined, highly finished wood case with rows of tools begging to be put to work. Write for FREE catalog of Moto-Tool attachments and accessories.

MOTO-TOOL FEATURES:

Oil-less, sealed, bearings • Patented automatic chuck lock pin • Over-size armature shaft, hardened, ground, polished • 110 Volt, AC-DC motor • Sliding snap-type switch • Cord protector • Shock-proof bakelite housing • Dust-filtered, air-cooling system • Weighs only 13 oz. • Dynamically balanced for vibrationless operation.

DO THESE BETTER-FASTER

- Finishing
- Sharpening
- Burnishing
- Engraving
- Mortising
- Polishing
- Cleaning
- Rasping
- Brushing
- Dressing

- Approx. 27,000 R.P.M.
- Burring
 - Grinding
 - Routing
 - Sanding
 - Touching-Up
 - Drilling
 - Inlaying
 - Sawing
 - Scoring
 - Carving
 - Cutting



Moto-Tool Kit No. 2 has 23 professional accessories and Model 2 Moto-Tool in wood case, \$23.50. (Items purchased separately would cost about \$30.00; you save \$6.50.) Moto-Tool No. 2 with one emery point . . . \$16.50

MONEY BACK GUARANTEE: Buy Dremel Moto-Tool and Accessories from your dealer; or order direct from factory on 10 day trial. Shipped postpaid for cash in full; or for \$2.00 sent C.O.D. for balance plus postage.

DREMEL MFG. CO., Dept. 117-E, RACINE, WISCONSIN

AT LAST! A HOBBY THAT OFFERS YOU PROFIT AS WELL AS PLEASURE!

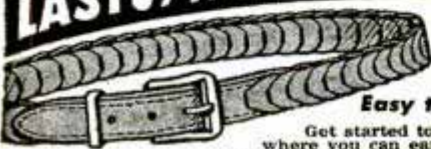

GENUINE LEATHER Hand Crafted LINK BELT

Easy to Make - Easy to Sell

Get started today on a fascinating hobby where you can earn up to \$10 or \$15 a week in spare time! Send for your complete profit-producing Handicraft Kit with all the material needed to make 6 genuine leather link belts. Sell all you make at \$2 each to people expecting to pay far more for genuine hand-made belts. Kit for 6 belts costs you only \$3.50—can easily be sold for \$12—leaving you a profit of \$8.50. Send \$3.50 for your Kit today, or mail only a dollar for sample Kit! Or C.O.D., you pay postage. Money back if not delighted.

FREE . . . IF YOU ACT NOW!
Beautiful Plastic Card Case, value 25c, free with \$1 Kit. Yours to keep, even if you return belt kit. Also, on request, big new 40-page CRAFT CATALOG FREE with or without order.

DWINNELL CRAFT SHOP, Dept. P-75, Elm Grove, Wheeling, W. Va.

ATTENTION FOREIGN BUYERS

Heavy duty sand-casted 8-pc. toy cooking sets, \$1.49 retailers. All metal "Put-Put" boats, actually run and sound like motor boats, \$1 retailers. Immediate shipment. WRITE FOR QUANTITY PRICES. SPECIAL VALUES!

SPECIALTY SALES CORP., Dept. PM55
3032 Olive St. St. Louis, Mo.

YOUR OWN BUSINESS!

MAKE MONEY in your own home, spare room, basement, garage! Manufacture popular "Plastic" plaques and figurines. Everything furnished! 5c material makes \$1.00 sellers! Start spare time. Full cooperation given. Pleasant business; small capital; BIG PROFITS! Write for FREE literature.

GENMERC, BOX 142, DORCHESTER CENTER, MASS.

FREE! FARM WELDING BOOK



101 IDEAS for building labor-saving farm equipment and repairing machinery. 64 pages—complete with instructions and more than 100 illustrations!

SHOWS HOW TO SAVE HUNDREDS OF DOLLARS A YEAR!

WELD any metal in any gauge or weight—from sheet to motor blocks. BUILD your own stanchions, steel gates, power rakes, hay loaders, conveyors. BRAZE water tanks, pipes, sheet metal. SOLDER radiators, wiring, leaky fuel cans, milk cans. HARD SURFACE plowshares, cultivator bits, shovels.

SEND FOR YOUR FREE BOOK TODAY!

FORNEY MFG. CO., FT. COLLINS, 2, COLO.

Please send me the big free book, "Welding on the Farm".

Name _____
Address _____
City _____ State _____

2500 WATT PORTABLE GENERATOR—ARMY SURPLUS

One of the greatest values offered in generators. Compare the output—2500 watts, 115-120 v., AC, 60 cyc.—and the price and you'll find it beats them all. A 4 cyc. air cooled engine, belt connected with Leland 2500 watt generator; mounted on steel skid frame, 36"x19½".

Farmers, contractors, home owners—anyone needing power or "standby"—can profitably use this powerful generator. Handles 40 sixty watt light bulbs. Guaranteed unused. Wt. 300 lbs. Price \$347.50 F.O.B. Chicago. Send check or shipped C.O.D. on deposit of \$25. 5 kw. and 10 kw. units at same proportionate bargains.

ALLIED SERVICE AND ENGINEERING

125 W. Ohio St. Chicago 10, Ill.

New Stock
\$347.50
ONLY



ASK FOR BULLETINS for Other Special Bargain Offers

Every home has its cracks and maybe its crackpot!

by don herold

At our house, I'm it. But I'm bright enough to know when I've finally found the way to plug holes and cracks!



Just mix REARDON'S WATER PUTTY as you use it. No waste, no caking in the can. Dries hard and can be painted over. Will not shrink or loosen. Swell for reseating screws and repairing wood, metal, tile, plaster. Cent-nationally economical.

Get a can at your hardware, paint, variety or department store. 25¢ lb. Can

Made by The Reardon Co.

St. Louis - Montreal

Makers of BONDEX Cement Paint



REARDON'S WATER PUTTY

Portable Paint Sprayers

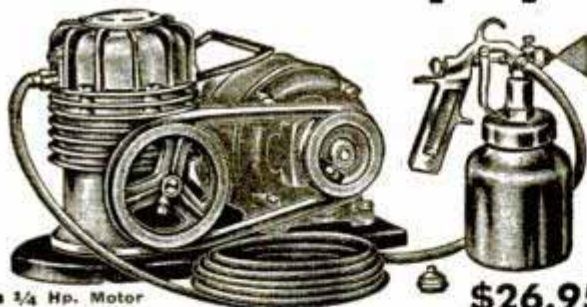

Uses 1/4 Hp. Motor

\$26.95

Complete as illustrated, less motor. Sprays all kind of paint, lacquer, varnish and etc. Oil-less ball bearing compressor. 2 cu. ft. air per minute. 15 to 50# pressure. Sprays paint 5 times faster than hand brushing.

No. 890—Outfit complete as shown, with "V" belt, motor pulley, 15 ft. high test air hose and No. 112 gun, but without motor. \$26.95

Spray Guns—Low Pressure
Operate on 15 to 50# pressure
#115—1 pt. cup \$4.95
#112—1 qt. cup 6.50
#121—Production type 7.95
#125—External mix 9.50
Regulator & Gauge 0 to 160# 4.95
Air Filters 1.85
Air Hose—15 ft. 1.75
Air Hose—25 ft. 2.75
3 Gal. Paint tanks, with hose, reg. and gauge 24.95
Less reg. and gauge 16.50

No. 444—Outfit, twin cyl. 4 cu. ft., production type gun, 15 ft. air hose, reg. and gauge, V belt and motor pulley. Complete less motor, \$47.50.

NEW BLACK & DECKER DRILLS
110 AC
3/8" \$16.95
1/2" 31.95

Super-Air Auto Engine Pump
Pumps 100# pressure. For inflating tires, spray painting and etc. Complete with hose, pump, gauge, and spark plug adaptors \$4.75
Less gauge 3.75

AIR COMPRESSORS — PAINT SPRAYING SUPPLIES

GAS ENGINES — 1/2 TO 1 1/2 HP. 37.95 UP

Hobbycraft supplies, engines and kits 15% discount.
Immediate delivery—check or M.O. shipped prepaid, cod's plus chgs.

INDIANA APPLIANCE CO.

20 East Sycamore

Dept. PM-15

Evansville, Ind.

Indian

WORLD'S FINEST
MOTORCYCLE
SPRINGFIELD, MASSACHUSETTS

GET SET FOR LIFE

This is not a doorbell ringing job—but an outstanding opportunity for a responsible man to set himself up in a permanent business. You invest little, yet you control steadily increasing repeat business. Your profits are limited only by your efforts. (1) You call on retailers to stock our quick-selling "Plastikpli" Liquid Plastic Paint, (2) you can open your own "Plastikpli" store; or (3) you can sell in volume for maintenance painting. This new-type plasticized paint spreads uniformly without brush marks. Extremely hard, yet elastic surface avoids chipping, cracking and withstands ravages of sun and frost to outlast ordinary high-priced paints and save constant re-painting. Non-porous surface prevents penetration of dirt so that it can wash clean and bright. For interiors and exteriors. If you want "A REAL BUSINESS" write us for the details.

Plastikpli is sold direct to user where we do not have distribution. Write for color-chart and prices.

PLASTIKPLI LABORATORIES, Dept. R
169 W. Wacker Drive Chicago 1, Ill.

AMAZING NEW WOOD PRESERVATIVE
DOUBLES LIFE OF LUMBER AND MILLWORK
COP-R-NAP offers a simple, easy and inexpensive method of preserving, protecting and greatly increasing the life of all types of lumber...porch flooring, fencing, sills, joists, sash and millwork, rope, sails, tarpaulins, boat planking and framing. Prevents decay, kills fungi, mildew and "blue stain". Easy to apply by dip, spray or brush methods. 1 Gal. treats 400 sq. ft. of wood. Paint right over it, makes paint last longer. Order a trial gallon for only \$3.00 post paid anywhere in U. S. Big discounts on larger quantities. Osmose Wood Preserving Co., Dept. M., 1437 Bailey Ave., Buffalo 12, N.Y.

NEW! LOW COST! RESPIRATOR

Wear DUPOR No. 1 when sanding, grinding, paint spraying, sweeping, dusting, furnace cleaning, etc. Handy as a pair of glasses. Just keep mouth closed and breathe through nose is all you do to operate. Protects against nuisance dusts, lint, coal, cement, grain dust. Weighs 1 oz. Has 9 sq. in. filter. For EYE protection against paint spray, dusts, gases, fumes, smoke, order our Fog-Proof Rubber GOGGLES \$2.00 p.p.

JERRY BRYANT, Dept. PM
919 N. Michigan Ave. Chicago 11, Ill.



Order Today \$1.00 POST PAID

GASOLINE ENGINES

Latest type, aircooled Briggs-Stratton and Wisconsin 6 H.P. Immediate Delivery. These engines are used government surplus, guaranteed by us to be in excellent mechanical and operating condition. Sale Price \$99.50

Immediate Delivery—Act Quick
No COD Orders. Write for descriptive circular.

MIDWEST SURPLUS SALES

1520 LOCUST ST.

KANSAS CITY, MO.

BUILD YOUR OWN MACHINE TOOLS!

Blueprints \$1.00—Catalog FREE

Detail construction Blueprints on 6 Lewis metal and wood-working tools postpaid for \$1.00. Includes prints for Lewis 10" Shaper, Milling Machine, Drill Press, Vise, 8" Circular Saw, 6" Jointer. Castings for these tools save up to 80% of comparable new tool cost. Illustrated 32-page Catalog—sent free with Blueprint Order—describes 21 Lewis tools. WRITE TODAY!

LEWIS MACHINE TOOL CO.
P. O. Box 7446, Sta. L, Dept. M, Los Angeles 23, Calif.



WILL BUY A HARDWARE PRODUCT!

**LEADING MANUFACTURER
WITH NATIONAL DISTRIBUTION . . .**

25 years in business, with facilities for high-speed mass production, desires to expand present line of nationally advertised hardware products **SOLD THROUGH ALL LEADING HARDWARE WHOLESALERS AND DEALERS.** Will consider the purchase of a controlling interest in the manufacture and sale of a **PRACTICAL PRODUCT** which can be made **IN OUR OWN PLANT, OR IN ANOTHER PLANT UNDER OUR SUPERVISION,** and which can be sold through our own sales organization. We will exchange financial and credit information with principals only. Please state briefly all the essential facts about your product . . . its present status . . . and enclose a photo or drawing. All information confidential! Reply in writing only.

Send replies to Foster & Davies, Inc.,
2116 Keith Bldg., Cleveland 15, Ohio

**MILL IT
ON YOUR LATHE**



WITH A **PALMGREN**

MILLING ATTACHMENT



No. 250

IMMEDIATE DELIVERY

No.	Width Jaws	Depth Jaws	Jaws Open	Weight Pounds	Wheel Opening	Price F. O. B. Factory
150	1 1/2"	1"	1 1/4"	6 1/2	1"	\$18.75
250	2 1/2"	1 1/4"	2 1/4"	11	1 1/4"	24.75
400	4"	1 1/2"	4"	25	2"	39.75

Order from your dealer or jobber. Write for circular No. 349

JUST A FEW OPERATIONS YOU CAN DO ON YOUR LATHE!

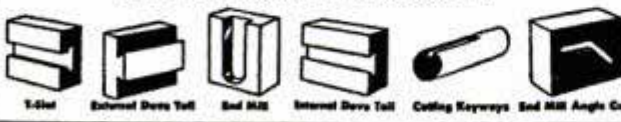

ENGINEERING CO.
DUCTS for Over 25 Years
Chicago 17, Illinois

MAGIC LIQUID CASTS PLASTICS

A New Liquid Plastic! Just pour Plasticast into any kind of mold or container and it hardens in a few minutes to a solid, smooth, clear as glass plastic! No machinery or tools required. Plasticast has Unlimited Possibilities . . . novelties, toys, jewelry, knick-knacks, fascinating, brilliant, sparkling clear or colored plastic articles . . . an endless variety of useful things. Being transparent it is ideal for imbedding flowers, coins, photos, souvenirs, charms, etc. Make plasticasting a thrilling new hobby or a profitable business! No experience required; start casting 10 minutes after you receive your outfit. Full instructions and accessories provided. **COMPLETE MASTER OUTFIT, will make over 200 articles. . . . \$3.00 ppd.** **FREE** Plastic Manual, crammed with the latest valuable information on all types of modern plastics! Source, use and methods of application. Sent free for 3c stamp.

PLASTICAST CO.
(Send order to nearest office)
Dept. C

5961 Madison St.
Chicago, Ill.

P.O. Box 987
Palo Alto, Calif.

New MILLING ATTACHMENT

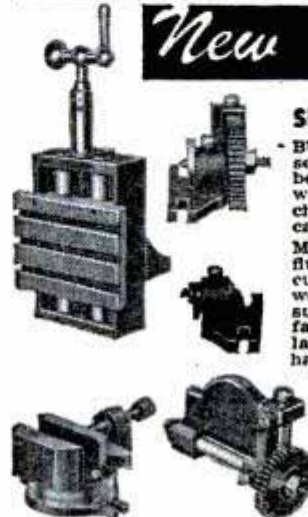

Sizes for 8" to 16" metal lathes

BUILD IT YOURSELF from our sets of semi-machined castings and save \$5. Can be finished on your lathe alone. Complete working drawings and step-by-step machining instructions furnished with castings.

Mill keyways, slots, splines, dovetails, flutes in reamers, taps, hobs, and special cutters; produce spur, bevel, mitre and worm gears, ratchets and racks; mill flat surfaces, square shafts, mill hexes, spot face, drill spaced holes, bore, etc. on your lathe with this precision attachment. It has a T-slotted table, a vise which swivels for angular milling, a gear cutting fixture and dividing centers.

FREE! Illustrated folder and price list. Mention your lathe. Write today.

HURON MACHINE AND TOOL CO.
YALE 4, MICHIGAN

SAVE ON CARBON PAPER

Box of 100 sheets 8 1/2 x 13 Typewriter Carbon Paper for only \$1.00 Postage Paid. No C.O.D. orders accepted. Satisfaction Guaranteed. U. S. orders only.

BCK CARBON COMPANY
2233 University Avenue St. Paul 4, Minnesota

HAUCK FLAME GUN KILLS WEEDS



2000° F controlled heat quickly, easily destroys seeds, roots, brush, poison ivy, wild morning glory, Canada thistle, other unwanted growths. Many uses; splitting rocks, burning stumps, sterilizing poultry houses. Burns kerosene. Does the work of 4 men. Safe, easy to use. 10 day trial. Satisfaction guaranteed. Free catalog.

HAUCK MFG. CO.

121 Tenth St. Brooklyn 15, N. Y.

BUILD AN ARC WELDER

We Show You How to build this new powerful welder without rewinding. For light or heavy work. Uses coils taken from old auto generators. Works on 110 or 220 volts A. C. Has 20 different heats. Send 35c for complete PLANS and valuable Catalog. Write today. **LEJAY MFG. CO., 1347 LeJay Bldg., Minneapolis 4, Minn.**



WIGGINS QUICK WATER HOSE COUPLING

SNAP - it's on! **PULL** - it's off! Easy, fast! Wiggins coupling is guaranteed leakproof! Saves water, time. No bruised fingers or twisted hose. Precision made of solid aluminum bar stock. Lifetime use. For the best in water hose couplings, buy Wiggins! On sale at better stores \$1.35 complete.



E. B. WIGGINS
3424 E. OLIVE

WILL BUY A HARDWARE PRODUCT!

**LEADING MANUFACTURER
WITH NATIONAL DISTRIBUTION . . .**

25 years in business, with facilities for high-speed mass production, desires to expand present line of nationally advertised hardware products **SOLD THROUGH ALL LEADING HARDWARE WHOLESALERS AND DEALERS.**

Will consider the purchase of a controlling interest in the manufacture and sale of a **PRACTICAL PRODUCT** which can be made **IN OUR OWN PLANT, OR IN ANOTHER PLANT UNDER OUR SUPERVISION**, and which can be sold through our own sales organization. We will exchange financial and credit information with principals only. Please state briefly all the essential facts about your product . . . its present status . . . and enclose a photo or drawing. All information confidential! Reply in writing only.

Send replies to Foster & Davies, Inc.,
2116 Keith Bldg., Cleveland 15, Ohio

MILL IT ON YOUR LATHE



WITH A **PALMGREN**

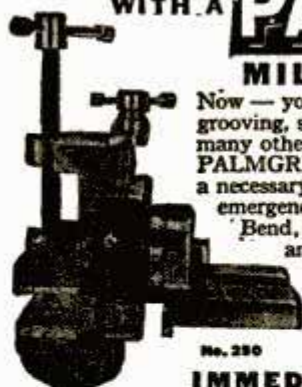

MILLING ATTACHMENT

Now — you can do milling, slotting, grinding, grooving, squaring shafts, sawing at angles, and many other important operations on your lathe. **PALMGREN MILLING ATTACHMENT** is a necessary fixture for small shops, schools and emergency work in large plants. Fits South Bend, Atlas, Craftsman, Logan, Sheldon and all other makes. It has graduation for rotary angle adjustments, also graduated feed and adjustment screw. Easily mounted by straddling lathe's regular tool post. Try one — it will quickly pay for itself.

IMMEDIATE DELIVERY

No.	Width Jaws	Depth Jaws	Jaws Open	Weight Pounds	Wheel Opening	Price F. O. B. Factory
150	1 1/2"	1"	1 1/2"	6 1/2	1"	\$18.75
250	2 1/2"	1 1/2"	2 1/2"	11	1 1/2"	24.75
400	4"	2 1/2"	4"	25	2"	39.75

Order from your dealer or jobber. Write for circular No. 349

JUST A FEW OPERATIONS YOU CAN DO ON YOUR LATHE!

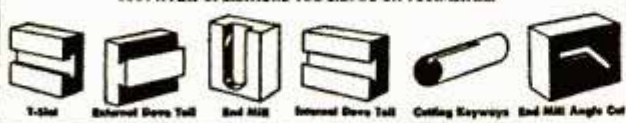

CHICAGO TOOL AND ENGINEERING CO.
Mfrs. of **PALMGREN PRODUCTS** for Over 25 Years
8365 South Chicago Avenue • Chicago 17, Illinois

MAGIC LIQUID **CASTS** PLASTICS

A New Liquid Plastic! Just pour Plasticast into any kind of mold or container and it hardens in a few minutes to a solid, smooth, clear as glass plastic! No machinery or tools required. Plasticast has **Unlimited Possibilities** . . . novelties, toys, jewelry, knick-knacks, fascinating, brilliant, sparkling clear or colored plastic articles . . . an endless variety of useful things. Being transparent it is ideal for imbedding flowers, coins, photos, souvenirs, charms, etc. Make plasticasting a thrilling new hobby or a profitable business! No experience required; start casting 10 minutes after you receive your outfit. Full instructions and accessories provided. **COMPLETE MASTER OUTFIT**, will make over 200 articles. . . . \$3.00 ppd. **FREE** Plastic Manual, crammed with the latest valuable information on all types of modern plastics! Source, use and methods of application. Sent free for 3c stamp.

PLASTICAST CO.

(Send order to nearest office)

5951 Madison St.
Chicago, Ill.

Dept. C

P.O. Box 957
Palo Alto, Calif.

New MILLING ATTACHMENT

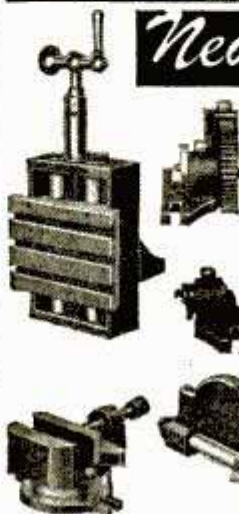

Sizes for 8" to 16" metal lathes

BUILD IT YOURSELF from our sets of semi-machined castings and save \$\$. Can be finished on your lathe alone. Complete working drawings and step-by-step machining instructions furnished with castings.

Mill keyways, slots, spines, dovetails, flutes in reamers, taps, hobs, and special cutters; produce spur, bevel, mitre and worm gears, ratchets and racks; mill flat surfaces, square shafts, mill hexes, spot face, drill spaced holes, bore, etc. on your lathe with this precision attachment. It has a T-slotted table, a vise which swivels for angular milling, a gear cutting fixture and dividing centers.

FREE! Illustrated folder and price list. Mention your lathe. Write today.

HURON MACHINE AND TOOL CO.
YALE 4, MICHIGAN

SAVE ON CARBON PAPER

Box of 100 sheets 8 1/2 x 13 Typewriter Carbon Paper for only **\$1.00**
Postage Paid. No C.O.D. orders accepted. Satisfaction Guaranteed.
U. S. orders only.

BCK CARBON COMPANY

2233 University Avenue

St. Paul 4, Minnesota

HAUCK FLAME GUN KILLS WEEDS



2000° F controlled heat quickly, easily destroys seeds, roots, brush, poison ivy, wild morning glory, Canada thistle, other unwanted growths. Many uses; splitting rocks, burning stumps, sterilizing poultry houses. Burns kerosene. Does the work of 4 men. Safe, easy to use. 10 day trial. Satisfaction guaranteed. Free catalog.

HAUCK MFG. CO.

121 Tenth St.

Brooklyn 15, N. Y.

BUILD ARC WELDER

We Show You How to build this new powerful welder without rewinding. For light or heavy work. Uses coils taken from old auto generators. Works on 110 or 220 volts A. C. Has 20 different heats. Send 35c for complete **PLANS** and valuable Catalog. Write today. **LEJAY MFG. CO., 1347 Lejay Bldg., Minneapolis 8, Minn.**



WIGGINS QUICK WATER HOSE COUPLING

SNAP - it's on! PULL - it's off! Easy, fast! Wiggins coupling is guaranteed leakproof! Saves water, time. No bruised fingers or twisted hose. Precision made of solid aluminum bar stock. Lifetime use. For the best in water hose couplings, buy Wiggins! On sale at better stores \$1.35 complete.



E. B. WIGGINS OIL TOOL CO., INC.
3424 E. OLYMPIC BLVD., LOS ANGELES 23

NEW
OHMITE
Ohm's Law
Calculator



New Pocket Size
Computing Scales on One Side
Gives Composition Resistor Color Code

25c

Figures Ohms, Watts, Amperes, Volts... Quickly!

Here's a new and improved version of the famous Ohmite Calculator. Handy pocket size—9" x 3". Solves any Ohm's Law problem with one setting of the slide. No slide rule knowledge necessary. Send 25c in coin for your Calculator.

OHMITE MFG. CO., 4839 Flournoy Street, Chicago 44, Illinois



War Surplus Bargains

B-29 AIR FORCE GUN SIGHT

Contains Double Achromat Lens System And Lighting Assembly, Can be used to build Slide Projector, viewer or Collimeter. Many optical or Photographic Uses.

Rush Check or Money Order
Post paid . . . \$5.00

Send 10c for complete surplus list

PHILLIPS SALVAGE CO., Dept. H
8522 Elgin Ave., Detroit 5, Mich.

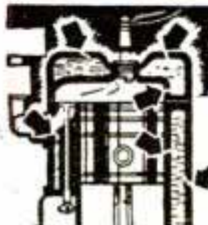

REPAIR CRACKED BLOCKS AND HEADS—

External and internal leaks in blocks, cylinders and valve ports quickly and easily with LUSCO PLASTIC SEAL. 90 day Service Guaranteed or your money back. Send money order or check for full pint—more than sufficient for average repair. . . \$3.00 Postpaid

C. F. LUSK CO., 5924 BONNA AVE., CLEVELAND 3, OHIO

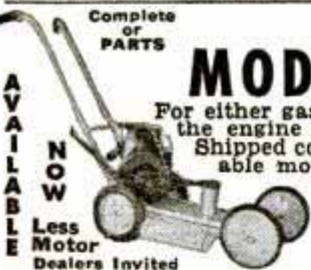

THE NEW MODERN MOWER

For either gas or electric power. You furnish the engine or motor, we furnish the rest. Shipped completely assembled with adjustable mounting brackets to fit any conventional engine or motor.

AIR-ELECTRIC MOWER
LOHRVILLE, IOWA

BE YOUR OWN BOSS
Men and women make up to \$100.00 or more a week! Design and fit corrective arch supports by the time-tested Stephenson Method. A profitable, full or part-time, profession. Train at home; pay as you go. No costly equipment to buy. No capital needed. Send for FREE booklet today.
STEPHENSON METHOD, 5-28 Irvington St., Boston, Mass.

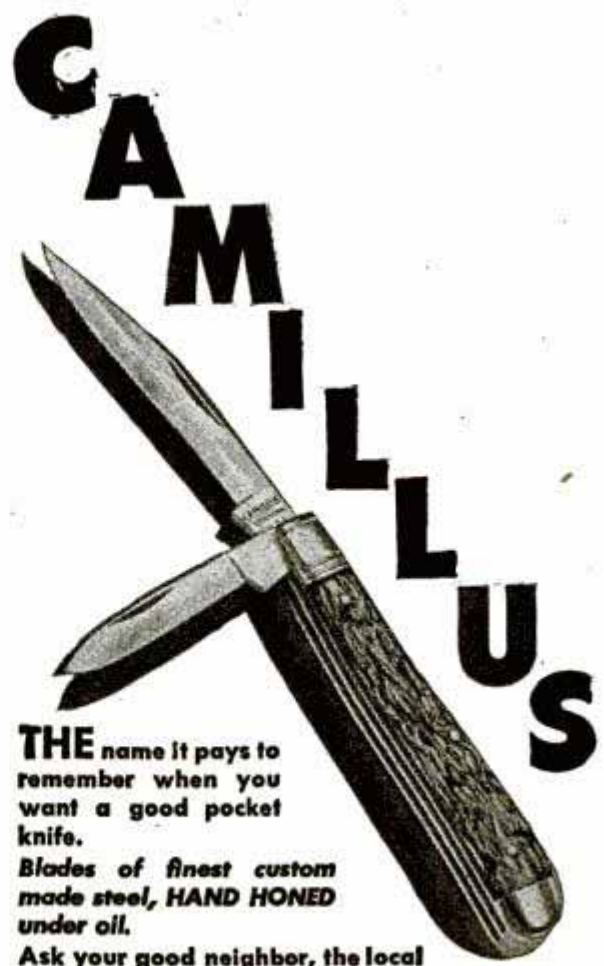

THE name it pays to remember when you want a good pocket knife.

Blades of finest custom made steel, **HAND HONED** under oil.

Ask your good neighbor, the local hardware or sporting goods dealer. We're doing our best to keep him supplied.

No. 21



K6-MILL-08

CAMILLUS CUTLERY COMPANY, New York 17, N. Y.
Established 1876 . . . Factory at Camillus, N. Y.

AIR RIFLES BENJAMIN AIR PISTOLS ARE AVAILABLE

SEND FOR FREE FOLDER OF LATEST MODELS TODAY
If you want a REAL GUN for PRACTICAL USE inside or outdoors get a **SAFE - CLEAN - ECONOMICAL - BENJAMIN** with Adjustable Power and Amazing Accuracy. For BEST RESULTS use **BENJAMIN H-C PELLETS**. WRITE AT ONCE. **BENJAMIN AIR RIFLE CO., 812 MARION ST., ST. LOUIS 4, MO.**

AUTOMATIC SAW SET AUTOMATIC RETOOTHER



HAND AND BAND SAWS
Set saw teeth automatically. Perfect hammer and anvil action sets teeth uniformly and tensions metal. No tooth breakage. No fatigue. Sets 400 teeth per minute.

Makes New Profits
Cuts teeth in 50 seconds! Any size tooth 4 to 16 points. Old teeth fall off as chips. Simple to operate. A perfect job.

Immediate Delivery

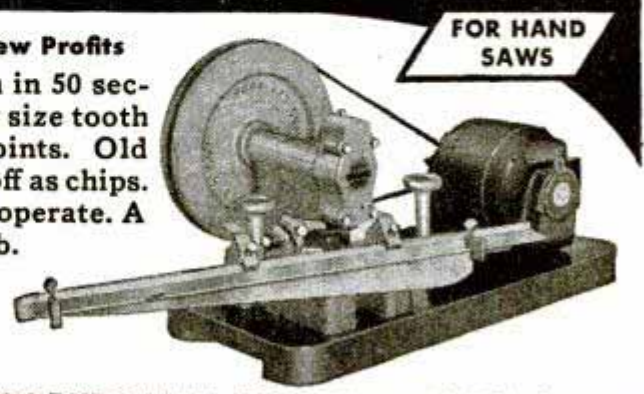

FOR HAND SAWS

WRITE TODAY
Saw Shops Need These Machines For Greater Profit
BURR MFG. COMPANY 8933-D Venice Blvd. Los Angeles 34, Calif.

Congress Drive

CONGRESS DIAMOND BORED DRIVES

3750 EAST OUTER DRIVE

DETROIT 12, MICHIGAN



**A WHOLE SHOP
FULL OF TOOLS
IN ONE!**

Use it for grinding, routing, drilling, sawing, polishing, carving, sanding and 9,994 other uses. Increases your skill and your scope. Precision-engineered, AC-DC. More exclusive features than any other tool.

Exclusive Safety Fingergrasp for fine detail work

\$2250

COMPLETE WITH 36 ACCESSORIES IN FITTED STEEL CASE

\$31.75 Value if Purchased Separately

Works Wood, Metal, Glass, Plastics

CASCO ELECTRI-CRAFT TOOL KIT

CASCO PRODUCTS CORPORATION, BRIDGEPORT 2, CONN.

AUTOMATIC GARAGE DOOR



Why get in and out of your garage door? Let the "Garage Boy" Door Operator do it for you automatically. The drive way contacts your doors open on the way in and closes them slowly on the way out. The doors may be operated manually. **EASY TO INSTALL.** Send for your "Garage Boy" Write for Free Literature **\$25.00** F.O.B. N.Y. **PURDY GARAGE BOY DISTRIBUTORS, Inc.** Dept. C Hewlett, New York

CHAPMAN CHINCHILLAS

The originator of the first Chinchilla Farm in the United States. For information on purchasing the finest, selected breeding stock of these aristocratic animals that were virtually trapped to extinction write or visit—

Established 1919

Chapman Chinchilla Farm

4957 West 104th Street
Inglewood, California



Raising adorable, pedigreed Chow pups is world's most fascinating, most profitable hobby. Sell all you raise \$50 up. Start home kennel, any dog-lover, housewife, disabled person. Low upkeep, big returns. Move to the country, if you like. We did. Write for interesting story of how we started.

EVENINGSHADE KENNELS

Box A-3 Helotes, Texas

METALLIZE BABY SHOES

Learn this easy, money making business from nationally recognized consultant. Small investment; perpetual market. For free details write Joseph B. Kushner, B.S. Ch.E., Metal Finishing Consultant, Stroudsburg, Pennsylvania, RD3G.

SAY YOU SAW IT IN POPULAR MECHANICS



••• INSTALL YOUR OWN LAWN SPRINKLERS—UNDERGROUND \$1.49 each with AQUA-SPRAY HEADS 6 HEADS SPRAY UP TO 800 SQUARE FEET Easily installed—fully adjustable to any shape lawn—full instructions—money-back guarantee. Send check or money order to

AQUA-SPRAY LAWN SPRINKLER CO.

439 EAST FORT STREET, DETROIT 26, MICH.

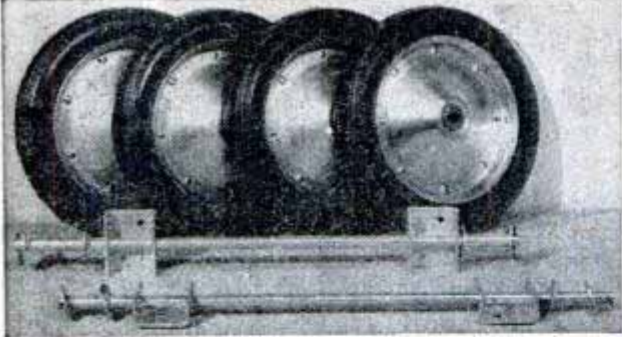

LARGE 12 x 2½ & 10 x 1¾ Ball Bearing WHEELS

BUDD STEEL WHEELS with GATES,
MADE TO OUTWEAR ANY GOODYEAR,
OTHER TYPE WHEELS . . . and OSBORN

NOTE: Not the toy tires used by most wheel manufacturers.

Semi-Pneumatic Puncture-Proof Deep Tread Tires

BUDD HEAVY STEEL WHEELS

Bright Zinc Plated . . . With Arguto Lifetime Oilless Bearings or Killian Ball Bearings. **4 FOR \$10.00**
For ½" or ¾" Axles.
10.00 x 1.75 (our regular) ½" Ball Bearing or ¾" and ¾" in Arguto Lifetime Oilless Bearings. Note: for ¾" Ball Bearing add 25c per wheel.

With 2 . . . ½" dia. Axles 20" long hangers, \$13.50 washers, cotter pins, Ready To Use. **ONLY \$13.50**

Here It Is . . . Combination V Belt Pulley Drive First Again— . . . and Brake Drum



Securely Held To Wheel . . . **READY TO USE.** Smart Design in Sturdy Pure Cast Aluminum . . . Precision Machined.
One Combination Drive and 10" x 1.75 Wheel Assembled. **PRICE \$5.50**
One Combination Drive Wheel and three without (set of 4). **PRICE \$13.00**
Same as above with 2-20" x ¾" axles, 4 hangers, washers, cotter pins. **READY FOR USE. PRICE \$16.50**

Same as above with 24" long x ¾" dia. axles, 4 hangers, washers and cotter pins. **READY FOR USE PRICE \$19.00**

Combination V Pulley Drive and Brake Drum, without wheel. **PRICE \$3.50**

F.O.B. Doylestown, or, add 10% for Prepaid Shipment anywhere in U.S.A.

INDUSTRIAL HEAVY STEEL WHEELS

—with ¾" Ball Bearings and Gates 10.00"x2.50" Heavy Duty Semi-Pneumatic 250 lb. Load Tire—
ONLY \$6.00 EACH PREPAID

SPECIAL: Electric Drive WHEEL CHAIR

All Hand Controlled FOR ANY AGE
24" wide x 42" long. Speed—Steering and Brake all hand controlled. Intended for level driving only. Inside or outdoors. **PREPAID \$275.00**
less battery. **IN U.S.A.**

OSBORN WHEEL COMPANY

115 So. Main St., Dept. P-5, DOYLESTOWN, PENN.

65 Inches Long
24 Inches Wide
Weight
Approx. 55 Pounds



Model "A" RACER CHASSIS
for POWER or PUSH
with 4 — 12x2.50 SUPER
Sturdy Built ALL-PURPOSE Chassis. **DeLux WHEELS**
Miles of Pleasure for any age. The two rear wheels have the Combination V Belt Pulley Drive and Brake Drum (not against tires as shown above). Engineered for Electric, Gasoline or Push Power. Equipped with Genuine Arguto OIL-LESS LIFETIME BEARINGS or Killian Ball Bearings. Ready to roll and steer. **COMPLETE AS ABOVE, F.O.B. Doylestown or, add 15% for Prepaid Shipment in U.S.A.** **ONLY \$56.00**

RUSH ORDER TODAY



Here It Is: Electric Motor for REAL POWER DRIVE

12 Volt Electric Motor With 3 Speed Control . . . Easy to Install. **ONLY \$33.50**
Write For Free Circular

Super DeLux 12x2½" Wheels
for ½" or ¾" Axles
Wheels Complete With Tire
1 ONLY \$ 5.50
2 ONLY \$10.00
4 ONLY \$18.00
Plus 10% for Prepaid Shipment

PIERCE MINIATURE GAS ENGINE

A MARVEL FOR SPEED AND POWER

Full 1/5th H.P.—.298 displacement. For model planes, boats, racing cars, etc. Easy starting. Extra speed and power! Precision engineered for long life. Hundreds of enthusiastic users. Priced right! Only \$12.95 less coil and condenser—only \$14.95 with. See your dealer or write for free details and literature. See your dealer. Literature FREE

PIERCE INDUSTRIES
430 So. Green St., Dept. PM5, Chicago 7

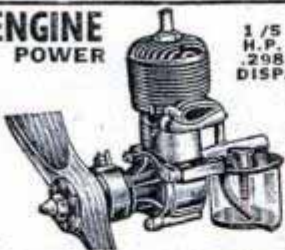

1/5
H.P.
.298
DISP.

A-2 JACKET \$18.75

Brand new horsehide leather, zippered front, cloth lined wool, knit cuffs and waist band.

Same as Above
WITH MOUTON FUR COLLAR. **\$20.75**

Send For Complete List
FLYING EQUIPMENT CO.
1641-43 Wolfram St., Chicago 13, Ill.



WHY WORRY ABOUT MONEY?

Pay your bills on the button . . . and have lots of cash left over for the luxuries of life! Go into a mail order business of your own right at home! Spare time can bring you many dollars of profit! It's easy, and you don't need any special experience or education. A few dollars gets you started . . . possibilities for growth are unlimited! Write today for complete details sent FREE without obligation.

NATIONAL OPPORTUNITY, Dept. P-57
4920 Lake Park Ave. Chicago, Illinois

free
CONCORD
Radio
Catalog



Radio Parts • Radio Sets • Record Changers-Players • Kits • Ham Gear • Amplifiers • Testers

It's here! The big, new 1947 Concord Catalog with a vast, complete selection of everything in Radio and Electronics for building, experimenting, testing, repair and maintenance. Thousands of items—hundreds now available for first time—latest 1947 prices. Now LOWER prices on Radio Sets, Receivers, Kits, Record Changers, Players, Portables, Amplifiers. Latest listing standard items. Complete stocks—IMMEDIATE SHIPMENT! Write for FREE COPY—please address Dept. P-57.

CONCORD RADIO CORP.
LAFAYETTE RADIO CORPORATION
CHICAGO / ATLANTA 3
901 W. Jackson Blvd. 265 Peachtree Street

NOW AVAILABLE

PLASTICS

CATALOG and HANDBOOK

FUN AND PROFIT AHEAD

Plastics, colorful and glamorous materials of the future, offer you a fascinating hobby—or a profitable plastics fabricating business of your own.

CATALOG LISTS NEW MATERIALS

Ready now, the new 40-page Carmen-Bronson CATALOG gives you complete prices and data on all materials you need. Plexiglas, Lucite, Bakelite, Lumarith, Lignolite, Tenite etc. in sheets, rods, tubes and special forms—crystal-clear and in many rich, glowing colors. Catalog also lists numerous cements, dyes, compounds, accessories, supplies and semi-fabricated kits.

HANDBOOK GIVES INSTRUCTIONS

The new Carmen-Bronson PLASTICS HANDBOOK tells how to fabricate plastics easily and simply into beautiful objects for gift or sale. Contains construction plans for many simple and advanced projects. Profusely illustrated. Gives practical advice on how to start your business in this profitable field.

25c BRINGS BOTH BOOKS

Take the first step TODAY toward your brilliant future in plastics. Send only 25 cents (refundable with first order) NOW for your copies of the Carmen-Bronson CATALOG and Carmen-Bronson PLASTICS HANDBOOK.

CARMEN-BRONSON COMPANY

165 East 3rd Street, Dept. 5-B, Mount Vernon, N. Y.



25c
BRINGS
BOTH
BOOKS

Make Up To \$600 An Hour!



Operate Your OWN Home-Weaving Business With AMAZING New DEEN Power Loom!

Make yourself financially independent! Start a steady business of your own . . . right in your home! Earn BIG PROFITS by weaving thousands of different designs of rugs on the new easily operated Deen Power Loom. Machine will automatically weave ten yards of beautiful intricate designs every hour.

DEEN LOOM TAKES UP LITTLE SPACE. You can put this marvelous weaving machine in a corner of your living room, basement, garage, or spare bedroom. Then later on, as your business expands, you can move into regular business establishment.

IDEAL BUSINESS FOR HANDICAPPED PEOPLE such as veterans and persons handicapped by loss of sight or limbs, and those unable to do strenuous labor. Loom is simple to operate . . . a child can run it. Any rug design you wish can be woven by merely changing paper guide pattern.

ORIGINAL INVESTMENT CAN BE RETURNED IN THIRTY DAYS. A small investment gets you started in your own business right away. Deen Loom has capacity of from eighty to one-hundred yards a day . . . in only one month it is possible to get back your original investment. Demand for home-woven rugs is GREATEST IN HISTORY. DON'T DELAY start making plans for your own business NOW. Write today for free descriptive booklet and full information. Address Dept. 31, DEEN LOOM DIVISION.

THE GIBSON CO., World Herald Bldg., Omaha, Neb.

"Makers of DEEN Looms — FAMOUS Since 1895"

15 Jewel **WRIST WATCH \$18.75** tax incl.

Elgin or Waltham or Bulova, Type A-11 Air Force watch. Waterproof, shockproof, anti-magnetic. Guaranteed.

15 JEWEL STOP WATCHES \$12.50
Elgin split second sweep hand 1 3/8" black dial. Govt. inspected for reissue.

PERISCOPE SIGHTING STATION—Bausch & Lomb and Eastman. New. Contains 32 coated lenses and prisms, Selsyns, gears, motors, dessicator pump, drives, etc. Cost \$9875.00 now \$49.50

SPERRY K-3 Computing Sight contains hundreds of precision bearings—gears—electronic parts—motor—clutches—shafts—optical system. Brand new in original box at \$12.50

Shipped prepaid anywhere in U.S.

ASSOCIATED SURPLUS 10838 Ventura Blvd. North Hollywood, Calif.

PIPE SMOKERS—HOBBYISTS

MAKE YOUR OWN PIPES TO SUIT YOURSELF

You can make 12 pipes for less than \$1.00 each. We furnish kit containing:

- 8 imported briar blocks.
- 8 imported briar rough bowls.
- 15 hard rubber stems.
- 15 aluminum filters.

Price \$7.50 postpaid. Please remit with order.

SYLVAN J. BENEDICT & CO. 100 West 42nd St., New York 18, N.Y.



CORROSION and FRICTION

Use Fiendoil on tools, electrical appliances, household devices. It actively

Lubricates·Cleans·Prevents Rust

3-oz. Spout Can
40c

FIENDOIL

"The Enemy of Corrosion and Friction"

WANTED

DISTRICT PURCHASING AGENTS

No experience or money required. Exceptional opportunity for those who want to establish themselves in a steady, year 'round, well paying business.

For details: Write

PURCHASING MANAGER, DEPT. C

2719 LAWRENCE AVE. CHICAGO 25, ILL.

Welding for Fun and Profit!

See our ad Page 275

DYNAMIC WELDER CO. 13 E. 23rd St., RD. CHICAGO 16, ILL.

LAWN ORNAMENT-NOVELTY PATTERNS

28 Lawn Ornament Patterns, 25c. Other patterns; 15-20" high; Dutch Girl, Dutch Boy, Pirate, Bull Terrier, Mexican Girl, Mexican Boy, Dwarf, Penguin, Flower Girl, 10c each. 25 Novelty Patterns, 30c. All 62 Full Size Patterns, \$1.00 Postpaid. Strother Pattern Service, Dept. V-8, Box 383, Belington, W. Va.

Balance 4" x 9" Base. With either \$6.00

Metric or Avoirdupois Weights . . .
Catalog with 3000 Illustrations of laboratory apparatus, and over 10,000 prices sent for \$1.00. Catalog of 80 Scientific books. Price \$1.00.

LABORATORY MATERIALS CO. 7321 Vincennes Ave. Chicago 21, Ill.

GOLD TEETH WANTED

Dental gold teeth, plates and bridges with metal attached. Any broken pieces of gold jewelry. Immediate payment and free mailing container to you or your friends upon request.

LOWES, DEPT PM Holland Bldg., St. Louis 1, Mo.

FINECRAFTERS

Headquarters for Craft Leather, Tools and Accessories
Write for Catalog

227-229 North Main St. Providence, R. I.

EXTRA SPECIAL

Sensational OFFER
USE THIS COUPON

Manufacturer's Clearance
Nationally Advertised HI-BALLER SCOOTER

Every child can have one at this *sensationally low price*. WHILE THEY LAST this sturdy, rubber tired, beautifully painted HI-BALLER now offered at \$9.95 each — when ordered in lots of 6, price is only \$8.95 ea. *Get your friends together and earn your own.* Plated Handle Bars, Strong Steel Tubular Spring Action Frame, Red and Cream Wheels. Length 38"; Height 33"; 8 1/2" Disc Wheels; 7/8" Rubber Tires; Rubber Grips; Snap Kick Stand. MAIL COUPON FOR IMMEDIATE DELIVERY.



Commercial Metal
2025 Fenkell - Detroit

Ship _____ H
SCOOTERS for which I
 Money Ordr.
 Check

Name _____
Address _____
City _____
State _____

COMMERCIAL METAL PRODUCTS - 2025 Fenkell - Detroit 3, Mich.

Build Your Power Tools With
"HOUR-BALL BEARING" ARBORS

New Departure
Self Lubricating
Bearings

10,000
R.P.M.

(No extra charge for left hand threads)

- B33—\$4.95 PP. 3/4 x 4 1/2 Spindle
 - B15 Plain Spindle \$3.45
 - C4—1/2 x 12 1/2 spindle, housing 2x8 \$8.25 PP.
 - C5—3/4 x 12 1/2 spindle, housing 2x8 \$8.25 PP.
 - C6—3/4 x 12 1/2 spindle, housing 2 1/4 x 8 \$9.25 PP.
 - D8—1 x 17 1/2 spindle, housing 2 3/4 x 11 \$16.95 PP.
- 1 INCH BETWEEN WASHER AND COLLAR
Shaper Arbors C4, C6, D8, 3 inches between collars, add \$6.00.
Plain Spindle models less threads and collars C4-\$8.00, C5-\$8.00, C6-\$9.00, D8-\$16.00 all P.P.
V BELTS \$.03 per inch PP. Courtesy to jobbers and dealers.

POLY PRODUCTS, 406 S. Chester Ave., Ct. 1, Dept. M5, Pasadena 5, Calif.

FREE RADIO CATALOG

Latest radio and electronic parts and devices, newest ham gear, gadgets, war surplus items. All in this new FREE catalog. Don't delay.

BURSTEIN-APPLEBEE CO.
1014 McGee, Kansas City 6, Mo.

CHANITE SELF-WELDING FLUX
REPAIRS ALL ELECTRIC HEATING ELEMENTS

So simple anyone can make repairs in your broken or burnt-out electrical appliances—irons, toasters, stoves, etc. Guaranteed nothing like it. From our mines to your appliances. \$1.00 per package. \$7.50 per doz. Stick form 25c. \$2.00 per doz.

CHANITE SALES COMPANY, 914 So. Main, Fort Worth 4, Texas

Make Your Own
RUBBER MOLDS

with
RED LATEX MOLDING COMPOUND

Earn money, have fun; make your own molds for plater objects. Produce novelties and gifts for home and to sell to friends. RED LATEX MOLDING COMPOUND (80% density) now available in quart and gallon quantities. Gives perfect results, easy to apply. Send for complete information and prices. FRANCIS SUPPLY CO., Dept. E2, 1836 E. Fulton St., Columbus 9, Ohio.

Now
for EVERY WORK SHOP!
NEW Invention Electroplates
by BRUSH



Easy to Plate CHROMIUM
GOLD, SILVER, NICKEL, COPPER
... For Pleasure and Profit!

If you have a workshop—at home or in business—you need this new Warner Electroplater. At the stroke of an electrified brush, you can electroplate models and projects—you can replate worn articles, faucets, tools, fixtures, silverware, etc. with a durable, sparkling coat of metal... Gold, Silver, Chromium, Nickel, Copper or Cadmium. Method is easy, simple, quick. Everything furnished—equipment complete, ready for use. *By doing a bit of work for others, your machine can pay for itself within a week.* So make your shop complete by getting a Warner Electroplater right away. Send today for FREE SAMPLE and illustrated literature. ACT AT ONCE! Mail Coupon.

WARNER ELECTRIC CO., DEPT. M-2
1512 Jarvis Avenue, Chicago 26, Ill.

FREE Details & Sample!

WARNER ELECTRIC CO., 1512 Jarvis Avenue, Chicago 26, Dept. M-2

Gentlemen: Send Free Sample and Details to:

Name _____
Address _____
City _____ State _____

The Library of Useful INFORMATION

5 for \$1.00
12 for \$2.00
25¢ Each

At an amazingly low cost is the practical help and information you have always wanted. Articles in previous issues of Popular Mechanics have been classified according to subject and are now available in these handy reprint booklets. Check Titles wanted, and mail today.

LET'S ON WORKSHOP EQUIPMENT

- Saws—74: Complete details two circular saws, sliding midsaw.
- Plane, Grinders—79.
- Complete constructional details of 8 useful machines.
- Wood & Metal-Turning Lathes—81: Two wood lathes, small metal-turning lathe.
- Filing Machine, Hacksaw, Cutoff Wheel, Shaper—82.
- Metal Lathe Tools You Can Make—101.
- Workbenches & Tool Cabinets—47.
- Spray Painting—94: Constructing spray guns, compressor, using spray gun.
- From Patterns to Castings—91: How to make your own patterns and small castings.

BOOKLETS ON SHARPENING—USING TOOLS

- Correct Measurement—106: How to use micrometers, gauges, calipers, etc.
- Tool and Saw Sharpening—92.
- Using & Sharpening Drills & Wood Bits—90.
- Successful Wood Turning—32: All the information you need to master this art.
- How to Read Blueprints—71: Tells you how to read and signs, symbols, and lines.
- Turning Lathe Kinks—89: Simple homemade tools, time and labor-saving shortcuts you can use.
- Operating a Metal Turning Lathe—100.
- Heat Treating & Case Hardening—102.
- Working with Glass—103: Cutting, drilling, etching, glazing.

ELECTRICAL BOOKLETS

- Rewinding & Servicing Electric Motors—75: Repairing and rewinding a.c. and d.c. motors. Locating trouble. Converting auto generators into 110 v. a. c. motors.
- House Wiring—89: All the information you need to do a complete wiring job or install extra outlets.
- Electromagnets & Solenoids—44: Designing and building.
- Transformer Construction—41: Easy-to-understand instructions for all kinds of transformers.
- The Boy Electrician—43: Easy-to-build motors, experiments.
- Soldering & Brazing—17.
- Arc & Spot Welders—5: Building and operating 110 v. a. c. arc and spot welders.
- Treasure Finders—13: Build your own treasure finder and metal locator. Details for both large and small radio types.

ELECTROPLATING BOOKLETS

- Electroplating with Copper, Nickel, Chromium, Lead, Zinc, Cadmium—86.
- Plating Leather & Other Non-Metallic Objects—Plating with Gold, Silver, Alloys—87.

HOME IMPROVEMENT BOOKLETS

- Simple Home Improvements—104: Modernizing; making storm sash, ironing boards, etc.
- Building Extra Rooms in Attic—23.
- Attractive Basement Playrooms—24.
- Lower Your Fuel Cost—31: Practical kinks that will save you hundreds of dollars.
- Hanging Wallpaper—38: Tricks of hanging wallpaper, removing old paper, etc.
- Curing Leaky Basements—45.
- Fitting Home Game Room—55: Construct own game & tennis tables, shuffleboard court, action game, portable playrooms.

- Hiding the Home of Insect Pests—107: Exterminating and protecting against moths, flies, termites, mosquitos, etc.
- Built-In Fixtures—78: Step and space-saving kitchen units, built-in beds, corner cabinets, vanities, linen chest.
- Constructing Indoor & Outdoor Fireplaces—58: Stone fireplaces, portable mantels, garden fireplaces.

GARDENING BOOKLETS

- Backyard Gardening—39: Selecting, planning and getting the best results.
- Lawn & Garden Novelties—72: Jig-sawed ornaments, parkway numbers, sundials, flower boxes.
- Trellises, Pergolas, Fences—76.
- Lawn & Garden Furniture—77: Modern bent-tube furniture, arbor and seat combinations, swings, lawn chairs.
- Ground Equipment—73: Two playhouses, ferris wheel, roller coaster, treadmill, play store, slide, two merry-go-rounds.
- Colored Concrete Garden Furniture—74: Garden benches, pottery, flower boxes, bird baths and sundial pedestals in colored concrete. How to build small concrete structures.
- Bird Houses—7: Easy to build homes for all kinds of birds.
- Farm & Garden Tractors—8: Two tractors you can build from old automobile parts.

CRAFT WORK—HOBBY BOOKLETS

Complete how-to-make-it instructions—hundreds of practical

- Working with Plastic—82: Using brilliant-colored plastics in craftwork.
- Magazine Racks—49: Ten attractive racks.
- Clock Cases—50: Large Hall, Colonial wall and mantel, ship's wheel, miniature grandfather, desk, Spanish style banjo.
- Serving Trays for Every Occasion—53: Fourteen different designs.
- Children's Room Furniture—51: Twelve attractive pieces.
- Book Ends—52: Ten designs offer good selection.
- Small Tables—54: Modern and colonial styling.
- Smoking Stands—56: Seven designs given.
- Jigsawed Novelties—57: Sewing kits, string holders, place-card holders, plywood kitchenware, plant and flower holders, coin banks, door stops, drawer pulls.
- Desks—55: Colonial writing desk, two modern-type desks, student's study desk of plywood, combined chest and writing desk.
- Book Cases—59: Eight designs.
- Doil House & Doil Furniture—60.
- 25 Shelves You Can Make—64.
- Novelties Turned on Lathe—62.
- Inlay Pictures—Veneering—63.
- Whittling and Wood & Soap Carving—65.
- Action Toys—66: 21 easy-to-make toys.
- High Flying Kites—67.
- Windmills & Weather-vanes—68.
- Lamps in Wood, Metal, Plastic—69: Selection of 14 designs.
- Metal Craft—28: Brass tapping and making of novelties both decorative and useful.
- Small Looms—37: Building hand looms for weaving rugs, etc.; leather novelties.
- Plain & Novelty Wood Finishing—40.
- Gem Cutting—42: How to cut and polish semi-precious stones.
- Rustic Furniture—18: How to build chairs, benches, tables, gates, summer house, etc.

BOAT BUILDING BOOKLETS

Build a boat at home—you can do it

- 14 Ft. Outboard Runabout—2: Here is a fast 14 foot V-bottom boat. Suitable for motors of 4 to 24 hp., estimated cost, \$30 to \$40.
- 14 Ft. Sailing Dinghy—26: This 14-foot boat combines strength and light weight. It carries 140 sq. ft. of canvas and weighs about 350 pounds. Actual photographs and diagrams illustrate every detail.
- 21 Ft. Sloop—46: Every fact needed by the amateur boat builder to construct this craft which carries eight to ten persons.
- Rowboats, Bicycle Boat, Small Dinghy—83: All the information you need to construct four low-cost boats.
- Small Sail Boats—84: 12-ft. sailing dinghy, 6-ft. "training ship" for young sailors, how to sail a boat.
- Two Outboard Runabouts—85: 14-FL and 11-FL outboard weighs about 400 lbs. and 1-ft. plywood outboard weighs about 110 lbs. Both are V-bottom type.
- Build Your Own Canoe, Kayak, Surfboard—30: Complete details on 16-ft. Canadian-style board.
- Fast Class-E Ice Yacht—22: Build your own Class-E ice yacht. Every detail of construction carefully explained.

AUTOMOBILE BOOKLETS

- Automobile Kinks and Shortcuts—10: Automobile styling, date of upkeep, etc.
- Building Trailers—27: Small utility house trailer; several utility trailers.
- Motor-Driven Midget Car & Scooter—34: Both use gas engine of washing machine type.
- Curing Auto Electrical Troubles—95.

PHOTOGRAPHY BOOKLETS

Save Money by constructing your own photo equipment.

- Photo Enlargers—1: Condenser lens type; simple vertical; horizontal.
- Photo Printers & Dryer—25: Describes three practical printers, timer and negative dryer.
- Photo Darkroom Equipment—96: Cabinets, light-tight box, timer, agitator, washer.
- Picture Projector, Trick & Table Top Photography—97: Projectors that enlarge magazine illustrations and shop drawings. Tips for table toppers, photomontages, tricks.
- Photo Kinks—98: 63 time and money-saving ideas you can use.

FORMULA BOOKLETS

- Cleaning Preparations—11: Easy-to-make cleaners for walls, glass, etc. Removing fabric stains.
- Cosmetic Formulas—12: Hand lotions, creams, rouge, bath salts, beauty clay, lipsticks, etc.
- Re-Silvering Mirrors—70: Formulas for silvering and coloring.

MISCELLANEOUS BOOKLETS

- Knots and Rope-work—105.
- Chemical Experiments—93: Easy-to-perform experiments. Inexpensive lab.
- Taxidermy—9: How to prepare skins and obtain life-like poses.
- Log Cabins & Tourists Cottages—14: Year-round log cabins; inexpensive tourists' cabin.
- Magic for Everybody—29: Simple tricks to puzzle your friends.
- Trapping Small Animals—33: How to lure fur bearers, prepare bait and traps, dress skins.
- Tricks of Training Your Dog—35.
- Small Furnaces—36: Build own gas or electric.
- Telescopes—20: Design and construction.
- Poultry Houses—108: Structures, brooders and incubators.
- Guns and Decoys—109: Cleaning, chocking; making decoys.

POPULAR MECHANICS PRESS,
 200 E. Ontario St., Chicago 11, Ill.

I enclose (U. S. bills may be mailed if carefully wrapped)
 for "Little Library" booklets numbers:

.....
 Name
 Address Zone.....
 City State.....

PAINT YOUR OWN CAR \$5.95

This New, easier way—for only

Insured By
LLOYD'S OF
LONDON!

DAB

Miracle Auto Paint That

Just Wipes On!

- NO BRUSH!
- NO SPRAY!



11 COLORS:

- Red
- Black
- Gray
- Pico Tan
- Sun Beige
- Brewster Green
- Washington Blue
- Monterey Blue
- Jewel Green
- Mahawk Maroon
- Burgundy
- Maroon

\$5.95
Quart

One quart paints
the average car

Guaranteed 2 Years
Not to chip, crack, peel or fade!

Now you can get a glossy, factory-like paint job on your car in just one hour with DAB! All you do is WIPE IT ON with the applicator pad provided free. No streaks, no lap marks! If your dealer cannot supply you, send check or money order—we will ship DAB prepaid at once.

DEALER INQUIRIES INVITED!

WORLD-WIDE DISTRIBUTORS

NU-WAY PAINT AND SUPPLY CO., INC.

310 Lincoln Avenue, N.W., Canton 3, Ohio

MAKE MORE MONEY

APPLYING OR SELLING

CORKSTONE PLASTIC FLOORING

EASY TO APPLY

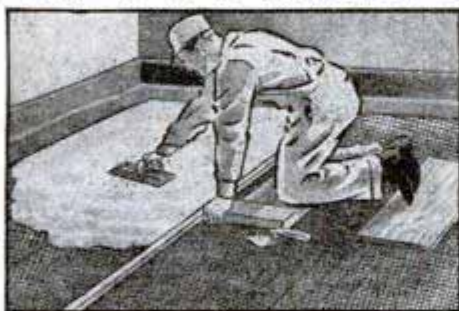

Here's your opportunity to get into business for yourself applying or selling Corkstone, the economical, top-grade plastic flooring. Plenty of profit. Act without delay!

Dealers & Agents Wanted

WRITE FOR DETAILS

LASTING PRODUCTS COMPANY

FRANKLINTOWN ROAD PLANT, BALTIMORE 23, MARYLAND

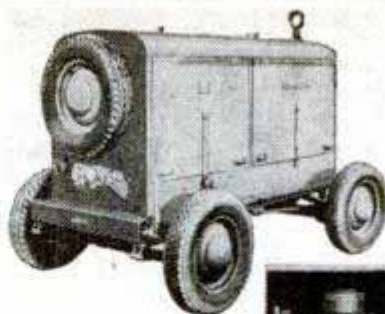

COMPLETE PORTABLE
POWER PLANT



POWER PLANT
Left-Side Interior View

ALL PURPOSE PORTABLE POWER PLANT

*... Ideal for heavy-duty Electric
Welder with very little conversion.*

This unit is a complete self-contained power plant consisting of:

1. A gasoline engine and miscellaneous engine auxiliaries, including radiator fan and governor for control of engine speed.
2. A direct-current generator direct-connected to the engine.
3. A control panel having mounted thereon power indicating instruments, main power switch, field rheostat, Tachometer, engine indicators, engine controls, and the necessary light switches.



THE POWER GENERATOR
Oblique Drive-End View

POWER GENERATOR: (G-E Type GT-1508-b1)

Rotation—CCW (facing commutator end)

Ratings:

Volts	Amperes	Rpm	Kilowatts
100	160	1200	16.0

Poles:

4 main	} 2 shunt-wound 2 compound-wound
2 commutating	

Complete, ready to go, PRICE: \$695.00 (F.O.B.—Chicago)

Lots of 3 PRICE: \$650.00 (F.O.B.—Chicago)

(25% CASH WITH ORDER)

Can Also Supply Searchlight Unit —
Ideal for Advertising Purposes

CHICAGO SURPLUS CO.

4545 West Madison Street Chicago 24, Illinois

SAY YOU SAW IT IN POPULAR MECHANICS



Paint it
YOURSELF
WITH
Plasti-Kote

The Plastic Finish for
AUTOS, BOATS, FLOORS
FURNITURE & WOODWORK

- Use Plasti-Kote wherever you want a gleaming, lasting and durable finish. Plasti-Kote leaves a cellophane-like surface that resists hot or cold water, alcohol, dirt, oil, vibration and changing weather.

Dries in 3 hours—leaves no brush marks. Easy to apply. 36 beautiful colors. \$2.95 quart.

PLASTI-KOTE, INC. 425 LAKESIDE AVENUE N. W.
CLEVELAND 13, OHIO

Send new color folder and descriptive literature: PM

Name

Address

City..... Zone..... State.....

**YOU CAN MAKE YOUR OWN
BUILDING MATERIAL**
... In Your Spare Time!

Planning to build a garage, workshop, shed, line a basement, build a fruit or vegetable room, or do other similar construction? You'll save plenty by building your own concrete blocks. Beat the high cost of materials. Speed up construction.

SIMPLE, EASY, SPEEDY

With the **DANDY BOY** Block Maker you can make up to 25 standard (8x8x16) concrete or cinder blocks per hour. Many different designs and styles. You save up to 17c per block. Operating costs are small.

DO CUSTOM WORK

Many friends and neighbors will want you to make blocks for them. Brings good cash return. Pay for the **DANDY BOY** Block Maker on a few jobs. Profitable sideline or good business full time for aggressive man.

WE SHOW YOU HOW

Fully illustrated instruction book tells you all about making concrete or cinder blocks — how to mix materials — how to cure blocks — how to make different patterns. Send for **DANDY BOY** Block Maker literature today and learn how simple it is to save — and earn — extra cash.

Ask for **DANDY BOY** Booklet C3
And name of nearest Dealer

THE MIDLAND CO.
South Milwaukee, Wis.



**IMMEDIATE
DELIVERY!**



\$24.95

F. O. B.
ROYERSFORD, PA.

8 in. BENCH SAW

COMPLETE AS SHOWN
TABLE SEGMENT—Shows degree of table tilt—graduated. **SPLITTER**—Hard temper cold rolled steel. **GUARD**—Aluminum. **MITER GAUGE**—Aluminum. Accurately graduated 45° each side of center. **BEARINGS**—(2) Oil-ite bronze. **CAPACITY**—0 to 2 1/4". **TABLE** 12"x14". **SHIPPING WEIGHT**—44 lbs.

AMERICAN MACHINE & TOOL CO., Inc.
DEPARTMENT 100 • ROYERSFORD, PA.

LOOK! LOOK! L-O-O-K!

THE ONE AND ONLY WORLD FAMOUS, GENUINE
REYNOLD'S BALL POINT PEN

Available Now From Us If You Order at Once!
Our Sensational Low Price! Act Fast While They Last!

The Reynolds Pen Company Says:
Reduced to:
98¢ each

- They write for years without refilling!
- No ink bottles necessary! Dries as you write!
- They make six to eight carbon copies!
- No caps to lose—just click ball point guard!
- 5 1/2" long! Safety clip on each pen!
- All metal—beautiful streamline design!
- Service agreement with every pen!

Mail cash, check or money order to:
APPEL INDUSTRIES, Dept. PM-5
5 N. Wabash Chicago, Illinois

SORRY, NO C.O.D.'s
Add 12c each for insurance and mailing.

NOTE
**STUDENTS!
OFFICE WORKERS!
PROFESSIONALS!**

Order 3 or more pens!
Postage and handling FREE!
3 for \$3

PANTS—SHIRTS
TO MATCH—FREE CIRCULAR

Also other work and sport garments including WAR SURPLUS merchandise. Suitable for indoor, outdoor work and sports. Sold by mail at money saving prices. Write for FREE Illustrated circular, order blank. **J. R. ADDISON UNIFORM CO., Dept. PM-5, Cambridge, O.**

Say You Saw It in
POPULAR MECHANICS



SPECIAL SET \$2.00

GENUINE CARBOLOY-TIPPED TOOLS

Same as used by the big factories. Long life, high production. Designed to perform home workshop jobs on metal, wood and plastic. Shipped in pairs as shown, either 1/4 or 5/16". Only \$2 cash with order, postage paid.

SCHMARJE TOOL & ENGINEERING CO., MUSCATINE, IOWA

Snap-On-Lawnmower Barrow

\$6.95 Free Wheeling
Fits all Lawnmowers

Convert your lawnmower into a wheelbarrow in one minute. Simply invert mower snap on. Strong, durable, will carry 250# loads. Barrow is 6" deep with two sturdy legs. Painted red and green with attractive flower designs on panel.



Dealers Write

IMMEDIATE SHIPMENT CHECK OR M.O. WITH ORDER

INDIANA APPLIANCE CO.

20 East Sycamore Dept. LM-20 Evansville 9, Ind.

(Pat. Pend.)

Saves Time, Effort, Money in Appliance Repairing!



Appliance Tester

A.C. ammeter range 0-10 amp. Serves as watt-meter with conversion chart range 55-1100 watts. Checks thermostats at point of cut in and out. In this single unit are all the necessary tests for examining every appliance. Controls heat on soldering irons, prevents overheating. Tests continuity, open circuits, automatic irons, vacuum cleaners, motors, switches, etc. Great time saver. Only \$14.50 complete postpaid. \$2 deposit required on C.O.D. Order today!

FREE with each tester. New, Complete Practical Course in electrical repairing. Write for circular.

HANLAN CO., 1419-A West Jefferson Blvd., Los Angeles 7, Calif.

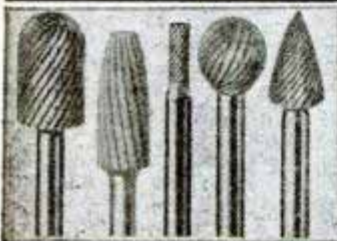

HIGH SPEED ROTARY FILES

Set of 5 Assorted.....\$2.00
Set of 10 Assorted.....\$3.75
Set of 20 Assorted.....\$7.25
Set of 30 Assorted.....\$10.00

Send for circular on High Speed DRILLS & TAPS. Enclose 3c stamp for mailing.

SID TOOL CO.
MACHINE SHOP SUPPLIES
183 Grand St., New York 13, N. Y.



8x2" TIRE & WHEEL - COMPLETE

Here is the Wheel you will want for your Wagon, Scooter, etc. Will never RUST! No painting needed—hub of cast aluminum—nuts & bolts cadmium plated. ARGUTO OILLESS bearing—7/16" bore. Never need be oiled! "Clipper" semi-pneumatic tire. Use as is—polished hub very attractive.

(Dealers & Manufacturers write for quantity discounts)

\$2.60 each ★ A set of 4 Wheels **\$10.00**

C. L. WALKER, P. O. Box 1023, Plant City, Fla.

FOOD FREEZER



CABINET - Easy economical to build. Plans professionally designed. Endorsed by refrigeration authorities. 4 sizes, 15, 21, 27, 34 cu. ft. store 525-1200 lbs. Sectional const., easily moved. No special knowledge needed. Ordinary tools and materials. Supply sources included.

FREEZING GUIDE - Authoritative information in convenient reference form. Covers food selection, care, preparation. **PLANS and GUIDE - \$2.00.**

FOOD FREEZER ENGINEERS Box 3322 Dept. B-57 St. Paul, Minn.

WINDOW SIGN LETTERS

For Store Fronts and Office Windows. Anyone can put them on. Samples furnished. Genuine Gold and Silver. **METALLIC LETTER CO., 430 N. Clark St., Chicago 10**

SELL MERCHANDISE by Mail

OPERATE Profitable Lifetime Business Selling Merchandise by Mail. Large Profits on Fast Selling \$1.00 Items. **WRITE TODAY!**

POWELL CO. DEPT. A SAMPLER BLDG., CLEVELAND 3, OHIO

Spring Bargains!

BRAND NEW

Government Released Items at Amazing Low Costs

O. D. BATTLE JACKET only \$4.95

Here is a trim, warm, lightweight 100% wool British-made Eisenhower-type jacket. "Just the job" for cool, spring days; for hunting, fishing, boating or gardening. Its many features include:

- Cotton gabardine lining
- Adjustable waist belt
- Two large flap pockets
- Tailored for comfortable fit
- Button-down fly front

All sizes available. Send height, chest and waist measurements. Act quickly on this sensational bargain.



Genuine "IRVINGTON BRIAR" PIPE and Famous "FISHER FLAME" LIGHTER Both for only \$1.98



Two outstanding items at one bargain price!

1. This genuine Irvington Imported Briar pipe alone retails for \$7.50 to \$10.00. Its flame-grained, slender bowl guarantees cooler, more enjoyable smoking. FREE velvet or corduroy pouch included.

2. Lighter is the famous Fisher Flame, known for its dependable service. Wind-proof, dust-proof and water repellent, it's the perfect outdoor cigarette and pipe lighter.

TOOL ROLL only 79c

This heavy O.D. canvas wrap-around bag with 19 pockets is fine for protecting your auto or workshop tools, carrying hunting and fishing equipment, storing small household items. Roll is 27 1/2" x 22", waterproof, dust-proof, with two raw-hide tie-strings.



CUSHIONED UTILITY BAG only \$1.98



A "two in one" article for many uses — combination waterproof zipper bag and cushion. Ideal for the beach this summer. Pack the 16" x 21" bag with your towel, cards, bill fold, robe, extra clothes etc., zip the bag tight and then use it as a cushion. Use also for boating or the ball game. Limited supply, so order fast on this item.

Government release on above articles makes these sensational low prices possible. Take advantage of this offer TODAY to ensure quick delivery. Fill out, clip and mail coupon below. We pay postage.

PERRY PRODUCTS

Dept. 2-A, 112 E. Walton Place, Chicago 11, Illinois

Enclosed is check money order for _____ Send item(s) checked:

- O.D. Battle Jacket \$4.95 Height _____ Chest _____ Waist _____
- Pipe and Lighter 1.98
- O.D. Canvas Tool Roll .79
- Cushioned Utility Bag 1.98

Name _____

Street _____

City and State _____



BAUSCH AND LOMB
7 x 50 Navy Binoculars
\$135.00

COATED OPTICS!

Mfgd. to U.S. Navy Standards! (Alignment guaranteed to .001") Brand new glasses. Dust proof! Climate proof! Individual eye adjustment. Instant focusing. Coated optics insure sharp, clear images! Ideal for long range hunting, yachting, watching planes, etc. This magnificent 7 power 50 mm. Navy Binocular gives better detail, heightening image contrast. Complete with carrying case only \$135.00 plus 20% Federal tax.



BAUSCH AND LOMB
6 x 30 Binoculars
\$37.50

6 power Binoculars made to rigid Army specifications by BAUSCH AND LOMB. Used in good condition. Sturdily constructed of genuine brass, leather covered. Ideal for hunting, sports, etc. These fine Bausch and Lomb glasses come complete with case and straps ready to use. Similar to picture. \$37.50 plus 20% tax. **WHILE THEY LAST!**

OTHER BINOCULARS (3 to 16 POWER!)

12x40 Carl Zeiss. Like new	\$200.00
16x40 French. No Case. Used	125.00
16x45 French Monte Carlo. New	185.00
12x38 French Monte Carlo. New	100.00
10x32 French Monte Carlo. New	79.00
10x50 German Dienstglas. Used	140.00
8x30 French Monte Carlo. New	62.00
8x25 French Monte Carlo. New	57.00
8x25 French Monte Carlo. Used	45.00
8x24 Busch. Lightweight. Used	65.00
7x50 German Dienstglas. Used	180.00
8x30 Carl Zeiss. Used	90.00
6x30 Carl Zeiss. Used	75.00
6x30 Universal. Navy. Lightweight. Used	88.50
6x25 Ross. London. Used	60.00
6x30 Hirsch. Used	55.00
6x24 USN. Turner Reich. Lightweight. Used	60.00
5x40 Nat'l. Field Glass. Coated Optics. New	29.75
4x50 Super Eye Field Glass. No Case. New	15.00
4x40 Fee & Stenwedel Field Glass. New	20.00
4x40 Fee & Stenwedel Field Glass. New	22.00
4x40 Wollensack Field Glass. New	16.25
3x30 Fee & Stenwedel Field Glass. New	4.25
10x, 20x, 30x, 40x Variable Telescope	42.50

Add 20% For Federal Excise Tax. Carrying case and straps included. Supply limited. Give second choice.

MONEY BACK GUARANTEE!

Use for 20 days at our risk and expense. If not fully satisfied, return for full refund of your money. **ORDER TODAY!** Send \$2.00 deposit and we will ship C.O.D. for balance. Cash orders sent postpaid.

UNITED PRODUCTS CO.

7941 S. Halsted Dept. ARF-208 Chicago 20, Ill.
(Reference Dun & Bradstreet)

TRAILER AXLES, HITCHES, AND PARTS

● If you are interested in purchasing trailer axles, hitches, and other trailer parts, contact us promptly. **Write for free literature.**



HAMMER BLOW TOOL COMPANY, Dept. 117, WAUSAU, WIS.

NOTHING ELSE LIKE IT!

NOW! NEW KIND OF BOOK
MAKES HOME WOODCRAFT EASY!

65 IDEAS

Illustrated by
Professional Instructor



Never before have you seen so many plans so easy to understand, so easy to follow! Fun for craftsmen and amateurs alike. This manual gives you all the benefits of the most expensive training course—yet you need only the simplest ordinary hand tools. You don't waste time reading or studying. Just

turn to what you want to build and get right to work.

SPECIAL VALUE: Now being introduced to readers of Popular Mechanics at the rock bottom price of only \$1.00. (Compares with similar \$2 to \$3 books) Send your dollar at once, for this special introductory offer is limited. And, remember, if this manual isn't the BEST you have ever seen, return it within five days and your money will be refunded immediately.

PROJECTS IN WOOD Dept. P57
 58 E. Washington Street Suite 1805
 Chicago 2, Illinois

MAKE UP TO \$10
ON EVERY SALE!

AIR CORPS TYPE
SUN GLASSES



SELLS EVERYWHERE
UP TO \$15 and MORE!

A Real Fast Money-Maker! Here are genuine 12 Karat gold filled, Air Corps Type SUN GOGGLES complete with "Pearllex" sweat bar, brow rest and rocking pads, scientific ray-absorbent "No Glare" ground and polished sage green lenses, dropped before curving, and self-adjusting comfort cable ear pieces. Handsome crush-proof case included. Will protect eyes from glare, sun, wind, dust and exposure. Wonderful for auto drivers, policemen, golfers, gardeners, farmers and all outdoor workers and sportsmen. Sold on 10 day no risk trial money-back guarantee. You can easily sell 3 or more pairs a day. Send for your sample pair of these fine Sun Goggles—only \$5.00, postage prepaid. Or send no money. Just deposit \$5.00 with your own postman, plus postage—your money back if not delighted.

MIDWEST SCIENTIFIC CO. Dept. 804, 1148-1160 W. Chicago Ave. CHICAGO 22, ILL.

BUILD YOUR OWN ZEOLITE
WATER SOFTENER



Save up to 50%. Pays for itself. Fun to build. Only a wrench required. All materials available. Send \$1.00 check or money order for simple and complete plans and operating instructions.

BOX 2732-P LAR MFG. CO. MINNEAPOLIS 7, MINN.

SMART RATS TRAPPED!

New Trap Can't Harm Children, Pets, Birds or Poultry!

It's amazing how the new HAVAHART catches rats, rabbits, squirrels, and other pests... yet it's harmless to you and yours! No springs, no jaws! Animal walks in to get bait, and the doors close! Send postal for free booklet. HAVAHART, 478 Water Street, Ossining, N. Y.



REPAIR ELECTRICAL APPLIANCES, SEWING MACHINES, MOTORS, BICYCLES, LAWN MOWERS, ETC.

Start with \$20.00 and common tools! Earn up to \$6.00 an hour! Build low cost equipment. Learn from illustrated instruction course. Free details. Only... **\$5.50**
REPAIRMAN'S SERVICE, 222 4th Ave., Janesville, Wis.

PRICE REDUCTIONS
EXPANDED STOCKS

Aluminum flats to 4", squares, rounds, hexagons, angles, tubing. Drill Rod in rounds, squares, flats and octagons. Plastic in sheets, rods and tubing, clear and color. Also Decorative Panels. Many other items. Listing (A47) on above 5c. Catalog 1046-B and Listing A47 which lists tools, supplies, equipment, etc. 15c.
METPLAS SUPPLY COMPANY, 1420 S. 16TH, MAYWOOD, ILLINOIS



SORORITY and FRATERNITY PINS

Also Club Pins and Emblems. Artistic designs. Finest quality. Reasonable prices from 30c up. Write for illustrated catalog. Dept. N, Metal Arts Co., Rochester, N. Y.

Make Your Own

250 POWER TELESCOPE

COMPLETE LENS SET only \$2.50

Immediate Delivery

See the mountains and craters on the moon, the ringed planet Saturn, the moons of Jupiter, distant ships, people, and hundreds of other interesting sights. Make your own high powered telescope in one evening of easy work. All optical parts for 6 ft. long refracting telescope completely finished. Set consists of 3 inch diameter 75 inch focal length ground and polished objective lens and all eyepiece lenses needed to give magnifications of 50X, 100X, 150X, 200X, and 250X as an astronomical telescope, and 50X, 100X, and 150X as a terrestrial telescope. Complete lens set with full directions for mounting, only \$2.50 postpaid.

BROWSCOPE CO., Dept. 5M, 24 W. 45th St., New York 19, N. Y.

PHONO-AMPLIFIER

\$3.25

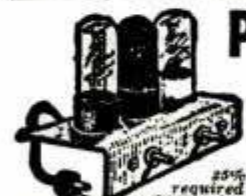

3-TUBE AC-DC-IMM. DEL. Volume and tone controls. Complete wired.

PHONO AMP. KIT

With 3 tubes and 5" speaker \$7.50
 Less tubes or speaker 8.00
 Complete kit wired & tested 8.00
 Alliance Phono motors and T.T. at 3.25
 Astatic curved arm pickup 1.95

Uses—12SQ7-50L6-55Z5

ORDER FROM THIS AD
 RISCO ELECTRONICS — WHOLESALE DISTRIBUTORS
 22 WARREN STREET NEW YORK 7, N. Y.

RECORD CHANGERS IN STOCK
 RISCO ELECTRONICS — WHOLESALE DISTRIBUTORS
 22 WARREN STREET

HY-SCORE AIR PISTOL

for ACCURATE SHOOTING

No pumping. Fast. Powerful. Finest made. Single shot. 30½ oz. 10¼" long. \$25.00 with pellets. Extra pellets per 1000 \$2.50 for cal .177, \$3 for cal .22.

SEE YOUR DEALER OR ORDER DIRECT

Send 10c for circular to Dept. M-5



SHOOTS CAL. 177 or 22 LEAD PELLETS

HY-SCORE ARMS Corp. BROOKLYN, I. N. Y.

DC MOTORS

¼, ½, and 1 hp Motors to operate on 12, 32, 110 and 220 volts DC, also AC Motors (high line) single phase repulsion induction in 1½ and 2 hp ONLY.

Mfgs. of AC Generators, Rotary Converters, Lighting Plants, Frequency Changers and high Frequency Generators.

KATOLIGHT 5 1402 First Ave. MANKATO, MINN.



MACHINISTS—TOOLMAKERS

Gerstner Tool Chests are made by skilled mechanics for tools of good craftsmen. Free Catalog.

GERSTNER TOOL CHESTS
 447 Columbia St., Dayton 7, Ohio



THIS BOOK SHOWS HOW TO DO IT

STEEL SQUARE POCKET BOOK

Completely Revised

This concise and handy little book illustrates and describes the best methods of using the carpenter's steel square in laying out all kinds of carpentry work. It is easy to understand as a picture of the square laying directly on the work shows exactly how the various cuts are made. Its compact and handy size makes it convenient to carry in the pocket for quick reference.

Price \$1.25 Postpaid

POPULAR MECHANICS PRESS
 DEPT. 627 200 E. ONTARIO, CHICAGO 11, ILL.

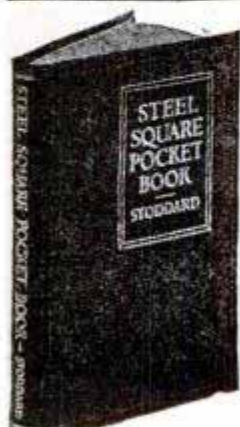

Move Daylight with You...

with this new Fluorescent "MOVE-A-LITE" FIXTURE



ONLY

\$3.95

Hang the MOVE-A-LITE fixture from ceiling hooks, plug it into any outlet—have bright, economical daylight any time you want it—any place: garage, work bench, poultry house, barn, kitchen! Blg. handsome fixture is 26" long; all steel construction. Rich brown satin finish with sparkling white enamel reflector. All materials UL approved.

SEND ONLY \$1.00 WITH ORDER

Postman will collect balance plus small postage charge.

T-12 20-watt

GE Fluorescent Bulb.....79c



MOVE-A-LITE MANUFACTURING CO.
 1135 Southern Blvd., Bronx 59, New York

AGENTS: Some territories open. Write for free details.

G & E Craftsmen's Bargains

ELECTRO MAGNETIC LIFT

An important labor-saver every repairman will use in many handy ways. For momentary work. Plug in any AC socket. 110 volt, 60 cycles; size 4¼" diam. by 3", with 22" cord and plug attached. Complete with instructions. Ship. Wt. 5½ lbs. No. 7618—only.....



\$7.35 each



FULFLO Heavy Duty FILTERS

Famous Fulflo Filter is ideal for gas, air or oil. Has ¼" inlet and outlet I.P.T. Heavy bracket attached for mounting. Complete, ready to install. Overall size 3-9/11" diam., 5" high. Ship. Wt. 4-3/4 lbs. No. 4753—only..... Lots of Ten \$1.85

\$1.95 each

HI-POWER ELECTRIC DRILL

Heavy duty ¼ inch capacity drill. Light weight—hand balanced. Three jaw chuck. Oil bronze bearings. Equipped with 6 feet flexible rubber cord and plug. 900 rpm at full load. Operates at 110V, AC or DC. \$17.95 No. 6202..... Each



Send check or money order, including postage. No C.O.D.'s
 DEALERS! WRITE FOR QUANTITY DISCOUNTS.

G & E EQUIPMENT SUPPLY CO.
 Dept. PM-17 400 N. SANGAMON ST., CHICAGO 22, ILL.

BOOST YOUR INCOME

with this



NEW LOW PRICED WELDER

WHEN you're equipped for arc welding, lots of profitable business comes your way—repairing broken parts, hard-facing worn parts, building special equipment. In photo above, a chipped tooth on an auto differential ring gear is being built up with "Fleetweld 47" electrode. Took 10 minutes for welding, 10 minutes for grinding. Income: \$3.00.



This new low-priced Lincoln "Fleet-Arc Jr." welder simplifies welding of all kinds. Its "Arc Booster" provides the world's easiest-striking A.C. arc. Continuous "Dial Tuning" current control—no plugs to shift. Range 20 to 180 amps. Meets utility and REA requirements. Write for free Bul. 365.

THE LINCOLN ELECTRIC COMPANY
Dept. 512 • Cleveland 1, Ohio

Largest Manufacturer of Arc Welding Equipment in the World

TRAILER AXLES, HUBS AND WHEELS

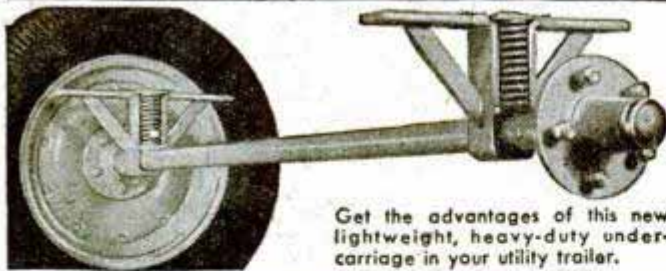

Get the advantages of this new lightweight, heavy-duty under-carriage in your utility trailer.

WHEELS
6:00 x 16
ONLY

\$10.90
EACH
HUBS

Complete with
Roller Bearing
ONLY

\$10.50
EACH

AXLES are strong tubular construction and are available with or without patented double-coil spring suspension. Straight axle has standard 58" tread; drop axle has 58½" tread. Spring centers 46" on both axles. Axle tested load capacity 2000 pounds. HUBS are pressed STEEL, equipped with roller bearings. WHEELS are ½" metal, strongly riveted, drop center, 6:00 x 16.

Remittance with order —No C.O.D.	Axle Only	Axle with Springs
Straight Axle, Std. Tread	\$10.90	\$25.25
Drop Axle, Std. Tread	19.40	34.45
(Springs fit our axles only)		
Wider tread axles available at additional cost		
PRICES F.O.B., FENTON, MICH.		

Write for descriptive literature

**MANUFACTURERS AND DEALERS
WRITE FOR QUANTITY LOT PRICES**

MANUFACTURED BY

INDUSTRIAL MACHINE TOOL CO., INC.

200 S. LEROY STREET

FENTON, MICHIGAN

USE THESE FAMOUS INDUSTRIAL DRILLS IN YOUR HOME WORKSHOP

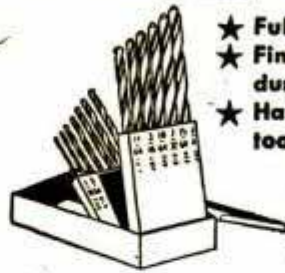

- ★ Full Length—Long Flutes
- ★ Finest H. S. Steel—Keen, durable
- ★ Handy case for pocket or tool kit

SPECIAL!

only **\$5.75** post paid

Michigan orders add 3% sales tax.

"Quarterpak" SEND CHECK, MONEY ORDER OR C. O. D.

13 DRILLS, 1/16" TO 1/4" BY 64THS IN HUOT CASE

LARGER SETS

No. 21—1/16" to 3/8" by 64ths, \$14.25

No. 15—1/16" to 1/2" by 32nds, \$15.50

No. 29—1/16" to 1/2" by 64ths, \$28.25

IF YOUR DEALER CAN'T SUPPLY YOU, WRITE DIRECT

ACE DRILL CORPORATION

DEPT. M • DETROIT 27, MICHIGAN

*Beautiful
Modern*

SIGN LETTERS

Signs anywhere, quickly, easily... Write for money making-saving plan... Samples
PINNACLE SIGN LETTERS, Mound City, Ill.

ELECTRIC LIGHT PLANTS: Used Government surplus. Guaranteed in good mechanical and operating condition. 110 volt, 3000 watts, powered by Briggs-Stratton or Wisconsin air cooled engines, \$149.50. No COD Orders, Limited quantity, act quick. Send for descriptive circular. **MIDWEST SURPLUS SALES CO., 1520 Locust St., Kansas City, Mo.**

FIVE ACRES AND INDEPENDENCE

A Practical Guide to the Selection and Management of the Small Farm

By M. G. Kains

This book is a complete, practical guide to the selection and management of a small farm. It explains how a small farm can be self-supporting. What farms not to buy. How to choose the right farm, based on proper soil, location, irrigation, elevation, climate, etc. Then a detailed explanation of what crops to plant and how to make them yield results, sure-fire methods of grafting, rotation, transplanting, etc. Finally, how to make a profit by selling your excess crops, livestock and preserves. Written by an expert who has made a

real success with many small farms. Revised, enlarged edition. 413 pages, profusely illustrated. Price \$2.50 Only \$2.50, Postpaid in U. S. A. (Outside U. S. \$2.75). Order Today

POPULAR MECHANICS PRESS Room 490 • 200 East Ontario St., Chicago

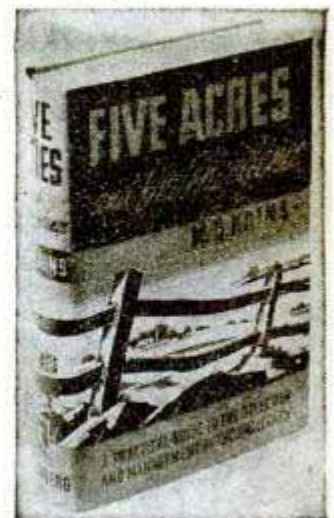

ROTARY DRILL MASONRY



Now easy to drill Concrete, Brick, Slate, Plaster

• Drills 4 Times Faster! • Stays Sharp up to 50 Times Longer! • Fits Any Rotary Drill, Hand Brace or Drill Press!

Your tool chest isn't complete without these new improved masonry drills. Tipped with Carbonyl Cemented Carbide—the hardest metal made by man—they drill clean, true-size holes with ease and speed. Handy 6-drill set, 3/16", 1/4", 5/16", 3/8", 1/2" and 5/8", in free canvas kit, \$13.70 postpaid, or C.O.D. From dealer or direct. Free leaflet.

CARBOLOY, COMPANY, INC.,
11185 E. 8 Mile Blvd., Detroit 32

CARBOLOY MASONRY DRILLS
CEMENTED CARBIDE

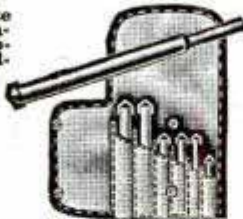

SCR-625 MINE DETECTOR BRAND NEW

The Mine Detector that tops them all. Metallic objects only. This detector is probably the best ever built for deep penetration and most positive detection of metallic objects. Portable and simple to operate. Operates from two flashlight batteries and 103 Volt battery, not furnished but easy to obtain. Originally sold by War Assets for considerably more money.

Price \$7950 ea.



PROSPECTORS OIL COMPANIES PLUMBERS, etc.

NOTE!

To locate gold, silver and ore-bearing rock, or for any use where deep penetration is necessary, we recommend the SCR-625 Detector. Its action is more accurate and positive. It will penetrate a far greater distance than the other detector.

MINE DETECTOR AN/PRS-1 BRAND NEW

For detection of metallic and non-metallic objects. Used to locate buried pipe, cables, sewer lines etc. The unit is a UHF transmitter and indicates objects by deflection of the microphone either to left or right depending upon whether metallic or non-metallic. Audio indication is also given by a change in volume of 1000 cycle tone. Ready to operate with addition of 1.5 V and 3.45 V batteries. Comes complete with spare tubes, antenna, reflector and instruction book—in wooden chest 9 1/2" x 28 1/2" x 15 1/2". Weight in operation 22 lbs. Shipped now in original overseas moisture proof container.

Price \$14.95 ea.

TERMS:
CASH WITH ORDER
or 25%
BALANCE C.O.D.
All items
Shipped Collect

ESSE Radio Company
130 W. New York St. - Indianapolis 4, Ind.

WAR SURPLUS BARGAIN SPECIAL

BRAND NEW! VACUUM-AIR HYDRAULIC FUEL PUMP

Original Cost
\$45.00
Now Only
\$9.95

Postpaid in U.S.A.

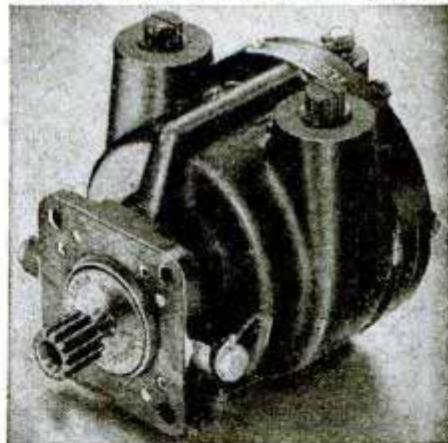

WORTH MANY TIMES THIS LOW SALE PRICE

USE THEM FOR
OIL BURNERS

SPRAYING
MACHINES

MILKING
MACHINES

COMPRESSORS
VACUUM PUMPS

HYDRAULIC
SYSTEMS

MANURE
LOADERS

PRESSES, etc.

Originally cost \$45.00. Used by the Air Corps to drive bomber de-icer boots, gyroscopes, automatic pilots, etc. May be used as air or fluid pump—for pressure or vacuum. Standard 3/8 inch pipe thread with interchangeable ports. Will pump 7 1/2 gal. SAE 30 oil per minute at 300 RPM. Builds air pressure of 30 lbs. per sq. in. at 1000 RPM. Vacuum will draw 26 inches of mercury at 1750 RPM. Develops up to 120 lbs. per sq. inch of hydraulic pressure, which in conjunction with a 3 inch hydraulic cylinder, will lift 840 lbs. minimum. Runs forward or reverse. Self-aligning shaft. Die cast aluminum housing 6x4x4 inches. Has stainless alloy steel vanes and impeller. Made by Bendix Avia, Corp. Spine terminal for direct drive—readily replaced with a pulley. Recommend a 1/4 H.P. or stronger electric motor as source of power. Rated capacity 1500 RPM with high overload factor. Special price for quantity users. Complete illustrated report and instruction booklet FREE with every pump. Send check or money order today. Postpaid in U.S.A.

\$9.95

GROBAN SUPPLY CO. 1522 So. Michigan Avenue
Dept. PMS Chicago 5, Ill.



\$179
PAIR

JUST IN SEASON
**MEN'S
SNEAKERS**

BLACK RUBBER SOLES
HEAVY BROWN CANVAS UPPERS

Sizes 6 to 10

Enclose Money Order & Shoe Size

Worth
\$3.00

EDWARD LAWRENCE CO., INC., 396 Broadway, N.Y.



New Designs in FRANZITE GRIPS

Modernize Your Gun! Improve Your Score!

Most durable grips made. Positively unbreakable! For Colt, Smith & Wesson, Hi-Standard, Ortgies, Luger & Mausers in a wide choice of beautiful designs in ivory, pearl, walnut, onyx, etc. Low prices. FREE CATALOG. Dealers Wanted.

SPORTS, INC., (Mrs.) 5501 Broadway, Dept. P-5, Chicago 40, Ill.

NEW! HOW TO WORK WITH PLEXIGLAS

Have fun or make money at home with plastics. Big book published by the makers of Plexiglas shows how. Dozens of pictures, full working instructions. Beautiful new things to make. Send this ad with your name, address and \$1.60 for your copy to

PLASTICS MFG. & SUPPLY CORP.

Dept. M-5, 4707 Euclid Ave.

Cleveland 3, Ohio.

MODELS DEVELOPED AND BUILT

The Thompson Engineering Co.

210-A WINCHESTER BUILDING

GRAND RAPIDS, MICHIGAN

WAR SURPLUS

Lathes, Milling Machines, Drill Presses, Sawing equipment, Motors and thousands of miscellaneous items. Also information on Helicopters, Sleeper Trailers, Garden Tractors, Power Lawn Mowers, Welders, Jet Impulsion for Cars and Tractors etc. Rush name for free literature.
THE WAYNE ENGINEERING CO., DEPT. 1122, GREENVILLE, OHIO

NOW 93% MORE ENERGY, LONGER LIFE

Get the New "Eveready" Flashlight Batteries

The word "Eveready" is a registered trade-mark of National Carbon Co., Inc.



**BOTTLE GAS
REGULATORS
CYLINDERS-ACCESSORIES**

WHOLESALE and RETAIL
WRITE FOR FREE CATALOG
AND LOW PRICES

APPLIANCE SERVICE CO.
Dept. 11 VIRGINIA • MINNESOTA



The New VICTORY KING

LAWN SPRINKLER

This no-tip, light weight stand will not mar your lawn. Sturdily constructed, nonbreakable, finished in blue baked enamel. All essential parts of best quality brass.

4⁹⁵

Postage
Prepaid
in U.S.A.

Will attain equal saturation over 40 foot lawn area. Operates on high or low pressure.

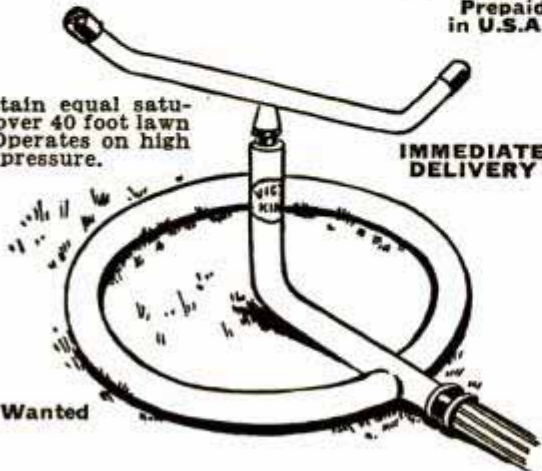

IMMEDIATE
DELIVERY

Agents Wanted

VICTORY WELDING & MFG. Co.

11115 South State St.

Chicago 28, Ill.

Become a Radio Ham! LEARN THIS FASCINATING HOBBY AT HOME With These Easy-to-Read BOOKS



Start now to become a member of the famous Radio Amateurs who make history with their thrilling world-wide contacts. It's easy to learn with these simple manuals.

RADIO AMATEUR HANDBOOK—1947 EDITION— Gives principles and design of receivers, Transmitters, Antennas, etc. All about code, telephony, tubes, data. Charts and diagrams. Over 600 Pgs. **\$1.25**

GET THESE INEXPENSIVE BOOKS

HOW TO BECOME A RADIO AMATEUR— Standard beginner's guide. Symbols and simple instructions, data, etc. 48 Pgs. **Only 25¢**

LEARNING THE RADIO-TELEGRAPH CODE—Home-Study course in code— Sending and Receiving. A valuable book. **Only 25¢**

LICENSE MANUAL— All FCC Rules and Regulations plus Questions and Answers for Class A, B, & C examinations. **Only 25¢**



TELEGRAPH KEY

Professional Signal Corps key. 3 3/4 x 3" Bakelite Base Switch and Silver Contacts. Ideal for code practice. A real bargain for **ONLY 49¢**

Send for Bargain Bulletins with Terrific Values. Visit any of our 3 Great Stores and see for yourself. Mail Orders Filled from Either New York or Chicago.

NEW YORK
Offices & Warehouse
242 W. 55th St., N.Y. 19

NEWARK CHICAGO
323 W. Madison St.
Chicago 6, Ill.
ELECTRIC COMPANY, INC.

New York City Stores: 115-17 W. 45th St. & 212 Fulton St.



PRACTICAL BOOKS ON HOME PLANNING BUILDING · REPAIRS

MAIL
ORDER
TODAY

Plan Now—Build When You Can
Books Sent C.O.D. Anywhere in U.S.A.

Select from this list of helpful books. In U. S. books sent postpaid if remittance accompanies order. Outside U. S. include 15% extra for shipping charges.

- How to Plan a House...\$4.50
- House Construction Details\$3.00
- Painting, Decorating.....\$1.50
- Carpentry\$2.00
- Painting, Furniture Finishing and Repairing
Includes floor renewal\$1.50
- How to Remodel a House
Complete, practical...\$4.75
- Building Insulation.....\$3.50
- Concrete Handbook
Do work for yourself, others\$1.50
- Blueprint Reading for Building Trades.....\$1.25
- Practical Bricklaying..\$1.75
- Simplified Carpentry Estimating\$3.00

FAMOUS PLAN BOOKS
Books contain floor plans, photos, descriptions of homes.
AMERICA'S BEST LOW COST HOMES. 125 designs.\$1.00
DE LUXE SMALL HOMES. 210 designs.\$1.00

OUR FUTURE HOME. Wide selection of residences, summer homes, garage apartments. \$1.00
MODERN HOME & GARDENING. 42 popular designs. Improvements, garden shortcuts, etc.50c

Set of
Four
Books
\$3.50



Stair
Building
\$2.00

POPULAR MECHANICS PRESS

Dept. 640 - 200 E. Ontario Street, Chicago 11

★ ★ ★

MAKE YOUR OWN POWER TOOLS at Low Cost from old Auto Parts, etc.



A New Edition

Featuring TOOLS of WOOD

Now you can have a good lathe, drill press, circular and band saw and other power tools in your home workshop, at a cost of only a few dollars each. Make them yourself from old auto parts, discarded sewing machines and other odds and ends that cost little or nothing. Get this new book—"Forty Power Tools You Can Make." Costs only \$1.25 postpaid. This book gives every detail in plain language you can understand and follow. Hundreds of pictures and plans show every step to follow in making the power tools you want. Actual photographs of finished machines included. Send \$1.25 today. Money back if not satisfied.



MAKE EVERY POWER TOOL NEEDED IN YOUR HOME WORKSHOP

- Some of the power tools you can make are:
- 2 Band Saws
 - 9 Sanding Machines
 - 2 Circular Saws
 - 1 Metal Lathe
 - 1 Power Hack Saw
 - 1 Jig Shears
 - 1 Cut-Off Wheel
 - 2 Drill Presses
 - 1 Scroll Saw
 - 2 Wood Turning Lathes
 - 3 Grinders
 - 1 Shaper or Moulding Machine
 - 1 Vibrating Pencil
 - and others

Information too, about pulleys, belts, motors and drive methods. Just published. No other book like it. Order today.

POPULAR MECHANICS PRESS

Dept. 621

200 E. Ontario Street, Chicago 11

POPULAR MECHANICS



... Quick Easy Way to BIG PROFITS

Read What Others Are DOING!

"Enclosed you will find 56 orders representing 9 1/2 hours' work on Monday and Tuesday."
 "Enclosed are twelve orders secured after supper this p.m."

Housewives are Enthusiastic

Everyone that sees this outstanding Cell-U-Mop immediately wants one . . . That's the reason why our distributors are so successful . . . You also have the advantage of our other QUICK SELLING PRODUCTS that step up your Volume Sales and Profits.

• We Teach You How •

Gets down under and around for MOPPING, DUSTING or WASHING

DOES THE WORK OF 6 TOOLS IN 1

Get Choice Territory NOW!

Holds 20 times its weight in water.



Sales QUICK, EASY Every Locality

SALES ARE EVERYWHERE . . . Sells quick to Taverns, Clubs, Hotels, Hospitals, Stores, Restaurants, Large and Small Buildings and the Homes . . . Scores can be sold on a single street . . . Note the Drain Bracket in the illustration . . . This squeezes out the water so thoroughly that HANDS NEVER TOUCH THE WATER . . . Makes no difference what you ever sold, you will like this proposition . . . Your name on a Post Card will bring you FREE PARTICULARS.

CELL-U-MOP CO., Dept. P-5, FREEPORT, Ill.

48" Long Handle

LAW

STUDY AT HOME for PERSONAL SUCCESS and LARGER EARNINGS. 38 years expert instruction—over 108,000 students enrolled. LL.B. Degree awarded. All texts furnished. Easy payments. Send for FREE BOOK—"Law and Executive Guidance."

AMERICAN EXTENSION SCHOOL OF LAW
 Dept. 77-M 646 N. Michigan Ave., Chicago 11, Ill.

SHINE

your shoes brighter this new easy way in less time than ever before.
 —For Office, Home and Travel—
 The Jay-O Patent Shoe Shiner buffs the heel, toe and sides with amazing speed. Uses less polish. Shoes last longer. Comes with polishing cloth, dauber brush, 2 boxes black & tan Dyanshine, and simple directions with money back guarantee.

COMPLETE \$2.00 POSTPAID
 "Give one to a friend"

THE JAY-O MFG. CO.

140 Manchester Lane, Kirkwood 22, Mo.



Agents, write for quantity discount.

TELEPHOLA RADIOS

Highest quality—written guarantee: Five tubes plastic walnut finish \$17.95; Six tubes \$21.45—Ivory Finish \$1.90 extra. Portables \$33.45—Batteries \$3.50 extra. Electric Phonograph, simulated alligator case \$33.95. Many others to choose from. Send for free illustrated circular—Cash with order or 25% cash balance C.O.D.

TELEPHOLA RADIO DIVISION, HORN ELECTRONIC COMPANY
 DEARBORN, MICHIGAN

No. 36 1/2 STANLEY CALIPER RULE

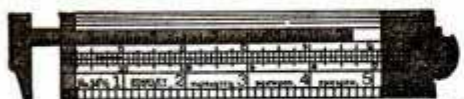

\$1.15
 POST PAID

Surplus stock—New 6" boxwood rule opens to 12". Catalogue of other tools 40c—Refunded on first \$10.00 order. No export sales.

VETERAN TOOL & SUPPLY CO.

88 BAXTER STREET

NEW YORK CITY

DEPT. 5

5 PLASTIC PROJECTS

\$1.00



Kit contains Flexiglas, cement, full-size plan sheets, sand paper, pin backs and instructions to make 5 beautiful plastic projects—projects that you would pay \$5.00 for at any retail store. Projects include: candy dish, 2 initial label pins, letter opener and tie clip. Easy to make. An excellent way to try this new hobby of plastics. Act now. Send only \$1.00 for your big introductory kit. Mail today.

JACKSON, 5440 N. Shoreland Ave., Dept. 15, Milwaukee 11, Wis.

Learn Welding • Spare Time!

See our ad Page 275

DYNAMIC WELDER CO. 13 E. 23rd St., RT. CHICAGO 16, ILL.

GET INTO YOUR OWN PROFITABLE BUSINESS!

BIG PROFITS IN CONCRETE CINDER BUILDING BLOCKS

Capture Your Share of the Big Building Boom. Supply the Great Demand for Quality Blocks Needed Everywhere for Every kind of Construction Work.



Prosperity and financial independence can be secured in this fast-moving, highly profitable field today. Think of the great building boom that's ahead of us. Everywhere there's a great demand for new homes, apartments, factories and stores. Aggressive men, with modest capital, are now desperately needed in this highly profitable field. Here is YOUR GREAT manufacturing opportunity. Don't wait! Send for

full money-making details today!
HURRY! LIMITED NUMBER AT SPECIAL PRICES!

So as to get our famous Blocker Vibrator Concrete Cinder Building Block Machines operating in many different localities we have a limited number at a special value price. Rush coupon immediately for full money-making facts. **DO THIS TODAY!**

CONCRETE BLOCK EQUIPMENT CO., INC.

920 Central Dept. 412 Kansas City 6, Mo.

MAIL THIS COUPON TODAY

920 Central Dept. 412 Kansas City 6, Mo.

Please tell me how I can start a profitable business of my own with highly profitable Concrete Cinder Building Blocks.

NAME _____
 ADDRESS _____
 CITY _____ STATE _____

(Paste on a 14 Post Card & Mail)

FACTORY REJECTS (UNPOLISHED)

FULL SIZED PIPES OF GENUINE
IMPORTED BRIAR

Below
Manu-
facturing
Cost —
(To Make
New
Friends)



3
PIPES
FOR
ONLY—
\$1.00
POST-
PAID

These pipes of genuine imported briar were taken out of the factory production line of \$3.50 to \$5.00 pipes before final smoothing and polishing due to defects which do not impair their smoking quality. Smoke them "as is" or fill the defects with wood filler, then smooth and polish. Limited supply. Act Today.

5 NEW YORK CITY STORES

10 E. 45th ST. • 3 W. 51st ST. • 157 B'way
1789 B'way cor. 58 ST. • 93 Nassau cor. Fulton ST.

Send Mail Orders to—

WALLY FRANK, Ltd.

150 NASSAU STREET, NEW YORK 7, N. Y., Dept. 324

Enclosed find \$1.00. Send postpaid 3 pipes described above. If, upon examination, I am not satisfied, I will return pipes for full refund. (Sorry . . . no C.O.D.'s).

PRINT NAME AND ADDRESS BELOW

Range Thermostat for the Blind Regulates Baking Temperatures

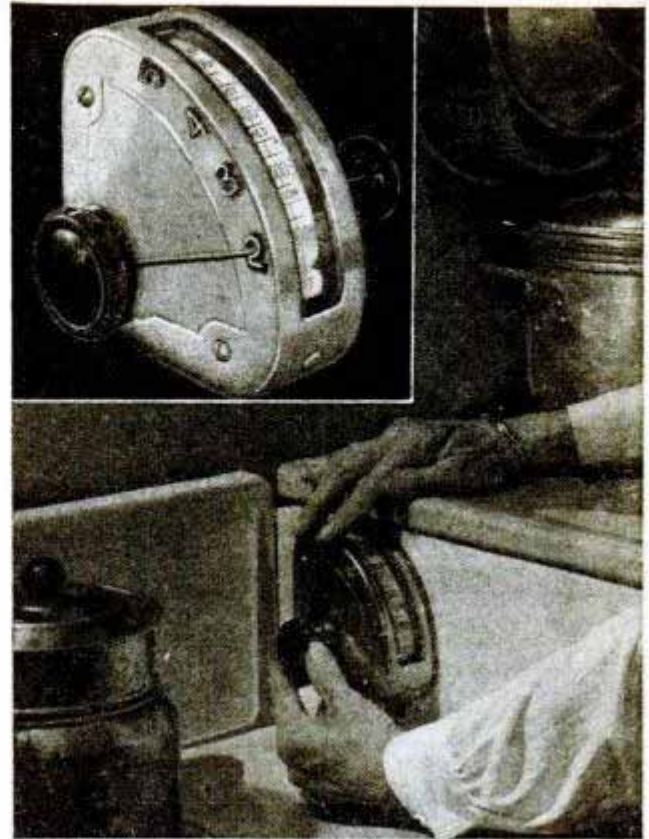

Raised numerals on a thermostat enable a blind woman in Carmel, Calif., to set her electric range for a desired temperature when cooking or baking. The numerals 2, 3, 4 and 5 correspond to 200, 300, 400 and 500 degrees temperature. Arthur Russell, appliance repairman for the Pacific Gas and Electric Company, designed the thermostat for Mrs. F. A. Bacher.

Pocket Filter Purifies Water

Sportsmen or construction crews isolated from safe public water supplies now can have pure drinking water. A pocket-sized filter kit, originally developed for the Army, is available. The kit includes a hand pump, filter and chlorinating tablets.



RICHLY TONED

BELL

**GENUINE
NAVAL BRASS
BELL METAL**

**CAST & MACHINED
by Famous ENGLISH BELL FOUNDRY**

Overall length 9½". Diameter 5". Ball and chain clapper. Hardwood handle with machined brass fittings. A perfect farm and ranch dinner bell. Easy to make into magnetic door or warning bell for home, auto or boat. The beautiful tone is audible up to ¼ mile, or may be muted.

LIMITED SUPPLY—ACT NOW!

Imported from England. Surplus war stock. Bells of this type seldom sell for less than \$15.00. Orders will be filled as received until stock is exhausted. Print name and address on paper. Attach to coupon and mail NOW. Immediate delivery.

MAKE THESE
YOURSELF!

DOOR
BELL



AUTO BELL



BOAT BELL



ORDER TODAY! **\$4.85**
plus
15c Postage

PATTERSON-FLETCHER CO.
FORT WAYNE 2, INDIANA

Enclosed Find CASH CHECK OR M. O.
for \$5.00 or Ship C. O. D.

Shipped Anywhere in the U. S. A. — SATISFACTION or MONEY BACK

LARGEST DISTRIBUTORS for

Mobile Gasoline 16 K-W G. E. Power Plant

GOVERNMENT SURPLUS!
Original cost approx. \$12,000.00!



For POWER UNIT Use
Same power plant as above
Less power generator and instrument panel.

PG60R-998, F.O.B. Chicago, ea. \$795.

Practically New self contained power plant ready to operate—100 V. at 1200 R.P.M.—16 K.W. Approx. 9 ft. long, 5 ft. high, 56 in. wheel centers. Equipped with 5 disc wheels and 4—6.00x16 New Tires, Hand Brake, Shock Absorbers, Tool Box containing Tools to service unit, Fire Extinguisher and Tow Bar. Has been run slightly by the govt., shows no signs of wear and GUARANTEED by us to give the same service as a new unit.

Hercules 6 cyl., JXD Gasoline Engine with accessories: Radiator, Gas Tank, Fan and Governor.

Hercules Engine—JXD, 6 cyl.; 84 H.P. at 2800 R.P.M.; Bore, 4 in.; Stroke, 4 1/4 in.; Displacement, 320 in.; Compression ratio, 5.78 to 1.

General Electric Type GT-1508-B1 D. C. Generator connected to engine.

Control Panel mounted with main power switch, field rheostat, tachometer, indicators, controls, light switches.

POWER GENERATOR—G. E.

Volts	Amps.	RPM	Kilowatts
100	5	1200	0.6
100	160	1200	16.0

Voltage and kilowatts can be increased by increasing engine speed.

PG60R-998
Our Low Price, **\$995**
F.O.B. Chicago, EACH....

NEW 5 Gal. CANS



FOR GAS, OIL OR WATER
Vented for Safety
Self-locking Safety Cap
Extra Heavy Construction
Will Float When Full
Heavy duty 5 gal. safety emergency cans as used by the Army. Size of can, 18" high, 8 1/4" thick, 13" wide.
PA35U-60—
Lots of 5, ea. 1.15
Lots of 50, ea. 1.05

Lots of 100, Each **98c**

Brand New DAYTON 33" FIFTH WHEELS



Complete with mounting plate.
PD36N-3—
Each \$42.50

Lots of 3, Each... **\$39.50**

POWER TAKE-OFF for JEEP ENGINE

Bolts to clutch housing on the Jeep engine. Has a spline shaft to engage with clutch and extending from rear is a keyed



shaft on which pulley can be mounted. Hand lever controls clutch.
PF4N-23J—
Each.....

\$42.50

New 2 Ton HAND WINCH

gear driven wheel, length of chain and hook.



PF9N-17—
Each \$22.50
Lots of 3, Each

\$1950

Voltage Circuit Tester

A New Low Voltage Tester for testing generator, voltage regulator, starter, battery, cut out, and ammeter without removing parts from car.



A trouble shooting device for complete and rapid check of the battery circuit, including any current and voltage regulator. Manual is included.
PB15N-49—
Each ... \$26.35
Lots of 3, \$2250
Ea.

Lots of 2, packed in wood box. Ea. Hoist **\$17.50**

65 KW-225 VOLT GENERATING UNIT

Hercules Engine with General Electric Generator 6 cylinder model RXLCT Hercules Gasoline Engine—4 1/2" bore, 5 1/4" stroke. Complete with Carburetor and electrical equipment. The 225 Volt-65 Kilowatt General Electric Generator is attached to the engine. Generator develops 290 amp. D.C. current at 1800 R.P.M. In good usable condition ready to operate. Complete Less Radiator.

PG60U-191—
Each..... **\$595**

DIESEL Electric Unit

Same unit as on left except equipped with DEXX Hercules Diesel Engine. 4 3/8" bore. 1 1/2" stroke.

120 H.P. at 2000 R.P.M.
PG60U-193—
Each..... **\$1750**

7 1/2 Gal. Capacity RADIATOR for generator units. Reconditioned.
PC2R-450—
Each..... **\$69.50**

60-H.P. JEEP Engines



\$4.20 Crating Charge

Rebuilt by the Government, and Dynamometer Tested! GUARANTEED EQUIVALENT TO A NEW MOTOR!
This Entire Engine Assembly is Ready To Install!

COMPLETE with . . . Generator, Starter, Distributor, Coil, Fan and Fan Belt, Water Pump, Fuel Pump, Intake and Exhaust Manifolds, Carburetor, Oil Filter, Spark Plugs, Flywheel, Clutch Assembly, Wiring.
Outright
PG58R-001
Each..... **\$11750**

Write for Special Price Quotations in Quantities.

USED JEEP ENGINES

Complete with all accessories. PG58U-001—
Outright, Ea..... **\$95.00**

5 Ton-Truck POWER WINCH



FITS ALL TRUCKS

Specify Year, Model and Type of Transmission of your truck so we can supply the proper take-off with winch.

5 Ton Winch Complete with Cable and Hook, Power Take-off, Roller Bearing Drive Shaft and Joints. (As shown.)
PF9N-10—Each

\$225

5 Ton Winch Only with Cable and Hook.
PF9N-11—
Each **\$159.50**

1/2 TON HAND HOIST



Ideal for Mechanics, Garages, Boats, Carnivals, Circuses

4000 lb. capacity. All New. Used by Army as bomb hoists. Cable is 3/16" stranded wire. 18 1/2 ft. long with steel hook. Long handle with 3 holes for various leverage. Wood box measures 21 1/2" long, 11 1/4" wide; holds 2 hoists and 2 handles—weight 68 1/2 lbs.

PFN-15—
Each Hoist **\$19.95** | Lots of 2, packed in wood box. Ea. Hoist **\$17.50**

SEND 25% or more DEPOSIT with Order. Balance C.O.D. Shipments F.O.B. Chicago. Specify way of shipment.

IMMEDIATE SHIPMENT!
GET OUR LOW PRICES on REBUILT MOTORS

- FORD
- PLYMOUTH
- CHRYSLER
- CHEVROLET
- DODGE
- LINCOLN ZEPHYR

J.C. WHITNEY & Co.

1917 Archer Ave. Chicago 16, Ill.

EVERYTHING AUTOMOTIVE....

SAVE MONEY at.....

FEET HURT? WEAR Airflow Cuboids

CHANGE TO ANY SHOE

PATENTED ARCH-WING HELPS MAKE SHOES HUG THE ARCH

PILLOW-SOFT METATARSAL EASES PRESSURE ON BURNING CALLOUSES

POCKETS UNDER ARCHES WITH EXTRA CUSHION INSERTS MAKE ADJUSTMENTS SIMPLE AS A B C TO RAISE ARCHES EXACT HEIGHT NEEDED FOR EACH INDIVIDUAL FOOT

CUBOID BONE SUPPORTED BY SOFT SPONGY AIR-CUSHIONS

WALK-STRAIGHT CUSHION HEEL ABSORBS SHOCKS AND JARS, AND HELPS PREVENT WHETTING OF SHOE HEELS

METATARSAL PILLOW

ARCH-WING

AIRFLOW

CUBOID

\$5.00 PAIR

ANY SIZE FOR MEN OR WOMEN

A SUPERIOR FOOT-COMFORT ARCH SUPPORT FOR THOSE WHO DEMAND THE MOST IN LIGHTNESS, SOFTNESS AND RESILIENCY! Airflow Cuboids are scientific and practical in design—for Weak Arches, Callouses, Tired, Aching Feet, Foot and Leg Pains. Send \$5 for each pair wanted—your shoe size, including width. Full directions, and extra arch lifts included with each pair, to raise arches the exact height needed for each individual foot. We pay postage on all mail orders if money accompanies the order. Made exclusively by

C. H. STEMMONS MFG. CO.
300 E. 51st St., Dept. 15 Kansas City 2, Mo.

SAY YOU SAW IT IN POPULAR MECHANICS

WORLD'S LOWEST PRICED ADDING MACHINE

VEST POCKET SIZE
IDEAL FOR BUSINESS OR PERSONAL USE

FREE TRIAL
ONLY \$2.50
TOTAL COST
SEND NO MONEY

Each Baby Calculator in Beautiful, rich-looking Leatherette case—at no extra cost. FREE!!



Fits vest pocket or purse. Guaranteed accurate. Operated as easily, and as reliable, as machines costing many times as much. Not a toy. Substantially made of 28-gauge steel—guaranteed for life against defects in construction. You positively can't buy a calculator of equal quality for as little money. **ACCEPTED AS THE FINEST LOW PRICED CALCULATOR FOR OVER 30 YEARS!** Operates with a flick of your finger. Adds, subtracts, multiplies, divides—counts up to ten million. Pays for itself over and over in mistakes avoided, and time saved. **MAKES IDEAL GIFT.**

Sold on a positive money back guarantee. Send only \$2.50, Calculator sent postpaid, or send name and address and pay postman \$2.50 plus postage. **MONEY BACK IN 10 DAYS IF NOT DELIGHTED!** (If outside U. S., send \$3.00.)

AGENTS WANTED.
CALCULATOR MACHINE CO. (Mfrs.)
Dept. 190, P. O. Box 248, Glenview, Illinois

Swivel Scoop Removes Clinkers



Small clinkers are easily removed from stoker-fired furnaces by a scoop which swivels on a friction joint. It gets into hard-to-reach places to pick up soft ash and small, broken clinkers. Swivel action is produced by pulling or pushing the handle which is attached to a curved shaft.

4000 Times Sweeter Than Sugar

So sweet is a newly discovered sugar substitute that the tiniest pinch of the substance on the tongue can still be tasted a half hour later. Unnamed as yet, the ultra-sweet chemical compound is derived from benzene and is 4000 times as sweet as cane sugar. Saccharin, a common sugar substitute, is only 200 to 700 times as sweet as sugar. The new compound, sweetest substance known, was developed by Professor Pieter Eduard Verkade of Holland.

Dirt Road Driving Proves Costly

Driving on dirt roads costs almost twice as much as driving on paved roads, according to figures compiled in a 330,000-mile test. On dirt roads, cars use more gasoline and nearly twice as much oil. Tire wear is two thirds greater and maintenance cost is doubled. Prof. R. A. Moyer of Iowa State College reported that on paved highways gas, oil, tires, maintenance and depreciation cost a little over two cents a mile compared with four cents a mile on dirt roads.

HAND MICROPHONE



Top quality hand microphone with control button in handle. Highly sensitive. Has rubber covered cord and tel. plug. Fine for use on home recorders, public address systems, etc. Brand new—perfect. Shp. wgt. 2 lbs. Stock No. 170. Each **\$1.95**

MESS KITS

Regulation two-piece Army Mess Kits with folding handle. Used but perfect. Weight 2 lbs. No. A116—Ea. **69c**



CANTEENS

Reg. U. S. Issue canteens. Plastic screw top chained to body. Slightly used but perfect. Wgt. 1 lb. 117—Metal **69c**
118—Plastic—Ea. **69c**



CANTEEN CUPS

All metal. Folding handle. Wgt. 1 lb. No. A120—Each **25c**

CANTEEN COVERS

Heavy canvas. Button fastener. New No. 530—Each **69c**
Used No. 119—Each **35c**

ARMY BANDOLEERS

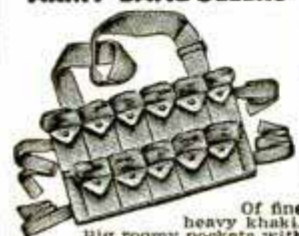

Of fine heavy khaki. Big roomy pockets with snap button fasteners. Fine for hunters, campers, boy scouts, etc., also for shop work in carrying small parts, etc. Material alone is worth this price. Shp. wt. 1 lb. 11 Pocket **49c**
120 Each **29c**

BAYONET BLADE

Fine forged steel. Ground but not polished. May be made into throwing or hunting knife or spear. Blade 6 3/4 x 1/2 inches, 11 3/4 inches overall. Will take and hold a fine edge. Shp. wgt. 1 lb. No. 664-R—Each **49c**

ARMY TENTS

16x16 Ft. A value you can't beat. Big 16x16 ft. pyramid tent with 4 foot drop wall. Used but in excellent condition. Poles not included. Fine for camping out, carnivals, etc. Worth twice this money. Shp. wgt. 100 lbs. Stock No. 521 Each only **\$35.00**



Professional TELEGRAPH KEY

No. 147 EACH **98c**



Purchased from the gov't. Finest design and construction. Base measures 3x4 3/4 inches. Original value \$2.50. All parts of instrument brass. Adjustable.

LIFE PRESERVER BELTS

Right from the invasion beaches. Consists of two air chambers. May be inflated automatically with "sparklet" cartridges or manually by attached hose. Adjustable in waist size. One air chamber guaranteed air tight—other may need a tire patch. All belts are used and slightly soiled but a bargain at this low price. No. 1261—Each **\$1.00**



WAR SURPLUS AND HUNDREDS OF OTHER BARGAINS

POPULAR RECORD ASSORTMENT



Fifty records of modern dance, race, blues and hillbilly selections. No two alike. Famous name bands and artists included. Used in juke boxes, but guar. perfect. Shipped exp. collect only—no exchanges or refunds. Wgt. 28 lbs. No. A303—50 records **\$9.64**

No. A300—25 Records. All Dance. Wgt. 14 lbs. **\$4.88**

No. A301—25 Records. Hillbilly, Race and Blues. Wgt. 14 lbs. Set... **\$4.88**

No. 302—25 Records. All Hillbilly numbers. Wgt. 14 lbs. Set... **\$4.88**

TELESCOPING BAIT AND FLY ROD

Combination 4 piece telescoping bait and fly casting rod. Screw locking reel seat. Cork grip. Snake guides. Extends to 9 feet, telescopes to 38 inches. Shp. wgt. 1 lb. No. F411—Each **\$3.65**



SACHEL POUCH

Heavy canvas pouch. Ideal for totting lunches, shopping, books, etc. Has 11x12 inch pocket. Brand new, guaranteed perfect. Has oversize flap with single strap fasteners. A113—EACH **\$1.69**



RADIO HEAD-PHONES

Extremely sensitive with 4000 ohms resistance. Brand new and fully guaranteed. With moisture-proof cord and phone plug. A splendid value for the radio serviceman and experimenter. A106—PAIR... **\$2.95**
New super sensitive phones. A108—Pair **\$5.95**



Plastic 8 oz. Flask

For hunters, scouts, fishermen. Waterproof and transparent. Use it for liquids. Use it for matches, files, bait, etc. Has screw cap top for liquids, plus full open top. Size 5 1/4 x 4 1/8 x 1 1/8 ins. Has hundreds of other uses. Wgt. 1 lb. No. A347. Each **29c**



FLYERS GOGGLES

Heavy rubber frame. chamolins skin lined. Made by Polaroid. Complete with 8 extra lenses, 3 green, 3 ruby, 2 clear. Shatterproof. Ventilated. Adjustable head band. Protects eyes from glare, dust, dirt, wind, etc. Use at work and play. Brand new. Shp. wgt. 1 lb. No. 329. Each only **98c**



7 LB. EXPERIMENTER PARTS ASSORT. KIT

A "gold mine" for the radio serviceman. Hundreds of valuable radio parts, new radar and electronic parts and subassemblies, coils, resistors, trimming condensers—worth many times this low price. A130R—7 lbs... **\$1.79**



OXYGEN TANKS

A shatterproof, welded seam oxygen tank. Fits gauge listed above. Measures 5 1/2 x 8 in. Internal volume 104 cu. in. Square inch pressure 1.4 cu. ft. Has 3/8 inch pipe thread vent. Shp. wgt. 2 lbs. No. 537. Each **49c**



WOOL SLEEPING BAG

G.I. type 100% wool with 30 inch Talon zipper. Used but renovated for reissue. Shp. wgt. 3 lbs. No. 65. Each **\$3.95**



LEVEL WIND ANTI BACK LASH REEL

Highest quality with chrome plated frame: 3 piece take down design, 4 x 6 3/8 in. bronze bearings and jeweled spool caps. Spool diameter 1 1/2 in.; pillar lengths 1 1/2 in. Capacity 100 yard line. Onyx head ring. Shp. wgt. 1 lb. No. 450F—Each only **\$8.55**



RAIN SUITS

New 2 piece rain suits. Of durable wear resisting water and wind repellent OD fabric. Bib style pants, zipper fly. Jacket has parka attached. Guaranteed 100% weatherproof. Small, medium and large sizes. Shp. wgt. 3 lbs. No. R549. Ea. **\$4.95**



2 Man Mountain Tent

Regulation Army type two man mountain tent, complete with poles, guy ropes, etc. Of durable nylon with reinforced seams. Ideal for outdoorsmen, campers, etc. Shp. wgt. 10 lbs. A splendid value. Stock No. 202—Each **\$9.95**

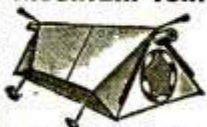

PUP TENTS

Regulation Army Pup Tents of durable, brown canvas. Used, but in good condition. Fine for campers, outdoorsmen, boy scouts, etc. Wgt. 8 lbs. A100—Tent only **\$3.95**
A110—Tent, new **\$7.95**
A101—Ropes, wooden poles and stakes for above. Per set **\$1.00**



27 LENSES, ALL NEW, PERFECT. For experimental work in optics. Consists of 27 precision ground and polished prisms and lens elements in assorted diameters and focal lengths. Big variety, positive, negatives, etc. Actual value over \$100.00 **\$7.95**
A519—27 PIECES



50 LENSES SEMI-FINISHED

Lenses similar to above but not polished. All are blanked and formed ready for polishing. Negatives, positives and prisms in Crown and Flint glass. Worth many times this low price. A520—50 **\$1.95**
LENSES, ONLY



ONE MAN RUBBER BOAT

Similar to above but smaller. Designed for one man use. Each boat complete with oxygen tank—packed in a special parachute bag. Wgt. 15 lbs. No. 526—Each **\$17.95**

METAL TOOL CHEST



All metal welded construction 16x 8 1/2 x 11 overall. Has 5 roomy, easy sliding drawers. Hinged drop front. Metal top and end handles. Use it for tools, small parts, etc. Shp. wgt. 40 lbs. Stock No. 282. Each **\$9.75**

CAMERA TRIPOD



Purchased from Gov't. Used but perfect. For cameras up to 8x10 inches. Folds to 32 inches, extends to 58 inches. Needs adapter to mount camera. Wgt. 5 lbs. Stock No. 190. Ea. **\$4.95**

ORDER DIRECT FROM THIS AD

Values galore! Hundreds of hard-to-find items for home, shop and outdoors. Make remittances by money-order, bank draft or personal check. Send 25% deposit on C.O.D. orders. No C.O.D.'s on orders for less than \$5.00. Include sufficient postage on parcel-post orders—any overage will be promptly refunded. All quotations F.O.B. Chicago. Used items and materials are guaranteed serviceable and as described. Your money back if not more than satisfied.

Big Illustrated Catalog Free
WRITE FOR YOUR COPY TODAY

STARK'S Dept. PM547
509 So. State St.
CHICAGO 5, ILL.

Drill Press

WORK SHOP TOOLS BY

Barron



5-in-1 ROTARY DRILL PRESS
PLANNER—PLANES, PANELS,
RABBETS, ROUTS, TENONS, GROOVES

\$7.50

Over 60 000 now in use by pattern and cabinet makers, carpenters, hobbyists, etc. Fits any drill press. Lightening fast, accurate, safe, easy to use. Complete. No special blades needed. No shop complete without COMPLETE it. Fully guaranteed. For all woods and plastics.

New Style MORTISING and ROUTER BITS

Range in size from 1/8" to 1/2". Priced in individual sizes or by the set. Provides entirely new spiral flute cutting principle for faster chip clearance, smoother, accurate routing, carving, veining, grooving, round-end mortising. Extra long cutting flutes. Finest hi-speed tool steel—Super for woods and plastics.

\$9.50



SET OF 6 SIZES

NEW! 4' Rotary Surface SANDER



New larger Barron Sander with live sponge rubber pad bonded to metal. Sanding discs changed instantly. For use on any drill press, flexible shaft or motor. Guarantees a dead-true, agate smooth surface. No ridges, waves, ripples, or striations. Fully guaranteed. Complete with 20 sanding discs.

\$5.95

ANNOUNCING

New Dovetail Cutting Tool for Drill Press \$1.85 each. All Metal 13" x 18" Auxiliary Drill Press Table \$9.85. Tapered and Threaded Drill Press Adapters \$1.00 and \$1.50 each.

Liberal 10 Day Money Back Guarantee

Workshop Guide FREE



BARRON TOOL CO.

569 Architects Bldg., Detroit 1, Mich.

CRAFT FINISHES SUPPLIES

Materials to produce a professional finish on every type article. Industrial finishes for the home craftsman's use on wood, metal, plastics, plaster, etc. Electroplating and shop supplies, novelty finishes. Catalog free.

CRAFT FINISHES Box M 467 Arlington, Virginia

STOP RADIATOR TROUBLES WITH

THE SCALE-TRAP

Scale Trap, an amazing rust-proof device with a special screen filter, prevents engine scale from the head and block entering and plugging car radiator. Allows free passage of water, but STOPS scale. Easily installed on upper hose connection. Helps eliminate the cause of radiator trouble—helps prolong the life of your engine.

195

STOP SCALE

Easily Installed—Easily Cleaned

Get one today from your dealer or order direct. Send check or money order.

CUMMING TOOLS, Inc. 501-03 East 18th St. Kansas City 8, Missouri

Enclosed find \$_____ for _____ Scale Trap at \$1.95 Postage Paid U.S.A.

Name _____

Address _____

City _____

State _____

Make of Car _____

Year _____

Dept. P.

P-2A

Use it to save time and money when you mow, plow, cultivate, disc, harrow, or plow snow.



It's easy with a

PAGE

—the Streamlined Garden Tractor

Mowing grass or weeds is only one of many jobs you do quickly at low cost — with the new Page. It's the product of 20 years experience in making quality garden tractors. Balanced for easy handling. Direct drive with worm-gear transmission, using cut gears and ball bearings. No cheap belts or chains. Gears and clutches in dust-free case. Wheels adjustable to fit rows. Individual wheel clutches make turning easy. Liberal clearance. 1 1/2, 2, and 3 H.P. Write for dealer's name and free catalog.

Page Dairy and Farm Equipment

1902 S. 81st Street • Milwaukee 14, Wisconsin

SEALED POWER PISTON RINGS

save oil, save gas, restore original power

Send postal for free booklet on oil-saving.

SEALED POWER CORP., DEPT. G5, MUSKEGON, MICH.

New! Easy-to-Use Invention

TRIMS your HAIR as it Combs

Less than 2c A TRIM



Save Money! Save Time!

Anyone in The Family Can Use It At Home! Now you can look more handsome by always keeping your HAIR NEAT with this simple amazing invention! Give yourself a BARBER-LIKE TRIM OR HAIRCUT by running it through your hair as a comb. Easy as combing! Absolutely safe for men, women, children! Also excellent for underarms, legs. More than pays for itself with the first few hair trims.

FREE! "KLEAN HAIRCUT COVER-ALL" Keeps Cut Hair Off Clothes, Body

SEND NO MONEY Don't send a penny! Just pay postman on delivery 98c plus postage for 1 "Hair Trimmer" plus 15 EXTRA BLADES with FREE "KLEAN HAIRCUT COVER-ALL"! Tie it around neck, whether dressed or in underwear before trimming hair. Helps cover your shirt, suit or body from the cut hair. If you wish to save postage, send only \$1 with order. Money back guaranteed if not satisfied. Order now!

TESTED SALES, Dept. T-5805, 20 Vesey St., New York City

SAY YOU SAW IT IN POPULAR MECHANICS

SANBORN Dog Whistle No. 1



\$2.00

Natural Alternating Two Tone Dog Call, Also Human Hailing Call

FACTORY TESTED AT 1 MILE—Pitched just below insect interference tones—a scientific precision-made instrument turned from a special aluminum alloy. Dogs respond without special training. All calls personalized by blower. See your dealer or order direct.

SANBORN PRODUCTS CO.

BOX 132-O

MENTOR, OHIO

All New

Remington Model 7 Noiseless

\$96.50

OR 4 MONTHLY PAYMENTS
OF \$27.50

Total. (Tax Included)

CASH
Plus Fed. Excise Tax

Liberal Allowance on Your Old Machine



**Handy
Transportation
Case Included**

Look at all these
Outstanding Features

- TABULATOR KEY
- NOISELESS PRINTING
- PERSONAL TOUCH
- CARD HOLDER
- STENCIL CUTTER
- VARIABLE LINE SPACER
- NON-GLARE FINISH
- FINE CARRYING CASE

No Waiting

If you've been hunting high and low for a typewriter—look no further. Here it is—tailored to fit every demand. No more than a whisper of sound. Compact, precision-built. A personal touch that responds instantly to operator's preference. And what's more you can put your Remington Noiseless in the handy transportation case and lock it up for safekeeping!

**IMMEDIATE
DELIVERY
WHILE
LIMITED
SUPPLY
LASTS**

STANDARD 4-Row Keyboard Standard Pica Type

Here's the typewriter you've been itching to own—a real Remington Noiseless—the kind you couldn't buy for love nor money during the war. But we now have a few—ready to ship to the lucky ones who ask for them first. Here is a typewriter you can use *anywhere*, any time, early or late, because it's noiseless and never disturbs anyone. Light in weight and portable, yet it has the same touch, speed and action of the great Remington Noiseless Office Machine. The demand for this new Remington Noiseless is so great that we are compelled to say "No C.O.D., please." But you take no risk in buying because *every machine is fully guaranteed*. Don't miss this opportunity to get this typewriter of your dreams—not 3 months or

6 months from now but today. Just mail handy coupon below and we'll see that your machine reaches you promptly.

CLIP AND MAIL NOW

EXTRA No Charge For Touch Method Typing Instruction Book

In addition to your Remington Portable we'll send you *absolutely FREE* a complete Home Study Course of that famous Van Sant Touch Typing System that makes it easy for you to learn typing quickly. *No Cost to you.*

Supply Limited...Don't Wait

We don't say this to "high pressure" you into buying. We can sell *twice as many* Remington Noiseless Typewriters as we have on hand. But unless you get your order in *now*, all machines may be sold. So act at once. Mail handy coupon at right.

INTERNATIONAL TYPEWRITER EXCHANGE

General Office - Factory - Warehouse
231 W. Monroe St., Dept. 51 Chicago 6, Ill.

INTERNATIONAL TYPEWRITER EXCHANGE

General Office - Factory - Warehouse
231 W. Monroe St., Dept. 51, Chicago 6, Ill.

Please ship me (F.O.B., Chicago) one Remington Noiseless Typewriter Model No. 7, complete with Carrying Case, fully guaranteed! If this request reaches you after all typewriters have been sold, you are to return my money at once and notify me promptly when more Remington Portables are available.

I am enclosing \$96.50 (plus Federal Excise Tax of \$6.15) as payment in full.

I am enclosing \$27.50 and agree to send you \$27.50 a month for three (3) months in full payment. Until then the title is to remain yours.

Name _____
(Sign with Pen & Ink)

Street _____

City _____ Zone _____ State _____

Give Reference for prompt shipment.

SOUTH BEND LATHES

*Famous for
Versatility*

Because they are capable of performing a wide variety of operations efficiently, South Bend Lathes have earned an enviable reputation for versatility. Their wide range of spindle speeds make them equally adaptable to slow speed work such as cutting screw threads in tough steel and machining large diameter castings, or high speed work such as drilling, turning, and polishing small diameters. Their precision accuracy is an essential quality for fine toolroom operations, and they have ample power for roughing cuts on production. A complete line of practical attachments simplify tooling them for many special classes of work.

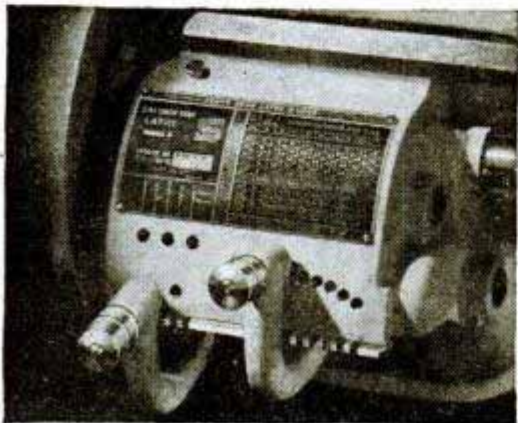

QUICK CHANGE GEAR BOX for 9" LATHES

The proper feed and speed for any operation on any material can be quickly selected by shifting only two levers. The quick change gear box provides 48 power longitudinal feeds, 48 power cross feeds, and 48 screw threads ranging from 4 to 224 per inch.



BUILDING BETTER LATHES SINCE 1906



SOUTH BEND LATHE WORKS

455 EAST MADISON STREET, SOUTH BEND 22, INDIANA

WRITE FOR
FREE CATALOG

Describes all South Bend Precision Lathes. Specify size lathe in which you are interested—9", 10", 13", 14-1/2" or 16" swing.

Printed by Popular Mechanics Company, Chicago, Ill., U. S. A.

CLASS ALWAYS TELLS by FRANK WILLIAMS

POLO'S LATEST SENSATION

PETER PERKINS

...AT 26, YOUNGEST PLAYER EVER NAMED TO REPRESENT THE U.S. IN INTERNATIONAL MATCHES!

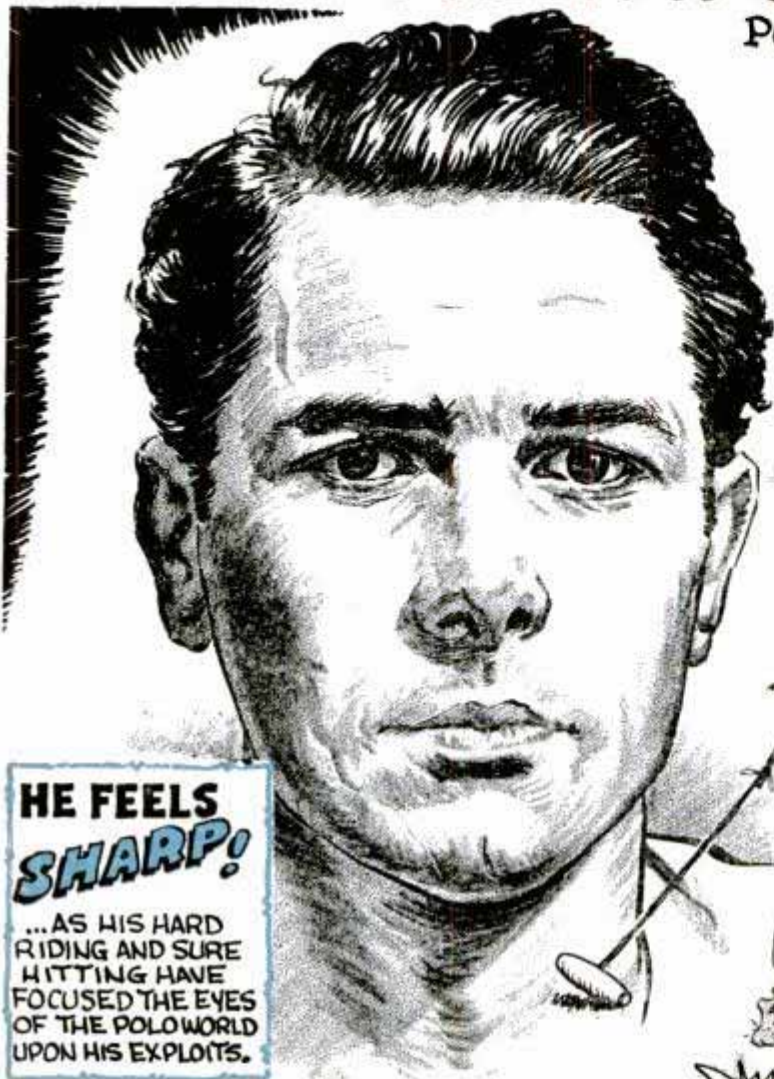

HE FEELS SHARP!
...AS HIS HARD RIDING AND SURE HITTING HAVE FOCUSED THE EYES OF THE POLOWORLD UPON HIS EXPLOITS.



...PETE STARTED PLAYING AT 15...

HE LOOKS SHARP!
...THE CALIFORNIAN'S BRILLIANT Mallet PLAY SHOWS NO EVIDENCE THAT HE WENT THROUGH THE BATAAN DEATH MARCH AND THREE AND A HALF YEARS IN JAP LABOR CAMPS.



look **SHARP**
feel **SHARP**
be **SHARP**

use
Gillette
Blue Blades
with the **SHARPEST** edges ever honed!

● You *look* sharp for you enjoy the swellest shaves ever. You *feel* sharp because they're refreshing and give you a lift. You *are* sharp for you get far more shaves per blade and save money. Ask for Gillette Blue Blades.

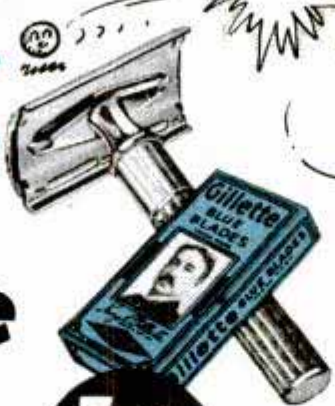

5 for 25¢

ENJOY BOXING FRIDAYS OVER ABC NETWORK. GILLETTE'S CAVALCADE OF SPORTS ALSO AIRS THE KENTUCKY DERBY, MAY 3, AND OTHER CLASSICS YEAR 'ROUND.



HE IS SHARP!
...PETE ENJOYS THE CLEANEST, SMOOTHEST SHAVES A FELLOW CAN HAVE, FOR HE ALWAYS USES **GILLETTE BLUE BLADES** WITH THE SHARPEST EDGES EVER HONED. YES, AND HE SAVES MONEY, TOO, FOR **DOUBLE EDGES MEAN DOUBLE ECONOMY!**

Gillette Safety Razor Company, Boston 6, Mass.

Copyright, 1947, by Gillette Safety Razor Company

**EXPERIENCE
IS THE BEST
TEACHER!**

Cecil Smith practically "grew up" with horses; and he's as sure-seated on a pony as he is a sure shot with his mallet.

He's one of America's polo "greats" — Texas-born Cecil Smith.



Cecil Smith
FAMOUS INTERNATIONAL POLO STAR



**EXPERIENCE IS
THE BEST TEACHER
IN POLO...AND
IN CIGARETTES!
CAMELS SUIT ME
BEST!**

More people are smoking CAMELS than ever before in history!

Yes, experience during the war shortage taught millions the differences in cigarette quality.

● Let polo star Cecil Smith tell you in his own words: "That cigarette shortage was a real experience. That's when I learned how much I appreciated Camels!"

Yes, a lot of smokers found themselves comparing brands

during that shortage. Result: More people are smoking Camels than ever before. But, no matter how great the demand:

We don't tamper with Camel quality. Only choice tobaccos, properly aged, and blended in the time-honored Camel way, are used in Camels.

R. J. Reynolds Tobacco Co., Winston-Salem, N. C.



MAYBE you're in this picture; but even if you're not you'll remember the cigarette shortage. You took any brand you could get. Millions discovered the cigarette that suited them best was Camel.



**YOUR 'T-ZONE'
WILL TELL YOU...**

T for Taste...
T for Throat...

That's your proving ground for any cigarette. See if Camels don't suit your 'T-Zone' to a 'T'!



According to a recent Nationwide survey:

MORE DOCTORS SMOKE CAMELS THAN ANY OTHER CIGARETTE

Three nationally known independent research organizations asked 113,597 doctors—in every branch of medicine—to name the cigarette they smoked. *More doctors named Camel than any other brand.*