



POPULAR MECHANICS MAGAZINE

WRITTEN SO YOU CAN UNDERSTAND IT

REG. TRADE MARK GREAT BRITAIN NO. 410426

REG. U.S. PAT. OFF.



in this issue



**THE HOUSE
YOU CAN BUILD
YOURSELF!**



ONE OF THE GREATEST EDITORIAL
FEATURES IN OUR HISTORY



Tune up your Horsepower

You can restore your car's lost pick-up, power and smoothness in just a few minutes with Casite. You'll scarcely believe it's the same old motor.

and keep it tuned up...

Casite speeds lubrication . . . retards formation of sludge and gum . . . keeps your motor clean and free-running. For continued top performance, use Casite regularly—a pint through the air intake every three months and a pint in the crankcase every oil change.

the Guaranteed Way!

Double-Your-Money-Back if your car doesn't run better and smoother with Casite. And Casite makes this famous guarantee no matter what kind of motor oil you're using. Get Casite at your service station, garage or car dealer today! The Casite Corporation, Hastings, Michigan • Casite Division, Hastings Ltd., Toronto.
LISTEN TO "I DEAL IN CRIME" • Saturday Nights • ABC

**CLEANS MOTORS
KEEPS MOTORS CLEAN**



65c a Pint
75c in Canada

More miles with
B.F. Goodrich
FIRST IN RUBBER



TYPICAL EXAMPLE: THE B. F. GOODRICH TIRE THAT OUTWEARS PREWAR TIRES

NOBODY even knows just how far a tire can go without being worn out. It depends on too many things. Shown above is one of the new B. F. Goodrich tires—the tires that outwear prewar tires. It had been shifted from wheel to wheel, and the wheels were *balanced*.

When this tire was first put on a car owned by Howard E. Reeder, plant superintendent of Funk Bros. Seed Co., Bloomington, Ill., the speedometer read 33,001 miles.

When the photo was taken, the speedometer showed a total mileage of 93,802. The tire had trav-

eled 60,801 miles, and it still wasn't quite smooth.

"As scarce as tires have been," said Mr. Reeder, "we would probably have been driving on bare rims if it had not been for such exceptionally good service from B. F. Goodrich tires."

A full report on this tire and the other B. F. Goodrich tires on Mr. Reeder's car was made, along with this picture, by photographer Kenneth H. Berglund of Bloomington, Ill. A copy will be sent on request to any reader of this magazine. Just address Advertising Department M, The B. F. Goodrich Company, Akron, Ohio.

Wheel balance is one of the things that keep tires wearing *evenly*. Any B. F. Goodrich dealer can tell you about it.

Most people who need tires can now get the new B. F. Goodrich Silvertown tires. A few sizes are still scarce, of course, but most dealers have a fair assortment right in stock.

Talk to your B. F. Goodrich dealer—you may not have to wait at all. *The B. F. Goodrich Company, Akron, Ohio.*

B.F. Goodrich
FIRST IN RUBBER

Writing with your voice

Years ago Alexander Graham Bell dreamed of "a machine that should render visible to the eyes of the deaf, the vibrations of the air that affect our ears as sound." He never realized that dream, but his researches led to the invention of the telephone.

Today Bell Telephone Laboratories have turned the dream into a fact—translating the spoken word into readable pictures.

By this new invention of the Laboratories, the talker speaks into a microphone. Vibrations of the voice are unraveled through electronic circuits, and then are reassembled as luminous patterns which travel across a screen. Each syllable of sound has a distinctive shape and intensity.

Visible speech is still in its infancy, and is not yet available to the public. But educators of the deaf are now evaluating it.

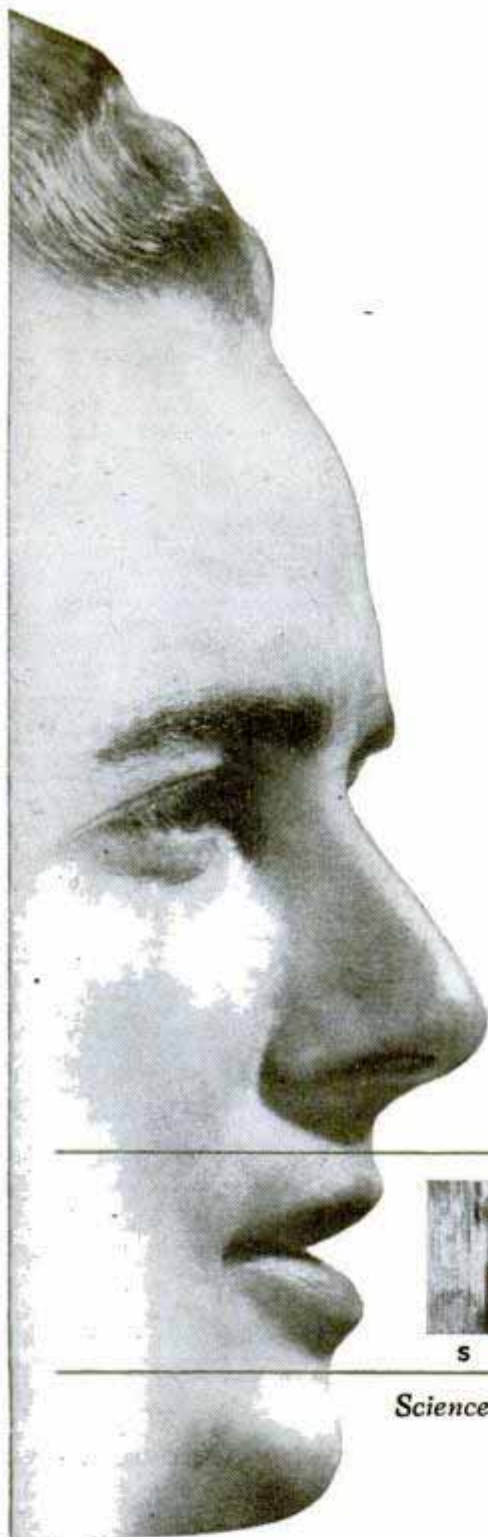

S I E N S U N R A V U L S S P E E T S H

Science unravels speech

Indications are that the deaf can learn to read the patterns and, by comparing the patterns their own voices make with the patterns of correct speech, can improve their diction.

Patterns of visible speech also provide a means for analyzing and recording sound in the study of phonetics and of languages. Eventually, visible speech may make possible visual telephony for the deaf.

This is but one of many contributions by Bell Telephone Laboratories to the understanding and control of sound.



BELL TELEPHONE LABORATORIES *Exploring and Inventing, Devising and Perfecting for Continued Improvements and Economies in Telephone Service*

Popular Mechanics Magazine

Registered in U. S. Patent Office and Canada

H. H. WINDSOR, Founder

H. H. WINDSOR, Jr., Editor and Publisher

Next Month

THIS month's color story of the Build-It Yourself House will be followed by an article in the May Craftsman section, taking you indoors to admire the built-in chests, the pine-paneled recreation room, and the spacious closets Jacques Brownson built behind double doors. The article will guide prospective home builders through the first steps of planning their homes.

MOST of us are very happy when our number comes up on a new car from Detroit, but out in California is a little coterie of folks who sneer at factory jobs. Nothing less than an out-of-this-world custom-designed car will do for them. The resultant dreams on wheels, which purr along Sunset Boulevard to the accompaniment of swoons from the sidewalks, are pictured for you next month in "They Tailor Their Own Cars."

GOING camping next summer? Timely tips in a May feature, "Get Ready for Camp," will save you a lot of last-minute headaches.

ANOTHER piece pointed for the outdoorsman appears in next month's Craftsman Section. It's the how-to-build story of a motor-driven surfboard, with hull of pontoon construction and an outboard motor housed in a low blister.

THE EDITORS had to be shown before they would believe the story they present next month—the story of one of the most revolutionary airplanes ever built. There's nothing like it in the air!

DARKROOM denizens will turn to the Craftsman section in May for the story of an electrically controlled unit for processing color photo prints at home.

RADIO experimenters will find a description of a compact all-wave self-powered four-tube set in the Radio and Electronics pages.

Volume 87

APRIL 1947

Number 4

Managing Editor.....	Roderick M. Grant
Assistant Managing Editor.....	Wayne Whittaker
Shop Notes and Crafts Editor.....	James R. Ward
Radio and Electronics Editor.....	Frank L. Brittin
Aviation Editor.....	Aubrey O. Cookman, Jr.
Associate Editor.....	John R. Kinsey
Eastern Editor.....	Bill Reiche
Western Editor.....	Thomas E. Stimson, Jr.
Art Director.....	Frank Beatty

Assistant Editors

Donald R. Brooks Clifford B. Hicks Virgil T. Swanson

Assistant Editors, Shop Notes and Crafts

W. Clyde Lammey Wayne C. Leckey John F. Shrock A. E. Youngquist

In This Issue

Report From Antarctica	90
Who Says It's a Sissy Game?	100
The Popular Mechanics	
Build-It-Yourself House	105
Death Valley Patrol	116
Synthetic Metals to Order	126
Age Doesn't Count on the Speedway	134
Smartest Ship Afloat	141
Hobbyist of the Month	148
The Land Comes Back	157
1947 Boat Show	168
Dinners Without Drudgery	174

For the Craftsman

A Home of 1000 Addresses	190
Pointers on Soap-Box Racer Design	202
Keep Your Car Radiator Clean	206
How to Repair a Reflex Camera	211
Farmette: the Odd-Job Tractor	220
Zinc Plating in the Home Workshop	229
Radio and Electronics	233

Table of Contents Continued on Page 8

Published monthly by POPULAR MECHANICS COMPANY, 200 East Ontario Street, Chicago 11, Ill. H. H. Windsor, Jr., president; Paul H. Dunakin, vice president and general manager; D. F. Windsor, vice president and secretary-treasurer; William Harrison Fetridge, vice president and assistant to the publisher; Clover L. Perkins, advertising manager; Alan M. Deyoe, circulation manager. Single copy in the United States and Canada, 25 cents; subscription rates in United States and possessions, Canada, and countries of the Pan-American Postal Union, 1 year, \$2.50; 2 years, \$4.50; 3 years, \$6.00. To all other countries add \$1.00 a year over United States prices for overseas postage. If you plan to move, notify us at least 60 days in advance so you will not miss an issue. Give both old and new addresses. Entered as Second Class Matter, September 15, 1903, at the Post Office at Chicago, Illinois, under Act of March 3, 1879. Entered as Second Class Matter at Post Office Dept., Canada, Copyright 1947, by Popular Mechanics Company, Copyright under International Copyright Union. Copyright in France. All rights reserved under Pan-American Copyright Union. Printed in the United States of America.

CRESCENT*... *Synonym*
for **QUALITY** *in hand tools*

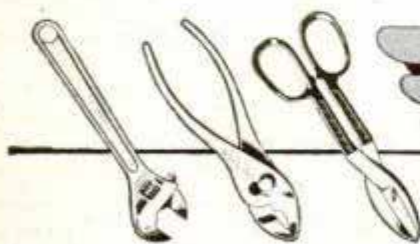

***CRESCENT TOOLS**

Give Wings to Work

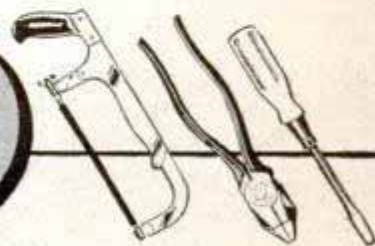

*"CRESCENT" is our trade mark registered in the United States and foreign countries for wrenches and other tools. "Crescent" tools are made only by Crescent Tool Company of Jamestown, N. Y.



**"THERE'S SOMETHING
MISSING IN THIS HOUSE"**

"SURE it's a cute house. And most of the equipment is right up-to-date. But I have my doubts about that heating plant."

Funny thing, how people will put only the best materials in a house—and then skimp on the heating plant.

If you have had the unhappy experience of buying or building a house with an unsatisfactory heating system, cheer up, for relief is in sight! Minneapolis-Honeywell has developed a remarkable control system that has corrected heating difficulties in thousands of

homes. It is called Moduflow. Moduflow furnishes heat *continuously* at whatever temperature is required to maintain comfort in any kind of weather. It eliminates the drafts and chilly spots caused by intermittent heat supply, and saves much of the heat formerly wasted at the ceiling.

Moduflow control can be easily and inexpensively installed on your present automatic heating plant, or in your new home. Mail the coupon today for your free copy of the booklet "Comfort Unlimited" that tells all about Moduflow.

**A GOOD HEATING SYSTEM + MODUFLOW
= COMFORT UNLIMITED**

MODUFLOW

the new HONEYWELL heating control system

Minneapolis-Honeywell Regulator Company, Minneapolis 8, Minnesota . . . Canadian Plant: Toronto 12, Ontario

Minneapolis-Honeywell Regulator Co.
2751 Fourth Avenue South
Minneapolis 8, Minnesota
Please send my free copy of
"Comfort Unlimited"



This One

Ne
Ac
Ci



HUY6-S74-BYSL

THE GREATEST
POWER ON
EARTH!

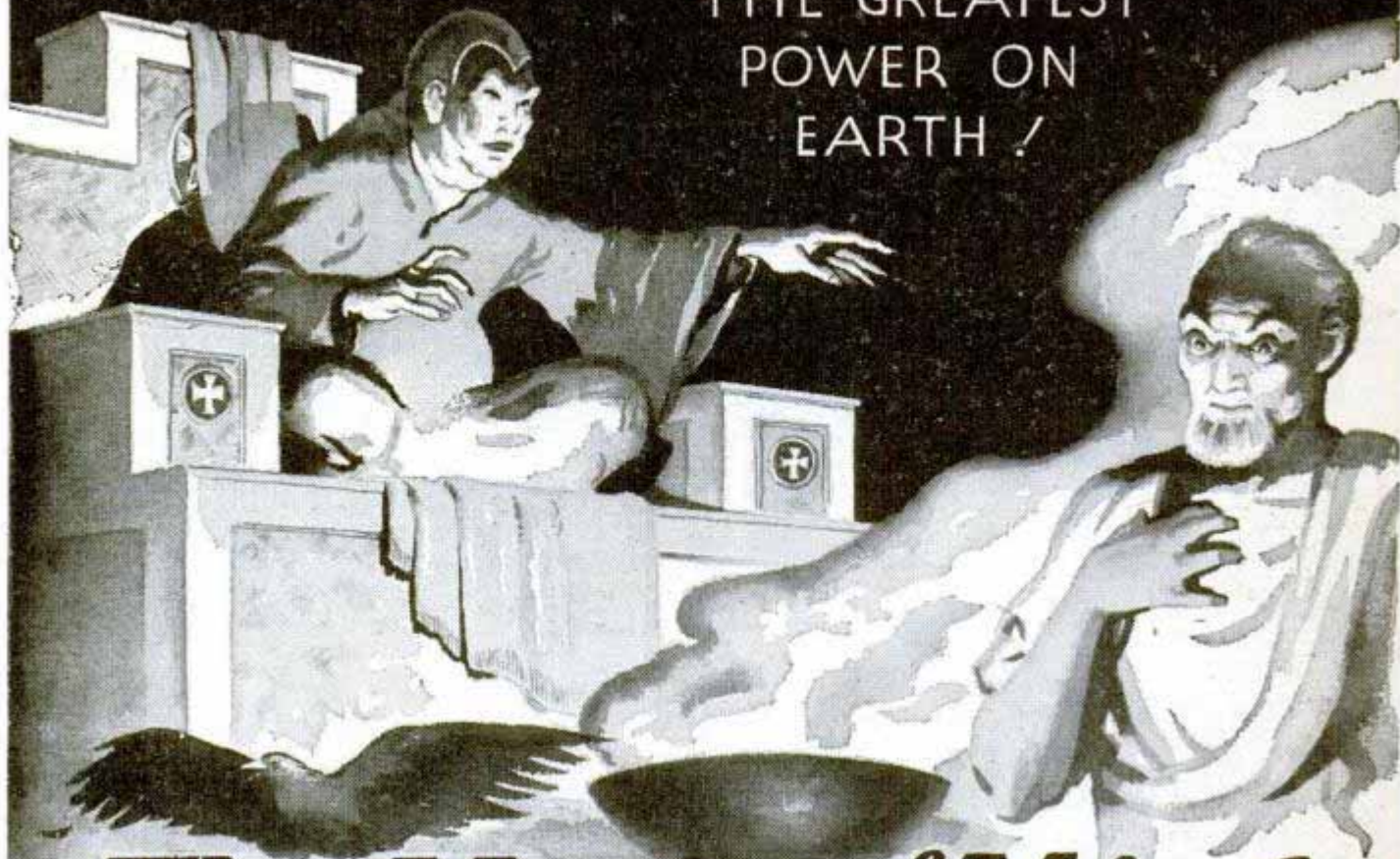

The Magic of Mind

WERE the great personages of the past victims of a stupendous hoax? Could such eminent men of the ancient world as Socrates, Pericles, and Alexander the Great have been deluded and cast under the spell of witchcraft—or did the oracles whom they consulted actually possess a *mysterious faculty of foresight*? That *the human mind can truly exert an influence over things and conditions* was not a credulous belief of the ancients, but a known and demonstrable fact to them. That there exists a wealth of infinite knowledge just beyond the border of our daily thoughts, which can be aroused and commanded at will, was not a fantasy of these sages of antiquity, but a dependable aid to which they turned in time of need.

It is time you realized that the rites, rituals and practices of the ancients were not superstitions, but subterfuges to conceal the marvelous workings of natural law from those who would have misused them. Telepathy, projection of thought, the materializing of ideas into helpful realities, are no longer thought by intelligent persons to be impossible practices, but instead, *demonstrable sciences*, by which a greater life of happiness may be had.

One of America's foremost psychologists and university instructors, says of his experiments with thought transference and the powers of mind—"The successes were much too numerous to be merely

lucky hits and one can see no way for guessing to have accounted for the results." *Have you* that open-minded attitude of today which warrants a clear, positive revelation of the facts of mind which intolerance and bigotry have suppressed for years? *Advance with the times*; learn the truth about your inherited powers.

Let this free book explain

The Rosicrucians (NOT a religious organization) have been leaders in introducing the ancient wisdom of mental phenomena. Established throughout the world for centuries, they have for ages expounded these truths to those thinking men and women who sought to make the utmost of their natural faculties. Use the coupon below—avail yourself of a pleasing book of interesting information which explains how you may acquire this most *unusual* and *helpful* knowledge.

The ROSICRUCIANS (AMORC)

USE THIS COUPON

Scribe O.T.N.,
The Rosicrucians, AMORC,
San Jose, California.

I am sincerely interested in knowing more about this unseen, vital power which can be used in acquiring the fullness and happiness of life. Please send me, without cost, the book, "THE MASTERY OF LIFE," which tells me how to receive this information.

Name _____

Address _____

State _____



6 KEYS TO OPPORTUNITY for Men and Women

They have helped over a million toward their
ambition... **THEY CAN HELP YOU!**

The great barrier to realizing ambition is the question "HOW?"

For the past 39 years more than a million ambitious men and women have found the "HOW" to greater success in business in one of the free 48-page books illustrated above.

These books are more than catalogues—they give you the facts about the field of your choice, tell you of the opportunities in that field, its demands, and how our training fits you for the field. They'll answer questions that may have bothered you.

We have perfected Home-Study Training—made it interesting and practical through the problem method. You train under specialists, men who have achieved success in their chosen field—you study principles and solve problems without any loss of time, pay or interference with your present job.

Our training is tried and proven—and what you study at home you can use on the job right away. Perhaps right in your own company there is a great opportunity to advance—to get an executive job with the prestige and money that go with such advancement.

The way to success is not magic. It requires study, and you will have to be willing to work earnestly—thoroughly.

But wouldn't it be worth your while to trade some of your leisure over a comparatively brief period for a bigger job and more money?

Why not be somebody in the business world—why be satisfied to go through life in a small job at small pay when the way to success is clearly marked. The years are going by very fast—and it's high time you did something concrete about your future.

The coupon below will bring you complete information about the field of your choice. **SEND IT TODAY.** Don't delay—it can be the turning point in your career to a better job and more money.

G. I. APPROVED

LASALLE Extension University
a Correspondence Institution
Dept. 464-R Chicago 5, Ill.

I want to better my position—make more money. Send me your free booklet on the field I have checked below.

<input type="checkbox"/> Higher Accountancy	<input type="checkbox"/> Traffic Management
<input type="checkbox"/> Industrial Management	<input type="checkbox"/> Foremanship
<input type="checkbox"/> Executive Management	<input type="checkbox"/> Law L. L. B. Degree

Name.....Age.....

Present Position.....

City, Zone and State.....

ADD economy, ADD starting ease, ADD miles, ADD PYROIL



When you drive up for gasoline or oil, learn the easy, good-driving habit of saying "add Pyroil." For Pyroil is an "under-the-hood" miracle worker. It prevents sludge and gum formation. It gives oil the property of clinging to cylinder walls even though you have parked it for the night. This is protection from corrosion. This is easy lubricated starting without scoring cylinder walls. This is longer car life — and less repair grief. It's easy — it's economical to say "add Pyroil."

PYROIL FOR AIRCRAFT ENGINES

Use Aircraft Pyroil B for lubricating oil, Aircraft Pyroil A for gasoline.

Manufactured and Guaranteed by Pyroil Company, 66 Pyroil Bldg., La Crosse, Wisconsin.

PYROIL COMPANY

66 Pyroil Bldg., La Crosse, Wisconsin

I want my car to last and run properly. Please tell me more about Pyroil and how it can accomplish this for me.

Name.....

Address.....

City or Town..... State.....



Jerry, the talking dog, is entertaining hospitalized veterans, by courtesy of the PYROIL Company. Picture of Jerry, sent on request.

TABLE OF CONTENTS (Continued)

AUTOMOTIVE

Roller beneath auto wheel transmits power to belt-driven tools	125
Midget vehicles are becoming popular in Italy.....	138
Sleek car for the French buyer.....	138
Jeep covered with cockpit section of plane makes all-weather auto	140
Jack pulls car off ground.....	140
Tire spreader speeds inspection.....	147
Ninety-mile-an-hour racer made of parts from six old automobiles	153
Sleek convertible assembled from scrapped car and airplane parts	162
Plastic and aluminum auto has engine in rear.....	167
Cars are parked automatically by push-button elevator.....	180

AVIATION

Blind bombing radar rivals visual method.....	95
One man operates "nerve center" to control air traffic.....	98
Largest droppable tanks.....	104
Inside the flying wing.....	124
Navy supersonic test plane.....	131
Telescoping stick hooked to wheel maneuvers plane.....	153
Roll-away map aids flyers.....	163

FISH AND FISHING

Fish helps catch himself with trip-lever hook.....	146
Springs inside plastic fly box keep lures separated.....	147
Metal spreader holds fish jaws open for removing hooks easily.....	153
Combined fishing rod and reel hooks onto side of boat.....	173
What's new in tackle.....	178

HOUSE AND HOME

Quonsets converted to peace.....	114
What's new for your home.....	154
Tiny electric sewing machine carried like typewriter.....	167
Double blade cake cutter lifts portions with ease.....	180

INDUSTRY

Spray removes "bad" fruit.....	98
"Y" switch for conveyor systems.....	99
Power-controlled ditcher "shaves" steep bank.....	99
Multipurpose earthmover mounted on truck chassis.....	121
Pilofilm cradle in shipping cases protects fruits and vegetables	123
Machine renovates worn asphalt.....	123
Hydraulic press for tile making handles clay automatically.....	132
Date workers get a lift.....	133
Self-sealing test plugs for tanks.....	147
Shower bath for "iron horse" uses 2400 gallons a minute.....	152
More charcoal from wood.....	156
Plastic liner in drill pipes stops oil well corrosion.....	179

LAWN AND GARDEN

Double duty sprinkler waters lawn and fertilizes it at the same time.....	122
Garden zoo.....	164
Cleaning fluid operates Mexican garden-type tractor.....	173

RADIO AND ELECTRICAL

Printed guides for phonograph records tell story behind classical music.....	122
Electrons identify metals.....	162
Helium traces leaks in huge transformers.....	183

RECREATION

Dog caddy serves California golfer.....	123
Computing machine figures "outdoor" distance of indoor drives	125
Shrinkable plastic provides tight-fitting cover for golf clubs.....	125
Mosquito hood for sportsman has zipper mouth slit.....	147
Four-ounce golf club carrier takes place of bulky bag.....	156
Robot baseball pitcher.....	166
Cork-insulated hamper keeps perishable foods fresh.....	179

TOOLS

Sanding tool for hard-to-reach spots.....	95
Dial on metal tape rule holder shows accurate measurements.....	99
Impact wrench for mechanics operates without torque.....	115
Iron rammer drives fence posts into unprepared ground.....	123
Short chains on pole stripper beat bark from logs.....	167

TOYS AND NOVELTIES

Portrait doll.....	113
Model built in half hour.....	156
Bearings make unique chessmen.....	163
Sheet metal murals.....	172
Collector has 25,000 pencils.....	179

MISCELLANEOUS

New atomic bomb may use hydrogen.....	95
Ideas jell at California Institute of Technology.....	96
Butter made from coal by new German method.....	98
Uranium rods will feed rayproof atomic power plant at Oak Ridge	104
Fires halted quickly by "lazy" Freon gas.....	115
Double-deck streets planned in England.....	115
PX train serves GIs in Japan.....	132
Enlarging and copying jobs speeded by quick-centering easel.....	132
Tricycles carry moving picture posters.....	138
Camera snaps, develops and projects pictures within 15 seconds	139
Endless fountain of coffee is supplied by automatic brewing robot	140
Rocket-powered craft steers by turning jet.....	146
Water from twin wells flows through one hole.....	152
What it will take to fly to moon.....	153
Nylon sea anchor.....	166

(Continued to page 10)

Training is essential to advancement in any field—and it's important to have it on record.

International Correspondence Schools' sound and practical training goes on record—and counts in the record. I. C. S. regularly reports the progress of its students to their employers, regularly receives letters expressing appreciation for this service.

A typical employer communication notes: "I have every I. C. S. report on my men filed with their personal records, the records which help to determine any action taken in regard to those men."*

YOU want your record to show you have *trained* for promotion. **YOU** want your employer to know that you have *prepared* yourself for larger responsibilities. Then *act* now to obtain that training. I. C. S. Courses cover more than 400 business and technical subjects. The coupon brings full information.

*Name furnished on request



INTERNATIONAL CORRESPONDENCE SCHOOLS



BOX 5601-K, SCRANTON 9, PENNA.

Without cost or obligation, please send me full particulars about the course *before* which I have marked X:

- | | | | |
|--|---|---|--|
| <p>Air Conditioning and Plumbing Courses</p> <p><input type="checkbox"/> Air Conditioning
<input type="checkbox"/> Heating <input type="checkbox"/> Plumbing
<input type="checkbox"/> Refrigeration <input type="checkbox"/> Steam Fitting</p> <p>Chemistry Courses</p> <p><input type="checkbox"/> Chemical Engineering
<input type="checkbox"/> Chemistry, Analytical
<input type="checkbox"/> Chemistry, Industrial
<input type="checkbox"/> Chemistry, Mfg. Iron & Steel
<input type="checkbox"/> Petroleum Refining <input type="checkbox"/> Plastics
<input type="checkbox"/> Pulp and Paper Making</p> <p>Civil Engineering, Architectural and Mining Courses</p> <p><input type="checkbox"/> Architectural Drafting
<input type="checkbox"/> Architecture
<input type="checkbox"/> Bridge and Building Foreman
<input type="checkbox"/> Building Estimating
<input type="checkbox"/> Civil Engineering
<input type="checkbox"/> Coal Mining
<input type="checkbox"/> Contracting and Building
<input type="checkbox"/> Highway Engineering
<input type="checkbox"/> Lumber Dealer
<input type="checkbox"/> Reading Structural Blueprints
<input type="checkbox"/> Sanitary Engineering
<input type="checkbox"/> Structural Drafting</p> | <p><input type="checkbox"/> Structural Engineering
<input type="checkbox"/> Surveying and Mapping</p> <p>Communications Courses</p> <p><input type="checkbox"/> Electronics
<input type="checkbox"/> Practical Telephony
<input type="checkbox"/> Radio, General
<input type="checkbox"/> Radio Operating
<input type="checkbox"/> Radio Servicing
<input type="checkbox"/> Telegraph Engineering</p> <p>Electrical Courses</p> <p><input type="checkbox"/> Electrical Drafting
<input type="checkbox"/> Electrical Engineering
<input type="checkbox"/> Electric Light and Power
<input type="checkbox"/> Lighting Technician
<input type="checkbox"/> Practical Electrician</p> <p>Internal Combustion Engines Courses</p> <p><input type="checkbox"/> Auto Technician <input type="checkbox"/> Aviation
<input type="checkbox"/> Diesel-Electric
<input type="checkbox"/> Diesel Engines <input type="checkbox"/> Gas Engines</p> <p>Mechanical Courses</p> <p><input type="checkbox"/> Aeronautical Engineering
<input type="checkbox"/> Aircraft Drafting
<input type="checkbox"/> Flight Engineer
<input type="checkbox"/> Foundry Work
<input type="checkbox"/> Heat Treatment of Metals</p> | <p><input type="checkbox"/> Industrial Engineering
<input type="checkbox"/> Industrial Metallurgy
<input type="checkbox"/> Machine Shop
<input type="checkbox"/> Mechanical Drafting
<input type="checkbox"/> Mechanical Engineering
<input type="checkbox"/> Mold-Loft Work
<input type="checkbox"/> Patternmaking—Wood, Metal
<input type="checkbox"/> Reading Shop Blueprints
<input type="checkbox"/> Sheet-Metal Drafting
<input type="checkbox"/> Sheet-Metal Worker
<input type="checkbox"/> Ship Drafting <input type="checkbox"/> Ship Fitting
<input type="checkbox"/> Tool Designing
<input type="checkbox"/> Toolmaking
<input type="checkbox"/> Welding—Gas and Electric</p> <p>Railroad Courses</p> <p><input type="checkbox"/> Air Brake <input type="checkbox"/> Car Inspector
<input type="checkbox"/> Diesel Locomotive
<input type="checkbox"/> Locomotive Engineer
<input type="checkbox"/> Locomotive Fireman
<input type="checkbox"/> Railroad Section Foreman</p> <p>Steam Engineering Courses</p> <p><input type="checkbox"/> Boilermaking
<input type="checkbox"/> Combustion Engineering
<input type="checkbox"/> Engine Running
<input type="checkbox"/> Marine Engineering
<input type="checkbox"/> Steam Electric <input type="checkbox"/> Steam Engines</p> | <p>Textile Courses</p> <p><input type="checkbox"/> Cotton Manufacturing
<input type="checkbox"/> Rayon Weaving
<input type="checkbox"/> Textile Designing
<input type="checkbox"/> Woolen Manufacturing</p> <p>Business and Academic Courses</p> <p><input type="checkbox"/> Accounting <input type="checkbox"/> Advertising
<input type="checkbox"/> Arithmetic <input type="checkbox"/> Bookkeeping
<input type="checkbox"/> Business Correspondence
<input type="checkbox"/> Business Management
<input type="checkbox"/> Certified Public Accounting
<input type="checkbox"/> Commercial
<input type="checkbox"/> Cost Accounting
<input type="checkbox"/> Federal Tax
<input type="checkbox"/> First Year College
<input type="checkbox"/> Foremanship <input type="checkbox"/> French
<input type="checkbox"/> Good English <input type="checkbox"/> High School
<input type="checkbox"/> Higher Mathematics
<input type="checkbox"/> Illustrating <input type="checkbox"/> Motor Traffic
<input type="checkbox"/> Postal Service
<input type="checkbox"/> Salesmanship <input type="checkbox"/> Secretarial
<input type="checkbox"/> Sign Lettering
<input type="checkbox"/> Spanish <input type="checkbox"/> Stenography
<input type="checkbox"/> Traffic Management</p> |
|--|---|---|--|

Name _____ Age _____ Home Address _____
City _____ State _____ Present Position _____

Working Hours _____ A.M. to _____ P.M. Length of Service in World War II _____

Special tuition rates to members of the Armed Forces. Enrollment under the G.I. Bill of Rights approved for War II Veterans. Canadian residents send coupon to International Correspondence Schools Canadian, Ltd., Montreal, Canada.

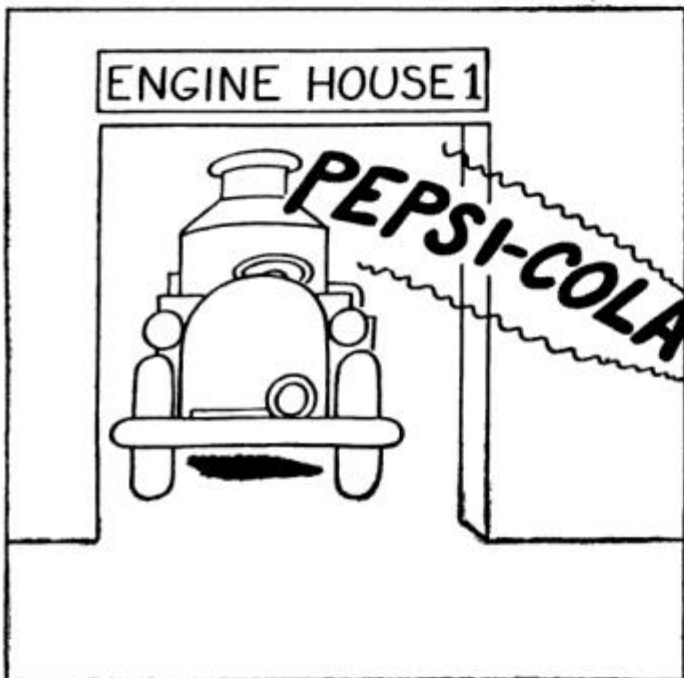
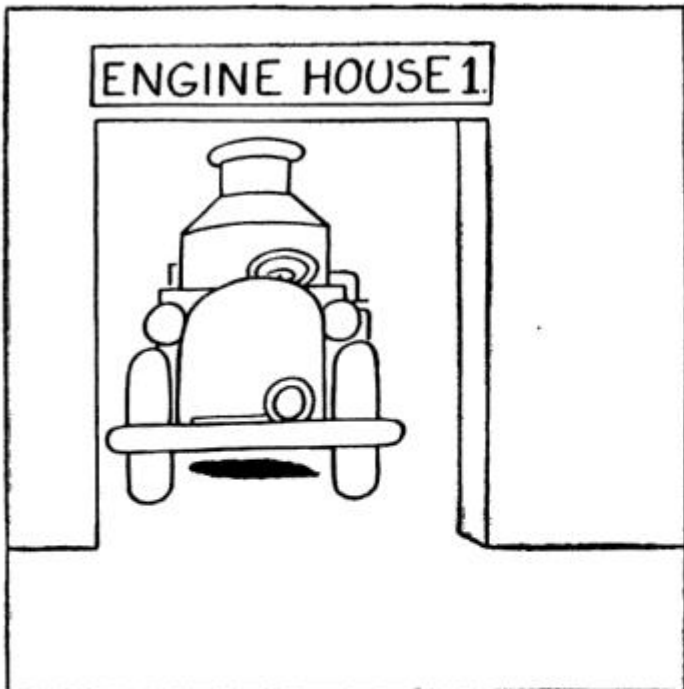

O. SOGLOW

(Continued from page 8)

Extract kills cancer in rats.....173
 Automatic fire fighter for range stops fuel and puts out flames.....173
 Age limit for inventors?.....179

Craftsman and Shop Notes Index

AUTOMOTIVE

Shovel with detachable handle can be carried in car.....200
 Reading worn numbers on tires.....200
 Spring lug on dome-light switch holds it in "off" position.....205
 Shield over auto exhaust protects showroom walls.....219
 Small-parts washer for garage.....227
 Tires inspected with mirror.....228

FARM

Wire mesh applied at corners rodent-proofs poultry house.....227
 Auto-tire rim buried in ground supports free end of gate.....228
 Paper scraps keep chickens from eating eggs.....228

FISH AND FISHING

Inner-tube "life preserver" keeps tackle box afloat.....184
 Rubber lining in fishing box.....184
 Loosening tight joints on fishing rods.....184
 Tobacco can keeps grasshoppers fresh on fishing trips.....188
 Cork holder for fishing flies is slipped over hatband.....201
 Separating fishing-rod ferrules.....201
 "Shock absorber" on fishline breaks impact of hard strike.....216

HOUSE AND HOME

Folding envelope tacked to wall holds recipes and clippings.....184
 Solving home problems.....186
 Water marks easily removed.....188
 Flower box cut from standard width metal.....195
 Single-board bathroom cabinet.....195
 Light bulb used as fire "bomb".....197
 Sealing holes in can of milk to keep it from spoiling.....197
 Quarter-round molding planed to fit over obstruction.....200
 Kitchen wastebasket swings underneath sink.....201
 Multiple hanger for trousers requires little room.....216
 Drawers in closet-step unit provide storage space.....216

LAWN AND GARDEN

Testing garden spray for leaks.....184
 Return bend serves as sprinkler.....188
 Rest eases strain for gardener when working on knees.....195
 Burlap holds newly seeded lawn.....200
 Soy-bean fence protects garden.....216

OUTDOOR RECREATION

Adhesive-tape repair for tent.....188
 Two-handed operation of bilge pump when footrest is used.....188
 Emergency washboard at camp.....210

PHOTOGRAPHY

Solution improves photographs.....214
 Pictures have canvas finish.....214
 Protecting often-handled prints.....214
 Knitting needle used as stirring rod.....214
 Diffuser for reflector photo flood.....214
 Color developing data on trays.....214

RADIO AND ELECTRONICS

Tubeless converter unit for the new FM band.....233
 Beginner's low cost progressive receiver—set No. 1.....234
 How to care for your record player.....236

TOOLS

Bench vise used with bar to loosen pipe fitting.....185
 Burned-out cartridge fuses furnish handle ferrules.....197
 Varied sizes of soldering irons made from welding tips.....200
 Screwdriver shank is insulated with rubber tubing.....210
 Craft quiz.....215
 Friction sawing is ten times faster than hacksawing.....217
 Wide boards beveled accurately in special miter box.....219
 "Saddle-bag" box keeps tools at hand on rung of ladder.....219
 Drilling irregular shaped work in a metalworking lathe.....226
 Multiple tool rack hangs down from edge of greasing pit.....227
 Small chuck used on large lathe.....228
 Pen flashlight illuminates level in hard-to-see corners.....232
 Welding jig holds round work.....232

TOYS AND NOVELTIES

Three useful articles from bamboo sections.....185
 A book for your surplus stamps.....189
 Unusual timepiece for playroom.....210
 Glass case for fragile models.....216

WOODWORKING

Turning laminated bowls.....182
 Shiplap is used for siding.....197
 Antique utensil smoking set.....210

MISCELLANEOUS

Resin glues mixed and applied through wax-paper cone.....185
 Eight uses for bricks.....196
 Spare key fastened to wallet.....197
 Dye your plastics any color.....198
 Snap-on reflector directs light where needed most.....205
 Roll top from desk is handy on workbench.....210
 Moving materials is simplified by using stairway ramp.....219
 Tape prevents smudged tracing.....225
 Reflectors on ends of lunch box help night worker in traffic.....227
 Quick method of painting border for signs and show cards.....228
 Pipette made from glass tubing helps laboratory workers.....232
 Sign indicates lack of vacancies in tourist camp.....232
 Metal stakes for building lines.....232

IMPORTANT NOTICE—It is the intention of this magazine to provide its readers with information regarding the latest developments in the mechanical arts. We take no responsibility as to whether the disclosures contained in our articles are covered by patents and advise readers to investigate this subject before making, using, or selling any of the products, machines, or processes described in order to avoid possible liability for patent infringements.

AUDELS REFRIGERATION & AIR CONDITIONING GUIDE.....\$4

New from Cover to Cover—1280 Pages, Fully Illus. Covering basic principles, servicing, operation & repair of household, commercial & industrial refrigeration & air conditioning. A gold mine of essential important facts for engineers, servicemen, users.

AUDELS CARPENTERS & BUILDERS GUIDES—4 Vols.\$6

A practical illustrated trade assistant on modern construction for carpenters, joiners, builders, mechanics and all woodworkers. 4 vols., 1600 pages, 3700 illustrations, flexible covers. Pocket size. Each volume sold separately \$1.50 a vol.

AUDELS AUTOMOBILE GUIDE.....\$4

A practical quick ready reference book for auto mechanics, service men, operators & owners. Explains theory, construction & servicing of modern motor cars, trucks, buses & auto type Diesel engines. 1540 pages, fully illustrated. 55 chapters. Indexed. A standard book for mechanics. New fluid drive covered.

AUDELS DIESEL ENGINE MANUAL \$2

A practical, concise treatise with questions and answers on the theory, operation and maintenance of modern diesel engines including General Motors 2 cycle Diesel. 384 pages, fully illus., flexible binding, pocket size. All details plainly brought out, this book is of extreme value to engineers, operators & students.

AUDELS WIRING DIAGRAMS.....\$1

210 Pages. Illustrated. Gives practical facts on wiring of electrical apparatus. It shows clearly how to wire apparatus for practically all fields of electricity. Each diagram is complete & self-explanatory. Highly Endorsed Pocket Companion.

AUDELS PLUMBERS & STEAMFITTERS GUIDES—4 Vols.\$6

A Practical Trade Assistant & Ready Reference. Explains in plain language & by clear illustrations, diagrams, charts, graphs, pictures principles of modern plumbing practice including Marine Pipe Fitting and Air Conditioning. 4 Vols.—1670 Pages—3642 Diagrams. Pocket size. Each Vol. Sold Separately \$1.50 a Vol.

AUDELS SHEETMETAL WORKERS HANDY BOOK.....\$1

Practical inside information. Fundamentals of Sheet Metal Work. 388 pages. Illustrated. 11 sections. Clearly written. Essential & important facts, figures, pointers in everyday language. Ref. Index.

AUDELS SHEETMETAL PATTERN LAYOUTS.....\$4

Developed by Experts for Sheet Metal Workers, Layout Men & Mechanics. A Practical Encyclopedia in 10 Sections, size 7 x 10 x 2—1125 Pages—350 Layouts—1600 Illustrations. 1001 Key Facts. Fully indexed for ready reference in answering your layout problems. Covers all phases of sheet metal work including Pattern Cutting, Pattern Development & Shop Procedure.

AUDELS ANSWERS ON BLUE PRINT READING.....\$2

For Mechanics & Builders. Covers all types of blue print reading including ship & airplane. 376 pages, fully illustrated.

AUDELS NEW MACHINIST & TOOLMAKERS HANDY BOOK... \$4

Covers modern machine shop practice in all its branches. 5 practical books in 1. New from cover to cover. Tells how to set up & operate lathes, screw and milling machines, shapers, drill presses and all other machine tools. 1600 pages, fully illustrated, 5 x 6 1/2 x 2. Indexed. 5 sections. 1—Modern Machine Shop Practice. 2—Blue Print Reading & How to Draw. 3—Calculations & Mathematics for Machinists. 4—Shop Physics. 5—How to Use the Slide Rule. 60 chapters. Easy to read and understand. A shop companion that answers your questions.

AUDELS MATHEMATICS & CALCULATIONS FOR MECHANICS \$2

Mathematics for home study or reference. 700 pages, 550 illus. Practical mathematics from beginning. How to figure correctly. Easy, correct methods covering a complete review. Ill. & Indexed.

AUDELS HANDY BOOK OF PRACTICAL ELECTRICITY.....\$4

For maintenance engineers, electricians & all electrical workers. 1440 Pages, 2600 illus. Covers important electrical information in handy form—including Marine Wiring, Radio Principles, Welding. Indexed. A Key to a practical understanding of electricity.

AUDELS RADIOMANS GUIDE.....\$4

A key to the practical understanding of radio including Frequency Modulation, Television, etc., Aircraft & Marine Radio. For radio engineers, servicemen, amateurs. 772 pages. 400 Illustrations & Diagrams. Photos. Review Questions & Answers. Reference Index. Authentic, clear, concise.

AUDELS ELECTRONIC DEVICES... \$2

Tells What You Want to Know About Electric Eye. Easily Understood. Covers photo-electric cells & their applications. Amplifiers, illumination, frequencies, voltage, photocell, tubes, Ohm's Law, wiring diagrams, etc.

AUDELS WELDERS GUIDE.....\$1

A concise, practical text on operation & maintenance of all welding machines for all mechanics. Over 400 pages, illustrated. Covers all methods of electric and acetylene welding including airplane work.

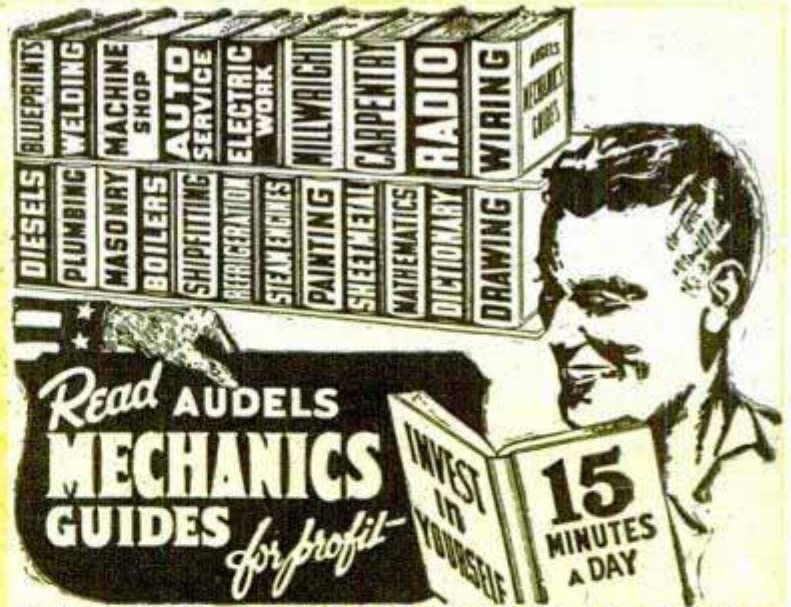

AN AUDEL GUIDE IS A GOOD FRIEND!

Use the brains and experience of others in these Guides of the Trades. Save time and money with right methods, short cuts, labor saving ideas. CHECK NOW! You can look over any Audel Guide in your home. Start the Easy Payments if satisfied.

CUT HERE MAIL ORDER

THEO. AUDEL & CO., 49 W. 23 St., New York 10, N.Y.

Please mail me for 7 days' free examination the books marked (X) below. I agree to mail \$1 in 7 days on each book or set ordered, and to further mail \$1 a month on each book or set ordered until I have paid purchase price. If I am not satisfied with Guides I will return them.

- Audels OIL BURNER GUIDE \$1.
- Audels REFRIGERATION & Air Conditioning Guide. 4.
- Audels POWER PLANT ENGINEERS GUIDE 4.
- Audels PUMPS, HYDRAULICS & AIR COMPRESSORS 4.
- Audels WELDERS GUIDE 1.
- Audels BLUE PRINT READING 2.
- Audels SHEET METAL WORKERS Handy Book 1.
- Audels SHEET METAL PATTERN LAYOUTS 4.
- Audels AIRCRAFT WORKER 1.
- Audels MATHEMATICS and CALCULATIONS 2.
- Audels MACHINISTS & TOOLMAKERS Handy Book 4.
- Audels MECHANICAL Dictionary 4.
- Audels AUTOMOBILE GUIDE 4.
- Audels DIESEL ENGINE MANUAL 2.
- Audels MARINE ENGINEERS Handy Book 4.
- Audels SHIPFITTERS Handy Book 1.
- Gueths MECHANICAL DRAWING COURSE 1.
- Rogers DRAWING and DESIGN 2.
- Audels MILLWRIGHTS and Mechanics Guide 4.
- Audels CARPENTERS and Builders Guides (4 vols.) 6.
- Audels PLUMBERS and Steamfitters Guides (4 vols.) 6.
- Audels MASONS and Builders Guides (4 vols.) 6.
- Master PAINTER and DECORATOR 2.
- Audels GARDENERS & GROWERS GUIDES (4 vols.) 6.
- Audels ENGINEERS & FIREMANS EXAMINATIONS 1.
- Audels ENGINEERS and Mechanics Guides Nos. 1, 2, 3, 4, 5, 6, 7 and 8 complete 12.
- Audels Answers on Practical ENGINEERING 1.
- Audels ELECTRICIANS EXAMINATIONS 1.
- Audels WIRING DIAGRAMS 1.
- Audels Handy Book of PRACTICAL ELECTRICITY 4.
- Audels ELECTRICAL POWER CALCULATIONS 2.
- Audels ELECTRONIC DEVICES 2.
- Audels ELECTRIC Dictionary 2.
- Audels RADIOMANS GUIDE 4.
- Audels NEW ELECTRIC LIBRARY at \$1.50 a Volume Vols. I, II, III, IV, V, VI, VII, VIII, IX, X, XI, XII

Name _____
 Address _____
 Occupation _____
 Employed by _____ PM

\$2000

of Old Line Legal Reserve LIFE INSURANCE

(at age 21) \$ **178** A MONTH*
ONLY — Other ages
in proportion

*One Half Permanent Rate in effect 5th year

Buy as little as \$1500. of this solid protection—or more—at proportionately low rates. *But buy your Postal Policy now!*

Postal Life of New York has specialized for 40 years in insurance by mail and over the counter. The savings due to this direct dealing are passed on to policy holders. Current dividends 9½%. Further savings are made if premiums are paid quarterly, semi-annually or annually.

POSTAL LIFE OF NEW YORK

operates under the rigid New York State Insurance Laws and has paid out over

\$60,000,000.00

to its Policy Holders and Beneficiaries.

Postal issues all Standard Policies to men or women, from ages 10-60, at low cost.

Send coupon today for rates on this Modified "4" Policy at your age and other details. *Life Insurance is vital!*

CLIP AND MAIL COUPON TODAY

POSTAL LIFE INSURANCE COMPANY

511 Fifth Ave., Dept. M-688
New York 17, N. Y.

Mail me without obligation complete information about your low-cost Modified "4" Policy at my age.

Name

Date of Birth

Occupation

Address

(Street and No., Zone, City and State)

No Waiting to LEARN

START NOW TO EARN!

This BIG BOOK SHOWS HOW



IF IT'S RESULTS YOU WANT—GET ACTION QUICKLY WITH THESE PRACTICAL IDEAS

Never before has a more helpful book been printed for those planning a business of their own. Gathered in this large illustrated volume are the formulas, recipes, facts and secrets that have contributed so largely to America's great industrial progress. Capitalize on this information for making most any conceivable product without experience, special equipment or previous knowledge of chemistry or manufacturing.

The experts who compiled this book are authorities, and present this information in simple, understandable language. They also give you wholesale supply sources for needed materials, short cuts and methods for the most profitable results.

START AT HOME—EXPAND OUT OF PROFITS

Hundreds of good paying businesses have been built on a product made from a simple recipe. Choose from any of the 162,000 facts and 10,000 formulas of which the following are only a very few: Adhesives, Alloys, Anti-Freeze Solutions, Cosmetics, Beverages and Liquors, Candy, Gum, Casein, Celluloid, Ceramics, Cheese, Cleaning Preparations, Concrete, Copper, Cotton, Dentifrices, Depilatories, Dyes, Embalming Fluids, Enameling, Glass, Glazes, Household Formulas, Inks, Insecticides, Iron, Jewelers' Formulas, Lacquers, Laundry Preparations, Leather, Linoleum, Lubricants, Manicure Preparations, Marble (artificial), Metals, Mirrors,

— ALSO —

We include Free —our new book of helpful money-making information: —
"The More You Know the More You Can Earn—Easier and Quicker."

Gum, Casein, Celluloid, Oils and Ointments, Paints, Paper, Perfumes, Photography, Polishes, Powders, Remedies for Man, Beast or Fowl, Rubber Products, Refrigerants, Soaps, Solder and Soldering, Tooth Cements, Transfers, Transparencies, Varnishes and Thousands of others for making all sorts of profitable and practical things.

MANY FORTUNES MADE FROM A SINGLE IDEA!

This comprehensive book is an accepted authority by chemists, schools, industry, etc. and is the largest and most comprehensive book of its kind ever issued. Nothing else like it in existence. A single formula has been worth a thousand times this book's small cost to countless owners. Crammed with money-making ideas. Invaluable for reference. Ideal for Factory, Home, Farm, Office or Workshop. As necessary as the dictionary and more useful for manufacturers, chemists and salesmen who put up products for profit.

\$3.98 U. S. Funds. Postpaid anywhere in the World. (C.O.D. in U. S. A. only) Immediate Shipment. Safe Delivery Guaranteed.

ADAMS BROWN COMPANY BOOKS OF APPLIED SCIENCE
Dept. 174, Chestnut Hill 67, Massachusetts, U. S. A.

POSTPAID
\$3.98
ANYWHERE IN THE WORLD

REFRIGERATION and AIR CONDITIONING

REFRIGERATION TRAINING Since 1927



MECHANICAL units everywhere need servicing. Soon new units will require installation service. You can be ready with reliable pay-knowledge of this

big income field. Unique home study-plus actual practice plan prepares you to enter servicing or installing field or get into business of your own. Great opportunities now and later. Get the facts FREE. No obligation. Write today.

Training approved under G. I. Bill

UTILITIES ENGINEERING INSTITUTE
1314 W. Belden Av., Dept. 147, Chicago 14, Ill.

Good Handwriting

HELPS YOU WIN SUCCESS!

It's so important to write a good hand for business and social advancement. Poor illegible penmanship often causes costly errors and marks you for failure. Why write a poor hand? It's so easy to learn at home in spare time. Write for our new free booklet today. If you wish, send 10c for a penpoint suitable for shaded writing and your name beautifully written.

THE TAMBLYN SCHOOL OF PENMANSHIP
In Business Since 1895 H-441 Ridge Bldg., Kansas City, Mo., U. S. A.

FREE! 32-PAGE ILLUSTRATED BOOKLET ABOUT WORLD'S MOST FASCINATING HOBBY



You're invited to hours of satisfaction with skilled tradesmen, business and professional men. Build your own scale model railroad—easy, inexpensive—looks and performs like the real thing. **Get started now!** Send for our FREE illustrated booklet—"Model Railroading For You." Send us your name and address TODAY!

MODEL RAILROADER MAGAZINE
DEPT. 724-D • MILWAUKEE 3, WISCONSIN



I will Train You at Home for RADIO with my Big Kits of Radio Parts

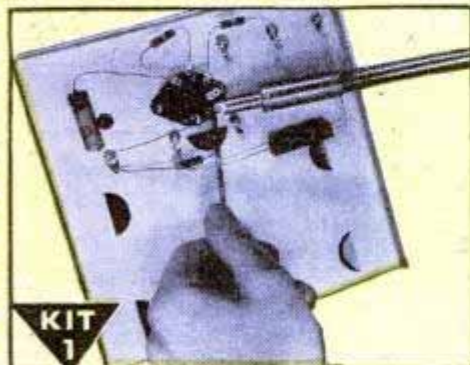

KIT 1
I send you Soldering Equipment and Radio Parts; show you how to do Radio soldering; how to mount and connect Radio parts; give you practical experience.

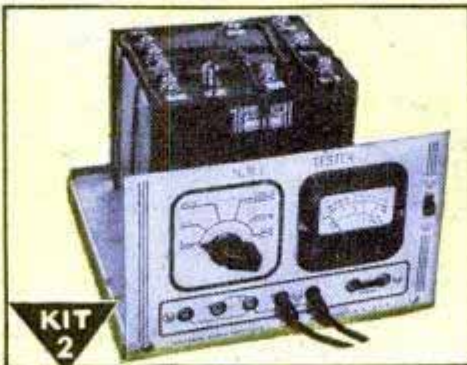

KIT 2
Early in my course I show you how to build this N.R.I. Tester with parts I send. It soon helps you fix neighborhood Radios and earn EXTRA money in spare time.

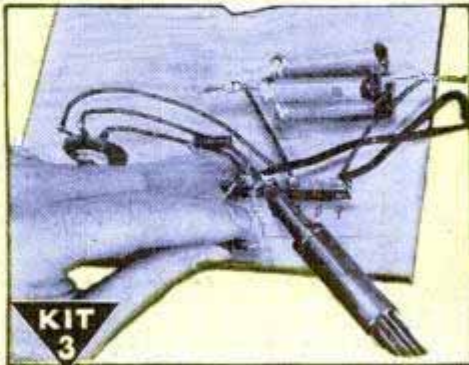

KIT 3
You get parts to build Radio Circuits; then test them; see how they work; learn how to design special circuits; how to locate and repair circuit defects.

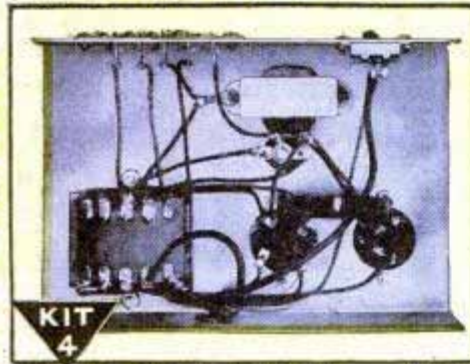

KIT 4
You get parts to build this Vacuum Tube Power Pack; make changes which give you experience with packs of many kinds; learn to correct power pack troubles.

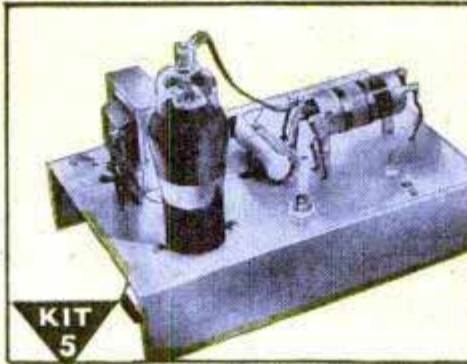

KIT 5
Building this A. M. Signal Generator gives you more valuable experience. It provides amplitude-modulated signals for many tests and experiments.



KIT 6
You build this Superheterodyne Receiver which brings in local and distant stations—and gives you more experience to help you win success in Radio.

Be a RADIO Technician-GET SAMPLE LESSON FREE

Do you want a good-pay job in the fast-growing Radio Industry—or your own Radio Shop? Mail the Coupon for a Sample Lesson and my 64-page book, "How to Be a Success in RADIO—Television, Electronics," both FREE. See how I will train you at home—how you get practical Radio experience building, testing Radio circuits with BIG KITS OF PARTS I send!

Many Beginners Soon Make Extra Money in Spare Time While Learning

The day you enroll I start sending EXTRA MONEY JOB SHEETS that show how to make EXTRA money fixing neighbors' Radios in spare time while still learning! It's prob-

ably easier to get started now than ever before, because the Radio Repair Business is booming. Trained Radio Technicians also find profitable opportunities in Police, Aviation, Marine Radio, Broadcasting, Radio Manufacturing, Public Address work. Think of even greater opportunities as Television, FM, and Electronic devices become available to the public! Send for FREE books now!

Find Out What NRI Can Do For You

Mail Coupon for Sample Lesson and my FREE 64-page book. Read the details about the Course; letters from men I trained; see how quickly, easily you can get started. No obligation! Just MAIL COUPON NOW in envelope or paste on penny postal. **J. E. SMITH, President, Dept. 7DP, National Radio Institute, Pioneer Home Study Radio School, Washington 9, D. C.**

My training includes TELEVISION • ELECTRONICS • F M

Good for Both—FREE

Mr. J. E. SMITH, President, Dept. 7DP
National Radio Institute,
Washington 9, D. C.

Mail me FREE, your sample lesson and 64-page book.
(No salesman will call. Please write plainly.)

Name _____ Age _____

Address _____

City _____ Zone _____ State _____

GETTING ACQUAINTED WITH
RECEIVER SERVICING



VETERANS

You can get this training right in your own home under G. I. Bill.
Mail coupon for full details.

The great **SUCCESS** instruction for men and women now in business . . . or planning to get into **PRODUCTIVE** work . . . The **PROFITABLE, EASY, SURE** method . . . Get it **NOW**

HOW TO MAKE MONEY BY MAIL

ENLARGED to 640 pages, 15th edition

Down-to-earth facts, directions (illustrated) for running business profitably, using expertly for **YOUR** good fortune the employees, trains, planes which Gov't places at your disposal **CHEAP**. Get orders by mail, ship by express or freight or mail, get out of the kindergarten . . . 15th edition, enlarged to 640 pages, now selling. It's **YOUR** winner. Make this year and the following years worth more. **THIS** knowledge really **PAYS OFF**.

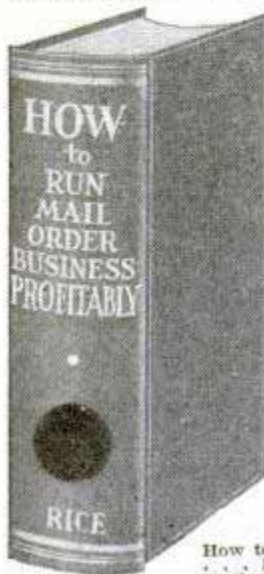

THE EASY WAY to start new or expand your present occupation. **Do it NOW.** Extraordinary plain, simple skill, know-how. **No theory.** Fact story of rich experience of author E. Rice day-by-day. How many times have we heard: "I wish I had some money, this patent would earn me a fortune," or "why can't my crop pay better?" or "I wish I knew how to sell this gadget myself," or "why should my boss alone do this when I too know how the money is made?" **Listen, YOU DO NOT NEED MONEY TO START THIS RICE WAY.** His method automatically pays all bills same day rendered, no bank loans, pay as you go, no borrowing from relatives or friends, no salesmen. Also no worry, quickly a home of your own all paid for. Rice paid off \$5000 in mortgages a year after using this skillful idea.

46 Years of PROOF

Sounds fishy? Sure, but this has been done steadily for 46 years, depression or no depression, by the author; that is why he wrote this book, to pass the good word along. **Make it go with anything you have** which is saleable, or with what you are now doing. Rice made his pay plan go from the start when living in one room in a city lodging house. Turn your city or country home, your work, your hobby, into money. How to get orders coming steadily at cost of only \$4 for each \$100 taken in. The popular error to avoid in trying for sales. Business won free while others have to pay for it.

How to conceive the money-getting advertisement. Profitable changes from ordinary ideas and methods. Not usual cut-and-dried pattern. 250 adventures, a dictated book in everyday talk by Rice himself, as he discloses in his book can be done by his method. No dictionary writing. . . . Read how others are profiting big.

Take a chance on this book being worth a fortune to you and yours and send \$2.95. Book mailed same day order is received. Hundreds of buyers whose letters we show you declare emphatically its superlative goodness. Follow its easy pattern for success. Cloth-bound, 640 pages, 8 1/2 by 5 1/2. Best seller, 15th edition now selling. Cut out the \$2.95 **HOW BOX** here, pin or stick it to sheet of paper bearing your name and address, mail in envelope with money order or check for \$2.95 to

HOW
640 PAGES
\$2.95

HOWARD ST. HOUSE, Melrose 76d, Massachusetts

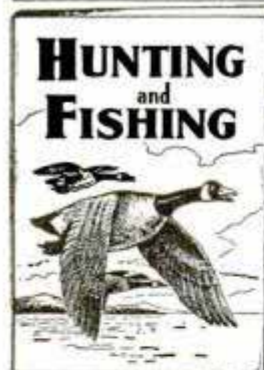

HUNTING and FISHING

is a monthly magazine crammed full of hunting, fishing, camping, dog and boating stories and pictures, invaluable information about guns, fishing tackle, game law changes, best places to fish and hunt—countless ideas that will add more fun to your days afield.

Special Trial Offer

Send 25c in stamps or coin and we will send you **Hunting & Fishing** for six months.

HUNTING & FISHING
MAGAZINE

251 Sportsmen's Bldg., Boston, Massachusetts

Tells How You Can Learn to



FREE BOOK

Learn At Home

Men, Boys, Hunters, Fishermen, mount and save your lovely wild-game trophies. Be a Taxidermist. Mount Birds, Animals, Heads, Fish, Tan skins. YOU learn easily, quickly in spare time. Have a grand home-museum. The finest and the greatest hobby known, for sportsmen. Fun, real profits.

Yes, **FREE**. Beautiful strange, valuable Book, telling all about Taxidermy. Contains over 100 beautiful name-pictures. And it's yours **FREE**, if you rush your request. You can mount all kinds of wild-game, and common specimens too. We can positively **TEACH YOU**. So **GRASP** this opportunity. **RUSH** letter or postal for this amazing **FREE BOOK**. Don't delay. State your **AGE**. **N. W. SCHOOL OF TAXIDERMY 9374 Elwood Bldg., Omaha 2, Neb.**

What Every Mason Wants



We have important Masonic books for **Blue Lodge, Chapter, Commandery, Scottish Rite, and Shrine.**

Our Rituals Are Used the World Over. Send for free catalog of books and rituals for Masons, Odd Fellows, Knights of Pythias, Knights of Columbus, etc.

EZRA A. COOK, Publisher, P. O. Box 796, PA, Chicago 90, Ill.



You can become a good penman right in your own home during spare time by my Simplified Method. Write for my **FREE** Book, "How to Become an Expert Penman," which shows what others have learned. If desired, send 10c for one of my favorite Pen Points and your name with a beautiful flourished bird written on a card. Write for the Free Book today.
T. M. TEVIS, BOX 25K, CHILLICOTHE, MO.

CHAPMAN CHINCHILLAS

The originator of the first Chinchilla Farm in the United States. For information on purchasing the finest, selected breeding stock of these aristocratic animals that were virtually trapped to extinction write or visit—

Established 1919 **Chapman Chinchilla Farm**
4957 West 104th Street
Inglewood, California

CORRESPONDENCE COURSES IN RADIO and ELECTRICAL ENGINEERING

ELECTRICAL ENGINEERING. Get good grasp of wide electrical field. Modern. Very understandable. Theory made easy. **RADIO ENGINEERING.** Extra fine course in radio, public address, photo-electric work. Trains you to be super-service man, real vacuum tube technician. Tuition **ONLY \$25**, either course. Deferred payment plan. Servicemen needed badly. Write for free copies of school catalogs, student magazines, etc. **FREE** LINCOLN ENGINEERING SCHOOL, Box 931-P100, Lincoln, Nebr.

★ GET ON "UNCLE SAM'S" PAYROLL ★

\$1,756 TO \$3,021 FIRST YEAR

Veterans Get Special Preference

Railway Postal Clerks—Mail Carriers—Mail Clerks — Patrol Inspectors — Storekeeper Gaugers—Positions at Washington, D. C. — Etc. Mail Coupon immediately — **32-Page Book on Civil Service—FREE**

FRANKLIN INST., Dept. G86, Rochester 4, N. Y.
Gentlemen: Rush to me, without charge, 32 page book with list of U. S. Government big paid positions. Advise me also regarding salaries, hours, work, vacations, etc. Tell me how to prepare for a position.
Name.....
Address.....
Age.....
Vet?.....

INVENTORS

The patent laws provide that any new and useful art, machine, article of manufacture, composition of matter, or design, or any new and useful improvement thereof, may be patented if the act of invention is involved. Therefore, every inventor with a valuable invention should take advantage of the patent laws and proceed for patent protection in order to safeguard his rights.

A patent gives the inventor the exclusive right to prevent others from making, using, or selling the invention claimed in the patent for a period of 17 years.

The patent laws were enacted for the benefit of the inventor to give him protection for the features of his invention which are patentable. These features must be properly and concisely set forth and claimed in a formal application for patent in order to comply with the requirements of the U. S. Patent Office. For that reason, the Patent Office advises the inventor to engage a competent registered patent attorney to prepare his application for patent and represent him before the U. S. Patent Office Examiner.

A specially prepared booklet containing detailed information with respect to patent protection and procedure will be forwarded to you without obligation upon request.

Patents
Trademarks
Copyrights

Registered Patent Attorneys

CLARENCE A. O'BRIEN
& HARVEY B. JACOBSON

71-D District National Building + Washington 5, D. C.

CLARENCE A. O'BRIEN & HARVEY B. JACOBSON
Registered Patent Attorneys
71-D District National Bldg., Washington 5, D. C.

Please send me booklet containing information regarding patent protection and procedure, and also "Record of Invention" form. This request does not obligate me.

Name _____

Address _____

City _____ State _____

(Please write or print plainly.)



NOW! An Amazing Opportunity to LEARN RADIO AT HOME

I SEND YOU 8 BIG KITS OF RADIO PARTS

Including a **COMPLETE 6 TUBE SUPER-HETERODYNE RECEIVER**

I TRAIN YOU RIGHT by PUTTING YOU TO WORK with REAL PROFESSIONAL EQUIPMENT!

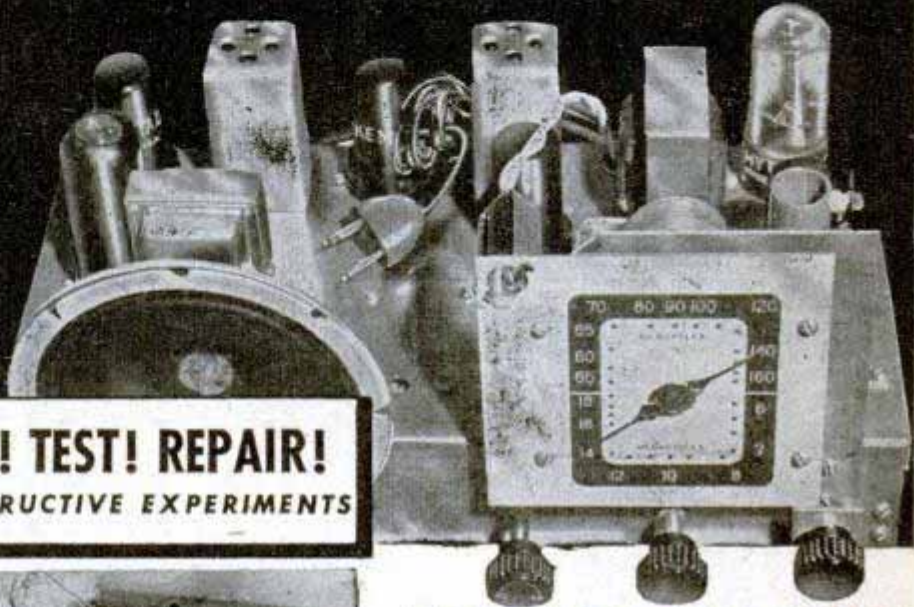

LEARN HOW TO BUILD CIRCUITS! TEST! REPAIR!
YOU DO OVER 175 INSTRUCTIVE EXPERIMENTS



YOU BUILD THIS USEFUL TEST EQUIPMENT!



I give you a fine, moving-coil type Meter Instrument on Jewel Bearings — with parts for a complete Analyzer Circuit Continuity Tester. You learn how to check and correct Receiver defects with professional accuracy and speed.

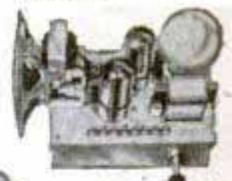

HERE'S THE EASIEST, MOST PRACTICAL WAY OF ALL TO PREPARE FOR GOOD PAY in RADIO ELECTRONICS and TELEVISION!

I train your mind by putting you to work with your hands on a big 6-Tube Superheterodyne Receiver. And, believe me, when you get busy with real Radio Parts — 8 big Kits of them — you really LEARN Radio and learn it RIGHT! You get the practical stuff you need to be useful in Radio, and that's what it takes to make money. You don't have to worry about what to do with these 8 Kits of Parts. Step by step, I show you how to build circuits, test, experiment, trouble-shoot. And you don't need any previous experience. The Sprayberry Course starts right at the beginning of Radio! You can't get lost! Simplified lessons, coupled with real "Shop" practice, makes every subject plain and easy to understand and remember. Soon after you begin Sprayberry Training, I'll send you my sensational BUSINESS BUILDERS.

A BUSINESS OF YOUR OWN . . . OR A GOOD RADIO JOB
You'll find out how to get and do neighborhood Radio repair jobs for nice profits and rich experience while learning. This sort of work can easily pave the way for a Radio Service business of your own. But with Sprayberry Training, you're not limited. You can swing into any one of the swiftly expanding branches of Radio-Electronics INCLUDING Radio, Television, FM, Radar, Industrial Electronics. Be wise! Decide now to become a fully qualified RADIO - ELECTRONICIAN. Get full details about my Training at once! Mail coupon below for my 2 big FREE Books.

Soldering, wiring, connecting Radio parts . . . building circuits — you can't beat this method of learning. When you construct this Rectifier and Filter, Resistor and Condenser Tester, etc., you get a really practical slant on Radio.

You'll get valuable experience and practice building this Signal Generator and multi-purpose Tester. Makes a breeze out of fixing Radios and you don't have to spend money on outside, ready-made equipment.

GET THESE VALUABLE FREE BOOKS
"How to Read Radio Diagrams and Symbols"
Here's a valuable and wonderfully complete new book which explains in simple English how to read and understand any Radio Set Diagram. Includes translation of all Radio symbols. Send for this volume at once. It's free! Along with it, I will send you another Big Free book describing in detail my Radio-Electronic Training.



RUSH COUPON!

SPRAYBERRY ACADEMY OF RADIO
F. L. Sprayberry, President, Room 1047, Pueblo, Colorado
Please rush my FREE copies of "How to MAKE MONEY in RADIO, ELECTRONICS and TELEVISION," and "HOW to READ RADIO DIAGRAMS and SYMBOLS."

Name Age

Address

City State

(Mail in envelope or paste on penny postcard)

How to Make YOUR Body Bring You **FAME**

... Instead of **SHAME!**

ARE YOU Skinny? Weak? Flabby?

Will You Let Me Prove I Can Make You a New Man?



Charles Atlas

Holder of title, "The World's Most Perfectly Developed Man." This actual snapshot is not retouched in any way.

I KNOW what it means to have the kind of body that people pity! Of course, you wouldn't know it to look at me now, but I was once a skinny weakling who weighed only 97 lbs. I was ashamed to strip for sports or undress for a swim. I was such a poor specimen of physical development that I was constantly self-conscious and embarrassed. And I felt only HALF-ALIVE.

But later I discovered the secret that turned me into "The World's Most Perfectly Developed Man." And now I'd like to prove to you that the same system can make a NEW MAN of YOU!

What "Dynamic Tension" Will Do For You

I don't care how old or young you are or how ashamed of your present physical condition you may be. If you can simply raise your arm and flex it I can add SOLID MUSCLE to your biceps—yes, on each arm—in double-quick time! Only 15 minutes a day—right in your own home—is all the time I ask of you! And there's no cost if I fail.

I can broaden your shoulders, strengthen your back, develop your whole muscular system **INSIDE** and **OUTSIDE!** I can add inches to your chest, give you a viselike grip, make those legs of yours lithe and powerful. I can shoot new strength into your old backbone, exercise those inner organs, help you cram your body so full of pep, vigor and red-blooded vitality that you won't feel there's even "standing room" left for weakness and that lazy feeling! Before I get through with you I'll have your whole frame "measured" to a nice new, beautiful suit of muscle!

"Dynamic Tension" is an entirely NATURAL method. Only 15 minutes of your spare time daily is enough to show amazing results—and it's actually fun. "Dynamic Tension" does the work.

"Dynamic Tension!" That's the ticket! The identical natural method that I myself developed to change my body from the scrawny, skinny chested weakling I was at 17 to my present super-man physique! Thousands of other fellows are becoming marvelous physical specimens—my way. I give you no gadgets or contraptions to fool with. When you have learned to develop your strength through "Dynamic Tension," you can laugh at artificial muscle-makers. You simply utilize the dormant muscle-power in your own body—watch it increase and multiply into real, solid LIVE MUSCLE.

My method—"Dynamic Tension"—will turn the trick for you. No theory—every exercise is practical. And, man, so easy! Spend only 15 minutes a day in your own home. From the very start you'll be using my method of "Dynamic Tension" almost unconsciously every minute of the day—walking, bending over, etc.—to BUILD MUSCLE and VITALITY!

Only 15 Minutes A Day

No "ifs," "ands" or "maybes." Just tell me where you want handsome, powerful muscles. Are you fat and flabby? Or skinny and gawky? Are you short-winded, peppy? Do you hold back and let others walk off with the prettiest girls, best jobs, etc.? Then write for details about "Dynamic Tension" and learn how I can make you a healthy, confident, powerful **HE-MAN.**

Mail Coupon For My **FREE Book**

FREE BOOK "Everlasting Health and Strength"

In it I talk to you in straight-from-the-shoulder language. Packed with inspirational pictures of myself and pupils—fellows who became **NEW MEN** in strength, my way. Let me show you what I helped **THEM** do. See what I can do for **YOU!** For a real thrill, send for this book today, **AT ONCE.** CHARLES ATLAS, Dept. 84, 115 East 23rd Street, New York 10, N. Y.

CHARLES ATLAS, Dept. 84, 115 East 23rd Street, New York 10, N. Y.

I want the proof that your system of "Dynamic Tension" will help make a New Man of me—give me a healthy, husky body and big muscle development. Send me your free book, "Everlasting Health and Strength."

Name.....Age.....
(Please print or write plainly)
Address.....
City.....State.....



INVENTORS

Patent Laws Encourage The Development Of Inventions

The Rules of Practice of the U. S. Patent Office advises—unless an inventor is familiar with such matters—that he employ a competent registered attorney, as the value of patents depends largely upon the skillful preparation of the specifications and claims.

The firm of McMorrow, Berman and Davidson is registered to practice before the U. S. Patent Office. Additionally, it maintains a staff of attorneys able to readily understand inventors' disclosures, to advise concerning patentability, and to prepare appropriate specifications and claims for filing with the Patent Office.

If an inventor believes he has an invention, a search of the most pertinent prior U. S. patents should be made and a report obtained relative to its patentability. Where such report indicates that the invention appears patentable, in order to secure protection, diligence should be exercised in making application for a patent.

McMORROW, BERMAN & DAVIDSON

Registered Patent Attorneys

PATENTS — TRADE MARKS — COPYRIGHTS

1354 VICTOR BUILDING, WASHINGTON 1, D. C.

McMORROW, BERMAN & DAVIDSON

Registered Patent Attorneys

1354 Victor Building, Washington 1, D. C.

Send me further particulars as to patent protection and procedure and "Invention Record" form at once. I understand that this request does not obligate me.

Name.....

Address.....

City..... State.....

(WRITE OR PRINT NAME CLEARLY)

PREPARE NOW for "a rainy day"

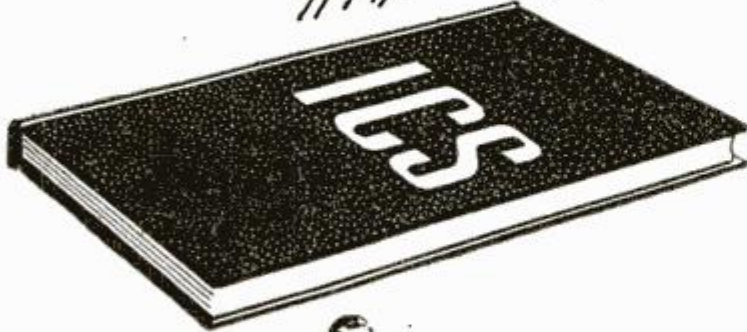

FORTUNE-TELLING is *not* one of the attributes of I. C. S. We're much more concerned with helping those who need specialized training. For, regardless of what the future may bring, *trained men* will continue to hold the important positions in business and industry.

That's why we strongly recommend that you prepare yourself now for changes that may threaten your occupational status. In periods of uncertainty, *training is your best protection.*

I. C. S. can help you acquire much of the technical knowledge you need. Courses cover more than 400 commercial and industrial subjects. You study in your spare time . . . set your own pace . . . progress just as fast as your abilities and ambition permit.

Don't delay your program for self-advancement. Clip and mail this coupon TODAY. It will bring you full particulars about the courses in which you are interested.

INTERNATIONAL CORRESPONDENCE SCHOOLS



BOX 5602-K, SCRANTON 9, PENNA.

Without cost or obligation, please send me full particulars about the course *before* which I have marked X:

Air Conditioning and Plumbing Courses

- Air Conditioning
- Heating Plumbing
- Refrigeration Steam Fitting

Chemistry Courses

- Chemical Engineering
- Chemistry, Analytical
- Chemistry, Industrial
- Chemistry, Mfg. Iron & Steel
- Petroleum Refining Plastics
- Pulp and Paper Making

Civil Engineering, Architectural and Mining Courses

- Architectural Drafting
- Architecture
- Bridge and Building Foreman
- Building Estimating
- Civil Engineering
- Coal Mining
- Contracting and Building
- Highway Engineering
- Lumber Dealer
- Reading Structural Blueprints
- Sanitary Engineering
- Structural Drafting

- Structural Engineering
- Surveying and Mapping

Communications Courses

- Electronics
- Practical Telephony
- Radio, General
- Radio Operating
- Radio Servicing
- Telegraph Engineering

Electrical Courses

- Electrical Drafting
- Electrical Engineering
- Electric Light and Power
- Lighting Technician
- Practical Electrician

Internal Combustion Engines Courses

- Auto Technician Aviation
- Diesel-Electric
- Diesel Engines Gas Engines

Mechanical Courses

- Aeronautical Engineering
- Aircraft Drafting
- Flight Engineer
- Foundry Work
- Heat Treatment of Metals

- Industrial Engineering
- Industrial Metallurgy
- Machine Shop
- Mechanical Drafting
- Mechanical Engineering
- Mold-Loft Work
- Patternmaking—Wood, Metal
- Reading Shop Blueprints
- Sheet-Metal Drafting
- Sheet-Metal Worker
- Ship Drafting Ship Fitting
- Tool Designing
- Toolmaking
- Welding—Gas and Electric

Railroad Courses

- Air Brake Car Inspector
- Diesel Locomotive
- Locomotive Engineer
- Locomotive Fireman
- Railroad Section Foreman

Steam Engineering Courses

- Boilermaking
- Combustion Engineering
- Engine Running
- Marine Engineering
- Steam Electric Steam Engines

Textile Courses

- Cotton Manufacturing
- Rayon Weaving
- Textile Designing
- Woolen Manufacturing

Business and Academic Courses

- Accounting Advertising
- Arithmetic Bookkeeping
- Business Correspondence
- Business Management
- Certified Public Accounting
- Commercial
- Cost Accounting
- Federal Tax
- First Year College
- Foremanship French
- Good English High School
- Higher Mathematics
- Illustrating Motor Traffic
- Postal Service
- Salesmanship Secretarial
- Sign Lettering
- Spanish Stenography
- Traffic Management

Name _____ Age _____ Home Address _____

City _____ State _____ Present Position _____

Working Hours _____ A.M. to _____ P.M.

Length of Service in World War II _____

Special tuition rates to members of the Armed Forces. Enrollment under the G.I. Bill of Rights approved for War II Veterans, Canadian residents send coupon to International Correspondence Schools Canadian, Ltd., Montreal, Canada.

ADVICE for the INVENTOR

The United States Patent Office advises the inventor, unless he is familiar with such matters, to employ a competent, registered patent attorney since the value of a patent depends largely upon the skillful preparation of the specifications and claims set forth in his application.

PRELIMINARY STEPS *toward* PATENT PROTECTION

The Evidence of Invention form mentioned below is offered as a convenience to the inventor in making his disclosure of invention. The inventor should date and sign his disclosure and have it witnessed by two or more persons who are capable of understanding his invention. The disclosure should then be mailed together with the inventor's authorization to conduct a pre-

liminary search at the U. S. Patent Office among previously granted U. S. Patents for similar types of invention. A report is then prepared on the probable patentability of his invention and a recommendation made as to the further course he should take in regard to his invention, provided that the patentability report indicates possible patentability.

Victor J. Evans & Co., has a staff of experienced, registered patent attorneys available to represent inventors in the preparation and prosecution of their cases before the Patent Office.

The **COUPON BELOW** is suggested as a convenience to the inventor in starting action on his invention.

**VICTOR J.
EVANS & Co.**

Merlin M. Evans

REGISTERED PATENT ATTORNEY

230-D Merlin Building, Washington 6, D. C.

PLEASE SEND DETAILED PATENT INFORMATION TOGETHER WITH CONVENIENT "EVIDENCE OF INVENTION" FORM.

Name.....

Address.....

City and State.....

MEN! Whether You're 16 or ^{up} 40..

Learn ELECTRICITY

Get Ready quickly
for the Field that offers
**STEADY WORK and
A REAL FUTURE!**

FREE BOOK shows how you can
prepare for a **GOOD JOB NOW**



A partial view of one of the Training Departments at Coyne

"LEARN-BY-DOING" IN COYNE SHOPS

Start now to prepare for a Lifetime of Success. Get into Electricity, the essential field that will continue to offer good pay and a real future all through the years. Coyne trains you, **NOT** by correspondence, but by actual shop work right here in the Coyne Shops in Chicago on real electrical machinery. You get necessary theory in a practical way by lectures, blackboard illustrations and equipment demonstrations.

In the Big Coyne Shops you get practical "all-around" training... wiring, installing, operating, testing, repairing and servicing various types of Electrical and Electronic equipment... you work on real armatures, motors, generators, refrigerators, electronic controls, etc. No advanced education or previous electrical experience needed. Many of our students had no previous experience. Others had experience in one or two branches but realized they needed all-around training for the better jobs and advancement.

Student Finance Plan

Don't let lack of money hold you back. Our "Pay-Tuition-after-Graduation" plan has helped thousands. Coupon brings details.

Earn While Learning

Many earn while learning, to help take care of living expenses while here. When you have graduated, our Employment Department will give you Lifetime Employment Service.



PREPARE FOR PERMANENT JOBS LIKE THESE
Light and Power Wiring
Power Plant Work
Armature Winding
Substation Operator
Maintenance Electrician
Electrical Testing and Repair
Signal Maintenance
Industrial Electronics
Electric Refrigeration
and many others
Our Employment Bureau for graduates gives FREE lifetime employment service.

Industrial Electronics and Electric Refrigeration Training Now Included

Added training in these two great fields is now included with our Electrical Course. Industrial Electronics and Electric Refrigeration offer big opportunities. Get BOTH at Coyne!



B.W. Cooke

MEN WITH PHYSICAL DISABILITIES—

We also have facilities for men with physical disabilities whether due to war or other causes. Check coupon for particulars if you have a physical disability of any nature.

GET THE FACTS

Don't let lack of money keep you from sending in the Coupon now. Our Big FREE Book is full of facts and photographs which tell you about Coyne training. It also gives you the details of our "Student Finance" Plan, Part Time Employment Plan, Graduate Employment Service, Lifetime Membership, etc.

OUR GRADUATE EMPLOYMENT SERVICE HAS LETTERS FROM DOZENS OF FIRMS ASKING FOR COYNE TRAINED MEN FOR GOOD JOBS WITH A REAL FUTURE.



This modern fireproof building is occupied entirely by the Coyne Electrical School.

VETERANS

Coyne is also equipped to train those who qualify for training under the G. I. Bill of Rights. Check coupon for special G.I. Bulletin

ADDED TRAINING IN INDUSTRIAL ELECTRONICS AND ELECTRIC REFRIGERATION Now Included!

B. W. COOKE, Director

COYNE ELECTRICAL SCHOOL
500 S. Paulina St., Dept. 47-72. Chicago, 12

Send Today for this FREE Book!

B. W. COOKE, Director
COYNE ELECTRICAL SCHOOL,
500 S. Paulina St., Dept. 47-72, Chicago 12, -IL

Without obligation send big free illustrated book with facts about Coyne and details of "Student Finance" Plan and added training in Industrial Electronics and Electrical Refrigeration you are now including.

- Send special G. I. Bulletin.
- Send physical disability details.

Name.....

Address.....

City.....State.....



HOW YOU CAN BUILD A MIGHTY BODY

Quickly! Easily! Pleasantly
—in 10 minutes a day in your own home

"The World's greatest molder of men"—at last reveals to you in these five complete book-courses (value \$5 each).

1. How YOU Can Build a Mighty ARM!



A. PASSAMONT
First prize for physical perfection.

Let me give YOU, TOO, such a pair of chain-breaking biceps. The strongest-armed man in the world, George F. Jowett, planned this course for you. His great experience stands as proof that YOU, TOO, can get the arms men respect and women admire.

Complete Arm Course 25c

2. How YOU Can Build a Mighty CHEST!



REX FERRIS
Champion of South Africa, says, "I owe everything to Jowett Methods."

Look at the Heroic Chest of this Jowett Pupil. A powerhouse of energy. Ferris writes, "I want to add my sincere gratitude to that of thousands of pupils for wonderful results from your course. Your course is by far the best." If you have a narrow, sunken chest I can improve it so that you will be proud to show it off.

Complete Chest Course 25c

3. How YOU Can Build a Mighty BACK!



CHAS. SCHAFER
An amazing Jowett product. Once a puny weakling. Now versatile athlete.

Look at his rock-like Back now! He says, "You have worked wonders for me. You are head and shoulders above the rest in your profession." Let me help YOU, TOO, build a back of power. Square shoulders with enviable military spread. A spine as strong as a steel shaft.

Complete Back Course 25c

4. How YOU Can Build a Mighty GRIP!



W. BURNS
A Jowett-made Olympic Strength Champion.

YOU, TOO, can have a Manly Grip like this Jowett pupil. What would you give for a forearm like that, with its bone-crushing grip? Fingers strong as steel pincers. A hand like an iron vise. YOU, TOO, can get these symbols of real manliness. I have proved to thousands this is no mere dream. Let me mold a pair of arms like this for you . . . with a grip of might. A handshake that will win friends—success.

Complete Grip Course 25c

5. How YOU Can Build Mighty LEGS



BOB MITCHELL
A Jowett Champion—not in words but by ACTUAL RECORDS.

What would you give to have the all-round man strength of Bob Mitchell? It's reasonable to assume that what I have done for thousands, I can do for you. I myself increased my thighs by 8 inches, my calves by 5 inches, by this simple, unbeatable method. I'll help you build legs that are real props of leaping, tireless power!

Complete Leg Course 25c

Last Chancel Get All 5 Picture Courses for \$1.00



RUSH COUPON NOW

BOOK WITH PHOTOS OF FAMOUS STRONG MEN
MAIL COUPON NOW **FREE**



George F. Jowett
Champion of Champions

Jowett Institute of Physical Culture
230 Fifth Avenue, Dept. PM-74A, New York 1, N. Y.
George F. Jowett: Your proposition looks good to me. Send by return mail, prepaid, the courses checked below, for which I enclose (), include FREE book of PHOTOS.

- All 5 courses for . . . \$1
- Molding a Mighty Arm 25c
- Molding a Mighty Back 25c
- Molding a Mighty Grip 25c
- Molding a Mighty Chest 25c
- Molding a Mighty Leg 25c
- Send all 5 C.O.D. (\$1 plus postage.) No orders less than \$1 sent C.O.D.

NAME Age
(Please print plainly. Include Zone Number.)

ADDRESS

SAY YOU SAW IT IN POPULAR MECHANICS

DOUBLE your INCOME IN YOUR SPARE TIME

LEARN SILK SCREEN PROCESS

Jealously Guarded Trade Secrets NOW Available to You

Develop a Profitable Business of Your Own . . . or a Hobby



Prepare yourself for an interesting top paying position. Thousands of jobs open. Silk Screen Process signs, displays, Xmas cards, toys, etc. IN GREAT DEMAND THE WORLD OVER. You may make enough the second week to pay for the entire course. EASY TO DO . . . EASY TO LEARN. No education or mechanical knowledge required. BOOKLET with 3-color Silk Screen Process cover and Samples sent FREE. Write NOW!

COURSE INCLUDES A COMPLETE KIT OF SUPPLIES

CALIFORNIA SCHOOL OF SCREEN PROCESS
Dept. PM-47, 3740 Overland Blvd., Los Angeles 34, California

Command a Substantial Salary BE AN ACCOUNTANT

FREE WRITE TODAY

Hill's, one of America's leading Business Schools, offers you the opportunity to advance yourself to a well paying accountant's job. Our FREE book, "Through Hill's to Success," tells how and where the best positions are found and how you can qualify for them by study at home or in our resident school. We have thousands of successful graduates and maintain nation-wide employment service. G. I. Approved.

HILL'S EXTENSION SCHOOL and BUSINESS UNIVERSITY

619 W. Main St. • Oklahoma City 2, Okla.



Get Started in Radio TEN "HOW-TO-DO-IT" BOOKS

Get a solid foundation in radio by means of these 10c timely text books. Each clearly written, profusely illustrated, contains over 15,000 words. You'll be amazed at the wealth of information packed into these handy books. Excellent for reference—ideal for technical library. Your money back if not satisfied.

5 Books for 50c - 10 Books for \$1
SENT TO YOU POSTPAID

- No. 1—How To Make Four Doerle Short Wave Sets
- No. 2—How To Make The Most Popular All-Wave 1 and 2 Tube Receivers
- No. 3—Alternating Current for Beginners
- No. 4—All About Aerials
- No. 5—Beginners' Radio Dictionary
- No. 6—How To Have Fun With Radio
- No. 7—How To Read Radio Diagrams
- No. 8—Radio for Beginners
- No. 9—Simple Electrical Experiments
- No. 10—Television

Remit by check or money order—register letter if you send cash or stamps.
RADIO PUBLICATIONS, 23-V West Broadway, New York (7)

LEARN MONEY-MAKING CARTOONING

IN SPARE TIME — by Easy Picture Chart Method Same Simplified Method that has helmed train creators of "Terry & Pirates," "Freckles," "Out Our Way," "Winnie the Winkle," "Reg'lar Fellers," "Strange As It Seems," "The Neighbors," and many others. Earn while learning. Send 10c for Picture Chart (to test your ability), and full details. (State age.)



Landon School of Cartooning, Dept. 4704 Philadelphia (1) Pa.

LAW
STUDY AT HOME for PERSONAL SUCCESS and LARGER EARNINGS. 38 years expert instruction—over 108,000 students enrolled. I.L.B. Degree awarded. All texts furnished. Easy payments. Send for FREE BOOK—"Law and Executive Guidance."

AMERICAN EXTENSION SCHOOL OF LAW
Dept. 76-M, 646 N. Michigan Ave., Chicago 11, Ill.

MONEY MEN ALL FREE

THE PLASTEX Industry needs manufacturers on small scale and for big production of Lamp and Clock Stands, Art Goods and Novelties in Plastex and Marble imitation. Experience unnecessary. 12c material makes regular 10c store sellers. Rubber moulds furnished for speed production. Small investment brings good returns. Big chain store orders now being placed. Ambitious men have chance for real prosperity. Our Free booklet will interest and benefit you.

PLASTEX INDUSTRIES, Dept. P, 1085 Washington Ave., New York, N.Y.

WHICH OF THESE *Opportunities* INTERESTS *You* MOST?

Accounting
Air Conditioning
Architecture & Building
Automotive Engineering
Aviation—Practical
Aviation Drafting & Design
Better Foremanship
Bookkeeping
Business Management

Contracting
Diesel Engineering
Drafting & Design
Electrical Engineering
Electricity—Practical
Electronics, Industrial
High School Courses
Machine Shop Operations
Mechanical Engineering

Plastics Engineering
Plumbing—Practical
Private Secretary
Radio Operating & Servicing
Railway Training
Refrigeration
Sheet Metal Pattern Drafting
Shop Management
Tool Making

THINK! LOOK FORWARD!

Business is making big, new plans

Men and Women are preparing for the future

WHAT ARE YOU DOING ABOUT YOUR TOMORROWS?

● *Today*, choose the job you want—and prepare for it. Or if you are already engaged in the work you like best, start training *now* for quicker promotion. Acquire the knowledge that will help you to get ahead faster, make more money and have greater security.

Invest part of your spare time in more rapid progress. Start training now, in spare time in your own home. Be ready to grasp your opportunity and step out ahead of those who lack the ability you have attained.

American School, founded in 1897 as an educational institution *not for profit*, can help you to reach your goal just as it has helped others during the past fifty years. Give serious thought to the list above. Pick one or more subjects that interest you. Then check the coupon at right, add your name and address and mail it at once. The school will send you details on its training plan and outline of study prepared by specialists. There is no charge, no obligation, so send the coupon immediately.

HOME - STUDY TRAINING SINCE 1897

Take This First Easy Step

CHECK, CLIP AND MAIL COUPON NOW

AMERICAN SCHOOL, Dept. G445, Drexel at 58th, Chicago 37, Ill.
Without obligation, Please send FREE and postpaid, bulletin and details of the Subject checked.

<input type="checkbox"/> PLASTICS ENG'R	<input type="checkbox"/> Accounting	<input type="checkbox"/> Drafting and Design for Men and Women
<input type="checkbox"/> Refrigeration	<input type="checkbox"/> Electrical Engr.	<input type="checkbox"/> Radio
<input type="checkbox"/> Architecture and Building	<input type="checkbox"/> Electricity-Pract.	<input type="checkbox"/> High School
<input type="checkbox"/> Contracting	<input type="checkbox"/> Electronics, Industr.	<input type="checkbox"/> Air Conditioning
<input type="checkbox"/> Practical Plumbing	<input type="checkbox"/> Bookkeeping	<input type="checkbox"/> Mechanical Eng.
<input type="checkbox"/> Automotive Engineering	<input type="checkbox"/> Private Secretary	<input type="checkbox"/> Shop Management
<input type="checkbox"/> Aviation Drafting	<input type="checkbox"/> Diesel Engineering	<input type="checkbox"/> Tool Making
<input type="checkbox"/> Aviation	<input type="checkbox"/> Sheet Metal	<input type="checkbox"/> Better Foremanship
<input type="checkbox"/> Business Mgmt	<input type="checkbox"/> Pattern Drafting	<input type="checkbox"/> Machine Shop Operations
<input type="checkbox"/> Railway Training		

PRACTICAL, EFFECTIVE

AMERICAN SCHOOL
Dept. G445, Drexel at 58th Street, Chicago 37

Name..... Occupation.....
Address..... Age.....
City..... State.....

FREE

**Radio's Greatest
Buying Guide!**

ALLIED'S NEW RADIO CATALOG

Send for this Big
Value Book NOW!



Send for your FREE copy of the leading Buying Guide for Everything in Radio! Here's the handiest catalog for Servicemen, Dealers, Soundmen, Amateurs, Builders and Experimenters. Features the world's largest and most complete stocks of quality radio and electronic supplies—all at lowest prices! Get the equipment, the speedy service, the expert help you want, from ALLIED—Radio's Largest Supply House!



HUGE STOCKS—MORE THAN 10,000 ITEMS

Everything for every radio use: new model home radios, phono-radios, communications receivers, Ham kits and gear, radio parts, tubes, tools, test instruments, public address equipment, low-cost easy-to-build radio kits, diagrams, instructive radio books, radio's most complete stocks—all at lowest prices!

HELPFUL RADIO BOOKS!

- Radio Formulas & Data No. 37-752 . . . 10c
- Dictionary of Radio Terms No. 37-751 . . . 15c
- Radio Circuit Handbook No. 37-753 . . . 25c
- Radio Builders' Handbook No. 37-750 . . . 15c
- Simplified Radio Servicing No. 37-755 . . . 10c
- Radio Data Handbook No. 37-754 . . . 25c
- ALL 6 BOOKS above No. 37-799 . . . \$1.00
- Parallel-Resistance and Series Capacitance Calculator. No. 37-960 . . . 25c
- R-F Resonance and Coil Winding Calculator. No. 37-955 . . . 25c

ALLIED RADIO

ALLIED RADIO CORP.
833 W. Jackson Blvd., Dept. 5-D-7
Chicago 7, Illinois

- Rush FREE 1947 Catalog
 - Send 6 Books No. 37-799
 - Send Books checked above
 - Send Calculators checked above
- } \$.....enclosed

Name.....
Address.....
City..... Zone..... State.....

**FREE
CATALOG**

AVIATION

Aeronautical University Approved Training meets exacting standards of aviation industry, prepares for key positions, big opportunities.

Courses in:

AERONAUTICAL ENGINEERING. B.S. degree.
AERONAUTICAL ENGINEERING DRAFTING
CERTIFIED ENGINE MECHANICS
ADMINISTRATION—including sales

PRE-ENGINEERING: Special course for high school graduates and veterans deficient in math and science.

Also refresher courses for Gov't Airplane and Engine Mechanics Licenses for those with aviation experience.

Oldest fully approved aviation school. Outstanding faculty, modern equipment, outside employment, placement service. Day, evening. Approved for Veterans. Send today for FREE catalog "Opportunities in Aviation."

AERONAUTICAL UNIVERSITY

Dept. 77, 116 S. Michigan Ave., Chicago 3, Ill.

**FOUNDED
BY
CURTISS-
WRIGHT**

Learn to MOUNT BIRDS

Tan SKINS, make up FURS
Be a Taxidermist. Double your hunting fun. We teach you at Home. Mount Birds, Animals, Fish, Heads, common specimens. Fun and profits. Decorate home and **don MAKE MONEY.** Mount game, tan for others. Big profits in spare time. **WRITE TODAY.** 100 game pictures in **FREE BOOK.** Hunters, get your copy. It's **Now Free.** Send post card. State your AGE. **NORTHWESTERN SCHOOL OF TAXIDERMISTRY** Dept. 3374 Omaha, Nebraska

FREE BOOK

**PLAY GUITAR
LIKE THE**



**COWBOYS
DO... only 8 1/2 \$
A LESSON**

Just out—very latest guaranteed, simple, easy method. Play cowboy songs the Western way in a few minutes by ear. Surprise and amaze your friends. Be in big demand at parties, camps, public entertainments, on the radio, etc. 12 Complete Lessons. **SEND NO MONEY.** Pay postman only \$1.00 plus postage and C.O.D. charges, or send \$1.00 and get **EXTRA SONGS** all postpaid. (Canada, \$1.25 money order only.) Nothing else to buy. Positive money back guarantee. **Rush order today.** **WESTERN RANGER STUDIOS, Dept. 154, Hutchinson, Kans.**

LEARN WATCH REPAIRING



AT HOME. By our modern and original system of instruction you can learn every part of the **WATCH REPAIRING TRADE AT HOME.** Prepare yourself for a well-paying position or start in business after completing our course of instruction. Good watch repairers are in demand and generally earn very good salaries. For particulars apply to the **Wisconsin School of Watch Repairing** 759 North Milwaukee St., Milwaukee 2, Wis.

PRINTING PAYS BIG

"Make your future secure. Prepare for a highly paid position or a print shop of your own. Students throughout the world are enthusiastic in their praise of our training program and the personal attention given each student. Rush name today for free literature and sample lesson. No salesman will call. Write Dept. M-106.

International School of Printing, Box 334, Dayton, Ohio



LEARN PORTRAIT PAINTING AT HOME

● Previous art training or talent NOT necessary. This new Stuart System teaches you, in 11 simple, easy-to-follow lessons, to make exact charcoal and oil likenesses. Guidance for your every step. Send for free book today.

STUART STUDIOS.

121 Monument Circle, Room 64, Indianapolis 9, Ind.
Please send me free book and outline of lessons.

Name.....
Street.....
City..... State.....

Now IN YOUR OWN HOME Learn

RADIO ELECTRONICS

The Practical
"HOME-TESTED"
Modern "A-B-C" Way



YOU USE ALL OF THESE RADIO PARTS
TO BUILD AND OPERATE
7
DIFFERENT RADIO RECEIVING CIRCUITS

WITH THE HELP OF

A EIGHT Big Kits of Actual "Learn-by-Doing" Radio Parts and Assemblies with which you make 133 fascinating SHOP METHOD EXPERIMENTS in your own home! Imagine building 7 different Radio Receivers that operate!

B A 16 mm Home Movie Projector and Twelve Reels of "Learn-by-Seeing" Home Movie Films . . . for picture-clear, fast understanding of Radio Fundamentals!

C Modern, well-illustrated, Loose-leaf Lessons, prepared in clear, simple, understandable language . . . to guide you throughout your training!

NO PREVIOUS RADIO OR ELECTRICAL EXPERIENCE NECESSARY

INCLUDING:

1. Simple Receiver
2. Two Tube Receiver
3. Tuned Radio-Frequency Receiver
4. Short Wave Receiver
5. Aviation Band Receiver
6. 4-Tube Superheterodyne
7. 5-Tube Superheterodyne with Magic Tuning Eye

THEN GET THE HELP OF OUR EFFECTIVE EMPLOYMENT SERVICE

••• PLUS SCORES OF OTHER FASCINATING, INSTRUCTIVE RADIO-ELECTRONIC EXPERIMENTS

VETERANS!

Big things are happening at DeForest's Training, Inc. for veterans! See how you can prepare yourself WITHOUT COST for a GOOD JOB or a BUSINESS OF YOUR OWN in the vast Radio-Electronic opportunity field.



E. B. DEVRY, President
DeFOREST'S TRAINING, INC.
2535-41 North Ashland Ave., Dept. PM-D4
Chicago 14, Illinois, U.S.A.

Send FREE "VICTORY FOR YOU!" BOOK, showing how I may make my start in Radio Electronics.

Name _____ Age _____

Address _____ Apt. _____

City _____ Zone _____ State _____

If under 16, check here for special information.

If a discharged Veteran of World War II, check here.

DeFOREST'S TRAINING, INC. INCLUDES INSTRUCTION IN MOTION PICTURE SOUND EQUIPMENT, FM RADIO AND TELEVISION . . . RESIDENTIAL TRAINING IN OUR MODERN CHICAGO LABORATORIES ALSO AVAILABLE—ASK US FOR INFORMATION

YOU USE "LEARN-BY-SEEING" MOVIES

16 MM MOVIE PROJECTOR



DeFOREST'S TRAINING, INC. CHICAGO 14, ILLINOIS



SO IT NEEDS FIXING

By S. T. CHRISTENSEN

the "Fix-it Man"

"WELL, I guess I'm the fellow to see, for I've repaired thousands of refrigerators (home and commercial both), vacuum cleaners, radios, washing machines, irons, fans, lamps, mangles, motors, etc. In fact, many of my customers call me their "electrical appliance doctor." And, "doctoring," I might add, has paid me a good substantial income for quite a few years. Funny, in a way, how I got started. Always liked to tinker and by experimenting around I found that most electrical appliances had many things in common. That, regardless of what the appliance was used for, or who the manufacturer was, the basic principles were much the same. From fixing my own appliances to fixing friends' and then for strangers at a fee, seems now to have been but a small step.

What to Charge?

At first, I let the owner decide the charge and, frankly, I was amazed at what I earned per hour. But then, when one figures what initial costs are involved in buying most electrical appliances, one can readily see that spending extra dollars for repairs is well worth while. Before long I was making more in my spare time repairing than from my regular job. The result . . . I went into business for myself. When war came, business boomed, for new appliances were not available.

For a while, repair parts (needed on some

jobs) were a little difficult to get. But that situation quickly adjusted itself and many repair parts were given the high priority rating of AA2. After all, we had to provide for the health and well-being of our civilian population.

The Future Offers

Friends ask me about my future. And, I think I've got a grand one. Age is no handicap in repairing. I have in my files enthusiastic letters from repairmen ranging in age from 18 to 79 years. Now the war is over we are certain to see hundreds of new products on the market . . . products that the average person never dreamt of. These new products and our old appliances are all going to need at some time or other "fixing." Well, I'll still be the fellow to do it. The field open for appliance repairmen is unlimited. I don't worry at all about too much competition.

If You Are Ambitious

To the contrary, I've prepared a complete course, chuck full of simple, easy to understand photos and drawings and written in the same non-technical language as this article. I know the course is good, because I have hundreds of men all over the country writing to me telling me how the course has helped swell their pockets with cash. If you too want to prepare now for your future, I suggest you read the next page and send me the handy coupon."

Advertisement



**BIG MONEY
INDEPENDENCE**
*A PROFITABLE
LIFETIME
BUSINESS
OF
YOUR OWN!*

LEARN ELECTRICAL APPLIANCE REPAIRING

PREPARE NOW FOR THE FUTURE

If now employed, start your home appliance repair business NOW in your spare time and be set with a business of your own no matter what happens. You don't need elaborate fixtures or expensive equipment to be a successful repairman. Operate from your garage, basement, vacant store, etc. Work as many hours as you wish—the home appliance repairman is his own boss. It is a profitable occupation for on many types of repairs it is not unusual for a repairman to charge on the basis of \$5.00 to \$6.00 per hour. Don't gamble with your future—learn a trade that will always support you. Remember, as long as electrical appliances are used, there will be a need for electrical appliance repairmen.

If you are at all mechanically inclined—can hold and use tools—then you have all of the qualifications required for becoming a big money earning home appliance repairman. It does not matter if you have not had a great deal of schooling or had previous experience along these lines—**WE WILL TEACH YOU.** Age should be no barrier—nor should any minor physical handicap.

New Course Tells All

Profusely illustrated, our new course shows you in simple, easy to understand language and drawings how to make each repair on refrigerators, vacuum cleaners, washing machines, motors, etc. Explains and gives you a working knowledge of electricity, welding, nickel plating, etc. Shows you how to build the power tools you need and how to solicit and keep business coming to you. Not a theory course but an honest to goodness course written by and used by repairmen the country over. Price of course is so low that the savings on your own household appliance repairs will quickly pay for it. Act now! Mail the handy coupon below today.

----- Read What Our Students Say About Course -----

I really believe your course the best investment a mechanically minded man can make.—Claude E. Allen, Indianapolis, Ind.

I have received your Course in Appliance Repairing and I must say I am well pleased with same. I am only sorry I did not have said Course some years ago. I have learned so much more through this course I would not part with it.—Charles Schwarz, Hamilton, Ohio.

The Course in Appliance Servicing arrived a few days ago. Want to take out a few minutes of my valuable time to let you know that this is just what I have been looking for ever since I opened up my Fix-It shop. I must admit that you told the truth when you said that it contains quite a bit more information than I bargained for.—P. J. Bretl, Sebring, Ohio.

I am a mechanic for the Western Union Telegraph Co. Three days after receiving the lessons in refrigeration I earned the exact cost of the course.—Henry S. Lee, Washington, D. C.

I work day times at the shipyard and after 4:00 P.M. I operate from my cellar and garage. I average \$10.00 to \$15.00 clear every day.—Walter Hanhy, Brockton, Mass.

GET STARTED TODAY — MAIL THIS COUPON

CHRISTY SUPPLY CO.
2835 N. Central Ave., Dept. D-4403
Chicago 34, Illinois

Please send me free illustrated literature about America's Fastest Growing Industry — **ELECTRICAL APPLIANCE REPAIRING.**

Name.....

Address.....

City..... State.....

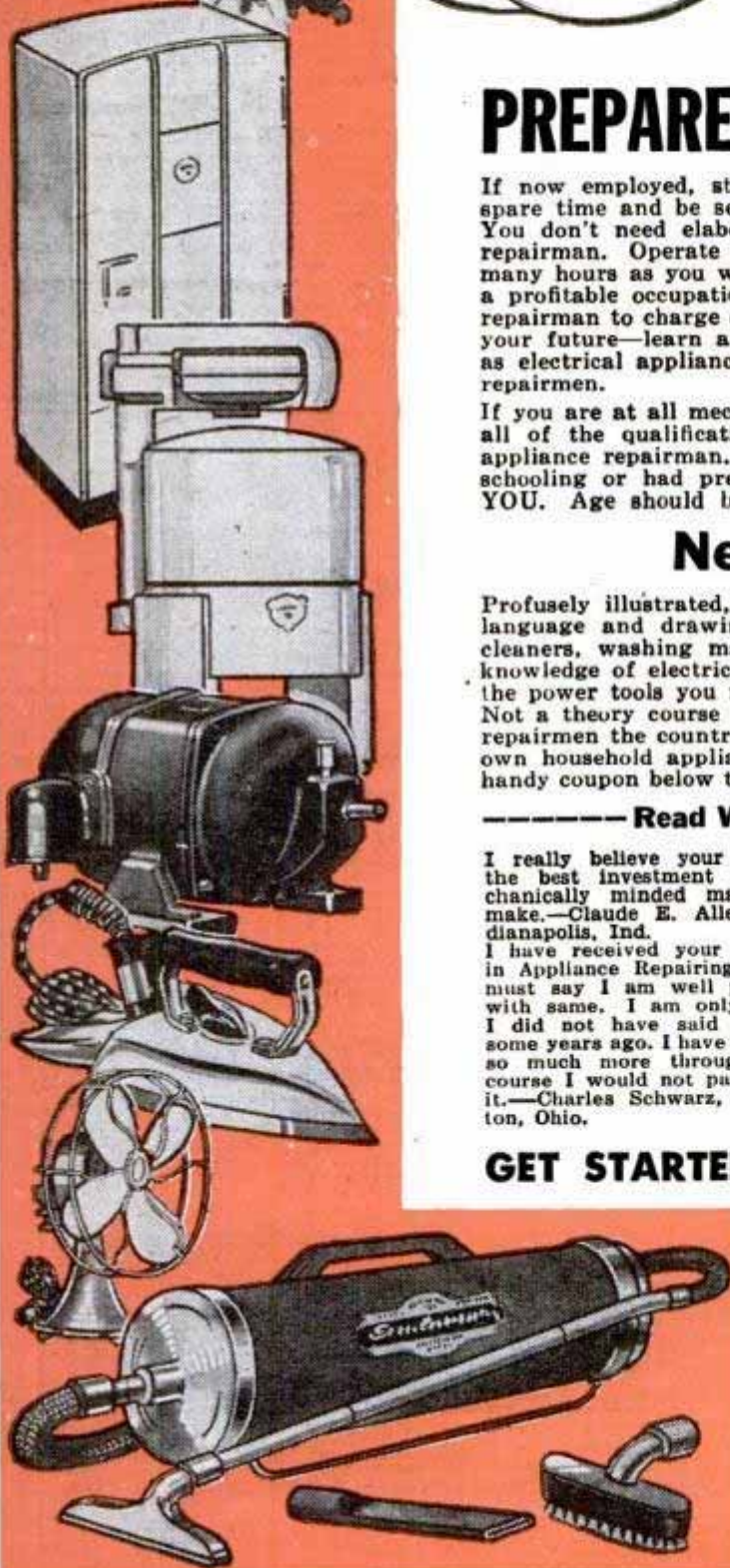

JUST OUT! NEW FROM COVER TO COVER

AUDELS
REFRIGERATION
and AIR CONDITIONING GUIDE



4 Books in One! Covering:
Basic principles, Servicing, Operation, Repair of
1—Household Refrigeration
2—Special Refrigeration Units
3—Commercial & Industrial Refrigeration
4—Air Conditioning Systems
A gold mine of essential important facts for ENGINEERS, SERVICE MEN & USERS.
A Good Book is a Good Friend! Here you have at your fingers' ends a Complete Library in ONE VOLUME, the necessary data you have been looking for on: MODERN UNITS, SYSTEMS & MACHINES, REFRIGERANTS, including Freon, Lockers, Water Coolers, Quick Freezing & Air Conditioning Systems.
1280 Pages, 46 chapters all Fully Illustrated & indexed for Ready Reference.

ANSWERS YOUR QUESTIONS
Get This Information for Yourself. Mail Coupon Today. No Obligation Unless Satisfied. **ASK TO SEE IT.**

\$4 COMPLETE • PAY ONLY \$1. A MONTH ←

AUDELS, Publishers, 49 W. 23rd St., New York 10, N.Y.
MAIL AUDELS NEW REFRIGERATION GUIDE for free examination. If O.K. I will send you \$1 in 7 days; then remit \$1 monthly until price of \$4 is paid. Otherwise I will return it.

Name _____
Address _____
Occupation _____
Employed by _____ PM



AUTO
BOOKS ON APPROVAL



SEND NO MONEY. Just mail the coupon for a complete set of Six Big Auto Books. 20th Edition. Whether you are a mechanic or helper, expert or apprentice, auto owner or driver, take immediate advantage of this FREE EXAMINATION OFFER.

MAKE GOOD MONEY NOW HOLD A PERMANENT JOB
America wants its automobiles kept in good repair. Men with "know how" are in demand, at big pay. These books will help you get and hold an important job, or give you a chance to go into business for yourself now or later. Any man who half tries to improve himself can learn auto servicing and repairing by this quick reference method. Use the JIFFY INDEX to find easily understood answer to any auto problem. These wonder books prepared by eleven of America's great automobile engineers. Many hundreds of valuable illustrations. Send the coupon TODAY.

[A year's consulting privileges with our engineers now given with these books without extra charge.]
Vocational Publishers Since 1898

CAN YOU FIX IT?

These wonder books tell step by step HOW to make difficult repairs and adjustments, how to keep a car at maximum efficiency, including latest improvements in car design and operation. Engine troubles and how to correct them well covered.
6 BIG VOLUMES
2800 pages, 2000 illustrations, wiring diagrams, etc., including Diesel engines. Beautiful modernistic, washable cloth binding.

AMERICAN TECHNICAL SOCIETY, Dept. A419
Drexel Ave. at 58th St., Chicago 37, Ill.

I would like to examine your Six-Volume Set of Auto Books. I will pay the delivery charges only, but if I choose I may return them express collect. If after 10 days' use I prefer to keep them, I will send you \$2 and pay the balance at the rate of only \$3 a month until \$24.60 has been paid. Please include consulting service as offered above.

Name _____
Address _____
City _____ State _____
Please attach letter stating age, occupation, employer's name and address and name and address of at least one business man as reference. Men in service, also please give home address.

Speak SPANISH

FRENCH, GERMAN OR ITALIAN

Learn This Easy Way JUST LISTEN TO THIS RECORD

Big opportunities and jobs waiting for those who speak Spanish. Increase social, business, travel and reading pleasures. **CORTINAPHONE Method, famous for over 60 years, teaches you to speak like a native. Learn quickly and easily at home, just "by listening" to CORTINA records as thousands have. No risk under our five-day approval offer. Send for FREE book "The Cortina Short-Cut." State language interested in.**

CORTINA ACADEMY (Established 1882)
Suite 644 105 West 40th Street New York 18, N. Y.

Be A MASTER PLUMBER

Earn \$15 To \$50 A Day

DON'T ENVY THE PLUMBER - BE ONE

Every skilled workman will tell you that Plumbers have the best of it. WINTER and SUMMER the Plumber is busy at top wages. No skilled Plumber is ever out of a job—compare his opportunities with any trade, plus the opportunities of having your own shop. We teach you Plumbing with TOOLS (not books) under Licensed Master PLUMBERS in one of the finest equipped schools in America. We make you a Plumber, every branch is taught thoroughly—Lead Work—Blueprint for plan reading—all other tricks.

LEARN IN 30 WEEKS WITHOUT PREVIOUS EXPERIENCE

If you like to work with tools you owe it to yourself to investigate. No need to ever work as an apprentice. Get free bulletin. Write now! **G.I. APPROVED.** Our 24th year.

UNIVERSAL PLUMBING SCHOOL
815 HOLMES STREET KANSAS CITY, MO.

LAW

STUDY AT HOME Legally trained men win higher positions and bigger success in business and public life. Greater opportunities now than ever before.
More Ability: More Prestige: More Money We guide you step by step. You can train at home during spare time. Degree of LL.B. We furnish all text material, including 14-volume Law Library. Low cost, easy terms. Get our valuable 48-page "Law Training for Leadership" and "Evidence" books FREE. Send NOW. **G. I. APPROVED.**
LASALLE EXTENSION UNIVERSITY, 417 South Dearborn Street
A Correspondence Institution Dept. 464-L Chicago 5, Ill.

INVENTING

—FOR PROFIT! If you have an inventive turn of mind, write for free 28-page booklet explaining how the Institute of American Inventors is helping inventors pre-test the profit possibilities of proposed devices to fill today's unprecedented demand for useful new inventions.

INSTITUTE of AMERICAN INVENTORS
Dept. 4, 1926 Eye St., NW, Washington 6, D. C.

HORSE MASTERY!

A FINE HOBBY — A GREAT VOCATION!

"The EXPERT HORSEMAN"



FREE BOOK — Tell how You can learn to: BREAK COLTS, GAIT SHOW HORSES, TRAIN RODEO, STOCK and RACE HORSES, BREAK BAD HABITS, HANDLE ANY HORSE, TRAIN CIRCUS TRICK HORSES. WRITE TODAY!

ANIMAL LOVERS ASSOCIATION
BOX KA-111 TARZANA, CALIFORNIA

SUBSCRIBE TODAY 50¢
One Year

MAKE YOUR OWN COSTUME JEWELRY
SPLENDID HOBBY OR VOCATION

Sea Shells • Pin Backs • Ear Screws • Screw Eyes
Plastic Discs • Ear Clips • Floral Stones • Jump Rings
Chains • Clasps • Wire • Boxes • Bracelets • Parts
Bow Knots • Catches • Plexiglas • Cements • Dyes

WRITE FOR FREE CATALOGUE • DEPT. B

PHILADELPHIA BADGE CO. 1007 Filbert St., Phila. 7, Pa

GET INTO THE NEW FIELD OF

INDUSTRIAL *Electronics*



THRILLING NEW FRONTIER OF OPPORTUNITY



AMERICA'S FOREMOST SCHOOL OF PRACTICAL TRAINING

Here is a **NEW** Industry—one that points the way to a vast new field of opportunity—Opportunities that beckon alike to men looking for new fields, and to experienced electrical men seeking a way to bigger earnings and a more secure future.

Industrial Electronics is *not* Radio. It has nothing to do with radio transmitters and receivers. It is a totally new application of electric power, applied to modern production by means of the magic of the vacuum tube. Everywhere industrial electronic devices are replacing the old-time electrical controls, and processes. Industrial Electronics is *Modern Industrial Electricity*.

GET READY NOW!

Now is the time to get into Industrial Electronics, while the field is in its infancy . . . and while it is rapidly developing a need for thousands of trained experts. Tomorrow's leaders are training today.

And here is a School equipped in every way to train you for Industrial Electronics work—one of the largest and most completely equipped, and one of the few of its kind in America—a School that already has trained thousands of men for industrial opportunities.

LEARN AT HOME OR COME TO OUR SCHOOL

Learn Industrial Electronics—now, while the time is ripe. You don't need any advanced schooling or previous experience. If you are at all mechanically inclined and have gone to highschool for at least one year or have an equivalent education, we can teach you Industrial Electronics.

You can take most of your training at home, in your spare time—or you can come to Chicago and take your entire training in our completely equipped shops and laboratories. Either way you quickly acquire the fine points, practical skill, and broad, technical "know how" that makes the expert Industrial Electronics Technician.

"Every electrician should know — must know — Industrial Electronics." That's what many Union leaders are telling their members today. They know that the use of Industrial Electronics devices is growing by leaps and bounds. They know that to install and service this equipment, even the best of present-day electricians must first have had special

FACTS ABOUT THE I. T. I.

Founded in 1916. Has trained more than 400,000 men for practical work in industrial fields. From 1942 through 1945 trained specialized technicians, exclusively, for the Army, Navy, and Marine Corps. Now training thousands of veterans under the G. I. Bill, both in its Residence Schools and by home-study. Occupies five buildings of its own. Has over \$500,000 invested in training facilities, with an instruction staff of more than 100 men. Known everywhere as America's foremost school of practical training for industry.

training.

Get all the facts about the opportunities in this interesting field of work and about the I.T.I. system of training that has helped so many men into key jobs in industry. Fill out the information, coupon below and mail it TODAY. You will be under no obligation whatsoever.

AUTHORIZED TO ACCEPT VETERANS FOR G. I. TRAINING

**REGISTRAR, P1Q
INDUSTRIAL TRAINING INSTITUTE,
2150 LAWRENCE AVE., CHICAGO 25, ILL.**

Please send me, FREE, your "Camera Visit" booklet and information about the opportunities for trained men in INDUSTRIAL ELECTRONICS. It is understood that I will be under no obligation.

NAME.....
ADDRESS.....
CITY.....STATE.....
ARE YOU A VETERAN?.....

**GET THE FACTS
ABOUT AMERICA'S
FOREMOST SCHOOL
OF PRACTICAL
TRAINING**



Give yourself the Backing of a
GREAT GROWING INDUSTRY



REFRIGERATION AIR CONDITIONING

Refrigeration and Air Conditioning have leading place in fast growing fields of our time. Trained men paid well to service, install, maintain, repair, rebuild household and commercial refrigerators. Important new developments such as Frozen Foods and many new industrial uses. Demand for commercial installations in restaurants, butcher shops, taverns, florists, bakeries, etc. — air conditioning in homes, offices, shops.



START NOW—Full and Part Time Earnings

There may never again be such opportunities for men who want better jobs or business of their own to get in on ground floor and go up fast! Many started with small investment who built good, growing business. If over 17 and under 60 learn how you can get started. **CONSULTATION AND PLACEMENT SERVICE WHETHER YOU ARE INTERESTED IN WORTHWHILE JOB OR SETTING UP YOUR OWN BUSINESS.**



Begin Training at Home or Come Directly to Shops

Begin your training at home in spare time, finish in our big, modern shops, or come directly to shops. At home you get C.T.I.'s **SHOP PROVED HOME STUDY** instruction—actual shop experience has gone into the practical lesson assignments. That is why it is easy for mechanically inclined men to learn by our Home Study training and start on actual refrigeration work.



A NATIONALLY KNOWN INSTITUTION

C.T.I. was only civilian school selected by Army to train service men for refrigeration. Same quality training available to you now. The method that has made rapid progress possible. Commercial Trades Institute has established its place in Air Conditioning and Refrigeration industries, and that is important to you in making your start.

VETERANS

Veterans qualifying under "G.I. Bill" have tuition paid by Government plus monthly subsistence allowance while in school. Just mail coupon, we will handle all details. (LOW TUITION, EASY TERMS if you are not a veteran.)

COMMERCIAL TRADES INSTITUTE
Dept. A24

1400 W. Greenleaf Ave., Chicago 26, Ill.

FREE — Important Information Telling How to Get Started

CUT OUT COUPON BELOW

Fill Out, Cut Out, Mail Today

FACTS FREE for Men Who Want to Get Ahead

COMMERCIAL TRADES INSTITUTE, Dept. A24
1400 W. Greenleaf, Chicago 26, Ill.

Send free illustrated Brochures and other information about Refrigeration and Air Conditioning.

Veteran Non Veteran

Name

Address

City



Catching Crooks Through Finger Prints!

A Steady, Regular-Pay Profession Can Be **LEARNED AT HOME!**

For over thirty years we have taught this exciting, fascinating work which may be learned at home in your spare time. Over 800 of America's Identification Bureaus employ I. A. S. students or graduates. As new Bureaus are established and old Bureaus grow larger, more trained men are needed. Prepare yourself to fill a responsible, well paid position in this important field. Cost is low. Pay as you learn. Write today.

FREE: "The Blue Book of Crime," full of interesting information. Send today. State age.

INSTITUTE OF APPLIED SCIENCE
Dept. 1354, 1920 Sunnyside Ave., Chicago 40, Ill.



AMAZING DISCOVERY!

CORRECTS POOR PENMANSHIP in few days—Big improvement in 3 hrs.—No failures. Now, it's fun to become an expert penman. Complete Outline Free. Write today.
OZMENT, The Inventor, 34, St. Louis, Mo.

ELECTRICIANS SCHOOL

PRACTICAL TRAINING IN
HOUSE AND COMMERCIAL WIRING
MOTOR REPAIR AND REWINDING
ELECTRIC REFRIGERATION
Approved for Veterans Training

PENNSYLVANIA INSTITUTE SCHOOL OF ELECTRICITY

42nd & SPRUCE STS. CATALOG PHILADELPHIA 4, Pa.

MASTER MACHINIST • MECHANICAL DRAFTING
TOOL-DIE DESIGNING • TOOL ENGINEERING

Completely equipped shops and drafting rooms, directed by an accredited staff of engineers and practical instructors. 18 years of successful training of men for industry.

Days, Evenings • Approved for Veteran Training

NEW CLASSES Now Forming • BULLETIN ON REQUEST

ALLIED SCHOOL OF MECHANICAL TRADES, INC.
42 ALLIED BLDG., 1336 S. MICHIGAN AVE. • CHICAGO 5, ILL.

LEARN ELECTROPLATING

Highly Paid, Uncrowded, Interesting Business. Part or Full Time, Common School Education Sufficient. Gold, Silver, Nickel, Chromium, etc. Money Making Secrets, Processes. Send postcard for FREE Electroplating Booklet and proof. **PLATER HYDE, Dept. M, P. O. Box 176, National City, California.**

Become a Doctor of PSYCHOLOGY

Win the degree of Ps.D. Teach the secret of contentment, happiness. Solve mental worries. Experience the revelation of truth. Chartered college. Individual help. Write for FREE book. **COLLEGE OF UNIVERSAL TRUTH, 5153-B North Clark St., Chicago.**

Store Route Plan PAYS BIG MONEY

SELL COUNTER CARD PRODUCTS

Build a good-paying business of your own. Call on dealers of all kinds; show nationally-advertised Aspirin, Vitamins, Cosmetics and 200 other necessities. Big 5c and 10c retail packages, high quality. Attractive counter displays sell goods fast. Free book gives amazing facts. Write!

World's Products Co., Dept. 10-M, Spencer, Ind.



GET INTO RADIO

TELEVISION ELECTRONICS NOW!



You build this complete, modern super-heterodyne receiver with the equipment that comes with your National Training at no cost.

This practical shop instruction system gives you actual experience with a Home Radio Laboratory—part of the

SHOP METHOD HOME TRAINING

from one of the world's Oldest and Largest Technical Trade Schools

FOR YOU—A REAL HOME LABORATORY IN MODERN RADIO

Send the coupon below immediately. Learn how this improved practical training can fit you for the **GREAT BUSINESS OF RADIO**—for the **NEW AND RAPIDLY EXPANDING FIELD OF FREQUENCY MODULATION (F.M.), TELEVISION AND ELECTRONICS.**

This is the thoroughly proved method used so extensively in wartime training—endorsed by the **success of National men everywhere**—a system by which you study in spare time—off hours, even minutes right in your home and yet have the **ADVANTAGE OF REAL SHOP EXPERIENCE** behind you.

Trained Radio Men Wanted

The man who really knows modern Radio is in greater demand today than ever before—**not only in Radio proper but in Television and Electronics—in Aviation, Transportation, Manufacturing, Communications.** Good jobs

await the trained man, in the production, operation and maintenance of modern electronic equipment—in radio stations, in hundreds of industries—in homes, theatres and studios. Good sound training in this important field is absolutely necessary. And now, National Schools brings such training to you **no matter where you live or what you may be doing**—not only the fundamental theory but the **actual experience that comes with knowing shop practice and working with real equipment**—demonstrating each step with first-hand knowledge. This is true **"learning by doing"**—direct from the great shops and laboratories of National Schools where new developments in methods, equipment and applications are constantly going forward.

National offers you such practical training and National has the facilities. **Sample this training yourself. MAIL THE COUPON FOR A FREE LESSON.**

Your National Training Kits include equipment for over a hundred practical electronic experiments in your own home. You

get standard radio parts for this audio oscillator which you get to understand by building it yourself.

You learn modulation, beat frequencies, signal generation by a actually building this small radio transmitter with your National shop parts.

Your training outfits from National are made up of the most modern radio equipment—much of it just out of the experimental laboratory. You learn new ways of handling equipment by modern methods.

Get the details by mailing the coupon.

SUCCESS and SECURITY FOR YOU

Radio is a Well-Established Business, Television and allied fields are just on the threshold of limitless expansion. Would you like to profit from these developments? An excellent job or perhaps into a business of your own? Answer these questions by reading the catalog sent you **FREE** from National Schools. Get the facts.

Check the Job You Now Have With These Opportunities in RADIO

1. **Financial Security** Radio has grown from \$100 million to \$5 billion in past few years.
2. **Limitless Future** predicted by over 1,800 manufacturers of equipment.
3. **Television promises** unrealized opportunity.
4. **Electronics opens** wide new fields in home and "industrial use."
5. **Your Own Business** with little capital.

Get the details. Use the coupon!

FREE GET THESE 2 **BIG BOOKS**



NATIONAL SCHOOLS

LOS ANGELES 37, CALIFORNIA EST. 1905

MAIL OPPORTUNITY COUPON FOR QUICK ACTION

National Schools, Dept. 4-PM
4000 South Figueroa Street
Los Angeles 37, California

(Mail in envelope or paste on penny post card)

Mail me **FREE** the books mentioned in your ad including a sample lesson of your course. I understand no salesman will call on me.

NAME..... AGE.....

ADDRESS.....

CITY..... ZONE..... STATE.....

Check here if veteran of World War II

NATIONAL TRAINING WINS BIG JOBS

You, too, can share the success of National graduates. Clifford Hannah, Portage La Prairie, Manitoba, Canada, writes: "My training has brought results as I'm in line for another raise, thanks to National's encouragement and thorough training. You can count on me as a real National booster and I am glad I used such good judgment in getting into a live and growing field."

While still a student of National training, I. Wilson of Vallejo, California, writes: "My pay has jumped from \$52.18 a week to \$72.65, and the end is not in sight. I am proud of my National Course."

Joseph Michel, Jr., Granite City, Illinois, writes: "I am enthused with National training. I am now earning \$225 a month as a radio operator and technician and \$20 a week more in my shop at home."

OIL BURNER

INFORMATION IN A HANDY FORM

JUST OUT!

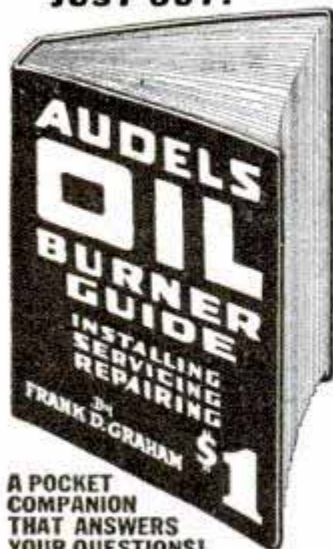

AUDELS OIL BURNER GUIDE.

— A new practical, concise treatise, 384 pages—31 Chapters—321 Diagrams and Illustrations—covering Domestic and Industrial Oil Burners.

New from Cover to Cover, for mechanics interested in Oil Burners. Gives practical inside working knowledge of theory, construction, installation, operation, testing, servicing and repair of all types of oil burners. Includes electrical hook-ups and wiring diagrams of automatic control systems.

PRICE \$1 POSTPAID

Get this information for yourself. Mail coupon today. No obligation unless satisfied.

ASK TO SEE IT

A POCKET COMPANION THAT ANSWERS YOUR QUESTIONS!

AUDEL, Publishers, 49 W. 23rd St., New York 10, N.Y.

Please mail AUDELS OIL BURNER GUIDE (Price \$1). If satisfactory, I will remit \$1 on its safe arrival, otherwise I will return the book.

Name _____
 Address _____
 Occupation _____
 Employed by _____ PM

AVIATION Career

MAXIMUM TRAINING IN MINIMUM TIME

CAL-AERO TECH TRAINING will add dollars to your pay check all the rest of your life. Specializing in AERONAUTICAL ENGINEERING and MASTER AVIATION MECHANICS since 1929, Cal-Aero Tech training is carefully designed for just one thing—TO MAKE MORE MONEY FOR YOU. An alumni of over 6000 successful graduates proves our career training is unsurpassed.

VETERANS —Write us about Aviation Training, as provided under "G.I. Bill of Rights."



CAL-AERO TECHNICAL INSTITUTE
 MAJOR C. C. MOSLEY PRES. SINCE 1929
 FORMERLY CURTIS-WRIGHT TECHNICAL INSTITUTE
 GRAND CENTRAL AIR TERMINAL
 GLENDALE 1, CALIFORNIA
 LOS ANGELES COUNTY

MAIL THIS COUPON TODAY!

Cal-Aero Technical Institute, Grand Central Airport, Glendale 1, California
 Please send full information on Aviation Training FREE—without obligation, Dept. PM-4

Name _____ Birth Date _____
 Street _____
 City _____ State _____

How to Start YOUR OWN BUSINESS

Make Flexible Molds, Composition Flooring

NO EXPERIENCE — UNLIMITED MARKET

Start your own business at home in your spare time. Tremendous money-making opportunities for both men and women.

FLEXIBLE MOLDS

Make your own FLEXIBLE MOLDS. Cast novelties, statuary, desk sets, book ends, etc. Hundreds of casts made from single mold. Large size mold costs but a few cents. No experience necessary. Steady year-round demand.

COMPOSITION FLOORING

Make floors that last a lifetime with amazing COMPOSITION FLOORING! New discovery now enables you to lay artistic floors, in beautiful patterns in most colors and shades. Can be laid over wood, concrete, brick, steel, etc. This composition flooring offers unlimited money-making possibilities.

Free Catalog!

For FREE information about these and many other profitable business opportunities, WRITE TODAY!

BING PRODUCTS

Dept. A17, 88 Broad Street BOSTON 10, MASS.

ANALYZE HANDWRITING

Qualify for Certified Grapho Analyst Degree at home, spare time. Credit, Employment, Personnel Managers, Business, Professional men, women use grapho-analysis in their work, earn substantial fees in spare time. Many study solely for personal benefit, no desire to earn money, find it so fascinating they start using it to add to their incomes. Entertainment field pays well, up to \$100 in a week reported. Others establishing profitable practices as Vocational and Family Problem Counselors, Personality Teachers, and lecturers.



GROWING—UNCROWDED PROFESSION

More and more police use grapho analysis handling suspects and criminals. They understand how criminals think. Their handwriting tells. Men like Hugh Dunlap, university student, Harry Allen, retired preacher, use it in court, win cases, earn fees even before graduation. Only school in world devoted to teaching grapho analysis offers thorough training to earnest, ambitious men and women regardless of where you live, small town, farm or city. Send for GRAPHO ANALYST, illustrated lesson, personal handwriting analysis offer, ALL FREE. Must be 21 or over. Address A. I. G. A. Inc., 120, Noel, Missouri.



ELECTRICAL TRAINING

Intensive 32 weeks residence course in fundamentals of industrial electrical engineering, including radio, electronics. Prepares for technician, engineering aides. Approved for veteran training. 54th year. Catalog.

BLISS ELECTRICAL SCHOOL
 7630 Takoma Ave., Wash. 12, D.C.



ARTISTS MAKE MONEY

Do you like to draw? Send name, address, age and occupation for FREE ART TEST, to find out your ability.

ART INSTRUCTION, Inc.
 4137 ART INSTRUCTION BLDG., MINNEAPOLIS 15, MINN.

FIX ANY RADIO

Amazing New Invention



Learn quickly to repair all radio sets. New, different Comparison method. No previous radio knowledge needed. Introductory training included. Simple, picture suggestions tell you where to look for faults and how to make the repair. No testers needed for most jobs. Manual 8 1/2 x 11 in., 63 job-sheets, 24 blueprints. Many hints. New edition. Order manual 5-5. Only \$1.50, post-paid. Money back guaranteed.

SUPREME PUBLICATIONS 9 S. Kedzie Ave. Chicago 12, Ill.

How to equal the PHENOMENAL PHYSIQUE of...

ALAN STEPHAN

Mr. America!

ALAN STEPHAN

official winner of the National A. A. U. title, "MR. AMERICA" offers you this **FREE BOOK**

This is an unretouched photograph

What "Mr. America" has done, you, too, can do. Every secret of the physical training program perfected and practiced by Alan Stephan is now made available to YOU.

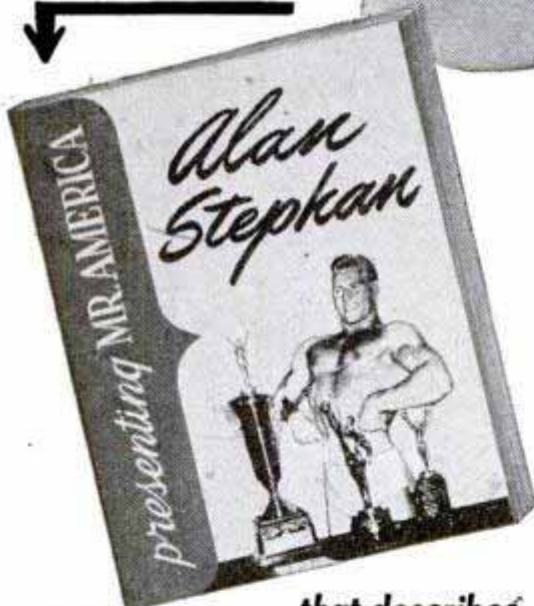

To help you attain an awe-inspiring, eye-catching body like "Mr. America," the revolutionary new Alan Stephan Course in Body Building speaks for itself as a builder of title-winning perfection. Alan Stephan, anything but a physical marvel at 15, is today **officially** recognized as the finest physical specimen in the nation. His progress in physical development was so rapid (he developed 70 additional pounds of muscle the **first year**) that he immediately became a physical training instructor when he enlisted in the United States Navy. By the phenomenal perfection of his own physique through a training system perfected and practiced by himself, **no man in America today is so well qualified as Alan Stephan** to show you the way to achieve sparkling health, glowing vitality, vital power, increased pep.

Make the physical perfection of "Mr. America" your goal! Act now! Get the profusely illustrated **FREE** book which gives you the complete facts about Alan Stephan's easy-to-follow physical training program.

HIS EASY-TO-FOLLOW PHYSICAL TRAINING PROGRAM

This vital new book explains how YOU can equal the phenomenal physique that has earned for Alan Stephan the official National A. A. U. title symbolic of physical perfection, the Finest Male Physique in America.

Alan Stephan's story should be an inspiration to every American. His miraculous body reveals **positive proof** of what proper training will do. As the photos in this book so clearly illustrate, Alan Stephan's chest is super-impressive, his arms and back are amazing; his column-like neck, his waist, hips and legs blend in harmonious proportions, forming the **perfect physique!**

MAIL THIS COUPON NOW

Alan Stephan, Box Number 1080, Chicago 90, Illinois

Write for the **FREE** Book

Please send me — **FREE** and without any obligation — a copy of your book, "Presenting Mr. America... Alan Stephan." PM57

NAME _____

ADDRESS _____

CITY _____ STATE _____

DATE OF BIRTH _____

"Presenting Mr. America... Alan Stephan"

TO ALL MEN WHO ARE INTERESTED IN

Famous TELEVISION SCHOOL Offers You These 2 PLANS

PLAN 1 { **YOU CAN BUILD A TELEVISION SET** } **RIGHT IN YOUR OWN HOME** }

IF you are unable to leave home to go to a resident school, the New York Technical Institute of New Jersey offers you this unusual opportunity. You can get all the parts, including tubes, speaker and 7-inch picture tube, of a television receiver like the one shown below, delivered right to your home.

With the Knockdown Kit will come exactly

the same instructions and directions with which the school's resident students are equipped, when they reach the stage in their training that calls for television set construction.

If you already have a sound radio background, with experience in building radio receivers, you will be surprised to find out how much you can learn about television *at home* by studying the

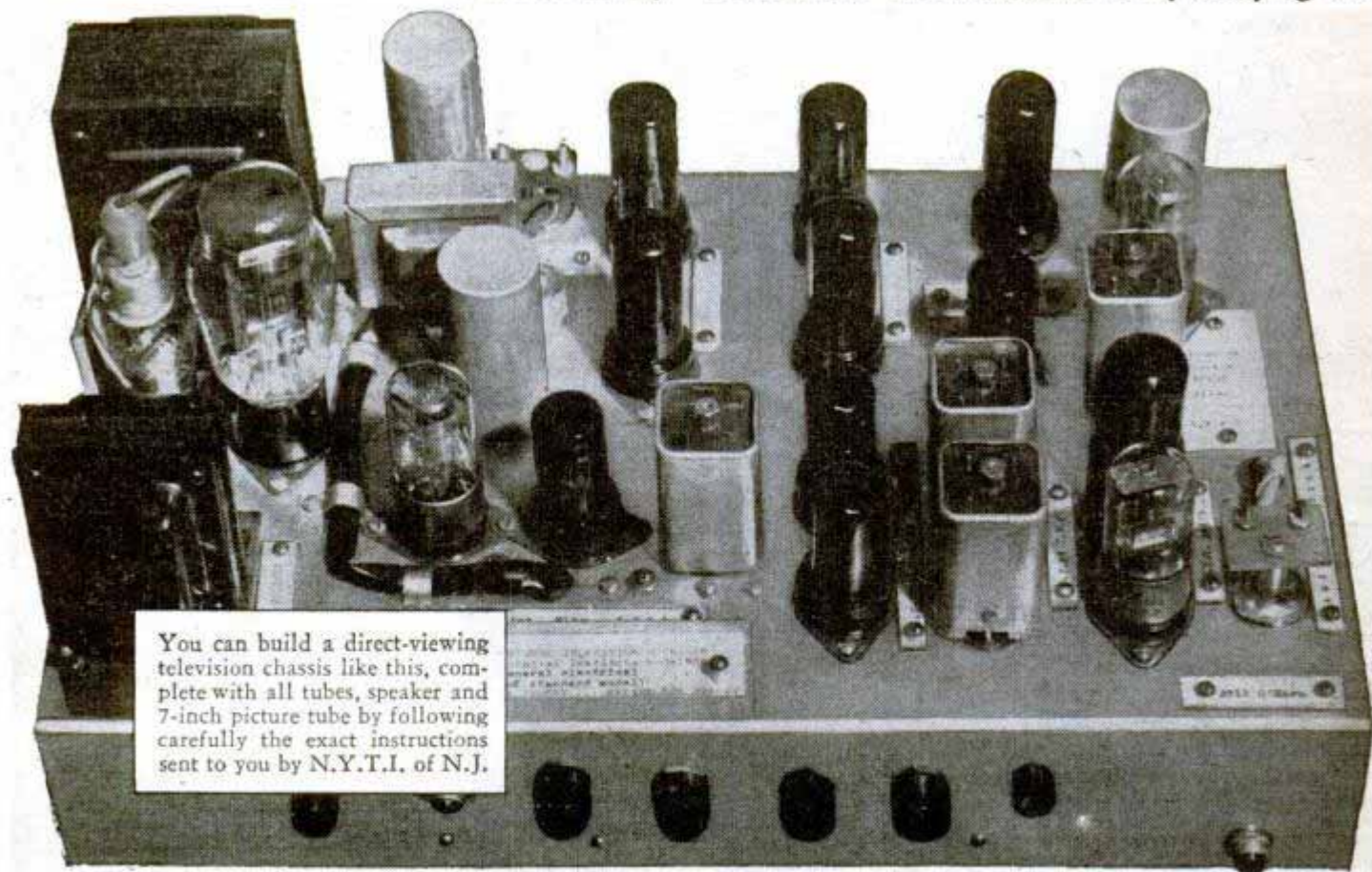

A HIGH-PAYING CAREER IN TELEVISION

directions and building this set.

The school will be happy to send you complete information about these television kits which are now available. Simply check proper box in coupon below, and mail to the address given.

(Plan 2, described below, not only provides expert instructors to teach resident students television receiver construction: as many as 7 different radio receivers and over 65 electronic educational devices are also constructed as part of practical laboratory training. Resident students may keep the television chassis they build, if they so choose.)

8 of these latest RCA Frequency Sweep Generators are in almost constant use by N.Y.T.I. of N.J. students in Advanced Television.



PLAN 2 { PREPARE, AT ONCE, TO BECOME A RADIO AND TELEVISION EXPERT }

MEN seeking thorough, dependable, up-to-the-minute training in radio and television should investigate the schooling offered by N.Y.T.I. of N.J., one of America's great radio and television resident schools.

Students are required to have at least a grammar school education; must be earnest and radiominded. Students without proper mathematical backgrounds are given special instruction. The school is fully approved by the Veterans Administration for G. I. Training.

N.Y.T.I. of N.J. is just across the river from New York City, in Newark, New Jersey, right

in the heart of America's great radio and television industry. R.C.A., Westinghouse, Dumont, Edison, Western Electric and other leading television equipment manufacturers are nearby. Qualified television and radio instructors are here in abundance. Equipment is easier to get. Television students are therefore offered exceptional advantages in this great electronic center.

Mail the coupon for the special FREE Bulletin—which describes classes, hours, costs, housing, etc.—to New York Technical Institute of N. J., Dept. 24, 158 Market St., Newark, New Jersey.



Ex-G.I. taking pictures with N.Y. Tech's Iconoscope Television Camera, which is used in the resident school's course entitled "Transmitters and Camera Technique."

**New York Technical Institute of N. J., Dept. 24
158 Market Street, Newark, New Jersey**

Check here if you wish to receive the Special FREE Bulletin describing the resident school of the New York Technical Institute of New Jersey located in Newark, N. J.—including its facilities, equipment, courses offered, costs, hours, etc.

Check here if you wish complete information about building a television chassis in your own home.

Check here if you are a War Veteran.

Name.....Age.....

Address.....

City.....(if any).....State.....
Zone

(N.Y.T.I. of N.J. employs no salesmen to call.)

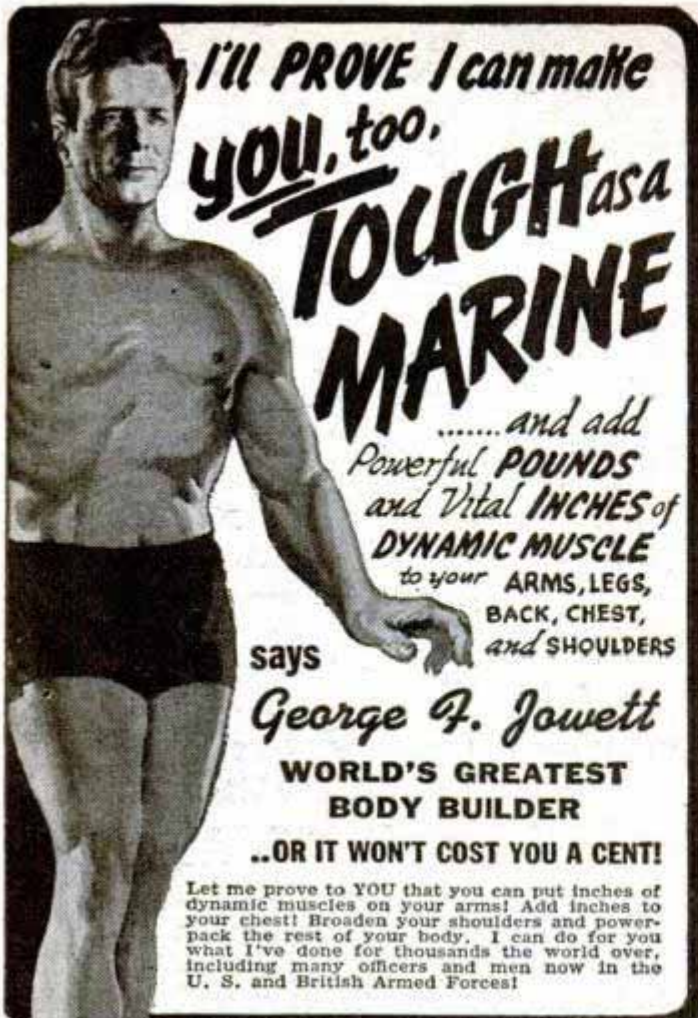

I'll PROVE I can make
you, too,
**TOUGH as a
MARINE**

..... and add
Powerful **POUNDS**
and Vital **INCHES** of
DYNAMIC MUSCLE
to your **ARMS, LEGS,**
BACK, CHEST,
and **SHOULDERS**

says
George F. Jowett
**WORLD'S GREATEST
BODY BUILDER**

..OR IT WON'T COST YOU A CENT!

Let me prove to YOU that you can put inches of dynamic muscles on your arms! Add inches to your chest! Broaden your shoulders and power-pack the rest of your body. I can do for you what I've done for thousands the world over, including many officers and men now in the U. S. and British Armed Forces!

GIVE ME 10 MINUTES A DAY!
I'll Show You My Secrets Of Body Building

I'll help you learn the "Progressive Power Method" through which I rebuilt myself from a physical wreck to the holder of more strength records than any other living athlete or teacher! No matter how skinny or habby you are, you can learn my methods right in your own home. Through my proved secrets I show you how to develop your power, inside and out, until YOU are fully satisfied that you are the man you want to be. "The Jowett System," says R. F. Kelly, Physical Director of the YMCA, Atlantic City, "is the greatest in the world!"

If you want a physique that will inspire respect from men, and admiration from women... **ACT LIKE A HE-MAN!** Decide at once! The famous book, "Nerves of Steel—Muscles Like Iron" will be included **FREE!** Priceless for the strength fan! Full of photos of marvelous power-bodied men who will show you what Jowett has done for them and how he can do the same for you. Reach out... Grasp this Special Offer today!

**PROVE TO YOURSELF
IN ONE NIGHT!**

Send only 25c for test Course, "Molding a Mighty Arm." Read it the evening it arrives—learn from experience the thrill you can give your muscles!

**SEND FOR THESE FIVE FAMOUS
COURSES IN BOOK FORM
ONLY 25c EACH
or ALL 5 for \$1.00**

Jowett Institute of Physical Culture
230 Fifth Avenue
Dept. PM-74B
New York 1, N. Y.

*This
Book
Free!*



**BOOK WITH PHOTOS OF FAMOUS STRONG MEN
MAIL COUPON NOW FREE**



Jowett Institute of Physical Culture
230 Fifth Avenue, Dept. PM-74B, New York 1, N. Y.
George F. Jowett Your proposition looks good to me. Send by return mail, prepaid, the courses checked below, for which I enclose (). Include **FREE** book of PHOTOS.

- George F. Jowett
Champion of
Champions
- All 5 courses for... \$1
 - Molding a Mighty Arm 25c
 - Molding a Mighty Leg 25c
 - Molding a Mighty Grip 25c
 - Molding a Mighty Back 25c
 - Molding a Mighty Chest 25c
 - Send all 5 C.O.D. (\$1 plus postage.) No orders less than \$1 sent C.O.D.

NAME _____ Age _____
(Please print plainly. Include Zone Number.)

ADDRESS _____

SAY YOU SAW IT IN POPULAR MECHANICS

APPLIANCE REPAIRMEN

MONEY SAVING PRICES — IMMEDIATE DELIVERY

- RENUALL Iron element. Guar. 1 year. Package of 6.....\$3.12
 - Toaster element forms. Clear Mica. Fits most toasters. 10 for. 1.80
 - Heating element wire 10 ft. coiled 1/4" O.D. #20.....2.55
 - Heating element wire 10 ft. coiled 3/16" O.D. #22.....1.77
 - Christy Electric Heating Element Welding Flux for repairing flat irons, toasters, electric stoves, etc. Enough for 50 elements.. 1.00
 - Hot Plate bricks 5-3/4" diameter. 6 for.....1.62
 - Appliance cord. Rubber covered. 20 ft. \$1.00; 100 ft.....4.50
 - Electricians Drill Bits. 1/2", 3/8", 1/4", 3/16" Complete set.....6.75
 - Ribbon element heating wire. Std. size. 100 ft.....7.75
 - Percolator elements. Universal. Flat type. 1 yr. guar. 2 for. 1.20
 - Element cement. Withstand 3000° F. 1 lb. pkg. \$1.00, 5 lb. pkg. 3.50
 - Lead wire. Asbestos covered heater hook-up wire. 10 ft.....1.00
 - Iron Cord Sets with complete plug attachments. 10 for.....5.00
 - Carbon brush set. Assorted. 104 brushes, 15 springs. Complete set.....3.00
 - Kerosene to Electric lamp conversion adapters. 5 for only.....1.00
 - Nickel Electroplating kit. Complete outfit. Ready to use.....1.50
 - Electric Scissor Sharpener. Will handle all sizes. Complete.....9.75
- Here is your opportunity to save on repairing your own appliances and to earn extra money repairing appliances for friends and neighbors.

CHRISTY SUPPLY COMPANY

2835 N. Central Ave., Dept. T-750, Chicago 34, Ill.

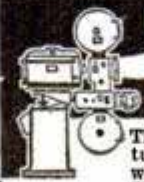

LEARN MOVIE PROJECTION THEATRE MANAGEMENT

The Motion Picture Theatre Business offers big opportunities for trained men. Get into a fascinating field with a post-war future. Train at home in spare time. Free Catalog. Established 18 years.

THEATRE INSTITUTE, 370 Washington St., Elmira, New York

PLASTIC KITS

NEW! PLASTICS FABRICATING MANUAL
How to cut, drill, saw, assemble and finish Plexiglas and Lucite 25c. Or—send 10c for illustrated circulars of complete line of kits with lay-outs for making many beautiful and useful articles from Sparkling Lucite and Plexiglas.

Home Craftsman Plastics, 1945 W. Harrison St., Chicago 12, Ill.

Learn Public Speaking

Learn theory and fundamentals at home—in spare time. Then acquire actual experience and practice. Send for **FREE** booklet "Power of Effective Speech."

North American School, Dept. 1354
1315 S. Michigan Ave., Chicago 5, Illinois

THERE'S MONEY IN CARTOONS!

RAYE BURNS will teach you HOW to CREATE ORIGINAL CARTOONS at home that you may SELL! Course contains 26 lessons and over 600 illustrations. All for Only..... **\$2.85**

Send name and address for free details.

RAYE BURNS SCHOOL, Dept. M, Box 3583, CLEVELAND, OHIO

Fit-Rite

makes False Teeth TIGHT

Makes loose dental plates fit snugly and comfortably. **LASTS for MONTHS!**

Simply squeeze on dental plate and put it in your mouth. Hardens and becomes part of plate. Money-back guarantee.

FREE Generous package of Dental Plate Cleanser with each order. Send \$1.00 or mailed parcel post collect.

Fit-Rite Co., 1557 Milwaukee Ave. Dept. 4-PM, Chicago, Ill.



MAKE MONEY AT HOME

RUBBER MOLDS

Low as **6¢ EA.**

Amazing rubber mold-making outfit makes perfect flexible molds of plaques, ash trays, book ends, etc. Molds cost 8c to 25c each. Each mold makes hundreds of novelties and gifts to sell for \$1.00 apiece and more! No experience necessary. Everything furnished. Quick and easy. Start profitable business in your home—sell to stores, gift shops, friends, resorts, road stands, by mail. Full or spare time. Write for complete **FREE** details and easy instructions.



50-10 WORKS, Inc., Dept. T-800, Loveland, Ohio



FARTHER ?

FASTER ?

HIGHER ?

HOTTER ?

COLDER ?

**LEAVE IT TO
AAF RESEARCH!**

NEVER in history has aviation research advanced so swiftly. Never have ambitious young men had such a glorious opportunity to take part in it! The aircraft of tomorrow are being designed to fly farther, faster and higher than the average person can comprehend.

At testing grounds of the Army Air Forces, enlisted technicians share with test pilots and leading aeronautical engineers the thrills of probing the unknown. How cold is it at 80,000 feet? Will supersonic speeds "burn up" plane fuselage? What should an airman wear when he bails out at 600 miles an hour? At 1500 miles an hour?

AAF men are helping to design and construct a huge supersonic wind tunnel. They

are studying the use of atomic power for aircraft. They are participating in the development of electronic systems for all-weather flying precision navigation, automatic blind landing devices, radar traffic control systems, guided missiles.

This is the type of work which appeals to the wide-awake young men of the AAF. Naturally the standards are high and only qualified men will be assigned to the jobs which are open. Eligible men who enlist for three years can choose the Air Forces. See your nearest Army Recruiting Officer for full details.

**A GOOD JOB FOR YOU
U. S. Army
CHOOSE THIS
FINE PROFESSION NOW!**

AUDELS Carpenters and Builders Guides 4 vols. \$6

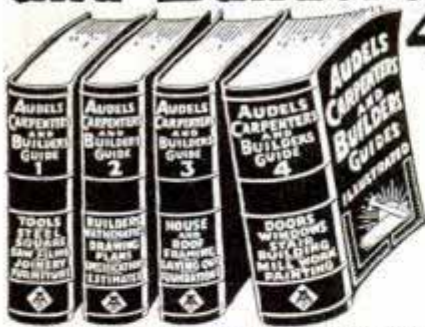

Inside Trade Information for Carpenters, Builders, Joiners, Building Mechanics and all Woodworkers. These Guides give you the short-cut instructions that you want—including new methods, ideas, solutions, plans, systems and money saving suggestions. An easy progressive course for the apprentice and student. A practical daily helper and Quick Reference for the master worker. Carpenters everywhere are using these Guides as a Helping Hand to Easier Work, Better Work and Better Pay. To get this assistance for yourself, simply fill in and mail the FREE COUPON below.

Inside Trade Information On:

How to use the steel square—How to file and set saws—How to build furniture—How to use a mitre box—How to use the chalk line—How to use rules and scales—How to make joints—Carpenters arithmetic—Solving mensuration problems—Estimating strength of timbers—How to set girders and sills—How to frame houses and roofs—How to estimate costs—How to build houses, barns, garages, bungalows, etc.—How to read and draw plans—Drawing up specifications—How to excavate—How to use settings 12, 13 and 17 on the steel square—How to build hoists and scaffolds—skylights—How to build stairs—How to put on interior trim—How to hang doors—How to lath—lay floors—How to paint



THEO. AUDEL & CO., 49 W. 23rd St., New York City

Mail Audels Carpenters and Builders Guides, 4 vols., on 7 days' free trial. If O.K. I will remit \$1 in 7 days, and \$1 monthly until \$6 is paid. Otherwise I will return them. No obligation unless I am satisfied.

Name.....

Address.....

Occupation.....

Reference.....PM

Learn this Profitable Profession



IN 90 DAYS AT HOME

Money-Making Career Open to Men and Women, 18 to 50

Hundreds of men and women between 18 and 50 make \$10 to \$20 in a single day giving scientific Swedish Massage and Hydro-Therapy treatments. There is big demand from doctors, hospitals, sanatoriums and clubs. Graduates earn large full time incomes from these or in private practice in their own offices. Others make good money from home treatments given in spare time. Learn this interesting, money-making profession in your own home, through our home study course. Same instructors as in our nationally known resident school. You can win independence and prepare for future security by qualifying for your Diploma. Course can be completed in 3 to 4 months. Many earn while they learn. Begin your training at once.

Anatomy Charts & Booklet FREE

Enroll now and we will include, at no extra cost, many needed supplies. Fit yourself to help meet growing demand for Scientific Swedish Massage. Send the coupon at once for complete details. Anatomy Charts and 32-Page Illustrated Booklet, FREE, postpaid.



THE COLLEGE OF SWEDISH MASSAGE

Dept. 764D, 100 East Ohio St., Chicago 11, Illinois

Please send me FREE and postpaid, Anatomy Charts, 32-page Booklet and complete details on Home Training.

Name.....

Address.....

City..... State.....

SUCCEED IN THE POULTRY BUSINESS!



You can make a good, comfortable living with poultry

A little study now at home in spare time will open the way to enjoy country life, home grown food, freedom from care—letting poultry pay expenses.

For 26 years our course of Home Study Training has been helping thousands to greater success. Proper Management and "know how" means extra profits from the start. Write today for prospectus describing courses, methods, service.

NATIONAL POULTRY INSTITUTE

DEPT. 50 — ADAMS CENTER, N. Y.

PHOTOGRAPHY

FOR FUN OR PROFIT

STUDY AT HOME—Photography offers leisure time enjoyment and well-paid, fascinating career. Ever-increasing opportunities! Success—proved N.Y.I. training qualifies you at home. Also resident courses. Details FREE!

NEW YORK INSTITUTE OF PHOTOGRAPHY
(37th Year)
Dept. 49, 10 West 33 St., New York 1, N. Y.

Learn RADIO TELEVISION ELECTRONICS

Train at home, in spare time, for a good pay job or start a business of your own *without capital*—under our *proven* 2-Way method that helps you get into this money-making field of radio *quicker*. You receive Lessons *plus* Home Shop Practice including 9 kits of radio parts to make hundreds of tests. Many students earn money in spare time while learning. Write for **FREE** book "Your Opportunities in Radio" to Hollywood Radio & Television Institute, (Established 1929), Dept. A 3, 810 W. 6th St., Los Angeles 14, Calif.

Learn CARTOONING

HAVE FUN! MAKE MONEY! Cash in on your sense of humor at HOME—BY MAIL. No experience needed to start. Write today FOR **FREE TRIAL LESSON** and full particulars.



Learn BAKING At Home

Baking is one of America's high industries in wages. Nearly depression-proof. Thorough basic home course lays sound foundation. If you have aptitude, write for **FREE BOOKLET**, "Opportunities in Commercial Baking."



National Baking School, 1315 Mich. Ave., Dept. 1354, Chicago 5

Learn to Write

Begin today. Write now for our Free Book, "How to Become a Good Penman." It contains specimens and tells how others learned to write in spare time. Enclose 10c for your name beautifully written and a pen point suitable for shaded writing. Write today.

THE TAMBLYN SCHOOL OF PENMANSHIP
N-441 Ridge Building, Kansas City, Mo.

Is Your Rupture HERE?

Why continue to suffer with an uncomfortable truss if we can help you? Relief **GUARANTEED** or it costs you nothing. Send for the facts about my perfected truss invention—the Brooks Appliance for reducible rupture—with the patented **AIR-CUSHION** support that works silently with **Nature** to give protection. Thousands bought by doctors.

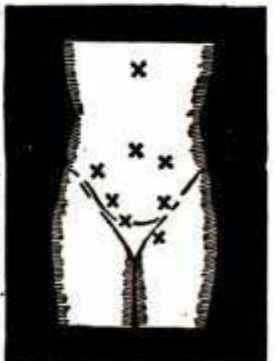

Sent on Trial—Made-to-measure, individual fitting for man, woman or child. Low-priced, sanitary, durable. No obnoxious springs or hard pads; no metal girdle to rust. Light weight, neat and comfortable. Not sold through stores or agents—beware of imitations. Write today for full information sent free in plain sealed envelope.

BROOKS APPLIANCE CO. 359-B State St. Marshall, Mich.

Now YOU Can Lick Any AUTO REPAIR JOB!

IN LESS TIME—WITH LESS WORK



**FREE
7-DAY OFFER**



USED BY
U. S.
ARMY

MoToR's New Auto REPAIR MANUAL shows you how to service and repair ANY part of ANY car!

No auto repair job is too tough when you've got MoToR's AUTO REPAIR MANUAL! YOU can repair anything from carburetor to rear end—quickly, easily, right! Just look up make, model, and the job in the quick index—and go to work! Clear, illustrated instructions lead you step by step.

To make such an amazing book possible, the engineer-editors of MoToR Magazine collected and "broke down" 150 official factory shop manuals for you, spotted all the vital repair information you need, dove-tailed it all together into ONE handy, easy-to-understand book.

No Other Manual Like It!

This BIG book—856 pages, 8½x11 inches, bound in sturdy fabric—brings you nearly 200,000 service, repair, adjustment, replacement, tune-up facts on every car built from 1935 through 1946! More than 1000 cut-away photos, diagrams,

drawings show you exactly WHAT to do and HOW to do it! Used by the U. S. Army, trade and technical schools everywhere, thousands of auto servicemen.

Now YOU—without cost—can see for yourself what a wonderbook MoToR's Auto Repair Manual really is. TRY it—FREE for 7 days! Learn first-hand how it can pay for itself the first few times you use it.

**SEND NO MONEY
*7-Day Free Examination**

Just mail coupon below—without money! When the postman brings your book, pay him nothing. First make it show you what it's got! Unless you agree this is the greatest time-saver and work-saver you've ever seen—return book in 7 days and pay nothing. Mail coupon today! Address: MoToR Book Department, Desk 1D, 572 Madison Ave., New York 22, New York.

Clear, Pictured Facts on Every Job on Every Car Built Since 1935!

Nearly 200,000 service and repair facts on all these makes:

- | | | |
|-----------|-----------|------------|
| American | Ford | Oldsmobile |
| Bantam | Graham | Overland |
| Auburn | Hudson | Packard |
| Austin | Hupmobile | Pierce |
| Buick | Lafayette | Arrow |
| Cadillac | La Salle | Plymouth |
| Chevrolet | Lincoln | Pontiac |
| Chrysler | Lincoln | Reo |
| Cord | Zephyr | Studebaker |
| Crosley | Mercury | Terraplane |
| De Soto | Nash | Willys |
| Dodge | | |

856 big pages; including 50 pages of carburetor text, charts, illustrations, covering all models. Over 500 charts, tables: Tune-up Chart; Valve Measurements; Compression Pressure; Torque Wrench Reading; Starting Motor; Engine Clearances; Generator; Clutch & Brake Specifications; Front End Measurements, etc.; Engines; Electric, Fuel, Cooling, Lubricating Systems; Transmissions; Universals; Front Ends; Wheels; Rear Ends, etc.

Same FREE 7-Day Offer Applies on

MoToR's TRUCK REPAIR MANUAL

For mechanics, truck specialists, service stations, fleet owners. Covers EVERY job on EVERY truck made since 1936! 1400 pictures, 952 pages, 300,000 facts. Used by Armed Forces. Warranted to contain every essential fact you need to know. Sturdy binding, size 8½x11. Covers all types Gasoline En-

gines; Diesels and Hesselmanns, Fuel Systems, Governors, Lubrication Systems, Ignition Systems, Starters, Generators, Clutches, Transmissions, Axles, Torque Dividers, Transfer Cases, Brakes, Steering, etc., etc.

ALSO SERVICES buses, farm and industrial tractors, contractor and road building equipment, stationary power machinery, etc. (on all parts described in Manual). Offered on same FREE 7-Day examination as Auto Repair Manual. Check box in coupon at right.



MoToR Published by MoToR, The Leading Automotive Business Magazine. MoToR's manuals assure high standards of repair work.

MAIL COUPON NOW FOR 7-DAY FREE TRIAL

MoToR Book Dept., Desk 1D, 572 Madison Ave., New York 22, N. Y. Rush to me at once: (check box opposite book you want)

- MoToR's AUTO REPAIR MANUAL. If O.K. I will remit \$1 in 7 days, (plus 35c delivery charge), then \$2 monthly for 2 months, and a final payment of 95c one month later. (Book's price \$5.95.) Otherwise I will return book postpaid in 7 days. (Foreign price, remit \$8 cash with order.)
- MoToR's TRUCK REPAIR MANUAL. (Described at left.) If O.K. I will remit \$2 in 7 days, and \$2 monthly for 3 months, plus 35c delivery charge with final payment (\$8.35 in all). Otherwise I will return book postpaid in 7 days. (Foreign price, remit \$10 cash with order.)

Print Name.....Age.....
 Print Address.....
 City.....
 State.....Occupation.....
 Zone No. (if any).....

SAVE 35c! Check here if enclosing full payment (Check, M.O. or Postal Note) WITH coupon. We pay 35c shipping costs. Same 7-day return-refund privilege.

NOW! Build Your Future On

DIESEL Opportunities



LOOK around you. See the way tractors, trucks, buses, railroads, ships, power plants and equipment of many kinds are "going Diesel." Every day new opportunities are opening—in industrial and farming communities—for trained men who can install, maintain, operate and repair Diesel engines. Plan now to build your future in this growing field.

Diesel Knowledge is Earning Power

You don't have to give up your present job. Now, you can begin learning DIESEL in spare time at home. UEI practical training teaches you, step by step, how Diesel engines operate, how fuel systems work, repairs, accessories and auxiliary equipment; a world of Diesel "know how." Includes actual practice on Diesel equipment in our shop under expert guidance. UEI training methods are successful. For 20 years they have helped mechanically inclined men better themselves.

NOW IT'S UP TO YOU!

Coupon below brings you all the facts without cost or obligation. Get going today! MAIL COUPON NOW.

UTILITIES ENGINEERING INSTITUTE
Diesel Division
1314 W. Belden
Dept. 147-D,
Chicago 14, Ill.

Founded 1927



Send Coupon for FREE FACTS

UTILITIES ENGINEERING INSTITUTE, Diesel Division
1314 W. Belden Ave., Dept. 147-D, Chicago 14, Ill.
Please send me Free Facts about Diesel opportunities and training.

NAME _____ Age _____

ADDRESS _____

CITY _____ Zone or County _____ STATE _____

Check here for special information if you are under 17.
 Check here if Veteran of World War II.

8 BIG BUILDING BOOKS

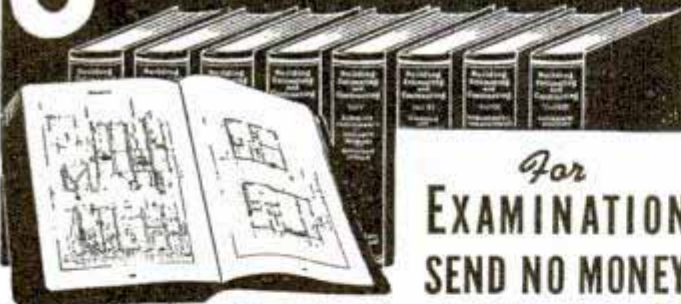

For EXAMINATION SEND NO MONEY

Learn to draw plans, estimate, be a live-wire builder, do remodeling, take contracting jobs. These 8 practical, profusely illustrated books cover subjects that will help you to get more work and make more money. Architectural design and drawing, estimating, steel square, roof framing, construction, painting and decorating, heating, air-conditioning, concrete forms and many other subjects are included.

BETTER JOBS — BETTER PAY

The postwar building boom is in full swing and trained men are needed. Big opportunities are always for MEN WHO KNOW HOW. These books supply quick, easily understood training and handy, permanent reference information that helps solve building problems.

Coupon Brings Eight Big Books For Examination

AMERICAN TECHNICAL SOCIETY Vocational Publishers since 1898
Dept. G419 Drexel at 58th Street Chicago 37, Ill.

You may ship me the Up-to-Date edition of your eight big books, "Building, Estimating and Contracting," without any obligation to buy. I will pay the delivery charges only, and if fully satisfied in ten days, I will send you \$2.00, and after that only \$3.00 a month, until the total price of only \$34.80 is paid. I am not obligated in any way unless I keep the books.

Name _____

Address _____

City _____ State _____

Please attach a letter stating your age, occupation, employer's name and address, and name and address of at least one business man as a reference. Men in service, also please give home address.

REFRIGERATION

AND AIR CONDITIONING

TRAIN FOR YOUR OWN BUSINESS

Now, not "next week," is the time to start training for a top-pay job in this vital field. A drastic shortage of trained service experts exists. Many thousands more will be needed for big post-war expansion caused by new industrial uses. Train NOW to get your pick of best jobs. We will give you the practical training you need. For 2 years we trained men and women for the Army and Navy only, in fine-precision aircraft instrument work. So our methods must be right. Common schooling is all you need. Our unique system makes everything easy to grasp. You can train at home and in our big Chicago shops. Write for full facts TODAY, without obligation, Dept. P8d.

Approved for Veterans' G.I. Training

Millions of Old Units Need Expert Service. Big Building Boom Will Create Even More Opportunities.

INDUSTRIAL TRAINING INSTITUTE

2130 Lawrence Avenue, Chicago 25, Illinois

"How to Make Money With Simple Cartoons"

A book everyone who likes to draw should have. It is free; no obligations. Simply address

CARTOONISTS' EXCHANGE

Dept. 94-D

Pleasant Hill, Ohio

LEARN MEAT CUTTING At Home — In Spare Time



Get into the vital meat industry. Concise, practical Home Training based on 25 years proven instruction methods used at National's famous resident school. Prepares you for bigger pay as Meat Cutter, Supervisor, market manager or more money in your own store. Go as rapidly as your spare time permits. Diploma. Start NOW to turn your spare hours into money. Send for FREE bulletin today. No obligation.

National School of Meat Cutting, Inc., Dept. U-80, Toledo 4, Ohio

"MAGIC VANISHING CARD"

THROW IT INTO THE AIR — It completely disappears. Reproduce it later from spectator's pocket. It amuses and confuses all. Easy to do — 25c with Amazing Catalog of 300 Tricks.

THE MAGICIAN, Dept. 5, 2463 Kensington Ave., Philadelphia 25, Pa.

WATCHES WANTED Broken or Usable

All kinds. Highest Prices paid for jewelry, rings, spectacles, gold teeth, diamonds, Sterling Silver, etc. Cash mailed promptly. Write for free shipping container.

LOWE'S, Dept. PM, Holland Bldg., St. Louis 1, Mo.

SAY YOU SAW IT IN POPULAR MECHANICS

FIBRE ARMS AND LEGS!

Light, correctly fitted, strong and comfortable. Natural appearance. Braces for all deformities. Scientific design. Fair Terms. BUCHSTEIN-MEDCALF 223 S. 6th St., Minneapolis, Minn.



59c

COMB-A-TRIM THE NEW QUICK TRIMMER

Something New! Trim your hair without any experience. It's easy! The excess hair comes off smoothly and easily by just pulling trimmer through hair like an ordinary comb. Also removes hair from legs—armpits. Save on hair-cut bills... Trim your own hair or the whole family's. Send 59c and your Comb-A-Trim will be sent at once.

SPECIAL OFFER

Send \$1.00 for 2 Comb-A-Trims and save 18c. **2 for \$1**

5 Extra Blades (Year's Supply) 25c

COMB-A-TRIM CO.

1734 Carew Tower

Dept. R-18

Cincinnati, O.

STEADY JOB! GOOD PAY! CLEAN WORK!

ELECTRICITY

NATION'S LARGEST EXCLUSIVE ELECTRICAL SCHOOL

LEARN QUICKLY AND THOROUGHLY LATEST, MOST ADVANCED METHODS

Learn Electricity Fast . . . at nation's largest exclusive electrical school . . . in only 19 weeks! Learn Electricity Right . . . topflight instructors help you learn easily, quickly, thoroughly . . . on-the-job, up-to-the-minute methods of training. Qualify yourself for Construction and Industrial Maintenance . . . Operation, Maintenance and Repair of AC and DC Motors, Generators, Controls, other Power Equipment . . . House and Factory Wiring . . . Armature and Motor Rebuilding. Entire building—4 floors devoted exclusively to this one course. Individual attention to students. Living quarters arranged for if desired.

Pay after you graduate . . . Lack of money need not hold you back. We will finance your training. Pay later in small monthly payments.



MICHIGAN TECHNICAL INSTITUTE

Dept. PM-4, 2281 W. Fort St., Detroit 16, Mich.

MICHIGAN TECHNICAL INSTITUTE Dept. PM-4
2281 W. Fort St., Detroit 16, Michigan

- Send me catalog and complete information.
- I am a GI. Send special information.

NAME _____
ADDRESS _____
CITY _____ STATE _____

APPROVED FOR TRAINING UNDER GI BILL

VETERANS!

Take this course at no cost to you, and receive \$65 to \$90 a month while training. Complete details furnished.

MAIL COUPON TODAY!

HOW TO CUT RAFTERS

New vest pocket book gives lengths, Side cuts, Plumb cuts, Deductions. For all rafters for any building from one inch to forty feet wide. Gives numbers to cut on square. Also degrees for same cuts for Radial Saws. All standard pitches from 1/8 to 5/8. Just open book to pitch page and there are your lengths, side cuts, etc. Anyone who knows what a jack rafter is can frame a roof if he has this great book. Price one dollar pre-paid. BUILDERS' TOPICS, Dept. M, Lock Box 828, Seattle, Washington. Original teachers of the square in five easy lessons by mail. SEND FOR FREE LIST OF TECHNICAL BOOKS. Learn to read blueprints etc.



CODE-RECEIVING SPEED

Learn to send and receive Radio Code with greater speed. Stop nervous tension. Have confidence. Be proficient. Same system used by radiotelegraph specialists. Thousands of operators needed. Rush name for FREE book.

CANDLER SYSTEM CO.
Dept. 5-D, Box 928, Denver 1, Colo., U. S. A.

LEARN-WATCH REPAIRING

FREE information write—American Institute Of Specialized Watch Repair—P.O. Box 117, Dept. 1, Grand Rapids 1, Michigan.

HOME STUDY OR SHOP TRAINING

Learn Plastics, Refrigeration or Diesel. Study at home, shop work later. Also shop courses in Body and Fender, Tool and Die, Auto, Diesel, Refrigeration. 45,000 graduates. Established 1902. Free booklet. Specify trade. **GREER SHOP TRAINING**, Dept. 147, 460 S. State St., Chicago.



RAISE CHIN-CHINS

No experience needed. Just a few minutes daily and a few feet of backyard, garage or barn space. Several females and a male starts a large, profitable herd. WE FURNISH FREE INSTRUCTIONS. TREMENDOUS DEMAND for breeding and laboratory stock, meat, and world's most beautiful rabbit fur. Brokers, cut off from imported rabbit pelts by world famins, NEED CHIN-CHIN FURS NOW, and for years to come! Write for free illustrated catalog today. **WILLOW BROOK FARM • R-36, SELLERSVILLE, PENNA.**



WANT A U.S. Government JOB?

START \$1,756 to \$3,021 YEAR

68,578 appointments from Civil Service Examinations in 1940 fiscal year.

Veterans Get Special Preference

Thousands appointments each year.

Prepare immediately.

32 Page book on Civil Service.

Mail Coupon Today—

SURE.

**Franklin Institute
Dept. G87
Rochester 4, N. Y.**

Gentlemen: Rush to me FREE of charge, list of U. S. Government big pay jobs. Send me FREE 32-page book describing salaries, vacations, hours and work. Tell me how to prepare for one of these jobs.

Name.....
Address..... Vet?.....

Carry 5000
ELECTRICAL FACTS
in Your Pocket!



ELECTRICIANS HANDBOOK
Helps You on the Job!

Handiest electrical reference book on the market. A "library" of 5,000 facts, wiring diagrams, formulas, charts, tables, rules—condensed into one pocket-size, 4½ x 7" volume. Weighs little more than your steel rule. Take it with you on the job—have the answers to daily problems always on hand without figuring. Saves you time and money. Flexible leatherette cover for hard usage.

Use This Book for 7 Days FREE

Try it on the job—use it for 7 days. You must be satisfied that it is worth at least the \$2.75 price to you, or we'll refund in full on return of book. Act at once and also get Home Wiring Booklet FREE. Send coupon today.

Book Division, COYNE ELECTRICAL SCHOOL
500 S. Paulina St., Dept. 47-R4, Chicago 12, Ill.

350 PAGES
INDUSTRIAL
ELECTRONICS
WIRING METHODS
MOTORS
ILLUMINATION
SWITCHING
AND CONTROL
...and thousands
of other facts!

EXTRA! Brand New 24-page booklet, "Residential Wiring Design" free for prompt action. YOU keep it even if Handbook is returned for refund. Rush coupon.

7 DAY TRIAL — FREE BOOKLET COUPON

Technical Book Div., COYNE ELECTRICAL SCHOOL
500 S. Paulina St., Dept. 47-R4, Chicago 12, Ill.

Please send me postpaid, Electricians Handbook on No-Risk 7 Days Trial. Include FREE, "Residential Wiring Design." I am enclosing \$2.75. If not satisfied, I may return Electricians Handbook in 7 days for money back.

Name Age

Address

City Zone State

() Send C.O.D. I'll pay postman \$2.75 plus postage on same offer.

Do you want

- ..to go to College?
- ..or to enter a Profession?
- (Such as Accounting, Architecture, Nursing, Dentistry; Teaching, Social Work, Osteopathy, Beauty Culture, Optometry, Embalming, Chiropody, Law, Medicine, etc.)
- ..or get an Office Position?

To get anywhere, you practically MUST finish High School FIRST. You can complete our simplified High School Course in SPARE time at home, as FAST as your time and abilities permit. Equivalent to resident school work—prepares you for college, pre-professional examinations, business, industry. Standard texts furnished. Diploma. Credit for H. S. subjects already completed. Single subjects if desired. Low tuition, easy terms. American School, Chicago, est. 1897—endorsed by educators. Finish your high school education NOW, Write TODAY!

High School Course at Home **Many Finish in 2 Years**

American School, Dept. H-445, Drexel Ave. at 58th St., Chicago 37, Ill.

Gentlemen: Send me FREE information covering special training in subjects checked below. No obligation on my part.

- | | |
|--|--|
| <input type="checkbox"/> High School Course | <input type="checkbox"/> Diesel Engineering |
| <input type="checkbox"/> Architecture and Building | <input type="checkbox"/> Drafting and Design for Men & Women |
| <input type="checkbox"/> Automotive Engineering | <input type="checkbox"/> Plastics |
| <input type="checkbox"/> Business Management | <input type="checkbox"/> Private Secretary |
| <input type="checkbox"/> Electrical Engineering | <input type="checkbox"/> Mechanical Engineering |
| <input type="checkbox"/> Elec. and Gas Refrigeration | <input type="checkbox"/> Aviation |
| <input type="checkbox"/> Air Conditioning | <input type="checkbox"/> Salesmanship |
| <input type="checkbox"/> Railway Training | <input type="checkbox"/> Radio |
| <input type="checkbox"/> Electronics, Industrial | |

Name.....

Address.....

OSWALD RABBIT—Walter Lantz Productions—3 MONKEYS

Show DONALD DUCK Cartoon Home Movies

Every film packed with thrills and laughs from start to finish.

GET THESE FEATURES

100 Ft. 8 MM.....\$3.00
200 Ft. 16 MM..... 6.00

Donald's Day Off.....1454-B
The Skater.....1456-B
Mexican Romance.....1457-B

Show also Mickey Mouse — Oswald Rabbit — 3 Monkeys films. At your dealers or order direct. Write for prices and lists.



HOLLYWOOD FILM ENTERPRISES, Inc.

6060 Sunset Blvd. Dept. 115 Hollywood 28, Calif.

WHY DON'T YOU WRITE?

Writing short stories, articles on business, homemaking, gardening, shop crafts, local and club activities, etc., will enable you to earn extra money. In your own home, on your own time, the New York Copy Desk Method teaches you how to write—the way newspaper men learn, by writing. Our unique "Writing Aptitude Test" tells whether you possess the fundamental qualities essential to successful writing. You'll enjoy this test. Write for it, without cost or obligation.

Veterans: This course approved for Veterans' Training.

NEWSPAPER INSTITUTE OF AMERICA

SUITE 559-D, ONE PARK AVENUE NEW YORK 16, N. Y.



HOW TO CREATE SOUND EFFECTS FOR HOME RECORDINGS

by ED. LUDES, Head of Sound Effects for the NATIONAL BROADCASTING COMPANY in Hollywood

Tells how YOU can make hundreds of the sound effects you hear on your radio

ORDER TODAY—Send \$1.50 Money Order or C.O.D.

NATIONAL HOLLYWOOD, 1475 EL MIRADOR DRIVE, PASADENA 2, CALIFORNIA

STAMMER?

This new 128-page book, "Stammering, Its Cause and Correction," describes the Bogue Unit Method for scientific correction of stammering and stuttering—successful for 46 years. Benj. N. Bogue, Dept. 1847, Circle Tower, Indianapolis 4, Ind.



Learn LANDSCAPE GARDENING

A thorough, interesting, home study course for those who wish to become LANDSCAPERS, GARDENERS, DESIGNERS, etc., for profit or pleasure. Write today for FREE BOOK to

APPROVED NATIONAL LANDSCAPE INSTITUTE
FOR VETERANS Dept. P-4, 310 So. Robertson, Los Angeles 36.

APTITUDE TESTS discover the kind of work or studies best for your success!

You get a personal report—a guide for life—more happiness—more prosperity. For men, women, boys and girls. Write for complete facts.

VOCATIONAL COUNSELING INSTITUTE
556 Maccahees Bldg., Detroit 2, Michigan

CONFIDENTIAL LOAN SERVICE

Borrow \$50 to \$300

Need money? No matter where you live you can borrow BY MAIL \$50.00 to \$300.00 this easy quick confidential way.

BY MAIL

IT IS EASY TO BORROW BY MAIL!
Completely confidential and private
CONVENIENT MONTHLY PAYMENTS

NO ENDORSERS NEEDED
EMPLOYED MEN and women of good character can solve their money problems quickly and in privacy with loans MADE BY MAIL. No endorsers or co-signers. We do not contact employers, friends or relatives. Convenient monthly payments. Send us your name and address and we will mail application blank and complete details FREE in plain envelope. There is no obligation.

STATE FINANCE CO.
Southern Surety Bldg., Dept. L-107, Des Moines 8, Ia.



SALES ENGINEER

MOLD DESIGNER

RESEARCHER

FABRICATOR

LAMINATOR

PARTS INSPECTOR

MOLDING TECHNICIAN

YOUR OWN BUSINESS

WHICH CAREER IN PLASTICS DO YOU WANT?

Plastics is one of the fastest growing industries—offering you unusual opportunities for an interesting, successful career and security in the years ahead. Trained men, with plastics know-how will fill the important, well-paying positions. YOU can be one of them. Mail the coupon below for a big, colorful, free catalog on Plastics and complete de-



tails about Plastics Institute, America's oldest and largest plastics school. Resident School located in beautiful Southern California. Comprehensive Home Training Courses to prepare you in your spare time at home for a career in plastics. You can enroll immediately! Write Plastics Institute, Dept. PM7-4, 1601 S. Western Ave., Los Angeles 6, California.

APPROVED FOR VETERANS

LEARN BY DOING

To give you practical experience we supply colorful plastics to make useful, attractive creations. You can also make and sell plastics articles to earn while learning.

Plastics INDUSTRIES TECHNICAL INSTITUTE

NEW YORK CHICAGO LOS ANGELES



FREE BOOKLET

Plastics Industries Technical Institute Dept. PM7-4, 1601 S. Western Ave., Los Angeles 6, Calif. Mail in Envelope or paste on penny postcard

Gentlemen: Please send me the booklet "World of Plastics" and information on your Resident School Courses () Home Training Courses. () I understand there is absolutely no obligation.

Name (PRINT)..... Occupation.....

Street (PRINT)..... Age.....

City..... Zone..... State.....

Important: Please fill out coupon completely. If Veteran, please check. () If in Armed Services now, please check. ()

PLASTICS INSTITUTE in the heart of sunny Los Angeles. Here modern laboratories and shops give Resident School students facilities for practice on the finest of industry-type plastics equipment. Also the headquarters for HOME TRAINING.

Learn PHOTOGRAPHY at Home

Splendid opportunities. Prepare in spare time. Practical basic training. Long-established school. Send for free book, "Opportunities in Photography." No obligation.

American School of Photography, 1315 S. Michigan Ave., Dept. 1354, Chicago 5, Ill.

NEW MIDGET ELECTRIC ARC WELDER

FULLY GUARANTEED RETAILS ONLY \$3.95

Plugs into Light Socket—AC or DC

It's new! It's handy! It's efficient! Use the Midget Electric Arc Welder for hundreds of light-metal jobs. Does comparable welding work with a 1/16 inch welding rod on thin metal as that of larger and higher priced welders. Operates on 15 ampere fuse, 110 volt 60 cycle A.C. or D.C. current, by use of our special standard-coated 1/16-inch welding rods. Generous supply of rods supplied with machine. Recommended for all light welding like automobile fenders, etc. Take the Midget Arc anywhere to the job. Sturdily built and fully guaranteed. Comes complete—ready to use. Nothing else to buy. No previous welding experience needed to strike an arc. In a short time, anyone mechanically inclined can learn to weld with this machine.

You'll find hundreds of money-saving, time-saving uses for the Midget Arc around your home, garage, or workshop. Also in garages, factories, repair shops, tin shops, mechanics, farmers, inventors, etc. Order a Midget Electric Arc Welder now! SEND NO MONEY. We'll rush one to you, complete with rods and helmet (equipped with APPROVED welding glass). Pay postman only \$3.95 plus postage charges. If not satisfied, return Midget Arc in 5 days from receipt and we'll refund your money immediately. RUSH YOUR ORDER NOW. MIDGET ARC WELDER CO., Strader Ave., Dept. W-202, Cincinnati 26, Ohio

DIESEL

Shop Training in a Nationally Known School

FREE Illustrated Brochure

Diesel engines are used in locomotives, ships, trucks, buses, power plants, tractors. Trained men are needed to repair, rebuild, install, maintain, operate equipment. A big field that promises even bigger things in the years right ahead. Get modern shop training on actual equipment under experienced instructors. Practical training makes rapid progress possible. Get benefits of services and training facilities of nationally known school.

BETTER JOBS—BETTER PAY

Use of Diesels in automotive and railway industries, other widespread uses all indicate Diesel knowledge means more earning power. LEARN DIESEL UNDER DIRECTION OF MEN WHO TRAINED DIESEL MECHANICS FOR U.S. ARMY. Mail coupon today. Diesel Division, Motive Trades Institute, Dept. F24, 1400 Greenleaf, Chicago 26, Illinois.



FREE—Important information telling how to get started CUT OUT COUPON BELOW

Fill Out, Cut Out, Mail Today

FACTS FREE for Men Who Want to Get Ahead Diesel Division, Motive Trades Institute, Dept. F24 1400 Greenleaf, Chicago 26, Illinois

Send free illustrated Brochures and other information on modern Diesel training. Veteran Non Veteran

Name.....
Address.....
City.....
State.....

SAY YOU SAW IT IN POPULAR MECHANICS

Now LEARN ELECTRIC MOTOR REPAIR!

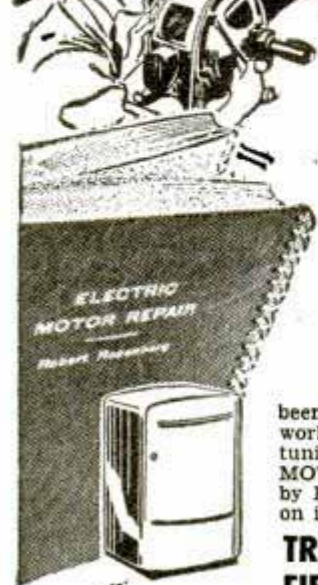

Easily, Quickly AT HOME \$ 5 for ONLY 5

Based on what you can learn at home from this big book—FOR ONLY \$5 complete—you can train to profitably trouble-shoot, repair and rewind all types of electric motors. Every home, every office, every business and factory is a prospect for electric motor repair work. The field is tremendous, the pay good. Up to now, there has been no easy, practical way to learn the work in spare time study. The opportunity is "wide open"—and ELECTRIC MOTOR REPAIR, the big 580-page book by Robert Rosenberg, helps you cash in on it within a few short weeks!

TRAIN FOR GOOD PAY IN A FIELD THAT ISN'T CROWDED

You learn fast! You learn right. ELECTRIC MOTOR REPAIR covers alternator-current motors, direct-current motors and synchronous motors and generators. ALSO, it covers BOTH mechanical and electrical motor control systems. Quick-reference guides show exactly how to handle specific jobs. Every subject is not only written understandably, but further explained VISUALLY by more than 900 clean-cut drawings. Invaluable for beginners or for bench use in busy shops. Book divides into two sections, enabling BOTH text and related illustrations to be seen AT THE SAME TIME. Lies open flat while you work!

"BORROW" IT FOR 5 FULL DAYS!

Send coupon now. Practice from ELECTRIC MOTOR REPAIR for 5 full days. If not more than satisfied with book, return it. Every cent of your money will be cheerfully refunded and absolutely no questions asked. What could be fairer?

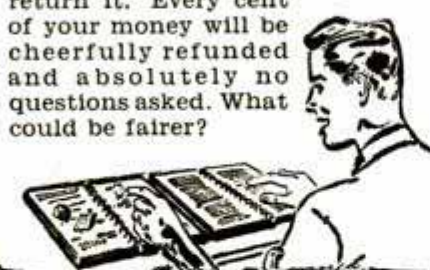

FREE!
Check coupon for free literature on famous **GHIRARDI RADIO-ELECTRONIC Training Books**

NO RISK COUPON mail today

Dept. PM-47, Murray Hill Books, Inc., 232 Madison Ave., New York 16, N. Y.
 Enclosed find \$5 (\$5.50 foreign) for my copy of the big ELECTRIC MOTOR REPAIR book; or send C.O.D. (no foreign C.O.D.'s) for this amount plus postage. In either event, if book is unsatisfactory for any reason, I may return it in 5 days and have my money refunded.
 CHECK HERE for free literature on Ghirardi RADIO-ELECTRONIC books.

Name.....
 Address.....
 City & Zone..... State.....

SAY YOU SAW IT IN POPULAR MECHANICS

Have an OFFICE of YOUR OWN!

LEARN NEW PROFITABLE PROFESSION At Home in 60 Days, Men & Women, 18 to 70!

Earnings of men and women in this profession run as high as \$5,000-\$15,000 yearly. Others make good money in spare time. Little money needed to start. A business where your earnings begin sooner. Easy to learn. No selling or goods to buy. No experience necessary. A depression-proof business. A course of action to guide you step by step as you earn. All 53 lessons sent at once to use as operating manuals. Easy terms. Diploma. Money-back agreement. Write for FREE BULLETIN.



FRANKLIN CREDIT SCHOOL
 Dept. 75-D ROANOKE 7, VIRGINIA

BY MAIL in Easy Lessons

BUILDING

Millions of homes needed. Nation wide call for builders. Big opportunities. Learn now in spare time.—at home. Practical training with blue prints. No books. Send for FREE Trial Lesson and blue print plans.
CHICAGO TECHNICAL COLLEGE
 D-151 Tech. Bldg., 2000 S. Mich. Ave. Chicago 16, Ill.

IMPROVE YOUR PLAYING

PIANISTS—Send for FREE Booklet showing how you may greatly improve your technique, accuracy, memorizing, sightreading and playing thru Mental-Muscular Coordination. Quick results. Practice effort minimized. Used by famous pianists, organists, teachers and students. No obligation.
BROADWELL STUDIOS, Dept. 157-D, Covina, Calif.



Beautiful brass Social Security plates (illustrated 1/2 actual size), priced at only 50c. Please print your name & number plainly.

ACME Stamping Service
 Box 836 Davenport, Iowa



LOOK. Verify this well-known statement in traditional mysterious KILROY manner. Distribute these intriguing little red and white discs SECRETLY on business and social calls, at parties, club meetings, dinners, dances, everywhere you go. Be mysterious. Be KILROY. Join the crowds. Have fun. Send for yours today. 245 for \$1 cash or M. O. No checks.
DEPT. A P. O. Box 188, 22nd St. Sta. St. Petersburg, Fla.

INDIANA TECHNICAL COLLEGE

Engineering B.S. degree in 27 mos. Aeronautical, Chemical, Civil, Electrical, Mechanical and Radio Engineering. 2-yr. diploma. Air Conditioning and Refrigeration; Drafting, 1-yr. Gov't approved for G.I.'s. Low rate. Earn board. Large industrial center. Demand for graduates. Enter June, Sept., Dec., March. Catalogue, 547 E. Washington Blvd., Ft. Wayne 2, Ind.

RADIO ENGINEERING. Broadcasting, Servicing, Electronics. Aviation. Marine & Police Radio taught thoroughly. 48 weeks' Engineering course equivalent to 3 years' college radio work. Approved Veteran Training. Co-educational. Catalog free.
VALPARAISO TECHNICAL INSTITUTE, Dept. D, Valparaiso, Ind.

Raise GOLDEN HAMSTERS

The new wonder animals. Look like toy bears. Delightful pets. Everybody wants them. Thousands needed by laboratories. Make money, get started now. Send 10c for illustrated literature, or send \$5 for a pair of hamsters and literature.
GULF HAMSTERY, 1536 BASIL ST., MOBILE 17, ALA.



ENSHRINE THEIR MEMORIES WITH
U.S. MONUMENTS \$14. UP
 Freight Paid
 There is none better. Our free catalog is ready for you. Write today. A-18 U.S. Marble & Granite Co., Oneco, Fla.



IF YOU CAN HUM **YANKEE DOODLE**

YOU CAN LEARN TO PLAY YOUR FAVORITE INSTRUMENT

YES, if you can hum "Yankee Doodle," or any other catchy tune for that matter, and if you spend only a half hour a day following our Print and Picture instructions, in an amazingly short time you should be playing simple melodies.

It's a grand pastime learning music this easy home-study way. Instead of spending hours at tedious exercises, you learn to play by playing real tunes from real notes. You start with simple melodies. Gradually you go on to more difficult tunes. And soon you're delighted to find you can play many popular pieces by note. What's more, learning music this modern way is not only easy as A-B-C, but inexpensive, too—costs only a few cents a day, no matter which instrument you select. Surprise your friends—win new popularity—by learning your favorite instrument.

NOTICE!
Please don't confuse our method with any systems claiming to teach "without music" or "by ear." We teach you easily and quickly to play REAL MUSIC, any music, by standard notes . . . not by any trick or number system.

If interested, send for our Free Booklet and Print and Picture Sample. See how easy it is to learn music in spare time, without a private teacher. U. S. School of Music, 74 Brunswick Bldg., N. Y. 10, N. Y. (49th year.)



FREE! Print and Picture Sample

U. S. School of Music, 74 Brunswick Bldg., New York 10, N. Y. I am interested in music study, particularly in the instrument indicated below. Please send me your free booklet, "How to Learn Music at Home" and your Print and Picture Sample. (Do you have instrument)

- | | | | |
|--------|-----------------|-------------|------------------|
| Piano | Piano Accordion | Reed Organ | Clarinet |
| Guitar | Saxophone | Tenor Banjo | Trombone |
| Violin | Trumpet | Cornet | Ukulele |
| | | | Other Instrument |

Name (Please Print)
Street
City State
 Check here if under 18 years of age.

TRAIN
Your VOICE!
Results **GUARANTEED**
We build, strengthen the vocal organs—not with singing lessons—but by sound, scientifically correct silent and vocal exercises and absolutely guarantee complete satisfaction with results. Write for Voice Book, FREE. Sent to no one under 17 years old unless signed by parent.
Perfect Voice Studios, Studio 1354, Kimball Hall Bldg., Chicago 4, Ill.

THOUSANDS OF SUFFERERS USE
BREATH EASY
FOR
ASTHMA
CARRY IT WITH YOU
USE IT ANYWHERE
Sold on Money-Back Guarantee
Write To Dept. PM
BREATHEASY DISTRIBUTORS, INC.
65 CEDAR STREET
SEATTLE 1 WASHINGTON

Keep that "Car" **TICKING**
7 DAYS FREE TRIAL
AUDELS NEW AUTO GUIDE FOR MECHANICS OPERATORS AND SERVICEMEN
A READY REFERENCE
Every operator and mechanic needs AUDELS AUTO GUIDE.
This book saves time, money and worry. Highly endorsed. It presents the whole subject of auto mechanics:
1—Basic principles
2—Construction
3—Operation
4—Service
5—Repair
Handy Size. Easily understood.
NEW FLUID DRIVE, HYDRAULIC SHIFT AND DIESEL ENGINES FULLY COVERED
Over 1500 pages—1540 illustrations showing inside views of modern cars, trucks and buses with instructions for all service jobs.
ASK TO SEE IT!—To Get This Assistance for Yourself Simply Fill in and Mail Coupon Today.
\$4 COMPLETE • PAY ONLY \$1. A MONTH
AUDEL Publishers, 49 West 23rd St., New York
MAIL AUDELS NEW AUTO GUIDE for free examination. If O. K. I will send you \$1 in 7 days; then remit \$1 monthly until price of \$4 is paid. Otherwise I will return it.
Name
Address
Occupation
Employed by PM



**A Bigger
Cash
Income**

*can be yours with
this new...*

HOBART arc WELDER

Own a profitable business with a minimum investment? It's easy if you start a welding shop with Hobart Arc Welders. People bring repair work to you - automotive, farm equipment, etc. There is profit in every job - and plenty of jobs to keep you busy the year round.



WELDING WITH HOBART IS EASIER! Only with Hobart do you get operation and convenience features that let you complete a job faster while producing better quality, more profitable welds. **"BUILD YOUR OWN" AND SAVE!** With the Hobart Generator, a used auto engine and chassis, you can build your own portable gasoline drive arc welder and save hundreds of dollars. Go everywhere for welding jobs. Send coupon. **HOBART BROTHERS CO., BOX M-47, TROY, OHIO**

*"One of the World's Largest Builders of
Hobart arc welders"*



You'll find every type and size of arc welder in the Hobart line - electric or gasoline drive, stationary or portable, AC or DC.

Attend the **HOBART WELDING SCHOOL**
Instruction in all phases of welding. Individual instruction. Qualified under G. I. Bill. A non-profit institution.

I'm Interested in the profit-making possibilities of Hobart Arc Welders. Send me free book, and details on items checked.

<input type="checkbox"/> Electric Drive	<input type="checkbox"/> A. C. Welder
<input type="checkbox"/> "Build Your Own"	<input type="checkbox"/> Welding School
<input type="checkbox"/> Gas Drive	<input type="checkbox"/> Catalog

HOBART BROTHERS CO., BOX M-47, TROY, OHIO

NAME _____

ADDRESS _____

STUDY AT HOME

With An Educational Institution
Men with specialized training win higher positions, insure larger earnings, and are bigger successes in business and public life. Opportunities NOW greater than ever before. Send for our Catalog.

ARTS and SCIENCES

Courses in Philosophy; Education; Letters; Public Health; Medical Jurisprudence; Psychology; Sociology; Physics; Chemistry; Plastics; Geology; Political Science; Theology; Business and Commerce; Accounting; Mathematics; Statistics; Agriculture.

ENGINEERING

Courses in Electrical, Civil, Mechanical, Drafting, Architectural, Steam, Aeronautical, Radio, Structural, Mining, Industrial, Petroleum, Marine, Chemical, Diesel, Automobile, Refrigeration, and Air Conditioning Engineering.

LAW

Complete Professional Law Course includes 18 Hornbook Series college grade textbooks. Courses also in Commercial Law, Patent Law and Medical Jurisprudence.
McKinley-Roosevelt Incorporated, 4610-K, Sheridan Rd., Chicago 40, Ill.



**Learn to Repair
ELECTRIC
APPLIANCES**

**WRITE
TODAY
for
FREE
BOOK**

Prepare now for a permanent future, independence and security with a business of your own. Our practical, easy-to-learn home course teaches you, during your spare time, how to repair washing machines, vacuum cleaners, electric ranges, lamps, motors, irons, etc., and do house wiring. Also how to get started on little capital. Write today for **FREE BOOKLET**. No obligation.

PACIFIC TRAINING SCHOOL
7217 S. Broadway, Dept. P-104, Los Angeles 3

INVENTORS Exhibit and possibly sell

your invention at the 2nd and greater **WORLD'S INVENTION EXPOSITION**, Chicago Arena, May 2 to 11. Thousands of mfgs. will see your invention—small rates to display model or drawing. Make reservations now. Write for free folder.

WORLD'S INVENTION EXPOSITION
Offices—39 South La Salle Street Chicago 3, Illinois

TRI-STATE COLLEGE

B. S. Degree in 27 months in Engineering (7 branches); Bus. Adm., Acct and Sec. Science. 4th year. School now filled to capacity. No applications can be accepted until further notice.
447 College Ave., Angola, Ind.

RUPTURED?

Get Relief This Proven Way

Why try to worry along with trusses that gouge your flesh—press heavily on hips and spine—enlarge opening—fail to hold rupture? You need the Cluthe. No leg-straps or cutting belts. Automatic adjustable pad holds at real opening—follows every body movement with instant increased support in case of strain. Cannot slip whether at work or play. Light. Waterproof. Can be worn in bath. Send for amazing **FREE** book, "Advice To Ruptured," and details of liberal truthful 60-day trial offer. Also endorsements from grateful users in your neighborhood. Write: **CLUTHE SONS, Dept. 31, Bloomfield, New Jersey**



MEN FROM 16 to 40! In fairness to Your Future, find out what COYNE offers in Practical "Learn-By-Doing" Training!

Learn **RADIO** - **ELECTRONICS-TELEVISION** *at* **COYNE!**



Here in the Great COYNE Shops, Prepare Quickly for Better Pay!

COYNE gives practical, "Learn-by-Doing" training on full sized equipment, plus necessary theory. In a few short weeks you're ready for "ALL-AROUND" opportunities in Radio — Radio Manufacturing, Radio Service and Sales, Sound Systems, F. M., Television, Electronics, or a Business of Your Own. Prepare NOW for a lifetime of better jobs, bigger pay. Mail Coupon!

STUDENT FINANCE PLAN

Don't let lack of money hold you back! Our Student Finance Plan has helped thousands. Pay most of tuition after you graduate. We also help you get part-time work while here, if you wish. Lifetime Job Service FREE to Coyne-trained men.

INCLUDED!

Added training in Electric Refrigeration Now Included with Radio Course.



VETERANS!

COYNE is also equipped to train those who qualify for training under the G. I. Bill of Rights. Check the coupon for special G. I. Bulletin.

ANY MAN WITH A PHYSICAL DISABILITY whether a Veteran or not may qualify for Coyne training at no extra cost to them for tuition or subsistence. Check coupon for details.

SEND NOW FOR BIG FREE BOOK

Dozens of actual photos in the great shops of Coyne — also vital facts about YOUR opportunities in Radio-Electronics-Television. No obligation. No salesman will call. Rush coupon now!



B. W. COOKE, Director, Radio Division

COYNE ELECTRICAL SCHOOL
500 S. PAULINA ST. Dept. 47-3H CHICAGO 12

FREE BOOK COUPON

B. W. Cooke, Director,
COYNE ELECTRICAL SCHOOL, Radio Div.
500 S. Paulina St., Dept. 47-3H, Chicago 12, Ill.

I want to build a REAL FUTURE for myself. Send your big FREE BOOK on Radio, also details of your Student Finance Plan. Check if interested in information on the following:

Send special G. I. Bulletin Physical Disability details

NAME.....

ADDRESS.....

CITY.....ZONE.....STATE.....

...MAIL THIS TODAY!

Accountancy Home-Study

made interesting and practical thru problem method

YOU know as well as we do that Accountancy fits many men for positions that pay three and five and ten thousand dollars a year—gives many other men unusual opportunity to start a profitable growing business of their own.

You probably realize also that the accounting profession faces the greatest opportunity it has ever had.

The only question is—just how practical is it for *you* to train yourself adequately in Accountancy through home study?

And the answer lies in the LaSalle Problem Method.

For this modern plan of training not only makes Accountancy study at home thoroughly practical but makes it interesting as well.

And here's how:

You Learn by Doing

Suppose it were your privilege every day to sit in conference with the auditor of your company or the head of a successful accounting firm. Suppose every day he were to lay before you in systematic order the various problems he is compelled to solve, and were to explain to you the principles by which he solves them. Suppose that one by one you were to work those problems out—returning to him every day for counsel and assistance—

Granted that privilege, surely your advancement would be far faster than that of the man who is compelled to pick up his knowledge by study of theory alone.

Under the LaSalle Problem Method you pursue, to all intents and purposes, that identical

plan. You advance by solving problems:

Only—instead of having at your command the counsel of a single individual—one accountant—you have back of you the organized experience of a great business training institution, the authoritative findings of scores of able accounting specialists, the actual procedure of the most successful accountants.

Thus—instead of fumbling and blundering—you are coached in the solving of the very problems you must face in the higher accounting positions or in an accounting practice of your own. Step by step, you work them out for yourself—until, at the end of your training, you have the kind of ability and experience for which business is willing and glad to pay real money.

One-Tenth of All C. P. A.'s Are LaSalle Trained

If you want still more proof, remember that over 2300 C.P.A.'s—approximately one-tenth of all those in the United States who have passed the difficult examination for this coveted degree—are LaSalle alumni.

And knowing these facts, ask yourself if there can be any further question about the practicability of this training for you—ask rather if the real question is not about the size of your own ambition and the quality of your determination.

For Accountancy is no magic wand for the lazy or the fearful or the quitter—it offers success only to the alert adult who has the courage to face the facts and the will to carry on till the job is done.

If you are that individual, the coupon below, filled out and mailed, will bring you free the information that may open up to you the future of which you have dreamed—ability and income and success. Is it not worth getting that information?



SEND FOR THIS... BOOK

LaSalle Extension University

A Correspondence Institution

Dept. 464-H 417 S. Dearborn St., Chicago 5, Ill.

Please send me, free of all cost or obligation, your 48-page illustrated book "Accountancy, the Profession That Pays," telling about the profession of accountancy and your training for success in that field.

Name.....

Address.....City & Zone.....

Position.....Age.....



**WORLD'S
BEST
WANT AD
MEDIUM**

CLASSIFIED Advertisements



Advertisements in this section 60 cents per word, each insertion, minimum 10 words, payable in advance
To be inserted under proper classification, copy must be in our office the 25th of the
second month preceding date of issue

F. W. Johnson, Manager, Classified Advertising
Popular Mechanics Magazine, 200 East Ontario Street, Chicago 11, Illinois

1459 CLASSIFIED ADVERTISEMENTS 1459 OPPORTUNITIES FOR YOU

AUTOMOBILES, MIDGET CARS

R & R Mfg. Co., marine and auto division, Anderson, Indiana, Robert M. Roof. \$1.00 for our new 1947 speed and power equipment catalogue with price sheet—showing racing cars, midgets, speed boats with recommendations how to rebuild your motors for racing. Dual ignition racing cylinder heads for V-60-100 and Mercury Ford engines. Dual intake manifolds, racing pistons, camshafts, compound valve springs, Lynite flywheels, quick change gear boxes and numerous other supplies.

MIDGET Racing car blueprint, 3 view professional layout, \$1.50. Sawin, Box 31, Seekonk, Mass.

"CUSTOM-STYLING" Manual—Easily make car look Hollywoodized, custom built, ultra-beautiful! Includes streamlining suggestions, simplified restyling, refinishing, illustrations, plans for accessories, mufflers, model changes—convertibles, custom, sport, etc. \$2. Almqvist Engineering, 447 (X) 64 Street, Brooklyn 20.

600 DIFFERENT Photos, race cars, drivers. List, sample, 25c. Frank Smith, Midland Park, N. J.

MOTORACES, New book Grand Prix auto racing. Includes 100 photos famous foreign cars, drivers. \$2.00 postpaid. Clymer, Dept. A41, 2125 W. Pico, Los Angeles 3, Calif.

SPEED & Mileage manual—Easily obtain greater speed, mileage, racing performance from any automobile! Includes simplified methods, speed tuning, gas saving secrets. Instructions on building economizers, speed equipment, mufflers, superchargers, duals, racing fuels, fast conversions. \$1.98. Almqvist Engineering, 447 (X) 64 Street, Brooklyn 20.

CLYMER'S Motor Scrapbooks (old automobiles) Editions 1, 2, 3, each different, \$1.50 each. Motor History of America, \$3.00. Fastest on Earth racing book, \$2.00. Motor Racing With Mercedes-Benz, \$2.00. Book Steam Automobiles, \$2.00. Power & Speed, \$2.50. Henry Ford, His Life & Work, \$3.00. Midget Automobile Racing Book, \$1.10. Indianapolis "500" Race History book 1909-1946, \$3.50; 1946 only, \$1.00. All postpaid. Catalog free. See ad motorcycle section. Clymer, Dept. A43, 2125 W. Pico, Los Angeles 6, Calif.

"STREAMLINED Roadster"—America's lowest priced car! Speedy, light, beautiful two passenger! Amazingly easy to build from inexpensive material—small motor. Complete instructions, drawings \$1.98. Almqvist Engineering, 447 (X) 64 Street, Brooklyn 20.

INDIANAPOLIS Official 1946 Race Program, 102 pages. Photos, results. Limited supply. 60c each postpaid. Clymer, Dept. A47, 2125 W. Pico, Los Angeles 6, Calif.

SEE Our ad under Motorcycles for midget racer bargains. Midget Motors Directory, Athens, Ohio.

TWIN-TONE Mufflers for V-8 and Mercurys 35 to 47 models. Gives more mileage, without back pressure. Mufflers are straight through-type and produce deep mellow tone, \$20.00 a set. Single through-type mufflers for all cars \$8.50 ea. Chrome tail pipe extension 2 1/2" dia., \$2.50 ea. Satisfaction guaranteed. Twin-Tone Mufflers, 139 East Manchester Ave., Los Angeles 3, Calif.

JEEP Owners. Plans and instructions for building station wagon type jeep body. Easy to follow. 78 views. 63 step-by-step instructions. Only \$5.00. Send name and address for free details. Southern Plan Service, P.O. Box 151, Charleston, S. C.

HISTORY Of Buick, city of Flint book, now available. Illustrations early, late Buick. Beautiful binding, \$3.00 postpaid. Clymer, Dept. A46, 2125 W. Pico, Los Angeles 6, Calif.

DUALTONE Crystalline packed mufflers. Single or twin mufflers for all cars. Duals priced complete V8's \$23.00, six cylinders \$33.00, eight cylinders \$36.00. Large chromed tailpipe extensions \$3.30. Polished carburetor velocity stacks \$1.30. Chromed Station Wagon stacks \$15.00. Request catalogue. Dualtone Mufflers, 2636C India Street, San Diego 1, California.

PACIFIC Speedway News auto racing magazine. Complete results, data, large and midget races. Subscribe now, \$6.00 yearly. Clymer, Dept. A40, 2125 W. Pico, Los Angeles 6, Calif.

JEEP Station wagon, body, safety glass, etc. Large how to build blueprints, instruction, parts list, etc., \$2.00. Circular illustrating before and after building, dime. Craftsmann Books, Box 1153-PJ, Milwaukee 1, Wis.

RACING Car performance for all cars. Complete specifications, \$1.00. Increase power, speed. Special "custom-built" equipment. Free literature. Write Lee Motorcraft, 1412-A Great Northern Bldg., Chicago 4, Illinois.

DUAL Mufflers for V-8's. Finest obtainable. Beautiful deep tone. Complete with necessary welded pipes, two mufflers, brackets. E-Z installation, \$20.00. Clymer, Dept. A42, 2125 W. Pico, Los Angeles 6, Calif.

SCOOTER-CAR Runabout! Two passenger, three wheeled, motorized, speedy. Simple construction from available second hand parts. Detailed plans \$1.00. Midget "Jeep" plans included free. Universal, 2671 Algonquin, Toledo 6, Ohio.

USED Car handbook. Dealers' tricks exposed, buying tips, previous owner clues, simple comprehensive tests. Postpaid \$1. Truvalu, Box 723-E, Arcadia, California.

HIGH Speed engine tuning. Car, boat, etc. No gadgets. Do it yourself. Race car mechanic advice each individual job. Information free. George Fawns, A-2552 N. 17th St., Philadelphia 32, Penna.

BUILD Speedy midget track racer from castoff parts! Plans, specifications, construction information, \$1.00. Motor Supply, Box CS-1682, Toledo, Ohio.

MAKE Your Ford fast! Complete details, photographs. How to construct 120 m.p.h. Hotrod. \$1 postpaid. California Bill, Eagle-rock Box L-1, Los Angeles 41, Calif.

CUSTOMIZE Your automobile. Illustrated, new restyling ideas, instructions, suggestions, specific model changes by simple methods. Postpaid \$1. Speedwheel, Box 723-E, Arcadia, California.

MUFFLER Manual. Convert easily to Hollywood, Laguna, Westwood, duals, etc. Includes construction details, regulations, diagrams. Postpaid \$1. Mellotone, Box 723E, Arcadia, California.

PROFESSIONAL Midget racer, motor-scooter, midget roadster, and midget motorcycle. Plans, specifications for all four contained in illustrated handbook, 25c. Big list bargain priced used motors, motorscooters, servicycles, etc., included free! Midwest, 3839 Drummond, Toledo, Ohio.

AUTOMOBILE Racing book, fifth edition, well illustrated. Instructions on building bodies, frames, engines. Ford A and B conversions. Plans. AAA rules, specifications. Roadster racing, Indianapolis cars. \$1.00 postpaid, \$1.30 C.O.D. Ray Kuns, Dept. 47, Madisonville, Cincinnati 27, Ohio.

AUTO SUPPLIES AND EQUIPMENT

SEAT Covers to 1933. Save \$10. Good plaid fiber. Leatherette trim. Full sets \$11.95. Fronts \$8.45. COD, postpaid, immediately. Lubbock Cover Co., 1911-N, Lubbock, Texas.

GASOLINE Vaporizer, 27 miles per gallon, at 35. Walert Company, 3429 North Tenth St., Milwaukee 6, Wisconsin.

DUAL Carburetors fit any year. Blueprints \$1.00. Corcraft, 80 Maxwell, Rochester 11, N. Y.

BRAND New army surplus sparkplugs for all cars and trucks. 39c each postpaid. State car model—year. Dahl Tire Co., Litchfield, Minnesota.

NEED Auto parts? We have them. New and rebuilt. Prompt shipment. Write requirements. Save money. Buy direct, (see our display advertisement page 270). Factory warehouse, Mechanics Auto Parts, 3807-PM-4 North Ashland, Chicago 13.

1947 SUPERIGNITIONER \$5.50. Atomic starting, pep, mileage. EG Mfg., 355A East 149th, New York 55.

PROTECT Your car. Use Chrome Lustre—sensational, new transparent, liquid rubber coating. For chrome and other metals. Resists salt, acids, alkali, water; stops corrosion. 1/4 pt., only \$1. Send order to: Quality Distributors, 6810 Snow Rd., Parma 9, Ohio. Dealers wanted.

INSTANT-KLEEN Auto Glaze. Quick, easy, inexpensive. Cleans and polishes—one application. Pint postpaid 50c or c.o.d. Guaranteed. Write for other products. Agents invited. Three Star Products, 3800 Genessee, Kansas City, Missouri.

DE-SO-LIZER Use diesel and stove oil in your car save 70%. Install it your self. Free literature. Box R188B, Seal Beach, Calif.

TIRES—All standard makes at wholesale prices. Direct Tire Co., 962 E. 129 St., Cleveland, Ohio.

TRIPLE Stitched automobile seat covers made with beautiful swirl leatherette and lacquered fibre with attractive piping welt. Fit perfectly. Priced low. Dealers wanted. Mono Auto Seat Cover Co., Hollywood 38, Calif.

BUY Wholesale 50% off auto accessories, parts, home supplies. Make money selling from truck, store, garage. Free price list. Main Supply, Fairfield, Ill.

WE Carry a complete stock of new, used and rebuilt parts for all cars. Send your request in now. Superior Auto Parts Co., 4937 N. Monticello Ave., Chicago 25, Ill.

CLUSTER, low and reverse gears for Chrysler, Plymouth, Dodge, De Soto 1935-1938. Positive quick delivery anywhere U.S. and Canada. Wholesale only, any quantity. Write! Bodkin Products Co., 816 Penobscot Bldg., Detroit 26, Michigan.

AUTO Parts, new and used. Bumper to bumper. Fast service. Rearend and transmission specialists. Describe needs. Arrow Auto Wreckers, 4128 Ogden Ave., Chicago 23, Illinois.

NEED An auto battery? Write, Veach & Co., Palestine, W. Va.

1000 MOTORISTS Needed to make gas saving test. Up to 30% savings. For trial test offer write Vacu-matic Carburetor Co., 7616-1306 W. State Street, Wauwatosa, Wis.

FLEXIBLE Valve fisher and tube inflator. New invention for fixing tires. A necessity for garages, filling stations, tire shops, car owners, etc. \$1.00. Agents wanted. E-Z Sales Co., 7670 South Hooper Ave., Los Angeles 1, California.

EVERY Car owner wants one: Sheepskin wash mitts. \$1.00 will bring you sample post-paid. Send for free catalogue. Shepherd Products Co., Worcester, Mass.

ATTENTION Auto body repair shops. Resharpen your own body files. Reasonable, simple, foolproof perfected commercial formula. Guaranteed. \$1.00. Cchematic Processes, Box 7702 DeValle Station, Los Angeles.

HAVING Car trouble? New, used, guaranteed auto, truck parts save money. Transmission specialists. Describe needs; immediate reply. Victory, 2930 1/2 Northwestern, Chicago 18.

AUTO Parts for all autos and trucks. Trans., motors, differentials, fenders, carburetors. Also body parts. Security Auto and Truck Parts, 1941 BJ Eddy, Chicago 13.

PLATING Outfits for auto parts. Connect to a battery. No tanks used. Free particulars and proofs. Gunmetal Co., Ave. J. Decatur, Ill.

GRILLES For all cars. Meyers Auto Parts, 820 Dryades, New Orleans, La.

AUTO TRAILERS

TRAILER Manual. Construction blueprints. New circular, illustrates 14 to 24 ft. three room designs. 10c. Manual 17 ft. Streamliner has everything. \$1.00 includes circular. Craftsmann Books, Box 1153 P3, Milwaukee 1, Wis.

SOFT Tire indicators for trailers. Inquire. Laidlaw Mfg. Co., Box 1108, Pasadena 20, Calif.

BUILD Your own trailer! Save money! Have every feature you want! Plans for house, sport, camp and utility trailers. Catalog describing 9 models 10c. 15c in Canada and overseas. Jim Dandy, Box 125-A, Wausau, Wisconsin.

MOTORCYCLES, BICYCLES, MOTOR-SCOOTERS AND SUPPLIES

ELECTRIC Energy can push your bike along. No gears; welding. Klaus, 1369 Missouri St., Pittsburgh 6, Penna. Plans \$1.00.

HARLEY Single motorcycle \$50, Harley twin \$65, complete. Motorscooters \$9 up, midget cars \$10 up, motorcycle \$25, less motors. Used motors \$3 up. Plenty of brand new 2 horsepower motors never taken from factory crates. Over 5000 balloon tires for motorscooters and small cars \$1 up, mailorder only. Send 25c for Big War-Bargain catalogue Number 18, just out listing the above and hundreds of other bargains in new and used motors, motorscooters, midget cars, racers, etc. (35c by first class mail.) Midget Motors Directory, Athens, Ohio.

MIDGET Car axles, etc. Write Behnke's Auto Supplies, 5721 Leland Ave., Chicago 30, Ill.

CLYMER'S Motorcycle books. Speedway Motorcycle Racing, \$2.00. Motorcycle Speedway Annual, \$1.00. How to Manage Motorcycles, \$1.50. Motorcycling Manual, \$2.00. How to Obtain Speed, \$1.50. Motor Scooter Plans, \$2.00. Books on Ariel, BSA, Norton, Triumph, Villiers engines, \$1.50 each. English Motorcycle Magazine, 50c. All postpaid. See our ad automobile section. Catalog free. Clymer, Dept. A44, 2125 W. Pico, Los Angeles 6, Calif.

FACTORY Built motorscooter \$45, 1946 midget car \$65, tires \$1.00! Send 25c for bargain catalog packed with money saving buys in motorscooters, motorbikes, midget cars, motors, wheels, tires and parts. Gail and Company, 538 Erie, Toledo, Ohio.

ILLUSTRATIONS. Specifications, general information on constructing motorbikes, scooters. Also motor adjustment and repair information \$1.00. Veco (A147), Box 124, Evansville 5, Indiana.

ATTRACTIVE New lapel pins. Harley-Davidson, Indian, midget or Indianapolis racing car. Daytona race souvenir double flag pin, crash helmet pin. Specify choice. \$1.00 each postpaid. Clymer's, 2125 W. Pico St., Los Angeles 6, Calif.

MOTORSCOOTERS. Wheels, motors, midget-cars. New bargain catalog 20c. Perry's, Wood Rd., R.F.D. #13, Richmond, Va.

MOTOR Scooters, bicycle engines. 120 miles gallon. Dime for catalog. Clymer, Desk A45, 2125 W. Pico, Los Angeles 6, Calif.

MOTORCYCLES, Parts, new and used, Harley, Indian, Henderson, Super-X. List 10c. Ballak, 811 N. 9th, St. Louis 1, Mo.

BUILD The first five passenger half-ton, three wheeled motorcycle in your locality, from Ford parts. Show your genius. Easy built, useful, handy. Nothing like it. Instructions \$1.00. Motorcycle Wizard, 73-E South Shirley, Pontiac 20, Mich.

NEW Schwinn bicycles, tricycles. Ideal gift for any occasion, all sizes, all makes. Prices reduced. Send dime for catalog. Atlas Cycle Company, 3002S Broadway, Chicago 14, Ill.

BICYCLES, Schwinn's, Monarks, mens, ladies'. \$37.50. Send dime for accessory list. Century Cycle, 3447 Lawrence, Chicago 25, Illinois.

HARLEY-DAVIDSON — New and used 45" motors, service, parts, accessories, tires. Send \$2.25 for army motorcycle manual, 10c for bulletins, Knuth's (Harley-Davidson factory dealer), 2491 Fondulac, Milwaukee, Wis.

TIRES, Inner tubes, wheels, for small trucks, wheelbarrows, power scooters, midget cars, farm equipment, carts, etc. Sizes 8" to 18" o.d. in 2, 4 and 6 ply first-line quality tires, with removable inner tubes and heavy duty demountable wheels. Also caster forks, straight or swivel types. Free circular and prices. Jahant Co., 626 East Exchange Street, Akron 6, Ohio.

MODERN Motorcycle Mechanics Manual, 560 pages, 300 illustrations, covers Harley, Indian and English makes. The most complete motorcycle book published. \$3.00 postpaid. Nicholson Bros., Motorcycle Engineers, Saskatoon, Sask., Canada.

COLUMBIA Bicycles, balloon tires, sizes 20, 24 and full size. \$38.00 each. \$5.00 deposit, balance c.o.d. Pulver's Sporting Goods, Hudson, N. Y.

MOTORSCOOTER \$10, Motor \$3, tires \$2! Send 25c for big catalog listing scores of other sensational bargains in motors, wheels, motorscooters, motorbikes, servicycles, tires, etc. Associated, Box CS-1764, Toledo, Ohio.

HARLEY-Davidson Parts, repairs, cylinders rebored, batteries and tires. 24 hour service. Special Polaroid goggles. \$1.29 postpaid. Authorized dealer. Philadelphia Harley-Davidson Company, 857 North Broad Street, Philadelphia 23, Penna.

SELL Sheepskin motorcycle saddle covers. Sensational profits. Money order for \$4.00 will bring you sample post-paid. Immediate delivery. Shepherd Products Co., Worcester, Mass.

WHEELS! Build wagons, scooters, mowers, trailers, wheelbarrows, grocery carts, baby carts, play pens, baby carriages. 4" to 16". Free list. Truelsen Mfg. Co., 811 E. 31, Kansas City, Mo.

MOTORCYCLE Cams ground for speed and power, carburetion. For information write Harold Schaller, 247 West Main, Turlock, Calif.

BICYCLE Book, how to buy, rebuild, sell used bicycles 50c. John Collett, Handley, Texas.

TIRES And industrial wheels, suitable for scooters, wheelbarrows, farm equipment, etc. All sizes. Bicycles and accessories. Largest assortment in America. Send dime for list. Cycle Transport Company, 1241 So. Michigan Ave., Chicago 5, Illinois.

BUILD America's lowest priced motor-scooter speedster! Complete plans, specifications, \$1.00. Big list bargain priced used motors, etc., included free! Motor Supply, Box 1682-CS, Toledo, Ohio.

LARGE Stock Indian parts. Expert motor rebuilding. New and rebuilt Chief motorcycle, motors only. Indian Motorcycle Sales, Kansas City 1, Mo.

"BICYCLE Repair Manual." Illustrated booklet, tells how to repair bicycles. 65c. Robert Klausner, Shelbyville, Ill.

AVIATION

PROPELLERS—Specializing—Airliner 3 blade for ice-snow sleds and boats. Also 2 blade. Illustrated literature free. Standard Aircraft, Ft. Worth, Texas.

LIGHTPLANE Manual. Blueprints. Home built, Lightplane now licensable. Circular illustrates ten different designs, motors, etc. 20c. Craftsmann Books, Box 1153 P1, Milwaukee 1, Wis.

NEW Catalog! Rush name. Experiment-er Supply, Tipp City 6, Ohio.

B-29 COMPUTERS, Dynamotors, amplidyne, auto pilots, amplidyne servo amplifiers, compressors, gun chargers, turret drives, generators, starters, Plexiglas domes, sighting stations, etc. Free list. Erec, 1006 Hewitt, Everett 1, Washington.

VETERANS: Flight training under G.I. bill. Private, commercial, and flight instructor ratings. Write for information. Gottschalk School of Aeronautics, Adrian, Michigan.

CUBS, Wacos, Taylorcrafts, Aeronaas. Big catalog. 25c. lists these and thousands of other sensational airplane bargains. Some are "easy to repair" crackups. National, Box 1682-CS, Toledo, Ohio.

BATTERIES, GENERATORS

BUILD an a.c. battery charger. \$20 starts shop. Garland Enterprises shows how. Dept. 447, Box 186, Windsor, Ontario, Canada.

EDISON Non-acid lifetime storage batteries for home lighting, motors, radios, etc. Free complete interesting literature. T. Hawley Smith Company, Croton Falls, N. Y.

BATTERY Repairing, rebuilding, plate making plans. L. Wertz, Pekin, Illinois.

ELECTRICAL SUPPLIES, EQUIPMENT

LAMPS—All parts to build or repair. Catalog 10c. Gyro Lamps, 5416 Clark, Chicago 40.

MAKE Powerful demagnetizer by using our ready made coils, \$4.25 postpaid. Heavy formvar magnet wire #20—750 ft., ideal for motorwinding, chokes, transformers, etc. \$4.75 postpaid. A.C. motor windings designed for all voltages, phases and speeds. Send for free data card. J. I. Weeks, 919 Neland, Grand Rapids 7, Mich.

ELECTRIC Pencil—writes, engraves all metals. Battery model \$1.00—110 volt model, \$2.00 postpaid. Guaranteed 5 years. C.O.D.s accepted. Reb Industries, Dept. 265-X, Elmhurst, Illinois.

OIL Burners, motors, pumps, circulators, converters, Expeditors and distributors of building materials. List your needs with us. Bruce Industries, Staten Island #1, N. Y.

WASHING Machines. Parts all makes. Northeast Burner, 1358 H St., Washington 2, D. C.

SENSITIVE Photo-Electronic equipment, operates hundreds of hours from 4 flashlight batteries! \$10.95 postpaid. Write: Electronics, 234 Clayton, Ottumwa, Iowa.

APPLIANCES, Tools, parts, radio tubes at bargain prices. Postcard brings free list. Robbie, 1900 Classen, Oklahoma City 6, Okla.

ELECTRICAL Supplies bought, sold and traded, agents wanted. Estes, Box 155, St. Matthews, Louisville 7, Ky.

SELSYNS 6G 110 a.c. bronze, pair \$7.50. Majtner, 201 W. 16, New York City.

MAGNETS — Alnico. Postcard brings 1947 list. Terry Sales Company, 3726 South Detroit Avenue, Toledo 9, Ohio.

FLUORESCENT Fixtures with tubes. Commercial, industrial, home units. Free price list. A. Kramer, Box 112, McDonald, Penna.

U. S. N. testing flashlight with test prods. Use as flashlight or as test light to test fuses, circuits, etc. \$3.00 postpaid. Lerer, Box 25, Lowell, Mass.

MANUAL On multispeed three phase induction motors \$2.00 free literature. Electric Generator Mfg. Co., 1333 N. Dale St., St. Paul 3, Minnesota.

LAMP Sockets, brass shell. Also Mogul sockets. Three way switches, cord sets, electrical repair parts, lamp parts, wires, etc. Catalog 10c. The Gearon Company, 4348 Broadway, Chicago.

B-29 FIRE-CONTROL Computers GE2-CH1C1. Single parallax. New \$75.00. Free list. Erec, 1006 Hewitt, Everett 1, Washington.

1000 AMPERE Starter solenoid relays. \$2.45. New. Specify coil voltage desired. Free list. Erec, 1006 Hewitt, Everett 1, Wash.

NEW Kohler electric plants a.c. and d.c. Other electric plants rebuilt. Bargain on Silvertronic electric outboard motors. E. F. Schmaltz, 314 Wyoming Ave., Kingston, Penna.

FREE Catalog of welders, welding supplies, generators, fencers, and other electrical items. Write LeJay Company, Minneapolis 8, Minn.

ELECTRIC Pencil: Writes, engraves all metals. \$1.00 postpaid. Beyer Mfg., 4515-H Cottage Grove, Chicago 15.

FLUORESCENT Tubes burned-out? You can relight and use indefinitely. Complete instructions \$1.00. Wallingford, 121 Burlington, York, Nebr.

ELECTRIC Fan assemblies. Make your own. Ted Riseman, 425 East Jefferson, Springfield, Illinois.

PRACTICAL Winding of a.c. motors. A course of instruction on winding, connecting, and testing single, two, and three phase motors. Clearly written in everyday non-technical language. Illustrated throughout. This book is recommended for beginners interested in learning motor re-winding and repair. Satisfaction guaranteed or remittance refunded. \$2.00 prepaid. Educational Advancement Co., Dept. Y, Lakewood, New York.

WELDING, SOLDERING, PLATING

NEW Model electric welder 110 volt a.c.-d.c.: will weld all metals; easy to use; full directions. Complete with power unit, flame and metallic arc attachments, carbons, fluxes, rods, mask; all for \$19.95. Used by the navy. Magic Welder Mfg. Co., 239-MP4 Canal St., New York City.

ELECTRO Plating outfit including solutions for jewelry, fishing spoons, etc. Plugs into lighting outlet. Instruction booklet tells how to plate baby shoes. \$19.50. Free folder. Hoover & Strong, Inc., 113 W. Tupper St., Buffalo 1, N. Y.

150 AMPERE Generators for welding \$47.50. Extra flexible cable, 6 ft. lengths \$2.75. Other bargains. Butler Electric Company, 1885 Milwaukee, Chicago 47.

WELDERS (Acetylene) become expert on white metal. Use own rod made from scrap. Details. LaCombe, Oakland 6, Calif.

"THUNDERBOLT"—Transformer welder, dial-control, 3 heats, 60 amps., 110 volts—a.c., carrying case, accessories, instructions. \$39.50. Also "Super-Welder," 110 volts, a.c.-d.c. \$19.95. Save 2%, send check. Or order c.o.d. Dealers wanted, liberal proposition. Super-Welder Mfg. Co., 23 E. 20th St., New York 3, N. Y.

WELD, cut, braze with gasoline! Amazing new discovery shatters costs. Boosts profits. Important! Write Matthews Mfg. Co., Calgary 21, Canada.

ELECTROPLATING By battery. Illustrated instructions. \$1.00. Alvin, 553 William, Winnipeg, Manitoba.

WELDING, Cutting, aircraft welding and soldering equipment. Electric arc welders. Superior Oxy-Acetylene Co., Hamilton, Ohio.

MACHINERY, TOOLS AND SUPPLIES

ACME Rust remover quickly dissolves rust and scale on iron, steel and other metals. 8 ounces 75c. Cliff Webber, Mfr., Coon Rapids, Iowa.

UNIVERSAL Tools dandy 10 piece set: Rigid pipe wrench, channellock pliers, adjustable wrench, Ceecee pliers, diagonal cutter, ballpeen hammer, plastic screwdriver, waterpump pliers, hacksaw and blade, cold chisel. \$19.85. Universal Tool Company, 1527 Grand, PM-4, Kansas City, Missouri.

PORTABLE Electric tools, "Skiltools," "Black & Decker." Drills, saws, sanders, grinders, buffers, band saw blades, twist drills. Immediate delivery! Tool bulletin on request. Forslund Pump & Machinery Company, 1717 Main, Kansas City, Mo.

IT'S Easy to build your own metal and woodworking tools from Lewis castings, materials and blueprints—and at savings up to 80%! Lewis mills, shapers, drill-presses and other shop tools have ample capacity and performance for home workshop jobs. New catalog—sent on receipt of 10c to cover mailing—describes 23 Lewis tools. Address Lewis Machine Tool Co., 3217 Union Pacific Avenue, Dept. M, Los Angeles 23, California.

NEW Glass drill. Free literature. Box R188B, Seal Beach, Calif.

HOLLOW Head (Allen type) set—cap screws, wrenches. Catalogue 3c. Reinhardt, 71 Gelston Ave., Brooklyn, N. Y.

DRILLS-TAPS — Reconditioned high speed, up to seventy-five percent off list. Send for free circulars. Perry Screw and Bolt Corporation, 4250 Grand River, Detroit 8, Michigan.

TABLE, Jig saws, bench, post drills, compressors, motors, rails, mandrels, castings. Circular 5c. Sunshine, Berkshire Heights, Penna.

MILLING, Shaper attachments fit all lathes, drill presses. Free circular. Corona Tool Co., Dept. M, 107-15 51 Ave., Corona, N. Y.

CONCRETE Building block machines and molds. Catalog free. Concrete Machine Co., 5129 South Compton Ave., St. Louis 11, Mo.

V-BELT Clutches complete with built-in pulley; vari-speed principle. Ready to install direct on engine or line shaft. Saves power units. V-Belt Clutch Co., 3759 Wilshire Blvd., Los Angeles 5, Calif.

JEWELERS Furnace melts 5 lbs. bronze. \$75.00. Folder. Hoover & Strong, Inc., 113 W. Tupper St., Buffalo 1, N. Y.

ANGLE Plate, 3x3"x4", ribbed machined \$2.00. Precision ground \$3.00. Casting 75c. Catalog 3c. Model Tool Service, Rock Falls, Ill.

MAKE Cement bricks. Tri-Brik, the wonder brick maker. \$19.90 f.o.b. Richmond, Va. Write Welding Service, Sect. A, PO Box 6014, Richmond, Va.

ANGLE Index unit, one degree movement bench layout or machine work, \$17.50. Baum Tool Co., 1832 Orleans St., Chicago, Ill.

MACHINE Shop tools released for private industry: 14 loose change lathes \$150; 16"—\$180; vertical miller \$410; 16" Quick Change lathe \$440; Gould & Eberhart gear cutter \$430; 18" lathe \$340; #3 Cincinnati miller \$820; #2 \$660; floor type sensitive drill \$40; 24" upright drill press, with back gears and tapping attachment \$200. Conversion Parts Co., 278 Adams St., Boston 22, Mass.

ELECTRIC Hand sander, plans \$2.00, kits \$6.50, descriptive circular stamp. Kalder Engineering, 255 Charles Avenue, Grand Rapids, Michigan.

WAR Surplus in small tools for machine shop—Send 10c for bulletin. Travers Tool Company, Dept. P, 5 Court Square, Long Island City, N. Y.

BARGAINS in machinist tools. Write Precision Tool Service, 55 E. Washington St., Chicago 2, Illinois.

INDEX Head for sale. Sixty-two divisions. Used on lathes up to twenty inch swing, drill-presses, milling machines, etc. Make gears, hobbs, cutters, etc. Very accurate and durable used by shops, factories and machinists. Write for free folder. Long's Index Head, 2117 East B Street, Torrington, Wyoming.

NON-CHATTER Cut-off tool holders for Homecraft lathes. \$7.50. Gustin, High Hill, Mo.

DRILL Grinder for twist drills \$2.95. See ad on page 270.

HAND Brick and block machines. Howe Brick Machine, Beaufort, N. C.

DRILL Grinder—Grinds drills to factory accuracy. Calipers with direct reading scales. Circle cutters. New Tool grinder. Lowest prices. Free literature. Factory, 811-B East 31st, Kansas City 3, Mo.

BLOCK Machines—Concrete, 200 to 240 hour, 2 blocks one time. Also other machines, 45 to 100 per hour. Power or hand brick machines. Batch mixers. Any size. Madison Equipment Co., Madison, Tenn.

AT Last! A hack saw with a blade that is always tight. The cam-action tension ends broken blades. Free folder. Pronto Tools, 2739 W. Ramsey, Banning, Calif.

SHEBEL Saw flier \$7.50. Files all saws. Circular. Free trial. Shebel, 730B S. 2nd St., Milwaukee 4, Wis.

BOATS, OUTBOARD MOTORS, ETC.

SPORTSMEN—You can build the famous folding Foldkraft Kayak. 10½' or 15'. Plans \$1.00 postpaid. F. J. Leary, 15 Park Row, Suite 1216, New York City 7.

OUTBOARD Stand \$1.95. Keeps motor upright when idle. Preserves appearance. Protects mechanism against damage and dirt. Insure quick starting. Portable, lightweight, folds up for packing on trips. Satisfaction guaranteed. Order today. Check or M.O. Owens Outfitters, 19465 Ward, Detroit 21, Michigan.

WHY Lug your outboard motor? New carrier \$8.75. Catalog free. Box 9D, Tahoe Valley, Calif.

GUIDE To Boat-Handling-Hooper. New book for power-boat operation. Essentials only, clear, concise, brief, diagrams. All yachting magazines recommend. Case-bound \$2.00, postpaid. Sent on approval. James Ladd Delkin, Publisher, Box 55, Stanford University, California.

KAYAK Blueprints, deluxe models—catalogue 10c. Viking Canoes, Merrick, N. Y.

PLYWOOD Boat kits! Complete materials for building "Deltacraft," "Junior Dinghy," "Tadpole Skiff," Mahogany marine plywood and oak construction! Send 10c today for illustrated folder featuring these boat kits and other marine materials and supplies. Carmen-Bronson, Marine Department, Mount Vernon, N. Y.

ATTENTION Sportsmen! Go kayaking! Build yours from complete easy-construction kits. Literature. Play-yacks, Dedham, Mass.

OUTBOARD Motor parts, new and used, for all makes. New pistons, standard and oversize. Cylinders rebored. Outboard Motor Mart, Inc., 309 Atlantic Ave., Boston 10, Mass.

BUILD Your boat from full size paper patterns, boats representing forty years careful designing. Send 10c for folders. Up to the minute book on small boat construction, \$1.50 postpaid. Germain Boat Company, Dept. 3, Saginaw, W. S., Mich.

ALL Copper water jacketed exhaust manifolds for marine conversions of automobile and aviation engines and marine engine replacements; any make, model or age. Joseph Van Blerck & Son, 391 Woodcleft Ave., Freeport, N. Y.

PROPELLERS: New army surplus, Michigan, 3 blade bronze, 12"x10"RH; 7/8" hub bore. Made for Johnson 22 h.p. outboard. Modify for other engines. Only \$5.65 each postpaid (with order). We will increase pitch to 11", 12" or 13" at \$1.00 additional per each propeller. Baker Bros. Supplies, Box 301-C, Palatine, Ill.

ROWBOAT Dry indefinitely, years. Inexpensive, copyrighted, \$1.00. Crsa, Box 8, Nanticoke, Penna.

MARINE Conversions for Ford and Jeep engines. Catalog 10c. Lehman Manufacturing Company, Department D, Newark 2, New Jersey.

USED Outboard motor parts. Outboard Exchange, 1194 Remsen Ave., Brooklyn 12, N. Y.

KAYAKS. Rowboats, weldwood ready cut kits, booklet. E. J. Croot Co., #103-D, Basking Ridge, N. J.

REBUILT Tachometers 0-5000 and 0-8000 r.p.m. 4 3/8 diameter face. \$10.00 each, specify rotation. Zakarian Engineering, Box 416, East San Diego, Calif.

BOATS And all about them. How to select, build, repair and operate. For 40 years the leading practical boating magazine. Half price trial subscription, 12 issues for \$1.00. Motor Boat, 62 Gold Street, New York 7.

TWENTY Plywood boat plans \$1.00. Catalog boat building plans 10c. The Rudder, 15 Murray Street, New York.

BOAT Designers are highly paid professionals. Complete course by mail. Catalog. Westlawn, Montville, N. J.

USED Marine motors, propellers, marine fittings, conversion manifolds. Stokes Marine Supply, Coldwater, Michigan.

ENGINES, MOTORS, DYNAMOS

INSTANT Reverse your present capacitor split phase motor. Yes, same effect as 3 phase. The Enoch Co., 533 N.E. 78th Ave., Portland 16, Ore.

MIDGET Magnetic motor: (1x1½"). Small flashlight cell operates. Parts complete plus instructions 30c postpaid. Two 55c. Special offer. Send today! Eltro, Deer Park, N. Y.

MOTOR Winding tester, indicates burned out or partly shorted coils in single or three-phase motors, indispensable for repairmen. Send for bulletin. Motor Industries, Quincy, Illinois.

400 CYCLE Dynamotors. GE5D21N3A. 27VDC to 110VAC. 485 watts, shaft extension. Will operate 60 cycle radio equipment. \$12.50. Free list. Eresco, 1006 Hewitt, Everett 1, Washington.

WINDING Data, listing 225 motors, single and three phase, \$1.00. Motor Data Co., Box 7631, Kansas City 3, Mo.

"BUILD Your Own" gas drive arc welder easily with Hobart Generator. Save \$300 to \$500, and need only add used auto engine and chassis to build portable gas drive welder that goes everywhere after profitable construction and repair jobs. Write for free instruction book, further details. Hobart Brothers Co., Box M-1066, Troy, Ohio.

AMPLIDYNE Motor-generators. GE5A-M31N9A. Input 27VDC, output 60-0-60 VDC. 530 watts. Shaft extension. New \$15.00. Free list. Eresco, 1006 Hewitt, Everett 1, Washington.

ATHLETIC EQUIPMENT, BODY-BUILDING COURSES

ONLY 35c—An outline course to athletic success by a former college football, track, and boxing star. J & B Athletic Ent., 316 Lincoln Ave., Lansdowne, Penna.

DEADLY Judo—Fiercest fighting technique. Trick knockouts. (200 photographs—plus illustrations). Expert instructions. Three volumes. Complete \$2.25. Variety House, Box 46-BP, Wall Station, New York 5.

HEALTH, Perfect body, personality fast! World's greatest system! Guaranteed! James Todd, 17 Ina, Springfield, Mass.

BARBELLS, Olympic revolving sleeve, highest quality. Stamp for folders. Jackson Barbells, Springfield, N. J.

BARBELLS, Exercise equipment. Courses. Free booklet. Good Barbell Co., Reading, Penna.

SPORTING GOODS, GUNS, FISHING TACKLE, ARCHERY, TRAPPING

GUNSMITHS—Now available, complete polishing kit for refinishing your guns. Long experience in refinishing guns qualifies us to furnish you at low cost proper wheels correctly shaped and sized to repolish guns at your plant or in your home. Write for complete information. Middletown Metal Finishing Co., Inc., River Road, Middletown, Connecticut.

"LIQUID Roach Trap," 50c, supplies choice fishbait unlimited. Roach Trap Co., Ft. Smith, Ark.

SEND 10c For list 100 new and used guns. Frayser's, Willmar, Minnesota.

CHIGGERS, Mosquitoes and biting flies. Don't let these bothersome, disease carrying insects spoil your outdoor fun or jeopardize your health. Skeeter-Skram cream repels these pests. Smooth on a dab of this easy-to-use repellent and enjoy protection for hours! Safe to use, yet amazingly effective. Skeeter-Skram is odorless, invisible and greaseless. Send \$1.00 today for an entire season's supply. The Chapman-Gilbert Company, Inc., 2201 Kettner Blvd., San Diego 1, California.

AUTOMATIC Lure—Positively weedless. Greatest invention in ages. Nothing like it. Circular free. Babcock Reel Co., Oak Harbor, Ohio.

NOW Available a complete Du-Lite installation for finishing guns and other small metal parts for \$150.00. Use it in your home or garage. Good money-making proposition. Further particulars from Middletown Metal Finishing Company, 45 River Road, Middletown, Connecticut.

CARTRIDGES, Shells, ammunition, guns, rifles list 25c. Frank Farish, Vicksburg, Mississippi.

FISHING Poles, ferrules, guides, tips, clamps, etc., native canes, bamboos, tonkins, 1-piece all-purpose rod, guides, top, reel-seat, butt, varnished, \$6.60. 3-piece native cane, painted, \$2.50. 2-piece steel rod, guides, tip, hardwood handle \$2.50. Dealers write. Bob Pace, Combs, Ark.

HUNTERS, Sportsmen: Here is what you have been looking for. A four piece steel cleaning rod with aluminum handle. Can be dismantled when not in use. Fits all shotguns and large caliber rifles. Only \$1.00 prepaid anywhere in U.S.A. Order now. Don't be disappointed later as supply is limited. Irving Goodman, Box 1998, Fargo, N. D.

CONVERT Your 22 cal. single shot rifle into a target pistol. State make and model. Send \$1.00 for plans, easy for anyone with simple tools. The Gunshop, Lovelaceville, Ky.

CAMPFIRES Easily started even with wet wood with Van's Fire Starter. Year's supply \$1.00 prepaid. Many other uses. Star Mfg. Co., Lincoln, Nebr., Dept. PM.

CARTRIDGES: P-38's, Lugers 15c. Complete firearms-ammunition list 25c. Frank Farish, Vicksburg, Mississippi.

PROTECT Guns, tackle, tools. Stop rust automatically with Altair plugs. Air corps surplus. Two for a dollar. Altair Company, 1600 Junction, Racine, Wisconsin.

3000 BARGAINS, Firearms, binoculars, war relics. Catalog 40c. Smith Firearms, Runnemeade, New Jersey.

ALLEN-DALE Sporting Goods, Inc., Box P187, Bayonne, New Jersey, offers complete catalog, fishing tackle, pocket knives, hunting, hardware, other useful sports items. Send 25c coin cover mailing. Deduct from first order.

FISH At night with Johnstone Electric lighted Bobber \$1.00 prepaid. Circular on request. Dealers wanted. Johnstone Bobber Co., Aurora, Ind.

1947 ILLUSTRATED Firearms collectors catalog 50c. "House of Guns," Kearny, New Jersey.

AMMUNITION—New and used shotguns, rifles, handarms, fishing tackle. List 10c. Rudolph's, Atchison, Kansas.

FIELD GLASSES, TELESCOPES, MICROSCOPES, MAGNIFIERS

NAVY Binoculars, excellent condition, at exceptionally low prices. 6x30, \$45.00; 7x50, \$90.00, tax included. Sent prepaid only. Optical Inst. Co., 4534 E. Thompson St., Philadelphia 37, Penna.

REFLECTING Telescope kit, complete optical parts, fully finished; 3" diameter, 44" f.l., mirror and diagonal, both hard aluminized, plus 3 lenses for high power eyepieces. Never again a bargain like this. All \$6.00 postpaid. Ross, C68 West Broadway, New York 7, N. Y.

BUILD Reflecting telescope. Catalog free. Instructions 10c. Mayflor, Katonah, N. Y.

TELESCOPES, Microscopes, binoculars, barometers, books, photographic equipment. Buy, sell, repair. Lists 10c. Rasmussen & Reece, Amsterdam, N. Y.

START Your career in science now! 50 power microscope plus science study kit. Guaranteed. Free literature. W. Wardell, 2509-A Clarendon Road, Brooklyn 26, N. Y.

60 POWER Telescope, \$2.95. 250 power microscope, \$2.45. Send for free catalog of telescopes, binoculars and microscopes. Brownscope Company, 24 West 45th Street, New York.

REFLECTING Telescopes, complete. 3 1/2" diameter, equatorially mounted. View planets, stars. \$19.75. Write Sky-scope Company, 475-P 5th Ave., New York.

BINOCULARS, Telescopes, watches. Buy, sell, trade. Paul Schweer, Donnellson, Iowa.

DOGS, PETS, BIRDS, RABBITS

ANGORAS, Chinchillas, giant rabbits—finest, pedigree! Catalogue free. Book "Profitable Rabbit Raising" tells everything \$1.00; scientific self-cleaning hutch plans \$1.00; automatic feeder plans \$1.00. All three \$2.50. Grinsteads, Dept. 15-E, Edwardsville, Illinois.

\$250 MONTHLY, Raising Angora rabbits. Particulars free. White's Rabbitry, Lawrence, Kansas.

70 VARIETIES—Pigeons, rabbits, pheasant, peafowls. Catalogue 10c. Jim Houck, Tiffin, Ohio.

REAL Giant Chinchilla rabbits. Offered by their originator. Free details. Stahl, Pearl River 7, N. Y.

FOR Sale—Heavyweight Chinchilla rabbits. Youngsters or grown stock. Price \$5.00 to \$15.00. Queen Rabbitry, 1062 Queen St., Pottstown, Penna.

RAISE Guinea pigs. Make money at home. Big demand. Booklet free. Taylor, Box 426A, Hapeville, Georgia.

\$50.00 WEEKLY Raising Angoras for us. Free literature. Angoraville, 1215-34th Northeast, Cedar Rapids, Iowa.

ANGORA Wool spinners, shearing tables, breeding stock. House of Angora, Springfield, Illinois.

INCREASE Your income by raising domestic rabbits. Small space needed. Ready market for delicious meat, fur and wool. Largest magazine in the industry tells you how. \$1 per year. Send dime for sample. No stamps. Small Stock Magazine, Lamoni 50, Iowa.

NO Rabbit. Chinchilla seven year payments. Booklet on raising. Send \$1.00. Montana Fur Farm, Billings, Montana.

BEAUTIFUL, Useful collie-shepherds, pups \$12.50. Paul Schultetus, New Liberty, Illinois.

GIGANTIC Chinchilla giants—Really profitable. Demand strong. Free literature. Illustrated catalogue. 25c. Fur samples, 25c. Behrens Chin-Chin Farms, Pearl River 4, New York.

RAISE Registered rabbits under cooperative marketing. Small investment. Thomas Hall, Vernal, Utah, received \$603.00 for 21 rabbits produced from four rabbits in 3 months. Illustrated booklet tells how. 25c. Hansen's Rabbitry, 1347 Miller Ave., Salt Lake City 5, Utah.

\$2000 PER Year raising Angora rabbits. We buy your output. Contract particulars free. Wilsons, 1065 Shryer, St. Paul 8, Minn.

GUARANTEED Chin-Chin giant Chinchilla rabbits. Greatest amount of delicious meat. Largest, finest, most valuable furs. Tremendous demand for breeding stock. We buy youngsters. Contact world's largest breeder. Willow Brook Farm, R15, Sellersville, Penna.

ZOOLOGICAL And pet animals for sale. Illustrated catalogue, literature, 25c. Trails End Zoo-5, St. Stephen, S. C.

RAISING Rabbits, Cavies, Hamsters, Chinchillas is a growing and profitable industry. Magazine 10c. Descriptive book and magazine 25c. Book and magazine (monthly) one year \$1.00. Address Small Stock Farmer, Pearl River 15, N. Y.

RAISE Guinea pigs. Profitable, low-cost feeding, small space required, small investment. Complete details 25c. Guinea Pig Farms, 3456 West 116th St., Chicago 43.

ST. BERNARD Pups: Champion sired beauties. Franklin Young, R4, Riverhead, Long Island, New York.

STANDARD Rabbit Journal, Milton, Pa. 3 years \$1.00, sample dime.

FARMS, FARM LANDS, REAL ESTATE

STROUT'S Green farm catalog—Over 2400 bargains, money-makers. 32 States, coast to coast. Mailed free. Tell us what you want—where? Price? Terms? We will try to save you time and money. Strout Realty, 255-P 4th Ave., New York 10, N. Y. 20 W. 9th St., Kansas City 6, Mo., 453 S. Spring, Los Angeles 13, Calif.

WANT A farm of your own? Good ones are available in Canada at comparatively low prices. Favorable terms. Why not write for information today? Indicate the kind and size of farm, and the province in which you are interested. Address inquiry to H. S. Cresswell, Canadian Pacific, Montreal.

IT'S Spring again—in the exciting pages of United's new free spring catalog of up-to-the-minute bargains! Farms, ranches, summer homes, resorts, orchards, business opportunities—over 100 pages with many photographs. Write for your free copy today! United Farm Agency, 1684 Arcade Bldg., St. Louis 1, Mo.

FREE Fertile lands obtainable in Canada, Australia, South-Africa. From 160 to 20,000 acres free! Produce cereals, fruits, cattle, timber. Valuable information explaining where, how to apply, \$1.00. Values. 395-MX Broadway, New York 13.

WEST'S 1947 Catalogue: Over 1000 farm and business bargains: Free copy write West's Farm Agency, HE-4, Pittsburgh 16, Penna.

OZARK Magazine, Eureka Springs, Ark. For homeseekers, tourists. Year, \$1.00.

MY 10TH and greatest year of giving the greatest land buys ever offered. 40 acres of real virgin land only \$155. Low terms. Free information. J. T. Armstrong, Shook, Mo.

CANADIAN Tax sale lands for a dollar an acre and up. Small monthly payments. Farms, timber, hunting and fishing camps, minerals. Limited number of properties. Write at once for free catalogue. Tax Sale Service, Room 613, 72 Queen St. W., Toronto 1, Canada.

\$5.00 MONTHLY Buys 40 acres. Near town. Price \$200.00. Free list. Box 425-P, Carthage, Mo.

GOVERNMENT Lands \$1.00 acre up. Information all states 25 cents. National Tax Service Bureau, 834A Majestic Building, Detroit.

HOMESITES \$450—Convenient payments. California's finest garden section. On Morro Bay's scenic shores. Wonderful fishing, hunting, boating, bathing. Fertile soil, softest water, temperate climate, congenial community. Free literature. Richard Motto, 6560 Hollywood Blvd., Hollywood 28, California.

GOOD Farms—Ranches, Washington, Minnesota, Montana, Idaho, Oregon, North Dakota. Dependable crops, favorable climate. Write for literature, lists describing typical postwar farm opportunities. Specify which state. J. W. Haw, 119 Northern Pacific Ry., St. Paul 1, Minn.

OZARK Lands for all purposes. Actual river frontages. 5 acres \$90.00 and upwards. Free list and literature. Hubbard, 424-I, Minnesota Ave., Kansas City 4, Kansas.

FARMS, Ranches. All kinds, sizes. Reasonable prices, terms. Wide variety locations, climates, recreational facilities. Free descriptive folders, price lists. Milwaukee Railroad territory: Washington, Idaho, Montana, the Dakotas, Minnesota, Iowa, Missouri, Indiana, Illinois, Wisconsin, Upper Michigan. R. W. Reynolds, 914, Union Station, Chicago 6, Illinois.

POULTRY, FARM SUPPLIES

YOUR Greatest poultry problem will look simple when you read American Poultry Journal regularly. 500,000 poultrymen do, why not you? 2 years 50c. 5 years \$1.00. American Poultry Journal, 572 So. Clark, Chicago.

POULTRY Pays! Learn how. Postcard brings free booklet. "Seven Keys to Poultry Profits." Informative—factual. Write Poultry Advisory Service, 1046 South Olive Street, Room 108B, Los Angeles 15, Calif.

BUILD Your own Poultry Picking Machine. We will furnish you blueprints, specifications, and "fingers." For full information write: E. J. Willard, 1744 Gaviota Avenue, Long Beach, California.

RAISE Turkeys, new way. Write for free information explaining how to make up to \$3000 in your own backyard. Address National Turkey Institute, Dept. 3, Columbus, Kans.

BABY Chicks, champion mated. 52 varieties, 6 Hybrids, licensed inspected, blood-tested. Rush postal, large colored book free, low prices. Berry's Farm, Route 12, Clarinda, Iowa.

PROFITABLE OCCUPATIONS

"ALASKA—The Last Frontier" offers excellent opportunities! \$1 brings official government map and 1947 copyrighted report describing potential opportunities in commercial fishing, mining, fur farming, prospecting, aviation, timber, agriculture, live stock raising, business enterprises, government homestead lands. Alaska Opportunity, 6417 Homewood Ave., Dept. PM, Hollywood 28, Calif.

SCRAP Metal costing 5c pound brings dollars in finished castings. Lifetime profits. Information. Fritz Foundry & Supply, 622 N. Fulton, Allentown, Penna.

MAKE Big money plastic coating cards, photos, etc. Easy inexpensive method preserves and protects. Send \$1.00 today for full instructions. Gordon, 2105-B Cottage Grove, Des Moines, Iowa.

MECHANICALLY Inclined men—Own and operate general appliance repair shop. Complete, illustrated course shows you how. Welding, refrigeration, motor repair, how to get business, etc., all phases covered. Free literature. Christy Supply, Dept. 475, 2835 N. Central Ave., Chicago.

STORY Writing simplified. Home study. Free circular. Box 834, Spokane, Wash.

MEDICAL Laboratory technicians in great demand. We train you in your spare time, in your own home. You can practice while studying. Write for free catalogue. Imperial Technical Institute, Box 973-T, Austin, Texas.

PUMACRETE Buildings. Better, faster, cheaper than wood or cement blocks. Simple homemade equipment. Materials available every locality. Big money building for self and others. Drawings, details, pictures, explain all. \$2.50. Earl Behling, General Contractor, Box 955, Inglewood, Calif.

START Big profit vendor business. Cost small. Free details. Factory Silver King Corp., 622 Diversey Pkwy., Chicago 14, Ill.

"SPROUT Profitable mung beans." 18 recipes 25c. Behr, 7145 Greenwood, Chicago.

"LOS Angeles Boom." Thousands of job opportunities. \$1.00 brings copyrighted booklet on post-war industrial expansion. Over 300 firms listed. Tells how to apply. Los Angeles Research Services, 507 N. Windsor Blvd., Los Angeles 4, Calif.

LINOTYPE—Intertype practice dummy with extra keyboard layouts, fingering charts, spelling aids etc. Complete, postpaid \$3.00. Callaghan, Box 1493, Great Falls, Montana.

BIG Money in fishworms. Our electrical worm digger gets them, you sell. Instructions, drawings \$2.00. You make simple. Valley Specialties, Dishman, Wash.

SHELL Jewelry—Easy to make. Free instruction and all materials for making six colorful pin and earring sets, postpaid anywhere, only \$3. Price list free. Box 1183B, Orlando, Florida.

MAKE Flexible molds. Few cents each! Cast plaques, novelties, bookends! Free sample! H. Tooker, Hamilton 9, Ohio.

LARGE Profits building efficient, inexpensive air conditioners for homes, stores, offices. Details free. Imperial, 3778 W. Chicago, Detroit 6, Michigan.

\$5000, UPWARDS. Annually operating dignified private "employment agency." Easily learned. Free details. Hunt, Box 308, Burlingame 1, Calif.

MAKE Big wages sharpening lawnmowers, knives, scissors, etc. Quick, easy method. Complete instructions and formulas \$1.00. P. J. Edmondson, 1623 H St., Bakersfield, Calif.

SHELL Jewelry, novelties. Easy to make at home as hobby or to sell. Beginners kit \$1.00. Catalog 5c. Burton, Box 27, Station A, St. Petersburg, Fla.

MIRRORS From window glass at 3c per foot. Formulas and silvering data \$1.00. Metallize baby shoes. Several methods \$1.00. Tes-Co., Box 189-MD, Wilkes Barre, Penna.

MAKE Beautiful costume jewelry at home for large profits, hobby or therapy. Free illustrated wholesale catalogue of sea shell, metal and plastic parts contains detailed instructions. Florida Supply House, Bradenton, Florida.

AT Home—Your own manufacturing business making popular \$1.00 novelties. Cost you 3c to 15c. Everything supplied. Write So-Lo Works, Dept. S-600, Loveland, Ohio

YOU Can sit in the boss' seat! Keep your job; start your own factory in your spare time. We provide 15 valuable tested trade secrets. You need no plant, very little money. See page 270 for details. Chemical Research Co., 130 W. 42 St., New York.

OWN A mirror shop! Resilver mirrors. Write for information. John Sprinkle, V50, Marion, Indiana.

LEATHERCRAFT Supplies. Catalog 10c. Art Craft Supply Company, 1205 Throckmorton, Fort Worth, Texas.

TRADES That often pay \$50.00 daily completely described and illustrated. "Flagpole Painting and Repairing"—\$2.00. "Smokestack Painting and Repairing"—\$2.00. The Skyline Co., Box 1601B, Uniontown, Penna.

INTERESTED In Latin American and foreign employment? \$1 brings 1947 Foreign Service Directory listing oil, aviation, mining, transportation, manufacturing, construction concerns with foreign interests and tips for immediate application. Global Reports, 6417 Homewood Ave., Dept. PM, Hollywood 28, Calif.

TATTOOING Machines. Worlds finest, supplies. Free catalogue. Jensen, 120 West 83rd Street, Los Angeles 3.

NO Selling, operate vendors, amazing profits, details free. Silver-King, 622 Diversey, Chicago 14, Ill.

WOULD You pay 3%—first \$350 made? Color-illustrated book "505 Odd, Successful Enterprises" free! Some offer occasional "day off." Work home. Expect something odd! Pacific, San Clemente, Calif.

LOCKSMITHING—Profitable business or hobby! New course teaches you lock secrets, how to fit keys, de-code, masterkey, etc. Easy self-instruction lessons. Bargain price. Fascinating 100-page illustrated catalog free! Write Nelson Company, Dept. 2-02, Chicago 5.

QUICK Money! "Repairing car batteries!" At home! Easy too! Write Batterymen, Grand Junction 6, Colorado.

MUSHROOMS Grown. Boxes. Barrels. Illustrated instructions 50c. Spawn \$1.00. Gordons, 553 William, Winnipeg, Manitoba.

TYPEWRITER Repairing instructions, standard typewriters. Webbers', Box 1008, Canton, Ohio.

\$40.00 WEEKLY Made growing mushrooms, fresh, dried. Dominion patent 331583. Free spawn. North American, 169P Yonge, Toronto, Canada.

TYPEWRITER Repairmen urgently needed. Earn \$40 to \$50 weekly spare time. Our easy to learn home study course teaches how to repair typewriters. Write for free information. Houston Typewriter Repair Service, P.O. Box 5357A, Houston 12, Texas.

TADPOLES Make frogs, tremendous demand. Both make you money. 25c brings tell-how information. Chariton Corporation, Century Building, Chicago 4.

WELDING—Electric arc. Learn profitable trade quickly through actual practice. Individual welder instructions at bare cost of materials. Full particulars free. Valuable welding lessons book 50c. Hobart Welding School, Box M-1064, Troy, Ohio.

ELECTRIC Clocks are every where you go, buildings, homes, parking lots, factories. Repairs increasing. Our easy to learn course with pictures and drawings teach you how to repair these clocks. Electronic Supply Co., P.O. Box 2350A, Houston 1, Texas.

BOOKS, PERIODICALS, PICTURES, POSTCARDS

WHAT Every Mason wants. We have Masonic books for Blue Lodge, Chapter, Commandery, Scottish Rite and Shrine. Our rituals are used the world over. Send for free catalog of books and rituals for Masons, Odd Fellows, Knights of Columbus, etc. Ezra A. Cook, Publisher, P.O. Box 796-PA, Chicago 90, Ill.

MYSTERY Novels, 5, \$1.00; 11, \$2.00. Comic books, 12, \$1.00; 25, \$2.00. Samples 25c. Ace Novelties, Box 101, Richmond, Indiana.

HOLLYWOOD—Los Angeles—San Diego picture postcards. You address them, we mail, 3 for 25c. Letters 25c. Box 1907, San Diego, Calif.

DIVER'S—Tender's manual, one dollar. Navy Diver, 31 Tyler, Vallejo, Calif.

BOOKS Found free! All subjects. Send wants! Jaher Book Service, 620-A East 178 St., Bronx 57, New York City.

MAGAZINE Subscriptions, technical books, if it's printed we have it! Catalog 10c. Cassell Publishers, Westfield, New Jersey.

POSTCARDS Retailed from Hawaii, 3 for 25c coin. Chings, 2647 Liliha Street, Honolulu, Hawaii.

BUSINESS On a shoestring! Money-making tips, secret formulas, success articles, supply sources, numerous dollar-getting ideas in "Profitable Opportunities." Copy 10c. AC. Chervence, Box 791, Chicago 90, Ill.

AMAZING New book gives instant solutions to 100,000 practical problems. Details free. Columbia Graphs, Columbia, Connecticut.

MAGAZINES—Business, vocational, diversion. Current copies. Choice over 850 periodicals. All fields. Free price-list. Commercial Engraving Publishing Co., 34C North Ritter, Indianapolis 19, Indiana.

YES! We are again accepting agents to handle magazine subscriptions, books, greeting cards, complete details 25c (refunded). Cassell Publishers Service, Westfield, New Jersey.

WAR Action Signal Corps pictures by divisions and campaigns. 20-4x5 glossy captioned photographs \$2.00 postpaid. State division, campaign wanted. Atom bomb explosion, war trials. List available. Official War Pictures Company, P.O. Box 242, Forest Hills, N. Y.

UNIQUE Publishing course, hillbilly books, swaps. Claude Johnson, Beebe, Arkansas.

PHOTOS Of stars—Radio, recording and movie. Postcard brings list. Famous Fotos, 1990 Como, St. Paul 8, Minn.

VERY Interesting and unusual books. Write for free catalogue. Faller Company, 201 Dewey Street, Newark 8, New Jersey.

BOOKS. Out-of-print, hard-to-find our specialty. Any book. Banker Book Co., Dept. H, 3518 Contour Dr., Sherman Oaks, Calif.

BOOKS! (Out-of-print, scarce): Quickly supplied. Send wants. Spotlight, 141 Broadway, New York 6.

OVERCOME Obstacles acquiring powerful personal and successful life book \$1.00 postpaid. Circular free. Brooks Book Shop, 1676 E. 48 Pl., Los Angeles 11, Calif.

CANDID Snapshots glamorous Hollywood stars, 10 different \$1.00. Frederick Forman, 868 Lorimer, Brooklyn 22, N. Y.

BOOK Catalog free—Drop post card in mail today for interesting catalogue. Milwaukee Book Mart, Dept. C, 620 W. Center St., Milwaukee 12, Wisconsin.

BACK-DATE Magazines, books. Send wants. Arkell's, Box 744, Tarzana, Calif.

ARCHITECTURAL Fine art and handicraft books. Catalog 10 cents. Artcraft, Box 6827, Baltimore 4, Maryland.

GOOD "Used" self-instruction educational books on all subjects bought, sold, rented, exchanged. Satisfaction guaranteed. Complete information and 100-page illustrated bargain catalog free! Write—Nelson Company, Chicago 5.

SELF-EXPLAINING Bible: Illustrated circular free. Box 446-P, Minneapolis, Minn.

NATIONAL Geographic Magazine, 1888-1945, any issue. Periodical Service, Dept. PM, Swarthmore, Penna.

MAGAZINE Export Sales Company, 2084 First Avenue, New York 29, N. Y. U. S. A. Over-issue popular American magazines and pocket-size novels. Comics, fashions, pictorials, romances, screens, pulps, many others. Export only.

BOOKFINDERS! (Scarce, out-of-print unusual books.) Quickly supplied. Send wants. Clifton, Box 1377PM, Beverly Hills, Calif.

BIG Profits taking subscriptions for all magazines. Agents' confidential catalog listing over 2500 periodicals and complete starting supplies free. Pines Subscription Agency, Flushing, New York.

MAGAZINES (Back dated)—foreign, domestic, arts. Books, booklets, subscriptions, etc. Catalog 10c (refunded). Cicero's, 863 First Ave., New York 17, N. Y.

GAMES AND ENTERTAINMENT

NEW Party game for teen-agers. Test your skill and have fun. \$1.00 post paid. Money back if not delighted. Hix Novelty Works, 1568 East 22nd Street, Los Angeles 11, California.

"84 CARD Tricks." 25c! "Scientific Boxing." 50c! Hirsch's, Spring Valley, N. Y.

MAGIC TRICKS, PUZZLES, JOKER NOVELTIES

FREE Catalog magic, puzzles, tricks, Scheetz's, 98-N Branch, Sellersville, Penna.

STARTLING, Bewildering Hindu mystic trick 10c! Postways, Box 5325-B, Philadelphia 42.

VENTRILOQUISM Taught, 3c stamp bring particulars. Smith, 801 Bigelow, Peoria 5, Ill.

EXPLODER Under chairs, plates, 50c incl. Catalogue. Box 99, Brookline, Mass.

SLICK Tricks, funny joke novelties, puzzles, Catalog 10c. Novelty fun package included. Magic, Box A35, Irvington 11, New Jersey.

PALMING, Shuffling and forcing cards. Instructions illustrated, 25c. Bowman, 2319 Orchard, Chicago 14.

FIVE Card tricks; magic race game; rubber dollar; hot pepper gum; also price list on unusual tricks. All for 25c. Betsy's Magic, 110 N. Eighth, Klamath Falls, Ore.

SENSATIONAL—Hands shown empty, sleeves turned back, presto! Bottle of cola appears in hand. Defies closeup detection. Send for particulars, Cammore, 201 W. 66th St., New York 23, N. Y.

MOST Clever and simple—Coin disappears under glass. Complete \$1.00, Box 276, Fairlawn, N. J.

MARVELOUS Magic trick and new magic catalogue 25c. Newman's, Box 1020, Houston, Texas.

WHOLESALE Jokers' novelties, 50c. Samples, catalogue—25c. Box 526, Jamaica, N. Y.

ILLUSTRATED Book, "34 Easy-do Magic Tricks," and magic catalog, 10c. Lee's, 2231-M McKinley, Berkeley 3, Calif.

BE A magician. Large professional magic catalogue of latest tricks 25c. Ireland, C-109 North Dearborn, Chicago 2.

VENTRILOQUISM. Complete course only \$1. LeSueur, 77 Wellesley, Toronto, Canada.

TRUE Secret of ventriloquism. First time published. Free booklet. Quackenbus, Big Flats, N. Y.

VANISHING Half dollar trick and catalog 25c. Sterling Magic Co., Royal Oak, Mich.

WORLD'S Largest professional magic shop, keeps you in touch with latest tricks. To receive mailings, send 35c for new catalog. Holden's, M220 West 42nd St., New York.

"MAGIC Vanishing card." Throw it into air, it completely disappears, reproduce it later from spectators pocket. Easy to do. Complete, 25c with magic catalog. The Magician, 2463-C Kensington Ave., Philadelphia 25, Penna.

200 ELECTRIC Stunts, 110 volts, \$1. Kutting Sons, Campbell, Calif.

500 TRICKS! New 1946-7 edition Douglas famous catalog now ready, only 10c. Brand new magic for pocket, parlor, club, stage, professional, amateur. America's fastest service to magicians everywhere for over 25 years. Send 10c today. Douglas Magicland, Dept. 1, Dallas, Texas.

EARN Money in any crowd. Call names of strangers, tell unspoken questions. Professional course mind reading, faked spiritualism, etc., \$1. Henderson, Box 341, San Bernardino, Calif.

AMAZE And mystify your friends with highest quality magic. New catalogue 25c coin. Mazda Magic Co., 1135 Westgate Ave., Oak Park, Ill.

LARGE Illustrated professional catalog 10c. Williams, 900 Plymouth, Ellwood City, Penna.

FREE! Large catalog of magical apparatus if you remit 25c for "Magic Is Fun" magazine. Robbins Co., 152-F West 42nd Street, New York.

ENTERTAIN! Mystify! New, bigger magic catalog and 4 secret tricks 25c. Herbert, P-192 N. Clark, Chicago 1.

MAGIC: Big 160 page Illustrated Catalog Latest Magic Goods, 25c. For over 1/3 century we have supplied Professional as well as Beginner. Chicago Magic Co., 2300 N. Mason, Chicago 39.

MAGIC Tricks, puzzles, books, cards, punch boards. Catalog 10c. Specialty, Box 671, St. Louis 1, Mo.

COINS, TOKENS, CURRENCY

WILL Pay \$10.00 each for certain Lincoln pennies! Indianheads \$50.00; dimes \$1,000.00. Catalogue 10c. Federal Coin Exchange, 4-PM, Columbus, Ohio.

COINS And currency, 57 all different, many countries, Bargain \$2.00. Reynolds, 1118 Mathews, Flint 3, Michigan.

OLD Money wanted. Will pay fifty dollars for nickel of 1913 with Liberty head (no buffalo). We pay cash premiums for all rare coins. Send 4c for large coin folder. May mean much profit to you. Numismatic Co., Dept. 20, Fort Worth, Texas.

JAPANESE Philippine invasion bills, three different for only 10c. Old 1896 Cuban \$10 bill 20c. Glenn Godwin, 5 Mildred Ave., Binghamton, New York.

BEAUTIFUL Foreign bill and coin price lists—10c. Oliver Arnold, Macon, Mo.

FOR Sale: 1893 Columbian World's Fair half dollar, 75c; U. S. 2-cent pieces or 3-cent pieces, 25c each; 50 assorted Indian head cents, \$1.25; large 50 page U.S. coin catalog, listing thousands of coins for sale at reasonable prices, 25c; Giant 72 page foreign copper-silver-gold catalog listing over 10,000 coins for sale, 25c. Ben's Coin Company, 72 West Washington, Chicago 2, Illinois.

20 FOREIGN Coins, 10 notes. Different. All \$1.00. Tapp, Greer, South Carolina.

COIN Dealer will buy all kinds U. S. coins. Send postcard for free catalogue listing prices we pay. Franklin Coin Company, 2029 Lincolnway West, Mishawaka 1, Indiana.

THIRTY Different coins and bills \$1.00. Oddehon, Box 482, St. Louis, Mo.

FREE \$5.00 Mexican currency with order, 10 different Indian cents 25c, 10 different San Francisco Lincolns 25c, large coin book 25c. Coins, Box 77, Alameda, Calif.

100 FOREIGN Coins \$5.00. Parker Fogler, 693 Mission, San Francisco 5, Calif.

WORLD Coins—25 different \$1.00. Harry Elsholz, Box 9014, Pittsburgh 24, Penna.

GET Profit and pleasure in collecting old coins. Send 10c for 56 page illustrated coin catalog. You'll be delighted with it. Send for it now. B. Max Mehl, 370 Mehl Bldg., Fort Worth, Texas. Largest rare coin establishment in U.S. Established 47 years.

FREE! Foreign coin, banknote and coin collectors illustrated catalog to approval service applicants. Send 3c postage. Tatham Coinco, Springfield-125, Mass.

OLD STAMPS WANTED

I WILL Pay \$100.00 each for 1924 1c green Franklin stamps, rotary perforated eleven (up to \$1,000.00 each unused). Send 6c today for large illustrated folder showing amazing prices paid for old stamps, coins, and collections. Vernon Baker, PM-74, Elyria, Ohio.

STAMP COLLECTING

POSITIVELY Greatest free offer—Latest Scott's International \$5.00 stamp album, covering entire world, contains 36,000 illustrated descriptive spaces; Scott's 1947 Standard \$6.00 catalogues "Philately's Encyclopedia"—absolutely free to applicants for foreign approvals becoming customers. Plymouth Specialty Company, Dept. A-9, Bell, California.

FREE! Complete Balkan aviation set with approvals. Beaman, Elliston, Virginia.

50 DIFFERENT French stamps and our price list, one silver dime. Stamp sales, Box 1649P, Oakland 4, California.

31 DIFFERENT With George Washington stamps from Brazil and Ecuador; Pirate Island; victory issue; medical set; others—all 4c with approvals. Grayson Company, Sherman, Texas.

WHAT Have you to offer? A collection? A "shoe box" accumulation? Anything in stamps. We urgently need them. Spot cash paid. Cosmopolitan Stamp Co., 1457 Broadway, Dept. 4-E, New York.

BET You haven't these! South Georgia, South Orkneys, Grahamsland, South Shetlands, Shortlived Falkland Dependencies. Everything 3c with approvals. Viking, 130ZZ Clinton St., Brooklyn, N. Y.

100 DIFFERENT Belgium 35c. 50 different Bulgaria 45c. 50 different San Marino 65c. 100 different Mexico 85c. 100 different Russia \$1.00. 50 different Luxembourg \$1.25. 200 different France \$1.50. 100 different Venezuela \$2.25. 100 different New Zealand \$2.75. 75 different Estonia \$3.25. 250 different airmails \$6.00. 500 different China \$9.75. Mission Mart, Washington 17, D. C.

FINE Approvals, freshly mounted. Fast, personal service. Tell me what countries you prefer and I'll send their stamps. Skinner, 438 Locust, Long Beach 12, Calif.

\$1.00, \$2.00, \$5.00 U. S., free with approvals. Alco, Box 57, Miami 35, Fla.

300 DIFFERENT Given free with approvals. Postage 3c. Windsor Stamps, 1435 East 67th Place, Chicago 37.

FREE—25 Different Canada; approvals. Knight, Box 3770, Portland 8, Oregon.

COMMEMORATIVES, Airmails, at face! 159 authentic, foreign sources, \$1.00. Peters, Box-29, Astoria 2, New York.

NEW Zealand triangle set, (2) 5c with approvals. Philip Mandel, 1912 N. Kimball Ave., Chicago 47, Ill.

AROUND The world—30 different countries. Includes Basutoland, Nyassaland, Tangier, Cyprus, Ascension. 10c. to approval applicants. Excello Stamps, P.O. Box 95, Hackensack, N. J.

AIRMAILS, Hitler heads, free to approval applicants. Lee, Box 1966, Miami, Florida.

ALBUM For 1200 stamps given with purchase of 25 different Iran stamps for 25 cents. Nagle, 1101 Marion, Reading, Penna.

NEW Issues on approval. Country Stamp Service, Route 76, Tacoma, Washington.

STRANGE Oltre Giuba! Complete set! Catalog value \$1.05! Only 10c with approvals. Star Company, Lakewood, N. Y.

GREECE Roosevelt set complete 20c to approval applicants. Standard, 3817 Sackett, Cleveland 9, Ohio.

BELGIUM—220 Different, \$2.00, 425, \$6.00. Lecomte, Frere Orban, Jumet, Belgium.

FREE Roosevelt (Argentina) with United States or foreign approvals. Sharp, 324 Washington, Reading, Pennsylvania.

PONY Express stamp and 99 different 10c to approval applicants. Tippet, 1118 Clay, Pelham Manor, N. Y.

STAMP Magazine—Chock-full, news, information, bargain ads! Copy free! "Stamp Post" Station A, Pasadena, Calif.

100 DIFFERENT United States commemoratives \$1.00. Stephan Schrod, Route 4, Box 3140, Tampa, Florida.

FREE! Tiny Chinese "midget" war set. Approvals. Seminole, Elliston, Virginia.

25 DIFFERENT San Marino pictorials and commemoratives 12c with approvals. Southern Stamp Shop, B.J.C., Cleveland, Tenn.

MEXICO Mixture—Plenty of pictorials, 400 for \$1.00. Biehl, Apartado 2887, Mexico City.

UNEQUALLED Bargain. Stamps from over 25 countries including Fiji, Swaziland, Pitcairn, Tonga, Trinidad, etc. Everything 10c to approval applicants. Bennett's, Box 252, Terminal 'A', Toronto, Canada.

PACKET Of "Free-French" stamps given with approvals. Hill Stamps, Box 732, Woodmere, N. Y.

PROTECT Your stamps with Crystal-Mount. Send for free samples. Harris & Co., 202 Transit Bldg., Boston 17, Mass.

MISSION Mixtures. Worldwide accumulations 1,500 \$1. Missions Outlet, Reverend Marshall, Paterson 1, N. J.

PHILIPPINE Independence—Complete set of three with approvals 10c. Murray, 2152 Vogel Road, Evansville 14, Indiana.

FLAG Stamp free with U.S. approvals. Wenigman, 929 Oakdale, Chicago.

MAGNIFYING Glass with plastic handle, 10c! To foreign or United States approval applicants only. Elliott Stamp Company, Box 51x, Miami Beach 39, Florida.

COMPLETE! Twelve Washington bicentennials, 10c to approval applicants. Midwest Approvals, 828 E. 95, Cleveland 8, Ohio.

FREE 25 Diff. Mexico with approvals. Karl Scheerer, 1736 Mahantongo St., Pottsville, Penna.

ANIMALS—25 Different \$1.00; 20 scenery 50c; 10 boats 25c; 5 trains 10c. Specialty approvals. E. Ferguson, 217 Charles, Westfield, New Jersey.

PROUD—You'll be proud to add these stamps to your collection. Write for United States approvals plus premium plan. Jarr, Box 217-G, Madison Square, New York 10.

GENUINE "Goya Nude" set, cataloging \$1.05, complete 40c. Approvals. Royal Stamp Company, Tamaqua, Penna.

PALESTINE: 250 mixed \$1.00. Maksis Snelders, Box 275, Seattle 11, Wash.

WRITE Today for our better U.S. approval. Box 488, Minneapolis.

WORLDWIDE, Different 200—25c; 500—60c; 1000—\$1.50. Beacon Sales, Maynard 2, Mass.

FREE! Airmail packet with approvals. Deane Stamps, Box 87, Miami 35, Florida.

DEALERS! Wholesale approvals and mixtures. Morco Trading, 354 So. Spring, Los Angeles 13, Calif.

WORLD-WIDE Approvals. Michael Matcham, 234 St. Pierre Rd., Los Angeles 24, Calif.

BREAKING Up large foreign collection. Approvals by countries. Lion, 200 W. 81 Street, New York 24.

ABSOLUTELY Free! Surprise packet. Approvals. Verne Stamp Co., 916-C Fallowfield, Charleroi, Penna.

COSTA Rican triangle and diamond stamps free to approval applicants. Jay-Dee Sales, 49 Chalmers, Youngstown, Ohio.

STAMPS From 40 countries, including Fiji 10c. Elsea, Bowling Green, Ohio.

U. S. COLLECTION—Thirty different fine unused commemoratives before 1939 including Columbians, bicentennials, parks price \$1.00 approval applicants only. Fort Orange Stamps, Albany 7, New York.

FREE Packet with our approvals. Godbey's, Box 77, Alameda, California.

GORGEOUS New Nicaragua diamond, Roosevelt commemorative, San Marino airmail, 50 different 3c with approvals. Chesapeake Stamps, 748 Overbrook, Baltimore 12, Maryland.

2 U. S. Mint flags given, return postage approvals. George Warrell, 226 W. 5th, Albany, Oregon.

FREE! Stamps worth \$4.10 cat. val. Write for details. No approvals. Huffman, Box 331, Miami 3, Fla.

VALUABLE Catalogs 10c each: (1) "United States, possession and Brit. N. America" complete with 1000 illustrations; (2) "Airmail stamps"; (3) "British Empire"; (4) "Modern Europe." Each catalog 128 or more pages, profusely illustrated, wonderfully informative, economical prices. H. E. Harris & Co., 202 Transit Bldg., Boston 17, Mass.

VICTORY Packet free—Includes stamps from Tanganyika, British Cayman Islands, animal, scarce babyhead, Coronation, Early Victorian, airmail, map stamps. Including big illustrated catalogue. Send 5c for postage. Gray Stamp Company, Dept. PM, Toronto, Canada.

SET Of twelve, 1940 centennial poster stamps. Gummed, unperforated. Price 15 cents sheet. 7 sheets dollar. Postage paid. H. Madigan, Box 862, Dunedin, New Zealand.

FREE! The Stamp Finder! Send today for the big new edition, fully illustrated, enabling you instantly to identify all difficult stamps! Also fine packet strange, fascinating stamps from Bosnia-Herzegovina, Monaco, Patiala, Cyprus, etc., including maps, ships, animals and strange scenes. All free to approval applicants inclosing 3c postage. Garcelon Stamp Company, Box 900, Calais, Maine.

200 DIFFERENT Stamps, 6c, to approval service applicants. Tatham Stamp Company, Springfield 30, Mass.

ABSOLUTELY Free! Scarce airpost stamp (guaranteed genuine—Catalog price 50c) and illustrated "Get-Acquainted Folder" describing other free stamps given with our valuable publications. H. E. Harris & Co., 202 Transit Bldg., Boston 17, Mass.

STAMPS 100 Years old. It is now 106 years since the world's first stamp was issued. Every collector should have at least a few stamps 100 years old or nearly so, but have you? Probably not because most early stamps are hard to get and are therefore not often offered. Nevertheless, we have prepared a selection of 12 all 19th century stamps. Very old, everyone of them, even if not fully 100 years old. We will send these for only 10c to sincere approval applicants. Write for them today, and kindly state whether approvals shall consist of United States or foreign stamps, or both. Approval Headquarters, Globus Stamp Company, 268 Fourth Ave., New York City 16, Dept. 201B.

25 DIFFERENT Airmails 10c with approvals. Schorr, 118-41M Metropolitan, Kew-Gardens 15, N. Y.

UNITED States. #305, #324, #329, #487 (mint), #490 (mint), #491 (mint), #511. Only 50c. Approvals accompany. Whiton-Stamps, Westport 4, Connecticut.

BEAUTIFUL Iceland packet free to approval applicants. Everglades Stamps, Box 3222, Station F, Atlanta, Georgia.

1000 MIXED United States 18c. Two pounds \$1.25. Lists free. Halay, 132 West 63rd, New York 23.

BRAZIL Diamond shaped set 10c, with approvals. Vargo Stamps, 6044 South Fairfield, Chicago 29, Illinois.

100 COMMEMORATIVES, Etc., 10c; 300 25c. P.O. Box 457, Newark 1, N. J.

DOLLAR Each: 1,200 better U. S.; 1,500 foreign; 2,000 British. Seiden, 1331-M, Intervale, N. Y. 59.

BARGAIN! All different, several mint, from Seychelles, Cyprus, Libia, Uruguay, Norway, etc. Only 10c with approvals. Wollaston Stamps, Wollaston 70, Mass.

LARGEST Stamp in the world. While they last, 25c. Fred Quatsak, 1242 Kelton, Pittsburgh 16, Penna.

BEAUTIFUL French Colony packet free with approvals. Gulfstream, 409 Professional Building, Miami 32, Florida.

ATTRACTIVE Mint packet free with approvals. Harvey Stamps, 2746 S.W. 15th Street, Miami 35, Florida.

PORTUGAL—30 Different 10c. Approvals on request. Stamp Chest, Box 748-A, Jamestown, New York.

FREE! 33 Transjordan, Trinidad, Haiti, others. Approvals. Stampco, Box 267, Forest Hills, N. Y.

FIVE Large mint French Colonies free with approvals. Cornell Stamps, Box 4259, Miami 26, Florida.

GIVEN—Tanganyika! Sudan! Rhodesia! Assortment. Approvals. Keating, 637 Bergen, Jersey City, N. J.

WHOOPIE—Wowie! 25c worth of U.S. stamps free! No obligations! Write: M&N Co., 742-A Sheffield Ave., Brooklyn 7, N. Y.

FREE, 77-Year-Old Canada, 25 different U. S. Foreign. Approvals. Freethorn, 2702 Dublin, New Orleans 18, La.

BEGINNERS! My progressive U. S. approvals, postage or precancels, are intended for you! Send a postal today! Cole, 43 Rinewalt, Williamsville, N. Y.

CANCELLATIONS, First Day, new P.O. Send 25c. Tolovana Traders', Tolovana, Alaska.

U. S. MIXTURE, 1000 25c; one pound \$1.00. Tarrago, 60 West 66, New York City.

FREE! Amazing "Queer Countries" packet! Peachy approvals! Saxon, Walden, New York.

LIBERAL Offer thick packet with Seychelles, Gilbert, Reunion, Inhambane, Mozambique, Inini, Porto Rico, Philippines and multitude others, everything only 10c to approval applicants. Burmaster, Box 1910 M, Los Angeles 53, Calif.

INTERNATIONAL Philaletic Centenary Exposition in New York next month. Send for penny approvals. Henry Jay Service, 15 Park Row, New York City.

BOLIVIA Music set, Greek occupation of Albania, airmail packet. Free to approval applicants. Middleton Stamp Co., 78-14 Woodside Ave., Elmhurst, N. Y.

BIGGER, Better, pleasingly priced foreign approvals. Inter-Continental Stamps, Englewood 2, Florida.

HITLER, Vatican, airmails, free with approvals. Granada Stamps, 4891 S.W. 5th Street, Miami, Florida.

AT Last—A stamp collectors dream, for fastidious collectors. Now you can remove stamps efficiently in 10% the normal time with Phesol—guaranteed to clean without bleaching or fading; insures flat drying. Send one dollar for collectors size to PM, Simpson, 4th floor, 466 West Superior, Chicago 10, Illinois.

UNITED States approvals. Fine quality, low priced. N. E. Whitlow, 302-B South Barnett, Dallas 11, Texas.

BRITISH, Spanish and French Colonies, Vatican, Hitler heads, and airmail packet, free with approvals. Pan-American Stampco, Box 145, New York 33, N. Y.

OVER 100,000 sold; 100 different Latin America only 33c; 100 different Greece 85c. Carlton's, 10243 Silverton, Tujunga, Calif.

EXOTIC Pictorial collection: Tahiti spearfishing, Melanesian idol, Ingavi battle, Reunion, Madagascar, St. Pierre Miquelon, Djibouti, Wurttemberg, Dutch Indies, Newfoundland, many others. This outstanding offer only 5c. Imperial, Box 1491, Tampa, Florida.

FREE! 25 Different foreign, mostly pictorials. Approvals. Streiner, 898 East 75, Cleveland 3, Ohio.

HITLERS, Triangles. Two sets—5c. Approvals. Mallo, 767-PM, Leith, Flint 5, Mich.

SIXTY-SIX Different stamps 3c. Approvals. Cornetta, 228 West 25th, New York 1.

100 STAMPS, Album, hinges — 20c. Northeast, Box 6618, Kansas City, Mo.

DOMINICAN Diamonds! Five cents to new approval applicants. J. Brafrod, Cloquet, Minn.

LATIN Americans, 175 different 50c. Approvals. Lists. Neulotz Co., Care Box 12, Newlots Station, Brooklyn 8, N. Y.

FREE—Pick 25c worth of stamps from our first U. S. approval selection. Special illustrated lists included. S. C. Engel Co., 38 Park Row, New York City.

U. S. Price list, send postage. Steger, 1165 Downing, Denver 3, Colorado.

15 U. S. Commemoratives 10c, approvals. Roger Stamp Mart, P.O. Box 316, New York 8, N. Y.

BRITISH Colonies and South America on approval. Theo. Stevens, Box 3705, Kercheval Station, Detroit 15, Mich.

U. S., Foreign, approvals, monthly auctions. Riffle, 211 Jefferson, York, Penna.

FREE—Famous Americans set, plus Flag Set, plus the National Parks Set, plus the Presidential Set to the \$5. A total of 90 stamps absolutely free to customers for our unsurpassed United States or foreign selections. Send 3c postage for 15 of the above mentioned stamps and full particulars. Triboro Stamp Company, 145 Nassau St., Dept. 103, New York.

1c TO 10c General foreign approvals. Russell Holcombe, Canton, Georgia.

BARGAIN Packets: Each 10c (11 for \$1.00). 20 Africa; 12 Airmail; 25 Argentina; 30 Asia; 15 Australia; 30 Belgium; 25 Brazil; 50 British Colonies; 30 Canada; 25 China; 15 Colombia; 20 Chile; 20 Cuba; 25 Czecho; 50 Denmark; 25 Ecuador; 25 Finland; 15 Greece; 15 Guatemala; 40 Hungary; 30 India; 50 Italy; 25 Mexico; 10 Mongolia; 10 Newfoundland; 15 New Zealand; 25 Netherlands; 25 Norway; 10 Paraguay; 25 Peru; 25 Portugal; 15 Russia; 25 Spain; 30 So. America; 30 Sweden; 25 Switzerland; 15 Turkey; 40 U. S.; 25 Uruguay; 15 West Indies. Special: All 40 packets above consisting over 1000 stamps with stamp album \$3.50. Longacre Shop, 108 West 42, New York City.

24c PRESIDENT Harrison. Don't miss this scarce stamp. Only 5c with United States and foreign approvals. Willett Stamps, Box 507, Port Chester, N. Y.

UNUSED British Colonials, world wide beauties, including bi-colors Basutoland, Cyprus, Seychelles, 10c to serious approval applicants. Mutual Stamp Service, 5145R Village Green, Los Angeles 16, California.

CHINA 20 Colorful historical stamps 10c with approvals. Collins', 71 Coleridge, San Francisco 10, Calif.

PHILATELIC Printing — Stockforms. Samples for postage. Acmeprint-6, East Flat Rock, North Carolina.

\$2,000 IN Stamps free to contest winners. Particulars, entry blank, to approval applicants enclosing only 10c for scarce Roosevelt Mourning stamps from Nicaragua, Greece and Argentina, plus photograph of "Roosevelt Collecting Stamps." National Stamp Sales, 276A West 43rd Street, New York 18, N. Y.

DANDY U. S. approvals; write immediately. Sullivan, Endicott Building, St. Paul, Minnesota.

CUBA'S Retirement set shows aged couple receiving pension check. This set sent to approval applicants for only 5c. Bryson Stamp Company, Drawer F-2, Rossford, Ohio.

ROUND The world colonies—British, Dutch, French, Portuguese; strange little known countries, primitives, cannibals etc. All for 3c to approval buyers. Dixie Stamp Company, Dept. 10, Milwaukee 1, Wis.

118 DIFFERENT Stamps including commemoratives, charities, airmail, surcharges, sets, etc. Only 3c to approval buyers. Badger Stamp Company, Dept. M, Milwaukee 3, Wis.

SMOKY Mountain souvenir commemorative sheet and 30 different U. S. stamps, including commemoratives, airmail, etc. (catalog value exceeds 65c) for 10c to approval applicants. Curhan Stamp Company, Dept. H, Gloucester, Mass.

FIRST Day covers on approval. Knobel, 1918 S.W. 12 St., Miami, Florida.

GIVEN Seychelles "palm tree," Hitler, Petain portraits, Norway "Quisling" traitor, Jap issued Philippines, snake, lion, others. All given for 3c postage. Approvals. Premium Stamp Service, Hartland, Maine.

UNITED States collection. 104 different commemoratives including Columbians, Pan Americans, Pan Pacific, bicentennials, parks, famous Americans. Price \$1.00. Approval applicants only. Orange Stamp Company, Albany, New York.

FREE. Irish commemorative collection, including dramatic Easter Rebellion issue with approvals. Raymax, 123-Z William St., New York City.

BERLIN Bears, complete set of eight and 100 different stamps only 10c to approval applicants. Reich Stamp Co., 4647 Kenmore, Chicago 40, Ill. Dept. M11.

20,000 VARIETIES 1c-5c each! Gordon Davison, Box 1019B, Manchester, N. H.

WOW! \$10.00 Worth of fun only 10c. What a treasure hunt! Big package 500 foreign stamps—just as received from foreign missions other sources. Includes stamps from Africa, South America, Philippines, Free French, Cape Juby, Palestine, etc., including airmails, commemoratives, and stamps worth up to 50c and 75c. This amazing offer is given for 10c to serious approval applicants only. One to a customer, money back if not more than delighted. Jamestown Stamp Co., Dept. 22, Jamestown, New York.

FIVE Vatican City stamps free to approval applicants. Florida Stamp Company, Box 807, Miami 5, Florida.

STAMP Collections wanted. Complete collections, duplicate lots, surplus stock, mint and used. Prefer trade for printing or other items, buy outright if priced right. What have you, what's wanted? Vanroy Shirk, Lebanon, Penna.

1000 MIXED U. S. old and new—25c; 2 lb. \$1.25. Weatherby, Medina, Ohio.

YOUR Money's worth! Seychelles, Djibouti, Angola, Chinese hunger stamps and over 100 different other stamps. Everything 10c to approval applicants. Atlas Stamps, 4220 West 16th, Dep't L, Little Rock, Ark.

FREE — Abyssinia, Cayman Islands, Tuna triangle, Indochina, Syria, Ivoire, Philippines (Jap "shame" issue), Turkish harem, Damascus, Cambodia, African "beauty," Pirate Islands, Colonials, others—All free for 3c postage with approvals. Belmont Stamps, Washington 10, D. C.

PORTUGUESE Colonies, 25 different 5c with approvals. Lorane Brown, Marion, Michigan.

ADEN To Zanzibar! 40 different British Empire, including Cyprus, Malta, Dominica; 5c with approvals. Lyman Company, 95 Nassau Street, New York City 7.

U. S. Price list. Send postage. State Stamp Service, 1225 Park Building, Pittsburgh 22, Penna.

OLD Scarce U. S. seconds on approval. Slightly defective, nice appearance, bargain prices. Hernfield, 551 Clinton, Newark 8, N. J.

U. S. Price list. Send postage. Stanley Gibbons, 38-P Park Row, New York.

PENNY Approvals, that satisfy. Neil Gronberg, Box 5441-P, Philadelphia 43, Penna.

MINT Pictorials free to approval applicants. Surf Stamp Co., Box 2296, Miami Beach 40, Florida.

ZOWIE-E! A barrel of fun for only a dime. 500 United States stamps—absolutely unpicked and unsorted—just as received from church missions. Many varieties, including large commemoratives, airmails, high denominations up to \$5.00! Stampdom's biggest package of fun—and you might find something really valuable! Price only 10c to serious approval service applicants. Money back if not delighted. Illustrated bargain lists with each order. Mystic Stamp Company, Dept. 80, Camden, New York.

50 DIFFERENT United States, 10c. Price-list free. Seidenberg, Cassopolis, Mich.

CANADA—75c Diff. 25c. Approvals, Lists. Victoria Stamp Co., London 4, Canada.

FREE! Negro Triangle; Turks Islands "Cactus"; Dakar; Guinea; Palestine; "Fairy Tale," Pirate Chart, Map, Ship, Sea Lion and Snake stamps; French, British, Portuguese Colonies, etc. Free for 3c postage. Approvals, Potomac Stamps, Washington 10, D. C.

UNITED States approvals complete coverage, fine quality, attractive prices. Seminole Stamps, Box 378, Coconut Grove, Florida.

50 DIFFERENT Including scarce diamond-shaped airmail 3c to approval service applicants. Avalon Stamp Co., Dept. M, Springfield 8, Mass.

1000 GRABAGS 15c Each. Super bags 25c. Zandy, 630 Bingaman, Reading, Pa.

FREE U. S. price list. Postage 3c. Mark Hanna, 335 - 5th Avenue, Pittsburgh 22, Penna.

FREE! Canadian sets, royal visit, George VI, George V, coronation, jubilee, others, to approval applicants. Ensign, Box 118-M, South Orange, N. J.

WORLD'S Largest diamond and triangle stamps, free stamp magazine, stamps from fighting Free French, 20 stamps from 20 different countries, pictorials, airmails, big bargain 5c with approvals. Capital Stamps, Dept. 2, Little Rock, Ark.

DEALERS—Wholesale list. Postage 3c. Frank, 5031 Queensberry, Baltimore 15, Md.

25 DIFFERENT Swiss 10c—with 1/4, 1/2, 1c approvals. Carroll's, 4357A S. Hoover, Los Angeles 37, Calif.

HOBBIES AND COLLECTIONS

"GEM Cutting," interesting hobby. Instructive illustrated booklet, one dollar. Mineral Specimens Company, Box 1191, Santa Monica, California.

CAMPAIGN Ribbons—Beginner's package. Introductory price 50c. Contains 15 assorted ribbons. L.H.G. Company, 19 E. 16 St., New York 3.

KLONDIKE! For hobby jewelry makers! Novelty jewelry findings from tables of large manufacturers—parts for bracelets, pins, earrings, etc.—unfinished. Chains, rings, pins, stones, clips, beads—many other items. 1 lb. bags, \$2.00 per bag in 5 bag lots. Sample bag \$3.00. Prepaid only. Mdse. Distributing Co., 19 E. 16 St., New York 3.

GEM Making—Fascinating! Profitable! Free equipment catalog, or send 25c for complete instruction book. Lapidary Company, 1545 West 49th, Seattle 7, Wash.

KNOW America. Fastest growing hobby. Scenes, subjects, towns, cities. Camping, bridges, churches, art, etc. Foreign assortment. 10 beautiful post cards only 35c. Three sets \$1. Or send 10c coin for catalogue. Box 116B, Back Bay Annex, Boston 17, Mass. No stamps please.

HOLLYWOOD, Calif., matchbox covers. 10, all different, 25c. Joe Wilson, Box 473, Moneta Station, Gardena, Calif.

AIRLINES Baggage labels—15 different labels—50c. Sullivan Enterprises, 7301 Belleview, Kansas City 5, Missouri.

WORLDWIDE Hobby contacting service for men and boys. Hobby Directory, Box 91M, So. Orange, New Jersey.

SWAPPERS' Hobby Bulletin! What's cha got? What'd'ya want? Trial two dimes. Royal Oak 128, Mich.

20 CALIFORNIA Sea shells \$2.00. Free lists. John Burch, 4206 Halldale, Los Angeles 37.

INSIGNIA Collectors. Our bargain assortment ten army patches, send fifty cents. Box 228, New York 10, New York.

SWAPPER? Collector? Send 25c for sample copy "Hobbyswap Contacts." 1326 South 27th, Omaha, Nebraska.

EXCHANGE Your duplicate stamps, match covers, or any hobby, with collectors everywhere! Exchange register listing swappers, 10c. (Mention hobby.) World Hobby House, Box 721-A, Olympia, Wash.

COLLECTING Hobbyists! Exchange duplicates. "Hobbyswap Contacts" directory 10c. C. Bishop, Route 8, Kalamazoo 88, Michigan.

CLEARANCE Sale, military emblems, choice of 300 different 5c each. Send 10c for illustrated price list. Hobbyguild, 35-P West 32nd Street, New York.

296 COLORED Illustrations, new book "Foreign Medal Ribbons." \$1.00. Foreign campaign bars, insignia, lists, samples, 20c. Packets \$1.00. Insigniacrafts, 236-28th Ave. N.W., Calgary, Canada.

INVENTING Can be an interesting and profitable hobby. Write for complete particulars. Institute of American Inventors, Dept. 40-E, 1926-Eye St. N. W., Washington 6, D. C.

COLLECT Colorful Army patches. Pictures, prices and sample patch only 10c. Insignia Mart, 703 Broadway, N. Y.

UNUSED Match book covers, 100 all different \$1.00. 35 Royal Flash covers \$1.00. Free list. Charles Edelman, 1311C East 84, Cleveland 3, Ohio.

JEWELRY Stones removed from rings, etc., 100 assorted \$2.40; 50 large ones \$2.40. B. Lowe, Holland Bldg., St. Louis 1, Mo.

"SELL Rocks!" Let "mother nature" finance your sparetime enterprises. Details, other hobby offers, free! McCampbell, Calexico, Calif.

BOOKS—All Kinds—Homecraft, Radio, Plastics, Boat Building, Photography, Model Building. Catalog free. Popular Mechanics Press, 200 E. Ontario St., Chicago 11, Ill.

ANTIQUES, RELICS, INDIAN GOODS, CURIOS

CURIOS: Mexican and biological; miniatures; nature books. Catalogue 10c. Free wholesale list for dealers. Quivira Specialties, Topeka, Kansas.

4 FINE Ancient arrowheads \$1.00. Stone tomahawk \$1.00. List free. Lear's, Box 569, Galveston, Texas.

SWORDS. Rapiers, daggers, pistols, armor. Illustrated catalog 50c. Robert Abels, 860-A Lexington Ave., New York.

PRECIOUS STONES, MINERALS

"GENUINE" Arizona rubies (garnets). Send quarter for packet. Mineral Specimens Company, Box 2651, Phoenix, Arizona.

OBSIDIAN Small stones 50c, large \$1.00, red and black \$1.00 per pound plus postage. Charles S. Richards, Box 556, Jackson, Wyoming.

ATTENTION Mineral collectors, receive large quantities of beautiful gold and silver specimens from America's richest gold mines. Only \$1.00. Alvin Mosch, Box 222, Arvada, Colorado.

MINERALS—Gems, Cutting, specimen. Low prices. Free list. Plummer's, 5068 Brighton, San Diego 7, Calif.

FOOL'S Gold from famous gold camp 10c per sample. Gold \$1. Others, Martin's, 506 Harrison, Leadville, Colorado.

CAMERAS AND PHOTO SUPPLIES

PHOTOGRAPHIC Equipment. Terms, Catalogs. Film rentals. Dayton Film, 2227 Hepburn, Dayton, Ohio.

SPEED-O-COPY Ground-glass focusing attachment for Leica, Contax, Argus C-2 and C-3. Send for literature. D. Paul Shull, Dept. PM-4 240 S. Union, Los Angeles, Calif.

GET Your copy of the "Surplus News Letter" for photographic "plus values." No charge—from Sterling-Howard, Dept. PM3, 1900 Monterey Avenue, New York 57.

BUILD Your own contact printer. Takes 35mm. to 4"x5" negatives. Free circular. Harvey Specialties, 3318 North Cramer Street, Milwaukee 11, Wisconsin.

SPARTUS Miniature candid camera—takes standard 35mm. film in sharp black and white or full natural color. No settings, no adjustments, just sight and snap for satisfying shots. 50mm. achromatic lens, eyelevel centering viewfinder, exposure counter. Only \$12.50. 10-day trial money back guarantee. Conway Camera Co., 34 N. Clark St., Chicago 2, Illinois.

CAMERA Repairing — shutters, bellows, rangefinders, synchronizers. Ship camera for estimate. 48 hour service. Free bargain circular. Jackson Laboratories, 27-GA Gore, Webster Groves 19, Missouri.

WHOLESALE—5 Rolls 127 film (not surplus) \$1.10; 120—620, \$1.40; 616—116 \$1.60. Marvelously improved 127 camera, focuses 2 foot and beyond. Retracting lens. It's a honey. \$6.90. Try 5 days. Money back. Dodge Studios, Albany, Wis.

\$50.00 EVENING Possible, new dignified portrait sales system; presells, furnishes customers. We train you, cooperate constantly. Only steady amateurs, freelance photographers. Unusual artistic finishing available triples value your work. Complete system \$5.00, plus \$5.00 after \$100.00 profit. Bel-Labs, Belmont, California, Studio M.

PHOTOGRAPHY For pleasure or profit. Learn at home. Practical basic training. Long established school. Write for booklet. American School of Photography, 1315 Michigan, Dept. 3431, Chicago 5.

OIL Coloring photographs can be a fascinating hobby or profitable sideline for those with artistic talent. Learn at home. Easy simplified method. Send for free booklet. National Photo Coloring School, 1315 Michigan, Dept. 3431, Chicago 5, Ill.

CAMERAS, Enlargers, projectors. Lowest prices. Free catalog. Cavalier Camera, 1822 Center, Pittsburgh 19, Penna.

CASH! Spot cash for cameras, lenses, binoculars, movie and still equipment. Send full description for prompt cash offer. Over 36 years of dependability. Bass Camera Company, Dept. AG, 179 W. Madison St., Chicago 2.

BASS Says: Trade cameras? For 36 years Bass has satisfied thousands everywhere! Finest equipment available. Always satisfaction guaranteed or your money back! Bass buys 'em, sells 'em, trades 'em. Bass Camera Company, Dept. AG, 179 W. Madison St., Chicago 2.

USED Camera Directory, Box 1031-M, Canton, Ohio—lists hundreds of war-bargain used cameras—35mm., Speed Graphics, Kodaks, Rolleiflex—many others. Send 25c for latest issue.

HAVE You a camera? Improve your hobby of photography and learn how to make better pictures. Write today for our latest book catalog and sample copy of American Photography, containing articles and pictures by the world's foremost writers and photographers. Camera House, 601, 353 Newbury St., Boston 15, Mass.

LITTLE Library of Useful Information, 102 different books. Catalog free. Popular Mechanics Press, 200 E. Ontario St., Chicago 11, Ill.

PHOTO FINISHING

5x7 OIL Colored enlargement, from negative \$1.00. Photo Lab., 4402 Barker, Omaha 5, Nebr.

ANY Size roll developed and 4x6 or 3 1/4 x 4 1/2 oversize glossy velox prints; 8 exposure 30c, 12 exposure 45c, 16 exposure 60c. Cimet Photo Service, 1318 W. Columbia Ave., Philadelphia 22, Penna.

SENSATIONAL Introductory offer! Send snapshot or negative, this ad and 3c. We'll send you a beautiful 7x5" enlargement! Or, Kodak roll developed and printed (with free coupon) only 25c; or 8 giant prints from roll, 30c. Reprints from negatives, any quantity, regular size, 3c; Giant size, 4c. Candid rolls—36 exp. 35mm. developed, vapo-rated, enlarged to 3x4, \$1.00, 18 exp. 50c. Free mailers. Free premium offers sent on request. American Studios, Dept. 364, Lacrosse, Wisconsin.

FAST Quality service. 8 exposure rolls developed, printed 25c; reprints 3c each. Harvey Photo, South Broadway, Rochester, Minn.

BIGGER Prints—better pictures. Roll of 6 or 8 developed 35c. Reprints 4c. (Western folks have liked our work for 30 years). Old Timer Photo-Lab, 610 W. Roma, Albuquerque, N. M.

UNIVEX Mercury film fine grain developed, beautifully enlarged 3 1/4 x 4 1/2 glossy, 65 exposure roll \$2.58, 32 exposure roll \$1.31. Fresh 65 exposure film 45c, accessories stocked. Spiratone, Dept. (ME), 49 W. 27 St., New York City.

ENLARGEMENTS—5x7—10c; 8x10—25c. National Film Service, 3111 West Tuscarawas, Canton, Ohio.

16"x20" ENLARGEMENTS—\$1.00. Any size negative, 35 mm. up. Matte or glossy paper. 11x14, 14x17—\$1.00. Cropped, moderately dodged. From picture 50c extra. Postage 25c. Free bargain circular. Jackphoto, 27-GA Gore, Webster Groves 19, Mo.

BIGGEST \$1.00 Value in 35mm. finishing today. 36 exposure fine grain 3 1/4 x 4 1/2 enlargements; deckled, embossed margin and date. Eighteen exposures 75c; 16 exposure splits 55c; 36 exposure reloads 50c. Special: return this ad with \$2.00 and we will send five 36 exposure reloads. Free mailers. 8 exposure rolls in beautiful, deckled contact finish with embossed wide margin, 25c. Mailbag Film Service, Box 5440A, Chicago 80.

SPECIAL—50 Reprints \$1. Suburban Studio, 1410-M Bond, Rockford, Illinois.

ROLL Film developed. 8 oversize Velox prints from any size roll up to 116, 35c; reprints 4 cents each. Colonial Studio, Sta. A Box 85, Charleston, S. C.

NEW Color process makes full color prints from black and white film or negatives. Send dime for sample. We have films. Midwest Photo, Janesville 26, Wis.

ROLL Developed, two prints each exposure 25c. Additional reprints 3c each. Skrudland, 6444Z Diversey, Chicago.

8 BEAUTIFUL Double size pictures and roll developed 30c. 8 hour service. Free mailers. Pacific Photo Service, Box 666, San Francisco, Calif.

PHOTOGRAPHY For pleasure or profit. Learn at home. Practical basic training. Long established school. Write for booklet. American School of Photography, 1315 Michigan, Dept. 3452, Chicago 5.

ROLL Developed and 8 prints 30c. Overnight service. Free mailers. Tri-Plex Photo Service, Box 375, San Francisco, Calif.

8 EXPOSURE Rolls developed. 1 print each and one enlargement coupon 25c. Two each and coupon 35c. 3 each and coupon 40c. Reprints 3c. Fred D. Eastman, Bode, Iowa.

8 HOUR Service. Your 8 exposure roll printed jumbo or regular size. 25c; 12 exposures, 35c; 16 exposures, 50c; 36 exposures, \$1.00. Reprints jumbo or regular, 3c. Regular prints deckled. Fine grain developing. Send for free mailers. Quality Photo Service, Box 468, San Francisco 1, Calif.

FREE Price list on quality developing, printing, enlarging. Write for it today. Roy Photo Service, G.P.O. Box 644, New York (1), N. Y., Dept. M.

SPECIALIZING 35MM. fine grain developed. 36 big 3x4 enlargements, \$1.25. Photoshop, Linton, Indiana.

ROLL Developed. 8 brilliant fadeproof Velox prints and two professional enlargements 25c. Overnight service. Young Photo Service, 405-C Albany 2, N. Y.

8 PRINTS. All enlarged to nearly post-card size, from your roll or negative, 25c. Willard Studios, Box 3535A, Cleveland 18, Ohio.

2 BEAUTIFUL Hi-Gloss prints each good negative and enlarging coupon with each 6 or 8 exposure roll developed 28c. Owlphoto Co., Weatherford, Oklahoma.

GLOSS Finish enlargements. 4 5x7 from negative 50c. 3 5x7 from photo 50c. Robert Renshaw, Jr., P.O. Box 478, Chester, Penna.

EVERY Picture an enlargement! 8 sparkling deckle-edge enlargements and roll developed 25c coin; 116 size or smaller; enlarge reprints 3c. Enlarge Photo, Box 791D, Boston, Mass.

MOTION PICTURES AND SOUND EQUIPMENT

8-16-35MM. Silent, sound films, projectors. Bedner, 5300 So. Talman, Chicago.

HILARIOUS Cartoons! Roaring westerns! Mammoth 8-16mm. discount catalog (films, equipment), samples, 10c. Cine-screens-B, 6419 San Vicente, Los Angeles 36, California.

FREE!—Six months subscription, Amateur Screen Photography, 3021A Narragansett, Chicago 34.

BIG Free list 35mm. s.o.f. Also want sound films. U. S. Films, Passaic, N. J.

MOVIE Equipment. Terms. Catalogs. Film rentals. Dayton Film, 2227 Hepburn, Dayton, Ohio.

FREE Home Movie Bulletin, Romeo Sales, Box 328, Patchogue 3, New York.

RENT 16mm. Sound, two-reel, comedy \$2.50 weekly. Howard H. Brown, Edgerton, Wisconsin.

LATEST Movies, equipment, 8mm., 16mm. Save! Immediate delivery new sound projectors! Surprise Kodachrome projection-sample \$1. Catalogues, color-sample, dime! Charlie Poorman, Dept. PM3, Schuylkill Haven, Penna.

35MM. Sound features, westerns. C. Rogers, Box 26, East Atlanta, Ga.

MOVIE Cameras and projectors. Film available. Selco Products, Danvers, Mass.

16 MM. Sound films, projectors. Bargain lists free. Myron Osborn, Lebanon, Ohio.

DEVELOPING Outfit for 8-16mm. movie film. Free literature, instructions. Duro Movie Products, 1519 Eggert, Eggertsville 21, N. Y.

FREE Movie titles. Dime brings details, samples, etc. Peerless Service, 6411 Hollywood Blvd., Suite 118, Hollywood 28, Calif.

PINEST Movie screens, inexpensive, make them yourself. Free literature. Snow White Screen Company, Danville, Illinois.

LEARN Professional motion picture technique at home. Approved for veteran training under G.I. Bill. Free catalog. Motion Picture Institute, Birmingham 4, Mich.

FREE, 1947 Catalog. Movies, cameras, projectors, films, samples 10c. Everything photographic. Goodwill Company, Jackson, Tennessee.

MOVIE Projector, 16mm. sound, slightly used, bargain. 2407 Garrison Blvd., Baltimore 16, Md.

MAKE \$8 to \$10 net profit daily with your 8mm. or 16mm. projector. Details free. Metcalf, 10806 Glenroy Ave., Chicago 43, Ill.

GUARANTEED Fresh anti-halo outdoor movie film! Weston 12! Daylight loading! Processing free! Three spools double 8mm. \$3.45! Six single 8mm. for Univex, \$4.60! Postpaid! Catalog. Eso-S, 828-B West 39th, Kansas City 2, Missouri.

UNUSUAL Home movies. Free list. Loja, Box 74B, Station B, Brooklyn.

"THE World's Greatest Passion Play," all sizes sound and silent. Write Hemenway Film, 33-F Melrose St., Boston 16, Mass.

I BUY. Exchange, swap movie films. Harvey Iris, Box 539, Brockton, Mass.

FIVE Slide views—Oldest convict ship afloat 25c. Slide Supply Service, 3111 West Tuscarawas, Canton, Ohio.

UNUSUAL Home movies: Travel, adventure, sports, comedies. Silent-Sound. Many film bargains. Big illustrated 1947 catalog, sample—dime. Audet, Box 6520BG, Philadelphia 38, Penna.

8-16MM. Silent-sound films. Complete rental library. All latest subjects. Free catalogue (sample film 10c). Garden Film, 317 W. 50th, New York 19.

EXCITING Films—bullfights, movie stunts. Unusual subjects. Send only dime for sample film and special list. Exciting Films, 1071-F El Centro, Hollywood, Calif.

HOME Movies. Rent, buy, swap 8mm.-16mm. silent and sound at money-saving rates. Details for a dime. Midland, Box 429, Oak Park 4, Ill.

COMPLETE Stocks always of Castle, Official, Pictorial films, 8mm., 16mm., sound. Musicals, soundies, free catalogs. We exchange your films and equipment, or buy them for cash. Frank Lane, 5 Little Bldg., Boston, Mass.

MOVIE Camera films, 100' 16mm. \$2.50. 25' double 8mm. \$1.25. Free developing. Better Films, 742 NewLots, Brooklyn 7, N. Y.

DISTRIBUTORS Wanted. Make big money selling our new 16-mm. sound specialties. Send \$10 for sample movie and our free wholesale price list. Standard Pictures Corp., Dept. A, Universal City, Calif.

BASS Says: 36 years of leadership in the motion picture equipment field. Sound projectors, 8 and 16mm. equipment, finest accessories. Bass buys 'em, sells 'em, trades 'em. Always satisfaction guaranteed or money refunded! Bass Camera Company, Dept. A, 179 W. Madison St., Chicago 2.

LEARN Movie projection, management. Free catalog. Theatre Institute, Elmira, N. Y.

TALKIES: Convert your silent 16mm. projector into sound with our guaranteed parts kit. Plays all 16mm. sound films. Quickly assembled at home. Special introductory offer: Send this ad now with \$19.95, check or money order, and we will include sound test film, instruction manual and full information on how to use with your radio. Kit includes photocell, exciter lamp, optic, which makes a sound head complete. Or send \$1.50 for complete blue prints showing how to make adapter yourself. Sound Tech, Box 3071, Hollywood 28, California.

MUSIC AND MUSICAL INSTRUMENTS

SONGWRITERS—Protect your songs. Get the facts first. Free booklet, attractive offer. Song Service, 331-C West 46th, New York.

SONG Poems wanted. Melodies set to your song poem, \$6.00. Thomas Raso, 90 Main St., Warren, R. I.

TEN Different songs, old and new words, music complete \$1.00. Satisfaction guaranteed. Long, 579 21st, San Bernardino, Calif.

SONGWRITERS: Free prizes each month for best song! Two prominent Hollywood composer-arrangers offer a complete song service to qualified authors of song poems. Write today for generous offer and free booklet! Hollywood Melodies, Box 2168, Dept. Z-2, Hollywood 28, Calif.

ATTENTION Fine harmonicas \$2.00, \$2.90; double \$5.00, \$7.75, \$9.75, \$14.75. Chromatic \$20.00. Guitars \$12.00, \$18.00, \$25.00, \$45.00. Drums \$15.00, \$25.00, \$45.00. Trumpets \$75.00, \$100.00, \$250.00. Accordions \$75.00, \$100.00, \$175.00, \$250.00. Clarinet \$95.00. Bass violin \$195.00. Musician's Shop, 2 E. Centre Street, Baltimore 2, Maryland.

GOOD Used jukebox records. Hillbilly, western, popular. Lists free. Olin Milner, 335 McDaniel, Atlanta, Ga.

PIANISTS Popular music chord chart: Shows names; symbols; readings; enharmonics; notation; 648 treble, 180 bass positions. Sensational! Desirable! Practicable! Only \$1.00. Carol Music Chart Co., Box 21 PM-Lefferts, Brooklyn 25, N. Y.

GUITARS. Mandolins, violins, accordions, banjos, amplifiers, pickups. Catalogs free. Wack Sales, 3131-W North, Milwaukee, Wisconsin.

PHONOGRAPH Records cheap. Catalogue. Paramount, MB-313 East Market, Wilkes-Barre, Penna.

MUSICAL-GLASSES: — Sensational; astonishing. How obtained, selected and played. Information \$1.00. MacDermid, Box 1365, Charleston 25, W. Va.

LEARN Guitar accompaniment, Spanish or Hawaiian, from diagram-chords. Full course, three dimes. Franks Musicians Supply, Box 103, San Diego 8, California.

SO! You want to write a song. Professional, beginner, you need "Wonder Wheel" jiffy composer. Perfect harmony, any note, any chord, at the turn of wheel. Saves hours. Jack Barnes Enterprises, Box 490 Times Sq. Station, New York 18, N. Y.

ACCORDIONS. Electrify your accordion now. Easier playing. Low melodious organ effect. Suitable for night clubs, barn dances, picnics and bands. Completely installed with dual pickups and speaker, with patented features only \$198.00. Del Principe Accordions, 307 So. Wabash Ave., Chicago, Ill.

MUSIC Composed to your song poems—send poems for free examination. Songs written by us were featured by leading screen and radio personalities. Paramount Music Co., Atlas Bldg., Dept. 6, Washington, D. C.

POEMS Wanted for musical setting: Send poem for immediate consideration. Hamann Service, 614 Manhattan Building, Milwaukee, Wisconsin.

ARE You annoying others with your piano practice? Use Mayo's Muting Device which enables you alone to hear your practicing. Easily attached or detached without harming mechanism. State make of piano and send \$5.00 for silencer and full instruction. (Guaranteed). Richard Mayo—Piano Tuner, Technician, 1120 Latona St., Philadelphia 47, Penna.

SONGWRITERS! Outstanding ethical offer. Hibbler, C5, 2157 N. Avers, Chicago.

LEARN To play the guitar by ear. Simplified method. Send \$1.00. Western Star Studios, 1112 W. Drew St., Ft. Worth 10, Texas.

YOU Can play piano by ear in one week. Quick short cut, detail free. Write E. Morrison, Box 9312-N Station S, Los Angeles 5, Calif.

BEFORE Sending your poem to be set to music, know your composer. Free folder. Al. Moquin, 5333 La Cresta Court, Hollywood 38, Calif.

SWISS Musical units, install powder. Cigarette boxes. Lloyd Kelley, Hanover, Mass.

POEMS Wanted for new songs. Send poem for free examination. Elliot Wright, Master Composer, 207 Rivoli Theater Building, Portland, Oregon.

ACCORDIONS. New or used, wholesale and retail, cash or terms. Our 57th year in business. Del Principe, 307 So. Wabash, Chicago, Ill.

POEMS Wanted for musical setting. Send poem for immediate consideration. Five Star Music Masters, 630 Beacon Building, Boston.

SONGWRITERS: Send poems for free examination and outstanding offer. United Music Service, 150, Salem, Indiana.

PIANISTS Acquire professional technique in quickest possible time. Most unique course ever put out. Low cost. Get literature. Wehner, 25 Fulda, Roxbury 19, Mass.

DUO-FLEX Reeds, for clarinets and saxophones. Eliminate your reed troubles. Circular free. Duo-Flex Reeds, 1204 First Ave., Evansville, Ind.

MUSIC Printing, \$5-100. Composing, complete service. Auto-Litho, Jensen, Fla.

SONGWRITERS, Submit songs for free analysis. Only worthy material accepted for development. Tommy Kilbourne, Box 1253, Bakersfield, Calif.

ACCORDIONS. Wholesale prices. Request circular. New streamline accordions. All sizes and makes. Monarch Accordion Co., 44 N. Albany Ave., Chicago, Ill.

SONG Poems wanted. Free examination. McNeill, Master of Music, 510-PM South Alexandria, Los Angeles, Calif.

WRITE Songs. Big money and reputation. Write for information. J. Gordon Pub Co., 201 N. Hoyne Ave., Chicago.

SONG Writer's attention! The amazing demand for phonograph records, accelerated by more than 300,000 juke boxes and the hits popularized warrants your immediate consideration. We are offering song-poem writers the rare opportunity of having established composers collaborate on appealing material received this month. Recola Records, Box 987P, Hollywood 28, Calif.

POEMS Wanted for musical setting. Send poem for immediate consideration and free rhyming dictionary. Richard Brothers, 24 Woods Building, Chicago.

RADIOS, SUPPLIES, INSTRUCTIONS

LOUD Speaking crystal radio, loudest design. Illustrated plans 25c. Radio Clinic, 10631-C Euclid, Cleveland 6, Ohio.

MILLION Radio parts. World's lowest prices. Catalog free. Offenbach-Reimus, 372 Ellis, San Francisco 2, California.

BUILD "Loudest" crystal set. Instructions and crystal, 25c. "Crystal Radio" booklet, 50c. Amorose Radio, Route Four, Richmond, Virginia.

CRYSTAL Set kits complete with phone, wire, solder. All you need is screwdriver and iron. \$3.95 postpaid. Antenna Kits \$1.50. Western Radio, Brady, Texas.

START Home manufacturing business making radio, electrical or electronic products. Details free. Huffman Research, Box 251-A, Orange, Texas.

TUBES, 6V6GT 39c. 1H6G 49c. 25Y5 79c. Guaranteed. S&S Radio Co., 140 Derby St., Salem, Mass.

BUILD Radio, phonograph, combination, complete kits: catalog, Radion, 6922 D 21st Ave., Brooklyn 4, N. Y.

25 YEARS Experience in radio repairing at your fingertips for \$1.00. I've repaired 45,000 radios and have perfected a system which you can follow step by step. My methods are far simpler than any other course on the market and require no calculations. Send \$1.00 to Ross Radio Company, Dept. B, 14615 Grand River, Detroit 27, Michigan.

RADIO Parts. Tremendous savings. List. Electronic Trading Post, Box 1076, Santa Fe, N. M.

"BIG Ten" crystal diode sets. Free information. Brassard, Box 353, Brunswick, Maine.

RADIOMEN, Servicemen, beginners—make big money, easily. \$250 weekly reached. We show you how. More information free. Merit, 216-32P 132nd Avenue, Springfield Gardens 13, New York, N. Y.

RADIO Listeners! "Don't blow your top"—Plug Earsaver remote volume control into your radio; from anywhere in room, fade down loud music, singing commercials, etc. Only \$4.95 with 15-ft. cord. Circular free. Earsaver, 724 E. Elmwood, Dept. 7, Burbank, Calif.

WORLD'S Smallest crystal radio. Operates with your headphones and aerial. No electricity necessary. Complete with easy illustrated instructions, only 70c postpaid. Al's Radio Service, Box 1285 P, Sioux City 7, Iowa.

TRANSFORMER—Heavy Duty—110 Volt, 25 or 50 cycle. Secondary, 6 volt, 12 amperes. Ham filament or make soldering outfit with carbon rod, weight five pounds. Price \$3.00, two for \$5.50. Radioco, 1110M Marshall Bldg., Cleveland, Ohio.

CRYSTAL Detectors from Bell Laboratories. A real microwave detector, fixed—no adjusting. Used in radar and long distance microwave. War product. Produced by Western Electric. Cost government originally over six dollars, now \$1.29 pre-paid. Supreme for crystal sets. Free list. Dept. 5, Radio City Labs., 30 Church St., New York 7, N. Y.

"CHINA Clipper," one tube sensation (kit) sweep the continent. Free information. Electronics Laboratories of America, P.O. Box 394, New York 8, N. Y.

PARATROOP All metal folding antenna, used by landing troops. New—real sensation—expands to 128 in. with flick of the wrist. Good for boats, radio, auto. Worth \$10.00, pre-paid \$1.98. Free list 9. John Barron, Box 128, Ft. Hamilton Sta., Brooklyn 9, N. Y.

NAVY Surplus bargain "Operators Control Box." Eighty useful parts. Only one dollar postpaid. Van Sickle Radio Supply, Indianapolis 6, Ind.

RADIO Men. Lowest prices in America. Big stock. Write for latest catalogue. McGee Radio, 1330 Broadway, Denver, Colorado.

NEVADIUM Super crystal. Write for details. Box 764, Elko, Nev.

RADIO Service men and experimenters send stamp for our giant radio catalogue. Save dollars. United Radio Co., (1000-V) Newark 1, N. J.

WIRERECORDERS—Limited quantity precision built Navy wire recorder magazines—new and in original boxes. Records ½ hour continuously, has level wind, erasing head, minute and second indicators, automatic stops etc. Marvelous bargain at \$49.50 f.o.b. Detroit. Photographs on request. Shipped c.o.d., weight 25#. Richard H. Wann, 3000 East Jefferson Avenue, Detroit 7, Michigan.

MAKE Simple, tubeless, batteryless, distance-getting crystal radios. Crystal and illustrated instructions 25c postpaid. Allen, 427-P, Clinton, Missouri.

RADIO Technician and radio service courses. Training for federal licenses. American Radio Institute, 101 W. 63 St., New York City. Approved under G. I. Bill of Rights.

RADIO tubes, parts, wholesale, retail large stock. Radio Mail Order Company, 46-13 188th St., Flushing, N. Y.

BUSINESS OPPORTUNITIES

315 GOLDEN Opportunities how to make money selling by mail. Send 3c stamp for free details. Joyce Distributing Co., 30-A West Washington, Chicago 2, Ill.

MONEY-MAKING Tips, ideas, schemes, opportunities galore in "Tip-Top Magazine." Tipton, Indiana. Year \$1.00, 3 months 25c.

RUBBER Molds, liquid rubber, statuary plaster, kits for beginners. Free "Plastercraft" instructions. Blue Rapids Supply, Blue Rapids, Kansas.

AGENT Or exclusive distributor for cigarette lighter mfg. Box 9X, Tahoe Valley, Calif.

"KEMO-PLASTIK"—Amazing new rubber molding liquid. Dries quickly. Easy to apply. Quart \$3.00. Gallon \$6.95. Mold-making instruction included free. B. Belfort, Engineering Bldg., Chicago.

VENDING Machines. Be independent. Own a big money business operating coin machines. Earn as high as \$7.00 weekly on machine costing as low as \$11.75 each. Car and experience unnecessary. Routes can be operated either in your spare or full time. Act quickly. Write for details and catalogue showing our amusement games, postage machines, candy-gum-nut vendor and scales. Parkway Machine Corp., 623J W. North Ave., Baltimore 17, Md.

START Home business making statuary, plaques, novelties, garden furniture, artificial marble flooring, liquid marble. Make your own flexible molds. Amazing profits. Folder free. Creative Publishers, Box 236-L, Winnetka, Illinois.

DOLLARS Daily! Cleared \$1900 in two months. Details. Loeb, 7201-A4 Montgomery, Cincinnati.

LIQUID Marble—Make in any color. Soundproof plastic flooring. Flexible molds. Cast novelties, plaques, statuary. Big money—your own business. Catalog free. Write—Bing Products, 88-A2T Broad Street, Boston 10, Mass.

INCORPORATE Your business. Delaware laws. Many advantages, free details. Tax Research Bureau, Inc., Delaware Trust Building, Wilmington, Delaware.

SHELL Jewelry kits, all materials furnished with instructions. \$2.60 and \$1.00 postpaid. Most distinctive and complete kits ever offered. Order today, earn while you learn. Catalogue free. Shell-O-Craft Co., Box 365 Station A, St. Petersburg, Fla.

UNPAINTED Wall plaques and statues. Variety of designs. Write for free list. ArBo Products Co., Dept. A, 232 Aurora, St. Paul 3, Minn.

UNPAINTED Plaster ornaments 2½c up. Beautiful designs. Easily painted with water colors. Illustrated list free. Omman, 642M Broadway, St. Paul, Minn.

IF You'd like to make \$5,000—\$10,000 yearly in the collection-credit agency business, write us at once. Outstanding opportunity. Cole Associates, Syracuse 2, New York.

MAKE Money making shell jewelry and novelties. Instruction book 75c. Kit \$5.00. Catalogue free. Palm Shellcraft Co., 220 W. 9th St., Sarasota, Fla.

OPERATE Profitable mail order business. Splendid opportunity. For details write Cline's Service Agency, 624 State, St. Paul 7, Minn.

MECHANICALLY Inclined men—Own and operate general appliance repair shop. Complete, illustrated course shows you how. Welding, refrigeration, motor repair, how to get business, etc., all phases covered.. Free literature. Christy Supply, Dept. 175, 2835 N. Central Ave., Chicago.

THE Mail Order News (54th year) shows you money-making opportunities in every issue. Sample copy 25c. Veterans Business Publications, Charleston 1, Ill.

OPERATE Profitable mail order business. Splendid opportunity. For details, write, U. S. Specialty Co., Box 13, Patchogue 3, N. Y.

CATALOG Free. Elmac's Service, 6516 So. May Street, Chicago 21, Illinois.

LIQUID Marble—Colorful, glazed! Molded, brushed, sprayed! Composition floors. Rubberlastic molds. Particulars free. Marbleizing Service, Edwardsville, Ill.

SMALL Capital. Start your own advertising agency at home in spare time. Complete operation revealed. No stock or equipment. Large earnings and permanent income. Free folder and proof. P. Snyder, Box 4907-A, Philadelphia 19, Penna.

SUCCEED In your own business. Big profit domestic service needed everywhere. We show you how, help you start, furnish everything. Fact-crammed booklet free. Opportunity lifetime. Textile Cleaning Service, Inc., 11106A So. Longwood Drive, Chicago.

RECAST Old batteries into new. Latest achievements. Battery Laboratories, Minneapolis.

BIG Mail income. Free particulars. Murray's, 196 Circle, Forestville, Conn.

PLASTIC Homes—Build yourself! Resurface old buildings! Wonderful building material. Particulars free. Marbleizing Service, Edwardsville, Illinois.

MAKE Money. Co-publish. 22,000 circulation. Details free. Rankin, 611 Central, Plainfield, N. J.

PARATOL—Amazing new rubber latex moulding compound for perfect detail castings of all kinds tested and approved in long service. No worries—easy to apply, quick drying, maximum strength and long life. Why pay more—buy direct! Quarts—\$1.60, 1 gal.—\$4.90, 5 gals. \$4.45 gal. 4 oz. samples on request. Send 25c to cover mailing and handling charges. Full instructions sent with each order. Test-worth Laboratories, Inc., Manufacturers of coating and adhesive products of all kinds, 407 S. Dearborn Street, Chicago 5, Illinois.

CHRONICLE Magazine. Exceptional money-making opportunities, articles. Year \$3.00. Sample quarter. PMR. McPlastens, 1430 Monroe, Chicago.

BIG Money. Window cleaning business. Full instructions. Own your business. Send \$1.00. Arrow Cleaners, P.O. Box 6, Springfield, Mass.

RUBBER Molds. Make big money duplicating hundreds of items, own your own business, start in spare time, make your own genuine rubber production molds, duplicate expensive molds for only a few dollars cost. Latest factory and shop methods. Also molds made to order. Get our prices. Information free. Write Shop Technician, 1832 E. 9th Street, Kansas City, Mo.

AMAZING Home business making new food product. Sells to food stands—soda fountains—bars, etc. Less than \$50.00 capital required. Complete formula, details \$1.00. Gregson, 307 N. Rampart Blvd., Room 205, Los Angeles 26, Calif.

RAISE Earthworms, exceedingly profitable. Extensive secret \$1.00. Stoner's, Chattanooga 6, Tennessee.

UP To \$1500 yearly selling by mail in spare time interest you? New ideas and plans every month. Details free. Idea of Month Club, 3023-A Greenmount, Baltimore 18, Md.

PAYS \$1. Takes 15 minutes. Periodically reconditioning, and restoring abrasive surface, on dull, worn, rat-tail knife sharpening steels, for butchers and cooks, with cheaply assembled, pocket tool kit. Original Steel Klags; illustrated, secret instructions, only \$2, air mail. Sample instruction pages and details, 25c. Arcay Service, 7601-A, Dudley, Cleveland 2, Ohio.

FORTUNES in formulas and trade secrets. Stillman, 555 Kingston Ave., Brooklyn 3, N. Y.

SERIOUS Adults only will be amply repaid by requesting our successfully proved business opportunities. Manning, 3259 Decatur Ave., New York 67, N. Y.

RED Latex for making molds! Cast plaques, novelties, bookends! Free sample! H. Tooker, Hamilton 35, Ohio.

MAIL-ORDER Schemes, secrets revealed. Book crammed with information, 25c. Wholesale sources, formulas, plans. Gilbert, Box 208, Boston 12, Mass.

\$46 FROM Square foot plywood. Jigsaw necessary. Excellent home business. Write, Woodarts, X-35, Bridgewater, Mass.

MAKE Beautiful plaster novelties, strong flexible moulds. Working instructions 35c. Bowman, 2837 Central, Chicago 34.

OWN A mail-order paper products business. Sell envelopes, tags, bags, boxes, by mail, wholesale. Tremendous demand. Steady profits. No capital necessary. Write Omaha Envelope Service, Dept. 201, 4721 California, Omaha 3, Nebraska.

MAKE Flexible molds! Few cents each! Cast plaques, novelties, bookends! Free sample! H. Tooker, Hamilton 44, Ohio.

MAKE Plastic jewelry. Free information. Attler Comp., 23-60 29th, Long Island City 5, New York.

PROFITABLE Business. New idea. Lowery, 1248 S. Union, Kokomo, Indiana.

PROFITABLE Home sparetime business, making wallets, belts, other fast-selling leather novelties. Simple to make. Tools not necessary. Amazing opportunity. Send for free catalog. Gold Leathercraft, 632 Desplaines, Forest Park, Ill.

EARN Up to \$480 month part or full time keeping books for small firms. Simplified system. Write Tax-Saver System, Dept. M. Ft. Worth, Texas.

DEVELOP And own permanent mail order business. Crompton, Box 2567, Hollywood 28, Calif.

MAKE Money selling by mail. Information free. Aragain Co., 1234-B 88th St., Niagara Falls, N. Y.

\$5.00 COMMISSION On booked distant moving jobs you recommend. United, 243 West 60th Street, New York, New York.

OPERATE Profitable mail order business at home. Postal brings details. Ellsworth Klein, 731 Northampton, Buffalo, New York.

\$100.00 A Week possible. Your own mail order business. Newest mail-order and agency propositions. Write today. Norman S. Rorick, 3514 Columbia Parkway, Cincinnati 26, Ohio.

FARM Lot, yard can bring you cash. Details free. Johnson, 2062-A East 14th, Brooklyn 29, N. Y.

315 MONEYMAKING Opportunities, supply sources. Neiman, 1136 Robeson, Reading, Pennsylvania.

EARN Up to \$5 hour making "Magic-Stone" plastic flooring or novelties! Palmer Co., Station A, Berkeley 2, California.

MAKE \$100.00 Weekly buying old Singer sewing machines for us. Essex Shop, 172 Washington St., Newark 2, N. J.

OPERATE Profitable mail order business. Tremendous profits. Patrick Service, 2026 E. 107, Cleveland 6, Ohio.

MAKE Liquid marble, flexible molds, statuary, art goods, novelties, artificial marble flooring. Literature free. Kemico, Park Ridge 50, Ill.

36 PAGES Business knowledge 10c. Big mails 10c. Studio, Box 339, Lake Orion, Mich.

DOUBLE Your income. New amazing idea. Repeat investment, build tremendous business. Contact Salesmen's Special Service, 1609 Manchester, Middletown 22, Ohio.

1947 GIGANTIC Directory of opportunities, advertisers supplies, sources, trade information, mail order ideas, products, wholesalers, valuable tips—just published! Descriptive literature free. Wilkin & Co., 118-AP East Main St., Hillsboro, Ohio.

BEST Tested moneymakers—68 page book 25c (coin) postpaid. Business secrets, mail order plans, formulas. Wholesale supply sources. Money back guarantee. Frank R. Carpenter, Boyes Hot Springs, Calif.

START Earthworm hatchery. New profitable business. No expense. Big demand. Send \$1.00 for booklet. Earthworm Farms Enterprises, Lamoni, Iowa.

\$6000 YEARLY Possible at home with Presto Rubber Molds which cost as low as 5c each. Make plaques, statues, etc., which glow in the dark. For free sample write today. Presto Company, 1012 N. Marshfield, Chicago 22D, Illinois.

OUR Unique service will help sell your idea or invention. Literature free. Ellis Martz, Representative, Muncy, Penna.

YOUR Own business. Bronze baby shoes. Make bronze castings, novelty castings, liquid marble, flexible molds. New methods, easier, quicker, more profitable. Productive Arts Co., Dept. M-7, Box 221, Seattle 11, Wash.

CORN Chips—Newest product to hit the market. Beats potato chips. Crunchy-crisp food products. Easily made. Huge profits. Information and big sample \$1.00. Ward Products, Capitol Heights, Md.

MAKE Money—have fun. Assemble and sell new handy screw starter tool. We furnish all parts. Send \$1.00 for sample. Steco, Box 16, Muscatine, Iowa.

FIREWORKS. Big, five color wholesale fireworks catalog. 25c coin (refundable). Intermountain Fireworks, 2435 South State, Salt Lake City 5, Utah.

CHAIN Of new "all-purpose" hot nut vending machines will make you financially independent. Small investment. Part or full time. Write for free booklet. B & R Sales, 1028 Ft. Worth Ave., Dallas, Texas.

PACKAGE, Sell, amazing cleaners under your name. Samples, 25c. Linnell Company, Box 1720A, Cleveland, Ohio.

LEARN The profitable jewelry and goldsmithing trade at home. Simplified course teaches jewelry designing, manufacturing and repairing; gemsetting, etc. Gemcrafters, Kalispell, Mont.

OPERATE Profitable mail order business. Splendid opportunity. For details, write Modern Specialty Company, 305-A North Broadway, Lexington 7, Kentucky.

EARN Good money at home as I do. Send stamp for details. Lollar, 678 Emmett, Battle Creek, Mich.

OPERATING Engineers, boiler setters, steam fitters can make money as dealers selling the famous Shear-Klean Shaking Grates. Any boiler can use Shear-Klean grates profitably. Write today. Shear-Klean Grate Engineers, P.O. Box 656, Evansville, Indiana.

REBUILT Standard brand spark plugs, 1/3 wholesale cost of new. Completely renewed, cadmium plated, polished, neatly boxed. Guaranteed 10,000 miles. Service stations, garages, car dealers all heavy repeat buyers. Substantial profit. Permanent business. Exclusive territory to producers. Standard Parts, 3033 Main, Kansas City, Mo.

OPERATE Profitable business selling air deodorant. Write Salesmanager, 652 Rutledge, Charleston 20, South Carolina.

HOME Mail order business, spare or full time. Good profits. Details free. Thomason's, Minneapolis 12, Minnesota.

PUBLISH Your own community newspaper! Big profits and prestige. "Know-How," the complete manual, shows how. Free literature. Success Publications, (Dept. A), 15870 Wisconsin, Detroit 21, Michigan.

BUY Wholesale 50% off auto accessories, parts, home supplies. Make money selling from truck, store, garage. Free price list. Main Supply, Fairfield, Ill.

SUCCEED With Oxium. Sell garages, shops, factories everywhere. Make it yourself. Small investment. Free literature. Weinman, Box 442, Elkhart, Indiana.

35 AUTHENTIC Pennsylvania Dutch designs with color chart and instructions 25c. Edison, 710 Weiser, Reading, Penna.

OPERATE Profitable mail order business. Splendid opportunity. For details write George Radatovich, Box 142, Fairmont, W. Va.

BIG Incomes from little businesses. Profitable small investment ideas. Free details. Pas, 246 Rev Blvd., Warren, Ohio.

PROFIT! Profit! Profit! Easy with our flower pot, drain tile and block machinery. Stamp brings data free. Concrete Machinery Company, Hickory 3, No. Carolina.

BE Your own boss. Install Venetian blinds, full or part time, we tell you how, your investment or ours. Plans and particulars 25c. Ward Products, Capitol Heights, Md.

HAVE Fine-paying, home-operated, mail business! Others have, you can too! Start small, grow big! Exclusive setups built-to-order by expert. Descriptive booklet free. Coates, 33-A Vassar, Dorchester, Mass.

PERMANENT Molds for metal novelty casting. Write Fritz Foundry & Supply, 622 N. Fulton, Allentown, Penna.

REPAIR Appliances, motors, bicycles, etc. \$20.00 capital! Illustrated instructions \$5.50. Repair Service, Janesville, Wis.

PADDLE Balls. Easy to make from plywood. Easy to sell. We make them so can you. Complete plans including sample 25c. Ward's, Capitol Heights, Md.

BECOME A locomotive engineer or railroad conductor, information 50c. The Student Railroader, Box A53, Elmhurst, Ill.

SELL Pin earring sets, novelty jewelry, \$2.50, \$5 sellers. Order assortment \$15 dozen. Manufacturers, 264 5th Ave., New York.

NOVELTY Advertising card. Sample, quarter. Manson, 1306 Rhodes St., Jackson, Michigan.

GROW Bean sprouts in dark room for market. Pays well. Free information. Mrs. Nickell, Rt. 1, Box 456, Bend, Ore.

MOULDED Fruit plaques, ready painted, dozen \$1.50. Plastex's, 1001 So. Hampton, Bay City, Michigan.

PROFIT 75c Or more per dollar. Postal brings literature. Trader, 216P Degraw, Brooklyn 2, N. Y.

BABY Shoes preserved. Instructions, formulas, \$1.00. Novelty Bronzing, Box 56, Hyde Park 36, Mass.

START A home business in spare time. Make extra money. Experience unnecessary. Literature free. Ellmar Services, Muncy, Penna.

CASTONE—Hardest coldcasting composition on earth. Any mold; white and colors; 10 pounds \$2.00. Hundred \$6.00. New Era, 1321-N Belmont, Chicago.

OPERATE Profitable mail order business, \$5 capital. Exceptional. Write, Crafts, Davison 2, Mich.

EARN \$10.00 For 2 hrs. spare time. Send \$1.00 for sample. Sample makes you \$2.00. Plumb Products, 427 Grant St., Vallejo, Calif.

\$25.00 WEEKLY. Spare time. Free information. Martin's Service, Bassett, Va.

OPERATE Profitable mail order business. Write Walter Service A, 4159 East 112th, Cleveland 5, Ohio.

START Profitable home publishing business. Pays well. Details free. Fred Hettick, Box 641, Bismark, No. Dak.

BOOKKEEPERS: General ledger and tax report experience operate permanent, profitable accounting service for the smaller business. Part or full time. Simplified method. Write now! L. A. Bell, 1404 West 25th Street, Cleveland 13, Ohio.

ANYONE Can make extra money. Over 100 new ideas. Write, Marshall, Box 655, Centralia, Wash.

MONEY In "Bobby-Jo" baby shoes. Complete successful mail order plan. No-Co-Ro, Oakland 6, Calif.

100 PAPERS, You as publisher, \$2.00 monthly. Sample and details 10c. Tes-Co., Wilkes Barre, Penna.

MONTANA State stock rancher names sold by county listing. Few ready. Test lists \$7.50 per thousand. Nearly 30,000 names in 52 counties. E. Manuel Anderson, 132C W. Granite Str., Butte, Montana.

GIVEN—National advertised gifts. Don't miss this. Write today. Mutual Merchandise Co., 1310 N. Wells St., Chicago 10, Ill.

BOOKKEEPING Service. Masterful, result producing letters, \$1.00. Free description, Andre, Barnegat, N. J.

PLASTIC—Liquid glass, china glazes, protects any plaster object. Pint, \$1.00; gallon \$3.00. New Era, 1321N Belmont, Chicago.

\$800 **BUYS** New coin holder just invented. Revolutionary. Sensational. Splendid mailorder item. Millions needed. Sell through agents all over world. Lowest cost manufacture. Send \$1.00 for copy-righted blueprints, essential sales features, particulars, sample. If dollar received after sold, dollar returned. Robert J. Drummond, 58 Eleventh St., Oakland 7, Calif.

BRONZED Baby shoe mountings and supplies. Beautiful all-metal bookends, picture frames, onyx, bronze powder, lacquer, etc. 30 amp. rectifiers, designed for plating non-metals, \$65.00. Complete shop equipment. Write for list. Hollywood Bronze Supply, 1770 N. Vermont, Hollywood 27, Calif.

MAILING Lists: New mothers \$7.00 a thousand. Trial 300 for \$1.00. Clarence Wells, 1444 N. Prospect, Milwaukee 2, Wis.

AUTOMOTIVE Garages buy on sight. Ten thousand mile guaranteed, cadmium plated, neatly boxed, reprocessed AC, Autolite and Champion spark plugs. Your cost 12c to 16c each. A permanent profitable business. Sample 15c. Carl's Supply Co., 7927 Paseo, Kansas City, Missouri.

RAISING Canaries pays good profits. Valuable bird books. "Its Care, Breeding & Training." "Mating for Color Breeding." Both \$5.00. American Canary, 2839P N. Halsted, Chicago 14.

MAKE Your living selling by mail. Start small with few dollars—Build from profits. Send stamp for eye-opening literature today, begin business quickly. W. Otis, Aurora 21, Missouri.

AT Home—Your own manufacturing business making popular \$1.00 novelties. Cost you 3c to 15c. Everything supplied. Write So-Lo Works, Dept. S-6001, Loveland, Ohio.

A FACTORY In your home garage! Mfg. and sales rights, mechanics' waterless hand cleaner. \$500-\$800 monthly. No special equipment necessary. Western Aircraft Co., Los Angeles 6, California.

RUBBER Molds. Make your own. Air-cure mold making liquid. 22 ounces \$2.00; quart \$2.95; gallon \$7.50. Directions. Rubbercoat, 3873A California, San Diego.

EARN Up to \$5.00 an hour installing the new sensational Left Side Accelerator. See advertisement page 270.

OWN Your own factory! Start on a shoestring, hold your job. Start at home, in your kitchen or basement, with very little money. See page 270 for details of 15 valuable tested trade secrets that will lead you to success and freedom. Chemical Research Co., 130 W. 42 St., New York.

CASH For common ashes! Information; sample product, 35c. Duffy, V59, Covington, Ky.

YOUR Own plastic business at home. Produce costume jewelry, novelties, statuettes. Liquid plastic, liquid marble. Flexible molds. Write for free book. American Trades, Box 1016-A, Peoria, Illinois.

BECOME A manufacturer's agent. Be your own boss and earn big profits with little or no capital investment. Send today for the Vimar Plan which provides you in detail with soundly-tested methods on how to become a representative for prominent manufacturers. Learn how to contact concerns, select products and build a successful business for yourself. \$2.00 postpaid. Vimar Co., 210 Loeb Arcade, Dept. A-4, Minneapolis 2, Minn.

POPCORN Machines, peanut roasters, carameltcorn equipment, vending machines, new, used. Northside Sales, Indianapolis, Iowa.

START Home manufacturing business making Cleaning Compounds, Soaps, Insecticides (DDT), Cosmetics, Polishes. No machinery. Literature free. Kemix, Park Ridge, Ill.

BIG Money in vending machines. Smallest capital start brings immediate profits that build permanent profitable business. Starting instructions free. Becker Vendors, 105-A Dewey, Brillion, Wisconsin.

A BIG Time mail-order business can be started in your spare time at home. No special equipment needed. We tell you how. Graff's Service, 1943 N. 37th St., Milwaukee, Wisconsin.

OWN A mirror shop! Resilver mirrors. Write for information. John Sprinkle, V60, Marion, Indiana.

MAKE Perfumes. Profitable business. Free book tells how. Walter Lawson, 21 Joiner, St. Augustine, Florida.

BECOME A finance man. Particulars free. George Lenhoff, Lincoln 8, Nebr.

GOT \$24,500 Using schemes from "Schemer" Magazine, Alliance, Ohio. 49th year, \$1.00; 3 samples, 25c.

COPPERIZE Baby shoes. Complete instructions, tested sales plan. Metaloids, Box 8087, Pittsburgh 16, Penna.

WANTED Unused U. S. postage stamps, small discount. Advance Stamp Company, 24 East 23rd Street, New York.

OPPORTUNITY To build fast growing, high grade, business without capital. This plan is used by large business throughout the United States. Address, Roy Vail, La-Grange 6, Indiana.

\$5000 Yearly possible selling books by mail. Wholesale and retail. Big profits. Free details. Dawsonoa, Box 20-A, Sta. J, New York.

BELTS! Make 'em and make money. No tools! Sample 50c. Artinc Leather, 411 Joseph Ave., Rochester 5, N. Y.

BUILD Your home or build your business with concrete brick. Minimum equipment expenditure for production machines and mixers. Reed Corporation, P.O. Box 237A, Three Rivers, Michigan.

BECOME Independent! Rent New York office under your own name, and sell what you have to offer through New York Metropolitan area, world's greatest business center. Rates \$7.30 and \$14.60 yearly. Co-Operative Offices, 126 Lexington Avenue, New York 16.

MAKE Your products, details free. Pharmacist, 939 East Euclid, Detroit 11.

AIR Curing liquid latex for flexible molds. Illustrated simple mold making instructions 50c. Advanced instructions \$1.00. Apex Plastic Products, 1915 Lunt, Chicago 26.

MANUFACTURE Beautiful name-plates, house-numbers, signs. Crabtree, Box 221, Newport News 6, Virginia.

WINDSHIELD Wiper and fuel pump rebuilding bring big profits. Free particulars. H. & H. Products, P.O. Box 430, East Akron Station, Akron 1, Ohio.

MAIL Order opportunities. Full or spare time. Hundreds of chances. No charge. Postal brings copy. Blackstone Press, Somerville, New Jersey.

EVERYBODY Eats. How to make money in the restaurant business. Illustrated success stories, \$1.00. Prize contest offer included. Luckock Press, 1047 Irolo Street, Dept. 5-A, Los Angeles 6, California.

SUPER X liquid molding rubber. Sample jar 25c, quart \$3.00, gallon \$10.00. Free sample. W. Wooley, 115-A Donald, Peoria, Ill.

METALIZE Baby shoes. Correct modern method. Information, stamp. Universal, Box 1076-A, Peoria, Ill.

SALESMEN! Double your money with Presto Plate silverware and jewelry cleaner. Brand new. Fast seller. Every home a prospect. Sample and selling instructions, \$1.00. Details free. Presto Plate Company, 5407-A North Houghton, Portland 3, Ore.

OPERATE Your own independent business without risk. Investigate new arrangement with special setup, free sales helps, profitable merchandise, sales guarantee. Small starting capital. Distributors Group, 5345-B Harper, Chicago 15.

CASH In on building boom. Machine now available to manufacture concrete interlocking building blocks. Quickly made. Easily laid. Territories open. Only financially responsible need reply. Delaware Industries, Muncie, Indiana.

TRAIN Yourself in crime detection and finger printing. Literature free. Perkins Publications, 300-B Brandeis Theatre Bldg., Omaha, Nebraska.

GREAT Opportunities and profits in mail order business at home. Free literature. F. Webster, Box 1972C, Hollywood, Calif.

LEARN Piano tuning, repairing, at home. Tremendous field! Piano parts, tools furnished. Established 1935. Empire School of Piano Tuning, 606-B East University Ave., Champaign, Ill.

THOUSANDS Business Opportunities. Magic Valley South Texas. Most prosperous, fastest growing area, great southwest. Will represent you. Questions answered, illustrated literature, \$1.00. McCants, Weslaco, Texas.

X-RAY Mirrors used by hotels, nightclubs, police. Process using window glass, common chemicals, \$1.00. Modern Devices, Hartford Terrace, Boston 25, Massachusetts.

MEN—Women—"Everybody likes candy." Learn to manufacture professionally at home. (Our 36th year). Ragsdale Candies, Dept. 4, East Orange, N. J.

HANDYMEN—Earn money home operating Community "Fix-It" Shop. Write Stafford, 708 Rawlings, Carbondale, Ill.

DO It with sea shells. Big profits. Werts, 1429 - 56th Avenue, Oakland 3, Calif.

BRONZE Baby shoes! Simple instructions \$1.00. Don Brady, 1618 Sage St., Topeka, Kan.

START Home plaster novelty business. Amazing course tells how. Literature free. W. Belfort, Engineering Building, Chicago 6.

RUBBER-AIRFLEX Liquid, makes molds "overnight." Pint \$1.25; gallon \$7.00 with instructions. New Era Products, 1321-N Belmont, Chicago.

SELL By mail, 25 plans 25 cents. Rex Newton, Loretto, Tenn.

BUILD Your own independent, fascinating and very profitable business at home, spare, or full time. \$75.00 and upwards weekly easily possible making beautiful brilliant, sparkling novelties and religious figures. Fast sellers through you, salesmen, stores. Quickly learned and few dollars starts you making real money. Successful manufacturer can tell you how and furnish everything. Start small, grow big. Write for full information and "amazing story of my success" at once. Inghram Company, 2845 Sixth Street, Detroit 1, Michigan.

MAIL Order business—Your opportunity. Start small—Grow big. Literature free. C-Belfort, Engineering Building, Chicago 6.

YOUR Town is ripe for a profitable Collection Agency. \$5,000 first year easily possible. We train you, coach you, get you started and help develop your business. Send \$1.00 for Starter Course, or ask for facts. American Collection Associates, 226 State Street, Schenectady 5, New York.

WOULD You pay 3%—first \$350 made? Color-illustrated book "505 Odd, Successful Enterprises" free! Some offer occasional "day off." Work home. Expect something odd! Pacific, San Clemente, Calif.

BOOKKEEPERS—Operate your own simplified "Dollar-A-Week" bookkeeping and tax service. Full or spare time. Details free. Ellis, Box 200, Cedar Grove, North Carolina.

MAIL Order business course shows you how to make money, spare or fulltime. Teaches professional mail order technique—not penny-snatching schemes. Fascinating 100-page illustrated success-catalog free! Write, Nelson Company, Dept. 4-02, Chicago 5.

BE First with newest items—New Products Bulletin Service brings listing 100 newest products. Tells where to get them long before they're on open market. Sample bulletin only \$1.00, details free. American Enterprises, Box 595-P, Grand Central Station, New York 17.

PLASTIC Discs, shapes, metal findings, wholesale, free catalog. "Secors," Bradenton Beach, Florida.

ELITE Collection contains 137 practical money-making plans; local and mail order. New edition. Particulars free. Elite Co., 220 Grand St., New York 13.

SELL Lamswool lined slippers, men's, women's and children's. Sensational profits. Sell from illustrated catalog or samples. Write for full details today. Shepherd Products Company, Worcester, Massachusetts.

137 WAYS To make money, in home or office, business of your own. Full particulars free. Elite Co., 220 Grand St., New York 13.

OPERATE Profitable home business. Levine's, Box 15-X, Boulevard Station, New York 59, N. Y.

BRONZING And metallizing baby shoes! Gold, silver, copper, nickel, bronze, pearl, ivory, and "luminous glow" colors! Big profits! New field! Details free! Write R. O. Morgan, Box 349, Long Beach 2, Calif.

ANYONE Can learn. Tune pianos by my system. \$1 2 lessons and chart. Oscar Fylling, 841 Robinson, Oroville, Calif.

LEARN Shell jewelry manufacturing. No tools or experience needed. Learn-earn within a week! Complete home instruction course, beautifully photographed, shows how to make 75 styles of pins, earrings, brooches, hair ornaments, dress clips, necklaces, bracelets, candy dishes, wall plaques, ash trays, candle sticks, etc. Includes pearlizing, gilding, dyeing, luminous methods. Illustrates 55 species of sea shells. Lists hundreds of raw materials with wholesale prices. Complete course \$1.00, postpaid. Beginner's kit, \$3.00. (\$3.50 in Canada). House of Gifts, Box 4550-RF, Coral Gables, Fla.

\$565.00 PROFIT From every \$15.00 invested. Standard Service System, La Grange 1, Indiana.

QUICK Money! "Repairing car batteries." At home! Easy too! Write. Batteryman, Grand Junction 5, Colorado.

"HOW To Make Simple Molds and Plaster Plaques." Profitable business or hobby! Instructive booklet 25c. Plastercraft Supply Company, 1406 East 43rd Street, Cleveland 3, Ohio.

SELL By mail!—Books and novelties! 35 different items! Large profits! Catalog free! Elco, 432 N. Wells, Chicago 10.

ORGANIZE Wholesale—retail—popcorn, potato chip shops. We sell beginner's outfits. Long-Eakins, 4760 Hi St., Springfield, Ohio.

MAKE Extra money now. Build to financial independence. Sell office supplies by mail from your home. I tell you how. Jo Troutwine, 8654 S.W. Ninth, Portland 1, Oregon.

OPERATE Profitable home business selling merchandise by mail. Fast sellers. Large profits. Powell Service, 5713 Euclid, Cleveland 3, Ohio.

COLOR Concrete with chemicals. Make Hollywood style pottery; home or shop. Marbling, water-paints. 10c brings sample, pictures. Hollywood Cementcraft, 8527 Wonderland, Hollywood 46, Calif.

INTERESTED In immediate mail order cash? Read "Advance"—Voice of mail order. Offers money-making opportunities. Personal guidance and benefits to all. Sample copy 25c. American Mail Trade Association, 313 East 21st Street, Dept. 400, New York 10, N. Y.

WHY Job worry? Learn electroplating. Highly paid, uncrowded, interesting business. Gold, silver, nickel, chromium, etc. Send postcard for free booklet and proof. Plater Hyde, Dept. MC, P.O. Box 176, National City, Calif.

COPUBLISH Leading m.o. paper. Latest copy Mail Sale Advertiser and proposition, commemorative stamp. Vanroy Shirk, Lebanon, Penna.

START Profitable mail order business. PMT lists new propositions available; products, sources, accurate methods. Covers ad writing, letter logic, trade information. Send 10c for copy and get free instruction folio offer. Progressive Magazine, Sheboygan, Wisconsin.

HOW And where to obtain capital. Fully explained. Particulars free. Star Service, Wapakoneta, Ohio.

LIQUID Rubber, for making flexible molds, literature and sample free. H. Chaney, 1130 E. 16th St., Jacksonville 6, Fla.

BIG Paying jobs in welding. Complete welding lessons and reference books, 516 pages, 41 lessons, \$2.00 copy. Money-back guarantee. Hobartweld, Box M-1065, Troy, Ohio.

START A clock shop. Fascinating, easily learned profitable business requiring little capital. We teach you how to repair all kinds of clocks. Information free. Houston Clock Shop, P.O. Box 5086A, Houston 12, Texas.

SYNTHETIC Latex with Neoprene base for making flexible molds! Quick drying! Safe! For home, classroom, or industry. Quart \$2.00. Gallon \$5.95. Full instructions. Plastercraft Supply Company, 1406 East 43rd Street, Cleveland 3, Ohio.

200 MONEY Making deals. Plans. Rare formulas. Schemes. Folio free. Formico Mart, Box 572, Dayton, Ohio.

SPECIALTY Manufacturing, the big money business that can be operated anywhere, start on a very small capital; we supply dependable formulas and complete instructions; get interesting free booklet, "Money-making Opportunities in Specialty Manufacturing." Howard Robinson, Ph.G., 1300-A South Ohio Street, Sedalia, Mo.

TADPOLES Make frogs, tremendous demand. Both make you money. 25c brings tell-how information. Chariton Corporation, Century Building, Chicago 4.

MAKE "DDT" Products. My ten master formulas show how. Literature free. Howard Robinson, Ph. G., 1302-A So. Ohio, Sedalia, Missouri.

COLORGLAZED Concrete pottery made without molds. New, low cost, patented method. Cemetery products, novelties, tiles, floors, etc. Basement leaksealing. Other money-making projects. Booklet, details free. Men only. National Potteries Company, Fergus Falls, Minnesota.

START Mailorder bookshop—Everything furnished; publisher cooperation. 25c brings booklet, exclusive setup, samples, exciting ideas. General Publications, Ossining, N. Y.

\$25 WEEKLY Working two hours daily. No canvassing. No manufacturing. Lycke, Box 2471, Cleveland 12, Ohio.

BRUSH Plating outfits connect to a battery. No tanks necessary. Good paying business at home plating autoparts, bathroom fixtures, bicycles, reflectors, silvering mirrors. No shop or experience required. Outfits furnished. Free booklet. Gunmetal Co., Ave. H, Decatur, Ill.

LATEX For making flexible rubber moulds. Thoroughly tested. No shrinkage. Complete instructions with each order. Stoneham Rubber Co., Box 244, Stoneham 80, Mass.

RUBBER Moulds for casting novelties. Latex for making moulds. Use thoroughly tested and approved products. Eastern Latex Laboratories, Box 153, Mattapan 26, Mass.

50 ALL Different magazine and adsheets, 25c. W. E. Martin, Bassett, Va.

MONEYMAKING OPPORTUNITIES

EARN Money sparetime. 10 mail order magazines, circulars 25c. R. L. Tipton, 229 Overton Place, Knoxville, Tenn.

MAKE Dollars. Working new mailorder plant. Details 3c. J. W. Arthur, Box 4, Montgomery, W. Va.

\$1 BRINGS 200 Opportunities, propositions, tips on wholesale sources, free books; ideas in "200 Bulletin." American Success Aids, Bellmore, N. Y.

GROW Medical herbs at home, spare time. Medical company buys from you, \$4.60 each 2 pounds. Write Roy Lowe, 514 Modena Street, Gastonia, N. C.

CO-PUBLISH For profits. Free details. Don't delay, start today. Cassco Enterprises, 119 Cremer Ave., Cleves, Ohio.

SELL By mail! Full or part time. No stock to carry—big profits! Write today. E. L. Bricker, Box K, Emmaus, Penna.

HOMEWORK Encyclopedias, twelve volumes for greater successful profits. Free literature. Driscoll, 1619 Third Avenue, Los Angeles 6, California.

START Your own business! Big money manufacturing novelties, plaques, statuary. Free catalog. Write Bing Products, 88-A2U Broad Street, Boston 10, Mass.

PERFUME—Brilliantine manufacturing business. Little capital. Big profits. Rosa, 907 Adams, Brownsville, Texas.

POSTCARD Brings mail order business details. Kenneth Osgood, Buckland, Conn.

EARNINGS Unlimited, brand new field, work at home, no selling, copyrighted material, instructions, \$2.00 refundable. Keirstead, 3541 North Meridian, Indianapolis, Indiana.

MAKE Flexible molds! Few cents each! Cast plaques, novelties, bookends! Free sample! H. Tooker, Hamilton 15, Ohio.

MAKE Beautiful belts and big profits. No tools needed. Sample kit 50c, 3 different kits \$1.30. Star-Craft, 1629 Edgewater, Chicago 26, Ill.

WHOLESALE Anything imaginable. New guaranteed list 25c. Refundable. Lasalle Novelties, Box 2127, Waterloo, Iowa.

I MADE \$1000.00 From 1000 tomatoes using my unique methods. Detailed instructions, \$1.00 (refundable). Alfred Dinsmore, Marlboro, Mass.

MAKE Big money at home preserving baby shoes in real metal, pearl, gold, silver, 1000% profit. Kiktavi Co., 8620 South Ruthelen, Los Angeles 44, Calif.

TRAVEL Anywhere or locate permanently. Earn \$85.00 per week up. Be your own boss. No experience necessary. Less than \$5.00 investment required. Literature free. Traveler, La Grange 1, Indiana.

WIN Money on contests advertised in every magazine and on radio. General Contest Magazine, published monthly, gives hundreds of tips. Lists current contests and rules. Details free. General Contests, 1609½ East 5th, Duluth, Minn.

THOUSANDS Articles wholesale. "Supply Source Directory" 10c. Ideal Service, Park Ridge 40, Illinois.

ARE You interested in profitable mail order business? Free details. Kerk's Supply Service, P.O. Box 454-A Wellston Station, St. Louis, Missouri.

FREE Literature describing 20 money-making plans. Dalles Ruth, Wheelersburg, Ohio.

SEWING Machine repairmen make big money lifetime. Start neighborhood shop today. Our course repairs all makes. \$2.00 postpaid. Serviceman, Hamilton 9, Ohio.

THOUSANDS Articles wholesale—Directory, 10c. coin. National, 378 "D" Hooper Street, Brooklyn 11, N. Y.

GET Dollar orders by mail! You keep 90c profit! Easy, pleasant, home operated business. Just \$5.00 capital starts you! Complete plan, only \$1.00. Interesting details free. Send today! William Redmond, 1216-A Park Row Building, New York 7, N. Y.

"TIMELY Tips Magazine." Paulding, Ohio contains promotional plans, ideas, opportunities. Monthly 10c. 19th Year, \$1.00. Trial four months, 25c.

PROFITABLE Gift shop in your own home! Illustrated book shows new, easy way of starting at tiny expense. \$1 postpaid. Letra Company, Westwood, N. J.

SUCCEED With Oxium. Sell garages, shops, factories everywhere. Make it yourself. Small investment. Free literature. Weinman, Box 442, Elkhart, Indiana.

SHELLCRAFT Sells! Have fun making genuine marine shell jewelry. Make money selling to stores and friends. Save money buying direct from wholesaler. Large kit \$1.00. Instructions free. Eastern Shellcraft, 985 Myrtle Ave., Brooklyn 6, N. Y.

MAKE Money. Paint and decorate wall plaques, and book ends. Big demand, good profits. We furnish you the plaques at small cost. Write Marbleite. Ames Station, Box 53, Omaha, Nebraska.

RAISE \$200.00-\$1,000.00 for club, lodge, school, PTA, VFW, Legion. Conduct "Frolic Night Festival." Complete instructions for games, money-making booths, \$2.00. Cleburne Hogue, Director, Box 63, Bonham, Texas.

YOUR Own business metalizing baby shoes. Complete instructions. Write. Technical Aid and Supply Co., P.O. Box 668, Los Angeles 53, Calif.

HAVE Your own business, plenty of it! Opportunities galore for you! Spare, full time; local, mail order. New magazine shows how! Copy, 25c—six issues, \$1.00. "Opportunities Preferred," 33-B Vassar, Dorchester, Mass.

EARN Up to \$2,000 year, inventing simple items for special cash markets. Ideas only, no patents. Hendrickson, Argyle 7, Wisconsin.

HOMEWORKERS — "Cash In" with handmade jewelry! Dollar starts you! Ideal hobby or therapy—nothing complicated. Free — wholesale proposition. Hughes Plastic Works, Danville 3, Illinois.

WHOLESALE Catalog, directory 10c. Stafford Sales, Box 5211, Indianapolis 1, Ind.

FREE Literature describing many money making plans. Jenkins, Atmore, Alabama.

"HOW To Build Your Own Mail Order Business" book 25c prepaid. Packed with ideas. Supply limited. Box 63, Station H, Dept. M12, Buffalo 14, N. Y.

EARN Money evenings, copying and duplicating comic cartoons for advertisers. Adservice, Argyle 1, Wisconsin.

MANUFACTURE Costume jewelry at home for profit, hobby, therapy. Free wholesale supply catalogue. Instructions. Florida Supply House, Bradenton, Florida.

MAKE More money in your own factory! Start at home in spare time, work hard, and others will be punching your time-clock! See page 270 for details of 15 valuable tested trade secrets, easy to make, easy to sell. Chemical Research Co., 130 W. 42 St., New York.

MEN—Women! \$6.60 puts you in business! Sell Vermont maple sugar! Ration free! Sells on sight! No competition! Repeat orders galore! Dozen fancy boxes postpaid \$6.60—set own retail prices! Order today! Eulalia Turner, Poultney, Vermont.

INVESTIGATE Mail selling! What's the one best thing to sell, happily, honestly, profitably? We know! Get free particulars, free samples. What-To-Do Shop, Box 1082, Tacoma, Wash.

"LUMINOUS Paint." Resilvering Mirror formulas 25c each. "Soap Substitute Formulas" \$1.00. Ideal Service, 300, Park Ridge, Ill.

SHELLCRAFT Instructions! Wholesale! Make beautiful seashell jewelry! Free! Make catalogue of complete line shells! Plastic discs! Animal shapes! Pinbacks! Earrings! Cameos! Etc. (Buy direct.) Pace's, Box 279, Bradenton, Florida.

START Make money, spare time. Experience not essential. Free details. Friendly, 17 South Penn Avenue, Philadelphia 11, Penna.

BIG Mail including mail order magazines 10c. Mallo, 767-PM Leith, Flint 5, Mich.

OWN A mirror shop! Resilver mirrors. Write for information. John Sprinkle, V55, Marion, Indiana.

START A home business in spare time. Make extra money. Experience not necessary. Literature free. Lloyd Linde, 14147 School, Chicago 27.

"FIFTY PLANS" for profitable, home-operated mail business. Details free. Lakeside Publishers, Detroit 15, Mich.

YOUR Backyard hobbies can pay off. Illustrated true stories of big business from backyard hobbies. \$1.00. Prize contest offer included. Luckock Press, 1047 Irolo Street, Dept. 6-A, Los Angeles 6, Calif.

I MAKE Big money in the mail-order business. You can do the same at home with my copyrighted system. Write me. I'll tell you how. F. Little, Box 8, Glenshaw, Penna.

BEST Tested Moneymakers, 68 page book, 25c postpaid. Business secrets, formulas, wholesale supply, sources galore. Book has no ads, meat only. Money back if dissatisfied. Write today, now. American Enterprises, Box 595, Grand Central Station, New York 17.

GET Dollar orders by mail. Keep 90c of each dollar. Easy, pleasant home business. Few dollars starts you. Start now. Details free. Roy H. Davidson, Box N640 Nots, Inyokern 3, Calif.

\$25 WEEKLY Working two hours daily. No canvassing or manufacturing. Lycke, Box 2471, Cleveland 12, Ohio.

WOULD You pay 3%—first \$350 made? Color-illustrated book "505 Odd Successful Enterprises" free! Proven! Work at home, office. Expect something odd! Pacific, San Clemente, Calif.

THERE'S Big money in junk," and repairing batteries. Write, Batteryman, Grand Junction 5, Colorado.

EARN Money at home! Thousands of "Home Worker Magazine" tells how. Sample, 25c (coin). Six issues, \$1.00. Arthur Sizemore, Pub., Box 870-M, St. Petersburg, Fla.

\$246.50 MAKING Unusual secret device without skill, machinery, from former war material costing \$1.50! Simple, baffling invention, unbelievably profitable! Illustrated proofs free. Rolls Enterprises, 115-D West 16th, New York 11.

LEARN Battery repairing, rebuilding. Engineer offers money making methods. Battery Bureau, 2225 North 44th St., Milwaukee, Wis.

EARN Money at home—steady income. Write Successful Income Builders, 508-A, Hollywood 28, California.

200 MONEY Making deals, plans, rare formulas. Schemes. Folio free. Formico-Eng., Box 572, Dayton, Ohio.

FORTIFY The future! Start own business; home, office. Booklet describing "Collection of 137 Tested Plans" free. Elite Co., 220-A Grand St., New York 13.

PUBLISH Your own magazine. Hand-some 52 page format, well edited, illustrated. Cost low as \$1.00 month. Brings you prestige, profits. 25c brings sample, details. National, Ord, Nebr.

FORMULAS, PLANS, ETC.

MAKE Moul Dex for rubber moulds, formula \$1.00. G. R. Schutter, 112 Sixteenth Street, Jeannette, Penna.

SELF Hair cutting wins. POM order \$1.00. Agent wanted. Engineering, Box 342, Cambridge 39, Mass.

TWENTY Moneymaking formulas, \$1.00. Wm. Gamble, 1155 Pondview, Akron, Ohio.

10,000 FORMULAS And trade secrets. Free literature. Stillman, 555 Kingston Ave., Brooklyn 3, N. Y.

SUCCEED with Oxium. Sell garages, shops, factories everywhere. Make it yourself. Small investment. Free literature. Weinman, Box 442, Elkhart, Indiana.

ANY Manufacturing formulae. Gigantic list 25c. Universal, Butler Building, Chicago 1.

ROOFING 100% Fireproof, low cost, lasts like slate. Insulates better. Apply like plaster. Formula \$1. Rav Roofing, 3 Box 98, New Hyde Park, New York.

15 TRADE Secrets that cost millions to develop and test—yours at low cost. You start your own business in spare time at home. Easy to make, easy to sell. See page 270 for details. Chemical Research Co., 130 W. 42 St., New York.

21 POPCORN, Candy apple, etc. formulas. All money-makers. \$1.00. We can supply equipment. Concession Supply Co., Dept. "A," Box 133 Sta. "B," Toledo, O.

MANUFACTURE Cleaners, soaps, polishes, flavors, cosmetics. Literature free. Kemico, Park Ridge 16, Illinois.

FIREWORKS, Twenty formulas, one dollar. Pyrotechnics, 215 West Haskell, Tulsa, Oklahoma.

FORMULAS—Modern, practical. Consultation, duplicating, research. Moon, 604 Broadway, Fulton, N. Y.

LARGE Formula catalog. Valuable information 10c. Refunded. Obermeyer's, 358 Uneeda, Fond du Lac, Wis.

NEED Chemists? Formulas? Analyses? Products duplicated, improved? Consulting Scientific Company, Swarthmore, Pennsylvania.

REAL Manufacturing formulas. Lists free. Cummings, Chemist, Gordon Ave., Syracuse 4, N. Y.

FORMULAS—Latest, best. Analysis. Giant formula catalog and chemical instruction sheet 10c. Refunded first order. Belfort, Engineering Building, Chicago 6.

PLASTICS

PLEXIGLAS Projects. Drawings and complete instructions for thirty useful novel and beautiful ideas. New Plexiglas and all necessary supplies for ten projects in 72 page work book rushed to you the same day for only \$5.00 postpaid in United States only. Send your order today to, Kosto, Washington 7, D. C.

PLASTICS—7 Colors sheets and rods. Send stamp for price list. Hanson Plastics, 7625 South Parkway, Chicago 19.

NEW Liquid plastic. Clear, colors. Cast without heat. Embed flowers, insects, coins. Saw, drill, carve. Manual tells how. Send \$3.35 for complete 20 project kit including one pound liquid Castolite. Castolite, Dept. D-21, Box 211, Kenilworth, Ill.

PLEXIGLAS Clear, masked. Prices per square foot—3/32"—\$1.35; 3/16"—\$1.77; 1/4"—\$2.09; 3/8"—\$3.10; plus 10% postage. J. Kitty, Rethel Plastics, 15 Walnut Street, Steelton, Penna.

MASTER Plastic injection machine, 1 1/2 ounce capacity, \$985. G. Baker Company, River Edge, New Jersey.

PLASTICS And supplies; book on plastics \$1.10, kits \$3.00—\$5.00. Internal carving drill, \$1.30; f.o.b. St. Louis. List. Plas-met Sales and Engineering, 4648 Shirley Pl., St. Louis 15, Mo.

LUCITE Supplies — Offer. Mid-West Plastic, 1717 No. 66, Omaha 4, Nebr.

LUCITE Sheets, rods, dyes, cements, cheap. Free price list. Thomas Cavaliere, 2141 So. Beechwood St., Philadelphia 45, Penna.

PLASTIC Injection machines; Plexiglas, dyes. Polystyrene rods, Tenite pellets, molding sets, jewelry findings, shellcraft. G. Baker Company, River Edge, New Jersey.

KITS: \$1.50 Each, Plexiglas tie-rack 18", 5"x7" picture frame or bud vase. Send for free price list. Free gift with each kit. Heah Mfg. Co., 5115 N. Neenah Ave., Chicago 31, Ill.

SPECIAL—One pound Lucite, cement, instructions, diagrams. Only \$1.00 c.o.d. Novalte Plastic, P.O. Box 106, Brooklyn 19, New York.

PLEXIGLAS Sheets 1/10"x12"x12" 78c; 12"x15" 96c; 1/8"x11 1/2"x12" 98c; 13"x17" \$1.60; 6" dia. x 12" length x 1/4" wall clear cylinders \$1.60; ten colors rod assortment includes phosphorescent \$4.00. Include postage. Julian Rhodes Muench Co., 1527 W. Alabama, Houston 6, Texas.

SELF-TRAINING At home through "Working With Plastics." Covers every step, every material; \$1.25—and Plastic hobby kit: 2 lbs. Lucite, Plexiglas, bottle cement, 2 bottles plastic dye (red, green), full instructions; \$3.25 postpaid. (c.o.d. plus charges.) Modern Technical Book Co., Dept. MMC, 55 West 42nd St., New York 18, N. Y.

LATEST Postwar rage. Start business making gifts, useful articles from Lucite Plastic. "Easy Home Outfit," complete supplies, directions \$10. 20th Century Plastic, 1288 Mission, San Francisco.

PLASTICS, Accessories from "one-stop" store for hobbies, money-making opportunities, Plexiglas, Lucite, Cellulose Acetate, sheets, rods, tubes, clear or colored, full range of sizes. Cements, dyes, polishing compounds, buffs. Metal findings, cameos, stones. Send 10c for catalog, price list, also details Burgess Vibro-Tool, Handee Moto-Tool, Plasticor Injection Molding Machine—molds novelties, toys, gifts. Plastic Parts & Sales, 1157 S. Kingshighway, Dept. H-24, St. Louis 10, Mo.

PLASTIC And accessory supplies. Floral carving drills \$1.00. Postpaid. Catalog free. Art Plastics of Calif., 8125 E. 14th St., Oakland 3, Calif.

PROJECTS, Ten marvelous plastic, guaranteed, 50c. Plasticplan Co., Box 181, Cincinnati 1, Ohio.

PLEXIGLAS: First grade, 1/8" \$1.50, 3/16" \$1.85, 1/4" \$2.00 pr. sq. ft. Clear and colors. Clear scrap. 35c lb. Shipped postage express collect or c.o.d. Rainbow Plastic Company, Arlington, Texas.

PLEXIGLAS Masked sheets 12"x12"—1/16"—\$1.00, 1/8"—\$1.25, 3/16"—\$1.55; 1/4"—\$1.85. Include 10% postage. Dyes, rods, cements, shells, buffing compounds, jewelry findings, tools. Free listings. Craft Plastics, Box 129-P, Somerville, New Jersey.

PLASTICS, Sheets, rods, tubes. Free list. Swiss music units \$3.50. Plastic Supply Co., 2618 St. Louis Ave., St. Louis 6, Mo.

FORMALIN Quick setting liquid plastic kit complete with price list \$3.00 f.o.b. Formalin Works, Box 199, Romeo, Michigan.

UNPAINTED Plaster plaques, send \$1 for three attractive vegetable or fruit plaques. B. Kirkup, 11 Murray Ave., Port Washington, New York.

CHEMISTRY

NEW Laboratory supply catalog of chemicals and apparatus, contains over 5000 items with illustrations, 212 pages. Send 50c. Standard Science Supply Co., 1232 No. Paulina Street, Chicago 22, Ill.

THE House of Winn, home of supplies for amateur chemists. See Winn's New Idea chemical kits and apparatus outfits for home experimenting. Send 10c for retail catalog. Established 1931. John H. Winn, Dept. 504, 124 West 23rd St., New York 11, N. Y.

RUBBER Tubing, sheet, flexible hard rubber buckets, dippers, funnels, gloves, aprons. Price list 3c. Bucey Supplies, 19465 Ward, Detroit 21, Michigan.

CHEMICALS—LAB. Supplies. New catalog 10c. Mel-Glo Chemical Co., 258 Fourth Avenue, Brooklyn 15, N. Y.

HANDBOOK For chemical experimenters, illustrated, hundreds of experiments, 50c. Experiment booklet 15c. Supply catalog 5c. Reading Scientific Company, Reading, Penna.

APPARATUS, Chemicals, ounce quantities, catalog 5c. Fleischer's Laboratories, Everett 49, Mass.

CHEMICALS And apparatus for industrial, analytical, and private laboratories. Complete supply service for correspondence school students. Send 3c for catalog. Dept. M-43, Biological Supply Co., 1176 Mt. Hope Ave., Rochester 7, New York.

FREE Catalog. Chemistry, mineralogy, biology, optics. Tracey Laboratories, Evanston, Illinois.

AGENTS WANTED

FREE Illustrated catalog hard to get fast selling merchandise. American Merchandising, Dept. PMWC-48, 12 Adams, Montgomery, Alabama.

AT Last! Something new and sensational in everyday cards. Gorgeous satin and velour designs never before offered. Get orders fast. Big profits. 14 assortments for year 'round occasions retail 60c to \$1. Get samples on approval. Puro Co., 2801 Locust, Dept. 740-D, St. Louis 3, Mo.

AMAZING Discovery Miracle glaze puts brilliant glass-like surface on cars. Free sample, information. Big profits. Miracle Glaze Company, 9714 S. Austin Ave., Oaklawn, Illinois.

WE Pay you \$25 for selling fifty \$1.00 assortments birthday, all occasion cards. Tremendous demand. Sell for \$1.00—your profit 50c. It costs nothing to try. Write for samples. Cheerful Card Co., 80 White Plains, N. Y.

CUT Cigarette smoking cost in half. Smoke Fire-Safe way. New Cig-Smoker is world sensation. Millions want it. Free data by airmail anywhere. Safe-Gard, 21 Perry-Payne Bldg., Cleveland 13, Ohio.

\$1 STARTS You in business. Sell deluxe ties, 100% wool interlining. Costs you only \$7 per dozen, you make \$5.00 dozen. Send \$1.00 for special introductory offer two deluxe ties. Catalog complete line free. Philip's Neckwear, 20 West 22nd St., Dept. K-10, New York 10.

SELL Greeting cards—Everyday, birthday, humorous, Easter assortments. Wrappings, stationery, correspondence notes. Over 100 money-makers. Special offers. Fast sales, big profits, extra bonus. Experience unnecessary. Request \$1.00 Everyday assortment on approval. Hedenkamp, 343 Broadway, Dept. A-21, New York 13.

AGENTS — Distributors \$28.00—\$140.00 daily. Flo-Glo plastic linoleum finish. Write, Acme, Box 404, Mount Vernon, N.Y.

HOUSE Numbers that glow in the dark. Luminous pictures, etc. Large mfr. wants factory representative. Wonderful new product. Fast seller. Free samples. Madison Mills, 303 4th Ave., New York City.

SELL Ultra blue stock signs to stores. 700 slogans, comedy, general, religious. 7x11, cost 6c, sells 35c. Make money. Sample free. Lowy, 8 West Broadway, Dept. 308, New York City (7).

DOUBLE-DUTY Shopping bag. Zips open. Instantly changes from small to large size. Lightning seller. Samples sent on trial. Kristee 134, Akron, Ohio.

DEALERS And distributors for amazing new Tel-A-Tale motion sign. Miniature reproduction in effect of moving electric light signs seen at Times Square, New York. Tel-A-Tale sign flashes sales messages 24 hours a day. Every store a prospect. Write today for further details, stating territory desired. Tel-A-Tale Sales Co., 120 East 86th St., New York 28.

NEW, Novel way to make money. Sell 5c and 10c individual greeting cards, \$1.00 and 60c box assortments. Up to 100% profit. Bonus. Special offers. Request free samples personal stationery and special feature \$1.00 All-Occasion assortment on approval. New England Art Publishers, Box C, North Abington, Mass.

MEN'S Watches, Swiss movement, sweep second, radium dial, precision made, sample \$6.50, retails \$9-\$10. Ladies' watches \$9.25. No c.o.d.'s. Dumont Watch Co., 307 Fifth Ave., New York 16.

EARNING Less than \$200 weekly? Boost income quickly. Fast selling celluloid price tags, metal moulding, menu covers. Every store, restaurant buys. Pricing Press, Dept. P.X., 124 White Street, New York.

BIG Cash year 'round profits. Show friends sensational value 14 card All-Occasion box assortment. Wildfire \$1.00 seller. Your profit up to 50c per box. Also quick money making birthday, get well, correspondence notes, gift wrapping boxes. Extensive personalized stationery line. No experience needed. Special offers. Request \$1.00 Everyday box on approval and free stationery samples. Holiday Card Co., 463 Congress St., Dept. E, Portland, Maine.

POCKET Pal: The All-Purpose cutting tool. 150% profit. Every man and housewife a prospect. 50c seller. Steady repeat item. Sample 25c. Nelson Mfg. Co., 222 W. Kellogg, St. Paul 2, Minn.

AMAZING New chemical discovery keeps trousers creased entire month for 4c. Gives crease knife-like edge. Sample and details for 25c. Sta-Rite Products, 355 Imperial Street, Youngstown 9, Ohio.

SELL Ball point pens wholesale. Free details. Friendly, 17 South Penn Ave., Philadelphia 11, Penna.

SALESMEN, Saleswomen, Agents—Establish your own all year round business. Tremendous demand sweeping country for glass animals and brass miniatures. Sells on sight everywhere — homes, offices, stores, shops; everyone a prospect. Exceptional earning opportunity, large profits, quick turnover. Write for convincing details. P Box No. 531, Roosevelt Park Station, Detroit 32, Michigan.

JUST Out! History of World War II. Huge volume. Popular price. Authentic text. Official photographs. Big profits. Riverside Book Company, Iowa Falls, Iowa.

DISTRIBUTORS—Exclusive territories with iron-clad sales contract for live wires. Cash in on the tremendous Spring season profits with "Wonder Plastic Linoleum Finish" and "Wonder Plastic Wood Finish." Sells to grocery, hardware, paint, department stores. You also receive profits on repeat orders from accounts already established in the territory. Write Wonder Plastic Products Company, 2609 S. Kedvale Avenue, Chicago 23, Ill.

"PIPE Smokers"—"Wedg-Y," world's smallest pipe rack-tray and adjustable bowl cleaner, send 50c. Borders, 5011 S. Hoover St., Los Angeles 37, California.

IS This My Opportunity? The NuProcess Products Laboratories, Dept. 286, Aurora, Illinois, is asking for letter inquiries from salespersons who would like to become genuine, exclusive, protected territory Sales-Distributors of their two products in territories where no introductory sales work is being done now. The letter inquiry should come from a man or woman of selling ability and experience, who has a car to work with, and enough funds to finance their first order. Very liberal cash profits should start coming in to them within one hour after they start work. The two products are . . . (1) Silver Plating Liquid (NuSilver and Re-Plate-O patent trademarks) a liquid in \$1.00 glass bottles, also in glass Pints, Quarts and Gallons, which cleans, silverplates and polishes (3 results) from the one application. It is basically a superior quality product for cleaning and preserving silverplated tableware and silverplated pieces of all kinds and sizes. But it also silverplates out onto copper, brass, bronze, zinc and some other new composition metals. It is put on either by being rubbed on with a cloth by hand or by immersion of the piece into the liquid for 1 minute. More uses are being constantly found for this Silver Plating Liquid in stores, offices, shops, factories; and even large Industrial Concerns, Institutions and Universities now purchase it. There is a very large potential market for NuSilver Plating Liquid wherever it is introduced and demonstrated . . . (2) The second product is the Lectrik Silver Kleaner Atomic Metal Electrode Plate. This is a metal de-tarnishing plate which, when used as directed, draws the tarnish off silverware, instantly . . . like a magnet will draw tacks to it . . . Restaurants, Hotels, and Eating Places like this de-tarnishing method because it is so quick and simple for the help to do. These 2 products are demonstration sellers. No demonstrations, no sales. Lots of demonstrations, lots of sales. Both products sell wholesale and retail. All sales in your territory are yours as long as you continue to introduce and sell the products. You are expected to secure, appoint and stock-up new selling agents and dealers at all points in your territory. This is a steady, permanent, well-paying job of your own. You are the boss of yourself and of everything in your territory. If this is the kind of a business you are looking for write a letter of full details about yourself to this concern and receive on return mail fuller and more complete details for your further consideration.

SELL Electric razors for \$5.00. Your cost only \$4.00 postpaid. Henderson, 1333 Santa Fe Ave., Los Angeles 21, Calif.

DEMONSTRATE Vanishing cigarette trick. Working sample, 25c. Scheetz's, Sellersville 1, Penna.

BEAUTIFY Your automobile or luggage with gold initials. Agents charge 25c per initial. Send \$1.00 for 135 initials. (Roman or Old English). Paskow's, Gold Letter Co., 1662 Cropsy Ave., Brooklyn, N. Y.

MAKE Flexible molds! Few cents each! Cast plaques, novelties, bookends! Free sample! H. Tooker, Hamilton 2, Ohio.

MEN And women: Sell household utility. Needed in every home. Earn \$75 per week. Write today. H. M. Jerome, 1600 Junction Ave., Dept. 6, Racine, Wisconsin.

OIL Burners \$145.00. Fully automatic, ready to install. 1/3 deposit, bal. c.o.d. Essex Shop, 172 Washington St., Newark 2, N. J.

EASY Money galore. Up to 100% profit plus bonus. Sell friends complete line greeting card box assortments, gift wrappings, correspondence notes. Experience unnecessary. Special offer. Request peak quality 14 card \$1.00 all occasion assortment on approval and free personal stationery portfolio. Tom-Wat Studios, Dept. PM, Bridgeport, Conn.

100% PROFIT on a 100% seller. Add the plastic twin rotary brush Kwik Komb Kleaner to your line. Costs 12½c, sells for 25c and up. For details write Rotary Brush Co., Dept. PM, Bay City, Mich.

SELL Genuine briar pipes direct. All men prospects. 100% profit. Lightweight sales kit. Write Abbott Pipes, 62 East 87th, New York 28.

OPERATE Profitable business selling, packaging products under your own name. Lyle A. Products, 5 E. Spaulding, Willoughby, Ohio.

FLUORESCENT Kitchen fixtures. Two 20 watt tubes \$3.65 in quantity (less tubes). Sample \$4.95 postpaid. Literature. Essex Shop, 172 Washington St., Newark 2, N. J.

POCKET Knives—largest variety! \$1.00 brings novelty sample and wholesale price-list for dealers. Rabinowitz, 108 Neptune, Brooklyn 24, N. Y.

AGENTS. Substantial profits. Repeat order products. Not mere "job" but opportunity establish steady income. Additive lubricant. Limitless field. Factories, autoists, service stations, fleet owners buy in huge quantities. Write Kidder Oil Company, LaCrosse 1, Wisconsin.

PHOTOGRAPHS And cards sealed in durable plastic, permanent lifetime protection, wallet size. 50c. Agents wanted. Plasticraft, Box 135, Wollaston, Mass.

NEW Patented invisible belt, keeps shirttail in. Men, women, unlimited earnings. Sell easily. Millions prospects. Free particulars. Invisibel, PM1, Box 26, Elmwood Station, Omaha 6, Nebraska.

EVERYDAY Cards. Earn \$5.00 with every ten \$1.00 assortments you sell. Also wrappings and note paper. Unusual quality. Send for samples today. Howard P. Ellis, Dept. PM-4, Pitman, New Jersey.

LIQUID Shampoo. Available in bulk—retail sizes, fast sellers. Details free. Delfa Co., 3956 Avondale, Chicago 41.

AUTOMATIC Crayon. New, practical. Whirlwind seller to offices, stores, stock-shipping rooms. Big profit. Hobby Bureau, Chicago 23-P.

300% PROFITS. Commodity used by millions since 1923. Sample 10c. Safe-Nu, 937 Withnell, St. Louis 18, Mo.

MAN Or woman to sell profitable steady repeat necessity on quick easy demonstration. Permanent business chance. Write Box 5672, Cleveland 1, Ohio.

QUICK Money! Men! Women! "You'll love this!" Free details! Battery Shop, Grand Junction, Colo.

MONEY In your spare time! Easy-selling Riteheat, only automatic room temperature regulator for wood or coal stoves. Every home needs one. National advertising builds big market. No experience needed. Just show neighbors and friends. Sells itself. Liberal commissions. Others making extra dollars. No obligation. Riteheat Regulator Division of Caloric Stove Corporation, Widener Bldg., Philadelphia 7, Penna.

BUILD Prosperous, steady business of your own. No investment, no experience necessary. Wonderful year 'round profits selling everyone quality shoes at exceptional values. Free outfit starts you making cash immediately. Merritt Shoes, Dept. PM, Brockton, Mass.

DISTRIBUTORS — Agents. Something really new. No competition. Year 'round item. Get exclusive territory rights now before national consumer advertising starts when territories will not be available. Sells to variety, drug, department, shoe, hosiery stores, gift shops. An item women have been waiting for! Prevents spotting hosiery and leg makeup after-snow thaws and rainy weather. Colored plastic. Must be seen to be appreciated. \$1.00 brings sample or write for full particulars. Tarrant-Demko & Co., 9606 So. Ridgeway, Chicago 42, Illinois.

AT Home—Your own business making, selling, popular \$1.00 novelties. Cost you 3c to 15c. Everything supplied. Write So-Lo Works, Dept. S-6003, Loveland, Ohio.

WONDER Cleaner. Different bubble bath, Glasklean—three money makers. Sell homes and stores. Everything furnished. Courier, 3829-I Delmore, Cleveland Heights 21, Ohio.

MAKE Money in your spare time! Helps furnished. Easy sales. Voluntary repeat orders. Liberal commissions. Write for free wholesale price list today! McGregor Magazine Agency, Dept. P.M.-7, Mount Morris, Illinois.

MAGIC Cleaner—Hotter than a fire-cracker. Saves soap—Big profits—Sample free. Bestco, 5007 Irving Park, Chicago.

BABY Shoes electroplated, shiny copper finish. Krall, 1627 Memorial Drive, Pittsburgh 16, Penna.

BIG Bargains for big profits. Over 100 sensational values. Men's used suits \$2.00, pants 35c, topcoats \$1.25, overcoats \$2.00, shoes 20c. Experience unnecessary. Free wholesale catalog. Superior, 1250-B Jefferson, Chicago 7.

FREE—Mexican novelty curiosities. Fast seller. Exceptional profits. "Productos," Apartado Postal 9318, Mexico City.

GREETING Card agents, "line up" with "Pines" for bigger, better, quicker profits. Rush name, address on postcard today. Box 32, Flushing 5, New York.

90c PROFIT Each \$1 sale. Sell positive mothproofing solution to housewives, stores, agents. Experience unnecessary. Postal brings details. Kinford, Wayne 3, Penna.

AGENTS: Stamping names on pocket-key protectors. Sample check with your name, address, 25c. Stamping outfits. Emblem checks, check-fobs, name plates. Hart Mfg. Co., 303 Degraw St., Brooklyn, N. Y.

SELL New-Used clothing from home, auto, store. Men's suits \$1.17. Leather jackets 85c. Overcoats 62c. Dresses 17c. Ladies' coats 38c. Other bargains. Catalog free. S & N, 565A Roosevelt, Chicago.

137 COMPLETE Plans for starting own business: local—mail order. Particulars free. Elite Co., 220 Grand St., New York 13.

COLLEGE Students! 100% profits selling costume jewelry. Wm. Morris, Maywood, New Jersey.

AGENTS—Big line including food products. Fast selling premium and bargain deals. Low prices. Send card for big profit offer with gift. Ho-Ro-Co, 2796 Dodier, St. Louis 7, Mo.

AGENTS—300 % Profit selling genuine gold window letters; stores and offices. Free samples. Metallic Letter Co., 438-B North Clark, Chicago.

200 MONEY Making deals. Plans, rare formulas. Schemes. Folio free. Formico Service, Box 572, Dayton, Ohio.

\$3 FIRE Extinguisher; quick sales, wholesale or direct; liberal profits. "Fire-Killer," 109 N. Franklin, Syracuse 1, N. Y.

PLATING Outfits for autouparts, reflectors. Connect to a battery. No tanks necessary. Free booklet and particulars. Gunmetal Co., Ave. N. Decatur, Ill.

FREE Water and our concentrates, makes flavors, lotions, shampoos. 72 products, labels, bottles furnished. Qualco, E-20030 Russell, Detroit.

GOLD Lacquered window sign letters. Large sizes penny each. New foils. Absolutely beautiful. Free samples. Atlas, 544 W. 79th, Chicago 20.

SELL Full, part time individualized belts, buckles, cap badges, tie holders. 2,000 emblems to choose. Fast profits. Repeats. Write today special outfit offer. Hookfast Specialties, Box 1425, PM, Providence, Rhode Island.

SELL Personalized soap. Name on every cake. Ideal for gifts. Get sample offer. Dunbar Soap, New Brunswick, N. J.

EXCELLENT Sideline for printing and advertising salesmen. Decalcomania name plates in small quantities. Great demand. Also make money applying initials on automobiles. Free samples. "Ralco" XL-Roxbury, Boston 19, Mass.

HELP WANTED

NAMEPLATES—Homes, offices. Profitable sideline. Quality. Whitney Signs, Box 41, Waterbury 85, Conn.

RELIABLE Man with car wanted to call on farmers. Wonderful opportunity now. \$15-\$20 in a day. No experience or capital required. Permanent. Write today. McNess Co., Dept. 25, Freeport, Illinois.

MAKE More money selling individualized buckles, belts, tie holders, cap badges. Choice of 2000 emblems. Quick profits—repeats. Special outfit offer, write Hook-Fast Products, Dept. A, Columbus 6, Ohio.

PARAMOUNT Atmospheric conversion gas burners. Quickly installs into any heating plant. Blowers. Gas floor furnaces. Sell and install. Peerless Sales, 4322 Sheridan, Lincoln 6, Nebr.

HIGH-GRADE SALESMEN

SENSATIONAL Offer! New fluorescent table lamp. Selling fast. Commissions advanced. Also complete line fluorescent fixtures. Write for free kit and sample offer. Rose Company, 529L South Franklin, Chicago.

LIQUOR Dispenser. New adjustable type. Sell bars, clubs, taverns on sight. Repeats. Sample \$3. Hawkeye Sales Company, 258 Highland Drive, Cedar Rapids, Iowa.

AMAZING New zipper shoe sells on sight. Big profits for salesmen. Leads line 200 splendid styles. Territories open. Get free sample outfit. Write, Consolidated Shoe, Dept. S-756, Chippewa Falls, Wis.

AMAZING Discovery, Master Glaze, puts brilliant glass-like surface on cars. Free sample, information. Big commissions. Master Glaze, Dept. 583, 7720 Harwood, Milwaukee, Wisc.

CALLING On auto repair shops. New small patented labor-saving equipment. Big demand; fast seller, large commission. We deliver. Write Johnson Equipment Co., Dept. PM-4, 1940 East Sixth, Cleveland, Ohio.

SELL Gift shops, department stores, etc. Write Kimley, 103 Highland, Williamsville, N. Y.

START Your own business on our capital. Always your own boss. Hundreds average \$6,000 to \$25,000 annual sales. We supply stocks, equipment on credit. 200 home necessities. Selling experience unnecessary to start. Wonderful opportunity to own pleasant, profitable business backed by world-wide industry. Write Rawleigh's, Dept. D-U-PPM, Freeport, Ill.

OPEN Territory—Paakus Chips exclusive product. Send 25c coin for sample box. Write Paakus Chips, P.O. Box 310, Binghamton, New York.

ADVERTISING Book matches—Cash in on political campaigns—sell Union Label matches. Cuts for all businesses and political parties. Free powerhouse selling kit, low prices. Protection guaranteed on repeat orders. Cash commissions. Superior Match Co., Dept. M47, 7530 Greenwood, Chicago.

BALLOON Assortment \$2.95 gross. #4 balloons, \$1.95 gross. Ellswood Distributors, La Junta, Colorado.

SALESMEN Wanted for advertising pencils (wood, mechanicals, bullets). New York Pencil Co., 70 Fulton Street, New York 7.

FRANCHISE Available. Supervise salesmen, make surveys for management engineering firm. Valuable training given. Sims & Associates, 120-C S. LaSalle, Chicago 3.

\$70.00 WEEKLY Selling twenty boxes greeting cards daily. Eighteen money makers. One earned \$160.00 weekly. Samples on approval. Details. Carleton Distributors, 25 W. 17th, Bayonne, N. J.

DISTRIBUTORS, Salesmen—Patented cigarette case holder for automobiles, trucks. Fine seller. New, 200% profit. Samples \$3.00 per doz. Literature free. Little Giant Holder Company, 919 South Vermont, Los Angeles 6, California.

STATE Distributors to sell simplified bookkeeping system small stores and public accountants. Sells \$13.50, your commission \$8.00. Exclusive franchise. Write Hawthorne Sales Co., Decatur, Ala.

DEMONSTRATE, Sell to taverns, amazing, original glass rinse "Clear Glass." No toweling, no water spots. Guaranteed. Sample 25c. Riesen Chemical, 419 Vliet, Milwaukee 12.

SELL Calendars full or part time—every business house a prospect—also wholesale to printers—calendars, novelties, sheet pictures. Fleming Calendar Company, 6535 Cottage Grove Avenue, Chicago 37, Ill.

WAGON—Jobbers, agents! Big profits selling stores, individuals sensational ball point pen. \$2.98 retailer. Free details; also list hundreds fast sellers. Salesmanager, Box 27, Atlanta, Georgia.

QUICK Profits with individualized belts, buckles, cap badges, tie holders, uniforms. Choice of thousand emblems. Sure repeat orders. Easy-selling outfit offer. Write Hook-Fast Company, Dept. 12, Roanoke, Virginia.

WAGON Salesman—Fast moving carded goods and 10c line. Long profit. Free facts. Peerless, 2717 Dodier, St. Louis 7, Mo.

FREE! Latest issue Opportunity Magazine. Salesman's Guide. Inspiring, constructive. Shows how to earn money selling for others or in your own business. Hundreds postwar opportunities. Send name and describe what you have sold or are selling. Illustrated copy sent free. Opportunity Magazine, 620 N. Michigan, Dept. 17, Chicago 11, Ill.

EDUCATIONAL AND INSTRUCTION

CORRESPONDENCE Courses. Unusual books all subjects. Bargain catalogue free. Baker, 5509-B Winthrop, Chicago 40.

LEARN Trigonometry better than others. Master method instructions \$1. Guaranteed. J. Ziemba, 6123 Orchard, Dearborn, Mich.

HAVE An office. Many earn up to \$5,000-\$15,000 annually. Learn credit-collection agency business by home study course. Write for free bulletin. Franklin Credit School, Dept. 202-E, Roanoke 7, Virginia.

LEARN Landscaping. Profitable, healthful career—absorbing hobby, for men, women. Thorough 45-lesson home-study course takes 8-12 months spare time. Hundreds of successful graduates. 31st year. Send for free catalog. American Landscape School, 6396 Grand Ave., Des Moines, Iowa.

PREPARE For Civil Service Examination. Pay for course after securing position. Write Free School, Dept. PM4, Kokomo, Indiana.

FACTS, Figures, faces, stick like burrs! New improved Supermemory course. Write Thor Books, ZC-3, Box 1210, Chicago.

"HOW To Break and Train Horses"—a book every farmer and horseman should have. It is free; no obligation. Simply address Beery School of Horsemanship, Dept. 1104, Pleasant Hill, Ohio.

HERBALISM—Complete course in 2 volumes. 1000 recipes. Home Service, Forestville 2, Va.

LINOTYPE—Intertype practice dummy with extra keyboard layouts, fingering charts, spelling aids, etc. Complete, postpaid \$3.00. Callaghan, Box 1493, Great Falls, Montana.

BETTER Your conditions through nerve force development. Instructions reveal all, tells how to overcome fear, nerves, worry obstacles; free details. O'Leary, Box 594-A3, Baltimore 3, Md.

BUILDING Boom is here. Free particulars about most lucrative trade. Lidemark, 226 Potomac Ave., Buffalo, N. Y.

TYPING. Learn at home easily in 60 hours. Amazing new system. Literature free. M. E. Egan, 205-J W. Cherry, Shendeah, Penna.

WANTED—Publication rights on trade, occupation and business training courses. Purchase or royalty basis. Box 1058, Omaha, Nebraska.

AN Amazingly interesting circle relationship for carpenters, engineers, teachers, mathematicians, puzzle enthusiasts, etc. Send 50c cash for cycle progression. Pure Science, Box 310, Moscow, Idaho.

3800 USED Correspondence courses. Cat. 25c. EG Mfg., Elmsford 1, N. Y.

LEARN To "speak in public." Banish fear. Speak fluently with confidence. Amazing new method. Easily mastered. Absolutely guaranteed. Literature free. Trissell-Heymann, Publishers, Mason City 2, Iowa.

LEARN Mail order business, \$5 capital, profitable, fascinating. Write, Crafts, Davison 2, Mich.

TUTORING Practical mathematics. Send postcard for circular. Math Tutor, Box 1214, Indianapolis 6, Indiana.

LEARN Modern-day auctioneering at home. All facts and instruction \$5.00. Col. Glenn R. Parrick, Box 71, La Grange, Illinois.

USED Correspondence courses and educational books bought, sold, rented, catalog free. Educational Exchange, Henagar, Ala.

LEARN Piano tuning. Prepare for career in fascinating profession. \$5000 year easily earned. Real security, pleasant easy work. No profession paying so well can be mastered so quickly. Natural aptitude, desire to get ahead chief requirements. Continuous enrollment. Veterans enter under G.I. Bill of Rights. Prospectus and full information on request. Harmony School of Piano Tuning, Box 582, Harrisburg, Penna.

HOME Study course, drugless therapy. Free literature. Institute of Drugless Therapy, Tama, Iowa.

AMAZE Others. Add faster than adding machine. Free details. Math Institute, Box 633, Mobile 4, Ala.

GOOD "Used" self-instruction educational books on all subjects bought, sold, rented, exchanged. Satisfaction guaranteed. Complete information and 100-page illustrated bargain catalog free! Write—Nelson Company, Chicago 5.

USED Educational books on all subjects sold, rented, also bought and exchanged. Moneyback guarantee. Write today for free catalog and details. Lee Mountain, Pisgah, Alabama.

INVESTIGATOR Training. Phillips Secret Service, 1917B North Kenneth, Chicago 39, Ill.

BIG Money rebuilding shoes. Help needed everywhere or start big-income business of your own. Learn practical, sure, easy way in 3 months. Anyone from 18-60 years can learn easily. Approved for GI training. Rush postcard today. Modern Shoe Rebuilding School, Est. 1927, 2935 Belmont, Chicago 18, Illinois.

29 LANGUAGES By Linguaphone. Russian, Spanish, Portuguese—Direct conversational method for mastering any language quickly, easily, correctly at home. Available under G.I. Bill of Rights. Send for free book. Linguaphone Institute, 83 RCA Bldg., New York 20.

LEARN Photo-engraving at home or in oldest, largest school in America. Work for newspaper or establish own profitable business. New Tasope' Photo-Engraving equipment available soon. Write for information. Veterans ask about G.I. training. The Aurora School of Photo-Engraving, Tasope' Bldg., Aurora, Mo.

MODERN Welding school gives thorough training for one of industry's best paid jobs. Experienced instructors. Individual attention. Non-profit institution. Qualified under G.I. Bill. Write for literature and details. Hobart Brothers Co., Box M-1067, Troy, Ohio.

SECRET Investigation. Experience unnecessary. Investigators particulars free. George Wagner, M 125 West 86th, New York.

HOME Bible course. Simple, helpful, instructive. Total cost \$3.00 includes textbooks, stationery, examinations, certificate. \$1.00 starts you, or simply request prospectus. The Bible Study School, Reverend Leslie Marshall, Secretary, 382 Van Houten Street, Paterson 1, N. J.

MEDICAL Laboratory technicians in great demand. We train you in your spare time, in your own home. You can practice while studying. Write for free catalogue. Imperial Technical Institute, Box 973-E, Austin, Texas.

PLAYS, STORIES, MANUSCRIPTS

POEMS Wanted for publication consideration, details free. J. Barnes, Publisher, Box 490 Times Sq. Station, New York 18, N. Y.

I WANT New writers to cash hundreds of checks for \$1 to \$100, offered each month. The easiest way to write for pay. No previous experience necessary. Send for free details. No obligation. Saunders M. Cummings, 467-M Independence Bldg., Colorado Springs, Colo.

NEW Writers needed to rewrite ideas in newspapers, magazines and books. Splendid opportunity to "break into" fascinating writing field. May bring you up to \$5.00 per hour spare time. Experience unnecessary. Write today for free details. No obligation. Postcard will do. Comfort Press, Inc., 210-P South Seventh St., St. Louis 2, Missouri.

BUSINESS SERVICE

RECEIVING And re-forwarding mail. For further particulars write to Dunn Mail System, 216 West 69th Street, Box 42, New York 23, N. Y.

5000 GUMMED Labels, 2"x1 3/4", postpaid \$5.50. J. Barnes, Publisher, Box 490 Times Sq. Station, New York 18, N. Y.

NEW York mail-address. Receiving, forwarding, Confidential. Free details. Arlington, 131-H West 42nd Street, New York 18, N. Y.

BUSINESS — Personal representation, World's principal cities. Associates wanted. Universal, Butler Building, Chicago 1.

SAVE—Buy direct from manufacturer. Any article. Guaranteed lists. Pittshire Research, Box 90, Pittsfield, Massachusetts.

To Whom it may concern: We will represent you in all principal cities of the world. Personal or business assignments \$1 per hour. James W. Farley, Citizens Bldg., Cleveland 14, Ohio. Note: Would appreciate hearing from someone who wishes to enter this business in your city. Will send you assignments immediately. References exchanged. State qualifications.

SPECIAL SERVICES

\$2.00 MONTHLY Maintains Washington, D. C., business, personal mail address. Letters reforwarded daily. "Hawkins," 1300-f Taylor.

DO You want representation in Honolulu. Letter, phone or personal contact. Lutts, Box 785 CHA3, Honolulu, TH.

PERSONAL Poetry is now being offered the public. Written under your instructions, by outstanding literary artist. Inquire: Hillscript Studios, 6427 Begole, Detroit 10.

SURPRISE Friends from Hollywood. Three beautiful post cards 25c. You address, return (stamped self-addressed envelope), we mail. Guaranteed. Letters forwarded (or mailed); give friends our address, we forward to you, 25c—monthly \$2.00. Box 57, Pacific Palisades, Calif.

DETROIT Postmarked letters remailed for you, 25c each. Morgan, North End Station, Box 127, Detroit 2.

LETTERHEAD Designing. Highest quality artwork. 200 attractive designs \$1.25. Samples free. Jacobson, 3510 Palmer, Chicago 47.

LETTERS Forwarded 25c each, \$2.00 monthly. E. Burroughs, 411 Greenwich, San Francisco.

MFG.—Wholesale sources. Most any item. Write: "Service," 1332B Findlay, New York City 56.

GLOBAL Mail—Receive picture postcards; surprise your friends; let us mail your letters from any place on earth. Free particulars. Travelpost, Box 528, El Centro, California.

GOOD "Used" self-instructional books on all subjects bought, sold, rented, exchanged. Satisfaction guaranteed. Complete information and 100-page illustrated bargain catalog free! Write—Nelson Company, Chicago 5.

CARTOONING, COMMERCIAL ART, SHOWCARD WRITING, SIGN PAINTING

"HOW To Make Money With Simple Cartoons"—a book everyone who likes to draw should have. It is free; no obligation. Simply address Cartoonists' Exchange, Dept. 94-C, Pleasant Hill, Ohio.

MAKE Extra money painting signs. Easily, quickly. \$1.00. Jantzen, 252 West New York, New Jersey.

UNEQUALLED Offer! Beginners outfit given away free with every purchase of our famous showcard writing course. Rush postal for full information. Sherwood Publishing Co., Dept. 104, Irvington 11, N. J.

LISTING Of major cartoon markets for free-lance cartoonists, 70 magazines and addresses, 25c. Cartoonists' Guide, Trudeau, N. Y.

CREATE Original pictures, don't copy. New painting method for everyone shows how. Colorful details free. Weidner, 1321 Wellesley, Los Angeles 25, California.

YOU Can draw. Amazing invention. Professional looking drawings, cartoons, pictures, produced easily. For fun, profit. Artcraft, Box 7, Cincinnati 30, Ohio.

754 QUICK Pictures in modern poster art-lettering. Free literature. Art Book Shop, Arnold, Mo.

ART Students—Write for commercial art talent test. Art Institute, Box 8066, Dallas 5, Texas.

SIGN Painting taught at home by an old master. Ben Kerns, Box 812, Greenville, S. C.

MAKE Signs. 9 complete alphabet pattern sets. 3 complete numeral pattern sets and catalog \$1.00. Sign Letter Distributors, P.O. Box 101, Mineola, N. Y.

CHALK Talks. Laugh producing program, \$1.00. Catalog 10c. Balda The Cartoonist, Oshkosh, Wisconsin.

ADVERTISING AGENCIES, LETTER WRITERS, FOR ADVERTISERS

LET A topflight advertising agency write and place your ads. Costs no more. Expert counsel and copy services free. John Moran Advertising Agency, Box 104, Wilkes-Barre 2, Pennsylvania.

PRODUCTIVE Cash buyer names. 300, \$1. 1,000, \$2.95. Underhill, Beebe, Ark.

FREE! 1947 Advertisers Rate and Data Directory. 52 pages! E. H. Brown Advertising Agency, 20 N. Wacker, Chicago 6.

ADVERTISERS: Mail order ad covering United States—2,000,000 circulation—\$21.00 1mo. Classified ad, 24 words, 20 metropolitan Sunday newspapers—\$25. Magazine, newspaper, mailing-list ratebook, advertising assistance—free. Chicago Advertising Agency, 20-PM West Jackson, Chicago 4.

NAMES, New, guaranteed. 1000 men \$5.00. 1000 housewives \$5.00. Bert Research, 1516 Jackson, New Orleans 13, La.

WALDO Advertising Agency, Box 266, Dallas 1, Texas. Mail order specialists.

I WRITE Mail order ads, letters, campaigns that pull inquiries, orders. Suggestions free. Gardner Service, 60 East 54th St., Kansas City 2, Mo.

ADS Placed in out of town newspapers and magazines. Low rates. Catalogue free. Ideas that pay. Baker Advertising Agency, Successors Ankrum Agency, 189 W. Madison, Chicago 2.

INCH Display advertisement Mailorder World, year \$24. Wood's Popular Services, Atlantic City, New Jersey.

ADVERTISE: 24 Words, 40 newspapers \$3.50. Lists free. Advertising Bureau, 4515-C Cottage Grove, Chicago 15.

ADVERTISING Service, art work, C. Sanford, 5029 Maple, St. Louis, Mo.

ADVERTISERS! Reach nearly 18,000,000 readers. 25 Sunday national key newspapers, 18 words, \$42.25. "Terrific pullers." 20 popular newspapers, \$8.50. "Free booklet." Special—One inch display 2,600,000 circulation, \$32.90. Newmark's Advertising Agency, (Established 1893) 217-7th Ave., New York 11.

MAILING Lists, certified, productive, inexpensive, \$5.00 1000. Homeworkers, agents, buyers, etc. Write Dixie Service, King, N. C.

24 WORDS In 64 weeklies \$4.96. H. J. Darnell, 730 Hays, Jackson, Tenn.

TYPEWRITERS, DUPLICATORS, OFFICE DEVICES

NEW, Improved duplicator, no stencils, ink, anyone can operate. Fully guaranteed. \$19.75. Premier Sales Company, 28 Conestee Avenue, Greenville, S. C.

"PRINT-O-MATIC" New adjustable model. Send for circular. Mimeographs bought, sold. Schubert, 2600 Sunset, Los Angeles 26.

MIMEOGRAPH, Multigraph, typewriter, multicolor, addressing machine. Folder. Printing press for sale. Grimsteads, Edwardsville, Illinois.

"PRINTOMATIC" Selffeeding post card stencil printing duplicators \$9.50 up. Office size duplicators, Speedprints, Hilcos, Excellographs \$33.41 up. Literature free. Pittsburgh Typewriter Supply, 336-WK Fourth Avenue, Pittsburgh 22, Penna.

RECONDITIONED Typewriters, mimeograph, multigraph printing devices, appliances, supplies. Catalog. Dixiegraph Service, King, N. Carolina.

RUBBER STAMPS AND OFFICE SUPPLIES

QUALITY Rubber stamps, gold-indexed, rubber-cushioned, full size handle, 35c line. 3 lines \$1. Bernel Products Co., 170 Broadway, New York 7.

3 LINES 40c; Pads 25c; signatures \$1.75. Stamprite, Wauwatosa, Wis.

3 LINES Or less 45c. Newman, 2020 Loma, Whittier, Calif.

PROMPT Service. 1 line 40c, 3 lines 60c. Guaranteed. Stamcraft, 1707 Virginia Street, Gary, Indiana.

QUALITY Rubber stamps. Three day service. Estimates given. Free catalog. Black's, Box 201, Bay City, Mich.

ADDING Machine stylus portable. 99.-999.99 capacity. \$19.90. Folder free. Appliance Mart, 21 Castine, Bangor, Maine.

RUBBER Stamps. Buy direct from manufacturer. Literature free. Lee-Vall Press, Box 1242, Indianapolis 6, Indiana.

PRINTING, MULTIGRAPHING, MIMEOGRAPHING, GUMMED LABELS

SPECIAL! 100 5 1/2 x 8 1/2 Letterheads and envelopes, \$1.25. Loweco, 915 Tunnel, Chattanooga 4, Tennessee.

MONEY Saving printing price list free. Low prices. Driscoll, 1619 Third Avenue, Los Angeles 6, California.

MORE Prestige for businesses, small or large, with printed stationery. Free samples, prices. Buffalo Printers, Buffalo, S. Dak.

1000 BUSINESS Cards \$2.35, 1000 6 3/4 envelopes \$4.45. Madison Printing Service, Madison, Ohio.

PHOTO-OFFSET, Printing, multigraphing. Samples free. Mango, 555-A, South 20th, Newark 3, N. J.

1,000—3 1/4 x 5 1/2 ADVERTISING Cards—\$4.95. 100 word limit. Schultheis, Box 449, Irwin, Penna.

100—8 1/2 x 11 HAMMERMILL Letterheads \$1.00 postpaid. Envelopes, billheads, statements, business cards same. Race Printing, Hudson, New York.

BUSINESS Cards to booklets. Correctly printed. Ace Printing, Brentwood, Md.

STATIONERY, Laundry-gas station lists, garage repair orders, free estimates. Southern Standard Publishing Company, Panama City, Florida.

WEDDING Invitations, announcements. Quality Vellum, double envelopes; smart Park Avenue type; box of 50, only \$4.00 postpaid. Williams, Specialty Printer, 2866 Madison Ave., San Diego 4, Calif.

1000 6 1/2 x 9 1/2 20 LB. Catalog, envelopes \$8.50. Trial 100 \$1.35 postpaid. Spender & Son, Millington, Mich.

1,000 POSTCARDS Printed, 15 lines, \$5.50. Castell, 2107 East Ninth, Brooklyn 23, N. Y.

100 TWO-COLOR Letterheads \$1.25. One color, larger quantities less. Samples, pricelist free. D'Yarmett Printing, Newark, Ohio.

FINE Printing for every use. Samples. Treaster Printing, Milroy, Pennsylvania.

SALES Books, prompt delivery, free sample. Doerr Printing, Lewiston, N. Y.

MIMEOGRAPHING—Lowest prices and highest quality. Universal, Butler Building, Chicago 1.

PERSONAL STATIONERY—extra quality, 50% rag content white bond. Name, address, beautifully printed, blue ink. 200 letterheads (6"x9 1/2"), 100 envelopes, post-paid \$2.95. Money back guarantee. Free samples. Cottage Bookshop, Box 726-M, Lincoln, Nebr.

MIMEOGRAPHING—Pricelists, letters, circulars, forms. Reasonable. Prices, samples free. Martin Mimeo, 3212 Harper St. Louis 7, Missouri.

250 **LETTERHEADS** \$1.50. Envelopes same. Mallo, 767 Leith, Flint 5, Mich.

QUALITY Printing: business, personal stationery. Prepaid delivery. Samples free. Mero Products, 100 Morrison, Punxsutawney, Penna.

QUALITY Mimeographing, multigraphing, printing and office supplies at the lowest prices. Catalogue free. National Sales Company, Dept. ND, 357 Halsey Street, Brooklyn 16, N. Y.

1000 **FOUR Line stickers,** \$1.00. Printing, mimeographing, best and cheapest in the country. Imprint, Emporia, Kansas.

500 3/4x2 1/4 **FOUR Line gummed stickers,** 35c. Moritz Printery, Saginaw, Mich.

CUT Printing costs, 1,000 offset 8 1/2x11 printed \$3.95; 5,000 \$15.75; larger quantities less. 48 hour service, Samples, price-list free. Fidelity Company, Parkersburg 14, W. Va.

MIMEOGRAPHING Specialists—Any copy. Reasonable. Mailers Service, Box 606-A, Chicago 90, Ill.

1000 **BUSINESS Cards** \$2.50, prepaid. Reliable Print Shop, 901 E. Jefferson, Louisville 6, Ky.

MIMEOGRAPHING. Highest quality. Reasonable. Letter Service, Box 1849, Chicago 90, Illinois.

SEND 10c Now, for our 36-page 1947 pricelist—refunded first order. McCall Press, 1326 South 27th, Omaha, Nebraska.

BETTER Grade printing reasonable. Estimates on anything. Economic Press, Leonia, N. J.

MIMEOGRAPHING—Letters, pricelists, formulas, instructions. Lowest prices. Lem's Letter Shop, 5710 Stanton, Detroit 8.

PRINTING OUTFITS AND SUPPLIES

PRINTERS Galley, quarterly magazine containing valuable information. 25c—year. Steiner, 24 Rockwell Road, Danbury, Connecticut.

CUTS—Make real halftones, line cuts yourself! Samples 25c. Particulars free. Rapid Chemical Service, Edwardsville, Ill.

PRACTICAL Printers, printers handbook, 50c. Steiner Publishers, R.F.D. 5, Danbury, Connecticut.

LINOTYPE—Intertype practice dummy with extra keyboard layouts, fingering charts, spelling aids, etc. Complete, post-paid \$3.00. Callaghan, Box 1493, Great Falls, Montana.

PRESSES. Cutters, perforators, cabinets, type. Bulletins 3c. Box 918, New York 8.

PRESSES. Type, cabinets, supplies. List for stamp. Lincoln Press Co., 220M Hartwell, Fall River, Mass.

PRINT At home—Send 10c for catalogue—presses, type, supplies. Barnhard Co., 6 Columbia St., Newark 5, N. J.

PRINTING Equipment, type and supplies. Send stamp for details or dime for complete illustrated supply book. Kelsey Inc., X-11, Meriden, Conn.

PRINTERS. Make a quick-etch etcher for cuts, halftones. Details. Charles Medlock, Box 256C, Goodland, Indiana.

HOME-MADE Presses. Proofs free. Riegel, 1111 Harrison, Phila. (24), Penna.

INEXPENSIVE Home-made printing press. Details free. Novelty Shop, Downsville, Louisiana.

PATENT ATTORNEYS

PATENT—Protection for inventors—detailed information end steps to take to secure patent protection for your invention will be mailed promptly without obligation. Victor J. Evans & Co., Merlin M. Evans, Registered Patent Attorney, 231-D Merlin Building, Washington 6, D. C.

PATENTS. "Proof of Invention" folder mailed without obligation. E. E. Vrooman, Registered Patent Attorney, 871 Woodward Building, Washington 5, D. C.

INVENTORS: Without obligation, write us for information as to what steps an inventor should take to secure a patent. Randolph & Beavers, Registered Patent Attorneys, 21-C Columbian Bldg., Washington 1, D. C.

INVENTORS—Patent laws encourage the development of inventions. The Rules of Practice of the U. S. Patent Office advises—unless an inventor is familiar with such matters—that he employ a competent registered attorney, as the value of patents depends largely upon the skillful preparation of the specifications and claims. Write for further particulars as to patent protection and procedure and "Invention Record" form at once. No obligation. Mc Morrow, Berman & Davidson, Registered Patent Attorneys, 134-F Victor Building, Washington 6, D. C.

"**INVENTOR'S Guide**" free on request. Frank Ledermann, Registered Patent Attorney, 154 Nassau St., New York 7, N. Y.

INVENTORS: Write for free brochure "Evidence of Invention." Labiner, World Building, New York 7.

C. A. SNOW & Co., M-427 Snow Bldg., Washington 1, D. C. Registered patent attorneys. Established 1875. Literature mailed on request.

PATENTS—Trade marks. Irving L. McCathran, 315 McLachlen Bldg., Washington 1, D. C. Registered Patent Attorney.

PATENT And Trade-Mark Practice before U. S. Patent Office. Validity and infringement investigations and opinions. Booklet and form "Evidence of Conception" forwarded upon request. Lancaster, Allwine & Rommel, Registered Patent Attorneys, Suite 411, 815-15th Street, N.W., Washington 5, D. C.

FOR INVENTORS

INVENTORS—Patent laws encourage the development of inventions. The Rules of Practice of the U.S. Patent Office advises—unless an inventor is familiar with such matters—that he employ a competent registered attorney, as the value of patents depends largely upon the skillful preparation of the specifications and claims. Write for further particulars as to patent protection and procedure and "Invention Record" form at once. No obligation. Mc Morrow, Berman & Davidson, Registered Patent Attorneys, 134-E Victor Building, Washington 1, D. C.

INVENTORS—Victor J. Evans and Co., established 1898, has a staff of registered patent attorneys, available to represent inventors in the preparation and prosecution of their cases before the Patent Office. Detailed information and the steps to be taken to obtain patent protection will be furnished upon request. Victor J. Evans & Co., 232-D Merlin Building, Washington 6, D. C.

PATENTED, Unpatented inventions promoted. M. Joyce Humphries, 1424 Landtitle, Philadelphia 10, Penna.

MACHINES. Machine parts, inventions designed, built. Louis, 86 Walthery Ave., Ridgewood, New Jersey.

WRITE FOR "Cooperative Combination," Explains patent protection and procedure. Invention sales help if you use my patent application services. Charles Morton, 11 West 42nd Street, New York.

YOUR Ideas developed. Send sketch, write for information. Confidential. Edwards, 1210 Griggs St., S.E., Grand Rapids 7, Michigan.

NEW Price, 25c for ironclad Aaberly Print Routine for proving your invention date! Outranks registered letters, "copy-rights," other dangerous makeshifts. No comparison at all with free invention forms. For dependability, guaranteed next to patent pending! No disclosure to me or other strangers! Preliminary searches, drawings, other services. Rely on 31 years "know how." Nicholas Aaberly, Patent Engineer, 302 Woodward Building, Wash.

HOW I made gadget inventing pay. Detail booklet \$1.00. W. C. DeWeese, Del Rio, Texas.

HIGHEST Royalties and cash for your inventions when we market them. Free particulars without obligation. Universal Marketing Co., Dept. 4M, 126 Lexington Ave., New York 16, N. Y.

INVENTIONS Wanted—Patented, unpatented. Cash waiting! Financial assistance, those forming company. Suite 665, 120A S. LaSalle, Chicago 3.

INVENTORS: You save up to 300% when dealing with your patent searcher direct. Complete search with patent copies \$6.00. Reports mailed in 5 days. Invention protection forms free. Write Raymond L. Smith, Patent Searcher, 703-M Albee Building, Washington 5, D. C.

INVENTORS: Avoid unnecessary expense. Write for free booklet explaining how our consulting and advisory service can assist you in deriving greatest profit from inventing. Institute of American Inventors, Dept. 40-A, 1926-Eye St. N.W., Washington 6, D. C.

"**INVENTOR'S Guide**" free on request. Frank Ledermann, Registered Patent Attorney, 154 Nassau St., New York 7, N. Y.

I SELL Patents. Established in 1900. Charles A. Scott, 773PM Garson Ave., Rochester, N. Y.

THE Inventor who believes he has a new and useful invention, and needs advice, should consult a competent registered patent attorney. Without obligation, write for full information on how to secure patents and trademarks. Randolph & Beavers, Registered Patent Attorneys, 11-E-Columbian Bldg., Washington 1, D. C.

INVENTIONS WANTED

WANTED: Small, simple, patented inventions for royalty manufacture. Bleefeld Products, New Knoxville 2, Ohio.

INVENTORS! Have you good, patentable ideas? Write Patent Agent Metzler, 11 West 42nd, New York.

WANTED—Products to manufacture and distribute. Schreck, 355 N. Water St., Kent, Ohio.

WANTED: Practical inventions by manufacturers, patented or unpatented. John D. & Son, Dept. PM-4, Box 3213, 285 Howard Ave., Bridgeport 5, Conn.

WANTED Patentable ideas. Write A. Rehkop, Box 4805, San Francisco 1, Calif.

WANTED: Practical inventions suitable for sale through 5c-\$1.00 stores, drug-stores, cigar stores; also sportsmen's items of all kinds. Write Matt, 1412-P, Great Northern Bldg., Chicago 4.

PATENTS—Wanted by manufacturers. Write Universal Guaranty Company, Lakewood, New York.

INVENTIONS Wanted. Patented or pending. Inventors Exchange, Dept. B, Hartford 1, Connecticut.

INVENTORS: Hundreds of manufacturers have requested our assistance in locating marketable new products. Complete information, free. Institute of American Inventors, Dept. 40-D, 1926-Eye St. N.W., Washington 6, D. C.

PATENTS FOR SALE

THE Perfect rat and mouse trap. Always set; no springs. Simple, will work when others fail. Lewis Christensen, Ellsworth, Wis.

TINY All rubber hat holding device for restaurants, hotels, etc. Amer, Box 1575, Medford, Oregon.

COUNTER Shoe heel support, patent pending. F. Kincaid, Mt. Vernon, Oregon.

INVENTORS: Test the commercial value of your patented or unpatented inventions, quickly and inexpensively. Write for free information. Institute of American Inventors, Dept. 40-B, 1926-Eye St. N.W., Washington 6, D. C.

MANUFACTURING

MANUFACTURING Machine, inventions, models, patents, devices, made. Baums Metal Specialties, Kansas City.

RUBBER Molds made to order. Stock molds. Vallance Art Products, 1873 E. 70 St., Cleveland, Ohio.

EXPERIMENTAL Work, models. Reasonable. Nelson Manufacturing, 948 First, Woodburn, Oregon.

MACHINING—Models, tooling, production. Eastside Mfg., Box 1585, Rockford, Illinois.

WANTED: Manufacturing or assembly of small products, light press and bench work, drilling, milling, etc., on job basis or cost plus. Jewel Industries, P.O. Box 889, Canton, Ohio.

MODELS—Small lot manufacturing. Metals, plastics, etc. Milburn, Burlington, Kentucky.

A BRAND New inventor's service. Write for information. J and M Company, Burlington, Kentucky.

MODELS Developed and built. Small run manufacturing. The Thompson Engineering Co., 206-C Winchester Bldg., Grand Rapids 2, Michigan.

MODELS AND MODEL SUPPLIES

MOTORS—Kits (Aeroplanes, racing cars, boats, model R.R.)—Tools. Everything for the hobbyist. Catalog 15c. Westchester Hobbies, Inc., 259 Mamaroneck Ave., White Plains, N. Y.

GAS Modelers! Powerful midget ignition coil weighs only 2/3 ounce. \$2.00. Electric Miniatures, 1607 S. Western, Los Angeles 6, Calif.

RAILWAY Models, complete informative catalog HO and O gauge. 128 pages, 50c. Walthers, 247 Erie, Milwaukee, Wisconsin.

SHIPS In bottles, easy to build. Instructions, 25c. Steiner's, R.F.D. 5, Danbury, Connecticut.

DIESEL Model engine, Displacement .10 cubic inch. For model boats, race cars, airplanes. 4000 to 10,000 r.p.m. Weight 5 1/2 oz. No coil, condenser, spark plug or batteries. \$18.50. C.I.E., 11929 So. Western, Los Angeles 44.

CAMERON .23 Engine for model airplanes, etc. Nationally advertised for \$16.95, now \$9.75 direct from factory. Send \$9.75 for immediate shipment post paid with money back guarantee or write for particulars. Cameron Bros., Chino, Calif.

FUN Building models—Airplanes, trains, ships. Everything furnished. Giant catalog 10c. Ben's Hobby Shop, 72 West Washington, Chicago 2, Illinois.

BUILD Sail for fun, profit! Authentic 2 1/2" 3 masted schooner. Easy, inexpensive. \$1.00 brings complete illustrated instructions. Milton Sailing Models, Dept. D-4, Box 466, Rye, N. Y.

STEAM Engines, boilers, castings. Catalog 25c. Anton Bohaboy, 2297 Price, Rahway, New Jersey.

BUILD HO gauge wrecking crane. Complete kit with brass wheel trucks. \$2.15 p.p. Catalog 10c. Ideal, 19 West 18th Street, New York 11, N. Y.

PLASTIC Sets! Build streamlined HO gauge trains from sparkling acetate plastic. Prepaid. Large \$4.95, small \$1.69. Plastiweid, Box 171, Swarthmore, Penna.

BALSA Wood, Generous supply \$1.00. Price list free. Sanlader, Manitowoc, Wis.

MIDGET Permag motors, 12-27VDC, 80-250RPM. Reversible. \$2.35, new. Free list. Erec, 1006 Hewitt, Everett 1, Wash.

BUILD Model ships, railroads. Catalog 10c. Ideal, 19 West 18th Street, New York 11, N. Y.

SPEEDY 1" Motor, runs atop flashlight cell! Parts, instructions, 35c. Fonskov, 655-K Amboy, Perth Amboy, N. J.

SHIP Models and yacht supplies complete. Large 64 page catalogue 30c. Bill Wild's, 510 East 11 St., New York City 9.

LANDLOCKED Sailors! Here's a beautiful, richly illustrated, fully descriptive catalogue of famous model ships—whalers, slavers, corvettes, etc.—authentic in every detail. Send for it today. Only 10c. Halesite Yacht Service, Inc., Halesite, Huntington, N. Y.

SHIP and Yacht model fittings; blueprints. Send 25c for illustrated catalog No. 20—listing hundreds of items. A. J. Fisher, 1002-1 Etowah Ave., Royal Oak, Mich.

BRASS Gears and model supplies for the inventors. Send 10c for catalog. Pierce Model Works, Tinley Park, Ill.

BIG Illustrated model engine catalog 10c. Active Products & Supply Co., 53 W. Jackson, Chicago 4.

MINIATURE Steam locomotives, 1/4" 1/2", 3/4" scales. Castings, parts, rail! Thorough drawings with instructions. Catalog 25c. Little Engines, Wilmington, Cal.

Homecraftsmen

ALUMINUM—1" Diameter x 12", \$1.10 postpaid. Free price list. Cap Metal, 452 E. 35th, Chicago 16.

RARE Wood grows only in Oregon and Palestine. Close grained hard—ideal for lathe work. Finished articles sell for 10 to 15 times cost material. Send dimensions of wood you need with \$2.00 for sample block. Oregon Myrtlewood Co., 112 SW. Pine, Portland 4, Oregon.

SWISS Musical movements easily installed. Popular and classical selections. \$3.98 plus postage. Pinto Brothers, 13 North Henry St., Brooklyn 22, N. Y.

JAGERMIX Water Plastic is the all around repair material you have been looking for. Has hundreds of uses around home, hobby, cabinet and fixit shops. 5 lbs. only \$2 postpaid in U.S. L. A. Jager-son Co., 1201 Loma, Long Beach, Calif.

LEATHERCRAFTERS: Ready made leather projects simple to complete are fully illustrated in our 1947 catalog of projects, tools, hides and accessories. Write for free catalog. Ester Leather Company, 145 St. Paul St., Rochester 4, N. Y.

WHAT-NOTS of scrap wood. 12 full size designs \$1. Albright Service, M6901 Railroad Ave., Omaha 7, Nebr.

SEASHELLS, Jewelry findings, and plastic accessories. Wholesale only. Free catalog. Beachcomber Novelty Co., Box 551, Fort Myers, Florida.

INSTALL Inexpensive domestic fire alarm. Details free. McVeigh, Box 3724, Kerchevale Station, Detroit 15, Mich.

135 DESIGNS For crafts projects in wood, metal, plastics, \$1.00. Contempo, 1467 East 18 St., Brooklyn 30, N. Y.

BURRS And steelcutters resharpened ten cents each. Minimum charge \$1.00. 3/32 shank tools a specialty. Illustrated catalogue ten cents. Hobby Outfitters, Box 81, Grove Hall 21, Boston, Mass.

STAMPED Steel wheels for small toys, models, etc. Priced as low as 5 cents each. Send for list. Also small stampings made to your specifications. Richard C. Judson, 4554 Eastway, Toledo 12, Ohio.

HANDICRAFTERS—Profitable deal. Unfinished, unusual novelty tie racks, ash trays 60c, lovely costume pins, caricatures, figurines 25c. Easily finished. Big demand. Popular assortment \$2.00. List. Wilhites, 927-B Palm Dr., Colton, Calif.

YOUR Dollar buys material for pearl necklace, shell comb and cameo brooch. Catalogue free. Dixie Shell Service, Lakeland, Fla.

CRAFTSMEN! Use new low temperature alloys. Hundreds of applications; forming, embossing, blanking dies; anchor machine and parts, bend thin wall tubing, make fixtures, special castings, easy to use, melts in boiling water. Samples and treatise on many uses, \$1.00. GTMCO, 514 South Jefferson, Springfield, Mo.

HARDEN Steels expertly, safely. Durable ingredients with instructions \$1. Roman Nejeleski, Box 185, PHISM47, Fort Wayne 1, Indiana.

LEATHER Designs on plastic eliminate tracing. Introductory offer \$1.00. Sample 10c. Lampkin Artcrafts, Box 641-M, Culver City, Calif.

JEWELRY Findings, imitation gems, Lucite, Plexiglas, all types of chemicals, ideas, for pleasure or profit. All in the big illustrated Craftmaster's Catalog. Everything for the jewelry and plastics hobbyist, at a cost that everyone appreciates. You can't do without this catalog long. Send 25c now, today. (Refunded on first order.) Pittshire Plastics, Box 90, Pittsfield, Massachusetts.

JIG Saw patterns. Full size, ready to use. Artistic Gothic wall shelf 20" high; corner shelf 17". Both for 10c. Jig Saw Guild, 117-JM Worth Street, New York 13.

LEATHERCRAFTERS! Send for catalog listing leathers, tools, supplies. Kit Kraft, 1607 S. Western, Los Angeles 6, Calif.

FULL Size patterns: pony car, see saw, doll stroller, swan rocker, and merry go round only \$1.00. Link's Craft Shop, Farmington, Conn.

LEATHERCRAFTERS! Send for free catalog on hand laced moccasin kits and instructions. Hollywood Mock, 1206 Venice Blvd., Los Angeles 6, Calif.

LEATHER Designs. Fifty belts, \$1.00. Twenty billfolds, \$1.00. Ten handbags, \$1.00. Lampkin Artcrafts, Box 641-M, Culver City, Calif.

LEATHERWORKER'S Bible. Every leatherworker should own one. An illustrated catalogue, combined with valuable instructions and information. Actual leather samples. Get your order in early. \$1.00 postpaid. Satisfaction guaranteed. Artcraft Leather of California, 271 Twelfth St., Oakland 7, California.

LEATHERCRAFT Tools—Free catalog. Maxon Tools, 252 Marcy, Omaha, Neb.

SEND Us your broken jewelry for repair estimates or send \$2.00 for jewelry repair kit. Joe Lee Novelty Co., Box 1236, Santa Barbara, California.

BIGGEST Complete shellcraft kits! Cameo Brooch, earrings \$1. Jewelry, etc. \$3.50. Six animals \$1. Instruction booklet 35c. Wholesale supplies. Shelart, 3027 1/2 6th St. South, St. Petersburg, Fla.

PERMANENT Molds for casting metal novelties. Write Fritz Foundry & Supply, 622 N. Fulton, Allentown, Penna.

SEA Shells, supplies. Wholesale catalogue. Tropical Shell Company, P.O. Box 1509, Sarasota, Florida.

BIRD Houses ready to assemble. Wren \$1.50, Bluebird \$2.00. Address Jepson, 95 Liberty Ave., Belleville 9, N. J.

MAGNESIUM Dowmetal for lightweight construction available miniature structural shapes and .005 to .064 sheet. Dowmetal can be joined with our special adhesive. See your dealer or write for size and prices to Sims & Associates, Dept. M, 464 Neff Road, Grosse Pointe, Michigan.

TOM Sawyer wood craft kit. Manufacture and sell from home work shop, using scrap lumber. Details stamp. Carl Volz, 212 Willow Ave., Takoma Park, Maryland.

BEAUTIFUL Lucite gifts. Assembled at home. No tools required. Free catalog. D-G Plastic Co., 177 Adams St., Newark 5, N. J.

CRAFTSMEN, Investigate this new, fascinating aquarium. Turn your evenings into profit. Be first in your town. Big profit, no competition. Sells on sight. Plans \$1.00 cash, money order. Box 465, Studio City, Calif.

HAND Grinder or router. Make your own by adding small chuck to this high speed 110 a.c. or d.c. reversible motor. \$3.50 or two for \$6.00. Radioco, 1110M Marshall Bldg., Cleveland, Ohio.

SHELVES—Pine, ready to assemble kits. Free list. Familycraft, Box 346, Oconomowoc, Wisconsin.

SHELLCRAFT Instruction book with 450 Caribbean shells, including findings for making \$6 worth, \$1; or beautiful African gold shell 75c earrings, including outfit making ten more pairs, with book, \$1. Satisfaction guaranteed. Shell Company, Miami 36, Florida. State representatives wanted.

PLYWOOD Cabinet kitchen plans 25c. Playne Cabinets, 4617 Johnson Avenue, Western Springs, Illinois.

CRAFTSMEN—Fast selling. Make children's, adults' lawn chairs, furniture. 5 plans \$1.00, 10—\$2.00. Summercraft Studio, 42 Vernon St., Newton 58, Mass.

SPECIAL Offer: 70 full size toy, novelty, and lawn ornament patterns only \$1.00. Lynds, Medway, Mass.

70 PATTERNS Lawn ornaments and novelties, \$1.00. Modern Woodcraft, Saginaw, Michigan.

TREASURE Chest plans, inexpensive, easy to build. \$1.00 postpaid. Henry Morgan, North End Station, Box 127, Detroit 2, Mich.

FREE Instructions, shell jewelry. Werts, 1429-56th Avenue, Oakland 3, Calif.

WHITTLES'S Supplies, readicut blanks, special woods, knives. Old Whittler, 1402 Charles, LaCrosse, Wis.

SHELLS, Plastics, findings. Lowest prices. Free catalog. Frances Jones, Box 251, Sarasota, Fla.

CERAMIC Jewelry supplies, bar pins, ear screws, for ceramic and woodworkers; also glass and seashell assemblers. Free catalog. Philadelphia Badge Co., Dept. B-1, 1007 Filbert St., Philadelphia, Penna.

EXPERIMENTERS! Interested in electrical, mechanical devices from war surplus? List free. F. Siefke, Box 18, Station E, Buffalo 11, N. Y.

MAKE Shell jewelry—for gifts, as a hobby or start a business. Free catalogue and price list. Complete illustrated book of instructions 75c. Florida Shellcraft Company, Box 1840, Sarasota, Florida.

SHELL Jewelry supplies. Wholesale only. McFarland Plastic Co., Sarasota, Fla.

CATALOG: Patterns plywood novelty furniture, letters, numerals, plaques, frames, weathervanes, silhouettes, lawn ornaments. 100 books and booklets on crafts and hobbies, picture frame mouldings, tools, large line decal transfers. Other lines. Hundreds articles finely illustrated. Write Wo-Met Shop, Ashburn, Ga.

MAKE IT YOURSELF

HOT Water free—from sunlight. System efficient any locality year 'round. Standard materials, easily built, low cost. Facts free. Solar Water Co., Box 175, Dept. G, Coral Gables, Florida.

CONCRETE Block maker—Daily capacity 100 blocks, complete equipment \$19.95. Write Jackson Manufacturing, 1300 East 59th, Kansas City, Missouri.

RUBBER Molds 50c up. List free. Win-nermolds, 228 P Grove, St. Paul, Minn.

BUILD Better tilting table circular saw. Details 10c refundable. Ward Manufacturing Co., Walsenburg, Colo.

BUILD Yourself an outdoor fireplace that bakes, broils, roasts, fries and barbecues. We supply the unit itself, complete with oven, you add the brick or stonework. You can build any style fireplace, and no chance for error because the unit functions independently of masonry. Many suggested designs sent with each fireplace unit. Size: 38"x18"x24". Price \$44.50 f.o.b. Hartford. Write Outdoor Oven Fireplace Co., 1479 Park St., Hartford 6, Conn.

ADDITIONAL Income in spare time sharpening lawn mowers. Build your own machine. Equals \$200.00 machine. Plans \$1.50. Wm. Lorenz, 3291 N. 35th St., Milwaukee 10, Wis.

BUILD Concrete block machine. 2 blocks per minute. Easy, inexpensive. Build concrete mixer; automatic electric water heater; stencil duplicator; electroplating outfit. Catalogue, details 10c. Horne, 206 West Valder, Tampa 3, Florida.

KITCHEN Cabinets—Build-em yourself. We furnish plans and layouts. Six easily built units. Details 10c. Tico Products, North Easton, Mass.

FREEZER Plans and complete instructions. Description upon postcard request. H. Gordon Anderson, Lakeshore Drive, Rome, Georgia.

MAKE Simple home-made electric generator for flashlights, door-bells, etc. Plans \$1 postpaid. Free: 50 electric stunts. Reiss, 3017 Ocean Parkway, Brooklyn 24, N. Y.

MAKE Leveling instrument. Learn leveling. Easy. Circular free. Design Service, Box 143-A, Aurora, Nebraska.

BEAT Summer's heat! Build efficient, inexpensive air conditioners for home, store, office. Details free. Imperial, 3778 W. Chicago, Detroit 6, Michigan.

MAKE Popular novelties, statues, at home—3c to 15c each. Sell at big profit. Everything supplied. Write So-Lo Works, Dept. S-6004, Loveland, Ohio.

BUILD Concrete block machine. Vibrator or hand. Easy. Economical. 150 blocks per hour. Build house, shop, garage, or other buildings. Save half. Sell blocks. Make money. Free details. Clyde Lee, Mountain View, Dept. A, Oklahoma.

STUDY Lamp. Make your own. All parts furnished in complete kit, with instructions. Buy your own shade to match. Send \$3.25. Check or money order to Lilly Engineering Service, 4656 N. Monticello Ave., Chicago 25, Illinois.

BUILD Home fast. Stretch building dollars. Save half. Not mud or plastic. Details free. O. E. Campbell, Box 534, Lima, Ohio.

LANE Oak table. Fun for all, felt side cards, wall side dice. Easy made. Patented instructions. \$1.00. Geo. H. Lane, 162, Edgewood, Md.

AIRPLANE Jettison gasoline tanks, streamlined, ten foot six inches by two foot four inches, 165 gallon, twenty gauge terne coated steel. Ideal for making boats, bob sleds, midget auto, etc. Price \$10.00 per tank, \$7.50 per tank quantities of five or more. General Truck Sales, Inc., 205 Market S.W., Grand Rapids, Michigan.

AIR Conditioning, low cost, material available. Complete plans show procedure. \$1.50 postpaid. Shopcraft, Box 332, Salt Lake City, Utah.

BUILD, Storm proof and save, half with concrete. Plans, \$1.00, details free. W. Denham, Box 265, Murray, Ky.

BUILD Own low cost sheet metal, brake, roller, and shear. 3 plans \$1. Home Workshop Engineering, 6359 S. Yale Ave., Chicago 21, Ill.

BUILD Your own powerful riding garden tractor. Engineered by expert; believed to be best ever made. Send for free circular. Campbell's Utility Tractor, Box 214, Spring Arbor, Mich.

FRAME Homes. 30 page booklet: drawings, instructions on how to build, \$1.00. H. C. Lightfoot, Civil Engineer, Richboro 1, Penna.

CONCRETE Block homes. 24 page booklet: drawings, instructions on how to build, \$1.00. H. C. Lightfoot, Civil Engineer, Richboro 1, Penna.

COMPLETE, Copyrighted plans and instructions for building combined frozen food locker and walk-in cooler at home \$1.00. Newman's, Box 1020, Houston, Tex.

BUILD Real heavy duty machines, using our production tested plans. 30" bandsaw, 12" lathe, dowel machine, portable sawmill, planer, concrete block machines, dozens other machines for shop, farm, home. Free lists. Nichols Equipment Co., Purvis, Miss.

FUN Or profit. Make own blueprinting and copying device. Plans and instructions \$1.00. Bluebird Novelty, Osceola, Indiana.

MAKE Brooches, earrings from seashells. Instruction book 35c. Supply catalog free. Whyteson, 358 W. 45 St., New York City.

COMPLETE Instructions to build a bow-gun. Only 50c. Mills, 1892 San Juan, Berkeley 7, Calif.

FLUORESCENT Lights. How to make your own 20 watt lights for less than \$1.00 each. Materials available. Complete, guaranteed, detailed instructions. \$1.00 cash or money order. Checks \$1.10. Specialty Sales, Box 1086, Muncie, Indiana.

WHY Plow? Build your own tiller. Stamp for details. Harold Mangus, Rt. 3, Alliance, Ohio.

WATCHES, OLD GOLD, JEWELRY

JEWELRY Made, repaired, remodelled. Modern, original designs submitted. Estimates free. Direct manufacturer's service saves money. Roth, 25 Maple, Bloomfield, N. J.

OLD Gold: Top price paid. Mail old or broken jewelry, rings, gold watches, gold teeth, silverware, diamonds. Receive cash immediately. 100% satisfaction or articles returned. Information free. Old Gold Specialist, Robert Wyndham, 1035 East 'A' Street, Ontario 1, California.

WATCH Repairing. For \$5.75 you get your watch cleaned, and broken parts replaced. Tested on electronics regulating machine. Over 45,000 satisfied customers. Carle Jewelers, 2211 Elmwood Ave., Springfield, Ohio.

20 WATCH Movements broken for student practice work, \$10.00. 3 pounds broken costume jewelry, \$8.00. 1000 costume jewelry stones, \$3.50. Lowe's, Holland Bldg., St. Louis 1, Mo.

GUARANTEED Swiss pocket or wrist watch, new. Send \$6.50 each, money order. Dale Finney, Humboldt, Iowa.

EXPERT Watch repairing—Ten to fourteen day service. All watches timed and tested by Western Electric Watchmaster. All work guaranteed. Cleaning \$3.00. Crystals 50c. Whiting's Jewelers, Sellersville, Penna.

CASH For old, broken jewelry. Highest prices paid immediately. Mail gold teeth, watches, rings, silverware, diamonds, spectacles. Satisfaction guaranteed. Information free. Rose Smelting Co., 29-A East Madison, Chicago.

WATCHES, Materials, tools, jewelry, diamonds—bought—sold. Catalogue. Gales, Box 1000, Chicago.

WATCH and clock repairing—Complete practical course in modern horology. 66 illustrated self-instruction lessons. Just out! Low price. Fascinating 100-page illustrated catalog free! Write—Nelson Company, Dept. 3-02, Chicago 5.

GEMS, Precious and semi-precious, all genuine, from world wide sources. Deal direct, no overhead, save money. Catalog 10c. Hill Co., Route 7, Salem, Oregon.

WATCH Repairing easy learned by our home study course. Watch repairers are in demand and are among the highest paid craftsmen today. Write for free information. Houston Chronometer & Watch Co., P.O. Box 1140A, Houston 1, Texas.

GOLD \$35.00 Ounce—Mail old gold teeth, diamonds, jewelry, watches—receive cash by return mail. Satisfaction guaranteed. Free information. Dr. Weisberg's Gold Refining Company, 1500-Q Hennepin, Minneapolis, Minn.

TOBACCO, SMOKERS' SUPPLIES

CIGARETTES: Save money on Camel, Chesterfield, Luckies, Philip Morris, Old Gold, Pall Mall, \$1.50 carton, postage included. Minimum 3 cartons. No order too large. Start a cigarette club among your friends. Mail check or money order to John Robert Sales Co., Box 1, Dept. L, Clayton 5, Missouri.

CIGARS—Your choice, popular Tampa brands, save 10% from retail price per box, postpaid. Andrew Tapia, 1903 Nebraska Ave., Tampa 3, Fla.

SMOKING Pipes repaired. Send for price list. The Humidor, 8129 Euclid, Cleveland 3, Ohio.

CIGARS—Imported, 50 Coronas \$3.60 postpaid. Grebne Distributors, 1410 Ardmore, Grand Rapids 7, Mich.

CIGARETTES—Introducing to smokers a popular priced brand of cigarettes \$1.45 carton. One windproof cigarette lighter \$1.00 value free with order of 4 cartons. Send \$1.00 with order—balance C.O.D. (Limit 1 deal to a customer.) Seneca Wholesale Co., Seneca, Kansas.

AIR Cooled pipe, 50% cooler smoke guaranteed. Sample \$3.50. N. V. Moor Company, 420 Market Street, San Francisco, Calif.

PIPE Smokers valet, pipe smokers what you've been waiting for. The Travelers Pipe Valet. Beautiful lucite rack, holding two pipes, tobacco, matches. Fits on dashboard of car, plane, or cruiser with guaranteed rubber suction cups. Enables you to fill and light pipe with one hand. Write for free descriptive booklet. Dealers and jobbers protected. Jalouse Art Co., Dept. C, 173 Hobart St., Ridgefield Park, N. J.

SURVEYING INSTRUMENTS

GUARANTEED Factory rebuilt transits and levels for sale (cash or terms) or rent (with purchase option). We will repair, trade, or buy old instruments. Ship prepaid for estimate and valuation. For complete information, write for list M-34. Warren-Knight Co., (Manufacturers of Transits and Levels), 136 N. 12th St., Philadelphia 7, Penna.

RAZORS, BLADES, SHARPENING

MORE Shaves from your blades. Simple effective method. No tools needed. Send 25c for instructions. Guaranteed results. Savabrade, 19465 Ward, Detroit 21, Mich.

FOR THE HOME

INEXPENSIVE Home Turkish bath. Collapsible. Applications cost practically nothing. Information free. Gordon Brothers, 656 Grand Street, Brooklyn 11, N. Y.

20TH Century soot removing method. Saves time, money, work, 20c. Coal saver formula, 10c. Both 25c postpaid. Nantco, 157-B West Noble, Nanticoke, Penna.

HEATING Bills cut as much as one third. Our treatise tells how. Details free. Write A. Claber Co., Box 491, Grandville, Mich.

SPARKLING House numbers mounted on artistic background \$1.00. W. Thompson, Box 125, Perrysburg, Ohio.

FOR SALE MISCELLANEOUS

MECHANICAL Drawing instruments—Veeco, 4 piece, compact, precision set, brand new in lined case, value \$12.50, special \$7.25. Hull Automobile Compass, for accurate road direction, brand new, \$2.50. Prisms for 6x30 or 8x30 binoculars, brand new, \$1.50 each. Offset prisms to be attached to 7x50 B. & L. binoculars gives double the field of the ordinary 7x50 binocular. Cost \$98.00, special \$25.00. Green sunshades for binoculars, size 6x30 and 7x50, snap on type, value \$7.50, special \$1.25 per pair. Forward money order. No c.o.d. shipments. Public Sport Shops, 13 S. 16th St., Philadelphia, Penna.

IT'S New—Non-Stic permits smooth removal of ice-trays. Eliminates sticking. Get acquainted, send 25c for sample jar postpaid. Tibet Products, Box 415, Summit, N. J.

SURPLUS Items. Tank compasses, instrument panels, pumps, winches, hydraulics, flying gloves. Write us your needs. Quality Surplus Co., 6810 Snow Rd., Parma, Ohio.

U. S. Surplus clothing bargains for men, women. Free catalogue. New York Clothing Co., Dept. P, 2079 Second Ave., New York 29.

NYLONS, Genuine Dupont, full fashioned perfects, 3 pair \$5.00 postpaid. Irregulars 3 pair \$4.00 postpaid. Martin Co., Box 298, Wernersville, Penna.

FOR Quick, easy smooth and as many as 100 shaves per blade use our hone for sharpening. Improves with use. Northland Products, 316 W. Munising Ave., Munising, Mich.

JEEP Hats 10c, meskits 35c, canteens 50c, covers, cups 15c, leggings 25c, holsters 50c, gunslings 75c, pistol cartridge belts 75c, field bags 95c, tool box, steel helmets, raincoats \$1, wading boots \$2.50, training rifles \$2.50, army tents \$2.95 up, army canvas 5c and 10c foot. Catalogue. New York Salvage Co., 144 Chambers St., New York City.

MODERN Kitchen cupboard construction and planning made easy with our plans. Free information. Masterprint Company, White Building, Buffalo, N. Y.

WANTED MISCELLANEOUS

INVENTIONS Or products to manufacture or sell for the automotive market. Send description not samples. G. E. Rider, 305 Pittsfield Bldg., Chicago 2.

PROMPT Cash for machinists' squares, rules, micrometers, indicators, gages, etc. Satisfaction guaranteed. Wm. Gruer, 460 Ryerson Ave., Elgin, Illinois.

MERCURY—Highest prices. Free containers. Write. Wholesale Terminal, Norwood, Mass.

MERCURY (Quicksilver). Write for quotation stating quantity. Metallurgical Products Co., 35th and Moore Sts., Philadelphia, Penna.

BOOKS—All Kinds—Homecraft, Radio, Plastics, Boat Building, Photography, Model Building. Catalog free. Popular Mechanics Press, 200 E. Ontario St., Chicago 11, Ill.

PERSONAL

GET More out of life, details free. Gerlach, 3267 North Sixteenth Street, Milwaukee 6, Wisconsin.

BORROW By mail! Loans \$50.00 to \$1,000.00 to employed men, women. Easy quick. Completely private, confidential. No endorsers. Up to 18 months to repay. Details free in plain envelope. Write First Loan Co., World Herald Bldg., Dept. L-20, Omaha, Neb.

STAMMER? Maybe I can help. Sauers, Box 139-C, Mars, Penna.

RECEIVE Moneymaking opportunities, mails, samples, catalogs, magazines. Your name in thousand mailing lists. 25c. Glassmine, 1654-MP Amsterdam Avenue, New York 31.

HAIR Culturists never grow bald. Why should you. Write James Hilton, 4819A Fourth Ave., Brooklyn 20, N. Y.

PRETEND Visiting old touristic Quebec city. One souvenir card 25c, 5 cards \$1.00. Address return, I stamp, remail. Denis Lapierre, 131 Mauflis, Quebec, Canada.

WEEKLY Withholding tax chart, 15c coin. Box 464, Saratoga Springs, N. Y.

LET Us make a pencil portrait from your photo. Free information. Presto Method, Box 805, Dept. A, Rockford, Ill.

NIAGARA Falls cards mailed from Buffalo. You visit two places! 3 cards 25c. Address, return, remailed free! Letter forwarding. Reliable! 25c each! FAD, 26 Frontenac Ave., Buffalo 16, N. Y.

GREETINGS From national capital. Post cards 3-35c, folders 30 views 40c, 3-81. You write 'em, stamp 'em, we mail free. Letters forwarded 25c each. R.P.C., 5009 7th Pl. N.W., Washington 11, D. C.

MAKE Believe touring Ceylon. Send dollar bill for 3 views. Return, I stamp, remail Colombo. Ernest D'Crux, Post Box 3, Nugegoda, Ceylon.

FROM Washington, D. C., Baltimore, Md. We remail postcards, letters. Quantity rates, quality service. Remail Service, 2729 Huntingdon Ave., Baltimore 11, Md.

SWAPPERS! Traders!—Free information. "Swappers' Gazette," 2836-PM Slevin, Louisville 12, Kentucky.

RUPTURED? Positive comfort, no understraps, no steel, no elastic. Write Smith Manufacturing Company, Preston, Ontario.

HAIR Falling? Dandruff? Write Trichologist, 137 Lewis St., Phillipsburg, N. J.

HOW You can find out! Information discreetly developed, any matter, person, problem, anywhere. Personal-business assignments, representations, undertaken. Nation-wide. Officially licensed and bonded service established 1922. Reasonable. All inquiries confidential. William Herman, 170 Broadway, New York.

MISCELLANEOUS

SURPRISE Friends. Letters forwarded Los Angeles, Hollywood 25c, 3 for 50c. Box 607, Los Angeles 43.

ORANGES At their best. Delicious, tree-ripened fruit direct from grove. Half-bushel \$2.95, bushel \$3.95 delivered. Prompt shipment. Satisfaction guaranteed. Zims, Glenwood 17, Florida.

FRIENDS Astounded, visit Glacier National Park, Spokane, Grand Coulee Dam, by proxy, 3 post cards 25c, you address return I mail, letters remailed 15c. Souvenirs of above, engraved penny 25c, charm bracelet \$1.00. Junior or adult, all for \$1.50. Western Souvenirs, P.O. Box 1017, Spokane, Wash.

FREE—New 42-page book entitled—"How To Become a Successful Direct Salesman," written by salesmen for those who want to become salesmen and earn up to \$100 and more weekly. Send penny postcard, Specialty Salesman Magazine, Dept. PM-2, 307 N. Michigan, Chicago 1, Ill.

KILLER! Use a really new, really effective weed killer on your lawn or farm. Slayz-Weed won't harm lawn grass yet it kills most weeds. Up to 5,000 square feet coverage with a one dollar supply. This amazing new product contains 70% 2,4-D. It's easy, quick and safe to use. Send \$1.00 today for a generous supply of Slayz-Weed. The Chapman-Gilbert Company, Inc., 2201 Kettner Blvd., San Diego 1, California.

MINIATURE Cactus plants, 10 varieties. Instructions. \$2.00 postpaid. Refundable. Natural Desert Displays, Box 876, Coolidge, Arizona.

PLANNING To Build? I furnish you sturdy practical concrete block mould. Make 100 blocks per day, save 1/2 cost of blocks, \$20.00 fob. Particulars free. Bryan's Wood Finishing Shop, Rt. 1, Greenwood, S. C.

PAINT Crackles forming designs. Samples 15c, 25c. Circular free. Mapcol, Hasbrouck Heights, N. J.

LARGE Size shoes for men. Sizes 11 1/2 to 16. Most widths. Satisfaction absolutely guaranteed. Write today. Kingsize, 120, Brockton, Mass.

YOUR Vacation in "Colorful Colorado" will be all too short, unless you plan your excursion beforehand. The "Preview Pack" containing roadmaps, full colored mountain views, illustrated, descriptive matter of tours, dude ranches, fishing spots, and suggestions will save you time, gas and many wild-goose chases. Send one dollar, now, for this "Preview Pack," and enjoy many hours of keen anticipation. Address: Colorful Colorado Preview Service, Box 1734F, Denver 1, Colorado.

GET What you want! We'll swap you something you can use, for things you no longer need—Guns, motors, etc. (Ship prepaid). The Swap Shop, N. Fla. Ave., Lakeland, Fla.

SEPTIC Tank booklet—Details complete system 50c. Bruvold, Hebron, North Dakota.

PERFUME Oils—Pound Jasmine Synth. \$1.70; Lavender Spick \$2.95; Bergamot Synth. \$4.95; add postage. Samples all above oils 25c. Price list, stamp, G & W Supply Co., 217 E. State St., Trenton 10, N. J.

TAKE Down, put up, conventional storm sash, no ladder, any floor. Instructions \$1.00. Reed, 9506 Winchester, Chicago 43.

WANTED—1000 Foot sufferers to test Custom Made Research Foot Balancers at our risk. Amazing foot relief awaits you. Rush name and address for free trial offer. Kindschi Foot Appliances, Dept. A4, 321 W. Jefferson, Dallas 8, Texas.

LEATHER Sandals outdoor shoes. Send footprints. Men's \$4.00, ladies' \$3.00, children \$2.50. Guaranteed fit. O. F. Burke, Sebring, Fla.

KITE Fliers—Have fun, make money with the astonishing Paratripper. Automatically releases parachutes any altitude. Send 25c for complete kit and instructions. Lad Ventures, Division B-447, 4815 Newport, San Diego 7, California.

SWISS Musical movements \$4.25. Swiss music boxes. Lucite photo albums. Novelties of Distinction, 131 West 42nd, New York 18, N. Y.

PANNING Gold—Learn now. \$60 ounce possible soon. Free illustrated booklet. How To Get Started. Catalog, mining books, supplies. Old Prospector, A-55, Dutch Flat, Calif.

INFORMATION. Any subject. The Roxbys, 747 S. New Hampshire, Los Angeles 5.

GIGANTIC Mails, magazines, catalogs, listing 10c, three times 25c. Waddell's Directory, 341 East 76th, New York 21.

FREE—Samples, magazines, catalogs, literature, moneymaking opportunities! Receive lots of mail from everywhere! Mails galore! Your name listed in over 15,000 "Surefire" mailing directories, \$1.00. 5000 listings, 50c; 2000, 25c. Stanford, 6220-M 16th, Philadelphia 41.

INSULMIX Insulates, makes warm basements, cement block houses. Also fade-proof cement colors cement. Blue Square, Excelsior, Minn.

SQUARE Dance calls, instructions, illustrated. \$1.00. Guide, Eureka Springs, Arkansas.

ZIRCON, Diamonds only rival available, reconditioned watches, catalogue free. Bluebonnet Jewelers Exchange, #2500 Carter, Ft. Worth 3, Texas.

THAT "Hard-to-find item"—we'll help you locate it! Send 25c coin for supplier's name-address. Wyterce Co., Dept. PMt4, 366 Madison, New York 17.

PROFIT And pleasure. Mailorder business in your sparetime. Free details, Box 121, Lefferts Sta., Brooklyn 25, N. Y.

KU-KUL-O-GRAPH—An ingenious mechanical device for automatically creating, drawing countless intriguing, novel patterns, designs. Fascinating, entertaining, useful. \$1.75. Free details. Nelson Manufacturing, 948A First, Woodburn, Oregon.

MEXICAN Jumping beans. July to December delivery. Order now. Dozen 25c; hundred \$1.00; thousand \$5.00. Mexican Products, 126 N. Main, Tulsa, Oklahoma.

GROUND Peanut hulls, just the thing to keep roses and other flowers blooming all summer; will also keep tomato plants bearing longer. Plants with two inch layer of hulls on ground around roots never require watering even in summer's driest spells. Minimum order 100 lbs; three cents per lb. f.o.b. Keel Peanut Company, Greenville, N. C.

"THE Case for Creation," 85c. Christian Evidence League, Malverne, N. Y.

MAKE Your own Plastoplate printing cuts. Simple, easy process. Plastoservice, Argyle 1, Wisconsin.

SENSATIONAL Genuine ball point pen only 50c and stamp. Thomas Pens, Box 3, Station W, Brooklyn 11.

MASTER Penman sends twelve different studies of your signature for two dollars. Please hand-print name. Handwriting Expert, Duluth Business University, Duluth 2, Minnesota.

PRECISION Thermometer, minus 30, plus 120 Fahrenheit. Ideal for all temperature control work, photography, chemistry, meteorology and general laboratory processes, only 79c each. Postage prepaid. Agents wanted. Maniplot Products Company, 277 Broadway, Dept. M, New York 7, N. Y.

AT Home—Your own manufacturing business; making popular \$1.00 novelties. Cost you 3c to 15c. Everything supplied. Write So-Lo Works, Dept. S-6002, Loveland, Ohio.

BIGGEST Money in tattooing now! No experience required. Complete instructions with outfit. Send for free literature. Tatuco, 651M South State, Chicago.

LUMINOUS Statuettes. Dutch boy, lamb, bear. \$1.00 each. P.O. Box 66, Orange, Mass.

ARTISTIC Bronze grave markers. Reasonable. Berg, Box 3162-A, Bridgeport 5, Conn.

"RECEIVE Mail." Moneymaking offers, opportunities, catalogs. Name listed 10c. Ideal Service, 100, Park Ridge, Ill.

JACKASS Cigar lighter. Amusing novelty. A laugh with every light. \$1.00 prepaid, or \$1.10 c.o.d. Mondell Company, 1261 Big Bend, St. Louis 17.

GET Big mail. Samples, catalogs, moneymaking opportunities. Your name put on many mailing lists. 10c. Lloyd Linde, 14147 School, Chicago 27.

POCKET Size can openers. Fits on your key ring. Send 25c in coin (no stamps) for trial order of 6. M.B.V. Sales, P.O. Box 1086, Fort Wayne, Indiana.

BAROMETER, Weather forecaster, accurately forecast weather. 4 inch dial, green leatherette case, \$2.50 postpaid. Morrison Co., Box 1313, Columbus, Ohio.

INDIAN River citrus fruits, Florida's juiciest. Basket-packed fresh from trees. Send stamp for price-list. Schuyler Jackson, Wabasso, Fla.

RARE Garden, field and tree seeds. Mexican Products Co., 126 N. Main, Tulsa 3, Okla.

GOOD "Used" self-instruction educational books on all subjects bought, sold, rented, exchanged. Satisfaction guaranteed. Complete information and 100-page illustrated bargain catalog free! Write—Nelson Company, Chicago 5.

PURE Vermont maple sugar postpaid in \$1, \$2 and \$5 lots. Eulalia Turner, Poulney, Vermont.

8 ALNICO Magnets plus 100 experiments, \$2.00. Eljay, Box 891, Newark 1, N. J.

BOOKFINDERS! (Scarce, out-of-print unusual books.) Quickly supplied. Send wants. Clifton, Box 1377PMM, Beverly Hills, Calif.

TATTOOING Outfits—engraving outfits. Circulars free. Write, Zeis Studio, 728 Lesley, Rockford, Illinois.

MEDICAL Laboratory technicians in great demand. We train you in your spare time, in your own home. You can practice while studying. Write for free catalogue. Imperial Technical Institute, Box 973-J, Austin, Texas.

CALENDAR 1753 To 2152. Shows actual calendar for each month. Accurate, simple and durable. 35 cents postpaid. Tracy Newton, Decatur, Georgia.

70 BIBLE Lessons, 25c. Bulletin, Box 87, Station H, New York 25.

M-SCOPE Metal, mineral locators latest 1947 electronic type ready for immediate shipment. Fisher Research Laboratory, Inc. manufactured some of the finest metal-locators for the U. S. army. Experience gained is yours in the most efficient metal, mineral locator. Free 16-page booklet upon request. Credit plan available. Fisher Research Laboratory, Inc., Palo Alto, California.

FREE—"Amazing New Book"—"Profits From Classified Advertising." Tells how and what to advertise. Be sure to read this book before you invest one cent in advertising. Remember—It's free! Write for your copy now. F. W. Johnson, Classified Advertising Manager, 200 East Ontario Street, Chicago 11, Illinois.

LOANS *by* MAIL

\$50 to \$300 IN A HURRY

CONFIDENTIAL

Salaried people, men or women, married or single, loans on your own signature, or your own security. NO personal interview. NO co-signers needed. NO wage assignments. You mail the application to us... we mail the money to you.

FOR A LOAN OF	YOU CAN REPAY MONTHLY			
	IN 15 PAYMENTS	IN 12 PAYMENTS	IN 9 PAYMENTS	IN 6 PAYMENTS
\$ 50	—	\$ 5.03	\$ 6.43	\$ 9.24
100	8.40	10.07	12.87	18.48
150	12.60	15.10	19.30	27.73
200	16.75	20.09	25.68	36.91
250	20.85	25.02	32.02	46.05
300	24.93	29.94	38.33	55.17

The above payments made at regular monthly intervals will repay the entire loan and all charges in the time indicated. Charges are based on the monthly rate of three per cent on unpaid principal balances to \$150.00 and two and one-half per cent on that portion of unpaid balances in excess of \$150.00 but not exceeding \$300.00. "Loans by Mail" may be repaid in larger amounts, more frequent payments or repaid in full at further savings to you.

CONVENIENT

Just write us how much money you need and how you wish to repay... there's no charge or obligation. Whatever your needs for cash now or in the future, write for your "Loans by Mail" plan, today.

MERCHANTS INVESTMENT CO.

819-G 1st Nat'l Bldg., Omaha, Nebr.

Without obligation, rush complete details and all papers necessary

for a loan of \$_____ to be repaid at \$_____

on the _____ day of each month.

Name _____

Address _____

City _____

State _____

Occupation _____

PRESTO! ANYONE CAN MASTER GLAZE

LEAVES HARD GLASS-LIKE FINISH
EASY TO APPLY
PROTECTS THE SURFACE
NO SNEAR OR STREAKS AS WITH WAX
LASTS SIX MONTHS TO A YEAR
SEALS THE PORES OF THE SURFACE
WILL NOT FINGER-MARK
NO OILY FILM AS WITH POLISH
SAVES YOU MONEY

Car Owners! Meet Master Glaze—the sensationally different luster for new and used cars! Not a wax—not an oil polish—not a paint!—nothing that "smears" over the surface.

MASTER GLAZE is a unique discovery—a creamy liquid—quick and easy to apply! Gives a hard, glass-like surface. Even gasoline cannot dull it! Lasts six months to a year! Amazing luster—beautiful, sparkling clean and brilliant! Doesn't finger-mark—doesn't smear! A match box full glazes an entire car. Seals the pores—protects! **NOTHING LIKE IT!**

AGENTS

An unusual opportunity! Quick, flashy demonstrator. Big profits. Good territory. Write today!

FREE SAMPLE

Just send your name and address to

MASTER GLAZE CO., 7720-585 W. Harwood Ave., Milwaukee, Wis.

SAY YOU SAW IT IN POPULAR MECHANICS

Do You Make These Mistakes in English?

MANY persons say "between you and I" instead of "between you and me"—or use "who" for "whom"—or don't know whether to spell certain words with one or two "e's" or "m's" or "r's," or with "ie" or "ei," etc. Every time you speak or write you show what you are. Mistakes in English reveal lack of education, refinement. Lack of language power prevents you from presenting your thoughts in the strongest way. Real command of English will help you reach ANY goal. Stop making mistakes in spelling, punctuation, pronunciation, grammar. Increase your vocabulary.



Sherwin Cody

WONDERFUL INVENTION

Only 15 minutes a day with Sherwin Cody's new invention—and you can actually SEE your English improve. It teaches by HABIT—makes it easier to do the RIGHT way. Wonderful self-correcting lessons.

FREE BOOK ON ENGLISH Lack of language power may be costing you friendships, income, every year. See what Mr. Cody can do for you; it costs nothing to find out. Write this very minute for free book, "How You Can Master Good English in 15 Minutes a Day." It will prove a revelation. WRITE NOW. SHERWIN CODY SCHOOL OF ENGLISH, 34 B & O Bldg., Rochester 4, N. Y.

New EASY WAY TO DRAW CARTOONS

MAKE MONEY... HAVE FUN!
10 EASY LESSONS

New EASY method teaches you to draw cartoons... tells WHERE and HOW to SELL them Send One Dollar to... **EASY CARTOONS** 4305 CROWN STREET, "M" INDIANAPOLIS 8, IND.

ONLY \$1.00

GASOLINE ENGINES

Latest type, aircooled Briggs-Stratton and Wisconsin 6 H.P. Immediate Delivery. These engines are slightly used government surplus, guaranteed by us to be in excellent mechanical and operating condition. Sale Price... **\$99.50**

Also new Briggs-Stratton 1 1/2 H. P., ball bearing engines... **\$69.50**

Limited Quantity — Act Quick
No COD Orders. Write for descriptive circular.

MIDWEST SURPLUS SALES

1520 LOCUST ST.

KANSAS CITY, MO.

GET INTO REFRIGERATION AND AIR-CONDITIONING

Build your future in fast-growing industry. Prepare for high pay jobs or get into your own business.

Send ad with name and address for information. VETERANS Eligible for training under G. I. Bill. Check here

BOSTON TECHNICAL INSTITUTE
School of Refrigeration, 4707 Euclid Ave., Cleveland 3, Ohio

COLLECTORS GUITARISTS

DJANGO REINHARDT DISCOGRAPHY
You'll treasure it! World favorite exponent of jazz.—Reviews of his many recordings, with dates, matrix, label numbers, etc. Also six pictures, plus actual autographed photograph of Django Reinhardt and 24 pages of his illustrated life story.

Send \$1 to VOLPE MUSIC CO., 32-78 88th St., Dept. M-4, Jackson Heights, N.Y.

Bicycle Repairing Pays Well!

Any one handy with tools can make money at once. Proprietor of successful shop shows how he started 10 years ago on practically no capital—completely illustrated manual covers every phase of repairs—refinishing and how to get started. Manual **POSTPAID \$1.00.**

CAHILL CYCLE SHOP, CENTREVILLE, MARYLAND

SIMPLE EASY INVENTION TRIMS HAIR AT HOME!

SAVES BARBER BILLS

Trims hair as it combs! Easy! Quick! Keeps men's, women's children's hair trim, neat, freshly-cut looking all the time! Trims, tapers, thins out uneven hair. Use like ordinary comb. Safe, Simple. No experience required. Fine for legs, underarms!

SAMPLES FOR AGENTS Sample offer sent immediately to all who send name at once. A penny postal will do. **SEND NO MONEY.** Just your name.

KRISTEE CO., 691 Bar St., AKRON, OHIO

DO ANY JOB.. EASIER.. QUICKER
MAKE MORE MONEY in the
BIG OPPORTUNITY
FIELDS

SEND NO MONEY
 Select the Books
YOU Need Now!
 We Ship C.O.D.
 Anywhere in U. S.
 and Will Refund
 Amount Paid if
 Not Satisfactory.

Here's the Help You Need
For Best Paying Jobs
Right NOW!

FREE TRIAL
IN YOUR OWN HOME

Used by Army, Navy, Other Government
Depts., 200 Schools and Industrial Firms.

Do it now! Get the better pay that goes to men with specialized knowledge. Get into one of these big opportunity fields. Big money and many other advantages await you if you prepare now. Here is the help you need—EASY—QUICK—AT LOW COST. Thousands of men have already used these famous books. Beginners and experienced men alike have doubled and tripled their earnings with this help. You too, can now get the special knowledge you need for top pay, better jobs, or a business of your own. This is your **GOLDEN OPPORTUNITY.**

AIR CONDITIONING

Big air conditioning boom interrupted by war will be bigger than ever. It's ready to GO now! Get this non-technical book by international authority and be ready for your share of millions to be spent. Covers whole field. 450 pages. Illustrated. \$4.00.

AIRPLANE WELDING

All metal airplane building offers big peacetime opportunities. New 2nd edition of this famous book by J. B. Johnson, Materials Division, Wright Field. The authoritative and practical book on Airplane welding and materials brought right up to date. 420 pages, 193 pictures. \$3.50.



MODERN WELDING PRACTICE

Newest book on all types of welding and heat treatment of metals. Written by recognized specialists in training men for production jobs. Practical and Non-Technical.

430 Pages
 277 Illus.
 Practical and Non-Technical

Covers everything you need to know. Prepare for best pay jobs now. Price \$4.00.

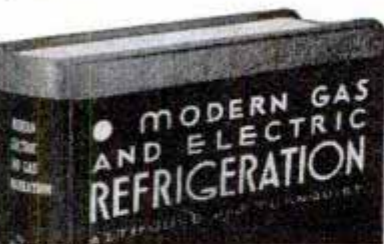

REFRIGERATION—Book of the Hour!
Biggest Opportunity in Many Years!

NEW PRINTING—ALMOST 1000 PAGES

408 Pictures—17 Diagrams in Colors Makes All Refrigerator Service Maintenance, Repairs Simple as A. B. C.

Thousands of Refrigerators need repairs! Owners will pay big for competent service which will be needed more and more. Get MODERN GAS AND ELECTRIC REFRIGERATION, the non-technical guide to all types of refrigerators and get your share of this new profit. Get a job or start your own service business. This book will help you make money anywhere. Price \$5.00.

BODY & FENDER REPAIR

Owners will spend big money to keep their good older cars looking like the new ones coming out. This is a practical money-making guide, ideal for shop owners and every man who wants a share of the millions to be spent in keeping old cars looking new. Tells how to get a good job or start business of your own with small capital. 325 pages, 232 illustrations. \$3.50.



DYKE'S FAMOUS CARBURETOR BOOK

This famous book has been the standard guide in the best paying auto work for a generation. It has helped thousands of men make money. New edition covers engine tune-up, compression, ignition, carburetion, fuel pump valves, etc. Use this book to specialize in this big field. 244 pages, 549 illustrations. \$3.50.

HOUSE WIRING NEW EDITION

Get this new sixth edition of this standard and practical electrical wiring book. It gives complete practical instruction on every phase of house wiring in one handy volume. Goes further than most books on subject. Handbook style. Gives National Electric Code. 400 pages, 669 illustrations. Electrical work will reach a new high with millions of new homes to be built. Get started now. \$3.00.

15 Million Refrigerators
Need Service and Repairs

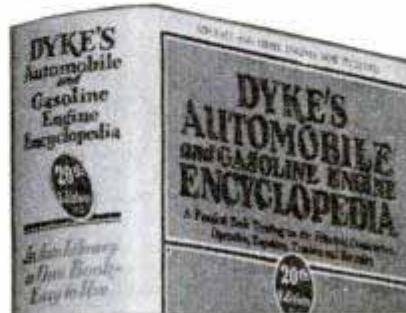

NEW 20th EDITION

Leading Auto Book for Over 32 Years

World's Greatest AUTO BOOK

New Material on Transmissions, Trucks, Tractors, Diesels, Aircraft and Auto Engines

Now with millions of cars needing repairs and thousands of men needed to do the work, you need the famous DYKE Auto Book more than ever before. Brand new 20th Edition covers all principles, construction, repair, adjustments, testing, troubles and remedies of all cars. Over a half million copies of 20 editions of Dyke's have been sold. Gives specifications of old and newer cars. **World's biggest book value. \$7.00.** This big book, a complete auto library in one volume, has 1483 pages—4600 illustrations and diagrams—weighs 6 lbs.—equal to 4 ordinary books.

ENGINEERS HANDBOOK

World famous Bailey's handbook of universal questions and answers for Stationary, Marine and DIESEL engineers and firemen. Prepares for any license examination. This is the one book that men should have if they want to reach the top in installation, maintenance and operation of Diesel and steam plants. Pocket size, \$2.00.

Goodheart-Willcox Co., Inc.
 209 S. Michigan Ave., Dept. 14, Chicago 16, Ill.

SEND NO MONEY! Mail Coupon

GOODHEART-WILLCOX CO.,

209 S. Michigan Ave., Dept. 14, Chicago 16, Ill.

Send books checked, C.O.D. I will pay postman, plus few cents charges. If not satisfactory I will return books in 5 days and you will refund money paid. (Outside U.S. or possessions remit with order.)

- | | |
|--|--|
| <input type="checkbox"/> Gas & Electric Refrigeration \$5.00 | <input type="checkbox"/> Air Conditioning \$4.00 |
| <input type="checkbox"/> Dyke's Auto Book \$7.00 | <input type="checkbox"/> Engineers Handbook . . . \$2.00 |
| <input type="checkbox"/> Dyke's Carburetor Book . \$3.50 | <input type="checkbox"/> Body and Fender Repair . \$3.50 |
| <input type="checkbox"/> Modern Welding \$4.00 | <input type="checkbox"/> House Wiring \$3.00 |
| <input type="checkbox"/> Airplane Welding \$3.50 | <input type="checkbox"/> Shop Math. (2 vols.) . . . \$3.00 |
| <input type="checkbox"/> Sheet Metal Layout . . . \$3.50 | <input type="checkbox"/> A.C. Power Wiring . . . \$4.00 |
| | <input type="checkbox"/> D.C. Power Wiring . . . \$4.00 |

If remittance accompanies order we will pay all postage charges under same return privilege.

Name
 Address
 City State

Opportunities and Advancement Get Started QUICK in DRAFTING



I Will Train You Until You Get
a **GOOD PAY JOB!** — *Engineer Dobe*

Act Now! Get ready for a better job, advancement, more pay and security. Drafting is the field of big opportunities and now bigger than ever before. Thousands of draftsmen and designers must come first—before any kind of production can begin. Get into Drafting. Engineer Dobe will train you at home in your spare time. You'll get experience on actual work—the same kind of jobs you will do for the best paying firms. You will be trained until you are competent, experienced, and are actually holding a position that will bring advancement and pay raises as deserved. Write today for details.

Previous Experience
Not Needed

I train you through practical jobs and give your experience as a reference to employers when you become competent. Lack of starting experience or higher education won't hold you back. Low cost—and monthly payments, if desired. Write today for illustrated book and all details. No salesman will call. Give your age to get reply.

WORKING TOOLS FURNISHED
Professional instruments, drawing table and other tools included and sent when you start.



Engineer Dobe, Div. 14, Libertyville, Ill.

Send me the Vital Facts on Drafting and Industrial Designing, your FREE BOOK and advertised list of positions for Draftsmen and Designers wanted.

Name..... Age.....

Address.....

City..... Zone..... State.....

VETERANS Learn WATCHMAKING

A Lifetime Profession

Regardless of Conditions, Age, Sex, or Physical Limitations
Veterans—Civilians!
Your Opportunity—
LEARN WATCHMAKING



Approved
G. L. Training

Lift yourself from a futureless job into a position paying better than your present work. Fit yourself for the job that will permit you to establish your own shop, or be employed in a pleasant environment.

Watch Repairing—Jewelry—Engraving will always be in ever greater demand. Our graduates wanted everywhere. Dignified positions \$50-\$75-\$100 per week. Veterans write today for latest FREE enrollment requirements.

Kansas City School of Watchmaking
Largest Horological School in America
617-621 Wyandotte St. Kansas City 6, Mo.

GET INTO YOUR OWN PROFITABLE BUSINESS

With Amazing **LEATHERFINISH**

- Brushes On Like Paint
- Looks and Wears Like Leather

Leatherfinish is the perfect answer to refinishing all leather and leatherette items. A new scientific discovery that can mean big profits for you. Aggressive men and women are wanted to establish themselves in this well-paying profession. Write today for full profit-making details.

CENTURY PRODUCTS CO., INC., Dept. 411
4261 N. 20th St. St. Louis, Mo.



**START
SMALL
GROW
BIG**



START YOUR OWN REFRIGERATOR REPAIR SHOP!

Learn to install and repair all types of REFRIGERATION and AIR-CONDITIONING equipment. You can start your own shop with as little as \$50 worth of tools. We show you how. Our practical, shop-tested home-training prepares you quickly and easily during your spare time, for a job or your own business in this fast-growing profitable industry. Send for FREE BOOKLET today. No obligation.

MECHANICS TRAINING SCHOOL
7217 S. Broadway, Dept. P-104, Los Angeles 3

YOU CAN DRAW

Amazing invention makes it easy. Draw professional looking drawings, cartoons, pictures. For fun or profit. No expense necessary. Write for FREE Folder.

ARTCRAFT, Box 7, Cincinnati 30, Ohio

MAKE MONEY IN YOUR OWN **SILK SCREEN PRINTING BUSINESS**

Print 100, 50c signs an hour!
Build your own press. Start with only \$50, sparetime at home!
We tell you HOW! Write today!

W. E. WOLFF CO., 817 HIGH ST., ANDERSON, INDIANA

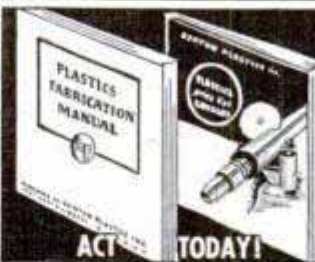

BIG MONEY FOR YOU IN PLASTICS

SEND Offer includes 2 books: New Fabrication Manual & Giant Catalog, listing the most complete stock of Plastic Materials, Accessories, Tools.

10¢
BERTON PLASTICS, INC.
19 W. 21st St., N. Y. 10, N. Y.



MUFFLERS

STEELS and ALUMINUMS with a motorboat tone
SINGLES, Chev, V-8, Plymouth, Steels \$5.50, Aluminum \$6.50. Chry., Olds., Buicks, etc., Steels \$7.50, Aluminum \$8.50. V-8 and MERCURY DUALS, Steel \$17.50, Aluminum \$20.00. Aluminums are guaranteed for life of your car.
DEALERS WANTED

SANDEE MUFFLER CO.
7523 S. WESTERN AVE., LOS ANGELES 44, CALIF.

WAR BARGAINS in LENSES and PRISMS

ASSEMBLE YOUR OWN BINOCULARS!

Complete Optics! Complete Metal Parts!
Save More Than 1/2 Regular Cost

ARMY'S 7X 50 BINOCULARS

Here's an unusual opportunity to secure a fine set of Binoculars at a substantial saving of money. Offered here are complete sets of Optics and Metal Parts for the Army's M-16 7X 50 Binoculars (M-16 is not the waterproof model). These components are new and all ready for assembly. We supply full instructions. Limit—1 set of Metal Parts and 1 set of Optics to a customer.



METAL PARTS—Set includes all Metal Parts—completely finished—for assembly of 7X 50 Binoculars. No machining required. Bodies have been factory hinged and covered. A sturdy brown leather Binocular Carrying Case is included with each set of Metal Parts.
Stock #824-H 7X 50 Metal Parts.....\$35.00 Postpaid

OPTICS—Set includes all Lenses and Prisms you need for assembling 7X 50 Binoculars. These Optics are in excellent condition—perfect or near perfect—and have new low reflection coating.
Stock #5102-H 7X 50 Optics.....\$25.00 Postpaid

NOTICE! If you buy both the Binocular Optics and the Binocular Metal Parts, your purchase becomes subject to 20% Federal Excise Tax. Be sure to add amount covering tax to your remittance or your order cannot be filled.

ARMY'S 6X 30 BINOCULARS

No Carrying Case with any Sets shown below. (None yet available in Surplus Market.) M-13A1 sets are waterproof model. M-3 sets are not waterproof. Limit—1 Set to a Customer on all Sets shown below.

COMPLETE OPTICS & METAL PARTS—Model M-13A1, 6X 30 Binoculars. Everything you need—ready for assembly. When finished will look like a regular factory job costing \$102 to \$120. The Optics are new, in perfect or near-perfect condition. Have new low reflection coating. Metal Parts are new and perfect, all completely finished. No machining required. Bodies factory hinged and covered. Complete assembly instructions included.
Stock #830-H.....\$40.00 Postpaid,
plus \$8.00 tax—Total—\$48.00

COMPLETE OPTICS & METAL PARTS—Model M-3, 6X 30 Binoculars. The Optics in this set are new, perfect or near-perfect. Prisms have new low reflection coatings. Factory mounted Eye Piece and Objective Assemblies not coated. Metal Parts are perfect, new, ready for assembly. When finished, this will look like a regular factory job, except a name has been filed off a cover plate. No machining required. Bodies factory hinged and covered.
Stock #831-H.....\$35.00 Postpaid,
plus \$7.00 Tax—Total—\$42.00

METAL PARTS ONLY—Model M-13A1, 6X 30 Binoculars. No Optics. Same Metal Parts as described for Stock #830-H.
Stock #832-H 6X 30 Metal Parts.....\$25.00 Postpaid

METAL PARTS ONLY—Model M-3, 6X 30 Binoculars. No Optics. Some machining on these Metal Parts required. Bodies hinged and Prism Shelf holes placed, but you must tap them. Prism Shelves have been machined. Six lead spiral focusing threads have been cut. Some less difficult components you must thread and machine yourself, but all material you need is furnished except body covering material and Optics.
Stock #833-H 6X 30 Metal Parts.....\$12.00 Postpaid

OPTICS FOR 6X 30 BINOCULARS (No Metal Parts). Slight seconds. Cemented but not coated.
Stock #5123-H.....\$10.00 Postpaid

SAME OPTICS AS ABOVE (6X 30), but coated.
Stock #5124-H.....\$12.75 Postpaid

If you buy both the Binocular Optics and the Binocular Metal Parts, your purchase becomes subject to 20% Federal Excise Tax. Be sure to add amount covering tax to your remittance or your order cannot be filled.

Optics and Metal Parts are Available for Monoculars (1/2 a Binocular). For Complete Details, Write for Bulletin #14-H.

BATTERY COMMANDER'S PERISCOPE

With Tripod—6 Power Instrument. Excellent condition. Length 27 1/2 inches—diam. 1 1/2 inches. Cost U. S. Gov't approximately \$175.00.
Stock #717-H.....\$20.00 F.O.B. Audubon

SATISFACTION GUARANTEED

YOU CAN EASILY MAKE

Telescopes, Magnifiers, Photographic Gadgets and
Hundreds of Experiments with these Low Cost Lenses

23 POWER PRISM SPOTTING TELESCOPE SET—Optics consist of perfect Achromatic Objective with dia. of 64 mm. and 20 inch F.L. (not a War Surplus item), an Eye Achromat. Field Lens and Prisms from 6X 30 Binocular. These are slight seconds. All low reflection coated except Objective. Half a covered 6X 30 Binocular Body, all parts for Eye-Piece end and Prism Shelf section are supplied. You must furnish an extension tube and any parts needed to mount the Objective Lens.
Stock #5127-H.....\$21.00 Postpaid

SCHMIDT OPTICAL SYSTEM. Black plastic body, size 3-15/16" by 5 1/2". F.L. 2.4" . . . with amazing speed of F.0.9. Used in Navy's Infra-Red Sniperscope and Signaling Units. Gov't cost \$134.00. Limit—1 to a customer.
Stock #720-H.....\$6.00 Postpaid

MOUNTED PROJECTING LENS SYSTEM. F.L. 91.44 mm. (just right for 35 mm. Projectors). Speed of F 1.9. Outside dia. of mount at one end 60 mm. Length of mount 64 mm.
Stock #4033-H.....\$3.00 Postpaid

MOUNT FOR ABOVE PROJECTING LENS SYSTEM.
Stock #715-H.....\$1.50 Postpaid

POLARIZING VARIABLE DENSITY ATTACHMENT FOR 7X 50 BINOCULARS—An amazingly effective unit for controlling amount of light reaching your eyes. Cuts down glare in sky and overwater observations. Easily snapped on and off over the eye cups of American-made 7X 50 Binoculars. Gov't cost \$8.30 each.
Stock #20,000-H.....\$2.00 Postpaid

CONDENSING LENSES for 35 mm. Projectors and Enlargers. Consists of set of 2 Lenses—diam. 2 3/8", F.L. 3" each.
Stock #1077-H.....\$2.00 Postpaid

MOUNTED KELLNER TELESCOPE EYE PIECE—Perfect, coated, in Ordnance sealed boxes. F.L. 1 3/4 inches. Outside dia. of steel mount 40 mm.
Stock #6198-H.....\$3.15 Postpaid

OPTICAL BENCH KIT—(Not a War Surplus Item). Everything you need, including four Lens Holders for checking Focal Lengths and setting up Lens Systems.
Stock #53-H.....\$8.50 Postpaid

35 MM. KODACHROME PROJECTING LENS SET—Consists of Achromatic Lens for projecting, plus a Condensing Lens and piece of Heat Absorbing Glass with directions.
Stock #4025-H.....\$1.95 Postpaid

AIR FORCES GUN SIGHT

With Polarizing Variable Density Attachment

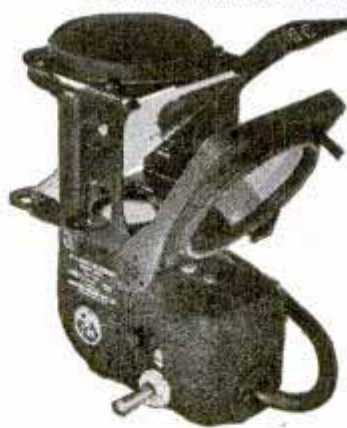

Can be used as Slide Viewer, or take it apart and you can get Polarizing Variable Density Attachment, Mangin Concave Mirror, Reflector Plate, Metal Reticle, Window, Lamp Housing, Ring and Bead Sight. The Polarizing attachment alone is worth many times the price of entire unit. Consists of 2 Polarizing Filters mounted with small handle which rotates one around the other. May be used in Photography, Research, Experiments, as Light Dimmer, etc.

Stock #908-H.....\$5.00 Postpaid
Same Unit Without
Polarizing Attachment

Stock #916-H.....\$2.50 Postpaid

BOMBER SIGHTING STATION—A double end Periscope Type Instrument of highest precision. Brand new and in perfect condition. 6 ft. tall, shipping wt. 360 lbs. Orig. cost \$9,850. Consists of numerous Lenses, Prisms, Mirrors, Gears, Motors, Metal Parts and Electrical Gadgets.
Stock #914-H.....\$50.00 F.O.B. Oklahoma

TANK PRISMS—90-45-45 deg., 5 1/4" long, 2 1/8" wide, finely ground and polished.

Stock #3004-H Silvered Prism (new & perfect).....\$2.00 Postpaid

Stock #3005-H Plain Prism (new & perfect).....\$2.00 Postpaid

Stock #3100-H Silvered Prism (Second)....\$1.00 Postpaid

Stock #3101-H Plain Prism (Second).....\$1.00 Postpaid

We have literally millions of war surplus lenses and prisms for sale at bargain prices. Write for Catalog "H" — Sent Free!



Order by Stock No.

EDMUND SALVAGE CO. P. O. AUDUBON, NEW JERSEY

Get into

ELECTRICITY & INDUSTRIAL ELECTRONICS

START NOW — BE READY IN FEW WEEKS

MODERN SHOP TRAINING

**FOR BIGGER JOB OPPORTUNITIES
LEARN ON ACTUAL EQUIPMENT
IN NATIONALLY KNOWN SCHOOL**

Now!

Get ready for good job or business of your own. Electricity is the heart of modern industry. Electricians are always needed, earn higher pay, work year around. Make rapid progress in step-by-step practical shop training in Electrical Wiring and Circuits; Armature Winding; Electrical Appliance Repairs; Electro Plating and Welding; Rural Electrification, the Building Boom, many new uses of Electricity opening more opportunities in this vast field. Get training under thoroughly experienced instructors, be ready in few short weeks for Job Opportunities in Electricity.



VETERANS qualifying under "G.I. Bill" have tuition paid by Government plus monthly subsistence allowance while in school. Just mail coupon, we will handle all details. (LOW TUITION, EASY TERMS if you are not a veteran.)

**ELECTRICAL DIVISION
COMMERCIAL TRADES INSTITUTE,
Dept. C-24**

6312 N. Broadway, Chicago 40, Ill.



FREE — Important Information Telling How to Get Started

Fill Out, Cut Out, Mail Today

FACTS FREE for Men Who Want to Get Ahead

COMMERCIAL TRADES INSTITUTE, Dept. C-24
6312 N. Broadway, Chicago 40, Ill.
Send free illustrated Brochures and other information about your training in Electricity.

Veteran Non Veteran

Name
Address
City State

SAY YOU SAW IT IN POPULAR MECHANICS



**SICKNESS or ACCIDENT
can't rob me of my savings**

**I'VE A FAMILY MUTUAL
HOSPITALIZATION POLICY**

Costs **3¢** A DAY · EACH ADULT
only **1½¢** A DAY · EACH CHILD

Benefits begin the day you enter a hospital
FOR SICKNESS OR ACCIDENT
Hospital Expenses paid, up to \$540.00
(beginning with the first day)
FOR ACCIDENT
Doctor Expense paid, up to \$135.00
Loss of Wages reimbursed up to \$300.00
Loss of Life by Accident \$1000.00
WAR COVERAGE AND EXTRA BENEFITS
Childbirth Expense paid, up to \$75.00

Sickness or accident can easily wipe out, in a few weeks, savings it may have taken years to accumulate. Don't let this happen to you. With a Family Mutual Hospitalization policy you'll be able to pay your hospital bills. In case of accident, you will be reimbursed for your doctor expenses and for loss of time from work. You may choose any hospital in the United States and your own family doctor may attend you. Benefits applying to children are 50% of those paid adults.

MAIL COUPON TODAY—No Agent Will Bother You

FAMILY MUTUAL LIFE INSURANCE CO., WILMINGTON 99, DEL.

Family Mutual Life Insurance Co. PM-18
601 Shipley St., Wilmington 99, Del.

Please send me, without obligation, complete information on your Economical Hospitalization Plan.

NAME
ADDRESS
CITY STATE

1847 A CENTURY OF PUBLISHING 1947
MERRIAM-WEBSTERS

The Handy-Sized Merriam-Webster

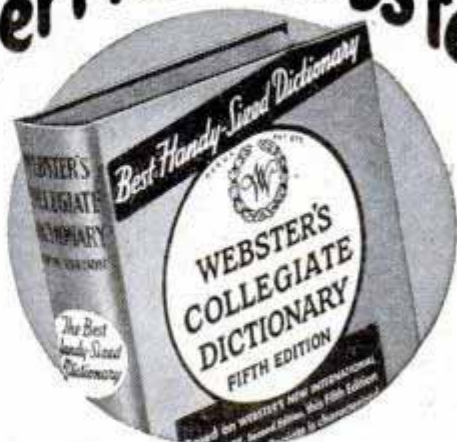

WEBSTER'S COLLEGIATE is the most dependable handy dictionary for home and office because it is a compact abridgment of the famous *Webster's New International Dictionary, Second Edition* — "The Supreme Authority." Defines all the words most commonly used. 1,300 pages; 110,000 entries. \$5 to \$10, depending on binding. Ask your bookdealer.
G. & C. MERRIAM CO., SPRINGFIELD 2, MASS.

MAKE YOUR OWN PLASTIC PRODUCTS

Operates hydraulically. Accurately. Economically. Pays **BIG DIVIDENDS** in a hurry. Electrically controlled heat under varying degrees of pressure and temperature. Used for hundreds of molding needs. Essential for **MANUFACTURERS, CUSTOM MOLDERS, INDUSTRIAL LABORATORIES, HOME WORKSHOPS, UNIVERSITIES** and **COLLEGES**. Saves money and makes money.

from **Molding Powders**
QUICK and EASY
with **The All-Purpose S-K-W COMPRESSION MOLDING MACHINE**

Write For Free Particulars

CLARENDON MFG. CO., Dept. P-4, 176 Adams St., CHICAGO 3



Learn modern watch and clock repairing

At home, spare time. Good field now... security and contentment in future. Start part-time business and **EARN while you learn**. Horology is precision instrument work... a great and growing field, sensational opportunities. Easy self-instruction course. Low price. **Money-back guarantee**. Write today for **FREE Success-Catalog!**
NELSON CO., 1139 S. Wabash Ave.
Dept. D-02 Chicago 5, Illinois

Thrilling Work COLORING PHOTOS

Fascinating vocation learned at home by those with aptitude. Thrilling pastime. National method brings out life-like colors. Free booklet.
EASY TO LEARN
NATIONAL PHOTO COLORING SCHOOL
1315 S. Michigan, Dept. 1354, Chicago 5

PULVEX FLEA POWDER

now also contains
Guaranteed by Good Housekeeping
if ineffective or not as advertised thereon

Kills the fleas QUICKLY!
Keeps others off for days!
Still 25¢ and 50¢



POPULAR MECHANICS

SAVE

up to **85%**

in WAR SURPLUS

at

"GADGETEER'S HEAVEN"

IN MANY ITEMS WE HAVE THE WORLD'S LARGEST SUPPLY



HYDRAULIC

Cylinders, Valves, Pumps, Fittings, Hose, Tanks

New! 51 sizes & types.

The World's Largest Supply
1001 LABOR SAVING ADAPTATIONS for pulling, pushing, pressing, lifting, tilting, squeezing, etc., operations. Finest precision workmanship. Aircraft alloy of aluminum and chrome steel, guaranteeing trouble-free operation. Liquid and/or air operation, developing terrific power.

PRICE TO SELL AT 15% GOVERNMENT COST!
WRITE FOR CATALOGUE.

CANTEEN #301

G.L. 1 qt. Aluminum, Porcelain lined and covered. Plastic screw top chained to body.

Slightly used but perfect.

cup 19c **59¢**



MESS KIT

Reg. 2-pc. Army. Aluminum. Folds into compact, non-rattling unit. Cover is 2-part dish.

Slightly used but perfect. #302 **79¢**



SLEEPING BAG

NEW! 100% wool. Mummy type Heavy duty 30" zipper.

Gov't. cost \$23.00

\$1 extra for used water repellent cover. #303 **\$4.95**



1/3 to 1/5 Gov't. Cost (approx.)

Air Corp Flange-lined LEATHER JACKET

To keep you warm in the coldest wind. Made to last practically a lifetime. Full sheepskin-pelt. Flange-lined collar. Leather taped seams. Full length zipper. 2 zippered, deep, slash pockets. Adjustable strap & buckle at throat. Type D-1. Styled for easy, hind-free action. Soft, silent "aviation tan" leather. Made to U. S. Gov't. specifications. "not sold!" Sizes: #401, small; #402, medium; #403 large. You've never seen them at **\$10.95** these prices! NEW... Used **\$8.95** (used cont.) **\$7.95**

WHILE THEY LAST!



A Real BUY!

New A 1000 uses!

WINCH HOIST

Capacity 2500 lbs. Winch with steel cable 1/4" diam. Ideal for garages, truck loading, machine shops, boat building, etc.

Without handle #100A **\$10.75** #100 **\$12.50**
With handle



GUN SIGHTS

L-3 **\$2.25**
con-co. tains triple lenses #102

#8A, with polarizer #103 \$3.95
K-18, Optical Gyroscope #104 \$8.75



Stop Watch

Elgin 15 jewel Waltham. Pocket style. Shatter-proof crystal. Split seconds (1/10th). Waterproof. In stainless steel, spring suspension case. #300 **\$12.75**

\$45 Value



Goggles

New. All purpose type. Shatterproof. Polaroid lenses. Sponge rubber trim.

Flexible lens (optional). Adjustable headband. Extra lens. With case. #305 **59¢**



9 Volt, dry Battery

New. Full strength. 8 1/2 x 6 x 4 in. Can be used for 6 volts. For portable radios, electric tools, signal lamps, boats, etc. 3 run a 24 volt motor. #315 **79¢**



Compound Action Metal Snips

Hard steel blades. Expansion spring. Locking device. Both lefts & rights. Now **\$2.59**

#107



Electric Motors

24 Volt.

NEW! #100
1/2 h. p. **\$5.45**
Only #101 **\$4.25**
1/2 h. p. Used #102 **\$3.95**



PRESSURE TANKS

Stainless steel, shatter proof. 400 lbs. /sq. in?

G-2 2100 cu. in. 26 x 12 in. #105 \$4.75
D-2 500 cu. in. #104 2.25



AMP. & VOLT METERS

Amp meter, A.C. - D.C. #510. Volt meter A.C., D.C. #511. Combination volt and amp meter. Each **\$2.50**



HAMMER

Ax & hammer combination for wood & metal work. 3 1/2 lbs. 14 1/2" hardwood handle. Hard steel cutting edge. #108 **69¢**



LIQUIDOMETER

\$10 value in parts alone! Used for any type of gasoline tank, with any automobile gage. A sensational value!

Elect. lit. box w/ 2 exposed pilot magnets. #109 **\$1.95**

Gov't. Cost \$40.00



COMPRESSOR

complete with tank and fittings.

G.E. 2-stage, A.C. or D.C. 1 1/2 h.p. 1000 lbs./sq. in. Spraying, laboratory use, inflating, painting. #106 **\$17.95**

Compressors and 24 volt motors can be adapted to 110 A.C. with transformers or 4 - 1000 heating elements. We stock both.



GADGET MIX

Hobbyists! An Unequaled Value!

Rivets, spacers, clamps, #104 5 Lbs. belts, nuts, radio parts, gears, etc. A gold mine! **\$1.19**



WORK HELMET

Alum. 2-pc. Leather pad allows air circulation around scalp. Slightly used but perfect. 12 oz. #400 **59¢**



VALUABLE GEARS

Bargains!

8 to 1 ratio, spindle drive... #110 \$2.98
4 to 1 with screw shaft... #111 4.95
85 to 1 (can be used for radio beam antennae, etc.)... #112 3.95
2 to 1. Box gear type... #113 4.95
1 to 1... #114 3.95

Flexible gear shaft with end drives. 30" #115 \$1.00



CLAMPS

Adel. Alum. rubber lined. Mixed. 4 doz. 25c. Aero-Seal. Rust resistant. Slotted with screw gear top. 1 1/2" to 2". Reg. 27c. New 10c \$1. doz. #120



ORDER DIRECT FROM THIS AD
All sales final. Make remittances by money-order, bank draft or personal check. Purchase orders acceptable from D & B firms. All quotations F.O.B. Los Angeles. BIG ILLUSTRATED CATALOGUE AVAILABLE
Send 25% deposit with C.O.D. orders. Also Aircraft Supply Catalog

PALLEY SUPPLY CO.

DEPT. PM47 10460 SO. VERMONT AVE. LOS ANGELES 44, CALIFORNIA

THE LARGEST FIRM OF ITS TYPE IN THE WORLD

COMPARE OUR PRICES WITH ANY OTHERS!

When in Southern California visit "Gadgets Heaven" at 6321 San Fernando Road — one of the showplaces of Los Angeles County

How the Russians learn Russian

Russians learn their language as you learnt English; not by studying it, but by living with and using it. That is nature's way. The Linguaphone Method is so successful because it employs that natural, effortless method. Instead of formally "studying" the language, you hear it spoken by the voices of expert native teachers. You follow their conversation in the text book, you listen and understand. Soon you yourself begin to speak and then to write the language easily and fluently. Thousands of people who thought they had no gift for languages have learned to speak Spanish, French, German, Russian, or any of 25 other languages, by this simple method in an amazingly short time. So can you.

Send for the **FREE** Linguaphone Book which reveals many little-known facts about mastering a language *in your own home.*

LINGUAPHONE INSTITUTE
98 RCA Building, New York 20, N.Y.
Without cost or obligation, send me the illustrated Linguaphone Book.

Name

Address

City..... Zone....

Language you want to speak.....

Are you a Veteran?.....

If you are a veteran, you can take a Linguaphone Course under the G.I. Bill of Rights.

BIG MONEY NOW IN YOUR OWN BUSINESS

Amazing Scientific Development Brings You a Fast Money Making Opportunity

A wonderful scientific discovery, now available for general use, enables you to start your own highly profitable business. Plastics, one of the country's fastest progressing businesses, brings brilliant opportunities to all aggressive men and women. Start in this highly profitable industry on a full time or spare time basis. Work in your own home. No experience necessary.

LIQUID MARBLE

Make this amazing plastic of untold uses. Liquid Marble can be cast in Flexible Molds into all types of useful and artistic articles as book ends, souvenirs, statuary, toys, etc.

FLEXIBLE MOLDS

For a few cents you can make your own FLEXIBLE MOLDS to use hundreds of times.

COMPOSITION FLOORING

Easy to make, big demand. Fiber-Tite Flooring enables you to cash in on today's great building boom.

MARKET IS LIMITED

You will find a steady year 'round demand for these products. Your big problem will not be in selling, but in supplying the great demand.

WRITE TODAY

Get in on the busy season now. Send for FREE catalog and full details of this amazing profession.

COMPOSITION PRODUCTS CO.

Box CC

Richmond Heights, Mo.

Dept. 41

Amazing New KLIK-RITE

BALL PEN

GUARANTEED to Write for Years Without Refilling
Name in 23K Gold FREE

CLICK THE BUTTON

A real BALL PEN! Works and performs exactly like highest-priced pens—PLUS amazing new "click-it-to-write" feature—PLUS "click-it-to-park-it" feature—PLUS your name in 23K gold—all for only \$2.98! Writes dry with water-proof ink—no blotter needed. Cannot leak. Writes anywhere... even under water. One piece—no cap to fuss with or lose. Touch the button on top & ball point "clicks" out to write. Another touch and the point "clicks" back into the barrel. A slim streamlined beauty—lightweight... **COMPACT!** Factory guaranteed.

Only
\$2.98

Send No Money!

Rush order today. PRINT NAME to be stamped in 23K Gold. Pay postman only \$2.98 plus few cents postage on delivery. Or send \$2.98 with order and save postage. If you are not delighted, return pen within 10 days for your money back. Order today!

KLIK-RITE PEN CO., Dept. F-69
215 W. Ontario Street, Chicago 10, Ill.

MAKE MONEY CASTING AT HOME

FREE FACTS SENT



Cast thousands of perfect Plaques, Book Ends, Ash Trays, Etc. Plaster, Liquid Marble, Etc. ENORMOUS PROFITS. Start in basement or garage. LITTLE CAPITAL NEEDED. QUICK, EASY, NO PREVIOUS EXPERIENCE NEEDED. Rubber molds for speed production. MAKE YOUR OWN. SAMPLE KIT \$1.00.
Plastic Arts Studio, Route 5, Dept. 29, Muncie, Ind.

C-THRU-MIRRORS

See thru one side. Mirror on other side. Leisurely watch others at close range who imagine themselves unseen. Loads of fun. Lasts a lifetime. 3"x4" or 2"x6" sizes only. \$2.95 postpaid. No C.O.D. One day shipment. **Beeler Enterprises, Dept. 21-D, North Hollywood, Calif.**

LEARN IMPORT-EXPORT



Represent manufacturers. Study at home. Splendid opportunities. Uncrowded field, big future. ITP trains you in few weeks. Low tuition. Diploma awarded. Folder FREE.

INTERNATIONAL TRADE PROMOTION, 246-P Fifth Ave., New York 1

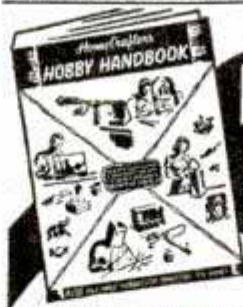

FREE NEW HOBBY HANDBOOK

A Gold Mine of Information on Newest Equipment,

Materials, Tools for HOME CRAFTSMEN AND MECHANICS

IF you work in metals, woods, plastics or glass, you need this Big, FREE Source Book of equipment, tools, parts and materials... including dozens of hard-to-get items you can't find in stores. Many things you must have for your home hobby or shop. Just loaded with ideas and illustrations.

A WAREHOUSE OF THINGS YOU WANT

More than 100 items including: Portable Welder; Bench Tools; Plastic Molder; Telephone System; Chemical Sets; Spray Guns; Electroplater; Drills; Grinders; Tool Chests; Model Tools; Key Maker... everything you need for your hobby or craft. Send for this Big, FREE Book TODAY. Mail postcard or coupon below.

WARNER ELECTRIC CO., 1512 Jarvis, Chicago 26, Dept. M-62

WARNER ELECTRIC CO., 1512 Jarvis, Chicago 26, Dept. M-62

PLEASE SEND BIG, FREE BOOK

NAME.....

ADDRESS.....

CITY..... ZONE..... STATE.....

Now Your
Dream Home
Comes True!

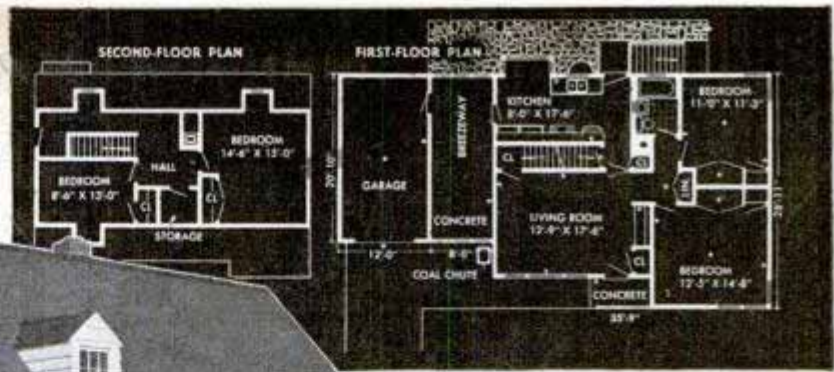
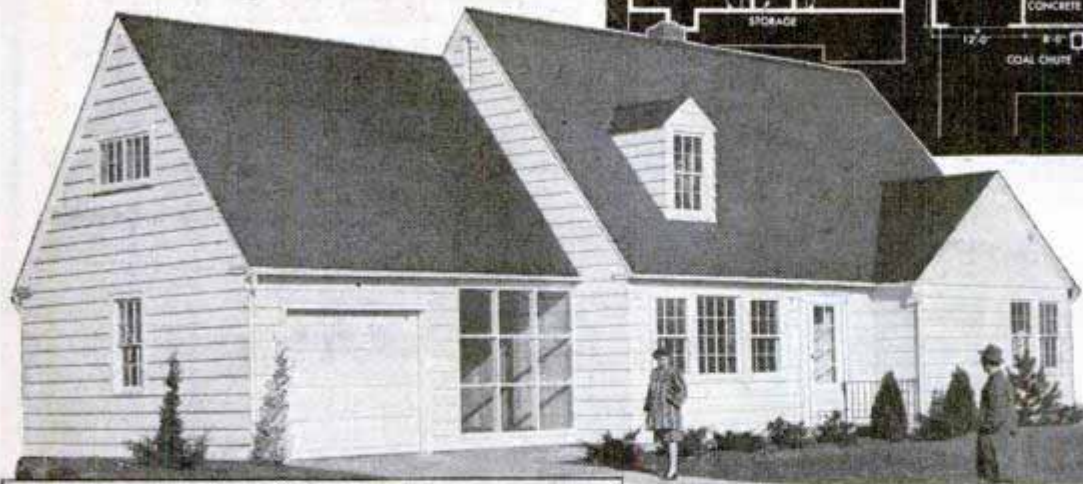

The House That Jack Built

From actual photograph of Build-It-Yourself House with breezeway and garage as built by Jack Brownson, Aurora, Illinois, a twenty-three-year-old veteran.

YOU CAN BUILD THIS HOUSE YOURSELF!

MAIL COUPON FOR BIG NEW BOOK AND PLANS • BUILD IT YOURSELF OR HAVE IT BUILT AT A BIG SAVING!

**GET THE BOOK NOW!
STUDY THE PLANS NOW!**

Start Building When You Can

You can get "Your Home and How to Build It Yourself" and complete plans by mailing the coupon below. Book is plastic bound and contains 100 pages, size 8½ x 11 inches. Three-fifths of the book consists of photographs and drawings. Several sections are printed in extra colors and a four-page, four-color insert shows just how your own house will look in actual colors. Every detail of the house and its construction are discussed in this book with minute details of Build-It-Yourself instruction that will guide you in every step.

PLANS YOU CAN READ AND FOLLOW

Plans consist of eight working size blueprints, giving floor plans, elevations, notes on construction, framing, lumber list, millwork list, specifications, plumbing and wiring diagrams. Every measurement is marked, every detail made as clear as A-B-C. With the book to guide you and the plans to follow, any handyman who can use simple tools can build this remarkable house and enjoy every minute of the work while saving thousands of dollars.



Can you use a hammer—saw a board straight—use common, everyday tools as well as the average *Popular Mechanics* reader? Then, startling as it may at first seem, you too, can build this modern house in any of its five designs, and do it easily and quickly, at a tremendous saving. *Popular Mechanics* and a famous firm of architects have designed it and worked out every detail so you can do every part of the job yourself, even though you have no experience whatever.

SPACE FOR LIVING AND FAMILY GROWTH

Illustrated is the *Popular Mechanics* "build-it-yourself" house Jack Brownson built from our plans, in Aurora, Illinois, with one inexperienced helper. This beautiful, modern house is 1½ stories, with basement, living room, kitchen, dining nook, two bedrooms, bath, plenty of closets and space for 2 additional bedrooms on the second floor. The house itself is 35'-9" x 28'-11"; breezeway 20'-10" x 8'; garage 20'-10" x 12 feet.

THE HOUSE THAT HAS EVERYTHING

The big, basic idea behind the design is ease of construction and the most living space and the most useful space, at the least cost, considering attractiveness and suitability for any neighborhood and most income groups. On top of this is its adaptability to other types of architecture, such as modified Dutch Colonial, modified Cape Cod, plain gable roof house without dormer windows, or the house as pictured, but without garage and breezeway.

USE CONVENIENT ORDER COUPON

You may never have thought about actually building your own house, but you can do it. And now that building restrictions have been lifted, it's easier than you think. So send for the big new book—Your Home and How to Build It Yourself, and set of construction plans, today. Even if you engage a contractor or builder to build this house for you, you will need the plans. Then too, you will certainly want the book, which can easily save you countless hundreds of dollars whether you build this house or any other house of your choosing.

**100 Pages
52 in Color
60% Illus.
8½" x 11"**

MAIL COUPON FOR BOOK AND PLANS

Popular Mechanics Press,
200 E. Ontario Street, Chicago 11.

I enclose \$ _____ Send me the items checked at once.

- Your Home and How to Build It Yourself \$ 3.00
- Complete set of plans for Popular Mechanics Home 12.50
- Book and Plans at reduced price 14.00
- Duplicate set of plans 5.00

Name _____
Address _____ Zone _____
City _____ State _____

**Bigger Opportunities
Than Ever in . . .**



**AUTO
BODY
AND
FENDER
REPAIR**

● **THE FIELD IS STILL GROWING** after more than 40 years . . . expanding with the giant auto industry! Millions of new cars are getting to market, millions of old ones are still on the road—**THE NEED for MAN-POWER** in the service field is **INCREASING!**

TRAIN NOW . . . FOR THE OPPORTUNITIES AHEAD!

Don't be stuck in a low-pay job! Opportunity here is big enough for thousands to find big-pay work either in a reliable job or in their own shops. UEI teaches Auto Body & Fender Repairing the *easy* way. No special education or experience needed . . . you can start in your spare time, right at home . . . keep your job while you learn. Then, when home study is finished, you continue at the well-equipped UEI shops getting practical experience. Fix and refinish damage, replace panels and tops. Learn up-to-date methods in use of tools, spray painting, welding, metal work—all under expert supervision.

GET THE FACTS . . . FREE!

UEI HAS TRAINED THOUSANDS for opportunity fields, and students are making good. If you want to get ahead, send coupon today for free facts on **AUTO BODY AND FENDER REPAIRING**. Don't delay!

**AUTOCRAFTS DIVISION
UTILITIES ENGINEERING
INSTITUTE**

1314 Belden Avenue, Dept. 147-X,
Chicago 14, Illinois

Approved for
training under
G. I. Bill

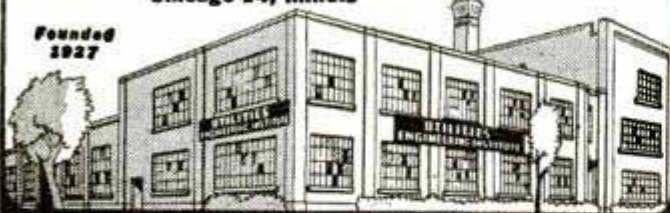

FILL OUT AND MAIL . . . TODAY!

**Autocrafts Division
Utilities Engineering Institute, Dept. 147-X,
1314 Belden Avenue, Chicago 14, Ill.**

Yes, I'm interested! Send me those Free Facts about Auto Body and Fender Repairing.

NAME _____ Age _____

ADDRESS _____

CITY _____ Zone or County _____ STATE _____

If veteran of World War II check here
 Check here for Special Information if under 17.

SAY YOU SAW IT IN POPULAR MECHANICS

INVENTORS

A New Kind of Service

**PRODUCTS AND IDEAS
INVESTIGATED**

INVENTORS—don't put the cart before the horse. Before you spend money on models, Patents, etc., find out whether your idea has any commercial value. Get full facts on new, modern Market Analysis and Investigation plan. We check markets, analyze sales possibilities, contact manufacturers, conduct sales negotiations. Help you get top prices. Service applies to both Patented and Unpatented inventions. Send at once for new **FREE** booklet, "A 12 Point Program for Inventors." **NATIONAL MERCHANDISERS**, Room 412D, Abbott Building, 28 East Huron Street, Chicago 11, Ill.



NEW FREE BOOKLET

**TO MEN WHO RESENT BEING
PUSHED AROUND IN LIFE, GREETINGS:**



*Do you know men no better than you who are doing much better than you? Do you know the reason? Learn the principles underlying achievement, contentment, a magnetic personality, better health. Back your self and dare to attack the hindrances in your life. Enjoy the thrill of progress, a sense of well-being. Reap the rich rewards of a good personality gained thru our Home-Study Self-development plan. Sincere help with a money-back guarantee of results in your case. Write today for **FREE LECTURE** and full details. No obligation.*

SCHOOL OF PERSONAL PSYCHOLOGY
(Chartered Non-Profit Correspondence Education)
Tenth Floor Washington Bldg., Louisville 2, Ky.

**AMATEUR CARTOONISTS
Sell Your Work!**

Amateur cartoons are bought by many Publishers and Firms. Our big new folio should be of tremendous help to every beginner. It tells how to present your work to best advantage—the type of cartoons wanted—where to send them—rates of pay. It covers cartoons, comic books, comic strips, advertising cartoons, syndicates, etc. A real gold mine of information for all who want to enter the big paying field of cartooning.



Complete Folio \$1.00 Postpaid.
LAWRENCE PUBLICATIONS, BOX 22
Ansonia Station New York 23, N. Y.

"PROFESSIONAL FINISHES"

Every Craftsman should have our catalog of hard to get materials: Electroplating and shop supplies; chemicals; novelty and industrial finishes for wood, metal, plastics and other materials.

CRAFT FINISHES, BOX M 467, ARLINGTON, VIRGINIA

SECRET FORMULAS PAY BIG

START NOW FOR IMMEDIATE RESULTS: Action-getting giant book with 924 big illustrated pages shows you **HOW**. This contains 10,000 practical ideas, helpful extraordinary large volume simple understandable language.

FORTUNES MADE FROM A SINGLE IDEA
Many good businesses were built on a product made from a single formula. Experts who compiled the book have made this masterwork the No. 1 authority in its field. Special equipment or previous knowledge of chemistry not needed.

START A PROFITABLE BUSINESS OF YOUR OWN
Profit from the 182,000 facts in this authentic, reliable, comprehensive book crammed with money-making ideas. A great opportunity with plenty of money awaits you. . . . \$2.98 postpaid.
Foreign or Canada \$3.25. C.O.D. in U.S.A. only.
Continental Publications, Woodside Ave. and Broadway, Elmhurst, N.Y.



**MAKE MORE MONEY
BE YOUR OWN BOSS!**

\$1.00 VALUE
25¢
**40,000
WORDS**
IN TEXT

In "CASH IN" you now get **THE** real money-makers—dozens of profitable tested mail order plans, confidential business secrets, dozens of practical tested formulas, successful tested schemes—actual experiences of men who have started on a shoestring—with less than \$10 capital.

25¢ a copy postpaid. Send U.S. stamps, money order, or coin.

MONEY BACK GUARANTEE

NATIONAL PLANS COMPANY
P. O. Box 26A, Ansonia Station, N. Y. C. 23, N. Y.
POPULAR MECHANICS

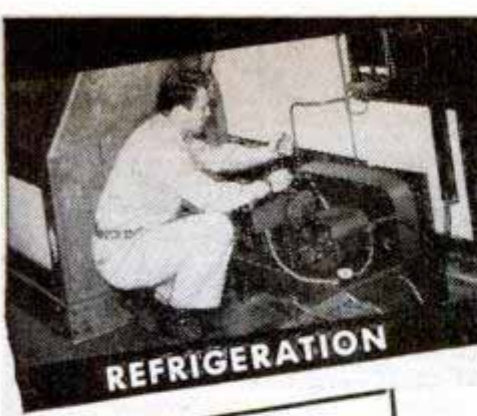

REFRIGERATION



ELECTRONICS



WELDING

Specialize in
6 months to 3 years
COURSES

SERVICE—6 months
Practical Electricity
Practical Welding
Refrigeration Service
Heating Service

TECHNICIAN—1 Year
Electro Technician
Radio Technician
Electronics Technician
Refrigeration, Heating
and Air Conditioning
Technician

PROFESSIONAL—3 Years
Electrical Engineering
B. S. Degree—Major in
Machinery or Electronics

PRACTICAL TECHNICAL TRAINING

Our time-tested *CONCENTRIC SYSTEM* enables you to build your career step by step. Each 6-month course is complete in itself. Stay as long as circumstances permit—until you reach your desired occupational objective. For 44 years this school has specialized in technical training. More than 35,000 former students in industries the world over. 1,248 students now enrolled from 46 states and 5 foreign countries. Faculty of 63 specialists. World-wide alumni counselor committee. *Terms start April, July, September.* **SEND COUPON TODAY!**

MILWAUKEE SCHOOL OF ENGINEERING

A Technical Institute

Milwaukee School of Engineering, Dept. PM-447
N. Broadway and E. State, Milwaukee, Wis.

Without obligation, send me free booklet "Career Building" and more details on course in

Name Age

Address

City State

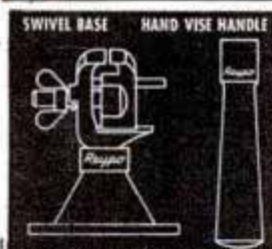

A MUST TOOL FOR FINE CRAFTSMEN
Jewelers • Technicians • Hobbyists
A dual purpose precision built vise.
Can be used as a hand or bench vise.
With swivel base . . . A quality tool.

SEE YOUR DEALER OR WRITE

Reypo CORPORATION

9900 Lincoln Blvd., Los Angeles 45, Calif.

AIR RIFLES BENJAMIN AIR PISTOLS ARE AVAILABLE

SEND FOR FREE FOLDER OF LATEST MODELS TODAY
If you want a **REAL GUN** for **PRACTICAL USE** inside or outdoors get a **SAFE - CLEAN - ECONOMICAL - BENJAMIN** with Adjustable Power and Amazing Accuracy. For **BEST RESULTS** use **BENJAMIN H-C PELLETS**. **WRITE AT ONCE.** **BENJAMIN AIR RIFLE CO., 812 MARION ST., ST. LOUIS 4, MO.**

LEARN MEAT CUTTING EASILY-QUICKLY At Home-In Spare Time



The steady, dependable trade of Meat Cutting taught easily, quickly by improved **HOME METHOD**. National School, established over 25 years, has organized its famous "Learn By-Doing" Classroom, Cutting room and Retail Market training system into sound, practical **HOME STUDY** form.

Now, by the miracle of this **EXTENSION TRAINING** you can prepare in Your Spare Time At Home, for a better job, bigger responsibilities or success and security in a store of your own. Remember, **PEOPLE MUST EAT!**

Buying, cutting, percentage, pricing, advertising, selling—a complete meat education. For beginner or men with ex-

perience. Thousands of successful graduates. Send coupon for **FREE Bulletin NOW!**

MAIL THIS COUPON TODAY FOR FREE BULLETIN

National School of Meat Cutting Dept. U80, Toledo 4, Ohio

Send me your **FREE Bulletin** on Meat Cutting and Meat Merchandising. No obligation. No Salesman will call.

Name

Street

City State

INVENTORS

The inventor who believes he has a new and useful invention, and finds himself in need of advice, should consult a competent registered patent attorney.

The question as to whether a subject matter is patentable can be substantially determined by a search of the United States Patent records.

Without obligation, write us for information as to what steps an inventor should take to secure a Patent.

RANDOLPH & BEAVERS

Registered Patent Attorneys

11-D Columbian Bldg., Washington 1, D. C.

RANDOLPH & BEAVERS

11-D Columbian Bldg., Washington 1, D. C.

Please send me full information on how to secure Patents & Trademarks.

Name.....

Street.....

City..... State.....

ELECTRICIANS

Get this Great Book

Book of 150 Shop Prints, Wiring Diagrams, Full Size 8 1/2 x 11"



FREE

For Merely Examining
Coyne's NEW Pay Raising

7 Volume Set APPLIED ELECTRICITY

Here's a brand new set of electrical books to give you the "know how" on all branches of electricity from appliance repairing to D. C. and A. C. equipment, electrical refrigeration, etc. 3,000 subjects, 10,000 facts, latest methods all explained in easy to follow instructions. In order to prove how valuable and Practical this set of electrical books is I'm willing to give you a FREE copy of my book "150 Shop Prints and How to Read Them" just for looking over this set. Written by the Coyne Technical Staff and backed by 47 years' experience, this set has helped many ambitious electrical workers to bigger pay, better jobs & added opportunity.

OFFER LIMITED - ACT NOW! Here's my offer to you - if you act promptly, I'll send you the 7 volume set Applied Practical Electricity for 7 days FREE examination... together with the 150 Shop Print Book. Look the set over 7 days. If you like it send either \$19.75 cash or send \$3.00 after 7 days and \$3.00 per month until \$21 is paid. If you don't want the set, return it and YOU OWE NOTHING. In either event, however, you keep the 150 Shop Print Book absolutely FREE.

SEND NO MONEY! Coupon below is just a request to see the books free and to get my gift book for doing it. ACT - Send coupon Today!

FREE BOOK
Coupon



COYNE ELECTRICAL SCHOOL, Dept. 47-R6,
500 SOUTH PAULINA STREET, CHICAGO 12, ILLINOIS

B. W. Cooke
Director

Send me that 7 volume set APPLIED PRACTICAL ELECTRICITY and your FREE gift of a copy of "150 Shop Prints and How to Read Them". I'll either return the set in 7 days and owe nothing or send you either \$3 in 7 days and \$3 a month until \$21 is paid or \$19.75 cash. Regardless of whether or not I keep the 7 Volume Set the 150 Shop Prints is mine FREE as a Gift.

NAME..... AGE.....
ADDRESS.....
TOWN..... ZONE..... STATE.....

LEARN WATCH REPAIRING

... AT HOME!



THERE is big money and a secure future for YOU in watch repairing even if you're just a beginner. The new "PRACTICAL COURSE" and complete "SELF-TRAINING" gives perfect SELF-TRAINING. (A marvelous refresher for Watchmakers). Every step in repair, adjustment, construction, Theory, operation. Complete coverage of tools and their use. Fully illustrated. Only... \$2.95 (If COD, plus COD charges)

\$2.95
Post Paid

Money Back Guarantee

WE SUPPLY ALL TOOLS, MATERIALS AND PARTS AT LOWEST COST - PROMPT DELIVERY!

Complete set of tools and materials for Students and Practical Repairmen. Single items of interest also. Send for FREE price list.

MODERN TECHNICAL BOOK CO., Dept. MMC
55 West 42nd Street New York 18, N. Y.

FREE - JOIN NEW TECHNICAL BOOK CLUB - FREE

We specialize in ALL BOOKS on technics: Chemistry, Plastics, Refrigeration, Building, Radio, Automotives, Mathematics, Watchmaking, Jewelry, Metalcraft, Homecraft, Farming, Sports, etc. Write for FREE literature and SPECIFY SUBJECT.

PATENTS

AND TRADE MARKS

C. A. SNOW & CO.

REGISTERED PATENT ATTORNEYS

WRITE FOR INFORMATION TO

428 SNOW BUILDING, WASHINGTON 1, D. C.

PATENTS

"Proof of Invention"
Folder mailed without obligation.

E. E. VROOMAN, Registered Patent Atty.

871 Woodward Building, Washington 5, D. C.

WINDOW SIGN LETTERS

For Store Fronts and Office Windows. Anyone can put them on. Samples furnished. Genuine Gold and Silver.

METALLIC LETTER CO., 430 N. Clark St., Chicago 10

LAW

STUDY AT HOME for PERSONAL SUCCESS and LARGER EARNINGS. 33 years expert instruction—over 108,000 students enrolled. LL. B. Degree awarded. All texts furnished. Easy payments. Send for FREE BOOK—"Law and Executive Guidance."

AMERICAN EXTENSION SCHOOL OF LAW
Dept. 76-M, 646 N. Michigan Ave., Chicago 11, Ill.

CARTOON TO SUCCESS!

Learn cartooning from a PROFESSIONAL! Let me show you how to create ORIGINAL cartoons and IDEAS. Send for FREE details about course.

Also **CARTOONIST'S MAGAZINE**—Lessons, plans and hints. Send 25c coin for copy.

CARTOONIST HARTMAN, 2776 California Court, LINCOLN 8, NEB.

RADIO PARTS GRAB BAG!!

\$25 value assortment of Coils, Condensers, Transformers, Resistors, Controls, etc. An experimenter's dream. Order today! Only... **\$3.98**

MARKO SUPPLY, Dept. PM-4
2924 Logan Blvd. Chicago 47, Ill.

Say You Saw It in POPULAR MECHANICS

CHOW PUPS

Raising world's most beautiful pet is world's most fascinating, most profitable hobby. You sell pups for \$50 up. We start you. Write—

EVENINGSHADE KENNELS, Box A-2, Helotes, Tex.

SIGNS EASILY AND EXPERTLY PAINTED WITH LETTER PATTERNS

AND SHOWCARDS MANY SIZES & STYLES WRITE FOR FOLDER!

JOHN F. RAHN
1380-31 N. Central Ave.
CHICAGO 51, ILL.



Earn While You Learn JEWELRY REPAIRING AND MANUFACTURING

From the Largest Approved School of Its Kind

Now . . . in your spare time at home, you may learn the fascinating art of repairing and manufacturing all types of jewelry—anklets, baby jewelry, belt buckles, bracelets, brooches, charms, collar grips, collar pins, crosses, cuff links, dainty pins, earrings, key chains, knives, forks, lockets, money clips, neck chains, pins, pendants, rings, sport jewelry, tie chains, tie clasps, silverware, etc.

Practical Spare Time HOME TRAINING COURSE

Prepares You For BIG MONEY EARNINGS

FROM HOME TRAINING TO YOUR OWN STORE



big-pay field and even to open a store of your own.

We Teach You All a Jeweler Should Know

Our thoroughly, practical course — that permits you to earn while you learn—includes Repairing, Manufacturing, Engraving, Enameling, stone setting, designing, plating, polishing, casting, gem setting, soldering, refining, smelting, etc. Enables you to step into a

No Salesman Will Call MAIL COUPON NOW

FREE DIAMOND Included With Working Tools



For your promptness in enrolling as a Home Student, we'll include a genuine unset diamond with working tools as part of our Jewelry Repairing and Manufacturing Home Study Course. ACT NOW!

ILLINOIS SCHOOL OF WATCH & JEWELRY REPAIRING

6312-14 Huntington St., Dept. PM-4, Chicago 30, Ill.

ILLINOIS SCHOOL OF WATCH & JEWELRY REPAIRING, 6312-14 Huntington St., Dept. PM-4, Chicago 30, Ill.

Gentlemen: Without obligation, send me FREE DETAILS of your JEWELRY REPAIRING AND MANUFACTURING Spare Time Home Study Course.

Name..... Age.....

Address.....

City..... Zone..... State.....

"GROWN-UP" TOY for MAN or BOY!

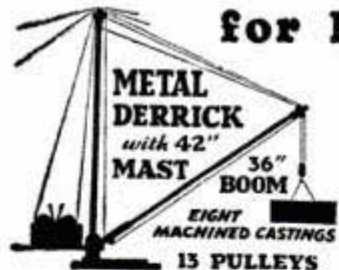

35 Parts. Fun to Assemble!

7 1/2 x 10 1/2 Proof of BLUEPRINT FREE!

Here's a real "He-man" Derrick that anybody—young or old—can have a lot of fun with—indoors or outdoors. No flimsy construction, but a strong 42" Mast with 6 Guys. The Boom is 36" long—all mounted

on a Cast Iron Carriage, 13 Aluminum Pulleys, 2 Drum Winding Winches complete with Cranks, Ratchets and Pawls. There are 35 parts altogether plus 100 feet of special Braided Cord and all necessary Rivets, Washers, Cotter Pins, etc. Black and white proof of Blueprint and Complete Instructions for assembling go with each Derrick. These Derricks formerly sold for \$9.95 but if you want one knocked-down, it's yours for only \$7.45. Or if you'd like more facts before you order, send name and address for illustration and complete information. Fully guaranteed. Order Derrick or write for facts to

BEAVER BROOK CO.

Dept. P.M. Stoughton, Mass.



START \$1,756 to \$3,021 YEAR

MEN — WOMEN

- Postoffice Clerks-Carriers
- Railway Postal Clerks
- Stenographers
- Accountants
- Statistical Clerks
- Typists
- Customs Inspectors
- Many Other Jobs

Veterans Get Preference

Franklin Institute
Dept. G85
ROCHESTER, N. Y.

Gentlemen: Rush to me, FREE of charge, list of U. S. Government big pay jobs. Send FREE 32-page book describing salaries, vacations, hours, work, etc. Tell me how to prepare for one of these jobs.

MAIL COUPON TODAY SURE

Name.....

Address..... Vet?.....

Build it Yourself



. . . of Cemadobe brick. Durable, attractive, fireproof, soundproof and dirt cheap. Make them yourself of earth and cement at low cost. Practical in all climates. Amazing discovery in soil stabilization. Acceptable to loan agencies. Complete instructions in attractive, easy-to-understand "Cemadobe" Handbook, 60 illustrations and 40 chapters. Money back guarantee of satisfaction. Now selling Enlarged Second Edition. Send \$2.00 to CEM-ADOBE CO., Box 81, Dept. PM47 West Los Angeles Station, Los Angeles 25, Calif.

MIDWEST RADIOS

at Greater-Than-Ever VALUES

**BIG, POWERFUL
WORLD-
RANGING
CHASSIS
with F M
(Frequency Modulation)
5 WAVE BANDS**



**30
DAYS
TRIAL**

SEPARATE CHASSIS or
COMPLETE CONSOLES AVAILABLE

EASY TERMS

**The SYMPHONY GRAND
AM-FM RADIO-PHONOGRAPH**
A magnificent radio console and musical instrument that is completely new—from the ground up. Big, powerful Series 16 Chassis brings in long wave, short wave and advanced FM reception. Automatic record-changing phonograph and scores of NEW post-war features including

**TRI-MAGNADYNE
COIL SYSTEM**

SEND FOR
**FREE
CATALOG**



... a sensational, exclusive MIDWEST feature fully described in our new 1947 catalog. Also, other console and table models [with Series 16, 12, and 8 Chassis, and portable AC/DC Battery Table Radios.

BUY DIRECT FROM FACTORY and SAVE!

FILL IN COUPON AND MAIL TODAY OR JUST
SEND YOUR NAME AND ADDRESS ON 1c POSTCARD

MIDWEST RADIO CORPORATION
Dept. 25-H, 909 Broadway, Cincinnati 2, Ohio

Please send me your new FREE Catalog.

NAME

STREET

CITY.....ZONE.....STATE.....

MIDGET AUTO RACING BOOK \$1.10



45 FOTOS, History 1946 Calif. Racing, \$1.10, 1946 Indianapolis "500" Race Book, \$1.00, Mercedes-Benz book, \$2.00. See our ad (Autos) Classified Section. Catalog free. CLYMER, Dept. A-4, 2125 W. Pico, Los Angeles 6, Calif.

**BE A REAL ESTATE BROKER
PAYS BIG!** EASY TO LEARN—Start and run your own business quickly. Many graduates report making up to \$1000 a month. Course of study covers Sales, Property Management, Appraising, Loans, Mortgages and hundreds of related subjects. Course offered in home study or residential classrooms.

FREE Big new illustrated catalog from this nationally known school. Send Post Card Today.

WEAVER SCHOOL OF REAL ESTATE
Dept. KA2, 15 E. Pershing Road Kansas City, Mo.

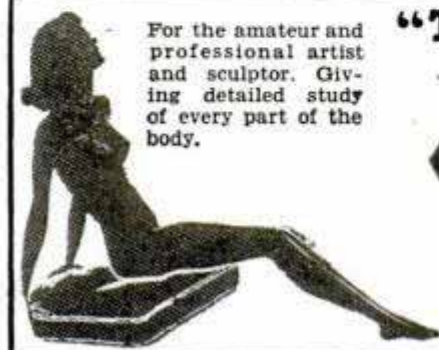

For the amateur and professional artist and sculptor. Giving detailed study of every part of the body.

"The Book They're Talking About"

Contains over 300 illustrations, charts and notes

ART ANATOMY OF THE HUMAN FIGURE

MALE AND FEMALE, POSED AND IN ACTION

(Sent in plain wrapper.) Outside of U. S. A. Send \$1.25

MAJOR BOOK CO., Dept. 320-E, Lynbrook, New York

**ONLY
\$1.00**

OH BOY! FIREWORKS!

Rich Bros' All-American Pre-war Quality ASSORTMENT. Over 172 pieces including 100-2" Salutes, 20 Cherry Flash Bombs, 25 Flitter Crackers, Comet, 2-shot Repeaters, Whistle Bomb, Red & Green Fire Cones, Whistle Devil, Humdinger, Gyro Flyer, Vesuvius Fountain, Flower Pot, Roman Candles, Aerial Bombs, Sparklers, 6 packages Chinese Firecrackers, FREE PUNK!
RETAIL VALUE \$8.55.
YOURS FOR ONLY..... **\$4.95**

RICH BROS' FIREWORKS CO.

Dept. M Box 514 Sioux Falls, S. D.

Shipped Ry. Express Only. None sent C.O.D.

Enclose Money Order or Check.

Name nearest Express Office.

Many other assortments and displays. Send for FREE CATALOG, FREE CAP and Cap Pistol circular.

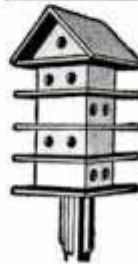

48 PLANS

48 complete plans of toys, ash trays, garden ornaments, Dutch boys and girls, what-not shelves, and many other interesting projects. Finest selection available. Novel method allows you to make finished project any size desired. PLUS FREE DeLuxe Plan of martin house. Send only \$1 to Jackson, Dept. 10, 5440 N. Shoreland Ave., Milwaukee 11, Wis.

\$100



Make Your Own RUBBER MOLDS

with
RED LATEX MOLDING COMPOUND

Earn money, have fun; make your own molds for plaster objects. Produce novelties and gifts for home and to sell to friends. RED LATEX MOLDING COMPOUND (60% density) now available in quart and gallon quantities. Gives perfect results, easy to apply. Send for complete information and prices. FRANCIS SUPPLY CO., Dept. D2, 1836 E. Fulton St., Columbus 9, Ohio.

WHY WORRY ABOUT MONEY?

Pay your bills on the button... and have lots of cash left over for the luxuries of life! Go into a mail order business of your own right at home! Spare time can bring you many dollars of profit! It's easy, and you don't need any special experience or education. A few dollars gets you started... possibilities for growth are unlimited! Write today for complete details sent FREE without obligation.

NATIONAL OPPORTUNITY, Dept. P-47

4920 Lake Park Ave.

Chicago, Illinois

TAXI OWNERS

Send for FREE sample copy of

TAXICAB OPERATOR

National Magazine of the Cab Industry

TAXICAB OPERATOR

1621 N. California Ave.

Chicago 47, Ill.

LIQUID MARBLE COLORED POTTERY



Different! Marvelous! Color-glazed. Brush, spray, mold tiles, table-tops, ornaments! **SANITARY COMPOSITION FLOORING**—Dustless, noiseless; put on like plaster, plain or tile designs; yielding as cork, lasting as stone. **RUBBERLASTIC Mold Compound**—For plaster casting, novelties, statuary, toys, plaques, dolls. **TILEX Colored Roofing**. Build Modern **PLASTIC HOMES**. Illustrated literature free.



RAPID MARBLEIZING SERVICE, Dept. 10-A, Edwardsville, Illinois

WRIST WATCH

Complete with New Style EXPANSION BAND

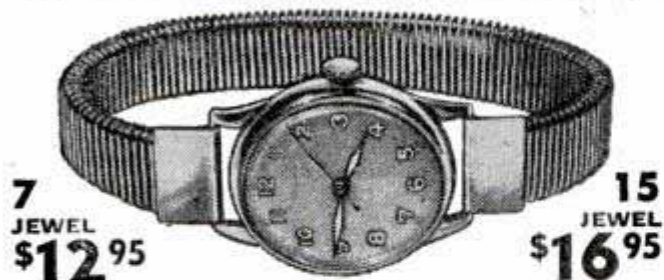

Sensational value! Genuine Military wrist watch precision built, split-second timekeeper, your choice of 15 jewel movement for ONLY \$16.95 plus tax! Or 7 jewel movement for only \$12.95 plus tax. Waterproof, shock-protected, anti-magnetic, Radium dial and hands, easily read in the dark, unbreakable crystal, red sweep second hand. Handsome, non-corrosive stainless steel case. Genuine non-corrosive stainless steel expansion bracelet fits all wrists. Order yours today! **SEND NO MONEY!** Rush order now stating which watch you want. Pay postman price listed above plus postage and 10% Fed tax. If not delighted, return within 10 days for refund.

BURTON SALES COMPANY

809 W. MADISON ST. DEPT. D-84 CHICAGO 7, ILL.

DOUBLE YOUR MONEY BACK!

If you can duplicate this deal at twice this price.

HARD-TO-GET HARDWARE

Hundreds of Pieces!

- | | | |
|------------|-----------|--------------------------------------|
| • GEARS | • SHAFTS | Most Pieces of
Aluminum or Brass |
| • BUSHINGS | • SPACERS | |
| • SPRINGS | • RIVETS | \$129 Postpaid
U.S.A. Only |
| • BRACKETS | • CLAMPS | |

GEORGE BROOKS AND ASSOCIATES

220 S. Halsted St. Chicago 6, Illinois

KNOW THE PRACTICAL SIDE OF ELECTRICITY



Get this new Drake book covering all phases of electricity in easy to understand terms. 227 illustrations. Explains basic principles, methods, codes, motors, etc. Check No. 1 on the coupon for PRACTICAL ELECTRICITY AND HOUSE WIRING. 200 pages. Cloth bound. Only \$2.00.

CHECK THESE OTHER DRAKE BOOK VALUES

- No. 2 House Painting Methods Brush and spray gun. 400 pgs. Cloth bound. Only \$2.50.
- No. 3 Carpentry (Craft Problems) 302 pgs. Over 700 illust. Cloth bound. Only \$2.50.
- No. 4 Plumbing, Installation and Repair 256 pgs. Only \$2.00.
- No. 5 Heating, Cooling and Air Conditioning Handbook 317 pgs. 148 illust. 64 charts and tables. Cloth. Only \$4.00.

All Drake's Books Sold on a Money-Back Guarantee

USE THE COUPON . . . MAIL TODAY

Frederick J. Drake & Co., Dept. A-5
600 W. Van Buren St., Chicago 7, Ill.
Please send me the books checked below. If not satisfied I will return them in 5 days and money will be refunded.

- 1 2 3 4 5 (Circle numbers wanted)
- Check or money order enclosed \$..... Send books postpaid.
 Send C. O. D. plus postage.

Name.....

Address.....

City..... State.....

Drake's books are sold by leading booksellers

Pay Is Good

in both these big Branches of the Automobile Industry

LEARN IN A FEW WEEKS IN OUR BIG MODERN TRAINING SHOPS

AUTOMOTIVE MECHANICS

NOW IS THE TIME TO PREPARE FOR YOUR PLACE IN A GIANT INDUSTRY

BODY & FENDER REBUILDING

Automobile industry making up for lost time! There may never again be such opportunities for men who want better jobs or business of their own to get in on ground floor and go up fast! Yes—FOR MEN WHO ACT FAST, THINGS CAN HAPPEN FAST!

TRAIN ON ACTUAL EQUIPMENT

Chicago Motive Trades Institute makes rapid progress possible by Learn-By-Doing SUPERVISED SHOP TRAINING. In motive trades our institute gained nation wide fame training Auto Mechanics for U. S. Army. Same quality training available to you now. CONSULTATION AND PLACEMENT SERVICE WHETHER YOU ARE INTERESTED IN WORTHWHILE JOB OR SETTING UP YOUR OWN BUSINESS.



AUTOMOTIVE MECHANICS

Practical shop training on all types of equipment. Automotive mechanics needed to keep millions of cars, busses, trucks rolling. Efficient auto mechanics get fine pay. Can service, repair, install all mechanical and electrical parts of autos. Learn to overhaul and repair engines, transmissions, differentials, and other assemblies. Good pay, steady work, excellent opportunities for increased earnings for properly trained auto mechanics.

BODY AND FENDER REBUILDING



Body and Fender rebuilding one of best paid fields in automobile industry. Body and Fender Rebuilding makes good profits in garages, service stations. Get practical, all-around Shop Training—welding, aligning, mixing and matching colors, spray painting, power and hand tools. Values increased when used cars are made to "look like New."

A NATIONALLY KNOWN INSTITUTION

Rapid progress possible by supervised learn-by-doing SHOP TRAINING. C.T.I. is an old established school, backed by years of experience—with trained instructors—with completely equipped shops. VETERANS qualifying under "G.I. Bill" have tuition paid monthly subsistence allowance while in school. Just mail coupon, we will handle all details. (LOW TUITION, EASY TERMS if you are not a veteran.)

CHICAGO MOTIVE TRADES INST.

Dept. B24
Div. of Commercial Trades Inst.
1400 W. Greenleaf Ave., Chicago 26, Ill.

FREE—IMPORTANT INFORMATION
TELLING HOW TO GET STARTED



CUT COUPON ALONG THIS LINE

Fill Out, Cut Out, Mail Today

FACTS FREE for Men Who Want to Get Ahead

CHICAGO MOTIVE TRADES INSTITUTE, Dept. B24

1400 W. Greenleaf, Chicago 26, Ill.

Send free illustrated Brochures and other information about the field I have checked below.

- Automotive Mechanics Body & Fender Rebuilding
 Veteran Non Veteran

Name.....

Address.....

City..... State.....

Please Mention Popular Mechanics When Answering Ads

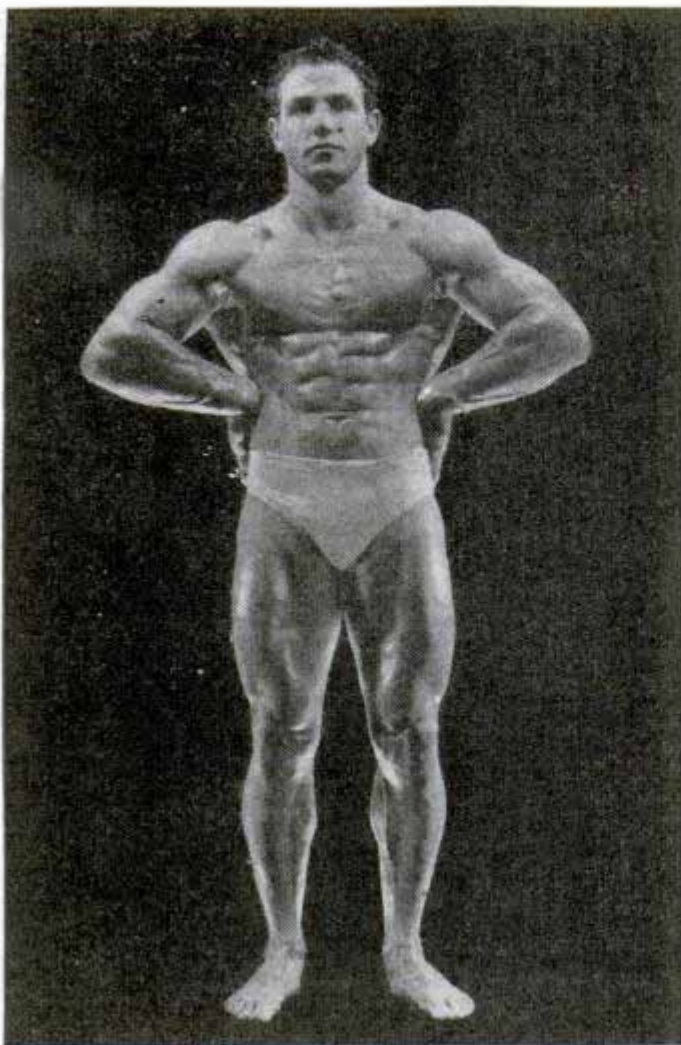

Al Urban

Inspiring Photographs for Your Training Course!!

Contains 4 beautiful lifelike photographs (10x8) of some of the MOST MUSCULAR MARVELS ever seen! INSPIRING pictures of World-Famous Giants of Strength and Physical Development. 2 different photos of Harold Zinkin, handsome Hercules from California. (1 picture as seen above), winner of the title of "Best Built Man on West Coast" and runner up to "Mr. America" in 1945. . . . A beautiful picture of the great Gene Stanlee, Blond Apollo known as the "Body." Gene was acclaimed as the "Best Built Man in the Navy." Performed before a million servicemen in the Pacific Theatre, undefeated in 134 wrestling contests. . . . Lenny Schaefer, formerly physical instructor at Great Lakes, whose magnificent physique has inspired thousands of boys in their physical training! These Photographic Masterpieces (2 of Zinkin, 1 of Stanlee, and 1 of Schaefer) were all personally taken by AL URBAN, WORLD'S FOREMOST PHYSIQUE PHOTOGRAPHER, whose cover pictures of STRONG MEN have been reproduced in leading physical culture magazines here and abroad. Offered for sale for the first time! Never available before! These pictures are perfect for framing and just what you need for your den or gymnasium! Be the FIRST in your neighborhood to add these Exclusive Photos of great athletes to your collection! When in Chicago, phone Kildare 3402 for an appointment.

F-R-E-E!! ORDER TODAY! To all those sending in \$5.00 for album, AL URBAN will give ABSOLUTELY FREE, one beautiful enlargement of another MUSCULAR MARVEL—whose Magnificent Physique will amaze and inspire YOU! HURRY—RUSH to the nearest post office and send \$5.00 money order for YOUR series of INSPIRING PHOTOGRAPHS! Address: AL URBAN, Dept. U, 5024 West Cullom Ave., Chicago (41), Ill.

ARTISTS—Your art file is NOT COMPLETE without this outstanding collection of Al Urban's famous studies of the male figure. AL URBAN, Dept. U, 5024 West Cullom Avenue, Chicago 41, Ill.



**SURPLUS BARGAIN
COMPLETE METAL
STAMPING DIE SET**

Stamp metal, wood, leather, plastics, etc. with your name. Stamp your tools for identification. Use it in the shop—on the farm—anywhere! Will pay for itself over and over again.

**LETTERS A TO Z
NUMERALS 0 TO 9**

Kit includes letters from A to Z—numbers from 0 to 9, hammer, jigs, guides, etc. 43 pieces in all. Letters approx. 1/8 inch high. All in solid drilled box 3 1/4 x 8 x 4 inches. Will last a lifetime. Sets are used but guaranteed perfect. Original cost to government approx. \$20.00. You'll find hundreds of uses for a die stamping set like this. **\$3.95** POSTPAID IN U. S. A.

OUTFIT INCLUDES

- Letters A to Z
- Numbers 0 to 9
- Hammer • Jig
- Guides • Box

GROBAN SUPPLY CO., Dept. PM4
1522 So. Michigan Ave. Chicago, Ill.

big pay in professional art

Successful professional artist offers a new course with amazing visual training aids to guide ambitious students. **NEW INVENTION** stimulates art class drawing from 3-dimensional life-like models. Learn how hundreds of America's leading professional artists trained for success. Learn how you can get our training at home—never before possible. Professional artists in big demand—choose your field—illustrations, covers, portraits, advertising, etc. Send for **FREE** book, "The Key to Professional Art."

AUSTIN STUDIOS
121 Opera Place, Dept. 24,
Cincinnati 2, Ohio.

free BOOK

"HANGAWAY" Garment Hanger

The Answer to Your Closet Problem

Utilize Wasted Space

ONLY \$2.00 POSTPAID

Does not wrinkle garments. Folds up or down in a jiffy. Easily installed on any door or wall with 2 or 3 screws.

ORDER 1 or MORE TODAY

Liberal Quantity Discounts
Salesmen Write for Details

AMERICAN TRADING COMPANY
230 W. Randolph St., Chicago 6, Ill.

Now for EVERY WORK SHOP!

NEW Invention Electroplates by BRUSH

Easy to Plate CHROMIUM GOLD, SILVER, NICKEL, COPPER . . . For Pleasure and Profit!

If you have a workshop—at home or in business—you need this new Warner Electroplater. At the stroke of an electrified brush, you can electroplate models and projects—you can replate worn articles, faucets, tools, fixtures, silverware, etc. with a durable, sparkling coat of metal . . . Gold, Silver, Chromium, Nickel, Copper or Cadmium. Method is easy, simple, quick. Everything furnished—equipment complete, ready for use. *By doing a bit of work for others, your machine can pay for itself within a week.* So make your shop complete by getting a Warner Electroplater right away. Send today for **FREE SAMPLE** and illustrated literature. **ACT AT ONCE! Mail Coupon.**

WARNER ELECTRIC CO., DEPT. M-1
1512 Jarvis Avenue, Chicago 26, Ill.

FREE Details & Sample!

WARNER ELECTRIC CO., 1512 Jarvis Avenue, Chicago 26, Dept. M-1
Gentlemen: Send Free Sample and Details to:

Name _____
Address _____
City _____ State _____

HUNDREDS OF THOUSANDS OF MEN



**Make
This
Test**

**with your own hands
and feel what we mean**

**The Secret of the
"Interlocking Hands"**

Only COMMANDER contains this New principle. A porous non-stretch material is built into the special stretchy body of the COMMANDER . . . In the outline of two interlocking hands for EXTRA DOUBLE SUPPORT where you need it most. NO BUCKLES, LACES or STRAPS.

Commander Wearers All Over America Say—

"I am sure you will be pleased to know that it is by far the best and most practical supporter I have ever had. I have been pleased to show it to several of my friends and they are likewise impressed with it. You shall probably hear from some of them in the future."
—Dr. A. M. S. Standish, Mich.

"Enclosed find order for another belt. I wouldn't be without this

Above are just a few of the many unsolicited testimonials for the Commander that we receive regularly. Originals of these and others are on file.

supporter for ten times what it costs."
—Dr. G. C. S., St. Charles, Ill.

"I recommend the Commander for what it is made for. It sure has been a great help to me. I want to thank you for what it has done. I might add it has helped me more than anything I have ever tried."
P. N., Fort Knox, Ky.



BEFORE



AFTER

**FREE
10 DAY TRIAL!**

If it fails to do all we say, send it back and the purchase price will be promptly refunded.

ONLY \$2.98

Special Large
Sizes, 48 to
60, \$3.98

SIZES
28 to 47

Appear

SLIMMER . .

FEEL BETTER, LOOK YOUNGER

with COMMANDER

The Amazing NEW Abdominal Supporter

Yes, instantly, you, too, can begin to feel ALIVE . . . ON TOP OF THE WORLD by joining the Parade of Men who are marching up the highway of happier living with the COMMANDER, the amazing new Men's Abdominal Supporter.

**GET "IN SHAPE" INSTANTLY
AND ENJOY A HAPPY STREAMLINED APPEARANCE**

The COMMANDER presents the exclusively designed "INTERLOCKING HANDS" principle for extra support where you need it most. It flattens the burdensome sagging "corporation" and restores to the body the zestful invigorating feeling that comes with firm, sure "bay window" control. Order this new belt today and begin enjoying the pleasure of feeling "in shape" at once.

BREATHE EASIER — TAKE WEIGHT OFF TIRED FEET

The helpful uplifting EXTRA SUPPORTING power of the COMMANDER firmly supports abdominal sag. The instant you pull on the belt you breathe easier . . . your wind is longer . . . you feel better!

**YOUR BACK IS BRACED —
YOUR CLOTHES FIT BETTER — YOU APPEAR TALLER**

The COMMANDER braces your figure . . . you look and feel slimmer . . . your clothes fit you better. Your friends will notice the improvement immediately.

COMMANDER IS NEW AND MODERN!

The absence of gouging steel ribs, dangling buckles and bothersome laces will prove a joy. COMMANDER has a real man's jock type pouch. IT GIVES GENUINE MALE PROTECTION. Try this amazing new belt with full confidence . . . and at our risk. SEND FOR IT NOW!

MAIL THIS COUPON TODAY

INTRODUCTORY TEN-DAY TRIAL OFFER

**WARD GREEN CO., DEPT. T-134
113 WEST 57TH STREET, NEW YORK 19, N. Y.**

Send me the "COMMANDER" for ten days Trial. I will pay postman the special price of \$2.98 plus postage. If not satisfied after wearing it ten days, I may return it and the purchase price will be promptly refunded.

My waist measure is My height is

NAME

ADDRESS

CITY STATE

Check here if you enclose \$2.98 with this order and we will pay postage charges. The same refund offer holds.

How to Write

For Extra Income or Full Time Career,
Learn At Home To Write Short Stories,
Mysteries, Articles.



Graduate Sells To Big Magazines

"Since studying the Palmer course, I've been able to sell to *The Post*, *American*, *Coronet*, *Esquire*, *Liberty*, and other top magazines. It's the finest course anywhere." *Keith Monroe, Santa Monica, California.*

Big New Opportunities Now

The public's new interest in technical, mechanical subjects offers big new opportunities for scientific minded writers who are trained to make dry facts interesting and exciting.

Editors agree: the demand for new writers is greater than ever and you don't have to be a genius to make money. Many beginners earn while learning, selling short stories, articles of all kinds, which bring in small but welcome checks of \$25, \$50, \$100 and more. Such material may be turned out quickly once you acquire the proper technique. And now this technique is easier to learn than you may imagine, through Palmer's unique method of training—for NOT just one field of writing, but for all; Fiction, Article, Radio. Palmer is endorsed by famous authors including Rupert Hughes, Ruth Comfort Mitchell, Katharine Newlin Burt, Gertrude Atherton.

You Learn To Write By Writing

We give you practical writing assignments which you do at home. Your work is *individually* handled by professional writers who *quickly* return it to you with helpful suggestions. You are shown how to correct weaknesses, how to capitalize on your good points. Thus *your own individual writing style* is carefully developed. Study fast or slow. Save time and effort. To find how you too may make money writing—part time or full time—send today for FREE illustrated book. Palmer Institute of Authorship (since 1917) 6362 Hollywood Blvd., Hollywood 28, Calif. Desk T44.

FREE BOOK Palmer Institute of Authorship Since 1917
6362 Hollywood Blvd., Desk T44, Hollywood 28, Calif.

Please send me free illustrated book "The Art of Writing Salable Stories," explaining how your training helps new writers get started. This is confidential. No salesman will call.

Mr.
Mrs.
Miss
Address.....
City.....Zone.....State.....

AT LAST! A HOBBY THAT OFFERS YOU PROFIT AS WELL AS PLEASURE!

GENUINE LEATHER Hand Crafted LINK BELT

Easy to Make — Easy to Sell

Get started today on a fascinating hobby where you can earn up to \$10 or \$15 a week in spare time! Send for your complete profit-producing Handicraft Kit with all the material needed to make 6 genuine leather link belts. Sell all you make at \$2 each to people expecting to pay far more for genuine hand-made belts. Kit for 6 belts costs you only \$3.50—can easily be sold for \$12—leaving you a profit of \$8.50. Send \$3.50 for your Kit today, or mail only a dollar for sample Kit! Or C.O.D., you pay postage. Money back if not delighted.

FREE WITH YOUR ORDER ... IF YOU ACT NOW!

Beautiful Plastic Identification Card Case. Value 25c. Yours to keep, even if you return belt kit. Also, on request, big new 40-page CRAFT CATALOG FREE with or without order.

DWINNELL CRAFT SHOP, Dept. P-74, Elm Grove, Wheeling, W. Va.

DRAW for MONEY... Be an ARTIST!

Trained Artists are Capable of Earning \$50 — \$60 — \$75 OR MORE A WEEK!

You can learn to draw at home in your spare time the well-known WSA way. COMMERCIAL ART, DESIGNING, CARTOONING — all in ONE complete course. No previous art experience necessary—we teach you step-by-step. Prepare now for a fascinating hobby or profitable career. For 33 years WSA graduates have been making good—WHY NOT YOU?

Veterans! WSA is approved for training under the G. I. Bill

MAKE UP TO \$5.00 AN HOUR In Your Own YEAR ROUND Business!

ONLY A FEW DOLLARS PUTS YOU IN BUSINESS!

Many Clearing as High as \$20 to \$30 a Day NET Renewing Rugs, Carpets, Upholstery. New Method Now Used for Auto Upholstery. Write for Facts About Quick, Easy Way to Get Started

Here is the chance you've been looking for to step into a pleasant, dignified, big-pay business of your own that offers you a steady, year 'round income. Start on "a shoe-string," full or spare time, right from your own home. Equal opportunities for men and women, young or old, in small towns or big cities. No experience needed. Many making big money with new American System just cleaning auto upholstery. Easy to learn. We send you complete instructions and quick-cleaning supplies so you can start making money the very first day! Quick method cleans upholstery, rugs and carpets like new without taking off floor! Tremendous demand in homes, apartments, hotels, stores, office and public buildings. Steady repeat business. Territories going fast. Write today for full FREE facts. No cost or obligation. Rush letter or postcard now to AMERICLEAN CO., Inc.; Dept. G-4; 211 North 7 St.; St. Louis 1, Mo.

WRITE FOR FREE DETAILS NOW!

USE Fine Walton Wheels to Make Your Own WAGONS—SHOPPING CARTS and RACERS



65¢ Each in Sets of 2 or 4 — plus 10c ea. for postage. 4 1/2-inch with 3/8-in. bushing

Coaster wagons, scooters, shopping carts, bike trailers, golf bag carriers, etc., are easy to make. Use fine Walton DeLuxé Wheels! They're strong welded pressed steel construction. Ideal for making many things for use and play. Solid rubber tires. Red enameled. Send check or money order. No C.O.D.'s. Dealers and manufacturers write.

WALTON WHEEL COMPANY, Dept. J-4
Plankinton Bldg. Milwaukee 3, Wis.

NEW PLASTICS Fabricating MANUAL

HOW TO USE Plastics AT HOME NOW ONLY 25c

Make beautiful objects of Plexiglas, Lucite, Catalin, Polystyrene at home. Jewelry, novelties, accessories. Send for new 10,000 word manual on how to fabricate, weld and form latest plastic materials in home workshop. Hundreds of practical suggestions. Written by leading plastics engineer. Price prepaid 25c (stamps or coin). Or get FREE information and price list covering transparent plastic sheets, rod, tubing cut to your size. Write today: HOUSE BEAUTIFUL PLASTICS, Dept. D3, 5534 W. Harrison St., Chicago 44, Ill.

Learn NEON!

- GLASS LETTER BENDING
 - NEON COLOR GASSING
 - NEON BOMBARDING
- at ACME NEON INSTITUTE
1648 Van Buren Chicago 12, Ill.

WANTED DISTRICT PURCHASING AGENTS

No experience or money required. Exceptional opportunity for those who want to establish themselves in a steady, year 'round, well paying business.

For details: Write
PURCHASING MANAGER, DEPT. C
2719 LAWRENCE AVE. CHICAGO 25, ILL.

It's YOUR future — Make the most of it!



Start now to earn the bigger pay in electrical repair

WAS there ever such an opportunity to get started in electrical maintenance and repair—and at top-notch wages? Are you ready—with experience and ability—to cash in on it? Others are getting just the sort of background needed—quick! practical!—to handle the great variety of electrical maintenance and repair work TODAY—from this well-known electrical library. You can too!

THE LIBRARY OF ELECTRICAL MAINTENANCE AND REPAIR

5 vols., 1826 pages, 1724 illustrations

Gives you the "know-how" to tackle any wiring or motor job. Five books show you HOW—to install all types of motor and generator units—to inspect and repair motor starters and generators—to diagnose motor and generator troubles—to figure new windings for old cores—DC and AC windings—to test armature windings—test induction motors, etc., etc. One book is full of trouble-shooting charts that show quickly symptoms, causes, specific remedies, etc.

Take the first step toward improving YOUR future—Mail this coupon TODAY

No money down—special price—easy payments—FREE trial

McGraw-Hill Book Co., 330 W. 42 St., New York 18, N. Y.

Send me for ten days' free examination the Electrical Maintenance and Repair Library. If satisfactory I will send you \$1.50 in 10 days and \$3.00 monthly until the price of \$16.50 is paid. If not wanted I will return books postpaid. (To insure prompt shipment write plainly and fill in all lines.)

Name

Home Address

City and State

Company

Position

BE A BUILDER! Learn Estimating and Blueprint Reading at Home

MAKE MONEY IN BUILDING! See this complete, simple, self-teaching course in building, estimating, blueprint reading for 10 days in your own home!

There is big money to be made in building! New home and commercial building construction will not equal demand for 5 to 10 years. Put yourself ahead of the next man by getting a good job as a highly-paid building cost estimator or start in business for yourself. Contract for building jobs—hire tradesmen to do the work and you take the profits.

The Tamblyn System reduces building material and labor costs to simple factors so that you can estimate any job promptly and accurately after you have studied this system. Based on 40 years of actual experience. Thousands have used it successfully during the 25 years it has been helping men get ahead.

Mail the free coupon today and we will send you the complete course, including plans, specifications, estimate sheets, the Building Labor Calculator and complete instructions on 10-day free examination offer. Send no money—you be the judge. Consultation service free to every student without extra charge. No fancy books—plenty of sound and valuable instruction. We teach you down-to-earth estimating which will get you a good job or bring you profitable business. Mail the coupon now. See this unusual course for yourself.

TAMBLYN SYSTEM, Johnson Bldg, PM4, Denver, Colo.

Send Tamblyn System for 10 days free inspection. If satisfied, I will pay you \$5.00 per month until \$30.00 is paid. Otherwise I will return it.

NAME _____ AGE _____

ADDRESS _____

CITY _____ ZONE _____ STATE _____

SEND NO MONEY • SEE IT FIRST!

You'll Save Money and Oil!

When your service station makes this Free AC Oil Test and the AC Test Pad shows this

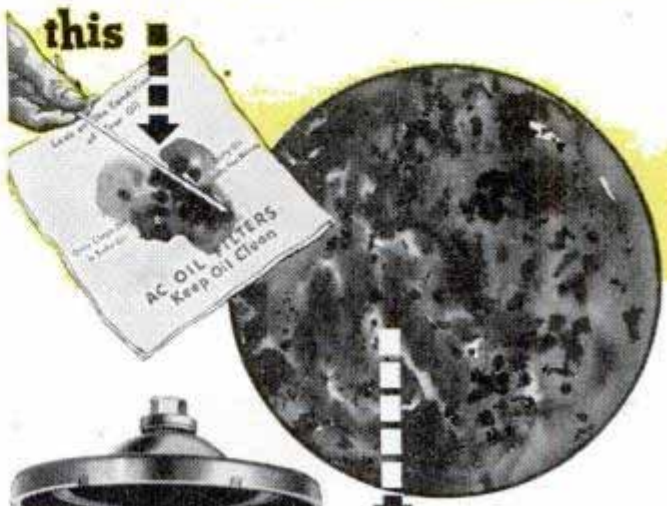

YOU TELL THE SERVICE MAN TO PUT IN THIS OR PUT IN THIS

Dirty oil wastes gasoline, as well as oil, and clogs vital oil slots in the piston rings. Then, carbon forms faster, valves gum, power is lost. Overhaul expense soon follows. So, get the FREE AC Oil Test, regularly, wherever you see the yellow - and - black

official AC Sign. Keep your oil clean with AC replacement Elements and AC Oil Filters.

AC SPARK PLUG DIVISION • GENERAL MOTORS CORPORATION



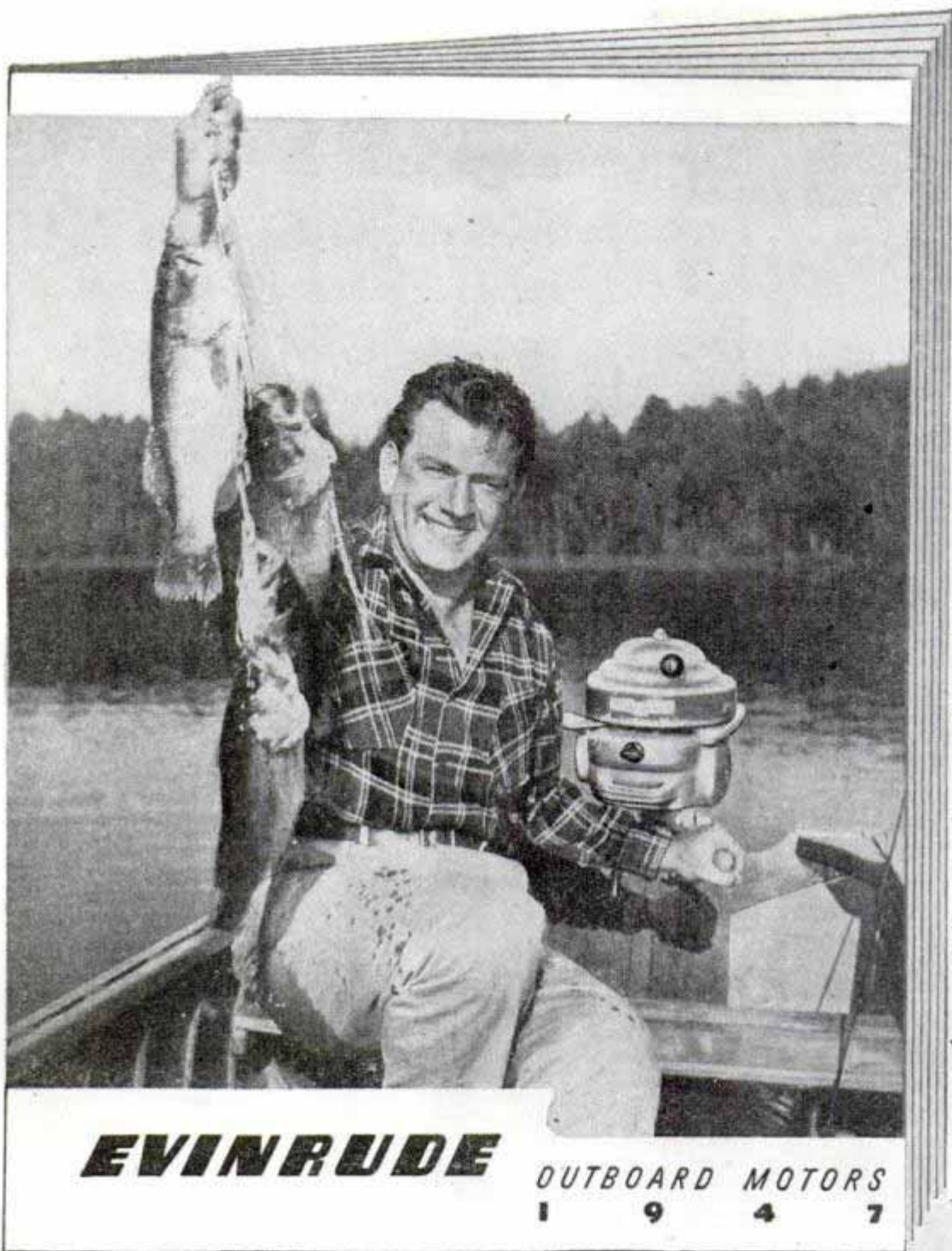

EVINRUDE

OUTBOARD MOTORS

1 9 4 7

- ✓ **COMPLETE LINE**
7 proved models—the right motor for every boat
- ✓ **THREE THRILLING "FOURS"**
The last word in fine outboard performance
- ✓ **REVOLUTIONARY WEEDLESS DRIVE**
A boon to fishermen!
- ✓ **FULL REVERSE**
— on two favorite fishing models
- ✓ **FAMED STARTING EASE**
— a "built-in" feature of every model
- ✓ **SIMPLEX STARTERS**
Standard on 5 models
- ✓ **FLEXIBLE MOTOR MOUNTINGS**
— for added smoothness
- ✓ **CO-PILOT STEERING**
For greater handling ease — on every model
- ✓ **CENTRIFUGAL PUMP COOLING**
Trouble proof for the life of the motor
- ✓ **38 YEARS OF "KNOW HOW"**
— and how that counts in performance, value, satisfaction!

"It's full of facts you'll want to know before you buy an outboard motor!"

Another fishing season coming up fast...plan now to make it the finest ever with the finest outboard ever! Send today for the new Evinrude catalog of 7 great motors for '47...the complete line that offers the right motor for every boat...the right motor for every kind of fishing service... with revolutionary Weedless Drive on two favorite fishing models...and thrilling four-cylinder models for those who want the last word in fishing motors!

Write for the catalog, or visit your Evinrude dealer—

look for his name in your classified phone directory under "Outboard Motors".

EVINRUDE MOTORS, 5484 N. 27th Street, Milwaukee 9, Wisconsin • In Canada: Evinrude Motors, Peterboro, Ontario.



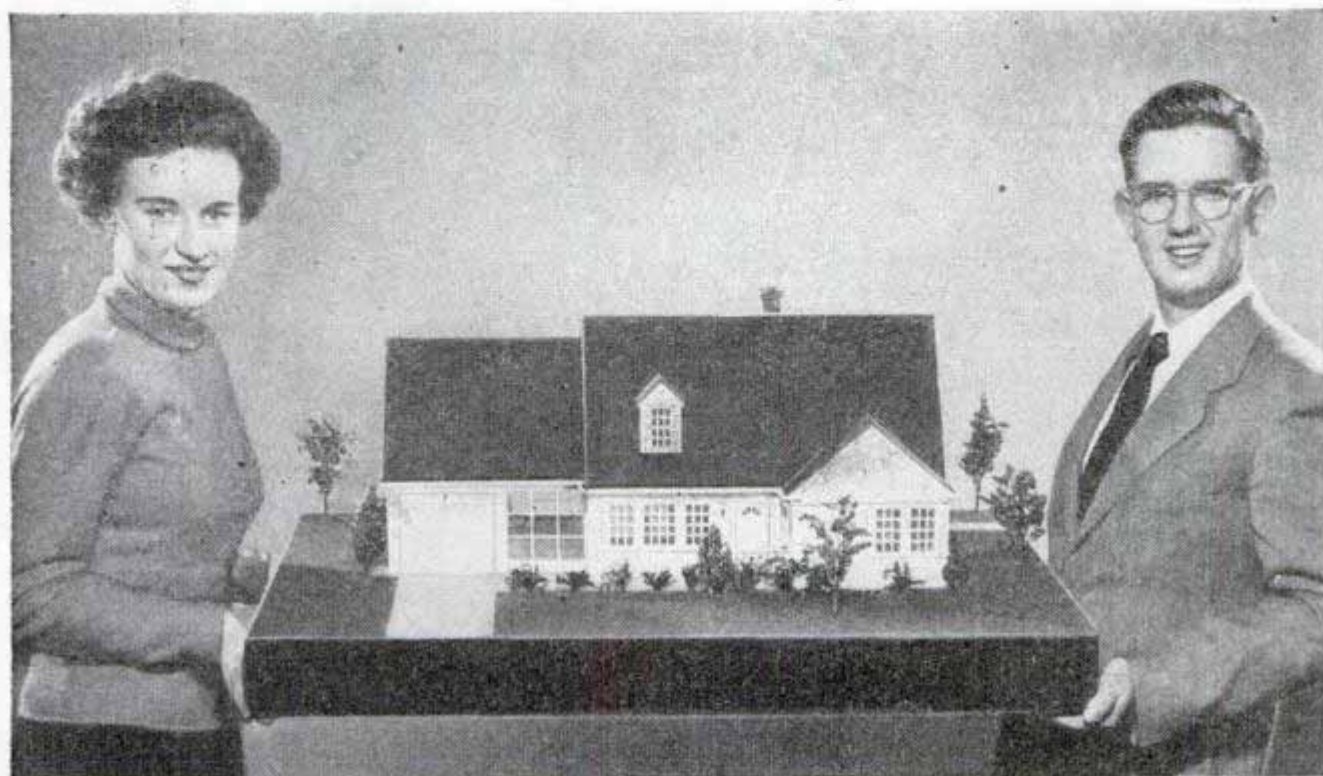

The House That Jacques Built

WITH THE HELP OF POPULAR MECHANICS

On page 105 we begin the inspiring story of how Jacques Brownson, young veteran of Aurora, Ill., met the housing shortage the American way—with fine craftsmanship and determination. He built his own home, the home planned for the average family by Popular Mechanics Magazine. It is a home you will want to build yourself. The full-color article in this issue introduces what we regard as one of the most important editorial projects in the history of this magazine.

THE EDITORS

“The *Popular Mechanics* BUILD-IT-YOURSELF HOUSE strikes close to the heart of every American who has pounded a nail or put up a storm window. This attractive house is actually a blueprint for many a family’s dream. The entire project of designing the house, building it and keeping a careful record of materials and requirements, and then giving this information to the public, is a truly unique and important achievement. Presented at this time of acute housing shortage, the house should have an enthusiastic reception. This is a practical approach to one of our greatest national problems. As governor of the state in which it was built, I congratulate the editors who conceived the project and the man whose craftsmanship translated the dream house into reality.”



Dwight H. Green
GOVERNOR OF ILLINOIS

CHART OF SHIPS AND AIRCRAFT

- Mount Olympus, flagship
- Philippine Sea, aircraft carrier
- 2 ice breakers
- 2 cargo ships
- 2 seaplane tenders
- 2 destroyers
- 2 oilers
- 1 submarine
- 6 DC-3 two-engine transports with jet-assist take-off units
- 6 Sikorsky helicopters
- 6 Martin PBMs
- 2 floatplanes
- 1 skiplane

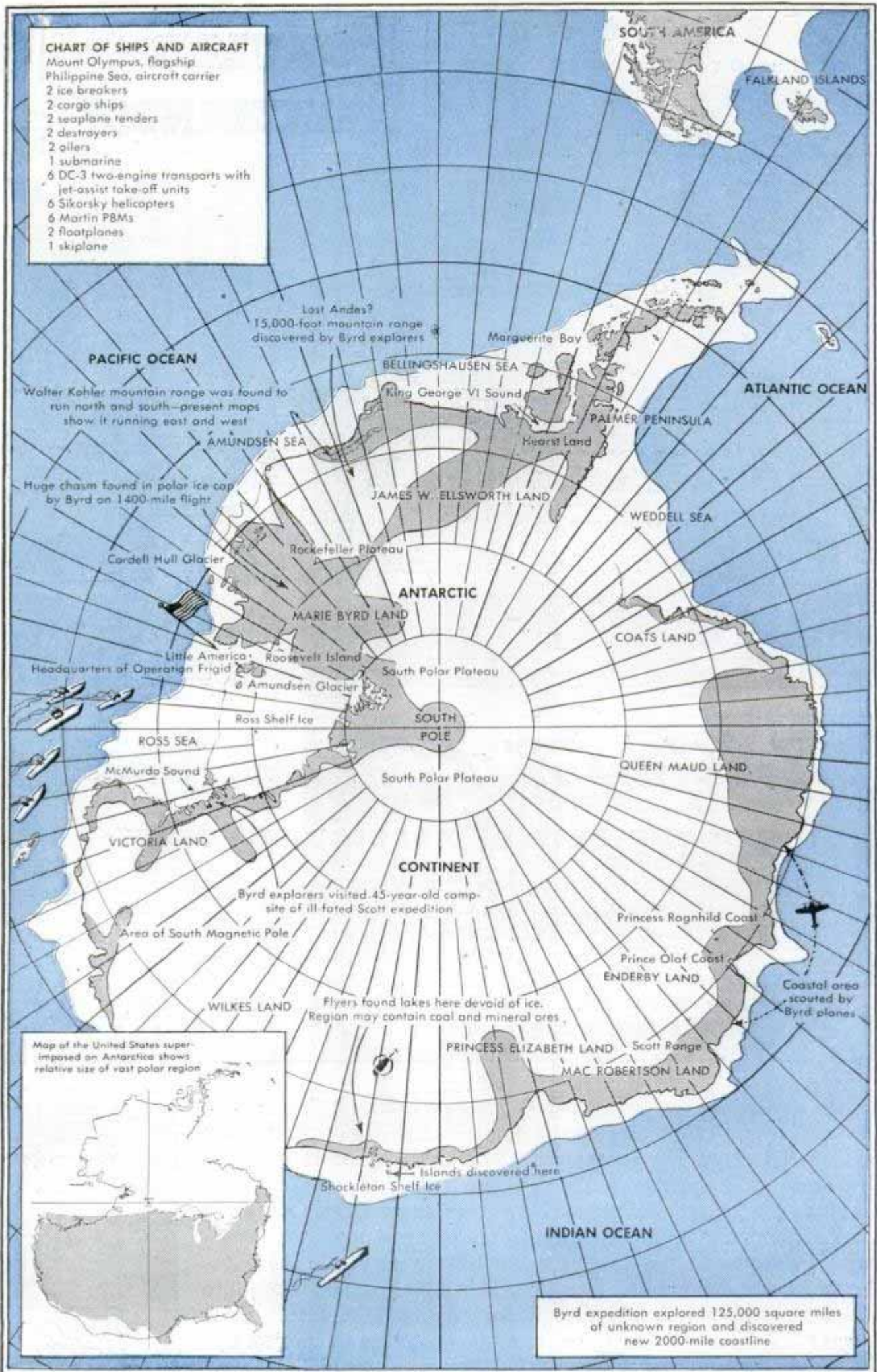



Crew member of icebreaker Northwind heaves a towline aboard the sub Sennet which was trapped by ice pack

REPORT from ANTARCTICA

By Tom Henry

(Correspondent with the Byrd expedition)

PART I

ABOARD the USS Mount Olympus (By Navy Radio)—The greatest exploring expedition in history is now at work on this planet's largest unknown territory—the six million square miles of land around the South Pole. Prior to this expedition science had more accurate maps of the moon than of this frigid land.

This is the first experiment in mass production exploration, as different from past laborious mile-by-mile progress beyond known frontiers as an old handicraft shop differs from a modern industrial plant. Thirteen Navy ships, numerous aircraft and 4000 men including a small regiment of photographers are engaged in outlining unknown coasts and mapping surface features of the trackless interior of the antarctic continent, most of which is a complete mystery. This lifeless land of everlasting ice, blizzards and cold has been by far the most difficult part of the world to penetrate. Few

have ever ventured beyond the towering blue walls which face the sea and constitute a nearly impassable barrier.

Out of the war came new exploration tools. Some of these were used in air operations to study enemy territory; others for plotting undersea conditions to combat

Left to right, Admirals Byrd, Sherman and Cruzen study explorers' "last frontier"—the bottom of the world



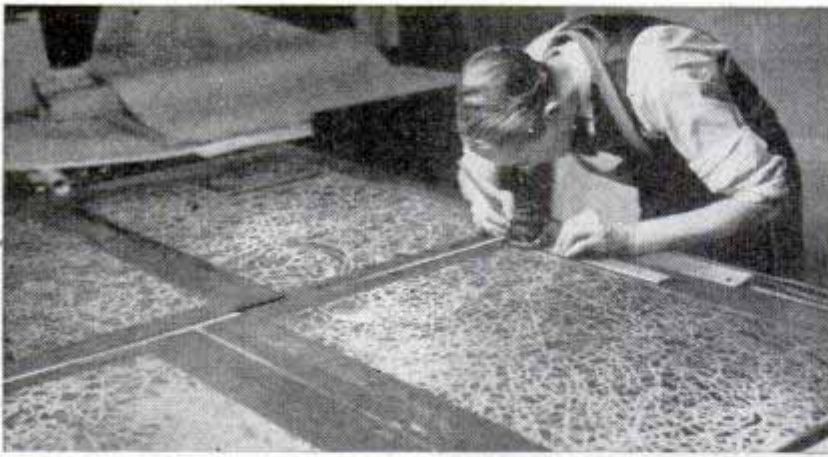

Four huge negatives, snapped by an aerial camera over adjacent regions, are assembled by a photo interpreter into a single large map



↑ Projectors in this 14-foot "bar" contain negatives taken from the air. Line-up represents plane's course when maps are made from photos

↓ Precision instrument checks finest measurements of negatives. The elevations of mountains can be determined within a couple of feet

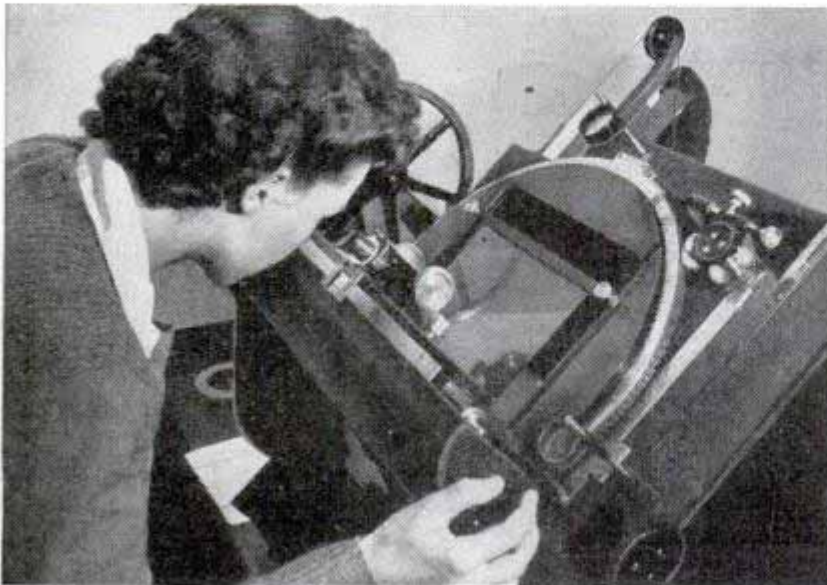

submarines. Many of these now are converted to the peaceful purpose of increasing human knowledge under the direction of the veteran polar explorers, Admirals Richard E. Byrd and Richard H. Cruzen, both long familiar with the peculiar difficulties of the antarctic.

Their major tools are air reconnaissance and photo mapping. The techniques of these two military arts have been improved since they were used in actual war operations.

This is the biggest single photographic job yet attempted. The intention was to obtain a composite photograph of mountains and ice fields never before seen by man, thus accomplishing in a few weeks with few men what would have required several years' work by an army of surveyors, even in easily accessible country. A single plane with a battery of cameras can, under favorable conditions, photograph nearly 50,000 square miles in six hours—the approximate duration of a 750-mile round-trip flight. Ordinarily such pictures show only the outstanding features when taken from an altitude of about three miles, but a new technique makes it possible to get an accurate photograph of unknown terrain.

At least four cameras are mounted in each plane. One points straight down and two are mounted at angles of 30 degrees from horizontal, thus sweeping almost from horizon to horizon. The fourth camera photographs a clock and other recording devices. An automatic switch clicks all four cameras simultaneously several times a minute. The number depends on the plane's speed and altitude and the nature of the country below. Sometimes there is only a flat waste of whiteness for hundreds of miles, so that all pictures are indistinguishable duplicates. The timing is so arranged that each set of pictures overlaps the preceding set by 60 percent. Ordinarily, two planes fly parallel courses

60 miles apart and the photos are taken so that both overlap. All are sent to Washington for coordination by photo interpreters who assemble them into an enormous composite from which a map can be constructed. Cooperating with the cameras in each plane are various other instruments including one which makes a continuous altitude record above ice surfaces, operating by radio pulse echoes similar to radar. This system is much like mapping contours of the sea bottom by sound echoes.

Map making by these methods is the same in principle as the triangulation used by surveyors on the ground but has the advantage of producing a visual picture of the countryside. Sometimes minute details are shown even from great heights. It was found during the war, for example, that truck tracks across an open field are shown clearly by air photos long after any disturbance to the grass disappears to the naked eye. Photos taken in England recently from a three-mile altitude show Roman fortification lines across fields plowed for a thousand years. Photo interpretation, largely developed for use as military intelligence during the war, was credited with obtaining about 75 percent of all the knowledge of enemy movements and installations. When the war ended there were great refinements in progress that had never actually been used. They are now available for peacetime mapping of the antarctic wastes.

Antarctic photo mapping missions are hardly less perilous than war reconnaissance. Here there are no guides for pilots in trackless skies over trackless snow. Even the weather predictions are unreliable, due to the lack of data on conditions around the pole, where storms start. White cloud blankets wrap themselves around the plane, producing zero visibility almost without warning. No-

Twin-engine transport used by Admiral Byrd in flights over the polar region is lashed to the deck of the aircraft carrier Philippine Sea

U. S. Navy photo

where else on earth do weather conditions change so suddenly.

The likelihood of completing a great composite picture during this brief polar summer declines each day. There is an average of only four or five days a month of good flying weather, and flights on bad days, with low white mist shrouding the ice surface, are both dangerous and useless for photography. The January and February schedule was badly delayed.

The expedition is divided into three groups, one skirting the continent eastward, another westward and the third entirely inland from the Bay of Whales, approximately on the international date line. During all January, eastern and western groups together were able to fly only about a dozen missions, and some of these without results, because of bad visibility. The greatest value of the work this year is expected to come from mistakes made and lessons learned that will guide future missions.

On the continent's threshold both eastern and western groups reported notable discoveries. Greatest to date is a mountain range about 150 miles south of the Amundsen Sea. The range appears, from preliminary observations, to be one of the highest in the world. Its average altitude for about

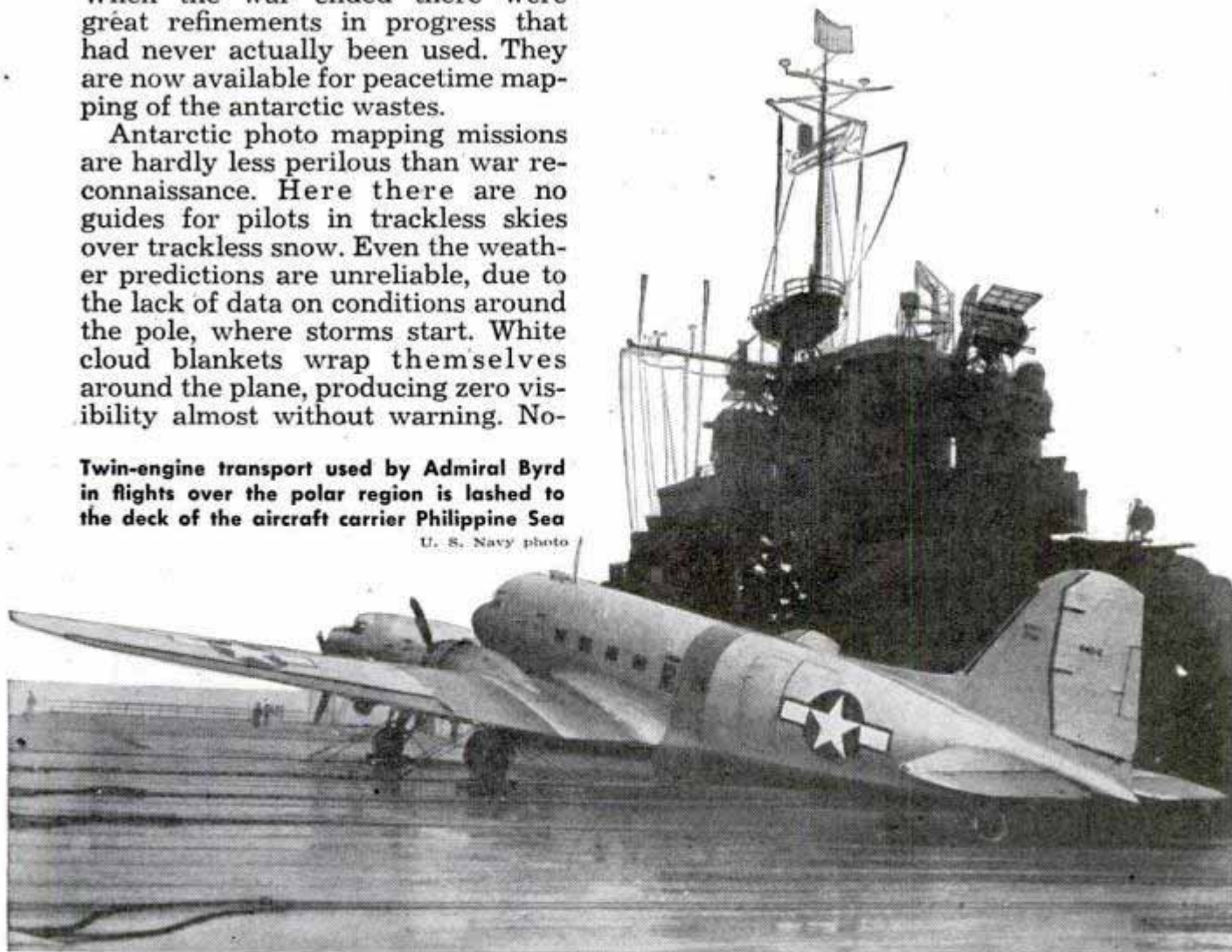

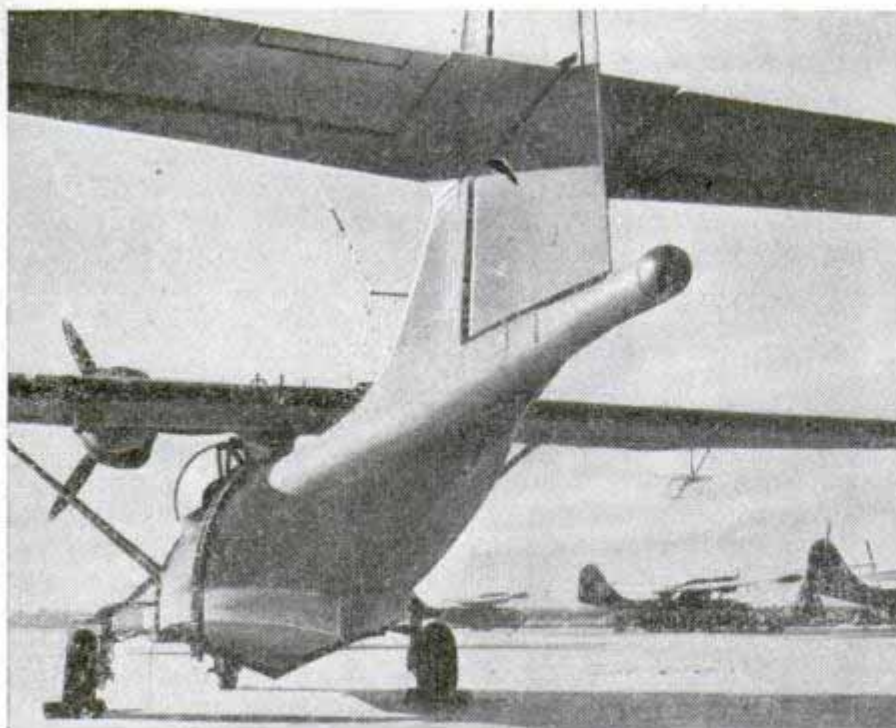

↑ Strange tail on this PB4Y houses the magnetometer, a war instrument that spotted subs, which now penetrates the ice cap to map the ground beneath.
↓ Magnetometer's intricate mechanism detects minerals through mile of ice

U. S. Navy photos

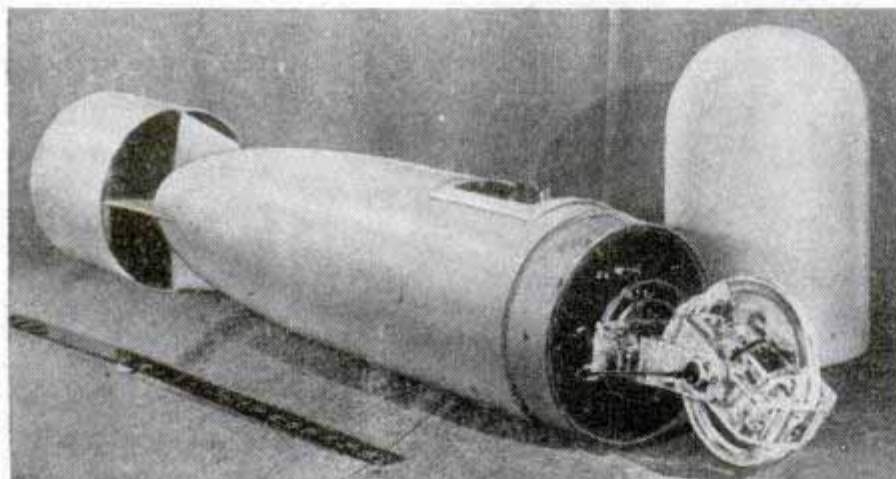

100 miles is 15,000 feet. This may be the long-sought "Lost Andes." A possible link in this range was found during one of the expedition's first flights on which one plane was lost with three members of the crew.

Considerable time was spent surveying the coastline west of the international date line. Parts of this coast were among the first sections of the continent seen almost simultaneously by the American Wilkes and the Frenchman Durville more than a century ago, but the region remains one of the least known in the world. No human ever has looked before on the all-white vastness reaching from the coast to the pole. The coastline surveyed to date for nearly 500 miles shows little resemblance to that on all antarctic maps. The difficulty has been that the land is usually buried in a low mist and seen only across the wide ice shelf from ships at sea. Visual illusions under those circumstances are probable.

is buried under an ice cap in most places a mile thick, an accumulation of a million winters. Only black crests of high mountain ranges protrude from the great "white desert." Hence all the land surface features, such as plains, hills and valleys, are unknown, but they are being explored by this expedition with an air-carried instrument which "starts where radar leaves off." This is the magnetometer, developed for detecting submarines during the war. Until recently a military secret, the magnetometer promises to be one of the greatest aids for rapid exploration ever developed. It has already proved valuable in locating oil reservoirs in the United States. Operated by Doctor James R. Basely of the Geological Survey, the instrument makes a magnetic map of the country traversed by the plane. It has extreme sensitivity for any magnetic materials below the ice, especially iron,

(Continued to page 276)

Although low mountains are found near the sea, most of the territory known as Wilkes Land appears to be a flat plateau of about 6000 feet elevation for at least 200 miles from the coast. The work of camera explorers was handicapped from the start by bad weather with poor visibility.

The topographical observations reported here are only preliminary, taken from verbal descriptions of what pilots saw. All photographs were sent to Washington for the Navy's expert analysis and interpretation of ground features.

Besides map makers, groups of government scientists are on the expedition to investigate in finer detail antarctic phenomena in fields of magnetism, wild life, geology and electrical disturbances. Their efforts have been handicapped by the brief summer, with unfavorable weather for field parties across the ice barrier. Life here is filled with almost constant bafflement, as is inevitable in a land of strange paradoxes, where often nature's laws seem to act in reverse.

The antarctic continent

Bombing by Radar Rivals 'Eye' Method

Blind bombing results at night with the Eagle radar system are nearly as good as those scored on visual targets, according to the Army Air Forces. The unique feature of the system is a 16-foot linear antenna which gives exceptionally sharp detail to images on the radar scope. With it bombardiers operating in complete darkness and through heavy overcast can distinguish specific objects from the surrounding terrain and drop bombs with precision. There are 250 tiny individual antenna spaces along the 16-foot framework, which is carried in a vane or wing beneath the fuselage and parallel with the plane's wing.

New Atomic Bomb May Use Hydrogen

Are American scientists working on a new kind of atomic bomb? Physicists best informed on this subject won't say, but a recent article in the *Infantry Journal* by former Assistant Secretary of War John J. McCloy has created a lot of conjecture. McCloy's hint of a new type of atom bomb raises this possibility: Research work may be under way to convert hydrogen into helium and release atomic energy, simulating the process which presumably takes place in the sun. Conversion of hydrogen into atomic energy would have tremendous significance, for hydrogen is very abundant whereas uranium and thorium, atomic-bomb raw materials, are scarce.

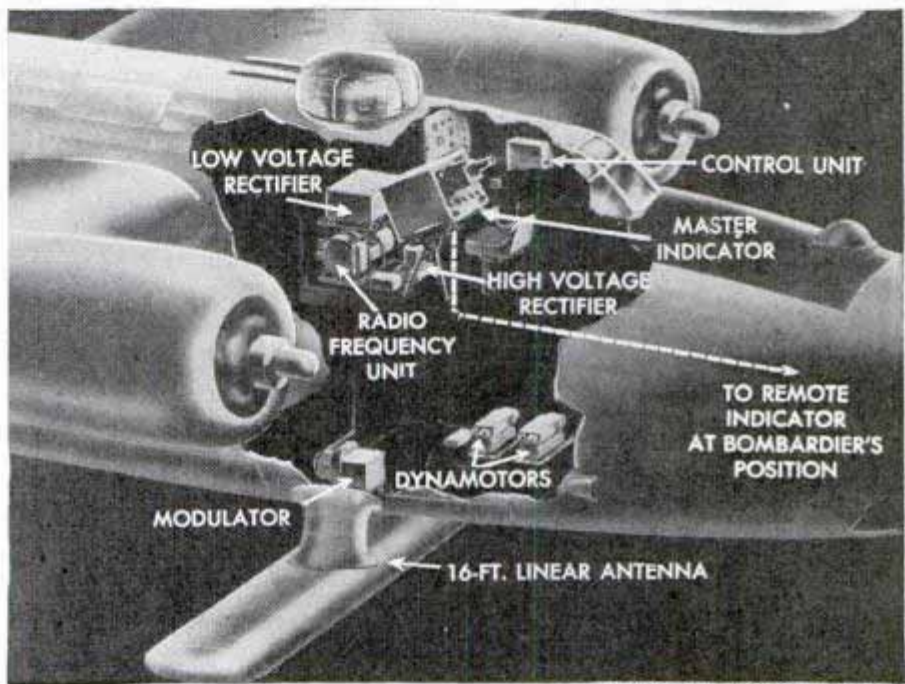
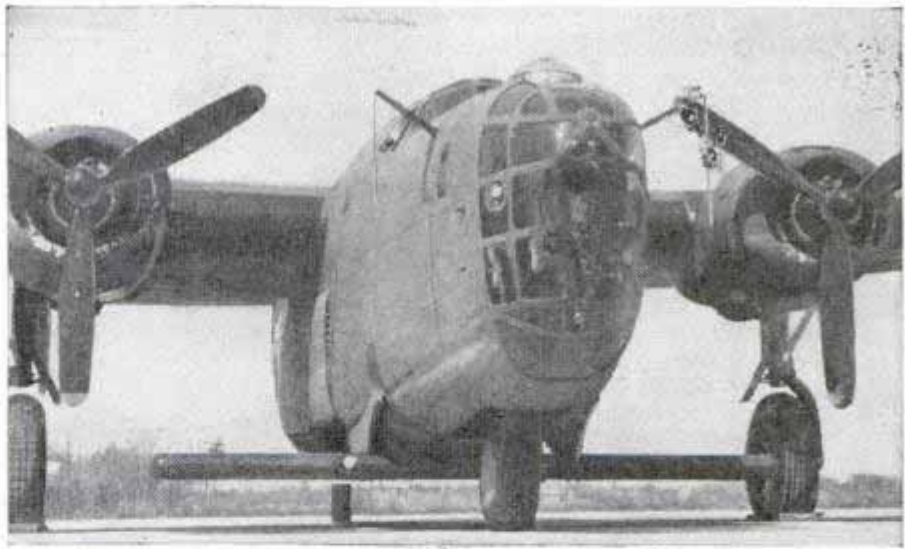

Air Materiel Command photos



Sanding Tool With Long Handle Used for Hard-to-Reach Spots

Sanding wood or metal surfaces is simplified with a tool equipped with a handle and a flat surface around which sandpaper or emery cloth is wrapped. Available in three sizes, the sander is useful for smoothing large areas and hard-to-reach spots. It is handy for carpenters, painters, cabinetmakers, workshop hobbyists and others.

ⓁDry cell batteries developed during the war for arctic regions produce electrical energy in frigid temperatures as low as 40 degrees below zero, whereas ordinary ammonium chloride dry cells cease functioning at four degrees below zero.



A HOUSEHOLD appliance manufacturer recently suggested to a group of college engineering students that they try to improve a modern electric kitchen mixer. What happened then surprised him; soon he had a dozen mixers awaiting inspection and all of them had new features. One, a combination mixer and grinder only seven inches high, performed 19 different kitchen food-preparation jobs.

The ideas came from a unique class in California Institute of Technology's School of Industrial Design. Students there are constantly trying to find ways to improve familiar products and processes. One, Dick Spencer, tried putting a small headlight on an electric iron. Housewives liked the idea and bought the iron. Another, Herman Heidt, designed a chair that saves furniture manufacturers sizable amounts in shipping costs. Heidt's chair can be shipped flat and then assembled in 30 seconds simply by tightening two screws.

The story of the electric mixer is typical of the way the class functions. When the manufacturer suggested the subject, the students first made surveys among house-

In Cal Tech's School of Industrial Design, top, students study chair model and then try to improve it. Above, School Director J. Paul Youtz looks over student Herman Heidt's idea of something new in chairs



In a Jap prison hospital, Harry T. Petterson made surgical tools of scrap. Now he designs home appliances

wives who used mixers. Then they studied potential markets, cost of making the machines and availability of necessary materials. By the time they incorporated their ideas in pilot models they had produced mixers which would suit the users and which could be manufactured profitably. Then a whole group of appliance manufacturers met with the students to consider and criticize the new designs.

Among the students is Harry T. Petterson whose mechanical genius while a prisoner of the Japanese in Shinagawa hospital saved the lives of American fellow prisoners. The story of how Petterson made intricate surgical instruments from scrap

metal was told in the March 1946 issue of *Popular Mechanics*.

It was Petterson's electric mixer that performed 19 different jobs. He decided that motors in present mixers do not do enough work to justify their expense. His new model shreds, grates, crumbs, slices, cuts shoestring potatoes, grinds meat, coffee or nuts, crushes ice, extracts vegetable juices and mixes in any size or shape container. Also it is detachable from its holder and can be used in any position.

There are 21 students in Cal Tech's design class now. Director J. Paul Youtz is confident that they will come up with still more ideas valuable in modern living.

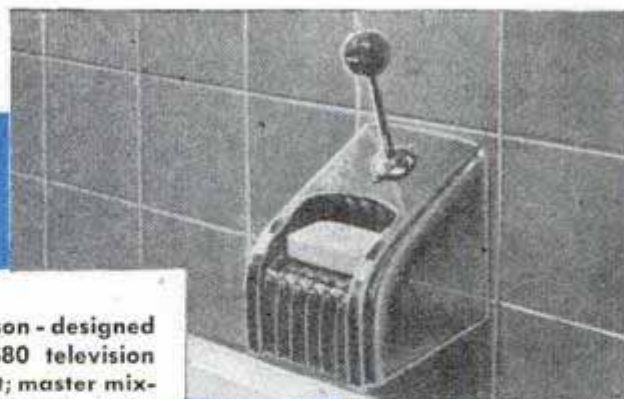

Among Petterson - designed appliances is \$80 television receiver, top left; master mixing valve for shower, right; and combination electric mixer and grinder, below, which does 19 different food-preparation jobs for a housewife



One Man Operates 'Nerve Center' to Control Air Traffic

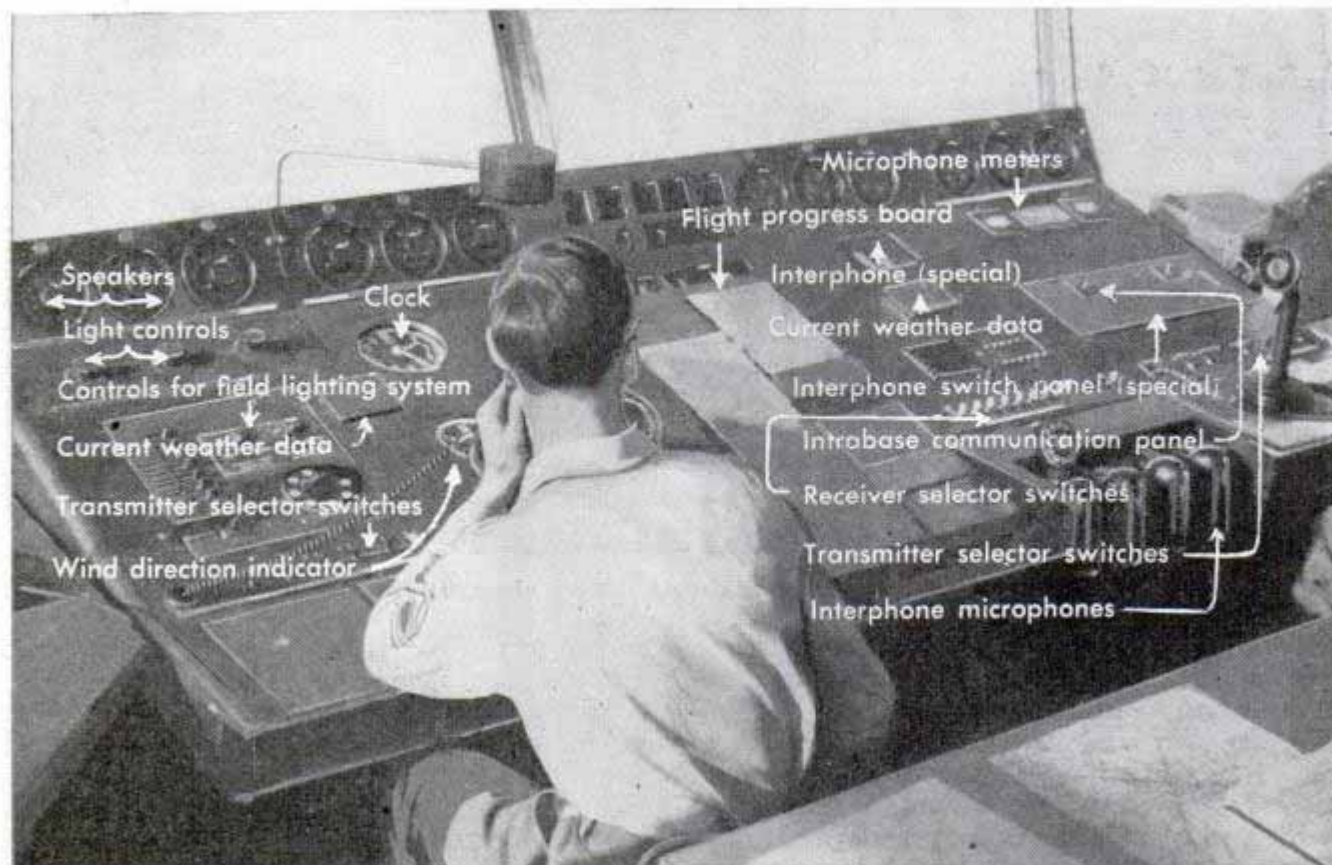

Army Air Forces photo

All the facilities needed to control air traffic, now scattered throughout the tower, are combined in a one-man console being tested at Langley Field. It has a unit that permanently records on plastic tape

all messages sent and received. Complete flight plans, instrument and contact flight records and the latest weather information are displayed prominently in the center of the panel, readily accessible to the operator.

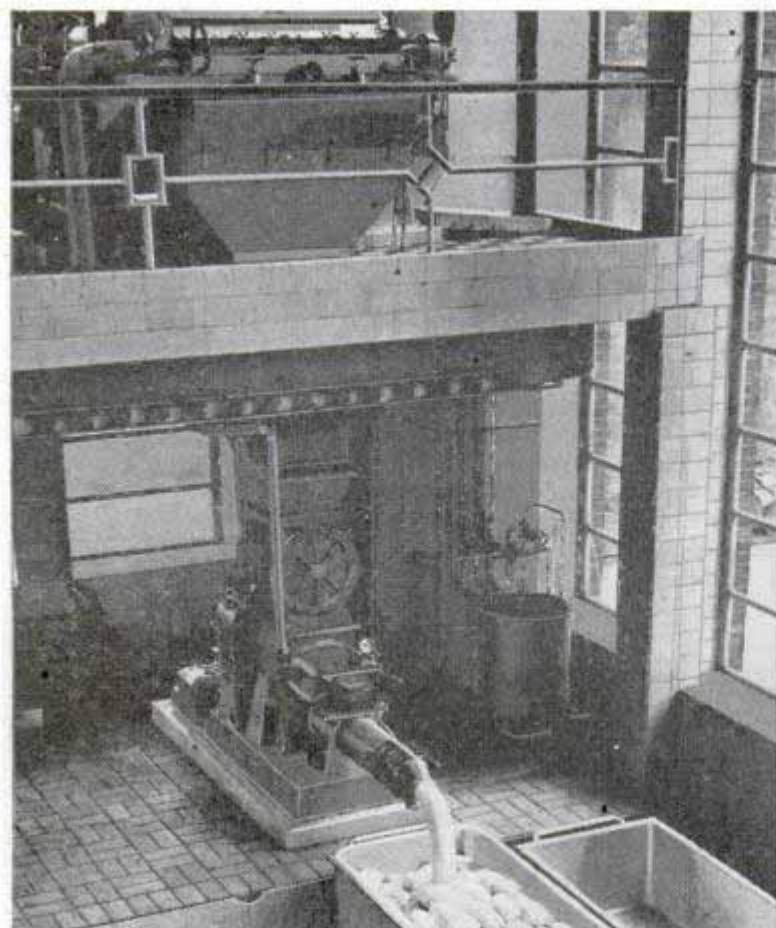

Ersatz Butter From Coal Helps Feed Germans

Butter can be produced from coal in a factory at Witten, Germany. In the process, developed by Dr. Arthur Imhausen, coal is transformed into coke which yields a synthetic paraffin. Edible fat produced from the paraffin is flavored and colored and vitamin A is added. The butter is squeezed out in sausage-like rolls by a machine. Capacity of the factory is 23,000 tons of butter per year.

Spray Removes 'Bad' Fruit

Undesirable fruit can be prevented from growing by a special chemical spray which takes the place of picking by hand. The spray, developed by B. F. Goodrich Chemical Company, is applied two weeks after trees are in full bloom. By removing excessive fruit before harvest, a larger and healthier crop is produced. The spray is not harmful to trees.

6500-Pound Drag 'Shaves' Steep Bank

Irrigation ditches up to 18 feet deep are cleaned by a power-controlled ditcher built by Owen L. Gregerson for use on his ranch near Gunnison, Utah. The machine weighs 6500 pounds and will function on canal banks as steep as 60 degrees or in canals up to 5½ feet deep. Pulled behind a Caterpillar Diesel tractor, it cleans up to three miles of ditch daily.

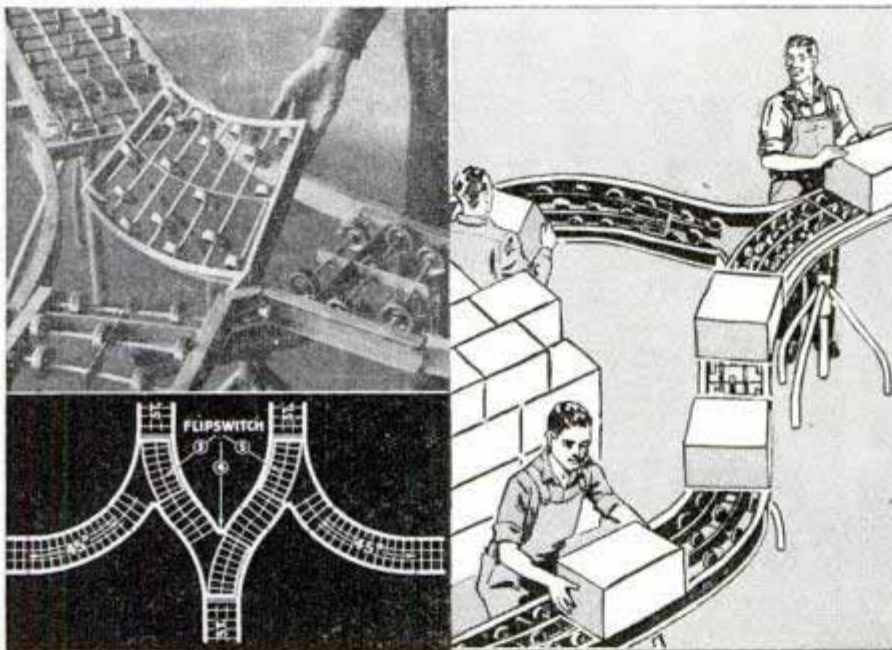

Conveyor Switch

Materials being loaded or unloaded can be shunted in either direction over a "Y" switch for conveyor systems. Mounted at the throat of the Y, the manually operated switch can be flipped over to divert goods from one direction to another. This permits loading or unloading from both sides of a freight car or a double flow of materials into warehouses. The Y branches off at 45-degree angles and, when combined with other switches, can deliver goods around corners.

Dial on Metal Tape Rule Holder Shows Accurate Measurements

Measurements are read through the plastic window of a metal tape rule that also can be used as a scribe. The measurement from the outer edge of the rule's case to the end of the tape appears beneath a hairline marked in the window. A scribe on the bottom of the instrument is housed inside the case when not in use, but will protrude when slight pressure is applied, marking the desired measurement. A felt wiping pad cleans the tape whenever it is used and the heavy case has a chrome finish both inside and out.

Ⓛ Pentolite, the superexplosive which gave the bazooka its armor-piercing power, has been applied to the oil-well-casing perforator to increase the flow of oil.

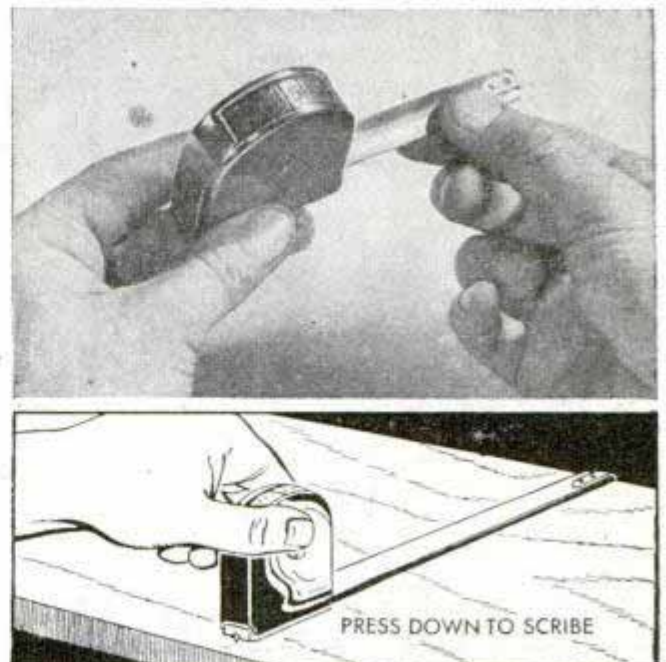

WHO SAYS IT'S A SISSY



Modern volleyball is a slam-bang game for speedy, leaping giants

By Harry Wilson
National Volleyball Referee

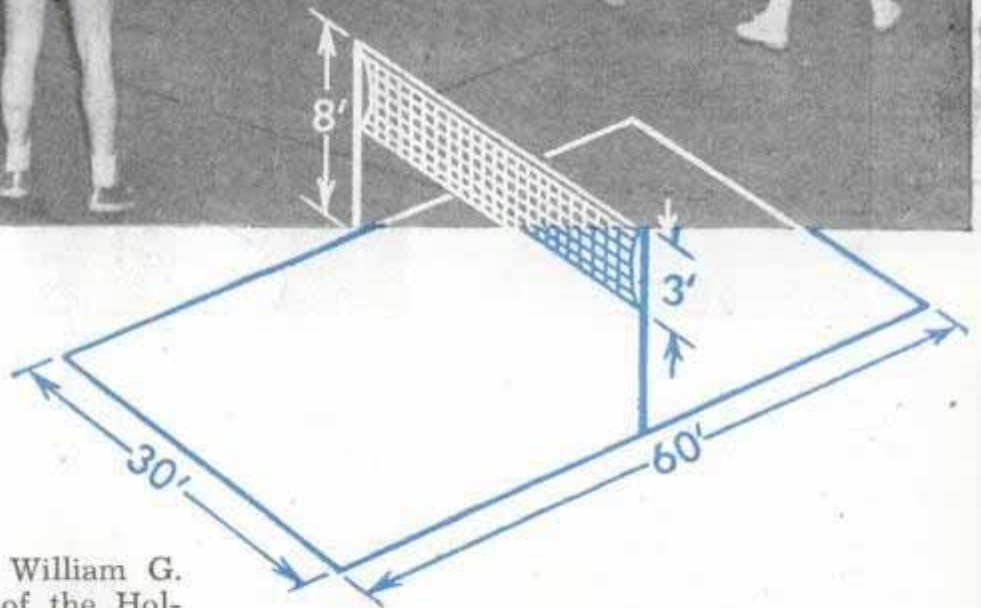

IN THE WINTER of 1895, William G. Morgan, physical director of the Holyoke, Mass., YMCA, invented volleyball for a group of businessmen who lacked the stamina to play basketball.

He raised a tennis net as high as a man's head and provided an old basketball bladder for the class to bat around. However, it proved too light. Morgan, therefore, asked A. G. Spalding & Brothers to design a ball especially for the new game. Spalding did—and essentially the same type is used today.

Even though the ball is similar, the game itself has undergone radical changes. It's no longer merely a refuge for tired busi-

nessmen or high school girls. Volleyball today is a rough, tough game that frequently results in broken noses, black eyes, smashed collarbones, sprained ankles, twisted tendons and pulled muscles. It has been a long time since anyone who knows this sport called it a "sissy" game.

Volleyball, as played by champions, requires players in tip-top physical condition and teams with split-second coordination. The present-day game combines the teamwork of football, the jumping and ball handling of basketball, the arm movements

GAME?

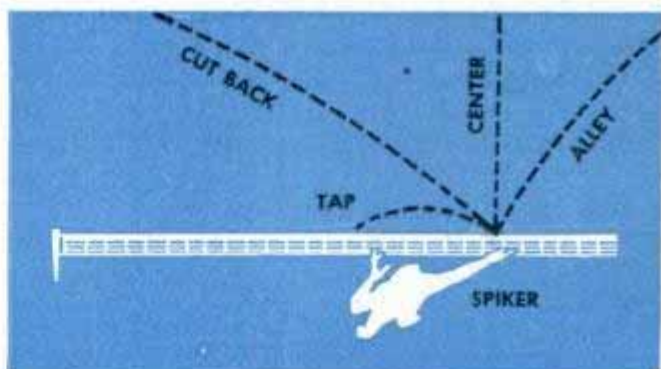
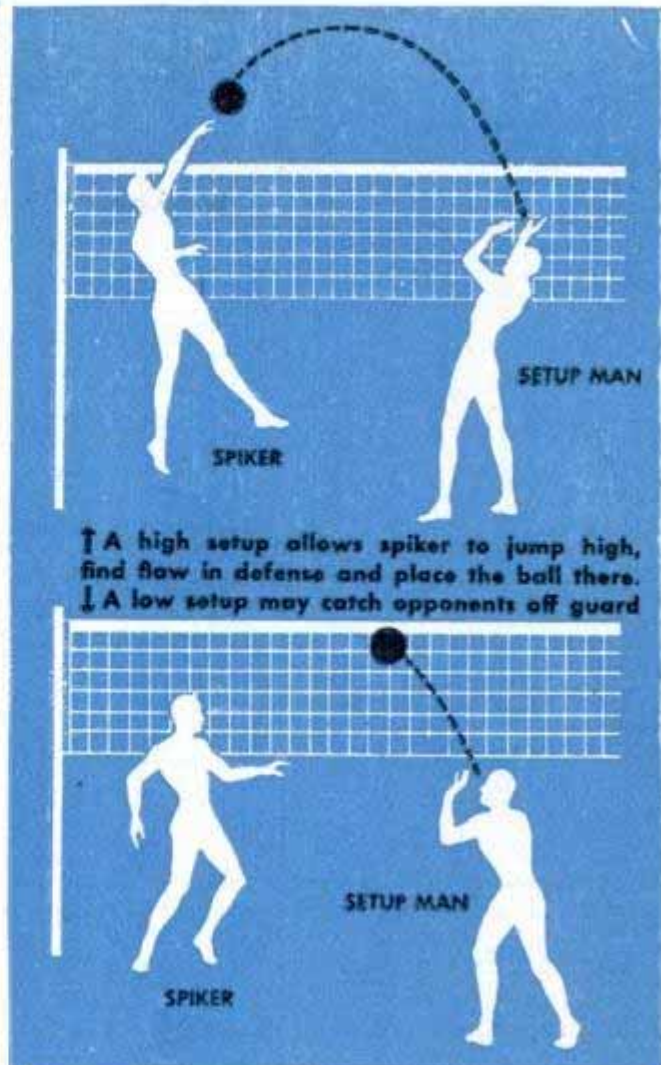
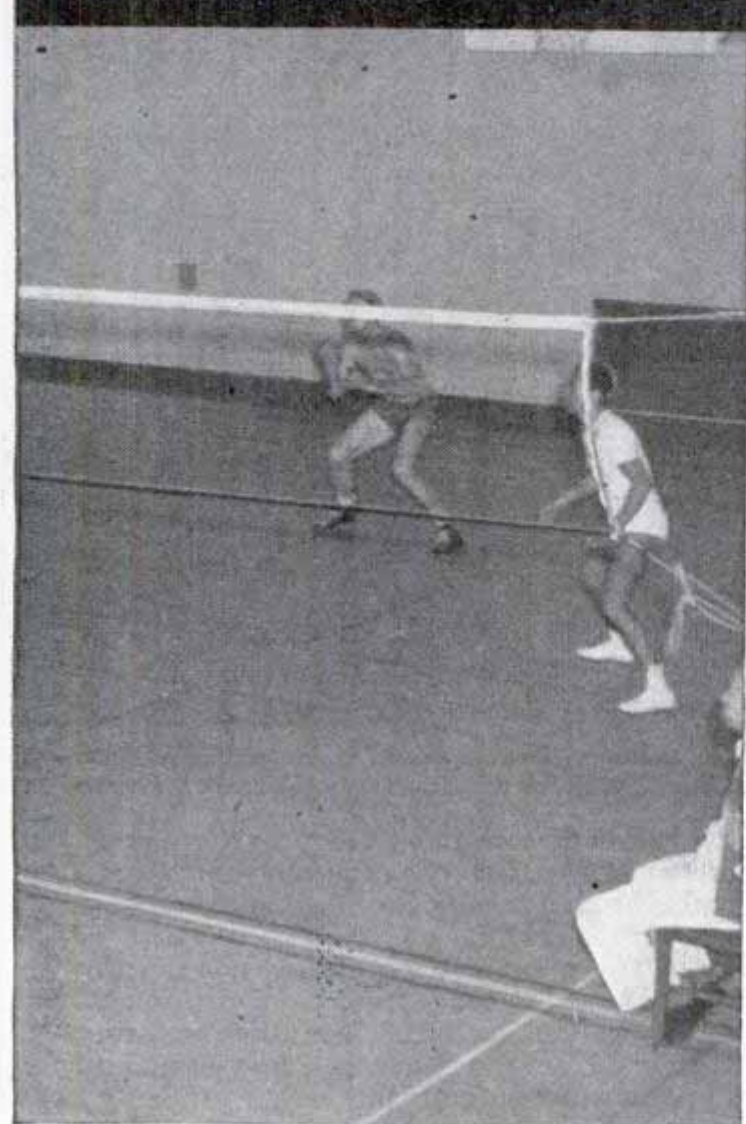

↑ Spiker has choice of four shots; the alley, center, cut-back or the change-of-pace tap.
 ↓ "Hard" block sends ball back to spiker's court; "soft" block sends it to a teammate for setup

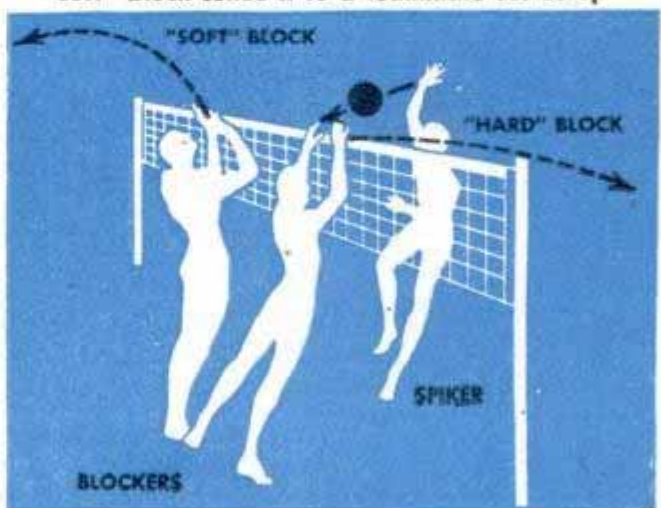

of handball and the placement of shots as in a tennis match between top-notch players.

World War II gave volleyball a shot in the arm. It was simple to toss a deflated ball and a rolled-up net in the back of a jeep or a sea bag. As a result, the game was played on the deserts of North Africa, in the bomber hangars of England and on the coral beaches of Guam and Okinawa.

Volleyball is a fast-growing sport, played by an estimated 4,000,000 players and finding favor with college, athletic club and commercial teams. It is most popular in California, Illinois, Michigan, Pennsylvania and Texas. Tournaments were in progress all winter and will be climaxed by the United States Volleyball Association Open Tournament at Houston, Tex., next month.

The national champions who will defend their title are the Pasadena, Calif., YMCA team. Members are Webb Caldwell, former All-American basketball center; Jim Ward, former college track star; Everett and Glen Keller, Bernard Holtzman and Paul Siano. This sextet is coached by Ira "Red" Swett.

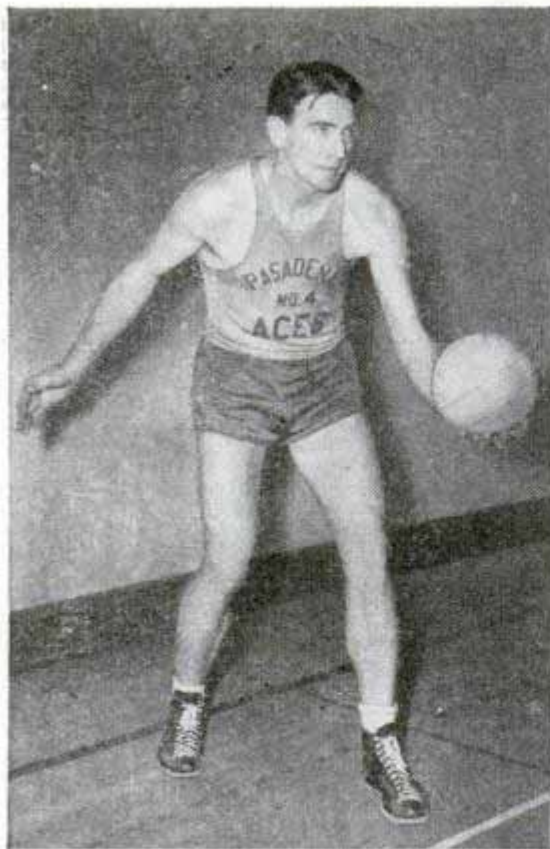

Underhand serve (left) and overhand serve (center) are demonstrated by Webb Caldwell of the Pasadena Aces. At right, Manuel Saenz, setup man for the Los Angeles Athletic Club, shows the correct way to receive the ball

Let's see how the experts play volleyball. The standard pattern of play is (1) serve, (2) pass, (3) setup, (4) kill, and (5) block. This has developed from a gentle, ping-pong style of play to a highly skilled, closely coordinated, smashing game.

(1) The serve: As in tennis, the serve puts the ball in play. For many years the object was merely to swat the ball across the net. But today expert teams give consideration to placement of the ball and to making it curve or drop.

The first type of serve is the underhand. This service is usually taught beginners. The ball is held in the left hand, waist high, and batted with the right in a sweeping, underhand motion as if you were pitching a softball. It may be hit either with the open palm or the fist.

Among certain players, however, the "roundhouse" serve is more popular. The server tosses the ball over his head (as in tennis) and strikes it hard with a sweeping overhand motion. This serve is more difficult than the underhand, but a skillful player uses it for speed and deception.

The third, or overhand, serve is a collection of baffling serves. These include a "floater" in which the ball does not spin; a side-arm swipe; a push-ball serve in which

the ball is thrown in a shot-put action, and the Statue of Liberty serve in which the ball is held high with the left hand and batted with the right.

(2) The pass: You bat the ball or tap it. If you hold it even a fraction of a second, the referee calls a foul. The ball, therefore, is played from the finger tips. As you make 10-point contact with the ball, your body acts as a huge shock absorber and you take

Harry Wilson, the author, uses these signals to "call" volleyball



the impact with fingers, wrists, arms, shoulders and knees. But immediately you apply power in the opposite direction and pass the ball to a teammate.

When handling the ball, your thumbs should be several inches apart, elbows out and fingers spread. In passing to a fellow player, it is preferable to feed him a high, looping pass. It is easier to handle than a low ball.

(3) The setup: Closely allied with the pass is the setup. Each team possesses three setup players; their job is to put the ball into position for the three "spikers." The setup man receives the ball from the back court and tosses it high alongside the net so that one of the spikers can smash it into the opposing court.

There are two main types of setups. A high setup is one in which the ball is placed about 15 feet above the court and falls to within 6 to 24 inches of the net. A low setup is where the ball is placed only a few feet above the net, giving the opposition less time to get set before the spike.

(4) The spike: The spike, or kill, is the most spectacular part of volleyball. One of the spikers—usually a tall man—leaps high into the air at the net and with a powerful overhand sweep tries to smash the ball into the opponent's court. Getting hit by a hard spiked ball often causes broken noses or black eyes.

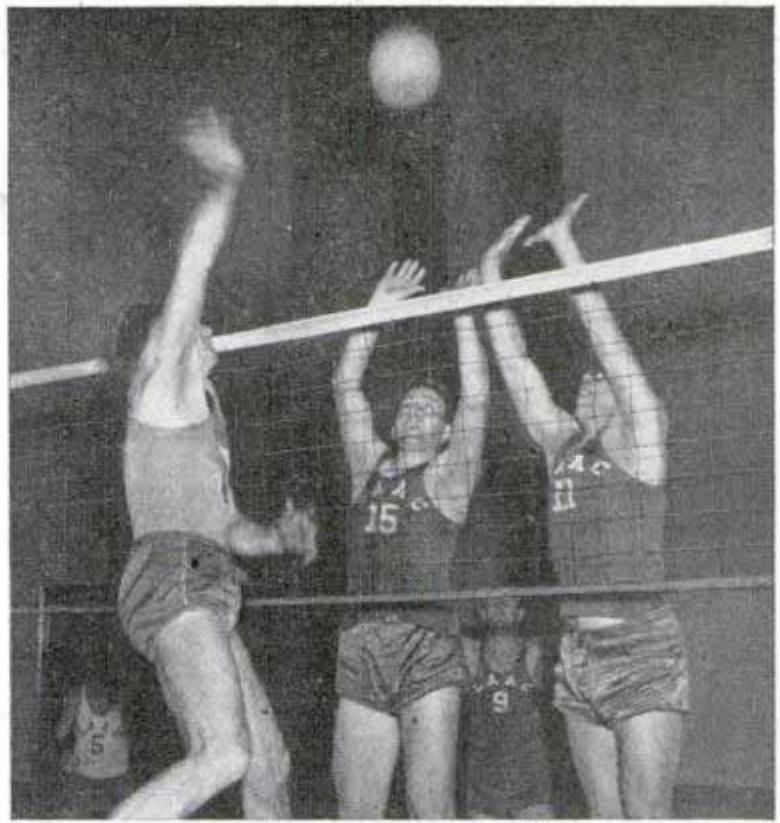

Players at right put up a "block" defense to return sizzling smash

Spikers use different techniques, but the two important factors are placement and power. The ball is hit with the arm slightly bent at the elbow. The whiplike motion of the hand and wrist gives the ball a powerful impetus. Some players hit with the open hand for better control; others hit with the heel of the hand and wrist for greater power. The spiker has four possible shots—an alley shot into the far right-hand court, a

(Continued to page 272)

Player at right (in left photo) delivers a smashing "spike." If the spiker's foot goes across the white line (right), or if blocker touches the net, the referee calls a foul. Volleyball players call fouls on themselves also

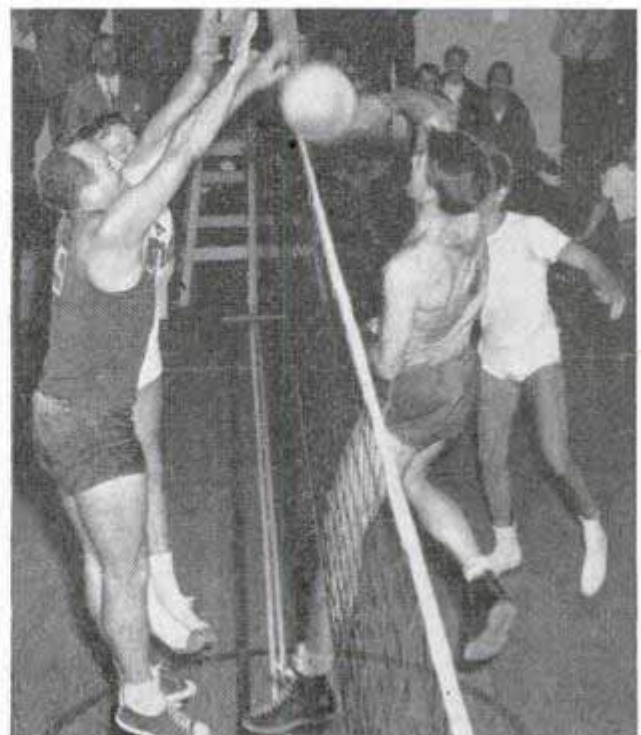

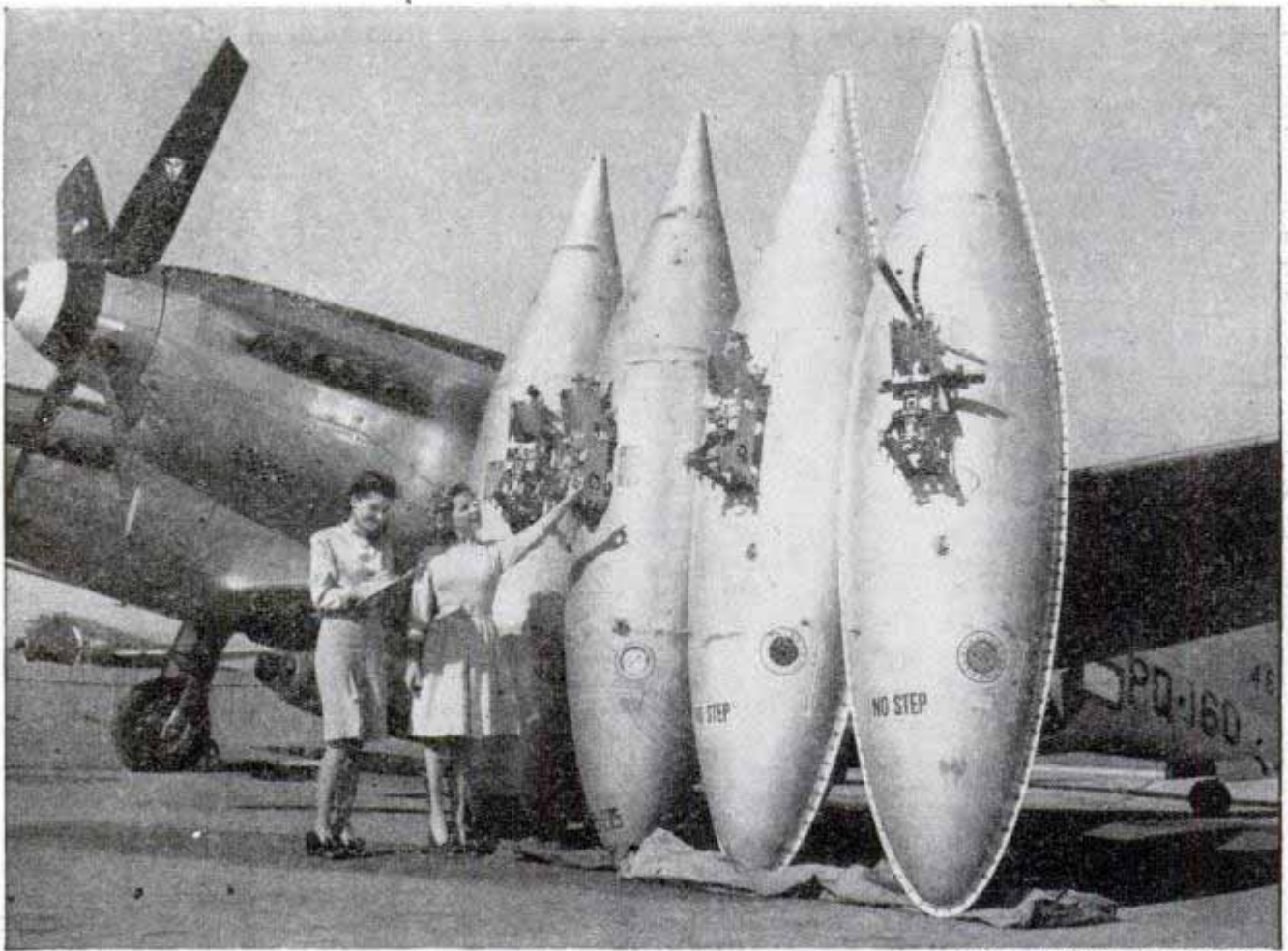

North American Aviation photo

5000-Mile Fighter Carries Largest Droppable Tanks

Four extra 310-gallon droppable gas tanks, largest ever carried by a fighter, made possible the record nonstop flight of an Army P-82 from Honolulu to New York.

It covered the 5051 miles in 14 hours and 33 minutes. The plane was built by joining two P-51 Mustangs, each with a pilot and separate controls, by a single wing section.

Uranium Rods Will Feed Rayproof Atomic Power Plant at Oak Ridge

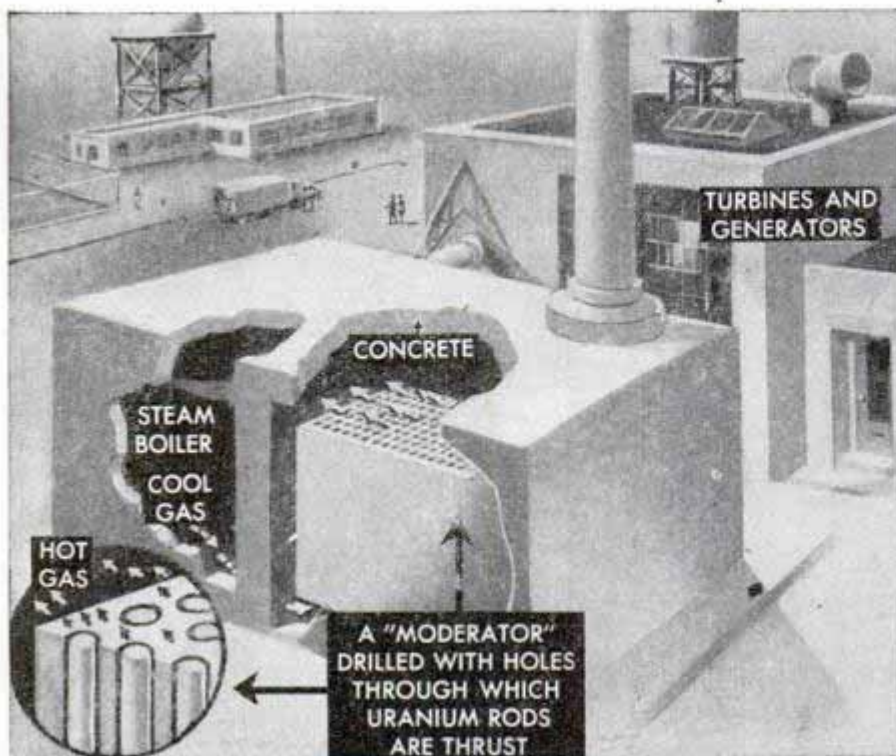

In the atomic power plant under construction at Oak Ridge, Tenn., uranium rods will feed the atomic fires in a thick-walled rayproof building. The erection of this plant, designed by Monsanto Chemical Company scientists, will mark man's first direct move to harness atomic energy as an aid to mankind.

Popular Mechanics is always ready to supply further information to readers about various products described in any issue. Just write to the Bureau of Information, Popular Mechanics, 200 East Ontario Street, Chicago 11, Illinois, for a prompt reply

Here Is the Home That Millions Want . . .

The POPULAR MECHANICS Build-It-Yourself House

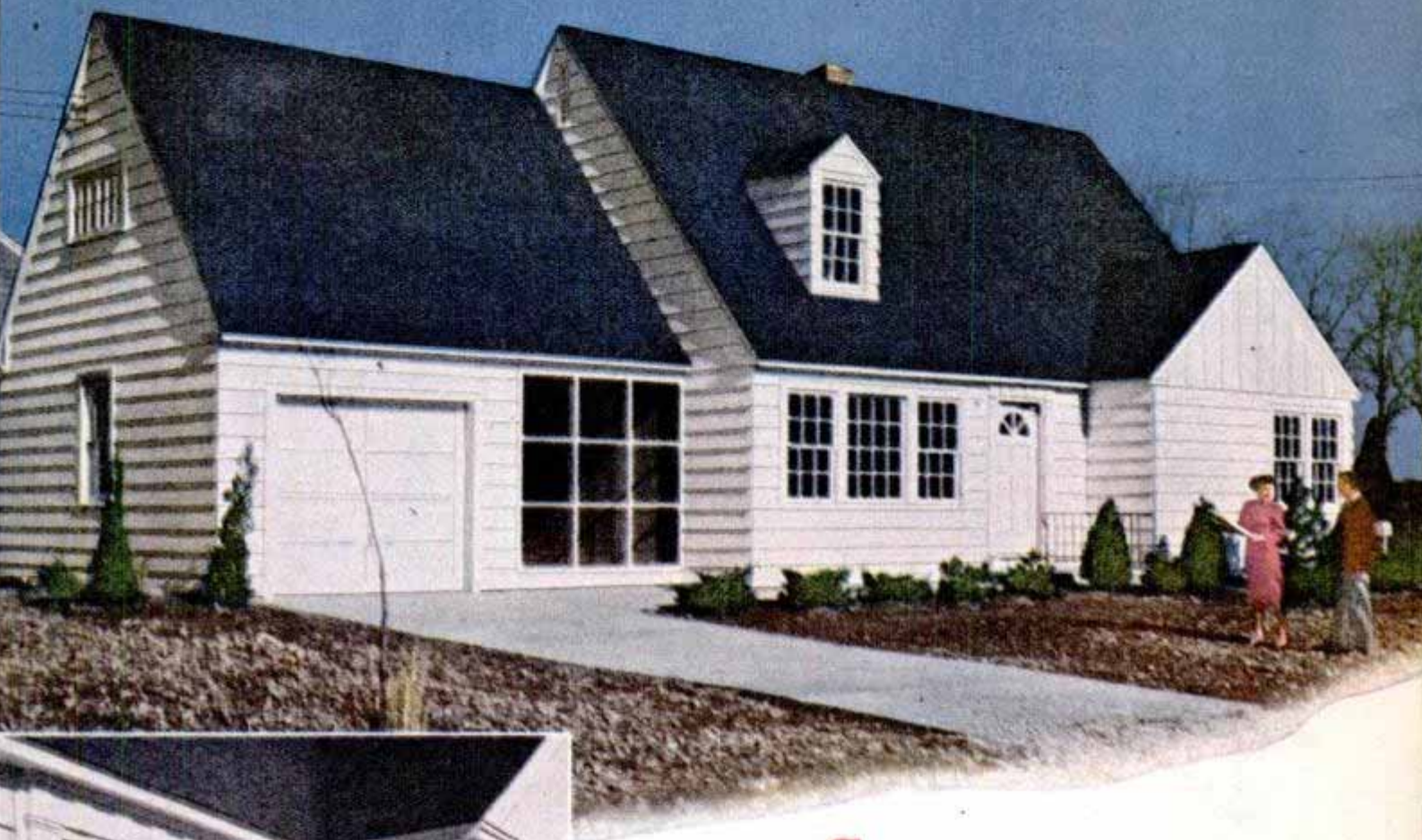

Can any man who can handle a hammer and saw build his own home? The editors of Popular Mechanics asked and answered this question. Here is the home that resulted—one of the most significant editorial projects we have ever undertaken. Turn the page and begin the story of The House That Jacques Built.

Right, the Brownsons study plans with (left) James R. Ward, Crafts Editor, and Wayne C. Leckey (right)





Meet Mr. and Mrs. Jacques Brownson

SOMEWHERE along the China coast a young carpenter's apprentice of the U. S. Army Corps of Engineers was bossing a gang of coolies building a home for his general.

With the humming of saws, the thud of hammers, the babble of coolies for orchestral background he let himself dream a little. Some day he would build a home for himself and The Girl. A small white house—the practical, expansible sort of house

As framework of house gets under way, Jacques proves to his wife, Doris, that he can saw board straight

most young Americans dream of building.

Pretentious? No—but it would be comfortable: with a yard, maybe a garden; room for a home workshop in the basement—or it could be a recreation room. If the stories of shortages and high prices back home were true, he'd build it himself. It'd be nice to have a gang of coolies to help—but he could do the whole job himself, if the war ever ended. From China it looked like a faraway dream.

"Look busy; that photographer is here again," Doris warns Jacques as he attaches handle to garage door



There's a lot of living space on the first floor; breezeway actually adds another room



PROPOSED SECOND-FLOOR PLAN

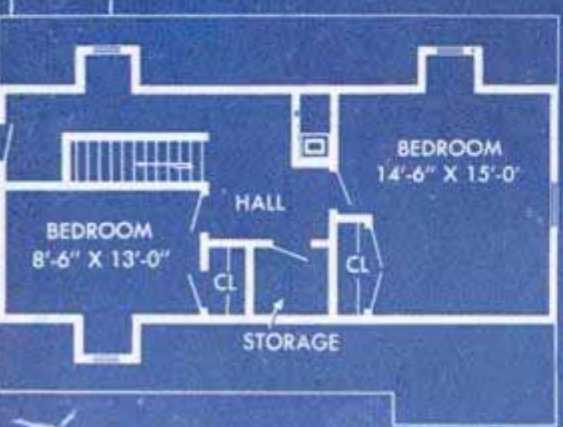

FIRST-FLOOR PLAN

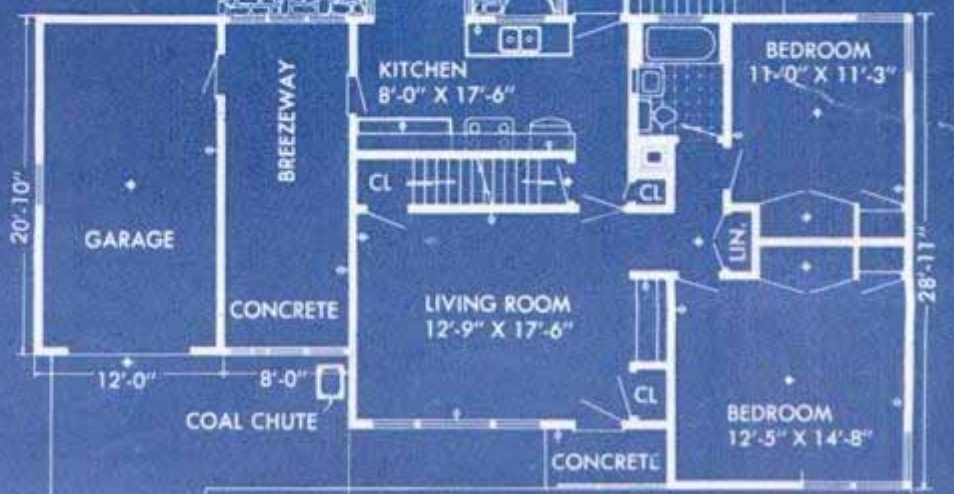



Jacques adds finishing touch to the plastering, one of the few jobs requiring expert assistance



One of chest units which Jacques built for bedrooms is set into wall. Below, applying sheathing



Halfway around the world some serious thinking was paralleling Jacques Brownson's wishful dreaming. The wartime holiday in home building, the postwar shortages of materials and labor and the high costs of both had provoked the most serious housing crisis ever experienced in America. Over their coffee cups the editors of *Popular Mechanics* wondered out loud what could be their best contribution to a home-hungry nation.

James R. Ward, Craftsman Editor, came up with an idea.

"Let's plan a house," he said. "A house for the average American family, give 'em blueprints and all, show 'em what it will look like furnished."

"Why not build it?" interrupted the Managing Editor, Roderick M. Grant. "That's the only way to prove a house. When you print plans for a sailboat or a photo enlarger or a home freezer you build it to prove it's right. Let's build the house and tell how to do it."

The staff began passing the objections around the table. Sounded like a pretty big project. We'd never done anything like that before. Doubt if any magazine ever actually built a house just to prove it up. Who could do it? Building a house was not for ordinary people, so why tell them how to build one?

"Anyone who can saw a board straight and hammer a nail can build a house," said Mr. Ward. "It takes more skilled workmanship to build a desk than a house. Sure, it takes more man-hours to build your own home, and maybe more headaches; but with the blueprints and step-by-step instructions that we could print, any man could build a home for himself. Particularly the men who read our magazine."

So the *Popular Mechanics* BUILD-IT-YOUR-

After the stock windows and doors were installed, Doris got busy on the stepladder with a brush and a can of paint

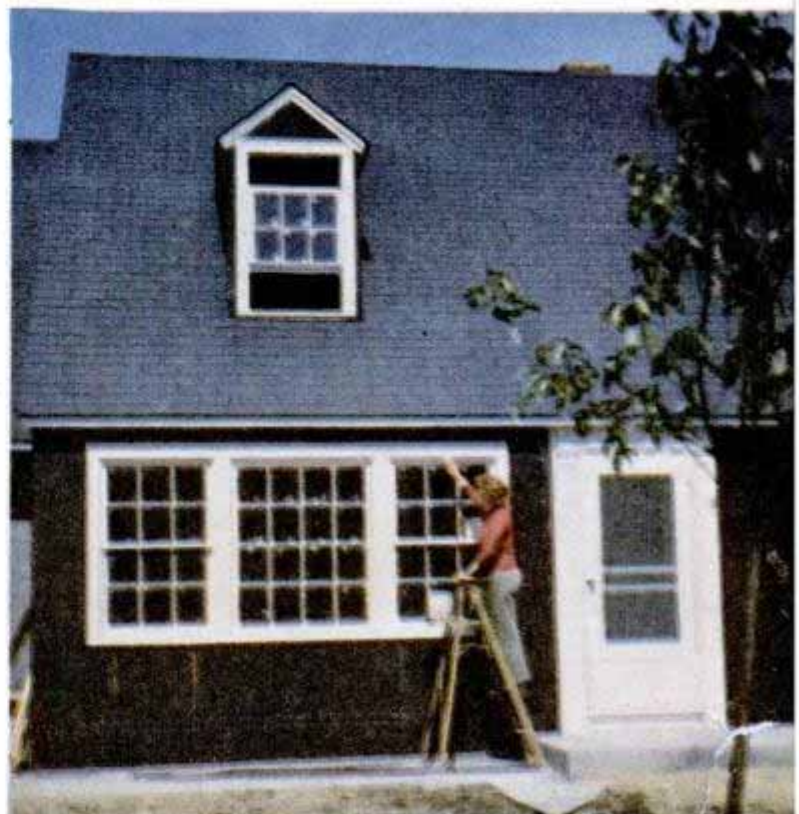

I hope you like my house: I sure do. It measures up to the dreams I had overseas a year and a half ago. Frankly, building this house is the biggest thing that has ever happened to Doris and to me. It was a challenge from beginning to end, but I assure you that no man could have greater pride than we have in having constructed our own home with our own hands. We had plenty of tough moments—you can't build any house without them. But the result is just about as satisfying as we could ask. I strongly urge others who need a house to do what I did—build their own. Jim Ward and Wayne Leckey and the other editors of *Popular Mechanics* have made it easy for anybody who can saw a board straight and drive a nail to build a house. If you do it, I'm sure you will agree with me that it is a thrill that comes only once in a lifetime.



SELF HOUSE began to take form. The editors of the Craftsman Section brought in plans and kicked them around. Surveys were made to determine the type most appealing to the average American. It couldn't be extreme, or prohibitive in cost, and it must not be a shanty. Folks have had enough of makeshift homes, and this was to be a house for a lasting appetite. It must be attractive, and a home that will adjust to a growing family. Probably an unfinished upstairs space that can be made into extra rooms as the youngsters come along. It ought to be adaptable to a variety of tastes in external architecture, a basic plan that will take dormers and gables and picture windows here and there if you like them. It should be efficient in its interior arrangement for housekeeping, and also in offering the most value for the money invested.

Along with the story in the magazine, we'd get out a book packed with every detail of instruction any man would need to build the house—"written so you can understand it." If he

preferred to hire a contractor or an ordinary carpenter to do the job, the book would help him to see that the workmen followed every specification of plans and materials.

Early in the spring of 1946 the editors commissioned one of Chicago's leading architectural firms to present its sketches of the home that millions of Americans would want. Meanwhile a search for the right man to build it was started. The dreams of Jacques Brownson and *Popular Mechanics* began to mesh.

During an editorial conference, Wayne C. Leckey, Assistant Editor of the Craftsman Section, came up with the answer.

"I think I've found just the fellow. He's an ex-GI named Jacques Brownson, living out in Aurora. He's just been married and he and his bride can't find a place to live—but he owns a slick lot on a corner at the

edge of town and he's toying with the idea of building his own home. He can handle tools; in fact, he's taking an architectural course at

The Popular Mechanics Build-It-Yourself House at 972 Sixth Ave., Aurora, Ill., is open to the public March 29 to April 13



MAY 29—"Big day for us. Ground broken for house and excavation well under way. Removed 200 yards fill dirt. Trucking cost \$30"



JUNE 24—"Bud helped set forms for the foundation. Also laid some sewer tile"

Illinois Tech. And as an exserviceman he should stand as good a chance as any at getting materials."

Brownson turned out to be a good gamble. It was a gamble, for *Popular Mechanics* was betting a vast amount of staff time and the cost of all materials going into the house—to be presented to Jacques when he completed it—that any man like 23-year-old Brownson, with mechanical aptitude, could build a lovely home from the plans and instructions prepared by the magazine editors.

But Brownson was a little let down when

he was called in to see the first sketches offered by the architects. They were of the "modern" matchbox type, flat roofed, no basement. The gleam went out of his eye.

"I suppose," Jacques said slowly, "these houses would be attractive to some people, but they don't look like the place I have in mind. It's not that I am opposed to modern improvements; I like those big windows and the general functional design, but couldn't you incorporate some of those features in, say, a modified Cape Cod house? For one thing, I want a basement. Where am I going to have my workshop?"

Feeling much the same way about it, the editors were secretly pleased. Tossing the problem back to the architects for more ideas, they began asking questions all around, surveying the average man's desires for his home, and started putting the Craftsman staff's

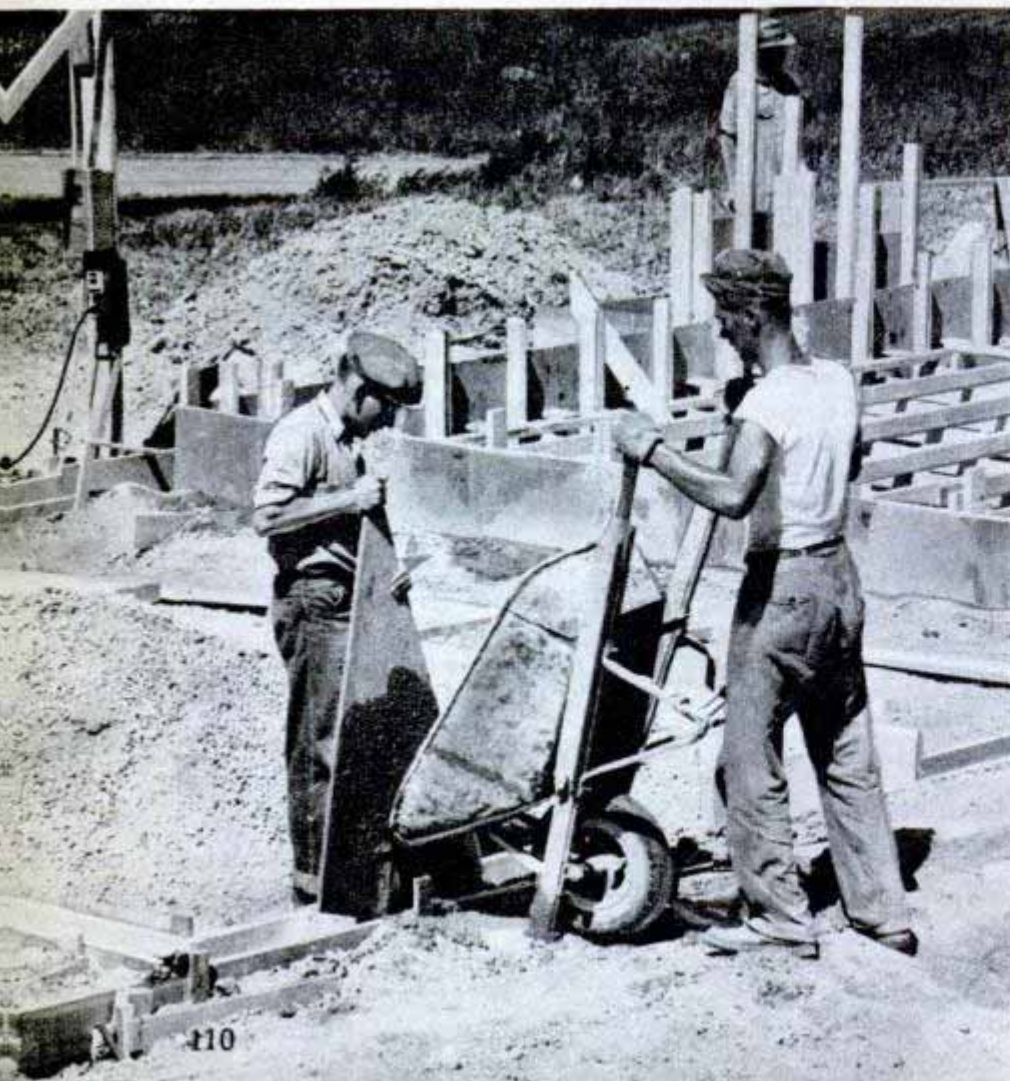

← **JULY 1**—"Had to hire some extra help to pour the foundation all in one day"

↓ **JULY 12**—"Bud and I put in eight hours each raising framework. Is my arm sore!"





JUNE 27—"Finished foundation forms for house and started forms for porch"

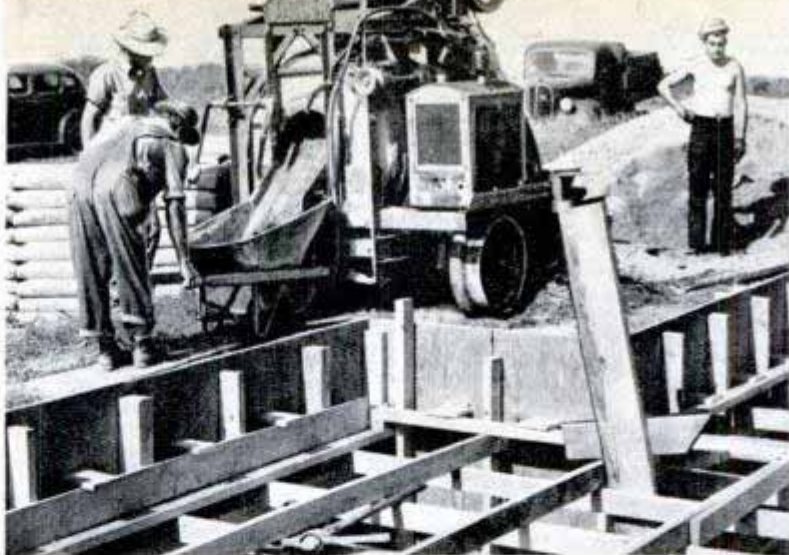

JULY 1—"Poured foundation for house, porch and garage; set in basement windows and anchor bolts. We used 200 sacks of cement"

own ideas down on the drawing boards.

By the time the ground had started to thaw in Aurora, Ill., 38 miles west of Chicago, the plans of architects and editors and Jacques Brownson had crystallized and the BUILD-IT-YOURSELF HOUSE was ready to take shape.

It is a 1½-story house with a heating plant and knotty-pine paneled shop or rumpus room in the basement, and complete living quarters on the first floor. There are two bedrooms and bath, living room and kitchen with dining nook. Between the house and its attached garage is a spacious breezeway, each end of which is enclosed by glass during the winter and screens during summer. The Brownsons planned to furnish this colorful, bright room with summer-type furniture as a dining room and lounge. Its high, broad window area in front, like the living room and one bedroom, overlooks a grove of oak trees and a golf course, a lovely vista in winter and summer. A stairway from the living room provides access to the second story, as yet unfinished but with ample space for

two or more additional bedrooms as the family increases.

Since the kitchen is readily accessible both to breezeway and living room, dinner can be served conveniently in either room. The Brownsons willingly sacrificed a separate dining room in order to get the most living space for the money.

Materials for the completed house and garage cost exactly \$7046.87 in the Chicago area—a relatively high-cost region, and in a high-cost year. This naturally would vary in other areas and other times, and many economies could be effected by eliminating the garage and breezeway. The house was built as the Brownsons wanted it. The basic considerations in the general plan were ease of construction, the greatest living space for the least cost without sacrificing attractiveness of design, and adaptability. The *Popular Mechanics* house can be altered easily to conform to other architectural preferences—modified Dutch Colonial, modified Cape Cod, plain gable-roof house without dormer windows, or the house as it stands but without garage or

JULY 27—"Put up the studding in front gables and built rear dormer" **AUG. 3**—"Roof covered—finally!"

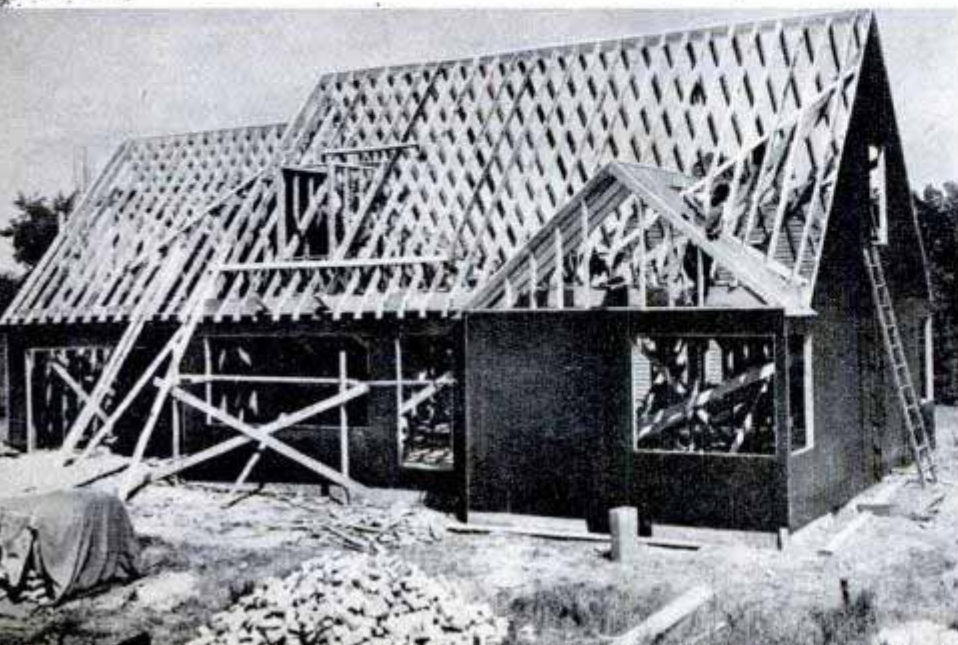

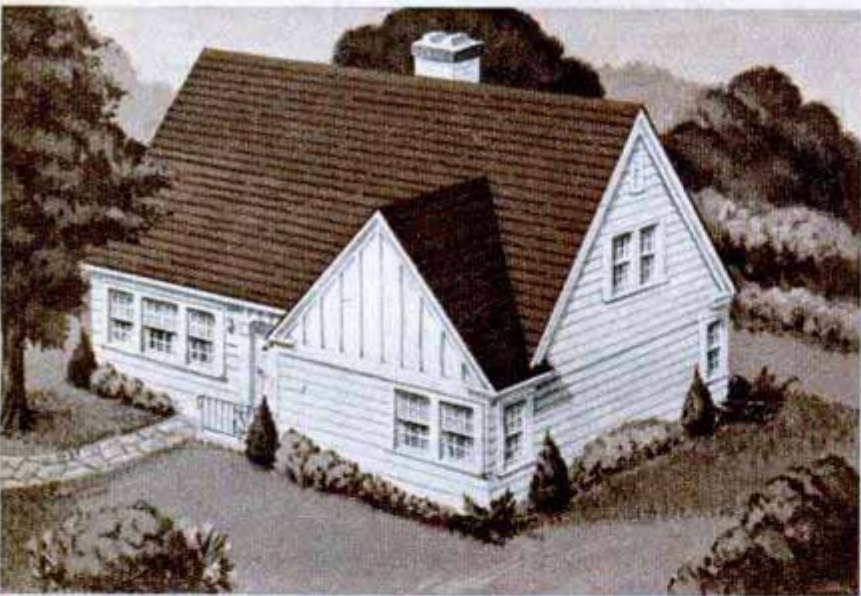
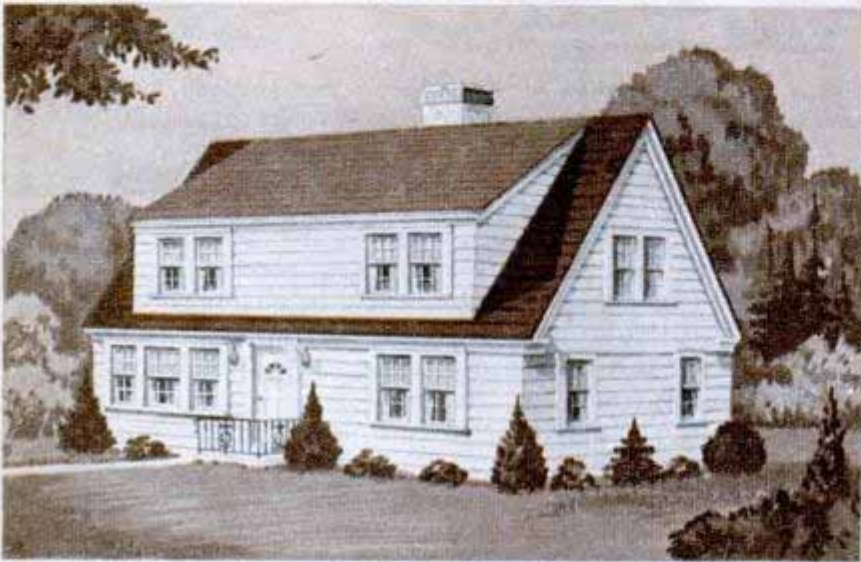
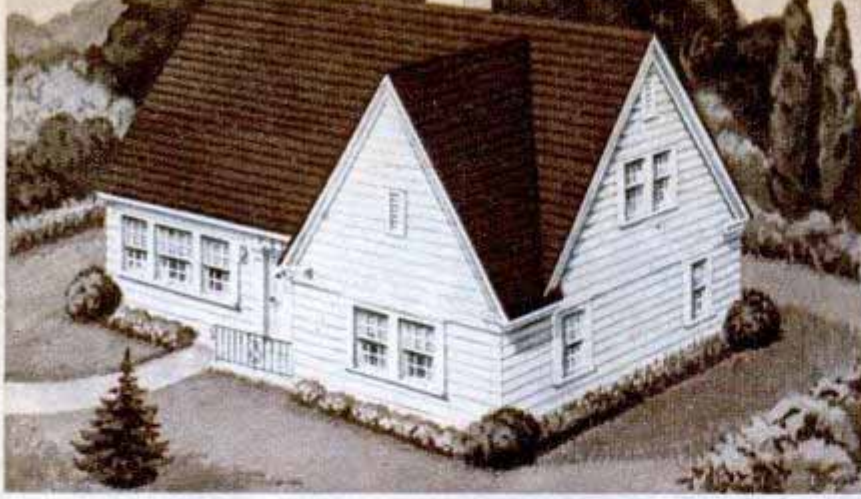

breezeway. These variations, as shown by the illustrations, are accomplished chiefly by changes in roof design.

For simplicity of construction, all windows and doors are stock products; this saved about one third in milling costs. In the two bedrooms, stock windows are used to simulate the popular corner window, and the effect is pleasing. Stock windows of the multiple-light type used in the living room were also planned originally for the breezeway, but this gave the appearance of a greenhouse. Wayne Leckey, the Assistant Editor who spent most of the summer with Jacques Brownson as observer, counselor and chronicler, suggested replacing these with larger panes 30 inches square, set in a framework of 2 by 6-inch pieces which affords shelf space for potted plants or bric-a-brac. Any or all of these panes can be replaced by screens in summer.

Leckey calls the breezeway "The Topsy" because it just grew from an unimportant three-foot-wide latticed areaway, as originally conceived, to an eight-foot room that is one of the most distinctive features of the house. The extra space was possible because the Brownson lot, although only 50 feet wide, is on a corner. Built lengthwise of the lot, its over-all width including breezeway and garage is 55 feet 9 inches; the house itself is 35 feet 9 inches by 28 feet 11 inches; the breezeway, 8 feet wide by 20 feet 10 inches deep, and the one-car garage 12 feet wide by 20 feet 10 inches. The house, however, can be built on an ordinary 50-foot lot by leaving off the garage and breezeway.

The full-size basement is Brownson's particular joy. Still, he hasn't found the final answer to his original query: "Where am I going to put my workshop?" The problem is now one of choice, for he has available a wealth of space—the pine-paneled room 14 by 27

(Continued to page 252)

Here are four possible variations, minus breezeway and garage, of basic plan. From top down, larger gable gives impression of bigger home; Dutch dormer means more second-floor room; modified basic plan has corner windows and no dormer; Cape Cod adaptation has dormers at front and rear

PORTRAIT DOLL



Rag dolls that look like tiny duplicates of famous people are made by Evelyn Ware Smith, Merrick, N. Y. Plaster-of-paris head is modeled from a photo



Doll's arms and legs, with all the contours of its namesake, are cut from patterns traced on cloth. When finished, the legs are encased in silk or Nylon hose



After being sewn, limbs are stuffed with cotton batting. The same material is used to fill out the body. With the human hair wig in place, the doll's face is painted with lifelike coloring. The complexion and hair are selected to match closely those of the subject



Sewing stuffed limbs to torso. Mrs. Smith exerts great care in every step, taking two weeks per doll. The finished doll sits beside a portrait of the subject, Ann Thomas, radio actress. Every detail in the doll's jacket matches the one worn by Miss Thomas



QUONSETS CONVERTED TO PEACE



To handle the overflow of children who enrolled in one Detroit school, a Quonset houses two classrooms

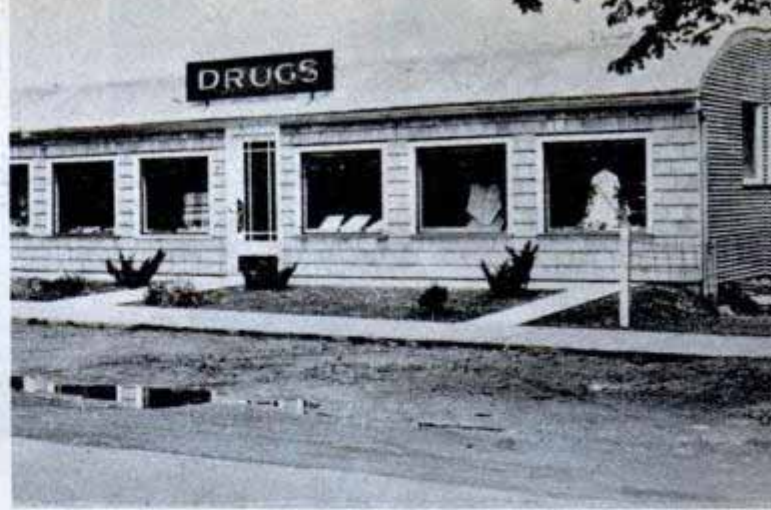

Wood shingles add a homey touch to this round-roofed steel structure at Sayre, Pa., which is occupied by a store

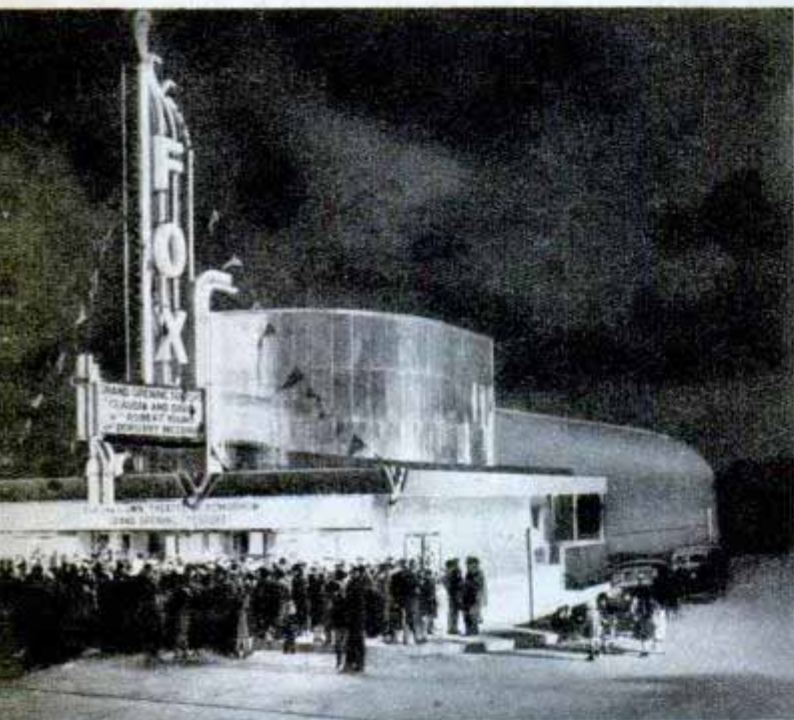

In Aurora, Colo., a builder added a special front to a 40-foot-wide Quonset and he had a movie theater

Stone applied to the exterior, plus landscaping, adds to appearance of an office building in Oklahoma City

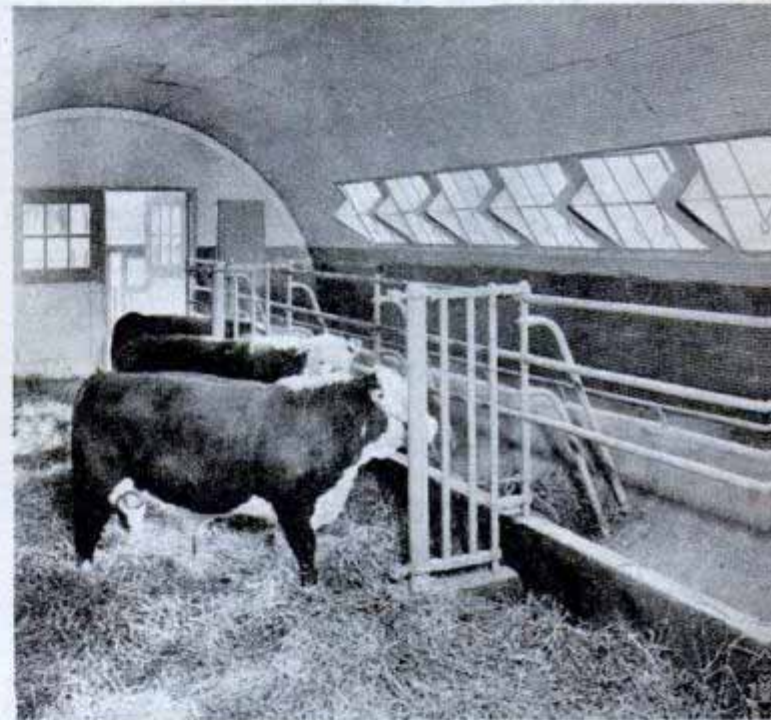

At least 257 peacetime uses have been found for Quonsets. This dairy barn at Brighton, Mich., illustrates one

A small factory in Chula Vista, Calif., has set up shop in well lighted, surprisingly roomy, multiarch Quonset

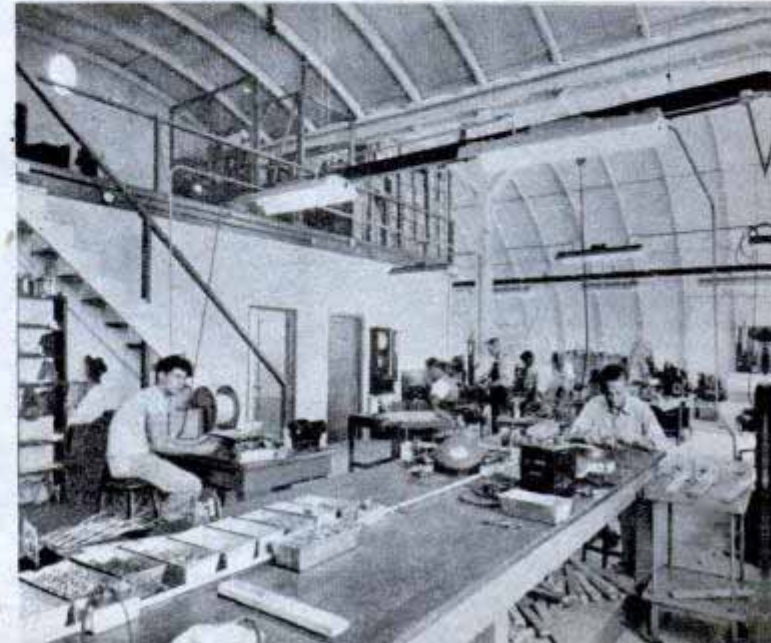

Double-Deck Streets Planned in England

Two different traffic levels may be built into the town of Hastings, England, if the borough's engineers have their way. The engineers recently exhibited a model to follow in rebuilding the town for its two-decker future. Streets will run on two levels, with stores and pedestrians on the lower level and vehicles on the top deck. Buses and delivery vehicles will move between the decks. The Battle of Britain was fought in 1940 over Hastings and other south coast towns.

Fires Halted Quickly By "Lazy" Freon Gas

Freon chemical compounds used in household refrigerators, air-cooling systems and as a DDT carrier in aerosol insect bombs have been found to be more effective in extinguishing gasoline fires than carbon dioxide. Use of the Freon gases to put out gasoline fires was recommended by the Bureau of Mines following a study of six inert gases and their effects on three different types of gasoline.

Three kinds of Freon gases were found to be the most effective flame-quenching agents with carbon dioxide next best.

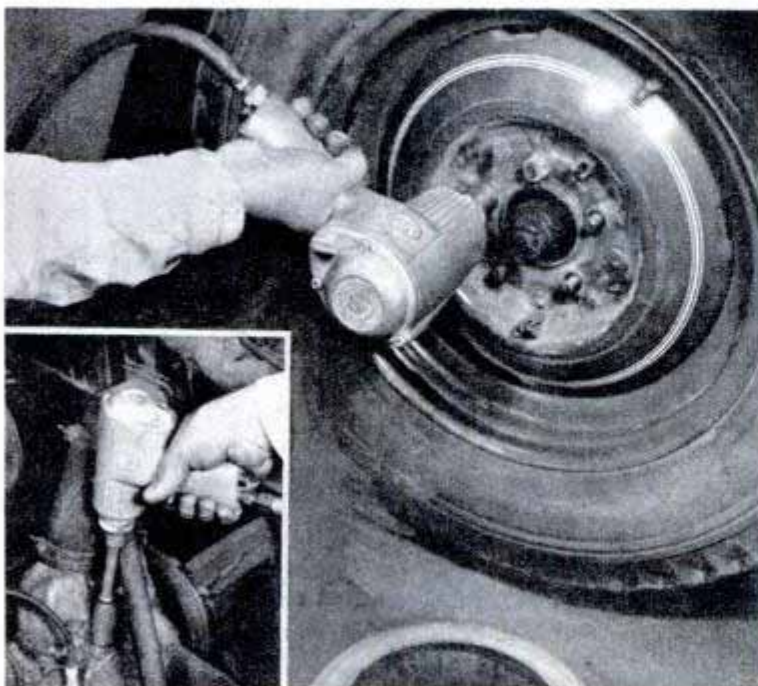
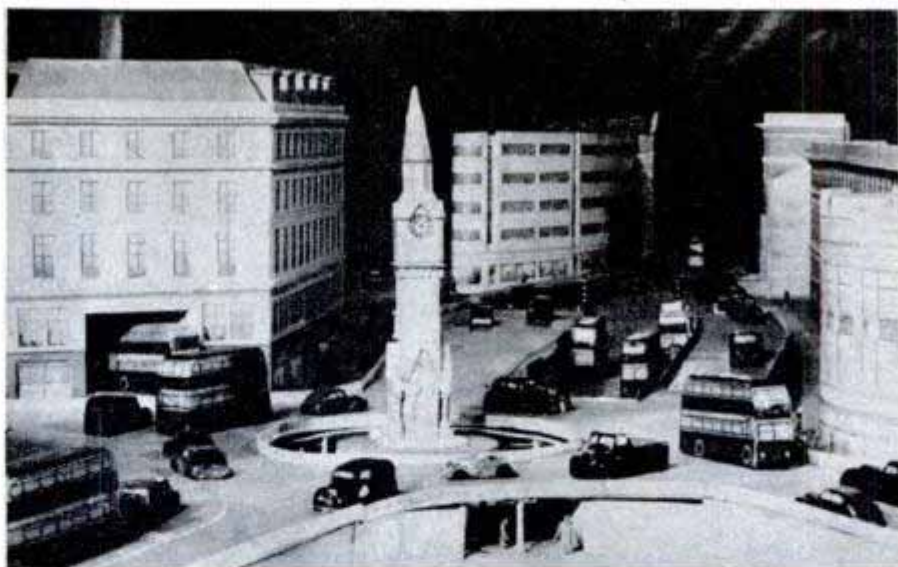

Impact Wrench for Mechanics Operates Without Torque

Powered by compressed air, an impact wrench for automobile mechanics removes or replaces nuts, studs and machine screws without transmitting torque to the operator. An extension bar and a flexible socket simplify nut running in inaccessible locations. The wrench can be used on knee-action bushings, wheel nuts, engine-block studs and cylinder-head nuts. With a puller attached, it can be used to pull cylinder sleeves.

Tests of Pliofilm wrapping indicate seafood shipped to interior states may reach your table with full-flavored salt-water freshness.

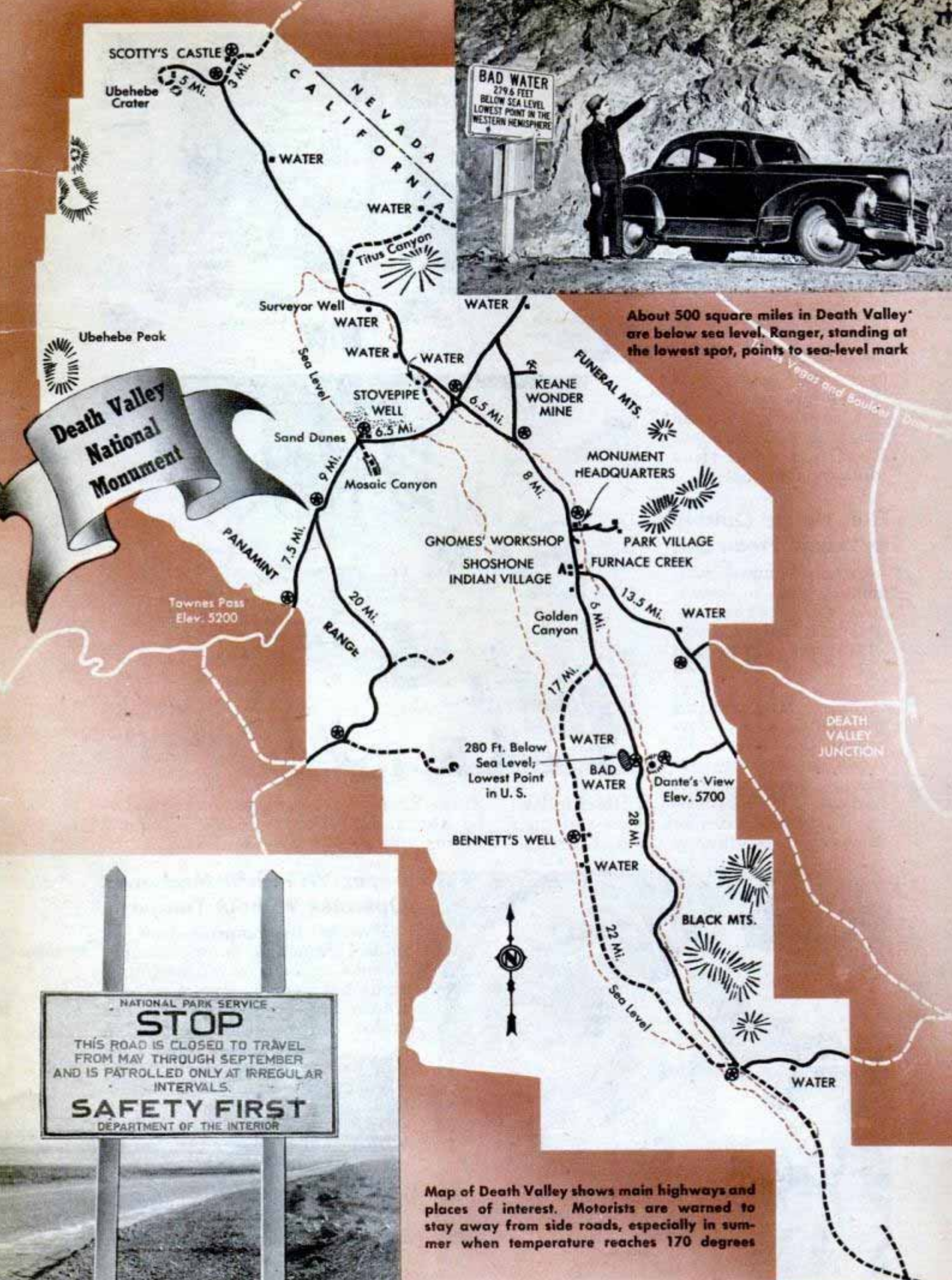

SCOTTY'S CASTLE
Ubehebe Crater

BAD WATER
279.6 FEET
BELOW SEA LEVEL
LOWEST POINT IN THE
WESTERN HEMISPHERE

About 500 square miles in Death Valley are below sea level. Ranger, standing at the lowest spot, points to sea-level mark

Death Valley National Monument

Townes Pass
Elev. 5200

280 Ft. Below
Sea Level;
Lowest Point
in U. S.

NATIONAL PARK SERVICE
STOP
THIS ROAD IS CLOSED TO TRAVEL
FROM MAY THROUGH SEPTEMBER
AND IS PATROLLED ONLY AT IRREGULAR
INTERVALS.
SAFETY FIRST
DEPARTMENT OF THE INTERIOR

Map of Death Valley shows main highways and places of interest. Motorists are warned to stay away from side roads, especially in summer when temperature reaches 170 degrees

CALIFORNIA
NEVADA
WATER
WATER
Titus Canyon

Surveyor Well
WATER

WATER

Ubehebe Peak

Sea Level

Sand Dunes

Mosaic Canyon

PANAMINT

RANGE

GNOMES' WORKSHOP
SHOSHONE INDIAN VILLAGE

KEANE WONDER MINE

FUNERAL MTS.

MONUMENT HEADQUARTERS

PARK VILLAGE

FURNACE CREEK

Golden Canyon

WATER

DEATH VALLEY JUNCTION

BENNETT'S WELL

WATER

Dante's View
Elev. 5700

BLACK MTS.

WATER



17 MI.

22 MI.

Sea Level

28 MI.

13.5 MI.

6 MI.

8 MI.

6.5 MI.

6.5 MI.

9 MI.

7.5 MI.

3 MI.

3.5 MI.

DEATH VALLEY PATROL

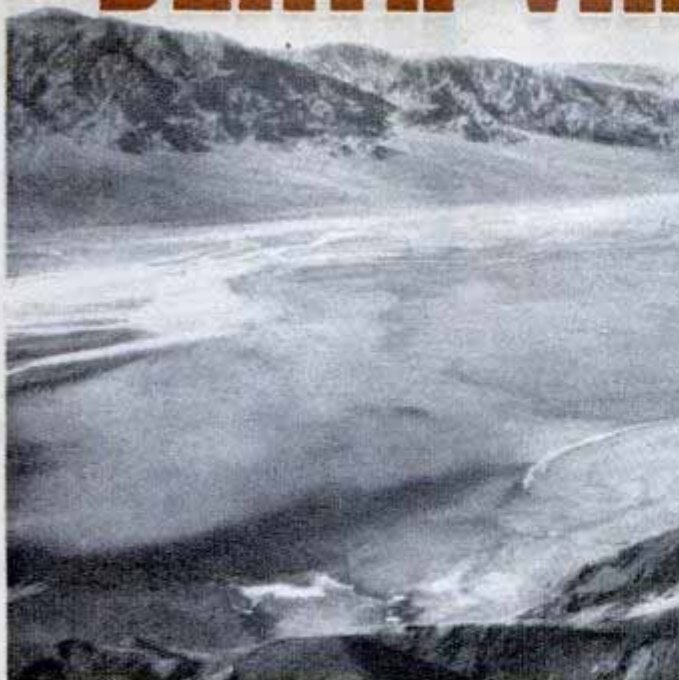

Looking down from Dante's View (6000 feet above Death Valley) to Bad Water, 280 feet below sea level. Waterlike areas are actually salt and alkali deposits

RIDING HERD on summer tourists sounds like a dull job but to rangers who patrol Death Valley it's a matter of life and death.

"Stay on the main paved highway," a ranger at the checking station cautions each motorist during the hot season. "The main road is patrolled every day and we can give you a hand in case you break down. If you take a side road and have trouble you'll be lucky to come out alive."

The combination of intense heat and extreme dryness that is common in the Death Valley region during the summer can practically dehydrate an unprotected person in a few hours. One man who had engine trouble on an infrequently traveled road decided to walk back 16 miles for help, but he never made it. He was found the next morning, unconscious and barely alive. He'd lost 80 pounds of weight overnight.

"If you have a flat tire," the ranger advises, "turn your car to provide shade while you change the flat. And don't drop your tire tools in the sun. In three or four minutes they'll be too hot to pick up."

The ranger isn't exaggerating. Summer temperature in the sun may climb to 160 or 170 degrees. The thermometer in the instrument shelter at Furnace Creek has registered 134 degrees in the shade. Some parts of the valley are believed to be hotter than Furnace Creek but no one has felt like installing thermometers and making daily trips to observe the readings.

Death Valley has a delightfully dry, warm



T. Raymond Goodwin, superintendent of Death Valley National Monument, climbs into a plane to search for lost motorist. Below, ranger scanning with field glasses

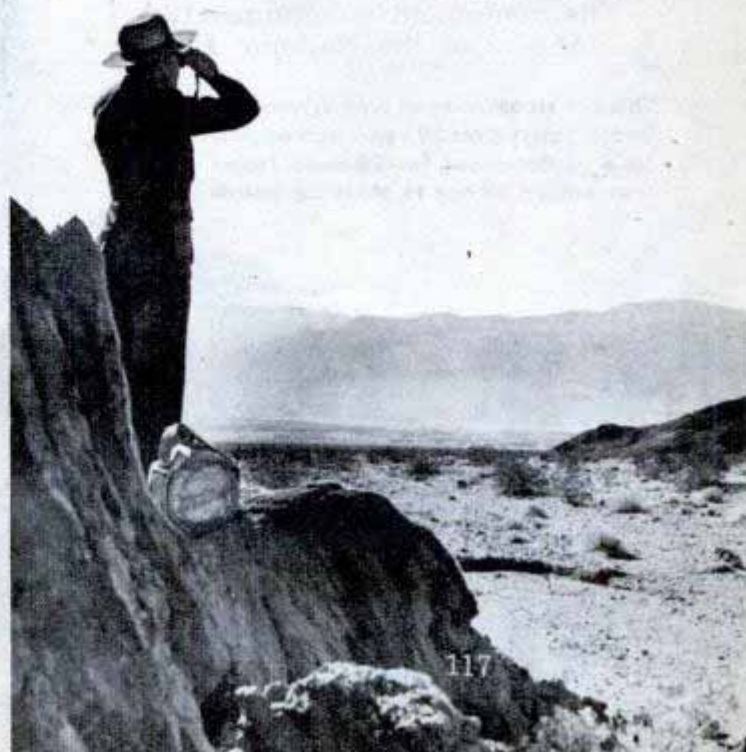



Grave of a visitor who became lost and died in terrific heat



Measuring humidity at 134-degree Furnace Creek

climate during the winter, but beginning with May it becomes a blazing, shriveling inferno. The Indians called it "Tomesha," meaning "ground afire." Residents move to the mountains when summer heat clamps down. Only emergency crews remain.

The valley and its surrounding mountain ranges were designated as a national monument in 1933. Embracing nearly 2,000,000 acres of primitive, unspoiled and spectacular desert country on the California-Nevada border, the monument is a geological and mineralogical wonderland. It contains snow-clad mountain peaks that rise to 11,000 feet. The long, narrow sink of Death Valley is 140 miles long and up to 16 miles wide. More than 500 square miles of the valley are below sea level; Bad Water, 280 feet below the level of the sea, is the lowest point in the Western Hemisphere.

The monument is administered by rangers of the National Park

This old steam wagon was driven into Death Valley over 50 years ago as possible replacement for 20-mule teams that hauled borax to shipping points

Service. These men play host to about 100,000 visitors per year, 90 percent during the winter months. The tourists stay at resort hotels and auto courts and drive over paved highways to visit Dante's View, Furnace Creek, Devil's Golf Course, Gnomes' Workshop, Stovepipe Wells, and Ubehebe Crater. They listen to talks by Edwin Alberts, park naturalist. They inspect the tremendous stone castle where Death Valley Scotty still lives. They explore ghost towns and abandoned borax mines, and some search for Lost Gunsight, Breyfogle, and other storied lost mines.

The 3000 visitors per month who cross the valley during the summer make few of these excursions. Crossing the valley is enough for most summer tourists. Motorists whose engines or tires are in poor condition are smart to turn back.

"In the first place," says T Raymond Goodwin, superintendent of the monument, "be prepared for a

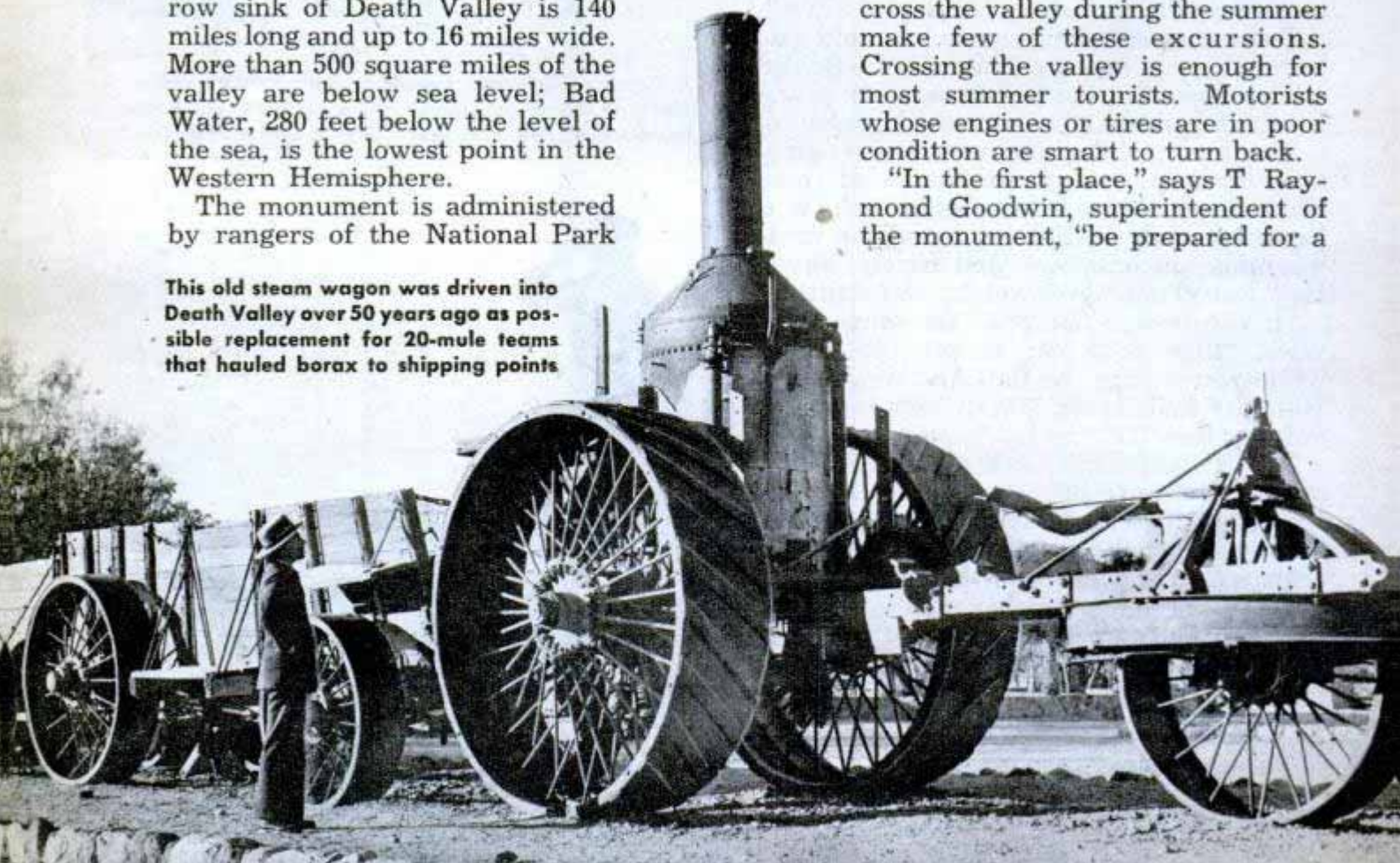



Abandoned pumping plant once was used to pump mineral-saturated water from wells drilled into "dry lake"

boiling radiator. It's easy to enter the valley but you have to climb steep grades to get out. From below sea level you climb to 5020 feet in 16 miles, traveling west. East-bound, you must climb from below sea level to a 2500-foot summit. Hot air rising from the valley during the daytime produces uphill tail winds on all these grades.

"Watch your temperature gauge and, when it approaches the boiling point, turn your car around and head it downhill into the wind, then sit there with the motor idling five or ten minutes while the temperature goes down. About halfway up each route is a water tank."

The penalty for not following this advice is a dry radiator and then a "frozen" motor. That happened to the traveler who lost 80 pounds in less than 24 hours. His radiator boiled dry on a level road because he hadn't taken the trouble to check the water at the last stop. His motor "froze" and he was stuck. This was in May when the peak temperature was only 110 degrees.

Adventurers who try to hike through the valley in summer risk their lives. Rangers find a shirt here, a wallet there, shoes abandoned half a mile apart, pants and under-

Ancient boiler works hauled into the valley in the '80s to refine borax taken from sand deposits

clothes hanging on bushes. Almost invariably a sun-crazed person strips himself while staggering around.

One August a driver on the main road found a naked man at the roadside, digging in the dry sand with his hands for water. He was out of his mind from thirst though he had walked only six miles from where his car broke down on an untraveled side road. He was taken to a ranger station, wrapped in blankets and given tiny sips of water. Then the rangers drove to his car and rescued a companion who was in pretty good shape because he stayed in the

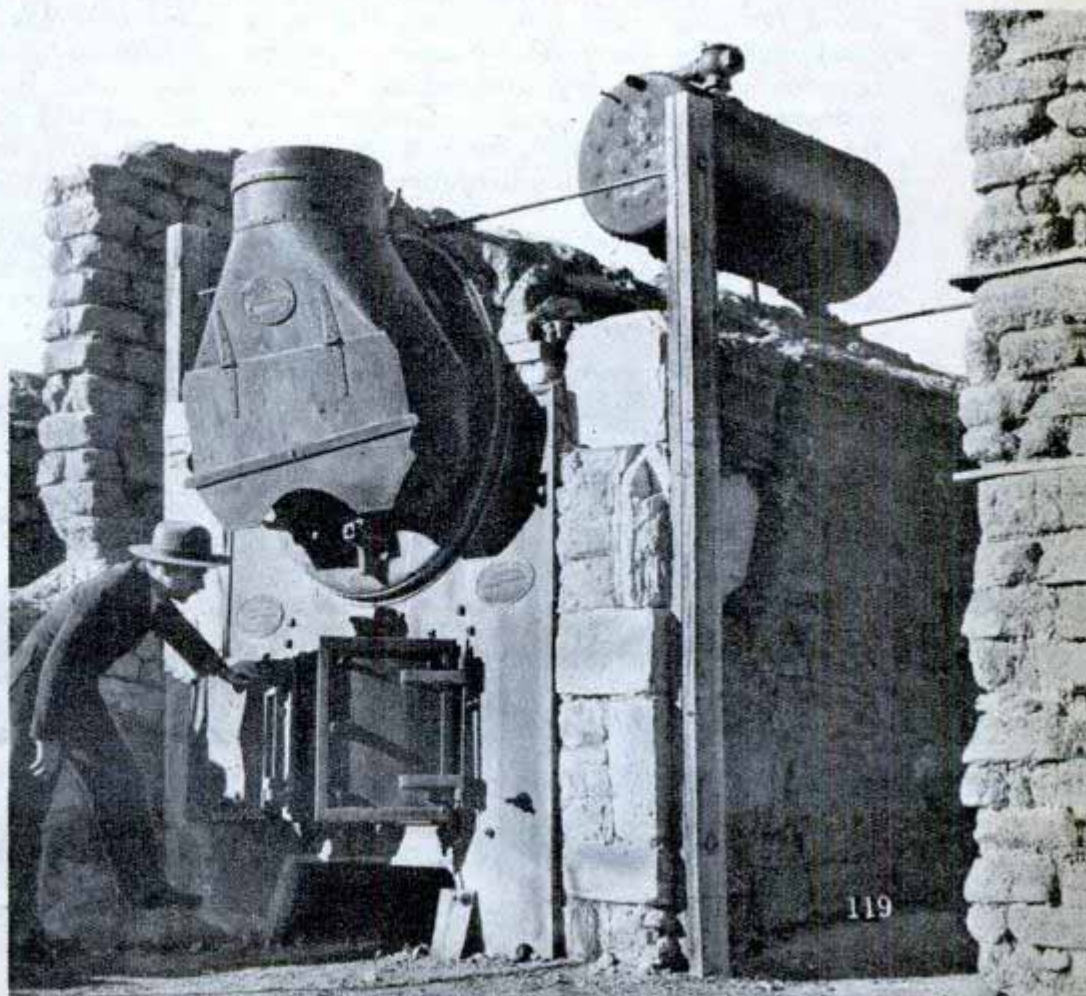

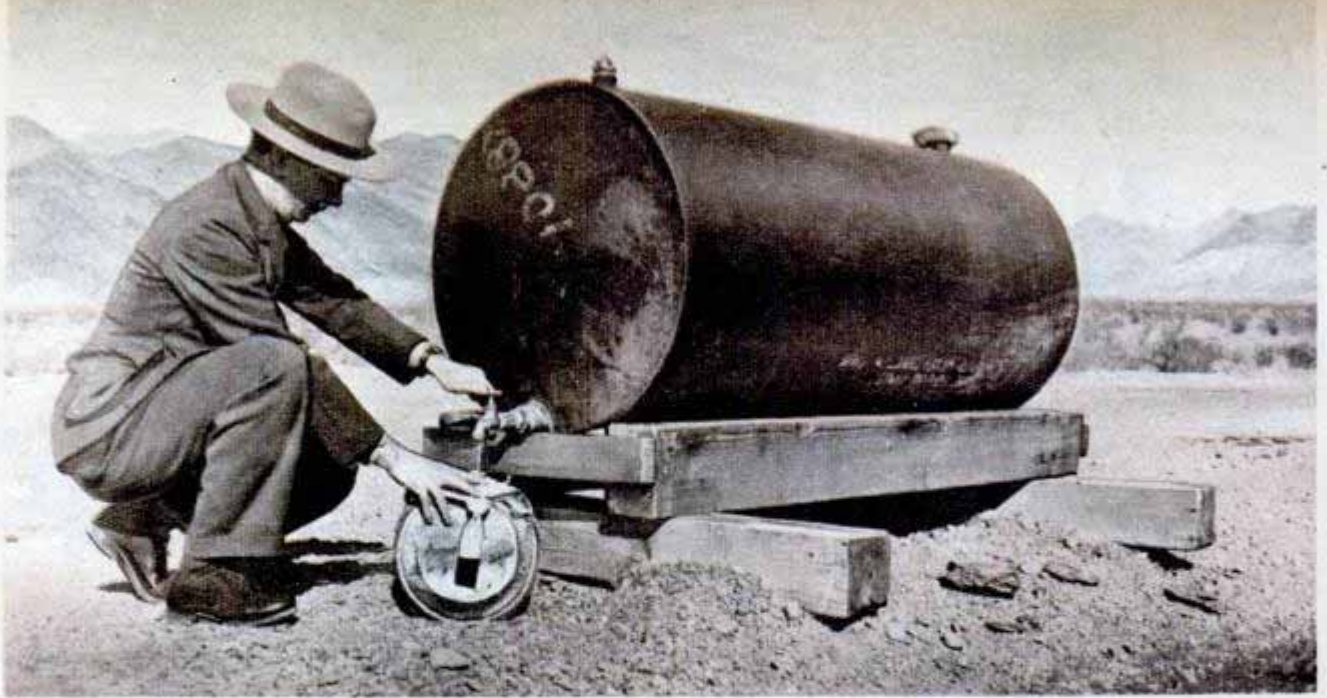

Tanks stationed along highways are filled with highly mineralized water for radiators and emergency drinking

car's shade. The hiker's clothes were found strewn over several acres.

Near-tragedies like these are rare because most summer visitors follow the rangers' suggestions. Visitors stay on main roads where they will be spotted in case of trouble. Most drivers are confident their cars are in good condition, yet the rangers give roadside service to about 100 cars per summer.

E. E. Ogston, chief ranger, and his staff of 20 men are experienced, desert-wise outdoorsmen who know how to travel in the desert, how to protect themselves from the elements, and how much heat they can stand. On their daily rounds over the main roadways they carry field glasses to study reaches of the valley into which unwise visitors may have strayed. On occasion they use aircraft to look for lost travelers.

No tourist has lost his life since the mon-

ument was established. A few prospectors in distant sections of the area have succumbed to the heat but the rangers had no way of knowing the prospectors were in the region.

In winter the rangers rescue prospectors or miners snowed-in in the mountains. A more frequent winter chore is rescuing tourists who drive off the roadways and become stuck in the sand. Modern pleasure cars are poor desert vehicles. Their low clearance, unbalanced weight with the motor over the front wheels, and hard tires make them unsuitable for soft ground. Jeeps and four-wheel-drive trucks are the best vehicles for desert travel.

When a tenderfoot gets stuck, he usually does this: Having driven into a patch of soft ground, he races the engine and lets the clutch in slowly, hoping to pull out. The

(Continued to page 268)

Ranger pauses for a drink in Devil's Golf Course where wind and rain have eroded rock-salt "floor" into spongelike pinnacles



Timbers were transported on huge wide-wheeled log carrier from wooded mountains to Death Valley gold mines during the last century. About 100,000 visitors view such relics as this every year

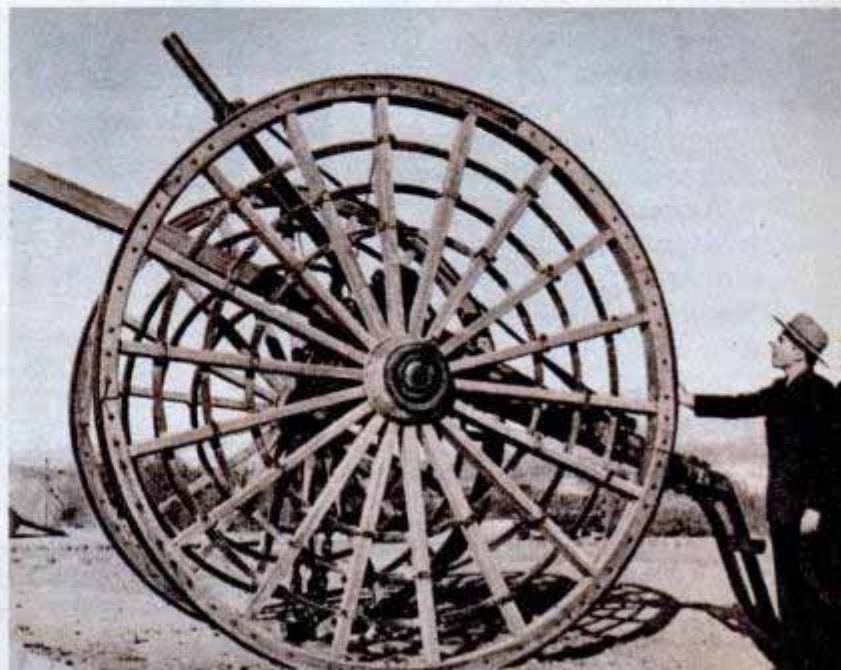

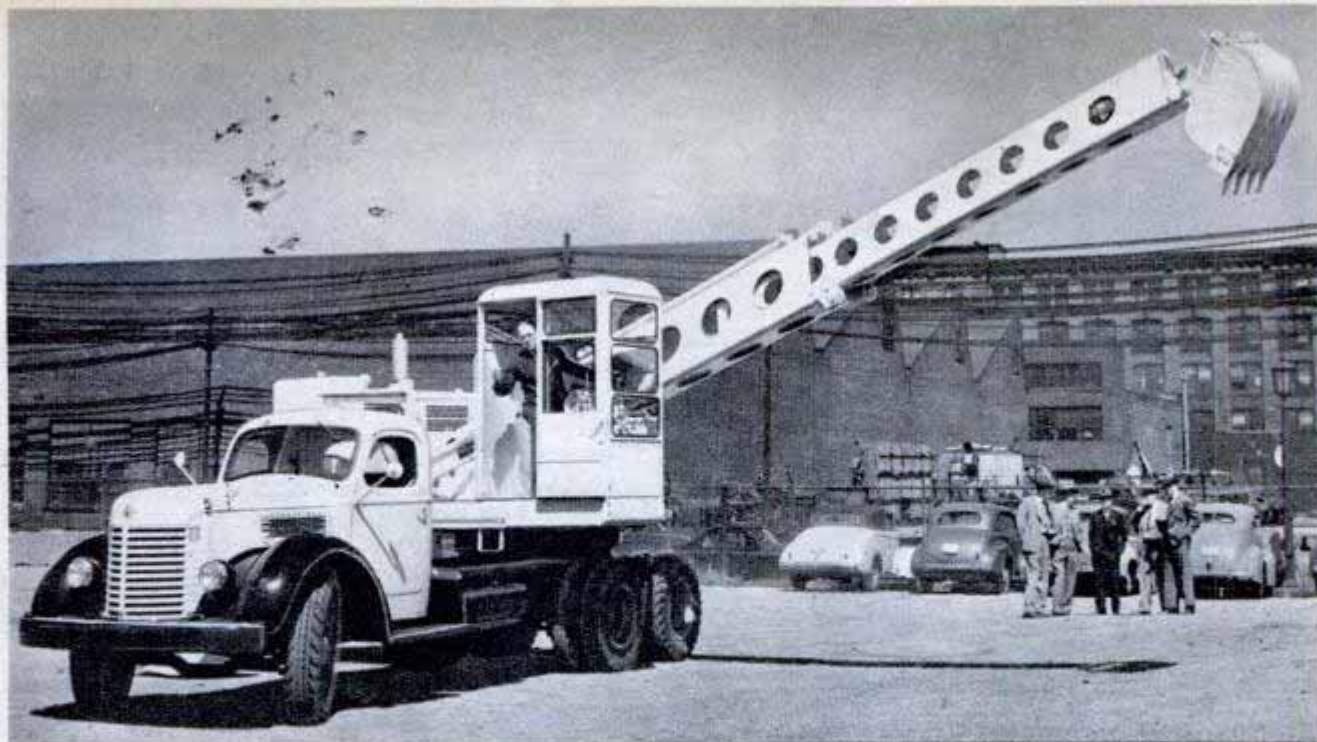

Multipurpose Earthmover Has an Armlike Boom

Several different earthmoving operations—excavating, trenching, filling and loading—are performed by one machine. It consists of a rotating turntable with a 24-foot telescopic boom mounted on the rear of an engine-driven chassis. Hydraulic controls govern the “arm action” movements of the boom. It may be extended and retracted, lowered and raised, tilted each way from horizontal and rotated a full 360 degrees. Various earth handling tools needed for individual jobs are attached to the end of the boom. Tool controls, running through the boom, give “wrist” action, permitting the operator to move the digging bucket or other attachments through a vertical arc of 116 degrees. Individual tools can be interchanged in less than 15 minutes because of the simplicity of the locking device.

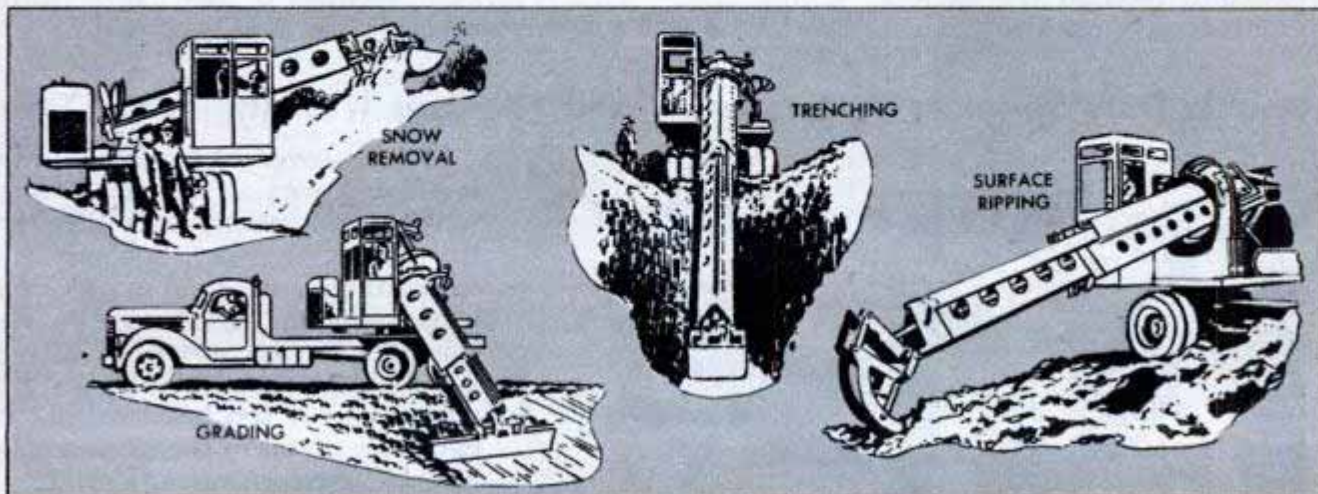



Carrying a complete line of stock, a special post exchange train rolls across Japan to serve American occupation troops and their families. The "department store on wheels" stops at points where normal post exchange facilities are not available. Most items that can be found in other post exchanges are available aboard the train. Children can

PX Train Serves GIs in Japan

shop in the toy department and for the wives there's a car filled with cosmetics. A white stripe on the side of each car distinguishes the train from all others, and a crowd of shoppers is usually on hand when the rolling post exchange arrives. Japanese girls staff some of the departments of the store, assisting the regular PX personnel.

Printed Guides for Phonograph Records Tell Story Behind Classical Music

Printed phonograph record guides are an aid to the appreciation of classical music. A guide consists of a slotted strip of cardboard and printed timetables of recorded music. By following the progress of the needle through the slot with the time indications of the guides, the listener learns from the timetables the story behind the music, the varying use of instruments and the general theme. The guide is also used to indicate the location



DEATH AND TRANSFIGURATION
 Composer: Richard Strauss
 Arr. New York City Symphony Orchestra
 Conductor: Leopold Stokowski
 First Group et. 0:10

10	0:13 Ten Ten. The Death Knell.
20	PART FOUR - Release of the Soul.
30	0:26 Mysterious effects in orchestra's deepest tones.
40	1:00 (16) Childhood Faith and Ideal Motives outlined.
50	1:18 (14)
10	2:00 (17) Ideals Achieved.
20	2:38 Ideals Thus Developed.
30	
40	
50	

on the record of a particular passage so that it can be replayed at any future time without replaying the whole record.

Double Duty Sprinkler Waters Lawn and Fertilizes It at the Same Time

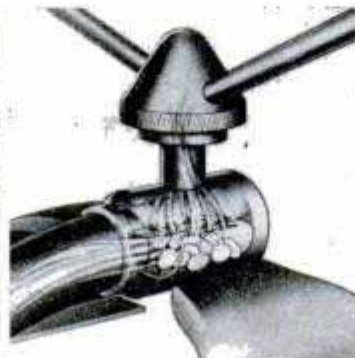
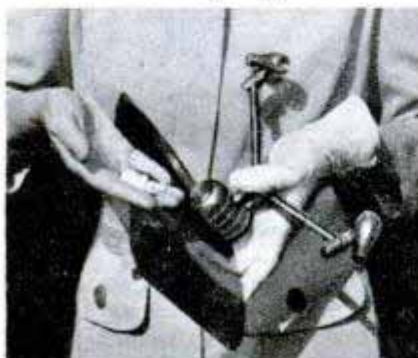

Home gardeners can water and fertilize lawns at the same time with a double-duty sprinkler. In the sprinkler head, special fertilizer tablets are held in a slotted brass chamber. The water passes through the chamber, dissolves the tablets and sprays fertilizing solution over the lawn so that it can soak down to the grass roots and be used immediately.

Pliofilm Cradle in Shipping Cases Protects Fruits and Vegetables

Fresh fruits and vegetables are protected against shipping damage and spoilage by a Pliofilm "hammock" which suspends them in a box, free from contact with each other or any part of the container. The foundation of the hammock pack consists of two sheets of cardboard in which holes are cut slightly larger in diameter than the fruit to be packed. Each sheet of cardboard is covered with a sheet of extremely thin Pliofilm. Then heat is applied to one sheet of Pliofilm. The fruit placed on its warm surface sinks down into the holes as the Pliofilm stretches and forms cradles. The other sheet seals in the fruit. The package is placed in a box fitted with partitions to prevent the fruit from touching top or bottom.

Iron Rammer Drives Fence Posts Into Unprepared Ground

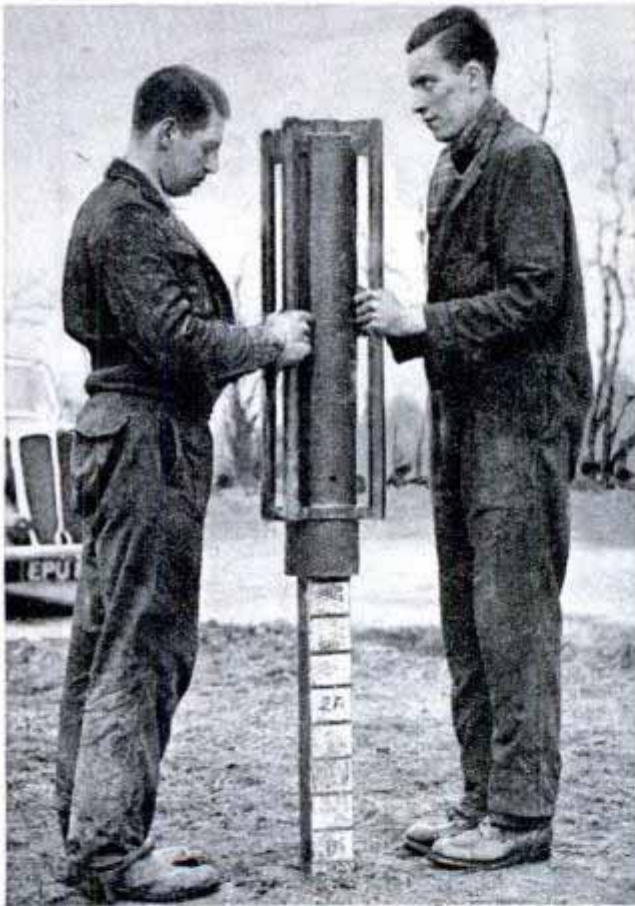

In France, wooden or metal fence posts with square ends are driven into unprepared ground with a cast iron rammer. Each blow sinks a post about three inches. A cylindrical tube with attached hand holds fits over the top of a post. Two or more operators raise and lower the tool to ram posts into the ground. The rammer fits either rectangular or rounded posts. Although square-ended posts generally drive more true, a wedge-shaped point is an advantage in sand or gravel.

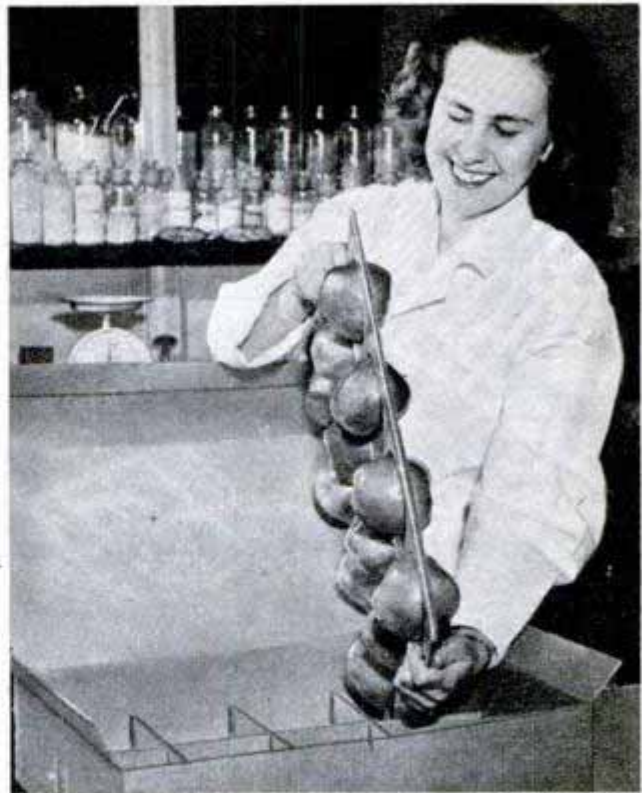

Machine Renovates Worn Asphalt

Worn-out asphalt pavement can be reprocessed in a steam machine and used again for road surfacing. The machine segregates chunks of asphalt from gravel and other broken pavement materials by re-converting the asphalt to liquid. Additional pavement material is mixed with the salvaged asphalt in accordance with the amount of resurfacing material required.

Dog Caddy Serves California Golfer

Mr. Wong, a Chow dog, recently completed his fourth year as a golf caddy. He hauls clubs at Del Monte, Calif., for Wayne Edwards, a history teacher. "Mr. Wong never barks when I'm shooting," Edwards reports, "but sometimes he gives me a smirk when I dub a shot."

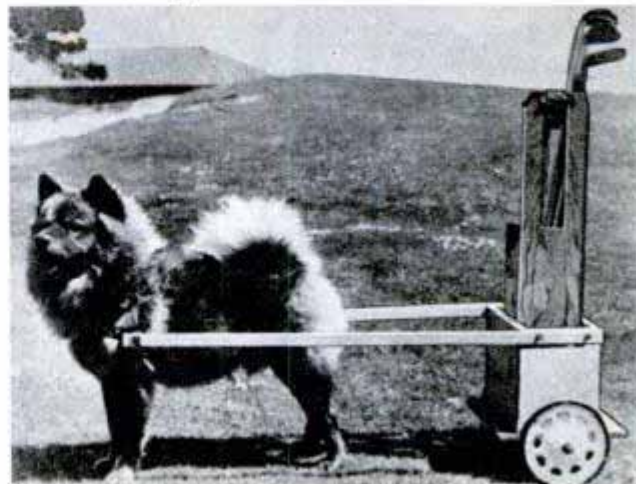

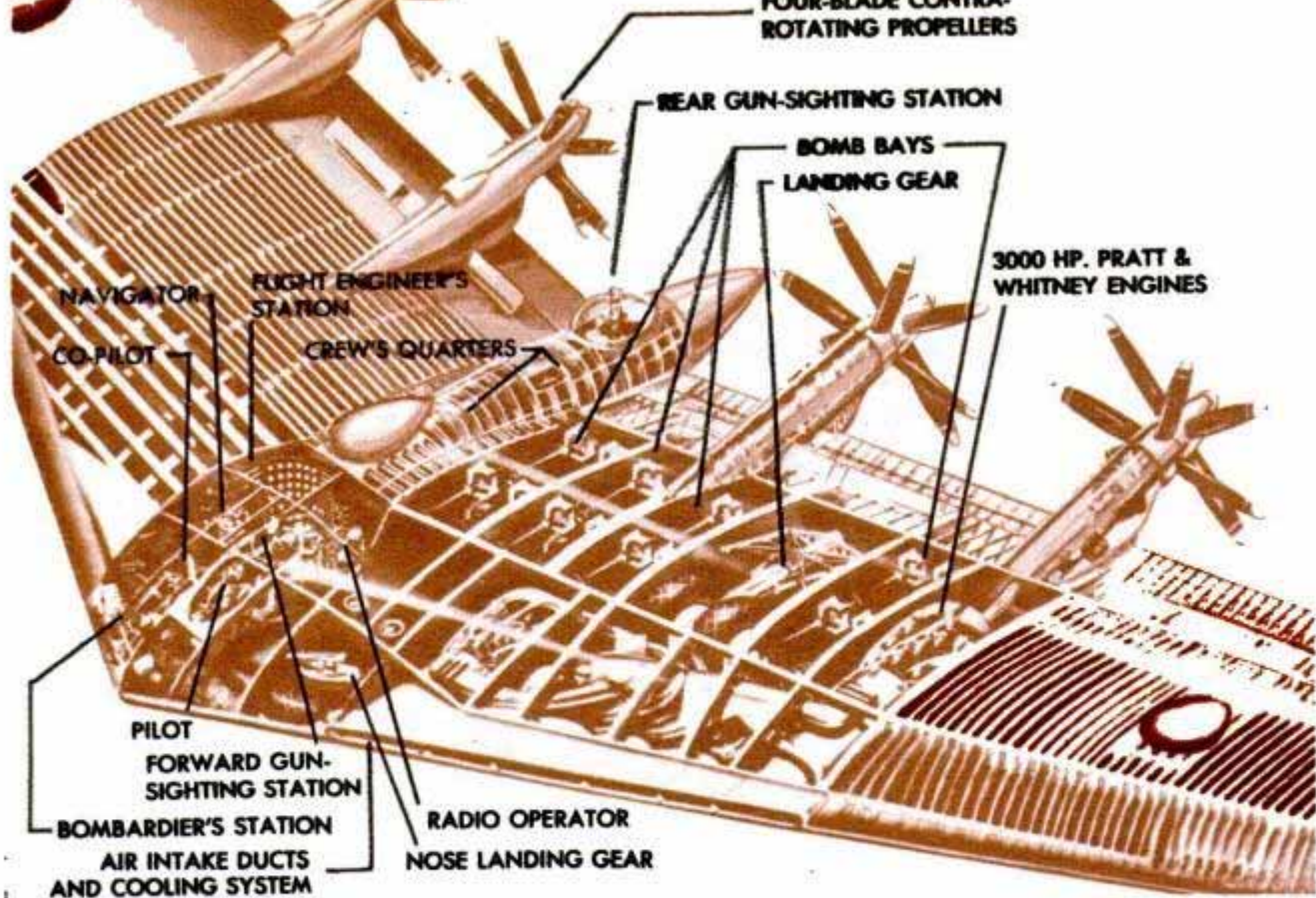

Inside the Flying Wing

Here's how crew and instruments fit inside the huge Northrop B-35, which is 39 tons heavier than the B-29 and has a range of at least 10,000 miles. The 15 men are in a pressurized center section 37½ feet long, with the pilot sitting in a raised nacelle at the extreme nose. The wing has a span of 172 feet and a gross peak load of 104 tons. Fourteen more are being built for the Army Air Forces



Without leaving his chair, the flight engineer (left below) can watch all of the instruments mounted on a curved wall. Forward vision for the copilot (right below) is through a plastic panel in the wing's leading edge

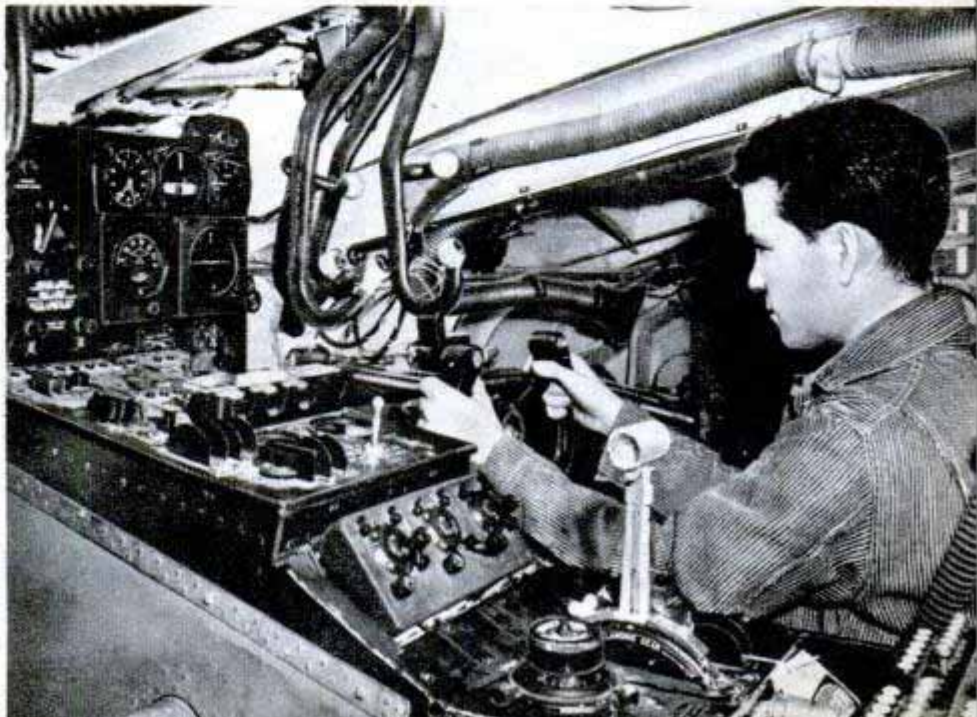

Shrinkable Plastic Provides Tight-Fitting Cover for Golf Clubs

Developed for dustproofing various manufacturing processes, a shrinkable plastic serves as a snug-fitting covering for the handles of golf clubs and tools, for bicycle handle bars and to patch garden hose. Before being applied, the plastic is immersed in a special chemical solution which expands the rubbery covering to half again its normal size. While wet, the plastic is placed over a handle. As it dries, it shrinks and forms a tight fit without losing any of its physical properties. The General Electric Plastics Division at Pittsfield, Mass., which developed the plastic, has no immediate plan to market the covering for general consumer use.



Computing Machine Figures "Outdoor" Distance of Indoor Drives



Golfers now can drive a ball indoors against canvas padding and learn immediately how far it would have gone on a golf course. An electronic device does the computing. Here's how it works: as the golfer hits a ball from a door mat, the ball breaks an electric eye beam. Breaking the beam starts an electrical circuit. The ball continues on its way and hits the canvas, 18 feet from the mat. This sound is picked up by a microphone hooked up in such a way that it stops the electrical circuit. A computing machine converts the duration of the circuit into yardage, which would have been the outdoor distance of the drive.

Roller Beneath Automobile Wheel Transmits Power to Belt-Driven Tools



Transmitting power from either of the rear wheels of a car or pickup truck, a take-off mechanism uses a roller system beneath the wheel to provide up to 10 horsepower to operate most belt-driven tools. The take-off consists of a double roller with mounting ramps and a power shaft housing. The car is driven into position so that either of the rear wheels rests between the rollers. When the engine is throttled down to idling speed, the wheel revolves the rollers, which in turn transmit the power to a pulley that can be connected by a belt to most farm tools. A special generator can be coupled to the mechanism to provide electric power. And a grinder is also available. A centrifugal pump that delivers 120 gallons a minute can be attached to the take-off.

SYNTHETIC METALS TO ORDER

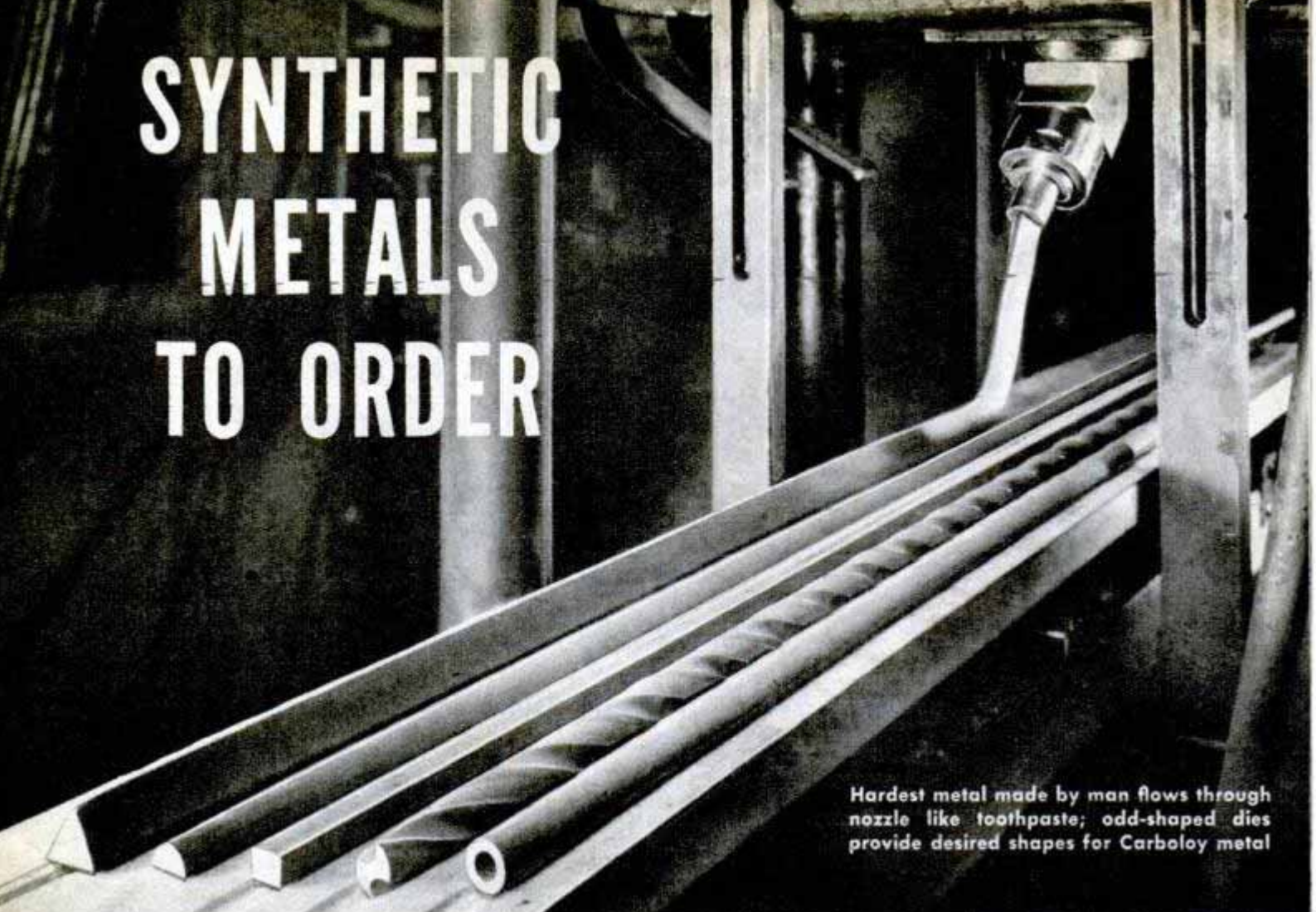

Hardest metal made by man flows through nozzle like toothpaste; odd-shaped dies provide desired shapes for Carboloy metal

"TOO SOFT!" "Too weak!" "Too brittle!"
"They'll never take the place of forgings and castings!"

Those were some of the remarks that greeted powder metal products such as small gears and oilless bearings when they first appeared. But times have changed and so has the acceptance of powder metallurgy. No longer are powder metal products called "metal cookies" and dismissed as too soft, too weak, or too brittle. Powder metallurgy is as respected today as the older metal-forming methods: forging, casting and rolling. Engineers have found they can get qualities with powder metals that they can't get any other way.

One group of powder metals is helping to

"Jigsaw puzzle" pattern illustrates the many sizes and shapes into which powder metals are now being formed



hold back the rising cost of future automobiles, refrigerators, washing machines and countless other items. This group comprises the superhard "carbide metals." They are true synthetic metals. Some of them are heavier than lead. They are twice as stiff as steel, nearly as hard as the diamond; it is almost impossible to wear them out, and they retain their hardness at extreme heat.

Another important characteristic of carbide metals is that they excel both as "tool metals" and as "use metals." As tool metals, the carbides are today cutting things which all of us will be buying tomorrow. Cemented carbide cutting tools and shaping, drawing and forming dies are consid-

Carbide inserts in wire nippers eliminate resetting or sharpening; these have been in use eight years



ered essential by industry today for low cost mass production of automobiles, refrigerators, radios, pots, pans, coffee percolators, pressure cookers and a host of other necessities and luxuries.

Produced only by powder metallurgy, metallic carbides are the hardest metals ever made in quantities by man. They are so hard that projectiles made of them pierced the heaviest German armor plate—armor plate from which the hardest of steel shells bounced off. Carbide tools also hewed out American guns, tanks, ships and planes at a higher speed and a lower cost than would have been possible with steel tools.

The hard carbide metals themselves are not really new, although most of their uses are. Back in 1896 a French chemist, Moissan, accidentally produced particles of tungsten carbide while he was trying to create a temperature equal to that of the sun in his newly invented electric furnace. Moissan tossed the hard carbide particles aside as worthless and grieved because he had not rivaled the sun.

The first commercial use of tungsten carbide came during World War I when the hard-pressed German industry hit upon the idea of "cementing" together the individual hard particles. The resultant blocks of solid metal were used as substitutes for the diamond dies so badly needed at that time for drawing filament wire to be used in electric light bulbs. It was lucky for us that the Germans didn't learn at that time how to make carbide tools for cutting metals. If they had learned that trick, Armistice Day might have been postponed indefinitely.

About a decade after the end of World War I large bars of solid ce-

Dark corner of this cutting tool is the carbide tip, nearly as hard as a diamond

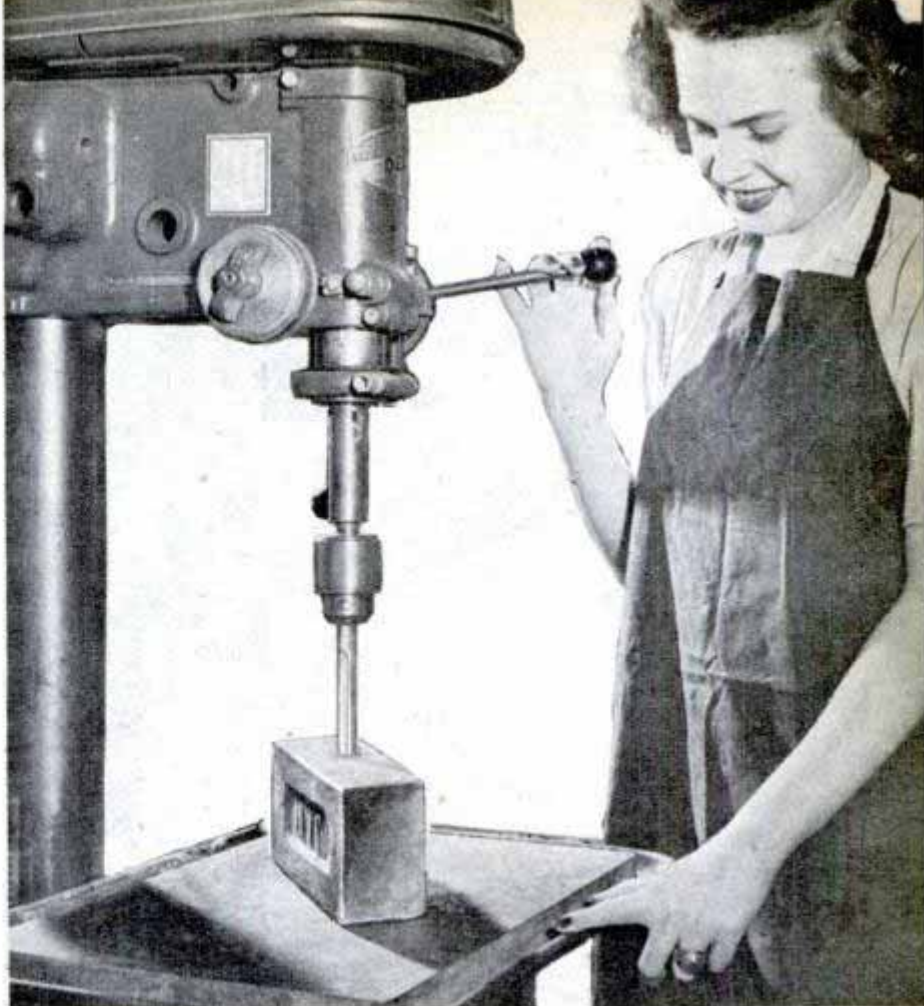
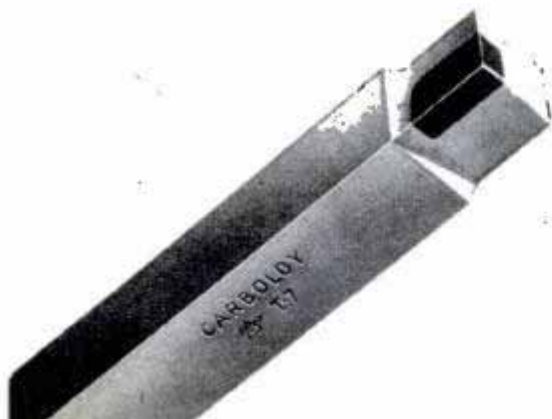

Carboloy masonry drill sinks quickly into ordinary firebrick—one of most highly abrasive materials. Below, this 300-foot threading operation was done with one grinding of cutting tool

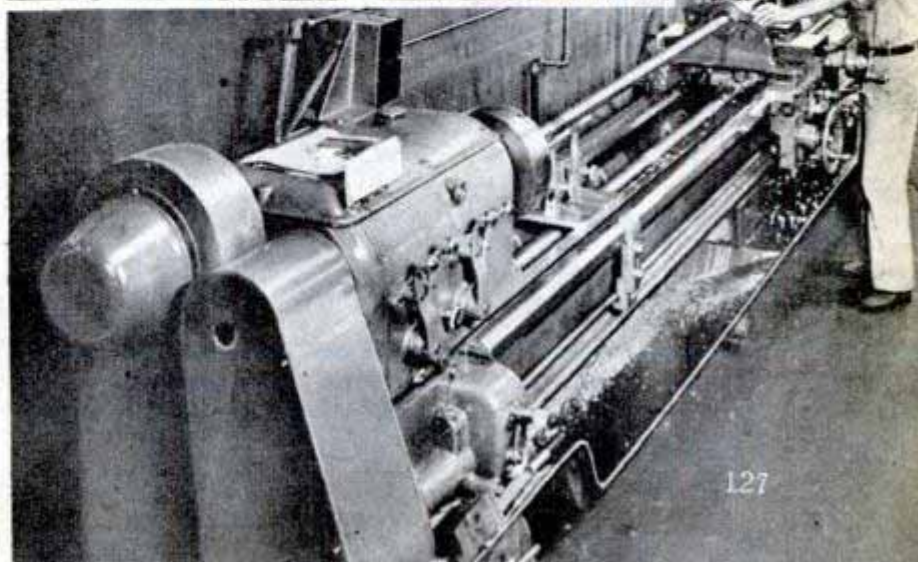
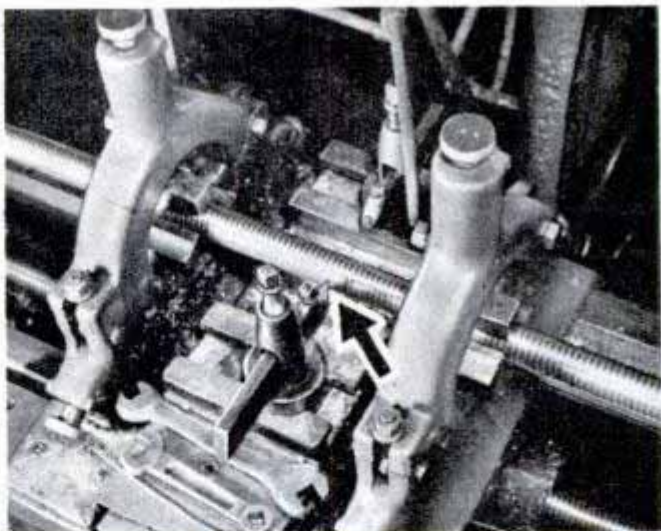



Section of heavy armor plate from German tank was pierced by hard carbide projectile. Carbide shell core shown below is centered in an aluminum housing



mented carbide were imported by this country. A few manufacturers tried to make cutting tools out of the metal, but it was difficult to work because it approaches the diamond in hardness. Applications were extremely limited. Finally, in 1928, engineers of the Carboloy Company hit upon the idea of forming the metal in smaller pieces, close to the desired finished shape. This launched carbides in the cutting tool field.

The manner in which the hard metal carbides are made may be illustrated by ordinary tungsten carbide, a grade widely used for cutting tools. The base metal, tungsten, and lampblack—both powdered as fine as flour—are mixed and heated to a high temperature in an atmosphere of pure hydrogen. The material that comes from the furnace is powdered

tungsten carbide. Each particle is extremely hard but so small that if all the particles in just one pound of tungsten carbide were bricks, there would be enough to build a wall 1000 feet high and 200 feet wide across the United States.

This powdered metal is mixed with a "binder"—usually powdered cobalt or nickel. The resulting mixture is then molded into the desired shape under pressure. These shapes are "sintered," or heated, at about 2650 degrees F. The material comes out of the sintering furnace in its final hardened form—so hard it will easily scratch the hardest file.

Structurally, a piece of carbide metal might be compared to a brick wall. The bricks are the tiny pieces of hard metal carbide. The cobalt or nickel is the mortar or binding material which cements the hard particles together to form one compact piece of metal. Carbide metals can be made so dense that X-rays have trouble penetrating even relatively thin sections.

At present, the greatest single use of the hard metal carbides is still as a tool metal. However, carbide metal forms only the cutting tips of such tools. A small tip or blank of carbide is brazed or otherwise fastened onto the end of a tough, inexpensive steel shank. The retention of hardness at high temperatures has caused carbide to replace high-speed steel and other steels as

a cutting tool metal in both industry and the home workshop. In addition to metals, "nonmetals" such as glass, wood, stone, plaster and plastics are being drilled, milled and otherwise machined with these hardest of all tools.

Carbide tools not only last from four to hundreds of times as long as steel tools, but they cut many times faster. Thus carbide tools make it possible for the worker to increase his production per hour with less work, since he doesn't have to keep sharpening and resetting his tools. Also, carbides can cut materials that are tougher and stronger than ordinary steel. For instance, armor plate and even some modern automobile pistons and brake drums—which are so hard or tough that they quickly turn or dull the edges of high-speed steel tools—are easily machined with carbides. It is no exaggeration to say that America's fantastic records on the production lines during the recent war would have been impossible had it not been for this powder metal product that is nearly diamond-hard.

Despite the records made by cemented carbides as a cutting tool metal, future applications may involve the supplanting of steel, bronze and other common metals by carbides in all kinds of products which are exposed to rubbing and abrasion.

Hard metal carbides have been used for a number of years to make dies for drawing steel bars and rods into wire. In these dies, the carbide metal is used to form the inner bearing surfaces of the die—that part which bears the entire brunt of the wear caused by the drawing process. Today, carbide dies are considered standard equipment in the wire drawing industry. Their use made possible what is known as the continuous wire-drawing process—one of the major reasons why our factories were able to supply quickly the unprecedented demand for wire for war uses.

Undoubtedly, the use of carbide metals for tools and dies will continue to increase under conditions of peacetime competition.

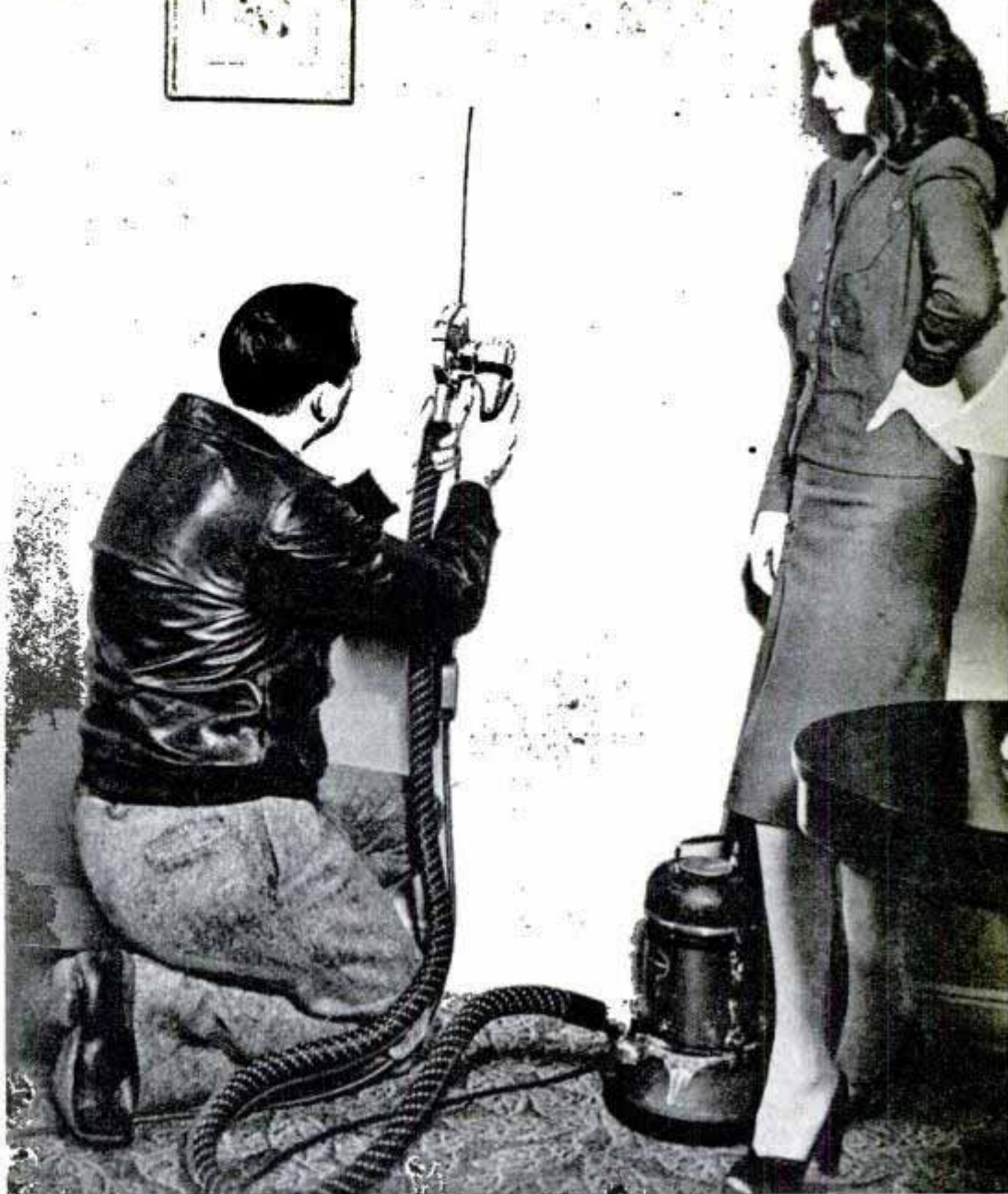

Carboloy-tipped electric saw cuts cleanly through plaster to install new heating control equipment. Below, a close-up of hard-tooth saw used on walls

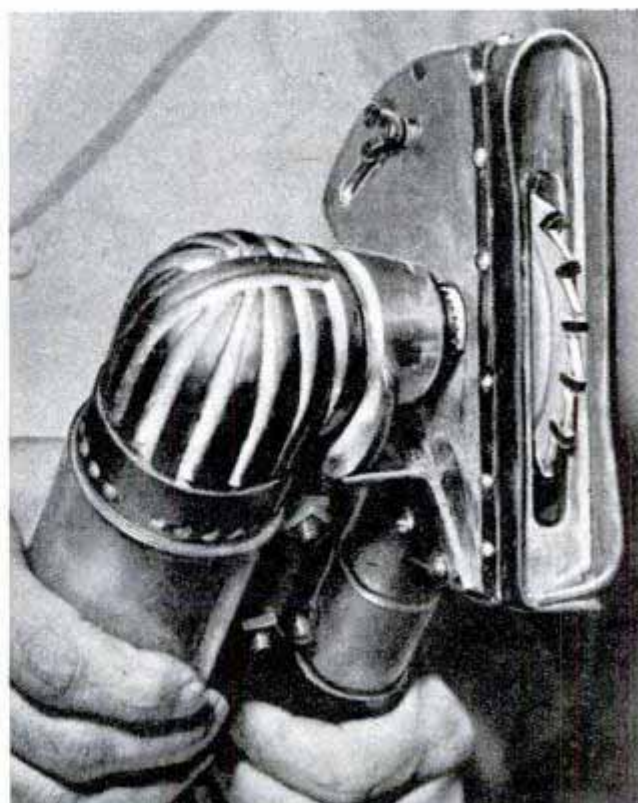

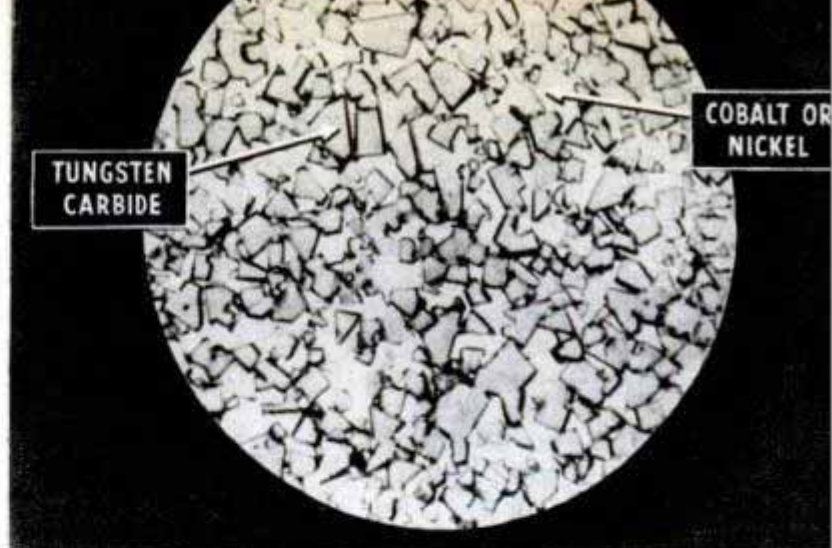

Steel chisel tipped with carbide is used in sculptor's air hammer. Right, magnified particles of Carboloy

since carbide equipment not only cuts costs of operation drastically but also helps lighten the load on the workers. Moreover, mass production of carbides has so greatly lowered their cost that today the hard metal industry seems to be standing upon a new threshold. It is a threshold which the industry is facing with restraint—for it leads into those fantastic realms of new ideas for consumer goods.

The men who make hard metal carbides are hesitant about predicting the extent to which these synthetic metals may be used in consumer items. They recognize that carbides have other exciting characteristics besides their unequalled hardness and tremendous resistance to wear. It is possible that the extreme density and weight of the carbides may suggest future uses. Or it may happen that carbide's stiffness—which is twice that of steel—together with carbide's resistance to crushing loads—which is higher than that of any other known metal—may result in uses now undreamed of. Other developments may center around the revolutionary characteristics of carbides as bearing materials.

Nevertheless, the carbide men know that each new use for carbide metals requires many months and sometimes years of patient research. The minute word leaks out that some new carbide product is under development, the producers are deluged with demands from manufacturers and consumers which cannot be met. That is why carbide men are watching and working, but are not doing much talking.

However, the fabricators of consumer goods are already beginning to use the hard metal carbides. The appeal of everyday items which will last "almost forever" because of carbide's ability to withstand wear is too strong to resist.

Right now, the hard metal carbides seem to be a promise of a new climax to man's age-old hunt for "hardness." Ever since the day when man first lashed a sharp flint to a stick and used it for splitting firewood—and the skulls of his enemies—he has striven to develop harder and ever harder materials from which to fashion better things.

Copper. Bronze. Iron. Steel. To that list we can now add: hard metal carbides.

Sheet metal shears with work edges of hard cemented carbide will retain sharp edges despite constant use

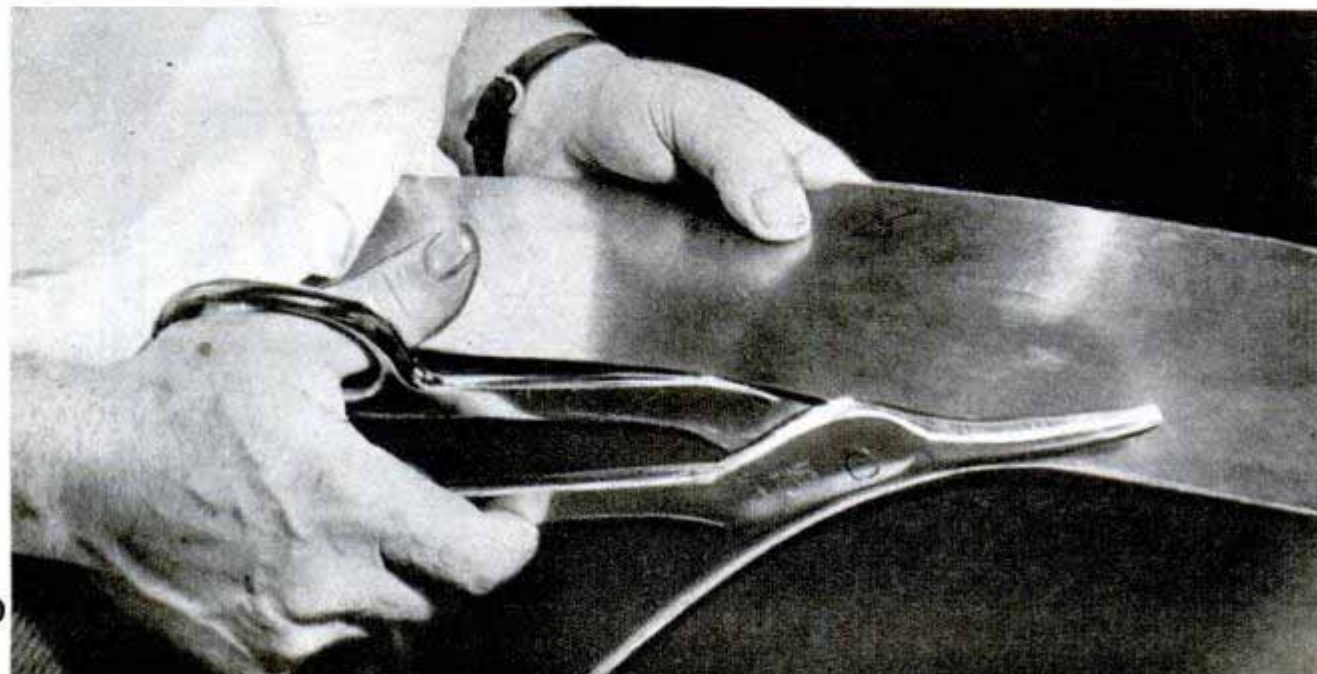

Navy's Supersonic Test Tube



Quick release connections and pull-apart electrical plugs, below, permit pilot to break cockpit and nose section free for emergency escape at supersonic speeds

Painted bright red for visibility, a new "supersonic test tube" will make runs between 550 and 800 miles an hour at Muroc Army Air Base this summer. Built for the Navy by Douglas, the D-558 Skystreak is a long open tube of extra-thick magnesium alloy housing a General Electric turbojet engine with thrust equal to the B-29's four power plants or the equivalent of 75 automobile engines. It is said to be 60 percent stronger than current fighters. The engine and ducting occupy most of the 35-foot fuselage, which is supported by a 25-foot wing span. With wing-tip tanks the D-558 can fly for an hour and a half. To permit escape at high speeds, the entire nose, with the pilot inside, can be blasted away from the fuselage. The plane has 500 pounds of instruments to record pressures at 400 separate points.

Douglas Aircraft photos

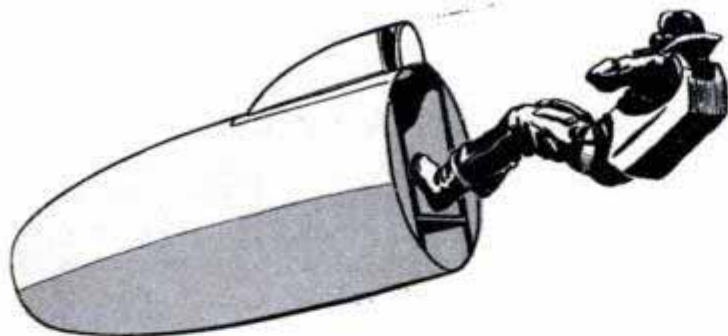
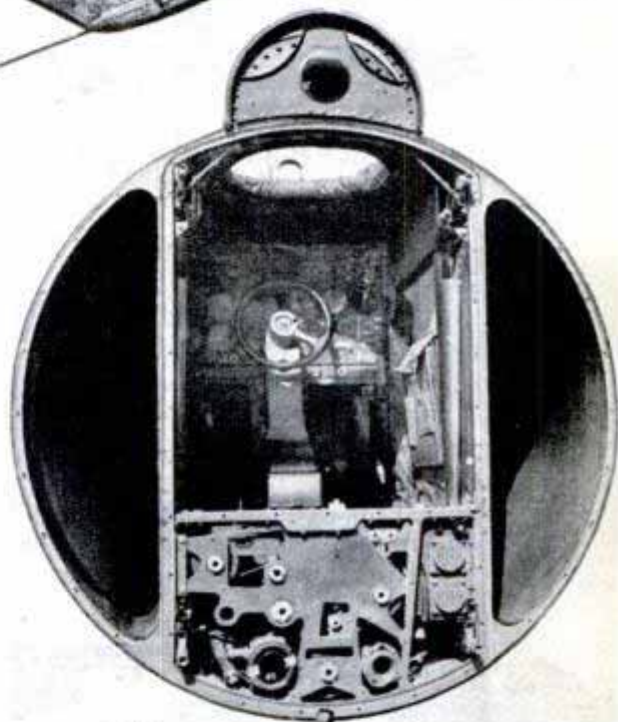

Pilot escaping from detached nose section. Below, inspecting hatch of pressurized cockpit

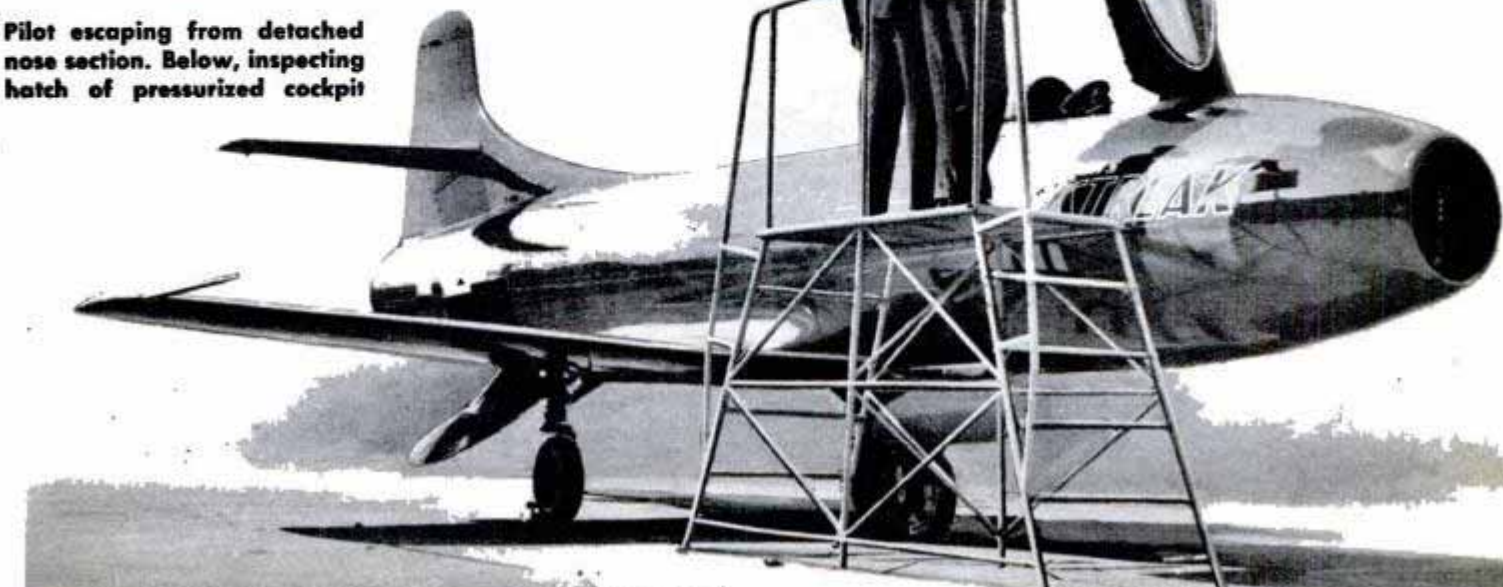

Enlarging and Copying Jobs Speeded by Quick-Centering Easel

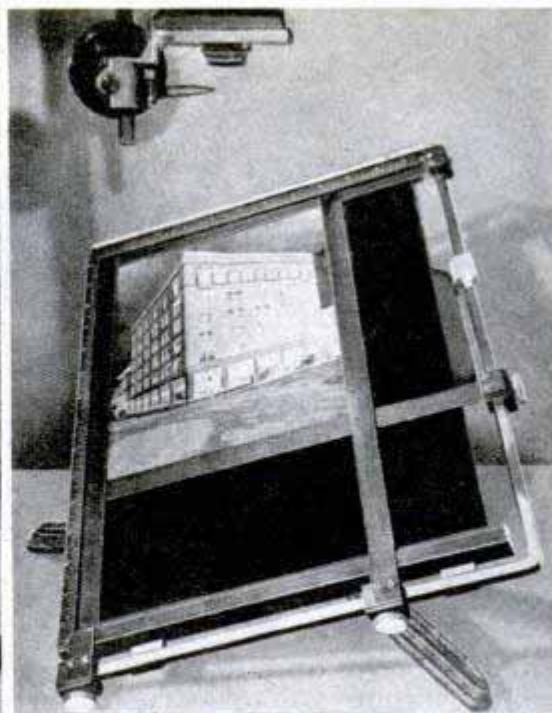
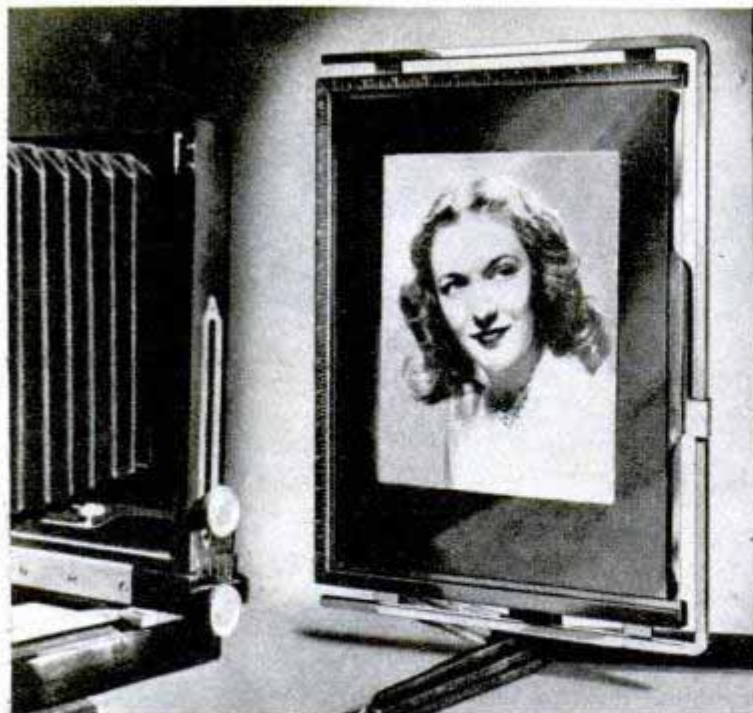

Interchangeable for enlarging or copying, a multipurpose easel speeds darkroom work. No guide pins or slots are needed to hold the sensitized paper in position. A downward push on the mask is said to center the paper so accurately that a partly exposed print can be removed and reinserted for further exposure without blurring the image. An adjustable base for use with the easel may be tilted to

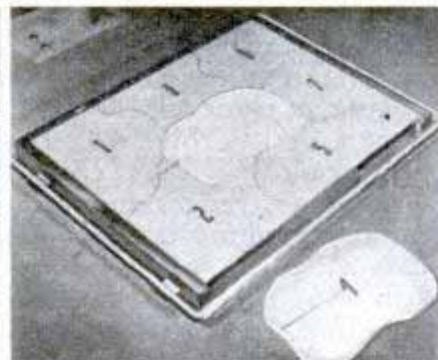
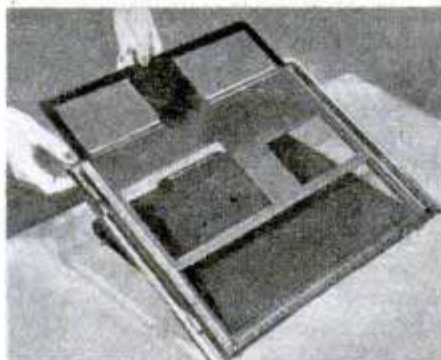

different angles for distortion control. It also can be turned in a vertical position for use as a copying easel

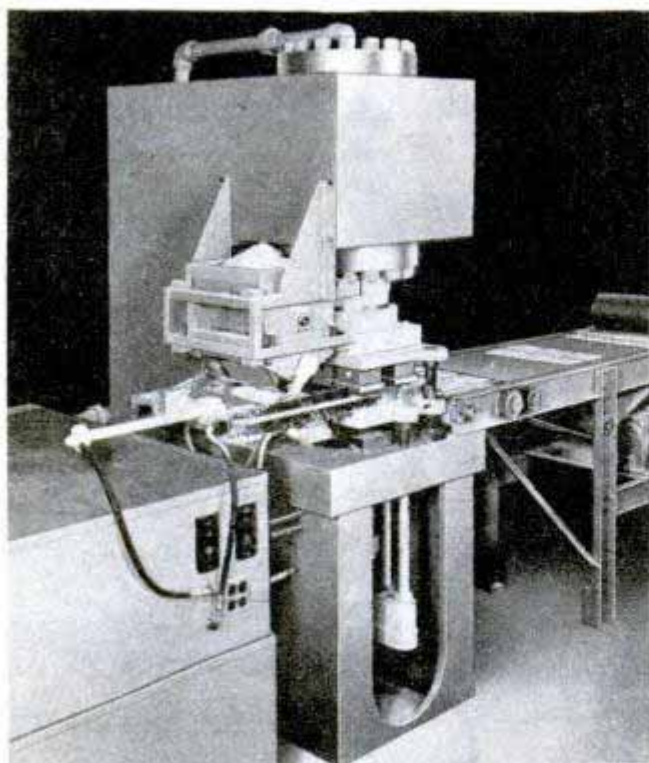

Hydraulic Press for Tile Making Handles Clay Automatically

Completely automatic in operation, a hydraulic tile press turns out tile under high pressure without human aid. The clay is unloaded automatically from a hopper into the shaker box where it fills each die cavity to a uniform depth. The dies are guided to positive alignment under hydraulic pressure. Because the machine utilizes high pressures, tile can be made by hitting the clay only twice instead of the three times ordinarily required. The elimination of one stroke saves wear on the die. One operator can supervise four of the machines.

You may wish to obtain additional information about the new products described each month in *Popular Mechanics*. If you want to know the name and address of the manufacturer or distributor, just write to Bureau of Information, *Popular Mechanics*, 200 East Ontario Street, Chicago 11, Ill.

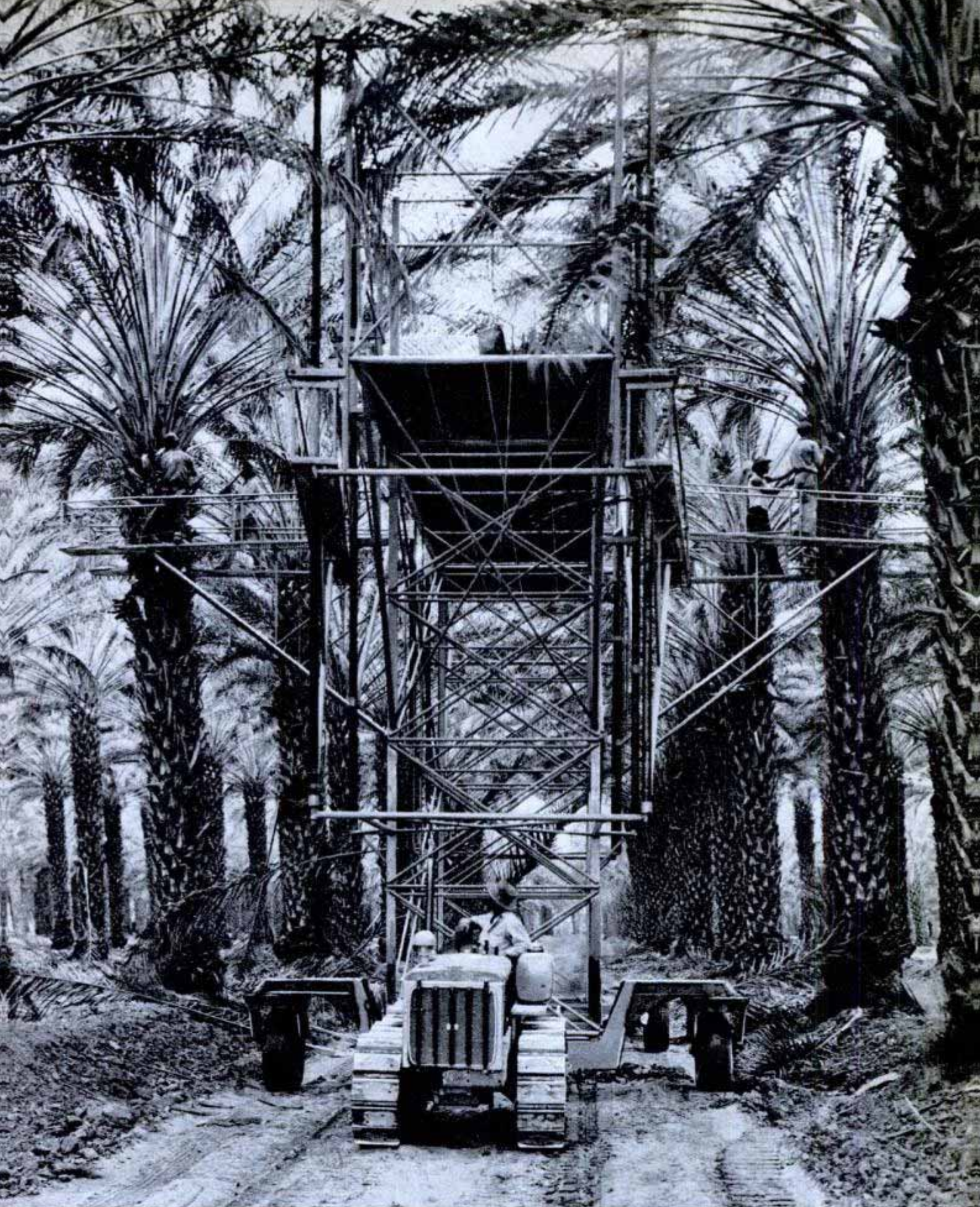

Caterpillar Tractor Co. photo

Huge tractor-drawn platforms provide safe footing for workers who pick dates in the palm gardens of California's Coachella Valley. The rigs have swinging catwalks that can be

Date Workers Get a Lift

raised or lowered to any level between 18 and 45 feet above the ground. Each platform will support a crew of eight men and enables them to tend four trees at the same time.

AGE DOESN'T



Rod on rear of car is the antenna of a two-way radio. Pit crew can warn driver at the first sign of trouble

By Thomas E. Stimson, Jr.

HALF A DOZEN of the best race car pilots in the country were out to give the new driver the works.

"Good enough to race at Indianapolis, is he? Okay, let's find out!"

The test driver who had applied for an Indianapolis racing permit had been instructed to hold to an average of 110 miles per hour for 10 laps around the track. That meant speeds of around 130 miles on the straightaways, slowing down to only 90 or 100 on the turns.

Wham! With his exhaust cracking and barking one of the veterans shot by the novice on the back straightaway. Another came up from behind, passed on the inside



and drifted across his course. Coolly the new driver cocked his wheel to avoid the car.

On the stretch in front of the grandstands two cars were loafing along at 90, hugging the middle of the track. The applicant sized up the distances, passed both cars, and backed off from his throttle in plenty of time to take the next turn without sliding.

Lap after lap the other drivers deliberately gave him samples of the high-speed traffic that is part of the 500-mile Memorial Day race. Meanwhile a committee of observers stationed at the turns and other vantage points watched every move that he made. Was he driving too wide on the stretches? Was he taking the turns safely? Was he holding close to his 110-mile average? Did the traffic fluster him? Let's call him in at the end of the 10 laps and see if he's tired or nervous.

If the new driver passes all these tests he'll be allowed to compete for a place in the starting line-up of the 500-mile race on May 30.

Crew tunes up the front and rear engines of a twin-engine racer. Circulated air is exhausted through the slot in the tail



COUNT ON THE SPEEDWAY

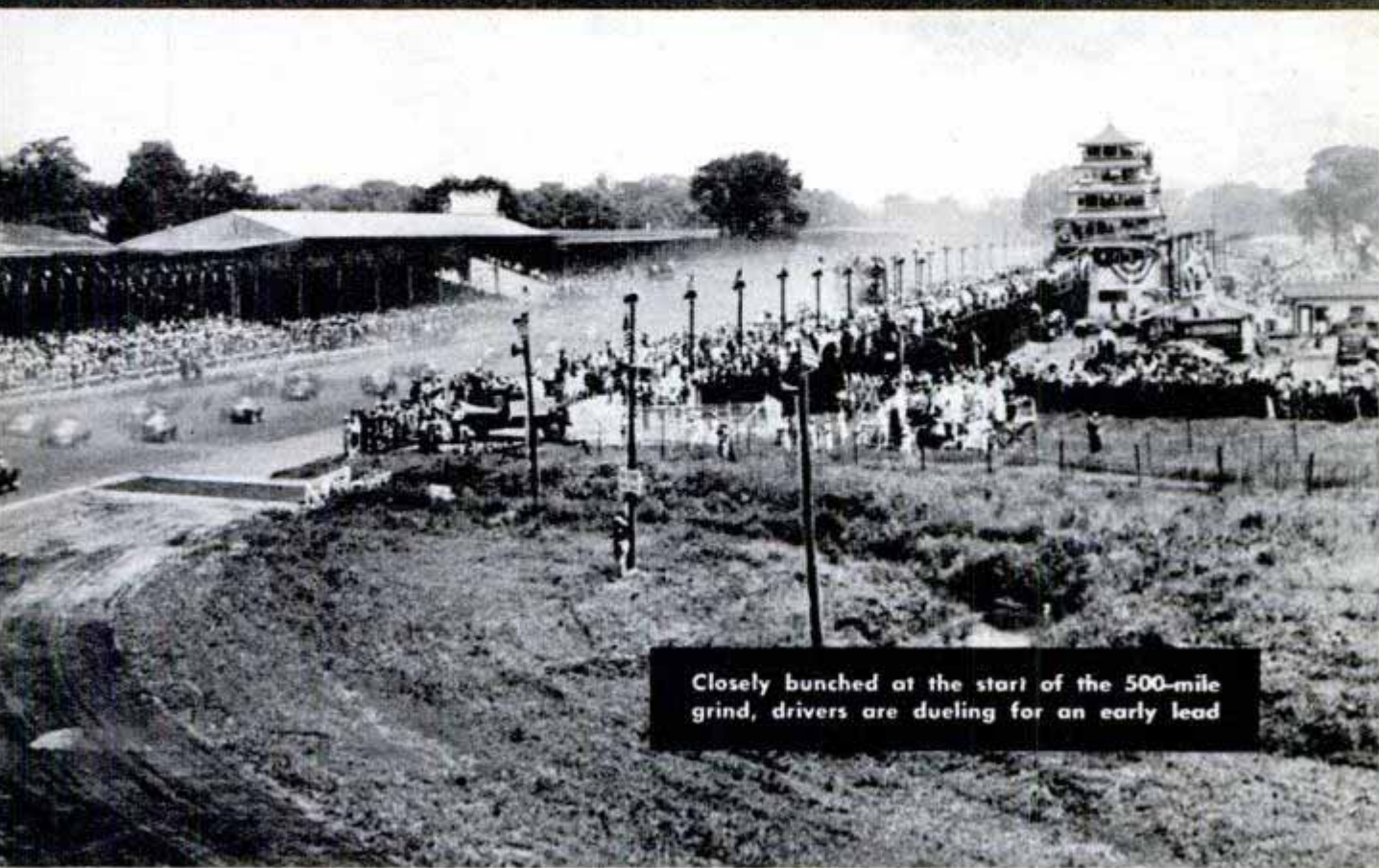

Closely bunched at the start of the 500-mile grind, drivers are dueling for an early lead

There's always a chance that one of the brand-new drivers will win the race itself. That hasn't happened in recent years, though Jimmy Jackson came close to winning the race last year, the first time he had driven on the track.

Jackson had ridden as a mechanic at Indianapolis in the past and more recently had been driving midgets. Last spring he bought a front-drive four-cylinder 258-cubic-inch racer from the Boyle team, nominated the car for the Indianapolis race and applied for the driving test. He passed his test, qualified the car and entered the big race itself. Leading at the 270-mile mark, he went into the pits for fuel and tires and was out again a minute later to try to regain his lead. At 300 miles a vital pin sheared off inside one carburetor. That cut his speed and he finished in second place. Even so, he won \$13,500 in place and lap prizes, thousands more than he had paid for his car. On his first appearance at the track as a driver Jackson made a better

When a driver slips into the pit his crew works like a well-drilled team to service, inspect and repair the car

showing than many veterans ever did.

No matter how good his past record, each new driver is required to pass special comprehensive driving tests before he enters his first race on the Indianapolis track. The purpose of this, says L. W. "Ike" Welch, chief observer, is to license only those drivers who are in good physical condition and who demonstrate safe driving habits. Those who drive dangerously or who appear to

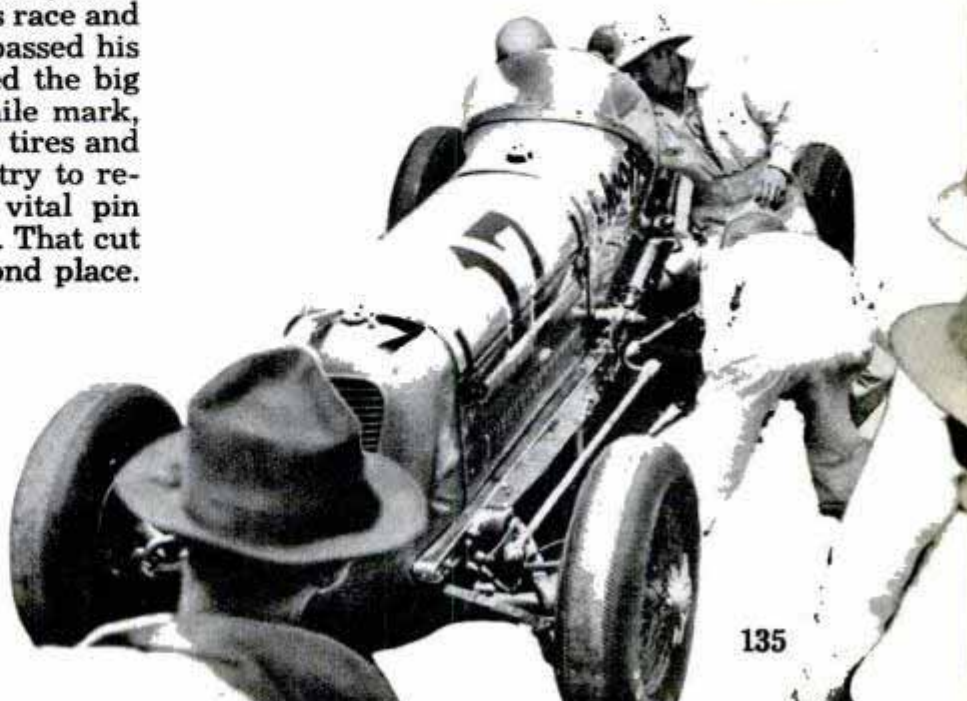



Copyright C. J. Bell-Tower Studios

Mauri Rose crashes into the speedway's north wall in 1946. Line in the sky above the car is its rear axle

lack the stamina needed for the 200 grueling laps around the 2½-mile track are weeded out.

Half or more of the applicants usually flunk. Even a veteran of the dirt track and midget circuits may fail to show good timing at high speed. Instead of finding the speed groove for his particular car he may be all over the track, hitting his brakes as he goes into the turns and weaving across the track as he comes out of them.

Some drivers can't finish their tests because their cars won't develop the high speeds that are necessary. Last year 28 new drivers started their tests but only 13 were certified for racing on the track. The tests are held during May in the four weeks preceding the Memorial Day race.

"After a new driver arranges with a car

owner for the use of his car he applies to Jack Mehan, the chief steward, or to the chief observer for permission to take the tests," Ike Welch explains. "If he is a registered AAA racing driver he gets the regular tests. If he doesn't hold a racing license he must take a special preliminary test of his ability. If he passes this test he is allowed to take the standard tests.

"In his special preliminary test he is instructed to drive 10 laps at an average speed not exceeding 95 miles per hour. A committee of car owners and others with track experience is placed around the track together with a few special observers who are connected to the chief observer by telephone. These men report any driving below the white lines on the insides of the turns, any lack of control, or any other erratic driving that they observe. Usually the driver isn't aware that he is being watched and he never knows the identity of the men who are picked to observe him. At the end of 10 laps the committee makes its report and if this is favorable the new driver is allowed to take the regular set of tests.

"The first of these is 10 laps at 85 miles per hour. This slow speed approximates the time that drivers make when the yel-

Drivers insist their cars run as smooth as a watch before race starts. Here a crew checks alignment of the front end

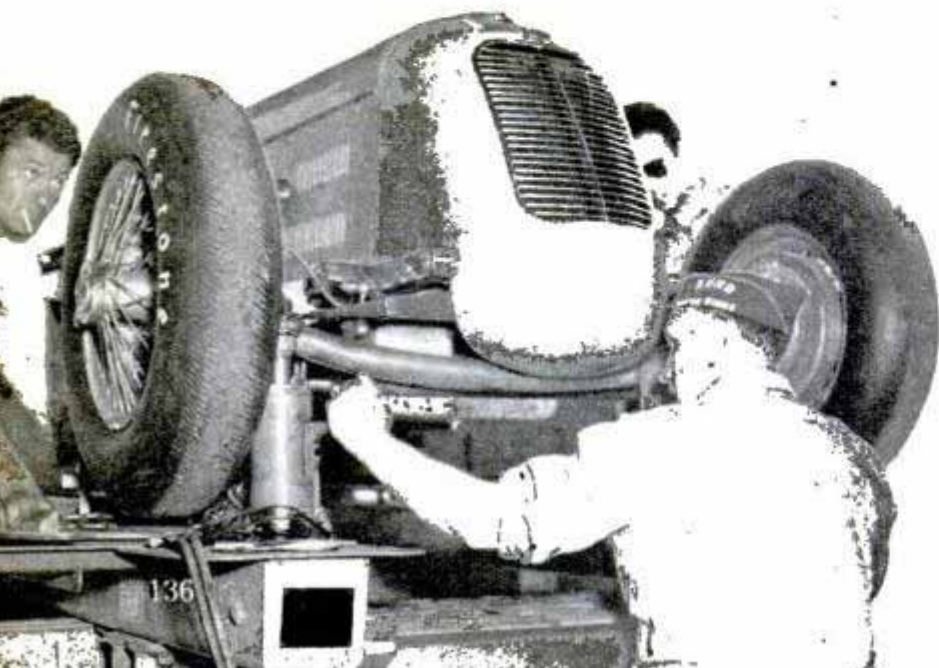



Pit crew observes car anxiously as it streaks past. Blackboard is used to signal driver's place and number of laps. Right, crew's electronic timer checks speed



low caution flag is displayed during a race. It is purposely included in the tests to accustom the driver to handling his car at slow speed. Most drivers, of course, watch their tachometer in order to gauge their speeds. During the test a man in the pits holds up a blackboard that tells the driver the time he is making so that he may change speeds to maintain the correct average.

The next test, held immediately if the driver shows good control at 85 miles an hour, is 10 laps at 95 miles per hour. This is followed by 10 laps at a speed of 105 miles, then the pace is stepped up to 110 miles for 10 laps. The final test is another 10 laps during which the driver must average 115 miles per hour.

Other drivers circle the track during one of his fastest runs to give the novice a taste of traffic. This "heckling" is done prudently without any moves that might lead to an accident and simply shows the new driver what to expect when

(Continued to page 264)

Forward scoop directs the flow of air through the radiator of this front-wheel-drive racing model

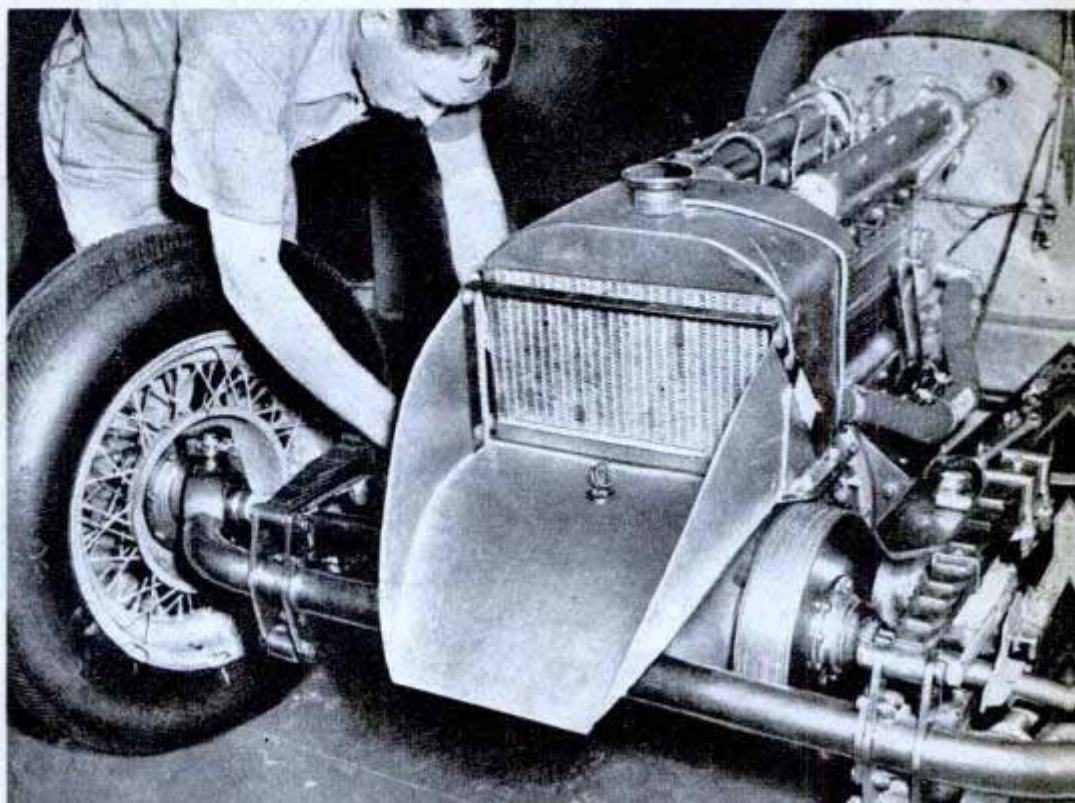

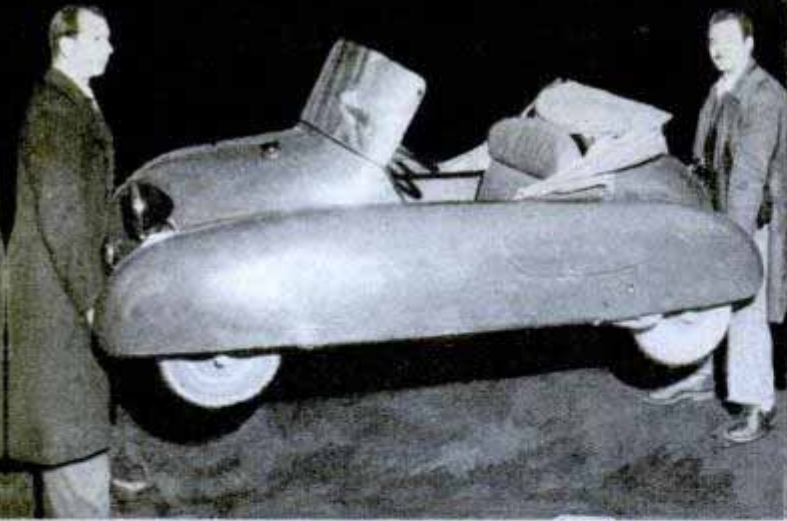

MIDGET VEHICLES are becoming popular in Italy because of their extremely low fuel consumption. The tiny car at the left covers 120 miles per gallon of gas under steady driving conditions and can be lifted by two men. The three-wheel dump truck at right carries as much as 1½ tons of cargo, yet goes 30 miles per gallon

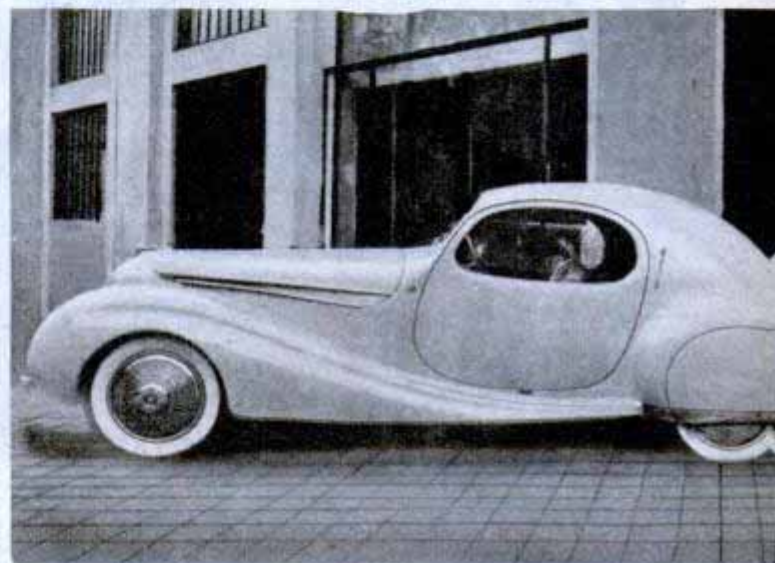

SLEEK CAR for the French buyer is the Delahaye Competition, a low-slung six-cylinder auto with super streamlining. Available in the models shown above, it has built-in headlights, an electromechanical gearbox and a special oil system. Cars built by this manufacturer have won several international races in the past

TRICYCLES carrying moving picture posters are pedaled along the busiest boulevards in Rome to advertise the latest films. The posters are mounted on the two faces of a big "sandwich" type billboard which rests on a steel frame mounted over the rear wheels. An Italian advertising agency developed the unique tricycle ads



Camera Snaps, Develops and Projects Pictures Within 15 Seconds



Photographs are snapped, developed and projected on a screen, all within 15 seconds, by an automatic instrument that combines a camera, processing cabinet and projector. The machine uses 16-mm. film to provide exposure-to-projection photography in a fraction of a minute. In a public demonstration recently, persons entering a room were photographed and their pictures appeared on the screen before they had reached their seats. Inside the camera a strip of film is pulled intermittently along a track and an exposure is made through the film base on every fifth frame. The exposed film moves into a processing cup where hot chemicals are squirted on to it to develop a direct positive image in about nine seconds. Excess chemicals are cleared by vacuum and the nearly dry image is pulled into a projection system where a stream of air completes the drying, cools the film and holds it flat for immediate projection. The developing and fixing solutions used are very active chem-

Camera snaps a photo every fifth frame (film strip at right) and projects it on the screen at left within 15 seconds. Below, side view shows principal parts and diagram gives exposure-developer-projector sequence

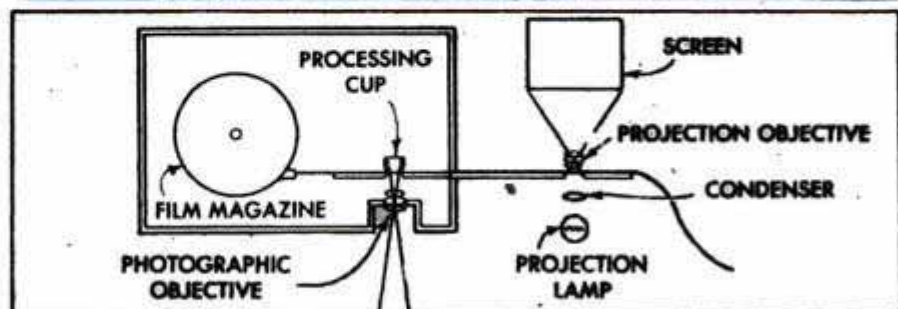
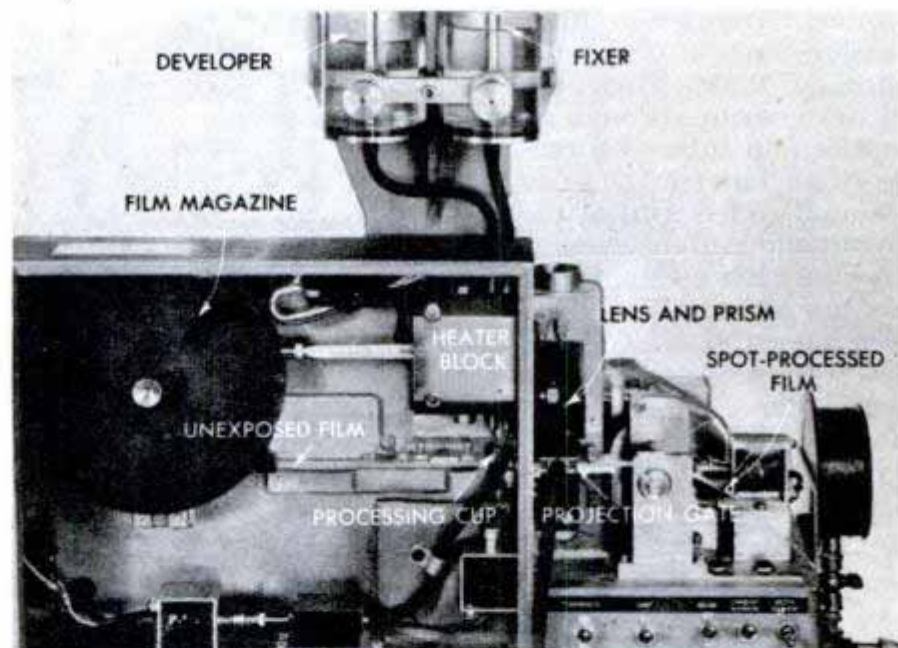

ically, especially when applied hot. The machine, developed by Eastman Kodak Company, may find use in the quick reproduction and projection of scientific data.

Jeep Covered With Cockpit Section of Plane Makes All-Weather Auto

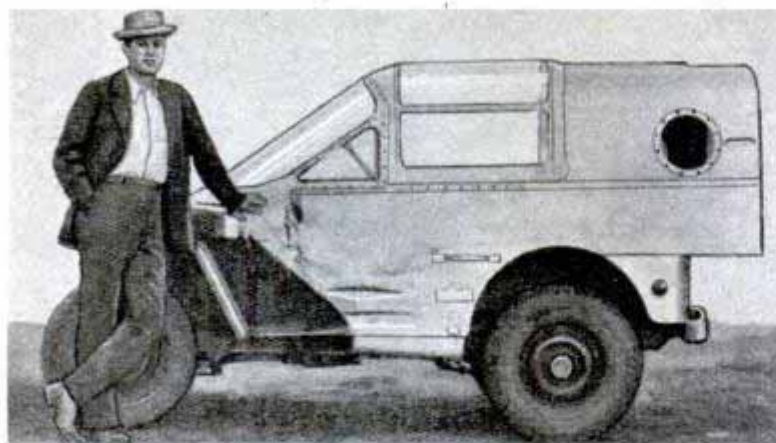

By covering a jeep with a section from the fuselage of an airplane, Cecil Malone of Henderson, Tenn., has remodeled the vehicle into a streamlined all-weather automobile. He bought the fuselage of an Army advanced trainer and cut out the cockpit section to fit over the jeep. The sloping windshield streamlines the little vehicle and the driver has a clear view in all directions—even overhead—through the plastic windows. The fuselage also protects the driver in case of an accident.

Endless Fountain of Coffee Is Supplied by Automatic Brewing Robot

Fresh hot coffee flows like a fountain from a coffee brewing robot that goes into action the instant a push button is pressed. As illustrated in the cutaway drawing, pushing a button moves a weight mechanism that opens a valve and admits water through a filter screen into a preheated storage tank. Then the water goes up through an outlet and tube to a cartridge that contains ground coffee. Out of the spout and into the decanter pours hot coffee, ready to be served. When the decanter becomes filled, its weight presses down on a balance which shuts off the flow of coffee and keeps the heat on below the decanter. This ingenious coffee maker was de-

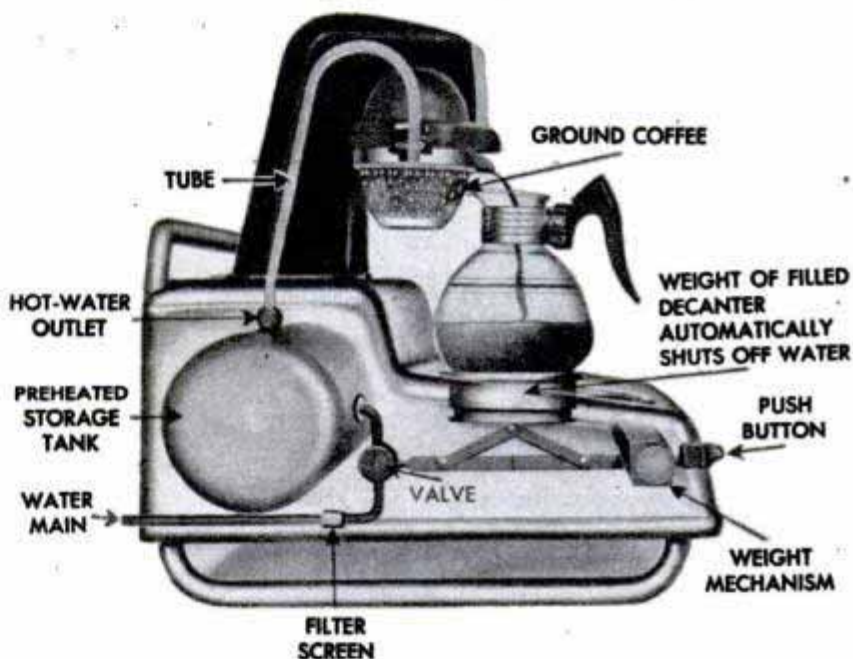

signed by the Cory Corporation for use in restaurants. The exact amount of water is supplied by attaching it to a water main.



Jack Pulls Car Off Ground

Automobiles are lifted instead of pushed off the ground by a new friction-type bumper jack. The lifting unit hangs from a suspension point above the bumper, formed by the jack's two legs which are chained together at the base and meet in an inverted V. For storage it collapses into the same space required by a standard bumper jack.

☐ Soiless gardens totaling 80 acres soon will supply American occupation troops in Japan with tomatoes, lettuce and other fresh greens fed by chemicals.

SMARTEST SHIP AFLOAT!



Science's newest navigation devices are being tested on this floating laboratory. Visible are radar antennas, bearing repeaters (left of the 20-inch searchlight and in the center of main deck), and loran antenna

By Bill Reiche

AN IDLE TOWBOAT loses from \$100 to \$200 an hour—but radar, which sees through fog and foul weather, can keep it on the job. A hand-steered fishing trawler can do six days' fishing in five after being

New York harbor as it appears in ship's radar scope



equipped with electromechanical steering. A device called loran eliminates lost time and costly errors in locating the best fishing grounds, and gyro-compasses keep 100-foot boats on courses exact enough for the Queen Elizabeth.

Used on naval ships and modern ocean

Compare radar scope (left) with this map of harbor

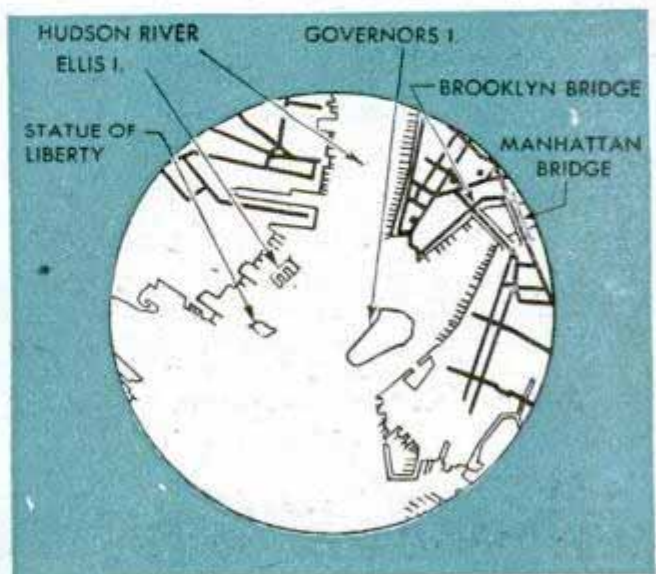

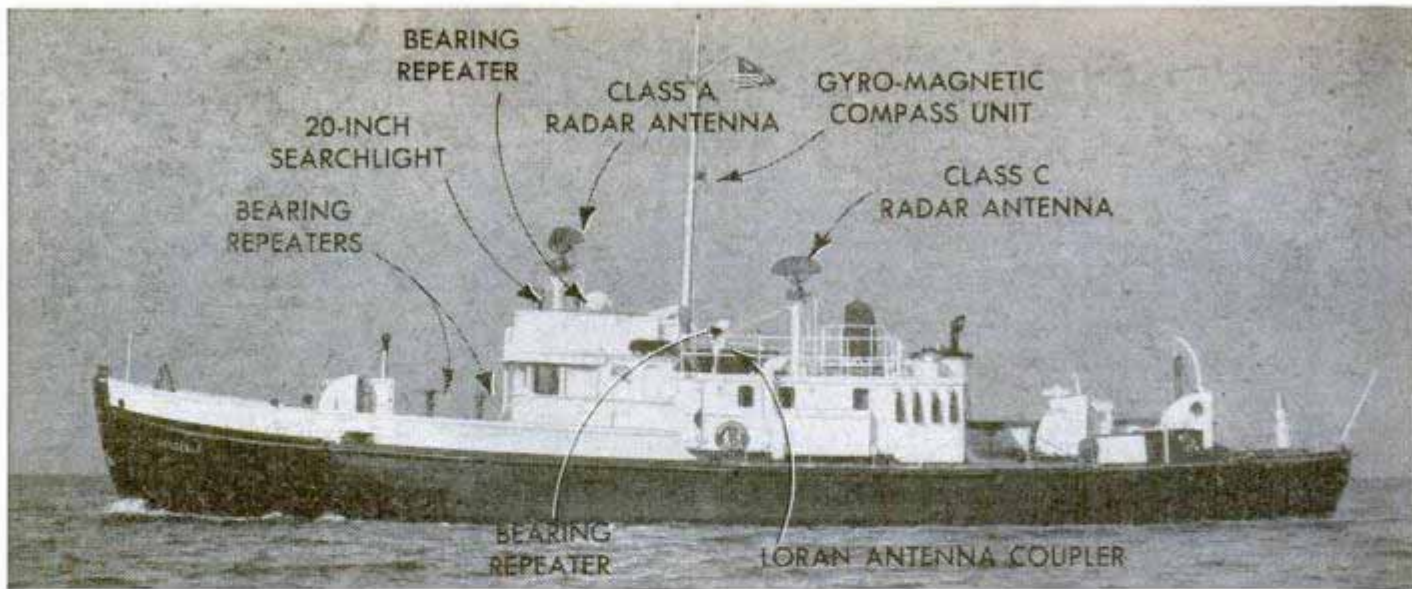

This view of the Wanderer, Sperry Gyroscope Company's test ship, shows location of the navigation equipment

liners, these navigation aids are being adapted for smaller craft. Soon even the sturdy fishing craft off the Grand Banks will have electronic and electric "crews" that will make the best prewar ship look like a Phoenician galley.

There is a unique "personality" behind the scenes in this drama of making small ships big-time performers—not an engineer or a scientist, but a motor yacht—the smartest ship afloat.

She is the Wanderer, a 101-foot Diesel-electric craft, termed a million-dollar floating laboratory. From her home port of Oyster Bay, Long Island, she puts out to sea or into inland waters with the most complete navigating equipment ever placed in a hull.

A long-range (she can cruise 5000 miles without refueling) seaworthy yacht, she was built for a private owner 15 years ago. During the war she served with the Coast Guard in defense of the eastern seacoast. After VJ Day she was leased by the Sperry Gyroscope Company for use as a floating test chamber of navigation aids.

Hollis Walter, Sperry engineer, explains the purpose of the tests: "Men and materials that go to sea have to be pretty rugged. We're not interested in operation or long-life duty when equipment is adjusted and cared for by a lot of lily-handed lab assistants. We want to put it out to sea and watch its operation when it's handled by a heavy-fisted bunch of salty squareheads."

Outstanding among the Wanderer's devices are the triplets of navigation: loran, which tells you where you are; the gyro-compass, which tells you where you're going, and radar, which tells you what's in your way.

Also in test service are devices for electromechanical steering, automatic steering in conjunction with the gyro-magnetic com-

pass, rudder angle indicator, marine gyro vertical and course recorder.

A recent 6000-mile cruise on the Atlantic, the Great Lakes and inland waterways provided acid tests for new and smaller models of radar, loran and the gyro-compass—the devices most in demand.

Using the new Class A radar, with the pilot house completely blacked out, blind approaches were made in the harbors of Bridgeport, Conn., Cleveland, Boston and New York. This set, about the size of a home radio-phonograph, can be set at ranges of 2, 10 or 30 miles. At its minimum

Gyro-compass steering equipment is now more compact



range it is guaranteed to show on its 12-inch scope a three-foot buoy at a distance of less than 100 yards from the ship.

River towboat operators and ferry companies are greatly interested in this equipment following its successful test on the towboat Tri-State between Pittsburgh and Catlettsburg, Ky., on the Ohio River. On this run the radar detected a tin can bobbing on the water less than 100 feet from the boat's bow.

Sperry engineers doubted this until the fact was confirmed by the company representative on board. They suspect, however, that the can acted as a resonator, thus returning a much stronger signal than would normally be found, and they do not wish to have this freak eagle eye performance considered as standard operating procedure.

But although this device is not offered as a locator of floating junk it enabled the Wanderer—its pilot house completely shielded—to thread its way safely through the bustling Detroit River.

The navigator studied the 12-inch scope, resembling a photographic negative with the background black and the objects in range glowing with a brilliant light. The image on the scope is seen in its true-north relationship, that is, with north at the top as on a chart or map. The ship's location is indicated by a spot in the exact center of

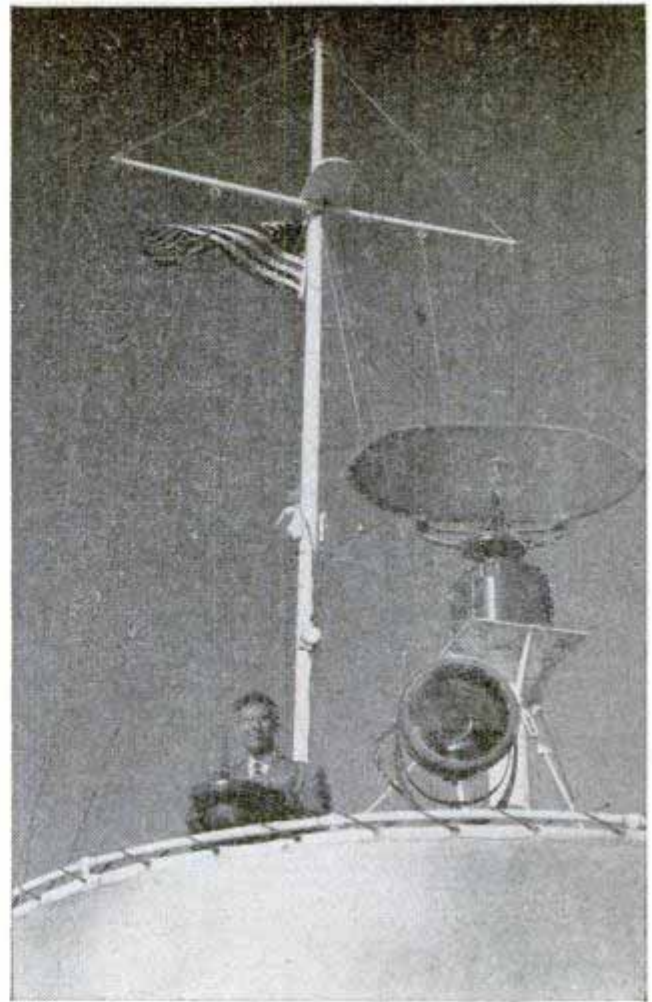

Twenty-inch searchlight is operated from pilot house

Inside the Wanderer's pilot house. Class C radar (left), loran chart on the table, gyro-magnetic compass on the wall (shown above the operator's head). Photograph at right shows a course recorder on an Italian liner

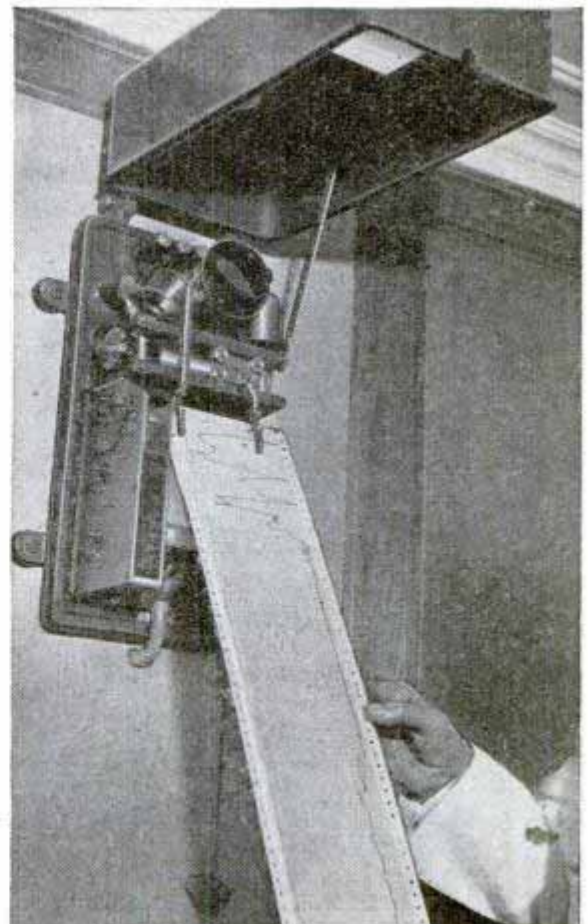



A ship's exact position is determined in two to six minutes by an electronic device called loran—an abbreviation for long range navigation

Chart shows how loran determines ship's position. It measures the difference in arrival time of radio pulses from two shore-based stations

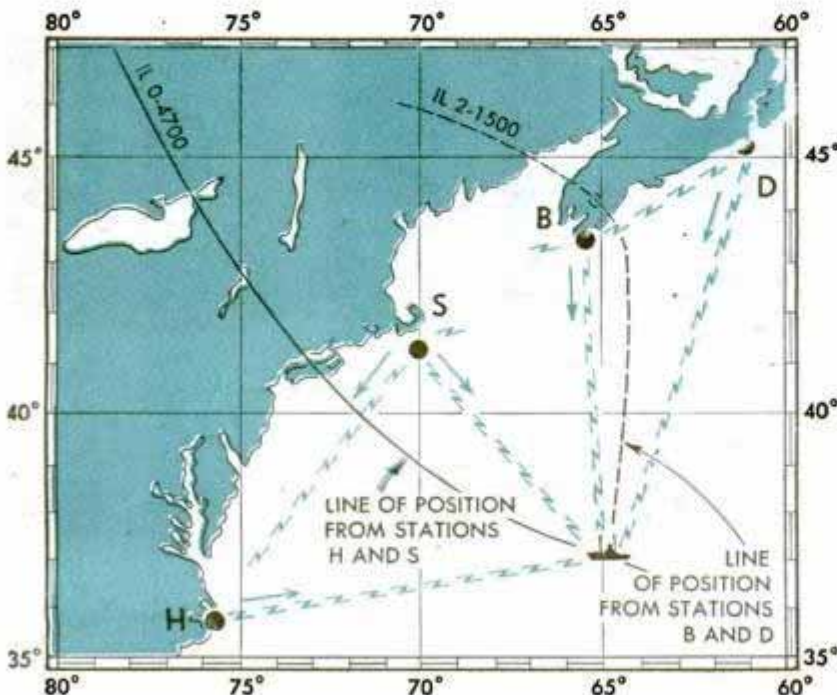

the scope, its course by a line extending from that spot almost to the perimeter of the scope. Land masses appear in their natural outlines, as seen on a map, and smaller objects, such as ships and buoys, can readily be recognized.

The true-north relationship of the scope and the relative bearing of the ship are achieved by coordinating the radar with the gyro-compass repeater system. The high-frequency impulses from the transceiver are transmitted from an automatic, rotating scanner in bursts of one quarter of a millionth of a second. They are received as they "bounce" back from objects within range and are visible immediately on the scope. This unit costs from \$13,000 to \$15,000 installed.

For craft which do not require a unit of such short-range sensitivity, but rather a set that will reliably pick up ships at sea, land masses, etc., Sperry is experimenting with a Class C radar which may have minimum range of 400 yards. The Class C installation, costing about \$5,000, is planned to protect against collisions with ships and icebergs and against going aground in fog or foul weather.

Prototypes of both these units are receiving exhaustive tests and plenty of rugged sea duty aboard the Wanderer. Test data confirm the impression of prospective users that the Class A unit will solve the problems of river and harbor boats and that the Class C set will do a job for the smaller of the ocean craft.

Loran—the war-born wizard that quickly answers the navigator's question, "Where am I?"—is a boon to the commercial fisherman, whose livelihood depends on his finding the day's best fishing spot, the location of which is known to him. In six minutes, using a newly developed loran unit, the trawler's exact position can be learned more accurately than by celestial navigation, radio direction finders or by soundings.

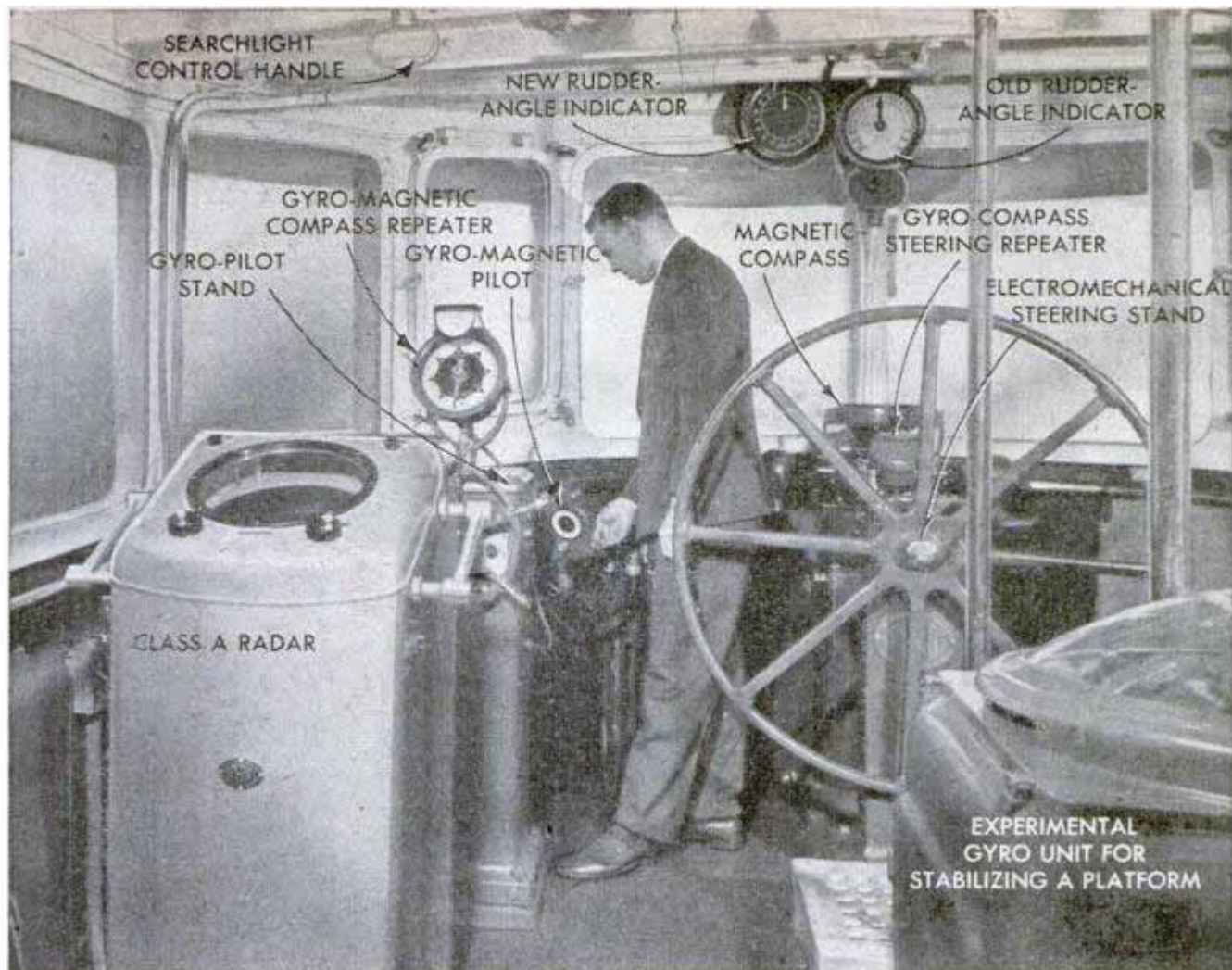

With its pilot house blacked out, the Wanderer relied entirely on these instruments to enter New York harbor

This conclusion is based on the experience of the Wanderer, backed up by reports of New England fishing skippers who have used loran to help them get home sooner with a bigger catch.

Loran's operation is based on the fact that radio waves travel in a straight line and at a constant speed of 186,000 miles per second at sea level. Pairs of transmitters, consisting of a "master" and "slave," at known positions constantly produce pulse signals at regular intervals. The slave retransmits the original signal of the master unit and thus there is a constant time difference between the two at a given location of the ship. Lining up the two signals on the fluorescent screen of an oscilloscope, the actual time difference is read from the dial of an indicator which is a stop watch capable of measuring microseconds.

Using this time difference and a prepared chart, the navigator can place his ship's position on one of an infinite number of lines which pass between the transmitters and extend out to sea. By repeating the process with a second pair of stations he obtains a second location line and the point of intersection indicates his exact position.

The entire procedure takes less than six minutes because the device provides the

time difference automatically on a visible dial. Until recently a loran operator had to count the hairlines separating the signals on the oscilloscope screen and compute the answer from three factors—a procedure that was slower and more liable to error.

The unit is 15 by 17½ by 43 inches in size. It operates on 60-cycle 115-volt single-phase alternating current and a converter may be used for direct current. It costs approximately \$3000. The first commercial installation was made on the Swedish liner Gripsholm last year.

Electromechanical steering substitutes electrically controlled mechanical power for muscle at the helm of a ship. To do this on a 10,000-ton vessel is simple, since weight is no great factor and expense not as important as on a fishing boat. Now years of experimentation and development work are coming to a head on the Wanderer, where a variety of lighter, less costly steering devices are undergoing final tests.

Each one of these units may put two men out of work—but just long enough for them to descend from the wheelhouse of a trawler to the deck where they will start handling net lines, thereby speeding the loading of fish by 20 percent. It takes two brawny

(Continued to page 240)



Rocket-Powered Craft Steers by Turning Jet

Speeds of nearly a mile a minute are made in a rocket-powered speedboat that has neither keel nor rudder. The engine is on swivels, turning horizontally or vertically, and the boat is steered by changing the direction of the jet. Liquid oxygen and alcohol are pressured through flexible lines to the engine's combustion chamber. The rush of hot gases from a nozzle a few inches above the water supplies the thrust that moves the boat. Another type of propellerless power for boats, hydropulsion or "water jet," involves a solid stream of water, ejected below the waterline at high velocity. Still experimental, it utilizes a marine engine.

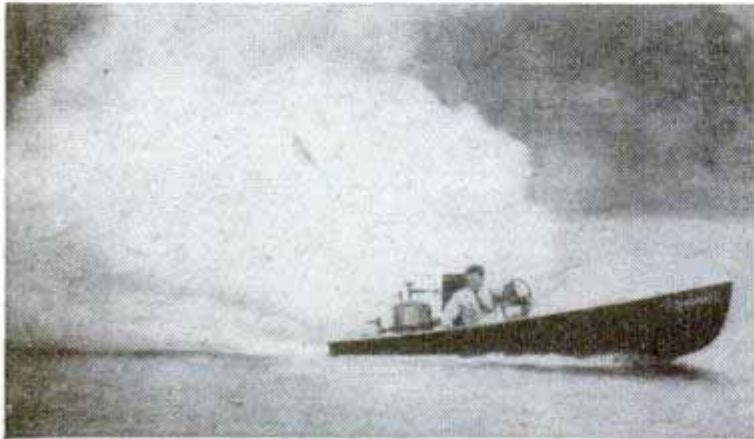

Sketch by Reaction Motors, Inc.

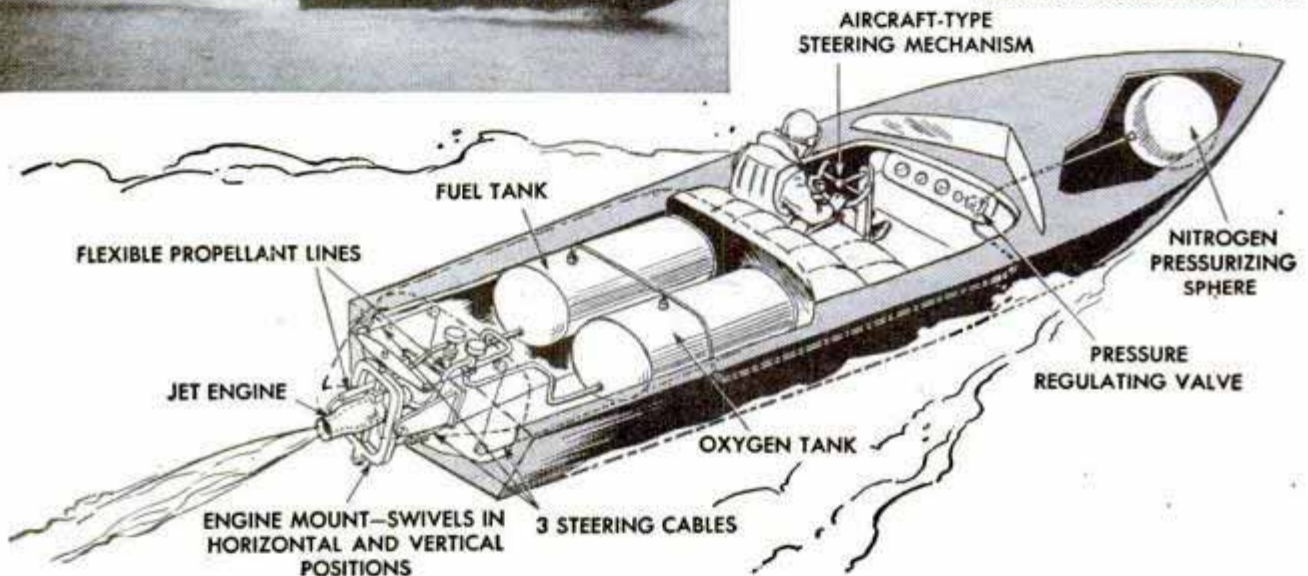

Fish Helps Catch Himself With Trip-Lever Hook

Setting a fishhook in a fish's mouth is accomplished mechanically with a new fishing accessory that is attached to the line. The device consists of a spring wound around an arm with a trip lever at one end. The hook is fastened by the line to one end of the lever. When the fish pulls slightly on the hook, a catch snaps open the lever, releasing the spring and giving a quick jerk to the line. The device is made of corrosion-resistant steel. It can be attached to a line in two minutes.

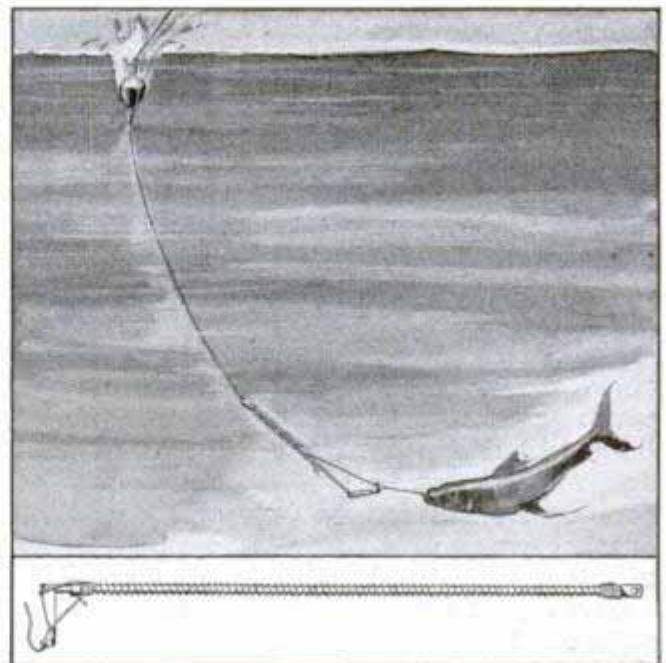

Information, including manufacturers' names, concerning products described in this issue may be obtained by writing Bureau of Information, Popular Mechanics, 200 E. Ontario St., Chicago 11, Ill.

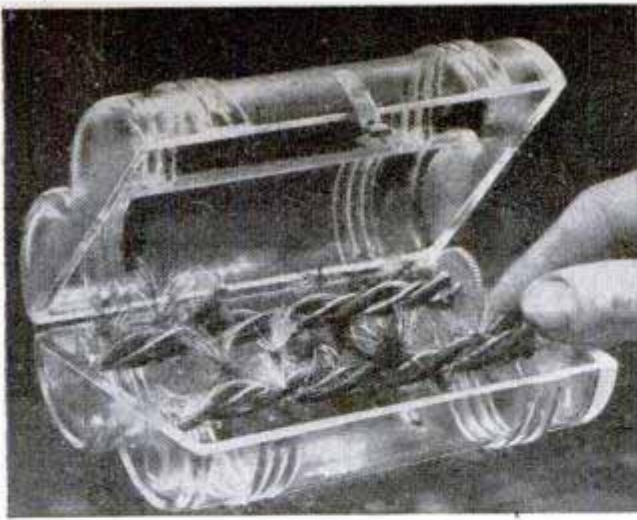

Springs Inside Plastic Fly Box Keep Lures Separated

Fishing lures are kept in good condition in a pocket-size transparent plastic fly box equipped with spiral-wrapped rustproof springs, extending lengthwise, to separate the flies and hold them in place for immediate selection. By turning a wheel attached to the springs, the fisherman quickly sees every fly and makes his choice.

Self-Sealing Test Plugs for Tanks

Self-sealing plugs are now used as substitutes for ordinary screw plugs to close openings in tanks and boilers when internal pressure tests are to be made. Available in 1/2-inch to 2-inch sizes, the plugs are so designed that test pressure within a tank hydraulically or pneumatically seals them.

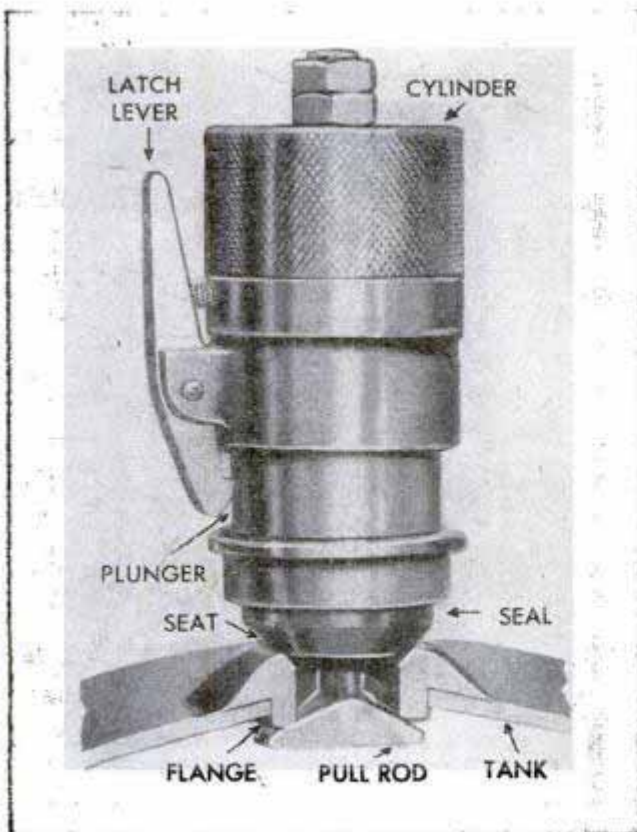

Mosquito Hood for Sportsman Has Zipper Mouth Slit

Lightweight and cool, an insectproof hood protects a sportsman's head and neck and at the same time enables him to smoke a pipe or eat by means of a zipper slit at the front. When not in use, the hood folds flat for compact carrying in a fishing kit or pocket.

Tire Spreader Speeds Inspection

To make it easy to inspect or work on the inside of tires, a self-locking spreader tool is available. To operate, the prongs of the tool are placed between the tire beads. Downward pressure on the handle spreads the tire nine inches and locks the tool in place. To release it, the locking latch is tripped. The steel tool weighs 2 1/2 pounds.

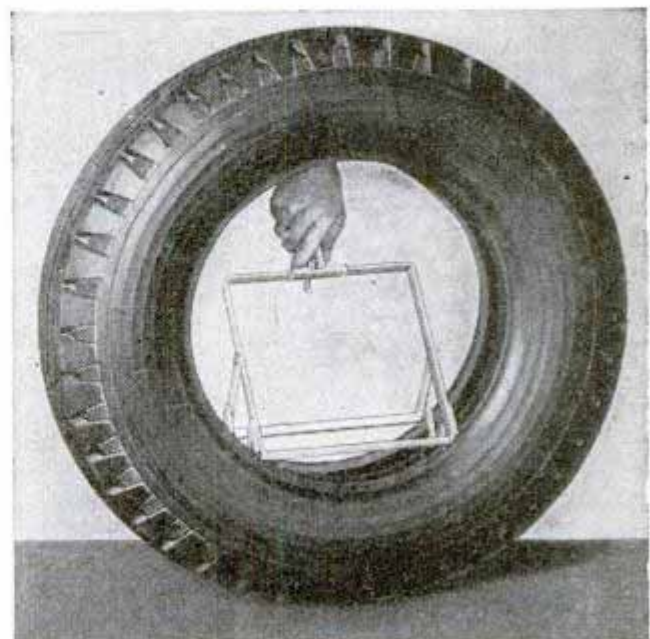

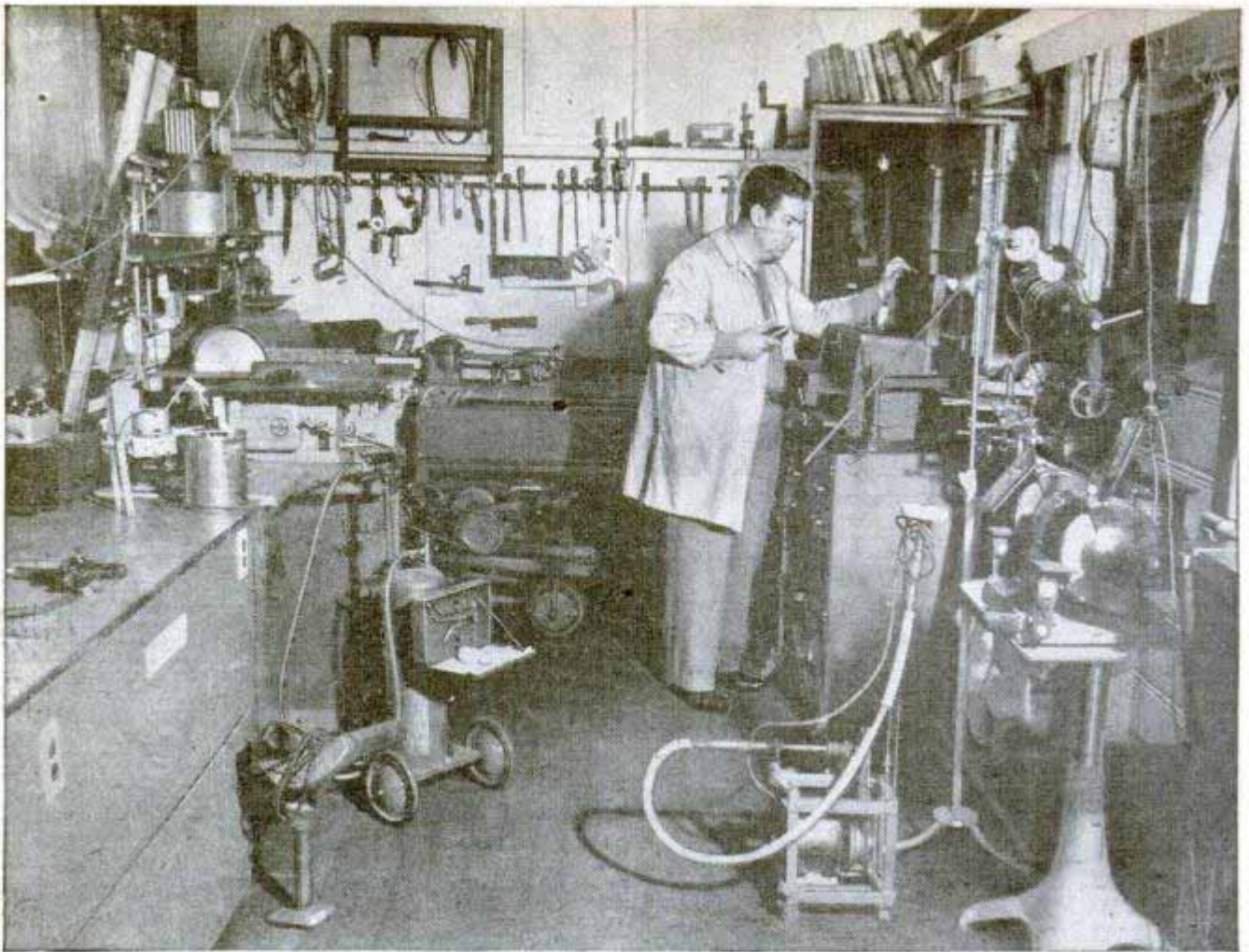

In his multiple-use workshop, the cowboy star can do everything from hand tooling leather cha' backs to repairing balky radios

HOBBYIST OF THE MONTH

Smiley Burnette

WHEN Smiley Burnette, cowboy star of Columbia Pictures, has a day off it usually turns out to be the busiest day in the week for him.

In his home workshop before dark he is apt to have repaired a neighbor's radio, spray-painted the garden furniture he built last week end, hand tooled the leather backs he designed for the furniture, and started modeling an Indian head that he will fire later in his homemade ceramic kiln. That night after dinner if he isn't enlarging photoprints the chances are he'll be tying wet flies for his next fishing trip.

Smiley has a couple of dozen hobbies. He took up blacksmithing for fun and put together a small smithy in his back yard. He's interested in microscopy and is a com-

petent electric welder. Wood burning offered a chance to decorate some western furniture he built so he learned to handle an electric burning outfit. He's a phonograph fan and cuts his own transcriptions for broadcasts and records. He has his own homemade electroplating outfit and he does linoleum block printing.

"People who specialize in one or two hobbies would enjoy themselves even more if they branched out," Smiley contends. "Half a dozen hobbies or a score of them aren't too many. Just about all of them will turn out to be useful."

When Burnette bought a 10-inch metal lathe he studied how to run it and then practiced making simple cuts and shapes. He added milling and screw cutting attachments and kept on practicing. Now he's a competent machinist without shop training. He learned blacksmithing, air brushing and all his other crafts the same way.

Smiley started his home workshop in 1940 in a 12 by 30-foot room alongside the garage. What he planned was a metalworking shop, woodworking shop, leatherwork-

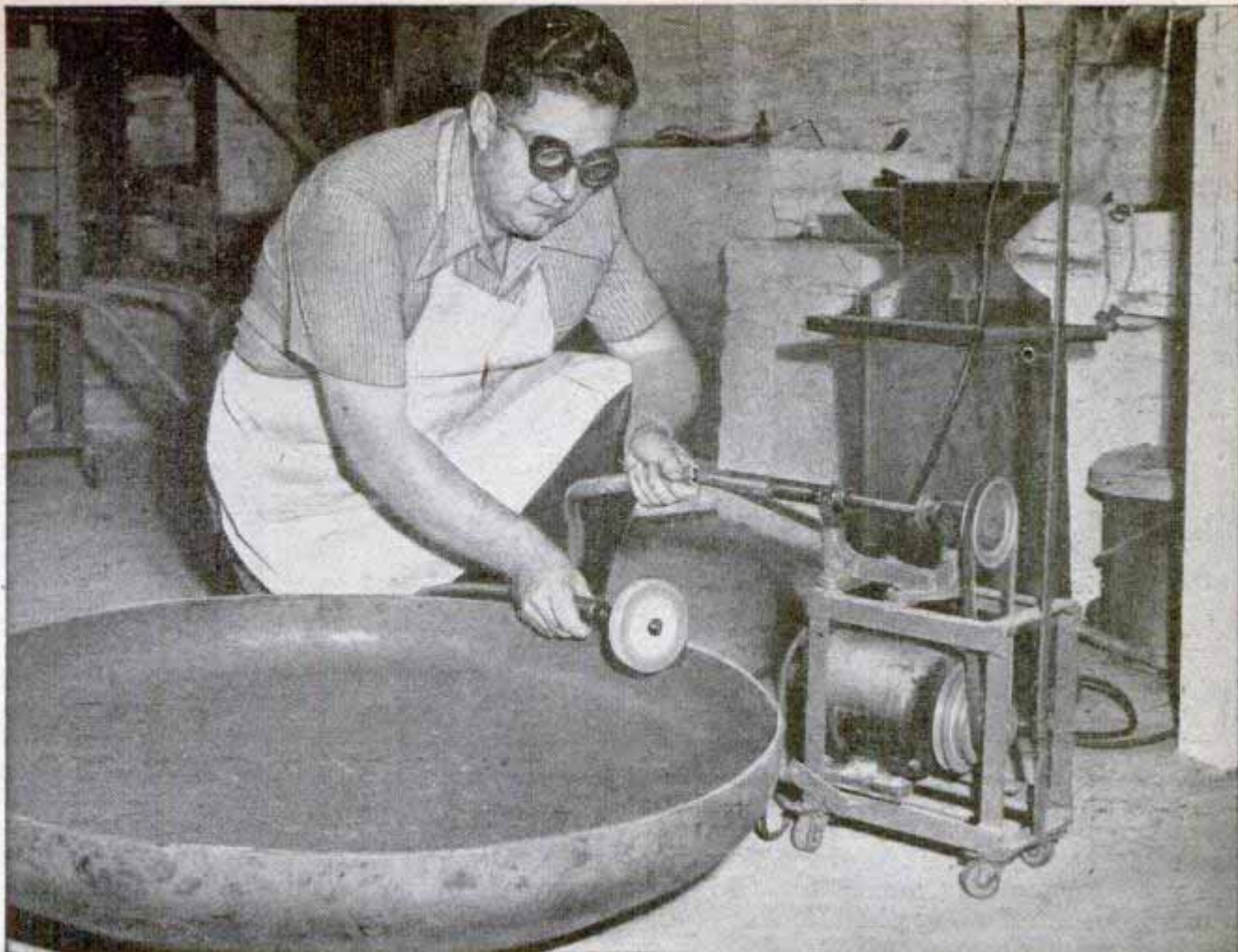

Burnette puts the finishing touches on a charcoal brazier with his homemade grinding tool and, at right, uses a gas-soldering unit he built for repair work

ing shop, photo gallery and darkroom, plus storage for other equipment. Visitors are surprised that he has plenty of room left for walking around and for working. This is achieved by compact storage.

All big tools except the lathes and other heavy equipment are mounted on wheeled stands that he built himself so they can be pushed out of the way into convenient niches when not in use. All the photo equipment except the enlarger is stored in one big bin mounted on roller skates. Normally it's pushed out of the way under a table.

The workshop becomes a portrait gallery by pulling down a choice of backdrops that roll down from the ceiling like window shades. Overhead photo lights are permanently in place. For eye-level lighting Burnette attaches photofloods to one or two of his specially built "robot" stands for which he has dozens of uses.

The robot is simply a sturdy photo lighting standard on wheels with a six-inch section of railroad iron fastened to the base for steadiness and to provide a place on which to pound things with a hammer. An electric junction box with several outlets is attached at hand height to the standard so that several lamps, power tools or other de-

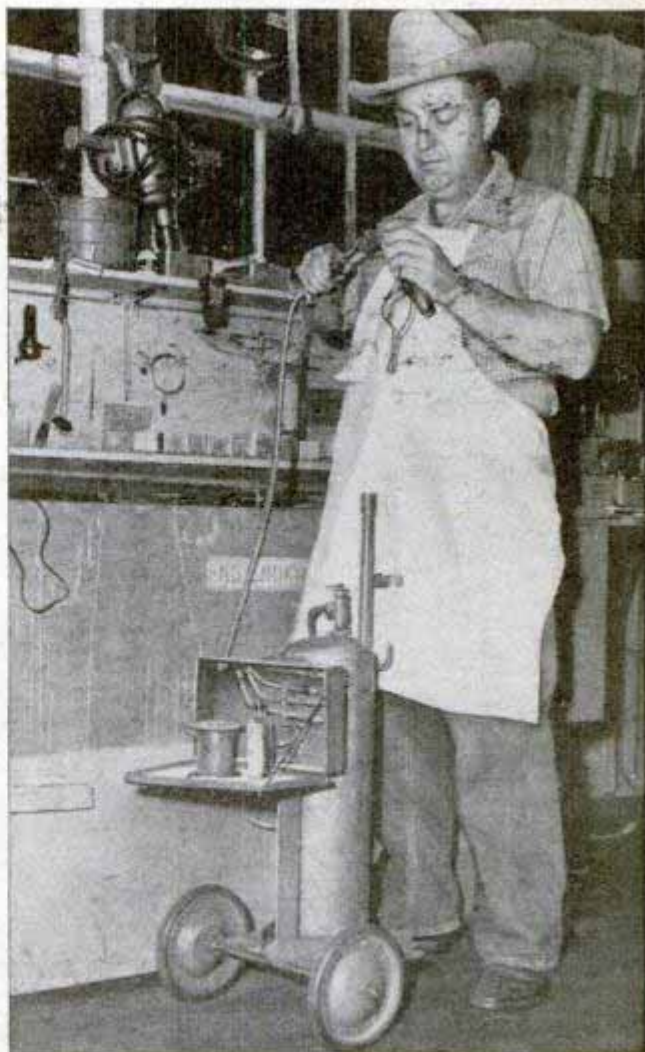

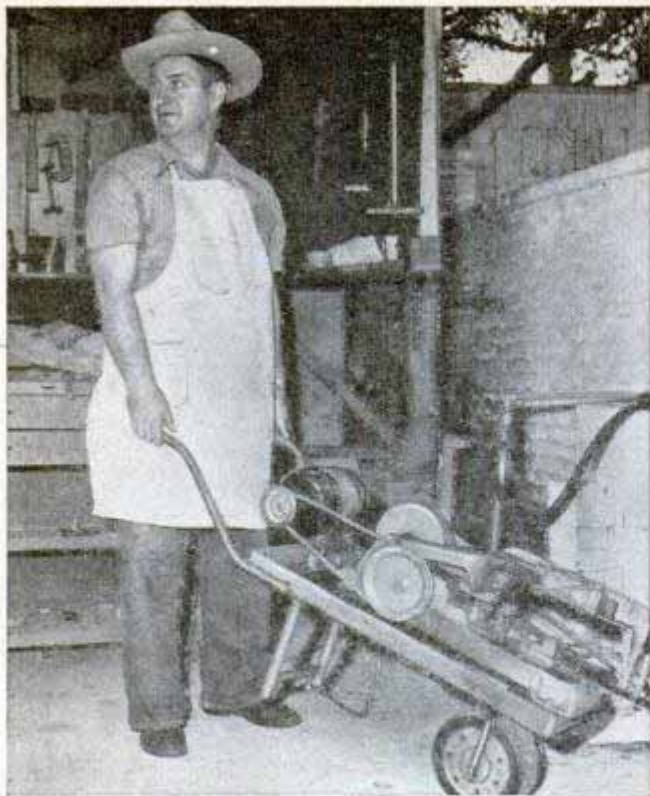

He made this power metal saw from bits of angle iron

vices can be plugged in at once. Clamps and attachments at the top of the standard are used for holding almost anything he wants to use, including photofloods, a hair drier for drying film, a magnifying glass, a lamp for working at the lathe, and even a

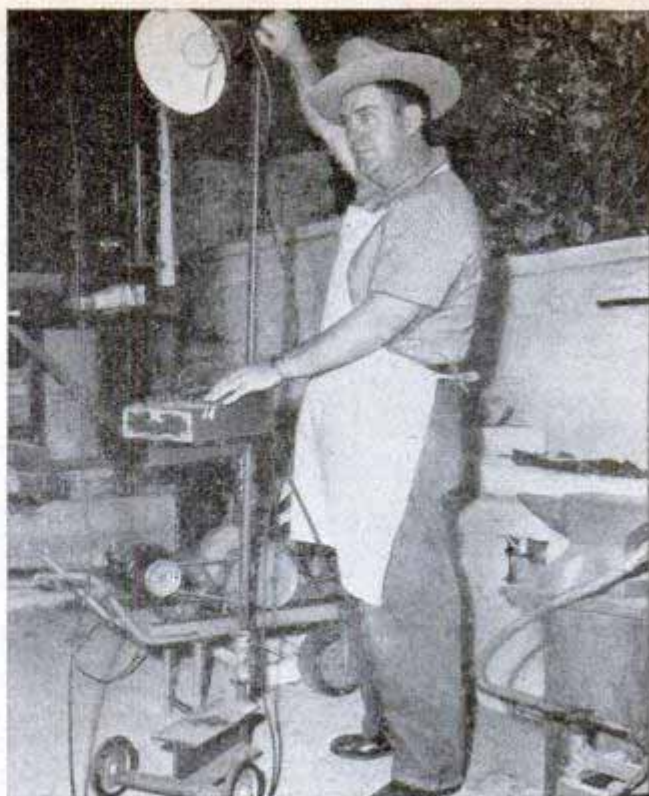

Wherever he moves, a portable light is close at hand

heat lamp for drying his pet dogs after their bath. These standards may be wheeled to any place in the shop and are as useful as a third hand.

Burnette has piped electricity, gas and compressed air to a number of handy out-

At home Burnette can turn the tables and aim the camera for a change. He built the copying easel himself

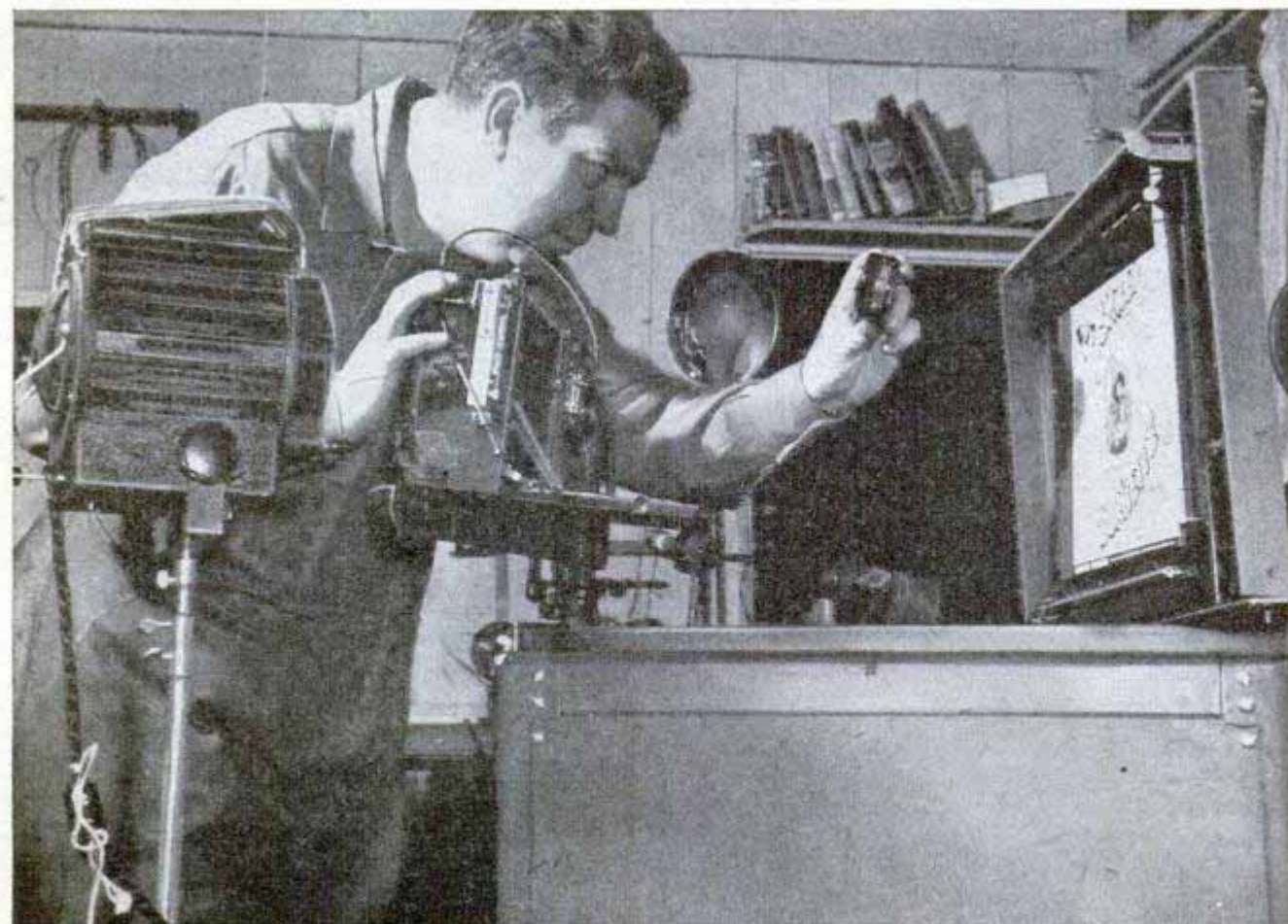



Among his inventions is an automatic brush cleaner

lets, with master switches outside the door for shutting off electricity and gas after shop hours. The air compressor builds up pressure only on demand. A six-volt relay system is used for turning it on and off.

Besides building scores of toys and pieces of furniture Burnette designed and constructed his own cement mixer. He built his own portable grinder and portable power metal saw as well as portable racks, on wheels, for transporting outboard motors and cans of fuel.

Once Smiley left a dirty paintbrush in a can of brush cleaner and next morning he found the solution had not only removed the paint but the bristles as well. That led to his inventing an automatic paintbrush cleaner, which sounds like a joke but does the job. It's a geared eccentric arm with an adjustable clamp for holding any size brush. Placed over a can of turpentine so that the brush is immersed, the arm stirs the brush back and forth and thoroughly cleans it in the safe solution in half an hour.

Before he moved to Hollywood, Smiley was announcer, chief entertainer, manager and engi-



He labeled the flexible vise he built a "shop stooge"

neer of a small radio station at Tuscola, Ill., where he'd started as singer and musician. While there he met Gene Autry and played the accordion to accompany Autry's singing. Eventually the pair got into pictures. Burnette is also becoming a well-known phonograph artist. Right now he is building a special recording studio, soundproofed and air conditioned, in his back yard.

There's even a "how to do it" library in the actor-hobbyist's combined home-built recording studio and office. He started his workshop in 1940



Shower Bath for "Iron Horse" Uses 2400 Gallons a Minute

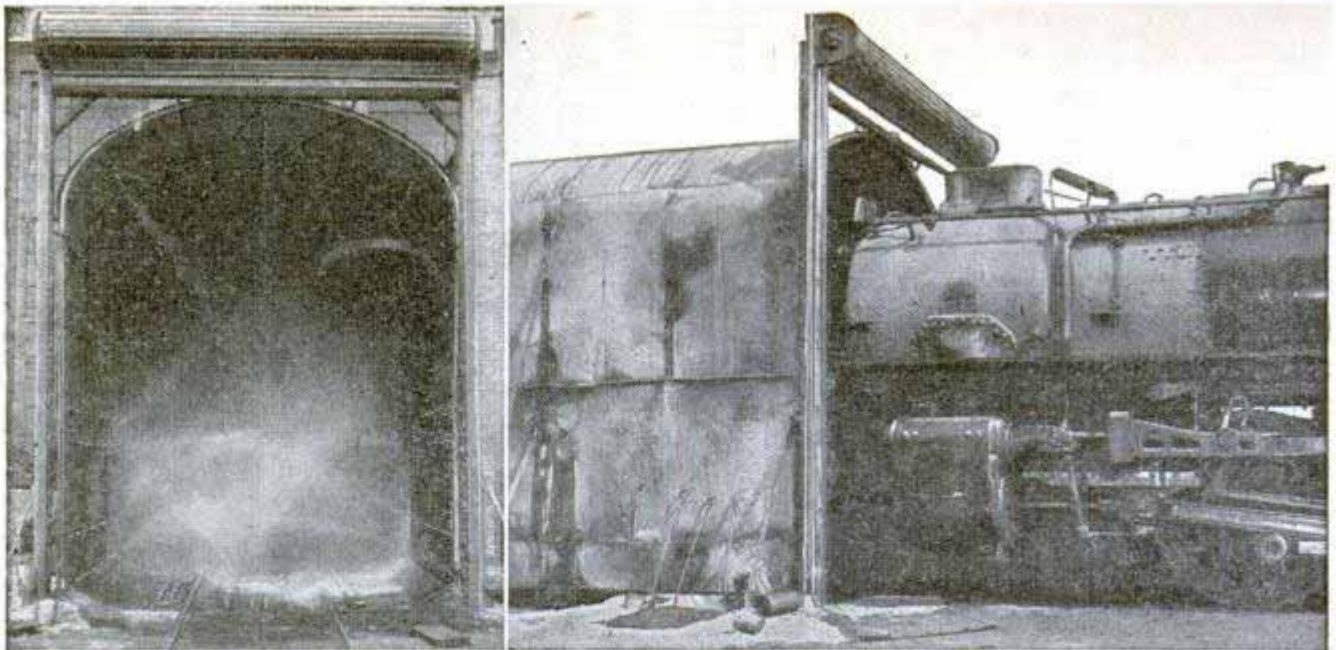

In two hours one man can strip grease and scale from a dirty locomotive inside a 90-foot-long bathhouse equipped with automatic chemical spray controls. Former method of doing the job by hand took 192 man-hours

Bathing an "iron horse" used to be a long, dirty job. Now, when it is time to remove the grease and paint from a Union Pacific locomotive, workmen do the job in two hours in a chemical shower bath. The 90-foot-long bathhouse will hold any locomotive. It is lined inside with 1350 feet of pipe ranging in diameter from 1 inch to 2½ inches. The pipe system is studded with 860 nozzles pointing in every direction. Through the nozzles 2400 gallons per minute of caustic soda solution are sprayed under 50 pounds pressure against all surfaces

of the locomotive. As the solution flows off the engine it drains back into a 5000-gallon storage tank through a filter system that removes the grease and paint. After 80 minutes under the chemical shower a locomotive is generally clean and the caustic solution is rinsed off in 35 minutes with clear water. Two of the chemical shower baths are in use on the Union Pacific system, one at Denver and the other at Cheyenne, Wyo. J. R. Frohoff and K. J. Glassman designed the structures, made almost entirely of reclaimed materials.

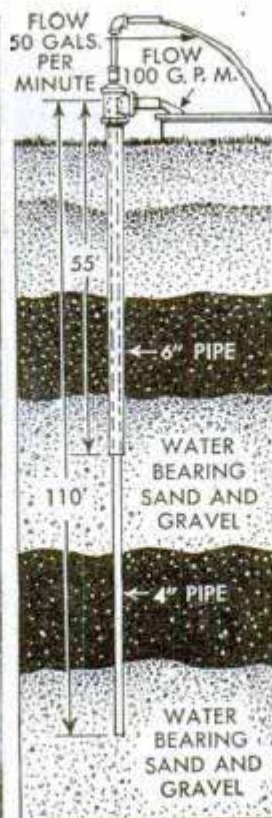

Water From Twin Wells Flows Through One Hole

Twin artesian wells supplied by two different subterranean pools were recently drilled on the same spot at a mink ranch near Washburn, Wis. Walter Gustafson, the well driller, says it's the first time he has heard of two wells flowing from the same hole. Knowing that there were two water-bearing strata beneath the surface, the driller sank a six-inch casing to a depth of 55 feet and struck water that flows at a rate of 100 gallons per minute. He then pushed down a four-inch pipe inside the larger casing to a depth of 116 feet and found a second source that sends up water at a rate of 50 gallons per minute. Now water from the two different layers of sand and gravel gushes out of the ground through the same hole.

Telescoping Stick Hooked to Wheel Maneuvers Plane

Planes can easily be maneuvered into tight parking places with a telescoping stick that hooks onto the plane wheel. It is made of telescoping tubing and is 53 inches long when fully extended. The stick weighs only 2½ pounds and fits conveniently into the storage compartment of small planes.



What It Will Take to Fly to Moon

If and when man flies to the moon, he will need a jet-propelled monoplane capable of speed up to three miles per second, according to Henry A. Erikson, emeritus professor of physics at the University of Minnesota. If it becomes possible to obtain atomic energy from small quantities of fissionable materials, it may be possible to vaporize water, mercury or lead, according to Dr. Erikson, and thus obtain the required speed. The proposed plane would weigh about 135 tons and have a housing of sheet aluminum alloy sufficiently strong to withstand air at atmospheric pressure inside the plane when there is a vacuum outside. The

plane would carry 5.6 tons of fuel and probably would be launched by a carrier plane at an approximate altitude of 55 miles.

Metal Spreader Holds Fish Jaws Open for Removing Hooks Easily

Jaws of big fish are held open by a metal spreader 9½ inches long, enabling fishermen to extract the lure with pliers or disgorger without getting cut by sharp teeth. A spring keeps the spreader closed when not in use, but pressure by the hand opens it to a maximum distance of six inches.

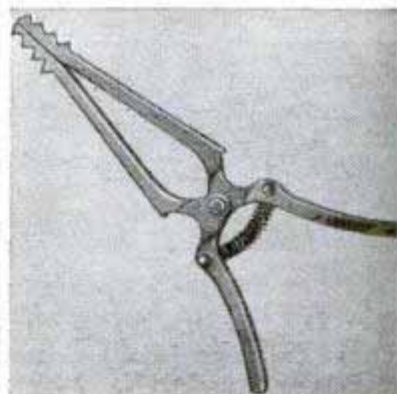
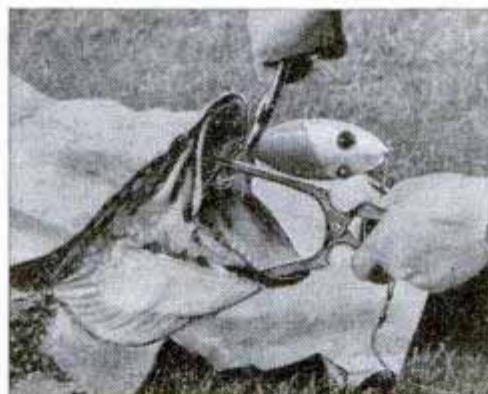

90-Mile-an-Hour Racer Made Out of Parts From Six Old Automobiles

Parts from six automobiles went into a "souped up" racer put together by Richard Bay of Arkansas City, Kan. The job re-

quired two years of spare time work. Total cost was about \$700 for a car that goes 90 miles an hour and gets 20 miles per gallon at ordinary driving speeds. Powered by a Ford V-8 60-horsepower engine, the car has a Columbia two-speed rear end, midget racer wheels and tires, grille from a 1938 Oldsmobile, bumpers from the grille of a 1942 Oldsmobile, fenders from two 1937 Ford hoods, windshield from the rear window of a 1937 Ford, doors and back part of the body from a 1928 Ford.



Operating troubles almost anywhere in an airplane can be quickly detected in flight by a new 90-pound "analyzer" device.



There's no need to put hands into water to wring a mop. A pull on a knob squeezes sponge head dry. Hinged covers made of transparent Plexiglas protect pictures mounted in loose-leaf type photo binder.



★
WHAT'S NEW
For Your Home
 ★

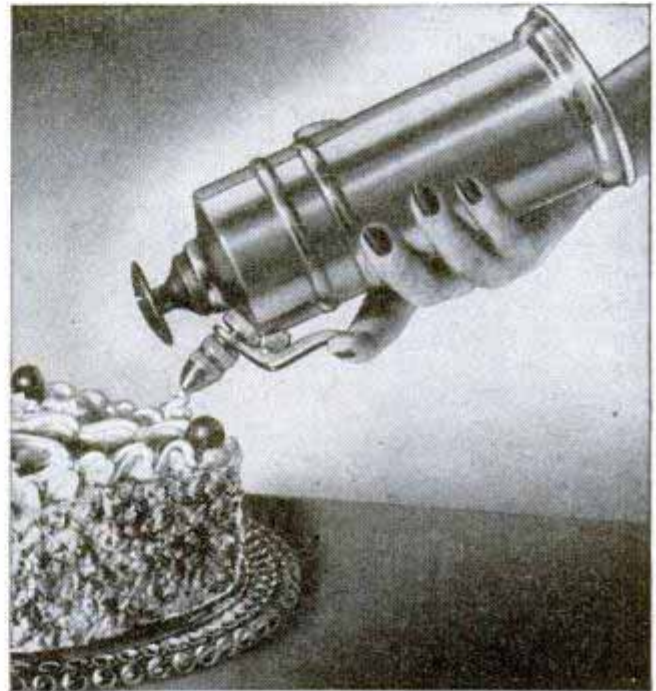

Whipped cream can be made in a jiffy by air forced into whipping chamber by this unit's built-in pump. Adjustable nutcracker takes any size nut and can be fitted with attachment for juicing lemons or limes.

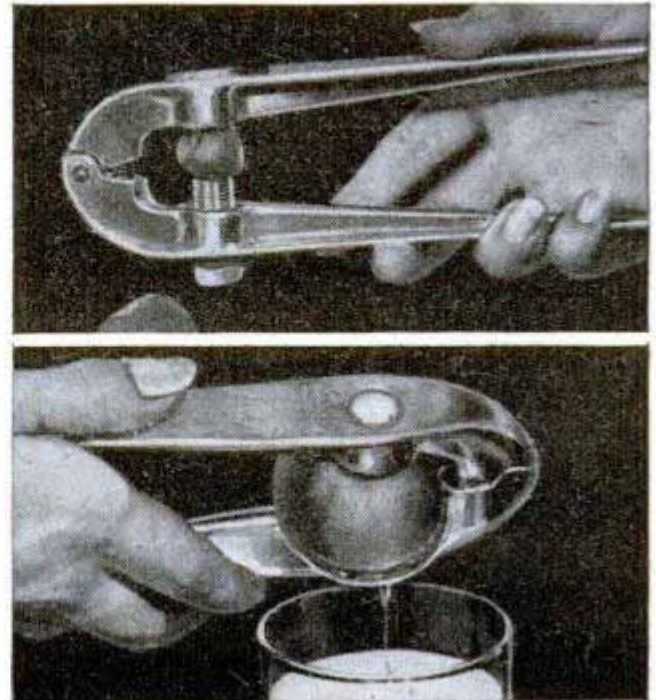



Swinging arms, concealed in twin bedside tables, pull out over the bed to make a convenient bed tray, writing desk or work space. Practical as well as novel, the tables can also accommodate either radio or telephone



Slices of cheese, meat or bread can be cut any thickness with kitchen knife having an adjustable blade

Baking, broiling, roasting — all at the same time — can be done in electric range with handy twin ovens



Attractive game room furniture can be made from wooden casks by padding seats and adding backrests

Water power from a kitchen faucet drives a small turbogrinder for sharpening knives, scissors or tools

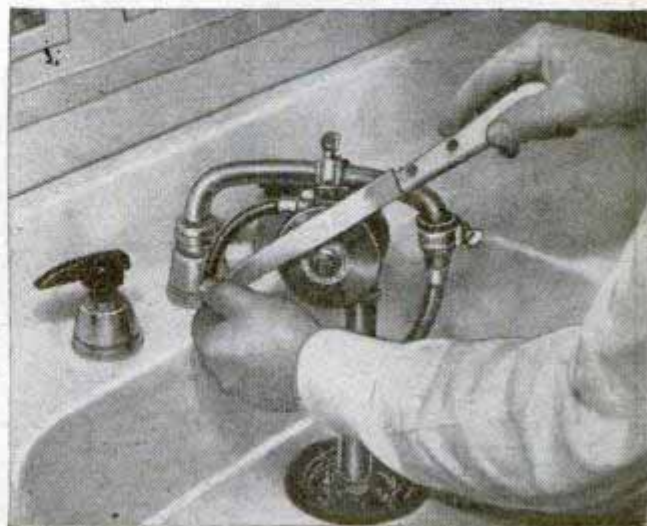



Instead of taking days of tedious shaping and fitting, a new plastic model airplane may be assembled in half an hour and flown at the end of a pair of 70-foot control wires. Equipped with a 30/100-horsepower gas engine, the plane has been clocked at 85 miles per hour. Using a larger engine it has done 120 miles per hour and may be climbed and dived at will. The model has a

Model Built in Half Hour

span of 27 inches, length of 19 inches and weighs two pounds. Fuselage is of laminated phenolic plastic, wings are of laminated veneer and elevators and stabilizer are of basswood. The plane is equipped with a drop-off landing gear. Its manufacturer has devised a model aircraft "hangar" in the form of a box that fits on the back of a truck for carrying the models.

Four-Ounce Golf Club Carrier Takes Place of Bulky Bag

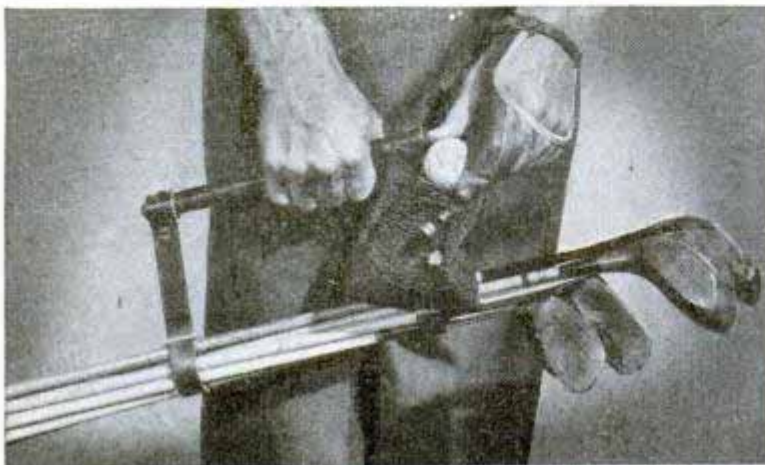

Golf clubs and balls are carried easily in a compact, balanced holder that weighs only four ounces and takes the place of a bag. It consists of a handle with leather loop straps. Lifting the bar connecting the strap buckles loosens the carrying strap for quick removal of any club. Lifting the handle tightens the strap so that clubs cannot slide or rattle, and the weight of the clubs keeps the carrying loops tight. Tees and balls are stored in a leather bag attached to the handle.

More Charcoal From Wood

One ton of dry wood yields 1000 pounds of charcoal by a process which exceeds by two thirds the output of existing oven methods. The new process employs a steel chamber into which the wood is fed to emerge later as charcoal. Flue gases are circulated several times in the chamber, drying the wood and saving on the amount of heat necessary for carbonization.



Even broad wheat fields with little slope should be terraced in some areas to prevent valuable topsoil from disappearing

THE LAND COMES BACK

YOUR ATLAS doesn't show it, but a new continent is being added to the map of the world. This new land mass is a geological freak that contains no steep mountains, no swamps and no wastelands. Every inch of it is rich, productive soil.

It was discovered by American farmers 10 years ago, captured without firing a shot, explored, and put under partial cultivation at once. Today it produces millions of dollars worth of food.

That's one way of picturing the results

of the soil conservation program fostered by the U. S. Department of Agriculture under which nearly half of the farms in the country are operated. Young as it is, the soil conservation movement already has revolutionized American farm practices.

Fifteen years ago American agriculture literally was sliding downhill. Accelerated erosion had stripped the precious topsoil from a fifth of our tillable land and had damaged badly about a third of the rest. Of a total 460,000,000 acres of good cropland in

ACTION OF MOLDBOARD TYPES OF PLOWS



STUBBLE IS BURIED

Moldboard plows bury the stubble, leaving the surface unprotected. Subsurface plows leave a blanket of stubble to resist erosion

ACTION OF DUCKFOOT OR OTHER SUBSURFACE SWEEPS



STUBBLE REMAINS ON SURFACE

ORIGINAL STUBBLE PLOWED GROUND

ORIGINAL STUBBLE

FIRM ORIGINAL GROUND

CRACKED BROKEN-UP GROUND

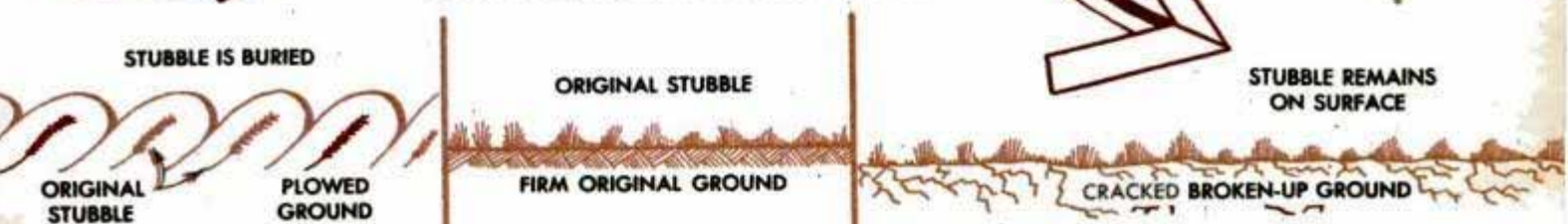

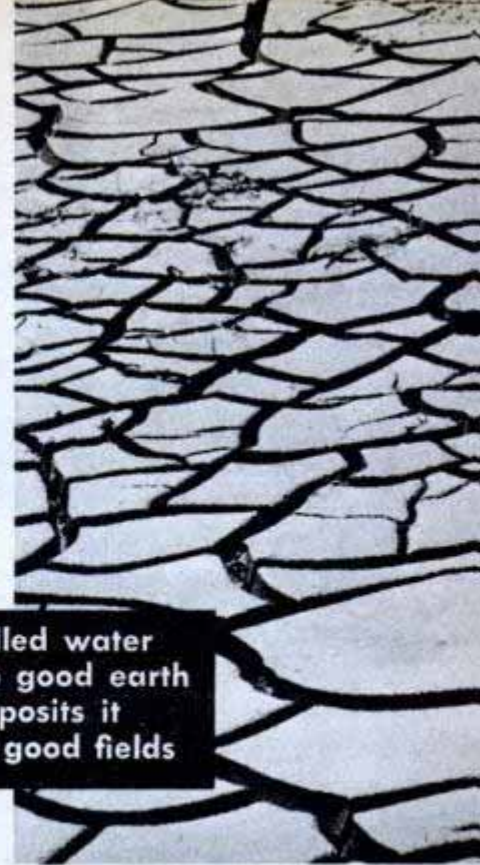

**Uncontrolled water
snatches up good earth
and deposits it
atop other good fields**

the United States 1,000,000 acres were washed out every year. The average depth of the fertile topsoil had shrunk from an original nine inches to only six inches.

Crops became sparse as the topsoil disappeared and research proved that crop yields were related directly to the depth of the topsoil. Premium seed, irrigation and expensive fertilizers can't produce crops by themselves. One survey showed that, other things being equal, certain topsoil that was three inches deep would produce 17 bushels of corn per acre as against 47 bushels in the same kind of topsoil 13 inches deep. A

single heavy rain can remove an inch of topsoil from critical portions of a field.

Thousands of farmers, especially in sub-marginal areas, were confronted by production that dwindled from year to year. Hundreds of them went broke. They didn't have the scientific background to understand what was happening but they did know that some land was being eaten up by gullies, other land was just blowing away in the wind, and still other ground had turned soggy and unproductive.

Nor did they know how to get together and apply remedies. That job was under-

Curved strips replace square-cornered fields in a contour-cultivated farm



taken by the Department of Agriculture in 1935, under the terms of an act that established the Soil Conservation Service and provided a basis for state laws by which farmers could organize local cooperative soil conservation districts. Since then all the states have passed enabling legislation and 1616 conservation districts have been formed. Judging by the rate at which new districts are being established, practically all our farmland will be under soil conservation control in a few more years.

The districts are self-governing. The chief function of the soil con-



The cure: contour plowing

ervation service is to provide skilled technicians who can make broad, comprehensive surveys for a whole district and then prepare detailed conservation charts for each farm in the district.

A farmer and one of the technical men make a tour of the farmer's land, looking over the ground, while the farmer describes the kind of farming he has done, what he plans for the future and what equipment he owns. From this the technician can advise him on how to stop erosion and keep his land productive. Often this includes reshaping some of the fields to fit

the terrain. Possibly the areas devoted to crops, pastures and grasslands need to be rearranged.

No two farms are exactly alike and the conservation expert makes up an individual program for each one. Then he and the farmer agree on a schedule of work for the year ahead, with most of the work to be done by the farm owner and possibly some of it to be performed by the district. Expensive terracing may be spread over five years, but a start is made at once to head off sudden soil losses.

Contour planting and strip cropping, two

Old automobile wheels have been put to work in this orchard to scrape broad furrows that hold rainwater

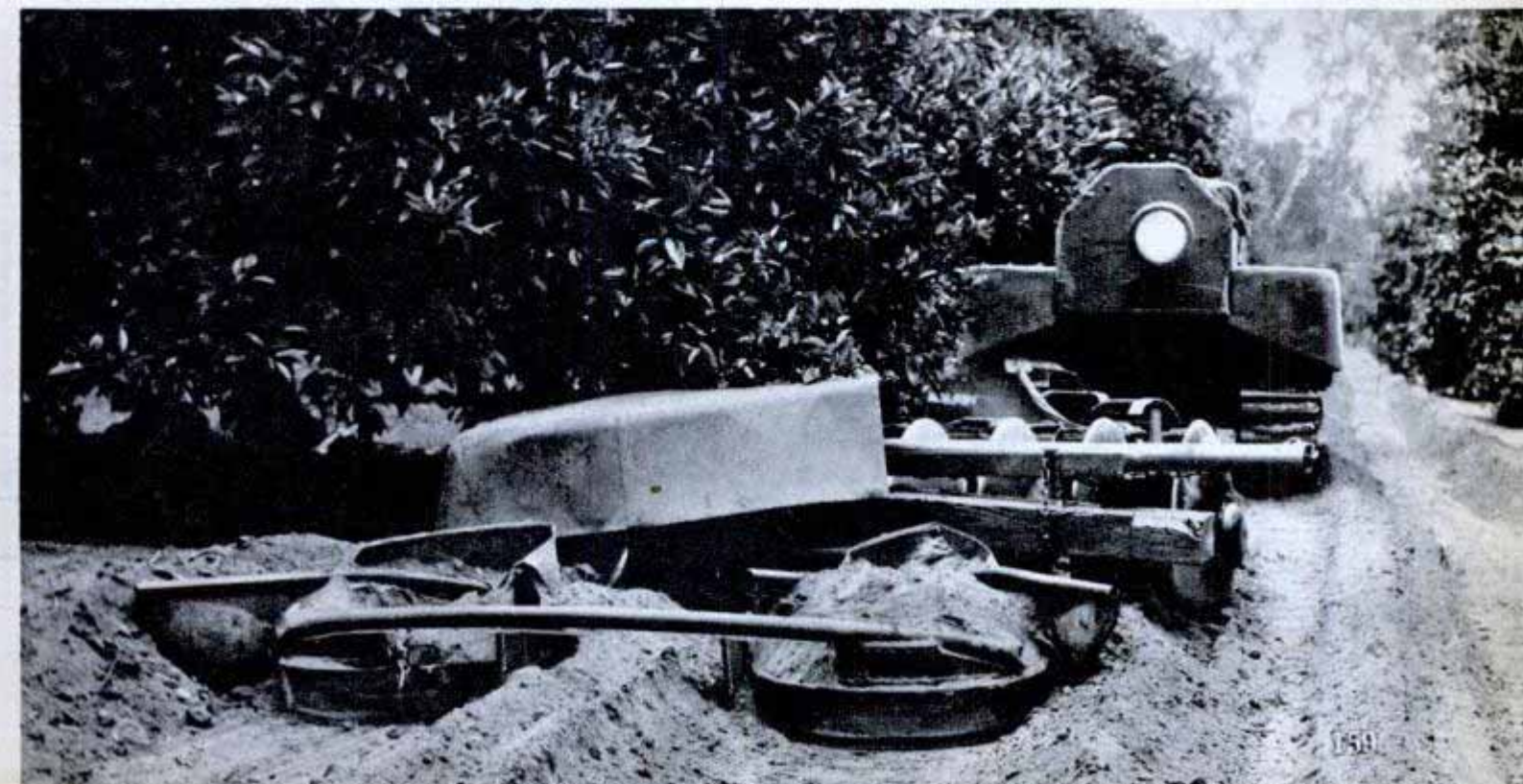



White bands are hay planted in strips between cultivated crops to keep loose soil from slipping downhill

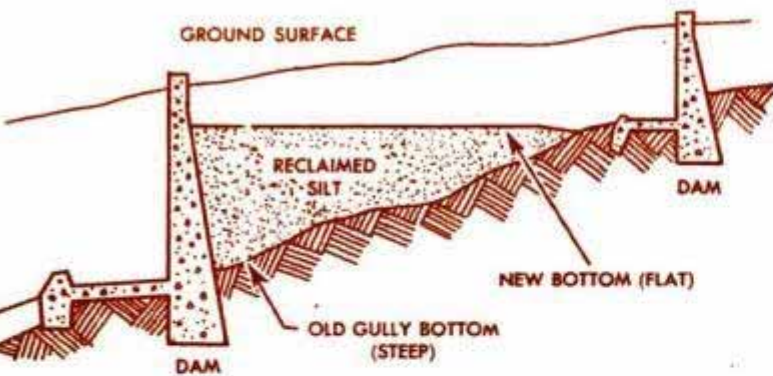

↑ Check dams recapture the silt from rapid streams
↓ Bottom of brush dam is covered with layer of straw or mulch and filled with brush which is staked down

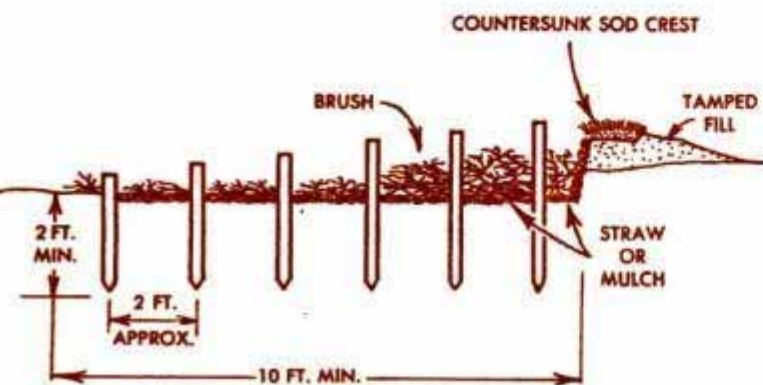

of the easiest and most effective measures, are widely practiced today. Contour planting simply means plowing, planting and cultivating along lines of equal elevation. Instead of running the rows uphill and downhill the rows curve around the sides of the slope, level all the way. This traps rainwater and reduces runoff. Strip cropping is the planting of crops in broad strips along the contours, alternating clean-tilled row crops with strips of close-growing plants such as clover. The close-growing plants catch and hold soil from above and hold back water that could erode the cultivated strip below.

Fence dam can be constructed quickly. Fence is staked across the gully, then filled in with straw and brush

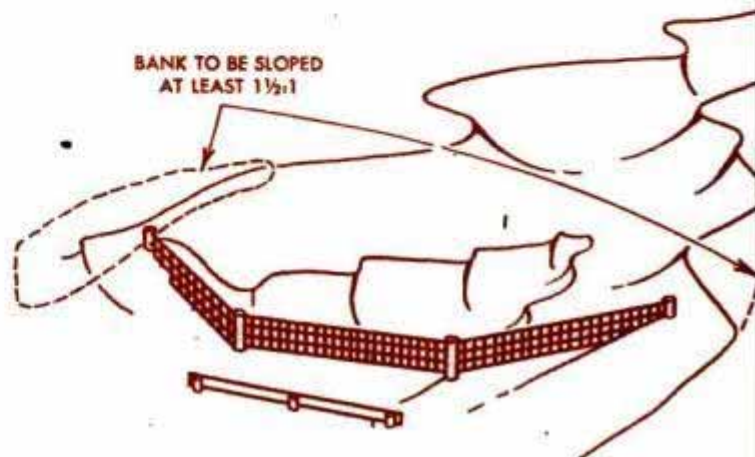



These two practices have changed the design of whole agricultural areas. Once from an airplane you looked down on checkerboard patterns of squares and oblongs, each a sharp-cornered field planted to a particular crop. Now the view has changed in conservation areas to crazy-quilt patterns of swirls and curving lines, the result of contour planting and strip cropping.

Ten years is a very short period in which to expect results in such a long-range program. But already some startling effects are apparent.

(Continued to page 244)

Loose rock dam is one of the most stable. Flat rocks are used because they bind together and won't slip

↑ Erosion has eaten a deep gully into this once rich farm land, subtracting scores of acres from the farm. Wind and rain vs. desert soil created pattern below

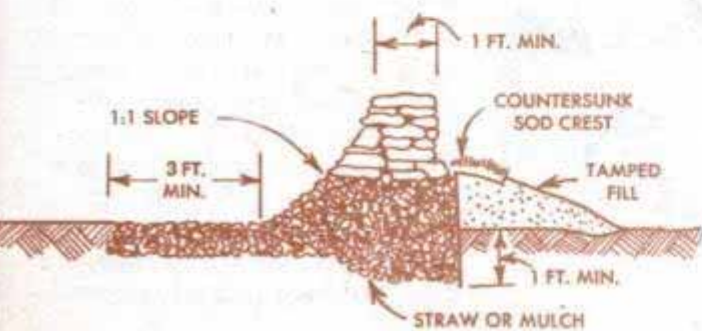

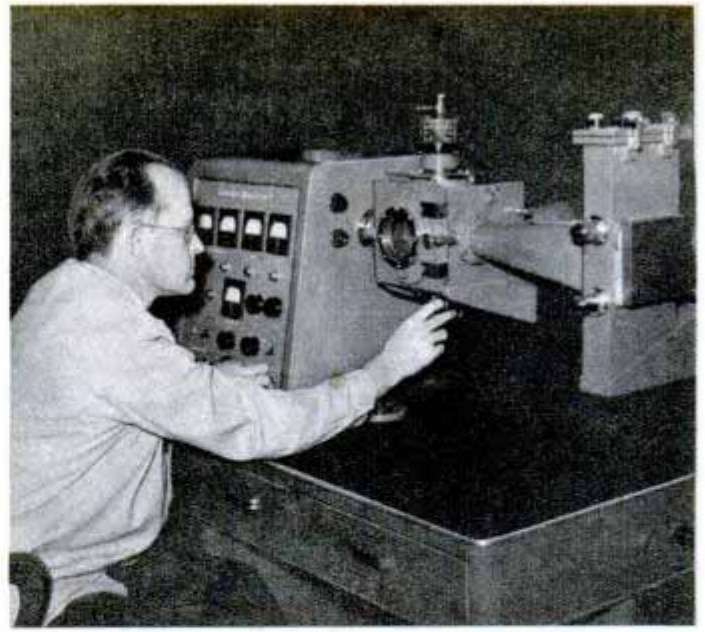
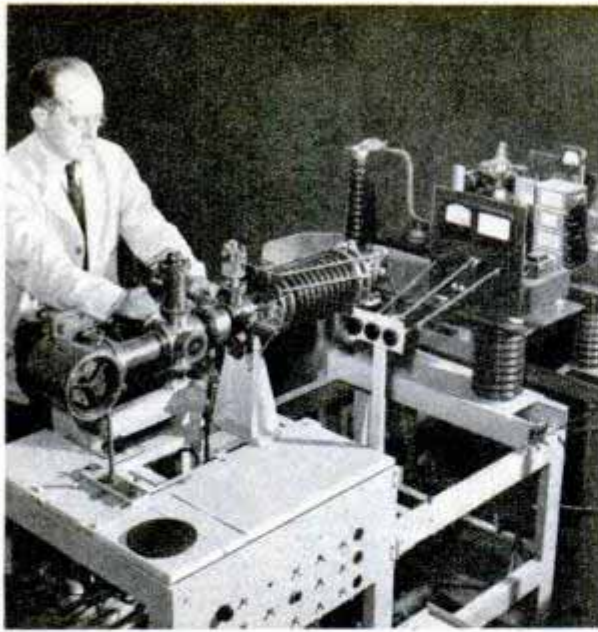

Streams of electrons are used to analyze metal surfaces for such processes as welding, lubricating and electroplating. Most metals are coated with a thin film of some sort, an oxide of the metal itself, oil, or some other "foreign material." Developed at the University of Michigan, the electron diffraction method employs a machine that produces a stream of 40,000-volt electrons in a vac-

Electrons Identify Metals

uum chamber. In the center of the chamber is a holder which grips the specimen to be studied. The specimen interrupts the electron stream, causing electrons to bend or break away from their normal path and form new patterns. These patterns, captured on a photographic plate, reveal the identity of the surface being analyzed. This method can also be used to identify gases.

Sleek Convertible Assembled From Scrapped Car and Airplane Parts

With engine parts from German cars, body parts from American autos and a few odd airplane pieces, Bunny V. Ronco of Allentown, Pa., has created a streamlined

rear-engine roadster. In 1944 he received two Volkswagen engines and three transmissions shipped from Africa as junk and since then the engineer has invested \$700

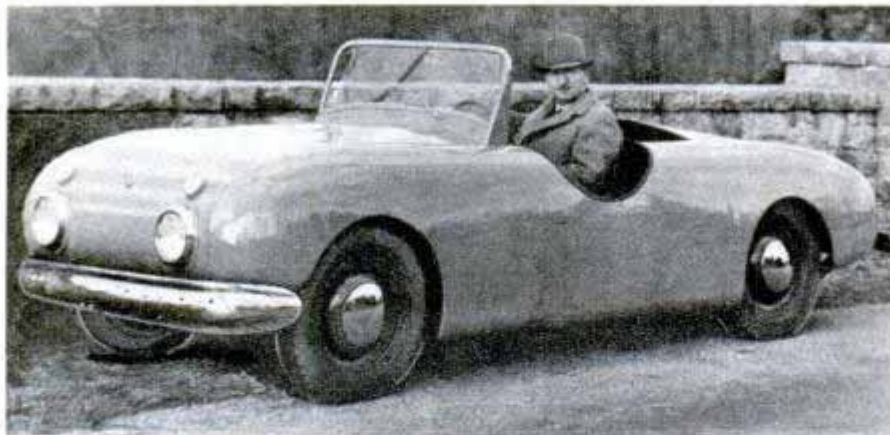

and 2000 man-hours in his vehicle. The air-cooled car weighs 1350 pounds with 62 percent of its weight in the rear. With the drive shaft eliminated, the car's floor is only 8½ inches above the ground. All four wheels are suspended individually and have hydraulic brakes. The differential is the self-locking type — when one wheel is on ice the other will drive. The transmission has four speeds forward with an overdrive in fourth. The body, topped by a convertible hood, is made from four fenders of American cars joined together with sheets of steel. The four-cylinder car goes 36 miles per gallon at 50 miles an hour. Oil consumption is negligible as the crank-case holds only 2½ quarts.

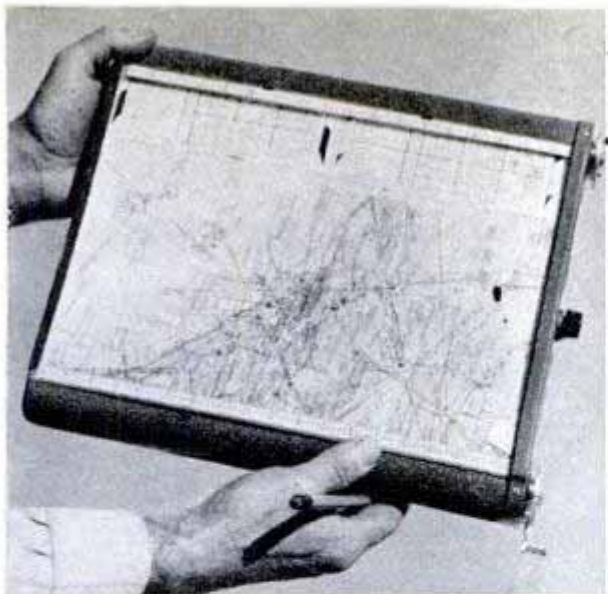

All maps needed for a cross-country flight are contained on a roll-away map which fits a case about a foot square. Twisting a knob unrolls 22 feet of the map, visible in sections, on a plastic face of the case. The plastic is treated for pencil notations and an

Roll-Away Map Aids Flyers

internal light makes map reading easy at night. Forty-one map rolls are available for the case, each covering 4000 miles of regional or route charts. A tab at the end of each route shows distances and magnetic courses between large cities and airports.



Bearings Make Unique Chessmen

Chess sets made of ball and roller bearings have been presented to high government officials by Henry A. Sherwood, a former consulting engineer for a ball and roller bearing firm. The first set, made for the King of Sweden in 1937, was put together in two weeks. A United States citizen since 1941, Sherwood made a set for President Truman to express his gratitude for relaxation of the immigration laws. Other sets have been presented to General Spaatz and Secretary of the Navy Forrestal. The chessmen, made from various parts and kinds of bearings, take a mirror-bright polish, giving them a novel appearance.

Helium Traces Leaks In Huge Transformers

Leaks in electrical transformers are detected by an instrument which uses helium as tracer gas and an electronic meter. A can of helium is attached to a stud in the cover of a transformer. To the opposite end of the stud a suction cup and the leak detector are fastened. If there is a leak, helium is sucked through the stud hole and past the gasket, reaching the meter where a recorder indicates the escaping gas.

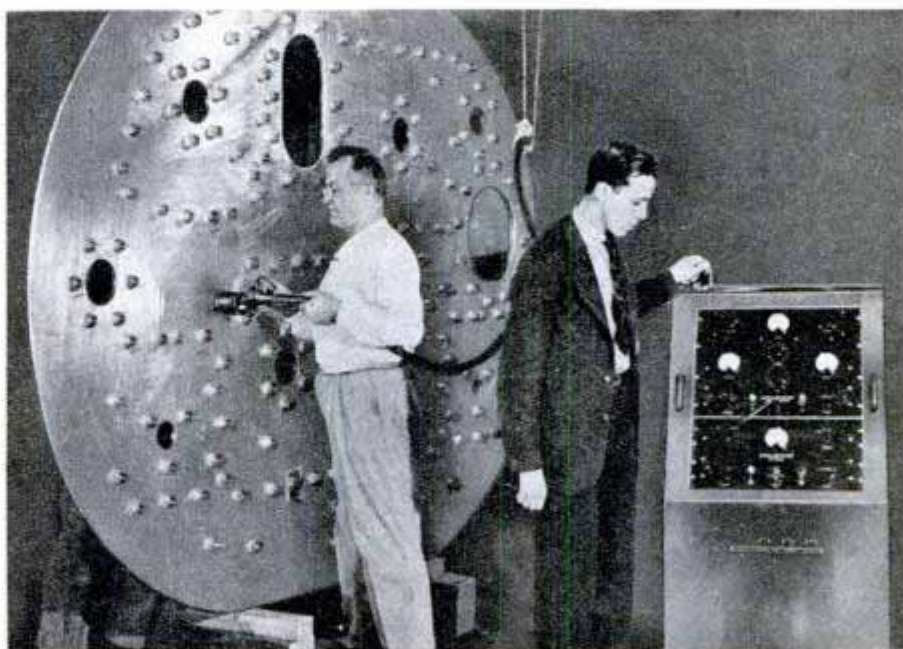



Lofty giraffe towers above the other animals of the zoo. Prucha once saw the Washington statue of General Grant astride his horse and duplicated it in red cedar leaves



Eagle pouncing on a rabbit forms another of the tree figures. They must be trimmed each spring

GARDEN ZOO

Towering above a lawn in Crete, Nebr., are a lofty giraffe and a sober elephant—just two of the stars of H. V. Prucha's unique tree zoo. Prucha planted 30 red cedar seedlings on his lawn in 1908 but 12 years later they threatened to shut out the sunlight and breeze. Instead of cutting down the trees, he trimmed them into the shapes of animals, birds and even a statue of General Grant mounted on a horse. Long branch-

Trimming the giraffe's neck is high-altitude work so the zoo "superintendent" keeps a ladder handy



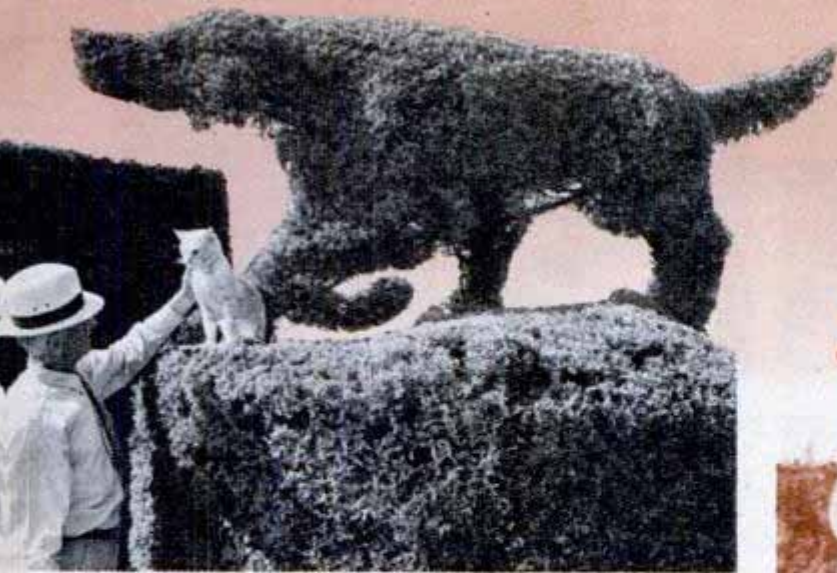

Cat isn't bothered in the least by the big hunting dog, which has been standing at point for 26 years

es were forced to grow in the proper pattern to form the elephant's trunk, the giraffe's neck and General Grant's arms. Today the zoo includes a buffalo, camel, peacock, two peahens on nests, the elephant and giraffe, an eagle sitting on a rock and another seizing a rabbit in its talons, a pointer dog, a tree house, the statue and several geometric patterns. The tree sculptor says he's worked the equivalent of a year's full time on the figures during his leisure hours. Droughts have not damaged the animals but one danger has appeared—the elephant's trunk offers a challenge to neighborhood small fry who have pulled it off several times.



"Sculptor" Prucha trims sprigs from shaggy buffalo. Neighborhood small fry are tempted to pull off elephant's trunk. Humped camel at left pays no attention



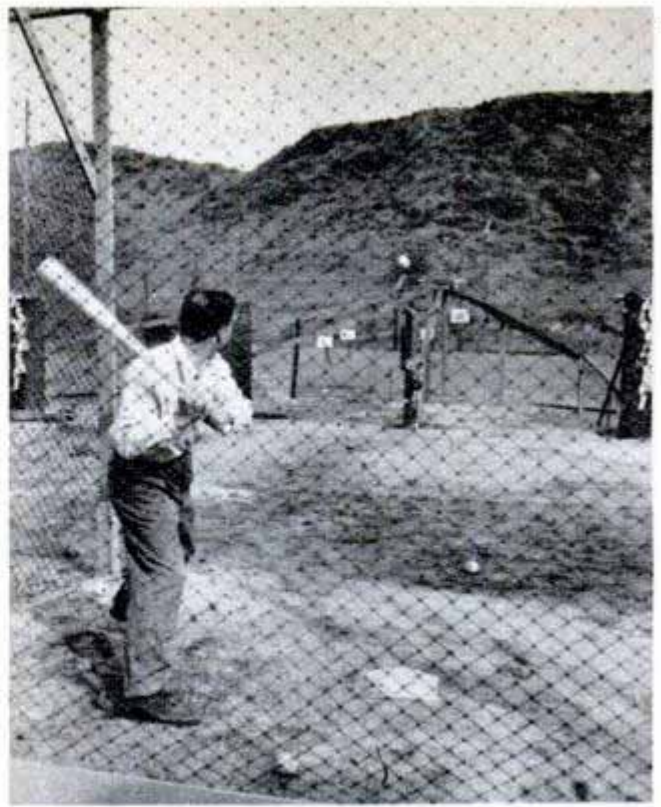

Robot Baseball Pitcher

Wartime bazookas are converted into robot baseball pitchers for batting practice. A bazooka tube, filled with baseballs, feeds the balls by the action of a piston to an at-

tached metal arm. The arm, swinging clockwise and operated by a small motor, hurls the balls in the direction of the batter. Pete Wald, New York war veteran, has built 10 bazooka pitchers and set them up in Hollywood for entertainment games.



Nylon Sea Anchor

One type of sea anchor is now made of Nylon to resist rotting. It is weighted at the crown and has cork floats to keep it at the correct level below waves. Shaped like a parachute, it is tossed overboard, particularly during a storm, to serve as a float to reduce a vessel's drifting or to keep her head to the wind to prevent capsizing. Sea anchors of correct sizes and strengths are scientifically determined for all types of vessels, from AAF rubber life rafts to the largest vessel afloat. Since it has no spreaders, the anchor requires very little storage space.

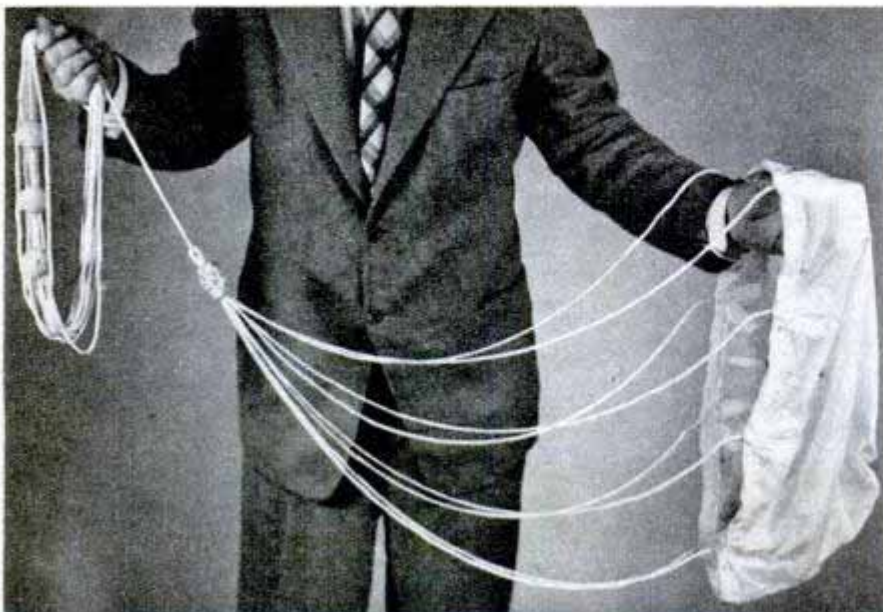

☞ Rubber gloves with rough palm and finger surfaces have been designed to prevent slippery materials from skidding out of workers' hands.

Tiny Electric Sewing Machine Carried Like Typewriter

About the size of a portable typewriter, an electric sewing machine made of aluminum has been designed in England. The miniature machine, weighing 15 pounds, has an aluminum carrying case which opens out to form the working table. A metal sphere replaces the usual flywheel. Light is thrown on the needle through a plastic tube which bends the rays to illuminate the working area. The speed of the machine is controlled by a knee lever.

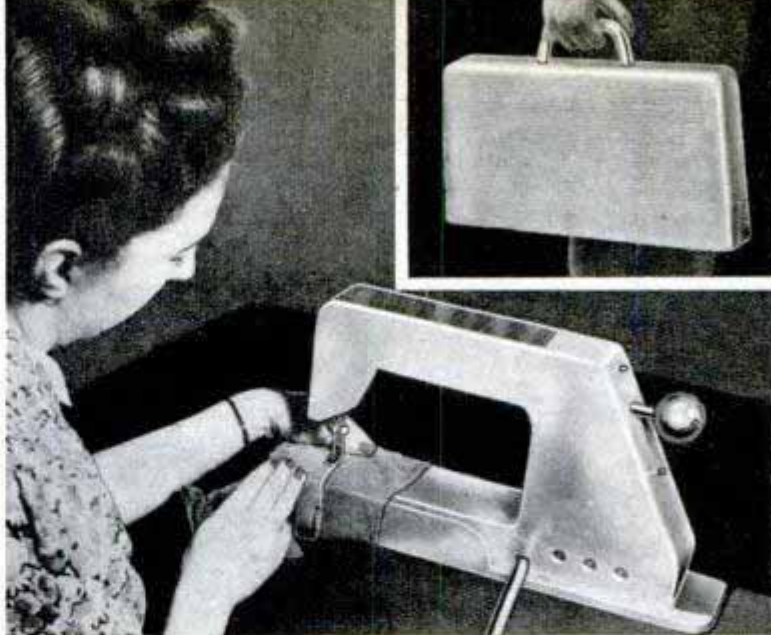

Short Chains on Pole Stripper Beat Bark From Logs

Bark is stripped from logs for fence posts by a simple machine that "beats" it away with short lengths of chain. The machine was invented by Emory Carter and Clarke Mathewson of Lake City, Fla., who decided that removing the bark with a knife or straightened hoe was too slow and expensive. They developed a simple "pole beater" consisting of two iron disks connected by an axle. Between the disks are loose chains. A one-cylinder motor rotates the disks as the operator feeds the logs across the machine. The chains literally beat the bark off the poles.

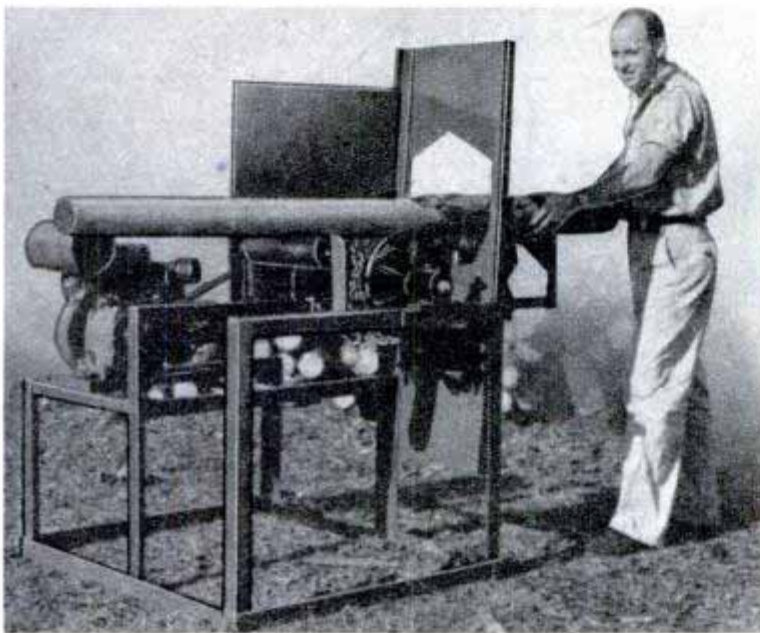

Plastic and Aluminum Auto Has Engine in Rear

Plastic, glass and aluminum are the three main materials in an ultrastreamlined car designed by Albert Gorgoni of Rome. The body is made of plastic, frame of aluminum and windows, of course, are glass. A small, high-powered motor is mounted at the back, and the wheels can be turned so far that the auto can almost make a 180-degree turn within its own length. The seats are hinged so they can be made into beds.

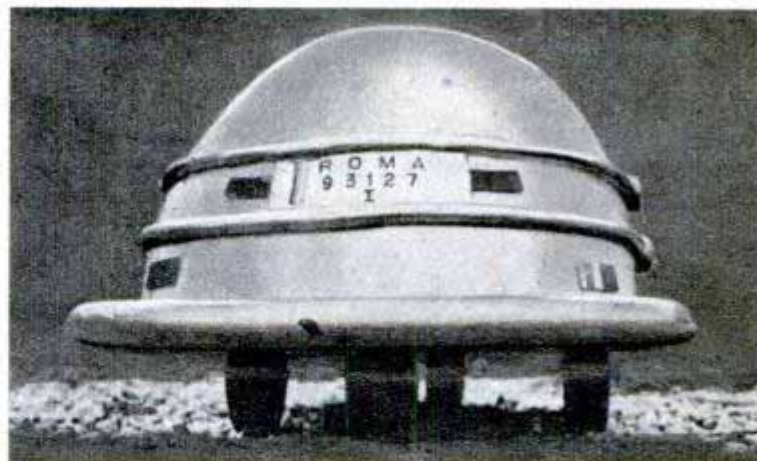

Popular Mechanics is always ready to supply further information to readers about various products described in any issue. Just write to Bureau of Information, Popular Mechanics, 200 E. Ontario St., Chicago 11, Ill., for a prompt reply



Now single-cabin cruiser by Richardson sleeps four. Below, Gar Wood, Jr., boat has molded hull of Fiberglas and plastic



Smallest cruiser is 20-foot Cruisalong which sleeps two. Below, Century will do 50 m.p.h. with 50-hp. outboard .





Screened sliding windows around the cabin of Chris-Craft's 27-foot cruiser make it open sport or closed family boat. Dinette in 26-footer, below, converts into double bed, and lounge seat at right makes up into upper and lower berths

1947 BOAT SHOW

IF YOU'RE one of the outdoorsmen who've been dreaming of a fishing trip or a week-end cruise in your new motorboat, this could be your year. Production is rolling to satisfy the biggest demand in history and builders can supply almost anything you want: utility, runabout, cruiser or yacht.

Prices are considerably higher than in 1940, the last good production year. Cruisers range from the 20-foot Cruisalong which sleeps two and sells for about \$2100 to a luxurious 46-foot double-cabin \$25,000 Chris-Craft that sleeps nine.

Gar Wood, Jr., is introducing a light-weight runabout molded of Fiberglas and plastic. It is powered by a 26-hp. marine engine that delivers one mile per hour of speed for each pound of weight. Other builders have switched from mahogany planking to molded plywood. Steelcraft uses an all-steel welded hull. One 26-foot cruiser of this type costs less than \$4000.

(Additional photos on following two pages)



Interior of the main cabin of Chris-Craft's largest stock model, a 46-foot double-cabin cruiser. It has accommodations for nine. Enclosed sundeck, below, is atop main cabin





Hull of the smart Steelcraft Sedan Cruiser is welded of six sheets of alloy steel; two cabins will sleep four

Plexiglas strip along hull of 33-foot craft provides something new in portholes. The square ports swing open on hinges to ventilate the cabin of the Sunlounge



This 20-foot Ventnor De Luxe Runabout can go 40 miles an hour; it has 150-horsepower engine

The Sport Fisherman has seats for six but bunks only two. Maximum speed is about 27 miles an hour with a choice of Chrysler, Gray or Kermath engines. Below, Elco Sports Cruiser — see plan view on opposite page



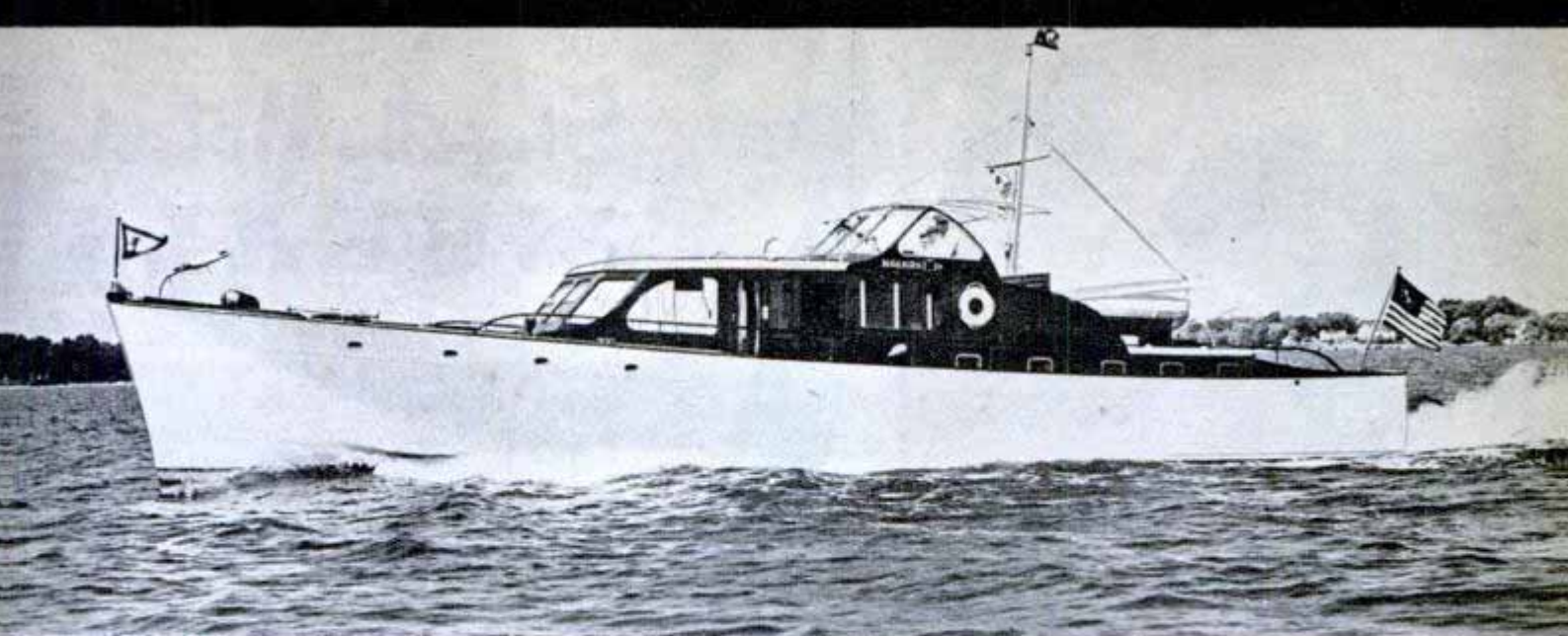

Sixty-five feet of marine beauty — palatially fitted Makaira has top speed of 18 miles an hour and is powered by two GM Diesels. It even has ship-to-shore phone

Below, controls on Chris-Craft Express Cruiser are easy to reach; some models boast dual controls



These trim 16 and 17-foot runabouts are 1947 Chris-Craft models. Speeds approach 40 miles an hour. The 16-footer is priced at \$1840, the 17-foot de luxe job costs \$2090, and a 20-foot runabout sells for \$3640



Below, plan view of Elco 27-foot Sports Cruiser. Engine is installed under the seat aft and cabin has sleeping quarters for four. This model is an adaptation of Navy's PT design. Speed, 27 m.p.h.

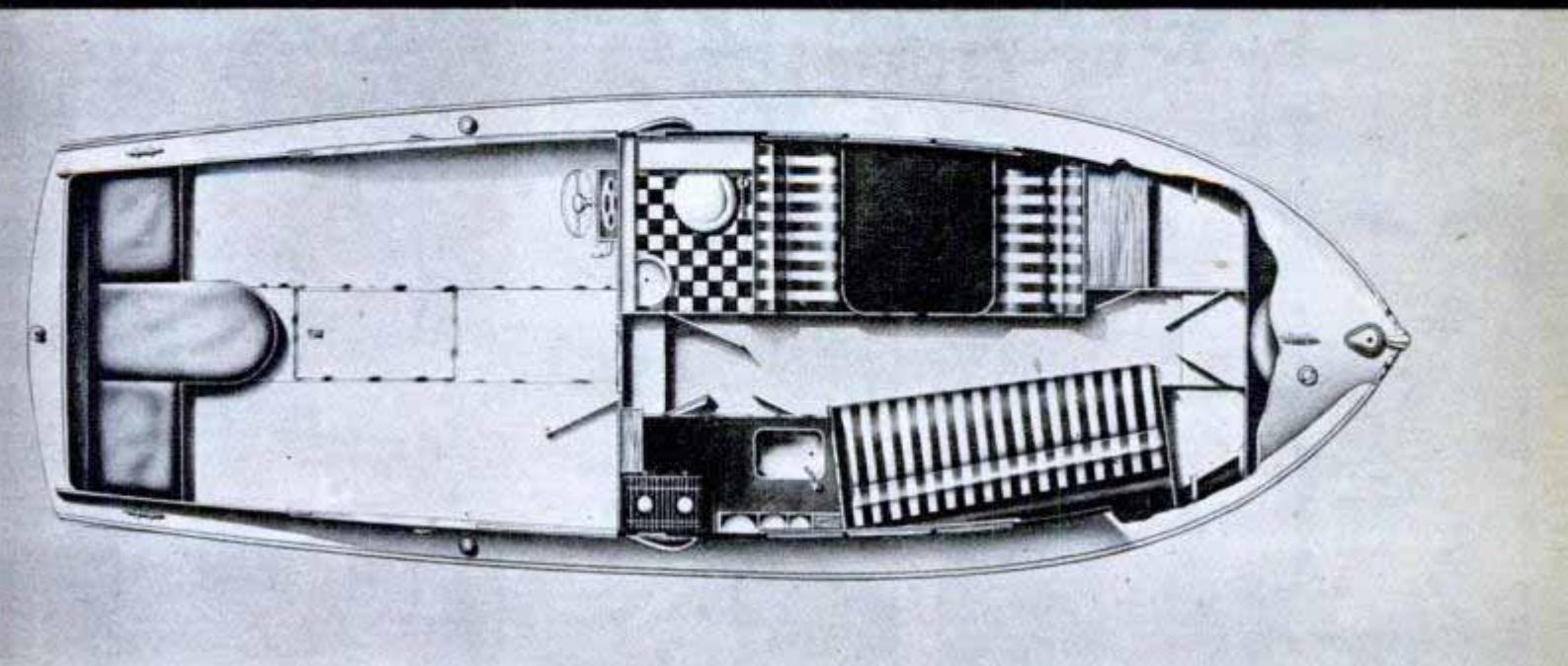

Sheet Metal MURALS

Harold Egan and his wife of New York make murals out of stainless steel sheets. First they make full-scale drawings (left) which are blueprinted and transferred to sheet metal. Then Mr. Egan uses a power saw to cut through the tough steel and follow the outlines. Fingers and other fine details are cut out by a pair of snippers wielded by Mrs. Egan (below). Parts of a figure are riveted together. Murals also are made of brass and copper.



To give the appearance of hair, Mrs. Egan (below) uses an electric vibrating tool to put whorls on the stainless steel. Right, finishing modernistic mural depicting "Sea, Earth and Sky," designed for New York store



Cleaning Fluid Operates Hand-Guided Mexican Tractor

Cleaning fluid, kerosene or gasoline operates a hand-guided tractor now being manufactured in the United States by a group of Mexican industrialists. Finding it difficult to buy tractors in the U. S., the Mexicans hired American engineers to design the tractor which is being sold exclusively in Latin America. Parts are interchangeable with those in stock at Ford parts distributors located throughout Central America. The one-cylinder engine develops from 9 to 14 horsepower.

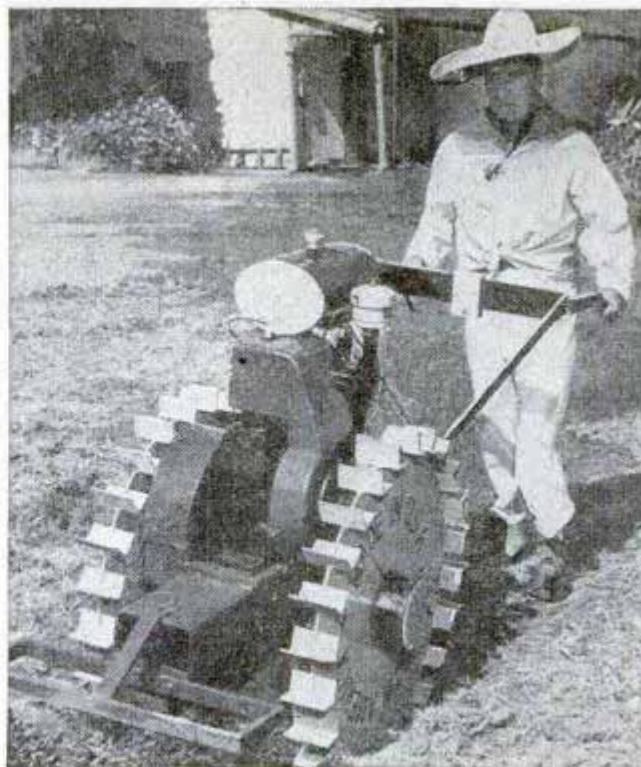

Combined Fishing Rod and Reel Hooks Onto Side of Boat



Fishing rod and reel are combined in a rustproof spring steel unit which is suitable for still and ice fishing and trolling. The spring, whose top part serves as a reel on which line can be wound, may be hooked over the side of a boat to free a fisherman's hands and yet keep the line in the water. The compact spring is handy for use by children and can be stored in a tackle box or automobile glove compartment.

Extract Kills Cancer in Rats

Cancer in rats is destroyed and the rodents are made immune to further cancers by treatment with an extract developed by the Carnegie Institution of Washington, D. C. The extract is made by grinding up rat tumors, adding alcohol and putting the solution through a distillation process.

Automatic Fire Fighter for Range Stops Fuel and Puts Out Flames

Highly inflammable fuel automatically is cut off from kitchen ranges at the first sign of fire by a new fire protection system in a large New York kitchen. Fire is detected immediately by a device that operates a valve to close the fuel line. Meanwhile carbon dioxide rushes out of steel cylinders to smother flames in the ranges and exhaust ducts before they spread.



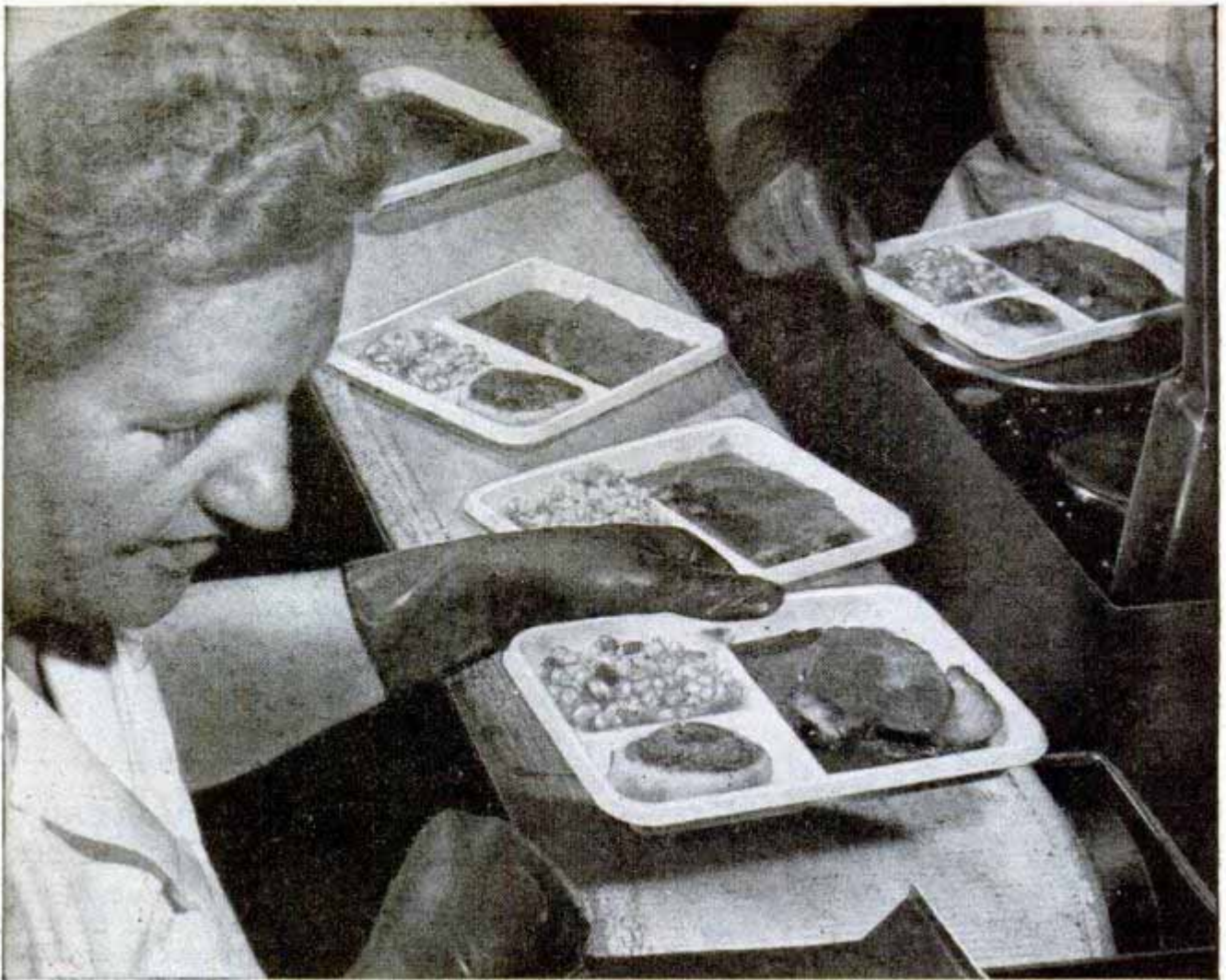

Precooked meals moving along an assembly line are wrapped in Cellophane jackets, then frozen and stored

DINNERS WITHOUT DRUDGERY

ON A HUNTING trip to Labrador before World

By Andrew Hamilton

War I, Clarence Birdseye observed that fish and caribou meat, chilled rapidly in the frosty air, were tender and fresh-flavored when cooked—though frozen for months. Why couldn't fruits, vegetables and other foods be preserved the same way?

Years later, William L. Maxson stood in his garden in West Orange, N. J., and wondered why someone didn't quick-freeze whole meals to save time and effort in the kitchen.

Because Birdseye and Maxson each found the answer to his question, the United States now has a fast-growing new industry. And the nation's 40,000,000 housewives can look forward to an era of dinners without drudgery.

The frozen food industry is a \$100,000,000-a-year business, compared with the nation's annual food bill of \$18,000,000,000. More than 500 companies freeze vegetables, fruits, poultry, seafoods, meats and pastries. Although Clarence Birdseye is no

longer with the company, the Birds Eye-Snyder Division

of General Foods is one of the leading producers. Others in the field are Stokely-Van Camp, Seabrook, Pratt's Fresh Foods, Courtley Frosted Foods, J. Walter Thompson and Lehman Brothers.

Because quick-frozen foods have become big business, science has taken a hand in assuring efficiency of operation and high quality of product. The 55 fruits, vegetables and meats issued under the Birds Eye label are watched as closely as the Dionne Quintuplets. Before the crop is planted, the soil is given scientific chemical tests. Seeds and plant varieties are carefully selected by agricultural experts. For example, more than 100 varieties of garden peas were examined before two sweet-flavored, tender-textured varieties were chosen. Mechanical devices for picking, shelling, sorting, washing and refrigeration take the peas from field to freezer in about two hours.

Research laboratories continually work to improve the foods. To date, 350 foods

have been frozen experimentally, including crab apple juice, persimmons, zucchini, soup, liquid coffee, squid, dry martinis, parsley, sweet potatoes, shark meat and eggs.

Most exciting news in the quick-frozen food industry centers around William L. Maxson, 260-pound engineer and Annapolis graduate, who thought up quick-frozen dinners. In 1944, Maxson Food Systems, Inc., contracted with the Navy to provide quick-frozen meals for the passenger-carrying planes of the Naval Air Transport Service. Until then, crew members and passengers had subsisted on cold sandwiches and K-rations. More than 500,000 "sky plates" have been served aboard NATS and Pan American planes and this experience has enabled Maxson to launch a nation-wide program.

Before long you may see frozen dinners served in hotels, trains, planes, ships, factories, offices and your own home. They probably will be sold in grocery stores and delicatessens.

The Maxson idea is simple. Why fool around with individ-

Peas shelled in field by drum (top) are cleaned (right), graded (below), and placed in quick-freezer (lower right)

Birds Eye Frosted Foods photos

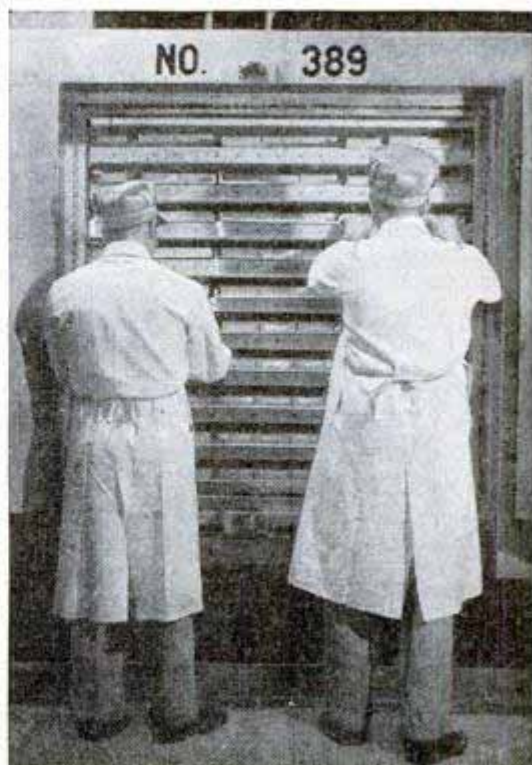
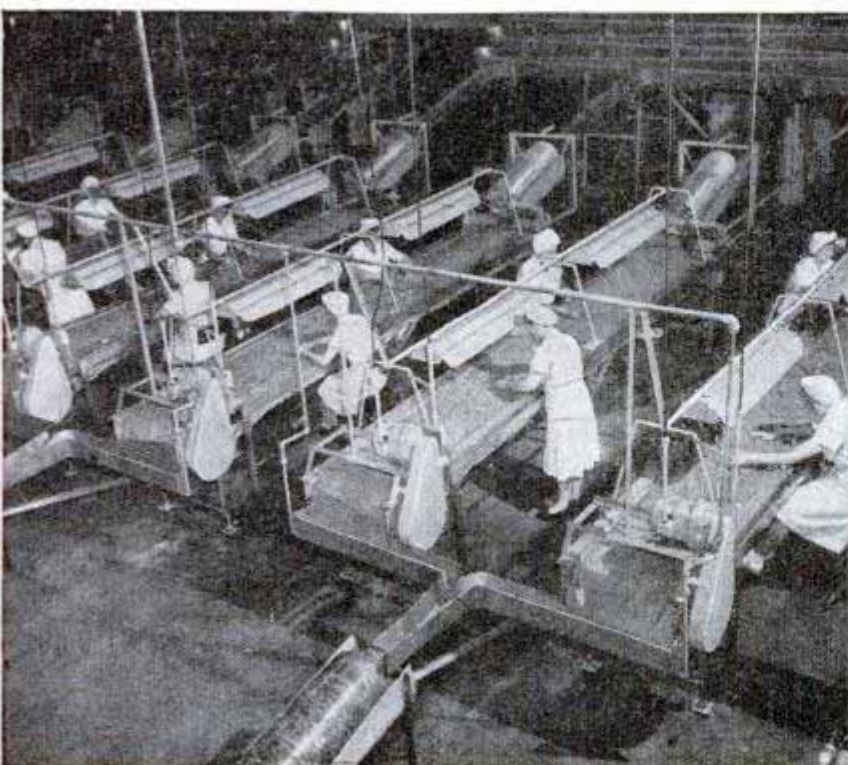
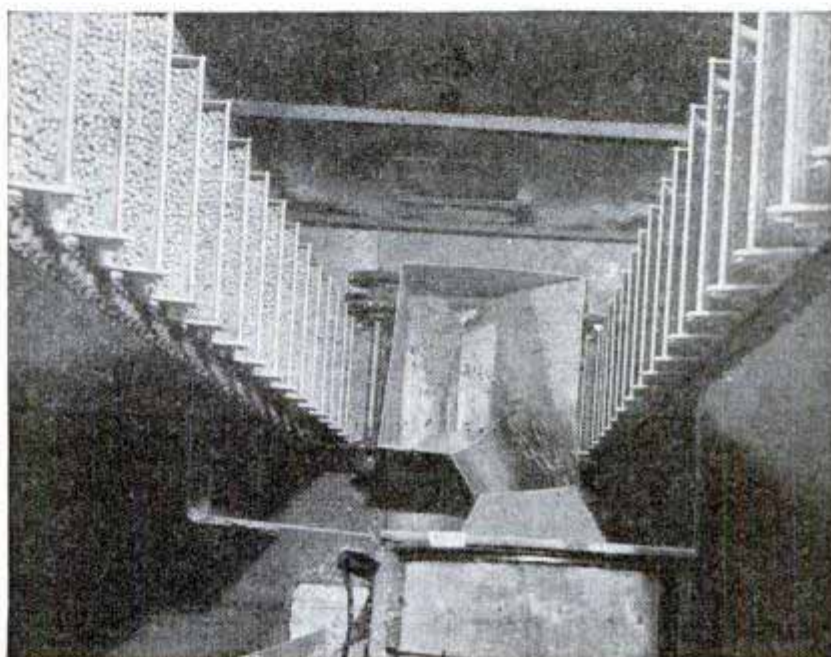
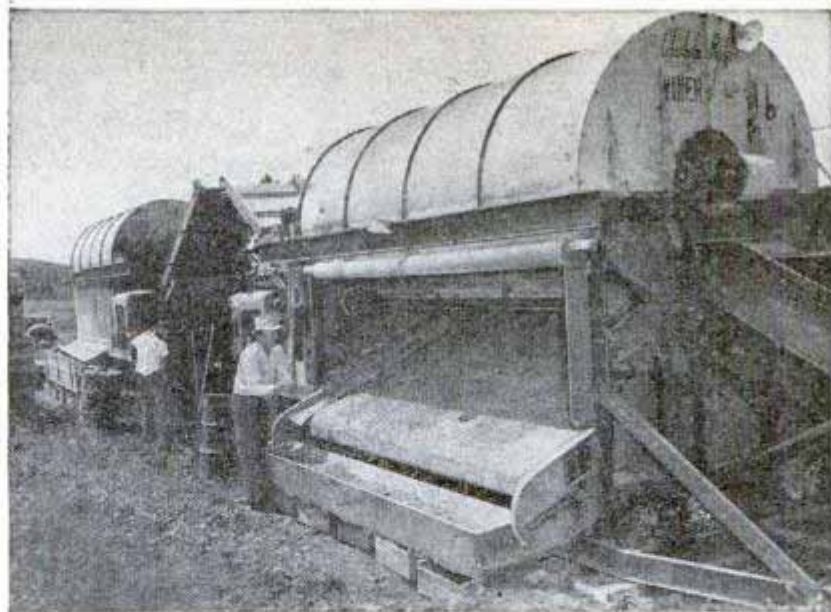



Army researchers weigh and grease dough before sealing it in tin cans during canned-bread experiments. Below, canned raisin bread, white bread and fruit cake. Cut horizontally, slice is round; vertically, it's square



ual packages of frozen meats, frozen vegetables, frozen fruits, frozen pastries? Why not combine all these items on a single plate, then precook, freeze and store until ready for use?

The Maxson Food Systems, Inc., buys meats, vegetables and fruits in carload lots, taking only choice cuts and high-quality items. Each food is precooked. Then the individual portions are combined on a partitioned cardboard plate (which is covered with plastic to guard against unwanted odors), slipped into a Cellophane bag and frozen. The food is constantly inspected and checked for flavor. Chefs, home economists

and dieticians prepare the frozen meals.

A wide selection of frozen dinners is expected to be available soon in grocery and frozen food stores. Eventually, frozen meals will be delivered from house to house. Plates for children and special plates for industrial workers and hospitals also are in the future.

About 30 minutes before dinner, the housewife removes the plates from the refrigerator, takes off the Cellophane cover and pops the dinner into the oven. Shopping and preparation of food are cut to a minimum, washing and peeling of vegetables is eliminated, cooking odors are banished and kitchen storage space is saved. And there's no dish washing! After the meal, the plastic covered plate is thrown away.

Maxson has set up a pilot plant in Queen's Village, Long Island, and frozen dinners are rolling out at the rate of 35,000 a month. Future plans call for the erection of additional frozen-food factories in Chicago, Kansas City, Los Angeles and other locations.

To date, Maxson is offering 40 blue plate specials, consisting of a generous-size entree and two vegetables. Entrees include steak, baked ham, veal cutlets, roast lamb, breast of chicken, roast turkey and many other

mouth-watering main dishes. At present, frozen dinners are being sold in New York department and grocery stores at 97 cents to \$1.63; in mass production later they should be considerably cheaper.

To meet the problem of thawing and reheating his frozen dinners, Maxson has developed for airplanes the Whirlwind oven. Weighing 35 pounds and made of aluminum and steel, the compact oven heats six frozen dinners at a time. It operates on gas, kerosene or electricity. A small fan inside the oven blows hot air and heats the frozen food in about 15 minutes. A regular oven takes twice as long. The Whirlwind is ex-

pected to be on the market in a few months and will sell for about \$35.

The Maxson Food Systems, Inc., recently signed a contract to install galleys on the Boeing Stratocruisers being built for Pan American World Airways. These galleys fit into the tail end of a plane and have storage space for 196 frozen meals, to be reheated at the rate of 12 every 15 minutes.

In addition to turning out frozen dinners and Whirlwind ovens, Maxson is also producing single food items for the busy housewife. The first of these is French fried potatoes. Packed in 10-ounce containers, this precooked, frozen food is being sold all over the country. Other items to be offered in the near future are Mexican corn, carrots Vichy, Swiss steak and turkey with giblet gravy and dressing.

Most of the large food packers are working on dishes which need only to be unfrozen and reheated: baked beans, chicken a la king, corned beef hash, Irish stew, meat balls and spaghetti, etc. The New York Waldorf-Astoria is considering putting out curried chicken and lobster a la king. One baker quick-freezes 12 kinds of pies. Other precooked frozen foods coming on the market include mashed potatoes, poached egg in a nest of spinach, cream puff shells, oyster Newburg, Welsh rarebit and sirloin tips with mushrooms.

The Army and Navy are showing continued interest in frozen and precooked foods. During 1944 and 1945 the Navy used about 55,000,000 pounds of frozen fruits and vegetables in training stations and shore bases within the United States and aboard submarines and aircraft carriers. Now Navy supply officers are working on plans to ship frozen foods to overseas bases.

The Army is also busy with research along these lines. One of their particular problems is canned bread which may be frozen in storage. Dur-

(Continued to page 240)



Pan American stewardess pops a frozen meal into Whirlwind electric oven. This oven, specifically designed for thawing and recocking six frozen dinners simultaneously, has the food ready in about 15 minutes



WHAT'S NEW IN TACKLE



FRICTION CLAMPS fasten the reel anywhere on the rod handle, tailoring the rod for individual use. Firm pull releases the clamps whenever reel is to be moved



LEADER CLIP fastens leader to line without knots. Loop in line is passed through clip, the leader, the clip again and then pulled tight around clip's point

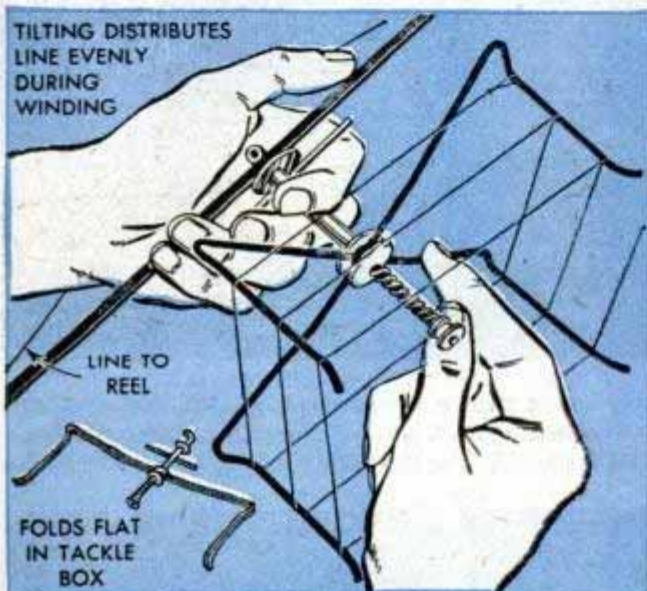

LINE DRIER with four metal arms clamps to the rod. Dried line can be wound directly from drier to reel

WORM BOX has false floor, hinged and perforated, through which worms crawl, making them easy to find

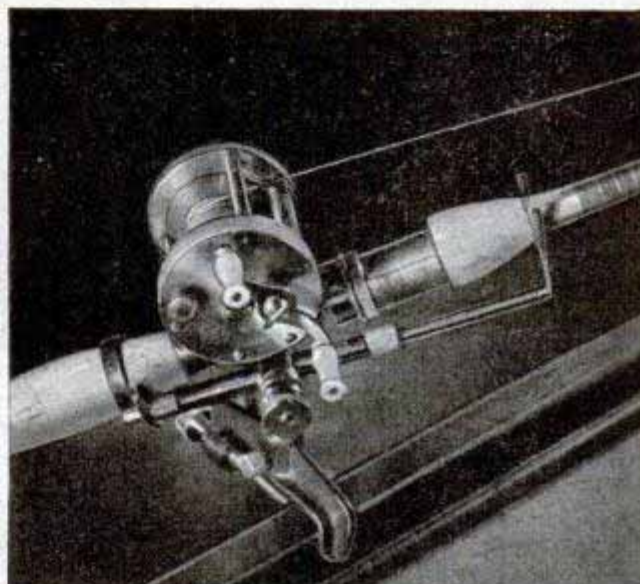

ROD HOLDER for fresh-water trolling clamps to gunwale, leaving fisherman's hands free to handle boat

TRANSPARENT BAIT BOX with compartments for flies and leaders eliminates fumbling for the correct bait



No Fumbling for Pencils—He Can Choose From 25,000

When Bill Hausman of Chicago wants to scribble a note he can choose any one of 25,000 pencils he has collected from all over the world. In his collection, valued at more than \$10,000, are pencils from kings, emperors and movie stars, some bearing tiny photographs of the former owners. The largest of his pencils is 12 feet long; the smallest is $\frac{1}{2}$ inch in length and $\frac{1}{8}$ inch in diameter. One 50-year-old pencil weighs 20 pounds and is 6 feet long.

Plastic Liner in Drill Pipes Stops Oil Well Corrosion

Steel pipes used in oil well drilling are now lined with plastic to prevent corrosion. The interior surface of 4½-inch drill pipes is shot-blasted to prepare for plastic lining. Then the pipe is upended in a rack and liquid plastic is forced up the inside until it reaches the top. Next, the plastic is drained slowly so that no air bubbles or streaks are formed. After a short drying period at room temperature, the pipe is placed in an oven and the plastic coating is baked on. Four successive coatings are applied. Field tests by the Spang-Chalfant Division of the National Supply Company demonstrated that in drilling 62,181 feet, plastic-



lined pipe had no failures while uncoated pipe failed 14 times, mostly because of corrosion. A special thermosetting plastic is used for the liner.

Cork-Insulated Hamper Keeps Perishable Foods Fresh

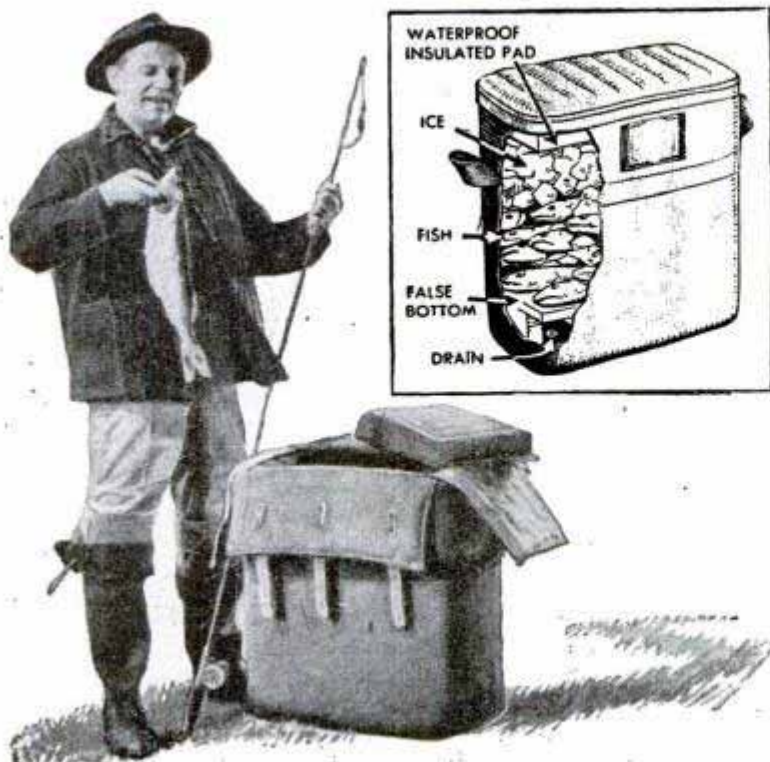

Covered with a cork-filled duck jacket and lined with a soldered and galvanized container, a lightweight food hamper serves sportsmen by keeping perishable foods fresh on the way to camp and carrying fish home on the return trip. Natural or dry ice can be used as preservative. Water from natural ice is released through a drain in the bottom of the metal liner,

Age Limit for Inventors?

Most inventions are born when the inventors are in their thirties or forties. A study of hundreds of patentable ideas — conducted by Thomas Spooner, Westinghouse research engineer — revealed that inventors reach two creative peaks. The first comes in the middle thirties and the second at about age 43.

Cars Are Parked Automatically by Push-Button Elevator

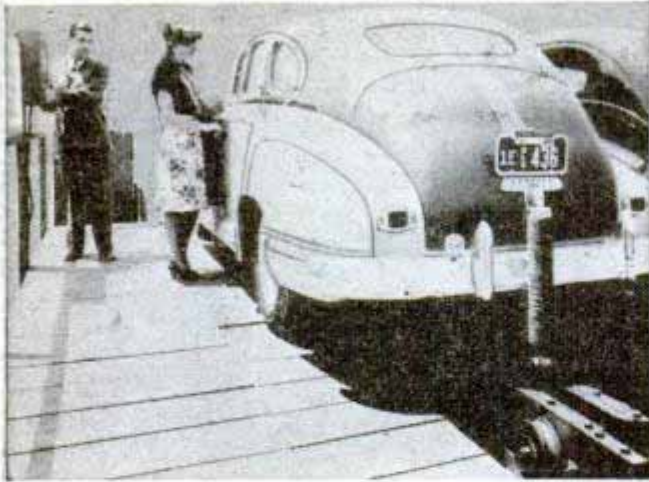

Car is driven into garage and locked. When operator pushes a button, heavy metal arms grip both bumpers. Car is pushed into a stall. The automatic parking device can be installed in buildings with several floors

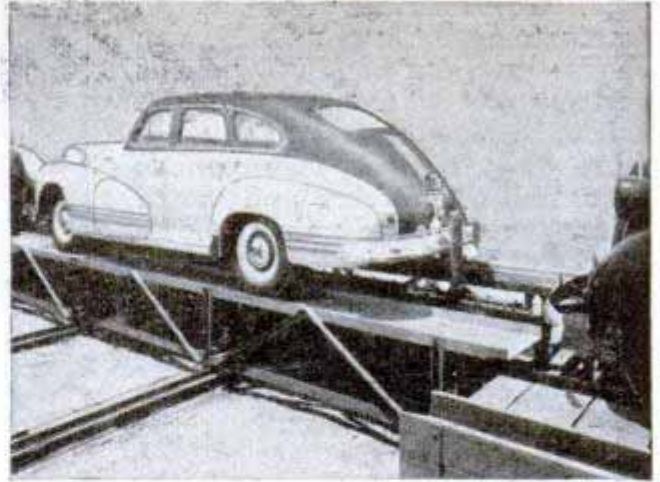

From the passenger platform the automobile is rolled onto a transfer table or elevator for the next move. Electrically operated car positioner is returned to its starting point, ready to park the next automobile

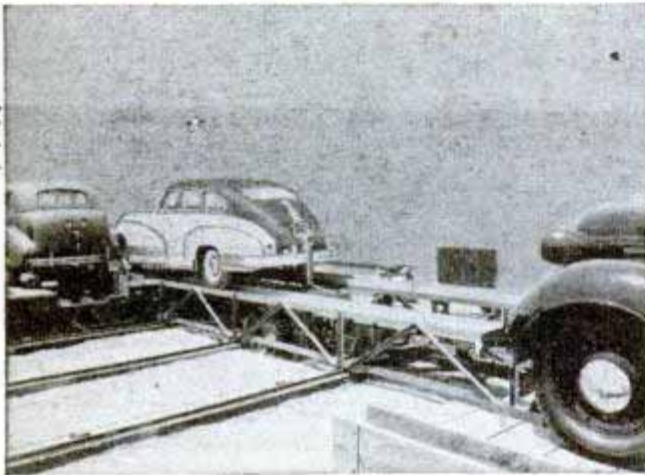

Cars can be parked automatically in public garages equipped with a newly designed push-button mechanism. A jack lifts the auto onto an elevator which carries it to the desired floor and slides it into

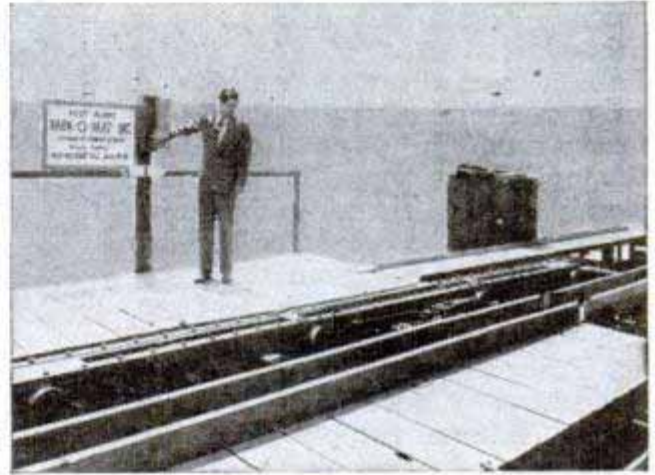

a stall. When the operator pushes another control board button, the elevator returns to its original position—ready for another car. The entire parking operation can be performed in approximately one minute.

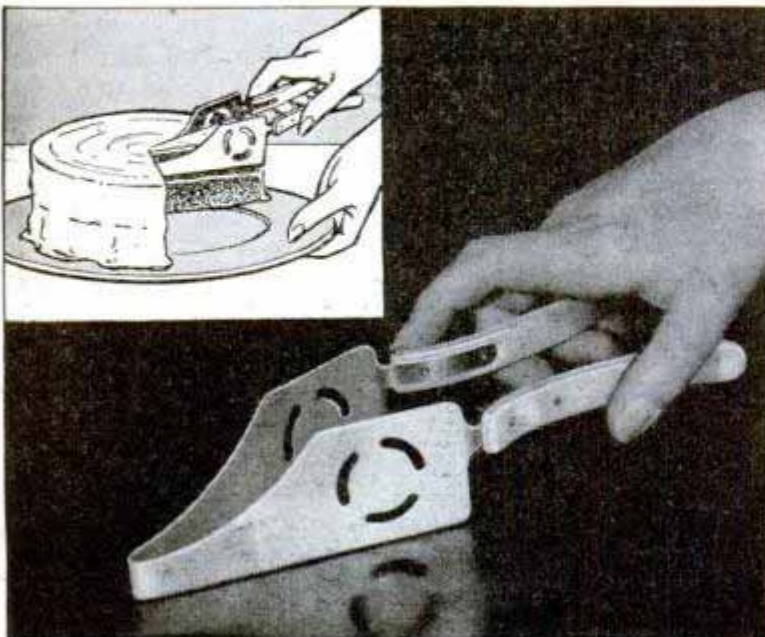

Double Blade Cake Cutter Lifts Portions With Ease

Cake is cut with a minimum of crumbling by a V-shaped cutter that can be adjusted by the handles to the desired size. The handles are squeezed to make the cut smaller. After the blades are pressed through the cake, the portion can be lifted out by a slight pressure on the handles.

Information, including manufacturers' names and addresses, concerning products described in this issue may be obtained by writing to Bureau of Information, Popular Mechanics Magazine, 200 E. Ontario Street, Chicago 11, Ill.

The Craftsman



7-HP TRACTOR

★ For the many odd jobs on a farm that require only a small amount of tractor power, Farmette, a 7-hp. tractor, is ideal. It will save the big tractor on such jobs as mowing fence rows and plowing snow, and it will handle practically all of your towing jobs and do much of the belt work. It's easy on the fuel bill, too, for Farmette, shown on page 220, is one of the smallest tricycle-type tractors you ever saw wrapped up in one package.

★ For photo fans there's a story on page 211 covering reflex camera repair that makes taking a camera apart and putting it together again look easy.

★ On page 182 we offer a two-evening project for the wood turners. Get out the stock and glue up parts one evening, turn and finish the work the next.

★ A piece on page 206 tells why it's essential to do a thorough job of cleaning your car radiator and what's likely to happen if you don't.



CAMERA REPAIR



COOLING SYSTEM CHECKUP



LAMINATED BOWLS

Turning



SELECTION OF WOOD FOR COLOR			
	WOOD	COLOR	HARDNESS
LIGHT	HOLLY	VERY WHITE	MEDIUM
	BASSWOOD	VERY WHITE	VERY SOFT
	MAPLE	WHITE-PINK	HARD
	WHITE PINE	WHITE-YELLOW	SOFT
	BIRCH	WHITE-BROWN	MEDIUM
MEDIUM	GREENHEART	GREEN-YELLOW	HARD
	BUTTERNUT	LIGHT BROWN	SOFT
	MAHOOGANY	RED-BROWN	MEDIUM
	RED GUM	RED-BROWN	MEDIUM
DARK	CHERRY	RED	MEDIUM
	WALNUT	BROWN	MEDIUM
	PURPLEHEART	PURPLE	MEDIUM
	ROSEWOOD (EAST INDIAN)	PURPLE-BROWN	HARD

By Edward R. Lucas

LAMINATED turned work looks like flush inlay when finished, more especially when you use quality hardwoods of pronounced color contrasts. That's why laminated projects have always been a natural for wood-turning hobbyists. Although finished work of this kind gives the appearance of being very difficult to accomplish, in reality it is quite simple to do.

Almost any wood can be used that will turn well. A typical selection is given in Fig. 1. Two-color pattern effects usually are based on a light-colored wood, such as holly or maple, combined with dark wood, such as cherry or walnut. Best results are obtained when the woods used are approximately the same degree of hardness. Softwoods should not be combined with hardwoods except in the case of thin spacers for laminated work. If woods of equal thickness but of unequal hardness are used the work may turn out-of-round, and sanding will develop flats. The humidor shown in Fig. 2 is made by gluing laminated blocks to the eight sides of a softwood core. This assembly is glued to the unfinished base, Fig. 4. Then you bore out the core after the glue has set, cut the blocks from

the strip either directly across, Fig. 4, B, lengthwise, Fig. 4, A, or at an angle as in Fig. 4, C. A more intricate pattern will be obtained by cutting half the blocks square across and the other half through lengthwise. Then alternate the colors when gluing them to the sides of the core. With the angle blocks, a herringbone pattern can be achieved. In assembling, glue the core to the base, then glue the laminated blocks to the base and sides of the core. This leaves 45-deg. openings between the blocks, which are filled by gluing in triangular filler blocks of contrasting wood the same length as the blocks.

Turn the outside of the bowl to the rough size first, leaving enough stock so that the inside can be bored out to a minimum wall thickness of $\frac{1}{4}$ in. Finish the outside by sanding while the work is still mounted in the lathe. Finished dimensions of the humidor shown in Fig. 2 are: 6-in. base diameter, $4\frac{1}{2}$ -in. outside diameter and $3\frac{7}{8}$ -in. inside diameter on the shell or body. Of course, it is not necessary to hold these dimensions which can be varied if desired.

The cover is turned from solid wood. Mount the cover in the lathe by gluing to a

Laminated Bowls



2



3

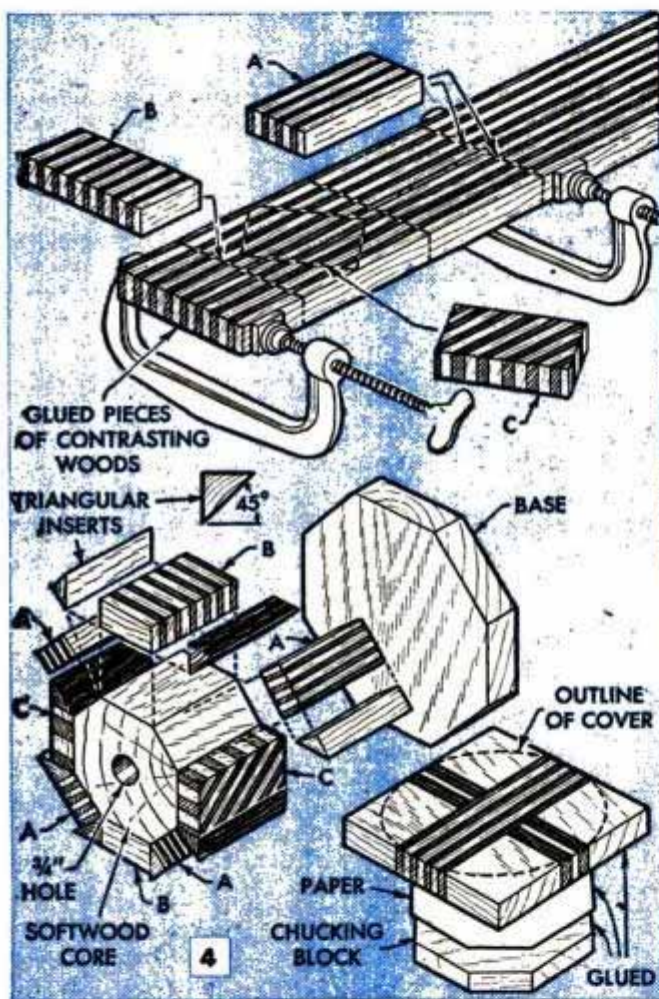

4

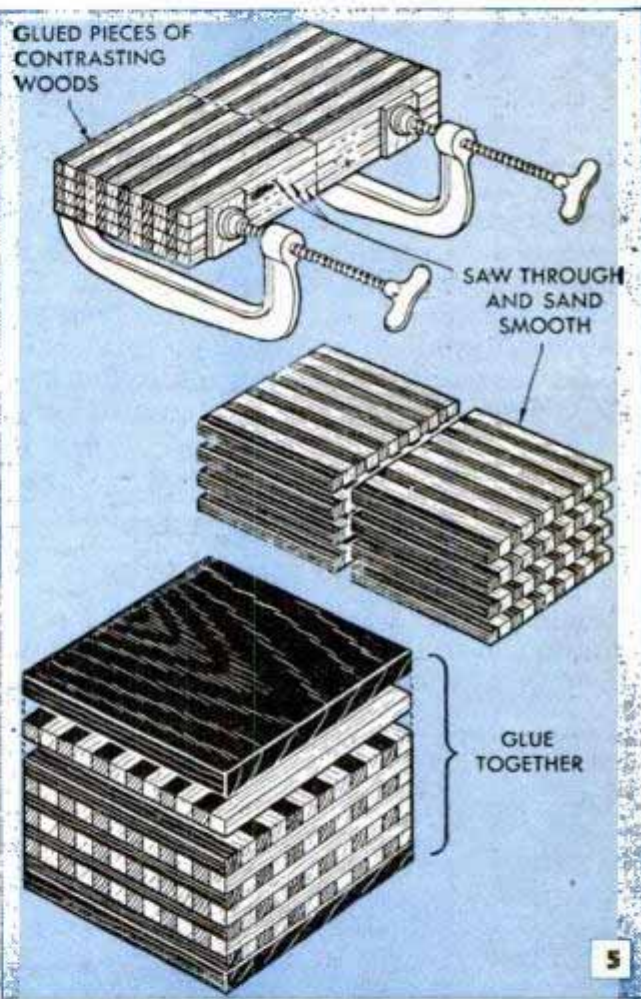

5

chucking block with a piece of paper in the joint. Rabbet the edge of the cover to fit easily inside the humidor, then turn the outside to the desired contour. Finish with lacquer or varnish.

Another method of lamination which results in an unusually attractive job is detailed in Fig. 5. A turned bowl built up in this manner is shown in Fig. 3. The lamination consists of layers of $\frac{1}{4}$ by $\frac{1}{4}$ -in. strips of alternately spaced contrasting woods glued together. Alternating layers are placed at right angles and glued together between top and bottom blocks of clear wood. Size of the glued-up block must be

somewhat larger than the finished dimensions of the bowl, of course. The top and bottom blocks are one piece as in Fig. 5. Turning the inside and outside to the desired size and contour is just another simple turning job. When undercutting the inside of a bowl or humidor one has to be especially careful that the chisel does not dig in suddenly and damage the work. Keep a firm grip on the chisel handle to prevent the tool from turning and thus presenting the cutting edge to the work at a new angle. Usually this is the cause of the cutting edge digging deeply into the wood and seriously damaging the work.

Folding Envelope Tacked to Wall Holds Recipes and Clippings

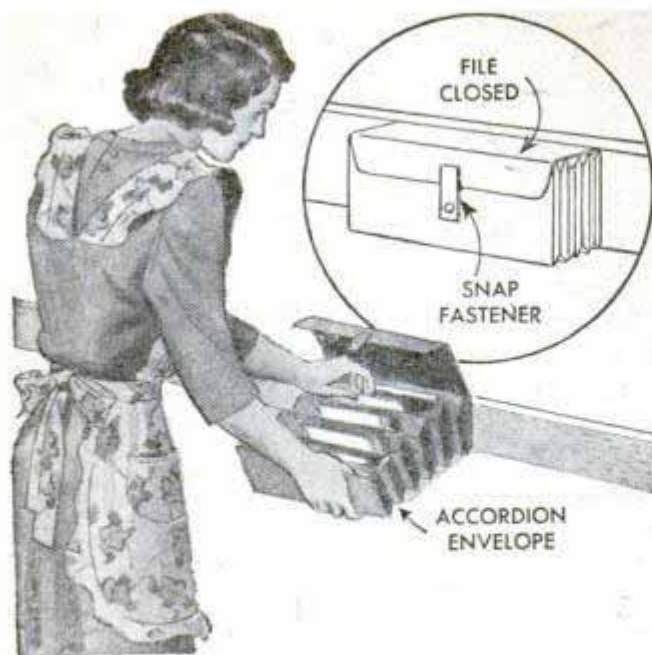

Recipes and clippings usually find their way into odd corners and finally are lost if there's no regular file to hold them. To make a convenient storage place, tack an accordion-type folding envelope to a chair rail on the wall and use it as a file. The envelope should have a snap fastener to keep it closed.

Inner-Tube "Life Preserver" Keeps Tackle Box Afloat

When a tackle box slides off the boat seat into the water, that doesn't mean the end of a fishing trip and the loss of tackle if the



box is equipped with a life preserver like the one shown. To make it, an inner tube is cut down so that it will fit snugly about the box when inflated. Cement rubber strips to the corners of the box to provide a grip for the tube. To make it easier to inflate the preserver, remove the valve core and use an airtight cap on the valve stem. Albert M. Lindner, Jr., Cold Spring, N. Y.

Rubber Lining in Fishing Box

The enameled finish of casting plugs and the plated surfaces of spoons and spinners will be preserved if the compartments in your fishing-tackle box are lined with inner-tube rubber. Pieces are cut to fit the sides and bottoms of the compartments and fastened in place with tire-patching cement.

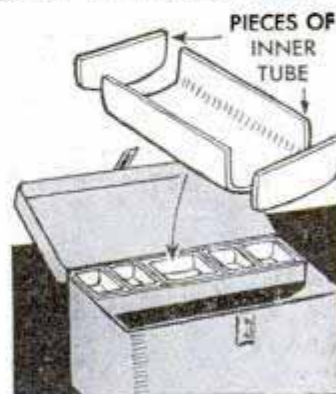

G. E. Hendrickson, Argyle, Wis.

Testing Garden Spray for Leaks

Having no convenient way to apply air pressure to the tank of a hand garden sprayer to test it for leaks, one gardener used carbide. Small, pea-sized pellets were dropped into the tank, water was added and all openings were closed. Submerged under water, the leak in the tank was located by the string of bubbles coming from it. The pressure in the tank, of course, was caused by the generation of carbide gas.—W. C. Wilhite, Carlinville, Ill.

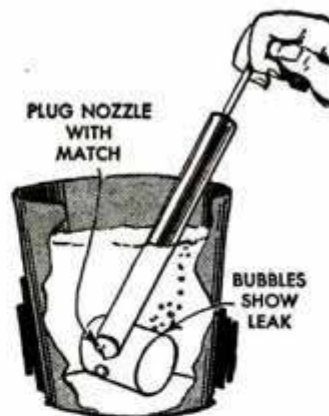

Loosening Tight Joints on Rods

If the joints on your fishing rod stick tightly together, wrap a piece of wet string or fishline around the male ferrule. Then fasten the ends of the string around a branch or the oar lock of a boat. A firm but gentle and steady pull should free the rod.

R. A. Jenkins, St. Louis, Mo.

☐ Grease on wallpaper generally can be removed by applying a paste of cornstarch to the discolored spot, allowing it to dry and then brushing it off.

Three Useful Articles From Bamboo Sections

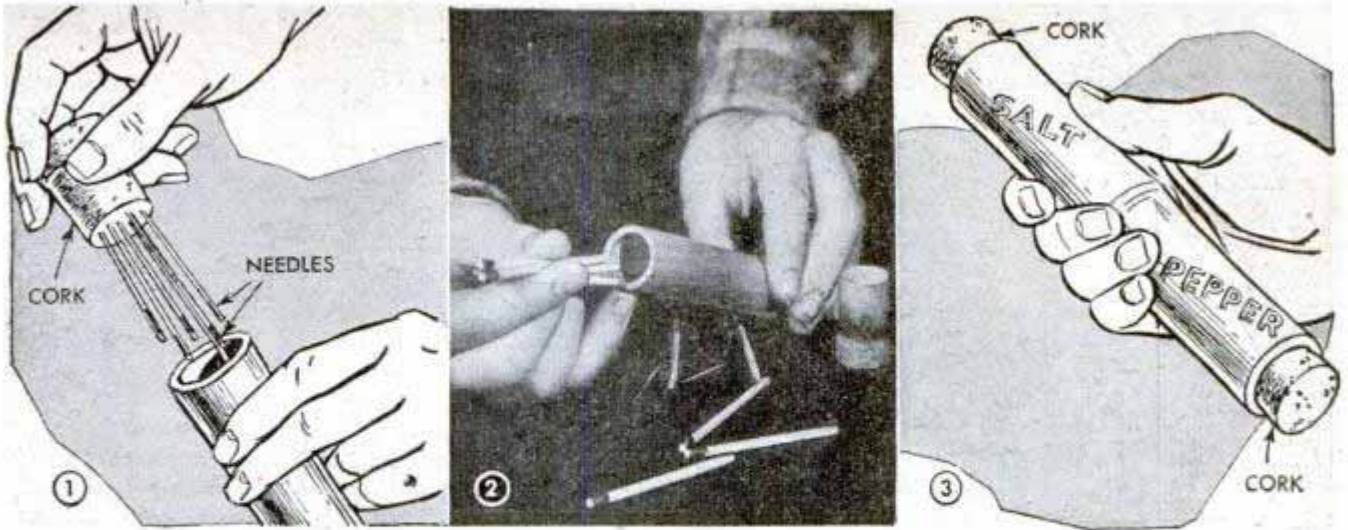

Matchbox, needle holder and a divided container for salt and pepper — all these items are essentials in the camp or summer home or in a trail pack on an outing. For a needle holder or matchbox, Figs. 1 and 2, cut the bamboo section about 4 in. long, making one cut just above a joint, which forms the closed bottom end. Stick needles

in a cork as in Fig. 1, slip the cork in the open end of the bamboo section and there's your needle holder. Use the same construction for the matchbox. For the salt-and-pepper container, cut the bamboo as in Fig. 3, with open sections on each side of a joint. Then fill the sections and insert tight-fitting corks.—D. E. Horn, River Forest, Ill.

Resin Glues Mixed and Applied Through Wax-Paper Cone

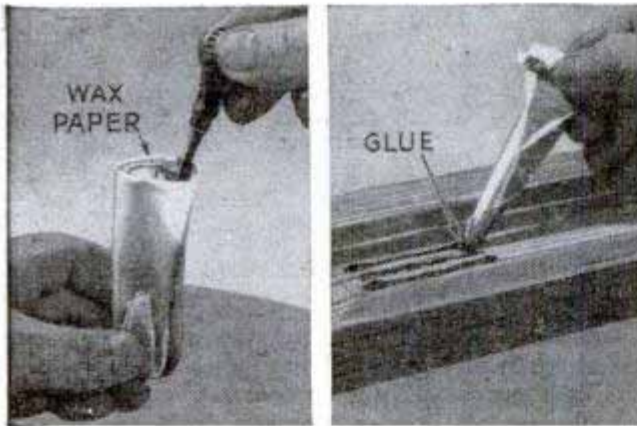

Resin glues that require mixing a liquid and a powder can be prepared in small quantities in the following manner: Make a cone of waxed paper and fold the tip. Then add the liquid and powder and mix thoroughly. Next fold over the large end of the cone, unfold the tip and apply the glue by squeezing the rolled end. This type of applicator permits placing the glue exactly where it is needed. When the job is done throw the paper away; there are no containers to wash.

Kenneth Murray, Colon, Mich.

Bench Vise Is Used With Bar To Loosen Pipe Fitting

When a pipe fitting is tightly rusted and you haven't a wrench that's large enough to turn it, use a bench vise and a wrecking bar to do the job. Grip the work in a pipe vise and clamp the bench vise to the fitting. Then place the bar between the fitting and the back jaw of the vise. Use the bar as a lever to turn the vise and fitting.

Wayne A. Ward, Watertown, N. Y.

After cleaning out your stoker for the summer, internal parts can be kept from rusting by running oil-soaked sawdust or wood chips through the feed screw into the retort. The sawdust will be burned in the first fire made in the autumn.

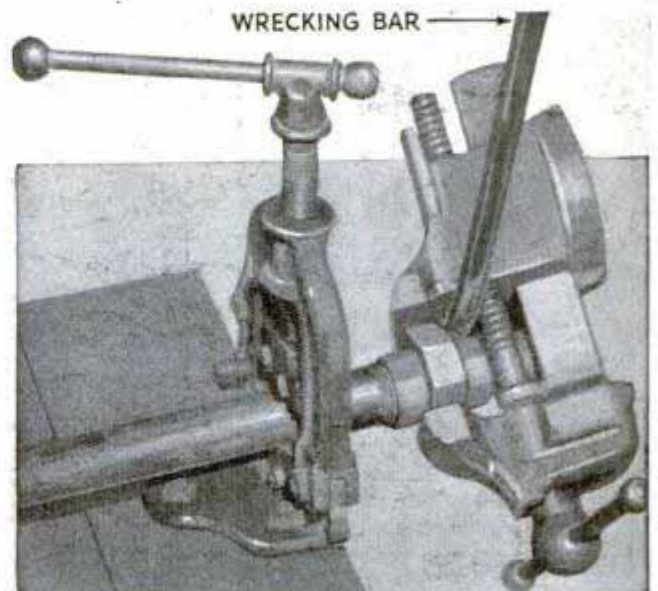

Solving HOME PROBLEMS

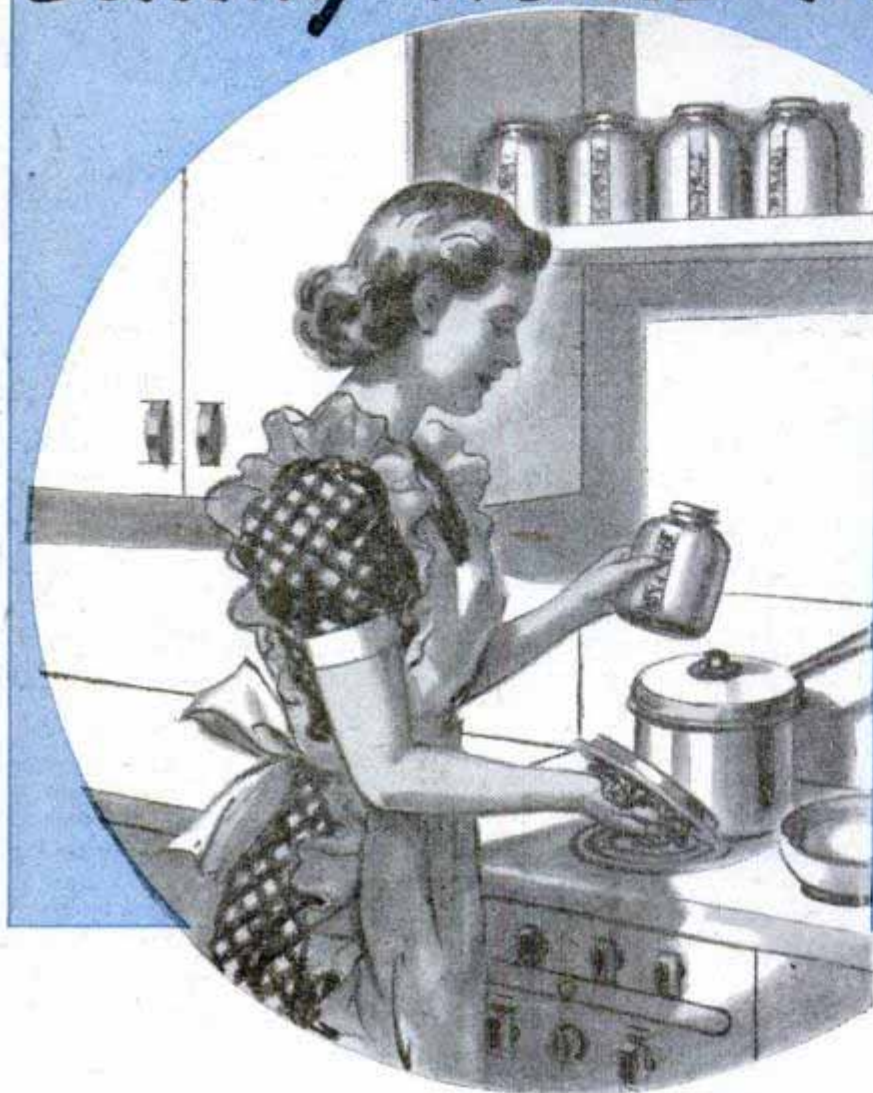

Placed as flower containers at each guest's plate, brilliantly dyed eggshells make unique favors for an Easter party. After the end of the shell is broken and the contents removed, color and mount the shell on a plaster-of-paris base



To have coffee, tea and other staples at hand, store them in painted glass coffee jars. Leave a strip of clear glass to identify the contents

You can hang decorative plates on a wall with ordinary dress hooks. Thread a stout cord through the hook eyes, which are on the back, and leave a length to hang the plate. Space the hooks equally

By installing two 3-way switches, one at the base of the porch steps and the other inside the front door, the light can be turned on at either location. This makes crossing the porch at night safe

If a caster cup sticks, trying to pry it loose may damage the finish of the linoleum. In such a case, pour hot water into the cup and let it stand a while. Usually the cup can be removed with ease

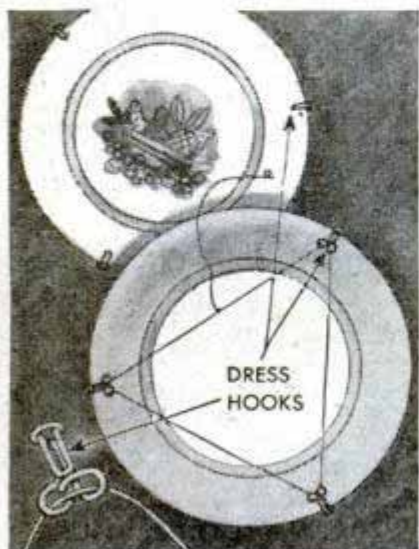

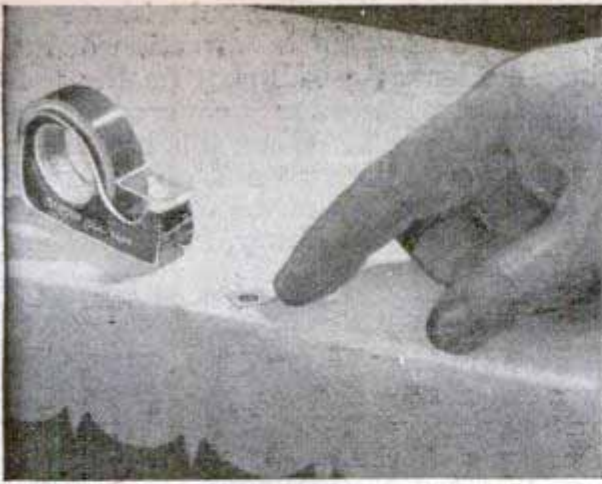

Shelf paper and decorative edging will not become wrinkled if held in place with cellulose tape placed over small holes punched in the paper

Soap shavings can be made in a hurry if there's a carpenter's plane handy. Simply hook the plane on a pail and then draw the soap over the knife



Use a china-marking pencil to write on the oven door when a dish was placed in the oven and when it should be taken out. The marks erase easily

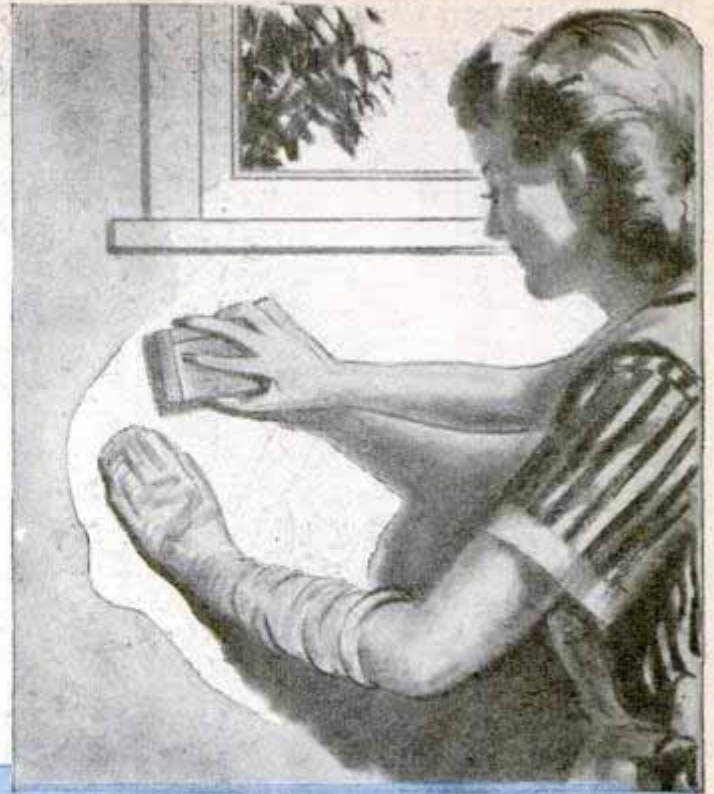

When sanding a painted surface, such as a wall, slip an old silk hose over one hand and run it lightly over the areas that have been sanded. Any spots that are not smooth will catch and snag the hose, indicating that additional sanding with finer paper is needed

Here's a simple way to hang a stepladder on the basement wall so there will be little danger of its falling. Take a length of 2-in. angle iron equal to the width of the top step and bend it so the legs of the angle are 45 deg. apart. Then fasten to the wall

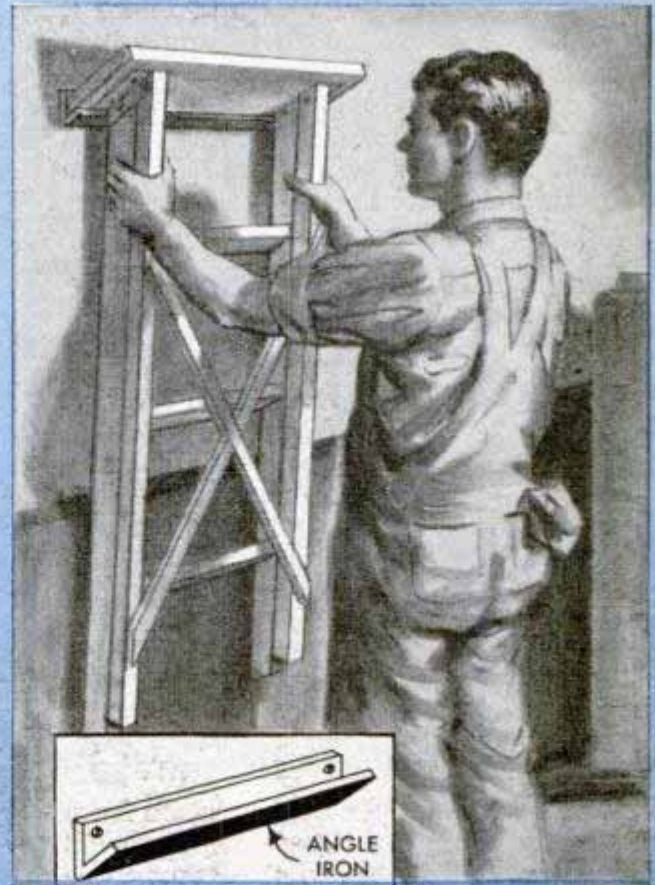

Two-Handed Operation of Pump When Footrest Is Used



Operation of a bilge pump is made easier if a footrest is provided so that both hands are free to operate the pump. This rest is made by brazing a strap hinge to the barrel of the pump. The projecting end of the hinge has a piece of flat iron welded to it to increase the area of the rest and make it more stable. A short length of angle iron provides a stop when the footrest is opened. Hold the pump against one of the seats with the end of the barrel near the bottom of the boat to determine at what height the rest should be located.

Return Bend Serves as Sprinkler

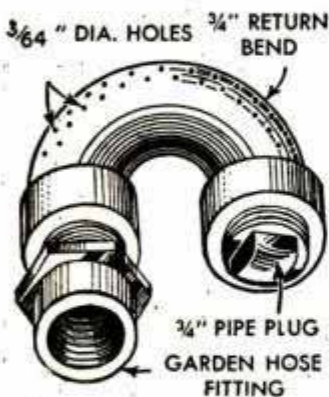

Here's a lawn sprinkler made from pipe fittings. A drilled return bend forms the sprinkler head. One end is plugged and the other is fitted with an attachment for a hose. — R. M. Anthis, Twin Falls, Idaho.

Water Marks Easily Removed

Water and dish marks are removed from furniture by using a mixture of powdered pumice stone and any kind of oil furniture polish. Make a puttylike paste of the stone

and oil and apply it to the spot with a very soft cloth, rubbing in the direction of the grain. This leaves a dull spot on the polished surface which then is covered with a coat of white shellac. When this has dried, rub lightly with pumice and oil until the spot matches the rest of the finish.

Francis W. Henry, Pottsville, Pa.

Adhesive-Tape Repair for Tent

That camping trip needn't be spoiled because you find a tear in the tent and suddenly hit a spell of rainy weather. Many outdoorsmen carry a roll of adhesive tape for just such an emergency. To repair the tent, punch a

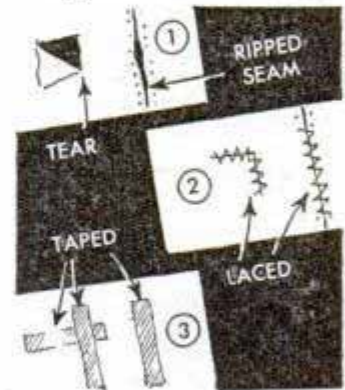

series of holes on both sides of the tear or rip, detail 1, and sew it with fish line or string, detail 2. Finally, cover the seam with adhesive tape, as in detail 3, and you have a patch that will stay put.

Tobacco Can Keeps Grasshoppers Fresh on Fishing Trips

A tobacco can makes a handy container to carry live grasshoppers used for fishing bait. An oblong hole is cut in the top which is closed by means of a slide cover. The guides in which the slide works are soldered to the top of the can, which can be carried in a jacket pocket.



Exp. W. L. H. 77

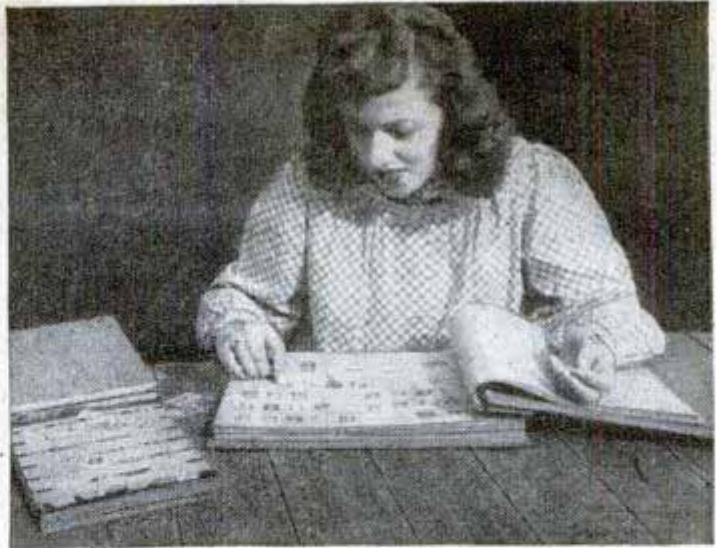
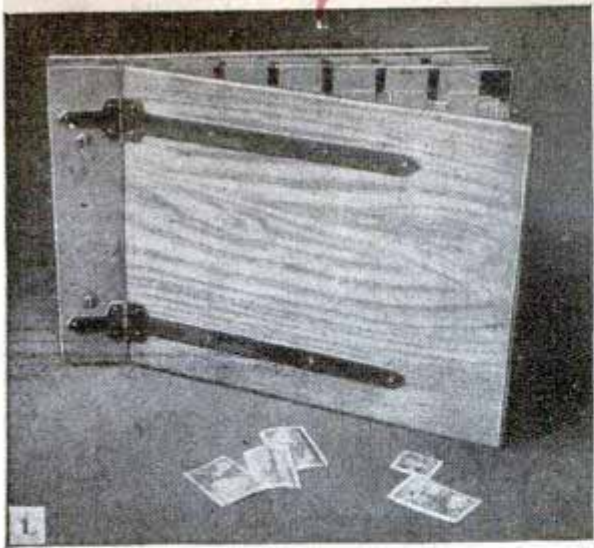

By Dick Hutchinson

STAMP collectors who find it hard to keep surplus and duplicate stamps filed in an orderly manner will welcome this book, Figs. 1 and 2, which provides plenty of space to keep the spare issues. The cover for the book is made from $\frac{1}{4}$ -in. chestnut, but any wood with an attractive grain will do equally well. Dimensions for the covers are given in the upper detail of Fig. 3. No. 22-ga. soft copper is used for the hinges, lower left-hand detail, which are hammered on the face side. The bends for the hinge pins are formed around a No. 20 brad. A method of page assembly for the pockets and hinges is shown in the lower right-hand detail. Note how the page hinges are spaced, center left-hand detail, so the pages will fold over.

A Book for Your Surplus Stamps

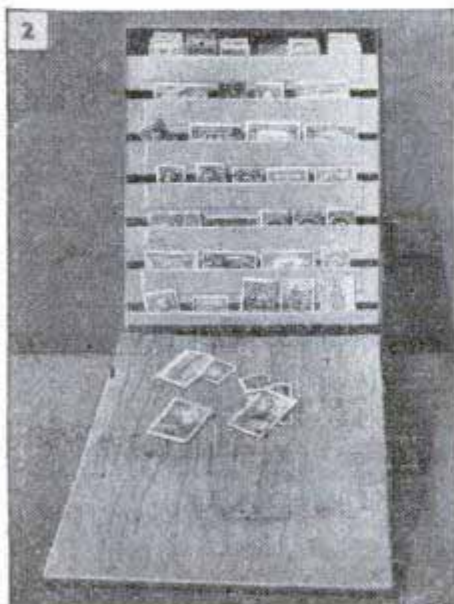
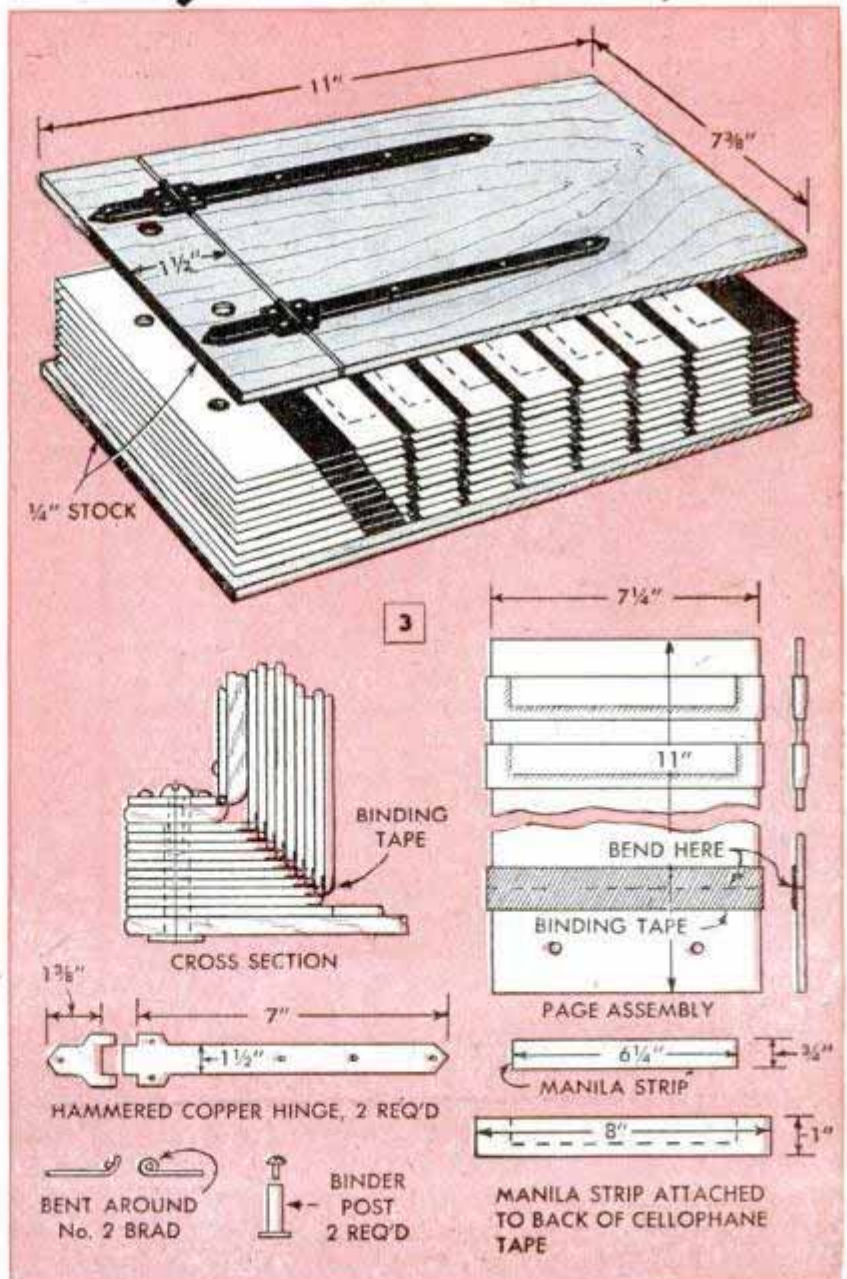

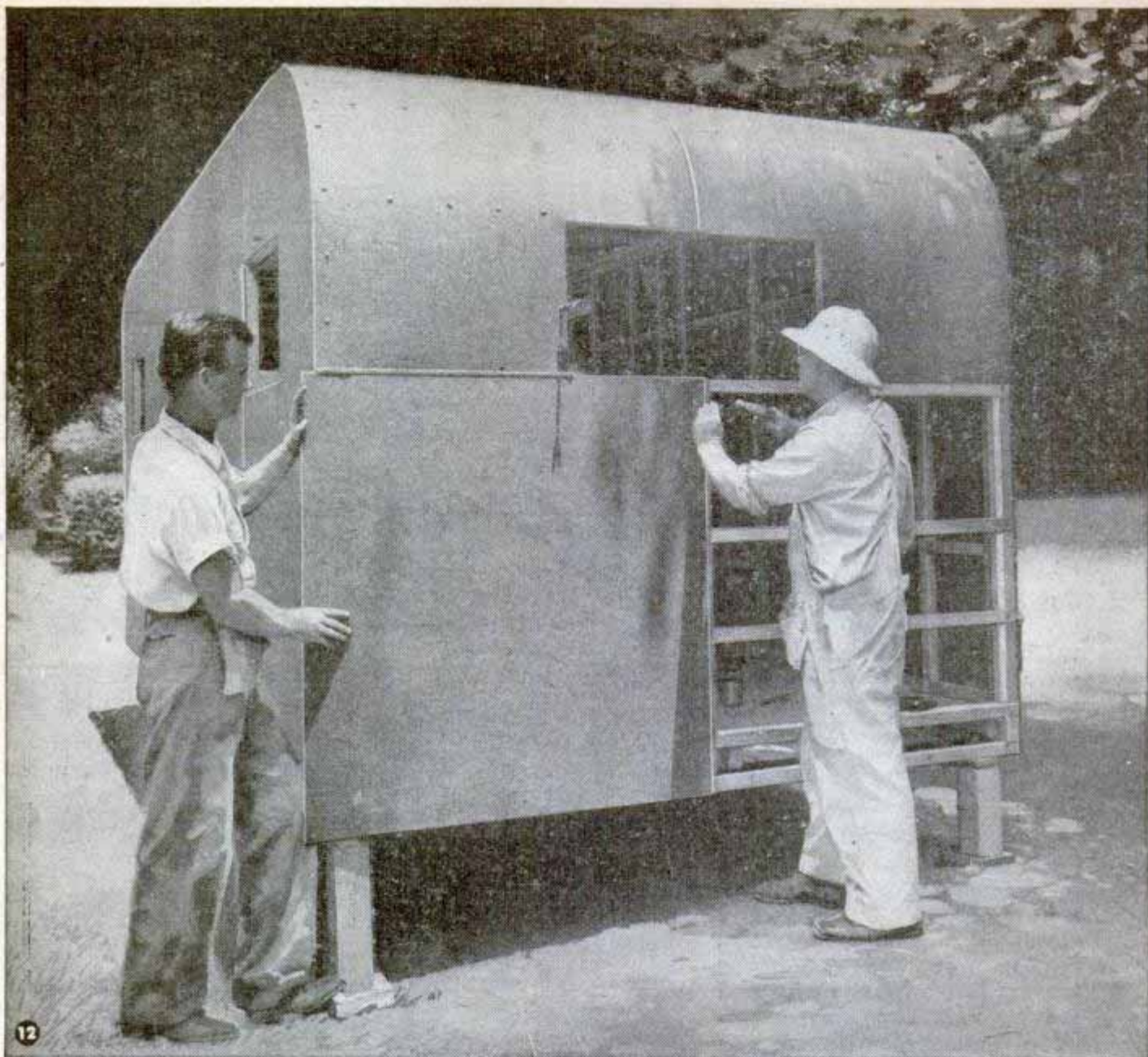

A Home of 1000

FROM now on, with the trailer framing done, construction begins to go along much faster. For outside sheathing $\frac{1}{8}$ -in. hard-pressed board was used on the original trailer, but, if this is not available, $\frac{1}{4}$ -in. waterproof plywood is a satisfactory substitute. Stainless-steel dividing strips first are installed on the studs where the panels will join, also at the roof joints, Figs. 12 and 13. Install moldings as in the sectional views, Fig. 13. Apply casein glue to all contacting surfaces of the wood framing and begin installation with the bottom panels, fastening with 1-in. No. 7 nickel-plated oval-head screws run down over flush-faced washers. Screws should be spaced 6 to 8 in. apart, depending on the location. Both ends of the trailer are paneled alike

except that on the forward end the material is cut away to admit the steel drawbar frame. Metal bearing plates are attached over the frame members with heavy screws as shown in the front view, Fig. 13.

On the roof, calking compound is applied liberally to the dividing strips as well as over the oval-head screws and washers. Panels are cut and fitted as in the top view, Fig. 13. At the curved ends the material should be bent down gradually, screws being driven in on both sides as the bending proceeds. After the roof has been applied, stainless-steel corner strips are installed as in Fig. 14.

All-metal sash and frames fitted with screens are used. This type of window is shown in Fig. 15. Side windows are the

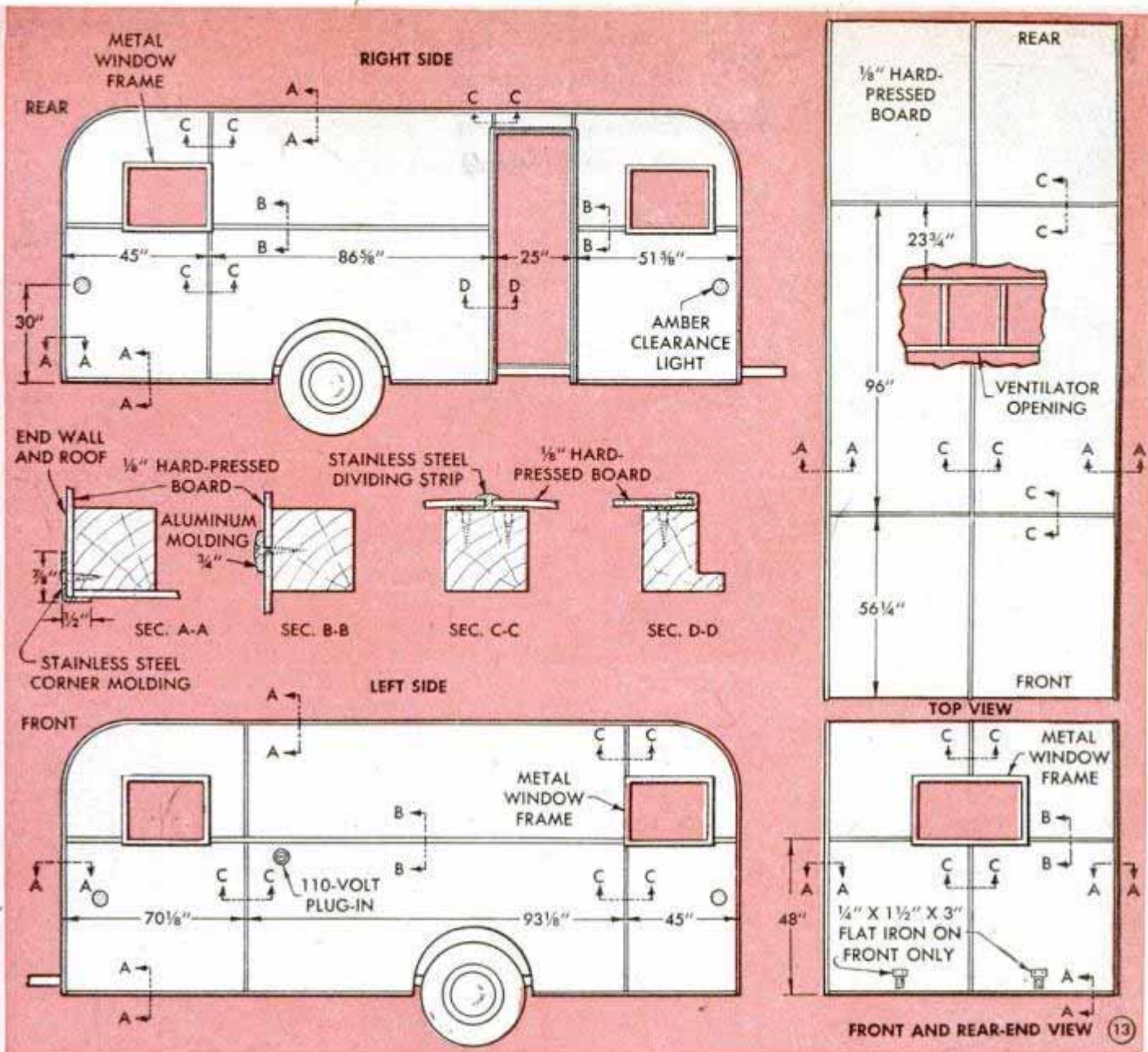

Addresses

PART II By Hi Sibley

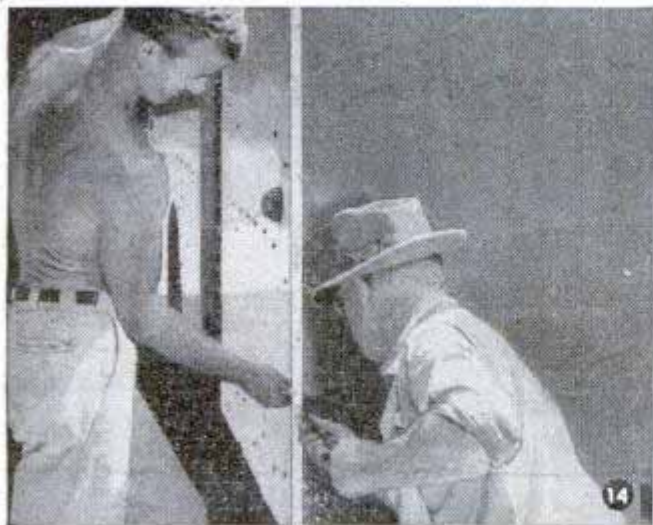

Stainless-steel corner molding is attached with nickel-plated oval-head screws. When driving screws be sure to seat them uniformly. Note clearance light



Rather than bother to make them yourself, buy the sash ready-made. These are all metal and come with the frame and sash in one unit. Fasten with screws

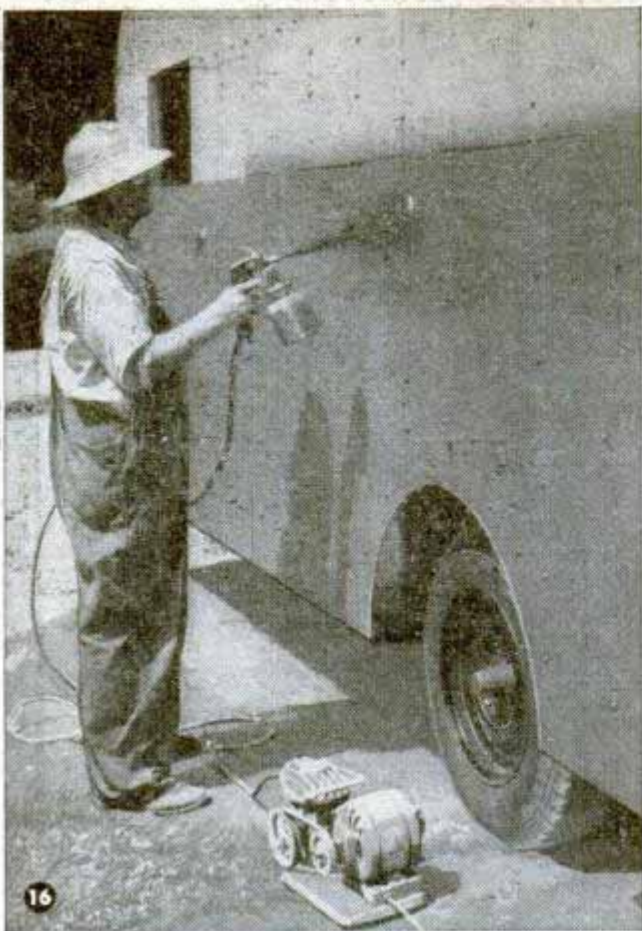

Blue, combined with a light gray above, makes a good two-tone paint job. Spray on the light color first

same size, 18 by 24 in., but those on the ends are 18 by 33 in. Before the windows are permanently installed it's a good idea to do the paint job. Color combinations are a matter of choice, of course, but blue and light gray make a pleasing two-tone job. On the original trailer body the blue was masked at the window sills all around and the balance, including the roof, was made a light gray. Use a top-grade outdoor enamel and apply with a spray gun as in Fig. 16. Wheel disks, chassis and the sash and frames are black.

Before installing inside paneling, the trailer should be wired as in Fig. 18. If you are not experienced in this work have it done by a licensed electrician. Wiring diagram is given in Fig. 17. Note that all cables are carried under the floor, as the channel frame does not permit going over the ceiling. When 110-volt current is unavailable for illumination, it is possible to use 6-volt current from the car battery. To do this, substitute 6-volt bulbs for the 110-volt ones. These are available with bases that will fit the regular 110-volt sockets. Then provide some means of connecting an extension cord to the car battery or circuit and plug it into the 110-volt circuit. Don't forget to change bulbs before using 110-volt current. If an electric stove, heater and

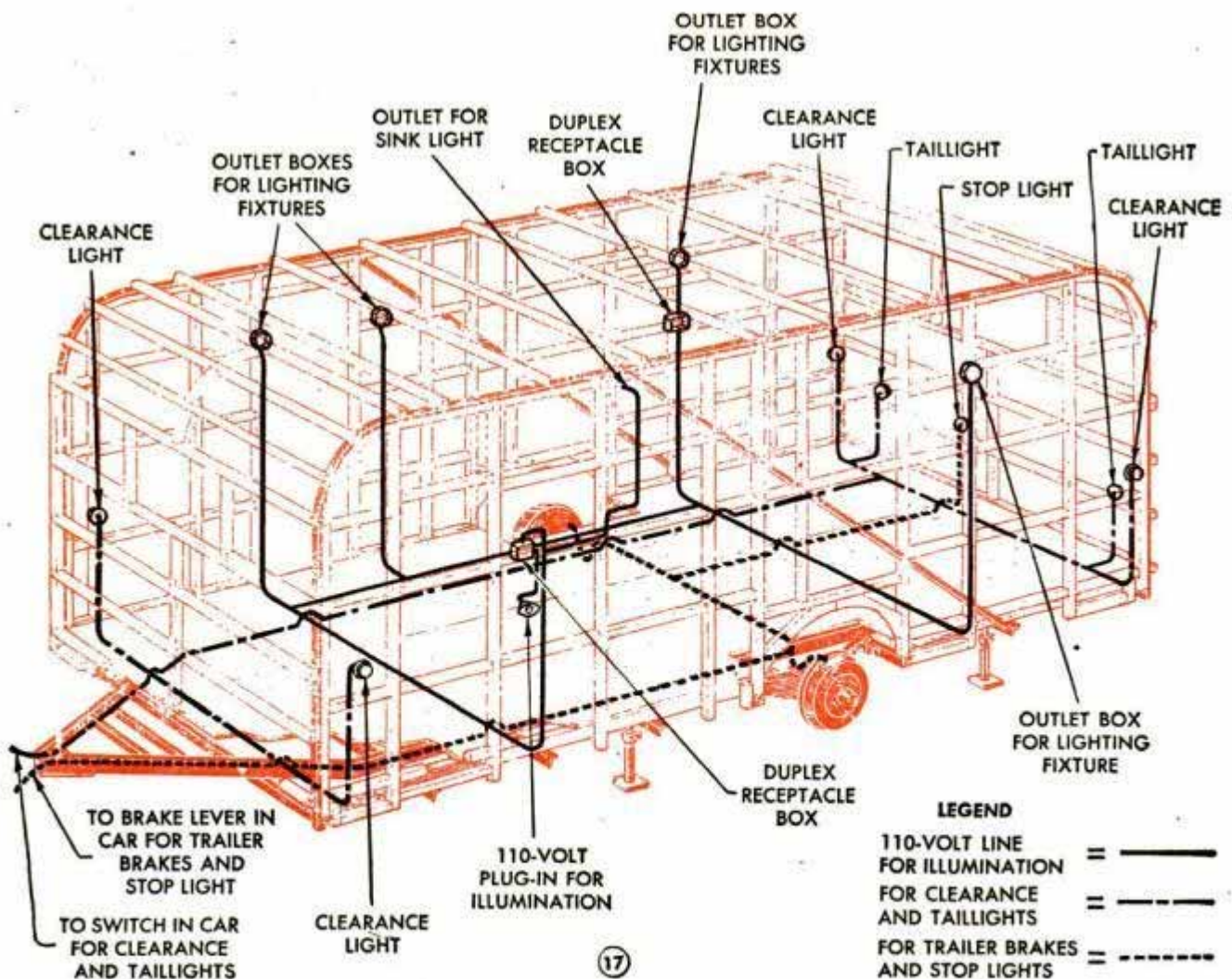



Wiring is carried through holes bored in the studs and frame members. Long runs should be stapled

After wiring is installed, auto-body insulation in quilted form is pressed into place between the studs and roof members

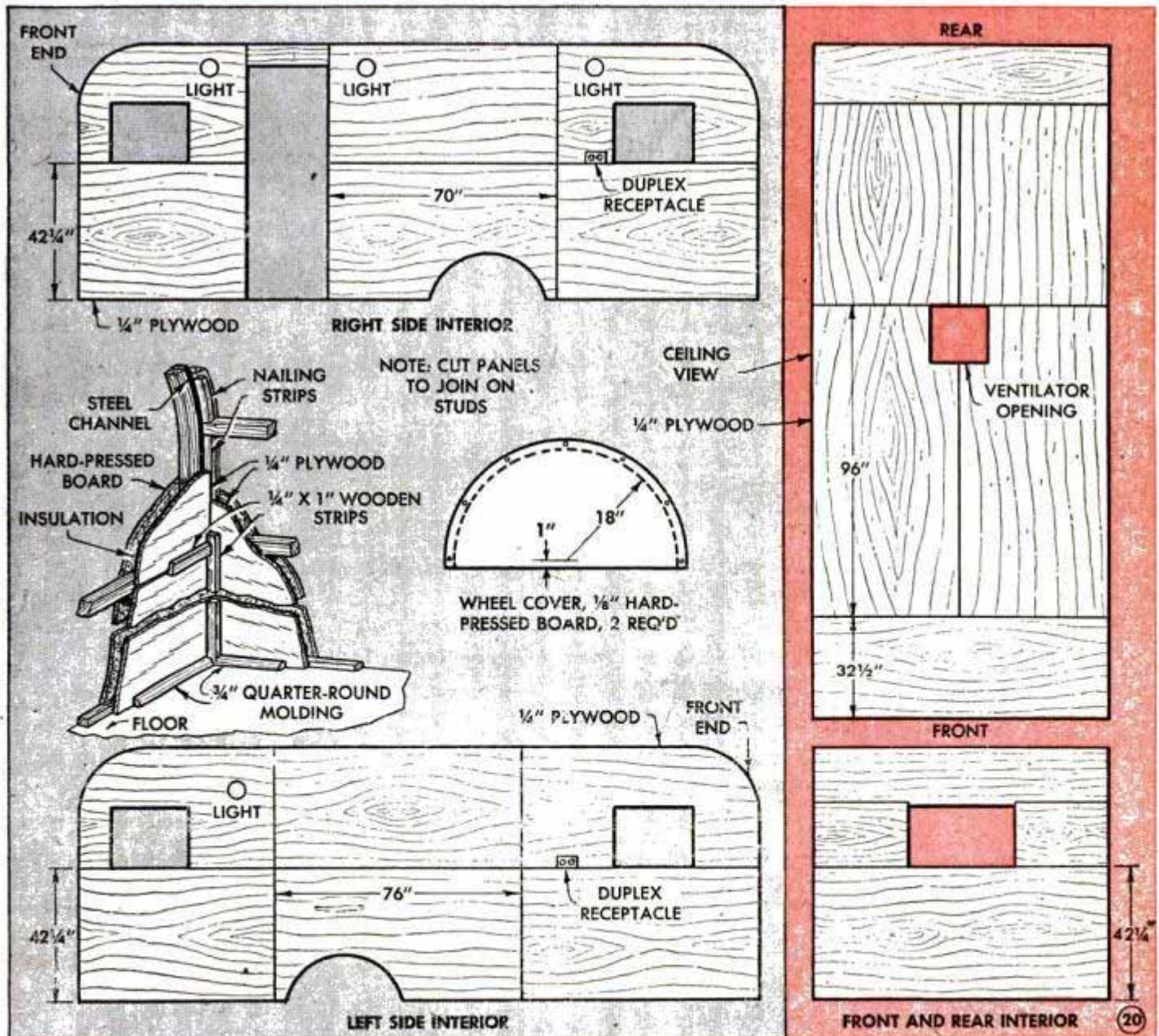

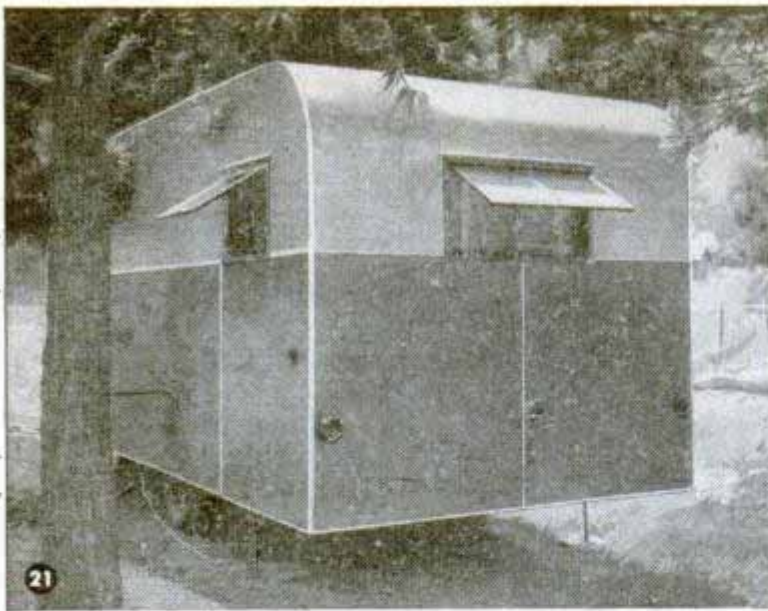

21 Rear view showing taillight, clearance light and reflectors. Copper tube on ground connects with camp water supply

refrigerator are to be used, wiring must be calculated accordingly.

After the wiring is completed and tested, the job is ready for the insulation of walls and ceiling. Automotive insulating material of the quilted type is cut to fit snugly in the spaces between framing, Fig. 19. Tacks hold the edges in place so that they do not lap over the frame pieces.

A ready-made ventilator is reasonable in cost and easy to install. Simply spread calking compound around the edges of the opening and screw the flanges of the frame down on top of the roof. Edges of the lid or cover come well down over the frame to prevent rain or dust from being blown in. The ventilator is fitted with a copper screen and an operating mechanism consisting of a worm gear and crank.

Birch plywood, $\frac{1}{4}$ in. thick, makes the finest interior paneling, but fir plywood of the same thickness can be used. Before installing, locate nailing strips on the ceiling and walls as shown in Fig. 9 of Part I. These are especially important in the curved sections of the ceiling. Begin with the ceiling paneling first, the panels being cut as in Fig. 20. Note that the curved panels come down to the top of the windows and are notched at the ends to allow the center to come down flush with the sides of the windows as in the end view, Fig. 20. The grain should run horizontally on these pieces. Layout of panels for the left wall is shown in Fig. 20. On this side cut out for the electric outlets and the cable which comes through the wall over the sink. On the right wall cut out the paneling for two lights flanking the door and one light and an outlet near the rear window. Joints on the interior walls and ceiling are covered with $\frac{1}{4}$ by 1-in. hardwood strips.

The door is of double-wall construction with insulation between as in Fig. 22. The inside is covered with $\frac{1}{4}$ -in. plywood and the outside with $\frac{1}{8}$ -in. hard-pressed board edged with a molding to match the wall. An auto-type door catch and handle is installed on the center cross member. The glass panel is set between the outside paneling and the inside molding and the joint is filled with calking compound. A drip molding is installed above the door and molding is nailed to the jamb on the inside as in the horizontal cross section. To finish up, semicircular pieces of hard-pressed board, Fig. 20, are screwed over the wheel wells. Fig. 21 shows a rear view of the finished trailer with lights, windows and wheel covers in place.

(To be continued)

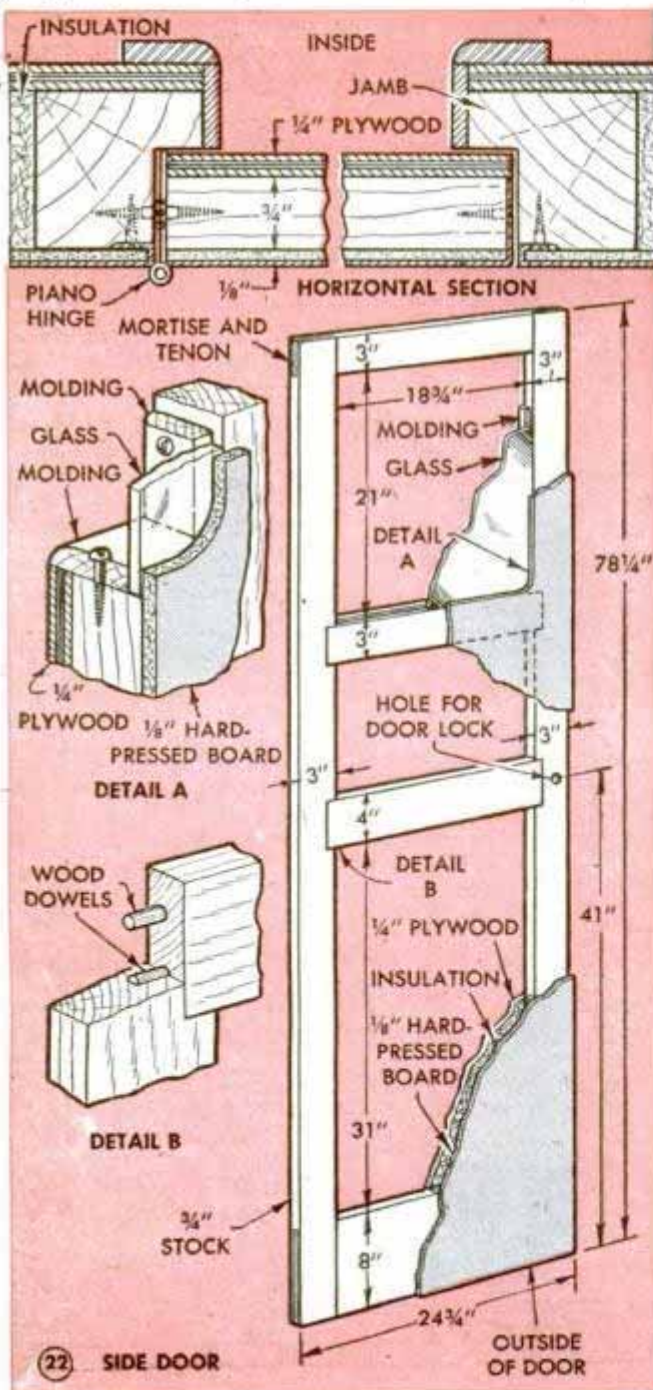

Flower Box Is Cut From Standard Width Metal

Cut from a standard width of 30-in. sheet metal, this flower box and brackets are an interesting project for the craftsman who enjoys working with metal. The proportions of the box are such that it can be made to fit almost any length window and still look well. After the box is cut and formed, drain holes should be punched in the bottom. Before painting, wash the metal with vinegar and then finish the inside of the box with liquid asphalt and the outside and brackets with a paint that matches the trim.—John C. Sommer, Saginaw, Mich.

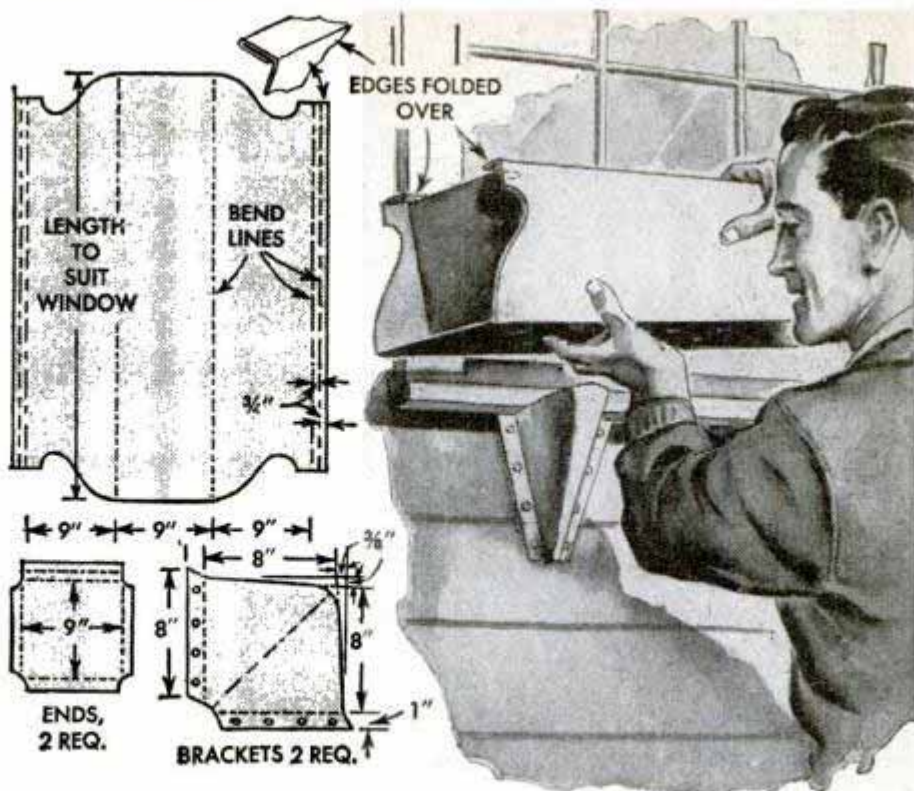

Rest Eases Strain for Gardener When Working on Knees

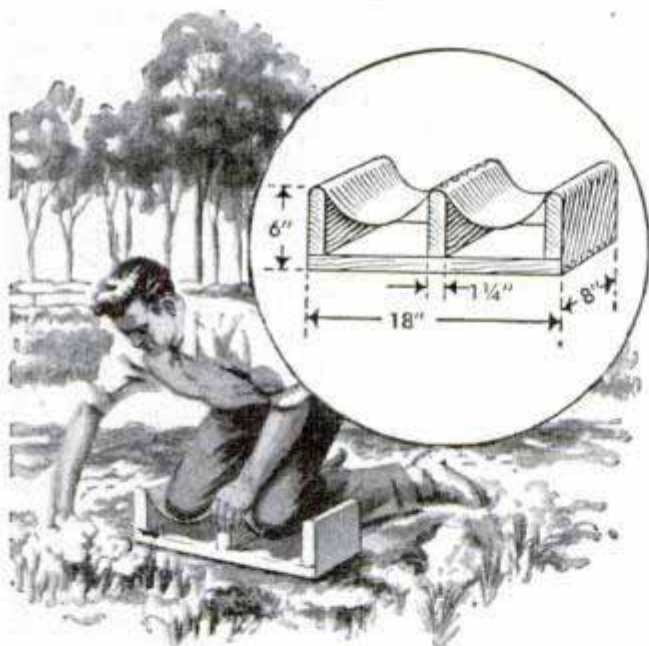

This knee rest will take the strain out of gardening when weeding or performing some similar operation where it's necessary to work on your knees. The base is large enough so that it won't sink into soft ground. The edges of the three vertical pieces should be rounded. Sufficient slack is left in the canvas cover to provide comfortable rests for the knees.

☐ A piece of adhesive plaster put on the inside of a thimble that is too large will make it fit your finger.

Single-Board Bathroom Cabinet

Here's an attractive corner cabinet that is cut from a single board 6 in. wide and 5 ft. 6 in. long. The upper detail shows the manner in which the board is cut, and the right-hand detail indicates the method of assembly. The only other wood required is a 3/8-in. dowel that is used for the towel bar. The cabinet is an ideal one for the bathroom because medicine chests are usually too small and extra shelf space is needed.

Peter B. Horsley, Calgary, Alta., Can.

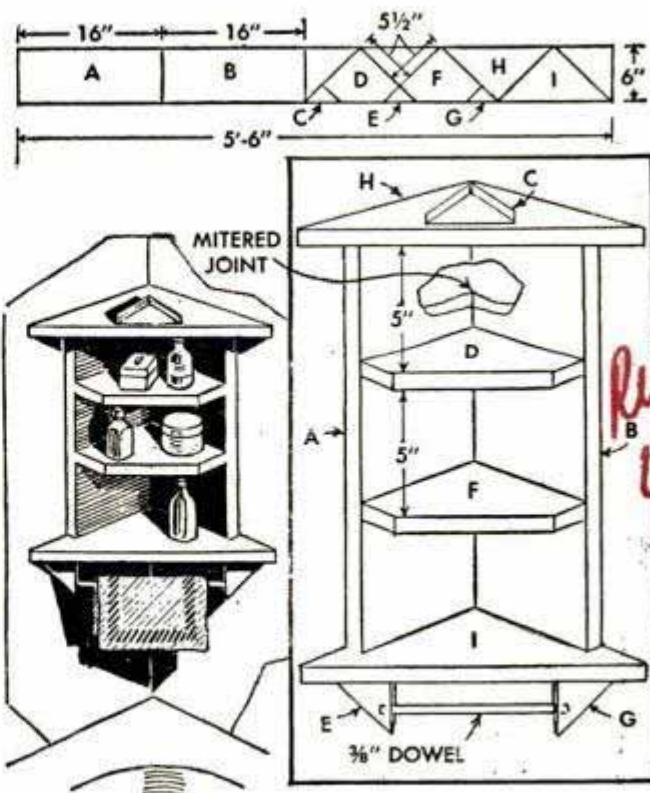

Uses for Bricks



Even a dozen jars of pickles can pose a major storage problem, that is, until you think of stacking bricks and boards like this



If you have leaves, rubbish or garbage to burn, stack the bricks in a circle, with broken joints, and there's your burner



Sixteen bricks and asbestos paper make a good gas-welding table—easy to work on and no danger of starting a fire



Old-timers on the farm will remember this one. A brick coated with oil makes a good polisher for plow moldboards



The weight of a brick inside a polishing cloth saves a lot of tiring muscle work when waxing and polishing your floors

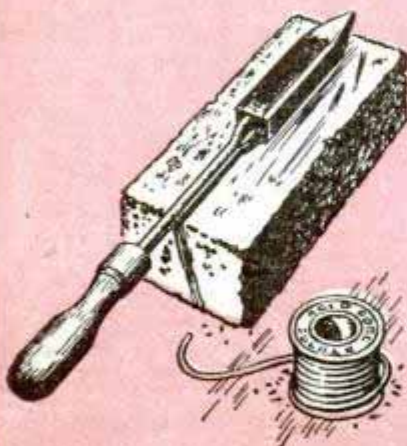

Partial refractory properties of an ordinary brick make it a safe place to lay the heated soldering iron when not in use

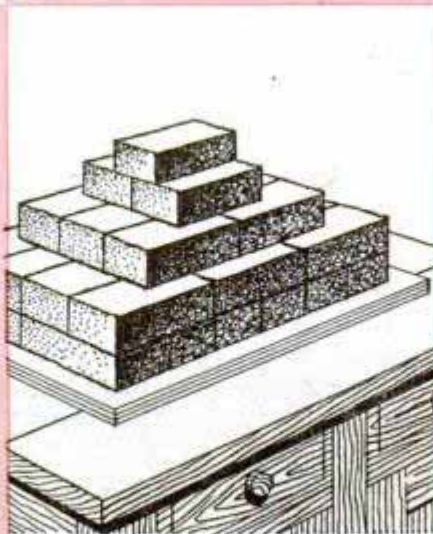

They make a good glue press for veneering, too. You can put a hundred pounds of uniform pressure where needed

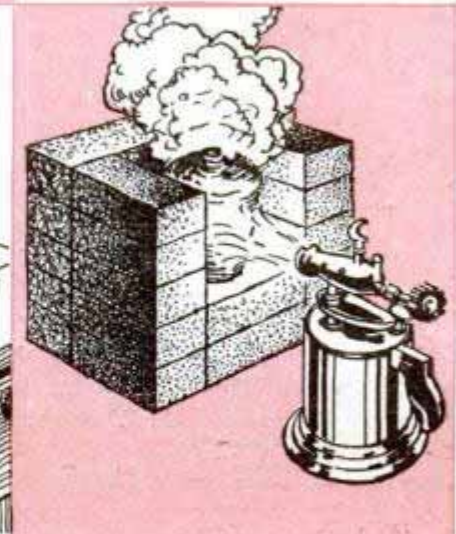

Or stack 'em up like this to make a furnace for soft metals. Arrangement is safe and bricks concentrate heat on crucible

Shiplap Is Used For Siding

If bevel siding isn't available when you want to make a garage or small service building, shiplap can be used as a substitute. The method of nailing it to the studding is indicated in the left-hand detail, one nail being driven through half the lap in each board. When shiplap is to be used as siding for a house, it must be nailed over sheathing.—Ray Harrison, Ft. Qu'Appelle, Sask., Can.

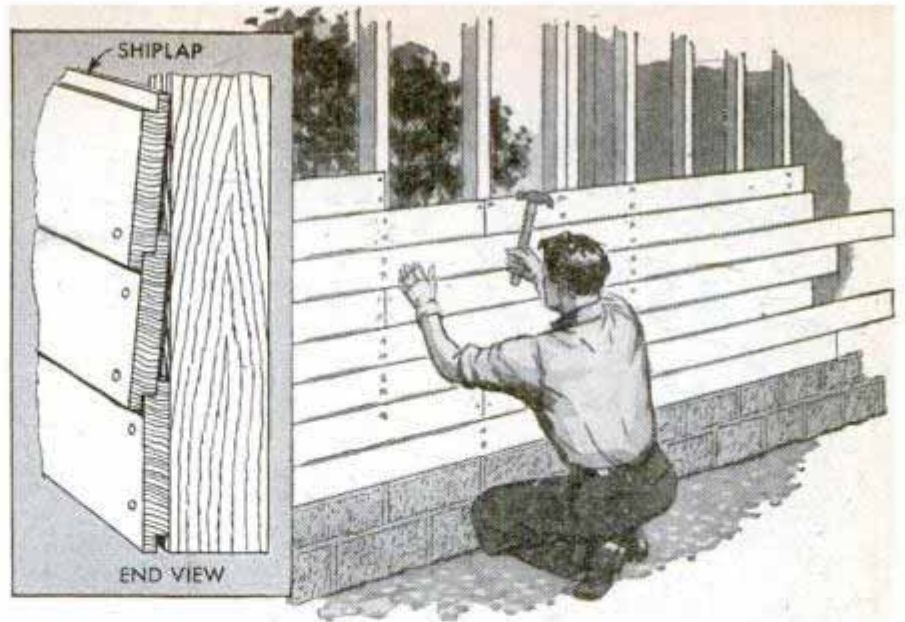

Burned-Out Cartridge Fuses Furnish Handle Ferrules

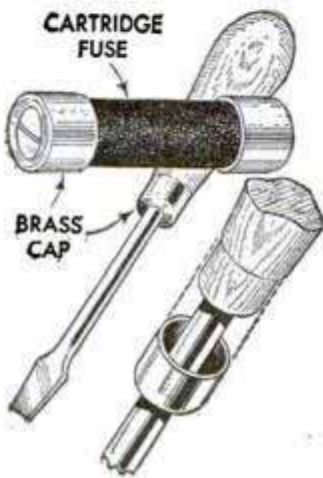

Ferrules for hand tools may be made from the end caps of cartridge fuses by cutting holes large enough to fit over the tool shanks. Since these fuses come in a variety of sizes, it is possible to fit many sizes of handles. Ferrules should always fit snugly.

Spare Key Fastened to Wallet

An important spare key can be carried in your wallet or billfold, ready for emergency use. It is bolted to an inside corner with washers on each side to prevent the bolt from pulling through. Although a standard-size nut is shown, a machine screw and thin nut would be less bulky.—Vernon Gzowski, Halifax, N. S., Can.

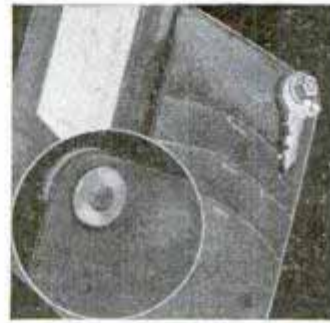

Light Bulb Used as Fire "Bomb"

Those burned-out light bulbs around the home aren't as useless as they seem. To make them serve as fire extinguishers or "bombs," saw off part of the base and break out the filament with an ice pick, cleaning out any irregularities. Fill the bulbs with carbon tetrachloride and cork the opening. The bombs can be left in various strategic spots in the house. When throwing them at a fire, direct the bombs toward the base of the flames.—A. J. Post, Whittier, Calif.

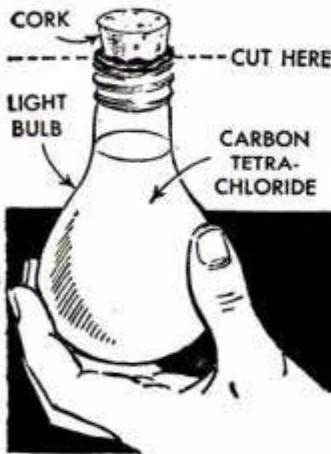

Sealing Holes in Can of Milk To Keep It From Spoiling

After holes have been punched in a can of condensed milk and some of it has been used, the milk will keep better if the can is tipped so that a film seals each hole. In a short time the liquid will harden and keep the air out. A toothpick or table-fork tine will break the seal when it is desired to use the milk again.

Jack Dempsey, Seattle, Wash.



White blotters, kept in a sideboard drawer, are useful in soaking up liquids spilled on the table.

DYE YOUR PLASTICS ANY COLOR

DYES for plastics can be obtained in all colors and are a useful aid to the craftsman seeking decorative effects. The actual job of dyeing is simple—just dip the plastic, let it soak from 1 to 5 minutes, depending on depth of color desired, and then rinse in running water. Although the dye is a surface coat, it bonds perfectly.

The dye vat can be any kind of tall can or a glass tumbler. A metal tube, flattened as in Fig. 2, is useful for dipping long strips. A coarse metal screen, Fig. 1, keeps the plastic clear of the container bottom. Dyes can be rebottled and used repeatedly. However, the dye evaporates very quickly in an open dish. Keep it away from an open flame when using.

Although over-all colors are the most practical, it is possible to obtain two-tone effects by masking. Fig. 3 shows a plastic square masked by dragging liquid glue across it to form a pattern. After dyeing, the glue

FLATTENED TUBE FOR DIPPING STRIPS



washes off in the water rinse, exposing the pattern as in Fig. 4. Silhouettes and straight lines can be similarly worked, thinning the glue as needed. Paper masking tapes are not suitable as the dye seeps under the edges. A special masking tape is available which is designed to avoid this fault.

Dyes are easily made as in Figs. 5, 6 and 7. Just use a dry-powder stain soluble in oil, the same product that is used in making wood stains. Mahogany makes a nice red; walnut a clear yellow. If prepared plastic dyes are used, they should be straight colors: oil red, oil blue, oil green, etc. Excess stain and impurities are fil-



MIX ACETONE AND WATER



ADD POWDER-FORM OIL STAIN



FILTER THE MIXTURE

*Laminating dyes
make colorful mattles*

tered out, Fig. 7. Most drugstores carry filter paper and acetone.

Laminating dyes are made by dissolving a few shavings of thermoplastic in 1C cement which is used in cementing this "glass" product. Then add oil stain for color. This product cements and dyes in one operation and is particularly good for mattles as shown in Fig. 8. The various colors should be streaked on with a matchstick, Fig. 9. They probably will dry before the job is complete, but are redissolved by quickly applying a generous portion of clear cement—

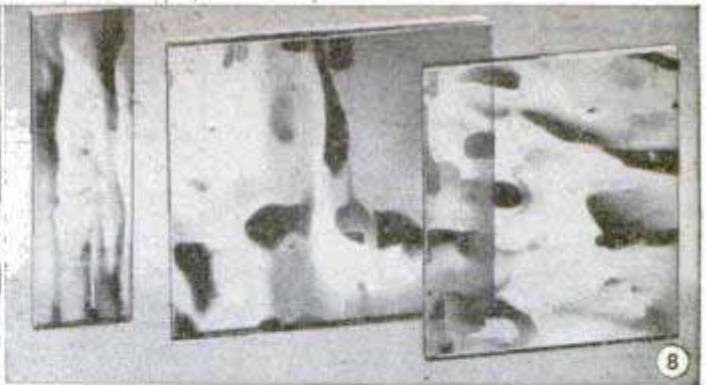

9

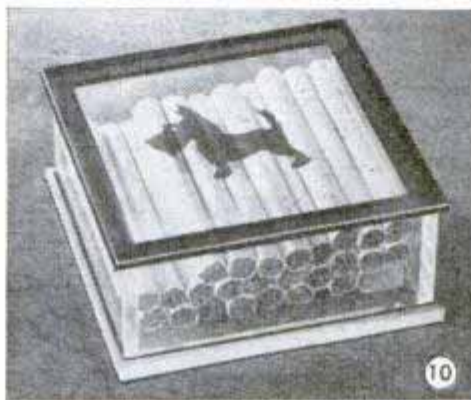

10

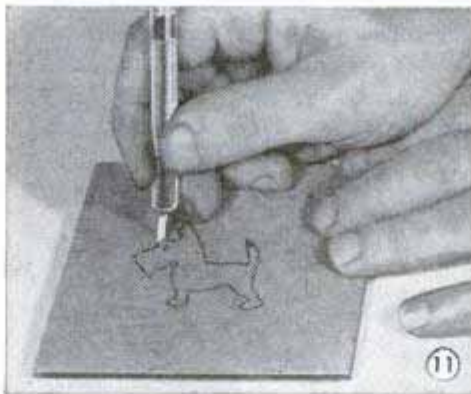

11

added—to the center of the work, after which the top piece is pressed in place. Squeeze gently to spread the cement and force out air bubbles. If clamping pressure is used it should be very light.

Dye inlays can be worked with plain dye by using a glue mask as already described, or by using the laminating dye. The latter can be masked off to a sharp, clean edge. Finished inlay, Fig. 10, is perfectly bonded. The original paper cover on plastic can be used as a mask, cutting out the desired figure with a stencil knife, Fig. 11. Colored dye-cement must be applied by flow-coating, as shown in Fig. 12. It is impossible to spray or brush the material because of rapid drying. Thus applied, the design will be translucent and will have a gloss equal to the plastic.

Concentrated dyes which can be mixed with 8 to 12 parts of water are available and are useful for certain types of work. Application requires heating the dye bath to about 190 deg. and then immersing the work for 1 to 5 min., depending on depth of color desired. However, heat of the dye bath tends to warp the plastic. For most craftwork the chemical dyes are preferable.

In general, work to be dyed can be colored before or after assembly. If dyed before assembly, the pieces should be cut to net size. If any color effect is unsatisfactory, remove it by using a clear dip of acetone and water. Similarly, if a two-tone effect is wanted, the piece can be dyed one color all over, then dipped in a second color which will strip the first coat and deposit the second on exposed areas. An instant dip and rinse will color sanded edges.

Varied Sizes of Soldering Irons Made From Welding Tips



Soldering irons of many sizes to fit almost any type of work can be made from discarded acetylene welding-torch tips. A suitable point is ground on one end and the other is drilled and tapped for an iron shank that serves as a handle. Also drill a small hole at right angles to the center hole near the tip. Solder is fed through the small hole and flows out the center one.

Shovel With Detachable Handle Can Be Carried in Car

Although you may not need it very often, having a shovel in a car may save a tow bill when mired in mud or stuck in snow. This shovel, which has a detachable handle, will take little space in your luggage compartment. The handle is sawed so the shovel is divided into two equal lengths. Then a short length of tubing that will

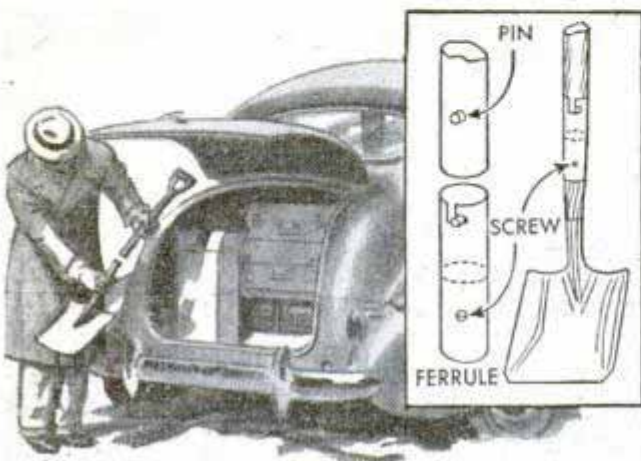

just slip over the handle is screwed to the lower half. A locking pin is fastened in the upper half. A slot is cut as indicated in the upper half. A pin to fit this is fastened to the shovel handle.

Quarter-Round Molding To Fit Over Obstruction

When applying quarter-round molding in old buildings, frequently the corners are caked with paint and the molding cannot be made to fit tightly, detail 1. In such a case, if the corner of the molding is planed off as in detail 2, a tight fit will result.—Arthur L. Dufour, Newcastle Bridge, New Brunswick, Can.

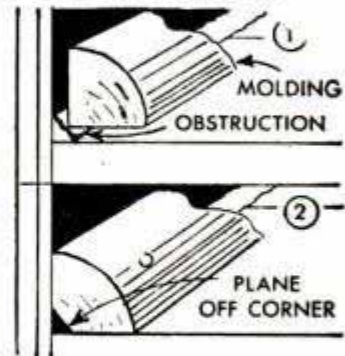

Reading Worn Numbers on Tires

Sometime, when you wish to read the serial number on the sidewall of a tire, you may find the figures so worn that they are illegible. To read the number, hold a piece of tracing paper over the spot and shade lightly with a pencil. After rubbing over the area, the numerals will become visible.

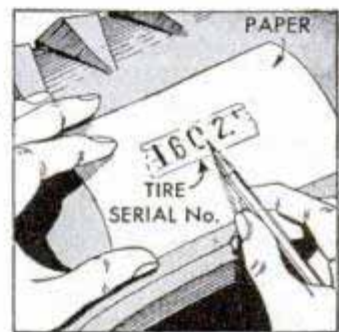

Burlap Holds Newly Seeded Lawn

To keep the rain from washing away newly seeded lawn on slopes and terraces, press sections of burlap bags into the earth. It is not necessary to remove the cloth as in time the grass will grow through the burlap and the fibers of the bag will rot. With this treatment, the lawn becomes well set.

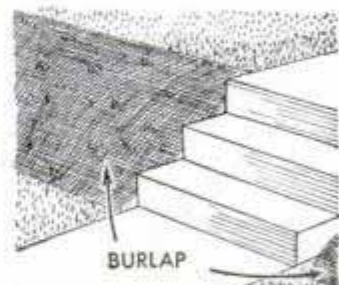

Owners of metal boats will find that a painting job will last longer if applied during cool weather, as in the spring. Paint that has been put on during hot weather when the metal is heated is more likely to blister and peel off, exposing the surface underneath.

Kitchen Wastebasket Swings Underneath Sink

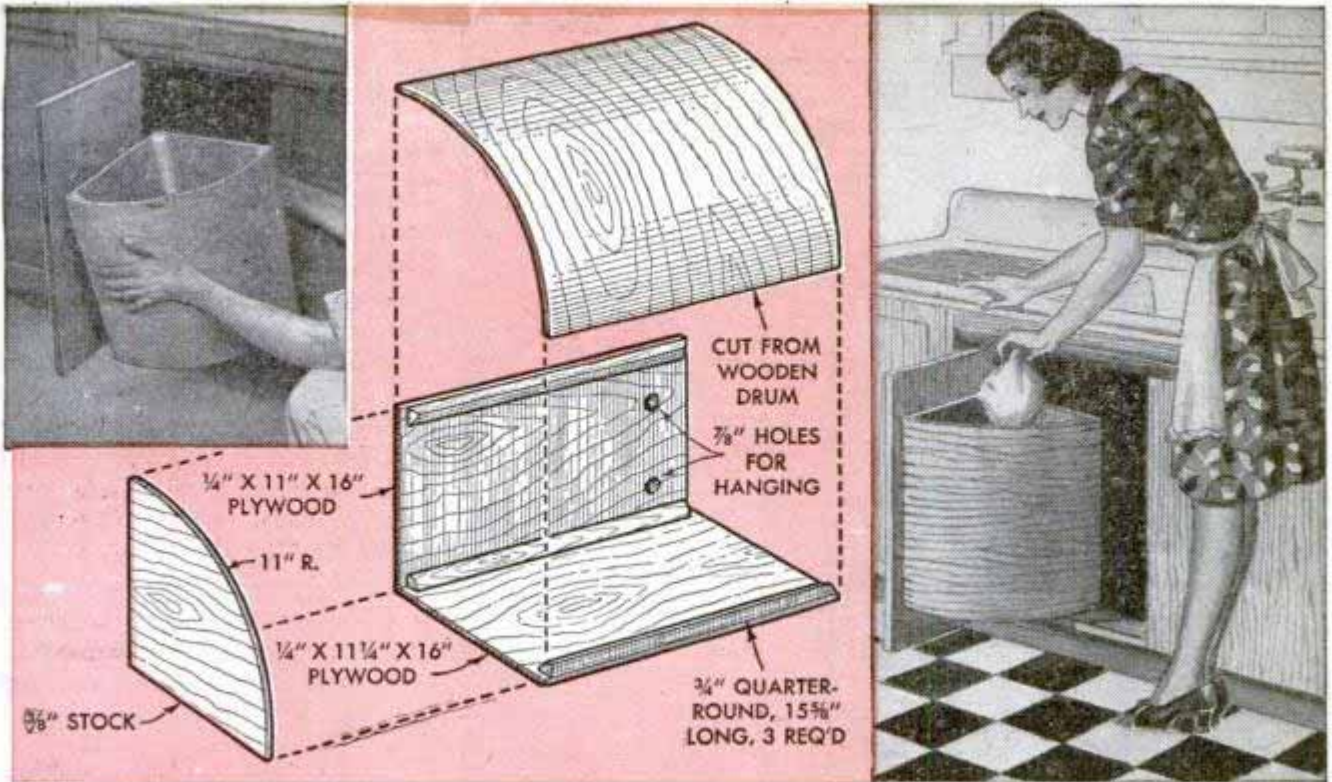

Hung inside the door of a cabinet sink, this handy kitchen wastebasket may be lifted off the supporting hooks, carried out for disposal and replaced in a jiffy. The flat sides are made from pieces of $\frac{1}{4}$ -in. plywood, the bottom from $\frac{3}{8}$ -in. stock and the curved side is cut from a wooden drum.

The three quarter-round strips to which the sides are nailed can be found in most workshop scrap piles. Dimensions for the parts and the method of assembly are shown in the center detail. Two coats of paint or varnish make it easy to keep the basket clean.—Benj. Nielsen, Aurora, Nebr.

Cork Holder for Fishing Flies Is Slipped Over Hatband

With a wire hairpin and a round piece of cork you can make a holder that will keep three or four of your favorite fishing flies in your hatband where they can be reached easily. Select a cork from a wide-mouth bottle—the larger the diameter of the cork the more flies it will hold—and cut a section about $\frac{3}{8}$ in. thick to form the body of the holder. Then bend an ordinary wire hairpin so the ends can be slipped into the cork and use the pin as a clip to hold the cork on the hatband. The flies fit into the edge of the cork.



Separating Fishing-Rod Ferrules

The ferrules of fishing rods that have not been taken apart when stored sometimes corrode so that the rod cannot be disassembled without damaging it. To separate the ferrules, apply a few drops of carbon tetrachloride to the joint and let it penetrate and dissolve the corrosion. After half an hour or so the rod can be taken apart. Then polish the corroded spots with a fine grade of emery cloth and apply light oil.

Pointers on SOAP-BOX



Above, Gilbert Klecan of San Diego, Calif., winner of the final heat of the 1946 All-American Soap Box Derby. Below, Klecan's car nosing over the finish line

WINNING the 1947 All-American Soap-Box Derby is not just something to dream about—it's going to be done by some boy with ingenuity, initiative, skill, designing ability and a willingness to compete with the best the field has to offer in a spirit of four-square sportsmanship and fair play. But to enter this great event you have to build and drive your own racer. The first rule is, know the rules. These have been carefully thought out and are designed to give everybody an equal chance. That means you get a 1947 copy and study every page — thoroughly — until you know every detail of the entry requirements. Then remember this: Both the speedy little racer that won the top honors last year and the boy who drove it to victory over the field were better than just good. All of them were good but one was a little better than the rest. This year it's your job to be a still better driver with a better, faster car.

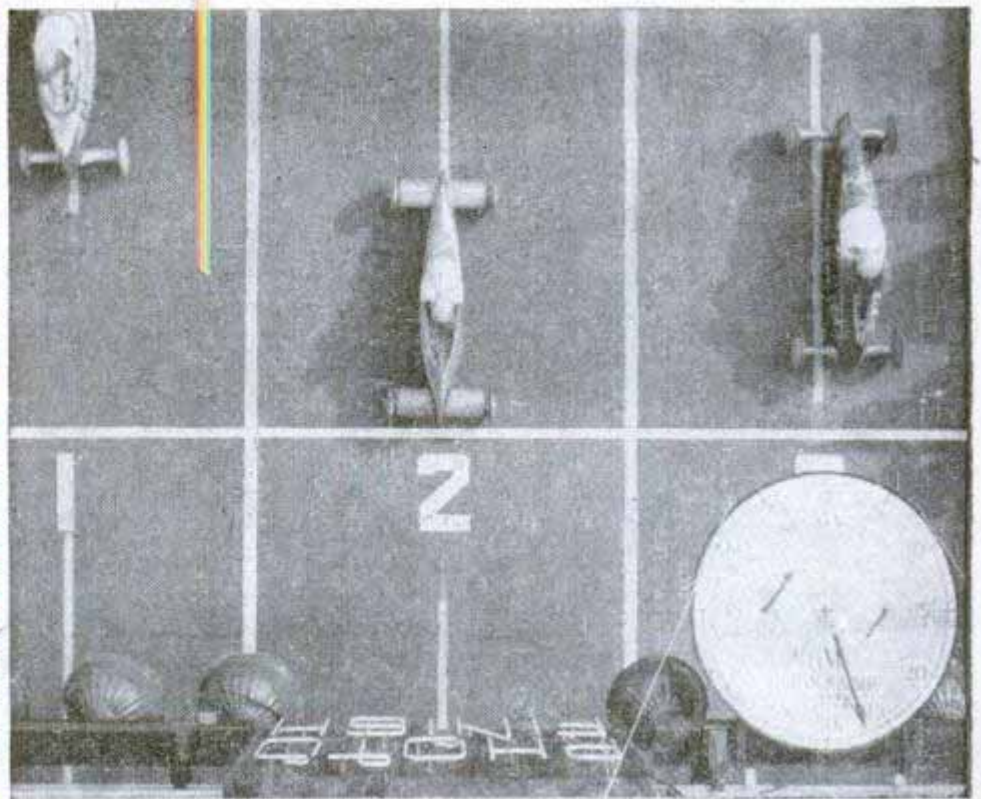
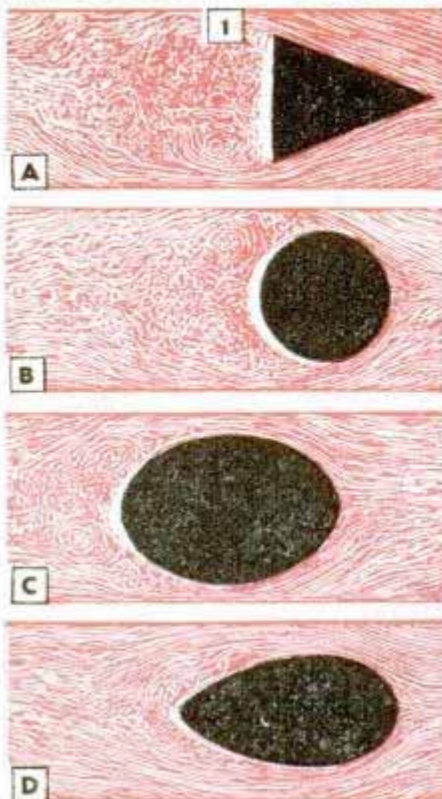

Racer Design

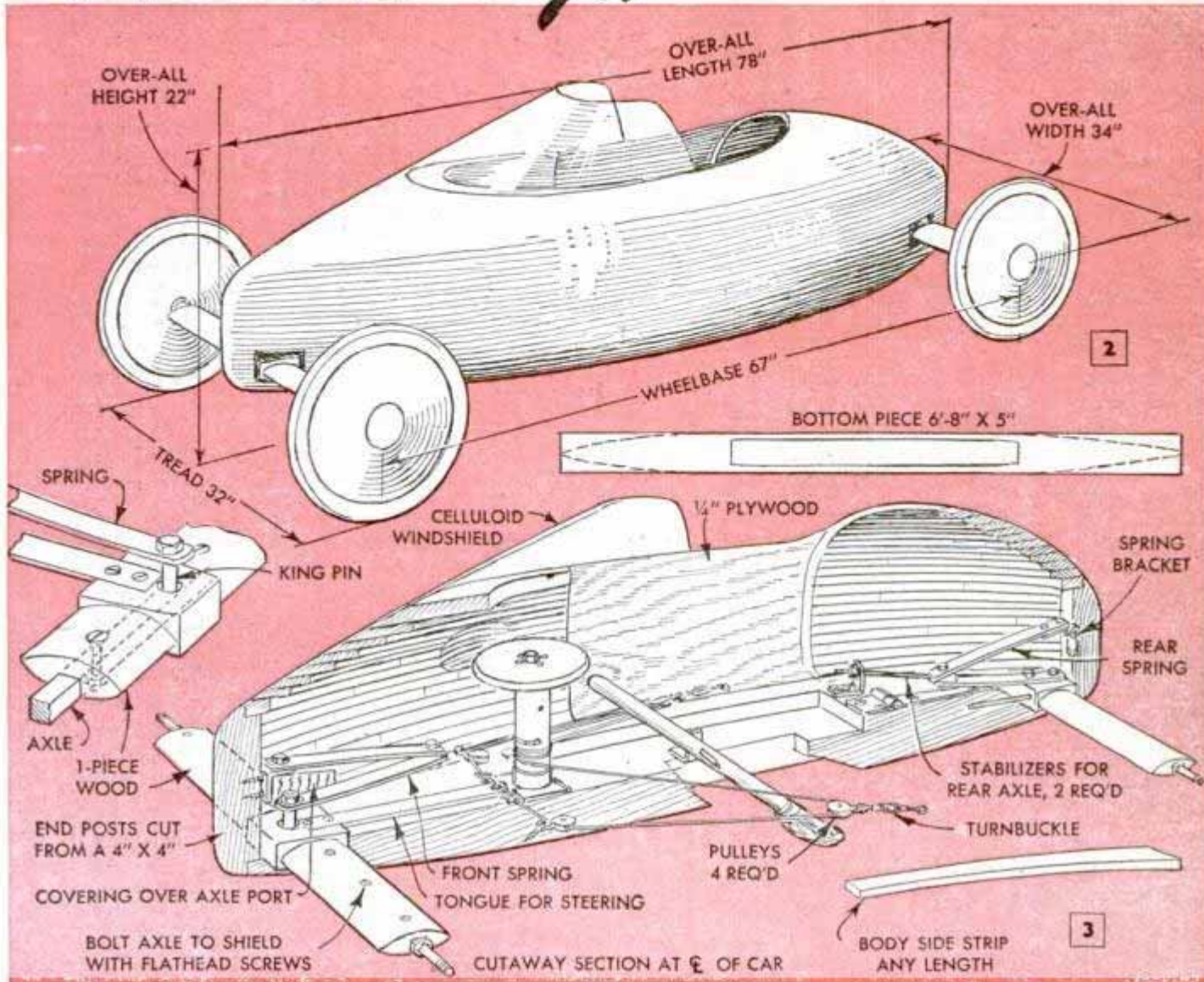

One of the rules says that "the car must be boy-built" and that's exactly what it means. But, you'll notice, it distinguishes clearly between advice and actual help. That's important, too. However, before you go searching for verbal help and suggestions from friends, think of this maxim: It obviously would be impossible to incorporate the ideas of these good people, all anxious to help you, into one racer. After you've thought about this angle you're sure to decide that it's better to consult with the best authorities you know, absorb their ideas and then combine such of these as you can use with your own. Your own ideas are of the greatest importance for with them you're going to build your racer—you have just as good a chance as anyone else of coming up with the winning car.

A study of the details in Figs. 2 and 3 will give you a good idea of the important points of soap-box-racer design. This little job is tops, too. Built and driven by Claude Smith of Akron, Ohio, it took both National

and International Championships in the 1941 finals at Akron. When you compare construction details with your 1947 rule book you'll see that two features of the Smith racer are no longer allowed. One is the hand-operated drag brake. That's out now. The drag brake must be foot operated. Also, the nose, or body, of your 1947 model racer must project beyond the front wheels. No tow hook is permitted. The body of the Smith car is sprung to the axles in a skillful and unusual manner. Springing still is permissible, but is not necessary in the simple designs now being approved. Although springs add legitimate weight, they are rather difficult to calibrate accurately. If springing is too "soft" the car is very likely to sway or roll, faults which can easily lose a race.

Figs. 4, 5 and 6 suggest methods of making steering gear, brakes and axles. Although these are officially approved methods you do not have to follow the suggestions in every detail. But be very sure that you

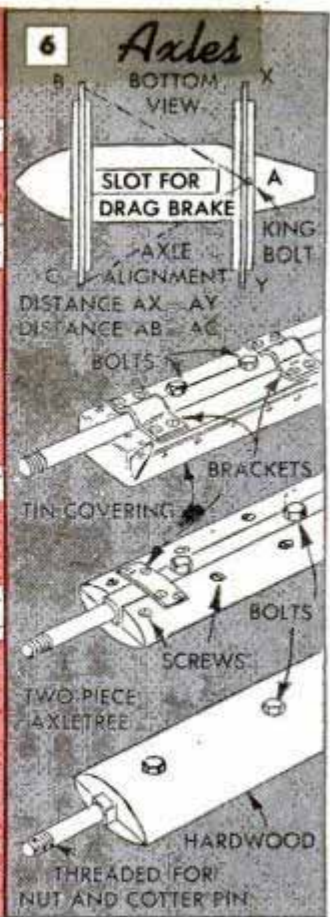
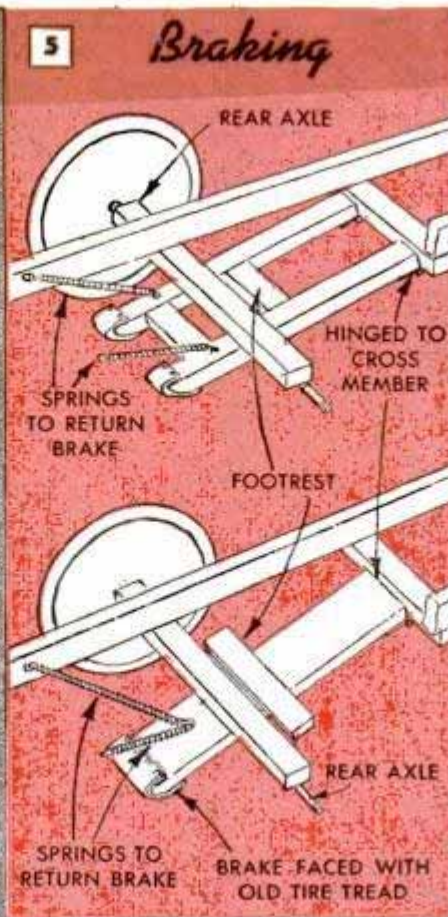
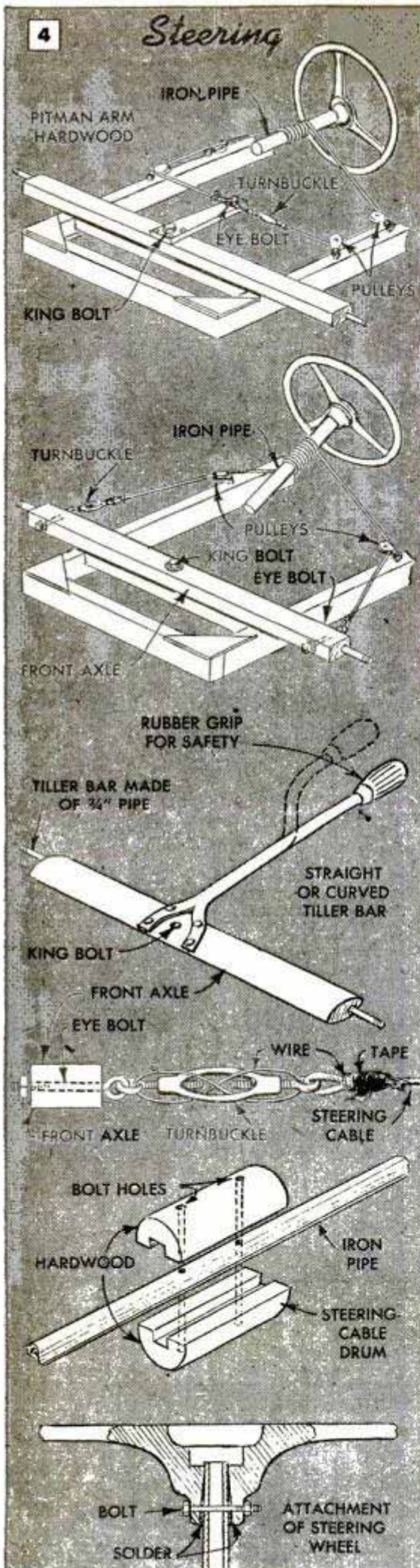

stick to the rules when making changes or using original ideas, otherwise you take the chance of having your racer disqualified. You'll note from the rule book that there's considerable latitude permitted in the construction of the steering gear. But however you design it—in accordance with the rules—test the gear by trial until you are absolutely sure of its performance. A gear that permits the front wheels to "wander" ever so slightly is almost sure to lose you a close race. A reliable steering gear also contributes to the safety of both yourself and others on the track and along the sidelines. Safety is being continually stressed by race officials, so keep it always in mind when building your car. For all practical purposes streamlining a slow-moving object or vehicle is of little importance. But as speed increases the value of a shape that will slip through the air with a minimum of resistance will be apparent from Fig. 1. Here the black shapes A, B, C and D represent bodies moving to the right through air. The red lines indicate the behavior of the air as the various shapes pass through it. Parting causes comparatively little disturbance but the turbulence and eddying of the air stream just back of the first two shapes indicate a heavy drag which would tend to retard forward motion. Now notice the three cars in the photo at the right of Fig. 1 and compare the body contour of all three with that of the "raindrop" shape, D, in Fig. 1. A modification of the raindrop shape, or as nearly as you can approach it with the materials and type of construction allowed by the official rules, is the ideal racer-body type. As you can see from Figs. 2 and

3 it is possible to achieve a practical job of streamlining with very simple body construction. Finally:

Don't start off wrong by buying just any kind of wheels. If possible, use only official Soap Box Derby wheel sets that comply with the strict rules. Official wheel sets have the official Soap Box Derby emblem.

Don't repaint the official wheel sets or remove the official emblem.

Don't forget about the over-all measurements of the car as specified in the rules.

Don't forget the entire weight of the car must be made up of parts and materials actually used, and necessary, in construction of the chassis and body.

Don't forget that the frame of the chassis must be made of wood and the entire body must be constructed by the boy who drives the car.

Don't forget that two or three boys cannot get together and build a car. The boy who drives the car in the race must be the boy who built the car.

Don't forget that the body of the car cannot be constructed with plaster or concrete. Both are prohibited. So is metal lath. But sheet metal, aluminum, paper, fiber wall-board, papier mache, plywood, linoleum, wire or cardboard may be used as a body covering.

Don't forget that the body must be so built as to permit easy inspection of all parts. The seat-back must be removable.

Don't forget that your car must have a road clearance of at least 3 in. with you in the car.

Don't forget that steering must be by hand.

Don't forget that steering connections of rope, chain or clothesline cable are barred. Steering may be by flexible connections which must be of woven wire cable, fitted with 2 turnbuckles, one on each side, that must be wired for safety.

Don't forget that suggested steering devices are: wheel, half-wheel, airplane-type wheel and tiller.

Don't forget that the nose must be the foremost part of the car. The nose must extend beyond the tires of the front wheels.

Don't forget that every car must be equipped with a drag brake.

Don't forget that glass is not permitted anywhere on the car.

Don't overlook the rule about total cost. No car may cost more than \$6.00 over and above the cost of the wheels and axles. Any steering device or steering shaft permitted by the official rules may be used regardless of the original purchase price, and need not be included in figuring the total cost of the car. Taxes and freight, express or postage charges are not considered as part of the total cost.

Spring Lug on Dome-Light Switch Holds It in "Off" Position



On some cars the dome-light switch is mounted on a side post where it can be turned on accidentally by anyone getting in or out of the car, or by a child climbing from one seat to another. And if the light is turned on during the daytime it is seldom noticed. To prevent this, fasten a lug made of spring steel to the switch plate, as indicated in the upper left-hand detail. This makes it necessary to lift the lug to turn on the light.

Herbert E. Fey, New Braunfels, Tex.

Snap-On Reflector Directs Light Where Needed Most

Adapted from a discarded flash gun, this reflector can be adjusted to direct light where it is needed most. The clip that snaps over the lamp socket is made of spring brass bent and cut to fit around the light switch. A short length of flexible tube connects the clip to the reflector, which can be adjusted to almost any desired position.

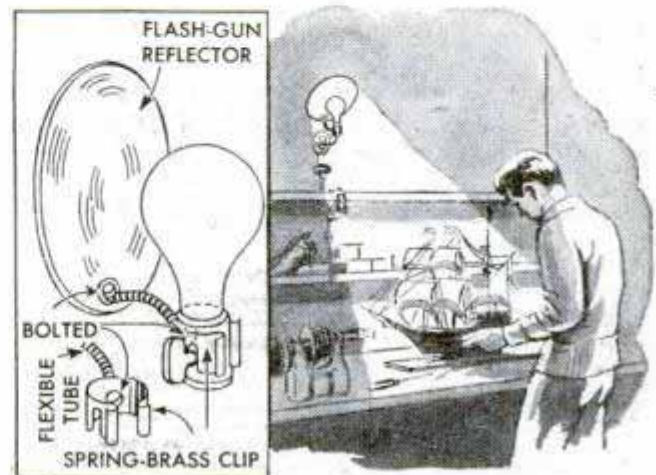

GET RID OF WINTER'S RUST AND SCALE

- ✓ CHEMICAL FLUSH THE RADIATOR
- ✓ REVERSE FLUSH RADIATOR CORE
- ✓ REVERSE FLUSH ENGINE JACKET
- ✓ CHECK THERMOSTAT OPERATION
- ✓ EXAMINE WATER HOSE FOR DEFECTS
- ✓ INSPECT THE FAN BELT FOR PLAY
- ✓ BLOW OUT THE RADIATOR CORE
- ✓ LOOK FOR WATER-PUMP LEAKAGE

Check ✓

SPRING means cooling system time—time to “clean house” on rust and scale and to take this eight-point precaution against **overheating**—the costly penalty of engine neglect. It’s corrosion—rust, lime and grease left by hard winter driving—that retards heat dissipation and becomes the unsuspected cause of scored pistons, bearings and cylinder walls, burned valves and warped and cracked engine blocks. So play safe and guard the motor against these costly repairs by cleaning the cooling system regularly.

Chemical flushing: Draining the radiator of antifreeze and then simply flushing with water is not enough. A good cleaner is needed first to loosen the rust and scale. Such deposits act as an insulator and, if allowed to build up, may in time clog the fine water passages of the radiator. There are a number of efficient cleaning compounds on the market. Alkali-type cleaners, such as washing soda, are not entirely effective. They cut grease and sludge but have no solvent action on hard rust. Be cautious and select one that does not contain strong

By Wayne C. Leckey

acids or caustics which might be harmful to the radiator core, and be especially careful if your motor is fitted with aluminum cylinder heads. Some chemicals used in cleaning preparations to loosen scale will also attack aluminum and damage the heads severely in a short time. After the cooling system has been drained, close both drain cocks and add the cleaner as in Fig. 1. Then refill and clean according to the directions.

Reverse-flushing core: The loosened particles are removed from the radiator most effectively by reverse flushing, that is, flushing in the direction opposite to that of the normal flow of water through the cooling system. This is done by first replacing the radiator cap, opening both drain cocks and disconnecting the lower and upper hoses. As shown in Fig. 5, the flushing is done from below and a drain hose is attached to the top. A satisfactory job of flushing can be done with a garden hose as shown in Fig. 2, although a more thorough cleaning is assured with a flushing gun which combines air pressure with water to



Don't be a Mr. Put-it-off. Make this eight-point inspection now and be ready for hot months ahead with a "cool" cooling system

increase the scouring action and send the water through the system in forceful spurts. If such a gun is not available, a garageman will do the flushing job for you. However, be sure that you remove the thermostat beforehand, as cold water will cause it to close and build up harmful pressure. Flush until the water runs clear.

Reverse-flushing jacket: The same thing is done now to the water jacket, Fig. 3, which flushes the particles out through the water pump in the manner shown in Fig. 5. Attach a drain hose to the water-pump inlet, insert the gun at the top and flush as before. Some cars require removal of the water pump before pressure flushing to avoid unseating the pump sealing washer and forcing water into the pump bearings. If the car has a water heater, it should be flushed out too, as rust particles will form in the heater core as they do in the radiator.

Thermostat test: After flushing, make sure that the thermostat is functioning properly. Normally, this can be checked by the gauge, but an accurate test can be performed by suspending the thermostat in water heated somewhat above the rated temperature, which is usually



Here's how rust, boiled out of water jacket, can build up to obstruct the radiator tubes



Test thermostat's working order. Gummy one that fails to open causes overheating

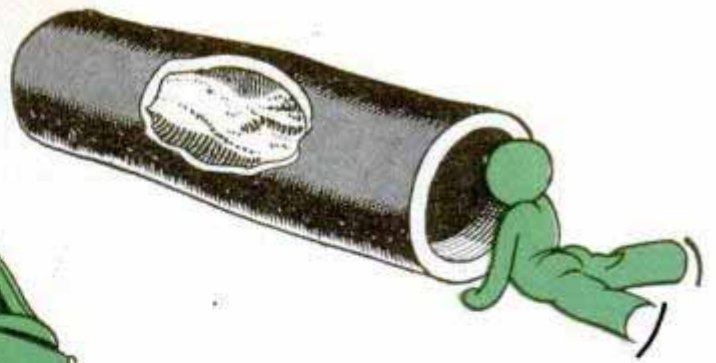

Radiator hose wears out too. Gradual deterioration loosens lining which may retard the flow of water, and particles of rotted rubber can be carried into radiator water passages

marked on the thermostat. If you find that the valve fails to open within 10 or 15 degrees of the rated temperature, it should be cleaned, if gummy, or replaced, as a faulty thermostat will cause the engine to overheat.

Water-hose checkup: Don't replace the radiator hoses without first examining them carefully, especially on the inside, for deterioration. If there are signs of rotting, replace them, as loose particles of rubber may clog the water passages of the radiator. Also, too soft tubing may collapse from suction. When replacing either the old or new hose, use gasket shellac on the metal parts over which the hose slips to assure an airtight seal at this point, and draw up the hose clamps tightly. Now, refill the radiator, preferably with soft or rain water. Lime in hard water causes scale to form in water passages much the same as it does in a teakettle. Bring the water level to about $\frac{1}{2}$ in. above the top of the tubes in the radiator. Avoid "filling" either summer or winter. Be sure to add a can of rust inhibitor, too. With a good active inhibitor in the water, rust can be kept to a minimum.

Fan-belt play: A loose fan belt is another source of overheating. If it slips, the fan speed is reduced. If it is too tight, there is excessive wear on the bearings. Adjust the fan pulley so that the belt can be depressed only about $\frac{3}{4}$ in. as in Fig. 4, and wipe off any grease that would cause the belt to slip.

Blowing out radiator: With dirt, insects and other foreign deposits clogging the air passages in the radiator core, heat dissipation is greatly reduced. Force out such deposits by directing a strong stream of water from a garden hose through the core from the rear. A bug screen is a good investment to keep these passages open.

Water-pump leakage: The water pump can be guilty of rust formation, too, by allowing air to enter the cooling system through a leaking packing gland. Oxygen in the air mixing with the cooling water in-

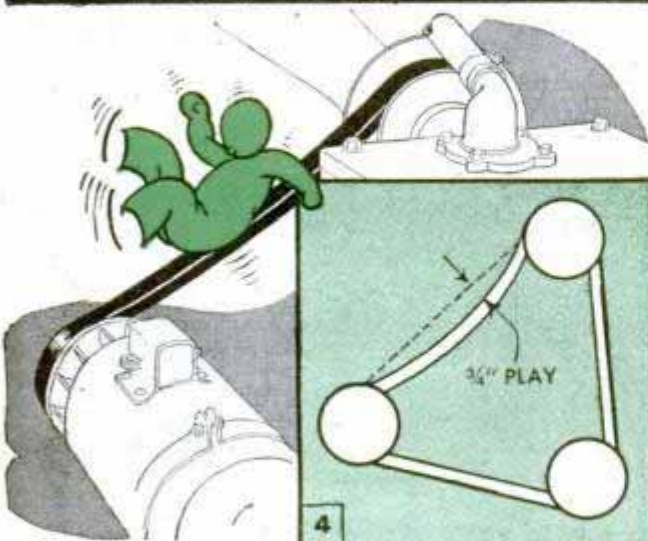
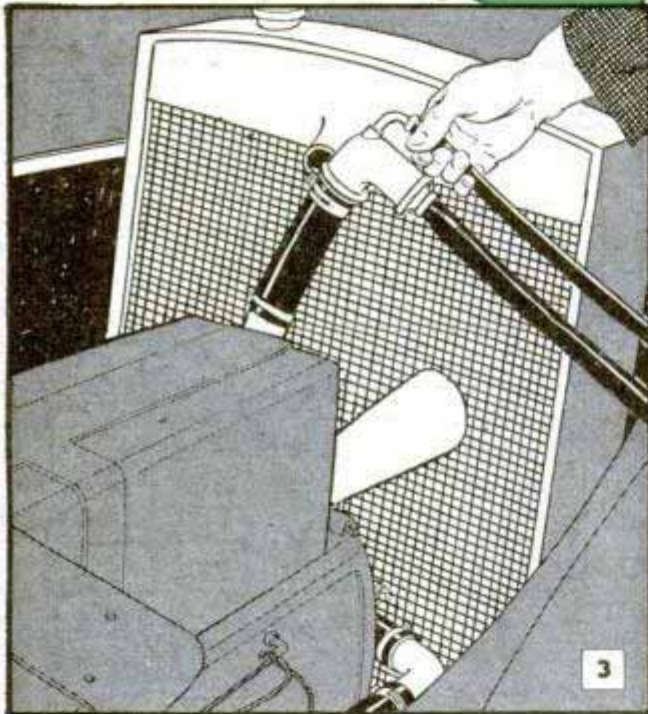

Cooling system suffers when fan belt is too loose. Both fan and water pump do their best when belt has $\frac{3}{4}$ -in. play. Tight belt wears bearings prematurely

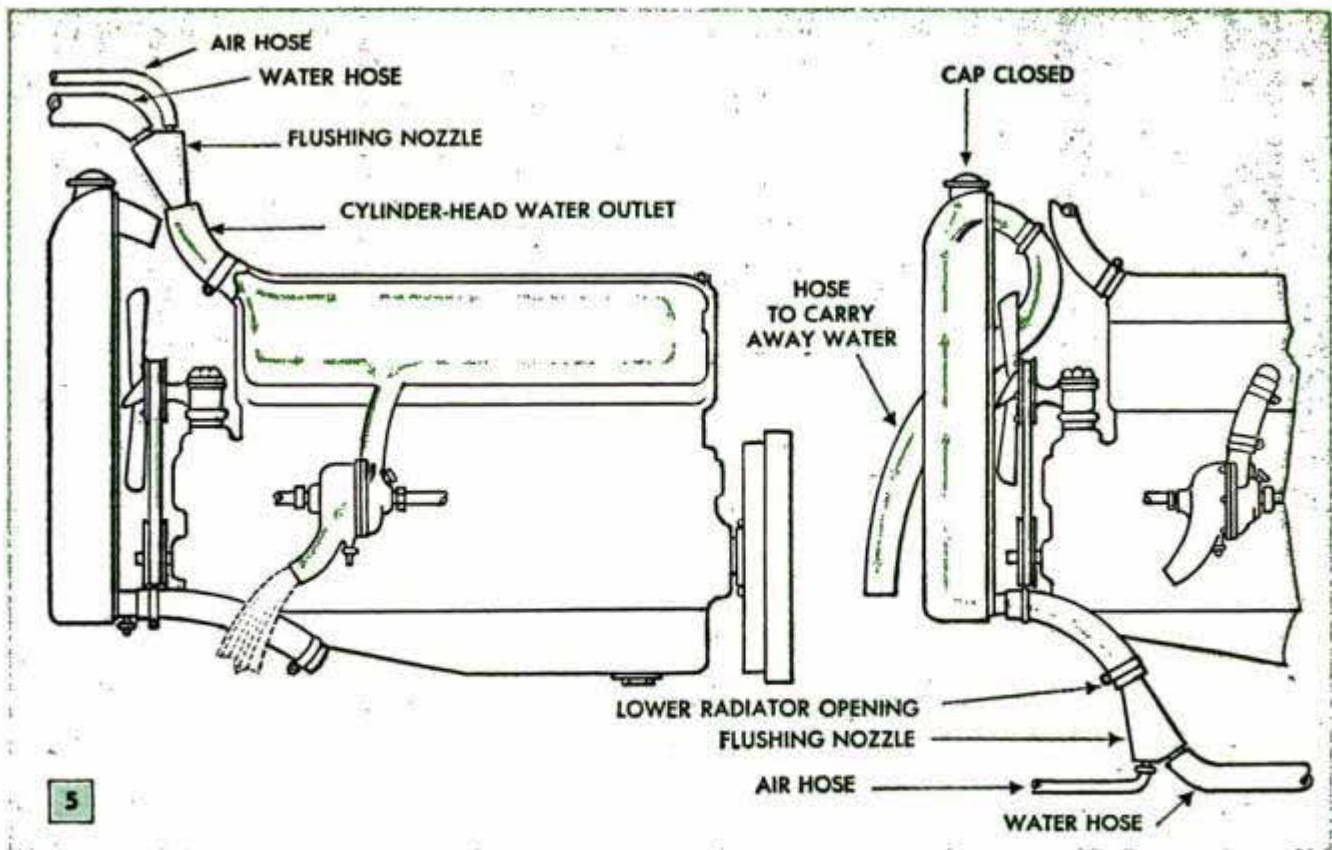

5

creases rusting of the metal parts. Also, besides losing water along the pump shaft, air sucked in at this point causes a turbulent bubbling action of the water which results in loss through the overflow pipe and consequent overheating. Check for leakage while the engine is running, and repack the gland if necessary. Don't overlook grease and dirt on the engine. Even a thin accumulation acts as insulation and reduces heat radiation. Use a good grease remover, but avoid inflammable solutions and do the job outdoors. Don't start the engine before it has dried thoroughly. A loose cylinder head or a damaged gasket will allow gases, which contain strong corrosive acids, to enter the cooling system and speed the formation of rust. A telltale indication that leaks have developed is the presence of a rusty stain along the seam. Tightening the cylinder-head bolts sometimes will stop such a leak. However, if the gasket is actually broken, it should be replaced. In taking up on the bolts, care should be used to avoid cracking the head by tightening it unevenly. Check the front and rear of the engine water jacket and cylinder-head joint, and also the underside of the bottom tank of the radiator. Internal leaks may not be serious enough to cause loss of liquid into the cylinder or crankcase, but they may allow loss of gas from the combustion chamber into the water jacket. While this is not too serious, it's the gas bubbles in the water jacket that displace liquid and consequently raise the water level above the overflow.

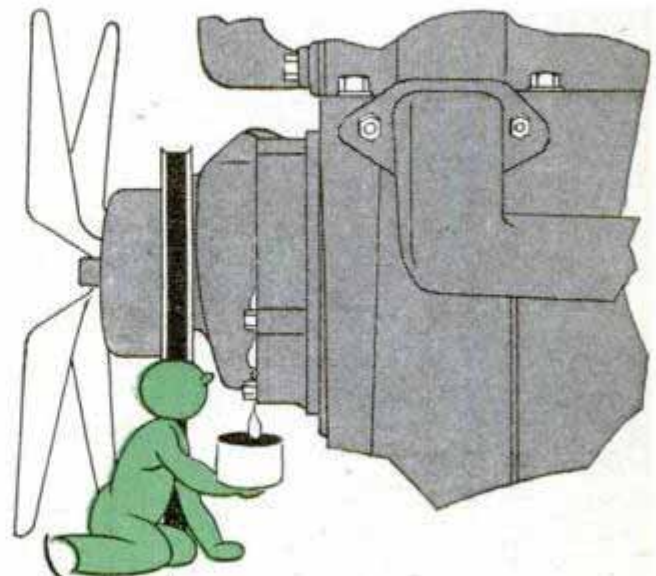
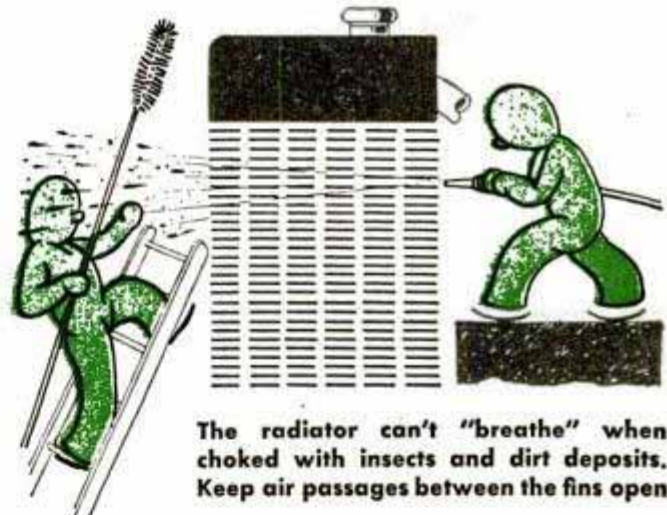

Watch for possible leaks at the water-pump packing gland. Air sucked in at this point causes water to foam excessively, resulting in loss through overflow

Antique Utensil Smoking Set

Best made as a lathe faceplate project, these antique cooking utensils are turned in miniature to serve as receptacles for matches, loose cigarettes and packs of cigarettes. First rough-cut three blocks of white pine about 3 in. thick and 3 in. in dia. Then turn the inside and outside, and sand to a fine finish. The legs for all three pots, as well as the handle for the left-hand one, are turned on the lathe also. Rings and bail are made of wire.—Wm. H. Freeman, Baldwin, N. Y.

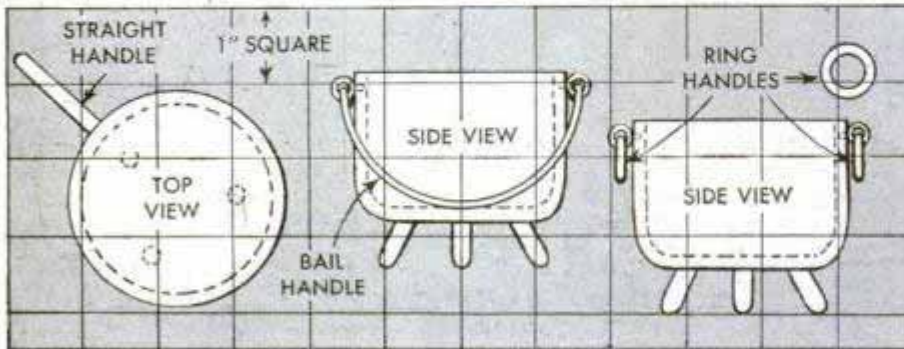
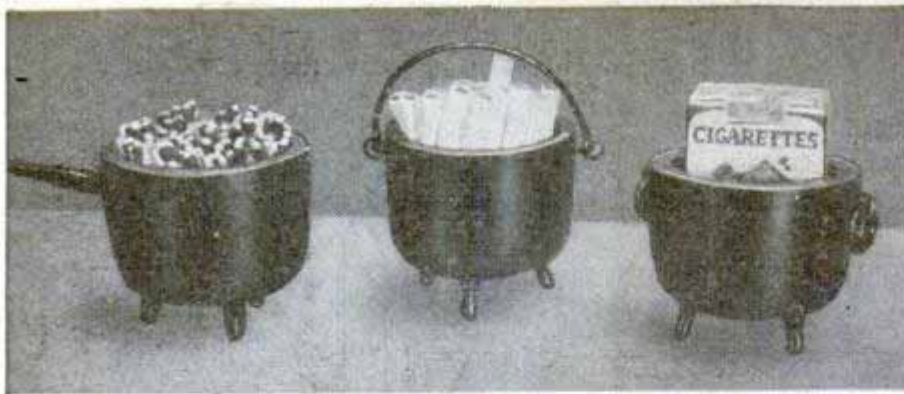

Unusual Timepiece for Playroom

To add a touch of the unusual to a playroom, you can make a novel timepiece that has a phonograph record for a face. Take the works from an old mechanical alarm clock and substitute the record for the regular face. Instead of numbers, paste on small pictures of your favorite recording artists to represent the hour numerals.

Robert S. Martin, Iowa City, Iowa.

Roll Top From Discarded Desk Handy on Workbench

If you have the upper half of a small roll-top desk, it will be handy as a container for tools, blueprints and other odds and ends in the workshop. One advantage is that you can pull the top down and lock it when you're not in the shop.

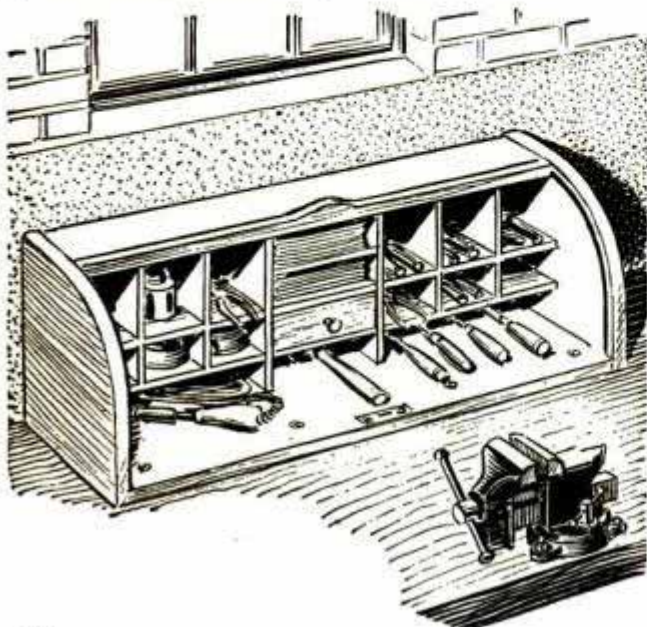

Screwdriver Shank Is Insulated With Rubber Tubing

When working around "hot" wires with a screwdriver, there's always a chance of getting a shock. To minimize this, slip a length of rubber tubing over the shank, detail A. Detail B shows another use for the tubing. It is slipped over the head of a screw to aid in starting it. — Roy G. Loughary, Portland, Ore.

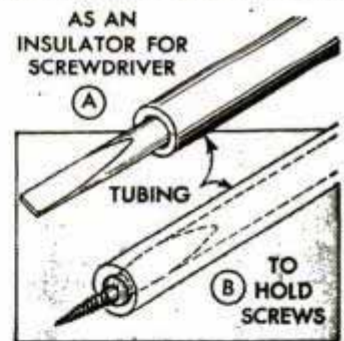

Emergency Washboard at Camp

About 25 or 30 ft. of sash cord or clothesline and a board about 10 or 12 in. wide of a suitable length, can be made to serve as a washboard. Wrap the cord around the board and knot the ends after passing them through holes drilled for that purpose. After the washing is done, the cord is removed to do double duty as a clothesline. — Jack Bronte, Colfax, Calif.



❏ Don't discard worn full-length bed sheets. Cut them into four equal squares, hem the edges and use them for crib sheets.

How's Your Reflex?

Long a favorite among many, a reflex camera, like any other type, sometimes develops ailments that must be corrected to get best results. Here's how you can keep this camera in tip-top condition

By Walter E. Burton

There are two general types of reflex cameras; one has a single lens that directs the image to a ground-glass focusing screen, with the mirror swinging out of the way just before the shutter operates. The other, the twin-lens reflex, has a fixed mirror behind a viewing lens and a second lens for taking the picture. In the latter type, the two lenses move simultaneously and are matched so the image on the ground glass is the same as that which appears in the picture. The single-lens reflex has a focal-plane shutter, while the twin-lens type usually has a between-the-lens shutter.

As far as the finish of the camera is concerned, a little attention with some shoe polish, touch-up lacquer, leather and glue will remove a shabby appearance. Areas that are finished with baked enamel are a little more difficult to restore, but the application of ordinary brushing lacquer will help. Never apply a glossy finish to the inside of a camera. There are special dull finishes for the interior that can be applied as in Fig. 1. Blackboard paint is another material that some photographers find satisfactory for this purpose.

One of the first points to check for repair in a single-lens reflex camera is the focal-plane shutter, removing it if necessary. The shutter curtain should be examined for tears, breaks and pinholes. Pinholes that are revealed by holding the cloth in front of a strong light are covered with black lacquer, Fig. 2. An opaque cloth sewed with black silk thread is necessary for larger patches. Use cellulose cement to further secure the patch, and paint needle holes with black lacquer.

When assembling a focal-plane shutter, be sure that the control-knob gears for slot opening and tension mesh so that the dial reading for the opening corresponds with the correct curtain position, and the tension click control is in step with its dial. The tension spring is wound to exert a definite pull that determines the speed of the curtain movement. One way to position the curtain on some focal-plane shutters is to center the fullest opening over the film aperture at the back of the camera while the plate covering the shutter control is removed. Turn the knob or key for this plate until the letter "O" is in position and bring the teeth of the gear and the shaft pinion into mesh. When adjusting the shutter, the tension spring must be wound and held until the tension-control plate is installed. With the tension at "1" and the shutter control at "O", the curtain tension for this type of camera should be just

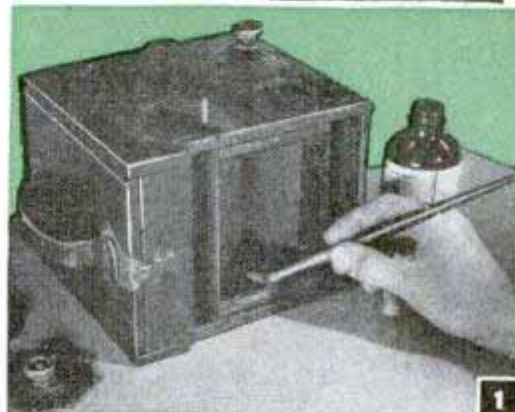

When touching up the inside of a camera, always use a dull, light-absorbing paint

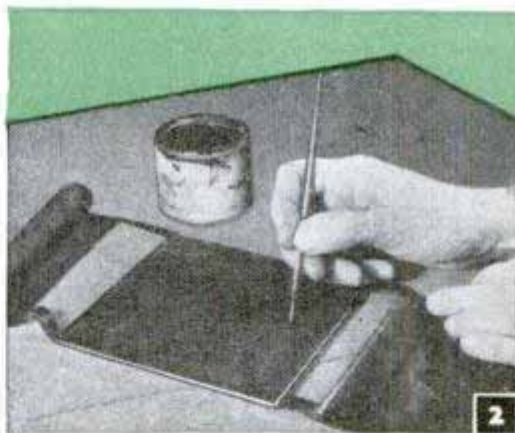

Pinhole light leaks in a curtain shutter are covered with a black, opaque lacquer

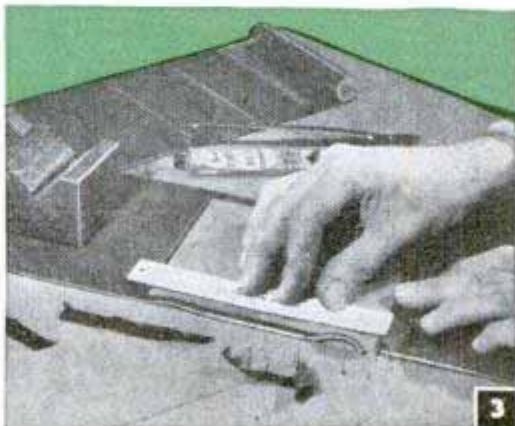

After repairing a break in a shutter opening, be sure that all edges are parallel

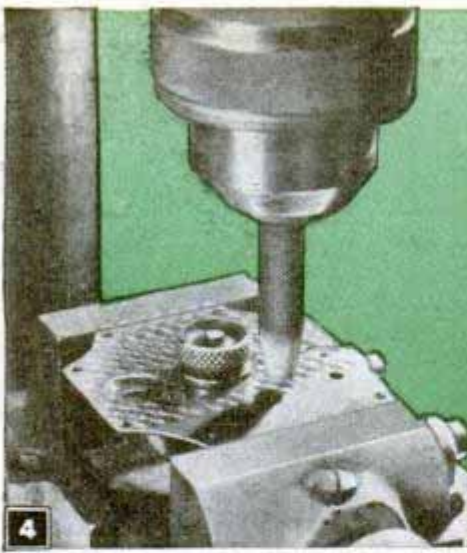

Exposed metal parts can be finished by spot polishing in a drill press

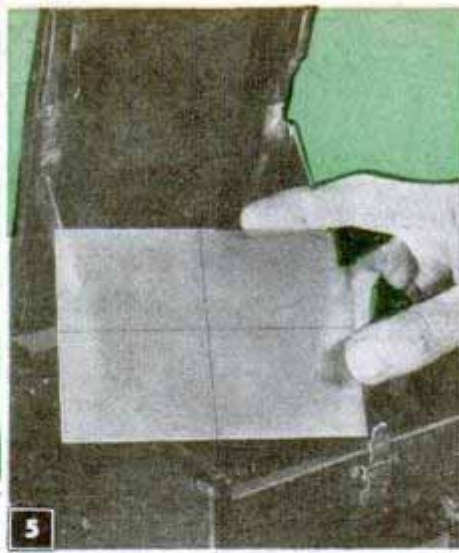

Cross lines ruled on a ground glass will aid in composing the picture



Shoe polish or leather dye is used to touch up the bellows

enough to move the curtain to the closed position. When repairing a curtain shutter, and a break affects the horizontal spacing of a slot, use a scale to make certain that the edges are parallel, Fig. 3. One way to test shutter speeds after replacing the curtain is given at the end of this article. Other methods are found in reference books.

Exposed metal parts that are worn may be covered with paint or lacquer. Or such parts may be removed, polished and then treated chemically to restore the "oxidized" finish. Also, the parts may be polished and chrome plated, or cleaned with fine abrasive cloth and then spot polished. This is done with a polishing stick made by gluing a small disk of abrasive cloth on one end and then using it like a bit in a drill press as in Fig. 4. Finish with a coat of clear lacquer. Leather bellows may be repaired by cementing kid-glove material over the break and covering with leather-shoe polish or dye, Fig. 6, followed with a coat of wax shoe polish. The fabric or leather hood is repaired in the same manner.

Movement in a rack-and-pinion focusing mechanism may be rough and stiff, or too free. In the former case, roughness may be caused by damaged teeth on the rack-and-pinion gears which can be touched up with a file. Often stiffness is eliminated by cleaning the gears and racks with a solvent, using a stiff wire brush. Excessive play may be due to worn pinion-shaft bearings or loose screws. Sometimes play can be removed by installing strips of bronze shim metal in the bearings or between sliding surfaces, or by shifting the bearings toward the racks. If the camera front is at an angle, with one side moving ahead of the other, one of the pinion gears is probably a tooth or so ahead. In this case, remove the pinion, straighten the front and re-install the shaft.

If it's necessary to remove the ground-glass focusing screen, always note whether its rough surface is toward or away from the lens and replace it in the same position. Clean the glass with soap and water. For composing a picture, it is helpful to mark the center of the focusing area with cross lines, Fig. 5. India ink applied with a ruling pen is used. Cleaning the mirror is a delicate operation since such mirrors usually have the coating on the front surface, protected by a thin layer of lacquer. When replacing a mirror, have the silvered surface in the same plane as that occupied by the original one. If the aperture marks and index lines are hard to see, clean them and refill with porcelain retouching enamel as in Fig. 8, wiping off the excess paint.

The lens on a single-lens reflex may be mounted in such a way that it has to be racked out a considerable distance before objects at infinity are in focus. This limits distance for close-up work because of the lessened amount of available travel. If space in front of the lens permits, an extension ring, Fig. 9, may be installed between the lens and lens board. Many twin-lens reflexes have metal hoods that become loose and will not stay in the fully opened position. In some cases, this is remedied by inserting a rivet that will act as a stop for the overlapping parts, Fig. 10.

To test a single-lens reflex for focus, use a regular focusing panel on the back, or fasten a piece of ground-glass screen so the rough surface is in the same plane as the film. Focus on a near-by object, viewing it through the top reflex screen; then check this against the ground glass at the back of the camera. If both images are sharp, the focus is correct. When the back image is not sharp, add or remove shims under the back glass or under the reflex screen (always adjusting the lens) until the image

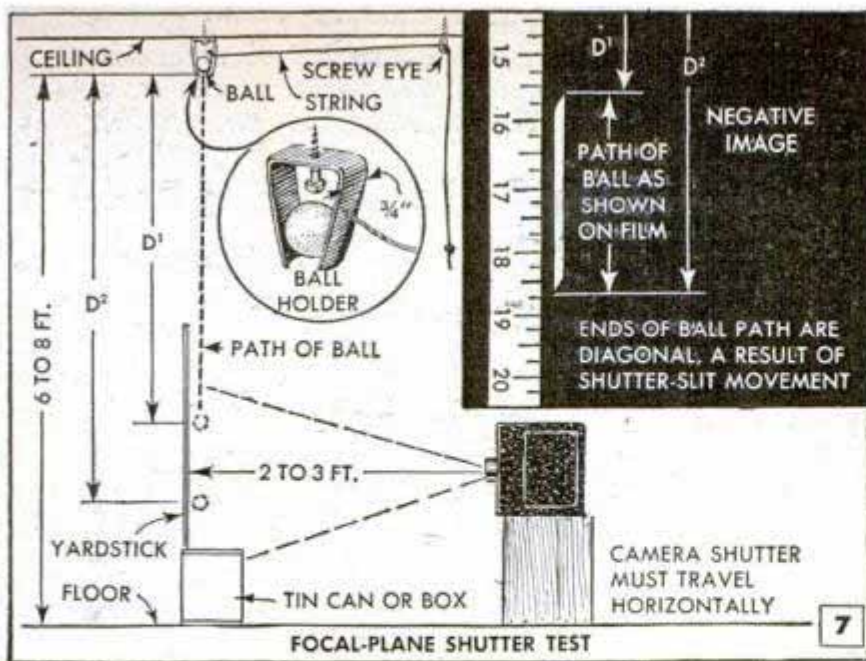

is in focus on both screens. Sometimes reversing the reflex screen will correct the condition. Strips of black velvet may be used as shims. In the twin-lens reflex, failure of images to be in focus simultaneously may indicate that the camera front is sprung, a lens is loose, dirty or partly unscrewed, or the mirror is not in its proper position.

When making close-up pictures with a two-lens reflex, the taking and viewing lenses do not always cover the same field and correction must be made for parallax. Arrange the camera as when checking focus, with a screen in place of the film, and focus on an object at the distance for which you desire to correct. Usually this is done with copying attachments over each lens. At the bottom edge of the back ground glass, note the top boundary of the image (which is inverted). Then draw a line on the regular focusing screen to indicate the same boundary, Fig. 11; this will be a short distance from the forward edge. Repeat for other close-up distances.

To test the speed of a focal-plane shutter, you will need a polished ball bearing $\frac{3}{8}$ in. or so in dia., a yardstick and a large tin can containing cloth or waste to catch the ball. Make a setup to hold and release the ball like that in Fig. 7, being sure to position the yardstick, tin can and camera correctly. The ball, when released, should travel close to the yardstick. Set the camera so the curtain of the shutter moves in a direction parallel with the floor. Use high-speed film and expose at $\frac{1}{50}$ to $\frac{1}{100}$ of a second with the lens almost wide open. If done correctly, the negative will show a streak beside the yardstick, upper right-hand detail of Fig. 7, which is the ball in motion. Then calculate the exposure:

Let D^1 —distance the ball fell to the beginning of the streak on the negative; D^2 —distance the ball fell to the end of the streak and G —acceleration of gravity, 386.4 in. per sec. per sec. (1) Multiply D^1 by 2, divide by G and extract the square root (or obtain it from a table). (2) Multiply D^2 by 2, divide by G and extract the square root. (3) Subtract (1) from (2). This difference is the exposure time in fractions of a second.

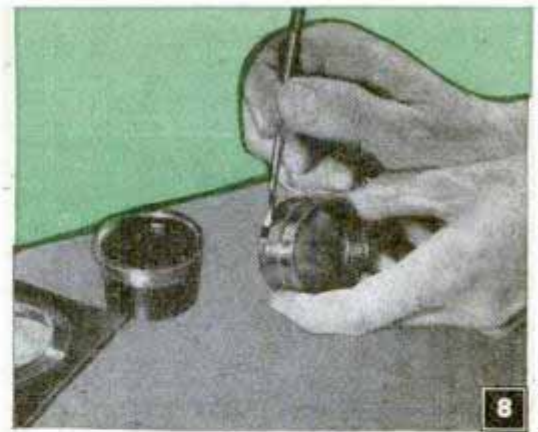

If aperture numerals and index marks are not legible, restore them with white paint

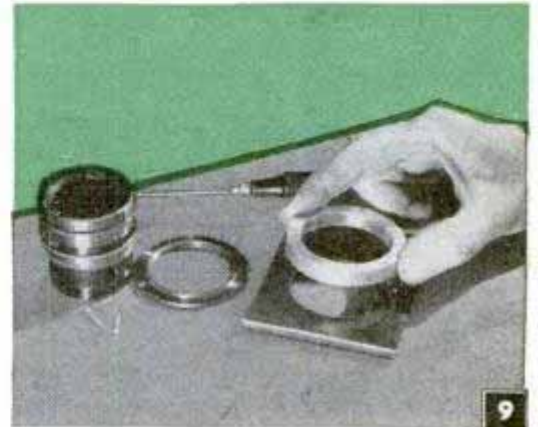

A ring between lens and lens board will permit more latitude in close-up pictures

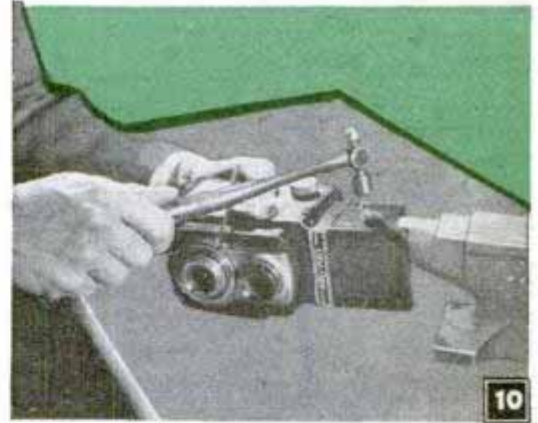

On cameras with a metal hood, a rivet will act as a stop to keep the leaves wide open

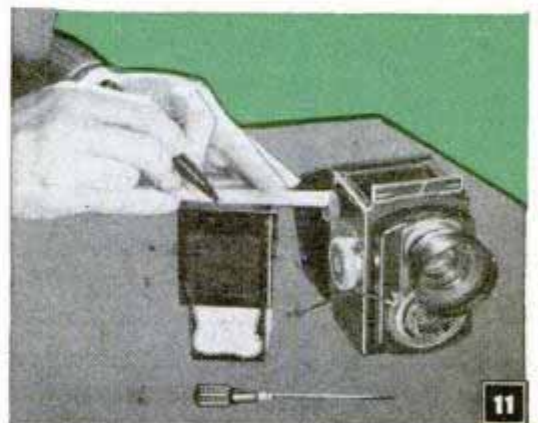

Lines ruled on the reflex screen indicate the corrections that are made for parallax

GLYCERIN AND WATER SOLUTION



Solution Improves Photographs

Glossy prints that are soaked in a glycerin solution will be more pliable, less likely to curl and not so inclined to stick to the ferrotype tins. A suitable solution may be made by mixing glycerin, 1 part, and water, 9 parts. After thorough washing, the prints are soaked for 10 or 15 min. in the solution. Then they are removed and squeegeed onto clean, wet ferrotype tins.—R. F. Donavan, Jersey City, N. J.

Pictures Have Canvas Finish

To make your prints a little different, give them a canvas-texture finish. Spread oilcloth smoothly on a table top. Squeegee the prints onto it in the usual manner and cover with a towel until dry. A little ferrotype waxing solution can be applied to the oilcloth if the prints seem inclined to stick.

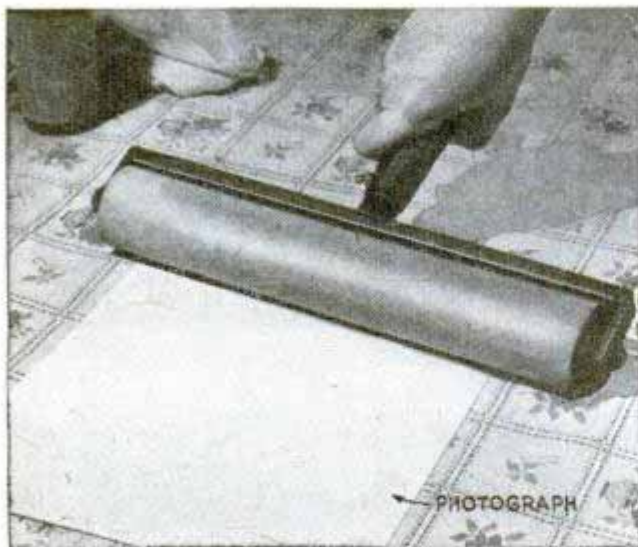

Protecting Often-Handled Prints

Photographic prints that are handled frequently will soon become soiled if the surface is not protected. To make a mixture that will preserve the print, mix clear plastic cement and lacquer thinner to the con-

sistency of thin cream and apply to the prints with a soft brush or an airbrush. Treat both sides of the print if necessary.

Will Thomas, Kenmore, N. Y.

Knitting Needle as Stirring Rod

If you need a stirring rod for your photo laboratory, an old knitting needle will serve the purpose. Cut off the point and use the ball end. Select a needle that has a ball at least 1/4 in. in diameter.



Diffuser for Reflector Photoflood

Sometimes it's advisable to diffuse the light to obtain the desired effect when taking portraits. Here's one way to attach a diffusing screen to a reflector photoflood. A shade holder is screwed to the socket and a 10-in. strip of flat iron is bolted to it and bent to allow for the curvature of the flood. The diffuser, which is an embroidery hoop fitted with tracing cloth, is fastened to the end of the flat iron. A knob should also be attached to the flat iron to prevent burned fingers.—Max Navis, New York.



Color Developing Data on Trays

When processing color transparencies in trays, it is convenient to identify each tray with the name of the solution and time required for development. Then, before you start, you can have your trays arranged in the proper order for all stages of development. The data can be printed directly on the bottom of the tray with colored fingernail polish.



Deposits that form on the inside of glass graduates can be removed by cleaning them with hot vinegar, which is allowed to stand in the glass for about an hour.

CRAFT QUIZ

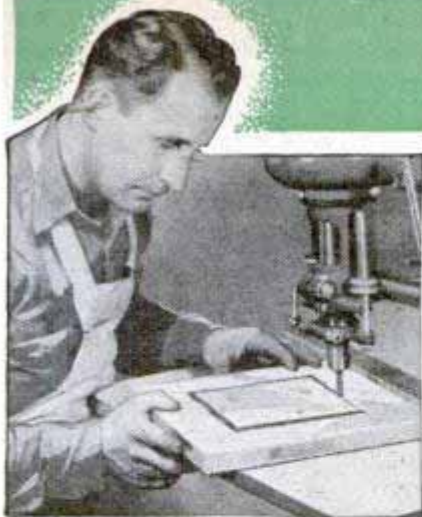

1. Cutting tool used here has—
 (a) 59° point (c) Extension spurs
 (b) Brad point (d) Double flutes

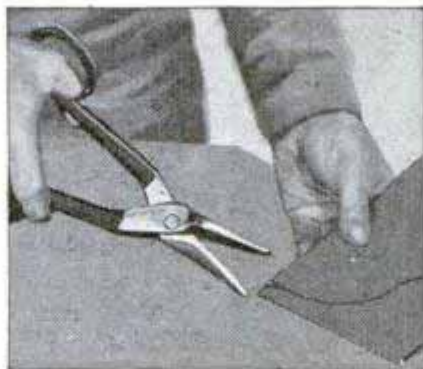

2. Tin snips shown are—
 (a) Straight blade (c) Hawk-billed
 (b) Pivoter (d) Double cutting

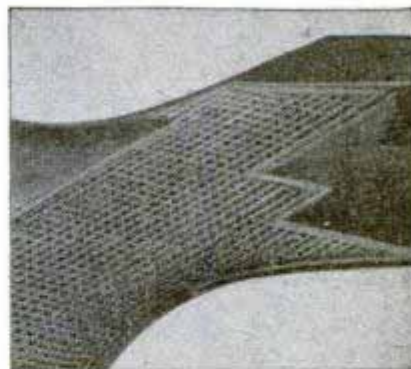

3. This work is called—
 (a) Squaring (c) Hatching
 (b) Pointing (d) Checkering

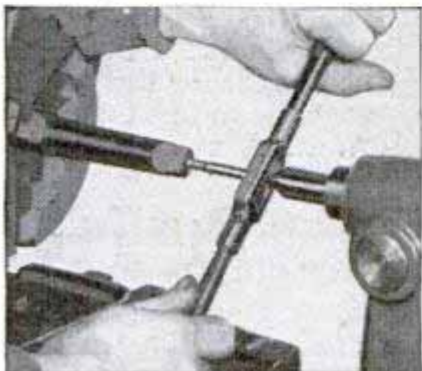

4. National coarse tap used here is—
 (a) 1/4" No. 20 (c) No. 6-40
 (b) 5/16" No. 24 (d) 3/8" No. 24



5. Placing roofing in the—
 (a) Gutter (c) Comb line
 (b) Verge-edge (d) Valley



6. Countersink for screws is—
 (a) 60 degrees (c) 72 degrees
 (b) 20 degrees (d) 82 degrees



7. This "two-by-four" has—
 (a) Edge grain (c) Banks
 (b) Star shakes (d) Checks

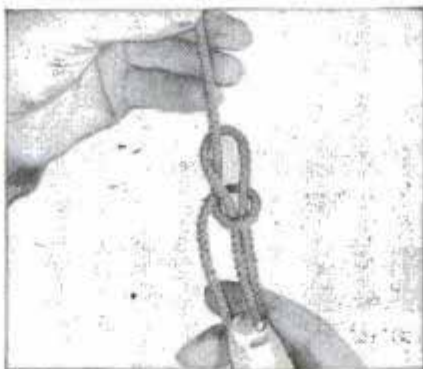

8. This knot is—
 (a) Half hitch (c) Blackwall hitch
 (b) Sheepshank (d) Single bowline

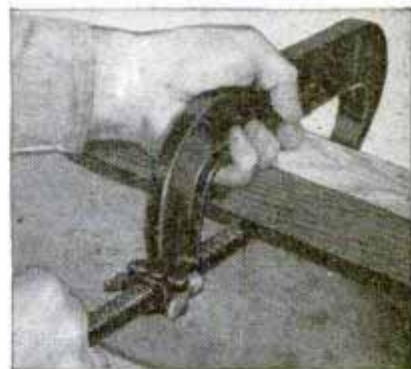

9. Ears on this clamp are for—
 (a) Better grip (c) Identification
 (b) Speed (d) Easy turning

ANSWERS: 1—d (operation is routing and tool is double-flute router bit); 2—c, 3—d, 4—at others are National Fine Thread); 5—d; 6—d; 7—d; 8—d; 9—b (ears are split nut which can be opened for rapid setting); 10—d; 11—c



10. This type of table is—
 (a) Extension (c) Pie plate
 (b) Kettle (d) Drum

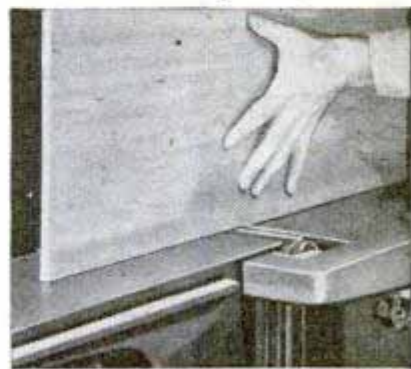

11. Jointers have a—
 (a) Splitter (c) Rabbeting ledge
 (b) Dado head (d) Depth stop

Multiple Hanger for Trousers Requires Little Room

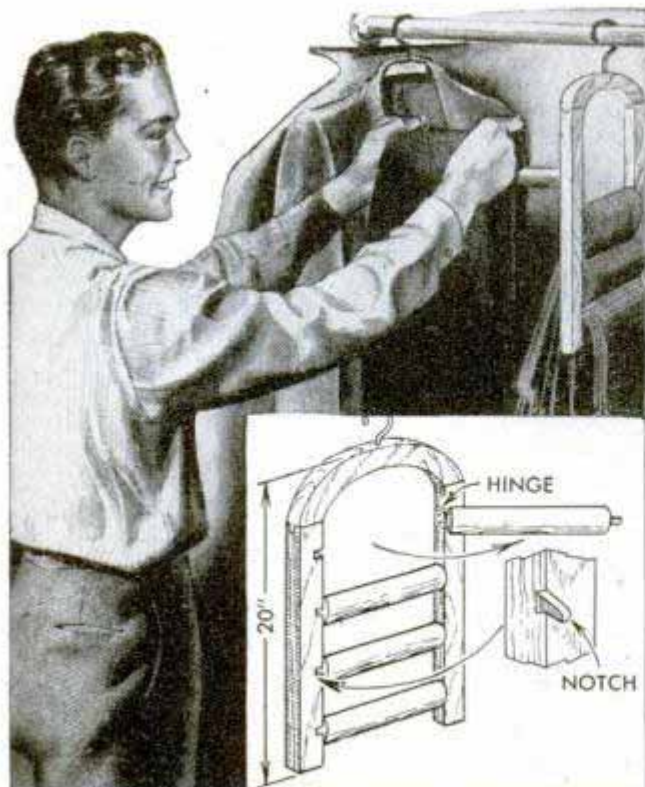

For the small-apartment dweller or the person whose home has small closets, this multiple hanger will permit many pairs of trousers to hang in the space taken by one pair before. The frame is U-shaped and should be wide enough for the trouser legs. The crossbars are fairly large dowels that are hinged to one side of the frame and have a pin in the other end that fits into a notch in the other side member. The hinge is loose so the pin will slide in the notch.

"Shock Absorber" on Fishline Breaks Impact of Hard Strike

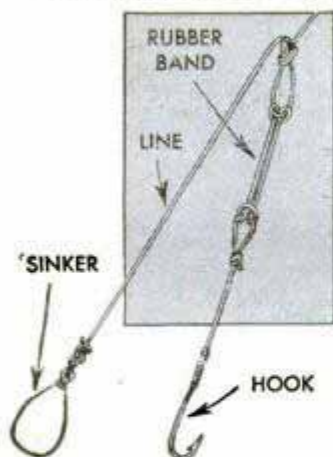

Fish with tender mouths often tear out the hook under the impact of a sudden strike or when making a run. To prevent this, a rubber band can be installed between the leader and line to absorb the shock. — Maj. R. S. Hudgins, Washington, D. C.

Soy-Bean Fence Protects Garden

Instead of using a wire fence to protect your garden from rabbits and other animals, grow a row of soy beans around the outside of the plot. One gardener found

that when he did this, the animals would feed on the soy beans but leave the vegetables inside the garden alone.

David B. Clapp, Livingston, N. J.

Glass Case for Fragile Models

To protect small, fragile models and delicate pieces of whittling, keep them under glass. Purchase a test tube that is large enough to fit over the object you wish to cover and cut the tube to the right height, using a triangular file. Make a wooden base and then set the model and the tube in modeling clay. Shape the clay inside the tube so that it forms a pleasing rest for the model and mold it on the outside to form a quarter round.—A. A. Wells, Verdun, Can.

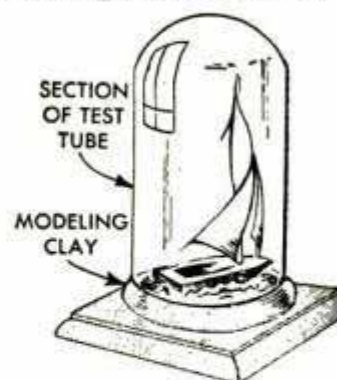

Drawers in Closet-Step Unit Provide Storage Space

If drawer space is at a premium, here's a unit that will serve as a stepladder and do double duty as a chest of drawers as well. It will fit neatly into the closet and shorter persons will find it handy to get at articles that are on the top shelves of the closet. If desired, the tops of the steps can be carpeted or covered with some composition material to save wear on the wood.





SHOP NOTES



FRICITION SAWING-10 Times Faster

METAL UP TO 14 GAUGE IS CUT AS FAST AS HAND CAN PUSH THE WORK

By Sam Brown

TEN times faster than hacksawing—that's what you can expect when you switch to friction cutting on the bandsaw. Three feet per minute in 1/8-in. steel is not a "souped-up" test figure obtained under ideal conditions, but exactly what you can expect with your 12 to 16-in. woodworking bandsaw.

Simply increase the saw speed to about 2800 f.p.m. and then change to a standard metal-cutting blade and you are all set to friction-saw sheet metal and angle iron up to about 1/8 in. thick. Friction sawing works by heating the metal red hot at the point of contact so that the saw teeth can strip it away. If you want to cut stock over 1/8 in., you will need more speed. For average work, the single speed setup of about 2800 to 3000 f.p.m. has the advantage of simplicity and is excellent for either wood or metal with nothing more than a change of blade. An ideal setup is a step-pulley drive, one step giving a 3000-f.p.m. speed for wood

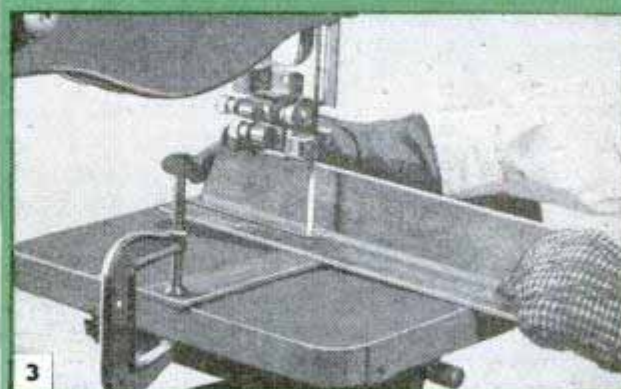
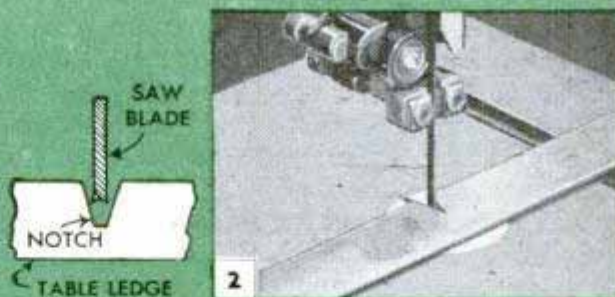
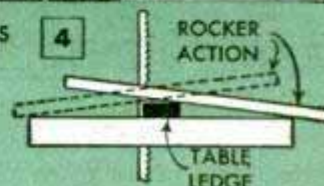
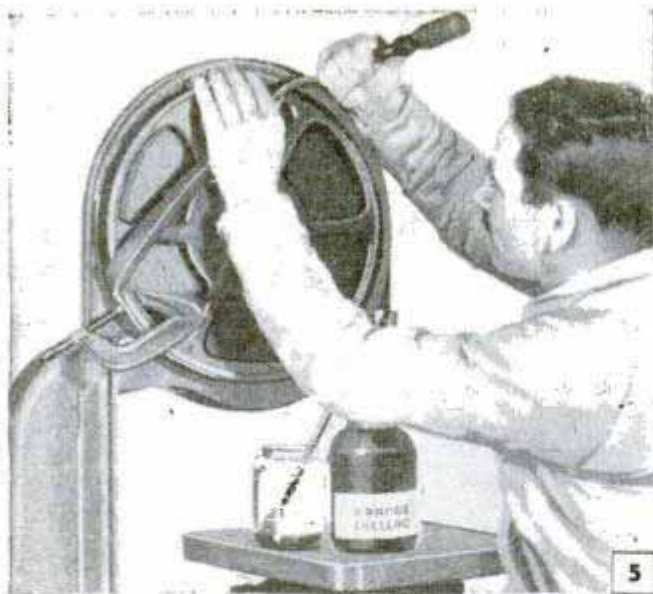

TABLE LEDGE PREVENTS BURRED EDGE FROM CATCHING IN TABLE INSERT . . . ALSO PERMITS ROCKING ON HEAVY CUTS





GLUE TIRES ON FOR SPEEDS OVER 4000 F.P.M.

sawing and sheet-metal cutting, and the second step a speed of about 4000 f.p.m. for friction-sawing metal up to about $\frac{3}{16}$ in. thick. The table, Fig. 6, will help you select a suitable pulley drive. Table, Fig. 8, shows thickness limitations and other factors.

Cutting technique is standard except that for work over $\frac{1}{8}$ in. thick use a strip of metal clamped across the saw table, as in Figs. 2, 3 and 4. Prime purpose of this is to prevent the burr, which forms on the underside of work, from catching in the slot in the table insert. A similar fixture is used for cutoff work, Fig. 7. Regarding the speed increase, any fair quality bandsaw will go up to about 3800 f.p.m. quite smoothly. At about 4000, the wheels will probably throw the tires; cement them to the wheel rims as in Fig. 5. It's also a good idea to drive with a $\frac{1}{2}$ -hp. motor. Be sure the V-belt is fairly tight and that the machine stands firmly on the floor or bench. If the blade should break, stop the machine as soon as possible.

Blade life is very good, averaging 28 to 30 hours, or an equivalent of about 5000 linear feet in $\frac{1}{8}$ -in. steel. The blade wears out by blunting of the teeth until the blunted area in contact with the work becomes too great for cutting clearance. The blade does not lose its temper because the red-hot cutting contact is only momentary—any one tooth has a cooling cycle several hundred times longer than its contact cycle. Blade life depends to a certain extent on the uniformity of feeding the work to the blade. Burring is the worst fault. It is negligible in thin stock, Fig. 1, but increases rapidly with work thickness. The cut itself is fairly smooth with but slight "wash-boarding." It is advisable to wear gloves—small work gets uncomfortably hot and all cuts have a raw, burred edge that can inflict a painful injury if you risk handling the work with bare hands.

6 BANDSAW SPEEDS* IN FEET PER MINUTE							
Motor Pulley	Dia. of Bandsaw Wheels	Machine Pulley Diameter					
		5"	5½"	6"	6½"	7"	8"
2¾"	10"	2418	2210	2028	1872	1742	1508
	12"	2883	2635	2418	2232	2077	1798
	14"	3441	3145	2886	2664	2479	2145
	15"	3627	3315	3042	2808	2613	2262
	16"	3906	3570	3276	3024	2814	2436
3"	10"	2652	2418	2210	2028	1898	1664
	12"	3162	2883	2635	2418	2263	1984
	14"	3774	3441	3145	2886	2701	2368
	15"	3938	3627	3315	3042	2847	2496
	16"	4284	3906	3570	3276	3066	2688
3½"	10"	3094	2808	2574	2340	2210	1924
	12"	3689	3348	3069	2790	2635	2294
	14"	4403	3996	3663	3330	3145	2738
	15"	4641	4212	3861	3510	3315	2886
	16"	4998	4536	4158	3780	3570	3108
4"	10"	3536	3224	2938	2730	2522	2210
	12"	4216	3844	3503	3255	3007	2635
	14"	5032	4588	4181	3885	3589	3145
	15"	5304	4836	4407	4095	3783	3315
	16"	5712	5208	4746	4410	4074	3570
4½"	10"	3978	3614	3302	3042	2834	2470
	12"	4743	4309	3937	3627	3379	2945
	14"	5661	5143	4699	4329	4033	3515
	15"	5967	5421	4953	4563	4251	3705
	16"	6426	5838	5334	4914	4578	3990
5"	10"	4420	4030	3692	3406	3146	2756
	12"	5270	4805	4402	4061	3751	3286
	14"	6290	5735	5254	4847	4477	3922
	15"	6630	6045	5538	5109	4719	4134
	16"	7140	6510	5964	5502	5082	4452

*With Standard 1725 R.P.M. Motor

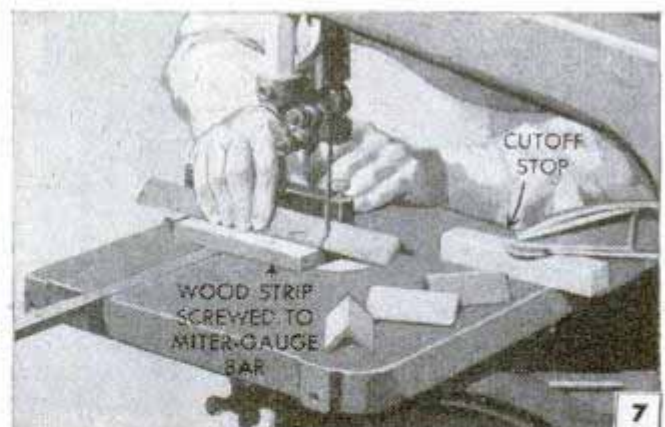

THIS $\frac{1}{8}$ " X 1" ANGLE WAS CUT OFF IN 7 SECONDS

8 BLADE SELECTOR AND DATA						
Material Thickness*	Blade Speed	Min. Blade Width	Teeth Per Inch	Min. Cutting Radius	Hp. Req'd	Feed Pressure
Up to $\frac{3}{32}$ " or 13 Gauge	2800	$\frac{1}{4}$ "	18-24	$\frac{5}{16}$ "-1"	$\frac{1}{4}$	Light
$\frac{1}{8}$ " to $\frac{3}{16}$ "	3600	$\frac{1}{4}$ "	14-18	1"-1½"	$\frac{1}{3}$ or $\frac{1}{2}$	Mod.
$\frac{3}{16}$ " to $\frac{1}{4}$ "	4400	$\frac{3}{8}$ "	14	1½"-3"	$\frac{1}{2}$	Fairly Heavy

*For iron and steel only—friction cutting cannot be done on nonferrous metals

Moving Materials Is Simplified by Using Stairway Ramp

Consisting of two lengths of channel iron suitably spaced and braced, this stairway ramp will simplify the moving of materials from one floor to another. The size of the channels and the intervals at which they are braced will depend to a large extent upon the bearing load. However, for average conditions, No. 18 ga. will serve if braced with 1-in. bars. The braces should be about 4 ft. apart and welded to fit snugly against the front of the step to minimize any danger of tripping when moving the truck up and down the stairs. The ramp may be made in sections so it can be removed and put away when not in use.

Mark Q. Mau, St. Paul, Minn.

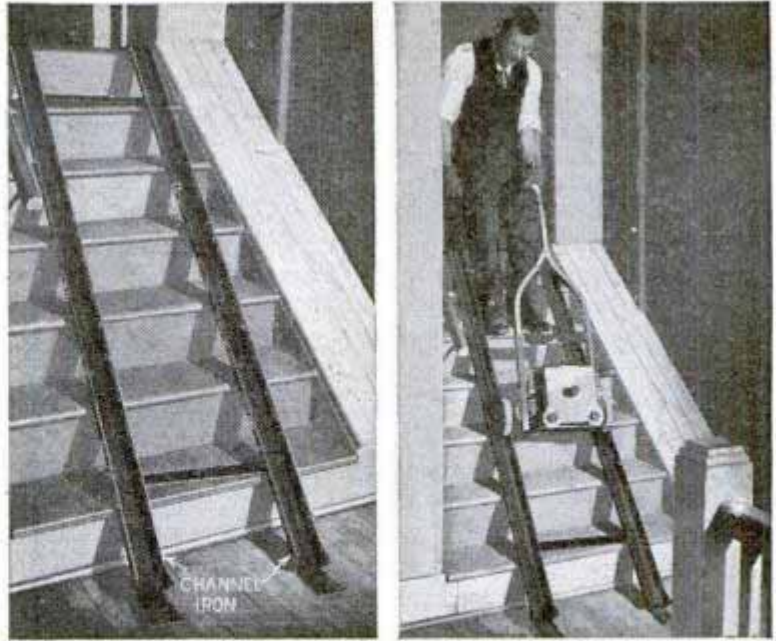

Wide Boards Beveled Accurately in Special Miter Box

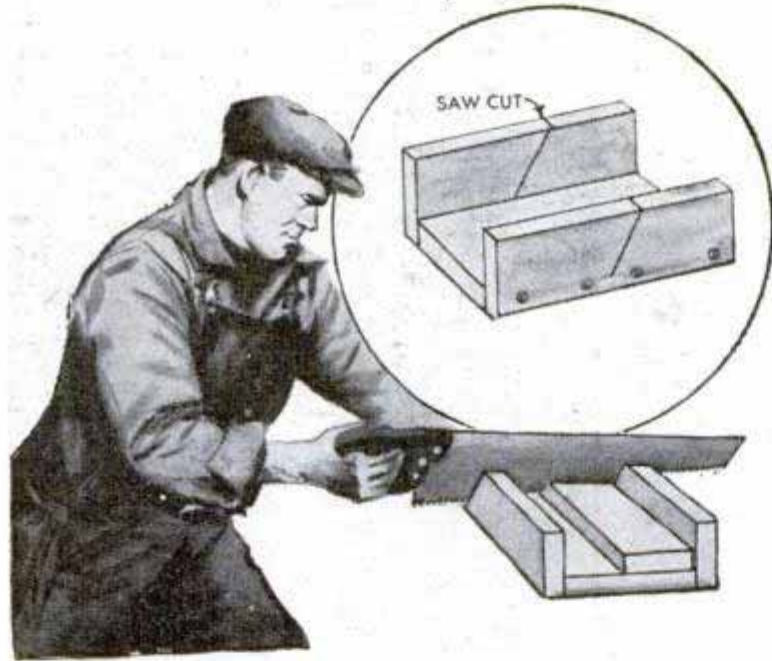

Sometimes difficulty is encountered in beveling the ends of wide stock accurately. If a box with a wide bottom is built for just this purpose, it will be easy to saw boards of almost any width.

R. E. Deering, Wichita, Kans.

Shield Over Auto Exhaust Protects Showroom Walls

To prevent smudging the lower parts of the showroom walls with smoke from the exhaust when demonstrating cars, one dealer hung a metal shield from the rear bumper directly behind the exhaust pipe. This served as a baffle which dissipated the smoke and kept the walls clean.

"Saddle-Bag" Box Keeps Tools at Hand on Rung of Ladder

This toolbox is one carpenter's solution to the problem of always having at hand all the tools and nails he wanted. The boxes are made of metal, being any convenient size, and are joined by a metal strap. Sufficient space is left between the boxes to weld a length of 2-in. pipe that has been cut in half lengthwise. For convenience in carrying, a handle is welded to the pipe. The latter fits over the rung of a ladder.

☐ If your windshield wiper does not clean effectively because of a worn edge, you can restore the edge with No. 280 or 320 silicon-carbide paper. Wet the paper with gasoline, fold it and insert the wiper, smoothing with a sawing motion.

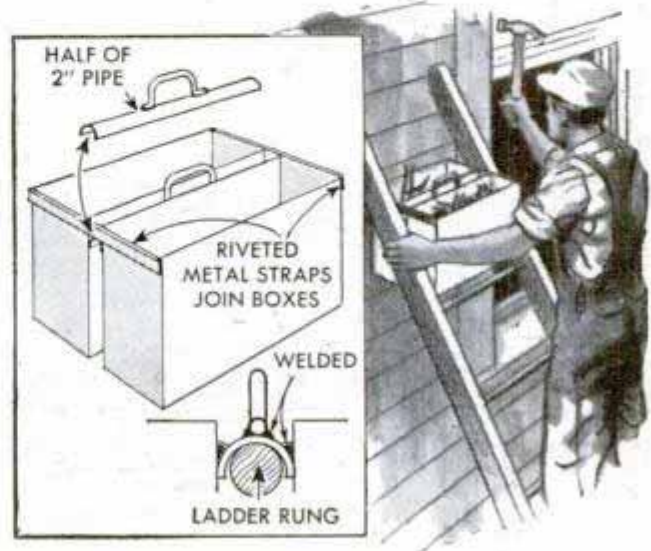

77
- from 11 articles
(47 + 55 eds)

THE ODD-JOB

IT WON'T take long to figure the needs for this tractor on your farm. That problem will immediately take care of itself when you get the tractor built, for Farmette is just chore-boy size and it's faster than any team of horses. So far as its uses are concerned you can take it from there.

Power from Farmette's 7-hp. air-cooled engine is taken off the engine crankshaft by flat belt to a 4-speed truck transmission and through this to a cut-down rear axle taken from a 1934 Chevrolet car. Of course, any suitable rear axle can be used, including a light truck axle. Positive clutching action is obtained by an idler pulley running on

the slack side of the flat-belt drive from engine to transmission. The idler pulley is actuated by a pedal, the arrangement giving smooth foot-clutch control of the tractor. The pedal works against tension springs attached to the frame and to the idler-pulley yoke as in Fig. 3. Provision is made for adjusting the spring tension, which determines the tension on the belt when the clutch is engaged. In Fig. 3 notice also that essentially the same clutching arrangement is used in controlling the power take-off. This consists of a short shaft with V-pulley mounted between bearings. The whole assembly is bolted to a hinged bracket. Movement is controlled by a rod carrying a compression spring, one end of which bears against an adjustable collar. The free

Here's Farmette mowing a fence row and making a good job of it, too. One can easily put together a small mower with a 3½ or 4-ft. cutter bar from stock parts. It's also possible to adapt some small tractor mowers to this type of mounting with very little alteration. A rigid, welded frame is essential for front mounting

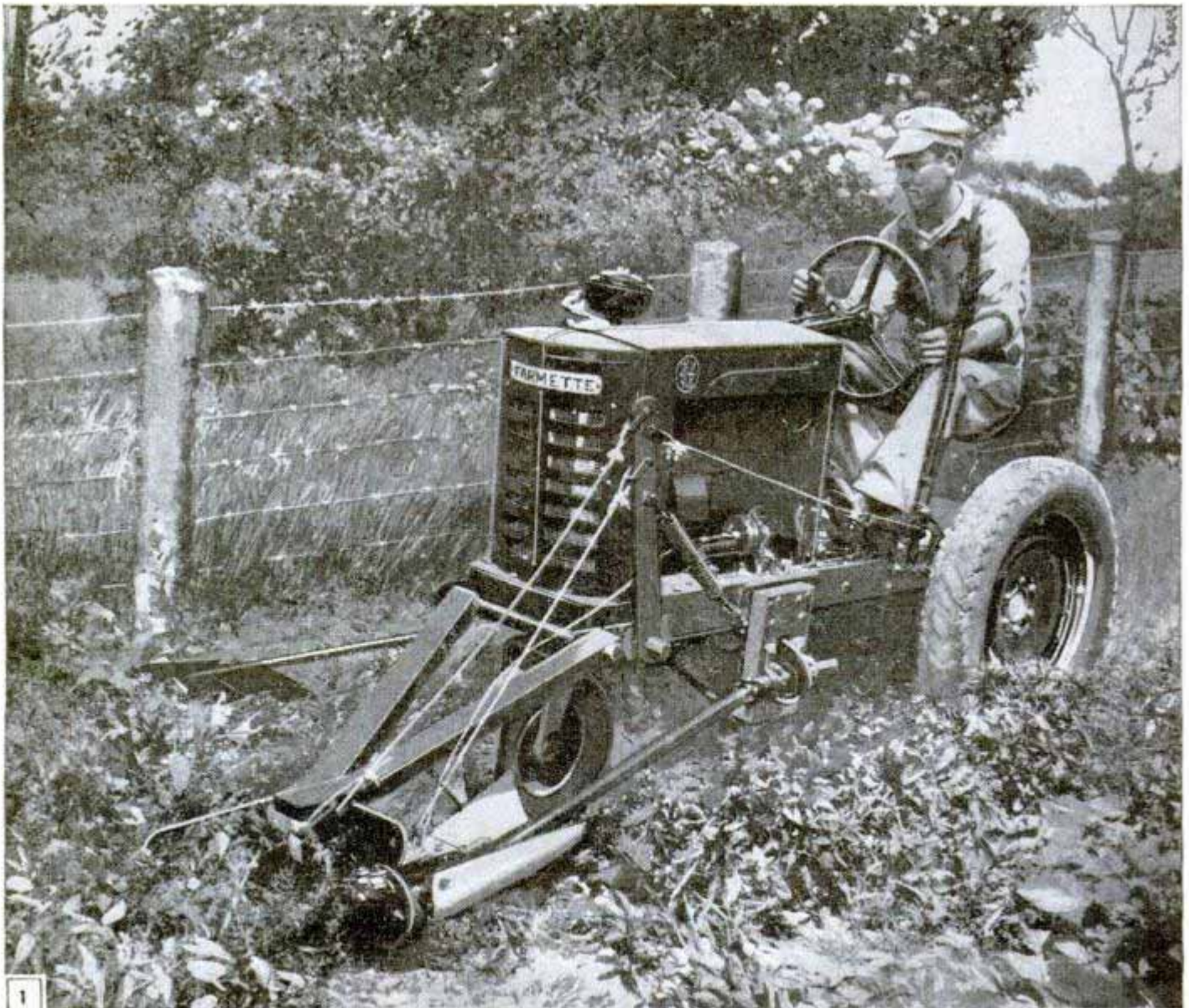

1

TRACTOR

Small jobs that tie up big tractors at busy times cost money for extra fuel and extra man-hours. That's where a nimble, pint-sized riding tractor like Farmette comes in. Farmette is narrow enough to slip between rows of standing corn or pass through a footpath gate, and it's ideal for mowing fence rows and plowing snow

By Marvin and Charles Neese

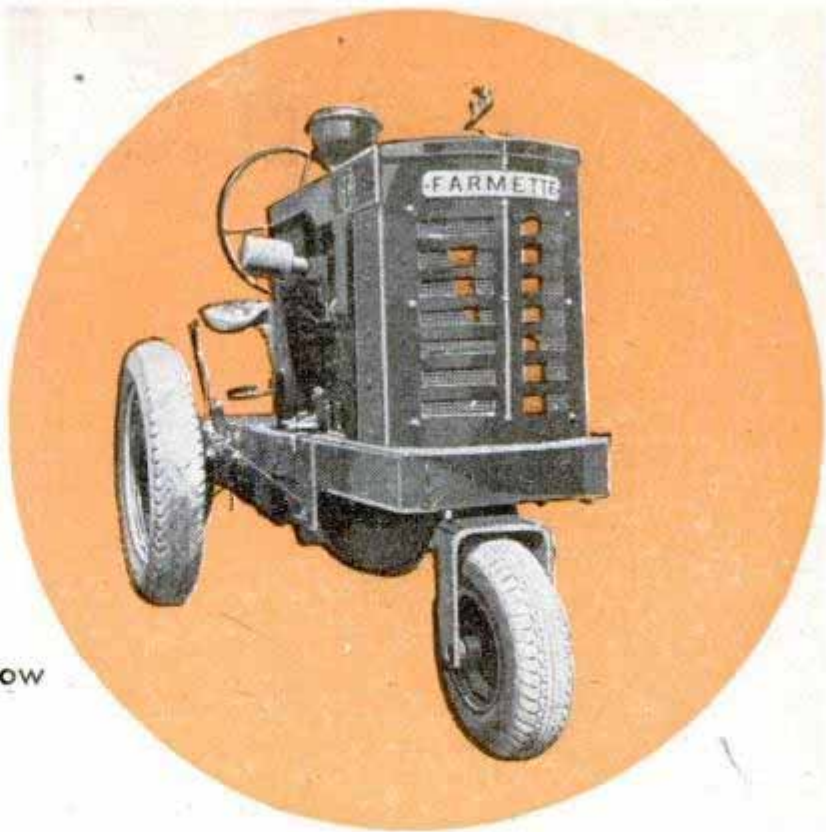

end of the rod passes through a hole drilled in a bracket piece as shown. A wire cable, passing through an awning pulley on the bracket, is attached to the adjustable collar. The free end of the cable is hooked to a control lever near the driver's seat. Moving the lever swings the power take-off assembly inward toward the tractor frame, slackening the V-belt. This whole driving assembly and clutch mechanism is shown clearly in the perspective view, Fig. 4. Speed range is from 1 to about 20 miles per hour.

Before cutting the parts it's a good idea to have all the necessary materials at hand, including the engine, such pulleys as are specified, belts, frame members, steel plates and the rear axle, wheel disks and tires. Looking over the cutaway view, Fig. 2, you get a good idea of what is needed. One of the first questions that comes up is the rear-wheel tread. By using "dished" truck-type wheel disks the tread can be varied by simply reversing the wheels and, if you expect to use Farmette as a cultivating tractor in narrow-rowed truck crops, this also must be taken into account in figuring the wheel tread. The axle can be any length up to the full tread width but of course the narrower tread is handier in close quarters. Where the axle housing is cut down it will be necessary to turn new axles. This is better than cutting and welding the original axles. With the axle cut down to the tread width you require, weld lengths of angle iron to the axle housing. These form mounting brackets for the longitudinal frame members, Fig. 2. The latter should be cut from seasoned oak, $2\frac{1}{4}$ by $3\frac{1}{4}$ in. sectional size. These frame members in the original

tractor are 78 in. long but some variation in length is possible. Don't attach frame members to the rear-axle brackets until you are sure of the exact location of the axle.

Next, assemble the frame as in Fig. 2 and the down view in Fig. 7. Then assemble the steering gear and front-wheel fork. The complete gear from a 1928 Chevrolet truck, including the wheel, spark and gas control levers, steering-wheel column and the stub shaft, are used. The steering-gear housing is supported on a length of $1\frac{1}{4}$ -in. pipe which screws into a pipe flange welded to the steel plate as indicated. The steering shaft, which is welded to the wheel fork, passes through this column. A ball thrust bearing carries the front end of the frame. One bearing race is welded to the wheel fork, the other to the bottom of the steel plate which forms the lower front cross member of the tractor frame.

Now comes the transmission-to-rear-axle hookup. Block the frame level and clamp the frame side members to the rear-axle brackets. Then the splined shaft projecting from the front end of the transmission is turned down to 1 in. in diameter, and a $\frac{1}{4}$ -in. keyway is cut to a length that will take two separate keys, one for each pulley. The front end of the shaft is carried on a self-aligning ball-bearing pillow block as in Fig. 4. Put on the 12-in. cast-iron drive pulley first and key in place, then the $4\frac{1}{2}$ -in. V-pulley which drives the power take-off. This means a careful job of machining. Locate the transmission between the frame members, blocking it in position if necessary, and hook up to the rear axle. Make a careful adjustment for alignment. When

you're sure of this, mark the location of bolt holes for brackets supporting the transmission, the pillow-block bearing at the front of the transmission, and also the bolt holes through the rear-axle brackets and side-frame members. One thing to look out for here is the alignment of the rear axle with the transmission. This is especially important because the axle is not sprung to the frame in the regular way, hence the transmission and drive-shaft housing are rigid when assembled. When you locate holes for bolts through the platform plate, side frames and axle brackets be sure that the

parts fit snugly together so that when these parts are bolted in place there will be no strain or twist on the axle housing. It may be necessary to shim slightly under one or the other of the side frames. Care in welding to make sure that the brackets are exactly in line will generally make shimming unnecessary. After bending the front wheel fork to shape as in Fig. 8, the next step is locating the holes for the wheel spindle. On the original tractor the rear tires are 6.50 by 20 in. and the front tire 4.00 by 8 in., as given in Fig. 2. These sizes stand the tractor level. When you know the tire size

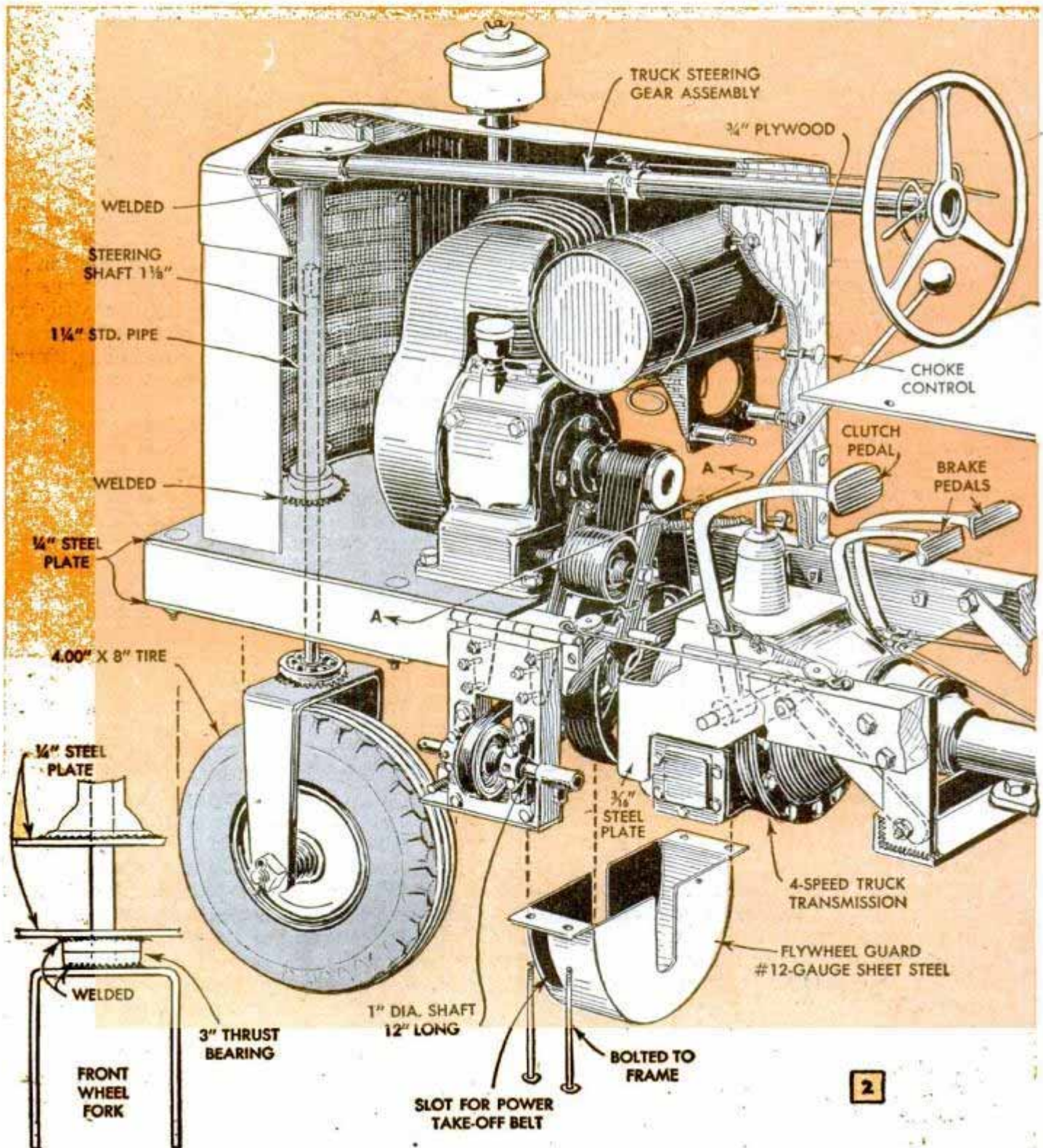

2

measure and drill holes in the front-wheel fork for the wheel spindle. The nut on the spindle should be cotter-pinned as shown. This last step puts the frame on wheels and leaves the engine mounting, hood and grille and other small parts yet to be made and assembled. High-speed air-cooled engines of the type used on the original tractor generally are self-contained units with fuel tank, air cleaner and other parts either built in or attached directly to the engine itself. In order to get the engine properly positioned over the transmission drive pulley it will be necessary, on most engines of

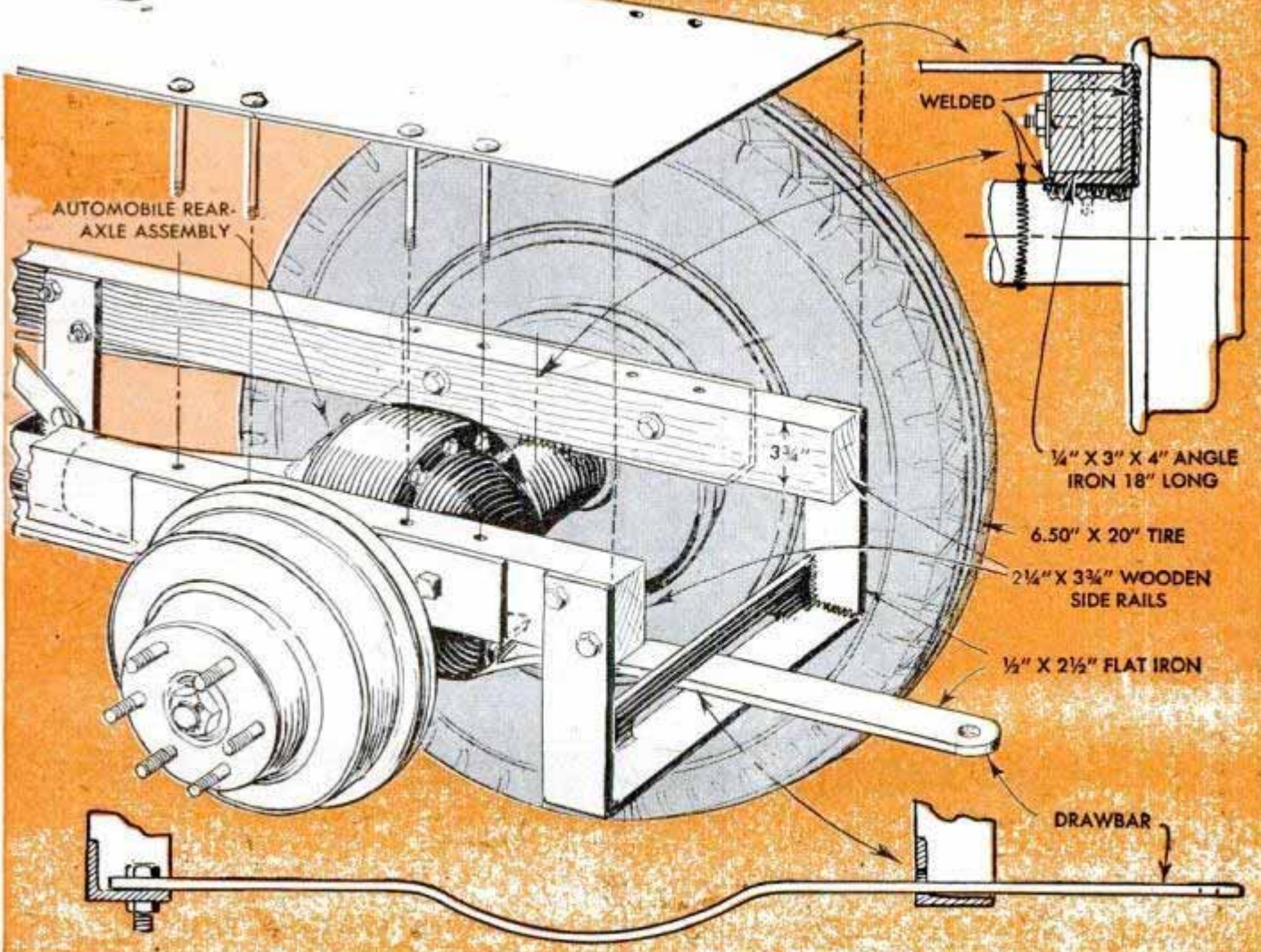
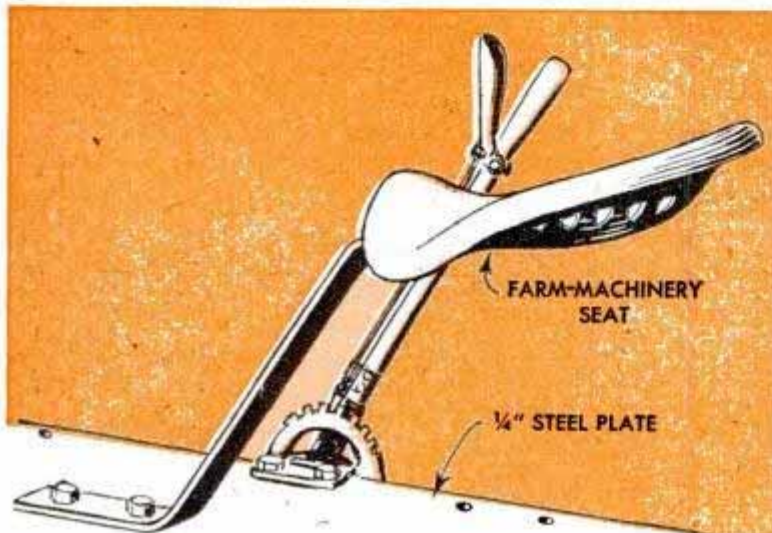
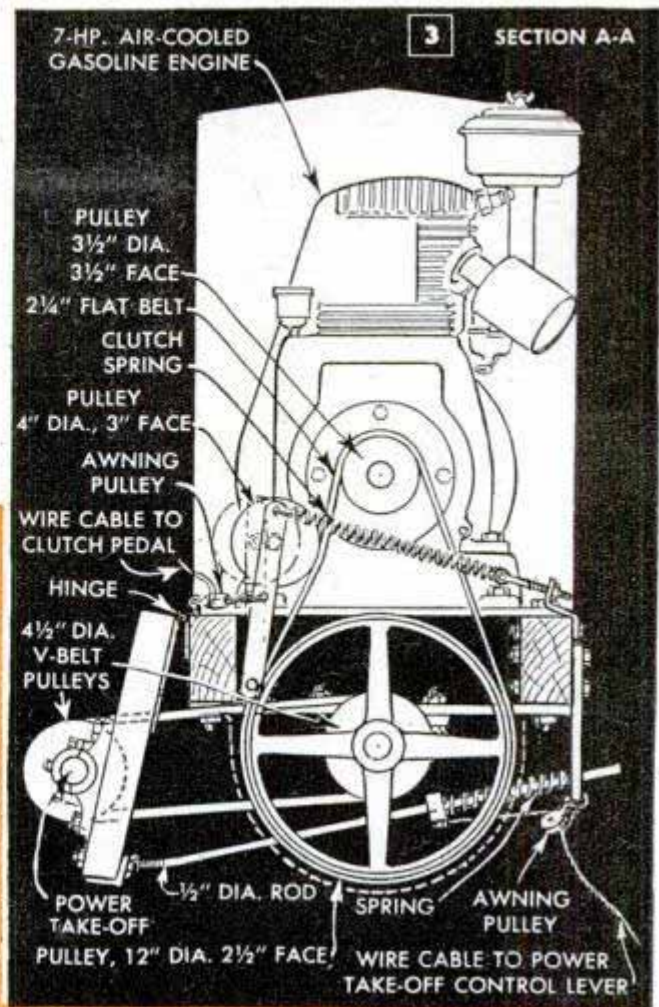

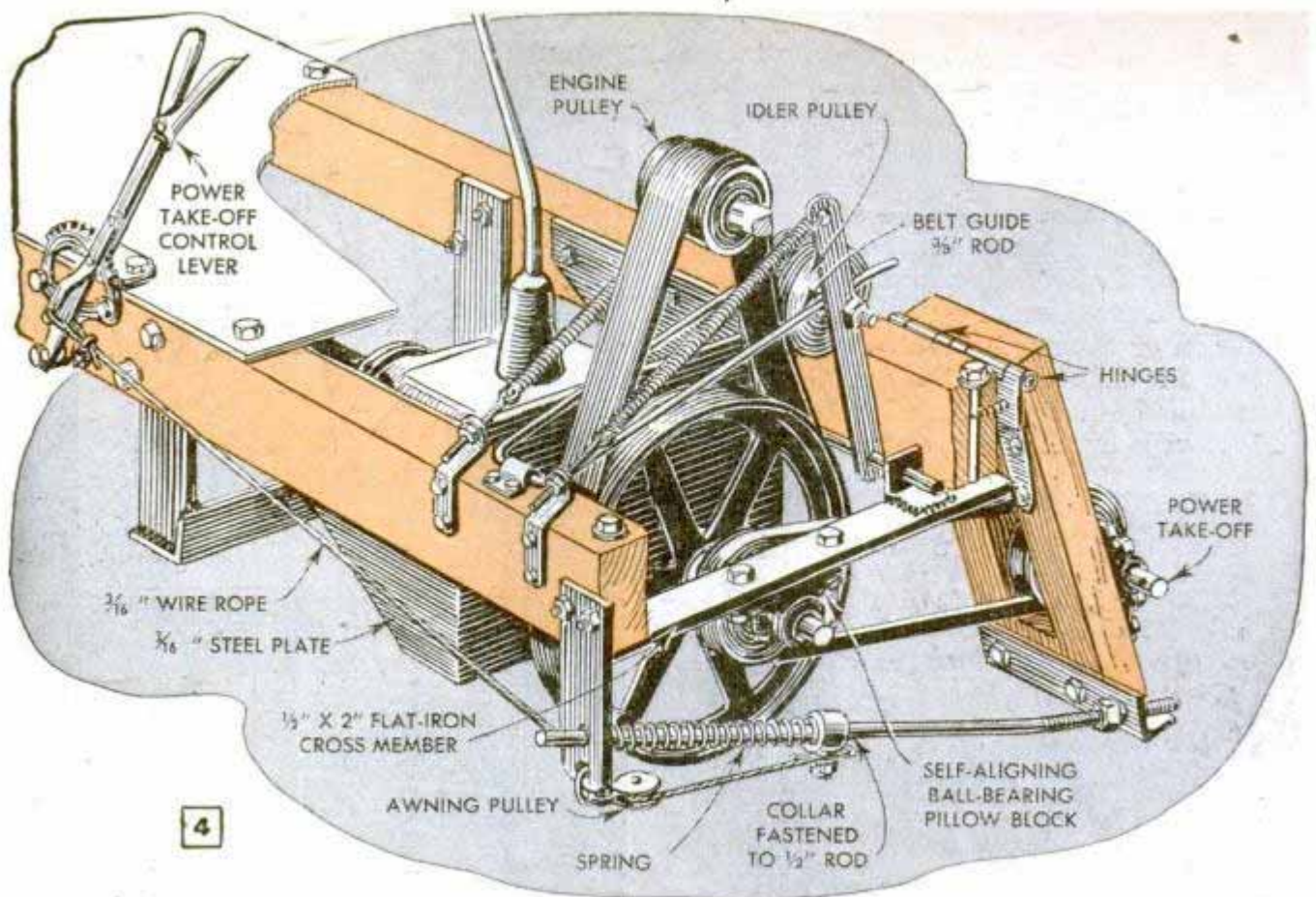

Above and below are views of the simple clutch assembly and power take-off drive. Clutch is pedal operated and is nothing more than an idler pulley which serves the dual purpose of belt tightener and clutch. Releasing pressure of the idler allows the flat belt to slip, thus stopping the tractor

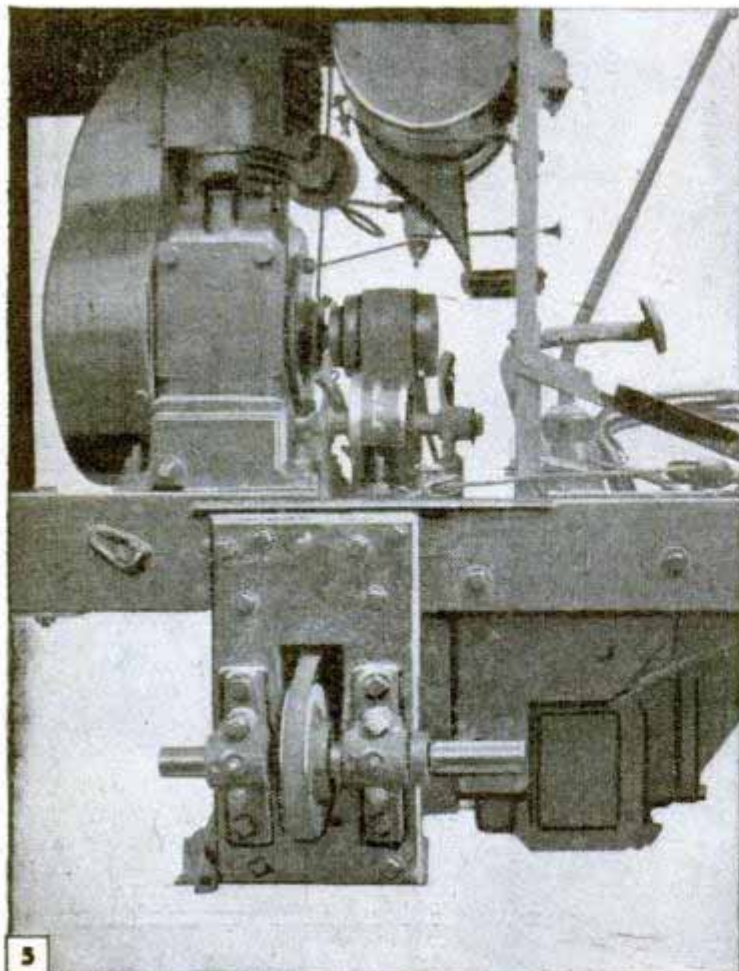

this type, to remove the fuel tank and mount it on the dash as in Figs. 2 and 5. But before the fuel tank is placed get the engine in position. Be sure that the pulleys line up properly, then locate and drill holes for the mounting bolts. Bolt the engine in place. It may be necessary to provide an extension for the air cleaner as it should be located above the hood as in Fig. 2. The extension should be a tight fit on the original tube so that there are no air leaks between the cleaner and carburetor. The dash, Fig. 2, is cut from $\frac{3}{4}$ -in. waterproof plywood and is attached to the frame with angle brackets as shown. The steering column is supported in a U-shaped notch cut in the dash. The fuel tank is mounted on the dash as in Fig. 2. Probably you can make use of the original brackets in mounting the tank but it may be necessary to use spacers. These can be cut from $\frac{3}{8}$ or $\frac{1}{2}$ -in. pipe to whatever length is required. The fuel tank should be located at about the same height in relation to the engine as it was on the original engine mountings. It also may be necessary to install new copper tubing from the tank to the carburetor. Fig. 8 gives general dimensions of the hood frame, which is made of hardwood. The parts are held in place with metal angle brack-

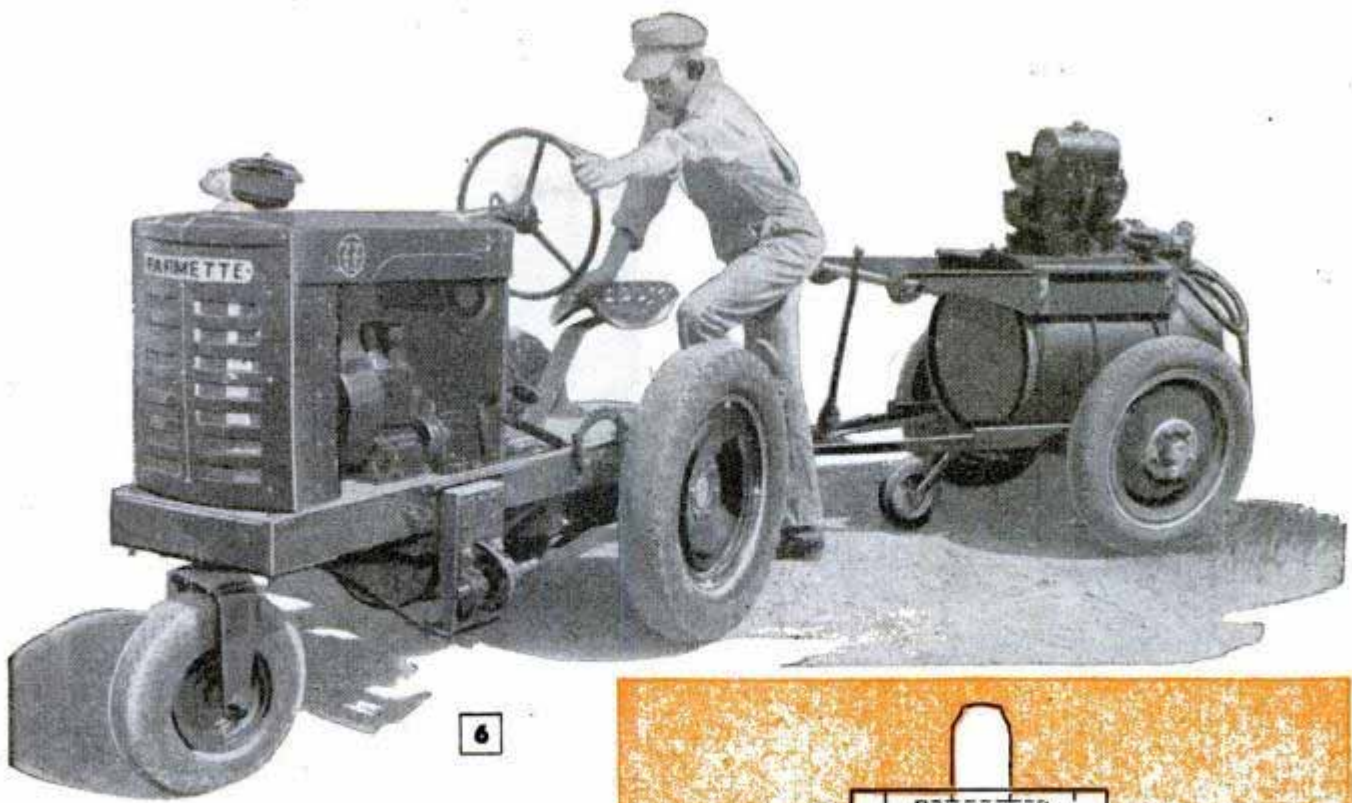

6

ets as shown. Hood and grille are of sheet metal and a clean, neat job of forming these parts adds much to the appearance of the tractor. Unless, of course, you have facilities for working sheet metal you'll want to take this job to your local tinsmith.

The idler pulley which runs on the drive belt serves the two-fold purpose of maintaining the proper tension on the belt and providing the clutching action when starting the tractor under load. Use a pulley fitted with oilless bushings. The pulley should run on a hollow shaft provided with a pressure grease fitting. The drive belt should be of full-grain leather running with the hair side next to the drive pulleys. To avoid pounding of the idler pulley the lacing should be made carefully so that it will be flat. After the new belt has been in use a few hours it will be necessary to adjust the idler-pulley tension springs to compensate for stretch of the belt. The idler support arms are mounted on a short cross shaft, one end of which is inserted in a hole drilled in the transmission support as in Fig. 2. The other end of the shaft is carried in an angle bracket welded to the pillow-block bearing support as in Fig. 4. Collars hold both shaft and arms in position. Note the belt guide in Fig. 4. Next comes the pulley, or flywheel guard, Fig. 2. This is made from 12-gauge sheet steel, welded, and it is bolted directly to the tractor frame. Be sure the

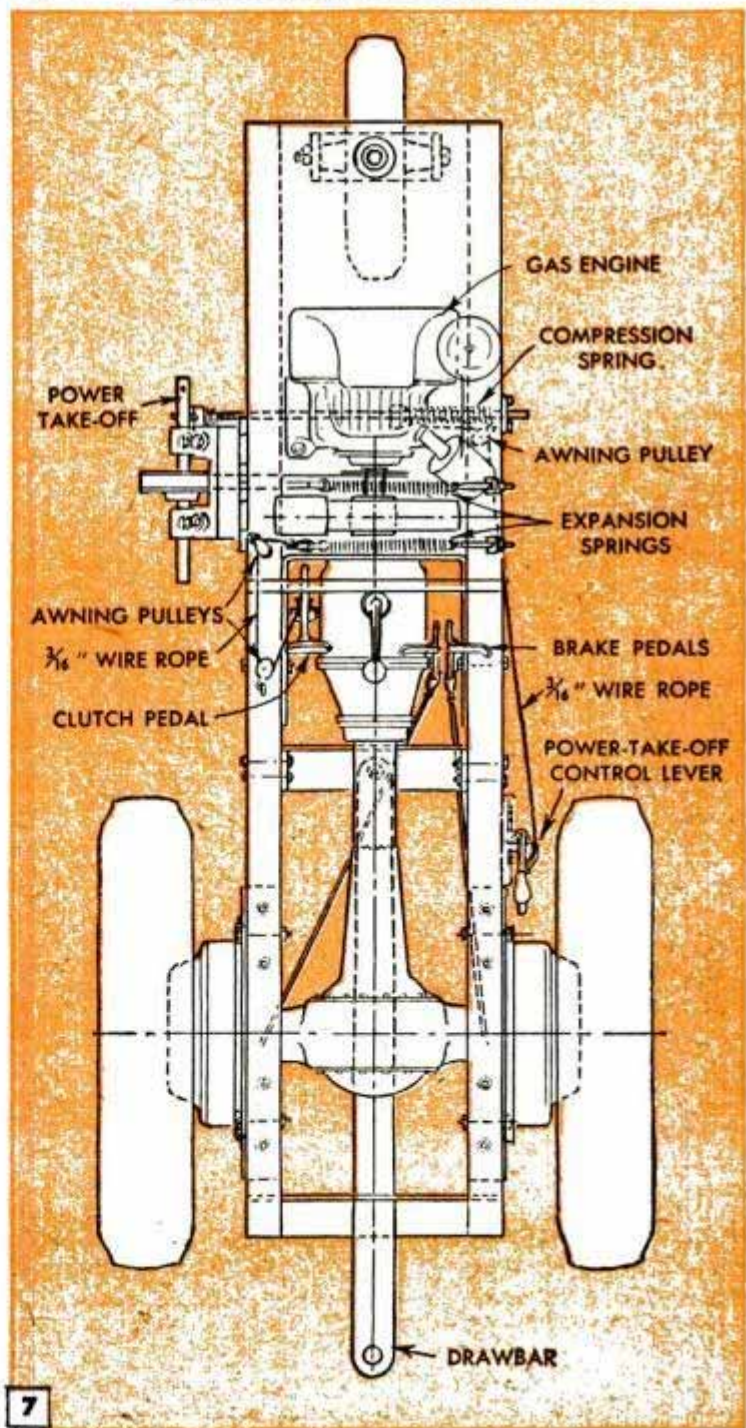

7

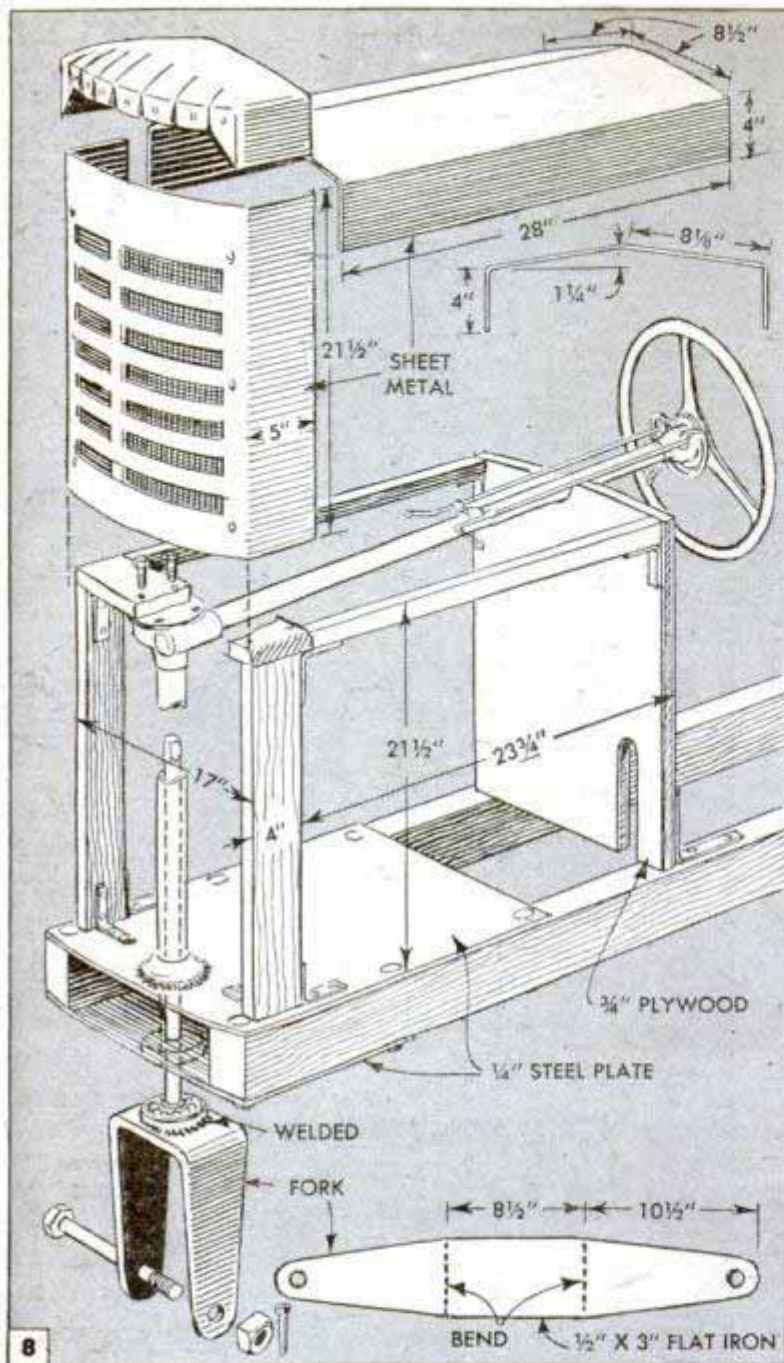

slot for the power take-off drive belt is large enough to clear the belt. The power take-off assembly as you see it in Figs. 2, 4 and 5 is optional equipment, but of course is essential for driving any mounted machine such as the front-mounted mower in Fig. 1. The swinging drawbar enables you to make short turns with pulled equipment, Fig. 6.

To finish up, there remains the installation of the clutch pedal, brake pedals, linkage and driver's seat, connecting a control lever on the steering column to the throttle and installing a choke control on the dash. Installation of the clutch pedal is very simple, as you can see from Fig. 2. Adjust the brakes so that they apply equally on both rear wheels. Install an implement seat as in Fig. 2. Then fit the drawbar as detailed in Fig. 2 and there you are, ready for work. Two coats of outdoor enamel applied with a spray gun make a fine-appearing job and help to prevent rusting of bare metal. And if you want the maximum in tractive effort the rear tires should be of the cleated tread type supplied for farm tractors. On some jobs dual tires on the rear wheels and an oversize balloon tire on the front wheel make the best combination, especially where light-footedness and easy maneuverability are the first requirement. Also, weight can be added by filling the tires with a nonfreezing solution.

Drilling Irregular Shaped Work in a Metalworking Lathe

When holes in small parts must be drilled in line, or when such parts are awkward to set up on a drill press, the work can often be done easier in a lathe by using a center support and driving the drill from the headstock. The holes are marked with a center punch. Then the piece is held firmly against the dead center while being fed into the drill with the tailstock handwheel.

Tape Prevents Smudged Tracing

Pencil tracings which are revised or handled frequently will smudge so that prints, or the tracing itself, becomes illegible. To protect important parts of the drawing such as the title, bill of materials, etc., paste cellulose tape over them. This keeps the printing clear and at the same time will produce good blueprints.

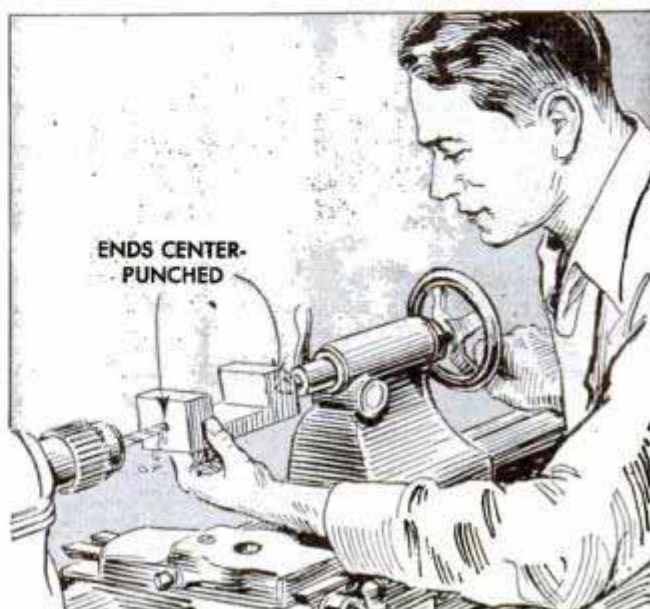

Wire Mesh Applied at Corners Rodent-Proofs Poultry House

If wire mesh is applied to joining sections of a poultry house, it will help keep the building free of rodents. The mesh is applied at the floor and ceiling line as well as the corners. The mesh should be about 24 in. wide and bent down the center. It should be well nailed.

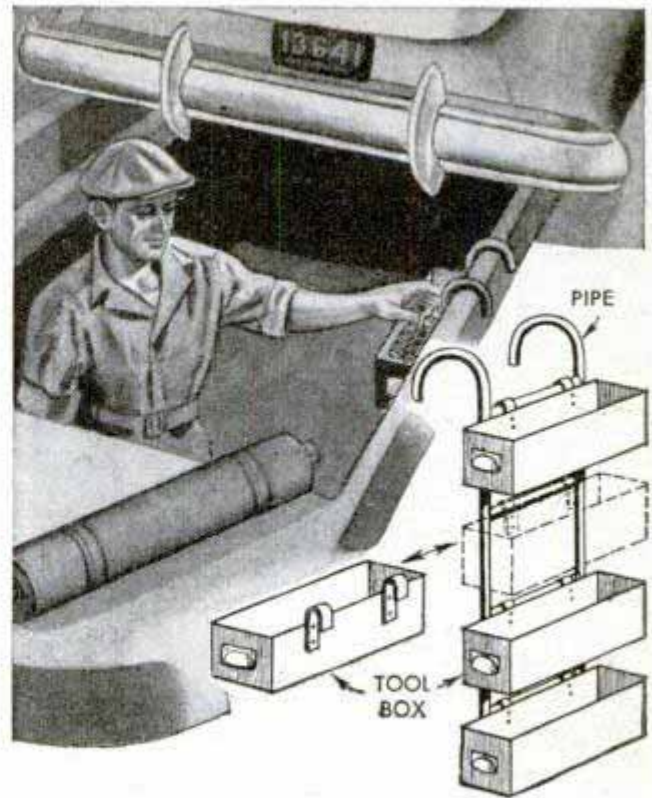
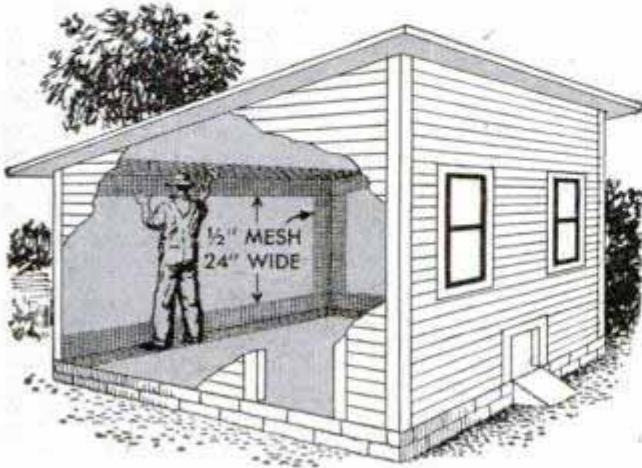

Reflectors on Ends of Lunch Box Help Night Worker in Traffic

For those who work at night and must pass through dimly lit areas when going to and from the job, red reflectors on the ends of a lunch box will serve to warn motorists of the worker's presence. The reflectors

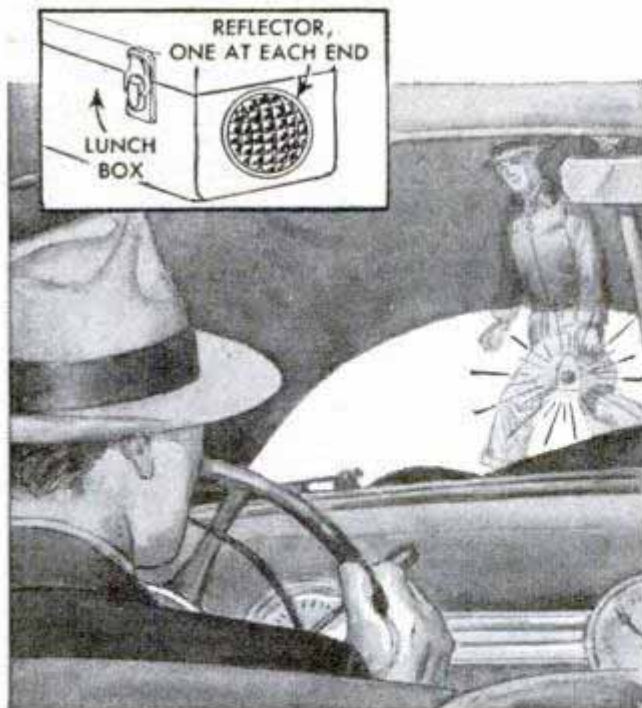

should be fairly large, about 2 or 3 in. in diameter, so that they will be picked up easily by the headlights of an approaching car. Reflectors of the type used on trucks are suitable.

Francis Thomas, South Paris, Maine.

Multiple Tool Rack Hangs Down From Edge of Greasing Pit

Here's a simple device that can do a big job around the filling station or garage greasing pit. Flat-iron hooks are bolted to three or four tool boxes which hang on the frame of the unit. The latter is of welded construction with curved ends to hook over the edge of the pit.

Small-Parts Washer for Garage

Using only an oil pan discarded from a car and some short lengths of flat iron, one mechanic made a handy washer for small parts. The legs, which are X-shaped, are welded to the pan and also at the point where they cross. Crosspieces are welded to the legs to strengthen them.

Elmer Vandrey, Truman, Minn.

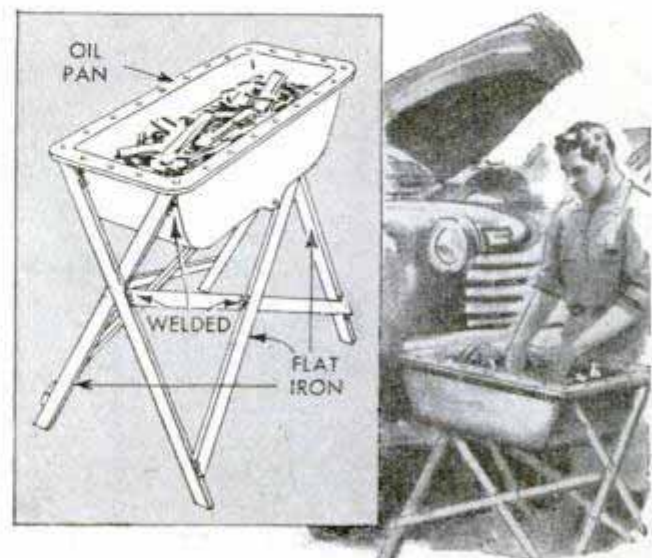

Auto-Tire Rim Buried in Ground Supports Free End of Gate

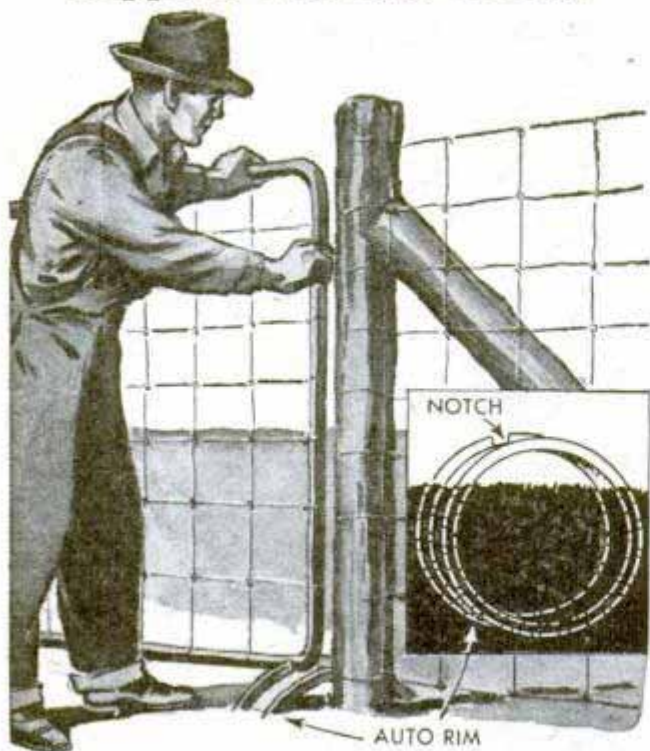

To keep a wide gate from sagging, use an auto-tire rim as a support when the gate is closed. Cut a notch in the rim large enough to engage the bottom bar of the gate. Then bury the rim so the gate will slide into the notch and be at the right height. Ordinarily no other fastener need be used.

Wm. P. Houser, Organ, N. Mex.

Quick Method of Painting Border For Signs and Show Cards

Instead of going through the slow process of putting the border on show cards one at a time, one show-card painter who had a number of duplicate signs to do used another method. The cards were laid out in

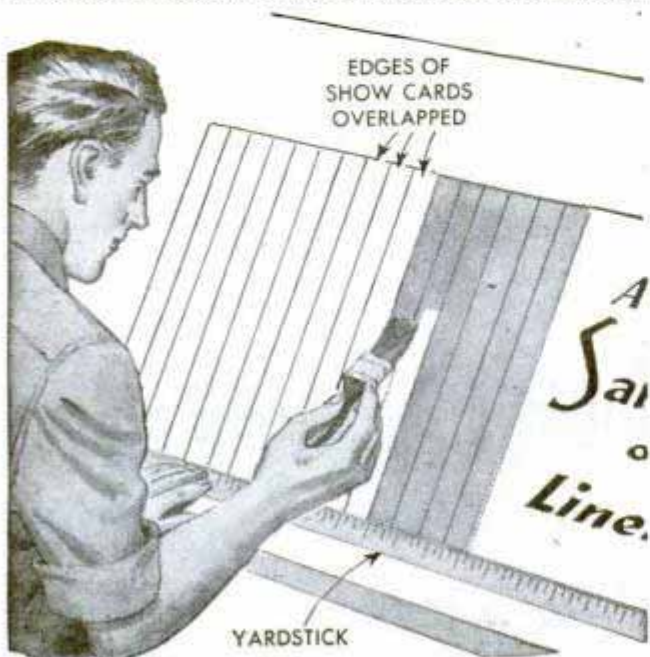

a row with each card overlapping the next one the exact width of the border. It was then a simple matter to paint the borders since each sign acted as a mask for the one preceding it. The process was repeated for all four sides.

Paper Scraps Keep Chickens From Eating Eggs

One man found that if small scraps of paper are sprinkled in front of the nest, chickens will be discouraged from eating eggs. The paper should be approximately the color of an egg so the chicken will think it is eating eggshell. After this, the chicken is no longer interested in eggs.—Opie Read, Jr., Chicago.



Tires Inspected With Mirror

One service man uses a mirror cold-soldered to a wire handle to locate defects on the inside walls of tires. The mirror is held inside the tire, which is rotated slowly. If any defects show, spreaders are put on the tire for a closer examination, but if there are no breaks, then the slower task of using spreaders is not necessary. The mirror can be polished steel or metal-backed glass.

John Krill, Youngstown, Ohio.



Small Chuck Used on Large Lathe

On a large lathe, which was fitted only with a 4-jaw chuck, a production job called for the use of a universal 3-jaw chuck to save time when setting up and removing the work. To use the smaller chuck, it was simply clamped and centered in the larger one, after which it was operated as though screwed onto the lathe spindle and the job was completed in short order.

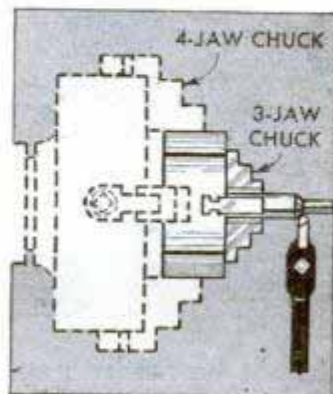

ZINC ELECTROPLATING

for the home workshop

Tools, metal parts and some appliances can be improved in appearance and protected against rust and corrosion by plating them with zinc. The equipment and chemicals required are easy to obtain and the process itself is fairly simple

By Nathan Bogoch



ZINC PLATING of small parts by the electrolytic process is not only a simple and effective method of rustproofing finished surfaces of steel, but also makes an attractive finish on brass and bronze. The zinc coating is especially effective on an assembly of small parts requiring the same finish. Use zinc coating to brighten up model work and protect tools and metal fittings of various kinds which are exposed to the weather.

The value of zinc coating lies in its resistance to atmospheric agents which induce corrosion. When exposed to severe outdoor conditions, the zinc plating turns white or gray in time but this oxidation forms an additional protective covering, serving to shield the zinc plate itself and, of course,

any underlying metal from undue corrosion.

The electrode-position method deposits a coating of zinc on the metal surface which is proof against the entry of moisture. Zinc coating applied to fittings or parts to be used indoors may be very thin and light.

The thickness of the coating deposited on the metal is roughly proportional to the plating time, that is, doubling the time will give approximately twice the thickness.

Thorough cleansing and preparation of the surfaces of the object to be plated are just as important as the plating operation. Dirt, oil and grease may be removed by boiling the objects in a strong alkali bath. A good cleansing solution may be made in accordance with the formula given in Fig. 2. Immersion in

1 CAUTION

Although poisonous chemicals used in electroplating are handled every day in large quantities in schools and industry without mishap, great caution should be exercised to prevent accidents. Handle the chemicals so that the solutions will not spatter and always add the acid slowly to the water while stirring. Never pour the water into the acid.

Cyanides can enter the body through the eyes, skin abrasions and perhaps through the pores of the skin after a period of time. When cyanide comes in contact with acids, deadly hydrocyanic acid fumes are generated. Do the work where a draft will carry all fumes outdoors from the plating bath or hot cyanide solutions. To dispose of the solutions, pour them into a floor drain into which a quantity of lye water has just previously been poured. Gloves used while plating with cyanide solutions should be rinsed thoroughly. To make sure that all cyanide has been removed, put the rinsed gloves in a pan of diluted vinegar outdoors. This will decompose any small amount of cyanide that may remain. Plating tanks should be rinsed thoroughly with several changes of clean water to remove the cyanide. As a final precaution, rinse the cleaned tanks with vinegar. Do this outdoors where the wind will blow fumes away from you.

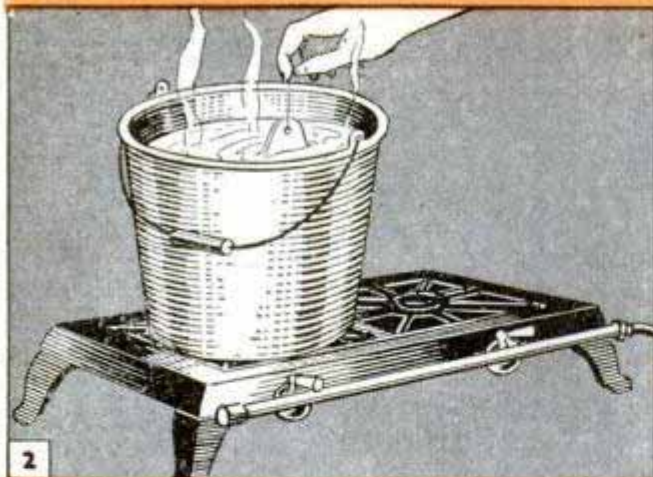

CLEANING

CAUSTIC SODA	3 OZ.
SODA ASH	3 OZ.
TRISODIUM PHOSPHATE	2 OZ.
WATER TO MAKE.....	1 GAL.

Heat to a boiling temperature and immerse object 10 to 15 minutes

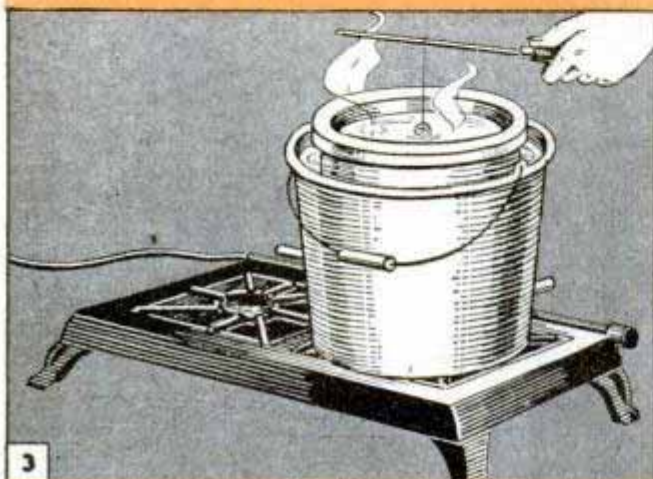

PICKLING

SULPHURIC ACID (78%).....	1 LB.
SODIUM CHLORIDE	3 OZ.
WATER TO MAKE.....	1 GAL.

Heat to 120° F.

CAUTION—Always add the acid to the water, in small amounts, while stirring slowly

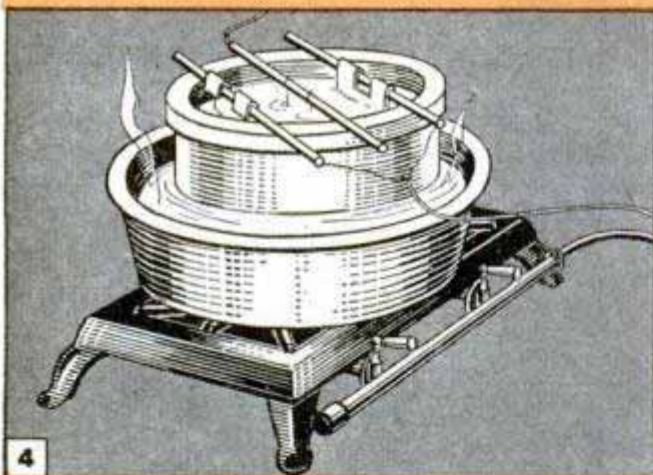

PLATING

SODIUM CYANIDE (96-98%).....	4 OZ.
ZINC CYANIDE	6 OZ.
CAUSTIC SODA	6 OZ.
CORN SUGAR	½ OZ.
DISTILLED WATER TO MAKE.....	1 GAL.

Heat from 90° to 105° F.

See caution note, Fig. 1, before mixing

this boiling solution will remove all dirt and grease. Scrape or wire-brush the surface to remove all loose material before placing in the bath. After immersing 10 to 15 minutes in the alkali solution the work is removed and rinsed in hot water, then in cold water. Next, it is placed in an acid bath, or pickle, to remove rust and scale. It should be remembered that it is essential to remove the grease or oil film first before placing the object in the acid bath; the solution cannot attack rust or scale unless the oil has been removed. The acid bath, or pickle, should be made according to the formula given in Fig. 3 and kept in a

stoneware vessel. Do not leave steel in the acid bath too long as the surface will become pitted. Remove it when the surface appears clean and bright. Immediately upon removal from the acid bath rinse the work in cold running water.

Most objects have one or more holes or projections by which they may be attached to a piece of No. 16-ga. copper wire. The long "pigtail" of wire offers a means of moving the object easily from one bath to another. One very important point: After the work is strung on a piece of bare copper wire and is ready for processing, do not allow it to be touched by the fingers or

to come into contact with any object. If you touch the surface a bare spot in the plating is likely to result. The vessel used for the plating solution must be non-metallic, such as a glass or earthenware jar. Before mixing any chemicals read the caution note, Fig. 1. To prepare electrolyte to the formula given in Fig. 4, take three quarters of the volume of water and heat to approximately 105 deg. F. Then add the sodium cyanide. When dissolved, add zinc cyanide and stir until dissolved. The caustic soda and corn sugar may then be added, and stirred until dissolved. Water is finally added to make up the required volume. It should be kept in mind that the formula calls for a prescribed volume. Don't use a full gallon, or four-liter, measure of water, plus the bulk of the added ingredients.

If you are using metric weights, substitute 30 grams for each ounce in the formulas and use $3\frac{3}{4}$ liters, or 3750 cubic centimeters for a gallon, these figures being sufficiently close approximations.

The wiring diagram is shown in Fig. 5. Almost any rheostat will do. It can be made of wire, or a substitute may be made as in Fig. 7. This consists of an old storage-battery box. Fill with a solution made by dissolving as much ordinary salt as possible in cold water. A pair of metal plates is inserted in the salt solution. The closer together the plates are, the higher the voltage.

For anodes, strips of pure sheet zinc, Fig. 6, are hung in the acid bath. If a quantity of work is to be done, use the cast zinc slabs. The ratio of anode surface to that of the cathode, which is the object being plated, should be about 1.5 to 1. Operating temperature should be from 90 to 105 deg. F. Four volts should be available at the bus



bars, while the current density should be from 40 to 60 amperes per square foot of cathode surface.

After the cold-water rinsing bath, the object is immediately hung on the cathode bar of the plating tank, the current being on, and the rheostat is manipulated until the proper voltage and amperage are reached.

For heavy plating a half hour is about the right time, while for thin plating a five-minute immersion will be sufficient. If the deposit is not thick enough, dip into the alkaline bath, rinse in hot water, then in cold water, and replat.

In any case, after removal from the plating bath rinse well in water and dry to prevent staining and spotting.

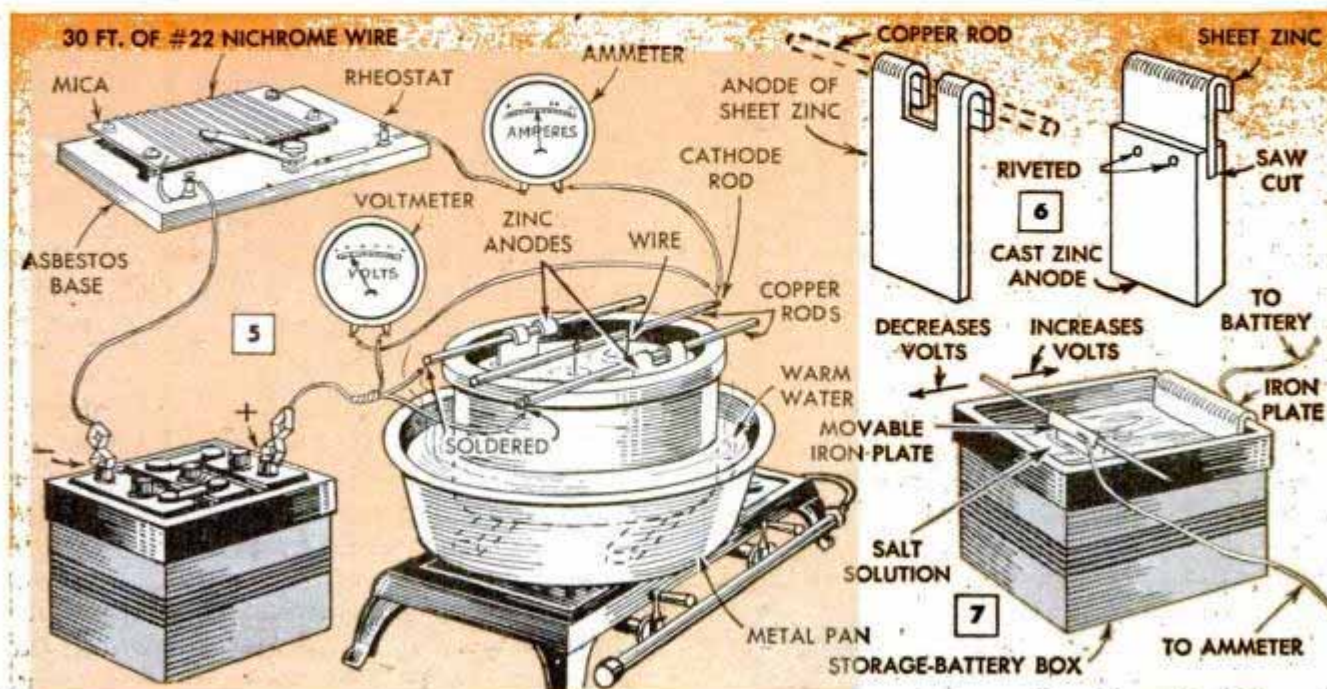

Pen Flashlight Illuminates Level In Hard-to-See Corners



If you're working in a dim light and it's hard to read a level, this flashlight will be an aid. A groove is cut in the side of the level at such an angle that the beam from the light is directed on the spirit glass. The flashlight is held in place with a rubber strip and is removed easily when not in use.—F. Hall, Maywood, Ill.

Pipette Made From Glass Tubing Helps Laboratory Workers

Any graduations you want—ounces, fractions of an ounce, tablespoons or other units—can be marked on this pipette that is made from a length of ordinary glass tubing. One end of the tubing is drawn to a

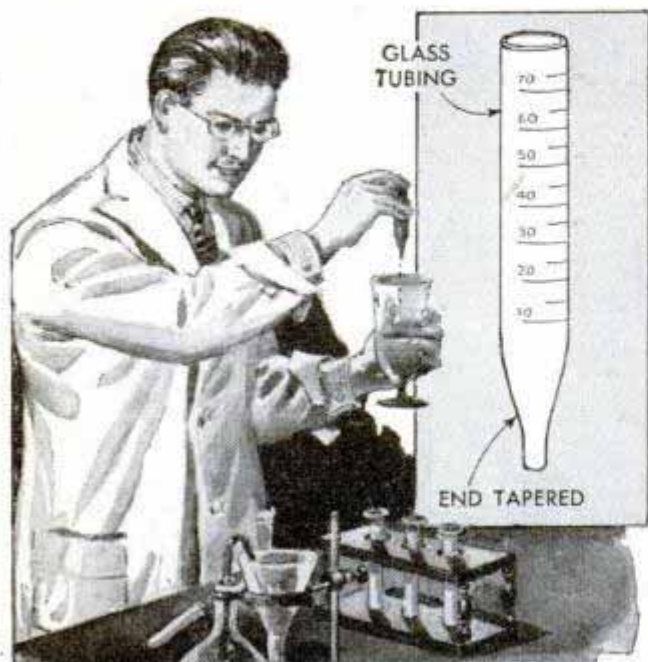

point over an open flame. Then the point is broken off so there is a small hole in this end. To mark the pipette, stop the tapered end and pour in one unit of the measure you are using. Mark this level with a file and continue pouring and marking until there are sufficient graduations to suit your purpose. In use, liquid is drawn in the tube to the desired level and held there by stopping the top of the tube with a finger. The fluid will be released when the finger is removed.

Walter E. Klein, Mansfield, Ohio.

Welding Jig Holds Round Work

This jig will serve to align the parts properly and hold them in position when welding rods, large bolts and lengths of pipe. It consists of a length of angle iron that is mounted on two V-shaped metal blocks. The upper half of a C-clamp is fastened to each block and used to hold the work in place while the weld is being made. The work can be turned easily.

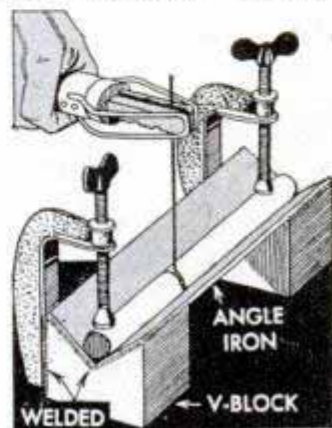

Sign Indicates Lack of Vacancies

To save time for himself and disappointment for travelers, one tourist camp proprietor had a sign made which would indicate whether he had any vacancies. The sign read, "No Cabins for Rent" with a pivoted cover placed over the word "No." When cabins were available, the cover was over the word "No" so the sign would inform travelers that there was space, but when all cabins were taken, the cover was swung down.

Gregor H. Glitzke, Kansas City, Mo.



Metal Stakes for Building Lines

When laying out lines for an excavation, instead of using wooden stakes, one builder found that 1-in. angle iron served the purpose better. The stakes should be long enough so that they remain driven in about 6 to 8 in. below the surface as the work progresses.—J. Issel, Petaluma, Calif.

Converter Unit for the New FM Band

THIS tubeless converter unit was built from a circuit designed by Henry R. Kaiser, chief engineer for FM station WMOT in Pittsburgh. When station WMOT switched over to the new higher frequency FM band approximately 6000 owners of prewar FM receivers in the Pittsburgh area obviously could no longer receive their FM programs.

To solve the problem Mr. Kaiser and his associates experimented with several converters using a crystal-multiplier for mixing with the FM signal to provide an IF frequency which would fall on the old band. They finally developed a single-tube quartz-crystal-controlled converter using a type 6SH7 oscillator-multiplier and a Sylvania 1N34 germanium detector crystal as a mixer. While experimenting with this unit, the oscillator in the converter accidentally failed. Much to the operator's surprise he could pick up the station on 94.5 megacycles at another spot on the old receiver dial. As the crystal oscillator was no longer working, the part of the circuit remaining consisted merely of two tuned circuits and the 1N34 detector crystal. This became the converter.

All construction details are given in diagrams Figs. 1 and 2 and photos A and B. The input frequency is tuned to the transmitter frequency and the output is tuned to a frequency in the old band. The coil dimensions given are for the low end of the new band. Merely spreading the turns on coil L2 should raise the frequency if required for your local FM stations.

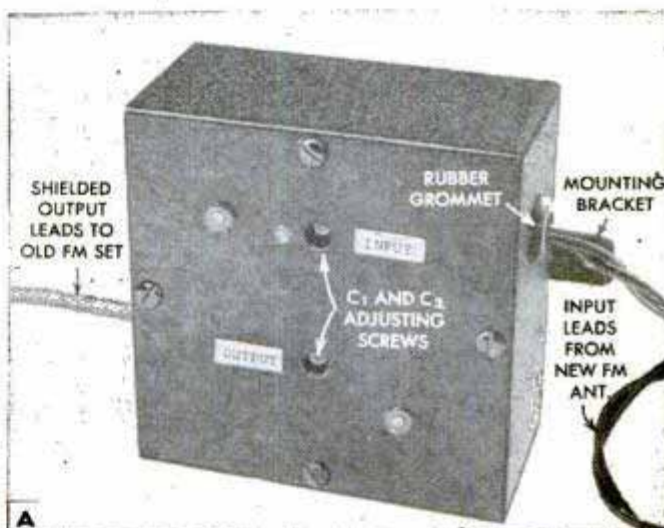

COIL WINDING CHART

- L1—2 turns of No. 18 insulated hookup wire (interwound with coil L2)
- L2—4 turns of No. 12 enameled copper wire (space-wound and supported on C1)
- L3—10 turns of No. 12 enameled copper wire (space wound and supported on C2)
- L4—3 turns of No. 18 insulated hookup wire (interwound with coil L3)

Note—Coils L2 and L3 are space-wound about the diameter of the wire. All coils are wound on a $\frac{3}{8}$ -in. form.

2—"air trimmer" midjet variable condensers (Hammarlund APC-25) or similar 7 or 8-plate "air trimmer" condensers C1 and C2

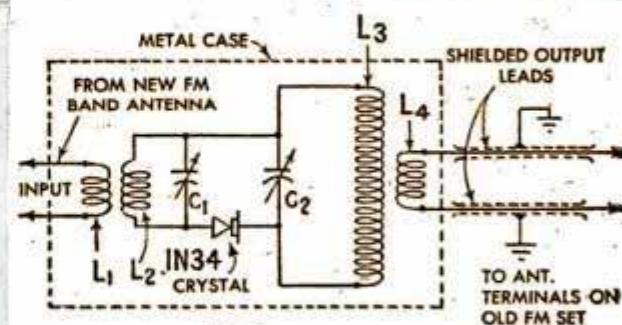
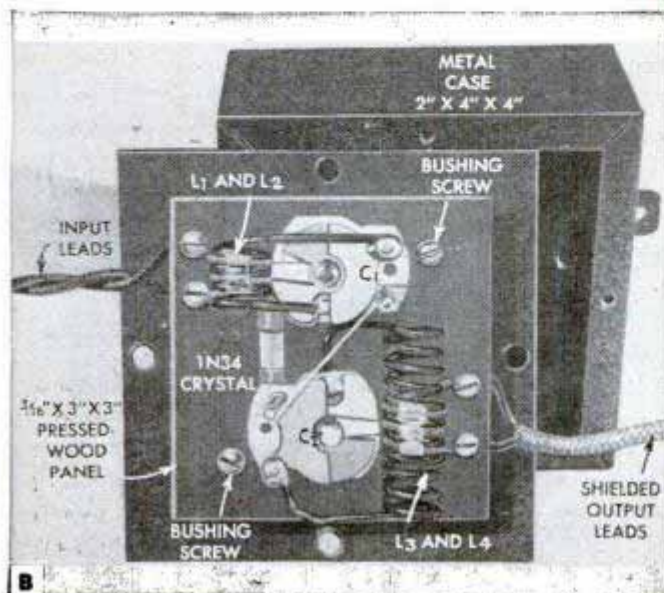

FIG. 1

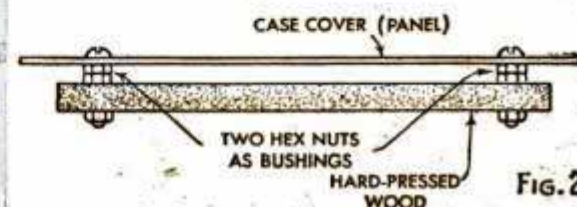
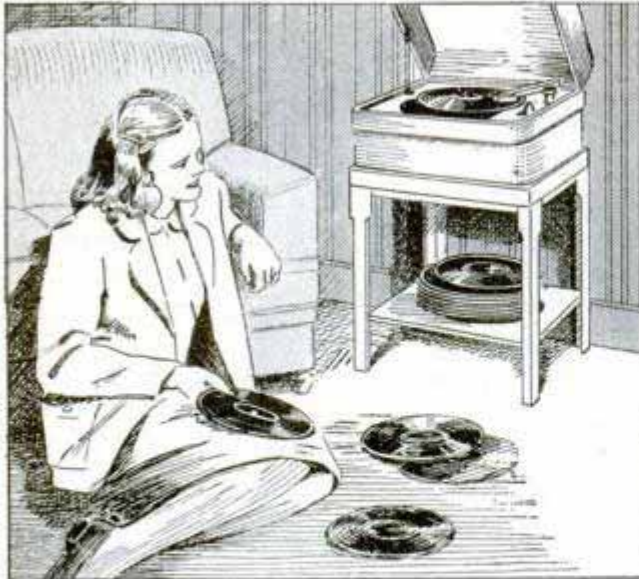

FIG. 2

HOW TO CARE FOR YOUR RECORD PLAYER



ALTHOUGH usually built to withstand rough handling, your record player, like any other precision instrument, must have occasional attention if maximum service is to be maintained. Separate record players designed to play through the audio stages of your regular broadcast receiver require more attention than those built into combination phono-radio consoles or table-top cabinets. However, the following service hints apply to all types.

When the wires under the pickup arm leading to the crystal cartridge become loose, as illustrated in photo A, they will drag on the record and cause noise. In the case of a separate record player, the bottom plate may be removed and the slack pulled out, after which the wires may be secured with a piece of adhesive tape. In combination phono-radio sets these wires may be reached, in most cases, from the rear of the cabinet.

If the record player does not operate, the pickup cartridge may be defective. Check the cartridge by grasping the needle as shown in photo B; if the needle holder may be moved back and forth to any extent, it usually means that the pickup has been damaged and a new cartridge is necessary.

Dust particles scratch records on the side in contact with the cloth covering on top of the turntable. A small brush should be used at regular intervals as indicated in photo C. The bearing of phonograph turntables in constant use may require an occasional oiling. Where the motor has a felt packing as in photo D apply a light application of oil with an eyedropper; in some motors it may be necessary to use a drop of oil on a wire to reach the bearing. Crystal pickups are fragile and should be kept tightened in their arm mounting bracket as illustrated in photo E.

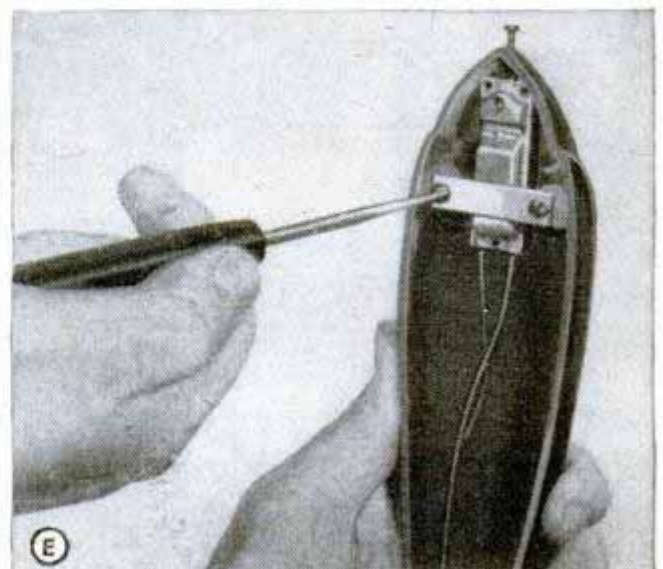
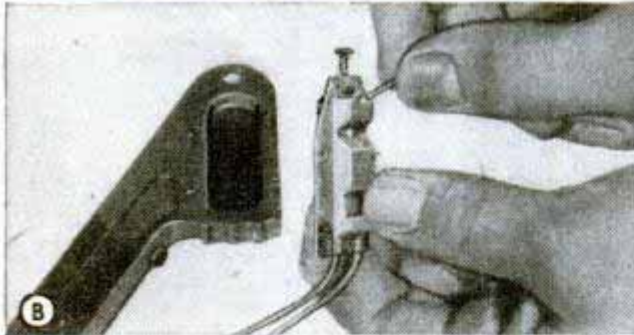

New Lightweight Tripod



... makes your camera steady and light on its feet

Kodak Eye-Level Tripod is light in weight, quick to set up . . . and built to last for years. It gives rigid, dependable support to movie and still cameras and helps you get pictures free from accidental camera movement. Extends from 22½ inches to 60 inches. \$16.75 plus tax.



Kodak Turn-Tilt Tripod Head angles your shots expertly

Easier panning with your movie camera, a versatile accessory support for still shots. New smoothness in performance with a minimum of adjustments. Fits your present tripod or *Kodak Eye-Level Tripod*. \$13.25 plus tax.



ENLARGING EASEL speeds making of album prints from miniature negatives

Kodak Miniature Enlarging Easel for 2¼x3¼ album prints (with ⅛-inch white margins) from miniature negatives. Makes a

rapid succession of record prints from which choice shots may be selected for further enlargement. With its white Tenite base insert, there's no need to use photographic paper while focusing. Two built-in bins hold your papers. It rests on the baseboard of your enlarger. \$6 plus tax.



Optipod
\$1.50 plus
tax



Kodapod
\$2 plus
tax

These clamp-on "tripods" are convenient and steady

Optipod (left) and *Kodapod* (right) are pocket-size and easy to carry—yet give you tripod steadiness. *Optipod* is felt-lined, fastens to chairs, tables, desks—*Kodapod's* teeth bite firmly into fences, tree branches, etc.

Eastman Kodak Company
Rochester 4, N. Y.

Kodak

"HULA DANCER DANCER Fools the Big Ones!"

*Writes C. W. "Duke" Mead,
Memphis Angler*



"Dear Fred:

"Have discovered it takes a Hula Dancer with your invisible bait casting leader to fool the big ones, especially in the colder months when they are down deep. I caught this 9-lb. bass and several others from Storm Creek Lake near Helena, Ark. — which isn't virgin waters.

"I have used your Hawaiian Wigglers and Jitterbugs for years. They have proved their worth time and again on numerous fishing trips. Previous to this 9-lb. bass, the largest I had ever caught was a 6½-lb. largemouth on a No. 2 Hawaiian Wiggler. If the boys want action and bass, I recommend that they try your lures." — C. H. "Duke" Mead, Memphis, Tenn.

Write for Free Catalog

Beautifully illustrated in colors, it tells all about Hawaiian Wigglers, Jitterbug, my famous surface bait, and Hula Dancers. Copy free on request.

Colored Movies Available

We have 8 reels of colored movies taken of bass fishing in Canada, Michigan and Florida. These are available without cost for showing to clubs. Advise what club and when you would like to use them.

FRED ARBOGAST & CO., 1604 North St., Akron 3, Ohio



\$1.21 ea.

Choice of 6 Colors

NEW

"EVEREADY" FLASHLIGHT BATTERY LASTS 93% LONGER!

Tiny Cell Packs Enough ENERGY to Hit 200 Home Runs!

Like baseball? Like to raise the roof when your favorite slugger blasts one out of the park? Then here's news: The amazing new "Eveready" flashlight cell contains energy equal to the amount needed to smash out 200 major league homers! Extra power makes "Eveready" batteries the season's champion for brilliant, lasting, low-cost light!

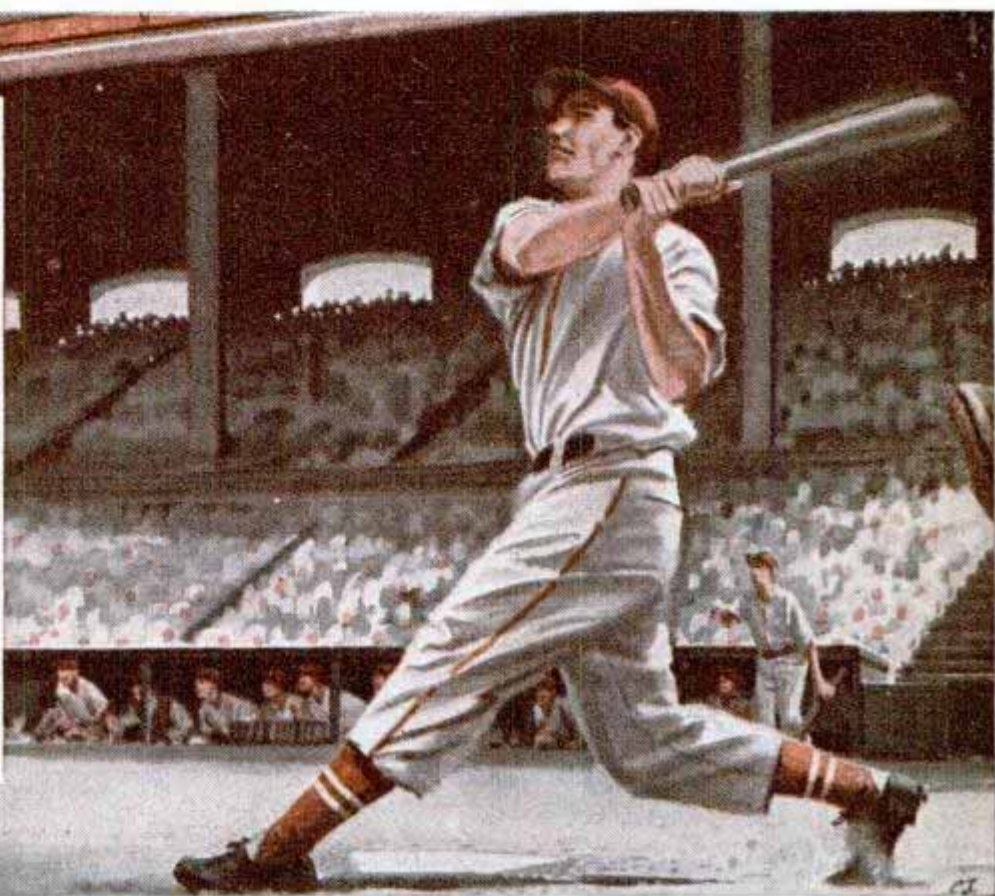

WHAT a supercharger is to a racing car—the new "Eveready" battery is to your flashlight. It "packs in the energy"—93% more of it than even the great pre-war "Eveready" cells gave you! You get nearly *double* the life... maximum light for nearly *twice* as long. For good service...better light...best quality... get these new "Eveready" brand flashlight batteries!

The registered trade-mark "Eveready" distinguishes products of
NATIONAL CARBON COMPANY, INC.
30 East 42nd Street, New York 17, N. Y.
Unit of Union Carbide  and Carbon Corporation

Nearly *twice* the electric energy... almost *two times longer life* of brilliant white light than even famous pre-war "Eveready" flashlight batteries. That's today's *high-energy* "Eveready" battery, as proved by the "Light Industrial Flashlight" test devised by the American Standards Association.

**93% MORE ENERGY
NOW**

1941



High Energy

MEANS

BRIGHTER LIGHT, LONGER LIFE

EVEREADY

TRADE-MARK

FLASHLIGHT BATTERIES



What's Missing in this Picture?

Not a thing!

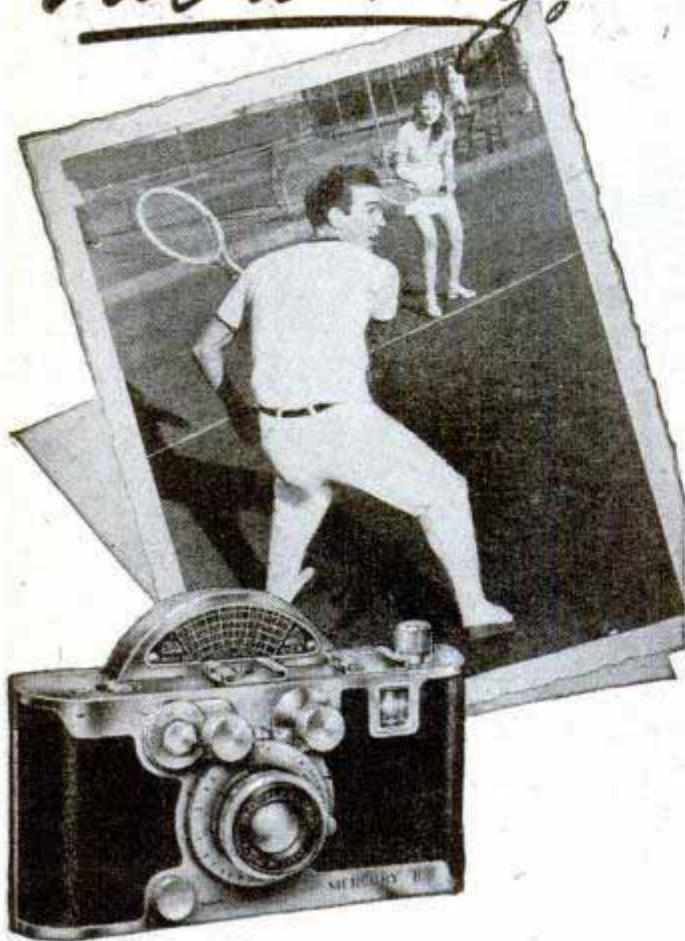

You, too, can get everything with

MERCURY II

It's a UNIVERSAL

Shoot *everything* with Mercury II — candid, split-second action, portrait, still-life — and you get *everything* with a maximum of ease.

COLOR! The only minicamera especially designed for color, gets pictures as fresh and vivid as new paint.

ACTION! Lightning-like shutter freezes rapid action.

LOOK-ALIVE DEPTH! Three-dimensional depth of focus guarantees clear focus even when you misjudge distances up to 50%.

FUSSPROOF SIMPLICITY! Extreme ease-of-operation leaves you free to concentrate on your subject.

FILM ECONOMY! Shoots *more* pictures — 36 exposures on a standard 20-exposure cartridge.

See the Mercury II at your dealer's today!

Shoot Pictures like the "Pros" with Mercury II

UNIVERSAL CAMERA CORPORATION

NEW YORK

CHICAGO

HOLLYWOOD

Manufacturers of Cinémaster and Mercury Cameras
and other Photographic Equipment

Smartest Ship Afloat!

(Continued from page 145)

men to handle the wheel of a stout fishing boat in the rugged seas off New England while the skipper gives the orders. With electromechanical steering the captain can maneuver the boat with his little finger.

Completely automatic steering can be had, of course, by coordinating this installation with a gyro-pilot.

Gyro-magnetic compasses and gyro-compasses in all stages of development get their seagoing "once-over" from the salty scientists. The gyro-compass, in particular, has undergone drastic modifications since before the war, when, because of its size, weight and cost, this vital navigational aid was found on few ships under 150 feet except luxury yachts.

The standard gyro-compass, five feet high, three feet across and weighing 600 pounds, was not suited for use on PT boats and small invasion craft. Since it was essential that patrol and invasion craft know exactly where they were going, the "impossible" was attempted and achieved in the production of an "invasion compass" only 20 inches wide and 20 inches deep which could be stowed under the bunk of a PT skipper.

While reduction in size and weight are the chief considerations to small boat owners and skippers, the fact that the small Mark 18 unit cost \$5000 against \$6500 for the smallest earlier model is increasing inquiries and the list of orders received from owners of fishing and pleasure boats.

Ten small boats on the Pacific Coast have been equipped with Sperry navigational equipment since the war, including the tuna clipper *Espirito Santo*, which holds the world record for the largest catch on a single trip—475 tons. Another ultra-modern clipper boasting "big ship" equipment is the *Chicken of the Sea*.

Dinners Without Drudgery

(Continued from page 177)

ing the war GIs griped so much about the crackers in K-rations that the Army developed a canned bread—fresher and tastier. Some 5,000,000 cans of it will be tested in 1947. It will be issued in a four-ounce can for E-rations (successor to K-rations) and a 10½-ounce can for the new 5-in-1 ration.

Machinery and transportation manufacturers are also getting on the frozen-food bandwagon. Harvesting, freezing and storage maintenance equipment in large quantities is needed. Airplanes, trains, trucks

(Continued to page 244)

Dependable

CHAMPION

AMERICA'S FAVORITE SPARK PLUG



Outstanding example of the dependability of Champions is the recent world's record, non-stop, non-refueled flight of the Navy Airship XM-1. Champion equipped engines kept her in sustained flight for over 170 hours, a record for any type of aircraft. Such dependability is inherent in every Champion Spark Plug for every engine and operating condition. Champion Spark Plug Company, Toledo 1, Ohio.



FOLLOW THE EXPERTS

DEMAND DEPENDABLE CHAMPIONS FOR YOUR CAR

Listen to the CHAMPION ROLL CALL,
Harry Wismer's fast sportscast every Friday night,
9:55 EST over the ABC network.



A full day's hunting on one loading with Marlin's dependable tubular magazine .22

● Shooting efficiency, with the least fuss and bother, is what you get in the 81-DL. Tubular magazine holds a load for a full day's hunting of small game. And this man-sized Marlin is light enough to carry all day without tiring.

CHECK THESE SPECIFICATIONS —FOR VALUE AND FOR SPORT!

One-piece buttstock, with fluted comb and semi-beavertail forearm.

Quick-release trigger; self-cocking action; side ejection; On and Off safety.

24" tapered blued steel barrel; Ballard type rifling; crowned muzzle.

Unique, patented feeding mechanism; magazine capacity 25 - .22 short, 18 long rifle cartridges.

Shoots .22 short, long and long rifle—regular and high speed—without adjustment.

Removable, plated bolt assembly; flush takedown screw.

Equipped with peep sight, ramp front sight and hood; sling strap swivels. Also available with open rear sights, bead front sights, no swivels.

Outstanding for rugged construction, reliability and accuracy.

Marlin 81-DL

25-Shot Tubular Magazine .22 Cal. Repeating Rifle

\$25.55. Price Slightly Higher West of the Rockies.



Unbeatable for pests and vermin...owls, rats, hawks and crows, the 81-DL carries up to 25 shots.



Marlin's 81-DL is a sure getter of woodchuck, raccoons, rabbits and other fur-bearing small game.



Finely balanced for plinking and general target work, the 81-DL is also an ideal "learning gun."

SEE THE MARLIN 81-DL AT YOUR DEALER'S TODAY.

THE MARLIN FIREARMS CO., NEW HAVEN, CONN. • Fine Guns Since 1870

RIDE YOUR FAVORITE "HOBBY" WITH...



THE COMPLETE HOBBYCRAFT ASSORTMENT THAT FILLS EVERY NEED

Whether your favorite hobby is model building, wood carving, leather working, linoleum cutting, you'll find in the new King Kut knives, tools and blades such standards of design, workmanship and PERFORMANCE that will gladden your craftsman's heart—at prices you're happy to pay! The delicately balanced, polished aluminum handle...all-purpose knurled handle...the chuck with the vise-like grip...22 blades, carvers, routers and punches...smooth-cutting spoke shaves and planes constitute King Kut's Regal Treasure Chest. Each King Kut blade is sized and shaped to do its specific job, is made of the finest steel...hardened throughout for money saving resharpening.

Try King Kut products. You'll agree King Kut meets every test in hobbycrafting—and wins!

King Kut Products are covered by Fair Trade Agreements.



KING KUT HOBBY TOOL SET No. 120

...contains one each of 22 cutting edges, the knife handle and plastic knob. Compactness and easy accessibility to the cutting edges...a place for each tool in its 3-color carton. For discriminating buyers \$5.00



KING KUT REGAL TREASURE CHEST No. 130

...contains entire line of 22 blades, carvers, punches, routers, the all-purpose handle with removable plastic knob, plane, flat and curved spoke shaves and a clear plastic parts box. Chest is beautiful in its select wood, nail-free natural finish...a chest every hobby crafter will truly treasure . . . \$10.00

Other King Kut Sets as Low as \$1.00



ONE HANDLE SERVES ALL CUTTING EDGES

At last—an exclusive chuck with a vise-like grip that tells the blade to stay put...and means it! No wiggling or working loose to ruin a bit of fine detail. Holds firmly all 22 cutting edges. Locks and unlocks with one turn.

See your Hobby, Sporting Goods, Hardware, Art and other Stores for King Kut Tools.

Address Dept. KK147

THE AP PARTS CORPORATION • TOLEDO, OHIO

Manufacturers of the famous AP "Mileage Getting" Mufflers and Pipes for Automotive Vehicles.



A drive
with beauty...
that never ends...

How thrilling to own a new car. Can you imagine the finish even more beautiful? It will be if you SIMONIZ now. SIMONIZ adds to the richness of color . . . increases the natural brilliance. And as the years roll by, applying SIMONIZ "builds up" this beauty. Makes it permanent and more glamorous than ever. Stops ultra violet rays from fading colors . . . gritty dirt from scratching . . . corrosive airborne chemicals from dulling and destroying the finish. Always insist on SIMONIZ. Nothing takes its place. That's why . . .

Motorists Wise Simoniz

TO RESTORE NEW BEAUTY to dull finishes . . . use the Simoniz Kleeners—liquid when it's in average condition . . . paste when the finish is exceptionally dull. Then apply SIMONIZ to make that sparkling finish last years longer. Sold everywhere.

The Simoniz Co., Chicago 16, Ill.



®"SIMONIZ" . . . TRADE MARK REG. U. S. PAT. OFF. & FOREIGN COUNTRIES

and trailers are undergoing alterations.

Douglas Aircraft Company recognized the need for a cargo plane to carry frozen products and redesigned a DC-4 for the job. It will carry 22,700 pounds for 1500 miles—two hops will cross the continent. Heretofore, perishables were carried in a restricted space in small racks chilled with dry ice. Temperature and humidity were uncontrolled. Flowers and meat, for example, require high humidity and moderate cold; frozen fruits and vegetables a dry cold. Ripe fruits need a temperature of about 45 degrees Fahrenheit to maintain peak freshness. The Douglas "flying refrigerator" will provide all types of freezing.

The Association of American Railroads is spending \$100,000 in a two-year program to improve railroad refrigeration cars. Consolidated Steel Corporation recently developed a stainless steel refrigerator car for transporting frozen foods. It has a new type of sliding door and a circulation system for cold air to keep frozen food products at required low temperatures.

Trucks also are being redesigned. Fruehauf has manufactured more than 600 refrigerator units for installing on truck and trailer chassis, to cost around \$2000 each.

New methods of packaging are emerging. The Pacific Grape Products Company of Modesto, Cal., is putting premium quality frozen fruits and vegetables in tin cans instead of the familiar cardboard carton. The square cans are vacuum sealed to provide absolute protection against oxidation and flavor changes.

One man who is betting on the future of frozen and ready-cooked food products is Laurence L. Graham of Ridgefield, Conn., who has organized Meals on Wheels. A nation-wide fleet of delivery trucks, supplied by independent, self-supporting restaurants, will bring sandwiches, bakery goods, soup, casserole items, hot plate meals, ice cream, milk and coffee to your door. These rolling restaurants will also serve outdoor sporting events and industrial plants.

The Land Comes Back

(Continued from page 161)

Soil losses from 30,000,000 acres alone have been reduced by more than 1,000,000,000 tons over a seven-year period, soil that would have started downhill toward the oceans. Already the annual loss of 1,000,000 acres of ground from the useful agricultural total has been cut in half.

Just as amazing is the increase in farm productivity that results almost immediately from soil conservation practices. Dr.

(Continued to page 248)

New X-acto Tools

Scientifically designed to fit those small, exacting jobs

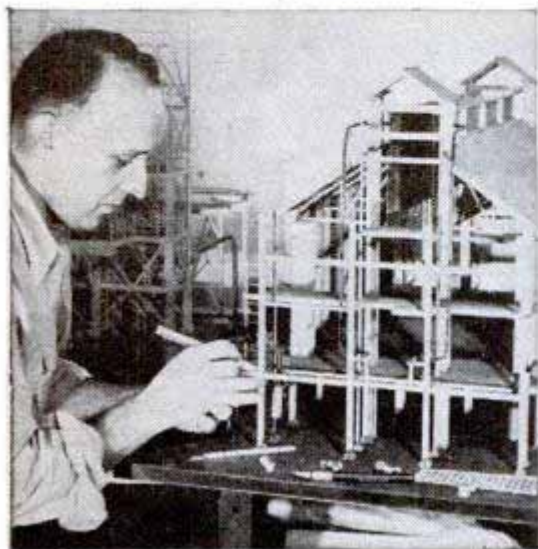

No. 50 X-ACTO HAMMER SET — 6 heads: 2 ball; 3 flat (steel, brass, plastic); 1 tinner's hammer with angle-locking set screw. Set, \$1.50.

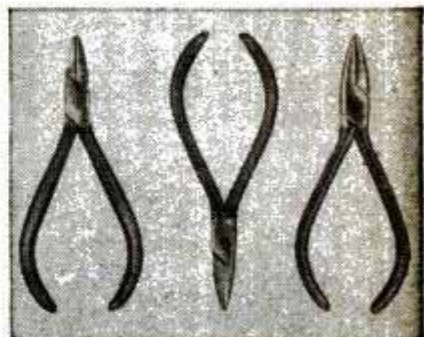

PLIERS — Case hardened. For wire-forming, etc. No. 58, combination round and flat, \$1.85. No. 56, flat nose, \$1.75. No. 57, point nose, \$1.75.

Makes Super-Furnace With Super-Knife

Wherever there's oil in the world, you'll find refineries designed by The M. W. Kellogg Company of New York. Here, Edmund Serafin, of the Kellogg Model Department, works on a model of a cracking furnace embodying new developments in engineering and design.

Naturally, Mr. Serafin is using the knife that embodies the newest developments in model-building tools . . . X-acto! He likes its scalpel-sharpness, its wide variety of blades. But especially he likes the way this long-handled knife reaches 'way inside the model to otherwise inaccessible parts.

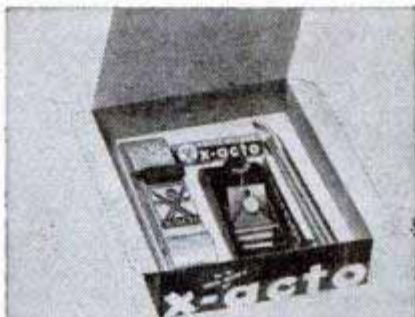

"BEGINNERS' LUCK" — No. 81 X-acto Modelbuilder's Basic Kit: No. 2 Knife; 5 regular, 2 3" blades; planer; sander. Complete, \$2.50.



No. 47 HAND DRILL — Double pinion action, spring steel chuck. Takes drills up to 3/16". \$2.75.



New No. 77 X-acto Woodcarving Set. Perfect tool for wood, plastics, linoleum, etc. Includes 6 different chisel and gouge blades, 4 assorted regular blades, 2 3-inch blades, 1 handle designed to take all blades. Complete with hardwood block, transparent cover, \$3. Other Knives, Tools, Chests, 25c to \$49.50. (Prices slightly higher in Canada.)

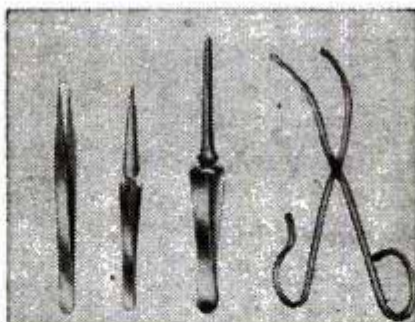

TWEEZERS — Steel, with plated finish. No. 36, plain, 35c. No. 38, cross-action self-locking, pointed, 50c. No. 37, cross-action self-locking, blunt, 45c. No. 39, cross-action, 60c.

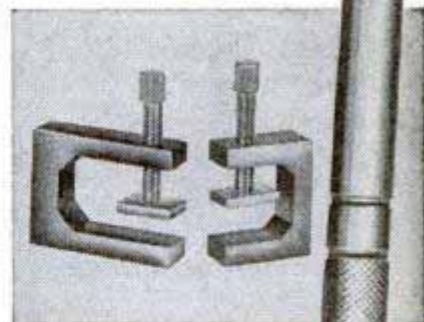

C-CLAMPS — Magnesium, high rigidity, steel screw, aluminum locking plate. No. 51, 30c. Nos. 52 & 53, 40c. No. 54, 50c.

x-acto
KNIVES & TOOLS



At hobby, gift and hardware shops

X-acto Crescent Products Co., Inc. 440 Fourth Ave., New York 16, N. Y. In Canada: Handicraft Tools, Ltd., Hermant Bldg., Toronto. *Reg. U.S. Pat. Off.

"Fred made this? Not really!"



JANE: That's right, Joan. Good job, don't you think?

JOAN: Why, it's—it's beautiful! How does he do it?

JANE: Fred says it's easy. Just takes good tools and a little patience. It's a grand hobby for him.

JOAN: You know... Jerry's always said *he'd* like a home workshop, but he just never gets around to starting. Maybe if we got the two of them together...

JANE: Let's try it this evening. Fred can give Jerry a lot of good tips. Like buying only branded tools, for instance.

JOAN: Branded tools?

JANE: Yes, tools with well-known brand names. Fred says anybody who buys "no-name" tools at bargain counters is just spending good money for junk. He does all his buying at the hardware store, where the tools and hardware have brand names he can depend on.

*Your HARDWARE DEALER
sells QUALITY tools and
hardware. Buy from HIM.*



POPULAR MECHANICS

Motorcycling is **TOPS**
for **FUN** and **THRILLS!**



Own a **HARLEY- DAVIDSON**

No wonder motorcycling is the favorite sport of so many fun-loving, vigorous, red-blooded young men and women! There's a thrill to riding a new 1947 Harley-Davidson that beats anything else on wheels. Owners have grand times — they belong to clubs—make new friends — compete in endurance runs, race meets and hillclimbs. They get out on the open road and tour the country — even tour other lands. Don't merely *wish* for good times — when you can roll up so many pleasure-filled miles on your own Harley-Davidson! Get set for the happiest evenings, weekends and vacations of your life — see your Harley-Davidson dealer **NOW** — and mail the coupon today.



**HARLEY-
DAVIDSON**
Motorcycles

HARLEY-DAVIDSON MOTOR CO.
Department P, Milwaukee 1, Wisconsin

Please send free copy of 24-page "ENTHUSIAST" Magazine, filled with motorcycle action pictures and thrilling stories.

Name.....

Address.....

City..... State.....

Smooth...
**BALL-BEARING
ACTION *plus*
DEPENDABLE
ACCURACY**

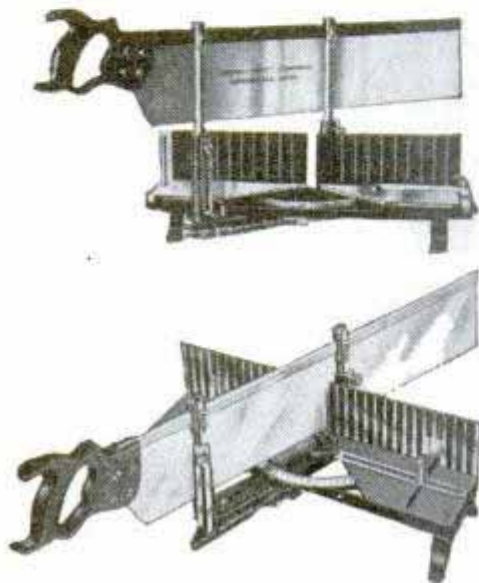

Ball-bearing saw-guides and saw-carriages to make work easier, positive adjustment for cutting angles to eliminate errors, graduated arcs and index plates to produce near-precision cutting, all-steel construction to last a lifetime—these are but a few of the many outstanding advantages offered by Millers Falls mitre boxes.

Like all Millers Falls products, these mitre boxes are quality-constructed throughout. You'll be surprised how much more simple, how much more accurate they can make your work. See them at your dealers.

MILLERS FALLS COMPANY
Greenfield, Massachusetts

One thing in common—Quality!



Hugh H. Bennett, father of the movement and chief of the soil conservation service, states that the annual average production of major crops has been increased by 35.7 percent on land under soil conservation planning. In Kentucky 165 farmers report that their increased yields amount to 39.7 percent, well above average. Some of the overcropped and eroded Kentucky farms were incapable of supporting the owners and their families a few years ago; now the farms have been restored to where they yield 1700 pounds of tobacco or between 50 and 60 bushels of corn per acre.

These Kentucky farmers retired more than 1000 acres from cultivation and put it into hay and pasturage. And yet the acreage that was left produced 17,000 more bushels of corn, 43,000 more pounds of tobacco, and 6700 more bushels of wheat than had been harvested in previous years. Meanwhile their increased pasturage and hayfields permitted a 120 percent increase in beef cattle, hogs and other livestock.

Soil conservation also pays off in increased property values. One man in Georgia wrote to the service that the farm he bought several years before had been able to produce only 13 tons of peanuts per year. Last year the same land produced 51 tons of peanuts, 1000 bushels of wheat and 11 tons of blue lupine and crotalaria. He figures he can sell out today for several times what he paid for the place.

Another man bought a worn-out 320-acre farm in North Dakota in 1937 for a one-dollar bill and a tom turkey; today it's a valuable farm from which he earns a good living. He has restored part of his acreage to range on which he grazes 45 head of cattle. He has a two-year supply of feed on hand and a large irrigated garden. Soil conservation techniques brought about the change.

There always is a certain amount of erosion from any ground. Natural geologic erosion, however, is held to a slow pace by the natural plant cover. New topsoil is formed from the underlying subsoil at about the same speed that topsoil is lost. But when land is cleared for cultivation or is overgrazed or otherwise left unprotected, erosion speeds up. In an extreme case erosion caused by man can remove as much topsoil in a year as nature would take away in 10 centuries.

Simple erosion control is only part of the entire conservation program. That includes any and all measures that will make the land produce at its best without damaging it. Wise land management helps to prevent loss of topsoil, exhaustion of plant food in

(Continued to page 252)

How to magnify the beauty of your car

This efficient liquid-type car polish makes car shining easy
... cleans and polishes in one operation

1. RUB CARNU ON! It's easy... rub only hard enough to loosen the grime. Then let Carnu *dry* completely to a white powder.

2. WIPE CARNU OFF! Nothing to it... just wipe off the powder. Dirt goes right along with it and the finish shines like a brand new car. The operation takes less than an hour!

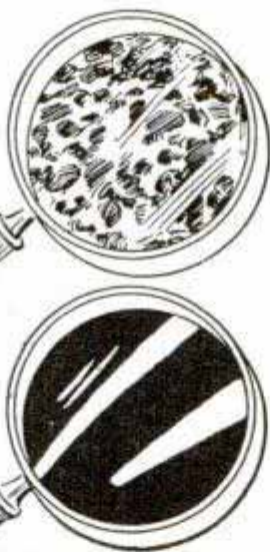
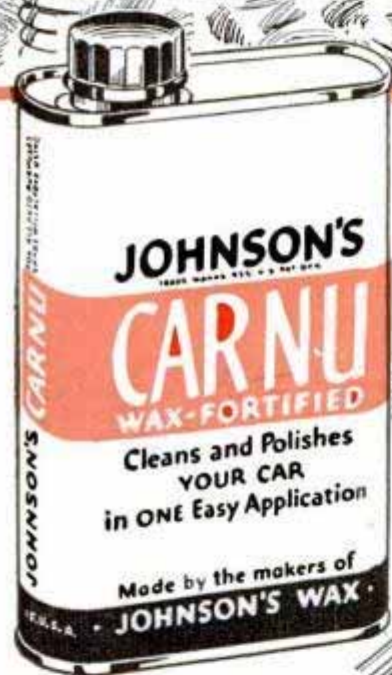
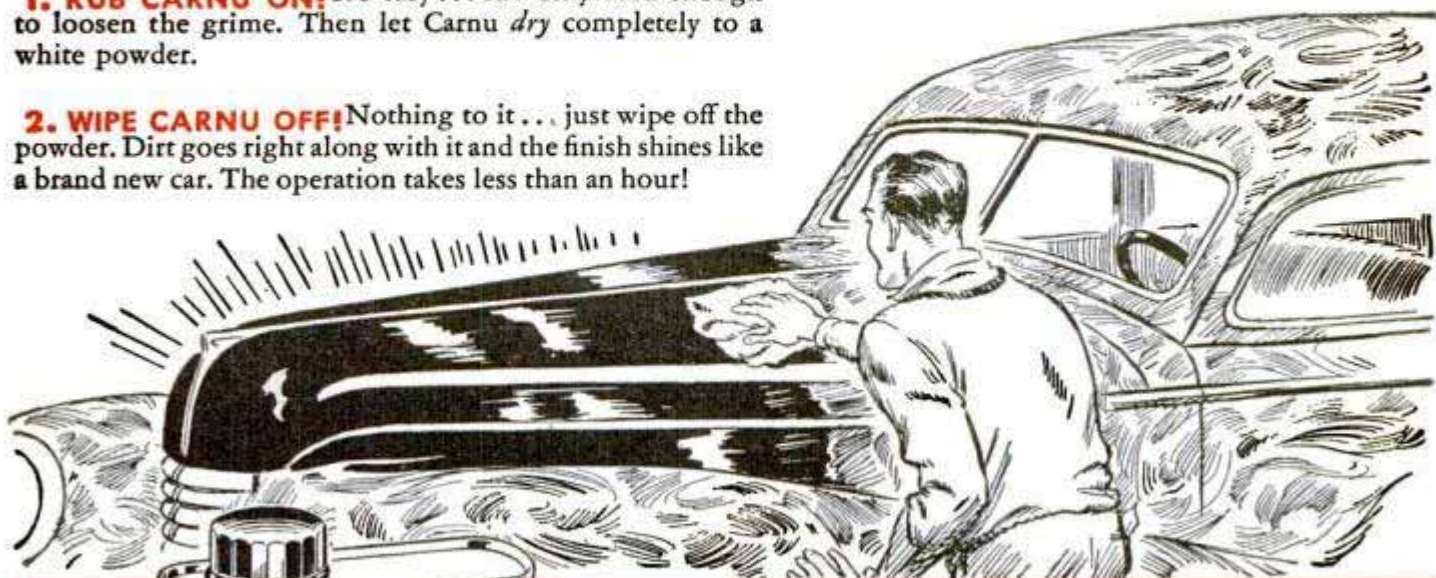

Look at
the difference
Carnu makes!

BEFORE CARNU Dirt and oxidation make finish rough, lusterless.

AFTER CARNU "Showroom shine" is restored. Finish is bright and beautiful — and so smooth dust and dirt may be wiped off in a jiffy!

EXTRA PROTECTION FOR THE MAN WHO DEMANDS "PERFECTION"

A tough, preservative coat of Johnson's Auto Wax does all these things:



1. Maintains the "Carnu" shine.



2. Protects the finish.



3. Helps preserve the color.

If you're the type who wants that "little bit extra"... and are willing to spend a little time to get it... Johnson's Auto Wax is right up your alley.

This special easy-buffing car wax gives your car a tough, protective film, protects it against sun, heat and moisture. Auto Wax also makes it easy to keep your car clean and shining because dirt can't get a foothold on the smooth, hard, waxed surface. Your auto supply store, filling station or regular Johnson's Wax dealer has Johnson's Auto Wax... Try it!



S. C. JOHNSON & SON, INC., RACINE, WISCONSIN

FREE

get

ALLIED'S NEW RADIO CATALOG

SEND FOR IT
NOW

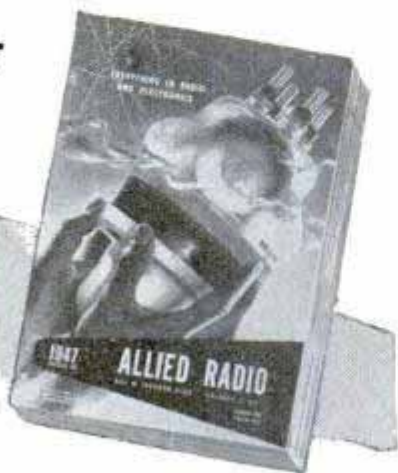

FOR
EVERYTHING
IN RADIO!



NEW HOME RADIOS



SERVICE SUPPLIES
BUILDERS' SUPPLIES



AMATEUR GEAR



SOUND SYSTEMS

164 Value-Packed Pages

Send for your FREE copy of the most complete Buying Guide for Everything in Radio! Here's the Catalog for Servicemen, Dealers, Soundmen, Amateurs, Builders and Experimenters. Features the world's largest and most complete stocks of radio and electronic supplies—quality equipment at lowest prices! Get the speedy service and expert help you want from ALLIED—Radio's Largest Supply House. Depend on ALLIED!

MORE THAN 10,000 ITEMS

Get everything for every radio use: New 1947 home model radios, phono-radios, recorders, communications receivers, Ham kits, and gear, code apparatus, radio parts, tubes, tools, test instruments, public address equipment, low-cost easy-to-build radio kits, diagrams and matched parts lists, largest selection of instructive radio books—all at lowest prices!

ALLIED RADIO

ALLIED RADIO CORP.
833 W. Jackson Blvd., Dept. 5-DD-7
Chicago 7, Illinois

FREE
CATALOG

Rush new FREE 1947 Catalog

Name.....

Address.....

City.....Zone.....State.....

ATTENTION GOLFERS!



FLASH! Notice to all Golfers, you can get rid of that nasty slice or that diving hook and keep from going into the rough or out of bounds! You can do it by use of our simple ground device, with a few practice shots at your favorite driving range or golf course. All this comes to you in simple form without a lot of complicated instructions and, with a small amount of practice you will have complete direction control. Don't wait.

Send \$2.00 cash or money order with this ad to

GOLF DIRECTION CONTROL

2301 Wabansia Avenue
Chicago 47, Illinois

I.K. - CD - P

DEPEND ON DIESEL POWER

FOR
LIGHTING

PUMPING
WATER

OPERATING
MACHINERY



DIESEL'S THE POWER...
Sheppard's the Diesel

If you can't afford a power failure...you can well afford Sheppard Diesel Power... the power that's free from all outside interference. Simple... economical to operate. Write for literature.

HATCHERY
OPERATIONS

POWER UNITS
GENERATING SETS
MARINE ENGINES

R. H. SHEPPARD CO., INC.
48, Middle St., Hanover, Pa.

THESE ARE JOHNSON DEVELOPMENTS

FULL PIVOT
REVERSE

DUAL
CARBURETION

ALTERNATE
FIRING



For **DEPENDability**

FREE HANDY CHART

Write for new Sea-Horse Handy Chart of motor sizes and specifications on the 5 great models of the 1947 line.

Reverse is a Johnson feature. So is Alternate Firing. So is Dual Carburetion—and there are many others. When you look for quality features, look for them in the motor where they were developed—and perfected. Consult your Johnson dealer about delivery. Look for his name under "Outboard Motors" in your classified phone book.

JOHNSON MOTORS, 400 PERSHING ROAD, WAUKEGAN, ILLINOIS
Johnson Motors of Canada, Peterboro, Canada

JOHNSON SEA-HORSES

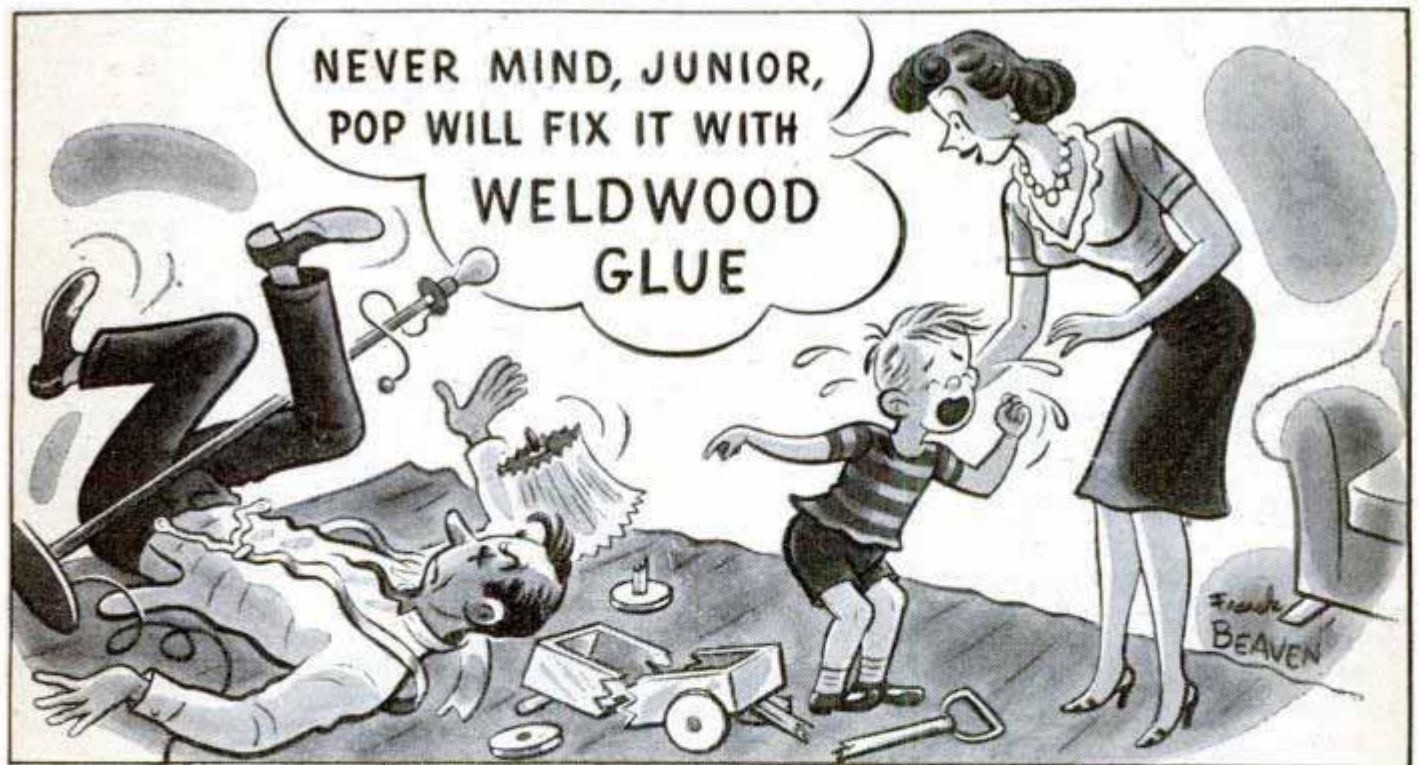

When you want to fix things fast . . . be sure to get Weldwood Glue. It's tremendously strong . . . waterproof and rot-proof. Easy to apply . . . quick to dry . . . stain-free and permanent. At hardware stores, chain stores and lumber dealers!



WELDWOOD
PLASTIC RESIN
WATERPROOF GLUE

UNITED STATES PLYWOOD CORPORATION, NEW YORK 18, N. Y.

USE AC's FOR UTMOST RELIABILITY

Factory-recommended AC's, of correct Heat Range for today's fuels and driving speeds, help millions to be punctual. Have your plugs checked to be sure that you have the right plugs for today's driving and fuels.

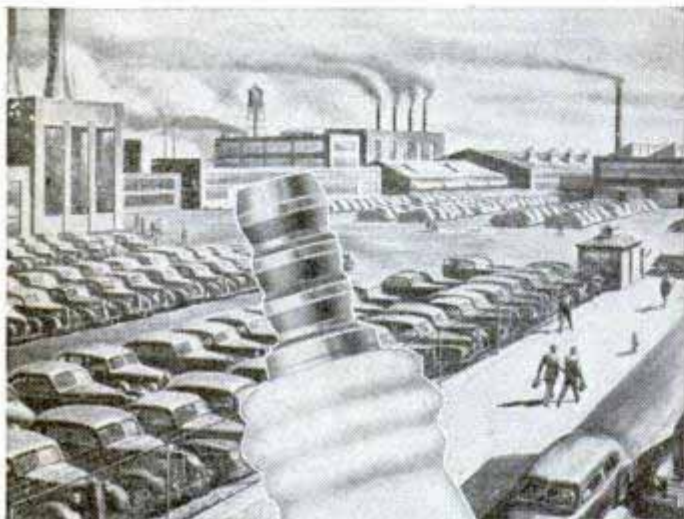

Look for this sign



Spark Plugs cleaned and adjusted "By the AC Method" may save as much gas as 1 gallon in 10

AC SPARK PLUGS

AC SPARK PLUG DIVISION • GENERAL MOTORS CORPORATION

the soil, accumulations of toxic salts, and prevents the covering of good soil with erosion debris. Too, it conserves water in the soil in dry areas and drains water from the soil in wet districts. In all there are between 50 and 60 major conservation practices now in use. They range from the construction of check dams and the planting of trees in gullies to the new but already widespread "stubble mulch farming."

So far, only a start has been made in permanently conserving our soil. Complete treatment of the millions of acres that remain will be a long, hard task. To give you an idea of its magnitude, a recent state-by-state survey shows that the full conservation program is going to require more than 775,000 man-years of labor, some 150 equipment-years of work with tractor-drawn equipment, and nearly 300 equipment-years with horse-drawn equipment.

Fifteen years ago statisticians could foresee the time, generations from now, when the nation would be in danger of starving to death. Now the trend has changed. So spectacularly successful has been the work of the soil conservation service that 30 other countries already have adopted our conservation program.

Popular Mechanics House

(Continued from page 112)

feet, laundry, fruit cellar and furnace room. At first he set up his workbench at one end of the small furnace room, then moved to the laundry, and now is claiming for his shop one end of the knotty pine recreation room. This idea has met some opposition from the distaff side of the household.

Closet space is an important feature of the house. The voice of Mrs. Brownson was heard clearly and distinctly when that topic came up in the planning sessions. The result is large built-in wardrobe closets in each bedroom, and adjoining these are built-in chests of drawers, constructed by Jacques himself. Both wardrobe closets and chests are concealed behind beautiful flush-type natural wood doors. The roomy linen closet is conveniently located in the small hall leading to bedrooms and bathroom. There is a broom closet in the kitchen, a guest closet just inside the front door, and additional storage space is available at the foot of the stairs until the second-story rooms are finished.

Ground was broken for the house on May 29, 1946—a memorable day for the young Brownsons and an exciting one for the *Popular Mechanics* staff. For several weeks the prospects of obtaining adequate

(Continued to page 256)

How to

catch more fish!



CATCHING FISH depends on two factors. *First*, you must know where the fish are. *Second*, you've got to get your boat to the good spots.

Scott-Atwater can help you do both.

With a smooth-purring Scott-Atwater motor on your boat, you are always assured of quick, trouble-free transportation to the good spots to fish.

The amazing flexibility of Scott-Atwater outboard motors permits you to speed to a distant point or idle down to the creepiest crawl for trolling, with even, positive power at any speed.

Backed by the long experience that made Scott-Atwater the world's second largest pre-war manufacturer of outboard motors, the new Scott-Atwater, introduced last season, is the last word in mechanical perfection.

Send coupon below for the sensational new book, "How to Catch More Fish", by Frank R. Steel, which tells you how to locate fish by the temperature of the water.

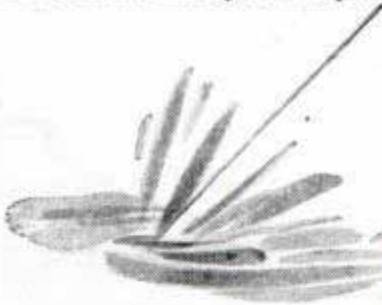

FOUR MODELS

A standard and deluxe single, developing 3.5 horsepower at 4000 R.P.M. OBC certified.

A standard and deluxe alternate firing twin, developing 7.5 horsepower at 4200 R.P.M. OBC certified.

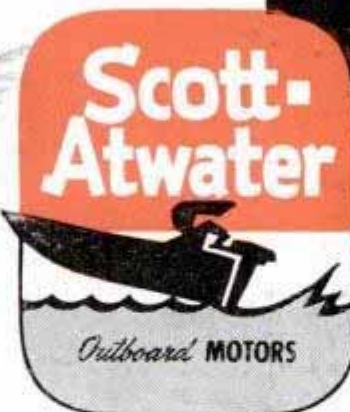

"HOW TO CATCH MORE FISH"—by Frank R. Steel, national authority on fishing. Tells you how to fish by revolutionary method of water temperatures. Specific instructions concerning at what depth fish will be according to temperature of water. 48 pages, illustrated in color, diagrams of lakes and streams. Send coupon for copy today.

Scott-Atwater Manufacturing Co., Inc.

2901 East Hennepin Avenue

Department PM47, Minneapolis, Minnesota

Enclosed find 10 cents for which please send me a copy of Frank R. Steel's new booklet "How to Catch More Fish". Booklet will be sent about May 15, 1947.

Name.....

Address.....

City.....State.....



Just Out

NEW
MACHINE TOOL
PRICE LIST

25% (or more) Below Market Fixed Price Established on 80 Types of Surplus General Production Tools

YES! WAA has established rock-bottom fixed prices on 29 MORE important types of machine tools for general use—and you don't need a priority. Just walk into any WAA office or WAA approved dealer in the U. S. with a check for the amount shown in this price catalog and the tool is yours (subject to prior sale).

Get your copy of the new price catalog at once. Simply write, wire, phone, or call in person at your nearest WAA office below. Do it today.

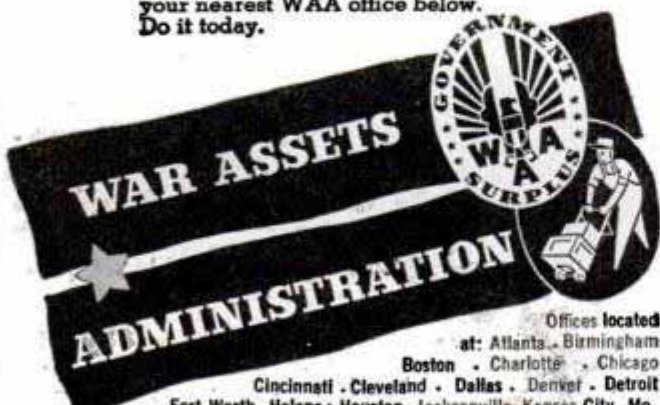

Offices located at: Atlanta, Birmingham, Boston, Charlotte, Chicago, Cincinnati, Cleveland, Dallas, Denver, Detroit, Fort Worth, Helena, Houston, Jacksonville, Kansas City, Mo., Little Rock, Los Angeles, Louisville, Minneapolis, Nashville, New Orleans, New York, Omaha, Philadelphia, Portland, Ore., Richmond, St. Louis, Salt Lake City, San Antonio, San Francisco, Seattle, Spokane, Tulsa

680-A-3

SAY YOU SAW IT IN POPULAR MECHANICS

REPAIR FURNITURE

WITH THE GLUE THAT MANUFACTURERS USE

FRANKLIN GLUE
 GENUINE LIQUID HIDE GLUE
 READY-TO-USE

Makes joints stronger than the wood itself. No mixing — No heating — No unpleasant odor — No chilled joints.

THE FRANKLIN GLUE CO., COLUMBUS 15, OHIO
 AT YOUR HARDWARE DEALER



FLUID PUMP

At last, a dependable, low priced coolant pump for machine tools. Fully guaranteed by old, reliable manufacturer.

Constructed of non-corrosive materials. Plastic screen quickly removed for cleaning. With this pump and small pan for fluid you obtain same results as with expensive equipment.

May be used for Evaporative Coolers, Fountains, Displays, etc.

DEPT. M **\$19.50** POSTPAID
 JOBBER AND DEALER INQUIRIES INVITED



AMERICAN METAL PRODUCTS CO.
 FORT WORTH 9, TEXAS

CUT ANY SIZE HOLE
 IN METAL • WOOD • PLASTICS

Bruno Adjustable Hole Cutter for home users, mechanics, farmers, technicians! High speed steel blade cuts clean holes quickly. Fits drill press, portable drill or hand brace. **Money back guarantee!** At all hardware stores or write direct, Dept. P.M.-5

Model No.	Shank Size	Cutter Expansion Capacity	Low Price
100	1/4" straight shank	5/8"-1 1/2"	\$2.45
100-B	Square Bit Stock	5/8"-1 1/2"	\$2.45
101	3/8" straight shank	1"-2 1/2"	\$3.45
101-B	Square Bit Stock	1"-2 1/2"	\$3.45

BRUNO The BIG BUY in Tools **\$2.45** Model No. 100
 9330 Santa Monica Blvd. Beverly Hills, California

Thompson BEATS the World on BOATS



Better Built Lower Prices



Safe Boats With Full Length Spray Rails
 Keep passengers perfectly dry—even at high speeds. Catalog also shows two new models of "Take-Along" Boats. Two big factories—save you freight.

CATALOG FREE
 Write for your copy. State kind of boat in which you are interested.

THOMPSON BROS. BOAT MFG. CO. (181)
 213 Ann St. PESHTIGO, Wis. (Write to either place.) 113 Elm St. CORTLAND, N.Y.

POPULAR MECHANICS

All CARLSON RULES

have this

**10-SECOND
BLADE CHANGE
FEATURE**

CARLSON

WITHOUT OPENING THE CASE, you can quickly replace the blade. Keep a 'spare' Replacement Blade on hand. Models in 6, 8 and 10-foot lengths.
SOLD BY LEADING HARDWARE DEALERS



WHEELS AT BARGAIN PRICES

- ...4" wheel & tire, 5/16" sleeve bearing & hub cap \$0.45 ea.
- ...5" wheel 5/8" solid tire 5/16" shaft hole 0.65 ea.
- ...6" wheel 5/8" solid tire 5/16" shaft hole 0.75 ea.
- ...7" wheel 3/4" solid tire 3/8" shaft hole 0.85 ea.
- ...8" wheel 1" solid tire 1/2" sleeve bearing 1.25 ea.
- ...8x2" wheel, semi-pneumatic tire 7/16" ball bearing 2.75 ea.
- ...10x1.75 wheel semi-pneumatic tire 7/16" ball bearing 3.25 ea.
- ...12x1.75 wheel semi-pneumatic tire 1/2" bronze bearing 4.00 ea.
- ...10x2.50 wheel semi-pneumatic 1/2" ball bearing 5.50 ea.
- ...6x2" wheel 5/8" ball bearing, solid tires 3.95 ea.

BUILD YOUR OWN—Wagons — Scooters — Soap Box Racers — Welding Carts — Baby Pens — Etc. To order above wheels write number wheels wanted in space provided, tear out and mail this ad with check or money order and your name and address. If other sizes are wanted write for **FREE LIST**.

TRULSON MFG. CO., 811 E. 31 St., Dept. M2, Kansas City, Mo.

New THOR "B" ENGINE—\$6.95

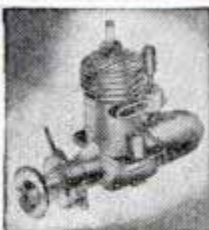

The new THOR "B"—Sensational miniature gasoline engine that really works. Super-power performance. Smooth, velvety power that roars into action with a "twist of the wrist." Over 20,000 already sold. 1/8 H.P. Complete with coil, condenser, and fully illustrated instructions, ready to run, only \$9.95. In KIT form, fully machined, 5 minutes to assemble. \$6.95, without coil and condenser. Powers all models. Send \$1.00—shipped collect same day C.O.D. or send full price plus 25c extra and we ship parcel post insured.

FREE. SEND FOR 32-PAGE ILLUSTRATED HOBBY CATALOG.

AMERICA'S HOBBY CENTER

DEPT. 847, 156 WEST 22ND STREET, NEW YORK 11, NEW YORK

LAW

STUDY AT HOME FOR PERSONAL SUCCESS and LARGER EARNINGS. 38 years expert instruction—over 108,000 students enrolled. LL.B. Degree awarded. All texts furnished. Easy payments. Send for **FREEBOOK**—"Law and Executive Guidance."

AMERICAN EXTENSION SCHOOL OF LAW
Dept. 76-M 646 N. Michigan Ave., Chicago 11, Ill.

STOP

CORROSION and FRICTION

Use Fiendoil on tools, electrical appliances, household devices. It actively

Lubricates - Cleans - Prevents Rust

3-oz.
Spout
Can
40c

FIENDOIL

"The Enemy of Corrosion and Friction"

BRIGHT STAR

BATTERIES

**GIVE MORE
BRIGHT LIGHT
LONGER
FOR YOUR 10¢**



HERE IS PROOF! BASED ON TESTS CONDUCTED UNDER GOVERNMENT STANDARDS

THREE LEADING BRANDS TESTED	BRIGHT STAR	BATTERY A	BATTERY B
VERY BRIGHT LIGHT			
GOOD LIGHT			
FAIR LIGHT			

Each column adds up to 10 cents, but **BRIGHT STAR** leads the field with **70% VERY BRIGHT LIGHT**.

And that's not all... Bright Star batteries give **150%** of the Light Industrial Test requirements as specified by the U. S. Gov't Bureau of Standards.

*... and there are more
BRIGHT STAR FLASHLIGHTS
sold than any other make,
they, too, have been
best since 1909!*

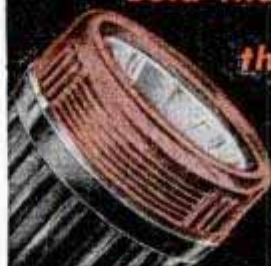

BRIGHT STAR BATTERY CO.
CLIFTON, N. J.

ANCO RAIN-MASTER

"Dead-Locker"

WINDSHIELD WIPER
ARMS and BLADES

BLADE SNAPS ON...
STAYS PUT

FINGER-
TIP
RELEASE

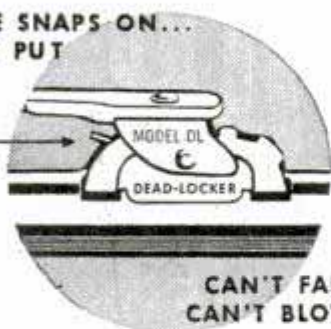

(A war-born invention—by ANCO—first)
for military aircraft—now for your car.)

DON'T SHOOT YOUR GAS-PUMP MAN!

He's doing the best he can. Sure, he knows how dangerous it is for you to drive your car... in stormy weather... with your dull old windshield wipers that smear and smear. He'd gladly put on for you quickly a pair of keen new ANCO RAIN-MASTER Wiper Blades and Arms. He has them—Newest Models! But he forgets to remind you? Too busy? You can't shoot him for that!



After all, it's *your* car to protect. So you remind him. Get RAIN-MASTERS... patented features... original equipment on many makes of high grade cars and trucks... used in war—on our fighting tanks and trucks and ships and bombers too... because ANCO RAIN-MASTERS clean quicker, clean cleaner... last longer. May save you a costly smashup.

Ask for RAIN-MASTER Windshield Wiper Arms and Blades next time you buy gas.

THE ANDERSON COMPANY
Established 1918
GARY, INDIANA

building materials had looked dark. There could have been no more difficult period to launch such a project, and the editors were determined to use no plea of special interest to obtain materials. Naturally there resulted a number of compromises and adaptations which would not trouble the home builder in normal times. As an example, Brownson was unable to find siding anywhere. When time had finally run out, he located a carload of 2 by 12-inch lumber and had it cut into one-inch siding. Despite its unusual thickness, this proved highly satisfactory both from its substantial construction and its beauty of effect.

From the moment he rented a power scoop to start excavations, Jacques Brownson kept a detailed day-by-day account of progress. This record proved invaluable to the editors in preparing the articles which will appear in the Craftsman Section in the May and June issues. These articles and a book written by Wayne Leckey are concerned with details of construction. They will follow the construction step by step, with easily understood illustrations, and will answer all questions on how to build the house.

To speed the project, Brownson had as his chief helper a 23-year-old apprentice carpenter, Bud Marshall. It was Marshall's first job. Neighbors were somewhat alarmed when they learned what these two youths who had been tramping over the vacant lot were up to. They had a reasonable concern for their own property values, probably fearing an unsightly shack would be the ultimate result. Today these same neighbors are the loudest of all in their praise of the project which they watched grow through the summer into the most attractive home in the neighborhood.

Plumbing and wiring, under the law, had to be installed by licensed workmen. And from time to time Jacques had to solicit the help of friends or laborers, just as in the early days of home building a pioneer would rally his neighbors. One such job was the pouring of concrete for the foundation, which had to be done in one day. This required the mixing and pouring of 200 bags of cement. The task was performed by 57 hours of labor in addition to the 12 hours put in by Brownson himself. The date was July 1.

The balance of July was consumed in raising the framework for the entire structure. On July 30 Brownson began work on the roof boards, which were all in place by August 3. During August the cornice work was completed, the roof was covered with asphalt shingles, electrical work was done,

(Continued to page 260)

*No rust
for the
wary!*



Clean rust out of your radiator with

DU PONT Cooling System **CLEANSER**

Drain out your anti-freeze, and clean out winter's accumulation of scum, scale, and rust. Neglect now may mean trouble and costly repairs later. Just pour a can of DU PONT COOLING SYSTEM **CLEANSER** into your radiator, run the engine 30 minutes or more, and drain. It dissolves rust—cleans thoroughly—improves engine performance. It's safe, sure, and easy to use.



Keep out rust with

DU PONT Acid and Rust **INHIBITOR**

After cleaning out the radiator, you can keep it free from rust all season by pouring in a can of DU PONT ACID AND RUST **INHIBITOR**. It prevents rust forming, and keeps out acid, too.



Avoid radiator leaks with

DU PONT Cooling System **SEALER**

Stop leaks quickly and securely—and make the cooling system **LEAKPROOF**—by pouring in DU PONT COOLING SYSTEM **SEALER**. It will not clog the radiator.



DU PONT

REG. U.S. PAT. OFF.

BETTER THINGS FOR BETTER LIVING
... THROUGH CHEMISTRY

Happy Moment



Her Vornadofan Arrives!

Here indeed is the beginning of a new era! No more hot, humid, sticky summer days for this lady—or stuffy, groggy winters to cause fatigue and discomfort. Her Vornadofan will send great billows of fresh, cool air swirling throughout the room, lowering the temperature in summer and eliminating that “breathless feeling”. Then next winter she’ll thrill to the luxury of warm air in motion—heat circulated by her Vornadofan. Ask your dealer for the whole, big story.



Rubber motor mounts eliminate noise and chatter.



Injector cones spiral air movement.



Deeply pitched propeller blades “bite” off more air

Vornadofan

World's Finest Air Circulators



THE O. A. SUTTON CORPORATION
WICHITA, KANSAS

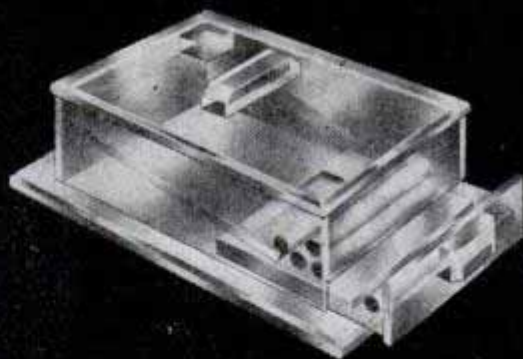

Automatic Cigarette Dispenser

Made of Lucite the jewel of plastics and ready to assemble into a beautiful and practical container holding 31 cigarettes. Ideal gift or saleable article to stores, individuals, etc. Home-crafters will find this a fascinating hobby or a profitable business. Complete illustrated instructions, polishing compound, brushes, and jig come with the kit. Actual size 4x6 inch. Sent prepaid if cash with order. Otherwise C.O.D. Only \$3.95. Any color 10% extra. Special price dozen lots. Free descriptive folder upon request.

CENTURY ENTERPRISES

P. O. Box 56 Station A Los Angeles, Cal.

TURNER

VT-73

DESK MICROPHONE

Here's the mike you want for your rig. It's got looks, it's tough, and man, oh man how it performs. It's a TURNER! Ask your dealer or write for Free Literature on other low cost Turner Microphones.



THE TURNER COMPANY

921 17th St., N.E., Cedar Rapids, Iowa

Sand Casting—Forging—Heat Treating—Case Hardening

BRONZE FOUNDRY



is again available in limited quantity without priority. Orders filled in sequence as received. **INVENTORS—SCHOOLS—CRAFTSMEN** use **FOUNDRYETTE** for making castings quickly for new inventions, for instruction, and general purpose. Order now for early delivery. Three sizes are available capable of making bronze castings of 1½, 3, and 6 pounds weight, aluminum, copper, brass, etc. Domestic gas supply and 110 volt AC or DC energy required for operation.

Write for circular.

KANSAS CITY SPECIALTIES CO.

Box 6022, Dept. P-77

Kansas City, Mo.



Banner has always been right there with the newest and best in fireworks. Now we offer you sensational new creations you never heard of before. Thrills galore. You'll be the envy of your friends and neighbors when you start celebrating with **BANNER FIREWORKS**... always rock bottom in price.

BIG SPECIAL DEAL—ONLY \$495

Big giant assortment of over 150 pieces including Salutes, Roman Candles, Sky Screamers, Chinese Firecrackers, Sparklers, Vesuvius Fountains, Aerial Bombs and many others... regular \$10.05, retail value for only \$4.95. Rush your order. Supply limited. Catalog FREE.

BANNER FIREWORKS MFG. CO., INC., DEPT. 240
446 Capistrano Toledo 12, Ohio

THE ONLY PIPE THAT ADJUSTS THE DRAFT TO YOUR TASTE!

Royalton
Smoke-Control



In SUPREME GRADE, Imported Briar \$2.50. Also in DELUXE GRADE \$1.50. Slightly higher in Canada and other countries.

Most seasoned pipe smokers crave a hearty flow of smoke. Others like a thinner draft until they get used to their pipes. And here, for the first time is a pipe that completely satisfies both. In every Royalton Smoke-Control there's a free-turning valve that regulates the smoke intake. For a full draft, turn the valve wide open. To decrease the draft, just narrow the opening. You draw in the exact amount of smoke for your taste. Enjoy this exclusive Royalton advantage, now! Ask your retailer for a demonstration.

Write for interesting *Free* Booklet • Henry, Leonard & Thomas, Inc., Ozone Park 17, New York, N. Y.

IT'S EASY PICKING FROM A HUOT DRILL INDEX

A handy container for indexing and filing twist drills. All steel—ten sizes. Correct drill always at your fingertips.

SEND \$1 for No. 13 holds drills from 1/16" to 1/4" by 64s. (Or see dealer) Order Today.

HUOT MFG. CO.

Foot, Schultz Bldg., St. Paul 1, Minn.



TELESCOPING MEASURING TOOLS

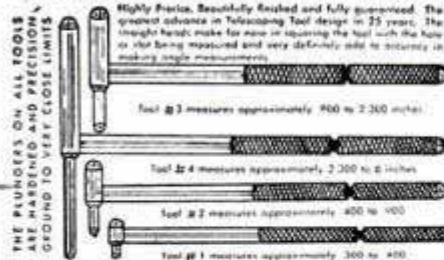

Micrometer Accuracy on Inside Measurements 5/16 Inch to 6 Inches

ONLY **\$4.95**

C.O.D. PLUS POSTAGE Completely finished parts. Save \$10. Anyone can assemble in less than one hour. No tools of any kind needed.

ALCO SHOP, Room 49-C, 2214 Terminal Annex, Los Angeles 54, Calif.

FEW EXCLUSIVE TERRITORIES AVAILABLE! DISTRIBUTORS WANTED!

Nationally Advertised Brand AUTO ACCESSORIES

\$500 TO \$600 SUPPLY LASTS ONLY WEEK TO 10 DAYS

Have your own big business in a territory that is exclusively yours. Year around steady demand; national advertising to back you up. Write today for catalog, information and territories available... give age, experience, and complete background in first letter.

KNICKS MEND-RITE CO. 1443-47 Gentry, N. Kan. City, Mo.

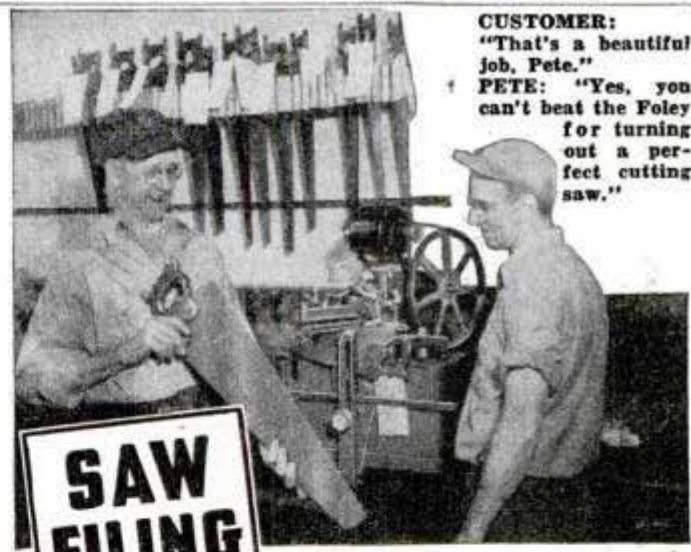

CUSTOMER: "That's a beautiful job, Pete."
PETE: "Yes, you can't beat the Foley for turning out a perfect cutting saw."

is a Good Business

With the Foley Automatic Saw Filer you can have a fine cash business with steady customers and make a good living. The Foley automatically joints the saw, making all teeth even in size, shape, spacing. The Foley is the only machine that files all hand saws, also band and cross-cut circular saws.

SEND FOR FREE PLAN—Shows how to start a saw repair shop. No canvassing. Send coupon today.

FOLEY Automatic SAW FILER

FOLEY MANUFACTURING CO.
416-7 Foley Bldg., Minneapolis 13, Minnesota
Send Free Plan on Saw Filing business, no obligation

Name _____
Address _____



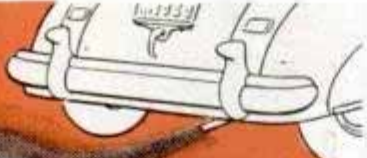

Performance goes up in smoke

when worn
connecting rod bearings
cause oil pumping

For a clean getaway at traffic lights and to make headway on the highway, replace those worn engine bearings. They let excess oil carbon-foul pistons, rings, valves and spark plugs, cause sluggish operation and performance goes up in exhaust smoke! Install Federal-Mogul Oil-Control Bearings to restore power, pep and economy. They are engineered for the job — ask your mechanic!

FEDERAL-MOGUL SERVICE
DIVISION OF FEDERAL-MOGUL CORPORATION
COLDWATER, MICHIGAN

Replace in sets with Genuine
FEDERAL-MOGUL
Oil-Control Bearings



window frames set, the house completely lathed, and concrete poured for the basement floor, breezeway, garage, front and back steps. August also saw the basement partitions built, and toward the end of the month Brownson hired help to expedite the plastering.

September was given over to completing a multitude of odds and ends. The interior was trimmed and doors hung. The first day of October found Brownson nailing on the siding. Other October days were occupied with framing and glazing the ends of the breezeway, setting wrought-iron railings on the front and back steps, and laying floors. Mrs. Brownson helped lay the asphalt tile floors in bathroom and kitchen.

During November the maple floors were laid in the bedrooms, the kitchen cabinets were installed and the outside painting completed—not without some vicissitudes in obtaining paint! The final dab of white was laid on the siding on November 20—nine days less than six months after the breaking of ground.

In reviewing the \$7046.87 cost of materials it must be remembered that these were purchased at abnormally high prices in the Chicago area. These materials, which will be detailed in later articles, included lumber, concrete work, fixtures for bathroom and kitchen, furnace, wiring, plumbing and sewers, and can be obtained probably for 20 percent less outlay in many parts of the United States. Those who prefer to build a less expensive home could save about \$2000 by omitting the breezeway and garage as they were built in the *Popular Mechanics* house. With this deduction, and an estimated saving of 20 percent in lower-cost regions, the cost of materials for the basic home might be reduced to about \$4000.

The BUILD-IT-YOURSELF book, which will be available shortly by writing to the Book Department of *Popular Mechanics*, will tell anyone how to construct the house with a minimum of outside help. But anyone who wishes to employ a contractor can ask him to follow the plans in the book. It should be borne in mind, in this case, that Jacques Brownson's labor saved him several thousand dollars.

By far the most difficult problem in this unique enterprise was the securing of lumber, particularly siding and flooring. There were long weeks during which Editors Ward and Leckey were grim and silent and anyone who even mentioned the house was in imminent danger of being thrown from a fifth-story window. But now that the project has been completed successfully and the editors themselves are a little envious

(Continued to page 264)

The
TRAVEL COACH
that is
a Perfect Home



Palace

Solves Both the Travel and the Housing Problem

The Palace Travel Coach! A luxurious home to take with you when traveling or to live in until houses again become plentiful. Has combination living room, dinette and kitchen, and separate bedroom all completely furnished. Automatic air and heat circulation. Fluorescent lighting and a host of other unusual features.

**The Only Trailer
With An Automobile-type Body**

It has a die-formed, "Pan-L-Frame," aluminum body—an exclusive Palace feature, resulting in increased strength and, at the same time, reduced weight. It's the trailer, above all others, that you will want to own. Moderately priced. Send postcard for literature showing exterior and interior in colors.

PALACE CORPORATION
Flint, Michigan



Best for Reels..

..for Guns

LUBRIPLATE

The universal white lubricant reduces friction and wear. Waterproof • Prevents rust • Stays put • Lasts longer

20c at your dealers

in U. S. A.

Ideal for the HOME WORKSHOP

BOYS!
Fly your own plane
REAL GAS ENGINE
Complete with
MODEL AIRPLANE KIT



All ready to build and fly... and anyone can do it!

More than a toy—a real gas-powered model plane that you'll get a kick out of building and flying. This little beauty will really perform in the sky! You'll be the envy of your pals! Fully detailed instructions provided. Complete outfit, including: 1/6 H.P., engine, coil and condenser; beautiful trim airplane; propeller, wheels, etc.

SEND ONLY \$1 We'll ship C.O.D. for balance. Don't delay, order NOW and be the first fellow in your neighborhood to fly this swell plane!

Have you our FREE catalog? Send for it!

AMERICA'S HOBBY CENTER, Inc.
DEPT. BN-47, 156 W. 22ND STREET, NEW YORK 11, N. Y.

ONLY \$11.95

Logan A NAME TO REMEMBER
WHEN YOU THINK OF BETTER
LATHES AND SHAPERS



Swing over bed, 10 1/2"
Distance between centers, 24"

**a Logan lathe
belongs in your shop**

A Logan Lathe in your shop puts at your disposal the same accuracy, speed and versatility that have made this lathe a standard tool of industry. The same ball bearing mounted spindle, the same rugged bed with ways ground to within .0005" of parallelism, the same precision construction throughout that make Logan Lathes outstanding industrial performers mean satisfying results for you. The compact Logan design takes up a minimum of space. The simplicity and safety of its operation, and its low maintenance, are further reasons why the Logan Lathe belongs in your shop.

WRITE FOR THE LOGAN CATALOG... complete information on Logan Lathes, Shapers and Accessories.

9 REASONS why LOGAN Lathes are BETTER lathes

- 1 **BALL BEARING HEADSTOCK**
for sustained accuracy.
- 2 **RUGGED, ACCURATE BED**
within .0005" of parallelism.
- 3 **SELF-LUBRICATING BEARINGS**
at vital points lengthen life.
- 4 **BACK GEARS ENCLOSED IN HEADSTOCK**
with shifter rack safely and conveniently at your finger-tips.
- 5 **RUBBER CUSHIONED COUNTERSHAFT**
for smoothness and accuracy in working area.
- 6 **THREE POINT SUPPORT**
Steadies the countershaft, prevents rocking.
- 7 **ENCLOSED BELTS, GEARS, PULLEYS**
Prevents accidents. Keeps lathe clean.
- 8 **AUTOMATIC BELT TENSION RELEASE**
Makes belt changing easy and safe.
- 9 **PRECISION BUILT THROUGHOUT**
For tool room accuracy in your shop.

DISTRICT OFFICES

Woolworth Bldg. New York 7, N. Y. Cortland 7-8024 • 550 W. Washington Blvd. Chicago 6, Illinois Central 1246 • 1672 Mission Street San Francisco, Calif. Underhill 6682

LOGAN ENGINEERING CO.,
DEPT. B-4, 4901 LAWRENCE AVE., CHICAGO 30, ILL.

WORKSHOP WISDOM

How to Test Glues

AS SHOWN below, glue three pieces of wood together. Glue one joint (A) with Cascophen and the other joint (B) with any other type glue.

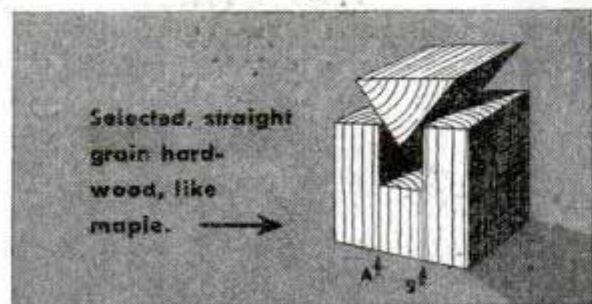

After the glues have set, boil test block for three hours (the Army test for aircraft plywood). Then, when the test block is cool enough to handle, drive in wedge as shown.

The result will prove that Cascophen is the only completely durable, waterproof glue now available to home craftsmen.

Cascophen has these outstanding features:

1. Withstands practically anything—water, heat, mold, fungus.
2. Requires only sufficient clamping, screwing, or nailing pressure to insure a firm bond between the surfaces.
3. Cures quickly at 70°F.; warmer temperatures shorten curing time.
4. Keeps indefinitely—not spoiled by freezing. Available in ¼-pint, pint, quart, and larger sizes at your hardware, building-supply, marine, or paint dealer's.

CASCOPHEN—for boatbuilding, sports equipment, outdoor furniture.

CASCAMITE—for veneering and fine cabinet work.

CASCO—for furniture construction and repair.

CASCO FLEXIBLE CEMENT—the ready-to-use household cement, "Sticks Most Everything."

Send for free descriptive folders and Gluing Guide:

Casein Company of America

Division of The Borden Company

350 Madison Ave., Dept. PM-47, New York, N. Y.

SAY YOU SAW IT IN POPULAR MECHANICS

Indian

WORLD'S FINEST
MOTORCYCLE
SPRINGFIELD, MASSACHUSETTS

FIND UNDERGROUND MINERALS and METALS with M-SCOPE

Employs same principle as Army Mine Detector. Unsurpassed in Efficiency. Write for Free 16 page booklet.



FISHER RESEARCH LABORATORY
PALO ALTO CALIFORNIA

RUMIN

Gold-Coated FLINTS and LIGHTER FLUID

Rumin Gold-Coated Flints... the only gold-coated flints made... plus Rumin blue-flame Lighter Fluid are a sure fire combination that make every lighter spark quicker, light brighter!

SOLD WHEREVER CIGARETTES, CIGARS AND TOBACCO ARE SOLD

ROCK FLINT CO., 123 Doughty Blvd., Far Rockaway, N.Y.

New MILLING ATTACHMENT

Sizes for 8" to 16" metal lathes

BUILD IT YOURSELF from our sets of semi-machined castings and save \$8. Can be finished on your lathe alone. Complete working drawings and step-by-step machining instructions furnished with castings.

Mill keyways, slots, splines, dovetails, flutes in reamers, taps, bores, and special cutters; produce spur, bevel, mitre and worm gears, ratchets and racks; mill flat surfaces, square shafts, mill hexes, spot face, drill spaced holes, bore, etc. on your lathe with this precision attachment. It has a T-slotted table, a vise which swivels for angular milling, a gear cutting fixture and dividing centers.

FREE! Illustrated folder and price list. Mention your lathe. Write today.

HURON MACHINE AND TOOL CO.
YALE 4, MICHIGAN

Get This Book on Fishing

FREE!



Back after 5 years! New "Fishing—What Tackle and When" shows South Bend and Oreno items. Color pictures of fishes. Casting instructions. Stories by famous writers. Every fisherman needs a copy. *Sent free!* A postal gets it!

FAMOUS BASS-ORENO No. 973



The unbeatable fish-getter that should be in every tackle box. Available in 6 finishes, 5 sizes. . . **\$1.10**

SOUTH BEND BAIT CO., 891 High St., South Bend 23, Ind.

SOUTH BEND *A Name Famous in Fishing*

JET PROPULSION



GAS TURBINE Model Engine

★ ★ Be one of the first to build a real Turbo-Jet Model Engine. Single-stage centrifugal compressor and turbine. This is a real engine, easily made with ordinary home workshop equipment. Complete plans for construction . . . design formulas and curves for checking performance and testing.

\$2.00
Post paid

THE ROTOJET CO. Department 11
BOX 757 • LOS ANGELES 25 • CALIFORNIA

ELECTRIFY your LAWNMOWER

Battery Operated . . .
SELF-CONTAINED • SELF-PROPELLED

We show you how to convert your own lawn mower for use with a car battery. Save energy, labor and time with this self-propelled unit. Our simplified plans make it easy.

LEJAY MFG. CO 247 LeJay Bldg.

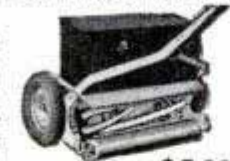

Complete Plans **\$1.00**
Minneapolis 8, Minn.

SAY YOU SAW IT IN POPULAR MECHANICS

BE YOUR OWN BOSS Men and women make up to \$100.00 or more a week! Design and fit corrective arch supports by the time-tested Stephenson Method. A profitable, full or part-time, profession. Train at home; pay as you go. No costly equipment to buy. No capital needed. Send for **FREE** booklet today.

STEPHENSON METHOD, 5-28 Irvington St., Boston, Mass.

POWERFUL BINOCULARS *only \$6.95*

All metal type with adjustable focusing wheel. Enjoy indoor, outdoor shows, sporting events, etc. Plated draw tubes extend for sharp instant focusing on distant objects. Low price includes handsome Carrying Case and long adjustable Shoulder Strap. **SEND NO MONEY.** Clip ad and mail. We'll ship COD for \$6.95 plus tax and postage charges. Address:

ILLINOIS MERCHANDISE MART Dept. 2216, 1227 Loyola Ave. Chicago 26, Ill.

Hobart helps you **SUCCEED**



in ARC WELDING

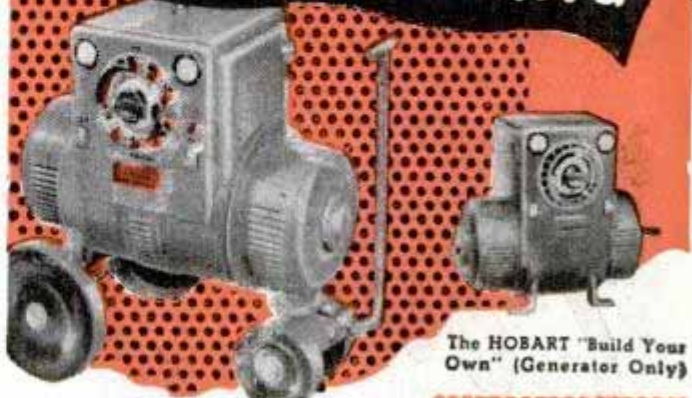

The HOBART "Build Your Own" (Generator Only)

A Big Pay Business—and it's all yours! It's so easy to start your own job welding shop and reap the big dividends that Hobart Arc Welders bring you. There's plenty of arc welding repair and construction work everywhere, customers even bring it to you.

Hobarts Weld Better—that's because of exclusive operation features that save you time and money. The exact welding heat is easy to get, for Hobart lets you select from 1000 volt-amp combinations. Hobart's Remote Control saves valuable time by allowing you to adjust welding heat at the work. Hobarts last longer because they're built better!

HOBART Jr. Electric 150 Ampere Welder



The HOBART A. C. Welder for single phase lines

"Build Your Own"—and save hundreds of dollars! Make your own gas drive portable arc welder using the Hobart "Build Your Own," a reconditioned motor and chassis. Free booklet gives complete instructions.

The HOBART SCHOOL of ARC WELDING

It's a modern trade school in which students learn by doing. Expert instructors give individual attention. Each student has own welding booth and welder. Fully accredited under G. I. Bill of Rights. Send coupon.

Send the Coupon—for complete details on the Hobart Arc Welder you desire—there's no obligation.

HOBART BROTHERS COMPANY
BOX M471, TROY, OHIO. "One of the World's Largest Builders of Arc Welders"



HOBART

HOBART BROS. CO., BOX M471, Troy, Ohio

Send me the Free Book, and also information on items I've checked below:

- Electric Drive
- "Build Your Own"
- A. C. Welder
- Welding School

Free!

Arc Welder's Vest Pocket Guide with charts, tables, equations, charts, etc.



NAME _____

ADDRESS _____

Sweeping the Country



Speed Sweep

**THE BRUSH WITH
THE STEEL BACK**

Speed Sweep brushes are replacing old style brushes in thousands of factories, warehouses, and stores because they sweep faster, cleaner and easier. Speed Sweep brushes also outlast ordinary brushes 3 to 1. There is a Speed Sweep to meet every requirement. Write for styles, sizes and prices today.

Milwaukee Dustless Brush Co.
530 North 22nd Street
Milwaukee 3, Wis.

Please send me complete information about Speed Sweep brushes.

Name _____

Address _____

City _____ State _____

of the Brownsons, to whom they have presented the fruit of their labors, Jim Ward admits:

"It was a lot of fun despite the headaches provoked by the present scarcity of materials. Building the *Popular Mechanics* house has been a valuable experience and has proved what I said at the beginning: Any man of average mechanical bent can build his own home. That's the biggest thing we learned in pushing the project to its happy conclusion."

This month Mr. and Mrs. Jacques Brownson are holding "open house" to show visitors their new home, decorated and furnished for inspection by Simons Furniture & Rug Company of Aurora. They are as proud as are we of the *House That Jacques Built*.

Brownson put it this way:

"I'd hate to have missed doing this job. It's a real thrill to build your own home. I have only one worry now, and that is that someone will pinch me and I'll wake up in my old bunk over in China and find the house is still a dream."

(Continued next month)

Age Doesn't Count on the Speedway

(Continued from page 137)

there are as many as 32 other cars on the track during the big race.

New drivers find big difference in the way their cars handle at 85 and at 115-mile-average speeds. At 85 most cars seem to guide themselves along the track and through the turns without help. At 115 the car may be flighty and require sure judgment and expert handling. The point at which to back off the throttle when going into a turn and the point in the turn at which it is safe to hit the throttle again, and how much and how long, must be learned almost automatically.

Experienced drivers give the beginners what advice they can, yet some new drivers who are entirely competent at the lower speeds seem to lose their touch at over 100 miles per hour. In case of doubt the chief steward or the chief observer allows them extra practice laps to develop their skill.

Other drivers who have come up from the ranks never develop a sense of speed. They drive inconsistently, one lap too fast and the next too slow. In the big race they would be pulling ahead on one lap and dropping behind the next, gaining nothing and increasing the chances of collisions. They are ruled off unless they have a satisfactory explanation.

(Continued to page 268)

BARGAIN

Original Cost \$150.00



3X Army Telescope ALL COATED LENSES — BRAND NEW

An ideal gift for viewing objects, landscapes, seashores, etc. The high resolving power of the six coated lenses, five of them achromats will bring out great details. For the experimenter it can be dismantled and used for hundreds of projects. Length 22 1/2 inches. 36° Field. Postpaid \$7.50.

500,000 Lenses and Prisms. Send 3c stamp for "Bargain" List
A. JAEGER, BOX 84P, SO. OZONE PARK 20, N. Y.

1,000 FREE



Yes, 1,000 Staples ABSOLUTELY FREE with every purchase of this new, compact, durable Stapler that

FASTENS or TACKS WITH EASE

Only Precision-Engineered to give unusual service, EFFICIENT, DURABLE, IDEAL for any fastening problem, tacking shelving or mounting pictures.
\$1.95 P.P. 50c deposit required on C.O.D. orders

Simple to Load — No Weak Points

GENERAL STAPLE CORP.

239 Fourth Ave.

New York 3, N. Y.



BUILD YOUR POWER TOOLS WITH OUR BALL BEARING ARBORS

New Departure Self Lubricating Bearings

10,000 R.P.M.

Right hand threads will be sent unless left hand ordered. No extra charge for left hand threads.

CS—5/8 Pictured

B33—\$4.95 PP. 5/8 x 4 1/2 Spindle B15 Plain Spindle 53.45	C4—1 1/2 x 12 1/2 spindle, housing 2x8 \$8.25 PP. C5—5/8 x 12 1/2 spindle, housing 2x8, \$8.25 PP. C6—3/4 x 12 1/2 spindle, housing 2 1/4 x 8, \$9.25 PP. D8—1 x 17 1/2 spindle, housing 2 5/8 x 11 \$16.95 PP.
---	--

1 INCH BETWEEN WASHER AND COLLAR
Shaper Arbors, C4, 6 or 8, 3 inches between collars, add \$6.00. Heavy Saw Arbors with four Multi-drive pulleys, f.o.b. factory D9-1 1/4 x 20 spindle \$37.25, D10-1 1/4 x 20 spindle \$39.50.
Full stock of V belts and pulleys for immediate delivery PP.
V BELTS \$.03 PER INCH PP.

POLY PRODUCTS, 406 S. Chester Ave., Ct. 1, Dept. 52, Pasadena 5, Calif.



NUMBERALL Rotary Stamp

(Patented)

1 Tool Instead of 12

For stamping figures and letters on metal, etc. One stamp does away with 12 individual hand stamps. Changes of characters are quickly made merely by rotating the indexed wheel. Wheel is made of finest tool steel. Sizes 1/16" to 3/16" figures can be furnished at \$5.00 each in pouch. Larger sizes and alphabet at higher prices. Write for Catalog.

NUMBERALL STAMP & TOOL CO.
HUGUENOT PARK STATEN ISLAND 12, N. Y.

*
Only *Martin* gives you mechanically-controlled poppet valves!

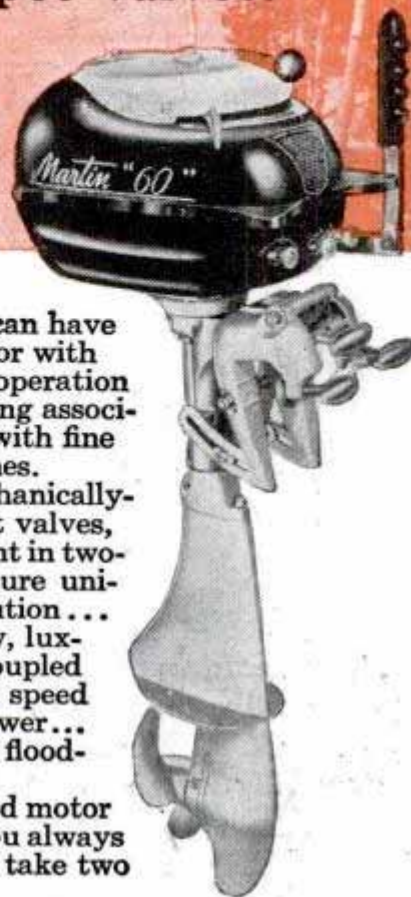

NOW sportsmen can have an outboard motor with the flexibility of operation and ease of starting associated in the past with fine automotive engines.

MARTIN'S mechanically-controlled poppet valves, an exclusive patent in two-cycle motors, insure uniform fuel distribution... unbelievably slow, luxurious cruising coupled with exhilarating speed and maximum power... instant, virtually flood-proof starting...

It's the outboard motor that does what you always thought it would take two motors to do!

MARTIN gives you all you'd expect in a fine outboard, PLUS many exclusive features—

- ★ Power-head swivel, 360° (patented)—Swings lower unit into boat, facilitates checking.
- ★ New Martin Vertical Stern Adjustment (patent pending)—Enables easy adjustment while underway.
- ★ New Streamlined, Leak-proof Filler Cap—Combines vent and spare shear pin clip.

Other highly desirable features: Full reverse steering • Steering stabilizer • Propeller clutch • Depend-a-pull starter • Easy grip stern bracket handles • Synchronized and centralized controls • Resiliently mounted handles and power head • Quiet underwater exhaust • Positive rotor water pump • Long-life sintered bronze rust-proof bearings • Positive oil and grease seals • Alternate firing.

See the new MARTIN at your dealer's, or write for free booklet to: MARTIN MOTORS, Dept. PM-477 Eau Claire, Wisconsin.

Martin

*The New Standard of Performance in

Outboard Motors

Repair Storm Windows

and Screens with

PLASTIC WOOD

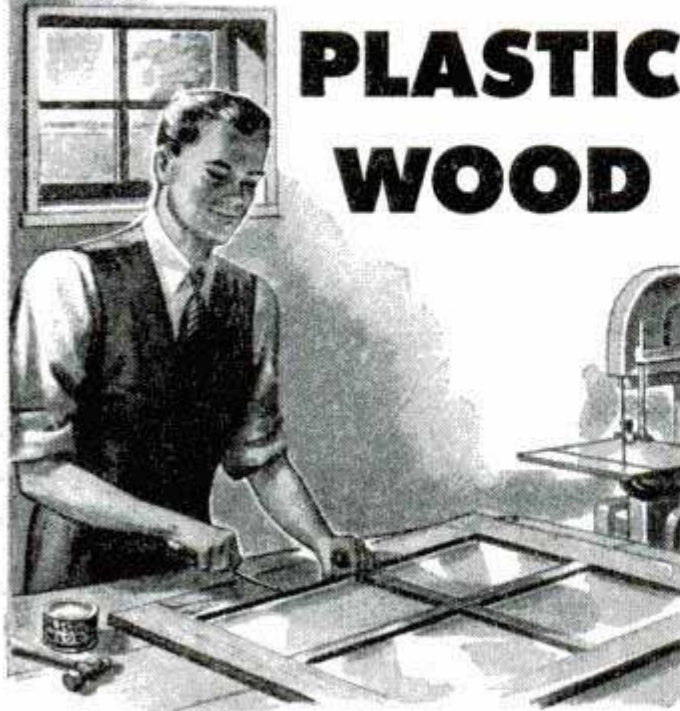

When making new screens, or replacing old rusted screen, apply thin layer of PLASTIC WOOD around frame after tacking down screen. This gives greater strength to the frame. PLASTIC WOOD can be easily shaped to match broken molding. Valuable in replacing rotted wood in storm windows.

... dozens of other uses

FOR FILLING ...

- Cracks in floors
- Countersunk screws
- Chipped furniture
- Nail and screw holes

FOR REPAIRING ...

- Loose tiles
- Loose casters
- Broken balusters
- Broken furniture

- PLASTIC WOOD SOLVENT is indispensable to the home workshop hobbyist for controlling the consistency of Plastic Wood and removing dried Plastic Wood from hands and tools.

T.M. Reg. U. S. Pat. Off.

At all Hardware, Paint and 10c Stores

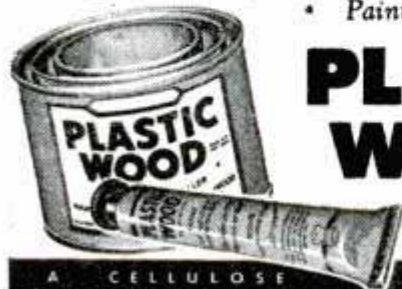

PLASTIC WOOD

Tube or Can

A CELLULOSE FIBRE FILLER

Mows and Trims Lawns



In One Simple Easy Operation

8 1/4 Lbs.



Save Time and Labor with a **MONTAMOWER**

New model. New type metal handle has special device to adjust cutting height. Drive shaft now mounted on free rolling, factory lubricated, and sealed ball bearings. No tired backs or aching arms. 8 1/4 lbs. of live precision made mechanism that first gathers, then cuts smoothly a clean 16" swath through grass, dandelions, spike grass and weeds. No noise or clatter. As modern and efficient as your electric razor. Cuts right up to walls, fences, trees or posts; leaves no fringes to be trimmed by hand. Cutters are self-sharpening. Built to last many years. Many thousands in use. Sold direct from factory. Costs little. Write at once for guarantee information and literature.

MONTAMOWER DISTRIBUTING CO.
820 Keeler Bldg. GRAND RAPIDS 2, MICHIGAN

For More Accurate Drilling—
For Precision Cutter Inspection

OPTI-TOOLS

OPTI-SETTER for Drilling to Exact Location

Used for aligning drill jig bushing with work layout. Retains accuracy of original layout whether drilled by hand or machine. Consists of precision optical eyepiece and reticle mounted in ground barrel. Universally used. Simplest, accurate locating method! Price 1/2" O.D. \$12.50, 3/4" O.D. \$14.00.



OPTI-CHECK Measures Exact Cutting Tool Angle

For inspecting drills, reamers, lathe bits, end mills, etc. Magnifies readings on rake and clearance angles to 1/4 degree. Saves time on regrinds, assures correct angle, lengthens cutter life. Checks tools right on machine! 1" dia. capacity. Price \$39.00.

OTHER OPTI-TOOLS AVAILABLE. FREE FOLDER!

Send dollar with order, balance C.O.D., plus postage. Purchase orders or checks also accepted. Moneyback guaranteed! Circulars available.

The BENTON CO., Dept. B, 351 S. La Brea Ave., Los Angeles 36, Calif.

WALKIE SIREN

Formerly \$15.00—Now Only \$3.95

GOV'T SURPLUS. A precision instrument. Easy turn of crank produces CLEAR, FULL SIREN TONE. Can be heard for great distance. Ideal for Boats, Autos, Schools, Sporting Events, etc. Dimensions 7" x 8" x 5". Wt. 4 1/2 lbs. Price includes shoulder strap and waterproof cover. SEND NO MONEY. Just name and address. We'll ship C.O.D. for \$3.95 plus postage, or send money in advance, we'll ship prepaid. Canadian price \$4.50. ILLINOIS MERCHANT MARY, Dept. 400-A, 1227 Loyola Ave., Chicago 26, Ill.

SAY YOU SAW IT IN POPULAR MECHANICS

Steel Wheels

To Build Your Own Wagon, Cart, Toy, etc.

Sturdy, rubber tired, precision-made pressed steel wheels with red enamel finish. Ready to use axles—threaded at both ends. Acorn nuts supplied. Order today, or send stamp for catalog.

WHEELS WITH SOLID RUBBER TIRES
4" Wheels, 1/4" bearing, Steel Disc.....\$.75
6" Wheels, 3/8" bearing, Steel Disc.....\$ 1.00

WHEELS WITH SEMI-PNEUMATIC TIRES
6"x1 1/2" with 3/8" Selflube Oil Bearing.....\$ 1.75
8"x1 3/4" with 3/8" or 1/2" Selflube Oil Bearing \$ 2.25

AXLES, COLD ROLLED STEEL
1/4"x14" long, threaded both ends, Nickel Cap Nuts .40
3/8"x16" long, threaded both ends, Nickel Cap Nuts .50
1/2"x18" long, threaded both ends, Nickel Cap Nuts .80

Sent postpaid in U. S. on receipt of price.

CIRCLE METAL MANUFACTURING COMPANY
4266 E. PACIFIC WAY LOS ANGELES 23, CALIF.



Luther POWER GRINDERS

HAND AND POWER GRINDERS

Like all Luther Grinders, the power grinder shown here is famous for high quality and rugged construction. It is built to exact specifications for those who demand fine tools. For the Luther grinder that fits your needs, see your hardware dealer.

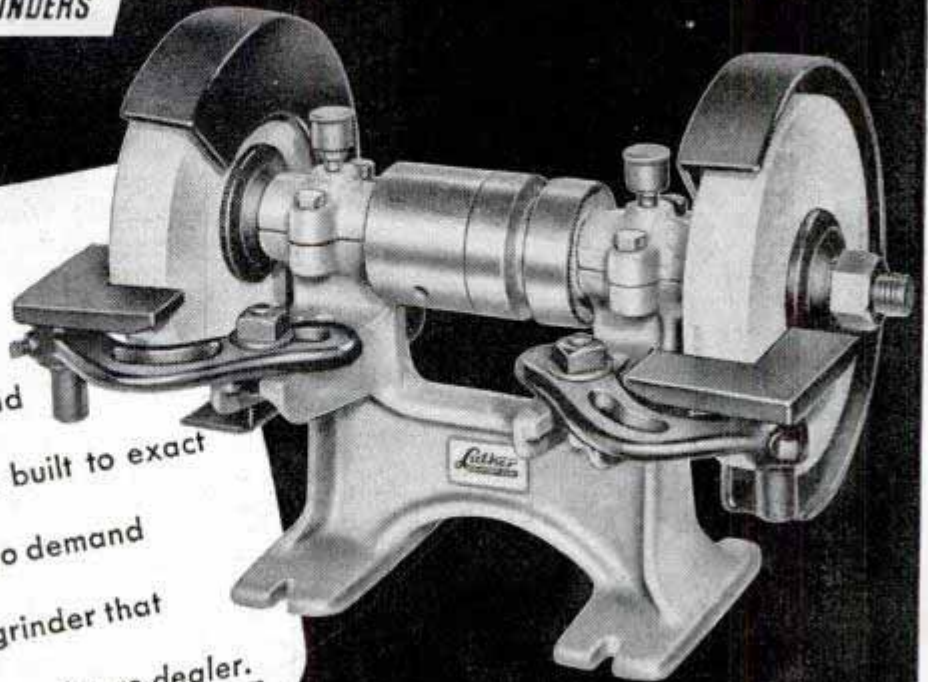

LUTHER GRINDER & TOOL CO.
(Established 1896) Sheboygan, Wisconsin

MYSTERY BOX - AMAZES ALL



You can produce a feat so startling and unbelievable it defies the imagination. Amazes everybody. So baffling it seems impossible. Words do not describe—must be seen. Boys from 12 to 60—have fun, dumbfound your friends, earn extra cash with this amazing contraption. Will last for years. Everybody wants one. Complete Mystery Box with its 17 associated parts and over 1500 words of illustrated instructions \$2.10. Try at our risk. SEND NO MONEY. ORDER TODAY. Just send your name and when you receive your Mystery Box package deposit \$2.10 plus a few cents C.O.D. charges with postman. Send today for best surprise of your life. Do this on positive guarantee that if you are not delighted you may return purchase for full refund. Mail your name and address to

NUHAUS TRADERS - DEPT. 3 - BOX 193 - RACINE, WISC.

At last...

an Amazing NEW TOOL

that reclaims

all types of lumber
SPLIT-FREE

BORD-PRI
TRADE MARK

FASTER • EASIER

SIMPLY LIFTS OFF
FLOORING, ROOFING, SIDING,
FORMS — READY FOR RE-USE

You can save time, work, and wood on dozens of home and workshop jobs with handy, lever-action BORD-PRI.

Gives many times its cost \$960

SEE YOUR DEALER OR WRITE
THE MACO CORP., Huntington, Ind.



Reversible Handle
Flat Plates
Free Pivot

Patent Pending

STRIPE WITH PAINT EASY AS USING A PENCIL PAINTERS' STRIPING TOOL

NOW you can do your own expert striping on furniture, bikes, model planes, bulletins, autos, toys, signs, linoleum, wall board . . . make plain walls look like tile! It's easy to paint straight, curved, circular, even parallel lines with any color. Handiest paint tool in your workshop! Type "M" Master Painters' Striping Tool complete with tip for 1/16" stripe, \$1.00. Extra tips 1/64", 1/32", 3/64", 1/16", 5/64", 3/32", 1/8"—75c each. Tool with complete set of 7 tips \$5.00. (C.O.D. orders 25c extra.) WENDELL MFG. CO., 4234 - 15 Lincoln Ave., Chicago 18, Ill.

A TOOL... NOT A BRUSH

\$1.00
POST PAID

Dealers Write Today!

SAY YOU SAW IT IN POPULAR MECHANICS

APRIL 1947

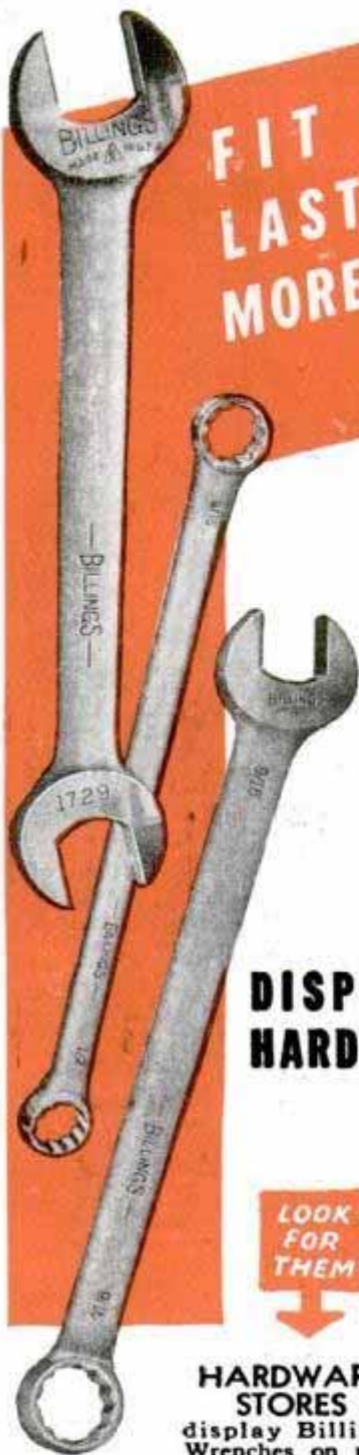

**FIT BETTER
LAST LONGER
MORE FOR YOUR
MONEY...**

BILLINGS *Vitalloy Wrenches — designed to give the perfect "feel" or balance you want in quality wrenches. Light weight and laboratory tested for strength. Opening sizes, clean, true, accurate are stamped on all wrenches. Chrome plated finish over nickel plated copper base. Craftsmen buy Billings in Sets and always have the right size wrench handy when needed.

**DISPLAYED IN
HARDWARE STORES**



HARDWARE STORES
display Billings Wrenches on natural wood panels. Look for them! Say "Billings" when buying wrenches.

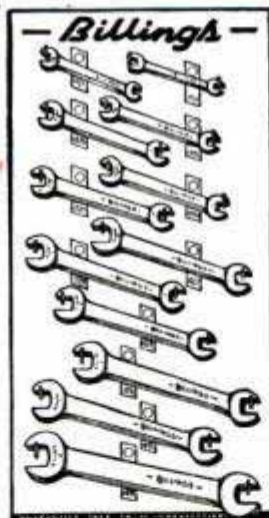

*Registered Trade Mark



Others are baffled by the long stretches and the sharp turns. Accustomed to shorter, more circular tracks, they can't stand the pressure of wide open throttle for long distances, followed immediately by turns so abrupt that at high speed the driver must correct for a slide most of the way.

Still others can't stand the tension of speed and they become exhausted and nervous part way through their tests. These drivers would be dangerous in the race itself. Some novices, too, are simply dare-devils who use the whole track without regard for the other cars. They could crack up or cause a multiple accident in the first few laps, so they too are ruled off.

The result of this careful weeding is that the 33 drivers who line up at the start of the big race represent the flower of American racing circles. Most of the drivers are in their thirties or late twenties. A few, skillful veterans who have competed in many races, are in their fifties. Some of the young drivers who pass their Indianapolis tests this year will be in their early twenties. Age won't count in the race. If his car stands up under the sustained beating and if the driver himself can take the punishment of lap after lap after lap of noise and snap decisions and nervous tension he'll finish in the money.

Death Valley Patrol

(Continued from page 120)

rear wheels spin, churn the sand and dig deeper. In desperation the motorist scoops some of the sand away and tries to provide traction by pushing a blanket, coat or floor mat under the wheels. This rarely succeeds. Often the ranger finds the motorist has dug in so deeply the car's rear axle is resting on the ground.

A tractor seems the only way of getting the car out of its hole but the ranger has a trick that's quick and simple. While the motorist stands by, the ranger uses the car jack to raise each rear wheel in turn. He packs sand into each hole and a little more on top. When the car is on level ground again, the ranger partially deflates both rear tires, starts the motor and backs away. The "rescue" takes less than half an hour.

Rescuing aviators has been another ranger job. During the war, student pilots from desert training fields delighted in flying through Death Valley. Some were attracted by the long flat stretches of what appeared to be hard-packed dry mud on the valley floor. Just the place to make practice landings, it appeared, but as soon as a plane settled in and lost its lift, the

(Continued to page 272)



**A book of ideas
to bring you
greater homecraft
happiness!**

New!

**Look at all the
helpful
information
you get:**

Floor plans for almost any size shop — to fit almost any size budget!

Scale drawings of the base dimensions of Delta Homecraft Power Tools — helpful in estimating the floor space you need!

Practical suggestions on the arrangement of tools, storage of lumber, etc.!

Page after page of useful ideas for convenience, economy, and safety!

Pictures of interesting workshops where other hobbyists find happiness!

New Delta* book . . . "21 Home Workshop Floor Plans," helps you plan a hobby room that's fun to work in

What a bargain! 32 pages of home workshop ideas: Ideas you can add to your own—to help make your dreams come true!

Whether you expect to build a homecraft shop "from scratch" or to modernize your old one . . . whether your shop is to be large or small — there's lots of worthwhile material here for you.

The Finest Plans Available!

These plans are the "cream of the crop". They are the ingenious ideas of top-notch woodworking hobbyists — selected from thousands of shop plans gathered by Delta.

Use This Help!

Combine this experience of others with your own ingenuity. Let this book help you plan a homecraft

shop that is the envy of your friends—one you're proud of and happy to work in, an attractive place where the whole family can enjoy close companionship as they join in your wholesome fun.

Send for your copy of Delta's new, big book, "21 Home Workshop Floor Plans." Use the coupon below. Mail it today with your check, money order, or dollar bill.

There's a store near you that handles Delta Homecraft® Power Tools. It is listed under "Tools" in the classified section of your telephone directory. The people there are glad to give you advice on planning and equipping your shop. Ask them about Delta Homecraft Power Tools — the popular tools with a reputation for quality.

\$1
Postpaid

**Tear out coupon
and mail today!**



DELTA MANUFACTURING DIVISION
Rockwell Manufacturing Company
680D E. Vienna Ave., Milwaukee 3, Wisconsin

Enclosed is one dollar { cash
 check
 money order } as payment in full
for the new Delta book, "21 Home Workshop Floor Plans."

Name.....
Address.....
City.....(.....) State.....

*Trade Mark Reg. U.S. Pat. Off.

MM-48

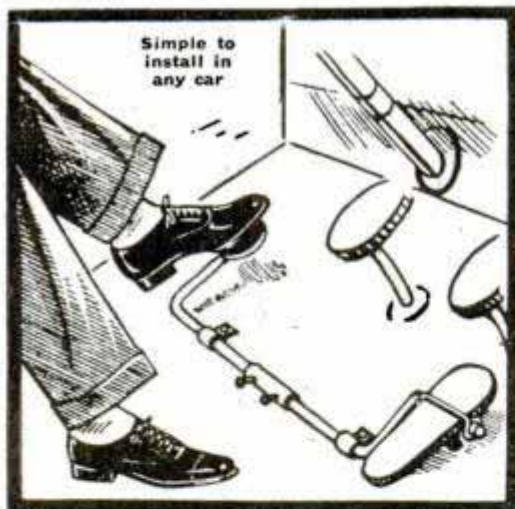

FOR AUTO OWNERS!
AMAZING INVENTION
NOW! DRIVE ALL DAY WITHOUT FATIGUE
 WITH THE **L&P** LEFT-SIDE ACCELERATOR

Only **\$1**

postpaid
 (Money-back Guarantee)

CLIP COUPON

If you are a good driver now, this Left Side Accelerator will make you sensational—for it gives you the complete maneuverability you could never attain before. Now at last you can accelerate with either foot, relieve constant strain on the right. In traffic you have one foot free for brake, and on hills you can use accelerator and brake together!

HARLO DISTRIBUTORS, Dept. M4
 30 West Washington St., Chicago 2, Ill.
 Enclosed is \$1.00 for one L & P Left Side Accelerator, \$8.40 for one dozen. Includes complete instructions.

Name _____
 Street _____
 City _____ State _____

Earn up to \$5.00 PER HOUR installing in other cars. Rock-bottom price of 70c per unit given to agents when purchased in dozen lots. You make money on both sale and installation.

SUCCESS Can Be Yours!

starting Now at Home, in your spare time, you can become a successful manufacturer with these

15 VALUABLE TRADE SECRETS

In America's largest laboratories millions of dollars were spent to develop and perfect these 15 processes. Now you can get started at home, in your kitchen or basement. You need no technical training, you invest very little money. To assure success manufacture such large-demand products as "Chem-Stone," a new plastic that makes concrete hard as stone and eliminates dusting; "Thermo-Sol," a new inexpensive fireproofing that has no competition; "Water-Seal," the secret sealer for leaking walls and ceilings, and 12 other easy-to-make, easy-to-sell products. We supply everything you need.



Own Your Own Factory! Write Today for Complete, Free Information!

CHEMICAL RESEARCH CO.
 130 WEST 42nd ST., NEW YORK-18, N. Y.

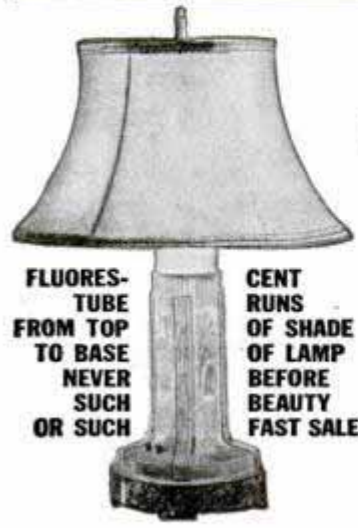

FLUORESCENT TUBE FROM TOP TO BASE NEVER SUCH OR SUCH

CENT RUNS OF SHADE OF LAMP BEFORE BEAUTY FAST SALES

Agents For the First Time—FLUORESCENT All-Lite TABLE LAMP!

FIRST to utilize the exclusive feature of UPRIGHT fluorescent illumination, the ALL-LITE gives off a soft, even distribution of light without glare—from shade top to bottom of base.

Selling like mad. Men order sample, show it and reorder in gross lots. Instant appeal. Plug it in and watch them buy. Comes complete with tube and plastic shade.

MAXILUME COMPANY 107 S. CLINTON, Dept. 84 CHICAGO 6, ILLINOIS

FREE SAMPLE OFFER

DON'T send a penny. Sample offer is free—Rush name for selling outfit and make money from the day it arrives. We will show you how to sell to hundreds of homes, restaurants and public places and to stores by the dozens for resale. Also immediate delivery on standard fluorescent fixtures. Get going with the MAXILUME line. It's a winner for others—it can bring big, fast profits to you. Rush name on penny postcard.

SUPER DRILL GRINDER



Sharpens round shank drills from 3/32" to 1-1/16" diameter. Grinds Old Drills like new in 4 different drill point angles. Grinds Short, Medium and Long Twist Drills from 1 1/2" up to 11" long, for hand or power grinding wheels.

200,000 IN USE!

Grinds your drills like factory in 25 seconds. Gives perfect center and clearance. Saves drills, time and money. No shop should be without the Super Drill Grinder. Guaranteed to do the work or money back. The Grinder that gives a rounded point!

Only **\$2.95**

At Your Dealer's or Postpaid
CRANDALL MFG. CO.

1512 West Slauson, Dept. FA-16 Los Angeles 44, Calif.

Now You Can GET THOSE MOTOR-CLUTCH-TRANSMISSION AND AXLE PARTS in stock

NEW AUTO PARTS

and SAVE MONEY

Get Our BARGAIN PRICE LIST for parts you want



Why worry about parts when we have them . . . All you want, at a BIG SAVING . . . We ship within 48 hours . . . We also have REBUILT UNITS for EXCHANGE at Bargain Prices: CARBURETORS — FUEL PUMPS — GENERATORS — STARTERS — SHOCKS AND KNEES . . . It will pay you to GET OUR PRICES or RUSH YOUR ORDERS.

Send Your Orders NOW! IMMEDIATE SHIPMENT

MECHANICS AUTO PARTS, Factory Warehouse
 3807 No. Ashland Ave., Dept. PM-4 CHICAGO 13

IT'S FUN TO SAVE MONEY

with a **Forney**
FT. COLLINS, CO.



TWO YEAR
 GUARANTEE
 110-230 &
 440 Volt A.C.
 32 Volt D.C.

All-Purpose ARC WELDER

- A Workshop in Itself. Ideal for Farm Use.
- Pays for Itself in Savings on Repairs.
- Easy to Use—Simple FREE Instructions.

WELD, BRAZE, SOLDER any metal in any gauge or weight—from sheet to motor blocks!

EXCLUSIVE NEW 1947 FEATURES

Weather-proof case. Fire-proof construction. Welding rod size indicator for each heat stage. Voltage regulation on each stage reduces splatter, increases efficiency. Capacitor equipped. Instant arcing. All electrical connections brazed or welded. Fully equipped—ready to use.

New Lower Prices—Models, \$25 to \$300

WRITE FOR FREE LITERATURE!

FORNEY MANUFACTURING CO.
 FT. COLLINS 2, COLORADO

The PRECISION Lawn Mower Sharpener

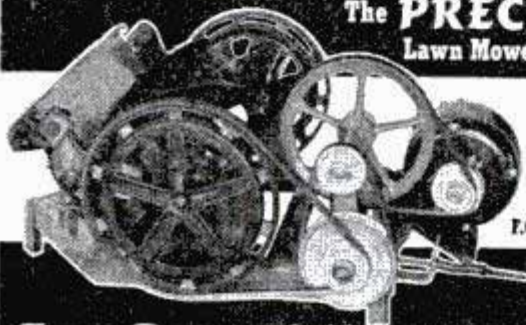

Only
\$37.50
 Less Motor
 F.O.B. Rock Island

EXTRA DOLLARS IN YOUR SPARE TIME...

Looking for an extra income sideline? Install a Precision Lawn Mower Sharpener in your workshop and turn your spare time into dollars. Sturdily constructed - Easy to operate.

QUAD-CITY PRODUCTS CO. - P.O. Box 42, Rock Island, Ill.

SAVES MANY ELECTRIC APPLIANCES

NICHROCITE REPAIRS HEATING ELEMENTS IN A JIFFY...

Simply overlap ends, apply Nichrocite Paste and turn on current. Used by large utility companies. Trial order, \$1.00; 4 oz., \$2.50; 1 pound, \$8.00.

ARROWHEAD SALES & DIST. CO. Dept. F
 1325 4th St. N., Minneapolis 11, Minn.

EXPERIMENTERS, LOOK!



POWERFUL ALL PURPOSE INDUCTION MOTOR

Sturdily constructed to precision standards, this self-starting shaded pole A.C. induction motor is ideal for experimenters—101 uses.

Consumes about 15 watts of power and has a speed of 3,000 r.p.m. When geared down, will constantly operate an 18-inch turntable loaded with 200 lbs. dead weight. 3" high by 2" wide by 1 3/4" deep; 4 convenient mounting studs; shaft 7/8" long by 3/16" diameter; runs in self-aligning oil retaining bearings. Designed for 110-20 volts, 50-60 cycles, A.C. only. Shp. **\$2.95** Wt. 2 lbs.

Send Money Order or Check. (No C.O.D.) Include Shipping Charges.
HUDSON SPECIALTIES COMPANY

AMAZING BLACK LIGHT!!

Powerful
 250 Watt
 Ultra-Violet
 Source

The best and most practical source of ultra-violet light for general experimental and entertainment use. Makes all fluorescent substances brilliantly luminescent. No transformers of any kind needed. Fits any standard lamp socket. Brings out beautiful opalescent hues in various types of materials. Swell for amateur parties, plays, etc.; to obtain unique lighting effects. Bulb only. Shp. Wt. 2 lbs.

ITEM NO. 87 **\$1.95**

YOUR PRICE
 40 West Broadway, Dept. PM-56,
 New York 7, N. Y.

An "AUTO TROUBLE LIGHT" You Can Use As A Spotlight ...



Lights Up
 STREET NUMBERS
 ROAD SIGNS

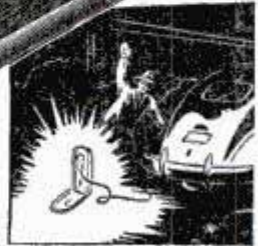

NEW

Ideal As An
 EMERGENCY FLARE

BMC ReadyRay

plugs into the lighter socket
 of your car ...

As bright as a headlamp ... as easy to use as the cigarette lighter on the dash ... this new, light-reflecting BMC READY-RAY Auto Trouble Light plugs into the lighter socket and throws a wide "safety zone" of light. Small, compact, easily handled. Lights up road signs and street numbers ... is visible as far as an approaching driver can see.

Use it as a road flare ... as a hand signal to flag approaching cars ... as a trouble lamp for changing tires, making motor repairs, or finding tools. Ideal as a utility spotlight for packing duffel, gathering up picnic equipment, etc.

NO DRY CELLS TO GO DEAD

The READY-RAY Light draws current from the storage battery of your car. It's always ready. There's no fading or flickering. The cover can be used as a base for supporting the light in any position. It's small enough to fit into the glove compartment, yet it throws a powerful 21-candlepower beam.

See it demonstrated at your nearest auto supply or hardware store or department.

Price only \$2.75.

BMC MANUFACTURING CORP.

BINGHAMTON, N. Y.

Makers of BMC Pressure Lock Wrenches ... Offset Screwdrivers for regular and Phillips-head screws ... and Change-A-Blade Scissors.

Rogers Air-tite

tobacco pouch
keeps tobacco
fresh!



"seals as it closes"

Cross section view showing how the patented "lips" of the inner pouch seal tightly as you zip the outer pouch closed. Keeps freshness and fragrance in. U. S. Pat. 1,801,192; Can. Pat. 374,167.

You enjoy your last pipeful of tobacco as much as your first with a Rogers Air-tite Tobacco Pouch which keeps tobacco wonderfully fresh and fragrant, thanks to its patented inner-pouch construction and exquisite craftsmanship. In a wide variety of leathers and models (Model 213 illustrated above \$3). Others from \$1.50 to \$15.00.

At leading shops everywhere.

ROGERS IMPORTS, INC., Manufacturers and importers of the finest in smokers' accessories
419 Fourth Avenue, New York 16, New York
U. S. AGENTS FOR PETERSON'S PIPES • DUBLIN, LONDON
© 1946 R. I. I.

wheels broke through the top crust and the plane upended on its nose. The rangers learned to spot a plane's tail sticking up into the air from miles away.

The rangers' oddest airplane rescue came during a vicious 50 mile-an-hour sandstorm when visibility was almost zero. Goodwin got a phone call from an air training field 200 miles away. "Superintendent," the speaker said, "one of our planes had motor trouble and had to land in the valley. Its position is 4.2 miles north-northwest of Devil's Golf Course. Two men on board. I'd appreciate it if you'd send a car down and pick them up."

"Certainly, certainly," Goodwin exclaimed. "We'll go down there at once. But how do you know the plane is down and what makes you so certain where it is?"

"Man," the voice replied, "the pilot has been broadcasting an SOS for the last 15 minutes and we have radio fixes on him from seven different stations. We know his location almost to the yard." He was right. The rangers found the plane right there.

Who Says It's a Sissy Game?

(Continued from page 103)

center shot down the middle, a cutback into the left-hand court and a "tap" shot which just dribbles over the net.

(5) **The block:** The block is a more or less recent innovation, but one which has tended to equalize the game between offense and defense. A few years ago the spikers were the key men and seemingly could not be stopped. But the Houston, Tex., team that entered the 1933 tournament in Chicago used a blocking defense that almost completely nullified the efforts of the spikers. Three men jumped on the opposite side of the net from the spiker—presenting a solid wall of hands that he found difficult to get the ball past. The Rules Committee of the National Volleyball Association later limited the blockers to two men.

Blockers leap into the air as the spiker makes his leap. The ball may hit their hands with such force that it bounds 20 to 30 feet high. There are two types of blocks. One is the "hard" block in which the ball bounces back into the opponent's court. The other is the "soft" block. The force of the ball is taken by the blockers and it is saved for their own back court men—thus gaining the offensive for that side.

Recent developments in spiking and blocking have put a premium on height. However, many medium-size men with plenty of spring in their legs play on top-notch teams. And even small men—such as

(Continued to page 276)



Frequency-Modulation radio reception is virtually free from natural static—even thunderstorms do not interrupt.

FM Radio—another world in listening pleasure!

It's as though the orchestra were right in the room with you—and the room suspended in the silence of space. When you listen to music over RCA Victor FM, you hear FM at its finest.

Natural static interference ordinarily caused by thunderstorms does not mar FM radio reception. You are in a world of utter quiet where you hear only the lifelike music. Moreover, you enjoy the same perfect reception day or night.

The vast experience, research and skills at RCA Laboratories, such as aided in the development of RCA

Victor FM, are constantly applied to all RCA products, so each one is at the top of its field.

And when you buy anything bearing the RCA or RCA Victor name—a radio (standard or FM, or both), a television receiver, Victrola radio-phonograph, a phonograph record or a radio tube, you know you are getting one of the finest science has yet achieved. "Victrola" T. M. Reg. U. S. Pat. Off.

Radio Corporation of America, RCA Building, Radio City, New York 20. Listen to *The RCA Victor Show*, Sundays, 2:00 P.M., Eastern Standard Time, over the NBC Network.



With the new RCA Victor AM-FM sets you'll hear FM radio—and standard AM radio too, at their finest. Ask your RCA Victor dealer to show you the new Crestwood Victrola radio-phonographs.



RADIO CORPORATION of AMERICA

**Make Up To \$600
An Hour!**



Operate Your OWN Home-Weaving Business With AMAZING New DEEN Power Loom!

Make yourself financially independent! Start a steady business of your own . . . right in your home! Earn BIG PROFITS by weaving thousands of different designs of rugs on the new easily operated Deen Power Loom. Machine will automatically weave ten yards of beautiful intricate designs every hour.

DEEN LOOM TAKES UP LITTLE SPACE. You can put this marvelous weaving machine in a corner of your living room, basement, garage, or spare bedroom. Then later on, as your business expands, you can move into regular business establishment.

IDEAL BUSINESS FOR HANDICAPPED PEOPLE such as veterans and persons handicapped by loss of sight or limbs, and those unable to do strenuous labor. Loom is simple to operate . . . a child can run it. Any rug design you wish can be woven by merely changing paper guide pattern.

ORIGINAL INVESTMENT CAN BE RETURNED IN THIRTY DAYS. A small investment gets you started in your own business right away. Deen Loom has capacity of from eighty to one-hundred yards a day . . . in only one month it is possible to get back your original investment. Demand for home-woven rugs is GREATEST IN HISTORY. DON'T DELAY . . . start making plans for your own business NOW. Write today for free descriptive booklet and full information. Address Dept. 30, DEEN LOOM DIVISION.

THE GIBSON CO., 1415 No. 18th St., Omaha, Neb.

"Makers of DEEN Looms — FAMOUS Since 1895"

IMMEDIATE DELIVERY

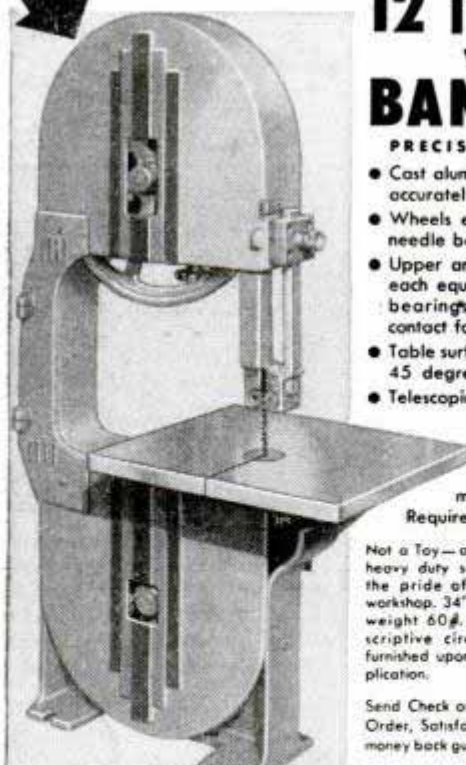

**12 INCH
VINCENT
BAND SAW**

PRECISION ENGINEERED

- Cast aluminum frame, solidly built, accurately machined.
- Wheels equipped with Torrington needle bearings.
- Upper and lower roller guides—each equipped with 3 large ball bearings—provide friction-free contact for blade.
- Table surface 12" x 13 1/2" tilts 0 to 45 degrees, blade length 6' 6"
- Telescoping blade guard.

A real buy — a 12 inch saw, cutting a maximum of 6" thickness. Requires 1/2 H. P. motor.

Not a Toy—a real heavy duty saw—the pride of any workshop. 34" high, weight 60#. Descriptive circular furnished upon application.

ORDER TODAY

\$98⁵⁰

Send Check or Money Order, Satisfaction or money back guarantee F. O. B. DETROIT

STERLING MACHINERY CO.
2310 W. WARREN • DETROIT 8, MICH.

SAY YOU SAW IT IN POPULAR MECHANICS



VEEDER-ROOT METER

Counts no. of ft. of trailing wire antennae; no. turns when winding on coil; applicable for many uses; flexible shaft can be attached and connected to another device for counting without direct attachment; speed 300 ft. per minute for reeling out; beautiful bakelite case, jeweled dialite, pilot light enclosed, 3 position switch, counts up to 1000. EACH **95c**

ARMY AIRCRAFT RECEIVERS

BC-946-B

Broadcast band from 520 to 1500 Kc, tube complement — 3-12SK7, 1-12SR7, 1-12A6, 1-12K8 can be used with 24V dynamotor supplying A & B power; can be converted to AC or DC or 32 volt sets 3 stages of IF used. Uses 3 gang condenser. Complete with **\$12⁹⁵** tubes and schematic, each
Dynamotor DM-32A, each **\$1.95**



SURPRISE PACKAGE

For the experimenter, radio serviceman, handy man, repairman, "ham," hundreds of valuable miscellaneous radio parts, 10 pounds **\$1.59**

Hickok 2 1/2" 0-150 AC Voltmeter, each **\$2.49**

All Shipments F.O.B. Chicago

20% deposit required on all orders

Dept. PM

ARROW SALES, INC., 59 W. Hubbard St., Chicago 10, Ill.

SUPerior 5575

MAKE MONEY with LARSON Leathercraft

Send ten cents to Leathercraft Headquarters for 16-page catalog describing all necessary materials for making belts, moccasins, purses, gloves and many other practical items. Easy to assemble. Instructions come with materials.

Send for this Catalog



J. C. LARSON COMPANY

176 N. Wacker Drive • Chicago 6, Illinois

POWER LAWN MOWER

BUILD ONE YOURSELF FROM YOUR OLD MOWER



We supply complete attachments that fit any make or size of mower, with or without 1 1/2 H.P. gas engine. Easy to install in less than an hour. No more back breaking mower pushing. Immediate delivery, at low prices, express prepaid.

MONEY BACK GUARANTEE

You'll be delighted! Complete satisfaction or your money back. Write for

FREE FOLDER

Dealers Wanted.

ROYAL OAK LAWN MOWER SHOP
Box 48 Royal Oak, Mich.



What puts addresses on to stay
And speeds each package on its way?

Dennison ADDRESS LABELS

At Stationery Departments Everywhere

Wash Your Hands without Soap or Water!



Remove Grime, Grease, Oil or Paint in Seconds... Save Time, Towels and Expense!

When hands are soiled and grimy with grease, paint, glue, printer's ink, tar stains . . . don't fuss and scour with gritty soap . . . don't waste time and towels in scrubbing up...clean your hands quick-

ly, easily, gently with E-Z Hand Cleaner, the successor to soap!

Gets ALL Dirt!

E-Z quickly and safely removes any kind of grime . . . because it's a combination of many newly - discovered cleaning agents . . . mixed together in one rich, smooth cream by a process known as "homogenization". No "one-purpose" soap or solvent with a single cleaning agent can hope to duplicate E-Z Cleaner's all-around effectiveness!

Use No Water!

Warning — never moisten hands when using E-Z! Water

has practically no solvent effect on oil, grease, paint, tar and other grime . . . actually slows down the powerful detergent action of E-Z!

Quick, Easy, Convenient
Just dip your fingertips in a can of E-Z Cleaner . . . rub into hands for 5 seconds . . . wipe on paper towel . . . and dirt, grime, sludge vanish like magic!

Safe and Gentle!

E-Z contains "Lanolin"—essential ingredient of famous face and hand creams. Won't hurt hands . . . actually makes them soft and smooth!

Perfected by Engineer!

E-Z was perfected by the Chief of Chemical Engineering in a large petroleum corporation . . . to help employees save time and energy wasted in "scrubbing up" several times daily!

Used by Thousands!

Literally hundreds of America's largest factories and shops provide E-Z for employees. Also sold by many automotive and hardware stores. Costs less than a penny per "clean-up." Mail coupon with dollar bill for big, introductory can containing almost 2 full pounds. Money-back on request if not completely satisfied.

MAIL COUPON FOR TRIAL CAN

E-Z Mfg. Co. 1210 Farnam, Omaha 2, Nebr.: Enclosed find \$1 bill—please send me postpaid an introductory can of E-Z Hand Cleaner.

Name.....

Address.....

City.....State.....



NEW—WAR SURPLUS JUNGLE HAMMOCKS

For the home, yard, farm, camping, scouting and many other uses. Can also be used for Pup tents.

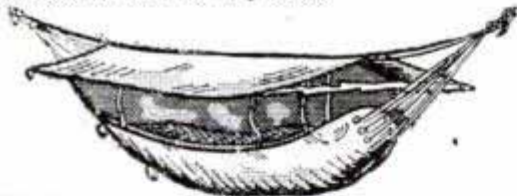

Made of high grade Poplin for the U. S. Army. Complete with ropes and canopy for protection against mosquitoes and other insects. Comes individually packed. Ready for immediate shipment. Order yours today. Sent postpaid for only **\$4.95**

Special quantity discounts

RoKo Company

729 Baltimore

Kansas City, Mo.



BACK AGAIN: All You Want BEARINGS (all types) (all sizes)

INDUSTRIAL — AUTOMOBILE — TRACTOR

NOW we can furnish you with exactly the kind of bearings you want and in quantities you need. **WE HAVE THEM**

- STEEL BALLS
- BRONZE STOCK
- OIL SEALS
- V-BELTS
- AUTO BEARINGS
- BALL BEARINGS
- ROLLER BEARINGS
- BEARING PILLOW BLOCKS
- THRUST BEARINGS

Special Quantity Prices to Large Users
Let us know your requirements.
WRITE FOR PRICES.

AUTO-INDUSTRIAL BEARINGS CO.
DEPT. PB-4
3811 No. Ashland Ave., CHICAGO 13



by AMERICAN



Here's the new American Portable Electric Saw—ideal to save time, labor and money in production work. Not a hobby tool. Speedy . . . powerful . . . easy for one hand operation. 8" blade. Adjustable. Precision-built, dependable. Write for free details, giving your occupation. The American Floor Surfacing Machine Co., 535 So. St. Clair St., Toledo 3, Ohio.

RED-ITCHY-SCALY ECZEMA

**Effective
Home
Treatment
Promptly
Relieves
Torture!**



First applications of Zemo—a Doctor's soothing yet highly medicated antiseptic formula—promptly relieve itching and burning and also help heal the red, scaly skin. Backed by a 40-year record of *continuous* success! *Invisible*—doesn't show on skin! First trial of clean, stainless *liquid* Zemo convinces! In 3 sizes. For severe cases ask for special *Extra Strength* Zemo. At all drugstores.

ZEMO

five-foot six-inch Manuel Saenz, of the Los Angeles Athletic Club, one of the best set-up men in the game today—find that they can compete with the giants.

Volleyball is played on a court 30 feet wide and 60 feet long, divided by a three-foot net, the top of which is eight feet above the floor. A team consists of six players who rotate clockwise when their team receives the service. A point can be scored only by the serving team. The ball is put into play by service from behind the back line, with only one serve permitted. A point is scored when the receiving team fails to bat the ball back across the net. If the serving team fails to score, the serve is yielded to the opponents. The ball may be touched not more than three times by players on one team before it is knocked over the net, and no player may touch the ball twice in succession while his team has possession of the ball. The first team scoring 15 points wins the game, and a match consists of two out of three victories. Players are not allowed to touch the net or reach over it.

Report From Antarctica

(Continued from page 94)

which occurs almost everywhere in sufficient amounts for detection. Since the record varies with the distance to the magnetic material, contours of the land below the ice can be plotted on the map. Two planes, outfitted with magnetometers and auxiliary instruments, have been operating on long flights inland toward the pole.

The instrument gives indications of large mineral resources besides iron. The continent is now known to contain some of the greatest coal deposits on earth, and vast oil reservoirs beneath the ice cap are almost certain. Although the precise nature of the minerals is not revealed this often can be deduced from the geological contour. With the magnetometer the ice cap disappears, since it contains no magnetic materials. Radar could give only the ice surface contours. The comparison is like that between visible light and powerful X-rays.

The only other method of determining the land contour under the ice cap is with a sonic depth apparatus similar to that used on ships to map the ocean bottom. This is slow, and requires apparatus set up on the ice surface, but would give more detailed information. Two Navy experts are determining the precise behavior of echoes through ice peculiar to polar regions, providing basic data for future surveys.

An important Navy problem is the magnetism of steel ships which changes with latitude. Variations also have been noted

(Continued to page 280)

WRITE FOR Free Sample

GLOWS
IN THE
DARK

★ ★ Make Big Money ★ ★

Be the first to sell luminous house numbers and light switch plates. Also luminous pictures, statues, etc. Religious, nursery, glamour and other subjects. Sell on sight. Represent a Large Manufacturer Est. 1917. MADISON MILLS • 303 Fourth Ave. • New York 10, N. Y.

Aladdin's Tool

THE "GENI" OF
A THOUSAND AND ONE USES !!!

\$5.95

**all types of
WOOD SHAPING**

Routing
Tonque & Groove
Fluting
Notching
Inlay
cuts any type of joint

use in any standard type chuck
HIGHEST QUALITY HIGH SPEED TOOL STEEL
6 blades will make 12 different cuts

IF YOUR DEALER DOES NOT STOCK THIS ITEM SEND \$5.95 IN CHECK OR MONEY ORDER FOR PREPAID SHIPMENT OR C.O.D.

DEALERS WRITE FOR INFORMATION

The DESIGN CO.
326 LAW BUILDING
KANSAS CITY 6, MO.

WAR SURPLUS BARGAIN SPECIAL

BRAND NEW! VACUUM-AIR HYDRAULIC FUEL PUMP

Original Cost
\$45.00
Now Only
\$9.95

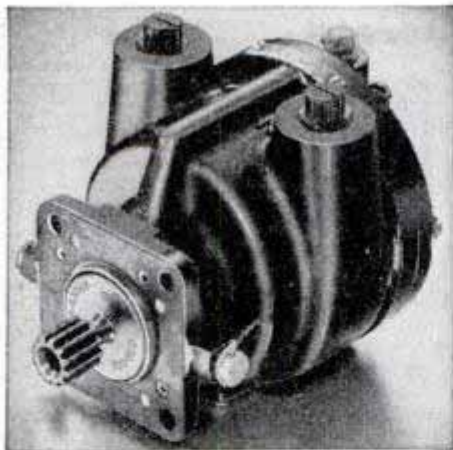

Postpaid in U.S.A.

Adaptable for use on Home Oil Burners, Spray Machines, Milking Machines, Compressors, Vacuum Pumps, Hydraulic Systems, Presses, etc. Originally cost \$45.00. Used by the Air Corps to drive bomber de-icer boots, gyroscopes, automatic pilots, etc. May be used as air or fluid pump—for pressure or vacuum. Standard 3/4 inch pipe thread with interchangeable ports. Will pump 7 1/2 gal. SAE 30 oil per minute at 300 RPM. Builds air pressure of 30 lbs. per sq. in. at 1000 RPM. Vacuum will draw 26 inches of mercury at 1750 RPM. Runs forward or reverse. Self-aligning shaft. Die cast aluminum housing 6x4x4 inches. Has stainless alloy steel vanes and impeller. Made by Bendix Avia Corp. Spline terminal for direct drive—readily replaced with a pulley. Recommend a 1/4 H. P. or stronger electric motor as source of power. Rated capacity 1500 RPM with high overload factor. Special price for quantity users. Send check or money order today. Postpaid in U.S.A.

GROBAN SUPPLY CO. 1522 So. Michigan Avenue
Dept. PM4, Chicago 5, Ill.

AUTOMATIC RETOOTH

Makes New
Profits

Cuts new teeth in 50 seconds! Any size tooth 4 to 16 points. Old teeth fall off as chips. Simple to operate. A perfect job.

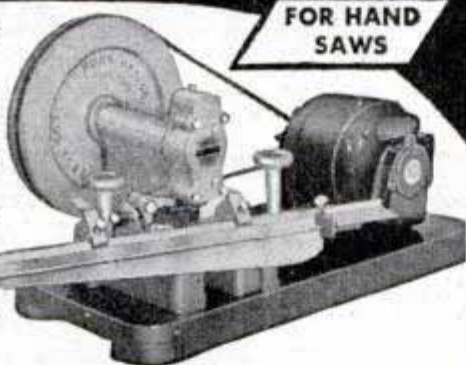

IMMEDIATE
DELIVERY

BURR MFG. COMPANY 8933-C Venice Blvd.
Los Angeles 34, Calif.

QUICK ACTING PRECISION VISE

1/4" JAWS
OPENING 1 1/8"

WITH SWIVEL BASE

Removable jaws • Gibbed for accuracy
• Machined dovetail base
Push! It's closed • Flick! It's open

SEE YOUR DEALER OR WRITE

Raypo CORPORATION

9900 Lincoln Blvd., Los Angeles 45, Calif.

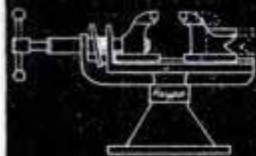

PRECISION VISE

KAYAKS

AQUA V-18

Easy to Build



OUTBOARDS
ROWBOATS

25¢
COIN
FOR ALL
THREE

BOATS for Home Assembly

"U-MAK-IT"

KAYAKS, ROWBOATS, DINGHIES,
INBOARDS, OUTBOARDS, RUNABOUTS
Cut-To-Fit for Quick Assembly. Everything
Complete plus Illustrated Instructions. No Ex-
perience Necessary. Simple as A. B. C.

SEND 25c POSTAGE (COIN) TODAY
FOR 3 MONEY SAVING ILLUS. CATALOGS
Showing all 47 Models (marine plywood)
and construction details.

AQUAMOBILE V-18

Designed for Auto Engines. Open or
with cab. Length 18 ft.
Fast VEE Bottom Hull.



KAYAK BOAT CO., 154P EAST 129th ST., NEW YORK 35, N. Y.

A TOOLSHOP IN YOUR HAND!

- GRIND • DRILL • ROUT
- POLISH • ENGRAVE
- CUT • SAND • SAW, etc.

Make Things From
Wood—Plastics—Metals—
Glass—Linoleum—Leather—
Alloys—Horn—Stone—Bone,
etc.

HANDEE TOOL OF 1001 USES

Smooth, steady power at your fingertips! Perform precision operations not possible with any other portable tool! With a Handee you can turn out professional looking projects for pleasure or profit—ship, plane and train models, costume jewelry, wood carvings, puppets, initialed tumblers, etc. AC or DC. 25,000 r.p.m. Wt. 12 oz. USE THE RIGHT ACCESSORIES! Choose them from the most complete line . . . more than 500 made right in the Handee plant.

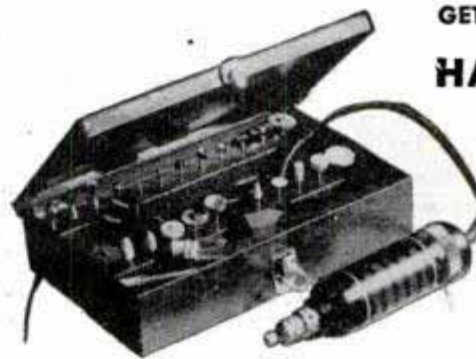

GET A GOOD START
GET THE
HANDEE KIT

HANDEE Tool and 40 most popular accessories packed in compact steel carrying case. You'll be amazed at what you can accomplish! Complete, postpaid, \$27.50

Handee only, with 7 accessories,
\$20.50

FOR YOURSELF OR A FRIEND...
THE GIFT OF A LIFETIME!

NEW PRECISION ATTACHMENTS

Fit Handee only; enable novice or craftsman to do perfect work. Magically, easily, your offhand carving, routing, shaping will be exact as to depth of cut, accuracy of line. Set of 6 attachments with instructions, postpaid, \$7.95

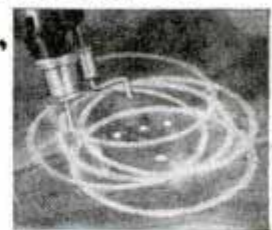

ORDER NOW. SATISFACTION GUARANTEED!
FREE! NEW 52-PAGE MANUAL

CHICAGO WHEEL & MFG. CO.

1101 W. Monroe St., Dept. PM, Chicago 7, Ill.

Send Handee Kit Handee Tool Precision Attachments
 C.O.D. Remittance enclosed Send Manual

Name.....

Address.....

SAY YOU SAW IT IN POPULAR MECHANICS

Time & Date AT A GLANCE

BELL
GUARANTEED
CALENDAR WATCH

Tells time, name of day and date. Day name changes automatically.

No. MX382—Calendar watch, 17 jewels waterproof, shockproof, anti-magnetic, radium dial and hands, stainless steel back. **\$49.75**

OTHER SPORTS WATCHES **WATERPROOF SHOCKPROOF**
 Precision tested, guaranteed, 17 jewels, anti-magnetic, radium dial and hands, unbreakable crystal, sweep second hand.

NOW AT RECORD LOW PRICES

No. MX196 — Stainless Steel Back..... **\$24.75**
 No. MX220 — ALL STAINLESS STEEL CASE... **\$29.95**

ORDER BY MAIL: Send check, money order or pay postman C.O.D. Prices incl. Fed. Tax and Postage. Write for FREE Booklet "MX".
 REPAIR SERVICE: All type and makes of quality watches. FREE estimate on request.

BELL WATCH COMPANY, INC.
 Time and Life Bldg., Rockefeller Center, New York 20, N. Y.

PRACTO U-BUILD-EM SETS Life-size everyday utility vehicles for boys who love to make things with their own hands. NOT A TOY! ALL FULL SIZE, dependable, sturdy.

BIKE TRAILER **SPEEDMOBILE**

No. 8B **\$8.00**

9" steel-welded, ball bearing, rubber tired wheels. Sturdy. COMPLETE metal parts — you supply only the wood.

Everything but the wood. 9" steel-welded, rubber tire wheels. ALL metal parts!

No. 10B Ball Bearings — **\$10.50**

U-BUILD-EM SETS also available:
WHEELBARRROW No. 6 Tru-Bearings — **\$3.00**
 No. 6B Ball Bearings — **\$3.50**
EXPRESS CART No. 9 Tru-Bearings — **\$9.00**
 No. 9B Ball Bearings — **\$11.00**

It may be difficult to get these sets at your dealer. SEND CHECK or MONEY ORDER and order direct. Sent express prepaid.

INTERNATIONAL MFG. CO.
 712 Beacon St. - Boston 15, Mass.
 Reference: National Shawmut Bank, Boston.

Build Practo Vehicles for re-sale! SPECIAL DISCOUNT for 6 units or more. Write now!

THE SCOUT SENIOR

A two-cylinder, slide valve engine for boats 18" long and larger. 7/16" bore by 5/8" stroke. Aluminum pistons. High-pressure, brazed boiler. Drives a 2 1/4", two-bladed prop of 3" pitch at 2000 r.p.m. for almost 20 minutes. Burns alcohol. Price postpaid, complete ready to run **\$950** with 70-lb. safety valve and prop rig

PHILIP STEVENSON CO.
 Box 162, Station D Cincinnati 6, Ohio

CROSMAN Silent RIFLE
 Most Amazing Gun Ever Invented for Target and Small Game Shooting

The ideal rifle for year 'round shooting indoors or out. Shoots low-cost SUPER PELLETS without noise, odor or recoil. Requires no cleaning.

Adjustable power—rifled barrel for accuracy. .177 and .22 caliber models. Write for information.

CROSMAN ARMS CO., INC.
 3 HENRIETTA ST., ROCHESTER 7, N. Y.

HULL AUTOMOBILE COMPASS

A travel companion that shows directions anywhere, any time. Write for Circular At your dealer's. Price **\$3.95**

HULL MFG. CO.
 WARREN, OHIO

P. O. BOX 246-D2

MAKE THESE SCARCE BUILDING MATERIALS

Today's huge demand for blocks and other masonry products makes opportunity for local manufacturing. Buy modern, cost-cutting machinery direct from large factory—national headquarters for 40 years. Complete line. Sold on 15 days' trial. Liberal terms. Free manufacturing instructions. Write for new catalog with all prices plainly marked. Early delivery.

CONCRETE EQUIPMENT COMPANY
 512 Ottawa Avenue Holland, Michigan

WAR SURPLUS

Lathes, Milling Machines, Drill Presses, Sawing equipment, Motors and thousands of miscellaneous items. Also information on Helicopters, Sleeper Trailers, Garden Tractors, Power Lawn Mowers, Welders, Jet Immulsion for Cars and Tractors etc. Rush name for free literature.

THE WAYNE ENGINEERING CO., DEPT. 1121, GREENVILLE, OHIO

NEW CHEAP OIL BURNER

FOR COOKING & HEATING STOVES-FURNACES
 HEAT YOUR HOME, COOK YOUR MEALS WITH CHEAP FURNACE OIL

NO MORE SHOVELING COAL OR ASHES. A New Fuelizer Starter Vaporizing System turns Cheap 130 Flash Furnace Oil, Distillate, Kerosene etc. into Oil Gas heat without clogging up. LIFETIME GUARANTEE against defects. **\$1.00 Bonus Offer** for Testing. We will let you try it in your own stove or furnace for one month. Get yours for introducing. Big Profits QUICK. Be first. Send in your name TODAY.

NORTHWEST MFG. CO., 567-D 5th. Mitchell, So. Dakota

GREAT NEW TOOL!

QUICKLY SHAPES, SANDS CARVES, PROFILES, BANDSANDER
GRINDS, BEVELS, SMOOTHS, POLISHES, CLEANS!

War industry's most versatile machine—now available to hobbyists, craftsmen, model makers, pattern makers, home workshops—cuts fast and clean on wood, metal, plastics! Works equally well on inside cut-out openings or irregular outside edges, on intricate scrolls, curves. Saves hours of tiresome hard work—does better job. Nothing else like it. IDEAL TO GIVE OR GET FOR WORK-SHOP! Sold on 5 Day's Trial, money back GUARANTEE.



FREE!

Write for free, lavishly illustrated Circular describing how Bandsander—the machine that amazed the experts—saves time, money, trouble. Write now—a post card will do!

MEAD SPECIALTIES CO.
4114 N. Knox Ave., Dept. 147, Chicago 41, Ill.



BY DEMAND

OF THE EXPERTS

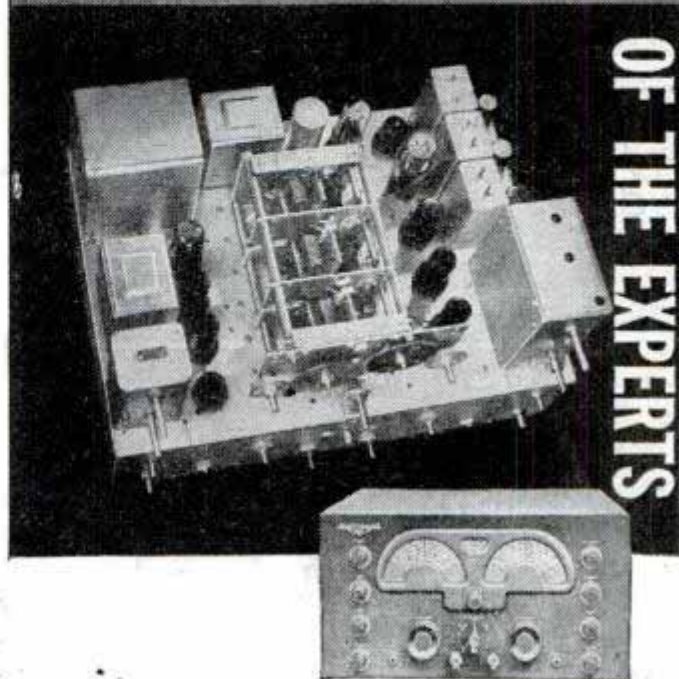

PROTECT YOUR EYES AND GLASSES



The SAF-I-SHIELD GOGGLE of "Optilite," the new optical plastic, weighs less than one ounce, yet, it will withstand the impact of a sharp piece of metal traveling at 240 miles per hour. Gives full protection . . . allows full vision . . . one size fits everyone . . . smart in appearance and comfortable . . . worn by workers in hundreds of the largest plants

in the country. Protect your eyes from flying particles, dust, chemicals and eye hazards in all kinds of work. Made of all crystal clear plastic (#202) for inside work and all antiglare green plastic (#A222) for outside work and sportswear. If your dealer can't supply you, order by number. Send \$1.50 money order, cash or check. No C.O.D. . . . Postpaid

UNITED STATES SAFETY SERVICE COMPANY
1215 McGee Street Kansas City 6, Missouri

ATTENTION MACHINISTS - HOMECRAFTERS



this HIGH-SPEED 6 piece POWER PACKAGE IS AVAILABLE TO YOU AT A SENSATIONAL SAVING! A \$10.00 VALUE FOR ONLY \$3.25!

	Hd. Dia.	Shank
a. Burring Reamer	1/2"	2 3/8"
b. Burring Reamer	1/8"	4 3/4"
c. Burring Tool	9/32"	4 1/4"
d. Burring Tool	7/32"	4 3/8"
e. Burring Tool	5/16"	5"
f. Rotary Burr	1" x 1/4"	

ORDER YOURS TODAY
Other Rotary and Burring tools in stock.

DWITE SUPPLY COMPANY

522A W. NATIONAL AVE. • MILWAUKEE 4, WIS.

MARCOT KEY MACHINE

Immediate Delivery

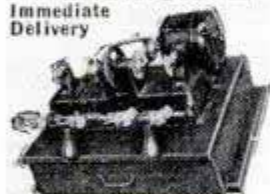

Marcot No. 8 Key Machine Mounted on Cabinet	\$ 82.50
Book on Modern Locksmithing	3.95
Auto Code Book and Auto Depth Keys	12.50
162 Doz. Popular Key Blanks	77.76
Set Key Files, Tools, Pins, Springs, Thimble	10.50
	\$187.21

A. J. MARCOTTE CO., 1200 N. KEDZIE AVE., DEPT. PM, CHICAGO 51, ILL.



SPECIAL SET \$2.00

GENUINE CARBOLY-TIPPED TOOLS

Same as used by the big factories. Long life, high production. Designed to perform home workshop jobs on metal, wood and plastic. Shipped in pairs as shown, either 1/4 or 5/16". Only \$2 cash with order, postage paid.

SCHMARJE TOOL & ENGINEERING CO., MUSCATINE, IOWA

THE GREAT NEW NC-173

Now you can enjoy the radio that was built to suit the world's most exacting radio fans—the amateurs who run their own stations. The new National NC-173 is the product of hundreds of their suggestions, plus five years of intensive research. Turn its dials and the world comes in . . . with marvelous clarity, pin-point sensitivity. Yet its cost is surprisingly moderate.

- 13-tube superheterodyne circuit.
- Standard and short-wave bands, 540 to 31,000, 48,000 to 56,000 KC. (Includes amateur bands.)
- AM reception, phone and code.
- AC-powered. Can also be operated on battery for portable or emergency use — 110/120 or 220/240 volts, 50/60 cycle.
- Distinctive streamlined styling.

Write for name of your nearest dealer today.

EST. 1914.



MALDEN, MASS.

NATIONAL

COMPANY, INCORPORATED

THE MOST DISTINCTIVE NAME IN RADIO COMMUNICATIONS

AMAZING NEW MAGNETIC SAW

READY for PROMPT DELIVERY!

SYNGRO

Deluxe Jig Saw

**WORLD'S
SAFEST
SAW!**

**SOLD ON
10 DAYS
MONEYBACK**

**TRIAL... Send
Coupon for Details**



Complete
with Cord,
3 Blades

**NO MOTOR NEEDED — JUST PLUG IN!
PORTABLE . . . SAFE . . . CUTS CLEAN and
SMOOTH . . . NO SANDING NECESSARY!**

ANNOUNCING SYNGRO . . . new, remarkable, patented magnetic jig saw! Needs no belts, no motor, no gears, no oiling! Just plug into any 60 cycle A. C. 110-130 volt outlet—and saw! Portable. Use anywhere, kitchen, basement, attic, etc. Cuts clean, smooth . . . no sanding necessary! Perfect for models, displays, inlays, silhouettes, etc. Ideal for hobbyists, craftsmen, light production. Cuts intricate designs on $\frac{3}{4}$ " soft wood, $\frac{1}{2}$ " plywood and thinner hardwoods, metals, plastics. Leaves **NO** ragged undersides on plywood or heavy cardboard. Cuts to center of 27" circle. This rugged, powerful power tool is **NOT** for ordinary lumber cutting but is unsurpassed for intricate and fancy scroll work, etc. Special magnetic safety stroke feature permits even small children to use. Nothing else like it! Sold on 10 Days Moneyback Trial. Prompt delivery guaranteed — if you hurry!



HURRY! SEND COUPON! CIRCULAR FREE!

Rush Coupon pasted on post-card for Free Circular, details of 10 Days Moneyback Trial Offer. 1947 production limited . . . so act promptly . . . now! Don't gamble—get your jig saw from SYNGRO—world's largest makers of electric jig saws!

FREE SYNGRO INFORMATION!

SYNGRO SAW CORP., Dept. A-47, ROCHESTER, MICHIGAN
Gentlemen: Rush me, without obligations, free, complete details on Syngro Saw, your 10 Days Moneyback Trial Offer, amazing low saw price.

NAME.....

ST. & NO.....

CITY..... ZONE NO. STATE

corresponding to the amount of pounding the craft has received. Navy ordnance experts are studying the differences between antarctic and arctic with craft which approached the North Pole last summer.

Apparently the position of the South Magnetic Pole has remained fixed as established in 1941, while that of its northern counterpart has shifted about two hundred miles to the northeast, as estimated from observations this summer. The South Magnetic Pole's position in northern Victoria Land, west of the Bay of Whales, is buried most of the time in thick fog and mist, lies behind unexplored mountains, and could be reached only by nearly superhuman effort. The farthest penetration was by Australian Sir Douglas Mawson in 1913. The position can be judged with fair accuracy by the behavior of compasses in planes and by calculations based on fluctuations of the needle at various distances. The pole is the mathematical center of probably a thousand square miles where a compass needle on a horizontal axis points straight down.

In this very large elliptical area, explored by many expeditions, nothing is known of the extent or shape of the southern region. The last Byrd expedition placed the center about 200 miles from Mawson's position, showing a probable 30-year shift. The search directed by Doctor H. H. Howe of the Coast and Geodetic Survey was made difficult by the fact that the direction of the magnetic needle is always influenced by metal deposits in the immediate neighborhood. It is curious that the pole is now several thousand miles away from a point on the antarctic continent which is precisely opposite the North Magnetic Pole.

Dr. Howe also is calculating the position of the geomagnetic pole, or the point where the magnetic pole would be if the earth were a perfect magnet. This is a vitally important search for science. It is somewhere near the center of the continent and is the center of a circle around which are seen the aurora australis or southern lights. It is also the center of magnetic storms which fringe the antarctic continent.

In another magnetic project the daily time is messaged by radio from top to bottom of the world between the weather bureau staff at Thule, Greenland, and the magnetic observers of the naval ordnance laboratory at Little America. The purpose is to get precise measurements of variations in the planet's magnetic field north of the North Magnetic Pole and south of the South Magnetic Pole, and to determine if they vary in alternating phase to each other, a job requiring split-second coordination.

(Continued next month)



Pouring new horsepower into an old engine

WHEN your car begins to show its age, burning oil and losing power, there's a sure-fire way to make it young again. You can pour new horsepower into the old engine and eliminate excessive oil consumption by having it reconditioned and equipped with new Sealed Power Piston Rings. By doing this you restore original power, lengthen engine life, save oil, save gas!

Whatever the make or model of car, truck or tractor, whatever the condition of cylinder wear, there's a Sealed Power Individually Engineered Ring Set specifically engineered to do the best possible job in that particular engine. These sets are made up from twenty-six (26) basic designs of piston rings, proud product of 36 years' use as original equipment by major engine builders. See your Sealed Power Franchise Dealer. Send a postal for illustrated, informative new booklet on 7 ways to save oil. It's free and may save you lots of money. Sealed Power Corp., Dept. G4, Muskegon, Mich.

For better results 26 Basic Ring Designs

No one piston ring design can meet all replacement needs. Sealed Power Individually Engineered Ring Sets are made up from twenty-six (26) basic ring designs, which permit each set to be specifically engineered to do the best possible job in a particular make of engine.

These ring sets are engineered to save gas without sacrifice of oil economy, to save oil without inducing friction and cylinder wear. Each set gives balanced performance in a particular engine.

*Piston Rings
Pistons
Cylinder Sleeves
Valves
Water Pumps
Chassis Parts*



© 1947,
Sealed Power Corp.

SEALED POWER PISTON RINGS

BEST IN NEW CARS! ★ BEST IN OLD CARS!

Here's what your boy wants...

(for boys 4 to 8)

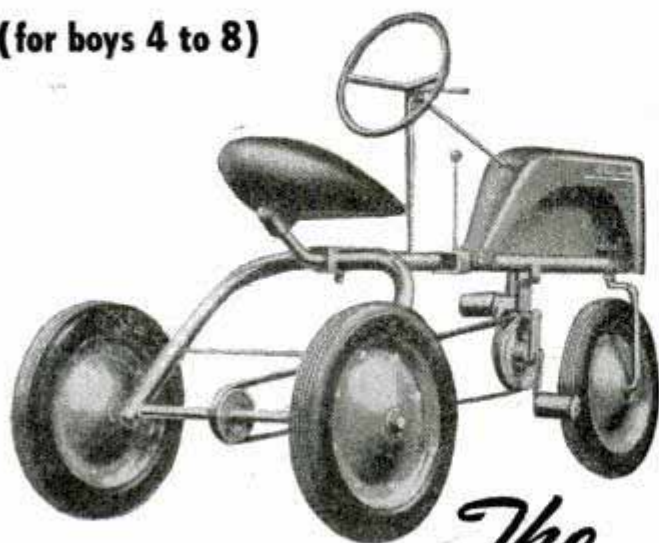

The Sensational

TRACTALL

A husky little giant of more fun and practical uses than any wheeled vehicle you've ever seen. New, original and fully guaranteed. Built of steel and aluminum with big oversized rubber tires on ball-bearing disk wheels. Powered by pedal driven V-Belt. Safe, clean and non-slipping. Gearshift lever and steel steering wheel just like a regular tractor. Finished in red baked enamel.

Only by direct sale from factory is this price made possible \$26.75

Use This Coupon

INLAND MFG. CORP., DEPT. A
BUFFALO 3, N. Y.
Ship one "TRACTALL" Express collect
for which I enclose check (), Money
order () for \$26.75.

Name _____

Address _____

Product of

INLAND MFG. CORP.

158-164 ELLICOTT ST. BUFFALO 3, N. Y.

SAY YOU SAW IT IN POPULAR MECHANICS

MORE PROFITS

with

MODERN LAWN MOWER SHARPENER



SHARPEN ANY LAWN MOWER from 5-inch Edger to 36-inch Power Mower in ten to twenty minutes with a MODERN LAWN MOWER SHARPENER because dismantling is unnecessary—neither handle, roller, wheels nor motor need be removed when sharpening any mower. . . . the MODERN SHARPENER eliminates all hand filing; it precision grinds to the extreme ends of both left or right reel blades. Bottom knife is held in same brackets for sharpening. **NO EXTRA ATTACHMENTS!** Order today! Price \$241.50 (less motor) f.o.b. Pasadena. (1/2 or 1/4 H.P. single phase motor recommended.)

Modern Mfg. Co., 156 N. Fair Oaks, Pasadena 1, Calif.

EVERSON

PRICE
\$11.50

Class "B" Miniature Gas Engine



A high speed power plant for your competition models.

FEATURING — Deep cooling fins — Floating Meehanite sleeve—Per-Mold aluminum castings — Rugged crankshaft precision ground—Open timer—Rotary valve — External parts plated—290 Cu. In. displacement.

Pully guaranteed against material and workmanship. Bench tested. Engine comes complete with plug, gas tank and fully illustrated instructions less coil and condenser.

Sent prepaid in U. S. for \$11.50 or send \$1.00 we will ship balance C.O.D.

6 FRANKLIN AVENUE

EVERSON BROS.

WEST ORANGE, NEW JERSEY

PRECISION JEWELERS SCREW DRIVERS

Complete Set of 8 for Every "Hobbyist"

At last—a complete set of precision screw drivers to meet the needs of every model builder. Not a miniature but the same type set used by U. S. Navy for precision instruments and watches during the war. Brass knurled handles, hexagon heads, finest tempered steel blades. Sizes 2-9. Never before a set of this quality and precision at such a low price. Your money back if not satisfied. C.O.D. \$2.00 plus postage or send \$2.00 and we pay postage. **PINE WATCH CO., Rm. 24, 29 Eldridge St., New York 2, N.Y.**

HAUCK FLAME GUN

KILLS WEEDS ★



2000° F controlled heat quickly, easily destroys seeds, roots, brush, poison ivy, wild morning glory, Canada thistle, other unwanted growths. Many uses; splitting rocks, burning stumps, sterilizing poultry houses. Burns kerosene. Does the work of 4 men. Safe, easy to use. 10 day trial. Satisfaction guaranteed. Free catalog.

HAUCK MFG. CO.

121 Tenth St.

Brooklyn 15, N. Y.

12 lbs. SURPLUS RADIO PARTS \$2.00

A gold mine of parts for repairmen, amateurs, and experimenters . . . sockets, condensers, resistors, transformers, coils, hardware, wire, etc. An outstanding bargain in usable parts! Send \$2.00 cash, check or M.O. today! (Pay small express charges on receipt.)

ELECTRONIC PARTS, Inc.

Dept. M4 622 W. Randolph St., Chicago 6, Ill.



OWN A "POCKET SIZE" MACHINE SHOP

IMPROVED MOTO-TOOL

APPROXIMATELY
27,000 R.P.M.
CUTS CLEANER;
SAVES CUTTERS

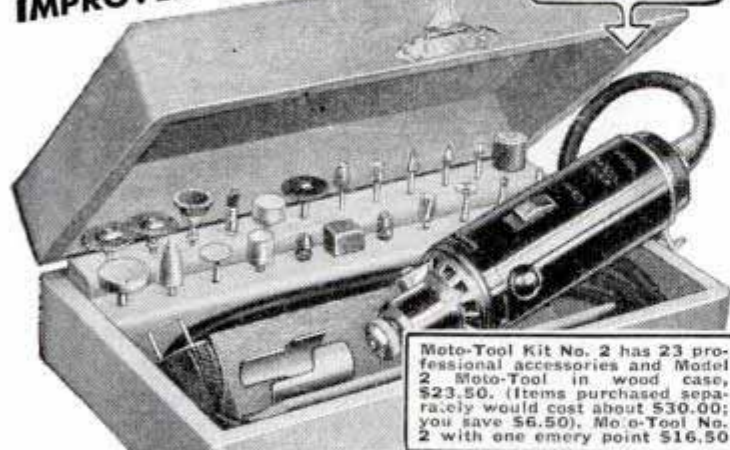

Moto-Tool Kit No. 2 has 23 professional accessories and Model 2 Moto-Tool in wood case, \$23.50. (Items purchased separately would cost about \$30.00; you save \$6.50). Mo-o-Tool No. 2 with one emery point \$16.50

"MAN... WHAT A POWERHOUSE!"

A TOOL THAT PACKS YEARS OF PLEASURE

Here's a tool to please a man's heart. A gleaming "powerhouse" that holds promise of endless creative hours. This "pocket-size machine shop" is a war veteran... used by all branches of the armed forces in far flung repair bases... and it helped set production records at General Electric, Westinghouse, Remington Arms, Ford and other plants. Hobby enthusiast or expert craftsman... first choice is Model 2 "Moto-Tool" kit, with its handsome, felt-lined, highly finished wood case... with rows of tools begging to be put to work. The usefulness of "Moto-Tool" for precision work is increased by two versatile attachments now available at slight additional cost (see below).

Look for These Features

Housing has "pencil-type" finger grip; instant-action, wrenchless chuck; oil-less (sealed) bearings; patented automatic chuck-lock pin; oversize armature shaft, hardened, ground and polished; 110 volt universal type motor; easily replaced commutator brushes; sliding, snap-type switch; handy hanger hook; cord protector; sturdy, shockproof bakelite housing; dust-filtered, air-cooling system; weighs only 13 oz; shaped to fit the hand; dynamically balanced for vibrationless operation.

MONEY BACK GUARANTEE

Buy Moto-Tool and Accessories from your dealer; or order direct from factory on 10 day trial, money back guarantee.

DREMEL MFG. CO.

Dept. 117-D • Racine, Wis.

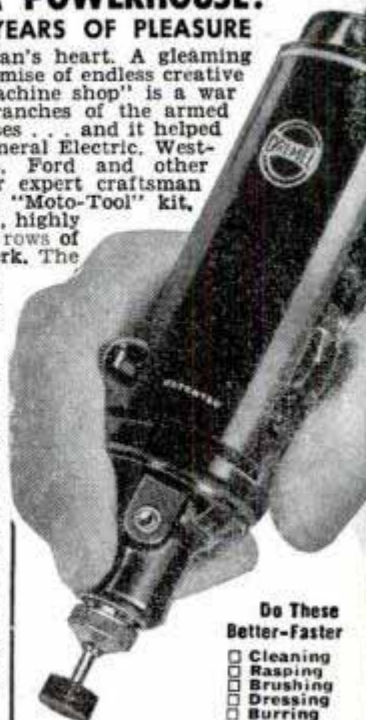

Do These Better-Faster

- Cleaning
- Rasping
- Brushing
- Dressing
- Burring
- Grinding
- Routing
- Sanding
- Drilling
- Inlaying
- Sawing
- Scoring
- Cutting
- Carving

Free Both Hands with Moto-Tool Attachments



A. Moto-Tool Universal Stand holds Moto-Tool at any angle — \$4.50.

B. Shaping Table and Stand in position to grind flat pieces to any shape. Both \$7.00.

C. Shaping Table, inverted, for routing — \$2.50.

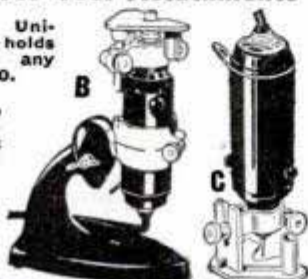

es; sliding, snap-type switch; handy hanger hook; cord protector; sturdy, shockproof bakelite housing; dust-filtered, air-cooling system; weighs only 13 oz; shaped to fit the hand; dynamically balanced for vibrationless operation.

MONEY BACK GUARANTEE

Buy Moto-Tool and Accessories from your dealer; or order direct from factory on 10 day trial, money back guarantee.

DREMEL MFG. CO.

Dept. 117-D • Racine, Wis.



LUMINALL, in lovely new colors, brightens your home at low cost. At your dealer's.

LUMINALL

Paint does more for rooms and furnishings

Its purer colors give better lighting



LUMINALL PAINTS, Chicago 9, Illinois



NOW ONLY \$2.89

GUARANTEED GENUINE POWER BINOCULARS

Have a close-up view of all events with these all-purpose, lite-weight, heavy duty plastic binoculars. Neck strap free with each pair. Test for 10 days. Be amazed at their power and beauty or your money back guaranteed. Send No Money, pay Postman \$2.89 plus tax and postage or enclose \$2.89 plus tax and we pay postage. Send to:

MILLER AND COMPANY, DEPT. 49-D
215 N. Michigan Ave., Chicago 1, Ill.

APRIL 1947

FINEST BLADES MONEY CAN BUY OR YOUR MONEY BACK



DOUBLE OR SINGLE EDGE
12 for 25¢

Marlin BLADES

America's Big Shaving Buy

Please Mention Popular Mechanics When Answering Ads

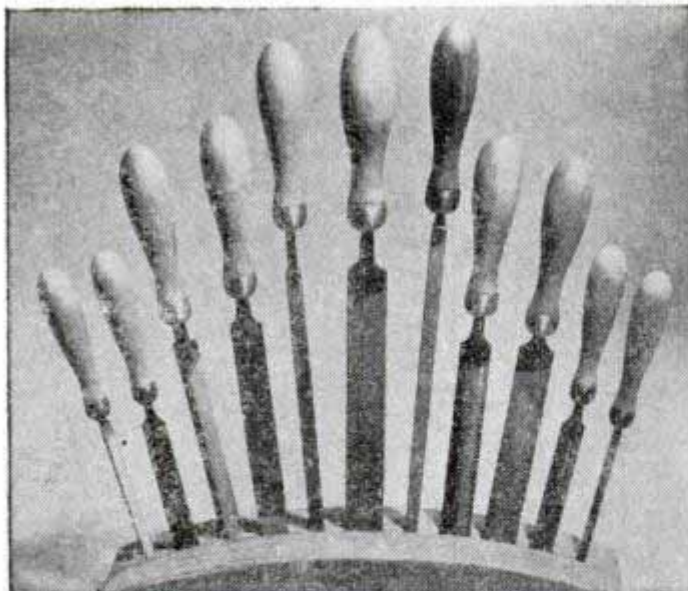

Invitation to craftsmanship

There's nothing like fine tools to awaken the latent skill in a man—to inspire him to use his talents to advantage. You'll find it especially true of Nicholson and Black Diamond files. Their recognized quality . . . their sure, keen bite . . . their wide variety of shapes, cuts and sizes make them the over-all favorite in home and industrial workshops. Equipped with a well-rounded assortment, you can be sure of having *The right file for the job.* Available through the better hardware stores.

NICHOLSON FILE CO.

22 Acorn Street, Providence 1, R. I.

(In Canada, Port Hope, Ont.)

NICHOLSON
U.S.A.

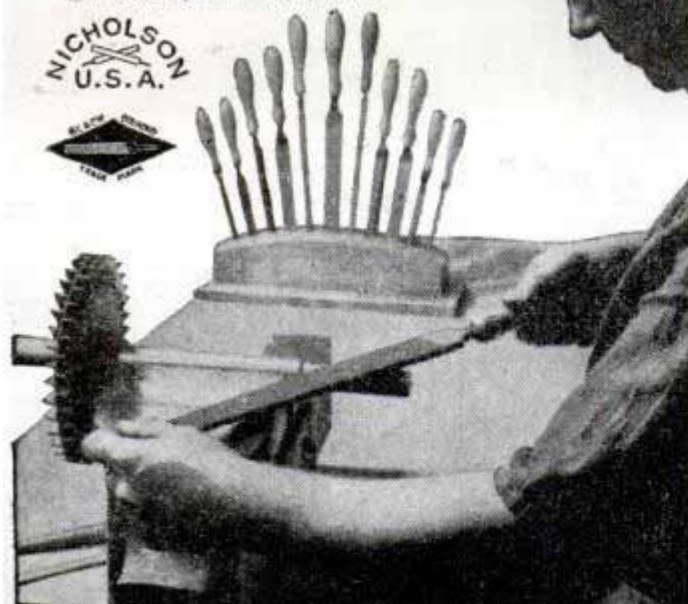

NICHOLSON FILES

FOR EVERY PURPOSE

SAY YOU SAW IT IN POPULAR MECHANICS

GUM GRIPPER Tightens FALSE TEETH or NO COST



Lasts from 3 to 6 Months!

New discovery makes loose dental plates fit snug and comfortable for months—almost like having your own teeth again. For uppers and lowers.

Easy to Apply at Home . . . Simply squeeze some "GUM GRIPPER" evenly on your denture, put plate in your mouth where it sets and hardens in few minutes. No heat—no fuss—no muss. Will not harm any denture.

SEND NO MONEY . . .

Order a tube today, for only \$1.00 (deposit with your own postman). Each application of "GUM GRIPPER" guaranteed to last from 3 to 6 months and delight you completely or your money will be cheerfully refunded.

GUM GRIPPER, INC.
127 N. Dearborn St., Dept. 71R, Chicago 2, Ill.

ARMY & NAVY BARGAINS



New Gov't JUNGLE HAMMOCK—Waterproof Cover—Zipper enclosed Nylon Netting, Value \$30.00—\$4.98

PUP TENT New \$5.95—Slightly Used \$3.95

U.S. ARMY PISTOL BELT Slightly Used 59c

New Gov't Watch Type JEWELLED COMPASS Longines Waltham \$1.49

New HUNTING KNIFE & SHEATH 6" Polished Blade \$1.98

Send Check or Money Order—

Include 30c for postage

THOUSANDS OF SATISFIED CUSTOMERS

Write for Illustrated Free Price List

NATIONAL SURPLUS SALES

184 Flatbush Ave. (dept 5) Brooklyn 17, N. Y.

OUR
25th
YEAR

SELL MERCHANDISE by Mail

OPERATE Profitable Lifetime Business Selling Merchandise by Mail. Large Profits on Fast Selling \$1.00 Items. **WRITE TODAY!**

POWELL CO. DEPT. A SAMPLER BLDG., CLEVELAND 3, OHIO



TIRES

new 1st grade. Firestone, Goodyear, Goodrich, U.S.—600x16, \$13.50 ea.; 650x16, \$16.50 ea.; 700x15, \$18.00 ea. — 20% deposit with order.

I. JAFFESS

1329-1st Ave., New York 21, N.Y., Tel. RH-4-1543

MICROSCOPES SUPPLIES-ACCESSORIES & SCIENTIFIC INSTRUMENTS

B&L SPENCER NEW & USED LEITZ ZEISS
BOUGHT-SOLD-EXCHANGED-REPAIRED
Send for FREE LIST
NATIONAL SCIENTIFIC INSTRUMENT CO. 119 CHAMBERS ST. NY 7

REPAIR ELECTRICAL APPLIANCES, SEWING MACHINES, MOTORS, BICYCLES, LAWN MOWERS, ETC.

Start with \$20.00 and common tools! Earn up to \$6.00 an hour! Build low cost equipment. Learn from illustrated instruction course. Free details. Only . . . **\$5.50**
REPAIRMAN'S SERVICE, 222 4th Ave., Janesville, Wis.

OLD SAWS MADE NEW

With FOLEY

You don't even remove the handle—just put saw in machine and in 3 minutes you have a perfect set of new teeth.

Handsaw Retoother

Accurate—positive—easy to use. Cuts 20 sizes of teeth from 4 to 16 points per inch on any handsaw. Saves filing time,—no eyestrain. Send for circular.



FOLEY MFG. CO.
490-7 FOLEY Bldg., Minneapolis 13, Minn.
Send full details on Foley Retoother

Name
Address

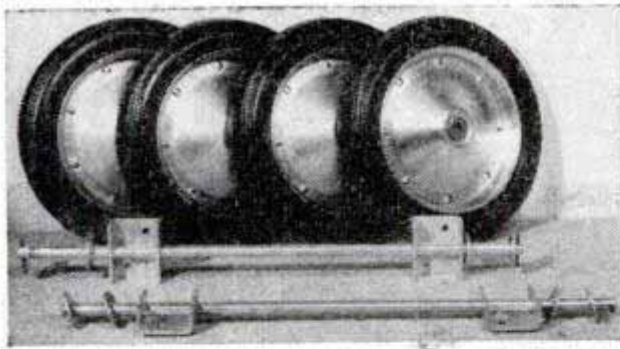

BUDD HEAVY STEEL WHEELS

Bright Zinc Plated . . . With Arguto Lifetime Oilless Bearings or Killian Ball Bearings. **4 FOR \$10.00**
For 1/2" or 5/8" Axles.
10.00 x 1.75 (our regular) 1/2" Ball Bearing or 1/2" and 5/8" in Arguto Lifetime Oilless Bearings. Note: for 5/8" Ball Bearing add 25c per wheel.

With 2 . . . 1/2" dia. Axles 20" long hangers, \$13.50 washers, cotter pins, Ready To Use. **ONLY \$13.50**

Here It Is . . . Combination V Belt Pulley Drive First Again— . . . and Brake Drum



Securely Held To Wheel . . . READY TO USE. Smart Design in Sturdy Pure Cast Aluminum . . . Precision Machined.

One Combination Drive and 10" x 1.75 Wheel Assembled. **PRICE \$5.50**
One Combination Drive Wheel and three without (set of 4). **PRICE \$13.00**
Same as above with 2-20" x 1/2" axles, 4 hangers, washers, cotter pins. **READY FOR USE. PRICE \$16.50**

Same as above with 24" long x 5/8" dia. axles, 4 hangers, washers and cotter pins. **READY FOR USE PRICE \$19.00**

Combination V Pulley Drive and Brake Drum, without wheel. **PRICE \$3.50**

F.O.B. Doylestown, or, add 10% for Prepaid Shipment anywhere in U.S.A.

INDUSTRIAL HEAVY STEEL WHEELS

—with 5/8" Ball Bearings and Gates 10.00"x2.50" Heavy Duty Semi-Pneumatic 250 lb. Load Tire—

ONLY \$6.00 EACH PREPAID

OSBORN WHEEL COMPANY

115 So. Main St., Dept. P-4, DOYLESTOWN, PENN.

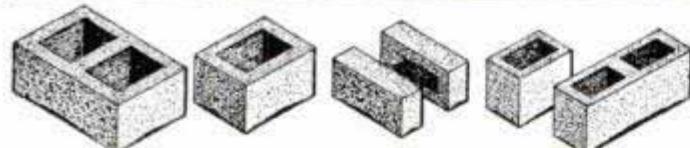

Profit by the Building Boom!

Start your own business manufacturing concrete building block and brick. Use Economy hand moulds. Make true, straight, easy-to-lay units which will pass any building code. Small investment, high production, big profits. One \$30.00 mould will make 1,000 5"x8"x12" blocks per day. Letters and repeat orders tell how pleased our customers are. Post card brings free folder.

Economy Manufacturing Company
Dept. P Stone Mountain, Georgia

LARGE 10" x 1.75 WHEELS

BUILD YOUR OWN RACER
with Genuine GATES
Style 508 and GOODYEAR
Style 19 DEEP TREAD
PUNCTURE PROOF SEMI-
PNEUMATIC TIRES.

NOTE: these ARE NOT the toy tires used by most wheel manufacturers.

65 Inches Long
24 Inches Wide
Weight
Approx. 55 Pounds



Model "A" Racer Chassis FOR POWER OR PUSH

Again we are FIRST with a sturdy built All-Purpose Chassis. Miles of pleasure, for any age, little ones or adults. This racer chassis engineered into the finest design for electric, gasoline or push power, giving you the choice of body design to build yourself. Equipped with Genuine Arguto OIL-LESS LIFETIME BEARINGS or Killian Ball Bearings. Ready to roll and steer. COMPLETE **\$46.00**
AS ABOVE, ONLY
F.O.B. Doylestown or, add 15% for Prepaid Shipment in U.S.A.

RUSH ORDER TODAY

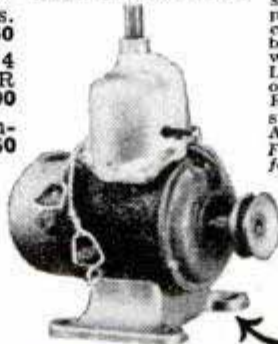

Here It Is: Electric Motor for REAL POWER DRIVE

Space does not allow to adequately describe this excellent POWER UNIT to complete the above described Model "A" RACER CHASSIS—
Write for Circular and Price on Electric Motors.



Super DeLux 12x2 1/2" Wheels
for 1/2" or 5/8" Axles
Wheels Complete With Tire
1 ONLY \$ 5.50
2 ONLY \$10.00
4 ONLY \$18.00
Plus 10% for Prepaid Shipment

Wheel Designed To Carry 200 Pounds

HOUSEHOLD TOOL KIT

ALL THE NEEDED TOOLS FOR HOUSEHOLD USE

Just the thing for emergency household repairs. Kit includes claw hammer, two screw drivers, comb. pliers, metal rule, tube of mending cement, four double end wrenches, picture wire and box assort. of screws, nails, brads, screw eyes, etc.—everything you need for emergency household or auto repairs. All in an attractive green canvas roll up kit. Worth much more. Satisfaction guaranteed.

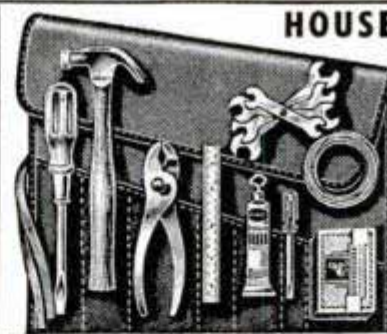

TEN EYCK INDUSTRIES, Dept. PM4
P.O. BOX 426, EVANSTON, ILL.

POSTPAID IN U.S.A. \$2.65 ONLY

IDEAL FOR HOME

Universal HOLDING FIXTURE WITH ADAPTER PLATE and PORTABLE KIT VISE

• Handy • WORKS AT ANY ANGLE

Two handy, sturdy tools. Universal holding fixture works on ball and socket principle. Allows clear vision and free movement. You can position your work at any angle. Ideal for holding, tearing down, assembling and inspecting small parts. Fine for line production.



ONLY \$7.60
POSTAGE PAID

AND INDUSTRIAL USE

Adaptable for welding, brazing, soldering, with its positive hold in any position feature. Makes it easy to do those tough unhandy jobs.

• Adaptable • Compact

Adapter plate, 2 1/2 x 4 inches, allows you to clamp your work firmly. PORTABLE KIT VISE fits holding fixture on top, at side or beneath work bench. Stronger than a wrench, just as handy, with pipe jaws holding pipe or rod from 1/4 inch to 1 1/2 inch. Weighs less than 3 pounds. \$7.60 complete postpaid U.S.A. (May be ordered separately).

UNIVERSAL HOLDING Fixture with adapter plate \$4.90

Portable Kit Vise \$2.80

If unobtainable from your local dealer, order direct. Send check or money order.

CUMMING TOOLS, Inc.

501-503 E. 18th Street DEPT. P
Kansas City 8, Mo.

40 POWER TELESCOPE

FINEST ACHROMATIC LENSES
OBJECTIVE LENS OVER 2" DIA.
VARIABLE POWER EYEPIECE
Length Open 27", Closed 9 1/2"

5 Sections
Brass Tubes
\$34.50



Variable magnification eyepiece adjustable to 10X, 20X, 30X, and 40X. Lower powers excellent for target spotting and wide angle viewing, higher powers for long range and astronomy. Brass tubes, black enameled. Main tube leather covered. This is a precision American made instrument. Only \$34.50 postpaid.

LABORATORY MICROSCOPE 600 POWER \$25.50



3 OBJECTIVES—75X, 300X, 600X
A professional type microscope priced within the reach of the amateur. For school, laboratory, physician, and student. Color corrected achromatic lenses. Professional size eyepiece and objective interchangeable with all standard professional makes. Height 14 inches. Weight 5 1/4 lbs. Stage 4"x4". 2 wheel focussing. Body tilts any angle. Microscope complete with 3 objectives, prepared specimen slide, and 96 page book on microscopy, only \$25.50.

We Pay the Postage—Immediate Delivery—Money Back Guarantee

BROWSCOPE CO.

Dept. 4M
TELESCOPES
24 West 45 St.
BINOCULARS
New York 19, N. Y.
MICROSCOPES

WAR SURPLUS BARGAIN

Brand New TOOL KIT!

7 Handy Tools with Canvas Case ONLY

\$2.95



Consists of seven handiest tools for home, shop or garage for repairing or working with any metal. Contains: 4 oz. Ball peen hammer, 7" metal snips, steel anvil with 2 punches, bucking punch, tweezers, package rivets, 14 six-inch-length steel tape, all in neat canvas roll.

Government Paid \$11.04 for Kit

All brand new government issue. Kits never have been opened or taken from original waterproof package. Shipped to you just as delivered to the Army at \$11.04, for only \$2.95. Your chance to save \$8.09.

While They Last—Only \$2.95

Send your order today as we only have a limited quantity. When they are gone there will be no more at this low price. Sent postpaid.

Satisfaction guaranteed or money refunded. Rush your order while they last.

SURPLUS MAIL ORDER CO.

1608 Reading Road

Cincinnati 2, Ohio

THE WORLDS' ONLY

"SKY-FLYER"

STAYS
IN THE AIR
FOR HOURS

GIANT 4 FT. PLANE
TRAVELS WITHOUT
A MOTOR

OVER 1000 FT.
ALTITUDE

MAIL YOUR
ORDER NOW

Write Name
Plainly and enclose
\$1.00

In Canada—\$1.40
Air-Craft Sales Co.
P.O. Box 328
St. Erie, N. Ontario

READY CUT & COLOR MARKED
VERY SIMPLE TO ASSEMBLE
We Pay Postage—U.S. Only

AGENTS WANTED
AMERICAN DISTRIBUTORS CO.
Dept. M—P.O. Box 216, Roosevelt, L.I., New York

Thrills...
Fun—Stunts
Galore
For Young & Old

Price Per Plane

\$100
POSTPAID

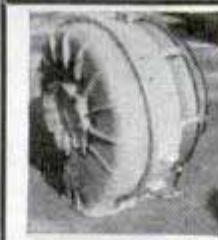

SUPERCHARGERS

Aircraft surplus, turbo type, complete. Can be converted into blowers, turbines, etc. Cost to Gov't approximately \$3,000. Sale price \$15.00 each while they last. FOB, Harrisburg, Pa. No COD. Send check or money order to: MICHEHL INDUSTRIES, ATLANTIC BLDG., WASHINGTON, D. C.

BRONZE BUSHING STOCK

IN SOLID AND CORED BARS

Cast Aluminum rods, round, square and hexagon.

Also Castings made in Bronze, Brass and Aluminum.

SALEM BRASS FOUNDRY, 3220 State St., Salem, Oregon

STOPS LEAKS PERMANENTLY

Leak in heating or water systems, tanks, boilers, pipes or motors sealed in a few minutes with METALON, the new efficient, permanent sealer. Metalon repairs leaks or cracks in brass, iron, copper, lead, aluminum and all other metals. Easy to use—requires no heat. Just mix the powder and liquid and apply.

If your hardware store does not have METALON (don't use a substitute). BE PREPARED—order now. Just send \$1.00 for 1/2 lb. can of powder with liquid. Guaranteed to do the job or your money refunded.

Plants Maintenance head of large corporation writes: "It is amazing how quickly Metalon stops a leak. It is a wonderful product."

METALON CORP., Box 431, Bayonne, N. J.

METALON



Nimrod PIPELITER

THE ONLY DOWN-DRAFT CHIMNEY-ACTION LIGHTER
MADE. DESIGNED EXCLUSIVELY FOR PIPE SMOKERS.

\$3.50 AT YOUR
DEALER



- WINDPROOF
- LIGHTWEIGHT
- LARGE FLAME

A perfect lighter for pipes, cigarettes or cigars too. Unconditionally guaranteed. If your dealer cannot supply you, send \$3.50 direct to us. Include your dealer's name.

WARD-NIMROD COMPANY

Dept. 35-B, 2968 Jessamine St., Cinti. 25, Ohio

Please Mention Popular Mechanics When Answering Ads

**"SCOOT" Away
to Work or Play!**

Cushman
MOTOR SCOOTER

On highways, in town,
on the farm, at the
factory, for deliveries,
service calls... go the
Cushman modern and
economical way.



Cushman Motor Scooters
are speedy, safe. Park any-
where. "Eye-dropper" gas
economy. Ruggedly built
with automatic clutch, two-speed trans-
mission on most models, 4 H.P. Cush-
man "Husky" engine. Balloon tires and
knee-action springing give easy riding,
load carrying capacity. Convenient lug-
gage compartment. Nationwide service.
CUSHMAN MOTOR WORKS, INC.
Dept. M-400 Lincoln, Nebr.

35
MILES PER HOUR
75
MILES PER GALLON

FREE

Send for literature
and name of your near-
est Cushman dealer.
Write postcard today.

Backed by 45 Years of Quality Engine Building

D. C. MOTORS

Good deliveries on 1/4, 1/3, and 1/2
hp Motors. Available at special
D.C. Voltages. Manufacturers of
A.C. Generators, Rotary Convert-
ers, Lighting Plants, Frequency
Changers and high Frequency
Generators.

KATO ENGINEERING COMPANY
1401 First Ave., Mankato, Minn.



**HY-SCORE
AIR PISTOL**

for ACCURATE SHOOTING



No pumping. Fast. Powerful. Finest
made. Single shot. 30 1/2 oz. 10 1/4" long.
\$25.00 with pellets. Extra pellets per 1000
\$2.50 for cal .177, \$3 for cal .22.

SEE YOUR DEALER OR ORDER DIRECT

Send 10c for circular to Dept. M-4

SHOOTS
CAL. 177
w. 22
LEAD
PELLETS

HY-SCORE ARMS Corp. BROOKLYN, I. N. Y.



New Scientific "GUZZLIN CHARLIE"
Mystery Drinking Bird with Roly Poly Eyes

\$2.95 Complete with glass and stand. No
springs, no gadgets, no wires, not
mechanical. Amazing "Guzzlin Charlie"
drinks and drinks; he is always thirsty.
You won't believe your eyes. Young and
old go wild over him. Mail your order
today. Special prices to dealers.

BERNARD FINE CO.

501-6th Ave., Dept. P2 N. Y. 11, N. Y.

BUILD ARC WELDER

We Show You How to build this new powerful weld-
er without rewinding. For light or heavy work. Uses
coils taken from old auto generators. Works on 110 or
220 volts A. C. Has 20 different heats. Send 35c for
complete PLANS and valuable Catalog. Write today.
LEJAY MFG. CO., 1347 LeJay Bldg., Minneapolis 8, Minn.



**Big Money for Workers
In Home or Shop**



Licensed Concrete Specialists wanted. No experience
needed. Make *Colorglazed* concrete pottery without
molds. New, low cost, patented method. Cemetery
products, novelties, tiles, etc. Basement leaksealing.
Other big pay projects. Booklet, details free. Men only.

NATIONAL POTTERIES COMPANY
542 Lincoln Avenue Fergus Falls, Minnesota



**DRILL
PRESSES**

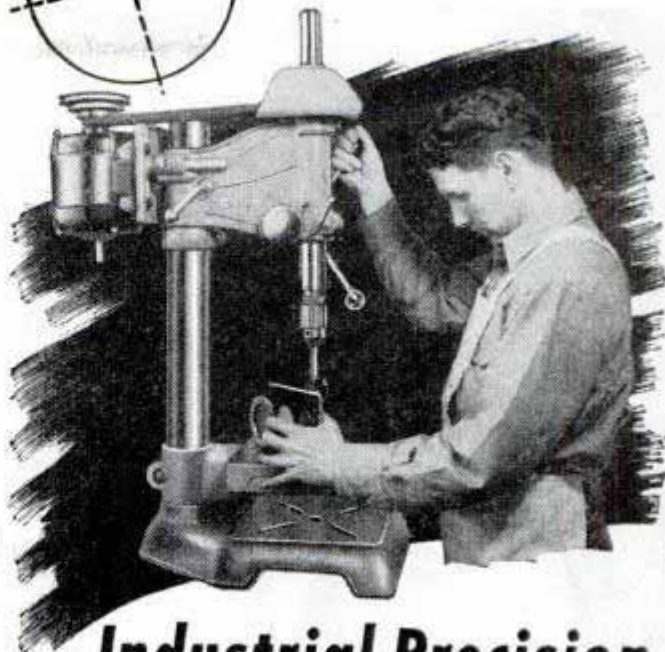

**Industrial Precision
for Your Home Shop**

From its finely balanced pulleys to its
solid, heavy base an Atlas drill press is
built to give you absolute rigidity, smooth-
ness, and lasting accuracy. It's the kind of
a tool you'll enjoy working with every
minute - quality through and through.

Important features are the extra size and
weight of the grey iron castings for base,
table, and head, and column. The table is
accurately ground, tilts 90° right or left.
Power is transmitted by the exclusive Atlas
"floating drive" spindle design - with deep-
grooved ball bearings - that keep the pre-
cision-ground spindle solidly and accurately
aligned for maximum smoothness.

Three sizes are available: 15-inch floor
or bench type, and 12 3/4" bench type. Get
all the facts about these drills that will give
you a lifetime of industrial precision on your
home shop work. Ask your Atlas
distributor to show them to you,
or send for the latest catalog.

FREE



ATLAS PRESS CO.

443 N. PITCHER ST.

KALAMAZOO 13, MICHIGAN



6"-10" Lathes



Milling Machines



Shapers



Drill Presses

ATLAS 4 TOOL TEAM

The Champs
Come out Swingin'

LOUISVILLE
SLUGGERS



Mickey Vernon

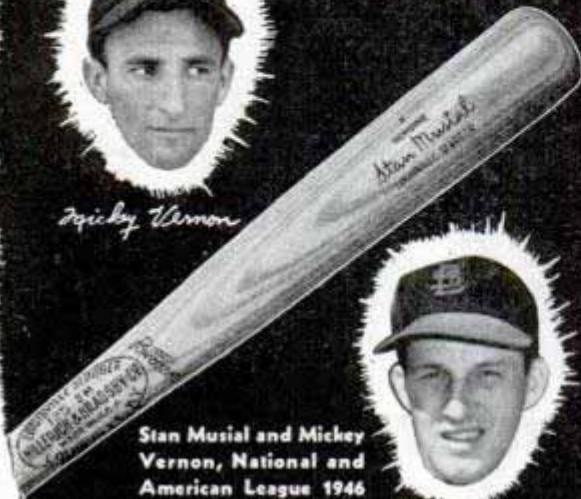

Stan Musial and Mickey Vernon, National and American League 1946 batting champs, swung to fame with Louisville Sluggers.



Stan Musial

When springtime beckons America back to her baseball diamonds, you'll find all great hitters armed with Louisville Slugger Bats. They know—from experience—a genuine Slugger is the thing to swing. It's safe to rely on a Louisville Slugger to get your base hits, too!



1947 Famous Slugger Year Book
FREE AT YOUR DEALERS
or Send 5 Cents to
Dept. P-31

Hillerich & Bradsby Co.
Louisville 2, Kentucky



HILLERICH & BRADSBY CO., INC.
Also Makers of
LOUISVILLE GRAND SLAM GOLF CLUBS

SAY YOU SAW IT IN POPULAR MECHANICS

V-8
DUALS
& SINGLES



MUFFLERS
STEELS and ALUMINUMS
with a motorboat tone
SINGLES, Chev, V-8, Plymouth,
Steels \$5.50, Aluminum \$6.50.
Chry, Olds, Buicks, etc., Steels
\$7.50, Aluminum \$8.50. V-8 and
MERCURY DUALS, Steel \$17.50,
Aluminum \$20.00. Aluminums are
guaranteed for life of your car.
DEALERS WANTED

SANDEE MUFFLER CO.
7523 S. WESTERN AVE., LOS ANGELES 44, CALIF.

Test-O-Lite the MODERN
TROUBLE SHOOTER

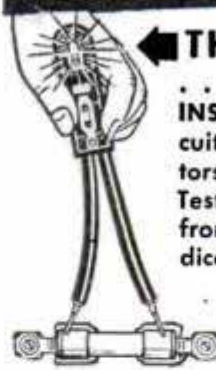

← THE NEON GLOW

... LOCATES TROUBLE INSTANTLY in electric circuits, fuses, cut-outs, motors, radios, appliances. Tests everything electrical from 100 to 550 volts. Indicates hot or grounded wires. Tells AC from DC. Engineers prefer it because it has patented safety features.

↑ PUTS "FINGER" ON THE TROUBLE SPOT -- QUICKLY

Far superior to ordinary clumsy test bulb. Saves precious time. Indispensable in shop or home. Vest pocket size. Lifetime guarantee. (Pat. No. 1,778,883) Purchase through regular electrical dealers.

L. S. BRACH MFG. CORP.

200 Central Ave. Newark, N. J.



FUSES



MOTORS



OUTLETS

New "THERMO-SAW" (CUTS WITH HEAT)

MAKE THINGS FOR THE HOME or FOR SALE

• Any Child Can Use It!

- NO NOISE
- NO VIBRATION
- NO SAWDUST

CUTS RAPIDLY AND CLEANLY THROUGH WOOD AND OTHER MATERIALS... AN IDEAL GIFT! Difficult patterns are made QUICK and EASY... No turning of work... Cuts in every direction... Cuts plywood 1/4" or 1/2"... Cuts 14"x36" board... Special Transformer produces high frequency current in a tough steel wire "blade" from ordinary Alternating (AC) current. No radio interference. IMMEDIATE DELIVERY!

NOTE:
Operates on 110 volt Alternating Current; 50 to 60 cycle. NO C.O.D.'s



Machine Measures 11x4 3/4" High, Throat 7" ONLY \$4.50
Deep. PATTERN FREE, Postpaid
COMPLETE SAW outfit as illustrated with transformer and 12 spare blades. READY TO USE.

ORDER \$4.75 in Canada and TODAY Mexico. \$5 Elsewhere.

BOISSELIER MFG. CO., Dept. P-4, GLEN ELLYN, ILL.

TRAILER AXLES, HITCHES, AND PARTS

• If you are interested in purchasing trailer axles, hitches, and other trailer parts, contact us promptly. Write for free literature.



HAMMER BLOW TOOL COMPANY, Dept. 116, WAUSAU, WIS.

NEW! 12" SHEET METAL BRAKE Only \$10

Fits in bench vise. Quickly, easily forms all kinds of angles in sheet metal, strap iron and aluminum, wire and plastic. Use it to make useful articles, experimental research work, patent models, etc., simple gages made for quantity duplicating. Now available. Send for details, or order direct. \$10.00 PP. C.O.D. \$2.00 deposit. Wt. 10 lbs.



VISE IRON BENDER. Easily bends 1/2" square or round; 1/4" up to 2" wide. Makes hooks, rings, hoops, etc. All steel. Price, \$7.50 PP. Immediate delivery.



VISE FORMING TOOL. Makes cylinders, ovals, cones and round corners in sheet metal, wire and 1/2"x1 steel strap, 2" to 60" in dia., 16" wide. \$7.50 PP.

SHEET METAL PLIERS. Forms any length, angles, channels, and crimps in sheet metal. Jaws 2 1/2" wide. Price, \$2.00. All items guaranteed.

VISE BRAKE MFG. CO., 1318 So. 30th Ave., Omaha 5, Nebr.

BUILD YOUR OWN ZEOLITE
WATER SOFTENER



Save up to 50%. Pays for itself. Fun to build. Only a wrench required. All materials available. Send \$1.00 check or money order for simple and complete plans and operating instructions.
BOX 2732-P BODEY MFG. CO. MINNEAPOLIS 7, MINN.

PERFECT DOWELS

... easily made



ON YOUR LATHE OR DRILL PRESS

Use a SPEE-DOWL and you can work wonders with wood. Quickly and easily you'll make dowels of any wood... perfect burnished dowels for furniture, toys and thousands of other projects. You merely push SPEE-DOWL on wood—the lathe or drill press does the

work! Cast body, tool steel blade. SIZES: 2, 3, 4, 5, 6, 7 and 8/16" (illustrated at left). Only \$1 ea. Special—any 4 of above for \$3.50; complete set of 7 for \$6. Also individual sizes 9 to 20/16" (illustrated at right) \$2.65 each. SPEE-DOWL is Unconditionally Guaranteed. Send postal note or check—we pay postage in North America.

FREE Literature.

JOHNS MFG. CORP., DEPT. C-7
DUNELLEN, N. J.

Today's Best PLANER VALUE

A Life-Time Tool
at Low Cost

\$119.50



THE "YAGER" —Thickness Planer—not a jointer, for homecraftsmen, or auxiliary tool in large shops. A marvel of efficiency, precision performance — at an amazingly low cost. Dependable for constant, uninterrupted, trouble-free service. Works any stock from soft balsa to hard ebony. Produces smooth, polished surfaces. Takes stock up to 10 in. wide, 2 3/4 in. thick or down to a thickness of 1/16 in. Handles light work with 1/3 H.P. motor and hand crank feed or heavy cuts up to 1/8 in. with 3/4 H.P. Sealed ball bearing arbor requires no lubricant. Feed gears packed in oil seldom need repacking. Now ready for immediate delivery. Write for prices and startling facts.

THE KNEISLEY ELECTRIC COMPANY

497 S. St. Clair St., Dept. 37

Toledo 3, Ohio

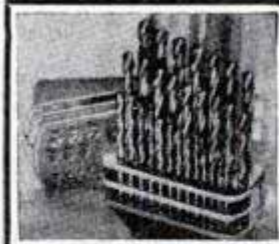

Why Hunt for Drills?

These Complete High Speed Drill Sets Now Available at Low Prices
#1 to 60 Drills.....\$12.95 Per Set
1/16-1/2 by 64ths....\$16.95 Per Set
Drill Sets A-Z.....\$15.50 Per Set
(Drill Stands Free)

Send For Free Circular

SID TOOL CO.
MACHINE SHOP SUPPLIES
183 Grand St., New York 13, N. Y.

EXTRA! JUST OUT EXTRA! INSTANT NICKEL

U. S. PATENT PEND. NO. 702581
NO CURRENT OR BATTERIES USED

Iron, Steel, Aluminum, Brass, Bronze, Copper and practically all Industrial metals (except Zinc) can now be HEAVILY nickelplated without EQUIPMENT, VESSELS, ELECTRICITY OR PREVIOUS COPPER PLATING, a blessing to Hobbyists, Doctors, Hospitals, Restaurants, bar and Beauty shop owners. Recommended for Auto, bicycle and Machinery parts and accessories, Surgical and Musical Instruments, Electrical appliances, Coffee Urns, and practically anything made of metal. THERE IS NO TRICKS CONNECTED WITH THIS MARVELOUS NEW INVENTION, the principles of the battery and electroplating have been harnessed into this compound, so when it is applied with a wet applicator on a clean metallic object, a bright nickelplate instantly appears, the thickness of plating is regulated by amount of applications given. JUMBO SHOP SIZE (Covers 50 Sq. Ft.) \$6.75 P.Pd. Sample Trial Offer \$2.00 P.Pd. INSTANT PLATING PRODUCTS, 3439 Michigan Ave., Chicago 16, Ill. (Applicator sent free.)

COMPLETE
\$2 POST PAID
Covers 10 Ft.
NO C.O.D.'s
PLEASE

KEEP SHARP THINGS SHARP!

with the
NEW

JET ACTION SPEED GRINDER



Another Quality Product
from the House of Hudson

SHARPENS
EVERYTHING



FOR HOME AND SHOP

The HUDSON TURBO GRINDER

End the annoyance of dull knives and blunt tools. The amazing new Hudson Turbo-jet Grinder sharpens knives, scissors, lawn mowers, wood planes, drills, chisels and all edged tools quickly and easily. Polishes silverware and metal.

Simplest operation imaginable...just attach to ordinary faucet, turn on the water and the patented Hudson Turbo-jet impeller spins the grinding wheel at 3000 to 10,000 revolutions per minute.

Precision built, quality throughout. Wheel, super-hard silicon carbide; Shaft, stainless steel; Bearings, Chrysler oilite (never need oiling). All metal parts gleaming chrome. Colorful Vinylite tubing.

ONLY
\$8.95

Ideal for the handyman, housewife, hobbyist, mechanic and everyone who uses knives and tools.

FULL MONEY BACK GUARANTEE
See your hardware dealer

HUDSON PRODUCTS CO.

4404 ST. AUBIN AVE.
DETROIT 7, MICHIGAN

HUDSON PRODUCTS CO.
4404 St. Aubin Ave., Detroit 7, Michigan

Enclosed is a \$8.95 () check () money order for which rush to me, postpaid, one Hudson Turbo Grinder with full instructions for use. I understand the Grinder carries a full, money back guarantee.

Name.....

Address.....

City.....State.....

Name of Hardware Dealer.....

Address.....

IF YOUR DEALER DOESN'T
HAVE THE HUDSON TURBO
GRINDER SEND COUPON
TODAY



Master II

WESTON EXPOSURE METER

Most picture failures are caused by incorrect exposure. With a WESTON, you can be sure of every exposure—in black-and-white or color—with still or movie camera. Easy-to-use, it gives exact camera settings for any scene. Ask your photographic dealer for a demonstration, or write . . . Weston Electrical Instrument Corporation, 671 Frelinghuysen Avenue, Newark 5, New Jersey.

The meter most photographers use



SAFE AS A HAND SAW
JUST GUIDE IT!

More like magic than any tool you ever saw. Imagine an electric scroll saw only slightly heavier than a hand coping saw . . . a tool that takes no effort to run, no pressure to feed. Works at any angle—on big assembly jobs or on the tiniest piece you can hold in your fingers. Runs 7200 strokes a minute . . . so fast the blade seems to stand still. Sturdily built . . . only two moving parts . . . never needs oiling. Easily cuts intricate designs—so smooth it eliminates sanding. Novice or craftsman, a thrill awaits you when you get a Moto-Saw in your hand.



Only \$5.85 Postpaid

No Limit To Length Of Stock It Will Cut. Saws To Center Of 19" Widths. It's fast . . . cuts on an average of 1 ft. per minute up to 3/4" medium hard wood. Operates on 110-120 V. 50 or 60 cycle alternating current. If your dealer does not yet have Moto-Saw, send we'll pay postage. Or send \$1, pay postman balance plus postage. MONEY BACK if not delighted after 3 days trial.

U. S. Patent 2233862
Other Patents Pending

DREMEL MFG. CO., Dept. S117-D, Racine, Wisconsin



MEXICAN FEATHER BIRD PICTURES

HAND MADE OF REAL FEATHERS
These exquisitely colored, tropical bird pictures are ideal for gift and souvenir stores. We sell wholesale, only. No foreign shipments.

Send for sample. Only 15c

C. O. STAFF — IMPORTER
14960 EVANSTON
DETROIT 24 MICHIGAN

MIKE Jr.
NOW ONLY \$1.69

SING—TALK—AMUSE YOUR FRIENDS—through your own radio set. Practice to become an announcer. Simple to install—Not a Toy. SEND NO MONEY—WRITE TODAY
Just send your name and address and when your MIKE Jr. arrives, pay postman \$1.69 plus few cents postage. Sent postpaid if check or money order accompanies your order. No stamps.

MART DISTRIBUTORS, Dept. P-10, P.O. Box 6, Evanston, Ill.

ADJUSTABLE WEDGES FOR SAW GROOVING

SAW OWNERS! SOMETHING NEW! With these Wedges you can cut up to 3/8" width with 10" blade! Can be used on any saw from 6" to 12". No Dado head needed. If your Dealer can't supply you, write direct. Sent any place in USA for \$3.95 postpaid. Specify 1/2"; 3/4"; 5/8" shaft. (Dealers write for discounts.)

Pat. Pending
H. W. LEINENWEBER • Woodruff St. • Pittsburgh 11, Pa.

QUICK! "REPAIRING CAR BATTERIES" MONEY! At Home! Easy Tool!

Write, BATTERYMAN, Dept. 5, Grand Junction, Colorado



WRITE FOR YOUR FREE COPY OF THE NEW KRW HYDRAULIC PRESS BOOK

Describes all manner of Production and Shop Work on KRW Hydraulic and Bench Type Arbor Presses. 32 pages illustrating the new KRW Hand-operated, Electric-operated and Air-operated Hydraulic Presses. Write for your copy today.

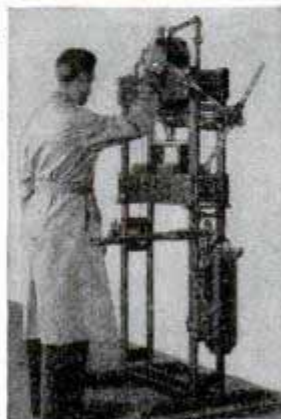

K. R. WILSON, DEPT. 17, 215 MAIN ST., BUFFALO 3, N. Y.
Builders of Shop Equipment for Ford Dealers Since 1916

**FINE TOOLS
NEED
FINE OIL!**



• Lubricates

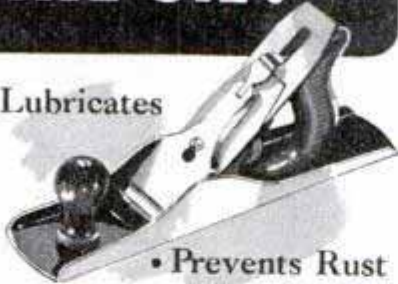

• Prevents Rust

• Cleans • Polishes

SOLD EVERYWHERE

3-IN-ONE Oil

SHARP EDGE in Seconds!

Powerful portable electric grinder gives quick keen beveled edge on any size knife or scissors. Ideal for chisels, plane blades, drill bits, cutters, etc. Anyone can use. Grinds cool. Marvelous time-saver for fix-it shops, model makers, butchers, cafes, barbers, etc. 6000 RPM Delco 115 V AC-DC motor. Plugs in any socket. Norton long-lasting grinding wheel. Users delighted. Guaranteed. Only \$14.95 postpaid. Send check or M. O. Immediate delivery.



MORGAN GRINDER MFG. CO., 810 So. 31 St., Omaha 5, Nebr.

BOILING HOT WATER IN A JIFFY !!

Place the Jiffy Electric Water Heater into the water and insert the plug in the nearest electric wall or light plug. You will have hot water in less than five minutes for baby's bath, your washing, shaving and a great many other uses in the home, camping, business, and on the farm. Mailed complete, including six feet of rubber covered wires and plug. One year guarantee. **JIFFY ELECTRIC COMPANY, Dept. PM1, 21321 Stephenson Highway, Hazel Park, Mich.**



Only \$2.95 plus twenty five cents for postage

**NU-WAY
Lawn Mower**

Write for Free Circular

PRICE
12.50

WHY PAY MORE?

**BUILD YOUR OWN
ROTARY TYPE
LAWN MOWER**

We Supply Cutting Unit Complete

No Increase in Price

Tractor-Lite Mfg. Co.
Spirit Lake, Iowa



**GET THE BEST IN
MUFFLERS
V-8
DUALS & SINGLES**

Finest Norman custom-built muffler sets - steel pack - torpedo type - heavy, perforated steel cores - chrome enamel finish - mellow, deep tone (improves with use) - designed to fit - all ways superior - double economy.

DUALS.....\$17.50 SINGLES.....\$7.50
V-8 Ford-Mercury Buick, Olds., Chrys.
SINGLES.....\$5.50 ORDER TODAY! Will outlast
Chev., Ford, Plym. three ordinary mufflers.

Dealers—Write Today for Full Details

NORMAN'S MUSICAL MUFFLERS

Dept. PM-5, 1216 W. Slauson Ave., Los Angeles 44, Calif.

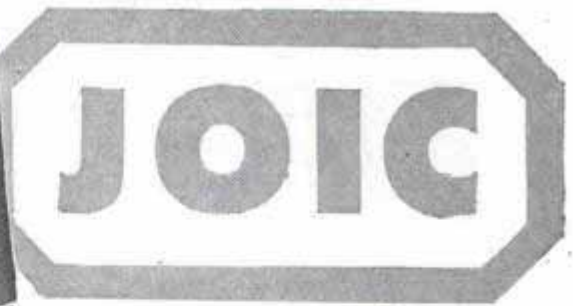

"It's the Wonder Drill"

Craftsmen say so
Hobbyists say so
You'll say so, too

PRICE
\$4.95

Chuck size . 1/4"
Length . . . 10"
Weight . . . 22 oz.

JOIC can even drill around a corner. Here's why. It's adjustable, the only hand drill with swivel chuck and handle.

JOIC is a handy tool for easy drilling in tight places. For example, you can drill any number of holes at exactly the same angle. (See bottom illustration at right.) JOIC will be a must, once you get your hands on it. Ask for JOIC Hand Drill at your hardware dealer's. If he can't supply you, write direct. Use coupon.



Drill's flat side holds bit parallel to surface.



Handle's 180-degree range locked by thumb screw.



Turret locks chuck in seven different positions.

Enclosed find \$..... (P. O. Order or Cashier's Check) for which send post-paid
.....JOIC Hand Drills @ \$4.95.
Name

JO MANUFACTURING COMPANY

8442 OTIS STREET • SOUTH GATE, CALIF



"In the new 4-passenger Crosley convertible I think we've struck a note in harmony with the youthful heart!"

Powell Crosley Jr.

PRESIDENT, CROSLLEY MOTORS, INC.

Have you a flair for youth and beauty? Then the new fine CROSLLEY Convertible is the car of your dreams! One ride will prove it.

Here's big-car roominess, ample for 4 husky 6-footers, plus baggage. An easy-to-manage top that snaps into a snug weather-proof in a jiffy. Real CROSLLEY economy that won the fine CROSLLEY Sedan a place in America's warm heart! CROSLLEY COBRA (Copper BRAZed) steel engine, of course—that 59 lb. 4-cylinder, valve-in-head powerhouse that gives 35-50 miles on a gallon of ordinary gasoline; speeds up to 60-plus. And typical CROSLLEY maneuverability, pick-up, sure-footed nimbleness! The new fine CROSLLEY Convertible is The Youth-Car-Of-The-Year. Clever new type convertible cloth top. See it today!



EXAMINE THESE FEATURES. ALL STEEL body, low center of gravity, great safety factors, MODERN Streamlining. "the Aircraft Flavor" gives extraordinary beauty • CAR WEIGHS only 1110 lbs., curb-side; perfectly balanced, weight-to-power • EASY DRIVING, virtually "parks on a dime"; oversize shock absorbers • MORE MANEUVERABLE in traffic; 20 inches narrower than most cars • ECONOMY that's almost unbelievable; speeds to 60-plus.

For information and literature write: Crosley Motors, 2537-Q Spring Grove Ave., Cin'ti 14, O.



STOP LEAKS!

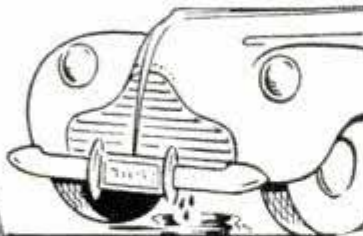

Cooling Systems Made Leak-Proof QUICKLY

WARNER LIQUID SOLDER—Non-Metallic—Deposits Tiny Fibers to Repair Leaks Anywhere in Cooling Systems. Simply pour in! Finds and REPAIRS every crack or hole. Do it yourself—or see your service man.

Warner-Patterson Co., 920 S. Michigan Ave., Chicago 5

ELECTRICITY *Anywhere*

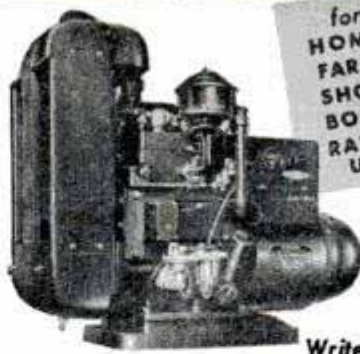

for HOMES FARM SHOPS BOATS RADIO USE

Onan gasoline-engine-driven Electric Plants supply reliable, economical electric service for any use. Portable, stationary or stand-by models. Water or air-cooled, compact and rugged.

A.C.: 350 to 35,000 watts in all standard voltages and frequencies. D.C.: 600 to 10,000 watts, 115 and 230 volts. BATTERY CHARGERS: 500 to 3,500 watts; 6, 12, 24, 32 volts.

Write for folder

D. W. ONAN & SONS INC.
2528 Royalston Ave., Minneapolis 5, Minn.



\$2.95



TORNADO GAS TORCH

The Modern Way of Soldering

Ideal for hard and soft soldering. Will heat quickly; solder will flow freely and smoothly. No compressed air required. Nothing to pump. Self-adjusting. Safe. Economical. Can be used for annealing small parts and bending metal parts. Generates a heat of 1700° Fahrenheit. Simply connect to any illuminating gas jet with a rubber hose and

operate. Tornado Torch No. 119 comes with three (3) tips, (3/8", 1/4", 3/16" blast).

The Tornado Gas Torch No. 119, complete with three tips, is \$2.95. See your dealer or order direct. Send check or money order—post paid.

Robco Corporation, 202 E. 44th Street, New York 17, N. Y.

New Designs in **FRANZITE GRIPS**



Modernize Your Gun! Improve Your Score!

Most durable grips made. Positively unbreakable! For Colt, Smith & Wesson, Hi-Standard, Ortgies, Luger & Mauser in a wide choice of beautiful designs in ivory, pearl, walnut, onyx, etc. Low prices. FREE CATALOG. Dealers Wanted.

SPORTS, INC., (Mfrs.) 5501 Broadway, Dept. P-4, Chicago 40, Ill.



Send for Free List of Leading Books and Catalog of Tools For Watch and Clock Repairing—

Engraving, Aircraft Instruments Etc. Address Dept. 12. Use Letterhead.

HENRY PAULSON & CO.
37 SO. WABASH AVE., CHICAGO 3, ILL.

BUILD THESE PROJECTS

For garden or lawn. Easy to build. Easy to sell. Detailed Blueprints Model B-25 Dutch Windmill 50c; Model OM-60 Old Mill, 85c. Lawn Figure Patterns—Sunbonnet Girl, Dutch Boy, Tulip Girl, Holland Pair, 35c each, all 4—81. Catalog illustrating many models, send 10c, today.

CRAFTSMAN'S MODEL CO., Dept. P-102, 2030 N. 41st St., Milwaukee, Wis.



FREE RADIO CATALOG

Latest radio and electronic parts and devices, newest ham gear, gadgets, war surplus items. All in this new FREE catalog. Don't delay.

BURSTEIN-APPLEBEE CO.
1014 McGee, Kansas City 6, Mo.

Electrically Welded Endless

Paramount

BAND SAW BLADES



Made in widths from 1/8" to 1-3/4"

Make your band saw do more work for you. The proper width of blade will extend the scope of this important machine. Burrill's Paramount Blades are made from tough Nickel Alloy Steel properly tempered. Teeth accurately set and filed, and all saws carefully straightened. Send order and check today. Delivery will be made as promptly as conditions permit, from a few days to a week or two. You can obtain these saws at the following prices:

1/8"-3/16"-1/4"-5/16" wide, 5'6" long.....\$.90 each
 1/4"-3/16"-1/2"-5/8" wide, 6'6" long..... .95 each
 3/8"-3/16"-1/2"-5/8" wide, 7'6" long..... 1.10 each

Other sizes at proportional prices

NO C.O.D. SHIPMENTS ACCEPTED

State Make of Machine

Your satisfaction is guaranteed

BURRILL SAW & TOOL WORKS

407 E. Main St., Ilion, N.Y.

New PERSONAL RADIO... Pocket Size



This little radio is substantially built and is so constructed that, if dropped, it will not break. It has a beautiful red leatherette case. May be carried in your pocket wherever you go. Reception is guaranteed when used according to instructions.

There is no cost in operating this radio as there are no tubes and no batteries to buy, and no electricity needed. Instead, the new "Crystal diode" rectifier same as used in Army and Navy ultra hi-frequency radar sets is being employed. It is not a toy, but a practical little radio for football or baseball games, news reports, or your favorite program. It is especially good to listen to in bed, or in hospitals, dormitories, barracks, and offices because it is not heard by anyone but yourself.

Send only \$1.00 (check, money order, cash) and pay postman \$3.95 plus delivery fees, or send \$4.95 for postpaid delivery.
SHEESS MFG. CO., LAKE GENEVA, WIS.

Please Mention Popular Mechanics When Answering Ads

WIGGINS QUICK WATER HOSE COUPLING

SNAP - it's on! PULL - it's off! Easy, fast! Wiggins coupling is guaranteed leakproof! Saves water, time. No bruised fingers or twisted hose. Precision made of solid aluminum bar stock. Lifetime use. For the best in water hose couplings, buy Wiggins! On sale at better stores \$1.35 complete.



E. B. WIGGINS OIL TOOL CO., INC.
 3424 E. OLYMPIC BLVD., LOS ANGELES 23

STRING YOUR OWN RACQUET

Make up to 500% profit in your own business of restringing racquets. Complete outfit includes restringing vise, dowel, awls, one coil of silk tennis string, and complete instructions only... \$6.00 postpaid. Additional silk 75c per coil. Write for low prices on gut and nylon.
LEDSON ENTERPRISES, 66 So. 6th Street, Brooklyn 11, N. Y.

MACHINE SHOP EQUIPMENT



Just off the press!—Every man who owns a workshop should have a copy of the new, up-to-the-minute, 200 page catalog of Machine Shop Equipment—the latest tools made by the biggest manufacturers in the U. S. Replete with illustrations, descriptions, prices. Prompt delivery on most tools listed in this book. Available at cost of printing—50c a copy—get yours today! **Price of Catalog Refunded on First Order over \$5.00.** Send check or Money Order to

CENTER TOOL CO., 154 Centre St., New York 13, N. Y.

WHAT TO DO FOR LOOSENED SCREWS

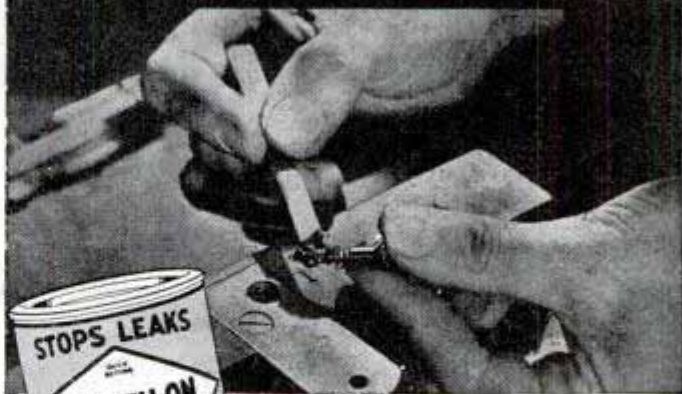

Wood screws that refuse to stay put obey promptly when anchored with SMOOTH-ON No. 1 Iron Cement. You simply apply a little Smooth-On and insert the screw. As Smooth-On hardens, it fills in the open spaces, insuring a tight fit that stays tight.

This quickly-made little repair job is typical of many useful things you can do around the house and in the garage when you have a container of Smooth-On handy. You can seal cracks, stop leaks, tighten loose hinges, bathroom fixtures, knobs, casters, tool and cutlery handles. Get Smooth-On from your neighborhood hardware store in inexpensive 1 3/4-oz., 7-oz. or larger size. If they haven't it, write us.

This quickly-made little repair job is typical of many useful things you can do around the house and in the garage when you have a container of Smooth-On handy. You can seal cracks, stop leaks, tighten loose hinges, bathroom fixtures, knobs, casters, tool and cutlery handles. Get Smooth-On from your neighborhood hardware store in inexpensive 1 3/4-oz., 7-oz. or larger size. If they haven't it, write us.

FREE HANDBOOK OF REPAIRS

40 pages. 170 diagrams. Clear, short-cut directions for many tested household repair jobs. You'll be glad you sent for this book. Just clip the coupon and paste it on a postcard—that's all.



— — — Sign and Mail NOW — — —
SMOOTH-ON MFG. CO., Dept. 37D
 570 Communipaw Ave., Jersey City 4, N. J.
 Yes — I'd like my free Smooth-On Handbook.

Name.....

Address.....

4-47

Do it with **SMOOTH-ON**
 Iron Cement of 1000 Uses

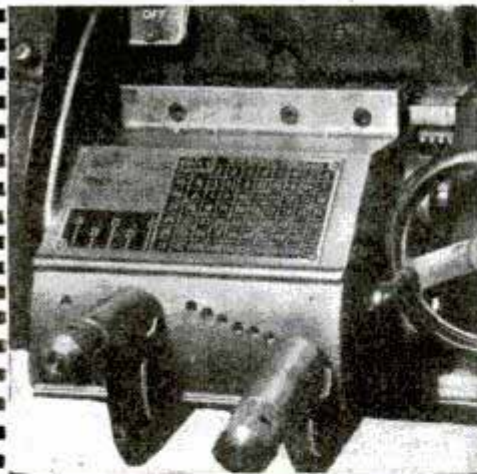

'QUICK-CHANGE' GEAR BOX

CUT THREADS — 4 TO 224 PER INCH

Approximately .003 feed, for fine turning.
 New reverse furnished with box for Atlas.
 Bronze bearings throughout entire unit.
 Aluminum casting — All steel gears.
 Maintained accuracy.
 Speeds up production.
 Easy to install.
 Simple to set.
 Immediate delivery.

Only **\$75.00**

F.O.B. Chicago
 Guaranteed

FOR- Atlas, Logan, Craftsman
 and Power-Kraft Lathes

Write for information or order direct. Full instructions with shipment.
O'BRIEN MACHINE CO., Sales Dept. PM, 1620 Highland Ave., Chicago, Ill.

LOOK AT THESE RADIO BARGAINS



T-17B MICROPHONE

A perfect carbon hand mike for every Radio Enthusiast. Fine quality, light weight, sturdy. 200 ohm, Single Button, press-to-talk switch.

With 5 ft. rubber cord, plug and dust cover. **\$1.69**
 A real bargain at only.....



TELEGRAPH KEY

What a buy! A professional quality Signal Corps key. Bakelite base 4 3/4" x 3", 2 sets of binding posts, circuit closing switch. Solid silver contacts. Don't miss it at only... **49c**

SIGNAL CORPS PHONES

Brand New and Guaranteed. You never saw better value! Light weight phones have bakelite shells and caps, adjustable headband, rubber cushions. 8,000 ohms impd. Limited quantity. Rush Your Order. Only **\$1.95**



Send for Bargain Bulletins with Terrific Values. Visit any of our 3 Great Stores and see for yourself. Mail Orders Filled from Either New York or Chicago.

NEW YORK
 Offices & Warehouse
 242 W. 55th St., N.Y. 19

NEWARK
 ELECTRIC COMPANY, INC.

CHICAGO
 323 W. Madison St.
 Chicago 6, Ill.

New York City Stores: 115-17 W. 45th St. & 212 Fulton St.

ONLY **60c** ELECTRIC MOTOR

CONSTRUCTION KIT
 EASY TO ASSEMBLE
 FUN—EDUCATIONAL

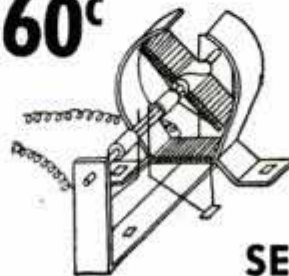

IDEAL GIFT

Runs on a Single Dry Cell (not included). Use it to run Toy Pumps, Pulleys, Etc.

SEND CHECK—MONEY ORDER or CASH (at your own risk) to
THE HAYDN CHEM. CO., Dept. C-4, Box 27, Kenmore 17, N. Y.

ATTENTION AUTO OWNERS!

New Power, Pickup, Pep!

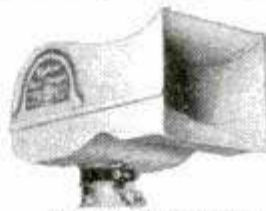

Amazing TYPHOON SUPERCHARGER is back again, ready to put new life into old motors, add to power, pickup, pep! 41,000 users find gas economy, you will, too. Motor knock vanishes, grease bath air cleaning keeps harmful dust out. Takes 5 minutes to install with screw driver on carburetor, replacing old air cleaner. Order today, mention make and model of car. Only \$5.95.

(Ohio orders add 3% sales tax, West of Rockies, add 10%)
 10 Day Money Back Guarantee!

TYPHOON PRODUCTS CO. 509-C Engineers Bldg.
 Cleveland 14, Ohio

THE GEM MAKER



Amateurs or professionals . . . hobbyists or jewelers . . . Polish your own gems with a B&I Gem Maker. You will find this a profitable adventure. All necessary lapidary equipment is furnished, including a super-charged diamond blade for sawing, and all wheels for grinding, shaping and polishing, also complete instructions. The complete equipment as shown, less motor and belt, for only \$29.50, f.o.b., Burlington, Wis. Write today for information and literature on the Gem Maker and accessories.

B&I MFG. CO., Dept. S, Burlington, Wis.

Thrills
 Galore

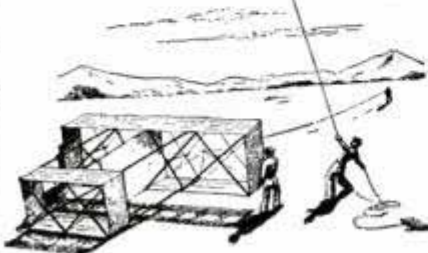

New GIANT Glider-Kite

TOWS AUTO OR LIFTS LIGHT PERSON
 LIFTING WING AREA EQUAL TO SMALL PLANE
 Cost Government \$108.00
YOURS FOR ONLY \$34.50

Not a toy for youngsters. Men with scientific or aeronautical turn of mind get thrill of lifetime with this genuine Barrage Glider-Kite. A "natural" for sky advertising. Took 12 years to perfect. Hundreds used during war to shield convoys. 134 sq. ft. special aircraft fabric. 10' long x 14' wide double wing and tail. Gives enough pull to move car on level ground. Act quick if you mean business. Cost Government \$108. You send only \$34.50 and we ship P.O.B. complete with spare parts and repair material. Ready made. Assembles easily in 15 minutes. Dismantle in 5 minutes. Or send \$10 and we ship C.O.D. for balance.

Write or Send card for Additional Information:

GREAT NORTHERN MART, North Adams 3, Mass.
 DEALERS LETTERHEAD INQUIRIES INVITED

Ball-Bearing SPEED WHEELS



with semi-pneumatic Tires

12" x 1.75" wheel.....\$3.25
10" x 1.75" wheel.....\$2.75
8" x 2" wheel.....\$2.00
Low Price Derby Steering Wheel
Write Us

— AXLES —

24" Steel axle.....75c

—Solid Tire WHEELS—

(no bearings)

7" wheel60c
6" wheel50c
4" wheel30c

ORDER NOW FOR
PROMPT DELIVERY
10% REQUIRED
WITH C.O.D.'S

JIM BROWN TOY COMPANY

1097 Home Ave. Akron 10, Ohio

A USEFUL GIFT THAT IS NEW AND DIFFERENT

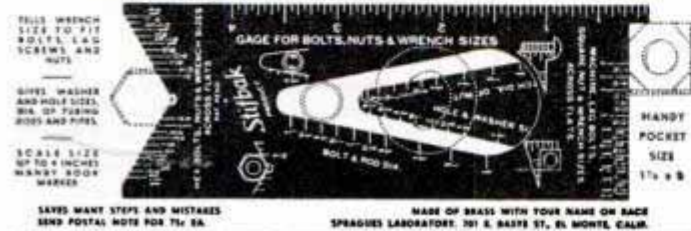

SAVES MANY STEPS AND MISTAKES
SEND POSTAL NOTE FOR 75c

MADE OF BRASS WITH YOUR NAME ON BACK
SPRINGER LABORATORY, 701 E. 84TH ST., EL MONTE, CALIF.

Get Acquainted With— LUCITE "The Gem of Plastics"

Write now for your copy of the illustrated booklet which gives step-by-step fabricating instructions, chemistry & properties of Lucite, wholesale and retail price list on CLEAR & COLORED sheets, rods, tubes, dyes, supplies. Booklet & Lucite sample 35c, postpaid; booklet only 10c GEM-O'-LITE, P.O. Box 686D, North Hollywood, Calif.



Assemble KING MIDGET

Practical highway racer runabout. We supply all parts. Just bolt together. Low Cost. Ready for delivery NOW. One or two cylinder, 40 m.p.h., up to 100 miles per gallon. Send 25c for complete literature with large picture, 3-view drawings, price of parts, or send \$1 for the above plus 4 actual photographs, plans for snow and ice conversion, catalogue of new and used motors, motorscooters, transmissions, clutches, other offerings, etc.

MIDGET MOTORS, Athens, Ohio

Please Mention Popular Mechanics When Answering Ads

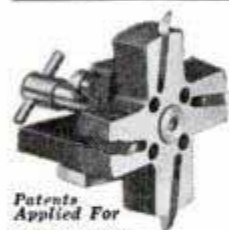

The NEW ELMER! Multiple Indexing Lathe Tool Holder . . .

For 9" and 10" craftsmen, Atlas, Logan, South Bend. Now Available! Face, turn, bore, undercut, thread, cut-off—for single piece or production run on external or internal jobs. Make one set-up for periodical runs. Precision Tool—accurate for closest tolerances. Write for circular.

Patents
Applied For
\$22.00

Postpaid F. E. Elmer, 1232 W. Chicago Rd., Bronson, Mich.



SHAW "DU-ALL" GARDEN TRACTORS and MOWERS

Get FREE FOLDER NOW!

Get details on 1 to 9 H. P. walking and riding tractors. Do 1000 jobs on small farms, estates, orchards, gardens. Low-priced. Send postcard today!

4504 Front Street, Galesburg, Kans.
668G North 4th St., Columbus, Ohio

SHAW MFG. CO.

MORE POWER!
MORE CAPACITY!
MORE FLEXIBILITY!



... than any other homeshop handgrinder



Now you can have the handgrinder you've always wanted for your workshop! Its full 1/14 HP motor has the extra power for "heavy" jobs. Its extra-capacity chuck takes all 3 tool sizes — 1/4", 1/8", 3/32". Attachments convert it instantly for bench, lathe, and flexible-shaft work!

Think what you can do with the extra power, capacity, and versatility of the Duplex. Work in wood, metal, and plastics is faster, easier—and twice the fun!

Tear out this coupon and mail today!

- The Dumore Company, Dept. D-51, Racine, Wisconsin
- Please send complete information on Duplex Grinder
 - Send me Deluxe Duplex Kit (27 accessories), \$27.50 enclosed
 - Send me Standard Duplex Kit (9 accessories), \$19.75 enclosed
- Shipping charges C.O.D.

Name.....
Address.....
City.....(.....) State.....

New PALMGREN ALUMINUM Hand Vise



Faster, Better Work on Small Pieces

Safeguard Workers Hands and Fingers. You can reduce spoilage—cut cost—protect workers and speed up production on small pieces, with a PALMGREN Hand Vise. It is light, comfortable to hold and so convenient when buffing, grinding or tooling. Firmly grips small parts without scratching or marring them. Made of Aluminum with accurately machined jaws, 1 1/2" wide, opening 1 1/2". Length overall 5". Weight 7 oz.



SPECIAL INTRODUCTORY OFFER!

We are making this special offer direct to user for a limited time until available materials warrant national distribution. Order one or as many as you can use in your shop. But order at once! Now—today! Send Cash or Money Order. If C.O.D. you pay postage. **\$1.95** Postpaid

IDEAL FOR Jeweler, Tool & Die Makers, Machine Shops, Auto Shops, Electrical Shops, Cabinet Makers, Gold & Silversmiths, Dentists, Etc.

USE THIS SPECIAL OFFER COUPON

CHICAGO TOOL and ENGINEERING CO.
8366 South Chicago Ave., Dept. 150, CHICAGO 17, ILL.
Please send me.....PALMGREN Hand Vises postpaid at \$1.95 each. Enclose find remittance for \$..... I prefer shipment C.O.D. @ \$1.95 each plus postage.

NAME.....
ADDRESS.....
TOWN..... STATE.....

A Stanley Plane

PUTS SKILL INTO YOUR HANDS



STANLEY

Trade Mark

HARDWARE · HAND TOOLS · ELECTRIC TOOLS

Examine a Stanley Plane and you'll note how well it conforms to its use—hand-fitting handles solidly set—adjusting features simple, fast and dependable—cutter solidly supported and firmly clamped against looseness and chatter. And consider, too, that the edge of the cutter is of extra high carbon crucible steel fused to a backing of softer steel—combining a long-lasting, super-keen, easier honing edge.

No other partnership between tool and craftsman can compare

with the record of Stanley Planes used by generations of woodworkers. Be guided by that and ask for Stanley Planes.

WOODWORKING IS FUN

Send for Stanley's free booklet, "The Joy of Accomplishment". It includes a primary list of tools and a special list of tools to be added as needed. You'll also find the big Stanley textbook, "How To Work with Tools and Wood," constantly useful. It's yours for only \$1.00. Mail coupon today.

MAIL NOW

Stanley Tools, 147 Elm St., New Britain, Conn.

Please send by return mail

- () The FREE booklet: "The Joy of Accomplishment".
 () 188-page book: "How to Work with Tools and Wood". \$1.00 enclosed.
 (In Canada: Send to Stanley Tool Co. of Canada, Ltd., Roxton Pond, Quebec)

Name.....

Address.....

City..... State.....

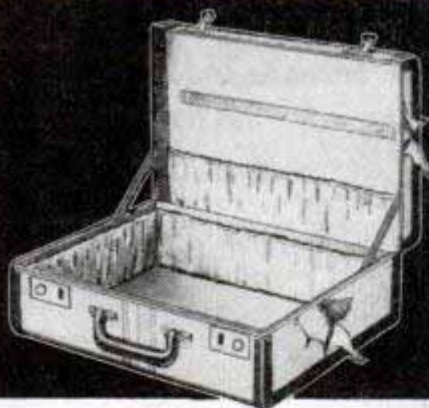

FIXES LUGGAGE, FURNITURE, DISHES, TOYS, AND BOOKS

It's transparent, water-proof, flexible and durable. Get a tube today.



DU PONT DU CO CEMENT

REG. U. S. PAT. OFF.



Send for Complete Price List No. 101

MEIER BRASS & COPPER CO.
1155 Bellevue, Detroit 7, Mich.

BRASS RODS For Home Work Shops

- Free Cutting Rods
 3/32 - 3" Round & Hex
 Naval Brass Rods
 1/8 - 2 1/4" Round
 Brass & Copper Tubing
 1/4 - 3/4" Outside Diam.

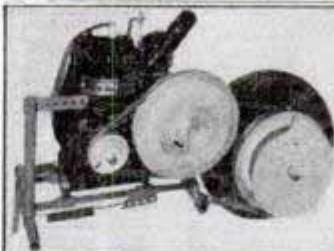

HATFIELD CLUTCH

Automatic and Adjustable only \$22.50

Wheel Drive Pulley and Brake only \$15.00

Send 10c for Folder

M. L. HATFIELD

Box 99 ELKHART, IND.

ONE-MAN SAWMILL

● EASY TO TURN TREES INTO MONEY... BELSAW MODELS in 10 to 24 foot sawing lengths. MECHANICAL FEED, accurate set works and positive

LESS THAN \$200⁰⁰

Makes lumber, ties, shingles, crates, lath, studing, siding. Use tractor or old auto engine for low cost power. Thousands used for commercial sawing. Pays for itself quickly. Send a postcard today for FREE booklet, HOW TO MAKE LUMBER"—and

Catalog of Woodworking Equipment.

BELSAW MACHINERY CO., 2811 KS Field Bldg. 315 Westport Road, Kansas City 2, Missouri

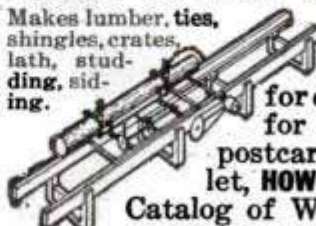

Something new!



You need the new Ross-Frederick FILE HANDLE IN YOUR WORKSHOP!

- Palm fitted
- Will not chip
- Can be reused
- Will not break
- Light in weight
- Non inflammable
- Permanent colors
- Form fits to any shank
- Will not loosen from file

**See your dealer
or write direct**

ROSS-FREDERICK CORP., Box 429, Mineola, N. Y.

Please send me the following:

- _____ small size @ \$.25 ea.
- _____ medium size @ \$.30 ea.
- _____ large size @ \$.35 ea.

I am enclosing check or money order for _____

Name _____

Address _____

My dealer's name _____

ARMY RADIO PHONES



**They're Weather - Water
and Shock Proof**

When we say they are made to Army specifications, that's enough assurance they must be of best quality. These Army Radio Phones are perfect and were O.K.'d by Signal Corps Inspectors. These Dynamic Mikes and Receivers, were used on aircraft and tank inter communication systems. Use them for recording, for battery-less phone, for pocket size set loud speaker or talk through your radio set. We bought a good many of these Radio Phones, they are brand new, and cost a great deal more than you can get them for. A complete dynamic hand mike, 2 earphones, headband, cord set. A wonderful buy for only...

\$3.45

Send check or Money Order, FOB warehouse

LEEDS RADIO CO.

75 Vesey St.

Dept. PM4

New York City 7

A SEAMAN TILLER

*is Your Best
Crop Insurance...*



Because this farm-size Rotary Tiller pulverizes the soil thoroughly; mixes fertilizer and humus into the growing area of the seedbed; conserves moisture; aerates soil; promotes earlier and more complete germination of seed; helps to destroy many crop pests; provides effective weed control... all with ONE machine!

Write for "Questions and Answers" booklet that tells you all about it! There is no obligation.



Motorized models
...4 to 6-ft tillage
widths.

Power Take-Off
Models...3 to 6-ft.
tillage widths.

SEAMAN MOTORS, Inc.

364 No. 25th Street
Milwaukee, Wis.

Keep Brushes like New

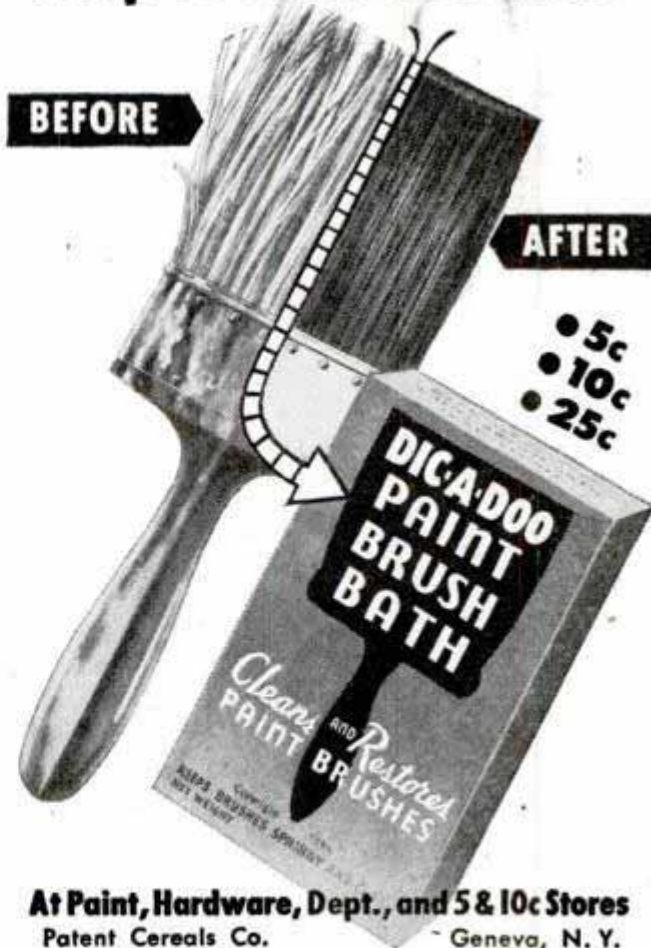

- 5c
- 10c
- 25c

At Paint, Hardware, Dept., and 5 & 10c Stores

Patent Cereals Co.

Geneva, N. Y.

SAY YOU SAW IT IN POPULAR MECHANICS

Inflates Tires Instantly!



TireX

SENSATIONAL NEW AUTO ACCESSORY

Enjoy new freedom from driving worries. Carry a TireX in your car. Soft or flat tires are inflated in 3 seconds. Just attach the convenient steel bottle to your tire valve, turn the handle and the tire is filled instantly! No pumping. Avoids most roadside tire changing. Ideal for areas where air pressure is not available. Enough pressure for 3 tires. Completely safe.

TireX Puts Out Fires, Too!

The TireX is filled with carbon dioxide under pressure. It is the perfect fire extinguisher for small gasoline or electrical fires. It smothers the flames without harming the car. TireX gives you double protection—pressure for tires—safety from fires. A lifetime accessory. TireX may be refilled for 75c. Send check (or M.O.) for \$5.95. Money refunded if not satisfied. *Distributor Inquiries Invited*

\$5.95

POSTPAID
IN U.S.

BREAKSTONE & CO.

2155 W. Harrison St. Chicago 12, Illinois

"Jet" Propelled! SPEED BOAT



Actually sounds like a real speedboat!

No Springs!

No Gears!

\$1

Complete,
Postpaid

Runs half an hour on a small piece of fuel. (Fuel included). Sounds like a real 2-cylinder speed boat. Easy to operate. Will delight both young and old. Order several. They make a wonderful gift.

.... Fuel
Supply In-
cluded at no
Extra Cost

All Metal!
No
Moving
Parts

MAIL ORDERS DIRECT TO
UTILITY STORES, 117 S. Wabash,

Dept. PP-5

CHICAGO 3, ILLINOIS

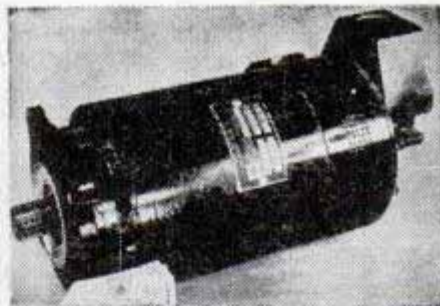

25 AMP. AIRPLANE GENERATOR

Can be used on homebuilt Electric Welder, Wind Charger, Battery charger, Light Plant, etc. Also can be used on boats, trucks, airplanes. Fits nearly any 24 volt airplane system.

Built by Leece-Neville, 24 volt, 50 amp., Model L-3.

BRAND NEW! Original cost \$212, NOW, only, \$24.95!

\$2.00 deposit required on CODs. Generators shipped Express charges collect.

AERO INSTRUMENT COMPANY
Houston 12, Texas.

.297 CU. IN. DISPL. DRONE GOLD CROWN diesel

Class 'B' for MODEL PLANES, BOATS, RACE-CARS AT LAST! America's first—America's finest, modern, ignitionless DIESEL, miniature power plant. No Spark Plug! No Coil! No Batteries! Sure, quick start, dependable run everytime! Wiring, ignition complications eliminated. Bore 21/32; Comp. Ratio 18/1. Ready-to-run \$21.50 at dealers or write direct. DRONE Eng. Co., 125 Broad, Elizabeth, N. J.

WOODWORKERS ... Get this! CONSTANTINE MASTER MANUAL

Get the Most Fun From Your Hobby

Indispensable to woodworkers. Newest, biggest edition, more pages, more color, helpful how-to-do-it articles, pre-war and new items, more bargains. Send 25c today and we will include **FREE! FULL YRS. SUBSCRIPTION** to Chips and Chats, published bi-monthly. Keeps you up-to-date on everything in woodworking, offers big money-saving bargains. Send now.

ALBERT CONSTANTINE & SON, Inc.
791-D 135th Street, New York 54, N. Y.



LADDERS, BOATS AND GENERAL LOADS

Carried Safely on a
GENUINE "TOP LOAD"

Carrier for Cars and Trucks
MODEL TL-30—Top load Cap 350#
MODEL TL-20—Top load cap 800#

Also TL-1—Fishing Pole Carriers
LIEBMAN MFG. CO. 464 McClellan Drive Pittsburgh 27, Penna.

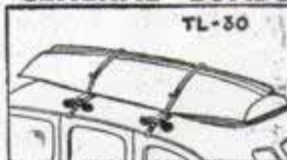

BURN WATER IN YOUR CAR

COSTS LESS THAN GAS
More Power, Cleaner Motor.
Mail card for data on \$17.50
Water-injecting Carburetor.

OCTA-GANE

2425 E. 57TH ST. • LOS ANGELES 11, CAL.

DIE-LESS DUPLICATING

Many small parts can be formed without dies, to duplicated accuracy of .001" with DI-ACRO Precision Machines. — Benders, Brakes, Shears. Save die expense and time delay. Ideal for experimental and research work, making samples, models, etc., as well as regular production runs. Write for descriptive literature.

O'Neil-Irwin Mfg. Company
341 8th Ave.
Lake City, Minnesota



ATTACH THIS
**FLEXIBLE
TOOL SHAFT**
to your motor

FOR EASY . . .
GRINDING, DRILLING,
POLISHING, SANDING
BUFFING,
BENCH WORK

Every plant, homeshop, farm, needs one or more of these STOW Flexible Tool Shafts. Hundreds of uses. Ample length and flexibility for reaching inconvenient places. $\frac{1}{2}$ H.P. capacity, 1725—3450 R.P.M. $\frac{3}{8}$ " Core, Extra Durable Rubber Case. $\frac{1}{16}$ " O.D. Precision Ball bearings both ends. Motor connection bored either $\frac{1}{2}$ " or $\frac{5}{8}$ ". In ordering specify diameter of your motor shaft. 5 ft. model: \$15, 6 ft. model: \$16.50

Order from your dealer or write us for complete information.

STOW

MANUFACTURING CO.
41 Shear St., Binghamton, N. Y.



**STOP LOOKING..
START LIVING!**



SCHULT OFFERS FULL VALUE IN A FURNISHED HOME

● The Schult Luxury Liner built to quality standards by pioneers of the trailer coach industry offers you an unbeatable combination of living comfort and value, available right now!

In one package you get well heated, well insulated mobile housing, ingeniously designed furniture, a kitchen equipped with refrigerator, oven range and double sink.

**EVERY FACILITY OF A
3-ROOM HOME**

The Luxury Liner contains three separate rooms . . . sleeps four comfortably . . . provides all the wardrobe, closet, and drawer space you need . . . is luxuriously furnished and decorated, includes vanity with built-in lavatory or toilet room.

See a Schult! Write today for dealer's name; we'll send latest catalog, too.

SCHULT CORPORATION
DEPT. 3204 • ELKHART, INDIANA
In Canada, John Inglis Co., Ltd., Toronto



TWO LUXURIOUS MODELS!
Schult Luxury Liner, and new sparkling deluxe Commodore for economical luxury travel.

SCHULT Trailer Coaches

WALL-TYPE \$
SWING SPOUT
FAUCET only **9.95**

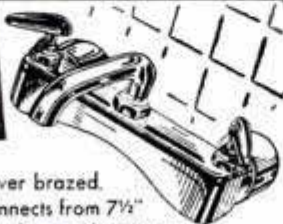

Made from brass stampings. Silver brazed. Chrome plated. Wear-tested. Connects from $7\frac{1}{2}$ " to $8\frac{1}{2}$ " sink centers. Spout $6\frac{1}{2}$ ". Ultra modern. Post-paid anywhere in the United States.



FREE! Drain Cleaner

Sensational New Water Pressure Type. Regular \$1.25! Free with faucet order.

STATE SALES CO.
P. O. BOX 49 MAYWOOD, CALIF.

RADIO PARTS ASSORTMENT

Experiment with many radio parts. Transformers, Coils, Sockets, Wire, Switches, etc. etc. Bargains like this only once in a lifetime.
SEND CASH, CHECK OR MONEY ORDER
10 lbs. Only \$1.69

THOR ELECTRONICS, 5051 No. Clark St., Chicago 40, Illinois

HANDY FOOTSWITCH

- Heavy Duty—1000 Watt
- For Drill Press—Lathe—Grinder—Saw
- Micromatic Smooth Operation
- Rubber Pad Prevents Slipping

Shipped all parts finished, ready to assemble. Only screw driver needed. Sold on money back guarantee. **\$3.95**
Postpaid U. S. A.

GILMAT CO., 802 N. Wash. Blvd., Kansas City 2, Kansas

UNIQUE LIGHTS with a HUNDRED USES!

FINGER FLASHLIGHT



SALESMEN!
Quantity
Prices
On Request

Handy for any type of work where fingers must remain free—automobiles, motor boats, night fishing, etc. ALSO CLAMPS ON SCREWDRIVERS (see lower left). Contains long-life Eveready Battery. **POSTPAID. SEND ONLY \$1.00.**

FLEXI-CORD PENLIGHT

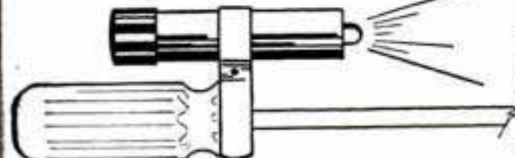

A handy light for the mechanic! 9" flexible cord stays rigid in any position, directing light where needed . . . in hard-to-see places. Plastic case prevents shorting in tool kit. Individually boxed. **POSTPAID. SEND ONLY \$1.00.**

PETIT SALES

1622 HOWARD ST. CHICAGO 26, ILL.

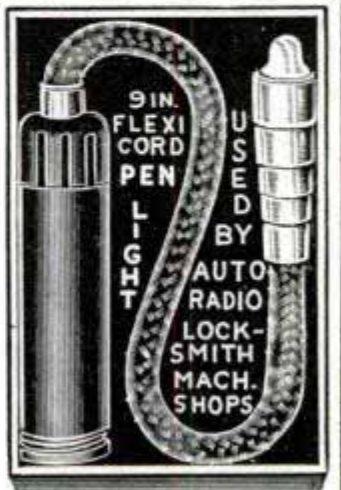

BUILD YOUR OWN TRAILER AND SAVE

\$28

Wheels, Axle Assembly with Mounting Saddles

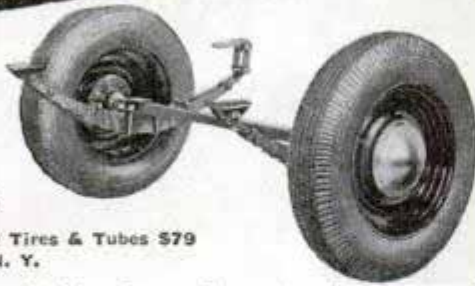

With Springs & New Tires & Tubes \$79
F.O.B. Mt. Vernon, N. Y.

All you need to start building that trailer you've always wanted is this brand new specially designed precision-built undercarriage. 54" track forged axle is 1 1/2" square. 11-leaf, heavy duty springs, 1 3/4" x 34", are complete with drilled shackles for easy mounting to the frame. Kelsey-Hayes automotive type wheels take standard 6.00 x 16 tires. Timken roller bearings assure smooth travel . . . easy towing. Permissible load, 2000 lbs. Tires and tubes are standard first line brands.

Other trailer equipment available: trailer chassis, rugged 3" channel section welded steel frame; ball and socket hitch; parking jack; tail and stop light.

FREE SET OF PLANS WITH EVERY PURCHASE

These complete plans make it easy to build just the kind of trailer you need—for camping, farming, carrying a boat, hauling equipment or tools. With these parts you can quickly have your trailer at a fraction of the cost you would ordinarily pay.

MONEY BACK GUARANTEE—Your money refunded if for any reason you find the equipment not as represented.

Old Colony Equipment Co., Inc.
232 E. 8th St., Mount Vernon, N. Y.

Gentlemen: An enclosing money order, check, in the amount of \$..... Please send me the following, with FREE plans included:

- COMPLETE Undercarriage, including Wheels, Axle, Springs, and 2 NEW Tires and Tubes at \$79.
- Wheels, Axle, Mounting Saddles, and 2 NEW Tires and Tubes at \$65.
- Wheels, Axle and Springs at \$44.
- Wheels, Axle and Mounting Saddles at \$28.
- Complete price list of other trailer parts.

MAIL THIS TODAY

NAME.....

ADDRESS.....

CITY..... STATE.....

Ship via freight or.....
I will pay shipping charges. CD-171

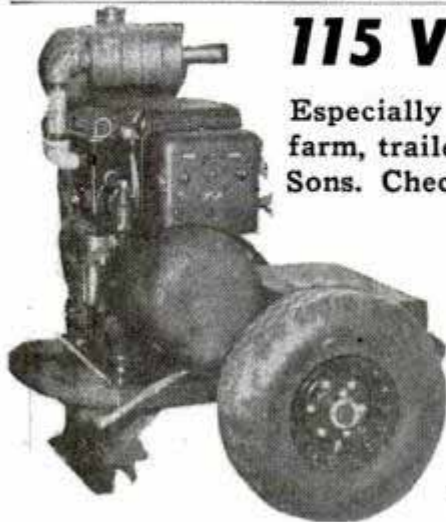

115 Volt A.C. Portable Lighting Plant

Especially suitable for field use or for permanent installation in cottage, farm, trailer, boat, etc. Built to rigid Army requirements by D. W. Onan & Sons. Check these outstanding features:

- Supplies 115 volts, 60 cycle A.C. at 350 watts. (Enough for a radio and several lights.)
- Supplies 12 volts D.C. for charging batteries.
- 1 H.P. 4 cycle gasoline engine with silencer.
- Automatic push-button starting (if used with 12V storage battery).
- Runs 4 hours on 1 gallon of fuel.
- Fuel tank holds 3/4 gallon (larger tank can be used).
- Steel carrying cart with pneumatic aircraft tires. (Cart may be unbolted for permanent installation.)
- Shipped new in original crate complete with instruction book, tools, starting rope, battery table (without battery) and full guarantee.

Priced at a fraction of original cost — only \$149.50 F.O.B. Chicago. Shipping wt. 275 lbs. Net wt. 150 lbs. 25% deposit required with C.O.D. orders.

WELLS SALES, INC., 4717 W. Madison St., Dept. P-4, Chicago 44, Ill.



OFFICIAL U. S. GOV.
COMPASS
Hunting Case, Watch Type, All Metal, Jeweled Waltham
\$1.95
\$3.50 Value

WHEATSTONE BRIDGES Used, in excellent condition. Mfg. by Thompson Lever Mfg. Co., Philadelphia. Value \$150.00.. **SPECIAL \$49.50**

Engineers' All Metal Army Type Hand-Sighting

LEVELS

\$2.00

PRECISION QUALITY



PUBLIC SPORT SHOPS

13 S. 16th St., Phila. 2, Pa.

No COD's

(Pat. Pend.)



Appliance Tester

Saves Time, Effort, Money in Appliance Repairing!

In the new improved HANLAN APPLIANCE TESTER you have all the necessary tests for examining the true conditions of any electrical appliance in common use today and in one single unit. This portable model tests thermostats at the point of cut-out and cut-on. Also controls heat on soldering irons. Tests continuity open circuits and grounds. An essential to electrical repairman, appliance dealers, shops, and trouble shooters. Order today! Only \$10.95 complete postpaid. \$1 deposit on C.O.D. orders. **MONEY BACK GUARANTEE.**

FREE with each tester. New, Complete Practical Course in electrical repairing. Write for circular.

HANLAN CO., 1419-A Jefferson Blvd., Los Angeles 7, Calif.



IMMEDIATE SHIPMENT

The angle you want when you want it
• Universal Ball Positioner and Vise •
Jaw width 2" • Jaw Opening 2 1/4" • Positive Simple lever lock and release. No lost motion

SEE YOUR DEALER OR WRITE

Reypo CORPORATION

9900 Lincoln Blvd., Los Angeles 45, Calif.

Ottawa Self-Propelled Buzz Master

CLEARs LAND FAST! Powerful 6-HP motor with friction clutch for safe operation. Cuts down timber, brush and hedge; turn blade vertically and saw logs to length. Can be equipped to fell largest trees. Has clutch pulley for belt work. Is fully guaranteed.



OTTAWA MFG. CO., 427 Brush Ave., Ottawa, Kansas

MAKE THINGS GLOW IN THE DARK

Professional Size LUMINITE KITS

PERFECT FOR LIGHT SWITCHES, EDGES OF STAIRS, STATUARY, DOOR KNOBS, WALL PLAQUES, ARTIFICIAL FLOWERS AND MANY OTHER INDOOR ITEMS.

SPECIAL OFFER
\$5⁹⁵
COMPLETE

Famous Luminite, a magic discovery, makes indoor articles glow with brilliance in the dark. Easy to apply. Invisible during daytime. All kits contain a liberal amount of materials for a volume coverage. Guaranteed high quality. Not a sample or a toy. Immediate shipment. **SUPPLY IS LIMITED!**

10-DAY FREE TRIAL Just mail name and address. Pay post-send **NO MONEY** man \$5.95 plus C.O.D. charges on delivery. Send remittance and save C.O.D. charges. Sold on a 10-day money back guarantee.

CENTURY PRODUCTS CO., Dept. PM5
4261 N. 20th St. Louis, Mo.

ALL-PURPOSE Fluorescent Fixture

Just plug in and light. No extra wiring or equipment. Saves up to 1/2 on light bills.

20 WATT LAMPS
White or daylite .75
Soft white .85

Immediate shipment—Check or M.O. with order—Postage prepaid

HI-PURE LABORATORIES
20 East Sycamore St.
Evansville 9, Ind.

ARMY AND NAVY SURPLUS \$3⁹⁵ ARMY COMBAT FIELD JACKET.

ARMY REGULAR FIELD JACKET.....\$ 2.95
AAF B-3 SHEEPSKIN JACKET.....\$14.95
NAVY GREEN ALPACA JACKET.....\$ 5.95
NAVY FOUL WEATHER JACKET.....\$ 4.95

All items reconditioned. Shipped Collect. Free Catalogue of Pants, Shoes, etc.

SURPLUS MERCHANDISE DEALERS, Dept. P.
408 COMMUNIPAW AVE., JERSEY CITY 4, N. J.



BAKED WHITE ENAMEL FINISH
2-LAMP FIXTURE, \$7.95
20 watt, without lamps
3-LAMP FIXTURE \$9.95
20 watt, without lamps



LOOKING FOR SOMETHING?

Why go crazy? We'll find it for you! Save your valuable time. Any hard-to-get item located for just \$1! We advise, locate, guarantee our service. Send your request to

Eddie DuPuy, P. O. Box 267, North Hollywood, Calif.

PLEXIGLAS

New Low Prices, new masked prime stock, clear thicknesses, per square foot: 1/16" @ \$1.00; 1/8" @ \$1.30; 3/16" @ \$1.60; 1/4" @ \$1.85; 3/8" @ \$2.75; 1/2" @ \$3.60; 3/4" @ \$5.50; 1" @ \$7.40. Sheet sizes 6" x 12"; 6" x 24"; 12" x 12"; 12" x 24" and 12" x 36". Add 10% for packing and postage any place in U.S.A. Minimum order \$5.00. Send money order for prompt shipment.

PLASTIC SUPPLY CO., 2618 St. Louis Ave., St. Louis 6, Mo.

GUNSIGHTS AND MECHANICAL EQUIPMENT

Write for list of War Surplus bargains

WARSHAWSKY & LAZAR

2126 S. Michigan Ave. Chicago 16, Ill.

BATTERIES FIXED TO WORK LIKE NEW!

with and without new materials. Everything needed supplied. Complete copyrighted course, tool list, etc., only \$10.00.

BATTERY LABORATORY SCHOOL, Dept. B, Minneapolis 13, Minn.

ARMY-NAVY SURPLUS BY MAIL CATALOG FREE

Now you can buy Genuine Brand New Surplus Clothing by mail at enormous savings. Trousers, jackets, shirts, rain coats, blankets, arctics, shoes, socks, gloves, underwear etc. Mail post card today for your FREE CATALOG sent promptly.

J. R. ADDISON UNIFORM CO., Dept. PM4 CAMBRIDGE, OHIO



Machinists, Tool, Die and Pattern Makers will want genuine Gerstner High Grade Tool Chests. Free Catalog.

GERSTNER TOOL CHESTS
447 Columbia St., Dayton 7, Ohio



A WHOLE SHOP FULL OF TOOLS IN ONE!

Use it for grinding, routing, drilling, sawing, polishing, carving, sanding and 9,994 other uses. Increases your skill and your scope. Precision-engineered, AC-DC. More exclusive features than any other tool.

Exclusive Safety Fingergrip for fine detail work

\$22⁵⁰

COMPLETE WITH 36 ACCESSORIES IN FITTED STEEL CASE

\$31.75 Value if Purchased Separately

Works Wood, Metal, Glass, Plastics

CASCO ELECTRI-CRAFT TOOL KIT

CASCO PRODUCTS CORPORATION, BRIDGEPORT 2, CONN.

IMMEDIATE DELIVERY!



\$24.95

F. O. B. ROYERSFORD, PA.

8 in. BENCH SAW

COMPLETE AS SHOWN

TABLE SEGMENT—Shows degree of table tilt—graduated. SPLITTER—Hard temper cold rolled steel. GUARD—Aluminum. MITER GAUGE—Aluminum. Accurately graduated 45° each side of center. BEARINGS—(2) Oil-lite bronze. CAPACITY—0 to 2 1/4". TABLE 12"x14". SHIPPING WEIGHT—44 lbs.

AMERICAN MACHINE & TOOL CO., Inc.

DEPARTMENT 100 • ROYERSFORD, PA.

Have this **HUSKY, PRECISION-BUILT**

Butler DRILL 1/4 inch PRESS

\$14.95

Delivered East of Rockies. Add 50c for shipment west of Rockies.

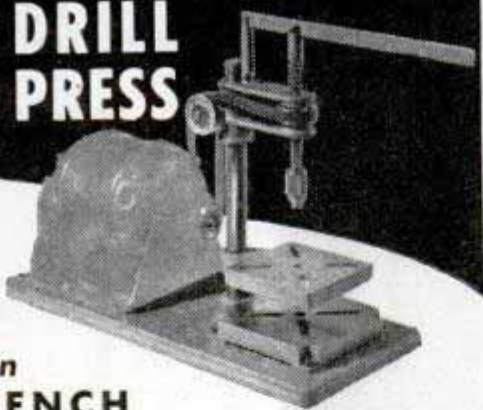

on your own WORK BENCH

Home Craftsmen • Veterans • High School Men! Here's the Power-driven, Bench Drill Press you've wished for a hundred times—that will do a clean, fast, workman-like job in metal or wood; that won't "stall"; that is accurate, true; that is portable; that is a real tool—not a toy, and that is reasonable in price

STURDILY BUILT FOR PRECISION WORK

- Drills to center of 6" circle.
- Machined chuck takes drills up to 1/4" shank.
- 5" square, adjustable table.
- Husky, solid 6" square base.
- Full 1/2" spindle with 25 1/2" travel.
- Sturdy column—1" diameter, 12" long.
- Bronze Bearings.
- Ball thrust bearing absorbs spindle thrust.
- Sensitive, hand lever feed; spring loaded.
- Adjustable drill head for quick belt adjustment.
- Overall height: 21". Width: 6". Depth: 15".
- Base to Table: 7 1/2". Table to Chuck: 6 3/4" maximum.

(Motor and Belt not included)

AVAILABLE FOR IMMEDIATE DELIVERY
SEND CHECK OR MONEY ORDER TO THE

BUETLER MANUFACTURING COMPANY, Dept.-A

5229 W. OHIO ST.

CHICAGO 44, ILLINOIS

Portable Paint Sprayers



Uses 1/4 Hp. Motor

\$26.95

Complete as illustrated, less motor. Sprays all kind of paint, lacquer, varnish and etc. Oil-less ball bearing compressor, 2 cu. ft. air per minute, 15 to 50# pressure. Sprays paint 5 times faster than hand brushing.

No. 890—Outfit complete as shown, with "V" belt, motor pulley, 15 ft. high test air hose and No. 112 gun, but without motor. **\$26.95**

Spray Guns—Low Pressure

- Operate on 15 to 50# pressure
- #115—1 pt. cup **\$4.95**
- #112—1 qt. cup **6.50**
- #121—Production type ... **7.95**
- #125—External mix ... **9.50**
- Regulator&Gauge 0 to 160# **4.95**
- Air Filters **1.85**
- Air Hose—15 ft. **1.75**
- Air Hose—25 ft. **2.75**
- 3 Gal. Paint tanks, with hose, reg. and gauge **24.95**
- Less reg. and gauge **16.50**

No. 444—Outfit, twin cyl. 4 cu. ft., production type gun, 15 ft. air hose, reg. and gauge, V belt and motor pulley. Complete less motor, **\$47.50.**

BLACK & DECKER ELECTRIC DRILLS

- 1/4" **\$16.95**
- 1/2" **31.95**

Super-Air Auto Engine Pump

Pumps 100# pressure. For inflating tires, spray painting and etc. Complete with hose, pump, gauge, and spark plug adaptors **\$4.75**
Less gauge **3.75**

AIR COMPRESSORS — PAINT SPRAYING SUPPLIES

GAS ENGINES — 1/2 TO 1 1/2 HP. 37.95 UP

Hobbycraft supplies, engines and kits 15% discount.

Immediate delivery—check or M.O. shipped prepaid, cod's plus chgs.

INDIANA APPLIANCE CO.

20 East Sycamore

Dept. PM-15

Evansville, Ind.

SAY YOU SAW IT IN POPULAR MECHANICS

302



BALL BEARING ARBOR

BUILD A SAW LIKE THIS IN YOUR OWN SHOP — WITH OUR BALL BEARING ARBOR

Features—

Precision built Arbor with Fafnir lubricated and sealed Ball Bearings. No further lubrication required.

8" Saw adjustable to cut from 0" to 2 1/4".
Top 27" by 32" tilts to 45 degree angle. Full 131 1/2" ahead of saw. Top is 3/4" plywood with three 1/4" panels spaced to provide channels for mitre gauge guide bar. Top may be smaller or larger to suit your needs.

Base is built of 3/4" plywood—double thickness at ends.
A sturdy, vibrationless saw which you can build at a fraction the cost of metal saws of comparable size and capacity.

Ball Bearing Arbor with Saw Plans and Instructions **\$7.75**. Arbor only without Saw Plans **\$6.95**. If your dealer cannot supply send check or money order and we will ship postpaid in U. S. A.

Manufactured by

WILLIAM H. CRANDALL COMPANY

1009 Fruitvale Avenue, Oakland 1, California

Little Giant \$1495

COMPLETE WITH BOILER AND BASE

Single cylinder Oscillating Steam Engine. A rugged high-speed precision-built engine made of highest quality material. Equipped with safety valve, throttle control and two fly wheels. Base 7" x 4". Boiler height 7 1/2". Satisfaction or money back guarantee. Order now. Supply limited. Cash orders prepaid or C.O.D.



THE THOMPSON ENGINEERING CO.
405 Winchester Bldg., Grand Rapids 2, Mich.

BOWS & ARROWS

Write for 94 page Illustrated Instruction Hand Book 50c; 20 page catalog 5c; stamps or coin.

L. E. STEMMLER CO. QUEENS VILLAGE, N.Y.

ELECTRIC LIGHT PLANTS: Used Government surplus. Guaranteed in good mechanical and operating condition. 110 volt, 3000 watts, powered by Briggs-Stratton or Wisconsin air cooled engines, \$149.50. No COD Orders. Limited quantity, act quick. Send for descriptive circular. **MIDWEST SURPLUS SALES CO., 1520 Locust St., Kansas City, Mo.**

NEW Liquid Casting Plastic

Makes
**1001
OBJECTS**

Craftsmen, Hobbyists! Here is a new craft, a fine hobby, or profitable home business. **CAST-OLITE**, Liquid Casting Plastic that pours without heat or pressure, sets at low temperature. Make beautiful crystal clear objects—lamp bases, book ends, candle holders, novelty jewelry. Drill, saw or carve. Other novel effects obtained by embedding real flowers, butterflies, coins, photos. Ordinary jars, glasses, tubes serve as molds. Easy, fascinating to use!

SPECIAL CASTO-KIT ONLY \$3.35

Get our new professional experimental Casto-Kit now at special low price of only \$3.35. Make lovely objects very first day. Kit contains materials for 20 projects. Contains 1 lb. liquid **CASTOLITE**, bottle hardener, buffing compound, measuring dropper, abrasive sheets, vial, flowers for embedding and Instruction Manual showing simple step-by-step method. Send \$3.35 for Kit prepaid or order C.O.D. Instruction Manual only, 25c (stamps or coin.) **The CASTOLITE COMPANY, Dept. D-1, Box 211, Kenilworth, Ill.**

DEALERS write for literature and prices.

Castolite
LIQUID PLASTIC
TRADEMARK



FERN IN LAMPBASE



NOVELTY JEWELRY

20-Project
KIT
\$3.35
PREPAID

POPULAR MECHANICS

Here They Are! WORLD WAR 2 PRECISION INSTRUMENTS

NOW A "Treasure Chest" GYRO GUN STABILIZER

ALL-IN-ONE UNIT!

**Colimeter
Slide Viewer
Baby Spot
Slide
Projector
Fixed Focus
Microscope**



ONLY \$8⁵⁰

Postpaid in U.S.A.

- Two Motors
- Perfect for Reconverting
- All Parts are Precision Made

This marvelous BRAND NEW-GYRO GUN STABILIZER is perfect for reconverting. All NEW valuable precision made parts in Metal Case. Consists of TWO 1/50 H.P., 12 Volt Motors high speed to 10,000 r.p.m. removable for separate use. Variable resistor assembly. Vibrator dampener. Small Condenser. Coils. Springs. Suspension System. Made by Westinghouse for government use, costing hundreds of dollars. With these valuable parts you can power your home work-shop machine . . . build an engine for model trains . . . make many motored parts.

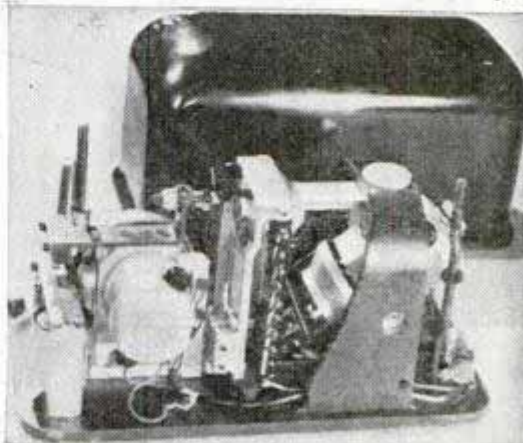

Priced at only 1/10 original **ONLY \$12⁵⁰**

cost to government F.O.B. Chicago

With the valuable parts found in this Famous B-29 Air Force GUN SIGHT you can build all these items plus many more. Composed of more than 25 expensive parts . . . All top quality construction, precision made for Finest Accuracy and Dependability . . . Possible adaptations are endless and fascinating . . . Free conversion sheet with each order . . . All NEW in original cartons . . . Worth many times our LOW PRICE.

Remit With Order

● SEND FOR FREE CATALOG ●

RUSH YOUR ORDER

B & B PRODUCTS CO., 111 W. Jackson Blvd., Dept. PM-4, CHICAGO 4

SAWS ANY PATTERN



CUTS DESIGNS NEVER BEFORE POSSIBLE

Here's a fast-cutting precision tool that simplifies intricate jobs in wood, plastics or light metals. Long-lasting spiral blade cuts in any direction - without binding or breaking. Lustrous baked enamel steel frame, with new lever-action blade adjustment, provides right tension constantly. Complete saw, with 3 extra blades, only 95¢. (Blades only, 3 for 25¢) - Get yours - today!

ENLARGED SECTION OF BLADE

AT YOUR NEAREST HARDWARE STORE or send \$1 direct for sample to

TYLER MANUFACTURING COMPANY
938 Pico Boulevard - Santa Monica, California

THE CHAMP

by Medana

An accurate, shock-proof, water-resistant wrist watch, with radio-lite hands, numerals, and sweep second hand. Fitted with handsome leather strap. A written and signed guarantee with each watch. If matching stainless steel expansion band is desired, add \$1.00 to your remittance. Comes to you Postage Prepaid. Send check or Money Order.



ONLY \$18⁶⁵

Includes Federal Tax

REPAIRS: Jewelry and watch repairs and pearl restringing done promptly at reasonable prices.

ANTIN'S JEWELERS-GIFT COUNSELORS

Dept. 7, 114 Baronne St. New Orleans 12, La.
Please send me The CHAMP (with) (without) the stainless steel expansion band.

Name _____
Address _____
City _____ Zone _____ State _____

you'll do faster, better work with this
EFFICIENT SHOP TOOL

THE
**Bantam
GRINDER**



Polishing
Grinding
Carving
Drilling
Buffing
Plastic
Glass
Metal
Wood
Bone

You'll enjoy doing many shop jobs with the Bantam Grinder. Correctly balanced for easy handling. Precision-built of quality materials for dependable, long-life service. Operates on 110-115 Volt AC-DC. Speed approx. 20,000 R.P.M. Internal ventilating fan. Fingertip switch. Weight—15 oz. With 8-ft. cord and plug, 23 accessories, substantial gift box... **\$25**

If your dealer doesn't have it, write us.



Small Motors, Inc.

Dept. 80, 2068 Elston Ave. • Chicago 14

Manufacturers of special small universal, fractional H. P. motors, shaded pole motors, heater motors for industrial and appliance uses.

Your chance to own a
BRITISH MADE CAR

- AUSTINS •
- TRIUMPHS •
- SINGERS •
- M. G. MIDGETS •

See story on page 116 in January issue of Popular Mechanics Magazine

Also Small English Panel Trucks
Immediate Delivery on all makes
new and used American Automobiles

USED CARS
CORDS
DUESENBERGS
BANTAMS
CROSLEYS

HARD TO GET
PARTS
CROSLEY
DUESENBERG
CORD & OTHERS

NEW HOUSE TRAILERS
WE TRADE—WRITE
JOSEPH NEIDLINGER
IMPORTER

7300 Stony Island Ave.

Chicago 49, Ill.

MARGIE



DIRT and DUST
YOUR DOUBLE-TROUBLE?



Fix it with **Mortite**

a household friend

Shut out dirt and dust! Press pliable Mortite around windows, doors, baseboards, etc. It's done in a jiffy. Keeps out ants, insects; fine for calking, stops rattles; the ideal weatherstripping. Roll covers about 80 ft. At Hardware, Paint, Dept. Stores, Lumberyards. Write for free booklet.

\$1.25 Higher West of Rockies and Canada



J. W. MORTELL CO.,

522 Burch St., Kankakee, Ill.

Complete or PARTS

THE NEW MODERN MOWER KIT

For either gas or electric power. You furnish the engine or motor, we furnish the rest. Shipped in kit form to save you money. Easy to assemble — fun to use.

For Details Write
AIR-ELECTRIC MOWER
LOHRVILLE, IOWA

AVAIL NOW
Less Motor
Dealers Invited

NEW
CONCORD RADIO
Bargain Catalog

Brand new—48 exciting pages of radio parts, equipment, and supplies for experimenting, building, testing, repair, maintenance—Big feature sections of Ham Gear, Radio Sets, Communications Receivers, Amplifiers, Record Players and Portables, Record Changers, complete Sound Systems. Pages and pages of top-quality standard-make radio and electronic parts—plus scores of special value bargains. Thousands of items NOW IN STOCK and ready for IMMEDIATE SHIPMENT! Write TODAY for your FREE COPY. Please address Dept. P-47

FREE!

CONCORD'S Outstanding 1947 RADIO VALUES

RADIO PARTS—SETS—TESTERS

SPECIAL VALUES HAM GEAR—AMPLIFIERS

RECORD CHANGERS—PLAYERS

CONCORD RADIO CORP.
LAFAYETTE RADIO CORPORATION
CHICAGO 7 901 W. Jackson Blvd.
ATLANTA 3 265 Peachtree Street

LOW PRICED AMMCO 7" PRECISION SHAPER

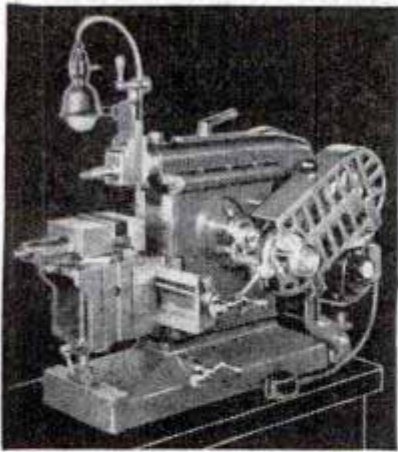

SMALL, COMPACT... for HOME or PLANT

You'll be amazed at the wide variety of jobs this AMMCO 7" SHAPER can handle quickly, accurately, economically. It does the precision work of a larger machine... has many features found only in the big expensive shapers.

Compactly designed for home and small plant use, sturdily constructed for long life—it comes in bench or portable models. At its new low price, you now can afford this Shaper of a "thousand uses".

Address Dept. PM-47 for specifications and prices.

AMMCO TOOLS, INC.

COMMONWEALTH AVENUE NORTH CHICAGO ILLINOIS
(Formerly Automotive Maintenance Machinery Co.)



THE SKILL IS BUILT INTO AMMCO MACHINES



AIR FORCE OFFICIAL GOGGLES

\$1.98

BRAND NEW — COMPLETE
WITH 8 OTHER LENSES
Add 25c for Mail Orders

NATIONAL SURPLUS STORES
CHICAGO 21, ILLINOIS

6519 S. HALSTED ST.

NEW TRUCK - TRAILER AXLE ASSEMBLY • War Surplus Buy!

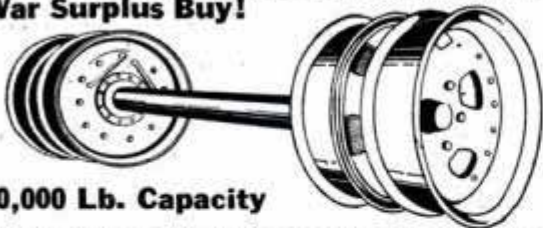

• 20,000 Lb. Capacity

EQUIPPED WITH THE LATEST TYPE DOUBLE CYLINDER HYDRAULIC BRAKES, 6 HOLE BUDD HUBS, ETC. . . .

\$158 COMPLETE
(Less Wheels)

Standard width with heavy type 4 in. tubular steel axle and 16 in. brake drum diameter.

6 HOLE - 20x7 BUDD WHEELS To Fit Axle \$6.75 Each

NEW 16 in. CAR TYPE TRAILER WHEELS

Ford - Chev. - Plym. - Model "T" and Universal
Double disc, drop center, heavy type to fit any
above pass. car hubs. Specify make and model!

\$6.45
EACH

"WELD-IN" WHEEL CENTER DISCS \$1.95 Each

For 16 in. drop center rims, fit same 5 types as wheels above.
Perfect fit! Specify make and model!

Send Full Remittance or 25% Deposit and Balance C. O. D.

NORTHWESTERN AUTO PARTS CO.

834 No. 7th St. • Dept. 7 • Minneapolis 11, Minn.

AT LAST!

An Amazing New ADDING MACHINE Everyone Can Afford!

Professional
Appearance

Figure-
Magnifying
Plastic Lens

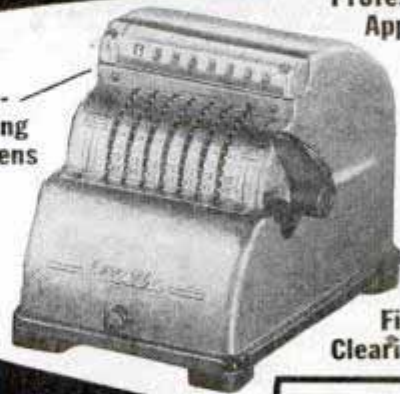

Figure
Clearing Lever

Lowest Price Ever Asked for a REAL ADDING MACHINE

This substantial, professional-looking GUARANTEED machine gives you lifelong, accurate figuring service at an amazingly low price! Pays for itself in errors avoided and time saved. The new "Precise" adds, subtracts, multiplies—with easy stylus operation. No paper tape to bother with. Totals come up on the Polystyrene magnifier instantly, automatically, accurately! Counts up to 99,999.99. Professionally built with internal construction of steel, bronze and brass throughout; Zamac cast metal case, in handsome, two-tone baked spray lacquer finish; number plate is solid bronze, with etched red and black figures for easy visibility. 7" x 5" x 4 3/4". With complete instructions. Portable, fool-proof, rugged. A real adding machine at a fraction of the usual cost!

NOT A POCKET
TOY OR GADGET
A *Real*
BUSINESS-LIKE
ADDING MACHINE

Easy to Use
Guaranteed
Accurate

ADDS! SUBTRACTS! MULTIPLIES!

For Everyone:

Homes
Stores
Offices
Factories
Teachers
Students

10 DAY TRIAL

Full Money-Back Guarantee!

YOU RISK NOTHING. Use the "Precise" Adding Machine for 10 days. If you're not completely satisfied, return it for full refund. Every machine is covered by a full year's guarantee for materials and workmanship; free repair during guarantee period. Order today—we'll ship C.O.D., or postpaid on paid orders.

ONLY
\$21⁹⁵
COMPLETE
(Postpaid on
paid orders)

FREE TRIAL!

TAM PRODUCTS
3814 Wrightwood Ave.
Chicago 47, Illinois, Dept. A-5

Ship me one "Precise" Adding Machine
 \$21.95 enclosed. Ship C. O. D.



**ORDER
TODAY!**

Name.....
Address.....
City..... Zone..... State.....

2 BIG OUTFITS GRINDING WHEELS ABRASIVES

#1 COMPLETE KIT

102 Grinding, Cutting and Polishing WHEELS PLUS 150 ass't items for Home or Shop

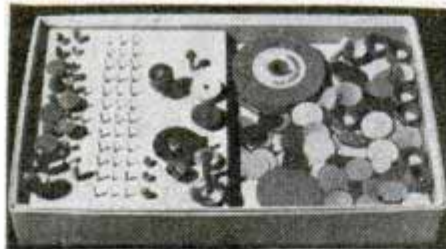

- 2 Grinding Wheels 3" and 2" dia.
- 2 Rotary Files, High Speed Steel.
- 6 Rotary Cutters 1/8" Shank.
- 3 Rotary Cutters 3/32" Shank.
- 6 Mounted Grinding Wheels 1/8" Shank.
- 6 Mounted Grinding Wheels 3/32" Shank.
- 4 Speed Drills 3/32" Shank.
- 36 Rotary Cutting Burs 3/32" Shank.
- 2 Mandrels 3/32" Shank.
- 1 Mandrel 1/2" Shank.
- 1 Screw Type Mandrel 3/32" Shank.
- 3 Rotary Bristle Brushes 3/32" Shank.
- 1 Rotary Wire Brush 3/32" Shank.
- 1 Circular Saw 1 1/2" dia.
- 1 Mandrel for Circular Saw 1/8" Shank.
- 1 Rubber Cylinder Mandrel 3/32" Shank.
- 1 Rotary Drum Sander 3/4" Shank.
- 10 Bands for Rotary Drum Sander.
- 15 Rotary Felt Wheels 1" dia.

Total Value \$45 if bought separately

FINEST ROTARY TOOLS EVER SOLD BY MAIL

ONLY \$9.75

Postpaid in U. S. A.

#2 COMPLETE ASSORTMENT

75 Grinding Wheels Sharpening Stones and Rotary Cutters PLUS 200 ass't items for Home or Shop



- 12—Ass't Grinding Wheels up to 4" dia.
- 1—Rotary File High Speed Steel 1/4" Shank.
- 1—Rotary Cutter 1/8th inch Shank.
- 12—Rotary Burs for Cutting Wood and Soft Metals.
- 10—Assorted Cut-Off Wheels, Ass't Sizes.
- 3—Mounted Grinding Stones 1/8th inch Shank.
- 3—Mounted Grinding Stones 3/32nd inch Shank.
- 1—Drum Sander on 3/32 inch Mandrel.
- 10—Bands for Drum Sander.
- 6—Rubber Wheels 3/4 inch Diameter.
- 10—Felt Wheels, Assorted Sizes Up To 2 inch Diameter.
- 1—Wire Brush 1 inch Diameter on 3/32nd inch Shank.
- 3—Bristle Brushes on 3/32nd inch Shank.
- 2—Mandrels 1 each 3/32nd inch and 1 each 1/8th inch Shank.

A BARGAIN

ONLY \$5.95

Postpaid

in U.S.A.

D. SCHUPACK

2256 E. 75th ST. • DEPT. PM-4 • CHICAGO 49

RUSH YOUR ORDER TODAY!

RISCO RECORD PLAYERS \$9.95



\$3.50 Alliance Phono Motors



\$2.15 ASTATIC L-70 Crystal Pickups



Walnut Cabinet Plays 10" & 12" records. Both easily attached to any radio

V.M. Mixer Changer Plays 10" & 12" Records at Same Time. \$16.50

Or—Complete 3-tube amplifier & 5" speaker for above—\$8.00 IDEAL MUSIC FOR HOME MOVIES

Detrola Record Changers \$15.50 Maguire 2-Post Changers \$15.00 25% on COD orders—24 hour Service—FREE CATALOG—ORDER FROM THIS AD Wholesale Distributors—RISCO ELECTRONICS, 22 Warren St. N.Y. 7

MEN WELCOME SIMPLER SHAVING!

World's Most Modern Razor Wins New Friends Every Day

Mystic, Conn., Mar. 2, 1947. Everywhere in America where it's been tried, the new simpler method of shaving is winning men over. The new Enders Razor gives the world's simplest shave!



Safer, swifter, smoother shaves are assured by the Enders with its amazingly simple construction. It's all one piece—no mechanics, no gadgets. All you do is click the blade in and shave! Furthermore it doesn't clog, it's easy to clean and it stays clean. Blades are sharp and long lasting—the razor is shaped to snuggle right into your hand. Just try it—you'll like it. If your nearby store doesn't have it yet, order direct from Durham-Enders Razor Corp., Dept. 103, Mystic, Conn.

SPECIAL OFFER...RAZOR AND 5 BLADES...49¢

Durham-Enders Razor Corp., Dept. 103, Mystic, Conn.

French Type PHONE TS-13C Hand Set



With butterfly switch on handle. When the switch is pressed, the microphone is connected into the circuit and an additional set of contacts are closed, to operate a change over relay. Has a 6 ft. length of cord, with a PL 55 plug for earphone and PL 68 for microphone and switch. Impedance of earphone approx. 2500 Ohm; impedance of microphone approx. 250 Ohm (carbon); connected with batteries it can be used for inter-communication system. They are brand new and the original cost is many times what we are offering them to you . . . while they last.

\$3.95

MICHAEL STAHL, Inc. 39 Vesey St., Dept. PM4 New York 7, N. Y.

RUN SINGLE PHASE MOTORS ON THREE PHASE POWER (OR THREE PHASE MOTORS ON SINGLE PHASE POWER) WIRING BLUE PRINT TELLS YOU HOW

Learn this method—of LIFETIME VALUE

How to run three phase motors on single phase power (or single phase motors on three phase power) is explained so anyone can understand in this valuable Wiring Blue Print. Not necessary to change any wiring inside motor. Job can be completed in five minutes. Solves tough power problems for hobbyist, small shops, electricians, mill-wrights, or maintenance men. Guaranteed satisfaction. Complete instructions given. Mail coupon with \$1.00 (one dollar) cash, check or money order. Home Products, Inc., 6801 Compton Avenue, Los Angeles 1, Calif.

A PROVEN TESTED METHOD

MAIL THIS COUPON WITH \$1.00

HOME PRODUCTS, Inc.

6801 Compton Ave.

Los Angeles 1, California — Dept. P.M.-1.

Send Wiring Blue print which shows how to run a three phase motor on single phase power (or single phase motor on three phase power) ENCLOSED is \$1.00 cash check or money order .

Name _____

Address _____

WAR SURPLUS

For the Sportsmen — Young or Old
All Year 'Round Use



Perfect all wool
Olive Drab
SLEEPING BAG

Comes in handy for fishing trips, hunting, camping, boating, just roughing it or use as auto robe and many other purposes. Has warmth of 2 blankets; zipper slide fastener; tie-strap on bottom; approx. Gov't cost \$12.90, our price postpaid, Ea. **\$3.49**

Outside Cover for Sleeping Bag—Water Repellent \$1.49

ARMY PUP TENTS Perfect without pole. **\$2.59** postpaid, EACH

Perfect **CANTEENS** (slightly used) 30c

Perfect **MESSKITS** 30c

SPURS—Cavalry with Straps (used) 79c

RAIN PONCHOS (used) \$1.49

ANGLE HEAD FLASHLIGHTS (New) Big Bargain \$1.00

NEW GOGGLES

For skiers, fliers, campers, hunters, fishing, beachwear, safety-wear, motorcycling, bicycling, boating and many other uses. Set comes complete (boxed) with 9 extra interchangeable shatter-proof, flexible, cellulose acetate lenses. Amber, Green and white colors. A rubber flexible chamois lined goggle frame. Back adjustment head strap. Made for A. A. P. Cost Gov't approx. \$4.50. Our Price Postpaid—EACH **\$1.49**



10% Discount in dozen lots or more on any of the above listed items.

AMERICAN SUPPLY CO. Dept. P.M., 5th & Broadway
Kansas City, Mo.
Special Dealers Quantity Discounts

BUILD YOUR OWN FAST FREEZER PLANS \$1.00

It's easy to build this household appliance and profitable to use. Save up to 75%. Operates on 110 or 32 volts. Plans show 5 sizes and are easy to follow. ENJOY MAKING ONE OF these freezers from new or used parts. No expert knowledge needed. Mail \$1.00 bill or check for complete plans and catalog.



LE JAY MFG., 447 LeJay Bldg., Minneapolis 8, Minn.

CATALOG OF PLASTICS for Fun and Profit

... Your key to greater hobby happiness! Describes low-cost Plexiglas kits, for making good-looking projects that amaze your friends. Gives you useful information on Hard-To-Find Materials—dyes, polishing rouges, cements, findings, etc. Suggests interesting things to make. Enjoy the convenience and inspiration of this helpful catalog. Mail ten cents in coin or postal note today! **10c**

Special Bonus! Full-size plans for 2 beautiful projects included with every catalog ordered now! Jackson Studio, Dept. 11, 5440 N. Shoreland Ave., Milwaukee 11, Wis.



WAKE UP YOUR Scalp

BE FAIR TO YOUR HAIR Want better looking hair? Embarrassed by falling dandruff, itching scalp? Then try VITABRUSH, new electric driven scalp brush that gives your scalp a vigorous and invigorating "workout" in just three minutes of fun. Cleans scalp. Stimulates blood supply. Restful. Pleasant. Write today for complete information and satisfaction-guaranteed offer. Hershey Mfg. Co., 149 S. La Salle, Chicago 3

Paint it YOURSELF WITH Plasti-Kote

The Plastic Finish for AUTOS, BOATS, FLOORS FURNITURE & WOODWORK

- Use Plasti-Kote wherever you want a gleaming, lasting and durable finish. Plasti-Kote leaves a cellophane-like surface that resists hot or cold water, alcohol, dirt, oil, vibration and changing weather.

Dries in 3 hours — leaves no brush marks. Easy to apply. 36 beautiful colors. \$2.95 quart.

PLASTI-KOTE, INC. 425 LAKESIDE AVENUE N. W. CLEVELAND 13, OHIO

Send new color folder and descriptive literature:

Name

Address

City..... Zone..... State.....

The ONE and ONLY ALL-PURPOSE PLIER-WRENCH

For HOME · WORKSHOP · FACTORY

A time-saving tool of a thousand uses. On square or hexagon nuts the seating prevents friction, slipping. As efficient as a Stillson type wrench on round or tubular pipe. The patented CAM action enables users to tighten or loosen with ease. Nut adjustable. Made of finest alloy-steel, drop-forged, heat treated. Guaranteed against mechanical defects.

Adjustable to 4 positions from zero to 1". suPERFORM can be used on finest wire to 1" square hexagon nut or pipe. Also an A-1 wire cutter!

Strongest Plier-Wrench ever made

ASK YOUR DEALER FOR suPERFORM OR CLIP THIS COUPON

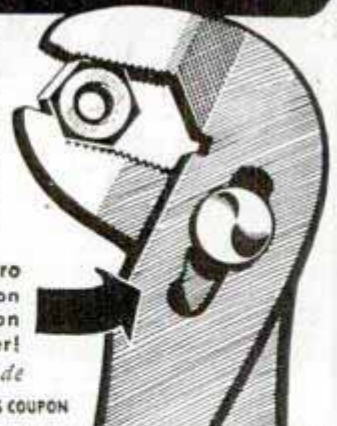

suPERFORM • 1133-3rd Ave. • Oakland 6, Calif.

Please send me _____ suPERFORM All-Purpose Plier-Wrenches at \$2.50 each.

Enclosed is my check (or money order) for _____

Please ship COD, plus postage and insurance _____

Name _____

Address _____

City _____ Zone _____ State _____



NEW
AMAZING PLASTIC DISCOVERY

Tightens False Teeth

REFIT MAGIC **PLASTI-LINER**

Makes all Plates FIT PERFECTLY . . . PERMANENTLY or Your Money Back

One application of Plasti-Liner lasts for life of plate. It's a professionally developed reliner for home use that ends forever the mess and bother of temporary applications that last for only a few hours or a few months. NOT a paste, nor a powder; but a strip of genuine dental plastic!

Safe and Easy to Use

Plasti-Liner is pure, non-toxic, non-irritating, harmless, odorless, tasteless, smooth, molds to mouth. No heat necessary. Makes your false teeth tight and comfortable. Safety and efficiency guaranteed by a leading insurance company.

USERS SAY: "Saved me buying new plates." "Now I can eat anything." "The improvement has been little short of wonderful."

SEND NO MONEY. Order from this ad. Deposit money with your postman when he delivers. \$2 for PLASTI-LINER for both upper and lower plates, with full directions. \$1 for PLASTI-LINER one plate. Or send the money, save the postage. Satisfaction guaranteed or money refunded.

PLASTI-LINER CO., Dept. 25A **Walbridge Bldg. BUFFALO 2, N.Y.**



WAR SURPLUS METERS!

D.C. MILLIAMMETER A good basic meter to build your own analyzer. COMPLETE WITH CIRCUIT DIAGRAM, VOLT-OHM-MILLIAMMETER SCALE AND LIST OF PARTS REQUIRED. Dejur Amseco, 0-1 Milliammeter movement with 0-4 Kilo-volt scale, 3 1/2", round flush bakelite case. Each **\$3.95**

A.C. VOLTMETER Triplett Model 331 J.P. (illustrated) 3 1/2", round flush bakelite case, white scale, 0-150 volts. Complete with external wire wound precision resistor to increase range to 300 Volts.

A.C. AMMETER Triplett Model 331 J.P. (same as above) 0-30 Amps. A.C.

SPECIAL OFFER — BOTH METERS FOR \$8.95
SURPLUS - NEW - GUARANTEED - GOV'T INSPECTED

All orders F.O.B., N.Y., 25% Deposit required on C.O.D.'S. Be sure to include sufficient postage, excess will be refunded. We carry a complete line of all types of Electrical Instruments. Send for our Free Circular

MARITIME SWITCHBOARD
Dept. PM 8 336 Canal Street New York 13, New York

McAleer
SIDE CAR CARRIERS **\$4.50**
THOUSANDS NOW IN USE



Slips on or off any car in a jiffy

Will carry anything too big for the inside of your car

PER PAIR COMPLETE

● Indispensable for carpenters, painters, plumbers, farmers, window washers, gardeners, campers, hunters, fishermen, home owners, salesmen, etc. Carries tent poles, lumber, pipe, oars, ladders, garden tools, fish poles, skis, etc., securely and conveniently. Guaranteed not to damage car finish. Instantly removable. Fully patented. Exclusive design.



Shipped prepaid on receipt of check, money order . . . or C.O.D. Or at your nearest dealer. Write Dept. 9.

SOLD ON 5 DAY MONEY BACK GUARANTEE

Makers of McAleer Automotive Cleaners, Polishes, Home Buffing Compounds, Waxes, Rust Removers

McALEER MFG. CO. Rochester, Michigan

FREE MACHINING
BRASS and ALUMINUM
FOR HOME WORK SHOPS

Aluminum rod—11 inches, each size:
5 Pcs. 1/4-in. to 3/4-in. round by 1/8ths.....\$1.00
3-ft. each size.....\$2.50
Brass—same sizes—11 in. each.....\$2.00
3-ft. each size.....\$5.00

Shipped Express Collect. Send Check or M.O. to:
NON-FERROUS METALS CO.
P. O. Box 1651 WACO, TEXAS

BRUSH PLATING OUTFITS

for re-plating articles in the home and shop. No tanks necessary. Free particulars.

GUNMETAL CO., AVE. M, DECATUR, ILLINOIS

Beautiful Modern **SIGN LETTERS**

Signs anywhere, quickly, easily... Write for money making-saving plan... Samples

PINNACLE SIGN LETTERS, Mound City, Ill.

LAW **STUDY AT HOME for PERSONAL SUCCESS and LARGER EARNINGS.** 38 years expert instruction—over 108,000 students enrolled. I.L.B. Degree awarded. All texts furnished. Easy payments. Send for FREE BOOK—"Law and Executive Guidance."

AMERICAN EXTENSION SCHOOL OF LAW
Dept. 76-M, 646 N. Michigan Ave., Chicago 11, Ill.

CHANITE SELF-WELDING FLUX
REPAIRS ALL ELECTRIC HEATING ELEMENTS

So simple anyone can make repairs in your broken or burnt-out electrical appliances—irons, toasters, stoves, etc. Guaranteed nothing like it. From our mines to your appliances. \$1.00 per package. \$7.50 per doz. Stick form 25c. \$2.00 per doz.

CHANITE SALES COMPANY, 914 So. Main, Fort Worth 4, Texas



U. S. NAVY FLASHLIGHT
Complete with 2 batteries, plus handy hook on bottom to fasten on your belt. Order 1 or more while they last. Postpaid, ONLY **\$1.00**

AMERICAN TRADING CO. 230 W. Randolph St. Chicago 6, Ill.

WINNERS ALL . . . BASS OUTDOOR FOOTWEAR

WEEJUNS FOR LEISURE COMFORT

QUAIL HUNTERS FOR FIELD AND STREAM

SKI BOOTS FOR SMOOTHER SKIING

SPORTOCASINS THE GOLFERS' DELIGHT

G. H. BASS & CO. 60 MAIN STREET WILTON, MAINE

Limited Stock! New, 27-Volt AC-DC AIR COMPRESSORS

- 1/3-HP Motor 3-stage Compressor
- 4500 RPM
- Weighs 28 lbs. Boxed

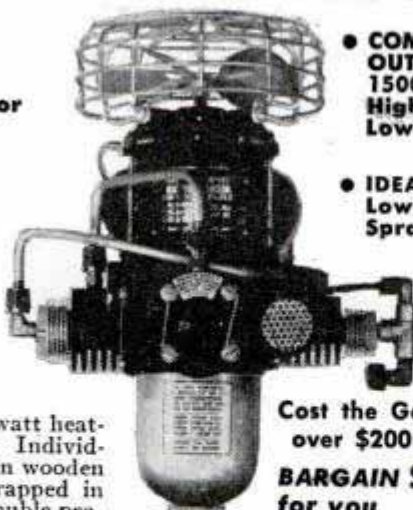

• COMPRESSOR OUTPUT is 1500 Lbs. High Pressure Low Volume

• IDEAL for Low Pressure Spray Gun

Precision built. Convert with transformer or 4 1000-watt heating elements. Individually packed in wooden boxes and wrapped in plicofilm for double protection. Simple directions for hook-up included. Rush us your order, today.

Cost the Government over \$200 to build
BARGAIN \$15 FOB for you

TRANSFORMERS... each only—\$14.50
1000 WATT HEATING ELEMENTS, each only... \$3.95
The above are only 2 methods for hooking up this compressor, additional hook-ups shown on the instruction sheet.

General Surplus Stores

1439 Grand Avenue

Kansas City 6, Missouri

Start a NEW BUSINESS

Sharpen Dull Pipe Wrenches

Industries save hundreds of dollars. Some "wrench shops" make \$50 a day.

Write for information.

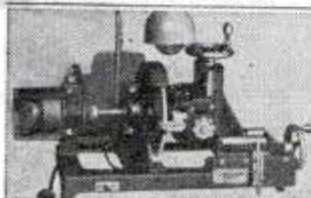

J. C. MOORE INDUSTRIES P. O. Drawer 276 FREDONIA, PA.

TALK-SING thru your own radio with **RADIO MICROPHONE**

Be the life of the party. Put on your own broadcasts at home. Talk-Sing make announcements from any room. Wonderful voice practice. Microphone easily attached to any radio. Follow enclosed instructions. SEND NO MONEY—pay postman \$1.95 plus postage. Send Money Order or check and save postage.

EMPIRE RADIO & TELEVISION CO. (Dept. R2) 1521 Bedford Ave. Brooklyn 16, N. Y.

MAKE YOUR OWN DISC SANDER

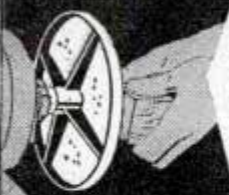

Mount this 8" cast aluminum sanding disc on any 1/2", 5/8" or 3/4" spindle. Sturdy ribbed design. Order direct—\$2.00 postpaid. Threaded bore 25¢ extra. Abrasive paper discs, 8"—1 doz. asst. grits \$1.25.

1726 Clinton Street
EMRICK INC. KALAMAZOO, MICH.

WRITE FOR FREE TOOL LIST.

LAWN ORNAMENT-NOVELTY PATTERNS

28 Lawn Ornament Patterns, 25c. Other patterns; 15-20" high; Dutch Girl, Dutch Boy, Pirate, Bull Terrier, Mexican Girl, Mexican Boy, Dwarf, Penguin, Flower Girl, 10c each. 25 Novelty Patterns, 30c. All 62 Full Size Patterns, \$1.00 Postpaid. Strother Pattern Service, Dept. U-8, Box 383, Belington, W. Va.

If They'll Bite You Can **CATCH 'EM** With The **FISHING GADGET** Sets Hook Automatically



The greatest fishing invention since the fish-hook! Automatically sets the hook on fish that bite. First day's results insure lifetime use. Will last for years. Made of non-corrosive metal. Use on any line... for any kind of fishing. See your dealer or send coupon and \$1 bill for your Fishin' Gadget... Now!

MONEY-BACK GUARANTEE

Send Coupon and \$1 Bill

Sent Postpaid Get Yours Now!

BRUNSON MFG. CO.

1405-7 Walnut St., Kansas City 6, Mo.

Here is a \$1 Bill. Send me a Fishin' Gadget quick!

NAME _____
STREET _____
TOWN _____ STATE _____

APRIL 1947

GET INTO YOUR OWN PROFITABLE BUSINESS!

BIG PROFITS IN CONCRETE CINDER BUILDING BLOCKS

Capture Your Share of the Big Building Boom. Supply the Great Demand for Quality Blocks Needed Everywhere for Every kind of Construction Work.



Prosperity and financial independence can be secured in this fast-moving, highly profitable field today. Think of the great building boom that's ahead of us. Everywhere there's a great demand for new homes, apartments, factories and stores. Aggressive men, with modest capital, are now desperately needed in this highly profitable field. Here is YOUR GREAT manufacturing opportunity. Don't wait! Send for

full money-making details today!
HURRY! LIMITED NUMBER AT SPECIAL PRICES!

So as to get our famous Blocker Vibrator Concrete Cinder Building Block Machines operating in many different localities we have a limited number at a special value price. Rush coupon immediately for full money-making facts. DO THIS TODAY!

CONCRETE BLOCK EQUIPMENT CO., INC.

920 Central Dept. 411 Kansas City 6, Mo.

MAIL THIS COUPON TODAY

CONCRETE BLOCK EQUIPMENT CO., INC.

920 Central Dept. 411 Kansas City 6, Mo.

Please tell me how I can start a profitable business of my own with highly profitable Concrete Cinder Building Blocks.

NAME _____
ADDRESS _____
CITY _____ STATE _____

(Paste on a 3x Post Card & Mail)

THEY'RE HOMELESS!



and a Pyrene* Fire Extinguisher at the start would have saved it.

Every other minute a home catches fire in this country—99% caused by carelessness of ordinary citizens. Our per capita loss is four to six times that of any European country.

An investment in Pyrene may save the investment in your home.

Insist upon Pyrene at home and auto supply dealers. Keep a Pyrene refill handy.



Pyrene Manufacturing Company

NEWARK 8 • NEW JERSEY

Affiliated with C-O-Two Fire Equipment Company

* T. M. Reg. U. S. Pat. Off.



Easy to Build and Repair with this NEW LOW-PRICED LINCOLN WELDER

Here is a versatile new welder that you can afford—the Lincoln "Fleet-Arc Jr." Its exclusive "Arc Booster" provides the world's easiest striking A.C. arc, greatly simplifies welding of light and heavy metals, hard-facing, general repair and construction work. "Dial tuning" current control—no plugs to shift. Range 20 to 180 amps. Meets REA and utility requirements.



In the picture above, a bumper bracket is being repaired with the "Fleet-Arc Jr." welder and $\frac{3}{32}$ " "Fleetweld 47" electrode. Welded with one pass on each side. Total time 7 min. Typical of hundreds of jobs you can do with the "Fleet-Arc Jr." Write for free Bul. 365.

THE LINCOLN ELECTRIC COMPANY
Dept. 511 • Cleveland 1, Ohio

Largest Manufacturer of Arc Welding Equipment in the World

PAINT YOUR OWN CAR \$5⁹⁵
This New, easier way—for only

DAB

Miracle Auto Paint That

Just Wipes On!

- NO BRUSH!
- NO SPRAY!



Insured By
LLOYD'S OF LONDON
Guaranteed Two Years

Now you can get a glossy, factory-like paint job on your car in just one hour with DAB! All you do is WIPE IT ON with the applicator pad provided free. No streaks, no lap marks! If your dealer cannot supply you, send check or money order—we will ship DAB prepaid at once.
DEALER INQUIRIES INVITED!

11 COLORS:

- Red
- Black
- Gray
- Pico Tan
- Sun Beige
- Brewster Green
- Washington Blue
- Monterey Blue
- Jewel Green
- Mohawk Maroon
- Burgundy
- Maroon

\$5⁹⁵
Quart

One quart paints the average car

WORLD-WIDE DISTRIBUTORS
NU-WAY PAINT AND SUPPLY CO., INC.

310 Lincoln Avenue, N.W., Canton 3, Ohio

**CONVERT your drill press
into a combination
LATHE OR DRILL PRESS**

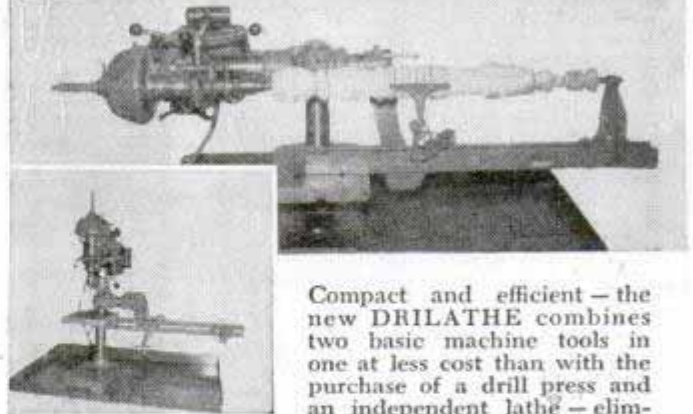

Compact and efficient—the new DRILATHE combines two basic machine tools in one at less cost than with the purchase of a drill press and an independent lathe—eliminates need for additional

electric motor—eliminates need of additional bench and floor space—precision made of rigid steel and cast iron—lathe capacity 36" between centers.

WRITE FOR DRILATHE CIRCULAR

NOBUR MANUFACTURING CO.
912 North Orange Drive Los Angeles 38, California

TRAU-BORE

The newest and most practical lathe tool. Speedy, accurate boring, internal threading and outside finishing. Three standard lathe sizes complete with boring bars and tool bits. Immediate delivery. Write for literature.

- No. 1-46 (9-12" Lathe)—\$13.00 ea.
- No. 1-41 (12-16" Lathe)—\$36.00 ea.
- No. 2-41 (18-36" Lathe)—\$54.00 ea.

**ACCURATE! SPEEDY!
PROFITABLE!**

MILES PRODUCTS
2532 S. Wabash Ave., Chicago 16, Ill.

KUT RITE

lawn mower sharpener

Patented. 3 popular sizes; retail prices: 14", \$1.40; 16", \$1.50; 18", \$1.60

F.O.B. Milwaukee, Wisc. Agents wanted.

Send Check or Money Order

Postage for mailing twenty cents.

Accurate Sharpener Mfg. Co.
2230-A N. Hubbard Street,
Dept. P.M. 1, Milwaukee 12, Wis.



Pat. No.
2239764

Air Liquid STORAGE TANKS

Airplane oxygen Tanks (used) good condition. Up to 400 lbs. pressure; non-rusting stainless steel, weighs 18 lbs. 9 gallon capacity, 24" long by 12" diameter, \$4.98. Same specifications 24" long by 8" diameter, weighs 5 lbs., 2 1/4 gallon capacity, \$2.98. Ends tapped 3/8" standard pipe thread. Ideal for compressed air tanks, any bottled gas, any liquids. Perfect for house trailers, compressors and other uses. Limited quantity. Prices FOB Kansas City. No COD orders.

MIDWEST BUY ANYTHING CO.

Dept. P.M., 1520 Locust

Kansas City, Mo.

OTTAWA LOG SAW

**Write For
FREE BOOK**



SAWS 10 to 20
CORDS A DAY—
FALLS TREES—SAWS LIMBS

**Put this OTTAWA to work
for you. MAKE MONEY!**
Wood is bringing highest prices ever known. Ottawa does more than 10 men. Easily operated. Falls trees—saws limbs. Use 5-hp. engine for other work.

OTTAWA MFG. CO., 427 Wood St., Ottawa, Kans.

POPULAR MECHANICS

G&E Craftsmen's Bargains

ELECTRO MAGNETIC LIFT

An important labor-saver every repairman will use in many handy ways. For momentary work. Plug in any AC socket. 110 volt, 60 cycles; size 4 3/4" diam. by 3", with 22" cord and plug attached. Complete with instructions. Ship. Wt. 5 1/2 lbs. No. 7618—only



\$7.35 each



FULFLO Heavy Duty FILTERS

Famous Fulflo Filter is ideal for gas, air or oil. Has 3/4" inlet and outlet I.P.T. Heavy bracket attached for mounting. Complete, ready to install. Overall size 3-9/11" diam., 5" high. Ship. Wt. 4-3/4 lbs. No. 4753—only
Lots of Ten \$1.85

\$1.95 each

HI-POWER ELECTRIC DRILL

Heavy duty 1/4 inch capacity drill. Light weight—hand balanced. Three jaw chuck. Oil bronze bearings. Equipped with 6 feet flexible rubber cord and plug. 900 rpm at full load. Operates at 110V, AC or DC. No. 6202..... Each



\$17.95

Send check or money order, including postage. No C.O.D.'s
DEALERS! WRITE FOR QUANTITY DISCOUNTS.

G & E EQUIPMENT SUPPLY CO.

Dept. PM-16 400 N. SANGAMON ST., CHICAGO 22, ILL.

MAKE MORE MONEY

APPLYING OR SELLING

CORKSTONE PLASTIC FLOORING

EASY TO APPLY

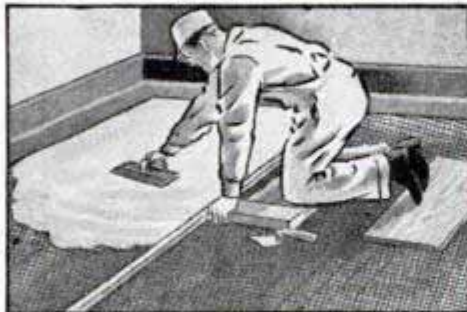

Here's your opportunity to get into business for yourself applying or selling Corkstone, the economical, top-grade plastic flooring. Plenty of profit. Act without delay!

Dealers & Agents Wanted

WRITE FOR DETAILS

LASTING PRODUCTS COMPANY
FRANKLINTOWN ROAD PLANT, BALTIMORE 23, MARYLAND

For A Perfect Day

USE

P & K

SPINNING MINNIE

A surface or underwater lure. Made of Plastic. Weighs 5/8 oz. No. 46. \$1.25 each. Also available in Fly rod size.

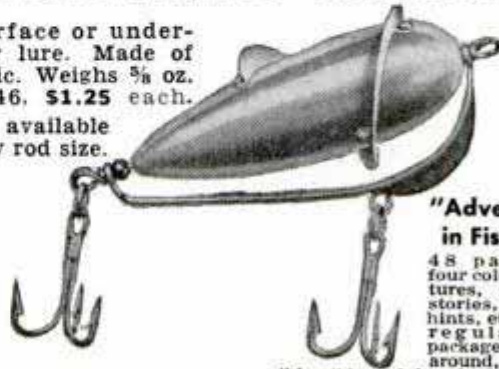

"Adventures in Fishing"

48 pages in four colors; pictures, fishing stories, secret hints, etc., with regular 10c package of Rap-around, invisible ribbon sinker, both for only 10c. Send your dime today.

10c. Send your dime today.

P & K INCORPORATED

(PACHNER & KOLLER, INC.)

3428 Archer Avenue

Chicago 8, Ill.

Canadian Distributors: Central Purchasing Agency, Ltd., Toronto, Ontario

TESTED AND PROVED LURES AND FISHING ACCESSORIES

Fill Holes, cracks, dents, gouges...

These BETTER FILLERS

- HARDEN FASTER
- SHRINK LESS
- STAY IN!

FILLS HOLES IN ONLY 1 APPLICATION

FILLS DENTS AND SCRATCHES

TAKES HIGH FINISH

CRACKS ARE EASILY FILLED

WEATHERPROOF WATERPROOF

SAW OR CUT IT

SAND OR POLISH IT

Duratite Wood Dough will fill rough or irregular cavities in wood, metal, plastic or plaster in one application. (Duratite Surfacing Putty for shallow cavities). Can be sawed, cut, milled, sanded; are waterproof, fire resistant. Seven wood colors, in tubes or cans, at Hardware and Paint stores. Made by Manufacturers of famous Arrowhead Cement.

LARGE TUBE 25c Postpaid

WEBB PRODUCTS CO.

228 South G Street, San Bernardino, California or Webb Company - Dept. M - Norcross, Georgia.



DURATITE

WOOD DOUGH AND SURFACING PUTTY

**WHILE THEY
LAST!**

BRAND-NEW

**GENUINE
SHERRILL**

Liquid-Type
Illuminated

**AVIATION
and MARINE COMPASSES**

Nationally Advertised at \$47.50

LIMITED GOVERNMENT-
RELEASED LOT

ONLY **\$17.95**
EACH

- Adjustable course indicator.
- Dependable no-glare illumination.
- Finger-tip compensators.
- No deviation card needed.
- Eye level mounting — easy reading.
- Universal bracket—easy to install.
- Sturdy molded plastic case.
- Weight only 2½ pounds.

Don't miss this golden opportunity to get a genuine brand-new \$47.50 Sherrill Compass, Model M-6, at a fraction of its original cost. Up-to-date, precision built, with latest features, including quadrantal, semi-circular and vertical correction for accurate compensation at all times. Limited government surplus release makes sensational \$17.95 price possible. We pay postage. Send check or money order.

ACT FAST—WHILE THEY LAST!

PERRY PRODUCTS
Dept. 1A 112 E. Walton
Chicago 11, Ill.

FREE—with each compass—40 page official Ordnance instruction manual. Handy plastic dial deviation calculator.



"YANKEE" VISES

*hold work through every step
without a misstep*

Any job locked in a "Yankee" Vise, is correctly positioned for every operation . . . hand or machine. Lifts on and off swivel base at bench. Machined accurately . . . top, bottom, sides and front end . . . V-grooved block for rounds. Four sizes, with and without swivel base . . . 1½", 2", 2¾" and 4" jaw widths. At your dealer's.



Write for
"Yankee"
Tool Book

NORTH BROS. MFG. CO.
Philadelphia 33, Pa.

YANKEE TOOLS NOW A PART OF
STANLEY
THE TOOL BOX OF THE WORLD

SILVER SOLDER KIT
Easy-Flo Sil-Fos Handy Flux

Handy all-purpose low melting point Silver Solder for General Home Repair, Hobbyists, Radio Mechanics, Electricians, Plumbers, Refrigeration Mechanics, Laboratory Technicians, Dental Mechanics, Costume Jewelers, Auto Mechanics, and Production Braising. Makes strong joints on Brass, Steel, Stainless Steel, Monel and other metals with Gas-Air, Gas-Oxygen, Prest-O-Lite, Alcohol or Oxy-Acetylene Flame. Kit contains 3 pieces each, Easy Flo and Sil Fos Wire, 1/32-3/64-1/16 inch dia., each 10 inches long (total 60 in.). Jar Handy Flux and Complete Instructions for use. Larger kits in selected wire sizes described in introductory kit. Mail \$1.00 to Melcor Engineering & Sales Company, 113 East 75th Street, Chicago 19, Ill.

\$1
NOW
ONLY
POSTPAID

Plastics Supplies

Everything in plastics — Lucite, Plexiglas, Dyes, Rods, Sheets. Lowest prices. Send 3c stamp with name, address and this ad for catalog.

PLASTICS MFG. & SUPPLY CORP.
Dept. M-4, 4707 Euclid Ave. Cleveland, Ohio

Please Mention Popular Mechanics When Answering Ads

The Fastest Action Game of 1947!

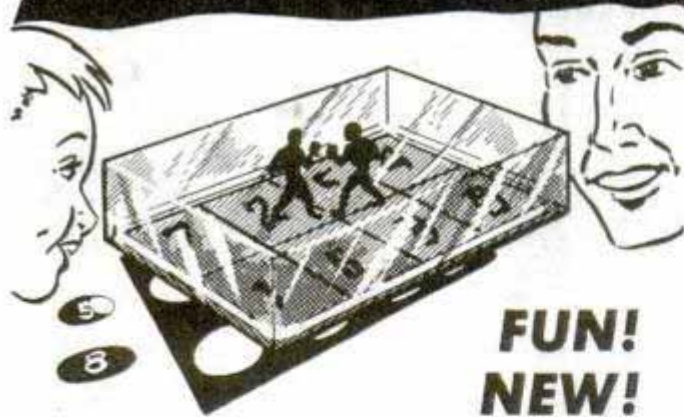

**FUN!
NEW!**

SENSATIONAL! MYSTERIOUS!

It's the fascinating **PLAY-A-BOUT**

An Actual "Prize Fighting" Game That Can
Be Played by 2 to 16 People!

No springs, no mechanical parts, no electrical connections! It operates through a mysterious electrical force that comes right from your fingertips! The miniature boxers actually seem to slug and feint before your very eyes, until one is knocked out on a numbered square. Wonderful fun for parties . . . a delight for the kiddies! Sent ready to operate. . . . **\$1.00** P.P.

Send Check or Money Order to

Agents: Write for
Special Deal

QUINN PRODUCTS

6831 S. Wabash Ave., Chicago 37, Ill.

AUTHENTIC WESTERN

SADDLE RING

FOR MEN
WOMEN or
CHILDREN

PURE
STERLING
SILVER

Only
\$4.95

POSTPAID
We Pay Tax

First time at anywhere near this low price! Authentic replica of romantic western saddle. Handsomely formed from solid Sterling Silver by expert silver craftsmen. Massive style for men, dainty style for women and children. A gift of distinction. A pleasure to wear. Sent on approval.

SEND NO MONEY! Just clip this ad and mail with your name and address. Pay postman only \$4.95 plus few cents postage on arrival; or send cash and we pay postage. Wear this sensational ring for 10 days. If not delighted, return for full refund. Specify for MAN, WOMAN or CHILD and RING SIZE. Use cut-out band to determine size.

ARIZONA CRAFTSMEN
Room 672C
1904 Farnam
OMAHA 2, NEBR.

POPULAR MECHANICS



I go for BIG YANK because it's 9 times more work shirt!

Not a boastful claim—check the 9 actual work-shirt advantages BIG YANK delivers to give you on-the-job performance like you've never had before. You get a plus bonus of comfort, long wear, good looks too! Buy BIG YANK today—at good stores everywhere—in popular fabrics and colors.

- ✓ Large Pockets with Flaps
- ✓ Danger-Check Safety Cuffs*
- ✓ Elbow-Action Sleeves*
- ✓ Sanforized (shrinkage less than 1%)
- ✓ Dress Shirt Styling
- ✓ Wet-Resistant Cigarette and Non-Jab Pencil Pocket*
- ✓ Reliance Strainproof Yoke*
- ✓ Full-Cut Roominess
- ✓ Non-Rip Seams

*Patented

BIG YANK

SHIRTS PANTS

Reliance Manufacturing Co., 212 W. Monroe St., Chicago 6

EXHAUST BLOWERS

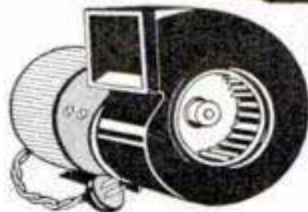

WORTH \$50

\$15⁸⁵

**FOR PHOTOGRAPHERS
HOSPITALS • LABORATORIES • WORK SHOPS
LAUNDRIES • OFFICES
RESTAURANTS • PRINTERS
PLAYROOMS**

100 CU. FT. FRESH AIR EVERY MINUTE!

Solve your ventilation problems with this rugged, built-for-service blower and exhaust. Quick and simple to install. Anyone can do it with ordinary household tools.

110 Volt, A.C., 50-60 cycles. Continuous duty, ball bearing motor assures quiet, trouble free operation.

Send Check, Money Order, No C.O.D.'s. West of Mississippi add \$1.00 for mailing, handling. Immediate delivery.

UNIVERSAL YONKERS CORP. (Dept. M-4) 41 Locust St., Yonkers 2, N. Y.

15 JEWEL STOP WATCHES \$12.50

ELGIN split second sweep hand 1 5/8" black dial. Govt. inspected for reissue.

PERISCOPE SIGHTING STATION—Bausch & Lomb and Eastman. New. Contains 32 coated lenses and prisms, Selsyns, gears, motors, dessicator pump, drives, etc. Cost \$9875.00.....now **\$49.50**

SPERRY K-3 Computing Sight contains hundreds of precision bearings—gears—electronic parts—motor—clutches—shafts—optical system—Brand new in original box at..... **\$12.50**

Shipped prepaid anywhere in U.S.

ASSOCIATED SURPLUS 10838 Ventura Blvd. North Hollywood, Calif.

**SAVE RETAILERS' PROFIT
BUY SHOES DIRECT**



OVER
TWO
MILLION
PRS. SOLD



**Famous SUTTON Bonded
DOUBLE DUTY \$3.95
MEN'S SHOES** MENS
Small Boys \$3.45

Long wearing, double tanned Brown cow-hide shoes for work or street wear. Built with full leather middle sole, heavy non-marking, waterproof Goodyear cord soles and heels—proved best by Army tests. Sewed and Nailed. Doubly reinforced at points of wear. Exactly as photographed. Save more by ordering direct. Men's sizes 6 to 12. Boy's sizes 1 to 6. Small boy's sizes 10 to 13 1/2.

FREE! U. S. Army Leather Preserver

Large container included with each pr. Fill out order blank
SUTTON SHOE COMPANY, Dept. 4
32 Sutton Street Baltimore 1, Maryland

Send me.....pairs Sutton Bonded Double Duty shoes.
Size wanted. Men's..... Boy's.....

Payment enclosed. Postage to be paid by Sutton Shoe Co.
 Send C. O. D., plus postage.

NAME.....
ADDRESS.....
P. O. STATE.....

Carries the Same 90 DAY GUARANTEE As a New Motor Assy.

Our Finest Precision REBUILT

MOTOR BLOCK ASSEMBLIES

Sold Outright or Exchange

Rebuilt by skilled mechanics. Assembly has Reborn Block with New Pistons, Pins, Rings, Re-ground Crankshaft, and all New Bearings. Guaranteed 90 Days.

Allowance on Old Motor

We ship at outright price. Send your motor prepaid, must be suitable for rebuilding. Send in notarized bill of sale showing title number if any. We refund difference when we receive your motor.

\$5.00 Crating Charge



For 1928-41 FORDS and 39-41 MERCURY

Year	Out'rt.	Exch.	Year	Out'rt.	Exch.
1928-31	98.00	73.00	1938, 24 Stud 85	149.00	99.00
1932-34, V8	149.00	99.00	39-41, 24 Stud 85	149.00	99.00
1935-36, V8	149.00	99.00	39-41, 95 H.P.	149.00	99.00
37-38, 21 Stud 85	149.00	99.00	1939-41 Mercury	149.00	99.00

For 1934-42 CHEVROLET Cars and Trucks

Year	Out'rt.	Exch.	Year	Out'rt.	Exch.
1934 Mstr.	117.50	87.50	1940 All	107.50	87.50
1935 All	117.50	87.50	1941-42	107.50	87.50
1936 All	127.50	87.50	41-42, Hi-Torq.	117.50	97.50

For 1935-42 DODGE Cars and Trucks, 3 1/4" Bore

Year	Out'rt.	Exch.	Year	Out'rt.	Exch.
1935-39	139.00	109.00	1941	125.00	95.00
1940	139.00	109.00	1942	125.00	95.00

For 1935-42 PLYMOUTHs

Year	Out'rt.	Exch.	Year	Out'rt.	Exch.
1935-39	139.00	109.00	1940-41	125.00	95.00
1942	125.00	95.00			

SEND 25% CASH WITH ORDER, BALANCE C.O.D.

J.C. WHITNEY & Co.

1917 Archer Ave. Chicago 16, Ill.

make your **TALLEST** wish come true instantly in **ELEVATORS**™

TRADE MARK

HEIGHT-INCREASING SHOES "YOUR PERSONAL PEDESTAL"

* TRADE MARK OF STONE-TARLOW CO., INC.

Why be satisfied with the "short end" of things when it's so easy to enjoy all the advantages that come from being taller. And you can be almost 1 3/4 inches TALLER the instant you step into a pair of "ELEVATORS". Secretly, too, for the heels are no higher.

Send for free booklet





STONE-TARLOW CO., Inc., Dept. PM4-47
Brockton 68, Mass.

Please send me Free Booklet and name of nearest dealer.

Name _____ (Please Print)
Address _____
City _____ State _____

The Original and Genuine "ELEVATORS"
Manufactured Exclusively by Stone-Tarlow Co., Inc.

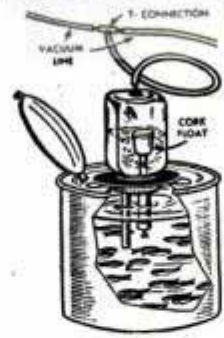
ITS NEW 9th Revolutionary IT'S MIN-O-LIFE FOR MINNOWS



Hook MIN-O-LIFE to any standard auto windshield vacuum line. Powerful action creates a vacuum inside jar, forcing agitated and aerated water into circulation. Actual tests prove minnows stay alive for hours. Now, transport big, live, healthy minnows overland to your favorite fishing spot, full of life and pep on arrival.

MIN-O-LIFE fits all standard size minnow buckets and comes complete, ready for connecting.

Ask your hardware or sporting goods dealer today for MIN-O-LIFE. If he doesn't have them in stock, order direct.

37.5

Postpaid.

LEE SALES CO., 608 Main St., Dallas, Texas

FOG-PROOF! AIR-TIGHT!



RUBBER GOGGLES

protect against dusts—gases—fumes—smoke! Ordinary air-tight goggles fog instantly, but patented water chamber keeps lenses of these goggles clear indefinitely! Order today! JERRY BRYANT, Dept. PM, 619 N. Michigan, Chicago 11, Ill.

Sent p.p. \$2.00

NEW-ALL QUICK CHANGE GEAR BOX
Increases Production up to 1000%

NEW IMPROVED MODEL!



PAYS FOR ITSELF in 30 DAYS!

30-DAY Money-Back Guarantee!

Drastically Cuts LABOR COSTS!

NO TIME LOST FINDING GEARS! Inexperienced workmen easily produce top output. Easy to install. You simply drill and tap four holes.

Guaranteed Accuracy!

IS GUARANTEED TO CUT ACCURATE THREADS from 4 to 224 per inch with approximately 3/1000 lead for fine turning. It safeguards entire production in process throughout the complete operation.

Precision Constructed

PRECISION CONSTRUCTED THROUGHOUT with gears of quality hobbed steel. Gear Box housing is made of high grade aluminum alloy casting—with replaceable bronze bearings.

NEW LOW PRICE . . . \$89.50 F.O.B. Los Angeles

For ATLAS, CRAFTSMAN, LOGAN, POWERKRAFT and SOUTH BEND 9-in., B & C.—Use Your Own Lead Screw.
Write Div. PM-1

WESTERN AIRCRAFT TOOL CO.
2505 North Ontario St., Burbank, Calif., Charleston 6-7750

**IT COST THE NAVY
Hundreds of Dollars—**



You Can Have It
for Only
\$8.95
The Famous
MARK 18 GUN-SIGHT...
The Miracle
OPTICAL GYROSCOPE!

This wonder of the war—The aircraft gunsight that measures and computes automatically! The precision-balanced GYRO UNIT is easily removed with all WIRES. The tiny ball-bearing MOTOR magic GOVERNOR maintains constant speed from 14-22 V. at only 1/10 amp. AC or DC—24 volts. Perfect YOKE and special BEARINGS. The GYRO maintains fixed position in space. The hand-figured SPINNING MIRROR supports a perfect optical image at full speed. Energizing 6 electromagnets with DC will show erection rate, compute lead and deflections. Twin projection systems fuse both images into one. One fixed and one moving variable demonstrate virtual images. 2 SUPERB ACHROMATS in threaded brass cells, cemented doublets. 2" dia. 7 1/2" e.f.l. tested perfect for telescope objectives. 3 Precision first surface FLATS, aluminized. 2 1/2"x4 1/4" REFLECTING GLASS. SUN FILTER. Two 22 V. lamps in door, changeable for another voltage without rewiring. 2 glass-enclosed RECTICLES. Stainless GEARS. PLASTIC GEL CELL DEHYDRATOR with tell-tale colored SILICA GEL. Die cast aluminum case hermetically sealed. 24" CABLE. 10 coded WIRES. Detailed instructions. Detachable recoil shock BASE. 25-leaf spring bronze SLIDE on precision stainless ground RODS, azimuth CLAMP, bolted to wood shipping base. Padded cover. New original package. Send check, money order, or cash. No C.O.D.'s. Express collect.

GE SELSYN CONTROL TRANSFORMER \$1.95
24 volts. Limited quantity — Only

BUFFALO SURPLUS CO.
26 E. NORTH ST. • PHONE GARFIELD 7706
BUFFALO 3, N. Y.

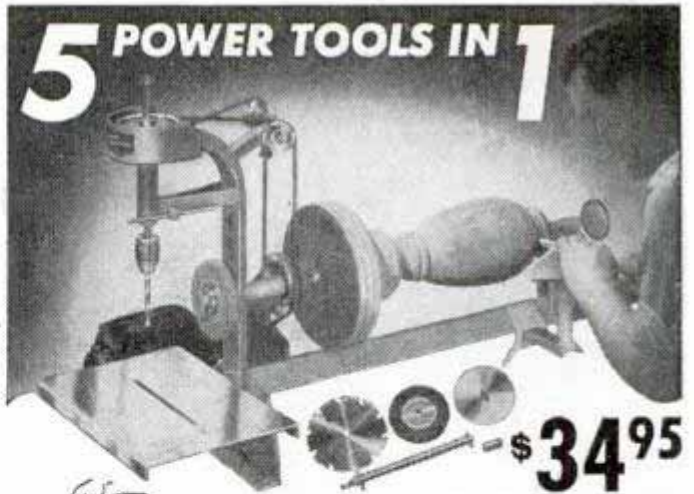

5 POWER TOOLS IN 1

COMPLETE HOME WORKSHOP
Here is power tool pleasure and profit in a ruggedly built, HEAVY steel unit—the Emrick Universal Woodworker. Handles big work. Drill press pulls 1/2" drill in steel. Saw takes 6" to 8" blade. Lathe 10" swing, 30" centers, spindle dia. 3/4". Takes all standard accessories. Sander 8" dia. Emery wheel 5". Bronze bearings, replaceable throughout. Price does not include motor and saw blade. Order today.

10 DAY TRIAL
1734 CLINTON STREET
EMRICK, Inc. KALAMAZOO 24, MICH.
 Ship on 10 Days Trial. I am enclosing \$17.50, balance C.O.D. Send free literature.
Name _____
Address _____ City _____

REMOVES ALL FINISHES



NO BENZOL-ACID-CAUSTIC-ALKALI-SAFER TO USE

New type semi-paste remover quickly lifts off paint, enamel, varnish, shellac, lacquer, bakelite and other synthetic resin finishes. (Removes emulsified resin water paints, too.) Stays wet longer — stays put on upright or overhead surfaces — strips clean, quick. One coat usually enough (apply with brush or spray). Contains no benzol, acid, caustic, alkali, or wax — harmless to hands, bristles, surface stripped. All sizes (pint 65c) at paint and hardware stores.

FREE CIRCULAR

"How to Remove Paints, Varnishes, Lacquers, etc." Also describes other Savogran Products: Heavy Duty Cleaner, Crack Filler, Wood Putty, Remover & Bleacher (renews floors), Paint Brush Cleaner, Coldfoam Soapless Soap Powder.

THE SAVOGRAN CO.
DEPT. 42, BOSTON 10, MASS.

It's Orange!



SAVOGRAN STRYPEEZE

IN EVERY WELL-EQUIPPED HOME WORKSHOP

Larson

"MAKE YOUR OWN" FOLDING SAW-HORSE SET



IN USE

A brand new LARSON construction set, with copyrighted instruction sheet for easy assembly. Set makes two complete Folding Saw Horses,

that can't be beat for general household use. They are rigid yet light in weight and fold compactly for storage. Can be made to any reasonable height or length. Lumber not included in set.



Prepaid \$2.50 FOLDED
CHAS. O. LARSON CO., BOX 358, STERLING, ILLINOIS

REALLY TOUGH!

Here's
30,125 Pounds
of Proof



GITS UNBREAKABLE PLASTIC FLASHLIGHTS

A 15-ton truck—running squarely over them—didn't crack any plastic part of these sturdy Gits flashlights! So—normal use cannot possibly damage them. They're made of unbreakable ethyl cellulose plastic. They give you a strong, pre-focused "Mile" of light beam... cast from brilliant nickel-plated non-tarnishing lacquered brass reflector... thru shatterproof lens. Their 3-way ON-OFF and Signalling switch always works! Available now at your dealer's in lustrous colors or transparent battery-view case. Get a Gits flashlight—and you'll have the best!

A Great Gift!

GITS
Molding Corporation
CHICAGO



Model 100
Retail \$1.15

Model 122
(with extra bulb)
Retail \$1.95



GET THE MOST IN POWER TOOLS

Make every dollar you invest in shop tools buy a full dollar's worth! Get all the versatility and true economy of a precision tool engineered by power tool specialists.

SANDMASTER

Lever controlled depth of cut; "sealed for life" bearings; graduated quadrant; 1/2" shaft extension for accessories; structural aluminum alloy construction.

See this and other D-J tools at dealers everywhere.



PLYWOOD Beautiful cabinet and paneling stock. Perfect for many projects, and for general construction and cabinet work. Thicknesses 1/32" through 3/4"; panels 6" x 6" through 48" x 96". Birch, Gum, Oak, Mahogany, Walnut, Maple, Basswood. Send 25c (refundable with first order), for Catalog.

Carmen-Bronson Corporation
165 East 3rd Street, Dept. 4-B, Mount Vernon, N. Y.

SIX BAND COMMUNICATION RECEIVER BC-348

Featuring coverage from 200 to 500 KC and 1500 to 18,000 KC on a direct reading dial with the finest vernier drive to be found on any radio at any price—extreme sensitivity with a high degree of stability—crystal filter—beat frequency oscillator with variable pitch control—antenna compensation—standard 6 volt tube types. Contains a 24 to 32 volt DC plate dynamotor in com-

ALUMINUM GEAR BOX 18x8x7 with 62 matched gears from 1/2 to 4", and 2 powerful electric motors—\$3.00. Send for catalogs.

BUFFALO RADIO SUPPLY, Dept. 4M, 219-221 Genesee Street, Buffalo, New York

partment within the handsome black crackle finish cabinet, the removal of which leaves plenty of room for installation of a 110 V power supply. These receivers, which make any civilian communications receiver priced under \$200.00 look cheap and shabby by comparison, are only \$44.50. Power supply kit for the simple conversion to 110 V, 25 or 60 cycles, is only \$8.50 additional.

Own a set with EXCLUSIVE FEATURES— NEW Bruning High Quality Drafting Set!

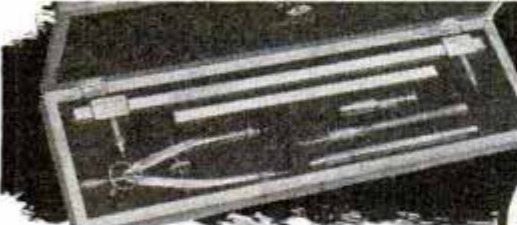

Nowhere Else Can You Get
ALL THESE ADVANTAGES!

New Type Ruling Pen—patented calibrated collet adjusts nib opening—easy to reset to maintain uniform width of lines. Mahogany club style handle.

New Beam Compass—rapid, simple and positive adjustment. Compass draws circles either in pencil or ink up to 24 inches in diameter.

New 6-Inch Giant Bow Compass—for drawing circles either in ink or pencil from 1-16 to 8 inches in diameter. Patented lead propelling device advances lead without soiling fingers.

New Draftsman's Refillable Pencil—can be converted to double point merely by removing screw cap and replacing it with extra tip and chuck furnished.

Plastic Tube containing extra leads, needle points, pen part, pencil tip and chuck completes the set.

PRICE
\$20.60
NO C. O. D.

Nowhere else can you get these patented exclusive features that help make your work easier—neater—more accurate! Set contains four essential, high precision instruments made of satin finish aluminum and chrome-plated steel in flock-lined natural finish mahogany case. Every instrument backed by the famous name Bruning! Get your set now—mail the coupon!

Charles Bruning Co., Inc.
4722-28 Montrose Avenue, Chicago 41, Illinois

Please send me (show number desired)..... Bruning
Industrial Drafting Set(s). I enclose \$.....

Name.....
Address.....
City..... State.....

RATS

K-R-O Kills on a Money-Back Guarantee

"I used K-R-O and killed 827 rats which invaded my farm," reports Adolph Bufe, Wilton, Calif., farmer. Think of it! . . . 827 rats! K-R-O is effective. It is also safer to use because it contains no deadly poisons. Two-ounce 75c package will make 200 baits. At most drug, feed, and seed stores. Get K-R-O today!

K-R-O

FOREDOM

Flexible Shaft

MACHINES

with the "PENCIL-SIZE" handpiece

Foredom's remarkable PENCIL-SIZE HANDPIECE gives you finger-tip control in performing scores of tasks—grinding, polishing, de-burring, sharpening, cleaning, slotting, milling, etc. Gets into tight places that ordinary tools cannot reach. Used on all metals, wood, glass and plastics. More and more Foredoms are coming off the assembly lines each day. Order Now,—you won't have to wait too long for delivery of your Foredom. Prices range from \$19.95.

Catalog No. 61 on request.

Over 60,000 Foredoms now in use!

FOREDOM ELECTRIC CO.

27 Park Place, Dept. 61.

New York 7, N. Y.

LEARN TRIG QUICKLY—EASILY

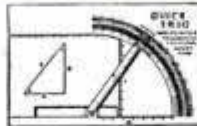

WITH QUICK TRIG, BY COMPETITIVE TESTS, it was found that QUICK TRIG gave answers faster to one with a slight knowledge of trig than to an expert on trig with a slide rule. Simply set the slides and read the answers for all three sides and angles of a triangle. Also gives degrees, sines, cosines and tangents of angles. Entirely automatic. Easy instructions included. We mail C.O.D. plus postage or enclose \$1.00, the full price, and we will mail postpaid. Send now for your QUICK TRIG, to REED MFG. CO., 124-T W. 4th St., Los Angeles 13, Calif.

BUILD THIS TILTING TABLE SAW



- 21x27 in. table tilts to 45°.
- 8 in. blade cuts from 0 to 2½ in.

- Ball bearing mandrel
- Self-aligning and indexed rip fence and mitre gauge

- Sturdy wood, steel, and aluminum construction
- No machining—build easily with hand tools
- Ability to read blueprints not necessary
- Precision mandrels available at low cost
- Operate with any ¼ to ½ H.P. motor
- Performance of \$60.00 saw at ¼ the cost

Send \$7.00 for easy step-by-step plans

GIL-BILT

P.O. Box 1-M, Lambert Field St. Louis 21, Mo.

New INVENTION



PURIFIES WATER

NOW ONLY

\$3.73

PLUS 12 DISCS

Amazing New Filtering Device YOU GET all 3 With Activated Charcoal . . .

NOW enjoy clear, clean water. Attach new handy Klearing Water Filter to your faucet or tap. Filtering disc with activated charcoal cleans all water, takes out chlorine, impurities. Have clean water for drinking, good coffee, washing hair, Nylons, etc. Valuable in photographic development. Remove base and convert filter into all-purpose spray. Made of durable, rust-proof metal with attractive plastic housing. Complete with 12 filtering discs, each good for 500 glasses of water. Discs replaceable.

CLEAN DRINKING WATER

SPRAY FOR VEGETABLES DISHES

NO SPLASH FULL RUNNING FAUCET

SPECIAL OFFER: Klearing does work of water conditioning systems costing many times as much. For limited time buy from factory at special low price of only \$3.73, prepaid. Fully tested and proved in leading laboratories.

SEND NO MONEY: Don't pay now. Upon delivery pay postman \$3.73 plus small delivery charge. Or send \$3.73 for prepaid delivery.

GUARANTEED: Klearing is absolutely guaranteed. Use five days and if not satisfied, return in good condition for money back. Rush order today. Supply limited at this low price. Illustrated Folder FREE. Dealer inquiries invited.

EMPIRE DISTRIBUTORS, 180 N. Wabash Ave., Chicago 1, Ill.

FREE

It's NEW, it's BIG, it's COMPLETE; it's Lafayette's latest, greatest catalog brimming with ALL that you want in Radio and Electronics. Radiomen and servicers, hams and dealers, hobbyists and experimenters. Send for it.

BIG NEW LAFAYETTE CATALOG



It's crammed with standard as well as new items—they're all in stock—they're ready for super-speed delivery—they're priced for super-economy. If radio's your hobby, if radio's your business, if you're mild about it or wild about it—this is the book for YOU. It's yours, FREE.

Lafayette Radio

RADIO WIRE TELEVISION INC.

NEW YORK 13
100 6th Ave.,

BOSTON 10
110 Federal St.,

NEWARK 2
24 Central Ave.,

■ LAFAYETTE RADIO, Dept. LD-7
■ 100 Sixth Avenue, New York 13, N. Y.

■ RUSH new big radio catalog to:

■ Name _____
■ Address _____
■ City _____ State _____

JUST OUT!
BRAND NEW GOV'T SURPLUS
SOLID BRASS 12 FOOT PORTABLE
RADIO ANTENNA
Real \$15 value now only \$4.95 POST PAID
FOR HOMES, BOATS or AUTOS

Same as used on Army tanks. These telescopic rustproof antenna have a tremendous pickup and eliminate dangerous wiring. Solid Brass throughout practically insures **NOISE FREE RECEPTION.**

12 exceptionally rugged sections
compress into 1 ft. 4 in.

Handy for Camping Trips, also Useful for
Transmitting, FM & Television sets

Each antenna comes with clamps, nut, lug, and wire. Easy to install anywhere.

QUANTITY LIMITED

MAIL ORDER TODAY. A real \$15 value for only \$4.95 Postpaid. Send check or money order now or mailed C.O.D. plus postage. Money back in 10 days if not satisfied.

RADIO HOSPITAL

1113 LEXINGTON AVE., DEPT A5
 NEW YORK 21, N. Y.



NO MORE BATTERIES FOR ME!

BRILLIANT LIGHT AT ALL RIDING SPEEDS—AND BULBS WON'T BLOW!
GOOD LIGHT EVEN AT A WALK—NO DIM-OUTS!

MAKE-A-LITE

BIKE LIGHT Generator

It's a knockout! Generates brilliant light for head and tail lamps. No more battery bother. Make-A-Lite's automatic voltage control generator prevents blowing of bulbs at high speeds... gives sure, bright light at snail's pace.

See the new MAKE-A-LITE head and tail lamps. Rich new finish makes your bike look like a million!



Now at your bicycle, sporting goods, hardware or automotive store

MAKE-A-LITE DIVISION
 Chefford Master Mfg. Co., Inc. • Fairfield, Illinois

MILL IT ON YOUR LATHE



WITH A **PALMGREN**
MILLING ATTACHMENT



No. 250

IMMEDIATE DELIVERY

No.	Width Jaws	Depth Jaws	Jaws Open	Weight Pounds	Base Opening	Price P. O. M. Factory
150	1 1/2"	1"	1 1/2"	6 1/2	1"	\$18.75
250	2 1/2"	1 1/2"	2 1/2"	11	1 1/2"	24.75
400	4"	2 1/2"	4"	25	2"	39.75

Order from your dealer or jobber. Write for circular No. 349

JUST A FEW OPERATIONS YOU CAN DO ON YOUR LATHE!

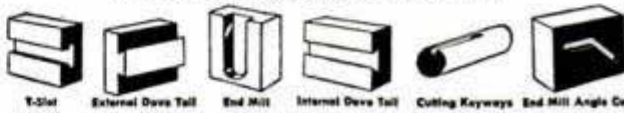

CHICAGO TOOL AND ENGINEERING CO.

Mfrs. of PALMGREN PRODUCTS for Over 28 Years

8365 South Chicago Avenue • Chicago 17, Illinois

BUILD YOUR OWN MACHINE TOOLS!
Blueprints \$1.00-Catalog FREE

Detail construction Blueprints on 6 Lewis metal and wood-working tools postpaid for \$1.00. Includes prints for Lewis 10" Shaper, Milling Machine, Drill Press, Vise, 8" Circular Saw, 6" Jointer. Castings for these tools save up to 80% of comparable new tool cost. Illustrated 32-page Catalog—sent free with Blueprint Order—describes 21 Lewis tools. **WRITE TODAY!**

LEWIS MACHINE TOOL CO.
 P. O. Box 7446, Sta. L, Dept. M, Los Angeles 23, Calif.



It's A COOLER!

It's AN ANCHOR!

It's ANCHORCHIEF!



FILL ANCHORCHIEF with stones; 25 lbs. makes a fine anchor! Fill ANCHORCHIEF with bottles, cans; cool them under water! Handy, convenient, ANCHORCHIEF folds to fit your pocket—adds more pleasure to fishing and boating. Get yours today!

ALCRAFT INC. DEPT. A-4
 P. O. Box 329, Bronxville, N. Y.
 Here's \$2.65—Rush my ANCHORCHIEF to:

Name _____
 Address _____
 City _____ State _____
 Name and address of my Favorite Dealer _____

King of Mini-Motors and Many Others!

All for \$3.95 ea.

- A DELCO new type ALNICO FIELD, 6 to 30 volts DC, 60 to 250 RPM powerful torque. REVERSIBLE.
- B DELCO new type ALNICO FIELD, 6 to 30 volts DC, 10,000 RPM at 30 volts. Bronze Flywheel.
- C BENDIX 7500 RPM 28V AC & DC REVERSIBLE.
- D F. A. SMITH 10,000 RPM 27V AC & DC with worm gear. Right angle gear drive and Clutch attach., \$2.00 add.
- E DIEHL 7500 RPM 24V AC & DC shunt wound, also 110V AC intermittent. REVER.

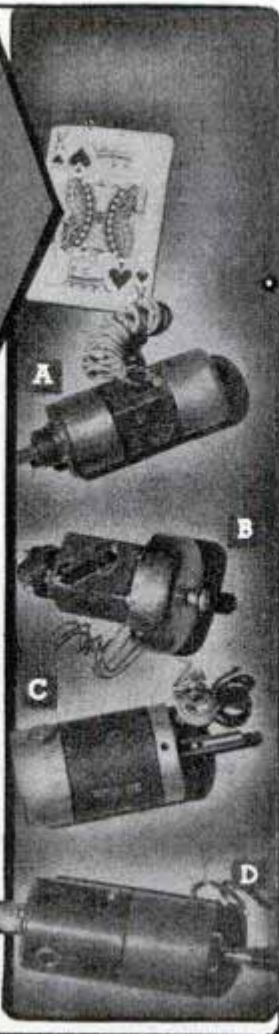

WRITE FOR COMPLETE INFORMATION

AMERICAN SURPLUS TRADING, 332 Canal St., N. Y. 13

Who Wants to Paint a Submarine?

OF COURSE—No one wants to paint a submarine, but to get a paint that is made from the same materials, the "miracle ingredient," they developed during the war to produce a paint that would stand up for submarine use, that's different. Such a remarkable paint is now available in the new RESINITE. Gives you the finest, hardest, glossiest finish you ever saw. It's a super-paint that withstands salt air, salt water, rain, snow, alcohol, road tar. Use it inside or outside, for autos, woodwork, furniture. Absolutely nothing else like it available to the home owner. Lasts longer, goes farther; one coat is enough when you use RESINITE. Comes in a range of popular colors. Would you like to give your sun porch furniture a finish as smooth, glossy and hard as your radio cabinet has, or like your enameled refrigerator? RESINITE will do it!



SPECIAL OFFER

RESINITE is now being introduced to leading paint dealers and hardware stores. If your own dealer has not yet stocked RESINITE, order direct from our factory. For a limited time, if you send the name and address of your dealer and the store manager's name, along with your order, we will allow you a discount of 25c on each quart of RESINITE you purchase direct. Price, only \$2.95 per quart. F.O.B. Chicago, RESINITE CHEMICAL CORPORATION, Dept. D-2, 332 South Michigan Ave., Chicago, Ill.



only \$2.95 PER QT.

RESINITE FOR ANY SURFACE ANYWHERE

Fishing Worms

ALWAYS AVAILABLE WITH THIS UNIQUE ELECTRICAL APPLIANCE WHICH BRINGS DOZENS TO THE SURFACE IN SECONDS. MAIL TWO DOLLARS FOR COMPLETE SET WITH INSTRUCTIONS.

\$2 POST PAID

AMERICAN ELECTRO BAIT CO. DEPT. A, P. O. BOX 4495 WASHINGTON 17, D. C.

FURNACES PROPANE BUTANE

Forced air furnaces for liquified gases. BLOWERS—gas & oil floor furnaces. Gas & Oil Burners. **SELL & INSTALL.** PEERLESS SALES, 4318 Sheridan Blvd., Lincoln 6, Nebr.

Do You STILL CHANGE MOTOR OIL??

If so—you can END this needless waste and expense forever, with "RECLAIMO"

America's Foremost Oil Re-Refining Filter. Continuously re-refines crankcase oil through an ingenious use of motor heat while driving!

1. Removes solids by filtration
2. Removes water-fuel dilution by heat and distillation
3. Prevents acid-sludge formation
4. Maintains stable viscosity
5. ELIMINATES ALL OIL CHANGES!

GET THE FACTS!

OIL FACTS

RECLAIMO Oil Re-Refining Filter

RECLAIMO MFG. CO. IN THIS

FREE 40 PAGE BOOK

CAR—TRUCK—TRACTOR and DIESEL OWNERS!
U. S. Bu. of Stds. Bul. 86 states: "Oil Does Not Wear Out Mechanically"—"Reclaimo's" re-refining action has fully confirmed that statement. This great oil-saving feature is indeed important, BUT of far greater importance are the savings resulting from "Reclaimo's" tremendous reduction of costly motor wear! Again available—also to dealers. Complete details in FREE Book "Oil Facts". Write now! RECLAIMO MFG. CO., 5087 Elston Ave., Dept. 39, Chicago 30, Ill.

A GALLON OF GAS

Think of it—a six-mile ride for just one cent! With a WHIZZER Motor on your bike, you'll enjoy America's thriftiest power transportation. 2½ rugged horsepower... modern 4-cycle design... speeds up to 35 miles an hour... precision engineered for trouble-free performance. Fits any man's balloon tire bike. Join the WHIZZER parade now!

TAKES YOU 125 MILES

RIDE ONE AND YOU'LL BUY ONE!

ONLY \$97.55 PLUS TAX

ON A **WHIZZER**

Whizzer Motor Company, Dept. 524, Pontiac, Michigan.

I enclose \$99.97, which includes \$2.42 Federal Excise Tax () check or () money order. Send me one WHIZZER Motor complete, ready for installation. If descriptive literature only is desired, check here ().

Name _____ City _____
Street _____ State _____

Drill Press

WORK SHOP TOOLS BY

Barron



5-in-1 ROTARY DRILL PRESS PLANNER—PLANES, PANELS, RABBETS, ROUTS, TENONS, GROOVES

\$7.50

Over 60 000 now in use by pattern and cabinet makers, carpenters, hobbyists, etc. Fits any drill press. Lightening fast, accurate, safe, easy to use. Complete. No special blades needed. No shop complete without COMPLETE it. Fully guaranteed. For all woods and plastics.

New Style MORTISING and ROUTER BITS

Range in size from 1/8" to 1/2". Priced in individual sizes or by the set. Provides entirely new spiral flute cutting principle for faster chip clearance, smoother, accurate routing, carving, veining, grooving, round-end mortising. Extra long cutting flutes. Finest hi-speed tool steel—Super SIZES for woods and plastics.

\$9.50



NEW! 4' Rotary Surface SANDER



New larger Barron Sander with live sponge rubber pad bonded to metal. Sanding discs changed instantly. For use on any drill press, flexible shaft or motor. Guarantees a dead-true, agate smooth surface. No ridges, waves, ripples, or striations. Fully guaranteed. Complete with 20 sanding discs.

\$5.95

ANNOUNCING

New Dovetail Cutting Tool for Drill Press \$1.85 each. All Metal 13" x 18" Auxiliary Drill Press Table \$9.85. Tapered and Threaded Drill Press Adapters \$1.00 and \$1.50 each.

Liberal 10 Day Money Back Guarantee

Workshop Guide FREE



BARRON TOOL CO.

569 Architects Bldg., Detroit 1, Mich.

THE WORLD'S COOLEST, CLEANEST SMOKE!

BRAND NEW, LIGHT, LUSTROUS

ALUMINUM PIPE \$2.50 Postpaid Complete

Thoro-Kleen Pipes have all the features of pipes selling for \$10 and more. Each pipe is packed in pipe-sack and handsome blue gift box. Fully guaranteed.

BANNER TOBACCO CO., Dept. PM
50 Court St. Brooklyn 2, N. Y.



WARNING SIGNAL WHEN TIRES GO LOW!

DETECTO SAFETY TIRE SIGNAL

SAVES TIRES! PREVENTS ACCIDENTS!

CLAK! CLAK! CLAK!

A crystal-clear signal reaches you above all car noises, even radio, before tires reach dangerous low levels. Warns you to stop before tire is ruined! Warns you to refill tires! Don't take chances. Install DETECTOS on your car, truck, trailer today.

EASY TO INSTALL! LOW COST PROTECTION!

You can install a set of DETECTOS in minutes time. Just deflate tire. Slip DETECTO between rim and tire on inside of each wheel, then inflate. You won't see it but you'll know it's there when tires get low.

10 DAY TRIAL: Try a set of DETECTO tire signals at our risk. Use them for 10 days. If not completely satisfied return for full refund.

SEND NO MONEY! Just clip this ad and mail with your name and address. Pay postman \$4.95 plus few cents postage on arrival; or send cash and we pay postage.

ROBERT REX & ASSOCIATES
641 WORLD-HERALD BLDG., OMAHA 2, NEBR.

PLEASE SEND ME _____ set of 5 Detectos—\$4.95 Postpaid
_____ trial Detectos—\$1.00 Each Postpaid

Ship C. O. D. Cash enclosed

Name _____
Address _____
City _____ State _____

FILL OUT & MAIL ORDER TODAY!

SAFE-T-PLANE

CUTS WOOD, METAL, PLASTICS
FITS ANY DRILL PRESS!

ONLY \$5.95 Versatile rotary planer for faultless wood surfacing. Improved cutter makes tenons, panels, grooves, beads and routing cuts. Adaptive blade speeds work in nonferrous metals and most plastics. Has exclusive, polished safety bell guard. Only one blade to adjust. Needs no adapter. Unconditionally guaranteed.

NOW SUPER STAIR GAGE FIXTURES NO. 49

Instantly clamped on carpenters' steel squares to lay out angles for stair stringers and other saw cuts. Hi-grade steel—brass set screws.

At Your Dealer — or Postpaid

A. D. MCBURNEY, 939 WEST SIXTH STREET
Dept. PM4 **ONLY 75c**
Los Angeles, Calif. per pair

You Now Can BE YOUR OWN BOSS

Start a business with this new modern invention. With a small investment you can, without exaggerating, make from \$75.00 to \$250.00 per week. No experience necessary. Write for FREE literature.

Precision Key Mfg. Co.
657 Columbia Street Dept. 5
San Diego 1, California

NEW **The Handy "SCREW GRIPPER"**

EACH \$1.00 POSTPAID
ONE DOZ. \$8.00 POSTPAID

Starts screws in hard-to-get-at places. Saves time and temper. Dealers, jobbers, salesmen wanted.

SCREW GRIPPER CO. MUSCATINE, IOWA

WORLD'S LOWEST PRICED ADDING MACHINE

VEST POCKET SIZE
IDEAL FOR BUSINESS OR PERSONAL USE

FREE TRIAL
ONLY \$2.50

TOTAL COST **SEND NO MONEY**

Each Baby Calculator in Beautiful, rich-looking Leatherette case — at no extra cost. **FREE!!**

Fits vest pocket or purse. Guaranteed accurate. Operated as easily, and as reliable, as machines costing many times as much. Not a toy. Substantially made of 28-gauge steel—guaranteed for life against defects in construction. You positively can't buy a calculator of equal quality for as little money. **ACCEPTED AS THE FINEST LOW PRICED CALCULATOR FOR OVER 30 YEARS!** Operates with a flick of your finger. Adds, subtracts, multiplies, divides—counts up to ten million. Pays for itself over and over in mistakes avoided, and time saved. **MAKES IDEAL GIFT.**

Sold on a positive money back guarantee. Send only \$2.50. Calculator sent postpaid, or send name and address and pay postman \$2.50 plus postage. **MONEY BACK IN 10 DAYS IF NOT DELIGHTED!** (If outside U. S., send \$3.00.)

AGENTS WANTED.
CALCULATOR MACHINE CO. (Mfrs.)
Dept. 189, P. O. Box 248, Glenview, Illinois

HAND MICROPHONE



Top quality hand microphone with control button in handle. Highly sensitive. Has rubber covered cord and tel. plug. Fine for use on home recorders, public address systems, etc. Brand new—perfect. Shp. wgt. 2 lbs. Stock No. 170. Each... **\$1.95**

MESS KITS

Regulation two-piece Army Mess Kits with folding handle. Used, but perfect. Weight 2 lbs. No. A116—Ea. **69c**



CANTEENS

Reg. U. S. issue canteens. Plastic screw top chained to body. Slightly used but perfect. Wgt. 1 lb. 117—Metal **69c**
118—Plastic—Ea. **69c**



CANTEN CUPS

All metal. Folding handle. Wgt. 1 lb. No. A120—Each... **25c**

CANTEN COVERS

Heavy canvas. Button fastener. New No. 530—Each... **69c**
Used No. 119—Each... **35c**

ARMY BANDOLEERS

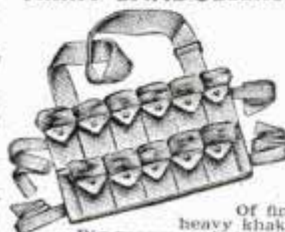

Of fine heavy khaki. Big roomy pockets with snap button fasteners. Fine for hunters, campers, boy scouts, etc., also for shop work in carrying small parts, etc. Material alone is worth this price. Shp. wt. 1 lb. 11 Pocket... **49c**
5 Pocket... **29c**
Type No. 110 Each **29c**

Wool Blanket
Full size and 100% wool. Used but renovated for re-issue. Use for camping, etc. Shp. wgt. 3 lbs. No. 233—Each... **\$4.89**

BAYONET BLADE
Fine forged steel. Ground but not polished. May be made into throwing or hunting knife or spear. Blade 6 3/4 x 1/8 inches, 11 3/4 inches overall. Will take and hold a fine edge. Shp. wgt. 1 lb. No. 664-R—Each... **49c**

PROF. TELEGRAPH KEY
Purchased from the gov't. Finest design and construction. Base measures 3 x 4 3/4 inches. Original value \$2.50. All parts of instrument brass. Adjustable. A-147—Each... **98c**



LIFE PRESERVER BELTS

Right from the invasion beaches. Consists of two air chambers. May be inflated automatically with "sparklet" cartridges or manually by attached hose. Adjustable in waist size. One air chamber guaranteed air tight—other may need a tire patch. All belts are used and slightly soiled but a bargain at this low price. No. 1261—Each... **\$1.00**

SPARKLET CARTRIDGES
May be used with above belts. In boxes of 10. Stock No. 254. Per Box... **50c**

WAR SURPLUS AND HUNDREDS OF OTHER BARGAINS

POPULAR RECORD ASSORTMENT

Fifty records of modern dance, race, blues and hillbilly selections. No two alike. Famous name bands and artists included. Used in juke boxes, but guar. perfect. Shipped exp. collect only—no exchanges or refunds. Wgt. 28 lbs. No. A303—50 records... **\$9.64**

No. A300—25 Records. All Dance. Wgt. 14 lbs. \$4.88	No. A301—25 Records. Hillbilly, Race and Blues. Wgt. 14 lbs. Set... \$4.88	No. 302—25 Records. All Hillbilly numbers. Wgt. 14 lbs. Set... \$4.88
---	---	--

TELESCOPING BAIT AND FLY ROD
Combination 4 piece telescoping bait and fly casting rod. Screw locking reel seat. Cork grip. Snake guides. Extends to 9 feet, telescopes to 38 inches. Shp. wgt. 1 lb. No. F411—Each... **\$3.65**

SATCHEL POUCH
Heavy canvas pouch. Ideal for totting lunches, shopping, books, etc. Has three 11 x 12 inch pockets. Brand new, guaranteed perfect. Has over-size flap with single strap fasteners. A113—Each... **\$1.69**

Plastic 8 oz. Flask
For hunters, scouts, fishermen. Waterproof and transparent. Use it for liquids. Use it for matches, flies, bait, etc. Has screw cap top for liquids. Size full open top. Size 5 1/2 x 4 1/8 x 1 1/8 ins. Has hundreds of other uses. Wgt. 1 lb. No. A347. Each... **29c**

7 LB. EXPERIMENTER PARTS ASSORT. KIT
A "gold mine" for the radio serviceman. Hundreds of valuable radio parts, new radar and electronic parts and subassemblies, coils, resistors, trimming condensers—worth many times this low price. A130R—7 lbs. **\$1.79**

RADIO HEAD-PHONES
Extremely sensitive with 4000 ohms resistance. Brand new and fully guaranteed. With moisture-proof cord and phone plug. A splendid value for the radio serviceman and experimenter. A106—PAIR... **\$2.95**
New super sensitive phones. A108—Pair... **\$9.95**

BOMB PARACHUTE
Of white rayon 5x8 feet in diameter. Split seam for directional dropping of bombs, emergency rations, etc. Each packed in a metal container. Material alone worth more than price quoted. Wgt. 6 lbs. No. 162. Each... **\$1.95**

OXYGEN TANKS
A shatterproof, welded seam oxygen tank. Fits gauge listed above. Measures 5 1/2 x 8 in. Internal volume 104 cu. in. Square inch pressure 1.4 cu. ft. Has 3/8 inch pipe thread vent. Shp. wgt. 2 lbs. No. 537. Each... **49c**

WOOL SLEEPING BAG
G.I. type 100% wool with 30 inch Talon zipper. Used but renovated for reissue. Shp. wgt. 3 lbs. No. 165. Each... **\$3.95**

LEVEL WIND ANTI BACK LASH REEL
Highest quality with chrome plated frame. 3 piece take down design, 4x gears, bronzed bearings and jeweled spool caps. Spool diameter 1 1/2 ins.; pillar lengths 1 1/2 ins. Capacity 100 yard line. Onyx head ring. Shp. wgt. 1 lb. No. 450F—Each only... **\$8.55**

RAIN SUITS
New 2 piece rain suits. Of durable wear resisting water and wind repellent OD fabric. Bib style pants, zipper fly. Jacket has parka attached. Guaranteed 100% weatherproof. Small, medium and large sizes. Shp. wgt. 3 lbs. No. R549. Ea. **\$4.95**

2 Man Mountain Tent
Regulation Army type two man mountain tent, complete with poles, guy ropes, etc. Of durable nylon with reinforced seams. Ideal for outdoorsmen, campers, etc. Shp. wgt. 10 lbs. A splendid value. Stock No. 202—Each... **\$9.95**

PUP TENTS
Regulation Army Pup Tents of durable, brown canvas. Used, but in good condition. Fine for campers, outdoorsmen, boy scouts, etc. Grand Xmas gift for children. Wgt. 8 lbs. A100—Tent only... **\$3.95**
A110—Tent, new... **\$7.95**
A101—Ropes, wooden poles and stakes for above. Per set **\$1.00**

27 LENSES, ALL NEW, PERFECT.
For experimental work in optics. Consists of 27 precision ground and polished prisms and lens elements in assorted diameters and focal lengths. Big variety, positive, negatives, etc. Actual value over \$100.00 A519—27 PIECES... **\$7.95**

50 LENSES SEMI-FINISHED
Lenses similar to above but not polished. All are blanked and formed ready for polishing. Negatives, positives and prisms in Crown and Flint glass. Worth many times this low price. A520—50... **\$1.95**
LENSES, ONLY... **\$1.95**

ONE MAN RUBBER BOAT
Similar to above but smaller. Designed for one man use. Each boat complete with oxygen tank—packed in a special parachute bag. Wgt. 15 lbs. No. 526—Each... **\$17.95**

METAL TOOL CHEST
All metal welded construction. 16x 8 1/2 x 11 overall. Has 5 roomy, easy sliding drawers. Hinged drop front. Metal top and end handles. Use it for tools, small parts, etc. Shp. wgt. 6 lbs. Stock No. 282. Each... **\$9.75**

CAMERA TRIPOD
Purchased from Gov't. Used but perfect. For cameras up to 8x10 inches. Folds to 32 inches, extends to 58 inches. Needs adapter to mount camera. Wgt. 5 lbs. Stock No. 190. Ea. **\$4.95**

ORDER DIRECT FROM THIS AD

Values galore! Hundreds of hard-to-find items for home, shop and outdoors. Make remittances by money-order, bank draft or personal check. Send 25% deposit on C.O.D. orders. No C.O.D.'s on orders for less than \$5.00. Include sufficient postage on parcel-post orders—any overage will be promptly refunded. All quotations F.O.B. Chicago. Used items and materials are guaranteed serviceable and as described. Your money back if not more than satisfied.

Big Illustrated Catalog Free
Dept. PM447
509 So. State St.
STARK'S CHICAGO 5, ILL.

FIND OUT WHY THE
DEAF
CALL IT A MIRACLE

THIS ONE
TINY UNIT
IS ALL
YOU
WEAR

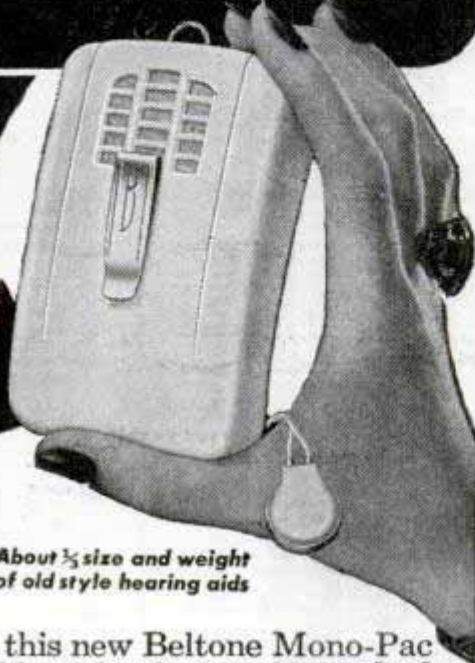

About $\frac{1}{2}$ size and weight
of old style hearing aids

You'd call this new Beltone Mono-Pac Hearing Aid a miracle, too, if you had been wearing a clumsy, annoying, battery pack strapped to your body with entangling wires, and then suddenly found the new Electronic Beltone. It's a single-unit hearing aid—so small you can hide it with the palm of your hand—so light you forget you are wearing it—so thin it is lost from sight—so efficient you bless the day you learned about it.

Those are a few of the reasons why more people are wearing Beltones than all other one-unit hearing aids combined.

GET FREE BOOK ABOUT HEARING PROBLEMS
and about the

NEW
Beltone
MONO-PAC
HEARING AID



FREE BOOK—MAIL COUPON

BELTONE HEARING AID CO., Dept. PM-74
1450 West 19th Street, Chicago 8, Illinois
Please send me, without obligation, FREE information concerning the new Beltone with the amazing X-Cell which out-performs units 5 times its size.

Name.....

Address.....

Town..... Zone..... State.....

YOU CAN NOW BECOME
A PROSPECTOR!

HERE IS ONE OF
THE WAR'S TOP SECRETS

BRAND (NEW)
ARMY MINE
DETECTORS!

Portable: Will Detect METALLIC and NON-METALLIC objects; Very Sensitive; using 955 Tube in detecting head; two tube amplifier using two 1N5gt; headset; or microphone; also 150 micro meter; Power supply; 3-45v.; one 6-v.; or 2 3-v. batteries. Complete with instr. Less Batteries; packed in original cases; shpg. wgt. 108 Lbs.

FOB. From N. Y.
Special

\$1750

No C.O.D.'s
With Batteries \$26.40
F.O.B. N. Y.

Send order to

COLUMBO TRADING CO., INC.
304 CANAL ST. NEW YORK 13, N. Y.

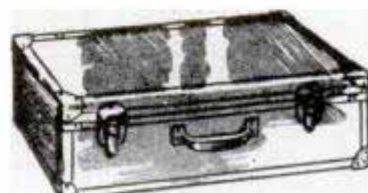

CARRYING CASE
DT-91/PRB-1

UNGAR Points
THE WAY TO BETTER SOLDERING

A LITTLE IRON THAT WILL
DO A BIG IRON'S WORK

Patterned for durability and soldering ease, this nimble pencil iron is equally at home performing large heavy duty jobs or in the hard-to-reach spots requiring pin-point accuracy.



No. 529 Pyramid
Tip, made from
Teflon



No. 530 Chisel
Tip, made from
Teflon



No. 537 Pencil Tip,
made from Delag
A. Tip Sp. 44.



No. 538 Chisel Tip,
made from Delag
A. Tip Sp. 44.

Check these points!

QUICK HEATING... 90 SECONDS
LIGHTWEIGHT... 3.6 OUNCES
HANDY SIZE... 7 INCHES
SAVES ELECTRICITY... 20 WATTS

These 4 INTERCHANGEABLE tips give
you a point for each particular job.

Light as a feather



Perfect balance

SEE YOUR NEAREST RADIO OR HOBBY DEALER

UNGAR Electric Tools Co.
BOX 2255, TERMINAL ANNEX - LOS ANGELES 54, CALIF.



Harold F. Hunt, Pres.

Get This Valuable New Book of 1500 ITEMS and IDEAS FOR THE WOODWORKER

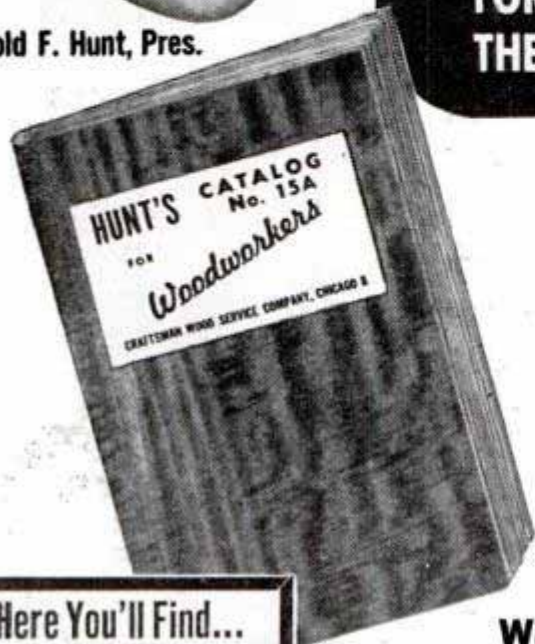

148 Pages of Bargains and Helpful Information

It's ready now—issue No. 15A of the woodworker's "bible!" Here is up-to-date information for all—beginners and experts. 148 pages packed with a world of the finest woodworking supplies obtainable. Enough practical hints and inviting projects to keep you going for years. Many pages in full color showing the natural beauty of fine woods and rich inlays.

World's Finest Selection of Imported and Domestic Woods

Once you get your hands on Catalog No. 15A you'll spend hours with it . . . time well spent checking the amazing selection of woods from all over the world, that are yours to work with at prices you can afford. There is Teak, Rosewood, Ebony, Mahogany, Zebra, Amaranth, Prima Vera and many others in a wide choice of sizes and veneers. Also Walnut, Birch, Cherry, Holly, Ma-

ple, plain and figured domestic woods. Large stock of plywoods, moldings, carvings, inlays, scroll patterns, clear and colored plastics, and hundreds of hard-to-get tools and hardware items. Included is a Special Beginners Guide and much information of value to the old timer on wood finishing, etc. More than a hundred special combination deals at extra low prices.

Here You'll Find...

- ★ Rare and Seasoned Lumber
- ★ Plywoods - Veneers - Inlays
- ★ Hard-To-Get Hardware
- ★ Stanley Tools and Routers
- ★ Paint Spraying Equipment
- ★ Electric Hand Grinders
- ★ Carving Tools
- ★ New Colored and Clear Plastics
- ★ 268 Patterns Illustrated

Everything at Money-Saving Prices

**YOUR COPY
OF BIG NEW
CATALOG No. 15A**

ONLY 15c

(Refunded on First Order)

AVAILABLE NOW!

This fascinating new book is the ONE source for all you need to get started and keep going in woodworking. Present edition is limited, so use the coupon below today. The 15c is refunded on first order. See for yourself how valuable this big new 1947 Bargain Catalog, backed by Craftsman's years of prompt and convenient service, can be to you. Better act right now.

Useful Wood Projects For Pleasure and Profit

You can't beat woodworking for the satisfaction it offers as a hobby, and even as a profit-maker.

Catalog No. 15A gives you hundreds of projects to choose from whatever your skill may be. Enjoy the thrill of working with rare and beautiful woods and in seeing and using the worthwhile articles you make. The catalog coupon starts you. Use it.



CRAFTSMAN WOOD SERVICE CO.
2729 S. Mary St., Dept. A-80, Chicago 8, Ill.

MAIL THIS CATALOG COUPON NOW!

HAROLD F. HUNT, President

CRAFTSMAN WOOD SERVICE CO.

2729 S. Mary St., Dept. A-80, Chicago 8, Ill.

Enclosed find 15c—refundable on my first order—for which please send me your new 1947 Catalog No. 15A.

Name _____

Address _____

City _____ Zone _____ State _____

SOUTH BEND LATHES

Simplify Precision Work

The ease with which South Bend Lathes can be changed from one set-up to another simplifies precision work. A wide variety of operations on special classes of work, ordinarily done on other types of machines, are readily performed by means of South Bend attachments. South Bend Lathes have wide ranges of spindle speeds for efficient performance on all materials. The quick change gear mechanism permits instant selection of any thread cutting feed, power turning feed, or power facing feed.



South Bend Lathes are made in five sizes—9" to 16" swings. Write for Catalog 100-F.

SOUTH BEND LATHE WORKS

BUILDING BETTER LATHES SINCE 1906

455 EAST MADISON STREET • • SOUTH BEND 22, INDIANA

ELECTRIC GRINDER

One of the 60 available attachments and tools that give South Bend Lathes unmatched versatility.

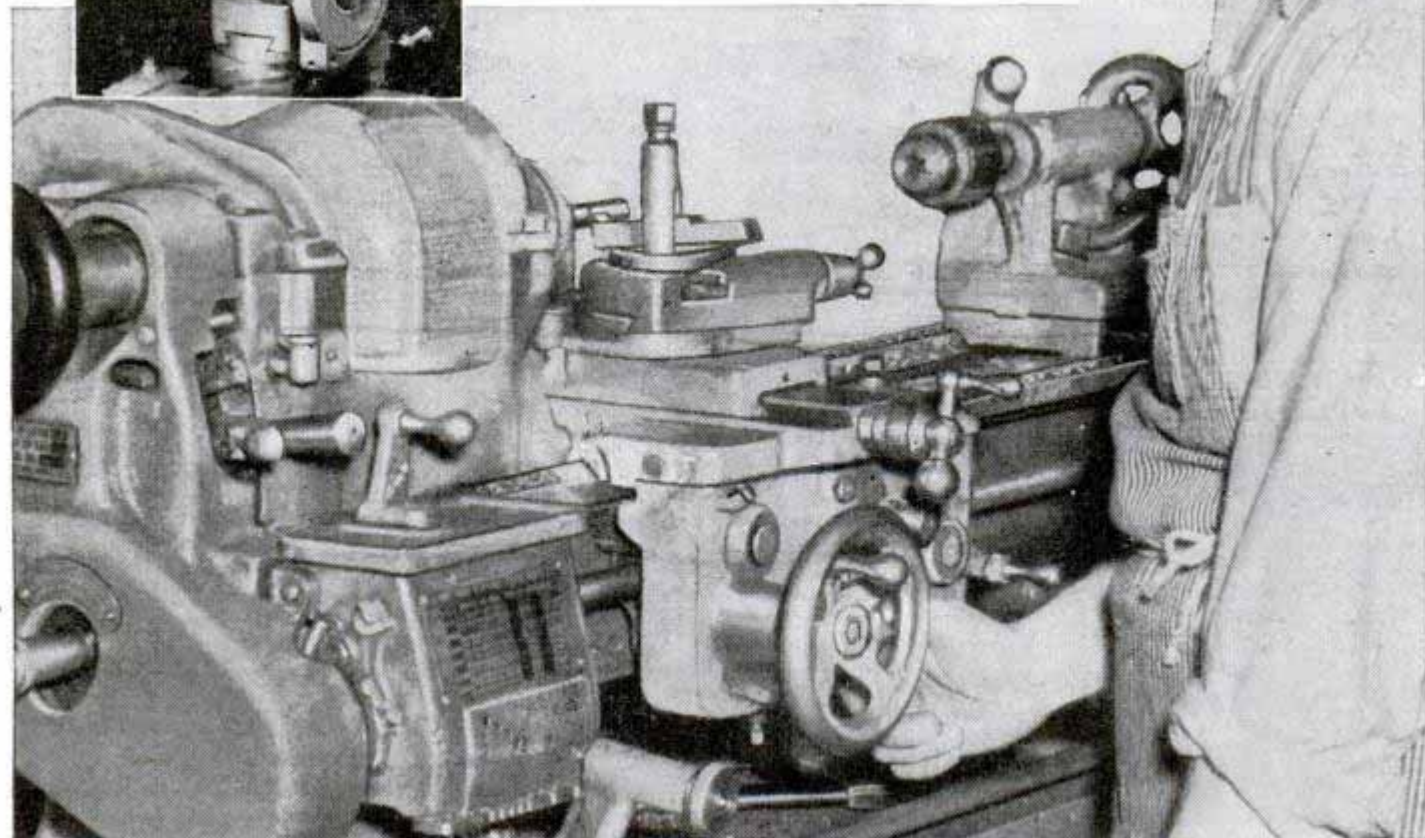
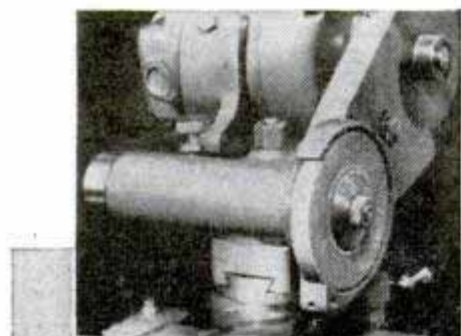

PRICES
START AT

\$145

F.O.B. FACTORY

A CHAMPION WITHOUT EQUAL by FRANK WILLIAMS

THE GRAND LITTLE MAN OF BILLIARDS

WILLIE HOPPE

...FOR 43 YEARS A WORLD'S TITLEHOLDER! TRY TO MATCH THAT RECORD IN ANY OTHER SPORT!

...IN 1906 HE DEFEATED VIGNAUX IN PARIS FOR THE WORLD'S 18.1 BALKLINE TITLE. SINCE THEN HE'S WON EVERY WORLD'S CHAMPIONSHIP... AT 59 HE STILL HOLDS MOST OF THEM!

WILLIE FIRST LEARNED TO HANDLE A CUE AT EIGHT...



...AT 16 HE WON THE JUNIOR MASTERS' TOURNAMENT.

HE LOOKS **SHARP!**

...CALMLY AND CONFIDENTLY SCORING A SPECTACULAR SHOT... HE HAS RUN MORE THAN 15 MILLION POINTS IN BILLIARDS DURING HIS LIFETIME!



HE FEELS **SHARP!**

SOME HOPPE!

...TRAVELLING CROSS-COUNTRY TO GIVE COUNTLESS EXHIBITIONS OF HIS SKILL... DURING THE WAR HOPPE TOURED USO CAMPS ...OFTEN MAKING 8 TO 10 APPEARANCES DAILY!

look **SHARP**
feel **SHARP**
be **SHARP**

use **Gillette Blue Blades** with the **SHARPEST** edges ever honed!

● You look sharp for you enjoy the swellest shaves ever. You feel sharp because they're refreshing and give you a lift. You are sharp for you get far more shaves per blade and save money. Ask for Gillette Blue Blades.



5 for 25¢

ENJOY BOXING FRIDAYS AT

10 PM EST OVER ABC NETWORK. GILLETTE'S CAVALCADE OF SPORTS ALSO AIRS WORLD SERIES AND OTHER CLASSICS YEAR'ROUND.



HE IS **SHARP!**

...WILLIE HOPPE TAKES NO CHANCE ON MISFIT BLADES OR FAULTY SHAVING-METHODS. HE WANTS THE CLEANEST, MOST REFRESHING SHAVES IN THE BOOK, SO HE ALWAYS USES **GILLETTE BLUE BLADES**. SURE HE KNOWS THAT **DOUBLE EDGES MEAN DOUBLE ECONOMY!**

Gillette Safety Razor Company, Boston 6, Mass.

**EXPERIENCE
IS THE BEST
TEACHER!**

Mrs. Dorothy Newstead
has followed the
trail of game fish
to the Atlantic
and Pacific.

*Mrs. Dorothy Allen
Newstead*

Holder of the
International
Women's All-
Tackle Record
for Cobia

A record catch!
The rare yellow-
bellied cobia
landed by
Mrs. Dorothy
Newstead.

**EXPERIENCE IS
THE BEST TEACHER...
IN DEEP-SEA FISHING...
IN CIGARETTES TOO!
CAMELS SUIT ME TO A T**

More people are smoking CAMELS today than ever before in history!

MR. DOROTHY NEWSTEAD speaking:
"During the war shortage, I smoked many dif-
ferent brands. And that's when I found that Camels
suit my 'T-Zone' best!"

You and millions of other smokers, Mrs. Newstead.

Result: *Today more people are smoking Camels
than ever before.* But, no matter how great the
demand:

*Camel quality is not to be tampered with.
Only choice tobaccos, properly aged, and
blended in the time-honored Camel way,
are used in Camels.*

According to a recent Nationwide survey:

**MORE DOCTORS
SMOKE CAMELS**
than any other cigarette

Three nationally known independent research organiza-
tions asked 113,597 doctors to name the cigarette they
smoked. More doctors named Camel than any other brand.

**YOUR 'T-ZONE'
WILL TELL YOU...**

**T for Taste...
T for Throat...**

That's *your* proving ground for any
cigarette. See if Camels don't
suit *your* 'T-Zone' to a 'T'



R. J. Reynolds Tobacco Co.
Winston-Salem, N. C.