

# POPULAR MECHANICS

## MAGAZINE

WRITTEN SO YOU CAN UNDERSTAND IT



REG. U.S. PAT. OFF. TRADE MARK, GREAT BRITAIN, NO. 40426

REG. U.S. PAT. OFF.

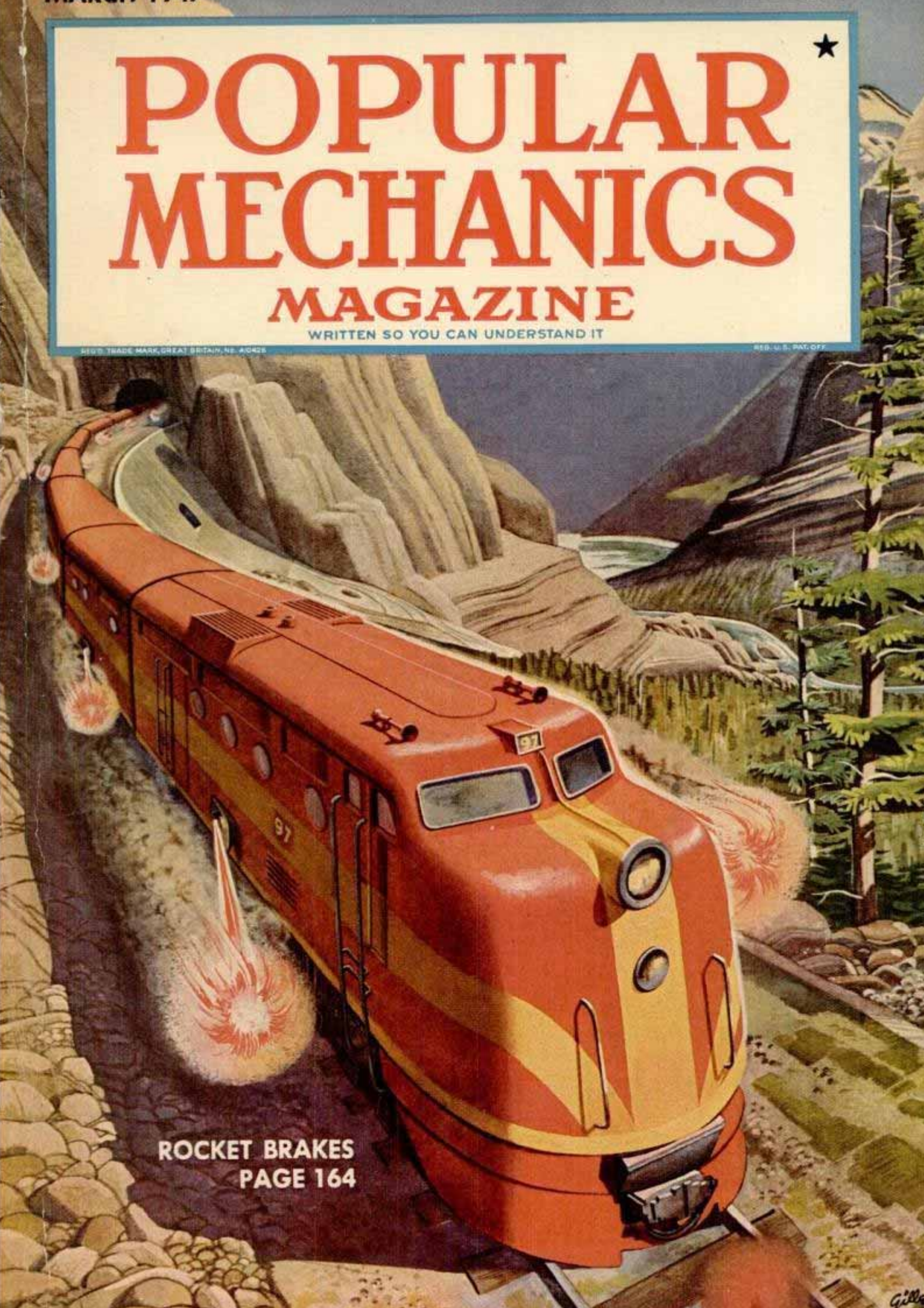

**ROCKET BRAKES**  
**PAGE 164**



IT'S A GRAND FEELING.  
TO CAPTURE A PICTURE  
IN A FLASH!



IT'S A GRAND FEELING, TOO,  
WHEN YOUR CAR IS  
CUSHIONED WITH MARFAK  
CHASSIS LUBRICATION

THAT CUSHIONY FEELING LASTS LONGER WITH **MARFAK!**

It's a grand feeling to snap good pictures of friends or family with a flash . . . the same grand feeling you get from your smooth riding, *Marfak* lubricated car.

*Marfak* is scientifically designed to cling to bearing surfaces, resist wash-out, jar-out and squeeze-out and stick to the job a thousand miles and more. See your Texaco Man today, and say: "*Marfak*, please!"



**THE TEXAS COMPANY**

**TEXACO DEALERS IN ALL 48 STATES**

Also in: { TEXACO STAR THEATRE presents the Eddie Bracken show every Sunday night.  
METROPOLITAN OPERA broadcasts every Saturday afternoon. See newspapers for time and stations.



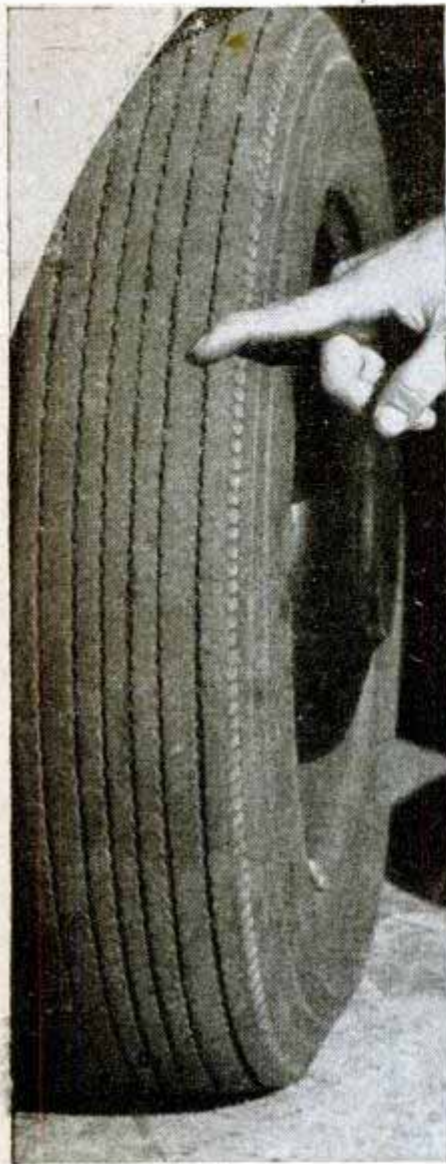

## TYPICAL EXAMPLE: THE B. F. GOODRICH TIRE THAT OUTWEARS PREWAR TIRES

**S**AFETY PATROLMAN OLSON, of the Everett, Wash., Police Dept., appears above, pointing to a B. F. Goodrich tire that has traveled 33,527 miles. He writes:

"Two years ago we started using the B. F. Goodrich Silver-town on our police cars. These tires have been subjected to all types of driving and road conditions, at high speed and in both wet and dry weather. From the standpoint of blow-out protection, the safety of these tires is unsurpassed.

"The tread design is the finest we have ever used—giving skid

protection, easy steering and long mileage. We are getting more mileage from this new tire than we got from any prewar tire. These tires are without doubt the finest automobile tires on the road today . . . *will outwear prewar tires.*"

Each week we receive letters such as this. They are written by owners and operators of police cars, passenger cars, taxis. They

show clearly that the new B. F. Goodrich tires outwear prewar tires.

In spite of greatly increased production, demand for tires is even greater. Please check your needs well in advance. Talk to your B. F. Goodrich dealer. He'll do his best to keep you rolling until he can get new tires for you. *The B. F. Goodrich Company, Akron, Ohio.*

# B.F. Goodrich

FIRST IN RUBBER





*Frank Vestal with  
bass caught on  
Hawaiian  
Wigglers  
in Arkansas*

## "Typical Hawaiian Wiggler Catch"

—writes Frank Vestal, Memphis Newspaperman

Dear Fred:

"This creel limit of Kentucky bass caught from Cache River, Arkansas, is typical of Hawaiian Wiggler achievements in the Mid South. Frankly, most of the bass I have caught in the past year have been caught with either the No. 1 or No. 2 Hawaiian Wiggler. My friends swear by these famous baits that are effective both in still lake water or that running in nearby streams."—*Frank Vestal, Memphis Commercial Appeal outdoors writer.*

### Hawaiian Wiggler Family

All five members of the Hawaiian Wiggler family are specialized bass baits. No. 1 runs deep and is for rocky streams, lakes and dams. No. 1½ runs medium; No. 2, shallow. No. 2½ sputters on the surface. No. 3, the most weedless, wiggles right through gooey weeds and moss.

### Write for Free Catalog

Gives all information on Hawaiian Wigglers; also Jitterbug, my famous surface bait, and my new Hula Dancers. It contains scores of letters from fishermen all over the country telling of their experiences with these popular baits. For a free copy of my catalog, write FRED ARBOGAST & CO., 1603 North St., Akron 3, Ohio



Deep Running  
No. 1 Hawaiian  
Wiggler, \$1.10



# Popular Mechanics Magazine

Registered in U. S. Patent Office and Canada

H. H. WINDSOR, Founder

H. H. WINDSOR, Jr., Editor and Publisher

## Coming Next Month

**The story of a house that anyone can build—planned by Popular Mechanics Magazine and built by a young veteran for his bride. Don't miss the Popular Mechanics Build-It-Yourself House, which will be featured in full color in the April issue.**

OUR color feature this month which starts on page 105 takes you behind the scenes at the Ice Follies. This was sort of a "cross-country" feature for us. The first photos were made in San Francisco and the last when the show was in New York. Biggest thrill for the cameramen was the timing of Harris Legg in his leap through the flaming "eggbeater."

WHEN you read "Death Valley Patrol" in the April issue we urge you to have a fan handy. This is the story of how rangers protect summer motorists exploring this 140-mile inferno. Another April feature, "The Smartest Ship Afloat," introduces a floating laboratory which tests electronic devices that may save millions of dollars for river and harbor craft.

EVERY farmer needs tractor horsepower in a small package for odd jobs. You'll meet "Farmette" in the Craftsman section next month with detailed how-to-make-it instructions. The tractor is a tricycle type with 7-hp. air-cooled engine, four-speed transmission, variable tread for cultivating narrow rows and a power take-off for driving a mower or similar machine. Other features next month will tell you how to clean the car radiator and how to care for a reflex-type camera.

BEGINNERS will find an unusual one-tube low-cost "progressive" receiver in the Radio section in April—also a converter for the new FM broadcast band.

Volume 87 MARCH 1947 Number 3

Managing Editor..... Roderick M. Grant  
Assistant Managing Editor..... Wayne Whittaker  
Shop Notes and Crafts Editor..... James R. Ward  
Radio and Electronics Editor..... Frank L. Brittin  
Aviation Editor..... Aubrey O. Cookman, Jr.  
Associate Editor..... John R. Kinsey  
Eastern Editor..... Bill Reiche  
Western Editor..... Thomas E. Stimson, Jr.  
Art Director..... Frank Beatty

### Assistant Editors

Donald R. Brooks Clifford B. Hicks Maston M. Jacks Virgil T. Swanson

### Assistant Editors, Shop Notes and Crafts

W. Clyde Lamme Wayne C. Leckey John F. Shrock A. E. Youngquist

## In This Issue

Proving Ground for Gasoline	89
Laboratory in Space	98
Putting a Show on Ice	105
Smash Hits	113
From Trading Post to Empire	116
Newest Wonder of the World	126
Power for the Air Age	134
Big Business in Dudes	142
Less Toil for Tillers	152
Steel Hideaways	160
What's New for the Home	168
Speeding the Ocean Freight Aboard	176

## For the Craftsman

Modern Radio Cabinet	182
A Home of 1000 Addresses	190
How to Paint Your Car	200
Plaster Casting	206
Close-Up Focusing Attachment	211
Four-Cylinder Garden Tractor	222
Ball Bearing "Know-How"	228
Radio and Electronics	233

## Table of Contents Continued on Page 8

Published monthly by POPULAR MECHANICS COMPANY, 200 East Ontario Street, Chicago 11, Ill. H. H. Windsor, Jr., president; Paul H. Dunakin, vice president and general manager; D. F. Windsor, vice president and secretary-treasurer; William Harrison Pettridge, vice president and assistant to the publisher; Clover L. Perkins, advertising manager; Alan M. Deyoe, circulation manager. Single copy in the United States and Canada, 25 cents; subscription rates in United States and possessions, Canada, and countries of the Pan-American Postal Union, 1 year, \$2.50; 2 years, \$4.50; 3 years, \$6.00. To all other countries add \$1.00 a year over United States prices for overseas postage. If you plan to move, notify us at least 60 days in advance so you will not miss an issue. Give both old and new addresses. Entered as Second Class Matter, September 15, 1908, at the Post Office at Chicago, Illinois, under Act of March 3, 1879. Entered as Second Class Matter at Post Office Dept., Canada, Copyright 1947, by Popular Mechanics Company, Copyright under International Copyright Union. Copyright in France. All rights reserved under Pan-American Copyright Union. Printed in the United States of America.



# Ingenious New Technical Methods

To Help You  
Simplify Production

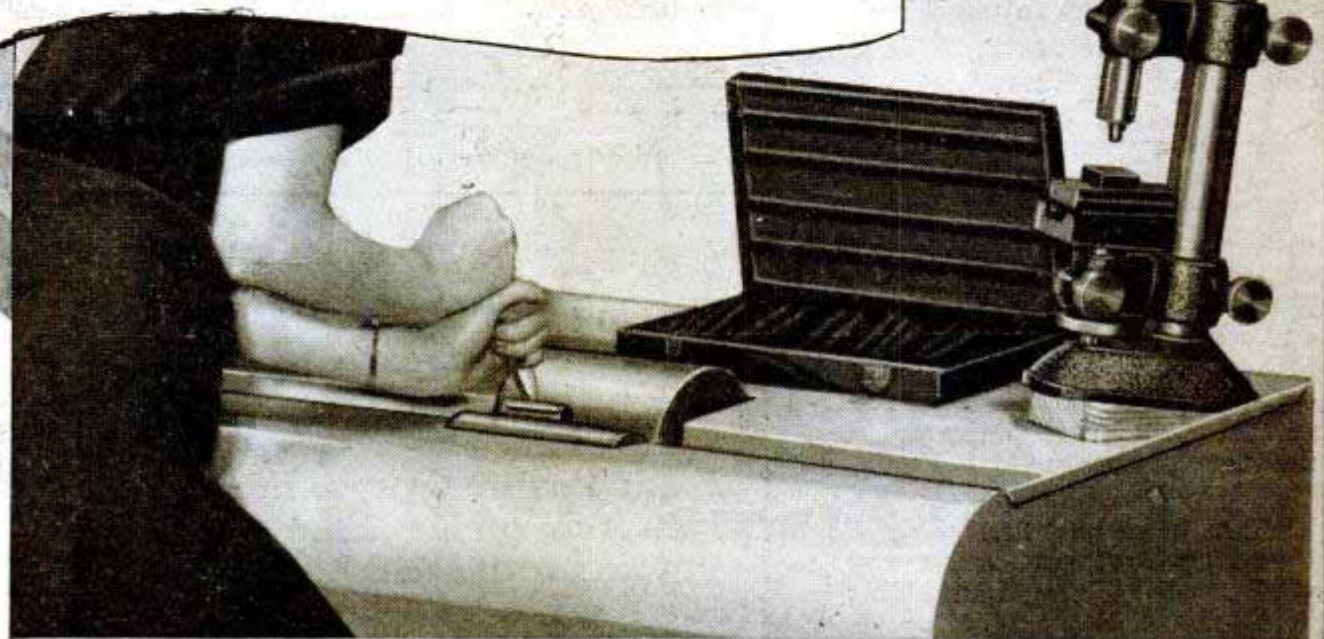

## New Centerless Lapping Machine Gives Precision of Less Than 2 Micro-Inches!

Now it's easy to lap cylindrical pieces—quickly—accurately—without specialized operator skill! The new Size Control Centerless Lapping Machine handles pieces from .010" to 10" diameter without costly set-ups.

The operator merely holds piece between lapping rolls with stick. Pressure applied determines quantity of metal removed. Small roll turns piece at slow constant rate. Large roll turns more rapidly to remove minute quantities of metal. Ideal for lapping oversize gages, worn gage plugs to next smaller size, bearings, bushings or shafts. Roll speeds easily changed. Adjustable for tapers.

Ideal also to save time on the job, is chewing gum. The act of chewing aids the workers' concentration; seems to make work go easier. Furthermore, chewing gum may be used even when both hands are busy—increasing worker safety—and reducing work interruptions. That is why many plant owners have made Wrigley's Spearmint Gum available to all.

*You can get complete information from Size Control Company  
2500 Washington Blvd., Chicago 12, Ill.*

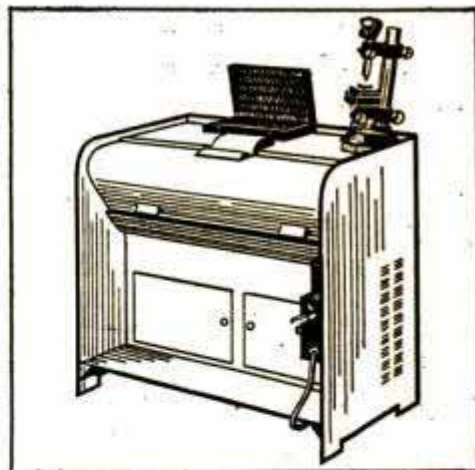

Centerless Lapping Machine



AB-58



# WHY MUST A BATTERY BE RECHARGED ?

## "Why the Reservoir Runs Dry"

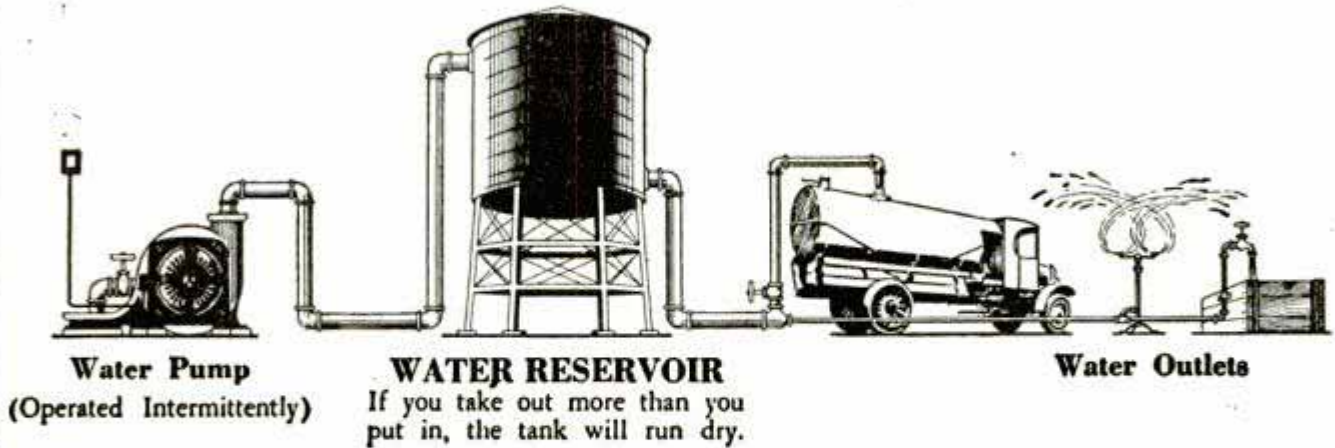

## "Why the Battery Runs Down"

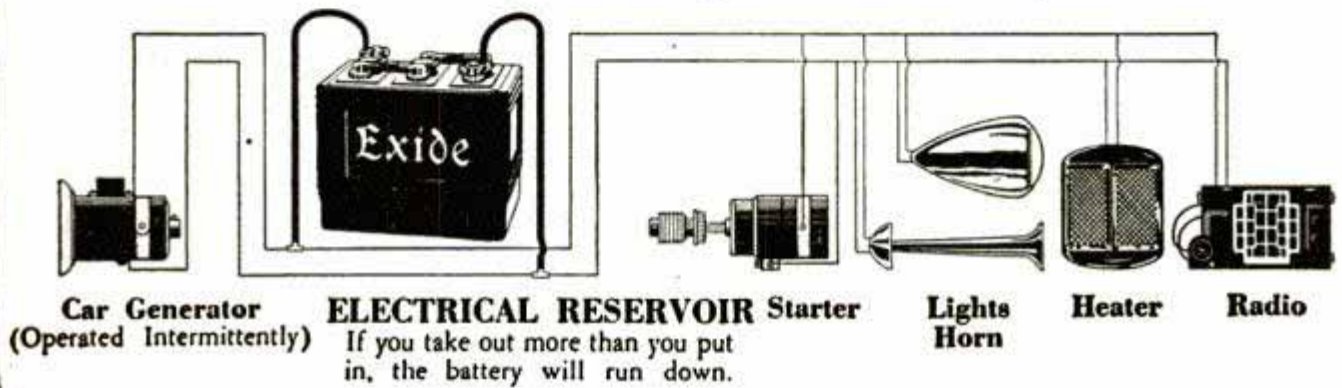

An automobile battery stores energy, which is constantly being drained by starting, lighting, and supplying current for other purposes. This energy must be restored; otherwise, like water in a tank, it eventually is exhausted.

But, unlike refilling a tank, the battery system on an automobile is automatic. When a car is in average use, the battery is kept at or near full charge; if the car is driven less than the normal minimum, charging is insufficient and the battery "runs down."

See that your battery is kept properly charged.

Check every two weeks to see if water is needed. If water is required more often, the amount of charging is too great; if too little water is required and the hydrometer reading shows below 1.225, the battery is charging too little. Any Exide Dealer will be glad to show you how to get the best service from your battery.

Would you like to know more about batteries? The complete story is told in a booklet, "THE STORAGE BATTERY, Its Fundamentals, Use and Maintenance." Mail a postal card today for a FREE copy.

"WHEN IT'S AN EXIDE YOU START"

# Exide

## BATTERIES

THE ELECTRIC STORAGE BATTERY COMPANY, Philadelphia 32

Exide Batteries of Canada, Limited, Toronto



# By These Signs -----

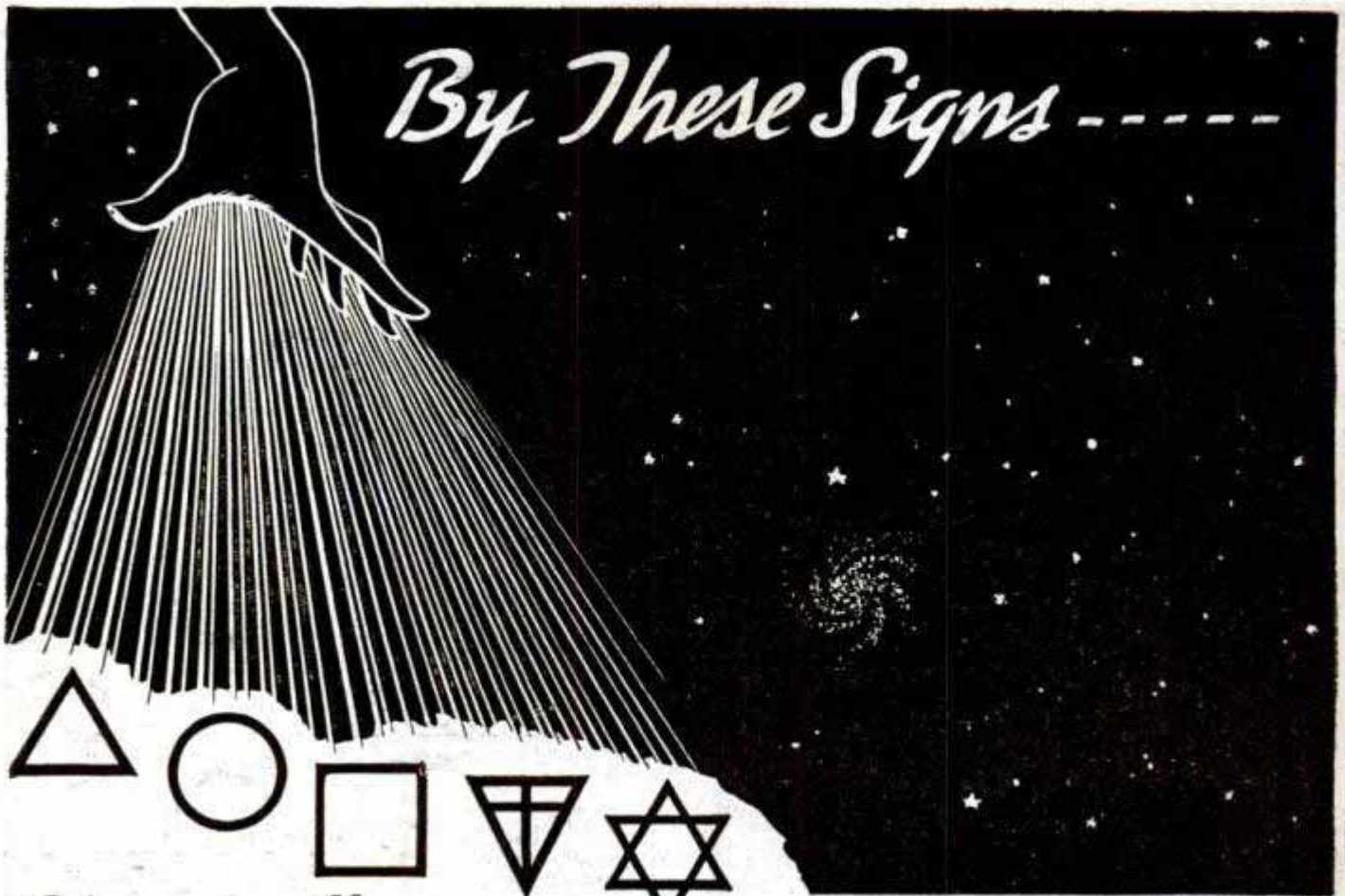

## Strange Keys to the Powers of the Universe

"GOD GEOMETRIZES," said an ancient sage. Within the straight line, curve, and angle—and their combinations—exist the forces of creation. These *secret symbols* contain the mysterious laws of the universe. Upon their right use—or the neglect of them—the success or failure of every *human enterprise* depends.

Have you a desire, *something you wish to accomplish* in life? Put your finger on a dot. In whatever direction you move your finger from the dot, you have made a beginning. Thus a dot is the symbol of *one*—or a beginning. Your desire then is also symbolized by *one*. If you follow the *proper method* or way to accomplish what you want, you have arrived at point *two*. Whenever these two symbols are brought together—the idea and the right way—you produce point *three*—the success of your plan. Success, therefore, is symbolized by the three equal sides of a *triangle*.

In planning your personal affairs—business, domestic, or the welfare of your family—do you use a *Cosmic formula*? Do you determine whether your acts are in accord with Divine truths eternally expressed in symbols? Why does the circle represent completion? Why is it said that a man is on the square? These

symbols are used by astronomers and scientists to prove the physical laws of the universe—why don't you apply them to the problems of your everyday world? Learn what symbols, as powers and forces of nature, you can simply and intelligently use in directing the course of your life.

Let the Rosicrucians (not a religious organization), a world-wide brotherhood of learning, reveal to you *the symbolism of successful living*.

### Let this GIFT BOOK Explain

If you want to prepare yourself through understanding for the greater rewards of life, write for the fascinating *free Sealed Book*. It explains how you may receive this age-old wisdom. Use the coupon below.

Scribe G. T. A.  
THE ROSICRUCIANS, AMORC  
San Jose, California, U. S. A.

Please send me the Free, Sealed Book. I am interested in knowing how I may obtain the masterful Rosicrucian teachings.

Name.....

Address.....



THE ROSICRUCIANS, AMORC - SAN JOSE, CALIFORNIA, U. S. A.





# If YOU were Boss would YOU promote "YOU"?

## Be honest now—

suppose that a better job had opened up in your company—carrying with it promotion and more money—could you qualify?

*If you were boss, would you select "YOU" for that better job?*

Consider before you answer.

First of all, could you *fill* the job? Has your experience fitted you for the step forward—have you been preparing for promotion apart from experience gained on the job?

Or have you just been filling a niche, doing daily tasks well but making no real and intelligent effort to learn and qualify for the job ahead so that if an opening should occur you would be ready to fill it?

The man who gets real promotion makes his own breaks—the man who slaves in the ordinary job at low pay just wishes and dreams of promotion and more money. Which are you?

Business is always willing to pay the man who knows—and pay him well. The man who is ready and willing to take responsibilities—and capable of directing the efforts of other men is a

valuable asset to any business organization. He never wants for a good job and above average earnings. He gets ahead.

We have helped thousands of men achieve promotion and more money—success sometimes beyond their dreams—a success that was started by a coupon similar to the one below.

Get out of that rut—don't be satisfied with a mediocre job at small pay—be a success in business—this coupon may be your first step.

So send it today—right now—tomorrow never comes for the man who consistently puts things off.

**G. I. APPROVED**

*La Salle Extension University*  
*A Correspondence Institution*

Dept. 364-R

417 S. Dearborn, Chicago 5

If you can help me get the ability and knowledge for real promotion, I want to know it. Please send me your free 48 page booklet telling how I can succeed in the field I have checked below. I understand you will send this without obligation to me.

- |  |  |
|--|--|
| <input type="checkbox"/> Accounting                    | <input type="checkbox"/> Law: LL.B. Degree     |
| <input type="checkbox"/> C. P. A. Coaching             | <input type="checkbox"/> Foremanship           |
| <input type="checkbox"/> Bookkeeping                   | <input type="checkbox"/> Industrial Management |
| <input type="checkbox"/> Business Management           | <input type="checkbox"/> Traffic Management    |
| <input type="checkbox"/> Effective Speaking            | <input type="checkbox"/> Business English      |
| <input type="checkbox"/> Stenotypy (Machine Shorthand) |  |

Name.....Age.....

Position.....

Address.....

City and State ..

This One



ABJN-JK5-6399



Start easy, Reduce battery drain, Prevent corrosion, Reduce wear, Remove sludge  
With...

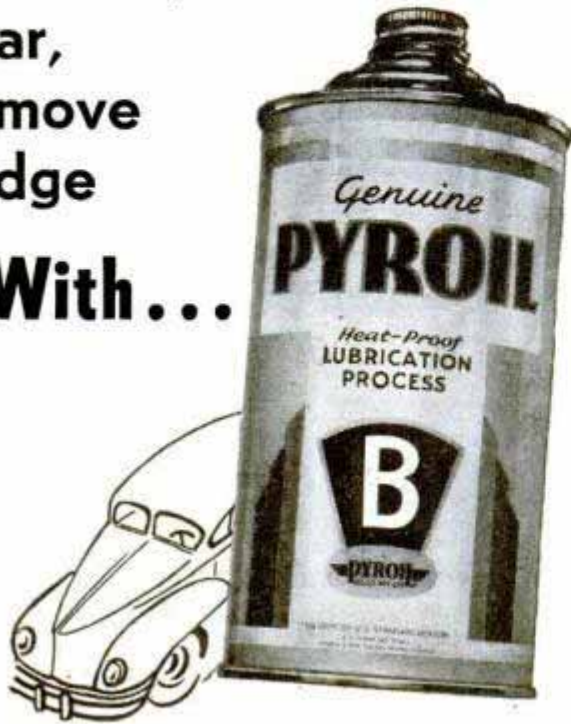

Pyroil gives oil the added property of clinging to cylinder walls and piston surfaces, protecting them from corrosion and assuring easy, quick lubricated starting. Ask your gas station attendant to add Pyroil . . . every time you buy gasoline or oil.

**PYROIL FOR AIRCRAFT ENGINES**

Use Aircraft Pyroil B for lubricating oil, Aircraft Pyroil A for gasoline.

Manufactured and Guaranteed by Pyroil Company, 65 Pyroil Bldg., La Crosse, Wisconsin.

**PYROIL COMPANY**  
65 Pyroil Bldg., La Crosse, Wisconsin  
I want my car to last and run properly. Please tell me more about Pyroil and how it can accomplish this for me.

Name.....  
Address.....  
City or Town.....State.....



Jerry, the talking dog, is entertaining hospitalized veterans, by courtesy of the PYROIL Company. Picture of Jerry, sent on request.

**TABLE OF CONTENTS (Continued)**

**AUTOMOTIVE**  
"Gas tank" auto powered by batteries.....123  
Sealed beam spotlight for autos projects glareless ray.....126  
Insert cylinder sleeve in 30 seconds.....140  
Gravity suspension system replacing springs saves trailer tires.....157  
"Tipless" auto jack safe on hills.....174  
Jeep carries lightweight crane and provides power for road work.....175

**AVIATION**  
New Army observation plane.....96  
Navy's first plane with turbine-driven propeller.....97  
1946 air safety mark doubles 1945 record.....103  
Tail-pusher plane cruises 200 m.p.h.....103  
Army rolls out first four-jet bomber for ground tests.....104  
Hulls of PBY flying boats are converted into seagoing cruisers.....124  
Glider descends vertically.....132  
Plane with folding wings can be towed like a glider.....141  
Helicopter movie of horse race helps check final results.....141  
Sailplane carries jettisonable water ballast in the wing.....150  
Tandem two-seat "Streak" cruises at 150 m.p.h.....151  
Cycrodyne combines features of helicopter and autogiro.....151  
Fog beacons guide plane to runway.....163  
Australia battles locusts from air.....163  
Helicopter lays mist of insecticide on crop.....175

**BOATS AND FISHING**  
Cartridge in spearhead of harpoon explodes when it hits target.....112  
Theftproof locks prevent oar loss.....125  
Gas tanks are hulls for speedy boat.....147  
"Duck" fitted with echo instruments aids shallow water surveys.....157  
Tractor built on "stilts" hauls seine into lake.....180

**FARM**  
Flame throwers burn weeds.....158  
Sit-down fatigue lessened by steps on tractor.....159  
Rubber coating for egg baskets.....167

**GAMES**  
Game combines features of both bowling and billiards.....95  
Plastic card holder aids rummy play.....123  
Poker rack counts stacks of chips.....131

**HOUSE AND HOME**  
Painting of windows simplified by guide.....96  
Pressure-fed trowels of wall-washing machine speed cleaning job.....124  
Wallpaper remover dissolves paste.....125  
Campus "village" of steel and aluminum homes set up in 90 days.....133  
Two buses converted into five-room home.....166

**INDUSTRY**  
Steam draws oil from shale.....124  
Bubbles trapped in concrete strengthen pavement.....131  
Safety dress for coal miners guarantees protection from head to toe.....133  
Ice mask protects actors' makeup.....140  
Vitamin harvest.....148  
Safer railroads ahead.....164  
Indicator detects one part carbon monoxide in 500,000,000 parts of air.....172  
Plastic glue cements duralumin.....173

**NOVELTIES**  
Novel goldfish bowl from plastic nose of B-29.....159  
Belt stretches as waistline grows.....167  
Folding pipe fits a man's pocket.....167

**OUTDOOR RECREATION**  
Minnows stay alive for long periods with vacuum attachment on car.....97  
Versatile outdoor range is complete with running water.....151  
Supercycle puts arms as well as legs to work in bicycling.....159  
Wad in shotgun shell expands to seal entire force of powder.....166

**RADIO AND ELECTRICAL**  
Metal strip smaller than common pin tunes in radio broadcasts.....95  
Radio waves shoot through walls for complex industrial jobs.....112  
Alarm system with 15 thermostats registers both heat and cold.....123  
Remote control keys run typewriter.....125  
Spool-size motor used on ships.....131  
Split wave transmits two messages.....132  
Radioactive bar removes static electricity from photographic prints.....132  
Self-soldering tape is ignited with ordinary match to connect two wires.....158

**STORE AND OFFICE**  
Push-button telephone dialer calls 50 numbers.....140  
Side-door delivery speeds service.....151  
Midget adding machine is portable.....167

**TOOLS**  
Prying tool stops splitting to boost lumber salvage.....94  
Resistance tightens grip of plier-action wrench.....103  
Instrument gauges rough surfaces by flow of compressed air.....112  
Welding electrode withstands bending without any loss of flux.....122  
Tool grips steel or soft plastic.....140  
One tool does nine jobs to aid modelmaker in precision work.....147  
Auxiliary drill-press table helps in routing or shaping.....150  
Circle cutting tool for craftsmen centers itself automatically.....150  
Oysters opened with new shucking device.....159  
Revolving blowtorch drills holes in iron ore for blasting charges.....172  
Flat safety step fits ladder rung.....173

**MISCELLANEOUS**  
Callers "checked" undetected through mirror-window.....94  
Fire escape reel lowers person at speed of elevator.....104  
Border guards use spotlight-mirror to peek under car for contraband.....122

(Continued to page 10)



# THERE'S NO SECRET OF SUCCESS!



**T**HE FORMULA for success in industry and business is an open book—no secret about it at all. Promotion comes when you've *trained* yourself to handle bigger jobs, *prepared* for larger responsibilities.

Such training you'll find in a library of extremely literal books—and it's up to you to open them and keep on opening them until you've mastered their contents. You can do this in your spare time for these are the easy-to-understand texts of the International Correspondence Schools with the teacher "built right in."

Covering more than 400 practical subjects, I. C. S. Courses have aided thousands of men and women to win better jobs and larger rewards in every business and industrial field. These thousands are the proof of the familiar saying, "Today's I. C. S. student is tomorrow's leader."

Mark and mail the coupon and you can be on the way to joining them. It brings you full information on the subject you're interested in. Act today—if you're serious about becoming a success!

## INTERNATIONAL CORRESPONDENCE SCHOOLS



BOX 5599-K, SCRANTON 9, PENNA.

Without cost or obligation, please send me full particulars about the course *before* which I have marked X:

- Air Conditioning and Plumbing Courses**
- Air Conditioning
- Heating  Plumbing
- Refrigeration  Steam Fitting
- Chemistry Courses**
- Chemical Engineering
- Chemistry, Analytical
- Chemistry, Industrial
- Chemistry, Mfg. Iron & Steel
- Petroleum Refining  Plastics
- Pulp and Paper Making
- Civil Engineering, Architectural and Mining Courses**
- Architectural Drafting
- Architecture
- Bridge and Building Foreman
- Building Estimating
- Civil Engineering
- Coal Mining
- Contracting and Building
- Highway Engineering
- Lumber Dealer
- Reading Structural Blueprints
- Sanitary Engineering
- Structural Drafting

- Structural Engineering
- Surveying and Mapping
- Communications Courses**
- Electronics
- Practical Telephony
- Radio, General
- Radio Operating
- Radio Servicing
- Telegraph Engineering
- Electrical Courses**
- Electrical Drafting
- Electrical Engineering
- Electric Light and Power
- Lighting Technician
- Practical Electrician
- Internal Combustion Engines Courses**
- Auto Technician  Aviation
- Diesel-Electric
- Diesel Engines  Gas Engines
- Mechanical Courses**
- Aeronautical Engineering
- Aircraft Drafting
- Flight Engineer
- Foundry Work
- Heat Treatment of Metals

- Industrial Engineering
- Industrial Metallurgy
- Machine Shop
- Mechanical Drafting
- Mechanical Engineering
- Mold-Loft Work
- Patternmaking—Wood, Metal
- Reading Shop Blueprints
- Sheet-Metal Drafting
- Sheet-Metal Worker
- Ship Drafting  Shipfitting
- Tool Designing
- Toolmaking
- Welding—Gas and Electric
- Railroad Courses**
- Air Brake  Car Inspector
- Diesel Locomotive
- Locomotive Engineer
- Locomotive Fireman
- Railroad Section Foreman
- Steam Engineering Courses**
- Boilermaking
- Combustion Engineering
- Engine Running
- Marine Engineering
- Steam Electric  Steam Engines

- Textile Courses**
- Cotton Manufacturing
- Rayon Weaving
- Textile Designing
- Woolen Manufacturing
- Business and Academic Courses**
- Accounting  Advertising
- Arithmetic  Bookkeeping
- Business Correspondence
- Business Management
- Certified Public Accounting
- Commercial
- Cost Accounting
- Federal Tax
- First Year College
- Foremanship  French
- Good English  High School
- Higher Mathematics
- Illustrating  Motor Traffic
- Postal Service
- Salesmanship  Secretarial
- Sign Lettering
- Spanish  Stenography
- Traffic Management

Name \_\_\_\_\_ Age \_\_\_\_\_ Home Address \_\_\_\_\_  
 City \_\_\_\_\_ State \_\_\_\_\_ Present Position \_\_\_\_\_

Working Hours \_\_\_\_\_ A.M. to \_\_\_\_\_ P.M. Length of Service in World War II \_\_\_\_\_  
 Special tuition rates to members of the Armed Forces. Enrollment under the G.I. Bill of Rights approved for War II Veterans.  
 Canadian residents send coupon to International Correspondence Schools Canadian, Ltd., Montreal, Canada.



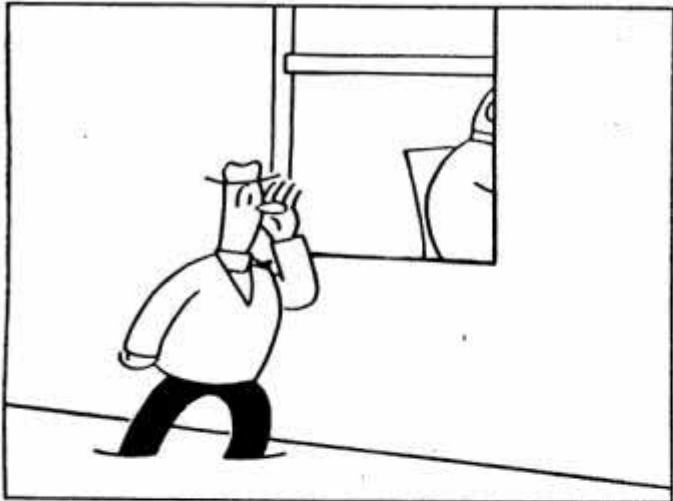
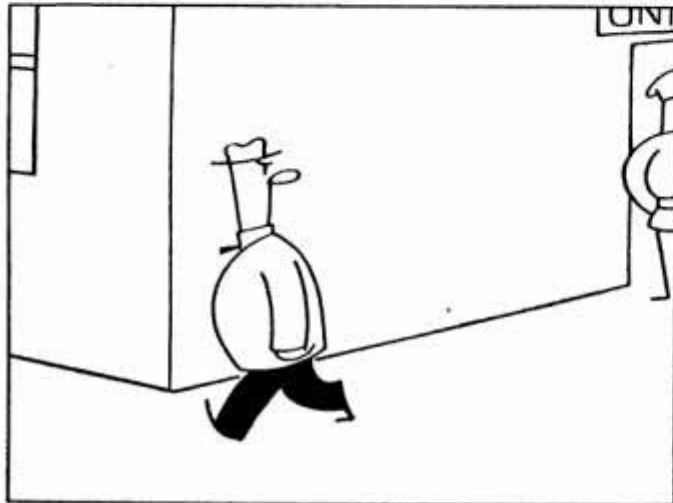

O. SOGLOW

(Continued from page 8)

Temperature taken in blood stream.....	122
Transparent plastic "baby poser" holds children for photographs.....	131
Radioactive gas from Bikini.....	133
More frozen food lockers.....	147
Glass prism weighing 300 pounds ground for Mexican observatory.....	173
Instruments chart hurricanes through earth tremors.....	173
"Hospital" in a suitcase fits car trunk or plane.....	174
Latest tanks outweigh and outshoot wartime weapons.....	180

## Craftsman and Shop Notes Index

### AUTOMOTIVE

Flashlight used as trouble lamp.....	185
Tire chains put on automobile wheels with aid of wooden block.....	199
Emergency wheel puller for car.....	210
Metal particles easily removed from auto-tire casing.....	220
Multiple-socket unit on creeper requires less extension cord.....	227

### FARM

Chicken feeder from tin can.....	188
Small watering trough for stock utilizes discarded oil drum.....	198
Spray attachment for your tractor.....	217
Auto wheel used to pull posts with aid of tractor.....	218
Colored bands on ignition cables of tractor help identify them.....	218
Fitting to grease wagon wheel.....	219
Maintenance of fence reduced.....	232

### HOUSE AND HOME

Drop lid of sewing machine serves as bed table.....	185
Recoloring worn spots on rugs.....	185
Solving home problems.....	186
Indirect shaving light for mirror-front medicine cabinet.....	189
Metal tray for stoker clinkers.....	197
Screen replaces broken window.....	197
Ironing board holder.....	198
Stains removed from upholstery.....	198
Luminous decoration is home convenience.....	199
Spare-tire lock as wall safe protects important papers.....	204
How to make reflecting house numbers.....	210
Novel drawer lock on dresser keeps children from prying.....	214

### LAWN AND GARDEN

Woven fencing used as form for piling compost neatly.....	188
Lawn mower wheel crank makes sharpening easy.....	197
Ridge protects early garden crops.....	210

### OUTDOOR RECREATION

Keeping hunting equipment dry.....	188
Slit tubing over point of arrow lessens danger to others.....	196
Emergency portable camp stove.....	196
Rubber ball covers gun muzzle.....	210
Extension handle on wood spoon is convenient for campers.....	216

### RADIO AND ELECTRONICS

"Tea can" field strength meter and monitor.....	233
1947 "Little Giant" a.c.-d.c. super for students and experimenters.....	234
Three-channel 18-tube television receiver kit.....	236

### STORE AND SHOP

Blind in show window lowered without disturbing display.....	198
Oil drum makes handy holder for seed sacks.....	220
Layout dye kept in polish bottle is convenient to handle.....	220

### TOOLS

Stop on drill prevents damage.....	196
Perfume atomizer used to spray glaze on pottery.....	198
Split fishline sinker on steel tape provides finger grip.....	204
Small jig holds L-shaped strips while filing and finishing.....	214
Craft quiz.....	215
Alteration of alcohol blowtorch increases heating capacity.....	216
Opener serves as tack remover.....	216
Portable bench an aid in maintenance work.....	219
Oiler fastened on cross slide follows the lathe tool.....	219
Bearing "worked" out of end bell with steel ball and tap.....	220
Dispenser holds artist's brushes.....	227
Electrically heated wire will cut glass tubing.....	227

### TOYS AND NOVELTIES

Cart pull-toy for small children.....	185
Animated doll amuses children.....	196
Attractive plastic letter holder made from single sheet.....	204
Fun with ink pictures.....	205

### WOODWORKING

Position of outlet box marked by using carbon paper.....	188
Bracket table saves space in narrow hallway.....	189
Folding workbench in the garage.....	221

### MISCELLANEOUS

Wire and bolt make hose clamp.....	188
Chart for approximate tonnage.....	196
Reflectors attached to umbrella warn autoists of pedestrian.....	204
Shelf "strapped" to column.....	210
Preventing books from slipping.....	210
Packing calking in wooden boats.....	214
Accurate way to shorten bolts.....	214
Tape-spool holder for thread.....	214
Easy way to start small nuts in inaccessible places.....	216
Ear syringe applies liquid glue.....	216
Wire aids when oiling machine.....	220
Flexible tubing attached to drum is an aid when filling containers.....	221
Tape protects painter's sleeve.....	227

**IMPORTANT NOTICE**—It is the intention of this magazine to provide its readers with information regarding the latest developments in the mechanical arts. We take no responsibility as to whether the disclosures contained in our articles are covered by patents and advise readers to investigate this subject before making, using, or selling any of the products, machines, or processes described in order to avoid possible liability for patent infringements.



## AUDELS REFRIGERATION & AIR CONDITIONING GUIDE.....\$4

New from Cover to Cover—1280 Pages, Fully Illus. Covering basic principles, servicing, operation & repair of household, commercial & industrial refrigeration & air conditioning. A gold mine of essential important facts for engineers, servicemen, users.

## AUDELS CARPENTERS & BUILDERS GUIDES—4 Vols. ....\$6

A practical illustrated trade assistant on modern construction for carpenters, joiners, builders, mechanics and all woodworkers. 4 vols., 1600 pages, 3700 illustrations, flexible covers. Pocket size. Each volume sold separately \$1.50 a vol.

## AUDELS AUTOMOBILE GUIDE.....\$4

A practical quick ready reference book for auto mechanics, service men, operators & owners. Explains theory, construction & servicing of modern motor cars, trucks, buses & auto type Diesel engines. 1540 pages, fully illustrated. 55 chapters. Indexed. A standard book for mechanics. New fluid drive covered.

## AUDELS DIESEL ENGINE MANUAL \$2

A practical, concise treatise with questions and answers on the theory, operation and maintenance of modern diesel engines including General Motors 2 cycle Diesel, 354 pages, fully illus., flexible binding, pocket size. All details plainly brought out, this book is of extreme value to engineers, operators & students.

## AUDELS WIRING DIAGRAMS.....\$1

210 Pages, Illustrated. Gives practical facts on wiring of electrical apparatus. It shows clearly how to wire apparatus for practically all fields of electricity. Each diagram is complete & self-explanatory. Highly Endorsed Pocket Companion.

## AUDELS PLUMBERS & STEAMFITTERS GUIDES—4 Vols. ....\$6

A Practical Trade Assistant & Ready Reference. Explains in plain language & by clear illustrations, diagrams, charts, graphs, pictures principles of modern plumbing practice including Marine Pipe Fitting and Air Conditioning. 4 Vols.—1670 Pages—3642 Diagrams. Pocket size. Each Vol. Sold Separately \$1.50 a Vol.

## AUDELS SHEETMETAL WORKERS HANDY BOOK.....\$1

Practical inside information. Fundamentals of Sheet Metal Work. 388 pages, Illustrated, 11 sections. Clearly written. Essential & important facts, figures, pointers in everyday language. Ref. Index.

## AUDELS SHEETMETAL PATTERN LAYOUTS.....\$4

Developed by Experts for Sheet Metal Workers, Layout Men & Mechanics. A Practical Encyclopedia in 10 Sections, size 7 x 10 x 2—1125 Pages—350 Layouts—1600 Illustrations, 1001 Key Facts. Fully indexed for ready reference in answering your layout problems. Covers all phases of sheet metal work including Pattern Cutting, Pattern Development & Shop Procedure.

## AUDELS ANSWERS ON BLUE PRINT READING.....\$2

For Mechanics & Builders. Covers all types of blue print reading including ship & airplane. 376 pages, fully illustrated.

## AUDELS NEW MACHINIST & TOOLMAKERS HANDY BOOK.....\$4

Covers modern machine shop practice in all its branches. 5 practical books in 1. New from cover to cover. Tells how to set up & operate lathes, screw and milling machines, shapers, drill presses and all other machine tools. 1600 pages, fully illustrated, 5 x 6 1/2 x 2. Indexed. 5 sections. 1—Modern Machine Shop Practice. 2—Blue Print Reading & How to Draw. 3—Calculations & Mathematics for Machinists. 4—Shop Physics. 5—How to Use the Slide Rule, 60 chapters. Easy to read and understand. A shop companion that answers your questions.

## AUDELS MATHEMATICS & CALCULATIONS FOR MECHANICS \$2

Mathematics for home study or reference. 700 pages, 550 illus. Practical mathematics from beginning. How to figure correctly. Easy, correct methods covering a complete review. Ill. & Indexed.

## AUDELS HANDY BOOK OF PRACTICAL ELECTRICITY.....\$4

For maintenance engineers, electricians & all electrical workers. 1440 Pages, 2600 Illus. Covers important electrical information in handy form—including Marine Wiring, Radio Principles, Welding. Indexed. A Key to a practical understanding of electricity.

## AUDELS RADIOMANS GUIDE.....\$4

A key to the practical understanding of radio including Frequency Modulation, Television, etc., Aircraft & Marine Radio. For radio engineers, servicemen, amateurs. 772 pages, 400 Illustrations & Diagrams. Photos. Review Questions & Answers, Reference Index. Authentic, clear, concise.

## AUDELS ELECTRONIC DEVICES.....\$2

Tells What You Want to Know About Electric Eye. Easily Understood. Covers photo-electric cells & their applications. Amplifiers, illumination, frequencies, voltage, photocell, tubes, Ohm's Law, wiring diagrams, etc.

## AUDELS WELDERS GUIDE.....\$1

A concise, practical text on operation & maintenance of all welding machines for all mechanics. Over 400 pages, illustrated. Covers all methods of electric and acetylene welding including airplane work.

**AUDEL, Publishers, 49 W. 23 St., N. Y. 10**



## AN AUDEL GUIDE IS A GOOD FRIEND!

Use the brains and experience of others in these Guides of the Trades. Save time and money with right methods, short cuts, labor saving ideas. CHECK NOW! You can look over any Au-del Guide in your home. Start the Easy Payments if satisfied.

# CUT HERE MAIL ORDER

THEO. AUDEL & CO., 49 W. 23 St., New York 10, N. Y.

Please mail me for 7 days' free examination the books marked (X) below. I agree to mail \$1 in 7 days on each book or set ordered, and to further mail \$1 a month on each book or set ordered until I have paid purchase price.

If I am not satisfied with Guides I will return them.

- Audels OIL BURNER GUIDE.....\$1.
- Audels REFRIGERATION & Air Conditioning Guide. 4.
- Audels POWER PLANT ENGINEERS GUIDE 4.
- Audels PUMPS, HYDRAULICS & AIR COMPRESSORS 4.
- Audels WELDERS GUIDE 1.
- Audels BLUE PRINT READING 2.
- Audels SHEET METAL WORKERS Handy Book 1.
- Audels SHEET METAL PATTERN LAYOUTS 4.
- Audels AIRCRAFT WORKER 1.
- Audels MATHEMATICS and CALCULATIONS 2.
- Audels MACHINISTS & TOOLMAKERS Handy Book 4.
- Audels MECHANICAL Dictionary 4.
- Audels AUTOMOBILE GUIDE 4.
- Audels DIESEL ENGINE MANUAL 2.
- Audels MARINE ENGINEERS Handy Book 4.
- Audels SHIPFITTERS Handy Book 1.
- Gueths MECHANICAL DRAWING COURSE 1.
- Rogers DRAWING and DESIGN 2.
- Audels MILLWRIGHTS and Mechanics Guide 4.
- Audels CARPENTERS and Builders Guides (4 vols.) 6.
- Audels PLUMBERS and Steamfitters Guides (4 vols.) 6.
- Audels MASONS and Builders Guides (4 vols.) 6.
- Master PAINTER and DECORATOR 2.
- Audels GARDENERS & GROWERS GUIDES (4 vols.) 6.
- Audels ENGINEERS & FIREMANS EXAMINATIONS 1.
- Audels ENGINEERS and Mechanics Guides Nos. 1, 2, 3, 4, 5, 6, 7 and 8 complete 12.
- Audels Answers on Practical ENGINEERING 1.
- Audels ELECTRICIANS EXAMINATIONS 1.
- Audels WIRING DIAGRAMS 1.
- Audels Handy Book of PRACTICAL ELECTRICITY 4.
- Audels ELECTRICAL POWER CALCULATIONS 2.
- Audels ELECTRONIC DEVICES 2.
- Audels ELECTRIC Dictionary 2.
- Audels RADIOMANS GUIDE 4.
- Audels NEW ELECTRIC LIBRARY at \$1.50 a Volume Vols. I, II, III, IV, V, VI, VII, VIII, IX, X, XI, XII

Name.....

Address.....

Occupation.....

Employed by..... PM



**NOW! Build Your Future On**



**DIESEL Opportunities**

LOOK around you. See the way tractors, trucks, buses, railroads, ships, power plants and equipment of many kinds are "going Diesel." Every day new opportunities are opening—in industrial and farming communities—for trained men who can install, maintain, operate and repair Diesel engines. Plan now to build your future in this growing field.

**Diesel Knowledge is Earning Power**

You don't have to give up your present job. Now, you can begin learning DIESEL in spare time at home. UEI practical training teaches you, step by step, how Diesel engines operate, how fuel systems work, repairs, accessories and auxiliary equipment; a world of Diesel "know how." Includes actual practice on Diesel equipment in our shop under expert guidance. UEI training methods are successful. For 20 years they have helped mechanically inclined men better themselves.

**NOW IT'S UP TO YOU!**

Coupon below brings you all the facts without cost or obligation. Get going today! MAIL COUPON NOW.

**UTILITIES ENGINEERING INSTITUTE**  
Diesel Division  
1314 W. Belden  
Dept. 137-D,  
Chicago 14, Ill.



Send Coupon for FREE FACTS

**UTILITIES ENGINEERING INSTITUTE, Diesel Division**  
1314 W. Belden Ave., Dept. 137-D, Chicago 14, Ill.  
Please send me Free Facts about Diesel opportunities and training.

NAME \_\_\_\_\_ Age \_\_\_\_\_

ADDRESS \_\_\_\_\_

CITY \_\_\_\_\_ Zone or County \_\_\_\_\_ STATE \_\_\_\_\_

Check here for special information if you are under 17.  
 Check here if Veteran of World War II.

**WORK FOR THE**



**GOVERNMENT**

**START**

**\$1,756 to \$3,021 YEAR**

**Veterans Get Special Preference**

**MEN - WOMEN**

Postoffice Clerks, Carriers  
Railway Postal Clerks  
Stenographers-Typists  
Patrol Inspectors  
Many Other Jobs

**PREPARE IMMEDIATELY**  
Common Education  
Often Sufficient

**Mail Coupon TODAY**

**Franklin Institute**  
Dept. F86  
ROCHESTER 4, N. Y.

Gentlemen: Rush to me, FREE of charge, list of U. S. Government big pay jobs. Send FREE 32-page book describing salaries, vacations, hours, work. Tell me how to prepare for one of these jobs.

Name.....  
Address..... Vet?.....

**EASY to PLAY**



Pitched in G or C

**Order TO-DAY**

*The New Luellen*  
**HARMONICA**

Most wonderful pocket instrument ever made is the harmonica. Easy to master, fun for Everyone. The Luellen has 10 holes, 20 notes. Key of G or C (state choice). Brass reeds and plates. Postpaid Only..... **\$2.35**

**INSTRUCTION BOOK.** Simple for youngest child. No notes, scales nor exercises. Lesson charts show everything. Includes popular songs. Price 35 cents. Here's our special introductory offer: The Instructor and the Harmonica, both postpaid, both for \$2.70. Send Check or Money Order Today.

**JOHN LUELLEN & CO., 17034 Page Avenue, Dept. 303, Hazelcrest, Ill.**

**TRAIN Your VOICE!**

**Results GUARANTEED**

We build, strengthen the vocal organs—not with singing lessons—but by sound, scientifically correct silent and vocal exercises and absolutely guarantee complete satisfaction with results. Write for Voice Book, FREE. Sent to no one under 17 years old unless signed by parent.

Perfect Voice Studios, Studio 1353, Kimball Hall Bldg., Chicago 4, Ill.

**What Every Mason Wants**

We have important Masonic books for Blue Lodge, Chapter, Commandery, Scottish Rite, and Shrine. Our Rituals Are Used the World Over. Send for free catalog of books and rituals for Masons, Odd Fellows, Knights of Pythias, Knights of Columbus, etc. **EZRA A. COOK, Publisher, P. O. Box 796, PM, Chicago 90, Ill.**

**PHOTOGRAPHY** for PLEASURE or PROFIT

**QUALIFY AT HOME!** Learn expert photography as a joy-full hobby, or to qualify for a well-paid position or your own studio. Previous experience unnecessary with N.Y.I.'s success-proved home study training. Details FREE. Also resident courses. **NEW YORK INSTITUTE OF PHOTOGRAPHY, Dept. 49, 10 W. 33 St., New York 1, N. Y. (37th Year)**

**Learn Public Speaking**

Learn theory and fundamentals at home—in spare time. Then acquire actual experience and practice. Send for FREE booklet "Power of Effective Speech." No obligation.

North American School, Dept. 1353  
1315 S. Michigan Ave., Chicago 5, Illinois

**SUPER YOUR GREATEST ASSET!**

**MEMORY** Facts, figures, faces, STICK LIKE BURRS with new improved SUPER-MEMORY Course. **THOR BOOKS, Z5, Box 1210, Chicago**

**LAW...**

**STUDY AT HOME** Legally trained men win higher positions and bigger success in business and public life. Greater opportunities now than ever before. **More Ability: More Prestige: More Money** We guide you step by step. You can train at home during spare time. Degree of LL.B. We furnish all text material, including 14-volume Law Library. Low cost, easy terms. Get our valuable 48-page "Law Training for Leadership" and "Evidence" books FREE. Send NOW. **G. I. APPROVED. LASALLE EXTENSION UNIVERSITY, 417 South Dearborn Street A Correspondence Institution Dept. 364-L Chicago 5, Ill.**





**KIT 1** (left) I send you Soldering Equipment and Radio Parts; show you how to do Radio Soldering; how to mount and connect Radio parts; give you practical experience.



**KIT 2** (left) Early in my course I show you how to build this N. R. I. Tester with parts I send. It soon helps you fix neighborhood Radios and earn EXTRA money in spare time.



## VETERANS

You can get this training in your own home under G.I. Bill. Mail coupon for full details.

# Be a RADIO Technician

## Learn by PRACTICING in Spare Time

with **BIG KITS** of **RADIO PARTS** I send you

Do you want a good-pay job in the fast-growing Radio Industry—or your own Radio Shop? Mail the Coupon for a Sample Lesson and my 64-page book, "How to Be a Success in RADIO—Television, Electronics," both FREE. See how I will train you at home—how you get practical Radio experience building, testing Radio circuits with **BIG KITS OF PARTS** I send!

**Many Beginners Soon Make Extra Money in Spare Time While Learning**

The day you enroll I start sending EXTRA MONEY JOB SHEETS that show you how to make EXTRA money fixing neighbors' Radios in spare time while still learning! It's probably easier to get started now than ever before, because the Radio Repair Business is booming. Trained Radio Technicians also find profitable opportunities in Police, Aviation, Marine Radio, Broadcasting, Radio Manufacturing, Public Address work. Think of even greater opportunities as Television, FM, and Electronic devices become available to the public! Send for FREE books now!



### Find Out What NRI Can Do For You

Mail Coupon for Sample Lesson and my FREE 64-page book. Read the details about my Course; letters from men I trained; see how quickly, easily you can get started. No obligation! Just MAIL COUPON NOW in envelope or paste on penny postal. J. E. SMITH, President, Dept. 7CP, National Radio Institute, Pioneer Home Study Radio School, Washington 9, D. C.

Sample Lesson **FREE**  
64 Page Book

Mr. J. E. SMITH, President, Dept. 7CP  
National Radio Institute  
Washington 9, D. C.

Mail me FREE, Sample Lesson and 64-page book. (No salesman will call. Please write plainly.)

Age.....

Name.....

Address.....

City..... State.....  
(Please include Post Office Zone number)

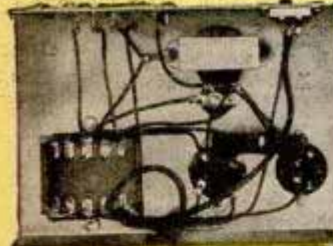

**KIT 3** You get parts to build Radio Circuits; then test them; see how they work; learn how to design special circuits; how to locate and repair circuit defects.

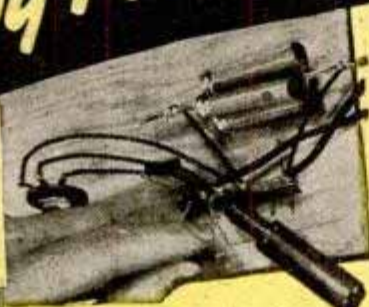

**KIT 4** You get parts to build this Vacuum Tube Power Pack; make changes which give you experience with packs of many kinds; learn to correct power pack troubles.

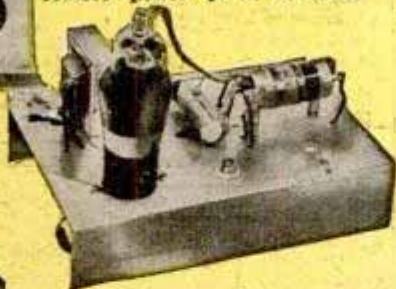

**KIT 5** Building this A. M. Signal Generator gives you more valuable experience. It provides amplitude-modulated signals for many tests and experiments.

**KIT 6** You build this Superheterodyne Receiver which brings in local and distant stations—and gives you more experience to help you win success in Radio.

My Course  
Includes Training in  
**TELEVISION • ELECTRONICS**  
FREQUENCY MODULATION



It's YOUR future — Make the most of it!



Start now to earn the bigger pay in electrical repair

WAS there ever such an opportunity to get started in electrical maintenance and repair—and at top-notch wages? Are you ready—with experience and ability—to cash in on it? Others are getting just the sort of background needed—quick! practical!—to handle the great variety of electrical maintenance and repair work TODAY—from this well-known electrical library. You can too!

## THE LIBRARY OF ELECTRICAL MAINTENANCE AND REPAIR

5 vols., 1826 pages, 1724 illustrations

Gives you the "know-how" to tackle any wiring or motor job. Five books show you HOW—to install all types of motor and generator units—to inspect and repair motor starters and generators—to diagnose motor and generator troubles—to figure new windings for old cores—DC and AC windings—to test armature windings—test induction motors, etc., etc. One book is full of trouble-shooting charts that show quickly symptoms, causes, specific remedies, etc.

Take the first step toward improving YOUR future—Mail this coupon TODAY

No money down—special price—easy payments—FREE trial

McGraw-Hill Book Co., 330 W. 42 St., New York 18, N. Y.

Send me for ten days' free examination the Electrical Maintenance and Repair Library. If satisfactory I will send you \$1.50 in 10 days and \$3.00 monthly until the price of \$16.50 is paid. If not wanted I will return books postpaid. (To insure prompt shipment write plainly and fill in all lines.)

Name .....

Home Address .....

City and State .....

Company .....

Position .....

PM-3-47

# Do you want

- ..to go to College?
- ..or to enter a Profession?
- ..or get an Office Position?

(Such as Accounting, Architecture, Nursing, Dentistry, Teaching, Social Work, Osteopathy, Beauty Culture, Optometry, Embalming, Chiropody, Law, Medicine, etc.)

To get anywhere, you practically MUST finish High School FIRST. You can complete our simplified High School Course in SPARE time at home, as FAST as your time and abilities permit. Equivalent to resident school work—prepares you for college, pre-professional examinations, business, industry. Standard texts furnished. Diploma. Credit for H. S. subjects already completed. Single subjects if desired. Low tuition, easy terms. American School, Chicago, est. 1897—endorsed by educators. Finish your high school education NOW. Write TODAY!

## High School Course at Home

Many Finish in 2 Years

American School, Dept. H-345, Drexel Ave. at 58th St., Chicago 37, Ill.

Gentlemen: Send me FREE information covering special training in subjects checked below. No obligation on my part.

- |  |  |
|--|--|
| <input type="checkbox"/> High School Course          | <input type="checkbox"/> Diesel Engineering                  |
| <input type="checkbox"/> Architecture and Building   | <input type="checkbox"/> Drafting and Design for Men & Women |
| <input type="checkbox"/> Automotive Engineering      | <input type="checkbox"/> Plastics                            |
| <input type="checkbox"/> Business Management         | <input type="checkbox"/> Private Secretary                   |
| <input type="checkbox"/> Electrical Engineering      | <input type="checkbox"/> Mechanical Engineering              |
| <input type="checkbox"/> Elec. and Gas Refrigeration | <input type="checkbox"/> Aviation                            |
| <input type="checkbox"/> Air Conditioning            | <input type="checkbox"/> Salesmanship                        |
| <input type="checkbox"/> Railway Training            | <input type="checkbox"/> Radio                               |
| <input type="checkbox"/> Electronics, Industrial     |  |

Name .....

Address .....

## How to Start YOUR OWN BUSINESS

Amazing Postwar Development Now Gives You the Opportunity to Make Money Fast!

Startling scientific discovery, just now becoming available for general use, will enable you to start your own business and reap great profits! Plastics, one of the most revolutionizing and rapidly expanding industries, offers a great opportunity to all enterprising men and women. This is one of the few industries in which home manufacturers thrive and prosper. You can start even on a spare time basis in your own home, and expand rapidly into a full time business, paying good profits.

**LIQUID MARBLE** the amazing Plastic, with a thousand uses. LIQUID MARBLE can be poured into FLEXIBLE MOLDS for casting all kinds of artistic and serviceable articles such as: ornaments, novelties, desk sets, paper weights, book-ends, souvenirs, statuary, toys, etc.

**FLEXIBLE MOLDS** Make your own FLEXIBLE MOLDS. The cost is low—in fact, a large sized mold costs but a few cents. Hundreds of casts can be taken from a single mold.

**NO EXPERIENCE NEEDED!** No skill or previous knowledge is necessary. All you do is follow our easy-to-understand instructions.

**UNLIMITED MARKET** The market is literally unlimited. You will find steady year-round demand in your own community. Your problem will not be in selling but in supplying the huge pent-up demand. Moreover, we supply you with names of big buyers for your finished products.

**WRITE TODAY** Bing Products will show you how to start with a small investment and build a permanent, independent, profitable business! Don't fail to grasp this opportunity! Write today for FREE CATALOG.

### BING PRODUCTS

Dept. A-16, 88 Broad Street BOSTON 10, MASS.

## VOCATIONAL TEST SENT FREE!

Discover your greatest Vocational Aptitudes to achieve financial success and happiness! Widely used, reliable Vocational Test and full details on how you can receive Psychologist's aptitude and personality analysis, sent FREE. State age and sex.

OHIO VOCATIONAL GUIDANCE, Box 3560, Cleveland 18, Ohio

## ANY BOOK IN PRINT



Delivered at your door. We pay postage. Standard authors, new books, popular editions, fiction, reference, medical, mechanical, children's books, etc. Guaranteed savings. Send for Clarkson's 1947 catalog.

**FREE** Write for our great illustrated book catalog. A short course in literature. The buying guide of 300,000 book lovers. Free if you write now—today!

CLARKSON PUBLISHING COMPANY  
Dept. PM473, 1257 So. Wabash Ave., Chicago, Ill.



## I WANT TO TRAIN YOU For A Big-Paying Job IN THE MEAT BUSINESS

Big-pay jobs go to expert Meat Cutters—essential trade—PEOPLE MUST EAT! Become Meat Cutting and Meat Merchandising expert in 6 weeks at Toledo. Learn easily, quickly. Actual practice. Training methods based on 20 years experience. Training for beginners or men with experience. Be own boss in profitable market. Diploma. Approved for training under G. I. Bill. Write TODAY for FREE facts. No obligation.

Thomas E. Lattin, President  
National School of Meat Cutting, Inc., Dept. 35, Toledo 4, Ohio

## MAGIC LIQUID MAKES PHOTOS APPEAR

Amazing discovery permits you to print pictures from any of your snapshot negatives on wood, cloth, leather or paper. Like magic your pictures will show on ties, handkerchiefs, purses, cards and letterheads. Takes only a few minutes in broad daylight. Won't rub off or harm negative. An attractive set with enough material for over 100 pictures. ORDER TODAY. Send \$2.49 postpaid. C.O.D. pay postman a few cents more in addition. (Foreign \$2.60 money order only.)



STYLE-ARTS, Inc.

Dept. 1-C, 4649 Broadway, Chicago 40, Ill.

## MAKE MONEY AT HOME

### RUBBER MOLDS Low as 6¢ EA.

Amazing rubber mold-making outfit makes perfect flexible molds of plaques, ash trays, book-ends, etc. Molds cost 6c to 25c each. Each mold makes hundreds of novelties and gifts to sell for \$1.00 apiece and more! No experience necessary. Everything furnished. Quick and easy. Start profitable business in your home—sell to stores, gift shops, friends, resorts, road stands, by mail. Full or spare time. Write for complete FREE details and easy instructions.



SO-LO WORKS, Inc., Dept. S-800, Loveland, Ohio



# INVENTORS

The patent laws provide that any new and useful art, machine, article of manufacture, composition of matter, or design, or any new and useful improvement thereof, may be patented if the act of invention is involved. Therefore, every inventor with a valuable invention should take advantage of the patent laws and proceed for patent protection in order to safeguard his rights.

A patent gives the inventor the exclusive right to prevent others from making, using, or selling the invention claimed in the patent for a period of 17 years.

The patent laws were enacted for the benefit of the inventor to give him protection for the features of his invention which are patentable. These features must be properly and concisely set forth and claimed in a formal application for patent in order to comply with the requirements of the U. S. Patent Office. For that reason, the Patent Office advises the inventor to engage a competent registered patent attorney to prepare his application for patent and represent him before the U. S. Patent Office Examiner.

A specially prepared booklet containing detailed information with respect to patent protection and procedure will be forwarded to you without obligation upon request.

**Patents**  
**Trademarks**  
**Copyrights**

**Registered Patent Attorneys**

**CLARENCE A. O'BRIEN**  
**& HARVEY B. JACOBSON**

71-C District National Building + Washington 5, D. C.

CLARENCE A. O'BRIEN & HARVEY B. JACOBSON  
Registered Patent Attorneys  
71-C District National Bldg., Washington 5, D. C.

Please send me booklet containing information regarding patent protection and procedure, and also "Record of Invention" form. This request does not obligate me.

Name \_\_\_\_\_

Address \_\_\_\_\_

City \_\_\_\_\_ State \_\_\_\_\_

(Please write or print plainly.)



# NOW SPRAYBERRY RADIO TRAINING

## GIVES YOU 8 BIG KITS OF RADIO EQUIPMENT

WITH A COMPLETE 6 TUBE SUPER-HETERODYNE RECEIVER

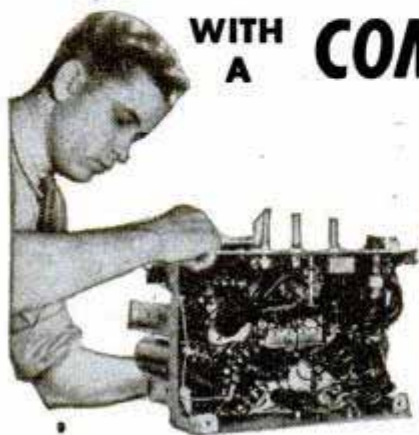

**YOU LEARN RADIO SERVICING THROUGH INTENSIVE "SHOP-BENCH" PRACTICE**

### YOU DO EXPERIMENTS, CONSTRUCTION, TROUBLE-SHOOTING

I'll show you how to perform over 175 instructive Experiments—how to build countless Radio Circuits. You'll learn a new, fast way to test Radio Sets without mfg. Equipment.



I give you a fine, moving-coil type Meter Instrument on Jewel Bearings—with parts for a complete Analyzer Circuit Continuity Tester. You learn how to check and correct Receiver defects with professional accuracy and speed.

You'll get valuable experience and practice building this Signal Generator and multi-purpose Tester. Makes a breeze out of fixing Radios and you don't have to spend money on outside, ready-made equipment.



Soldering, wiring, connecting Radio parts . . . building circuits with your own hands—you can't beat this method of learning. When you construct this Rectifier and Filter, Resistor and Condenser Tester, etc., you get a really practical slant on Radio that leads to a money-making future.



### HERE'S THE LATEST, SIMPLEST WAY TO TRAIN at HOME for a GOOD LIVING in RADIO-ELECTRONICS & TELEVISION

I train your mind by putting you to work with your hands on a big 6-Tube Superheterodyne Receiver. And, believe me, when you get busy with real Radio Parts—8 big Kits of them—you really LEARN Radio and learn it RIGHT! You get the practical stuff you need to be useful in Radio, and that's what it takes to make money. You don't have to worry about what to do with these 8 Kits of

with real "Shop" practice, makes every subject plain and easy to understand and remember.

#### A BUSINESS OF YOUR OWN . . . OR A GOOD RADIO JOB

Soon after you begin Sprayberry Training, I'll send you my sensational BUSINESS BUILDERS. You'll find out how to get and do neighborhood Radio repair jobs for nice profits and rich experience while learning. This sort of work can easily pave the way for a Radio Service business of your own. But with Sprayberry Training, you're not limited. You can swing into any one of the swiftly expanding branches of Radio-Electronics INCLUDING Radio, Television, FM, Radar, Industrial Electronics. Be wise! Decide now to become a fully qualified RADIO-ELECTRONICIAN. Get full details about my Training at once! Mail coupon below for my 2 big FREE Books.

### SEND FOR THESE FREE BOOKS



"How to Read Radio Diagrams and Symbols"

Here's a valuable and wonderfully complete new book which explains in simple English how to read and understand any Radio Set Diagram. Includes translation of all Radio symbols. Send for this volume at once! It's free! Along with it, I will send you another Big Free book describing in detail my Radio-Electronic Training.

Parts. Step by step, I show you how to build circuits, test, experiment, trouble-shoot. And you don't need any previous experience. The Sprayberry Course starts right at the beginning of Radio! You can't get lost! Simplified lessons, coupled

#### SPRAYBERRY ACADEMY OF RADIO

F. L. Sprayberry, President, Room 1037 Pueblo, Colorado

Please rush my FREE copies of "How to MAKE MONEY in RADIO, ELECTRONICS and TELEVISION," and "HOW to READ RADIO DIAGRAMS and SYMBOLS."

Name ..... Age .....

Address .....

City ..... State .....

(Mail in envelope or paste on penny postcard)

**MAIL COUPON TODAY!**



# The Insult That Turned a "CHUMP" Into a CHAMP

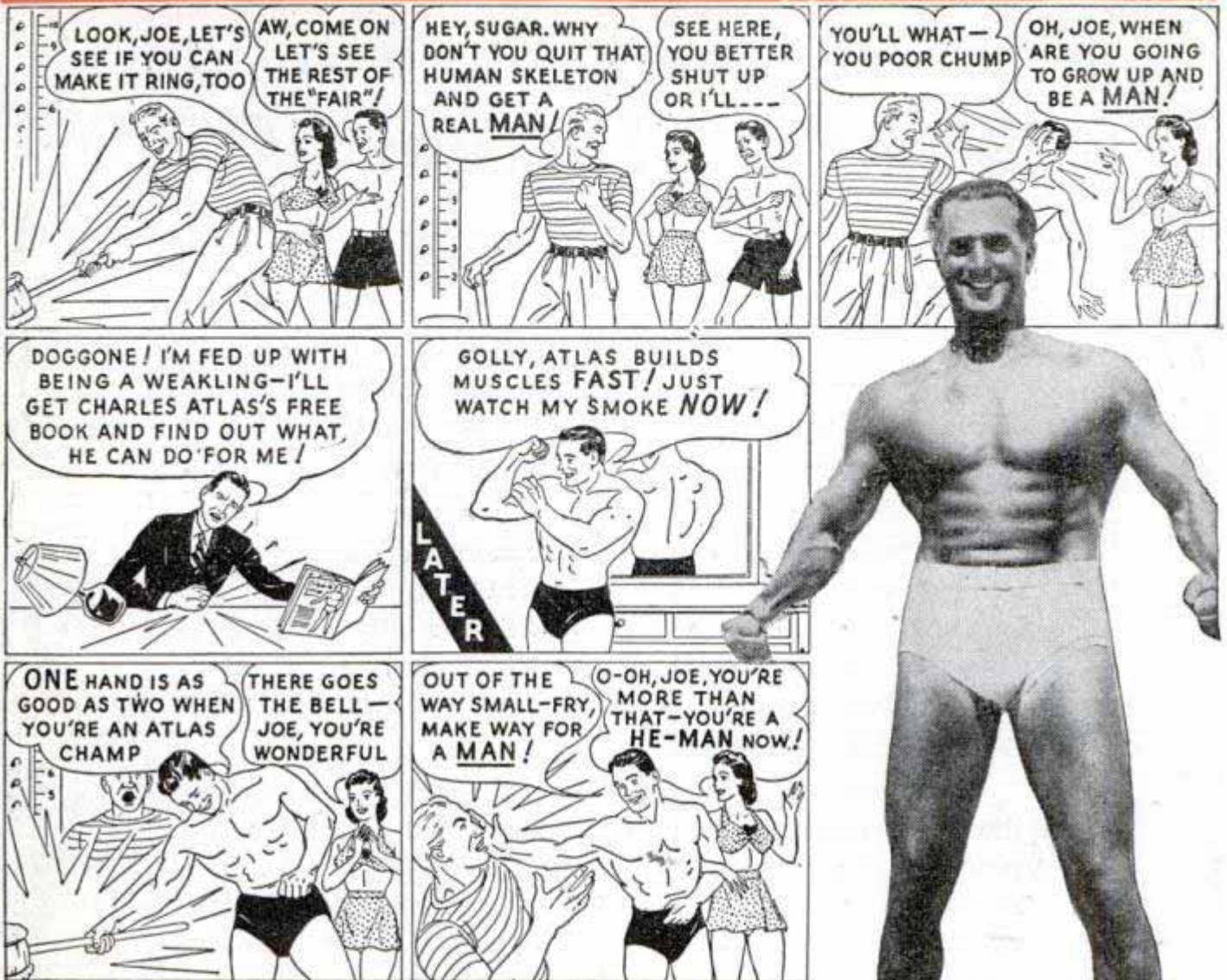

*Charles Atlas*  
—actual photo of the man who holds the title, "The World's Most Perfectly Developed Man."

## I Can Make YOU A New Man, Too In Only 15 Minutes a Day!

HAVE YOU ever felt like Joe—absolutely fed up with having bigger huskier fellows "push you around"? If you have, then give me just 15 minutes a day! I'LL PROVE you can have a body you'll be proud of, packed with red-blooded vitality!

"Dynamic Tension." That's the secret! That's how I changed myself from a scrawny, 97-pound weakling to winner of the title, "World's Most Perfectly Developed Man."

### "Dynamic Tension" Does It!

Using "Dynamic Tension" only 15 minutes a day, in the privacy of your own room, you quickly begin to put on muscle, increase your chest measurements, broaden your back, fill out your arms and legs. This easy, NATURAL method will make you a finer specimen of REAL MANHOOD than you ever dreamed you could be!

### You Get Results FAST

Almost before you realize it, you will notice a general "toning up" of your entire system! You will have more pep, bright eyes, clear head, real

spring and zip in your step! You get sledge-hammer fists, a battering ram punch—chest and back muscles so big they almost split your coat seams—ridges of solid stomach muscle—mighty legs that never get tired. You're a New Man!

### FREE BOOK

Thousands of fellows have used my marvelous system. Read what they say—see how they look before and after—in my book, "Everlasting Health and Strength."

Send NOW for this book — FREE. It tells all about "Dynamic Tension," shows you actual photos of men I've turned from puny weaklings into Atlas Champions. It tells how I can do the same for YOU. Don't put it off! Address me personally: **Charles Atlas, Dept. 83, 115 East 23rd Street, New York 10, New York.**



**CHARLES ATLAS, Dept. 83  
115 East 23rd St., New York 10, N. Y.**

I want the proof that your system of "Dynamic Tension" will help make a New Man of me—give me a healthy, husky body and big muscular development. Send me your free book, "Everlasting Health and Strength."

Name.....  
(Please print or write plainly)

Address.....

City.....State.....

Check here if under 16 for Booklet A



# INVENTORS

## Patent Laws Encourage The Development Of Inventions

The Rules of Practice of the U. S. Patent Office advises—unless an inventor is familiar with such matters—that he employ a competent registered attorney, as the value of patents depends largely upon the skillful preparation of the specifications and claims.

The firm of McMorrow, Berman and Davidson is registered to practice before the U. S. Patent Office. Additionally, it maintains a staff of attorneys able to readily understand inventors' disclosures, to advise concerning patentability, and to prepare appropriate specifications and claims for filing with the Patent Office.

If an inventor believes he has an invention, a search of the most pertinent prior U. S. patents should be made and a report obtained relative to its patentability. Where such report indicates that the invention appears patentable, in order to secure protection, diligence should be exercised in making application for a patent.

## McMORROW, BERMAN & DAVIDSON

*Registered Patent Attorneys*

**PATENTS — TRADE MARKS — COPYRIGHTS**

1353 VICTOR BUILDING, WASHINGTON 1, D. C.

### McMORROW, BERMAN & DAVIDSON

*Registered Patent Attorneys*

1353 Victor Building, Washington 1, D. C.

Send me further particulars as to patent protection and procedure and "Invention Record" form at once. I understand that this request does not obligate me.

Name.....

Address.....

City..... State.....

(WRITE OR PRINT NAME CLEARLY)



# HOW'S YOUR POST-WAR PROGRESS?



• Remember when you were going to prepare for the period of post-war opportunities? *This is it!* New industries are coming into being, established industries are expanding . . . and there are rewarding openings for *trained* men in all lines.

• If you failed to get ready for them, it still isn't too late to do something about it! You don't have to slip back . . . you don't have to content yourself with merely hanging to the same old job. The famous International Correspondence Schools can help you to catch up with the procession.

• But don't delay again . . . or it may be too late. Mail the coupon today for full information on I. C. S. training in the field of your interests. Thousands of leaders in American business and industry started up the ladder of success in just that way. It can be the beginning of your climb to higher pay and a more responsible position.

## INTERNATIONAL CORRESPONDENCE SCHOOLS



BOX 5600-K, SCRANTON 9, PENNA.

Without cost or obligation, please send me full particulars about the course *before* which I have marked X:

### Business and Academic Courses

- Accounting  Advertising
- Arithmetic  Bookkeeping
- Business Correspondence
- Business Management
- Certified Public Accounting
- Commercial
- Cost Accounting
- Federal Tax
- First Year College
- Foremanship  French
- Good English  High School
- Higher Mathematics
- Illustrating  Motor Traffic
- Postal Service
- Salesmanship  Secretarial
- Sign Lettering
- Spanish  Stenography
- Traffic Management

### Air Conditioning and Plumbing Courses

- Air Conditioning
- Heating  Plumbing
- Refrigeration  Steam Fitting

### Chemistry Courses

- Chemical Engineering
- Chemistry, Analytical
- Chemistry, Industrial
- Chemistry, Mfg. Iron & Steel
- Petroleum Refining  Plastics
- Pulp and Paper Making

### Civil Engineering, Architectural and Mining Courses

- Architectural Drafting
- Architecture
- Building Estimating
- Civil Engineering  Coal Mining
- Contracting and Building
- Highway Engineering
- Lumber Dealer
- Reading Structural Blueprints
- Sanitary Engineering
- Structural Drafting
- Structural Engineering
- Surveying and Mapping

### Communications Courses

- Electronics
- Practical Telephony
- Radio, General
- Radio Operating

### Electrical Courses

- Radio Servicing
- Telegraph Engineering
- Electrical Drafting
- Electrical Engineering
- Electric Light and Power
- Lighting Technician
- Practical Electrician
- Power House Electric
- Ship Electrician

### Internal Combustion Engines Courses

- Auto Technician  Aviation
- Diesel-Electric
- Diesel Engines  Gas Engines

### Mechanical Courses

- Aeronautical Engineering
- Aircraft Drafting
- Flight Engineer
- Forging
- Foundry Work
- Heat Treatment of Metals
- Industrial Engineering
- Industrial Metallurgy
- Machine Shop
- Machine Shop Inspection

- Mechanical Drafting
- Mechanical Engineering
- Mold-Loft Work
- Patternmaking—Wood, Metal
- Reading Shop Blueprints
- Sheet-Metal Drafting
- Sheet-Metal Worker
- Ship Drafting  Ship Fitting
- Tool Designing  Toolmaking
- Welding—Gas and Electric

### Railroad Courses

- Air Brake  Car Inspector
- Diesel Locomotive
- Locomotive Engineer
- Locomotive Fireman
- Railroad Section Foreman

### Steam Engineering Courses

- Boilermaking
- Combustion Engineering
- Engine Running
- Marine Engineering
- Steam Electric  Steam Engines

### Textile Courses

- Cotton Manufacturing
- Rayon Weav'g  Textile Design'g
- Woolen Manufacturing

Name \_\_\_\_\_ Age \_\_\_\_\_ Address \_\_\_\_\_

City \_\_\_\_\_ State \_\_\_\_\_ Present Position \_\_\_\_\_

Working Hours \_\_\_\_\_ A.M. to \_\_\_\_\_ P.M. Length of Service in World War II \_\_\_\_\_

Special tuition rates to members of the Armed Forces. Enrollment under the G.I. Bill of Rights approved for War II Veterans. Canadian residents send coupon to International Correspondence Schools Canadian, Ltd., Montreal, Canada.



# PATENT PROTECTION *for* INVENTORS

## A PATENT IS A VALUABLE RIGHT

On the basis of a provision in the Constitution of the United States, Congress has established a system under which inventors may secure the exclusive right to prevent the unauthorized use, manufacture and sale of their inventions for periods of seventeen years. The inventor secures this protection by obtaining a patent from the United States Patent Office.

**V**ICTOR J. EVANS & CO., has a staff of experienced registered patent attorneys, available to represent inventors in the preparation and prosecution of their cases before the Patent Office. Detailed information and the steps to be taken in obtaining patent protection will be furnished upon request.

—FORM BELOW FOR MAILING CONVENIENCE—

**VICTOR J.  
EVANS & Co.**

*Merlin M. Evans*

REGISTERED PATENT ATTORNEY

230-C Merlin Building, Washington 6, D. C.

Please forward to me detailed information regarding procedure to obtain Patent Protection, together with your convenient "Evidence of Invention" form.

Name \_\_\_\_\_

Address \_\_\_\_\_

City and State \_\_\_\_\_

**PATENTS • TRADEMARKS • COPYRIGHTS**



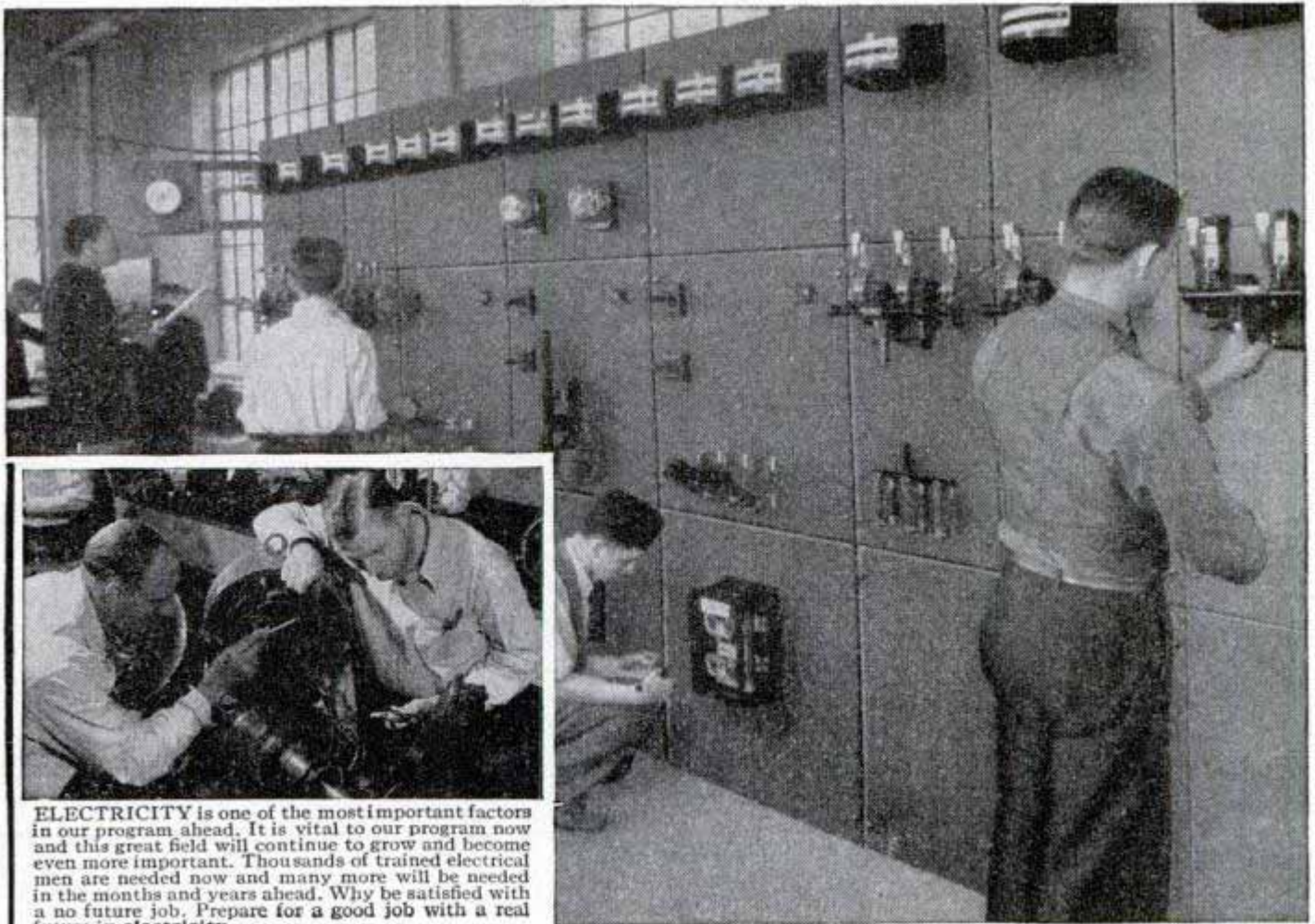

ELECTRICITY is one of the most important factors in our program ahead. It is vital to our program now and this great field will continue to grow and become even more important. Thousands of trained electrical men are needed now and many more will be needed in the months and years ahead. Why be satisfied with a no future job. Prepare for a good job with a real future in electricity.

# Learn ELECTRICITY

## IN A FEW SHORT WEEKS AT COYNE

Get into the fascinating, fast-growing, well-paid field of Electricity—a field that offers you opportunities and a future—in good times or bad times—a field that is a permanent necessity. Here is your chance to prepare yourself for a lasting permanent future.

### LEARN BY DOING

Here at Coyne—in a few short weeks, you can train for your Big Opportunity. "Learn-by-doing"—train on real electrical machinery. Not a correspondence course but actual shop work plus necessary theory. Here you get all-around training in the many branches of

**INDUSTRIAL ELECTRONICS**  
and  
Electric Refrigeration  
Training  
Included



Electricity, so you are equipped for the better jobs in this field.

### COYNE GIVES "ALL-AROUND" TRAINING

Coyne training is easily mastered. Many of our students have never had previous Electrical experience—many others have had experience in one or two branches but realize to advance they must have all-around Electrical training.

ANY MAN WITH A PHYSICAL DISABILITY whether a Veteran or not may qualify for Coyne training at no cost to them for tuition or subsistence. Check coupon for details.



**DON'T LET LACK OF CASH HOLD YOU BACK... OUR STUDENT FINANCE PLAN HAS HELPED MANY MEN**

*B.W. Cooke*

**VETERANS!** Coyne is also equipped to train those who qualify for training under the G.I. Bill of Rights. Check coupon for special G.I. Bulletin.

Coyne Training is EASY, PRACTICAL! You LEARN BY DOING on real, actual machinery and apparatus. Don't let lack of money stop you. You can get training first—then pay most of your tuition after you graduate. If you need part-time work to help out with living expenses, we'll help you get it.

W. COOKE, Director

**COYNE ELECTRICAL SCHOOL**  
500 S. Paulina St., Dept. 37-72, Chicago 12, Ill.

### SEND FOR FREE BOOK

Coyne is 48 years old. Coyne training is tested and proven with a background of nearly half a century of training experience. Mail coupon for big free Coyne book and the complete story about our plans to help you. Act at once. Just mail coupon.



B. W. Cooke, Director,  
COYNE ELECTRICAL SCHOOL, Dept. 37-72,  
500 S. Paulina St., Chicago 12, Ill.

Send me your Free Book and tell me about your plans to help me—including Student Finance and added Training in Industrial Electronics and Electric Refrigeration. Check if you are interested in information on the following:

- Send special G.I. Bulletin.
- Send physical disability details.

NAME.....  
ADDRESS.....  
CITY.....STATE.....



**I'll PROVE I can make you, too, TOUGH as a MARINE**

.....and add Powerful POUNDS and Vital INCHES of DYNAMIC MUSCLE to your ARMS, LEGS, BACK, CHEST, and SHOULDERS

says **George F. Jowett**

**WORLD'S GREATEST BODY BUILDER**

**..OR IT WON'T COST YOU A CENT!**

Let me prove to YOU that you can put inches of dynamic muscles on your arms! Add inches to your chest! Broaden your shoulders and power-pack the rest of your body. I can do for you what I've done for thousands the world over, including many officers and men now in the U. S. and British Armed Forces!

**GIVE ME 10 MINUTES A DAY!**

**I'll Show You My Secrets Of Body Building**

I'll help you learn the "Progressive Power Method" through which I rebuilt myself from a physical wreck to the holder of more strength records than any other living athlete or teacher! No matter how skinny or baby you are, you can learn my methods right in your own home. Through my proved secrets I show you how to develop your power, inside and out, until YOU are fully satisfied that you are the man you want to be. "The Jowett System," says K. F. Kelly, Physical Director of the YMCA, Atlantic City, "is the greatest in the world!"

If you want a physique that will inspire respect from men, and admiration from women... **ACT LIKE Muscles Like Iron!** will be included FREE! Priceless for the strength fan! Full of photos of marvelous power-bodied men who will show you what Jowett has done for them and how he can do the same for you. Reach out... Grasp this Special Offer today!

**PROVE TO YOURSELF IN ONE NIGHT!**

Send only 25c for test Course, "Molding a Mighty Arm." Read it the evening it arrives—learn from experience the thrill you can give your muscles!

**SEND FOR THESE FIVE FAMOUS COURSES IN BOOK FORM ONLY 25c EACH or ALL 5 for \$1.00**

Jowett Institute of Physical Culture  
230 Fifth Avenue  
Dept. PM-73  
New York 1, N. Y.



**BOOK WITH PHOTOS OF FAMOUS STRONG MEN MAIL COUPON NOW FREE**

Jowett Institute of Physical Culture  
230 Fifth Avenue, Dept. PM-73, New York 1, N. Y.  
George F. Jowett: Your proposition looks good to me. Send by return mail, prepaid, the courses checked below, for which I enclose ( ) Include FREE book of PHOTOS.

- George F. Jowett Champion of Champions
- All 5 courses for... \$1
  - Molding Mighty Arms 25c
  - Molding a Mighty Arm 25c
  - Molding a Mighty Grip 25c
  - Molding a Mighty Back 25c
  - Molding a Mighty Chest 25c
  - Send all 5 C.O.D. (\$1 plus postage.) No orders less than \$1 sent C.O.D.

NAME \_\_\_\_\_ Age \_\_\_\_\_  
(Please print plainly. Include Zone Number.)

ADDRESS \_\_\_\_\_

**Do You Make These Mistakes in English?**

MANY persons say "between you and I" instead of "between you and me"—or use "who" for "whom"—or don't know whether to spell certain words with one or two "c's" or "m's" or "r's," or with "ie" or "ei," etc. Every time you speak or write you show what you are. Mistakes in English reveal lack of education, refinement. Lack of language power prevents you from presenting your thoughts in the strongest way. Real command of English will help you reach ANY goal. Stop making mistakes in spelling, punctuation, pronunciation, grammar. Increase your vocabulary.



**WONDERFUL INVENTION**

Only 15 minutes a day with Sherwin Cody's new invention—and you can actually SEE your English improve. It teaches by HABIT—makes it easier to do the RIGHT way. Wonderful self-correcting lessons.

**FREE BOOK ON ENGLISH** Lack of language ing your friendships, income, every year. See what Mr. Cody can do for you; it costs nothing to find out. Write this very minute for free book, "How You Can Master Good English in 15 Minutes a day." It will prove a revelation. WRITE NOW. **SHERWIN CODY SCHOOL OF ENGLISH, 53 B & O Bldg., Rochester 4, N. Y.**

**Command a Substantial Salary BE AN ACCOUNTANT**

**FREE WRITE TODAY**

Hill's, one of America's leading Business Schools, offers you the opportunity to advance yourself to a well paying accountant's job. Our FREE book, "Through Hill's to Success," tells how and where the best positions are found and how you can qualify for them by study at home or in our resident school. We have thousands of successful graduates and maintain nation-wide employment service. G. I. Approved.

**HILL'S EXTENSION SCHOOL and BUSINESS UNIVERSITY**  
619 W. Main St. • Oklahoma City 2, Okla.

**LEARN MONEY-MAKING CARTOONING**

**IN SPARE TIME — by Easy Picture Chart Method**

Same Simplified Method that has helped train creators of "Terry & Pirates," "Freckles," "Out Our Way," "Winnie Winkle," "Regular Peilers," "Strange As It Seems," "The Neighbors," and many others. Earn while learning. Send 10c for Picture Chart (to test your ability), and full details. (State age.)

Landon School of Cartooning, Dept. 4703 Philadelphia 1/Pa.



**WHY JOB WORRY? LEARN ELECTROPLATING**

Highly paid, uncrowded, interesting business. Part or full time. Chromium, Nickel, Gold, Silver, etc. Send postcard for FREE booklet and proof.

**PLATER HYDE, Dept. M Post Office Box 176 National City, Calif.**

**SHORTHAND in 6 Weeks at Home**

Famous Speedwriting system. No signs or symbols; uses ABC's. Easy to learn; easy to write and transcribe. Fast preparation for a job. Surprisingly low cost. 100,000 taught by mail. Used in leading offices and Civil Service. Write for free booklet.

**SPEDWRITING, Dept. 1503-7, 55 West 42 St., N. Y. 18**

**MONEY for MEN ALL DATA FREE**

THE PLASTEX Industry needs manufacturers on small scale and for big production of Lamp and Clock Stands, Art Goods and Novelties in Plastex and Marble imitation. Experience unnecessary, 1/2c material makes regular 10c store sellers. Rubber moulds furnished for speed production. Small investment brings good returns. Big chain store orders now being placed. Ambitious men have chance for real prosperity. Our Free booklet will interest and benefit you.

**PLASTEX INDUSTRIES, Dept. P, 1085 Washington Ave., New York, N. Y.**





# WHICH OF THESE *Opportunities* INTERESTS *You* MOST?

Accounting  
Air Conditioning  
Architecture & Building  
Automotive Engineering  
Aviation—Practical  
Aviation Drafting & Design  
Better Foremanship  
Bookkeeping  
Business Management

Contracting  
Diesel Engineering  
Drafting & Design  
Electrical Engineering  
Electricity—Practical  
Electronics, Industrial  
High School Courses  
Machine Shop Operations  
Mechanical Engineering

Plastics Engineering  
Plumbing—Practical  
Private Secretary  
Radio Operating & Servicing  
Railway Training  
Refrigeration  
Sheet Metal Pattern Drafting  
Shop Management  
Tool Making

## THINK! LOOK FORWARD!

Business is making big, new plans

Men and Women are preparing for the future

### WHAT ARE YOU DOING ABOUT YOUR TOMORROWS?

● *Today*, choose the job you want—and prepare for it. Or if you are already engaged in the work you like best, start training *now* for quicker promotion. Acquire the knowledge that will help you to get ahead faster, make more money and have greater security.

Invest part of your spare time in more rapid progress. Start training now, in spare time in your own home. Be ready to grasp your opportunity and step out ahead of those who lack the ability you have attained.

American School, founded in 1897 as an educational institution *not for profit*, can help you to reach your goal just as it has helped others during the past fifty years. Give serious thought to the list above. Pick one or more subjects that interest you. Then check the coupon at right, add your name and address and mail it at once. The school will send you details on its training plan and outline of study prepared by specialists. There is no charge, no obligation, so send the coupon immediately.

PRACTICAL, EFFECTIVE HOME - STUDY TRAINING SINCE 1897

Take This First Easy Step

**CHECK, CLIP AND MAIL COUPON NOW**

AMERICAN SCHOOL, Dept. G345, Drexel at 58th, Chicago 37, Ill.  
Without obligation, Please send FREE and postpaid, bulletin and details of the Subject checked.

- |  |   |  |
|--|---|--|
| <input type="checkbox"/> PLASTICS ENG'R            | <input type="checkbox"/> Accounting                   | <input type="checkbox"/> Drafting and Design for Men and Women |
| <input type="checkbox"/> Refrigeration             | <input type="checkbox"/> Electrical Engr.             | <input type="checkbox"/> Radio                                 |
| <input type="checkbox"/> Architecture and Building | <input type="checkbox"/> Electricity-Pract.           | <input type="checkbox"/> High School                           |
| <input type="checkbox"/> Contracting               | <input type="checkbox"/> Electronics, Industr.        | <input type="checkbox"/> Air Conditioning                      |
| <input type="checkbox"/> Practical Plumbing        | <input type="checkbox"/> Bookkeeping                  | <input type="checkbox"/> Mechanical Eng.                       |
| <input type="checkbox"/> Automotive Engineering    | <input type="checkbox"/> Private Secretary            | <input type="checkbox"/> Shop Management                       |
| <input type="checkbox"/> Aviation Drafting         | <input type="checkbox"/> Diesel Engineering           | <input type="checkbox"/> Tool Making                           |
| <input type="checkbox"/> Aviation                  | <input type="checkbox"/> Sheet Metal Pattern Drafting | <input type="checkbox"/> Better Foremanship                    |
| <input type="checkbox"/> Business Mgmt             |   | <input type="checkbox"/> Machine Shop Operations               |
| <input type="checkbox"/> Railway Training          |   |  |

Name..... Occupation.....  
Address..... Age.....  
City..... State.....

**AMERICAN SCHOOL**

Dept. G345, Drexel at 58th Street, Chicago 37



# OIL BURNER

## INFORMATION IN A HANDY FORM

JUST OUT!

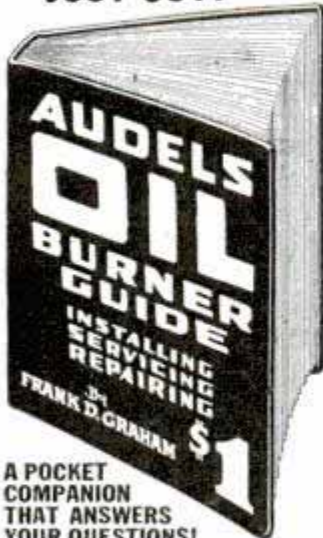

A POCKET COMPANION THAT ANSWERS YOUR QUESTIONS!

### AUDELS OIL BURNER GUIDE

— A new practical, concise treatise, 384 pages—31 Chapters — 321 Diagrams and Illustrations — covering Domestic and Industrial Oil Burners.

New from Cover to Cover, for mechanics interested in Oil Burners. Gives practical inside working knowledge of theory, construction, installation, operation, testing, servicing and repair of all types of oil burners. Includes electrical hook-ups and wiring diagrams of automatic control systems.

PRICE \$1 POSTPAID

Get this information for yourself. Mail coupon today. No obligation unless satisfied.

ASK TO SEE IT

**AUDELS, Publishers, 49 W. 23rd St., New York 10, N. Y.**

Please mail AUDELS OIL BURNER GUIDE (Price \$1). If satisfactory, I will remit \$1 on its safe arrival, otherwise I will return the book.

Name \_\_\_\_\_

Address \_\_\_\_\_

Occupation \_\_\_\_\_

Employed by \_\_\_\_\_ PM

# AVIATION

## Career

### MAXIMUM TRAINING IN MINIMUM TIME

CAL-AERO TECH TRAINING will add dollars to your pay check all the rest of your life. Specializing in AERONAUTICAL ENGINEERING and MASTER AVIATION MECHANICS since 1929, Cal-Aero Tech training is carefully designed for just one thing—TO MAKE MORE MONEY FOR YOU. An alumni of over 6000 successful graduates proves our career training is unsurpassed.

**VETERANS** —Write us about Aviation Training, as provided under "G.I. Bill of Rights."



### MAIL THIS COUPON TODAY!

Cal-Aero Technical Institute, Grand Central Airport, Glendale 1, California  
Please send full information on Aviation Training FREE—without obligation. Dept. PM-3

Name \_\_\_\_\_ Birth Date \_\_\_\_\_

Street \_\_\_\_\_

City \_\_\_\_\_ State \_\_\_\_\_

# ANALYZE HANDWRITING

Qualify for Certified Grapho Analyst Degree at home, spare time. Credit, Employment, Personnel Managers, Business, Professional men, women use grapho-analysis in their work, earn substantial fees in spare time. Many study solely for personal benefit, no desire to earn money, find it so fascinating they start using it to add to their incomes. Entertainment field pays well, up to \$100 in a week reported. Others establishing profitable practices as Vocational and Family Problem Counselors, Personality Teachers, and lecturers.



### GROWING—UNCROWDED PROFESSION

More and more police use grapho analysis handling suspects and criminals. They understand how criminals think. Their handwriting tells. Men like Hugh Dunlap, university student, Harry Allen, retired preacher, use it in court, win cases, earn fees even before graduation. Only school in world devoted to teaching grapho analysis offers thorough training to earnest, ambitious men and women regardless of where you live, small town, farm or city. Send for GRAPHO ANALYST, illustrated lesson, personal handwriting analysis offer, ALL FREE. Must be 21 or over. Address A. I. G. A. Inc., 120, Noel, Missouri.



# REFRIGERATION and AIR CONDITIONING

REFRIGERATION TRAINING Since 1927

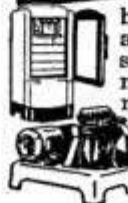

MECHANICAL units everywhere need servicing. Soon new units will require installation service. You can be ready with reliable pay-knowledge of this big income field. Unique home study-plus actual practice plan prepares you to enter servicing or installing field or get into business of your own. Great opportunities now and later. Get the facts FREE. No obligation. Write today.

Training approved under G.I. Bill

UTILITIES ENGINEERING INSTITUTE  
1314 W. Belden Av., Dept. 137, Chicago 14, Ill.

# INVENTING

—FOR PROFIT! If you have an inventive turn of mind, write for free 28-page booklet explaining how the Institute of American Inventors is helping inventors pre-test the profit possibilities of proposed devices to fill today's unprecedented demand for useful new inventions.

### INSTITUTE of AMERICAN INVENTORS

Dept. 4, 1926 Eye St., NW, Washington 6, D. C.

# PRINTING PAYS BIG

"Make your future secure. Prepare for a highly paid position or a print shop of your own. Students throughout the world are enthusiastic in their praise of our training program and the personal attention given each student. Rush name today for free literature and sample lesson. No salesman will call. Write Dept. M-106.

International School of Printing, Box 334, Dayton, Ohio

# APTITUDE TESTS

discover the kind of work or studies best for your success! You get a personal report—a guide for life—more happiness—more prosperity. For men, women, boys and girls. Write for complete facts.

VOCATIONAL COUNSELING INSTITUTE  
956 Maccabees Bldg., Detroit 2, Michigan

# Say You Saw It in POPULAR MECHANICS

# MAKE YOUR OWN COSTUME JEWELRY

## SPLENDID HOBBY OR VOCATION

- Sea Shells • Pin Backs • Ear Screws • Screw Eyes
- Plastic Discs • Ear Clips • Floral Stones • Jump Rings
- Chains • Clasps • Wire • Boxes • Bracelets • Parts
- Bow Knots • Catches • Plexiglas • Cements • Dyes

WRITE FOR FREE CATALOGUE • DEPT. B

PHILADELPHIA BADGE CO., 1007 Filbert St., Phila. 7, Pa.



# Let Us Show You How to Prepare TO MAKE REAL MONEY QUICKLY!!



EX-G. I.

TEEN-AGE  
YOUTH

OLDER MAN

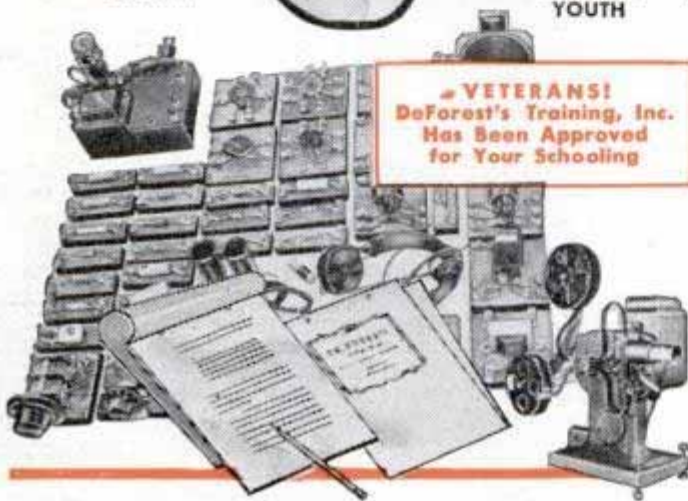

**VETERANS!**  
DeForest's Training, Inc.  
Has Seen Approved  
for Your Schooling

Whether you are an ex-G. I., a teen-age youth, or an older man eager to earn real money...There can be a place for you in The Billion Dollar Field of Electronics and Radio

You will probably find no greater variety of money-making opportunities than in the fields of Electronics and Radio. Hundreds of men, who today either successfully operate their own business or hold important jobs in these fascinating fields, are graduates of DeFOREST'S TRAINING, INC.

Our Home Study or Residence courses, thorough in every detail, offer a unique combination of training advantages. We furnish you with a 16 millimeter Motion Picture Projector and 12 reels of valuable movie film. You also use 8 big kits of Radio-Electronic parts as shown on this page, enabling you to work out 133 MODERN EXPERIMENTS for valuable practical experience.

When you prepare to enter the exciting fields of Electronics and Radio, you will want every necessary home study benefit. DeFOREST'S TRAINING, INC., gets you off to a brighter future by supplying these major benefits at home; (1) Learn by Seeing from movies showing radio circuits in action as well as other clearly animated illustrations (2) Illustrated Loose-leaf lessons with handy fold-out diagrams help make our training easy to understand. (3) Learn By Doing . . . in your home laboratory you have the opportunity to get real "SHOP METHOD" experience from the many commercial type Radio-Electronic parts you receive. (4) Employment service . . . after you complete your training, our effective employment service helps you GET STARTED.

DeFOREST'S TRAINING, INC., offers the only Home Study or Laboratory training in the nation endorsed by the New York Museum of Science and Industry, Radio City, New York City.

See how easily you may enter this interesting and profitable field to build a brighter future for tomorrow . . .

## Nationally Known Radio Station Consulting Engineer Recommends Courses of DeForest's Training, Inc.



"Now is the time . . . to prepare to enter the fields of Radio and Electronics . . . no greater opportunity is afforded the high school student . . . the war veteran . . . or the man who is eager to make more money," says Ellery L. Plotts, nationally known Radio Station Consulting Engineer and former Special Research Associate at Harvard University's Radio Research Laboratories. "A study of the DeForest Training, Inc., courses enables me to highly recommend either the Home Study or Residence course."

## Ex-G. I. Student Lauds DeForest's Employment Service

"Dear Sir: Due to the fact that I am enrolled in your school, I am now employed by the Westinghouse Manufacturing Company instead of a steel mill. This is a great opportunity for me because this is a new branch opening in this territory and there is a great chance for advancement.



Elmer H. Havens  
Lancaster, New York"

Without obligation, send for our valuable, information-packed book, "VICTORY FOR YOU" MAIL COUPON TODAY!



**DeFOREST'S TRAINING, INC.**  
2533-41 N. Ashland Ave., Dept. PM-D3  
Chicago 14, Illinois, U. S. A.

Send me both your big book "VICTORY FOR YOU" and Kit Supplement, showing how I may make my start in Radio-Electronics with your modern home training plan. No obligation.

Name . . . . . Age . . . . .  
Address . . . . . Apt. . . . .  
City . . . . . Zone . . . . . State . . . . .  
 If under 16, check here for special information.  
 If a discharged veteran of World War II, check here.

**DeFOREST'S**  
TRAINING, INC.  
CHICAGO, ILLINOIS





**YOUR OWN BUSINESS**

*Learn*

## BE INDEPENDENT

Why work for others at the wages they want to pay you? Learn a good trade and operate your own business and determine just how long you work each day and the amount of money you make. The field of repairing electrical appliances offers any mechanically inclined man the opportunity of a lifetime. There are millions of electrical appliances in this country. Appliances such as refrigerators, irons, sewing machines, vacuum cleaners, heaters, toasters, washing machines, motors, etc. To replace any of these is mighty expensive. In addition, since the end of the war each month brings new inventions in the electrical appliance field and the purchase of each appliance makes another prospect for you if you learn NOW how to repair various types of electrical appliances.

## WHAT YOU NEED

All you need to become a successful electrical appliance business repairman is ambition plus a little training at home in your spare time. If you are mechanically inclined—that is to say—can hold and use tools, our profusely illustrated course written in simple, easy to understand language will prepare you for the years to come. It does not matter if you have not had a great deal of schooling or have had no previous experience along these lines—**WE WILL TEACH YOU.** Age should be no barrier—nor should any minor physical handicap. To repair all types of electrical appliances you do not need expensive tools and equipment or elaborate fixtures. Work as many hours a week as you wish—the home appliance repairman is his own boss. Operate from your garage, basement, kitchen or vacant store, etc.

## WE TEACH YOU

With photographs and simple drawings what troubles to look for and how to make each repair on an electrical appliance. We give you a good sound working knowledge of electricity, and how to do welding, nickel plating, etc. Our course shows you how to build the power tools you need and how to solicit business and keep it coming to you. Not a theory course but an honest to goodness course written by and used by repairmen the country over. Price of course is so low that the savings on your own household appliance repairs will quickly pay for it. Act now! Mail the handy coupon on the next page today.

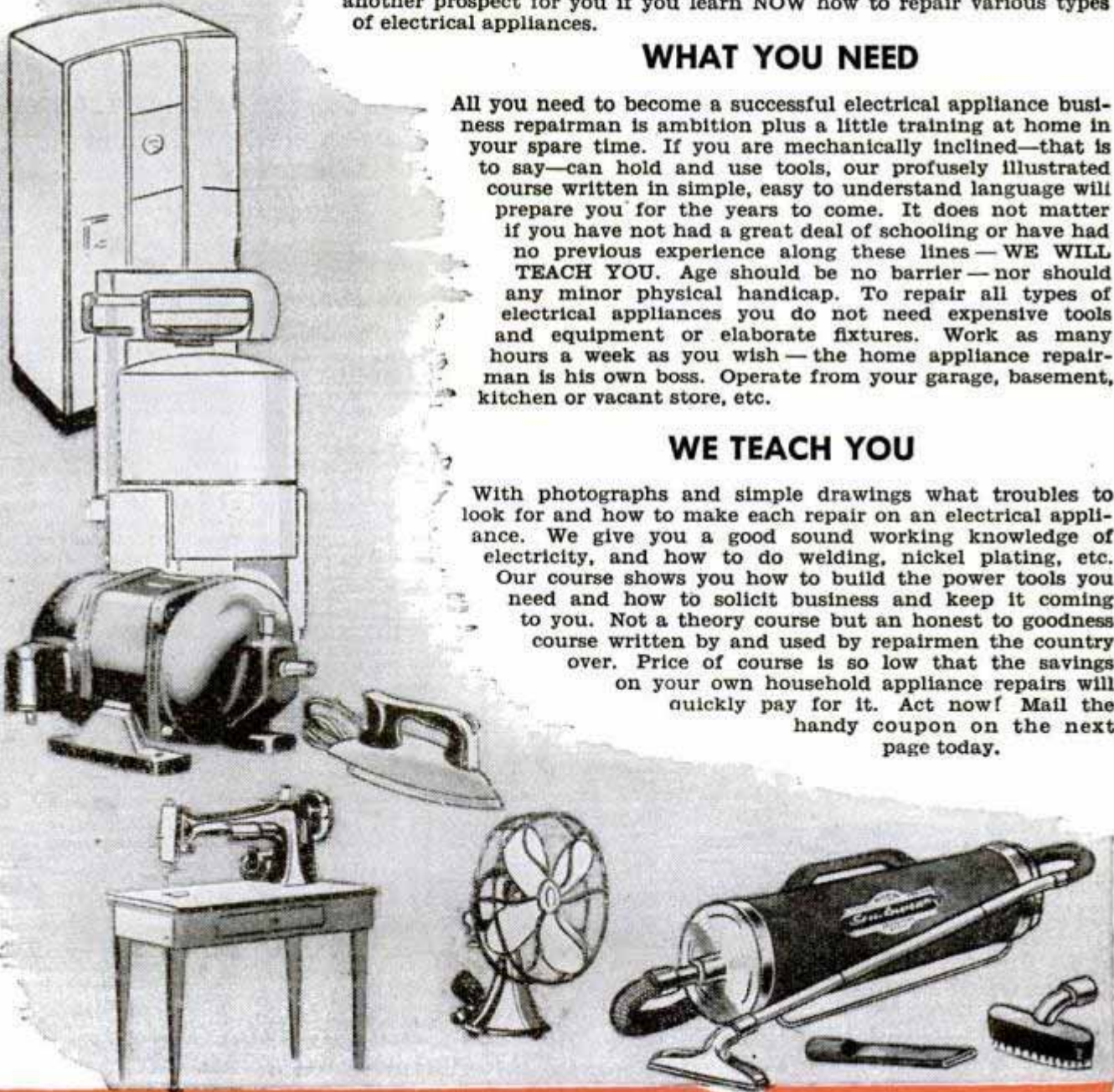



# ELECTRICAL APPLIANCE REPAIRING

## EARN BIG MONEY

The business of repairing electrical appliances for friends, relatives, neighbors and even strangers, offers any ambitious man a real future for it is not at all unusual for appliance repairmen to charge on the basis of \$5.00 to \$6.00 per hour. Then, too, knowing how to repair appliances is often the stepping stone to selling new appliances or parts at a good profit. Don't gamble with your future—learn a trade that will always support you.

## ALWAYS IN DEMAND

Are good appliance repairmen. It is not a war time, prosperity business but a business that provides a real opportunity no matter what the country's general business condition. Ever so many men have written to us of how they prospered after taking our course. Read them for yourself and be convinced.

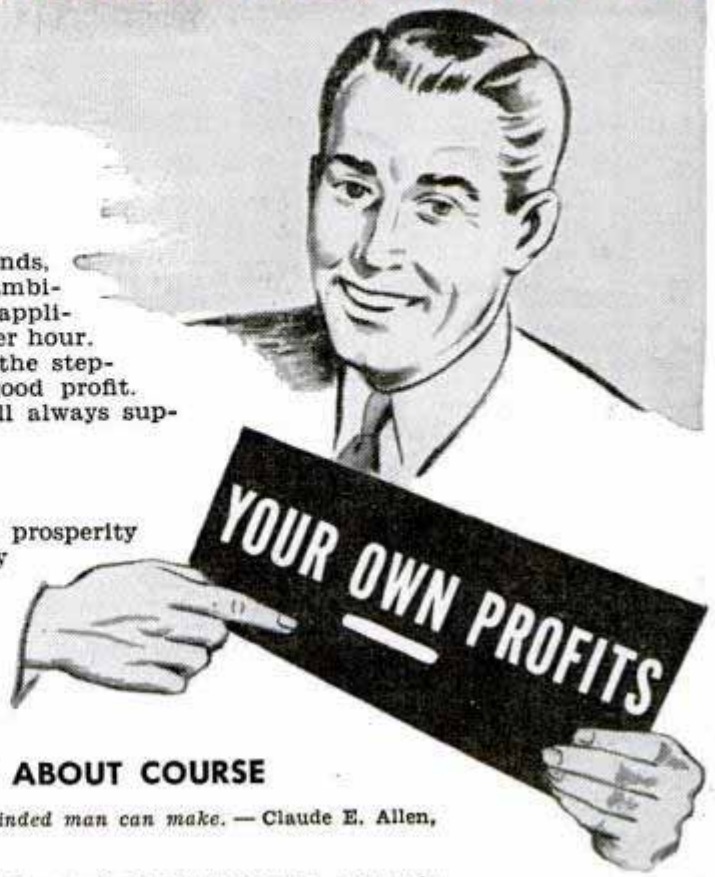

## READ WHAT OUR STUDENTS SAY ABOUT COURSE

*I really believe your course the best investment a mechanically minded man can make. — Claude E. Allen, Indianapolis, Ind.*

*I have received your Course in Appliance Repairing and I must say I am well pleased with same. I am only sorry I did not have said Course some years ago. I have learned so much more through this course I would not part with it. — Charles Schwarz, Hamilton, Ohio.*

*The Course in Appliance Servicing arrived a few days ago. Want to take out a few minutes of my valuable time to let you know that this is just what I have been looking for ever since I opened up my Fix-It shop. I must admit that you told the truth when you said that it contains quite a bit more information than I bargained for. — P. J. Bretl, Sebring, Ohio.*

*I am a mechanic for the Western Union Telegraph Co. Three days after receiving the lessons in refrigeration I earned the exact cost of the course. — Henry S. Lee, Washington, D. C.*

*I work day times at the shipyard and after 4:00 P.M. I operate from my cellar and garage. I average \$10.00 to \$15.00 clear every day. — Walter Hanhy, Brockton, Mass.*



## MAIL COUPON TODAY

CHRISTY SUPPLY CO.

2835 N. Central Ave., Dept. D-4303

Chicago 34, Illinois

Please send me free illustrated literature about America's Fastest Growing Industry—ELECTRICAL APPLIANCE REPAIRING.

Name.....

Address.....

City.....State.....

*Assure*



# 8 BIG BUILDING BOOKS

*For*  
**EXAMINATION**  
**SEND NO MONEY**

Learn to draw plans, estimate, be a live-wire builder, do remodeling, take contracting jobs. These 8 practical, profusely illustrated books cover subjects that will help you to get more work and make more money. Architectural design and drawing, estimating, steel square, roof framing, construction, painting and decorating, heating, air-conditioning, concrete forms and many other subjects are included.

**BETTER JOBS — BETTER PAY** UP-TO-DATE EDITION  
The postwar building boom is in full swing and trained men are needed. Big opportunities are always for MEN WHO KNOW HOW. These books supply quick, easily understood training and handy, permanent reference information that helps solve building problems.

**Coupon Brings Eight Big Books For Examination**

AMERICAN TECHNICAL SOCIETY Vocational Publishers since 1898  
Dept. G319 Drexel at 58th Street Chicago 37, Ill.

You may ship me the Up-to-Date edition of your eight big books, "Building, Estimating and Contracting," without any obligation to buy. I will pay the delivery charges only, and if fully satisfied in ten days, I will send you \$2.00, and after that only \$3.00 a month, until the total price of only \$34.80 is paid. I am not obligated in any way unless I keep the books.

Name .....

Address .....

City..... State.....

Please attach a letter stating your age, occupation, employer's name and address, and name and address of at least one business man as a reference. Men in service, also please give home address.

## Keep that "TICKING" Car

**7 DAYS FREE TRIAL**

588 PAGES  
1500 ILLUSTRATIONS

Every operator and mechanic needs AUDELS AUTO GUIDE. This book saves time, money and worry. Highly endorsed. It presents the whole subject of auto mechanics:

- 1—Basic principles
- 2—Construction
- 3—Operation
- 4—Service
- 5—Repair

Handy Size, Easily understood.

### NEW FLUID DRIVE, HYDRAULIC SHIFT AND DIESEL ENGINES FULLY COVERED

Over 1500 pages—1540 illustrations showing inside views of modern cars, trucks and buses with instructions for all service jobs.

**\$4 COMPLETE • PAY ONLY \$1. A MONTH** ←  
ASK TO SEE IT!—To Get This Assistance for Yourself Simply Fill in and Mail Coupon Today.

AUDEL Publishers, 49 West 23rd St., New York  
MAIL AUDELS NEW AUTO GUIDE for free examination. If O.K. I will send you \$1 in 7 days; then remit \$1 monthly until price of \$4 is paid. Otherwise I will return it.

Name .....

Address .....

Occupation .....

Employed by..... P.M.

# LET US TEACH YOU TO Mount Birds



Animals, Fish, Heads; to TAN. Hunters, Trappers, be a Taxidermist. Let this old reliable school teach you—at home, in spare time. Our school has over 300,000 students. Save your fine trophies. Mount and keep ducks, deer, ALL wild-game. Tan skins, make robes and rugs, double your interest in HUNTING AND FISHING. Have a home museum.

**Free Book** Yes, FREE, this great strange book, with 100 fine wild-game pictures. Tells how YOU can become a real TAXIDERMIST, easily and quickly. It is amazing, thrilling, and may bring you a lifetime of PLEASURE and PROFIT. SPORTSMEN, grasp this opportunity. SEND NOW. A postal will do. But WRITE TODAY—don't fail. State your age.

**N. W. SCHOOL OF TAXIDERMY**  
DEPT. 3373 OMAHA 2, NEBR., U. S. A.



## "How to Make Money With Simple Cartoons"

A book everyone who likes to draw should have. It is free; no obligations. Simply address  
CARTOONISTS' EXCHANGE

Dept. 93-D Pleasant Hill, Ohio

## LEARN MOVIE PROJECTION THEATRE MANAGEMENT

The Motion Picture Theatre Business offers big opportunities for trained men. Get into a fascinating field with a post-war future. Train at home in spare time. Free Catalog. Established 18 years.

370 Washington St.,  
**THEATRE INSTITUTE, Elmira, New York**

## HORSE MASTERY!

A FINE HOBBY — A GREAT VOCATION!

**"The EXPERT HORSEMAN"**

**SUBSCRIBE TODAY 50¢**  
One Year

**FREE BOOK** — Tells how You can learn to: BREAK COLTS, GAIT SHOW HORSES, TRAIN RODEO, STOCK and RACE HORSES, BREAK BAD HABITS, HANDLE ANY HORSE, TRAIN CIRCUS TRICK HORSES. WRITE TODAY!

**ANIMAL LOVERS ASSOCIATION**  
BOX KA-111 TARZANA, CALIFORNIA

## WATCHES WANTED Broken or Usable

All kinds. Highest Prices paid for jewelry, rings, spectacles, gold teeth, diamonds, Sterling Silver, etc. Cash mailed promptly. Write for free shipping container.

**LOWE'S, Dept. PM, Holland Bldg., St. Louis 1, Mo.**

## "MAGIC VANISHING CARD"

THROW IT INTO THE AIR — It completely disappears. Reproduce it later from spectator's pocket. It amuses and confuses all. Easy to do — 25c with Amazing Catalog of 300 Tricks.

**THE MAGICIAN, Dept. 5, 2463 Kensington Ave., Philadelphia 25, Pa.**

## LEARN WATCH REPAIRING

**AT HOME.** By our modern and original system of instruction you can learn every part of the **WATCH REPAIRING TRADE AT HOME.** Prepare yourself for a well-paying position or start in business after completing our course of instruction. Good watch repairers are in demand and generally earn very good salaries. For particulars apply to the **Wisconsin School of Watch Repairing** 759 North Milwaukee St., Milwaukee 2, Wis.





**INDUSTRIAL TRAINING INSTITUTE**

# AMERICA'S FOREMOST SCHOOL OF *PRACTICAL* TRAINING

**WILL TRAIN YOU FOR A KEY JOB  
OR A BUSINESS OF YOUR OWN IN**

## **REFRIGERATION AND AIR CONDITIONING**

### **A FIELD OF OPPORTUNITY**

Here is an industry that offers every opportunity you could ask for. Good jobs—security—plenty of chance for advancement—a business of your own.

And here is a school equipped in every way to train you for Refrigeration and Air Conditioning work—the largest and most completely equipped school of its kind in America—a school that already has trained thousands of men for just such opportunities.

### **GET READY FOR YOUR BIG CHANCE**

Learn Refrigeration and Air Conditioning—now, while the time is ripe. You don't need any advanced schooling or previous experience. If you are at all mechanically inclined and have gone to high school for at least one year or have equivalent education, we can teach you Refrigeration and Air Conditioning. Everything is made simple, fascinating and easy to grasp.

#### **FACTS ABOUT THE INDUSTRIAL TRAINING INSTITUTE . . .**

Founded in 1916. Has trained more than 400,000 men for practical work in industrial fields. From 1942 through 1945 trained specialized technicians, exclusively, for the Army, Navy, and Marine Corps. Now training thousands of veterans under the G. I. Bill, both in its Residence Schools and by home-study. Occupies five buildings of its own. Has over \$500,000 invested in training facilities, with an instruction staff of more than 100 men. Known everywhere as America's foremost school of practical training for industry.

**AUTHORIZED TO ACCEPT  
VETERANS FOR G. I. TRAINING**



**REGISTRAR, Pip  
INDUSTRIAL TRAINING INSTITUTE,  
2150 LAWRENCE AVE., CHICAGO 25, ILL.**

Please send me, FREE, your "Camera Visit" booklet and information about the opportunities for trained men in Refrigeration and Air Conditioning. It is understood that I will be under no obligation.

NAME.....  
ADDRESS.....  
CITY.....STATE.....  
ARE YOU A VETERAN:.....

**GET THE FACTS WRITE FOR TODAY  
FULL DETAILS**



**WANT A GOVERNMENT JOB?**

**\$1,756 to \$3,021 a Year**  
**(Veterans Get Special Preference)**  
**Get Ready Now for Next Examinations**

**Railway Postal Clerks**

Railway Postal Clerks get \$2,300 the first year of regular employment, being paid on the first and fifteenth of each month. (\$95.84 each pay day.) Their pay is automatically increased yearly to \$3,400 and \$3,600 in large organizations. Advance may be had to Chief Clerk at \$5,400 a year. Men 18 to 35.

**3 Days On—3 Days Off—Full Pay**

Railway Postal Clerks on long runs usually work 3 days and have 3 days off duty or in the same portion. During this off duty their pay continues just as though they were working. They travel on a pass when on business. When they grow old, they are retired with a pension.

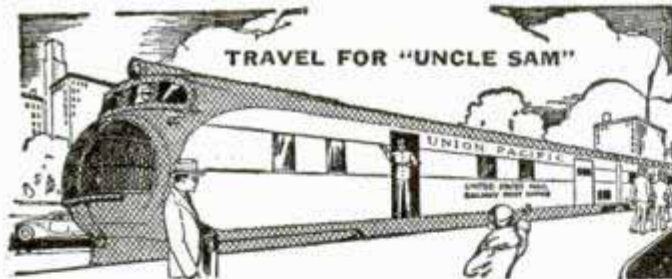

**City Mail Carriers, Post Office Clerks**

Clerks and Carriers now get \$2,100 the first year of regular employment and automatically increase \$100 a year to \$3,100. Open to Men—Women 18 to 50.

**Many Other Positions**

Many other positions are obtainable. Rural Carriers—Stenographers—Typists—Patrol Inspectors—Assistant Statistical Clerks—etc. Those wishing these positions should prepare at once.

**Get Free List of Positions**

Fill out the following coupon. Tear it off and mail it today—NOW, at once.

This investment can result in your getting a big-paid government job.

FRANKLIN INSTITUTE, Dept. F87, Rochester 4, N. Y.

Rush to me, entirely free of charge (1) a full description of U. S. Government Jobs; (2) Free copy of illustrated 32-page book, "How to Get a U. S. Government Job" with (3) List of U. S. Government Jobs; (4) Tell me how to prepare for one of these jobs.

Name.....

Address..... Veteran?.....

Use This Coupon Before You Mislaid It. Write or Print Plainly.

**SEND FOR THIS**

**HOW TO BREAK and TRAIN HORSES**

**FREE!**

Make money with horses. Every farmer, every lover of horseflesh should have a copy of this booklet. If you want to know how to break, train and make money with horses, write today for full information FREE, together with my special offer of a course in Animal Breeding. If you are interested in Gaiting and Riding the saddle horse check here.  Do it today—now. You'll never regret it.

**BEERY SCHOOL OF HORSEMANSHIP**  
 Dept. 1103-D Pleasant Hill, Ohio

**Be A MASTER PLUMBER**

**Earn \$15 To \$50 A Day**

**DON'T ENVY THE PLUMBER—BE ONE**

Every skilled workman will tell you that Plumbers have the best of it. WINTER and SUMMER the Plumber is busy at top wages. No skilled Plumber is ever out of a job—compare his opportunities with any trade, plus the opportunities of having your own shop. We teach you Plumbing with TOOLS (not books) under Licensed Master PLUMBERS in one of the finest equipped schools in America. We make you a Plumber, every branch is taught thoroughly—Lead Work—Blueprint for plan reading—all other tricks.

**LEARN IN 30 WEEKS WITHOUT PREVIOUS EXPERIENCE**

If you like to work with tools you owe it to yourself to investigate. No need to ever work as an apprentice. Get free bulletin. Write now! G.I. APPROVED. Our 24th year.

**UNIVERSAL PLUMBING SCHOOL**

815 HOLMES STREET

KANSAS CITY, MO.

**PLASTIC KITS**

Complete line of kits with full scale lay-outs for making your own items. Picture Frames, Jewelry and Cigarette Boxes, Tie Backs and numerous other articles from Sparkling Lucite and Plexiglas. Send today for free catalog of kits and supplies.

Home Craftsman Plasties, 1945 W. Harrison St., Chicago 12, Ill.

**LAW**

STUDY AT HOME for PERSONAL SUCCESS and LARGER EARNINGS. 38 years expert instruction—over 108,000 students enrolled. LL. B. Degree awarded. All texts furnished. Easy payments. Send for FREE BOOK—"Law and Executive Guidance." AMERICAN EXTENSION SCHOOL OF LAW Dept. 75-M, 646 N. Michigan Ave., Chicago 11, Ill.

**CODE SPEED SHORT CUT**

Be an expert. Learn to be a Telegraph or Radio Operator. Thousands of men needed. Intensely interesting work—good pay. Learn at home or wherever you are, quickly, easily with the famous Candler Speed System. Book of particulars Free. CANDLER SYSTEM CO., Dept. 5-C, Box 928, Denver 1, Colo. U.S.A.

**Photography**



for

**PLEASURE or PROFIT**

Learn at home. Spare time. Practical basic training. Long-established school. Many have earned while learning. Send coupon below for free booklet, "Opportunities in Modern Photography" and full particulars.

**AMERICAN SCHOOL OF PHOTOGRAPHY**

1315 Michigan Avenue

Dept. 1353

Chicago 5, Illinois

Send booklet, "Opportunities in Modern Photography," full particulars and requirements.

Name..... Age.....

Address.....

City..... Zone..... State.....



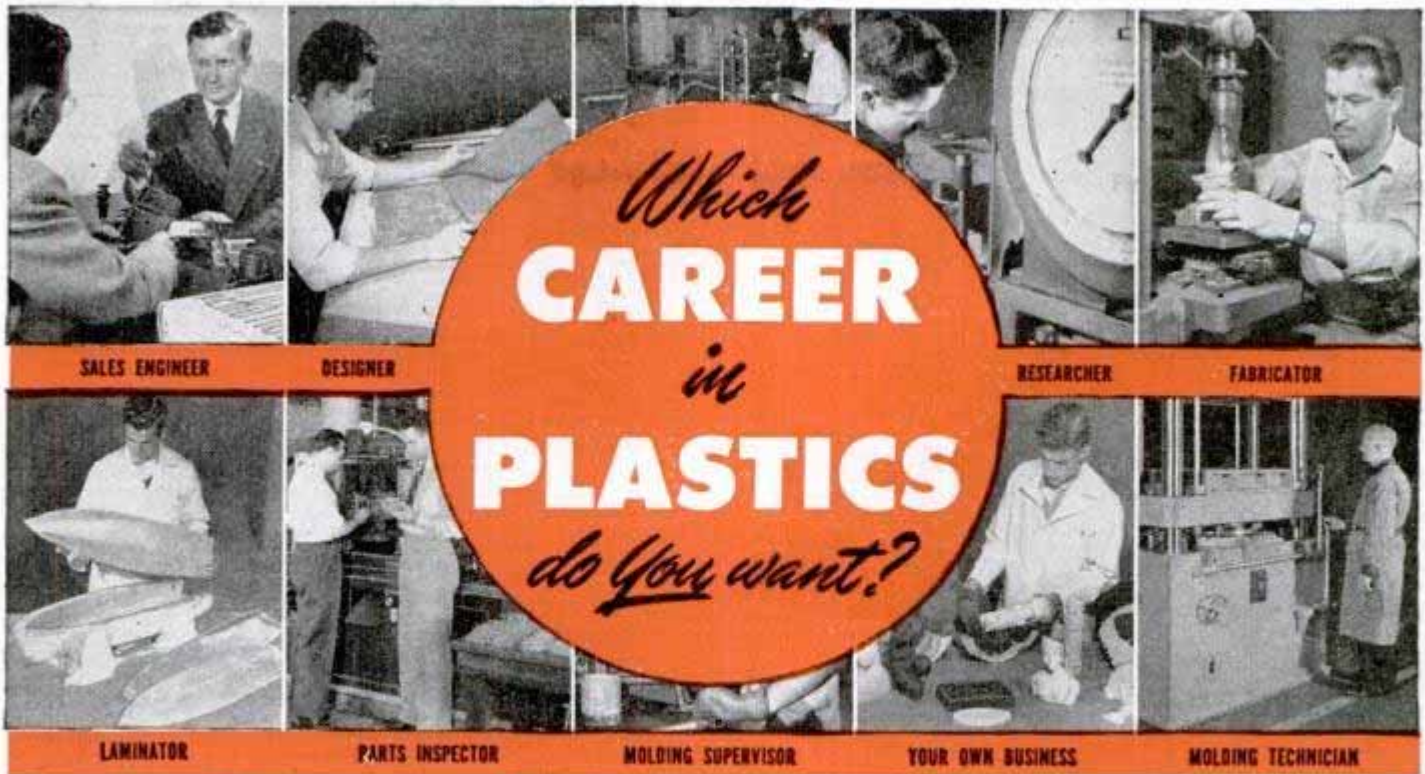

# The Plastics Industry is Growing Fast!

Every day you can read glowing descriptions of how plastics are improving old products and creating interesting new ones. Men who know plastics, who are trained in its many phases fill the important, well-paying positions. *You* can be one of them. **ACT NOW** to prepare yourself for a successful future in a *growing* industry... and all the security and satisfaction that such a future brings.

**PLASTICS EXCLUSIVELY—**Plastics Institute, America's oldest and largest plastics educational organization devotes its entire facilities to plastics instruction with no time spent on other subjects. **IMMEDIATE ENROLLMENT** can be arranged. Send for our interesting catalogue *today!*



**LEARN BY DOING**  
To give you practical experience we supply colorful plastics to make useful, attractive creations. You can also make and sell plastics articles to earn while learning.

**A COMPLETE COURSE**—Everything you should know about plastics... materials, designing, molding, fabricating, laminating and testing. Acquire a basic knowledge of plastics... invaluable in getting a fine position in this great industry.

**START YOUR FUTURE TODAY**—Mail the coupon below, now! Get an interesting, illustrated free booklet about plastics. Get complete details about Plastics Institute Resident School, located in beautiful Southern California. Also learn about the comprehensive Plastics Home Training Course which prepares you for a future in plastics while you continue your present job. Clip the coupon and mail it **TODAY!**

Write Dept. PM-7-3. • 1601 S. Western Avenue • Los Angeles 6, California  
**Home Training Courses and Resident School APPROVED FOR VETERANS**

# Plastics

**INDUSTRIES TECHNICAL INSTITUTE**  
NEW YORK      CHICAGO      LOS ANGELES



**PLASTICS INSTITUTE** in the heart of sunny Los Angeles. Here modern laboratories and shops give Resident School students facilities for practice on the finest of industry-type plastics equipment. Also the headquarters for **HOME TRAINING.**

**FREE BOOKLET**  
**Send For It Today!**

Plastics Industries Technical Institute  
Dept. PM-7-3, 1601 S. Western Ave., Los Angeles 6, Calif.      Mail in Envelope or paste on penny postcard

Gentlemen: Please send me the booklet "World of Plastics" and information on your Resident School Courses  Home Training Courses.  I understand there is absolutely no obligation.

Name (PRINT) ..... Occupation.....  
Street (PRINT) ..... Age.....  
City..... Zone..... State.....

Important: Please fill out coupon *completely*. If Veteran, please check.  If in Armed Services now, please check.



**Bigger Opportunities  
Than Ever in . . .**



**AUTO  
BODY  
AND  
FENDER  
REPAIR**

●THE FIELD IS STILL GROWING after more than 40 years . . . expanding with the giant auto industry! Millions of new cars are getting to market, millions of old ones are still on the road—THE NEED for MAN-POWER in the service field is INCREASING!

**TRAIN NOW . . . FOR THE  
OPPORTUNITIES AHEAD!**

Don't be stuck in a low-pay job! Opportunity here is big enough for thousands to find big-pay work either in a reliable job or in their own shops. UEI teaches Auto Body & Fender Repairing the *easy* way. No special education or experience needed . . . you can start in your spare time, right at home . . . keep your job while you learn. Then, when home study is finished, you continue at the well-equipped UEI shops getting practical experience. Fix and refinish damage, replace panels and tops. Learn up-to-date methods in use of tools, spray painting, welding, metal work—all under expert supervision.

**GET THE FACTS . . . FREE!**

UEI HAS TRAINED THOUSANDS for opportunity fields, and students are making good. If you want to get ahead, send coupon today for free facts on AUTO BODY AND FENDER REPAIRING. Don't delay!

**AUTOCRAFTS DIVISION  
UTILITIES ENGINEERING  
INSTITUTE**  
1314 Belden Avenue, Dept. 137X,  
Chicago 14, Illinois

Approved for  
training under  
G. I. Bill

Founded  
1927



**FILL OUT AND MAIL . . . TODAY!**

Autocrafts Division  
Utilities Engineering Institute, Dept. 137X,  
1314 Belden Avenue, Chicago 14, Ill.

Yes, I'm interested! Send me those Free Facts about Auto Body and Fender Repairing.

NAME \_\_\_\_\_ Age \_\_\_\_\_

ADDRESS \_\_\_\_\_

CITY \_\_\_\_\_ Zone or County \_\_\_\_\_ STATE \_\_\_\_\_

If veteran of World War II check here

Check here for Special Information if under 17.

No Waiting to LEARN

**START NOW TO EARN!**  
This BIG BOOK SHOWS HOW



**IF IT'S RESULTS YOU WANT—GET ACTION QUICKLY WITH THESE PRACTICAL IDEAS**

Never before has a more helpful book been printed for those planning a business of their own. Gathered in this large illustrated volume are the formulas, recipes, facts and secrets that have contributed so largely to America's great industrial progress. Capitalize on this information for making most any conceivable product without experience, special equipment or previous knowledge of chemistry. Start at home, expand with profits—build for a profitable independence.

The experts who compiled this book are authorities, and present this information in simple, understandable language. They also give you wholesale supply sources for needed materials, short cuts and economy methods for the most profitable results. Hundreds of good paying businesses have been built on a product made from a simple

recipe. Opportunities in this field exist everywhere. Choose from any of the 162,000 facts and 10,000 formulas of which the following are only a very few: Adhesives, Alloys, Anti-Freeze Solutions, Cosmetics, Beverages and Liquors, Candy, Gum, Casein, Celluloid, Ceramics, Cheese, Cleaning Preparations, Concrete, Copper, Cotton, Dentifrices, Depilatories, Dyes, Embalming Fluids, Enameling, Glass, Glazes, Household Formulas, Inks, Insecticides, Iron, Jewelers' Formulas, Lacquers, Laundry Preparations, Leather, Linoleum, Lubricants, Manicure Preparations, Marble (artificial), Metals, Mirrors, Oils and Ointments, Paints, Paper, Perfumes, Photography, Polishes, Powders, Remedies for Man, Beast or Fowl, Rubber Products, Refrigerants, Soaps, Solder and Soldering, Tooth Cements, Transfers, Transparencies, Varnishes and Thousands of others for making all sorts of profitable and practical things.

**ALSO**

We include Free—our new book of helpful money-making information:—  
"The More You Know the More You Can Earn—Easier and Quicker."

Paints, Paper, Perfumes, Photography, Polishes, Powders, Remedies for Man, Beast or Fowl, Rubber Products, Refrigerants, Soaps, Solder and Soldering, Tooth Cements, Transfers, Transparencies, Varnishes and Thousands of others for making all sorts of profitable and practical things.

**FORTUNES MADE FROM A SINGLE IDEA!**

This comprehensive book is an accepted authority by chemists, schools, industry, etc. and is the largest and most comprehensive book of its kind ever issued. Nothing else like it in existence. A single formula has been worth a thousand times this book's small cost to countless owners. Crammed with money-making ideas. Invaluable for reference. Ideal for Factory, Home, Farm, Office or Workshop. As necessary as the dictionary and more useful for manufacturers, chemists and salesmen who put up products for profit.

\$3.50 postpaid. Canada or Foreign, \$3.85 U. S. Funds. (C.O.D. shipments U.S.A. only.) Immediate Shipment—Safe Delivery Guaranteed.  
**ADAMS BROWN COMPANY BOOKS OF APPLIED SCIENCE**  
Dept. 173, Chestnut Hill 67, Massachusetts, U. S. A.

POSTPAID!  
**\$3.50**  
U.S.A.  
**\$3.85**  
FOREIGN

**BUILDING**



Millions of homes needed. Nation wide call for builders. Big opportunities. Learn now in spare time, — at home. Practical training with blue prints. No books. Send for FREE Trial Lesson and blue print plans.

**CHICAGO TECHNICAL COLLEGE**  
C-151 Tech. Bldg., 2000 S. Mich. Ave.  
Chicago 16, Ill.

**MASTER MACHINIST • MECHANICAL DRAFTING  
TOOL-DIE DESIGNING • TOOL ENGINEERING**

Completely equipped shops and drafting rooms, directed by an accredited staff of engineers and practical instructors. 18 years of successful training of men for industry.

Days, Evenings • Approved for Veteran Training

NEW CLASSES Now Forming • BULLETIN ON REQUEST

**ALLIED SCHOOL OF MECHANICAL TRADES, INC.**  
42 ALLIED BLDG., 1336 S. MICHIGAN AVE. • CHICAGO 5, ILL.

**RADIO ENGINEERING**, Broadcasting, Servicing, Electronics, Aviation, Marine & Police Radio taught thoroughly. 48 weeks' Engineering course equivalent to 3 years' college radio work. Approved Veteran Training. Co-educational. Catalog free.  
**VALPARAISO TECHNICAL INSTITUTE**, Dept. D, Valparaiso, Ind.



**LEARN PORTRAIT PAINTING  
AT HOME**

● Previous art training or talent NOT necessary. This new Stuart System teaches you, in 11 simple, easy-to-follow lessons, to make exact charcoal and oil likenesses. Guidance for your every step. Send for free book today.

**STUART STUDIOS.**

121 Monument Circle, Room 63, Indianapolis 9, Ind.  
Please send me free book and outline of lessons.

Name \_\_\_\_\_

Street \_\_\_\_\_

City \_\_\_\_\_ State \_\_\_\_\_



How to equal the PHENOMENAL PHYSIQUE of...

# ALAN STEPHAN

## Mr. America!

### ALAN STEPHAN

official winner of the National A.A.U. title, "MR. AMERICA" offers you this **FREE BOOK**

*This is an unretouched photograph*

What "Mr. America" has done, you, too, can do. Every secret of the physical training program perfected and practiced by Alan Stephan is now made available to YOU.

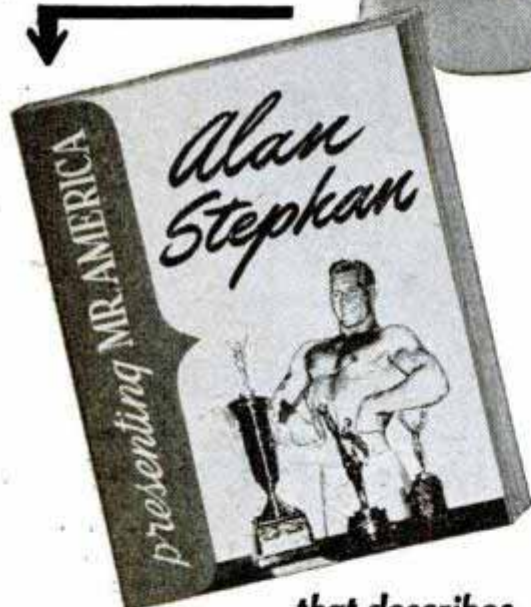

To help you attain an awe-inspiring, eye-catching body like "Mr. America," the revolutionary new Alan Stephan Course in Body Building speaks for itself as a builder of title-winning perfection. Alan Stephan, anything but a physical marvel at 15, is today officially recognized as the finest physical specimen in the nation. His progress in physical development was so rapid (he developed 70 additional pounds of muscle the first year) that he immediately became a physical training instructor when he enlisted in the United States Navy. By the phenomenal perfection of his own physique through a training system perfected and practiced by himself, no man in America today is so well qualified as Alan Stephan to show you the way to achieve sparkling health, glowing vitality, vital power, increased pep.

*that describes*  
**HIS EASY-TO-FOLLOW PHYSICAL TRAINING PROGRAM**

This vital new book explains how YOU can equal the phenomenal physique that has earned for Alan Stephan the official National A.A.U. title symbolic of physical perfection, the Finest Male Physique in America.

Alan Stephan's story should be an inspiration to every American. His miraculous body reveals positive proof of what proper training will do. As the photos in this book so clearly illustrate, Alan Stephan's chest is super-impressive, his arms and back are amazing; his column-like neck, his waist, hips and legs blend in harmonious proportions, forming the perfect physique!

Make the physical perfection of "Mr. America" your goal! Act now! Get the profusely illustrated FREE book which gives you the complete facts about Alan Stephan's easy-to-follow physical training program.

**MAIL THIS COUPON NOW**

Alan Stephan, Box Number 1080, Chicago 90, Illinois

Write for the **FREE Book**

Please send me — FREE and without any obligation — a copy of your book, "Presenting Mr. America ... Alan Stephan." (P.M.)

NAME \_\_\_\_\_

ADDRESS \_\_\_\_\_

CITY \_\_\_\_\_ STATE \_\_\_\_\_

DATE OF BIRTH \_\_\_\_\_

"Presenting Mr. America... Alan Stephan"



# DIESEL

## Shop Training

in a Nationally  
Known School

**FREE  
Illustrated  
Brochure**

Diesel engines are used in locomotives, ships, trucks, buses, power plants, tractors. Trained men are needed to repair, rebuild, install, maintain, operate equipment. A big field that promises even bigger things in the years right ahead. Get modern shop training on actual equipment under experienced instructors. Practical training makes rapid progress possible. Get benefits of services and training facilities of nationally known school.

### BETTER JOBS—BETTER PAY

Use of Diesels in automotive and railway industries, other widespread uses all indicate Diesel knowledge means more earning power. **LEARN DIESEL UNDER DIRECTION OF MEN WHO TRAINED DIESEL MECHANICS FOR U.S. ARMY.** Mail coupon today.

Diesel Division, Motive Trades Institute, Dept. F23, 1400 Greenleaf, Chicago 26, Illinois.



FREE—Important information telling how to get started  
CUT OUT COUPON BELOW

## Fill Out, Cut Out, Mail Today

**FACTS FREE for Men Who Want to Get Ahead**  
Diesel Division, Motive Trades Institute, Dept. F23  
1400 Greenleaf, Chicago 26, Illinois

Send free Illustrated Brochures and other information on modern Diesel training.

Veteran  Non Veteran

Name.....

Address.....

City.....

State.....

## Learn this Profitable Profession



**IN 90 DAYS  
AT HOME**

## Money-Making Career Open to Men and Women, 18 to 50

Hundreds of men and women between 18 and 50 make \$10 to \$20 in a single day giving scientific Swedish Massage and Hydro-Therapy treatments. There is big demand from doctors, hospitals, sanatoriums and clubs. Graduates earn large full time incomes from these or in private practice in their own offices. Others make good money from home treatments given in spare time. Learn this interesting, money-making profession in your own home, through our home study course. Same instructors as in our nationally known resident school. You can win independence and prepare for future security by qualifying for your Diploma. Course can be completed in 3 to 4 months. Many earn while they learn. Begin your training at once.



### Anatomy Charts & Booklet FREE

Enroll now and we will include, at no extra cost, many needed supplies. Fit yourself to help meet growing demand for Scientific Swedish Massage. Send the coupon at once for complete details. **Anatomy Charts and 32-Page Illustrated Booklet, FREE, postpaid.**

THE COLLEGE OF SWEDISH MASSAGE  
Dept. 764-C, 100 East Ohio St., Chicago 11, Illinois

Please send me FREE and postpaid, Anatomy Charts, 32-page Booklet and complete details on Home Training.

Name.....

Address.....

City..... State.....

# STUDY AT HOME

With An Educational Institution

Men with specialized training win higher positions, insure larger earnings, and are bigger successes in business and public life. Opportunities NOW greater than ever before. Send for our Catalog.

## ARTS and SCIENCES

Courses in Philosophy; Education; Letters; Public Health; Medical Jurisprudence; Psychology; Sociology; Physics; Chemistry; Plastics; Geology; Political Science; Theology; Business and Commerce; Accounting; Mathematics; Statistics; Agriculture.

## ENGINEERING

Courses in Electrical, Civil, Mechanical, Drafting, Architectural, Steam, Aeronautical, Radio, Structural, Mining, Industrial, Petroleum, Marine, Chemical, Diesel, Automobile, Refrigeration, and Air Conditioning Engineering.

## LAW

Complete Professional Law Course includes 18 Hornbook Series college grade textbooks. Courses also in Commercial Law, Patent Law and Medical Jurisprudence.

McKinley-Roosevelt Incorporated, 4610-K, Sheridan Rd., Chicago 40, Ill.



## START YOUR OWN REFRIGERATOR REPAIR SHOP!

**START  
SMALL  
GROW  
BIG**

Learn to install and repair all types of REFRIGERATION and AIR-CONDITIONING equipment. You can start your own shop with as little as \$50 worth of tools. We show you how. Our practical, shop-tested home-training prepares you quickly and easily during your spare time, for a job or your own business in this fast-growing profitable industry. Send for FREE BOOKLET today. No obligation.

**MECHANICS TRAINING SCHOOL**  
7217 S. Broadway, Dept. P-103, Los Angeles 3

## SIGN MEN EARN WELL

Tremendous demand always for glass and electrical sign men. Post war expansion assures growing need for more sign men. Only small investment required to start own business. Write today for full FREE particulars. **SIGN SERVICE, 5944 Newark, Dept. S-401, Chicago 31, Ill.**

## ARTISTS MAKE MONEY

Do you like to draw? Send name, address, age and occupation for FREE ART TEST, to find out your ability.

**ART INSTRUCTION, Inc.**

3137 ART INSTRUCTION BLDG., MINNEAPOLIS 15, MINN.

## COLOR CONCRETE WITH CHEMICALS

Get into business on small capital working at home, or shop. Start small grow big. There is real money in making Hollywood style pottery and birdbaths without moulds. Our instructions cover a large variety of designs. Washing-wells, benches, garden light-houses, stucco-rock, imitation marble, cement water-paints and many more. 10c brings sample, details and pictures.

Hollywood Cementcraft, 8529 Wonderland Ave., Hollywood 46, Calif.

## STAMMERER?

This new 128-page book, "Stammering, Its Cause and Correction," describes the Bogue Unit Method for scientific correction of stammering and stuttering—successful for 46 years. **Benj. N. Bogue, Dept. 1846, Circle Tower, Indianapolis 4, Ind.**



You can learn plain, rapid writing or fancy ornamental writing for social and business advancement, right in your own home during spare time by my Simplified Method. Write for my free book, "How to Become an Expert Penman," which shows what others have accomplished by taking my Courses. Send 10c for one of my favorite Pen Points and your name with a beautiful flourished bird written on a card. Write today. **T. M. Tevis, Box 25K, Chillicothe, Mo.**



# How YOU Can Get BIG MONEY

## FOR LITTLE IDEAS!



**\$280,000,000 a Year Is Awarded to American Inventors. You Can Get Your Share — IF You First Find Out WHAT NEEDS TO BE INVENTED!**

A MAN waiting for a streetcar in Washington, D. C., idly picked up a hairpin and bent it around his finger. Thus was born the lowly PAPER CLIP—and a fortune of \$200,000 for its inventor. The inventor of the Kiddie Kar netted a cool million. Grandma White of Chicago, 70 years old, got an idea for a better OVERALL BUCKLE—her reward was \$350,000! The crimped BOTTLE CAP paid its originator \$135,000. Industry pays \$280,000,000 a year to American inventors—many of them just ordinary tinkerers who happened to hit upon a profitable idea.

You DON'T need a "higher education" to be a successful inventor. But you DO need to know WHAT to invent. Many inventors (such as the one who patented an electric motor to rock a rocking chair) waste their lives perfecting a gadget for which manufacturers have no earthly use!

### New Book Puts You "On Right Track"

So don't waste your time and break your heart working on something nobody needs, wants, or will pay you for. Let the amazing new book, "2100 NEEDED INVENTIONS" stimulate and guide your efforts in PRACTICAL channels.

Its author, Raymond F. Yates, noted science editor and inventor, lists and describes the money-making ideas that are simply crying aloud to be invented! Just a few of these 2100 ideas may wake up your mind and send it racing toward an invention that manufacturers WANT and WILL BUY right now.

### 2100 Inventions That Are Really NEEDED

These 2100 needed inventions are the things most needed and surest to make money in EVERY field. For quick reference, you get them under 34 different headings: Electrical, Radio, Automotive, Agricultural, Mechanical, Building, Household, Clothing, Food, Toys, Time-Savers, etc., etc.

This book ALSO tells how to think inventively; how to PROTECT your ideas; how to develop an invention STEP-BY-STEP; most needed inventions in everyday life.

### FREE EXAMINATION OFFER

See for yourself what this amazing book can do for you. It doesn't cost a penny to find out! Simply mail coupon below without money—now. The book will be sent to you for 5 days' FREE examination. If you're not convinced that it's jam-packed with money-making ideas for YOU, return it in 5 days, pay nothing. Otherwise send only \$2.50, plus few cents actual postage, as payment in full.

Wouldn't YOU like a slice of the \$280,000,000 in royalties that is paid out to American inventors every year? Then you owe it to yourself to get started with this book NOW!

Military inventions are still eagerly sought by the Army and Navy. And thousands of companies are looking for new postwar products to convert to, now that war contracts are completed. Any ONE of the 2100 "self-starting" ideas fully described in this great book will bring somebody a fortune—and it may as well be YOU! So mail coupon at once! WILFRED FUNK, Inc., Publishers, Dept. T493, 227 East 44th Street, New York 17, N. Y.



**WILFRED FUNK, Inc., Publishers, Dept. T493  
227 East 44th Street, New York 17, N. Y.**

Please send me 2100 NEEDED INVENTIONS for FREE EXAMINATION. If I keep the book I will send you \$2.50 plus few cents actual postage. Otherwise I will return it within 5 days, without further obligation.

Name .....

Address .....

City ..... Zone No. (if any) ..... State .....

Check here if enclosing \$2.50 WITH this coupon, and we will pay all postage charges. Same 5-day return privilege, for full refund, applies. Canadian and foreign orders must remit in U. S. Currency.



# BUILD a TELEVISION SET

*To stimulate its radio and television training programs, this famous resident radio and television school is offering men interested in television this unusual opportunity.*



Instructor demonstrating rare

Schmitt Optical System, used in big picture, projection type, television receivers. At N.Y.T.I. of N.J. all types of television receivers are available for student study.

**I**F you are unable to leave home to go to a resident school, N.Y.T.I. of N.J. can supply you with all the parts to build a television chassis in your own home. You will be supplied with exactly the same instructions and directions with which the school's resident students are equipped, when they reach the stage in their training that calls for television set construction. If you already have a sound radio background, with experience in building radio receivers, you will be sur-

prised to find how much you can learn about television by studying the directions, and building this set

N.Y.T.I. of N.J. is one of America's leading resident schools in television for men seeking dependable, thorough, up-to-the-minute training in the various fields of radio and television.

The schooling offered by N.Y.T.I. of N.J. is particularly useful to those who recognize the high-earning possibilities of technical training in radio and television and are willing to tackle the class and laboratory work offered.

A grammar school education definitely is required. Moreover, N.Y.T.I. of N.J. requires that a student be earnest, sincere and radio-minded. Students without proper mathematical backgrounds are taught the radio and television mathematics and theory they need.

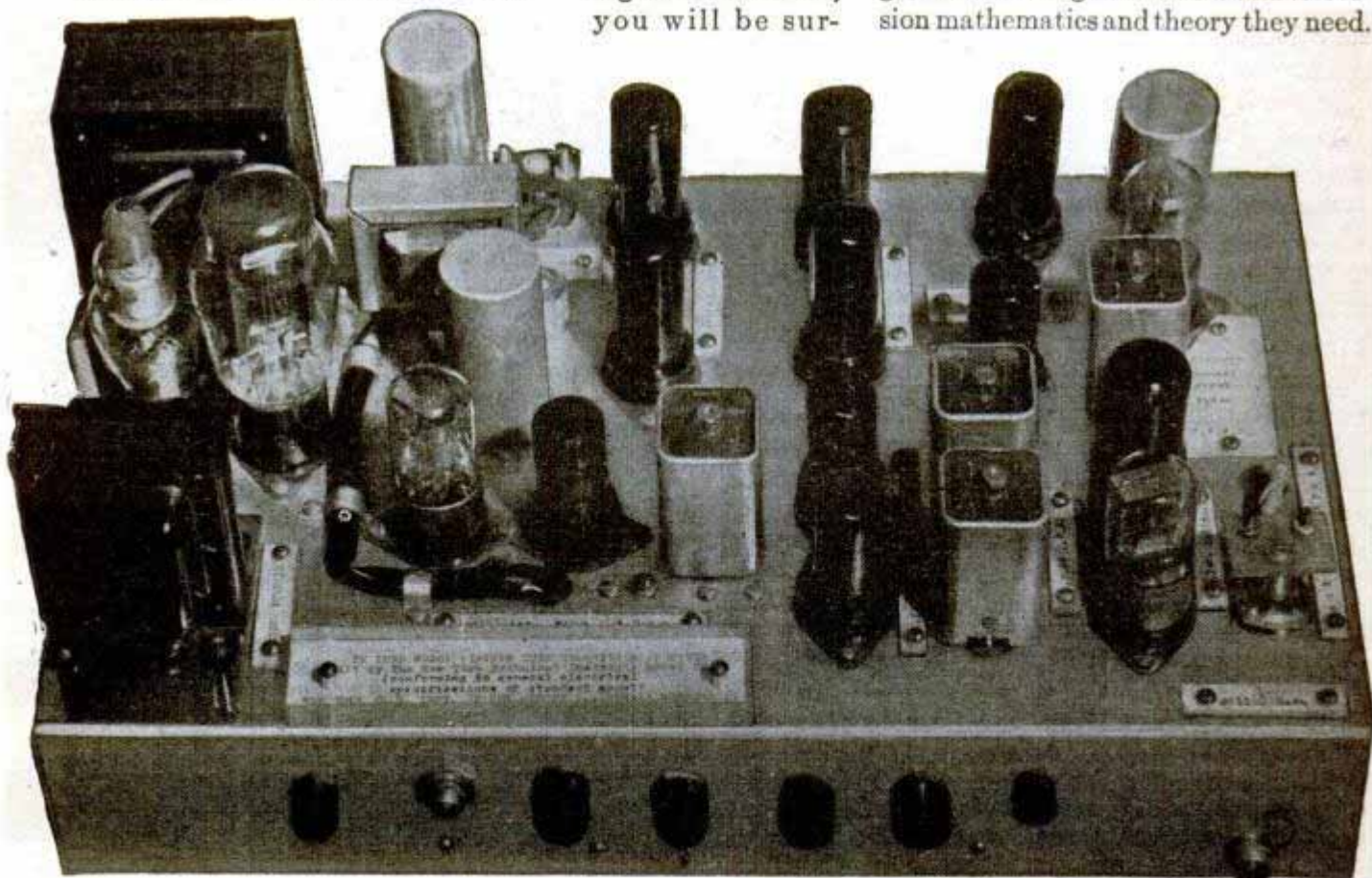

You can build a direct viewing television chassis similar to the one pictured above, complete with all tubes, including 7-inch picture tube and speaker, right in your own home by following carefully the exact instructions sent to you by

this famous television school, located square in the HEART of America's television manufacturing and broadcasting industry. Mail the coupon at the right to get full details. It costs you nothing to learn about this big opportunity.

Advertisement



# RIGHT in YOUR OWN HOME!

A considerable number of out-of-state students attend the school because of its excellent, practical type of radio and television courses, so difficult to get anywhere else in the world today. Living quarters are obtainable by single students. Married students are requested not to bring their families until they can find suitable accommodations for them.

## You Put Into Practice Everything You Learn

Students at N.Y.T.I. of N.J. particularly like the way the school puts into practice what it teaches. You may actually build a 17-tube television chassis. You also help build as many as 7 radio receivers of different types, a total of 75 electronic educational devices. Class study and laboratory study, in the proper combination, increase interest—and your hands get as smart as your head.

A 17-tube, experimental, television chassis may be built by all resident students of television, and may be kept as their own property, if they so choose.

## Located in the Heart of the Radio, Electronic, and Television Industry

The New York Technical Institute of New Jersey is in Newark, N. J., just across the river from New York City (only 20 minutes from Broadway by subway or train). The school is located in the heart of America's great radio and television industry. Such leading television, radio and electronics manufacturers as R.C.A., Western Electric, Du Mont, Federal, Westinghouse and Edison are nearby. This means that the school offers numerous advantages, as it is in touch with the most recent developments.

Highly qualified television and radio instructors are here in abundance. Equipment is easier to get. Television students are offered exceptional advantages in this great television center.

## Coupon Brings Full Information — FREE

The school issues a special Bulletin which illustrates and describes its truly exceptional laboratory facilities and equipment. This Bulletin also describes classes that may be attended, housing conditions, costs, hours, etc. If you are interested in Television—you will want to read this Bulletin. You can have it free, merely by mailing the coupon at right.

The school will also be happy to send you complete information about the television kits and directions which are now available to you if you desire to build your own television chassis at home.

Just fill out the coupon at right and mail it NOW to: *New York Technical Institute of New Jersey, Dept. 23, 158 Market Street, Newark, N. J.*

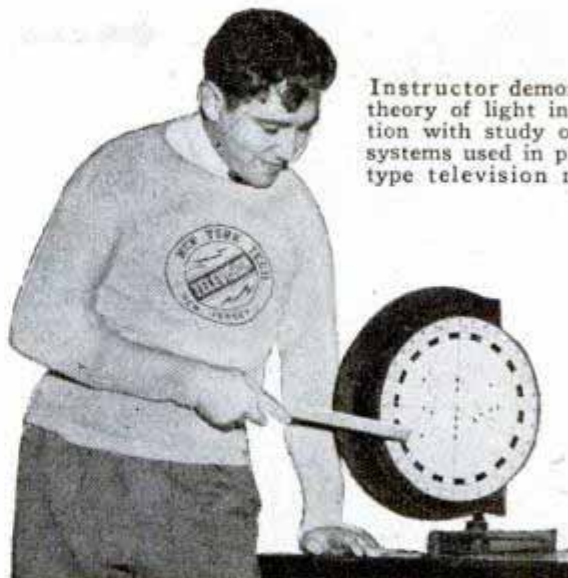

Instructor demonstrating theory of light in connection with study of optical systems used in projection type television receivers.

Big picture television (16" x 21 1/4") in the flesh at N.Y. T.I. of N.J. All types of television receivers are available for student use and instruction in the resident school.

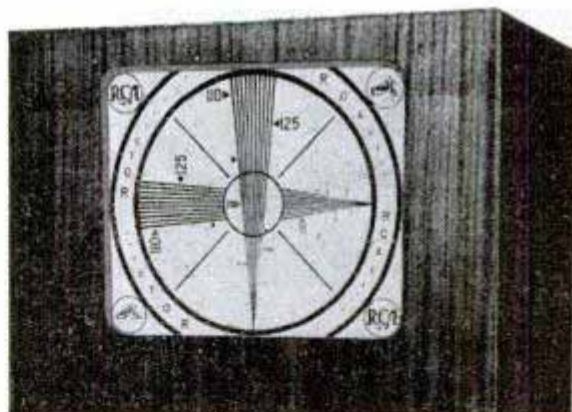

Standard laboratory type test pattern used for testing all types of television transmitters and receivers. (You can see it at N.Y.T.I. of N.J.)

**New York Technical Institute of New Jersey, Dept. 23, 158 Market Street, Newark, New Jersey**

- Check here if you wish to receive the Special FREE Bulletin describing the resident school of the New York Technical Institute of New Jersey located in Newark, N. J.—including its facilities, equipment, courses offered, costs, hours, etc.
- Check here if you wish complete information about building a television chassis in your own home.
- Check here if you are a War Veteran.

NAME \_\_\_\_\_ AGE \_\_\_\_\_

ADDRESS \_\_\_\_\_

CITY \_\_\_\_\_ ZONE \_\_\_\_\_ STATE \_\_\_\_\_  
(if any)

(N.Y.T.I. of N.J. employs no salesmen to call)

Advertisement



Give yourself the Backing of a  
GREAT GROWING INDUSTRY



# REFRIGERATION AIR CONDITIONING

Refrigeration and Air Conditioning have leading place in fast growing fields of our time. Trained men paid well to service, install, maintain, repair, rebuild household and commercial refrigerators. Important new developments such as Frozen Foods and many new industrial uses. Demand for commercial installations in restaurants, butcher shops, taverns, florists, bakeries, etc. — air conditioning in homes, offices, shops.



## START NOW—Full and Part Time Earnings

There may never again be such opportunities for men who want better jobs or business of their own to get in on ground floor and go up fast! Many started with small investment who built good, growing business. If over 17 and under 60 learn how you can get started. **CONSULTATION AND PLACEMENT SERVICE WHETHER YOU ARE INTERESTED IN WORTHWHILE JOB OR SETTING UP YOUR OWN BUSINESS.**



### Begin Training at Home or Come Directly to Shops

Begin your training at home in spare time, finish in our big, modern shops, or come directly to shops. At home you get C.T.I.'s SHOP PROVED HOME STUDY instruction—actual shop experience has gone into the practical lesson assignments. That is why it is easy for mechanically inclined men to learn by our Home Study training and start on actual refrigeration work.



### A NATIONALLY KNOWN INSTITUTION

C.T.I. was only civilian school selected by Army to train service men for refrigeration. Same quality training available to you now. The method that has made rapid progress possible. Commercial Trades Institute has established its place in Air Conditioning and Refrigeration industries, and that is important to you in making your start.

### VETERANS

Veterans qualifying under "G.I. Bill" have tuition paid by Government plus monthly subsistence allowance while in school. Just mail coupon, we will handle all details. (LOW TUITION, EASY TERMS if you are not a veteran.)

COMMERCIAL TRADES INSTITUTE  
Dept. A23

1400 W. Greenleaf Ave., Chicago 26, Ill.

FREE — Important Information Telling How to Get Started

CUT OUT COUPON BELOW

Fill Out, Cut Out, Mail Today

FACTS FREE for Men Who Want to Get Ahead

COMMERCIAL TRADES INSTITUTE, Dept. A23  
1400 W. Greenleaf, Chicago 26, Ill.

Send free illustrated Brochures and other information about Refrigeration and Air Conditioning.

Veteran  Non Veteran

Name .....

Address .....

City ..... State .....

SAY YOU SAW IT IN POPULAR MECHANICS

# Learn to Write

Short Stories, Mysteries, Novels,  
Articles—at home in spare time

THE demand for writers is creating great new opportunities for people with an urge to write. It's not as hard to succeed as you may imagine. Most famous authors come from ordinary walks of life. At home, you too may learn fiction writing, the best basis for all fields—short stories, novels, features, articles, radio scripts. Palmer Institute's Home Study Training (Established 1917) is endorsed by Rupert Hughes, Ruth Comfort Mitchell, Gertrude Atherton, Katharine Newlin Burt and other famous authors and by scores of successful graduates. Complete instruction material and professional coaching to develop your own style. FREE book explains how you may enjoy an ideal part time or full time career. Write today (no salesman will call).

PALMER INSTITUTE OF AUTHORSHIP, Desk T-37  
Palmer Building, Hollywood 28, Calif.

## CONFIDENTIAL LOAN SERVICE

Borrow \$50 to \$300

Need money? No matter where you live you can borrow BY MAIL \$50.00 to \$300.00 this easy quick confidential way.

BY MAIL

IT IS EASY TO BORROW BY MAIL! Completely confidential and private CONVENIENT MONTHLY PAYMENTS

NO ENDORSERS NEEDED EMPLOYED MEN and women of good character can solve their money problems quickly and in privacy with loans MADE BY MAIL. No endorsers or co-signers. We do not contact employers, friends or relatives. Convenient monthly payments. Send us your name and address and we will mail application blank and complete details FREE in plain envelope. There is no obligation.

STATE FINANCE CO.  
Southern Surety Bldg., Dept. J-107, Des Moines 8, Ia.

## Fit-Rite makes False Teeth TIGHT

Makes loose dental plates fit snugly and comfortably. LASTS for MONTHS!

Simply squeeze on dental plate and put it in your mouth. Hardens and becomes part of plate. Money-back guarantee.

FREE Generous package of Dental Plate Cleanser with each order. Send \$1.00 or mailed parcel post collect.

Fit-Rite Co., 1557 Milwaukee Ave.  
Dept. 3-PM, Chicago, Ill.



## THERE'S MONEY IN CARTOONS!

RAYE BURNS will teach you HOW to CREATE ORIGINAL CARTOONS at home that you may SELL! Course contains 26 lessons and over 600 illustrations. All for Only.....

\$2.85

Send name and address for free details.

RAYE BURNS SCHOOL, Dept. M, Box 3583, CLEVELAND, OHIO



Begin today. Write now for our Free Book, "How to Become a Good Penman." It contains specimens and tells how others learned to write in spare time. Enclose 10c for your name beautifully written and a pen point suitable for shaded writing. Write today.

THE TAMBLYN SCHOOL OF PENMANSHIP  
N-441 Ridge Building, Kansas City, Mo.

## CRIPPLES

Great benefit to sufferers from Infantile Paralysis, Spinal Deformities, Arthritis, etc. State your case. Write for booklet and testimonials.

NEW YORK SURGICAL APPLIANCE CO.  
132 Lexington Ave. New York City, N. Y.

## Store Route Plan PAYS BIG MONEY

SELL COUNTER CARD PRODUCTS

Build a good-paying business of your own; Call on dealers of all kinds; show nationally-advertised Aspirin, Vitamins, Cosmetics and 200 other necessities. Big 5c and 10c retail packages, high quality. Attractive counter displays sell goods fast. Free book gives amazing facts. Write!

World's Products Co., Dept. 10-L, Spencer, Ind.





# GET INTO RADIO ELECTRONICS & TELEVISION

for Success and Security!

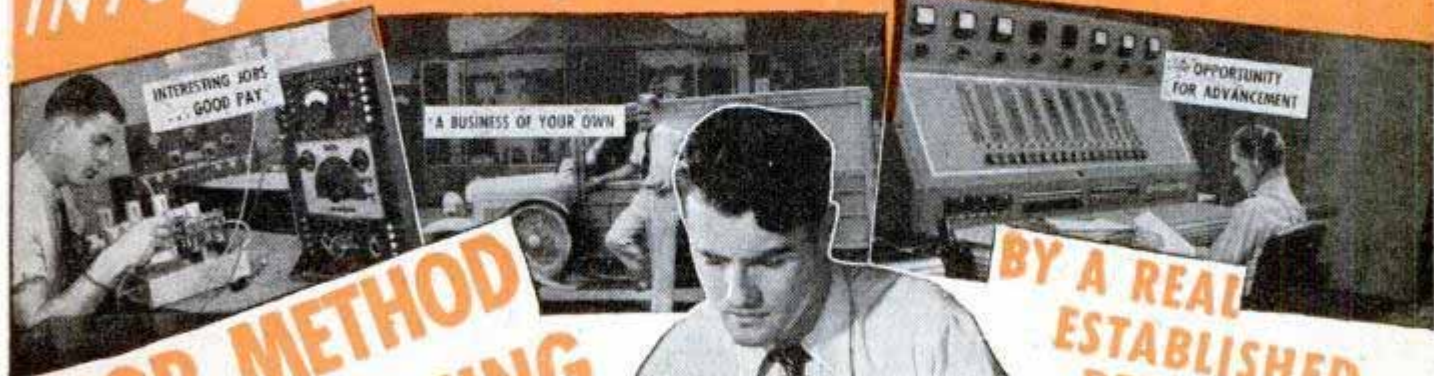

**SHOP METHOD HOME TRAINING**

**BY A REAL ESTABLISHED RESIDENT SCHOOL**

In the Classrooms, Shops and Laboratories of this Established School, improved training methods have been designed for practical Home Study instruction in the great field of Radio—in the rapidly expanding branches of Television and Electronics. National graduates everywhere have qualified, through spare time study, for well-paying jobs, success and security. Here is training created BY Practical men FOR Practical men.

You build this powerful super-heterodyne receiver.

are constantly absorbing trained men. If you like mechanics—like to work with your hands as well as your head, you too can find your opportunity in industry or in a business of your own.

**LEARN BY DOING RIGHT AT HOME**

The secret of success of this practical training method is the EXPERIENCE OF WORKING WITH ACTUAL FULL SIZE, STANDARD EQUIPMENT DURING YOUR TRAINING. Here's a fully tested and approved method—thorough, complete and easy to put into PRACTICE! As you go along, you check PROGRESS right on your own equipment! You can see advancement from the start. It will only take a moment to fill out and send the coupon for a sample lesson. PROVE TO YOURSELF HOW MUCH YOU CAN ACCOMPLISH WITH NATIONAL TRAINING SHOP METHODS.

**BECOME A RADIO EXPERT IN YOUR SPARE TIME**

The Radio, Television and Electronics industries are demanding more and more trained, experienced men as service men, operators and technicians. It is a field with a proved future. Untold Radio sets are in use—they need maintenance or repair. Radio service organizations, broadcasting, marine and police Radio, public address, and other specialized phases

BIG KITS OF EXPERIMENTAL EQUIPMENT ARE INCLUDED WITH YOUR TRAINING

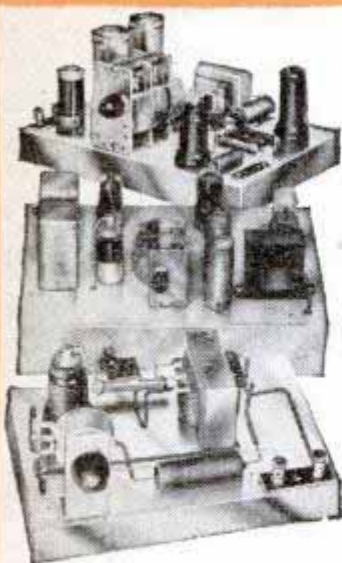

Here are a few of the units of Standard Radio equipment supplied. Build a big, long distance receiver, an audio oscillator, a signal generator and conduct many other experiments.

**BIG OPPORTUNITY BOOK AND SAMPLE LESSON**

*Free*

Learn how National trains you for good paying jobs—a business of your own. Get this valuable "Modern Radio Servicing" manual without obligation. Send coupon NOW!



**VETERANS**

If you qualify for training under G. I. Bill, check the coupon for a Special Bulletin.

**NATIONAL SCHOOLS**  
LOS ANGELES 37, CALIFORNIA EST. 1905

**MAIL OPPORTUNITY COUPON FOR QUICK ACTION**

National Schools, Dept. 3-PM  
4000 South Figueroa Street  
Los Angeles 37, California

(Mail in envelope or paste on penny post card.)

Mail me FREE the books mentioned in your ad including a sample lesson of your course. I understand no salesman will call on me.

NAME.....AGE.....

ADDRESS.....

CITY.....ZONE.....STATE.....

Check here if veteran of World War II





**MY DOBE TRAINING WAS ALL PRACTICAL EXPERIENCE!**

**I WILL TRAIN YOU AT HOME UNTIL YOU GET A GOOD PAY JOB!**

**Get Started NOW in DRAFTING**

**EXPERIENCE WHILE LEARNING**

Your training will be experience because I give you practical jobs to do. And I list your experience and send it to employers as a reference when you are ready. All Dobe trained men start out with experience. You will too, because I will train you until you get a good pay job in drafting.

Take the first step now and step into Drafting—the big opportunity field—as an experienced, well paid draftsman. Act now for a better job, better pay and better working conditions. The field for draftsmen is bigger now than ever before for all new products, machines, construction start with the draftsman. Get into drafting now. I will train you at home in your spare time, and give you actual experience on actual work—the same kind of jobs you will do with the best paying firms. I will train you until you are competent, fully experienced, and holding a position that will bring advancement and pay raises. Write me today.

**WORKING TOOLS SENT WHEN YOU START**  
All drafting instruments and table and other needed equipment sent when you start. Nothing to buy. Act today. Mail coupon to me now and be sure to give age.



**MAIL COUPON FOR VITAL FACTS**

Engineer Dobe, Div. 13, Libertyville, Ill.

Send me the Vital Facts on Drafting and Industrial Designing, your Free Book and advertised list of positions for Draftsmen and Designers wanted.

Name..... Age.....  
Address.....  
City..... Zone..... State.....



**AUTO BOOKS ON APPROVAL**



**SEND NO MONEY.** Just mail the coupon for a complete set of Six Big Auto Books, 20th Edition. Whether you are a mechanic or helper, expert or apprentice, auto owner or driver, take immediate advantage of this FREE EXAMINATION OFFER.

**MAKE GOOD MONEY NOW HOLD A PERMANENT JOB**

America wants its automobiles kept in good repair. Men with "know how" are in demand, at big pay. These books will help you get and hold an important job, or give you a chance to go into business for yourself now or later. Any man who half tries to improve himself can learn auto servicing and repairing by this quick reference method. Use the JIFFY INDEX to find easily understood answer to any auto problem. These wonder books prepared by eleven of America's great automobile engineers. Many hundreds of valuable illustrations. Send the coupon TODAY.

**[A year's consulting privileges with our engineers now given with these books without extra charge.]**  
Vocational Publishers Since 1898

**AMERICAN TECHNICAL SOCIETY, Dept. A319**  
Drexel Ave. at 58th St., Chicago 37, Ill.

I would like to examine your Six-Volume Set of Auto Books. I will pay the delivery charges only, but if I choose I may return them express collect. If after 10 days' use I prefer to keep them, I will send you \$2 and pay the balance at the rate of only \$3 a month until \$24.50 has been paid. Please include consulting service as offered above.

Name.....  
Address.....  
City..... State.....

Please attach letter stating age, occupation, employer's name and address and name and address of at least one business man as reference. Men in service, also please give home address.

**BE A BUILDING CONTRACTOR**

**FREE FACTS: Use Our Training Plan to Learn at Home in Spare Time**

Do you want to be on the inside in the building boom—where big money is made? Learn about opportunities for Building Contractors whether or not you have previous experience in this field. Millions of dollars are going to be made in home and farm buildings, in construction of stores, garages, small industrial buildings. The building industry uses men with organizing ability by thousands in construction, supervision, management, sales. Properly trained men needed in production, distribution, finance, installation, marketing. Government estimates housing demand at 40 billion dollars. Others are preparing to get in now! Act immediately—get the facts! Mail postcard today—no obligation.

**HOME BUILDERS TRAINING INSTITUTE, Dept. D23**  
7050 N. Glenwood Ave. Chicago 26, Illinois

**TRAIN NOW FOR A WELL PAID JOB IN POST-WAR AVIATION!! AIRCRAFT INSTRUMENT MEN**

will be needed by manufacturers, airlines, service organizations. Don't wait until competition gets tough! Be ready! Study now! Let Eastern's Home Study Course give you training in your own home. Actual instruments furnished. Send for folder now.

**EASTERN AIRCRAFT INSTRUMENT SCHOOL, Dept. PM**  
Division of National Technical Institute, Inc.  
116 Newark Ave. Jersey City 2, New Jersey

**BOYS-IT'S FREE!**

This exciting book "THE WONDERS OF CHEMISTRY" Shows how to amaze your friends with chemical magic, describes many fascinating home experiments, tells of fun, thrills, adventure and big future opportunities for boys who know chemistry. Send today!

**THE PORTER CHEMICAL COMPANY**  
45 Prospect Avenue Hagerstown, Md.



**ELECTRICIANS SCHOOL**

**PRACTICAL TRAINING IN**  
HOUSE AND COMMERCIAL WIRING  
MOTOR REPAIR AND REWINDING  
ELECTRIC REFRIGERATION  
Approved for Veterans Training

**PENNSYLVANIA INSTITUTE SCHOOL OF ELECTRICITY**  
42nd & SPRUCE STS. CATALOG PHILADELPHIA 4, Pa.

**Learn BAKING At Home**

Baking is one of America's high industries in wages. Nearly depression-proof. Thorough basic home course lays sound foundation. If you have aptitude, write for FREE BOOKLET, "Opportunities in Commercial Baking."

National Baking School, 1315 Mich. Ave., Dept. 1353, Chicago 5



**INDIANA TECHNICAL COLLEGE**

Engineering B.S. degree in 27 mos. Aeronautical, Chemical, Civil, Electrical, Mechanical and Radio Engineering. 2-yr. diploma. Air Conditioning and Refrigeration; Drafting, 1-yr. Gov't approved for G.I.'s. Low rate. Earn board. Large industrial center. Demand for graduates. Enter March, June, Sept., Dec. Catalogue. 537 E. Washington Blvd., Ft. Wayne 2, Ind.

**CARTOON TO SUCCESS!**

Learn cartooning from a PROFESSIONAL! Let me show you how to create ORIGINAL cartoons and IDEAS. Send for FREE details about course.

Also **CARTOONIST'S MAGAZINE**—Lessons, plans and hints. Send 25c coin for copy.

**CARTOONIST HARTMAN, 2776 California Court, LINCOLN 8, NEB.**



**RAISE CHIN-CHINS**

No experience needed. Just a few minutes daily and a few feet of backyard, garage or barn space. Several females and a male starts a large, profitable herd. WE FURNISH FREE INSTRUCTIONS. TREMENDOUS DEMAND for breeding and laboratory stock, meat, and world's most beautiful rabbit fur. Brokers, cut off from imported rabbit pelts by world famines, NEED CHIN-CHIN FURS NOW, and for years to come! Write for free illustrated catalog today.

**WILLOW BROOK FARM • R-64, SELLERSVILLE, PENNA.**







**H. T. ARMSTRONG**  
General Manager

**START YOUR OWN  
APPLIANCE REPAIR SHOP  
Be Independent!**



**YOUR JOB IS SAFE  
IF YOU HAVE  
YOUR OWN SHOP**

No new-fangled machine can ever take your place in this work . . . for it takes hands to fix appliances. So you will never be out of a job. Further, everyone needs a repair man from time to time . . . so everyone is literally a potential customer. Yes, and everyone respects and admires a man who can fix things . . . so there is a lot of satisfaction being in this business. But there's even more satisfaction in knowing you and your family will never be out on a limb . . . because you will never be out of a job. Let's talk it over by mail.

**NEW BOOK  
"HOW TO START YOUR  
OWN BUSINESS"**

**Sent at No Extra Cost  
If You Act Promptly**

This valuable book covers locating your shop, contains drawings of how to build and wire work-benches, where and how to advertise, what to charge, how to hire solicitors, etc. Sent to students who enroll promptly.

**FREE BOOKLET  
MAIL THIS COUPON  
TODAY**

*Learn* at HOME in  
Your Spare Time  
**How To REPAIR & SERVICE  
ELECTRICAL  
APPLIANCES**

Our practical, thorough course teaches you this interesting, good-paying business AT HOME, DURING YOUR SPARE TIME. A grade school education is all you need. We teach repairing electrical appliances, motors and house wiring. And from long, daily experience we know how to make our lessons understandable and easy to grasp . . . and how to give you the answers to the questions you'll want to ask. For the man who is handy with tools, and likes to work with his hands as well as his head, there is a WIDE OPEN OPPORTUNITY today, in this great growing field.

**YOU CAN PAY FOR YOUR TRAINING  
WITH JUST ONE GOOD REPAIR JOB**

It's a fact! One good repair job can more than pay the cost of the entire course of training. And here's a business you can start as small as you like, in your basement or garage . . . work when you want to . . . and grow as big as you like. Or, you can take a well paid job most anywhere, to start . . . as the need for service mechanics is tremendous in this field and will grow bigger as more and more appliances are released.

**AN INDUSTRY WITH A FUTURE**

Just think! Despite war, shortages, priorities and restrictions, nearly 3,000,000 more U. S. homes were wired for electricity for the first time . . . since 1940. It's almost like discovering a new continent filled with customers . . . added to the millions already here. And electrification is in for a big boom with government projects in plan for all over the nation.

H. T. ARMSTRONG, General Manager,  
**PACIFIC TRAINING SCHOOL, Dept. P-103,  
7217 So. Broadway, Los Angeles 3, Cal.**

Dear Sirs: Please send me, without obligation, your FREE BOOK-LET, and full details.

Name .....

Address .....

City ..... State .....



# LOANS *by* MAIL

\$50 to \$300 *IN A HURRY*

**CONFIDENTIAL**

Salaried people, men or women, married or single, loans on your own signature, or your own security. NO personal interview. NO co-signers needed. NO wage assignments. You mail the application to us... we mail the money to you.

FOR A LOAN OF	YOU CAN REPAY MONTHLY			
	IN 15 PAYMENTS	IN 12 PAYMENTS	IN 9 PAYMENTS	IN 6 PAYMENTS
\$ 50	—	\$ 5.03	\$ 6.43	\$ 9.24
100	8.40	10.07	12.87	18.48
150	12.60	15.10	19.30	27.73
200	16.75	20.09	25.68	36.91
250	20.85	25.02	32.02	46.05
300	24.93	29.94	38.33	55.17

The above payments made at regular monthly intervals will repay the entire loan and all charges in the time indicated. Charges are based on the monthly rate of three per cent on unpaid principal balances to \$150.00 and two and one-half per cent on that portion of unpaid balances in excess of \$150.00 but not exceeding \$300.00. "Loans by Mail" may be repaid in larger amounts, more frequent payments or repaid in full at further savings to you.

**CONVENIENT**

Just write us how much money you need and how you wish to repay... there's no charge or obligation. Whatever your needs for cash now or in the future, write for your "Loans by Mail" plan, today.

**MERCHANTS INVESTMENT CO.**  
819-G 1st Nat'l Bldg., Omaha, Nebr.

Without obligation, rush complete details and all papers necessary for a loan of \$ \_\_\_\_\_ to be repaid at \$ \_\_\_\_\_ on the \_\_\_\_\_ day of each month.

Name \_\_\_\_\_

Address \_\_\_\_\_

City \_\_\_\_\_ State \_\_\_\_\_

Occupation \_\_\_\_\_

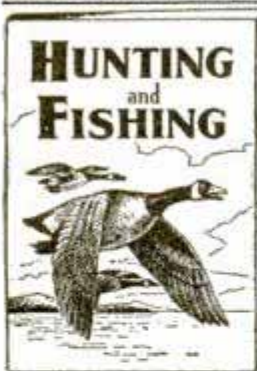

**HUNTING and FISHING** is a monthly magazine crammed full of hunting, fishing, camping, dog and boating stories and pictures, invaluable information about guns, fishing tackle, game law changes, best places to fish and hunt—countless ideas that will add more fun to your days afield.

**Special Trial Offer**  
Send 25c in stamps or coin and we will send you Hunting & Fishing for six months.

**HUNTING & FISHING MAGAZINE**  
251 Sportsmen's Bldg., Boston, Massachusetts

# Electric Heating Element FLUX

Repair burned out electric elements of coffee urns, electric stoves, flat irons, toasters, and other electrical appliances. Simply apply Christy Electric Heating Element Flux to the break, turn on the current and PRESTO the job is done and your appliance is ready again for years of satisfactory service. Generous size package (enough to repair 50 elements) sent postpaid for only \$1.00.

## ELECTRICAL APPLIANCE REPAIR PARTS

- Renual Iron element. Guar. 1 year. Package of 6.....\$3.12
- Toaster element forms. Clear Mica. Fits most toasters. 10 for... 1.80
- Heating element wire. 10 ft. coiled 1/4" O.D. #20..... 2.55
- Heating element wire. 10 ft. coiled 3/16" O.D. #22..... 1.77
- Hot plate bricks. 5 3/4" diameter. 6 for..... 1.62
- Appliance cord. Rubber covered. 20 ft. \$1.00; 100 ft.... 4.50
- Ribbon element heating wire. Std. size. 100 ft..... .75
- Percolator elements. Universal. Flat type. 1 yr. guar. 2 for... 1.20
- Element cement. Withstand 3000° F. 1 lb. pkg. \$1.00. 5 lb. pkg.. 3.50
- Lead wire. Asbestos covered heater hook-up wire. 10 ft..... 1.00
- Iron Cord Sets with complete plug attachments. 10 for..... 5.00
- Carbon brush set. Assorted. 104 brushes. 15 springs. Complete set 3.00

## HOW TO FIX IT BOOKS

- Modern Electric & Gas Refrigeration.....\$5.00
- Practical Electricity & House Wiring..... 1.50
- Armature & Magnet Winding..... 1.50

Here is your opportunity to save on repairing your own appliances and to earn extra money repairing appliances for friends and neighbors.

## CHRISTY SUPPLY COMPANY

2835 N. Central Ave., Dept. T-650, Chicago 34, Ill.



## Get Started in Radio

TEN "HOW-TO-DO-IT" BOOKS  
Get a solid foundation in radio by means of these 10c timely text books. Each clearly written, profusely illustrated, contains over 15,000 words. You'll be amazed at the wealth of information packed into these handy books. Excellent for reference—ideal for technical library. Your money back if not satisfied.

**5 Books for 50c - 10 Books for \$1**  
SENT TO YOU POSTPAID

- No. 1—How To Make Four Doerle Short Wave Sets
  - No. 2—How To Make The Most Popular All-Wave 1 and 2 Tube Receivers
  - No. 3—Alternating Current for Beginners
  - No. 4—All About Aerials
  - No. 5—Beginners' Radio Dictionary
  - No. 6—How To Have Fun With Radio
  - No. 7—How To Read Radio Diagrams
  - No. 8—Radio for Beginners
  - No. 9—Simple Electrical Experiments
  - No. 10—Television
- Remit by check or money order—register letter if you send cash or stamps.  
**RADIO PUBLICATIONS, 23-Q West Broadway, New York (7)**

## HOME STUDY OR SHOP TRAINING

Learn Plastics, Refrigeration or Diesel. Study at home, shop work later. Also shop courses in Body and Fender, Machine Shop, Tool and Die. 41,000 graduates. Established 1902. Free booklet. Specify trade.  
**GREER SHOP TRAINING, Dept. 137, 460 S. State St., Chicago.**

SAY YOU SAW IT IN POPULAR MECHANICS

## TRI-STATE COLLEGE

B. S. Degree in 27 months in Engineering (7 branches); Bus. Admin., Aec't and Sec. Science. 64th year. School now filled to capacity. No applications can be accepted until further notice.  
437 College Ave., Angola, Ind.

## HIGHWAY ENGINEERING

PRACTICAL TRAINING IN HIGHWAY DESIGN AND PRACTICE.  
HOME STUDY — BY MAIL ONLY — WRITE US NOW!  
**SCHOOL OF HIGHWAY PRACTICE**  
DEPT. A, 2161 SHATTUCK AVE. BERKELEY 4, CALIF.

# DRAW for MONEY... Be an ARTIST!



Trained Artists are Capable of Earning \$50 — \$60 — \$75 OR MORE A WEEK!

You can learn to draw at home in your spare time the well-known WSA way. COMMERCIAL ART, DESIGNING, CARTOONING — all in ONE complete course. No previous art experience necessary—we teach you step-by-step. Prepare now for a fascinating hobby or profitable career. For 33 years WSA graduates have been making good—WHY NOT YOU?

**Veterans!**  
WSA is approved for training under the G. I. Bill

Write today for FREE BOOK, "Art for Pleasure & Profit," it fully describes our well-known course, instruction service and commercial opportunities for you. TWO AIRCRAFTS and other features included with training.

**WASHINGTON SCHOOL OF ART, Studio 123 H 1115-15th St., N.W., Washington 5, D. C.**

Please send me full information and your Free Book, "Art for Pleasure and Profit."

Name..... AGE.....

Street.....

City..... Zone..... State.....

I am entitled to training under the G. I. Bill.



# NOW!

## You Can Make Your Present Radio Into An Advanced **FM** RECEIVER

with this Powerful New **1947**

# MIDWEST RADIO

**LOW**  
**FACTORY-TO-YOU**  
**PRICE**  
COMPLETE WITH  
SPEAKER

**SERIES 16\***  
**AM-FM**  
**CHASSIS**  
with  
**5 Wave Bands**

ONCE again Midwest demonstrates its 27 years of leadership with this powerful Super De Luxe Series 16\* 5-band world-ranging radio that brings you noise-free FM reception plus Standard Broadcast and 3 short wave bands. You'll be thrilled by its marvelous tone...its wealth of new post-war features...its world-ranging performance that brings you the finest programs with amazing clarity and strength. Send today for the new FREE 1947 Midwest Catalog before you buy any radio. Take advantage of our sensational Factory-to-you values and liberal 30 days Trial Offer.



**\*SERIES 16 CHASSIS USES ALL OF THESE LATEST TYPE TUBES**

**14 1/2"**  
**PANASONIC**  
**SPEAKER**

Plus the Exclusive **TRI-MAGNADYNE** Coil System - the Heart of Every **MIDWEST** in

**30**  
**DAYS**  
**TRIAL**



## THE MAGNIFICENT LINE OF BRILLIANT NEW CONSOLE AND TABLE MODEL RADIOS AND RADIO-PHONOGRAPHS



The **SYMPHONY GRAND** SERIES 16\* AM-FM RADIO-PHONOGRAPH CONSOLE with **NEW AUTOMATIC RECORD-CHANGER**

A REAL masterpiece of cabinet design and radio engineering... a luxurious musical instrument that brings you the newest marvels of radio science, including static free FM, automatic record changing, 5 wave bands and scores of new features and improvements for your listening pleasure. For complete details of this and other Midwest Radio models send for your copy of the 1947 Midwest Catalog today.

**EASY TERMS**

**Rush for Free Catalog!**  
FILL IN COUPON AND MAIL TODAY OR JUST SEND YOUR NAME AND ADDRESS ON 1c POSTCARD

**MIDWEST RADIO CORP.**  
Dept. 25-G 909 Broadway  
Cincinnati 2, Ohio

Gentlemen: Please send me your new FREE catalog and details of your liberal 30 Days Trial.

Name \_\_\_\_\_  
Address \_\_\_\_\_  
City \_\_\_\_\_ Zone \_\_\_\_\_ State \_\_\_\_\_

**MIDWEST RADIO CORP.**  
Dept. 25-G • 909 BROADWAY • CINCINNATI 2, OHIO

**RADIO MANUFACTURERS**  
Since 1920





# LANGUAGE IS POWER

... Forge ahead, win special assignments, promotion, better job in global peace time opportunities through ability to speak a foreign language.

**MASTER A NEW LANGUAGE quickly, easily, correctly by**

## LINGUAPHONE

The world-famous Linguaphone Conversational Method brings voices of native teachers INTO YOUR OWN HOME. You learn the new language by LISTENING. It's amazingly simple; thousands have succeeded.

**HOME-STUDY COURSES IN 29 LANGUAGES**

Available to Veterans under  
**G I BILL OF RIGHTS**

**SEND FOR FREE BOOK**

### LINGUAPHONE INSTITUTE

98 RCA Building, New York 20, N. Y. • Circle 7-0830

LINGUAPHONE INSTITUTE,  
98 RCA Bldg., New York 20, N. Y.  
Send me the FREE Linguaphone Book.

Name.....  
Address..... City.....  
Language Interested.....  
State if G.I.....

SAY YOU SAW IT IN POPULAR MECHANICS

**LOOK!**  
CHORD SYMBOLS  
OLD FOLKS AT HOME

**LEARN PIANO**

**LISTEN!**

**WITH RECORDS SPECIAL**

**PLAY!**

**LOW COST! NO RISK! SEND NO MONEY!**  
**SENSATIONAL RESULTS IN 10 EASY HOME LESSONS!**

ONLY piano course in world with RECORDED lessons! With Tracy special records it's thrilling how quickly, easily you learn to play popular tunes, semi classic, western songs, hymns, etc.

**HEAR YOUR TEACHER'S ACTUAL VOICE ALWAYS HELPING YOU**  
Records repeat any portion, often as you wish. Prints and pictures show you how and Teacher's voice on records guides you. No "ear" or number systems. No tiresome exercises. First lesson starts you reading real notes, playing with both hands. In ten days you start playing actual songs—or money back. Stop wishing. Start playing. Write us today.

**SEND NO MONEY—Mail coupon for information kit! ACT NOW**  
TRACY INSTITUTE OF MUSIC, Dept. P-2, 54 Holmehurst Ave., Baltimore 28, Md.

**MAIL COUPON TODAY**

TRACY INSTITUTE OF MUSIC, Dept. P-2, 54 Holmehurst Ave., Baltimore 28, Md.  
Send me Free Information Kit showing how I can learn to play piano with print and picture lessons plus Records.

Print Name.....  
Street.....  
City..... State.....

## "THREE MONKEYS" Cartoons



Triple action fun, escapades and thrills with three "Stars" in every film. A Walter Lantz feature.

50 Ft. 8MM.....\$1.75  
Red Hot Tires..... 1212-A  
Auto Race..... 1213-A  
100 Ft. 16MM....\$3.00  
Midnight Spooks... 1214-A  
House of Tricks... 1215-A  
Show also a Mickey Mouse-Donald Duck and the Walter Lantz 3 Monkeys cartoon. All packed with laughs.  
See at your dealers or order direct.  
For prices and catalog write to—

**HOLLYWOOD FILM ENTERPRISES, INC.**  
6060 Sunset Blvd. Dept. 115 Hollywood 28, Calif.

### Be Your Own Boss — In Your Own Business

Start at home . . . small capital needed . . . prepare for exciting plastics jobs or Your Own Plastics Business. We teach you Fabrication and Casting right in your own home. All materials furnished. Send ad with name and address for information.  
VETERANS: Eligible for resident training under G. I. bill, Check here

**LEARN**

## PLASTICS

**PLASTICS TECH**  
School of America, Inc.  
5200 Euclid Avenue  
Dept. M-3, Cleveland 3, Ohio

### INVENTORS Exhibit and possibly sell

your invention at the 2nd and greater WORLD'S INVENTION EXPOSITION, Chicago Arena, May 2 to 11. Thousands of mfgs. will see your invention—small rates to display model or drawing. Make reservations now. Write for free folder.

**WORLD'S INVENTION EXPOSITION**  
Offices—39 South La Salle Street Chicago 3, Illinois

## ELECTRICAL TRAINING

Intensive 32 weeks residence course in fundamentals of industrial electrical engineering, including radio, electronics. Prepares for technician, engineering aides. Approved for veteran training. 54th year. Catalog.

**BLISS ELECTRICAL SCHOOL**  
7628 Takoma Ave., Wash. 12, D.C.



### Thrilling Work COLORING PHOTOS

Fascinating vocation learned at home by those with aptitude. Thrilling pastime. National method brings out life-like colors. Free booklet.  
**NATIONAL PHOTO COLORING SCHOOL**  
1315 S. Michigan, Dept. 1353, Chicago 5



**AMAZING DISCOVERY!** Guaranteed to correct poor penmanship in few days—big improvement in 3 hours. Write, Ozment, 34, St. Louis, Mo., IMMEDIATELY.



### SIMPLE EASY INVENTION TRIMS HAIR AT HOME!

**SAVES BARBER BILLS**

Trims hair as it comb! Easy! Quick! Keeps men's, women's children's hair trim, neat, freshly-cut looking all the time! Trims, tapers, thins out uneven hair. Use like ordinary comb. Safe. Simple. No experience required. Fine for legs, underarms!



**SAMPLES FOR AGENTS**  
Sample offer sent immediately to all who send name at once. A penny postal will do. **SEND NO MONEY.** Just your name.  
**KRISTEE CO., 689 Bar St., AKRON, OHIO**



# 4 Career Ways to Success

CHOOSE THE ONE THAT FITS YOU BEST

APPROVED FOR TRAINING THE YOUNG MEN OF AMERICA—VETERAN AND NON-VETERAN

## WATCHMAKING— A CAREER FIELD!

WORK — and plenty of it — Millions of watches and clocks need fixing. An interesting and needed service in the top-pay bracket, or start an independent business of your own. The AMERICAN SCHOOL OF WATCHMAKING



offers proven training under QUALIFIED watchmaker-instructors. Complete information free upon request. Enclose coupon in envelope or paste on penny postcard.

**AMERICAN SCHOOL OF WATCHMAKING.**  
Dept. P-37, 5145 W. San Fernando Rd., Los Angeles 26, Calif.  
Gentlemen: Please send me free booklet and information on your training.

Name (PRINT) \_\_\_\_\_  
Street \_\_\_\_\_ Age \_\_\_\_\_  
City \_\_\_\_\_ State \_\_\_\_\_  
Veteran \_\_\_\_\_ Non-Veteran \_\_\_\_\_

## PLASTICS — MAGIC WORD!



Here at Plastics Tech in Los Angeles, men are learning the secrets of this glamorous industry for which the future seems unlimited. Hundreds of new products are being made of plastics requiring trained men to develop and fabricate them. Plastics Tech is the pioneer and leader in the field of plastics instruction. Its faculty and directors are leaders in

the industry. Write for beautiful four-color catalog today. No obligation. Courses available either residential or study at home. Mail coupon in envelope or paste on penny postcard.

**PLASTICS INDUSTRIES TECHNICAL INSTITUTE.**  
Dept. PM37-1Q, 1601 S. Western Ave., Los Angeles 6, Calif.

Gentlemen: Please send me free booklet "World of Plastics" and information on your training.

Name (PRINT) \_\_\_\_\_  
Street \_\_\_\_\_ Age \_\_\_\_\_  
City \_\_\_\_\_ State \_\_\_\_\_  
Veteran \_\_\_\_\_ Non-Veteran \_\_\_\_\_  
Residence School \_\_\_\_\_ Home Study \_\_\_\_\_



## BE AN AIRCRAFT INSTRUMENT TECHNICIAN

More than 750,000 trained men (CAA survey) will be needed to fill important jobs in the Aviation industry in next 10 years. All planes require delicate instruments. There must be trained men to service, maintain and repair them — Instruments must be right ALWAYS. AMERICAN SCHOOL OF AIRCRAFT INSTRUMENTS



teaches men to perform this important, interesting and well-paid work. The world's future depends on more Aviation-INSTRUMENTS. Write today for free booklet. Send coupon in envelope.

**AMERICAN SCHOOLS OF AIRCRAFT INSTRUMENTS.**  
Dept. P-37, 5145 W. San Fernando Rd., Los Angeles 26, Calif.  
Gentlemen: Please send me free booklet and information on your training.

Name (PRINT) \_\_\_\_\_  
Street \_\_\_\_\_ Age \_\_\_\_\_  
City \_\_\_\_\_ State \_\_\_\_\_  
Veteran \_\_\_\_\_ Non-Veteran \_\_\_\_\_

## AERONAUTICAL ENGINEERING MASTER AIRCRAFT MECHANIC

AERO TECH training is thorough, specialized, intensive and practical. It assures you of a profitable, interesting career. Independence and financial security. Ideally located on huge Oakland airport — gateway to the Pacific—we are preparing many other ambitious young men for success. Why not join them? The next move is yours. Mail coupon today. Approved for Veterans. Early enrollment possible.



**AERO INDUSTRIES TECHNICAL INSTITUTE.**  
Dept. P-37, Oakland Municipal Airport, Oakland 14, Calif.

Gentlemen: Please send me free booklet and information on your training.

Name (PRINT) \_\_\_\_\_  
Street \_\_\_\_\_ Age \_\_\_\_\_  
City \_\_\_\_\_ State \_\_\_\_\_  
Veteran \_\_\_\_\_ Non-Veteran \_\_\_\_\_

ALL ARE MEMBERS NATIONAL COUNCIL OF TECHNICAL SCHOOLS

SEND COUPON TODAY



# "I'll show YOU how to make yourself COMMANDO-TOUGH

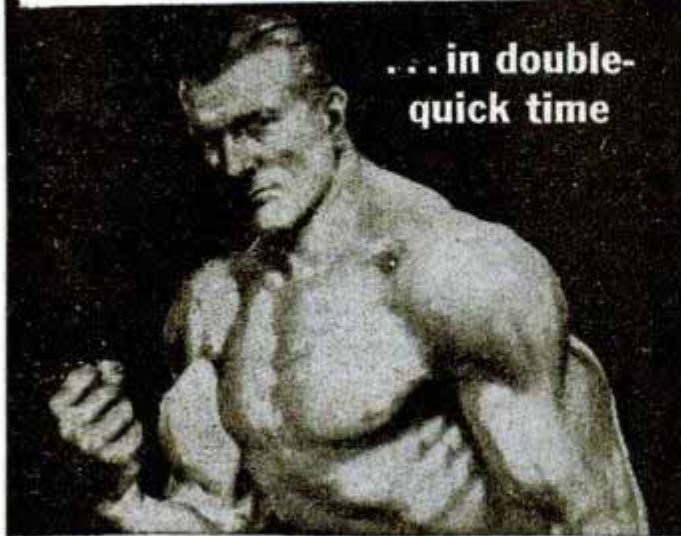

... in double-quick time

...OR IT WON'T COST YOU A CENT!"

says *George F. Jowett*

**WORLD'S GREATEST BODY BUILDER**

Let me prove to YOU that you can put inches of dynamic muscles on your arms! Add inches to your chest! Broaden your shoulders and power-pack the rest of your body. I can do for you what I've done for thousands the world over, including many officers and men now in the U. S. and British Armed Forces.

## GIVE ME 10 MINUTES A DAY! I'll Show You My Secrets Of Body Building

I'll help you learn the "Progressive Power Method" through which I rebuilt myself from a physical wreck to the holder of more strength records than any other living athlete or teacher! No matter how skinny or flabby you are, you can learn my methods right in your own home. Through my proved secrets I show you how to develop your power, inside and out, until YOU are fully satisfied that you are the man you want to be. "The Jowett System," says R. F. Kelly, Atlantic City, Physical Director, "is the greatest in the world!"

If you want a physique that will inspire respect from men, and admiration from women... **ACT LIKE A HE-MAN!** Decide at once! The famous book, "Nerves of Steel—Muscles Like Iron" will be included **FREE!** Priceless for the strength fan! Full of photos of marvelous power-bodied men who will show you what Jowett has done for them and how he can do the same for you. Reach out... Grasp this Special Offer today!

Jowett Institute, Dept. PM-73A  
230 Fifth Ave., New York 1, N. Y.

### PROVE TO YOURSELF IN ONE NIGHT!

Send only 25c for test Course, "Molding a Mighty Arm." Read it the evening it arrives—learn from experience the thrill you can give your muscles!

SEND FOR THESE FIVE FAMOUS COURSES IN BOOK FORM

ONLY 25c EACH  
or ALL 5 for \$1.00

QUICK ACTION BRINGS

**THIS  
BOOK  
FREE!**



### PHOTO BOOK OF FAMOUS STRONG MEN **FREE**



Jowett Institute of Physical Culture  
230 Fifth Avenue, New York 1, N. Y. DEPT. PM-73A

George F. Jowett: Your proposition looks good to me. Send by return mail, prepaid, the courses checked below, for which I enclose ( ). Include **FREE** book of PHOTOS.

George F. Jowett  
Champion of  
Champions

- |  |   |
|--|---|
| <input type="checkbox"/> All 5 courses for... \$1  | <input type="checkbox"/> Molding Mighty Legs 25c    |
| <input type="checkbox"/> Molding a Mighty Arm 25c  | <input type="checkbox"/> Molding a Mighty Grip 25c  |
| <input type="checkbox"/> Molding a Mighty Back 25c   | <input type="checkbox"/> Molding a Mighty Chest 25c |
| <input type="checkbox"/> Send all 5 C.O.D. (\$1 plus postage.) No orders less than \$1 sent C.O.D. |   |

NAME..... Age.....  
(Please print plainly. Include zone number.)

ADDRESS.....

# SUCCEED IN THE! POULTRY BUSINESS!



You can make a good, comfortable living with poultry

A little study now at home in spare time will open the way to enjoy country life, home grown food, freedom from care—letting poultry pay expenses.

For 26 years our course of Home Study Training has been helping thousands to greater success. Proper Management and "know how" means extra profits from the start. Write today for prospectus, describing courses, methods, service.

**NATIONAL POULTRY INSTITUTE**

DEPT. 50 — ADAMS CENTER, N. Y.

## DOUBLE your INCOME IN YOUR SPARE TIME

**LEARN SILK SCREEN  
PROCESS**

Jealously Guarded Trade Secrets NOW Available to You

Develop a Profitable Business of Your Own... or a Hobby

Prepare yourself for an interesting top paying position. Thousands of jobs open. Silk Screen Process signs, displays, Xmas cards, toys, etc. IN GREAT DEMAND THE WORLD OVER. You may make enough the second week to pay for the entire course. EASY TO DO... EASY TO LEARN. No education or mechanical knowledge required. BOOKLET with 3-color Silk Screen Process cover and Samples sent FREE. Write NOW!

**CALIFORNIA SCHOOL OF SCREEN PROCESS**

Dept. PM-37 3740 Overland Blvd., Los Angeles 34, California



**COURSE INCLUDES  
A COMPLETE  
KIT OF  
SUPPLIES**

## LEARN AT HOME TO MOUNT BIRDS



Animals, Heads, Fishes, Pets; to TAN. Be a Taxidermist. Profit and FUN.

Hunters, save your valuable TROPHIES. Mount ducks, squirrels, everything. Learn to TAN for leather and furs. Wonderful HOBBY Have a HOME MUSEUM.—BIG PROFITS mounting for others. INVESTIGATE NOW.

**FREE BOOK** With 100 fine game pictures. NOW absolutely FREE. Write TODAY.

Send Postal TODAY for FREE BOOK. State AGE. N. W. SCHOOL OF TAXIDERMISTRY, Dept. 3373, Omaha, Neb.



### FIGURE DRAWING WITHOUT A MODEL

This book brings famous art schools right to your home! Over 300 "real-life" drawings in this new Cliff Young book. Copy from them to guide your Art Career. Only \$1 postpaid. Order Now; Art Books list included FREE.

HOUSE OF LITTLE BOOKS, 80-A East 11th St., New York 3



## LAW

STUDY AT HOME FOR PERSONAL SUCCESS and LARGER EARNINGS. 38 years expert instruction—over 108,000 students enrolled. LL.B. Degree awarded. All texts furnished. Easy payments. Send for **FREE BOOK**—"Law and Executive Guidance."

**AMERICAN EXTENSION SCHOOL OF LAW**  
Dept. 75-M, 646 N. Michigan Ave., Chicago 11, Ill.

## BATTERIES FIXED TO WORK LIKE NEW!

with and without new materials. Everything needed supplied. Complete copyrighted course, tool list, etc., only \$10.00.

**BATTERY LABORATORY SCHOOL, Dept. B, Minneapolis 13, Minn.**

*Trial offer to*

### PHOTOGRAPHERS

4-35c issues of The Camera Magazine for \$1.00. Each containing over 100 illustrations; 1 how-to-do-it booklet; late color info.; many feature articles. Book-case size. Offer expires August 1. Send \$1.00 now to THE CAMERA, 517-3 Morris Bldg., Balto. 1, Md.



# Learn RADIO- ELECTRONICS- TELEVISION



**ELECTRONIC CIRCUIT TESTING** — Instructor showing students use of large Cathode Ray Oscilloscope.



**RADIO TESTING AND SERVICING**—Students learning to locate troubles with modern radio analyzers.

**TRAIN FOR A GOOD  
JOB NOW** one that  
offers **STEADY WORK**  
with a **REAL FUTURE**

Don't be caught napping. Prepare for a good job now that will still be a good job with a real future when conditions change. If you are not a trained man you may have to compete with millions of other untrained men. Get into a field that offers real opportunities in good-times and bad-times. Tremendous expansion in Frequency Modulation and Television is predicted because of war time discoveries now being re-converted to civilian use. Radio-Electronics trained men are needed today—they will be needed in the years ahead!

## "Learn by Doing"

**RIGHT HERE** in the SHOPS of COYNE — in a Few Weeks  
*Student Finance Plan*

We train you on real Radio, Television and Sound equipment—RIGHT HERE IN THE COYNE SHOPS IN CHICAGO. Necessary theory is given in a practical way by practical lectures, blackboard illustrations and equipment demonstrations. Whether or not you have had Radio experience you need Coyne all-around Radio Electronics training. Many of our students had no previous experience. Others had experience in one or two branches but realized they needed all-around training for better jobs and advancement.

### EARN WHILE LEARNING

If you need part-time work to help pay living expenses while at school, we will help you get it. Coyne graduates also receive a Life Membership with Lifetime Employment Service.

**MEN WITH PHYSICAL DISABILITIES**—whether due to war or other causes—we also have facilities for you. Check coupon for particulars if you have a physical disability of any nature.

B. W. COOKE, Dir.

**COYNE** **ELECTRICAL SCHOOL**  
RADIO-ELECTRONICS DIV.

500 So. Paulina Street Dept. 37-3H CHICAGO 12, ILLINOIS

### PREPARE FOR JOBS LIKE THESE

Radio Servicing  
Radio Sales  
Radio Manufacturing  
Factory Inspecting and Testing  
Auto Radio Installation & Servicing  
Sound and Public Address, etc.  
Your Own Radio Shop

**Electric Refrigeration  
Now Included**

**ADDED  
TRAINING**

This training included to help you get ready for the better jobs in this great field

THE HOME OF  
COYNE



**VETERANS!** Coyne is also equipped to train those who qualify for training under the G. I. Bill of Rights. Check coupon for special G. I. Bulletin.

### Real Opportunities for the Radio Trained Man

Prepare for jobs as assembler, inspector and tester—Radio sales or service and installation work, electronics, television, sound work, aircraft-radio, auto-radio, etc. Many opportunities in the vast Radio-Electronics field.

### GET OUR BIG NEW BOOK

It tells all about our big Chicago shops and our plans to help you get ahead. Packed with facts and pictures of students at work in our shops. Mail coupon for this Big New Book now! Coupon will also bring details on how we'll finance most of your tuition...facts on how we help you "Earn-While-Learning"...information on FREE EMPLOYMENT SERVICE FOR LIFE...and other plans to help you. ACT NOW TO MAKE SURE YOU GET OUR GENEROUS OFFER. Sending for this interesting free book can be your first big step to success. No obligation. No salesman will call. Mail coupon today. B. W. Cooke



B. W. COOKE, Dir., Radio-Electronics Div.,  
COYNE ELECTRICAL SCHOOL  
500 S. Paulina St., Dept. 37-3H,  
Chicago 12, Ill.

Dear Mr. Cooke, Send me your Big Free Radio-Electronics Book and all the facts... also full details of your "Student Finance" plan.  Send special G. I. Bulletin.  Send physical disability details.

NAME.....

ADDRESS.....

CITY.....STATE.....



# Why be a BOOKKEEPER?

...When Accountancy  
offers more Money  
and Success...

If you are a bookkeeper, you are right on the threshold of a profession that pays far above average—where there's real opportunity to get ahead and move up fast.

Why not step *UP* from bookkeeping—be an accountant—make *real* money!

You can learn Accountancy by the interesting LaSalle Problem Method—in your convenient spare time, at home, without losing a day from your work. You learn by *doing*... you study Accounting principles and solve Accounting problems under the clear guidance of experienced C.P.A.'s. You cover Accountancy from the basic principles right up through Accounting Systems and Income Tax Procedure—to advanced training for the C.P.A. degree if you so desire. And as you go along step-by-step, you master the principles of auditing, business law, statistical control, cost accounting, organization, management, finance, etc.

You go as fast or as slowly as you choose. And you may start "cashing in" on your new ability long before you complete the training—as thousands of others have proved. Many advance quickly to better positions, even before they are half way through. And that is only the *beginning* of a growing and continuing success for the rest of your business life.

Why remain "just a bookkeeper" when Accountancy holds so much for you? Our free 48-page booklet, "ACCOUNTANCY, THE PROFESSION THAT PAYS," tells you what you must know to be an Accountant, and how you can prepare in your leisure time, at moderate cost and on easy terms.

Send the coupon today. Get all the facts and judge for yourself. There is no obligation. You are already started in this field...find out how you can rapidly go to the top! Mail coupon NOW!

FREE BOOKLET

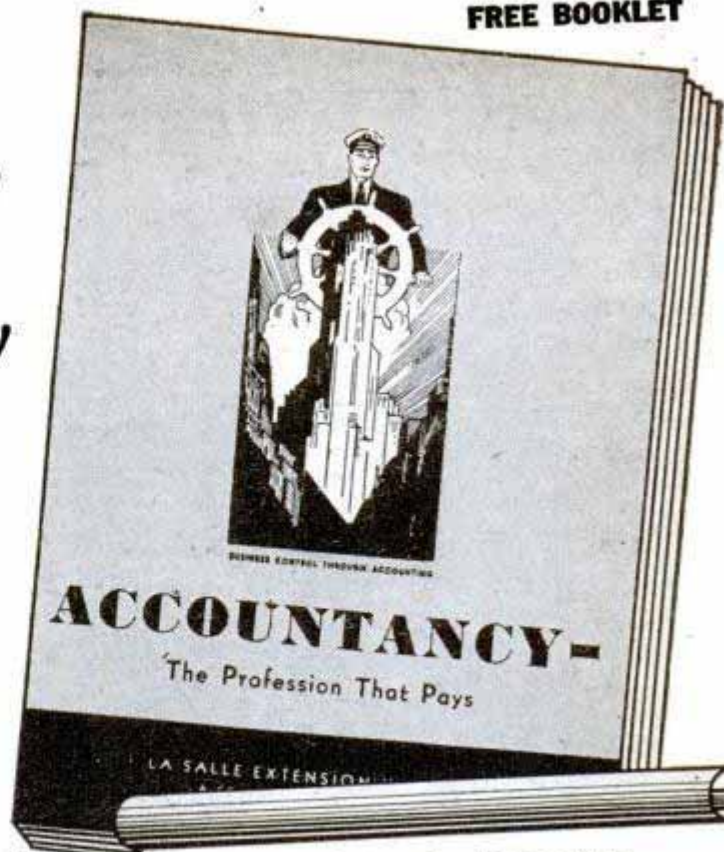

G. I.  
APPROVED

**LA SALLE Extension University**  
*A Correspondence Institution*

Dept. 364-H • 417 S. Dearborn • Chicago 5, Ill.

I'd like to know more about your home study program to help me prepare for an accounting career. Please send me your free 48-page booklet, "Accountancy, the Profession That Pays."

Name .....

Position ..... Age .....

Address .....

City, Zone and State .....

"I'm GOING  
to be an  
ACCOUNTANT!"



**LASALLE**  
**EXTENSION UNIVERSITY**  
*A Correspondence Institution*

POPULAR MECHANICS



**WORLD'S  
BEST  
WANT AD  
MEDIUM**

# CLASSIFIED Advertisements



Advertisements in this section 60 cents per word, each insertion, minimum 10 words, payable in advance  
To be inserted under proper classification in April issue, copy should be in our office February 25th

April issue on sale April 1st

F. W. Johnson, Manager, Classified Advertising

Popular Mechanics Magazine, 200 East Ontario Street, Chicago 11, Illinois

## 1454 CLASSIFIED ADVERTISEMENTS 1454 OPPORTUNITIES FOR YOU

### AUTOMOBILES, MIDGET CARS

**SCOOTER-CAR** Runabout! Two passenger, three wheeled, motorized, speedy. Simple construction from available second hand parts. Detailed plans \$1.00. Midget "Jeep" plans included free. Universal, 2671 Algonquin, Toledo 6, Ohio.

**USED Car handbook.** Dealers' tricks exposed, buying tips, previous owner clues, simple comprehensive tests. Postpaid \$1. Truvalu, Box 723-E, Arcadia, California.

**1947 SUPERIGNITIONER** \$5.50. Atomic starting, pep, mileage. EG Mfg., 355 East 149th, New York 55.

**INDIANAPOLIS Official 1946 Race Program,** 102 pages. Photos, results. Limited supply. 60c each postpaid. Clymer, Dept. A37, 2125 W. Pico, Los Angeles 6, Calif.

**DUALTONE** Chrystalline packed twin muffler sets for all cars. Priced complete V8's \$23.00, six cylinders \$33.00; eight cylinders \$36.00. Large chrome tailpipe extensions \$3.30. Polished carburetor velocity stacks \$1.30. Replacement mufflers for all cars. Request catalog. Dualtone Mufflers, 2636C India Street, San Diego 1, California.

**600 DIFFERENT Photos,** race cars, drivers. List, sample, 25c. Frank Smith, Midland Park, N. J.

**HISTORY Of Buick,** city of Flint book, now available. Illustrations early, late Buick. Beautiful binding. \$3.00 postpaid. Clymer, Dept. A36, 2125 W. Pico, Los Angeles 6, Calif.

**HIGH Speed engine tuning.** Car, boat, etc. No gadgets. Do it yourself. Race car mechanic advice each individual job. Information free. George Fawns, A-2552 N. 17th St., Philadelphia 32, Penna.

**BUILD Speedy midget track racer** from castoff parts! Plans, specifications, construction information. \$1.00. Motor Supply, Box CS-1682, Toledo, Ohio.

**DUAL Mufflers for V-8's.** Finest obtainable. Beautiful deep tone. Complete with necessary welded pipes, two mufflers, brackets. E-Z installation. \$20.00. Clymer, Dept. A32, 2125 W. Pico, Los Angeles 6, Calif.

**AMAZING New booklet on auto care.** Revealing facts worth millions to car and truck owners. Also opens new fields in novel ideas. Send \$1 for booklet. Auto Care, Box 320, Holland, Michigan.

**CHEVROLET Owners and mechanics—**Information stop oil leak rear main bearing \$1.00. Mechanic, 2506 So. Glass St., Sioux City 20, Iowa.

**MOTORACES,** New book Grand Prix auto racing. Includes 100 photos famous foreign cars, drivers. \$2.00 postpaid. Clymer, Dept. A31, 2125 W. Pico, Los Angeles 6, Calif.

**SEE Our ad under Motorscooters** for midget car bargains. Midget Motors Directory, Athens, Ohio.

**PICTURES For collectors.** American, European, early modern. Free list. R. W. Pratt, 245 North Street, Dalton, Mass.

**PACIFIC Speedway News** auto racing magazine. Complete results, data, large and midget races. Subscribe now, \$6.00 yearly. Clymer, Dept. A30, 2125 W. Pico, Los Angeles 6, Calif.

**MAKE Your Ford fast!** Complete details, photographs. How to construct 120 m.p.h. Hotrod. \$1 postpaid. California Bill, Eagle-rock Box L-1, Los Angeles 41, Calif.

**AUTOMOTIVE Trouble shooting,** 500 questions and answers. \$1.00 postpaid. Charles Nelson, 2908 Washington Ave., Santa Monica, California.

**JET Engines.** See Dyna-Jet advertisement under Models classification this issue.

**SPEED And Mileage manual.** Easily obtain greater speed, mileage, racing performance from any automobile! Includes simplified methods, speed tuning, gas saving secrets. Instructions on building economizers, speed equipment, dual carburetors, mufflers, superchargers, racing fuels, fast conversions. \$1.98. Almquist Engineering, 447 (G)—64 St., Brooklyn 20.

**"CUSTOM-STYLING" Manual.** Easily make car look Hollywoodized, custom built, ultra-beautiful! Streamlining suggestions, simplified restyling, refinishing, illustrations, plans, accessories, mufflers, model changes—convertibles, custom, sport, etc. \$2.00. Almquist Engineering, 447(G)—64 Street, Brooklyn, 20.

**GOGGLES,** Heavy duty Aero, \$4.50 pair. Summer helmets \$1.50 each. Winter leather helmets slightly used \$3.00 ea. New \$5.00 ea. Send payment with order. Western Aircraft, Hawthorne, California.

**RACING Car performance** for all cars. Increase power, speed. Special "custom-built" equipment. Free literature. Write Lee Motorcraft, 1412-A Great Northern Bldg., Chicago 4, Illinois.

**CUSTOMIZE Your automobile.** Illustrated, new restyling ideas, instructions, suggestions, specific model changes by simple methods. Postpaid \$1. Speedwheel, Box 723-E, Arcadia, California.

**CLYMER'S Motor Scrapbooks** (old automobiles) Editions 1, 2, 3, each different, \$1.50 each. Motor History of America, \$3.00. Fastest on Earth racing book, \$2.00. Motor Racing With Mercedes-Benz, \$2.00. Book Steam Automobiles, \$2.00. Power & Speed, \$2.50. Henry Ford, His Life & Work, \$3.00. Midget Automobile Racing Book, \$1.10. Indianapolis "500" Race History book 1909-1946, \$3.50; 1946 only, \$1.00. All postpaid. Catalog free. See ad motorcycle section. Clymer, Dept. A33, 2125 W. Pico, Los Angeles 6, Calif.

**"STREAMLINED Roadster"—**America's lowest priced car! Speedy, two passenger, light, three wheeled, beautiful! Amazingly easy to build from inexpensive material—small motor. Instructions, drawings \$1.98. Almquist Engineering, 447(G)—64 Street, Brooklyn 20.

**MUFFLER Manual.** Convert easily to Hollywood, Laguna, Westwood, duals, etc. Includes construction details, regulations, diagrams. Postpaid \$1. Mellotone, Box 723E, Arcadia, California.

**PROFESSIONAL Midget racer,** motor-scooter, midget roadster, and midget motorcycle. Plans, specifications for all four contained in illustrated handbook. 25c. Big list bargain priced used motors, motorscooters, servicycles, etc., included free! Midwest, 3839 Drummond, Toledo, Ohio.

**AUTOMOBILE Racing book,** fifth edition, well illustrated. Instructions on building bodies, frames, engines, Ford A and B conversions. Plans, AAA rules, specifications. Roadster racing, Indianapolis cars. \$1.00 postpaid, \$1.30 C.O.D. Ray Kuns, Dept. 47, Madisonville, Cincinnati 27, Ohio.

**LITTLE Library of Useful Information.** 102 different books. Catalog free. Popular Mechanics Press, 200 E. Ontario St., Chicago 11, Ill.

### AUTO SUPPLIES AND EQUIPMENT

**CONVERT Hub-caps** inexpensively to spinning bar type. Plans, instructions 25c. Gilhewco—212, 7016 Euclid, Cleveland, Ohio.

**KNOBS For gear shifts,** 35c each, \$26 hundred. Paul Dillon, Route 4, Waynesboro, Penna.

**BURN Water** in your car with the Vanderpool water injecting carburetor. More power, faster pickup, cleaner, cooler, smoother motor. \$22.25 complete with tank and fittings. State make and year of car. Ralph A. Shade, 563 Lake Road, Webster, N. Y.

**SAVE 10%.** Standard brand auto parts sent c.o.d. postpaid at 10% discount. Akron Garage Supply, PO Box 308, Akron 9, Ohio.

**OIL Pumping motors** corrected. Details. Mullner, Box 3102, St. Paul 1, Minn.

**PARTS For most all makes and models** of autos, trucks and tractors. Belts and belting for most every purpose. Write needs. Protect valuable papers with our fire-safe vault. Write for circular. Box 317, Cape Girardeau, Mo.

**DISTINCTIVE Automobile seat covers** individualized with your initials in gold. Perfectly tailored in tastefully colored fiber and leatherette with sturdy sailcloth or mercerized cotton. Reasonably priced. Hollywood-Craft Auto Seat Cover Co., 1127 Wilshire Blvd., Los Angeles 14, California.

**AUTO Seat covers—**Maroon plaid fiber with leatherette trim. \$17.50 value. 1,000 models back to 1933. Front covers for 2-drs. or coupes \$8.45. Full sets for coaches or sedans \$11.95. Sent immediately c.o.d. postpaid. Lubbock Cover Co., 1911-N, Lubbock, Texas.

**NEW Motor parts** all cars. Eddy, 1516-169th, Hammond, Ind.

**PLATINUM Ignition points** assure instant starting, positive sparking, smooth performance, eliminate costly tune-ups. Complete \$5.95. State car model—year. Jacon Industries, 3 Seaside Terr., Lynn, Massachusetts.

**GAS Station men—**Hot motors, overheating due to rust and sediment in radiators and blocks cured. Pictures show you how. Money back on first job. You guarantee work. Price \$3.00, money order. R & R Trading Co., 1930 East 34th St., Brooklyn, N. Y.

**EVERY Car owner** wants one: Sheepskin wash mitts. \$1.00 will bring you sample post-paid. Send for free catalogue. Shepherd Products Co., Worcester, Mass.

**ATTENTION Auto body repair shops.** Resharpener your own body files. Reasonable, simple, foolproof perfected commercial formula. Guaranteed. \$1.00. Chematic Processes, Box 7702 DeValle Station, Los Angeles.

**BRUSH-PAINT Your car.** Finish-Rub reduces "grittiness." brush marks. Professional appearance. Can \$1.00, postpaid. E-Zee Products, Box 533, Massillon, Ohio.

**SHEEPSWOL And cloth auto wash mitts.** Hanson's Chamois, Gloversville, N. Y.

**NEED Auto parts?** We have them. New and rebuilt. Prompt Shipment. Write requirements. Save money. Buy direct. (see our display advertisement page 270). Factory warehouse. Mechanics Auto Parts, 3807-PM3 North Ashland, Chicago 13.

**TIRES.** (Brand new) cut rate, standard brands 6.00x16 \$13.25, 650x16 \$15.75, all sizes. limited quantities, money order. R & R Trading Co., 1930 East 34th St., Brooklyn, N. Y.



**TARNISH** Proof chrome parts of your car. Send \$1.00 for a bottle. "Chrom-guard." Transparent, protective. Simple to apply. Exclusive, 4348 Broadway, Chicago.

**33 MILES** Per gallon, Center Flow carburetor throttle. Walert Company, 3429 North Tenth St., Milwaukee 6, Wisconsin.

**HAVING** Car trouble? New, used, guaranteed auto, truck parts save money. Transmission specialists. Describe needs; immediate reply. Victory, 2930 1/2 North-western, Chicago 18.

**AUTO** Parts for all autos and trucks. Trans., motors, differentials, fenders, carburetors. Also body parts. Security Auto and Truck Parts, 1941 BJ Eddy, Chicago 13.

**PLATING** Outfits for auto parts. Connect to a battery. No tanks used. Free particulars and proofs. Gunmetal Co., Ave. J, Decatur, Ill.

**TWIN-TONE** Mufflers for V-8 and Mercurys 35 to 47 models. Gives more mileage, without back pressure. Mufflers are straight through-type and produce deep mellow tone, \$20.00 a set. Single through-type mufflers for all cars \$6.50 ea. Chrome tail pipe extension 2 1/2" dia. \$2.50 ea. Satisfaction guaranteed. Twin-Tone Mufflers, 139 East Manchester Ave., Los Angeles 3, Calif.

**BUILD** An a.c. battery charger. \$20 starts shop. Garland Enterprises shows how. Dept. 2-47, Box 186, Windsor, Ontario, Canada.

**GRILLES** For all cars. Meyers Auto Parts, 820 Dryades, New Orleans, La.

### AUTO TRAILERS

**TRAILER**, Streamliner has everything. Large manual drawings, instructions, parts list \$1.00. Circular 10c. Tandem 3 room trailer. 24x36" six views floor plans, principal dimensions, \$1.00. Craftsmann Books, Box 1153 P3, Milwaukee 1, Wis.

**VISIT** The trailercoach show, Navy Pier, Chicago, March 15-23. Subscribe to the personalized trailercoach journal, Trail-R-News, 1 year, \$1. Box 431, Glendale, Calif.

**SOFT** Tire indicators for trailers. Inquire. Laidlaw Mfg. Co., Box 1108, Pasadena 20, Calif.

**BUILD** Your own trailer! Save money! Have every feature you want! Plans for house, sport, camp and utility trailers. Catalog describing 9 models 10c. 15c in Canada and overseas. Jim Dandy, Box 125-A, Wausau, Wisconsin.

### MOTORCYCLES, BICYCLES, MOTOR-SCOOTERS AND SUPPLIES

**TIRES**, Inner tubes, wheels, for small trucks, wheelbarrows, power scooters, midget cars, farm equipment, carts, etc. Sizes 8" to 18" o.d. in 2, 4 and 6 ply first-line quality tires, with removable inner tubes and heavy duty demountable wheels. Also caster forks, straight or swivel types. Free circular and prices. Jahant Co., 626 East Exchange Street, Akron 6, Ohio.

**MODERN** Motorcycle Mechanics Manual, 560 pages, 300 illustrations, covers Harley, Indian and English makes. The most complete motorcycle book published. \$3.00 postpaid. Nicholson Bros., Motorcycle Engineers, Saskatoon, Sask., Canada.

**BICYCLES** Schwinn, Monark; mens, ladies, \$39.95. Wholesale, retail. Send money order. Send dime for accessory list. Century Cycle, 3447 Lawrence, Chicago 25, Illinois.

**BICYCLES** All makes special this month \$42.95. Large chrome light, bell, mirror, \$1.94 extra. Atlas Cycle Co., 3002 Broadway, Chicago 14, Illinois.

**MIDGET** Car axles, etc. Write Behnke's Auto Supplies, 5721 Leland Ave., Chicago 30, Ill.

**BICYCLE** Motors \$68 complete. 2 h.p. Charles Carter, Angie, La.

**WOOD** U like sum information on building moterbikes an scuters, hear it is—manual \$1.00. Veco, A137, Box 124, Evansville 5, Ind.

**BUILD** The first five passenger half-ton, three wheeled motorcycle in your locality, from Ford parts. Show your genius. Easy built, useful, handy. Nothing like it. Instructions \$1.00. Motorcycle Wizard, 73-D South Shirley, Pontiac 20, Mich.

**CUSHMAN** Motorscooter \$40, motors \$5, tires \$1.00! Send 25c for new bargain catalog packed with money saving buys in motorscooters, motorbikes, midget cars, motors, wheels, tires and parts. Gail and Company, 538 Erie, Toledo, Ohio.

**MOTORCYCLE** Illustrated magazine. \$1.00 year. Special edition featuring movie star motorcyclists 25c. Buzzzz, 5424-A Sawyer, Chicago 25.

**COLUMBIA** Bicycles, balloon tires, sizes 20, 24 and full size. \$38.00 each. \$5.00 deposit, balance c.o.d. Pulver's Sporting Goods, Hudson, N. Y.

**GENUINE** Moto-Scot parts. Amsco Centrifugal Clutch, Windshield. All other parts and accessories. Write for parts list. Also genuine Briggs and Stratton and Lauson engine parts. American Moto-Scot Company, 1319 West Carroll Ave., Chicago 7, Ill.

**MOTORSCOOTER** \$10, Motor \$3, tires \$2! Send 25c for big catalog listing scores of other sensational bargains in motors, wheels, motorscooters, motorbikes, servicycles, tires, etc. Associated, Box CS-1764, Toledo, Ohio.

**WHEEL** Kits, complete, 5" to 10". Free list. Wilber Mfg., Box 667, Kokomo, Ind.

**225 BRIGGS** Motors, cheap. Send dime. Pico, 1252 Thurman, Camden, New Jersey.

**HARLEY-Davidson** Parts, repairs, cylinders rebored, batteries and tires. 24 hour service. Special Polaroid goggles, \$1.29 postpaid. Authorized dealer. Philadelphia Harley-Davidson Company, 857 North Broad Street, Philadelphia 23, Penna.

**SELL** Sheepskin motorcycle saddle covers. Sensational profits. Money order for \$4.00 will bring you sample post-paid. Immediate delivery. Shepherd Products Co., Worcester, Mass.

**JET** Engines. See Dyna-Jet advertisement under Models classification this issue.

**HARLEY** Single cylinder motorcycle \$50, Harley twin \$65, complete. Motorscooters \$9 up, midget cars \$10, motorcycle \$25, less motors. Motors \$3 up; outboard motors \$6 up. Over 5000 balloon tires for motorscooters and small cars \$1 up, mailorder only. Send 25c for Big War-Bargain catalogue Number 18, just out, listing the above and hundreds of other bargains in new and used motors, motorscooters, midget cars, racers, etc. (35c by first class mail.) Midget Motors Directory, Athens, Ohio.

**WHEELS!** Build wagons, scooters, mowers, trailers, wheelbarrows, grocery carts, baby carts, play pens, baby carriages. 4" to 16". Free list. Trulsen Mfg. Co., 811 E. 31, Kansas City, Mo.

**HARLEY-DAVIDSON** New and used 45" motors, service, parts, accessories. Send \$2.25 for army motorcycle manual, 10c for bulletins. Knuth's (Harley-Davidson factory dealer), 2491 Fondulac, Milwaukee, Wis.

**MOTORCYCLE** Cams ground for speed and power, carburetion. For information write Harold Schaller, 247 West Main, Turlock, Calif.

**BICYCLE** Book, how to buy, rebuild, sell used bicycles 50c. John Collett, Handley, Texas.

**TIRES** And industrial wheels, suitable for scooters, wheelbarrows, farm equipment, etc. All sizes. Bicycles and accessories. Largest assortment in America. Send dime for list. Cycle Transport Company, 1241 So. Michigan Ave., Chicago 5, Illinois.

**BUILD** America's lowest priced motorscooter speedster! Complete plans, specifications, \$1.00. Big list bargain priced used motors, etc., included free! Motor Supply, Box 1682-CS, Toledo, Ohio.

**CLYMER'S** Motorcycle books. Speedway Motorcycle Racing, \$2.00. Motorcycle Speedway Annual, \$1.00. How to Manage Motorcycles, \$1.50. Motorcycling Manual, \$2.00. How to Obtain Speed, \$1.50. Motor Scooter Plans, \$2.00. Books on Ariel, BSA, Norton, Triumph, Villiers engines, \$1.50 each. English Motorcycle Magazine, 50c. All postpaid. See our ad automobile section. Catalog free. Clymer, Dept. A34, 2125 W. Pico, Los Angeles 6, Calif.

**LARGE** Stock Indian parts. Expert motor rebuilding. New and rebuilt Chief motorcycle, motors only. Indian Motorcycle Sales, Kansas City 1, Mo.

**WHEELS**—Steel disc, rubber tired, sizes 5"—6"—7"—8"—10". Available. United Wheels Mfg. Co., 11727 La Fayette Ave., Chicago 28, Ill.

**GOGGLES**, Heavy duty Aero, \$4.50 pair. Summer helmets \$1.50 each. Winter leather helmets slightly used \$3.00 ea. New \$5.00 ea. Send payment with order. Western Aircraft, Hawthorne, California.

**MOTOR** Scooters, bicycle engines, 120 miles gallon. Dime for catalog. Clymer, Dept. A35, 2125 W. Pico, Los Angeles 6, Calif.

"**BICYCLE** Repair Manual." Illustrated booklet, tells how to repair bicycles. 65c. Robert Klausner, Shelbyville, Ill.

### AVIATION

**PROPELLERS** — Illustrated literature, correct type, sizes. Special 3 blade for ice-snow sleds and boats. Motor aircool conversion diagrams 50c. Standard Aircraft, Fort Worth, Texas.

**PLANES**, Gliders, autogiros made of paper, toothpicks, pins, glue. Easily assembled. Twenty plans and instructions, \$1.00. Dent, Box 262, Starkville, Mississippi.

**VETERANS:** Flight training under G.I. bill. Private, commercial, and flight instructor ratings. Write for information. Gottschalk School of Aeronautics, Adrian, Michigan.

**OWN** A plane? Make money with it. New plan. Complete folio \$1.00. Chas. Eichhorst, Box 809, Dakota City, Nebr.

**B-29 COMPUTERS**, Dynamotors, amplidyne, auto pilots, amplidyne servo amplifiers, compressors, gun chargers, turret drives, generators, starters, Plexiglas domes, sighting stations, etc. Free list. Eresco, 1006 Hewitt, Everett 1, Washington.

**JET** Engines. See Dyna-Jet advertisement under Models classification this issue.

**AIRLINE** Jobs—How and where to go after one you want. 50c. Box 512, Hartford, Connecticut.

**CUBS**, Wacos, Taylorcrafts, Aeronacs. Big catalog, 25c, lists these and thousands of other sensational airplane bargains. Some are "easy to repair" crackups. National, Box 1682-CS, Toledo, Ohio.

### ELECTRICAL SUPPLIES, EQUIPMENT

**LAMPS**—If you build or repair and have trouble finding parts—your search is ended! We carry practically every part necessary. Harps, finials, vase caps, etc. Illustrated catalog 10c. Gyro Lamps, 5416 Clark, Chicago 40.

**MANUAL** On multispeed three phase induction motors \$2.00 free literature. Electric Generator Mfg. Co., 1333 N. Dale St., St. Paul 3, Minnesota.

**LAMP** Sockets, brass shell. Also Mogul sockets. Three way switches, cord sets, electrical repair parts, lamp parts, wires, etc. Catalog 10c. The Gearon Company, 4348 Broadway, Chicago.

**OIL** Burners, motors, pumps, circulators, convectors. Expeditors and distributors of building materials. List your needs with us. Bruce Industries, S 1 #1, N. Y.

**BARGAIN!** New small 110 v. 1 ph. a.c. motors, many uses. Price only \$1.00 postpaid. Alko Labs, 335 E. 94 St., New York City.

**B-29 FIRE-CONTROL** Computers GE2-CH1C1. Single parallax. New \$75.00. Free list. Eresco, 1006 Hewitt, Everett 1, Washington.

**1000 AMPERE** Starter solenoid relays. \$2.45. New. Specify coil voltage desired. Free list. Eresco, 1006 Hewitt, Everett 1, Wash.

**NEW** Kohler electric plants a.c. and d.c. Other electric plants rebuilt. Bargain on Silvertron electric outboard motors. E. F. Schmaltz, 314 Wyoming Ave., Kingston, Penna.

**NEON** Window signs complete with transformers. Inter-State Laboratories, 4049 Minnehaha Avenue, Minneapolis 6, Minnesota.

**FREE** Catalog of welders, welding supplies, generators, fencers, and other electrical items. Write LeJay Company, Minneapolis 8, Minn.

**FLEXIBLE** Non metallic conduit, 1/2 inch to 2 inch. U.L. approved type. Is used to replace pipe. Also automotive loom. Large quantities at a bargain price. Send for price list. State Ignition, 2521 Indiana, Chicago 16, Ill.

**ELECTRIC** Pencil: Writes, engraves all metals. \$1.00 postpaid. Beyer Mfg., 4515-H Cottage Grove, Chicago 15.

**FLUORESCENT** Tubes burned-out? You can relight and use indefinitely. Complete instructions \$1.00. Wallingford, 121 Burlington, York, Nebr.

**ELECTRIC** Fan assemblies. Make your own. Ted Riseman, 425 East Jefferson, Springfield, Illinois.

**PRACTICAL** Winding of a.c. motors. A course of instruction on winding, connecting, and testing single, two, and three phase motors. Clearly written in everyday non-technical language. Illustrated throughout. This book is recommended for beginners interested in learning motor re-winding and repair. Satisfaction guaranteed or remittance refunded. \$2.00 prepaid. Educational Advancement Co., Dept. Y, Lakewood, New York.



## BATTERIES, GENERATORS

**EDISON** Non-acid lifetime storage batteries for home lighting, motors, radios, etc. Free complete interesting literature. T. Hawley Smith Company, Croton Falls, N. Y.

**BATTERY** Repairing, rebuilding, plate making plans. L. Wertz, Pekin, Illinois.

## WELDING, SOLDERING, PLATING

**VETS**—Earn good money. Do welding easily, quickly, with the Chief Arc Welder. Operates on 110 or 220 volts. Completely equipped, ready for use. Low cost. See our ad in this magazine. Write: Chicago Precision Machine Company, 926 S. Michigan Avenue, Chicago 5, Illinois.

**A.C. Welders**, 110 v., welds  $\frac{3}{8}$ " steel. \$29. Money back guarantee. Paul Morris, 1850 State St., Schenectady 4, N. Y.

**MAKE** Your own welder, using 110 volt a.c. input and 5 volt 190 amp. output transformer. \$15.75 check or money order. Lewis, 1266M Gun Hill Rd., N. Y. 67.

**FIRST** Class acetylene generator blueprints and literature \$1.50. Hasco, Box 103, Hastings, Nebr.

**NEW** Model electric welder 110 volt a.c.-d.c.; will weld all metals; easy to use; full directions. Complete with power unit, flame and metallic arc attachments, carbons, fluxes, rods, mask; all for \$19.95. Used by the navy. Magic Welder Mfg. Co., 239-MP3 Canal St., New York City.

**"THUNDERBOLT"**—Transformer welder, dial-control, 3 heats, 60 amps., 110 volts—a.c., carrying case, accessories, instructions, \$39.50. Also "Super-Welder," 110 volts, a.c.-d.c. \$19.95. Save 2% send check. Or order c.o.d. Dealers wanted, liberal proposition. Super-Welder Mfg. Co., 23 E. 20th St., New York 3, N. Y.

**ACETYLENE** Welding outfits, combination torch with tips, wrenches, 25' hose \$95.00. Freedom Motor Co., 1731 Maryland Ave., Baltimore, Md.

**MAKE** Inexpensive soldering flux, penetrating oil. Formulas, \$1.00. P.O. Box 174. Grants Pass, Ore.

**BUILD** 32 Volt welder, 32 volt electric churn, or portable d.c. arc welder. Three plans \$1.00. Welder, Fairmount, N. D.

**MAKE** 400 Amp. a.c. welder from burned-out pole transformer, 6 plans. Various sizes \$1.00. Information dime. Hi-Point Electric, Box 539, Leesburg, Fla.

**WELDER**—Portable unit, 2 welders in one. Metallic arc and flame torch 110-v., 3 heat stages. Complete accessories, metal carrycase. Illustrated instructions. Only \$34.50. Guaranteed. American Industrial Equipment Corp., 116-B 49th St., Union City, N. J.

**BUILD** Small, medium or large d.c. or a.c. arcwelder. Plans \$1.00 each. Welders Club, AB-3432, Chicago 54.

**WELD**, cut, braze with gasoline! Amazing new discovery shatters costs. Boosts profits. Important! Write Matthews Mfg. Co., Calgary 21, Canada.

**ELECTROPLATING** By battery. Illustrated instructions. \$1.00. Alvin, 553 William, Winnipeg, Manitoba.

**WELDING**, Cutting, aircraft welding and soldering equipment. Electric arc welders. Superior Oxy-Acetylene Co., Hamilton, Ohio.

## MACHINERY, TOOLS AND SUPPLIES

**KINGSLEY** "Bonder" lays cement block fast. Pays for itself; saves time, effort, material; lightweight, handy for amateur or professional. Trowel mortar into slot, sweep clean, lift off. \$2.00 postpaid from Kingsley Shop, Inc., P.O. Box 1832, Atlanta, Georgia. Specify 12" or 16" length.

**BORING** Tool holders, for Home Craft lathes. Gustin, High Hill, Missouri.

**BUILD** Quickchange gear box without castings for \$10.00. Craftsman, Atlas and other lathes. Complete drawings \$3.75. Stevens Engineering, 2604 Military, Los Angeles 34.

**MAKE** Collet chuck and collets complete on your lathe. Fits small face plate. New design collets easily and quickly made. Sizes  $\frac{1}{8}$ " to  $1\frac{1}{2}$ ". Prints, complete instructions \$3.00. Cash, money order. Pat. pending. J. M. Sabo, 10141 Laurel Canyon, Pacoima, Calif.

**NEW** Postwar design, not war surplus, large heavy duty aluminum keyhole saw handle, no blade, fits standard blades. Postpaid in U.S. \$1.00. No c.o.d. Discount on dealer letterhead inquiry on this \$1.35 retail item. J. H. Laughead, 5403 Braeburn, Bellaire, Texas.

**HAND** Brick and block machines. Howe Brick Machine, Beaufort, N. C.

**HOBBYISTS!** You can equip your workshop at a fraction usual cost by building your own mill, shaper, drillpress and other shop tools for metal and woodworking from Lewis castings, materials and blueprints. Easy to complete, and ideal for home use. Send 10c to cover cost of mailing latest catalog describing 21 items. Lewis Machine Tool Co., 3217 Union Pacific Ave., Dept. M, Los Angeles 23, Calif.

**HEAVY** Duty turning tool holders, for Home Craft lathes. Gustin, High Hill, Missouri.

**DRILL** Grinder—Grinds drills to factory accuracy. Callipers with direct reading scales. Circle cutters. New Tool grinder. Lowest prices. Free literature. Factory, 811-B East 31st, Kansas City 3, Mo.

**MAGNETIC** Chuck; dial indicator base; \$3.45! Free literature. Eyrich, Box 849, Milwaukee 1.

**SHOP** Labels \$1.00, sample 10c, returnable. Hinds, 223 Second, Niagara Falls 1, N. Y.

**COIL** Springs, 6 assorted, 25c. Paul Dillon, Route 4, Waynesboro, Penna.

**CUT-OFF** Tool holders, chatterless, for lathes. Free circular. Gustin, High Hill, Missouri.

**TEMPERING** Chisels, dies, etc. Dollar brings proven formula and instructions. Struve, 308 West 6th, Fremont, Nebr.

**TOOL** Kit with brand new, quality tools from government surplus for grinding, milling, carving, engraving, polishing steel, bronze, brass, plastic, wood, glass.  $\frac{1}{8}$ " and  $\frac{3}{32}$ " shanks fit electric hand tools or drills. 34 items neatly boxed. Ideal for home and shop. \$15.25 value for \$7.95 postpaid. Supply limited. Send check or money order. No c.o.d. Money back guaranty. Send 10c for well illustrated bulletin. The Tool Kit Co., 1629 Blaine Blvd., Racine, Wisconsin.

**TABLE** Saws \$18.00. Jig saws \$12.50. Compressors, motor mounts, rails. Aluminum, brass, iron castings from your patterns, reasonable. Circular 3c. Sunshine, Berkshire Heights, Penna.

**BLOCK** Machines—Concrete, 200 to 240 hour, 2 blocks one time. Also other machines, 45 to 100 per hour. Power or hand brick machines. Batch mixers. Any size. Madison Equipment Co., Madison, Tenn.

**ANGLE** Plate 3"x3"x4". Ribbed, machined 4-sides, \$2.00. Casting, 75c Vises, V-blocks, etc. Catalog 3c. Model Tool Service, Rock Falls, Ill.

**AT** Last! A hack saw with a blade that is always tight. The cam-action tension ends broken blades. Free folder. Pronto Tools, 2739 W. Ramsey, Banning, Calif.

**AIR** Tanks, weight 18 lbs., inflates 5 tires, or blows out clogged pipes, etc. Assemble yourself, complete instructions and fittings. Hundreds sold. Shipped postpaid in U. S. Rush \$12.95. Tank Sales, Box 885, Topeka, Kansas.

**SHEBEL** Saw filer \$7.50. Files all saws. Circular. Free trial. Shebel, 730B S. 2nd St., Milwaukee 4, Wis.

**UNIVERSAL** Tools dandy 10 piece set: Rigid pipe wrench, channellock pliers, adjustable wrench, Ceetee pliers, diagonal cutter, ballpeen hammer, plastic screwdriver, waterpump pliers, hacksaw and blade, cold chisel, \$19.85. Universal Tool Company, 1527 Grand, PM-3, Kansas City, Missouri.

**LAWN** Mower sharpening machines. Direct order. M. C. Hardies, 4148 Cornwall Drive, Berkley, Michigan.

**BIG** Profits with quality cement block making machinery. Also easiest, safest stump remover. Blue Square, Excelsior, Minn.

**SAW** Jointer, fifty cents. Simplex Co., Rural 7, Palestine, Tex.

**AIR** Cooled 4 cylinder air compressor complete with moisture trap, safety valve, fifteen feet 2 ply hose. Quart paint gun, tire chuck, blow gun. Ideal for painting, inflating tires, blowing air. Complete with  $\frac{1}{4}$  h.p. ball bearing motor \$96.50. Less motor \$66.50. Guaranteed. X-L Supply Company, 233 Main Street, Cincinnati 2, Ohio.

**GEARS** For inventors, experimenters, model makers, schools, work shops, laboratories, etc. Government surplus made of brass, bronze, dural steel and stainless steel. 12 matched pairs; 24 gears, bevel, spur and ratchet. List price \$12.00, our price \$2.50. 25 matched pairs; 50 gears, includes larger gears, also sets of worm gears. List price \$30.00, our price \$5.00. Limited quantity. Order now. Write for our bulletins on ball bearings, rectifiers, relays, selsyns, horns and government surplus materials. Met Exchange, 323 Canal Street, New York.

**BALL-BEARINGS**, One-fourth list price. Free list. Burgess, Box 168, Ferguson, Mo.

**SHARPEN** Dull pipe wrenches with new patent grinder. No competition. One operator made \$321 in one week. J. C. Moore Industries, Box 234, Fredonia, Penna.

**CONCRETE** Building block machines and molds. Catalog free. Concrete Machine Co., 5129 South Compton Ave., St. Louis 11, Mo.

**48-PITCH** Gears, assemblies; fifty assorted, \$4.75; hundred, \$8.50; postpaid. Scientific, Box 438, Hackensack, New Jersey.

## BOATS, OUTBOARD MOTORS, ETC.

**PROPELLERS**: New army surplus, Michigan, 3 blade bronze, 12"x10"RH;  $\frac{1}{8}$ " hub bore. Made for Johnson 22 h.p. outboard. Modify for other engines. Only \$5.65 each postpaid (with order). We will increase pitch to 11", 12" or 13" at \$1.00 additional per each propeller. Baker Bros. Supplies, Box 301-C, Palatine, Ill.

**OUTBOARD** Motor parts, new and used, for all makes. New pistons, standard and oversize. Cylinders rebored. Outboard Motor Mart, Inc., 309 Atlantic Ave., Boston 10, Mass.

**ATTENTION** Sportsmen! Go kayaking! Build yours from complete easy-construction kit. Literature. Play-yacks, Dedham, Mass.

**ALL** Copper water jacketed exhaust manifolds for marine conversions of automobile and aviation engines and marine engine replacements; any make, model or age. Joseph Van Blesck & Son, 391 Woodcleft Ave., Freeport, N. Y.

**PROFITABLE** Boats. Tells how to build and own money-making boats. \$1. Albert Schantz, Baden, St. Louis 15, Mo.

**ROWBOAT** Dry indefinitely, years. Inexpensive, copyrighted, \$1.00. Crsa, Box 8, Nanticoke, Penna.

**PONTOON** Dock with built-in swimming basin. Safe, practical. Childrens delight. Easily built. Plans \$1.00. Lidemark, 226 Potomac, Buffalo, N. Y.

**CRUISERS** From \$1980.00, propellers, guaranteed rebuilt marine engines and outboard motors, free data sheets on request. Marine hardware and supply catalog 40c. W. L. Masters & Son, 214 W. Chicago Avenue, Chicago 10, Illinois.

**MARINE** Conversions for Ford and Jeep engines. Catalog 10c. Lehman Manufacturing Company, Department D, Newark 2, New Jersey.

**USED** Outboard motor parts. Outboard Exchange, 1194 Remsen Ave., Brooklyn 12, N. Y.

**KAYAKS**, Rowboats, weldwood ready cut kits, booklet. E. J. Croot Co., #103-D, Basking Ridge, N. J.

**REBUILT** Tachometers 0-5000 and 0-8000 r.p.m.  $\frac{4}{8}$ " diameter face. \$10.00 each, specify rotation. Zakarian Engineering, Box 416, East San Diego, Calif.

**BOATS** And all about them. How to select, build, repair and operate. For 49 years the leading practical boating magazine. Half price trial subscription. 12 issues for \$1.00. Motor Boat, 62 Gold Street, New York 7.

**TWENTY** Plywood boat plans \$1.00. Catalog boat building plans 10c. The Rudder, 15 Murray Street, New York.

**BOAT** Designers are highly paid professionals. Complete course by mail. Catalog. Westlawn, Montville, N. J.

**USED** Marine motors, propellers, marine fittings, conversion manifolds. Stokes Marine Supply, Coldwater, Michigan.

## ENGINES, MOTORS, DYNAMOS

**DYNAMOTORS**, Generators, motors, amplydine generators. Send for free list. Electromac Associates, 4002 University Way, Seattle 5, Washington.

**150** AMPERE Generators for welding \$47.50. Extra flexible cable, 6 ft. lengths \$2.75. Other bargains. Butler Electric Company, 1885 Milwaukee, Chicago 47.

**400** CYCLE Dynamotors, GESD21NJ3A, 27VDC to 110VAC. 485 watts, shaft extension. Will operate 60 cycle radio equipment. \$12.50. Free list. Eresco, 1006 Hewitt, Everett 1, Washington.

**NEW** 200 Amp. 28.5 volt generators \$20. Hoffman, 1109 E. 62nd St., Chicago 37, Ill.

**SIMPLEX** Rotary water motors. Adapted to air or steam pressures, 125 lbs. or less. Sizes  $\frac{1}{8}$  to 1 h.p. Larger sizes to order. March specials while they last. No. 30-A (3")  $\frac{1}{8}$  h.p., \$5.00; No. 40-A (4")  $\frac{1}{8}$  h.p., \$7.50; No. 60-A (6")  $\frac{1}{2}$  h.p., \$12.50; No. 80-A (8") 1 h.p., \$16.50. Double driven vertical or horizontal duplex motors,  $\frac{1}{4}$  to 3 h.p. Duplex Motors, Burlington, Iowa.



**AMPLIDYNE** Motor-generators. GE5A-M31N9A. Input 27VDC, output 60-0-60 VDC. 530 watts. Shaft extension. New \$15.00. Free list. Eresco, 1006 Hewitt, Everett 1, Washington.

**INSTANT**—Reverse your present capacitor split phase motor. Cost no more than good controller. Write for folder. The Enoch Co., 533 N.E. 78th Ave., Portland 16, Oregon.

**HEAVY Duty** voltage control boxes: Cut-out, current and voltage control units with genuine silver contacts. Also large radio filter. All enclosed in a weather proof die-cast box. Like new condition. 24 volt-50 amp. Wt. 12½ lbs. Original cost \$140.90. \$5.95 each delivered. State Ignition, 2521 Indiana, Chicago 16, Ill.

**WINDING Data**, listing 225 motors, single and three phase, \$1.00. Motor Data Co., Box 7631, Kansas City 3, Mo.

**"BUILD Your Own"** gas drive arc welder easily with Hobart Generator. Save \$300 to \$500, and need only add used auto engine and chassis to build portable gas drive welder that goes everywhere after profitable construction and repair jobs. Write for free instruction book, further details. Hobart Brothers Co., Box M-1066, Troy, Ohio.

#### ATHLETIC EQUIPMENT, BODY BUILDING COURSES

**DEADLY Judo**—Fiercest fighting technique. Trick knockouts. (200 photographs—plus illustrations). Expert instructions. Three volumes. Complete \$2.25. Variety House, Box 46-BO, Wall Station, New York 5.

**PERSONAL Course** quickly develops proportions, strength. Weights 100#s \$18.75. EG Mfg., Elmsford 1, N. Y.

**BARBELLS**, Olympic revolving sleeve, highest quality. Stamp for folders. Jackson Barbells, Springfield, N. J.

**BARBELLS**, Exercise equipment. Courses. Free booklet. Good Barbell Co., Reading, Penna.

**BUILD Bulging muscles**. Complete course \$1.00. Health-O-Matic System, Covington, Ky. YMCA.

#### SPORTING GOODS, GUNS, FISHING TACKLE, ARCHERY, TRAPPING

**AUTOMATIC Lure**—Positively weedless. Greatest invention in ages. Nothing like it. Circular free. Babcock Reel Co., Oak Harbor, Ohio.

**CAMPFIRES** Easily started even with wet wood with Van's Fire Starter. Year's supply \$1.00 prepaid. Many other uses. Star Mfg. Co., Lincoln, Nebr., Dept. PM.

**GOLF Balls**, \$4.00 to \$8.00 per dozen. Details free. I. G. Co., Box 5651, Indianapolis 19, Indiana.

**MAKE Rubber flies**, novelties. Circulars. Shuman Tackle, Green Terrace, Kent, Ohio.

**GUN Owners**: "blue" or "brown" your guns, rifles, revolvers, and "temper" springs. Money saving guaranteed. Manufacturers secrets. \$1.00 each, the three \$2.00. P. Chubb, P. O. Box 776, Walla Walla, Washington.

**FLY-TYERS!** Best materials, lowest prices. Catalogue. Perry Lures, Box 205, West Haven, Conn.

**CARTRIDGES**: P-38's, Lugers 15c. Complete firearms-ammunition list 25c. Frank Parish, Vicksburg, Mississippi.

**PROTECT Guns**, tackle, tools. Stop rust automatically with Altair plugs. Air corps surplus. Two for a dollar. Altair Company, 1600 Junction, Racine, Wisconsin.

**SPORTSMAN**, Fisherman, hunters; boots, shoes re-soled; wonder water-heat-snow proof. Leather soles. Satisfaction guaranteed. Mail for prompt service, to United Shoe Rebuilders, Vicksburg, Mississippi.

**MITCHELL Sun glasses**. Superior in quality. Wear with complete comfort. See your dealer or write direct. Mitchell Optical Company, Kirkwood 22, Mo.

**3000 BARGAINS**, Firearms, binoculars, war relics. Catalog 40c. Smith Firearms, Runnemede, New Jersey.

**FISHING Poles**: Native canes, bamboos, calcuttas, tonkins. Sample 3-piece native cane \$2.50. 3-piece hollow calcutta with guides, tip, varnished \$11.25. Baseball bats, softball bats, expertly made of finest Ozark mountain ash. Dealers only. Bob Pace, Combs, Ark.

**FINEST Glass eyes**; taxidermy supplies. Catalog free. Elwood Company, Department 234, Omaha 2, Nebr.

**FISHWORMS** Aplenty everywhere. Why dig or raise when shocker brings them to surface? Complete, simple plans and instructions \$1.00. Really works. Smith, Box 314, Corsicana, Texas.

**SEND 10c** For list 100 new and used guns. Frayser's, Willmar, Minnesota.

**ALLEN-DALE Sporting Goods, Inc.**, Box P187, Bayonne, New Jersey, offers complete catalog, fishing tackle, pocket knives, hunting, hardware, other useful sports items. Send 25c coin cover mailing. Deduct from first order.

**FISH At night** with Johnstone Electric lighted Bobber \$1.00 prepaid. Circular on request. Dealers wanted. Johnstone Bobber Co., Aurora, Ind.

**1947 ILLUSTRATED Firearms collectors catalog** 50c. "House of Guns," Kearny, New Jersey.

**AMMUNITION**—New and used shotguns, rifles, handarms, fishing tackle! List 10c. Rudolph's, Atchison, Kansas.

**BOOKS**—All Kinds—Homecraft, Radio, Plastics, Boat Building, Photography, Model Building. Catalog free. Popular Mechanics Press, 200 E. Ontario St., Chicago 11, Ill.

#### FIELD GLASSES, MICROSCOPES, TELESCOPES, MAGNIFIERS

**PORRO Prisms** 6x30 binoculars. Limited quantity. 4 for \$1.00. Ross, 68 C West Broadway, New York 7, N. Y.

**PERFECT Lenses** and instructions for making 100 power, clear vision astronomical telescope \$2.50. Instructions alone 10c. Carl Jamer, Manorville, N. Y.

**MODERNIZE** Your optical equipment with our new high temperature reflection reducing coating process. Mitchell Optical Company, Kirkwood 22, Missouri.

**MYSTERIOUS Wonders!** 50 power microscope. Heavy gauge aluminum, 2 lenses, adjustable reflector, specimen slides, instructions. \$2.98. Wardell, 2509 Clarendon Road, Brooklyn 26, N. Y.

**TELESCOPES**, Microscopes, binoculars, barometers. Bought, sold, repaired. Lists 10c. Rasmussen & Reece, 41 Market, Amsterdam, N. Y.

**60 POWER Telescope**, \$2.95. 250 power microscope, \$2.45. Send for free catalog of telescopes, binoculars and microscopes. Brownscope Company, 24 West 45th Street, New York.

**REFLECTING Telescopes**, complete. 3½" diameter, equatorially mounted. View planets, stars. \$19.75. Write Sky-scope Company, 475-P 5th Ave., New York.

**BINOCULARS**, Telescopes, watches. Buy, sell, trade. Paul Schweer, Donnellson, Iowa.

**LITTLE Library** of Useful Information. 102 different books. Catalog free. Popular Mechanics Press, 200 E. Ontario St., Chicago 11, Ill.

#### DOGS, PETS, BIRDS, RABBITS

**\$50.00 WEEKLY** Raising Angoras for us. Free literature. Angoraville, 112—31st Northeast, Cedar Rapids, Iowa.

**RAISE Guinea pigs**. Make money at home. Big demand. Booklet free. Taylor, Box 426A, Hapeville, Georgia.

**\$250 MONTH** Raising Angora rabbits. Wool \$15 pound. Free instructions, prices, markets. White's Rabbitry, Lawrence, Kansas.

**ANGORA Wool spinners**, shearing tables, breeding stock. House of Angora, Springfield, Illinois.

**CHINCHILLAS** No rabbit—3 cents day payments and booklet on raising \$1.00. Montana Fur Farm, Billings, Montana.

**MAYBE** We can supply that puppy you want. Also supplies. "Royal," Chazy, N. Y.

**BEAUTIFUL**, Useful collie-shepherds, pups \$12.50. Paul Schultetus, New Liberty, Illinois.

**GIGANTIC Chinchilla giants**—Really profitable. Demand strong. Free literature. Illustrated catalogue, 25c. Fur samples, 25c. Behrens Chin-Chin Farms, Pearl River 4, New York.

**RAISE Registered rabbits** under cooperative marketing. Small investment. Thomas Hall, Vernal, Utah, received \$603.00 for 21 rabbits produced from four rabbits in 3 months. Illustrated booklet tells how. 25c. Hansen's Rabbitry, 1347 Miller Ave., Salt Lake City 5, Utah.

**RACCOONS**, Minks, foxes. Bred females. Baby skunks. Colored catalog, 25c. Shady Fur Farm, Springfield, Minnesota.

**\$2000 PER Year** raising Angora rabbits. We buy your output. Contract particulars free. Wilsons, 1065 Shryer, St. Paul 8, Minn.

**GUARANTEED Chin-Chin giant** Chinchilla rabbits. Greatest amount of delicious meat. Largest, finest, most valuable furs. Tremendous demand for breeding stock. We buy youngsters. Contact world's largest breeder. Willow Brook Farm, R15, Sellersville, Penna.

**ZOOLOGICAL** And pet animals for sale. Illustrated catalogue, literature, 25c. Trails End Zoo-5, St. Stephen, S. C.

**RAISING Rabbits**, Cavies, Hamsters, Chinchillas is a growing and profitable industry. Magazine 10c. Descriptive book and magazine 25c. Book and magazine (monthly) one year \$1.00. Address Small Stock Farmer, Pearl River 15, N. Y.

**SPORTSMEN**: 200 Pointers, setters, straight cooners, combination hunters, rabbit and fox hounds. Reasonable. List free. Ramsey Creek Kennels, Ramsey 1, Illinois.

**RAISE Guinea pigs**. Profitable, low-cost feeding, small space required, small investment. Complete details 25c. Guinea Pig Farms, 3456 West 116th St., Chicago 43.

**ST. BERNARD Pups**: Champion sired beauties. Franklin Young, R4, Riverhead, Long Island, New York.

**STANDARD Rabbit Journal**, Milton, Pa. 3 years \$1.00, sample dime.

#### SEEDS AND NURSERY STOCK

**FIFTEEN Baby evergreens**, 4-8 inches \$2 postpaid. Arbor Vitaes, Junipers, Retinosporas, Yew (Taxus). Hardy better evergreens. Fischer's Nursery Service, Box 36, Bakerstown, Penna.

#### FARMS, FARM LAND, REAL ESTATE

**CHICKEN-FARM** In Canada! Low-priced land and good markets make this an opportunity worth investigating. Farms available in most parts of the Dominion. Don't delay, write today for information (state province in which you are interested). Address H. S. Cresswell, Canadian Pacific, Montreal.

**STROUT'S Spring farm catalog** just out! Bigger than ever—bargains galore! 136-page Green Book. 30 states—coast to coast. Write today. Mailed free. Strout Realty, 255 4th Ave., New York 10, N. Y. 20 W. 9th St., Kansas City 6, Mo. 453 S. Spring, Los Angeles 13, Calif.

**BEST Choice** of Western Oregon farms and ranches. Contact Henry C. Kelley, Realtor, Sutherlin, Oregon, in the heart of famous Douglas County.

**BARGAINS** In mountain lands. James Palmer, 126 Courtland, Asheville, North Carolina.

**CANADIAN Tax sale lands** for a dollar an acre and up. Small monthly payments. Farms, timber, hunting and fishing camps, minerals. Limited number of properties. Write at once for free catalogue. Tax Sale Service, Room 613, 72 Queen St. W., Toronto 1, Canada.

**\$5.00 MONTHLY** Buys 40 acres. Near town. Price \$200.00. Free list. Box 425-P, Carthage, Mo.

**WEST'S 1947 Catalogue**: Over one thousand farm and business bargains. Free copy, write Buck & West Realtors, HE-3, Pittsburgh 16, Penna.

**IT'S Spring again**—in the exciting pages of United's new free spring catalog of up-to-the-minute bargains! Farms, ranches, summer homes, resorts, orchards, business opportunities—over 100 pages with many photographs. Write for your free copy today! United Farm Agency, 1684 Arcade Bldg. 1, St. Louis, Mo.

**"100,000 SQUARE Miles Free!"** Interesting illustrated booklet describing fertile South-American lands obtainable free, 25c. Vallesp; 395-MX Broadway, New York 13.

**GOVERNMENT Lands** \$1.00 acre up. Information all states 25 cents. National Tax Service Bureau, 834A Majestic Building, Detroit.

**HOMESITES \$450**—Convenient payments. California's finest garden section. On Morro Bay's scenic shores. Wonderful fishing, hunting, boating, bathing. Fertile soil, softest water, temperate climate, congenial community. Free literature. Richard Motto, 6560 Hollywood Blvd., Hollywood 28, California.

**GOOD Farms**—Ranches. Washington, Minnesota, Montana, Idaho, Oregon, North Dakota. Dependable crops, favorable climate. Write for literature, lists describing typical postwar farm opportunities. Specify which state. J. W. Haw, 119 Northern Pacific Ry., St. Paul 1, Minn.

**OZARK Magazine**, Eureka Springs, Arkansas. For homeseekers, tourists. Year, \$1.00.



**OZARK** Lands for all purposes. Actual river frontages. 5 acres \$90.00 and upwards. Free list and literature. Hubbard, 424-I, Minnesota Ave., Kansas City 4, Kansas.

**FARMS, Ranches.** All kinds, sizes. Reasonable prices, terms. Wide variety locations, climates, recreational facilities. Free descriptive folders, price lists. Milwaukee Railroad territory; Washington, Idaho, Montana, the Dakotas, Minnesota, Iowa, Missouri, Indiana, Illinois, Wisconsin, Upper Michigan. R. W. Reynolds, 914, Union Station, Chicago 6, Illinois.

### POULTRY, FARM SUPPLIES

**RAISE** Poultry for profit! Learn how others succeed. Read America's leading poultry magazine. Subscribe! One year 25c; five years, \$1.00. Poultry Tribune, Dept. 41, Mount Morris, Ill.

**POULTRY** Pays! Learn how. Production line methods. More money. Less work. Send postcard for free booklet "Seven Keys to Poultry Profits and Fryer Growers' Yardstick." to Poultry Advisory Service, Room 108, 1046 So. Olive St., Los Angeles 15, California.

**YOUR** Greatest poultry problem will look simple when you read American Poultry Journal regularly. 500,000 poultrymen do, why not you? 2 years 50c. 5 years \$1.00. American Poultry Journal, 539 So. Clark, Chicago.

**MONEY-MAKING** Experimental farm turkey raising helps, yours for only \$2.00 per year. Increase profits with latest reliable information. Act today! Turkey World, Dept. 92, Mount Morris, Ill.

**RAISE** Turkeys the new way. Write for free information explaining how to make up to \$3000 in your own backyard. Address National Turkey Institute, Dept. 3, Columbus, Kans.

**BABY** Chicks, champion mated. 52 varieties, 6 Hybrids, licensed inspected, blood-tested. Rush postal, large colored book free, low prices. Berry's Farm, Route 12, Clarinda, Iowa.

### PROFITABLE OCCUPATIONS

**LINOTYPE-INTERTYPE** dummy practice outfit; extra keyboard layouts, illustrated fingering chart, spelling aids and all accessories. Complete outfit, postpaid \$2.00. Callaghan, Box 1493, Great Falls, Montana.

**MAKE** Big money plastic coating cards, photos, etc. Easy inexpensive method preserves and protects. Send \$1.00 today for full instructions. Gordon, 2105-A Cottage Grove, Des Moines, Iowa.

**OWN** A mirror shop! Resilver mirrors. Write for information. John Sprinkle, V50, Marion, Indiana.

**PHOTO** Stamp printer. Illustrated instructions \$1.00. Alvin, 553 William, Winnipeg, Manitoba.

**GROW** Sell potted flowers, vegetable plants. Details and packet mixed flower seeds. 10c. Bowers, Loyaltown, Penna.

**MAKE** Money with duplicator. Free folio. Rucker, 2836-P Slevin, Louisville 12, Kentucky.

**CHEMICAL** Farming: Instructions, chemicals \$1.00. Alvin, 553 William, Winnipeg, Manitoba.

**YOUR** Own profitable business! Prominent company will help you to build in spare time a successful subscription agency in your community, making money year after year with subscription orders for all magazines published. No experience required. For details clip this ad now and mail with your name and home address to Agency Bureau, International Circulation Co., Inc., 57th St. at 8th Ave., New York 19, N. Y.

**SCRAP** Metal costing 5c pound brings dollars in castings. Lifetime profits. Information. Fritz Foundry & Supply, 622 N. Fulton, Allentown, Penna.

**MIRRORS** From window glass at 3c per foot. Formulas and silvering data \$1.00. Metallize baby shoes. Several methods \$1.00. Tes-Co., P.O. Box 189-M, Wilkes Barre, Penna.

**LEATHERCRAFT** Supplies. Catalog 10c. Art Craft Supply Company, 1205 Throckmorton, Fort Worth, Texas.

**MECHANICALLY** Inclined men—Own and operate general appliance repair shop. Complete, illustrated course shows you how. Welding, refrigeration, motor repair, how to get business, etc., all phases covered. Free literature. Christy Supply, Dept. 474, 2835 N. Central Ave., Chicago.

**BIG** Money in fishworms, our electric worm digger gets them. You sell. Instructions, drawings \$2.00. You make, simple. Valley Specialties, Dishman, Wash.

**STORY** Writing simplified, home study, complete, \$5.00. Free circular. Box 834, Spokane, Wash.

**TRADES** That often pay \$50.00 daily completely described and illustrated. "Flagpole Painting and Repairing"—\$2.00. "Smokestack Painting and Repairing"—\$2.00. The Skyline Co., Box 1601B, Uniontown, Penna.

**AMUSEMENT** Business. Uncrowded. Delightful work. Circus, carnival, fairs, parks, also nite club, music, stage. Many business opportunities for yourself, small investment. Hundreds of jobs for amateur and professional performers. All craftsmen wanted; carpenters, painters, electricians, Diesel mechanics, drivers. Subscribe to Monthly Newsletter Service. Year \$10.00. Trial one month \$1.00. My lists and show contact services free to subscribers. World wide show business interests since 1907. Herman Kennedy, Euclid Beach Park, Cleveland 10, Ohio.

**INTERESTED** In Latin American and foreign employment? \$1 brings 1947 Foreign Service Directory listing oil, aviation, mining, transportation, manufacturing, construction concerns with foreign interests and tips for immediate application. Global Reports, 6417 Homewood Ave., Dept. PM, Hollywood 28, Calif.

**THIS** is it! Paint plaster plaques! Sell locally. Artist's brushes, paints, instruction books, molding rubber available. Pioneer, 394A3, Austin, Minnesota.

**DRAW** House plans. Experience unnecessary. Under expert guidance you make plans, specifications for your home—others. \$15. Home Design Service, 740-A Pontalba, New Orleans 19.

**PROFITABLE.** Inexpensive mailing business 10c. Parcell, 2701 Main, Elkhart, Indiana.

**START** Lamp and shade factory. Profitable, fascinating. Easy to learn. Illustrated course teaches you. Complete instructions and wholesale catalog \$1.00. The Gearon Company, 4348 Broadway, Chicago.

**INDUSTRIAL** Relations, personnel jobs available. Enter growing profession. Free details. Personnel Recruitment Service, Highland Park, New Jersey.

**YOU** Can sit in the boss' seat! Keep your job; start your own factory in your spare time. We provide 15 valuable tested trade secrets. You need no plant, very little money. See page 270 for details. Chemical Research Co., 130 W. 42 St., New York.

**FOR** An extremely profitable lifetime business, operate a collection agency—credit bureau. Easily learned. Write: Cole & Associates, Syracuse 2, New York.

**BIG** Pay, buying, selling, repairing motors, refrigeration, tavern equipment. Lists, wholesale suppliers, manuals, circulars (10c). Myers Electric, Manitowoc, Wis.

**SHELL** Jewelry profitable hobby. Illustrated booklet and sample kit, \$1.50. For instruction folder write, Sarasota Shell Shop, Box 2046, Sarasota, Florida.

**TATTOOING** Machines. Worlds finest, supplies. Free catalogue. Jensen, 120 West 83rd Street, Los Angeles 3.

**"LOS** Angeles Boom." Job opportunities in nation's fastest growing industrial area. \$1.00 brings copyrighted booklet giving facts on expansion programs totaling \$80,000,000. Lists over 300 firms. Explains how—where to apply. Los Angeles Research Services, 507 N. Windsor Blvd., Los Angeles 4, Calif.

**NO** Selling, operate vendors, amazing profits, details free. Silver-King, 622 Diversey, Chicago 14, Ill.

**WOULD** You pay 3%—first \$350 made? Color-illustrated book "505 Odd, Successful Enterprises" free! Some offer occasional "day off." Work home. Expect something odd! Pacific, San Clemente, Calif.

**MAKE** Seashell jewelry. Illustrated instructions and catalog 10c. Beginners kit \$3.00. Frissells, Dept. C, 4627 Woodside Drive, Houston 3, Texas.

**"ALASKA—The Last Frontier"** offers thousands of excellent opportunities! \$1 brings official government map and 1947 copyrighted report describing potential opportunities in commercial fishing, mining, fur farming, prospecting, aviation, timber, agriculture, live stock raising, business enterprises, government homestead lands. Alaska Opportunist, 6417 Homewood Ave., Dept. PM, Hollywood 28, Calif.

**ANNOUNCING** Home study course in commercial baking. Practical basic training. Good field for those with aptitude. Nearly depression proof. Send for free booklet, "Opportunities in the Baking Industry." National Baking School, 1315 Michigan Ave., Dept 3431, Chicago 5, Ill.

**LOCKSMITHING**—Profitable business or hobby! New course teaches you lock secrets, how to fit keys, de-code, masterkey, etc. Easy self-instruction lessons. Bargain price. Fascinating 100-page illustrated catalog free! Write Nelson Company, Dept. 2-02, Chicago 5.

**QUICK** Money! "Repairing car batteries!" At home! Easy too! Write Battery-man, Grand Junction 6, Colorado.

**BE** A Novelty manufacturer, fascinating, interesting work. Exceptional profits. No expensive equipment needed, quickly learned. Use garage or basement. Successful manufacturer shows how, orders waiting. Write today. Plastex Products, 127 Clement, San Francisco (18).

**WASHING** Machines. Parts all makes. Northeast Burner, 1358 H St., Washington 2, D. C.

**MUSHROOMS** Grown. Boxes. Barrels. Illustrated instructions 50c. Spawn \$1.00. Gordons, 553 William, Winnipeg, Manitoba.

**TYPEWRITER** Repairing instructions, standard typewriters. Webers', Box 1008, Canton, Ohio.

**\$40.00 WEEKLY** Made growing mushrooms, fresh, dried. Dominion patent 331583. Free spawn. North American, 169P Yonge, Toronto, Canada.

**TYPEWRITER** Repairs men urgently needed. Earn \$40 to \$50 weekly spare time. Our easy to learn home study course teaches how to repair typewriters. Write for free information. Houston Typewriter Repair Service, P.O. Box 5357A, Houston 12, Texas.

**TADPOLES** Make frogs, tremendous demand. Both make you money. 25c brings tell-how information. Chariton Corporation, Century Building, Chicago 4.

**WELDING**—Electric arc. Learn profitable trade quickly through actual practice. Individual welder instructions at bare cost of materials. Full particulars free. Valuable welding lessons book 50c. Hobart Welding School, Box M-1064, Troy, Ohio.

**ELECTRIC** Clocks are every where you go, buildings, homes, parking lots, factories. Repairs increasing. Our easy to learn course with pictures and drawings teach you how to repair these clocks. Electronic Supply Co., P.O. Box 2350A, Houston 1, Texas.

### BOOKS, PERIODICALS, PICTURES, POSTCARDS

**MAGAZINES**—Business, vocational, diversion. Current copies. Choice over 800 periodicals. All fields. Free price-list. Commercial Engraving Publishing Co., 34C North Ritter, Indianapolis 1, Ind.

**BEAUTIFUL** Cards: Italy-Corsica, North Africa. 15 different, \$1.00. Order by country. Satisfaction guaranteed. E. Strangeman, 423 W. 65th Pl., Chicago, Ill.

**PICTURES**, 20 Delightful 8x10, postpaid \$1.00. Color, Box 2343, New Orleans.

**MAIL** Friends scenic postcards from Grand Canyon state, 3 for 25c. You address and return. I mail. Letters forwarded 25c. 1337 E. Garfield, Phoenix, Arizona.

**INTERESTING** And unusual books. Write for free catalogue. Faller Company, 201 Dewey Street, Newark 8, New Jersey.

**HOW** To publish. America's only textbook. Free copy offered. Claude Johnson, Beebe, Arkansas.

**BOOKS!** (Out-of-print, scarce): Quickly supplied. Send wants. Spotlight, 141 Broadway, New York 6.

**100,000 PROBLEMS** Solved graphically, in mechanics, hydraulics, electricity, physics, shop-work, etc. Read off the answer instantly. Details free. Columbia Graphs, Columbia, Connecticut.

**ARCHITECTURAL**, Fine art and handicraft books. Catalog 10 cents. Artcraft, Box 6827, Baltimore 4, Maryland.

**BARGAINS** In books: Art, cartooning, advertising, photography, hobby, sports, etc. Free catalogs. Publishers' Book Company, 475-B Fifth Avenue, New York 17, N. Y.

**WHAT** Every Mason wants. We have Masonic books for Blue Lodge, Chapter, Commandery, Scottish Rite and Shrine. Our rituals are used the world over. Send for free catalog of books and rituals for Masons, Odd Fellows, Knights of Columbus, etc. Ezra A. Cook, Publisher, P.O. Box 796-PM, Chicago 90, Ill.

**POSTVIEW** Cards. Texas. 12-25c. Mexico 12-60c. Mexican feather bird cards 15c each. Latin American Mail Service, Box 1467, Laredo, Texas.



**FREE** Movie stars photographs. Introductory offer. Send names of two favorites with ten cents for handling. Hollywood Screen Exchange, Dept. PM, Drawer 1150, Hollywood 28, Calif.

**POST** Cards of navy ships. Beautiful post cards of ships of the navy, all modern, all different, 20 for 25c, mailed post paid. Liberty Picture Co., Richmond, Calif.

**GOOD** "Used" self-instruction educational books on all subjects bought, sold, rented, exchanged. Satisfaction guaranteed. Complete information and 100-page illustrated bargain catalog free! Write—Nelson Company, Chicago 5.

**SELF-EXPLAINING** Bible: Illustrated circular free. Box 446-P, Minneapolis, Minn.

**NATIONAL** Geographic Magazine, 1888-1945, any issue. Periodical Service, Dept. PM, Swarthmore, Penna.

**SHIP** Pictures (World War II navy ships) reproduced in color, size 9½x13½ inches, suitable for framing, all different, 50 for \$1.00 mailed prepaid. Liberty Picture Co., Richmond, Calif.

**MAGAZINE** Export Sales Company, 2084 First Avenue, New York 29, N. Y. U. S. A. Over-issue popular American magazines and pocket-size novels. Comics, fashions, pictorials, romances, screens, pulps, many others. Export only.

**BOOKFINDERS!** (Scarce, out-of-print unusual books.) Quickly supplied. Send wants. Clifton, Box 1377PM, Beverly Hills, Calif.

**BIG** Profits taking subscriptions for all magazines. Agents' confidential catalog listing over 2500 periodicals and complete starting supplies free. Pines Subscription Agency, Flushing, New York.

**MAGAZINES** (Back dated)—foreign, domestic, arts. Books, booklets, subscriptions, etc. Catalog 10c (refunded). Cicero's, 863 First Ave., New York 17, N. Y.

**NAVY** Ship pictures. Beautiful reproductions of Lowell Heckings pens and ink sketches, size 14x20 inches, each suitable for framing, 10 for \$1.00 mailed prepaid. Liberty Picture Co., Richmond, Calif.

#### GAMES AND ENTERTAINMENT

**RACE** Announcer. New, sensational horse race game. Keen sport for any number of players. Announcer "calls" the races from 42 colorful description cards. Scientific odds, 2-1 to 15-1. Can be played anywhere over and over again. Complete game \$2 postpaid. Robetk Sales, 915 Selwyn Road, Cleveland 12, Ohio.

**ENTERTAINER'S**, Comedian's catalog, 10c. Kleinman, 25-31-B 30th Road, Astoria 2, N. Y.

"84 **CARD** Tricks," 25c! "Scientific Boxing," 50c! Hirsch's, Spring Valley, N. Y.

**PHONOGRAPH** Records cheap. Catalogue. Paramount, M-313 East Market, Wilkes-Barre, Penna.

**GYROSCOPES**, Precision-built. Traverse string—defies gravity. Postpaid \$1.00. Hamilton Company, Box 2074, Waterloo, Iowa.

**LITTLE** Library of Useful Information. 102 different books. Catalog free. Popular Mechanics Press, 200 E. Ontario St., Chicago 11, Ill.

#### MAGIC TRICKS, PUZZLES, JOKER NOVELTIES

**FREE!** Illustrated book of magic (101 tricks) given with Super Magic "Bag-O-Tricks"—\$2.00 complete. Kit contains 15 professional type tricks, equipment, instructions. Catalog also free. Magic Shoppe, 19 Springfield Ave., Newark 2, N. J.

**MASTER** Cigarette vanisher will fool even your wife! 25c, catalog included. Scheetz's 98-N Branch, Sellersville, Penna.

**VENTRILLOQUISM** Taught. 3c stamp brings particulars. Smith, 801 Bigelow, Peoria 5, Ill.

**LOW-PRICED**, Easy-to-do pocket tricks. Circular free. Family Book Store, 264 E. 198th St., Bronx 58, N. Y.

**SNEEZING**, Itching powders, 18 other tricks, cigarette plugs, etc. with joker's catalog 25c. Factory, 2404-N, Fifteenth, Philadelphia.

**MARVELOUS** Magic trick and new magic catalogue 25c. Newman's, Box 1020, Houston, Texas.

**NAME** Any card in deck. 25c, including catalog. Scheetz's, Sellersville, Penna.

**WHOLESALE** Joker's novelties. 50c. Samples, catalogue—25c. Box 526, Jamaica, N. Y.

**APRIL Fool**. Ten big jokes and magic tricks for \$1.00 including free catalog other magic tricks, jokes, novelties, toys. Halo Novelty Co., 2015A N. 16th St., Harrisburg, Penna.

**VENTRILLOQUISM**, Learn the right and easy way. Complete course \$5.00. K. J. McCormick, 1124 West Maple, Independence, Missouri.

**MAGIC** Races, a cigarette touch—six horses run. Dozen 50c. Sample 10c. Switch Company, Newark 1, N. J.

**ILLUSTRATED** Book, "34 Easy-do Magic Tricks," and magic catalog, 10c. Lee's, 2231-M McKinley, Berkeley 3, Calif.

**DOLLAR** Magic set free with gigantic catalog 25c. Mysto, 4462-A Germantown, Philadelphia.

**BE A** magician. Large professional magic catalogue of latest tricks 25c. Ireland, C-109 North Dearborn, Chicago 2.

**VENTRILLOQUISM**, Complete course only \$1. LeSueur, 77 Wellesley, Toronto, Canada.

**TRUE** Secret of ventriloquism. First time published. Free booklet. Quackenbush, Big Flats, N. Y.

**VANISHING** Half dollar trick and catalog 25c. Sterling Magic Co., Royal Oak, Mich.

**WORLD'S** Largest professional magic shop, keeps you in touch with latest tricks. To receive mailings, send 35c for new catalog. Holden's, M220 West 42nd St., New York.

"**MAGIC** Vanishing card." Throw it into air, it completely disappears, reproduce it later from spectators pocket. Easy to do. Complete, 25c with magic catalog. The Magician, 2463-C Kensington Ave., Philadelphia 25, Penna.

**200 ELECTRIC** Stunts, 110 volts, \$1. Kutting Sons, Campbell, Calif.

**500 TRICKS!** New 1946-7 edition Douglas famous catalog now ready, only 10c. Brand new magic for pocket, parlor, club, stage, professional, amateur. America's fastest service to magicians everywhere for over 25 years. Send 10c today. Douglas Magicland, Dept. 1, Dallas, Texas.

**EARN** Money in any crowd. Call names of strangers, tell unspoken questions. Professional course mind reading, faked spiritualism, etc., \$1. Henderson, Box 341, San Bernardino, Calif.

**AMAZE** And mystify your friends with highest quality magic. New catalogue 25c coin. Mazda Magic Co., 1135 Westgate Ave., Oak Park, Ill.

**LARGE** Illustrated professional catalog 10c. Williams, 900 Plymouth, Ellwood City, Penna.

**FREE!** Large catalog of magical apparatus if you remit 25c for "Magic Is Fun" magazine. Robbins Co., 152-F West 42nd Street, New York.

**ENTERTAIN!** Mystify! New, bigger magic catalog and 4 secret tricks 25c. Herbert, P-192 N. Clark, Chicago 1.

**MAGIC:** Big 160 page Illustrated Catalog Latest Magic Goods, 25c. For over 1/3 century we have supplied Professional as well as Beginner. Chicago Magic Co., 2300 N. Mason, Chicago 39.

**MAGIC** Tricks, puzzles, books, cards, punch boards. Catalog 10c. Specialty, Box 671, St. Louis 1, Mo.

#### COINS, TOKENS, CURRENCY

**COINS** Bought and sold. Coin book all U.S. coins, values, 50c. Mailing charge 15c. Coin Exchange, Box 92, Fairfield, Ohio.

**OLD** Money wanted. Will pay \$100.00 for 1894 dime, S. mint. \$50.00 for 1913 Liberty head nickel (not buffalo). Big premiums paid for all rare coins. Send 4c for large coin folder. May mean much profit to you. Numismatic Co., Dept. 20, Fort Worth, Texas.

**UNUSUAL** Worldwide collection twelve different foreign coins and bills only 25c. Webb, Box 473, San Bruno, Calif.

**FREE** \$5.00 Mexican currency with order, 10 different Indian cents 25c, 10 different San Francisco Lincolns 25c, large coin book 25c. Coins, Box 77, Alameda, Calif.

**100 FOREIGN** Coins \$5.00. Parker Fogler, 693 Mission, San Francisco 5, Calif.

**WILL** Pay \$10.00 each for certain Lincoln pennies! Indianheads \$50.00; dimes \$1,000.00. Catalogue 10c. Federal Coin Exchange, 3-PM, Columbus, Ohio.

**LINCOLN** Cents—1931S 75c, 1909S 65c, 1914D \$2.50, 1922P \$2.00. All other dates, your pick, 12 different for \$1.25. Add 50% for extra choice coins. Wanted 1909-SVDB. Guarantee Coin Co., Dept. 102, Box 6370A, Chicago 80, Ill.

**WHITMAN** Folders 30c; four \$1.00. Ten uncirculated pennies 30c. List 10c. Foreign coin free. Olson, 434 North Menard, Chicago 44.

**THIRTY** Different coins and bills, \$1.00. Oddehon, Box 482, St. Louis, Mo.

**WORLD** Coins—25 different \$1.00. Harry Elsholz, Box 9014, Pittsburgh 24, Penna.

**GET** Profit and pleasure in collecting old coins. Send 10c for 56 page illustrated coin catalog. You'll be delighted with it. Send for it now. B. Max Mehl, 370 Mehl Bldg., Fort Worth, Texas. Largest rare coin establishment in U.S. Established 47 years.

**FOR** Sale: 1893 Columbian half dollar, 60c; 50 assorted Indian head cents, \$1.00; 50 foreign coins, \$2.00; large coin price list, 10c. Ben's Coin Company, 72 West Washington, Chicago 2, Illinois.

**FREE!** Foreign coin, banknote and coin collectors illustrated catalog to approval service applicants. Send 3c postage. Tatham Coinco, Springfield-125, Mass.

#### OLD STAMPS WANTED

**I WILL** Pay \$100.00 each for 1924 1c green Franklin stamps, rotary perforated eleven (up to 1,000.00 each unused). Send 6c today for large illustrated folder showing amazing prices paid for old stamps, coins, and collections. Vernon Baker, PM-73, Elyria, Ohio.

#### STAMP COLLECTING

**MAMMOTH** Bargain: Seychelles, Inhabane, Albania, Bolivia, Dominica, Portugal, British Colonies, Latin American, and over 100 different others for 10c to approval applicants. Erhard, Bohemia, N. Y.

**UNITED** States approvals. Fine quality, low priced. N. E. Whitlow, 302-B South Barnett, Dallas 11, Texas.

**BRITISH**, Spanish and French Colonies, Vatican, Hitler heads, and airmail packet, free with approvals. Pan-American Stampco, Box 145, New York 33, N. Y.

**25 DIFFERENT** Commemoratives, U. S. and foreign—only 10c or 200 different U. S. including airmails, Civil War revenues \$1.00 to approval applicants. AAA Stamp Company, Arcade Building, St. Louis, Mo.

**OVER** 100,000 sold; 100 different Latin America only 30c; 100 different Greece 85c. Carlton's, 10243 Silverton, Tujunga, Calif.

**EXOTIC** Pictorial collection: Tahiti spearfishing, Melanesian idol, Ingavi battle, Reunion, Madagascar, St. Pierre Miquelon, Djibouti, Wurttemberg, Dutch Indies, Newfoundland, many others. This outstanding offer only 5c. Imperial, Box 1491, Tampa, Florida.

"**GOYA** Nude" set, cataloging \$1.05, complete 40c. Approvals. Royal Stamp Company, Tamaqua, Penna.

**FREE!** 25 Different foreign, mostly pictorials. Approvals. Streiner, 898 East 75, Cleveland 3, Ohio.

**1c TO 5c** Approvals, mounted in books. Sturgill's, Arno, Virginia.

**300 COMMEMORATIVES**, Pictorials, etc., plus surprise packet \$1.00. Schneider, 6609a S. Bishop, Chicago 36.

**1000 DIFFERENT** World \$2.50; 500, \$1.00. Long Beach Stamp Company, Long Beach, New York.

**VATICAN!** Beautiful Saint Peters. Catalogs \$1.00-10c. Approvals. Victor Logsdon, Hyndman, Pennsylvania.

**MEXICO**—Newest material, 200 mixed 35c. Biel, Apatado 2887, Mexico City.

**BOLIVIA** Music issue free with approvals. Miami Stamp Company, Box 2437, Miami 14, Florida.

**FREE!** 33 Haiti! Trinidad! Philippines! Approvals. Stampco, Box 267, Forest Hills, New York.

**50 BRITISH** Colonies with approvals 10c. O. Burgett, Lima 2, Ohio.

**HITLERS**, Triangles. Two sets—5c. Approvals. Mallo, 767-PM, Leith, Flint 5, Mich.

**MINT**, Hitler heads, 12 different—35c. Blocks, \$1.40. Scarce 42 pfg. Hitler 10c. The Philatelic Corner, 175 Stratford Rd., Buffalo 16, N. Y.

**SIXTY-SIX** Different stamps 3c. Approvals. Cornetta, 228 West 25th, New York 1.

**55 DIFFERENT** United States 10c, approval applicants. Standard. 3817 Sackett, Cleveland 9, Ohio.

**3 BEAUTIFUL** Foreign sets. Complete. 10c. Approvals. Dorsett Company, 2001 Mamie, Hattiesburg, Miss.

**EXCHANGE** Duplicates. Swappers everywhere. List 10c. Particulars free. Box 2166-M, Denver 1, Colorado.



FIVE British coronations 10c. Approvals. Thode, 14302A 119 Avenue, Jamaica, N. Y.

100 STAMPS, Album, hinges — 20c. Northeast, Box 6618, Kansas City, Mo.  
1c, 2c, 3c WORLDWIDE Approval assortments. Hoffman, A301 Stonehurst Court, Upper Darby, Penna.

"STAMPLETS" Magazine contains U. S. catalogue; 4 issues with valuable booklet "First Aid to Philately" 25c. 2187 E. 2nd, Cleveland 15, Ohio.

DOMINICAN Diamonds! Five cents to new approval applicants. J. Bradford, Cloquet, Minn.

25 BEAUTIFUL Stamps from 25 French colonies and our price lists. One silver dime. Stampsales, Box 1649-P, Oakland 4, California.

U. S. Mixture. Pound 60c. Nichols, 746 River, Mattapan 26, Mass.

CUBA: 150 Super mixture 30c. Guzman, J 159, Vedado, Havana.

100 DIFFERENT Selected foreign—25c. Approvals. Gragg, Box 1431, Amarillo, Texas.

FREE Bolivian bi-colored national anthem set, 4 values, to approval applicants. Wesken Stamp Company, Box 66M, Queens Village, N. Y.

300 WORLD Wide 87c; 150, 47c; postage. Penny approvals. Pacific, P.O. Box 5704, Los Angeles, Calif.

U. S. Price list, send postage. Steger, 1165 Downing, Denver 3, Colorado.

LATIN Americans, 175 different 50c. Approvals. Lists. Neulutz Co., Care Box 12, Newlots Station, Brooklyn 8, N. Y.

FREE! Beautiful pictorial set. Approvals. Verne Stamp Co., 916 Fallowfield, Charleroi, Penna.

VATICAN City, 12 beautiful varieties, 10c with approvals. G. A. Hogenbarth, 1545 Ardmore Ave., Chicago 26, Ill.

100 DIFFERENT Foreign stamps and Mexican banknote only 10 cents. Nagle, 1101 Marion, Reading, Penna.

GREEK Occupations free to serious approval applicants. Seiden, 1331-M Intervale, New York 59.

FREE! Set French, 1/2c up approvals. Marjay's, Box 14, Station B, Brooklyn 16, New York.

\$4.25 CATALOG Value stamps free, with approvals. Postage 3c. Appleman, Ida, Mich.

GIFT Plan for serious collectors. Approvals 1c up. Crown Stamp Co., 412 Maple, Holyoke, Mass.

LESS Than 300 U. S. in your collection? You need my progressive U. S. approvals. Precancel selections also available. Cole, 43 Rinewalt, Williamsville, N. Y.

LIBERAL Offer, thick packet with Seychelles, Gilberts, Reunion, Inhambane, Mozambique, Inini, Porto Rico, Philippines and multitude others, everything 10c to approval applicants. Burmaster, Box 1910-M, Los Angeles 53, Calif.

VATICAN, 25 Different (mint) 25c. Jones, 1942 Wallace, Philadelphia 30, Pennsylvania.

FREE! Amazing "Queer Countries" assortment! Peachy approvals! Saxon, Walden, New York.

CURACAO 1943 Mint set six beautiful bicolors only 15c to applicants our worthwhile foreign approvals. Inter Continental Stamps, Englewood 2, Florida.

100 U. S. Commemoratives, Airm etc., 10c, 300—25c. P.O. Box 457, Newark 1, New Jersey.

INTERNATIONAL Collection! Over 30 countries—not more than 10 from any one country—a grand total of 300 different stamps to fill those empty spaces! Just 25c with approvals. Johnson's, 3665 West 140th, Cleveland 11, Ohio.

1933 VATICAN Set 25c with approvals. Vargo Stamps, 6044 South Fairfield, Chicago 29, Illinois.

FREE! Airmail packet with approvals. Deane Stamps, Box 87, Miami 35, Fla.

FREE Mint Greece glory set with foreign approvals. 20th Century, P.O.B. 3413, Philadelphia 22, Penna.

FREE Norway "ship" stamps (2). Request approvals. Suburban Stamp Sales, St. Louis 14, Mo.

FREE Beautiful new issues, five countries, with approvals. Green and Company, Norwood 12, Ohio.

UNITED States. #294, #429, #431, #437, #E5, #E6. Send 50c. Approvals accompany. Whiton-Stamps, Westport 4, Connecticut.

15 U. S. Commemoratives 10c, approvals. Roger Stamp Mart, P.O. Box 316, New York 8, N. Y.

HAWAII, 5 Different scarce, 25c. United States and foreign price lists free. Tam, Box 3028, Honolulu, Hawaii.

FREE—Pick 25c worth of stamps from our first U. S. approval selection. Special illustrated lists included. S. C. Engel Co., 38 Park Row, New York City.

TREMENDOUSLY Popular, virtually certain to rise in value, is Nicaragua's Roosevelt memorial issue, picturing Roosevelt collecting stamps, conferring with Churchill at Atlantic Conference, and signing declaration of war against Japan. Three handsome genuine unused stamps (#'s 695-7) that every collector wants! Special price, with attractive approval selection, only 10c. Garcelon Stamp Company, Box 800, Calais, Maine.

FREE—Famous Americans set, plus Flag Set, plus the National Parks Set, plus the Presidential Set to the \$5. A total of 90 stamps absolutely free to customers for our unsurpassed United States or foreign selections. Send 3c postage for 15 of the above mentioned stamps and full particulars. Triboro Stamp Company, 145 Nassau St., Dept. 103, New York.

GIBRALTAR Packet free—Nice collection Gibraltar, New Zealand Centennial, British Uganda, French Colonials, Early British Colonial, West Indies, South American, war stamps plus Philatopic Monthly Magazine. All for 5c postage. Empire Stamp Company, Dept. PM, Toronto 5, Canada.

FREE Wonder packet to approval applicants. Detroit Postage Stamp Co., Box 56, Detroit 23, Mich.

BRITISH Colonies and South America on approval. Theo. Stevens, Box 3705, Kercheval Station, Detroit 15, Mich.

FREE—Worldwide stamps with first approvals. U. S. want lists solicited. Peter Nerger, Palisade, New Jersey.

50 DIFFERENT Peru 35c. 100 different Italy 55c. 7 different Greenland 75c. 100 different Finland 75c. 100 different Switzerland 80c. 200 different Hungary 85c. 100 different Norway 90c. 100 different Canada \$1.25. 100 different Netherlands \$1.35. 1000 different world \$1.50. 100 different Salvador \$2.00. 100 different Belgian Congo \$4.95. Mission Mart, Washington 17, D. C.

U. S., Foreign, approvals, monthly auctions. Riffle, 211 Jefferson, York, Penna.

FREE 25 Diff. foreign with approvals. Laskowicz, 669 Wilson Ave., Muskegon, Mich.

1c TO 10c General foreign approvals. Russell Holcombe, Canton, Georgia.

BARGAIN Packets: Each 10c (11 for \$1.00). 20 Africa; 12 Airmail; 25 Argentina; 30 Asia; 15 Australia; 30 Belgium; 25 Brazil; 50 British Colonies; 30 Canada; 25 China; 15 Colombia; 20 Chile; 20 Cuba; 25 Czech; 50 Denmark; 25 Ecuador; 25 Finland; 15 Greece; 15 Guatemala; 40 Hungary; 30 India; 50 Italy; 25 Mexico; 10 Mongolia; 10 Newfoundland; 15 New Zealand; 25 Netherlands; 25 Norway; 10 Paraguay; 25 Peru; 25 Portugal; 15 Russia; 25 Spain; 30 So. America; 30 Sweden; 25 Switzerland; 15 Turkey; 40 U. S.; 25 Uruguay; 15 West Indies. Special: All 40 packets above consisting over 1000 stamps with stamp album \$3.50. Longacre Shop, 108 West 42, New York City.

EXCHANGE Stamps universe. Particulars free. "Exchangers," Bry 126, Seine, France.

UNPICKED: 5000 U. S., \$2.00; 3000 foreign \$2.00. 1100 different worldwide commemoratives, etc. \$4.00. Satisfaction guaranteed. Kuhn, 3315 80th, Jackson Heights, N. Y.

FAR East Mission mixture, including French India, Burma, Ceylon. 1000 \$1.00. Satisfaction guaranteed! Club directory free! Super-Exchange, Cranford, New Jersey.

QUARTER Brings 18 beautiful Morocco or seven unusual St. Pierre or 14 Dominican pictorials. All three fifty cents. Stuart Stamps, Box 72, Station P, New York 4, N. Y.

SOUTH Pole map stamp plus 10 others 3 cents to approval applicants only. L. Marceau, 118 Garner Ave., Buffalo 13, N. Y.

GOYA Nude (2) 5c. Approvals. Hanay's, 310 Quail, Albany 3, N. Y.

GOOD Approvals, try us. Oak Stamp Service, 137 Oak, Gardner, Mass.

WHAT Have you to offer? A collection? A "shoe box" accumulation? Anything in stamps. We urgently need them. Spot cash paid. Cosmopolitan Stamp Co., 1457 Broadway, Dept. 3-E, New York.

FREE! 20 Mint recent Hungary to approval applicants. Quality Stamp Company, Box 202, Sta. F, Buffalo 12, N. Y.

BURMA Victory issue complete (4 varieties). 20c. Approvals. Millhiser, 7724 Abbott, Pittsburgh 21, Penna.

POSITIVELY Greatest free offer—Latest Scott's International \$5.00 Stamp album, covering entire world, contains 36,000 illustrated descriptive spaces; Scott's 1947 Standard \$5.00 catalogues "Philately's Encyclopedia"—absolutely free to applicants for foreign approvals becoming customers. Bargain Stamp Service, Palm Springs, California.

FRESHLY Mounted foreign on approval to dependable beginners and advanced collectors. Also new issue service. References. Wlaschm, 55 Nagle Ave., New York 34.

FREE—18 Different Switzerland with approvals. Excel, Box 1315, Chicago 90.

100 DIFFERENT Stamps 5c and approvals. Gottardo, 1226 Rossell, Oak Park, Ill.

FREE—15 Different presidentials. Approvals included. Frontier's Stamp, 1280A Ocean Avenue, Brooklyn 30, N. Y.

10 BIG Packets 10c. 25 Switzerland, 5 Palestine, 25 Hungary, 10 Egypt, 20 Norway, 25 Canada, 20 Sweden, 20 India, 10 New Zealand, 10 Australia. Not 10c each. But special to approval applicants. All for only 10c. Dept. P. Rabols Co., 3631 Corlear Ave., New York 63, N. Y.

24c PRESIDENT Harrison. Don't miss this scarce stamp. Only 5c with United States and foreign approvals. Willett Stamps, Box 507, Port Chester, N. Y.

FREE Illustrated lists of new issues. Essex, Box 1214, Omaha 1, Nebraska.

CANADA War set 10c with attractive approvals. Rheume, 8949 Routhier, Montreal, Canada.

HITLER, Vatican, French, Spanish, British Colonies, U.S. \$1, \$2, \$5. free to approval applicants. Middleton Stamp Co., 78-14 Woodside Ave., Elmhurst, N. Y.

UNUSED British Colonials, world wide beauties, including bi-colors Basutoland, Cyprus, Seychelles, 10c to serious approval applicants. Mutual Stamp Service, 5145R Village Green, Los Angeles 16, California.

MAGNIFYING Glass—50 different, 10c. Approvals. Buchanan, 307 East 23rd, New York 10.

CHINA 20 Colorful historical stamps 10c with approvals. Collins, 71 Coleridge, San Francisco 10, Calif.

PHILATELIC Printing — Stockforms. Samples for postage. Acmeprint-6, East Flat Rock, North Carolina.

\$2,000 IN Stamps free to contest winners. Particulars, entry blank, to approval applicants enclosing only 10c for scarce Roosevelt Mourning stamps from Nicaragua, Greece and Argentina, plus photograph of "Roosevelt Collecting Stamps." National Stamp Sales, 276A West 43rd Street, New York 18, N. Y.

STAMPS From 40 countries, including Fiji 10c. Elsea, Bowling Green, Ohio.

150 DIFFERENT, 5c. Approvals. Best Stamps, Box 139, Bangor, Maine.

ROOSEVELT Nicaragua set of three 10c to approval applicants. Murray, 2152 Vogel Road, Evansville 14, Indiana.

DANDY U. S. approvals; write immediately. Sullivan, Endicott Building, St. Paul, Minnesota.

CUBA'S Retirement set shows aged couple receiving pension check. This set sent to approval applicants for only 5c. Bryson Stamp Company, Drawer F-2, Rossford, Ohio.

UNITED States, 150 all different, \$1.00 postpaid. Free premiums. Box 22, New York 34.

ROUND The world colonies—British, Dutch, French, Portuguese; strange little known countries, primitives, cannibals etc. All for 3c to approval buyers. Dixie Stamp Company, Dept. 10, Milwaukee 1, Wis.

VATICAN City! Four varieties of Vatican City (world's smallest country) including portrait of Pope Pius! Also stamps from Afghanistan, Cape Juby, Libya, Macao, Palestine, Syria, Liechtenstein, San Marino, and many other interesting countries. All together 48 different stamps, total catalog price over \$2.50!—only 10c to approval applicants! Methuen Stamp Service, Inc., Dept. 211, Lawrence, Mass.

118 DIFFERENT Stamps including commemoratives, charities, airmail, surcharges, sets, etc. Only 3c to approval buyers. Badger Stamp Company, Dept. M, Milwaukee 3, Wis.

FREE Persia and China packet to approval applicants. Everglades Stamps, Box 3222, Station F, Atlanta, Georgia.



ALL Different: 200, 25c; 500, 60c; 1000, \$1.50. Beacon Sales, Maynard, Mass.

SMOKY Mountain souvenir commemorative sheet and 30 different U. S. stamps, including commemoratives, airmail, etc. (catalog value exceeds 65c) for 10c to approval applicants. Curhan Stamp Company, Dept. H, Gloucester, Mass.

FIRST Day covers on approval. Knobel, 1918 S.W. 12 St., Miami, Florida.

COLLECTORS: Write today for famous "four star approvals." Nothing like them! Kessel's, Box 808, Tucson, Arizona.

GIVEN Seychelles "palm tree," Hitler, Petain portraits, Norway "Quisling" traitor, Jap issued Philippines, snake, lion, others. All given for 3c postage. Approvals. Premium Stamp Service, Hartland, Maine.

UNITED States collection. 104 different commemoratives including Columbians, Pan Americans, Pan Pacific, bicentennials, parks, famous Americans. Price \$1.00. Approval applicants only. Orange Stamp Company, Albany, New York.

FREE Irish commemorative collection, including dramatic Easter Rebellion issue with approvals. Raymax, 123-Z William St., New York City.

ILLUSTRATED Stamp Magazine, 26 weeks 25c. Stamp Journal, Kalamazoo, Michigan.

U. S. COLLECTION—Thirty different fine unused commemoratives before 1939 including Columbians, bicentennials, parks price \$1.00 approval applicants only. Fort Orange Stamps, Albany 7, New York.

BERLIN Bears, complete set of eight and 100 different stamps only 10c to approval applicants. Reich Stamp Co., 4647 Kenmore, Chicago 40, Ill. Dept. M11.

20,000 VARIETIES 1c-5c each! Gordon Davison, Box 1019B, Manchester, N. H.

WOW! \$10.00 Worth of fun only 10c. What a treasure hunt! Big package 500 foreign stamps—just as received from foreign missions other sources. Includes stamps from Africa, South America, Philippines, Free French, Cape Juby, Palestine, etc., including airmails, commemoratives, and stamps worth up to 50c and 75c. This amazing offer is given for 10c to serious approval applicants only. One to a customer, money back if not more than delighted. Jamestown Stamp Co., Dept. 22, Jamestown, New York.

ATTRACTIVE Packet free to approval applicants. Rare Stamp Service, P.O. Box 4077, Miami, Fla.

FIVE Vatican City stamps free to approval applicants. Florida Stamp Company, Box 807, Miami 5, Florida.

SOLOMON Islands, Grenada, Turks Caicos, Caymans, Dominica—everything 2c with approvals. Viking, 130-Z Clinton St., Brooklyn, N. Y.

PENNY Approvals by country. M. H. Hoerning, 115, Farmington, Ark.

STAMP Collections wanted. Complete collections, duplicate lots, surplus stock, mint and used. Prefer trade for printing or other items, buy outright if priced right. What have you, what's wanted? Vanroy Shirk, Lebanon, Penna.

1000 MIXED U. S. old and new—25c; 2 lb. \$1.25. Weatherby, Medina, Ohio.

YOUR Money's worth! Seychelles, Djibouti, Angola, Chinese hunger stamps and over 100 different other stamps. Everything 10c to approval applicants. Atlas Stamps, 4220 West 16th, Dept. L, Little Rock, Ark.

FREE! Rhodesian bi-colored waterfall; old El Salvador issues; plus 25 different worldwide stamps. All free to approval applicants. Pladon Stamps, 1717-M Idaho, Toledo 5, Ohio.

FREE — Abyssinia, Cayman Islands, Tuna triangle, Indochina, Syria, Ivoire, Philippines (Jap "shame" issue), Turkish harem, Damascus, Cambodia, African "beauty," Pirate Islands, Colonials, others—All free for 3c postage with approvals. Belmont Stamps, Washington 10, D. C.

AMAZING Offer! Assortment each of giant stamps, midget stamps, flag stamps, airmail stamps, Free French Colonies, U. S. commemoratives and numerous others. Everything only 10c to approval applicants. Simon, Box 608, Iraan, Texas.

PORTUGUESE Colonies. 25 different 5c with approvals. Lorane Brown, Marion, Michigan.

ADEN To Zanzibar! 40 different British Empire, including Cyprus, Malta, Dominica; 5c with approvals. Lyman Company, 95 Nassau Street, New York City 7.

U. S. Price list. Send postage. State Stamp Service, 1225 Park Building, Pittsburgh 22, Penna.

OLD Scarce U. S. seconds on approval. Slightly defective, nice appearance, bargain prices. Hernfield, 551 Clinton, Newark 8, N. J.

ZANZIBAR, Palestine, Manchukuo, Azerbaijan, Haiti, Iraq, Siam, Victoria, Hitler stamp 5c. Approvals. Postzegel, Windham, New York.

U. S. Price list. Send postage. Stanley Gibbons, 38-P Park Row, New York.

PENNY Approvals, that satisfy. Neil Gronberg, Box 5441-P, Philadelphia 43, Penna.

MINT Pictorials free to approval applicants. Surf Stamp Co., Box 2296, Miami Beach 40, Florida.

COMPLETE "United States" catalog with 1000 illustrations! Send 10c for mailing. Harris & Co., 137 Transit Building, Boston, Mass.

ZOWIE-E! A barrel of fun for only a dime. 500 United States stamps—absolutely unpicked and unsorted—just as received from church missions. Many varieties, including large commemoratives, airmails, high denominations up to \$5.00! Stampdom's biggest package of fun—and you might find something really valuable! Price only 10c to serious approval service applicants. Money back if not delighted. Illustrated bargain lists with each order. Mystic Stamp Company, Dept. 80, Camden, New York.

50 DIFFERENT United States, 10c. Price-list free. Seidenberg, Cassopolis, Mich.

CANADA—75c Diff. 25c. Approvals, Lists. Victoria Stamp Co., London 4, Canada.

FREE! Negro Triangle; Turks Islands "Cactus"; Dakar; Guinea; Palestine; "Fairy Tale," Pirate Chart, Map, Ship, Sea Lion and Snake stamps; French, British, Portugese Colonies, etc. Free for 3c postage. Approvals. Potomac Stamps, Washington 10, D. C.

FREE! Leeward Is., Cayman Is., Turks and Caicos plus 54 different mint World's Fair poster stamps, to approval service applicants sending 3c postage. Tatham Stamp Co., Springfield 30, Mass.

UNITED States approvals complete coverage, fine quality, attractive prices. Seminoe Stamps, Box 378, Coconut Grove, Florida.

50 DIFFERENT Including scarce diamond-shaped airmail 3c to approval service applicants. Avalon Stamp Co., Dept. M, Springfield 8, Mass.

1000 GRABAGS 15c Each. Super bags 25c. Zandy, 630 Bingham, Reading, Pa.

FREE U. S. price list. Postage 3c. Mark Hanna, 335 - 5th Avenue, Pittsburgh 22, Penna.

FREE! Canadian sets, royal visit, George VI, George V, coronation, jubilee, others, to approval applicants. Ensign, Box 118-M, South Orange, N. J.

WORLD'S Largest diamond and triangle stamps, free stamp magazine, stamps from fighting Free French, 20 stamps from 20 different countries, pictorials, airmails, big bargain 5c with approvals. Capital Stamps, Dept. 2, Little Rock, Ark.

DEALERS—Wholesale list. Postage 3c. Frank, 5031 Queensberry, Baltimore 15, Md.

25 DIFFERENT Swiss 10c—with 1/4, 1/2, 1c approvals. Carroll's, 4357A S. Hoover, Los Angeles 37, Calif.

#### HOBBIES AND COLLECTIONS

SEND \$1.00 For packet of 20 different shoulder patches. P. O. Box 228, New York City 10.

SWAPPER? Collector? Send 25c for sample copy "Hobbyswap Contacts." 1326 South 27th, Omaha, Nebraska.

EXCHANGE Your duplicate stamps, match covers, or any hobby, with collectors everywhere! Exchange register listing swappers, 10c. (Mention hobby.) World Hobby House, Box 721-A, Olympia, Wash.

COLLECTING Hobbyists! Exchange duplicates. "Hobbyswap Contacts" directory 10c. C. Bishop, Route 8, Kalamazoo 88, Michigan.

TWELVE Issues worldwide Hobby Magazine \$1.00; sample 10c. Klings, Blue Island, Illinois.

COLLECT Beautiful novelties hand-made from world-famed, giant redwood trees of California! Also make wonderful gifts. Miniature vase and pitcher knickknacks; ornamental initial, Laddie Pup, Ducky Duck dress pins—75c each. Many others. Order from ad, or write for free catalog. Gruenewald, 3837-M Coolidge, Oakland, Calif.

WANTED: Old cigarette cards. Write Charles Bray, East Bangor, Penna.

CLEARANCE Sale, military emblems, choice of 300 different 5c each. Send 10c for illustrated price list. Hobbyguld, 35-P West 32nd Street, New York.

KLONDIKE! For hobby jewelry makers! Novelty jewelry findings from tables of large manufacturers—parts for bracelets, pins, earrings, etc. unfinished. Chains, rings, pins, stones, clips, beads, many other items—1 lb. bags, \$2.00 per bag in 5 bag lots. Sample bag \$3.00. Prepaid only. Mdse. Distributing Co., 19 E. 16 St., New York 13.

296 COLORED Illustrations, new book "Foreign Medal Ribbons." \$1.00. Foreign campaign bars, insignia, lists, samples, 20c. Packets \$1.00. Insigniacrafts, 236-28th Ave. N.W., Calgary, Canada.

CAMPAIGN Ribbons—Beginner's package. Introductory price 50c, contains 15 assorted ribbons. Collectors desiring special ribbons specify your requirements. L. H. G. Company, 19 E. 16 St., New York 13.

INVENTING Can be an interesting and profitable hobby. Write for complete particulars. Institute of American Inventors, Dept. 40-E, 1926-Eye St. N. W., Washington 6, D. C.

COLLECT Colorful Army patches. Pictures, prices and sample patch only 10c. Insignia Mart, 703 Broadway, N. Y.

UNUSED Match book covers, 100 all different \$1.00. 35 Royal Flash covers \$1.00. Free list. Charles Edelman, 13110 East 84, Cleveland 3, Ohio.

JEWELRY Stones removed from rings, etc., 100 assorted \$2.40; 50 large ones \$2.40. B. Lowe, Holland Bldg., St. Louis 1, Mo.

"SELL Rocks!" Let "mother nature" finance your sparetime enterprises. Details, other hobby offers, free! McCampbell, Calexico, Calif.

#### ANTIQUES, RELICS, INDIAN GOODS, CURIOS

4 FINE Ancient arrowheads \$1.00. Stone tomahawk \$1.00. List free. Lear's, Box 569, Galveston, Texas.

SWORDS, Rapiers, daggers, pistols, armor. Illustrated catalog 50c. Robert Abels, 860-A Lexington Ave., New York.

#### PRECIOUS STONES, MINERALS

MINERAL And fossil collectors! Read The Earth Science Digest. Sample copy 25c. Dept. PM, Box 57, Omaha 3, Nebr.

MINERALS—Gems. Specimen or cutting. Ten pieces \$1.00. List free. Plummer's, 5068 Brighton, San Diego 7, Calif.

METAL Detectors. We have the latest in circuit and mechanical design plus the know how. Free literature. Hedden Metal Detectors, 538 North Homewood Avenue, Pittsburgh 8, Pennsylvania.

BEAUTIFUL Unpolished slab agate 25c (coin). Smith, Box 422F, Albany, Oregon.

FOOL'S Gold from famous gold camp 10c per sample. Gold \$1. Others. Martin's, 506 Harrison, Leadville, Colorado.

#### CAMERAS AND PHOTO SUPPLIES

MOVIE Cameras, 16mm. magazine loading, new 24-volt electric-drive. Famous army-navy AN model; f3.5 lens; complete with enclosed view finder installed. Easily converted for use with dry cell batteries. Value over \$200. Special \$45.00. Limited quantities, act fast! All necessary parts available for easy conversion. Photo Surplus Sales, Dept. F4, 12 Duane Street, New York City.

CAMERAS—Sensational color candid type, \$3.95. Hand colored enlargements, fotopaks, wood statuettes, packetpics. New, different. Free literature. E. J. Lyman, 622 Penfield Bldg., Philadelphia 7, Penna.

SPEED-O-COPY Ground-glass focusing attachment for Leica, Contax, Argus C-2 and C-3. Send for literature. D. Paul Shull, Dept. PM-3 240 S. Union, Los Angeles, Calif.

SPEEDLIGHT Equipment, parts, data available from pioneer manufacturers Lee Strobospeed. Limited quantity a.c. and battery portable units special year end clearance prices. G. E. Lee, Sylvania, Amgo, Flash tubes stocked. Irvin Aaron Associates, 3617 Greenbay Avenue, Milwaukee 12, Wisconsin.

CAMERA Repairing—Shutters, bellows, rangefinders, synchronizers. Free estimate. 48 hour service. Money-back guarantee. Jackson Laboratories, 27-GM Gore, Webster Groves 19, Mo.

PRINT Your own pictures, kit \$1.00. Spada Enterprises, 10 Lexington, Wethersfield 9, Conn.



**PHOTOGRAPHY** For pleasure or profit. Learn at home. Practical basic training. Long established school. Write for booklet. American School of Photography, 1315 Michigan, Dept. 3431, Chicago 5.

**COMPLETE** Repairing on all types of foreign and domestic cameras. Factory trained specialist on Kodelle and Foth cameras. B. & V. Camera Repair Service, 22 East Van Buren, Chicago 5, Illinois.

**OIL** Coloring photographs can be a fascinating hobby or profitable sideline for those with artistic talent. Learn at home. Easy simplified method. Send for free booklet. National Photo Coloring School, 1315 Michigan, Dept. 3431, Chicago 5, Ill.

**CAMERAS**, Enlargers, projectors. Lowest prices. Free catalog. Cavalier Camera, 1822 Center, Pittsburgh 19, Penna.

**CASH!** Spot cash for cameras, lenses, binoculars, movie and still equipment. Send full description for prompt cash offer. Over 36 years of dependability. Bass Camera Company, Dept. AG, 179 W. Madison St., Chicago 2.

**BASS** Says: Trade cameras? For 36 years Bass has satisfied thousands everywhere! Finest equipment available. Always satisfaction guaranteed or your money back! Bass buys 'em, sells 'em, trades 'em. Bass Camera Company, Dept. AG, 179 W. Madison St., Chicago 2.

**USED** Camera Directory, Box 1031-M, Canton, Ohio—lists hundreds of war-bargain used cameras—35mm., Speed Graphics, Kodaks, Roliflex—many others. Send 26c for latest issue.

**HAVE** You a camera? Improve your hobby of photography and learn how to make better pictures. Write today for our latest book catalog and sample copy of American Photography, containing articles and pictures by the world's foremost writers and photographers. Camera House, 601, 353 Newbury St., Boston 15, Mass.

#### PHOTO FINISHING

**ROLL** Developed 8 high gloss Velox prints 35c, reprints 4c. 30 years experience. Old Timer Photo Lab., 610 W. Roma, Albuquerque, N. Mex.

**ENLARGEMENTS** From your negative—8 x 10-40c; 5 x 7-25c. Mass. Photo, 581 Mass. Ave., Boston, Mass.

**BIGGEST** \$1.00 Value in 35mm. finishing today. 36 exposure fine grain 3 1/4 x 4 1/2 enlargements; deckled, embossed margin and date. Eighteen exposures 75c; 16 exposure splits 55c; 36 exposure reloads 50c. Special: return this ad with \$2.00 and we will send five 36 exposure reloads. Free mailers. 8 exposure rolls in beautiful, deckled contact finish with embossed wide margin. 25c. Mailbag Film Service, Box 5440A, Chicago 80.

**FILMS** Developed 6 or 8 prints and 5x7 enlargement 30c silver. Our customers send roll after roll. Dover Photo Service, Dover-Foxcroft 22, Maine.

**SPECIAL**—50 Reprints \$1. Suburban Studio, 1410-M Bond, Rockford, Illinois.

**8"x10"** HAND Colored framed enlargement from negative or clear photograph \$1.50. Promenade Photos, Sta. D, Box 198-C, New York 3.

**NO** Free stuff. Just good prints. If a picture's worth taking, it's worth printing right! Develop roll, eight extra good prints, only 30c. Royal Film Service, Box 979, Dayton, Ohio.

**FILM**—127 Four roll \$1.00. Cavalier Camera, 1822 Center, Pittsburgh 19, Penna.

**20 REPRINTS** 25c. 50 Or more 1c each. Guaranteed double clear, never-fade pictures. Sample free. Penny Photos, Box 904G, Des Moines 8, Iowa.

**ANY** Offer 35c—8 x 10 framed enlargement. Three 8x6 enlargements. 12 prints plus one 8 x 6 enlargement. Six 4 x 6 enlargements. Roll developed, 16 prints plus one 8 x 6 enlargement. Photo album plus 100 art corners. Prompt, guaranteed. Lifetime Photo Co., Dept. 139, Des Moines, Iowa.

**16"x20"** ENLARGEMENTS—\$1.00. Any size negative, 35mm. up. From picture 50c extra. Postage 25c. Jackphoto, 27-GM Gore, Webster Groves 19, Mo.

**ROLL** Film developed. 8 oversize Velox prints from any size roll up to 118, 35c; reprints 4 cents each. Colonial Studio, Sta. A Box 85, Charleston, S. C.

**NEW** Color process makes full color prints from black and white film or negatives. Send dime for sample. We have films. Midwest Photo, Janesville 26, Wis.

**CENTURY** Delivers work and service that can't be beat. Sixteen famous Century-Tone prints each 8-exp. roll 30c. Free mailers. Century Photo Service, LaCrosse, Wis.

**SENSATIONAL** Introductory offer! Send snapshot or negative, this ad, and 3c. We'll send you a beautiful 7"x5" enlargement! Or, kodak rolls developed with 8 giant double-size prints, 25c. Special, from your negatives, 16 regular-size or 8 double-size reprints, 25c! Candid rolls—36 exp. 35mm. developed, vapo-rated, enlarged to 3x4, \$1.00! 18 exp. 50c. Reprints, 3x4, 3c each. We have new, perfect 35mm. film. Low prices. Free mailers, details on request. American Studios, Dept. 279, LaCrosse, Wis.

**ROLL** Developed, two prints each exposure 25c. Additional reprints 3c each. Skrudland, 6444Z Diversey, Chicago.

**8 BEAUTIFUL** Double size pictures and roll developed 30c. 8 hour service. Free mailers. Pacific Photo Service, Box 666, San Francisco, Calif.

**PHOTOGRAPHY** For pleasure or profit. Learn at home. Practical basic training. Long established school. Write for booklet. American School of Photography, 1315 Michigan, Dept. 3452, Chicago 5.

**ROLL** Developed and 8 prints 30c. Overnight service. Free mailers. Tri-Flex Photo Service, Box 375, San Francisco, Calif.

**8 EXPOSURE** Rolls developed. 1 print each and one enlargement coupon 25c. Two each and coupon 35c. 3 each and coupon 40c. Reprints 3c. Fred D. Eastman, Bode, Iowa.

**8 HOUR** Service. Your 8 exposure roll printed jumbo or regular size, 25c; 12 exposures. 35c; 16 exposures. 50c; 36 exposures. \$1.00. Reprints jumbo or regular. 3c. Regular prints deckled. Fine grain developing. Send for free mailers. Quality Photo Service, Box 468, San Francisco 1, Calif.

**FREE** Price list on quality developing, printing, enlarging. Write for it today. Roy Photo Service, G.P.O. Box 644, New York (1), N. Y., Dept. M.

**SPECIALIZING** 35MM. fine grain developed. 36 big 3x4 enlargements, \$1.25. Photoshop, Linton, Indiana.

**ROLL** Developed, 8 brilliant fadeproof Velox prints and two professional enlargements 25c. Overnight service. Young Photo Service, 405-C, Albany 2, N. Y.

**8 PRINTS**, All enlarged to nearly postcard size, from your roll or negative, 25c. Willard Studios, Box 3535A, Cleveland 18, Ohio.

**2 BEAUTIFUL** Hi-Gloss prints each good negative and enlarging coupon with each 6 or 8 exposure roll developed 28c. Owphoto Co., Weatherford, Oklahoma.

**GLOSS** Finish enlargements. 4 5x7 from negative 50c. 3 5x7 from photo 50c. Robert Renshaw, Jr., P.O. Box 478, Chester, Penna.

**EVERY** Picture an enlargement! 8 sparkling deckle-edge enlargements and roll developed 25c coin; 116 size or smaller; enlarge reprints 3c. Enlarge Photo, Box 791D, Boston, Mass.

#### MOTION PICTURES AND SOUND EQUIPMENT

**FILM**—Free processing 100 ft. 16mm. Weston 12 \$3.25, Weston 24 \$4.90, Weston 64 \$4.95, 25 ft. double 8mm. Weston 12 \$1.50, Weston 24 \$1.89, Weston 64 \$1.99. Free circulars. Fromader Genera, Davenport 7, Iowa.

**MOVIE** Projectors—Used 35mm. sound portables—also 16mm. silent \$29.50 up. New and used 16mm. sound. Gallagher Films, Green Bay, Wisconsin.

**"SURPRISE"** Assortment 8mm. Colorful titles! \$1 postpaid. Guaranteed. LeMoine Films, Nevada, Missouri.

**PROCESS** Your own 8-16mm. movie film. Tank, drying reel, complete, single unit. Free literature. Duro Movie Products, 1519 Eggert, Eggertsville 21, N. Y.

**YOUR** Movies enlarged, 5x7 photograph \$1.00. Artcraft, 1602 Coney-Island, Brooklyn 30, N. Y.

**35MM.** Sound silent films, projectors bought, sold. Edward Elwell, Brockport, N. Y.

**TITLES** Of quality. Title Technicians, 3964 Ames Street N.E., Washington 19, D. C.

**16-35MM.** Silent sound films, projectors. Bedner, 5300 S. Talman, Chicago.

**HOLLYWOOD** Films: Sample and catalog, 10c. Stone, Lunenburg 6, Mass.

**RARE** 8-16MM. Silent-sound films. International, 2120 Strauss, Brooklyn, N. Y.

**FINEST** Movie screens, inexpensive, make them yourself. Free literature. Snow White Screen Company, Danville, Illinois.

**16MM.** Cameras, projectors. Silent, sound. Lists, film sample 10c. Richardson, Wyoming, Penna.

**NEW** 400 Ft. 16mm. motor driven projectors, \$25.95, \$40.95 postpaid. Sterling's, 679 Northampton, Easton, Pennsylvania.

**16MM.** Films duplicated, 5c foot.—(10) motion background "End" titles, all different, \$1.75 (16mm.), \$1.40 (8mm.) MK Photo, 451 Continental, Detroit 14, Michigan.

**LEARN** Professional motion picture technique at home. Approved for veteran training under G.I. Bill. Free catalog. Motion Picture Institute, Birmingham 4, Mich.

**FREE** For the asking—Big catalog of camera film, rental library subjects. If you take or show movies you need this book. Solar, 4247 South Kedzie, Chicago 32, Illinois.

**FREE** Home Movie bulletin, Romeo, Box 328, Patchogue 3, New York.

**FREE**, 1947 Catalog. Movies, cameras, projectors, films, samples 10c. Everything photographic. Goodwill Company, Jackson, Tennessee.

**MOVIE** Projector, 16mm. sound, slightly used, bargain. 2407 Garrison Blvd., Baltimore 16, Md.

**MAKE** \$8 to \$10 net profit daily with your 8mm. or 16mm. projector. Details free. Metcalf, 10806 Glenroy Ave., Chicago 43, Ill.

**8MM.**—16MM. silent cameras and projectors also 16mm. sound equipment for immediate delivery. Large rental library of silent and sound films for rent. Free new catalog. Also kodaks, cameras and still photographic supplies. The Dayton Film, Incorporated, 2227 Hepburn Avenue, Dayton 6, Ohio.

**GUARANTEED** Fresh anti-halo outdoor movie film! Weston 12! Daylight loading! Processing free! Three spools double 8mm. \$3.45! Six single 8mm. for Univex, \$4.60! Postpaid! Catalog, Eso-S, 828-B West 39th, Kansas City 2, Missouri.

**UNUSUAL** Home movies. Free list. Loja, Box 74B, Station B, Brooklyn.

**"THE** World's Greatest Passion Play," all sizes sound and silent. Write Hemenway Film, 33-F Melrose St., Boston 16, Mass.

**FRESH** Movie films. 100' 16mm. \$2.25, three rolls \$6.00. 25' double 8mm. \$1.25. Ambassador, 479-A Quincy Street, Brooklyn, N. Y.

**I** BUY, Exchange, swap movie films. Harvey Iris, Box 539, Brockton, Mass.

**FIVE** Slide views—Oldest convict ship afloat 25c. Slide Supply Service, 3111 West Tuscarawas, Canton, Ohio.

**UNUSUAL** Home movies: Travel, adventure, sports, comedies. Silent-Sound. Many film bargains. Big illustrated 1947 catalog, sample—dime. Audet, Box 6520BG, Philadelphia 38, Penna.

**8-16MM.** Silent-sound films. Complete rental library. All latest subjects. Free catalogue (sample film 10c). Garden Film, 317 W. 50th, New York 19.

**EXCITING** Films — bullfights, movie stunts. Unusual subjects. Send only dime for sample film and special list. Exciting Films, 1071-F El Centro, Hollywood, Calif.

**RENT** 16mm. sound films 50c reel. Large selection; free catalog. Film Service, 128 Chestnut St., Roselle Park, N. J.

**HOME** Movies. Rent, buy, swap 8mm.-16mm. silent and sound at money-saving rates. Details for a dime. Midland, Box 429, Oak Park 4, Ill.

**COMPLETE** Stocks always of Castle, Official, Pictorial films, 8mm., 16mm., sound, Musicals, soundies, free catalogs. We exchange your films and equipment, or buy them for cash. Frank Lane, 5 Little Bldg., Boston, Mass.

**MOVIE** Camera films, 100' 16mm. \$2.50. 25' double 8mm. \$1.25. Free developing. Better Films, 742 NewLots, Brooklyn 7, N. Y.

**DISTRIBUTORS** Wanted. Make big money selling our new 16-mm. sound specialties. Send \$10 for sample movie and our free wholesale price list. Standard Pictures Corp., Dept. A, Universal City, Calif.

**TALKIES:** Convert your silent 16mm. projector into sound with our guaranteed parts kit. Plays all 16mm. sound films. Quickly assembled at home. Special introductory offer: Send this ad now with \$19.95, check or money order, and we will include sound test film, instruction manual and full information on how to use with your radio. Kit includes photocell, exciter lamp, optic, which makes a sound head complete. Or send \$1.50 for complete blue prints showing how to make adapter yourself. Sound Tech, Box 3071, Hollywood 28, California.



**BASS** Says: 36 years of leadership in the motion picture equipment field. Sound projectors, 8 and 16mm. equipment, finest accessories. Bass buys 'em, sells 'em, trades 'em. Always satisfaction guaranteed or money refunded! Bass Camera Company, Dept. A, 179 W. Madison St., Chicago 2.

**LEARN** Movie projection, management. Free catalog. Theatre Institute, Elmira, N. Y.

### MUSIC AND MUSICAL INSTRUMENTS

**ARE** You annoying others with your piano practice? Use Mayo's Muting Device which enables you alone to hear your practicing. Easily attached or detached without harming mechanism. State make of piano and send \$5.00 for silencer and full instruction. (Guaranteed). Richard Mayo—Piano Tuner, Technician, 1120 Latona St., Philadelphia 47, Penna.

**GUITARISTS** Dream chart: Shows names, readings, symbols, diagrams, fingerings, all guitar chords. \$1.00. Guitarist, Box 21-GPM-Lefferts, Brooklyn 25, N. Y.

**SONGWRITERS!** Outstanding ethical offer. Hibbeler, C5, 2157 N. Avers, Chicago.

**WOULD** You like to buy a hard to get musical instrument that could not be told from new for less? Send for catalog listing everything musical. Harden's Musical Merchandisers, Marion, Ohio.

**GOOD** Used jukebox records. Hillbilly, western, popular. Lists free. Olin Milner, 335 McDaniel, Atlanta, Ga.

**LEARN** To play the guitar by ear. Simplified method. Send \$1.00. Western Star Studios, 1112 W. Drew St., Ft. Worth 10, Texas.

**YOU** Can play piano by ear in one week. Quick short cut, detail free. Write E. Morrison, Box 9312-N Station S, Los Angeles 5, Calif.

**BEFORE** Sending your poem to be set to music, know your composer. Free folder. Al. Moquin, 5333 La Cresta Court, Hollywood 38, Calif.

**SONGWRITERS:** Free prizes each month for best song! Two prominent Hollywood composer-arrangers offer a complete song service to qualified authors of song poems. Write today for generous offer and free booklet! Hollywood Melodies, Box 2168, Dept. Z-1, Hollywood 28, Calif.

**SONGS**—Lyrics arr. pub. Music free. Radio license. National Songwriters, 6770 Hollywood Blvd., Hollywood.

**PHONOGRAPH** Records cheap. Catalogue. Paramount, MA-313 East Market, Wilkes-Barre, Penna.

**SWISS** Musical units, install powder. Cigarette boxes. Lloyd Kelley, Hanover, Mass.

**SONGWRITERS.** Just out! "How to write, Sing and Sell Popular Songs," by Nick Kenny, noted songwriter. Articles by Cole Porter, Oscar Hammerstein, Richard Rodgers, many others. 255 pages, \$2.00, returnable in 5 days if unsatisfied. Hermitage Press, 1133 Broadway, New York City 10.

**MUSIC** Lovers for eight new songs send \$1.00. Art Music, 1658 Broadway, New York 19.

**PLAY** Favorite tunes in a few minutes with the famous Rodenius simplified playing system. Amazingly easy. Complete instructions for guitar, piano, piano accordion, Hawaiian guitar, tenor banjo mandolin, ukulele. Send \$1.00 for complete course. Money back guarantee. Rodenius Studios, Box 1198-A, Chicago 90, Ill.

**POEMS** Wanted for new songs. Send poem for free examination. Elliot Wright, Master Composer, 207 Rivoli Theater Building, Portland, Oregon.

**ACCORDIONS.** New or used, wholesale and retail, cash or terms. Our 57th year in business. Del Principe, 307 So. Wabash, Chicago, Ill.

**POEMS** Wanted to be set to music. Free examination. Send poems. McNeil, Master of Music, 510-PM S. Alexandria, Los Angeles, California.

**SONGWRITERS** — Free explanatory booklet, attractive offer. Song Service, 331-C West 46th, New York.

**POEMS** Wanted for musical setting. Send poem for immediate consideration. Five Star Music Masters, 630 Beacon Building, Boston.

**SONGWRITERS:** Send poems for free examination and outstanding offer. United Music Service, 150, Salem, Indiana.

**PLAY** Music without study \$1.00 postpaid. Dr. P. Wilson, P.O. Box 3851, Station D, Philadelphia 46, Penna.

**PIANISTS** Acquire professional technique in quickest possible time. Most unique course ever put out. Low cost. Get literature. Wehner, 25 Fulda, Roxbury 19, Mass.

**DUO-FLEX** Reeds, for clarinets and saxophones. Eliminate your reed troubles. Circular free. Duo-Flex Reeds, 1204 First Ave., Evansville, Ind.

**MUSIC** Printing, \$5-100. Composing, complete service. Auto-Litho, Jensen, Fla.

**SONGWRITERS.** Submit songs for free analysis. Only worthy material accepted for development. Tommy Kilbourne, Box 1253, Bakersfield, Calif.

**ACCORDIONS.** Wholesale prices. Request circular. New streamline accordions. All sizes and makes. Monarch Accordion Co., 44 N. Albany Ave., Chicago, Ill.

**MUSIC** Arranged. Songs printed. Frank Wildt, Music Publisher, Lancaster, Penna.

**SONG** Poems wanted. Free examination. McNeil, Master of Music, 510-PM South Alexandria, Los Angeles, Calif.

**WRITE** Songs. Big money and reputation. Write for information. J. Gordon Pub Co., 201 N. Hoyne Ave., Chicago.

**SONG** Writer's attention! The amazing demand for phonograph records, accelerated by more than 300,000 juke boxes and the hits popularized warrants your immediate consideration. We are offering song-poem writers the rare opportunity of having established composers collaborate on appealing material received this month. Recola Records, Box 987P, Hollywood 28, Calif.

**POEMS** Wanted for musical setting. Send poem for immediate consideration and free rhyming dictionary. Richard Brothers, 24 Woods Building, Chicago.

### RADIOS, SUPPLIES, INSTRUCTION

**TELEVISION** Receiver circuits of RCA, GE, instructions, blueprints for building, parts source—\$1.00. Jackson Engineering, 27-GF, N. Gore, Webster Groves 19, Mo.

**LOUD** Speaking crystal radio, improved design. Illustrated plans 25c. Radio Clinic, 10631-C Euclid, Cleveland 6, Ohio.

**EARN** Big money on the air. Improve your speaking voice easily, quickly. Complete book \$2.00 postpaid. Free folder on request. Hollywood Radio Publishers, Dept. PM-3, 5855 Hollywood Blvd., Hollywood, Calif.

**COMPLETE** Crystal detector radio kit. 1947 model with easy instructions. You get: 1-pair 2000-ohm double headphones; aerial kit; radio kit with wound coil and giant galena crystal. Nothing else to buy. Sent postpaid for \$3.75. "A bargain," you'll say. V. M. Stump, R. #8, Anderson, Indiana.

**BUILD** "Loudest" crystal set. Instructions and crystal, 25c. Simplest one-tube a.c. radio plans, 25c. Amorose Radio, Route Four, Richmond, Virginia.

1947 REVISED "Plans 18 Long Distance Crystal Sets," catalog, "Radiobuilder"—25c. 4 issues "Radiobuilder"—25c. Laboratories, Box 1-c, San Carlos, California.

**RADIOS.** New or used. Combinations. Scarce tubes. Record changers. Re-Amplifier, 2345 Hopkins, Milwaukee 6, Wisconsin.

**ELECTRONICS** Guide for television, radio, radar men. Years trouble-shooting experience packed into handy chart. Mail \$1. Allied Radionics, P.O. 625 G.C.T., New York 17, N. Y.

25 YEARS Experience in radio repairing at your fingertips for \$1.00. I've repaired 45,000 radios and have perfected a system which you can follow step by step. My methods are far simpler than any other course on the market and require no calculations. Send \$1.00 to Ross Radio Company, Dept. A, 14615 Grand River, Detroit 27, Michigan.

**ASSEMBLE** And hear your own crystal detector radio. Complete with crystal, parts, base, easy illustrated instructions, only 70c postpaid. Operates with headphones and aerial. Al's Radio Service, Box 1285-P, Sioux City 7, Iowa.

**BUILD** Radio, phonograph combination, complete kits: catalog. Radion, 6922 D 21st Ave., Brooklyn 4, N. Y.

**NAVY** Surplus bargain "Operators Control Box." Eighty useful parts. Only one dollar postpaid. Van Sickle Radio Supply, Indianapolis 6, Ind.

**ONE-TUBE** A.C.-D.C. radio. Simple. Efficient. Free details. Hayes, Box 636-A, Santa Barbara, California.

**FOUR** New books—25c each. #1, 1 tube battery sets; #2, plans for pocket radio; #3, make crystal detectors, and crystal circuits; #4, testing apparatus and servicing points. Ro-Nel Products, 7752 N. Haskins, Chicago, Ill.

**RADIO** Men. Lowest prices in America. Big stock. Write for latest catalogue. McGee Radio, 1330 Broadway, Denver, Colorado.

**VEST** Pocket radio! What fun! Listen while strolling or cycling. Local or distant reception. Plans sold around the world. Kits available. Cheap, easy. Free photograph with plans. Rush \$1.00. United Manufacturing Associates, 3316 Ave. G, Fort Worth 5, Texas.

**FAMOUS** "Allen" midget semi-fixed crystal detector. Set building plans and 100 late crystal set distance reports all for 50c postpaid. Allen, 427-2, Clinton, Mo.

**NEVADIUM** Super crystal. Write for details. Box 764, Elko, Nev.

**RADIO** Service men and experimenters send stamp for our giant radio catalogue. Save dollars. United Radio Co., (1000-V) Newark 1, N. J.

**MAKE** Simple, tubeless, batteryless, distance-getting crystal radios. Crystal and illustrated instructions 25c postpaid. Allen, 427-P, Clinton, Missouri.

**RADIO** Technician and radio service courses. Training for federal licenses. American Radio Institute, 101 W. 63 St., New York City. Approved under G. I. Bill of Rights.

**RADIO** tubes, parts, wholesale, retail large stock. Radio Mail Order Company, 46-13 188th St., Flushing, N. Y.

### BUSINESS OPPORTUNITIES

**MAIL** Order Beginners! "Business Development Plan," "Profitable Mail Selling Idea," "Pointers Along the Mail Order Trail." Noted mail sales specialist's, three-in-one, 10,000-word treatise shows "how" at home, spare time, small capital. From idea to mailbag. 25c postpaid. Satisfaction guaranteed. Maupin & Maupin, Lafayette 3, Indiana.

**MAKE** Money raising earthworms. Excellent opportunity in this new, amazing business. Write immediately for valuable information. Earthworm Farms Enterprises, Lamoni, Iowa.

**IDEAL** Business stamping metal key protectors, social security plates. Information upon request. General Products, 11 No. Pearl (M), Albany, N. Y.

**START** Home manufacturing business making Cleaning Compounds, Soaps, Insecticides (DDT), Cosmetics, Polishes. No machinery. Literature free. Kemix, Park Ridge, Ill.

**BIG** Money in vending machines. Smallest capital start brings immediate profits that build permanent profitable business. Starting instructions free. Becker Vendors, 105-A Dewey, Brillion, Wisconsin.

**A BIG** Time mail-order business can be started in your spare time at home. No special equipment needed. We tell you how. Graff's Service, 1943 N. 37th St., Milwaukee, Wisconsin.

**POPCORN** Machines, peanut roasters, carameltorn equipment, vending machines, new, used. Northside Sales, Indianola, Iowa.

**EARN** Up to \$480 month part or full time keeping books for small firms. Simplified system. Write Tax-Saver System, Dept. L, Ft. Worth, Texas.

**HIGH** School seniors: Make good money selling our graduation name cards. Biggest commissions! Season starting. Hurry! Craftcards, Box 235(AL), Pittsburgh 30, Penna.

**OWN** A mirror shop! Resilver mirrors. Write for information. John Sprinkle, V60, Marion, Indiana.

**D.D.T.** Insecticides, 95 page book: useful data, formulas; powders, sprays, emulsion, concentrates. \$1.50 postpaid. Inter-American Technical Pubns, 140 West 42 St., New York 18.

**MAKE** Perfumes. Profitable business. Free book tells how. Walter Lawson, 21 Joiner, St. Augustine, Florida.

**BE** Independent. New and used, indoor-outdoor type stamp vending machines. Very reasonable. Christie, 1823 Second Ave. So., Great Falls, Mont.

**START** Your own business! Steady weekly income assured with a route of 5c Asco Hot Nut Dispensers. For full information send 25c in stamps for completely illustrated booklet. Asco Vending Machine Exchange, 55 Branford Street, Dept. PM, Newark 5, New Jersey.

**SELL** Big-profit religious items. Every home a prospect. Send \$1.00 (refundable) for samples to Bella Products Company, 26 East 17th Street, New York 3, N. Y.

**MAKE** Liquid marble, flexible molds, statuary, art goods, novelties, artificial marble flooring. Literature free. Kemico, Park Ridge 50, Ill.



**MANUFACTURE** Colored Lycopodium for florists. Decorate novelties. Make memorial wreaths. Beautiful samples 25c. Lycopodium Foundation, Owasso, St. Paul 8, Minn.

**BECOME** A finance man. Particulars free. George Lenhoff, Lincoln 8, Nebr.

**MECHANICALLY** Inclined men—Own and operate general appliance repair shop. Complete, illustrated course shows you how. Welding, refrigeration, motor repair, how to get business, etc., all phases covered. Free literature. Christy Supply, Dept. 174, 2835 N. Central Ave., Chicago.

**MAIL** Order business at home. Large profits. Interesting work. Write today for free details. G. R. Remson, 158-10 Sanford Ave., Flushing, N. Y.

**OPERATE** Profitable mail order business. Splendid opportunity. For details, write U. S. Specialty Co., Box 13, Patchogue 2, N. Y.

**UNPAINTED** Statuettes and plaques. Perfect models. Free list. Edison, 710 Weiser St., Reading, Penna.

**LIQUID** Marble—Make in any color. Soundproof plastic flooring. Flexible molds. Cast novelties, plaques, statuary. Big money—your own business. Catalog free. Write—Bing Products, 88-A2R Broad Street, Boston 10, Mass.

**OPERATE** Profitable business selling, packaging products under your own name. Lyle A. Products, 5 E. Spaulding, Willoughby, Ohio.

**BECOME** A real estate broker. A profitable lifetime career in one of America's finest professions. Many make fortunes selling real estate. Literature free. Schulte, Box 2983, Houston, Texas.

**GOT** \$24,500 Using schemes from "Schemer" Magazine, Alliance, Ohio. 49th year, \$1.00; 3 samples, 25c.

**CALIFORNIA** Motels pay. For circulars write Frank Dykema, 813 A Gretna Green Way, Los Angeles 24, Calif.

**START** Profitable mail order business. Splendid opportunity. For details write: S. A. Wolf, 148 North Park, Buffalo, N. Y.

**DISTRIBUTORS**—Nut vending machines, nationwide. Acme, 3405 Lisbon, Milwaukee, Wisconsin.

**COPPERIZE** Baby shoes. Complete instructions, tested sales plan. Metalloids, Box 8087, Pittsburgh 16, Penna.

**OPERATE** Profitable mail order business. Write, Walter Service, A-4159 East 112th, Cleveland 5, Ohio.

**ASK** Mid-West Agencies how to start your home mail order business. Successful plan we recommend mailed free. Mid-West Agencies, 114 Highland Ave., Marion, Ind.

**OPERATE** Profitable mail order business. Splendid opportunity. For details, write Lollar, 678 Emmett, Battle Creek, Mich.

**500 MONEYMAKING** Plans—25c. Reimer, X-1119 Chestnut, Saginaw, Michigan.

**WANTED** Unused U. S. postage stamps, small discount. Advance Stamp Company, 24 East 23rd Street, New York.

**START** Profitable mail order business. Tremendous profits. Patrick Service, Box 1322, Cleveland 3, Ohio.

**MEN**, Make regular income collecting and selling us old used spark plugs. Every garage accumulates large amounts. Carl, 1927 Paseo, Kansas City, Mo.

**UPHOLSTERING** Furniture pays. Details dime. Lyle, Box 385-AD, Lombard, Illinois.

**AVAILABLE** After March 15, useful item—75% profit. Territory now available. Sample 10c. Radica Mfg. Co., 6110 S. Washtenaw St., Chicago, Ill.

**EARN** Money with textile painting course. Details. Gundrum, LeRoy, Mich.

**FARM**, Lot, yard can bring you cash. Details free. Johnson, 2062-A East 14th, Brooklyn 29, N. Y.

**OPPORTUNITY** To build fast growing, high grade, business without capital. This plan is used by large business throughout the United States. Address, Roy Vail, La-Grange 6, Indiana.

**FORGE** Ahead—have a business of your own. New instructive, helpful, eye-opening folio tells how. Only ten cents. Clark Enterprises, 125-B West 7th Avenue, Cheyenne, Wyoming.

**\$6000 YEARLY** Possible at home with Presto Rubber Molds which cost as low as 5c each. Make plaques, statues, etc., which glow in the dark. For free sample write today. Presto Company, 1012 N. Marshfield, Chicago 22C, Illinois.

**MAKE** Money by mail—20 home operated, small capital opportunities now open to you. Eye opening literature free. Shook's Mail Mart, 1331 Main Street, Follansbee, W. Va.

**SELL** By mail. Amazing new book tells how. Literature free. M. E. Egan, 205-H-W, Cherry St., Shenandoah, Penna.

**10c BRINGS** Mailorder's fastest dollar puller. Reap rich rewards from record sales. Tremendous cash profits. Harrison, R2, Berrien Springs, Mich.

**FREE** Literature describing many money making plans. Albert Pearson, Box 1182, Milwaukee 1, Wis.

**SUBSTANTIAL** Mail order opportunities. Oldest trade journal in the field shows you how. 54th year. Copy 25c. Veterans Publications, Charleston 1, Illinois.

**MAKE** Big home earnings in uncrowded field casting novelty, utility, scientific objects with Castolite, amazing new liquid casting plastic. Transparent or can be colored. Cast without heat, pressure. Embed real flowers, insects, coins. Saw, drill, carve. Manual tells how. Send \$3.35 for complete 20 project kit including 1 lb. liquid Castolite. Home project instruction manual only 25c. Illustrated folder free. Castolite, Inc., Dept. OC21, Box 211, Kenilworth, Ill.

**101 WAYS** To be your own boss. Details free. American Success Aids, Bellmore, N. Y.

**ACTION**—Big demand for electric appliances. Large source available. Good profits. Rush letter for details. Soltz, Box 303, Silverton, Oregon.

**OPERATE** Profitable mail order business. Splendid opportunity. For details write Cline's Service Agency, 624 State, St. Paul 7, Minn.

**SELL** Names by mail. Collect them at home in spare time. Interesting, profitable. Details free. MacAndrews, Box 351, Calais, Maine.

**100 PAPERS**, You as publisher, \$2.00 monthly. Sample and details 10c. Tes-Co, Wilkes Barre, Penna.

**MAKE** Money at home. Write immediately. Duffy, T56, Covington, Ky.

**FRESH** Mailing list. 2000 mailorder buyers \$7.00, 1000 \$4.00. Guaranteed accurate. H. Schwieger, 8404 W. Chestnut, Wauwatosa 13, Wis.

**\$5000** Yearly possible selling books by mail. Wholesale and retail. Big profits. Free details. Dawsona, Box 20-A, Sta. J, New York.

**PERFUME**—Brilliantine manufacturing business. Little capital. Big profits. Rosa, 907 Adams, Brownsville, Texas.

**FAST-SELLING** Items. Large profits! Velazquez, Box 55, Hamilton Grange, New York 31.

**AMAZING** Inside secrets for making quick cash—local mailorder. Unlimited possibilities! Folder free. Bryden, Box 776M, Columbus 16, Ohio.

**BELTS!** Make'm and make money. No tools! Sample 50c. Artnic Leather, 411 Joseph Ave., Rochester 5, N. Y.

**BUILD** Your home or build your business with concrete brick. Minimum equipment expenditure for production machines and mixers. Reed Corporation, P.O. Box 237A, Three Rivers, Michigan.

**DISTRIBUTORS** Wanted to call on taverns, roadstands, etc., with complete line of five and ten cent nut meats, also boneless herring card. Write Royal Nut and Candy Co., Inc., 1015 Grand Street, Hoboken, N. J.

**SALESMEN**, Distributors, jobbing or on commission. Exclusive line stuffed toys. Call on gift, novelty, furniture stores, etc. Flush Stroller Horse or Rabbit on Wheels. Size 22"x19"x9". Holds 150 lbs. Send for demonstration samples, \$6.50 each (cash in advance) f.o.b. New York City. 16 page catalogue, 50c (free with sample order). Money-back guarantee. Ace Toy Mfg. Co., Toy Dept., 122-130 West 27th St., New York City.

**START** Neighborhood grocery. New ten chapter book written by successful grocer tells you how. Satisfaction guaranteed. \$1.00 postpaid. J. De Smidt, 1250 77th Avenue, Oakland 3, California.

**BECOME** Independent! Rent New York office under your own name, and sell what you have to offer through New York Metropolitan area, world's greatest business center. Rates \$7.30 and \$14.60 yearly. Co-Operative Offices, 126 Lexington Avenue, New York 16.

**MAKE** Your products, details free. Pharmacist, 939 East Euclid, Detroit 11.

**PURE** Rubber moulds (make novelties). No shells. No time to waste. No knowledge required. They are complete—ready for production. Two pennies material makes \$1.00 retail statue. Our mass production saves you 50%. Send for details. Artilliano, 690 North Main Street, Waterbury 26, Conn.

**AIR** Curing liquid latex for flexible molds. Illustrated simple mold making instructions 50c. Advanced instructions \$1.00. Apex Plastic Products, 1915 Lunt, Chicago 26.

**MANUFACTURE** And sell the new 35c deodorant flowers. Cost 7c. Fast repeat. No competition. National Sales & Service, Dept. P. Main Street, Greenville, Penna.

**BE** Wealthy. Get business self-starters. Own homes that pay for themselves. Midco, 67 S. Harris, Columbus 4, Ohio.

**PACKAGE**, Sell amazing cleaners under your name. Samples 25c. Linnell Co., Box 1720A, Cleveland, Ohio.

**SECRETS** Mail order schemes revealed, book crammed with information, 25c. Wholesale sources, formulas, plans. Gilbert, Box 208, Boston 12, Mass.

**BABY** Shoes preserved. Complete instructions. Exclusive rights. M. E. Watson, Bellefontaine, Ohio.

**MAKE** \$100.00 Per week, and more on old Singer sewing machines. Write for circular. Essex Vacuum Shop, 172 Washington St., Newark 2, N. J.

**YOUR** Own business. Sparetime. Ten big profit plans, \$1.00. Fred Quatsak, 1242 Kelton, Pittsburgh 16, Penna.

**START** Your own advertising agency, in spare time at home. Opportunity for big earnings and permanent business. Complete operation revealed. No stock or equipment needed. Folder and proof free. P. Snyder, Box 4907-A, Philadelphia 19, Penna.

**MAIL** Order opportunities. All good money makers. Details free. Aragain Co., 1234-S 88th St., Niagara Falls, N. Y.

**OWN** Your own factory! Start on a shoestring, hold your job. Start at home, in your kitchen or basement, with very little money. See page 270 for details of 15 valuable tested trade secrets that will lead you to success and freedom. Chemical Research Co., 130 W. 42 St., New York.

**METALLIZE** Baby shoes! Learn this money making business from nationally recognized consultant. Get "know how" from outstanding authority! See Kushner ad, page 262.

**MANUFACTURE** Beautiful name-plates, house-numbers, signs. Crabtree, Box 221, Newport News 6, Virginia.

**GOOD** Jobs, business opportunities in foreign trade. Now is the time to start or expand your own business and make profits in this thrilling field. Tremendous possibilities for the resourceful. Our book starts you step-by-step. Gives valuable inside facts. Special section on private and U. S. government jobs abroad. Price \$3.00 postpaid. Return for refund in 7 days if not satisfied. U. S. General Trading Company, 150 Broadway, Room 914, New York.

**OPERATE** Profitable mail order business. Splendid opportunity. For details write Luther Driver, Cortez, Colorado.

**BABY** Shoes preserved. Formulas, instructions. \$1.00. Novelty Bronzing, Box 56, Hyde Park 36, Mass.

**WINDSHIELD** Wiper and fuel pump rebuilding bring big profits. Free particulars. H. & H. Products, P.O. Box 430, East Akron Station, Akron 1, Ohio.

**MAKE** Money at home. Sell by mail. Amazing opportunity. New mailorder books tells how 25c. Money-back guarantee. Robert Hughey, 841-W Lawrence Ave., Chicago 41, Ill.

**MAIL** Order opportunities. Full or spare time. Hundreds of chances. No charge. Postal brings copy. Blackstone Press, Somerville, New Jersey.

**EARTHWORM** Culture. A profitable home industry. Send postcard for free copy of my valuable bulletin on "Successful Earthworm Farming." Thos. J. Barrett, Earthmaster Publications, Dept. 22, Box 488, Roscoe, Calif.

**EVERYBODY** Eats. How to make money in the restaurant business. Illustrated success stories. \$1.00. Prize contest offer included. Luckcock Press, 1047 Irolo Street, Dept. 5-A, Los Angeles 6, California.

**OPERATE** Profitable mailorder business. Free details. Schneider, 1038 Holland, Schenectady, N. Y.

**SUPER** X liquid molding rubber. Sample jar 25c, quart \$3.00, gallon \$10.00. Free sample. W. Wooley, 115-A Donald, Peoria, Ill.

**LEARN** Import—Export! Represent manufacturers! Study at home. Uncrowded field, splendid opportunities, big future. ITP trains you in few weeks. Low tuition. Diploma awarded. Folder free! International Trade Promotion, 246-P, New York 1.



**METALIZE** Baby shoes. Correct modern method. Information, stamp. Universal, Box 1076-A, Peoria, Ill.

**SALESMEN!** Double your money with Presto Plate silverware and jewelry cleaner. Brand new. Fast seller. Every home a prospect. Sample and selling instructions, \$1.00. Details free. Presto Plate Company, 5407-A North Houghton, Portland 3, Ore.

**OWN** A mail-order paper products business. Sell envelopes, tags, bags, boxes, by mail, wholesale. Tremendous demand. Steady profits. No capital necessary. Write Omaha Envelope Service, Dept. 196, 4721 California, Omaha 3, Nebraska.

**FORTUNES** In formulas and trade secrets. Stillman, 555 Kingston Ave., Brooklyn 3, N. Y.

**OPERATE** Profitable mail order business. Full details free. Write Albert Sixsmith, 7129 Cottage Street, Philadelphia 35, Penna.

**MAIL** Order offers increased income, independence, unlimited possibilities. Free literature. Manhattan House, 126-L Lexington, New York 16.

**40 MAIL** Order magazines, ad-sheets and circulars. Opportunity unlimited for 25c. Theodore Gordon, Box 1223, New Haven, Conn.

**OPERATE** Your own independent business without risk. Investigate new arrangement with special setup, free sales helps, profitable merchandise, sales guarantee. Small starting capital. Distributors Group, 5345-B Harper, Chicago 15.

**AGENTS** Wanted—New product. Removes iodine stains instantly. Kemiclean, Box 263, Far Rockaway, N. Y.

**SOAPMAKING.** 25 Pages of easy instructions. 36 formulas. No machinery needed. 50c. C-B, 9111 S. Hoyne, Chicago.

**35 AUTHENTIC** Pennsylvania Dutch designs with color chart 25c. Edison, 710 Weiser St., Reading, Penna.

**CASH** In on building boom. Machine now available to manufacture concrete interlocking building blocks. Quickly made. Easily laid. Territories open. Only financially responsible need reply. Delaware Industries, Muncie, Indiana.

**PLAQUES** Unfinished. List ready Mar. 1. Craft-Way, Box 3447, St. Paul 1, Minn.

**PRESERVE** Beautiful baby shoes at home. Profitable business. Easy, complete instructions one dollar. Talent, 8515 Ellsworth, Detroit 21, Mich.

**BRONZE** Baby shoes! Simple instructions \$1.00. Don Brady, 1618 Sage St., Topeka, Kan.

**LETTERS,** Advertisements, circulars prepared by top flight mail order advertising experts. Surprisingly low cost. John Moran Advertising Agency, Box 104, Wilkes Barre 1, Pennsylvania.

**START** Home plaster novelty business. Amazing course tells how. Literature free. W. Belfort, Engineering Building, Chicago 6.

**UP** To \$10.00 for your old snapshots. The funnier the better. Full particulars and list, 25c. Jolles Printing Co., Box 565, Clinton, Iowa.

**POST** Card mailers wanted. Very profitable. Nation Mailers, 1395 Yosemite, San Jose 11, California.

**SUCCEED** In your own business. Big profit domestic service needed everywhere. We show you how, help you start, furnish everything. Fact-crammed booklet free. Opportunity lifetime. Textile Cleaning Service, Inc., 11106-A So. Longwood Drive, Chicago.

**"KEMO-PLASTIK"**—Amazing new rubber molding liquid. Dries quickly. Easy to apply. Quart \$3.00. Gallon \$6.95. Mold-making instruction included. B. Belfort, Engineering Bldg., Chicago.

**DOLLARS** Daily! Cleared \$1900 in two months. Details. Loeb, 7201-A-3 Montgomery, Cincinnati.

**CARDED** Nuts—Candies (24—10c pkgs.) per card. \$1.10 each. For information, write Mercier Dist. Co., 67 Shipley St., San Francisco, Calif.

**BUILD** Your own independent, fascinating and very profitable business at home, spare, or full time, \$75.00 and upwards weekly easily possible making beautiful brilliant, sparkling novelties and religious figures. Fast sellers through you, salesmen, stores. Quickly learned and few dollars starts you making real money. Successful manufacturer can tell you how and furnish everything. Start small, grow big. Write for full information and "amazing story of my success" at once. Inghram Company, 2845 Sixth Street, Detroit 1, Michigan.

**LEARN** Piano tuning, repairing, at home. Tremendous field! Piano parts, tools furnished. Established 1935. Empire School of Piano Tuning, 606-B East University Ave., Champaign, Ill.

**METALLIZE** Baby shoes. Instructions forwarded. Send \$2. Wonderful business opportunity or hobby. S. Schreiberman, P.O. Box 3576, Philadelphia 22, Penna.

**TRAIN** Yourself in crime detection and finger printing. Literature free. Perkins Publications, 300-B Brandeis Theatre Bldg., Omaha, Nebraska.

**PROFITABLE** Home mail order business, details. Weed, 772 Cleveland Avenue, Bridgeport 4, Conn.

**\$500 MONTHLY** By mail. Free particulars. Murray's, 196 Circle, Forestville, Conn.

**\$2000.00 CLEAR** Profit in three months, exclusive in your county, reference required, you handle your own money. Details free. C. J. Maguire, Cannon Ave., Lansdale, Penna.

**ABSOLUTELY!** Positively something new never before advertised, hot as a red fox everywhere, Corn Chips, crunchy, crisp with that popcorn flavor. Generous sample and information \$1.00. Ward Products, Capitol Heights, Md.

**THOUSANDS** Business Opportunities. Magic Valley South Texas. Most prosperous, fastest growing area, great southwest. Will represent you. Questions answered, illustrated literature, \$1.00. McCants, Weslaco, Texas.

**LAWN** Mower grinder, easily constructed! Plans; repair course, \$1.50. Mowers, Janesville, Wis.

**SUPER** Balloons 42" size. 19c each wholesale. These retail to 59c each. Sell fast anywhere. Ellswood Balloon Headquarters, La Junta, Colorado.

**YOUR** Own business. Big profits, very small capital. National organization teaches, helps, supplies everything. Interesting service business. Big demand everywhere. American, 211N. 7th St., St. Louis 1, Mo.

**GREAT** Opportunities and profits in mail order business at home. Free literature. F. Webster, Box 19720, Hollywood, Calif.

**MANUFACTURE** Cleansing cream. Big profits. Formula and complete business setup \$5.00. L. Luft, P.O. Box 921, Chicago 90, Ill.

**X-RAY** Mirrors used by hotels, nightclubs, police. Process using window glass, common chemicals, \$1.00. Modern Devices, Hartford Terrace, Boston 25, Massachusetts.

**START** Selling costume jewelry \$2.00-\$5.00. Sellers send for \$25.00-\$50.00 assortment. Double your investment. Manufacturers, 264 5th Ave., New York.

**MONEY-MAKING** Opportunities, exclusive supply sources, personal guidance guaranteed. For complete details, remit 25c. Winklepost, Box 517, Grand Central Annex, New York 17.

**PROFITABLE** Concrete block business. Details free. Wm. Horne, 206 West Wilder, Tampa 3, Florida.

**MEN—Women—**"Everybody likes candy." Learn to manufacture professionally at home. (Our 38th year). Ragsdale Candies, Dept. 4, East Orange, N. J.

**BUILD** Your own mail order business. Free literature. Hamilton Service, Box 865-A, Waterbury 87, Conn.

**POWERFUL** Program for achieving personal and business success; works without expense or guesswork. Applicable for you. Free literature. Menders, 15857-A Coram Ave., Detroit 5, Michigan.

**MONEY** Making opportunities. Tested plans, ideas galore for successful operation mail order business. Full or part time. Details free. Levand, 6410 Kenwood, Chicago 37.

**RUBBER** Molds, liquid rubber, statuary plaster, kits for beginners. Free instructions. "Everything for the plastercrafter." Blue Rapids Supply, Blue Rapids, Kansas.

**MAKE** Strange plastic—1c pound. Makes durable, attractive floors, walls. Build with waste. Save half. Bays Laboratory, Oklahoma City 9.

**HANDYMEN—**Earn money home operating Community "Fix-It" Shop. Write Stafford, 708 Rawlings, Carbondale, Ill.

**DO** It with sea shells. Big profits. Werts, 1429 - 56th Avenue, Oakland 3, Calif.

**EXCLUSIVE** Territory to men who are capable of organizing a sales force to cover a state or several counties. Must have contacts with wholesale houses, jobbers, etc. Wonder Plastic Linoleum Finish and Wonder Plastic Wood Finish. Write Wonder Plastic Products Company, 2609 S. Kedvale Avenue, Chicago 23, Illinois.

**EVERYBODY** Eats. How to make money in the restaurant business. Illustrated success stories. \$1.00 postpaid. Luckoff Press, 1047 Irolo Street, Los Angeles 6, Calif., Dept. 5-A.

**MAIL** Order business—Your opportunity. Start small—Grow big. Literature free. C-Belfort, Engineering Building, Chicago 6.

**YOUR** Town is ripe for a profitable Collection Agency. \$5,000 first year easily possible. We train you, coach you, get you started and help develop your business. Send \$1.00 for Starter Course, or ask for facts. American Collection Associates, 226 State Street, Schenectady 5, New York.

**WOULD** You pay 3%—first \$350 made? Color-illustrated book "505 Odd, Successful Enterprises" free! Some offer occasional "day off." Work home. Expect something odd! Pacific, San Clemente, Calif.

**\$5,000 YEARLY** Possible in spare time selling by mail with expert assistance. Small investment. Details free. Diafas, 109 Mt. Hope, Dover 2, New Jersey.

**COMPLETE** Mail selling setups built-to-order, for financially responsible mail order aspirants by leading mail order association. Descriptive booklet free! National Mail Dealers' Association, 46-P King, Dorchester, Mass.

**OPERATE** Own wholesale candy business. Sell stores. Free list. Information. Sally Dee Candies, 142-Sims, Newport, R.I.

**YOUR** Own business metallizing baby shoes. Complete course \$3.50. Technical Aid and Supply Co., P.O. Box 668, Los Angeles 53, Calif.

**CASTONE—**Hardest coldcasting composition on earth. Any mold; white and colors; 10 pounds \$2.00. Hundred \$6.00. New Era, 1321-N Belmont, Chicago.

**PLASTIC—**Liquid glass, china glazes, protects any plaster object. Pint, \$1.00; gallon \$3.00. New Era, 1321N Belmont, Chicago.

**RUBBER-AIRFLEX** Liquid, makes molds "overnight." Pint \$1.25; gallon \$7.00 with instructions. New Era Products, 1321-N Belmont, Chicago.

**LIQUID** Rubber for molds. Gal. \$10.00. Midwest Supply, Paullina, Iowa.

**SIGNS** Made easily. Instructions and ten sets modern alphabets, numerals, patterns. Sizes up to eight inches. All for \$1.00. Co-operative Business, 7 West Madison, Chicago, (2).

**BOOKKEEPERS—**Operate your own simplified "Dollar-A-Week" bookkeeping and tax service. Full or spare time. Details free. Ellis, Box 200, Cedar Grove, North Carolina.

**IF** You would like to make \$5,000 yearly in an easily learned office business of your own, send for free details immediately. G. H. Cole, Pres., Syracuse 2, New York.

**SELL** By mail, 25 plans 25 cents. Rex Newton, Loretto, Tenn.

**LOOKING** For new opportunities? Mail order and others? Get "The Practical Idea." Write: Veteran, Charleston 6, Illinois.

**EARN** \$100 Per day profit with Master Concrete Tile Machine. Materials and markets everywhere. Descriptive literature free. Concrete Machinery Company, Box #2248-B, Hickory, N. C.

**MAIL** Order business course shows you how to make money, spare or fulltime. Teaches professional mail order technique—not penny-snatching schemes. Fascinating 100-page illustrated success-catalog free! Write, Nelson Company, Dept. 4-02, Chicago 5.

**BE** First with newest items—New Products Bulletin Service brings listing 100 newest products. Tells where to get them long before they're on open market. Sample bulletin only \$1.00, details free. American Enterprises, Box 595-P, Grand Central Station, New York 17.

**\$46** FROM Square foot plywood. Jigsaw necessary. Write, Woodarts, Bridgewater, Mass.

**MAKE** Flexible molds! Few cents each! Cast plaques, novelties, bookends! Free sample! H. Tooker, Hamilton 44, Ohio.

**PLASTIC** Discs, shapes, metal findings, wholesale, free catalog. "Secors," Bradenton Beach, Florida.

**RENT** Amidon scaffolds to contractors. Amidon Engineering Co., Elyria, Ohio.

**ELITE** Collection contains 137 practical money-making plans; local and mail order. New edition. Particulars free. Elite Co., 220 Grand St., New York 13.

**SELL** Lamswool lined slippers, men's, women's and children's. Sensational profits. Sell from illustrated catalog or samples. Write for full details today. Shepherd Products Company, Worcester, Massachusetts.



137 WAYS To make money, in home or office, business of your own. Full particulars free. Elite Co., 220 Grand St., New York 13.

**OPERATE** Profitable home business. Levine's, Box 15-X, Boulevard Station, New York 59, N. Y.

**ARE You "fed up" working for bosses?** Own permanent mail order business. Crompton, Box 2567, Hollywood 28, Calif.

**BRONZING** And metallizing baby shoes! Gold, silver, copper, nickel, bronze, pearl, ivory, and "luminous glow" colors! Big profits! New field! Details free! Write R. O. Morgan, Box 349, Long Beach 2, Calif.

**\$15 TO \$20 Daily** if you can walk, talk, read and write. Elcom Service, Box 910, Tampa 1, Florida.

**VENDING Machines.** Be independent. Own a big money business operating coin machines. Earn as high as \$7.00 weekly on machine costing as low as \$11.75 each. Car and experience unnecessary. Routes can be operated either in your spare or full time. Act quickly. Write for details and catalogue showing our amusement games, postage machines, candy-gum-nut vendor and scales. Parkway Machine Co., 623J W. North Ave., Baltimore 17, Md.

**WHAT Sells—How to start.** 10c places your name many mailing lists. Zech, 7532 Buist, Philadelphia 42.

**"BULK Vending"** machines make easy steady income. Have you considered or would you like to learn this fascinating business. Post card brings free booklet. Vending, 1051 "L" St., San Bernardino, Calif.

**ANYONE** Can learn. Tune pianos by my system. \$1 2 lessons and chart. Oscar Fylling, 841 Robinson, Oroville, Calif.

**BRAND** New proposition. Extra money spare time. No selling. No canvassing. Absolutely different. You do it. Full particulars free. R. H. Callaway Specialty Co., P.O. Box 341, Fort Smith, Ark.

**LEARN** Shell jewelry manufacturing. No tools or experience needed. Learn-earn within a week! Complete home instruction course, beautifully photographed, shows how to make 75 styles of pins, earrings, brooches, hair ornaments, dress clips, necklaces, bracelets, candy dishes, wall plaques, ash trays, candle sticks, etc. Includes pearlizing, golding, dyeing, luminous methods. Illustrates 55 species of sea shells. Lists hundreds of raw materials with wholesale prices. Complete course \$1.00, postpaid. Beginner's kit, \$3.00. (\$3.50 in Canada). House of Gifts, Box 4550-RF, Coral Gables, Fla.

**EARN \$2000** Or more during March 15th tax period. Be a tax consultant. Bookkeepers, etc. can qualify quickly. Details free. Edw. H. Smith, 17 Rockland Ave., Yonkers, N. Y.

**\$565.00 PROFIT** From every \$15.00 invested. Standard Service System, La Grange 1, Indiana.

**QUICK Money!** "Repairing car batteries." At home! Easy too! Write. Batteryman, Grand Junction 5, Colorado.

**"HOW To Make Simple Molds and Plaster Plaques."** Profitable business or hobby! Instructive booklet 25c. Plastercraft Supply Company, 1406 East 43rd Street, Cleveland 3, Ohio.

**SELL** By mail!—Books and novelties! 35 different items! Large profits! Catalog free! Elco, 432 N. Wells, Chicago 10.

**ORGANIZE** Wholesale—retail—popcorn, potato chip shops. We sell beginner's outfits. Long-Eakins, 4760 Hi St., Springfield, Ohio.

**MAKE** Extra money now. Build to financial independence. Sell office supplies by mail from your home. I tell you how. Jo Troutwine, 8654 S.W. Ninth, Portland 1, Oregon.

**OPERATE** Profitable home business selling merchandise by mail. Past sellers. Large profits. Powell Service, 5713 Euclid, Cleveland 3, Ohio.

**START** Home business making statuary, plaques, novelties, garden furniture, artificial marble flooring, liquid marble. Make your own flexible molds. Amazing profits. Folder free. Creative Publishers, Box 236-L, Winnetka, Illinois.

**COLOR** Concrete with chemicals. Make Hollywood style pottery; home or shop. Marbling, water-paints, 10c brings sample, pictures. Hollywood Cementcraft, 8527 Wonderland, Hollywood 46, Calif.

**INTERESTED** In immediate mail order cash? Read "Advance"—Voice of mail order. Offers money-making opportunities. Personal guidance and benefits to all. Sample copy 25c. American Mail Trade Association, 313 East 21st Street, Dept. 400, New York 10, N. Y.

**WHY** Job worry? Learn electroplating. Highly paid, uncrowded, interesting business. Gold, silver, nickel, chromium, etc. Send postcard for free booklet and proof. Plater Hyde, Dept. MC, P.O. Box 176, National City, Calif.

**COPUBLISH** Leading m.o. paper. Latest copy Mail Sale Advertiser and proposition, commemorative stamp. Vanroy Shirk, Lebanon, Penna.

**START** Profitable mail order business. PMT lists new propositions available; products, sources, accurate methods. Covers ad writing, letter logic, trade information. Send 10c for copy and get free instruction folio offer. Progressive Magazine, Sheboygan, Wisconsin.

**HOW** And where to obtain capital. Fully explained. Particulars free. Star Service, Wapakoneta, Ohio.

**LIQUID** Rubber, for making flexible molds, literature and sample free. H. Chaney, 1130 E. 16th St., Jacksonville 6, Fla.

**1946 GIGANTIC** Directory of opportunities, advertisers supplies, sources, trade information, mail order ideas, products, wholesalers, valuable tips—just published! Descriptive literature free. Wilkin & Co., 118-AP East Main St., Hillsboro, Ohio.

**BIG** Paying jobs in welding. Complete welding lessons and reference books, 516 pages, 41 lessons, \$2.00 copy. Money-back guarantee. Hobartweid, Box M-1065, Troy, Ohio.

**START** A clock shop. Fascinating, easily learned profitable business requiring little capital. We teach you how to repair all kinds of clocks. Information free. Houston Clock Shop, P.O. Box 5086A, Houston 12, Texas.

**SYNTHETIC** Latex with Neoprene base for making flexible molds! Quick drying! Safe! For home, classroom, or industry. Quart \$2.00. Gallon \$5.95. Full instructions. Plastercraft Supply Company, 1406 East 43rd Street, Cleveland 3, Ohio.

**200 MONEY** Making deals. Plans. Rare formulas. Schemes. Folio free. Formico Mart, Box 572, Dayton, Ohio.

**RAISING** Canaries pays good profits. Valuable bird book—"Its Care, Breeding and Training." Price \$1.00. American Canary, 2839 N. Halsted, Chicago.

**SPECIALTY** Manufacturing, the big money business that can be operated anywhere, start on a very small capital; we supply dependable formulas and complete instructions; get interesting free booklet, "Money-making Opportunities in Specialty Manufacturing." Howard Robinson, Ph.G., 1300-A South Ohio Street, Sedalia, Mo.

**MINK** Raising, information free. Complete. Lake Superior Mink Farm, Superior, EE, Wisconsin.

**TADPOLES** Make frogs, tremendous demand. Both make you money. 25c brings tell-how information. Chariton Corporation, Century Building, Chicago 4.

**MAKE "DDT"** Products. My ten master formulas show how. Literature free. Howard Robinson, Ph. G., 1302-A So. Ohio, Sedalia, Missouri.

**COLORGLAZED** Concrete pottery made without molds. New, low cost, patented method. Cemetery products, novelties, tiles, floors, etc. Basement leaksealing. Other money-making projects. Booklet, details free. Men only. National Potteries Company, Fergus Falls, Minnesota.

**RECAST** Old batteries into new. Latest achievements. Battery Laboratories, Minneapolis.

**START** Mailorder bookshop—Everything furnished; publisher cooperation. 25c brings booklet, exclusive setup, samples, exciting ideas. General Publications, Ossining, N. Y.

**\$25 WEEKLY** Working two hours daily. No canvassing. No manufacturing. Lycke, Box 2471, Cleveland 12, Ohio.

**BRUSH** Plating outfits connect to a battery. No tanks necessary. Good paying business at home plating autoparts, bathroom fixtures, bicycles, reflectors, silvering mirrors. No shop or experience required. Outfits furnished. Free booklet. Gunmetal Co., Ave. H, Decatur, Ill.

**LATEX** For making flexible rubber molds. Thoroughly tested. No shrinkage. Complete instructions with each order. Stoneham Rubber Co., Box 244, Stoneham 80, Mass.

**RUBBER** Moulds for casting novelties. Latex for making moulds. Use thoroughly tested and approved products. Eastern Latex Laboratories, Box 153, Mattapan 26, Mass.

**OPERATE** profitable mail order business. Splendid opportunity. For details write Albert Taves, Zolfo Springs, Fla.

**50 ALL** Different magazine and ad sheets, 25c. W. E. Martin, Bassett, Va.

**YOUR** Backyard hobbies can pay off illustrated true stories of big business from backyard hobbies. \$1.00 postpaid. Luckock Press, 1047 Irolo Street, Los Angeles 6, Calif., Dept. 6-A.

## MONEYMAKING OPPORTUNITIES

**MEN—Women!** \$6.60 puts you in business! Sell Vermont maple sugar! Ration free! Sells on sight! No competition! Repeat orders galore! Dozen fancy boxes postpaid \$6.60—set own retail prices! Order today! Eulalia Turner, Poultney, Vermont.

**INVESTIGATE** Mail selling! What's the one best thing to sell, happily, honestly, profitably? We know! Get free particulars, free samples. What-To-Do Shop, Box 1082, Tacoma, Wash.

**SHELLCRAFT** Instructions free! Make beautiful seashell jewelry! Wholesale catalogue of complete line shells! Plastic discs! Animal shapes! Pinbacks! Earrings! Cameos! Etc. (Buy direct.) Pace's, Box 279, Bradenton, Florida.

**MAKE** Money statuizing baby shoes. Free details. Schauder's, Dept. "F," Shawano, Wisconsin.

**"LUMINOUS** Paint." Resilvering Mirror formulas 25c each. "Soap Substitute Formulas" \$1.00. Ideal Service, 300, Park Ridge, Ill.

**START** Your own business! Big money manufacturing novelties, plaques, statuary. Free catalog. Write Bing Products, 88-A25 Broad Street, Boston 10, Mass.

**MAIL** Opportunities, descriptive circulars 10c. Robbins, 487-A Shiloh Dr., Dayton 7, Ohio.

**EARN** Money spare time mailing circulars for mail dealers. Pioneer, P-404, Yonkers 1, N. Y.

**START** Make money, spare time. Experience not essential. Free details. Friendly, 17 South Penn Avenue, Philadelphia 11, Penna.

**BIG** Mail including mail order magazines 10c. Mallo, 767-PM Leith, Flint 5, Mich.

**LADIES,** Want independent income? Write for particulars about The Very Thing to do. No selling. Spare time work. West Agency, Box 2115, Pueblo, Colo.

**FOLIO:** "How to Sell by Mail." 25 starting offers, 10c. Baker, Fountain City 2, Tennessee.

**TRAVEL** Anywhere or locate permanently. Earn \$85.00 per week up. Be your own boss. No experience necessary. Less than \$5.00 investment required. Literature free. Ralph Vail, La Grange 1, Indiana.

**FREE** Details, moneymaking opportunities. Supply sources. Neiman, 1136 Robeson, Reading, Pennsylvania.

**WHOLESALE** Anything imaginable. New guaranteed list 25c. Refundable. Lasalle Novelties, Box 2172, Waterloo, Iowa.

**OWN** A mirror shop! Resilver mirrors. Write for information. John Sprinkle, V55, Marion, Indiana.

**FINANCIAL** Education, is the secret of wealth. Postcard brings descriptive information free. E. Kaib, Gen. P.O. Box 553, New York 1, N. Y.

**THOUSANDS** Articles wholesale. "Supply Source Directory" 10c. Ideal Service, Park Ridge 40, Illinois.

**START** A home business in spare time. Make extra money. Experience not necessary. Literature free. Lloyd Linde, 14147 School, Chicago 27.

**HOME** Mail order business, spare or full time. Good profits. Details free. Thomason's, Minneapolis, Minnesota.

**"FIFTY PLANS"** for profitable, home-operated mail business. Details free. Lakeside Publishers, Detroit 15, Mich.

**\$1,000 MONTHLY** OK? Lifetime, legitimate business. Hundreds of satisfied customers, men and women. Complete details \$1.00. Proven success. 511 Frederick, San Francisco.

**NAME** Lists! Opportunity seekers, ministers, housewives, astrology, farm women. Other lists. Trial 300—\$1.00—25c. J. D. Pinkerton, Siloam Springs, Arkansas.

**PUBLISH** Magazine! Sample, plan, 25c. Thomas, Drawer 1806, Providence 1, R. I.

**EARN** Up to \$5 hour with magic stone plastic flooring novelty casting material. Palmer Co., Station A, Berkeley, Calif.

**NEW** Profitable mail order specialty. Pier, 718 Main, Dubuque, Iowa.

**137 TESTED** Money making plans, local, mail order. Start anywhere. Details free. Useful Service, 3702-A West Austin, Seattle 6, Wash.



**WIN Money** on contests advertised in every magazine and on radio. General Contest Magazine, published monthly, gives hundreds of tips. Lists current contests and rules. Sample 25c. General Contests, 1609 1/2 East 5th, Duluth, Minn.

**MAKE More money** in your own factory! Start at home in spare time, work hard, and others will be punching your time-clock! See page 270 for details of 15 valuable tested trade secrets, easy to make, easy to sell. Chemical Research Co., 130 W. 42 St., New York.

**THOUSANDS Articles** wholesale—Directory, 10c coin. National, 378D Hooper Street, Brooklyn 11, New York.

**HAVE Your own business**, plenty of it! Opportunities galore for you! Spare, full time; local, mail order. New magazine shows how! Copy, 25c—six issues, \$1.00. "Opportunities Preferred," 46-B King, Dorchester, Mass.

**REALTY Salesman**, how to buy, sell farms, properties, business. Covers every angle of salesmanship. Book 50c. Free list unusual books. Mell Specialties, Kerrick, Minn.

**ESTABLISH Pleasant**, honorable, money making business. Home, interesting, profitable. Get money in advance. Write, Crafts, 15888 Santa Rosa, Detroit, Mich.

**UNPAINTED Plaques** and statues 1c up. Variety of samples \$1.00. Free list. Get an oil burner free for introduction. Henri's Industries, 1141 Manhattan Ave., Brooklyn 22, N. Y.

**YOUR Backyard hobbies** can pay off. Illustrated true stories of big business from backyard hobbies, \$1.00. Prize contest offer included. Luckock Press, 1047 Irolo Street, Dept. 6-A, Los Angeles 6, Calif.

**I MAKE Big money** in the mail-order business. You can do the same at home with my copyrighted system. Write me. I'll tell you how. F. Little, Box 8, Glenshaw, Penna.

**BEST Tested** Money-makers, 68 page book, 25c postpaid. Business secrets, formulas, wholesale supply, sources galore. Book has no ads, meat only. Money back if dissatisfied. Write today, now. American Enterprises, Box 595, Grand Central Station, New York 17.

**GET Dollar orders** by mail. Keep 90c of each dollar. Easy, pleasant home business. Few dollars starts you. Start now. Details free. Roy H. Davidson, Box N640 Nots, Inokern 3, Calif.

**UNPAINTED Figurines**, plaques. List, Progress Company, 4033 Chowen, Minneapolis 10, Minn.

**\$25 WEEKLY** Working two hours daily. No canvassing or manufacturing. Lycke, Box 2471, Cleveland 12, Ohio.

**WHOLESALE Catalog**, directory, 10c. Stafford Sales, Box 5211, Indianapolis 1, Indiana.

**WOULD You pay 3%**—first \$350 made? Color-illustrated book "505 Odd Successful Enterprises" free! Proven! Work at home, office. Expect something odd! Pacific, San Clemente, Calif.

**SEWING Machine** repairs make big money lifetime. Start neighborhood shop today. Our course repairs all makes. \$1.98 postpaid. Serviceman, Hamilton 9, Ohio.

**BUILD Neon signs** and neon lighting. Easy to learn. Very small capital required. McMaster Sign Co., 730 State St., Bellingham, Wash.

**EARN Up to \$2,000 year**, inventing simple items for special cash markets. Ideas only. No patents. Hendrickson, Argyle (7), Wisconsin.

**THERE'S Big money** in junk," and repairing batteries. Write, Batteryman, Grand Junction 5, Colorado.

**EARN Money** evenings, copying and duplicating comic cartoons for advertisers. Adservice, Argyle (1), Wisconsin.

**EARN Money** at home! Thousands do! "Home Worker Magazine" tells how. Sample, 25c (coin). Six issues, \$1.00. Arthur Sizemore, Pub., Box 870-M, St. Petersburg, Fla.

**\$246.50 MAKING** Unusual secret device without skill, machinery, from former war material costing \$1.50! Simple, baffling invention, unbelievably profitable! Illustrated proofs free. Rolls Enterprises, 115-D West 16th, New York 11.

**EARN While you learn** clock repairing. With our method your income can start immediately. Write Akron Clock Clinic, 964 Wye Drive, Akron 3, Ohio.

**LEARN Battery** repairing, rebuilding. Engineer offers money making methods. Battery Bureau, 2225 North 44th St., Milwaukee, Wis.

**EARN Money** at home—steady income. Write Successful Income Builders, 508-A, Hollywood 28, California.

**LEARN Metascience**. Remarkable drugless healing. No manipulation. No apparatus. Unbelievable simplicity and results. Inexpensive correspondence course. Write Metascience, De Land, Florida.

**200 MONEY Making** deals, plans, rare formulas. Schemes. Folio free. Formico-Eng., Box 572, Dayton, Ohio.

**FORTIFY The future!** Start own business; home, office. Booklet describing "Collection of 137 Tested Plans" free. Elite Co., 220-A Grand St., New York 13.

**PUBLISH Your own magazine**. Hand-size 52 page format, well edited, illustrated. Cost low as \$1.00 month. Brings you prestige, profits. 25c brings sample. details. National, Ord. Nebr.

#### FORMULAS, PLANS, ETC.

**21 POPCORN**, Candy apple, etc. formulas. All money-makers. \$1.00. We can supply equipment. Concession Supply Co., Dept. "A," Box 133 Sta. "B," Toledo, O.

**BRUSHLESS Shave cream**. Equal to advertised brands. Easily made from available materials. Guaranteed formula. Instructions \$1.00. Wayne Laboratories, 1116 West Berry Street, Fort Wayne 2, Indiana.

**MANUFACTURE Cleaners**, soaps, polishes, flavors, cosmetics. Literature free. Kemico, Park Ridge 16, Illinois.

**GRIFFOIL**. Inexpensive and simple to mix. Peps up your motor, saves gas, oil and rings. Valves will not stick. Formula 50 cents. Griffoil, 1010 West 4th North Street, Salt Lake City 3, Utah.

**FIREWORKS**. Twenty formulas, one dollar. Pyrotechnics, 215 West Haskell, Tulsa, Oklahoma.

**BIG Money** making honey. \$1.00. S. Summerville, Hazel, Butler, Penna.

**FROZEN Custard formula**. Very best money maker. All flavors 5 dollars for full instructions. B. C. Stroud, Tallmadge, Ohio.

**THREE Amazing formulas**. How to make magic tinning fluid, how to weld aluminum and die-cast. \$1.00 each or 3 for \$2.00. New Trix Formulas, Box 71, La Grange, Illinois.

**MAKE Toilet**, laundry and liquid soap, 7 formulas \$1. M. Elsbury, 717 N. Dearborn, Chicago 10.

**FORMULAS—Modern**, practical. Consultation, duplicating, research. Moon, 604 Broadway, Fulton, N. Y.

**WASHING Fluid** made at home with crock, one ingredient and water. Formula, labels \$1.00. Melvin Allen, 506 Erin Street, Pittsburgh 19, Penna.

**15 TRADE Secrets** that cost millions to develop and test—yours at low cost. You start your own business in spare time at home. Easy to make, easy to sell. See page 270 for details. Chemical Research Co., 130 W. 42 St., New York.

**HOW To make liquid soap**. Amazing formula \$1.00. New Trix Formulas, Box 71, La Grange, Illinois.

**ROOFING 100%** Fireproof, low cost, lasts like slate. Insulates better. Apply like plaster. Formula \$1. Rav Roofing, Box 98, New Hyde Park, New York.

**LARGE Formula** catalog. Valuable information 10c. Refunded. Obermeyer's, 358 Uneeda, Fond du Lac, Wis.

**10,000 FORMULAS** And trade secrets. Free literature. Stillman, 555 Kingston Ave., Brooklyn 3, N. Y.

**NEED Chemists?** Formulas? Analyses? Products duplicated, improved? Consulting Scientific Company, Swarthmore, Pennsylvania.

**REAL Manufacturing formulas**. Lists free. Cummings, Chemist, Gordon Ave., Syracuse 4, N. Y.

**FORMULAS—Latest**, best. Analysis. Giant formula catalog and chemical instruction sheet 10c. Refunded first order. Belfort, Engineering Building, Chicago 6.

#### PLASTICS

**PLEXIGLAS Sheets** .1"x12"x12" 78c, 12"x15" 96c; 1/8"x11 1/2"x12" 98c, 10"x12" 84c, 13"x16 3/4" \$1.60. Ten colors in 12" rod assortment one fluorescent \$4.00, 6" o.d. x 1/4" wall x 12" length Plexiglas cylinders—\$1.60. Julian Rhodes Muench Co., 1527 W. Alabama, Houston 6, Texas.

**PLEXIGLAS Masked sheets** 12"x12"—1/16"—\$1.00, 1/8"—\$1.25, 3/16"—\$1.55; 1/4"—\$1.85. Include 10% postage. Dyes, rods, cements, shells, buffing compounds, jewelry findings, tools. Free listings. Craft Plastics, Box 129-P, Somerville, New Jersey.

**MAKE Your own plastic lamps** ridiculously low prices. Send for free illustrated catalog of ready to assemble kits. Marcoy Plastics, P.O. Box 1514, Tacoma, Washington.

**NEW Liquid plastic**. Clear, colors. Cast without heat. Embed flowers, insects, coins. Saw, drill, carve. Manual tells how. Send \$3.35 for complete 20 project kit including one pound liquid Castolite. Castolite, Dept. C21, Box 211, Kenilworth, Ill.

**TEN Marvelous** guaranteed plastics projects. 50c. Plasticplan Co., Box 181, Cincinnati 1, Ohio.

**GUARANTEED**: We are America's lowest priced plastic supply house. Write for free price lists. Allcraft Products, Hempstead, New York.

**BEAUTIFY Your plastic novelties** with color. Get acquainted, send for 5 different brilliant concentrated plastic dye samples. 25c postpaid. Tibet Products, Box 415, Summit, N. J.

**KITS: \$1.50 Each**, Plexiglas tie-rack 18", 5"x7" picture frame, or bud vase. Free gift with each kit. Heah Mfg. Co., 5115 N. Neenah Ave., Chicago 31, Ill.

**PLASTICS**, Sheets, rods, tubes. Free list. Swiss music units \$3.50. Plastic Supply Co., 2618 St. Louis Ave., St. Louis 6, Mo.

**PLASTICS**, Accessories from "one-stop" store. Plexiglas, Lucite, Cellulose Acetate for hobbies, money-making opportunities. Sheets, rods, tubes, clear or colored. Full range of sizes. Cements, dyes, polishing compounds, buffs. Send stamp for free price list, also details. Burgess Vibro-Tool, Handee Moto-Tool, Plasticator Injection Molding Machine, molds novelties, toys, gifts. Plastic Parts & Sales, 1157 S. Kingshighway, Dept. H-2, St. Louis 10, Mo.

**FORMALIN** Quick setting liquid plastic kit complete with price list \$3.00 f.o.b. Formalin Works, Box 199, Romeo, Michigan.

**PLASTIC Sets!** Build streamlined HO gauge trains from sparkling acetate plastic. Prepaid. Large \$4.95, small \$1.69. Wm. Trumpler Co., Media, Penna.

**HOME Crafters** plastic formula, moulding instructions \$1.00. Box 84 Station K, Toronto, Canada.

**LUCITE** Sheets, rods, dyes, cement cheap; free price list. Thomas Cavaliere, 2141 So. Beechwood St., Philadelphia 45, Penna.

**LUCITE—Catalog**, special. Mid-West Plastic, 1717 No. 68, Omaha 4, Nebr.

**LEARN At home**, "Working With Plastics." Full information on sheets, blocks, rods, tubes. Designing, tooling, bending, polishing, etc. \$1.25 postpaid. Money back guarantee—"Plastic Hobby Kit": 2 lbs. Lucite and Plexiglas, 1 bottle cement, 2 bottles plastic dye (red and green). Full instructions. Only \$3.00 postpaid, or c.o.d. plus charges. Modern Technical Book Company, Dept. MMC, 55 West 42nd St., New York 18, N. Y.

**PLASTIC Injection** molding machines, tenite pellets, plexiglas, dyes, cements, shellcraft kits, molding sets, polystyrene rods, low prices; free literature. G. Baker Company, River Edge, New Jersey.

**PLASTICS—Supplies**. Kits, \$3.00; \$5.00; \$8.00. Internal carving drill. List. Plastmet Sales & Engineering, 4648 Shirley Place, St. Louis 15, Mo.

**MONEY In plastics!** Lucite plastic hobby kit. 2 pounds Lucite material, coloring dye, cement. Instructions. Send \$2.50 (plus 40c express charges, total \$2.90) to Plastic Specialty Co. (Dept. M), 127 East 28th St., New York City. Also Swiss Music Movements, \$3.50 (operatic, popular, ballad tunes, but no specific selection). Full line of plastic materials.

**NEW 10,000 Word Plastics Manual** tells how to fabricate, weld and form latest plastic materials in home work shop. Many suggestions for making jewelry, novelties, other saleable items. Written by leading plastics engineer. Send 25c, stamps or coin. House Beautiful Plastics, Dept. BC3, 5534 West Harrison St., Chicago 44, Ill.

**MAKE Plastic novelties** with Hollywood kit containing 2 lbs. of Lucite and Plexiglas; 3 colors of dye, bottle of cement and complete instructions. Postpaid \$3.25. Hollywood Items Co., Dept. PM, Box 1151, Hollywood 28, Calif.

**PLASTICS!**—10c Brings our complete 1947 plastics catalog containing many fascinating ideas! Kits, bulk assortments. Profitable full line of plastics. Details about our national contest. Wins cash prizes. Write. Belco Plastics, Box 70, Mt. Vernon, N.Y.

**UNPAINTED Plaster plaques**, send \$1 for three attractive vegetable or fruit plaques. B. Kirkup, 11 Murray Ave., Port Washington, New York.



**PLEXIGLAS**—Everything for the plastic craftsman. Free listings. Novalt Plastic, P.O. Box 106, Brooklyn 19, N. Y.

**PLASTICS**, Material and supplies. Information folio, list free. Art Plastics of Calif., 8127 East 14th St., Oakland 3, Calif.

**PLEXIGLAS** Lucite slashed, free listings. Douglas Home Craftsman, Dept. M, Stamford, Conn.

**MAKE** Money assembling our pre-fabricated plastic kits. Sample kit 50c. Catalog free. Fabros, Box 156, Station F-1, Buffalo 12, N. Y.

### CHEMISTRY

**CHEMICALS**, Formulas, apparatus, any quantity. Catalogue 5c. Helett Products, 1305 Sheridan Ave., 56, New York.

**THE** House of Winn, home of supplies for amateur chemists. See Winn's New Idea chemical kits and apparatus outfits for home experimenting. Send 10c for retail catalog. Established 1931. John H. Winn, Dept. 503, 124 West 23rd St., New York 11, N. Y.

**CHEMICALS**—LAB. Supplies. New catalogue 10c. Mel-Glo Chemical Co., 258 Fourth Avenue, Brooklyn 15, N. Y.

**HANDBOOK** For chemical experimenters, illustrated, hundreds of experiments, 50c. Experiment booklet 15c. Supply catalogue 5c. Reading Scientific Company, Reading, Penna.

**APPARATUS**, Chemicals, ounce quantities, catalog 5c. Fleischer's Laboratories, Everett 49, Mass.

**CHEMICALS** And apparatus for industrial, analytical, and private laboratories. Complete supply service for correspondence school students. Send 3c for catalog. Dept. M-43, Biological Supply Co., 1176 Mt. Hope Ave., Rochester 7, New York.

**FREE** Catalog. Chemistry, mineralogy, biology, optics. Tracey Laboratories, Evanston, Illinois.

**LABORATORY** Supplies. Chemicals and apparatus all descriptions. 36 page book 10c. Standard Science Supply Co., 1232 N. Paulina St., Chicago 22, Illinois.

### HELP WANTED

**MAKE** More money selling individualized buckles, belts, tie holders, cap badges. Choice of 2000 emblems. Quick profits—repeats. Special outfit offer, write Hook-Fast Products, Dept. A, Columbus 6, Ohio.

**RELIABLE** Man with car wanted to call on farmers. Wonderful opportunity now, \$15-\$20 a day. No experience or capital required. Permanent. Write today, McNess Co., Dept. 25, Freeport, Illinois.

**PARAMOUNT** Atmospheric conversion gas burners. Quickly installs into any heating plant. Blowers. Gas floor furnaces. Sell and install. Peerless Sales, 4322 Sheridan, Lincoln 6, Nebr.

### AGENTS WANTED

**AMAZING** Discovery. Miracle glaze puts brilliant glass-like surface on cars. Free sample, information. Big profits. Miracle Glaze Company, 9714 South Austin Ave., Oaklawn, Illinois.

**\$1 STARTS** You in business. Sell deluxe ties, 100% wool interlining. Costs you only \$7 per dozen, you make \$5.00 dozen. Send \$1.00 for special introductory offer two deluxe ties. Catalog complete line free. Philip's Neckwear, 20 West 22nd St., Dept. K-9, New York 10.

**SELL** Greeting cards—Everyday, birthday, humorous, Easter assortments. Wrappings, stationery, correspondence notes. Over 100 money-makers. Special offers. Fast sales, big profits, extra bonus. Experience unnecessary. Request \$1.00 Everyday assortment on approval. Hedenkamp, 343 Broadway, Dept. M-21, New York 13.

**EXTRA** Cash quickly selling friends tremendous value 16 card \$1.00 all-occasion assortment—your profit as much as 50c per box. Also birthday, get-well, baby, humorous, gift wrapping, correspondence notes boxes 33-1/3c up. New 1947 line. Experience unnecessary. Extra bonus. Special money-saving offer. Request feature everyday assortment on approval and free personal stationery sample portfolio. Elmira Greeting Card Co., M-28 Elmira, N. Y.

**WONDER** Cleaner. Different bubble bath. Glasklean—three money makers. Sell homes and stores. Everything furnished. Courier, 3829-I Delmore, Cleveland Heights 21, Ohio.

**PLASTIC** Tablecloth covers, curtains, drapes, baby pants, bowl covers and other plastic articles selling like wildfire! Make big money now! Free details! Write Plastics, Dept. 49-C, 206 N. Fourth, St. Louis, Mo.

**SELL** Reconditioned men's and women's watches. Elgin, Waltham, Benrus, Illinois, Bulova, Hamilton, Gruen, Swiss. Also new watches, complete line jewelry and gifts. Satisfaction guaranteed. Write for free catalog today. Kane Watch Co., 104 Canal St., Dept. P-1, New York 2.

**MAKE** Money in your spare time! Helps furnished. Easy sales. Voluntary repeat orders. Liberal commissions. Write for free wholesale price list today! McGregor Magazine Agency, Dept. P.M.-7, Mount Morris, Illinois.

**WE** Pay you \$25 for selling fifty \$1.00 assortments birthday, all occasion cards. Tremendous demand. Sell for \$1.00—your profit 50c. It costs nothing to try. Write for samples. Cheerful Card Co., 54 White Plains, N. Y.

**SCHOOL** Seniors: Sell classmates superb Craftcards for super profits. Write Craftcards, Box 235 (AK), Pittsburgh 30, Penna.

**MAGIC** Cleaner—Hotter than a firecracker. Saves soap—Big profits—Sample free. Bestco, 5007 Irving Park, Chicago.

**QUALITY** Cigars guaranteed. S. Kelley, 2302 Ontario St., Ft. Wayne 6, Ind.

**SELL** Inexpensive fire extinguishers. 200% profit. Lorrac Products, Albany 1, N. Y.

**LUMINOUS** Paint (Shines in dark). Sample bottle \$1.00. Price-list. Gems, B-345, Wilkes-Barre, Penna.

**TRIM** Hair at home. Save barber bills. New invention. Simple. Easy. Lightning seller. Samples sent on trial. Kristee 133, Akron, Ohio.

**MOST** Amazing facts ever published concerning secret service tricks to find missing persons and astounding gags of collection agents only 25c. Kopinski, 342 Paderewski, Buffalo, N. Y.

**BABY** Shoes electroplated, shiny copper finish. Krall, 1627 Memorial Drive, Pittsburgh 16, Penna.

**AGENTS:** Big profits in counter card merchandise; combs, blades, etc. Write for wholesale prices. B & B Sales, 307 N. Ervay, Dallas 1, Texas.

**MYSTERY** Drinking bird. Drinks constantly. Super attraction. \$2.75 prepaid. H. Hayes, Blue Earth, Minnesota.

**AGENTS,** Jobbers, dealers, write to inventor and manufacturer for picture and price of 5 gaited wood horse. Sells on sight. Wm. Baltz, Pochahontas, Ark.

**DRIPPING** Faucets are water thieves. Use Apex faucet repair kit. Safe, simple, economical. Sample kit, six units \$1.00 cash with order. Apex Engineering Co., 205 West Wacker, Chicago 6, Ill.

**"THE Sun Comes Up,"** beautiful gift poem, for framing. Sample 25c. Box 222, Gainesville, Texas.

**BIG** Commissions—selling to stores celluloid pricing tickets, metal shelf moulding—to restaurants, menu covers, signs. Pricing Press, 124 White St., Dept. P, New York 13, N. Y.

**TO** 100% Profit selling greeting card box assortments. Details and assortment sent on approval. Glorian, 515 East 45th Street, Brooklyn, New York.

**BIG** Bargains for big profits. Over 100 sensational values. Men's used suits \$2.00, pants 35c, topcoats \$1.25, overcoats \$2.00, shoes 20c. Experience unnecessary. Free wholesale catalog. Superior, 1250-B Jefferson, Chicago 7.

**FREE** Illustrated catalog hard to get fast selling merchandise. American Merchandising, Dept. PMWC-47, 12 Adams, Montgomery, Alabama.

**100% PROFIT** Or more no investment. Build a profitable steady business, full or part time. Real glossy photo. Amazing stamp size miniatures. Sheet of 100 photo stamps retailed for only \$2.00. Write now for free samples and information. American Foto Stamp Co., 103 East 125th St., Dept. (PM1), New York 35, N. Y.

**AGENTS** Who do woodwork, please write. Curtis Specialties, Box 1916M, Denver 1, Colorado.

**MIRACLE** Wax in powder form; home and auto; cleans, polishes and waxes in one application. Miraculous as name implies. One trial convincing. Send 50c for regular \$1 can and all particulars. Bless Chemical Company, 4806 North Drake, Chicago, Ill.

**MAKE** Cleanup selling perfumes, toiletries, over 100% profit. Behm-Charnelle Products, 3635-E Roosevelt, Chicago 24.

**EARN** Big money. Sunshine everyday cards. Take orders galore from friends for America's most beautiful everyday assortment. 14 folders. Costs 50c. Sells \$1. Also 1947 Sunshine notes, birthday, convalescent, everyday gift wraps. Samples on approval. Write today. Sunshine Art Studios, 115 Fulton St., Dept. EE3, New York City.

**AREA** And State Demonstrating—Distributors Wanted where none are working now. To demonstrate and introduce 2 splendid demonstration products. And to appoint and setup agents and dealers throughout their allotted, exclusive, protected territory. (1) Silver Plating Liquid (NuSilver and Re-Plate-O trademarks) cleans, silverplates and polishes from one application. Either rub-on or dip-in process may be used. Keeps silverware and silvered articles new-looking. Keeps tableware from tarnishing so frequently. Also silverplates onto brass, copper, bronze, zinc, nickel-silver, german-silver, chrome-silver, and some other metal surfaces. Many different uses in every home, office, store, garage, shop, factory, etc. (2) Lectrik Silver Kleener Atomic Metal Electrode Plates, for de-tarnishing silverware quick (instantly) and fast (as to quantity done). Needed in eating places, lunch-counters, cafes, restaurants, hotels, coffee-shops, roadside stands, etc. Demonstrate it and they want it. Both products sell wholesale and retail, the profits are good, you are in business for yourself, it is a steady business and you can work at it as long as you want to. You ought to have a car if you cover territory, but that is not absolutely necessary (some Distributors work without cars). You should be able to sell, and you should be able to buy your first order to start out with. The cash profits start coming in to you within one hour after you start out. This is a sure-fire good profit business of your own exclusively as long as you work at it. The first item named is a good repeater-seller. You build up a repeat profit business for yourself as you work. Complete details will be sent free by sealed letter-mail if you are located in open territory and if you will write to NuProcess Products Laboratories, Dept. 280, Aurora, Illinois.

**AT** Last! Something new and sensational in everyday cards. Gorgeous satin and velour designs never before offered. Get orders fast. Big profits. 14 assortments for year round occasions retail 60c to \$1. Get samples on approval. Puro Co., 2801 Locust, Dept. 740-C, St. Louis 3, Mo.

**AT** Home—Your own manufacturing business; making popular \$1.00 novelties. Cost you 3c to 15c. Everything supplied. Write So-Lo Works, Dept. R-600, Loveland, Ohio.

**FREE**—Mexican novelty curiosities. Fast seller. Exceptional profits. "Productos," Apartado Postal 9318, Mexico City.

**WONDER** Silver Plating Liquid. (Silver-plates metals without tanks or electricity.) Applied with cloth or by dipping. New, improved, concentrated, double-strength formula; plates larger surface with heavier coating. Good carded item for stores. Wonderful demonstration. Big profits. Free details! Wonder Products, 1265-D Broadway, New York 1, N. Y.

**AGENTS** Wanted—full or part time—taking orders for household specialties. For particulars write Steinbraker, 1910 Newport, Chicago 13.

**GREETING** Card agents, "line up" with "Pines" for bigger, better, quicker profits. Rush name, address on postcard today. Box 32, Flushing 5, New York.

**EVERYDAY** Cards. Earn \$5.00 with every ten \$1.00 assortments you sell. Also wrappings and note paper. Unusual quality. Send for samples to-day. Howard P. Ellis, Dept. PM-3, Pitman, N. J.

**REMNANTS**—Amazing values, housewives buy on sight. Good profit. Write B & M Textiles, 415 East 26th St., Paterson 4, N. J.

**LAWN** Mowers—gas-electric. Factory franchise. Write quick. Rotacut, M-2003, Excelsior Springs, Mo.

**FIREWORKS**, Cap guns, caps, balloons, tops, etc. Fast selling items. Send for catalog at once. Wentworth Sales, Inc., 117 North Wabash Ave., Chicago 2, Ill.

**"27"** AGENTS—Salesmen Wanted! Liberal territory allotted. Demonstrate amazing "27 Second" eye glass cleaner. Whirlwind seller. Year's supply in compact only 59c. 2 for \$1.00. \$40.00 per gross—110% profit. 27 Second Cleaner Co., Dept. 192, 6337 N. Talman, Chicago 45.

**90c** PROFIT Each \$1 sale. Sell positive mothproofing solution to housewives, stores, agents. Experience unnecessary. Postal brings details. Kinford, Wayne 3, Penna.

**AGENTS.** Substantial profits. Repeat order products. Not mere "job" but opportunity establish steady income. Additive lubricant. Limitless field. Factories, autoists, service stations, fleet owners buy in huge quantities. Write Kidder Oil Company, LaCrosse 1, Wis.



**MEXICAN Feather pictures.** Unusual novelty. \$1.00 (stamps) bring \$2.00 worth samples, details. Refunded if unsatisfied. Aztec Art-P, Apartado 762, Mexico City.

**AGENTS:** Stamping names on pocket-key protectors. Sample check with your name, address, 25c. Stamping outfits. Emblem checks, check-fobs, name plates. Hart Mfg. Co., 303 Degraw St., Brooklyn, N. Y.

**SELL New-Used clothing** from home, auto, store. Men's suits \$1.17. Leather jackets 85c. Overcoats 62c. Dresses 17c. Ladies' coats 38c. Other bargains. Catalog free. S & N, 565A Roosevelt, Chicago.

**137 COMPLETE Plans** for starting own business: local—mail order. Particulars free. Elite Co., 220 Grand St., New York 13.

**COLLEGE Students!** 100% profits selling costume jewelry. Wm. Morris, Maywood, New Jersey.

**SELL Full, part time individualized belts, buckles, cap badges, tie holders.** 2,000 emblems to choose. Fast profits. Repeats. Write today special outfit offer. Hookfast Specialties, Box 1425, PM, Providence, Rhode Island.

**SELL Personalized soap.** Name on every cake. Ideal for gifts. Get sample offer. Dunbar Soap, New Brunswick, N. J.

**EXCELLENT Sideline** for printing and advertising salesmen. Decalcomania name plates in small quantities. Great demand. Also make money applying initials on automobiles. Free samples. "Ralco" XL-Roxbury, Boston 19, Mass.

**SELLING To housewives?** Double your sales with inexpensive premiums. Postal brings interesting details. A. Kinford, Wayne, Penna.

**AGENTS—Big line** including food products. Fast selling premium and bargain deals. Low prices. Send card for big profit offer with gift. Ho-Ro-Co, 2796 Dodier, St. Louis 7, Mo.

**AMAZING Seller:** "Soilless Garden Chemical." Grow plants, vegetables, fruits, flowers all year round without soil. In or outdoors. Tremendous demand. Excellent profits. Literature free. Nega & Co., 1824 W. Dickens, Chicago 14.

**SCHOOL Seniors—Sell classmates America's most beautiful, distinctive graduation name cards.** 40% commission. Largest selection. Lowest prices. Free cards and sample kit. Printcraft, 1425 E. Elm Street, Scranton 5, Penna.

**AGENTS—300 % Profit** selling genuine gold window letters; stores and offices. Free samples. Metallic Letter Co., 438-B North Clark, Chicago.

**200 MONEY Making deals.** Plans, rare formulas. Schemes. Folio free. Formico Service, Box 572, Dayton, Ohio.

**\$3 FIRE Extinguisher;** quick sales, wholesale or direct; liberal profits. "Fire-Killer," 109 N. Franklin, Syracuse 1, N. Y.

**SCHOOL Seniors!** Your postal will bring our wonder, Kwick-Sell Catalog of popular graduation name cards. Biggest profits! Only firm giving free souvenir chest and card case. Don't miss out! Hurry that postal! Craftcards, Box 235(L), Pittsburgh 30, Pennsylvania.

**PLATING Outfits** for autoparts, reflectors. Connect to a battery. No tanks necessary. Free booklet and particulars. Gunmetal Co., Ave. N. Decatur, Ill.

**FREE Water** and our concentrates, makes flavors, lotions, shampoos, 72 products, labels, bottles furnished. Qualco, E-20030 Russell, Detroit.

**GOLD Lacquered window sign letters.** Large sizes penny each. New foils. Absolutely beautiful. Free samples. Atlas, 544 W. 79th, Chicago 20.

#### HIGH GRADE SALESMEN

**DISTRIBUTORS, Salesmen — Patented cigarette case holder** for automobiles, trucks. Fine seller. New, 200% profit. Samples \$3.00 per doz. Literature free. Little Giant Holder Company, 919 South Vermont, Los Angeles 6, California.

**SELL Year's supply cartoon ads** to filling stations for \$52! Complete sales kit with mats; send \$15. Apollo Advertising Agency, Gainesville, Texas.

**SALESMEN** Wanted to sell 6c quality cigars. Commission basis. T. Miller & Son, Est. 1898, 874 Broadway, New York.

**STATE Distributors** to sell simplified bookkeeping system small stores and public accountants. Sells \$13.50, your commission \$8.00. Exclusive franchise. Write Hawthorne Sales Co., Decatur, Ala.

**SALESMEN:** Carded saccharin for quick sales. Complete price list free. Consumers Products, Tiffin, Ohio.

**DEMONSTRATE.** Sell to taverns, amazing, original glass rinse "Clear Glass." No tawling, no water spots. Guaranteed. Sample 25c. Riesen Chemical, 419 Vliet, Milwaukee 12.

**JOBBERS** Sell sensational spring metal clothes pins, 39c dozen, cost \$2.30 gross. Also aluminum laundry tub shelf \$1.00; fits standard tub. Your cost 50c. Clothes line set with pulleys and tightener \$2.00. Your cost \$1.00. Immediate shipment. Thomas Products Company, Detroit 21, Michigan.

**\$70.00 WEEKLY** Selling twenty boxes greeting cards daily. Eighteen money makers. One earned \$160.00 weekly. Samples on approval. Details, Carleton Distributors, 25 W. 17, Bayonne, N. J.

**AMAZING Discovery,** Master Glaze, puts brilliant glass-like surface on cars. Free sample, information. Big commissions. Master Glaze, Dept. 575, 7720 Harwood, Milwaukee, Wis.

**START Your own business** on our capital. Always your own boss. Hundreds average \$6,000 to \$25,000 annual sales. We supply stocks, equipment on credit. 200 home necessities. Selling experience unnecessary to start. Wonderful opportunity to own pleasant, profitable business backed by world-wide industry. Write Rawleigh's, Dept. C-U-PPM, Freeport, Ill.

**AMAZING New zipper shoe** sells on sight. Big profits for salesmen. Leads line 200 splendid styles. Territories open. Get free sample outfit. Write, Consolidated Shoe, Dept. S-755, Chippewa Falls, Wis.

**SELL Calendars** full or part time—every business house a prospect—also wholesale to printers—calendars, novelties, sheet pictures. Fleming Calendar Company, 6535 Cottage Grove Avenue, Chicago 37, Ill.

**OLD Toy, new idea.** Good opportunity in your territory for an additional line. Excellent item mail order or premium house. 25c brings sample prepaid. Allied Metal Products Co., 85 Prescott St., Worcester, Mass.

**POCKET Pal:** The all-purpose cutting tool. Wagon jobbers-salesmen. Sell to retailers and jobbers. 50c seller. Steady repeat item. Exceptional profit. Sample 25c. Nelson Mfg. Co., 232 W. Kellogg, St. Paul 2, Minn.

**WAGON—Jobbers, agents!** Big profits selling stores, individuals sensational ball point pen. \$2.98 retailer. Free details; also list hundreds fast sellers. Salesmanager, Box 27, Atlanta, Georgia.

**QUICK Profits** with individualized belts, buckles, cap badges, tie holders, uniforms. Choice of thousand emblems. Sure repeat orders. Easy-selling outfit offer. Write Hook-Fast Company, Dept. 12, Roanoke, Virginia.

**WAGON Salesman—Fast moving** carded goods and 10c line. Long profit. Free facts. Peerless, 2717 Dodier, St. Louis 7, Mo.

**FREE! Latest issue Opportunity Magazine.** Salesman's Guide. Inspiring, constructive. Shows how to earn money selling for others or in your own business. Hundreds postwar opportunities. Send name and describe what you have sold or are selling. Illustrated copy sent free. Opportunity Magazine, 620 N. Michigan, Dept. 17, Chicago 11, Ill.

#### EDUCATIONAL AND INSTRUCTION

**WHY Don't you write?** Writing short stories, articles, etc., will enable you to earn extra money. In your spare time we teach you to write the way newspaper men learn—by writing. Free "Writing Aptitude Test" tells whether you possess the fundamental qualities essential to successful writing. Veterans! This course approved for Veterans' Training. Write today! Newspaper Institute of America, Suite 572-C, One Park Avenue, New York 16, N. Y.

**LINOTYPE—Intertype dummy practice outfit;** extra keyboard layouts, illustrated fingering chart, spelling aids and all accessories. Complete outfit, postpaid \$2.00. Callaghan, Box 1493, Great Falls, Montana.

**LEARN Scientific massage.** Home study. Free booklet. College Massage, 315 Fairfield, Bridgeport, Conn.

**BOOKS—All Kinds—Homecraft, Radio, Plastics, Boat Building, Photography, Model Building.** Catalog free. Popular Mechanics Press, 200 E. Ontario St., Chicago 11, Ill.

**WANT A gov't job?** Commence \$145—\$250 month. Yearly raises. Paid vacations. Men—women. Jobs without strikes. Prepare immediately for next examinations. Vets get preference. 32-page civil service book free. Write today, Franklin Institute, Dept. F24, Rochester, N. Y.

**BECOME A Doctor of Psychology or Metaphysics.** Teach secret of contentment, happiness. Win degree of Ps.D. or Ms.D. Solve mental worries. Free book. College of Universal Truth, 5153-B North Clark, Chicago.

**BE A Pedopractor:—Foot correctionist.** Extension. Degree. Alaska Foot Institute, Juneau, Alaska.

**GAIN Success** through nerve force development. Instructions reveal all, tells how to overcome fear, nerves, worry obstacles; free details. O'Leary, Box 594-A2, Baltimore 3, Md.

**LEARN Modern-day auctioneering** at home. All facts and instruction \$5.00. Col. Glenn R. Parrick, Box 71, La Grange, Illinois.

**USED Correspondence courses** and educational books bought, sold, rented, catalog free. Educational Exchange, Henagar, Ala.

**HERBALISM—Complete course** in 2 volumes. 1000 recipes. Home Service, Forestville, Va.

**SPANISH** By mail. Easy practical method. Spanish Correspondence School, Box 1467, Laredo, Texas.

**LEARN Landscaping.** Profitable, healthful career—absorbing hobby, for men, women. Thorough 45-lesson home-study course takes 8-12 months spare time. Hundreds of successful graduates. 31st year. Send for free catalog. American Landscape School, 6395 Grand Ave., Des Moines, Iowa.

**"HOW To Break and Train Horses"**—a book every farmer and horseman should have. It is free; no obligation. Simply address Beery School of Horsemanship, Dept. 1103, Pleasant Hill, Ohio.

**HAVE An office.** Many earn up to \$5,000-\$15,000 annually. Learn credit-collection agency business by home study course. Write for free bulletin. Franklin Credit School, Dept. 202-A, Roanoke 7, Virginia.

**LEARN Piano tuning.** Prepare for career in fascinating profession. \$5000 year easily earned. Real security, pleasant easy work. No profession paying so well can be mastered so quickly. Natural aptitude, desire to get ahead chief requirements. Continuous enrollment. Veterans enter under G.I. Bill of Rights. Prospectus and full information on request. Harmony School of Piano Tuning, Box 582, Harrisburg, Penna.

**3800 DIFFERENT Used correspondence courses.** Cat. 25c. E.G. Mfg., Elmsford 1, N. Y.

**HOME Study course, drugless therapy.** Free literature. Institute of Drugless Therapy, Tama, Iowa.

**AMAZE Others.** Add faster than adding machine. Free details. Math Institute, Box 633, Mobile 4, Ala.

**YOUR Favorite subject in books:** Mineral Identifications Simplified—over 200 minerals \$3.50; Real Estate Dictionary and Appraisal Manual \$5.00; X-Ray Training illustrated \$6.00; Canaries at Work and Play illustrated \$2.50; Rockets, Jet Motors, Dynamotors—280 answers to questions \$2.50; Spanish-English Dictionary and Conversation, 400 pages \$1.00. Catalog. Will ship c.o.d. Wetzel Publishing Co., Inc., Dept. M, 524 South Spring Street, Los Angeles, California.

**GOOD "Used" self-instruction educational books** on all subjects bought, sold, rented, exchanged. Satisfaction guaranteed. Complete information and 100-page illustrated bargain catalog free! Write—Nelson Company, Chicago 5.

**USED Educational books** on all subjects sold, rented, also bought and exchanged. Moneyback guarantee. Write today for free catalog and details. Lee Mountain, Pisgah, Alabama.

**INVESTIGATOR Training.** Phillips Secret Service, 1917B North Kenneth, Chicago 39, Ill.

**BIG Money rebuilding shoes.** Help needed everywhere or start big-income business of your own. Learn practical, sure, easy way in 3 months. Anyone from 18-60 years can learn easily. Approved for GI training. Rush postcard today. Modern Shoe Rebuilding School, Est. 1927, 2935 Belmont, Chicago 18, Illinois.

**29 LANGUAGES** By Linguaphone. Russian, Spanish, Portuguese—Direct conversational method for mastering any language quickly, easily, correctly at home. Available under G.I. Bill of Rights. Send for free book. Linguaphone Institute, 83 RCA Bldg., New York 20.

**MODERN Welding school** gives thorough training for one of industry's best paid jobs. Experienced instructors. Individual attention. Non-profit institution. Qualified under G.I. Bill. Write for literature and details. Hobart Brothers Co., Box M-1067, Troy, Ohio.



**SECRET Investigation.** Experience unnecessary. Investigators particulars free. George Wagner, M 125 West 86th, New York.

**HOME Bible course.** Simple, helpful, instructive. Total cost \$3.00 includes textbooks, stationery, examinations, certificate. \$1.00 starts you, or simply request prospectus. The Bible Study School, Reverend Leslie Marshall, Secretary, 382 Van Houten Street, Paterson 1, N. J.

**LEARN Photo-engraving** at home or in oldest, largest school in America. Work for newspaper or establish own profitable business. New Tasope' Photo-Engraving equipment available soon. Write for information. Veterans ask about G.I. training. The Aurora School of Photo-Engraving, Tasope' Bldg., Aurora, Mo.

**MEDICAL Laboratory technicians** in great demand. We train you in your spare time, in your own home. You can practice while studying. Write for free catalogue. Imperial Technical Institute, Box 973-E, Austin, Texas.

#### PLAYS, STORIES, MANUSCRIPTS

**WIN Fame, success, security** writing short stories, newspaper features. New, easy plan shows you how. Write today for exclusive details. Writer's Institute, 4-M So. 15th St., Philadelphia 2, Penna.

**AUTHORS** Write your story for Hollywood movie studios. Particulars free. Hollywood Select Press, 858 No. Mansfield Ave., Hollywood 38, Calif., Dept. P.M.

**POEMS** Wanted for publication consideration, details free. J. Barnes, Publisher, Box 490 Times Sq. Station, New York 18, N. Y.

**I WANT** New writers to cash hundreds of checks for \$1 to \$100, offered each month. The easiest way to write for pay. No previous experience necessary. Send for free details. No obligation. Saunders M. Cummings, 467-M Independence Bldg., Colorado Springs, Colo.

**NEW Writers** needed to rewrite ideas in newspapers, magazines and books. Splendid opportunity to "break into" fascinating writing field. May bring you up to \$5.00 per hour spare time. Experience unnecessary. Write today for free details. No obligation. Postcard will do. Comfort Press, Inc., 210-P South Seventh St., St. Louis 2, Missouri.

#### BUSINESS SERVICE

**SAVE**—Buy direct from manufacturer. Any article. Guaranteed lists. Pittshire Research, Box 90, Pittsfield, Massachusetts.

**ACCOUNTING**—Bookkeeping and tax service. Associates throughout U. S. Write for details. Barnhart & Kennedy, Public Accountants, Chambersburg, Penna.

**\$2.00 MONTHLY** Maintains Washington, D. C., business, personal mail address. Letters reforwarded daily. "Hawkins," 1300 Taylor.

**COMMERCIAL** And personal, information, contacts, investigations. Write World Research Service, 4239 Third Avenue, New York, New York.

**TO Whom** it may concern: We will represent you in all principal cities of the world. Personal or business assignments \$1 per hour. James W. Farley, Citizens Bldg., Cleveland 14, Ohio. Note: Would appreciate hearing from someone who wishes to enter this business in your city. Will send you assignments immediately. References exchanged. State qualifications.

#### SPECIAL SERVICES

**FLORIDA** Postmarked letters remailed to astonished friends. 25c each. P.O. Box 1772, Orlando, Fla.

**TRANSLATIONS.** All languages. Suner, Suite 1102, 210 Fifth Avenue, New York 10.

**RECORDINGS:** Your favorite poems, dialogues, scripture. Manuscripts electrically transcribed professionally. Mailable. Send material—free estimate. Dean & Gene Recording Company, P.O. Box 45, Sebring, Ohio.

**LETTERS** Forwarded 25c each, \$2.00 monthly. E. Burroughs, 411 Greenwich, San Francisco.

**GLOBAL Mail**—Receive picture postcards; surprise your friends; let us mail your letters from any place on earth. Free particulars. Travelpost, Box 528, El Centro, California.

**VISIT Norfolk** by proxy. 3 souvenir cards 25c. Address return, I remail. Letters mailed 25c. Bernard Cook, P.O. Box #653, Norfolk, Va.

**MFG.—Wholesale sources.** Most any item. Write: "Service," 1332B Findlay, New York City 56.

**MAINTAIN** New York City mailing address, mail forwarded daily, \$2.00 monthly. J. Barnes Publisher, Box 490 Times Sq. Station, New York 18, N. Y.

**GOOD "Used"** self-instructional books on all subjects bought, sold, rented, exchanged. Satisfaction guaranteed. Complete information and 100-page illustrated bargain catalog free! Write—Nelson Company, Chicago 5.

#### CARTOONING, COMMERCIAL ART, SHOWCARD WRITING, SIGN PAINTING

**ANIMATED Cartooning** book. A preparatory course for movies and television. Free information. Cartoonimator Co., 5029 Illinois N. W., Washington 11, D. C.

**"BLOWUPS!"** Easily made. Big profits. Details free. Fogarty, 49 Longview, Fairfield, Conn.

**UNEQUALLED Offer!** Beginners outfit given away free with each purchase of our famous showcard writing course. Rush postal for full information. Sherwood Publishing Co., Dept. 101, Irvington 11, N. J.

**ART Students**—Write for commercial art talent test. Art Institute, Box 8066, Dallas 5, Texas.

**PAINT** Beautiful pictures quickly, easily, inexpensively. Free literature. Art Book Shop, Arnold, Mo.

**LEARN** Painting landscapes quickly. New art method for everyone. Colorful details free. Weidner, 1321 Wellesley, Los Angeles 25, California.

**"HOW To Make Money With Simple Cartoons"**—a book everyone who likes to draw should have. It is free; no obligation. Simply address Cartoonists' Exchange, Dept. 83-C, Pleasant Hill, Ohio.

**SIGN** Painting taught at home by an old master. Ben Kerns, Box 812, Greenville, S. C.

**SIGN** Painting course prepared by one of America's best sign artists. \$2.00 postpaid. Progressive Signs, 3607 Fifteenth Avenue, Chattanooga, Tennessee.

**EARN** Money evenings, copying and duplicating comic cartoons for advertisers. Adservice, Argyle (1-B), Wisconsin.

**MAKE** Signs. 9 complete alphabet pattern sets. 3 complete numeral pattern sets and catalog \$1.00. Sign Letter Distributors, P.O. Box 101, Mineola, N. Y.

**CHALK** Talks. Laugh producing program, \$1.00. Catalog 10c. Balda The Cartoonist, Oshkosh, Wisconsin.

#### ADVERTISING AGENCIES, LETTER WRITERS, FOR ADVERTISERS

**BOOKLETS.** Sales letters, written or rewritten, any subject, \$3.00 page. Satisfaction guaranteed. Dudley Bunn, 126-PM Lexington Avenue, New York 16.

**MAKE** More money from classified advertising, with our help. Booklet free. Machen & Co., Station "F," Toledo, Ohio.

**6c WORD,** 25,000 Readers, 4c word 10,000. Renick, Holland, New York.

**24 WORDS** In 140 Canadian weeklies \$8.00. Lists free. Lever Advertising Agency, 109 PM LaSalle Avenue, Comeau Bay, P.Q. Canada.

**ADS** Placed in out of town newspapers and magazines. Low rates. Catalogue free. Ideas that pay. Baker Advertising Agency, Successors Ankrum Agency, 189 W. Madison, Chicago 2.

**INCH** Display advertisement Mailorder World, year \$24. Wood's Popular Services, Atlantic City, New Jersey.

**ADVERTISERS:** Mail order ad covering United States—2,000,000 circulation—\$21.00 inch. Classified ad, 24 words, 20 metropolitan Sunday newspapers—\$25. Magazine, newspaper, mail-list ratebook, advertising assistance—free. Chicago Advertising Agency, 20-PM West Jackson, Chicago 4.

**ADVERTISE:** 24 Words, 40 newspapers \$3.50. Lists free. Advertising Bureau, 4515-C Cottage Grove, Chicago 15.

**ADVERTISING** Service, art work, C. Sanford, 5029 Maple, St. Louis, Mo.

**ADVERTISERS!** Reach nearly 18,000,000 readers. 25 Sunday national key newspapers, 18 words, \$42.25. "Terrific pullers." 20 popular newspapers, \$8.50. "Free booklet." Special—One inch display 2,600,000 circulation, \$32.90. Newark's Advertising Agency, (Established 1893) 217-7th Ave., New York 11.

**MAILING** Lists, certified, productive, inexpensive, \$5.00 1000. Homeworkers, agents, buyers, etc. Write Dixie Service, King, N. C.

**FREE!** 1946 Advertisers Rate & Data Directory. 52 pages! E. H. Brown Advertising Agency, 20 N. Wacker, Chicago 6, 24 WORDS in 64 weeklies \$4.96. H. J. Darnell, 730 Hays, Jackson, Tenn.

#### TYPEWRITERS, DUPLICATORS, OFFICE DEVICES

**ADDING** Machines, adds and abstracts, fast, accurate, immediate delivery. \$27.50. Check or money order with order. Precise Distributing Company, 608 S. Dearborn St., Chicago 5, Ill.

**"PRINTOMATIC"** Selffeeding post card stencil printing duplicators \$9.50 up. Office size duplicators, Speedprints, Hilcos, Excellographs \$33.41 up. Literature free. Pittsburgh Typewriter Supply, 336-WK Fourth Avenue, Pittsburgh 22, Penna.

**RECONDITIONED** Typewriters, mimeograph, multigraph printing devices, appliances, supplies. Catalog. Dixiegraph Service, King, N. Carolina.

#### RUBBER STAMPS AND OFFICE SUPPLIES

**RUBBER** Stamps. Send for catalog. Excello, Box 500, Shreveport, Louisiana.

**PROMPT** Service guaranteed. 1 line 40c, 3 lines 60c. Stampcraft, 1707 Virginia Street, Gary, Indiana.

**RUBBER** Stamps. Buy direct from manufacturer. Literature free. Lee-Vall Press, Box 1242, Indianapolis 6, Indiana.

#### PRINTING, MULTIGRAPHING, MIMEOGRAPHING, GUMMED LABELS

**PERSONAL STATIONERY**—extra quality, 50% rag content white bond. Name, address, beautifully printed, blue ink. 200 letterheads (6"x9 1/2"), 100 envelopes, postpaid \$2.95. Money back guarantee. Free samples. Cottage Bookshop, Box 726-M, Lincoln, Nebr.

**MIMEOGRAPHING**—Pricelists, letters, circulars, forms. Reasonable. Prices, samples free. Martin Mimeo, 3212 Harper, St. Louis 7, Missouri.

**DELUXE** Two color gummed labels, about 7/8x1 1/4", with name and address, 3 lines. 500 for \$1 or 1000 for \$1.50. Mutual Sales, 751 Jenifer St., Madison 3, Wis.

**THOUSAND #10** Envelopes \$6.95; 500—\$4.25. Thousand 6 3/4 or 6 1/4 envelopes \$4.25; 500—\$2.75. Williams Sales Company, Box 4100, Portland 8, Oregon.

**2 1/4x3 1/4 GUMMED** Labels; 500—\$1.75; 40 word limit. Schulteis, Box 449, Irwin, Penna.

**250 LETTERHEADS** \$1.50. Envelopes same. Mallo, 767 Leith, Flint 5, Mich.

**1000 6 3/4 ENVELOPES** \$3.95. Harry Boynton, 1909 Glade Road, Columbus, Georgia.

**125 6 3/4 ENVELOPES** \$1.00. Get sample. P.O. Box 356, Nazareth, Penna.

**75 HAMMERMILL** Letterheads and 75 envelopes \$1.00 postpaid. Benneville Printing, Box 1931, Pittsburgh 30, Penna.

**PHOTO** Offset, printing, multigraphing. Samples free. Mango, 555-A South 20th, Newark 3, N. J.

**100 BOND** Sheets 8 1/2x5 1/2; 100 bond envelopes, 6 3/4. Printed \$1.25. Biggs Press, Lewis, Indiana.

**WHEN** You need good printing write Lakeside Press, Bolton Landing, N. Y.

**1000 6 1/2x9 20 LB.** Catalog envelopes \$8.50. Trial 100 \$1.35 postpaid. Spender & Son, Millington, Mich.

**QUALITY** Printing: business, personal stationery. Prepaid delivery. Samples free. Mero Products, 100 Morrison, Punxsutawney, Penna.

**OUR** Customers say—"You do good work." Send copy for free estimate and sample of package inserts, cards, labels, stationery, etc. S. & M. Press, 3206 Eastwood Ave., Chicago 25, Ill.

**100—8 1/2x11 HAMMERMILL** Letterheads \$1.00 postpaid. Envelopes, billheads, cards same. Race Printing, Hudson, New York.

**QUALITY** Mimeographing, multigraphing, printing and office supplies at the lowest prices. Catalogue free. National Sales Company, Dept. ND, 357 Halsey Street, Brooklyn 16, N. Y.

**FINE** Printing for every use. Samples. Treaster Printing, Milroy, Pennsylvania.

**NAME,** Address on 66 gov't stamped postals \$1.00. Bowers, Box 130, Bloomington, Ill.

**BOX** Stationery, executive size, printed \$1.00 postpaid. Kalataprint, Ironwood, Michigan.



200 IMITATION Typewritten letters, 8 1/2 x 11 bond with printed letterhead—\$2.00, 1000—\$5.00. Photo-offset pricelist. Jack-print, 27-GM Gore, Webster Groves 19, Mo.

GOOD Printing, any amount. Estimates free. O'Reilly, 31027 Detroit, Pittsfield 3, Maine.

1000 FOUR Line stickers, \$1.00. Printing, mimeographing, best and cheapest in the country. Imprint, Emporia, Kansas.

500 3/4 x 2 1/4 FOUR Line gummed stickers, 35c. Moritz Printing, Saginaw, Mich.

250 8 1/2 x 11 LETTERHEADS And 6 3/4 envelopes \$2.75. Advance, Strasburg, Ohio.

CUT Printing costs. 1,000 offset 8 1/2 x 11 printed \$3.95; 5,000 \$15.75; larger quantities less. 48 hour service. Samples, price-list free. Fidelity Company, Parkersburg 14, W. Va.

MIMEOGRAPHING Specialists — Any copy. Reasonable. Mailers Service, Box 606-A, Chicago 90, Ill.

1000 BUSINESS Cards \$2.50. prepaid. Reliable Print Shop, 901 E. Jefferson, Louisville 6, Ky.

MIMEOGRAPHING. Highest quality. Reasonable. Letter Service, Box 1849, Chicago 90, Illinois.

SEND 10c Now, for our 36-page 1947 pricelist—refunded first order. McCall Press, 1326 South 27th, Omaha, Nebraska.

BETTER Grade printing reasonable. Estimates on anything. Economic Press, Leonia, N. J.

MIMEOGRAPHING—Letters, pricelists, formulas, instructions. Lowest prices. Lem's Letter Shop, 5710 Stanton, Detroit 8.

#### PRINTING OUTFITS AND SUPPLIES

PRINTERS' Galley, small printers' magazine. Informative articles. Copy—10c, year—25c. Steiner, Rockwell Road—26, Danbury, Connecticut.

HAND Presses available, cutters, jobbers. Bulletin 3c. Box 918, New York 8.

PRINTING Equipment, type and supplies. Send stamp for details or dime for complete illustrated supply book. Kelsey Inc., X-11, Meriden, Conn.

PRINTERS. Make a quick-etch etcher for cuts, halftones. Details. Charles Medlock, Box 256C, Goodland, Indiana.

HOME-MADE Presses. Proofs free. Riegel, 1111 Harrison, Phila. (24), Penna.

INEXPENSIVE Home-made printing press. Details free. Novelty Shop, Downs-ville, Louisiana.

#### PATENT ATTORNEYS

INVENTORS—Victor J. Evans and Co. has a staff of registered patent attorneys, available to represent inventors in the preparation and prosecution of their cases before the U. S. Patent Office. Detailed information and the steps to take to obtain patent protection will be sent to you upon request. Victor J. Evans & Co., 231-C Merlin Building, Washington 6, D. C.

INVENTORS—Patent laws encourage the development of inventions. The Rules of Practice of the U. S. Patent Office advises—unless an inventor is familiar with such matters—that he employ a competent registered attorney, as the value of patents depends largely upon the skillful preparation of the specifications and claims. Write for further particulars as to patent protection and procedure and "Invention Record" form at once. No obligation. McMor-row, Berman & Davidson, Registered Patent Attorneys, 134-D Victor Building, Washington 6, D. C.

"PATENT Proof of Invention" folder mailed without obligation. E. E. Vrooman, Registered Patent Attorney, 871 Woodward Building, Washington 5, D. C.

INVENTORS: Learn how to protect your invention. The patent laws were enacted for the benefit of the inventor to give him protection for the features of his invention which are patentable. The United States Patent Office advises the inventor to engage a competent, registered patent attorney to represent him. We offer inventors experienced, conscientious counsel and prompt, confidential service. A specially prepared booklet containing detailed information concerning patent protection and procedure with "Record of Invention" form will be forwarded to you upon request—without obligation. Clarence A. O'Brien & Harvey Jacobson, Registered Patent Attorneys 71B-A District National Building, Washington, D. C.

"INVENTOR'S Guide" free on request. Frank Ledermann, Registered Patent Attorney, 154 Nassau St., New York 7, N. Y.

PATENT And Trade-Mark Practice before U. S. Patent Office. Validity and infringement investigations and opinions. Booklet and form "Evidence of Conception" forwarded upon request. Lancaster, Allwine & Rommel, Registered Patent Attorneys, Suite 411, 815-15th Street, N.W., Washington 5, D. C.

INVENTORS: Write for free brochure "Evidence of Invention." Labiner, World Building, New York 7.

C. A. SNOW & Co., M-427 Snow Bldg., Washington 1, D. C. Registered patent attorneys. Established 1875. Literature mailed on request.

INVENTORS: Without obligation, write us for information as to what steps an inventor should take to secure a patent. Randolph & Beavers, Registered Patent Attorneys, 21-C Columbian Bldg., Washington 1, D. C.

PATENTS—Trade marks. Irving L. McCathran, 315 McLachlen Bldg., Washington 1, D. C. Registered Patent Attorney.

#### FOR INVENTORS

INVENTORS—Patent laws encourage the development of inventions. The Rules of Practice of the U.S. Patent Office advises—unless an inventor is familiar with such matters—that he employ a competent registered attorney, as the value of patents depends largely upon the skillful preparation of the specifications and claims. Write for further particulars as to patent protection and procedure and "Invention Record" form at once. No obligation. McMor-row, Berman & Davidson, Registered Patent Attorneys, 134-C Victor Building, Washington 1, D. C.

INVENTORS—Victor J. Evans and Co., established 1898, has a staff of registered patent attorneys, available to represent inventors in the preparation and prosecution of their cases before the Patent Office. Detailed information and the steps to be taken to obtain patent protection will be furnished upon request. Victor J. Evans & Co., 232-C Merlin Building, Washington 6, D. C.

"HOW To Create New Ideas," a complete creative thinking course for inventors, writers, advertisers, others who want to get ahead more quickly. Idea criticism service included. \$3.00, postpaid. Satisfaction guaranteed. Dudley B. Bunn, 126-A Lexington Avenue, New York 16.

PATENTED, Unpatented inventions promoted. M. Joyce Humphries, 1424 Land-tite, Philadelphia 10, Penna.

INVENTORS! 50c Brings you listing of ten leading manufacturers in any field. Licht, 10530 Clairdoan Ave., Cleveland 8, Ohio.

LET Us help you sell your invention or idea. Our method is different. Gets results. Firms buy outright or pay royalties. Write for details. Success Sales, 27 Lin-wood Ave., Columbus, Ohio.

INVENTORS—Having patent applications prepared and filed through my office can pay cost in six installments and receive assistance in selling their inventions. Details free. Charles Morton, 11 West 42nd Street, New York.

MONEY Saving Facts—New copyrighted booklet, "What An Inventor Should Know," \$1.00 postpaid. Let technical experts advise you on marketability, manufacturing problems, practicability, sales potential of your invention. Write, Carson Consultants, 30F West Washington St., Chicago 2, Ill.

INVENTIONS Developed. From blue print or idea stage. Darrow Engineering Service, 4315 South Burrell Street, Mil-waukee 7, Wisconsin.

INVENTORS: Learn how to protect your invention. The patent laws were enacted for the benefit of the inventor to give him protection for the features of his invention which are patentable. The United States Patent Office advises the inventor to engage a competent, registered patent attorney to represent him. We offer inventors experienced, conscientious counsel and prompt, confidential service. A specially prepared booklet containing detailed information concerning patent protection and procedure with "Record of Invention" form will be forwarded to you upon request—without obligation. Clarence A. O'Brien & Harvey Jacobson, Registered Patent Attorneys, 71A-A District National Building, Wash-ington, D. C.

INVENTORS: You save up to 300% when dealing with your patent searcher direct. Complete search with patent copies \$6.00. Reports mailed in 5 days. Invention pro-tection forms free. Write Raymond L. Smith, Patent Searcher, 703-M Albee Building, Washington 5, D. C.

CASH For practical ideas and inventions. Mr. Ball, AB-9441 Pleasant, Chicago.

"INVENTOR'S Guide" free on request. Frank Ledermann, Registered Patent At-torney, 154 Nassau St., New York 7, N. Y.

I SELL Patents. Established in 1900. Charles A. Scott, 773PM Garson Ave., Rochester, N. Y.

THE Inventor who believes he has a new and useful invention, and needs ad-vice, should consult a competent registered patent attorney. Without obligation, write for full information on how to secure patents and trademarks. Randolph & Beavers, Registered Patent Attorneys, 11-E-Columbian Bldg., Washington 1, D. C.

INVENTORS: Avoid unnecessary expense. Write for free booklet explaining how our consulting and advisory service can assist you in deriving greatest profit from in-venting. Institute of American Inventors, Dept. 40-A, 1926-Eye St. N.W., Washing-ton 6, D. C.

#### INVENTIONS WANTED

INVENTORS! Sell your inventions your-self. Send \$1.00 for Directory of 212 manu-facturers buying inventions. Free legal forms. Invention Market Research, 342-PMC Madison Ave., New York 17.

WANTED Patentable ideas. Write A. Rehkop, Box 4805, San Francisco 1, Calif.

WANTED: Practical inventions by man-ufacturers, patented or unpatented. John D. & Son, Dept. PM-3, Box 3213, 285 Howard Ave., Bridgeport 5, Conn.

WANTED: Practical inventions suitable for sale through 5c-\$1.00 stores, drug-stores, cigar stores; also sportmen's items of all kinds. Write Matt, 1412-P, Great Northern Bldg., Chicago 4.

PATENTS—Wanted by manufacturers. Write Universal Guaranty Company, Lake-wood, New York.

INVENTORS! Save time, money, by reading the book "Selling Inventions With and Without Patents"; contains methods for selling before patenting, court rulings, mechanical principles; how to market, finance inventions successfully. \$1 prepaid. Metzler, 11 West 42nd, New York.

INVENTIONS Wanted. Patented or pending. Inventors Exchange, Dept. B, Hartford 1, Connecticut.

EARN Up to \$2,000 year, inventing simple items for special cash markets. Ideas only. No patents. Hendrickson, Argyle (7-B), Wisconsin.

CASH For inventions, patented, unpat-ented. Mr. Ball, A-9441 Pleasant, Chi-cago.

INVENTORS: Hundreds of manufac-turers have requested our assistance in locating marketable new products. Com-plete information, free. Institute of Amer-ican Inventors, Dept. 40-D, 1926-Eye St. N.W., Washington 6, D. C.

#### PATENTS FOR SALE

FREE To manufacturers—Send for our new Invention Sales Bulletin describing over 500 inventions. Address Patentee System, D-2, 9441 Pleasant Ave., Chicago 20, Ill.

GOPHER Poison attachment for farm machinery. Controlled from tractor. Ex-celent results in field tests. Patent pend-ing, Canada, U. S. Cash, royalty. C. McDougall, Bankend, Saskatchewan, Can.

LOCOMOTIVE Oil burner. No smoke or carbon; fuel saver. Will sell for part cash and royalty. M. Brittain, Chickasha, Okla.

INVENTORS: Test the commercial value of your patented or unpatented inventions, quickly and inexpensively. Write for free information. Institute of American In-ventors, Dept. 40-B, 1926-Eye St. N.W., Washington 6, D. C.

#### MANUFACTURING

JIGS, Fixtures. Permanent moulds for plastics, aluminum castings. Unamit Mould & Machine Company, Bunker Hill, Ill.

MACHINING—Models, tooling, produc-tion. Eastside Mfg., Box 1585, Rockford, Illinois.

WANTED: Manufacturing or assembly of small products, light press and bench work, drilling, milling, etc., on job basis or cost plus. Jewel Industries, P.O. Box 889, Canton, Ohio.

MODELS—Small lot manufacturing. Metals, plastics, etc. Milburn, Burlington, Kentucky.



A BRAND New inventor's service. Write for information. J and M Company, Burlington, Kentucky.

MODELS Developed and built. Small run manufacturing. The Thompson Engineering Co., 206-C Winchester Bldg., Grand Rapids 2, Michigan.

### MODELS AND MODEL SUPPLIES

CATALOGS (Illustrated) for modellers! Airplanes, 60 page book on solids. Features construction data, specifications, camouflaging, 15c. Railroads: 128 "HO" guide. Equipment, accessories, fittings 25c (includes refund coupon). Send coin or stamps for each profusely illustrated catalog desired. Polk's, "Nation's Leading Hobby House," 314-PM Fifth Ave., New York City 1.

MINIATURE Race cars, engines, planes, trains. Free list. Ridgway Model Hobbies, P.O. 7637 Sta. D, Kansas City, Missouri.

BALSA Wood. Generous supply \$1.00. Price list free. Sanlader, Manitowoc, Wis.

DOWMETAL Magnesium basic structural shapes and sheets now available. This new construction metal is one-third lighter than aluminum. Its strength-weight ratio gives you better model performance from lighter weight automobiles, trains, planes and boats. This material can be glued with our special adhesive. It can also be welded, soldered or riveted. For prices, sizes and construction information, write: Sims & Associates, 464 Neff Road, Grosse Pointe, Michigan.

DYNA-JET Famous miniature jet gasoline engine for planes, boats, cars. Guaranteed deliver 3½ pounds thrust. \$24.50 ready to run. Aeromarine, 5201 Old Springfield Pike, Dayton 3, Ohio.

MIDGET Permag motors. 12-27VDC. 80-250RPM. Reversible. \$2.35, new. Free list. Efeco, 1006 Hewitt, Everett 1, Wash.

BUILD HO gauge wrecking crane. Complete kit with brass wheel trucks. \$2.15 p.p. Catalog 10c. Ideal, 19 West 18th Street, New York 11, N. Y.

BUILD Model ships, railroads. Catalog 10c. Ideal, 19 West 18th Street, New York 11, N. Y.

WIZZ Electric motor: (1½x2½"). Small flashlight cell operates. Parts complete, plus illustrated instructions 35c. Two 65c. Immediate delivery. Send today! Eltro, Deer Park, N. Y.

SPEEDY 1" Motor, runs atop flashlight cell! Parts, instructions, 35c. Fonskov, 655-K Amboy, Perth Amboy, N. J.

STAMPED Steel wheels for small toys, models, etc. Priced as low as 5 cents each. Send for list. Also small stampings made to your specifications. Richard C. Judson, 4554 Eastway, Toledo 12, Ohio.

SHIP Models and yacht supplies complete. Large 64 page catalogue 30c. Bill Wild's, 510 East 11 St., New York City 9.

BUILD Model gas and steam engines using our no casting plans. Very fast. Only lathe and scrap required. Illustrated folder 10c. Rowe Engineering, 8889 Appoline, Detroit 27, Mich.

SHIP Models, coaches, covered wagons, blueprints, supplies, catalog 25c coin. R. E. Hancock, 323 Douglas Ave., Portsmouth, Virginia.

LANDLOCKED Sailors! Here's a beautiful, richly illustrated, fully descriptive catalogue of famous model ships-whalers, slavers, corvettes, etc., authentic in every detail. Send for it today. Only 10c. Halesite Yacht Service, Inc., Halesite, Huntington, N. Y.

SHIP and Yacht model fittings; blueprints. Send 25c for illustrated catalog No. 20—listing hundreds of items. A. J. Fisher, 1002-1 Etowah Ave., Royal Oak, Mich.

MIDGET Steam engines \$2.98, boilers \$2.65. Stamp for literature. R. Looker, Box 105, Michigan City, Indiana.

BRASS Gears and model supplies for the inventors. Send 10c for catalog. Pierce Model Works, Tinley Park, Ill.

FREE Catalog of model trains, airplanes, ships, accessories and tools. Ben's Hobby Company, 72 West Washington, Chicago 2, Illinois.

BUILD Model ships, airplanes, railroads. Catalog 10c. Ideal, 21 West 18th Street, New York 11, N. Y.

ENGINE Castings, Supplies. Catalogue 10c. Howard A3, 2417 N. Ashland, Chicago, Ill.

RAILWAY Models, complete line, 128 page catalog, HO and O gauge 25c. Walters, 247 Erie, Milwaukee 2, Wis.

DIESELIZE—Convert your gasoline engine easily. Complete information, secret fuels, diagrams, detailed instructions, etc., booklet "Dieselize" tells all. \$1. P.O. Box 1473, Santa Ana, California.

BIG Illustrated model engine catalog 10c. Active Products & Supply Co., 53 W. Jackson, Chicago 4.

MINIATURE Steam locomotives, ¼", ½", ¾" scales. Castings, parts, rail! Through drawings with instructions. Catalog 25c. Little Engines, Wilmington, Cal.

### HEMOCRAFTSMEN

SHELLCRAFT Instruction book with 450 Caribbean shells, including findings for making \$6 worth, \$1; or beautiful African gold shell 75c earrings, including outfit making ten more pairs, with book, \$1. Satisfaction guaranteed. Shell Company, Miami 36, Florida. State representatives wanted.

HANDY Tricks for machinists and hobbyists, illustrated. Lathe and milling machine. Send \$1.00 to M. Charles, Sta. D, Box 136, Los Angeles 7.

STEEL Saddle stamps. Leather tools. Hartes Craft Shop, Holyoke, Colorado.

PLYWOOD Cabinet kitchen plans 25c. Playne Cabinets, 4617 Johnson Avenue, Western Springs, Illinois.

CRAFTSMEN—Fast selling. Make children's, adults' lawn chairs, furniture. 5 plans \$1.00, 10—\$2.00. Summercraft Studio, 42 Vernon St., Newton 58, Mass.

LEATHERCRAFTERS: Eliminate lacing splices. Use modern ending on double Cordova stitch; practically undetectable. Sample and instructions \$1.00. Palm Springs Leathercraft, Box 1034, Palm Springs, Calif.

MAKE A floral spray, pearl necklace comb, with shells for dollar. Free catalogue. Dixie Shell Service, Lakeland, Fla.

GENUINE Leather scraps for leathercraft items, assorted colors, 6 pounds, \$2.00. Send 10c for sample. International Cushion Co., 515 No. Halsted, Chicago 22, Illinois.

FURNITURE Finishers kit, complete with instructions. Repair scratches, burns, etc., permanently, the professional way. Not a polish stain. \$4.95. Finishers Supplies, 6728 Northwest Highway, Chicago 31, Illinois.

35 PATTERNS Of action pull toys, trucks, carts, toy furniture, etc., \$1.00. Continental Homecrafters, 907 Birch, Eau Claire, Wisconsin.

WHAT Nots of scrap wood. 12 full size designs \$1.00. Albright Service, 6901 Railroad Ave., Omaha 7, Nebr.

ATTRACTIVE, Dainty costume pins, figurines, caricatures, easily finished materials; painting, carving or woodburning. Well liked assortments \$1.00 and \$2.00. Sample set 50c. Personalize—wood, leather items, very impressive style. Instructions 50c. Wilhites, 927 Palm Dr., Colton, Calif.

PLYWOOD Panels—walnut, mahogany, birch, gum, fir. Veneers. Mahogany and Spanish cedar lumber and turning squares. Sedlo Company, P.O. Box 7161, New Orleans, La.

MECHANIX Shopcraft motor set. Powerful 1/25 h.p., a.c. motor with interchangeable drill chuck, grinder, wire brush, and polisher. Complete with switch, \$16.50. 3 speed control extra \$6.50. Surg. Spec. Sales, 4868½ Sheridan Rd., Chicago 40, Illinois.

BIRDHOUSES—Ready to assemble. Wren—\$1.50, bluebird—\$2.00. Address—Jepson, 95 Liberty Ave., Belleville 9, N. J.

SEASHELL Dealers and shell jewelry manufacturers, write on business letterhead for catalog. Wholesale only. Beachcomber Novelty Co., Box 551, Fort Myers, Florida.

HARDEN Steels quickly, safely. Durable ingredients with instructions \$1. Roman Nejski, Box 185, PHSM37, Fort Wayne 1, Indiana.

SPECIAL Offer: 70 full size toy, novelty, and lawn ornament patterns only \$1.00. Lynds, Medway, Mass.

SHELLCRAFTERS, Approximately two pounds of assorted Pacific coast shells mailed you on receipt of \$2.00. Eric Lee, Box 245 P.O., San Anselmo, Calif.

BIG Money selling leather goods. Lace yourself. Sample \$1. Free catalogue. Donald Saugstad, Wholesale Leathercraft, Statesan, Wis.

1000 WASHERS, Tremendous \$6.00 assortment. Only \$1.00 postpaid. Technical, 2180 Amsterdam Ave., New York City.

LEATHERCRAFTERS! Lady's handbag pattern. Guided assembly instruction \$1.00. Guided Crafts, 1582 Lurting Avenue, New York 61, N. Y.

70 PATTERNS Lawn ornaments and novelties, \$1.00. Modern Woodcraft, Saginaw, Michigan.

UNUSUAL Wood projects, easy to build from professional full size plans. Cute animals and figures forming clever novelties and toys. 8 plans for only \$1.00. Park Products, 78 Grand, Coldwater, Mich.

DOLL Furniture, Early American. (Five piece living room). Scale model. Wood parts ready to assemble. Complete kit 50c. Plans 10c. Knock-down doll house \$2.00. Plans 50c. Familycraft, Box 346, Oconomowoc, Wisconsin.

SEA Shells and all parts. Make pins, earrings, combs, novelties. Free instructions with \$2.00 kit. Free catalogue. Herbert Diamond & Co., P.O. Box 4619, Miami 28, Florida.

BRASS Rods. List free. American, 388 East 34th Street, Brooklyn 3, N. Y.

BEVELED Plexiglas foundations for costume jewelry and fabricated articles. Variety of colors and shapes. Send 10c for catalog. Genesee Craft Shop, 279 Selye Terrace, Rochester 13, N. Y.

TREASURE Chest plans, inexpensive, easy to build. \$1.00 postpaid. Henry Morgan, North End Station, Box 127, Detroit 2, Mich.

CELLULOID—New postwar, beautiful assortment. Mottles, opaques, onyx, pearls. Used by ring makers everywhere. One pound assortment—pieces approximately 30 sq. in. each. Price \$1.00. Please add 10c for postage. Craft Service, 337 University Ave., Rochester 7, New York.

LEATHER Designs for tooling, carving. Imprinted instantly. No tracing. Introductory set \$1.00. Three folios of designs available; fifty belts, twenty billfolds, ten handbags, \$1.00 each. Lampkin Artcrafts, Box 641, Culver City, Calif.

FREE Instructions, shell jewelry, Werts, 1429-56th Avenue, Oakland 3, Calif.

RARE Wood—Selected burls and sections from rare Myrtlewood. Grows only in Oregon and bush form in Palestine. Ideal for lathe work. A hardwood which takes a beautiful finish. Jewel boxes, candlesticks, lamps and other articles sell for ten to fifteen times the cost of the Myrtlewood used. Send two dollars for a sample block. Let us give you a price on Myrtlewood for your requirements. Oregon Myrtlewood Company, 112 S.W. Pine Street, Portland 4, Oregon.

WHITTLES'S Supplies, readicut blanks, special woods, knives. Old Whittler, 1402 Charles, LaCrosse, Wis.

SHELLS, Plastics, findings. Lowest prices. Free catalog. Frances Jones, Box 251, Sarasota, Fla.

PIPE Makers supplies. Pipe Makers Manual \$1.00. Briar blocks, stems, rough pipes. Free price list. Harold Mangus, Rt. 3, Alliance, Ohio.

MASONITE Mill ends, 10# \$1.00, plus postage. Carl Sign Co., Wooster, Ohio.

CERAMIC Jewelry supplies, bar pins, ear screws, for ceramic and woodworkers; also glass and seashell assemblers. Free catalog. Philadelphia Badge Co., Dept. B-1, 1007 Filbert St., Philadelphia, Penna.

THE Craftmaster's Catalog lists one of the most extensive lines of quality jewelry findings in the country. Lucite, Plexiglas, all types of chemicals, ideas, for pleasure or profit—all in this big, new catalog. For values galore, send 25c (refunded on first order) now, don't wait, you can't do without it long. Pittshire Plastics, Box 90, Pittsfield, Mass.

LEATHERCRAFTERS! Send for free catalog listing leather, kits, supplies. Kit Kraft, 1607 S. Western, Los Angeles 6, California.

EXPERIMENTERS! Interested in electrical, mechanical devices from war surplus? List free. F. Siefke, Box 18, Station E, Buffalo 11, N. Y.

MAKE Shell jewelry—for gifts, as a hobby or start a business. Free catalogue and price list. Complete illustrated book of instructions 75c. Florida Shellcraft Company, Box 1840, Sarasota, Florida.

SHELL Jewelry supplies. Wholesale only. McFarland Plastic Co., Sarasota, Fla.

CATALOG: Patterns plywood novelty furniture, letters, numerals, plaques, frames, weathervanes, silhouettes, lawn ornaments, 100 books and booklets on crafts and hobbies, picture frame mouldings, tools, large line decal transfers. Other lines. Hundreds articles finely illustrated. Write Wo-Met Shop, Ashburn, Ga.

KNOCKDOWN Cedar chest lumber veneers. Free price list. Giles-Kendall, Huntsville, Ala.

LITTLE Library of Useful Information. 102 different books. Catalog free. Popular Mechanics Press, 200 E. Ontario St., Chicago 11, Ill.



## MAKE IT YOURSELF

**BUILD** Your own powerful riding garden tractor. Engineered by expert; believed to be best ever made. Send for free circular. Campbell's Utility Tractor, Box 214, Spring Arbor, Mich.

**FRAME** Homes. 30 page booklet: drawings, instructions on how to build. \$1.00. H. C. Lightfoot, Civil Engineer, Richboro 1, Penna.

**TIES**, Make your own, patterns and instructions 25c. Box 5651, Indianapolis 19, Indiana.

**BUILD** Better tilting table circular saw. Patterns free. Write Ward Manufacturing Co., Walsenburg, Colo.

**MAKE** Leveling instrument. Level like surveyors do. Easy. Profitable. Circular free. Design Service, Box 143-A, Aurora, Nebraska.

**RUBBER** Molds 50c up. List free. Winner, 228-P Grove, St. Paul 1, Minn.

**CONCRETE** Mixer, hand power. Efficient, inexpensive, plans, \$2.00. Mitkos, 8802 Corwin, St. Louis 21, Mo.

**CONCRETE** Block homes. 24 page booklet: drawings, instructions on how to build. \$1.00. H. C. Lightfoot, Civil Engineer, Richboro 1, Penna.

**ROTARY** Power lawn mower kit. Complete or parts. Free literature. Air-Electric, Lohrville, Iowa.

**COMPLETE**, Copyrighted plans and instructions for building combined frozen food locker and walk-in cooler at home \$1.00. Newman's, Box 1020, Houston, Tex.

**BUILD** Real heavy duty machines, using our production tested plans. 30" bandsaw, 12" lathe, dowel machine, portable sawmill, planer, concrete block machines, dozens other machines for shop, farm, home. Free lists. Nichols Equipment Co., Purvis, Miss.

**MAKE** Your own residential water softener. Plans \$3.00. Dean Products, Inc., 141 W. Jackson Blvd., Chicago 1.

**FUN** Or profit. Make own blueprinting and copying device. Plans and instructions \$1.00. Bluebird Novelty, Osceola, Indiana.

**GRANDFATHER** Clock building system, simple, shop-tested, thousands built, with weight movements pictured in production \$1. Kempel Clock Plant, Minneapolis 16, Minn.

**MAKE** Brooches, earrings from seashells. Instruction book 35c. Supply catalog free. Whyteson, 358 W. 45 St., New York City.

**COMPLETE** Instructions to build a bow-gun. Only 50c. Mills, 1892 San Juan, Berkeley 7, Calif.

**BUILD** Child's auto. Steel essential kit. Belt drive. Circular. Paradise Craftsmen, Box 98, Bradley Beach, New Jersey.

**WHY** Plow? Build your own tiller. Stamp for details. Harold Mangus, Rt. 3, Alliance, Ohio.

**BUILD** Concrete block machine. 2 blocks per minute. Build concrete mixer. Easy, inexpensive. Details free. Horne, 206 West Wilder, Tampa 3, Florida.

**FLUORESCENT** Lights. How to make your own 20 watt lights for less than \$1.00 each. Materials available. Complete, guaranteed, detailed instructions. \$1.00 cash or money order. Checks \$1.10. Specialty Sales, Box 1086, Muncie, Indiana.

## PLANS AND BLUEPRINTS

**REVOLUTIONARY** New postcard. Sensational possibilities. Replaces letters. Exclusive, patented. Folio, plans, \$1.00. Jolless Printing Co., Box 565, Clinton, Iowa.

## WATCHES, OLD GOLD, JEWELRY

**WHOLESALE** Men's guaranteed new military style jeweled wrist watches, sweep second hand. Regular \$20.00 value now \$12.00 for sample. No tax. In dozen lots \$10.00 ea. Money back in five days if desired. King, 33 West Harrison St., Chicago 5, Ill.

**WATCH** And Clockmakers Handbook. Britten, \$5.79. Most complete on subject. Catalogue free. Engineers' Book Service, 19 W. 44th St., Rm. 1002, New York 18.

**BEGINNERS** Jeweled pocket watch movements "as is" \$2.00 each. Bezkor, 1491 Metropolitan Ave., New York 62.

**CASH** For old, broken jewelry. Highest prices paid immediately. Mail gold teeth, watches, rings, silverware, diamonds, spectacles. Satisfaction guaranteed. Information free. Rose Smelting Co., 29-A East Madison, Chicago.

**WATCHES** Repaired. Precision adjustments and repairing of all kinds of watches. Mail us your watch (insured) and you will receive an estimate by return mail. No obligation. Your watch immediately returned if you do not want work done. Quick service, reasonable. Tesla Watch Co., (Dept. A), Box 372, Times Square, New York 18, N. Y.

**MEN'S** Wrist or pocket watch, 0 jewels, radium dial, \$7.00. Agent's bonus. Jacob Koenig, 112 West 45 St., New York 19, N. Y.

**WATCH** And chronograph repairing. Electronically timed for accuracy. Estimates sent if requested. All work guaranteed. Karlin Co., 924 E. Main St., Alhambra, Calif.

**BROKEN** Or unusable discarded movements, etc. Highest prices and satisfaction guaranteed or merchandise returned. Box 471 P.O., Newark, New Jersey.

**WATCHES**, Materials, tools, jewelry, diamonds—bought—sold. Catalogue, Gales, Box 1000, Chicago.

**WATCH** Repairing: Complete course. Every part of watch fully explained. Many large pictures and drawings. Tools, material. Where to buy. \$2.75 money back guarantee. Park Place Supply Co., P.O. Box 1983, Houston 1, Texas.

**ATTENTION!** Just very few left. Brand new Hamilton pocket watches. 22 jewel movement, adjusted and timed to 6 positions, 24 hour dial, sweep second hand and non-magnetic. An excellent timepiece for a life time wear. Price \$28.50. M. M. Rudy, 406 Bloy St., Hillside, New Jersey.

**WATCH** And clock repairing—Complete practical course in modern horology. 66 illustrated self-instruction lessons. Just out! Low price. Fascinating 100-page illustrated catalog free! Write—Nelson Company, Dept. 3-02, Chicago 5.

**WATCHES**, Jewelry bought, sold, repaired. Catalogue, Justice, Box 6, Preuss Station, Los Angeles 35, California.

**OLD** Gold: Top price paid. Mail old or broken jewelry, rings, watches, gold teeth, silverware, diamonds. Receive cash immediately. 100% satisfaction or articles returned. Information free. The Old Gold Specialist, Robert Wyndham, 1035 East A. Street, Ontario 1, California.

**GEMS**, Precious and semi-precious, all genuine, from world wide sources. Deal direct, no overhead, save money. Catalog 10c. Hill Co., Route 7, Salem, Oregon.

**WATCH** Repairing easy learned by our home study course. Watch repairers are in demand and are among the highest paid craftsmen today. Write for free information. Houston Chronometer & Watch Co., P.O. Box 1140A, Houston 1, Texas.

**GOLD** \$35.00 Ounce—Mail old gold teeth, diamonds, jewelry, watches—receive cash by return mail. Satisfaction guaranteed. Free information. Dr. Weisberg's Gold Refining Company, 1500-Q Hennepin, Minneapolis, Minn.

## TOBACCO, SMOKERS' SUPPLIES

**LATIN** American cigars direct. Stahl's Service, 1609 Manchester, Middletown 22, Ohio.

**AIR** Cooled pipe, 50% cooler smoke guaranteed. Sample \$3.50. N. V. Moor Company, 420 Market Street, San Francisco, Calif.

**CIGARETTES**—Popular brands; minimum 3 cartons. Price \$1.45 per carton; postpaid. Send check or money order. Ace Mail Order Co., East Orange 84, N. J.

**CIGARS**, Wholesale and retail. Write. Natural leaf homespun. Mild air or fire cured chewing 5 pounds \$1.90, smoking \$1.60 postpaid. William Crews, Dresden, Tennessee.

**SELL** Genuine briar pipes direct. All men prospects. 100% profit. Lightweight sales kit. Write Abbott Pipes, 62 East 87th, New York 28.

**PIPE** Smokers valet, pipe smokers what you've been waiting for. The Travelers Pipe Valet. Beautiful lucite rack, holding two pipes, tobacco, matches. Fits on dashboard of car, plane, or cruiser with guaranteed rubber suction cups. Enables you to fill and light pipe with one hand. Write for free descriptive booklet. Dealers and jobbers protected. Jalouse Art Co., Dept. C, 173 Hobart St., Ridgefield Park, N. J.

**MAKE** Smoking pipes, briar blocks and stems. Send for circular. Michelson & Sternberg, 67 West 44th St., New York 18.

## RAZORS, BLADES, SHARPENING

**MORE** Shaves from your blades. Simple effective method. No tools needed. Send 25c for instructions. Guaranteed results. Savablade, 19465 Ward, Detroit 21, Mich.

**SAVE** Money. Send \$1.00 for 100 high-grade double edge razor blades. Postpaid. Exclusive, 4348 Broadway, Chicago.

## FOR THE HOME

\$24.00 **BUYS** Essential kit to make 30 gallon automatic electric hot water heater, 10c brings bulletin. MacElectric, Grandview, Washington.

## FOR SALE MISCELLANEOUS

**MECHANICAL** Drawing Instruments—Veeco, 4 piece, compact, precision set, brand new in lined case, value \$12.50, special, \$7.25. Army surplus slide rules, slightly used, 75c each. Hull automobile compass, for accurate road direction, brand new, \$2.50. Brand new folding valise knapsacks made of heavy olive green duck, heavily bound and reinforced, repellant to fire or water. Inside 3 large snap fastened pockets, heavy webbed straps, hand and shoulder handles, size opened 22"x54", closed 22" rolled. Useful to hunters, Boy Scouts, hikers and for all traveling use. A \$7.50 value, special \$2.25 postpaid. Prisms for 6x30 or 8x30 binoculars brand new \$1.50 each. Offset prisms to be attached to 7x50 B. & L. binoculars gives double the field of the ordinary 7x50 binocular. Cost \$98.00, special \$25.00. Green sunshades for binoculars size 6x30 and 7x50 snap on type, value \$7.50, special \$1.25 per pair. Forward money order. No C.O.D. shipments. Public Sport Shops, 13 S. 16th St., Philadelphia, Penna.

**MEN'S** Slacks, gabardines. Zipper pleats \$8.95. Give size, two choice colors. Send \$1.00. WHB Mfg. Co., 1395 Yosemite, San Jose, Calif.

**MODERN** Kitchen cupboard construction and planning made easy with our plans. Free information. Masterprint Company, White Building, Buffalo, N. Y.

**KU-KUL-O-GRAPH**—Fascinates everyone. A simple mechanical device for automatically creating and drawing countless varieties of intriguing, novel designs and patterns. Used by designers, artists, students. Entertains everyone. A unique gift. In attractive box, postpaid \$1.75, check or money order. Nelson Manufacturing Co., Box 70-A, Woodburn, Oregon.

**SHOP** by mail. Catalog free. R. E. Reese, Emmaus, Penna.

**GOVERNMENT** Surplus Sperry S-1 bomb sights consisting of hundreds of precision built parts, gears, lenses, roller brgs., shafts, motors, switches, relays—ideal for experimenters, inventors, hobbyists, \$49.50 each. Three or more, \$42.50 ea. With metal container and lock ideal for strong box, \$9.50 extra. Oxygen masks. Can be used for spraying, electric welding, painting, grinding, by farmers for tree spraying. Made of genuine rubber with sponge filters. 1 to 5, \$2.75 ea., 6 to 11, \$2.50 ea., 11 to 24, \$2.25 ea., 25 to 50, \$2.00 ea. B-11 safety belts for many uses on farms, homes and industrial. Also safety belts on jeeps. 1 to 11, \$2.00 ea., 12 to 24, \$1.75 ea., 25 to 50, \$1.50 ea. Genuine Autolite heavy duty generators, Universal, with 3 unit apparatus box, ammeter, output 55 amperes—12 volt. Can be used for radio, truck, boats, power plant, etc. 1-3, \$85.00; 4 or more, \$79.50. C.O.D., F.O.B. Chicago. Ace Surplus Sales Co., 1449 W. 69th St., Chicago 36, Ill.

## WANTED MISCELLANEOUS

**CARTOONIST** With promising future desires live-wire gag writer. Percentage basis. Jim Blitch, 1032 State, New Orleans 15, Louisiana.

**PRODUCTS** Wanted by central Wisconsin manufacturer, established since 1883, with plant facilities including pattern, machine shops, gray iron and brass foundries, welding and structural departments, selling to industrial markets. Able to do good manufacturing and selling job if what you have is beyond your means. Advantageous arrangement for you. Write D. J. Murray Manufacturing Co., Wausau, Wisconsin.

**CATALOGUES**, Reliable for mail order business. E. A. Wamsley, Mt. Jewett, Penna.

**WANTED**—Precision machinist tools, micrometers, indicators, etc. Send tools, get appraisal, cash promptly. Wm. Gruer, 460 Ryerson Ave., Elgin, Illinois.

**JUSTICE** Buys "Anything." List free. Box 6, Preuss Station, Los Angeles 35, California.

**MERCURY**—Highest prices. Free containers. Write. Wholesale Terminal, Norwood, Mass.

**MERCURY** (Quicksilver). Write for quotation stating quantity. Metallurgical Products Co., 35th and Moore Sts., Philadelphia, Penna.



## PERSONAL

**COMIC** Pen and ink sketch made from your photograph. Picture returned unharmed. State hobby or pastime. Send photo and \$1 to G. Franks, 1400 E. 53rd St., Chicago, Ill.

**MAGNETIC** Clothes personality. Haberdashers proven secrets. Graham, Box 448, Toronto 2, Canada.

**BORROW** By mail! Loans \$50.00 to \$1,000.00 to employed men and women. Easy, quick. Completely private, confidential. No endorsers. Repay in convenient monthly payments. Details free in plain envelope. Write First Loan Co., World Herald Bldg., Dept. J-20, Omaha, Neb.

**PROM** Washington, D. C., Baltimore, Md. We remail postcards, letters. Quantity rates, quality service. Remail Service, 2729 Huntingdon Ave., Baltimore 11, Md.

**NEWSPAPER** Clippings for scrapbook. The surprise of the year. Amaze your friends. In your own words—photo inserted free. Clipped from newspaper page. Sample and details, two airmail stamps. Bolduc Studio, 33 West 67th Street, New York City.

**GET** More out of life. Details free. Gerlach, 3267 North Sixteenth Street, Milwaukee 6, Wisconsin.

**PRETEND** Visiting California. 3 postcards 25c. We remail free. Letters 15c each. Free information. Smith, Box 4685, San Francisco, Calif.

**FALLING** Hair. Free educational pamphlet explaining cause, and prevention. James Hilton, 4819A Fourth Ave., Brooklyn 20, N. Y.

**STAMMER?** Maybe I can help. Sauer, Box 139-B, Mars, Penna.

**SWAPPERS!** Traders!—Free information. "Swappers" Gazette, 2836-PM Slevin, Louisville 12, Kentucky.

**FALSE** Teeth wearers. If your dental plate is loose and uncomfortable I have good news for you. Send name on postcard. No obligation. Dr. Reese, Dentist, Box 268-X, Winnetka, Illinois.

**LITTLE** Library of Useful Information. 102 different books. Catalog free. Popular Mechanics Press, 200 E. Ontario St., Chicago 11, Ill.

**RUPTURED?** Positive comfort, no understraps, no steel, no elastic. Write Smith Manufacturing Company, Preston, Ontario.

**HAIR** Falling? Dandruff? Write Trichologist, 137 Lewis St., Phillipsburg, N. J.

**HOW** You can find out! Information discreetly developed, any matter, person, problem, anywhere. Personal-business assignments, representations, undertaken. Nation-wide. Officially licensed and bonded service established 1922. Reasonable. All inquiries confidential. William Herman, 170 Broadway, New York.

**FREE**—"Amazing New Book"—"Profits From Classified Advertising." Tells how and what to advertise. Be sure to read this book before you invest one cent in advertising. Remember—it's free! Write for your copy now. F. W. Johnson, Classified Advertising Manager, 200 East Ontario Street, Chicago 11, Illinois.

## MISCELLANEOUS

**ORANGES** Direct from grower. Full bushel, sweet, tree-ripened Valencia oranges only \$3.95, half-bushel \$2.95 express paid. Western states \$4.95; \$3.75. Satisfaction guaranteed. H. G. Zimmerman, Glenwood 7, Florida.

**SPECIAL!** Finest Texas tree-ripened grapefruit and oranges, family assortment, bushel \$4.90 prepaid. Erdahl's Fruit Co., Mission, Texas.

**FIREWORKS.** Any time, any quantity, newest ideas, highest quality, best values. Giant salutes, aerial bombs, skyscreamers, battle-in-the-clouds, Chinese firecrackers, sparklers, roman candles, sky rockets and many others. Over 200 piece combination offer, retail value over \$10.00 for only \$4.95. Write for big new catalog. Banner Fireworks Mfg. Co., Inc., Dept. 300, 446 Capistrano, Toledo, Ohio.

**SEPTIC** Tank problems solved. "What to Do and What Not to Do." A booklet compiled from years of experience. Order now! \$1.00 per copy. Reuben Selfridge, Septic Tank Engineer, Dept. M, Clymer, N. Y.

**RAT** Control. Kill safely, surely, with Antu-Rat Bombs—Gases—Squill's Correct bad practice, what happened on McDonnell's Farm? "Kildonan Rat Program." Copyright. Send \$1.00. Kildonan Pest Control, Highwood, Ill.

**BALLOONS.** Army targets inflate 3½ feet in diameter. Flies better than a kite. 29c postpaid. Harry Freedman, Box 68, Revere, Massachusetts.

**LUMINOUS** Statuettes. Dutch boy, lamb, bear. \$1.00 each. P.O. Box 66, Orange, Mass.

**WHOLESALE** Radio service. Any radio repaired. Ship via express. Satisfaction guaranteed. Elkins Radio, Elkins, W. Va.

**ARTISTIC** Bronze grave markers. Reasonable. Berg, Box 3162-A, Bridgeport 5, Conn.

**BEAUTIFY** Your watch! Men's and ladies highest quality gold filled expansion watch bands in yellow, pink or white gold. Regular \$9.00, only \$4.95 postpaid. Lee Distributors, Box 536, Miami 4, Fla.

**FREE**—New 42-page book entitled—"How to Become a Successful Direct Salesman," written by salesmen for those who want to become salesmen and earn up to \$100 and more weekly. Send penny postcard, Specialty Salesman Magazine, Dept. PM-1, 307 N. Michigan, Chicago 1, Ill.

**"RECEIVE** Mail." Moneymaking offers, opportunities, catalogs. Name listed 10c. Ideal Service, 100, Park Ridge, Ill.

**CACTUS** Wood veneer, unique for covering. Sample and catalog. Natural desert displays, Box 876, Coolidge, Arizona.

**JACKASS** Cigar lighter. Amusing novelty. A laugh with every light. \$1.00 prepaid, or \$1.10 c.o.d. Mondell Company, 1261 Big Bend, St. Louis 17.

**FREE** Samples, catalogues, magazines, literature, moneymaking opportunities! Receive lots of mail from everywhere! Mails galore! Your name listed in over 15,000 "Surefire" mailing directories, \$1.00. 5000 listings, 50c; 2000, 25c. Stanford, 6220-M 16th, Philadelphia 41.

**GET** Big mail. Samples, catalogs, moneymaking opportunities. Your name put on many mailing lists. 10c. Lloyd Linde, 14147 School, Chicago 27.

**RECEIVE** Big mails, opportunities, magazines, samples. Name listed 10c. Lawson, Box 1302-P3, Detroit 31.

**KITE** Flyers—Have fun, make money with the astonishing Paratripper. Automatically releases parachutes any altitude. Send 25c for complete kit and instructions. Lad Ventures, Division B-347, 4815 Newport, San Diego 7, Calif.

**LOOK!** Beautiful Corozo nut rings from Puerto Rico. Only \$1.00 each. Fletcher, Post Office Box 3051, Little Rock, Ark.

**POCKET** Size can openers. Fits on your key ring. Send 25c in coin (no stamps) for trial order of 6. M.B.V. Sales, P.O. Box 1086, Fort Wayne, Indiana.

**ORIGIN,** Age of Earth, 30c. Christian Evidence League, Malverne, New York.

**ZIRCONS**—The diamonds only rival, again available. Jewelry catalogue free. Expert watch repairing. Bluebonnet Jewelers Exchange, 2500 Carter, Ft. Worth 3, Texas.

**HYDROGEN** Gas, make your own, no electricity, inflate toy balloons. Cheap materials, easy to get. Simple formula. Complete instructions \$1.00. G. R. Calkins, R. 1, Box 217-B, Atascadero, Calif.

**BAROMETER,** Weather forecaster, accurately forecast weather. 4 inch dial, green leatherette case. \$2.50 postpaid. Morrison Co., Box 1313, Columbus, Ohio.

**INDIAN** River citrus fruits, Florida's juiciest. Basket-packed fresh from trees. Send stamp for price-list. Schuyler Jackson, Wabasso, Fla.

**SHARPENED,** Reconditioned, saws \$1.50, scissors 50c, postage prepaid. Overland's Saw Service, Independence 2, Iowa.

**ROBALL** Pen—years of use without refilling! Beautifully designed, accurately engineered, lifetime guaranteed. Writes smoothly, dries rapidly, satisfies permanently. Send \$5 to Wardell, 2509 Clarendon Road, Brooklyn 26, N. Y.

**HELPFUL** Books. Correspondence courses. Bargain catalogue free. Baker, 5509-B Winthrop, Chicago 40.

**RECEIVE** Moneymaking opportunities, mails, samples, catalogs, magazines. Your name in thousand mailing lists, 25c. Glassmine, 1654-MX Amsterdam Avenue, New York 31.

**ORANGES,** Grapefruit or half and half \$3.95 bushel basket, express charges collect. Timberlake Fruit Company, 16 Davis Boulevard, Tampa, Florida.

**CONTACT:** Over 375 Hollywood names and addresses of motion picture studios, agents, and producers. Complete, prepaid, \$5.00. Mail check, cash, or money-order to: Hollywood Select Press, 858 N. Mansfield, Hollywood 38, Calif. Dept. PM.

**WAR** Surplus—Self contained oil transmissions, input up to 2 hp. @ 4000 r.p.m. Output infinitely variable either direction. Suitable for motor scooters, machine drives, etc. \$25.00 prepaid. C. J. Cartwright, Box 583, Keego Harbor, Michigan.

**TELEGRAPH** Model kit. Educational authentic. Flash light battery operated. Instructions, materials for two sets 98c. Dick Morgan, Dept. 5A, 151 E. Morton, St. Paul 7, Minn.

**BALL-TYPE** Pens \$2.75. Mystery drinking bird \$2.75 p.p. Pretend visiting Milwaukee (Beer City), 3—25c. Address, I remail, Slamka, R 1, Box 64A, So. Milwaukee, Wis.

**ELECTROKLEEN.** Revolutionary no-rub silverware luster restorer. Generous supply this amazing product yours for \$1.00 postpaid. Wesleyville Radio, 3206 Buffalo Rd., Wesleyville, Penna.

**RARE** Garden, field and tree seeds. Mexican Products Co., 126 N. Main, Tulsa 3, Okla.

**BRAZILIAN** Orchids. Ask catalog. Orquideario Catarinense, Exporters, Corupa, Santa Catarina, Brazil.

**NAVY** Ship pictures. Any ship in the navy, size 8x10 inches, actual photo. Price \$1.00 each mailed post paid. Liberty Picture Co., Richmond, Calif.

**MERCHANTS** Business Builder, sample 10c. Write James Lamont, Beacon, N. Y.

**STAMPS** Wanted by thousands of our readers. Your ad in this space will bring you some nice orders. One advertiser sold 150,000 stamps. Write for positive proof. F. W. Johnson, Classified Advertising Manager, Room 301, 200 East Ontario St., Chicago 11.

**MAGNET,** "Alnico" 4 oz. horseshoe, powerful (lifts about 5 lbs.), \$1.00. 8 oz. (lifts 10 lbs.), \$1.50 postpaid. Ross, 68C W. Broadway, New York, N. Y.

**POST** Card folders. Beautiful folders with the pictures of 16 navy ships, price 10c each, mailed post paid. Liberty Picture Co., Richmond, Calif.

**GOOD** "Used" self-instruction educational books on all subjects bought, sold, rented, exchanged. Satisfaction guaranteed. Complete information and 100-page illustrated bargain catalog free! Write—Nelson Company, Chicago 8.

**PURE** Vermont maple sugar postpaid in \$1, \$2 and \$5 lots. Eulalia Turner, Poultney, Vermont.

**8 ALNICO** Magnets plus 100 experiments, \$2.00. Eljay, Box 891, Newark 1, N. J.

**MAKE** Your own plastoplate printing cuts. Simple, easy process. Plastoservice, Argyle 1, Wisconsin.

**BOOKFINDERS!** (Scarce, out-of-print unusual books.) Quickly supplied. Send wants. Clifton, Box 1377PMM, Beverly Hills, Calif.

**BOOKS**—All Kinds—Homecraft, Radio, Plastics, Boat Building, Photography, Model Building. Catalog free. Popular Mechanics Press, 200 E. Ontario St., Chicago 11, Ill.

**TATTOOING** Outfits—engraving outfits. Circulars free. Write, Zels Studio, 728 Lesley, Rockford, Illinois.

**MEDICAL** Laboratory technicians in great demand. We train you in your spare time, in your own home. You can practice while studying. Write for free catalogue. Imperial Technical Institute, Box 973-J, Austin, Texas.

**SQUARE** Dance instructions, 25 sets, \$1.00. Rayburn, Eureka Springs, Arkansas.

**CALENDAR** 1753 To 2152. Shows actual calendar for each month. Accurate, simple and durable. 35 cents postpaid. Tracy Newton, Decatur, Georgia.

**70 BIBLE** Lessons, 25c. Bulletin, Box 87, Station H, New York 25.

**M-SCOPE** Metal, mineral locators latest 1947 electronic type ready for immediate shipment. Fisher Research Laboratory, Inc. manufactured some of the finest metal-locators for the U. S. army. Experience gained is yours in the most efficient metal, mineral locator. Free 16-page booklet upon request. Credit plan available. Fisher Research Laboratory, Inc., Palo Alto, California.

**PHOTO** Cards. Assortment 25c. Books, Nylons. Details free. Persil, 436 N. Y. Ave., Brooklyn 25, N. Y.

**SENSATIONAL** Buys in new and interesting toys and novelties! Write today for latest listings. Windy City Mail Order House, 5159 S. Paulina Street, Chicago 9, Illinois.

**FREE**—"Amazing New Book"—"Profits From Classified Advertising." Tells how and what to advertise. Be sure to read this book before you invest one cent in advertising. Remember—it's free! Write for your copy now. F. W. Johnson, Classified Advertising Manager, 200 East Ontario Street, Chicago 11, Illinois.



# Pay Is Good

in both these big Branches  
of the Automobile Industry

LEARN IN A FEW  
WEEKS IN OUR  
BIG MODERN  
TRAINING SHOPS

## AUTOMOTIVE MECHANICS

## BODY & FENDER REBUILDING

NOW IS THE TIME  
TO PREPARE FOR  
YOUR PLACE IN A  
GIANT INDUSTRY

Automobile industry making up for lost time! There may never again be such opportunities for men who want better jobs or business of their own to get in on ground floor and go up fast! Yes — FOR MEN WHO ACT FAST, THINGS CAN HAPPEN FAST!

### TRAIN ON ACTUAL EQUIPMENT

Chicago Motive Trades Institute makes rapid progress possible by Learn-By-Doing SUPERVISED SHOP TRAINING. In motive trades our institute gained nation wide fame training Auto Mechanics for U. S. Army. Same quality training available to you now. CONSULTATION AND PLACEMENT SERVICE WHETHER YOU ARE INTERESTED IN WORTHWHILE JOB OR SETTING UP YOUR OWN BUSINESS.



### AUTOMOTIVE MECHANICS

Practical shop training on all types of equipment. Automotive mechanics needed to keep millions of cars, busses, trucks rolling. Efficient auto mechanics get fine pay. Can service, repair, install all mechanical and electrical parts of autos. Learn to overhaul and repair engines, transmissions, differentials, and other assemblies. Good pay, steady work, excellent opportunities for increased earnings for properly trained auto mechanics.

### BODY AND FENDER REBUILDING



Body and Fender rebuilding one of best paid fields in automobile industry. Body and Fender Rebuilding makes good profits in garages, service stations. Get practical, all-around Shop Training—welding, aligning, mixing and matching colors, spray painting, power and hand tools. Values increased when used cars are made to "look like new."

### A NATIONALLY KNOWN INSTITUTION

Rapid progress possible by supervised learn-by-doing SHOP TRAINING. C.T.I. is an old established school, backed by years of experience—with trained instructors—with completely equipped shops. VETERANS qualifying under "G.I. Bill" have tuition paid monthly subsistence allowance while in school. Just mail coupon, we will handle all details. (LOW TUITION, EASY TERMS if you are not a veteran.)

**CHICAGO MOTIVE TRADES INST.**  
Dept. B23  
Div. of Commercial Trades Inst.  
1400 W. Greenleaf Ave., Chicago 26, Ill.  
**FREE—IMPORTANT INFORMATION**  
TELLING HOW TO GET STARTED



CUT COUPON ALONG THIS LINE

Fill Out, Cut Out, Mail Today

FACTS FREE for Men Who Want to Get Ahead

CHICAGO MOTIVE TRADES INSTITUTE, Dept. B23  
1400 W. Greenleaf, Chicago 26, Ill.  
Send free illustrated Brochures and other information about the field I have checked below.

- Automotive Mechanics       Body & Fender Rebuilding  
 Veteran                               Non Veteran

Name.....

Address.....

City..... State.....

SAY YOU SAW IT IN POPULAR MECHANICS

## CRIME DETECTION Learn At Home!



For over 80 years we have taught it. Hundreds who have prepared themselves through I. A. S. home study courses in Crime Detection now hold positions with steady pay as peace officers or fingerprint experts. You, too, may have this training.

### OVER 800 AMERICAN IDENTIFICATION BUREAUS

now employ I. A. S. trained students or graduates. Most of these men are heads of their departments. Send now for complete list of Bureaus using the services of I. A. S. trained personnel. When writing, please state age.

Be A  
FINGER  
PRINT  
Expert

**FREE!!!**  
Send for thrilling  
"BLUE BOOK  
OF CRIME"

**INSTITUTE OF APPLIED SCIENCE**  
1920 Sunnyside Ave., Dept. 1353 Chicago 40, Ill.

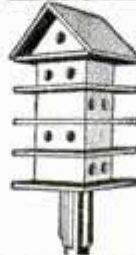

## 48 PLANS

\$100

48 complete plans of toys, ash trays, garden ornaments, Dutch boys and girls, what-not shelves, and many other interesting projects. Finest selection available. Novel method allows you to make finished project any size desired. PLUS FREE DeLuxe Plan of corner shelves. Send only \$1 to Jackson, Dept. 5-5440 N. Shoreland Ave., Milwaukee 11, Wis.



## Learn modern watch and clock repairing

At home, spare time. Good field now... security and contentment in future. Start part-time business and EARN while you learn. Horology is precision instrument work... a great and growing field, sensational opportunities. Easy self-instruction course. Low price. Money-back guarantee. Write today for FREE Success-Catalog! NELSON CO., 1139 S. Wabash Ave. Dept. C-02 Chicago 5, Illinois

## FENCING HEALTHFUL SPORT

Keep fit and enjoy the exciting pastime of swordsmanship with our two 3 ft. Spring Steel Foils (swords) Safety Rubber buttons, hand guards and our Free Instruction manual—all available now for only \$1.98 payable by CHECK or M. O. Add 28c for Foreign Postage. LEE PRODUCTS, Dept. 26, 1613 First Ave., N.Y. 28, N.Y.



## CORRESPONDENCE COURSES IN RADIO and ELECTRICAL ENGINEERING

Tuition  
\$25

ELECTRICAL ENGINEERING. Get good grasp of wide electrical field. Modern. Very understandable. Theory made easy. RADIO ENGINEERING. Extra fine course in radio, public address, photo-electric work. Trains you to be super-service man, real vacuum tube technician. Tuition ONLY \$25, either course. Deferred payment plan. Servicemen needed badly. Write for free copies of school catalogs, student magazines, etc. FREE LINCOLN ENGINEERING SCHOOL, Box 931-P99, Lincoln, Nebr.



## CARTOONING

HAVE FUN! MAKE MONEY! Cash in on your sense of humor AT HOME—BY MAIL. No experience needed to start. Write today FOR FREE TRIAL LESSON and full particulars. Moon Gag Cartoon School, Dept. B, Fall Creek, Wis.



### MUFFLERS

## STEELS and ALUMINUMS with a motorboat tone

SINGLES, Chev, V-8, Plymouth, Steels \$5.50, Aluminum \$6.50. Chry., Olds, Buicks, etc., Steels \$7.50, Aluminum \$8.50. V-8 and MERCURY DUALS, Steel \$17.50, Aluminum \$20.00. Aluminums are guaranteed for life of your car. DEALERS WANTED

**SANDEE MUFFLER CO.**  
7523 S. WESTERN AVE., LOS ANGELES 44, CALIF.



# WAR BARGAINS in LENSES and PRISMS

## ASSEMBLE YOUR OWN BINOCULARS!

Complete Optics! Complete Metal Parts!  
Save More Than 1/2 Regular Cost

### ARMY'S 7X 50 BINOCULARS

Here's an unusual opportunity to secure a fine set of Binoculars at a substantial saving of money. Offered here are complete sets of Optics and Metal Parts for the Army's M-16 7X 50 Binoculars (M-16 is not the waterproof model). These components are new and all ready for assembly. We supply full instructions. Limit—1 set of Metal Parts and 1 set of Optics to a customer.



**METAL PARTS**—Set includes all Metal Parts—completely finished—for assembly of 7X 50 Binoculars. No machining required. Bodies have been factory hinged and covered. A sturdy brown leather Binocular Carrying Case is included with each set of Metal Parts.  
Stock #824-H 7X 50 Metal Parts.....\$35.00 Postpaid

**OPTICS**—Set includes all Lenses and Prisms you need for assembling 7X 50 Binoculars. These Optics are in excellent condition—perfect or near perfect—and have new low reflection coating.  
Stock #5102-H 7X 50 Optics.....\$25.00 Postpaid

**NOTICE!** If you buy both the Binocular Optics and the Binocular Metal Parts, your purchase becomes subject to 20% Federal Excise Tax. Be sure to add amount covering tax to your remittance or your order cannot be filled.

### ARMY'S 6X 30 BINOCULARS

No Carrying Case with any Sets shown below. (None yet available in Surplus Market.) M-13A1 sets are waterproof model. M-3 sets are not waterproof. Limit—1 Set to a Customer on all Sets shown below.

**COMPLETE OPTICS & METAL PARTS**—Model M-13A1, 6X 30 Binoculars. Everything you need—ready for assembly. When finished will look like a regular factory job costing \$102 to \$120. The Optics are new, in perfect or near-perfect condition. Have new low reflection coating. Metal Parts are new and perfect, all completely finished. No machining required. Bodies factory hinged and covered. Complete assembly instructions included.  
Stock #830-H.....\$40.00 Postpaid,  
plus \$8.00 tax—Total—\$48.00

**COMPLETE OPTICS & METAL PARTS**—Model M-3, 6X 30 Binoculars. The Optics in this set are new, perfect or near-perfect. Prisms have new low reflection coating. Factory mounted Eye Piece and Objective Assemblies not coated. Metal Parts are perfect, new, ready for assembly. When finished, this will look like a regular factory job, except a name has been filed off a cover plate. No machining required. Bodies factory hinged and covered.  
Stock #831-H.....\$35.00 Postpaid,  
plus \$7.00 Tax—Total—\$42.00

**METAL PARTS ONLY**—Model M-13A1, 6X 30 Binoculars. No Optics. Same Metal Parts as described for Stock #830-H.  
Stock #832-H 6X 30 Metal Parts.....\$25.00 Postpaid

**METAL PARTS ONLY**—Model M-3, 6X 30 Binoculars. No Optics. Some machining on these Metal Parts required. Bodies hinged and Prism Shelf holes placed, but you must tap them. Prism Shelves have been machined. Six lead spiral focusing threads have been cut. Some less difficult components you must thread and machine yourself, but all material you need is furnished except body covering material and Optics.  
Stock #833-H 6X 30 Metal Parts.....\$12.00 Postpaid

**METAL PARTS ONLY**—Model M-3, 6X 30 Binoculars. No Optics. All parts you need. You must do machining on most parts, but not all. No body covering material.  
Stock #834-H 6X 30 Metal Parts.....\$8.00 Postpaid

**OPTICS FOR 6X 30 BINOCULARS** (No Metal Parts). Slight seconds. Cemented but not coated.  
Stock #5123-H.....\$10.00 Postpaid

**SAME OPTICS AS ABOVE** (6X 30), but coated.  
Stock #5124-H.....\$12.75 Postpaid

If you buy both the Binocular Optics and the Binocular Metal Parts, your purchase becomes subject to 20% Federal Excise Tax. Be sure to add amount covering tax to your remittance or your order cannot be filled.

Optics and Metal Parts are Available for Monoculars (1/2 a Binocular). For Complete Details, Write for Bulletin #14-H.

SATISFACTION GUARANTEED

## YOU CAN EASILY MAKE

Telescopes, Magnifiers, Photographic Gadgets and  
Hundreds of Experiments with these Low Cost Lenses

**MOUNTED 35 MM. PROJECTING LENS SYSTEM** (May Also Be Used for Enlarging). Focal Length 91.44 mm. and speed of f 1.9. Outside dia. of mount at one end 60 mm. Length of mount 64 mm. May be used as Enlarging Lens by stopping down speed. Most useful for Portrait work. Less useful for pictures requiring perfect definition out to edges of print.  
Stock #4033-H.....\$3.00 Postpaid

**CONDENSING LENSES** for 35 mm. Projectors and Enlargers. Consists of set of 2 Lenses—diam. 2 3/8", F.L. 3" each.  
Stock #1077-H.....\$2.00 Postpaid

**MOUNTED KELLNER TELESCOPE EYE PIECE**—Perfect, coated, in Ordnance sealed boxes. F.L. 1 3/4 inches. Outside dia. of steel mount 40 mm.  
Stock #6198-H.....\$3.15 Postpaid

**OPTICAL BENCH KIT**—(Not a War Surplus Item). Everything you need, including four Lens Holders for checking Focal Lengths and setting up Lens Systems.  
Stock #53-H.....\$8.50 Postpaid

**35 MM. KODACHROME PROJECTING LENS SET**—Consists of Achromatic Lens for projecting, plus a Condensing Lens and piece of Heat Absorbing Glass with directions.  
Stock #4025-H.....\$1.95 Postpaid

**16 MM. PROJECTOR CONDENSING LENSES**—Consists of two Condensing Lenses with combined F.L. of one inch.  
Stock #4026-H.....\$1.00 Postpaid

**POLARIZING VARIABLE DENSITY ATTACHMENT FOR 7X 50 BINOCULARS**—An amazingly effective unit for controlling amount of light reaching your eyes. Cuts down glare in sky and overwater observations. Easily snapped on and off over the eye cups of American-made 7X 50 Binoculars. Govt. cost \$8.30 each.  
Stock #20,000-H.....\$2.00 Postpaid

**PRISM TELESCOPE**—All the Lenses You Need to build your own 20 power Telescope! No mounts. Has wide field of view.  
Stock #5012-H.....\$7.25 Postpaid

**BATTERY COMMANDER'S PERISCOPE** With Tripod—6 Power Instrument. Excellent condition. Length 27 1/2 inches—diam. 1 1/2 inches. Cost U. S. Gov't. approximately \$175.00.  
Stock #917-H.....\$20.00 F.O.B. Audubon

## AIR FORCES GUN SIGHT

With Polarizing Variable Density Attachment

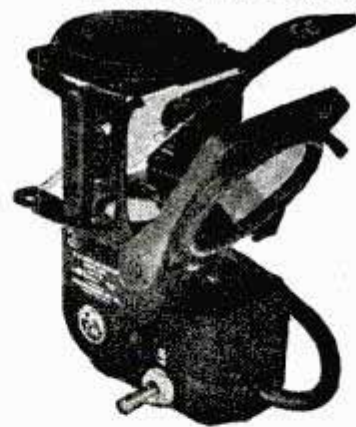

Can be used as Slide Viewer, or take it apart and you can get Polarizing Variable Density Attachment, Magnifying Concave Mirror, Reflector Plate, Metal Reticule, Window, Lamp Housing, Ring and Bead Sight. The Polarizing attachment alone is worth many times the price of entire unit. Consists of 2 Polarizing Filters mounted with small handle which rotates one around the other. May be used in Photography, Research, Experiments, as Light Dimmer, etc.

Stock #908-H.....\$5.00 Postpaid  
Same Unit Without  
Polarizing Attachment

Stock #916-H.....\$2.50 Postpaid

**BOMBER SIGHTING STATION**—A double end Periscope Type Instrument of highest precision. Brand new and in perfect condition. 6 ft. tall, shipping wt. 360 lbs. Orig. cost \$9,850. Consists of numerous Lenses, Prisms, Mirrors, Gears, Motors, Metal Parts and Electrical Gadgets.

Stock #914-H.....\$50.00 F.O.B. Oklahoma

**TANK PRISMS**—90-45-45 deg., 5 3/4" long, 2 1/8" wide, finely ground and polished.

Stock #3004-H Silvered Prism (new & perfect).....\$2.00 Postpaid

Stock #3005-H Plain Prism (new & perfect).....\$2.00 Postpaid

Stock #3100-H Silvered Prism (Second).....\$1.00 Postpaid

Stock #3101-H Plain Prism (Second).....\$1.00 Postpaid

We have literally millions of war surplus lenses and prisms for sale at bargain prices. Write for Catalog "H" — Sent Free!

Order by Stock No.

**EDMUND SALVAGE CO. P. O. AUDUBON, NEW JERSEY**



# NEW! FOR BEGINNERS Learn ELECTRIC MOTOR REPAIR!



**Easily, Quickly, at home for only \$5**

Every day, more and more electric motors are being used BOTH in industry and in home appliances. The motor repair expert is a valuable man in this Electrical Age! **ELECTRIC MOTOR REPAIR**, the new big book for only \$5, teaches all about this fascinating work—quickly and easily. Explains every detail of motor trouble diagnosing, repair and rewinding.

**TRAIN FOR GOOD PAY IN AN UNCROWDED FIELD!**

Covers alternating—and direct-current motors, synchronous motors and generators and BOTH mechanical and electronic motor control systems. Quick-reference guides at end of every chapter show exactly how to handle specific jobs. Invaluable for either beginners who want to learn **HOW**—or for actual bench use in busy repair shops. There's big money in the work. The field is not overcrowded.

580 pages  
900 illustrations  
and diagrams

**SHOWS YOU HOW EVERY STEP OF THE WAY!**

Based on what you can learn at home from this big book, you can train yourself to prompt and **PROFITABLY** service practically any motor. Every step of the work is demonstrated **VISUALLY** by more than 900 easily-understood diagrams. These are indexed for quick on-the-job reference. The unique Duo-Spiral Binding divides book into 2 sections permitting **BOTH** text and related illustration to be seen **AT THE SAME TIME**. Lies open flat on bench while you work!

**Unique Duo-Spiral binding**

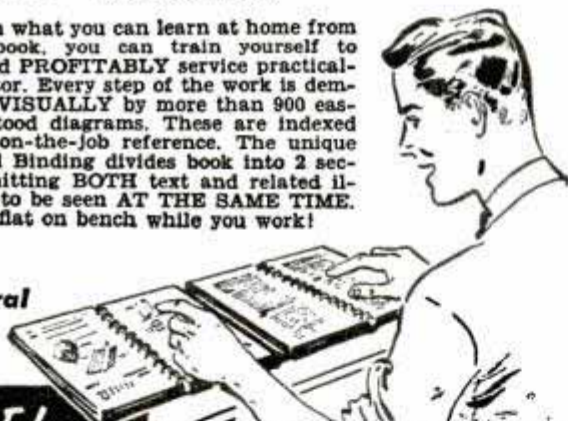

**FREE!** Check coupon for free literature on famous **GHIRARDI RADIO-ELECTRONIC Training Books**

**"BORROW" IT FOR 5 DAYS**

Send coupon now. Practice from **ELECTRIC MOTOR REPAIR** for 5 full days. If not more than satisfied with the book, return it to us. Every cent of your money will be cheerfully refunded—and no questions asked. What could be fairer?

**5-DAY MONEY-BACK GUARANTEE**

Dept. PM-37, Murray Hill Books, Inc.  
232 Madison Ave., New York 16, N. Y.

Enclosed find \$5 (\$5.50 foreign) for my copy of the big **ELECTRIC MOTOR REPAIR** book; or  send C.O.D. (in U.S.A. only) for this amount plus postage. In either event, if unsatisfactory for any reason, I may return book in 5 days and have my money refunded.

**CHECK HERE** for free literature on Ghirardi **RADIO-ELECTRONIC** books.

Name.....  
Address.....  
City & Dist. No..... State.....

# VETERANS Learn WATCHMAKING

**A Lifetime Profession**

Regardless of Conditions, Age, Sex, or Physical Limitations  
**Veterans—Civilians!**  
Your Opportunity—  
**LEARN WATCHMAKING**



Lift yourself from a futureless job into a position paying better than your present work. Fit yourself for the job that will permit you to establish your own shop, or be employed in a pleasant environment.

Watch Repairing—Jewelry—Engraving will always be in ever greater demand. Our graduates wanted everywhere. Dignified positions \$50-\$75-\$100 per week. Veterans write today for latest **FREE** enrollment requirements.

**Kansas City School of Watchmaking**  
Largest Horological School in America  
617-621 Wyandotte St. Kansas City 6, Mo.

"The Books They're Talking About"

**The Art of Drawing the Female Form**

Picture packed with photographic reproductions in various colors of beautiful artist's models, showing every curve and contour of the body from head to toe, posed and in action. These books are a **MUST** for students of Art Anatomy, who wish to gain excellence in their work, where no 'life' model is available.

These books come in 2 editions, \$1.50 Vol. 1 and Vol. 2, Each Only.....  
Outside U.S.A., send \$1.75 each.



**MAJOR BOOK CO., DEPT. B-1**

241 EAST BROADWAY

N.Y.C. 2, N.Y.

# NEW PLASTICS Fabricating MANUAL



Make beautiful objects of Plexiglas, Lucite, Catalin, Polystyrene at home. Jewelry, novelties, accessories. Send for new 10,000 word manual on how to fabricate, weld and form latest plastic materials in home workshop. Hundreds of practical suggestions. Written by leading plastics engineer. Price prepaid 25c (stamps or coin). Or get **FREE** information and price list covering transparent plastic sheets, rod, tubing cut to your size. Write today: **HOUSE BEAUTIFUL PLASTICS**, Dept. C3, 5534 W. Harrison St., Chicago 44, Ill.

**RADIO** BOOKS, Diagram Manuals. Low priced. Many only 10c, 25c. Radio Course, 22-lessons, \$2.50. Write for **FREE** catalog.  
**SUPREME PUBLICATIONS, 9 S. Kedzie Ave., Chicago 12, Ill.**

**Now You Can Join CLUB PLAN For BUSINESS SUCCESS**

**FREE**  
Full Details and Illustrated Brochure

Club Plan of Practical Business Administration now offered men in business and industry who want to follow a program in order to move up to executive positions. Plan available to employed men who wish advancement with present employer or elsewhere. Program will not interfere with present job. Serious minded, ambitious men invited to send for free facts at once.

**AMERICAN TECHNICAL SOCIETY, Dept. 523 Drexel & 58th CHICAGO, ILL.**



**DO ANY JOB.. EASIER.. QUICKER**  
**MAKE MORE MONEY** *in the*  
**BIG OPPORTUNITY**  
**FIELDS**

**SEND NO MONEY**  
 Select the Books  
**YOU Need Now!**  
 We Ship **C.O.D.**  
 Anywhere in U. S.  
 and Will Refund  
 Amount Paid if  
 Not Satisfactory.

**Here's the Help You Need**  
**For Best Paying Jobs**  
**Right NOW!**

**FREE TRIAL**  
**IN YOUR OWN HOME**

**Used by Army, Navy, Other Government**  
**Depts., 200 Schools and Industrial Firms.**

Do it now! Get the better pay that goes to men with specialized knowledge. Get into one of these big opportunity fields. Big money and many other advantages await you if you prepare now. Here is the help you need—**EASY—QUICK—AT LOW COST.** Thousands of men have already used these famous books. Beginners and experienced men alike have doubled and tripled their earnings with this help. You too, can now get the special knowledge you need for top pay, better jobs, or a business of your own. This is your **GOLDEN OPPORTUNITY.**

**AIR CONDITIONING**

Big air conditioning boom interrupted by war will be bigger than ever. It's ready to GO now! Get this non-technical book by international authority and be ready for your share of millions to be spent. Covers whole field. 450 pages. Illustrated. \$4.00.

**AIRPLANE WELDING**

All metal airplane building offers big peacetime opportunities  
 New 2nd edition of this famous book by J. B. Johnson, Materials Division, Wright Field. The authoritative and practical book on Airplane welding and materials brought right up to date. 420 pages, 193 pictures. \$3.50.

**BODY & FENDER REPAIR**

Owners will spend big money to keep their good older cars looking like the new ones coming out. This is a practical money-making guide, ideal for shop owners and every man who wants a share of the millions to be spent in keeping old cars looking new. Tells how to get a good job or start business of your own with small capital. 325 pages, 232 illustrations. \$3.50.

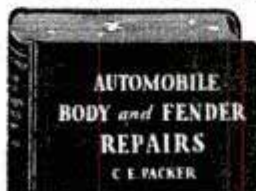

**NEW 20th EDITION**  
**Leading Auto Book for Over 32 Years**

**World's Greatest AUTO BOOK**

**New Material on Transmissions, Trucks, Tractors, Diesels, Aircraft and Auto Engines**

Now with millions of cars needing repairs and thousands of men needed to do the work, you need the famous DYKE Auto Book more than ever before. Brand new 20th Edition covers all principles, construction, repair, adjustments, testing, troubles and remedies of all cars. Over a half million copies of 20 editions of Dyke's have been sold. Gives specifications of old and newer cars. World's biggest book value. \$7.00. This big book, a complete auto library in one volume, has 1483 pages—4600 illustrations and diagrams—weighs 6 lbs.—equal to 4 ordinary books.

**MODERN WELDING PRACTICE**

Newest book on all types of welding and heat treatment of metals. Written by recognized specialists in training men for production jobs. Practical and Non-Technical.

430 Pages  
 277 illus.  
 Practical and Non-Technical

Covers everything you need to know. Prepare for best pay jobs now. Price \$4.00.

**DYKE'S FAMOUS CARBURETOR BOOK**

This famous book has been the standard guide in the best paying auto work for a generation. It has helped thousands of men make money. New edition covers engine tune-up, compression, ignition, carburetion, fuel pump valves, etc. Use this book to specialize in this big field. 244 pages, 549 illustrations. \$3.50.

**HOUSE WIRING NEW EDITION**

Get this new sixth edition of this standard and practical electrical wiring book. It gives complete practical instruction on every phase of house wiring in one handy volume. Goes further than most books on subject. Hand-book style. Gives National Electric Code. 400 pages, 669 illustrations. Electrical work will reach a new high with millions of new homes to be built. Get started now. \$3.00.

**ENGINEERS HANDBOOK**

World famous Bailey's handbook of universal questions and answers for Stationary, Marine and DIESEL engineers and firemen. Prepares for any license examination. This is the one book that men should have if they want to reach the top in installation, maintenance and operation of Diesel and steam plants. Pocket size, \$2.00.

**Goodheart-Willcox Co., Inc.**  
 2009 S. Michigan Ave., Dept. 13, Chicago 16, Ill.

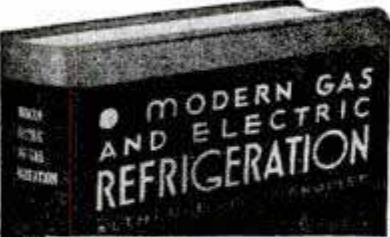

**15 Million Refrigerators Need Service and Repairs**

**REFRIGERATION—Book of the Hour!**  
**Biggest Opportunity in Many Years!**

**NEW PRINTING—ALMOST 1000 PAGES**

**408 Pictures—17 Diagrams in Colors Makes All Refrigerator Service Maintenance, Repairs Simple as A. B. C.**

Thousands of Refrigerators need repairs! Owners will pay big for competent service which will be needed more and more. Get **MODERN GAS AND ELECTRIC REFRIGERATION**, the non-technical guide to all types of refrigerators and get your share of this new profit. Get a job or start your own service business. This book will help you make money anywhere. Price \$5.00.

**SEND NO MONEY! Mail Coupon**

**GOODHEART-WILCOX CO.,**  
 2009 S. Michigan Ave., Dept. 13, Chicago 16, Ill.

Send books checked, C.O.D. I will pay postman, plus few cents charges. If not satisfactory I will return books in 5 days and you will refund money paid. (Outside U.S. or possessions remit with order.)

- |  |  |
|--|--|
| <input type="checkbox"/> Gas & Electric Refrigeration . . . . . \$5.00 | <input type="checkbox"/> Air Conditioning . . . . . \$4.00 |
| <input type="checkbox"/> Dyke's Auto Book . . . . . \$7.00             | <input type="checkbox"/> Engineers Handbook . . . \$2.00   |
| <input type="checkbox"/> Dyke's Carburetor Book . \$3.50               | <input type="checkbox"/> Body and Fender Repair . \$3.50   |
| <input type="checkbox"/> Modern Welding . . . . . \$4.00               | <input type="checkbox"/> House Wiring . . . . . \$3.00     |
| <input type="checkbox"/> Airplane Welding . . . . . \$3.50             | <input type="checkbox"/> Shop Math. (2 vols.) . . . \$3.00 |
| <input type="checkbox"/> Sheet Metal Layout . . . \$3.50               | <input type="checkbox"/> A.C. Power Wiring . . . \$4.00    |
|  | <input type="checkbox"/> D.C. Power Wiring . . . \$4.00    |

If remittance accompanies order we will pay all postage charges under same return privilege.

Name . . . . .  
 Address . . . . .  
 City . . . . . State . . . . .



**solve tough math problems easily!**

**NEW**

Instruction Manual  
**BRUNING**

**BRUNING All-Plastic Pocket Slide Rule**

Don't confuse the new Bruning slide rule with ordinary wood and plastic rules! This new 5-inch is all-plastic construction. Unaffected by weather conditions, it won't warp, stick or bind—stays accurate always!

**Only \$4.25**  
NO C.O.D. ORDERS

**BUILT FOR FAST, SMOOTH WORK!**

Molded in, high precision-graduations will not lose visibility through use—can't rub off. Instrument is suited for every type of service—contains A, B, C, D, K, S, L and T scales—with C scale in red for easy reading. Beveled edges bear graduated scales in both inches and centimeters. Glass indicator is enclosed in

frame of non-corroding stainless steel—won't wobble.

**YOURS** Instruction Manual With Every Slide Rule!

Furnished in an attractive, genuine leather case, the new Bruning all-plastic pocket rule comes complete with an instruction manual showing how to make quick calculations—solve tough problems in seconds! Act now to get yours! Mail the coupon!

Charles Bruning Company, Inc.  
4722-26 Montrose Avenue, Chicago 41, Illinois  
Gentlemen: Please send me (indicate number) \_\_\_\_\_ Precision All-Plastic Pocket Slide Rule. I enclose \_\_\_\_\_  
Name \_\_\_\_\_  
Address \_\_\_\_\_  
City \_\_\_\_\_ State \_\_\_\_\_

**ELECTRICAL BOOKS** shipped for **EXAMINATION**

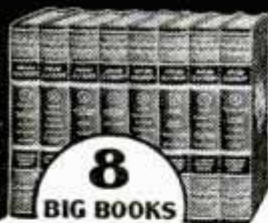

**8 BIG BOOKS**

**SEND NO MONEY MODERN ELECTRICITY INCLUDING RADIO AND REFRIGERATION**

Here's great news for anyone interested in Electricity. NEW, up-to-date 19th Edition of Applied Electricity with new subjects fully covered, including blueprint reading, electronics, P. M. radio, fluorescent lighting, 8 Big Books sent for examination!

**NEW Edition for Beginners and Experts**

Over 3700 pages, 2700 illustrations and 134 tables in most complete electrical work we have published. Dynamos, motors, diesel plants, power stations, transmission, everything explained for easy understanding.

**BIG FIELD! Big Demand! Big Pay!**

Men who understand electricity are needed now in all kinds of industries. Practically every business depends on electrical knowledge, and men who know this subject make big money. Learn easily with these new, interesting books. Send coupon for a set of books on approval. See how they will help you to get ahead faster.

**SEND NOW** [ A year's consulting privileges with our engineers now given to all buyers of this famous Cyclopaedia of Electricity. ]

**AMERICAN TECHNICAL SOCIETY**  
Vocational Publishers Since 1898

American Technical Society, Dept. E319, Drexel at 58th St., Chicago 37  
Send for 10 days' free use, 8 volume set of New 19th Edition, Applied Electricity, including a certificate entitling me to consulting privileges for one year. I will pay the delivery charges only on the books. If I wish I may return them in 10 days and owe you nothing, but if I keep them, I will send \$2.00 after 10 days, then \$3.00 a month until the total price of only \$34.80 is paid.

NAME \_\_\_\_\_  
ADDRESS \_\_\_\_\_  
CITY \_\_\_\_\_ STATE \_\_\_\_\_  
Please attach letter stating age, occupation, employer's name and address, and name and address of at least one business man as reference. Men in service, also please give home address.

**SAY YOU SAW IT IN POPULAR MECHANICS**

**REFRIGERATION AND AIR CONDITIONING**

**BECOME A SERVICE EXPERT**

Now, not "next week," is the time to start training for a top-pay job in this vital field. A drastic shortage of trained service experts exists. Many thousands more will be needed for big post-war expansion caused by new industrial uses. Train NOW to get your pick of best jobs. We will give you the practical training you need. For 2 years we trained men and women for the Army and Navy only, in fine-precision aircraft instrument work. So our methods must be right. Common schooling is all you need. Our unique system makes everything easy to grasp. You can train at home and in our big Chicago shops. Write for full facts TODAY, without obligation. Dept. P-8c.

Approved for Veterans' G.I. Training

Millions of Old Units Need Expert Service. Big Building Boom Will Create Even More Opportunities.

**INDUSTRIAL TRAINING INSTITUTE**  
2150 Lawrence Avenue Chicago 25, Illinois



**NOW! EASY-TO-MAKE HOMECRAFT NOVELTIES** FOR PLEASURE AND PROFIT!

**FREE! NEW 40-PAGE CATALOG**

**SPECIAL EASY MONEY-MAKER!**

Our new free book is crammed with money-making facts about Leather Craft, Wood Carving, Clay Modeling, Lacing and Braiding, Wood Burning (Pyrography), Showcard Lettering, Ready-to-Finish Woodcraft, Plastics, Marbleite Molding and much more. Send for FREE copy TODAY!

**SPECIAL! 5-LB. LEATHER BARGAIN!**

A real deal for the leather worker! 5 lbs. of generous-size deluxe leather remnants (average 44 pieces); 6 craft patterns, 4 swivel-hook key plates with rivets, 2 key-case binder posts, 50-yds. Brown Pyro Lacing, and 12 snap-buttons; unusual bargain at only \$3.98 postpaid. Or C.O.D. you pay postage. (No Canadian or Foreign.) Money back if not delighted.

**DWINNELL CRAFT SHOP, Dept. P-73, Elm Grove, Wheeling, W. Va.**

**MAKE MONEY CASTING AT HOME**  
**FREE FACTS SENT**



Cast thousands of perfect Plaques, Book Ends, Ash Trays, Etc. Plaster, Liquid Marble, Etc. ENORMOUS PROFITS. Start in basement or garage. LITTLE CAPITAL NEEDED. QUICK, EASY, NO PREVIOUS EXPERIENCE NEEDED. Rubber molds for speed production. MAKE YOUR OWN. SAMPLE KIT \$1.00. Plastic Arts Studio, Route 5, Dept. 29, Muncie, Ind.

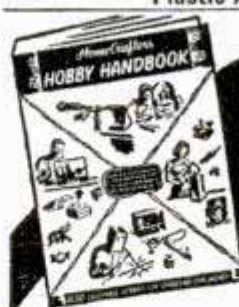

**FREE NEW HOBBY HANDBOOK**

**A Gold Mine of Information on Newest Equipment, Materials, Tools for HOME CRAFTSMEN AND MECHANICS**

IF you work in metals, woods, plastics or glass, you need this Big, FREE Source Book of equipment, tools, parts and materials . . . including dozens of hard-to-get items you can't find in stores. Many things you must have for your home hobby or shop. Just loaded with ideas and illustrations.

**A WAREHOUSE OF THINGS YOU WANT**

More than 100 items including: Portable Welder; Bench Tools; Plastic Molder; Telephone System; Chemical Sets; Spray Guns; Electroplater; Drills; Grinders; Tool Chests; Model Tools; Key Maker . . . everything you need for your hobby or craft. Send for this Big, FREE Book TODAY. Mail postcard or coupon below.

**WARNER ELECTRIC CO., 1512 Jarvis, Chicago 26, Dept. L-111**

**WARNER ELECTRIC CO., 1512 Jarvis, Chicago 26, Dept. L-111**  
**PLEASE SEND BIG, FREE BOOK !**

NAME \_\_\_\_\_  
ADDRESS \_\_\_\_\_  
CITY \_\_\_\_\_ ZONE \_\_\_\_\_ STATE \_\_\_\_\_

**POPULAR MECHANICS**





# Now ANY **AUTO REPAIR JOB** Can Be "Duck Soup" For You!

**MoToR's New AUTO REPAIR MANUAL**  
 Shows You How to Service and Repair  
**ANY Part of ANY Car!**

**FREE 7-DAY OFFER!**

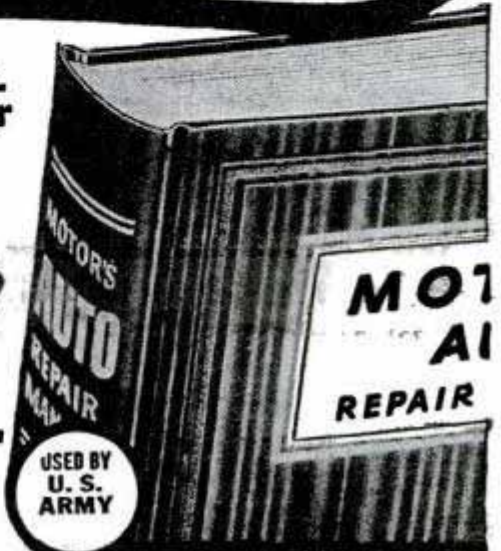

**N**OW you can "polish off" the **HARDEST** jobs the **EASIEST** way! MoToR's **AUTO REPAIR MANUAL** is ready to show you how to repair anything from carburetor to rear end—with the *least* possible amount of time and effort!

Suppose plain-talking car engineers from every auto plant in America got together and showed you all the things you needed to know about repairing and servicing the cars they had designed and manufactured! That's really what you get in this big manual! Right at your fingertips, the main "dope"

from 150 *Official Factory Shop Manuals*, covering every make car built since 1935!

Easy to use, too! Quick-index leads you to right page in jiffy! Just follow simple instructions step-by-step.

**SEE HOW MUCH YOU GET!**

856 pages, 8½x11 inches, bound in sturdy covers. 200,000 service, repair, adjustment replacement, tune-up facts on all makes and models, 1935 through 1946. More than 1000 cut-away photos, diagrams, drawings show you exactly **WHAT** to do and **HOW** to do it. Used by U. S. Army, trade and technical schools everywhere, thousands of auto servicemen.

Now **YOU**—without cost—can see for yourself what a wonderbook MoToR's Auto Repair Manual really is. **TRY it—FREE** for 7 days! Learn first-hand how it can pay for itself the first few times you use it.

**SEND NO MONEY**  
**7-Day Free Examination**

Just mail coupon at right, without money! When the postman brings your book, pay him nothing. First make it show you what it's got! Unless you agree this is the greatest time-saver and work-saver you've ever seen—return book in 7 days and pay nothing. Mail coupon today! Address: MoToR Book Dept., Desk 1C, 572 Madison Ave., New York 22, N. Y.

Published by MoToR, The Leading Automotive Business Magazine. MoToR's manuals assure high standards of repair work.

**Covers All These Makes!**

- American
- Bantam
- Auburn
- Austin
- Buick
- Cadillac
- Chevrolet
- Chrysler
- Cord
- Crosley
- De Soto
- Dodge
- Ford
- Graham
- Hudson
- Hupmobile
- Lafayette
- La Salle

**USED BY U. S. ARMY**

**Clear, Pictured Facts on Every Job on Every Car Built Since 1935!**

Nearly 200,000 service and repair facts on all 31 makes. 856 big pages; including 50 pages of carburetor text, charts, illustrations, covering all models. Over 500 charts, tables; Tune-up Chart; Valve Measurements; Compression Pressure; Torque Wrench Reading; Starting Motor; Engine Clearances; Generator; Clutch & Brake Specifications; Front End Measurements, etc.; Engines; Electric, Fuel, Cooling, Lubricating Systems; Transmissions; Universals; Front Ends; Wheels; Rear Ends, etc.

**Same FREE 7-Day Offer Applies on MoToR's TRUCK REPAIR MANUAL**

For mechanics, truck specialists, service stations, fleet owners. Covers **EVERY** job on **EVERY** truck made since 1936! 1400 pictures, 952 pages. 300,000 facts. Used by Armed Forces.

All types Gasoline Engines, Diesels, Hesselman, Fuel Systems, Governors, Lubrication Systems, Ignition Systems, Starters, Generators, Clutches, Transmissions, Axles, Torque Dividers, Transfer Cases, Brakes, Steering, etc.

Also **SERVICES** buses, farm and industrial tractors, contractor and road building equipment, stationary power machinery, etc. (on all parts described in Manual.) Check box in coupon at right.



**MAIL COUPON NOW FOR 7-DAY FREE TRIAL**

MoToR Book Dept., Desk 1C, 572 Madison Ave., New York 22, N. Y. Rush to me at once: (check box opposite book you want).

- MoToR's **AUTO REPAIR MANUAL**. If O.K. I will remit \$1 in 7 days, (plus 35c delivery charge), then \$2 monthly for 2 months with a final payment of 95c one month later. (Book's price \$5.95.) Otherwise I will return book postpaid in 7 days. (Foreign price, remit \$8 cash with order.)
- MoToR's **TRUCK REPAIR MANUAL**. (Described at left.) If O.K., I will remit \$2 in 7 days, and \$2 monthly for 3 months, plus 35c delivery charges with final payment (\$8.35 in all). Otherwise I will return book postpaid in 7 days. (Foreign price, remit \$10 cash with order.)

Print Name.....Age.....

Print Address.....

City.....Zone No. ....State.....

Occupation.....(if any).....

**SAVE 35c!** Check here if enclosing full pay. (check, m.o., postal note) WITH coupon. We pay 35c shipping cost. Same 7-day return-refund privilege.



Get into

# ELECTRICITY & INDUSTRIAL ELECTRONICS

Now!

START NOW — BE READY IN FEW WEEKS

**MODERN SHOP TRAINING**

**FOR BIGGER JOB OPPORTUNITIES  
LEARN ON ACTUAL EQUIPMENT  
IN NATIONALLY KNOWN SCHOOL**

Get ready for good job or business of your own. Electricity is the heart of modern industry. Electricians are always needed, earn higher pay, work year around. Make rapid progress in step-by-step practical shop training in Electrical Wiring and Circuits; Armature Winding; Electrical Appliance Repairs; Electro Plating and Welding. Rural Electrification, the Building Boom, many new uses of Electricity opening more opportunities in this vast field. Get training under thoroughly experienced instructors, be ready in few short weeks for Job Opportunities in Electricity.



**VETERANS** qualifying under "G.I. Bill" have tuition paid by Government plus monthly subsistence allowance while in school. Just mail coupon, we will handle all details. (LOW TUITION, EASY TERMS if you are not a veteran.)

**ELECTRICAL DIVISION  
COMMERCIAL TRADES INSTITUTE,  
Dept. C23  
6312 N. Broadway, Chicago 40, Ill.**



FREE — Important Information Telling How to Get Started

Fill Out, Cut Out, Mail Today

**FACTS FREE for Men Who Want to Get Ahead**

**COMMERCIAL TRADES INSTITUTE, Dept. C23  
6312 N. Broadway, Chicago 40, Ill.**  
Send free illustrated Brochures and other information about your training in Electricity.

Veteran  Non Veteran

Name .....  
Address .....  
City ..... State .....

## LEARN SPRAY PAINTING BIG PAY— JOBS AWAIT YOU!



This new book covers fundamentals of spray painting—explains fully all phases—industrial spray-gun work—commercial studio and sign work—interior and exterior decorating. Simply written—easy to understand. Over 125 pages, fully illust. Only \$1.50 (Check No. 1 on coupon).

**ALSO NOTE THESE OTHER VALUABLE DRAKE BOOKS**

- No. 2. Wood Finishing. Plain and Decorative. 360 pages, only \$2.50.
- No. 3. House Painting Methods—with Brush and Spray Gun. 400 pages, over 150 illust. and color chart. Only \$2.50.
- No. 4. Cyclopedia of Painting and Decorating. 350 pages, 288 illust. Only \$3.50.

**Drake's Books Are Sold on a Money-Back Guarantee  
USE THE COUPON — NOW**

**Fred'k. J. Drake & Co., Dept. A-4,  
600 W. Van Buren St., Chicago 7, Ill.**

Please send me the books checked below. If not satisfied I will return them in 5 days and money will be refunded.

1 2 3 4 (Circle numbers wanted)

Check or money order enclosed \$..... Send books postpaid.  
 Send C. O. D. plus postage.

Name .....

Address .....

City ..... State .....

Drake books sold by leading booksellers

THE ONLY GENUINE WEBSTER IS THE

# Merriam WEBSTER

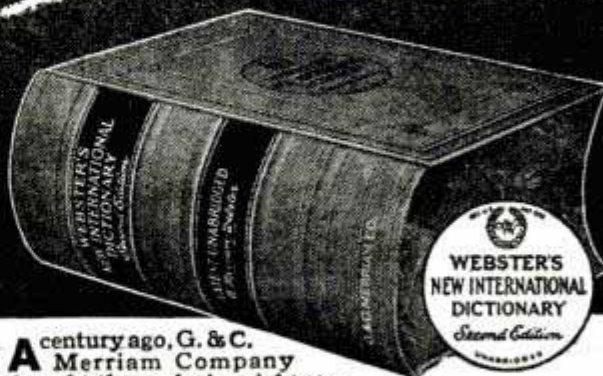

A century ago, G. & C. Merriam Company bought the exclusive rights to publish Webster's Dictionary. Through the years, with each new edition, Merriam has constantly enlarged the scope and usefulness of Noah Webster's original work, until today the names MERRIAM and WEBSTER are equally important in identifying "The Supreme Authority." Ask for WEBSTER'S NEW INTERNATIONAL DICTIONARY, Second Edition—the great unabridged Merriam-Webster.

G. & C. MERRIAM Co., Springfield 2, Mass.

1847 A CENTURY OF PUBLISHING MERRIAM-WEBSTERS 1947

"THE SUPREME AUTHORITY"

# RUPTURED?

Get Relief This Proven Way

Why try to worry along with trusses that gouge your flesh—press heavily on hips and spine—enlarge opening—fail to hold rupture? You need the Cluthe. No leg-straps or cutting belts. Automatic adjustable pad holds at real opening—follows every body movement with instant increased support in case of strain. Cannot slip whether at work or play. Light. Waterproof. Can be worn in bath. Send for amazing FREE book, "Advice To Ruptured," and details of liberal truthful 60-day trial offer. Also endorsements from grateful users in your neighborhood. Write:

**CLUTHE SONS, Dept. 31, Bloomfield, New Jersey**

SAY YOU SAW IT IN POPULAR MECHANICS



## New Invention PLAY PIANO IN 1 HOUR

PLAY 27 SONGS WITH 4 CHORDS!

Can you hum, sing or whistle a tune? Newly INVENTED CHORD-SLIDE DEVICE makes you play Popular Songs by EAR AND NOTE off the sheet music, at once. Play 2-hand professional radio style at one sitting. It's Fun! A Game! No exercises or drills. Startle your friends! Send NO MONEY just 1c card.

**DALE SHEAR'S SCHOOL OF MUSIC  
Studio 4204, Struthers 3, Ohio**

- Rush my complete course—25 lesson ABC PICTURE METHOD, including many POPULAR SONGS, plus CHORD-SLIDE DEVICE for \$2 plus C.O.D. MONEY BACK GUARANTEE! No C.O.D. in Canada.
- \$2 cash, check, M.O., you pay postage.

NAME .....

ADDRESS .....



WHAT DO YOU KNOW ABOUT

# JET

# PROPULSION?

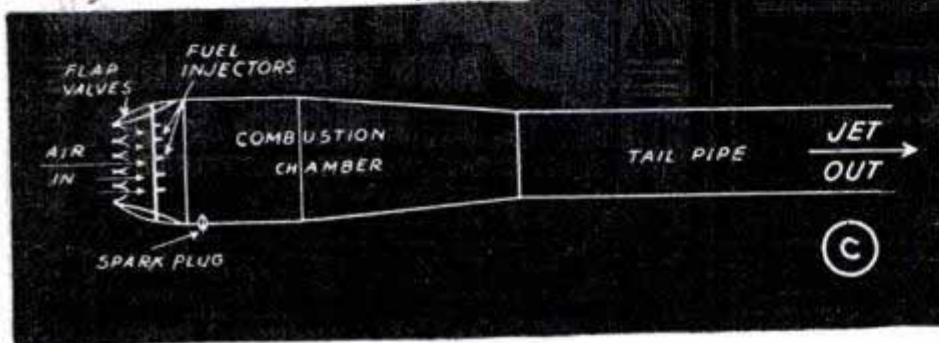
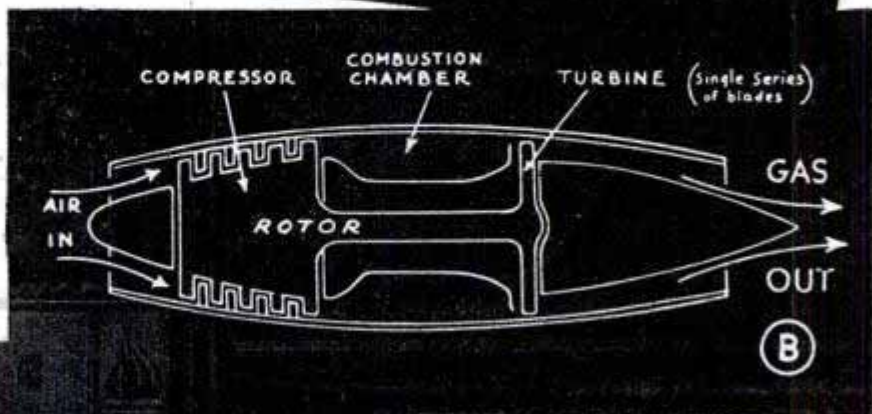
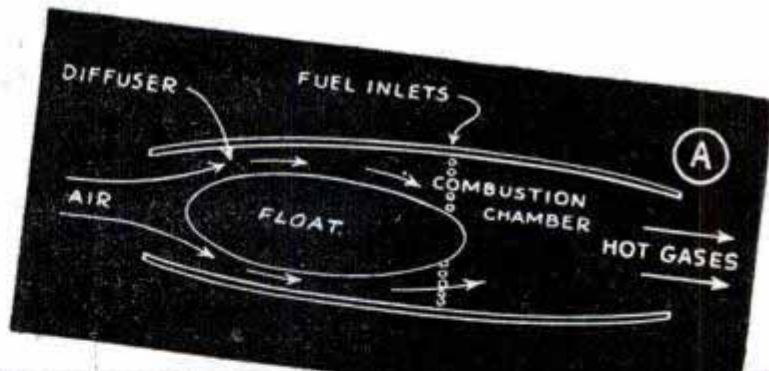

- A. RAMJET
- B. TURBOJET
- C. INTERMITTENT JET

**I**F YOU KNOW even the lone guiding principle, you're far and away ahead of the average American citizen!

But in the Army Air Forces where Jet research is going on every day in the year, scientifically minded young men are getting first-hand knowledge *right where the greatest progress is being made.*

Some information on this subject is still restricted, but here are answers to the most commonly asked questions:

Q. *What makes a Jet plane go?*

A. Compression of a gas to a high pressure in a confined chamber, and conversion into a high-velocity gas stream expelled into the air.

Q. *Are all Jet devices the same?*

A. No. The three types used on aircraft are the Ramjet, Turbojet and Intermittent Jet.

Q. *Can any of these drive a plane out of the earth's atmosphere?*

A. No. All three need oxygen from the air. Rockets, which carry their own oxygen, are the only known source of power for inter-planetary travel. The Army Air Forces is experimenting with rockets, too.

Q. *Can any of these start from a standstill under its own power?*

A. Only the Turbojet. Its compressor acts as a starting motor, sucking air for combustion. The other types depend upon forward motion for intake of the necessary air.

This is but one of the fields of important research and development in your new Regular Army Air Forces. Fortunate indeed is the young man who is good enough to qualify for a 3-year enlistment and one of many thrilling jobs in a branch of service of his own choice! Already several branches are closed. See your nearest Recruiting Officer for further details.

**YOUR REGULAR ARMY SERVES THE NATION  
AND MANKIND IN WAR AND PEACE**

A GOOD JOB FOR YOU  
**U. S. Army**  
CHOOSE THIS  
FINE PROFESSION NOW!



# INVENTORS

The inventor who believes he has a new and useful invention, and finds himself in need of advice, should consult a competent registered patent attorney.

The question as to whether a subject matter is patentable can be substantially determined by a search of the United States Patent records.

Without obligation, write us for information as to what steps an inventor should take to secure a Patent.

## RANDOLPH & BEAVERS

Registered Patent Attorneys

11-D Columbian Bldg., Washington 1, D. C.

### RANDOLPH & BEAVERS

11-D Columbian Bldg., Washington 1, D. C.

Please send me full information on how to secure Patents & Trademarks.

Name .....

Street .....

City ..... State .....

# Carry 5000 ELECTRICAL FACTS in Your Pocket!



## ELECTRICIANS HANDBOOK Helps You on the Job!

Handiest electrical reference book on the market. A "library" of 5,000 facts, wiring diagrams, formulas, charts, tables, rules—condensed into one pocket-size, 4 1/2 x 7" volume. Weighs little more than your steel rule. Take it with you on the job—have the answers to daily problems always on hand without figuring. Saves you time and money. Flexible leatherette cover for hard usage.

### Use This Book for 7 Days FREE

Try it on the job—use it for 7 days. You must be satisfied that it is worth at least the \$2.75 price to you, or we'll refund in full on return of book. Act at once and also get Home Wiring Booklet FREE. Send coupon today.

Book Division, COYNE ELECTRICAL SCHOOL  
500 S. Paulina St., Dept. 37-R7, Chicago 12, Ill.

**350 PAGES INDUSTRIAL ELECTRONICS WIRING METHODS MOTORS ILLUMINATION SWITCHING AND CONTROL ... and thousands of other facts!**

EXTRA! Brand New 24-page booklet, "Residential Wiring Design" free for prompt action. YOU keep it even if Handbook is returned for refund. Rush coupon.

## 7 DAY TRIAL — FREE BOOKLET COUPON

Technical Book Div., COYNE ELECTRICAL SCHOOL  
500 S. Paulina St., Dept. 37-R7, Chicago 12, Ill.

Please send me postpaid, Electricians Handbook on No-Risk 7 Days Trial. Include FREE, "Residential Wiring Design." I am enclosing \$2.75. If not satisfied, I may return Electricians Handbook in 7 days for money back.

Name ..... Age .....

Address .....

City ..... Zone ..... State .....

( ) Send C.O.D. I'll pay postman \$2.75 plus postage on same offer.

# FIRE EXTINGUISHER

## SALESMEN WANTED

Immense demand today for Fyr-Fyter Approved Extinguishers. People are interested in saving property from fire as it's a problem when fire strikes. You can start to earn while you learn. Plenty of prospects, Factories, Schools, Hotels, Farms, Homes, Trucks, Churches, Public Institutions, Elevators, etc. Chance for hustlers to earn some real money. Write quick today for our Sales Plan.

**FYR-FYTER CO.** Dept. 90-27,  
FIRE FIGHTER DAYTON 1, OHIO

**PATENTS AND TRADE MARKS**  
**C.A. SNOW & CO.**  
REGISTERED PATENT ATTORNEYS  
WRITE FOR INFORMATION TO  
428 SNOW BUILDING, WASHINGTON 1, D. C.

**PATENTS** "Proof of Invention"  
Folder mailed without obligation.  
**E. E. VROOMAN, Registered Patent Atty.**  
871 Woodward Building, Washington 5, D.C.

SAY YOU SAW IT IN POPULAR MECHANICS

# NEW MIDGET ELECTRIC ARC WELDER

RETAILS ONLY \$3.95  
FULLY GUARANTEED

**Plugs into Light Socket—AC or DC**

It's new! It's handy! It's efficient! Use the Midget Electric Arc Welder for hundreds of light-metal jobs. Does comparable welding work with a 1/16 inch welding rod on thin metal as that of larger and higher priced welders. Operates on 15 ampere fuse, 110 volt 60 cycle A.C. or D.C. current, by use of our special standard-coated 1/16-inch welding rods. Generous supply of rods supplied with machine. Recommended for all light welding like automobile fenders, etc. Take the Midget Arc anywhere to the job. Sturdily built and fully guaranteed. Comes complete—ready to use. Nothing else to buy. No previous welding experience needed to strike an arc. In a short time, anyone mechanically inclined can learn to weld with this machine.

You'll find hundreds of money-saving, time-saving uses for the Midget Arc around your home, garage, or workshop. Also in garages, factories, repair shops, tin shops, mechanics, farmers, inventors, etc. Order a Midget Electric Arc Welder now! SEND NO MONEY. We'll rush one to you, complete with rods and helmet (equipped with APPROVED welding glass). Pay postman only \$3.95 plus postage charges. If not satisfied, return Midget Arc in 5 days from receipt and we'll refund your money immediately. RUSH YOUR ORDER NOW

**MIDGET ARC WELDER CO., Strader Ave., Dept. U-202, Cincinnati 26, Ohio**



# IMAGINE THEIR JOY WHEN THEY FOUND THEY COULD PLAY

this easy-as-ABC way!



### LEARNED QUICKLY AT HOME

"I didn't dream I could actually learn to play without a teacher. Now, when I play for people they hardly believe that I learned to play so well in so short a time."  
\*H.C.S., Calif.



### PLAYS AT DANCES

"Your lessons have been most satisfactory. I can play all of the popular songs. I have earned money playing at dances."  
\*E.N.J., New York.



### PLAYS ON RADIO

"I can't keep from telling you that I have a good position playing from KTHS, Hot Springs, Ark., every morning."  
\*J. S., Okla.

## What Instrument Would You Like to Play?

JUST name your instrument and we'll show you how you can learn to play it—quickly, easily, in spare time at home. Never mind if you don't know one note of music from another—don't worry about "special talent." And forget all you've ever heard about music being hard to learn.

The truth of the matter is that *thousands now play who never thought they could!* Yes, men and women everywhere have discovered this amazingly easy way to learn music at home. Now they are enjoying the thrilling satisfaction of playing the piano, violin, guitar, saxophone or other favorite instruments. Some of them are playing in orchestras and over the radio; others are teaching music, making money in spare or full time. And thousands are having the time of their lives playing for their own enjoyment and the entertainment of their friends.

- LEARN TO PLAY BY NOTE**
- Piano Guitar
  - Violin Saxophone
  - Organ Mandolin
  - Tenor Banjo
  - Hawaiian Guitar
  - Piano Accordion
  - Or Any Other Instrument

**QUICK! "REPAIRING CAR BATTERIES" MONEY. At Home! Easy Too!**

Write, **BATTERYMAN, Grand Junction 6, Colorado**

**GOV'T JOBS!**

**VALUABLE INFORMATION FREE**  
Columbian Correspondence College, Dept. 7, Washington 2, D. C.

**LEARN MEAT CUTTING EASILY-QUICKLY**  
At Home - In Spare Time



The steady, dependable trade of Meat Cutting taught easily, quickly by improved HOME METHOD. National School, established over 25 years, has organized its famous "Learn By Doing" Classroom, Cutting room and Retail Market training system into sound, practical HOME STUDY form.

Now, by the miracle of this EXTENSION TRAINING you can prepare in Your Spare Time At Home, for a better job, bigger responsibilities or success and security in a store of your own. Remember, **PEOPLE MUST EAT!**

Buying, cutting, percentage, pricing, advertising, selling—a complete meat education. For beginner or men with ex-

No tedious study and practice, no tiresome exercises. You learn to play *by playing*—start right in with the melody of a simple tune! It takes only a few minutes a day; the cost is trifling. Does it sound too good to be true? Mail the coupon and get the **FREE PROOF!**

### FREE PRINT AND PICTURE SAMPLE

Fascinating illustrated booklet answers all your questions; free Print and Picture Sample shows how method works. If interested, just mail coupon. U. S. School of Music, 73 Brunswick Bldg., New York 10, N. Y. 49th Successful Year.  
\*Actual pupils' names on request. Pictures by professional models.

**U. S. SCHOOL OF MUSIC**  
73 Brunswick Bldg., New York 10, N. Y.

I am interested in music study, particularly in the instrument indicated. Please send me your free illustrated booklet, "How to Learn Music at Home" and the Free Print and Picture Sample.

Name \_\_\_\_\_ (PLEASE PRINT)

Address \_\_\_\_\_

Instrument \_\_\_\_\_ Have you Instrument? \_\_\_\_\_

**PLYWOOD** Beautiful cabinet and paneling stock. Perfect for many projects, and for general construction and cabinet work. Thicknesses 1/32" through 3/4"; panels 6" x 6" through 48" x 96". Birch, Gum, Oak, Mahogany, Walnut, Maple, Basswood. Send 10 cents today for complete Plywood Catalog.

**Carmen-Bronson Corporation**  
165 East 3rd Street, Dept. 3-B, Mount Vernon, N. Y.

Say you saw it in Popular Mechanics

perience. Thousands of successful graduates. Send coupon for **FREE Bulletin NOW!**

**MAIL THIS COUPON TODAY FOR FREE BULLETIN**

**National School of Meat Cutting Dept. U79, Toledo 4, Ohio**

Send me your **FREE Bulletin** on Meat Cutting and Meat Merchandising. No obligation. No Salesman will call.

Name \_\_\_\_\_

Street \_\_\_\_\_

City \_\_\_\_\_ State \_\_\_\_\_



# BE A BUILDER! Learn Estimating and Blueprint Reading at Home

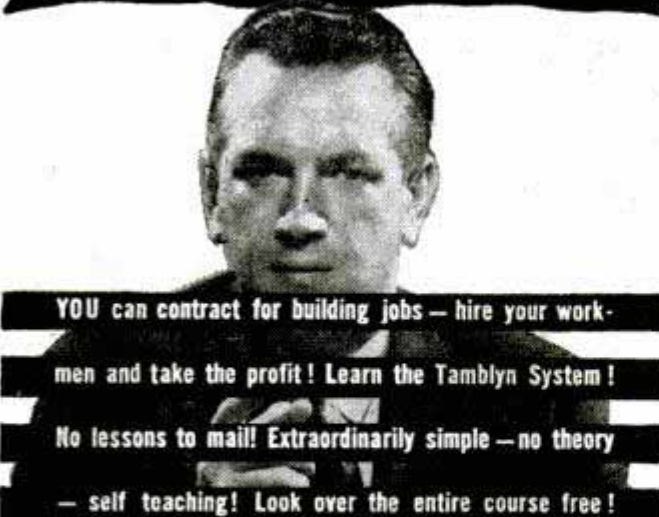

**YOU can contract for building jobs — hire your workmen and take the profit! Learn the Tamblyn System! No lessons to mail! Extraordinarily simple — no theory — self teaching! Look over the entire course free!**

## TAMBLYN SYSTEM

Johnson Building, PM3 • Denver, Colorado

Send Tamblyn System for 10 days free inspection. If satisfied, I will pay you \$5.00 per month until \$30.00 is paid. Otherwise I will return it.

NAME \_\_\_\_\_ AGE \_\_\_\_\_

ADDRESS \_\_\_\_\_

CITY \_\_\_\_\_ ZONE \_\_\_\_\_ STATE \_\_\_\_\_

**SEND NO MONEY • SEE IT FIRST!**

# AUDELS Carpenters and Builders Guides 4 vols. \$6

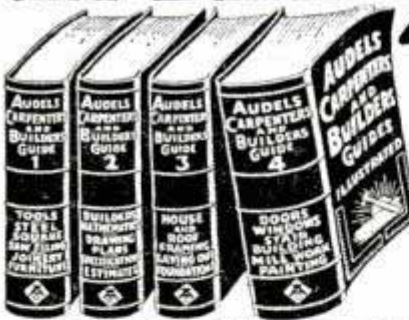

Inside Trade Information for Carpenters, Builders, Joiners, Building Mechanics and all Woodworkers. These Guides give you the short-cut instructions that you want—including new methods, ideas, solutions, plans, systems and money saving suggestions. An easy progressive course for the apprentice and student. A practical daily helper and Quick Reference for the master worker. Carpenters everywhere are using these Guides as a Helping Hand to Easier Work, Better Work and Better Pay. To get this assistance for yourself, simply fill in and mail the FREE COUPON below.

### Inside Trade Information On:

How to use the steel square—How to file and set saws—How to build furniture—How to use a mitre box—How to use the chalk line—How to use rules and scales—How to make joints—Carpenters arithmetic—Solving mensuration problems—Estimating strength of timbers—How to set girders and sills—How to frame houses and roofs—How to estimate costs—How to build houses, barns, garages, bungalows, etc.—How to read and draw plans—Drawing up specifications—How to excavate—How to use settings 12, 13 and 17 on the steel square—How to build hoists and scaffolds—skylights—How to build stairs—How to put on exterior trim—How to hang doors—How to lay floor—How to paint



**THEO. AUDEL & CO., 49 W. 23rd St., New York City**

Mail Audels Carpenters and Builders Guides, 4 vols., on 7 days' free trial. If O.K. I will remit \$1 in 7 days, and \$1 monthly until \$6 is paid. Otherwise I will return them. No obligation unless I am satisfied.

Name.....

Address.....

Occupation.....

Reference..... PM

**SAY YOU SAW IT IN POPULAR MECHANICS**



# Build it Yourself

Send for booklet showing how to make your own bricks of Cemadobe and build an attractive low cost home yourself. Amazing discovery in soil stabilization. Bricks of earth and cement. Attractive; heat and cold resisting. Easy to make. A Godsend to anyone who needs a home. Now being used by hundreds of satisfied home builders. Acceptable to loan agencies. Complete instructions in attractive, easy-to-understand booklet entitled "Cemadobe". 50 illustrations and 40 chapters. Money back guarantee of satisfaction. Send \$2.00 to **Cem-Adobe Company, Box 81, Dept. PM-37, West Los Angeles Station, Los Angeles 25, California.**

**ANYONE CAN DO THIS IF THEY HAVE OUR CHART**

**SPECIAL OFFER FOR AGENTS**

Blue Print 27" x 36" now printed on both sides showing squares full size. Shows how to find the length of any rafter, find any angle in degrees, frame any polygon 3 to 16 sides, read the board foot and brace tables, octagon scale, rafter tables, many other uses can be scaled down for model work as well as full scale framing. Also chart changing pitches to degrees. For use with radial saws. About 13 square feet of printed copy. Sent post paid for \$1. Money order or check—no stamps. **MASON ENGINEERING SERVICE, 2031 N. Burdick St., Dept. 3, Kalamazoo 81, Mich.**

**LOOKING FOR SOMETHING?**

Why go crazy? We'll find it for you! Save your valuable time. Any hard-to-get item located for just \$1! We advise, locate, guarantee our service. Send your request to **Eddie DuPuy, P. O. Box 267, North Hollywood, Calif.**

**MAKE UP TO \$5.00 AN HOUR IN YOUR OWN YEAR ROUND Business!**

**ONLY A FEW DOLLARS PUTS YOU IN BUSINESS!**

Many Clearing as High as \$20 to \$30 a Day **NET** Renewing Rugs, Carpets, Upholstery. New Method Now Used for Auto Upholstery. Write for Facts About Quick, Easy Way to Get Started

Here is the chance you've been looking for to step into a pleasant, dignified, big-pay business of your own that offers you a steady, year 'round income. Start on "a shoestring," full or spare time, right from your own home. Equal opportunities for men and women, young or old, in small towns or big cities. No experience needed. Many making big money with new Americlean System just cleaning auto upholstery. Easy to learn. We send you complete instructions and quick-cleaning supplies so you can start making money the very first day! Quick method cleans upholstery, rugs and carpets like new without taking off floor! Tremendous demand in homes, apartments, hotels, stores, office and public buildings. Steady repeat business. Territories going fast. Write today for full FREE facts. No cost or obligation. Rush letter or postcard now to **AMERICLEAN CO., Dept. G-2, St. Louis 1, Missouri.**

**WRITE FOR FREE DETAILS NOW!**



**"a little land—a lot of living!"**



**How To Do Wonders on an Acre!**

Our FREE BOOKLET will tell you all about our "HAVE-MORE" PLAN for "a little land—a lot of living" . . . how to do wonders with an acre or so of land . . . wonders with a garden, fruits, berries, poultry, livestock, etc. . . . all on a small scale . . . in your spare time!

How, thanks to the New Science of Miniature Farming, thanks to the quick freezer and many other new inventions, you can actually raise most of your family's food in a few hours of spare time a week and enjoy doing it. . . . How to add a "Harvest Kitchen" to make your house a more pleasant and productive home (your wife will love it!) . . . how this new way to live on an acre or so of land can mean better health, more happiness, more security and independence for you and your family.

**FREE BOOKLET**

We Robinsons know because we've lived this way for years. Our "HAVE-MORE" PLAN gives you the benefit of all our experience working out the small-scale, scientific, wonder-working methods we tell you about. (Perhaps you've seen the stories about our 2-acre miniature farm in *Readers Digest*, *Better Homes and Gardens*, etc.)

If you'd like to do WONDERS with an ACRE . . . if you'd like to make the very most of the garden, farm or country home you now have—or hope to have some day—please write to me now for our FREE BOOKLET about our "HAVE-MORE" PLAN. I guarantee it will open your eyes to some mighty good new ideas—and to a far more satisfying way to live in these United States! Send now to:

**Ed Robinson, Box 2703, Noroton, Conn.**

**EXPIRED PATENTS can make MONEY for YOU!**

"PUBLIC DOMAIN", new research service, reviews 1000 recently expired patents—in a 200-pg. bound book. Cash in on these royalty-free money-makers! Send check or M. O. to **SCIENTIFIC PUBLISHING CORP.** 614 W. 49th ST. • NEW YORK 19, N. Y.

Get Your Copy \$2.00 POST PAID

THOUSANDS OF SUFFERERS USE

# BREATH-EASY

FOR

# ASTHMA

CARRY IT WITH YOU  
USE IT ANYWHERE

*Sold on Money-Back Guarantee*

Write To Dept. PM

**BREATH-EASY DISTRIBUTORS, INC.**  
65 CEDAR STREET  
SEATTLE 1 WASHINGTON

**ELECTRICIANS! RADIO MEN!**

**Valuable BOOK**

# FREE

150 Wiring Diagrams

*It's My Gift to Help You Get Ahead*

HERE'S one of the greatest "get acquainted" offers ever made. This new book of 150 selected Electrical Shop Prints and Wiring Diagrams is YOURS — absolutely FREE.

This book is 'chuckfull' of valuable charts, diagrams, wiring methods and instructions for reading and using wiring shop prints. All the shop prints are full size 8 1/2" x 11" with full explanatory information. Here's all you have to do to get this free book:

**150 Diagram Book Free for MERELY EXAMINING COYNE'S NEW 7 Volume Set**

To get your FREE copy of this Shop Print Book, all you have to do is to let me send you my complete new 7 volume set of electrical books—COYNE APPLIED PRACTICAL ELECTRICITY for 7 days' FREE examination. Here's a set of books written for the "beginner" or "old-timer" in electrical work who is anxious to get ahead.

This 7 volume set contains thousands of "show how" methods and photos—the latest information in "easy-to-understand language." Electricity from "A" to "Z" presented in new, practical, modern methods of explanation. A leader in electricity today must "know his stuff." To succeed from now on you must know many branches.

**SEND NO MONEY** You have to see this new 7 volume set to really appreciate how much it can mean to you and your future. I'll send you the complete set of 7 volumes (pictured below) at my risk, postpaid for 7 days' FREE Examination. I'll also send you the New Coyne Book of 150 Shop Prints and Motor Diagrams as my FREE gift to you TO KEEP REGARDLESS OF WHETHER OR NOT YOU DECIDE TO KEEP THE 7 VOLUME SET COYNE PRACTICAL APPLIED ELECTRICITY.

**Coupon is Not an Order**

Just a Request to See the Books FREE

YOU ARE NOT BUYING THE 7 VOLUME SET WHEN YOU SEND THIS COUPON. You are merely asking to see the books free for 7 days. The coupon only becomes an order if you decide to keep the 7 volume set after 7-Day Free Examination. OFFER IS LIMITED—Don't delay! Fill in and Mail FREE BOOK Coupon Now!

**FREE BOOK COUPON**

B. W. Cooke, Dir., COYNE ELECTRICAL SCHOOL, Dept. 37-R6  
500 S. PAULINA ST., CHICAGO 12, ILLINOIS

Send me the NEW 7 Volume COYNE APPLIED PRACTICAL ELECTRICITY. Also send the Bound Volume of 150 Shop Prints and Diagrams which I am to keep FREE whether I keep the 7 Book Set or not. I'll either return the 7 Book Set in 7 days and owe you nothing or pay \$3 within 7 days and \$3.00 a month until \$21 is paid, or I'll send the cash price of \$19.75. You also include FREE one full year of Consultation service and technical bulletins.

NAME \_\_\_\_\_ Age \_\_\_\_\_

ADDRESS \_\_\_\_\_

TOWN \_\_\_\_\_ Zone \_\_\_\_\_ STATE \_\_\_\_\_

Check here if you want to pay postman cash price of \$19.75 (you save \$1.25) delivered. Same 7 day examination privilege and Money-Back Guarantee.



# HOW TO PLAY CHESS

CHESS REVIEW, world's leading chess magazine, is now featuring a new PICTURE GUIDE TO CHESS — a complete course in the rules and principles of the greatest game in the world. By a simplified, pictorial method, this course teaches you how to play chess in one evening! Pictures, diagrams and examples make everything clear. When you finish the first few easy lessons you will know how to play this most fascinating of all games. No other game compares with chess for life-long interest and pleasure.

## Now Running in CHESS REVIEW

This Picture Guide is running serially in CHESS REVIEW, a new-type chess magazine unlike any other before! Up to 48 pages of news, games, puzzles, quizzes, pictures. Popular features by Fine, Horowitz, Pinkus and other leading masters. Postal chess games arranged between readers for cash prizes. Fascinating new features: "Game of the Month!" "The World of Chess!" "Games from Recent Events!" "Chess Movies!" "Chess Quiz!" "Solitaire Chess!" "Readers' Games Reviewed!" Every page bristles with instruction and entertainment for beginners and experts.

### Chess Primer FREE

Order sample 6-month subscription to CHESS REVIEW at introductory price of only \$2. Your subscription starts with February issue featuring current instalment of Picture Guide to Chess. We will also send you, as a FREE GIFT, a 224-page clothbound book containing the first four chapters of the Picture Guide, so that you can start this course from the beginning. The book you receive is a complete chess primer in itself, explains all the rules and basic principles of the game. It sells in all retail stores for \$2. You get it FREE with your trial subscription to CHESS REVIEW! Mail \$2 now for subscription and free book to CHESS REVIEW, Dept. PM, 250 West 57th St., New York 19, N. Y.

The great SUCCESS instruction for men and women now in business . . . or planning to get into PRODUCTIVE work . . . The PROFITABLE, EASY, SURE method . . . Get it NOW

# HOW TO MAKE MONEY BY MAIL

ENLARGED to 640 pages, 15th edition

Down-to-earth facts, directions (illustrated) for running business profitably, using expertly for YOUR good fortune the employees, trains, planes which Gov't places at your disposal CHEAP. Get orders by mail, ship by express or freight or mail, get out of the kindergarten . . . 15th edition, enlarged to 640 pages, now selling. It's YOUR winner. Make this year and the following years worth more. . . . . THIS knowledge really PAYS OFF.

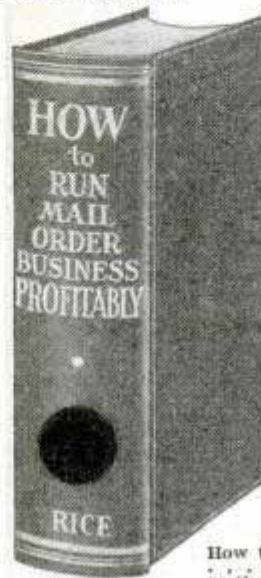

**THE EASY WAY** to start new or expand your present occupation. Do it NOW. Extraordinary plain, simple skill, know-how. No theory. Fact story of rich experience of author E. Rice day-by-day. How many times have we heard: "I wish I had some money, this patent would earn me a fortune," or "why can't my crop pay better?" or "I wish I knew how to sell this gadget myself," or "why should my boss alone do this when I too know how the money is made?" . . . Listen, YOU DO NOT NEED MONEY TO START THIS RICE WAY. His method automatically pays all bills same day rendered, no bank loans, pay as you go, no borrowing from relatives or friends, no salesmen. Also no worry, quickly a home of your own all paid for. Rice paid off \$5000 in mortgages a year after using this skillful idea.

### 46 Years of PROOF

Sounds fishy? Sure, but this has been done steadily for 46 years, depression or no depression, by the author; that is why he wrote this book, to pass the good word along. Make it go with anything you have which is salable, or with what you are now doing. Rice made his pay plan go from the start when living in one room in a city lodging house. Turn your city or country home, your work, your hobby, into money. How to get orders coming steadily at cost of only \$4 for each \$100 taken in. The popular error to avoid in trying for sales. Business won free while others have to pay for it.

How to conceive the money-getting advertisement. . . . Profitable changes from ordinary ideas and methods. Not usual cut-and-dried pattern, 250 adventures, a dictated book in everyday talk by Rice doing day by day what he discloses in his book can be done by his method. No dictionary writing. . . . Read how others are profiting big.

Take a chance on this book being worth a fortune to you and yours and send \$2.95. Book mailed same day order is received. Hundreds of buyers whose letters we show you declare emphatically its superlative goodness. Follow its easy pattern for success. Cloth-bound, 640 pages, 8 1/2 by 5 1/2. Best seller, 15th edition now selling. Cut out the \$2.95 HOW BOX here, pin or stick it to sheet of paper bearing your name and address, mail in envelope with money order or check for \$2.95 to

**HOW**  
640 PAGES  
**\$2.95**

HOWARD ST. HOUSE, Melrose 76d, Massachusetts

## Learn to Speak SPANISH FRENCH, GERMAN OR ITALIAN This Easy Way



ONLY 15 MINUTES A DAY. Know a second language for better business or social position; read foreign books; really enjoy travel. Speak like a native just "by listening" to CORTINA RECORDS. Learn quickly, easily at home as thousands have! Cortina-phone Method famous for 60 years. Write today for FREE book "The Cortina Short-Cut." State language interested in.

CORTINA ACADEMY (Established 1882)  
Suite 643 105 West 40th Street New York 18, N. Y.



## MAKE MORE MONEY BE YOUR OWN BOSS!

\$1.00 VALUE  
**25¢**  
40,000  
WORDS  
IN TEXT

In "CASH IN" you now get THE real money-makers—dozens of profitable tested mail order plans, confidential business secrets, dozens of practical tested formulas, successful tested schemes—actual experiences of men who have started on a shoestring — with less than \$10 capital.

25c a copy postpaid. Send U. S. stamps, money order, or coin.

MONEY BACK GUARANTEE

NATIONAL PLANS COMPANY  
P. O. Box 26M, Ansonia Station, N. Y. C. 23, N. Y.

# Now A DYNAMIC HEAVY DUTY INDUSTRIAL WELDER

## IDEAL FOR AUTO - HOME APPLIANCE AND FARM REPAIRS

DESIGNED TO DO HIGH GRADE WELDING INEXPENSIVELY—Maintenance Men; Farmers; Mechanics; Machine Shops; Foundries; Auto, General Repair and Job Welding Shops; all using the DYNAMIC find it so indispensable and useful that they cannot afford to be without it. If inexperienced, you can easily learn to do a variety of high grade welding jobs by following the practical, simplified operating and welding instructions furnished. Once you see a DYNAMIC in operation, you won't want to be without it. Its simplicity will amaze you. In a year the DYNAMIC only costs you about 6c a day. Helmet, rods, cables, holder and operating instructions, etc., furnished.

### SAVES YOU VALUABLE TIME AND MONEY!

This portable DYNAMIC WELDER—easily carried to the job—can be operated from any convenient, properly wired 110 volt, 60 cycle line. Can also be supplied for 220 volt, 60 cycle operation and for other voltages and cycles at slight additional cost. Works on IRON, STEEL, BRASS, BRONZE, AND OTHER METALS—has 8 metallic and carbon arc welding heat stages—does work you would think only possible with larger more expensive machine.

DYNAMIC WELDER CO. • 13 East 23rd St., FT., Chicago 16, Ill.

FOR ONLY  
**\$23.50**

COMPLETE . . .  
AVAILABLE NOW  
IMMEDIATE  
DELIVERIES

Write today  
For Particulars

Get details on our  
10 day trial offer.

Member Chicago  
Association of  
Commerce





**WANT TO  
EARN  
MORE**

*Money?*

**I Show You How  
at Home**

# Start Your Own RADIO

**Business With Little Capital**

**or Qualify for a Well Paid Radio Job  
Make Extra Money in Spare Time While Learning**

Find out about the many money-making opportunities Radio offers you. Learn how you can qualify for a good-pay job or start a business of your own without capital. Send coupon below for my big **FREE** book, "Your Opportunities in Radio and Television," which tells of radio's vast opportunities and how **HOLLYWOOD RADIO & TELEVISION INSTITUTE** has been training men for success in Radio for over 17 years, in over 40 different countries, through its proven **2-WAY METHOD—LESSONS PLUS HOME SHOP PRACTICE!**



**ABOVE—**You build this transformer coupled audio stage. (Experiment No. 260)

**ABOVE—**You build this A. C. Power Supply. (Experiment No. 195)

**LEFT—**You build this Multi-range Voltmeter. (Experiment No. 61)

### YOU LEARN BY DOING

You build these and many other radio circuits and testers with the 9 kits I send you, to help you learn faster, more thoroughly. All kits become your property.

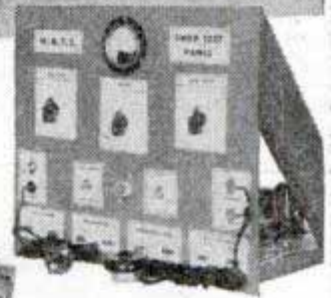

**ABOVE—**You build this Multi-purpose Shop Test Panel. 5 Test instruments in one.

**LEFT—**You build this tuned radio stage, regenerative detector and audio amplifier. (Experiment No. 329)

**I Give You 9 KITS OF RADIO PARTS** and Complete Practical Experimental Lessons  
**You Do Over 300 Fascinating Tests** ★ **Learn This Practical Way**  
(All kits remain your own property)

I send you 9 kits of radio parts with which you make hundreds of interesting, fascinating tests and experiments. You learn the "why and hows" of radio first hand, by doing. Thus, you learn more thoroughly, faster!

### HOLLYWOOD IS A WORLD CENTER

of radio broadcasting and manufacture-television-motion picture production. Thus, H. R. T. I. is in an excellent location to bring you modern, up-to-the-minute instruction. Before you decide on any course you owe it to your future to find out about H. R. T. I. training. Read what graduates in 40 different countries say about this famous course.

**BIG BOOK FREE**

Just paste coupon on a postcard or send in envelope for free big fully illustrated Book "Your Opportunities in Radio, Television and Electronics" and explaining the advantages of HRTI training. No salesman will call.



### MANY H.R.T.I. STUDENTS EARN MONEY IN SPARE TIME WHILE LEARNING

From the very start, through special "Spare Time Work Sheets," I show you how to earn money in spare time by doing good-pay radio jobs that abound in nearly every neighborhood. Many students earn \$5, \$10, and more a week while learning. A mighty good way to lay the foundation for a future radio business of your own.

Now is the time to start preparing for your career in this fast-growing industry. Take the first step—send coupon for my big **FREE** Book today.

### MAIL COUPON NOW

C. H. Mansfield, President, Dept. A-2  
HOLLYWOOD RADIO & TELEVISION INSTITUTE  
810 WEST 6TH ST., LOS ANGELES 14, CALIF.

Send me your **FREE** book, "Your Opportunities in Radio, Television and Electronics" which explains your 2-way training method at home. (No salesman will call.)

Name \_\_\_\_\_ Age \_\_\_\_\_

Address \_\_\_\_\_

City \_\_\_\_\_ Zone \_\_\_\_\_ State \_\_\_\_\_

Air Mail Reaches Me Overnight

**HOLLYWOOD RADIO & TELEVISION INSTITUTE**  
810 West 6th Street, Los Angeles 14, California



JUST OUT! NEW FROM COVER TO COVER

# AUDELS REFRIGERATION and AIR CONDITIONING GUIDE



4 Books in One! Covering:

- 1—Basic principles, Servicing, Operation, Repair of
- 2—Household Refrigeration
- 3—Special Refrigeration Units
- 4—Commercial & Industrial Refrigeration
- 5—Air Conditioning Systems

A gold mine of essential important facts for ENGINEERS, SERVICEMEN & USERS.  
A Good Book is a Good Friend! Here you have at your fingers' ends a Complete Library in ONE VOLUME, the necessary data you have been looking for on: MODERN UNITS, SYSTEMS & MACHINES, REFRIGERANTS, including Freon, Lockers, Water Coolers, Quick Freezing & Air Conditioning Systems. 1280 Pages, 46 chapters all Fully Illustrated & Indexed for Ready Reference.

**ANSWERS YOUR QUESTIONS**  
Get This Information for Yourself. Mail Coupon Today. No Obligation Unless Satisfied. ASK TO SEE IT.

**\$4 COMPLETE • PAY ONLY \$1. A MONTH** ←

AUDEL, Publishers, 49 W. 23rd St., New York 10, N.Y.  
MAIL AUDELS NEW REFRIGERATION GUIDE for free examination. If O. K. I will send you \$1 in 7 days; then remit \$1 monthly until price of \$4 is paid. Otherwise I will return it.

Name.....  
Address.....  
Occupation.....  
Employed by..... PM

## Learn WATCH REPAIRING From An Approved School The Largest of Its Kind

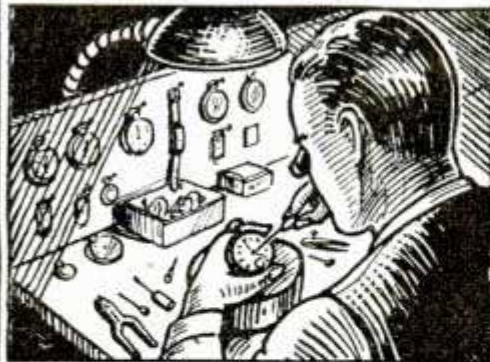

**EARN  
WHILE  
LEARNING**

**Spare Time Home Training  
Prepares You For Big Pay**

**FREE WATCH** working tools and watch included as part of our Watch Repairing Course

The demand for skilled watch repairers—men and women—is increasing with the step-up in the manufacture of watches. Now is the time to prepare yourself in this fascinating profession with the aid of our highly practical HOME TRAINING COURSE—in your spare time at home. Start your own business or accept a big pay position.

**WRITE TODAY FOR FREE DETAILS**

Earn while you learn with an "approved" school.  
Get the facts—then judge.

**ILLINOIS SCHOOL OF WATCH REPAIRING**  
6312 Huntington Street, Dept. PM-3, Chicago 30, Illinois



## PRACTICAL BOOKS ON HOME PLANNING BUILDING • REPAIRS

MAIL  
ORDER  
TODAY

Plan Now—Build When You Can  
Books Sent C.O.D. Anywhere in U.S.A.

Select from this list of helpful books. In U. S. books sent postpaid if remittance accompanies order. Outside U. S. include 15% extra for shipping charges.

- How to Plan a House.....\$4.50
- House Construction Details.....\$3.00
- Painting, Decorating.....\$1.50
- Carpentry.....\$2.00
- Painting, Furniture Finishing and Repairing  
Includes floor renewal.....\$1.50
- How to Remodel a House  
Complete, practical.....\$4.75
- Building Insulation.....\$3.50
- Concrete Handbook  
Do work for yourself, others.....\$1.50
- Blueprint Reading for Building Trades.....\$1.25
- Practical Bricklaying.....\$1.75
- Simplified Carpentry Estimating.....\$3.00

**FAMOUS PLAN BOOKS**  
Books contain floor plans, photos, descriptions of homes.

**AMERICA'S BEST LOW COST HOMES.**  
125 designs.....\$1.00  
**DE LUXE SMALL HOMES.** 210 designs.....\$1.00

**OUR FUTURE HOME.**  
Wide selection of residences, summer homes, garage apartments.....\$1.00  
**MODERN HOME & GARDENING.** 42 popular designs. Improvements, garden shortcuts, etc.....50c

Set of  
Four  
Books  
**\$3.50**



Stair  
Building  
**\$2.00**

## POPULAR MECHANICS PRESS

Dept. 640 - 200 E. Ontario Street, Chicago 11

★ ★ ★

**MAKE YOUR OWN  
POWER TOOLS  
at Low Cost**  
from old Auto Parts, etc.



**A New Edition  
Featuring TOOLS of WOOD**

Now you can have a good lathe, drill press, circular and band saw and other power tools in your home workshop, at a cost of only a few dollars each. Make them yourself from old auto parts, discarded sewing machines and other odds and ends that cost little or nothing. Get this new book—"Forty Power Tools You Can Make." Costs only \$1.25 postpaid. This book gives every detail in plain language you can understand and follow. Hundreds of pictures and plans show every step to follow in making the power tools you want. Actual photographs of finished machines included. Send \$1.25 today. Money back if not satisfied.



**MAKE EVERY POWER TOOL NEEDED IN YOUR HOME WORKSHOP**

Some of the power tools you can make are:

- 2 Band Saws
- 9 Sanding Machines
- 2 Circular Saws
- 1 Metal Lathe
- 1 Power Hack Saw
- 1 Jig Shears
- 1 Cut-Off Wheel
- 2 Drill Presses
- 1 Scroll Saw
- 2 Wood Turning Lathes
- 3 Grinders
- 1 Shaper or Moulding Machine
- 1 Vibrating Pencil and others

Information too, about pulleys, belts, motors and drive methods. Just published. No other book like it. Order today.

## POPULAR MECHANICS PRESS

Dept. 621

200 E. Ontario Street, Chicago 11

POPULAR MECHANICS



**STEADY JOB! GOOD PAY! CLEAN WORK!**

# ELECTRICITY

**NATION'S  
LARGEST  
EXCLUSIVE  
ELECTRICAL  
SCHOOL**

**LEARN QUICKLY AND THOROUGHLY  
LATEST, MOST ADVANCED METHODS**

*Learn Electricity Fast . . . at nation's largest exclusive electrical school . . . in only 19 weeks! Learn Electricity Right . . . topflight instructors help you learn easily, quickly, thoroughly . . . on-the-job, up-to-the-minute methods of training. Qualify yourself for Construction and Industrial Maintenance . . . Operation, Maintenance and Repair of AC and DC Motors, Generators, Controls, other Power Equipment . . . House and Factory Wiring . . . Armature and Motor Rebuilding. Entire building—4 floors devoted exclusively to this one course. Individual attention to students. Living quarters arranged for if desired.*

*Pay after you graduate . . . Lack of money need not hold you back. We will finance your training. Pay later in small monthly payments.*

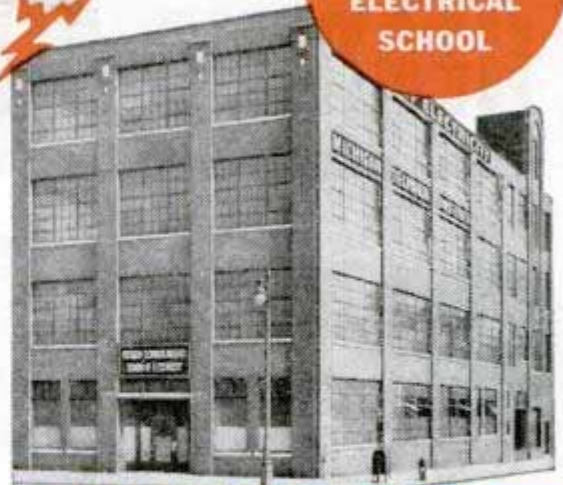

## MICHIGAN TECHNICAL INSTITUTE

Dept. M-3 2281 W. Fort St., Detroit 16, Mich.

MICHIGAN TECHNICAL INSTITUTE Dept. M-3  
2281 W. Fort St., Detroit 16, Michigan

- Send me catalog and complete information.  
 I am a GI. Send special information.

NAME \_\_\_\_\_  
ADDRESS \_\_\_\_\_  
CITY \_\_\_\_\_ STATE \_\_\_\_\_

APPROVED FOR TRAINING UNDER GI BILL

### VETERANS!

Take this course at no cost to you, and receive \$65 to \$90 a month while training. Complete details furnished. **MAIL COUPON TODAY!**



**REFRIGERATION**



**ELECTRONICS**



**WELDING**

Specialize in  
6 months to 3 years  
**COURSES**

**SERVICE—6 months**  
Practical Electricity  
Practical Welding  
Refrigeration Service  
Heating Service

**TECHNICIAN—1 Year**  
Electro Technician  
Radio Technician  
Electronics Technician  
Refrigeration, Heating  
and Air Conditioning  
Technician

**PROFESSIONAL—3 Years**  
Electrical Engineering  
B. S. Degree—Major in  
Machinery or Electronics

## PRACTICAL TECHNICAL TRAINING

Our time-tested *CONCENTRIC SYSTEM* enables you to build your career step by step. Each 6-month course is complete in itself. Stay as long as circumstances permit—until you reach your desired occupational objective. For 44 years this school has specialized in technical training. More than 35,000 former students in industries the world over. 1,248 students now enrolled from 46 states and 5 foreign countries. Faculty of 63 specialists. World-wide alumni counselor committee. *Terms start April, July, September.* **SEND COUPON TODAY!**

## MILWAUKEE SCHOOL OF ENGINEERING

A Technical Institute

Milwaukee School of Engineering, Dept. PM-347  
N. Broadway and E. State, Milwaukee, Wis.

Without obligation, send me free booklet "Career Building" and more details on course in .....

Name ..... Age .....  
Address .....  
City ..... State .....



Now! The **ONE-UNIT HEARING AID**  
Thousands Have Waited For

THE NEW ONE-UNIT  
**Beltone**  
MONO-PAC  
HEARING AID

THIS IS  
ALL YOU  
WEAR

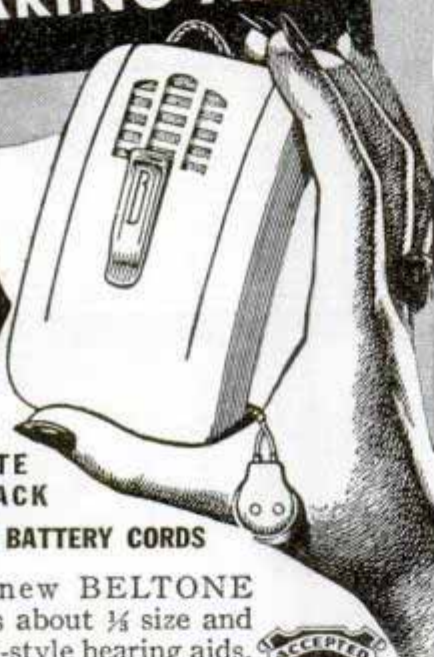

NO SEPARATE  
BATTERY PACK  
NO DANGLING BATTERY CORDS

The tiny new BELTONE Mono-Pac is about 1/4 size and weight of old-style hearing aids, yet so powerful you hear even *whispers!* Get helpful facts about this new "MIRACLE" aid in valuable FREE book about deafness.

**BELTONE HEARING AID CO.**  
Dept. PM-73  
1450 W. 19th St., Chicago 8, Ill.



**FREE BOOKLET**

**Beltone Hearing Aid Co.**  
Dept. PM-73, 1450 W. 19th St., Chicago 8, Ill.  
Please send me FREE booklet about deafness and what can be done to overcome it.

Name \_\_\_\_\_  
Address \_\_\_\_\_  
Town \_\_\_\_\_ Zone \_\_\_\_\_ State \_\_\_\_\_

This Easy Way  
**TEACHES GUITAR**  
to Your Satisfaction in  
30 Days Or Money Back



Astounding new Jim Major Home Method teaches you to play guitar easily, quickly, without long hours practicing scales or exercises. *No musical knowledge necessary.* Play many popular songs, hymns in very short time. 30 lessons, complete course for only \$1.69. EXTRA — BIG 53 SONG BOOK included without additional cost. Send no money . . . pay postman \$1.69 plus postage. (Cash with order we pay postage.) Money back guarantee. Send today to Jim Major, Room 49-C, 230 East Ohio, Chicago 11, Ill.

**GOV'T. JOBS**

Inexpensive, Keyed Lessons prepare you for Exam. Write, Ozment School, 80, St. Louis, Mo. (Veterans get preference.)

**MAKE MAGIC YOUR HOBBY**  
**BE A MAGICIAN FOR FUN OR PROFIT!**  
Rush 25c; for first issue of "MAGIC IS FUN," new magazine that teaches how to do tricks with coins, cards, ropes, etc. FREE, with order, large catalog of magical apparatus. D. Robbins & Co., Dept. M77, 152 W. 42 St., N.Y. 18, N.Y.

**5¢ LITTLE BLUE BOOKS**  
Send postcard for our FREE CATALOGUE. Thousands of bargains. Address:  
**HALDEMAN-JULIUS CO.,** Catalogue Dept., Desk M-2435, GIRARD, KANSAS

**PLASTIC HOMES** New Building Material! Resurface old homes; build new ones. Colorful, Beautiful! **LIQUID MARBLE—** Color-glass! Molded, brushed, sprayed. **SANITARY COMPOSITION FLOORING—**Dustless, noiseless; put on like plaster; resilient—yielding as cork; lasts like stone; plain or marked in tile design. **RUBBERLASTIC Mold Compound—**Mo'd novelties, statuary, toys, gifts, plaques, plaster animals. **COLORLED POTTERY—**Birdbaths, garden furniture, vases. **TILEX** colored roofing. Illustrated literature FREE. **RAPID MARBLEIZING SERVICE,** Dept. 10-B, Edwardsville, Illinois

**MIDGET AUTO RACING BOOK \$1.10**  
45 FOTOS, History 1946 Calif. Racing, \$1.10. 1946 Indianapolis "500" Race Book, \$1.00. Mercedes-Benz book, \$2.00. See our ad (Autos) Classified Section. Catalog free.  
**CLYMER,** Dept. A-3, 2125 W. Pico, Los Angeles 6, Calif.

**Learn LANDSCAPE GARDENING**  
A thorough, interesting, home study course for those who wish to become **LANDSCAPERS, GARDENERS, DESIGNERS,** etc., for profit or pleasure. Write today for FREE BOOK to  
**APPROVED FOR VETERANS** **NATIONAL LANDSCAPE INSTITUTE,** Dept. P-3, 310 So. Robertson, Los Angeles 36.

**COMB-A-TRIM**  
**THE NEW QUICK TRIMMER**  
Something New! Trim your hair without any experience. It's easy! The excess hair comes off smoothly and easily by just pulling trimmer through hair like an ordinary comb. Also removes hair from legs—armpits. Save on hair-cut bills . . . Trim your own hair or the whole family's. Send 59c and your Comb-A-Trim will be sent at once.

59c

**SPECIAL OFFER**  
Send \$1.00 for 2 Comb-A-Trims and save 18c. **2 for \$1**

5 Extra Blades (Year's Supply) 25c **COMB-A-TRIM CO.**  
1734 Carew Tower Dept. R-17 Cincinnati, O.



# LEARN WATCH REPAIRING

AT HOME

## New and Complete "PRACTICAL COURSE"

for beginners . . . an ideal refresher for professional repairmen. Construction, repair, adjustment. Every essential step. Theory, Operation. Many test cases. Complete coverage of tools and materials needed. Fully illustrated

Only **\$2.95** Post Paid  
(If COD plus COD charges)  
Money Back Guarantee

We Supply All Tools, Materials and Parts at Lowest Cost — Prompt Delivery!

Complete set of tools and materials for **STUDENTS AND PRACTICAL REPAIRMEN**. For single items of interest send for **FREE** price list.

MODERN TECHNICAL BOOK CO., Dept. MMC  
55 West 42nd Street New York 18, N. Y.  
FREE — JOIN NEW TECHNICAL BOOK CLUB — FREE

We specialize in **ALL** books on technics, Chemistry, Plastics, Refrigeration, Building, Radio, Automotives, Mathematics, Woodworking, Home-craft, Business, Farming, Sports, etc. Write for **FREE** literature and specify subject.



# Earn Big Money Arc Welding with a HOBART



welds faster

more economical

easier to operate

heavy duty

cooler running

Own a profitable business with a minimum investment? It's easy if you establish a welding shop with Hobart Arc Welders. People bring repair work to you—automotive, farm equipment, etc. There's profit in every job—and plenty of jobs to keep you busy.

**WELDING WITH HOBART IS EASIER!** Only with Hobart do you get operation and convenience features that let you complete a job faster while producing better quality, more profitable welds. Write for details on the Electric Drive Welder—ideal for job welding shops. **"BUILD YOUR OWN" AND SAVE!** With the Hobart Generator Only, a used auto engine and chassis, you can build your own portable gasoline drive arc welder and save hundreds of dollars. This equipment goes everywhere to handle welding jobs. Send coupon.

**COMPLETE HOBART LINE.** You'll find every type and size of arc welder in the Hobart line—electric or gasoline drive, stationary or portable, AC or DC.

**HOBART WELDING SCHOOL.** Instruction in all phases of welding in short, intensive course. Modern building, individual instruction. Qualified under G. I. Bill. A non-profit institution. Hobart Bros. Co., Box M-371, Troy, Ohio



Hobart Stationary Electric Drive—Shaft Extension

Hobart "Build Your Own" Generator

Hobart AC Model for Single Phase



"One of the World's Largest Builders of arc welders"



**Free!** I'm interested in the profit-making possibilities of Hobart Arc Welders. Send me free book, and details on items checked.  
 Electric Drive  A.C. Welder  
 "Build Your Own"  Welding School

NAME \_\_\_\_\_  
ADDRESS \_\_\_\_\_



## TURN ON THE POWER IN YOUR LIFE!

Wake up your Personality and stop being pushed around by Worry, Fears, Nerves and Inferiority.

Learn to create positive impulses to order. Make your emotions obey you, not you them. Team up with your abler self and dare to attack the hindrances in your life. Experience the thrill of growing into a bigger person, even late in life. Reap the rich rewards of Personal Know-How with our Home-Study Self-Development plan. Discover new powers to meet life's demands. We offer you sincere help with a money-back guarantee of results in your case. Write today for **FREE** LECTURE and full details. No obligation.

## SCHOOL OF PERSONAL PSYCHOLOGY

(Chartered Non-profit Correspondence Education)

1008-1009 Washington Bldg., Louisville 2, Ky.

## Say You Saw It in POPULAR MECHANICS



## BUILDING HUMAN STATURE

"I grew 6 inches during a year I followed instructions given in 'BUILDING HUMAN STATURE,'" says the younger man at left. "Now I am a head taller than my father."

If you wonder why you are short send for **FREE** outline of this remarkable book loaded with practical information.

CARILLON BOOKS, Dept. 96, Boerne, Tex.



Balance 4" x 9" Base. With either Metric or Avoirdupois Weights . . . **\$6.00**

Catalog with 3000 illustrations of laboratory apparatus, and over 10,000 prices sent for \$1.00. Catalog of 80 Scientific books. Price \$1.10.

LABORATORY MATERIALS CO.  
7321 Vincennes Ave. Chicago 21, Ill.

## 500 TRICKS MAGIC TRICKS

**IT'S FUN TO DO MAGIC**

Amaze—mystify—entertain! you, too, can enjoy this fascinating hobby. Only 10c brings our new 1946-7 Catalog 500 Tricks, containing brand new easy-to-do tricks for pocket, parlor, club, stage. Hundreds of tricks require no skill. Join in the fun—send 10c today!

Douglas Magicland, Dept. C, Dallas, Texas





# P.A.\* means Pipe Appeal

There's something about the *masculine* look of a pipe that has an irresistible appeal. Women go for it—as men go for the mild, rich taste of Prince Albert Tobacco.

**PRINCE ALBERT IS AN  
EYE-OPENER FOR COMFORT  
AND JOY IN A PIPE!**

# P.A. means Prince Albert

● The initials P. A. stand for America's favorite smoking tobacco—crimp cut Prince Albert. You'll like P. A. for its rich taste . . . its mellow mildness. Prince Albert is specially treated to insure against tongue bite. For real smoking joy and comfort—try P. A. today!

R. J. Reynolds Tob. Co., Winston-Salem, N. C.

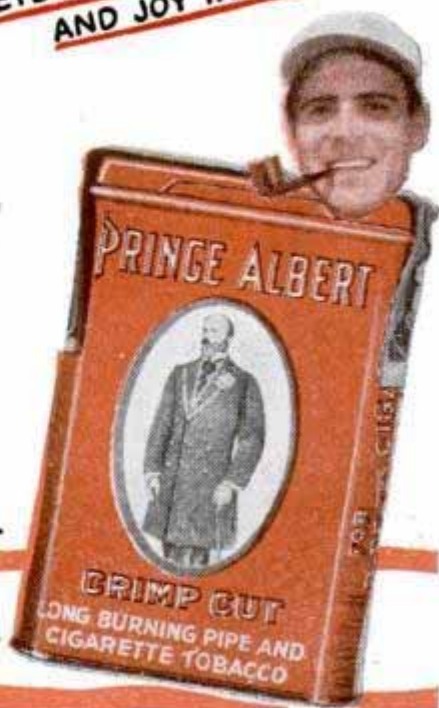

## The National Joy Smoke



**I**F YOU burned 600 gallons of gasoline in the family jalopy last year, the chances are you will be buying only 480 gallons in 1950 for the same mileage. That's a saving of 20 percent, a respectable figure on anybody's budget. It also means that 5,000,000 additional American automobiles may be operated 40,000,000,000 miles without using any more gasoline than was burned in 1946!

These figures are not somebody's pipe dream or something pulled out of a hat to startle the public. They are "well within the realm of possibility," according to Earl Bartholomew, general manager of the new Ethyl Corporation Research Laboratories in Detroit. His conservative predictions are based on research he has conducted by rolling up his sleeves and working alongside the men in his vast laboratory.

This laboratory is filled with some of the most intricate research equipment ever devised by man. Electronic recording devices perform superhuman stunts that amaze

# POPULAR MARCH 1947 MECHANICS

WRITTEN SO YOU CAN UNDERSTAND IT  
VOL. 87 NO. 3

the layman. The prime function of the lab is to take the hit-or-miss out of both engine and fuel research by combining the two under one roof.

The engineers reasonably point out that the development of a super gasoline is futile without the proper engine in which to burn it; also that increasing the compression ratio of an engine and introducing other refinements is just so much wasted effort unless the proper fuel is available. Visitors to the labs are greeted with this sign: The

## *Proving Ground for Gasoline*

By Wayne Whittaker

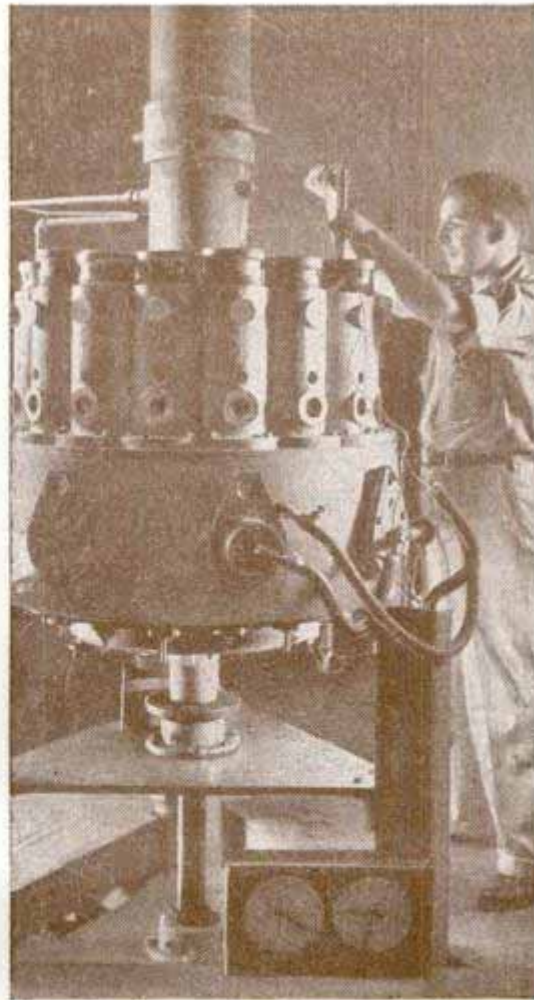
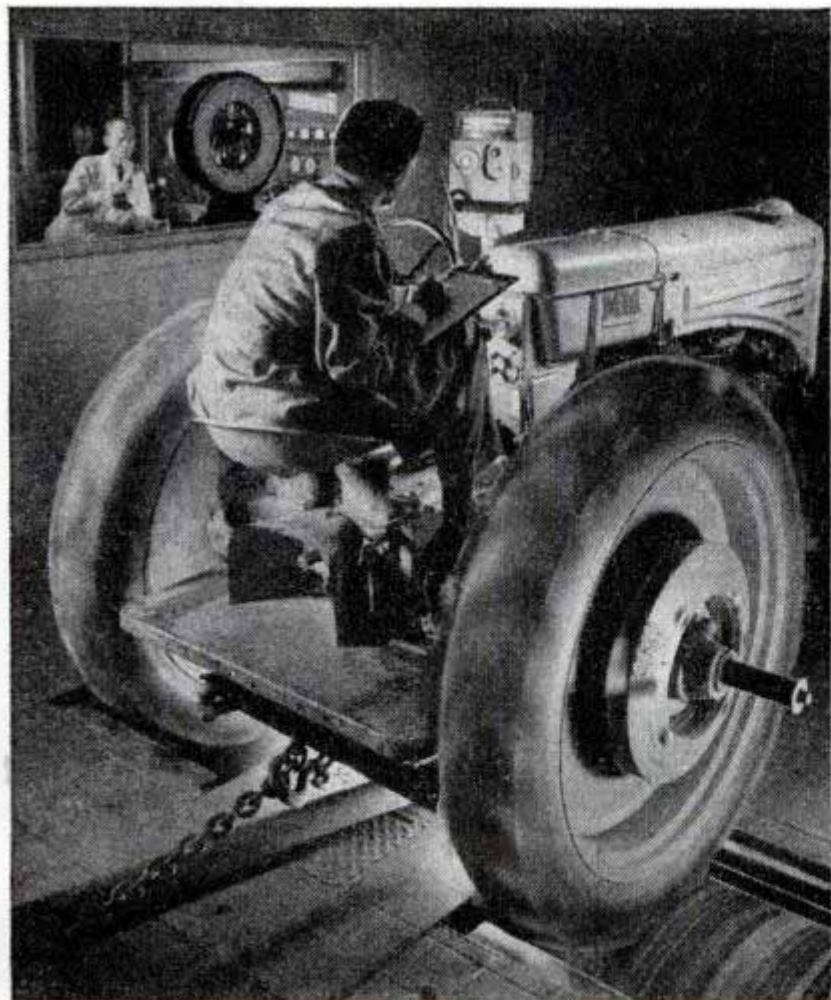

Tractor rides chassis rolls for fuel test in room with temperature range from 50 below zero to 150 above  
Right, corrosion furnace is the only one of its kind and tests metals under heat and stress for jet planes



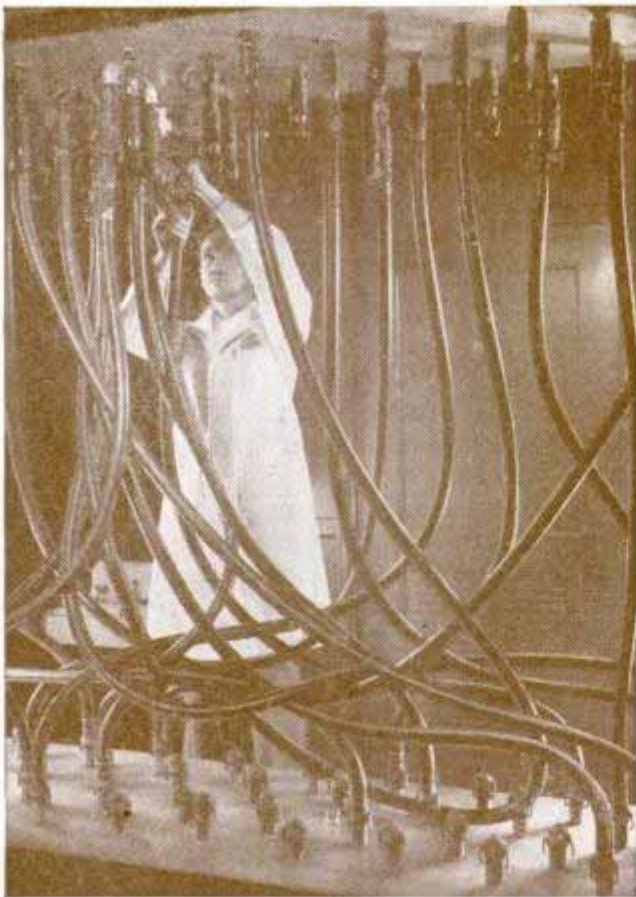

Fuel "switchboard" routes various blends to engines

Problems of Engines, Fuels and Lubricants Are Inseparable. Automobile drivers became acutely conscious of this fact when low-grade gasoline knocked and pounded in their engines during the war.

The Ethyl Research Laboratories were virtually a wartime secret and only recently made their bow to the public. Construc-

Engineer readies autoclave in small pilot plant for making tetraethyl lead

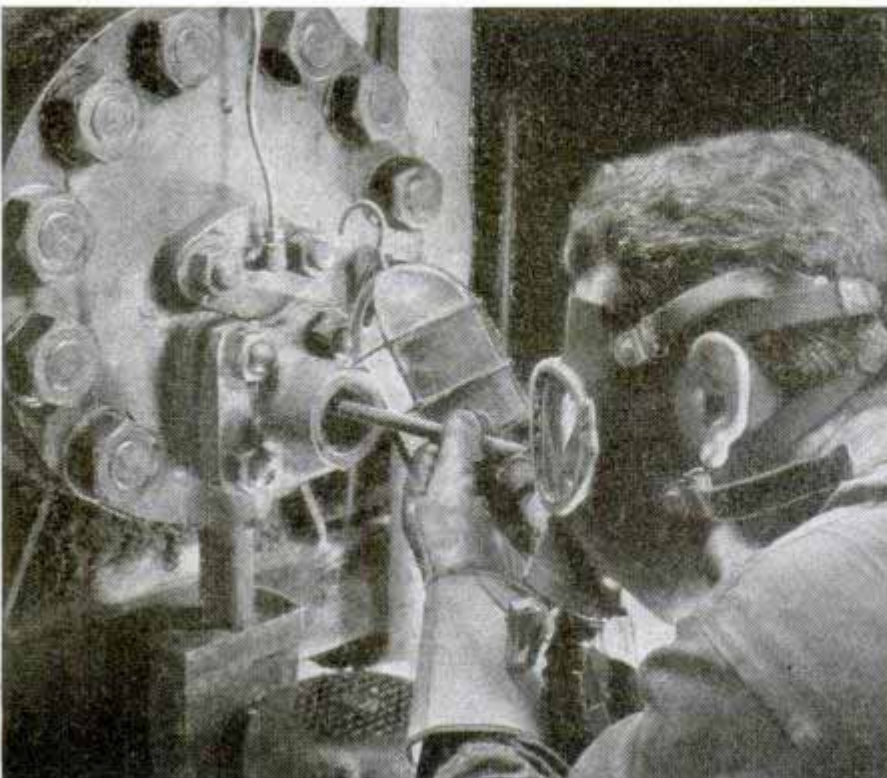

Gauge shows wear to nearest 0.0001 inch in cylinders

tion of the laboratories was almost finished at the time of Pearl Harbor and the project was rushed to completion. Then the Army, Navy and Air Forces promptly swamped the place with demands that taxed resources to the limit.

"It seemed as if this place had more guards than the White House," said one engineer, "and we had our share of red tape, too. Still, we managed to find some right answers."

These "right answers" were concerned with tanks roaring into battle in desert heat and grit; lifting bombers into the substratosphere and boosting the speeds of fighter planes; the starting of trucks in subzero Aleutian weather, and the propelling of landing craft onto tropic beaches. The military demanded more and more horsepower, greater and greater dependability, and better fuels of the highest anti-knock quality possible.

All of this, of course, is in the past, but it will always be an important chapter in the more than



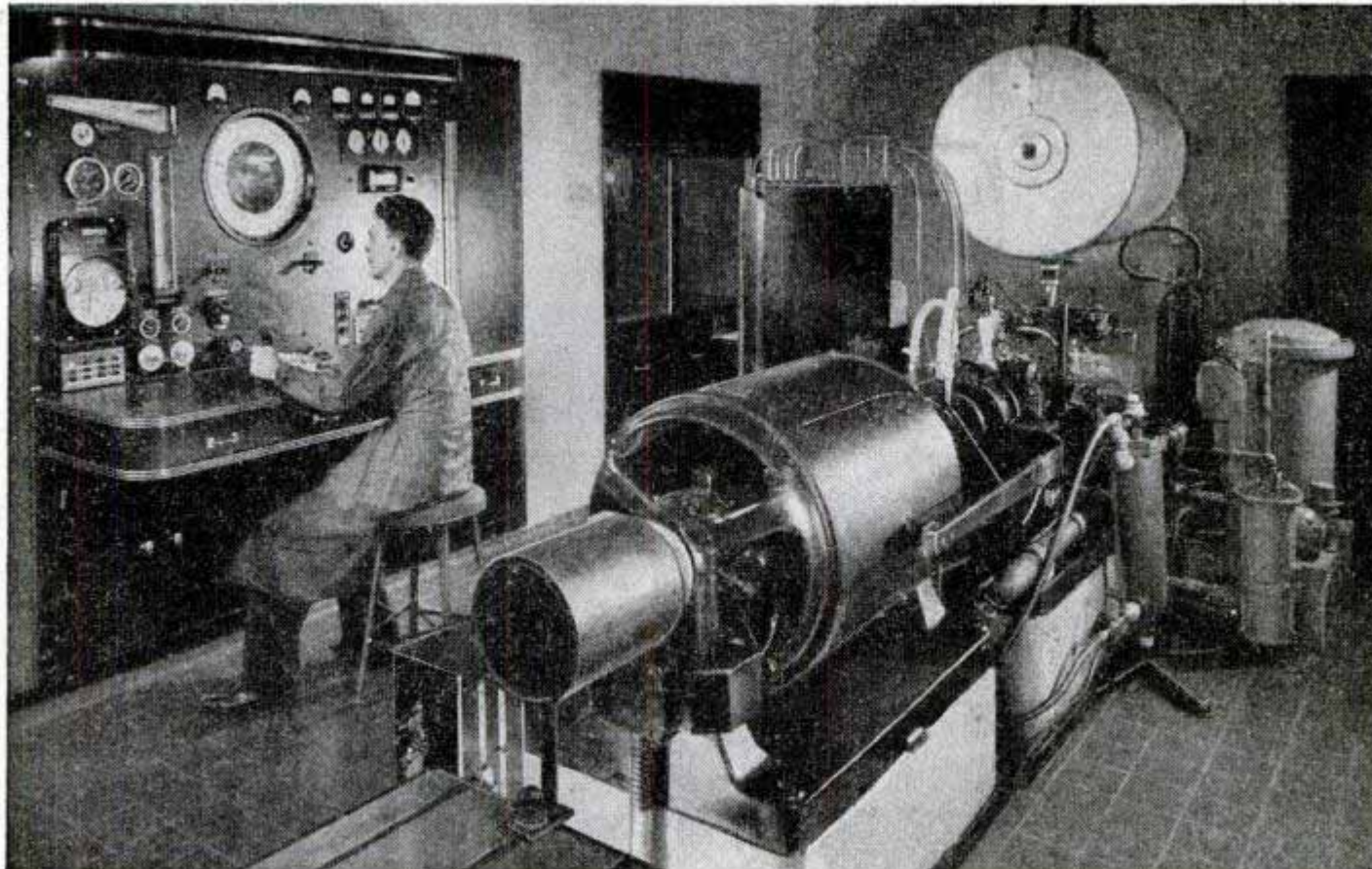

Dials reveal knock rating, air-fuel ratios and other vital data; the dynamometer rests on a concrete block

20 years of Ethyl research. Now there is a turnabout in lab activity and the projects are devoted to fuels and engines for peacetime use. However, much that was learned during the war will have a profound effect on future engines and fuels.

One of the first things that impresses a visitor to the lab—aside from the spotless and attractive layout of the plant and its general efficiency—is the possessive air of the engineers, chemists and other research experts. This is explained by the fact that the research workers themselves took an active part in planning the layout. Practical suggestions ranged all the way from the positioning of a dynamometer control panel to placing double doors between laboratory rooms and adjacent offices to reduce noise.

The laboratories are built in the shape of the letter E with the two-story back of the E fronting to the south on a suburban highway. Three one-story wings extend north to form the legs of the E.

Let's open a few of those double doors for a close look at some of the activities that may help save us one gallon of gas for every five in 1950.

In the instrument section in the main wing, Emil Gillig, the section head, is busy completing construction on a new test stand for calibrating electronically operated spark advance and tachometer indicators.

"Most of the instruments you see here," he explained, "are the only ones of their

kind, for we had to design and build them to do special jobs. Our great problem in the labs is to duplicate actual road operation and to build instruments that will record accurately what happens in investigations both in the laboratory and on the road."

One instance was cited where a valve material seemed perfect under a constant speed and throttle opening test in the lab,

**Atomic model in library aids study of fuel makeup**





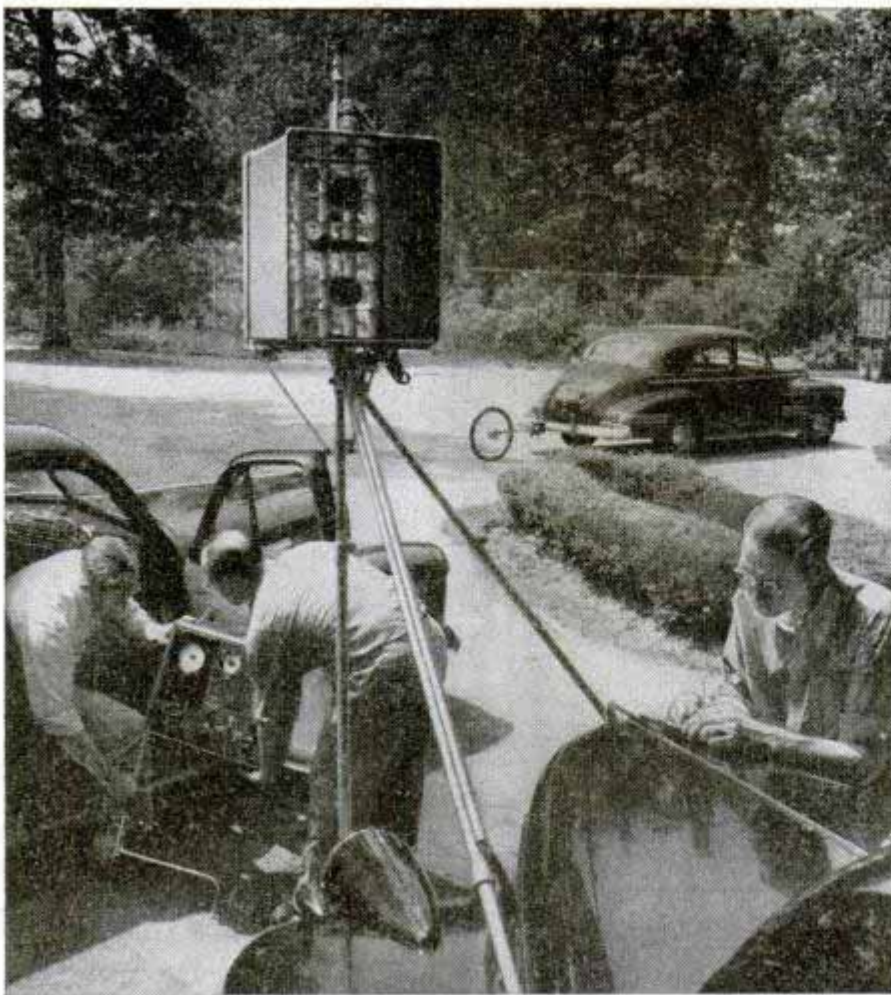

Preparing cars for road tests with an anemometer (foreground) to measure wind velocity, a spark advance meter (being lifted into car) and a "fifth wheel" speed indicator. Below, window in burner tube aids jet fuel research

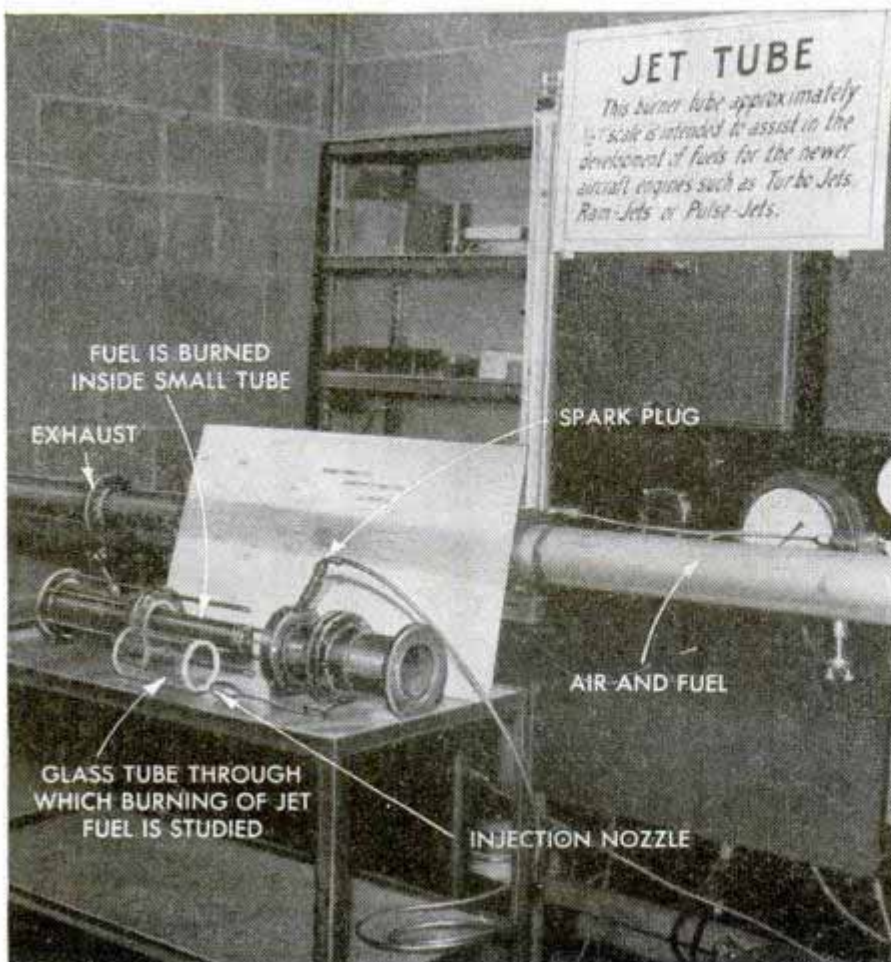

but later failed in engines undergoing the wide variety of speed and load changes encountered in actual road operation. Such flaws show up under simulated road conditions with electronic recorders taking the "pulse" of the engine. One electronic self-balancing strip-chart recorder prints at two-second intervals a continuous record of temperatures measured at 12 points on an engine.

One of the most ingenious instruments is a pneumatically operated "piano player" machine that plays not a tune but an actual road trip on an electric dynamometer and engine. First a perforated tape about six inches wide is prepared from a log of speeds and manifold vacuums obtained during actual operation of a vehicle on the road. This tape travels across a tracker bar having 25 holes connected to bellows which operate switches providing 20 engine speeds and 31 different throttle settings. Listening to an engine which is controlled by this apparatus, particularly of a recording made in traffic, gives the illusion of a sound track for a movie scene in a car.

The infinite care with which research is conducted is evidenced by a gauge used to determine wear on cylinders. This gauge and a master reference ring are used at the start and end of an endurance test to reveal wear to the nearest 0.0001 inch at as many as 42 locations in each cylinder.

Also on the ground floor of the main wing is the single-cylinder engine section. Here one experimental fuel mixture after another is run. C. L. Davidson, head of this section, explained that there are thousands of potential fuel blends and only



by systematic studies of the different classes can the most satisfactory combinations be determined. Using normal heptane and iso-octane as bases he prepared several samples of 70, 80 and 90-octane fuels. During research on auto ignition every abnormal combustion in certain engines is counted and recorded electronically. The counter, Davidson says, is far more accurate than the human ear and has made a tedious job almost entirely automatic. Special fuels in such small quantities as only 50 or 100 cubic centimeters can be switched in for a test of 30 or 40 seconds.

In one special engine for comparisons of gasolines, two separate fuel systems are used. The fuels are weighed and pumped into the air stream. One fuel is run with the engine set at a certain compression ratio and the spark is advanced until a knock is registered on a knockmeter. An identical test for the second fuel may show no knock at an even greater spark advance—evidence of a better fuel under specified engine conditions. Chemical antiknock agents were discovered by the late Thomas Midgley, Jr., former vice-president of the Ethyl Corporation. Tetraethyl lead, the principal one of these, is added to most automobile gasolines, and it is also an essential ingredient of all high octane aviation gasolines.

There are 17 engine dynamometers in the laboratories, ranging in capacity from 7½ to 450 horsepower. The engines are moved about by traveling cranes. Fourteen of the dynamometers have engines mounted at either end so one engine can be in operation while work is being done on another.

Two chassis dynamometers are installed in "hot" and "cold" rooms for high and low temperature studies. Load limit on the chassis rolls, which are placed slightly below

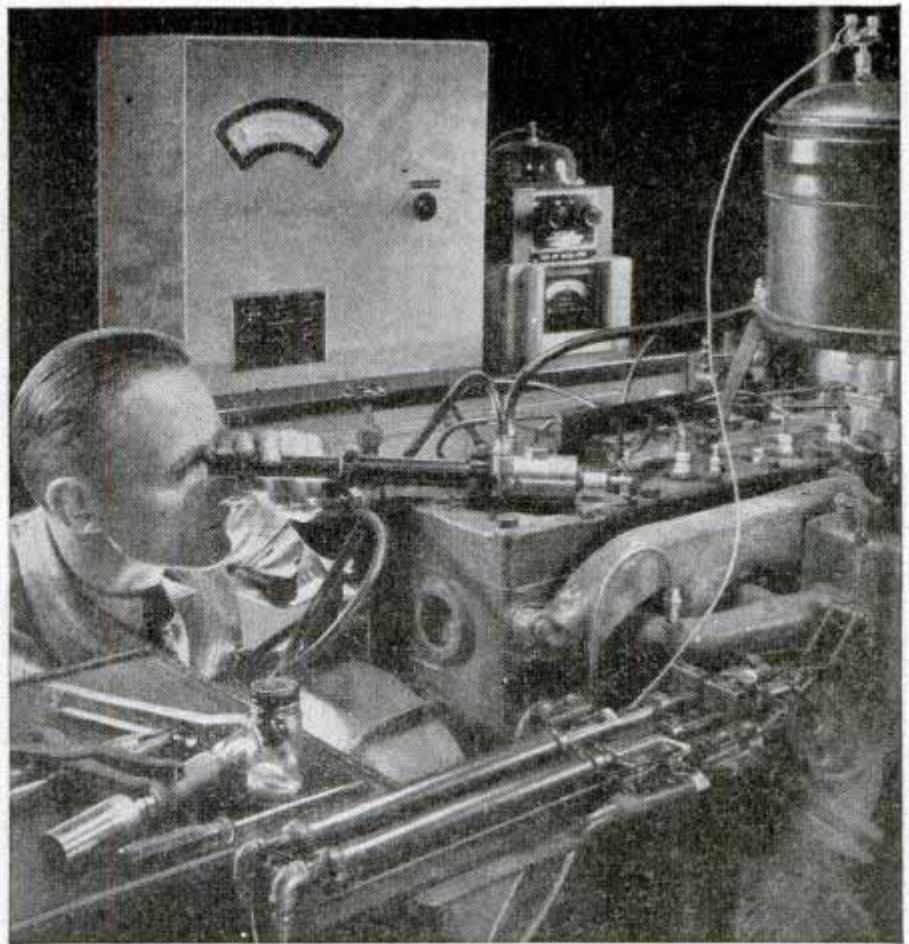

Spark plug viewer shows what goes on in area immediately surrounding gap

floor level, is five tons. In case of a blowout of a rear tire on an automobile or truck during operation on the rolls, the differential drops down on a block which prevents a vehicle from swinging off the rolls. A blower facing the car can create a blast of air up to 100 miles an hour. The air speed may be automatically controlled by rear-wheel roll speed. This control, together with additional automatic equipment to

(Continued to page 280)

Engineer takes readings from electronic spark advance meter on the road





## Callers "Checked" Undetected Through Mirror-Window

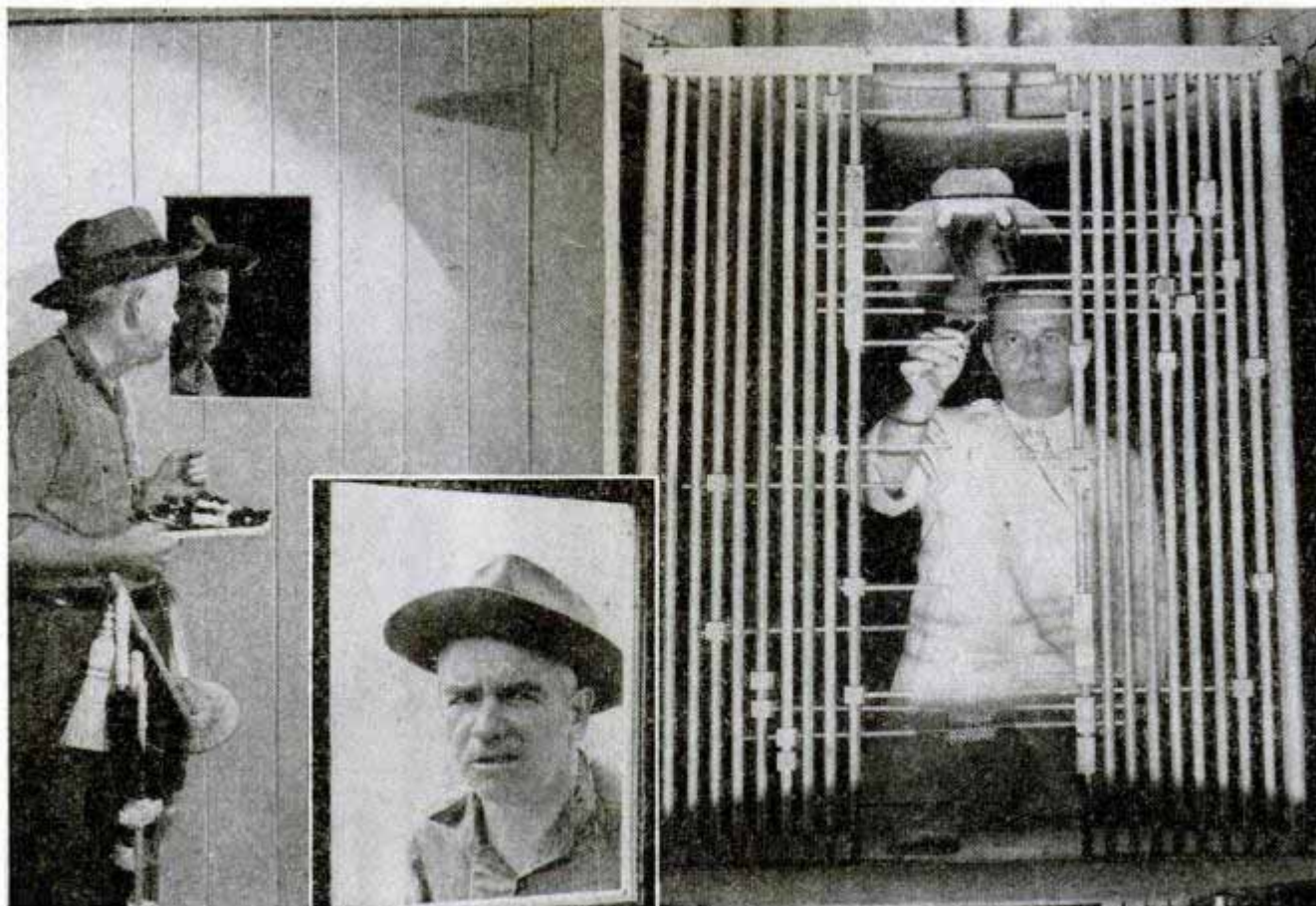

While the peddler sees only his own reflection in the mirror-window, housewife's view of him is shown in inset. Right, loading chrome alloy in a tungsten filament for surfacing glass in a hot evaporation chamber

Now you can give callers the once-over undetected through glass that is a mirror from the outside, a window from within. Ordinary mirrors are silvered chemically by hand on the back surface, then covered with an opaque backing to prevent tarnishing or rubbing off. The new transparent mirrors are surfaced by "molecular bombardment" with chrome alloy, which forms a film four ten-millionths of an inch thick. While providing an effective reflective sur-

face that won't rub off or tarnish, the film permits sufficient light passage so that clear photographs can be made through it. It is also expected to be used as a door panel between kitchens and dining rooms, for observation screens in child behavior clinics, psychiatric wards and hospital operating rooms, in glazing shower stalls and as a "security" window in banks. The process employed is based upon an invention of Dr. John Strong of Johns Hopkins University.

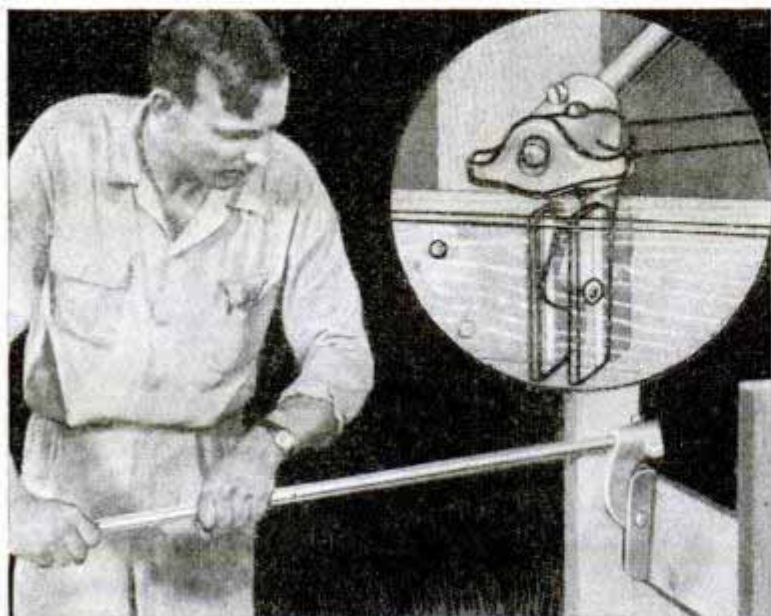

## Prying Tool Stops Splitting To Boost Lumber Salvage

Reclamation of usable lumber in razing jobs is made easier by a prying tool said to prevent splitting. When placed against the board to be removed, the tool hugs adjacent studding and its extended steel lips support the leverage pressure applied to the handle. The tool lifts and loosens ordinary planking, tongue and groove flooring and shiplapped siding.

☐ Birds in the Bikini area were unharmed by the two atomic bomb bursts and recent surveys showed no noticeable change in numbers.



# Game Combines Features of Both Bowling and Billiards

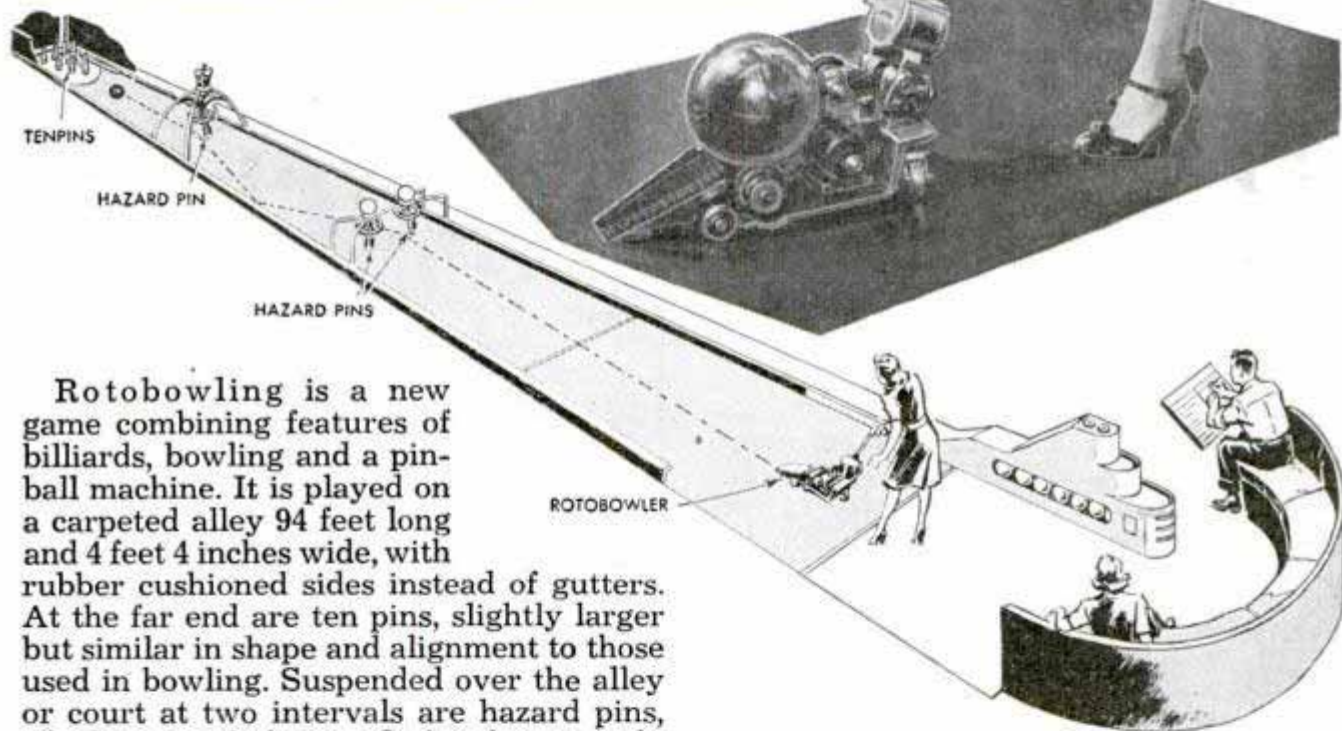
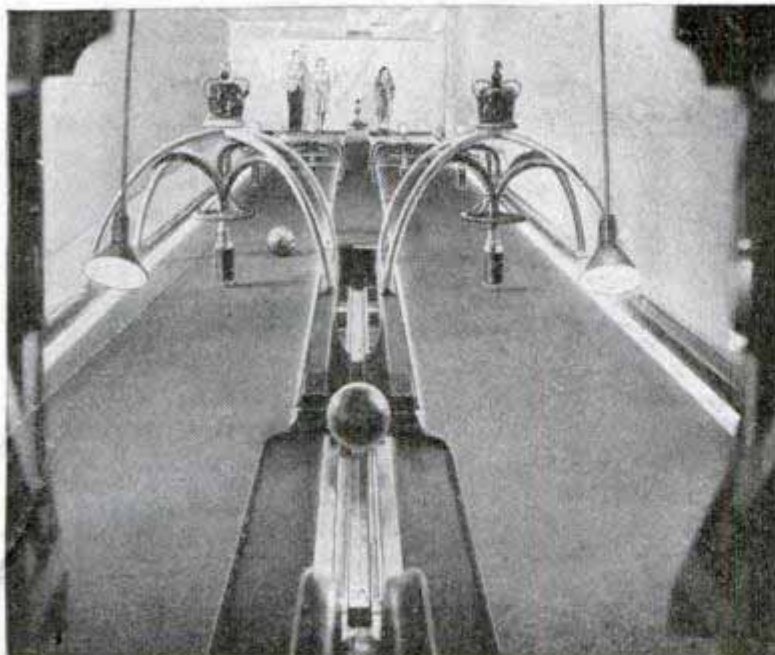

Rotobowling is a new game combining features of billiards, bowling and a pin-ball machine. It is played on a carpeted alley 94 feet long and 4 feet 4 inches wide, with rubber cushioned sides instead of gutters. At the far end are ten pins, slightly larger but similar in shape and alignment to those used in bowling. Suspended over the alley or court at two intervals are hazard pins, which cause lights to flash when struck. The ball, an inch-thick aluminum shell nine inches in diameter and weighing 18 pounds, is propelled by the player from an electric machine resembling a vacuum cleaner. It delivers the ball at any speed up to 4500 revolutions a minute. The object is to knock down the most pins while banking the ball the greatest number of times

against the sides or hazard pins. The game is scored by multiplying pins downed by banks made, with 600 points as a perfect game. For example, four banks times eight pins equals 32 points. A game is six plays, with two balls to each play, and each delivery is scored separately, rather than by bowling's strike-and-spares system.

## Metal Strip Smaller Than Common Pin Tunes in Radio Broadcasts

With a strip of metal smaller than a common pin for a receiver, scientists at Johns Hopkins University in Baltimore are tuning in radio broadcasts. The scientific freak was discovered during experiments with a bolometer, a device developed during the war for "seeing" in the dark with infrared

rays. A threadlike ribbon of columbium nitride is the "receiver" of the bolometer. It picks up broadcasts when cooled to a temperature of 435 degrees below zero Fahrenheit. Tests with the bolometer are continuing although its sensitive qualities offer no revolutionary radio development.



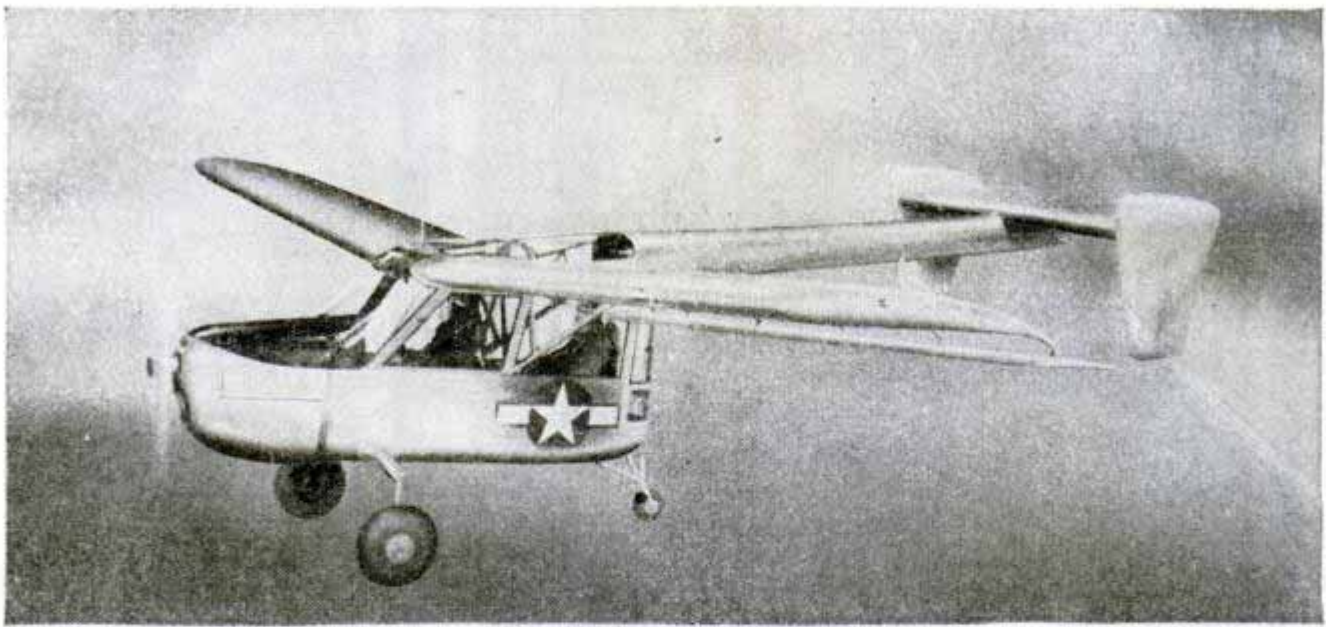

## "Eye" for Ground Forces Flies as Low as 50 M.P.H.

Designed to spot and direct artillery fire, the Boeing L-15A flies under 50 miles an hour and has a transparent gondola that affords exceptional visibility in all directions. Another distinguishing feature is its reversed tail surfaces. The two-place craft takes off and clears 50-foot obstacles in 600 feet and lands under similar conditions in 517 feet. It can be towed in the air as a glider and freed to fly after its engine has been started. The gondola's large-size rear door is completely transparent and the observer's seat can be faced either forward or backward. At normal cruising speed of 100 miles an hour and with an extra fuel tank, the plane can fly 5½ hours. The wing span is 40 feet, length 26 feet 1 inch, gross weight 2050 pounds and the service ceiling 16,400 feet. The entire airplane can be quickly taken apart and loaded on a standard 2½-ton Army truck. The L-15A is also adapted to courier and photographic work.

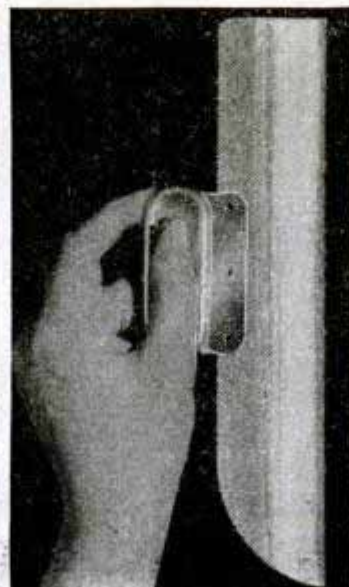
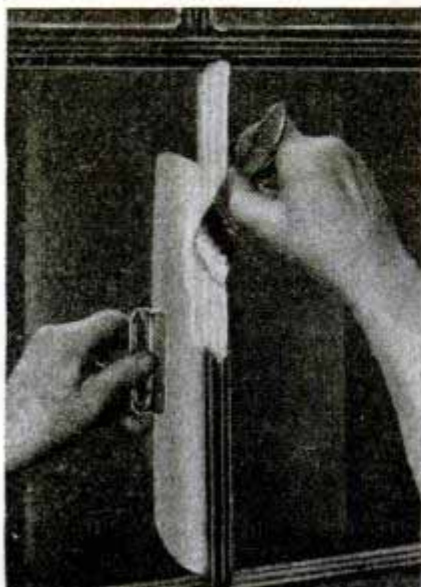

## Guide for Painting Frames Protects Window Glass

Painting the frames of windows and screens is simplified by a guide held against the glass or screen and adjacent to the frame to catch excess paint. The guide has a thin, curved metal blade 10 inches long and two inches wide with a duralumin handle in the center. One end is shaped like a knife blade to reach into corners and other obscure places.

☐ Ultraviolet rays from flames actuate a new sensitive fire alarm device developed by the Navy.



# U. S. Navy's First Plane With Turbine-Driven Propeller

First Navy plane with a turbine-driven propeller is the bullet-nosed Ryan XF2R-1 fighter, adaptable to either land or carrier use. Nicknamed the Dark Shark, it is believed to be in the 500-mile-an-hour class, although performance figures have not yet been revealed. It has two General Electric engines, a turbine in the nose and a turbojet in the tail that provides thrust on take-offs and whenever extra speed is needed. The propjet unit in front, using about three quarters of its power for the propeller and the rest for exhaust, operates alone for cruising. The Shark is 36 feet long, about four feet longer than an earlier Ryan model combining piston engine and turbojet. The added length came from substituting a long, narrow jet unit for the short, stocky engine. The XF2R-1 has a 40-foot wing span, is 13 feet 11 inches high and has a four-blade Hamilton Standard hydromatic propeller. It weighs five tons.

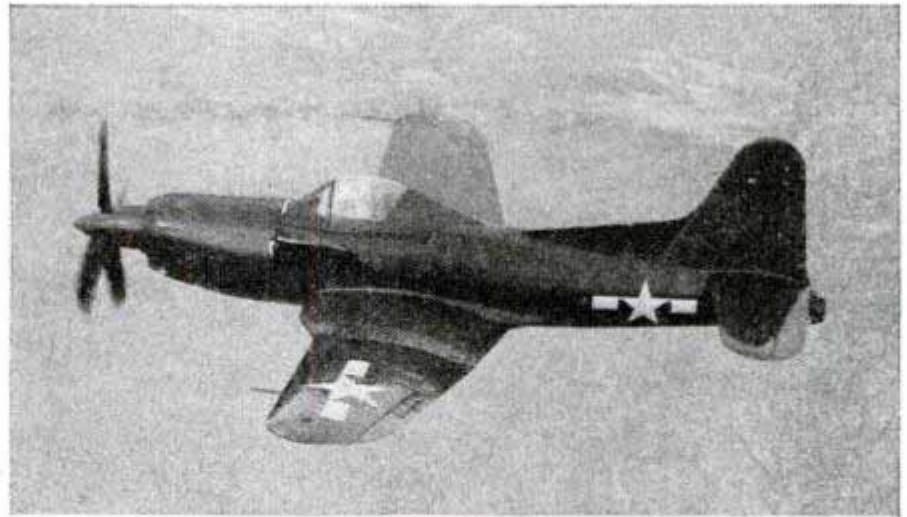

## Minnows Live for Long Periods in Jar With Vacuum Attachment

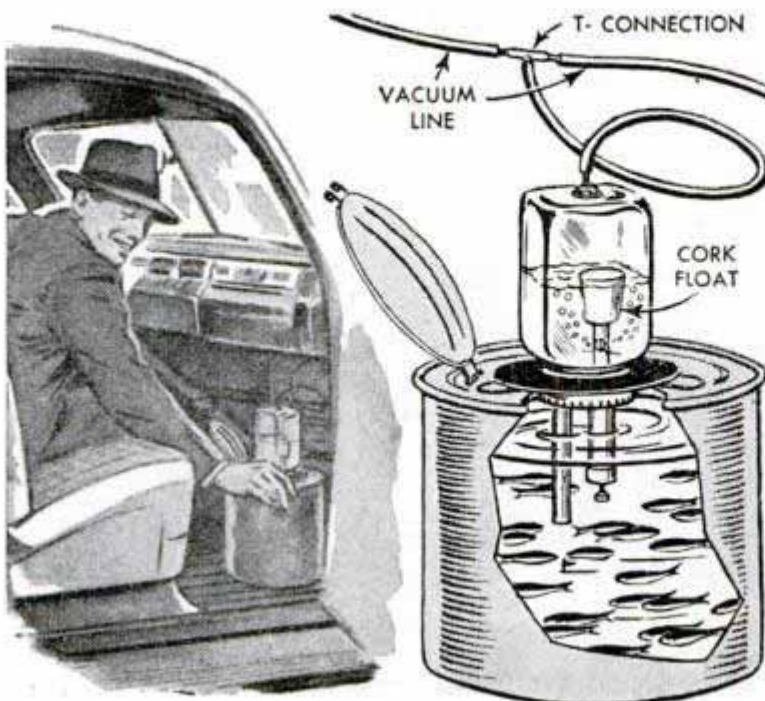

Live minnows in standard bait buckets can be transported long distances in an automobile with a glass jar and valve attachment that agitates and aerates the water. The attachment connects by rubber hose with the vacuum line beneath the automobile dashboard and draws fresh air into the jar through a system of intakes and outlets. The air forces the water to circulate, providing a constant flow of "fresh" water.

You may wish to obtain additional information about the new products described each month in *Popular Mechanics*. If you want to know the name of the manufacturer or distributor, just write to Bureau of Information, *Popular Mechanics*, 200 E. Ontario St., Chicago 11.



# LABORATORY IN SPACE

## Part Two



One of the three Superforts being used at Inyokern for very high altitude cosmic ray photography missions

**H**IGH-CLIMBING V-2s are measuring the quantities of cosmic rays in the upper air but these samplings tell very little about the nature of the rays. For more thorough study the scientists are using B-29 bombers that have been converted into flying laboratories.

Dr. Carl D. Anderson of California Institute of Technology and Dr. Robert B. Brode of the University of California are heading two research teams that are making stereoscopic and other cloud chamber photographs of cosmic ray phenomena at 40,000 feet. Their B-29s, based at Inyokern Naval Ordnance Test Station in the Cali-

fornia desert, carry up to three tons of equipment for making the photographs.

Scientists are seeking the infrequent pictures that show the disintegration of cosmic rays when they collide with other particles of matter. Study of the debris from such collisions is one of the most important tasks in which physicists are engaged. As one explains, "These studies may lead to a better understanding and hence to a better control of nuclear forces."

The collisions are quite rare close to the earth's surface. The B-29s are obtaining some photos of them eight miles up and plans are under way for taking similar pictures 20 miles up. To do this the Army and the National Geographic Society expect to build a passenger balloon capable of rising to 100,000 feet this year. Carrying a stratochamber in which two men would work, the balloon actually will consist of several separate balloons attached to the stratochamber. Various upper air studies as well as primary cosmic ray photography will be undertaken.

Some instruments designed for the balloon are being tested at medium

Dr. Robert Brode checks 12-inch cloud chamber for studying cosmic rays in the B-29 laboratory

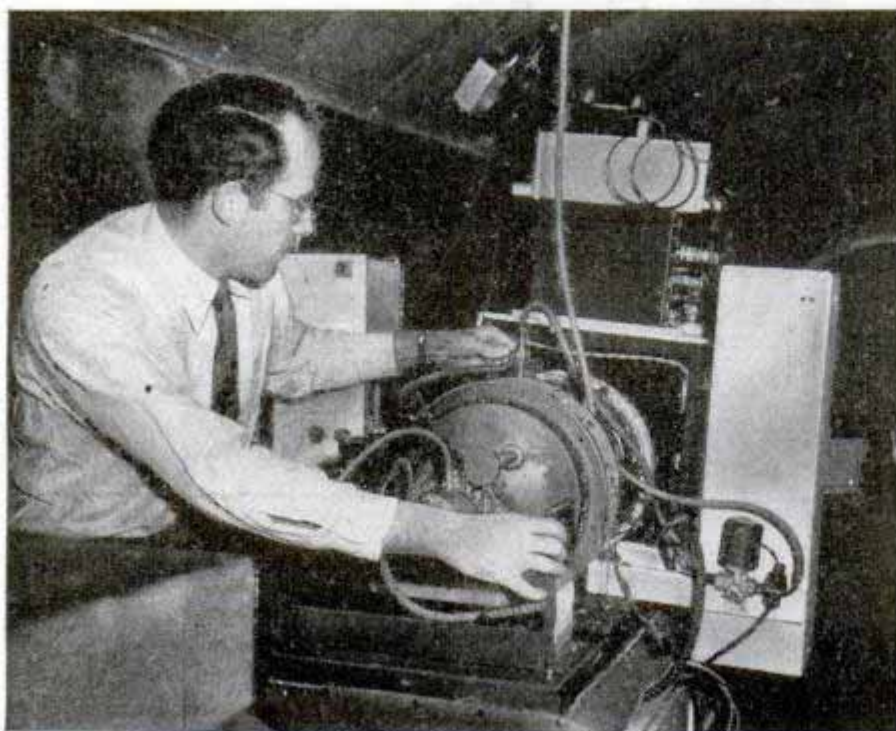

Dr. Robert Brode checks 12-inch cloud chamber for studying cosmic rays in the B-29 laboratory



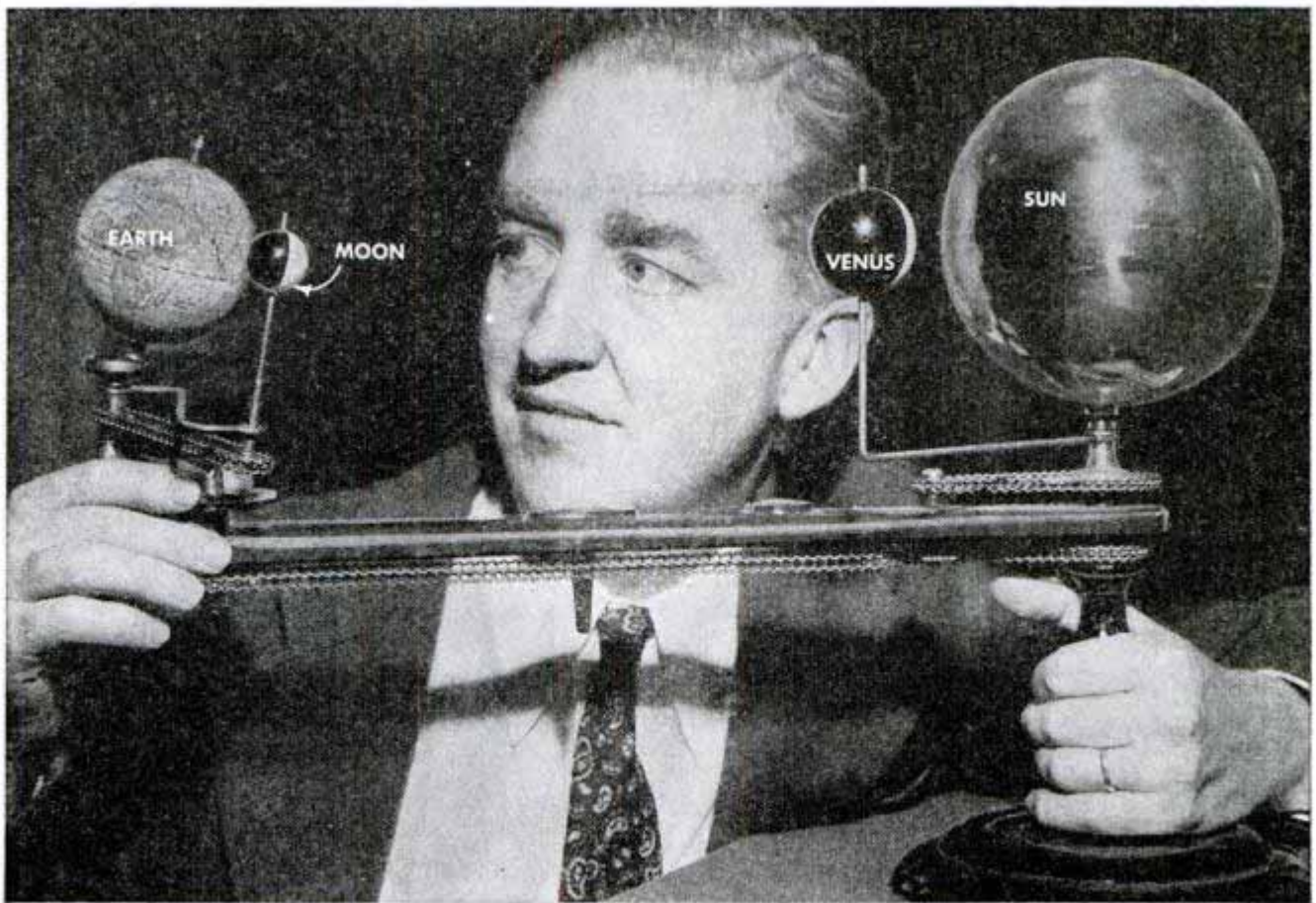

Device used by Dr. Samuel Herrick in rocket navigation classes to trace motions of earth, moon and Venus

### TABLE OF VELOCITIES FOR ROCKETS (theoretical distances achieved)

1-mile-per-second take-off (V-2) . . . . .	80-mile-plus climb . . . . .	Suitable for point-to-point on earth
4-m.p.s. take-off . . . . .	2000-mile climb . . . . .	Suitable for satellite space island
6.95-m.p.s. take-off . . . . .	Velocity of escape . . . . .	Suitable for traveling to moon or beyond

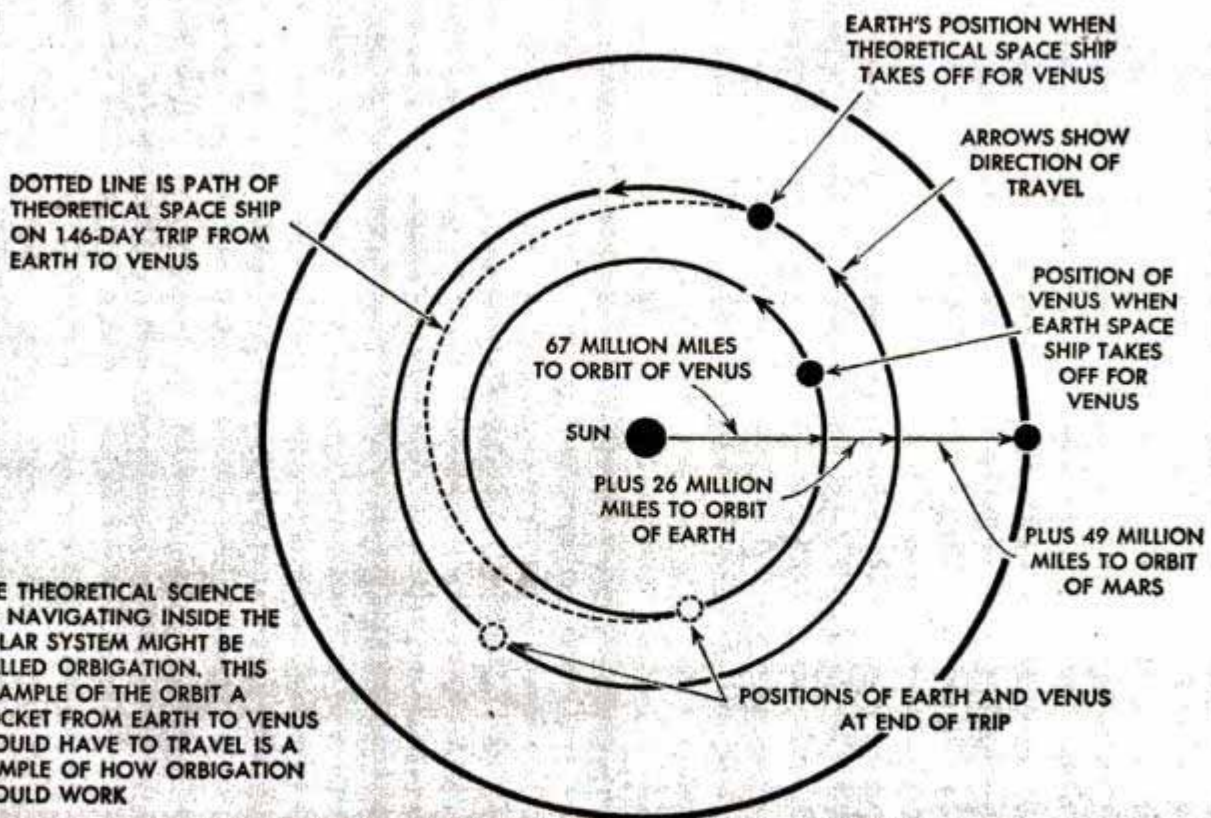



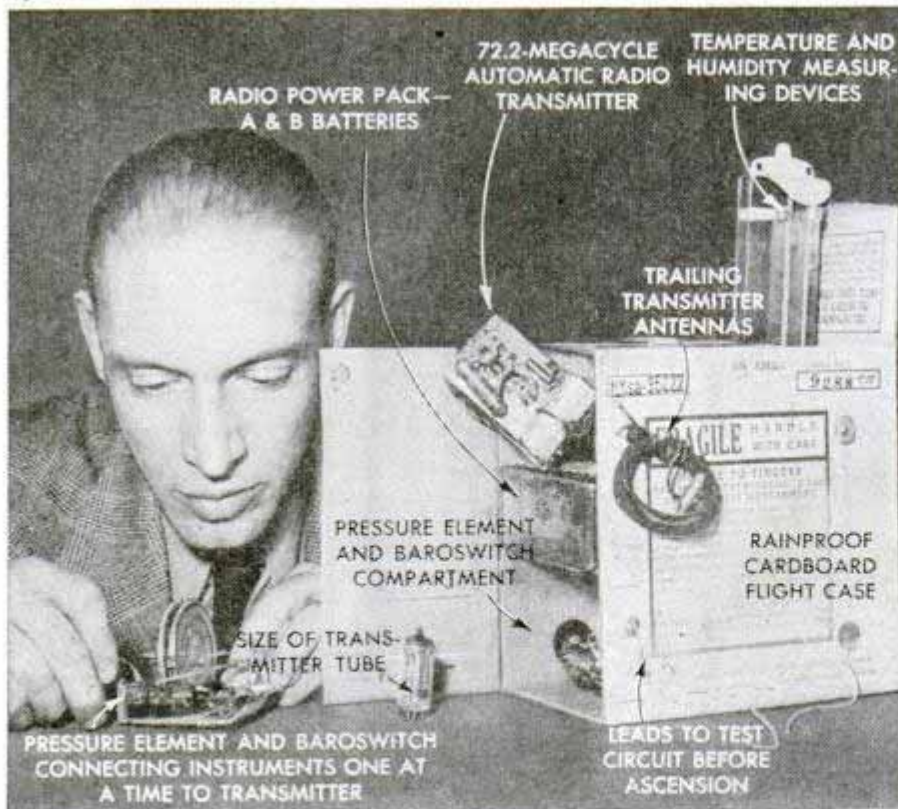

Rockets equipped with automatic weather recording instruments and transmitters could short-wave weather data from the moon 240,000 miles away

altitudes at Inyokern. These or similar ones will some day be carried far out beyond the atmosphere's limits by rockets.

The broad pattern of the campaign for the conquest of space has been pretty well outlined and scientists are beginning to take up its tactical details. One of the first steps will be attempts to launch small satellite bodies that will revolve around the earth. This is to be part of the artificial meteorite project at White Sands.

Much more ambitious and now considered scientifically plausible is the German proposal of a "space island" that would circle the earth at a distance of several thousand miles. Like the moon, the island would revolve around the earth without

hundred degrees below zero.

This observation post would be ideal for certain astronomical studies, might be important in long-range weather forecasting, and valuable for some kinds of research in physics and chemistry.

More attention, however, is being given another idea—that of launching rockets at the moon. No rocket yet built can escape from the earth but a two-stage step rocket capable of making the trip probably could be designed today. Carrying instruments, the rocket would automatically radio reports back to earth on conditions on the lunar surface.

Space ships, of course, are still in the misty future. To escape from the earth

Photos of cosmic rays, showing trails of ionized water vapor particles left behind as they speed through the cloud chamber, are made with stereoscopic camera at left. Dr. Carl Anderson, right, at chamber's control panel





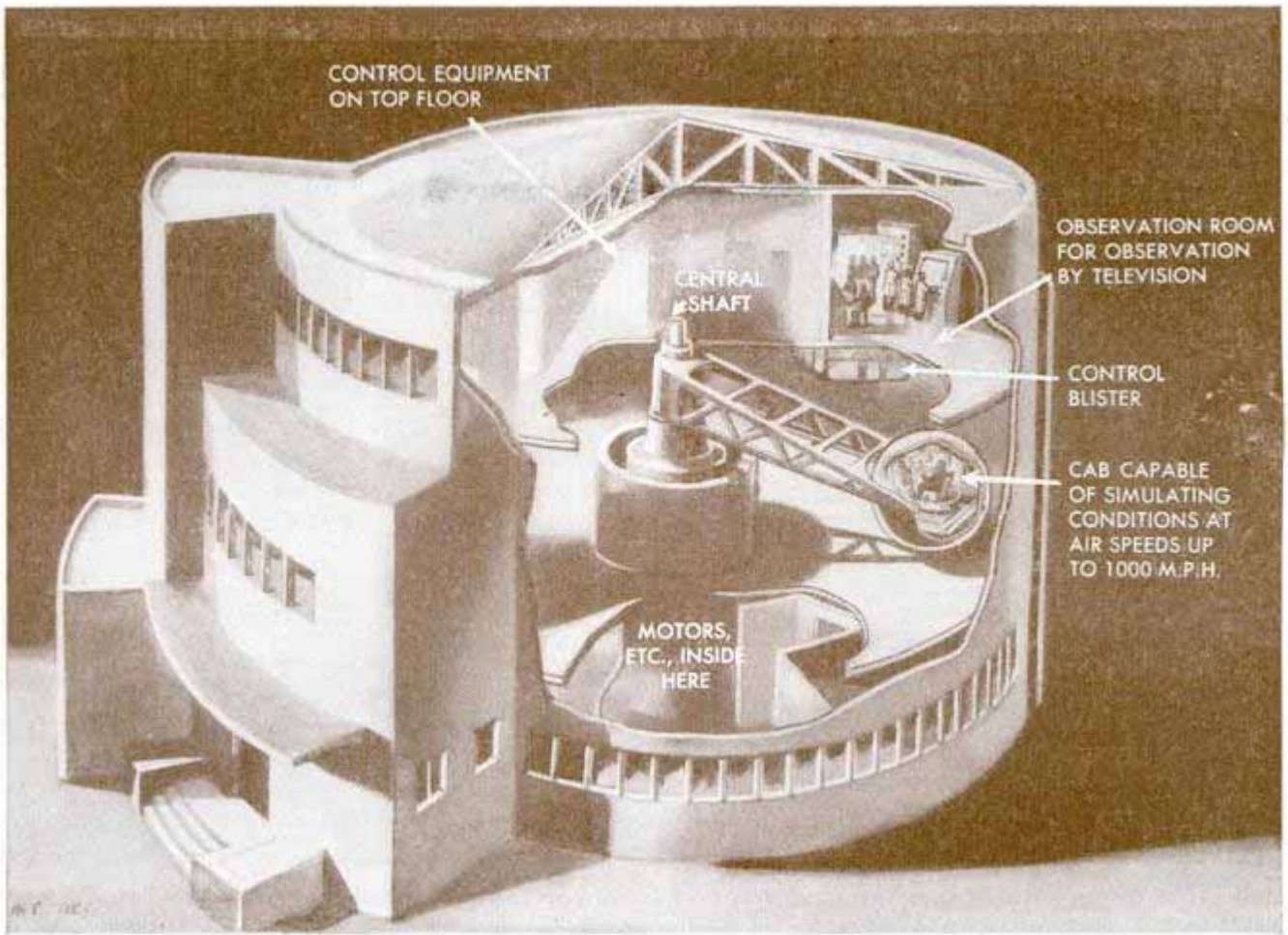

One of the biggest unknowns in the campaign to conquer space is man's reactions to supersonic flight. Tests of this will be made in the giant centrifuge, shown above and below, being built by the U. S. Navy at Johnsville, Pa. The pilot's pressurized cabin will be spun around a central shaft at simulated speeds up to 1000 miles an hour

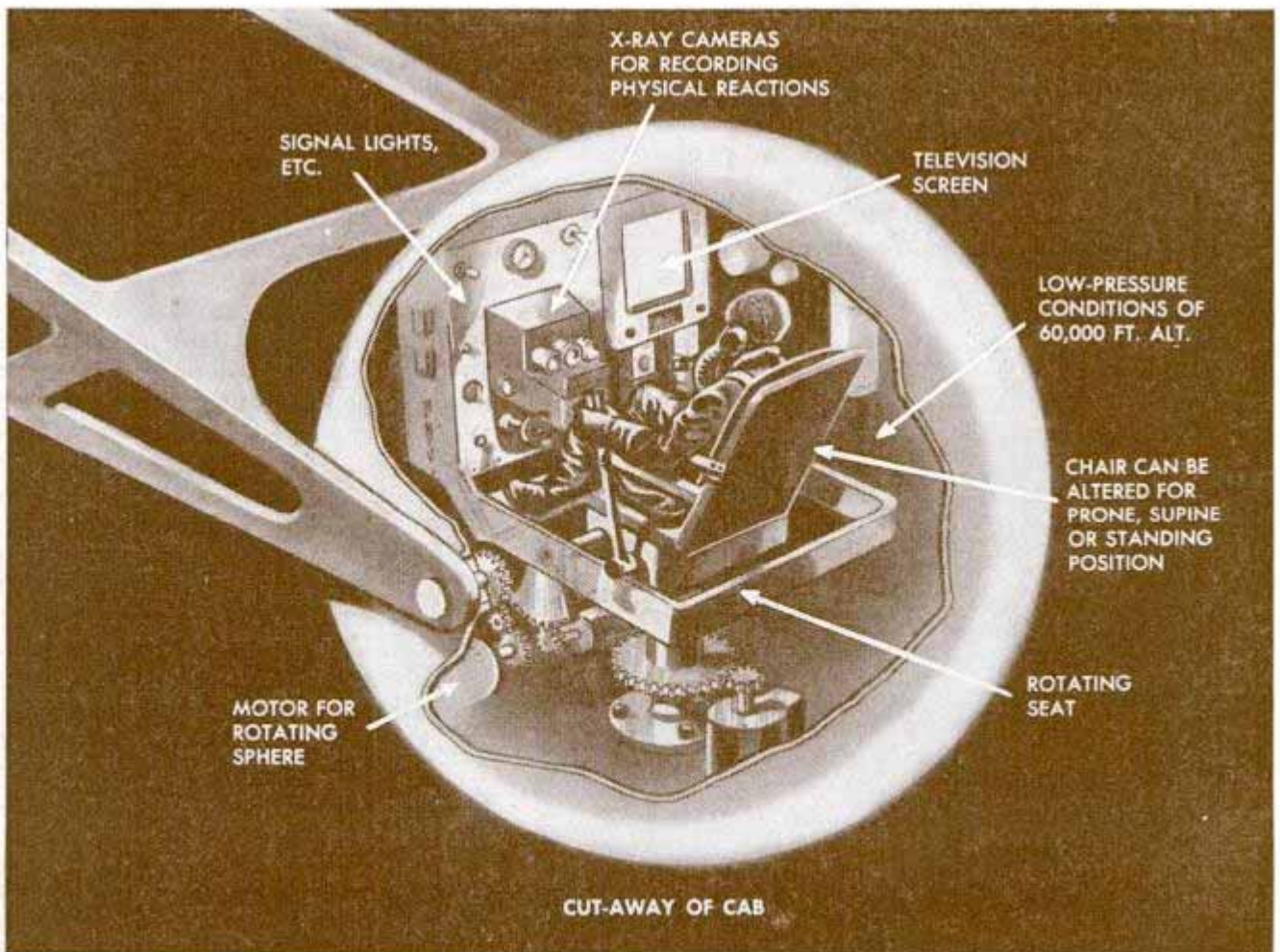



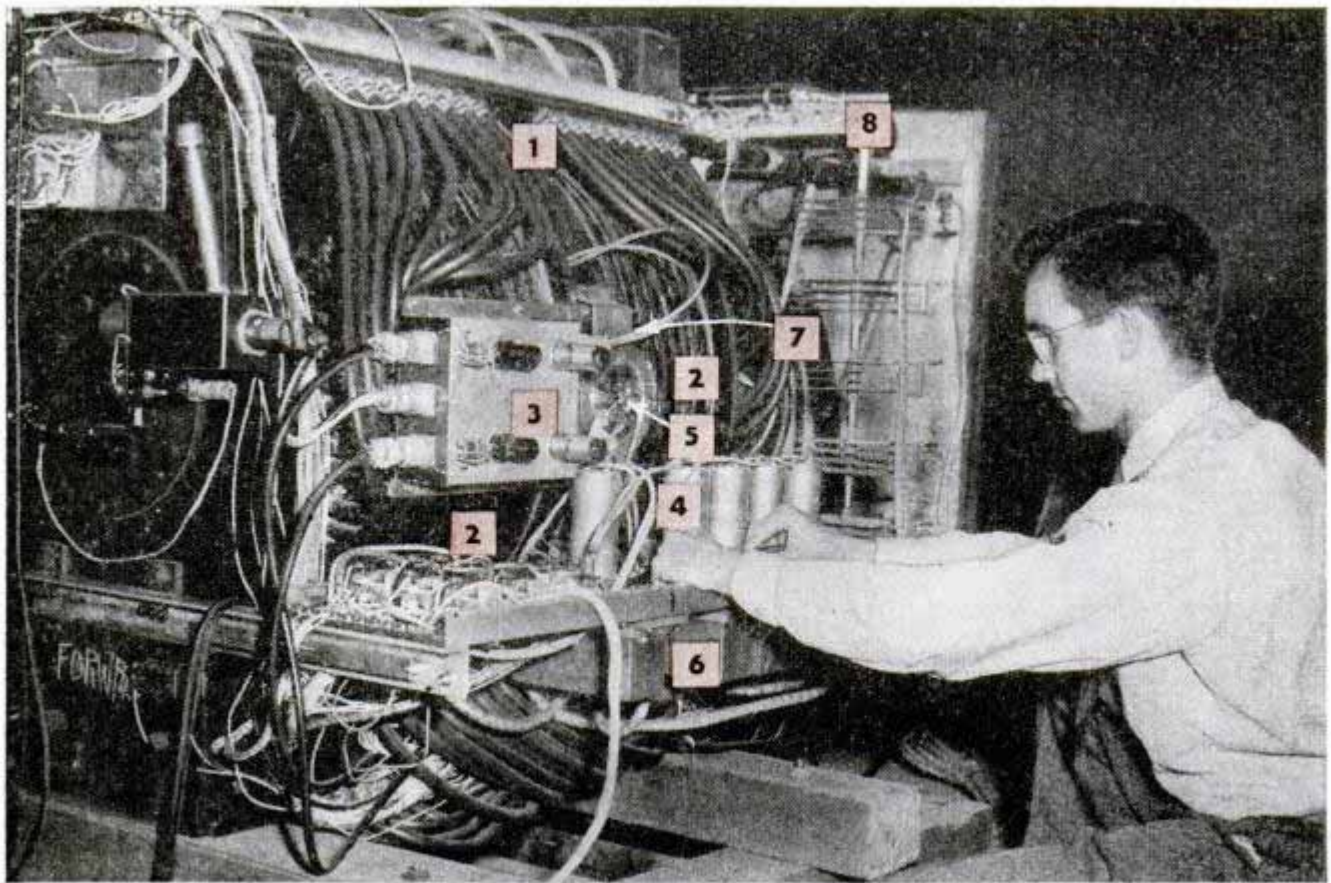

Exterior of three-ton cloud chamber, carried in B-29 bomb bay for high-altitude cosmic ray studies. Its main parts are: (1) hose carrying cooling water for electromagnet, (2) electromagnet windings, (3) vacuum tubes in Geiger counter circuits, (4) row of Geiger counters, which trip cloud chamber, camera and high-speed flash when actuated by cosmic radiation, (5) inspection lamp, (6) circuit breakers, (7) cloud chamber and 6000-volt flash inside housing, with camera hidden at far left, (8) selenium rectifiers to prevent surges from magnetic field

they would need to be launched at a speed up to seven or eight miles per second, some eight times faster than the top speed of a V-2. No power plant capable of doing this has been developed.

Scientists are pecking away at the problem. They have begun to develop, for instance, the navigational technique that would need to be used for any kind of space travel. Dr. Samuel Herrick of the University of California, Los Angeles, who is con-

ducting classes in rocket navigation, has drawn some surprising conclusions about future space travel.

In the first place, extremely little fuel would be needed, considering the distances involved. Instead, the rocket captain would take advantage of the gravitational attractions of the sun and planets and would be drawn steadily toward his goal. The orbit of Venus is 26,000,000 miles closer to the sun than the earth is and a space ship bound for Venus would become a tiny asteroid. It would follow a curved path around the sun and would be aimed to intercept Venus itself. The quarter of a billion miles total distance would be traveled in some 146 days.

Venus travels faster than the earth and so the space ship would take off while Venus was still far behind. Venus would overtake the earth and pass the space ship, then the ship would catch up with it.

"It probably would be necessary to fire the space ship backwards from the earth, so to speak," Dr.

(Continued to page 284)

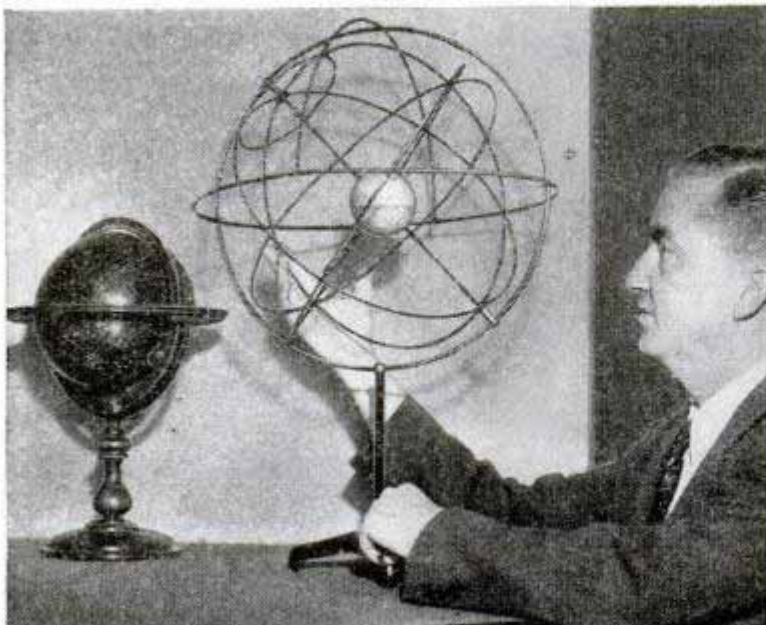

Model of celestial coordinates, with earth in its center, used by Dr. Herrick in working out problems of interplanetary navigation



## Tail-Pusher Plane Cruises 200 M.P.H.

Both engines and an eight-foot propeller are behind passengers in the Douglas Cloudster, a low-slung five-seater for charter or executive use. Having the cabin ahead of the wings permits greater visibility and entrance through an automobile-type door 15 inches from the ground. Either or both engines drive the two-blade propeller. A design offshoot of the big Mix-master bomber, the plane cruises 200 miles an hour and has a range of 1100 miles. It has a wing span of 39 feet 9 $\frac{3}{8}$  inches and is 35 feet 4 $\frac{1}{2}$  inches long. An exceptionally wide spread of over 15 feet between the main landing wheels is intended to give greater ground stability.

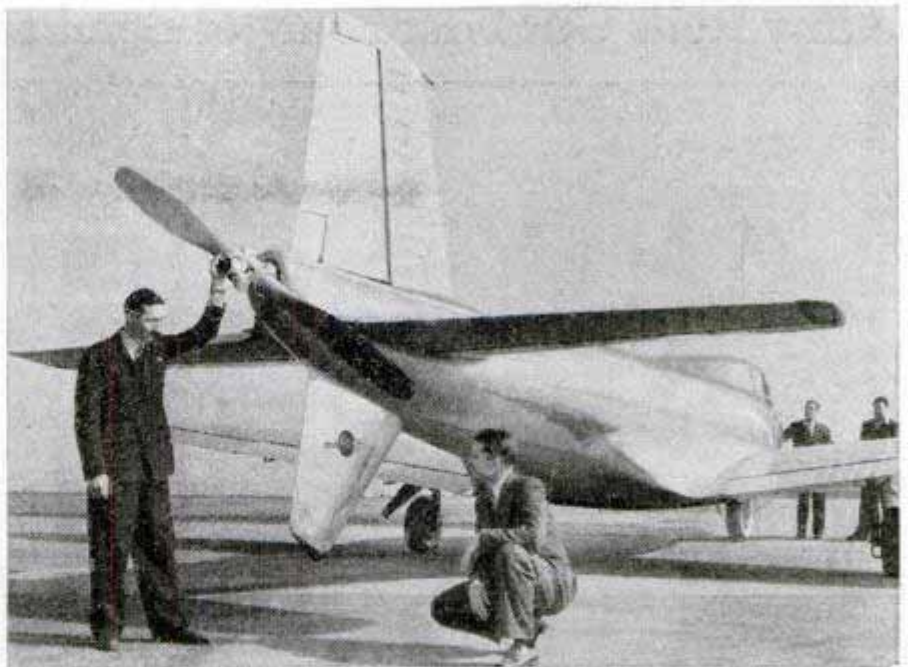

## '46 Air Safety Mark Doubles '45 Record

In 1946, when 13,000,000 air line passengers traveled 6,000,000,000 miles in the U. S., it was twice as safe to fly as it was in 1945. The Air Transport Association estimates there were 1.2 passenger fatalities per 100,000,000 revenue miles, compared with 2.17 the year before. On international runs, a million passengers covered a billion miles

during the year. The number of planes in operation rose to 816, of which 655 were used domestically, and total seating capacity jumped from 10,889, in 1945, to 24,541.

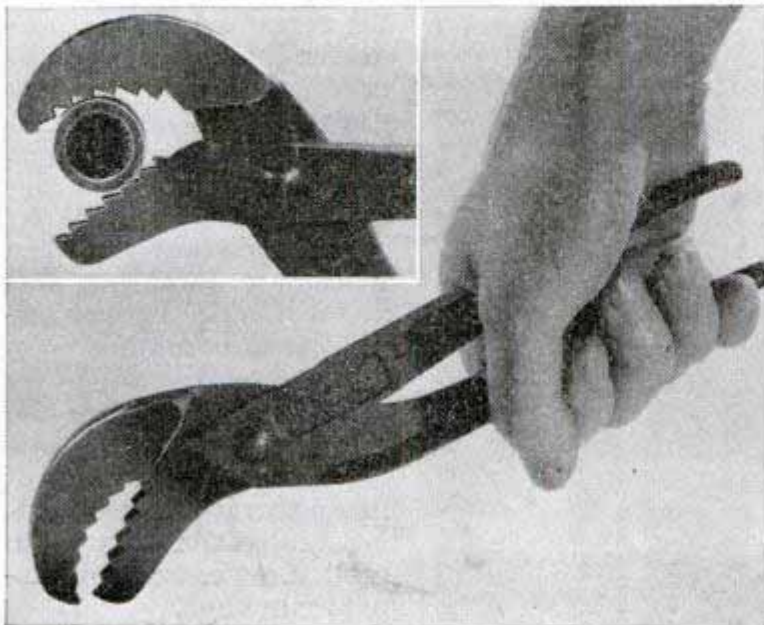

## Resistance Tightens Grip Of Plier-Action Wrench

Instantly adaptable to a wide variety of work, a wrench with plier-type action grips firmly without excessive pressure. The set of the jaws and the direction in which the teeth exert force tightens the "bite" as resistance increases. One size handles objects from  $\frac{3}{16}$  to  $\frac{3}{4}$  inches and a larger model has a range from  $\frac{1}{4}$  to 1 $\frac{1}{2}$  inches.

Men have been safely hurtled from planes flying 300 miles an hour in testing pilot ejector seats for jet and rocket aircraft.



## Army Rolls Out First Four-Jet Bomber for Ground Tests

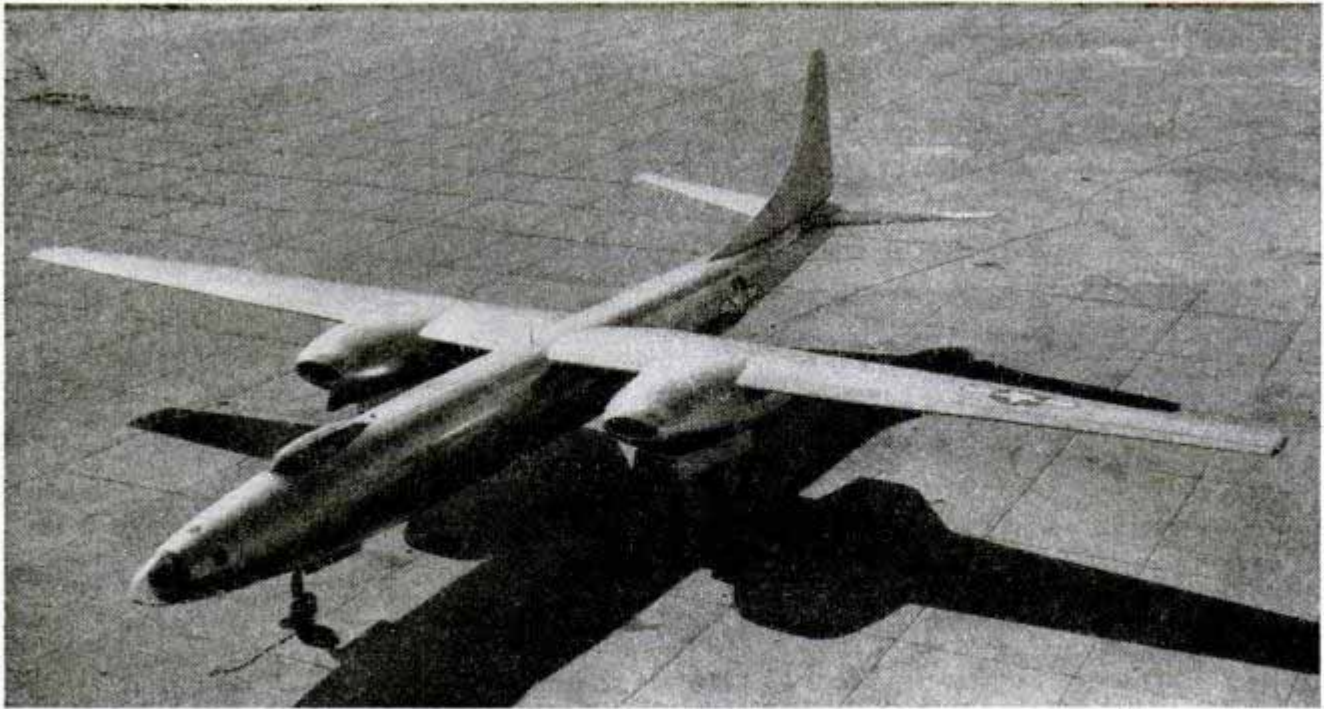

Secretly built at San Diego during the last two years, the Army Air Forces' first four-jet bomber has been rolled out for preliminary ground tests. Designated the

XB-46, it has two General Electric turbojets in each low-slung nacelle. It is 105 feet 9 inches long, with a 113-foot wing span, and was built by Consolidated-Vultee.

## Fire Escape Reel Lowers Person at Speed of an Elevator

People trapped in burning buildings are lowered to the ground at about the speed of an elevator by a new escape mechanism. The safety apparatus, invented by Irving

Bassett, a Detroit barber, and his two brothers, consists of a steel ribbon wound on a reel regulated by a system of gears and a governor to assure a safe but speedy

descent. The reel is mounted on the window frame of a building and swung outward in an emergency. The user steps into a loop on the end of the ribbon which slips tight around his chest. He then steps into space and the reel unwinds at a predetermined speed to lower him safely to the ground. In demonstrations the inventor, who weighs 160 pounds, descended 12 floors in about 18 seconds and landed without a jolt. The reel has a handle for rewinding the ribbon.



Experiments by the Army Chemical Corps have led to the use of flame throwers, spectacular weapons of the war, to melt snow and ice off airport runways.





Brother-sister act — Ruby and Bobby Maxson execute a "stag jump" in the Ice Follies of 1947

## Putting a Show on Ice

THE homespun skating show that began on a frozen Minnesota swamp a decade ago is playing to a gallery of 3,000,000 people this year. That cheering gallery will pay out \$4,000,000 to watch a carnival on ice that is a blend of musical comedy in waltz time, circus at the tempo of lightning and stagecraft that packs in all the miracles of radio controls and ultraviolet effects, of plastic costumes and mechanical props, that a staff of geniuses can dream up.

While the Ice Follies of '47 are rounding the country for the 11th annual circuit, the Ice Follies of '48 are being re-engineered and redecorated by a score of technicians at the year-round home office in San Francisco.

The Shipstads and Johnson, who started their career on ice with a troupe of 23 youngsters before an audience smaller than the cast, still carry in their trainload of performers 14 of that original troupe. But it is no longer a monopoly of the gay young blades of Minneapolis and St. Paul







▲ Snowman and the three bears prepare for their act. The snowman performs on stilt skates two feet tall  
← Mae Ross glides across the ice in a graceful spiral



ice ponds. Stars from Switzerland and Canada race and waltz along with skaters from Omaha and Chicago. There's a young fellow from Charleston, W. Va., who has never skated outdoors, and a Brooklyn mother in her forties who takes four-year-old Susan along on her travels and who spends most of her time in the air executing acrobatic impossibilities above the ice.

Skating of the ballet variety, the slapstick comedy or the circus stunt is what the folks pay to see but the mechanical marvels are what make the show different each year. There is the \$2000 Constellation plane model that "flies" across the arena and magically turns itself about for the return trip. There is the "ice-mobile" grand piano, circling the rink under the hidden power of an electric truck while a concerto is played. There are the portable light-control board and the glittering transparent plastic gowns and the battery of ultraviolet lamps that bring nightly sighs and cheers as they transform the dancing scene into a pageant of luminous color.

One of the magic effects being perfected during the current tour is a remote control



system by which a radio turns on a battery of lights inside translucent plastic columns spotted across the ice, without any connection to a power source.

But the mechanical Man of the Year is not one of the technical staff but a star skater, Harris Legg, who himself invented the flaming eggbeater through which he leaps with split-second timing in the brief moment when its revolving hoops are wide open. Back in 1933 Legg varied his routine of leaping over a long line of barrels by jumping through a stationary flaming hoop. In subsequent years the prop became a rotating single hoop, then a double one. While serving in the South Pacific some friends laughingly proposed that he invent a flaming eggbeater. So this year he added to his horizontally rotating hoops two inner hoops revolving vertically, operated on universal joints. All four hoops open in a flat plane for his jump for less than a second. The eggbeater itself is made of piping, and beneath it is a box containing a cylinder charged with propane gas, regulator valves, gearbox, air blower and quarter-horsepower motor. Orange flames spurt from 300 holes in the outer rims of the four hoops as he circles the ice with lightning speed to time his leap. In some cities, authorities have been reluctant to permit the use of flames. The Chicago fire marshal, however, changed

Chorus wears plastic skirts and feature dancers cover skates with Fiberglas shoes in Dutch number

Werner Frick of the comedy team—Frick and Frack—defies gravity by skating with his head a foot above ice as his partner hurdles over him

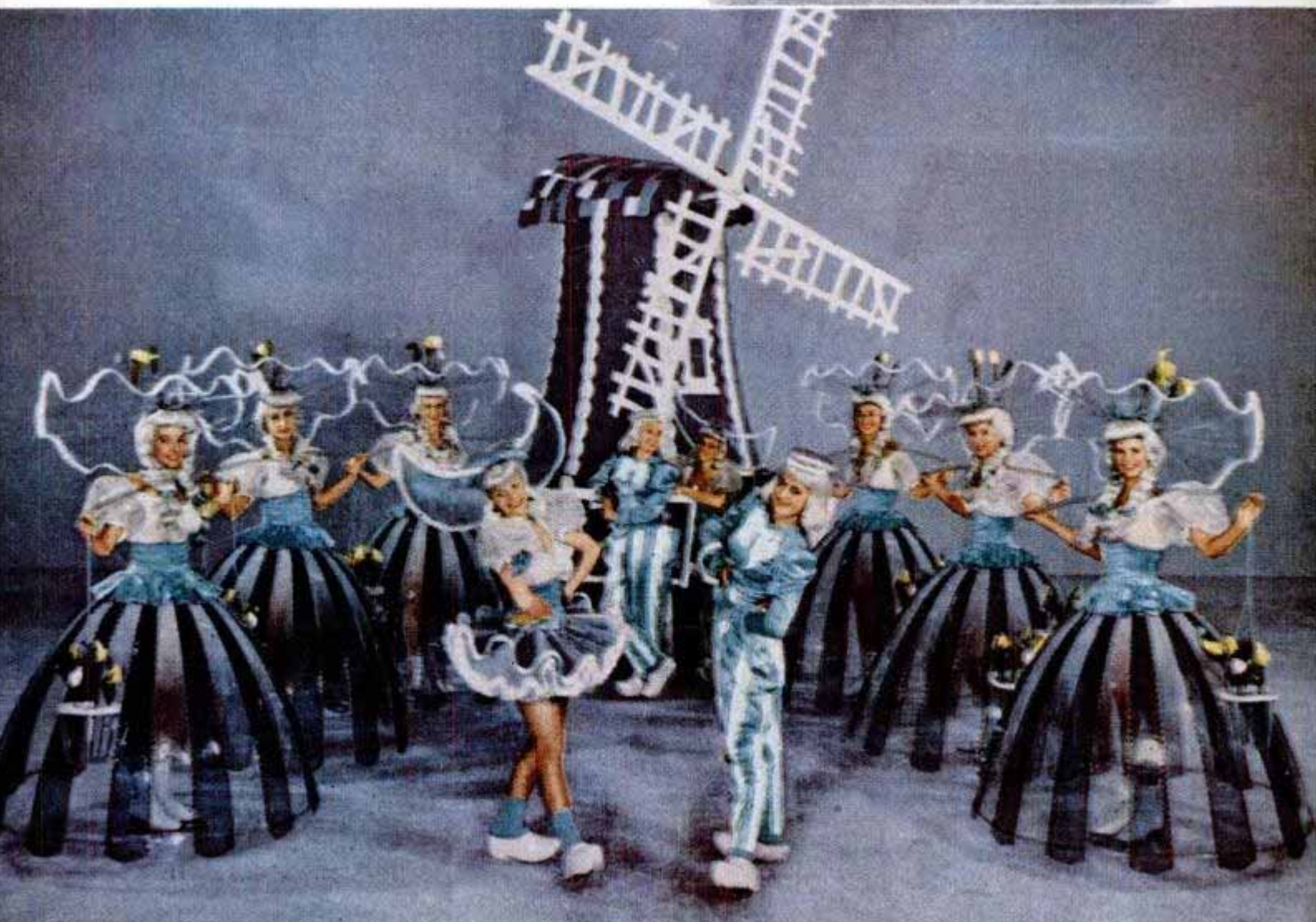
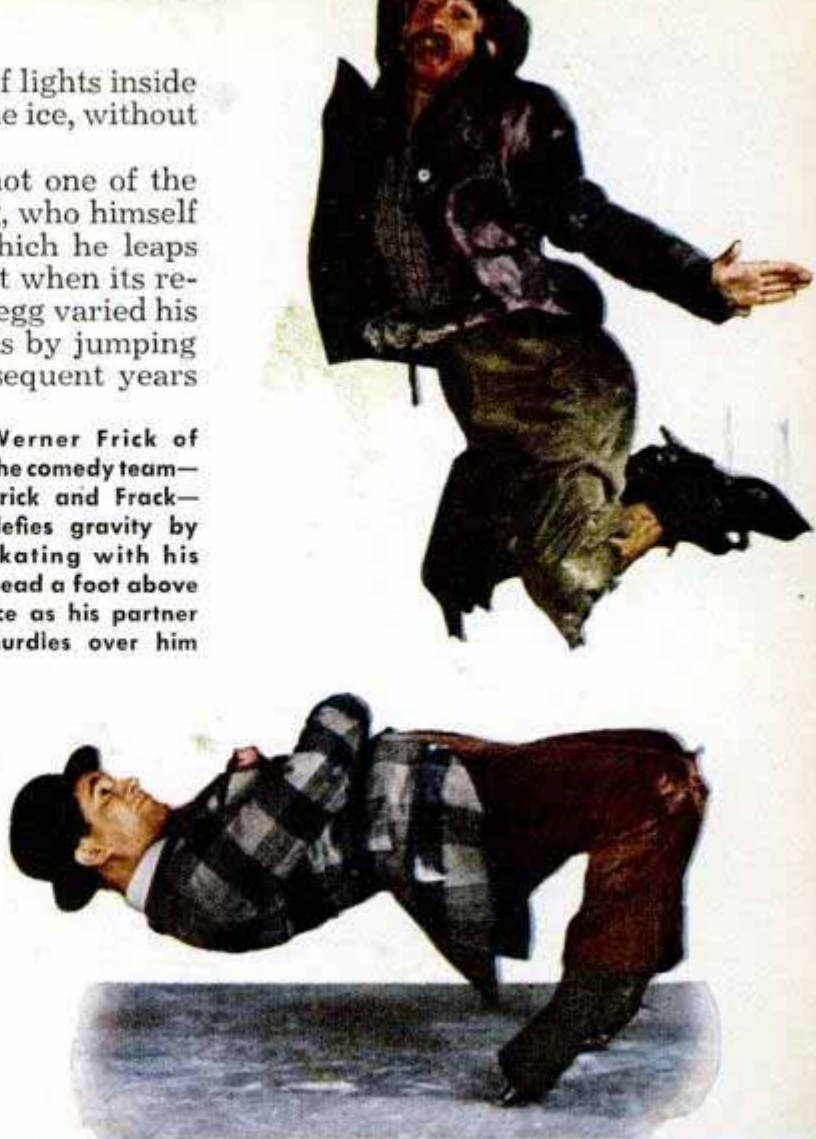





▼ In football sequence "coach" flips a reluctant player head over heels



← Harris Legg jumps through four flaming hoops during split second they are open. Above, mount has tank that feeds propane gas to perforated hoops

▼ Dumbo, a mechanical elephant operated by two men, waggles his ears, picks up articles by magnet in his trunk, squirts ground corncobs over spectators



his ruling for later performances after a demonstration; there are only 200 cubic feet of gas in the cylinder, and the accidental touch of a skate on the eggbeater's hoops will stop the mechanism quickly.

The Ice Follies, pioneer of the three big-time skating extravaganzas, spends 11 months on the road touring 17 cities, always to sold-out houses; the Twin Cities provide a yearly highlight, the three-week stand in the old home town of Minneapolis being a sellout weeks in advance. Miami used to be on the schedule, but when skaters continually became lost in the fog that rose above the ice in the humid Miami arena that southern stop had to be canceled. The troupe of 165 performers and technicians travels in its own special train of six sleeping cars, a diner, lounge and six baggage cars.

The Shipstad brothers, Eddie and Roy, learned trick skating as kids, practicing on a local rink in St. Paul. The other partner, Oscar Johnson, grew up in the same neighborhood and became a speed-skating champion. Later he and Eddie teamed up to do a comedy vaudeville act between hockey games at Madison Square Garden. The three young men decided that entertainment on ice could have mass appeal, so they rounded up 23 neighborhood kids back in Minnesota and rehearsed a show. Their first season was a rocky one. No one had heard of watching a show on an ice rink. But repeat performances in the same cities the second season drew big crowds to see the "amateur" professionals.

The acts in today's program read like an old-time vaudeville card but they're presented



Mae Ross, as Gypsy Queen, poses atop the fire rock that contains a fan and lights. ← Sketch explains mechanical elephant

with the showmanship of a Billy Rose spectacle. On skates the actors have a smoothness and grace that can't be approached on dry land, their speed allows stunts that would be impossible on an ordinary floor.

One amazing and ludicrous act

This looks comfortable; try it yourself!

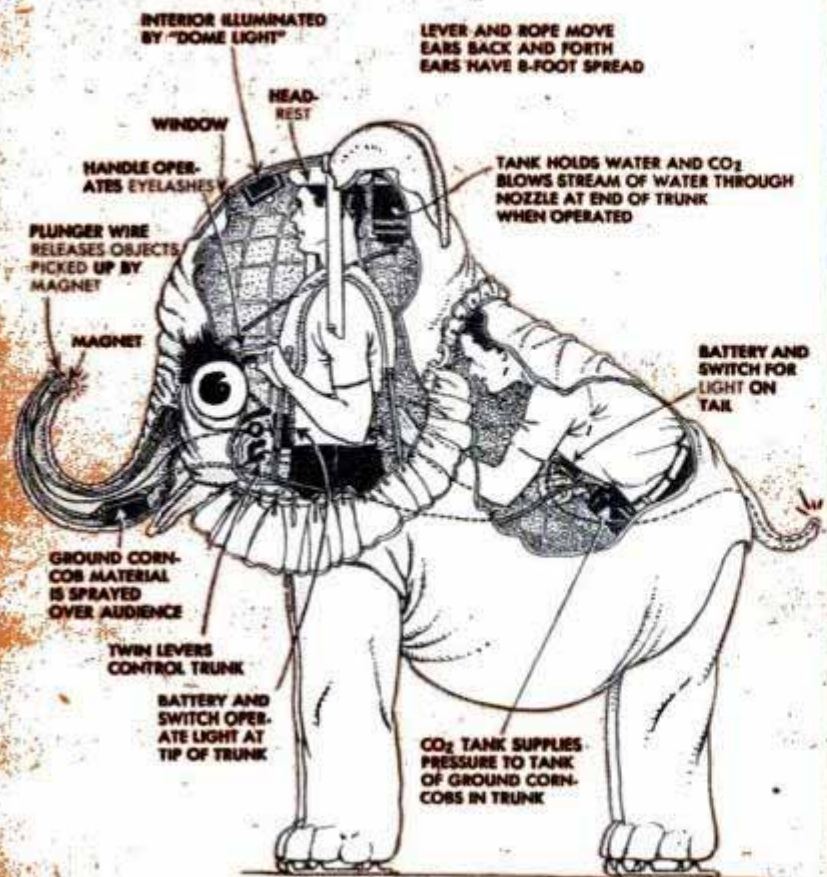





Evelyn Chandler performs difficult butterfly leap. Right, skate is sharpened against edge of grinding wheel cut to convex shape



is the gravity-defying performance of Werner Frick, who appears to rest on the air while moving at 20 miles an hour. Traveling sideways with his feet turned heel to heel, Frick bends his knees and lies back until his head and shoulders are only a foot above the ice. Common sense tells you that he can't hold the position and yet he continues to move around in wide curves with his body parallel with the ice while the spectators howl with glee.

Offstage, Frick explains that centrifugal force holds him up during this cantilever spreadeagle. After spreading his feet he sets the inside edges of his blades and leans back just as if he were banking around a

curve. The stunt sounds simple but Frick has few imitators.

Front-row spectators gasp when a speed skater sprints straight at them, apparently intent on crashing into them. Then, just as he reaches the edge of the ice, he comes to a dead stop. Shaved ice from under his blades showers over the front rows.

Speed-stops like these are faster than emergency stops by an automobile. Harris Legg, for instance, is traveling more than 30 miles per hour when he lands within yards of the spectators after hurtling over a long row of obstacles. But he stops in three or four feet. The terrific deceleration is obtained by turning the feet broadside and lying back, setting the blades into the ice.

Then there's Dumbo, the two-man elephant that shambles across the ice on the skates of Ole Ericson and Jim Hutchinson. Ericson wears football shoulder pads to support the head and trunk and guides him-

George Voorhies, chief electrician, explains mobile control board used for auxiliary lighting effects

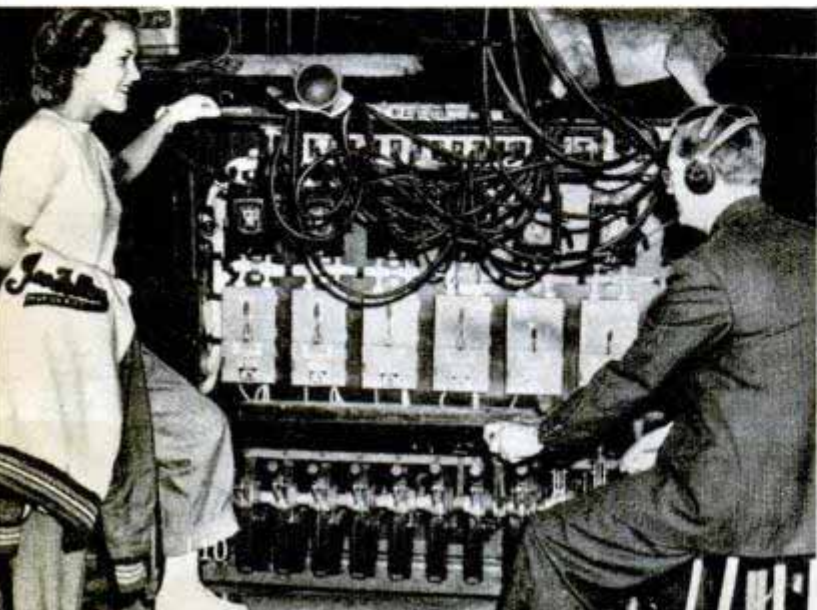

"Ice-mobile" grand piano is powered by an electric truck; it circles ice rink with maestro at the keys







Traveling 30 miles an hour, Harris Legg makes a speed stop in three or four feet. Right, Evelyn Chandler does a high leap

self by peering through small windows in the cloth head. Hutchinson brings up the rear and sees only the ice between his feet.

Inside the elephant's head are so many strings, levers and controls that Ericson needs a small overhead light to see what he's doing. One set of levers wiggles the huge ears, another blinks the eyes, a third lowers and raises the trunk. Dumbo picks up wire-stemmed flowers from the ice by means of a magnet in the end of his trunk. He sprays water into the air when Ericson releases a siphon of water through the trunk, and shoots ground corncocks over the spectators when another control is pulled.

Each show is planned for 12 months before it appears on the ice and as much as a third of a million dollars is spent for a season's costumes and properties. This year's show features huge plastic flowers in trans-



parent vases, striped plastic hourglass skirts for the dancers and large Fiberglas boats with transparent sails.

Precision dance numbers on the ice are particularly beautiful because the girls are

(Continued to page 252)

Rear and front views of stage backdrop; scenes are painted on single curtain which is rolled up and down like a window shade. This system saves space and time in shifting scenes—an operation performed in dark

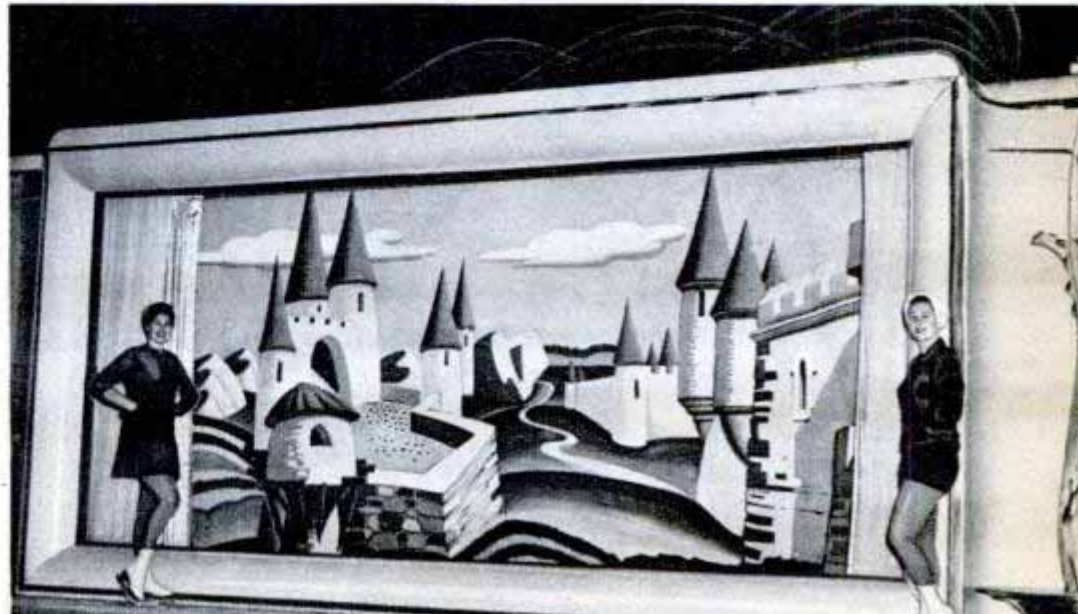
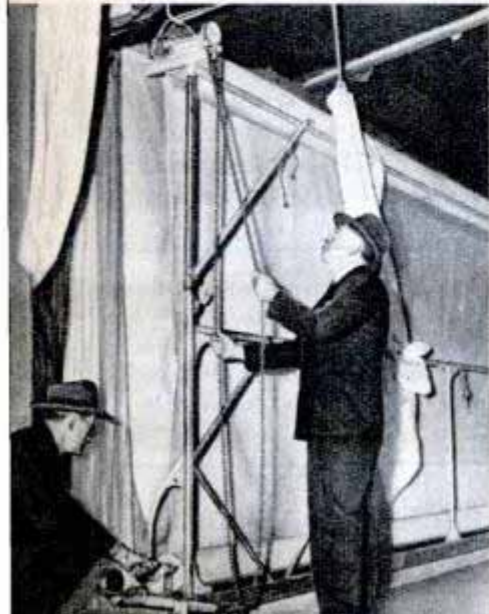





### Radio Waves Shoot Through Walls For Complex Industrial Jobs

"Seeing" through walls and around corners is accomplished by a microwave unit which combines characteristics of radar and the electric eye. Unlike an electric eye, however, the microwave device "sees" by high-frequency radio waves instead of a light beam. By means of a parabolic reflector, microwaves are focused in a beam and reflected from objects in the same manner that radar impulses and a beam of light are reflected, according to General Electric electronics engineers. Like the photoelectric cell, the microwave unit can be used for counting, opening, closing, signaling or discarding—but through a wall, partition or housing, if necessary.

### Cartridge in Spearhead of Harpoon Explodes When It Hits Target

In a unique fishing harpoon, the spearhead is driven deep into the target by a .22-caliber cartridge fired upon impact. The spear was devised by F. W. Johnson of San

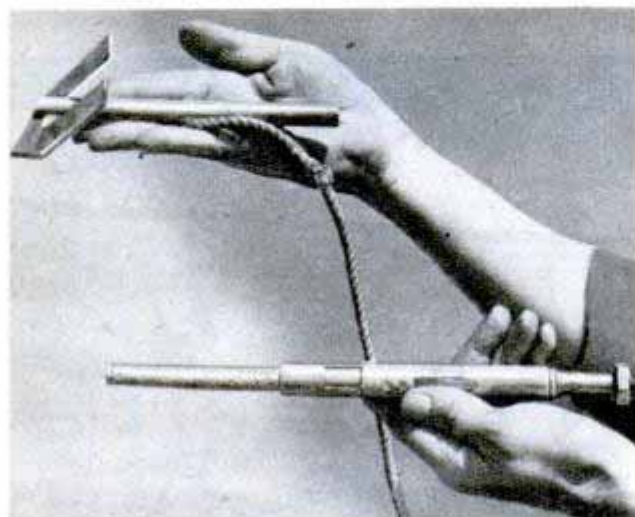

Diego, Calif., a spearfishing enthusiast, in an effort to improve the accuracy of his harpoon casts. So that the point will penetrate the fish, it is ordinarily necessary to throw a harpoon with such force that accuracy suffers. With the cartridge-fired spearhead, the harpoon can be thrown with less force and more accuracy. The impact of the harpoon against the target causes the cartridge to fire, driving the detachable spearhead deep into the fish. The point is secured to a line by which the fisherman retrieves his catch. A safety device on the harpoon prevents accidental misfiring.

### Instrument Gauges Rough Surfaces By Flow of Compressed Air

Roughness of sheet rubber is measured by an instrument that computes the rate of escape of compressed air across the surface. The instrument, called a rugosimeter, was



developed by the United States Rubber Company to gauge the roughness of rubber sheeting used for footwear and other products. A round steel weight is placed on the surface to be tested and compressed air is introduced between the weight and the sample through a hole in the weight. If the surface is rough the air escapes easily through the "valleys." If the surface is smooth the air has difficulty in escaping.

You may wish to obtain additional information about the new products described each month in *Popular Mechanics*. If you want to know the name and address of the manufacturer or distributor, just write to Bureau of Information, *Popular Mechanics*, 200 East Ontario Street, Chicago 11, Ill.



# SMASH HITS

Three pages of pictures from the Navy's rocket laboratory at Inyokern, California

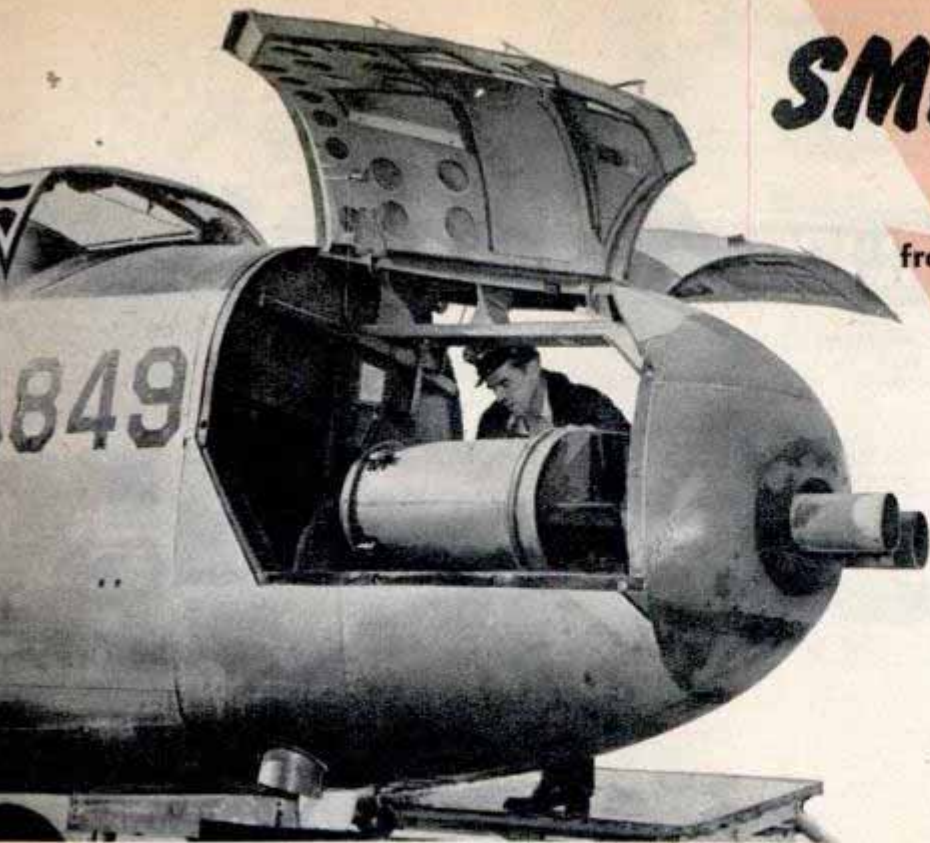

Crew member loads five-inch spinner rockets into first magazine-type rocket gun carried inside an aircraft. The gun, a double-barreled revolver, can fire a salvo of 10 rockets

**R**OCKET missiles packing a superwallop are crashing through targets in tests at the Navy's new ordnance station at Inyokern, California. The station is a section of the Mojave Desert as big as the state of Rhode Island.

One of the new weapons under test is the first magazine-type rocket gun to be carried inside an aircraft, supplanting rockets that are attached to the wings or fuselage. It's a twin revolver that fires five-inch spinner-type rockets, as many as 10 in a salvo, giving the airplane the fire power of a cruiser. The



↑ Searing flame jets out through exhaust stack of the test ship just before rocket emerges from its tube  
↓ Two rockets streak from the plane's nose in the first ground test of new weapon designed for air combat







↑ Double motors give an 11.75-inch rocket airplane speed when it's launched from the 1500-foot test track  
↓ Strip photos show the same rocket penetrating a 2½-inch armor-plate target and exploding just beyond

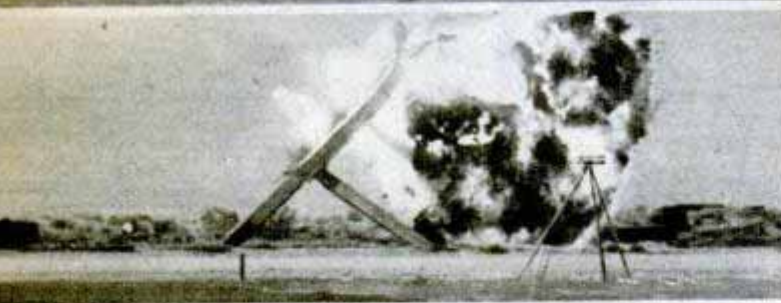
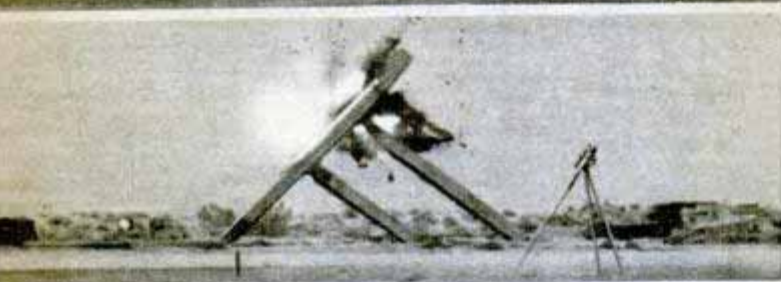
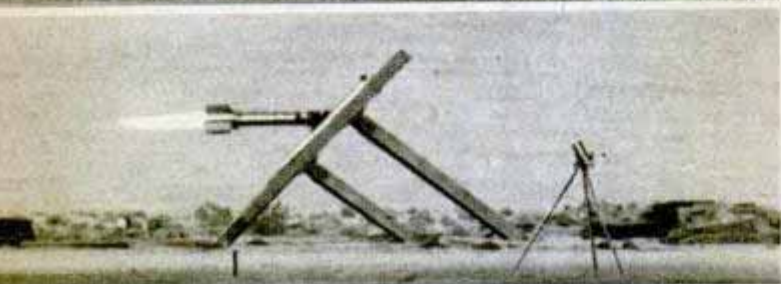

↑ Note marks left by fins when rocket penetrates target  
↓ Ordnance experts examine opposite side of the armor

↓ PBJ Navy bomber releases a dummy Tiny Tim rocket in a drop test above the Mojave Desert ordnance range





magazine rotates as the rockets are fired and can be reloaded by the crew from inside the plane.

The Tiny Tim, an 11.75-inch rocket developed as an air-to-ground missile during the war, is undergoing new tests as a special purpose weapon. Twin rocket motors have been installed on some of the missiles in ground tests to give them aircraft speed at launching. They are launched from a special 1500-foot rail covered with a sheet metal canopy to reduce temperature changes. In service, the Tiny Tim carries a heavy charge of TNT fused to explode immediately after the target has been pierced.

Still bigger than the Tiny Tim is the 14-inch rocket recently announced by the Navy and now under test at Inyokern. Known as the Richard, the new missile is powered by solid fuel and is one of the largest short-range rockets that have been developed, exclusive of the big directed-missile types. Zooming through the air with the sound of a gigantic blowtorch, the Richard carries a heavier high-explosive charge a greater distance than the Tiny Tim.

They're testing other methods of warfare on the great Mojave range, too. There the Navy not long ago demonstrated its new aerial bombing technique called "toss bombing." The toss-bomber pilot dives toward his target from a great height and distance, pulls out of his dive, and releases his bomb as he is climbing upward again. The missile moves toward the target in a great arch, sometimes traveling a mile beyond the point of release.

In order to toss the missiles accurately, an ingenious new bombsight called the Mark Three Toss Director has been developed which automatically computes the plane's air speed, altitude, angle of dive and distance to the target. When the instrument has completed its calculations a red light flashes. The pilot then can pull out of his dive and the instrument releases the missile at the right moment. The pilot is not required to dive right at the target but can drop his bombs from some distance away to avoid anti-aircraft fire.

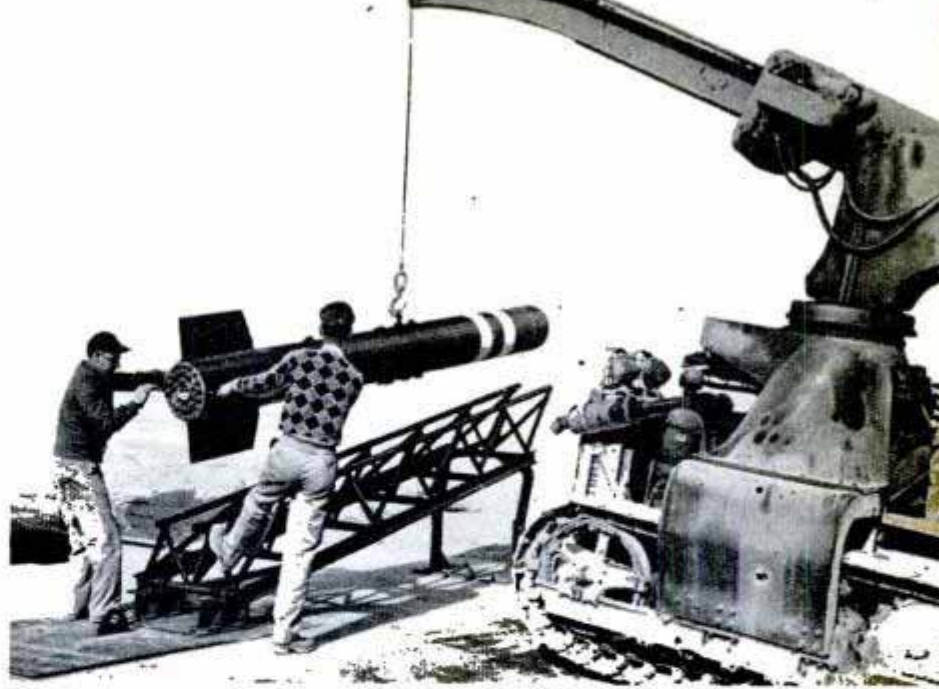

↑ New solid fuel 14-inch rocket, one of the biggest, is loaded on its launching rails for a firing test

↓ A Richard zooms toward target after leaving rails

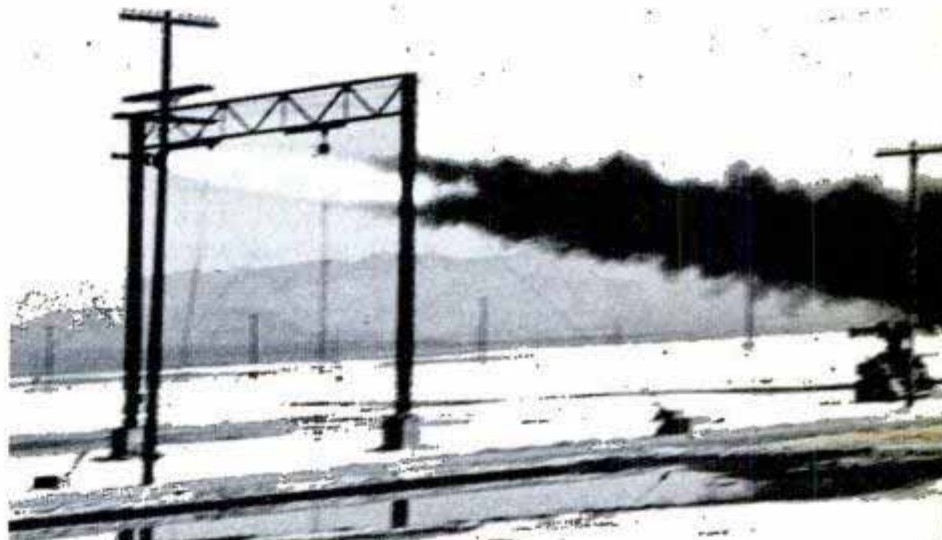

↓ Fighter plane suspended from a special tower fires a big Richard rocket during a simulated flight test





# From Trading Post

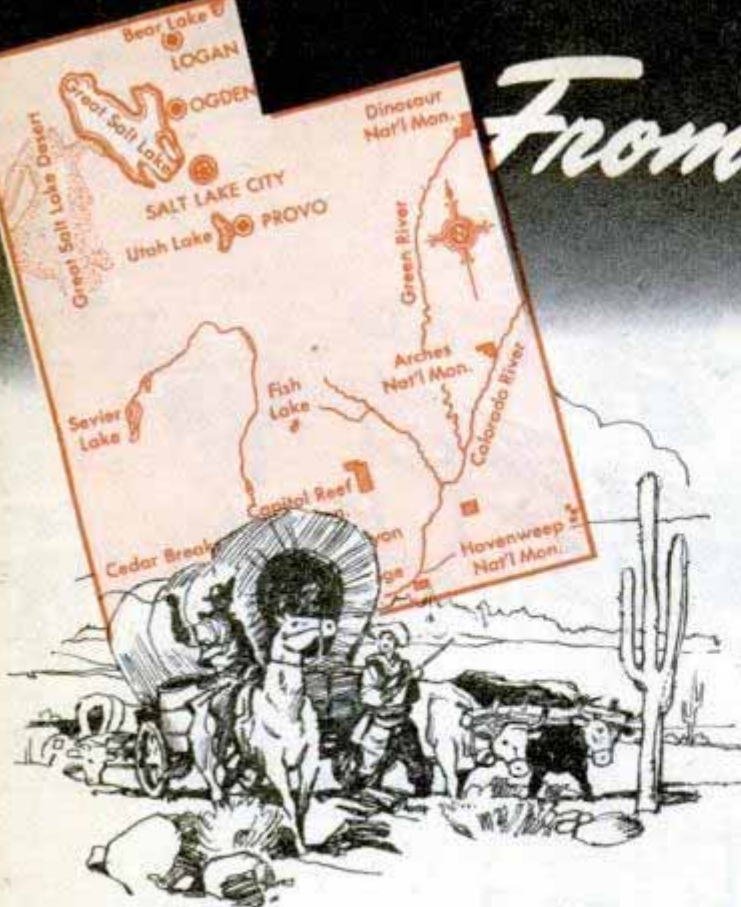

Utah's centennial recalls an inspiring past and points to a bright future for a land once so desolate that no one wanted it

as useless as a mirage—it was too salty to drink. The whole region was unexplored; except for a few wandering Indians it was uninhabited.

The Mormon pioneers didn't know that they had chosen an area that abounds in natural wonders and that later would be called the center of scenic America. They weren't aware then that irrigation water from the mountains would transform the barren ground into rich soil. They didn't realize, either, that there were billions of tons of copper, coal and other ores under their feet.

**T**HIS SUMMER Utah celebrates 100 years of progress since Brigham Young gazed across the arid wastes of Salt Lake Valley and told his Mormon followers: "This is the place."

The "place" was so desolate that the Mormons hoped that no one else would ever want it. Driven out of the Middle West, the group had traveled over 1000 miles to find just such a sanctuary. Forbidding mountains rose up in the east and to the west there was little but sterile desert. The vast lake that shimmered in the distance was

The first company of 148 people laid out their temple grounds, surveyed and plotted Salt Lake City and established farms on which they hoped to live in peace. They never really had any isolation because the gold rush to California in the early '50s promptly turned Salt Lake City into a trading center. By 1852 the population of the area had grown to 15,000. Local mines were

Land of scenic contrasts, Utah abounds in natural wonders. Erosion carved the grandeur of Monument Valley





# *to Empire*

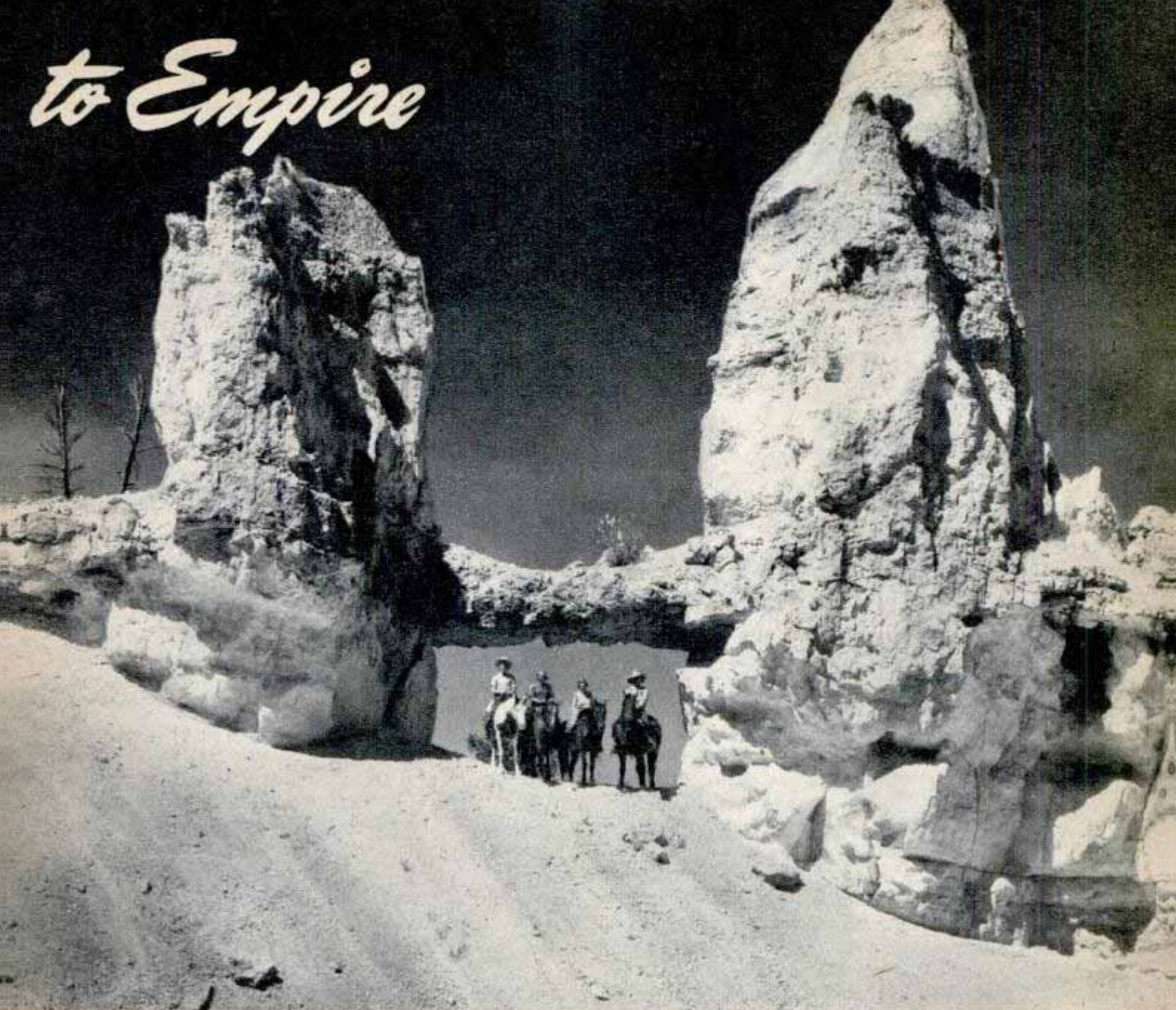

Vacationists on horseback are dwarfed by the craggy towers of a rock bridge in the Cedar Breaks country



opened and Utah settled down as a territory. In 1896 it became the 45th state to be admitted to the Union.

This year's centennial celebration commemorates both the past and the future, for Utah is becoming an industrial state of increasing importance. Pioneer pageants are to be held in all of Utah's cities and towns during the summer. A state exposition opens in Salt Lake City June 1 and will continue until fall. Seven national sports events will be staged during the season, together with aquacades, ice follies shows, art exhibits and symphony orchestra concerts. The celebration will last all summer and will attract tourists from all parts of the country. The visitors will get their money's worth out of the scenery alone.

Possibly nowhere else but in Utah can you fish for trout, hunt deer, acquire a desert tan, ski in snow, excavate bones of pre-





Pneumatic-tired scoop stock-piles salt crystals in drying beds

historic animals, gather relics of ancient Indian tribes and prospect for gold all in the same day. There are a dozen other novel pastimes that you can try if you run out of things to do, from testing your car's top speed on the Bonneville salt flats to trying to swim under water in the Great Salt Lake. The last is possible but extremely difficult.

The lake, 75 miles long and 35 miles wide, is the concentrated residue of vast Lake Bonneville that during the glacial age covered one third of the entire state. The water gradually receded, principally by evaporation, with the result that the present Great Salt Lake has a saline content of 25 percent. A century ago the pioneers pickled beef and buffalo meat in the water. Table salt, sodium sulphate and other salts are refined from great evaporation beds along the lake's shores today. It is estimated that the lake contains six billion tons of salts.

Its water weighs 12.5 pounds more per cubic foot than does fresh water and people can float in it without effort. Conventional life preservers are never needed. Only an unconscious person floating face down could drown. The recommended life preserver in such a case consists of a 15-pound weight attached to the legs to keep the head in the air.

Power shovels load long strings of ore cars with salt taken from a high stock pile of crystals on the beach of Great Salt Lake



Sixty miles west of Great Salt Lake are the Bonneville salt flats. The dazzling snow-white surface is 20 miles long, almost as hard as concrete and as level as a table top. The crystal pavement is from one to six feet deep. The world's automotive speed and endurance records were established there.

Prehistoric beasts roamed the palm and bamboo forests that flourished in the great basin area during the Lake Bonneville period, and the remains of these monsters are now found at scores of sites up and down the eastern side of the state. Fossil remains of flying reptiles, footprints of giant three-toed lizards, leg bones as tall as a man, and the vertebrae of mammals that weighed 20 tons and measured 100 feet in length have been excavated from cliffs and bluffs. One of the richest of these boneyards, from which thousands of bones including 22 complete saurian skeletons have been removed, is now preserved as the Dinosaur National Monument on the Utah-Colorado border.

Ancient man roamed over the same region and left his mark in the form of old campsites, gnawed sloth and camel bones, rock carvings and cliff dwellings. Still a puzzle to archeologists are the weird stone towers and buildings that some early race erected in southeast Utah. Hovenweep National Monument has been set up to protect them.

Many of Utah's famed scenic spots are in the southern part of





the state and all but two of these may be reached over good highways. Most of southern Utah is typical desert country dotted with mountain ranges and occasional 8000 to 10,000-foot peaks. Travelers who leave the main highways are advised to carry plenty of water. Dirt roads alone, for instance, lead to Monument Valley inside the Navajo Indian Reservation extending into Arizona. The valley takes its name from the multitude of vertical-sided and flat-topped crags that it contains, the tops of which mark the plateau from which the valley has been eroded.

You can reach Zion National Park over good highways. This region is noted for the range of colors and odd rock formations on the walls of its canyon. One entrance to the park is via a 5600-foot highway tunnel that pierces the heart of a mountain.

Cedar Breaks National Monument, not far from Zion, is a wildly colored badlands in the form of an amphitheater half a mile deep and two miles from rim to rim. Bryce Canyon National Park, also in southern Utah, contains spectacular spires and pinnacles that rise nearly a thousand feet above the floor of the canyon. Capitol Reef National Monument, also in the same region, consists of a tremendous 20-mile-long reef or upthrust that in addition to fantastic eroded formations contains numerous petrified forests and archeological remains.



**Open pit mine at Bingham produces one third of nation's copper**

At nearly any time of the year you will find one or more Hollywood movie groups on location in one of the parks or in the surrounding area. Many of Hollywood's big color features are filmed in part in Utah. At Cedar City, adjacent to several of the parks, one busy enterprise rents saddle horses, herds of cattle, covered wagons and other pioneer equipment to the movie companies. A movie village near Zion is in use for months on end.

Natural bridges are a rarity in most parts of the world but not in Utah. The Arches National Monument alone contains 81. Considerably larger are the three big rock bridges in Natural Bridges Na-

**Coal veins spread under 13,000 square miles of Utah's surface**





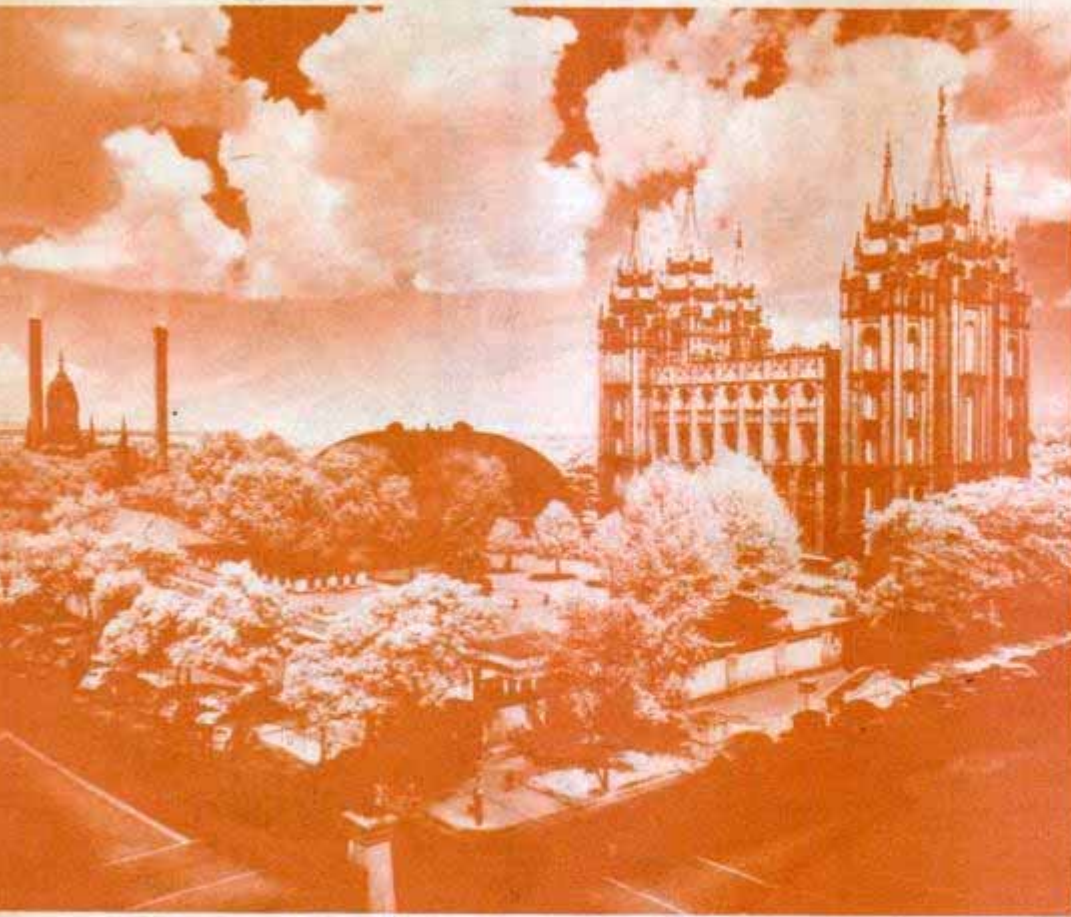

Mormon Temple in Salt Lake City is world-famous. Eroded spires, above, in Cedar Breaks National Monument attract many tourists



tional Monument. The largest known is Rainbow Bridge. Its curved rock arch is 278 feet long and 309 feet above the streambed below.

Utah's mines produce nearly a third of the nation's copper plus important amounts of gold, silver, lead and zinc. The state has rich deposits of tungsten, vanadium and molybdenum, and some uranium. It is rich in phosphates and oil shale and there are coal deposits under 13,000 square miles of its lands.

Records may fall when racing driver Ab Jenkins drives this car in a 24-hour-long speed run over Bonneville salt flats

Its newest large industry is steel production. Geneva Steel Company's \$200,000,000 plant 40 miles south of Salt Lake City gets its ore from Iron Mountain 225 miles to the southwest, its limestone and dolomite from quarries 25 miles away, its coal from a mine 130 miles southeast and its water from artesian wells and the nearby Wasatch Mountains. Now operating at partial capacity, Geneva has a potential output of 1,280,000 net tons of steel ingots per year. Its production is increasing and subsidiary industries are moving in.

Too, Utah is an export state in canned, frozen and fresh vegetables and fruits. It refines large amounts of sugar from its own sugar beets. It is a leader in livestock. Salt Lake City is the trade and distribution center for the intermountain region.

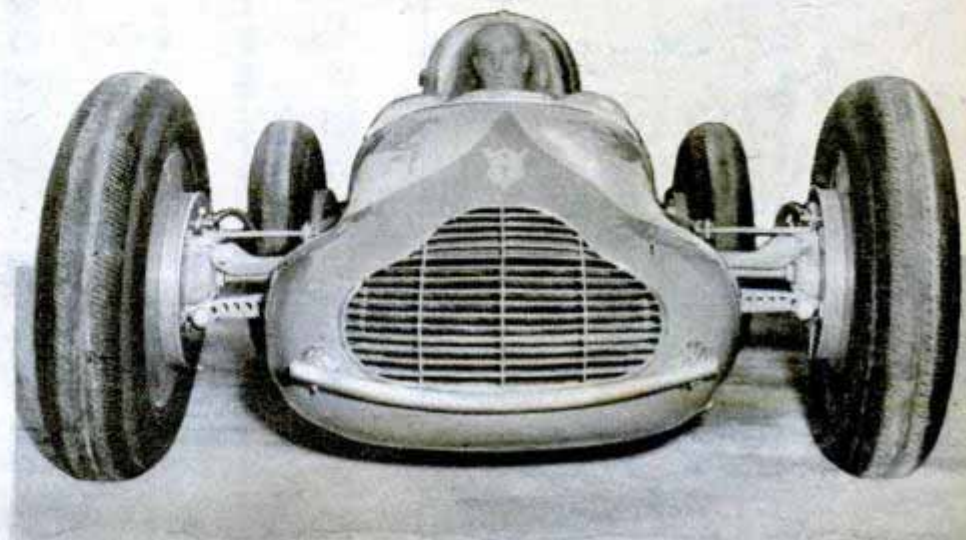



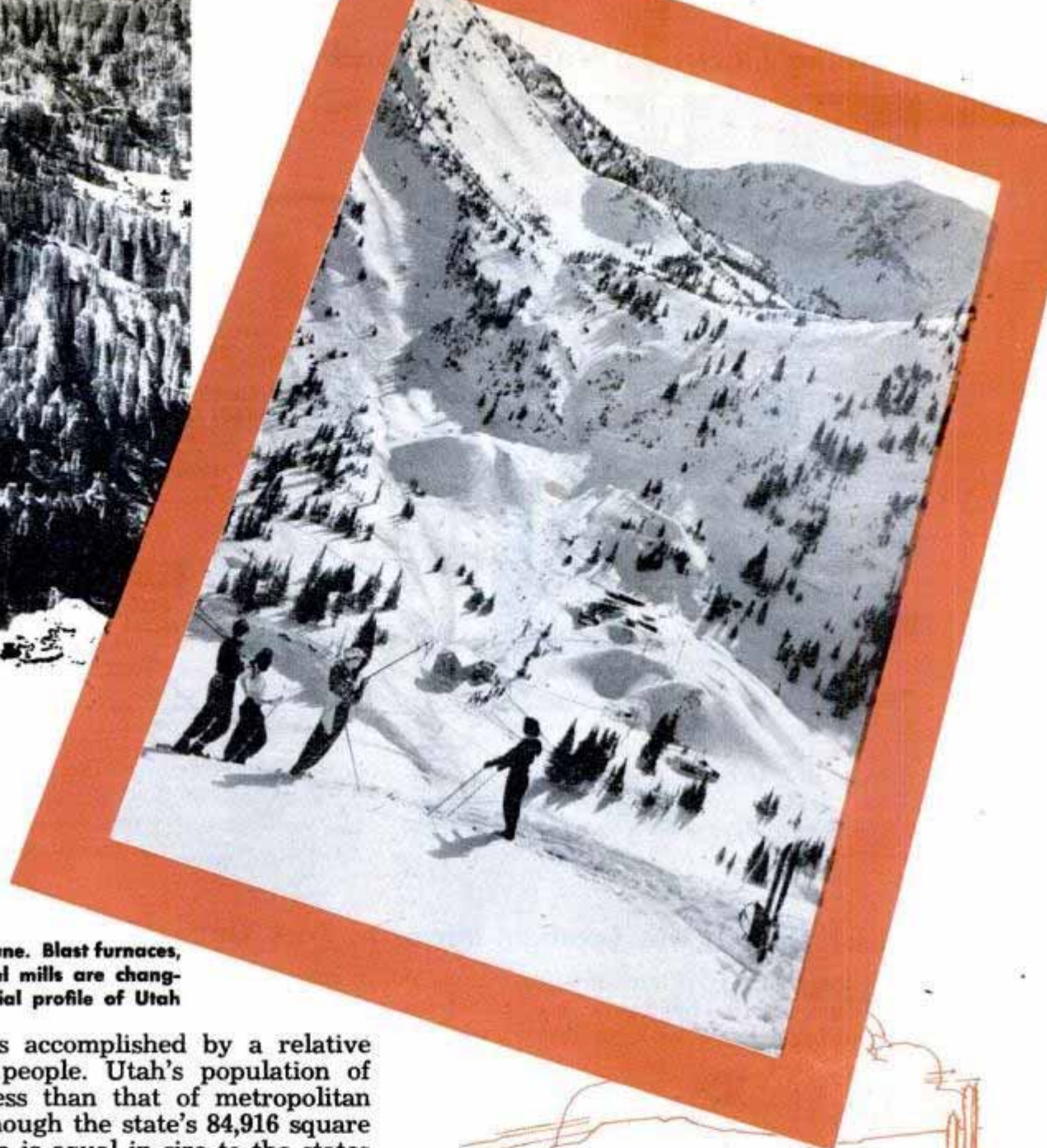
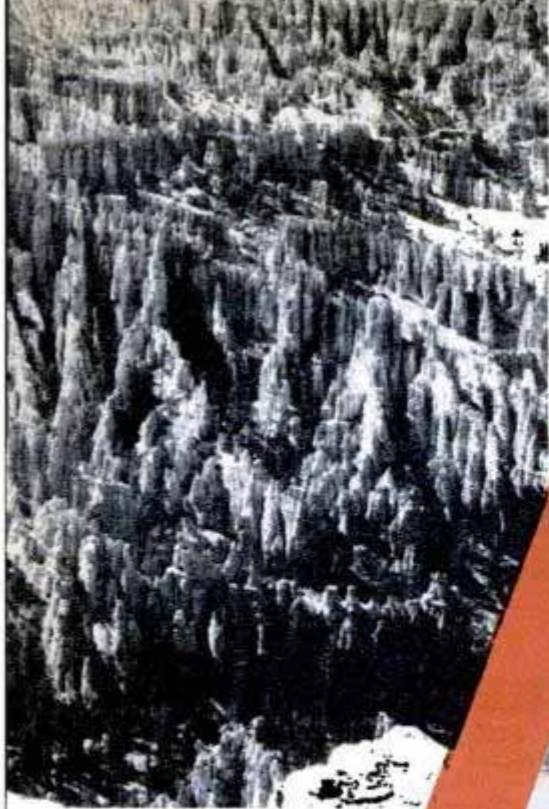

Almost on the edge of the desert, mountain ski runs operate from November to June. Blast furnaces, bottom, of steel mills are changing the industrial profile of Utah

All this is accomplished by a relative handful of people. Utah's population of 600,000 is less than that of metropolitan Buffalo, although the state's 84,916 square miles of area is equal in size to the states of New York, Massachusetts, Connecticut, New Hampshire and Vermont combined. Much of the population lives in an agricultural and industrial belt east of Great Salt Lake, extending from Logan through Og-

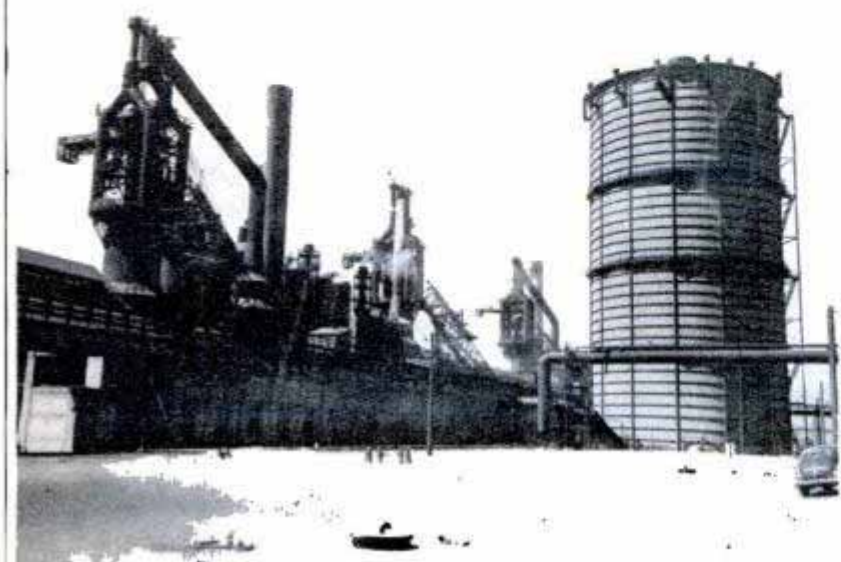

den and Salt Lake City to Provo. Extensive farming goes on in the long north-and-south valleys between the mountain ranges that reach down toward Arizona. Most of the state is at elevations of from 4000 to 6000 feet. The climate ranges from dry semitropical in the south to temperate in the north.

Utah calls itself the Beehive state. If the next 100 years are as busy as the first, it's the right name for the isolated trading post that has grown into an empire.



## Welding Electrode Withstands Bending Without Any Loss of Flux

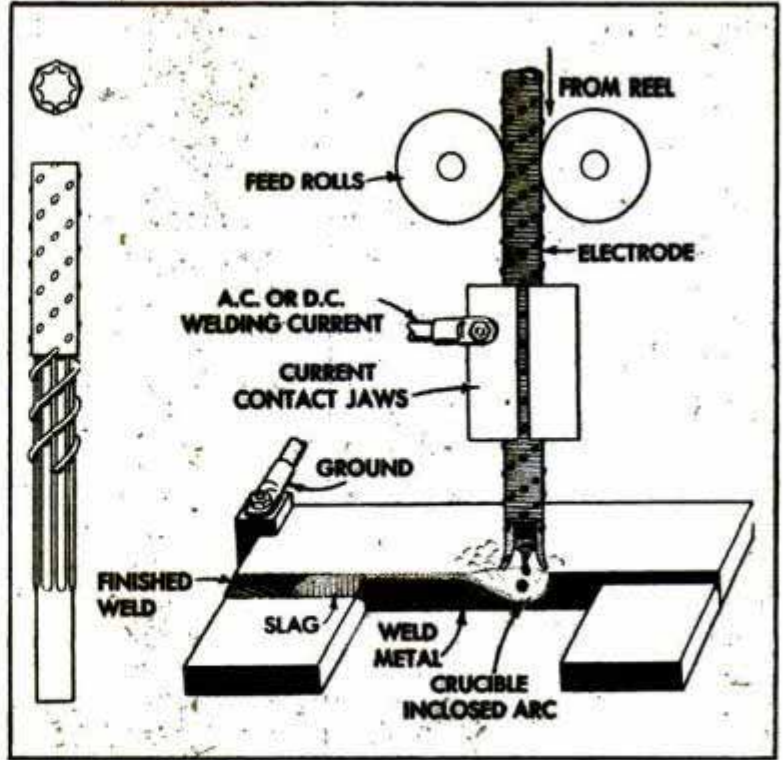
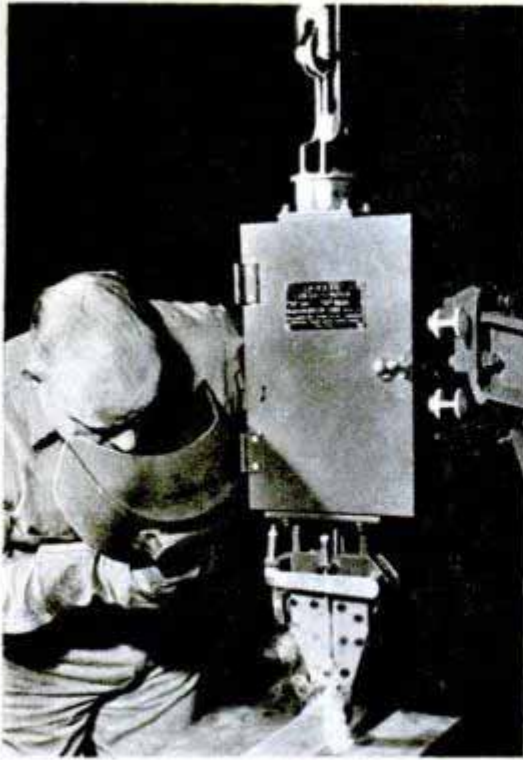

Advantages of both the manual shielded arc welding process and continuous automatic welding are combined in a continuous feed welding electrode. Metallic grid construction binds a heavy flux coating to

the wire core to provide an electrode that withstands extreme flexing and bending without loss of flux. At the same time the electrode can be fed continuously into a mechanically maintained arc from a reel.

## Border Guards Use Spotlight-Mirror to Peek Under Car for Contraband

No longer do U. S. customs inspectors at the Texas-Mexico border have to crawl under automobiles to look for hidden contra-

band. They now use an inspection device equipped with mirror and spotlights which is pushed under a car to examine the undercarriage. Metal rods welded together in a rectangle support the mirror and lights. A handle at one end and wheels at the other make it easy to move the contrivance. It was designed by David C. Ellis, young El Paso, Texas, customs inspector, to reduce undercarriage inspection from three minutes to 20 seconds—and eliminate a lot of backaches. A 20-foot extension cord supplies power to the two sealed-beam lights.



## Temperature Taken in Blood Stream

Electric thermometers measure blood temperatures directly in the blood stream. The sensitive part of the apparatus, known as a thermistor, is embedded in a glass bead which is  $\frac{1}{25}$  inch in diameter. This is encased in the tip of a rubber tube so slender it can be pushed through a hollow needle inserted in a blood vessel. From the thermistor a pair of slender wires leads back to a small box containing apparatus for measuring changes in electrical resistance. By noting these changes, blood temperatures can be determined within a range of 97 to 133 degrees Fahrenheit.



## Hulls of PBY Flying Boats Are Converted Into Seagoing Cruisers

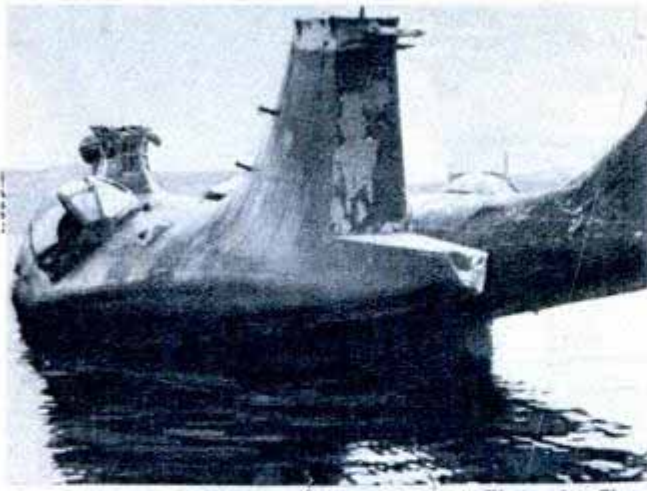

Photos by Clary

Converted into streamlined cruisers, the hulls of retired Navy PBY flying boats have gone back to sea. Ingenious Seattle yachtsmen bought the hulls, stripped of wings, at auction for \$100. To convert them into seagoing cruisers, the tail was clipped leaving a hull 30 to 45 feet long. Built of aluminum alloy impervious to salt water and with watertight compartments, the clipped PBYs are seaworthy boats.



With tails clipped and converted auto engines added, abandoned PBY hulls become sleek salt-water cruisers



## Pressure-Fed Trowels of Wall-Washing Machine Speed Cleaning Job



Time required to clean walls is reduced by a wall-washing machine which employs cleanser and rinse water under pressure. Designed to eliminate the annoyance of streaking and dripping, the machine applies cleanser and rinse water through large trowels covered with cloth pads. The liquids are fed into the pads by pressure storage tanks.

## Steam Draws Oil From Shale

One of the most efficient methods of extracting oil from low grade shale was developed by desperate Germans during the closing days of the war. They produced limited quantities of oil from shale deposits in Wurtemberg. Shale was heated in a retort. Then steam, superheated to 800 degrees Centigrade, was passed horizontally through a downward-moving mass of crushed shale. Oil vapors and gases passed out the opposite side of the retort along with steam to be recovered later. The remaining shale was usable as hydraulic lime or for making cement.

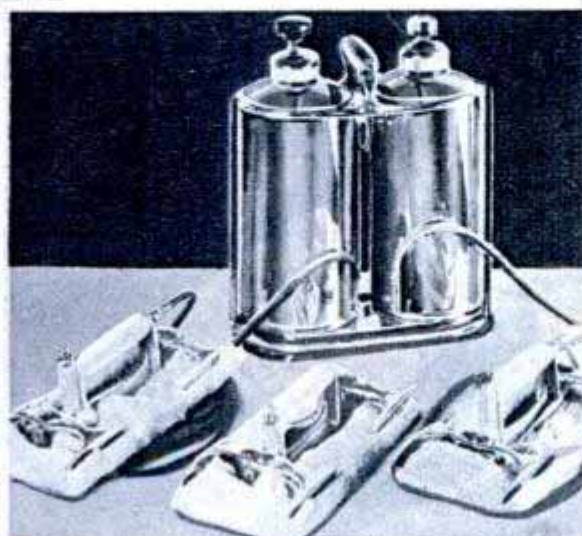



## "Gas Tank" Auto Powered by Batteries

Scooting along the highways near Buffalo, New York, is a midget automobile built by J. Fred Schœllkopf from a surplus warplane "belly tank." The tank became a car with the addition of electric motors, diminutive wheels and a few other trimmings. The little vehicle rolls along at 15 miles an hour and has a range of 40 miles, 20 from each of two automobile batteries, before the batteries must be recharged.



## Alarm System With 15 Thermostats Registers Both Heat and Cold

Warnings of cold damage as well as fire alarm are registered by an electric alarm system for farms and industrial plants. Fifteen thermostats are spotted in danger areas and connected with a thermostat in a main building. When there is a critical rise in temperature at any of the locations a bell in the control unit rings, a red light glows and a dial indicates the location of the fire. The "cold" thermostats of the system can be placed in brooder houses or greenhouses to warn of drops in temperature. If a wire or thermostat is broken anywhere in the system the alarm bell rings and the dial indicates the area of damage. Each of the 15 thermostats in the system is effective over an area of 4800 cubic feet and as many as 300 auxiliary thermostats can be added to the unit.

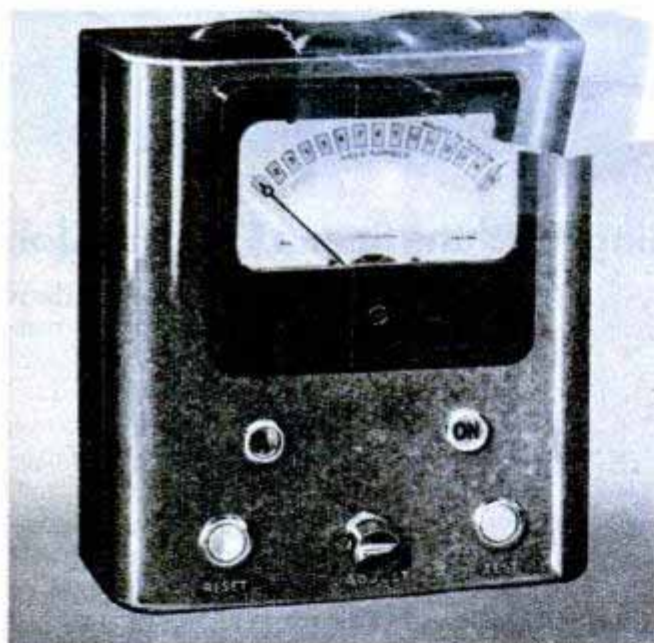

## Plastic Card Holder Aids Rummy Play

One card at a time is released by a plastic holder designed to prevent accidental two-card draws in rummy and other card games requiring single-card draws. It also keeps cards from blowing away when playing out of doors. A pull drawer in the bottom of the device holds one deck and also serves as a convenient discard tray. The holder is four inches wide and seven inches long.

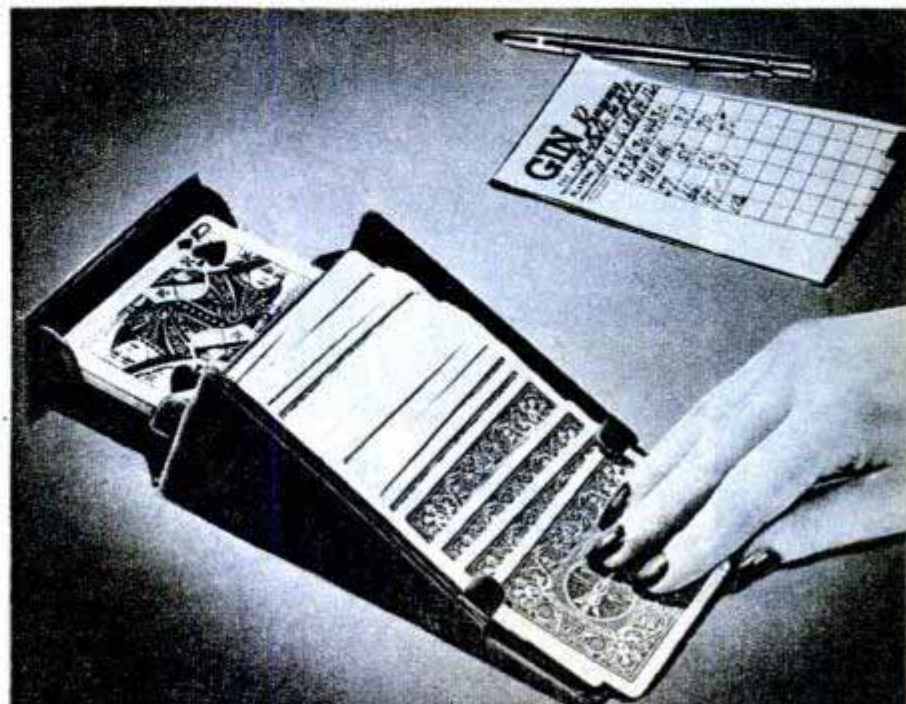



## Remote Control Keys Run Typewriter

Remote control typewriters, designed for bedridden and seriously disabled persons, are in use in veterans' hospitals. The remote control keyboard of the machine can be operated in any position. Striking the letter keys on the keyboard transmits electrical impulses to the typewriter.

## Wallpaper Remover Dissolves Paste

Wallpaper can be peeled off easily after applying a new remover that penetrates and dissolves the paste. It is odorless and the quick acting chemicals won't harm woodwork, painted surfaces, clothing or the skin.

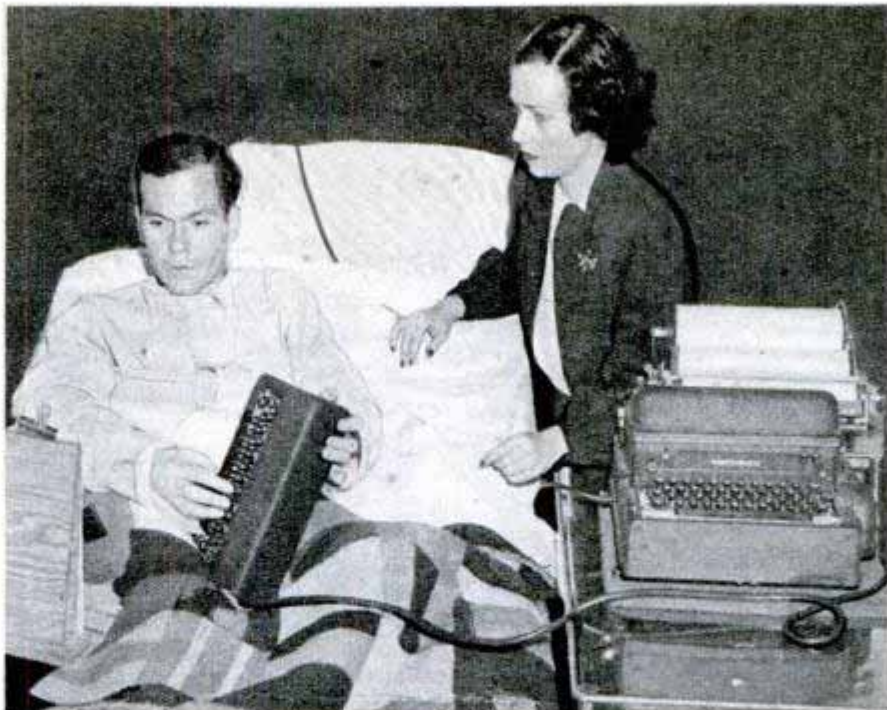

The remover comes in powder form, and a two-ounce jar dissolved in hot water is enough for an average-size room.



## Sealed Beam Spotlight for Autos Projects Glareless Ray ½ Mile

← Sealed beam spotlights for automobiles and boats cast a concentrated, glareless ray for half a mile. A peacetime "sister" of the landing lights used on warplanes, the spotlight has a sealed disklike reflector and a tungsten filament. A parasol-shaped filament shield eliminates stray light and prevents blinding glare in the area between the observer and a distant object being illuminated. Westinghouse engineers, who developed the light, report that its ray is four times more powerful than that of a sealed beam auto headlight.

## Theftproof Locks Prevent Oar Loss →

Oar locks that consist of three units prevent theft or loss of oars. Made of manganese bronze castings, the locks consist of a vertically slotted bracket permanently attached to the inside of the boat, a conventional oar lock with lock-rod and a cross-rod passing through the oar handle. The cross-rod prevents the oar from slipping out of the flexibly anchored oar lock. The lock-rod on the bottom of the oar lock terminates in a ball sealed in the slotted bracket. This serves as

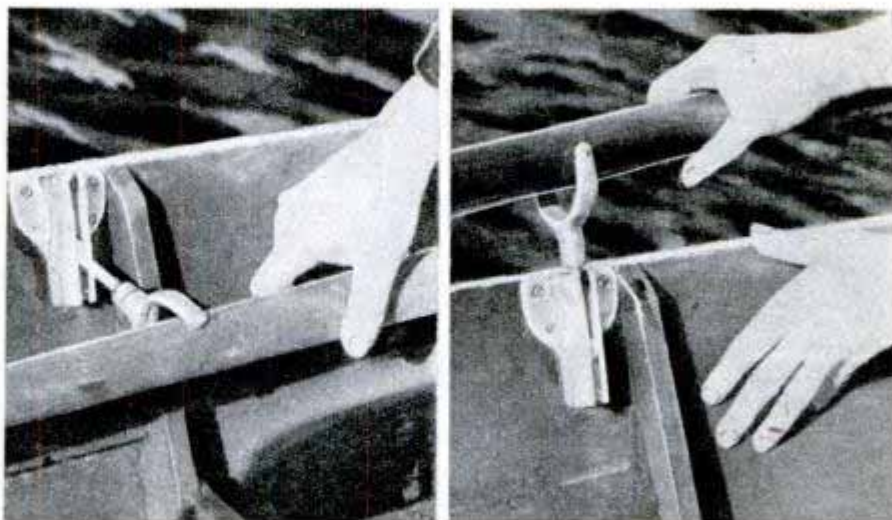

a ball-bearing socket and also prevents lifting the rod or the attached oar out of the anchored bracket.



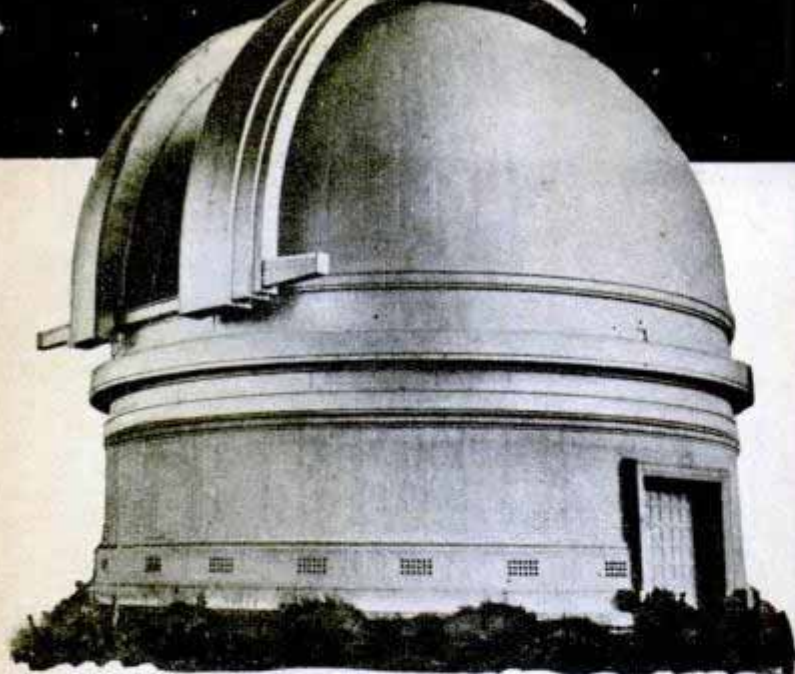

The rotating part of the Palomar observatory dome weighs 1000 tons, is insulated with aluminum panels

By Thomas E. Stimson, Jr.

**T**HOUSANDS of visitors every month are driving to the top of Palomar Mountain near San Diego to inspect the giant 500-ton telescope that in 1948 will begin to probe unknown reaches of the universe.

Inside the observatory dome they gasp at the size of the five-story-tall instrument. They marvel at the ingenious engineering by which the massive parts will be made to move in tracking distant stars. The Palomar telescope is one of the wonders of the modern world.

Meanwhile, in the optical shop at California Institute of Technology in Pasadena, the telescope's mirror disk is undergoing

final shaping. Precision work is being done that has no parallel in history.

At Palomar the telescope's structural parts must be true to a thousandth of an inch; at Pasadena, a millionth of an inch is acceptable tolerance. No mechanical measuring device can be calibrated so finely, so technicians use the wave length of light, 1/50,000 inch, as their yardstick.

The 200-inch Pyrex disk, almost 17 feet across, received its rough grinding before the war. Two tons of glass were removed in the process of grinding out the spherical concave surface. Now the opticians are polishing this surface and deepening it to the shape of a parabola.

The glass disk rotates on a big turntable. Above the disk, a traveling crane moves back and forth, its weight supported by tracks on either side of the turntable. Suspended from the crane's cross member is the flat, round polishing tool. The polishing medium is a thin solution of flour-smooth red ferric oxide suspended in water.

Only one third ounce of glass is removed in a week. For weekly inspection, the glass disk is tilted down from its turntable and given the knife-edge test. This method is used by amateur astronomers to check surfaces they grind and polish by hand. In this test the mirror disk is viewed through a narrow slit formed by two razorlike pieces of metal. The perfect portions of the glass surface reflect light from a lamp placed near the test apparatus. The zones in the surface of the mirror that do not reflect light

When the giant telescope is completed, certain observations will be made from the "prime focus" platform on which this man stands

Five-horsepower motors, "geared" to the wall by rubber tires, will turn the dome

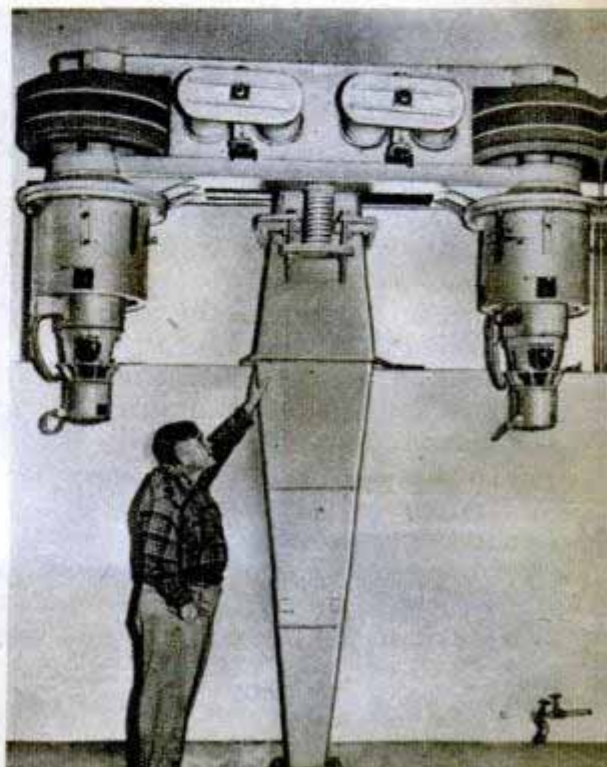
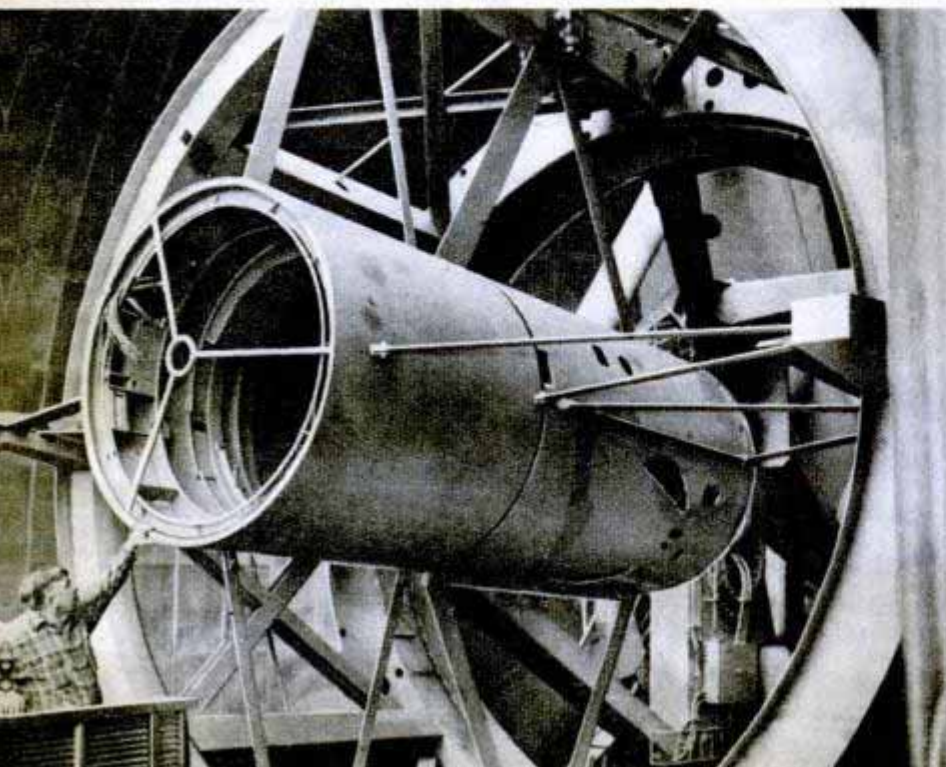



# WONDER OF THE WORLD

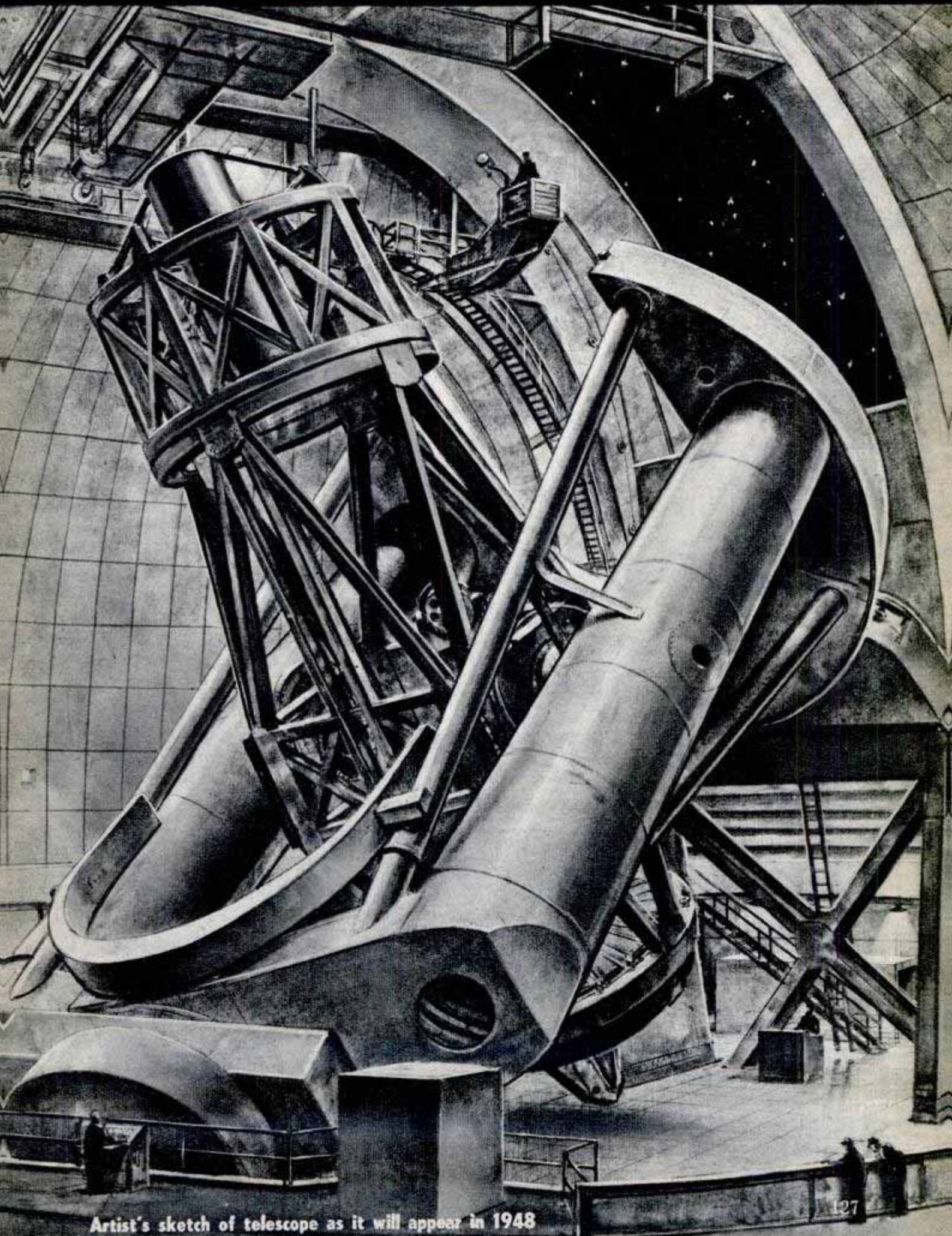

Artist's sketch of telescope as it will appear in 1948



PHANTOM DRAWING SHOWS HOW  
OBSERVER GETS ON AND OFF TUBE

CRANE  
TRACK

TELESCOPE  
CAGE

PRIME FOCUS  
 $f=3.3$

60-TON CRANE

COUDE &  
CASSEGRAIN  
MIRRORS

HORSESHOE,  
NORTH POLAR  
AXIS BEARING

DECLINATION  
AXIS

NORTH  
PRESSURE  
BEARINGS

200-INCH  
MIRROR

CASSEGRAIN  
FOCUS  $f=16$

NORTH  
CONTROL DESK

DOME  
DRIVE

DOME  
TRUCKS

PRIME FOCUS  
PLATFORM

DOME, 137-FT.  
DIAMETER

DOME SHUTTER  
30-FT. OPENING

RIGHT  
ASCENSION  
DRIVE

PASSENGER  
ELEVATOR

COUDE FOCUS  
 $f=30$

CONSTANT-  
TEMPERATURE  
ROOM

AIR-  
CONDITIONING  
DUCTS

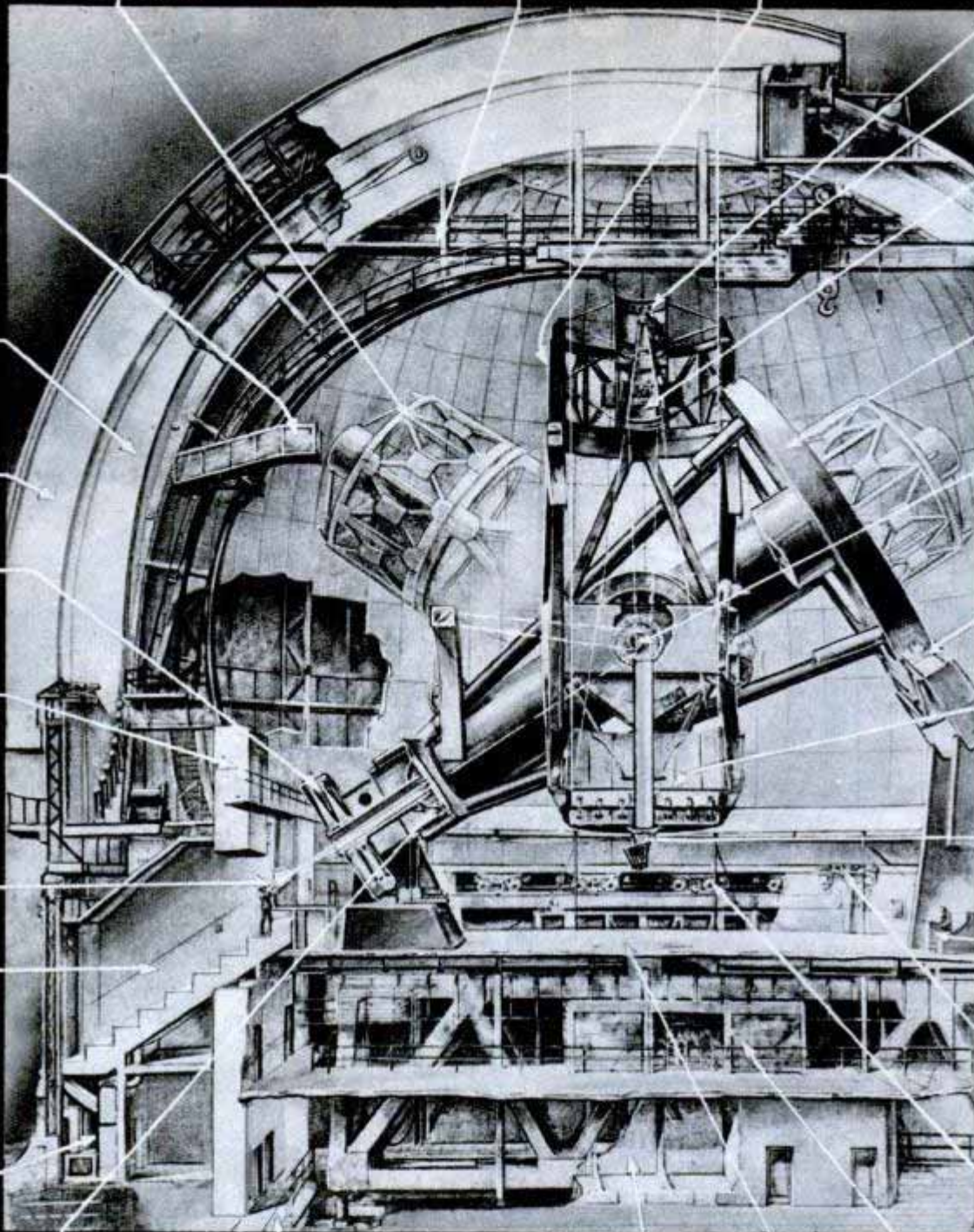

SOUTH  
POLAR AXIS  
BEARING

GROUND FLOOR

OFFICES

OBSERVATION  
FLOOR

ELECTRICAL  
CONTROL PANELS

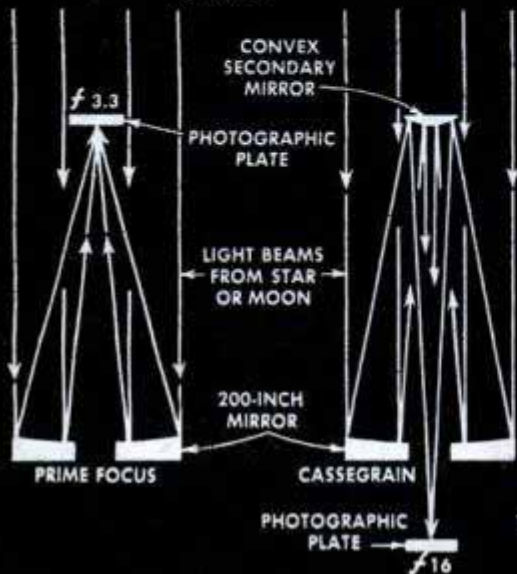

These drawings represent three telescopic mirror combinations. Prime focus is used when photographic plate is mounted near top, Cassegrain for observations at bottom of instrument. Coude is for observations in a constant temperature chamber

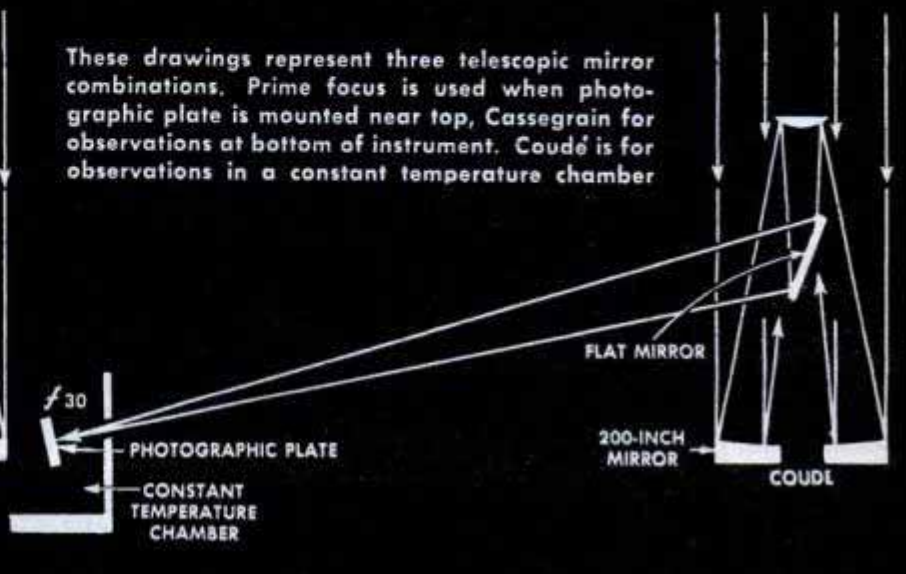



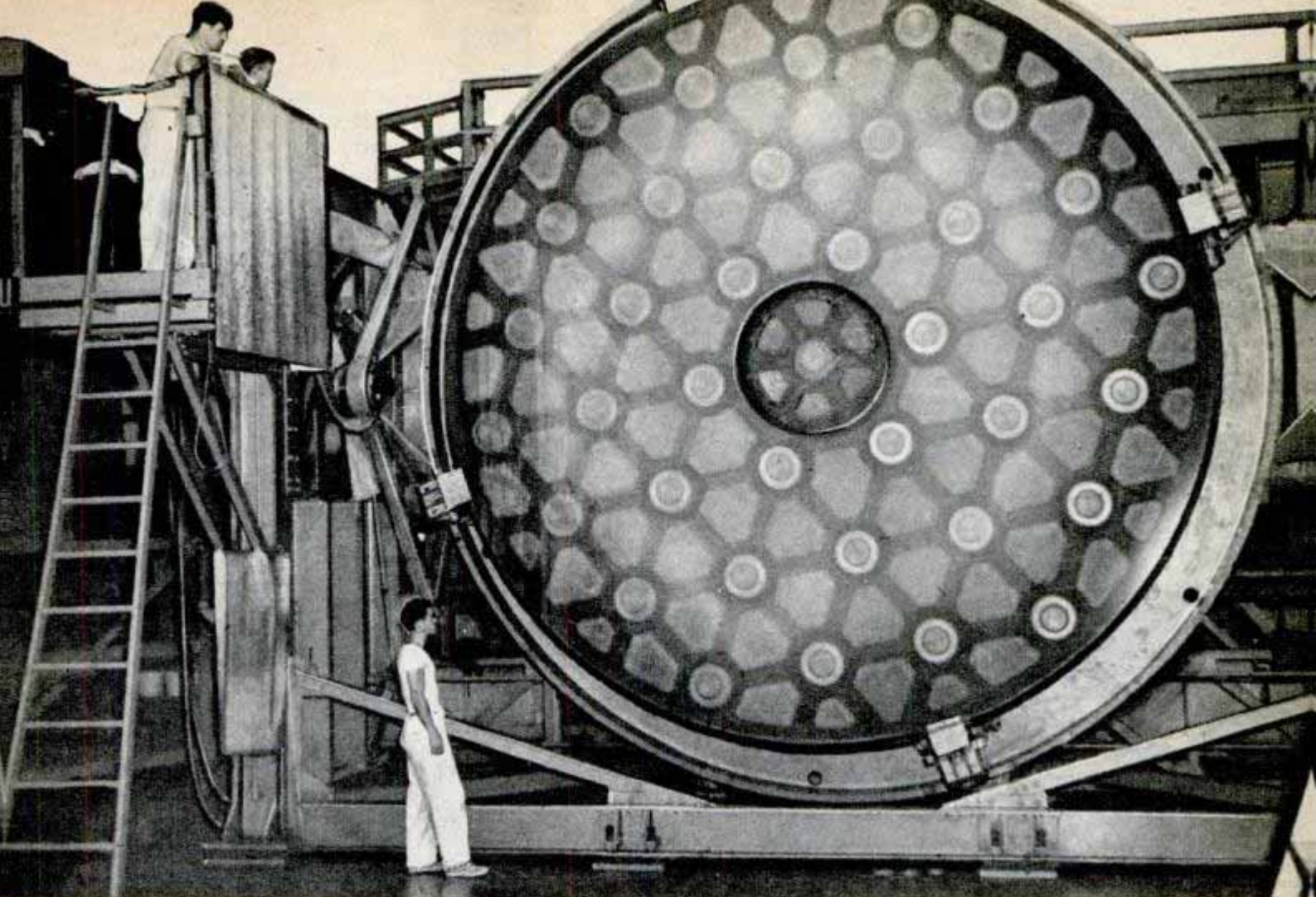

to the focal point appear to be in shadow.

This past winter the 200-inch disk was virtually perfect except for one shadow zone about  $\frac{1}{25,000}$  inch deep. Polishing the rest of the surface with specially shaped tools was begun so that the whole surface could be brought into a perfect curve. Before the technicians finish their task, they expect to make the surface accurate to within  $\frac{1}{1,000,000}$  inch of the ideal curve.

A speck of grit so small you couldn't feel it would ruin the glass surface at this stage of polishing. For this reason no visitors are allowed in the optical laboratory. They may view the scene only through a glass partition from a visitors' gallery.

The opticians themselves change from street clothes and shoes to special garments before entering the laboratory, then change their shoes again to a third pair before mounting the polishing machine. The entire laboratory floor is swept twice daily with a vacuum cleaner and a magnetic sweeper that picks up all particles of magnetic metal. Filtered air is admitted to the laboratory all night; in the morning the fans are shut down. Thus, the air is dead and still during the working day.

Laboratory temperature is balanced so that on even the hottest day outdoors it

Mirror disk for the 200-inch telescope is tilted down from polishing turntable for surface inspection. Below, slip-ring trolley system will distribute power





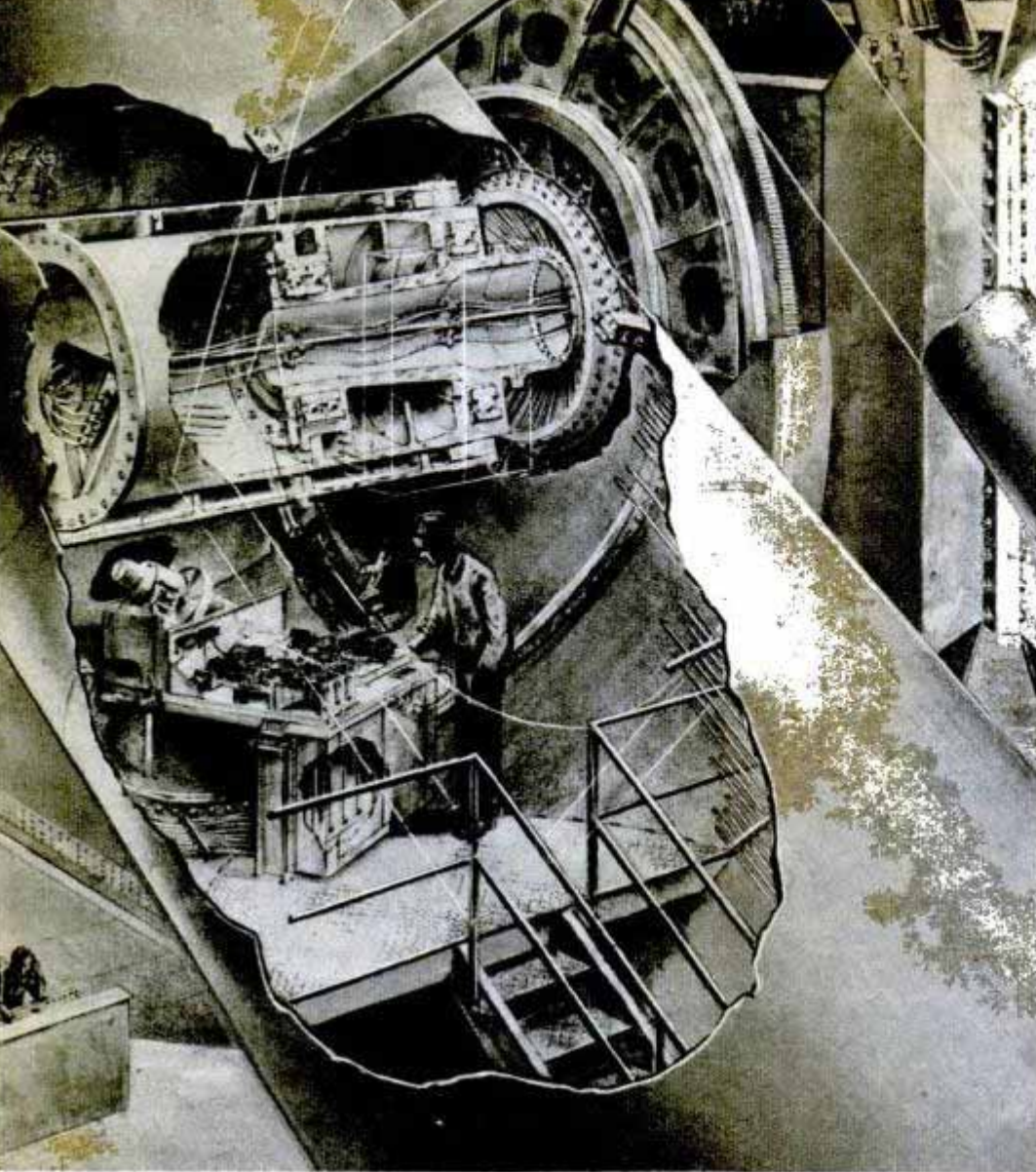

Drawings by Russell W. Porter

Cutaway view shows declination drive and control mechanism in tubular arm

of about 25 years. After that the aluminum will be renewed.

Because of its weight and size, so huge a mirror would be subject to all sorts of distortions when placed in some positions. The disk would sag out of shape when tilted one way or stretch enough to spoil a perfect focus when tilted another. To eliminate deformations the disk is to be held inside a  $\frac{3}{4}$ -inch-thick steel pan that will support it and provide fulcrum points for 36 automatic counterbalances set into the rear of the disk. Each counterbalance will support the weight of its portion of the mirror. Each is made up of 1100 machined parts and is adjustable to push directly against gravitational pull. The counterbalancing apparatus is expected to hold the big mirror true to within  $\frac{1}{10}$  a wave length of light no matter in what position the mirror is placed.

The telescope, minus its mirror, is being tested now. To check its motions, a concrete block equal in weight to the mirror has

has a range of only half of one degree from floor to ceiling. Insulation keeps the temperature virtually constant—a three-degree change could expand the glass disk and the polishing tool at unequal rates, causing the tool to cut a distorted shape.

Some time this summer or fall, tests will show that the glass surface has been polished to perfection. Then the disk will be trucked to Palomar, 125 miles away, and placed in a huge vacuum chamber where it will receive its reflective coating.

The only function of the glass disk on which so much work is being done is to provide a stable support for an aluminum film,  $\frac{1}{1,000,000}$  inch thick, to be spread over its surface. The film will be deposited on the glass surface in the vacuum aluminizing chamber by a process somewhat like evaporation. Next, a transparent protective coating of pure quartz, one or two wave lengths deep, will be deposited on the aluminum by a similar method. This coat will reduce the rate of oxidation of the aluminum reflecting surface, will permit cleaning and give the aluminum surface a life

been installed temporarily in the telescope.

The telescope is in a mount that enables it to be pointed toward any part of the sky from the North Pole to the southern horizon. Intricate automatic control mechanisms turn the instrument so as to offset the rotation of the earth and keep the study object in view.

In other reflecting telescopes a small flat mirror is placed diagonally in the shaft above the main concave mirror so that the concentrated light from a star may be reflected to a suitable point for study. The Palomar instrument is so huge that for some purposes the observer himself will take the place of the diagonal mirror. He will sit in a cylindrical housing suspended in the open tube over the mirror. Various arrangements of mirrors also may be used for obtaining various focal lengths for special types of studies.

The 100-inch telescope on Mount Wilson, now the largest in use, has revealed star clusters at distances of half a billion light years away. A light year is nearly six tril-

(Continued to page 264)



## Transparent Plastic "Baby Poser" Holds Children for Photographs

Seats made of transparent plastic may solve the biggest problem of baby photography. The seat holds a squirming baby in an upright position without interfering with the natural movements of his body. The arms of the "poser" are spread apart to place the baby on a wooden seat.

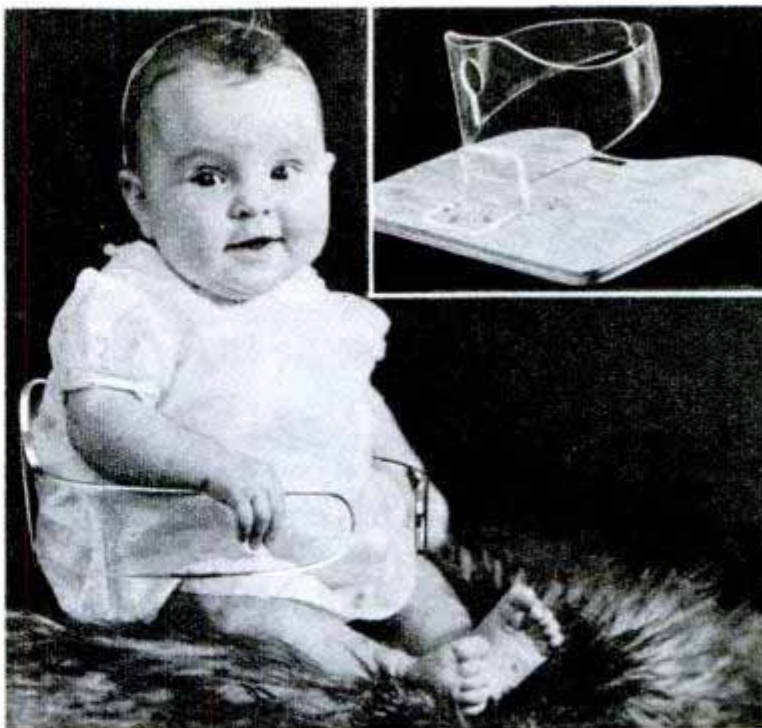

## Bubbles Trapped in Concrete Strengthen Pavement

Air bubbles are trapped in concrete to counteract chemical attack and to increase resistance to frost action. The air pockets are flexible enough to adjust themselves to the movement of grains in the concrete and they resist the chemical action of salts used for de-icing pavement. Pine resins, animal or vegetable fats and oils are added directly to the cement or introduced at the concrete mixer to produce the bubbles. Favorable tests of air-impregnated pavement have resulted in the use of similar concrete in buildings.

## Poker Rack Counts Stacks of Chips



Stacks of poker chips are counted and released instantly by an adjustable selector attached to a plastic case that holds 280 chips and two decks of cards. From one to 35 chips are dispensed by setting a dial and lifting a lever. A locking cover fits snugly over the case and keeps out dust.

Incandescent lamps convert only two or three percent of the electrical energy consumed into light rays, says the Better Vision Institute.

## Spool-Size Motor Used on Ships

Almost small enough to slip into a watch pocket, an electric motor  $1\frac{5}{8}$  inches in diameter and  $2\frac{5}{8}$  inches long is completely enclosed to resist corrosion caused by dampness, particularly salt water. In tests the motor has stood up under salt-water sprays for more than 200 hours, proving its usefulness in ships and planes for fans, blowers, vacuum pumps and control of radios and instruments. The motor can be "tailored" to operate from 2000 to 20,000 revolutions per minute on alternating or direct current or both, ranging from six to 230 volts.

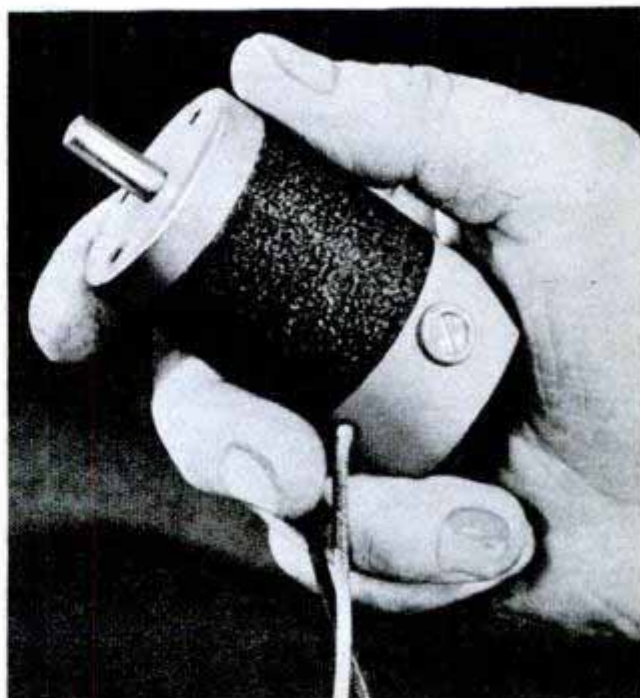





Without wings or an engine, a "trailer" glider now being tested can descend almost vertically, more slowly than a parachute. Towed aloft and released like a standard glider, it is eased to earth by two nine-foot horizontal revolving blades. The craft

## Glider Descends Vertically

weighs only 120 pounds but can carry an additional 300 pounds.

Known as a Gyro-Glider and developed by General Electric, it is expected to have commercial use for reaching isolated regions without adequate landing facilities for conventional aircraft.

## Radioactive Bar Removes Static Electricity From Photographic Prints

Static electricity is removed from photographic prints as they roll off the drum drier by a radioactive metal bar that prevents the prints from adhering to each other or

to the drum. The static eliminator consists of a shielded radioactive strip fastened at the discharge end of the drier where the static charge tends to increase. Alpha rays from the radioactive source ionize the air, which then acts as a conductor to remove the charges as they are generated. The unit, acting without a power source, has a permanent action directed toward the prints, so that radiation effects are negligible except at the point desired. It can be installed on standard automatic drum driers.

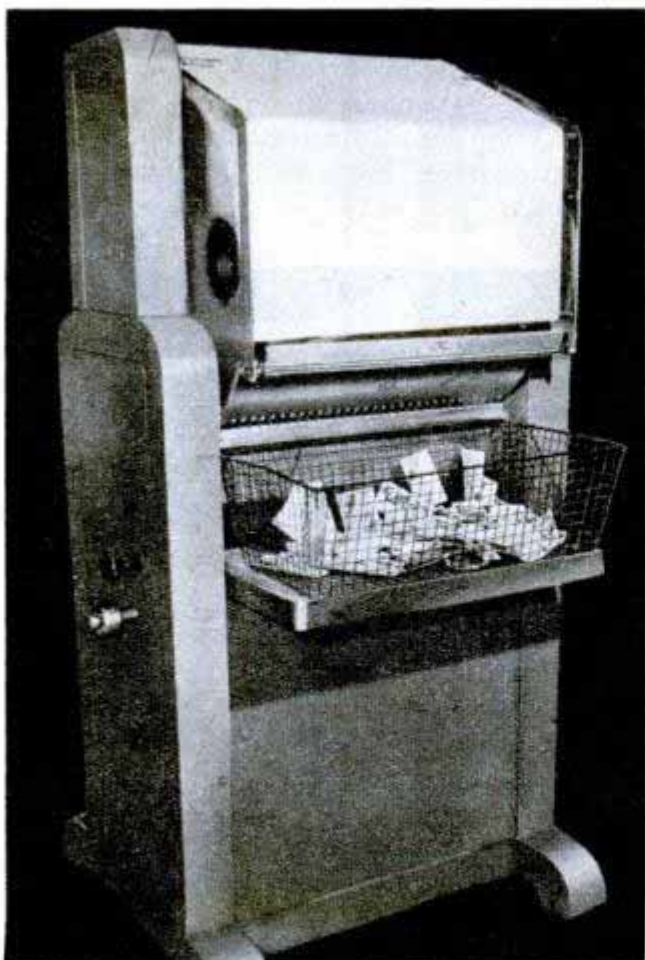

## Split Wave Transmits Two Messages

Two different transmissions, one a voice broadcast and the other a radiotype message, can be carried on the same wave length over a dual-purpose radio system invented by Walter S. Lemmon, president of the World Wide Broadcasting Foundation. In ordinary broadcasting the demands for wave lengths far exceed the number of bands available. The new system doubles the number of channels that can be used for transmission. A crystal on the short-wave transmitter "splits" the wave by changing very slightly the wave length of one of the messages. The two transmissions then travel together but are independent of one another. Receivers for the two messages can be together or far apart. A special electronic attachment in the receiver is tuned to pick up either transmission, eliminating the one not wanted.



## Campus "Village" of Steel and Aluminum Homes Set Up in 90 Days

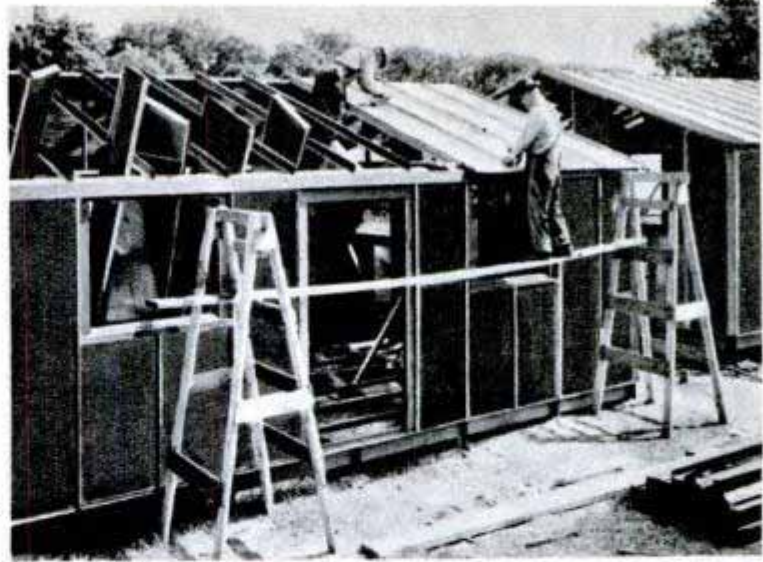

Steelcraft Manufacturing Co. photos

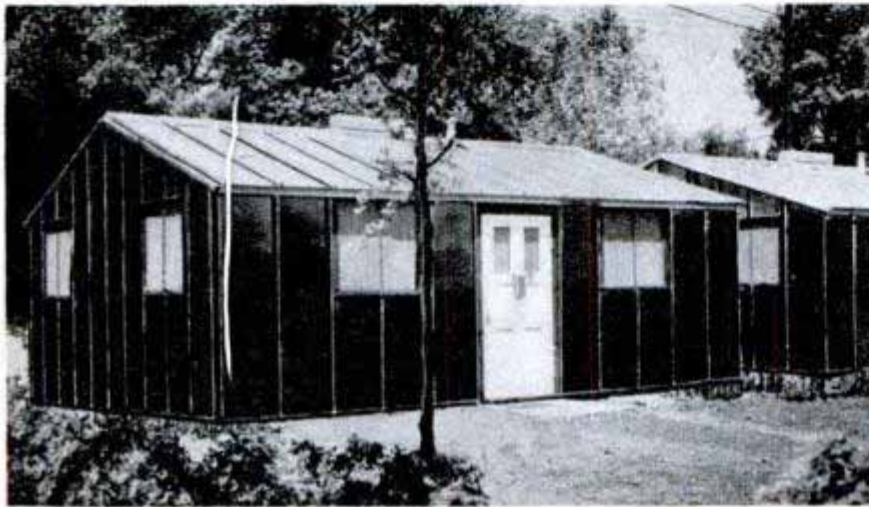

Spurred by the needs of student veterans with families, a "village" of 100 packaged steel and aluminum homes was set up on Northwestern University's campus in 90 days. Each home has two bedrooms, combined living and dining room, kitchenette and a shower stall in the bathroom. Normally unused overhead space was fashioned into convenient book shelves.

## Safety Dress for Coal Miners Guarantees Protection From Head to Toe

To insure the utmost in safety, the well-dressed coal miner and other underground workers wear equipment that guarantees head-to-toe protection. Attached to the crashproof helmet is a safety lamp. Spectacles are shatterproof. A featherweight dust mask prevents the inhaling of respiratory irritants. Coveralls are tied at the shoe tops and a self-rescuer is buckled on at the safety belt. Shoes are high-topped and hard-toed.

## Radioactive Gas From Bikini

Radioactive gas was detected in the atmosphere over Oklahoma three days after the second Bikini atomic bomb exploded, according to a recent report by five Tulsa scientists. An isotope of radon, a rare gas normally released by the disintegration of radium, was discovered in the air. Scientists throughout the world attempted to detect atmospheric changes caused by the bomb but results recorded in most locations were negative. A marked increase in gamma rays was reported at Houston, Texas, after the first bomb exploded at Bikini.

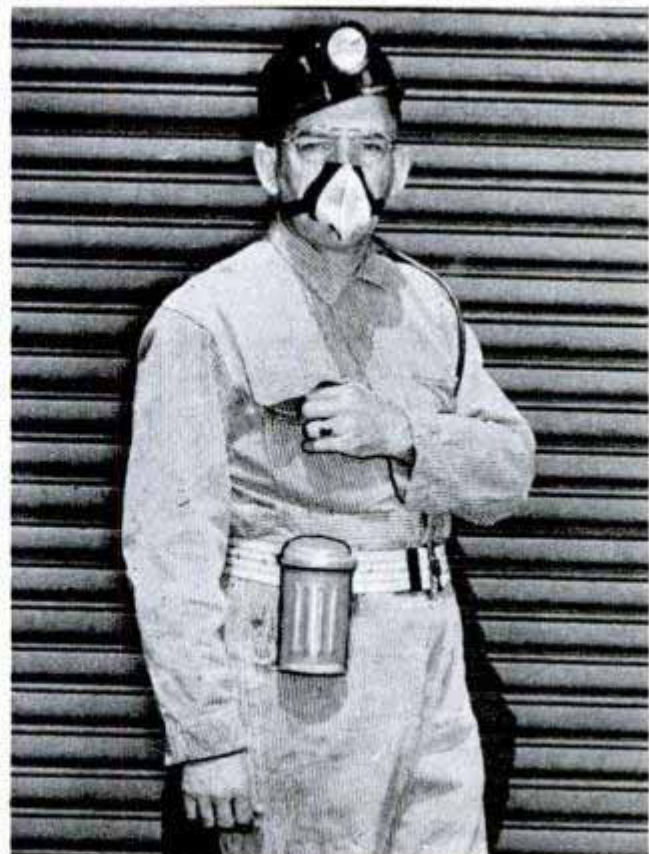



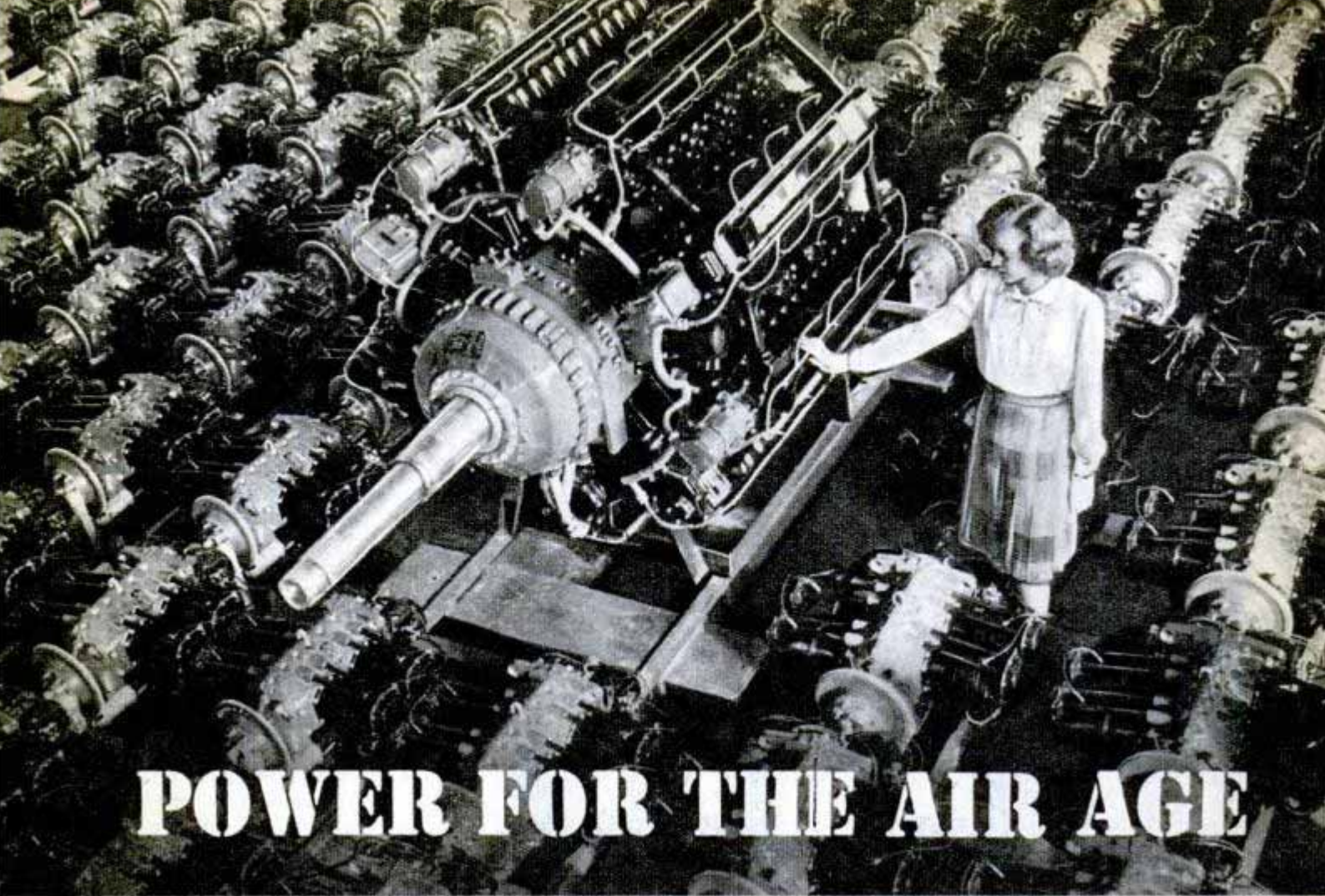

# POWER FOR THE AIR AGE

World's largest, the 5000-horsepower Lycoming above equals the combined might of the surrounding lightplane engines. It has 36 cylinders, weighs 6050 pounds and would use 580 gallons of gasoline hourly at full power

**R**ECENTLY, the director of one of the world's largest aeronautical laboratories was showing a visitor around the place. After roving over acres of test space, mainly devoted to jet research, they finally came to a conventional piston engine.

"We keep one of these around as a curiosity," the director explained.

Although he smiled when he said it, the remark is a tip-off to the thinking of air-

**By Aubrey O. Cookman, Jr.**

craft engineers who must stay five to ten years ahead of their time. Where the piston or reciprocating engine ruled the roost alone a few years ago, now there are rocket and Diesel engines, turbojets, ramjets, propjets, steam turbines and electric power to choose from. Even atomic energy is being vigorously explored as a possibility. And a group of French scientists hope to convert cosmic rays into propulsion forces.

Combining two new ideas, Britain's jet-propelled flying wing is the forerunner of a proposed 88-ton transport

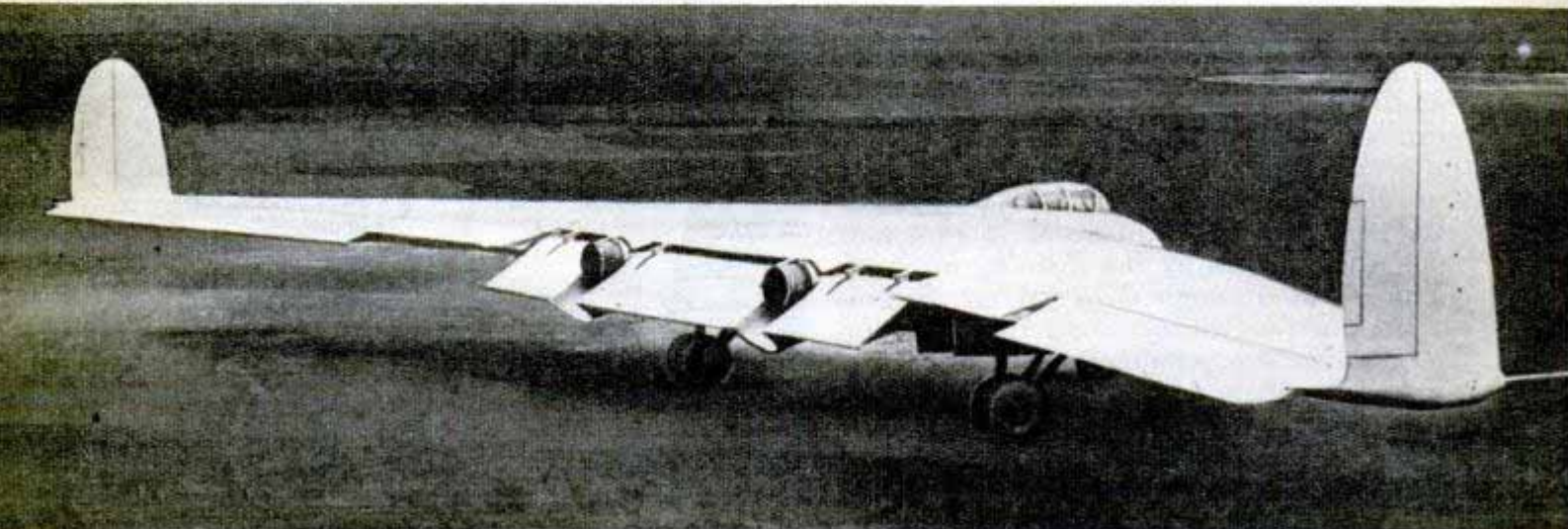





Rocket power's possibilities are being explored in the 600-mile-an-hour Tiamat. The National Advisory Committee for Aeronautics says it's the first guided missile actually to fly through predetermined maneuvers

Major conventional engine builders, alert to potential successors, have earmarked huge sums for research in these new fields.

For the first time in history the aircraft designer is attempting to catch up with the power plant designer. There already exist engines for which there are no suitable planes. Speeds have hurtled, within the memory of living men, from 12 miles an hour to more than 10 miles a minute. And speed is aviation's greatest advantage.

If you're impatiently waiting to fly in one of these new planes, though, let's remember that engineers are predicting it'll be 1949 or 1950 before they're in commercial operation. To design and build a plane with aerodynamic features tailored to a new kind of power will probably take at least two years, with another year to get it into service. As a realistic example, the U. S. had to rely during the war entirely on

planes designed before Pearl Harbor, and that was under the prodding of a national urgency program.

One of the biggest advances thus far has been experimentally modifying a heavy British bomber, the Lancaster, with two conventional engines inboard and two turbojet units outboard. Using only the jets, 30 minutes was pared from the best round-trip transport time between London and Paris. One way was flown in 49 minutes.

But this trial by no means indicates a readiness to meet the stiff schedule, safety and operating economy demands of the regular air lines. The British have also built the first jet-propelled flying wing aircraft.

Sketches by the noted British artist, G. H. Davis, of major European ramjet developments follow on the next two pages. This article [continues on page 138](#)

Keeping pace with power plants, two four-bladed contrarotating propellers (left below) provide speedy engines with a better "bite" into the thin upper air. Right, wind tunnel testing 13-foot blades for an air liner

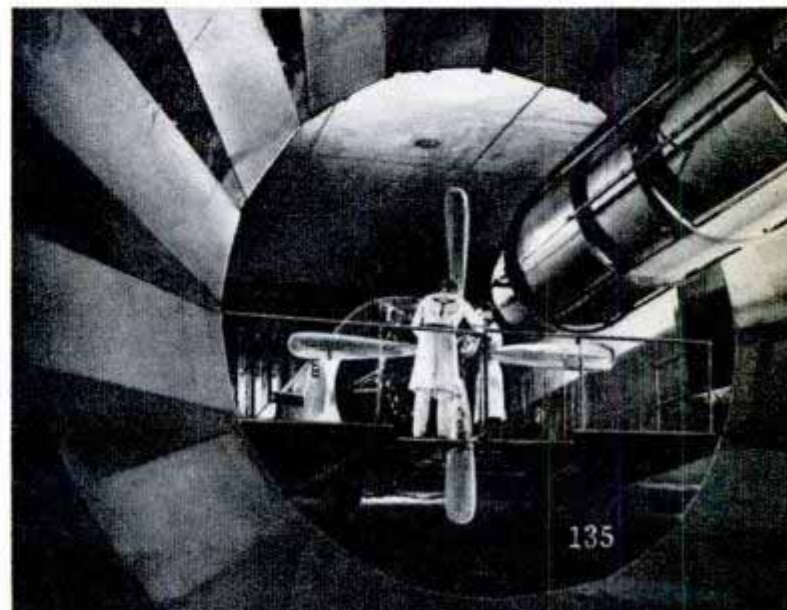
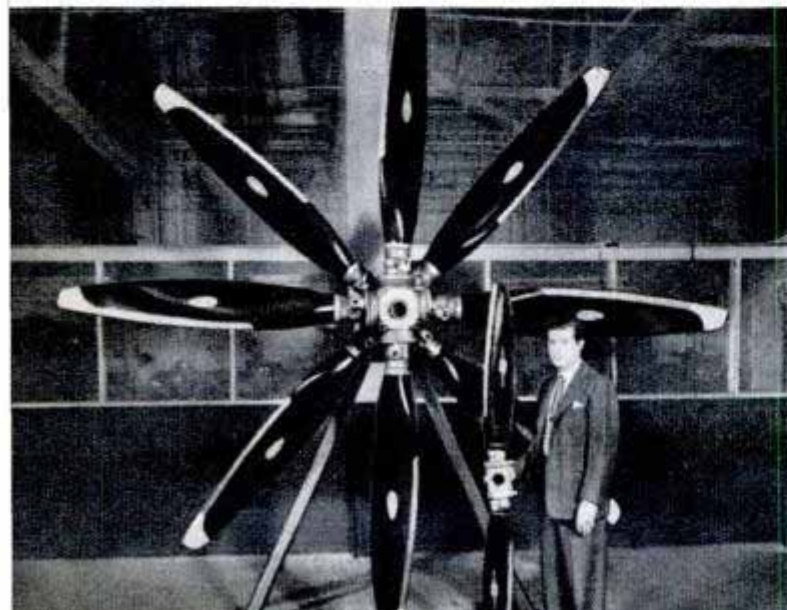



# THE RAMJET

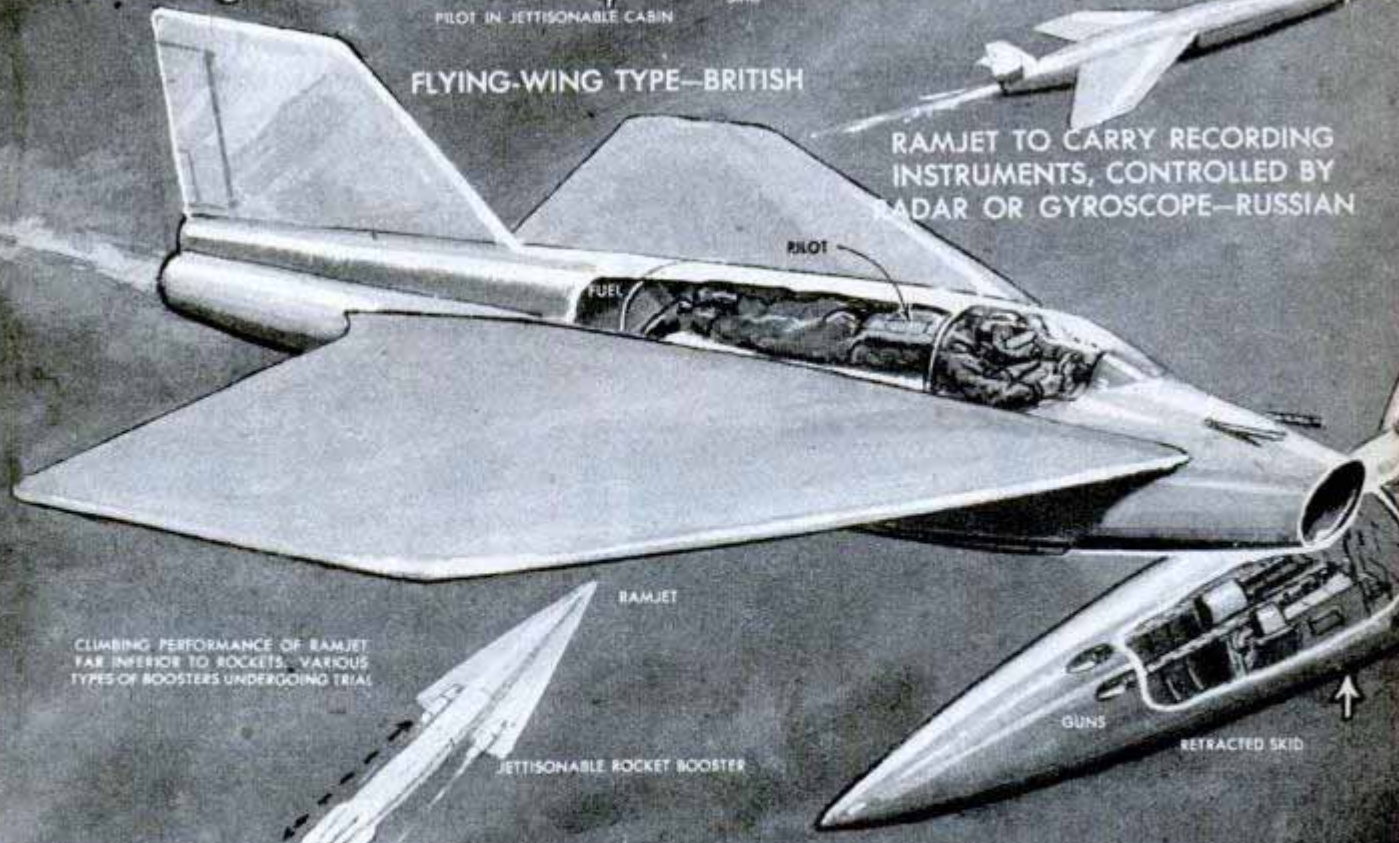
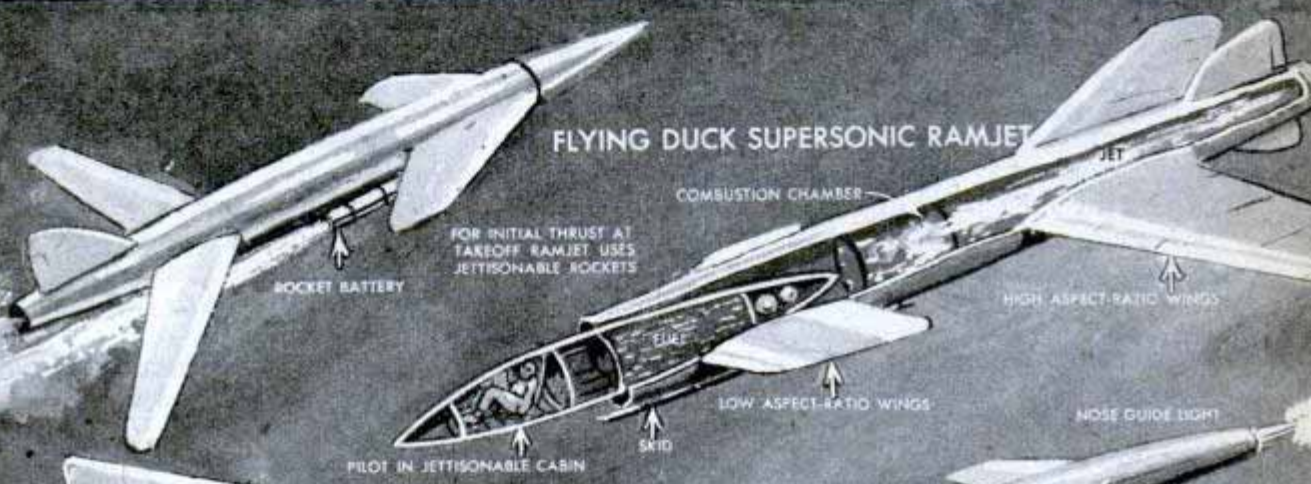
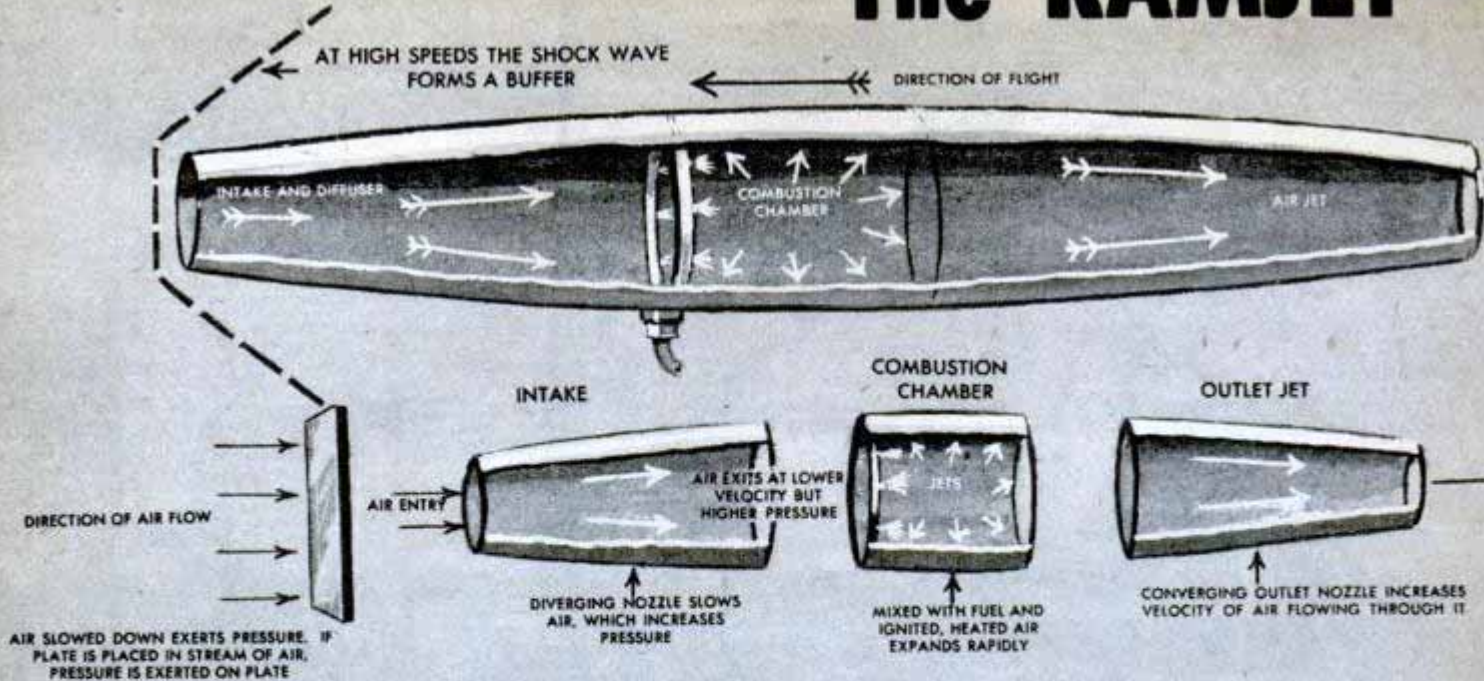



# Simplicity of Thrust Movers

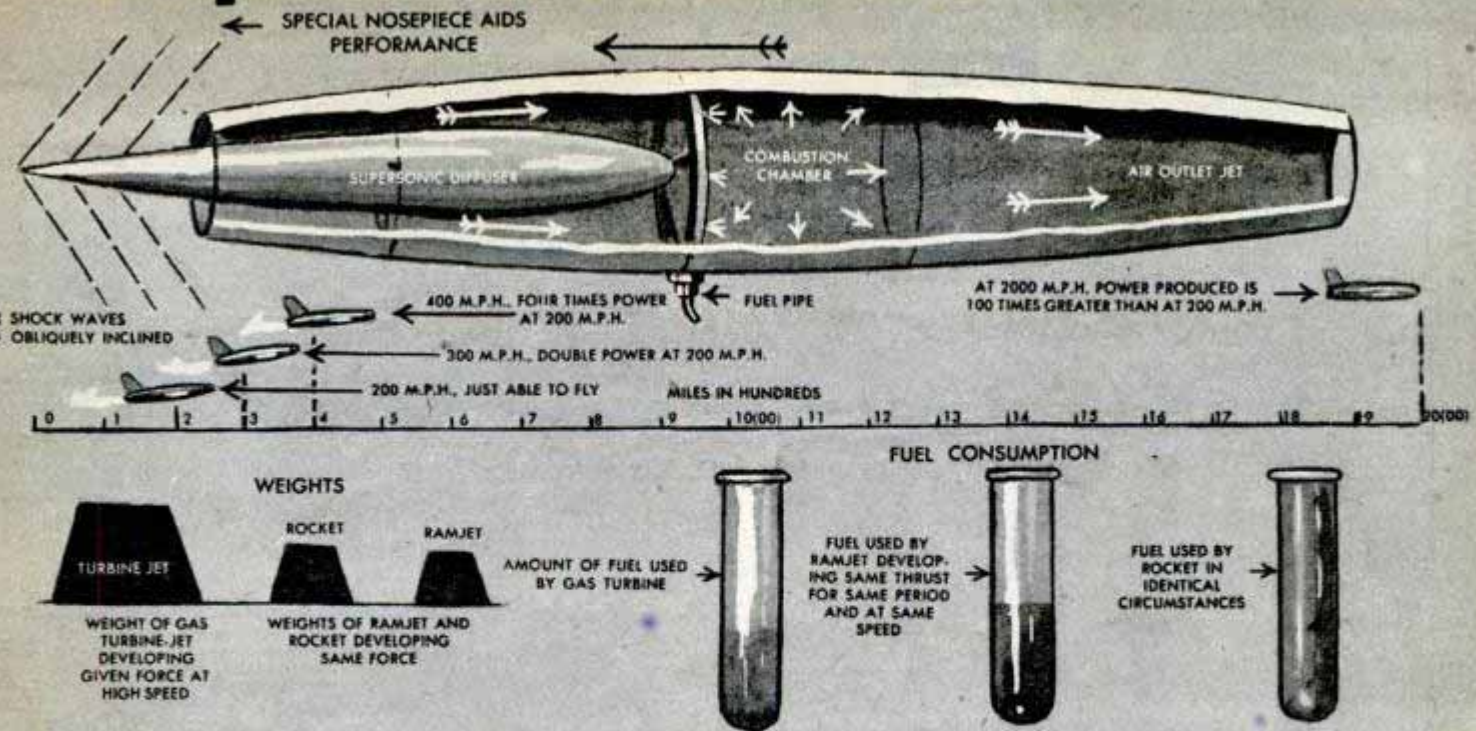

## SOME TYPES OF RAMJETS BEING DEVELOPED IN EUROPE

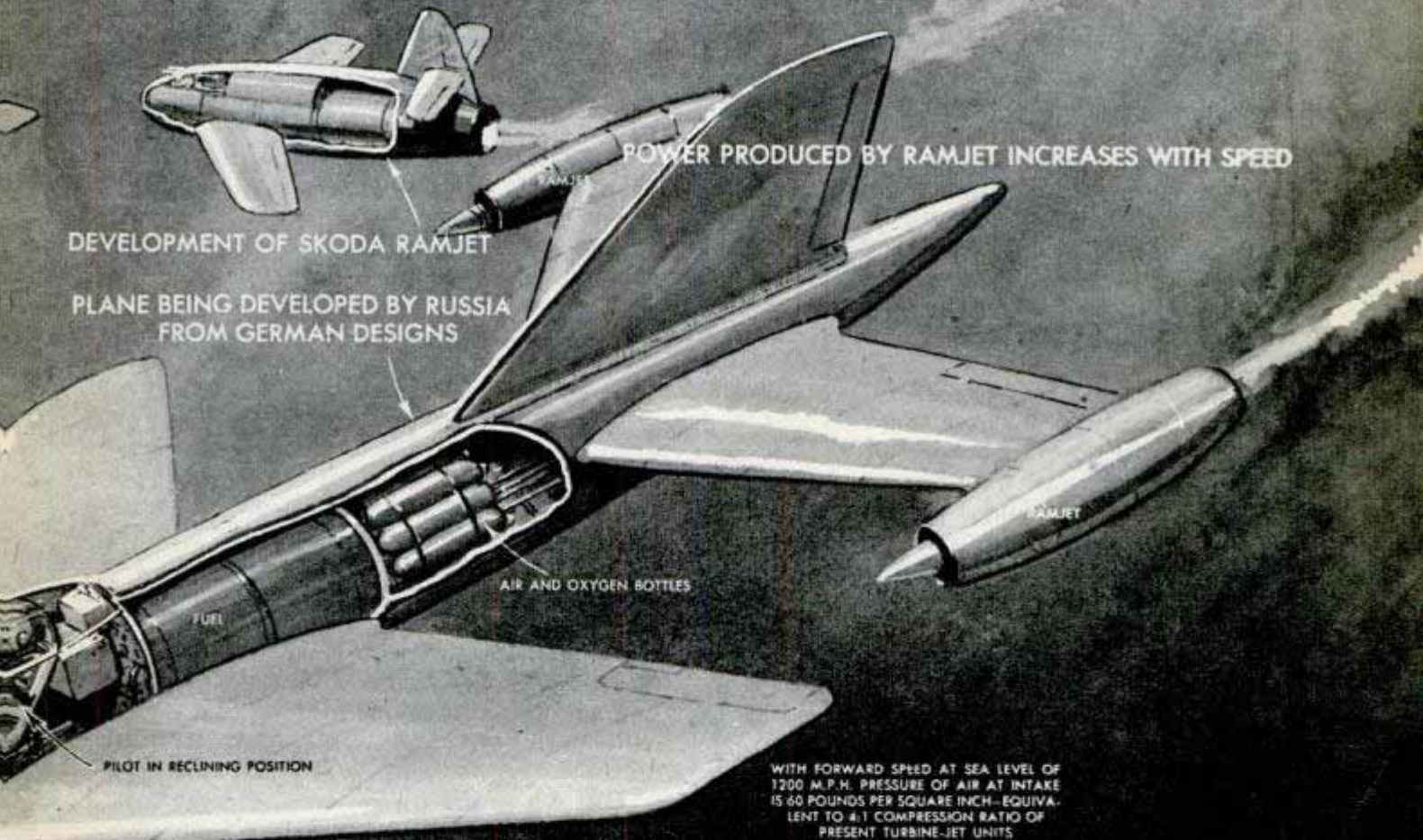

Russia, Britain and the United States have pushed well ahead in developing the ramjet as a possible man-carrying, or at least guided, missile. Known in Europe as athodyd (aero-thermo-dynamic-duct), it is simply a tube into which air is forced by the speed that the tube is driven through the atmosphere. This air is mixed with a fine spray of fuel and fired, issuing from the narrowed tail as a tremendously powerful jet. Unlike gas turbines, in which a compressor raises the pressure of air supplied to the combustion chamber, the ramjet relies on its own speed for this and has no moving parts. Its chief drawbacks at present are excessive fuel consumption, the need for supplementary launching power and a mediocre rate of climb. Now rockets are being used for launchers and as a booster until the ramjet first begins operating at a speed of at least 200 m.p.h. From there on to supersonic speeds its efficiency increases sharply, limited only by combustion factors



ROCKET

XS-1

2000 M.P.H.?



RAMJET

RAMJET

1500 M.P.H.

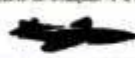

TURBOJET



P-84

OVER 600 M.P.H.

TURBOJET+PROP.



P-81

500 M.P.H.

PISTON



P-82

400-500 M.P.H.

the AW-52, and put it through test paces. Weighing 14½ tons, it represents five years' intensive work by designers and engineers.

Another test arousing comment has been the Army Air Forces' flights with a rocket-powered fighter, the XS-1, "held down" initially to speeds around 550 miles an hour. This, too, has been conducted under selected, laboratorylike circumstances, rather than normal conditions. Our knowledge of the plane's supersonic capabilities is still painfully limited.

The most popular prediction is that each of the major power plant forms—piston engine, turbine driving a propeller, and turbine-jet—may dominate an exclusive field, with the more versatile turbine-prop combination overlapping the other two.

At altitudes around 25,000 feet and speeds bordering 300 miles an hour, the conventional piston engine may continue as the most efficient form; above that, up to 500 miles an hour and approximately 45,000 feet, the turbine-prop is likely to be the choice; and exceeding that in speed and altitude the propellerless jets are conceded to be the probable answer.

A British authority, speaking of all aircraft, estimated that the piston engine will remain the leader for five years, the various forms of turbine power would be predominant during the following five-year span, and the third period might see the practical end of the piston engine. Military leaders, placing the premium on speed, are already

overwhelmingly committed to jet programs in the fighter class.

Let's take a look at the various power plant forms and what they have to offer.

Foremost since the Wrights' pioneering flights, the highly dependable piston engine has developed to an astonishing efficiency. Within a quarter of a century it boomed from 200 horsepower to the 36-cylinder 5000-horsepower giant recently unveiled by Lycoming and the AAF.

Engine weight per horsepower dropped from 5½ pounds to less than a pound, useful loads went from one ton to well over 30 tons, and speeds rose from 150 to 500 miles. Range has stretched from a few hundred to more than 11,000 miles.

Engineering changes went on constantly. For example, the new 5000-horsepower engine has a two-speed gear as one of its most distinctive features. "Low" is used for take-offs, climb and landings, and "high," consuming an estimated eighth as much gasoline, for cruising.

But while the piston engine grew into a complicated and more perfect instrument with some 50,000 parts, propeller efficiency dropped sharply as speeds moved towards 400 and 500 miles an hour. Even with the development of fuel and water injection, cooling fans, extension shafts, superchargers that permit engines to "breathe" and function efficiently at extreme altitudes, and many other devices to boost power utilization, the piston engine has apparent-



ly hit a ceiling at approximately 500 miles an hour.

This all happened while equally remarkable advances were being made in propellers. From stubby, crude wooden models we've progressed to hollow steel electric propellers 19 feet in diameter, with blade angle controlled in flight to meet varying flight conditions. They can be electrically de-iced either internally or externally.

Another improvement was dual rotation, where a pair of three or more bladed propellers, contrarotating, supply the increased airfoil surface needed in high, thin air. Two manufacturers have gone on to experiment with eight-bladed dual rotation spinners. A comparatively new feature, reverse thrust, cuts long landing runs and allows even heavy transports to "back" into ramp positions.

Within the piston field are two camps, air-cooled and liquid-cooled, each claiming superlative performance. One of the believers in liquid cooling broadly explains their essential differences this way: "The liquid-cooled engine, properly installed, has a circulating system like the constant-temperature blood circulation of birds and warm-blooded animals. The air-cooled engine is much more akin to insects, which lack a circulating system. The much greater capacity of birds and warm-blooded animals to withstand wide variations of climate is well known."

Air-cooled engines have been far more popular in American planes, especially transports and bombers, with Pratt & Whitney and Curtiss-Wright the acknowledged leaders. The liquid-cooled school, however, scored a notable triumph when an Allison-engined P-39 won the grueling 1946 Thompson Trophy Race, premiere U. S. speed course event.

Foremost challenger of complete piston supremacy is jet propulsion. Though the principle was illustrated by Hero of Alexandria in 130 B. C., it wasn't until 1940 that an Italian made the first jet-powered flight. Most credit for pioneer development, however, properly belongs to Britain's Air Commodore Frank F. Whittle. His original patent was granted in 1930.

One of jet's outstanding virtues

(Continued to page 268)

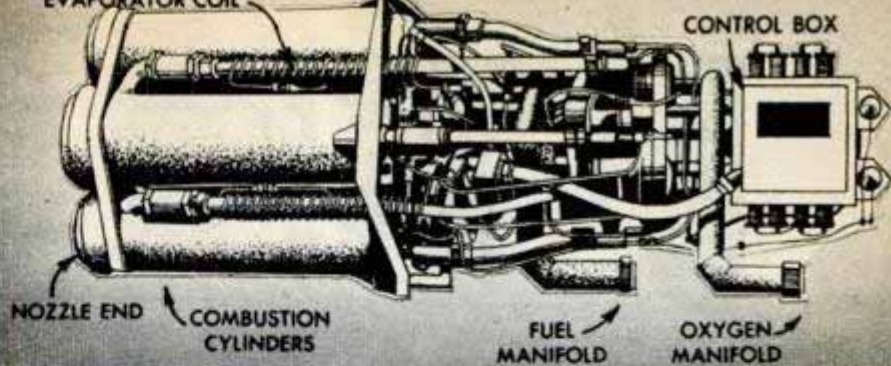

RAMJET

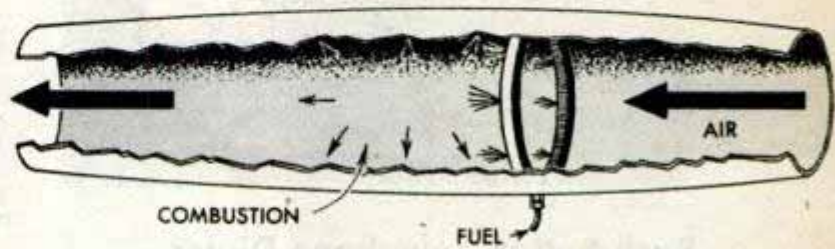

TURBOJET

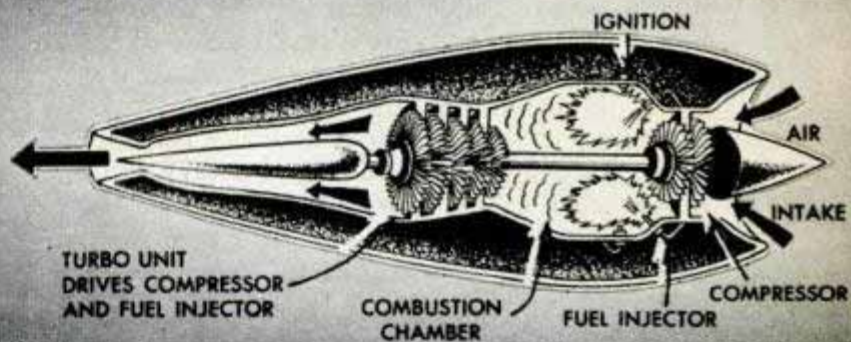

TURBOJET + PROP

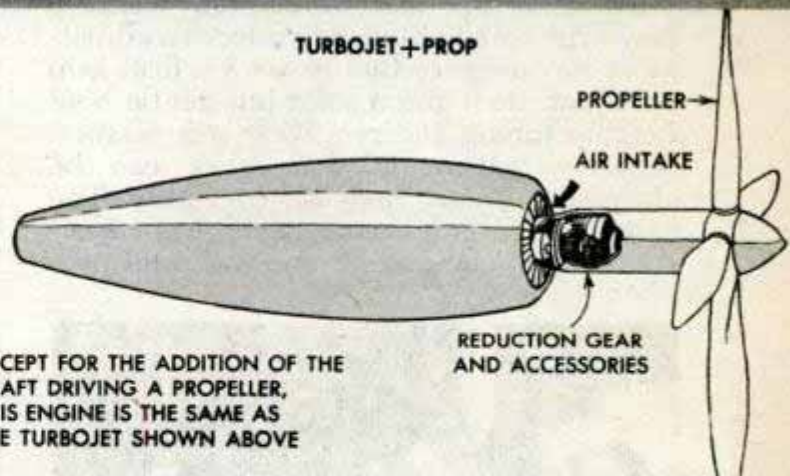

EXCEPT FOR THE ADDITION OF THE SHAFT DRIVING A PROPELLER, THIS ENGINE IS THE SAME AS THE TURBOJET SHOWN ABOVE



PISTON ENGINE

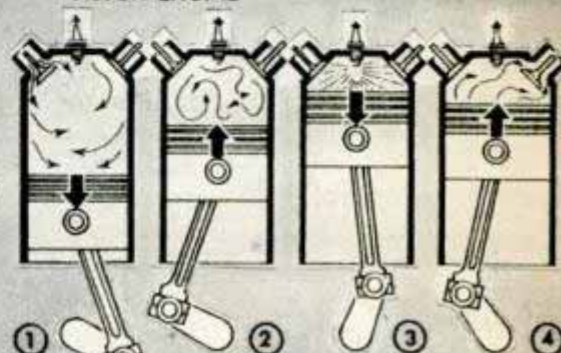





### Push-Button Telephone Dialer Calls 50 Numbers

Telephone numbers are dialed with one push of a button on an automatic dialing box designed for the busy executive or businessman. Selection of any of 50 numbers is made by moving a small blade along the top of the box until a pointer indicates the name of the person to be called. Pushing a button at the bottom causes a number to be dialed automatically by a rotary shaft fitted with tooth disks hidden inside the box. The device does not interfere with finger dialing other numbers.

### Tool Grips Steel or Soft Plastic

Designed for fast production work, a new-type collet chuck has selective adjustment for pressure that assures a firm grip for tough steel and a solid but gentle hold for thin tubing and relatively soft plastics. Another feature is that work can be changed without stopping the lathe. The collet, which is lever-operated, has capacity for diameters up to one inch and pro-

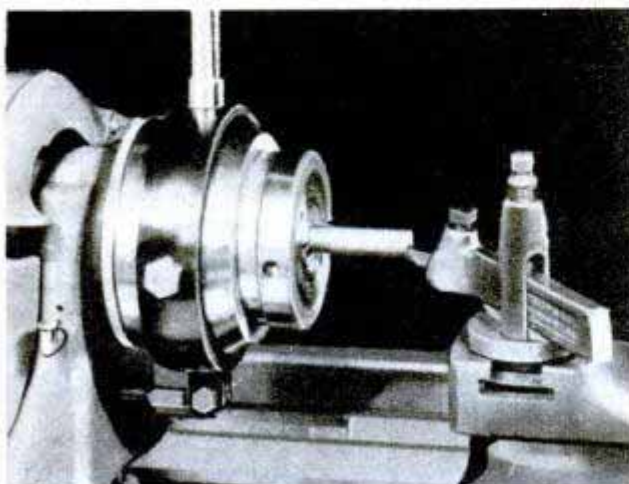

vides a steady hold through its full length to compensate for any irregularities in the material being machined.

### Insert Cylinder Sleeve in 30 Seconds

Without removing the engine, cylinder sleeves can be inserted in an automobile engine in 30 seconds with a new type of tool. Assuring perfect alignment, the tool makes it impossible to drive the new sleeve in crooked. The tool is precision ground to exact size and fits over the sleeve so that

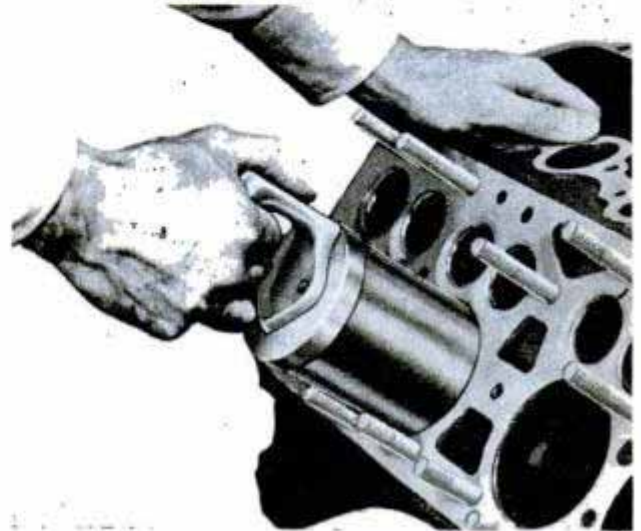

the sleeve will not collapse or otherwise become damaged during insertion. The weight of the device drives the sleeve in.

### Ice Mask Protects Actors' Makeup

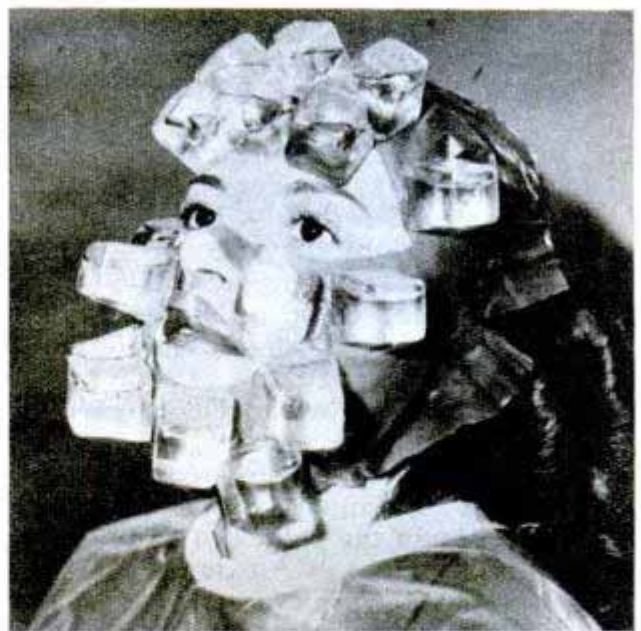

Five-minute applications of an ice mask prevent perspiration from spoiling makeup on faces of stage and screen actors performing under hot lights. The mask, consisting of plastic covered ice cubes to avoid dripping, is applied just before the actor is to appear under the lights.



## Plane With Folding Wings Can Be Towed Like a Glider

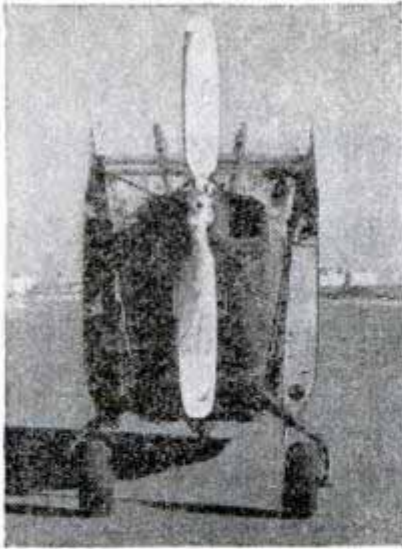

Exceptionally large wing area enables the Army Air Forces' first all-metal liaison plane to take off or land within 230 feet and be towed in the air like a glider without removing the propeller. The wings fold back and the landing gear is adjustable, with a 92-inch tread for takeoff and landing and 61 inches for ground hauling and towing. Built by Consolidated-Vultee and designated L-13 by the AAF, it is 31 feet nine inches long, eight feet five inches high and spans nearly 40½ feet. Its empty weight is just under a ton and its useful load about a half ton. Cruising speed is 92 miles an

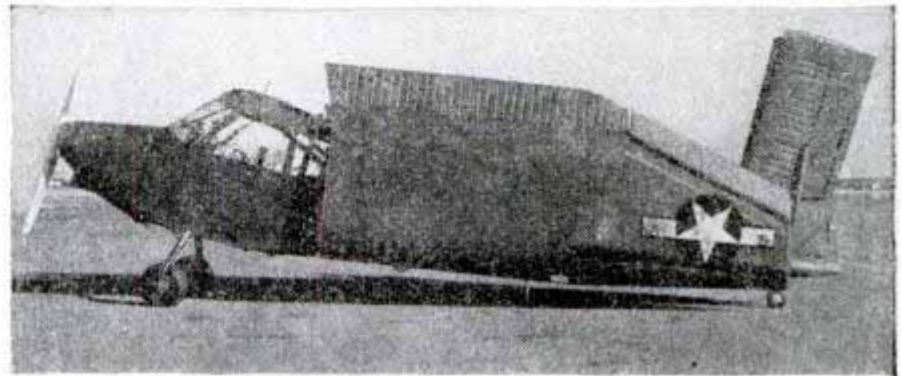

hour, range 368 miles and lowest landing speed slightly above 43 miles an hour. Although normally intended for three persons, it can accommodate six. The right-hand controls are removable to convert the plane into an ambulance for two patients besides the pilot and an attendant.

## Helicopter Movie of Horse Race Helps Check Final Results

Racing equipment at the Salem, N. H., track includes a helicopter that carries the steward of the race and a motion picture cameraman to register the results on film. The helicopter hovers above the horses as

they circle the track, which gives the flying steward an excellent view of the entire race and any fouls that might be committed. Race results and disputed fouls can be checked with the movie film.

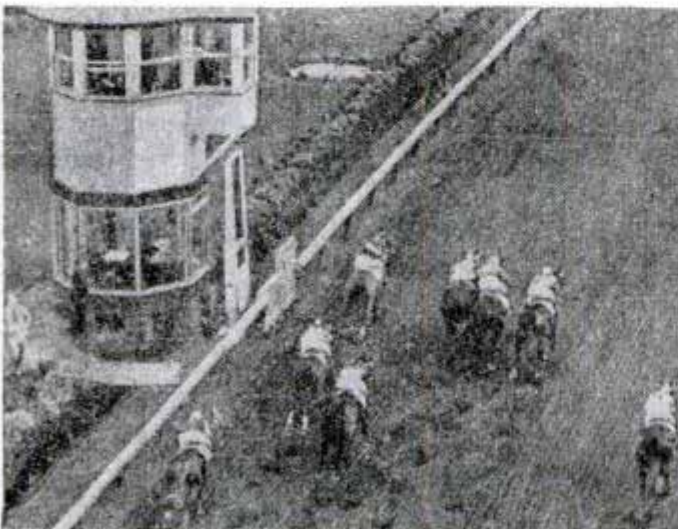



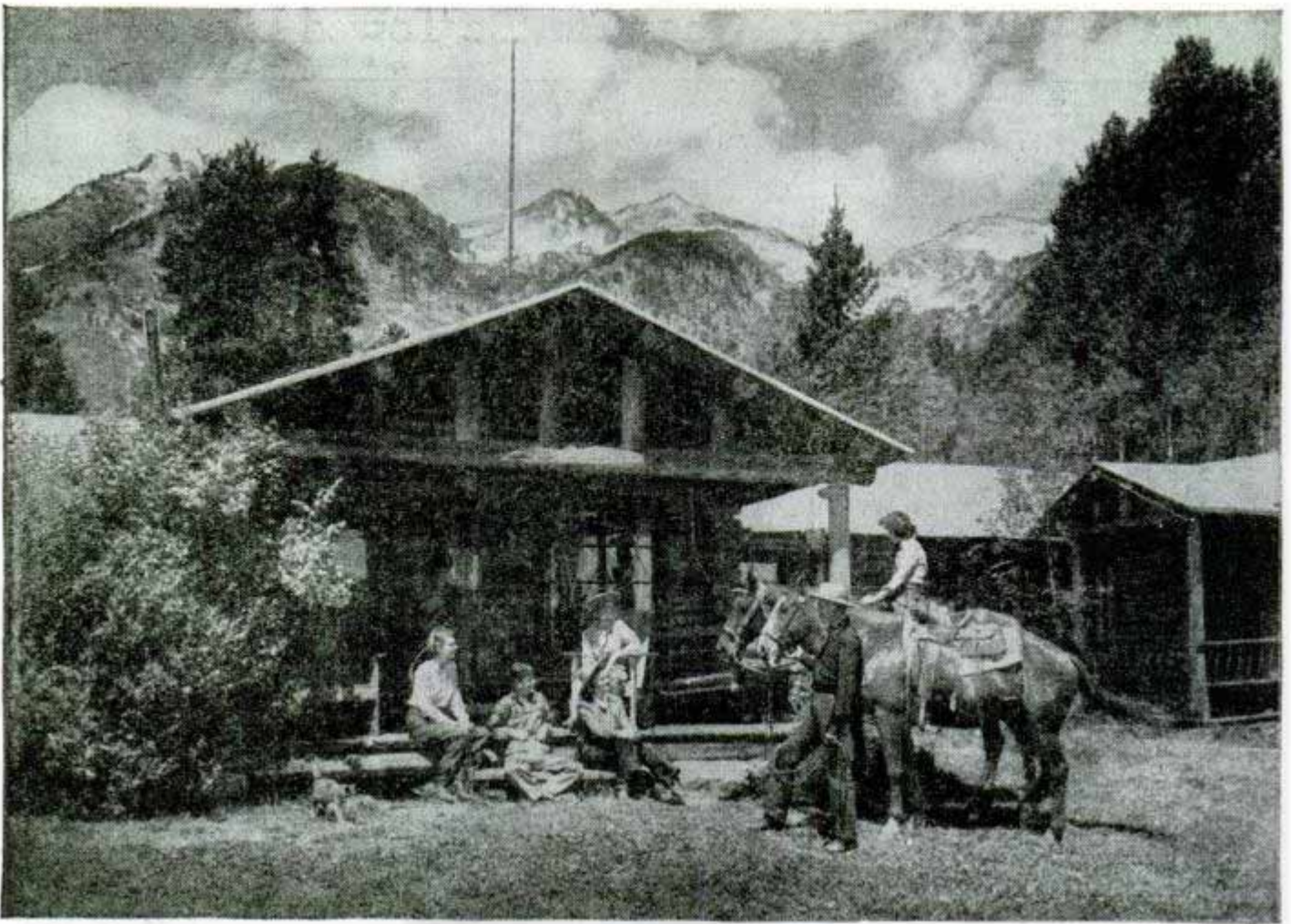

Scenery and horses are the lures at all dude ranches. Below, a dude's first riding lesson is in saddle cinched to a corral fence

## BIG BUSINESS IN DUDES



**D**EEP in their hearts tens of thousands of people hanker for the old days of the West when a man could fork a horse and ride all day long without seeing a fence.

The fact is, the coyotes still howl in the western hills and, if you wish to try it, there are dude ranches where it's still possible to get up before dawn, saddle a horse and spend the day with cowhands poking through the brush for stray stock. You can eat beans at the chuck wagon and spend the night in a blanket roll. With a pack animal carrying food, you can avoid civilization for weeks while following old trails, dry panning for gold in lonely gulches and fishing untouched streams. Or, if all that is too active, you can stick close to ranch headquarters and do nothing more exhausting than watch the neighborhood rodeos.





There are hundreds of western cattle ranches that raise beef and, on the side, take in paying guests. You can help with the chores, ride the range as soon as you get toughened to a saddle, or drift off into the hills on exploration trips. Within reason you may do as you please.

Cattle ranching hasn't changed much with the years. The ranch owner today may have a landing strip adjacent to headquarters and he may truck cattle to the shipping point but the horse is still primary transportation on the ranch itself. He still brands calves and holds roundups just as in the past.

Dude ranches range all the way from bona fide cattle ranches that accept a few vacationists at a time to the guest ranches whose chief business is providing entertainment. Accommodations



Stay with 'im, boy! Bronc riding's not for dudes but they see lots of it at ranch rodeos. New to West are aluminum spurs and bits and Nylon lariats, lower left. Photo at right compares western saddle (left) with eastern

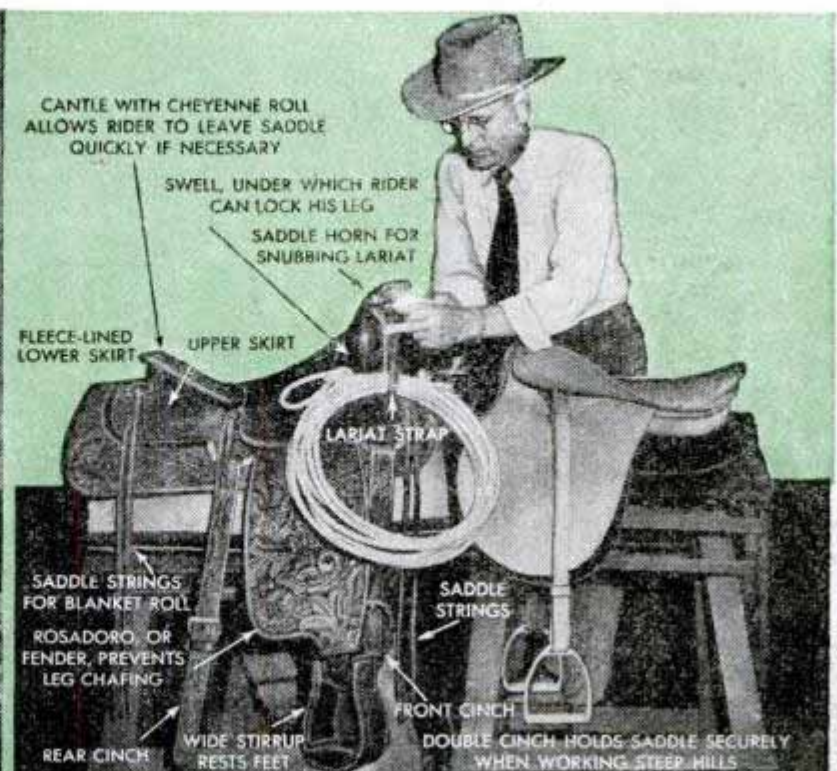



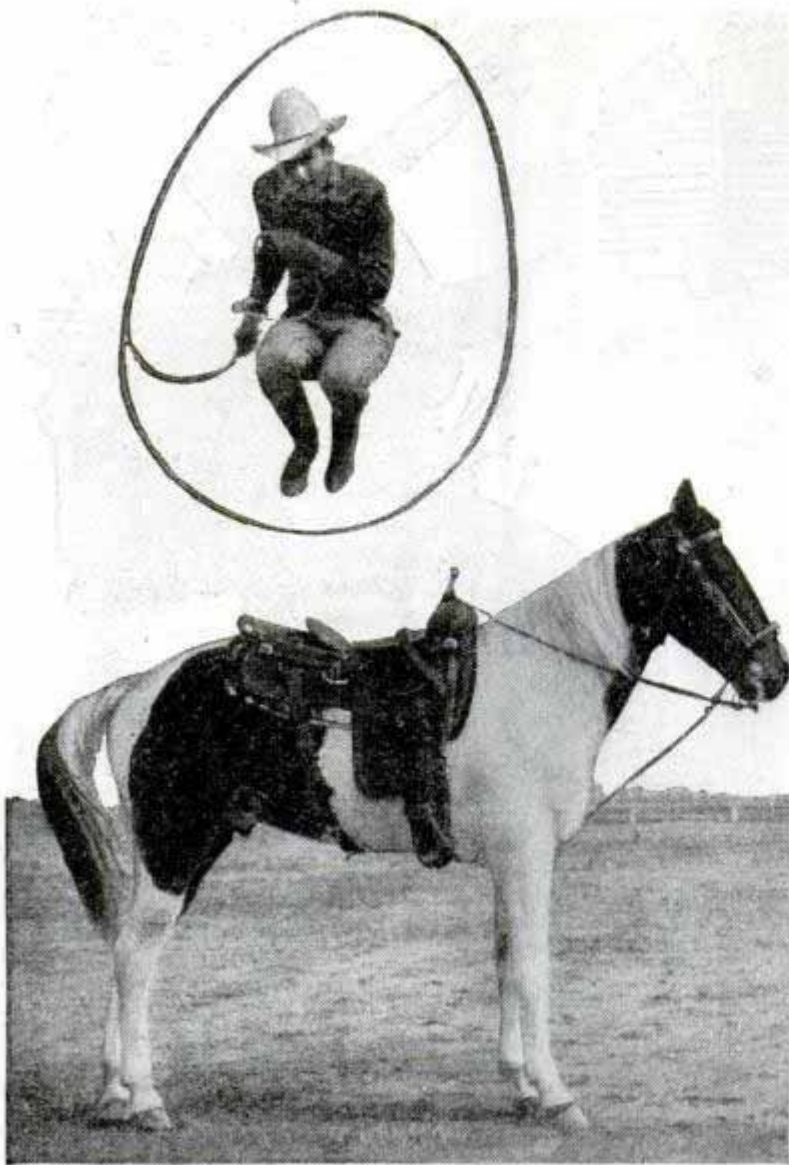

Rodeo star Monty Montana skips through lariat atop trained horse

The chuck wagon brings chow to steak fry (left). At right, dudes watch calf-roping contest at an Arizona rodeo

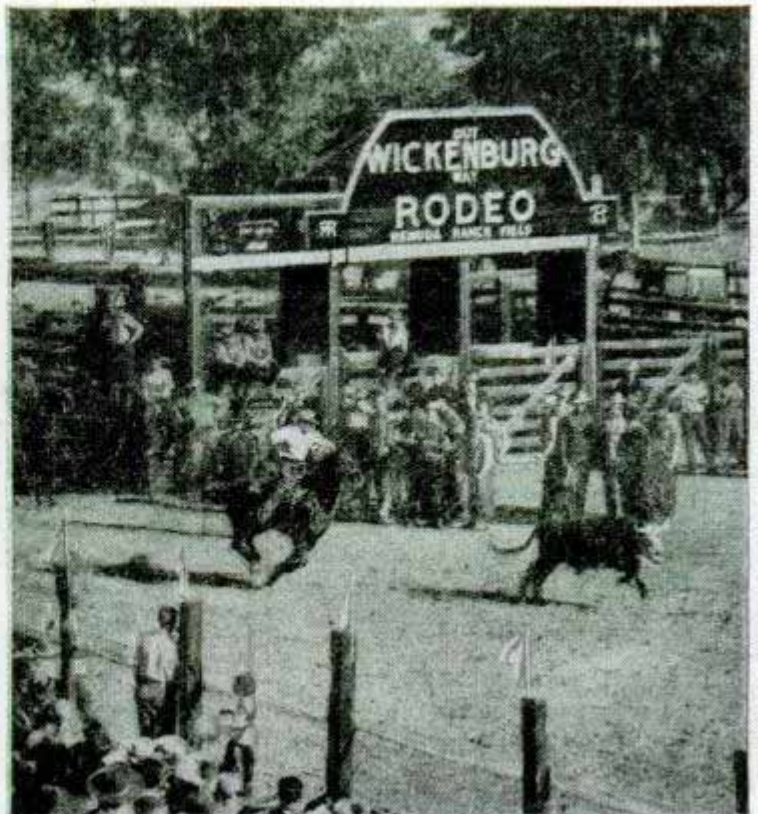

are more luxurious at guest ranches and include facilities for such sports as swimming, tennis and badminton. Rates range from \$5 to \$50 per day, board and horses included.

Dude ranching started back in the last century when a few easterners talked some cattlemen into allowing them to make extended visits as paying guests. These dudes sometimes helped in ranch work and were a source of extra income.

When the visitors went back home they told stories of long days in the saddle, of brushes with wild animals, and hinted at glamorous parts played in capturing bands of rustlers. Soon more and more people wanted to share such experiences. The demand became so steady that a number of cow outfits built guest houses and announced that they were ready to accept boarders. The dudes came back year after year. Some of them stayed on and helped to build up the country. During bad years the extra income from vacationists was all that kept some ranches from going broke.

Today you will find dude ranches of every description in scenic parts of the West. Reno and Las Vegas are mailing ad-



dresses for dozens. They abound on both sides of the Rockies in Colorado; they are scattered through Utah and Idaho, and there are dozens more in the coastal states.

The dudes pack up and leave the central and northern ranching states by the time autumn begins. That's when the southern ranches, from Fort Worth to Palm Springs, open. Dry, sparkling days and blue skies characterize the southwestern winter and the season extends from November until April.

By Thanksgiving time the ranches around Phoenix and Wickenburg are filled. The more than 50 ranches within a 100-mile radius of Tucson become active. Horseback parties spend long days in the saddle exploring the dry desert plains and hills or riding through the timber of the higher ranges. The region is hot in summer but has perfect vacation weather in winter.

You can even go dude ranching in New York state, in many



Phoenix Chamber of Commerce photo

**Class of eastern girl dudes gets lessons in the art of throwing a lariat loop. The target for their efforts is a stuffed calf**

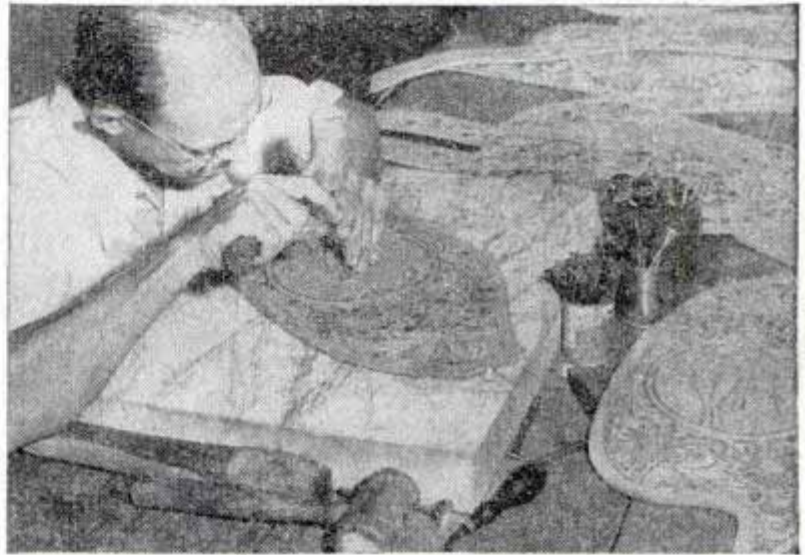

**Hand-tooling leather for fancy saddles is an art of skilled craftsman. Flag will drop the instant cowboy, below, ties calf in roping contest at Tucson's Fiesta de los Vaqueros**

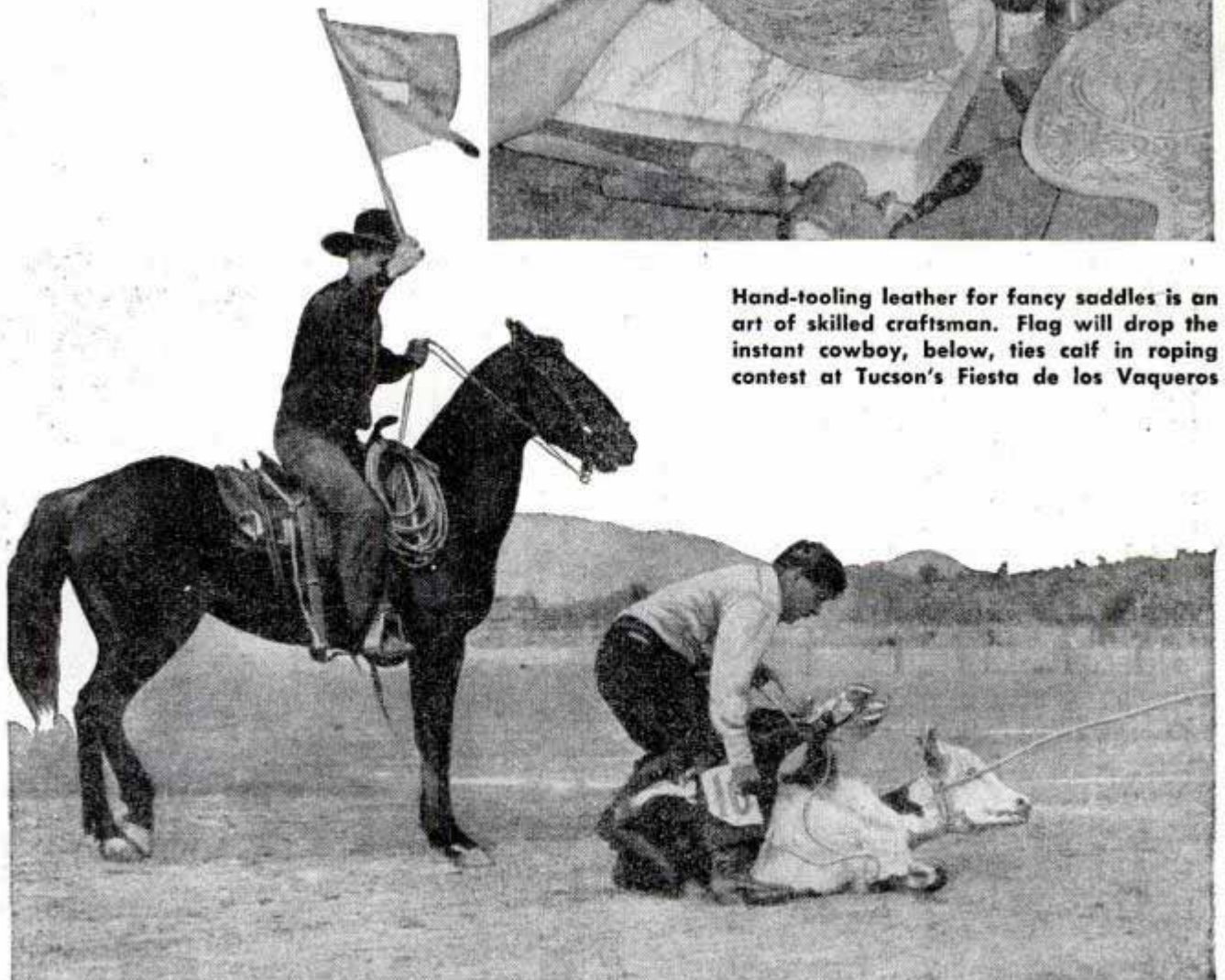



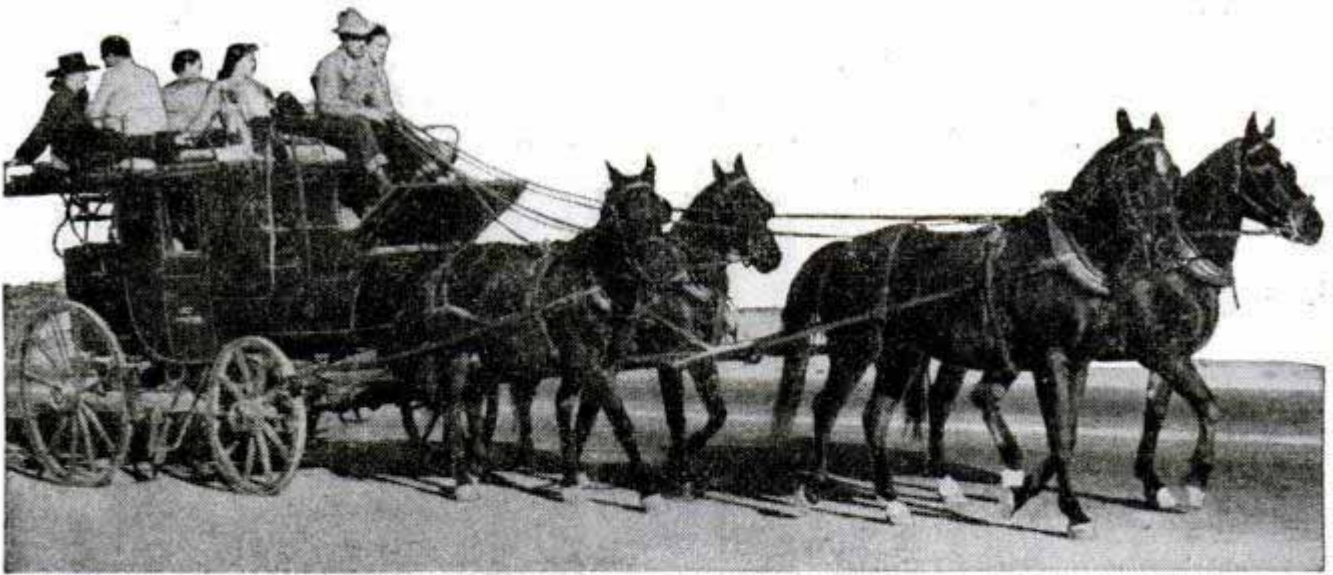

**Old stage coach, above, hauls dudes at Las Vegas. Desert cools quickly at night and a campfire warms moonlight riding party**

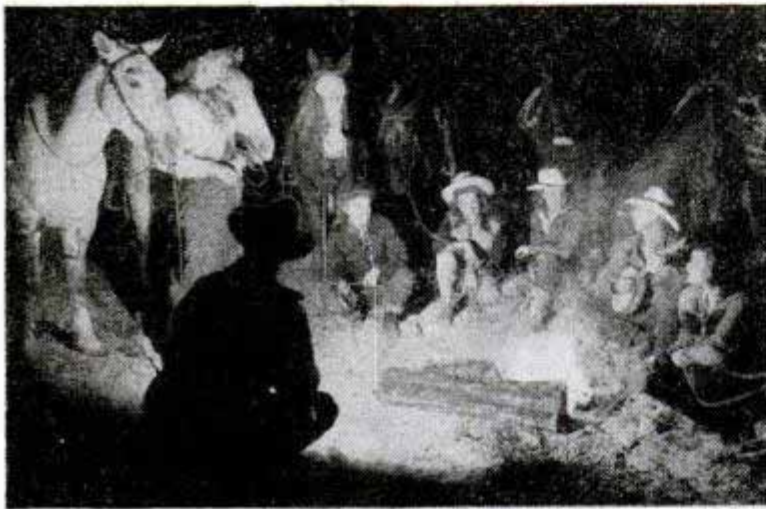

**The automobile hasn't replaced the horse on dude ranches but bulldogging steers from a running board thrills the visitors**

*Phoenix Chamber of Commerce photo*

parts of New England and down the seaboard to the Carolinas these days. Many resorts have added western atmosphere by building corrals and acquiring riding stock, western saddles and hired hands who know how to wrangle dudes. Trail riding on good horses is the chief sport at all of them.

Dudes and westerners alike dress up in fancy togs on holidays. Western boots, 10-gallon hats, gaudy colored shirts and tight frontier pants are typical. Rough and ready clothes are best for ordinary ranch life. An old wide-brimmed hat, cotton shirt and a pair of the blue pants known as levis make a good outfit. Leather jackets are comfortable after dark in most parts of the West all summer long.

(Continued to page 256)





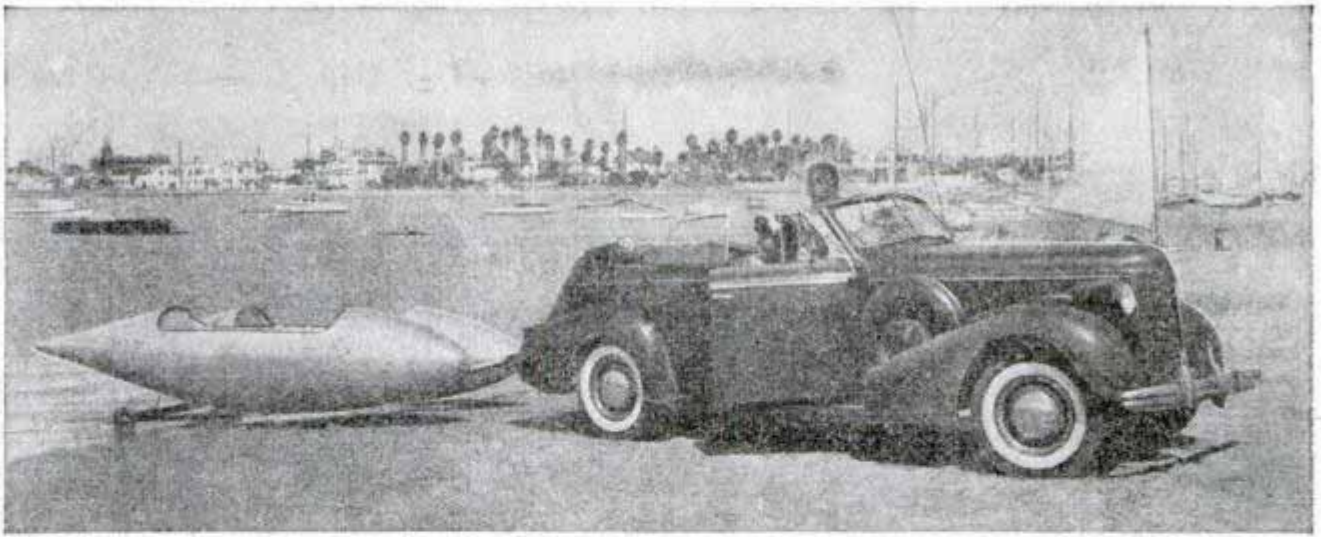

## Gas Tanks Are Hulls For Speedy Boat

Surplus plywood auxiliary gasoline tanks for light bombers serve as twin hulls for a speedy outboard catamaran built by Alvin D. Bloom, 22-year-old ex-Marine, at Long Beach, Calif. Weighing only 280 pounds (plus 30 pounds for the outboard motor), the 14-foot craft skims across the water at speeds up to 20 miles per hour. The catamaran rig is adaptable to center-board and sail. Bloom hauls his boat on a trailer dolly which is made of steel tubing and weighs only 60 pounds. The 310-gallon tanks from which the boat was made are said to have cost \$460 each during the war, but are now available at a much lower figure.



## One Tool Does Nine Jobs to Aid Modelmaker in Precision Work

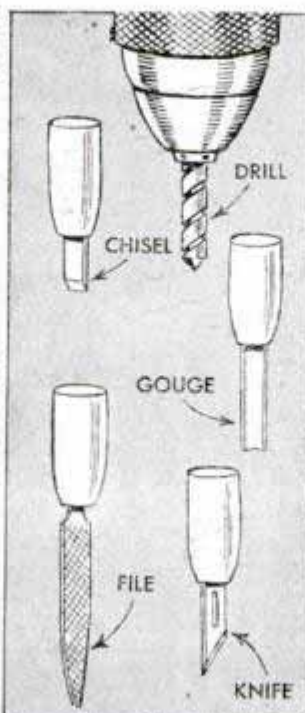

Interchangeable accessories on a tool for modelmakers perform nine different cutting jobs. By fitting different tools to the chuck the craftsman can notch, cut V-shapes, punch holes, chisel, drill, carve, file, saw or cut razor-thin.

## More Frozen Food Lockers

There are now 8025 frozen food locker plants in the United States, 1561 more than a year ago, according to a survey conducted by the U. S. Department of Agriculture. The 8025 plants contain about 3,250,000 individual lockers and provide storage for approximately 1,250,000,000 pounds for about 2,500,000 families. Nearly three fourths of the locker patrons are farmers.



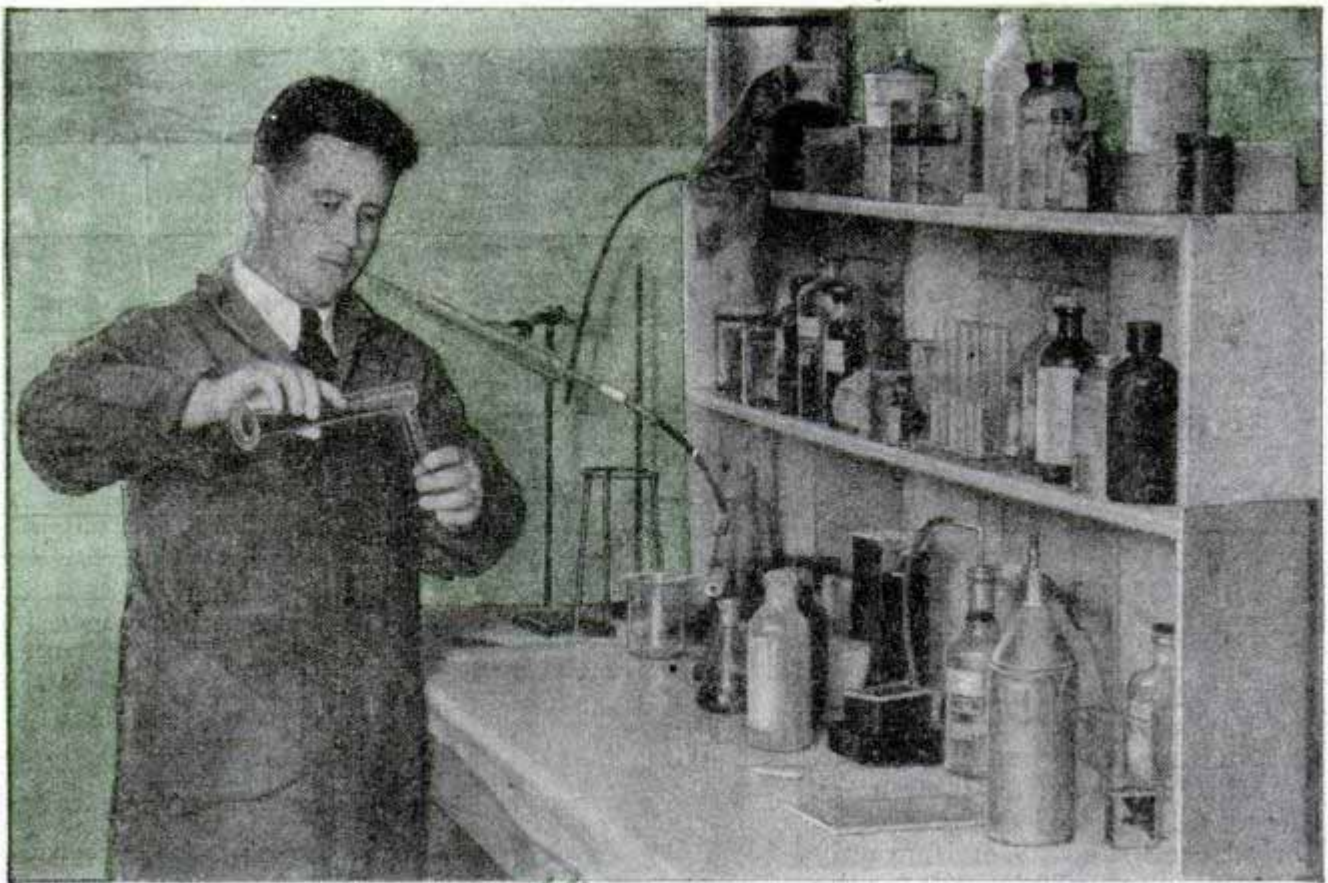

# VITAMIN HARVEST

Ted Rowell pours sample of burbot-liver oil; it is eight times more potent than cod-liver oil

By Robert Page Lincoln

**A**LONG the Canadian border at Baudette, Minn., a new industry is being hailed as a medical find. The raw material for this industry is a lowly fish known as the burbot. Ted Rowell, founder of the industry, discovered the burbot yields a gold mine of vitamins in the form of liver oil.

Commercial fishermen, who ply their operations in Lake of the Woods border waters, long considered the burbot worthless. They have dumped untold thousands of these fish on the lake shores to rot.

Young Ted Rowell, a graduate of the University of Minnesota School of Pharmacy, was struck by this wastage of fish. Preliminary studies of the burbot revealed that its liver is unusually large; in fact, the liver accounts for about 10 percent of the weight of the fish. Knowing that in ages past the burbot was a relative of the salt-water cod, Rowell went to work to extract oil from burbot livers. He hoped its value as a vitamin provider would equal that of cod-liver oil.

His first experiments were conducted on a cookstove at home. That was in 1933. Two years later he had set up a small factory-laboratory. He estimated from tests that burbot-liver oil had a vitamin content

four times more potent in vitamin A than the best cod-liver oil on the market. More recently investigations by the American Medical Association Council on Pharmacy and Chemistry, the high court of pharmaceutical research in this country, rated burbot-liver oil eight times more potent than cod-liver oil!

It was not until the onset of World War II that Ted Rowell's burbot oil product came to national attention. Importation of cod-liver oil from Norway, one of the greatest producers, became prohibitive when the price soared to nearly \$145 a barrel. When Germany invaded Norway this supply was cut off. In the search for a substitute, Rowell's burbot-liver oil came into the limelight. It received the closest inspection by medical experts. Almost overnight the young scientist at Baudette found opportunity knocking at the door.

In 1940 Rowell handled a half million pounds of burbot in his laboratories and the over-all total now is about 5,000,000 pounds from Lake of the Woods alone. Thirty commercial fishing crews remove the fish from these waters. Burbot livers are also shipped to Rowell from as far east as the Great Lakes and from other regions.

"The question is often asked if sufficient burbot are available to keep this industry



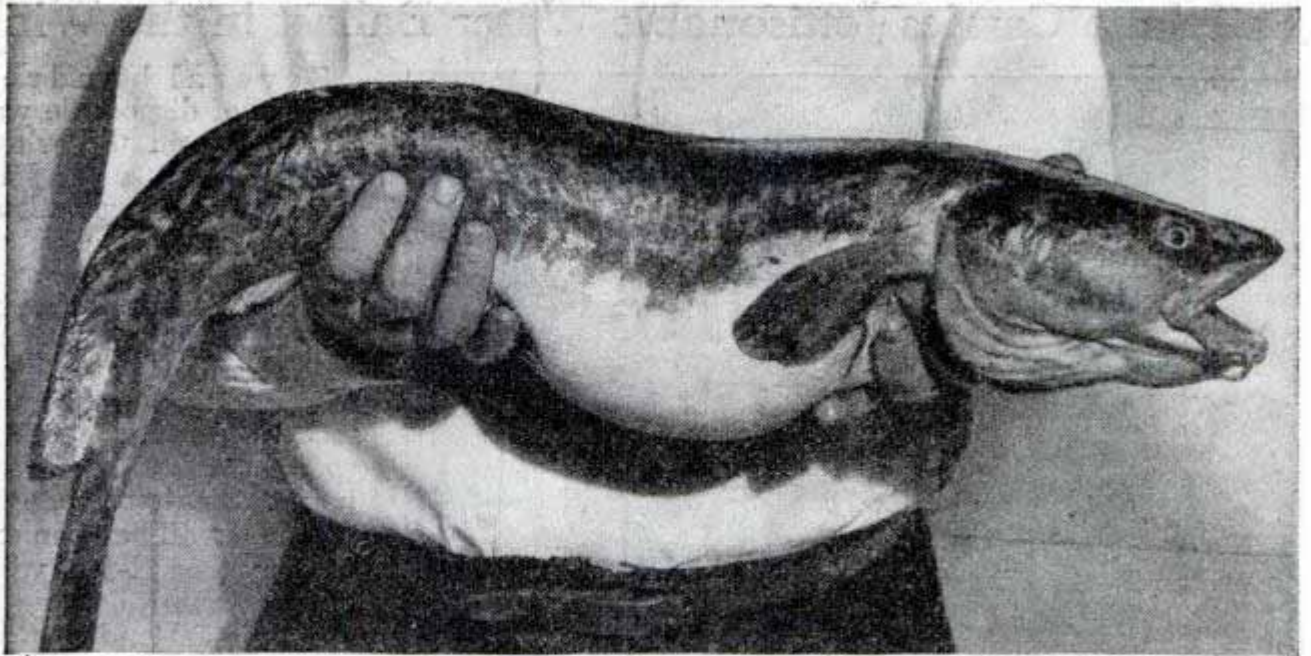

going," says Rowell. "The truth is that although other supplies of fish have been tapped enormously all over their northern range, the burbot has never been hindered. The range of the burbot is from Labrador and the maritime provinces of Canada down to New England, New York, the Great Lakes and west to the upper Missouri, the Columbia River basin, Alaska and the entire arctic region. We have merely touched the outer fringes of supply."

What is the nature of this remarkable fish which few ever see and know so little about? Not so long ago in a north central town in Minnesota a dead burbot was found on a lake shore. It was displayed in a

(Continued to page 244)

Fresh-water cousin of the cod is the burbot which lurks in deep waters and is seldom seen by sportsmen. Its unusually large liver (below) has been found to be rich in vitamin A

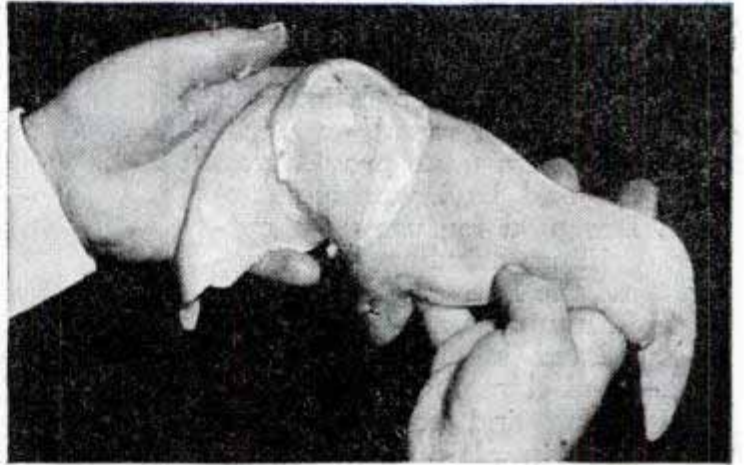

Once tossed aside as worthless, the burbot now is considered a prize catch by the local fishermen in Lake of the Woods





## Sailplane Carries Jettisonable Water Ballast in the Wing



Schweizer Aircraft photo

Several hundred pounds of disposable water ballast in the wings will be a feature of a sailplane, now being built at Elmira, N. Y., to better the world's distance record of 465 miles. It can be jettisoned at will to enable the pilot to use lighter soaring conditions and makes possible cruising speeds of 80 miles an hour. Single-place, the sailplane will have an extremely thin 51-foot wing of aluminum alloy and a single-wheel landing gear, with a rubber-mounted skid forward of the wheel.

### Auxiliary Drill-Press Table Helps in Routing or Shaping

For drill-press operations in wood, plastics or metal, an auxiliary drill-press table provides an enlarged and true working surface. Designed for use with cutting, drilling, grinding and shaping tools, the 13 by 18-inch table is cast of aluminum alloy. The cadmium-plated steel fence has a high-speed clamping arrangement for guiding and controlling the workpiece in planing, mortising, routing or other operations. The table comes equipped with irregular shaping pin, anchor bolts, fence and fence-clamp assembly.

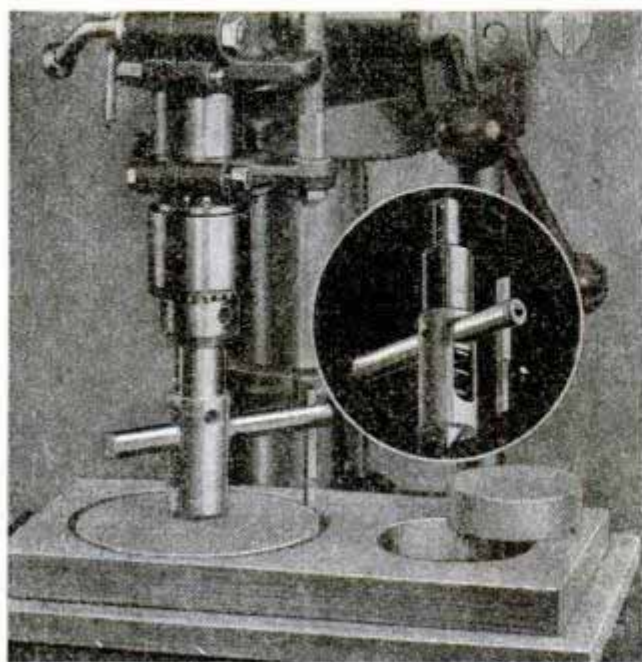
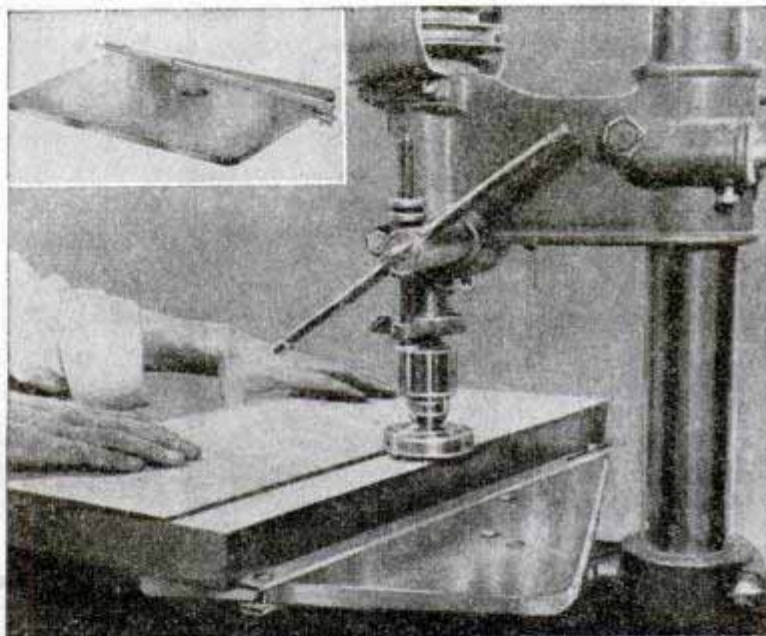

### Circle Cutting Tool for Craftsmen Centers Itself Automatically

Drilling a pilot hole is unnecessary with a circle cutting tool utilizing a spring-tension cone center. The spring forces the cone tight against the exact center of the work and holds it tight on the table. If a craftsman desires, he can later drill any size center hole. If a solid disk is wanted, use of the tool leaves no hole to be plugged. The circle cutter can be mounted in a drill press or, with an adapter, on a bandsaw or jigsaw. It will cut diameters up to 14 inches in wood or plastic materials.

Information, including manufacturers' names, concerning products described in this issue may be obtained by writing Bureau of Information, Popular Mechanics, 200 E. Ontario St., Chicago 11, Ill.



## Versatile Outdoor Range Is Complete With Running Water

Food can be barbecued, roasted, baked, broiled, fried, boiled or smoked on a versatile range that Paul Reich, a Minnesota sportsman, designed and built in his own backyard. The range has running water and storage space for pots, pans and condiments. The barbecue spit is turned by a small motor.

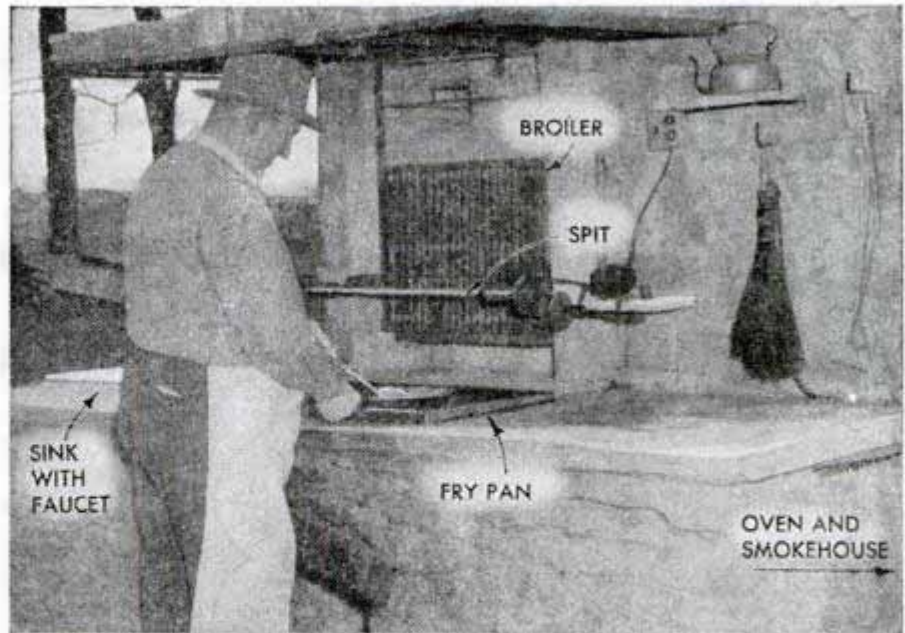

### Side-Door Delivery Speeds Service

Telephone - operated side-door delivery service speeds heavy or bulky items to customers of a Little Rock, Ark., department store who do not want to wait for regular delivery. After the purchase is made, the article is sent to the basement for wrapping. The customer drives to the

side door of the store and calls over a direct telephone for his package. Basement employees then deliver the package to the customer's car, which is allowed three-minute parking for this purpose.

## Tandem Two-Seat "Streak" Cruises at 150 Miles an Hour



Two occupants sit tandem fashion under the bubble canopy of the Streak, a new personal plane. Its cruising speed and range are estimated at 150 miles an hour and 700 miles, using an air-cooled Continental engine with direct fuel injection. The tricycle landing gear is retractable.

## Gyrodyne Combines Features of Helicopter and Autogiro

First of a new class of rotary wing aircraft, the British Fairey FB-1 is moved forward by a propeller as well as forward,

backward and sideways by a rotor. Called a gyrodyne, it differs from a helicopter, which is propellerless, and an autogiro, which gets lift but not movement from a rotor. The propeller is offset on a wing tip and also serves to counteract torque set up by the rotor. A prototype being built will be used mainly for research.



☞ To the relief of hay fever sufferers in one New Jersey community, 95 percent of the ragweed was killed by spraying with 2,4-D, antiweed chemical.



# LESS TOIL FOR TILLERS

Laborsaving machines point the way to an era when farmers will wear white shirts to work and sit at a master control board

*By Robert L. Crane*

**W**HEN a farmer made a trip to town 40 years ago he hitched his team to a buggy or wagon and spent almost an entire day driving to the nearest town and back.

Today, thanks to the Wright brothers, many farmers are flying to comparatively far-away towns and cities to do their shopping. This transition from clumsy horse-drawn buggies to the sleek light planes seen parked in many a pasture lot is typical of many recent changes on U. S. farms.

These changes — improvements wrought by a mechanical age — are timesavers, laborsavers, money-savers, and sometimes lifesavers. Some of the laborsaving machines are so practical and familiar that they seem almost commonplace. Mechanical hay load-

**Antifrost machine for truck garden or orchard warms an acre by infrared heat waves**

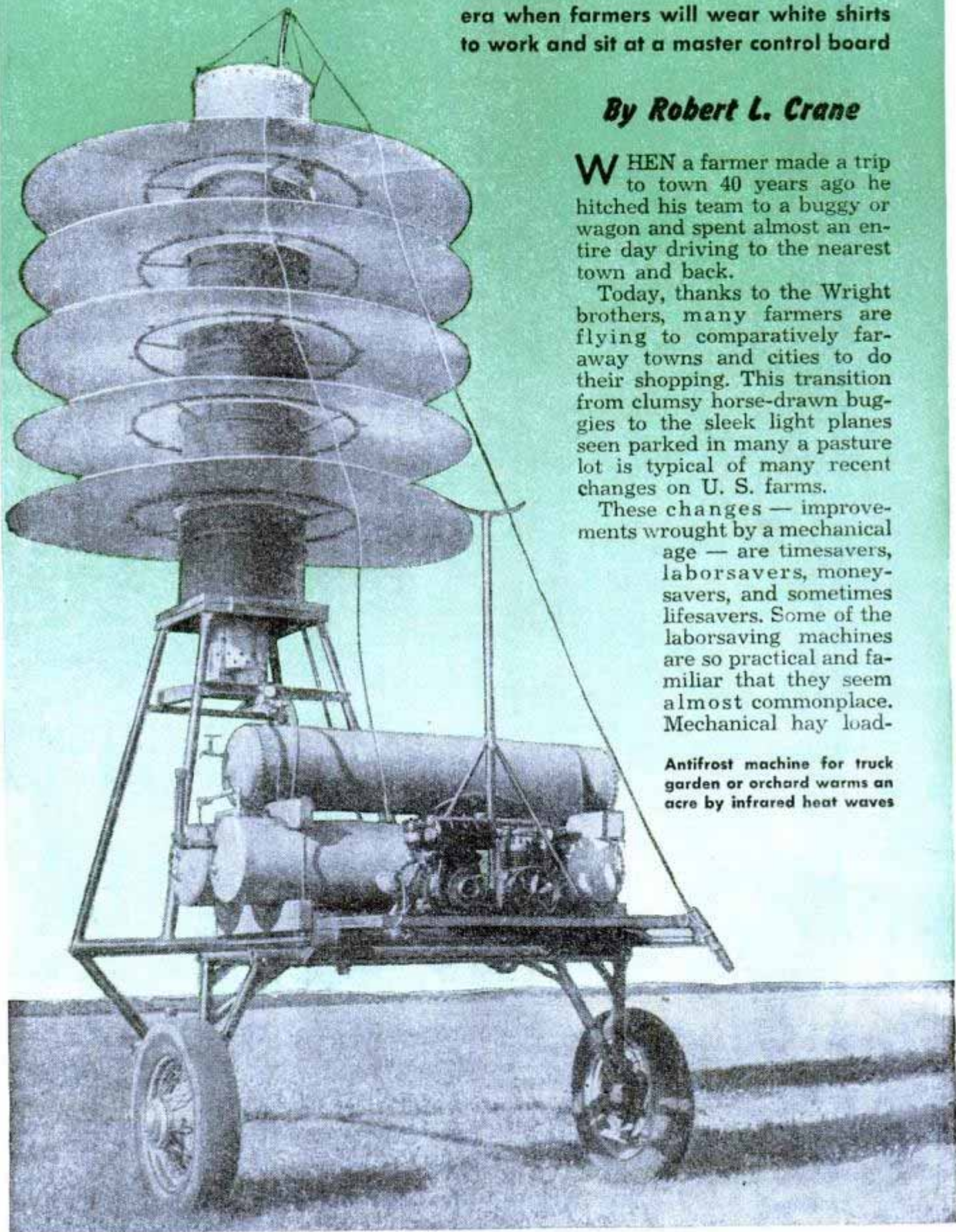



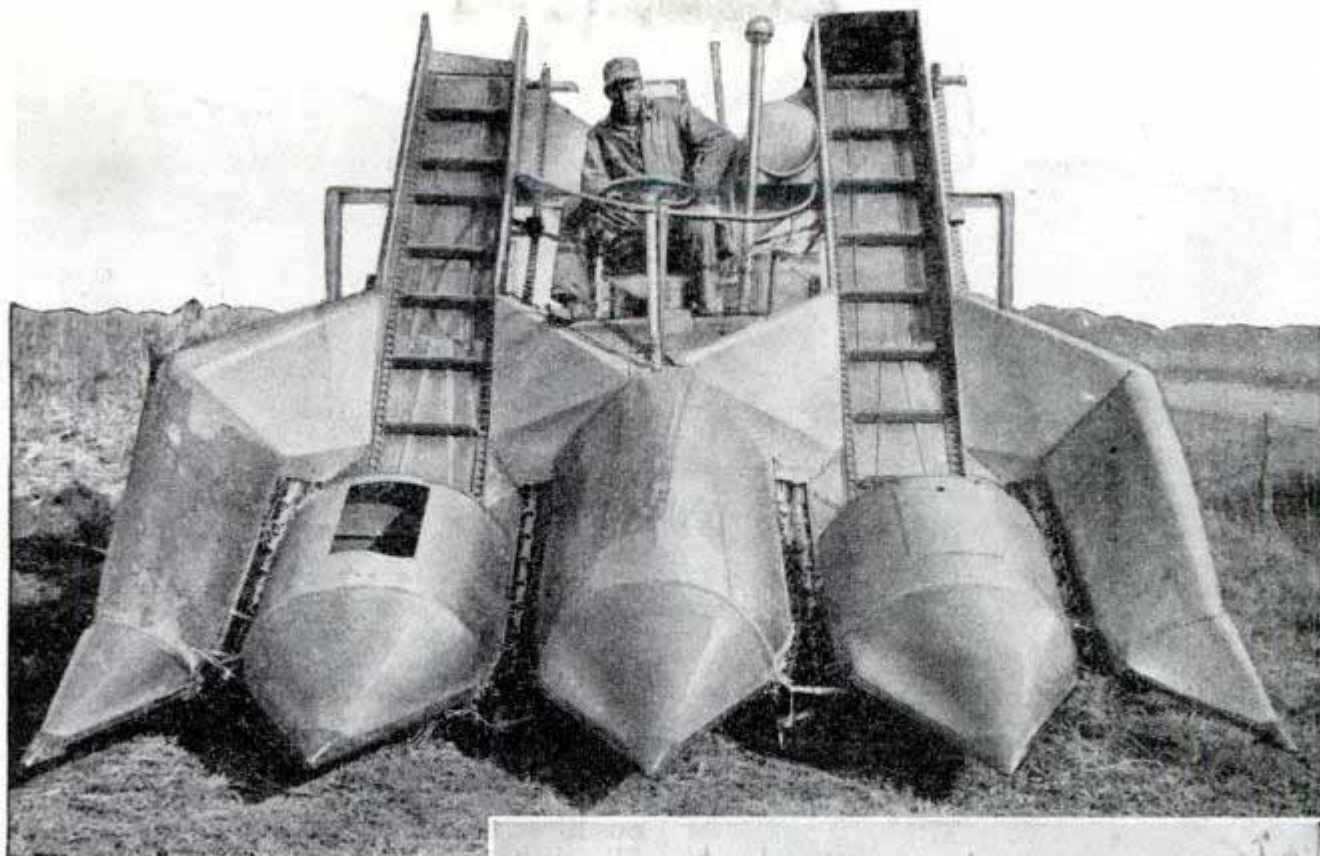

**Four-row corn picker is powered by combine motor and propelled by tractor. It husks more corn in 20 minutes than a man can pick in an entire day**

ers and rakes, corn huskers, hydraulically operated manure loaders, power saws and sprayers are in this category.

On the other hand, there are some strange-looking machines which perform some highly unusual tasks. Such is the antifrost machine developed at the Michigan State College of Agriculture. Mounted on two wheels, the machine looks like a large transformer. It contains an oil-

burning heater which sends out infrared heat rays to plants and soil in an acre of ground. The heat is radiated from big aluminum reflectors and the unit requires a minimum of maintenance.

Another machine, which is as odd looking as it is practical, is a tractor-powered conveyor used by Long Island potato growers to move heavy water pipes across a field. The conveyor consists of an endless chain mounted on a tubular frame to which are attached at one-foot intervals 3 by 6-inch boards at right angles to hold the pipes. The frame sets on a trailer pulled by a tractor. Workers disconnect the pipes as the conveyor moves down the field and place them on the chain to be deposited on the other side of the conveyor.

Of all the farm timesavers, the airplane



is probably the most dramatic—even if not the most practical machine. The light plane, which is a sportsman's luxury item in the city, can be put to earning its gas and oil on the farm. One Oklahoma farmer counts his cattle, scatters salt to livestock and checks soil erosion from his plane. A rancher in New Mexico uses his hedgehopper to shoot coyotes. Sowing oats and grass seed, spreading fertilizer, inspecting crops and fences are a few of the tasks a flying farmer in Illinois accomplishes from the air. One county farm adviser makes all his calls by plane. Other common uses of small planes on farms are for spraying orchards and field crops, for traveling long distances to get repair parts, or for marketing such perishables as strawberries.

The farmer of yesterday and his numer-



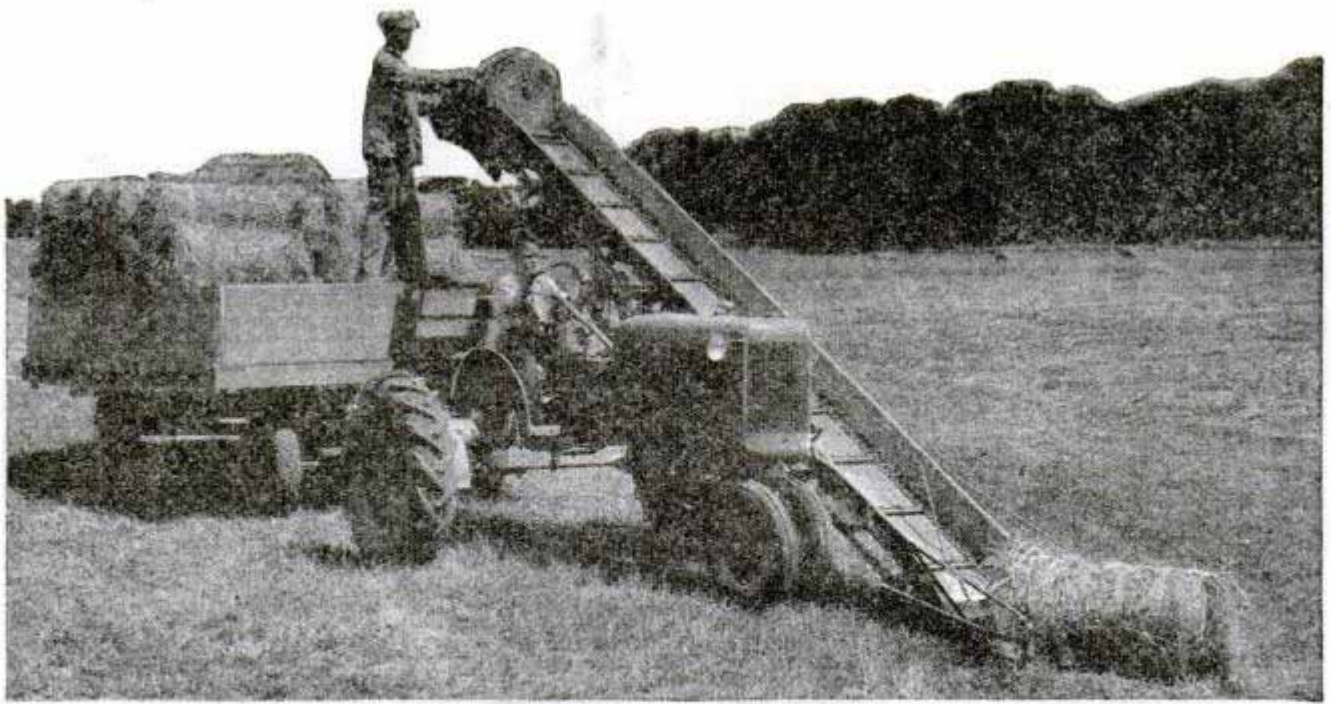

Pickup baler saves lifting the heavy rolls of hay. Left, power saw cuts heavy underbrush and saplings

ous hired men used to spend an entire week filling the silo each fall. Often the neighbors were called in to assist. First, a day or two was spent cutting the green corn by hand with a long knife and laying it in bunches. Each heavy pile of stalks was loaded on a wagon, hauled to the silo, fed into the ensilage cutter and blown into the silo. Later on, as the ensilage was fed, it was necessary for someone to climb into the silo and throw the feed down every morning and evening.

Today, corn to be ensiled is cut in the field by a mechanical cutter and loaded into a self-unloading wagon following behind. The corn in the wagon is unloaded with an electrical motor attachment and blown into the silo. Unloading from the silo is accomplished with an electrically driven unit which revolves, picks up the silage and tosses it into a chute where it falls into a cart below. The entire operation—from field to feed bin—is completed without the farmer once lifting the heavy green cornstalks or the ensilage. It saves many man-hours and backaches.

The "making" or harvesting of hay has been a favorite subject with song writers and artists for years. Mechanical hay loaders and rakes are taking the romance as well as the drudgery out of this task. Not many years ago the pickup baler was hailed as a remarkable laborsaver. Alert-minded farmers soon realized that considerable lifting of bales could be eliminated by hooking a wagon directly behind the baler and loading it as the bales were delivered. The mobile baler of today is a big improvement

Peacetime job for jeep is powering threshing machine





over the old stationary baler that required a crew of half a dozen men.

Another haying innovation known as the "chopper" picks up either green or dry hay from the windrow, chops it and delivers it to the wagon. The hay is blown into the haymow. Green hay can be cured by drying units installed in the barn loft.

One of the most welcome modern labor-saving devices on the farm is the hydraulically operated manure loader, or scoop. The loader is converted easily to handle grain, gravel, sand or hay.

A single machine—the power saw—has revolutionized two laborious farm jobs. These are mowing fence rows and cutting firewood. For centuries, hedgerows have been cleared of light brush, weeds and rank growths of hay with a hand scythe. The power saw not only does this job quickly and efficiently, but will cut down a tree 30 inches in diameter and saw it into lengths of firewood. This saw can be operated all day on only three gallons of fuel.

**This farmer uses his Aeronca to make business calls**



**An Illinois farmer fights the corn borer by spraying DDT from high-slung rig attached to a tractor. Below, rotating silo unloader chops frozen ensilage**

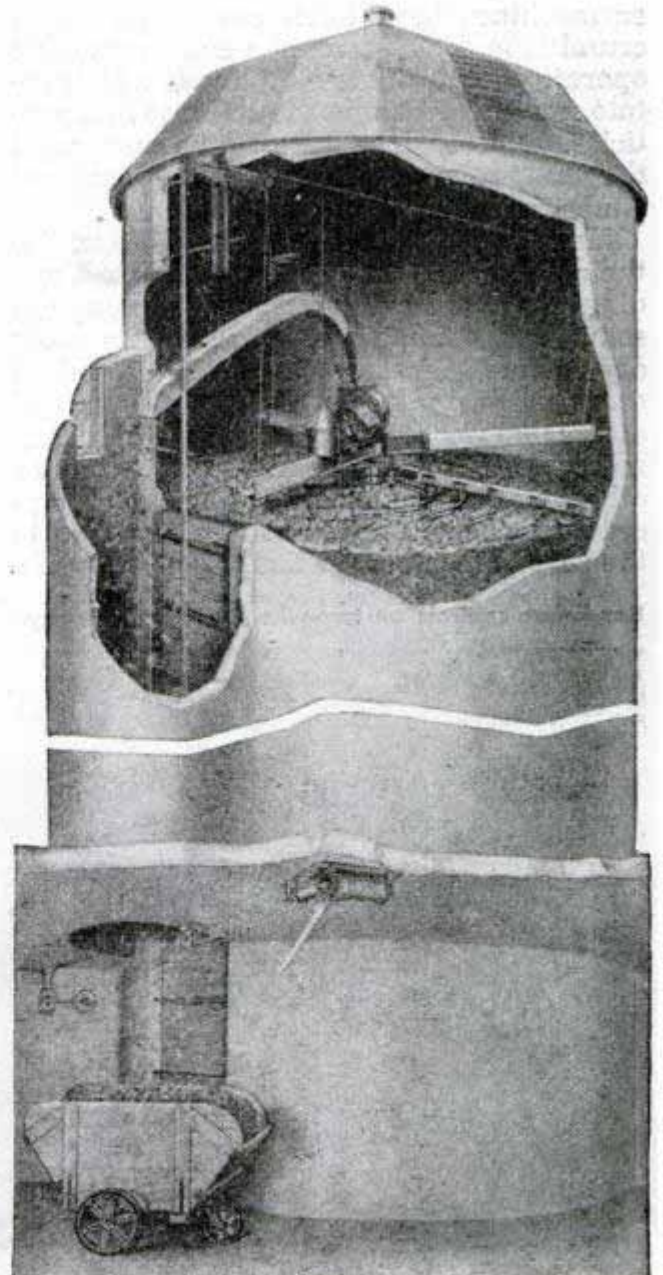



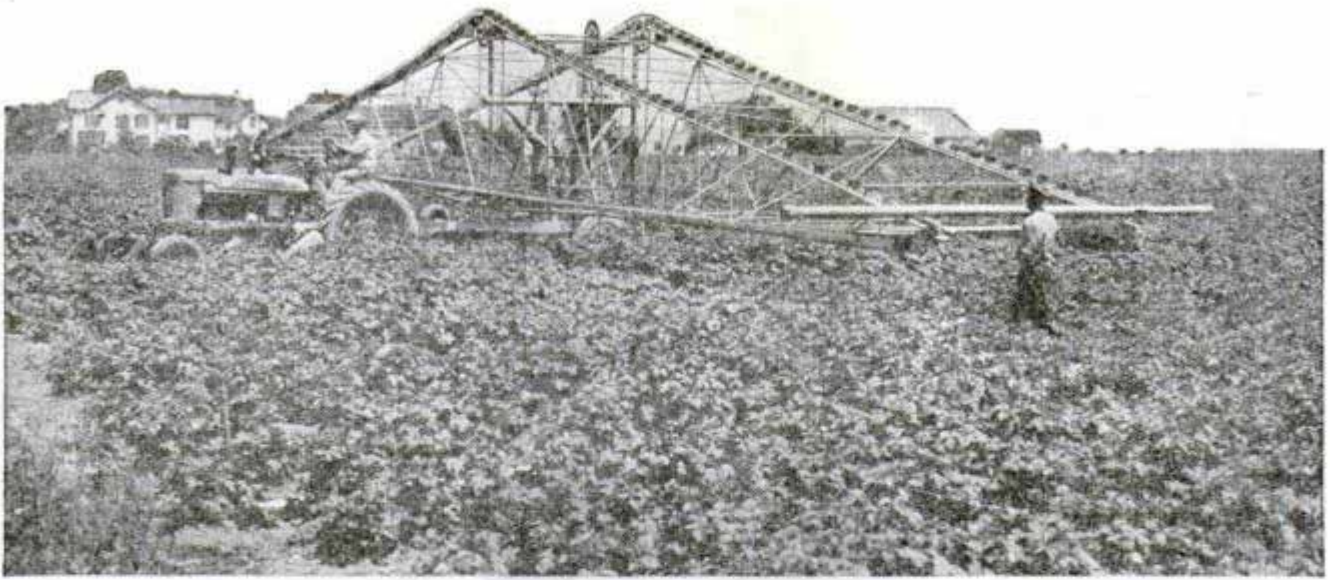

**Tractor-powered conveyor saves manpower by moving water pipes 70 feet on irrigated Long Island potato farm**

One of the most time-consuming and therefore expensive operations on the farm is the preparation of soil for planting. This has always been a triple operation: plowing, disking and harrowing. Recently, power machines have been developed which crumble and pulverize the soil in a single operation. This is done by hooks which rotate rapidly, breaking the soil into fine particles. If these machines prove successful they may revolutionize the manufacture of American farm machinery.

Many farmers have not learned to utilize their tractors to the fullest extent. Posthole diggers, wood saws and transport boxes are some of the important attachments often overlooked. Dirt scoops can be used to great advantage in digging ponds and ditches or for cleaning out old ones. They are handy also for moving sand, bricks or other building materials. Hydraulically operated transport boxes can be attached to the rear of tractors for hauling a few bush-

els of corn, several bags of grain, cans of water or other heavy items.

Another mechanical device that is stepping up efficiency and income on the farm is the power sprayer. Many spray units are powered by compressors operated by either electric or gasoline motors. Others derive their pressure for operation from the pistons of an idling automobile, truck or tractor motor. These sprayers apply paint about seven times faster than the average painter and distribute the coat evenly. Farmers also use the power sprayer in their orchards and for treating animals to guard against insect pests.

Some sprayers and various other machines mentioned in this article make use of electric motors which are a boon to farm work. Farmers use electricity to pump water, grind grain, turn separators and perform scores of other operations. All of these improvements are making farming one of the most attractive occupations in the U. S.

**Handlebar controls on two-wheel tractor allow operator to walk to one side when plowing or cultivating**





## "Duck" Fitted With Echo Instruments Aids Shallow Water Surveys

Shallow water surveys of the Lake Michigan shore line are made by U. S. Engineers aboard a converted Army "duck" equipped with special sounding instruments. The eight-ton amphibious truck has been found ideal for beach survey work, requiring no dock facilities and climbing up the beach at almost any spot selected. A Navy echo sounding instrument has been fitted inside the steel hull. Engineers send supersonic waves through the duck's thin skin to bounce off the lake bottom and back to the instrument. A measure of the time interval between sending the impulse and receiving the echo tells the engineers the depth of the water. Another instrument, a self-tripping grapple, is thrown overboard periodically to obtain a sample of the bottom soil.

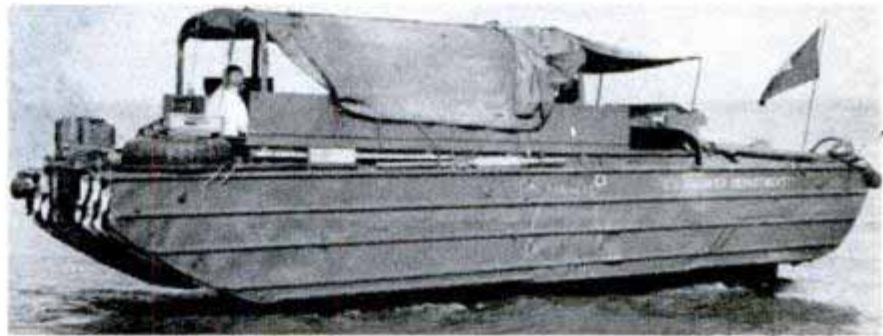

## Gravity Suspension System Replacing Springs Saves Trailer Tires

Trailer tire mileages are increased by a gravity suspension system which replaces conventional springs on the tandem rear wheels of a trailer. Gravity suspension al-

lows the tandem axles to track themselves around corners, thus reducing tire scuffing. One semitrailer, so equipped and carrying loads averaging 36,000 pounds, has traveled

220,000 miles on one set of tires without need of re-capping or repairs. The system uses torsion bars instead of springs. The body of the trailer is attached to its axles by swivel-type shackle levers. The position of these determines the amount of twist imposed on the torsion bars by the weight of cargo or road shocks. The bars are connected at the forward ends by meshed gear wheels which serve as torque equalizers. The system adjusts the center of gravity so that the trailer leans in on curves. This reduces roll-over hazards. It also gives increased stability on all kinds of ground.

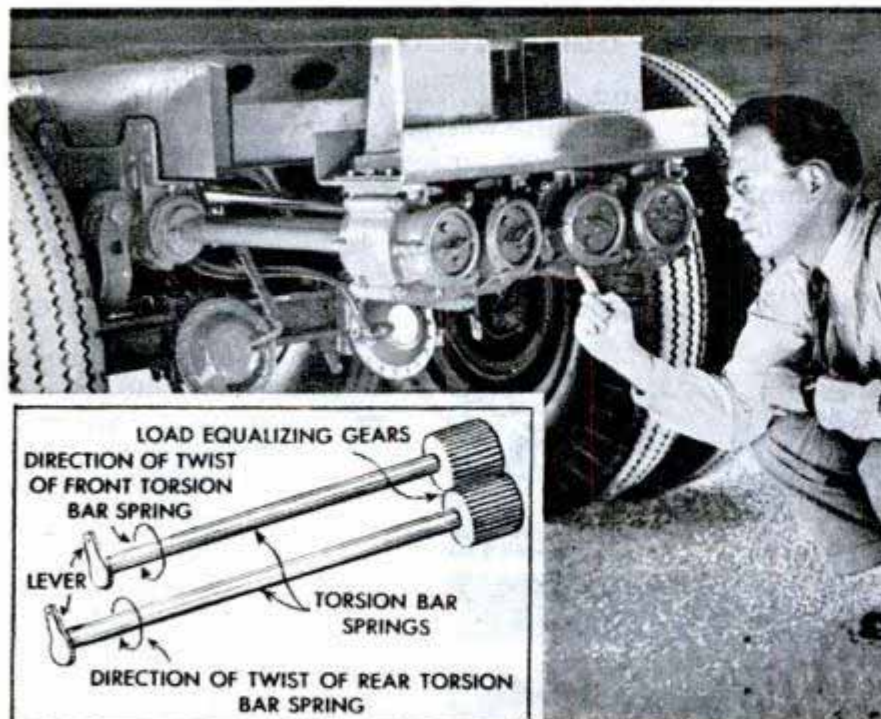



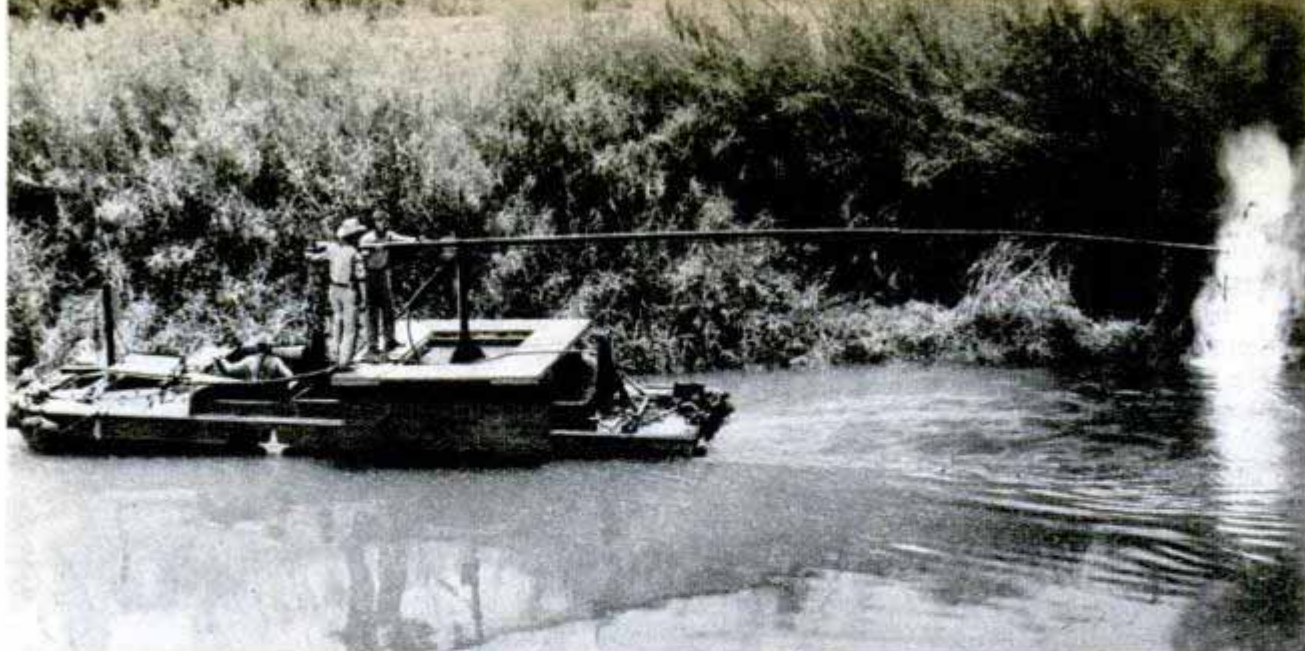

Flame throwers developed during the war are being used by the U. S. Bureau of Reclamation to burn weeds off irrigation projects and other public works. The flame throwers are mounted on trucks, amphibian tractors, ducks and other war vehicles

### Flame Throwers Burn Weeds

that can navigate rough roads, swamps and canals. When large vehicles cannot reach the weeded areas, operators fight the weed war on foot with small flame throwers. If burning is impracticable, war developed chemicals are sprayed on the weeds.

### Self-Soldering Tape Is Ignited With Ordinary Match to Connect Two Wires

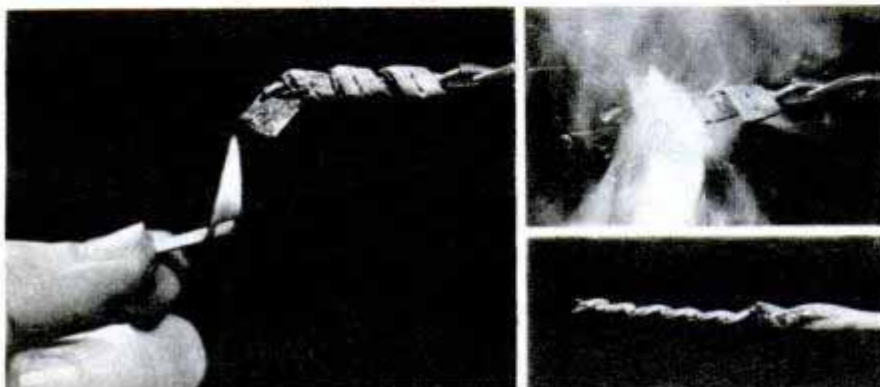

With a length of self-soldering tape and an ordinary match, soldered connections between wires can be made without a soldering iron or torch. The tape is wrapped around the wires to be joined and ignited with a match. This generates enough heat to melt the solder.





**OPENING OYSTERS** is no longer a struggle. By placing pressure on the center of the oyster, new shucking device opens the shell without damaging the oyster

**SIT-DOWN FATIGUE** is lessened by a pair of steps for the right and left side of a tractor. The steps allow the driver to change position and relax occasionally



MARCH 1947



**JAPANESE GOLDFISH** from Hirohito's own pool frolic in the plastic nose of a B-29, converted into Hollywood's oddest fish bowl by screen star Robert Cummings

**SUPERCYCLE** used in Italy puts the arms as well as the legs to work in bicycling. Pumping the handle bars works a chain drive applying power to the front wheel

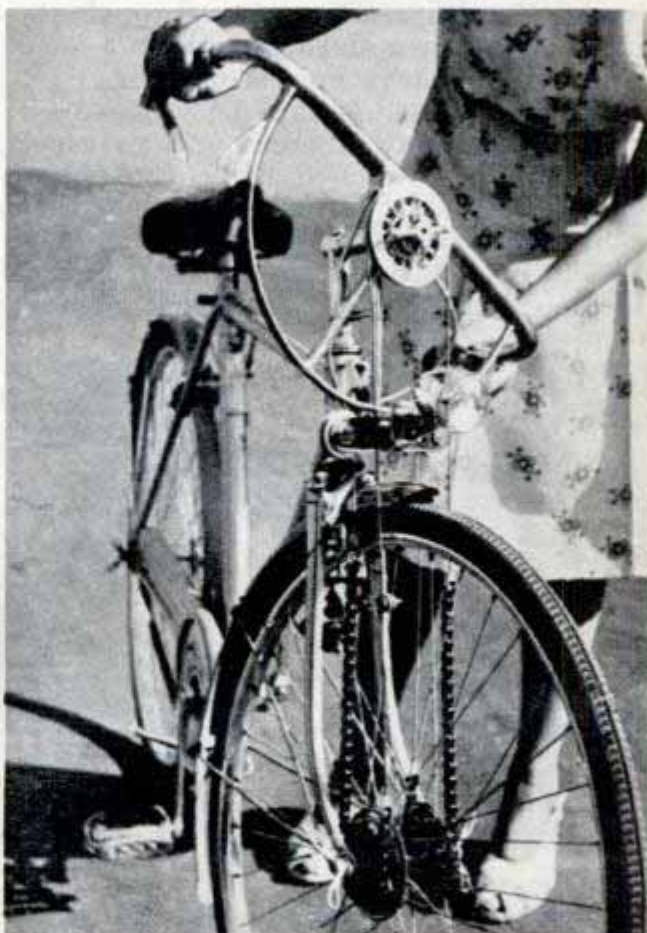



# STEEL HIDEAWAYS

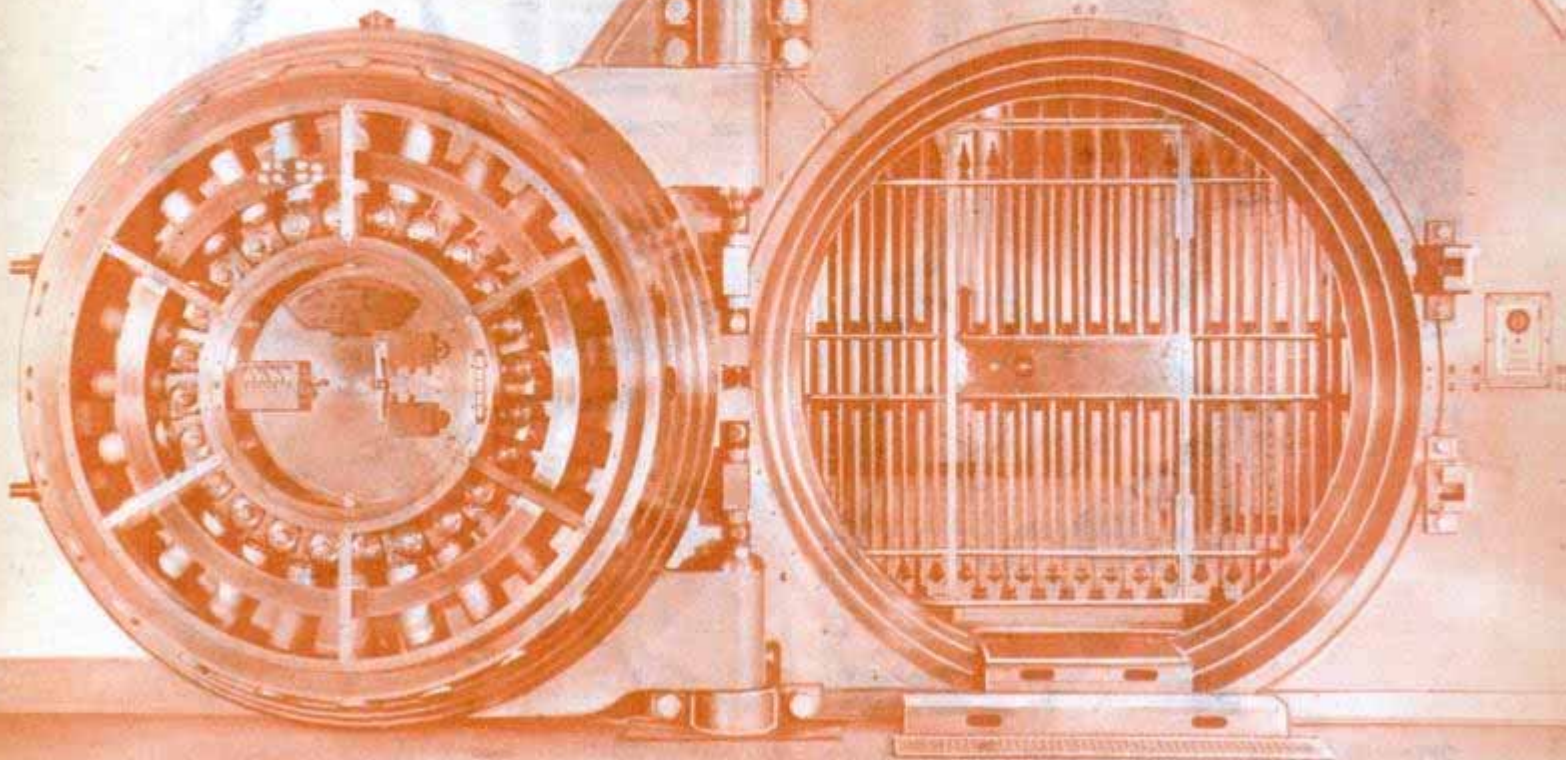

By Jules B. Billard

**T**HAT morning the usual combination failed to open the old safe in the local bank. Word spread quickly through the little Texas town and by the time a locksmith from nearby Fort Worth arrived, a sizable crowd had gathered.

Blue-denimed farmers and gallused storekeepers watched while the expert talked briefly with the bank president, then went to work on the dial. Ten minutes of patient twirling and trying the handle, and the safe clicked open. From that moment

on, you couldn't convince an individual for miles around that the stories about yeggs with supersensitive ears who could hear tumbler pins drop or whose sandpapered fingers could solve the trickiest combination weren't gospel truth.

Actually, that's far from the case. Tumblers don't drop—the right key or the right combination merely lines up the pins inside the lock so that none interferes with the lock's opening. And sandpapered fingers aren't any help in figuring out combinations—a good modern safe dial has as many as 1,000,000 possible groupings. It would take you nearly two years to try them all—provided you worked night and day at a rate of one combination every minute. The reason some crooks are able to open combination locks is because they know it's human nature for people to want their locks set with easily remembered combinations of numbers—10-20-30 or 2-4-6-8, for example.

The explanation of the Texas "miracle" is easy. When he talked to the locksmith



Set flush with the floor, a fire and burglar-resistant home safe is concealed by rug. Lid lifts automatically when unlocked

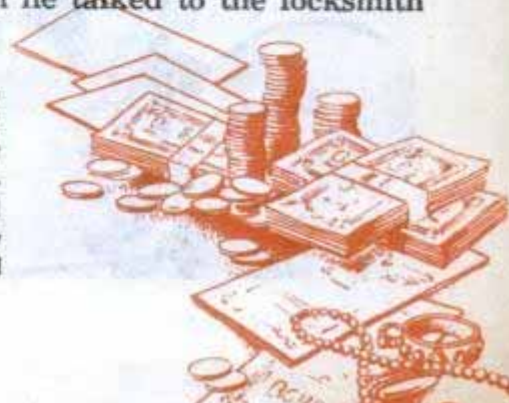



at the bank, the president told him the safe's combination. The expert, knowing that the safe was old, guessed rightly that one of the pins had become worn just enough so that it wouldn't line up properly when the correct numbers were dialed. After that it was merely a job of trying a few numbers to the right and left of the correct ones until, by a simple process of elimination, the worn pin had been located and an opening combination hit upon. The locksmith never could have done it if the bank president hadn't given him the old numbers to begin with.

However, there's no such thing as a burglarproof safe. Even the companies which manufacture safes will tell you that anything man can build, man can also destroy. But they will tell you that their product can successfully resist even the canniest safecracker under the conditions indicated by the chest's label.

Here's what a burglar-resistant chest has to go through, for example, in order to qualify for top classification under standards set by the Underwriters' Laboratories: attack by experts using sledges, chisels, drifts, rotary hacksaws, wedges, portable electric drills or any other commonly available tools; exposure to the cutting action of any commercially available oxygas burning or welding torch; and finally, use of nitroglycerin or other common explosive in any manner desired.

The laboratories' experts can try any or all of these methods for a solid hour. As an advantage over the yegg, they have the safe manufacturer's detailed drawings of the chest's construction and specifications

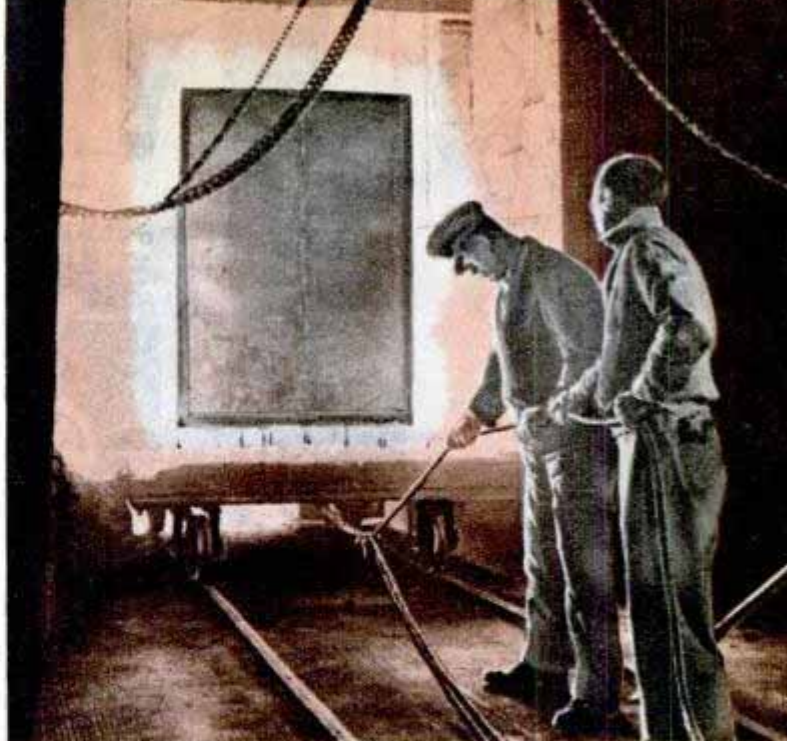

In Underwriters' Laboratories test, safe must protect contents in fire hotter than in a burning building

of the kind of steel or torch-resisting metal of which it is made.

That hour's attack by experts under favorable laboratory conditions is equal to a whole night's hacking by the most skilled cracksman. Little wonder the manufacturers feel their safes are plenty burglar-resistant.

These modern chests are far better than the types Jesse James used to pry open with a pickax. Nowadays no safecracker can knock off the dial, punch out the spindle and release the lock. Not if it's a really good safe. Neither do you hear of an up-

**How strong are bank vaults? In Hiroshima, after the atomic bomb exploded, American-made safes, below, were intact and functioning despite fire-blackened doors. Two Jap safes in the wrecked building were demolished**

Mosler Safe Co. photo





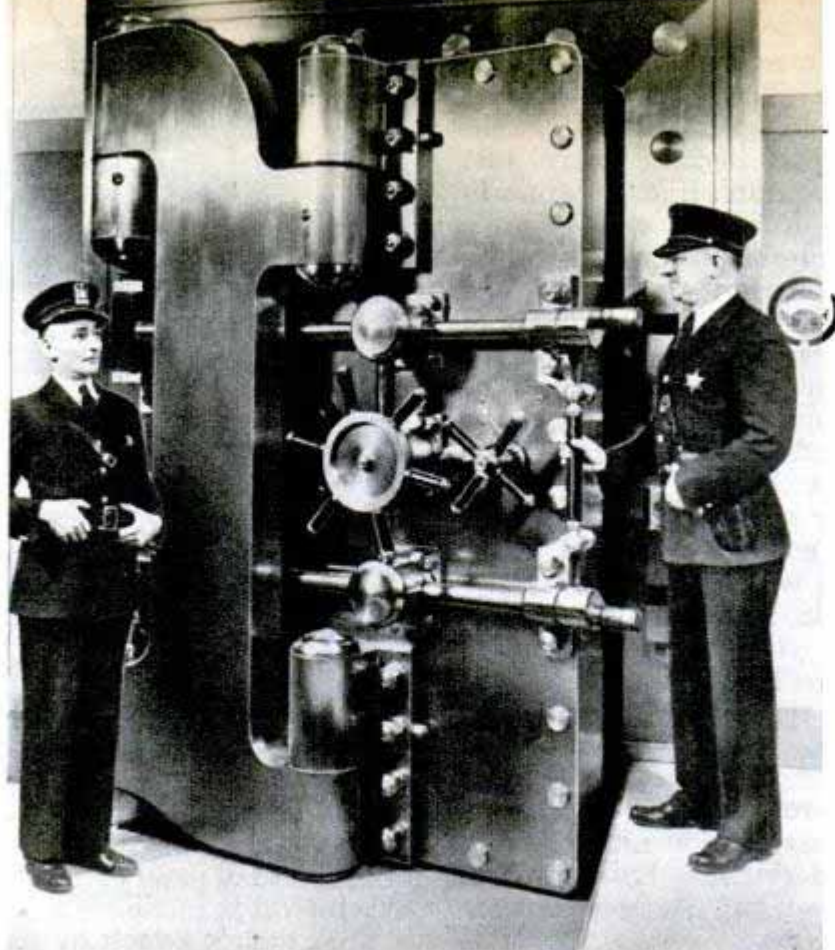

A thin rubber band might prevent closing this huge door to a Chicago bank vault, but once it's locked a dozen safe crackers couldn't open it in a week

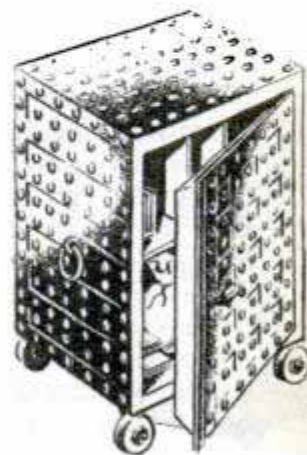

to-date chest being "blown" by a cracksmen whose stock in trade is a few ounces of nitroglycerin poured into the crack around the door. The reason is that science is on the side of the safe manufacturers.

When Nevada Mike and the boys started grabbing their loot by breaking off dials and handles, safe manufacturers countered with relocking devices. These automatically—and effectively—lock the safe from inside if there is any tampering with the regular means of entry. And when Texas Slim and his followers started drilling their way through to the valuables inside, the answer was drillproof steel. Walls and door plates now are made from tough chrome and manganese alloys, too hard for even the best of points.

The nitroglycerin boys were beaten by building chest doors along the lines of a cannon breech, carefully machining door and jamb to tolerances of a few thousandths of an inch. A thin rubber band can keep a bank vault door from closing, and several instances have been recorded in which safes kept their contents dry despite days under water during floods. No chance here for the yegg to pour in enough "soup" to blow off the door.

Neatest accomplishment, however, in the safemaker's long battle against the night-stalking fraternity is the torch-resistant chest. It had to come because crooks were cutting a wide and profitable swath with oxyacetylene and oxyhydrogen torches. At first the yeggs had trouble—the 6000-

degree heat from the flame turned the safe interior into an oven, charring paper and melting coin. Then one of them hit on the idea of burning a small hole through the top of the safe, filling the inside with water, and then leisurely cutting an arm-size hole while the water kept the temperature safely down.

Now, however, your valuables can be protected with a torch-resistant chest whose walls are made from an alloy of iron, copper and other elements. While this metal can be melted with a torch, it flows so rapidly that it seals itself the moment the torch is moved—something like butter when cut with a very hot knife. The knife slides through but the melted butter solidifying behind it closes the gap.

The safe manufacturers have the yeggs pretty well licked, but they aren't resting on their laurels. New and tougher wartime steels made for armor plate, tank parts and ordnance are going into new chests.

Science and the safe manufacturer have also joined forces against that other destroyer of valuables—flame. A burglar-resistant chest isn't much protection in a fire. Steel transmits heat, and it doesn't take long for a burning structure to build up temperatures inside a chest past the point at which paper chars. So fire-resistant safes have been developed.

They have to undergo grueling tests, too. The Underwriters' Laboratories and the Safe Manufacturers' National Association

(Continued to page 240)





Powerfully lighted approach corridors to runways are being tested to guide pilots down through fog, still one of aviation's greatest hazards. A system undergoing trials at the Landing Aids Experiment Station, Arcata, Calif., has 32 high-intensity lamps mounted on two rows of towers that funnel toward the runway. This light-fringed approach zone is 3000 feet long and the towers step down in height from 60 feet to five feet near the runway. Beam spread of the lamps for landings under an eighth

## Fog Beacons Guide Plane to Runway

of a mile visibility is 45 degrees

horizontal and 30 degrees vertical. Values of lens systems and color filters are being determined in the tests. Used with electronic landing systems, the lights give pilots a visual ground check during the final letdown of a blind approach. At Arcata the system is being used with gasoline or fuel-oil burners that dissipate the fog. A recent innovation is the use of high-intensity sonic and supersonic systems that precipitate mist into rain, thus clearing the air.

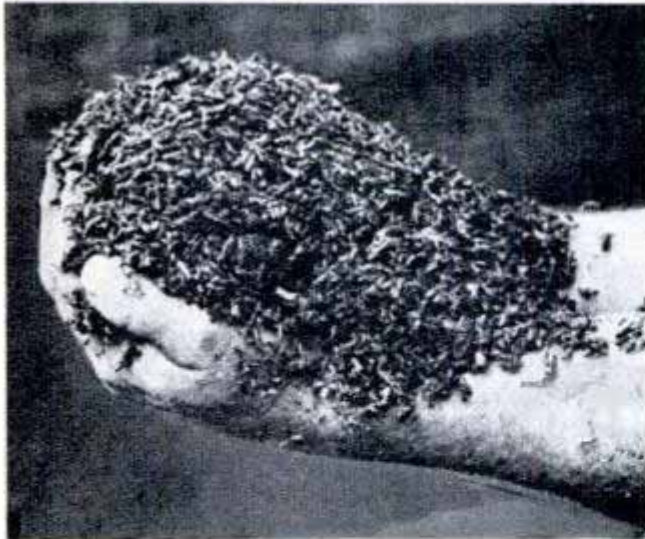

Australia is winning another war this year—a war against locusts. The battles are being waged by bombers which spray insecticide over hatching grounds, by farmers armed with hand or power sprays, and by scientists from the Department of Agriculture. The result has been a 90 percent mortality rate for the locusts and a potential saving of millions of dollars worth of grain. The Australian Air Force

## Australia Battles Locusts From Air

is cooperating in the project, making

use of techniques learned in spraying malarial infested beachheads during the war. A special spray for a gammexane and Diesel oil solution was devised where ordinary equipment produced too heavy droplets. The antilocus campaign is widely acclaimed by Australians who remember the plague of 1934-35 when the ravenous insects ate a path of ruin across the country.





Sketch shows experimental use of jato rockets (inset) for emergency stop of train

# SAFER RAILROADS AHEAD



Red stop light on rear car warns following trains if engineer brakes or stops Union Pacific streamliner

**T**HE same rockets that enabled heavily loaded Navy planes to take off from carriers after short runs are undergoing experiments as emergency brakes for trains.

By reversing the thrust of the jato (jet-assisted take-off) rockets, engineers believe they can bring a train to a halt in one third the distance required by conventional air brakes. Pairs of rockets mounted on the locomotive and perhaps on cars would be ready for emergency use by the engineer.

This is one of several innovations being tried out by railroad safety engineers, utilizing war-developed techniques. Another

Air-filled rubber doughnut spring, right, may replace usual steel spring, left. It lessens bouncing and sideway

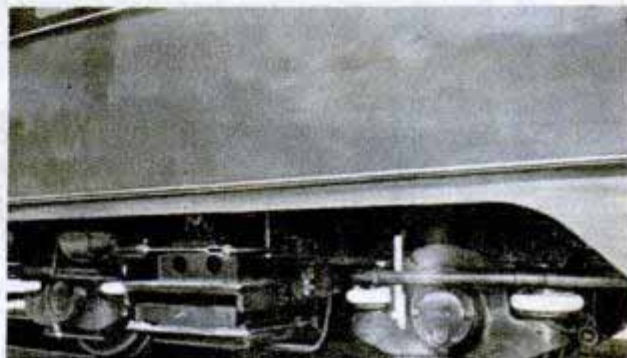
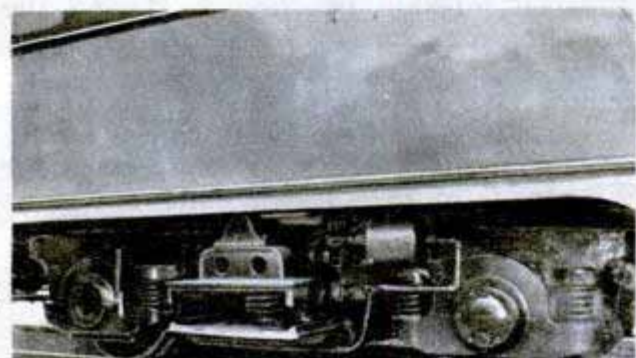





BROADCAST SIGNAL IS RETURNED BY TRAIN AHEAD TO ACTIVATE RADIN MILEAGE DIAL



Bi-directional antenna on Rock Island car (top) handles radio signals to activate radin dial (right) showing distance in miles to train ahead

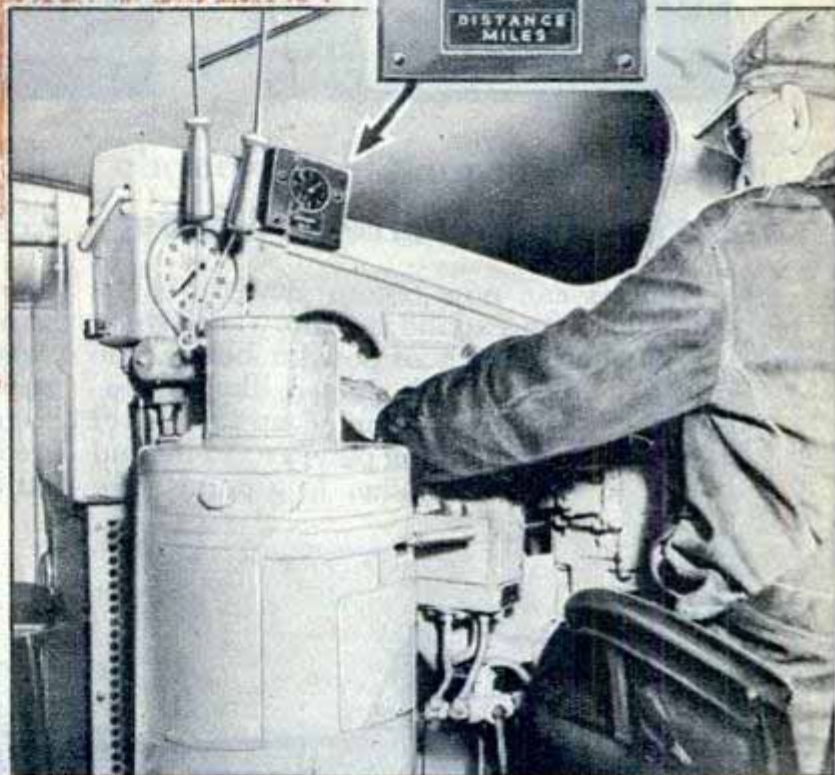

↓ Gear-driven diagonal bars move through opposite corners of Monroe noiseless crossing to form solid rail for moving train

is the Rock Island's experimental radin, a high-frequency radio system which would warn the engineer of any train within eight miles of him.

Experts who engineered the jato rockets are working on the revolutionary rocket brake idea. Dr. Theodore von Karman of California Institute of Technology estimates that the distance needed to stop a 100-m.p.h. train can be reduced 1000 feet by rocket brakes delivering 500,000 pounds of thrust over a four-second period. Because such a sudden deceleration would slide passengers from their seats, researchers are working on rockets in which the thrust increases gradually.

The Rock Island's radin has been tested on the Golden State Limited and on Chicago suburban trains. Antennas on the locomotive send out a signal which is rebroadcast by similar equipment on any train within eight miles. When the rebroadcast signal is received, it activates a dial showing the gap in miles ahead or behind to the other train. This would be most practical for trains of two or three sections running a few minutes apart.

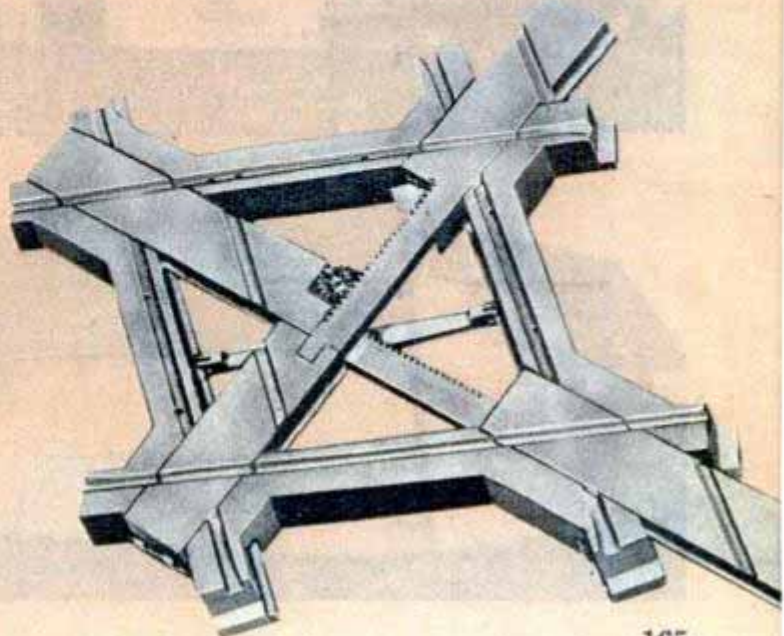



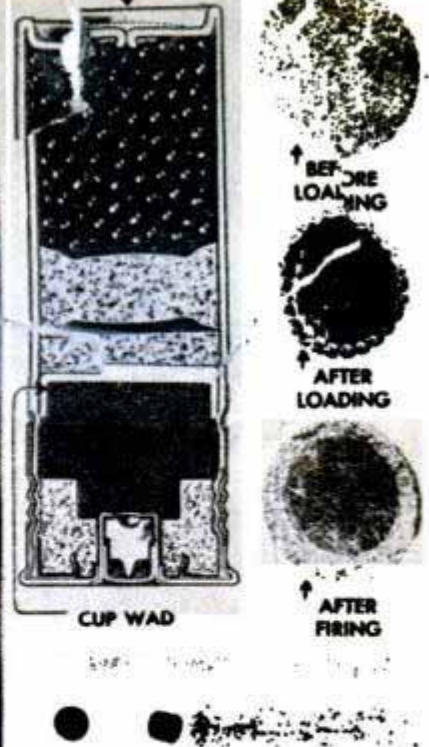
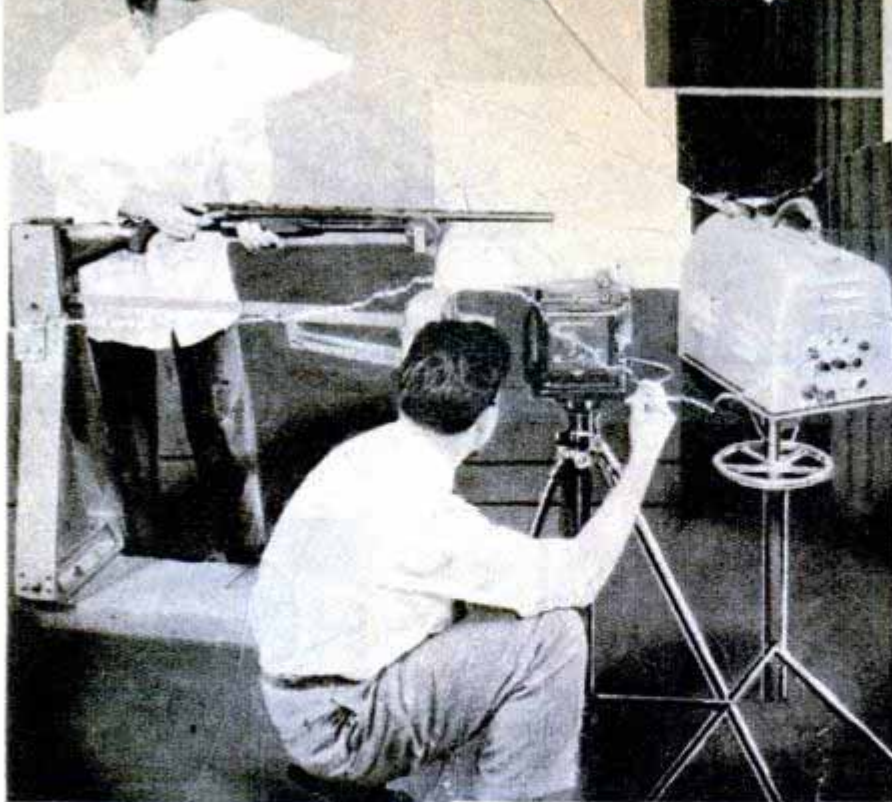

## Wad in Shotgun Shell Expands To Seal Entire Force of Powder

Hunters can now obtain shotgun shells equipped with expanding cup wads which seal the entire force of powder behind the shot pellets. The wad, shaped like an umbrella, expands as it is forced up the barrel and seals the expanding powder gas behind it, like the leather washer in a pump. The

High-speed photo directly above shows flying pellets from exploded shell, followed by filler wads. The expanding cup wad had dropped out of sight. To right of cutaway drawing are three views of expanding wad

nose of the new shell has a folding waxed crimp which eliminates the old style top wad that deflected pellets as they left the gun muzzle. The new shell's ability to concentrate the spray of pellets is expected to reduce the chances of crippling, but not killing, game birds.



## Two Buses Converted Into Five-Room Home

Two obsolete buses converted into a five-room cottage solved the housing problem for a family in Dallas, Texas. The ancient motor coaches, minus engines, were placed on foundation blocks and boxed in with studding and siding. Roofing and porch were added, then a coat of paint.

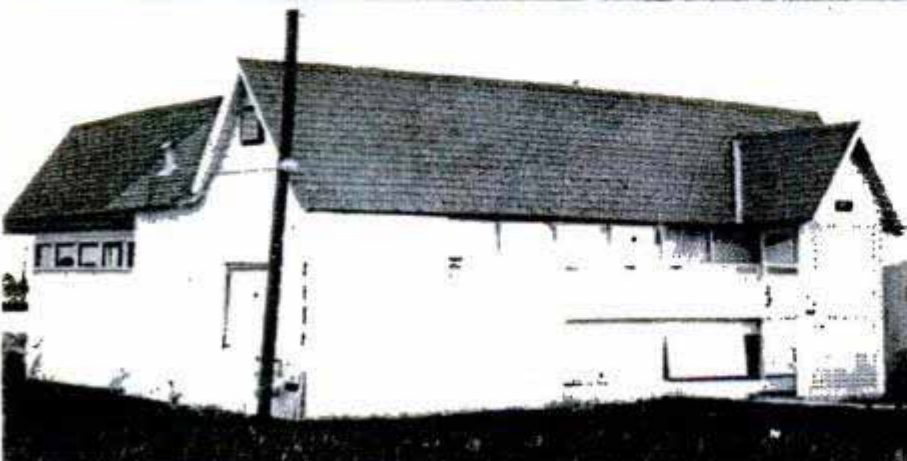

You may wish to obtain additional information about the new products described each month in Popular Mechanics. If you want to know the name and address of the manufacturer or the distributor, just write to Bureau of Information, Popular Mechanics Magazine, 200 E. Ontario Street, Chicago 11, Ill. Your letter will be answered promptly



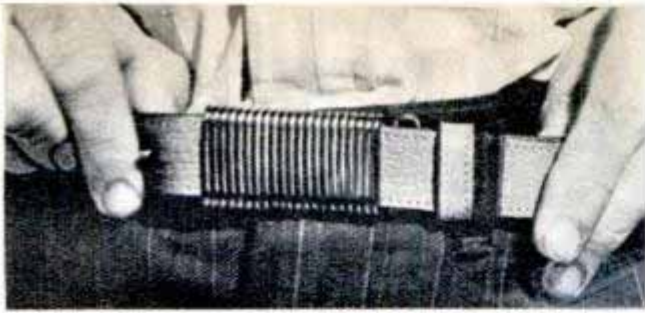

### Belt Stretches as Waistline Grows

Hearty eaters and athletically inclined men and boys will find comfort in a belt which stretches with every movement of the body. The "give" is supplied by a chrome steel spring which serves as the buckle. The spring is rectangular, permitting the belt to pass through it and fasten on to the spring stud at the free end. Perforations holding the belt end in place are reinforced with rivets to prevent tearing.

### Folding Pipe Fits a Man's Pocket

To make a smoking pipe more compact for carrying in a man's pocket, one manufacturer designed a shank that folds at two points. This also lessens chances of breaking the shank.



### Rubber Coating for Egg Baskets

Rubber coating is added to the wire network of egg baskets to reduce breakage during collection from nests. The basket also is rustproof. Rubber covering is also applied to potato baskets to safeguard potatoes against bruising.

### Midget Adding Machine Is Portable

Weighing less than five pounds, a midget adding machine for office or home can be carried easily. The machine is especially useful for taking inventory in crowded storerooms or in places where a calculator must be moved frequently. It is operated by stylus rather than push buttons. The stylus is inserted into the tooth of a wheel to the left of the number to be registered. A downward pull registers the number. Totals appear enlarged through a magnifier. The machine adds and subtracts and registers numbers in seven columns.

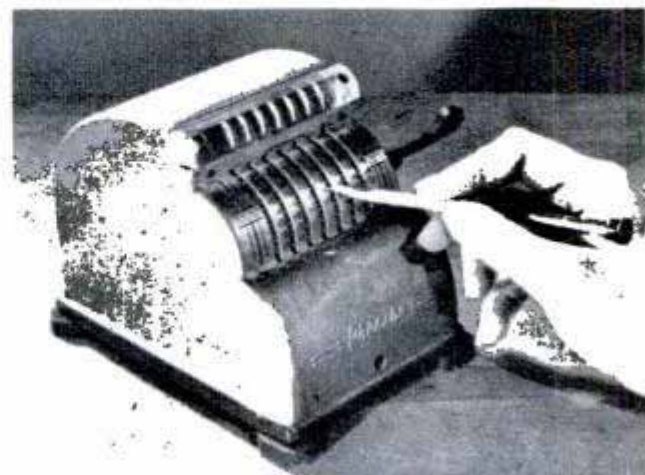



★  
**WHAT'S NEW**  
*For Your Home*

A four-page "shopping section" dedicated to modern homemakers

★

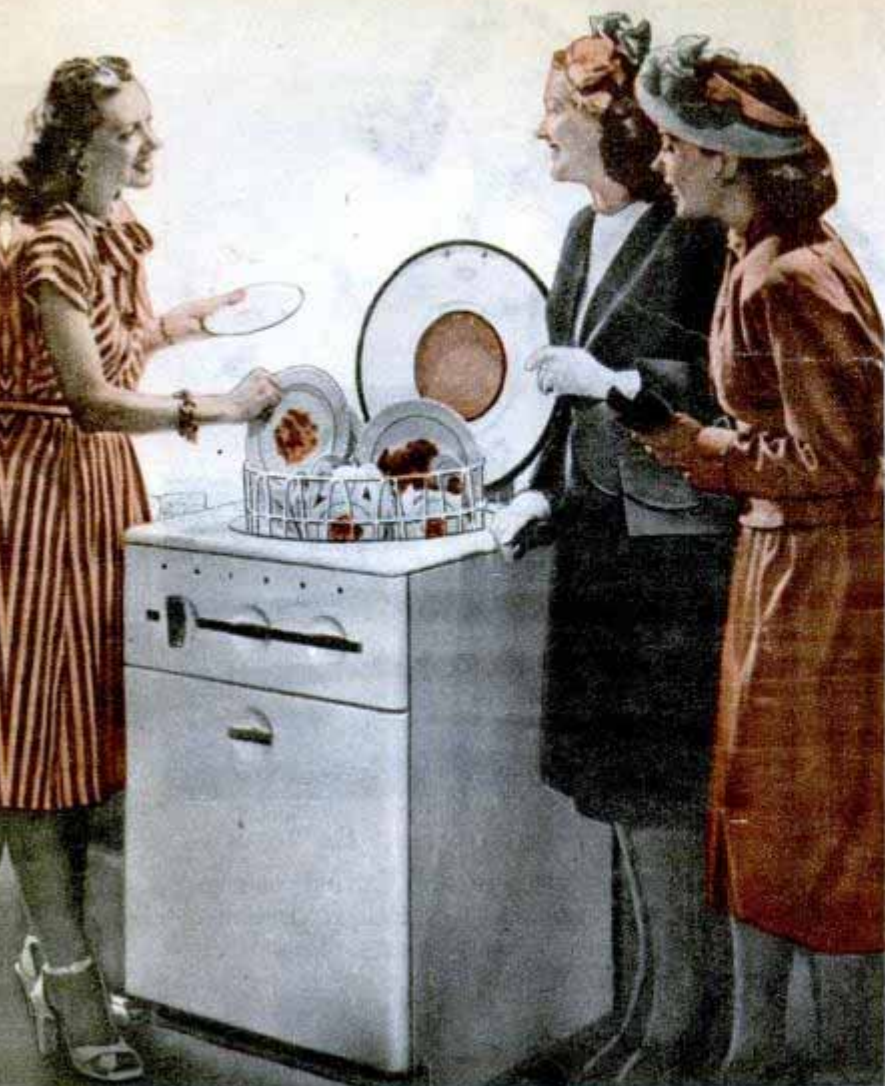

**DISHWASHER** powered by ordinary water pressure instead of electric current uses eight high-powered jets to wash, dry and rinse complete service for four within five minutes



**ROOM CONDITIONER** consists of a fan with a detachable heating element. Fan is used alone in the summer, heater is clamped on in winter



**PHONOGRAPH** made in England can reproduce all the sounds audible to the human ear. Front louvers provide 180-degree sound dispersal

**DRAWER PULL** flush with surface pivots in to provide grip

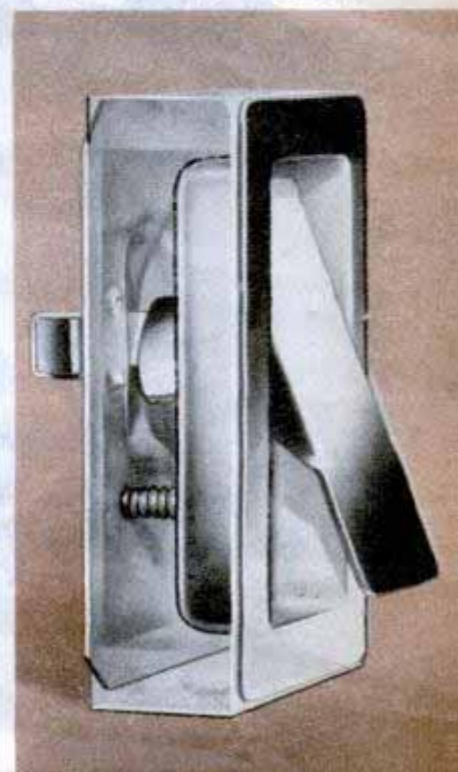





**CURTAIN RAISER** eliminates dangerous reach from chair or ladder. Curtain rod is attached to sliding shaft which can be raised safely from floor level



**WASHABLE WALL COVERING** made of a plastic-treated fabric is available in a wide variety of patterns. Marks can be wiped off the stainproof surface



**STOCKING HOLDER** holds up to eight pairs for drying, folds against wall when not in use



**BOTTLE HOLDER** saves time for busy mothers by supporting standard baby bottles in any desired position

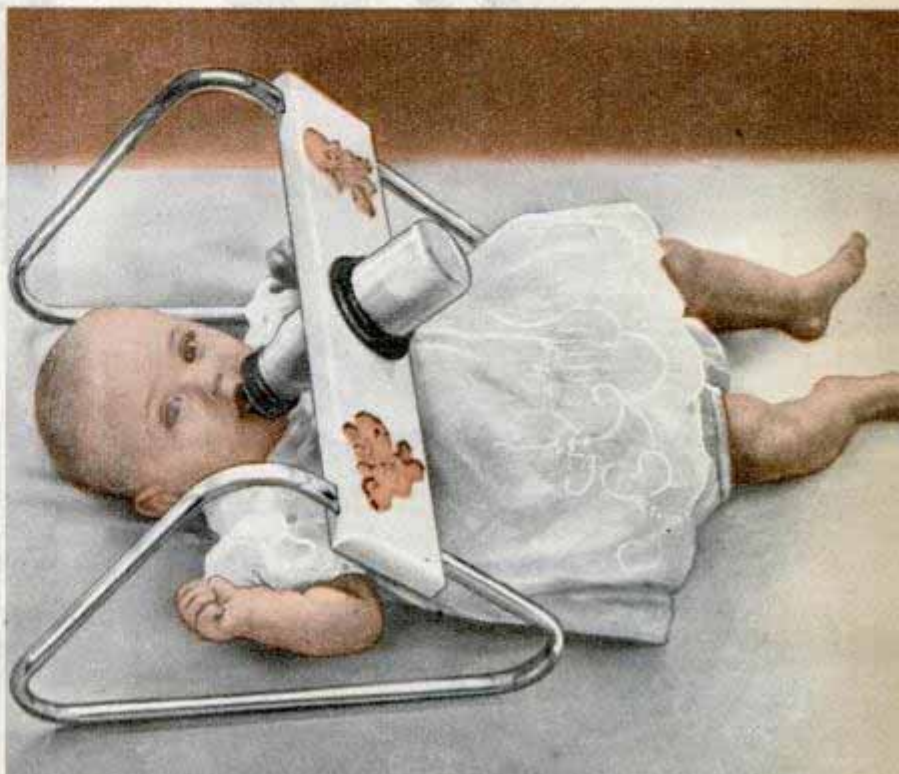



# WHAT'S NEW For Your Home

Continued from preceding page



**FLEXIBLE ARM** holds the cord above ironing board, preventing it from kinking or becoming entangled with clothing



**HOME DISPOSAL UNIT** has tiny gas flame which eliminates refuse. Flame dries refuse which burns by itself

← **ASH TRAY** for pipe smokers features a bowl reamer, cork knocker and tool for packing tobacco in the bowl

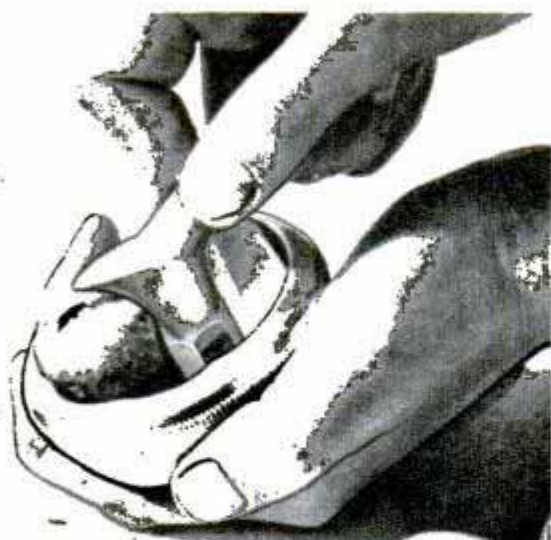

**BIRD CAGE** made of Plexiglas is transparent from all angles, has a "bubble" dome, perches and swings

← **NUTCRACKER** works on off-center cam principle. Turning the handle cracks shell against side of the bowl

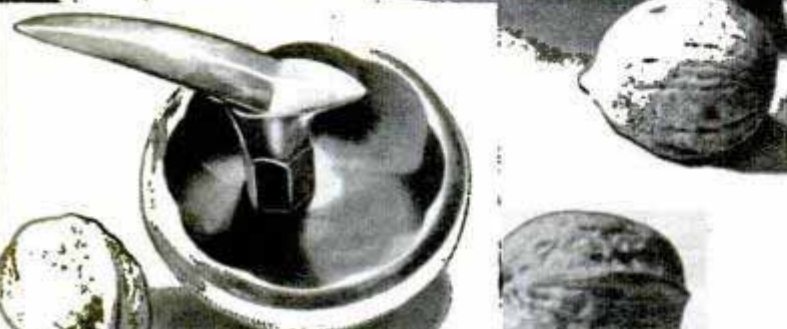





↑ **ELECTRIC HAIRBRUSH** with revolving bristles gives scalp quick massage

↓ **SINK STOPPER** fits flush with the drain, can't be dislodged accidentally



**ELECTRIC BED WARMER** is spread just beneath the bottom sheet, bathes the sleeper in a comfortable warmth that rises from below



**POTATO CUTTER** delivers shoe-string potatoes in a continuous spiral ribbon about  $\frac{1}{4}$  inch square. Onions and other vegetables also can be cut on the machine

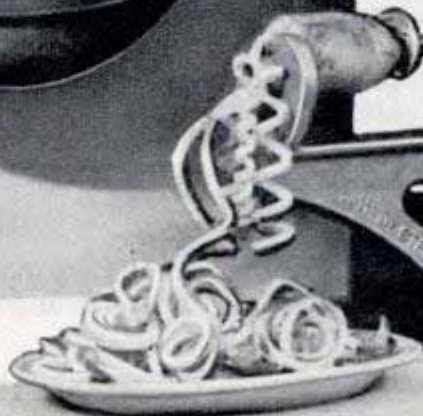



# Revolving Blowtorch Drills Holes in Iron Ore for Blasting Charges

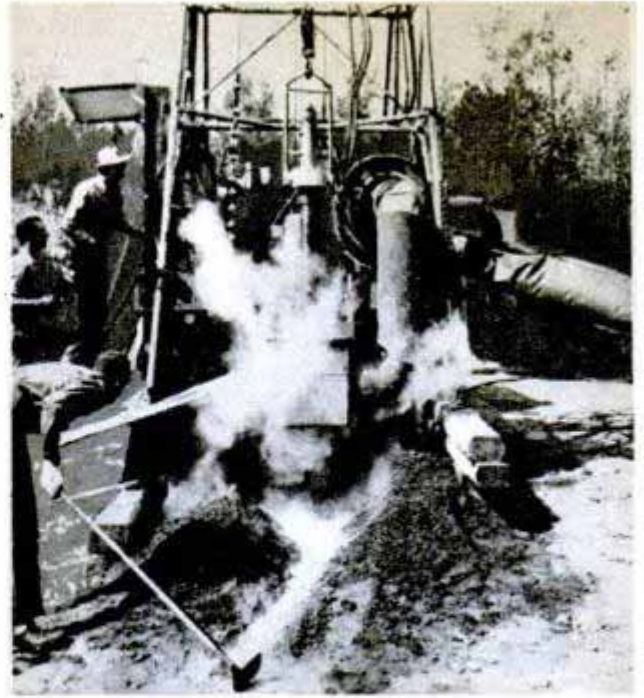
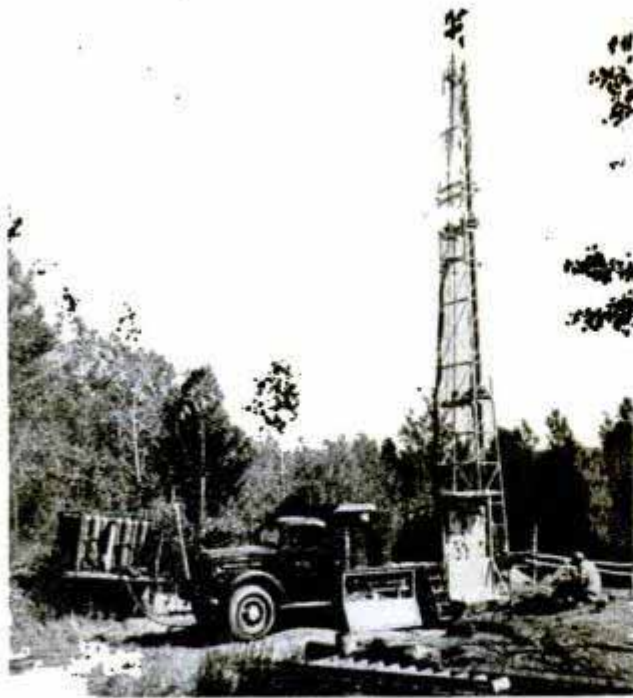

Above left, experimental rig is set up for a fusion-piercing test. Left, diagram shows how an intense flame melts hole through rock. Above, rig expels slag during test. Right, six-inch blast hole was drilled 30 feet by fusion piercing



Vertical holes for blast charges are drilled in iron ore 10 times faster with a revolving blowtorch. Called fusion piercing, the method has been tested on hard, low-grade iron ore. A 4000-degree Fahrenheit flame, produced by burning oxygen and fuel in a special blowpipe, is directed against the surface to be drilled, melting some of the rock and flaking off the remainder. The pressure of burning gases forces the molten material past a water spray, and steam aids in forcing the material out of the hole. In field tests, six-inch-diameter holes were fusion pierced at 10 feet per hour. An average of one foot per hour was drilled by former methods.

## Indicator Detects One Part Carbon Monoxide in 500,000,000 Parts of Air

Poisonous carbon monoxide fumes can be detected in extremely minute quantities with a chemical indicator 100 times more sensitive than any previously known. Developed by the National Bureau of Standards, the indicator consists of a sealed glass tube about five inches long and the diameter of a lead pencil. To make a test, the end of the tube is broken off and the yellow indicating material inside is exposed to air. If carbon monoxide is present the gelati-

nous indicating chemical turns a blue-green color. The indicator can detect one part of carbon monoxide in 500,000,000 parts of air. Among its uses are the examination of air in and around buses, automobiles, garages, furnaces, industrial plants and transport planes.

☛Cashew nut shells are made into "friction fortifiers" for brake linings by a New Jersey company.



## Glass Prism Weighing 300 Pounds Ground for Mexican Observatory →

Weighing more than 300 pounds and measuring 27½ inches in diameter, the largest glass prism ever ground was completed recently for an observatory in Puebla, Mexico. It will be used as auxiliary equipment in the world's largest Schmidt-type telescope to photograph stars 100,000 times fainter than the faintest star visible to the naked eye. It took the Perkin-Elmer Corporation six months to grind and polish the prism, whose dimensions check to an accuracy of three millionths of an inch.

## Flat Safety Step Fits Ladder Rung



Foot comfort for painters, fruit pickers and others who use ladders for long periods is provided by a flat safety step which fits over the rungs. Adjustable steel brackets hold the platform securely.

## Plastic Glue Cements Duralumin

Gluing metal aircraft parts together is a possibility now being investigated by research engineers. If it proves a successful substitute for riveting, this technique will reduce surface drag of wings and fuselages. The glue—a new plastic adhesive—is extremely strong. In one series of tests conducted by the American Society of Testing Materials, the glue was used to cement together two pieces of ¼-inch duralumin. Under bending stresses, the glue was stronger than the metal itself.



## Instruments Chart Hurricanes Through Earth Tremors

Seismographs, the instruments that record earthquakes, are being used by the Navy in a new method of charting hurricanes. The hurricanes produce vibrations which are transferred through the water to the floor of the ocean and then through the ground to seismographs in the area. The earth tremors are recorded on a roll of sensitized paper by a pinpoint light through a slit in the seismograph. The charts show in graph form the severity of the hurricane tremors that shake the earth.





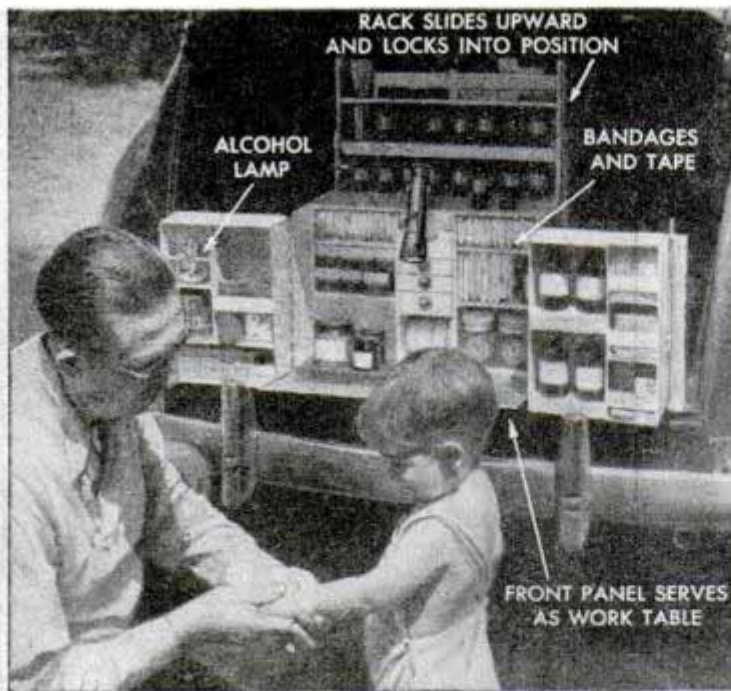

Ample medical supplies for most emergencies are contained in a first-aid cabinet which fits in the trunk of a car. It was designed for ambulances and crash wagons and as a "portable hospital" for quick transportation to mining and construction accidents or similar disasters. Inside the cabinet, which can be carried like a suitcase, are 15 three-ounce bottles of medicine

## "Hospital" in a Suitcase Fits Car Trunk or Plane

mounted securely on an elastic base to prevent breakage. Also accessible when the unit is opened are a cotton holder, adhesive tape on a roll, jars of ointment, a supply of splints, hypodermics and thermometers, an alcohol lamp for sterilization and a flashlight holder for night work. The unit can be carried in a light plane and mounted on a tripod at the scene of an accident.

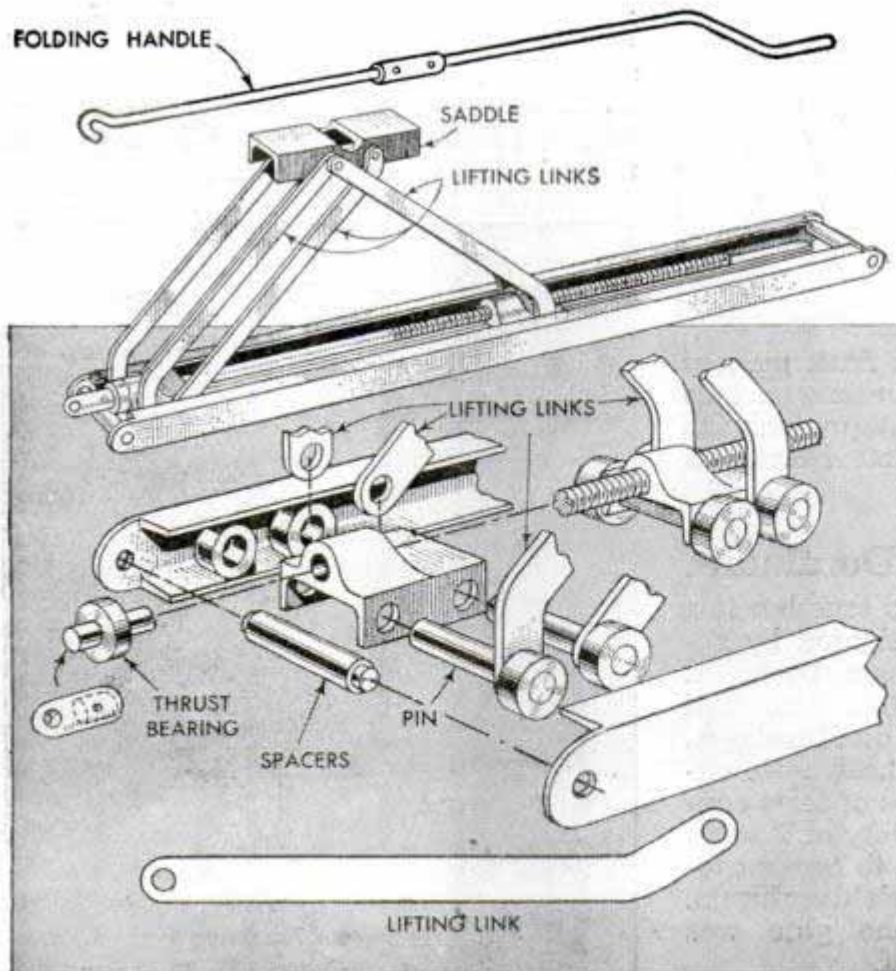

## "Tipless" Auto Jack Safe on Hills

Any danger of your car or trailer rolling, even when changing tires on rough ground or a steep incline, is eliminated with a "tipless" auto jack. Base of the jack is 26 inches long. It is 4½ inches wide and in retracted position is only 2½ inches high. Maximum lifting height is 13 inches. The lifting saddle is mounted on four lifting arms. Lower ends of the lifting arms are mounted on rollers in the base to enable them to move slightly with the car as it is lifted. A folding handle allows operation from the side of the car.

Four-room houses are being built in Britain of concrete from waste of the china-clay industry.



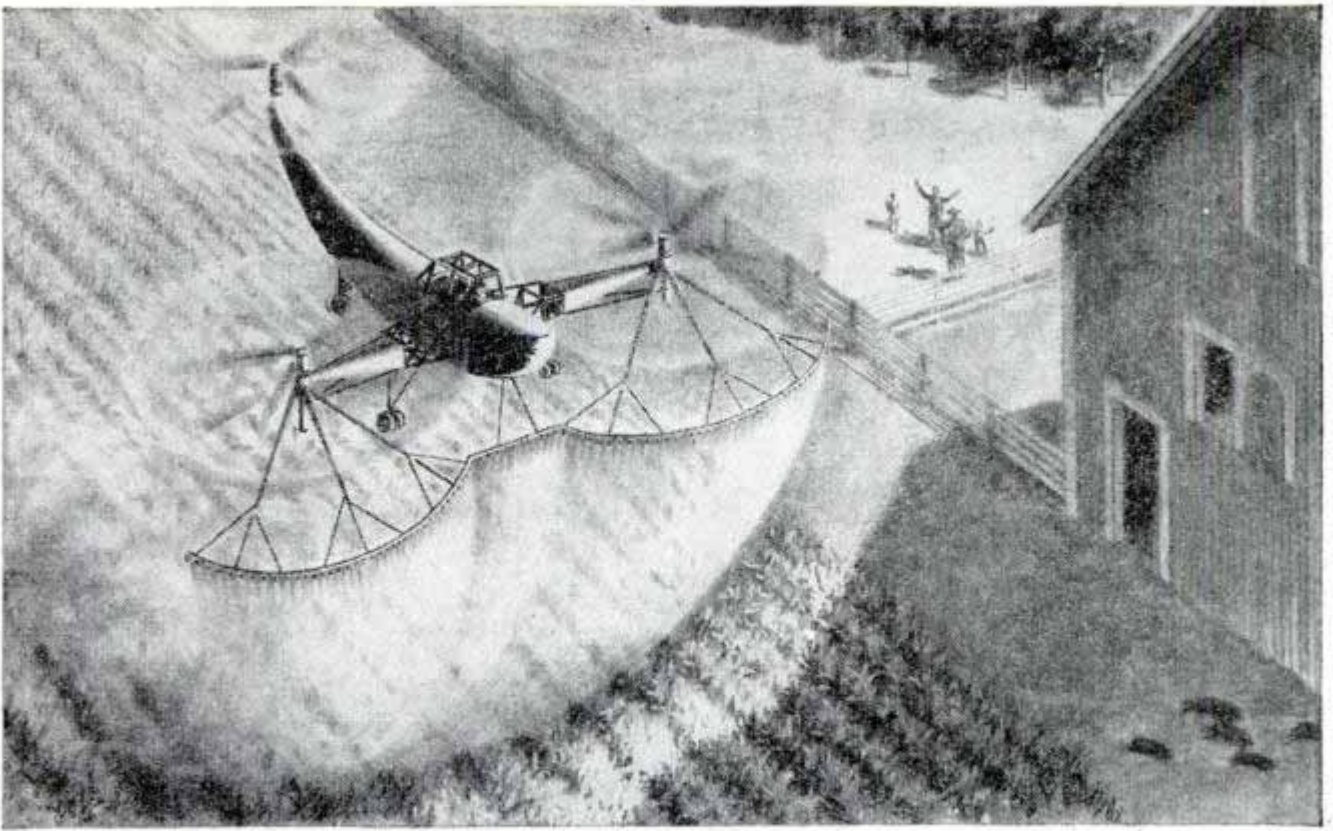

## Helicopter Lays Mist Of Insecticide on Crop

Spraying Mantis is the apt name of a British helicopter planned to shower insecticide on nearly 500 acres a day through its 100 nozzles. It will carry four tons of insecticide or fungicide, depositing about 50 gallons per acre. The spraying attachment has a 90-foot span. Normal operating speed for the helicopter, which is still in the design stage, is 80 m.p.h.

With insecticide showering from 100 nozzles, the Spraying Mantis can cover nearly 500 acres in a day. Designed specifically for pest control work, it holds four tons of insecticide or fungicide

*Farmer & Stock Breeder photo*

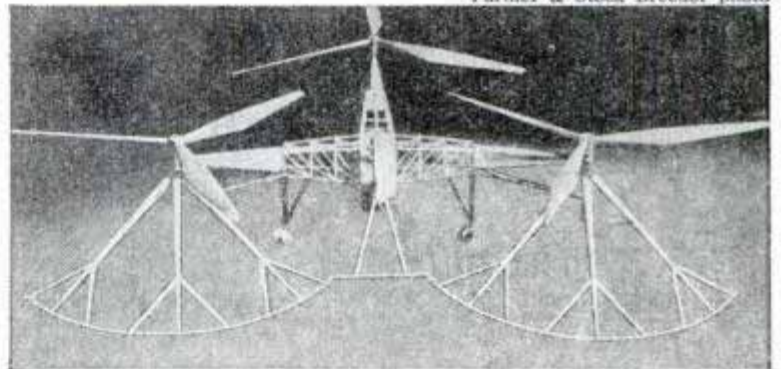

## Jeep Carries Lightweight Crane and Provides Power for Road Work

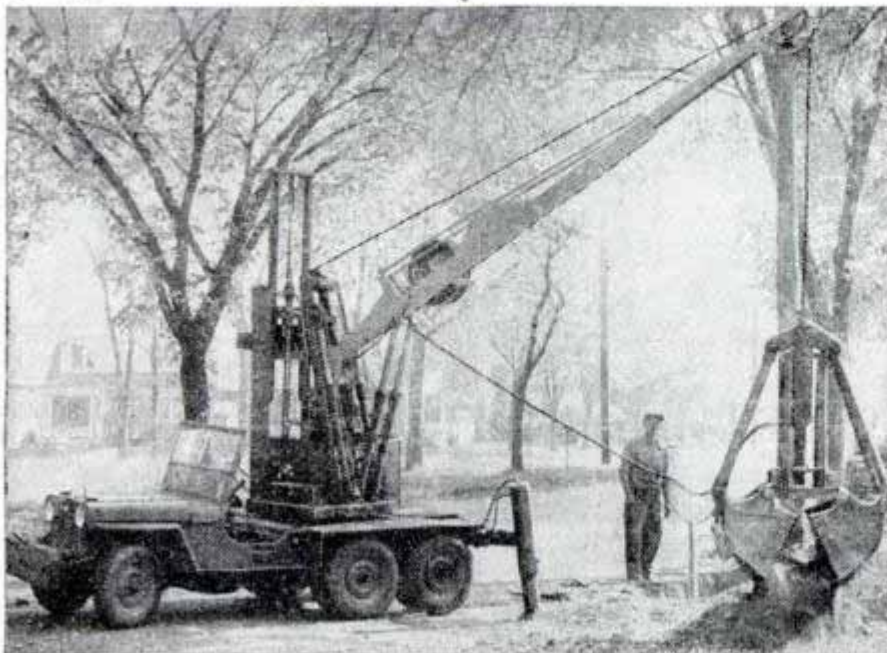

Another job has been shouldered by the versatile jeep: carrying a compact hydraulic crane for light road work. With hoisting power furnished by the idling jeep engine, the crane spots its bucket or hook at any point within reach of a complete circle. The bucket is closed by hydraulic power instead of the standard two-cable device used on many larger cranes.

☐ An Australian air line provides colorful felt toys and dolls for children and small cots for naps.



By John L. Kent

**A** QUEER-LOOKING ship in an east coast port is drawing excited comment these days. It might be just another freighter except for one thing. It has no masts, booms or winches in the forward section.

Close inspection reveals strange rails supported high in the air on steel columns. Riding each pair of rails and spanning each loading hatch is an overhead crane of the type used in foundries and steel mills.

To the ship's crew, the engineers and the designers on board, the unorthodox apparatus represents an answer to the greatest problem in ocean shipping—how to load and unload a cargo

← Rail-riding winch now under test may replace the masts and booms of older vessels. Below, arms folded at sides of ship are extended above the dock to carry winch during unloading

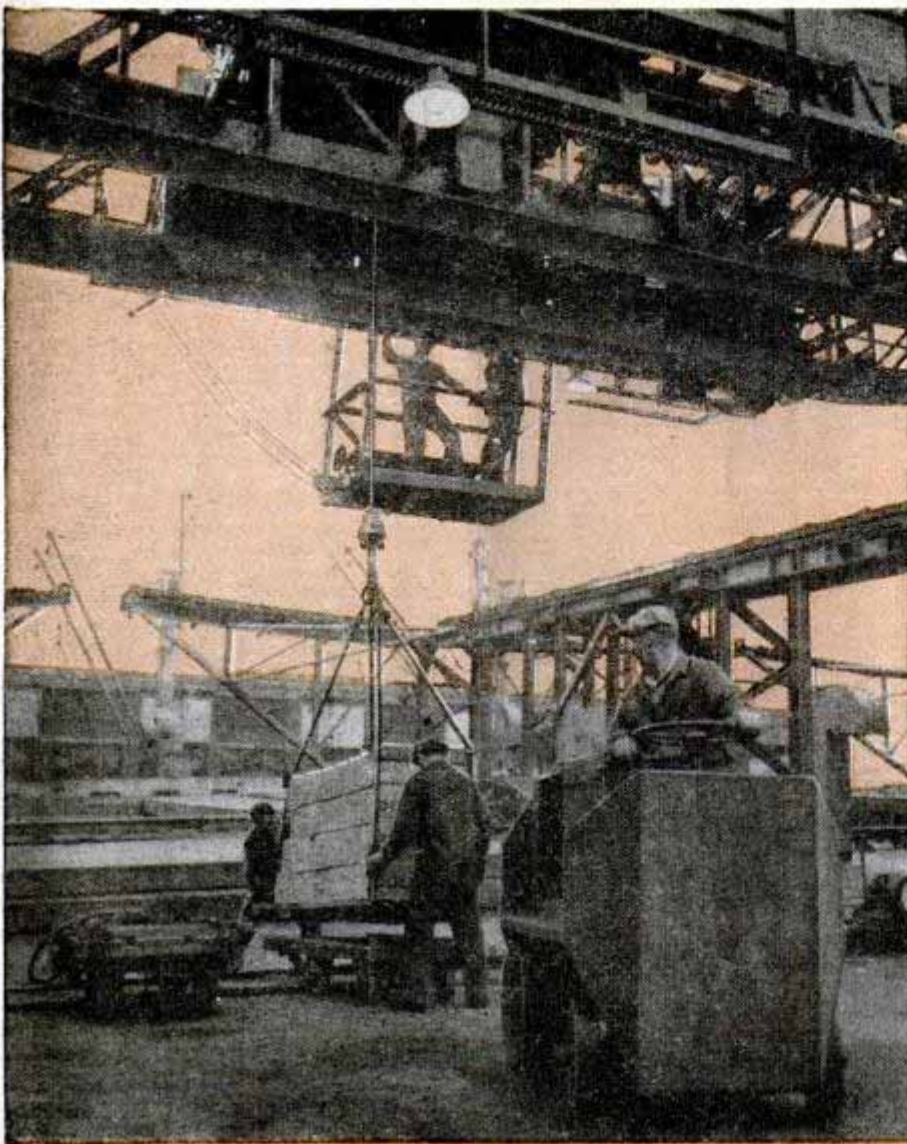

## *SPEEDING THE OCEAN*

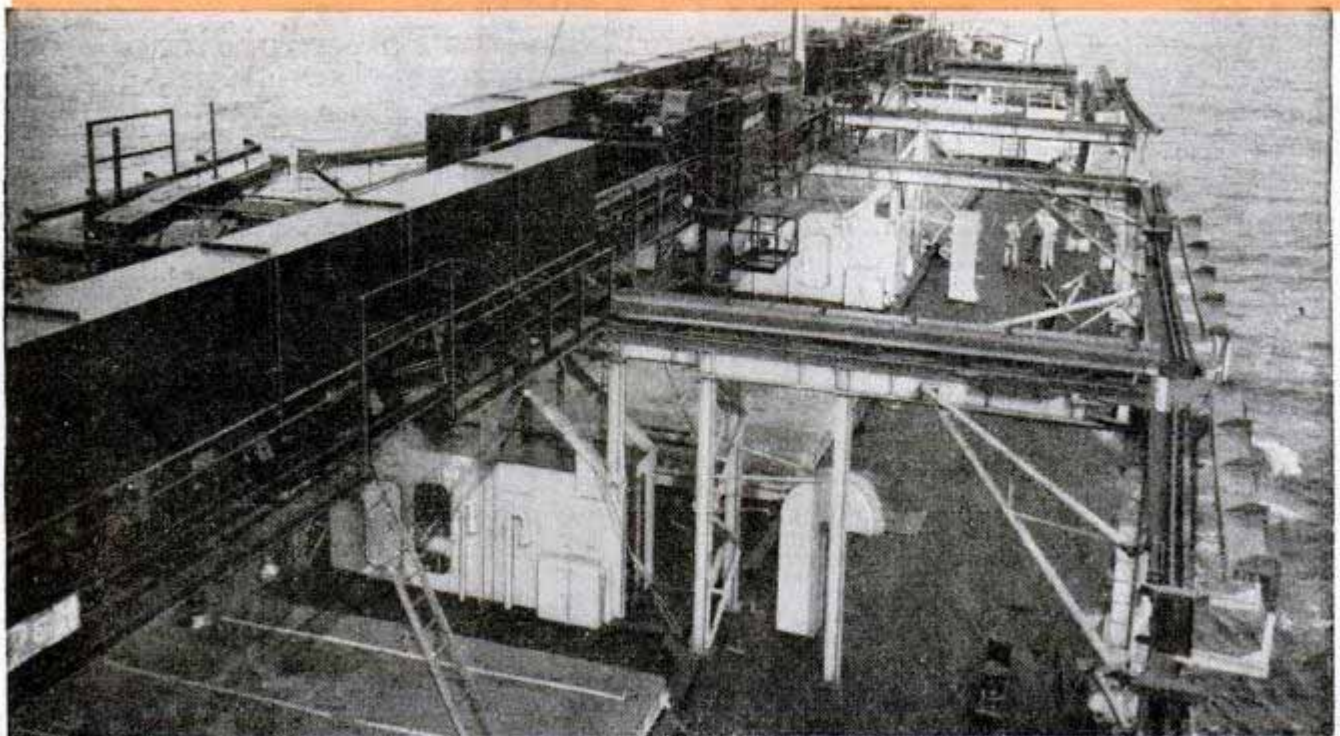



ship in the most efficient way.

Since the days of sailing vessels, cargo has been swung out of ships' holds by cargo booms. All our Liberty, Victory and newly built C-type freighters are equipped with the traditional winch-operated mast-and-boom hoisting apparatus.

The new method of loading and unloading a ship, which may revolutionize the handling of cargo on ocean vessels, is being tested by the U.S. Maritime Commission aboard the SS Sea Hawk, crack C-3-type merchantman.

There is a reason for this and similar recent experiments with novel ship loading devices. On the successful outcome of any of these methods may depend the continued supremacy of the U.S. merchant marine.

The United States emerged from the war with about 60,000,000 tons of ocean-going shipping. This is more than five times our prewar strength. Our fleet before the war constituted about one sixth of the world total. Today it is four sixths.

But the period of U. S. leadership, reminiscent of the Yankee Clipper era, won't last long unless ways are found to cut load-

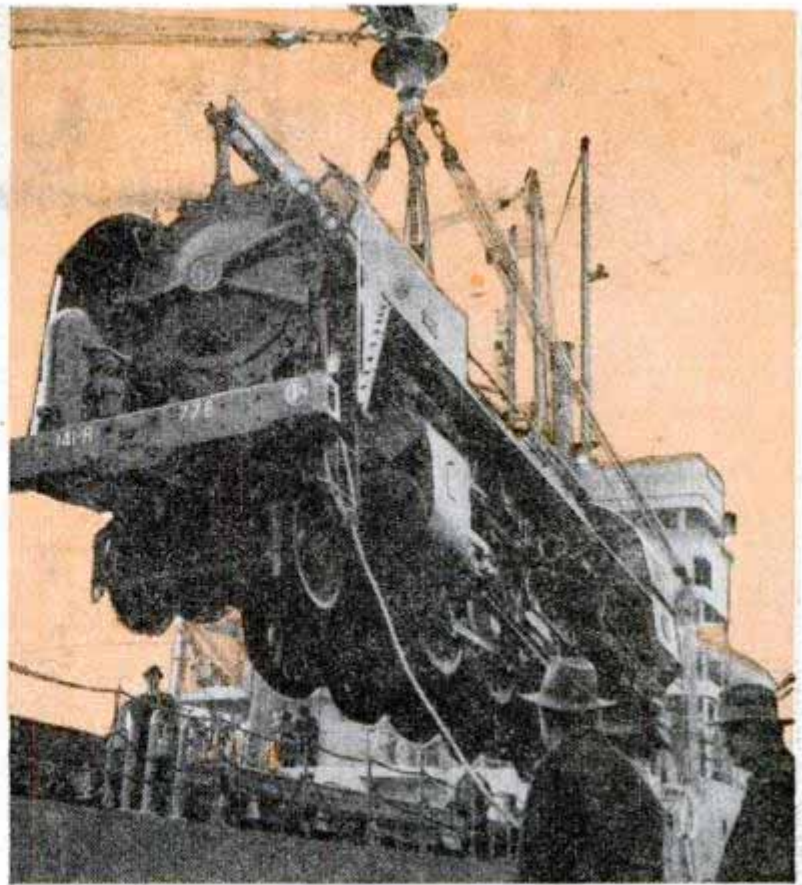

ing and unloading costs. England, Canada, Norway and other maritime nations are rushing construction of new ships. Once their ships, which are loaded, unloaded and manned by labor much cheaper than ours,

## FREIGHT ABOARD

↑ 125-ton locomotive is loaded aboard the only ship in the nation with boom strong enough to support such weight. Below, more engines await loading

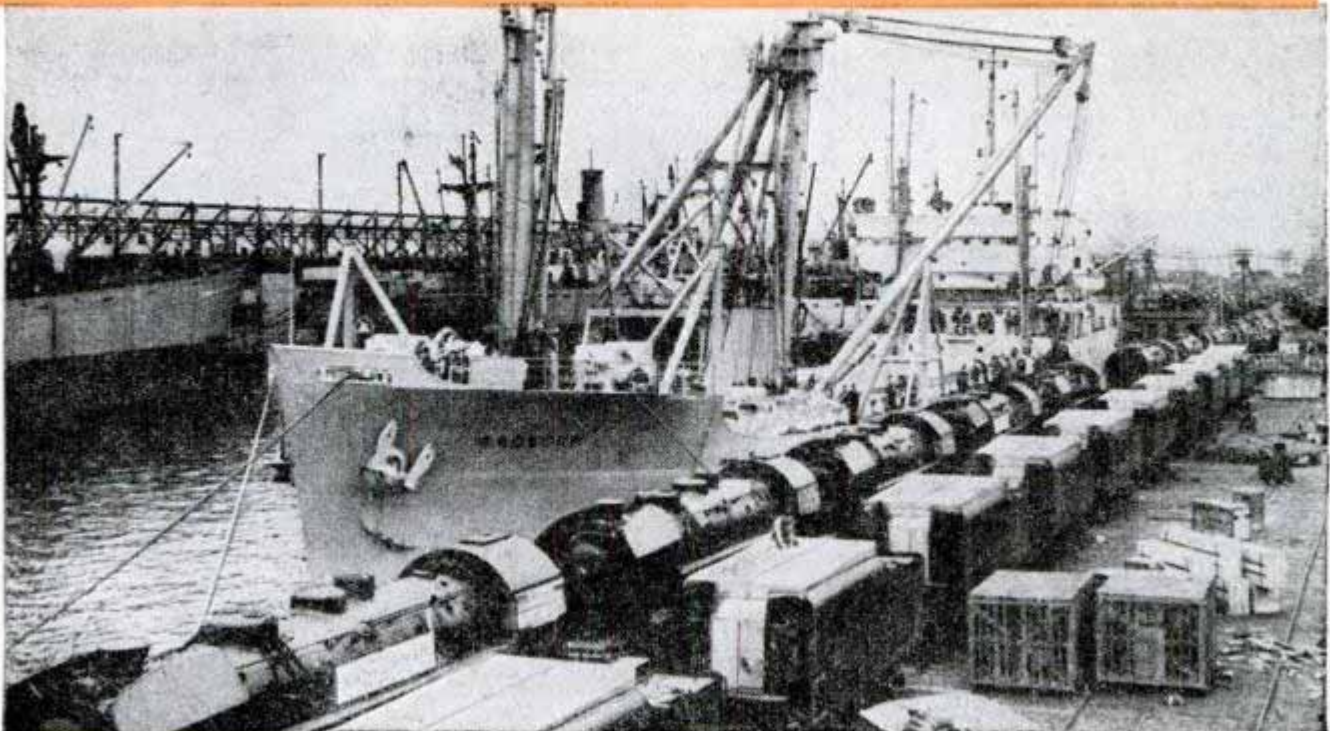



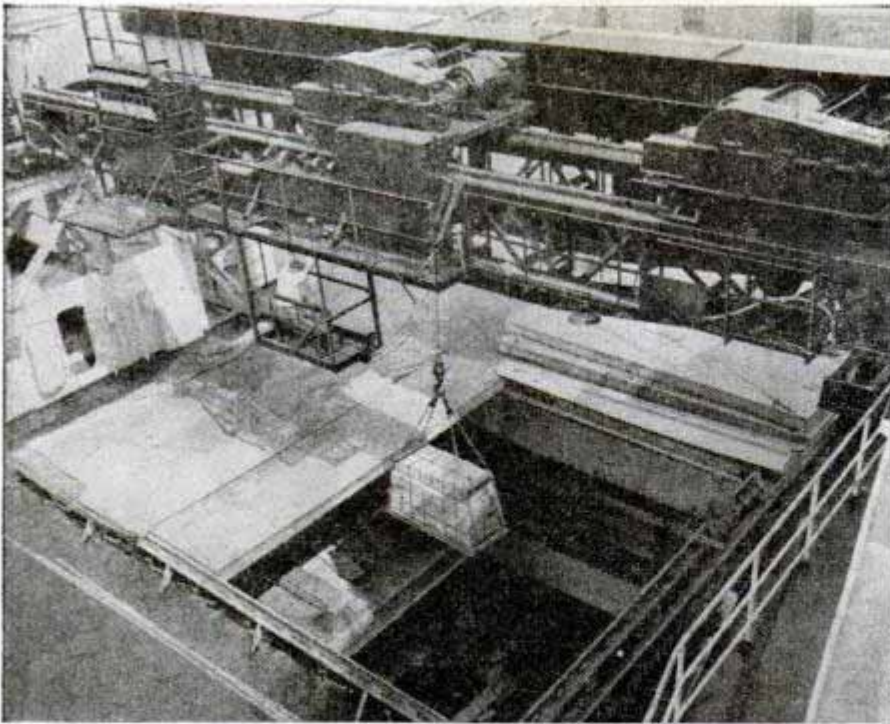

Load of pineapple is plucked from the hold by the new cargo handling gear. The load will move along the beam until it hangs above the dock

are afloat, the United States will be at a disadvantage.

To keep our ships in the lead, the U. S. Maritime Commission, shipowners and ship operators are experimenting with new types of loading and unloading equipment designed for more efficient service.

The Maritime Commission's design uses several overhead cranes, one over each hatch, to move the cargo into and out of the ship's holds. Three such cranes have been installed over the three forward hatches of

the SS Sea Hawk. They run across the ship on folding tracks which can be extended outboard over piers or lighters.

To load a ship, the two folded outrigger arms on which each crane travels are extended out from the ship's side over the pier. Large steel pins hold each track in the open position. An electric motor and hoisting winches, together with an underslung cab for the operator, ride the tracks, which are of a spur and pinion construction, thus assuring no slippage and exact control for spotting the cable hook. The cable is unwound and the stevedores hook up the pallet or ends of the full cargo net.

The electric motor gives a short whine and the hoist reeves up the cable. With the net or pallet hoisted clear of the ship's side, the entire crane mechanism rides back to stop above the ship's hatch. The operator lowers the cargo into the hold and the cable is unhooked. He then reels up the empty hook and rolls the crane back over the dock for another load.

Experimental performance of these cranes on the SS Sea Hawk showed them capable of handling cargo 15 percent faster

Rail extended, the experimental loading ship SS Sea Hawk is ready to discharge her cargo

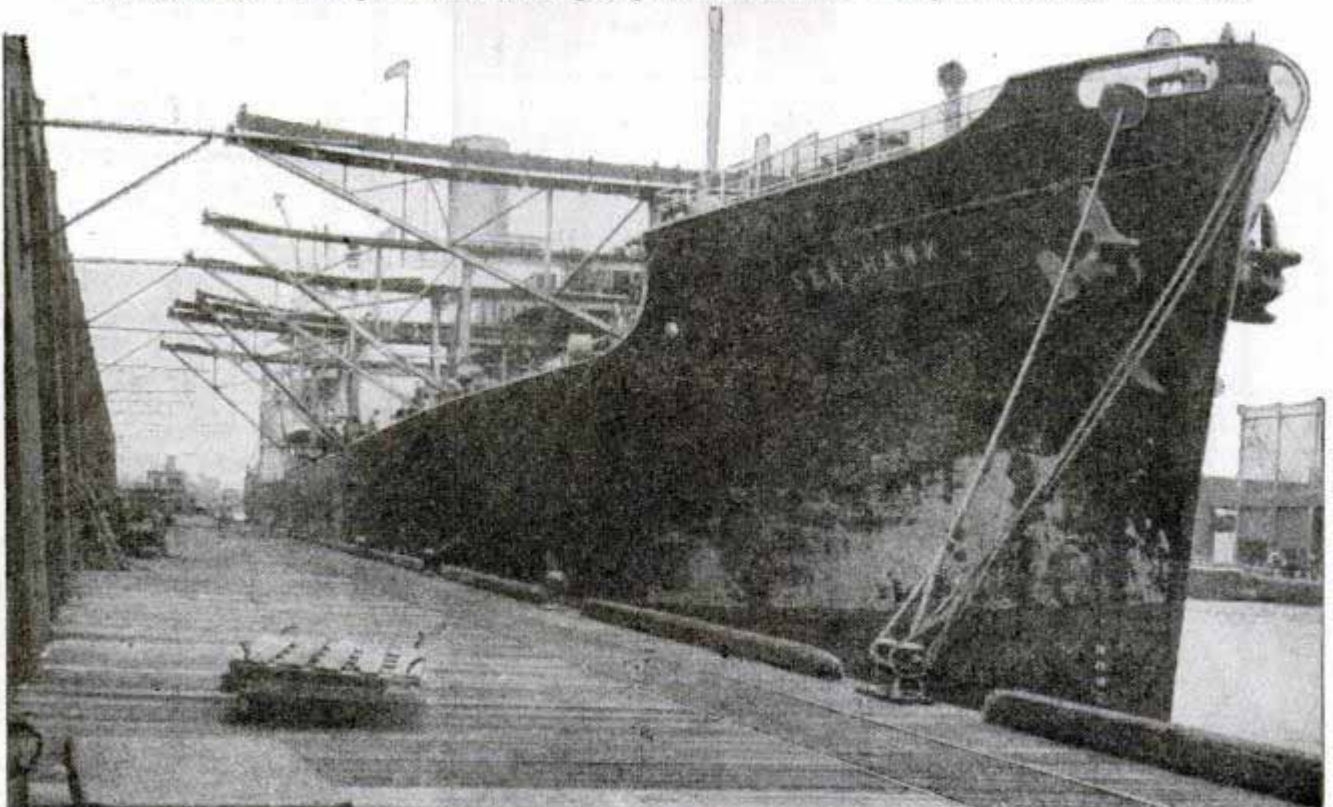



**Liberty ships have conventional loading gear consisting of several booms with individual winches**

than conventional types of cargo gear with masts, booms and winches.

Stevedoring is the biggest single item in the cost of ship operation; twenty cents out of every dollar expended by American merchant marine goes for the handling of cargo. In the coastwise trade, the figure may run as high as 40 cents. In some trades it costs more to put cargo into a ship than it does to transport it.

But loading and unloading a ship is only half the problem. The ship's master must stow the cargo to protect the ship and crew from damage and injury, protect the cargo from damage and make the best use of cargo space. He must distribute the cargo so that it can be promptly and readily unloaded upon arrival at scheduled ports.

The modern ocean-going vessel is provided with good-sized hatch openings and relatively clear holds. But there are still numerous problems to be solved. Stowage nowadays, for example, is frequently complicated by the fact that many vessels load cargo at several ports—for discharge at a number of foreign ports.

Take the case of the captain sailing from New York with a partial shipload of automobiles, cheese and condensed milk. He is ordered to pick up electric generators in Philadelphia and lumber, turpentine and cotton in Savannah. This cargo is to be unloaded about a month later in Brisbane, Sydney and Melbourne.

Generally he stows the cargo so that there is a fair distribution for each port throughout the ship. For example, if there are

**Ship model at Army-Navy Stevedore School helps teach young officers the secrets of loading**

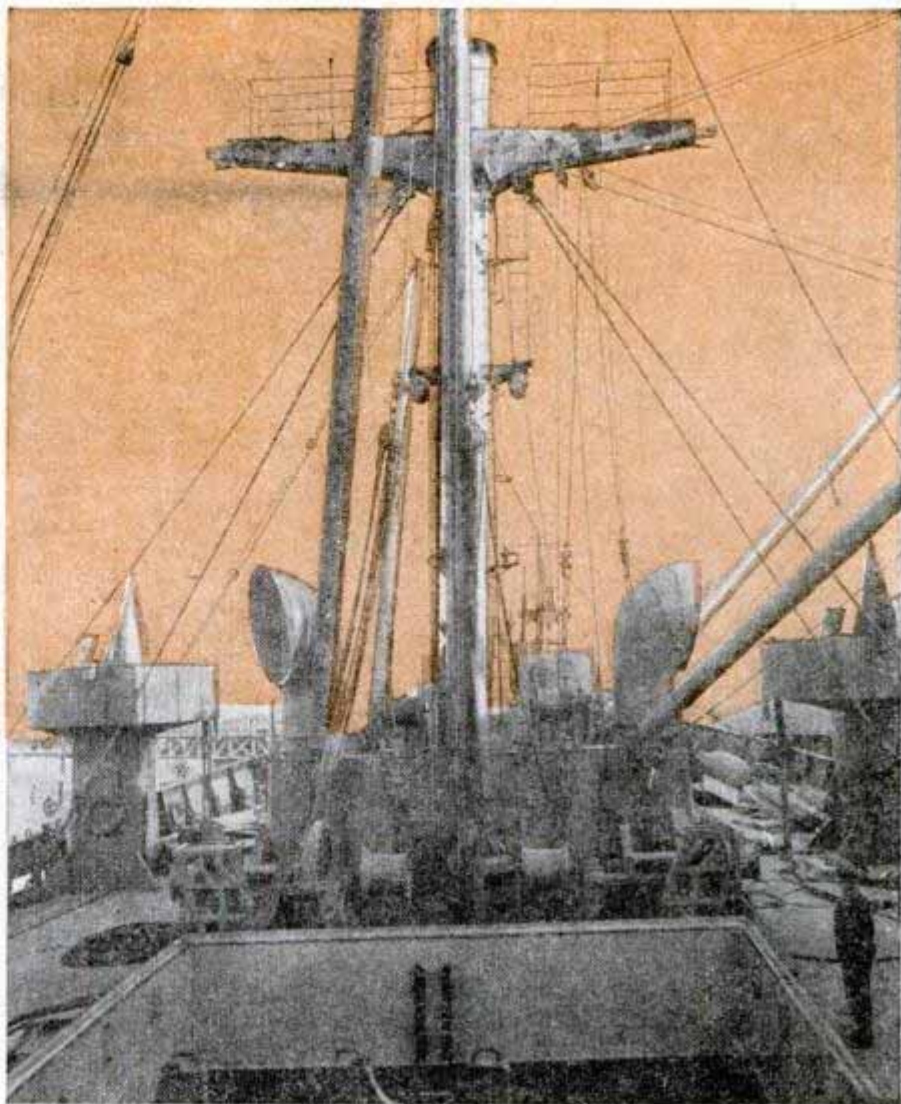

500 tons of cargo for Brisbane, he places 100 tons in each of the five holds. This not only helps to make cargo for the various ports accessible at the proper time, but also speeds the discharge of cargo, since all

(Continued to page 260)

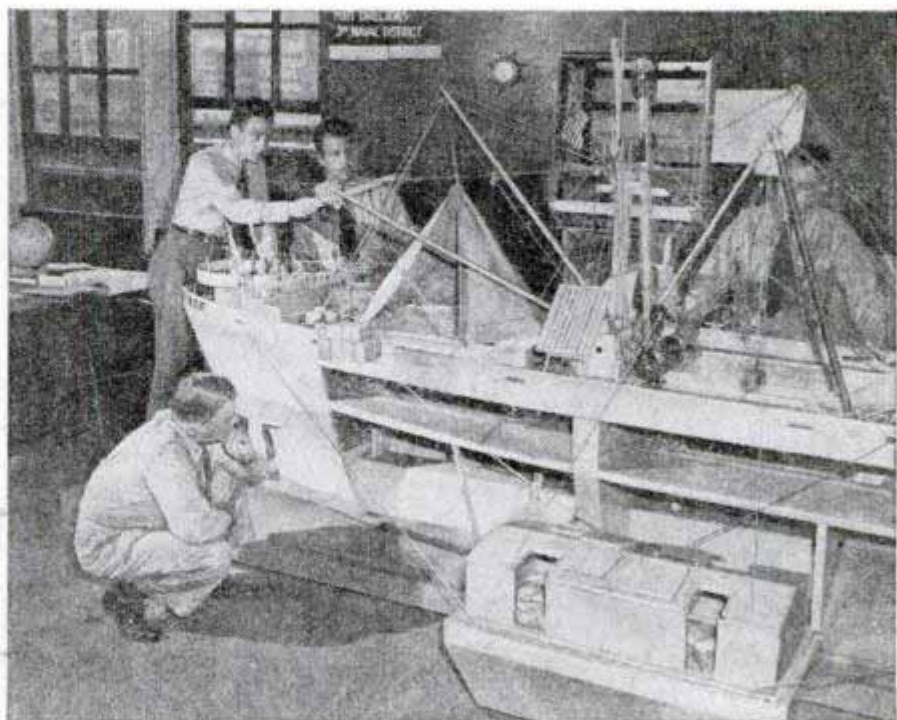



# Latest Tanks Outweigh and Outshoot Wartime Weapons



Left, fast 60-ton tank has double the armor protection of earlier tanks. Lower left, tank-type land battlewagon mounts a 10-inch howitzer or (below) can be fitted with eight-inch rifle



Heavy high-speed tanks and land battlewagons mounting big guns are among the latest weapons developed for the Army. The new 60-ton tank has twice the speed of any other tank of comparable size and mounts a 90-mm. 21½-foot-long rifle which hurls a shell at three times the speed of sound—an armor-piercing power greater than any gun used during the war. Carrying a crew of five, the tank has double the armor protection of earlier tanks. The land

battlewagon mounts either a 10-inch howitzer that can shoot a 360-pound shell 16 miles or an eight-inch rifle that hurls a 240-pound shell 27 miles. Despite its 63½-ton weight the battlewagon can travel 20 miles an hour. In contrast to previous mobile guns which took hours to set up and depended upon roads and railroads for transportation, the new artillery pieces are prepared for action in five minutes by backing the spade tail into the ground to resist recoil.



## Tractor Built on "Stilts" Hauls Seine Into Lake

Discarded automobile, truck and tractor parts were used to build two elevated amphibious tractors which are employed to save time in hauling a 2400-foot fishing seine into a lake and back to shore. Lawrence N. Trombley, a commercial fisherman at Saginaw, Mich., designed the vehicles.

Popular Mechanics is always ready to supply further information to readers about various products described in any issue. Just write to Bureau of Information, Popular Mechanics, 200 E. Ontario St., Chicago 11, Ill., for a prompt reply.



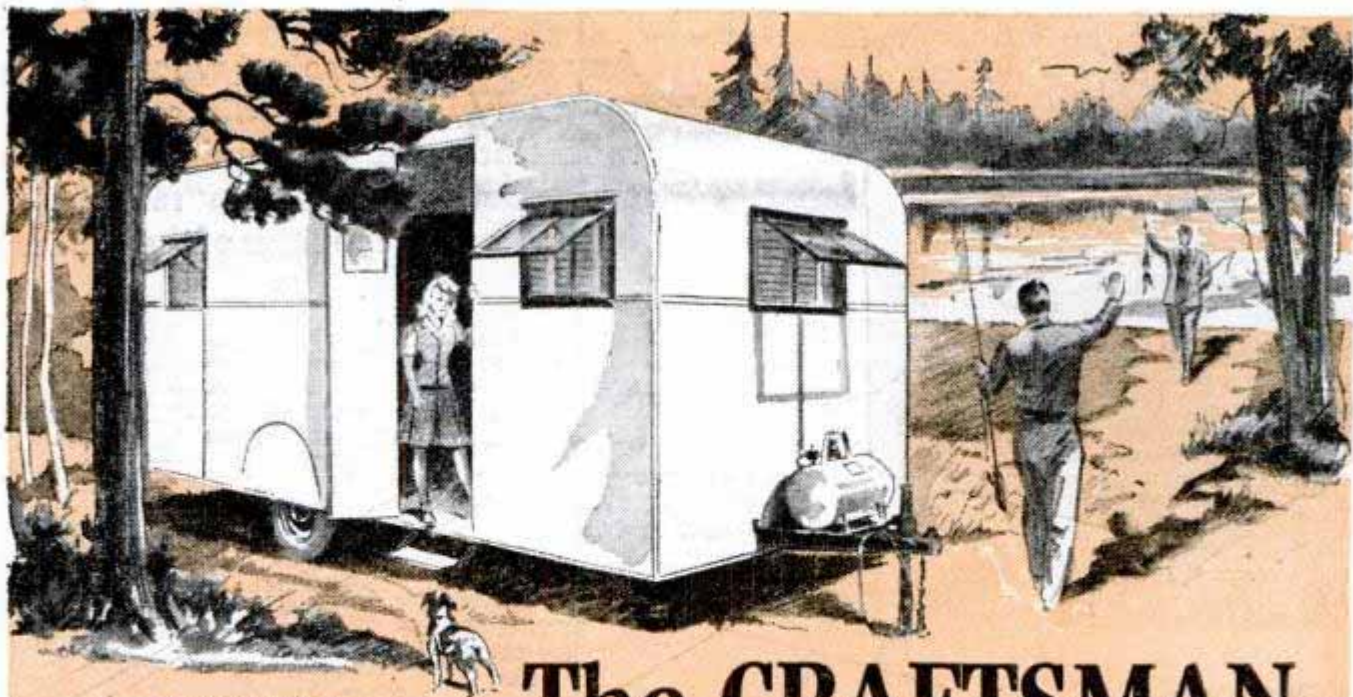

HOUSE TRAILER

# The CRAFTSMAN

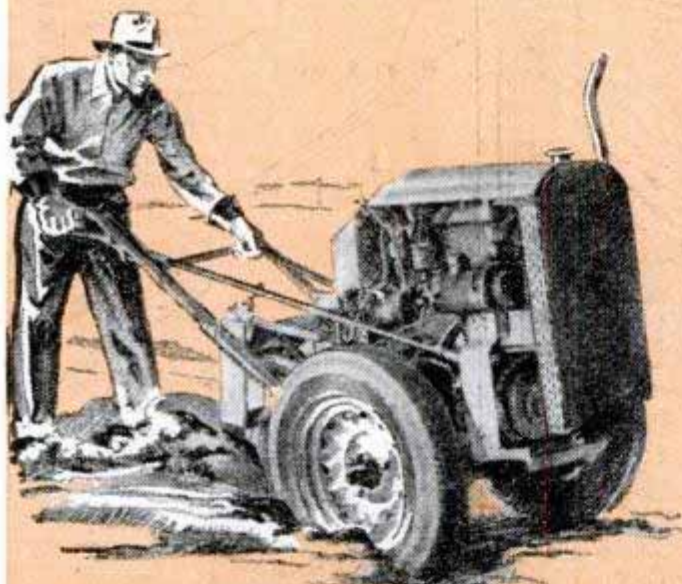

4-CYLINDER  
GARDEN TRACTOR

Set up housekeeping wherever you stop—that's something to dream about when you're planning to hit the open road. All right, make it come true by building PM's new house trailer. The how-to-build story starts on page 190 and here you'll find all that's good in trailer living for four people arranged on a floor space only 7 by 17 ft. That should be enough to start you off. And then along on page 222 there's a story on building a garden tractor from old auto parts. "So what," you say. But this one is powered by a 4-cylinder engine and that, brother gardeners, is really new in a "walking" tractor. The next offering, page 182, is a radio cabinet in modified modern design. Made of fine cabinet woods, it's easy to look at, especially if you built it yourself. With spring just around the corner, a story on page 200 gives inside information on how to do a bang-up job of car painting



RADIO CABINET

CAR PAINTING

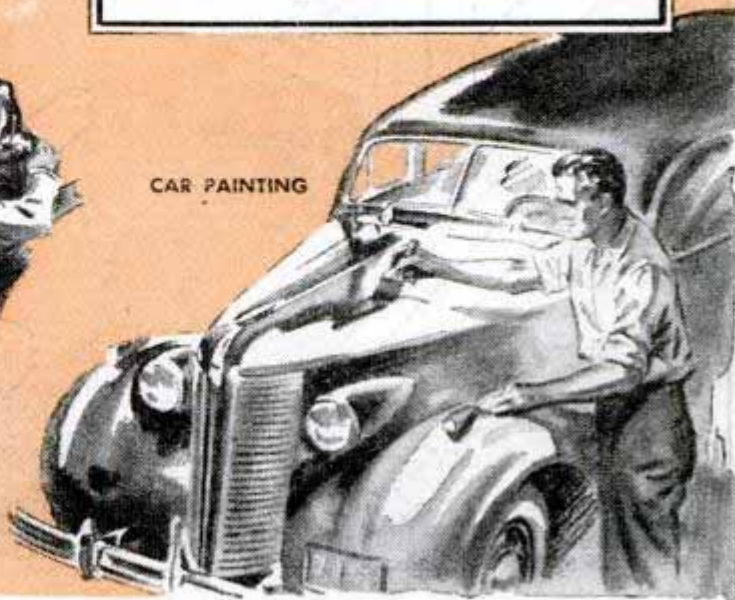









2

## MODERN RADIO CABINET

WITH the exception of the novel "telescoping" doors, which open out and then slide back into pockets, this floor-type radio cabinet is almost as simple and easy to build as a box. Character and individuality of design are added by beading around the double-door opening, built-up door handles and one-piece inset wood legs or feet. Absence of curved parts on the exterior of the cabinet gives the whole job a pleasing plumbness of line that appeals to both the craftsman and the home decorator.

Due to the width of the sides, top and bottom, it will be necessary to build up to the required widths by edge-gluing several pieces together. Select the wood for quality and grain and cut all the pieces slightly longer and wider than the finished

By Gene Russell

dimensions to allow for fitting.

The kind of wood to use depends on the finish you desire. Plain oak will take a beautiful limed finish, which is especially popular on this modified modern design. Any of the other fine cabinet woods are, of course, suitable for finishing in the natural color, bleached or stained. However, if you like an enamel finish, then use a close-grained wood such as birch, gum or poplar.

When clamping edge-glued work, you can save a lot of time and extra sanding by making sure that the edges are flush. Draw the bar clamps tight and then even up the edges by tapping lightly with a hammer. Wipe off excess glue with a damp cloth. Allow plenty of time for the glued joints to dry before releasing the clamps. Doors







A delight to the heart of very young children, this pull-toy is made with a few odds and ends that are found in most workshops. The body of the wagon is a small basket that is woven of gaily colored materials. It can be reed, raffia, wicker or any other suitable material. Place the basket on a piece of plywood and trace the outline on the board. When cutting the base make it about  $\frac{3}{4}$  in. oversize. Next cut the axle and allow it to overlap the base slightly. A length of sturdy dowel is cut to serve as a handle, with a smaller dowel to serve as a crosspiece. Two corner irons are screwed to the wooden axle and roller-skate wheels are bolted to the irons. The entire assembly is bolted or screwed together.

Touches of color can be added here and there with a crayon, after which all parts of the toy are given protective coatings of shellac.—Simon S. Palestrant, Bronx, N. Y.

## Cart Pull-Toy for Small Children Made From Gaily Colored Basket

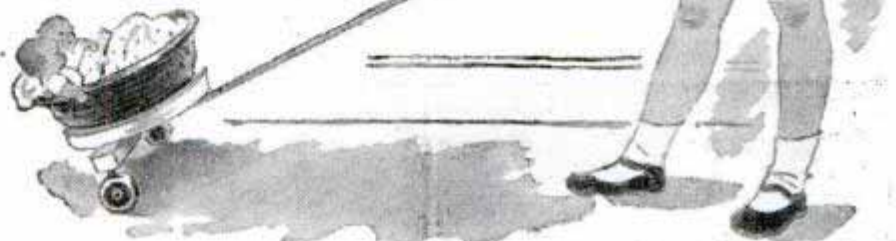
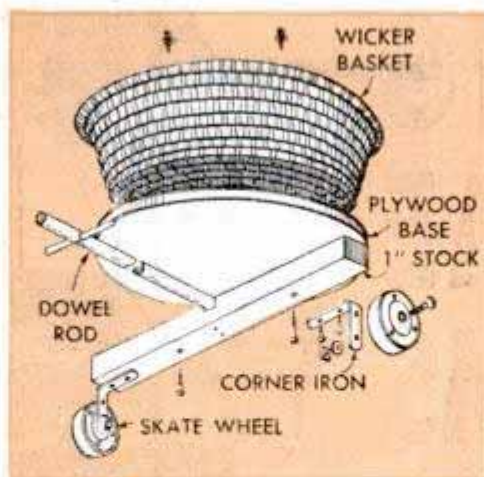

## Drop Lid of Sewing Machine Serves as Bed Table

If you have no bed table, the lid on a drophead-type sewing machine will do in an emergency. Simply wheel the machine in position and open the lid so it extends over the bed and covers the patient's lap. The table can be used for meals, as a writing desk, for reading or for playing games.

Mrs. F. J. Miller, Bakersfield, Calif.

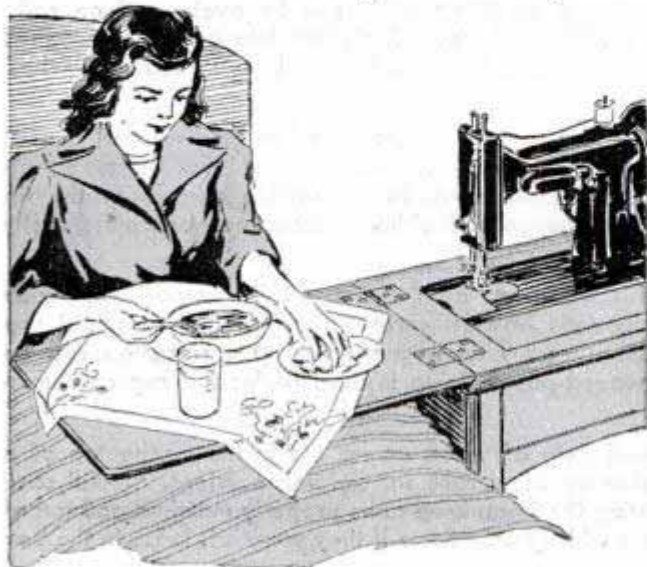

## Flashlight Used as Trouble Lamp

You can make good use of an old flashlight by converting it into an auto trouble light. After the cells have been removed, solder a wire to the end of the bulb and another to the back of the reflector. The other ends of the wires are fitted with radio or battery clips. The light is used by attaching the clips to the battery terminals, or to the motor or frame and any "hot-wire" terminals. The wires should be long enough so that the light will reach any part of the car. It will be necessary to use a 6-volt bulb. When not in use, the wires and clips are stored inside the flashlight case.

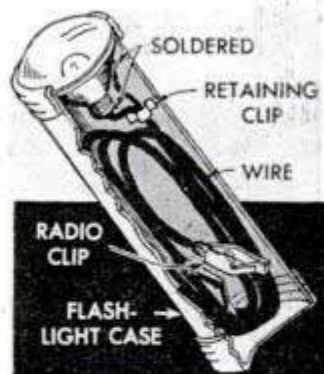

## Recoloring Worn Spots on Rugs

When a rug becomes worn in spots, these areas sometimes take on a color that is lighter than the rest of the rug. To remedy this defect, get some dress dye the same color as the rug and brush it on the threadbare spots. Such parts will then blend with the rest of the rug. This "touch-up" may be used for rugs of one color or those having a closely blended pattern.



# SOLVING HOME PROBLEMS



To avoid soiling a recipe and to keep it handy while preparing food, use a celluloid "envelope" with a cardboard support bracket into which the recipe can be slipped



1

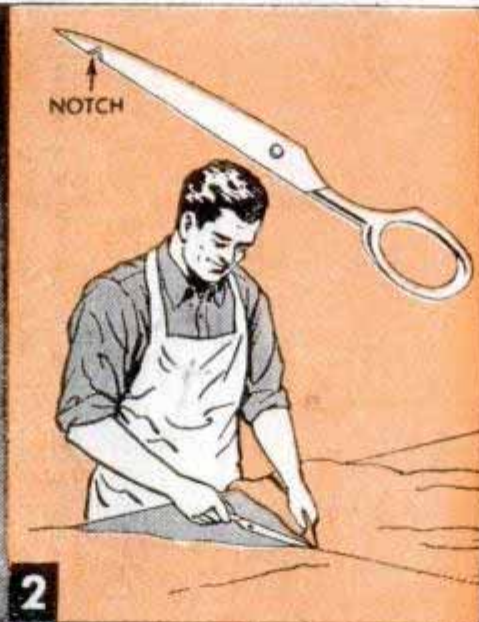

2

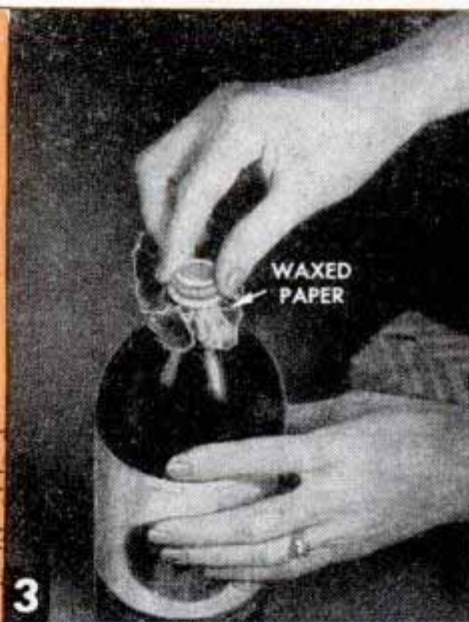

3

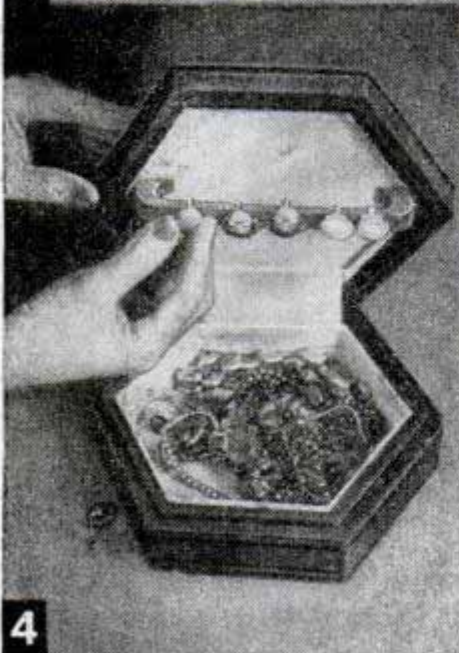

4

1. Shelling popcorn with bare hands is apt to result in sore and tender palms. However, this trouble can be avoided if an ordinary grater is used and the corn is shelled into a cake pan. Shell enough for several "poppings" and store in a sealed paper bag

2. One of the blades salvaged from a broken or discarded pair of scissors makes an excellent seam-ripping tool for home upholsterers. Grind a shallow notch in the cutting edge near the tip of the blade and sharpen both sides so seams can be ripped easily

3. Because of the nature of their chemical composition, many bleaching compounds have a corrosive action on the metal cap of the bottle that serves as a container. This corrosion can be avoided if a waxed-paper lining is used under the cap as shown

4. A scroll-sawn strip of wood across the inside of the top of a jewel box makes an ideal rack for holding earrings. It will save time when hunting for them; keep pairs properly matched and guard against damage which might occur if they were left loose in the box



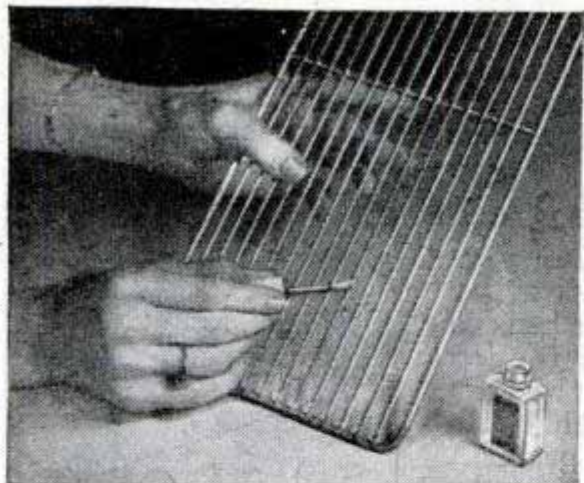

Above: If you have rusty spots on the refrigerator racks, remove them with fine steel wool and then wash in soapy water. After the racks have dried, cover the rusted spots with colorless nail polish to prevent any further spread. Right: To keep a youngster from cluttering up his room, use a vegetable bin for toy storage

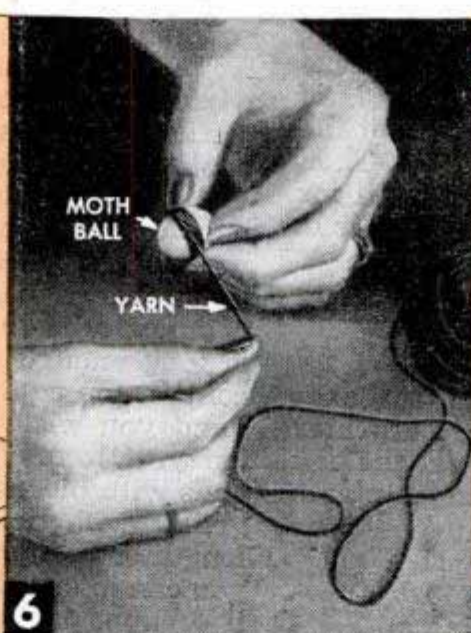
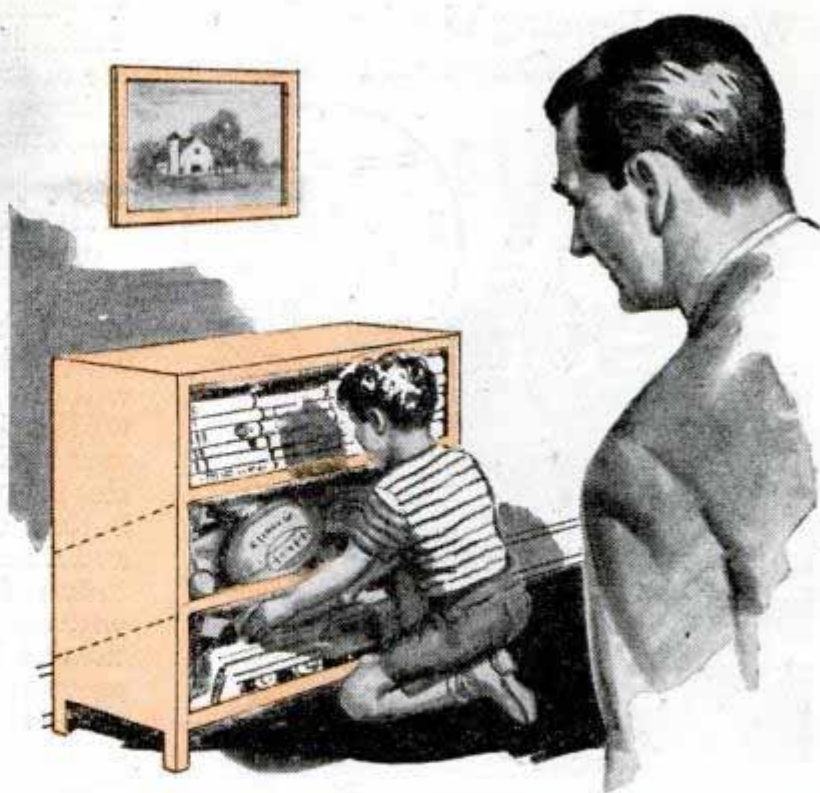

5. To avoid getting scratched by the ends of tiny feathers that work through a pillow, remove the feathers and turn the ticking inside out. Go over the ticking carefully, pulling out all feathers that may be sticking through. Then press with a hot iron coated with beeswax

6. When winding yarn from a hank into a ball, use a moth ball as the core. This will protect the yarn against damage when it is stored or not used for some time. If considerable yarn is kept in one box, it's also a good idea to scatter moth balls in the box

7. Sew a horizontal seam, with both ends open, at the lower end of an apron. This should be of a size to accommodate several kneeling pads. When scrubbing a floor or performing some other task that requires working on your knees, the apron will come in handy

8. An easy way to clean venetian blinds is to use a photo-film squeegee of the type that consists of a soft sponge on each end of a pair of tongs. These can be obtained in most photographic supply houses. Clean the blinds with a solution of soap and water

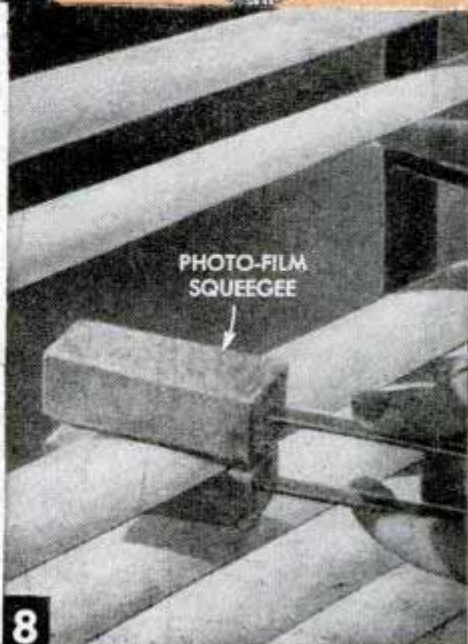



## Woven Fencing Used as Form For Piling Compost Neatly

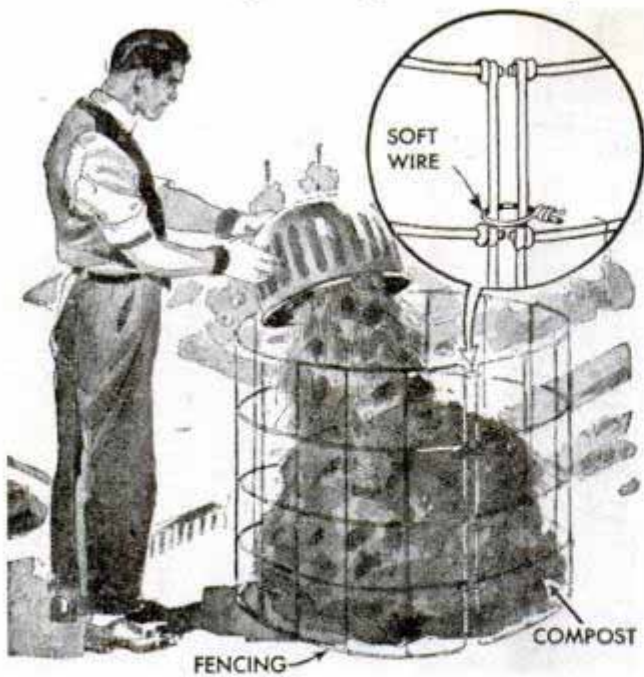

As a means of preventing his compost pile from spreading over the ground, one gardener enclosed it with a circular form made of woven-wire fencing. The ends of the fencing are wired together so that the form can be removed when it is full. Then the form is set in a different location for filling again.—J. Krill, Youngstown, Ohio.

## Position of Outlet Box Is Marked By Using Carbon Paper

To mark the position of outlet boxes when installing wallboard, one carpenter tacks a sheet of carbon paper over the box with the carbon side out. Then he places

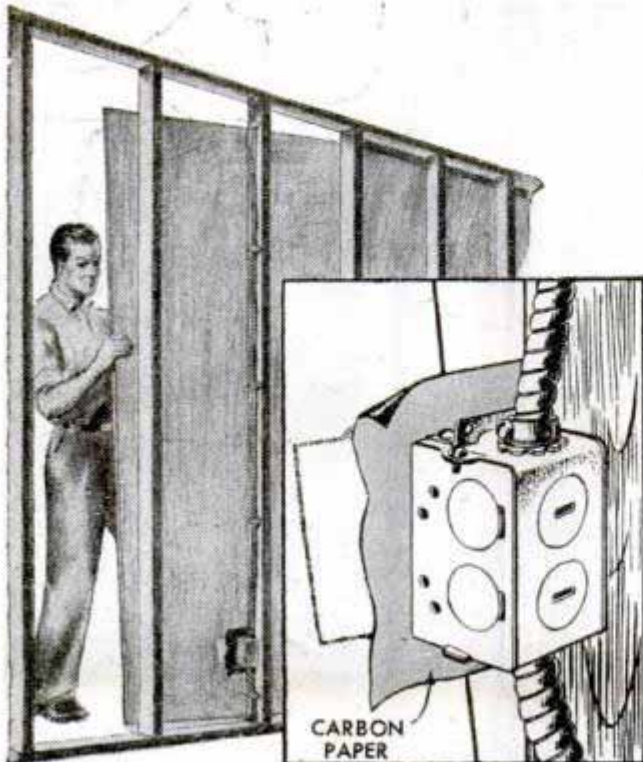

the panel of wallboard in position and presses it firmly against the box. The outline of the box is left on the board and it's a simple matter to cut the hole to fit.—R. L. MacLean, Prince Edward Island, Can.

## Chicken Feeder From Tin Can

Whether you have a few, or many, chickens to feed, this feeder will do the job well with little waste of grain. A slot is cut near the bottom of the can and a small indentation is formed with an opening in the can. If a lid is placed on the can, it will prevent fowl from wasting feed out of the top.—Wm. P. Houser, Organ, N. Mex.

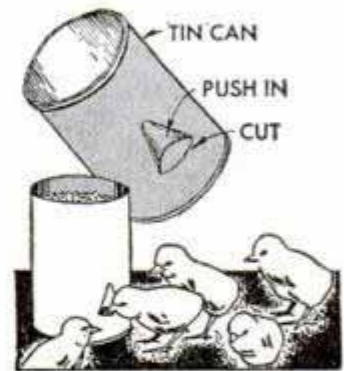

## Keeping Hunting Equipment Dry

When hunting from a boat, or on a boating trip, you can keep guns, binoculars and other valuable equipment dry with this watertight container. Cut a piece of inner tube that is long enough to contain the equipment you wish to carry. Close the ends with pieces of hardwood clamped together with bolts and wing nuts. If the length of tube selected contains the valve, you can inflate the container so it will float if dropped in the water.

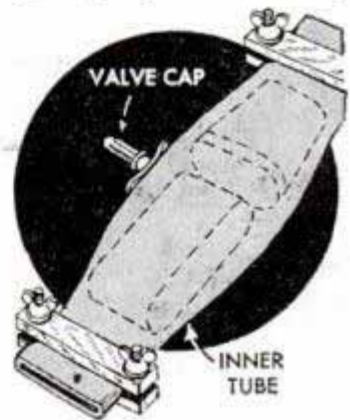

C. L. Meehan, Lakeview, Ont., Can.

## Wire and Bolt Make Hose Clamp

If a hose clamp is not at hand, a substitute can be made from No. 8 or 10 wire. Wrap the wire around the hose twice and bend an eye at each end. Then slip a bolt through the eyes and tighten.

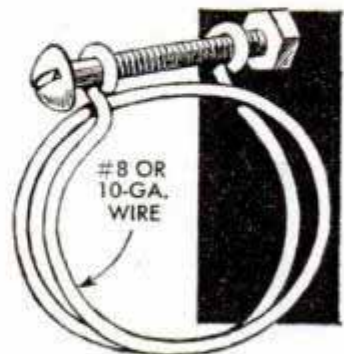

Ring or earring stones that have loosened or fallen out can be reset by using colorless nail polish for glue. The polish will dry quickly and is waterproof.



# Bracket Table Saves Space in Narrow Hallway



Table legs in a narrow hallway are very much in the way during the weekly housecleaning. Moreover, they make a small hallway appear even smaller and more congested. But mount the table top on a scroll-sawed wall bracket and you gain in both space and decorative values. In the crosshatched detail at the left,  $\frac{3}{4}$ -in. plywood is suggested for both pieces but instead you can use  $\frac{3}{4}$ -in. solid stock for the top and  $\frac{3}{8}$  or  $\frac{1}{2}$ -in. plywood for the bracket piece. This makes the scroll-sawing job a little easier, especially if you do it by hand. The scroll pattern is rather intricate in detail so sketch in the curved lines full-size on heavy paper. Then transfer the pattern to the wood. Bore all the holes necessary for insertion of the saw blade. Saw slowly. If you hurry the job you'll get rough, irregular edges here and there. Sand both pieces smooth, round the edges or shape them if you have power equipment, then finish with stain, shellac and wax or with clear lacquer. In assembly, the pieces are screwed to a short length of angle iron as shown. This takes the place of shelf supports so commonly used.

Edward J. Hobert, Hampstead, N. Y.

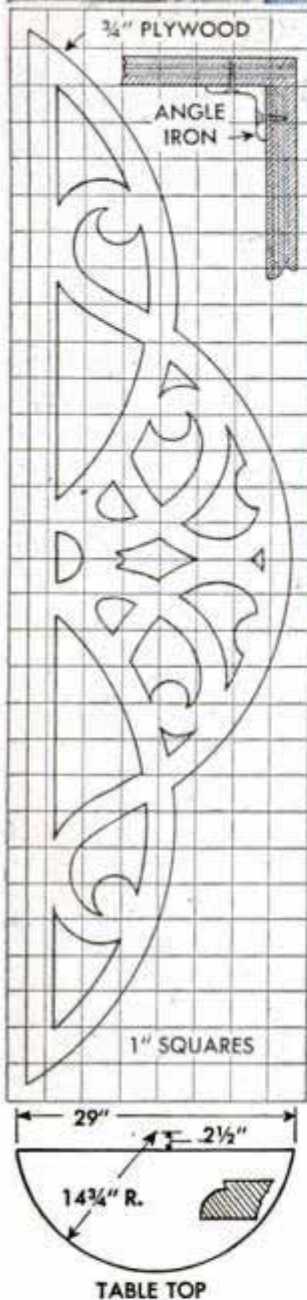

# Indirect Shaving Light for Mirror-Front Medicine Cabinet

Any medicine cabinet with a mirror front can be improved by the addition of an indirect shaving light. The dimensions given here are approximate and it may be necessary to alter them in some cases. First the rectangular opening is cut in the backing and an area the same size is scraped on the back of the mirror, removing the silver. Frosted glass is taped to the backing to cover the clear area in the mirror. If the mirror has wood backing instead of metal, small clips can be used to hold the frosted glass. The reflector is made of light sheet metal. Then porcelain receptacles are mounted on each side of the cabinet inside the reflector. A toggle switch will control the light.—G. M. Singer, Erie, Pa.

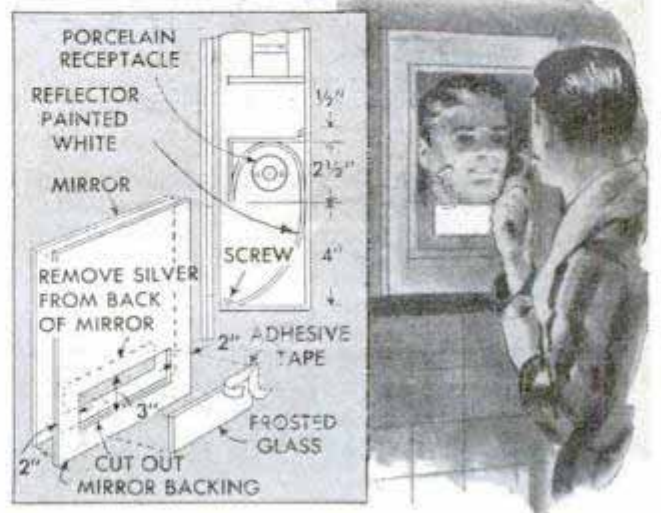



(DAWSON IS BUILDER).

5012 SIERRA ST. RIVERSIDE, CALIF.

# A Home of 1000

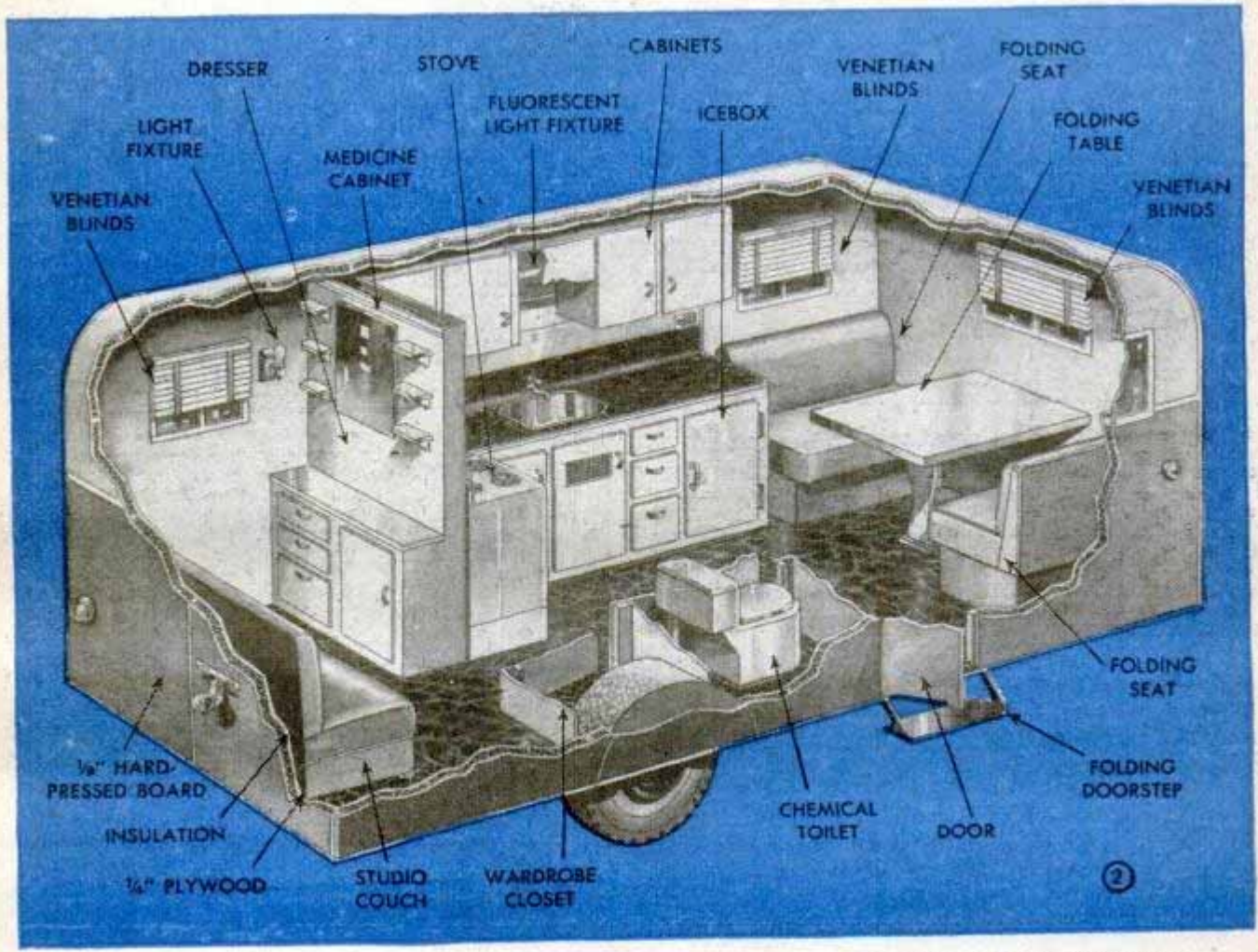
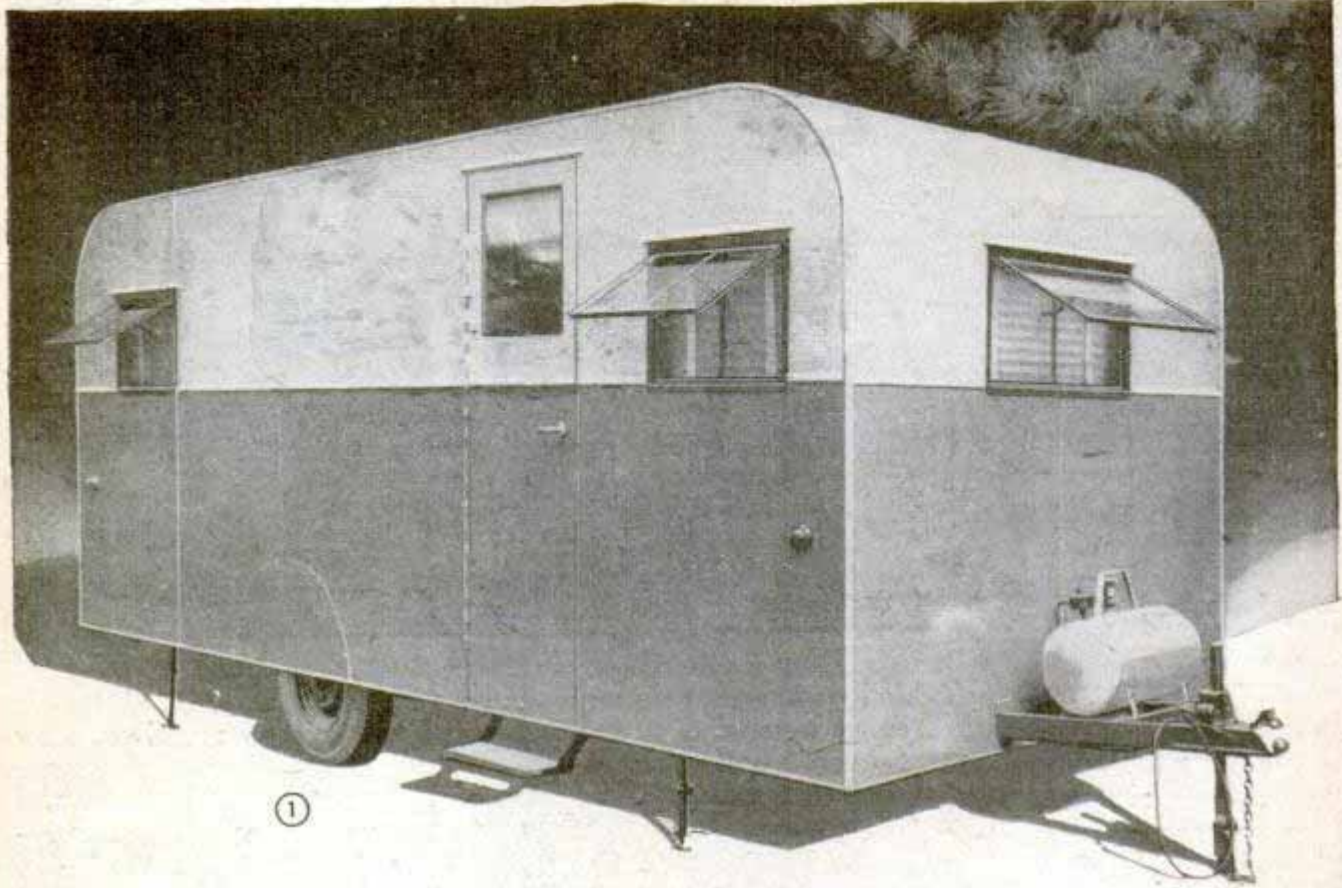



# Addresses

All facilities for housekeeping are built into this trailer, which is 7½ by 17 by 6 ft. 4 in. inside and sleeps four comfortably. Any car will easily tow it and an all-steel chassis and rugged framework permit it to roll along safely over the roughest roads

By Hi Sibley

## PART I

**S**HORT enough to park easily and take through any kind of traffic, the house trailer in Fig. 1 will take care of four comfortably whether it be a week-end trip, a vacation or an extended tour of the country. Neat appearance and a compact yet roomy interior have been obtained without difficult compound curves or complicated carpentry—just a strong framework set on a welded, all-steel chassis of angle iron, Fig. 10.

Before starting work on the chassis or frame, you should acquire all inside equipment, Fig. 2, and then build the structure to fit, retaining over-all outside dimensions. The bill of materials, Fig. 5, lists major items.

Dimensions are given in Figs. 3 and 4. Angle beams ¼ by 2 in. are welded crosswise under the main frame, which is a 3-in. steel channel having a plate welded to the open side to form a strong box-beam as indicated in Sec. B-B, Fig. 4. Forward ends are brought together in a vee and further strengthened with two 1¼-in. angle irons and a triangular plate, which is welded across the end. Mountings for the spring shackles are welded to the angle beams, which also are boxed for a length of 18 in. by welding on a second angle as indicated in detail A of Fig. 4. Ten-leaf springs ¼ by 1¾ by 34 in. are used. When tightening the bolts in the spring eyes draw up the nuts snugly and then release them half a turn. This will prevent them from binding.

Next come the floor joists, which are 2 by 3-in. stock set on edge to be the same height as the steel main frame. They are bolted to the cross-beams as in Sec. B-B, and the heads countersunk. Several makes of axles

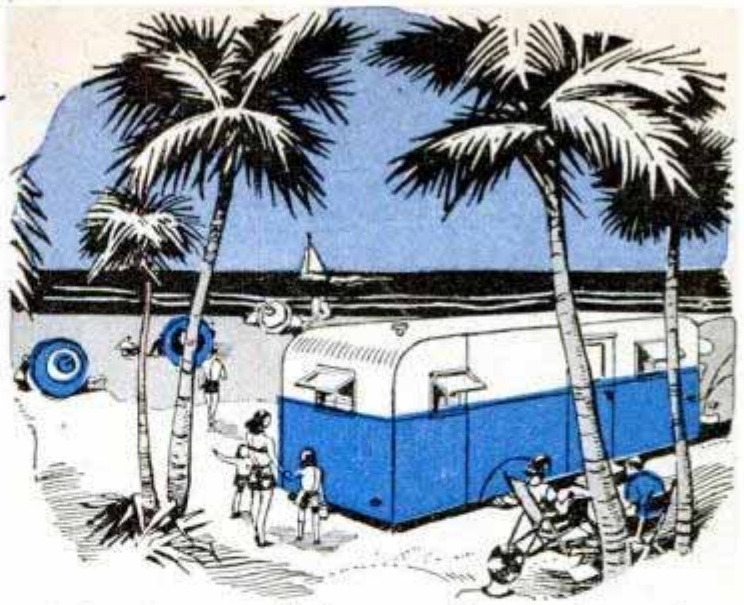

It doesn't matter whether you wish to spend a week end, a few days, a month's vacation or the summer at a beach, in the woods or at your favorite lake . . .

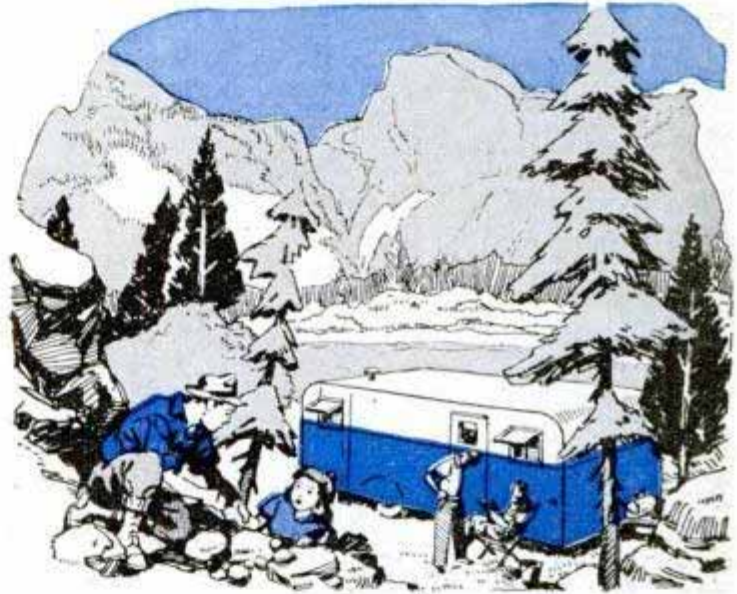

or maybe make frequent trips to an isolated spot high up in rugged mountain country, this trailer will get there and provide the comforts of home

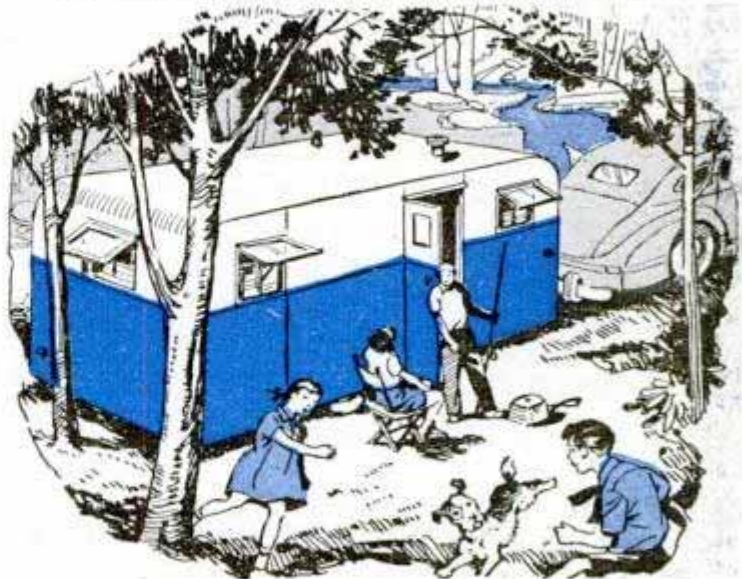

And if you like to take week-end fishing or hunting trips to some favored locality, the trailer provides a comfortable overnight home for you and your family







## (5) BILL OF MATERIAL

40 lin. ft.	¼x1½x3 in.	Channel iron
60 lin. ft.	3/16x½x1¾ in.	Channel iron
63 lin. ft.	¼x2x2 in.	Angle iron
4 lin. ft.	3/16x1¼x1¼ in.	Angle iron
40 lin. ft.	¼x3 in.	Flat iron
20 lin. ft.	¼x1 in.	Flat iron
32 lin. ft.	¾ in.	Rolled-edge aluminum molding
112 lin. ft.		Stainless steel corner molding
90 lin. ft.		Stainless steel dividing strip
112 lin. ft.	# 12	Two-wire 110-V. cable
52 lin. ft.	2x3 in. (net)	Clear Douglas fir
600 lin. ft.	1½x1½ in. (net)	Clear Douglas fir
12 lin. ft.	2x8 in.	Clear Douglas fir
18 lin. ft.	2x4 in.	Clear Douglas fir
2 pieces	¾ in. x 4x6 ft.	Plywood
18 pieces	¼ in. x 4x8 ft.	Plywood
5 pieces	¾ in. x 4x8 ft.	Plywood
18 pieces	½ in. x 4x8 ft.	Tempered hard-pressed board
12 rolls	3 in.	Processed-cotton automotive insulation
136 sq. ft.		Floor linoleum
16 sq. ft.		Sink linoleum
40	¼x4 in.	Lag screws
20	¼x2½ in.	Lag screws
70	¼x2½ in.	Carriage bolts
35	¼x4 in.	Carriage bolts
65	5/16x2½ in.	Carriage bolts
24	¾x3¾ in.	Carriage bolts
1 gross	1½ in. # 8	Flathead screws
1 gross	½ in. # 2	Flathead screws
½ gross	¾ in. # 6	Round-head screws
½ gross	1 in. # 7	Round-head screws
4 gross	1¼ in. # 9	Nickel-plated oval-head screws
2 gross	1 in. # 7	Nickel-plated oval-head screws
4 gross		Nickel-plated flush-face washers
3 quarts		Caulking compound
4		Running lights
2		Taillights
1		Stop light
1		Male and female connection for 110-volt lights
4		Octagon outlet boxes
2		Duplex receptacle boxes
2		Duplex receptacles
2		Duplex receptacle plates
1		Trailer hitch
1		Trailer axle
1 set		Electric brakes
2		¼x1¾x34 in. 10-leaf springs
1		Trailer folding step
1		Trailer stove (4-burner with oven)
1		Trailer sink and fittings
1		Trailer icebox
1		Trailer tilt-back davenport
1		Trailer roof ventilator
2 18x33 in.		Trailer windows with screens
4 18x24 in.		Trailer windows with screens
1		Pullman bed
1		Medicine cabinet
1		Chemical toilet
1 10 gal.		Butane tank and regulator
18 lin. ft.		High-pressure copper tubing
		Light fixtures (to suit builder)

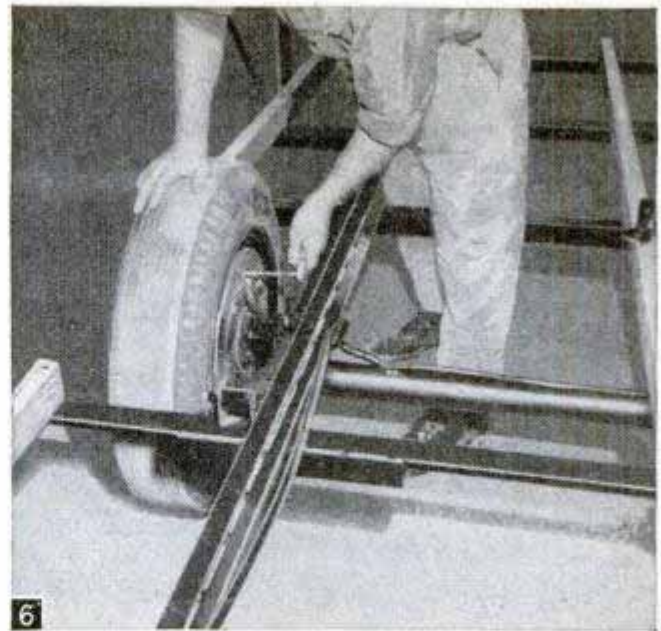

6 Connecting the electrically controlled brakes. Clips are welded to the axle housing to hold electric cable

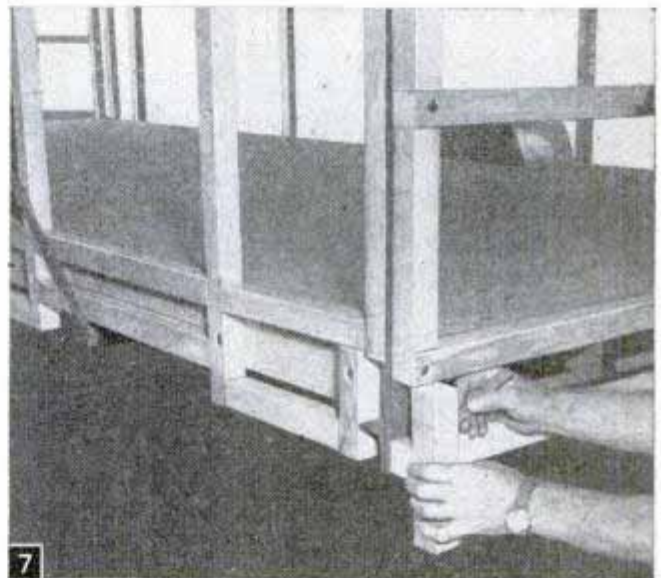

7 Completing corner blocking. These blocks should be a snug fit. Angle brace at left is mortised in flush



8 The sheet-metal fenders are carried down below the floor line to prevent water from seeping in onto floor







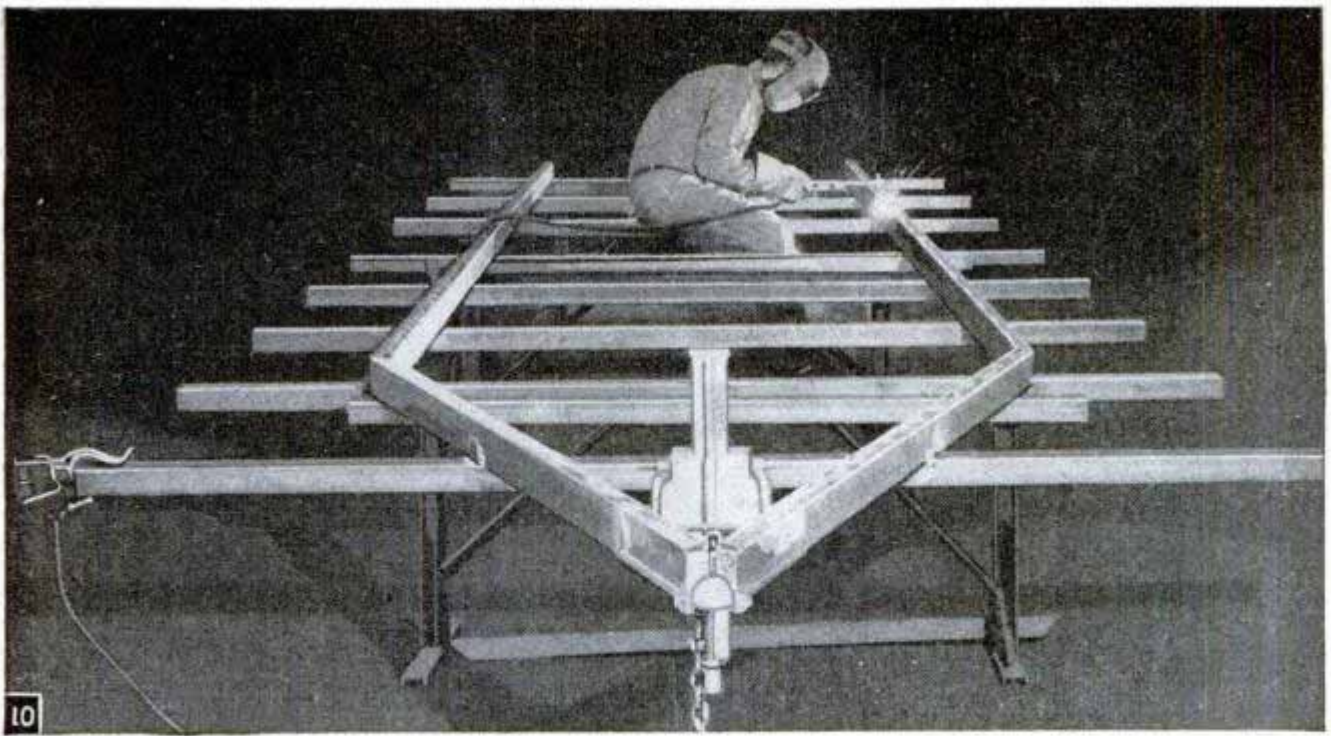

**Complete metal chassis set up for welding. Main frame members are steel channels with a steel strip welded to the open side, forming a box beam. This results in a nontwisting frame that will support heavy loads**

will meet on the center line. All studs are bolted at the bottom to the floor joists and at the top through the channel frame previously installed. Horizontal members are then placed. Note the blocking on top and bottom of the channel frame. This is to serve as nailing strips for the plywood walls on the inside and hard-pressed board on the outside of the double walls as well as the roof. Blocking for the curved upper corners is bandsawed from 2-in. material. Fig. 11 shows this blocking in place.

The doorframe is rabbeted  $\frac{1}{2}$  in. as indicated in Sec. A-A, Fig. 3. Along the bottom of the sides, blocking is installed between

studs where shown; between some of them the nailing piece must set on top of the angle beam, Fig. 7.

Curved nailing pieces are installed in the wheel wells to hold the upper flange of the fenders, which are of galvanized sheet iron, the lower edges being bent to form a flange as well as an extension, which comes below the floor to carry off water. There also is a flange on the outside curved section. Fig. 8 shows the completed fender.

Four jacks are hung on brackets welded to the chassis and when not in use swing up and are screwed against a hanger.

(To be continued)

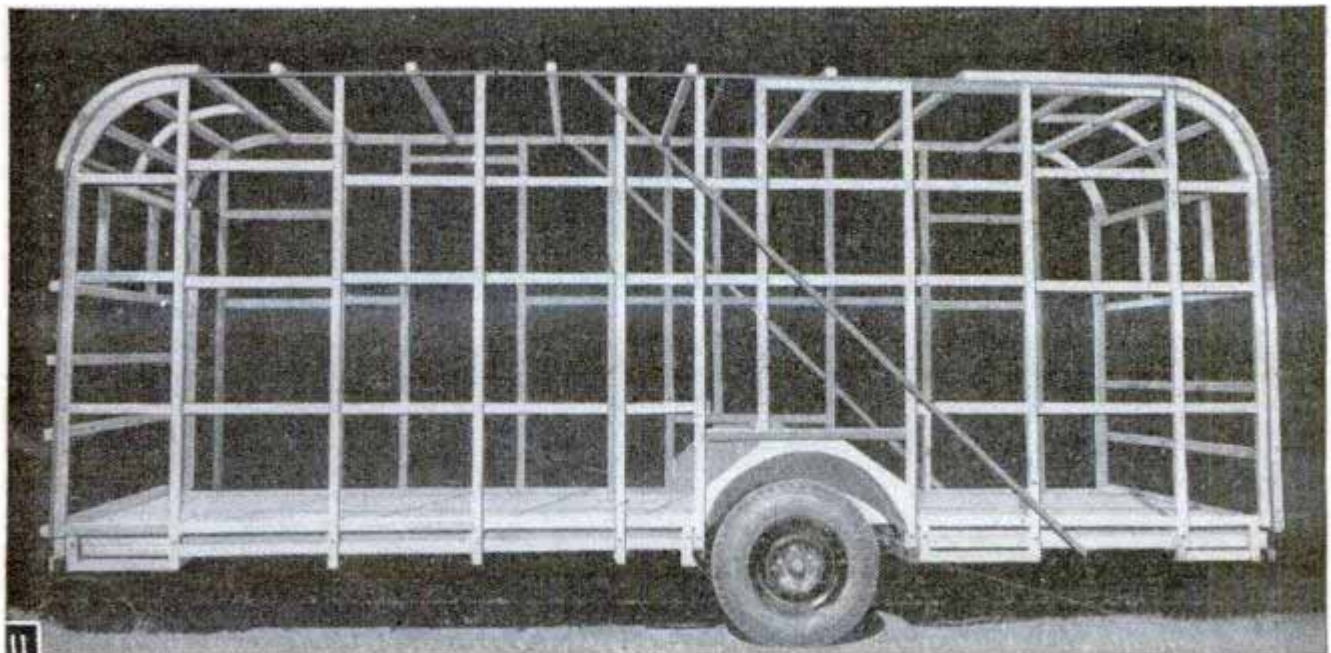

**Here you have the frame structure nearly completed with most of the curved blocking in place at the upper corners. This square box construction modifies streamlining but it gives you much more headroom at the ends**



## Slit Tubing Over Point of Arrow Lessens Danger to Others

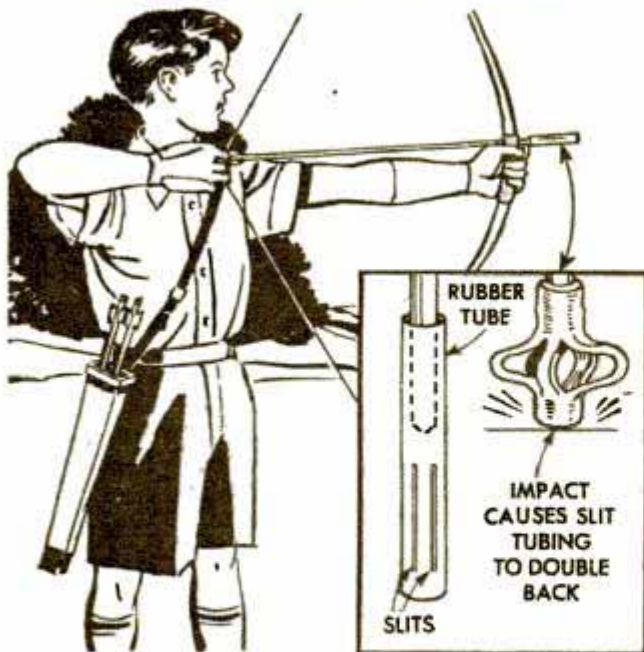

To shorten the range of arrows and minimize the danger to others, one parent puts a protective head on the arrows of his son's archery set. The head consists of a length of rubber tubing with 5 slits about 1 in. long. These heads are slipped over the points and serve to break the impact when the arrow hits an object.

## Emergency Portable Camp Stove

An improvised portable camp stove is assembled easily from the base of an old kerosene lantern and a 1-gal. can or pail. Punch holes about 1 in. from the top and the same distance from the bottom of the pail or can to provide draft. Then place the lantern base inside the inverted pail and adjust the flame to reduce smoking. Enough heat will be furnished to make coffee and warm small amounts of food.

D. E. Horn, River Forest, Ill.

## Animated Doll Amuses Children

With a flashlight, a handkerchief and a bit of paint, you can make a toy doll that will be a delight to youngsters. The handkerchief is fastened over the lens



kerchief is fastened over the lens with a rubber band and a face is painted on this area. Then the rest of the handkerchief is shaped to simulate a body and arms. To manipulate the arms, insert the thumb and forefinger in

the sleeves, holding the light as indicated in the lower detail. When turned on, the light animates the face.

## Stop on Drill Prevents Damage

Users of push drills find that unless extreme care is exercised, the drill will break through and mar finished work. To prevent this, one craftsman slips a rubber stopper over the shank of the drill which cushions the shock when the point breaks through.

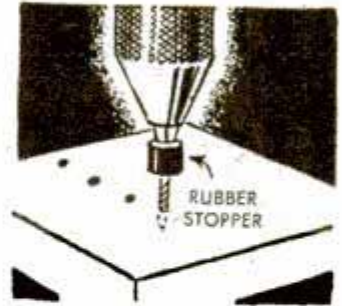

A. H. Waychoff, Phoenix, Ariz.

## Chart for Approximate Tonnage

Although not exact, this chart will enable you to estimate the approximate tonnage of coal in a bin from its dimensions. To use the chart, locate the height of the bin on column A. In the example this is given as 10 ft. Then find the width, also 10 ft., on column E. Connect the two points and note where the line crosses column B. From this point, project a line to the length, 20 ft., on scale D. The tonnage in the bin is indicated on C where the line from B to D intersects it. In this case the answer is about 55 tons. This chart is based on 2000 lbs. per ton.—W. F. Schaphorst, Newark, N. J.

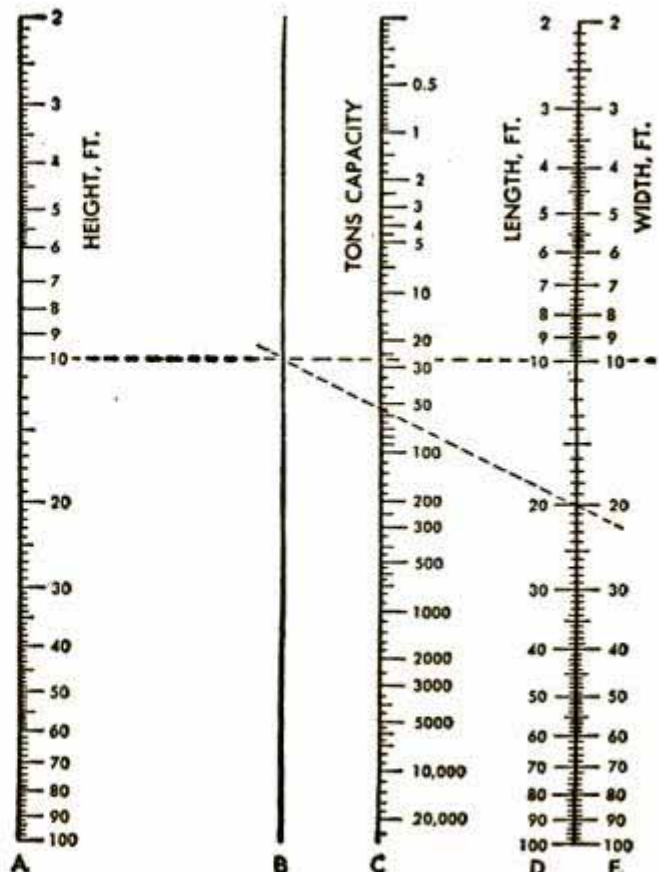



# Lawn Mower Wheel Crank

## Makes Sharpening Easy

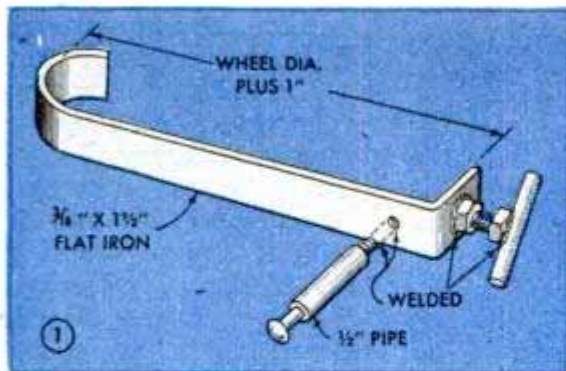

Velvet-smooth cutting edges on lawn mower blades are something you think about when pushing a dull mower through heavy grass. A professional job of sharpening is quite simple as you can see from Figs. 1, 2 and 3 and the upper right-hand photo. First, make a wheel crank as in Fig. 1 and attach it to one drive wheel with the clamping screw shown in the detail, Fig. 1. Then clamp the mower in a vise, remove the drive wheels and interchange the reel-driving pinions as in Fig. 2. Replace the drive wheel to which the crank is attached. Then set the bed knife, Fig. 3, so that the blades "drag" very lightly when the reel is turned backwards. Mix medium-grade emery powder with crankcase oil to the consistency of thick cream and drop or

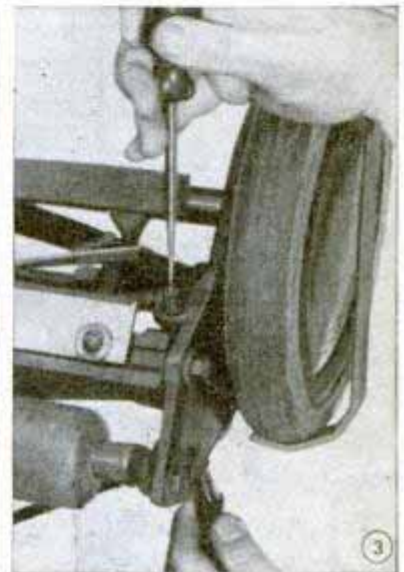

paint the mixture on the edges of the blades. Turn the crank, spinning the reel backwards at moderate speed. Reset the bed knife and continue the operation until the blades are uniformly sharp. Finally, clean, oil, and reassemble the mower.

Merlin Dappert, Taylorville, Ill.

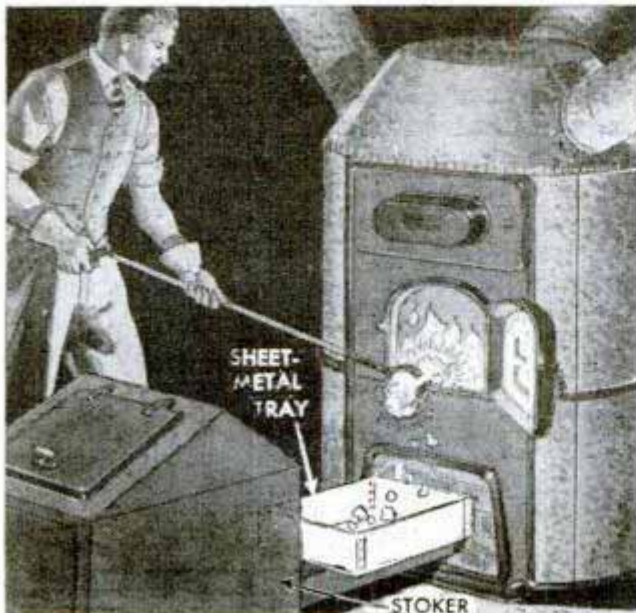

### Metal Tray for Stoker Clinkers

←When removing clinkers from a stoker, a sheet-metal tray is convenient to keep them off the floor or from endangering shoes and clothing. The tray rests on the sheet-metal housing covering the feed. A lightweight metal will do and the tray can be of riveted or welded construction.

### Screen Replaces Broken Window

To replace small broken window panes, cut wire-screen cloth the same size as the broken pane. Suspend the cloth in a tray of shellac, remove and allow to dry. The shellac should fill all the holes. This pane will keep out wind and rain and will admit a fair amount of light.



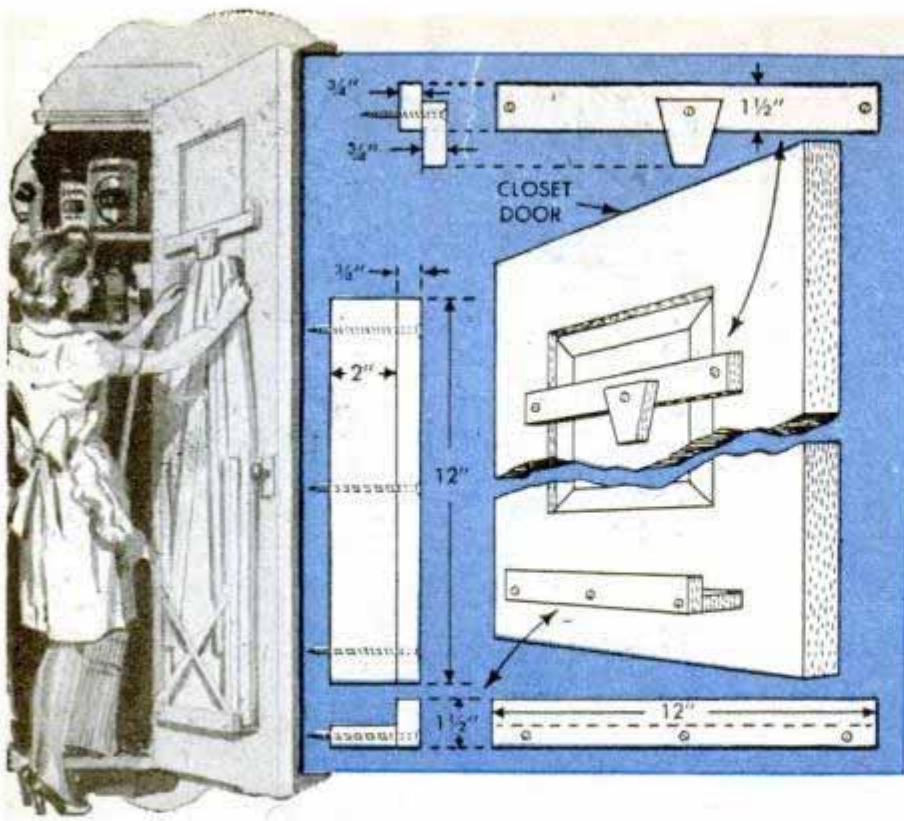

## Ironing Board Holder

With this on-a-door holder it's easy to keep an ironing board in place. The base, which supports the board, is made according to the dimensions in the detail, although it may be necessary to alter them to fit some ironing boards. The manner in which the upper cleat is made is shown in the upper detail. Some boards are constructed in such a way that the legs won't stay up if they face out from the door when placed in the holder. In this case the legs should rest against the door.—J. F. Grece, New York.

## Blind in Show Window Lowered Without Disturbing Display

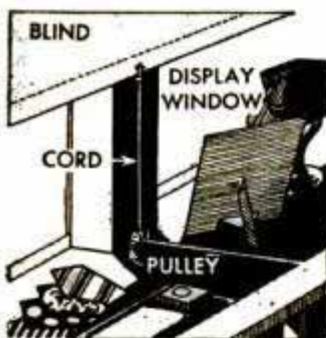

One merchant found that it was possible to raise and lower the blind in his display window without having to step among the articles on display to reach the blind. A small pulley was screwed to the base of a column that divided the window, and a cord was run from the blind through the pulley to the back of the display so that the blind could be raised and lowered from that point.—Ray Harrison, Fort Qu'Appelle, Sask., Can.

## Perfume Atomizer Used to Spray Glaze on Pottery



The spraying unit from a discarded perfume atomizer is excellent for spraying glaze on small pieces of pottery before they are fired. Or it can be used to lacquer pottery or other similar craft projects. If the glass container is broken, a test tube with a rubber stopper can be used as a reservoir.

## Stains Removed From Upholstery

Many stains on upholstery can be removed with a solution consisting of oxalic acid granules, 1 teaspoon, dissolved in water, 1 pt. Wet the stain repeatedly and, for the last step, make a paste of the acid, using fuller's earth. Spread this over the spot and, when dry, brush it off.

Francis W. Henry, Pottsville, Pa.

## Small Watering Trough for Stock Utilizes Discarded Oil Drum

Of simple construction, this watering trough is made by cutting an oil drum in half. Before the cut is made, however, check to be sure that the drain will be at the bottom. Slit garden hose is placed over the edges of the trough to protect the stock from any irregularities in the metal caused by cutting. The tank is held in position by wood braces along the sides and a short piece of flat iron bolted over the lip at each end. The trough rests on a wooden platform.—Victor H. Lamoy, Upper Jay, N. Y.

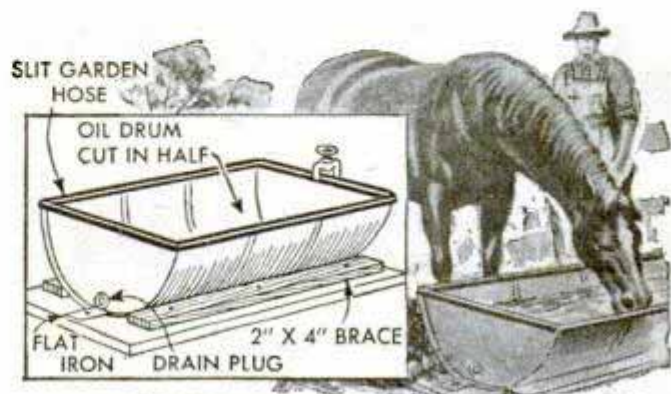



# Luminous Decoration Is Home Convenience

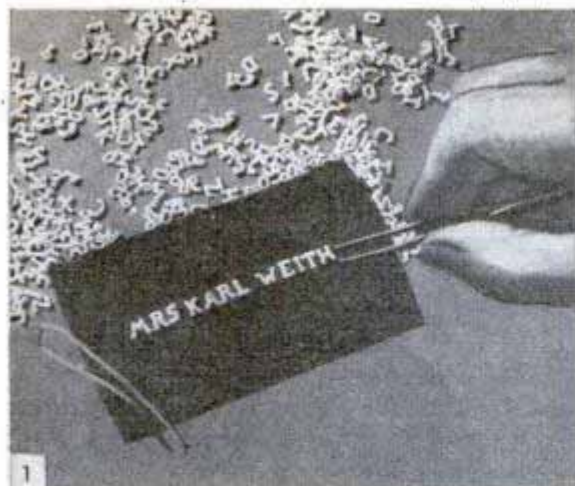

Paint that glows in the dark has many uses in the home, some practical and others decorative



Luminous paints that are available in several colors have varied applications in the home, some for convenience and others for novel decoration. The illustration in the upper right-hand corner is a combination of both.



Where the lamp shade has been coated with the paint, it will glow in a dark or semidarkened room. This is decorative and it also serves to locate the lamp when it would not otherwise be visible. A wall stencil can be used for the pattern and the paint is applied with a small pointed brush. Another decorative treatment is to apply the paint to decals that often are used in bathrooms, playrooms and kitchens. Cover only the white part of the decal, lower left-hand photo, and when the room is in darkness a new pattern will appear. The name plate, upper left-hand photo, has a hard-pressed board base and utilizes the letters found in alphabet macaroni. They are waterproofed by dipping them in thin, clear fingernail polish, and after drying are coated with luminous paint and fastened to the board with cellulose cement. A rubber band is fastened around the board when applying the letters to serve as a guideline.—Kenneth Murray, Colon, Mich.

## Tire Chains Put on Automobile Wheels With Aid of Wooden Block

If you're driving in territory where snow is apt to be deep, putting chains on auto wheels is a difficult and slow task, but if you carry a block similar to the one in the lower detail it's no trick to get the chains on in a hurry. A 4 by 4-in. block 24 in. long with a shallow bevel at each end is fitted with cleats; the cross links of the chain fit into the spaces formed by the cleats. With the chain in place, drive your car on the block, bring the ends of the chain around the tire and fasten them. Repeat for the other rear wheel.

Leather chairs and other leather goods can be kept clean and shiny by rubbing them frequently with egg whites which have been beaten to a stiff consistency.

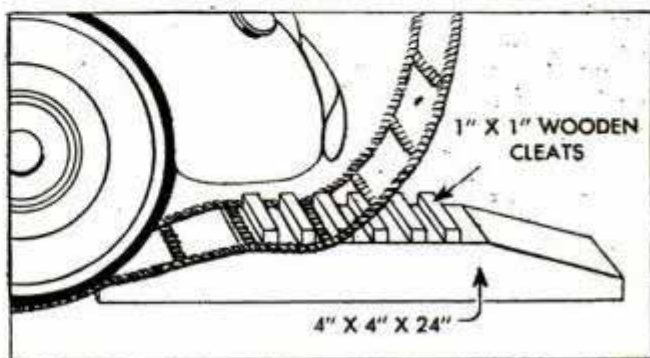



# HOW TO PAINT YOUR CAR

Painting makes the old car a lot easier to look at and adds many dollars to its trade-in value

By Charles Smith

**T**O PAINT, or not to paint. Likely you've considered the question, but after another studied look at the battered old bus, you decided that a commercial paint job was too expensive and a home job too complicated. But with several hundred names ahead of you on the dealer's list for a new car, maybe it does deserve a new paint job. Also keep in mind that painting will add a hundred dollars or so to trade-in value. So, if you are willing to take a little extra care in the preparation of a good painting surface, use the right paint and approved methods of application, you'll finish up with a paint job that'll make you wonder for a while whether this is really your car.

Preparation's the thing. At the start, take off all parts that can be readily removed such as the radiator grille, Fig. 1, and cover all other areas you don't want the paint to hit, with masking tape, Figs. 6, 7 and 9. Perhaps the most tedious part of the whole job is "bumping" out deep scratches and dimples that every car body suffers after several years of use. Usually it will pay to have the worst of the bends and dents taken out by a reputable body shop. But you can level shallow fender dents with a bumping hammer and dolly block. This job gets easier after you try it. In treating an ordinary shallow fender dent, the trick is

First step in preparation is to remove all the bright work, such as radiator grille, head-lamp rims and hub caps

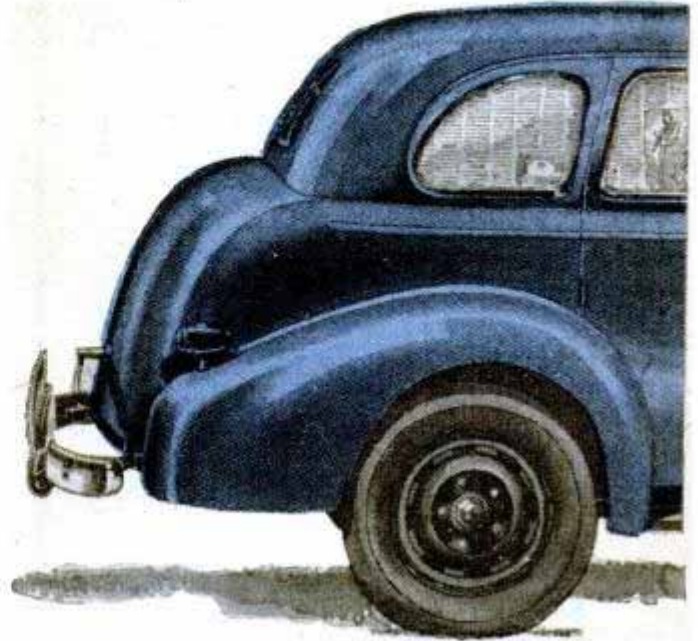

to begin at the edge of the depression and work inward. Easy on the hammer does it. No hard blows, just a light tapping, and always taking the hammer blow on the dolly held against the opposite side of the metal. With this simple procedure you can iron out ordinary body and fender dents without leaving a trace. Usually there'll be rust spots along the lower edges of the fenders and doors. These can be sanded out by hand, Fig. 3, or removed with a motor-driven disk sander, Fig. 2. For hand work

A motor-driven disk sander helps a lot in preparing a good surface for either enamel or lacquer

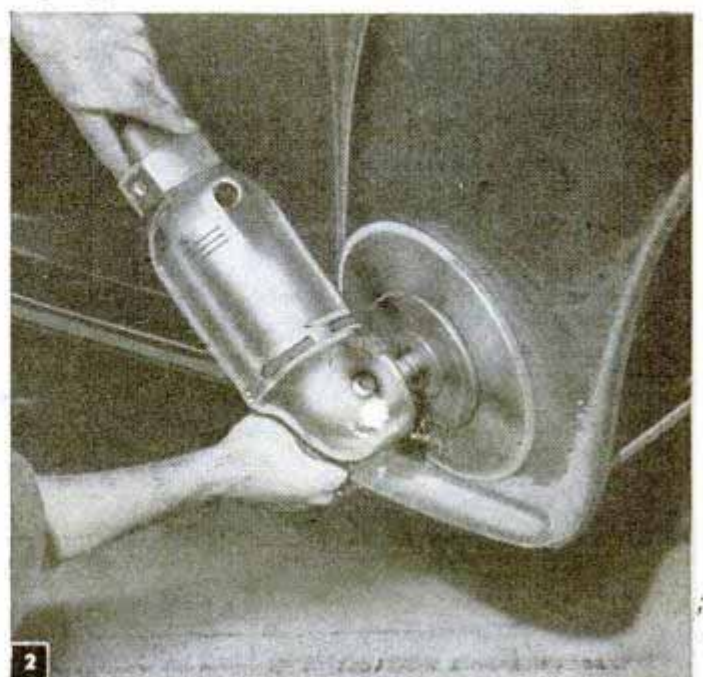
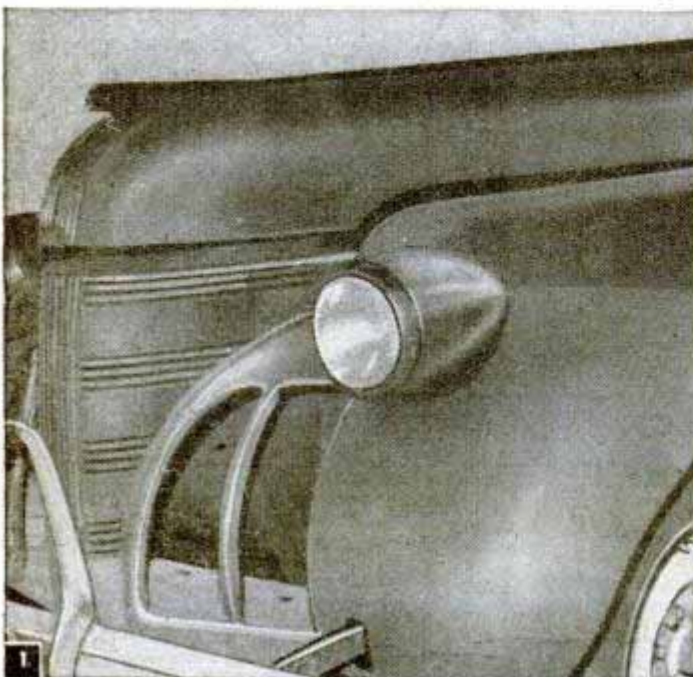



*Body & fender*

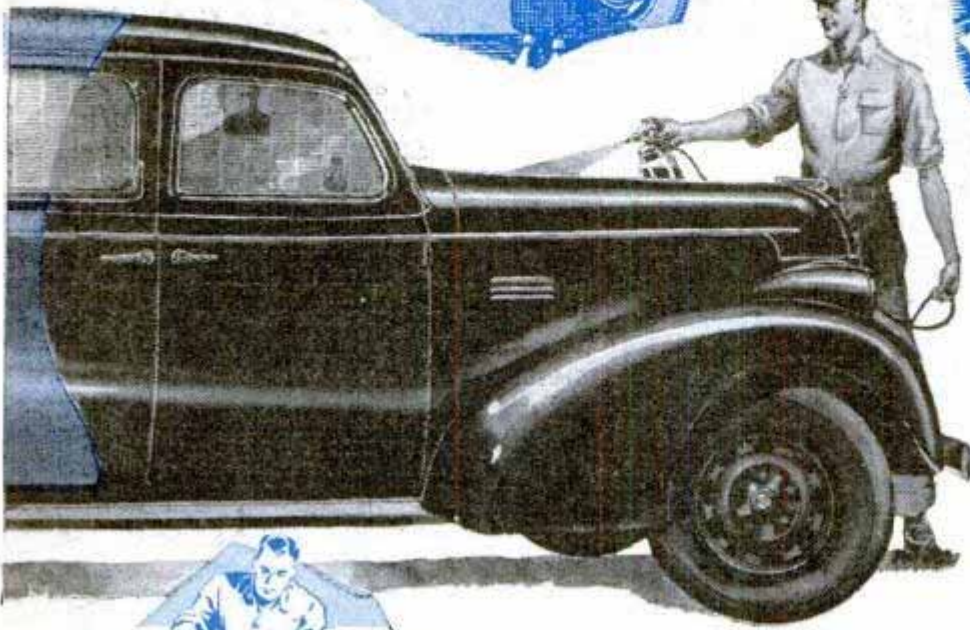

You can do all the sanding and smoothing by hand where the body and fender metal is in good shape

After sanding do a thorough job of cleaning body and fenders, using a cleaner made especially for the purpose

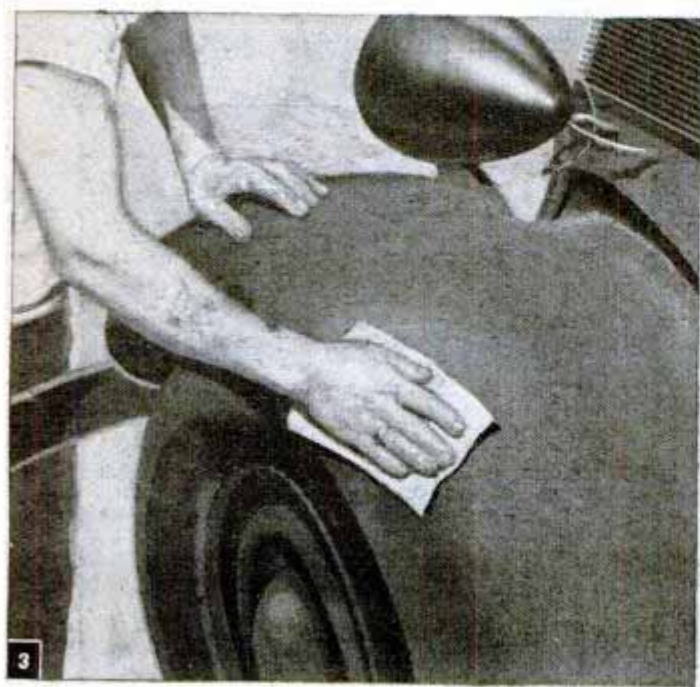





5

In cleaning up, pay special attention to exposed portions of the rear deck, for here's where dirt collects



6

Above, mask glass and trim, using masking tape to cover small parts and to hold newspapers as below



7

use No. 100 dry sandpaper and for the machine No. 80 grit. In using the machine, watch the work closely for the high-speed disk cuts very fast. Finish all sanded areas with No. 240 grit. Then go over the whole body with a prepared cleaner as in Figs. 4 and 5 to remove the accumulated road grime and loose pigment from the original paint coats and also any grease that may be on the surface. Next, any areas where the metal has been bared in the preparatory steps will need to be primed before the final painting or lacquering. Use either an enamel or lacquer primer depending on which you are going to use for the finish.

Most ordinary quick-drying, self-leveling enamels used in car finishing can be applied with a brush without any trouble with brush marks or laps. It takes these finishes nearly an hour to dry dust free so precautions against dust must be taken. One of the best ways to do this is to work with the car in the garage. Then, just before you begin painting, spray the floor with water and go over the car with a painter's tack rag. Plan the procedure so that you can finish all the large surfaces without any lapse of time. In painting the top, for example, keep working back and forth across the width. Don't paint half the top area and then the other, because the edge of the painted area you have just covered will have started to set and you'll likely have some trouble getting a smooth lap. On the large surfaces always finish the work to the edge before you stop. Lay the enamel on with a well-filled brush, using short strokes and light pressure and do not brush it out as you would an oil paint. Be careful at the lower edges of the fenders that the brush does not pick up dirt or sand. It's a good idea to wipe or brush these lower edges before you bring the enamel down to them. Although enamel sets dust free in an hour or so, the job



8



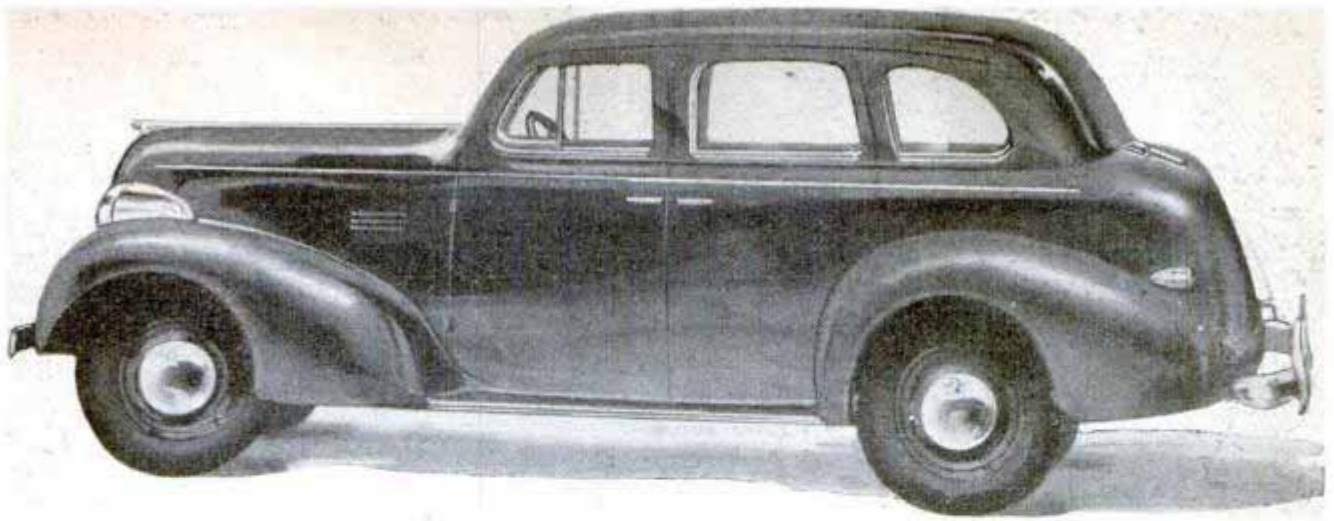

should not be touched or the car moved for at least 48 hours after you've finished enameling. Then wait two weeks before you do any polishing, or "compounding" as it is sometimes referred to in body shops. Actually, there's little need for a preparatory rubbing on an enameled job. Just wipe it with a soft cloth at the end of a couple weeks and wax in the regular way.

A lacquer job requires application of a lacquer undercoater or sealer, made especially for the purpose. Both the undercoater and the lacquer must be applied with a spray gun, Fig. 8. In spraying you don't have to be quite so particular about laps as the sprayed coat is much thinner. However, there are several tricks in handling a spray gun that one should know about. First, dilute both the undercoater and the lacquer exactly as the manufacturer directs for spray-gun use, be sure that the gun is clean and properly adjusted, then, in spraying vertical surfaces, hold the gun level about 6 to 8 in. from the surface and make sweeping back-and-forth strokes, releasing the trigger at the end of each stroke to avoid "piling" up the sprayed material at the edges of the area being covered.

Don't use a circular or zigzag stroke except possibly where it is necessary to cover small irregular-shaped objects. Hold the gun at an angle of about 45 degrees when working on horizontal surfaces. As in hand brushing, finish up small areas at a time. Don't spray-paint one side of the car from end to end and then the other side the same way, but rather finish the hood, a fender or a door panel separately. Take the same precautions against dust as in hand brushing. If you work inside the garage even more elaborate precautions are sometimes necessary as the air blast from a spray gun will raise dust several feet away. Sprinkle everything nearby thoroughly and go over every part of the car with a tack rag before beginning work. If you work inside, wear an approved respirator. Although the quick-drying lacquers permit application of a second or third coat almost immediately, be sure that the material is thoroughly dry before applying another coat. Finish the whole car with one coat before applying the second to any part. Two to three coats of lacquer will be sufficient to produce a good job. Finish up by waxing in the regular way.

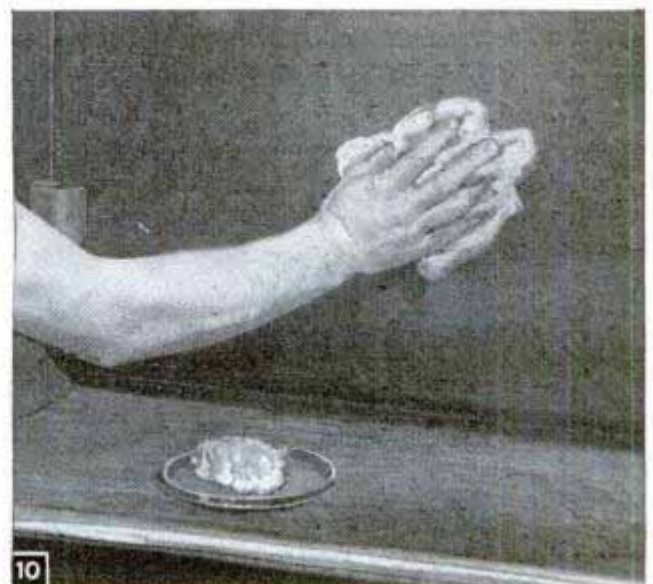
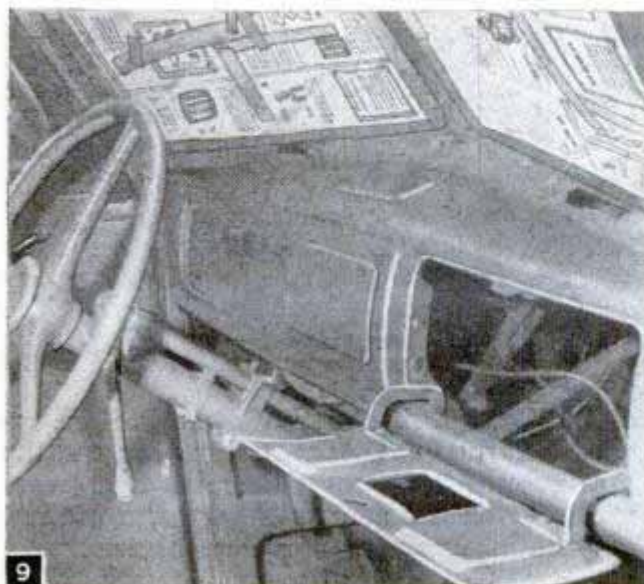



## Attractive Plastic Letter Holder Made From Single Sheet



Attractive as well as useful, this letter holder is made from a single sheet of  $\frac{1}{8}$ -in. plastic. Cut the material with a hacksaw to the dimensions given in the upper right-hand detail. Make each bend separately, being sure that the curves are symmetrical. After the piece has been formed, file the rough edges and then sand with progressively finer grades of sandpaper. Finally, finish with an abrasive polish to obtain a high luster.—Frank Shore, New York.

## Reflectors Attached to Umbrella Warn Autoists of Pedestrian

For those rainy nights when motorists' vision is poor, ruby reflectors attached to an umbrella will warn drivers of the presence of a pedestrian. A number of the reflectors are attached to a short piece of

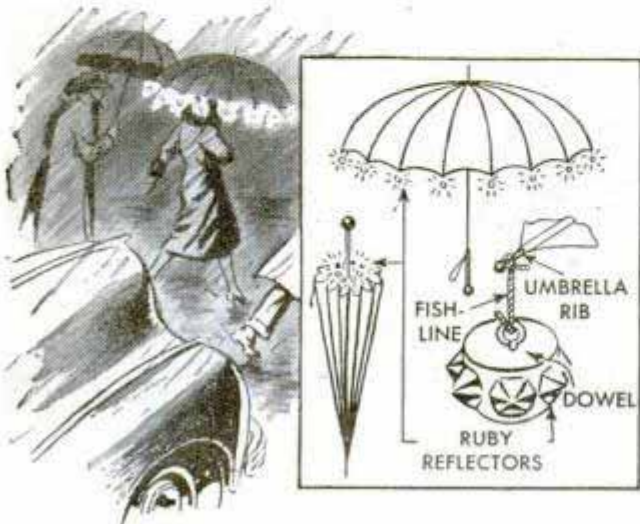

dowel which has a screw eye in one end. Fishline is used to attach the reflectors to the tips of the umbrella ribs.

## Split Fishline Sinker on Steel Tape Provides Finger Grip

If you've lost the finger grip on a steel measuring tape, hammer a grip made from a fishline sinker in its place. This will serve to weight the line slightly when taking vertical measurements.

G. E. Hendrickson, Argyle, Wis.

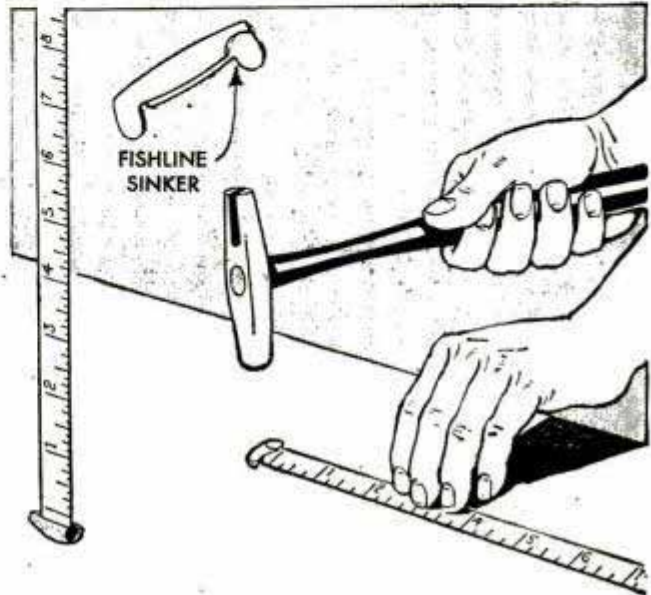

## Spare-Tire Lock as Wall Safe Protects Important Papers

You can make a wall safe to hold important papers by using a spare-tire lock, of the type shown, and an auto wheel that fits the lock. The spokes of the wheel are cut

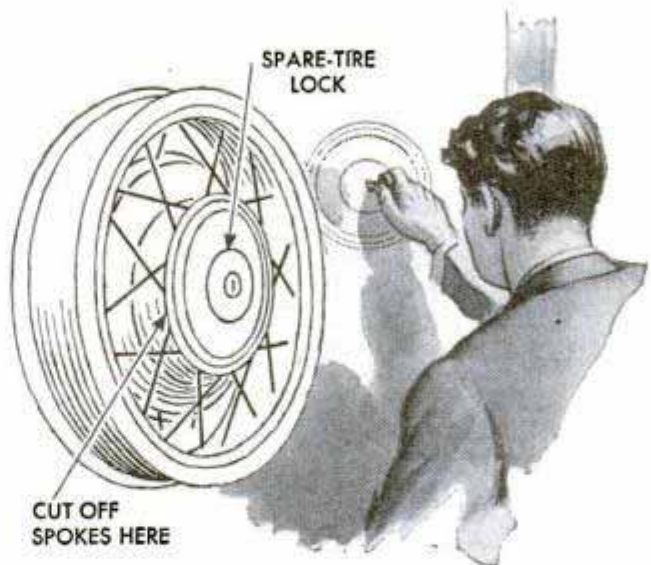

close to the hub and the latter is then recessed in the wall. Any opening around the hub should be covered so that it appears flush. After the safe is in place, a picture may be hung over it for concealment.

George Rutkoski, Newark, N. J.



# Fun with INK PICTURES



Fascinating ink pictures that will amuse youngsters for hours at a time can be made easily by the children themselves with a few simple articles that are found in every home. However, before starting to make the pictures, it is well to cover the table to be used with old wrapping paper or newspapers so that any ink which might be spilled accidentally will not mar the finish. If available, an old piece of oilcloth makes an ideal cover. The materials needed are several medicine droppers, as many kinds of colored ink as are available, and sheets of white and colored paper. Don't use paper that is too absorbent or too slick. The paper is folded as in Fig. 2 and several drops of ink are placed in the crease, Fig. 1. The paper is

By Lloyd E. Keller

again folded on the crease and the ink is formed into patterns by running the fingers over the outside of the sheet. When it is opened, Fig. 3, the finished picture can be seen. Some of the pictures may resemble an animal or article of everyday life, while others may look like creatures from another world. A greater variety is achieved by using several colors of inks. For example, red and green ink could be dropped on one sheet to make a two-colored picture. When using several colors, care should be taken that they do not run together and neutralize each other, as would occur when certain kinds of ink are used. Each new picture will differ somewhat from the ones that have been made, and this will hold the child's interest.

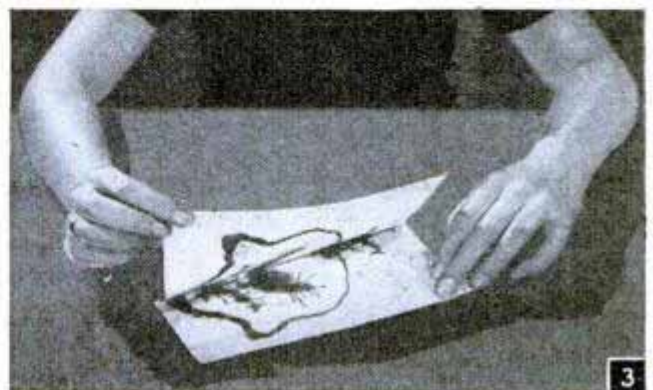
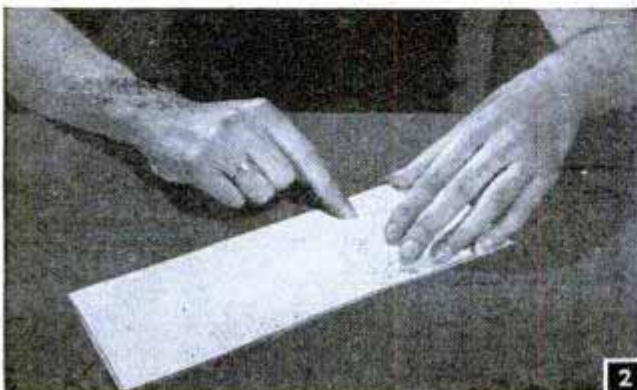



Registered U.S. Pat. & TM Off. 49

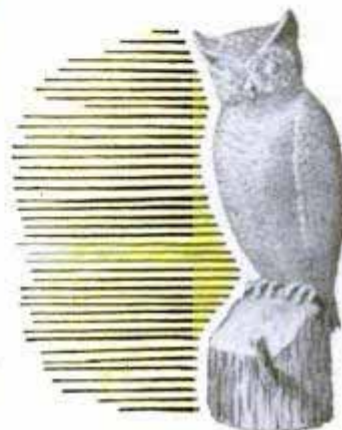
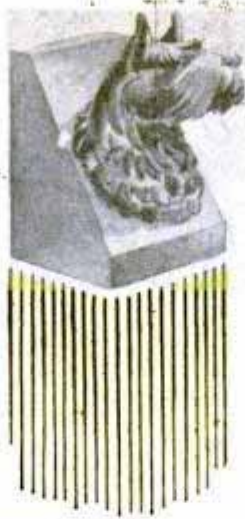

# PLASTER CASTING

Using liquid rubber to form the mold is something special in a plaster-casting process. Paint it on the pattern, strip it off, and there's your mold. It's as simple as that and the reason industrial designers use it is that rubber captures the finest details worked into the original pattern

**S**TATUETTES, plaques, shelf novelties and experimental designs for new products can easily be worked out by the plaster-casting process, using liquid rubber as a mold. The process starts with a pattern or "slip" made from modeling clay. This material can be worked into almost any desired shape with the hands, and fine detail can be modeled into the surface with modeling tools as in Fig. 2. In forming the pattern of any large object you first put together a wood core which is roughly the shape of the finished product, but smaller in all dimensions so that a layer of modeling clay can be applied over it. The core is mounted on a baseboard as in Fig. 1 so

that it may be handled easily. Here a pattern is being made of a streamlined automobile body and this is used as an example of the work throughout the series of photos illustrating the various steps. Once modeling clay is applied as in Fig. 1, and worked down to a fairly uniform thickness over the core, you begin work with the modeling tools. The big thing about modeling clay is that it allows plenty of latitude for trial and error. There's no need to hurry, for the clay retains a certain amount of plasticity. So if you scrape off a little too much in shaping a window, an eye, an ear or a nose, just stick some more of the clay back in place, smooth it into the contours with



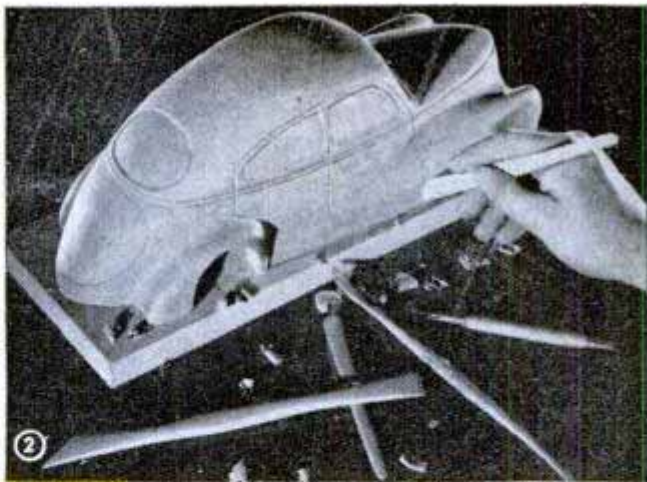
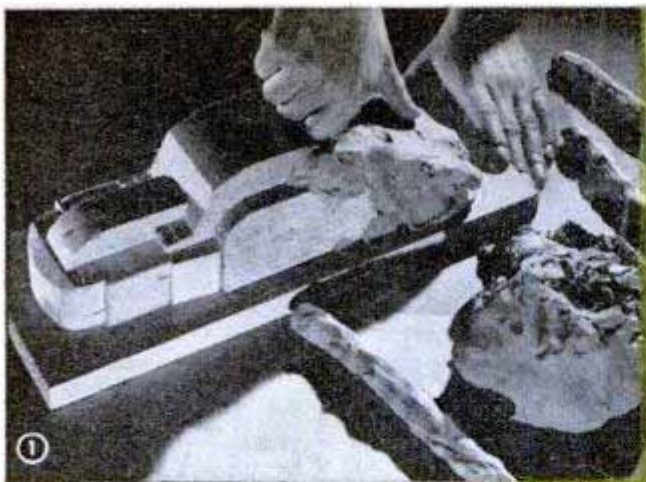

your finger and try again. Even a beginner can turn out a creditable job of modeling such an object as the car body after a little experimentation in working with the material and tools. Modeling facial features, of course, is an art and one attempts such advanced projects as statuettes, plaques or other work requiring the modeling of faces and figures only after considerable experience. In modeling an object such as the car body you learn right away to depend on your eye to tell you whether things are progressing properly or not. If a fender is off center or a window frame lopsided, your eye will catch it immediately.

In Fig. 2 the clay pattern is nearly finished and, after a few more smoothing

touches here and there, the next step is shown in Fig. 3. Here the pattern is being dusted with talcum powder which serves as a parting between the pattern and the rubber mold, just as does parting sand in the foundry process of sand molding. Be sure to cover all parts of the pattern with talcum. Thus prepared, the pattern is ready to take the coating of liquid molding rubber. If the object is small this can be applied by dipping several times in the liquid. Only a certain amount of the rubber will adhere to the pattern at each dipping, hence the process must be repeated until the coating is at least  $\frac{1}{8}$  in. thick. Allow each coat to dry. Molding rubber must be applied to the larger patterns with



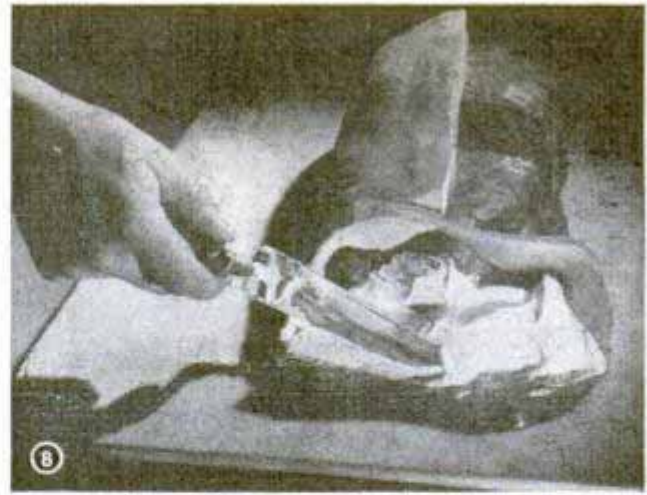
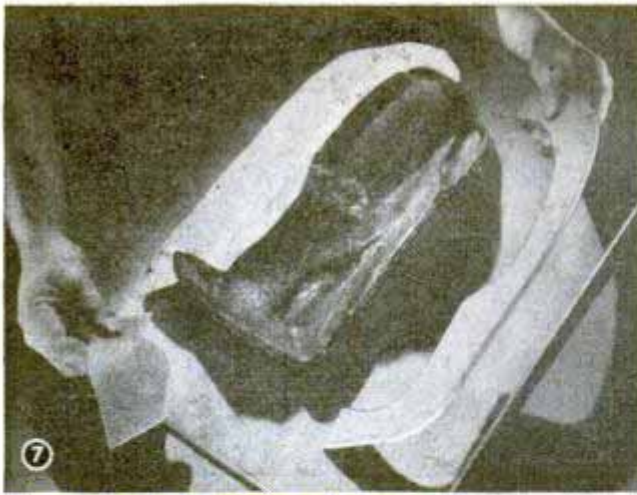

a brush as in Fig. 4. Use a fine-haired brush about 1 in. wide, lay the material on in quick, short strokes and be sure to cover all areas to a uniform thickness. Look out for bubbles, especially in the first coat. If any form, eliminate them by blowing gently on the surface. In the drying intervals between coats, wash out the brush in water and keep it in a can of water to prevent any residue remaining in the brush from hardening. It takes 10 to 12 brush coats of rubber to build up to about  $\frac{1}{8}$ -in. thickness. Should the size or shape of the pattern require a thicker, stiffer coating, then apply layers of cheesecloth or bandage cloth as you go along, Fig. 5. In most cases it is better to apply five to six coats of liquid rubber before reinforcing with cloth.

After the rubber has been built up to the required thickness it must be supported in a reinforcing cast or shell made from plaster of paris. This must be made so that it is easily removed from the rubber mold. If the pattern surface is undercut at several points—undercuts being places where the pattern changes contour—then the reinforcing shell must be formed in several parts. The car body shown required a three-part shell. Fig. 6 shows how the first

part is built up against dams made from thin plywood cut to the contour of the body top. The dams are held in place with candle wax. Fig. 7 shows the finished half shell with the dams removed. Before the second half is applied, notches are cut into the edge of the first half as in Fig. 9 so that when completed the two parts will fit together in exact register. Notches in the first half and tongues cast in the second half show in Fig. 11. Edges of the first half are coated with rubber cement before the front piece is applied as in Fig. 8. This prevents the parts from sticking together. Finally, the second half is applied as in Fig. 10. Then you have the three pieces shown in Fig. 11. Lifting the rubber mold from the clay pattern as in Fig. 12 completes the preparation for casting the model.

Now for the actual casting. The setup is shown in Fig. 13, the rubber mold being supported inside the reinforcing shell and filled about half full of either plaster of paris or dental plaster. In this case a rough wood core is used, as you see in Fig. 13. The core is embedded in the wet plaster and centered below the top of the mold as in Fig. 14. The core should be about  $\frac{1}{2}$  in. smaller in each over-all dimension than the





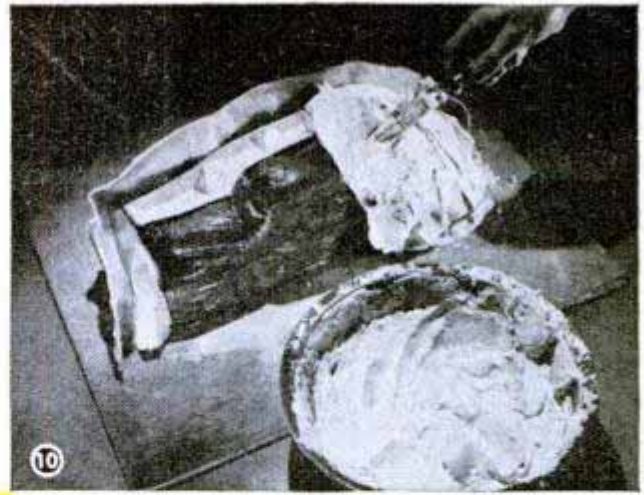
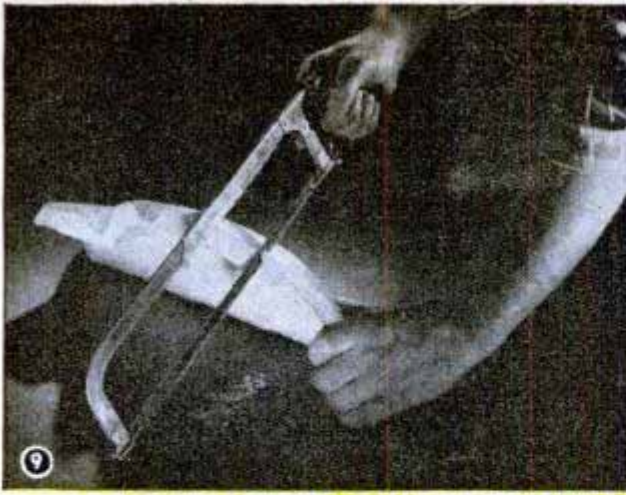

finished model. Bore several small holes in it to give the plaster a firm key, then coat with shellac to prevent absorption of moisture. Allow the casting to harden completely, remove the rubber mold, Fig. 15, and there's your completed job as in Fig. 16. Casts made from plaster of paris can be hardened by soaking in a solution made by dissolving 1 part of alum in 6 parts of hot water. Large castings should soak 48 hours or more. Castings then may be painted any desired color by a regular procedure, first sanding smooth and applying a primer, following with as many coats of finishing material as are required to produce the quality of finish desired. A really fine finish requires careful preparation, sanding between coats and then a final rubbing down to get a smooth surface. On small castings with fine detail, spraying the finishing material gives best results. Other materials similar to wood putty may be used in place of plaster of paris or dental plaster. When dry, a casting of this material can be worked much like wood. In some cases this product can be used advantageously for the pattern as well as the final casting.

Photos courtesy Fisher Body Craftsman's Guild

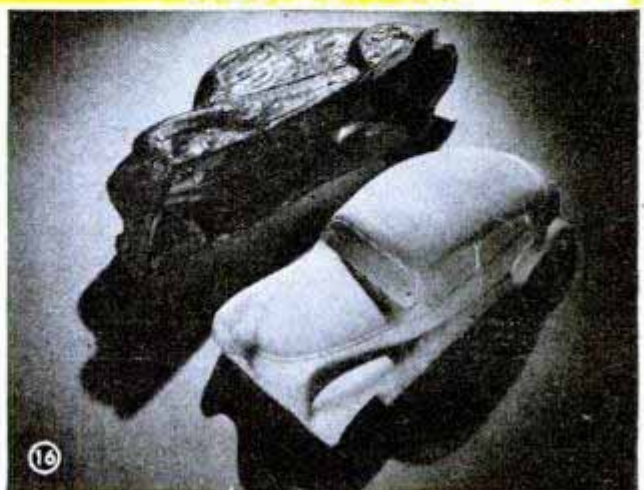
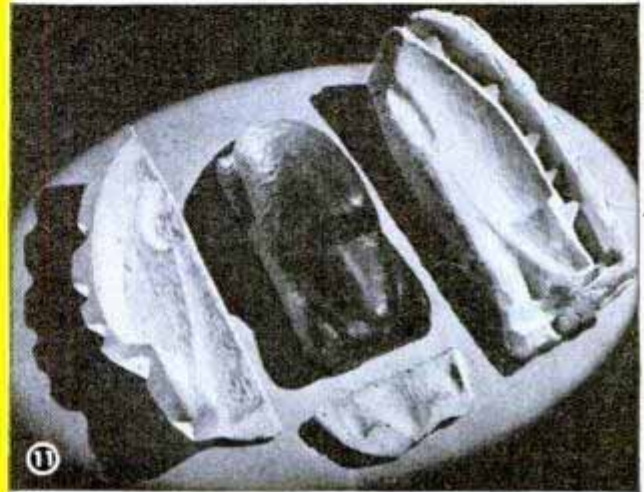



## How to Make Reflecting Numbers



ALUMINUM  
FOIL



Reflecting house numbers can be made from the metal or plastic type that are now available, or they can be cut from wood or heavy cardboard. Crumple squares of aluminum foil and then flatten them out slightly. Paste the foil over the numbers and cover the surface with several coats of clear varnish to serve as weather-proofing.

## Emergency Wheel Puller for Car

If you don't have the proper tools at hand to remove the wheel from a car, you can do it with a jack if the wheel is not too tight. Fasten heavy wires to opposite points

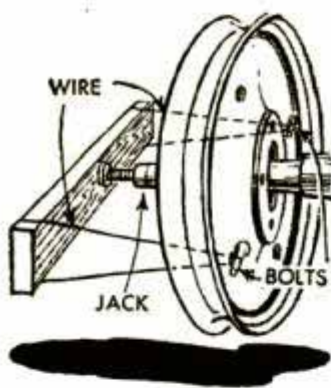

on the wheel and loop both wires over a heavy wood strip or piece of metal. Then put the base of the jack against the end of the axle and the top against the wood strip. Extending the jack will force the wheel off.

## Shelf "Strapped" to Column

Where it is impractical or undesirable to use nails or screws to fasten shelves to posts or columns, strap iron can be used instead.

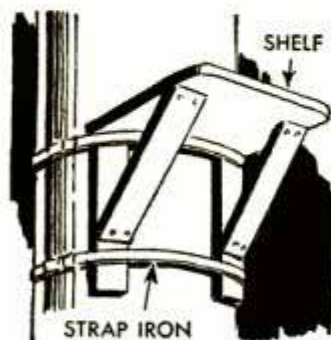

The shelves are made as indicated and the straps are passed around the two uprights and then tightened. Wire can be used as a substitute for the strap iron. — C. A. Lecki, Cicero, Ill.

## Ridge Protects Early Garden Crops

Early garden crops such as radishes and lettuce will be protected from cold wind and rain if, when the ground is prepared, a ridge of earth is pulled up to a height of 2

or 3 in. Planted on the sheltered side, the seeds will have a much better chance of maturing properly.

Sadie G. Lasley, Queen City, Mo.

## Preventing Books From Slipping

When you have to carry several books under your arm, it's difficult to do so without having them slip. If the books are stacked and a piece of paper slipped between the front cover of one and the back of the book on top, continuing in this manner for all books, you will be able to carry them easily. — D. Streby, Lancaster, Pa.

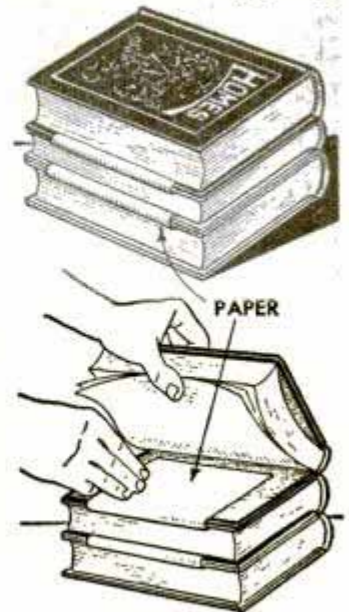

## Rubber Ball Covers Gun Muzzle

Keeping mud or snow from clogging a rifle or shotgun barrel can be accomplished by using a hollow rubber ball. Cut a small hole in the ball with slits or slots on either side. When outdoors in bad weather, slip the ball over the end of the gun. The ball should be removed as soon as you are indoors to prevent moisture accumulating inside and causing the barrel to rust. — R. A. Jenkins, St. Louis, Mo.

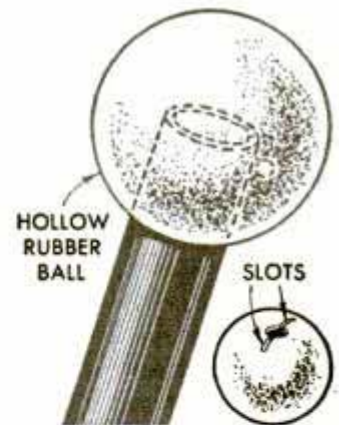

## Dam Aids in Lubricating Bolts

Bolts that are badly rusted must be lubricated with penetrating oil for some time before the nut can be loosened. In many cases a dam of modeling clay can be built around the nut to act as a small reservoir that will retain the oil. The dam is firmly pressed in place, filled with oil and allowed to stand for several hours or overnight. — James Vick, Church Road, Va.

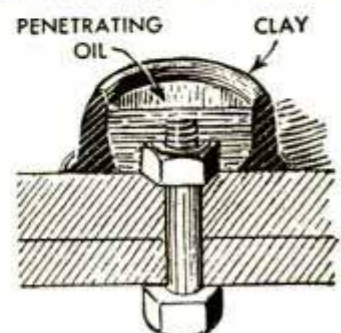



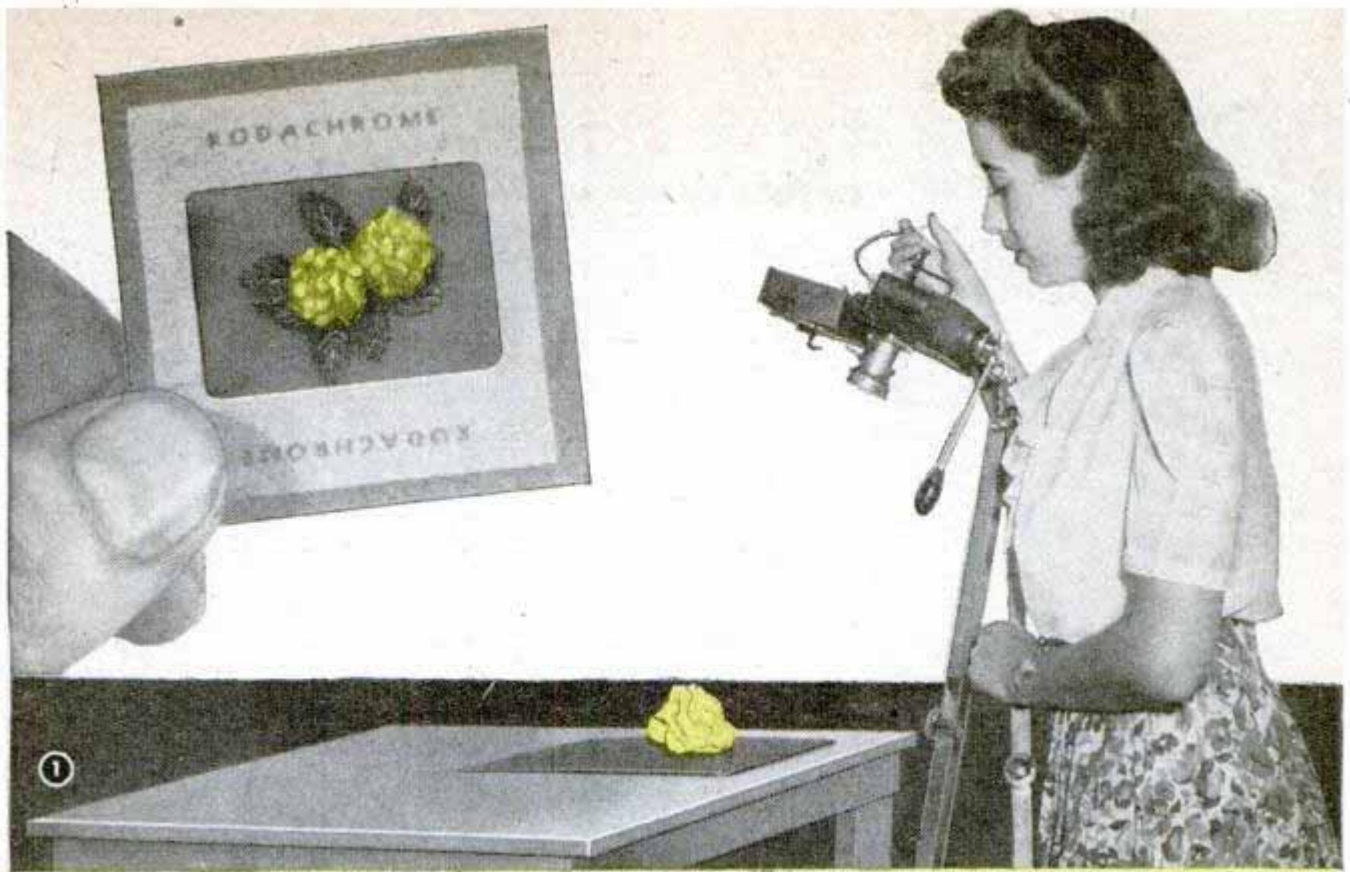

# Close-ups WITH THIS FOCUSING COPY ATTACHMENT

By Robert C. Frampton

**U**LTIMATE solution to the problem of close-up photos with a miniature camera is the use of ground glass focusing with its accurate visual indication of both field and focus. But not many of the smaller cameras are regularly equipped with this convenience. Here is a copying attachment that makes needle-sharp focusing possible at a cost of less than \$5.00. With minor changes in the dimensions it can be made to suit several makes of miniature cameras of the type having a removable tube-mounted lens. The attachment consists of three units. One holds the lens and takes the tripod screws. Hinged to it at the bottom is a second unit which holds the camera box. Hinged at the top of the first unit is the third which carries the ground glass for focusing. This latter unit swings down into focusing position as in Fig. 2, while the second hinged unit holding the camera body swings out of the way as shown. Figs. 1 and 7 show the positions reversed with the camera box back in shooting position. Parts are shown in order of assembly in Fig. 3 and are detailed in Figs. 4, 5 and 6.

First get a lens mount or adapter ring to fit your camera lens. Then make up the lens-and-tripod unit as in Fig. 6. One mem-

ber should be made of  $\frac{3}{8}$ -in. plywood as in Fig. 3. Bore a hole of the size indicated, or vary it to suit the adapter ring you have, and screw the latter in place. Next come the swinging friction catches, which are bent to the shape shown in the lower view, Fig. 3. It will take a little careful measurement and then perhaps a trial bend or two in order to get these catches to perform properly. As you see in Fig. 7, these hold the camera supporting unit when it is swung up into position. Notice especially how the camera unit is made. The hole through it is counterbored and this forms a light trap when the camera box is in position back of the lens. The camera box is held tightly against the opening by means of a bracket and clamp screw detailed in Fig. 5 and shown in the center view, Fig. 3. When hinging the camera unit to the lens unit be sure that the lens openings line up.

The ground-glass unit, Fig. 4, is made last. One dimension is quite important and will vary slightly with different makes of cameras. The dimension— $1\frac{29}{64}$  in.—is, in this particular instance, equal to the distance from the front of the panel of the camera unit to the film-emulsion surface





in the camera box. A shift of  $\frac{1}{64}$  in. or so in a 2-in. lens changes its focus from 18 or 20 ft. to infinity. So it's important to make sure of this dimension by using a depth-gauge reading to  $\frac{1}{64}$  in. or less. Also, the front and back faces of this part should be parallel.

Next, bore a  $1\frac{1}{8}$ -in. hole through the block, locating it on the center indicated in Fig. 4. When the block is in position on the lens unit, the top edges of both units should be flush and the holes should register. Then attach hinges and hooks.

Two pieces of 2 by 2-in. lantern-slide glass are required for the ground glass although only one actually is used. The other serves as a grinding "tool." Mix abrasive powder of the grade known as "microscopic fine" with a few drops of oil and apply this to one side of one piece of glass. Then simply rub the two pieces together to produce a focusing surface. Draw diagonal lines from the corners of one glass and, with these as a guide, draw a rectangle 1 by  $1\frac{1}{2}$  in. to represent the picture or image area. Then center the glass over the lens opening with the ground side next to the block and with the top edge flush with the top edge of the unit. Fasten with adhesive tape. Two rubber-headed tacks, placed as in Fig. 5, protect the glass from breakage should the camera unit inadvertently be swung upward.

Now you are ready to check for correct focus and field. To check for focus, fit the camera lens on the adapter ring and, with the diaphragm wide open, set the focusing

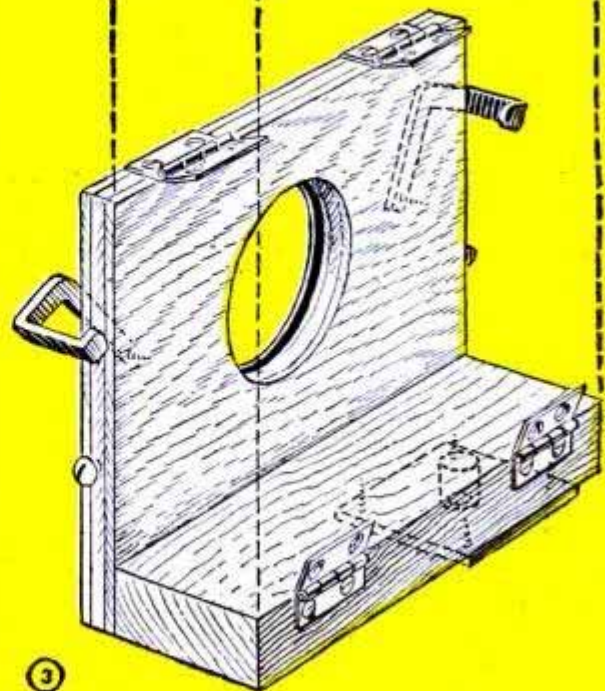
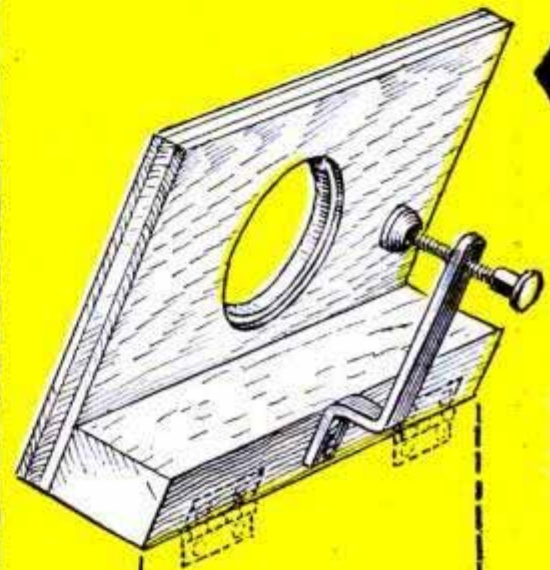
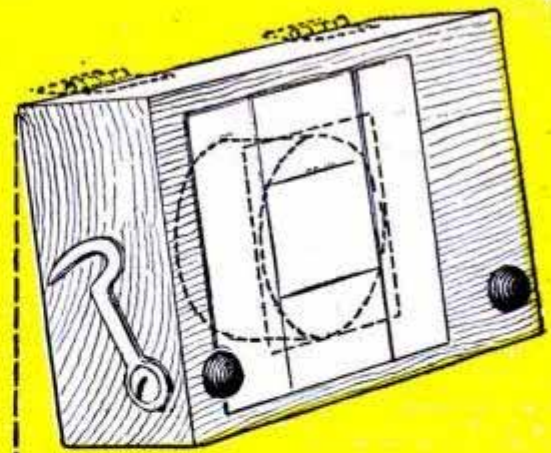

3



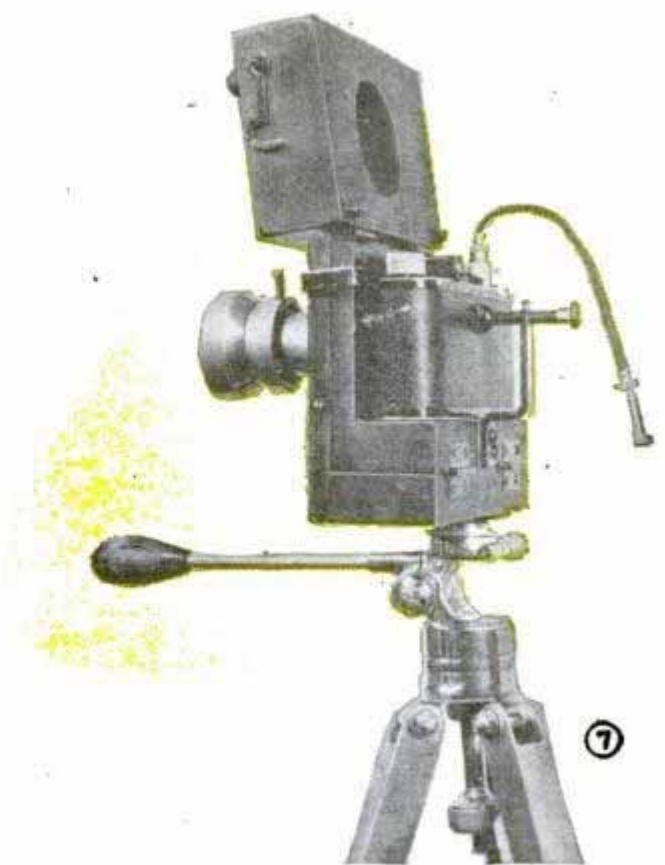
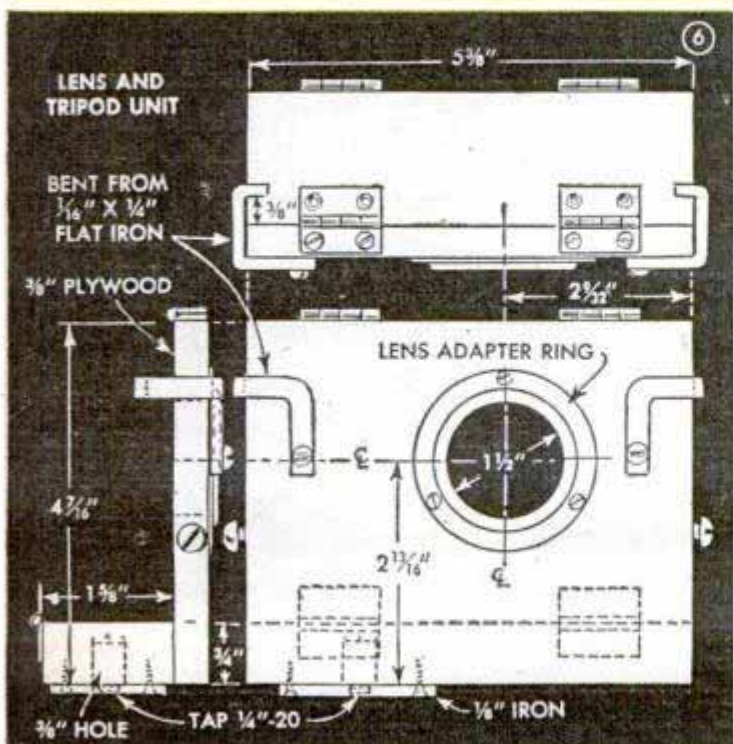
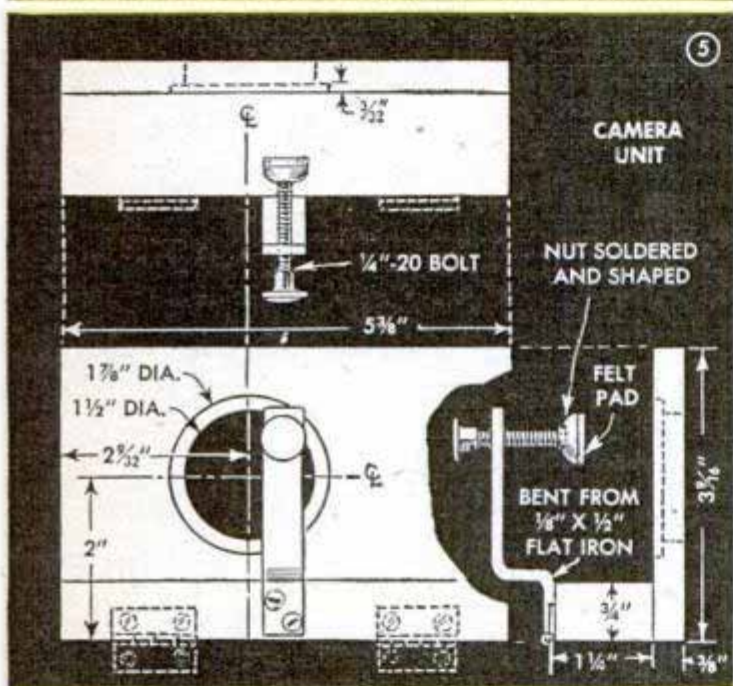
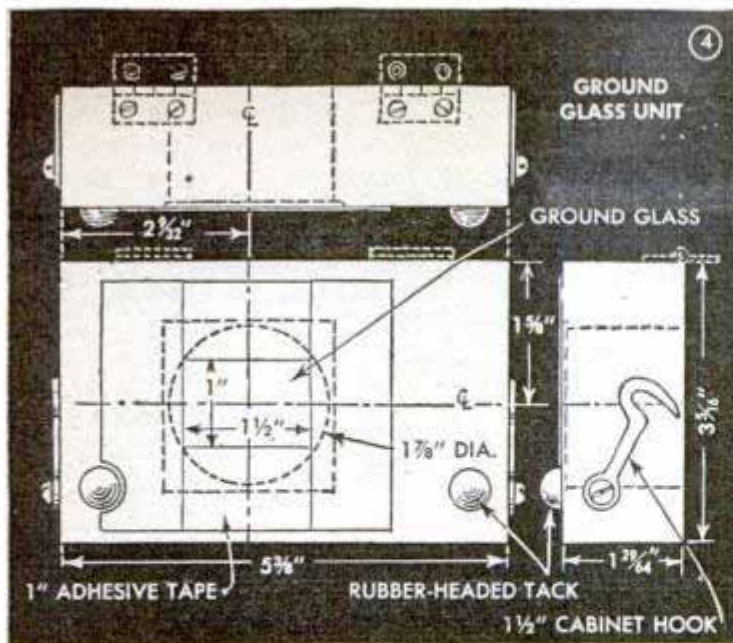

scale near the middle of its range, say about 12 ft. Load the camera and lock it in place on the camera-holder unit. Swing the ground glass unit into position as in Fig. 2. Place a magazine page about 12 in. directly in front of the lens and bring the camera into position as in Fig. 7. Make a test exposure. Then, without altering the lens setting, change the focus one division on the scale and make another exposure. Proceed in the same way until you have exposed film at four settings each way on the scale. Keep notes on each exposure.

Make 8 by 10-in. blowups from all negatives. The first should be the sharpest. But should a closer scale reading give the sharpest negative, then it's necessary to determine the amount of lens movement between the two settings. Usually this can be done by inserting a thickness gauge between the focusing scale ring and the depth of focus indicating collar. From this you can determine the difference in the two settings. Shim the ground glass back an equal distance and you have the focus corrected.

To check the field, use the same setup and mark on the magazine page the four points corresponding to the corners of the field on the ground-glass image. Enclose the rectangle with heavy ink lines and draw diagonals from the corners. Print a bold letter "T" near the top of the rectangle and then make a test exposure. With this point as a guide, it's easy to shift the ground glass slightly to correct any error in position.



## Novel Drawer Lock on Dresser Keeps Children From Prying



Children are naturally curious, and a dresser or chest of drawers is a fertile field for exploration. To keep youngsters out of the drawers, one parent connected a series of latches in such a manner that no lower drawer could be opened unless the top one, which the children could not reach, was first pulled out. The latches, as shown in the detail, were connected to a screw eye in the top drawer with a cord. Pulling out this drawer lifted all the latches.

Peter B. Horsley, Brandon, Man., Can.

## Tape-Spool Holder for Thread

Here's a handy reel that will hold many different kinds of darning thread. Take an empty adhesive-tape spool and fit short dowels between the sides. These are pivoted on round nailheads that are set in dents. The dowels should be cut and sanded to have a slightly concave shape. The cover is kept on the spool to make it convenient to carry.

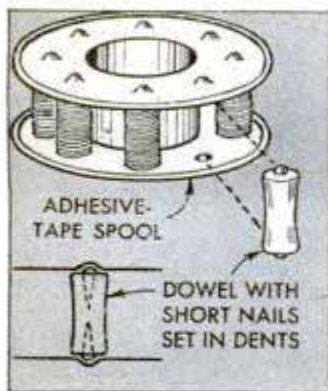

## Packing Calking in Wooden Boats

Owners of wooden boats should not pack calking too tightly in the seams. When the wood swells, the screws may be pulled loose and cause the boat to leak. If a narrow space is left between the calking and

the wood to allow for swelling when the boat is put in the water, it will remain dry throughout the season.

Dean K. Brown, Syracuse, N. Y.

## Accurate Way to Shorten Bolts

The next time you have to cut off a bolt to shorten it, try this way to secure a square end. Screw two nuts on the bolt, allowing space between them for a hack-saw blade where the bolt is to be cut. Grip the nuts in a vise and saw half-way through; then reverse and complete the cut. This assures a neat end.

H. Klein, Pittsburgh, Pa.

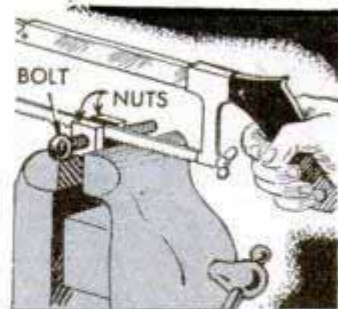

## Small Jig Holds L-Shaped Strips While Filing and Finishing

Having a number of L-shaped pieces of sheet metal with edges that were to be filed and finished, one man made a wooden jig that held the pieces securely. The V-shaped cleats are mounted on a common base. The strip of wood that acts as a hold-down should be long enough to extend out from the work at both ends and is drilled for wing nuts and bolts. Round the 90-deg. corner of the hold-down to allow for the inner radius of the bend in the metal.

W. H. McClay, Pasadena, Calif.

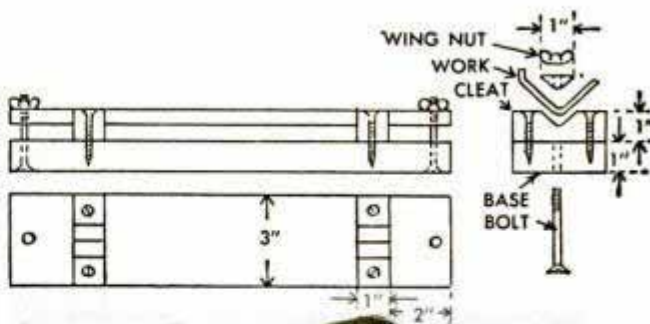



# CRAFT QUIZ

## 11 PLANES—Can You Name Them?



1  
This plane is used for long work such as truing up the surface before edge-joining boards with glue

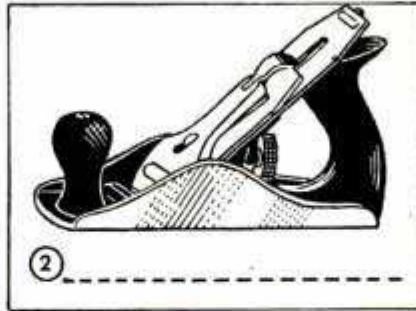

2  
A short, finely set plane, which you can use for surface smoothing and finishing boards of all kinds

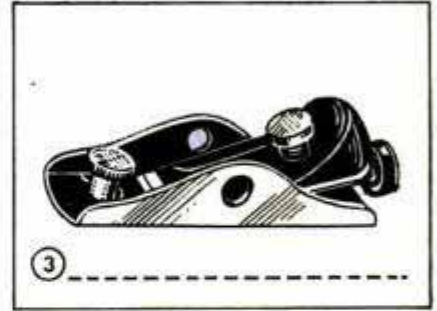

3  
A small plane that can be held in one hand and used for almost any light work, especially thin stock

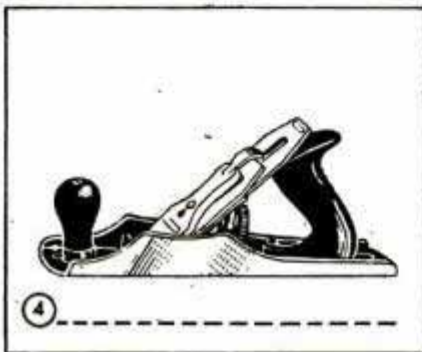

4  
Used to true the edges of a board as it comes from a saw. It also is used for rough-planing other work

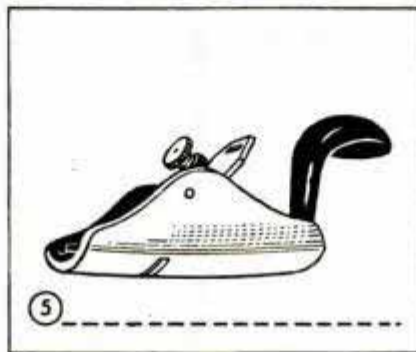

5  
Used by modelmakers, violin makers, etc. Bottom is curved upward from the center at sides and the ends

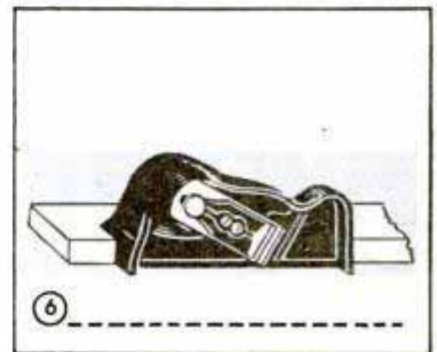

6  
For trimming or squaring the edges of boards when it is necessary to get a square or a very close fit

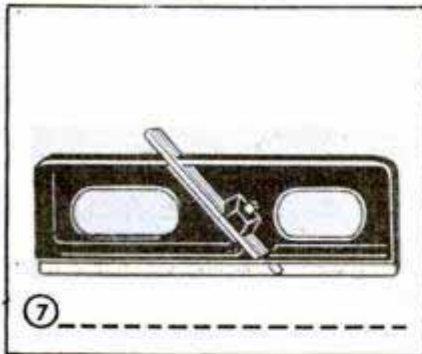

7  
Made especially for rounding corners on baseboard casings, shelves, wallboard battens and similar work

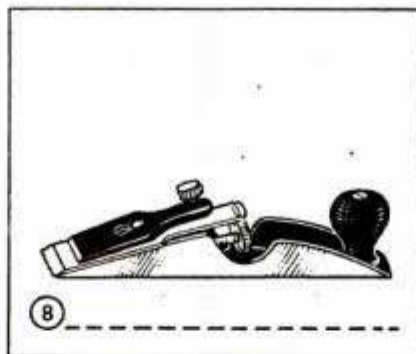

8  
The cutting edge on this plane is located right at the front end. It is used mainly by cabinetmakers

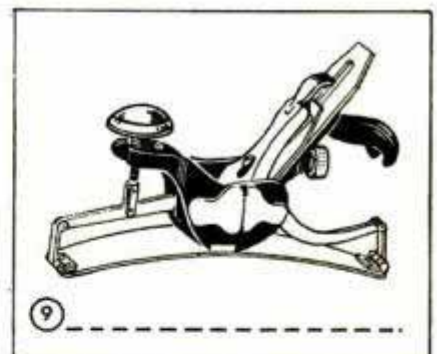

9  
It has a flexible steel bottom and can be adjusted quickly to plane either convex or concave surfaces

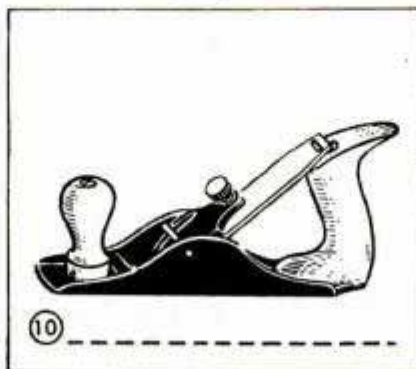

10  
Ideal for use when there is quite a bit of wood to remove but not enough to warrant use of rip saw

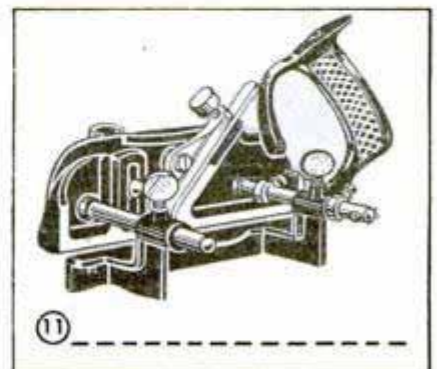

11  
Used to make rabbet cuts in almost any kind of straight work. It has an adjustable fence for guiding it

ANSWERS: 1 — Jointer Plane; 2 — Smooth Plane; 3 — Block Plane; 4 — Jack Plane; 5 — Modelmakers' Plane; 6 — Edge-Trimming Plane; 7 — Corner-Rounding Plane; 8 — Cabinetmakers' Edge Plane; 9 — Circular Plane; 10 — Scrub Plane; 11 — Rabbet Plane



## Extension Handle on Wood Spoon Is Convenient for Campers



Steam rising from that simmering stew won't burn your hand if you stir the food with a spoon that has an extension handle. Too, with this handle, the spoon won't take much space in your duffel. Make a brass ferrule to fit the cut-down handle and use an extension that fits the ferrule.

## Alteration of Alcohol Blowtorch Increases Heating Capacity

It's possible to "step up" the heating capacity of an automatic alcohol blowtorch by fitting the nozzle with an extension. A .30-cal. shell that has been fired is used for this purpose. The head of the shell is cut off and the neck is expanded to be a tight fit over the nozzle of the torch. Then

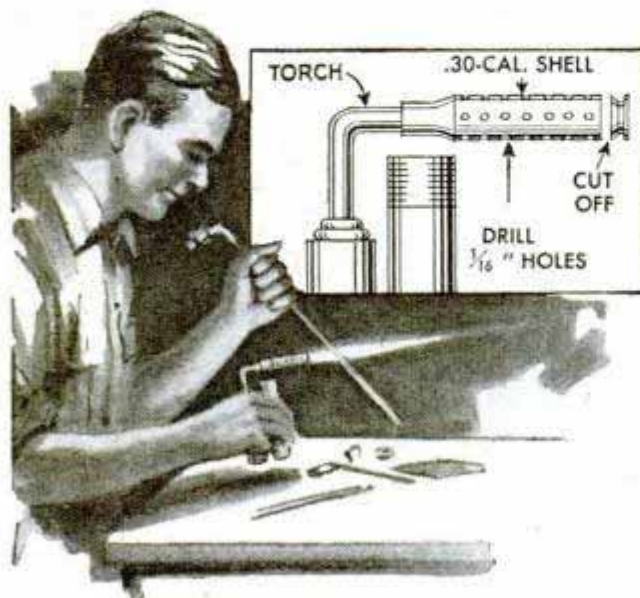

$\frac{1}{16}$ -in. holes are drilled at regular intervals, and the altered unit is ready for use.

Jon Matlog, Portsmouth, N. H.

## Easy Way to Start Small Nuts In Inaccessible Places

When you wish to start a small nut in a place that is difficult to reach, merely sharpen a long wood dowel at one end so that the nut can be partly screwed on to it. Then you can reach inside any small opening and start the nut without difficulty by using the dowel as a screwdriver.



## Opener Serves as Tack Remover

If you do not have the proper tool at hand, a common type of can opener can be used to remove thumb and carpet tacks that have been driven in too far. Grind the point down and file a V-notch so there are two points. File the ends so they will slip under a tack. You will find the tack remover will still serve as a can opener.



## Ear Syringe Applies Liquid Glue

For rapid application of liquid glue, an ear syringe can be used to advantage. The tip is cut as shown in the upper left-hand detail so that it will fit into narrow joints and corners better than a brush and do a neater job. After use the syringe should be washed thoroughly. — Arthur P. Warner, New Haven, Conn.

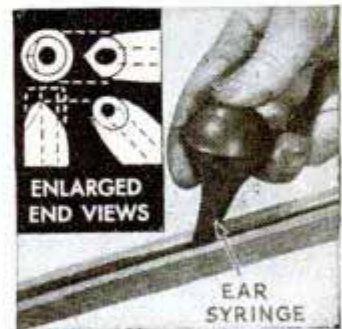

Instead of breaking a glass toy bank to get the coins out, just invert the bank and insert a hacksaw blade in the coin slot. By manipulating the blade, the coins can be made to slide out along the blade.





# Shop Notes



## SPRAY ATTACHMENT For Your Tractor

By Robert Emenhiser

**F**ARMERS with only a few fruit trees and berry bushes don't feel that investment in a heavy power sprayer is justified. And, of course, it isn't, judged on the returns from the outlay. But the bugs and various scales that attack fruit trees and shrubs don't bother with any such practical considerations. They can ruin a valuable fruit or shade tree or a row of prized berry bushes in a single season if you give them half a chance. So far there seems only one effective control—spray and more spray, applied at the right time. And on the farm, with other work always waiting, spraying must be done as quickly and effectively as possible. By making use of the farm tractor and a small centrifugal pump you can put together a mobile spray unit with a reach of 30 to 40 ft. and sufficient pressure at the nozzle to give the proper spread. As most farm tractors of the "tricycle" or cultivating type are fitted with side frames so that you can mount implements or other attachments on either or both sides, it's easy to attach brackets and mount a small centrifugal pump on the belt-pulley side and take power from the pulley with a V-belt as in Fig. 1. Then on the back of the tractor you mount a 55-gal. oil drum to serve as a tank. Run a suction hose from the tank to the pump and another of convenient length to a spray nozzle. Fit it with a brass extension if you want to get up high in tall trees, and you have a simple spray rig that will do efficient work.

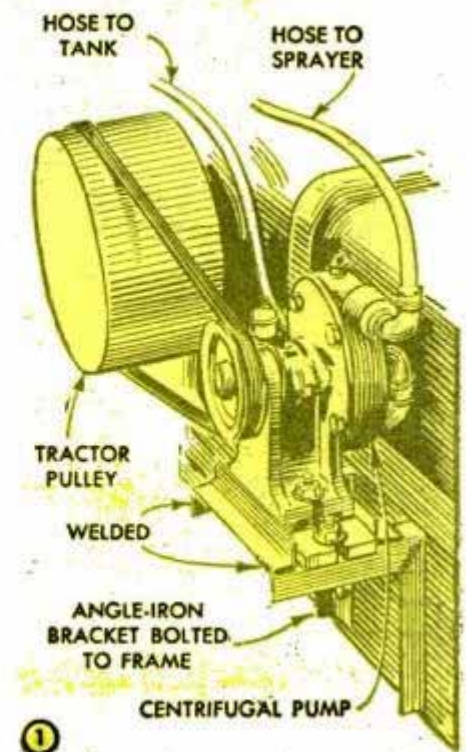



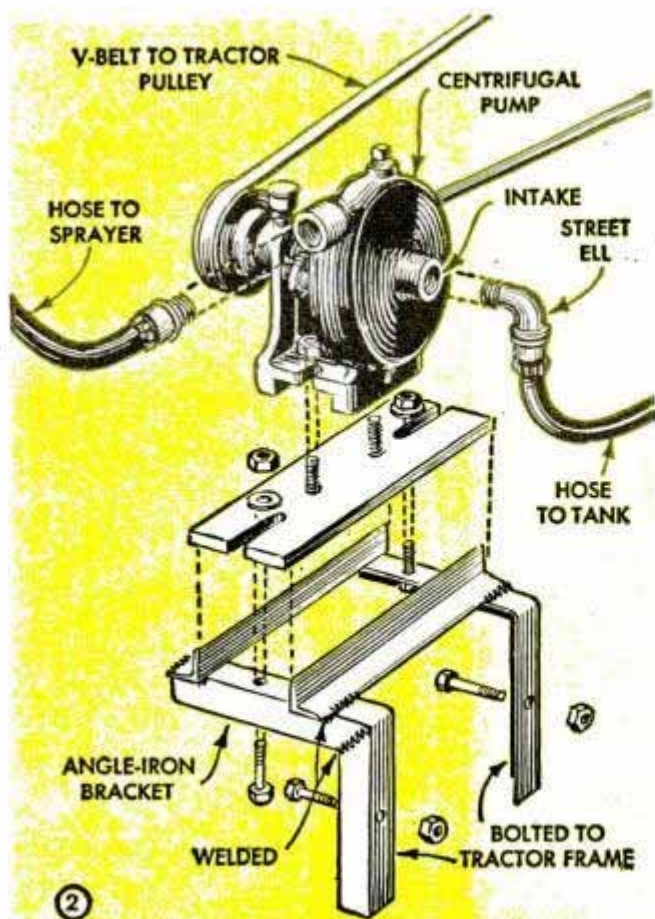

Use any small centrifugal pump with a  $\frac{3}{4}$ -in. intake and  $\frac{1}{2}$ -in. discharge. Weld a hose connection to the 55-gal. steel tank  $\frac{3}{4}$  in. above the bottom and connect the pump to the tank with ordinary garden hose

Brackets to mount the pump on the tractor frame can be made from angle iron as in Fig. 2. No dimensions of these parts are given because sizes depend on what pump you use and what tractor it is mounted on. Any small centrifugal pump with a  $\frac{3}{4}$ -in. intake and  $\frac{1}{2}$ -in. discharge will serve the purpose. Use ordinary garden hose between the tank and the pump intake. Weld a garden-hose connector on the side of the oil drum  $\frac{3}{4}$  in. above the bottom. If you strain the spray material before pouring in the tank, it will not be necessary to fit a strainer screen. Use spray hose between the pump and nozzle. Any spray nozzle with a hand-operated shutoff valve will do. Or an ordinary garden spray nozzle with a snap-action adjustment may be used. No by-pass valve is needed unless you shut off the spray at the nozzle frequently with the pump running. It is usually easier to throw out the tractor clutch and stop the pump, whenever necessary, than it is to install a by-pass valve.

Pressure at the nozzle will vary with the speed of the tractor engine. The higher the speed, the greater the pressure. The pump pulley should be about  $\frac{1}{3}$  the diameter of the tractor belt pulley. Small centrifugal pumps usually deliver greatest efficiency at fairly high speeds, and by using a small pulley on the pump it won't be necessary to race the tractor engine.

## Automobile Wheel Used to Pull Posts With Aid of Tractor

With an auto wheel, a plank and a length of chain, fence posts are pulled easily, using a tractor as motive power. The chain is hooked to the post near the ground and passed over the wheel. The other end of the chain is hitched to the tractor. The chain should be long enough to prevent the top end of the post striking the driver. — Paul Criton, Kayville, Sask., Can.

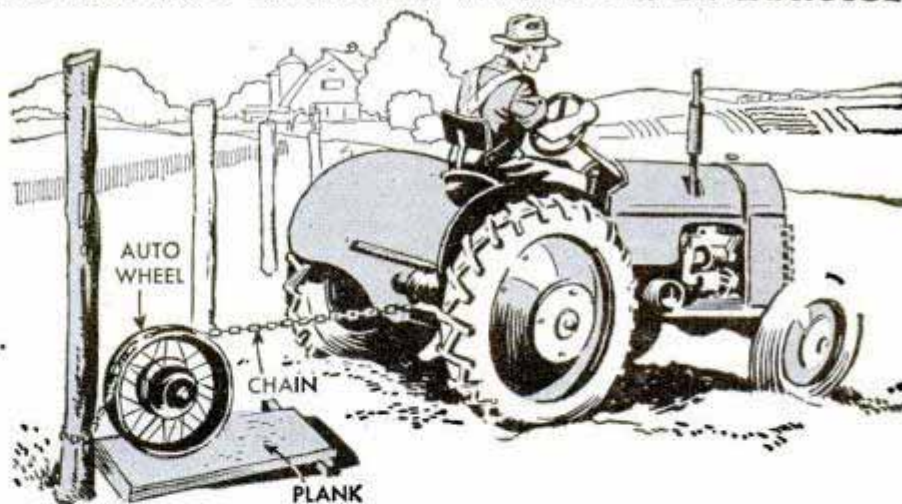

## Colored Bands on Ignition Cables Helps Identify Them

When several ignition cables have been removed from the spark plugs on a tractor, it is always a problem to reconnect them. One farmer identified the cables by painting colored bands around them. One band was for the plug nearest the radiator, two bands indicated the second plug and so on. Then any number of cables could be removed without wasting time tagging them.

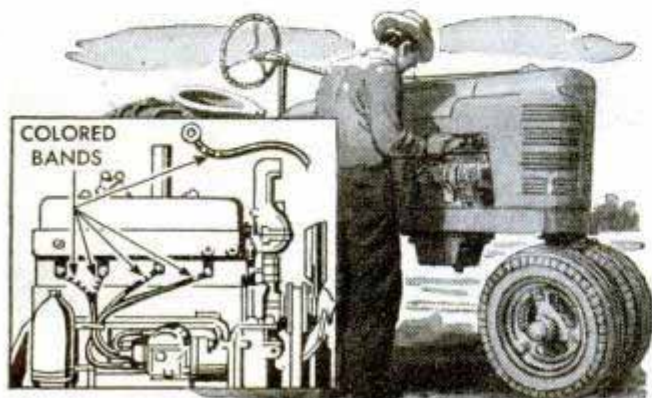



# Portable Bench an Aid in Maintenance Work

When doing maintenance work around a shop, especially where the work covers a large area, such as a factory, this portable workbench will save many trips back and forth to obtain materials and tools. It is made from the chassis of a wheelbarrow, preferably a rubber-tired one that will move over concrete floors easily. The box for tools and supplies rests on the chassis and can be connected to it in the same manner that the body of the barrow was fastened. The lid of the box opens out to form the working area and the outer edge has legs that must be rigid enough to support the table. A hasp and padlock for the lid will protect the tools when the unit is not in use. The vise is removed when the workbench is closed.

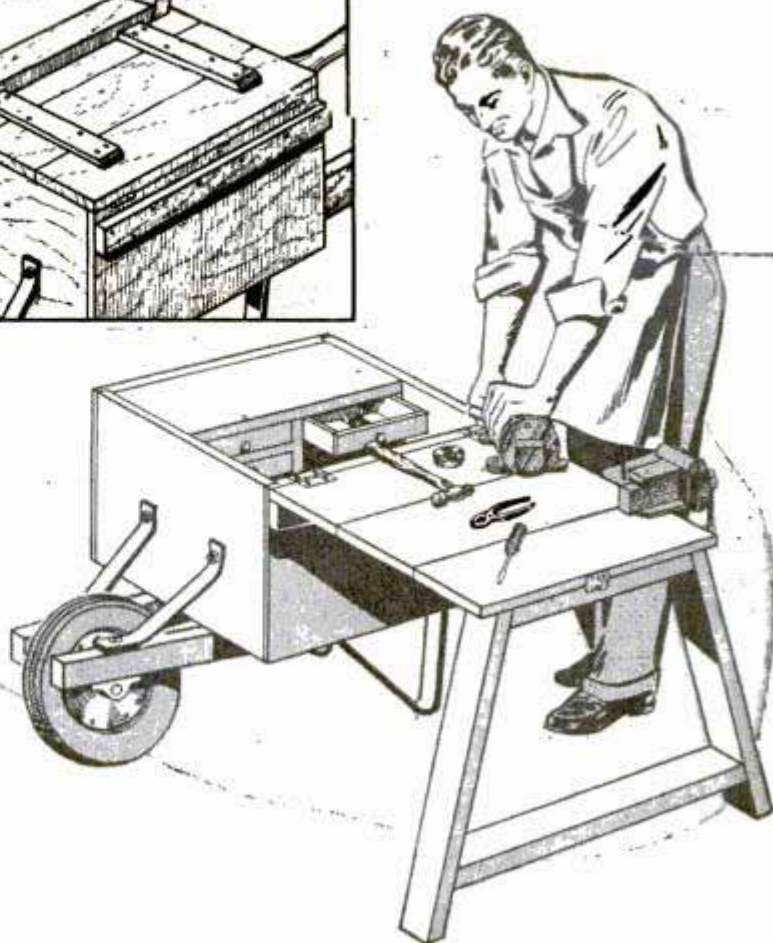
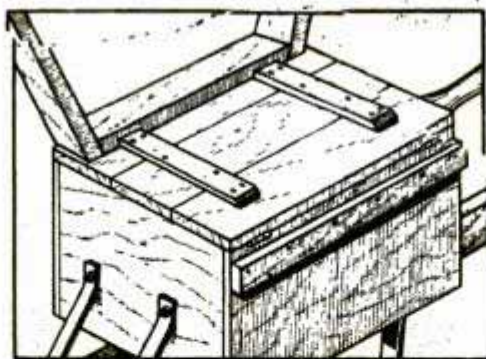

## Oiler Fastened on Cross Slide Follows the Lathe Tool

Easily made, this automatic oiler is attached to the lathe cross slide and "meters" the flow of cutting oil to timed drops, thus preventing flooding and waste. The body of

the oiler is cut from a can and the tubing that directs the flow of oil onto the work is soldered to the bottom and bent so the end is over the work. Support for the reservoir is a strip of flat iron soldered to the can and slotted at the other end to slip over a bolt in the cross slide. A small strip of flat iron is soldered to the top of the can and tapped for a screw which is fitted with a lock nut. The end of the screw is filed to a point and it is adjusted like a needle valve to regulate the flow of the oil.

Axel E. Jensen, Horsens, Denmark.

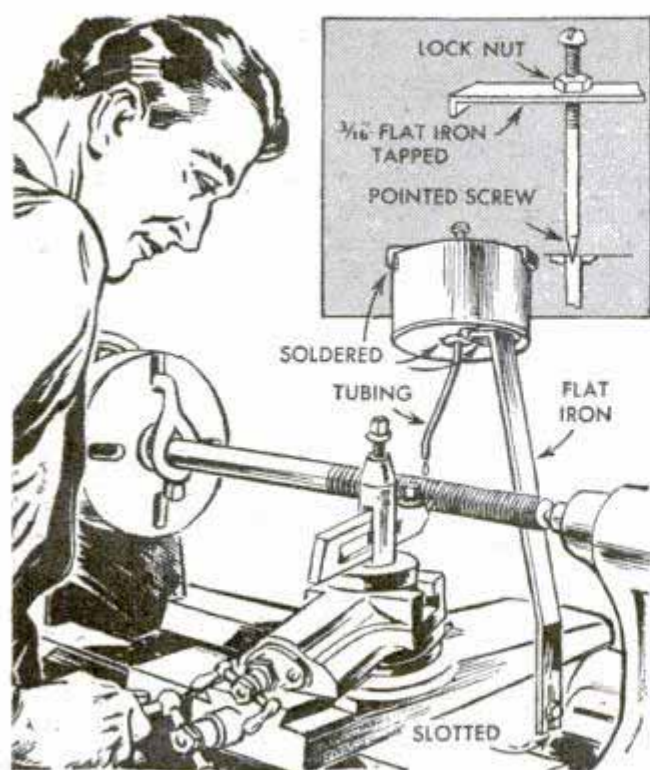

## Fitting to Grease Wagon Wheel

Instead of removing a wagon wheel to lubricate it, you can install a grease fitting in the hub and lubricate it with a grease gun. A hole is drilled through the hub to receive a  $\frac{1}{8}$ -in. pipe nipple and the fitting is screwed to a  $\frac{1}{8}$ -in. coupling. The nipple should be a tight fit so no grease will be lost.

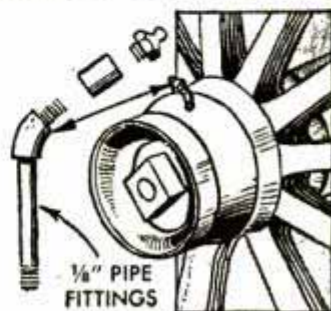



## Bearing 'Worked' Out of End Bell With Steel Ball and Tap



To remove a sleeve bearing from the end bell of an electric motor, one mechanic uses a steel ball and a tap. The end bell is placed on a work table and the ball dropped through the sleeve. The tap is turned into the bearing and when the end presses against the ball, continued turning forces the sleeve out. The diameter of the ball should be slightly less than the bearing, but it should not be so small that the end of the tap does not rest solidly on it.

## Oil Drum Makes Handy Holder For Seed Sacks

An oil drum, cut as indicated in the detail, will make two holders for sacks of seed. Held in such containers, the sacks will not tip and the tops can be rolled for better display of the contents. Seed leaking



through small holes in the sacks will be caught in the metal holders. Handles are welded to the top rim of the holder.

Opie Read, Jr., Chicago.

## Metal Particles Easily Removed From Auto-Tire Casing

If the inside of a tire casing is buffed with a wire brush, bristles are apt to break off and lodge in the rubber, later causing damage to the inner tube. To prevent this, pass a magnet over the inner surface of the casing to pick up the bristle pieces. A fairly strong magnet should be used.

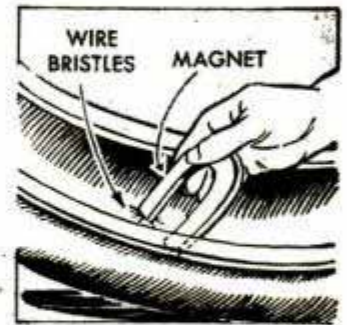

## Layout Dye Kept in Polish Bottle Is Convenient to Handle



Layout dye for template and pattern work is handled conveniently if kept in a shoe-polish bottle. The dauber-type stopper makes it easy to apply and also prevents the contents from evaporating when not in use.

## Wire Aids When Oiling Machine

Bent to fit around obstructions, a short length of wire is used to lubricate hard-to-get-at oil holes. The end of the wire is placed in the hole and the lubricant flows along it.





# Folding Workbench in the Garage Saves Space

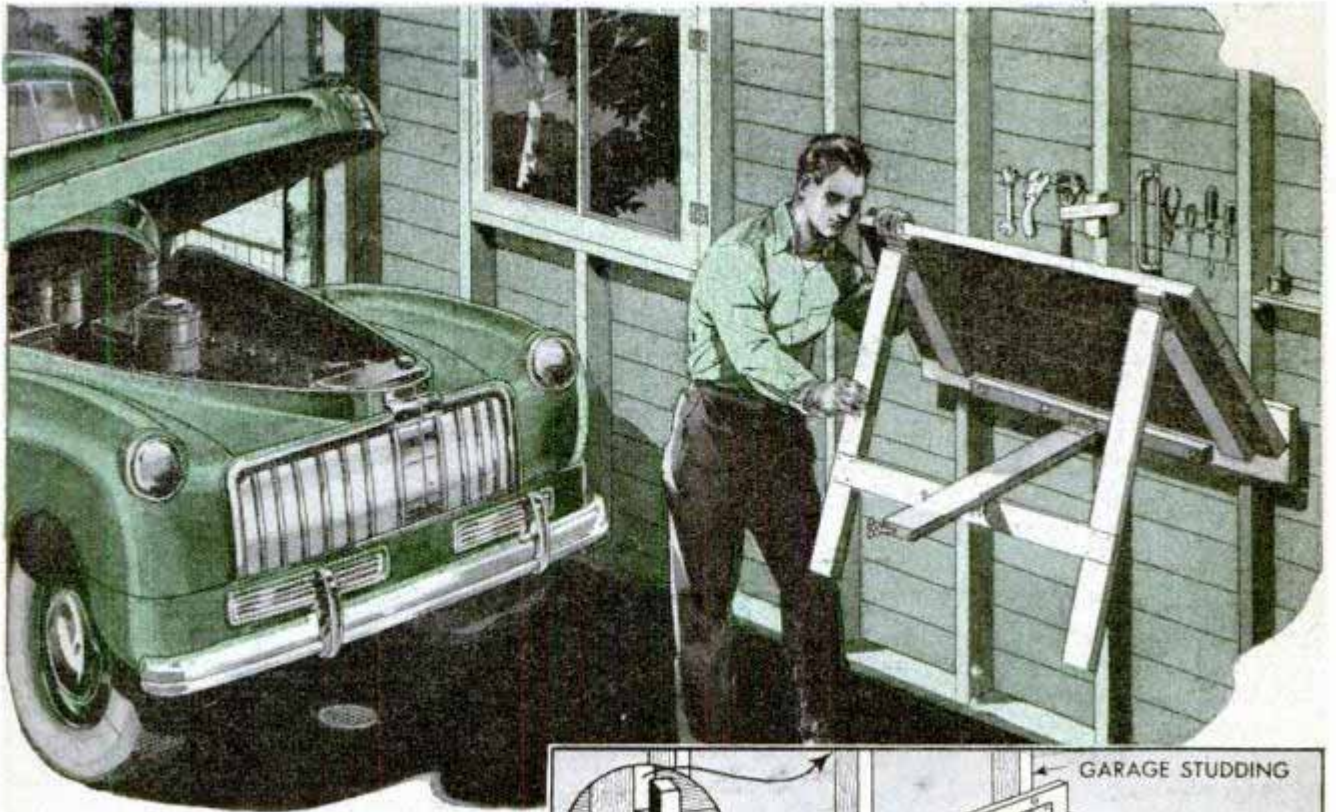

By Daniel Hyland

Not having enough space elsewhere, one craftsman made a folding workbench in his garage that proved satisfactory and when folded left plenty of room for a car. The back of the bench, which is 2 by 8-in. stock, is screwed to the studding and a brace for the top is screwed to the back. As can be seen from the illustration, the top and the front legs are hinged in such a manner that the top folds against the wall and the legs fold against the top. The bench is held in the closed position by a cleat, detail A, that is screwed into the studding. The diagonal brace which extends from the back to the horizontal cross member bracing the two legs is hinged at the back and connected to the cross member with a hanger bolt and hasp, the latter having been cut as indicated in the lower right-hand detail. Squarehead bolts fasten the horizontal brace to the legs

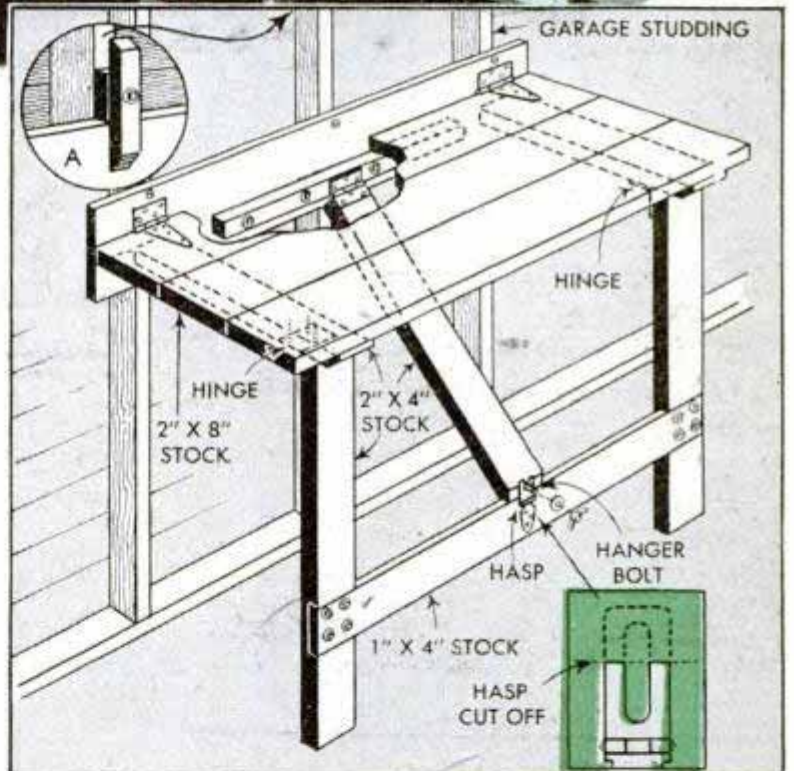

## Flexible Tubing Attached to Drum Is an Aid When Filling Containers

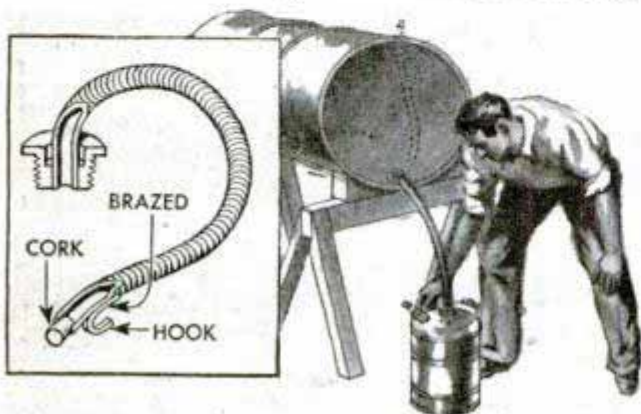

It won't be necessary to look high and low for a funnel when filling small containers with oil if you attach this flexible tubing to the drum. Get a plug that will fit the hole in the drum and drill it to take the tubing. Then braise the tubing to the plug and braise a wire hook to the nozzle end. When not in use, the tube is hooked over the top of the drum.

☐ Hardened glue can be softened by placing a few drops of vinegar in the container.



# Garden Tractor

has 4-cylinder power, differential,  
dual transmission, starter, variable  
tread and hand-controlled brakes

By Floyd Carlson

**B**UILT from a few pieces of pipe, pipe fittings and old auto parts, including the engine, this powerful garden tractor handles all the larger garden-tractor implements such as a 10 or 12-in. turning plow, 5 or 6-ft. disk harrow, any of the larger cultivators, mowing machines, etc., with plenty of power left over for the hard pulls. Because of its extra weight and compact-unit construction it's easy to handle even on the heaviest jobs. Stability and balance plus a close throttle control make it easy to steer and prevent whipping of the handles so common in the lighter garden tractors. Controls are located on the handle bars within easy reach of the operator. A heavy perforated steel grille protects the radiator core from damage in case you bump into something. Handles and frame are one unit, built up from pipe and fittings. Power is taken off the front end of the engine crankshaft by roller chain to a Harley-Davidson motorcycle transmission which contains an "over-center" clutch controlled by a lever on the handle bars. From this transmission, power is taken by roller chain to a second transmission, the latter from a Ford Model-A or 1931 Dodge automobile. This second transmission is bolted directly to a cut-down Ford Model-T rear axle as you see in Fig. 1. The "worm's-eye" view in Fig. 1 gives a clear idea of the compact, efficient drive. Sounds like a cranky job to assemble, but it happens that these parts fit together with the minimum of alteration. In the process the drive pinion of the rear axle is "transplanted" to the transmission and then the two parts are "telescoped" together. A study of the exploded view in Fig. 2 will give you an idea of how these various parts are assembled. No dimensions are given on any of the parts except the size of pipe used for the frame.

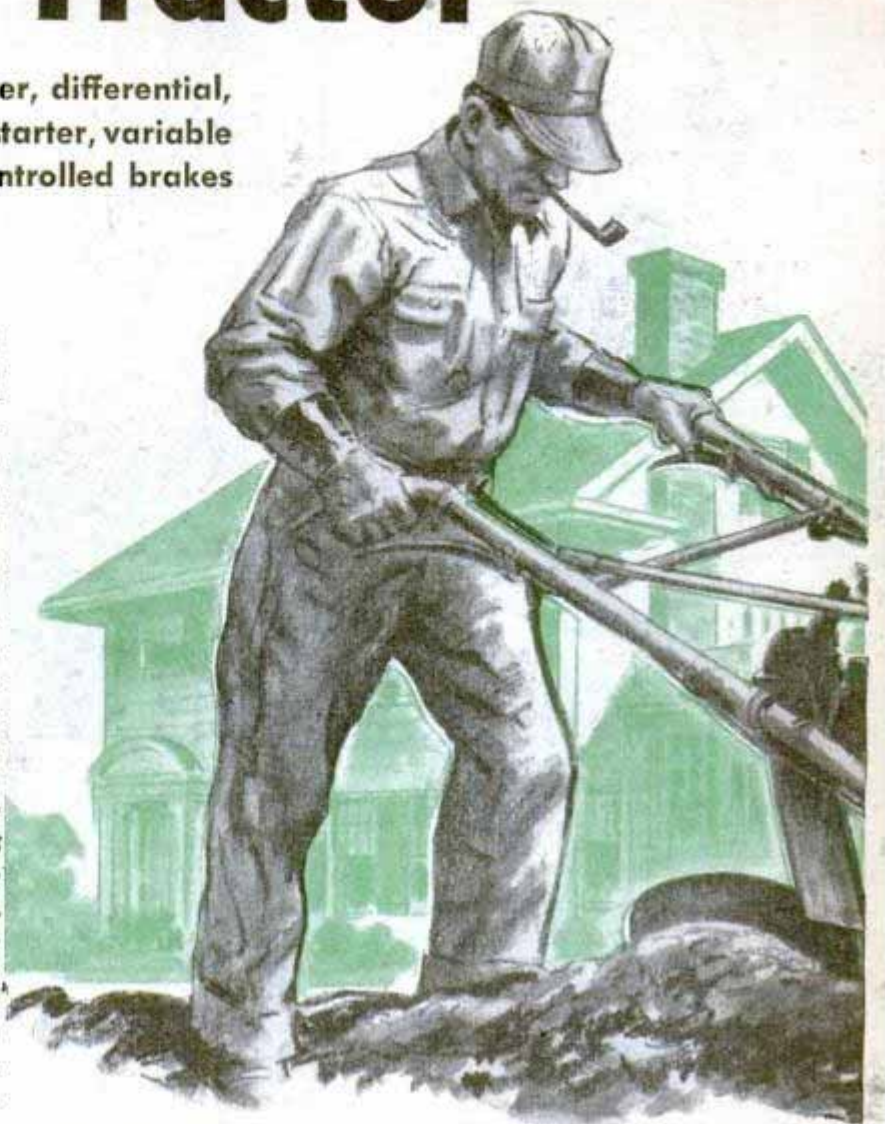

The "worm's-eye" view below shows the drive. Transmission is bolted directly to the differential housing of a Ford Model-T rear axle. Brakes and hubs are from a Ford Model-A axle

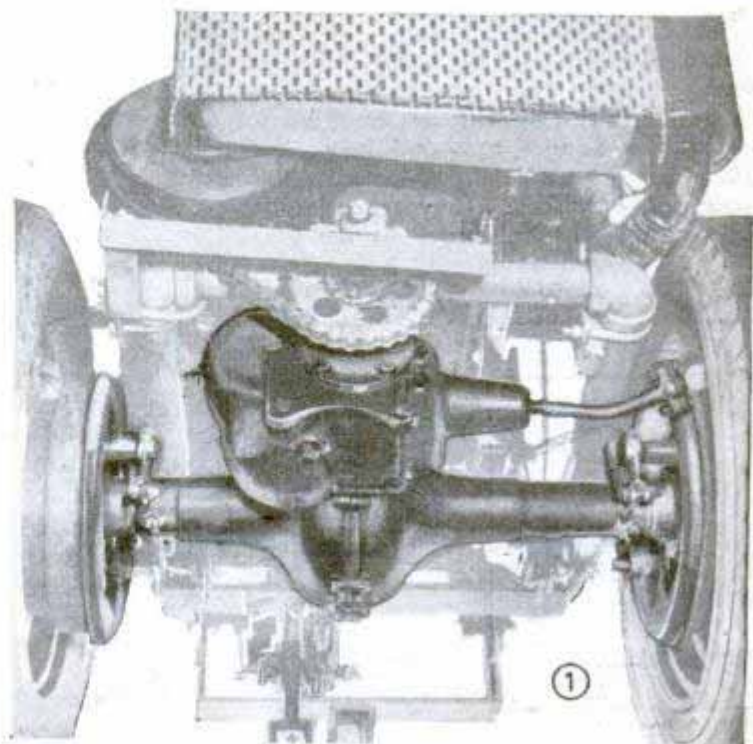



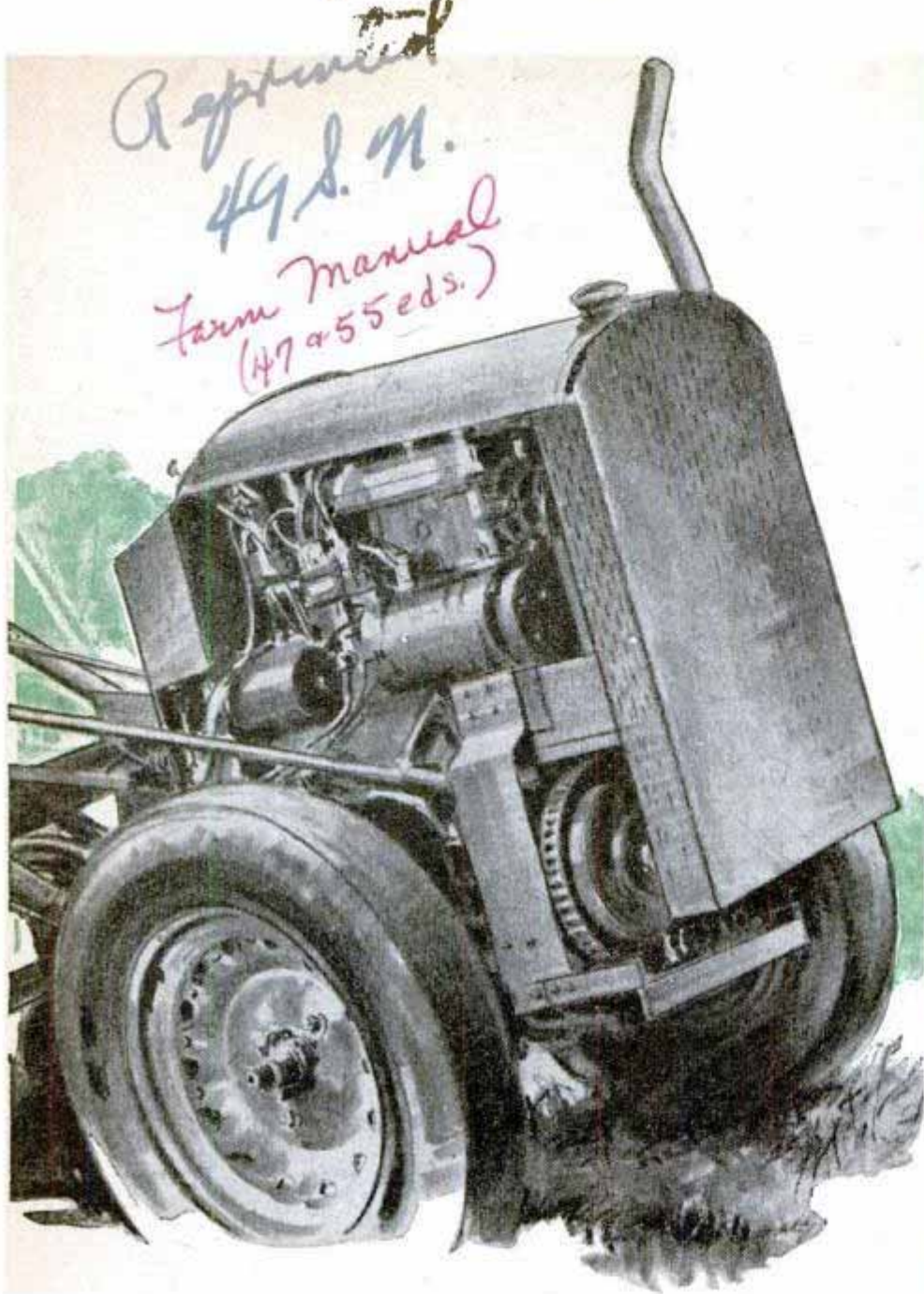

This whole job is of such a nature that size of the parts must be determined as you go along. Much depends on what you will use the tractor for, what engine you use, whether 1931 Willys auto engine, as was used on the original, or the popular Willys Jeep engine, now so readily available. Due to variations in the mounting brackets on the Jeep engine alterations must be made from the original plan of assembly. This is not at all difficult, but will make material differences in the dimensions of certain parts.

The first thing to determine is the distance, measured both lengthwise and across the width, of the engine mounting brackets. Distance across the width of the Willys auto engine used in the original tractor was cut down to approximately 16 in. This done, you remove the clutch assembly and the clutch housing. Then make a sling from light chain and fit the chains with hooks attached to the engine in such a way that when it is raised with a tackle block the engine will hang level. Now you're ready for the rest of the job.

It's a good idea to get all the necessary material at hand before you begin work. For the handle bars you need two pieces of 1¼-in. pipe of the grade known to the trade as "extra heavy," also one piece approximately 15 in. long for



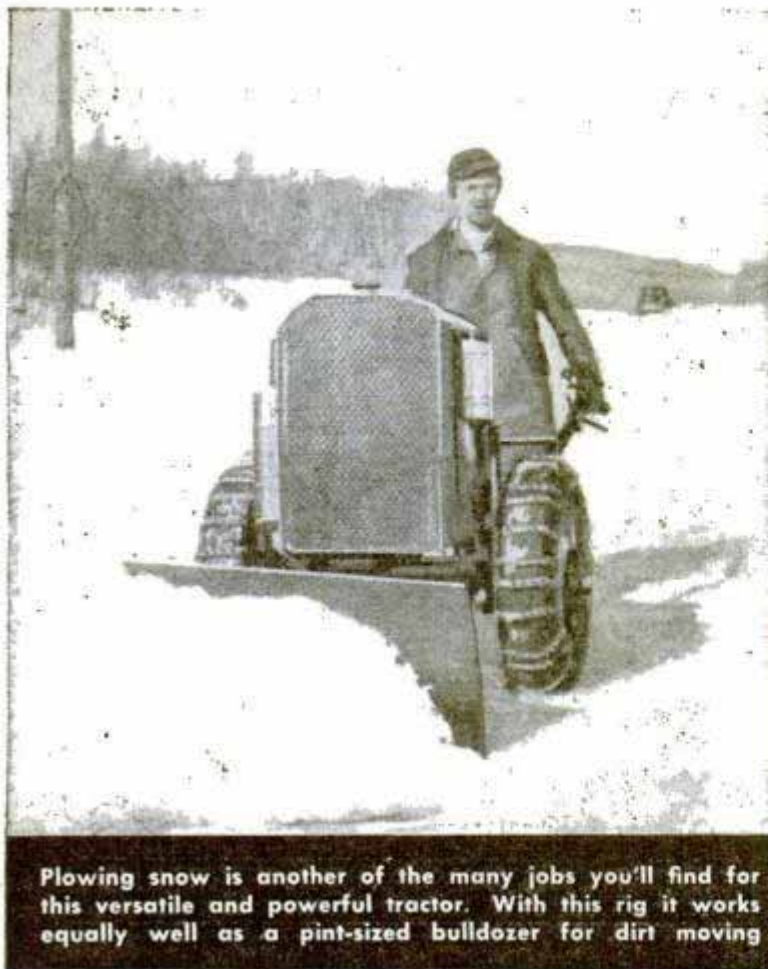

Plowing snow is another of the many jobs you'll find for this versatile and powerful tractor. With this rig it works equally well as a pint-sized bulldozer for dirt moving

the front member. Over-all width of the frame when assembled is 17 in. In addition, two 90-degree elbows, two 45-degree elbows, two 6-in. nipples and two caps are required. Then for the engine supports you require three pieces of flat steel  $\frac{3}{8}$  by 4 by 20 in. and one piece  $\frac{3}{8}$  by 4 by 22 in. long. These dimensions make considerable allowance. In addition several pieces of angle iron are needed for bearing supports, axle brackets, etc.

Next, you work on the axle assembly, shown in the lower detail, Fig. 2. Tread of the original tractor with the furrow wheel reversed was 34 in. However, the tread width depends on the work to be done with the tractor. If, for example, you plan to cultivate multiple rows of such garden truck crops as carrots or onions, then the tread width with the wheels "in" must be planned accordingly. Either way, cut up two axle assemblies to make one. You'll require one Ford Model-T rear axle complete and one Ford Model-A axle. Then, with the tread width required in mind, cut up the axle housings and reassemble the parts as shown in the lower view, Fig. 2. Machine separate axle shafts. This is a job for the local machine shop, unless, of course, you have equipment. The Model-T drive pinion and bearing are removed from the differential assembly and the pinion is mounted on the transmission as in the lower detail, Fig. 2. To do this it will be necessary to disas-

semble the transmission, machine a taper on the transmission shaft, also cut a thread and drill the shaft transversely for a castle nut and cotter pin. Then, to reassemble, first make a paper template of the form of the Model-T propeller-shaft mounting boss and from this scribe four evenly spaced holes on the driven end of the transmission case, keeping in mind that the transmission is turned 90 degrees as in the lower detail, Fig. 2, and also in Fig. 1. Discard the retainer ring for the end ball bearing and also the  $\frac{1}{8}$ -in. spacer where the main shaft telescopes into the driveshaft. This allows the end bearing to seat flush with the end of the case. Make a washer of thin sheet metal to hold the bearing in place. Drill  $2\frac{1}{16}$ -in. clearance holes in the transmission case. Reassemble the main shaft and bolt the transmission case directly to the differential housing, using  $\frac{5}{16}$ -in. studs, tightening nuts from inside the case. Check clearance of the pinion. It may be necessary to shim between the two parts. Then cut off the end-plate flange and

weld on a  $1\frac{1}{4}$  by  $1\frac{1}{2}$ -in. pipe coupling, shown separately in Fig. 2. Cut off the transmission lever to about 8 in. long and weld on a ball-joint fitting taken from a Model-T tie rod. Later a suitable ball end is welded to the lower end of the gearshift lever which extends to the handle bars.

Assemble the frame and handle-bar unit, making a 30-degree bend in the long lengths of pipe, the bend 24 in. from the end on both pieces. Bolt the engine supports in place with  $\frac{5}{16}$ -in. U-bolts. Block up the axle and frame assemblies in their relative positions under the suspended engine. Lower the engine into position and clamp or otherwise hold the parts in place. With the setup at this stage you can easily determine the location of the first transmission which bolts to one of the engine supports as in the center detail, Fig. 2. Also the location of the bearing support A, the amount of the bend in the engine support B and the location of the bracket pieces C to which the bearing support A is welded. This bearing takes the power takeoff shaft and is optional equipment. Also the position of the axle brackets shown in the center detail, and the bearing bracket which supports the bearing D. Mark the locations of all these parts. Support pieces are welded to the engine brackets and the other parts are either welded or bolted in place as shown.

Use 16-gauge sheet metal for the hood and instrument panel and also the fuel



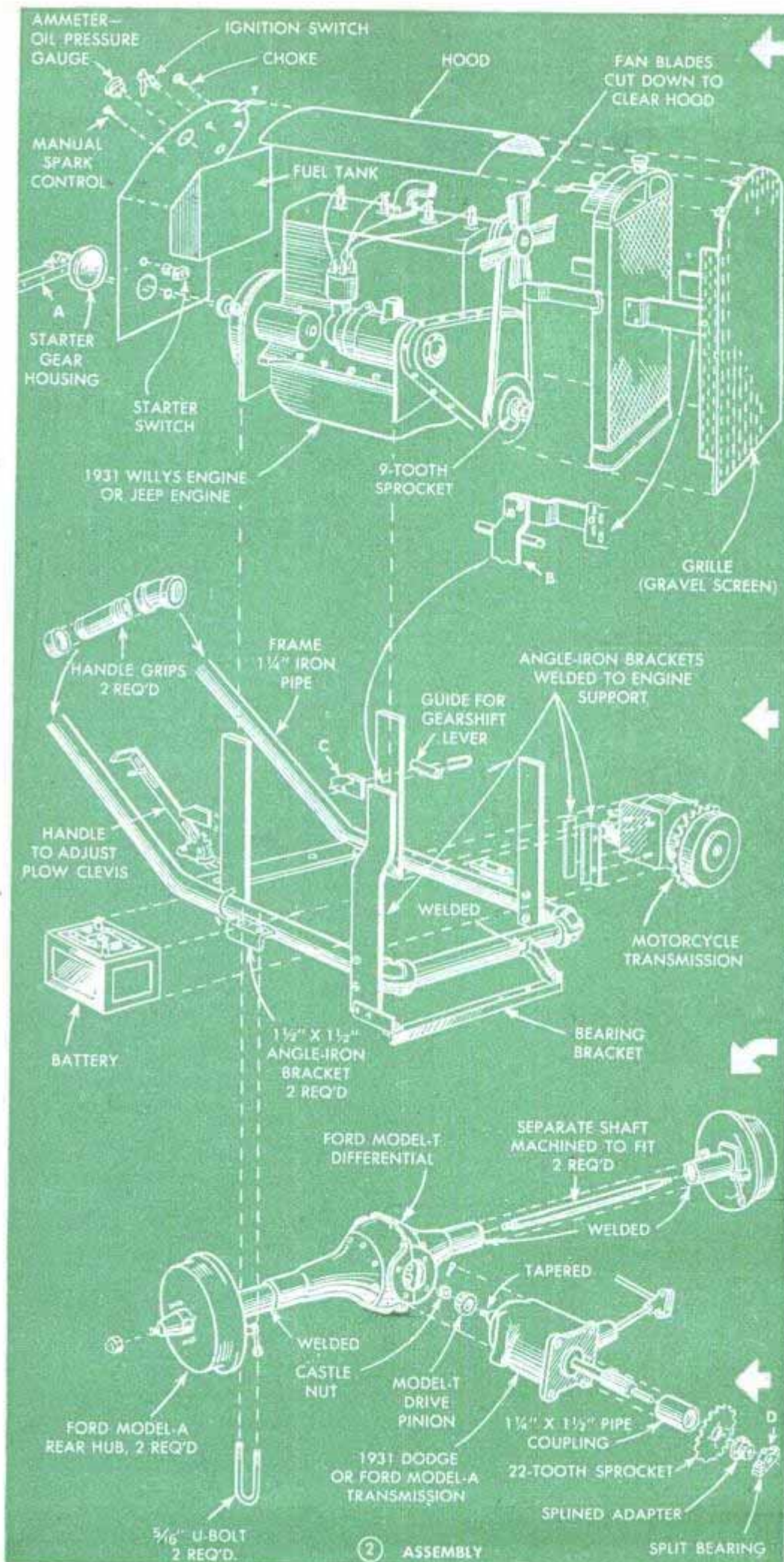

The power plant complete—conventional 4-cylinder auto engine with starter, lights if you want them, and the usual complement of radiator, heavy protective grille, fuel tank, instrument panel and hood—all assembled into one self-contained unit . . .

which is welded to the standing supports of the frame unit. The latter includes the first transmission as shown. Standing supports are U-bolted to the main frame. This manner of assembling permits easy removal of the power unit if necessary

Right and left braking and differential action are essential to easy operation of a "walking" tractor. This composite axle has all three features. The brakes are sufficiently powerful to lock either wheel at full load and are finger-tip controlled from the handle grips

The second transmission and the axle assemble into one unit which is U-bolted to the frame in such a position that there is just enough weight at the rear to tip the tractor back on the handles when it's in the level position



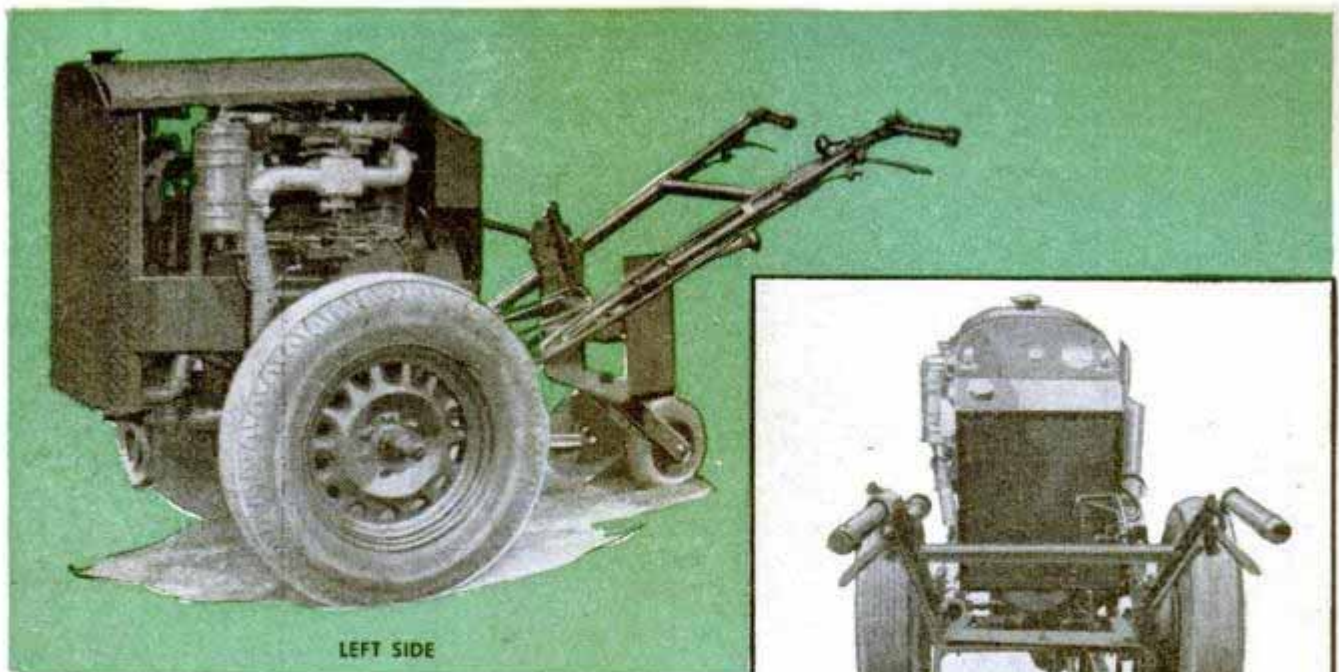

LEFT SIDE

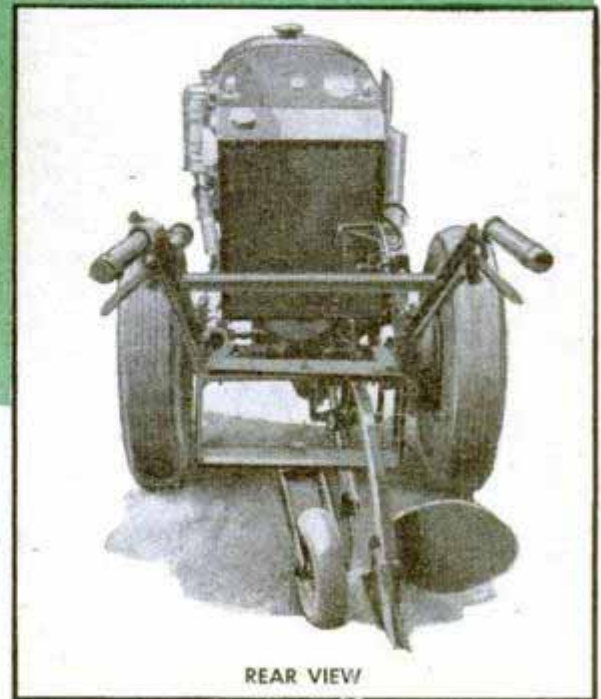

REAR VIEW

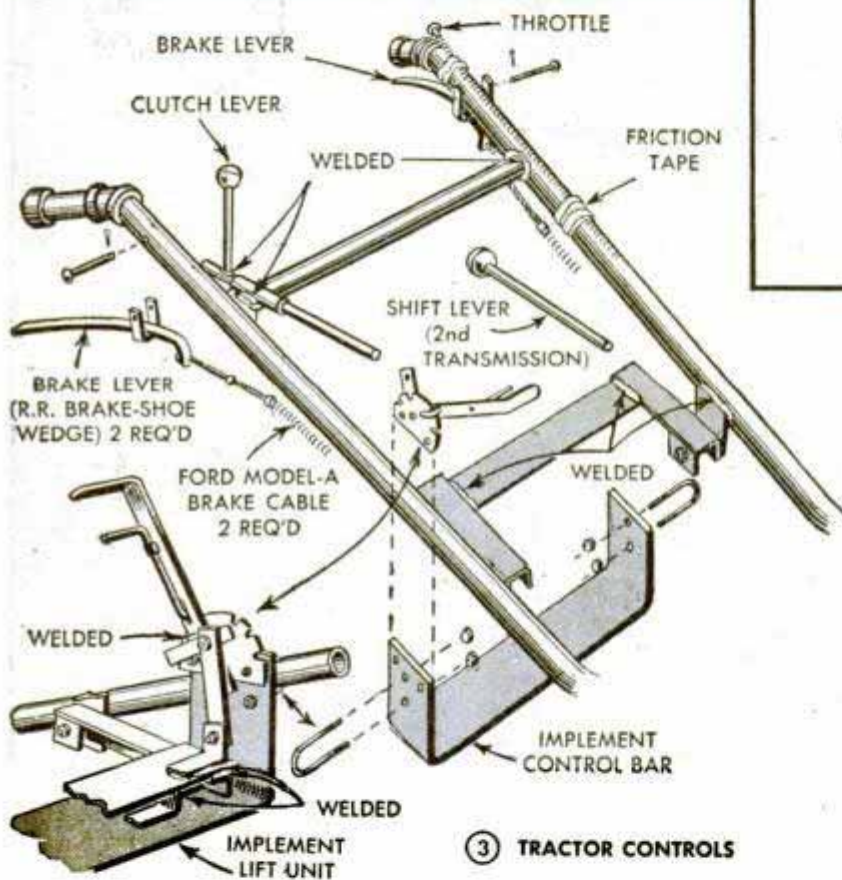

3 TRACTOR CONTROLS

tank, which is welded to the panel as indicated. The starter-gear housing is a domed cover from a discarded gasoline pump, and is welded over the hole cut in the panel. In most cases the fan blades must be cut down to clear the hood. Radiator used on the original tractor was taken from a 1931 Willys automobile and cut down in width. Have this done by a service shop. It's also necessary in most cases to straighten the top hose connection. Do this by cutting diagonally and then soldering together to make a straight connection.

Finish the assembly by fitting sprockets as indicated and hooking up the drive chains. Bolt the grille and hood in place

and attach the controls, ignition switch, oil-pressure gauge and ammeter, and wire to the battery. Increase the engine oil pressure to the maximum. Fit the carburetor with an air cleaner. Fuel feed to the carburetor is by vacuum tank, although of course a fuel pump can be fitted. Note in detail B, Fig. 2, the sleeve welded to the engine support. This serves as a bearing for the lower end of the clutch lever, which is a 1/2-in. rod with a short length of gear-shift lever welded on at an angle as you see in Fig. 3. A short arm welded to the clutch lever

at the lower end connects to the clutch throw-out arm on the motorcycle transmission-clutch assembly by means of a short link bent from a piece of 1/4-in. steel rod. Weld in a cross member about 8 in. below the handle grips to serve as a stiffener, Fig. 3. Balance of the detail in Fig. 3 is more or less optional and must be arranged to suit the implements you will use. A rubber-tired caster wheel is fitted at the center of the implement-control bar to carry the weight of certain other implements and serve as a rest when the tractor is standing idle. Use Ford wheels on the Model-A hubs. Other wheels can be used but likely it will be necessary to lengthen the studs.



# Electrically Heated Wire Will Cut Glass Tubing

With a cutter like this one, which consists of a loop of electrically heated Nichrome wire fitted to a plierlike holder of hardwood or plastic, you can cut a number of lengths of glass tubing quickly. The resistance wire is taken from an electric iron, coil heater or a similar appliance. Power is supplied by a 6-volt storage battery or a toy transformer of 10-ampere capacity. In use, the loop is slipped over the tubing and pressed firmly against the glass, then current is applied for 4 or 5 seconds, after which the tube is touched to a wet cloth, causing it to break because of the sudden change in temperature. Prolonged contact with the hot wire will overheat the glass and cause it to melt.

Sam Brown, Marion, Ohio.

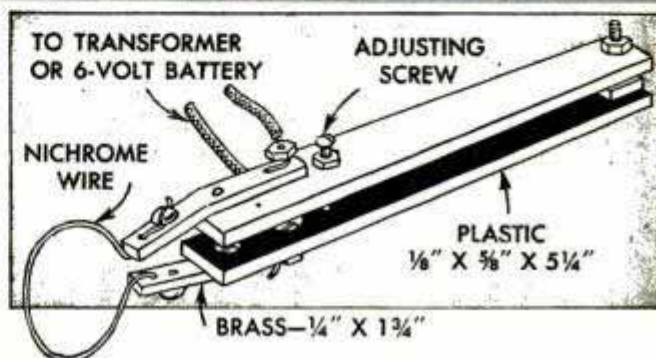
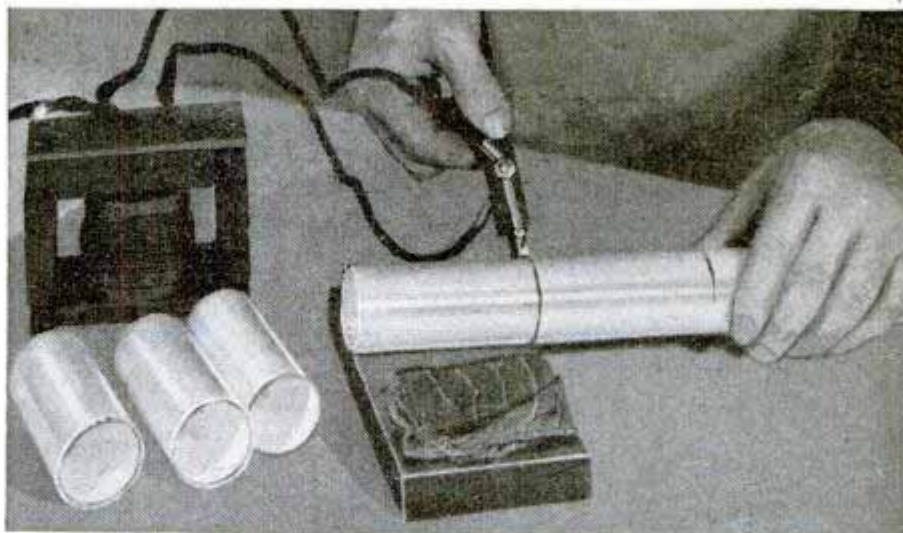

## Tape Protects Painter's Sleeve



In order to prevent his sleeve from coming in contact with the finish on the car, one automobile spray painter wraps a 1-in. strip of masking tape around the cuff with the tacky side out. When removed, the tape

will not stick to the sleeve. Taping the sleeve in this way also serves to keep paint off his wrist and forearm.

## Dispenser Holds Artist's Brushes



the tips should point upward. A wood block will hold the brushes at the proper height for easy access.

## Multiple-Socket Unit on Creeper Requires Less Extension Cord

Instead of equipping his trouble light and power tools with long extension cords to reach distant outlets, one mechanic ran a power cord to a multiple outlet that was mounted on the side of his creeper. Thus, he required only short extensions on his light and power tools. The outlet box should be watertight to prevent possible shorts caused by water on the floor.

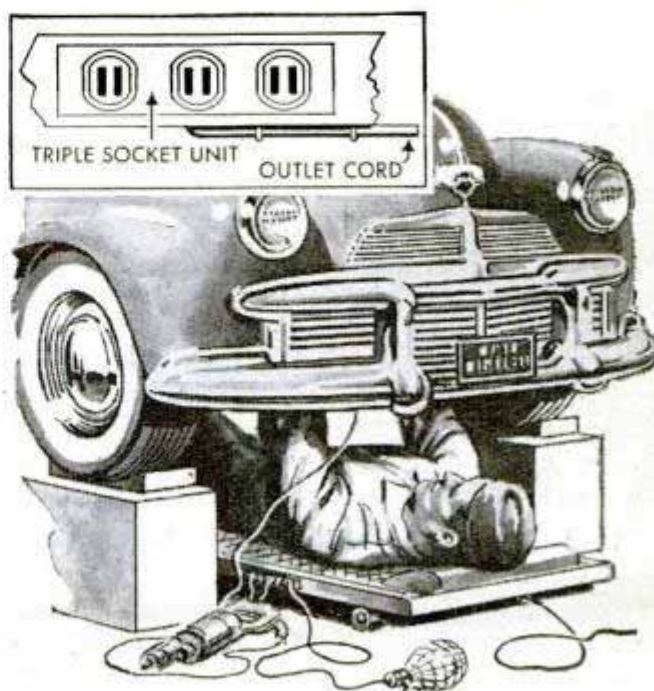



# BALL

By Sam Brown

**B**ECAUSE of excellent manufacturing methods, servicing of ball bearings usually is negligible, but the time does come when a bearing may need replacement or, more often, adjustment. Also, if interested in building your own power tools, ball bearing "know how" is essential for best results.

**Kinds of loads:** Any bearing is subject to two kinds of loads: thrust and radial. The thrust load is a push or pull parallel with the spindle, Fig. 2; the radial load is across the spindle, Fig. 1; both types of loads are diagrammed in Fig. 3. In most power tools, the load is a combination of the two. The load in a wood lathe, for example, is primarily radial, but it can be seen that in certain operations such as boring and faceplate turning there is a thrust load as well. Some consideration must always be given the nature of the load when selecting bearings for any job.

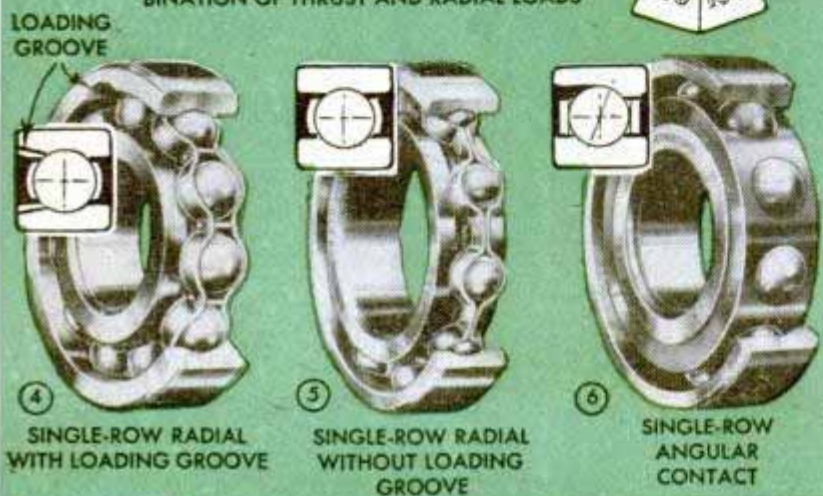
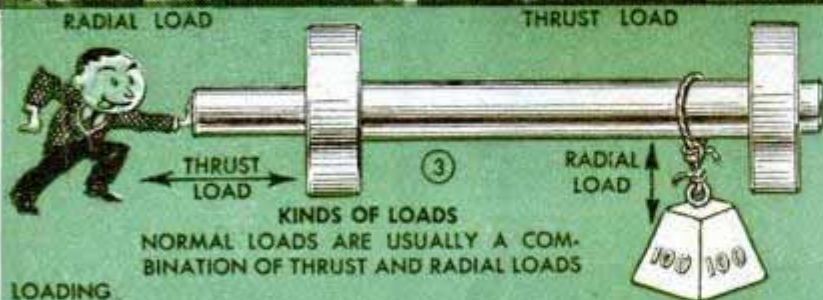
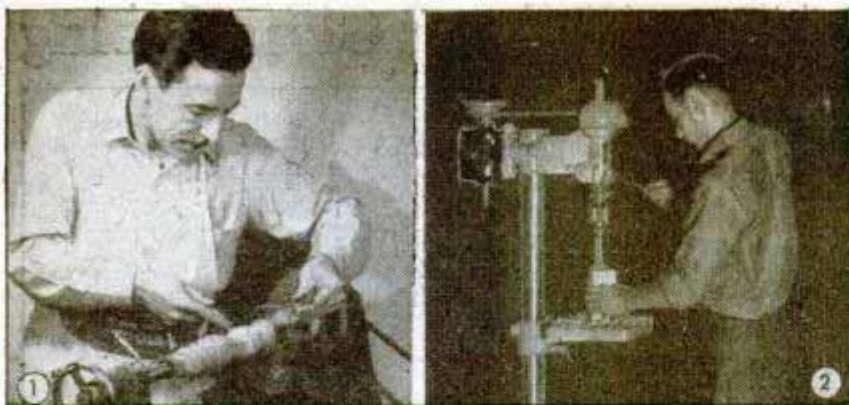

### BEARING TYPES

FIVE OF THE MOST POPULAR TYPES ARE SHOWN ABOVE

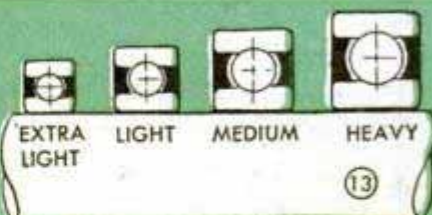
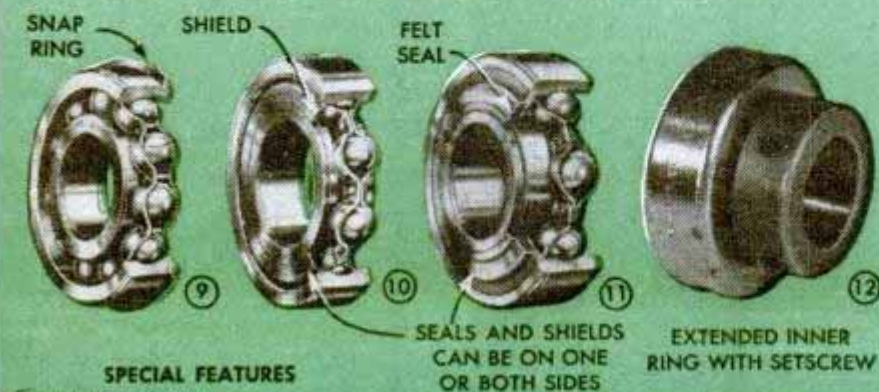

BORE SIZES		
Bore No.	Bore Size in Inches	Average Load*
0	.3937	¼ HP.
1	.4724	¼ or ⅓ HP.
2	.5906	¼ or ⅓ HP.
3	.6693	⅓ or ½ HP.
4	.7874	½ or ¾ HP.
5	.9843	¾ or 1 HP.
6	1.1811	¾ or 1 HP.
7	1.3780	1 or 1½ HP.
8	1.5748	1 or 1½ HP.

\*HP. rating is for light series.

New Departure photos.



# BEARINGS

- SELECTING
- SERVICING
- INSTALLING

**Bearing types:** Although there are hundreds of bearing types, selection for typical power tools usually is confined to three or four popular styles, as shown in Figs. 4 to 8. The single-row radial with loading groove or a similar device, Fig. 4, contains the maximum number of balls which can be introduced into a bearing. It is the strongest type of bearing for a pure radial load, and will also stand up under all average thrust loads. It is never used for thrust alone. The single-row radial, Fig. 5, has fewer balls, but because the outer and inner rings are continuous this bearing has higher thrust capacity. The angular-contact type, Fig. 6, is preferred for jobs where end play must be restricted. This bearing will take a maximum thrust load, but from one direction only unless it is of the type manufactured to take thrust from either direction. The double-row angular contact, Fig. 7, is used where maximum rigidity is desired. The latter is seldom used in pairs because it has practically no "give," indicating that two in tandem would re-

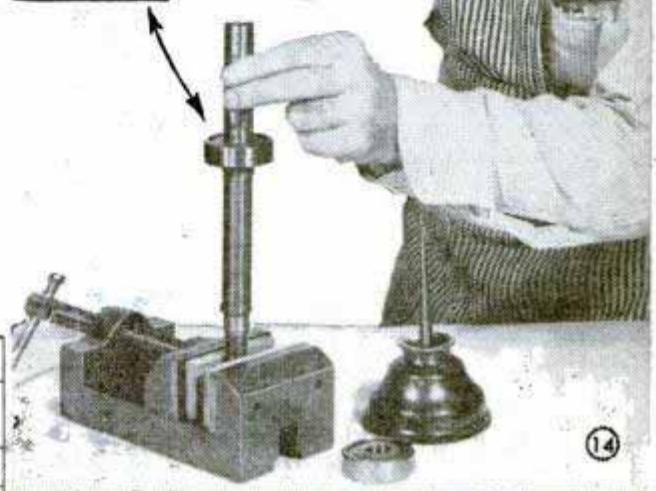
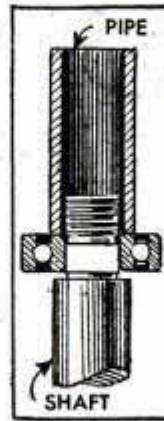

**HEATING**  
HEAT FROM 60-W. LAMP IS IDEAL FOR SHRINK FITS



15 DRIVING SLEEVES		
Bore No.	Standard Pipe	Tubing
0	—	1/2" O.D. - 18 Gauge
1	3/8"	5/8" O.D. - 1/16" Wall
2	1/2"	3/4" O.D. - 1/16" Wall
3	—	7/8" O.D. - 3/32" Wall
4	3/4"	1" O.D. - 3/32" Wall
5	1"	1 1/4" O.D. - 1/8" Wall
6	—	1 1/2" O.D. - 1/8" Wall
7	1 1/4"	—

**FITTING**  
BEARINGS SHOULD BE A PRESS FIT ON SHAFT, AND CAN BE FITTED BY DRIVING OR WITH USE OF ARBOR PRESS

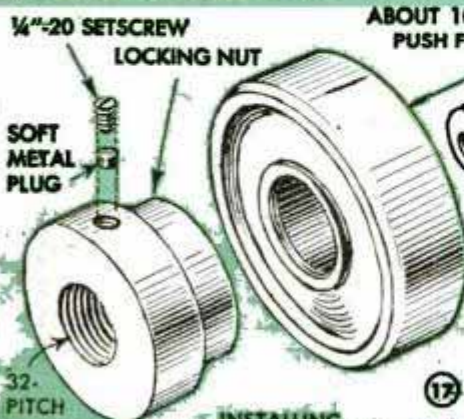
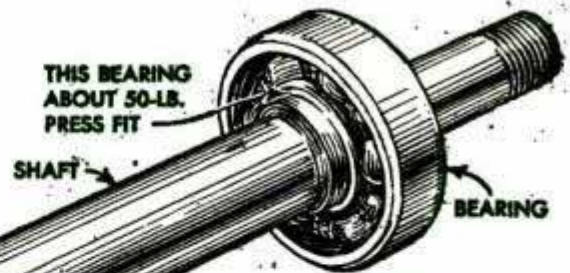

CLEARANCE GROOVE (OPTIONAL)

ABOUT 10-LB. PUSH FIT

SHOULDER ABOUT 1/2 HEIGHT OF RING

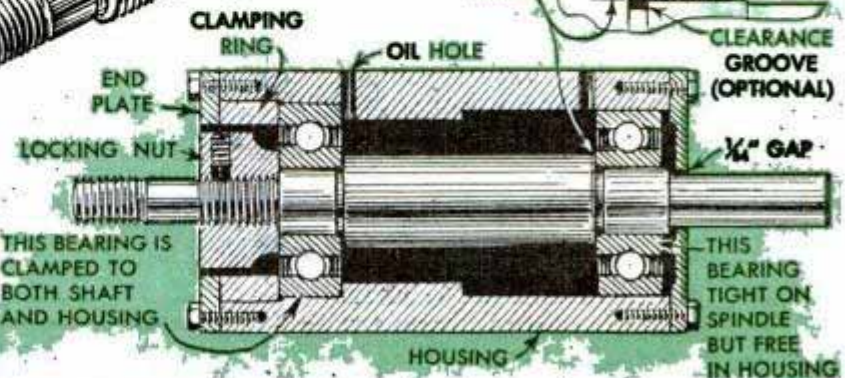

THIS BEARING IS CLAMPED TO BOTH SHAFT AND HOUSING

THIS BEARING TIGHT ON SPINDLE BUT FREE IN HOUSING

**INSTALLING**  
ONE BEARING CLAMPED AND ONE FREE IS COMMON METHOD OF MOUNTING



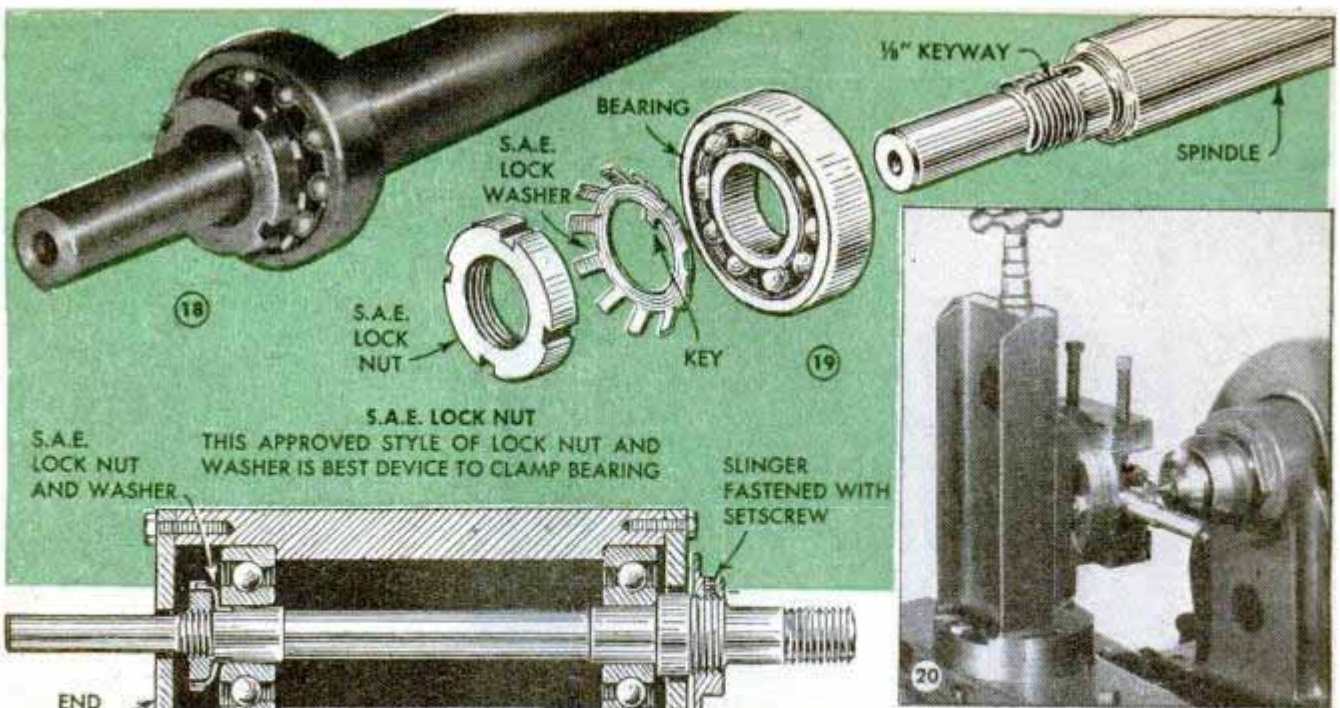

**21** **PRELOADED SPINDLE**  
 SPINDLE MOUNTED LIKE THIS PERMITS PRELOAD AND TAKE-UP. ANGULAR CONTACT BEARINGS ARE SHOWN BUT SINGLE-ROW RADIAL CAN BE USED

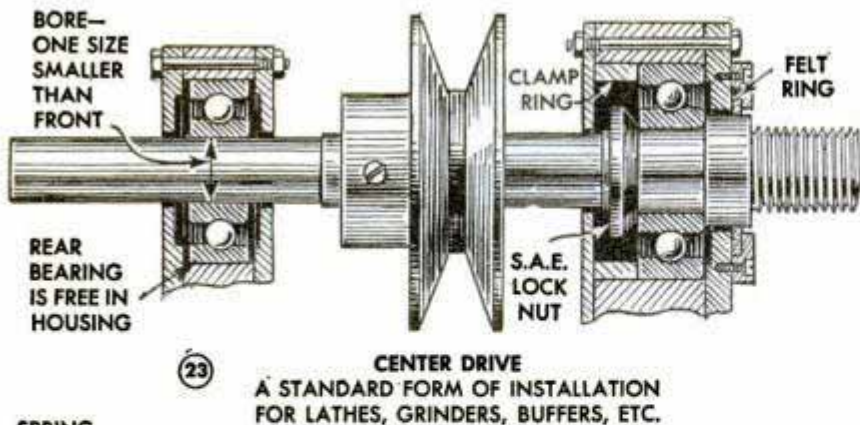
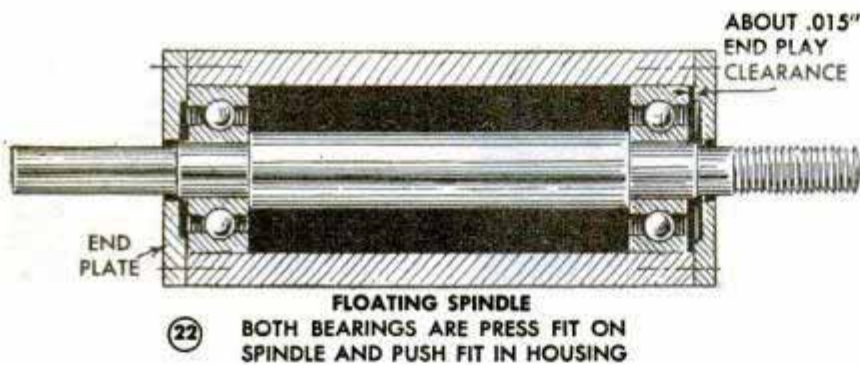

quire perfection in alignment when installed. However, when combined with a single-row bearing, this type makes an excellent installation for certain tools. Fig. 8 shows the double-row self-aligning type. Although rated somewhat lower than the single-row radial for any kind of load, the self-aligning feature makes it very popular with the home mechanic.

**Special features:** Most bearings can be obtained with a metal shield or felt seal on one or both sides, Figs. 10 and 11, the latter, the "sealed for life" type. A snap or retaining ring, Fig. 9, is sometimes useful when there is no shoulder against which the bearing can be located. An extended inner ring, Fig. 12, is a favorite with home workshopers because it provides an easy way to clamp the bearing to the shaft.

**Sizes and numbering of bearings:** The most-used bearing sizes for home-workshop power tools are those having bores of about 3/8 in. and up. These sizes are standardized with a system of bore numbers, of which sizes 0 to 8 are given in Fig. 13. Each bore number is made in four outer ring sizes, Fig. 13, the light and me-



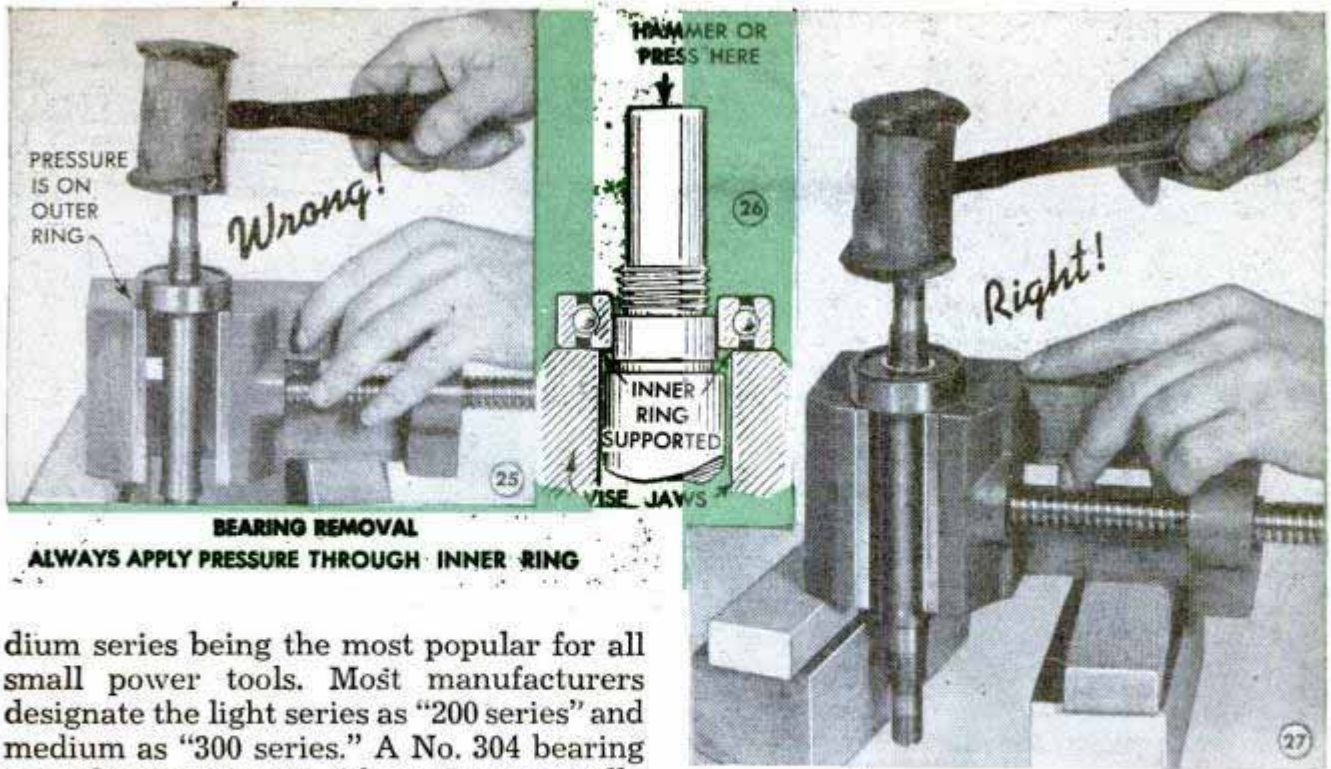

**BEARING REMOVAL**  
**ALWAYS APPLY PRESSURE THROUGH INNER RING**

dium series being the most popular for all small power tools. Most manufacturers designate the light series as "200 series" and medium as "300 series." A No. 304 bearing is medium series, No. 4 bore. In practically all numbering codes, the two right-hand figures give the bore number or the bore size in millimeters. L or 1 in the third digit from the right indicates extra light series; 2 is light series; 3 is medium series; 4 is heavy series; 5 is nonloading groove light series, and 6 is nonloading groove medium series. Other numbers to the left indicate type or extra features. Small power-tool construction is mainly of the light series type. This is sturdy enough for all average loads and does not require a bulky housing. A fair guide to the selection of a suitable bore size for any power tool is the motor rating given in Fig. 13. For example, if you are making a lathe to be driven with a 1/3-hp. motor, you would use No. 2 or 3 bore light series bearings. Of course, if you wanted a hollow spindle, you would have to take a bigger bore to accommodate the Morse taper.

**Installation:** In the basic installation, Fig. 17, both bearings are a press fit on the spindle and a push fit in the housing. The press fit should require about 50 lbs. pressure with an arbor press, or equivalent hammer taps, Fig. 14. The turning allowance for press fitting should be about .0002 or .0003 over the bore size, Fig. 13. If the bearing is held with a lock nut, as shown in Fig. 17, a press fit of about 10 lbs. is sufficient. Both bearings are a push fit in the housing, which means that they can be pushed in by hand but there should be no looseness. A study of Fig. 17 will show that one bearing is clamped to the spindle and in the housing. This bearing fixes the spindle and takes up the thrust load. The other bearing, as stated before, is a press fit on the spindle and is a push, floating fit in the housing, which allows for shaft expansion. Press-fit bearings are commonly driven on with a piece of pipe, Fig. 14. Fig. 15 suggests suitable pipe sizes for the bores of various bearings. Heat often is used to expand the bearing so that it can be pushed on by hand for a shrink fit. A 60-watt bulb, Fig. 16, gives off about 240 deg. F. heat and can be used in some cases. Immersion in an oil bath is sometimes used to heat bearings but care should be taken in either case not to use too high a heat.

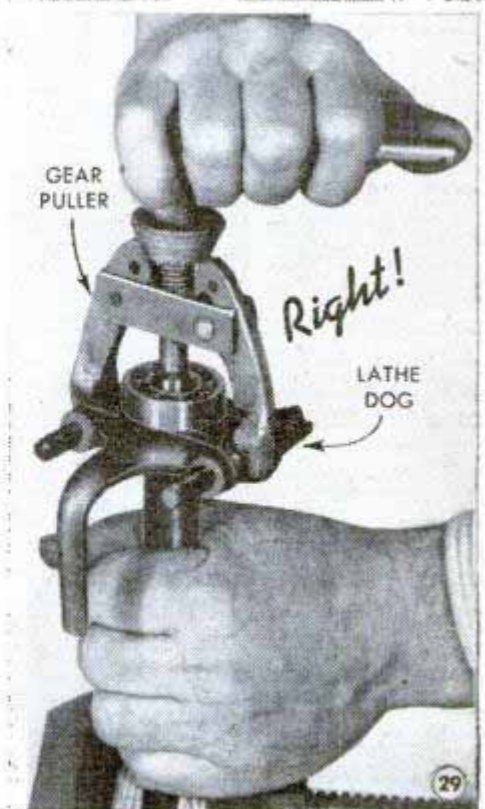





30

#### CLEANING

BEARINGS SHOULD BE WELL BRUSHED WITH SOLVENT AND THEN BLOWN OUT WITH COMPRESSED AIR

The approved method of locking the fixed bearing to the spindle is the S.A.E. lock nut and washer, illustrated in Figs. 18 to 20. However, this requires a keyway, Fig. 20, which makes more work than the plain lock nut shown in Fig. 17. The S.A.E. lock nut and washer are so arranged that a  $\frac{1}{4}$  turn of the lock nut will permit engaging one of the washer prongs.

Fig. 21 shows the S.A.E. lock nut used as the take-up nut on a preloaded spindle to align the inner and outer races. In this installation, the outer rings of both bearings butt against shoulders in the housing. The lock nut is then used to squeeze the inner rings into alignment, creating a preload on the bearings. This kind of installation is particularly recommended for lathes, grinders and other tools where end play must be restricted and a rigid spindle is essential. Fig. 22 is just the opposite. Here, both bearings float in the housing, with about .015 in. end play. This installation is suitable for buffers, countershafts, motors and other jobs where end play need not be controlled exactly. Fig. 23 is a standard installation for center drive and features one bearing locked and the other floating, as previously described. Fig. 24 is a typical installation of the self-aligning bearing. A stiff circular spring is indicated as a means of taking up end play. This is optional and can be eliminated, in which case the left end plate would butt against the bearing, as does the right end. Slings and felt rings shown in some of the installations are used to keep out dirt.

**Bearing removal:** Two rules govern bearing removal: keep the bearings clean, and always drive against the inner ring. It can

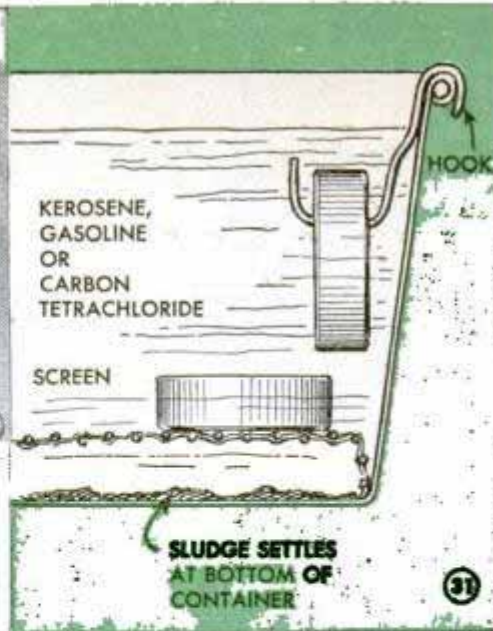

31

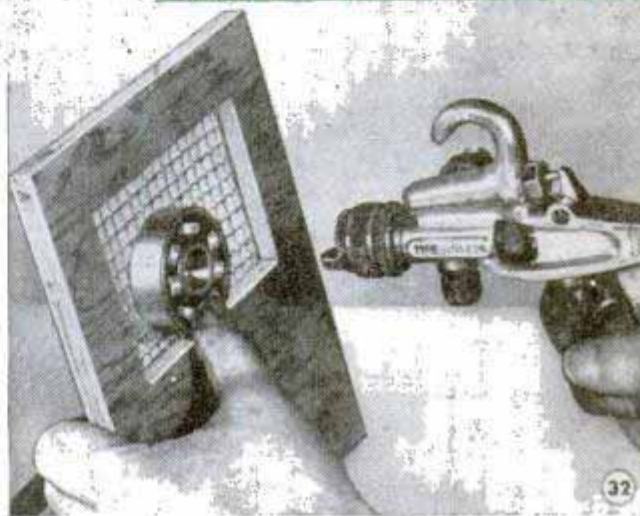

32

be seen that pressure against the outer ring, Figs. 25 and 28, puts the load through the balls and may damage the bearing. Figs. 26, 27 and 29 show the right way—the inner ring is supported and takes the full force applied.

**Cleaning:** Surplus grease should be wiped from bearings, after which they are soaked and brushed with suitable solvent. The cleaning pan should have a wire rack, as shown in Figs. 30 and 31, to keep the bearing above the sludge. After cleaning, the bearing should be blown dry with compressed air, Fig. 32. Bearings should not be spun without lubricant since the dry condition makes them liable to scratching. Oil immediately after cleaning, especially if a drying solvent like carbon tetrachloride or alcohol is used.

## Maintenance of Fence Reduced

After running a strand of barbed wire directly above the woven-wire portion of the fence, instead of 3 in. above as is the general practice, one farmer found that stock did not attempt to reach through the fence. This greatly reduced the maintenance work required.





## "Tea Can" Field-Strength Meter and Monitor

EVERY amateur operating in the 10, 20 and 75-meter phone bands should have some dependable means for checking the performance of his transmitter. The thoroughly tested unit illustrated employs a type 1N34 germanium fixed crystal in a combination field-strength meter, monitor and wave meter. Housed in an ordinary tea can 5 in. high and 4 in. square, it consists of an 0-1 milliammeter, a 35-mmfd. variable condenser, three 5-prong tube bases and a few odds and ends from the junk box. The rod antenna was made from three steel knitting needles; however, brass rod or stiff wire may be substituted. This rod is mounted by means of a "banana" plug and jack in a common "beehive" porcelain standoff insulator.

Photos A, B and C show various views of the completed unit; the schematic circuit diagram and parts specifications are given in Fig. 1. The 10 and 20-meter coils are self-supporting, but a 1 $\frac{3}{4}$ -in.-long Bakelite tube form is left in the 75-meter coil. All coil terminals are soldered in the tube base prongs as shown in Fig. 1-A.

As a field-strength meter it is easy to check antenna radiation. Used for a listening monitor the quality and amount of modulation may be checked continuously while the station is on the air. It also acts as a wave meter, for a station using an electron-coupled oscillator, to check the limits of the phone band selected.

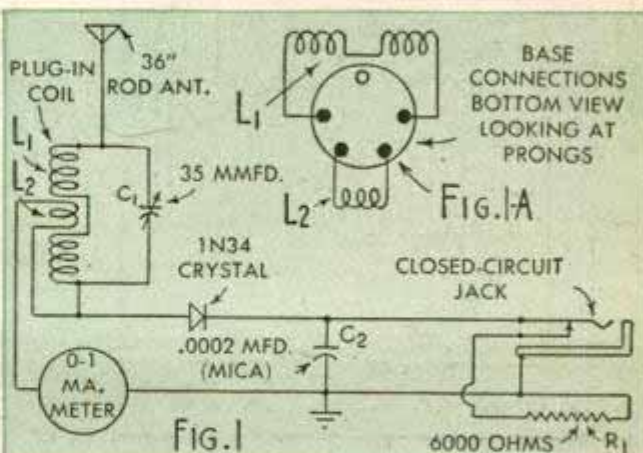
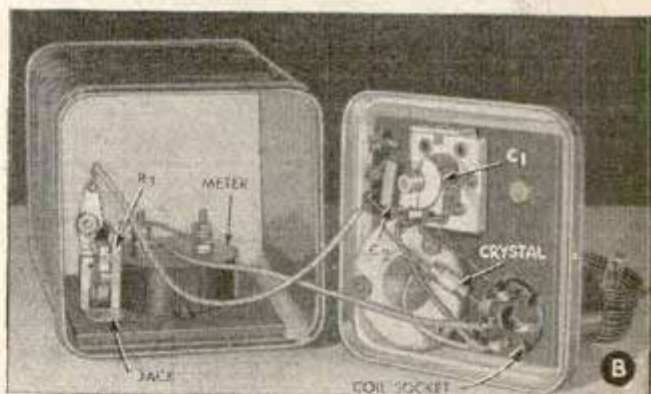

### COIL WINDING CHART

- L1 for 10 meters— 4 turns of No. 14 enameled wire spaced at center for L2
  - L2 for 10 meters— 3 turns of No. 14 enameled wire
  - L1 for 20 meters— 8 turns of No. 14 enameled wire spaced at center for L2
  - L2 for 20 meters— 3 turns of No. 14 enameled wire
  - L1 for 75 meters— 30 turns of No. 28 enameled wire spaced at center for L2
  - L2 for 75 meters— 8 turns of No. 28 enameled wire
- Note—All coils are wound on a form 1 $\frac{1}{2}$  in. in diameter and mounted in a standard 5-prong tube base. The L2 coils are coupled inductively in the space provided by dividing the L1 coils.



By L. M. Dezettel

**E**LMINATING the still-hard-to-get variable condenser, this 1947 model of the popular "Little Giant" student set uses a standard "Air-Com" permeability tuner unit which is the equivalent of a 2-gang variable condenser, antenna coil, oscillator coil and a 5-in. slide rule dial. This unit comes complete and is used just as received, except that the fixed oscillator coil is removed from the dial frame and mounted under the chassis base. Instead of varying a capacitance across a fixed inductance, the capacity is fixed and the inductance is varied. It is done by moving a plastic molded powdered iron core in and out of the coils. Both the antenna coil and the combination fixed-variable oscillator coil are varied simultaneously by a simple string drive mechanism.

Students and experimenters have always found something practical, and different,

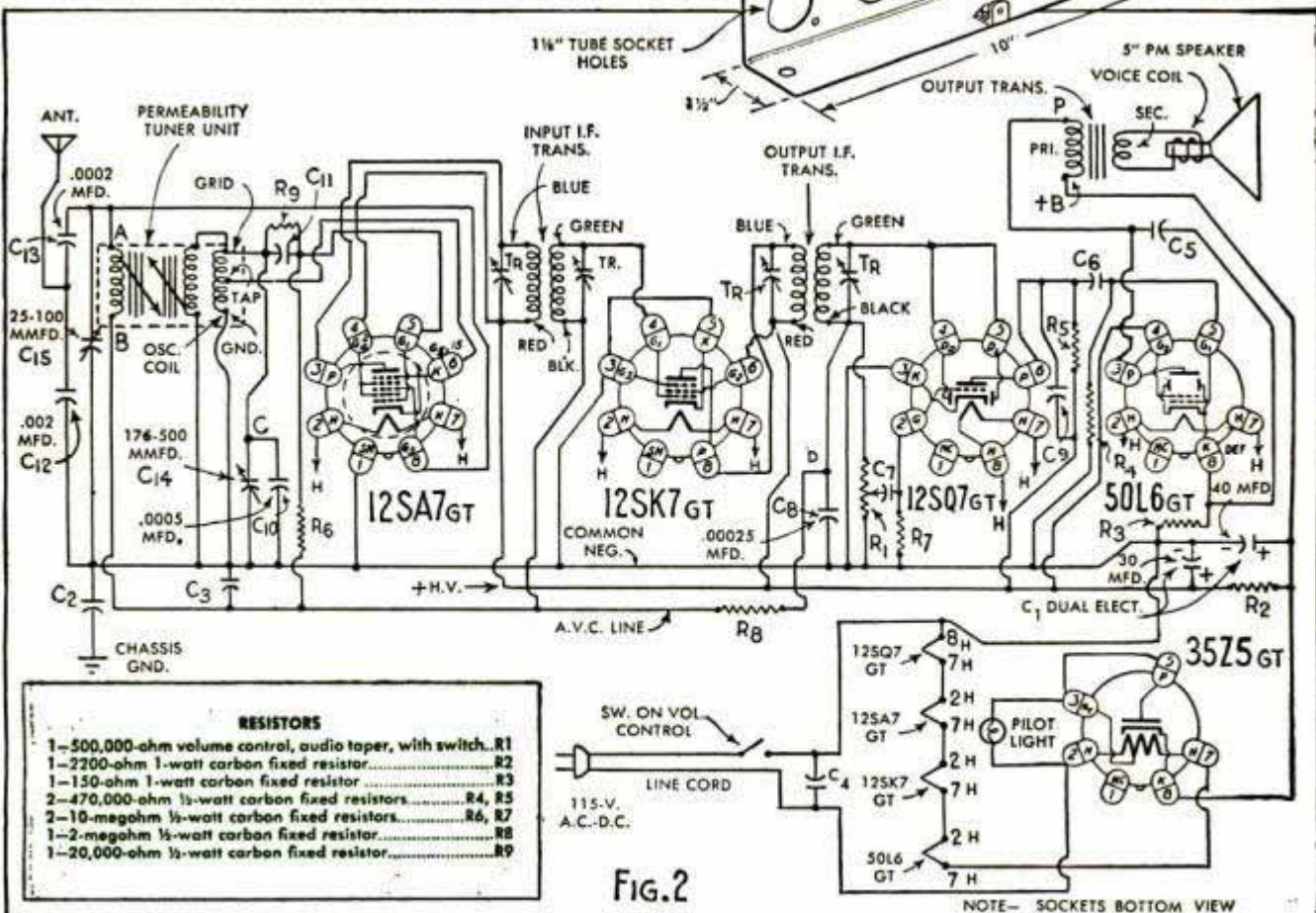
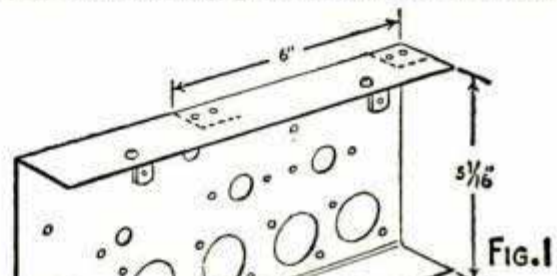
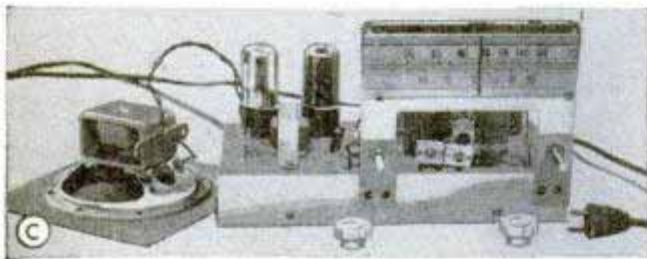
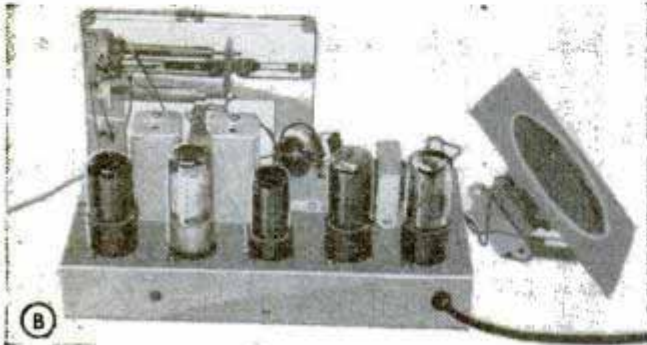
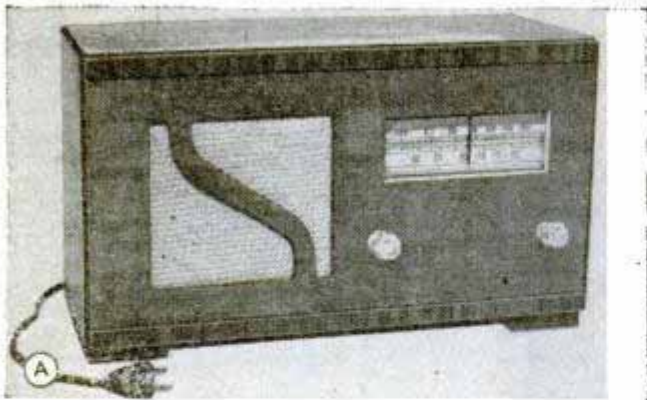

- RESISTORS**
- 1-500,000-ohm volume control, audio taper, with switch.....R1
  - 1-2200-ohm 1-watt carbon fixed resistor.....R2
  - 1-150-ohm 1-watt carbon fixed resistor.....R3
  - 2-470,000-ohm 1/2-watt carbon fixed resistors.....R4, R5
  - 2-10-megohm 1/2-watt carbon fixed resistors.....R6, R7
  - 1-2-megohm 1/2-watt carbon fixed resistor.....R8
  - 1-20,000-ohm 1/2-watt carbon fixed resistor.....R9



# USES PERMEABILITY TUNING UNIT

in the March "Little Giant" broadcast receiver; this one is an excellent performer in the broadcast band, gets police calls and is easy to build. The circuit includes automatic volume control and is carefully engineered as to the values of the components selected.

Photos A, B, C, E and F show various views of the completed receiver; the chassis base, Fig. 1, is a standard type with the socket holes punched. The schematic circuit diagram is given in Fig. 2 and a detailed pictorial wiring diagram appears in Fig. 3. Any stock cabinet about 5 3/4 in. deep, 7 in. high and 14 in. long may be used. The pilot light bracket is bent and soldered to the center terminal of the 5-terminal tie-point strip on top of the chas-

(Continued to page 248)

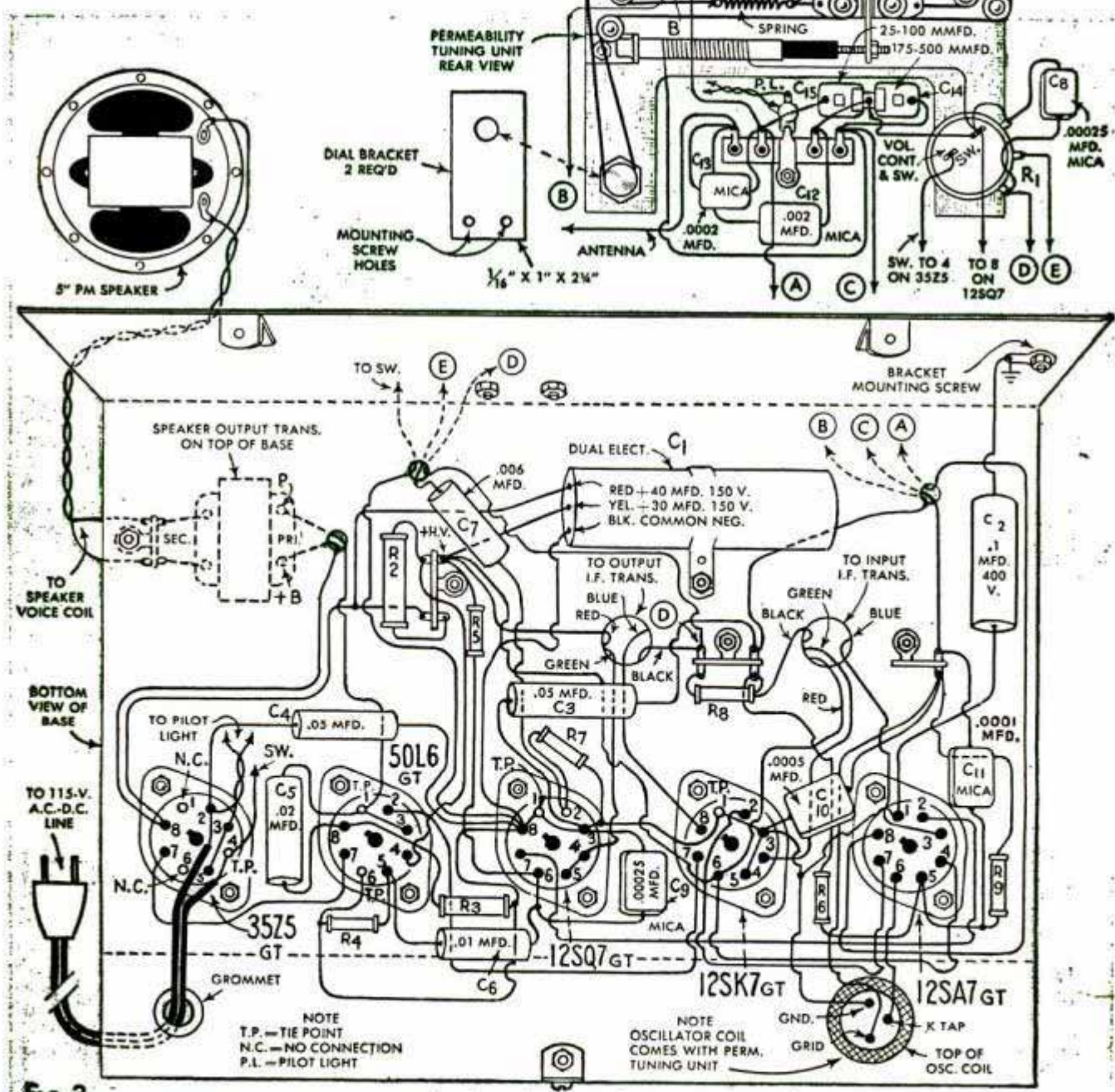
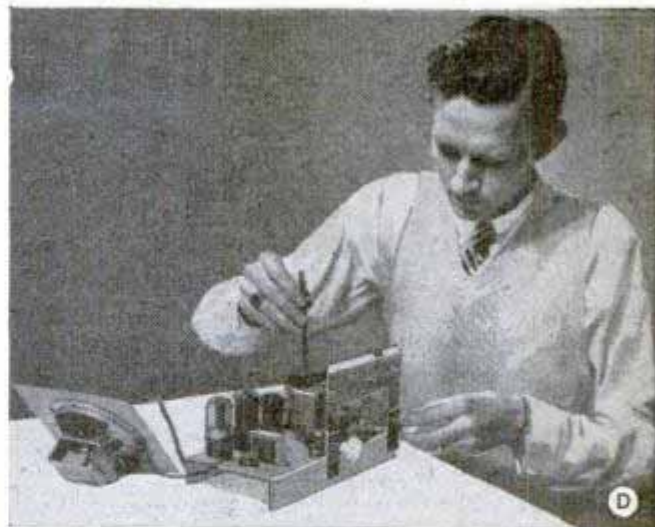
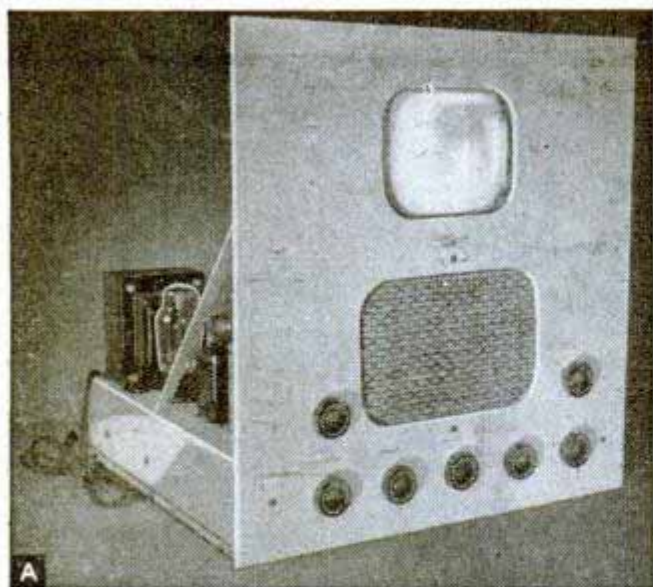

FIG. 3



# Three-Channel 18-Tube Television Receiver Kit



ALL necessary components are included in this television receiver kit, and it is claimed that nothing is required except a screwdriver, cutting pliers and a soldering iron to complete the assembly and place it in operation in any locality where television reception is available.

The 18 tubes include a 7-in. picture tube, and no instruments are necessary for checking as all difficult assemblies are pre-wired and tuned. Pretuned for any three stations desired by the user, it is said to provide a picture large enough to be viewed comfortably by 10 or more people. All wiring diagrams and directions are included with the kit.

Photo A shows a front view of the panel and controls. This panel is 18 in. high and 17½ in. wide; the distance from front to back of the chassis is 15 in. and the depth of the chassis base is 3½ in. An underside view of the chassis base appears in photo B; each component part is placed in a package and labeled with a number. An early stage in construction is shown in photo D.

This \$159.50 kit is suggested for use as a trainer for schools and those interested in obtaining a knowledge of television design and servicing. It is claimed to have a newly designed sweep and synchronizing circuit and high signal sensitivity of 100 microvolts for the picture circuit. A 6-in. permanent-magnet speaker is used for good quality sound performance. Careful insulation, an interlock switch, a bottom plate under the chassis base and a ceramic cap on the high-voltage rectifier tube provide safety factors, as the second anode voltage is 3000 volts. A rear view of the completed television receiver is shown in photo C. No detail has been overlooked and a specially designed dipole antenna is included.

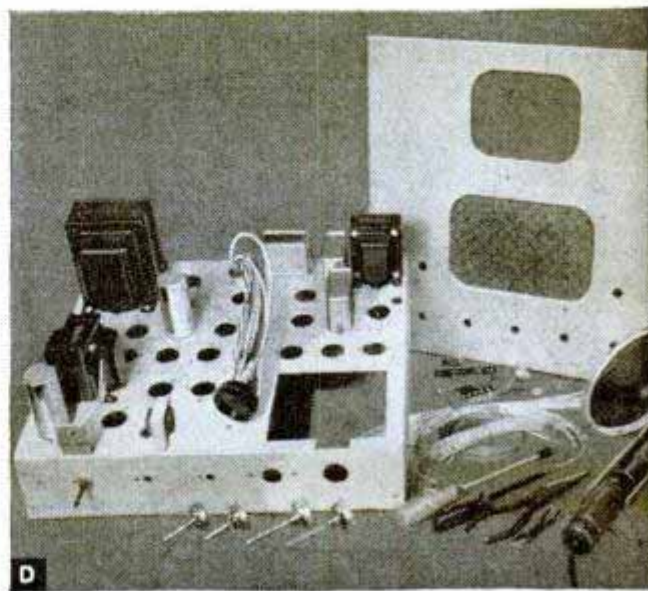
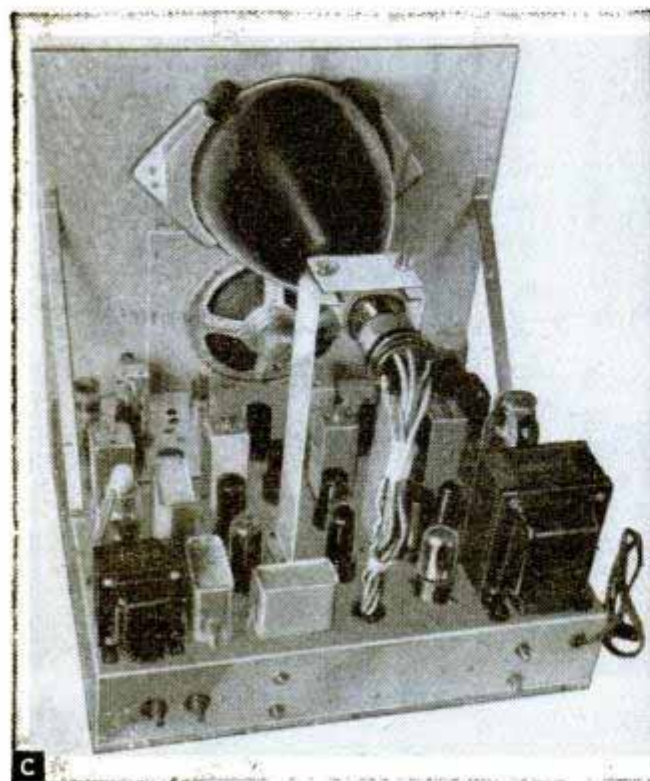
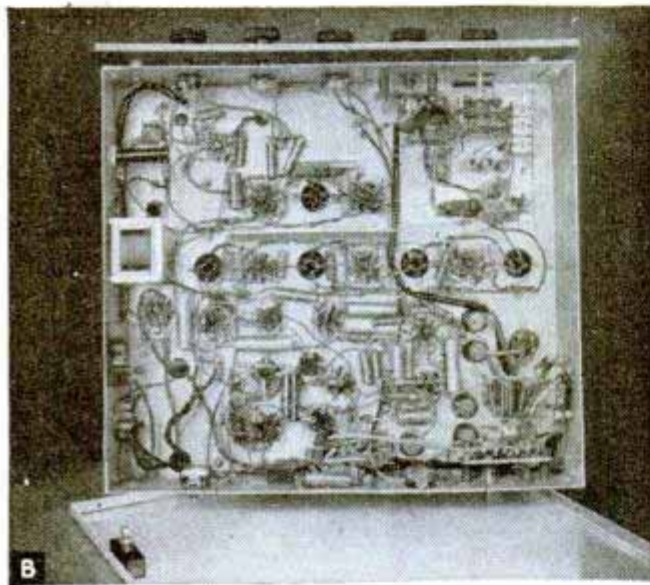



# Guns, Dolls, Planes

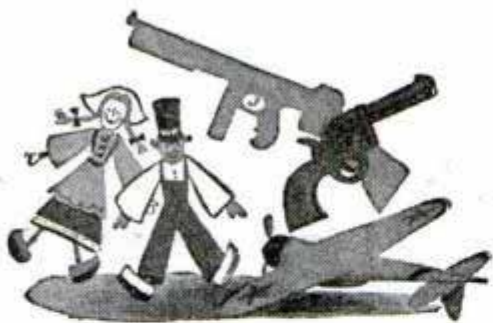

**X-acto does a bang-up job on All!**

Scalpel-sharp, always ready, with just the right blade and tool for every job, X-acto's the choice of experts for wood, leather, plastics, paper . . . or what's your hobby?



**ROBERT O'BRIEN** of Madison, Wisconsin, says "I make better models (his hobby's guns) in one-third the time, and always have a sharp edge when I need it."



**VERONICA R. STEVENS** of Riverside, Illinois, made her "Paquita Dolls" hobby into a full-time business, for which she "uses X-acto tools daily and endorses them whole-heartedly."

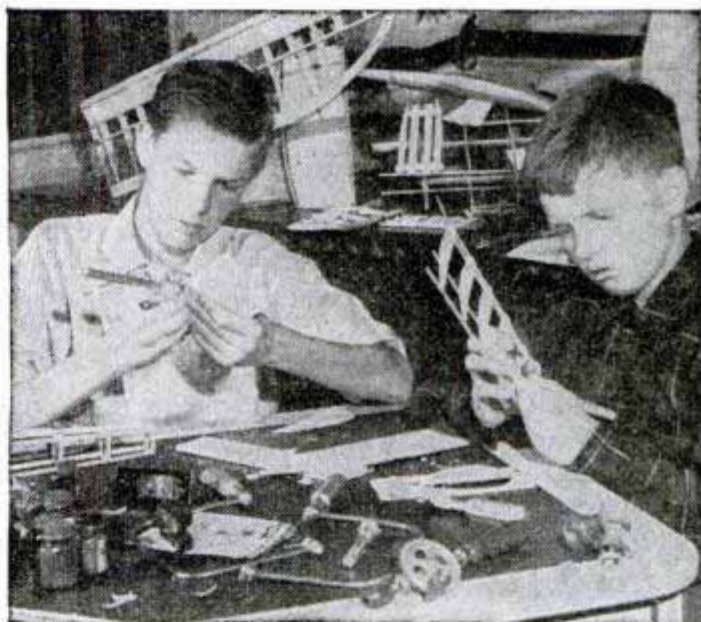

**DONNIE UHL** of Great Neck, Long Island, has made more than fifty scale-model planes. He and his pal Craig Jennings say "X-acto's thought of everything a model-builder needs. That 'Big Shot' Tool Chest is swell!"

**X-acto**<sup>\*</sup>  
KNIVES & TOOLS



Singly or in sets, 25c to \$45.  
At hobby, gift and hardware shops

X-acto Crescent Products Co., Inc., 440 Fourth Av., N. Y. 16  
In Canada: Handicraft Tools, Ltd., Hermant Bldg., Toronto

\*Reg. U. S. Pat. Off.

NEW!  
only  
\$3



**THE PERFECT TOOL**  
for wood, linoleum, plastics. No. 77 X-acto Woodcarving Set: 6 chisel and gouge blades; 4 assorted regular blades; 2 three-inch blades. Special handle takes all blades.





"What's the best blade to shave with...the 30-Second Marvel, the Hyper-Honed, or the one that wows the ladies?"

Nothing can beat a fine steel edge for removing whiskers. The *quality* of your *shave* depends on the *quality* of your *blade*. For your guidance, Marlin takes the mystery out of blade buying...shows you how quality blades are made.

**Steel** The best for blades is "high carbon," alloyed with chromium according to scientific analysis. Marlin has worked in steel for 75 years.

**Tempering** makes steel hard and tough. From bulky ingot to ribbon-like strip, blade steel is heat-treated again and again. Final tempering "sets" the metallic structure to take a sharp tough edge.

**Precision** manufacture requires complex machinery—which produces blades with finer, keener edges...more uniformly perfect...than is possible by hand. Photograph: Marlin grinding and honing machine.

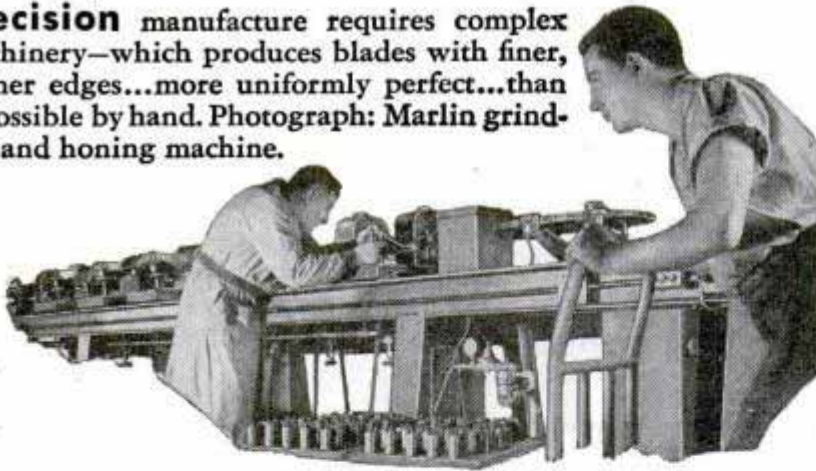

**Inspection** is continuous with top quality the goal. Shown is one of the precision instruments which check dimensions and "centricity"—insuring perfect fit in your razor.

**Actual shaving Tests** are conducted among changing groups of shavers. Results give the final verdict on quality.

**TRY MARLIN BLADES AT OUR RISK!** We believe that Marlin Blades are the best that can be made. If you don't agree, we will cheerfully refund your money.

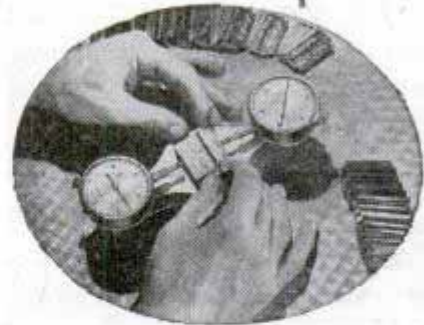
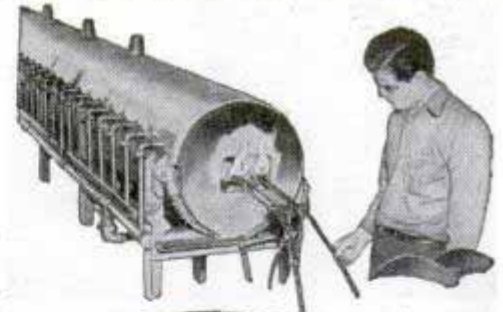

DOUBLE OR  
SINGLE  
EDGE



**THE MARLIN FIREARMS COMPANY • Fine Guns Since 1870**





**New Thrills Every Day -  
OWN A HARLEY-DAVIDSON**

Make this the biggest fun year of your life —in motorcycling, the world's greatest sport! Swing into the saddle of your own new 1947 Harley-Davidson and go where there's fun. Pack your evenings, weekends and vacations with pleasure. Ride along

shimmering lakes and rivers, over majestic hills and through mighty forests. There are always plenty of thrills when you ride a world-famous Harley-Davidson on tours and endurance runs — or take in race meets, hill-climbs and other motorcycling events. See your Harley-Davidson dealer NOW — and mail the coupon today!

**HARLEY-  
DAVIDSON**  
*Motorcycles*



**HARLEY-DAVIDSON MOTOR CO.**  
Department P, Milwaukee 1, Wisconsin

Please send at once free copy of 24-page "ENTHUSIAST" Magazine, filled with motorcycle action pictures and thrilling stories.

Name.....  
Address.....  
City..... State.....



# ANCO RAIN-MASTER

"Dead-Locker"

WINDSHIELD WIPER  
ARMS and BLADES

BLADE SNAPS ON...  
STAYS PUT

FINGER-  
TIP  
RELEASE

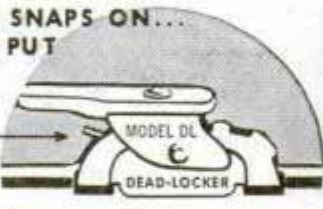

CAN'T FALL OFF  
CAN'T BLOW OFF

(A war-born invention—by ANCO—first  
for military aircraft—now for your car.)

## DON'T SHOOT YOUR GAS-PUMP MAN!

He's doing the best he can. Sure, he knows how dangerous it is for you to drive your car... in stormy weather... with your dull old windshield wipers that smear and smear. He'd gladly put on for you quickly a pair of keen new ANCO RAIN-MASTER Wiper Blades and Arms. He has them—Newest Models! But he forgets to remind you? Too busy? You can't shoot him for that!



After all, it's *your* car to protect. So *you* remind *him*. Get RAIN-MASTERS... patented features... original equipment on many makes of high grade cars and trucks... used in war—on our fighting tanks and trucks and ships and bombers too... because ANCO RAIN-MASTERS clean quicker, clean cleaner... last longer. May save you a costly smashup.

Ask for RAIN-MASTER Windshield Wiper Arms and Blades next time you buy gas.

**THE ANDERSON COMPANY**

Established 1918  
GARY, INDIANA

## Steel Hideaways

(Continued from page 162)

set standards which samples must meet. A Class A safe, for example, must protect material inside it through four hours of cooking in a gas furnace whose temperature reaches 2000 degrees. It also must stand up under an "explosion" test. That means popping it while cold into a pre-heated furnace to determine if any excess hydrogen-air-steam mixture might form. These gases could explode, rupturing the safe and spoiling its resistance to fire. Finally, the sample must undergo an impact test. The safe is heated for an hour, dropped 30 feet while red-hot onto a pile of rubble, then popped back into the furnace upside down for another hour's torture. That's comparable to a two or three-story fall when floors collapse in a burning building.

Fire-resistant safes usually have thin steel inner and outer walls with insulating material between. Protection during a blaze comes from the moisture in this insulating material. In a fire, that moisture fills the interior of the safe with steam, keeping the temperature below the point at which the contents would be destroyed.

An interesting service is being offered by a few big-city banks. It's a coin-operated day and night depository. When the bank is closed, you can do your banking by dropping a nickel in a slot. This opens a small door through which you shove a special envelope. It also automatically issues you a printed receipt. The next day the bank mails an acknowledgment for your deposit or, in the event of a withdrawal, a check as requested. You don't lose the nickel—it's credited to your account.

Modern bank vaults represent the acme of safety for your valuables. Their doors weigh from 2½ to 20 tons and provide every conceivable protection. One such

(Continued to page 244)



### Model Builders Attention!

	V	V-2	V-3
Hex	½"	¾"	⅝"
Thread	⅜"-24	¼"-32	¼"-32
Thread Length	⅞"	⅞"	⅞"
Weight, Grams	8	3½	2½

Actual Size V-Plug

Champion spark plugs for model gas engines give the same dependable performance as regular Champions. Sillment sealed. Sillimanite insulator. Alloy needlepoint electrodes for easy starting. One piece construction.

**CHAMPION**

SPARK PLUG COMPANY • TOLEDO 1, OHIO



Dependable

# CHAMPION

AMERICA'S FAVORITE SPARK PLUG



When the American public, through its buying habits, indicates a decided preference for *any product*—you can be certain that it has merit above all others.

Dependable Champion Spark Plugs are in this enviable position, and are preferred and purchased by more motorists than any other spark plugs. Champion Spark Plug Company, Toledo 1, Ohio.

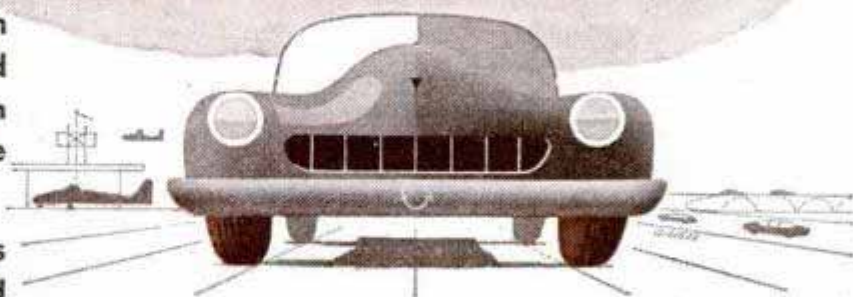

***FOLLOW THE EXPERTS***

DEMAND DEPENDABLE CHAMPIONS FOR YOUR CAR

Listen to the CHAMPION ROLL CALL, Harry Wismer's fast sportscast every Friday night, 9:55 EST over the ABC network



# RADIO Builders, Experimenters

**BUILD YOUR OWN 5-TUBE AC-DC RADIO!**

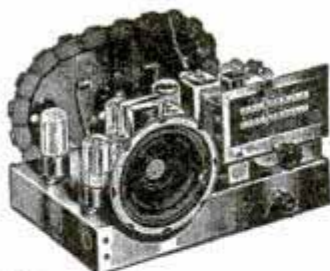

**Complete Kit, only \$2275**

Latest easy-to-build AC-DC Superhet Kit covering entire Broadcast band. Operates on 105-125 volts AC or DC. A real performer you will enjoy building and be proud to own. Kit includes all necessary parts, complete with tubes, antenna loop, and step-by-step 4-page instruction pamphlet. Build it with only a screwdriver, pliers and soldering iron.  
No. 83-224. Only, \$22.75

## GET THESE HELPFUL ALLIED RADIO BOOKS!

Radio Formulas & Data No. 37-752 . . . 10c  
Dictionary of Radio Terms No. 37-751 . . . 15c  
Radio Circuit Handbook No. 37-753 . . . 25c  
Radio Builders' Handbook No. 37-750 . . . 15c  
Simplified Radio Servicing No. 37-755 . . . 10c  
Radio Data Handbook No. 37-754 . . . 25c  
ALL 6 BOOKS above No. 37-799 . . . \$1.00

Parallel-Resistance and Series Capacitance Calculator. No. 37-960 . . . 25c  
R-F Resonance and Coil Winding Calculator. No. 37-955 . . . 25c

### ALLIED RADIO

833 W. Jackson Blvd. • Dept. 5-C-7 • Chicago 7



ORDER FROM

## ALLIED RADIO

See your ALLIED Catalog for Everything in Radio

# MEN WANTED In Building Industry



Here's a chance to get into one of the future's most profitable and promising businesses... Be a floor surfacing contractor and sand both new and old floors during the coming building boom! Sanders are easy to operate—no big overhead—no large investment—no special schooling... Just the ambition to get ahead and be your own boss. Ask for latest "tell-all" booklet entitled "Opportunities in Floor Surfacing"—use coupon and enclose 25c in coin or stamps to cover handling.

## AMERICAN FLOOR SURFACING MACHINE CO.

535 So. St. Clair St. • Toledo 3, Ohio  
Gentlemen:  
Enclosed find 25c in stamps or coin for booklet "Opportunities in Floor Surfacing," telling me how I can start my own floor sanding business.

Name \_\_\_\_\_  
Street \_\_\_\_\_  
City \_\_\_\_\_ State \_\_\_\_\_



# Ball-Bearing —SPEED WHEELS—

with semi-pneumatic Tires



12" x 1.75" wheel.....\$4.25  
10" x 1.75" wheel.....\$3.25  
8" x 2" wheel.....\$2.25

## — AXLES —

24" Steel axle.....75c

## —Solid Tire WHEELS— (no bearings)

7" wheel .....60c  
6" wheel .....50c  
4" wheel .....30c

ORDER NOW FOR PROMPT DELIVERY  
10% REQUIRED WITH C.O.D.'S

**JIM BROWN TOY COMPANY**  
1097 Home Ave. Akron 10, Ohio

# FIND UNDERGROUND MINERALS and METALS with M-SCOPE

Employs same principle as Army Mine Detector. Unsurpassed in Efficiency. Write for Free 16 page booklet.



**FISHER RESEARCH LABORATORY**  
PALO ALTO CALIFORNIA



NEW DIFFERENT Scientific "GUZZLIN CHARLIE"  
Mystery Drinking Bird with Roly-Poly Eyes  
\$2.95 complete with glass and stand. No springs, no gadgets, no wires, not mechanical. Amazing "Guzzlin Charlie" drinks and drinks. You won't believe your eyes. Kids go wild over them.

Dealers write for special prices  
**BERNARD FINE**  
501 6th Ave., Dept. F1, N. Y. 11, N. Y.

**SELL MERCHANDISE by Mail**  
OPERATE Profitable Lifetime Business Selling Merchandise by Mail. Large Profits on Fast Selling \$1.00 Items. **WRITE TODAY!**  
POWELL CO. DEPT. A SAMPLER BLDG., CLEVELAND 3, OHIO

# JET PROPULSION



## GAS TURBINE Model Engine

★ ★ Be one of the first to build a real Turbo-Jet Model Engine. Single-stage centrifugal compressor and turbine. This is a real engine, easily made with ordinary home workshop equipment. Complete plans for construction . . . design formulas and curves for checking performance and testing.

**\$2.00**  
Post paid

**THE ROTOJET CO.** Department 11  
BOX 757 • LOS ANGELES 25 • CALIFORNIA



# "I bought it before you were born"



**JIM:** That wrench? Are you kidding?

**SAM:** It's a fact. I got it in 1923.

**JIM:** Wow! That's a long time back. Wonder if any of *my* tools will last that long.

**SAM:** Sure they will—if you buy the right ones to start with. I picked this wrench because it had a good name—a name I knew I could trust.

**JIM:** You mean that was a well-known brand even way back then?

**SAM:** Right. And when a reliable manufacturer puts his name on a tool—or any other hardware item—you *know* it's good.

**JIM:** Say, I'm going to buy some tools next

pay day. How about coming along and steering me right?

**SAM:** I'd be glad to, Jim, but you don't need me. You know the quality brands as well as I do. And if you do your buying down at the hardware store, they won't try to sell you anything else.

*Your HARDWARE DEALER  
sells QUALITY tools and  
hardware. Buy from HIM.*



## POPULAR MECHANICS



# SUPERIOR

THE GREAT NEW NC-173

You can buy pre-war sets in post-war clothing by the carload. But you'll find only one really new, really post-war National NC-173. Engineered from the start to give you all the advances four years of production-for-war and a solid year of peacetime research made possible. Here's undreamed-of versatility in radio reception. Flick the switch and the world is yours . . . as only tomorrow's radio, the 13-tube NC-173, can bring it to you, with incomparable clarity and pin-point sensitivity. AM reception, phone and code . . . both standard and short-wave bands, from 540 to 31,000 and 48,000 to 56,000 KC. Connections for latest phonograph record-players. Streamlined styling . . . AC powered. Will also operate on battery for portable or emergency use. Write today for name of your nearest dealer.

EST.



1914



# NATIONAL

COMPANY, INCORPORATED

MALDEN, MASS.

THE MOST DISTINCTIVE NAME IN RADIO COMMUNICATIONS

door, despite four years of Jap depredation and then American shelling during Manila's recapture, kept unharmed the assets of the Bank of the Philippine Islands. The building in which the vault stood, however, was in ruins.

Another such door guards the \$12,000,000,000 worth of solid gold bricks buried at Fort Knox. And 16,500 cubic feet of granite, 4200 cubic yards of concrete, 750 tons of reinforcing steel and 670 tons of structural steel went into the building surrounding it.

Modern vaults and chests may not be absolutely burglar-proof, but they can be mighty exasperating to them. In New York not long ago some yeggs tried to break into an office safe. Unsuccessful, they tried tossing it out a window to the pavement seven floors below. It still didn't open.

## Vitamin Harvest

(Continued from page 149)

sporting goods store and labeled as a new species of fish. People were challenged to identify it.

The burbot is a relative of the cod, which is known solely in salt water. The presence of the burbot in fresh water is explained by the fact that untold ages ago members of the cod family were trapped inland and became landlocked. As time went on the waters became fresh instead of saline and the burbot, or landlocked cod, became a reality. Throughout the ages the burbot underwent many physical changes, some of which are different from those found in any other fresh-water fish.

The burbot (*lota masculosa*), also known as the lawyer, eel pout, and ling, spends the greater part of its life in the depths of the lakes. It is rarely seen or caught by sportsmen. Only in the autumn and early winter does it come inshore to feed and spawn and it is then that the commercial fishing crews get busy. The burbot is between two and three feet long, and is distinguished by brownish or yellowish spots on its catfish-colored skin. It feeds on perch, bass and wall-eyed pike. Its stomach often contains as many as 50 to 100 one-year-old perch and as many as 250 pike minnows have been found in a seven-pound burbot.

The removal of burbot from Lake of the Woods waters in great quantities has increased the number of game fish by about 50 percent. Fishing authorities are now able to put their finger on one reason for hitherto unexplained decreases in game fish. Rowell's vitamin industry is as highly praised by sportsmen as it is by medical scientists.



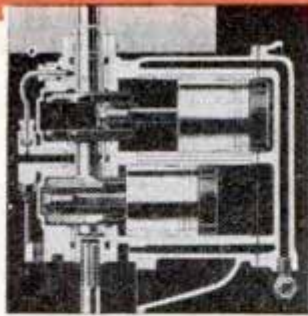

SIMPLICITY OF  
**TWIN CYLINDER** CONSTRUCTION  
 CONTRIBUTES TO JOHNSON'S FAMOUS  
**DEPENDABILITY**

It is *Johnson* that gives you the simplicity and DEPENDability of twin-cylinder construction with the liquid smoothness of Perfected Alternate Firing. Plus Reverse. Plus Dual Carburetion. Plus Ready-Pull Starter. All these (and more) are *Johnson* developments. 5 great models for '47—a size for every outboard need. See your Johnson dealer for advice on the right motor for your boat. Look for his name under "Outboard Motors" in your classified telephone directory...

**FREE HANDY CHART:** Write. Complete data on 1947 line.

JOHNSON MOTORS, 400 PERSHING ROAD, WAUKEGAN, ILL.  
*Johnson Motors of Canada, Peterboro, Canada*



# JOHNSON

## SEA-HORSES

# Great for Fishing!

Take it along! 6-volt spotlight and floodlight. Shoots light 800-ft. A genuine Delta. At hdwe., sport, electrical stores. Less battery **\$3.95**

**Delta** ELECTRIC CO.  
Marion, Indiana



## POWERlite 2-LITE ELECTRIC LANTERN

# FLUID PUMP

At last, a dependable, low priced coolant pump for machine tools. Fully guaranteed by old, reliable manufacturer.

Constructed of non-corrosive materials. Plastic screen quickly removed for cleaning. With this pump and small pan for fluid you obtain same results as with expensive equipment.

May be used for Evaporative Coolers, Fountains, Displays, etc.

DEPT. M **\$19.50** POSTPAID  
 JOBBER AND DEALER INQUIRIES INVITED

**AMERICAN**  
 METAL PRODUCTS CO.  
 FORT WORTH 9, TEXAS



## IMMEDIATE DELIVERY!



**\$24.95**

F. O. B.  
ROYERSFORD, PA.

# 8 in. BENCH SAW

COMPLETE AS SHOWN

**TABLE SEGMENT**—Shows degree of table tilt—graduated. **SPLITTER**—Hard temper cold rolled steel. **GUARD**—Aluminum. **MITER GAUGE**—Aluminum. Accurately graduated 45° each side of center. **BEARINGS**—(2) Oil-lite bronze. **CAPACITY**—0 to 2 1/4". **TABLE** 12"x14". **SHIPPING WEIGHT**—44 lbs.

**AMERICAN MACHINE & TOOL CO., Inc.**  
 DEPARTMENT 100 • ROYERSFORD, PA.

SAY YOU SAW IT IN POPULAR MECHANICS



# SKAN

your way to  
**BETTER PICTURES**

with this fine  
precision-built  
photoelectric  
Exposure Meter





I CAN'T SUPPORT YOUR FAMILY  
IF YOU DON'T HURRY WITH  
THE WELDWOOD GLUE!



When you want to fix things fast...be sure to get Weldwood Glue. It's tremendously strong... waterproof and rot-proof. Easy to apply... quick to dry... stain-free and permanent. At lumber dealers, chain and hardware stores, in 10¢, 25¢, 50¢ sizes and larger.



**WELDWOOD**  
PLASTIC RESIN  
**WATERPROOF GLUE**  
UNITED STATES PLYWOOD CORPORATION  
NEW YORK 18, N. Y.

**EXHAUST  
BLOWERS**

WORTH \$50

**\$15<sup>85</sup>**

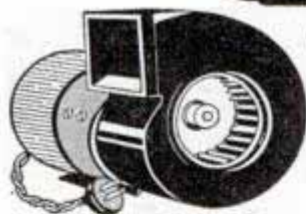

FOR PHOTOGRAPHERS  
HOSPITALS • LABORATORIES • WORK SHOPS  
LAUNDRIES • OFFICES  
RESTAURANTS • PRINTERS  
PLAYROOMS

**100 CU. FT. FRESH AIR EVERY MINUTE!**

Solve your ventilation problems with this rugged, built-for-service blower and exhaust. Quick and simple to install. Anyone can do it with ordinary household tools.

110 Volt, A.C., 50-60 cycles. Continuous duty, ball bearing motor assures quiet, trouble free operation.

Send Check, Money Order. No C.O.D.'s. West of Mississippi add \$1.00 for mailing, handling. Immediate delivery.

**UNIVERSAL YONKERS CORP.** (Dept. M-3) 41 Locust St., Yonkers 2, N. Y.

**A. C. CURRENT ANYWHERE!**

With **KATOLIGHT** PLANTS.

Furnish the same kind of Current as the highlines. Sizes 500 watt to 50 KW. Also Manufacturers of Rotary Converters, Frequency Changers. D.C. Motors ¼; ½; & ¾ hp., A.C. Motors, single phase in 2, 3, and 5 hp.

**KATOLIGHT** 1402 First Avenue  
MANKATO, MINN.

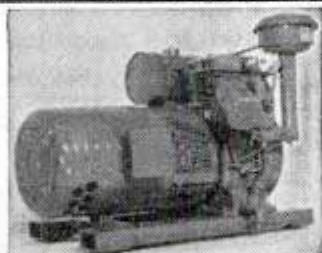

**HOW TO CUT RAFTERS**

New vest pocket book gives lengths, Side cuts, Plumb cuts, Deductions. For all rafters for any building from one inch to forty feet wide. Gives numbers to cut on square. Also degrees for some cuts for Radial Saws. All standard pitches from 1/8 to 3/8. Just open book to pitch page and there are your lengths, side cuts, etc. Anyone who knows what a jack rafter is can frame a roof if he has this great book. Price one dollar pre-paid. **BUILDERS' TOPICS**, Dept. M, Lock Box 828, Seattle, Washington. Original teachers of the square in five easy lessons by mail. SEND FOR FREE LIST OF TECHNICAL BOOKS. Learn to read blueprints etc.

MARCH 1947

**CONGRESS  
PULLEYS**



No matter what kind of a pulley you need, your hardware dealer — who displays the sign below — has it for you. He has pulleys to drive your bench saw, lathe, grinder — or to drive the refrigerator, washing machine or furnace blower. Highest quality, perfect balance, long pulley life are yours with **CONGRESS DRIVES**.



Sign of an Authorized Congress Dealer

**CONGRESS** *DIAMOND BORED* **DRIVES**  
3750 EAST OUTER DRIVE DETROIT 12, MICHIGAN

SAY YOU SAW IT IN POPULAR MECHANICS





# Performance goes up in smoke

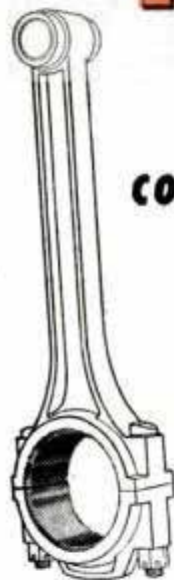

**when worn  
connecting rod bearings  
cause oil pumping**

Oily exhaust smoke signals trouble in the engine, caused by worn bearings. They let excess oil carbon-foul pistons, rings, valves and spark plugs, robbing your car of pep and pick-up at traffic light and of power on the road. To stop oil pumping, to restore power, pep and economy, install Federal-Mogul Oil-Control Bearings. *Ask your mechanic!*



**FEDERAL-MOGUL SERVICE**  
DIVISION OF FEDERAL-MOGUL CORPORATION  
COLDWATER, MICHIGAN

Replace in sets with Genuine  
**FEDERAL-MOGUL**

**Oil-Control Bearings**



## 1947 "Little Giant" Super

(Continued from page 235)

sis. Solder all connections carefully with rosin core solder and keep all leads as short as possible.

The receiver should play as soon as completed; however, some adjustment will be necessary to make the tuning scale read correctly. Set the tuner so the coil cores are completely within the coils. With Duco cement, fasten the dial pointer over the

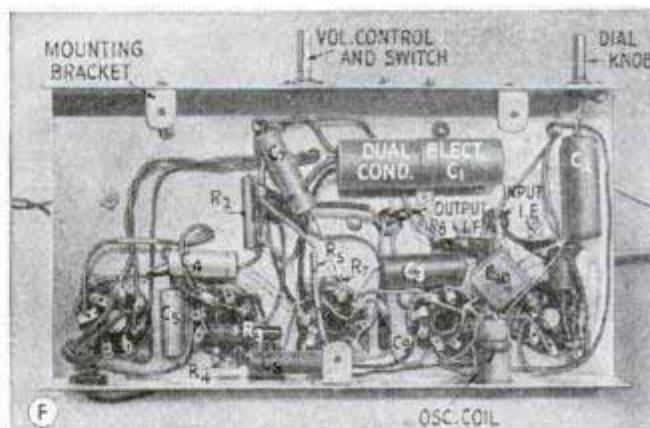
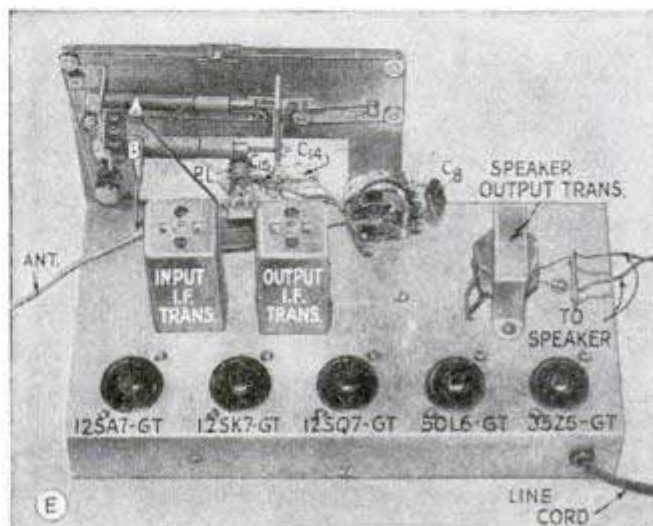

cord at the extreme left of the dial scale. Tune in a station at about 600 kc. and adjust the oscillator condenser (C14), at the same time turning the tuner knob until the station comes in at the right dial setting. Adjust the antenna condenser (C15) for maximum volume. Next adjust each of the I.F. trimmer condensers, photo D, for loudest signal. Now tune to a station at about 1400 kc. and adjust the lower coil iron core so that the dial pointer reads the proper frequency; next adjust the core of the top (antenna) coil for maximum signal strength. These last adjustments are made with the threaded brass rods in the iron cores. Detailed student material list R-353 is available from Popular Mechanics Radio and Electronics department upon receipt of ordinary letter postage.



Get This Book on Fishing

**FREE!**



Back after 5 years! New "Fishing—What Tackle and When" shows South Bend and Oreno items. Color pictures of fishes. Casting instructions. Stories by famous writers. Every fisherman needs a copy. *Sent free!* A postal gets it!

**FAMOUS BASS-ORENO No. 973**



The unbeatable fish-getter that should be in every tackle box. Available in 6 finishes, 5 sizes. . . **\$1.10**

SOUTH BEND BAIT CO., 891 High St., South Bend 23, Ind.

**SOUTH BEND** *A Name Famous in Fishing*

**THE GEM MAKER**



Amateurs or professionals . . . hobbyists or jewelers . . . Polish your own gems with a B&I Gem Maker. You will find this a profitable adventure. All necessary lapidary equipment is furnished, including a super-charged diamond blade for sawing, and all wheels for grinding, shaping and polishing, also complete instructions. The complete equipment as shown, less motor and belt, for only \$29.50, f.o.b., Burlington, Wis. Write today for information and literature on the Gem Maker and accessories. B&I MFG. CO., Dept. S, Burlington, Wis.

**BOWS & ARROWS**

Write for 94 page Illustrated Instruction Hand Book 50c; 20 page catalog 5c; stamps or coin. LE STEMMLER CO. QUEENS VILLAGE, N.Y.

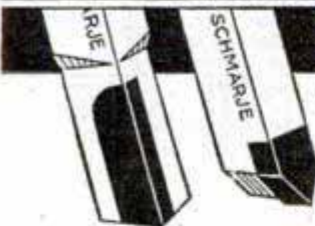

**SPECIAL SET \$2.00**

GENUINE CARBOLOY-TIPPED TOOLS

Same as used by the big factories. Long life, high production. Designed to perform home workshop jobs on metal, wood and plastic. Shipped in pairs as shown, either 1/4 or 5/16". Only \$2 cash with order, postage paid.

SCHMARJE TOOL & ENGINEERING CO., MUSCATINE, IOWA

SAY YOU SAW IT IN POPULAR MECHANICS

**BRUSH PLATING OUTFITS**

for re-plating articles in the home and shop. No tanks necessary. Free particulars.

GUNMETAL CO., AVE. M, DECATUR, ILLINOIS

**New THOR "B" ENGINE—\$6.95**

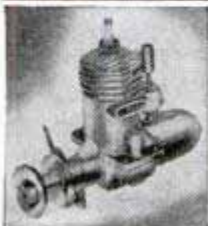

The new THOR "B"—Sensational miniature gasoline engine that really works. Super-power performance. Smooth, velvety power that roars into action with a "twist of the wrist." Over 20,000 already sold. 1/8 H.P. Complete with coil and condenser. Ready to run, only \$9.95. In KIT form, fully machined, 5 minutes to assemble, \$6.95, without coil and condenser. Powers all models. Fully illustrated instructions. Send \$1.00—shipped collect same day C.O.D. or send full price plus 25c extra and we ship parcel post insured.

FREE. SEND FOR 32-PAGE ILLUSTRATED HOBBY CATALOG. AMERICA'S HOBBY CENTER DEPT. 837, 156 WEST 22ND STREET, NEW YORK 11, NEW YORK

You don't have to be a *Magician* to get *True-to-life Movies!*



... SHOOT THEM WITH

*Cinémaster II*  
(It's a *UNIVERSAL*)

You can be an expert movie cameraman overnight! Universal makes "movie directing" easy as rolling off a log with foolproof Cinémaster II features that eliminate guesswork, "blind" shooting. (1) A built-in exposure meter shows you how to take advantage of all light conditions. And (2) a built-in optical view finder helps you shoot your subject and *get it* just the way you see it. Cinémaster II is the only 8 mm. movie camera that gives you *both* these exclusive features in combination. Action! Camera! — see it! try it! at your dealer's today!

**UNIVERSAL CAMERA CORPORATION**

NEW YORK CHICAGO HOLLYWOOD

Manufacturers of Cinemaster and Mercury Cameras and other Photographic Equipment



# PRESSURE QUEEN

FOUR CYLINDER  
PORTABLE AIR COMPRESSOR  
SPRAY PAINTING OUTFIT

**\$69<sup>75</sup>**

(WITHOUT MOTOR)



COMPACT • RUGGED • POWERFUL

The ideal air supply for home and farm workshop, machine shop, garage and contracting painter; for product finishing, inflating tires, painting automobiles, trucks, machinery, etc. Indispensable for building maintenance, interior and exterior. Handles any paint, insecticide or disinfectant.

This 4 cylinder compressor has drop forged crankshaft, stainless steel, heat treated valves; bronze bearings and positive forced feed lubrication. Maximum pressure 50-60 lbs., free from pulsation. Standard equipment includes the compressor mounted on steel base with carrying handle, belt, compressor pulley, air chamber, air gauge, 15-ft. hose, spray gun. Requires 1/2 or 3/4 h.p. motor or gas engine, not included.

If your dealer does not sell Pressure Queen write direct

**THE CAMPBELL-HAUSFELD CO.**

1046 RAILROAD AVE., HARRISON, OHIO

## G&E Craftsmen's Bargains

### ELECTRO MAGNETIC LIFT

An important labor-saver every repairman will use in many handy ways. For momentary work. Plug in any AC socket. 110 volt, 60 cycles; size 4 3/4" diam. by 3", with 22" cord and plug attached. Complete with instructions. Ship. Wt. 5 1/2 lbs. No. 7618—only.....



**\$7<sup>35</sup>** each

### FULFLO Heavy Duty FILTERS

Famous Fulflo Filter is ideal for gas, air or oil. Stands 250 lbs. pressure. Has 1/4" inlet and outlet I.P.T. Heavy bracket attached for mounting. Complete, ready to install. Overall size 3-9/11" diam., 5" high. Ship. Wt. 4-3/4 lbs. No. 4753—only.....



**\$1<sup>95</sup>** each

Lots of Ten \$1.85

### SANDING CLOTH 3-M-I.T.E.



The perfect abrasive for metal and wood. Extra tough-grained. Grit 150 x (4/0); 12" diam., 3" hole. Use on disc or cut up as emery cloth. Made by Minnesota Mining and Mfg. Co. Ship. Wt. 2 lbs. While supply lasts. No. 2908—25 discs for only

**\$1<sup>25</sup>**

### FREE CATALOG

New! Lists hundreds of hard to get Electrical & Refrigeration parts. Wholesale only. Write Today!



Send check or money order, including postage. No C.O.D.'s

**G & E EQUIPMENT SUPPLY CO.**

Dept. PM-15 400 N. SANGAMON ST., CHICAGO 22, ILL.



The Modern PLASTIC  
for lasting Home Repairs

PERMANENTLY mends cracks or holes in wood, tile, stone or plaster. Sticks and stays put—Does not chip, shrink or fall out. Easy to use. Economical. Mold it, chisel it, polish or paint it. If unobtainable from your lumber, paint or hardware dealer, the big 4-lb. can will be sent you post-paid (in U.S.) for only \$1. Full money-back guarantee, order now.

**DONALD DURHAM CO.**

Box 804-C, Des Moines, Iowa

## MACHINE SHOP EQUIPMENT



Just off the press!—Every man who owns a workshop should have a copy of the new, up-to-the-minute, 200 page catalog of Machine Shop Equipment—the latest tools made by the biggest manufacturers in the U. S. Replete with illustrations, descriptions, prices. Prompt delivery on most tools listed in this book. Available at cost of printing—50c a copy—get yours today! **Price of Catalog Refunded on First Order over \$5.00.** Send check or Money Order to

CENTER TOOL CO., 154 Centre St., New York 13, N. Y.

## BUILD YOUR OWN MACHINE TOOLS!

Blueprints \$1.00—Catalog FREE

Detail construction Blueprints on 6 Lewis metal and wood-working tools postpaid for \$1.00. Includes prints for Lewis 10" Shaper, Milling Machine, Drill Press, Vise, 8" Circular Saw, 6" Jointer. Castings for these tools save up to 80% of comparable new tool cost. Illustrated 32-page Catalog—sent free with Blueprint Order—describes 21 Lewis tools.

WRITE TODAY!

LEWIS MACHINE TOOL CO.

P. O. Box 7446, Sta. L, Dept. M, Los Angeles 23, Calif.



## PLATE USERS! Give Your Mouth A Treat!

### "CAMCO" Dental Plate Reliner

Restores original comfortable fit. Odorless. Tasteless. Not \$2.00 post-adhesive. Will not dissolve in mouth. Easy to apply.

CATHAY AMERICAN CO., San Francisco 11, Calif.

## ONE-MAN SAWMILL LESS THAN \$200<sup>00</sup>

Easy To Turn Trees Into Money

Makes lumber, ties, shingles, crates, lath, studding, siding. Belsaw Models in 10 to 24 foot sawing lengths. MECHANICAL FEED, accurate set works and positive dogs. Use tractor or old auto engine for low cost power. Thousands used for commercial sawing. Pays for itself quickly. Send post card today for FREE booklet, "How To Make Lumber" and Catalog of Woodworking Equipment.

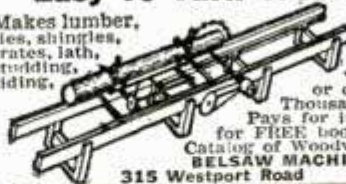

BELSAW MACHINERY CO., 2811 J Field Bldg. 315 Westport Road Kansas City 2, Mo.

## do you WORRY?

Why worry and suffer any longer if we can help you? Try a Brooks Patented Air Cushion. This marvelous appliance for most forms of reducible rupture is GUARANTEED to bring YOU heavenly comfort and security—day and night—at work and play—or it costs you NOTHING. Thousands happy. Light, neat-fitting. No hard pads or springs. For men, women, and children. Durable, cheap. Sent on trial to prove it. Not sold in stores. Beware of imitations. Write for Free Book on Rupture, no-risk trial order plan, and proof of results. All correspondence Confidential.



### ABOUT RUPTURE

Brooks Company, 359-D State St., Marshall, Mich.



15 JEWEL SWISS

\$17.50

**MEN'S SUPERB WATCH**

15 jeweled movement insures accuracy, dependability. Waterproofed! Radium dial and hands. Sweep second hand. Unbreakable crystal. Stainless steel back. The Swiss master watch craftsmen put these superb movements in handsome, lustrous, chrome cases. Truly a distinctive watch priced to sell quickly.

**WRITTEN GUARANTEE WITH EACH WATCH!**

Wear for 10 days at our risk and expense. SEND NO MONEY. Simply pay postman \$17.50 plus 10% tax and postage on delivery. Cash orders sent postpaid. Limited supply.

UNITED PRODUCTS CO., 7941 S. Halsted St., Dept. RR-354, Chicago 20, Ill.



New LOW COST "CHIEF"  
**PORTABLE  
ELECTRIC ARC  
WELDER**



A  
COMPLETE  
WELDING  
SHOP  
IN  
1 CASE  
•  
CARRY IT  
ANYWHERE  
•  
VERY  
SIMPLE  
TO  
OPERATE

**MAKE THESE SCARCE  
BUILDING MATERIALS**

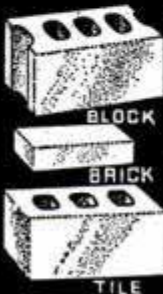

Today's huge demand for blocks and other masonry products makes opportunity for local manufacturing. Buy modern, cost-cutting machinery direct from large factory—national headquarters for 40 years. Complete line. Sold on 15 days' trial. Liberal terms. Free manufacturing instructions. Write for new catalog with all prices plainly marked. Early delivery.

**CONCRETE EQUIPMENT COMPANY**

512 Ottawa Avenue Holland, Michigan

**WANTED**

**DISTRICT PURCHASING AGENTS**

No experience or money required. Exceptional opportunity for those who want to establish themselves in a steady, year 'round, well paying business.

For details: Write

**PURCHASING MANAGER, DEPT. C**  
2719 LAWRENCE AVE. CHICAGO 25, ILL.

**WOODWORKERS ... Get this**  
**CONSTANTINE MASTER MANUAL**

Get the Most Fun From Your Hobby  
Indispensable to woodworkers. Newest, biggest edition, more pages, more color, helpful how-to-do-it articles, pre-war and new items, more bargains. Send 25c today and we will include **FREE! FULL YRS. SUBSCRIPTION** to Chips and Chats, published bi-monthly. Keeps you up-to-date on everything in woodworking, offers big money-saving bargains. Send now.

ALBERT CONSTANTINE & SON, Inc.  
791-C 135th Street, New York 54, N. Y.



**WINDOW SIGN LETTERS**

For Store Fronts and Office Windows. Anyone can put them on. Samples furnished. Genuine Gold and Silver. **METALLIC LETTER CO., 430 N. Clark St., Chicago 10**

The **PRECISION**  
Lawn Mower Sharpener

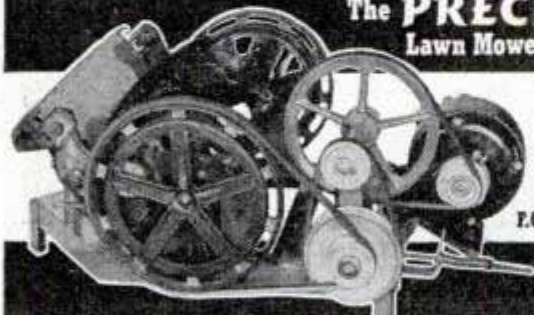

Only  
**\$37.50**  
Less Motor  
P.O.B. Rock Island

**EXTRA DOLLARS IN YOUR SPARE TIME...**

Looking for an extra income sideline? Install a Precision Lawn Mower Sharpener in your workshop and turn your spare time into dollars. Sturdily constructed - Easy to operate.

**QUAD-CITY PRODUCTS CO. - P.O. Box 42, Rock Island, Ill.**

SPECIALLY DESIGNED  
FOR EASY PORTABILITY  
AND GENERAL PURPOSE  
**WELDING  
BRAZING  
SOLDERING**  
HARD SURFACING · PRE-HEATING



**Works On Iron, Steel, Aluminum, Brass, Bronze, Copper and Alloys. Excellent Results Achieved On Thin Gauge Metals**

The "CHIEF" is a remarkably efficient new low-cost Electric Arc Welder that brings easier portability and greater simplicity of operation than ever before. Its wide range of application makes it ideal for all-around use in home workshops, welding shops, farms, garages, machine, auto and general repair shops. Lightweight, easily carried. Accessories fit into a tray on bottom of case, providing a complete welding outfit all in ONE compact portable unit.

**Amazingly Simple Low Cost Operation**

Very simple to operate. Even inexperienced workers can achieve good results right from the start. Does high-grade work you would think only possible with larger, more expensive outfits. The Hy-Flash Arc Torch included, simplifies welding of all light and medium gauge metals, as well as brazing, soldering and heating operations. 110 or 220 volt models. Complete, as illustrated. America's greatest welder value!

**SEND COUPON FOR FREE DETAILS NOW!**

Dealers: Write for territory and dealership propositions

**CHICAGO PRECISION MACHINE CO.**  
926 S. Michigan Ave., Chicago 5, Illinois  
Send free details on Chief Welder. No obligation.

Name \_\_\_\_\_  
Street \_\_\_\_\_  
City \_\_\_\_\_ State \_\_\_\_\_



## Putting a Show on Ice

(Continued from page 111)

able to glide through their routine four times faster than ordinary dancers. On the ice they complete in one musical count of eight the same patterns that would require four counts of eight on a ballroom floor.

Starting and stopping gracefully on skates, in unison, requires long hours of practice. Maintaining a straight line on skates also is difficult. Always the hazard of an accident is present when alternate lines of dancers are moving at top speed in opposite directions with only a few feet separating the lines. To keep in perfect form the members of the dance groups rehearse several times a week, all season long, in addition to scheduled performances.

Some ice performers use racing blades for extra speed but most of them wear standard figure skates. None needs ankle supports even after long hours on the ice because their blades are expertly fitted under their boots. Some performers weld small steel balls on the rear of their blades to avoid spiking themselves during athletic routines. Blades need resharpening twice a month and a pair of skates and boots lasts about a season.

Hockey ice is too hard, rough and slow for the flashing stunts and scintillating dance routines of an ice show. Fast ice is required, only a few degrees below freezing. Being soft, the ice scars easily under the blades and during intermissions the rink is "swept" with hot water that smooths and clears the surface.

Most large indoor rinks use an ice sheet that is only two or three inches deep. First a primary layer of water is frozen, then large templates are placed on the surface and the colors of the floor design are sprayed on, after which the templates are removed and the rink is flooded and frozen to its standard thickness.

The compact control board which operates all lighting effects was devised by George Voorhies, chief electrician. It provides 36,000 watts of illumination, and its operator never sees the show. He is prompted by a director who watches the performance and telephones his cues.

Curtains can't be lowered between acts of the ice show so blackouts are used to conceal the shifting of properties on the rink. At the conclusion of a big dance number, for example, all the lights in the house go out. Fifteen seconds later they come on to reveal an entirely different group of skaters and properties on the ice. During the period of darkness as many as 100 dancers move at

(Continued to page 256)

# Sweeping the Country



*Speed Sweep*

**THE BRUSH WITH  
THE STEEL BACK**

Speed Sweep brushes are replacing old style brushes in thousands of factories, warehouses, and stores because they sweep faster, cleaner and easier. Speed Sweep brushes also outlast ordinary brushes 3 to 1. There is a Speed Sweep to meet every requirement. Write for styles, sizes and prices today.

Milwaukee Dustless Brush Co.  
530 North 22nd Street  
Milwaukee 3, Wis.

Please send me complete information about  
Speed Sweep brushes.

Name \_\_\_\_\_

Address \_\_\_\_\_

City \_\_\_\_\_ State \_\_\_\_\_





# More Fun

**Cook 'Em Where  
You Catch 'Em**

Here's the handy, ready-on-the-spot stove every outdoorsman needs... for hot food or a pot of hot coffee in a jiffy.

The Coleman Pocket Stove lights instantly. Burns any kind of gasoline—white or leaded. Boils a quart of water in eight minutes. Aluminum case makes two handy cooking utensils. Perfect for hunting, fishing, camping trips, picnics, vacations, in the home workshop.

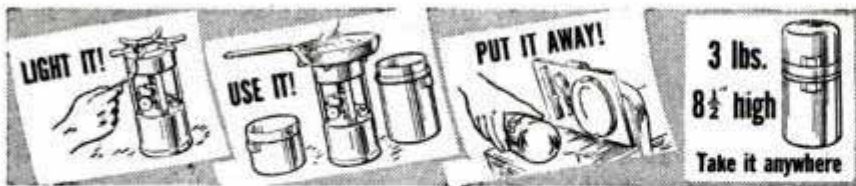
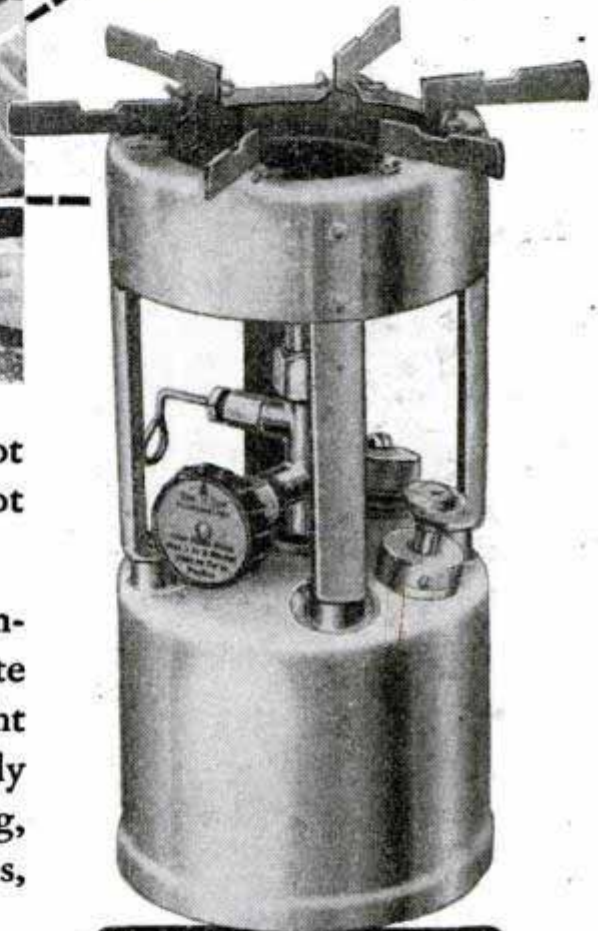

## Coleman POCKET STOVE



**Coleman**

FOLDING CAMP STOVE

### Like Having a Miniature Gas Range

when you have a quick-cooking Coleman Folding Camp Stove. Instant lighting. Carries like a suitcase. See it at your dealer's.

### Floodlight Your Entire Camp

with a Coleman Floodlight Lantern. Its powerful brilliance makes night fishing and camp chores easier, safer. Floodlights 100-ft. area. Stormproof. Safety sealed fount can't spill fuel. Burns 20 hours for a dime. Ask your dealer for a demonstration.

**FREE!** Write for illustrated book telling about these and other Coleman Appliances. Address the nearest office.



**Coleman**

FLOODLIGHT LANTERN

**THE COLEMAN COMPANY, Inc., Dept. 202-PM,**  
Wichita 1, Kans.; 401 N. Broad St., Philadelphia 8, Pa.;  
Los Angeles 54, Calif.; Honolulu, T. H.; Toronto, Can.



# WESTON



## Master II EXPOSURE METER

All the science and skill necessary to take perfect pictures every time is built right into the compact WESTON Exposure Meter. Ask your dealer for a demonstration today... Weston Electrical Instrument Corporation, 671 Frelinghuysen Avenue, Newark 5, New Jersey.

**"The meter most photographers use"**

SAY YOU SAW IT IN POPULAR MECHANICS



## WAKE UP YOUR Scalp

### BE FAIR TO YOUR HAIR

Want better looking hair? Embarrassed by falling dandruff, itching scalp? Then try VITABRUSH, the new electric driven scalp brush that gives your scalp a vigorous and invigorating "workout" in just three minutes of fun. Cleans the scalp. Stimulates the blood supply. Restful. Pleasant. Write *today* for complete information and money back satisfaction-guaranteed trial offer. Hershey Mfg. Co., 3767 Field Building, Chicago 3, Ill.

Hershey Mfg. Co., 3767 Field Bldg., Chicago 3  
Please send me your free literature about Vitabrush.

Name .....  
Address ..... (Please Print)  
City ..... Zone ..... State .....

## PAINTERS' STRIPING TOOL

A TOOL... NOT A BRUSH

### NEW, IMPROVED

Modern—streamlined—fits the hand like a fountain pen! Easy to use as a pencil. Draws parallel lines—straight, curve or circular. Does expert job on autos, furniture, toys, bikes, model planes, signs, bulletins, linoleum. (Makes wall board look like tile.) Every painter and craftsman needs one! Type "M" MASTER Painters' Striping Tool complete with tip for 1/16" stripe, \$1.00. Extra tips 1/64", 1/32", 3/64", 1/16", 5/64", 3/32", 1/8"—75c each. Tool with complete set of 7 tips \$5.00. (C.O.D. orders 25c extra.) Paint dealers, write!

EASY AS  
USING A  
PENCIL!

\$1.00  
POST  
PAID

WENDELL MFG. CO.

4234-B Lincoln Ave., Chicago 18, Illinois

Save with  
**LARSON**  
Leathercraft

For  
Pleasure and Profit

Send ten cents to Leathercraft Headquarters for 16-page catalog describing all necessary materials for making belts, moccasins, purses, gloves and many other practical items. Easy to assemble. Instructions come with materials.

Send for this Catalog

J. C. LARSON & COMPANY  
176 N. Wacker Drive • Chicago 6, Illinois

## CROSMAN Silent RIFLES



NOW AVAILABLE

America's favorite compressed air rifles for indoor or outdoor shooting are back again! Available in .22 Cal. Single Shot and Magazine Loading types. At your dealer—or order direct. Ask for Crosman SUPERPELLS too—the better ammunition for all compressed air rifles, available in .177 Cal. and .22 Cal.

CROSMAN ARMS CO., INC. ROCHESTER 7, N. Y.





# OWN A "POCKET SIZE" MACHINE SHOP

## IMPROVED MOTO-TOOL

APPROXIMATELY  
27,000 R.P.M.  
CUTS CLEANER;  
SAVES CUTTERS

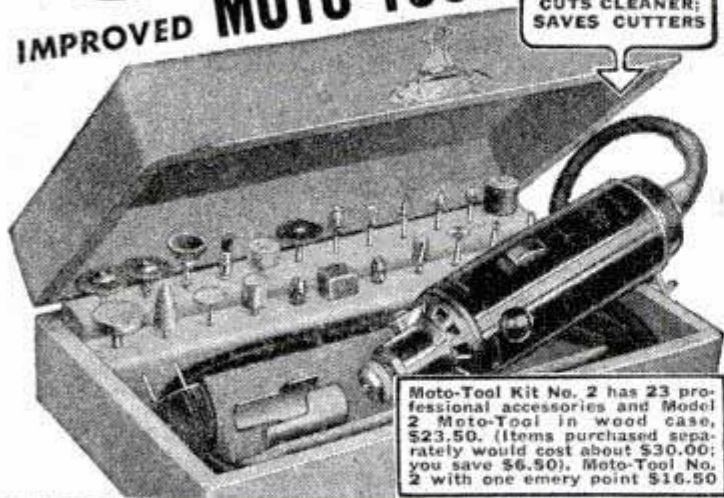

Moto-Tool Kit No. 2 has 23 professional accessories and Model 2 Moto-Tool in wood case, \$23.50. (Items purchased separately would cost about \$30.00; you save \$6.50). Moto-Tool No. 2 with one emery point \$16.50

### Free Both Hands with Moto-Tool Attachments



A. Moto-Tool Universal Stand holds Moto-Tool at any angle — \$4.50.

B. Shaping Table and Stand in position to grind flat pieces to any shape. Both \$7.00.

C. Shaping Table, inverted, for routing — \$2.50.



### "MAN... WHAT A POWERHOUSE!"

#### A TOOL THAT PACKS YEARS OF PLEASURE

Here's a tool to please a man's heart. A gleaming "powerhouse" that holds promise of endless creative hours. This "pocket-size machine shop" is a war veteran... used by all branches of the armed forces in far flung repair bases... and it helped set production records at General Electric, Westinghouse, Remington Arms, Ford and other plants. Hobby enthusiast or expert craftsman... first choice is Model 2 "Moto-Tool" kit, with its handsome, felt-lined, highly finished wood case... with rows of tools begging to be put to work. The usefulness of "Moto-Tool" for precision work is increased by two versatile attachments now available at slight additional cost (see below).

#### Look for These Features

Housing has "pencil-type" finger grip; instant-action, wrenchless chuck; oil-less (sealed) bearings; patented automatic chuck-lock pin; oversized armature shaft, hardened, ground and polished; 110 volt universal type motor; easily replaced commutator brushes; sliding, snap-type switch; handy hanger hook; cord protector; sturdy, shockproof bakelite housing; dust-filtered, air-cooling system; weighs only 13 oz; shaped to fit the hand; dynamically balanced for vibrationless operation.

#### MONEY BACK GUARANTEE

Buy Moto-Tool and Accessories from your dealer; or order direct from factory on 10 day trial, money back guarantee.

#### DREMEL MFG. CO.

Dept. 117-C • Racine, Wis.



#### Do These Better-Faster

- Cleaning
- Rasping
- Brushing
- Dressing
- Burring
- Grinding
- Routing
- Sanding
- Drilling
- Inlaying
- Sawing
- Scoring
- Cutting
- Carving

### It's a NEW Hull AUTOMOBILE COMPASS

• A new dress for the old reliable Hull Streamline. Now in Dark Woodgrain Brown as well as ebony satin finish, with chrome mount. Same price, \$3.95. At your dealer's. Write for circular.

HULL MFG. CO., P.O. Box 246-D3, Warren, Ohio



### MARCOT KEY MACHINE

Immediate Delivery

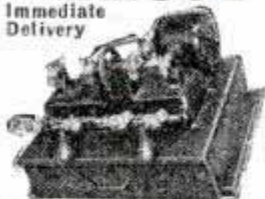

Marcot No. 8 Key Machine Mounted on Cabinet..... \$ 82.50  
Book on Modern Locksmithing..... 3.95  
Auto Code Book and Auto Depth Keys..... 12.50  
162 Doz. Popular Key Blanks... 77.76  
Set Key Files, Tools, Pins, Springs, Thimble..... 10.50  
\$187.21

A. J. MARCOTTE CO., 1200 N. KEDZIE AVE., DEPT. PM, CHICAGO 51, ILL.

### SAY YOU SAW IT IN POPULAR MECHANICS

## The KALART Compak Passive SPEED FLASH



FOR OWNERS OF POPULAR PRICED CAMERAS WHO WANT TO MAKE PICTURES LIKE PROFESSIONALS DO!

**\$8.95**  
Complete Federal Taxes Included

Pocket size! Light weight! Built on the proven principles that have made the KALART SPEED FLASH line famous for dependable performance. Has a specially designed "concentrating" reflector for midget bulbs. Grand for black and white—excellent for color—the Compak Passive is ideal for Kodaks, Ansco's, Argus and many other popular cameras.

See the KALART Compak today at all better dealers or write KALART Dept. PM-3, Stamford, Conn. for free descriptive literature.

# KALART

## Thompson BEATS the World on BOATS



### Better Built Lower Prices

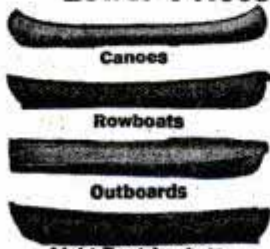

Safe Boats With Full Length Spray Rails Keep passengers perfectly dry—even at high speeds. Catalog also shows two new models of "Take-Along" Boats. Two big factories—save you freight.

CATALOG FREE Write for your copy. State kind of boat in which you are interested.

THOMPSON BROS. BOAT MFG. CO. (161) 213 Ann St. PESHTIGO, WIS. Write to (either place) 113 Elm St. CORTLAND, N.Y.



# SENSATIONAL NEW JET ACTION SPEED GRINDER

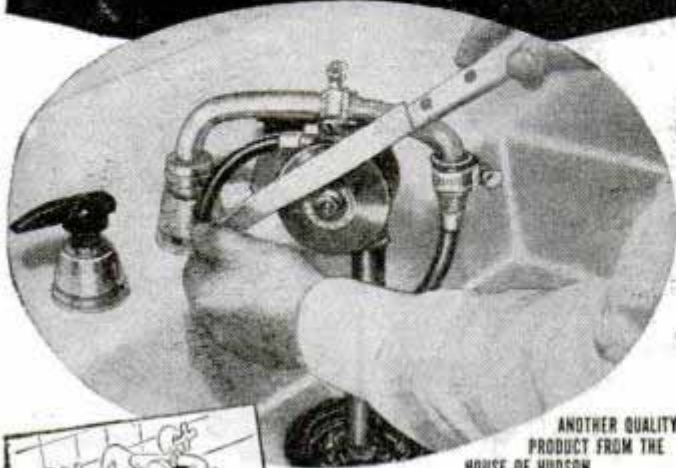

ANOTHER QUALITY  
PRODUCT FROM THE  
HOUSE OF HUDSON

**SHARPENS EVERYTHING  
FOR HOME AND SHOP**  
Knives, scissors, hobby tools, skates, wood  
planes, bits, chisels, axes and all edged tools

## The HUDSON TURBO GRINDER

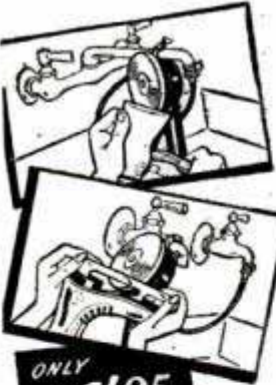

ONLY  
**\$8.95**

Ideal for the handyman, housewife, hobbyist, mechanic. Just attach to any ordinary faucet, turn on the water and the patented Hudson Turbo-jet impeller spins the grinding wheel at 3000 to 10,000 revolutions per minute depending on pressure. Precision built throughout. Super hard silicon grinding wheel; stainless steel shaft; Chrysler oilite bearings; all metal parts chrome plated; colorful Vinylite tubing.

**FULL MONEY BACK GUARANTEE**  
See Your Hardware Dealer

**HUDSON PRODUCTS CO.**  
4403 ST. AUBIN AVENUE  
DETROIT 7, MICHIGAN

**IF YOUR DEALER DOESN'T  
HAVE THE HUDSON TURBO  
GRINDER—SEND  
COUPON TODAY** 

**HUDSON PRODUCTS CO.**  
4403 St. Aubin Ave., Detroit 7, Michigan

Enclosed is a \$8.95 ( ) check ( ) money order for which rush to me, postpaid, one Hudson Turbo Grinder with full instructions for use. I understand the Grinder carries a full, money back guarantee.

Name .....

Address .....

City ..... State .....

Name of Hardware Dealer .....

Address .....

high speed toward the exits while others stream out to take their places. Properties and decorations, mounted on glides, are placed by skaters assigned to the tasks.

Backdrops are changed quickly with a unique roller system. The apparatus has rollers at top and bottom and the backdrop scenes are painted on a continuous strip which can be rolled up or down like a window shade. All the act-changing routines are rehearsed just as carefully as are the acts themselves. Even so, occasional collisions occur in the dark.

The Ice Follies and the other ice shows are always on the lookout for new talent. Salaries are somewhat higher than on the legitimate stage. Most of the performers are girls of from 18 to 20 years of age, chosen for their skating ability, beauty, figure and showmanship. At least four years of experience at figure skating are a requisite. New members of a group usually spend several months in rehearsal before they appear on the rink. Auditions for prospective skaters are conducted in each city in which performances are held.

This year the Ice Follies and the Icecapades are jointly sponsoring a new junior ice show, the Icecycles, as a talent farm for the parent shows. The Icecycles are barnstorming across country on routes not covered by the other shows. Including attendance figures of the Icecapades and Sonja Henie's troupe, about 7,000,000 people applaud the spectacles on ice every year.

## Big Business in Dudes

(Continued from page 146)

Today aluminum spurs are replacing the heavier steel spurs worn by many ranch riders. Aluminum bits, inlaid with silver, are replacing steel bits. Nylon lariats have appeared and many experts favor them because the springy stretch of the rope is easier on both horse and steer. Confirmed dudes who can afford it often buy fancy saddles for holiday use. A good western saddle, hand tooled and ornamented with silver, costs several hundred dollars.

As much as a quarter of a million dollars has been spent in building a luxurious guest ranch but others have been started at a cost of only a few thousands. Almost any ranch situated in a good scenic area can go into the business as a side line and make money at it. Construction need not be expensive but most vacationists prefer individual cabins and bathrooms. Reliable horses are necessary plus saddle handlers who also coach new riders and act as guides.

Vacationing dudes are reviving some of

(Continued to page 260)



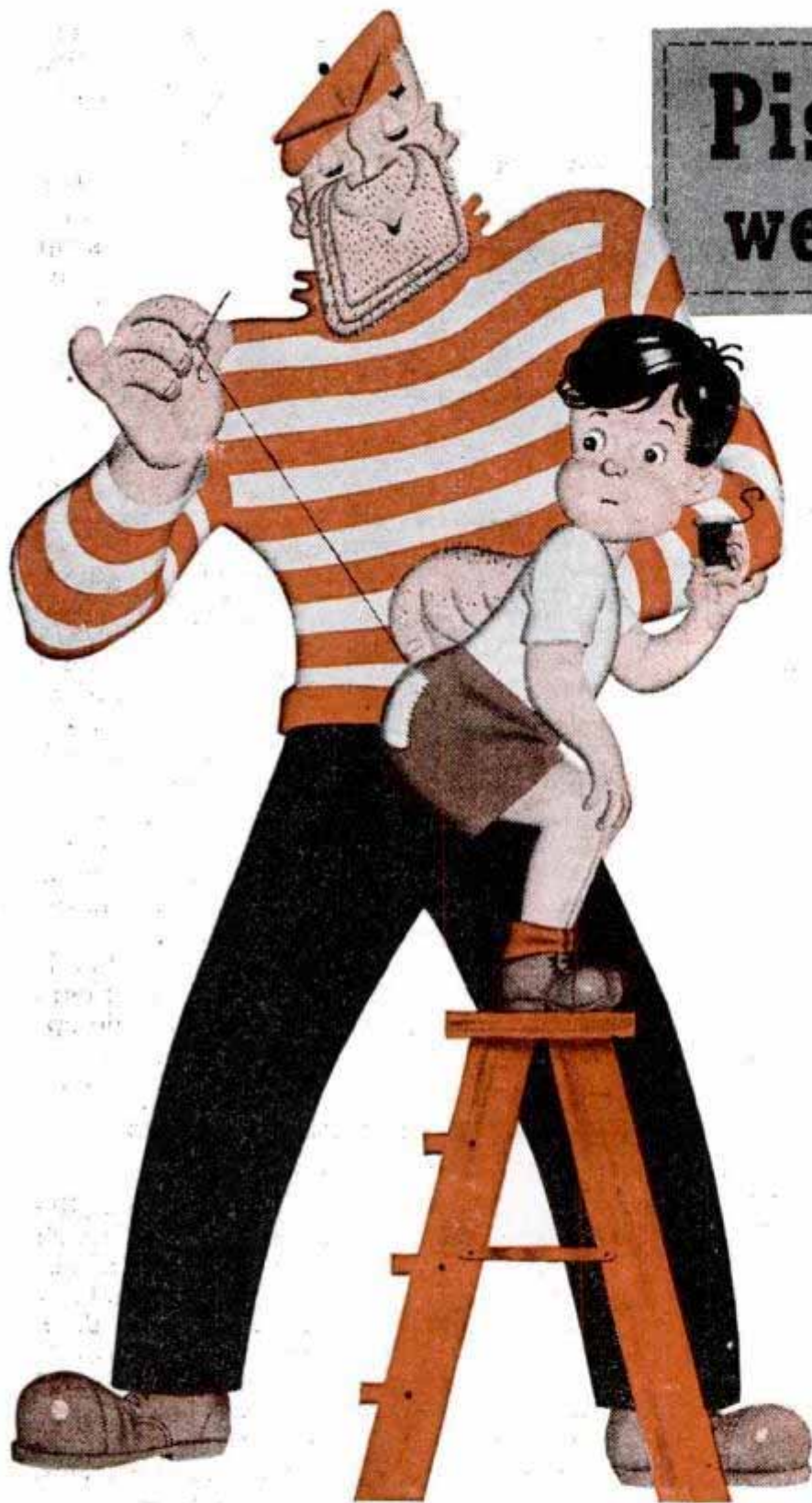

# Piston rings wear out, too

**P**iston rings are designed to "take" the wear . . . to protect your engine. When they wear out they waste oil, cause loss of power and lead to excessive cylinder wear. Fortunately, piston rings can be replaced—again and again—renewing engine protection—restoring engine performance.

So, when your car first begins to smoke, waste oil, or lose power, install Hastings Piston Rings at once. They *stop* oil-pumping, *check* cylinder wear, *restore* performance. It's the best money you can spend on your car.

HASTINGS MANUFACTURING COMPANY  
Hastings, Michigan • Hastings Ltd., Toronto

LISTEN TO: "I DEAL IN CRIME"  
SATURDAY NIGHTS • ABC

TOUGH BUT OH SO GENTLE



# HASTINGS

**STEEL-VENT PISTON RINGS**

TOUGH on oil-pumping  
GENTLE on Cylinder Walls



# SPEED LINER

REG. U.S. PAT. OFF.

Fishing Boats and Runabouts

## Your DREAM BOAT!

The boat you've dreamed of owning ... a SPEED LINER. And you have seven super models from which to choose ... for fishing, fun and family pleasure. Precision-built, streamlined design ... for attractive appearance, durability, maneuverability and seaworthiness.

Place your order with your dealer now to be assured of delivery in 1947. If no dealer near you, write us.



"TROPHY" MODEL

**GENERAL MARINE COMPANY**  
ST. JOSEPH 25, MISSOURI

# MEN WELCOME SIMPLER SHAVING!

*World's Most Modern Razor  
Wins New Friends Every Day*

Mystic, Conn., Mar. 2, 1947. Everywhere in America where it's been tried, the new simpler method of shaving is winning men over. The new Enders Razor gives the world's simplest shave!

Safer, swifter, smoother shaves are assured by the Enders with its amazingly simple construction. It's all one piece—no mechanics, no gadgets. All you do is click the blade in and shave! Furthermore it doesn't clog, it's easy to clean and it stays clean. Blades are sharp and long lasting—the razor is shaped to snuggle right into your hand. Just try it—you'll like it. If your nearby store doesn't have it yet, order direct from Durham-Enders Razor Corp., Dept. 103, Mystic, Conn.

**SPECIAL OFFER...RAZOR AND 5 BLADES...49¢**

Durham-Enders Razor Corp., Dept. 103, Mystic, Conn.

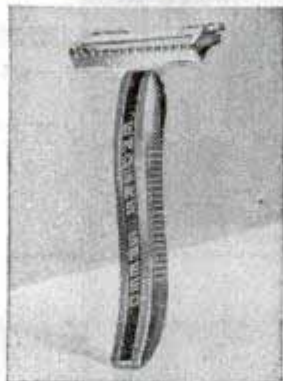

## SPECIAL HUNTER'S COMPASS

Hunting Case,  
Watch Type,  
All Metal,  
Jeweled Waltham

**\$1.95**

## SPORTSMEN'S GOGGLES

White Plastic Lens and Extra green Polarizing Lens. Plastic Lens are shatterproof, Polarizing Lens a protection against reflected glare, excessive light, dust and wind. Ideal for industrial use, Motoring, skiing and all kinds of outdoor use. Value \$3.50.

**SPECIAL \$1.50**

Engineers All Metal Army Type Hand-Sighting

## LEVELS

**\$2.00**

PRECISION  
QUALITY



**WHEATSTONE BRIDGES** Used in excellent condition. Mfg. by Thompson Lever Mfg. Co., Philadelphia. Value \$150.00. **SPECIAL \$49.50**

**PUBLIC SPORT SHOPS**

13 S. 16th St., Phila. 2, Pa.

No COD's

## TURNER

VT-73

### DESK MICROPHONE

Here's the mike you want for your rig. It's got looks, it's tough, and man, oh man how it performs. It's a TURNER! Ask your dealer or write for Free Literature on other low cost Turner Microphones.



THE TURNER COMPANY

921 17th St., N.E., Cedar Rapids, Iowa



TEMPLE PIPES with  
**GOO TRAP**  
and REMOVABLE PLUG FOR CLEANING

A patented pipe individually made with extra sturdy stem. Smokes dry and sweet—never hot.

U.S. PAT. #146000

**TEMPLE PIPECRAFTERS**  
Temple, Pennsylvania

SOLD ONLY BY MAIL

**\$2** POST PAID

CASH OR C. O. D. MONEY-BACK GUARANTEE

## 3 in 1 OTTAWA SAW

THE WORLD'S FASTEST.



**6-H. P.**  
EASY TO MOVE



**FELLS TREES,  
SAWS BIG LOGS, SMALL LOGS, LIMBS**

One motor performs all three operations. Furnished with or without attachments shown below. Thousands in use.

Make **BIG** profits in the ever increasing wood business. Pulley for belt work. Fully guaranteed. Low direct-to-user prices. **FREE** details—write **TODAY**.

**OTTAWA MFG. CO., 327 Pine St., Ottawa, Kansas**



Best for Reels..



..for Guns

## LUBRIPLATE

The universal white lubricant reduces friction and wear - Waterproof - Prevents rust - Stays put - Lasts longer

**20c** at your dealers

in U. S. A.

Ideal for the HOME WORKSHOP

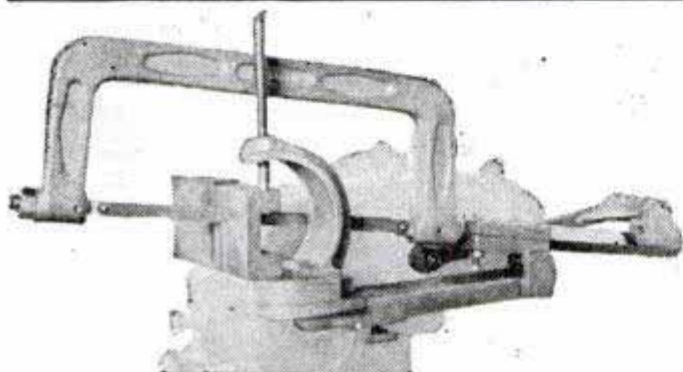

## LARRY POWER HACK SAW

A thoroughly tested, well designed attachment to fit the Lathe in your workshop. Saw will fit any small lathe such as Logan, Clausing, South Bend, or Atlas. The capacity of this saw is 4"x6" Length unlimited. Will cut steel, brass, etc. \$19.25 F.O.B. Factory. Send for free literature.

LARRY TOOL CO., OTTUMWA, IOWA

## WOOD WORKERS

### LUMBER - PLYWOOD AVAILABLE

Harold Hunt wants to send new No. 15 catalog. Over 148 pages of woodworking ideas. UNEQUALED BARGAINS in imported and American woods, supplies, hard-to-find hardware. Send only 15c to cover postage and handling.

CRAFTSMAN WOOD SERVICE CO.  
27295. Mary St., Dept. A-79, Chicago 8, Ill.

only  
**15c**



## MASTER CHAMPION LAWN MOWER SHARPENER

Also Mfg., Saw Sharpening  
& Key Machines

## FRANK'S MFG. CO.

Dept. PM9  
2501 E. Imperial Highway  
Los Angeles 2, Calif.

## IT'S EASY PICKING FROM A HUOT DRILL INDEX

A handy container for indexing and filing twist drills. All steel—ten sizes. Correct drill always at your fingertips.

SEND \$1 for No. 13 holds drills from 1/16" to 1/4" by 64s. (Or see dealer) Order Today.

HUOT MFG. CO.

Foot, Schultz Bldg., St. Paul 1, Minn.



# Repair Storm Windows

and Screens with

# PLASTIC WOOD

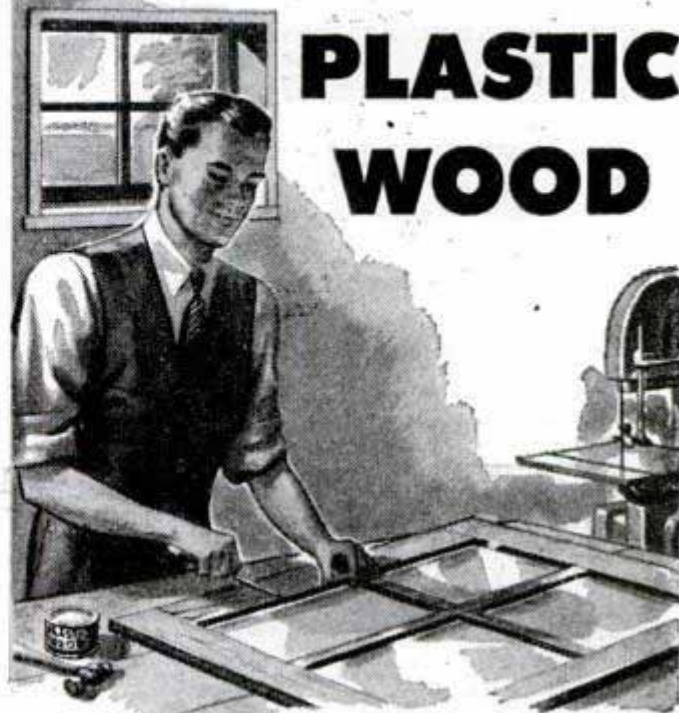

When making new screens, or replacing old rusted screen, apply thin layer of PLASTIC WOOD around frame after tacking down screen. This gives greater strength to the frame. PLASTIC WOOD can be easily shaped to match broken molding. Valuable in replacing rotted wood in storm windows.

... dozens of other uses

### FOR FILLING ...

- Cracks in floors
- Countersunk screws
- Chipped furniture
- Nail and screw holes

### FOR REPAIRING ...

- Loose tiles
- Loose casters
- Broken balusters
- Broken furniture

- PLASTIC WOOD SOLVENT is indispensable to the home workshop hobbyist for controlling the consistency of Plastic Wood and removing dried Plastic Wood from hands and tools.

T.M. Reg. U. S. Pat. Off.

At all Hardware,  
Paint and 10c Stores



# PLASTIC WOOD

Tube or Can

A CELLULOSE FIBRE FILLER





### HOW TO MAKE ANY CAR START QUICKER - RUN BETTER

Eliminating the leakage around intake valve guides steps up compression, improves combustion. The careful mechanic uses Burd Valve Packing. Installed on top of valve guides, it keeps oil in, crankcase vapors out, lubricates valve stems. Its soft tension spring does not hinder valve action. The next time the head is off your engine, put in Burd Valve Packing . . . get a lot of satisfaction for just a few extra dollars. Mail the coupon for two FREE booklets described below.

**BURD PISTON RING CO.**

Dept. PM • Rockford, Ill.



**BURD VALVE PACKING**



#### THIS COUPON BRINGS FREE BOOKS

BURD PISTON RING CO., DEPT. PM  
Rockford, Illinois

Gentlemen:

Please send me folder "Little Leaks That Run Into Big Money." Also, include FREE a copy of your "Serviceman's Handy Handbook."

Name.....

Address.....

City..... State.....



the West's ghost towns, too. These once flourishing mining communities were abandoned when the mines gave out. Situated in mountain areas, today they are next door to good fishing, hunting and hiking. Aspen, Colorado, 7800 feet high on the western slope of the Rockies, is one. In 1889, with four newspapers, streetcars and an opera house, Aspen was a silver boom town of 17,000. In 1893 the mines closed and only 700 persons stayed behind.

Today Aspen is booming again. Its old Jerome Hotel, "a model for comfort and convenience" 60 years ago, has reopened. The opera house has been restored. As much as possible the whole town is being renovated without excessive modernization. You can get to Aspen by highway or by the D. & R.G.W. Railroad which plans to carry passengers in old-fashioned coaches.

Within a 15-mile radius of Aspen are seven peaks more than 14,000 feet high as well as 13 fishing streams and more than a dozen lakes. A three-mile downhill ski run has been mapped out for winter use.

### Speeding the Ocean Freight Aboard

(Continued from page 179)

the hatches can be worked simultaneously.

But at the same time he must see that the turpentine is not stowed above the cotton, as the inevitable leaking barrel would ruin many bales, and that the cheese is not put in with the turpentine and automobiles.

In loading and unloading his ship, the master also must distribute his cargo properly to maintain the stability of his vessel. In a cargo vessel the position of the center of gravity depends very largely on the disposition of the cargo and ballast. If most of the weight is low in the hold, the center of gravity will be low, and stability assured.

For this reason the ship's master uses only light-weight goods for his "on-deck" cargo. Sometimes cargo shifts in the hold during a stormy voyage, and the ship which sailed in perfect transverse equilibrium will arrive with a pronounced list.

Toward the end of the war, the United States Lines conducted a stevedore school at Pier 59 in New York to teach young officers some of the "tricks of the trade" of cargo loading. A large scale model of a Liberty ship was used for the instruction.

The greatest progress in ship loading and unloading has been made on the Great Lakes in the handling of bulk ore, grain and coal. Using mechanized equipment on the piers, the modern bulk ore ship, carry-

(Continued to page 264)



# MIRACULOUS OPTICAL GYROSCOPE!

The Famous Mark 18 Gyro-sight...

New—Ready to Run—For Only \$12<sup>95</sup>!

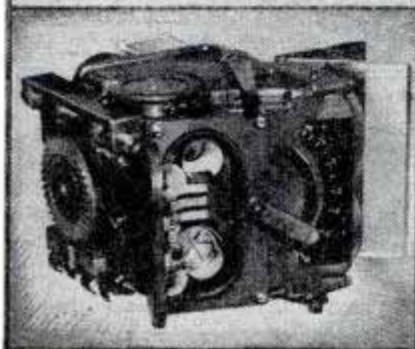
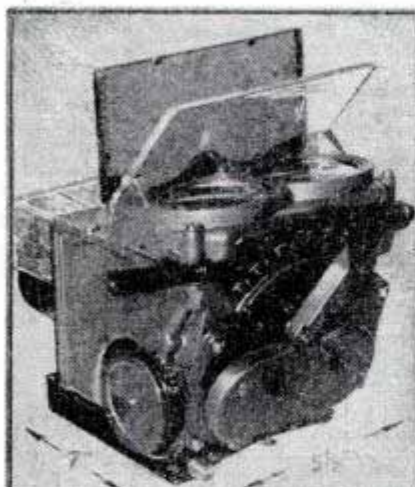

THIS magnificent precision instrument is a triumph of Applied Physics. Its breathtaking ingenuity fascinates every engineer who sees it. **IT WORKS!** Operate this inspired aircraft gunsight that measures and computes automatically—see how sheer designing genius made gear-trains and amplifiers unnecessary. **GYRO UNIT COMES OUT** easily with all wires intact. Remove it and see how tiny ball-bearing motor's clever governor maintains constant speed from 14-22 V. **at only 1/10 amp.** AC or DC (no 3-phase or 400 - stuff!) You'll marvel at the precision-balanced gyro, its beautiful yoke and special bearings. Demonstrate how **GYRO MAINTAINS FIXED POSITION IN SPACE**, and this one has a hand figured *spinning mirror* supporting a perfect optical image at full speed! Energizing 6 electromagnets with DC will show erection rate or compute lead and deflections.

Light up the twin projection systems and see both images fuse into one. One fixed, one moving and variable, demonstrate *virtual* images **TWO SUPERB ACHROMATS** in threaded brass cells, cemented doublets, 2" dia, 7/4 e.f.l. *tested perfect for telescope objectives!* (Unusual—see instructions.) 3 Precision first surface flats, aluminized, one 2 1/4" x 4 1/4". Reflecting glass, sun filter. Two 22v. lamps in door, changeable if another voltage is desired, no rewiring. Two reticles, glass enclosed. Stainless gears. **PLASTIC GEL CELL DEHYDRATOR** with tell-tale colored silica gel. Die-cast aluminum case **HERMETICALLY SEALED**. 24" cable, 10 coded wires. Detailed instruction sheets. Detachable recoil shock base, 25-leaf spring, bronze slide on **PRECISION STAINLESS** ground rods, azimuth clamp, bolted to wood shipping base. Elegant padded cover for complete unit—brand new, original package. Cost Navy hundreds of dollars. **What a Buy at Only \$12.95.** Send check or money order, no C.O.D.'s. Ship. wt. 13 lbs. Express Collect.

**COLUMBO TRADING CO., Inc.**

304 Canal Street, New York 13, N. Y.

25 years on Canal St.—Five Floors of bargain values.

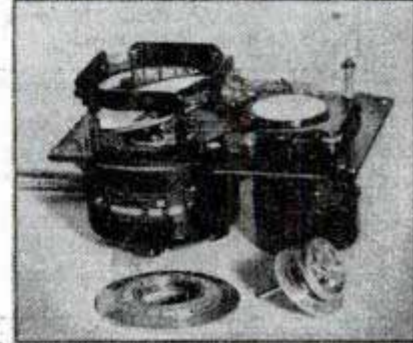
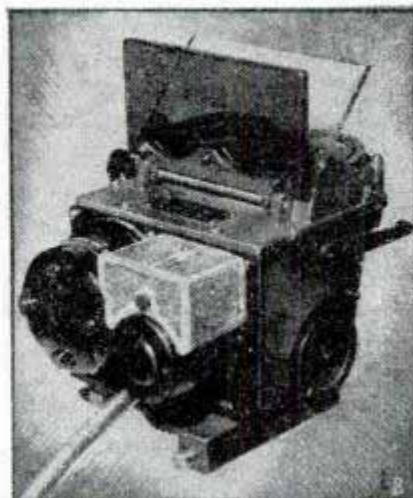

Sand Casting—Forging—Heat Treating—Case Hardening

## BRONZE FOUNDRY



is again available in limited quantity without priority. Orders filled in sequence as received. **INVENTORS—SCHOOLS—CRAFTSMEN** use **FOUNDRYETTE** for making castings quickly for new inventions, for instruction, and general purpose. Order now for early delivery. Three sizes are available capable of making bronze castings of 1 1/2, 3, and 6 pounds weight, aluminum, copper, brass, etc. Domestic gas supply and 110 volt AC or DC energy required for operation.

Write for circular.

**KANSAS CITY SPECIALTIES CO.**

Box 6022, Dept. P-76

Kansas City, Mo.

**FINE TOOLS  
NEED  
FINE OIL!**



• Lubricates



• Prevents Rust

• Cleans • Polishes

SOLD EVERYWHERE

**3-IN-ONE Oil**

MARCH 1947



Have  
YOUR OWN  
Business

**SAW FILING**

You can have a good, steady, cash business of your own reconditioning saws with the Foley Automatic Saw Filer, which makes old saws cut like new again. The Foley is the **ONLY** machine that files all hand saws, also band and circular saws. Easy to operate—no eyestrain.

**SEND FOR FREE PLAN**—shows how to start in spare time—no canvassing. Send coupon today—no salesman will call.

**FOLEY Automatic SAW FILER**

**FOLEY MANUFACTURING CO.**

316-7 Foley Bldg., Minneapolis 13, Minnesota

Send Free Plan on Saw Filing business, no obligation

Name \_\_\_\_\_

Address \_\_\_\_\_





# PRACTO

## U-BUILD-EM SETS

Life-size everyday utility vehicles for boys who love to make things with their own hands. NOT A TOY! ALL FULL SIZE, dependable, sturdy!

### U-BUILD-EM WHEELBARROW

9" steel-welded wheel . . . rubber tires. ALL METAL PARTS — you supply wood.

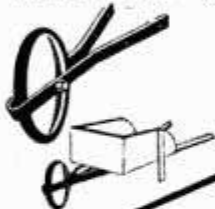

No. 68 Ball Bearings — \$3.50

### EXPRESS CART



COMPLETE metal parts, 9" steel welded, rubber tire wheels, 500 lb. capacity. You supply the wood.



No. 98 Ball Bearings — \$11.00

Build Practo Vehicles for resale! SPECIAL DISCOUNT for 6 units or more. Write now!

# PRACTO

U-BUILD-EM SETS also available:  
**BIKE TRAILER**  
 No. 88 — \$8.00\*  
**SPEEDMOBILE**  
 No. 10 Tru-Bearings \$8.50  
 No. 10B Ball Bearings \$10.50

It may be difficult to get these sets at your dealer. SEND CHECK or MONEY ORDER and order direct. Sent express prepaid.

**INTERNATIONAL MFG. CO.**  
 712 Beacon St., Boston 15, Mass.  
 Reference: National Shawmut Bank, Boston.

## GREAT NEW TOOL!

The world-famous Mead Bandsander is ideal for home workshop use! This remarkable machine quickly shapes, sands, carves and polishes wood, metal, plastics! Works equally well on inside cutout openings or irregular outside edges. Gets at places no other can! Tilting table for bevelling, chamfering. Rust-and-sweat proof top. Ball bearings. Saves time, labor, money on jobs in any home or industrial shop. **INVALUABLE** to home-craftsmen, makers of patterns, tools, dies, signs, costume jewelry, castings, forgings, ornaments, radio and electrical parts, stampings, etc. Nothing else like it. Sold on 5 Day Trial, money back guarantee. Circular Free! Cuts Fast and Clean . . . Saves Filing, Sanding Work.



Shows use on inside cut-out openings

# Mead Bandsander

**THE MACHINE THAT AMAZED THE EXPERTS!**



WRITE for FREE Circular  
 Send for free details on "the machine that amazed the experts!" Rush a post-card today for Circular, surprisingly low price. Hurry!  
**MEAD SPECIALTIES CO.**  
 4114 N. Knox Ave., Dept. 137, Chicago 41, Ill.

## SMALL EFFICIENT SPEED REDUCER



**\$18.56**

NET — POSTPAID

Just the thing for the Home Work Shop, Hobby Shop, Bench Work, Animated Displays, Light Production work. Used daily in thousands of homes and shops. Sturdy, compact, (see dimensions). Case of heat treated aluminum. Gears, SAE 65 (British) Gear Bronze. Worm of case hardened steel. Timken Bearings throughout. Torque capacity 100 inch pounds. Available in 4 different assemblies (shown below) and in these standard ratios:

4-1	25-1	64-1	200-1
8-1	30-1	75-1	300-1
10-1	40-1	80-1	400-1
16-1	50-1	100-1	600-1
20-1	60-1	150-1	800-1

When ordering be sure to specify assembly and ratio required. Shipping weight in carton, 8 lbs. Full money back guarantee. Prompt deliveries.

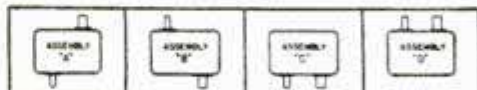

## THE OHIO GEAR CO.

1403 EAST 179th ST. • CLEVELAND 10, OHIO

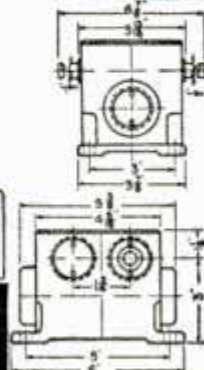

## TALK-SING thru your own radio with RADIO MICROPHONE

Be the life of the party. Put on your own broadcasts at home. Talk-Sing make announcements from any room. Wonderful voice practice. Microphone easily attached to any radio. Follow enclosed instructions. SEND NO MONEY—pay postman \$1.98 plus postage. Send Money Order or check and save postage.



**EMPIRE RADIO & TELEVISION CO.** (Dept. R2) 1521 Bedford Ave. Brooklyn 16, N. Y.

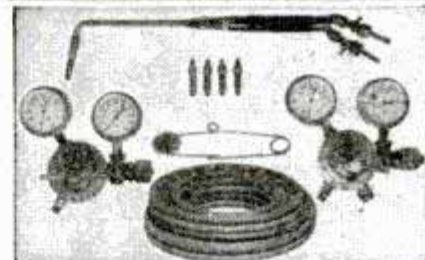

## New Welding Outfit

Complete like picture  
**\$54.50**

Electric Welding Outfits from \$39.00 up. (Welders Manual \$1.75) 400 pages.

**EAGLE WELDING EQUIP. CO.**  
 Dept. 40  
 5085 Broadway, Chicago

## New Designs in FRANZITE GRIPS

### Modernize Your Gun! Improve Your Score!

Most durable grips made. Positively unbreakable! For Colt, Smith & Wesson, Hi-Standard, Ortgies, Luger & Mausers in a wide choice of beautiful designs in ivory, pearl, walnut, onyx, etc. Low prices. FREE CATALOG. Dealers Wanted.

**SPORTS, INC., (Mfrs.) 5501 Broadway, Dept. P-3, Chicago 40, Ill.**

## METALLIZE BABY SHOES

Learn this easy, money making business from nationally recognized consultant. Small investment; perpetual market. For free details write Joseph B. Kushner, B.S. Ch.E., Metal Finishing Consultant, Stroudsburg, Pennsylvania, RD3W.

## NEW CHEAP OIL BURNER

FOR COOKING & HEATING STOVES-FURNACES  
 HEAT YOUR HOME, COOK YOUR MEALS WITH CHEAP FURNACE OIL



NO MORE SHOVELING COAL OR ASHES. A New Fuelizer Starter Vaporizing System turns Cheap 130 Flash Furnace Oil, Distillate, Kerosene etc. into Oil Gas heat without clogging up. LIFETIME GUARANTEE against defects. \$1.00 Bonus Offer for Testing. We will let you try it in your own stove or furnace for one month. Get yours for introducing. Big Profits QUICK. Be first. Send in your name TODAY.



**NORTHWEST MFG. CO., 567-C 5th. Mitchell, So. Dakota**



**MORE PROFITS**

with

**MODERN LAWN MOWER SHARPENER**



**S**HARPEN ANY LAWN MOWER from 5-inch Edger to 36-inch Power Mower in ten to twenty minutes with a MODERN LAWN MOWER SHARPENER because dismantling is unnecessary — neither handle, roller, wheels nor motor need be removed when sharpening any mower. . . . the MODERN SHARPENER eliminates all hand filing; its precision grinds to the extreme ends of both left or right blades. Bottom knife is held in same brackets for sharpening. NO EXTRA ATTACHMENTS! Order today! Price \$241.50 (less motor) f.o.b. Pasadena. (1/3 or 1/4 H.P. single phase motor recommended.)

Modern Mfg. Co., 156 N. Fair Oaks, Pasadena 1, Calif.

*Do a Better Job*

**WITH ONE OF THESE EMPIRE LEVELS**

**EMPIRE TORPEDO LEVEL**  
Smallest, most handy and accurate Level made. "Cigar-shaped" — no sharp corners to tear pocket. Aluminum stock. Only 3 oz. wgt. 9" long. Has Level, Plumb, 45° Vials.  
No. 26 .....\$1.75



**ALUMINUM LEVEL — No. 151**

Cast and Machined, a Beautiful Tool, with Patented, Removable Level and Vial.  
With 2 Plumb, 2 Levels, 2 — 45° Vials. 18" .....\$6.00  
24" .....\$6.00 28" .....\$7.00

Order EMPIRE LEVELS from your local dealer.  
Write direct for literature.

**EMPIRE LEVEL MFG. CO.**

717 S. 6th St. Dept. P-245 Milwaukee 4, Wis.

**BE YOUR OWN BOSS**

Men and women make up to \$100.00 or more a week! Design and fit corrective arch supports by the time-tested Stephenson Method. A profitable, full or part-time, profession. Train at home; pay as you go. No costly equipment to buy. No capital needed. Send for FREE booklet today.

STEPHENSON METHOD, 5-28 Irvington St., Boston, Mass.

**TRAILER AXLES, HITCHES, AND PARTS**

• If you are interested in purchasing trailer axles, hitches, and other trailer parts, contact us promptly. Write for free literature.



HAMMER BLOW TOOL COMPANY, Dept. 115, WAUSAU, WIS.

**Big Money for Workers In Home or Shop**



Licensed Concrete Specialists wanted. No experience needed. Make Colortized concrete pottery without molds. New, low cost, patented method. Cemetery products, novelties, tiles, etc. Basement leaksealing. Other big pay projects. Booklet, details free. Men only.

NATIONAL POTTERIES COMPANY  
542 Lincoln Avenue Fergus Falls, Minnesota

**WORKSHOP WISDOM**

**Laminating waste stock for turning**

**M**AKE use of your waste stock by laminating scrap pieces with CASCAMITE, because it's strong, stain-free, and highly water-resistant.

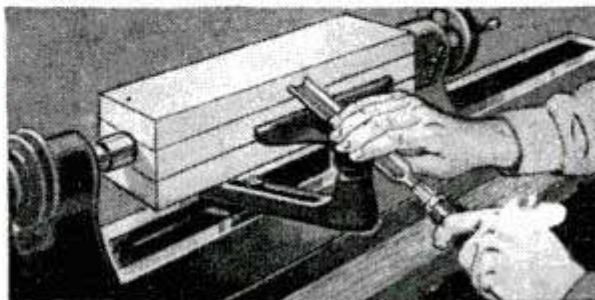

**To laminate waste stock**

Choose pieces of stock to roughly approximate finished size and shape. Plane surfaces to be glued so that they are perfectly smooth. Spread a thin film of CASCAMITE on the surfaces to be glued. Clamp and let set (at 70°F. or warmer) until glue is hard.

CASCAMITE is also recommended for laminating stock for table and chair legs, banisters, deep wooden bowls—wherever large dimensions discourage use of solid stock.

**A "cinch" you'll prefer—CASCAMITE**

**Easy to mix.** Just add CASCAMITE to cold water and stir.

**Strong.** CASCAMITE forms a bond stronger than the wood itself.

**Thrifty tool!** Mix CASCAMITE as you need it. No waste.

Get CASCAMITE urea-resin glue—and CASCO, the standard casein household repair glue, at your hardware store in 10¢, 25¢, and larger sizes. For outdoor and boat work, use CASCOPHEN the new, completely durable, waterproof resorcinol-resin glue.

FREE GLUING GUIDE containing complete gluing directions plus helpful hints for household repairs. Free on request. Address a post card to Casein Company of America, Dept. PM37, 350 Madison Avenue, New York 17, N. Y.



**CASCAMITE**

**Dry Powder Urea Resin Glue**





## PROTECT YOUR ENGINE!

Prevent overheating the **WHIZ** way!

Burned out bearings, warped valves, blown gaskets, frozen rings—*this, so often, is the toll of overheating!* But cooling system trouble won't trouble *you*, if you use WHIZ cooling system chemicals.

Among the many WHIZ favorites are these popular cooling system products: KLEEN FLUSH to clean out the rust, scale, corrosion, and sludge that clog the system and cause overheating...COMMANDORUSTPREVENTIVE to guard against the formation of new deposits and to lubricate sealed water pumps . . . INSTANT SEALER to quickly stop all leaks.

*Keep your car, truck, or tractor out of trouble!* Have your cooling system serviced the WHIZ way *now!* You'll find WHIZ products at your service station, garage, or implement dealer

—in fact, wherever automotive products are sold.  
R. M. Hollingshead Corp.,  
Camden, N. J.; Toronto, Can.



PRODUCTS OF

*Hollingshead*

LEADER IN MAINTENANCE CHEMICALS

ing 16,000 tons, can be loaded in eight hours or less. Performances like this have made the bulk cargo handling operations on the Great Lakes one of the miracles of water transportation.

But the methods used on the Great Lakes in handling bulk cargo cannot be applied to ocean-going vessels which handle a variety of packages, boxes and bags, and which stop at ports which often have no modern unloading facilities. For this reason, considerable thought has been given to the improvement of conventional deck gear.

High-speed electric winches have become standard for ships built under the government's long-range program. Some are equipped with 7½ and 10-ton booms in place of the customary 5-ton booms.

Among the many proposals for lowering the cost of cargo handling is the adoption of the container idea used by the railroads. The cargo, packed in wood or metal containers of identical size, would be carried in a ship with holds designed to stow the containers economically. Upon arrival at the foreign port, the containers could be lifted out more easily than uncrated cargo.

A shipbuilding company has prepared sketch plans of a proposed container ship for use on the Great Lakes, and a transportation company is considering a proposal to build three ships of the design outlined. Another company is giving the container stowage idea a trial in service.

Although the Sea Hawk experiments have already resulted in the design of a still newer type of crane gear, which is now being built, the ultimate solution to the handling of miscellaneous cargo has not yet been found. The ideal system will load and unload the vessel with greater dispatch at less cost and with reduced damage.

## Newest Wonder of the World

(Continued from page 130)

lion miles, the distance that light travels in a year. The Palomar telescope, with four times the light-gathering capacity of the Mount Wilson instrument, will have a range of one billion light years and will cover eight times the volume of space that can be probed by the 100-inch instrument.

For the first time astronomers will have a telescope so powerful that some nearby stars such as Betelgeuse and Antares could be viewed as disks of light instead of pin-points if it were not for the diffusion created by our own atmosphere. Within range of the new telescope, it is thought, will be some 10 billion star systems, each the size of our own Milky Way and each probably containing several million stars as large or many times larger than our own sun.



**"SCOOT" Away  
to Work or Play!**  
*Cushman*  
MOTOR SCOOTER

On highways, in town, on the farm, at the factory, for deliveries, service calls... go the Cushman modern and economical way.



Cushman Motor Scooters are speedy, safe. Park anywhere. "Eye-dropper" gas economy. Ruggedly built with automatic clutch, two-speed transmission on most models, 4 H.P. Cushman "Husky" engine. Balloon tires and knee-action springing give easy riding, load carrying capacity. Convenient luggage compartment. Nationwide service. **CUSHMAN MOTOR WORKS, INC.** Dept. M-300 Lincoln, Nebr.

**35**  
MILES PER HOUR  
**75**  
MILES PER GALLON  
**FREE**

Send for literature and name of your nearest Cushman dealer. Write postcard today.

**Backed by 45 Years of Quality Engine Building**



**TINY TIM \$14.95**

COMPLETE WITH BOILER AND BASE  
Single cylinder Oscillating Steam Engine. A rugged high-speed precision-built engine made of highest quality material. Equipped with safety valve, throttle control and two fly wheels. Base 7" x 4". Boiler height 7 1/2". Satisfaction or money back guarantee. Order now. Supply limited. Cash orders prepaid or C.O.D.

**THE THOMPSON ENGINEERING CO.**  
405 Winchester Bldg., Grand Rapids 2, Mich.

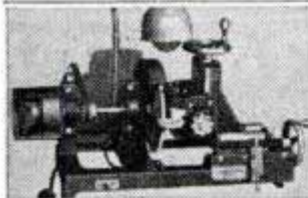

Start a NEW BUSINESS

**Sharpen Dull  
Pipe Wrenches**

Industries save hundreds of dollars. Some "wrench shops" make \$50 a day.

Write for information.

**J. C. MOORE INDUSTRIES** P. O. BOX 234  
FREDONIA, PA.



**POWERFUL BINOCULARS** only \$6<sup>95</sup>

All metal type with adjustable focusing wheel. Enjoy indoor, outdoor shows, sporting events, etc. Plated draw tubes extend for sharp instant focusing on distant objects. Low price includes handsome Carrying Case and long adjustable Shoulder Strap. SEND NO MONEY. Clip ad and mail. We'll ship COD for \$6.95 plus tax and postage charges. Address:

**ILLINOIS MERCHANDISE MART** Dept. 2216, 1227 Loyola Ave. Chicago 26, Ill.



**ONE-PACKAGE  
Home Comfort  
AT LOW INVESTMENT**



SEE SCHULT AT THE SHOW!  
Attend National Trailer Coach Show,  
Navy Pier, Chicago, March 15 to 23

● A SCHULT Trailer Coach, available *right now*, offers you every facility of a 3-room home in one modestly-priced package! You get well heated, well insulated mobile housing, ingeniously designed furniture, and a kitchen equipped with refrigerator, oven range and double sink.

Luxuriously furnished and decorated, the Luxury Liner (3 separate rooms) sleeps four

in comfort... provides ample wardrobe, drawer, and closet space... has toilet room or vanity with built-in lavatory. (Optional.)

FULL VALUE, for years of living or travel!—Every Schult is built to quality standards by a pioneer of the industry. See... compare... Write today for dealer's name; we'll send the latest Schult catalog, too.



**SCHULT CORPORATION**  
DEPT. 3203 • ELKHART, INDIANA  
In Canada, John Inglis Co., Ltd., Toronto

**SCHULT Trailer Coaches**

SAY YOU SAW IT IN POPULAR MECHANICS

**SPEEDGRIP**

**JUST FLIP YOUR THUMB  
AND THE JAW IS SET!**

Simple one-hand operation makes "SPEEDGRIP AUTOMATIC" ideal for every mechanic's tool box, for every motorist's car. Wrench has 1 5/16" jaw opening, 8" length. SAE 1045 steel, precision tooled, heat treated, and Rockwell tested. Order from your dealer or direct. No C.O.D. Agents wanted.

Manufactured by

**POLARIS ★ PRODUCTS, INC.**

**AUTOMATIC WRENCH**

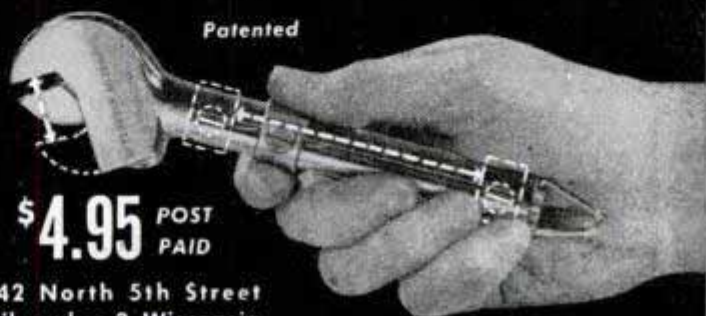

**\$4.95** POST PAID

642 North 5th Street  
Milwaukee 3, Wisconsin



## NEW-ALL QUICK CHANGE GEAR BOX

Increases Production up to 1000%

NEW IMPROVED MODEL!

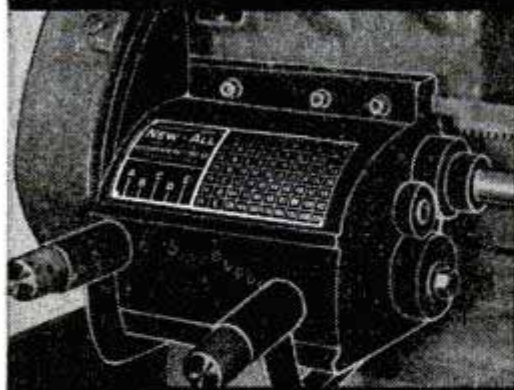

PAYS  
FOR  
ITSELF  
in  
30  
DAYS!

30-DAY Money-Back Guarantee!

### Drastically Cuts LABOR COSTS!

NO TIME LOST FINDING GEARS! Inexperienced workmen easily produce top output. Easy to install. You simply drill and tap four holes.

**Guaranteed Accuracy!**

IS GUARANTEED TO CUT ACCURATE THREADS from 4 to 224 per inch with approximately 3/1000 lead for fine turning. It safeguards entire production in process throughout the complete operation.

**Precision Constructed**

PRECISION CONSTRUCTED THROUGHOUT with gears of quality hobbled steel. Gear Box housing is made of high grade aluminum alloy casting—with replaceable bronze bearings.

NEW LOW PRICE . . . \$89.50 F.O.B. Los Angeles

For ATLAS, CRAFTSMAN, LOGAN, POWERKRAFT and SOUTH BEND 9-in., B & C.—Use Your Own Lead Screw.

Write Div. PM-1

WESTERN AIRCRAFT TOOL CO.  
2505 North Ontario St., Burbank, Calif., Charleston 6-7750

## ROTO-ETTE

REG. U.S. PAT. OFF.

THE ALL-PURPOSE  
POWER GARDENER

ROTARY TILLAGE PLUS



Makes  
Work  
Fun!



For HOME OWNERS and SMALL-ACREAGE GROWERS. Turns back-breaking, outdoor jobs into healthy enjoyment. A new, vastly better machine—product of 17 years' experience manufacturing outstanding tillage machinery.

As tiller for seed bed preparation or cultivating; by far the most efficient we've ever built! As a lawn mower; equal to the best, superior to most. Rigged for hauling; a 10-year-old can easily handle loads up to 400 lbs. Conversion to a wide variety of other outdoor uses a matter of minutes.

Write Dept. N for Folder

ROTOTILLER, INC. TROY, N.Y.

## READYCUT HOMES

Order Now

Homes \$1365.00 and up, freight paid. Orders filled in order received. Save \$500 at least on modern production compared with builders' prices. Anyone can assemble with simple plans furnished. Complete, including paint, hardware, roofing, glass, nails, etc. Send 35c in coin for full color catalogue showing 57 modern low-priced homes and floor plans. Complete building plans ready for filing at low cost. Sold separately if desired.



NEW COLOR CATALOG FOR ONLY

Dept. PM-37  
INTERNATIONAL MILL & TIMBER CO. 35c  
Bay City, Mich.

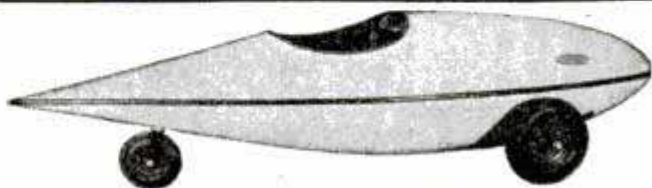

### AUTOPLANE

New — Streamlined — Low Cost  
Airplane Type Control — Automatic Clutch

BUILD IT YOURSELF!

Speed—15 to 50 MPH depending on motor size. Over 10 feet long. Most parts standard and available at any accessory store. You will be amazed at low cost and simplicity of constructing one of these cars from our detailed plans. Finished product can look like factory job.

Elaborately detailed booklet containing photos, numerous drawings and materials itemized postpaid \$2.00

AUTOPLANE DISTRIBUTORS, MANSFIELD, OHIO

## REFRIGERATION and AIR CONDITIONING



Train where the Army trained. Learn at home or in our big shops. Expert instructors—real machines. Easy to learn. Write for big FREE catalog today. No obligation. COMMERCIAL TRADES INSTITUTE, 1400 W. Greenleaf (Dept. X23), Chicago 26, Ill.



VETERANS ASK FOR GI PLAN

## LAW

STUDY AT HOME for PERSONAL SUCCESS and LARGER EARNINGS. 38 years expert instruction—over 108,000 students enrolled. LL.B. Degree awarded. All texts furnished. Easy payments. Send for FREE BOOK—"Law and Executive Guidance."

AMERICAN EXTENSION SCHOOL OF LAW  
Dept. 75-M, 646 N. Michigan Ave., Chicago 11, Ill.

SAY YOU SAW IT IN POPULAR MECHANICS

NOW 93% MORE ENERGY, LONGER LIFE

Get the New "Eveready" Flashlight Batteries

The word "Eveready" is a registered trade-mark of National Carbon Co., Inc.



### The GLENWOOD MEMORIAL

Freight Paid Anywhere in U.S.A.

In all its beauty and durability is pictured in our free catalog of genuine Marble and Granite. Write for yours today.

U. S. MARBLE & GRANITE CO., A-18, Oneco, Fla.

## FREE Bikini Crossroads Patch



Send only \$1.00 for our beautiful selection of 20 different Flight Squadron and Shoulder Insignia and receive the HAIRE BIKINI BOMBER leatherette breast patch absolutely FREE. Tremendous value. Colored insignia book with your order at no cost. Send to-day. Offer limited.

THE INSIGNIA MART, Dept. F. F.  
703 Broadway, New York 3, N. Y.





# MOTO-SCOOT

Welded tubular frame and body; Timken bearings; Lauson or Briggs engines optional. Firestone or Goodyear tires. Speeds to 40 miles an hour; up to 80 miles per gallon.

You will find years of reliable service in the New 1947 Lightweight Moto-Scoots. See your dealer—if no dealer available, write or wire direct.

**AMERICAN MOTO-SCOOT CO., DEPT. 3PM**  
1305-23 W. Carroll Ave. Chicago 7, Ill.



## HOLD-E-ZEE

**AUTOMATIC GRIP  
SCREW-DRIVERS**

**UNSURPASSED  
QUALITY**  
Plus the  
**EXCLUSIVE GRIPPER**



Gripper slides up out of way when not in use. Insulating handles. Complete range of sizes. **AT LEADING DEALERS EVERYWHERE**

UPSON BROS., INC., 86 EXCHANGE ST., ROCHESTER 4, N. Y.

MODERNIZE YOUR GARDEN TOOLS WITH

## TUG-O-WHEEL COMPLETE GARDENING OUTFIT

Does away with slow, back-breaking spading. Ideal equipment for vegetable gardens. Improved all steel Gardening Outfit plows 5" deep, marks, hills and cultivates rows 12" to 36" wide. Fast, efficient, easy to use. Cultivator and many other practical attachments.



Patented. Thousands of satisfied users. Material and workmanship fully guaranteed. Write today for information.  
**TUG-O-WHEEL HAND PLOW CO.**  
Dept. P Ballston Spa, New York

## Cut NEW TEETH in 3 Min.

With **FOLEY RETOOTHER**

**For All  
HAND SAWS**

Cuts 20 sizes of teeth from 4 to 16 points per inch. Immediate delivery



No need to grind off old teeth—cut new ones over them. Fast, accurate, no eye-strain. Cuts filing time in half.

**FOLEY MFG. CO.**  
390-7 Foley Bldg., Minneapolis 13, Minn.  
Send full details on Foley Retoother.

Name.....  
Address.....



## Cracks Around the Tub?

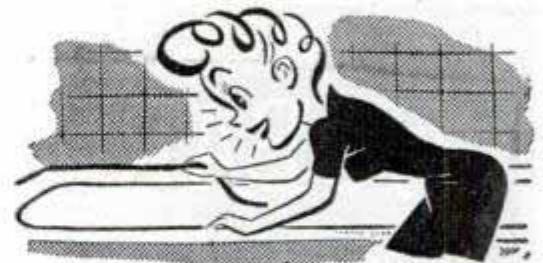

Fix it with *Mortite*

a household friend

Pliable Mortite fills cracks around tubs, sinks, baseboards, etc. Fine for caulking, an ideal weather-stripping, stops rattles, keeps out dirt, insects. Never shrinks or cracks. Easy to apply—just press into place. Roll covers about 80 ft. At Hdwe., Dept. Stores, Lum-**\$1.25** beryards.

Higher west of Rockies & Canada

Write for free booklet.



**J. W. MORTELL CO., 522 Burch St., Kankakee, Ill.**

A \$3.00 VALUE

FOR ONLY \$1.00



**SPECIAL  
Introductory  
OFFER**

**6**

**LIBERAL  
JARS**

DIFFERENT GRADES

Ultra-fine quality abrasive compounds. Grades suited to variety of metal finishing. Carton carries service recommendations.

**\$1.00  
ONLY  
POST  
PAID**

ALL THESE  
*Uses*

**SHARPENING  
LAPPING IN  
GRINDING  
CLEANING  
BUFFING  
POLISHING**

**HOME WORKSHOP FANS, MODEL BUILDERS, MECHANICS—You'll find plenty of use for this valuable kit. Contains six generous jars of compounds—all fine grit sizes best suited to a variety of precision work. Money back guarantee.**

**SPECIAL TRIAL OFFER \$1.00**

U. S. Products Co.  
518 Melwood St., Pittsburgh, Pa.  
Please send me postpaid your kit containing six different grades of abrasive compounds. I enclose \$1.00. (No C.O.D.'S. accepted). My money will be refunded if kit is returned within 10 days.

NAME.....  
ADDRESS.....  
CITY..... STATE.....

Pin a \$1.00 bill to this **COUPON MAIL TODAY**



Make  
big money...  
— start a business  
of your own with a



# HOBART

## multi-range arc welder



Electric Stationary

### Start Your Own Business!

Be your own boss, get into the big money! Start your own job welding shop — minimum investment. Hobart offers 1,000 welding combinations with Multi-Range control for better welds — Remote Control speeds up work — makes you more prof-

It from repair and construction work to be found everywhere.

### "Build Your Own"

Save hundreds of dollars, build your own gasoline drive Hobart Arc Welder. Need only a Hobart generator, used auto engine and chassis. Free booklet tells you how. Write for details.



### The Hobart Welding School

It's a modern trade school in which students learn by doing. Expert instructors give individual attention. Each student has own welding booth and welder. Fully accredited under G. I. Bill. Send coupon for details.

"Build Your Own"



**HOBART BROTHERS COMPANY**  
Box M37, Troy, Ohio

Electric Portable



*Hobart*

"One of the World's Largest Builders of arc welders"



**HOBART BROTHERS CO., Box M37, TROY, OHIO**

I'm interested in the profit making possibilities of Hobart Arc Welders. Send me details on items checked.

- |  |   |
|--|---|
| <input type="checkbox"/> "Build Your Own"      | <input type="checkbox"/> Gas Engine Drive |
| <input type="checkbox"/> Electric Drive        | <input type="checkbox"/> A. C. Welder     |
| <input type="checkbox"/> Hobart Welding School |   |

NAME \_\_\_\_\_

ADDRESS \_\_\_\_\_

## Power for the Air Age

(Continued from page 139)

is simplicity of construction and operation. The turbo unit has only a compressor, combustion chamber and turbine. Air is sucked in at the front end of the compressor, compressed and forced into the combustion chamber, where it is mixed with fuel and burned. The heated air expands and is directed in a stream against the turbine buckets, causing both turbine and compressor, on the same shaft, to revolve. This forces more air into the combustion chamber, speeding up the constant cycle. The difference between the power required to run the turbine and that developed in the chamber is the thrust power that actually drives a jet plane forward.

Along with the 10,000-horsepower engine it brings into sight, the jet boasts several other important advantages. It approximately halves the piston's one pound per horsepower weight and utilizes any hydrocarbon that will burn, including inexpensive kerosene, coal or hair oil. Initial and maintenance costs are lower, noise and vibration less and pilot operation is simpler.

The jets operate most effectively and economically at high speeds, between 90 and 100 percent of full power, while the piston begins to operate less economically above 50 to 60 percent full power. A complete jet engine transfer has been made in 14 minutes, about twice as fast as their piston competitor's best time.

On the debit side, jets have an extravagant rate of fuel consumption under 500 miles an hour. One possibility for extra thrust is a water-ethyl-alcohol injection into the combustion chamber. Any fuel cut promises sizable gains in performance and pay load, particularly in long flights, and is of prime importance in both commercial and military aviation.

Even very slight improvements in compressor or turbine efficiency will appreciably boost net power output and cut travel time. In some instances compressors now use about two thirds or more of the power generated, leaving only a minor fraction for the all-important thrust.

Another jet drawback is the short life of turbines, subjected to heats well above 1200 degrees Fahrenheit. Chrome-nickel-cobalt alloys appear to be the most satisfactory replacement for the materials now used. Ceramic materials are also undergoing intensive trials and silver magnesium solder is regarded as another possible solution. Ways will also have to be found to screen foreign material from entering the compressor-turbine region.

(Continued to page 272)



# ALL YOURS with an Evinrude

Check every quality and feature you want in a modern outboard motor . . . chances are, you'll find that Evinrude offers every one . . . *and more!* Each developed and perfected the sure and steady way . . . through 38 years of progressive engineering, experimenting, *proving*. That background is worth remembering—when you choose an outboard motor!



**Want Sure Starting?** Fine! That's an Evinrude "specialty" . . . always, on every model, it's mechanically *built right in!*



**Co-Pilot Steering!** On every model the "unseen hand" that grips when you let go . . . holds the motor on the course you set.



**Operating Ease!** — with controls so simple and troubleproof that even youngsters handle an Evinrude easily and capably.



**Quiet! Smooth!** Perfected underwater silencing buries exhaust fumes and noise. Motors float in vibration-absorbing bearings.



**Slow Trolling Speed!**—enables you to check right down to a slow trolling glide without choking, stuttering or stalling.



**Full Reverse!** On two great fishing models—and new *Weedless Drive* enables you to drive through thickest weeds.



**Four-cylinder Performance!** Nothing like it for smoothness, thrilling responsiveness — and Evinrude offers it in three models!



**Widest Range of Models!** The right motor, for every boat, every service. Seven models, all with O.B.C. horsepower certification.

It all adds up to finer *performance!* And back of every Evinrude is the priceless advantage of organized, responsible, nationwide *service* . . . available everywhere through a veteran organization of selected dealers. *See your Evinrude dealer* — look for his name in your classified phone directory under "Outboard Motors". *Catalog free!* Address, EVINRUDE MOTORS, 5456 N. 27th St., Milwaukee 9, Wisconsin  
In Canada: Evinrude Motors, Peterboro, Ontario



## EVINRUDE

FIRST IN OUTBOARDS • 38TH YEAR



**Start Now on a Shoestring!**  
**BE A MANUFACTURER**  
**Hold Your Job! Use Your Spare Time!**  
**START AT HOME**  
**In Your Kitchen or Basement!**  
**15 TRADE SECRETS**  
**That Cost Millions of Dollars to Perfect**  
**WILL GET YOU GOING**

Yes, you can succeed as a manufacturer! You need no plant, no technical training. You keep your job. You invest very little money. With these 15 processes, developed and tested in the country's largest laboratories, it's easy to make products which are in great demand. For example, "Chem-Stone", a new plastic that makes concrete hard as stone and eliminates dusting; "Thermo-Sol", a new inexpensive fireproofing that has no competition; "Water Seal", the secret sealer for leaky walls and ceilings, and 12 other easy-to-make, easy-to-sell products. We supply everything you need. Get started now!

Own Your Own Factory! Write Today  
 for Complete Free Information

**CHEMICAL**  
 130 WEST 42ND ST.



**RESEARCH CO.**  
 NEW YORK - 18, N. Y.

**High accuracy with low-cost OPTI-TOOLS**

**OPTI-LOCATOR Positively Aligns Spindles to Layouts**

Use on Lathes, Mills, Drills, Boring Mach's., etc. Aligns spindle axis to exact location. Corrects for run-out. Assures split-thousandth accuracy in 60 seconds or less! View from reading distance in room light. Produces jig boring accuracy at low cost! Price \$24.50.



**OPTI-SPOT Illuminates Precision Set-ups**

Projects cool, bright light. 110 V. 50-60 cy. transformer illuminates automotive bulb behind condensing lens. Switch included. Two types: Model A has flexible gooseneck connection. Model B utilizes 18" rubber covered lamp cord. Price \$15.00 each. Specify preference. OTHER OPTI-TOOLS AVAILABLE. FREE FOLDER!

Send dollar with order, balance C.O.D., plus postage. Purchase orders or checks also accepted. Moneyback guarantee! Circulars available.

The BENTON CO., Dept. B, 351 S. La Brea Ave., Los Angeles 36, Calif.

**Limited Stock! New, 27-Volt AC-DC AIR COMPRESSORS**

- 1/3-HP Motor 3-stage Compressor
- 4500 RPM
- Weighs 28 lbs. Boxed



- COMPRESSOR OUTPUT is 1500 Lbs. High Pressure Low Volume
- IDEAL for Low Pressure Spray Gun

Precision built. Convert with transformer or 4 1000-watt heating elements. Individually packed in wooden boxes and wrapped in plicofilm for double protection. Simple directions for hook-up included. Rush us your order, today.

Cost the Government over \$200 to build  
**BARGAIN \$15** for you

TRANSFORMERS... each only \$14.50  
 1000 WATT HEATING ELEMENTS, each only... \$3.95.  
 The above are only 2 methods for hooking up this compressor, additional hook-ups shown on the instruction sheet.

**General Surplus Stores**  
 1439 Grand Avenue Kansas City 6, Missouri

**Blow Sawdust Away From Your Circular Saw**

Comet Saw Fan whisks sawdust out of chute. Keeps sawdust off table top, operator. Improves vision, safety. Quickly attaches to 8" and 10" circular saw with 5/8" arbor. **SEND NO MONEY!** Send only name, address. Pay postman \$1 plus C.O.D. Or, save C.O.D. by sending \$1 with order. Money back Guar. **SCHARF MFG. CO., 4626 Dodge, Omaha, Nebr.**

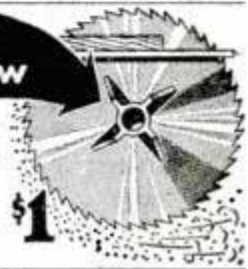

**B-M MOWERS**

**NOW AVAILABLE!** Newest type, three-wheel, whirling blade mower.

The perfect answer to grass and weed cutting problems. Choose from two models of assembled mowers ( - motors) or build-it-yourself kit of parts.

Write for literature. **B-M MOWER COMPANY, Box 65, Blue Mound, Kansas**



**Send for Free List of Leading Books and Catalog of Tools For Watch and Clock Repairing—**

**Engraving, Aircraft Instruments Etc. Address Dept. 12. Use Letterhead.**

**HENRY PAULSON & CO.**  
 37 SO. WABASH AVE., CHICAGO 3, ILL.



**Now You Can - GET THOSE NEEDED AUTO PARTS and SAVE MONEY**

Make the old car run longer and faster with REBUILT UNITS and NEW PARTS. We are specialists in Rebuilding used UNITS to work Good As New. Our experts turn out only the highest quality work. All parts thoroughly degreased and rebuilt with precision for perfect performance. Our workmanship ABSOLUTELY GUARANTEED. Due to the tremendous volume of business we handle you will find our PRICES THE LOWEST. We Ship Anywhere in the U.S.A.—Get Our Prices.

- AUTO PARTS REBUILDERS
- REBUILT UNITS EXCHANGED

All rebuilt units are sold on an exchange basis. You simply ship us your unit and we will PROMPTLY ship you a REBUILT UNIT plus a nominal charge. Or we will rebuild your unit... Put it in FIRST CLASS CONDITION and return it to you C.O.D. All Exchanged Units Shipped the Same Day received.

**LOCAL AGENTS WANTED EVERYWHERE**

**MECHANICS AUTO PARTS, 3807-11 No. Ashland Ave., Dept. PM-3, CHICAGO 13, ILL.**

**Just to Get Acquainted GET YOURS TODAY**

- 6 Piece IGNITION TOOL SET \$1
- 4 OPEN END WRENCHES (4 sizes) ONLY \$1
- 1 ADJUSTABLE PAIR PLIERS Postpaid
- 1 Top Quality POINT FILE

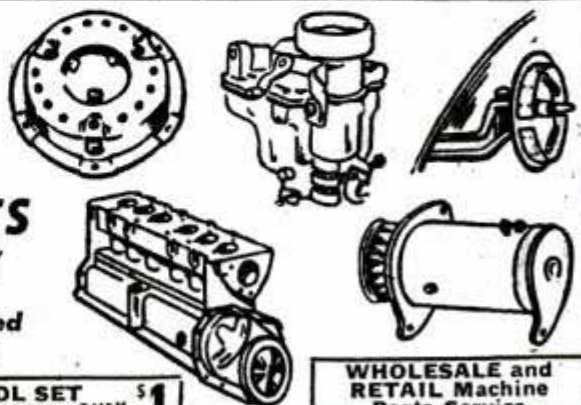

**WHOLESALE and RETAIL Machine Parts Service**

• ESTABLISHED 1920 •





**New!**  
 Complete, original designs  
 for authentic period furniture  
 you're proud to own

It's easy to build an attractive  
 American Empire-style Armchair  
 with these actual-size plans . . .



Enjoy the deep-down satisfaction of producing a tasteful furniture original that can't be bought in stores

This Stylecraft design brings to the experienced craftsman an exciting adventure in woodworking!

Now you can follow actual-size plans by one of America's foremost furniture designers, to build a graceful Empire-period armchair. You do more than just copy; interesting alternate treatments suggest opportunities to express your originality without deviating from the period design.

**An Intriguing Project!**

This new Delta original is a simple, modern interpretation of the American Empire period. Yet,



it sacrifices none of the traditional richness.

The effectiveness of this charming chair depends upon its beauty of line and form. Its distinctive back, arms, legs, and ornamentation enable you to demonstrate your advanced skill as a craftsman.

**Enjoy this Thrill!**

Exercise your ability on a worthwhile project you can be proud of when it is finished — a piece that enhances the beauty of your home. Construct this American Empire-style armchair.

Send today for the plans that make your job easy. The complete set is only \$2.50 postpaid. Check Design No. 4205 in the coupon at the right. Then, mail it with check or money order.

**Other Stylecraft Period Furniture Originals**

Hepplewhite-inspired Lamp Table, simplified for use with modern furnishings. Check Design No. 4204 in coupon. \$2.50 postpaid.

Ample-size Sheraton Cocktail Table. Attractively shaped, classically designed. Check Design No. 4202 in coupon. \$2.50 postpaid.

**Each set of designs includes all this:**

- Clear, easy-to-follow actual-size plans.
- Informative folder that highlights construction details . . . suggest alternate treatments . . . gives brief historical background of the furniture described.
- Biographical sketch of the noted designer who made up Stylecraft originals for you.

**Tear out coupon and mail today!**

DELTA MANUFACTURING DIVISION  
 680C E. Vienna Ave., Milwaukee 1, Wisconsin

I enclose  check  money order for \$\_\_\_\_\_ as payment in full for designs I have checked below

American Empire-style Armchair Design No. 4205  
 Hepplewhite-inspired Lamp Table Design No. 4204  
 Sheraton Cocktail Table Design No. 4202

Name \_\_\_\_\_  
 Address \_\_\_\_\_  
 City \_\_\_\_\_ (\_\_\_\_) State \_\_\_\_\_



# a float

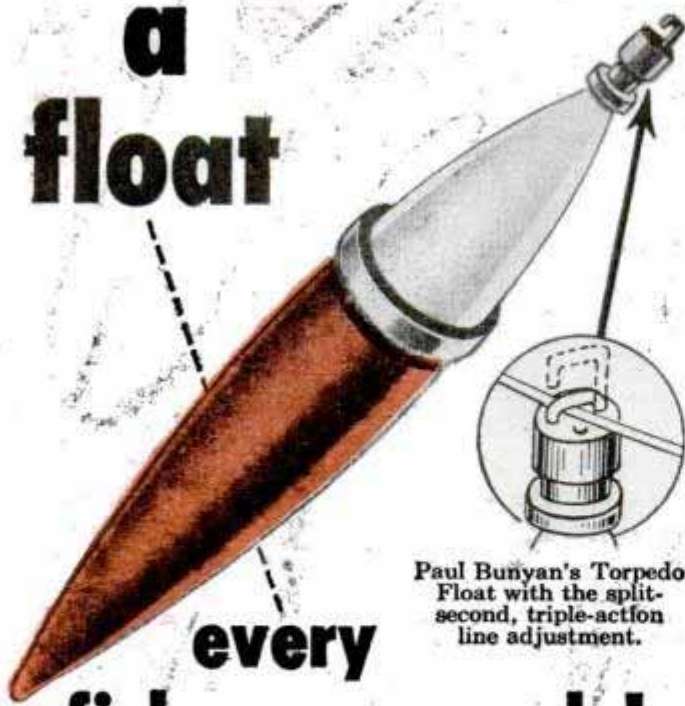

Paul Bunyan's Torpedo Float with the split-second, triple-action line adjustment.

## every fisherman needs!

**YOU'LL WANT** this truly modern Torpedo Float with its triple-action head that enables you, *in a split second*, to attach or detach your line—to lock your line firmly in position desired—or to release as a free-running line for casting. And the spring-lock action is always positive, yet unharmed to the line. Its added buoyancy helps to set the hook when a fish strikes. Perfect for casting, trolling or still fishing. Designed by fishermen for fishermen. Price 75¢.

**PAUL BUNYAN  
FLASH EYE!**



Here's the old reliable "fish getter" that always gets results—Paul Bunyan's Flash Eye! Flashing transparent eyes that attract Northerns, Lake Trout, Wall-Eyes, Muskies, etc. The Flash Eye spoon comes in two finishes: copper for dark days, nickel for bright days. Thousands of guides and men who know fishing go all out for this tantalizing killer that attracts the big ones. In two sizes priced at \$1.00 and \$1.10.

**PAUL BUNYAN BAIT CO.**  
Department PM37  
Minneapolis 5, Minn.



# PAUL BUNYAN BAITS



If your dealer can't supply you, write us.

Within the jet family, a turbopropeller combination is most likely to experience greatest initial popularity in the transport field, as well as in long-range fighters. One application simply calls for gearing a conventional propeller to the turbine shaft, using the excess gas for added thrust. Where operating economy is a decisive factor, this combination pairs up a lighter weight power plant with the propeller's proven efficiency below 500 miles an hour.

Propellerless turbojets, like Britain's Meteor and America's Thunderjet and Shooting Star, are predicted for early domination in the shorter-ranged fighter field. In this category, for speeds over 600 miles an hour, the propeller is a handicap.

There are two basic turbojet types, the centrifugal, or rotary, and the axial flow. Built on Whittle's original conception, the former pulls air in near the center, whirls it out toward the circumference of the compressor blades, then into the combustion chamber. The air changes direction twice before mixing with the fuel. It is shorter than the coaxial but presents a greater frontal area.

The more streamlined coaxial type brings air straight in through a series of longitudinally arranged compressor blades, compresses it and forces it right back into the combustion chamber. It has found greater favor with American designers at General Electric and Westinghouse, though a Rolls Royce centrifugal type in the Meteor holds the present world's speed mark.

Simplest and lightest of jet forms, ramjets appear to have their brightest future as a very high-speed propellant, probably for guided missiles, although their aircraft possibilities are being vigorously explored. A French design was exhibited as early as 1938. One engine under investigation by the National Advisory Committee for Aeronautics, 20 inches in diameter and weighing only 400 pounds, has a thrust equivalent to 50 horsepower per pound.

Pulsating jet engines, like those in Nazi buzzbombs, have been proposed for helicopters and as auxiliary units for conventional aircraft. In helicopter blade tips they promise very low fuel consumption.

Rockets, though operating on the jet principle, have the added ability to carry their own oxygen and operate independently of the atmosphere. This self-contained oxygen also does away with the need for inflow air scoops in the forward section of the plane, thus cutting down the drag. Also, they have a much smaller percentage of power waste than the jets.

Probably the outstanding aircraft rocket

(Continued to page 276)





**Snap-on**  
**Vacuum Grip**  
REG. U.S. PAT. OFF.  
**Pliers**  
 A complete line . . . engineered for performance

Pliers are basic tools in an extremely wide and varied range of operations. The *right pliers for the job* can make a tremendous difference in speed and workmanship. The Snap-on pliers illustrated are typical of the many types of Vacuum Grip pliers . . . each type *job-engineered* for peak performance on the work for which it is designed. Snap-on builds Vacuum Grip pliers in a modern plant devoted exclusively to the production of the finest, most efficient pliers that can be produced. Vacuum Grip pliers are hammer forged

from special high carbon chrome-silico-manganese alloy tool steel, hardened and tempered through and through. Light in weight, perfectly balanced. Smooth, easy riding joints, sharp, deeply milled teeth. Hand filed, perfectly aligned cutters. Spring-tempered, "Vacuum Grip", non-slip handles.

A famed name in Snap-on's complete line of tools for production and service, Vacuum Grip pliers are available through Snap-on's nationwide direct-to-user tool service. Write for free catalog.

**SNAP-ON TOOLS CORPORATION**  
 8062-C 28th AVENUE KENOSHA, WISCONSIN





# NEW Tool!

for  
**HOME • SHOP • FARM**  
**TOOL CHEST**

THE DAY TOOL DRIVER is the first practical improvement in screwdrivers for years. CARPENTERS, MECHANICS, MACHINISTS and HANDYMEN need never be without the right size screwdriver with the DAY TOOL DRIVER... 8 different-sized blades with just 2 convenient automatic locking handles. Blades and locking nuts made of high quality steel. Handles moulded from tough plastic. A press of the thumb unlocks the old blade—another press of the thumb locks the new blade securely in place. It's quick, practical, more convenient and unconditionally guaranteed... 8 screwdrivers in ONE THIRD THE SPACE! Dealer inquiries invited.

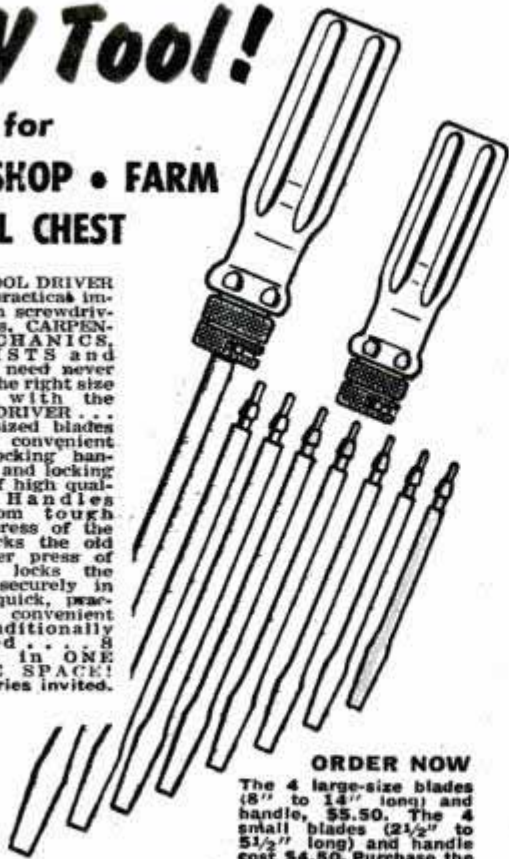

### ORDER NOW

The 4 large-size blades (8" to 14" long) and handle, \$5.50. The 4 small blades (2 1/2" to 5 1/2" long) and handle cost \$4.50. Purchase the COMPLETE SET of 8 blades and 2 handles for \$9.50 and save. Immediate shipment, postage prepaid.

**2 HANDLES**  
**8 BLADES**

THE CONWAY COMPANY, 953 So. Grand Ave., Los Angeles 15, Calif.

## THE CHAMP

by Medana

An accurate, shock-proof, water-resistant wrist watch, with radiolite hands, numerals, and sweep second hand. Fitted with handsome leather strap. A written and signed guarantee with each watch. If matching stainless steel expansion band is desired, add \$1.00 to your remittance. Comes to you Postage Prepaid. Send check or Money Order.



ONLY  
**\$18.65**

Includes Federal Tax

REPAIRS: Jewelry and watch repairs and pearl restringing done promptly at reasonable prices.

### ANTIN'S JEWELERS—GIFT COUNSELORS

Dept. 7, 114 Baronne St. New Orleans 12, La.  
Please send me The CHAMP (with) (without) the stainless steel expansion band.

Name \_\_\_\_\_  
Address \_\_\_\_\_  
City \_\_\_\_\_ Zone \_\_\_\_\_ State \_\_\_\_\_

## RUBBER-TIRED WHEELS

**Immediate Delivery!**

These wheels are of best steel, with zero pressure, puncture-proof rubber tires. Lightweight, sturdy, silent. Streamline design with plenty of eye appeal.

**Size 10 x 1.75** Set of 4  
With Olite Bearings.....\$9.95  
**Size 8 x 2.00** Set of 4  
With Roller Bearings.....\$9.95  
(Postage paid anywhere in U. S.)



Excellent for use on scooters, industrial equipment, wheelbarrows, trailers, coaster wagons, dock trucks, etc. Immediate shipment. Order now! Send check or money order.

### PROPULSION ENGINE CORPORATION

Dept. 2W 7th and White Eagle Rd., Kansas City 15, Kansas

## CUT ANY SIZE HOLE TO ANY DEPTH IN WOOD

Something new in wood-boring tools! Bruno Expansive Bit works like a lathe... requires less pressure... actually pulls itself through. Positive lock with patented triangle blade. Diamond grind on lead screw prevents splitting. Wide throat for chip clearance. Easy-to-read scale. All cutting surfaces of high grade tool steel. Replaceable blades.

NOW ONLY  
**\$2.45**

### \*Wide Cutting Range!

No. 200-B cuts 1/4" to 1 3/4" Diameter.  
No. 201-B cuts 1 1/2" to 3 1/2" Diameter.  
Each comes with 1 long, 1 short cutter.

Money Back Guarantee  
At All Hardware Stores  
or Write Dept. PM-3



### The BIG BUY in Tools

BRUNO TOOLS 9330 SANTA MONICA BOULEVARD BEVERLY HILLS, CALIFORNIA

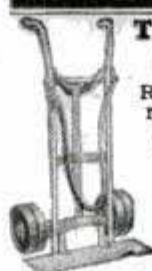

## TRUCK FOR APPLIANCES

Rolls like baby buggy on 4 big (Dual) 8 x 2 rubber tires. Unusually resilient, quiet. Easily handles refrigerators, and all appliances up to 800 lbs., 54" ht.; 24" nose; 13' web strap. Also handles crates, boxes, bags, etc. \$31.95 f.o.b. Over 10,000 Handees trucks sold by mail. Send back express collect if not satisfied. Order Monday—get Friday, from  
**HANDEES CO., Dept. P.M. 3, Bloomington, Ill.**

## NU-WAY Lawn Mower

## BUILD YOUR OWN ROTARY TYPE LAWN MOWER

Write for Free Circular

We Supply Cutting Unit Complete

PRICE  
**12.50**

No Increase in Price



Tractor-Lite Mfg. Co.  
Spirit Lake, Iowa

WHY PAY MORE?

## ACE LATHE TOOL SET

## Be permanently tooled-up for every operation on your Metal Cutting Lathe



The ACE Set is complete—there's nothing more to buy. Drop forged by the manufacturers of cutting tools used by 90 per cent of the plants and shops in industry that are correctly designed, are of special steel, are finely finished, are stronger—will last a lifetime. You can cut easier, faster and more accurately with ACE TOOLS. At your Hardware Store—

Turning Tools, Cutting-off Tools, Boring Tool, Threading Tool, High Speed Steel Cutters and Blades, and 2 Wrenches in Fitted Steel Case.

**ARMSTRONG BROS. TOOL CO.**  
"The Tool Holder People"  
368 N. Francisco Ave., Chicago 12, U.S.A.



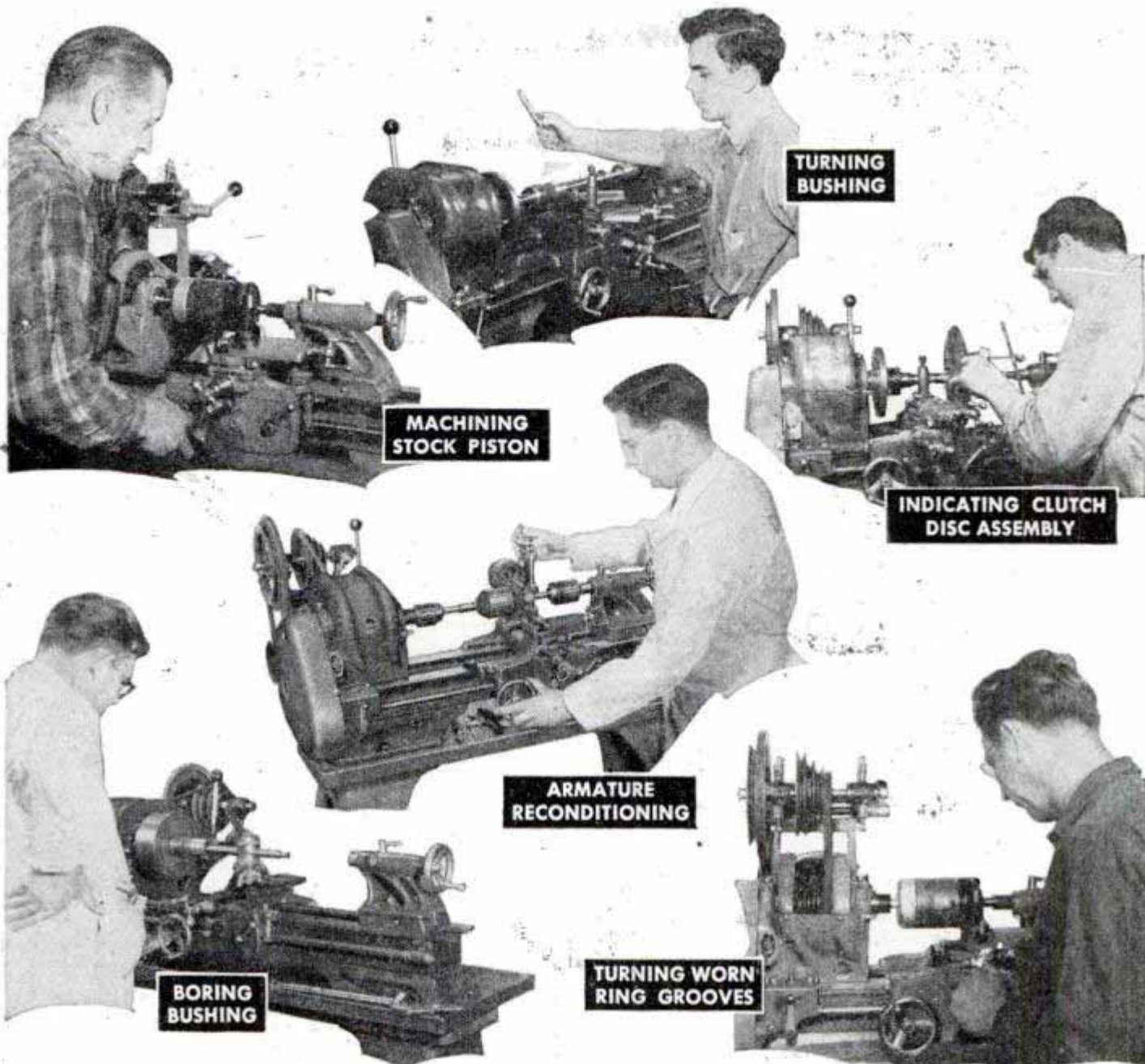

**TURNING BUSHING**

**MACHINING STOCK PISTON**

**INDICATING CLUTCH DISC ASSEMBLY**

**ARMATURE RECONDITIONING**

**BORING BUSHING**

**TURNING WORN RING GROOVES**

## Atlas LATHES Speed Up Auto Servicing

Garages and automotive shops all over the country are rapidly equipping with Atlas lathes. It's a profit hint to consider if you operate or work in such a shop — something to remember as a valuable use for an Atlas in your home shop.

Six typical Atlas lathe servicing jobs are shown above. All told there are 44 different ways to keep an Atlas busy in modern automotive repairing.

Atlas lathes are preferred for such work because they are: (1) compactly engineered

for minimum space (2) easy to set-up and operate (3) work to close tolerances (4) extremely versatile (5) ruggedly built for years of precision service (6) available at low cost.

Ask your Atlas distributor for complete details and delivered prices.

### SEND FOR FREE CATALOG

Get complete information about Atlas lathes, drill presses, millers, shapers, and the many inexpensive accessories available for Atlas tools. Send for this free catalog today. Atlas Press Co., 343 North Pitcher Street, Kalamazoo 13D, Michigan.



### Atlas 4 TOOL TEAM





# Paint Your Automobile

WITH

ONE COAT COVERS  
**NU-ENAMEL**  
TRADE MARK REG. U. S. PAT. OFFICE  
NO BRUSH MARKS



Paint your entire car with **NU-ENAMEL** for only **\$3<sup>45</sup>**

Paint all your fenders for only **\$1<sup>95</sup>**

Ask your **NU-ENAMEL Dealer** for this **Instruction Folder**

Contains the step-by-step story of how you can Paint-It Yourself with Nu-Enamel and get a professional looking job.



"Paint-it-Yourself" with **NU-ENAMEL**

application is the engine developed for the XS-1. Built by Reaction Motors, it is believed capable of turning up 24,000 horsepower at 1500 miles an hour, though it weighs only 210 pounds. Alcohol and water mixed, with liquid oxygen as the oxidizer, are injected into the four cylinders to burn at about 4500 degrees Fahrenheit. Cooling is accomplished by routing the alcohol-water mixture over the thin cylinder walls on the way to the burning chamber, giving the cylinders a 25-hour life.

The Germans applied the rocket principle in their ME-163 and were able to prolong the power supply to about 15 minutes. The pilot would glide for long periods between short bursts of power.

NACA scientists recently described the Tiamat rocket as the "first guided missile to be flown successfully through a predetermined program of maneuvers." Built as a flying guinea pig for future supersonic robot weapons, it is over 14 feet long, weighs more than 600 pounds and flies faster than 600 miles an hour. Data on its speed, control movements, degrees and speed of roll are relayed from instruments in the missile to the ground by telemetering.

The most glaring shortcoming of rockets, like jets, is excessive fuel consumption, although this was improved slightly in the XS-1 engine. The Nazi V-2 rocket, for instance, required about 200 pounds of propellant per second, or 8½ tons, on its highest ascents. Also, liquid oxygen is a dangerous and temperamental material to handle, as researchers have learned.

An engineering study is currently under way to explore the possibilities of an all-electric airplane. It is theorized that electric motors, driven by turbines, might offer large savings in weight and power because of more efficient propeller location and reduced drag. A 500-kilowatt auxiliary prime mover, with generator equipment and an over-all weight of less than ¾ pound per horsepower, is in the design stage.

One of the most recent exhibitions of the potentials of Diesel flight was made with a four-cylinder engine equal in weight to a conventional engine of like horsepower. For an hour's flying in a small monoplane, where a comparable piston engine would drink seven gallons of aviation gasoline, the Diesel used just over two of a fuel costing a third as much as aviation gasoline.

Indicating the serious consideration of atomic energy for aircraft power is the cooperative development program being carried on by the AAF, the Manhattan Engineering District and several plane companies. Emphasizing its importance,

(Continued to page 280)





**"Me...  
a magician?"**

"Honest, I'm not. I'm only a mechanic, a Doctor of Motors, perhaps *your* Doctor of Motors.

"Most of my 'patients' are broken down jalopies that have been neglected for three or four years straight. Yet, the owners expect me to wave a magic wrench and make their cars purr like next year's models!

"No, I'm not a magician but I *do* bring those cars back to life. We mechanics have had to specialize in old cars since '41. And we have learned how to make motors last—and last—and last."

**Notice to Car Owners!**

*You can help* your Doctor of Motors help your car last, merely by taking it in to him for regular care. That way he can spot troubles in advance, keep all those little troubles from becoming big ones, save you money, probably save you your car.

So see him soon and regularly. Your favorite mechanic—*your* Doctor of Motors—recommends Perfect Circle Piston Rings. They are available at every automotive repair shop.

The Perfect Circle Companies, Hagerstown, Indiana, U.S.A. and Toronto, Ontario, Canada.

*Your Doctor of Motors  
restores power... saves gas  
... saves oil with...*

**PERFECT  
CIRCLE PISTON  
RINGS**



**MOTHER ENJOYS CHURCH AGAIN SINCE SHE GOT HER WESTERN ELECTRIC HEARING AID!**



**There is a difference in Hearing Aids**

• A better hearing aid may help you enjoy life more. Western Electric Hearing Aids are the *only* ones designed by Bell Telephone Laboratories, designers of the famous Bell telephone. They are made by the nation's largest producer of communications and electronic equipment.

Mail the coupon today for free helps to better hearing, including details on the new Model 64 Western Electric Hearing Aid.

**Western Electric**

Dept. 380-PM3, 195 Broadway, New York 7, N. Y.

Please send me your free guides to better hearing and information about the Model 64.

Name.....  
 Address.....  
 City..... Zone..... State.....

Distributed in Canada through Northern Electric Co., Ltd.

**SHELDON**

*New*  
 TRB—S56  
 Precision  
 Lathe  
 \$1000.00



**MORE ACCURACY, MOST LATHE PER \$**

No other moderate priced lathe and but a few of the most expensive, have the "Zero Precision" tapered roller spindle bearings, have beds and ways or lead screws held to such close tolerances. In standard quality tool features, no other lathe can offer as much capacity, utility, and convenience per dollar, as you get in the new Sheldon TRB—S56.

This 11 1/4" swing, 1" collet capacity, 56" bed precision lathe comes with full quick change gears, a full double walled apron with power longitudinal and cross feeds, 8 spindle speeds (35-1350 r. p. m.) and a fully enclosed double V-Belt underneath motor drive, mounted on a modern welded steel bench, complete, less motor for \$1000.00 f.o.b. Chicago.

Write for "TRB" Circular

**SHELDON MACHINE CO., INC.**  
 4266 N. Knox Ave., Chicago 41, U.S.A.

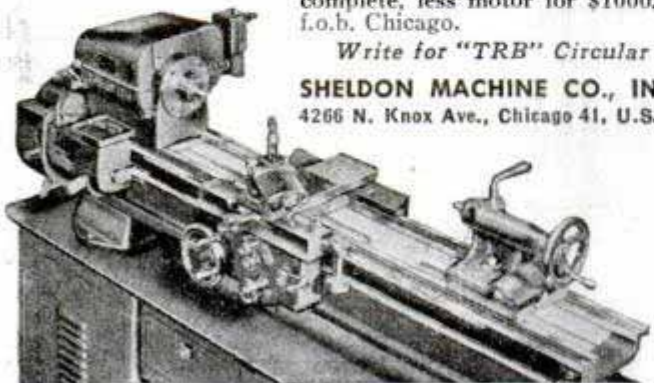

FOR *Beauty and Protection*  
**CHROMELYTE**

Super Fine Chrome Silver  
 "Coat of Metal"

**ALUMINUM ENAMEL**

Quickly, easily apply CHROMELYTE the bright, smooth, silvery coat of metal to hundreds of surfaces about your home, shop and farm. For utmost beauty and protection against wear and weather use CHROMELYTE.

This war proven product used by America's largest industries on machinery, equipment, walls, etc., to protect and beautify by one application. Ideal on metal, wood, brick, tile or fabric.

Dries in 2 hours! May be brushed or sprayed. Comes ready mixed. Keeps indefinitely. One gallon CHROMELYTE covers 700 square feet! At dealers or postpaid direct. Quart cans \$2.00. Gallon cans \$6.00. Satisfaction guaranteed.

**USE IT ON**

- Boilers, Furnaces,
- Heaters, Stoves,
- Bicycles, Wagons,
- Trailers, Pipes,
- Boats, Yachts,
- Tents, Camping
- Equipment, etc.

**THE A. F. WOLKE COMPANY**

New Albany

Indiana, U.S.A.

**CECO WHIZZ!!**

**10" All-Purpose Wheel**



Double Radial Ball Bearings give this wheel speed plus! Puncture proof balloon—10" x 1 3/4". Heavy duty wheels — for racers, 4 wheel trucks, wagons, market carriers, golf bag carriers, scooters, garden and porch furniture, etc., etc.

Ceco "Whizz" wheels are completely assembled; ready for immediate use. They're smooth, quiet, stream-lined, STURDY. (We have axles and other parts; ask for prices.)

Cash with order or P.P., C.O.D. Supply limited; order today!

Dealers—Write for Quantity Prices.

**CECO SALES CO.**

**\$2.75** COMPLETE  
 Including Tire and Bearings  
 EACH Set of 4—\$10.80

507 Fifth Ave., New York 17, N. Y.

**BUILD YOUR OWN POWER LAWN MOWER**

**WHY BREAK YOUR BACK MOWING FIELD OR LAWN?**

WRITE FOR FREE LITERATURE The Rite-Way Mower Attachment Ball Bearing



SAVE MONEY SAVE TIME

Now anyone can save time and effort mowing field or lawn by building their own whirl type power mower. Build according to your own ideas and needs at small cost. Cut close to fences, walks, buildings, etc. Build in short time with parts and instructions we furnish. Save hours of time and back breaking labor. Write today for FREE information.



T & H MFG. CO., Dept. PM2  
 811 E. 31, Kan. City 3, Mo.



**Profit by the Building Boom!**

Start your own business manufacturing concrete building block and brick. Use Economy hand moulds. Make true, straight, easy-to-lay units which will pass any building code. Small investment, high production, big profits. One \$30.00 mould will make 1,000 5 1/2"x8"x12" blocks per day. Letters and repeat orders tell how pleased our customers are.

WRITE FOR FOLDER

**Economy Manufacturing Company**  
 Dept. P Stone Mountain, Georgia



*Hey, Fellows!*

**A REAL RADIO  
FOR ONLY \$6.15  
You Build It Yourself**

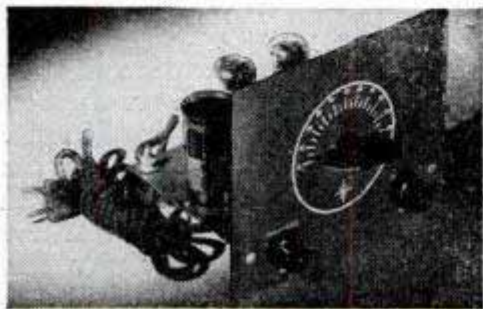

**BEGINNERS, STUDENTS! . . .**  
Here's what you have always wanted—a low cost, foolproof, build-it-yourself radio (AC-DC) that's a top performer. Gain experience and confidence making it — fun using it. Ask for Kit R-3. Supplied less 3 inexpensive tubes, wire, solder, earphones for only **\$6.15.**

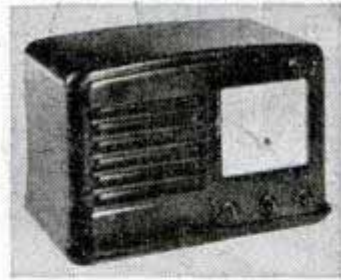

*Newark also offers:*

A five-tube AC-DC superhet, automatic volume control, true tone reproduction, Alnico magnet in speaker — many other features. Beautiful brown or ivory cabinet included. An excellent kit. All stations on broadcast band. Ask for Kit S-5. Cost, complete, less tubes, only **\$14.45.**

Short wave and regular broadcast band receiver kit. Many top features that will interest more advanced radio students and enthusiasts. Kit also includes good looking brown or ivory plastic cabinet. Ask for Kit S-6-X. Cost, less tubes **\$18.95.**

- MAIL ORDERS FILLED FROM EITHER NEW YORK CITY OR CHICAGO
- Write: 242-C W. 55th St., N.Y. C. OR 323-C W. Madison St., Chicago

**NEW YORK**  
Offices & Warehouse  
242 W. 55th St., N.Y. 19

**NEWARK**  
**ELECTRIC COMPANY, INC.**

**CHICAGO**  
323 W. Madison St.  
Chicago 6, Ill.

New York City Stores: 115-17 W. 45th St. & 212 Fulton St.

## AUTOMATIC RETOOTHER

**Makes New Profits**

Cuts new teeth in 50 seconds! Any size tooth 4 to 16 points. Old teeth fall off as chips. Simple to operate. A perfect job.

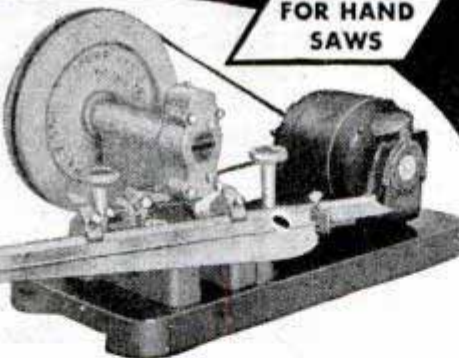

**FOR HAND SAWS**

**IMMEDIATE DELIVERY**

**BURR MFG. COMPANY**

8933-B Venice Blvd.  
Los Angeles 34, Calif.

## GET THE BEST IN MUFFLERS V-8 DUALS & SINGLES

Finest Norman custom-built muffler sets — steel pack — torpedo type — heavy, perforated steel cores — chrome enamel finish — mellow, deep tone (improves with use) — designed to fit — all ways superior — double economy.

DUALS . . . . .	<b>\$17.50</b>	SINGLES . . . . .	<b>\$7.50</b>
V-8 Ford-Mercury		Buick, Olds., Chrys.	
SINGLES . . . . .	<b>\$5.50</b>	ORDER TODAY! Will outlast	three ordinary mufflers.
Chev., Ford, Plym.			

Dealers—Write Today for Full Details

**NORMAN'S MUSICAL MUFFLERS**

Dept. PM-5, 1216 W. Slauson Ave., Los Angeles 44, Calif.

## *New!* MODEL 151M .22 Caliber MOSSBERG AUTOMATIC

Tops in beauty, mechanical perfection and value. Embodies many new features. Shoots 15 shots as fast as you can pull the trigger. Equipped with all Mossberg's finest sighting devices and many other Mossberg conveniences. See it at your dealers...

Write for  
free catalog

No sales at  
factory

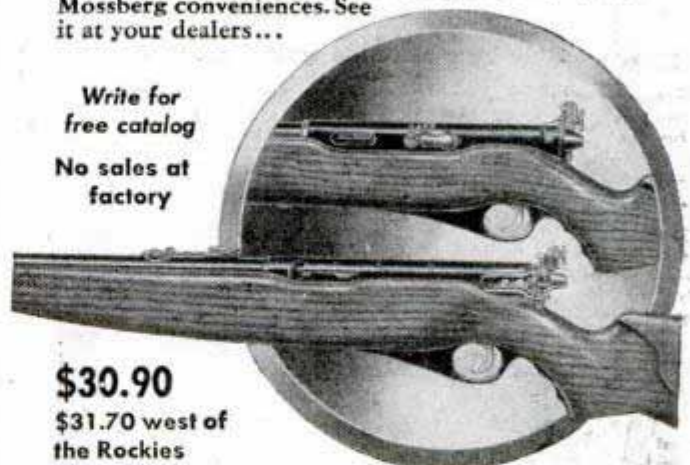

**\$30.90**  
\$31.70 west of  
the Rockies

**O.F. Mossberg**  
**& SONS, INC.**

76503 St. John Street • New Haven 5, Conn.



**BOYS** Here's  
just what you've  
been waiting for.



The  
*Sensational*

# TRACTALL

A husky little giant of more fun and practical uses than any wheeled vehicle you've ever seen. New, original and fully guaranteed. Built of steel and aluminum with big oversized rubber tires on ball-bearing disk wheels.

Powered by pedal driven V-Belt. Safe, clean and non-slipping. Gearshift lever and steel steering wheel just like a regular tractor. Finished in red baked enamel.

Only by direct sale from factory is this price made possible ..... \$26.75

Use This  
Coupon

INLAND MFG. CORP., DEPT. A  
BUFFALO 3, N. Y.  
Ship one "TRACTALL" Express collect  
for which I enclose check ( ), Money  
order ( ) for \$26.75.

Name \_\_\_\_\_

Address \_\_\_\_\_

Product of

**INLAND MFG. CORP.**

158-164 ELLICOTT ST. BUFFALO 3, N. Y.

Major General Curtis E. Le May, chief of AAF research, said: "From a military standpoint the development of nuclear-powered aircraft may be as significant as the development of the atomic bomb."

It is agreed to be perfectly feasible to use atomic energy to drive a turbine, and atomic-heated hydrogen has been suggested as a rocket propellant. One of the toughest problems will be finding a shield, light and small enough for aircraft use, to protect personnel from the deadly radiation.

So with speed, range, reliability and operating economy the final arbiters in each category, the battle is on. And one sure winner is the public, who'll get there faster, surer and cheaper as a result!

## Proving Ground for Gasoline

(Continued from page 93)

control the rate of acceleration of the rear wheels, makes it possible to conduct knock tests under simulated road conditions.

The temperature of the hot room can be maintained at a high of 150 degrees Fahrenheit and the cold room has been used in research on trucks at 50 below zero. The capacity of the cooling system in the cold room is sufficient to keep the temperature at zero while an automobile is being operated at 60 miles an hour.

Where is all the fuel stored, how is it distributed and how much is used in a month at the labs? Answers to these questions are provided by Wilson Y. Hancock. The fuel is stored in 34 underground tanks of 500, 1000, 5000 and 10,000-gallon capacities. These tanks hold 78,500 gallons and soon other tanks will be installed to boost the total to 130,500 gallons; 25,000 gallons are consumed each month.

Hancock displays with pride a system for measuring the amount of gasoline in the underground tanks. This is done by "bleeding" air through the tanks. Each tank is pitched slightly toward one end and has a sump of about one gallon capacity at that end. A tube extends down through the top of the tank into the sump and leads back to a manifold system on a panel in the fuel house. Compressed air is passed into the tube, and the resistance offered by the weight of the gasoline, or "back pressure," is registered on a manometer. Calibration curves on a chart quickly tell the operator how much gasoline is left in the tank. The manifold can also be connected to a small pump to clean waste or dirty fuel from the tank sump. A "sight glass" shows when all the impure fuel has been removed.

A "switchboard" arrangement can sup-

(Continued to page 284)



## SUPER DRILL GRINDER



Sharpens round shank drills from 3/32" to 1-1/16" diameter. Grinds Old Drills like new in 4 different drill point angles. Grinds Short, Medium and Long Twist Drills from 1 1/2" up to 11" long, for hand or power grinding wheels.

**200,000 IN USE!**

Grinds your drills like factory in 25 seconds. Gives perfect center and clearance. Saves drills, time and money. No shop should be without the Super Drill Grinder. Guaranteed to do the work or money back. The Grinder that gives a rounded point!

At Your Dealer's or Postpaid  
**CRANDALL MFG. CO.**

1512 West Slauson, Dept. FA-15 Los Angeles 44, Calif.

## New Glider-Kite TOWS AUTO OR LIFTS LIGHT PERSON

LIFTING WING AREA EQUAL TO SMALL PLANE

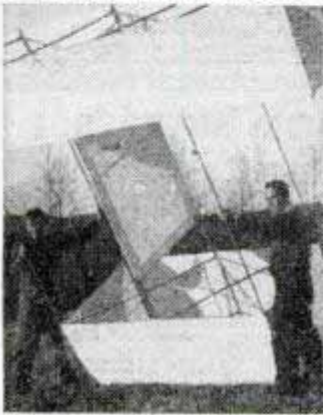

Cost Government \$108  
Yours for \$34.50

Not a toy for youngsters. Men with scientific or aeronautical turn of mind get thrill of lifetime with this genuine Barrage Glider-Kite. A "natural" for sky advertising. Took 12 years to perfect. Hundreds used during war to shield convoys. 134 sq. ft. special aircraft fabric, 10' long x 14' wide double wing and tail. Gives enough pull to move car on level ground. Act quick if you mean business. Cost Government \$108. You send only \$34.50 and we ship F.O.B. complete with spare parts and repair material. Ready made. Assembles easily in 15 minutes. Dismantle in 5 minutes. Or send \$10 and we ship C.O.D. for balance. Write Great Northern Kite Mart, Dept. PM-2, North Adams, Mass. (Dealers letterhead inquiries invited.)

## A BIG 25¢ WORTH OF TOOL TIPS



● Everything about tools . . . at a glance. More than 2000 views of boring and cutting tools, squares, gauges, jigs, etc. Years of tool experience in one, low-priced book . . . 25¢ postpaid. Write today. Stanley Tools 137 Elm St., New Britain, Connecticut.

**STANLEY**

Trade Mark

SAY YOU SAW IT IN POPULAR MECHANICS

## SAVES MANY ELECTRIC APPLIANCES



**NICHROCITE** REPAIRS HEATING ELEMENTS IN A JIFFY . . .

Simply overlap ends, apply Nichrocite Paste and turn on current. Used by large utility companies. Trial order, \$1.00; 4 oz., \$2.50; 1 pound, \$8.00.

ARROWHEAD SALES & DIST. CO. Dept. F  
1325 4th St. N., Minneapolis 11, Minn.



## ● POWER LAWN MOWER

**BUILD ONE YOURSELF FROM YOUR OLD MOWER**

We supply complete attachments that fit any make or size of mower, with or without 1 1/2 H.P. gas engine. Easy to install in less than an hour. No more back breaking mower pushing. Immediate delivery, at low prices, express prepaid.

**MONEY BACK GUARANTEE**

You'll be delighted! Complete satisfaction or your money back. Write for

**FREE FOLDER**  
Dealers Wanted.

**ROYAL OAK LAWN MOWER SHOP**  
431 N. Main St., Royal Oak, Mich.



**AT LAST!**

## An Amazing New ADDING MACHINE Everyone Can Afford!

Professional Appearance  
Figure-Magnifying Plastic Lens

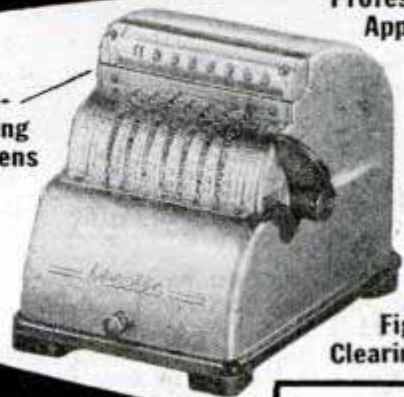

Figure Clearing Lever

**Lowest Price Ever Asked for a REAL ADDING MACHINE**

This substantial, professional-looking GUARANTEED machine gives you lifelong, accurate figuring service at an amazingly low price! Pays for itself in errors avoided and time saved. The new "Precise" adds, subtracts, multiplies—with easy stylus operation. No paper tape to bother with. Totals come up on the Polystyrene magnifier instantly, automatically, accurately! Counts up to 99,999.99. Professionally built with internal construction of steel, bronze and brass throughout; Zamac cast metal case, in handsome, two-tone baked spray lacquer finish; number plate is solid bronze, with etched red and black figures for easy visibility. 7" x 5" x 4 3/4". With complete instructions. Portable, fool-proof, rugged. A real adding machine at a fraction of the usual cost!

**NOT A POCKET TOY OR GADGET**  
A Real BUSINESS-LIKE ADDING MACHINE

Easy to Use  
Guaranteed Accurate

**ADDS!  
SUBTRACTS!  
MULTIPLIES!**

For Everyone:

Homes  
Stores  
Offices  
Factories  
Teachers  
Students

ONLY  
**\$21.95**  
COMPLETE  
(Postpaid on paid orders)

**10 DAY TRIAL Full Money-Back Guarantee!**

YOU RISK NOTHING. Use the "Precise" Adding Machine for 10 days. If you're not completely satisfied, return it for full refund. Every machine is covered by a full year's guarantee for materials and workmanship; free repair during guarantee period. Order today—we'll ship C.O.D., or postpaid on paid orders.

**FREE TRIAL!**

**TAM PRODUCTS**  
3814 Wrightwood Ave.  
Chicago 47, Illinois, Dept. A-4

Ship me one "Precise" Adding Machine  
 \$21.95 enclosed,  Ship C. O. D.

**ORDER TODAY!**

Name .....

Address .....

City ..... Zone ..... State .....



# AMMCO 7" SHAPER

"A Precision Machine of a Thousand Uses"

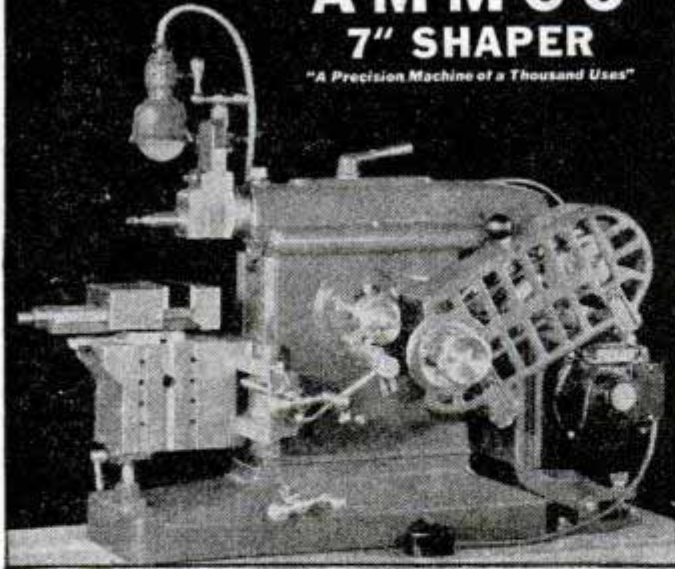

A wide variety of jobs can be done accurately, quickly, easily, and economically on the AMMCO Shaper (7" stroke). Construction incorporates many features you would expect to find only in larger, more expensive machines... For example: WAYS of ram, tool head, and front face of the main frame are of the "VEE" type, hand scraped to insure accuracy and long life. Available for stationary installation or as portable unit.

Write today for specifications and prices

## AMMCO TOOLS, INC.

COMMONWEALTH  
AVENUE



NORTH CHICAGO  
ILLINOIS

(Formerly Automotive Maintenance Machinery Co.)

**DRIVE  
Your  
MODELS**  
with A. C.  
Plug-In Motor

**IMMEDIATE  
SHIPMENT**

**\$3.75**

plus 25c  
shipping charge

**Mail  
Today**

Sturdy 1/100 HP motor 1500 rpm. High torque. Drives models, toys, signs, etc. 110 volt, 60 cycle A. C. Height, 3-3/4" Meets U. L. specifications. Shipped complete with cord, ready to run.

**BURTON SALES COMPANY**  
903 Foshay - Minneapolis 2, Minn.

Send \_\_\_ motors at \$3.75 each, plus 25c for packing, shipping  
Enclose check or money order No C. O. D.s. Please.

Name \_\_\_\_\_

Street \_\_\_\_\_

City \_\_\_\_\_ State \_\_\_\_\_

# WRIST WATCH

Complete with New Style  
**EXPANSION BAND**



7  
JEWEL  
**\$12.95**

15  
JEWEL  
**\$16.95**

Sensational value! Genuine Military wrist watch precision built, split-second timekeeper, your choice of 15 jewel movement for ONLY \$16.95 plus tax! Or 7 jewel movement for only \$12.95 plus tax. Waterproof, shock-protected, anti-magnetic. Radium dial and hands, easily read in the dark, unbreakable crystal, red sweep second hand. Handsome, non-corrosive stainless-steel case. Genuine non-corrosive stainless steel expansion bracelet fits all wrists. Order yours today! **SEND NO MONEY!** Rush order now stating which watch you want. Pay postman price listed above plus postage and 10% Fed tax. If not delighted, return within 10 days for refund.

### BURTON SALES COMPANY

809 W. MADISON ST. DEPT. C-84 CHICAGO 7, ILL.

**AHOY, GAME-ROOM SKIPPERS!**  
**BUILD THE JOE LANE!**

This beautifully detailed, authentic replica of one of the first revenue brig is a real collector's item. Easy to build from clear, carefully drawn plans. A model you'll be mighty proud to display! Complete kit of parts, plans and assembly instructions... **\$11.00**

**SHIP MODELS ILLUSTRATED**  
The complete guide to modeling. Pictures of all types from clippers to corvettes — actual plans and detailed drawings... **\$2.50**

**HALESITE YACHT SERVICE** Dept. PB  
Halesite, L. I., New York

**HANDYMAN'S Steel-Cutting**

**SHEAR**

Cuts flat steel up to 1/8" thick, with ease. Can be mounted in vise or bolted to bench. Built for hard use by maker of famous "Handnib" Machine Shop tools. EXTRA: Has built-in die for cutting rods up to 5/16" dia. **ONLY \$27.50** Shipped express prepaid for cash with order.

National Machine Tool Co., Dept. L 157-C, Racine, Wis.

**SAY YOU SAW IT IN POPULAR MECHANICS**

**UTICA TOOLS**

**PLIERS FOR EVERY NEED**

**Ask Your Dealer**

**UTICA DROP FORGE & TOOL CORP.**  
UTICA 4, NEW YORK





# AUTO-LITE

## Plug Tips

**MAKE SURE** you have the right spark plug for the type of driving you give your car. Your Auto-Lite Spark Plug Dealer can tell you when plugs are lazy or faulty and when plugs of a different heat range\* will give better results. Let your friendly neighborhood Auto-Lite Spark Plug Dealer give you a complete Auto-Lite "Plug-Chek" regularly, at least once every 5,000 miles.

### TOO HOT



If the firing tips on your spark plugs are fused or blistered, the spark plugs are operating too hot and may be causing costly loss of power and harmful spark knock.

### HOT PLUG

The longer firing tip of this plug dissipates heat slowly and operates at a relatively high temperature. Stop-and-go driving and slow speeds

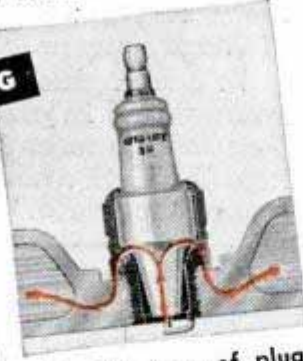

require this type of plug.



\*Even though Auto-Lite Spark Plugs are wide range spark plugs, it is still necessary for best results to select the plug whose heat range will be most suitable for the speed and loads required.

### TOO COLD



If the firing tips on your spark plugs show deposits of carbon or are wet with oil, the spark plugs are too cold and may be causing slow, difficult starting and high gas consumption.

### COLD PLUG

The shorter firing tip of this spark plug dissipates heat rapidly and operates at a relatively low temperature. High speeds and wide open throttle operation



require this type of spark plug.



*Switch to*

# AUTO-LITE SPARK PLUGS



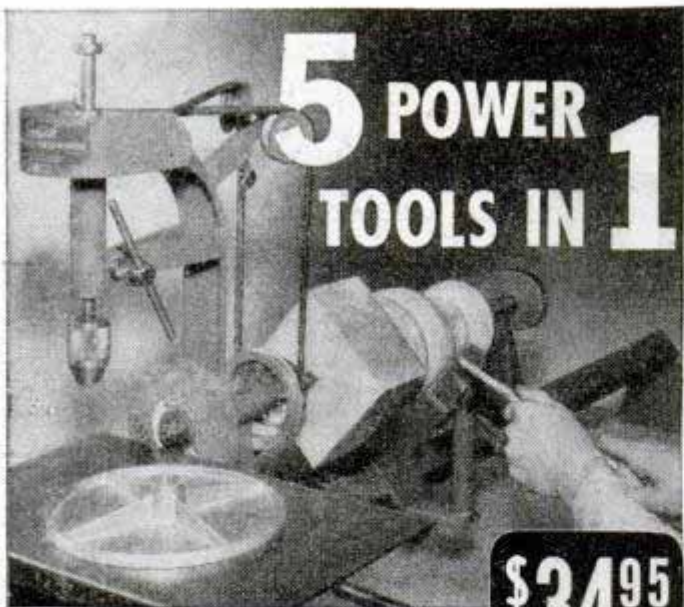

**COMPLETE HOME**

**\$34<sup>95</sup>**

**WORK SHOP** The Emrick Universal Woodworker gives you the five most useful power tools in one rugged, compact HEAVY fabricated steel frame. Free running in bronze bearings. Thousands of satisfied users.

It's a **LATHE**—precision built and easy running. 10" swing over bed, 30" between centers, 3/4" main spindle. Face plate, spur center and tool rest included.



It's a **DISC SANDER** that cuts fast and clean on edges or surface of any stock. 8" diameter disc takes any type abrasive.

It's a **CIRCULAR SAW** taking a 6" blade. Arbor takes dado saws, moulding cutters, scratch wheels or buffing wheels.

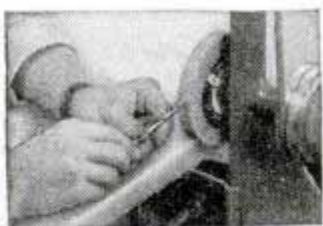

A high quality 5" **EMERY WHEEL** is furnished. 4-step cone pulley gives choice of running speeds for efficient grinding.

It's a **DRILL PRESS** that pulls 1/2" drill in steel. Chuck takes drills up to 1/2". 2" travel. 1/2" spindle. Drills to center of 12" circle.

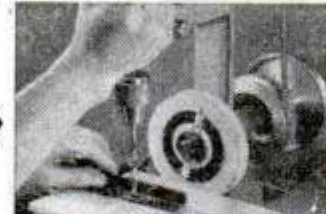

Uses 1/4 H.P. motor. Shipping weight 65 lbs. Motor and saw blade not included in price quoted. Prompt shipment.

**10 DAY TRIAL**

**EMRICK, Inc., 1733 Clinton St., Kalamazoo 24, Mich.**  
 Ship on 10 Days Trial. I am enclosing \$17.50, balance C.O.D.  Send Free Literature  Send Free Tool List  
 NAME \_\_\_\_\_  
 ADDRESS \_\_\_\_\_ CITY \_\_\_\_\_

ply 32 different fuels to the dynamometer labs. Hundreds of feet of fuel lines extend through service tunnels beneath the floors.

In the road test laboratory are many new car models used in studies of knock rating, acceleration, fuel economy, air-fuel ratios, spark plug performance and other points of vital concern to automotive manufacturers, refiners and car buyers.

The chemical laboratories contain the most modern equipment available for distillation, purification and preparation of organic compounds, physical chemistry studies and analytical work.

The pilot plant, a separate building at the rear, houses a complete 1/100-scale manufacturing setup for tetraethyl lead. Here improvements for the manufacture of this basic antiknock agent are discovered and passed along to the big manufacturing plant at Baton Rouge, La.

Research workers casually refer to the "furnace house" as a point of interest. This contains a small high-temperature furnace where metal bars are placed under stress and terrific heat applied for long periods of time. The results show strength and corrosion resistance of various alloys. Here, also, jet fuels are studied—thus combining two basic problems of jet engines: proper fuels and heat-resistant metals.

Searching for right answers to engine and fuel problems aptly sums up the activities not only in the jet and corrosion furnace lab, but in the pilot plant, chemistry labs, dynamometer rooms, aeronautical lab, the library and right out to the front door of this proving ground for tomorrow's fuels.

As one engineer remarked, it's the answers found in places like the Ethyl Corporation Research Laboratories that "have kept the U. S. a couple of laps ahead of the rest of the world."

**Laboratory in Space**

(Continued from page 102)

Herrick figures. "The earth moves around the sun at 18 1/2 miles per second. So, if the rocket is launched in the opposite direction from the earth's travel, at eight miles per second, its net forward speed would be 10 1/2 miles per second.

"After the ship pulls away from the earth its rocket motor could be turned off. The earth's attraction then would increase the ship's speed, pulling it along behind at about 17 miles per second. Gradually the ship would curve in toward the sun and the solar attraction would increase its speed to 23 miles per second. Approaching Venus, the ship's speed would increase

(Continued to page 288)



# HONES! and strops! RAZOR BLADES

More shaves,  
better shaves  
from every blade



**Allegro**—that's the name of this clever device from Switzerland—and it will give you a brand new idea of shaving comfort. For Allegro will put a perfect, professional cutting edge on any single- or double-edge blade in 30 seconds. First it hones on a regular honing stone; then it strops. Just snap the blade in place and stroke back and forth.

Strongly built for years of service. \$6.50 at leading cutlery stores. If not available locally, we send post-paid on receipt of \$6.50. State name of blade used. Voss Cutlery Co., Inc., 258 Broadway, New York 7, N.Y., Dept. 13

## EVERSON

PRICE  
**\$11.50**

### Class "B" Miniature Gas Engine



A high speed power plant for your competition models.

**FEATURING** — Deep cooling fins — Floating Meehanite sleeve — Per\*Mold aluminum castings — Rugged crankshaft precision ground — Open timer — Rotary valve — External parts plated — .290 Cu. In. displacement. Fully guaranteed against material and workmanship. Bench tested. Engine comes complete with plug, gas tank and fully illustrated instructions less coil and condenser.

**EVERSON BROS.**  
WEST ORANGE, NEW JERSEY

Sent prepaid in U. S. for \$11.50 or send \$1.00 we will ship balance C.O.D.  
6 FRANKLIN AVENUE

## PRINT YOUR OWN COPIES

with **ROLL-A-COPY** duplicator

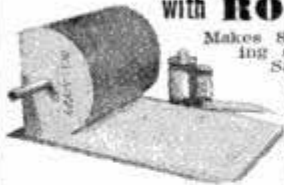

Makes 8 1/2" — 11" copies of letters — advertising special forms — of your own devising. Save printing costs. Make your own business forms. Complete with stencils, ink, brush, stylus, correction fluid and instructions. Sent prepaid if money order accompanies your order. Complete **\$9.50**

**H. W. JOHNSON** 2547 N. Lamer Burbank, Calif.

## GET SET FOR LIFE

This is not a doorbell ringing job—but an outstanding opportunity for a responsible man to set himself up in a permanent business. You invest little, yet you control steadily increasing repeat business. Your profits are limited only by your efforts. (1) You call on retailers to stock our quick-selling "Plastikpli" Liquid Plastic Paint, (2) you can open your own "Plastikpli" store; or (3) you can sell in volume for maintenance painting. This new-type plasticized paint spreads uniformly without brush marks. Extremely hard, yet elastic surface avoids chipping, cracking and withstands ravages of sun and frost to outlast ordinary high-priced paints and save constant re-painting. Non-porous surface prevents penetration of dirt so that it can wash clean and bright. For interiors and exteriors. If you want "A REAL BUSINESS" write us for the details.

Plastikpli is sold direct to user where we do not have distribution. Write for color-chart and prices.

**PLASTIKPLI LABORATORIES, Dept. P**  
169 W. Wacker Drive Chicago 1, Ill.

# War Surplus BARGAINS



## BRAND NEW TANK INSTRUMENT PANELS

Genuine Stewart Warner instruments. Two recording tachometers, one speedometer, two oil gauges, one ammeter, two heat gauges, plus many switches and panel lights. 26 lbs.

**\$25.00**

### SERVO UNIT

For Automatic Pilot. Includes 28 volt D. C. 1/4 h.p. motor, 3 gear hydraulic pump, heating element, etc. Weight 38 lbs. Original cost \$1900.

**\$9.75**

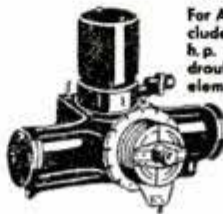

**GUNSIGHT** Contains polaroid filter, prism mirror, and lenses. 14 lbs. Original cost \$700.

**\$8.50**

### GUNSIGHT COMPUTER

Contains 27 volt DC motor, 125 ball bearings, over 100 gears, lenses, switches, flexible drive connections, etc. 36 lbs.

**\$12.50**



### RADIO RECEIVER SWITCH BOX

Contains 2 selector switches, 2 multi-terminal receptacles, phone, jacks, potentiometer. 3 lbs. A real buy.

**\$2.25\***

### RADIO SWITCH BOX

Contains 2 windowed selector switches, multi-terminal receptacle and toggle switch. 2 lbs.

**\$1.75\***



### BRAND NEW PIONEER COMPASS

6-1/2" diameter luminous face, built in magnetic correction.

**\$29.50**



### 25 TON BRONZE SCREW JACKS

Excellent for sagging buildings.

**\$9.50**



### 1/4" ELECTRIC HAND DRILLS

Operates on 12 to 24 volts, a.c.-d.c. 2 lbs.

**\$8.50**

### 3 WHEELED DRUM DOLLIES

1000 pound capacity. Weight 55 lbs.

**\$7.50**

### OXYGEN TANKS

Carries 400 lbs. pressure, 280 cu. in. capacity. Weight 3 lbs.

**\$1.95\***

### MICRO SWITCHES

28 volt 10 amp. feather-touch operation.

**75¢\***

### HYDRAULIC CYLINDERS

Many sizes available. Write for "Hydraulic Cylinder" List.

**\*POSTAGE PAID**

## TERMS OF SALE

All Sales Final. Sales in State of Ohio subject to 3% state sales tax. SEND MONEY ORDER OR BANK DRAFT • ALL CANADA SALES \$1.00 ABOVE LIST PRICE

## PARMA SURPLUS CO.

7010 Hampstead Dept. #1 Cleveland, (Parma) 9, Ohio

Telephone Florida 4401

SAY YOU SAW IT IN POPULAR MECHANICS



# BUILD THIS FAST FREEZER

8 to 40 CU. FT. CAPACITY

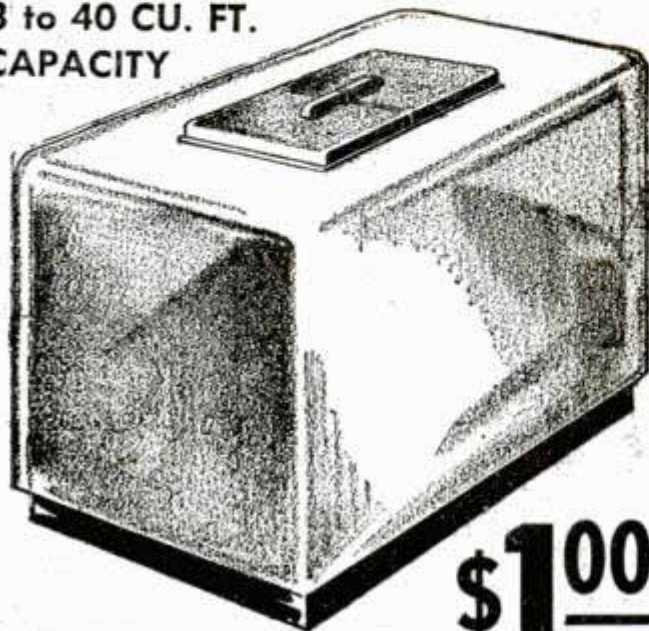

**\$100**

**COMPLETE PLANS ONLY**

**NO KNOWLEDGE OF REFRIGERATION REQUIRED**

Every amateur will be proud to make this household necessity. Operates on 32 or 110 volts. Plans are easy to follow and you may have much of the material at hand. No special tools required.

**MILK COOLER PLANS, TOO,** are included with the FAST FREEZER plans at no extra cost.

Send \$1.00 bill, check or money order for complete plans and catalog. Canada \$1.10. Satisfaction guaranteed.

**LEJAY MFG. CO.**

447 LeJay Building Minneapolis 8, Minn.

SAY YOU SAW IT IN POPULAR MECHANICS

Amazing New **KLIK-RITE**

## BALL PEN

**GUARANTEED to Write for Years Without Refilling**  
Name in 23K Gold **FREE**

CLICK THE BUTTON

A real BALL PEN! Works and performs exactly like highest-priced pens—PLUS amazing new "click-it-to-write"... "click-it-to-park-it" feature—PLUS your name in 23K gold—all for only \$2.98! Writes dry with waterproof ink—no blotter needed. Cannot leak. Writes anywhere... even under water. One piece—no cap to fuss with or lose. Touch the button on top & ball point "clicks" out to write. Another touch and the point "clicks" back into the barrel. A slim streamlined beauty—lightweight... **COMPACT!** Factory guaranteed.

Only **\$2.98**

**Send No Money!**

Rush order today. PRINT NAME to be stamped in 23K Gold. Pay postman only \$2.98 plus few cents postage on delivery. Or send \$2.98 with order and save postage. If you are not delighted, return pen within 10 days for your money back. Order today!

**KLIK-RITE PEN CO., Dept. E-69**  
215 W. Ontario Street, Chicago 10, Ill.

**M-1944 POLAROID GOGGLES**

Formerly \$7.50

Now only **\$1**



Government surplus, but brand new, priced far below surplus ceiling. Complete with one clear lens and one green lens.

Extra lenses Clear, Green, Amber 50c ea.

P.O. BOX 6000 **ROY PARIS** DALLAS TEXAS



**BUILD YOUR OWN PLANS**

Build this new, modern, streamline trailer. Complete detail plans and building instructions sent postpaid for only \$2.50. Send postoffice money order to



**MITCH-CRAFT PLANS, P.O. Box 362, McCook, Nebraska**

## COMPRESSED AIR INSTANTLY, Anywhere!!

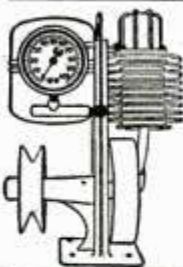

Portable Air Compressor and storage tank. Ruggedly built of best materials using lifetime lubricated ball-bearing on connecting rod and oil impregnated main bearing on shaft. Unusual design forever eliminates valve trouble, the most common fault in air compressors. **PATENTED** unique air intake system increases efficiency tremendously over other compressors so that air output is much greater than that from larger compressors powered by heavier motors. Will deliver approximately 3500 cu. inches of air per minute at maintained pressure of 30 lbs., or will inflate a 90 lb. truck tire in less than one minute. Comes complete with 100 lb.

gauge, although finger-tip adjustment allows setting of output pressure at any value, which will automatically be maintained. Works from any 1/4 H.P. motor. Useful for spraying paints or lacquers, disinfectants, insecticides, annealing or brazing with natural gas, inflating tires, etc. Price \$14.50 postage prepaid anywhere in the U. S. Efficient, completely adjustable syphon type spray gun complete with 12 ft. of 100 lb. tested hose available for only \$7.75 with pint container, also prepaid. 25% required on all C.O.D. orders. Send for free catalogs of radio parts and surplus items.

**BUFFALO RADIO SUPPLY; 219-221 GENESEE ST., DEPT M-3, BUFFALO, N. Y.**

**NOW** you can get **HOT WATER...**

**QUICKLY . . . ANYWHERE . . . ANYTIME**  
with this New **ELECTRIC WATER HEATER**  
**GUARANTEED**

**Practical! Economical!**

Now—hot water in a jiffy—for washing dishes, preparing foods, warming baby's milk, in the sick room—many other valuable uses. Just insert cord in any AC or DC light socket and place the HEATER unit in the water . . . and PRESTO—in a few minutes you will have all the water you want for any convenient

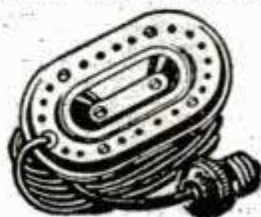

purpose. **PORTABLE**, carry it anywhere—most economical. **HURRY ORDER NOW—SUPPLY LIMITED—ONLY 2 TO A CUSTOMER! MAKES AN IDEAL HOUSE GIFT, TOO!**

**SEND NO MONEY**—Pay postman only \$4.95 each plus postage on delivery. Or enclose \$4.95 each for postpaid delivery. Simple instructions included. If not delighted, return in 10 days for refund. **Factory guaranteed for one full year. Immediate Delivery Now!**

**AMERICAN MERCHANDISING CO., Inc., 12 Adams Ave., Montgomery 4, Ala., Dept. PMWH47**

ONLY **\$4.95**  
COMPLETE READY TO USE



# BOYS LIKE THESE LARGE 10" x 1.75 WHEELS

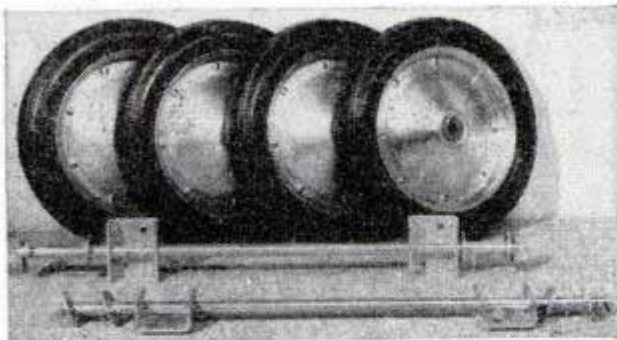

**BUILD YOUR OWN RACER**  
with Genuine GATES  
Style 508 and GOODYEAR  
Style 19 DEEP TREAD  
PUNCTURE PROOF SEMI-  
PNEUMATIC TIRES.

NOTE: these ARE NOT the toy tires used by most wheel manufacturers.

65 Inches Long  
24 Inches Wide  
Weight  
Approx. 55 Pounds

also HEAVY DUTY  
12"x2 1/2" SUPER DELUX  
All Purpose Wheels  
(See Price List Below)

## BUDD HEAVY STEEL WHEELS

Bright Zinc Plated . . . With Arguto Lifetime Oilless Bearings or Kilian Ball Bearings. **4 FOR \$10.00**  
For 1/2" or 3/8" Axles. . . . .  
With 2 . . . 1/2" dia. Axles 20" long hangers, \$13.50  
washers, cotter pins, Ready To Use. . . . . **ONLY**

Here It Is . . . **Combination V Belt Pulley Drive First Again— . . . and Brake Drum**



Securely Held To Wheel . . . **READY TO USE.** Smart Design in Sturdy Pure Cast Aluminum . . . Precision Machined.  
One Combination Drive and 10" x 1.75 Wheel Assembled. . . . . **PRICE \$5.50**  
One Combination Drive Wheel and three without (set of 4). **PRICE \$13.00**  
Same as above with 2-20" x 1/2" axles, 4 hangers, washers, cotter pins. **READY FOR USE. . . . . PRICE \$16.50**

Same as above with 24" long x 3/8" dia. axles, 4 hangers, washers and cotter pins. **READY FOR USE . . . . . PRICE \$19.00**

Combination V Pulley Drive and Brake Drum, without wheel. . . . . **PRICE \$3.50**  
F.O.B. Doylestown, or, add 10% for Prepaid Shipment anywhere in U.S.A.

### INDUSTRIAL HEAVY STEEL WHEELS

—with 5/8" Ball Bearings and Gates 10.00"x2.50" Heavy Duty Semi-Pneumatic 250 lb. Load Tire—

**ONLY \$6.00 EACH PREPAID**

## OSBORN WHEEL COMPANY

115 So. Main St., Dept. P-3, DOYLESTOWN, PENN.



### Model "A" Racer Chassis FOR POWER OR PUSH

Again we are **FIRST** with a sturdy built All-Purpose Chassis. Miles of pleasure, for any age, little ones or adults. This racer chassis engineered into the finest design for electric, gasoline or push power, giving you the choice of body design to build yourself. Equipped with Genuine Arguto OIL-LESS LIFETIME BEARINGS or Kilian Ball Bearings. Ready to roll and steer. **COMPLETE \$46.00**  
AS ABOVE, ONLY  
F.O.B. Doylestown or, add 15% for Prepaid Shipment in U.S.A.

**RUSH ORDER TODAY**

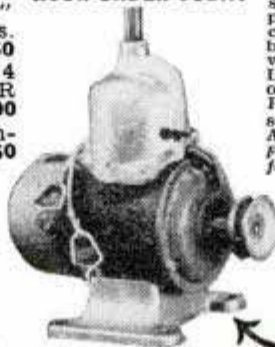

### Here It Is: Electric Motor for REAL POWER DRIVE

Space does not allow to adequately describe this excellent POWER UNIT to complete the above described Model "A" RACER CHASSIS—

Write for Circular and Price on Electric Motors.



Wheel Designed To Carry 200 Pounds

**Super DeLux 12x2 1/2" Wheels**  
for 1/2" or 5/8" Axles  
Wheels Complete With Tire  
1 ONLY . . . . . \$ 5.50  
2 ONLY . . . . . \$10.00  
4 ONLY . . . . . \$18.00  
Plus 10% for Prepaid Shipment

## INTRODUCTORY OFFER!

**\$1.98**

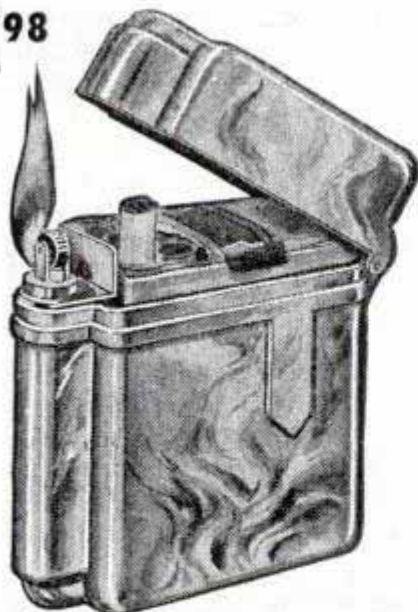

All-In-One Cigarette Lighter and Full-Pack Case gives you cigarettes and lights together as you want them. Streamlined, smart, modern . . . a wonderful convenience, the ideal gift. For men or women. Built for lifetime service of beautiful plastic. Deep-well lighter holds month's supply fluid **SEND NO MONEY . . . 7 DAY TRIAL.** Order on trial, inspection and approval. On arrival deposit \$1.98 plus C.O.D. Use 7 days. If not delighted, return for full refund. (Send \$1.98 with order and we pay postage.) (Dealers . . . write for prices, discounts.)

**HENRY SENNE & CO., Dept. 49-C**  
500 N. State St. Chicago 10, Ill.

MARCH 1947

## BLADE MASTER'S Magic Black Box CONDITIONS DOUBLE BLADES

Gives you as many as 30 smoother shaves from an ordinary blade!



No more face-burning soreness, no painful nicks, no skin irritation! **BLADE MASTER** removes microscopic jagged teeth present on even new blades due to mass production. 10 seconds of gentle stroking in magic black box before daily shave makes each shave cleaner, closer than the last! Users report 20 and 30 perfect shaves from just one blade! Exclusive rotary honing action simultaneously conditions all four edges! Send for your **BLADE MASTER** today on 5-Day money-back guarantee. Enclose check or money order.

**only \$1.95**

Post Paid

**BLADE MASTER, INC.**

315 East 91st St., Dept. P, New York 28, N.Y.

287



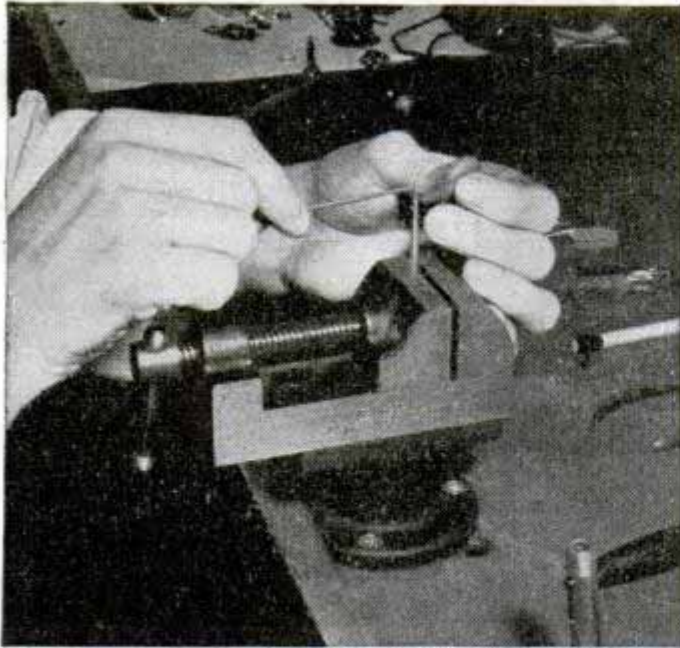

Photo courtesy Boeing Aircraft Company

the files for

# SKILLFUL HANDS

When you're working to tolerances of a thousandth inch or so, the selection of *The right files for the job* becomes an important factor. Accurate cut (of teeth); uniform hardness and sharpness—for even cutting and wear . . . these are the things that count. They help to steady the hand; to translate skillful effort into desired results.

*Nicholson X. F. Swiss Pattern Files* carry the quality reputation of the world's foremost file manufacturer; the assurance of fine performance and top value. Available in a wide variety of shapes, lengths and cuts. Prized by the hobbyist, jeweler, die and fine-instrument maker! Sold through industrial supply and the better hardware houses.



**NICHOLSON FILE CO., 22 Acorn St.  
Providence 1, R. I.**  
(In Canada, Port Hope, Ont.)



# NICHOLSON FILES

FOR EVERY PURPOSE

to 30 miles per second because of the gravitational pull of that body. Venus itself travels ahead at nearly 22 miles per second and so the net approach speed would be about the same as that of the take-off.

"The sun's gravitational pull would predominate during most of the trip. Disturbances by the earth, the moon, Venus and other bodies would have to be allowed for, especially at the start and the finish. The exact orbit would be precomputed for all stages of the journey and this would be checked en route by celestial observations. The edge of the earth or the moon plus a star, for example, could be used in obtaining fixes. If the rocket got badly off course it would miss its target and probably would drift around the sun until the end of time."

Minor corrections in speed and direction likely could be made by blasts from rocket nozzles projecting at different angles.

Venus is a question-mark planet. Almost as large as the earth and with a gravitational pull about 14 percent less, its surface is always hidden by thick clouds composed in part of carbon dioxide. Oxygen and water vapor haven't been detected in the cloud layer. No one knows what lies under the clouds or whether the surface of Venus is solid or liquid. Some suspect that the surface consists of a sea of formaldehyde. The temperature might be equable or it might be above the boiling point of water. In other words, we don't know whether life as we know it could exist on Venus.

If and when a space ship is built, other problems will immediately arise. Its crew would have no inkling of what they would find until after they had plunged through Venus' cloud curtain. If they landed safely they would have to begin manufacturing, at once and from whatever materials they could find, an atmosphere similar to ours.

Not for more than a year would Venus and the earth be in positions suitable for the return trip. In the meantime the crew would need to continue to breathe, eat and drink. They would have to refine sufficient fuel for their return from the elements available. They would need to work out the navigation problem of returning home against the attraction of the sun. They would need derricks and other apparatus for re-aligning the craft for launching. They might even need a ground handling crew.

Obstacles like these make interplanetary travel appear almost as fantastic today as the idea of talking great distances over metal wire would have seemed several centuries ago. But the miracle of the telephone is old stuff now and in 1947 scientists only say that they don't yet command the magic to make space travel practical.



# Ready! AMAZING NEW PORTABLE MAGNETIC JIG-SAW!

Model No. 2000

## SYNGRO

DELUXE JIG SAW  
For Hobbyists, Craftsmen  
and Light Production

PROMPT SHIPMENT! LIMITED SUPPLY!

IDEAL  
For  
APARTMENT  
USE . . . in kitchen  
. . . any room

NO MOTOR  
NEEDED  
. . . JUST  
PLUG IN

Sold On  
10 DAYS  
Moneyback  
TRIAL  
Send For  
FREE  
Details!



"It's easy . . . fun . . . and the safest saw made, Son!"



Now I can help you, Dad . . . and do my own work, too!

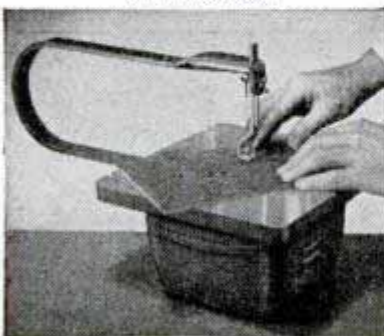

There is nothing like SYNCRO for intricate design work!



Complete  
with cord, 3 blades

World's Safest Saw!

CUTS CLEAN..SMOOTH...NO SANDING!

ANNOUNCING a remarkable, PATENTED, MAGNETIC Jig Saw—better-performing, better-quality than famous PRE-WAR SYNCROS—now ready for immediate shipment anywhere! Get this husky, powerful, 18 pound saw . . . so easily portable . . . you can use it anywhere—even on the kitchen table . . . so smooth-cutting no sanding is necessary! SYNCRO needs NO belt, NO gears, NO oiling. NO motor to buy. The high-speed, short stroke action, and freedom from belts, makes SYNCRO so SAFE even small boys and girls may operate it. Cuts intricate designs on  $\frac{3}{4}$ " soft wood,  $\frac{1}{2}$ "

plywood and thinner hard woods, plastics, thin metals. Leaves NO ragged undersides on plywood or heavy cardboard. The rapid action blade cuts to the center of a 27" circle. SYNCRO is a rugged, powerful power tool for exceptionally high quality work but is not for ordinary lumber cutting. Ideal for hobbyists, craftsmen, light production. Perfect for models, displays, puzzles, inlays, silhouettes, toys, marquetry, games, what nots, etc. Enjoy a lifetime of use! Mail coupon now for FREE details, 10 Days Money Back Trial Offer, amazing low price! Hurry!

### 15 OUTSTANDING SYNCRO FEATURES

(1) **WORLD'S SAFEST SAW.** (2) **PORTABLE** . . . plugs in to 60 cycle A. C. 110-130 volt wall outlet. (3) **NO ROTATING MOTOR NEEDED.** Syncro's self-contained magnetic power unit transmits A. C. magnetic impulses to armature diaphragm—power transferred to saw blade. **COIL** contains  $\frac{1}{4}$  lbs. No. 19 insulated copper wire, completely taped, impregnated, baked. **Guaranteed** not to burn out! **MAGNET CORE** contains 58 layers of metal. **DIAPHRAGM** of spring steel, heat-treated under special process, suspended on L-I-V-E rubber

mounting cartridges. (4) **14,400 STROKES PER MINUTE!** (5) **NO RECIPROCATING OR ROTATING PARTS TO WEAR OUT!** (6) **NEVER NEEDS OILING.** (7) **TABLE TOP** 10"x10", a heavy, thick, durable alloy die casting  $\frac{3}{8}$ " thick, ribbed base. **Surface** smooth for easy sliding. (8) **BASE** 7 $\frac{1}{2}$ "x4 $\frac{1}{2}$ " . . . a heavy, durable die casting. (9) **ARM** is of specially formed steel stamping  $\frac{1}{4}$ " x1". **Return Spring** of heavy duty steel. **Guide Slide** of plated steel and adjustable to varying wood thicknesses. **Adjustment Screw** permits easy, quick changes in

length of saw blade stroke to compensate for voltages of 110 to 130 A.C. (10) **THROAT CLEARANCE** 1 $\frac{1}{2}$ " permitting work on square sheet of wood, metal, plastic, 27" on the diagonal. (11) **5' CORD** . . . extension. **Underwriter's approved** electric cable with molded rubber plug. (12) **BLADES** are 6", pin end style, of finest steel. 18 teeth per inch. (13) **NO-MAR, NON-SLIP RUBBER FEET.** (14) **DURABLE** — will last a lifetime. (15) **HIGHEST QUALITY** — guaranteed by the trademark name "SYNGRO." Get Free details now!

### FREE CIRCULAR!

Send this instant for Free, complete details on SYNCRO SAW, 10 Days Moneyback Trial Offer, amazing low price! But hurry! 1947 production is strictly limited . . . but if you act quickly, you can be SURE of getting yours! Send no money—send Coupon for Free facts. Paste Coupon on penny post-card—or mail in envelope . . . today!

### Mail Coupon Now!

#### FREE INFORMATION COUPON!

**SYNGRO** SAW CORPORATION, Dept. A-37  
ROCHESTER, MICHIGAN  
(Export Address: 120 Wall St., N.Y. City)

Gentlemen: Rush me, without obligations, free, complete details of Syncro Saw, your 10 Days Trial Offer, amazing low saw price.

Name.....

St. & No.....

City..... Zone No. .... State .....

## SYNGRO

World's Safest Saw

**SAW CORPORATION**  
Dept. A-37, ROCHESTER, MICHIGAN  
Export Address: 120 Wall St., N. Y. City

WORLD'S LARGEST MAKERS OF ELECTRIC JIG SAWS  
MARCH 1947



**NOW  
AVAILABLE**

**Famous Gleason JUMBO Deluxe Semi-Pneumatic  
Rubber Tired WHEELS for  
Homecraft, Farm, Shop USE!**

Air-cushion, puncture-proof tires on welded steel discs *engineered for industry* now available at your hardware store. If your dealer can't supply you, order direct from factory. No COD's. Send money with order. *Dealers, Manufacturers write for information.*



**CHECK THESE  
Gleason Features**

- Heavy, thick walled tires
- Hardened roller bearings
- Specially designed hub
- Fits all 1/2" axles

**Gleason**

INCORPORATED

Dept. 127, 2401 N. Maryland Ave., Milwaukee 11, Wis.

**BUILD YOUR OWN**  
Trailers, farm carts, wagons, carry-alls, trucks, special wheeled equipment.

**Gleason Wheel Prices**

8x1 1/4 ea.	\$2.80	4-\$10.80
8x2 ea.	\$2.90	4-\$11.00
10x1 3/4 ea.	\$3.60	4-\$14.00
10x2 3/4 ea.	\$7.10	4-\$28.00

FOB Milwaukee, Wisconsin

*Powerful!*



Gripping power exceeds a ton! Does more things—easier, quicker—than any other tool. Remains locked to work with hands removed. Adjusts to super-plier action (handle opens automatically when grasp is released.) Greater range of jaw-adjustment than any other type of toggle-wrench. Vise-Grip is the original toggle-wrench, long proved to be superior, stronger. Built of fine alloy steel. Nickel plated. Two sizes:  
7", \$1.65  
10", \$1.95

Double Lever  
Action  
DOES IT!

**WISE-GRIP  
WRENCH**

Sold thru Tool Jobbers and Dealers  
Invented, Developed and Made World Famous by  
**PETERSEN MFG. CO., Dept. 28, DeWitt, Nebr.**

SAY YOU SAW IT IN POPULAR MECHANICS



**NUMBERALL Rotary Stamp**  
(Patented)

*1 Tool Instead of 12*

For stamping figures and letters on metal, etc. One stamp does away with 12 individual hand stamps. Changes of characters are quickly made merely by rotating the indexed wheel. Wheel is made of finest tool steel. Sizes 1/16" to 3/16" figures can be furnished at \$5.00 each in pouch. Larger sizes and alphabet at higher prices. Write for Catalog.

**NUMBERALL STAMP & TOOL CO.**  
HUGUENOT PARK STATEN ISLAND 12, N. Y.



**BRASS RODS**  
For Home Work Shops

- Free Cutting Rods  
3/32 - 3" Round & Hex
- Naval Brass Rods  
1/8 - 2 1/4" Round
- Brass & Copper Tubing  
1/4 - 3/4" Outside Diam.

Send for Complete  
Price List No. 101

**MEIER BRASS & COPPER CO.**  
1155 Bellevue, Detroit 7, Mich.

**Ottawa Self-Propelled Buzz Master**

**CLEAR LAND FAST!** Powerful 6-HP motor with friction clutch for safe operation. Cuts down timber, brush and hedge; turn blade vertically and saw logs to length. Can be equipped to fell largest trees. Has clutch pulley for belt work. Is fully guaranteed.



**OTTAWA MFG. CO., 327 Brush Ave., Ottawa, Kansas**

WRITE FOR YOUR **FREE** COPY OF THE NEW  
**KRW HYDRAULIC PRESS BOOK**

Describes all manner of Production and Shop Work on KRW Hydraulic and Bench Type Arbor Presses. 32 pages illustrating the new KRW Hand-operated, Electric-operated and Air-operated Hydraulic Presses.  
*Write for your copy today.*

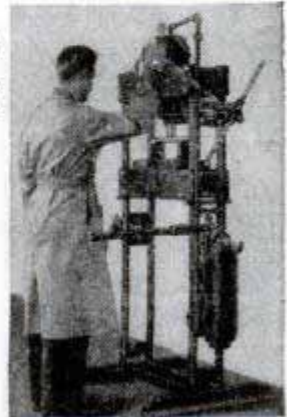
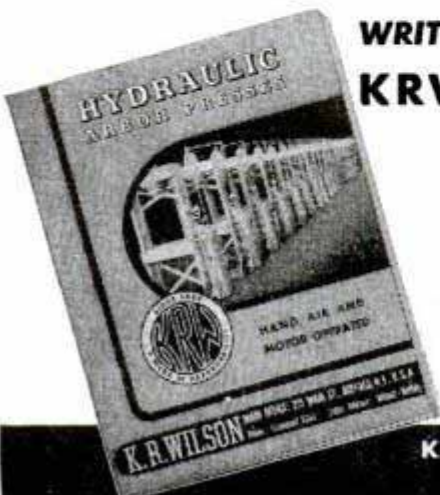

**K. R. WILSON, DEPT. 17, 215 MAIN ST., BUFFALO 3, N. Y.**  
*Builders of Shop Equipment for Ford Dealers Since 1916*



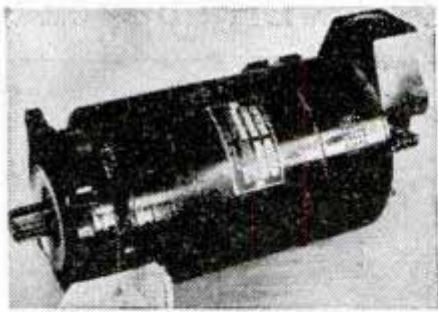

## 50 AMP. AIRPLANE GENERATOR

Can be used on homebuilt Electric Welder, Wind Charger, Battery charger, Light Plant, etc. Also can be used on boats, trucks, airplanes. Fits nearly any 24 volt airplane system.

Built by Leece-Neville, 24 volt, 50 amp., Model L-3.

**BRAND NEW!** Original cost \$212, NOW, only, \$24.95!

\$2.00 deposit required on CODs. Generators shipped Express charges collect.

**AERO INSTRUMENT COMPANY**

Municipal Airport

Houston 12, Texas.

## WIGGINS QUICK WATER HOSE COUPLING

**SNAP - it's on! PULL - it's off!** Easy, fast! Wiggins coupling is guaranteed leakproof! Saves water, time. No bruised fingers or twisted hose. Precision made of solid aluminum bar stock. Lifetime use. For the best in water hose couplings, buy Wiggins! On sale at better stores \$1.35 complete.



**E. B. WIGGINS OIL TOOL CO., INC.**

3424 E. OLYMPIC BLVD., LOS ANGELES 28

## BUILD YOUR POWER TOOLS WITH OUR BALL BEARING ARBORS

New Departure  
Self Lubricating  
Bearings

10,000  
R.P.M.

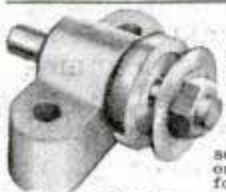

B33—\$4.95 PP.  
5/8 x 4 1/2 Spindle  
B15 Plain Spindle  
\$3.45

Right hand threads will be sent unless left hand ordered. No extra charge for left hand threads.  
C4—1 1/2 x 12 1/2 spindle, housing 2x8 \$8.25 PP.  
C5—5/8 x 12 1/2 spindle, housing 2x8, \$8.25 PP.  
C6—3/4 x 12 1/2 spindle, housing 2 1/4 x 3, \$9.25 PP.  
C8—1 x 17 1/2 spindle, housing 2 3/4 x 11 \$16.95 PP.

1 INCH BETWEEN WASHER AND COLLAR

Sanding Discs. Tru-Running. Aluminum Alloy, 1/2 inch or 5/8 hole, 8 inch dia. \$3.50 PP. 9 inch dia. \$4.95 PP. 10 inch dia. \$6.50 PP.  
Full stock of V belts and pulleys for immediate delivery PP.  
V BELTS \$.03 PER INCH PP.

POLY PRODUCTS, 406 S. Chester Ave., Ct. 1, Dept. 52, Pasadena 5, Calif.



## FREE RADIO CATALOG

Latest radio and electronic parts and devices, newest ham gear, gadgets, war surplus items. All in this new FREE catalog. Don't delay,

**BURSTEIN-APPLEBEE CO.**

1014 McGee, Kansas City 6, Mo.

**BUILD YOUR OWN**

## ARC-WELDER

For Light or Heavy Work

No rewinding necessary—use coils taken from old auto generators. Works on 110 or 220 A.C. Has 20 different heats. Complete plans and BIG Catalog 35c.

LEJAY MFG. CO.

3347 LeJay Bldg.

Minneapolis, Minn.



# LEPAGE'S GLUE

**LEPAGE'S GRIPSREADER MUCILAGE**

**LEPAGE'S WHITE PASTE**

# A TOOLSHOP IN YOUR HAND!

- GRIND • DRILL • ROUT
- POLISH • ENGRAVE
- CUT • SAND • SAW, etc.

Make Things From  
Wood—Plastics—Metals—Glass—Linoleum—Leather—Alloys—Horn—Stone—Bone, etc.

## HANDEE TOOL OF 1001 USES

Smooth, steady power at your fingertips! Perform precision operations not possible with any other portable tool! With a Handee you can turn out professional looking projects for pleasure or profit—ship, plane and train models, costume jewelry, wood carvings, puppets, initialed tumblers, etc. AC or DC. 25,000 r.p.m. Wt. 12 oz.

USE THE RIGHT ACCESSORIES! Choose them from the most complete line . . . more than 300 made right in the Handee plant.



## GET A GOOD START GET THE HANDEE KIT

HANDEE Tool and 40 most popular accessories packed in compact steel carrying case. You'll be amazed at what you can accomplish!

Postpaid, \$27.50

Handee, with 7 accessories, \$20.50

FOR YOURSELF OR A FRIEND... THE GIFT OF A LIFETIME!

## NEW PRECISION ATTACHMENTS

Fit Handee only; enable novice or craftsman to do perfect work. Magically, easily, your offhand carving, routing, shaping will be exact as to depth of cut, accuracy of line. Set of 6 attachments with instructions, postpaid, \$7.95

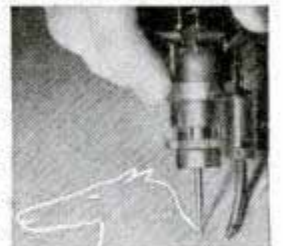

ORDER NOW. SATISFACTION GUARANTEED!

FREE! NEW 52-PAGE MANUAL

**CHICAGO WHEEL & MFG. CO.**

1101 W. Monroe St., Dept. PM  
Chicago 7, Ill.

Send  Handee Kit  Handee Tool  Precision Attachments  
 C.O.D.  Remittance enclosed  Send Manual

Name.....

Address.....



# RA-TOX

ROLL-UP • WOOD SPLINT  
SHADES  
FOR  
INDUSTRIAL WINDOWS

## ELIMINATE GLARE

Stop DRAFTS and SunHEAT  
INCREASE EFFICIENCY  
SPEED-UP PRODUCTION  
REDUCE WORK SPOILAGE  
AVOID ACCIDENTS

GLARE is one of the common causes of "EYE FATIGUE". Momentary Blindness may result in a severe accident or it may ruin days of painstaking work.

For STEEL  
or WOOD  
SASH

RA-TOX SHADES roll up or down to offset changing daylight conditions. They will improve the appearance of your plant and add to the comfort and safety of your employees. There is a type to fit every industrial window.

LIGHT without GLARE  
AIR without DRAFT



A nation-wide shading service. Representatives in all principal cities...

Write for Latest Bulletin

**HOUGH SHADE CORPORATION**

INDUSTRIAL DIVISION

1107 JACKSON ST., JANESVILLE, WISCONSIN

## MILL IT ON YOUR LATHE



WITH A **PALMGREN**

### MILLING ATTACHMENT

Now — you can do milling, slotting, grinding, grooving, squaring shafts, sawing at angles, and many other important operations on your lathe. PALMGREN MILLING ATTACHMENT is a necessary fixture for small shops, schools and emergency work in large plants. Fits South Bend, Atlas, Craftsman, Logan, Sheldon and all other makes. It has graduation for rotary angle adjustments, also graduated feed and adjustment screw. Easily mounted by straddling lathe's regular tool post. Try one—it will quickly pay for itself.

No. 250

### IMMEDIATE DELIVERY

No.	Width Jaws	Depth Jaws	Jaws Open	Weight Pounds	Base Opening	Price F. O. B. Factory
150	1 1/4"	1"	1 1/4"	6 1/2	1"	\$18.75
250	2 1/4"	1 7/8"	2 1/4"	11	1 1/2"	24.75
400	4"	1 1/2"	4"	25	2"	39.75

Order from your dealer or jobber. Write for circular No. 349

JUST A FEW OPERATIONS YOU CAN DO ON YOUR LATHE

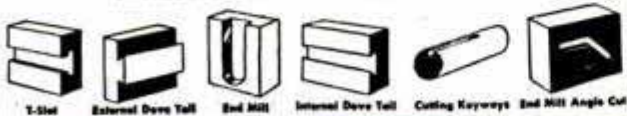

**CHICAGO TOOL AND ENGINEERING CO.**

Mfrs. of PALMGREN PRODUCTS for Over 28 Years

8365 South Chicago Avenue • Chicago 17, Illinois

## Hot 'Blotter' Dries Inks on Fabric

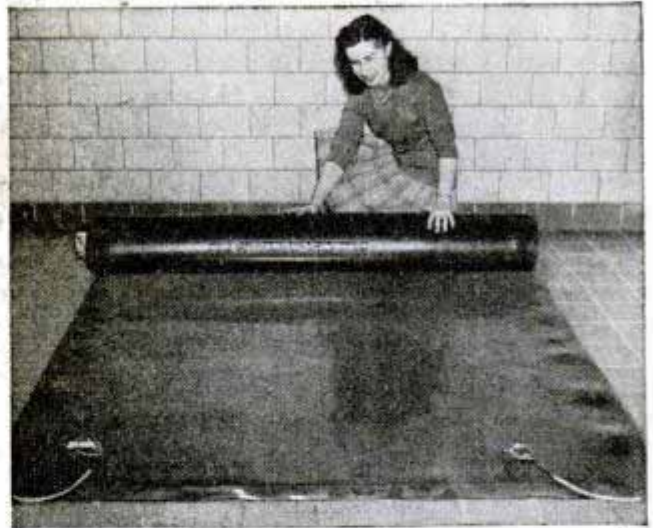

Dried quickly by the world's biggest rubber blotter, multicolored inks are now printed on fabrics in one continuous operation to speed the processing of textiles. Actually an electric heating pad with layers of specially compounded conductive rubber sandwiched between insulating sheets, the unit dries the ink by warming it. Heat output is eight kilowatts and temperatures up to 170 degrees can be maintained with it. It was built by Goodyear as a new application of war-developed heated ice guards for airplane propellers.

## Experimental Wing Tip Aileron Tested for Pilotless Aircraft

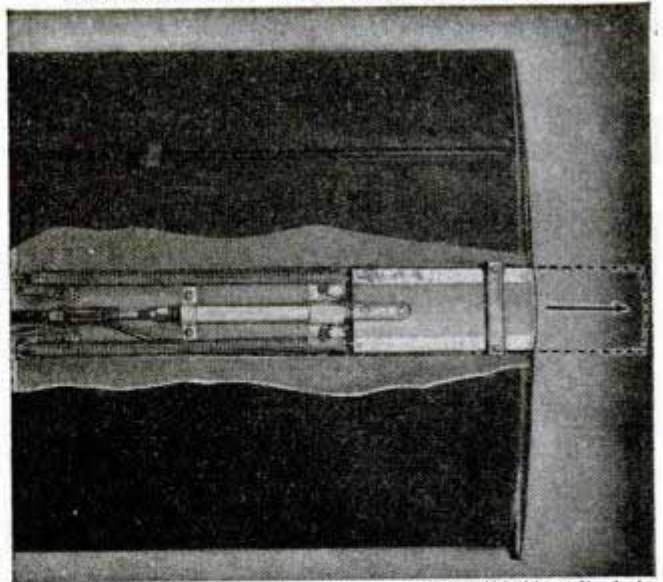

Fairchild Aircraft photo

To better control pilotless aircraft, the Navy is testing a retractable aileron which protrudes from the wing tip instead of the trailing edge. Housed completely inside the wing, the aileron is extended by compressed air forced into a tube and plunger attachment and retracted by springs. Orthodox ailerons are moved up and down but remain fixed at the rear of the wing.



# 2 Bushels of Ripe TOMATOES from ONE VINE



2 or 3 vines will produce enough tomatoes for the average family.

## New BURGESS CLIMBING TRIP-L-CROP

TOMATO rapidly grows to a height of 10 to 18 feet. Grow on trellis, side of house or barn or as a bush in garden. Beautiful crimson, solid, meaty fruits of best quality, some weighing over 2 lbs. each. The most productive of all tomatoes. Trial packet 10c—3 for 25c, postpaid.

**CASH PRIZE CONTEST**  
Send for FREE Garden Book giving full details about CASH PRIZES to growers of this wonderful tomato.

**BURGESS SEED & PLANT CO.**  
217 C.T., GALESBURG, MICH.

## MAKE YOUR OWN DISC SANDER



Mount this 8" cast aluminum sanding disc on any 1/2", 5/8" or 3/4" spindle. Sturdy ribbed design. Order direct—\$2.00 postpaid. Threaded bore 25¢ extra. Abrasive paper discs, 8"—1 doz. asst. grits \$1.25.

1726 Clinton Street  
**EMRICK INC. KALAMAZOO, MICH.**

WRITE FOR FREE TOOL LIST.

## MILK UP TO 25% FASTER WITH NEW 2-PIECE TEAT CUP!



Cleans 50% Quicker

Nothing else like it. Cleans 50% quicker. Milks faster, cleaner, less stripplings. Just 2 parts to clean. Sticks better to any size, shape teat. Best for DeLaval, McCormick-Deere, Sears, Empire, Universal, Conde, Perfection, Rileway, similar milkers. Style B especially designed for DeLaval. NO threads, rings, gadgets. Takes apart, assembles in an instant—without tools! Thousands in daily use. Rush postcard NOW for facts of Guaranteed MONEY-BACK 30 DAY TRIAL, free amazing Cup Circular. State name of milker.

R. E. MAES 206 BEAR CREEK FARM MARSHALL, MICH.

## Pins and Rings FREE CATALOG

Class pins, club pins, rings and emblems. Finest quality. Reasonable prices from 30c up. Write today. Department N. Metal Arts Co., Rochester, N. Y.

## Make Your Own RUBBER MOLDS

### Amazing New Method!....



Now, an amazing new method to make your own flexible rubber molds to recast sculptured models or subjects. Duplicate singly or in quantity, expensive original subjects at amazing low cost. Reproduce statuettes, plaques or any other models—any surface—with this new liquid rubber material. Hundreds of other uses.

**PROFITABLE HOBBY!**  
Start this fascinating hobby that can lead to beginning of your own business. For only a few cents each, make hundreds of castings to resell at big profit prices. Easy to start. Big list of subjects you can reproduce.

**SEND NO MONEY!**  
Just your name and address for BIG INTRODUCTORY KIT containing 14 different items; everything you need to work with including famous Indian model. Pay postman only \$1.49 plus C.O.D. postage. Money back if not satisfied. Or save C.O.D. by sending \$1.49 with order and we pay postage. Write for FREE CATALOGUE!



**RUBBER-FOR-MOLDS, 6044 N. Avondale, Dept. 49-C, Chicago 31, Ill.**

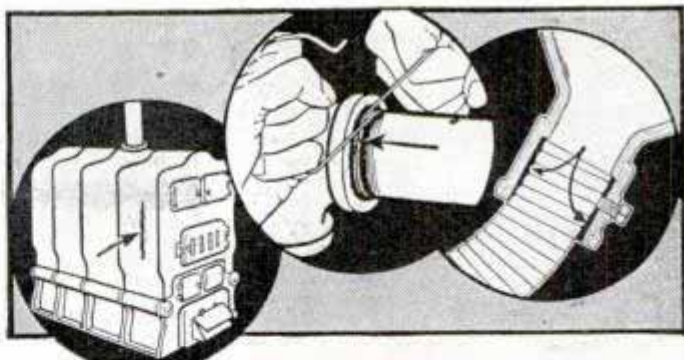

# How You Can Make HOUSEHOLD AND AUTO REPAIRS THAT STAY TIGHT!

Make them without using heat, without special experience, usually without taking things apart. Stop leaks, seal cracks, tighten loose parts. Repair boilers, piping, auto connections, radiators, tanks, pumps, utensils, tools, etc. effectively, inexpensively. Do it as professional repair men do, with

## SMOOTH-ON NO. 1 IRON CEMENT

You use Smooth-On as you would putty. It hardens like metal and remains tightly in place.

Keep Smooth-On No. 1 handy and get after leaks, cracks, and loose parts promptly. Get it at your hardware store in economical 1 3/4-oz., 7-oz. or larger size. If they haven't Smooth-On, write us.

## FREE Repair Handbook

Clear directions for ingenious, short-cut repairs on household equipment of many kinds. 40 pages. 170 diagrams. A book every home should have. Paste coupon on a post-card and send for your free copy today.



## — Sign and Mail Now —

Smooth-On Mfg. Co., Dept. 37C,  
570 Communipaw Ave., Jersey City 4, N. J.  
Please send me my Smooth-On Handbook.

Name .....

Address .....

3/47 .....

# Do it with SMOOTH-ON

Iron Cement of 1000 Uses



# Now A DYNAMIC HEAVY DUTY INDUSTRIAL WELDER

## IDEAL FOR AUTO - HOME APPLIANCE AND FARM REPAIRS

DESIGNED TO DO HIGH GRADE WELDING INEXPENSIVELY—Maintenance Men, Farmer's Mechanics; Machine Shops; Foundries; Auto, General Repair and Job Welding Shops; all using the DYNAMIC find it so indispensable and useful that they cannot afford to be without it. If inexperienced, you can easily learn to do a variety of high grade welding jobs by following the practical, simplified operating and welding instructions furnished. Once you see a DYNAMIC in operation, you won't want to be without it. Its simplicity will amaze you. In a year the DYNAMIC only costs you about 6¢ a day. Helmet, rods, cables, holder and operating instructions, etc., furnished.

### SAVES YOU VALUABLE TIME AND MONEY!

This portable DYNAMIC WELDER—easily carried to the job—can be operated from any convenient, properly wired 110 volt, 60 cycle line. Can also be supplied for 220 volt, 60 cycle operation and for other voltages and cycles at slight additional cost. Works on IRON, STEEL, BRASS, BRONZE, AND OTHER METALS—has 8 metallic and carbon arc welding heat stages—does work you would think only possible with larger more expensive machine. DYNAMIC WELDER CO. • 13 East 23rd St., FW, Chicago 16, Ill.

FOR ONLY  
**\$23.50**

COMPLETE...  
AVAILABLE NOW  
IMMEDIATE  
DELIVERIES

Write today  
For Particulars

Get details on our  
10 day trial offer

Member Chicago  
Association of  
Commerce

FARM  
IMPLEMENTS  
BICYCLE  
REPAIRS  
SHOP  
WORK  
HOME  
APPLIANCES  
AUTOMOBILE REPAIRS



# Electrify YOUR LAWNMOWER

WITH  
**BATTERY  
POWER**

COMPLETE  
PLANS

Only \$1.00

SELF-  
PROPELLED



We show you how to convert your own lawnmower for use with an ordinary car battery. Save energy, labor and time with this self-propelled unit. Our simplified plans make it easy.

### Makes Grass-Cutting Easy

Operates quietly on any ordinary auto battery, which is easily charged from house service. Our plans make it simple to convert almost any hand mower to power operation. Be the envy of your neighbors with a quietly propelled mower.

WRITE  
TODAY  
FOR  
PLANS

**LEJAY MFG. CO**

247 LeJay Bldg.

MINNEAPOLIS - 8 - MINN.

## ROTARY DRILL HARD MASONRY



Now easy to drill Con-  
crete, Brick, Slate, Plaster

• Drills 4 Times Faster! • Stays Sharp up to 50 Times  
Longer! • Fits Any Rotary Drill, Hand Brace or Drill-Press!

Your tool chest isn't complete without these new improved masonry drills. Tipped with Carbonyl Cemented Carbide—the hardest metal made by man—they drill clean, true-size holes with ease and speed. Handy 6-drill set, 3/16", 1/4", 5/16", 3/8", 1/2" and 5/8", in free canvas kit, \$13.70 postpaid, or C.O.D. From dealer or direct. Free leaflet.

CARBOLOY COMPANY, INC.,  
11185 E. 8 Mile Rd., Detroit 32

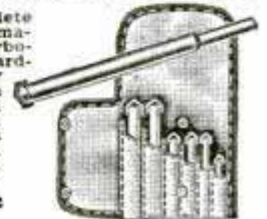

**CARBOLOY MASONRY DRILLS**

CEMENTED CARBIDE

## PLASTICS . . . At New Low Prices

Grade 1 Plexiglas—no seconds—no scraps—big full sheets. Complete instructions and cement included. Big bargains. Kit No. 22, \$3.95—Kit No. 33, \$5.70—Kit No. 55, \$9.20. Permanent dyes also available. Save money—Order your kits now. Send check or money order today. Add 10% for postage and handling. Catalog available.

JACKSON STUDIO, Dept. 7,  
5440 N. Shoreland Ave., Milwaukee 11, Wis.

Free  
Project  
Sheets!

## Have Your Own ELECTRO-PLATING Business

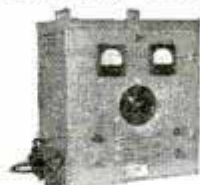

### Profitable - Simple - Pleasant

The VARI-PLATER—110 V. A.C.—plus a glass or rubber tank and chemicals, which are always available, and accompanying handbook, that is illustrated and easy to understand, will give you many money making opportunities.

You can PLATE Gold—Silver—Chromium—Nickel—Copper—Cadmium, etc. on metals and non-metals with the VARI-PLATER.

**FREE** Write today for descriptive literature and price list.

LEWIS ELECTRICAL MFG. CO. 1266P Gun Hill Rd.  
New York 67, N. Y.

# AUTO ENGINE SPEED CONTROL GOVERNORS

Give constant or changeable speed to any auto or truck engine, when used for power. Guaranteed. Instructions. Oil ring bearing, \$14.25. Full ball bearing, \$21.75. Postage, 50¢; east of Miss., 85¢. COD, or— Postage any country \$1.00 each.



These valves used where carburetors have outside attachments.

State exact size of opening and distance between bolt holes. Send gasket if possible. 1", \$3.75; 1 1/4", \$5.25; 1 1/2", \$6.50; 1 3/4", \$7.50; We can supply up to 2 1/2". VB, \$8.00. Note difference between A and B types. Mailing weight, 3 lbs. If remitting, enclose for postage. Stocks carried: In Canada, Montreal 15: 7546 Wiseman St. In Skaneateles, N. Y.: Horie Welding Supply. Circulars.

CANDEE, Dept. P-3, 2641 S. Hill, Los Angeles 7, Calif.



**AGENTS WANTED**  
Parts and Implement Dealers,  
Garages, Welders, Wreckers,  
Catalog and Mailing List  
Houses, etc.



# BARGAIN

Original Cost \$150.00



## 3X Army Telescope ALL COATED LENSES — BRAND NEW

An ideal gift for viewing objects, landscapes, seashores, etc. The high resolving power of the six coated lenses, five of them achromats will bring out great details. For the experimenter it can be dismantled and used for hundreds of projects. Length 22½ inches. Postpaid \$7.50.

500,000 Lenses and Prisms. Send 3 cent stamp for "BARGAIN" List.  
A. JAEGER, BOX 84P, SO. OZONE PARK 20, N. Y.



## Assemble KING MIDGET

Practical highway racer runabout. We supply all parts. Just bolt together. Low cost. Ready for delivery NOW. One or two cylinder. 40 m.p.h., up to 100 miles per gallon. Send 25c for complete literature with large picture, 3-view drawings, price of parts, or send \$1 for the above plus 4 actual photographs, plans for snow and ice conversion, catalogue of new and used motors, motorscooters, transmissions, clutches.  
MIDGET MOTORS, Athens, Ohio

## End Putty Trouble



**HOME OWNERS**—Make your windows puttyless with our metal glazing strip. Fits any window. Easily installed. Rust Resistant. Permanent. Economical. End Putty Trouble Forever. Send \$1

money order for demonstrator. Distributorships available.  
METALLIC GLAZER • BOX 422, WARREN, O.

## REPAIR CRACKED BLOCKS AND HEADS—



External and internal leaks in blocks, cylinders and valve ports quickly and easily with LUSCO PLASTIC SEAL. 90 day Service Guaranteed or your money back. Send money order or check for full pint—more than sufficient for average repair. **\$3.00** Postpaid

C. F. LUSK CO., 5924 BONNA AVE., CLEVELAND 3, OHIO

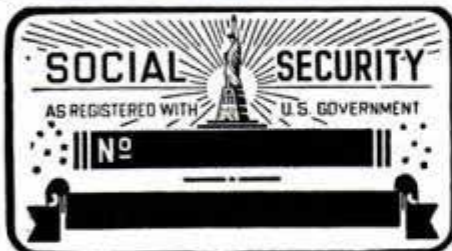

Beautiful brass Social Security plates (illustrated ½ actual size), priced at only 50c. Please print your name & number plainly.

ACME  
Stamping Service  
Box 836  
Davenport, Iowa

## OTTAWA TRACTOR SAW



350 Cuts Per Minute—cuts them down, saws them up, one man operates. Thousands in use, stiff heavy blade, built to last, safety clutch control, uses power take-off any tractor. Low price. OTTAWA MFG. CO., D-327 Forest Avenue, OTTAWA, KANSAS

**NEW!** here it is  
the **GREAT**  
*Lafayette*  
**RADIO CATALOG**  
and it's yours...

**FREE!**



144

Value-Packed Pages

**LAFAYETTE IS THE WORLD'S  
LARGEST RADIO SUPPLY HOUSE**

It's here—now—the new Lafayette 25th anniversary catalog. And what an amazing catalog it is. Packed with *everything* in radio and electronic equipment. Such items as radio parts, complete sets, build-it-yourself kits, automatic record changers, tools, amplifiers, etc.

**HANDSOMELY ILLUSTRATED—Fully Described**

Yes, there's nothing you could possibly want in radio and electronic equipment that you won't find in this amazing catalog. Everything is in stock—economy priced—ready for super-speed delivery. Your free copy will be mailed the day we receive the coupon. *Mail it now!*

*Experimenters!*

No matter what you are building, you're sure to find all the parts you need in the new Lafayette Catalog. Our big stock includes everything for building, experimenting, repair and maintenance in radio and electronics.

*Lafayette Radio*

**RADIO WIRE TELEVISION INC.**

100 Sixth Ave., New York 13  
110 Federal St., Boston 10  
24 Central Ave., Newark 2

**LAFAYETTE RADIO** Dept. LC-7  
100 Sixth Avenue, New York 13, N. Y.

**RUSH** your big new catalog to me by return mail.

NAME.....

ADDRESS.....

CITY.....ZONE.....STATE.....

Clip and paste on penny postcard





## WALKIE TALKIE

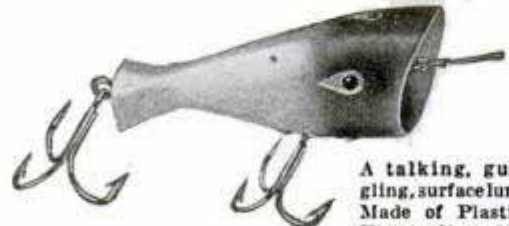

### "Adventures in Fishing"

48 pages in four colors; pictures, fishing stories, secret hints, etc., with regular 10c package of Rap-around, invisible ribbon sinker, both for only 10c. Send your dime today.

A talking, gurgling, surface lure. Made of Plastic. Weighs 1/2 oz. No. 43. \$1.25 each.

## P & K INCORPORATED

(PACHNER & KOLLER, INC.)

3428 Archer Avenue Chicago 8, Ill.  
Canadian Distributors: Central Purchasing Agency, Ltd., Toronto, Ontario

TESTED AND PROVED LURES AND FISHING ACCESSORIES

## 40 POWER TELESCOPE

FINEST ACHROMATIC LENSES  
OBJECTIVE LENS OVER 2" DIA.  
VARIABLE POWER EYEPIECE  
Length Open 27", Closed 9 1/2"

5 Sections  
Brass Tubes  
**\$34.50**



Variable magnification eyepiece adjustable to 10X, 20X, 30X, and 40X. Lower powers excellent for target spotting and wide angle viewing, higher powers for long range and astronomy. Brass tubes, black enameled. Main tube leather covered. This is a precision American made instrument. Only \$34.50 postpaid.

## LABORATORY MICROSCOPE

**600 POWER \$25.50**

**3 OBJECTIVES—75X, 300X, 600X**  
A professional type microscope priced within the reach of the amateur. For school, laboratory, physician, and student. Color corrected achromatic lenses. Professional size eyepiece and objective interchangeable with all standard professional makes. Height 14 inches. Weight 5 1/4 lbs. Stage 4"x4". 2 wheel focussing. Body tilts any angle. Microscope complete with 3 objectives, prepared specimen slide, and 96 page book on microscopy, only \$25.50.



We Pay the Postage—Immediate Delivery—Money Back Guarantee

## BROWNSCOPE CO.

Dept. 3M 24 West 45th St. New York 19, N. Y.  
TELESCOPES BINOCULARS MICROSCOPES

## Blasting "Wedge" Splits Logs

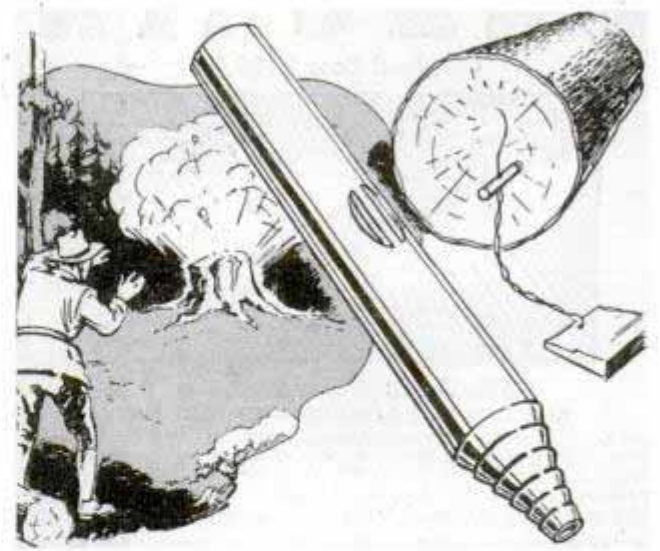

Log splitting is made easy by a small steel blasting tool that looks like a short piece of pipe tapered at one end. The blasting tool is driven into the end of a log and the hollow blast chamber is filled with a small quantity of powder. The explosive force splits the log from the inside. The tool weighs 11 pounds, is 15 inches long and two inches in diameter.

## File Clerk "Rolls" to Work

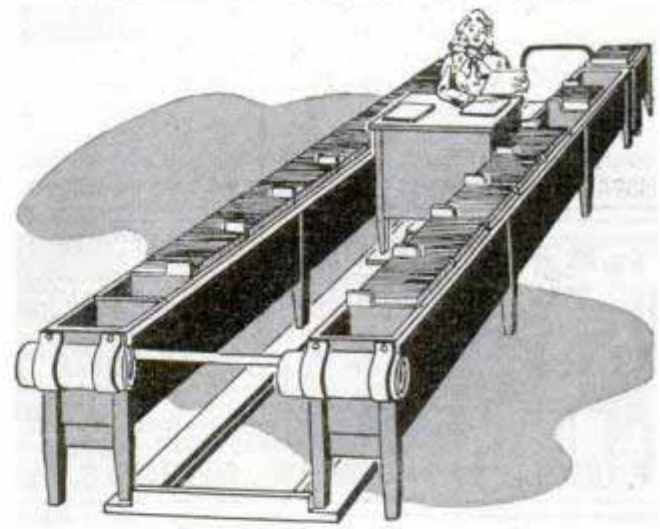

Instead of trotting back and forth along rows of filing cases, the file clerk sits at a desk and rides from A to Z in a system patented recently. The clerk's desk and chair are on a platform which is rolled easily by hand along a track between the files. In a de luxe model, an automatic motor drive eliminates hand pushing. The system was devised by Blaine Hunter, who assigned all patent rights to the government.

Ⓢ In the split second of explosion, an atom bomb blast softens massive granite blocks to such an extent that they can be crumbled by hand.



**Make Up To \$600  
An Hour!**



**Operate Your OWN Home-Weaving Business With AMAZING New DEEN Power Loom!**

Make yourself financially independent! Start a steady business of your own . . . right in your home! Earn BIG PROFITS by weaving thousands of different designs of rugs on the new easily operated Deen Power Loom. Machine will automatically weave ten yards of beautiful intricate designs every hour.

**DEEN LOOM TAKES UP LITTLE SPACE.** You can put this marvelous weaving machine in a corner of your living room, basement, garage, or spare bedroom. Then later on, as your business expands, you can move into regular business establishment.

**IDEAL BUSINESS FOR HANDICAPPED PEOPLE** such as veterans and persons handicapped by loss of sight or limbs, and those unable to do strenuous labor. Loom is simple to operate . . . a child can run it. Any rug design you wish can be woven by merely changing paper guide pattern.

**ORIGINAL INVESTMENT CAN BE RETURNED IN THIRTY DAYS.** A small investment gets you started in your own business right away. Deen Loom has capacity of from eighty to one-hundred yards a day . . . in only one month it is possible to get back your original investment. Demand for home-woven rugs is GREATEST IN HISTORY. DON'T DELAY . . . start making plans for your own business NOW. Write today for free descriptive booklet and full information. Address THE GIBSON COMPANY, DEEN LOOM DIVISION, HARLAN, IOWA.

*Distributorships Still Available in Some States*

**"Makers of DEEN Looms — FAMOUS Since 1895"**

**ATTENTION AUTO OWNERS!**

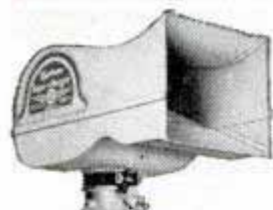

**New Power, Pickup, Pep!**

Amazing TYPHOON SUPERCHARGER is back again, ready to put new life into old motors, add to power, pickup, pep! 41,000 users find gas economy, you will, too. Motor knock vanishes, grease bath air cleaning keeps harmful dust out. Takes 5 minutes to install with screw driver on carburetor, replacing old air cleaner. Order today, mention make and model of car. Only \$5.95.

(Ohio orders add 3% sales tax, West of Rockies, add 10%.)  
10 Day Money Back Guarantee!

**TYPHOON PRODUCTS CO. 509 Engineers Bldg. Cleveland 14, Ohio**



**ELECTRIC WELDER**

AC or DC 110 Volts  
Pre-war type—All metal—No chemical—5 year written guarantee. Welds 1/8" thick metal or money back. Repairs tanks, tools, fenders, machine parts, etc. Comes complete with rods, unit directions and eye shield. We also manufacture a set you can \$3.95 complete. On C.O.D.

**\$645**

Complete

Learn with for only mailing charges extra.  
ESSAY MFG. CO., INC., Dept. P.M., Quincy 69, Mass.



**MUFFLERS**  
**STEELS and ALUMINUMS**  
with a motorboat tone  
SINGLES, Chev, V-8, Plymouth, Steels \$5.50, Aluminum \$6.50, Chry., Olds., Buicks, etc., Steels \$7.50, Aluminum \$8.50. V-8 and MERCURY DUALS, Steel \$17.50, Aluminum \$20.00. Aluminums are guaranteed for life of your car.  
**DEALERS WANTED**

**SANDEE MUFFLER CO.**  
7523 S. WESTERN AVE., LOS ANGELES 44, CALIF.

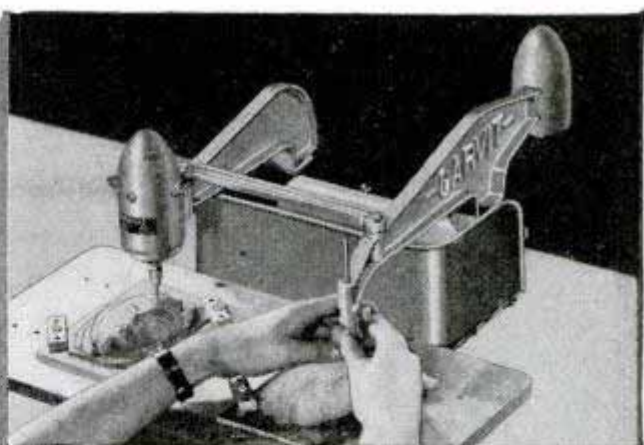

**Amazing New DUMORE "CARVIT" Makes You a Skilled WOOD CARVER in Twenty Minutes!**

**A fascinating new hobby, complete in 1 tool!**

Making fine wood carvings with a Carvit is so simple a child can do it! You can amaze your friends with finished work on your very first attempt. You can add a "professional" touch to other woodworking projects by embellishing them with fine carvings.



**Fascinating Fun—and Profitable!**

The Carvit is a duplicating tool, made by a famous manufacturer of precision industrial tools. With it you can carve dozens of beautiful and useful objects in mahogany, ebony, and other fine woods. For models, you can use plaques, costume jewelry, ash-trays, and a wide variety of other inexpensive objects of plaster, metal, glass and plastic. Your carvings are many times more beautiful and valuable than your models!

Think of the useful and ornamental things you can make for your own home — think of the distinctive gifts you can make for your friends!

**You are an expert at once—with a Carvit!**

Here's how the easy-to-use Carvit works: You clamp a model to the table below the tracer, and a wood block below the cutter. Then you switch on the motor and guide the tracer over the raised contours of your model. The cutter moves with the tracer to carve an exact duplicate of your model. That's all there is to it!

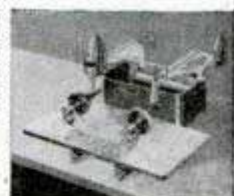

With a center attachment you can carve objects in the round—statuettes, busts, and figures. The Carvit comes complete with cutters, wrenches, and instructions, ready to use, for \$48.50. Center attachment extra.

Production is too limited to supply your local dealer, but while our stock lasts we can accept your direct order for immediate delivery. To avoid waiting for your new Carvit,

H-2

**tear out this coupon and mail today!**

THE DUMORE COMPANY, Dept. C-51, Racine, Wis.

**10 DAYS FREE Trial!**

Please send me —  
 One Carvit complete as described above.  
 Complete information on the Dumore Carvit.

(If I am not completely satisfied with my Carvit, I can return it in 10 days for a complete refund of the purchase price.)

Enclosed is my check or money order, in the amount of \$.....  
 Ship C.O.D. plus insurance and postage.

Name.....

Street Address.....

City.....(.....) State.....



# CUT JOB COSTS



Powered by Air, Air-Speed Saw and File eliminates slow, expensive hand hack-sawing or hand filing. Gets in awkward spaces with ease. Speeds auto-body repair, factory maintenance, aircraft service and dozens of other jobs requiring fast accurate cutting or filing. AIR-SPEED IS DESIGNED for one hand operation. Simple finger pressure adjusts the exact speed required. **WEIGHS 3½ LBS. • RETAILS FOR \$44.50**

For Literature Write:

**AIR-SPEED TOOL COMPANY**

1500 W. Slauson Ave., Los Angeles 44, Calif., Dept. PM-14

**A BETTER MACHINE  
for BETTER SEEDBEDS...**

THE  
**SEAMAN  
TILLER**

Used by U. S. Dept. of  
Agriculture for Many Years



The SEAMAN TILLER helps to produce better yields by: (1) thorough pulverization of the soil; (2) hastening and promoting earlier and more complete germination of seed; (3) distributing plant food uniformly and effectively throughout the growing area of the seedbed; (4) helping to increase the supply of nitrogen through complete seed-bed aeration; (5) eliminating "air pockets" and hard plow soles that usually retard plant growth; (6) helping to destroy crop pests and diseases such as grubs, cut-worms, beetles, grasshopper eggs, weevils, borers, potato scab and certain varieties of fungus; (7) providing more effective weed control; (8) reducing soil erosion.

If you want to know HOW all this is possible, write for free copy of "Questions and Answers" booklet... and see your local SEAMAN dealer or write us direct.

**SEAMAN MOTORS, Inc.** 341 North 25th Street  
Milwaukee 3, Wis.



## VEEDER-ROOT METER

Counts no. of ft. of trailing wire antennae; no. turns when winding on coil; applicable for many uses; flexible shaft can be attached and connected to another device for counting without direct attachment; speed 300 ft. per minute for reeling out; beautiful bakelite case, jeweled dialite, pilot light enclosed, 3 position switch, counts up to 1000. EACH..... **95c**

## ARMY AIRCRAFT RECEIVERS

BC-946-B

Broadcast band from 520 to 1500 Kc, tube complement — 3-12SK7, 1-12SR7, 1-12A6, 1-12K8 can be used with 24V dynamotor supplying A & B power; can be converted to AC or DC or 32 volt sets 3 stages of IF used. Uses 3 gang condenser. Complete with **\$12.95** tubes and schematic, each...  
Dynamotor DM-32A, each.....\$4.95



## SUPREME FOUNDATION METER

40 Micro Amps. 25,000 ohms per volt 4½" square. **\$8.95**  
Manufactured by Supreme Instruments Corp. Each...

Hickok 2½" 0-150 AC Voltmeter, each.....\$2.49  
Dept. PM

**ARROW SALES, INC., 59 W. Hubbard St., Chicago 10, Ill.**  
SUPERIOR 5575

## New MILLING ATTACHMENT

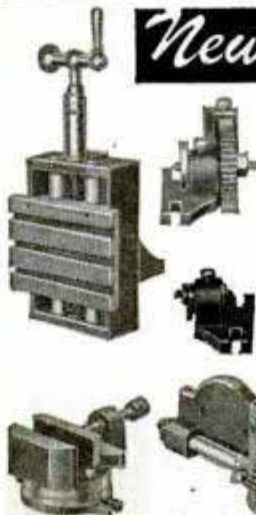

Sizes for 8" to 16" metal lathes

**BUILD IT YOURSELF** from our sets of semi-machined castings and save \$\$\$. Can be finished on your lathe alone. Complete working drawings and step-by-step machining instructions furnished with castings.

Mill keyways, slots, splines, dovetails, flutes in reamers, taps, hobs, and special cutters; produce spur, bevel, mitre and worm gears, ratchets and racks; mill flat surfaces, square shafts, mill hexes, spot face, drill spaced holes, bore, etc. on your lathe with this precision attachment. It has a T-slotted table, a vise which swivels for angular milling, a gear cutting fixture and dividing centers.

**FREE!** Illustrated folder and price list. Mention your lathe. Write today.

**HURON MACHINE AND TOOL CO.**  
YALE 4, MICHIGAN

## MAKE 200% to 1000% PROFIT AT HOME

in your own business preserving Baby Shoes in REAL metal, pearl, gold, silver, bronze and colors. Lifetime opportunity. America's biggest paying home business. This is YOUR big chance for independence and big money. Write for free details.

**KIKTAVI COMPANY 8620 S. Ruthelen, Dept. 2**  
Los Angeles 44, California

**BUILD THESE PROJECTS**  
For garden or lawn. Easy to build. Easy to sell. Detailed Blueprints Model B-25 Dutch Windmill 50c; Model OM-80 Old Mill, 85c. Lawn Figure Patterns—Sunbonnet Girl, Dutch Boy, Tulip Girl, Holland Pair, 35c each, all 4—\$1. Catalog illustrating many models, send 10c, today.

**CRAFTSMAN'S MODEL CO., Dept. P-101, 2030 N. 41st St., Milwaukee, Wis.**



## CORROSION and FRICTION

Use Fiendoil on tools, electrical appliances, household devices. It actively

Lubricates - Cleans - Prevents Rust

**FIENDOIL**

"The Enemy of Corrosion and Friction"

3-oz.  
Spout  
Can  
**40c**



CUT OUT THIS BAND TO FIND RING SIZE

AUTHENTIC WESTERN  
**SADDLE RING**  
FOR MEN  
WOMEN or  
CHILDREN

PURE  
STERLING  
SILVER

Only  
**\$4.95**

POSTPAID  
We Pay Tax

First time at anywhere near this low price! Authentic replica of romantic western saddle. Handsomely formed from solid Sterling Silver by expert silver craftsmen. Massive style for men, dainty style for women and children. A gift of distinction. A pleasure to wear. Sent on approval.

**SEND NO MONEY!** Just clip this ad and mail with your name and address. Pay postman only \$4.95 plus few cents postage on arrival; or send cash and we pay postage. Wear this sensational ring for 10 days. If not delighted, return for full refund. Specify for MAN, WOMAN or CHILD and RING SIZE. Use cut-out band to determine size.

**ARIZONA CRAFTSMEN** Room 672B  
1904 Farnam  
OMAHA 2, NEBR.

**FINE Cabinet WOODS**

For immediate delivery! Thousands of feet in sizes and grades to exactly meet your homecraft or woodshop needs. Bargains in Turning Blocks, Mouldings, Plywoods.

CATALOG OFFER: (U.S.A.)  
Complete Hobbywoods catalog with periodic helpful supplements sent along with a twenty-five cent can of Waterproof Veriply (urea resin) Glue—Both prepaid for 25c.

**Hobbywoods**  
Eastern Ave. and Cedar  
Baltimore 3, Md.



**PLEXIGLAS**

New Low Prices, new masked prime stock, clear

Thicknesses, per square foot; 1/16" @ \$1.00; 1/8" @ \$1.30; 3/16" @ \$1.60; 1/4" @ \$1.85; 3/8" @ \$2.75; 1/2" @ \$3.60; 3/4" @ \$5.50; 1" @ \$7.40. Sheet sizes 6" x 12"; 6" x 24"; 12" x 12"; 12" x 24" and 12" x 36". Add 10% for packing and postage any place in U.S.A. Minimum order \$5.00. Send money order for prompt shipment.

PLASTIC SUPPLY CO., 2618 St. Louis Ave., St. Louis 6, Mo.

**FEW EXCLUSIVE TERRITORIES AVAILABLE!**  
**DISTRIBUTORS WANTED!**

**Nationally Advertised Brand  
AUTO ACCESSORIES**

**\$500 TO  
\$600 SUPPLY  
LASTS ONLY  
WEEK TO 10  
DAYS**

Have your own big business in a territory that is exclusively yours. Year around steady demand; national advertising to back you up. Write today for catalog, information and territories available . . . give age, experience, and complete background in first letter.

KNICKS MEND-RITE CO. 1443-47 Gentry, N. Kan. City, Mo.

"Say," he exclaims, "this  
**GRIZZLY** brake  
lining still stops  
on a dime!"



"Naturally," I grin, "but is that all you can say for my reline job?"

"No," he adds quickly, "through all these months I've found that just easy pressure on my brake pedal brings smooth, quick stops. Ann mentions that a lot."

"That," I emphasize, "is what we call a 'soft' pedal—it's a major feature of Grizzly Brake Lining! Sure, you get extra long life and hardly ever need an adjustment, but on top of that, you also get smooth, sure stops with that 'soft' pedal. That's what makes Grizzly the safe lining for both men and women. 'Big Foot' or 'Little Foot'—driving is easier for both."

"You're right," he agrees. "The wife and I will back you up on that!"



**BIG FOOT LITTLE FOOT**  
Grizzly Brake Lining is engineered for both. Next time you reline, reline with Grizzly—for over 30 years a leading name in brake lining!

"Bear in Mind" . . . ask for

**GRIZZLY**  
REG. U.S. PAT. OFF.  
**BRAKE LINING**

**WHEREVER BRAKES ARE SERVICED**



# AMAZING VALUES!

## PARACHUTE SHOULDER HARNESS

No. PH9—8 to 9 feet of the finest quality 1 3/4 inches wide reinforced canvas webbing. Use it for hoist slings, tow ropes, children's swings, safety belts, etc. Guaranteed over 4000 lbs. snapping pressure. Complete with buckles and clip hasps at a small fraction of the original cost. 50c each or

**3 FOR \$1.00**



## TWO BRAID RUBBER PACKING

No. RP82—22 feet of the very best grade two braid rubber packing 3/8 inches thick and 6 1/2 inches wide. A real buy in hard-to-get material. Each 22 foot length priced at only..... **\$3.30**

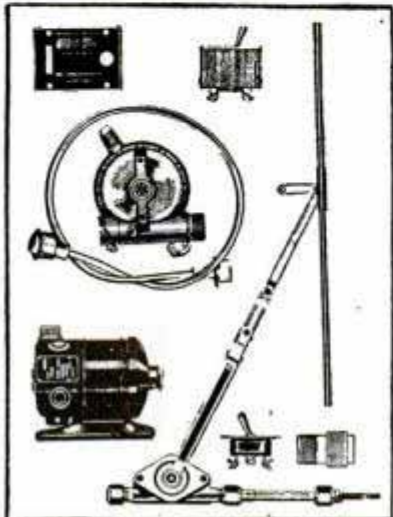

Compact 1/6 H. P., 10,000 forward or 5,000 reverse R.P.M. motor complete with 30" flexible shaft, eccentric reducing drive, switch circuit breaker, wiper and wiper bracket, arm and blade. All packed in original carton. Can be converted into a high speed, rigid or flexible grinder, drill, tatter, flier, saw and various other items. Originally mfd. for the U.S.A.F. wind-shield wiper with 24 V. D.C. series wound motor; can be used on A.C. by means of your own transformer. Compared to the original Govt. cost this is priced very low at..... **\$17.50**



## Hundreds of Brand New Parts!

**K3 GUNSIGHT UNIT** contains fascinating array of parts useable in 1001 ways! Amazing 1/50th H.P., 24 V. D.C. High-Speed Motor. Many regular and bevel gears, switches, shafts, lenses, bearings and various other parts too numerous to mention. Original cost approx. \$3000.00. You pay only..... **\$17.50**

SHIPPED PREPAID ANYWHERE IN CONTINENTAL U. S. A.

## CASH WITH ORDER

24 V. quilted electric Bomb-Sight heating pad, 5 ft. cord, twist-lock connector, thermostat, 20" zipper, No. HP 10, only..... **\$1.49**

WRITE FOR LIST OF OTHER WAR SURPLUS VALUES

## WARSHAWSKY & LAZAR

Dept. M

2126 S. Michigan, Chicago 16, Ill.

## STOPS LEAKS PERMANENTLY

Cut your fixture replacement, water and fuel bills with Economy Renewable Seats. Make economical, permanent repairs quickly and easily with the Junior Kit (illus.). Repair bathroom, kitchen and laundry fixtures. Everything you need included in steel box. Price complete with Seats..... **\$22.50**

Senior Master Kit also available—repairs faucets and valves up to 1" pipe. At Better Jobbers and Hardware Stores...or Write Direct

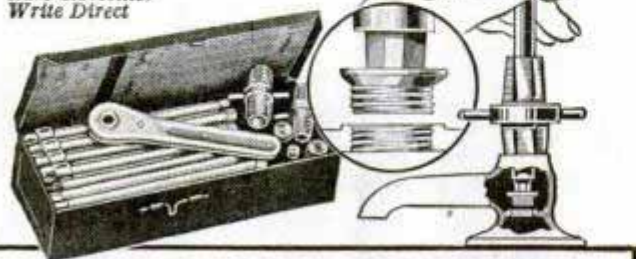

## ECONOMY VALVE SEAT CO.

2811 W. Fletcher Street Chicago 18, Ill.

## World's Biggest Research Bell Jar Withstands 12 Tons of Pressure



It would take more than 12 tons of air pressure to break what is believed to be the world's largest research bell jar. This bell jar is used by the Army Air Forces as a high-altitude chamber for studying radio interference during storms. Made of plastic and reinforced with ribs of the same material, it is six feet high and eight feet in circumference.

## Squeeze-On Fish Bait in Tube Sticks Firmly to Hook

Bait that comes in a tube and is squeezed onto a hook is the latest teaser to lure fish from their watery homes to the frying pan. Made from a secret formula, the bait is said to stick to a hook in the fastest streams and to be particularly appetizing to trout, bass and bluegills. The bait stays fresh indefinitely in the tube.



Some 150 electric locomotives will pull passenger trains over a 2156-mile system operated by the Southern Railway of Great Britain in southeast England.





**Genuine AAF  
PILOT  
HELMET**

For Men, Women, Boys and Girls

New, for service and warmth! Quality light tan twill, wind and rain resistant.

**FOR ALL OUTDOOR SPORTS**

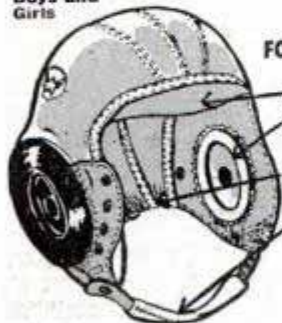

- Chamois Lined Visor
- Chamois Covered, Kapok Filled Ear Pads
- Adjustable for Most Head Sizes
- Velvet Covered Chin Strap

**\$1** postpaid, del. anywhere in U. S.  
\$4 value

Mail your dollar today

**NORTH AMERICAN SALES, INC.**  
8 South Dearborn St., Chicago 3, Ill.

**EARN MORE MONEY  
GRINDING LAWN MOWERS  
"THE UNIVERSAL WAY"**

**FULL OR SPARE TIME**

Build a Business of Your Own in Your basement or garage and earn \$135 a month. Mr. Felber of Ind., writes, "My UNIVERSAL GRINDER is faster and more accurate than any other grinder. Its efficiency enabled me to sharpen 450 mowers in 4½ months." More than paid for itself the first month. Every customer satisfied. Only on the UNIVERSAL can the inside face and edge of stationary blade as well as the edge of the reel blades, be ground to proper clearance ALL IN ONE SET-UP without removing any blade from the mower. Tool Grinding Rest included.

"The Universal Way is the Modern Way" Write for Free Folder Rogers Mfg. Co., Dept. M37, Lindsay, O.



**NEW  
CONCORD  
RADIO  
Bargain  
Catalog**

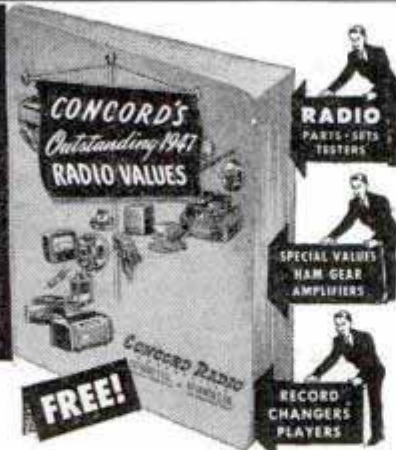

Brand new—48 exciting pages of radio parts, equipment, and supplies for experimenting, building, testing, repair, maintenance—Big feature sections of Ham Gear, Radio Sets, Communications Receivers, Amplifiers, Record Players and Portables, Record Changers, complete Sound Systems. Pages and pages of top-quality standard-make radio and electronic parts—plus scores of special value bargains. Thousands of items NOW IN STOCK and ready for IMMEDIATE SHIPMENT! Write TODAY for your FREE COPY. Please address Dept. P-37

**CONCORD RADIO CORP.**

LAFAYETTE RADIO CORPORATION

CHICAGO 7

ATLANTA 3

901 W. Jackson Blvd.

265 Peachtree Street



"I am proud to give my name to this fine, light car--the kind I have championed for 35 years!"

*Powell Crosley Jr.*

PRESIDENT, CROSLLEY MOTORS, INC.

You'll like this new kind of automobile—the bigger, economical, beautifully-balanced new fine CROSLLEY. It's a big car in everything but weight and price!

Created by a 6'4" husky, the trim, streamlined body affords ample space—and leg-room—for 4 men equally large plus baggage. Yet the new, fine CROSLLEY weighs only about 1/3 as much and operates for approximately 1/2 the cost of heavier, more cumbersome and expensive cars advertised as "low priced", but actually costing for more!

No internal combustion engine in 40 years has caused as much comment as the new, revolutionary CROSLLEY COBRA (Copper BRAZED). Made of steel, this 4-cylinder, valve-in-head engine weighs but 59 lbs.; delivers 35-50 miles per gallon of ordinary gasoline; speeds to 60-plus. Be sure to see and drive this new, fine CROSLLEY before you buy any car!

**LOOK AT THESE FEATURES:** ALL STEEL Construction, low center of gravity, great safety factors • MODERN Streamlining, "the Aircraft Flavor" gives extraordinary beauty • CAR WEIGHS only 1150 lbs., curbside; perfectly balanced, weight-to-power • EASY DRIVING, virtually "parks on a dime"; oversize shock absorbers • MORE MANEUVERABLE in traffic; 20 inches narrower than most cars • ECONOMY that's almost unbelievable; instant pick-up; speeds to 60-plus • DELIVERS for less than \$1000 in the U.S.A.

For information and literature write: Crosley Motors, 2537-H Spring Grove Ave., Cin'ti 14, O.



Please Mention Popular Mechanics When Answering Ads



**STOP  
LEAKS!**

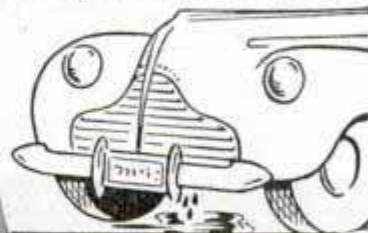

**Cooling Systems  
Made Leak-Proof QUICKLY**

WARNER LIQUID SOLDER—Non-Metallic—Deposits Tiny Fibers to Repair Leaks Anywhere in Cooling Systems. Simply pour in! Finds and REPAIRS every crack or hole. Do it yourself—or see your service man.

Warner-Patterson Co., 920 S. Michigan Ave., Chicago 5



# ALLISON ENGINES

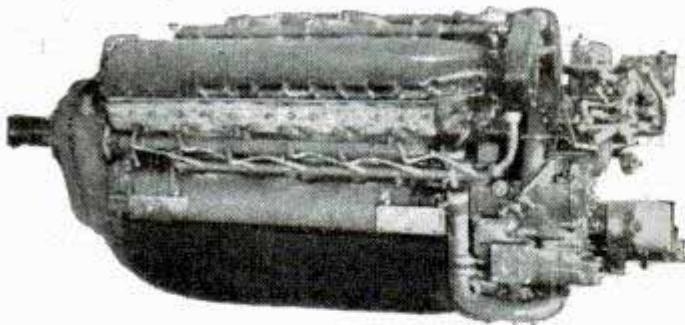

**WAR SURPLUS ENGINES IN PERFECT CONDITION OFFERED TO YOU AS THE GREATEST POSTWAR BARGAIN OF ALL TIME**

**MODEL 1710-12 CYLINDER-V TYPE LIQUID COOLED-1100 H.P. AT 2600 R.P.M.—2 to 1 REDUCTION**

This is the famous Allison engine manufactured by Allison division of General Motors to be used as the power plant for the P-38, P-39 and P-40 fighter planes.

These engines turn up a normal speed of 2600 R.P.M. and are equipped with a 2 to 1 reduction gear which may be dismantled as a unit if desired.

Each engine is complete with magnetos—carburetor—supercharger—ignition harness—oil pumps—oil filter and water cooling pump. Engines average 300 hours use and are in excellent condition.

This power unit is easily adaptable for use in speedboats—cruisers or auto-racers or as a stationary or portable power plant for drilling rigs or electric generators.

**ORIGINAL COST TO GOVERNMENT \$12,000.00**

**Our Selling Price**

**\$200<sup>00</sup>**

**FOB New Orleans Crated and Ready for Immediate Delivery**

**STARTERS and GENERATORS Extra \$5.00 Each**

## INDUSTRIAL SUPPLY CO.

4163 Bienville St. P. O. Box 381 Tel. GA. 1181  
New Orleans 1, La.



## RIDE TO WORK

Tired of waiting for streetcars, buses? Be your own transportation boss with a WHIZZER Motor on your bike. You'll go 125 miles and more on a gallon of gas—that's six miles for just one cent! Speeds up to 35 miles per hour . . . 2½ sturdy horsepower. Backed by eight years of progressive engineering. Fits any man's balloon tire bike.

## FOR JUST ONE CENT

**RIDE ONE AND YOU'LL BUY ONE!**



**ONLY \$97<sup>55</sup> PLUS TAX**

FOB Pontiac, Mich.

# WHIZZER

Whizzer Motor Company, Dept. 523, Pontiac, Michigan.

I enclose \$99.97, which includes \$2.42 Federal Excise Tax ( ) check or ( ) money order. Send me one WHIZZER Motor complete, ready for installation. If descriptive literature only is desired, check here ( ).

Name \_\_\_\_\_ City \_\_\_\_\_  
Street \_\_\_\_\_ State \_\_\_\_\_

**BOYS!**  
Fly your own plane  
**REAL GAS ENGINE**  
Complete with  
**MODEL AIRPLANE KIT**

**ONLY \$11<sup>95</sup>**



All ready to build and fly . . . and anyone can do it!

More than a toy—a real gas-powered model plane that you'll get a kick out of building and flying. This little beauty will really perform in the sky! You'll be the envy of your pals! Fully detailed instructions provided. Complete outfit, including: 1/6 H.P. engine, coil and condenser; beautiful trim airplane; propeller, wheels, etc.

**SEND ONLY \$1** We'll ship C.O.D. for balance. Don't delay, order NOW and be the first fellow in your neighborhood to fly this swell plane! Have you our FREE catalog? Send for it!

**AMERICA'S HOBBY CENTER, Inc.**  
DEPT. BN 37, 156 WEST 22ND STREET, NEW YORK 11, N. Y.

## ONLY ELECTRIC MOTOR

**\$1<sup>00</sup>**

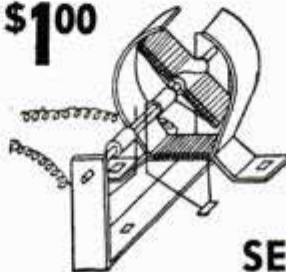

**CONSTRUCTION KIT EASY TO ASSEMBLE FUN—EDUCATIONAL**

**IDEAL GIFT**

Runs on a Single Dry Cell (not included). Use it to run Toy Pumps, Pulleys, Etc.

**SEND CHECK—MONEY ORDER or CASH (at your own risk) to**

**THE HAYDN CHEM. CO., Dept. C 3, Box 27, Kenmore 17, N. Y.**

**BIG MONEY FOR YOU IN PLASTICS**

**SEND \$10<sup>00</sup>** Offer includes 2 books: New Fabrication Manual & Giant Catalog, listing the most complete stock of Plastic Materials, Accessories, Tools.

**BERTON PLASTICS, INC.**  
19 W. 21st St., N. Y. 10, N. Y.

**ACT TODAY!**

## HAUCK FLAME GUN KILLS WEEDS ★

**2000° F controlled heat quickly, easily destroys seeds, roots, brush, poison ivy, wild morning glory, Canada thistle, other unwanted growths. Many uses; splitting rocks, burning stumps, sterilizing poultry houses. Burns kerosene. Does the work of 4 men. Safe, easy to use. 10 day trial. Satisfaction guaranteed. Free catalog.**

**HAUCK MFG. CO.**  
121 Tenth St. Brooklyn 15, N. Y.

**A USEFUL GIFT THAT IS NEW AND DIFFERENT**

**Slitpak**

TRUSS WRENCH  
SIZES 7/8" FIT BOLTS, LAG SCREWS, AND NUTS

CIRCS, WASHER AND HOLE SIZES, DIA. OF TUBING, RODS AND PIPE

SCALE 1/16" UP TO 4 INCHES  
HARDY, EASY TO HANDLE

GAGE FOR BOLTS, NUTS & WRENCH SIZES

MADE OF BRASS WITH YOUR NAME ON EACH  
SEND POSTAL NOTE FOR 1/4 EA.

SPRAGUE LABORATORY 701 E. BAKER ST., EL MONTE, CALIF.

**WHY WEAR DIAMONDS**

When diamond-dazzling Zircons from the mines of far-away mystic Siam are so effective and inexpensive! Thrilling beauty, stand acid, true backs, full of FIRE! Exquisite mountings. See before you buy. Write for FREE catalog.

**National Zircon Co., Dept. 20 Wheeling, W. Va.**

**Catalog FREE!**



## An Easier, Quicker Way to CUT GRASS and WEEDS

Get a MOW-MASTER... the Rotary Mower built to do a hard job the easy way. Plenty of power from famous air-cooled, 2 H. P. gasoline motor with muffler. Easily adjustable rotary blade.

### LOW PRICED

Modern methods of volume production make MOW MASTER low priced.

**SEE YOUR DEALER** or write us for Free Folder.



Adjustable handle, handle-bar control, precision built of quality materials.

Lightweight — a woman can run it. Cuts thru high grass and weeds. Keeps lawn velvety smooth.



The **PROPULSION ENGINE CORP.** Dept. 200

7<sup>th</sup> and White Eagle Rd. Kansas City, Kansas

POWERED BY 2 H. P. POWER-PAK GASOLINE ENGINE with MUFFLER.

## MOW-MASTER Rotary Mower

### NEW! 12" SHEET METAL BRAKE Only \$10

Fits in bench vise. Quickly, easily forms all kinds of angles in sheet metal, strap iron and aluminum, wire and plastic. Use it to make useful articles, experimental research work, patent models, etc., simple gages made for quantity duplicating. Now available. Send for details, or order direct. \$10.00 PP. C.O.D. \$2.00 deposit. Wt. 10 lbs.

**WISE IRON BENDER.** Easily bends 1/2" square or round; 1/4" up to 2" wide. Makes hooks, rings, hoops, etc. All steel. Price, \$7.50 PP. Immediate delivery.

**WISE FORMING TOOL.** Makes cylinders, ovals, cones and round corners in sheet metal, wire and 1/8x1 steel strap, 2" to 60" in dia., 16" wide. \$7.50 PP.

**SHEET METAL PLIERS.** Forms any length, angles, channels, and crimps in sheet metal. Jaws 2 1/2" wide. Price, \$2.00. All items guaranteed.

**WISE BRAKE MFG. CO., 1318 So. 30th Ave., Omaha 5, Nebr.**

### PHOTO-PRINTING WITHOUT DARKROOM

Profitable business or hobby in photo-printing post-cards from negatives **WITHOUT DARKROOM.** Print advertising, souvenir or personal picture post-cards. No experience needed. Automatic machine complete with chemicals, trays, and supplies to print 50 picture post-cards. Only \$5.98 taxpaid, postpaid. **ORDER NOW.**

**CRAFTEX PRODUCTS, 6815 E. End Ave., Dept. P-11, Chicago 49, Ill.**

## PRESTO! ANYONE CAN MASTER GLAZE

LEAVES HARD GLASS-LIKE FINISH  
EASY TO APPLY  
PROTECTS THE SURFACE  
NO SMEAR OR STREAKS AS WITH WAX  
LASTS SIX MONTHS TO A YEAR

SEALS THE PORES OF THE SURFACE  
WILL NOT FINGER-MARK  
NO OILY FILM AS WITH POLISH  
SAVES YOU MONEY

Car Owners! Meet Master Glaze—the sensationally different luster for new and used cars! Not a wax—not an oil polish—not a paint!—nothing that “smears” over the surface.

**MASTER GLAZE** is a unique discovery—a creamy liquid—quick and easy to apply! Gives a hard, glass-like surface. Even gasoline cannot dull it! Lasts six months to a year! Amazing luster—beautiful, sparkling clean and brilliant! Doesn't finger-mark—doesn't smear! A match box full glazes an entire car. Seals the pores—protects! **NOTHING LIKE IT!**

**AGENTS** An unusual opportunity! Quick, flashy demonstrator. Big profits. Good territory. Write today!

**FREE SAMPLE** Just send your name and address to **MASTER GLAZE CO., 7720-580 W. Harwood Ave., Milwaukee, Wis.**

### Find Youth Dead After Deer Hunt

Special to the Inquirer  
WHITE HAVEN, PA., DEC. 19—Three rabbit-hunters found the body of 19-year-old Rudolph Weaver huddled behind a little stone shelter. He lost his way 8 miles from his party. It is the opinion that if he had a compass this tragedy would have been avoided.

## BEWARE!

### U. S. ARMY LENSATIC COMPASS

A sturdy pathfinder with luminous marking, jeweled floating dial marked 0 to 360 degrees, has hinged sight vane and powerful lens.

\$7.50 VALUE **\$1.95**



**WALTHAM JEWELLED COMPASS**

REG. \$2.50 FOR **\$1.25**

### SPECIAL OFFER — BOTH FOR \$3.00

1744 POST PREPAID—ANYWHERE IN U. S. & MAIL ORDER DEPT. E

**J. JACOB SHANNON & Co.** 214 NORTH 22nd ST., PHILA., 3, PA.

SEND CHECK OR MONEY ORDER - NO C. O. D.

SAY YOU SAW IT IN POPULAR MECHANICS

## NEW Liquid Casting Plastic

Makes 1001 OBJECTS  
Craftsmen, Hobbyists! Here is a new craft, a fine hobby, or profitable home business. **CAST-OLITE**, Liquid Casting Plastic that pours without heat or pressure, sets at low temperature. Make beautiful crystal clear objects—lamp bases, book ends, candle holders, novelty jewelry. Drill, saw or carve. Other novel effects obtained by embedding real flowers, butterflies, coins, photos. Ordinary jars, glasses, tubes serve as molds. Easy, fascinating to use!

### SPECIAL CASTO-KIT ONLY \$3.35

Get our new professional experimental Casto-Kit now at special low price of only \$3.35. Make lovely objects very first day. Kit contains materials for 20 projects. Contains 1 lb. liquid **CASTOLITE**, bottle hardener, buffing compound, measuring dropper, abrasive sheets, vial, hoppers for embedding and Instruction Manual showing simple step-by-step method. Send \$3.35 for Kit prepaid or order C.O.D. Instruction Manual only, 25c (stamps or coin.) **THE CASTOLITE COMPANY, Dept. C-1, Box 211, Kenilworth, Ill.**

DEALERS write for literature and prices.



FERN IN LAMPBASE



NOVELTY JEWELRY

20-Project KIT \$3.35 PREPAID



# RUGGED! TUFF!

## PRECISION BILT

# 8" BENCH SAW

### FACTORY TO YOU



**\$42.50**  
LESS MOTOR  
**ON EASY TERMS**

The Universal Table Saw is the outstanding Precision Bilt power tool available. Engineered to exacting standards and the biggest buy in the field. NOT A TOY—A REAL PRODUCTION TOOL. TERMS: — \$15.00 with order, F.O.B. St. Louis, balance two payments \$13.75 each within 60 days. If you prefer to pay cash, deduct \$4.25. Unit will be shipped prepaid.

**UNIVERSAL ELECTRIC PRODUCTS CORP.**  
122 N. SEVENTH ST. • SAINT LOUIS 1, MO.

**Paint it YOURSELF WITH Plasti-Kote**

The Plastic Finish for AUTOS, BOATS, FLOORS FURNITURE & WOODWORK

- Use Plasti-Kote wherever you want a gleaming, lasting and durable finish. Plasti-Kote leaves a cellophane-like surface that resists hot or cold water, alcohol, dirt, oil, vibration and changing weather.

Dries in 3 hours — leaves no brush marks. Easy to apply. 36 beautiful colors. \$2.95 quart.

**PLASTI-KOTE, INC.** 425 LAKESIDE AVENUE N. W. CLEVELAND 13, OHIO

Send new color folder and descriptive literature;

Name .....

Address .....

City..... Zone..... State.....

# PAY-RAISING — EXTRA MONEY BOOKS

Use these books to prepare for a better job—bigger pay—to start a profitable spare time or full time business of your own, improve your home, start a hobby. Popular Mechanics specializes in supplying outstanding self-help books on many subjects. Send for our FREE catalog.

- How to Remodel a House** Nothing is omitted... \$4.75
- Painting, Furniture Finishing & Repairing** New self-help book for craftsmen, home owners... \$1.50
- Shop Notes for 1947** Now ready. For every man who uses tools... .60c
- Shop Notes Library** 5 Vols.—1946, 45, 44, 42, 41. (No Dup. Mat.)... \$3.00
- Welding, Brazing & Soldering** How to build own equipment and use it effectively... \$1.25
- Garden Book** Build own trellises, lawn furniture, fireplaces, ornaments, etc... \$1.00
- Forty Power Tools** Build own saw, drill, lathe, sander, etc., from scraps—save money... \$1.25
- Rewinding & Servicing Electric Motors (No. 75)**... .25c
- Turn Scrap into Money** Convert old auto generators into motors, welders, etc. \$1.00
- House Wiring (No. 89)** All information needed to do complete job... .25c
- Modern Refrigeration** Electric, Gas, Be service expert... \$3.00
- Dyke's Auto Ency.** (includes Diesels, airplane engines) New 20th Ed. World's greatest book for mechanics. \$7.00
- Sheet Metal Work** Self instruction in all phases... \$2.50
- Tool & Saw Sharpening (No. 92)**... .25c
- Armature Winding** Construction, winding, repairing AC & DC Motors, generators... \$2.00
- Build Your Own Boat** Describes 17 popular boats—rowboats, sailboats, plywood outboards, etc. 192 pages \$1.50
- Forging Practice**... \$1.50
- Toys You Can Make of Wood**... \$2.50
- Carpentry** Learn modern methods. \$2.00
- Foundry Work**... \$2.00
- Pattern Making** Wood, metal... \$2.00
- Action Toys (No. 66)** Plans for 21 easy-to-make toys... .25c
- The Young Craftsman** Over 450 things boys can make... \$1.50
- Five Acres and Independence** How to make money on small farm... \$2.50
- Modern Welding Practice** Useful data on welding of all kinds. Simplified, non-technical, easy-to-understand. \$3.50
- How to Plan a House** Every detail carefully explained. 325 pages... \$4.50
- A Small Store and Independence** Guide to successful retailing... \$2.00
- Modern Gas Turbine** Complete up-to-date information on uses as supercharger and prime mover. Includes jet propulsion... \$4.00
- A.B.C. of Poultry Raising** \$2.50
- How to Build Violin, Pipe Organ, Banjo-Uke**... \$1.00
- Knots, Ties, Splices** For everyone who uses rope... \$1.25
- Plastics** Latest information on manufacture and use... \$4.00
- Workbenches & Tool Cabinets You Can Build (No. 47)** .25c
- Concrete Handbook** New book on using concrete around home, garden, farm... \$1.50
- Oil Burner Handbook**... \$2.50
- Photo Guide** Construct own equipment, gadgets. Make better photos \$1.50
- Welding, Electric**... \$1.25
- Welding, Oxy-Acetylene** Welding, cutting... \$1.25
- Metallurgy**... \$2.50
- Ropp's Calculator** Figuring made easy... .50c
- Plumbing Installation & Repair** For those without previous training... \$2.00
- Judo, 30 Lessons in Modern Jiu-Jitsu**... \$2.50
- Tool Making**... \$3.50
- Tool Design**... \$4.50
- Mechanism**... \$3.50
- Air Conditioning—Heating and Ventilating** Principles and general applications of steam, hot water, vapor and vacuum heating... \$4.00
- Audels Sheet Metal Pattern Layout**... \$4.00
- Estimate for the Building Trades** How To: Material and labor costs for masonry, plumbing, electricity, carpentry, heating, hardware, painting, etc. 629 pp... \$4.75
- Audels Masons and Builders Guides** For Bricklayers, Cement workers, Plasterers, Tile Setters and Stone Masons. 4 Vols... \$1.50 each
- Lejay Manual of Homemade Electric Equipment** How to construct 100 items that are scarce and valuable... \$1.50
- Drake's Refrigeration Service Manual**... \$2.00
- Slide Rule Simplified**... \$2.50
- Mathematics for Ready Reference** Covers all phases of mathematics... \$2.00
- Mechanical Drawing Self-Taught** With 21 simple step-by-step exercises. 56 pages of illustrations showing how to do it... \$1.00
- Audel's New Automobile Guide** 1600 pages... \$4.00
- New Small Homes** 62 practical and popular designs... .50c
- The Vegetable Growing Business**... \$3.50
- Rabbits for Food and Fur** \$2.50
- Furniture Joinery**... \$2.50
- Principles of Woodworking** Tools, processes, materials, projects... \$2.00
- Pottery Made Easy**... \$2.50
- The Art of Wood Turning** \$2.00
- Essentials of Upholstery** \$2.75
- Radio Physics Course**... \$5.00 A thorough training in radio fundamentals.
- Bookkeeping for Personal and Business Use**... \$2.25
- The Art of Inventing and What to Invent**... \$3.00

## MAIL THIS COUPON TODAY

Check the books you want, write your name and address below, and mail this advertisement with money order or check. Outside U. S. A. include 15% additional for shipping charges.

Books selected will be mailed promptly on our "money back if you're not entirely satisfied" guarantee.

Name .....

Address .....

City..... State.....

Mail to **POPULAR MECHANICS PRESS.**  
Dept. 604—200 East Ontario St., Chicago 11, Ill.



**THE IRON HAMMER WAS ON THE SPOT, TOO, WHEN WE LEFT THE STONE AGE**

Our machine is made to fit into standard, open-head 11 1/4 in. (3 1/2 & 5 gallon) steel cans. We will make a unit for open-head 13 1/2" Id, 100# drums

How to fill all makes of Grease & Calking guns

No more air pockets or dirt in your Calking or Grease-guns

How to change from empty can. Traffic dents Ok.

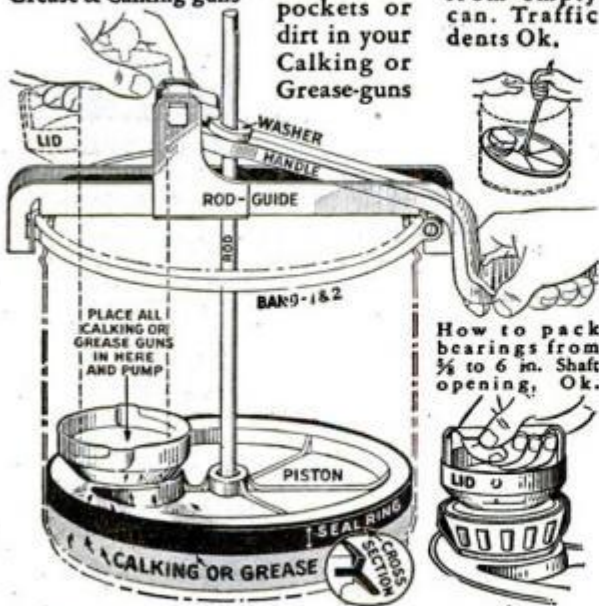

Cut this ad out, hand to the man you buy your Calking or Grease products from, he will demonstrate to you Free HK9-621 Fullerton Pky. Chicago 14, Ill. Patent No. 2,224,509 Trade Mark Reg.



**IMMEDIATE SHIPMENT**

The angle you want when you want it • Universal Ball Positioner and Vise • Jaw width 2" • Jaw Opening 2 1/4" • Positive Simple lever lock and release. No lost motion

SEE YOUR DEALER OR WRITE **Reypo CORPORATION**

9900 Lincoln Blvd., Los Angeles 45, Calif.



**Save a Thousand Hours Hard Labor**

**\$16.50** postpaid

Build a whirlblade power lawnmower with this lightweight construction KIT and mow your lawn the easy way. Electric motor or gasoline engine bolts on aluminum base.

Kit contains: Aluminum alloy permanent mold die casting with engine base and 3/4" OILITE bearings; 16", 18" or 20" width cutter bar; two

extra blades; two pulleys—all beautifully finished. Sent \$16.50 postpaid. 10" rubber tired wheels to match \$3.25 each. Dealers and mfrs. write for discount.

THE WEBB MFG. CO., 703 E. Poplar Avenue, Arkansas City, Kans.

**Do You STILL CHANGE MOTOR OIL??**

**GET THE FACTS!**



**FREE 40 PAGE BOOK**

If so—you can END this needless waste and expense forever, with "RECLAIMO"

America's Foremost Oil Re-Refining Filter. Continuously re-refines crankcase oil through an ingenious use of motor heat while driving!

1. Removes solids by filtration
2. Removes water-fuel dilution by heat and distillation
3. Prevents acid-slugge formation
4. Maintains stable viscosity
5. ELIMINATES ALL OIL CHANGES!

**CAR—TRUCK—TRACTOR and DIESEL OWNERS!** U. S. Bu. of Stds. Bul. 86 states: "Oil does Not Wear Out Mechanically"—"Reclamo's" re-refining action has fully confirmed that statement. This great oil-saving feature is indeed important, BUT of far greater importance are the savings resulting from "Reclamo's" tremendous reduction of costly motor wear! Again available—also to dealers. Complete details in FREE Book "Oil Facts". Write now! RECLAIMO MFG. CO., 5087 Elston Ave., Dept. 30, Chicago 30, Ill.

**FACTORY NEW—60 H. P.**

**JEEP ENGINES**

**148<sup>95</sup>**  
**Outright**

The perfect small power plant! Same Jeep engine Army and Navy used. Complete—In original factory crate, ready to install. 4 cylinders, 6.48-1 compression ratio, 2000 rpm., 105 max. ft. lbs. torque. Govt. list price is 257.70. Immediate delivery.

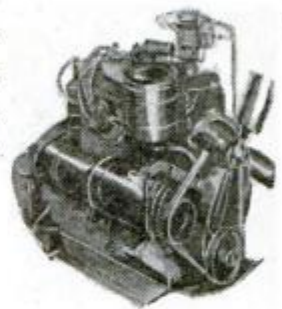

For Farms  
For Shops  
For Cars

**MAIL THIS COUPON**

Goldblatt Brothers, 333 S. State St., Chicago 4, Illinois  
Please send me..... Jeep Engines. (\$20 deposit must accompany all COD orders.)

Name.....

Address.....

City..... State.....

Cash ( ) COD ( ) Charge Acct No.....

Illinois Residents Add 2% Occupational Tax  
Extra Charge for Mailing Outside Delivery Zone

**GOLDBLATT'S**

333 S. State St., Chicago 4, Ill.

**UTILITY TRAILER AXLES**

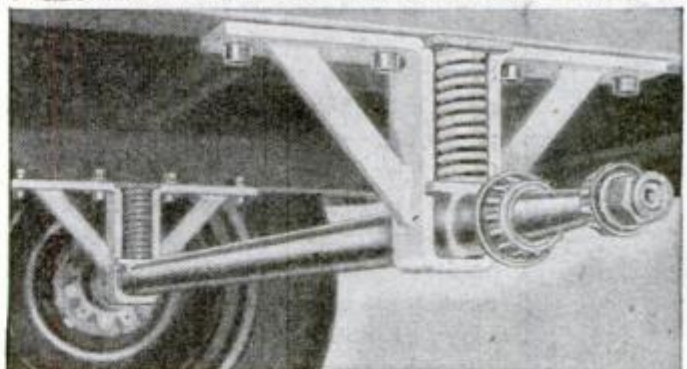

Get the advantage of its new lightweight, heavy-duty tubular construction. Available with or without patented double-coil spring suspension. Straight axle has standard 58" tread; drop axle has 58 1/2" tread. Spring centers 46" on both axles.

BIG CAPACITY: Axles made of 1 1/8-inch O.D. steel tubing have tested load capacity of 2000 pounds.

Ride-Rite axles will fit hubs and wheels made by Motor Wheel Corp., Kelsey Wheel Co., Ford Motor Co., and Industrial Machine Tool Co.

PRICED LOW AS

**\$6<sup>75</sup>**

PRICES F.O.B. FENTON, MICH.

Remittance with order —No C.O.D.	Axle Only	Axle with Springs
Straight Axle, Std. Tread	\$ 6.75	\$19.70
Drop Axle, Std. Tread	12.50	25.45
(Springs fit Ride-Rite axles only)		
Axles can be furnished any tread desired for slight additional cost.		

**MANUFACTURERS AND DEALERS!**

Write for descriptive literature  
QUANTITY LOT PRICES  
FURNISHED ON REQUEST  
WRITE ON YOUR LETTERHEAD

MANUFACTURED BY

**INDUSTRIAL MACHINE TOOL CO., INC.**  
200 S. LEROY STREET FENTON, MICHIGAN



# AIR COMPRESSORS

Curtis Two Stage Air Cooled

5½ H.P. Briggs & Stratton Engine

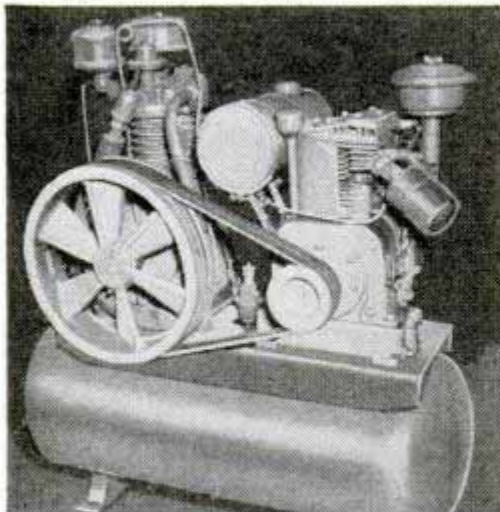

**\$475<sup>00</sup>**

F.O.B.

GARDEN CITY

KANS.

**100 FEET AIR HOSE WITH EACH COMPRESSOR. KIT OF PARTS TO COMPLETELY OVERHAUL ENGINE AND COMPRESSOR.**

Compressor two stage, size low cylinder, Bore 4 3/16, Stroke 3 1/4. High cyl. 2 1/4 x 3 1/2. Air cooled. Displacement—17 C.F.M. at 200 lb. pressure. 24 C.F.M. at 100 lb. pressure. Engine Briggs & Stratton 5 1/4 H.P. Air Cooled Model Z. Air receiver size 16x44 A.S.M.E. Complete with centrifugal unloader, (unit idles when maximum pressure reached). Safety valve, pressure gauge, draincock, 4 air discharge outlets. Manufactured by Curtis Compressor Co., St. Louis, Mo. Brand new in original factory crates. Shipping weight 700 lbs.

Can be operated with 3 or 5 H.P. electric motor.

**KEMPER AUTO ELECTRIC  
GARDEN CITY KANSAS**

## Quick, Easy, Lasting REPAIRS!

Cracks, holes, dents in wood, plaster, concrete, metal, etc. — loose handles, rungs, knobs, screws — mistakes in carpentry, etc. — fix them all with Savogran Crack Filler (hard as stone) or Savogran Wood Putty (easily tooled). Just mix with water, press into place. Stays put, hardens quickly, will not shrink! Can be painted, pre-colored. Ideal for models, inlays, etc. Patented! Big 1-lb. can only 30c at hardware and paint stores.

### FREE CIRCULAR

Describes these and other Savogran Products: Heavy Duty Cleaner, Remover & Bleacher (renews floors), Paint Brush Cleaner, Stryp-eeze (removes all finishes), Coldfoam Soapless Soap Powder.

THE SAVOGRAN CO.  
Dept. 40, Boston 10, Mass.



**SAVOGRAN**  
CRACK FILLER • WOOD PUTTY

IN EVERY WELL-EQUIPPED HOME WORKSHOP

## PERFECT DOWELS

... easily made



### ON YOUR LATHE OR DRILL PRESS

Use a SPEE-DOWL and you can work wonders with wood. Quickly and easily you'll make dowels of any wood... perfect burnished dowels for furniture, toys and thousands of other projects. You merely push SPEE-DOWL on wood—the lathe or drill press does the work! Cast body, tool steel blade. SIZES: 2, 3, 4, 5, 6, 7 and 8/16" (illustrated at left). Only \$1 ea. Special—any 4 of above for \$3.50; complete set of 7 for \$6. Also individual sizes 9 to 20/16" (illustrated at right) \$2.65 each. SPEE-DOWL is Unconditionally Guaranteed. Send postal note or check—we pay postage in North America.

FREE Literature.

JOHNS MFG. CORP., DEPT. C-6  
DUNELLEN, N. J.

**BURN  
WATER  
IN YOUR CAR**

## COSTS LESS THAN GAS

More Power, Cleaner Motor.  
Mail card for data on \$17.50  
Water-injecting Carburetor.

### OCTA-GANE

2425 E. 57TH ST. • LOS ANGELES 11, CAL.

### A-2 JACKET \$15.95

BRAND NEW—Brown leather. Zipper front. Cloth lined. 36-46



### G. I. RAINCOAT \$2.75

Sturdy rubberized cloth. Nearly New.

Write for free illus. list Army Surplus

Orders sent postpaid except C. O. D.

Satisfaction or Money Back

CONSUMERS CLOTHING CO.

Box 17 2066 1st Ave. New York 29



## MAKE MONEY WITH DOGS!



Start your own business. Cash in on man's love for dogs. \$10,000 yearly possible. \$60,000 from a single acre. No dog selling, breeding. We tell you how! Send for FREE folder, "MONEY IN DOGS."

THE DOG PRESS, Dept. A-1  
St. Petersburg, Florida.

## NEW! DECAL-CRAFT FULL COLOR TRANSFERS

Make circus wagons, animals, miniature streamliner train. Easy to use—stick 'em on—saw 'em out, or use to decorate children's furniture. All for \$2.00 postpaid. Instructions included.

DECAL-CRAFT, 1112 BIRCH ST., EAU CLAIRE, WIS.

## FALSE TEETH

KLUTCH holds them tighter

KLUTCH forms a comfort cushion; holds dental plates so much firmer and snuggler that one can eat and talk with greater comfort and security; in many cases almost as well as with natural teeth. Klutch lessens the constant fear of a dropping, rocking, chafing plate. 25c and 50c at druggists... If your druggist hasn't it, don't waste money on substitutes, but send us 10c and we will mail you a generous trial box. © I. P. INC.

KLUTCH CO. Box 4793-C ELMIRA, N. Y.







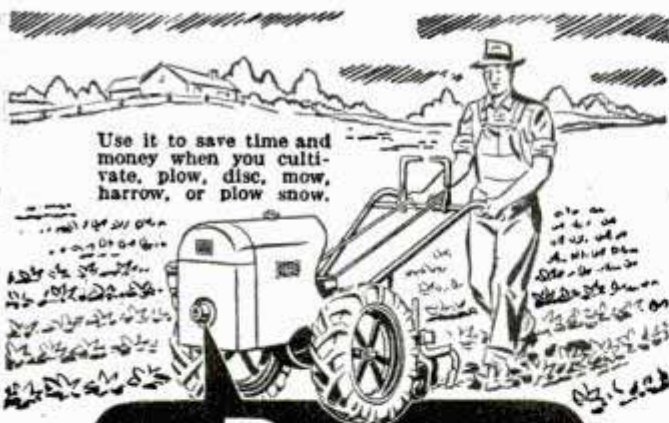

Use it to save time and money when you cultivate, plow, disc, mow, harrow, or plow snow.

## PAGE the streamlined Garden Tractor

... does your job quickly, easily, at low cost

This new Page gives you the benefits of 20 years' experience in making quality garden tractors. Balanced for easy handling. Direct drive, worm-gear transmission, using cut gears and ball bearings. No cheap belts or chains. Gears and clutches in dust-free case. Adjustable wheels. Individual wheel clutches make turning easy. 1½, 2, and 3 H.P. Write for dealer's name and free catalog.

**Page Dairy and Farm Equipment**

1904 S. 81st Street

Milwaukee 14, Wis.

## SURPLUS ITEMS

### At Give Away Prices

We have the following new surplus items for Sale which have so many uses it is impossible to name them.



**40,000 Rheostats** for heated clothing 24 Volt, original cost \$12.60. **ONLY \$2.40 Ea.**



**1000 Hand Operated Gasoline and Oil Pumps**, all brass, easily motorized, original cost \$15.00. **ONLY \$5.00 Ea.**



**1/50 H.P. 24 Volt Gyrosopic Motors**, original cost \$9.00. **ONLY \$2.95 Ea.**



**1500 12-Volt DC Solenoids** for aromatic fuels. **ONLY \$1.50 Ea.**

All Prices F.O.B. Chicago

**Alert Industrial Equipment Corp.**

3430 W. 38th St.

Chicago 32, Ill.

## Extra Special BARGAIN MEN'S Wrist Watch

### Year's Greatest Value!

Here at last is that watch you have been waiting for! Now you can fulfill your desire to own a fine imported SWISS WRIST WATCH. The exact watch you've been wanting at a price you can afford to pay.

Our direct-to-you, no-middle-man, mail order plan, makes this low price possible. We import our own watches direct from Switzerland and only have a limited number available to offer.

**SEND NO MONEY  
ORDER NOW!**

Never mind paying now. Upon delivery, pay postman only \$8.49 plus 85c Fed. Tax and C.O.D. charges, or send \$9.34 (tax included) with order and we pay postage. **WRITTEN GUARANTEE WITH EVERY WATCH.** If not delighted, return within 10 days for refund, providing watch has not been tampered with. **Hurry — order now — supply limited!**

### Style!

1947 Streamlined Model. Genuine Imported Swiss movement — All with Sweep second hands — Ideal for professional use — Smart — easy to read — dial, Ch F O M e plated. Unbreakable crystal. Complete with leather band.



Written Guarantee with every watch

Limited Special Price

**\$8.49**

Plus 10% FED. TAX

**AMERICAN MERCHANDISING CO., Inc.**

Dept. PMW-49

12 Adams Avenue

Montgomery 4, Alabama

### New "THERMO-SAW"

Cuts Rapidly & Cleanly  
No Noise—No Sawdust  
BOYS & MECHANICS thrill over the many interesting things they can make with this NEW ALL-STEEL THERMOSAW. Difficult patterns are made QUICK and EASY.

**CUTS WITH HEAT**

Note—Operates on 110 volt Alternating Current; 50 to 60 cycle NO C.O.D.'s

ORDER TODAY. \$1.75 in Canada & Mexico. \$5 Elsewhere.

BOISSELIER MFG. CO., Dept. P-3, GLEN ELLYN, ILLINOIS



Machine Measures 11x4x 3½" High, Throat 7" **ONLY \$4.50**  
Deep. PATTERN FREE. Postpaid

## CHAPMAN CHINCHILLAS

The originator of the first Chinchilla Farm in the United States. For information on purchasing the finest, selected breeding stock of these aristocratic animals that were virtually trapped to extinction write or visit—

Established 1919

**Chapman Chinchilla Farm**

4957 West 104th Street  
Inglewood, California



### Big Profit AUSTRALIAN WHITES

Sensational MONEY MAKING HYBRID. Customers report broilers 8 weeks, laying 4-12 mos. Disease resistant. Hardy Layers. 60,000 chicks weekly. Started pullets. Profit Sharing Plan. FREE Book. Write today. BERRY BROS. FARMS, Box 582, ATCHISON, KANS.



### FREE MRS. BERRY'S POULTRY BOOK

BABY CHICKS or STARTED. Champion-Mated, Licensed-Inspected, B.W.D. TESTED. 52 BREEDS, 6 HYBRIDS. Sexed or straight. Mature fowls, Hatching Eggs and Remedies. LOW PRICES. The ORIGINAL Berry's Farm—over 50 years' service. LARGE BEAUTIFUL BOOK FREE. Stamps appreciated. BERRY POULTRY FARM, Bx. 29, CLARINDA, IOWA

## REAL RELIEF FOR RUPTURE



Thousands of wearers tell of real relief. Scientifically shaped, made of strong washable materials, gives the RIGHT support WHERE NEEDED. Satisfaction GUARANTEED. Write for FREE literature NOW.

The WEB Truss Co. Dept. M-18, Hagerstown, Md.



# ELECTRICITY *Anywhere*

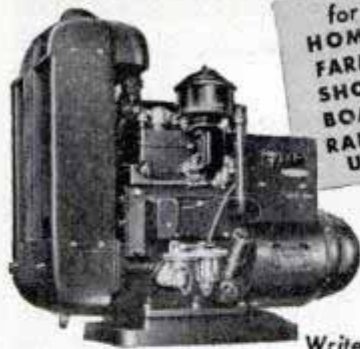

for  
HOMES  
FARMS  
SHOPS  
BOATS  
RADIO  
USE

● Onan gasoline-engine-driven Electric Plants supply reliable, economical electric service for any use. Portable, stationary or stand-by models. Water or air-cooled, compact and rugged.

A.C.: 350 to 35,000 watts in all standard voltages and frequencies. D.C.: 600 to 10,000 watts, 115 and 230 volts. BATTERY CHARGERS: 500 to 3,500 watts; 6, 12, 24, 32 volts.

Write for folder

**D. W. ONAN & SONS INC.**  
2527 Royalston Ave., Minneapolis 5, Minn.



# ONE MOVING PART

Spins water from your well



New "H" Series  
Ejecto Water System

The only moving part in this\* amazingly simple Myers Water System is the precision-cut, revolving impeller, assuring quiet, vibrationless operation. Special design and construction give this Myers Ejecto remarkable efficiency. Delivers up to 1500 gallons of water per hour with a fractional horsepower motor. Handles gas or air in water without repriming. Same pump, tank and motor used for either shallow or deep well service. Mail coupon for complete line booklet.



THE F. E. MYERS & BRO. CO.  
Dept. G-84, Ashland, Ohio.

Send your water system book.

Name \_\_\_\_\_  
Address \_\_\_\_\_

## THE UNIVERSAL LIQUID CEMENT



The "Mr. Fix-it" for "a million things"

Tops in quality for 37 years. Uses unlimited . . . sticks and mends permanently. Waterproof . . . quick drying. Keep a tube on hand always. Extra quality . . . extra strength. Ready to use. LOOK! Get acquainted with Ambroid quality. At your dealers or send 25c for big 2-oz. tube postpaid (U.S.A. only). Money back guarantee. **25¢**

Also 50c 4-oz. tube.  
Pts., qts., gals. for industrial use.

**AMBROID CO.**

303 Franklin St., Boston 10, Mass.

## MAKE YOUR OWN PLASTIC PRODUCTS

Operates hydraulically. Accurately. Economically. Pays BIG DIVIDENDS in a hurry. Electrically controlled heat under varying degrees of pressure and temperature. Used for hundreds of molding needs. Essential for MANUFACTURERS, CUSTOM MOLDERS, INDUSTRIAL LABORATORIES, HOME WORKSHOPS, UNIVERSITIES and COLLEGES. Saves money and makes money.

CLARENDON MFG. CO., Dept. P-3, 176 Adams St., CHICAGO 3

from Molding Powders  
**QUICK and EASY**  
with The All-Purpose  
**S-K-W COMPRESSION  
MOLDING MACHINE**

Write For Free Particulars

## 12 lbs. SURPLUS RADIO PARTS \$2.00

A gold mine of parts for repairmen, amateurs, and experimenters . . . sockets, condensers, resistors, transformers, coils, hardware, wire, etc. An outstanding bargain in usable parts! Send \$2.00 cash, check or M.O. today!  
(Pay small express charges on receipt.)

**ELECTRONIC PARTS, Inc.** Dept. M3 622 W. Randolph St., Chicago 6, Ill.

## INSTANTLY REMOVE NICKEL

Take nickel — black tarnish from brass or copper articles with little expense. No elec. or tanks. Swab on, rinse off. No pitting or burning. Ingredients cheap at drug stores. Thousands of satisfied nation-wide users. Written formula \$2.00.

**BOONE PRODUCTS • 236 W. 63rd St. • Chicago 21, Ill.**

## Don't Spoil it ...KROIL it!



Don't ruin valuable equipment merely because some part is rusted tight. KROIL, the new chemical lubricant, creeps into millionth inch spaces, dissolves rust and loosens frozen parts, faster than any penetrating oil known. 5000 industrial plants still use KROIL to keep production going. Try it on money back basis. AT YOUR DEALER or send \$1 for two 8 oz. spout cans, postpaid. Send dealer's name.

**KANO LABS, 3023 Lincoln Tower, Chicago 1, Ill.**

## Larson

### "MAKE YOUR OWN" FOLDING SAW-HORSE SET



IN USE

A brand new LARSON construction set, with copyrighted instruction sheet for easy assembly. Set makes two complete Folding Saw Horses,

that can't be beat for general household use. They are rigid yet light in weight and fold compactly for storage. Can be made to any reasonable height or length. Lumber not included in set.



FOLDED

Prepaid \$2.50

**CHAS. O. LARSON CO., BOX 358, STERLING, ILLINOIS**





**BAUSCH AND LOMB**  
**7 x 50 Navy Binoculars**  
**\$135.00**

**COATED OPTICS!**

Mfgd. to U.S. Navy Standards! (Alignment guaranteed to .001") Brand new glasses. Dust proof! Climate proof! Individual eye adjustment. Instant focusing. Coated optics insure sharp, clear images! Ideal for long range hunting, yachting, watching planes, etc. This magnificent 7 power 50 mm. Navy Binocular gives better detail, heightening image contrast. Complete with carrying case only \$135.00 plus 20% Federal tax.



**BAUSCH AND LOMB**  
**6 x 30 Binoculars**  
**\$37.50**

6 power Binoculars made to rigid Army specifications by BAUSCH AND LOMB. Used in good condition. Sturdily constructed of genuine brass, leather covered. Ideal for hunting, sports, etc. These fine Bausch and Lomb Glasses come complete with case and straps ready to use. Similar to picture. \$37.50 plus 20% tax. WHILE THEY LAST!

**OTHER BINOCULARS (3 to 16 POWER!)**

12x40 Carl Zeiss. Like new. . . . .	\$225.00
16x40 French. No case. Used. . . . .	125.00
16x45 French. New. . . . .	135.00
12x38 French. New. . . . .	100.00
10x32 French. New. . . . .	79.00
10x50 German Dienstglass. Used. . . . .	150.00
8x30 French. New. . . . .	62.00
8x25 French. Used. . . . .	45.00
8x24 Busch. Lightweight. Used. . . . .	65.00
7x50 German Dienstglass. Used. . . . .	145.00
8x30 Carl Zeiss. Used. . . . .	100.00
6x30 Carl Zeiss. Used. . . . .	85.00
6x25 Ross, London. Used. . . . .	60.00
6x30 Heesch. Used. . . . .	55.00
6x24 USN, Turner Reich, Lightweight. Used. . . . .	60.00
5x40 Nat'l. Field Glass. Coated Optics. New. . . . .	29.75
4x50 Super Eye Field Glass. No Case. New. . . . .	15.00
4x40 Fee & Stenwedel Field Glass. New. . . . .	20.00
5x40 Fee & Stenwedel Field Glass. New. . . . .	22.00
4x40 Wollensack Field Glass. New. . . . .	16.25
3x30 Fee & Stenwedel Field Glass. New. . . . .	3.50

Add 20% For Federal Excise Tax. Carrying case and straps included. Supply limited. Give second choice.

**MONEY BACK GUARANTEE!**

Use for 20 days at our risk and expense. If not fully satisfied, return for full refund of your money. **ORDER TODAY!** Send \$2.00 deposit and we will ship C.O.D. for balance. Cash orders sent postpaid.

**UNITED PRODUCTS CO.**

7941 S. Halsted Dept. ARF-108 Chicago 20, Ill.  
 (Reference Dun & Bradstreet)

SAY YOU SAW IT IN POPULAR MECHANICS

**WORLD'S LOWEST PRICED**  
**ADDING MACHINE**

**VEST POCKET SIZE**

**IDEAL FOR BUSINESS OR PERSONAL USE**

FREE TRIAL  
**ONLY \$2.50**  
 TOTAL COST  
**SEND NO MONEY**

Each Baby Calculator in Beautiful, rich-looking Leatherette case—at no extra cost. **FREE!!**



Fits vest pocket or purse. Guaranteed accurate. Operated as easily, and as reliable, as machines costing many times as much. Not a toy. Substantially made of 28-gauge steel—guaranteed for life against defects in construction. You positively can't buy a calculator of equal quality for as little money. **ACCEPTED AS THE FINEST LOW PRICED CALCULATOR FOR OVER 30 YEARS!** Operates with a flick of your finger. Adds, subtracts, multiplies, divides—counts up to ten million. Pays for itself over and over in mistakes avoided, and time saved. **MAKES IDEAL GIFT.**

Sold on a positive money back guarantee. Send only \$2.50. Calculator sent postpaid, or send name and address and pay postman \$2.50 plus postage. **MONEY BACK IN 10 DAYS IF NOT DELIGHTED!**

**AGENTS WANTED.**

**CALCULATOR MACHINE CO. (Mfrs.)**  
 Dept. 188, P.O. Box 248, Glenview, Illinois



**THOUSANDS of USES! FIND BURIED** pipe lines; metal, non-metal lines, cables, wires, hidden jewelry, coins metal or non-metal objects and hundreds of other uses. **UNIT** comes complete with Spare Tubes, Antenna Dipole, Reflector and Instruction Manual in Wooden chest 9"x15"x28". Weight in operation 22 lbs. Shipping wt. 80 lbs. It is ready to operate with addition of one 6 volt and three 45 volt batteries. **NO C.O.D.s.**

**F.O.B. from N. Y. \$17.50**  
 (LESS BATTERIES)

**With Batteries \$26.40 F.O.B.**  
 SEND YOUR ORDERS TO: N. Y.

**COLUMBO TRADING CO.**  
 304 CANAL ST. • NEW YORK 13, N. Y.

**THE SCOUT SENIOR**

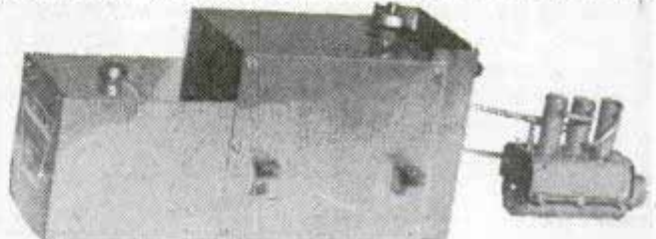

A two-cylinder, slide valve engine for boats 18" long and larger. 7/16" bore by 3/4" stroke. Aluminum pistons. High-pressure, brazed boiler. Drives a 2 1/4", two-bladed prop of 3" pitch at 2000 r.p.m. for almost 20 minutes. Burns alcohol. Price postpaid, complete ready to run with 70-lb. safety valve and prop rig. **\$9.50**  
**PHILIP STEVENSON CO.,** Box 162, Station D, Cincinnati 6, Ohio

**MODEL MAKERS FINISH KIT**

Mix your own fast drying, tough, durable model finishes and airplane dopes in any color, speed, sheen or hiding power. Kit contains seven highly concentrated paste colors, a flattening paste, a retarder and one pint each of clear and thinner for mixing. Complete Instructions. \$3.75 Postpaid.

**MADISON LABORATORIES, P.O. BOX 41, MADISON, NEW JERSEY**

**Be Comfortable Be At Ease**  
**EMENESS READING STAND, ONLY \$3.95**

Can be used to hold instruction books while working in shop; for reading in bed; for eating tray while convalescing; and many other uses. Get yours today. Only \$3.95 postpaid or send name and pay postman \$3.95 plus postage and fee.  
**MART DISTRIBUTORS P.O. Box 6, Evanston, Ill.**



**CHANITE SELF-WELDING FLUX**

**REPAIRS ALL ELECTRIC HEATING ELEMENTS**

So simple anyone can make repairs in your broken or burnt-out electrical appliances—irons, toasters, stoves, etc. Guaranteed nothing like it. From our mines to your appliances. \$1.00 per package. \$7.50 per doz. Stick form 25c. \$2.00 per doz.  
**CHANITE SALES COMPANY, 914 So. Main, Fort Worth 4, Texas**

**LAWN ORNAMENT-NOVELTY PATTERNS**

28 Lawn Ornament Patterns, 25c. Other patterns: 15-20" high; Dutch Girl, Dutch Boy, Pirate, Bull Terrier, Mexican Girl, Mexican Boy, Dwarf, Penguin, Flower Girl, 10c each. 25 Novelty Patterns, 30c. All 62 Full Size Patterns, \$1.00 Postpaid. Strother Pattern Service, Dept. T-8, Box 383, Belington, W. Va.

**FIBRE ARMS AND LEGS!**  
 Light, correctly fitted, strong and comfortable. Natural appearance. Braces for all deformities. Scientific design. Fair Terms.  
**BUCHSTEIN-MEDCALF**  
 223 S. 6th St., Minneapolis, Minn.



AT  
HARDWARE  
ART  
STORES



\$3.00  
WITH  
INK

## Cada FLO-MASTER POCKET FOUNTNBRUSH

- WRITES LIKE A PEN
  - MARKS LIKE A CRAYON
  - DRAWS LIKE A PENCIL
  - PAINTS LIKE A BRUSH
- ON ANY SURFACE  
(Paper, wood, glass,  
metal, cellophane, etc.)  
WITH Instant Dry CADA INKS  
(Black & 7 colors)

The new, indispensable tool for Home, Farm, School, Art, Industry. At your Stationery, Hardware, Art Store. If your dealer can't supply you send check or money order to us.

**CUSHMAN & DENISON MFG.**

135P West 23rd Street New York 11, N. Y.

## GRIPSHUR

### New Safety Crutch Tip!

New protection for crutch users on snow, ice or wet pavements. GRIPSHUR'S easily attached to end of crutch or standard one-inch cane—simple quarter turn also allows regular rubber tip for use indoors or on dry pavement. Ask your surgical supply store or we will send a pair. \$3.80 postpaid. GRIPSHUR, Peck Industries, Incorporated, P. O. Box 3923, Cleveland 20, Ohio.

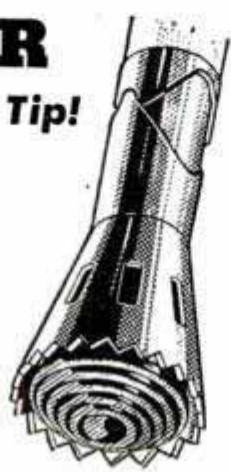

## Get Acquainted With— LUCITE "The Gem of Plastics"

Write now for your copy of the illustrated booklet which gives step-by-step fabricating instructions, chemistry & properties of Lucite, wholesale and retail price list on CLEAR & COLORED sheets, rods, tubes, dyes, supplies. Booklet & Lucite sample 35c, postpaid; booklet only 10c GEM-O'-LITE, P.O. Box 686D, North Hollywood, Calif.



**A MUST TOOL FOR FINE CRAFTSMEN**  
Jewelers • Technicians • Hobbyists  
A dual purpose precision built vise. Can be used as a hand or bench vise. With swivel base . . . A quality tool.  
SEE YOUR DEALER OR WRITE  
**Reyco CORPORATION**  
9900 Lincoln Blvd., Los Angeles 45, Calif.

### ARMY-NAVY SURPLUS BY MAIL CATALOG FREE

Now you can buy Genuine Brand New Surplus Clothing by mail at enormous savings. Trousers, jackets, shirts, rain coats, blankets, arctics, shoes, socks, gloves, underwear etc. Mail post card today for your FREE CATALOG sent promptly.  
J. R. ADDISON UNIFORM CO. CAMBRIDGE, OHIO



## WALKIE SIREN

Formerly \$15.00 - Now Only \$3.95

GOV'T SURPLUS. A precision instrument. Easy turn of crank produces CLEAR, FULL SIREN TONE. Can be heard for great distance. Ideal for Boats, Autos, Schools, Sporting Events, etc. Dimensions 7" x 8" x 5". Wt. 4 1/2 lbs. Price includes shoulder strap and waterproof cover. SEND NO MONEY. Just name and address. We'll ship C.O.D. for \$3.95 plus postage, or send money in advance, we'll ship prepaid. Canadian price \$4.50. ILLINOIS MERCHANT MUSE MART, Dept. 400-A, 1227 Loyola Ave., Chicago 26, Ill.

## REMOVE WALLPAPER

THIS NEW,  
QUICK, EASY WAY!

Redecorating? Use Peel to remove old wallpaper with a minimum of time and effort! Unlike ordinary removers, Peel is composed of quick-acting materials with two-way action which penetrates the paper and dissolves the paste. Result—paper peels off quicker, easier with Peel! Odorless, perfectly safe—harmless to woodwork, painted surfaces, clothing or hands. Concentrated—one 85c jar makes a two-gallon solution—enough to remove paper, from one average-sized room.



# Peel

Ask your dealer to write us if he cannot supply you, or write direct to:

**Paul Lewis**  
Laboratories, Inc.  
MANUFACTURING CHEMISTS

Dept. 30—Milwaukee, Wis.

\$2750

## 1/2-INCH ENTERPRISE DRILL PRESS

15 day approval.  
Money refunded  
if not satisfied.



At last, a large capacity Drill Press at a price you can afford. Handles any metal or wood drilling task around the workshop, garage or farm. Order without risk. You can return it for full refund at any time within 15 days.

Drills to center of 7-inch circle . . . 4 speed spindle . . . 6x6 inch table.

Has cast aluminum base, head, motor bracket. Spindle travels 2 inches. Max. height, chuck to table, 10 1/2 inches. Head raises, lowers. 3-jaw chuck takes bits up to 1/2-inch. Floating bracket for 1/4 or 1/2 H.P. motor. Two 4-step pulleys, belt, instructions included. Motor, bits, not furnished. Shipped prepaid if you send check or money order. Sent collect if C.O.D.

**THERMO-CRAFT  
ELECTRIC CO.**  
4810 N. DRAKE AVE.  
CHICAGO 25, ILL.



# BRAND NEW WAR SURPLUS

**EDWARD LAWRENCE CO., INC.**  
396 BROADWAY—NEW YORK 13, N. Y.  
SEND MONEY ORDER — WE PAY THE PARCEL POST

U. S. NAVY  
with batteries  
**FLASHLIGHT**  
**\$1.65**



U. S. AIRFORCE  
**COMPASS**  
Made by Longine Wittnauer Co.  
**\$1.50**



2 MAN RUBBER INFLATING  
**LIFE BOAT**  
**\$16.50**  
Complete with hand paddles



CANVAS CARRY-ALL  
16 INCH ZIPPER  
**BAG**  
**\$2.50**  
STURDILY MADE



U. S. NAVY  
**LANTERN**  
**\$6.00**  
complete with batteries



## Portable Paint Sprayers

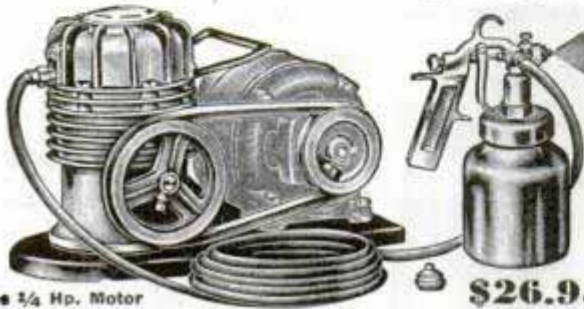

Uses 3/4 Hp. Motor  
**\$26.95**  
Complete as illustrated, less motor. Outfit consists of, compressor, 15 ft. hose, Spray Gun with qt. cup, "V" belt and drive pulley for motor. Sprays any kind of paint, lacquer, varnish.

Spray Gun—1 pt. cup.....	4.95	Black & Decker
Spray Gun—1 qt. cup.....	5.95	Electric Drills
Air Reg. & Gauge, 0 to 160 #.....	4.95	1/4".....
Air Hose—25 ft.....	2.90	1/2".....

**SUPER-AIR #560—4.75**  
Complete outfit includes:  
• 10 mm. spark plug adaptor  
• 14 mm. spark plug adaptor  
• 18 mm. spark plug adaptor  
• 16 ft. ribbed rubber hose with tire fittings  
• 100 lb. pressure gauge  
• 3/8" spark plug adaptor

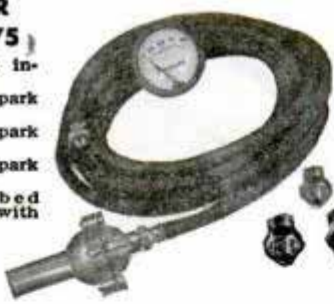

**INFLATING PUMP #561—3.75**  
Complete outfit includes:  
• 10 mm. spark plug adaptor  
• 14 mm. spark plug adaptor  
• 18 mm. spark plug adaptor  
• 13 foot ribbed rubber hose with tire fittings (without pressure gauge)  
• 3/8" spark plug adaptor

Day or night, on the farm or in the city . . . wherever your car goes, Super-air insures Power Air Service for auto and tractor tires, for paint and insecticide spraying, inflating footballs, rubber boats, cushions, beach toys, etc. Pumps up to 100# pressure. Immediate delivery. Check or M.O. with order.

### INDIANA APPLIANCE CO.

20 East Sycamore Dept. PM-15 Evansville 9, Ind.

**NEW OHMITE Ohm's Law Calculator**  
25¢  
New Pocket Size  
Computing Scales on One Side  
Gives Composition Resistor Color Code  
**Figures Ohms, Watts, Amperes, Volts... Quickly!**  
Here's a new and improved version of the famous Ohmite Calculator. Handy pocket size — 9" x 3". Solves any Ohm's Law problem with one setting of the slide. No slide rule knowledge necessary. Send 25c in coin for your Calculator.  
**OHMITE MFG. CO., 4940 Flournoy Street, Chicago 44, Illinois**



*Make Your Own*  
**RUBBER MOLDS**  
with  
**RED LATEX MOLDING COMPOUND**  
Earn money, have fun; make your own molds for plaster objects. Produce novelties and gifts for home and to sell to friends. RED LATEX MOLDING COMPOUND (60% density) now available in quart and gallon quantities. Gives perfect results, easy to apply. Send for complete information and prices. FRANCIS SUPPLY CO., Dept. C3, 1836 E. Fulton St., Columbus 9, Ohio.



**BIG MONEY! SUCCESS!**  
★ BE YOUR OWN BOSS! INCREASE YOUR INCOME! MAKE FRIENDS! "PRICELESS PERSONALITY" and "FACE VALUE" our latest books can show you the way as it has for thousands. Cloth bound, \$2 each. Paper bound, \$1 each.  
**THE MARSHALL ADRIAN CO.**  
371 Colorado Bldg., Denver 2, Colo.



**SAVE 1/3 On Your Favorite Drills!**  
**CENTURY High Speed Drill Sets** Mechanics Lengths

M-1 29 Drills 1-16 to 1-2 by 64ths, complete with Huot Index .....	\$18.85	M-3 13 Drills - 1-16 to 1-4 by 64ths .....	\$4.15
M-2 21 Drills - 1-16 to 3-5 by 64ths .....	\$9.95	M-15 15 Drills - 1-16 to 1-2 by 64ths. Packed in M-1 Huot Index with capacity for 14 additional drill sizes .....	\$11.45

Send Money Order, Check, Cash or C.O.D. — We Pay The Postage

**PARKER PRODUCTS • Sales Division**  
328 S. SAGINAW STREET • FLINT 3, MICHIGAN

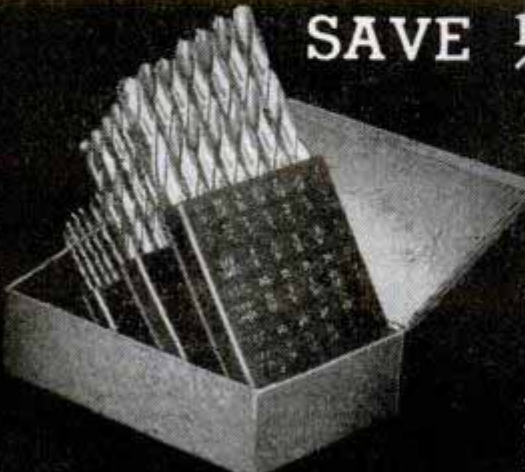



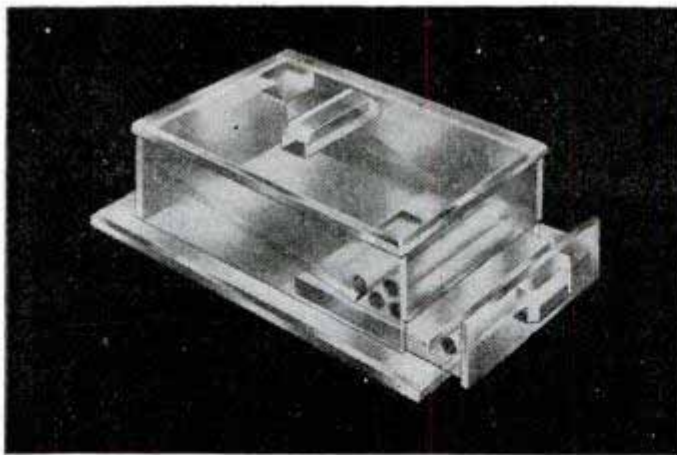

### Automatic Cigarette Dispenser

Made of Lucite the jewel of plastics and ready to assemble into a beautiful and practical container holding 31 cigarettes. Ideal gift or saleable article to stores, individuals, etc. Home-crafters will find this a fascinating hobby or a profitable business. Complete illustrated instructions, polishing compound, brushes, and jig come with the kit. Actual size 4x6 inch. Sent prepaid if cash with order. Otherwise C.O.D. Only \$3.95. Any color 10% extra. Special price dozen lots. Free descriptive folder upon request.

#### CENTURY ENTERPRISES

P. O. Box 56 Station A Los Angeles, Cal.

### CUTS INTRICATE DESIGNS never before possible



Sharp spiral blade saws in any direction. Cuts wood, plastics, or light metals without binding or breaking. Sturdy steel frame, with new lever adjustment, keeps tension right. Complete saw with 3 extra blades, 95c. Blades only, 3 for 25c. Get yours—today. AT YOUR NEAREST HARDWARE STORE, or send \$1 direct for sample to

**TYLER MANUFACTURING COMPANY**  
938 Pico Boulevard — Santa Monica, California

ENLARGED  
SECTION  
OF BLADE

### PLUG-IN TEST LAMP

TESTS EVERYTHING ELECTRICAL  
SPEEDS UP TROUBLE-SHOOTING

Used by Electricians, Mechanics, Appliance Men, Radio Men and Experimenters. Always ready! Plugs into any outlet! Tests continuity, open circuits, short circuits, grounds, etc. Checks all motors, radios, electrical appliances and other devices. Guaranteed. ONLY \$1.95 Postpaid. Complete with lamp and test leads. FREE CIRCULAR (Pat. Pend.)

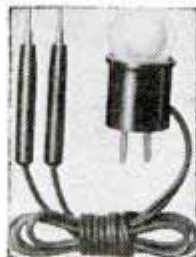

**HANLAN CO.**

1419A W. Jefferson St., Los Angeles, Cal.



### MACHINISTS — TOOLMAKERS

Gerstner Tool Chests are made better.  
Choose yours from free Catalog.  
**GERSTNER TOOL CHESTS**  
447 Columbia St., Dayton 7, Ohio

### "Professional Finishes"

Every Craftsman should have our price list on: Electroplating chemicals and supplies, wood and metal finishes; shop chemicals; industrial and novelty finishes; shop supplies.  
**CRAFT FINISHES • Box M-467 • Arlington, Virginia**

### RADIO PARTS GRAB BAG!!

\$25 value assortment of Coils, Condensers, Transformers, Resistors, Controls, etc. An experimenter's dream. Order today! Only.....  
**MARKO SUPPLY, Dept. PM-3**  
2924 Logan Blvd. Chicago 47, Ill.

**\$3.98**

### Air Corps Coveralls Genuine Aviators' ALL WOOL GABARDINE COVERALLS



1/2 COST TO GOVT.  
**only \$6.95**

**ALL BRAND NEW**  
Get Several at This Low Price!

Something New — Not the old-fashioned overalls, but a finely tailored garment created and designed especially for Air Corps. Proven to be the perfect coverall or uniform for the outdoor man. Tailored like a fine suit of clothes, will outlast several pairs of overalls.

Made of all-wool Forest Green Gabardine. Two-way zipper closing crotch to collar. Extra strong reinforced. Action back. Adjustable pants bottom and belt. Exceptional workmanship. Has 2 breast and ankle pockets. Full range of sizes 36 to 44. Warm—fine fitting—will outwear any average type of coverall. A Sensational Value!

Order DIRECT and SAVE!

Please send check or money order for \$6.95. Pay a few cents express charges on delivery.

**BENNETT MARSHALL** 2801 UNION CENTRAL BLDG. Dept 414  
CINCINNATI 12, OHIO

### 25 Ass't'd CUTTERS, SAWS REAMERS, BORERS

**\$5.95**



If you can duplicate this wonder value in any hobby shop at less than \$15.00, return your set and get your money back.

This is the greatest value we have ever offered — 25 assorted hardened steel cutters

for working on plastics, metals and wood. Assorted shanks 3/32, 7/64,

and 1/8" diameters. The large illustration shows the tools actual size.

**UTILITY MOTOR \$3.50**



Can be used for running tools, toys, experimental work, etc. A series wound motor 3 3/4" long x 2 1/2" wide and 1 3/4" high. 1/4" shaft. A resistor is included at no extra cost making this an AC-DC Motor.

Both above items Post Paid in U.S.A. and possessions

**GENERAL AIRE CO.** Dept. PM-3  
447 W. Norris Street Philadelphia 22, Pa.



**102 Booklets filled with Money and Time-Saving Helps**

**Little Library of Useful INFORMATION**

**5 for \$1.00**  
**12 for \$2.00**  
**25¢ Each**

Here at amazingly low cost is the practical help and information you have always wanted. Articles in previous issues of Popular Mechanics have been classified according to subject and are now available in these handy reprint booklets. Check Titles wanted, clip ad and mail today.

**BOOKLETS ON WORKSHOP EQUIPMENT**

- Power-Driven Saws—74:** Complete details on scrollsaw, two circular saws, sliding cut-off saw, bandsaw.
- Drill Presses, Plane, Grinders—79.**
- Sanders—80:** Complete constructional details on 8 useful machines.
- Wood & Metal-Turning Lathes—81:** Two wood lathes, small metal-turning lathe.
- Filing Machine, Hacksaw, Cutoff Wheel, Shaper—82.**
- Metal Lathe Tools You Can Make—101.**
- Workbenches & Tool Cabinets—47.**
- Spray Painting—94:** Constructing spray guns, compressor, using spray gun.
- From Pattern to Casting—91:** How to make your own patterns and small castings.

**BOOKLETS ON SHARPENING—USING TOOLS**

- Correct Measurement—106:** How to use micrometers, gauges, calipers, etc.
- Tool and Saw Sharpening—92.**
- Using & Sharpening Drills & Wood Bits—90.**
- Successful Wood Turning—32:** All the information you need to master this art.
- How to Read Blueprints—71:** Tells you how to understand signs, symbols, and lines.
- Metal Turning Lathe Kinks—99:** Simple homemade tools, time and labor-saving shortcuts you can use.
- Operating a Metal Turning Lathe—100.**
- Heat Treating & Case Hardening—102.**
- Working with Glass—103:** Cutting, drilling, etching, blowing.

**ELECTRICAL BOOKLETS**

- Rewinding & Servicing Electric Motors—75:** Repairing and rewinding a.c. and d.c. motors. Locating trouble. Converting auto generators into 110 v. a. c. motors.
- House Wiring—89:** All the information you need to do a complete wiring job or install extra outlets.
- Electromagnets & Solenoids—44:** Designing and building.
- Transformer Construction—41:** Easy-to-understand instructions for all kinds of transformers.
- The Boy Electrician—43:** Easy-to-build motors, experiments.
- Soldering & Brazing—17.**
- Arc & Spot Welders—5:** Building and operating 110 v. a. c. arc and spot welders.
- Treasure Finders—13:** Build your own treasure finder and metal locator. Details for both large and small radio types.

**ELECTROPLATING BOOKLETS**

- Electroplating with Copper, Nickel, Chromium, Lead, Zinc, Cadmium—86.**
- Plating Leather & Other Non-Metallic Objects—Plating with Gold, Silver, Alloys—87.**

**HOME IMPROVEMENT BOOKLETS**

- Simple Home Improvements—104:** Modernizing; making storm sash, ironing boards, etc.
- Building Extra Rooms in Attic—23.**
- Attractive Basement Playrooms—24.**
- Lower Your Fuel Cost—31:** Practical kinks that will save you hundreds of dollars.
- Hanging Wallpaper—38:** Tricks of hanging wallpaper, removing old paper, etc.
- Curing Leaky Basements—45.**
- Fitting Home Game Room—55:** Construct own game & tennis tables, shuffleboard court, action game, portable playrooms.

- Ridding the Home of Insect Pests—107:** Exterminating and protecting against moths, flies, termites, mosquitos, etc.
- Built-in Fixtures—78:** Step and space-saving kitchen units, built-in beds, corner cabinets, vanities, linen chest.
- Constructing Indoor & Outdoor Fireplaces—88:** Stone fireplaces, portable mantels, garden fireplaces.

**GARDENING BOOKLETS**

- Backyard Gardening—39:** Selecting, planning and getting the best results.
- Lawn & Garden Novelties—72:** Jig-sawed ornaments, parkway numbers, sundials, flower boxes.
- Trellises, Pergolas, Fences—76.**
- Lawn & Garden Furniture—77:** Modern bent-tube furniture, arbor and seat combinations, swings, lawn chairs.
- Playground Equipment—73:** Two playhouses, ferris wheel, roller coaster, treadmill, play store, slide, two merry-go-rounds.
- Colored Concrete Garden Furniture—6:** Garden benches, pottery, flower boxes, bird baths and sundial pedestals in colored concrete. How to build small concrete mixer.
- Bird Houses—7:** Easy to build homes for all kinds of birds.
- Farm & Garden Tractors—8:** Two tractors you can build from old automobile parts.

**CRAFT WORK—HOBBY BOOKLETS**  
 Complete how-to-make-it instructions for hundreds of practical projects.

- Working with Plastics—61:** Using brilliantly-colored plastics in craftwork.
- Magazine Racks—49:** Ten attractive racks.
- Clock Cases—50:** Large Hall, Colonial wall and mantel, ship's wheel, miniature grand-father, desk, Spanish style banjo.
- Serving Trays for Every Occasion—53:** Fourteen different designs.
- Children's Room Furniture—51:** Twelve attractive pieces.
- Book Ends—52:** Ten designs offer good selection.
- Small Tables—54:** Modern and colonial styling.
- Smoking Stands—56:** Seven designs given.
- Jigsawed Novelties—57:** Sewing kits, string holders, place-card holders, plywood kitchenware, plant and flower holders, coin banks, door stops, drawer pulls.
- Desks—58:** Colonial writing desk, two modern-type desks, student's study desk of plywood, combined chest and writing desk.
- Book Cases—59:** Eight designs.
- Doll House & Doll Furniture—60.**
- 25 Shelves You Can Make—64.**
- Novelties Turned on Lathe—62.**
- Inlay Pictures—Veneering—63.**
- Whittling and Wood & Soap Carving—65.**
- Action Toys—66:** 21 easy-to-make toys.
- High Flying Kites—67.**
- Windmills & Weathervanes—68.**
- Lamps in Wood, Metal, Plastic—69:** Selection of 14 designs.
- Metal Craft—28:** Brass tapping and making of novelties both decorative and useful.
- Small Looms—37:** Building hand looms for weaving rugs, etc.; leather novelties.
- Plain & Novelty Wood Finishing—40.**
- Gem Cutting—42:** How to cut and polish semi-precious stones.
- Rustic Furniture—18:** How to build chairs, benches, tables, gates, summer house, etc.

**BOAT BUILDING BOOKLETS**

**Build a boat at home—you can do it**

- 14 Ft. Outboard Runabout—2:** Here is a fast 14 foot V-bottom boat. Suitable for motors of 4 to 24 hp., estimated cost, \$30 to \$40.
- 14 Ft. Sailing Dinghy—26:** This 14-foot boat combines strength and light weight. It carries 140 sq. ft. of canvas and weighs about 350 pounds. Actual photographs and diagrams illustrate every detail.
- 21 Ft. Sloop—46:** Every fact needed by the amateur boat builder to construct this craft which carries eight to ten persons.
- Rowboats: Bicycle Boat, Small Dinghy—83:** All the information you need to construct four low-cost boats.
- Small Sail Boats—84:** 12-ft. sailing dinghy, 6-ft. "training ship" for young sailors, how to sail a boat.
- Two Outboard Runabouts—85:** 14-Ft. family outboard weighs about 400 lbs. and 12-ft. plywood outboard weighs about 110 lbs. Both are V-bottom type.
- Build Your Own Canoe, Kayak, Surfboard—30:** Complete details on 16-ft. Canadian-type canoe, 17-ft. kayak, and 12-ft. hollow surfboard.
- Fast Class-E Ice Yacht—22:** Build your own Class-E ice yacht. Every detail of construction carefully explained.

**AUTOMOBILE BOOKLETS**

- Automobile Kinks and Shortcuts—10:** Money-saving hints on upkeep, operation.
- Building Trailers—27:** Small Streamlined house trailer; several utility trailers.
- Motor-Driven Midget Car & Scooter—34:** Both use gas engine of washing machine type.
- Curing Auto Electrical Troubles—95.**

**PHOTOGRAPHY BOOKLETS**

**Save Money by constructing your own photo equipment.**

- Photo Enlargers—1:** Condenser lens type; simple vertical; horizontal.
- Photo Printers & Dryer—25:** Describes three practical printers, timer and negative dryer.
- Photo Darkroom Equipment—96:** Cabinets, light-tight box, timer, agitator, washer.
- Picture Projector, Trick & Table Top Photography—97:** Projectors that enlarge magazine illustrations and shop drawings. Tips for table toppers, photomontages, tricks.
- Photo Kinks—98:** 63 time and money-saving ideas you can use.

**FORMULA BOOKLETS**

- Cleaning Preparations—11:** Easy-to-make cleaners for walls, glass, etc. Removing fabric stains.
- Cosmetic Formulas—12:** Hand lotions, creams, rouge, bath salts, beauty clay, lipsticks, etc.
- Re-Silvering Mirrors—70:** Formulas for silvering and coloring.

**MISCELLANEOUS BOOKLETS**

- Knots and Ropework—105.**
- Chemical Experiments—93:** Easy-to-perform experiments. Inexpensive lab.
- Taxidermy—9:** How to prepare skins and obtain life-like poses.
- Log Cabins & Tourists Cottages—14:** Year-round log cabins; inexpensive tourists' cabin.
- Magic for Everybody—29:** Simple tricks to puzzle your friends.
- Trapping Small Animals—33:** How to lure fur bearers, prepare bait and traps, dress skins.
- Tricks of Training Your Dog—35.**
- Small Furnaces—36:** Build own gas or electric.
- Telescopes—20:** Design and construction.
- Poultry Houses—108:** Structures, brooders and incubators.
- Guns and Decoys—109:** Cleaning, shooting; making decoys.

**POPULAR MECHANICS PRESS,**  
 200 E. Ontario St., Chicago 11, Ill.

I enclose ..... (U. S. bills may be mailed if carefully wrapped)  
 for "Little Library" booklets numbers:

.....  
 .....  
 Name .....  
 Address ..... Zone .....  
 City ..... State .....



# WAR SURPLUS BARGAIN HUNTING KNIFE

10 1/2 INCHES WITH LEATHER SHEATH



ALL brand new and made to government specifications. Now released to the public at a fraction of the real value. Sold in many retail stores at \$4.95. Blade is 6" long, of finest carbonized tempered steel with a rust-protection gun-metal finish. Has 4 1/2" leather handle with steel protective guard. The sheath is solid cowhide leather, riveted and stitched with a safety hold clasp.

**Limited Quantity at this Price**

Send only \$2.65 for complete knife and sheath. Shipped postpaid. Satisfaction guaranteed or your money back. Rush your order while they last.

**SURPLUS MAIL-ORDER CO.**

1610 Reading Road  
Cincinnati 2, Ohio

Only  
**\$2.65**  
POSTPAID

EXTRA! **JUST OUT** EXTRA!  
**INSTANT NICKEL**  
U. S. PATENT PEND. NO. 702581  
NO CURRENT OR BATTERIES USED

Iron, Steel, Aluminum, Brass, Bronze, Copper and practically all Industrial metals (except Zinc) can now be HEAVILY nickelplated without EQUIPMENT, VESSELS, ELECTRICITY OR PREVIOUS COPPER PLATING, a blessing to Hobbyists, Doctors, Hospitals, Restaurants, bar and Beauty shop owners. Recommended for Auto, bicycle and Machinery parts and accessories, Surgical and Musical Instruments, Electrical appliances, Coffee Urns, and practically anything made of metal. **THERE IS NO TRICKS CONNECTED WITH THIS MARVELOUS NEW INVENTION**, the principles of the battery and electroplating have been harnessed into this compound, so when it is applied with a wet applicator on a clean metallic object, a bright nickelplate instantly appears, the thickness of plating is regulated by amount of applications given. **JUMBO SHOP SIZE** (Covers 50 Sq. Ft.) \$6.75 P.Pd. Sample Trial Offer \$2.00 P.Pd. **INSTANT PLATING PRODUCTS.** 3439 Michigan Ave., Chicago 16, Ill. (Applicator sent free.)

**COMPLETE**  
**\$2** POST PAID  
Covers 10 Ft.  
NO C.O.D.'s  
PLEASE

Say You Saw It in  
**POPULAR MECHANICS**

**KAYAKS**  
**AQUA VIR**  
*Easy to Build*  
**OUTBOARDS ROWBOATS**

**BOATS for Home Assembly**  
**"U-MAK-IT"**  
KAYAKS, ROWBOATS, DINGHIES, INBOARDS, OUTBOARDS, RUNABOUTS  
Cut-To-Fit for Quick Assembly. Everything Complete plus Illustrated Instructions. No Experience Necessary. Simple as A. B. C.  
**SEND 25c POSTAGE (COIN) TODAY FOR 3 MONEY SAVING ILLUS. CATALOGS**  
Showing all '47 Models (marine plywood) and construction details.

**25¢ COIN FOR ALL THREE**

**AQUAMOBILE V-18**  
Designed for Auto Engines. Open or with cab. Length 18 ft.  
Fast VEE Bottom Hull.  
**KAYAK BOAT CO., 154K EAST 129th ST., NEW YORK 35, N. Y.**

## C-THRU-MIRRORS

See thru one side. Mirror on other side. Leisurely watch others at close range who imagine themselves unseen. Loads of fun. Lasts a lifetime. 3" x 4" or 2" x 6" sizes only. \$2.95 postpaid. No C.O.D. One day shipment. **Beeler Enterprises, Dept. 21-C, North Hollywood, Calif.**

## TOOLS — PLASTICS — SUPPLIES — ETC.

New Decorative Plastic Panels for table tops, etc. also aluminum trim, Plexiglas, Plastic Screws, Cement, Drills, Taps, Dies, Milling Cutters, Torches, Fink, Brazing Wire, Screws, Aluminum, Shafting, Bearings, Pulleys, Mandrels, Machine Handles, Flexible Shaft Tools, Electric Drills, etc. Many other items, 70% in stock. New Illustrated Catalog E-15c. **Metiplas Supply Co., 1420 South 16th Avenue, Maywood, Illinois.**

# Drill Press

WORK SHOP TOOLS BY  
**Barron**



**5-in-1 ROTARY DRILL PRESS  
PLANER — PLANES, PANELS,  
RABBETS, ROUTS, TENONS, GROOVES**

**\$7.50**

Over 60 000 now in use by pattern and cabinet makers, carpenters, hobbyists, etc. Fits any drill press. Lightening fast, accurate, safe, easy to use. Complete. No special blades needed. No shop complete without COMPLETE it. Fully guaranteed. For all woods and plastics.

### New Style MORTISING and ROUTER BITS

Range in size from 1/8" to 1/2". Priced in individual sizes or by the set. Provides entirely new spiral flute cutting principle for faster chip clearance, smoother, accurate routing, carving, veining, grooving, round-end mortising. Extra long cutting flutes. Finest hi-speed tool steel—Super for woods and plastics.

**\$9.50**



### NEW! 4' Rotary Surface SANDER



New larger Barron Sander with live sponge rubber pad bonded to metal. Sanding discs changed instantly. For use on any drill press, flexible shaft or motor. Guarantees a dead-true, agate smooth surface. No ridges, waves, ripples, or striations. Fully guaranteed. Complete with 20 sanding discs.

**\$5.95**

### ANNOUNCING

New Dovetail Cutting Tool for Drill Press \$1.85 each. All Metal 13" x 18" Auxiliary Drill Press Table \$9.85. Tapered and Threaded Drill Press Adapters \$1.00 and \$1.50 each.

Liberal 10 Day Money Back Guarantee

Workshop Guide FREE

**BARRON TOOL CO.**

569 Architects Bldg., Detroit 1, Mich.



## BRONZE BUSHING STOCK

In solid and cored bars

## ALSO CAST ALUMINUM RODS

Round, square and hexagon

Write for our low prices today.

**SALEM BRASS FOUNDRY, 3220 State St., Salem, Oregon**

when you build your own,  
hand-pick the finest parts

## GARRARD "the world's finest"

### AUTOMATIC RECORD CHANGER

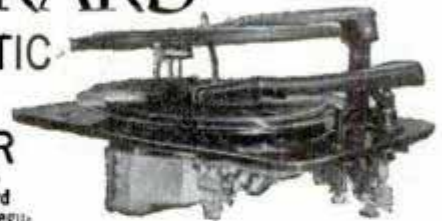

The one and only record changer with a speed-regulated, governor-controlled motor and exclusive tone arm design. It is hand-assembled by master craftsmen.

**FREE!** Send for this booklet: "Don't Overlook the Record Changer". Find out how the record changer contributes to tone quality and record wear. Also, how to judge performance and features. Clip coupon.



**GARRARD SALES CORP., Department MC**  
315 Broadway, New York 7, N. Y.

Please send me FREE copy of "Don't Overlook the Record Changer"

Name.....

Address.....

City..... Zone..... State.....



# Every Youngster WANTS THIS

BOYS and GIRLS are enthusiastic over this **SPEEDY RACER** . . . It runs like a streak . . . Fully Streamlined . . . Heavy Cast Unbreakable Aluminum 9 1/2 inches long with 4 1/4 inch Axles . . . Fully mounted with smooth running Rubber Tire Wheels; that can't come off . . . Beautiful High Lustre Finish . . . Wins the admiration of all youngsters . . . Worth much more than our **LOW PRICE** . . . Therefore do not delay ordering. We can make **IMMEDIATE SHIPMENT NOW**.

**SPEEDY RACER**

**NOTE: Looks Like Models Selling Up to \$13.00**

**ORDER YOURS TODAY**

**JODEL PRODUCTS, 756 West 69th St., Dept. P, CHICAGO 21**



**Start a Racer Club Now**

Send **ONLY \$2.79** Postpaid in U.S.A.

**Dealers Wanted Everywhere**



**USE OUR CAPITAL**

## NO SALES EXPERIENCE NEEDED

The biggest opportunity ever, to quickly establish a money-making, lifetime business, now awaits you as a McNess Dealer. Sell things farmers need and use up. Serve same families year after year. Pleasant work--no bosses--easy to do. We supply capital to work on. Also provide offers--advertising--premiums and trade secrets that bring sales.

First to apply get best trading areas. Don't wait--write us today for McNess proposition. Tell us county and state you want to serve. Ask for free McNess Book.

The McNESS CO., 392 Adams St., Freeport, Ill.

## SPECIAL—METERS

**SURPLUS—NEW—GUARANTEED—GOV'T. INSPECTED**

### BUILD YOUR OWN TEST PANEL



**A. C. VOLTMETER**, Triplett Model 331-J.P., 3 1/2", round flush bakelite case, 0-150 Volts A. C., white scale. Accuracy within 3% on Direct Current. (See Illustration.)  
**A. C. AMMETER**, Triplett Model 331-J.P., 3 1/2", round flush bakelite case, 0-30 Amperes A. C., white scale.  
**D. C. AMMETER**, Triplett, 3 1/2", round flush bakelite case, 0-15 Amperes D.C., white scale.

These meters make an ideal Set-Up for your own test panel for farm, home laboratory experimenting, repair shops and testing.

**SPECIAL OFFER** Any TWO meters for **ONLY \$7.95**  
 ALL THREE meters for **ONLY \$9.95**

Postage Prepaid Anywhere in U. S. or Canada. We carry a complete line of all types of Electrical Instruments. SEND FOR OUR FREE CIRCULAR.

### MARITIME SWITCHBOARD

Dept. PM-7 336 Canal Street New York 13, New York

## 6-Piece IGNITION SET



Complete for every ignition repair need! Screw-driver, 3 wrenches, pliers and file. Leatherette case. Postpaid anywhere in the U.S.

**EXTRA! FREE KEY RING, SPRING-TYPE, WITH ORDER, 15¢ VALUE!**

**STATE SALES CO.**  
 P. O. BOX 49 MAYWOOD, CALIF.

## RADIO SURPLUS

Western Electric fixed crystal Bell Lab. Product. No adjusting. Excellent for Crystal Sets. Cost Government originally \$6.00. Special \$1.29 prepaid—New—Free—Surplus list No. 3.  
**RADIO CITY LABS., 30 Church Street, New York 7, N. Y.**

## AGENTS... Be First With Newest Products

It means quick easy sales and large profits. Our monthly **NEW PRODUCTS BULLETIN SERVICE** lists 100 **NEWEST** products, where to buy them, long before they appear on the market. Sample Bulletin \$1.00. **FREE** information. **HURRY—BE FIRST—BEAT COMPETITION.**  
**EDUCATIONAL BOOK CO., 2907 Berwick Ave., Baltimore 14, Md.**

## WAR SURPLUS

Lathes, Milling Machines, Drill Presses, Sawing equipment, Motors and thousands of miscellaneous items. Also information on Helicopters, Sleeper Trailers, Garden Tractors, Power Lawn Mowers, Welders, Jet Impulsion for Cars and Tractors etc. Rush name for free literature.  
**THE WAYNE ENGINEERING CO., DEPT. 1118, GREENVILLE, OHIO**

## AIR RIFLES BENJAMIN AIR PISTOLS ARE AVAILABLE

**SEND FOR FREE FOLDER OF LATEST MODELS TODAY**  
 If you want a **REAL GUN** for **PRACTICAL USE** inside or outdoors get a **SAFE - CLEAN - ECONOMICAL - BENJAMIN** with Adjustable Power and Amazing Accuracy. Use **BENJAMIN H-C PELLETS** for **BEST RESULTS**. **WRITE AT ONCE.**  
**BENJAMIN AIR RIFLE CO., 812 MARION ST., ST. LOUIS 4, MO.**

## FURNACES PROPANE BUTANE

Forced air furnaces for liquified gases.  
 Gas & Oil Burners. **SELL & INSTALL.**

**PEERLESS SALES, 4318 Sheridan Blvd., Lincoln 6, Nebr.**

## AMAZING LOW PRICE Look At This BIG ASSORTMENT



• **Complete Assorted** •  
**75 GRINDING WHEELS SHARPENING STONES and ROTARY CUTTERS PLUS 200 assorted items for Home or Shop**

**ONLY \$5.95 RUSH YOUR ORDER TODAY**

Postpaid in U.S.A.

- 12—Ass't Grinding Wheels up to 4" dia. Ass't Shapes and Sizes.
- 1—Rotary File High Speed Steel 1/4" Shank.
- 1—Rotary Cutter 1/8th inch Shank.
- 12—Rotary Burs for Cutting Wood and Soft Metals, Ass't Sizes.
- 10—Assorted Cut-Off Wheels, Ass't Sizes.
- 3—Mounted Grinding Stones 1/8th inch Shank.
- 3—Mounted Grinding Stones 3/32nd inch Shank.
- 1—Drum Sander on 3/32 inch Mandrel.
- 10—Bands for Drum Sander.
- 6—Rubber Wheels 7/8 inch Diameter.
- 10—Felt Wheels, Assorted Sizes Up To 2 inch Diameter.
- 1—Wire Brush 1 inch Diameter on 3/32nd inch Shank.
- 3—Bristle Brushes on 3/32nd inch Shank.
- 2—Mandrels 1 each 3/32nd inch and 1 each 1/8th inch Shank.

PLUS 200 ASS'TD ITEMS FOR HOME OR SHOP

**D. SCHUPACK, 2256 E. 75th St., Dept. PA-3, CHICAGO 49**



# MAKE MORE MONEY

## APPLYING OR SELLING CORKSTONE PLASTIC FLOORING

**EASY  
TO  
APPLY**

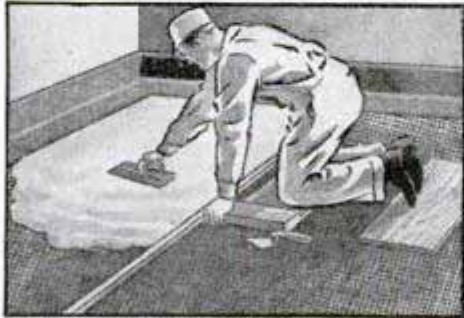

Here's your opportunity to get into business for yourself applying or selling Corkstone, the economical, top-grade plastic flooring. Plenty of profit. Act without delay!

### Dealers & Agents Wanted

WRITE FOR DETAILS

**LASTING PRODUCTS COMPANY**  
FRANKLINTOWN ROAD PLANT, BALTIMORE 23, MARYLAND

#### Handy Mail Order List

Little Library of Useful INFORMATION

5 for \$1.00  
12 for \$2.00  
25¢ Each

Here at amazingly low cost is the practical help and information you have always wanted. Articles in previous issues of Popular Mechanics have been classified according to subject and are now available in these handy reprint booklets.

How to Use Measuring Tools—Micrometers, Calipers, etc.—106.

Power Driven Saws—74.  
Drill Presses, Grinders, Etc.—79.  
Wood, Metal Turning Lathes—81.  
Filing Machine, Hacksaw, Cutoff Wheel, Shaper—82.

Lathe Tools You Can Make—101.  
Workbenches—Tool Cabinets—47.  
Spray Painting—94.  
From Pattern to Casting—91.  
Tool and Saw Sharpening—92.  
Sharpening Drills, Wood Bits—90.

Successful Wood Turning—32.  
How to Read Blueprint—71.  
Metal Turning Lathe Kinks—99.  
Operating a Metal Lathe—100.  
Heat Treating, Hardening—102.  
Working With Glass—103.

Servicing Elec. Motors—75.  
Electromagnets & Solenoids—44.  
Transformer Construction—41.  
The Boy Electrician—43.  
Soldering and Brazing—17.  
Arc and Spot Welders—5.

Electroplating With Nickel, Chromium, Cadmium, Etc.—86.  
Plating Leather, Wood, etc.—87.  
Lower Your Fuel Costs—31.  
Curing Leaky Basements—45.  
Fitting Home Game Room—55.

Indoor & Outdoor Fireplaces—88.  
Backyard Gardening—39.  
Lawn and Garden Novelties—72.  
Trellises, Pergolas, Fences—76.  
Lawn and Garden Furniture—77.  
Playground Equipment—73.  
Concrete Garden Furniture—6.  
Making Serving Trays—53.

Sanders—80.  
House Wiring—89.  
Treasure Finders—13.  
Hanging Wallpaper—38.  
Built-in Fixtures—78.  
Bird Houses—7.  
Magazine Racks—49.  
Clock Cases—50.

Book Ends—52.  
Small Tables—54.  
Smoking Stands—56.  
Desks—58.  
Book Cases—59.  
Action Toys—66.  
High Flying Kites—67.  
Telescopes—20.  
Metal Craft—28.

Small Looms—37.  
Gem Cutting—42.  
Photo Enlargers—1.  
Photo Kinks—98.  
Cleaning Formulas—11.  
Taxidermy—9.  
Magic—29.  
Training Dogs—35.  
Small Furnaces—36.

Knots and Ropework—105.  
Working With Plastics—61  
Simple Home Improvements—104  
Ridding Home of Insect Pests—107  
Children's Room Furniture—51.  
Jigsawed Novelties—57.  
Doll House & Doll Furniture—60.  
25 Shelves You Can Make—64.  
Novelties Turned on Lathe—62.  
Inlay Pictures—Veneering—63.  
Wood, Soap Carving—65.  
Windmills & Weather vanes—68.  
Lamps from Wood, Metal—69.  
Rustic Furniture—18.  
Wood Finishing—40.

Boats—14 ft. Outboard—2.  
Boats—14 ft. Sail Dinghy—26.  
Boats—21 ft. Sloop—46.  
Rowboats, Small Dinghy—83.  
Small Sail Boats—84.  
Two Outboard Runabouts—85.  
Build Own Canoe, Kayak—30.  
Build Class-E Ice Yacht—22.  
Auto Kinks, Shortcuts—10.  
Building Trailers—27.  
Motor-Driven Midget Cars—34.  
Stop Auto Elect. Troubles—95.  
Photo Printers and Dryers—25.  
Photo Darkroom Equipment—96.  
Trick and Table Top Photos—97.  
Cosmetic Formulas—12.

Poultry Houses—108.  
Guns and Decoys—109.  
Re-Silvering Mirrors—70.  
Chemical Experiments—93.  
Log Cabins, Tourist Houses—14.  
Trapping Small Animals—33.  
Farm and Garden Tractors—8.  
Building Extra Attic Rooms—23.  
Attractive Basement Rooms—24.

Small Looms—37.  
Gem Cutting—42.  
Photo Enlargers—1.  
Photo Kinks—98.  
Cleaning Formulas—11.  
Taxidermy—9.  
Magic—29.  
Training Dogs—35.  
Small Furnaces—36.

Small Looms—37.  
Gem Cutting—42.  
Photo Enlargers—1.  
Photo Kinks—98.  
Cleaning Formulas—11.  
Taxidermy—9.  
Magic—29.  
Training Dogs—35.  
Small Furnaces—36.

Small Looms—37.  
Gem Cutting—42.  
Photo Enlargers—1.  
Photo Kinks—98.  
Cleaning Formulas—11.  
Taxidermy—9.  
Magic—29.  
Training Dogs—35.  
Small Furnaces—36.

Small Looms—37.  
Gem Cutting—42.  
Photo Enlargers—1.  
Photo Kinks—98.  
Cleaning Formulas—11.  
Taxidermy—9.  
Magic—29.  
Training Dogs—35.  
Small Furnaces—36.

Small Looms—37.  
Gem Cutting—42.  
Photo Enlargers—1.  
Photo Kinks—98.  
Cleaning Formulas—11.  
Taxidermy—9.  
Magic—29.  
Training Dogs—35.  
Small Furnaces—36.

Small Looms—37.  
Gem Cutting—42.  
Photo Enlargers—1.  
Photo Kinks—98.  
Cleaning Formulas—11.  
Taxidermy—9.  
Magic—29.  
Training Dogs—35.  
Small Furnaces—36.

Small Looms—37.  
Gem Cutting—42.  
Photo Enlargers—1.  
Photo Kinks—98.  
Cleaning Formulas—11.  
Taxidermy—9.  
Magic—29.  
Training Dogs—35.  
Small Furnaces—36.

Check Titles Wanted, Clip, Mail with Remittance to

POPULAR MECHANICS PRESS, Dept. 635, 200 E. Ontario, Chicago 11

## WAR SURPLUS BARGAIN SPECIAL

BRAND NEW!  
VACUUM-AIR  
HYDRAULIC

### FUEL PUMP

Original Cost  
\$45.00

Now Only

**\$9.95**

Postpaid in U.S.A.

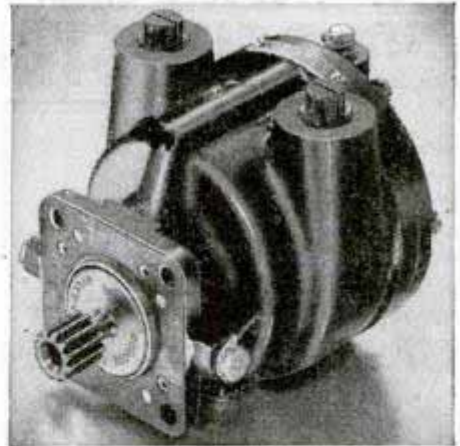

Adaptable for use on Home Oil Burners, Spray Machines, Milking Machines, Compressors, Vacuum Pumps, Hydraulic Systems, Presses, etc.

Originally cost \$45.00. Used by the Air Corps to drive bomber de-icer boots, gyroscopes, automatic pilots, etc. May be used as air or fluid pump—for pressure or vacuum. Standard  $\frac{3}{8}$  inch pipe thread with interchangeable ports. Will pump  $7\frac{1}{2}$  gal. SAE 30 oil per minute at 300 RPM. Builds air pressure of 30 lbs. per sq. in. at 1000 RPM. Vacuum will draw 26 inches of mercury at 1750 RPM. Runs forward or reverse. Self aligning shaft. Die cast aluminum housing 6x4x4 inches. Has stainless alloy steel vanes and impeller. Made by Bendix Avia. Corp. Spline terminal for direct drive—readily replaced with a pulley. Recommend a  $\frac{1}{4}$  H. P. or stronger electric motor as source of power. Rated capacity 1500 RPM with high overload factor. Special price for quantity users. Send check or money order today. Postpaid in U.S.A.

**GROBAN SUPPLY CO.** 1522 So. Michigan Avenue  
Dept. PM3, Chicago 5, Ill.

## GRINDING WHEELS

• ABRASIVES •

**305** PIECES \$ **9.95**  
FOR ONLY

REGULAR \$50.00 VALUE

Nationally Advertised  
Brands Including

**NORTON — CARBORUNDUM  
MANHATTAN — MACKLIN**

Every possible type of grinding job can be accomplished quickly and easily with this huge assortment of nationally known makes of grinding wheels—NORTON—MACKLIN—CARBORUNDUM and others ranging in size from  $\frac{3}{4}$ " to 6" in diameter. Only because they are War Surplus and only because we have bought in such large quantities are we able to make this amazing offer. Think of it . . . 305 items in all! Little more than 3 cents apiece! A sensational value! Every hobbyist—every farmer—every craftsman will find in this assortment the answer to every grinding need . . . for little more than 3 cents per item.

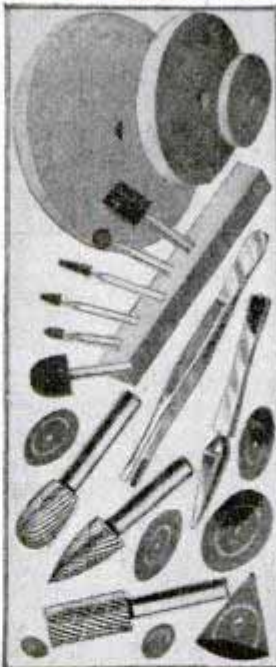

A TOTAL OF  
305 PIECES

A \$50.00 VALUE

**\$9.95**

ORDER NOW

**GROBAN SUPPLY CO.** 1522 So. Michigan Ave.  
Dept. PM3, Chicago 5, Ill.

#### HERE IS WHAT YOU GET

- 10 Grinding wheels from  $\frac{3}{4}$ " to 6" in diam.,  $\frac{1}{8}$  to  $1\frac{1}{4}$  Face  $\frac{1}{8}$  to  $1\frac{1}{2}$  Holes
- 5 Cut off wheels from 2 to 4 inch,  $\frac{1}{8}$  to  $\frac{1}{4}$  hole
- 5 Mounted Grinding Wheels  $\frac{1}{8}$  inch shank
- 3 Mounted Grinding Wheels  $\frac{1}{4}$  inch shank
- 3 Rotary files  $\frac{1}{4}$  inch shank high speed
- 1 India oil stone 4x3 $\frac{1}{2}$
- 1 Pr. nickel plated forceps
- 1 Pr. spring back pliers
- 1 Grinding wheel 6 $\frac{1}{2}$ x1 $\frac{1}{2}$
- 1 Grinding wheel 6x1 $\frac{1}{2}$ x1
- 1 Grinding wheel 6x1 $\frac{1}{2}$ x1 $\frac{1}{4}$
- 1 Grinding wheel 7x1 $\frac{1}{2}$ x1 $\frac{1}{4}$
- 1 Grinding wheel 10x3 $\frac{1}{4}$ x3
- 1 Cut off wheel 10x060x5 $\frac{1}{8}$
- 1 Cut off wheel 10x1 $\frac{1}{8}$ x1 $\frac{1}{2}$
- 1 Saucer wheel
- 1 Flaring cup
- Cloth abrasives
- 100 Sanding strips up to 10x2
- 2 Felt hobs 1x2 1x1 $\frac{1}{2}$  to 1 $\frac{1}{2}$
- 5 Felt wheels 1x $\frac{1}{2}$
- 100  $\frac{7}{8}$  Paper abrasive discs
- 50 3-inch Butterfly crocus cloths
- 10 Abrasive cones

TOTAL 305 PIECES



# A "Treasure Chest" of Parts GYRO GUN STABILIZER

- Two Motors
- Perfect for Reconverting
- All Parts are Precision Made

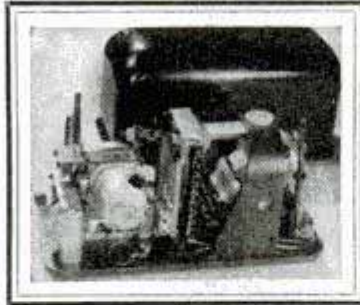

All-new valuable precision-made parts in metal case . . . perfect for reconverting. Consists of two 1/50 H.P. 12 Volt motors high speed to 10,000 r.p.m. removable for separate use. Variable resistor assembly. Vibrator dampener. Small condenser. Coils. Springs. Suspension system. Made by Westinghouse for government use, costing hundreds of dollars. With these valuable parts you can power your home workshop machine . . . build an engine for model trains . . . make any number of motored parts.

**ORDER TODAY!**  
Send for  
**FREE CATALOG!**

**\$12.50** F.O.B.  
CHICAGO

**B & B PRODUCTS CO.**

111 W. Jackson Blvd., Dept. M

Chicago

## ATTENTION

AIRPORTS—SCHOOLS—LOGGERS—OIL MEN  
FACTORIES—MUNICIPALITIES—BOAT OWNERS  
**FOR ALL TYPES OF POWER**

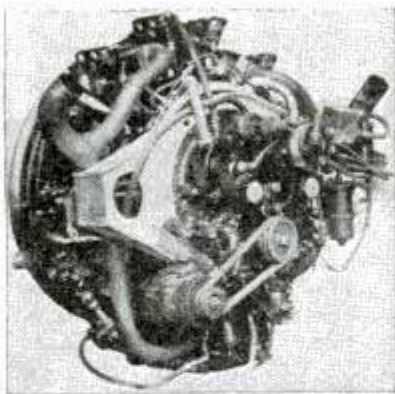

250 H.P. Engines, Complete. Limited quantity — New and rebuilt Gasoline Continental Motors. Model W-670; Series 9-A Radial Type, Air Cooled, 7 cylinders.

### IMMEDIATE DELIVERY

At fraction of original cost of \$4000.00-\$6000.00  
Located at Chicago

PACKED IN ORIGINAL CRATES

**SALE PRICE \$350<sup>00</sup>** F.O.B. CHICAGO

**ALERT INDUSTRIAL EQUIPMENT CORP.**

3430 W. 38th St.

Chicago 32, Ill.



A must tool for electricians, maintenance men, home owners. Replaceable lamp inside Plier tests 110 to 250 Volts. Plier pulls fuses from 10 to 100 Amperes. Shockproof. Requires the use of only one hand. Can be obtained from General Electric or Westinghouse stores, or from local electric dealers.

Order one TODAY

Price \$2.75 without Leads, \$1.50 additional for Leads

**STAR FUSE CO., 233 Canal St., New York 13, N. Y.**



## BACK AGAIN: All You Want BEARINGS (all types) (all sizes)

INDUSTRIAL — AUTOMOBILE — TRACTOR



BEARINGS have been on the "short" list for a long time . . . difficult and in many cases impossible to get . . . NOW we can furnish you with exactly the kind of bearings you want and in quantities you need . . . BALL BEARINGS . . . ROLL-ER BEARINGS . . . THRUST BEARINGS . . . AUTO BEARINGS . . . BEARING PILLOW BLOCKS . . . STEEL BALLS . . . BRONZE STOCK OIL SEALS, Etc. Let us know your requirements. WRITE FOR PRICES.

**WE HAVE THEM**  
SPECIAL QUANTITY PRICES TO LARGE USERS



**AUTO-INDUSTRIAL BEARINGS CO.**

DEPT. PB

3811 No. Ashland Ave., CHICAGO 13

Say You Saw It in  
**POPULAR MECHANICS**

**Automatic Clutch Pulley and Wheel Drive Pulley  
AND BRAKE FOR YOUR MOTOR-BIKE AND SCOOTER**  
Send 10c for illustrated folder and price list.  
**M. I. HATFIELD, P. O. BOX 99, ELKHART, INDIANA**

## CHOW PUPS PEDIGREED

World's most beautiful pets, in demand everywhere. Start your home kennel. Sell all you raise, \$50 up. We show you how. For data write—

**EVENINGSHADE KENNELS, Box DPM1, Helotes, Tex.**



### A FINE MOTOR FOR BETTER MODELS

The new **BULLET, MODEL "100"**, .275 cu. in. displacement is loaded with improvements and is of stronger construction. You're way ahead with—positive friction-lock needle valve; increased exhaust porting; higher efficiency tapered fuel transfer—and a warp proof cylinder head. As always Bullet is your best buy. Only \$15.00 Less C & C Postpaid. Send 25c for our New **GMCO Perpetual Catalogue, GMCO MODEL CRAFT HOBBIES, 165-15 JAMAICA AVE., JAMAICA 3, N. Y.**

**New 1947 Shop Notes Now Ready!  
FOR EVERY MAN WHO USES TOOLS**



One of these books is issued each year and is a reprint of articles published in our Shop Notes Department. It contains the cream of experience of years, of hundreds of our country's most successful mechanics. 50c per copy at your News Dealer, or send 60c to

**POPULAR MECHANICS PRESS**

Dept. 634 200 E. Ontario St. Chicago 11



**MAKE MONEY**

*Selling*  
**FLUORESCENT SAVES**

**1/2**

on Electric Light Bills

**INTO SOCKET JUST LIKE BULB!**

**SALESMEN!**

Once expensive—once costly to install—out of the reach of most people, Fluorescent Lights still sold in millions. Experts now predict war starved market of 3 1/2 BILLION, and with invention of fixture that screws in like an ordinary light bulb, a fixture that can be installed in an instant, a fixture that sells complete with tubes at a new low price—the most spectacular sales opportunity of the decade has been opened up for salesmen and distributors. Enormous advance commissions. Exceptional factory co-operation includes financing big orders by shipping open account to your customers.

**FREE** If earnings of \$5,000, \$10,000 and \$15,000 a year don't scare you, rush your name by fastest way for sensational facts—sales plans—complete line with pictures and prices. This is the hottest item in direct selling today. Even if you don't answer another ad in this magazine, rush your name on this proposition—right now.

North American Mfg. Co., 5042 Cottage Grove, Dept. 33, Chicago 15, Ill.

*Now for EVERY WORK SHOP!*

**NEW Invention Electroplates by BRUSH**



**Easy to Plate CHROMIUM GOLD, SILVER, NICKEL, COPPER . . . For Pleasure and Profit!**

If you have a workshop—at home or in business—you need this new Warner Electroplater. At the stroke of an electrified brush, you can electroplate models and projects—you can replate worn articles, faucets, tools, fixtures, silverware, etc. with a durable, sparkling coat of metal . . . Gold, Silver, Chromium, Nickel, Copper or Cadmium. Method is easy, simple, quick. Everything furnished—equipment complete, ready for use. *By doing a bit of work for others, your machine can pay for itself within a week.* So make your shop complete by getting a Warner Electroplater right away. Send today for **FREE SAMPLE** and illustrated literature. **ACT AT ONCE! Mail Coupon.**

**WARNER ELECTRIC CO., DEPT. L-18 1512 Jarvis Avenue, Chicago 26, Ill.**

**FREE Details & Sample!**

WARNER ELECTRIC CO., 1512 Jarvis Avenue, Chicago 26, Dept. L-18  
Gentlemen: Send Free Sample and Details to:  
Name \_\_\_\_\_  
Address \_\_\_\_\_  
City \_\_\_\_\_ State \_\_\_\_\_

Just Plug in and Light



**NO MORE** extra equipment. No more special wiring.

**Screws**



**DUMORE DUPLUX GRINDER**

**More Power—More Capacity More Durability and Utility than any other homeshop handgrinder!**

Now you can have—for your workshop—the high-quality tool used by industry, at the price of an ordinary homeshop handgrinder. The Duplex Grinder is made by a famous manufacturer of precision industrial tools. Actually it's an industrial grinder modified for home workshop use, without sacrificing the extra power, endurance, capacity, and utility required by industry. Hobbyists in wood, metal, and plastics welcome this new tool. It makes their work easier, faster, better—and twice the fun. Lightens the job of the "handyman" around the home or farm.

**Full Power to Handle 1/4" Shank Tools**  
You can do a countless variety of jobs with the Duplex—sanding, sharpening, grinding, sawing, and many more. Its chuck takes tools with 1/4", 3/8", and 3/32" shank—ordinary handgrinders usually handle only up to 3/16" shank tools. A full 1/14 HP motor has plenty of power for heavier jobs. Long-life bearings guarantee trouble-free service.



The Deluxe Duplex Grinder Kit (illustrated above) includes the Duplex Grinder and 27 different tools and accessories, packed in a permanent case of handsome polished wood. Complete as described—\$27.50. Standard, 9-accessory kit, without case—\$19.75. With a simple, easy-to-use attachment your Duplex becomes a flexible-shaft tool. Write for information on this kit, and other attachments which convert the Duplex into a lathe- and bench-grinder.

**Money-Back Guarantee—10-Day Trial**  
Take advantage of our 10-day Trial Money-Back Guaranteed—prove to yourself that the Duplex Grinder is the best hobby-tool value on the market today. Production is still too limited to stock your dealer, but while the supply lasts, we can accept direct orders for immediate delivery.

**H-1 Tear out and mail this coupon today!**

THE DUMORE COMPANY, Dept. C-51, Racine, Wisconsin

Please send me —  One Deluxe Dumore Duplex Grinder Kit -----Price \$27.50 } Check One  
 One Standard Dumore Duplex Grinder Kit -----Price \$19.75 }  
Enclosed is my check (or money order) for \$ \_\_\_\_\_   
Please ship C.O.D. plus postage and insurance.

If not completely satisfied with my Duplex, I can return it within 10 days for a complete refund of the purchase price.

Please send complete information on the Dumore Duplex Grinder.  
Name \_\_\_\_\_  
Street Address \_\_\_\_\_  
City \_\_\_\_\_ State \_\_\_\_\_



# FUN and PROFIT with PLASTICS

Now you can get a plastic injection molding machine to cast plastic parts right in your own work-shop. You can make an endless variety of jewelry novelties, true-scale building materials, model parts, poker chips, golf tees, buttons, etc., quickly and inexpensively. You'll find it a fascinating new handicraft, and you can make it a profitable business.

There are 22 different stock molds already available, and more will be offered regularly. You can make scale models of homes, railroad stations, tunnels, etc.—there are 9 molds for bricks, roof tiles, and other building materials. The skilled man can make his own molds with Plasticor easy-to-work die blanks. And there are 16 beautiful colors of plastic available, in 1/2, 1, 5 and 10 lb. packages.

**IMPORTANT:** NRK service continues, after you buy Plasticor, with the Plasticor News, a planned educational program in plastics that reports regularly what's new, what's fun and what's profitable.

**N. R. K. MFG. and ENGINEERING CO.**  
5646 North Western Avenue Chicago 45, Illinois

THE NEW  
IMPROVED 1947  
**Plasticor**  
JUNIOR

a miniature plastic molding machine, built like a fine machine tool, yet so simple and safe a child can operate it.

Price only **\$54.00**  
(F.O.B. Chicago)  
Molds (22 diff.) each .....\$1.50



**PAINT YOUR OWN CAR \$5.95**  
This New, easier way—for only

**DAB**  
Miracle Auto Paint That  
*Just Wipes On!*

- NO BRUSH!
- NO SPRAY!



**11 COLORS:**

- Red
- Black
- Gray
- Pico Tan
- Sun Beige
- Brewster Green
- Washington Blue
- Montgrey Blue
- Jewel Green
- Mohawk Maroon
- Burgundy
- Merseon

**\$5.95**  
Quart

One quart paints the average car

**Guaranteed 2 Years**

Not to chip, crack, peel or fade!

Now you can get a glossy, factory-like paint job on your car in just one hour with DAB! All you do is WIPE IT ON with the applicator pad provided free. No streaks, no lap marks! If your dealer cannot supply you, send check or money-order—we will ship DAB prepaid at once.

DEALER INQUIRIES INVITED!

**WORLD-WIDE DISTRIBUTORS**  
**NU-WAY PAINT AND SUPPLY CO., INC.**

310 Lincoln Avenue, N.W., Canton 3, Ohio

## KNIVES, TOOLS AND BLADES

**KING KUT**

REGAL TREASURE  
CHEST No. 130

Contains handle, knob, 22 cutting edges, flat and curved spoke shaves, plane and clear plastic box for spare parts. Beautiful grained, natural finish chest of select wood. Price \$10.00.



**KING KUT HOBBY TOOL SET NO. 120** . . . contains one each of 22 cutting edges, the knife handle and plastic knob. Compactness and easy accessibility to the cutting edges is a feature to this set. A place for each tool in its 3-color carton. A handy, attractive set for discriminating buyers. . . . . \$5.00

IMMEDIATE DELIVERY — ALL PRICES POSTPAID  
**SAWS & KNIVES CO., 177 Lafayette St., New York 13, N. Y.**

## Steel Wheels

To Build Your Own Wagon, Cart, Toy, etc.

Sturdy, rubber tired, precision-made pressed steel wheels with red enamel finish. Ready to use axles—threaded at both ends. Acorn nuts supplied. Order today, or send stamp for catalog.

- WHEELS WITH SOLID RUBBER TIRES**
- 4" Wheels, 1/4" bearing, Steel Disc . . . . . \$ .75
  - 6" Wheels, 3/8" bearing, Steel Disc . . . . . 1.00
- WHEELS WITH SEMI-PNEUMATIC TIRES**
- 6"x1 1/2" with 3/4" Selflube Oil Bearing . . . . . 1.75
  - 8"x1 3/4" with 3/4" or 1/2" Selflube Oil Bearing 2.25
- AXLES, COLD ROLLED STEEL**
- 1/4"x14" long, threaded both ends, Nickel Cap Nuts .40
  - 3/8"x16" long, threaded both ends, Nickel Cap Nuts .60
  - 1/2"x18" long, threaded both ends, Nickel Cap Nuts .80
- Sent postpaid in U. S. on receipt of price.

**CIRCLE METAL MANUFACTURING COMPANY**  
4266 E. PACIFIC WAY LOS ANGELES 23, CALIF.



Say you saw it in  
**POPULAR MECHANICS**

## Marvelous New Attachment

**SAWS — FILES — PEENS — RIVETS or EMBOSSES**

**WOOD  
STEEL  
PLASTIC  
or SIMILAR  
MATERIALS**

**The Biggest  
Low Priced  
Machine on  
the Market**

Without a doubt here is the greatest invention for the convenience and practical advantages to do the job better and quicker for . . . **ELECTRICIANS . . . MECHANICS . . . CARPENTERS . . . SHEET METAL WORKERS . . . PLUMBERS . . . MILLWRIGHTS . . . INSTALLATION WORKERS . . . HOME CRAFTSMEN, ETC.** No special skill required—anyone can operate **THE GREENE ATTACHMENT** with the ease of an expert. A marvelous time saver because you can take the **GREENE ATTACHMENT** to the job . . . In a jiffy you can insert **SAW BLADE** or **FILE** and you simply hold this marvelous machine against the **METAL** or **WOOD** and the oscillating speed goes through the material without any effort on your part . . . Marvelous beyond description. The **GREENE ATTACHMENT** is complete ready to **QUICKLY ATTACH** to any Electric Hand Drill or if you want to connect to your Drill Press then order Model #1750 and you have the advantage of using, in both cases, either the Electric Hand Drill or the Drill Press. When ordering give name of Drill Press for proper fitting. **ORDER YOURS TODAY.**

**Does Any Job  
QUICK & EASY**  
• 2 Models •  
**\$1650 & \$1850**

Model #1625 at \$16.50 fits Any Electric Hand Drill. Shipping Weight 2 pounds. Model #1750 at \$18.50 fits Any Electric Hand Drill & Your Drill Press. Weight 2 1/2 lbs. Shipments F.O.B. Chicago.

Local Distributors Wanted

**The J. D. WHITTLE COMPANY • 208 No. Wells St., Dept. PM • CHICAGO 6, ILL.**



IMMEDIATE DELIVERY

**Quickly Attached to Any Electric Hand Drill or Drill Press—2 Models**



# ARMY—NAVY SURPLUS BARGAINS!



**1. Gas Powered Light Plant**  
 Homelite model HRU. Powered by 2 1/2 HP gasoline engine, one cylinder, two cycle. Generator attached; output 24 volts, 2000 watts, 70 amps. Used but reconditioned. Can be used as portable lite plant for farm, boat, camp, etc. Also usable for battery chargers, light arc welders, etc. Crated, shipping weight, approximately 115 lbs. Original cost \$75.00 over \$500. Now \$75.00 (State method of transit, Express or Freight)

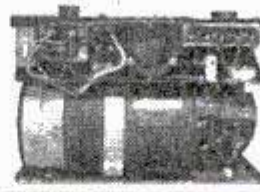

**2. Triple Output Dynamotor**  
 Input voltage 12 or 24 volts! Output is 300, 150 and 14.5 volts DC. RPM 6000, continuous duty, temperature rise 50 deg. C. Built by Bendix Radio. Has voltage regulator and fan for cooling. Weight approximately 18 lbs. Closing out at less \$6.50 than one percent of cost...



**3. AIRCRAFT MACHINE SCREW AND RIVET ASSORTMENT**  
 Treasure Box of at least ten different sizes desirable machine screws and at least ten different sizes and types of aircraft rivets. Not mixed but in separate containers. Contains over 15,000 separate pieces! Brand New! Shipped in fine steel mechanics tool box size 7"x17"x16" at no extra charge. A treasure of hardware, weight \$9.95 app. 27 lbs. only.



**4. ALUMINUM CLAMP KIT**  
 An assortment of at least six different sizes of aluminum rubber bonded clamps. Sizes up to 1 3/8" diameter. Regular price was from 10c to 16c each. Now a ten pound assortment containing between 600 and 700 clamps for only, \$6.95 Weight app. 12 lbs.



**5. MINIATURE ULTRA-HIGH FREQUENCY RADIO RECEIVER**  
 Radio receiver BC357 was used by the Air Force. It responds to 75 meg. It was used on either 12 or 24 volt systems. Contains tubes, coils, tuning capacitors, RF amplification, leak detector, relay, phone jack, plugs, tube plugs, condensers as well as many more valuable parts. Weight app. 3 1/2 lbs. Circuits furnished. Parts alone are worth many times \$9.95 the price.



**6. Interphone Amplifier Type RL-7**  
 Ruggedly built; built by Magnavox Corp. for Navy. Fine interphone; especially good for experimenters. Contains many valuable radio items including tubes, coils, condensers, phone plugs, mike plugs, fuse holders, receptacles, switches, 24 volt dynamotor (250 volts output), as well as many many more fine parts. Carbon of magnetic mike may \$9.95 be used. Weight approximately 8 lbs.



**7. Solenoid Electric Valve**  
 Type G102AY16CA1, made by Stewart-Warner Co. Operates on 24 volts, used in aircraft electrical circuits but is readily adaptable to other uses such as experimental and laboratory work. Brand new! Weight app. \$1.49 2 lbs.

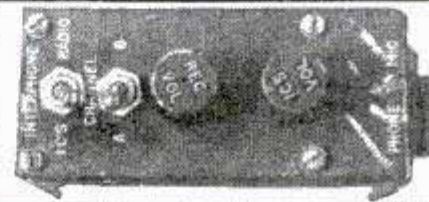

**8. INTERPHONE CONTROL BOX RL9 (for RL7 Interphone)**  
 Should prove valuable to gadgeteers for it contains 2 toggle switches, 2 volume control switches (10M) with knobs, phone & mike jacks, receptacle, small relay, shielded wire, etc. Weight \$1.29 1 lb.

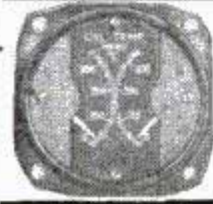

**9. Dual Cylinder Head Temp. Gage**  
 0 to 350 deg. Cent. 8 ohm lead type, iron constantan. Type #76AT3. When properly wired can be used to record temperature of water, oil, cylinder heads, etc. Has two sensitive micro-amp. jeweled movements! Brand new! \$6.95 Weight 2 lbs.



**10. ELECTRIC THERMOMETER**  
 By Weston, Type 20L. Used by aircraft to record Free Air temperature, plus or minus 50 deg. Cent. Has sensitive micro-amp. jeweled movement; used 24 volt current. With proper wiring can be used as heat thermometer. Brand new. Weight \$5.95 app. 2 lbs.



**11. ELECTRIC GYROSCOPE (From Bombsight)**  
 For experimenters, practical jokesters, etc. Mystify your friends with the whirling gyro which resists movement while in motion. Cost hundreds of dollars; from Uncle Sam's best bombsight. Precision bearing mounted, built to run from DC power (6, 12, 24) but does run on 110 AC power, but not recommended. Weight app. \$2.49 11 lbs.



**12. OXYGEN CYLINDER GAGE AND VALVE**  
 Type ASA. 0 to 3000 lbs. Used condition. Wt. 2 lbs. . . . each . . . 99c

**13. ELECTRIC FUEL QUANTITY GAGE**  
 Used condition, minor damage. Four scales. Msc. switch, electronic parts, etc. Weight 3 1/4 lbs. . . . \$1.29 each



**14. Radio Headphones, AAF Type N-H-1**  
 Fine for Hams or experimenters. Complete with headbands, cord and plug. Used, good condition. Weight 1 lb. . . . \$1.10

**15. Toggle Switches**  
 New condition. Double pole-double throw, 1 1/2"x2", . . . . . 49c  
 Slightly used. Single pole-single throw, 1"x2", . . . . . 39c

**16. Interphone Amplifier BC347A**  
 24 volt interphone, 6"x4". Brand new! Without tube. Weight 2 lbs. . . . . \$2.49

**17. Mallory Radio Noise Filter**  
 Radio noise filter, size 2 1/2"x3x3 1/4", metal box. For cutting noise between radio and motor, etc. Brand new! Weight two lbs. . . \$1.29

**18. Airspeed, Army Air Force**  
 Indicates air flow or speed from 40 mph up to either 500 mph or 700 mph. Wonderful for water and ice boats, airplanes, autos, motorcycles, etc. Used condition. Weight 1 lb. 3" face. . . . . \$4.95

**19. Automatic Pilot Hydraulic Servo Unit**  
 Contains fine machined gears, fittings, parts, etc. Can be used by experimenters, inverters, etc. Operation similar to small air compressor. Weight app. 32 lbs. Used. Also has 24 volt D.C. motor. \$7.50

**20. Stainless Steel Air Tank**  
 Used by Air Force to store oxygen. 24" long, 6" diameter. High pressure range up to 400 lbs: 500 cu. inch volume. Threaded for 1/4" pipe size each end. Air pressure use for small air compressor tank storage, auto air horns, etc. Also for boat buoys, markers, etc. Also used for small butane tanks. Weight app. 5 lbs. . . . . \$3.95

**IMPORTANT:** We pay no shipping charges! Include adequate on cash orders to pay charges or we will ship collect charges. No orders accepted for less than \$2.00. No C.O.D.s shipped unless 20% deposit made in advance. App. shipping weight of each item is listed.

**AERO INSTRUMENT CO.**  
 Municipal Airport, Houston 12, Texas

Send  Express,  Mail,  Best Way — the following:

.....

.....

.....

I have inclosed check, cash or money order for \$..... or  send COD.

Name.....

Address.....

Town and State.....

SP

**AERO INSTRUMENT CO.**  
 MUNICIPAL AIRPORT HOUSTON 12, TEXAS



# WAR SURPLUS AS MADE FOR U. S. NAVY

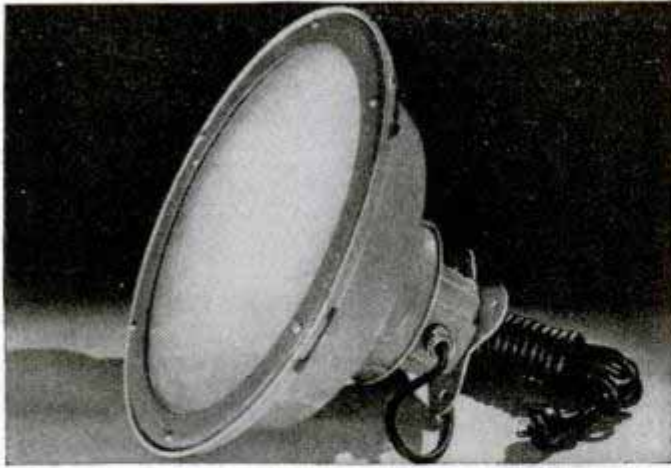

## GIANT FLOOD LIGHT ILLUMINATES YOUR ENTIRE YARD

PROTECT YOUR HOME AGAINST BURGLARS AND PROWLERS

**FOR:** Estates—Homes—Gardens—Courts—Lawn Parties  
—Patios—Camps—Boats—Schools—Plants—Churches—  
Playgrounds—Parking Areas—Contractors.

Easily installed. Takes AC or DC current. Frosted convex lens. 14 ft. heavy rubber cord.

**GIANT:** 14" diameter. Includes 150 watt bulb.  
Weight—10 lbs. **ONLY \$15.00**

**SUPER GIANT:** 17" diameter. Includes 300 watt bulb.  
Weight—17 lbs. **ONLY \$20.00**

(PRICE ONLY A FRACTION OF WHAT THEY COST THE NAVY)  
Mail Order Today With Money Order or Check  
Shipped Express Charges Collect

**CARNEY'S**

P.O. Box 426, Dept. MM-1

Tarrytown, N. Y.

FOR STEADY-VOLTAGE POWER...  
FREE FROM OUTSIDE INTERFERENCE

**DIESEL'S THE POWER...**

*Sheppard's the Diesel*

YOU CAN SERVICE IT YOURSELF

OPERATE IT ON LOW-COST DOMESTIC FURNACE OIL

WRITE FOR COMPLETE INFORMATION

Generating Sets... 2,000 to 36,000 Watts  
Power Units... 3/4 to 56 continuous H. P.  
Marine Engines... 3/4 to 62 continuous H. P.

E. H. SHEPPARD COMPANY, INC., 48 Middle St., Hanover, Pa.

# FIVE ACRES AND INDEPENDENCE

*A Practical Guide to the Selection and Management of the Small Farm*

By M. G. Kains

This book is a complete, practical guide to the selection and management of a small farm. It explains how a small farm can be self-supporting. What farms not to buy. How to choose the right farm, based on proper soil, location, irrigation, elevation, climate, etc. Then a detailed explanation of what crops to plant and how to make them yield results, sure-fire methods of grafting, rotation, transplanting, etc. Finally, how to make a profit by selling your excess crops, livestock and preserves. Written by an expert who has made a

real success with many small farms. Revised, enlarged edition. 413 pages, profusely illustrated. Price \$2.50

Only \$2.50, Postpaid in U. S. A. (Outside U. S. \$2.75). Order Today

**POPULAR MECHANICS PRESS**

Room 490 • 200 East Ontario St., Chicago

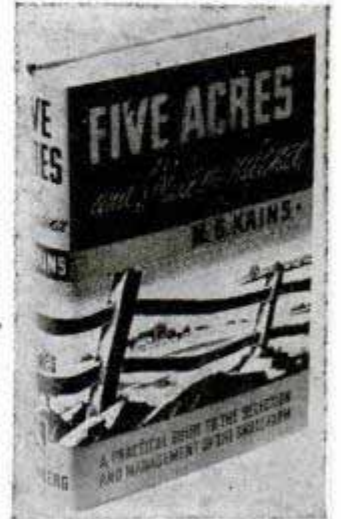

## BUILD A BOAT

**FOR PLEASURE OR PROFIT DESCRIBES 17 LOW COST BOATS**  
Get this outstanding book and build a boat at home for your own use or to sell at a profit. You can do it. Just the boat you've always wanted—power, sail or row boat—17 different kinds and sizes.  
Order BUILD A BOAT on postal card and pay only \$1.50 plus postage on delivery. Return in 5 days if not pleased and get money back. Or send \$1.50 with order and we'll pay postage. (Outside U. S. \$1.70 with order.) Order today.

**POPULAR MECHANICS PRESS**  
Dept. 598, 200 E. Ontario, Chicago 11

**Row Boat—12 Foot**  
**Dinghy—8 Foot**  
**Dinghy—14 Foot Sailing**  
**Training Ship—6 Foot**  
**Sea Sled—9 Foot**  
**Outboard—12 Foot**  
**Cruiser—18 Foot**  
**Bicycle Boat—Kayak**  
**Row Boat—Sectional**  
**Dinghy—Sailing**  
**Canoe—16 Foot**  
**Sailing—12 Foot**  
**Outboard—Runabout**  
**Pontoons Ice Yacht**

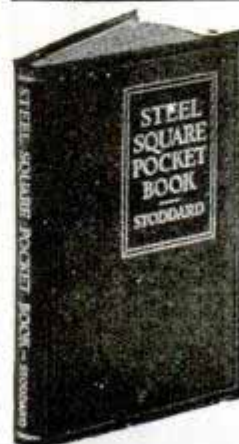

THIS BOOK SHOWS  
HOW TO DO IT

## STEEL SQUARE POCKET BOOK

*Completely Revised*

This concise and handy little book illustrates and describes the best methods of using the carpenter's steel square in laying out all kinds of carpentry work. It is easy to understand as a picture of the square laying directly on the work shows exactly how the various cuts are made. Its compact and handy size makes it convenient to carry in the pocket for quick reference.

Price \$1.25 Postpaid

**POPULAR MECHANICS PRESS**  
DEPT. 627 200 E. ONTARIO, CHICAGO 11, ILL.



**HAND MICROPHONE**



Top quality hand microphone with control button in handle. Highly sensitive. Has rubber covered cord and tel. plug. Fine for use on home recorders, public address systems, etc. Brand new—perfect. Shp. wgt. 2 lbs. Stock No. 170. Each **\$1.95**

**Shatterproof Goggles**



All purpose type. Rubber frame. Red shatterproof flexible lens. Adj. headband. With case. New. Wgt. 1 lb. No. 139—Each **39c**

# WAR SURPLUS AND HUNDREDS OF OTHER BARGAINS

**LEVEL WIND ANTI BACK LASH REEL**

Highest quality with chrome plated frame: 3 piece take down design, 4x gears, bronzed bearings and jeweled spool caps. Spool diameter 1 1/2 ins.; pillar lengths 1 1/2 ins. Capacity 100 yard line. Onyx head ring. Shp. wgt. 1 lb. No. 450F—Each only **\$8.55**



**RAIN SUITS**

New 2 piece rain suits. Of durable wear resisting water and wind repellent OD fabric. Bib style pants, zipper fly. Jacket has parka attached. Guaranteed 100% weatherproof. Small, medium and large sizes. Shp. wgt. 3 lbs. No. R549. Ea. **\$4.95**



**U.S. Govt. BOLO KNIFE**



Extra heavy. For farm, home or jungle use. Blade of Gov't. formula cutlery steel. Walnut riveted handle. 3 1/2 inch hilt. 10 1/2 inch blade. You'll find hundreds of uses for a Bolo knife. Blade will take and hold a keen cutting edge. Wt. 2 lbs. A112—with Army **\$4.95**

**MESS KITS**

Regulation two-piece Army Mess Kits with folding handle. Used, but perfect. Weight 2 lbs. No. A116—Ea. **69c**



**CANTEENS**

Reg. U. S. issue canteens. Plastic screw top chained to body. Slightly used but perfect. Wgt. 1 lb. A147—Metal **69c**



**CANTEN CUPS**

All metal. Folding handle. Wgt. 1 lb. No. A120—Each **25c**

**CANTEN COVERS**

Heavy canvas. Button fastener. New No. 530—Each **69c**  
Used No. 119—Each **35c**

**ARMY BANDOLEERS**

Of fine heavy khaki. Big roomy pockets with snap button fasteners. Fine for hunters, campers, boy scouts, etc., also for shop work in carrying small parts, etc. Material alone is worth this price. Shp. wt. 1 lb. 11 Pocket Type No. 49c 15 Pocket Type No. 110 Each **29c**

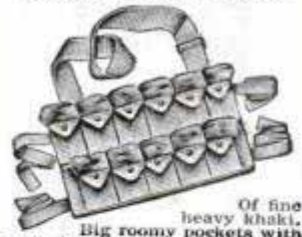

**Wool Blanket**

Full size and 100% wool. Used but renovated for re-issue. Use for camping, etc. Shp. wgt. 3 lbs. No. 233—Each **\$4.89**



**METAL TOOL CHEST**

All metal welded construction 16x 8 1/2 x 11 overall. Has 5 roomy, easy sliding drawers. Hinged drop front. Metal top and end handles. Use it for tools, small parts, etc. Shp. wgt. 6 lbs. Stock No. 282. Each **\$9.75**



**CAMERA TRIPOD**

Purchased from Gov't. Used but perfect. For cameras up to 8x10 inches. Folds to 32 inches, extends to 58 inches. Needs adapter to mount camera. Wgt. 3 lbs. Stock No. 190, Ea. **\$4.95**



**TELE-SCOPING BAIT AND FLY ROD**

Combination 4 piece telescoping bait and fly casting rod. Screw locking reel seat. Cork grip. Snake guides. Extends to 9 feet, telescopes to 35 inches. Shp. wgt. 1 lb. No. F411—Each **\$3.65**

**BAYONET BLADE**

Fine forged steel. Ground but not polished. May be made into throwing or hunting knife or spear. Blade 6 3/4 x 7 3/8 inches, 1 1/4 inches overall. Will take and hold a fine edge. Shp. wgt. 1 lb. No. 664-R—Each **49c**

**POPULAR RECORD ASSORTMENT**



Fifty records of modern dance, race, blues and hillbilly selections. No two alike. Famous name bands and artists included. Used in juke boxes, but guar. perfect. Shipped exp. collect only—no exchanges or refunds. Wgt. 28 lbs. No. A303—50 records **\$9.64**

**PROF. TELEGRAPH KEY**

Purchased from the gov't. Finest design and construction. Base measures 3 x 4 3/4 inches. Original value \$2.50. All parts of instrument brass. Adjustable. A-147. Each **98c**



No. A300—25 records. All Dance. Wgt. 14 lbs. **\$4.88**

No. A301—25 Records. Hillbilly, Race and Blues. Wgt. 14 lbs. Set **\$4.88**

No. 302—25 Records. All Hillbilly numbers. Wgt. 14 lbs. Set **\$4.88**

**6x30 PRISM BINOCULARS**

Bausch & Lomb make. Prism type individual eye focus. With leather case. Power 6x30. Used but perfect. \$100 value. Wgt. 5 lbs. No. 505—Price **\$45.00**  
\$37.50 plus \$7.50 tax. Total **\$45.00**



**BOMB PARACHUTE**

Of white rayon 5x8 feet in diameter. Split seam for directional dropping of bombs, emergency rations, etc. Each packed in a metal container. Material alone worth more than price quoted. Wgt. 6 lbs. No. 162. Each **\$1.95**



**RADIO HEAD-PHONES**

Extremely sensitive with 4000 ohms resistance. Brand new and fully guaranteed. With moisture-proof cord and phone plug. A splendid value for the radio serviceman and experimenter. A106—PAIR **\$2.95**  
New supersensitive phones. A108—Pair **\$5.95**



**2 Man Mountain Tent**

Regulation Army type two man mountain tent, complete with poles, guy ropes, etc. Of durable nylon with reinforced seams. Ideal for outdoorsmen, campers, etc. Shp. wgt. 10 lbs. A splendid value. Stock No. 202—Each **\$9.95**



**PUP TENTS**

Regulation Army Pup Tents of durable, brown canvas. Used, but in good condition. Fine for campers, outdoorsmen, boy scouts, etc. Grand Xmas gift for children. Wgt. 8 lbs. A1—Tent only **\$3.95**  
A10—Tent, new **\$7.95**  
A101—Ropes, wooden poles and stakes for above. Per set **\$1.00**



**LIFE PRESERVER BELTS**

Right from the invasion beaches. Consists of two air chambers. May be inflated automatically with "sparklet" cartridges or manually by attached hose. Adjustable in waist size. One air chamber guaranteed air tight—other may need a tire patch. All belts are used and slightly soiled but a bargain at this low price. No. 1261—Each **\$1.00**

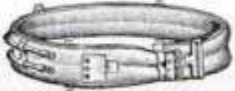

**SPARKLET CARTRIDGES**

May be used with above belts. In boxes of 10. Stock No. 254. Per Box **50c**

**ORDER DIRECT FROM THIS AD**

Values galore! Hundreds of hard-to-find items for home, shop and outdoors. Make remittances by money-order, bank draft or personal check. Send 25% deposit on C.O.D. orders. No C.O.D.'s on orders for less than \$5.00. Include sufficient postage on parcel-post orders—any overage will be promptly refunded. All quotations F.O.B. Chicago. Used items and materials are guaranteed serviceable and as described. Your money back if not more than satisfied.

**Big Illustrated Catalog Free**

**STARK'S** Dept. PM347  
509 So. State St.  
CHICAGO 5, ILL.



# Ask The Toolmaker

He can tell you why South Bend Lathes are popular. They have the accuracy that toolmakers can depend upon. Their unusual versatility simplifies the performance of an exceedingly wide range of operations. And the ease with which they are operated saves both time and tempers. Regardless of the type of work you are doing South Bend Lathes will contribute to better craftsmanship.

#### WRITE FOR CATALOG 100-F

Describes South Bend Engine and Toolroom Lathes with 9", 10", 13", 14½", and 16" swings; also attachments, accessories, and tools.

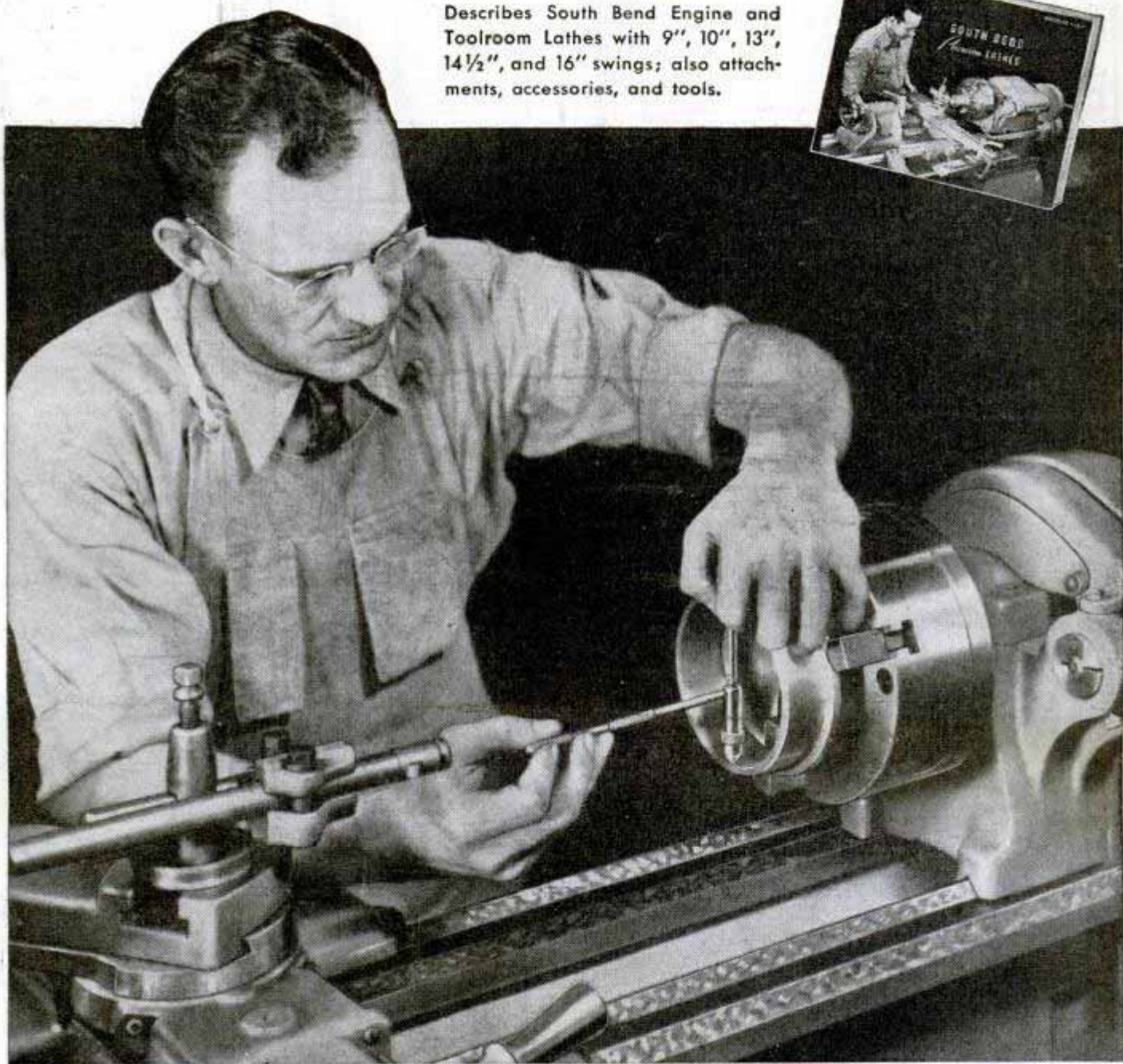

**BUILDING BETTER  
LATHES SINCE 1906**



**SOUTH BEND LATHE WORKS**

**455 EAST MADISON STREET • SOUTH BEND 22, INDIANA**

Printed by Popular Mechanics Company, Chicago, Ill., U. S. A.



# SPEAKING OF TEN-STRIKES by FRANK WILLIAMS

## NED DAY

...RATED BY MANY EXPERTS AS THE GREATEST MATCH BOWLER OF ALL TIME!

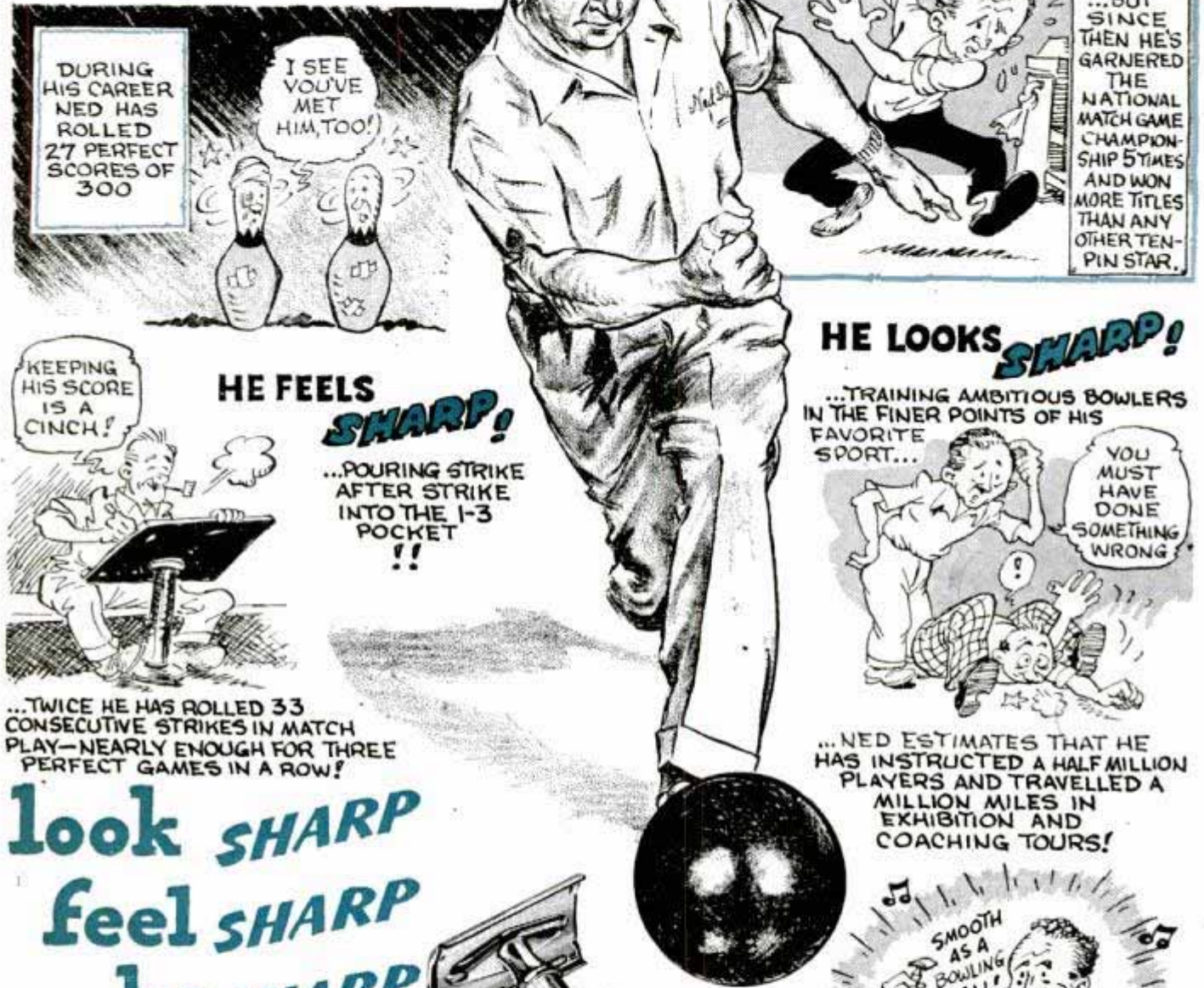

DURING HIS CAREER NED HAS ROLLED 27 PERFECT SCORES OF 300

I SEE YOU'VE MET HIM, TOO!

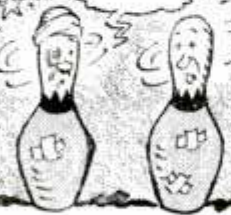

...IN HIS FIRST GAME THE CURLY-HAIRED WEST ALLIS, WIS., WONDER SCORED A LOWLY 63!

DO THEY NAIL THOSE PINS DOWN???



...BUT SINCE THEN HE'S GARNERED THE NATIONAL MATCH GAME CHAMPIONSHIP 5 TIMES AND WON MORE TITLES THAN ANY OTHER TEN-PIN STAR.

KEEPING HIS SCORE IS A CINCH!



HE FEELS **SHARP!**

...POURING STRIKE AFTER STRIKE INTO THE 1-3 POCKET !!

HE LOOKS **SHARP!**

...TRAINING AMBITIOUS BOWLERS IN THE FINER POINTS OF HIS FAVORITE SPORT...



YOU MUST HAVE DONE SOMETHING WRONG!

...TWICE HE HAS ROLLED 33 CONSECUTIVE STRIKES IN MATCH PLAY—NEARLY ENOUGH FOR THREE PERFECT GAMES IN A ROW!

...NED ESTIMATES THAT HE HAS INSTRUCTED A HALF MILLION PLAYERS AND TRAVELLED A MILLION MILES IN EXHIBITION AND COACHING TOURS!

look **SHARP**  
feel **SHARP**  
be **SHARP**

use **Gillette Blue Blades** with the **SHARPEST** edges ever honed!



5 for 25¢



SMOOTH AS A BOWLING BALL!

HE IS **SHARP!**

...NED DAY GETS THE SLICKEST SHAVES IN THE BOOK AND SAVES MONEY, TOO, FOR HE ALWAYS USES **GILLETTE BLUE BLADES** WITH THE SHARPEST EDGES EVER HONED! TAKE IT FROM HIM, THAT'S THE WAY TO SKIM OFF STUBBLE IN JIGTIME WITH PERFECT COMFORT. YES, AND REMEMBER—**DOUBLE EDGES MEAN DOUBLE ECONOMY!**

ENJOY BOXING FRIDAYS AT 10 PM EST OVER ABC NETWORK. GILLETTE'S CAVALCADE OF SPORTS ALSO AIRS WORLD SERIES AND OTHER CLASSICS YEAR 'ROUND.

Gillette Safety Razor Company, Boston 6, Mass.

Copyright, 1947, by Gillette Safety Razor Company