

# POPULAR MECHANICS

## MAGAZINE



WRITTEN SO YOU CAN UNDERSTAND IT

REG. TRADE MARK GREAT BRITAIN NO. 40428

REG. U.S. PAT. OFF.

FEBRUARY 1947  
25 CENTS



SNOW TRACTOR  
PAGE 169



# FAST STARTS

ON FROZEN MORNINGS

WITH **CASITE**

**Or Double Your Money Back**

★ Casite guarantees that your car will start quickly—even in the coldest winter weather—or you get back double your money. Casite retards congealing of oil, lets the motor spin over rapidly and s-t-a-r-t. Get Casite—sold by car dealers, garages, service stations, everywhere.

## GUARANTEE

We guarantee that any motor capable of being started in a warm room will start quickly in the coldest weather when Casite is added to the crankcase according to instructions. If your car fails to start quickly, you get double-your-money-back by filling out guarantee certificate and mailing it to The Casite Corporation, Hastings, Mich. Maximum refund is \$1.30 per pint, twice the advertised price of Casite.

**THE CASITE CORPORATION**  
HASTINGS, MICHIGAN  
Casite Division, Hastings Ltd., Toronto

*Casite Protects New Motors  
During Break-In*



65c  
A PINT  
75c  
IN CANADA

CASITE GIVES BETTER AND SMOOTHER PERFORMANCE ALL-YEAR-ROUND



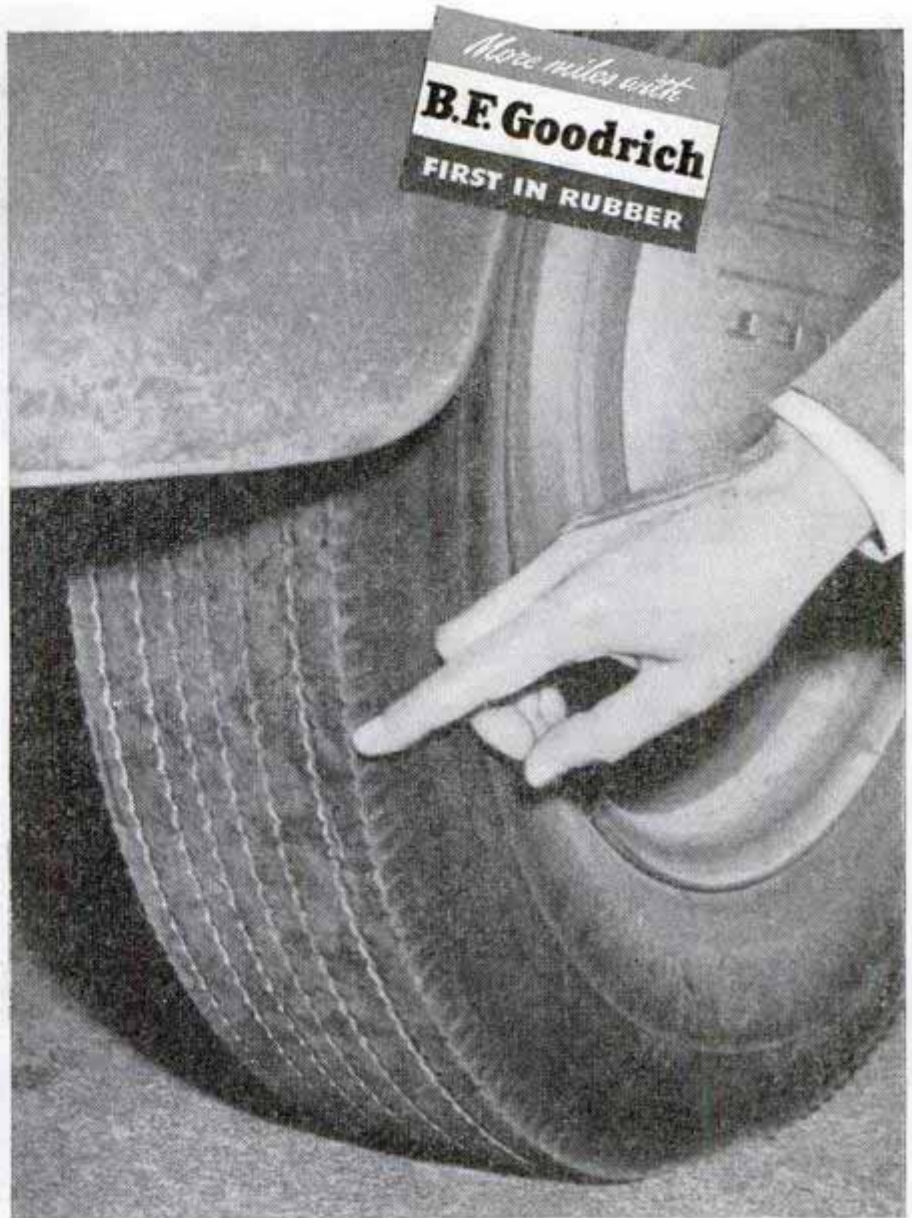
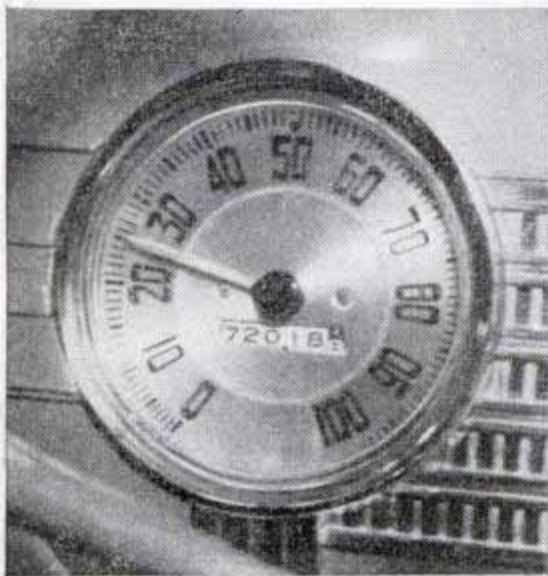

## TYPICAL EXAMPLE: THE B. F. GOODRICH TIRE THAT OUTWEARS PREWAR TIRES

**R**ALPH J. MORISSETTE of Ogdensburg, N. Y. (at left in the upper picture), points to one of his B. F. Goodrich tires that still isn't worn out after 38,377 miles. Mr. Morissette writes:

"I have received 38,377 miles from these tires in very difficult service on all types of roads. Many long trips were made at consistent high speeds. Also the car was used in my plumbing business, carrying heavy loads thousands of miles, over country and unpaved roads.

"This mileage is far in excess of prewar tires used. While former tires broke down in service,

these tires were never removed except to repair a puncture. I can truly say that your new tires most certainly can and do outwear prewar tires as stated in your advertising, since I have proof of this."

When the pictures were taken, Mr. Morissette's speedometer read 72,018 miles. When the tires were put on, the mileage was 33,641.

Supplies of tires are still lim-

ited, of course. Even today's increased production cannot keep up with the demand. This is particularly true of the B. F. Goodrich tire that outwears prewar tires. It's best to check your needs with your B. F. Goodrich dealer well in advance. He'll do his best to keep you rolling until he can get new tires for you. *The B. F. Goodrich Company, Akron, Ohio.*

# B.F. Goodrich

**FIRST IN RUBBER**



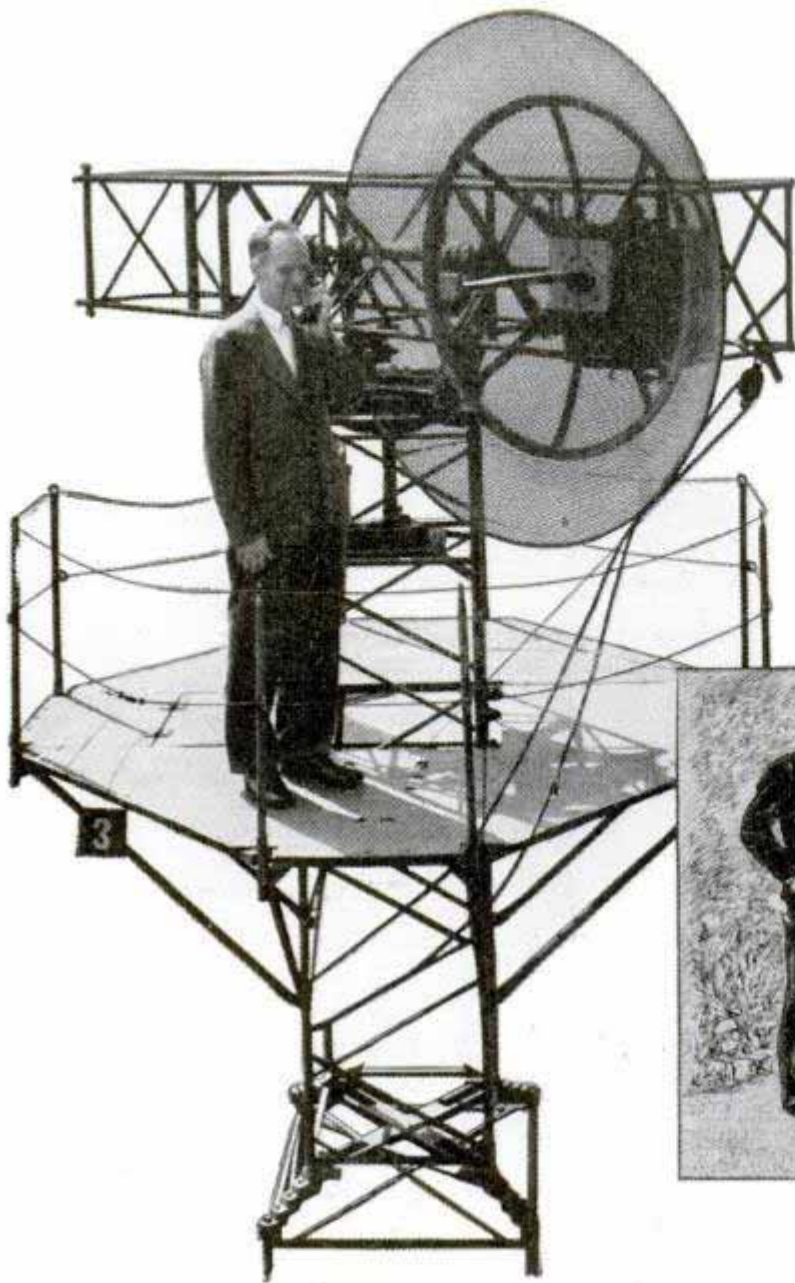

## Words that rode on a beam of light

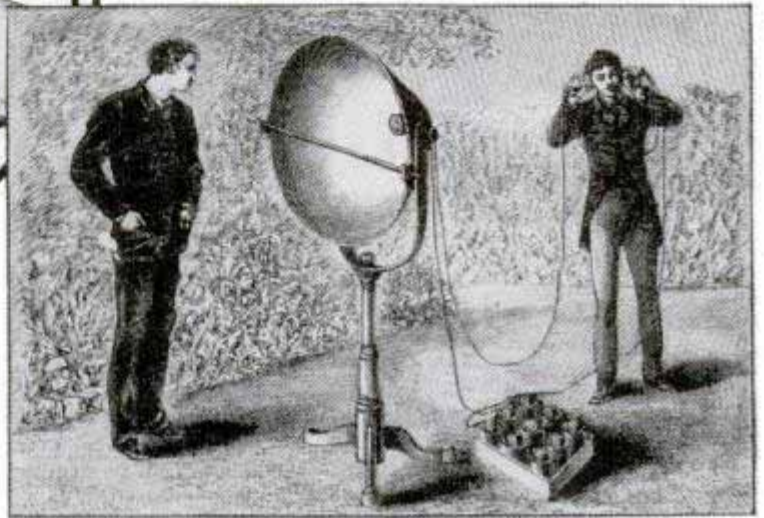

**I**F Alexander Graham Bell could look at the microwave antenna in the illustration, how quickly his mind would go back to his own experiments, 67 years ago!

For in 1880 the inventor of the telephone had another new idea. Speech could be carried by electric wires, as Bell had demonstrated. Could it be carried also by a *light beam*?

He got together apparatus—a telephone transmitter, a parabolic reflector, a selenium cell connected to handphones—and “threw” a voice across several hundred yards by waves of visible light, electromagnetic waves of high frequency.

Bell's early experiment with the parabolic antenna and the use of light beams as carriers

was for many years only a scientific novelty. His idea was far ahead of its time.

Sixty years later communication by means of a beam of radiation was achieved in a new form—beamed microwave radio. It was developed by Bell Telephone Laboratories for military communication. In the Bell System it is now giving service between places on the mainland and nearby islands and soon such beams will be put to work in the radio relay.

In retrospect, Bell's experiment illustrates once again the inquiring spirit of the Bell Telephone System.

**BELL TELEPHONE LABORATORIES**



*Exploring and Inventing, Devising and Perfecting for Continued Improvements and Economies in Telephone Service*



# Popular Mechanics Magazine

Registered in U. S. Patent Office and Canada

H. H. WINDSOR, Founder

H. H. WINDSOR, Jr., Editor and Publisher



G. H. Davis, noted British artist, at work

PICTURES of the "Whale Factory" on pages 123-125 were drawn by G. H. Davis of England, one of the world's leading diagrammatic artists. Mr. Davis, a contributor to these pages for many years, gets his material the hard way. During the war he rode subs and bombers to get some of his famous on-the-scene drawings. Recently he has been delving into the progress of jet propulsion in Europe for a March picture story on ramjets.

ALSO NEXT MONTH there's a yarn on lab research to find a better fuel for your car. Scientists hope to cut gas consumption 20 percent by 1950, a healthy saving for any penny-wise motorist. In a picture-packed feature on dude ranches you can pan for gold, eat beans from a chuck wagon and ride the sprawling range.

HOME ON WHEELS—that's the well-equipped house trailer described in a new Craftsman series beginning next month. The rolling house can be built with a few ordinary tools. Another how-to-build story features something new—a "walking" garden tractor powered by a four-cylinder engine. A timely article in the same issue gives complete instructions for painting the faithful car that lasted through the war years.

RADIO students and experimenters will find a new tuning feature in the 1947 "Little Giant" broadcast set described in the March Radio and Electronics section.

Volume 87 FEBRUARY 1947 Number 2

Managing Editor.....Roderick M. Grant  
 Assistant Managing Editor.....Wayne Whittaker  
 Shop Notes and Crafts Editor.....James R. Ward  
 Radio and Electronics Editor.....Frank L. Brittin  
 Aviation Editor.....Aubrey O. Cookman, Jr.  
 Associate Editor.....John R. Kinsey  
 Eastern Editor.....Bill Reiche  
 Western Editor.....Thomas E. Stimson, Jr.  
 Art Director.....Frank Beatty

Assistant Editors

Donald R. Brooks Clifford B. Hicks Maston M. Jacks Virgil T. Swanson

Assistant Editors, Shop Notes and Crafts

W. Clyde Lammey Wayne C. Leckey John F. Shrock A. E. Youngquist

## In This Issue

Laboratory in Space . . . . .	89
Waterloo for the Atom . . . . .	99
Highballing the Highway Freight . . . . .	105
Germ Warfare Against Bugs . . . . .	116
Whale Factory . . . . .	123
Riggers Ride High . . . . .	131
Synthetic or Natural Tires? . . . . .	137
Filming the Sun's Diary . . . . .	147
Edison Started Something . . . . .	153
Oven-Baked Gems for Industry . . . . .	164
Can Cities Harness the Wind? . . . . .	171

## For the Craftsman

"Studioettes"—Unit End Tables . . . . .	178
Build a Deep Freezer . . . . .	186
Stage Your Own Marionette Show . . . . .	201
Transparency Projector . . . . .	208
Mechanical "Hired Man" . . . . .	217
How to Cut Multiple Threads . . . . .	222
Radio and Electronics . . . . .	229

*Table of Contents Continued on Page 8*

Published monthly by POPULAR MECHANICS COMPANY, 200 East Ontario Street, Chicago 11, Ill. H. H. Windsor, Jr., president; Paul H. Dunakin, vice president and general manager; D. F. Windsor, vice president and secretary-treasurer; William Harrison Petridge, vice president and assistant to the publisher; Clover L. Perkins, advertising manager; Alan M. Deyoe, circulation manager. Single copy in the United States and Canada, 25 cents; subscription rates in United States and possessions, Canada, and countries of the Pan-American Postal Union, 1 year, \$2.50; 2 years, \$4.50; 3 years, \$6.00. To all other countries add \$1.00 a year over United States prices for overseas postage. If you plan to move, notify us at least 60 days in advance so you will not miss an issue. Give both old and new addresses. Entered as Second Class Matter, September 15, 1903, at the Post Office at Chicago, Illinois, under Act of March 3, 1879. Entered as Second Class Matter at Post Office Dept., Canada. Copyright 1947, by Popular Mechanics Company. Copyright under International Copyright Union. Copyright in France. All rights reserved under Pan-American Copyright Union. Printed in the United States of America.



# "Hawaiian Wigglers Get Results!"



*Franklin Martin  
and Party*

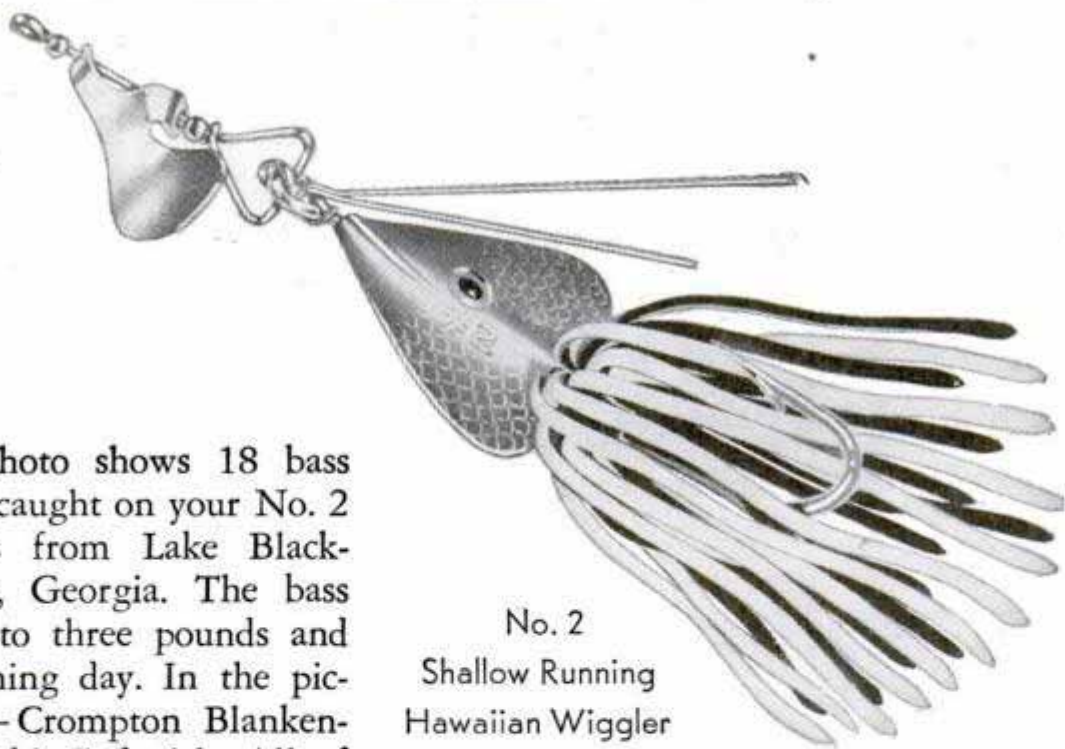

No. 2  
Shallow Running  
Hawaiian Wiggler  
\$1.10

"Dear Fred:

"The enclosed photo shows 18 bass and one crappie we caught on your No. 2 Hawaiian Wigglers from Lake Blackshear near Cordele, Georgia. The bass weighed from one to three pounds and were taken on opening day. In the picture left to right — Crompton Blankenship, myself and Hubie Leftwich. All of us enjoy using Hawaiian Wigglers. They sure get results." — *Franklin Martin, Marietta, Georgia.*

FRED ARBOGAST & CO.  
1602 North St., Akron 3, Ohio

**Write for Free Catalog —**

Contains many interesting letters and photographs of catches made with Hawaiian Wigglers, Jitterbug, my famous surface bait, and my new Hula Dancers. Sorry, no mail orders.



# If today's Heating System were in the Parlor . . .

IT WOULD  
GET THE  
CONSIDERATION  
IT DESERVES

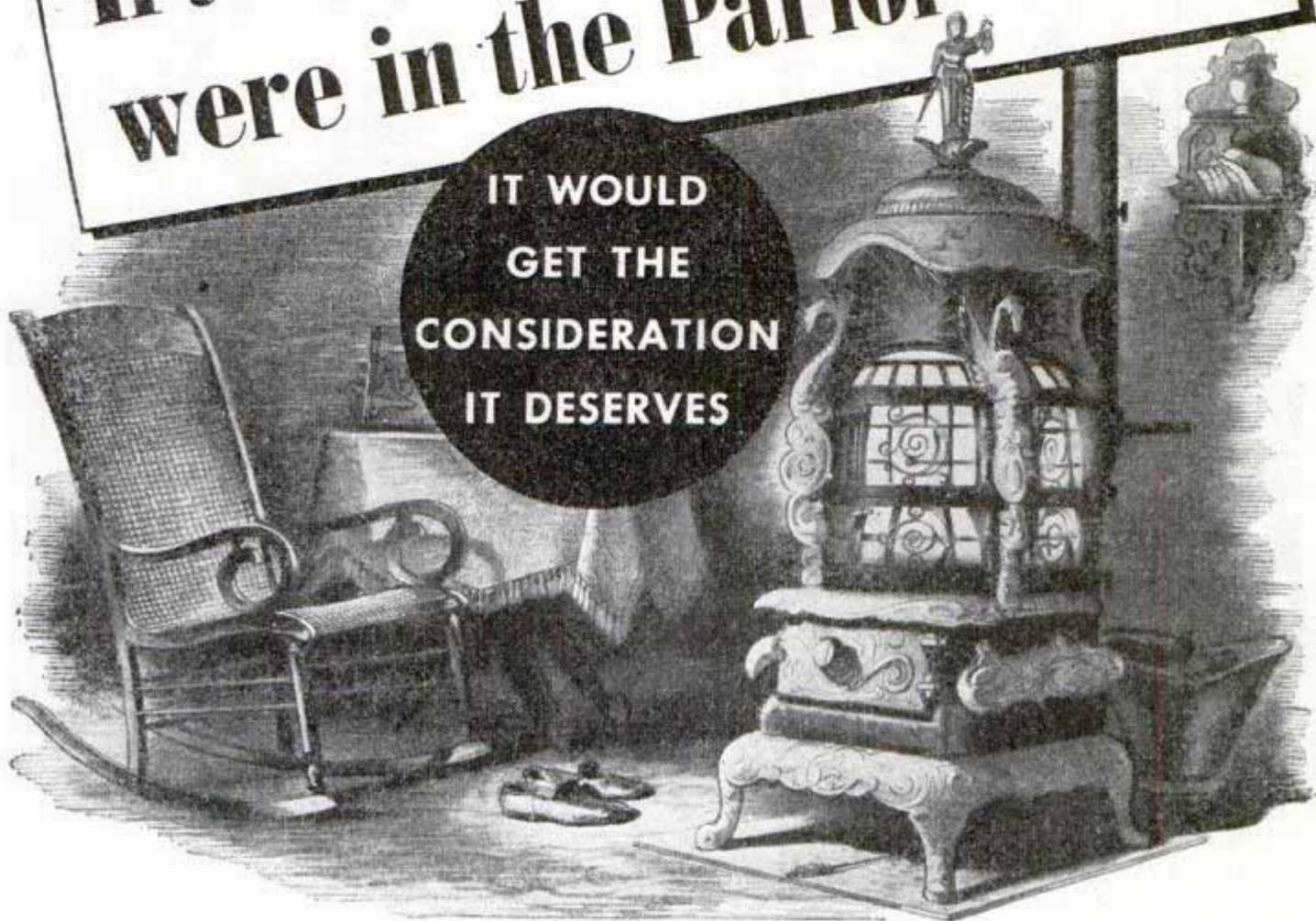

Yes, you couldn't ignore the old nickel-trimmed stove that was the center of family gatherings. Too bad that since the heating plant has been banished to the basement it is so often "out of sight out of mind." Many an attractive home has been built with all the eye-catching gadgets, but without enough attention given to the heating system. And no matter how much it may have cost, it isn't really a home unless it is comfortable in cold weather.

Minneapolis-Honeywell has developed an

**A GOOD HEATING SYSTEM + MODUFLOW  
= COMFORT UNLIMITED**

# MODUFLOW

the new **HONEYWELL** heating control system

Minneapolis-Honeywell Regulator Company, Minneapolis 8, Minnesota . . . Canadian Branch: Toronto 12, Ontario.

entirely different type of heating control system that has brought a new conception of comfort to thousands of homes. This remarkable control is called Moduflow. Whether or not your heating system seems to be satisfactory, you'll find that you will have greater comfort with Moduflow.

Learn how easily and inexpensively Moduflow control can be applied to your present heating plant, whether old or new. Mail the coupon today for the booklet "Comfort Unlimited" that tells all about Moduflow.

Minneapolis-Honeywell Regulator Co.  
2749 Fourth Avenue South  
Minneapolis 8, Minnesota  
Please send my free copy of  
"Comfort Unlimited"



F3E4-UFA-HOS9



THIS ONE



# Thoughts . . . THAT MOVE MOUNTAINS



## . . . IS MIND POWER REAL?

**H**AVE YOU READ volumes on the power of thought? Perhaps you have listened to lengthy theoretical addresses on the forces of mind. You may have wondered if these same writers and lecturers on mind power know how to use it. How many mountains of personal obstacles—everyday trials and tribulations—have *they* moved? What are these subtle principles whereby man can skillfully remove the barriers that impede his progress? How can *you* displace the obstructions and hindrances to *your* goal... the mountains in *your* life? Can practical information about inner power be reduced to mere words... words for public dissemination? Or, is there a secret method especially and uniquely preserved for the worthy seeker... practicable only under ideal circumstances? If so, who has the secret method? Where can it be found?

*The*

**ROSICRUCIANS (AMORC) San Jose, California**

Investigate the Rosicrucians (NOT a religion), the oldest *practical* philosophical fraternity on earth. See if they cannot show you a method for attainment such as you may not have dreamed. Thousands of men and women today are enjoying mental mastery... realization of ideals... the attainment of their objectives. They *know* the secret methods for converting mountains of personal problems into green valleys of achievement.

### ACCEPT THIS OFFER

A FREE book, *The Mastery of Life*, is yours for the asking. It explains how easily you may enter upon the path of attainment. Fill in and send coupon *today!*

SCRIBE M. H. A.  
THE ROSICRUCIANS (AMORC)  
San Jose, California

Please send me the book, *The Mastery of Life*, which explains how I may learn to use my faculties and powers of mind.

Name \_\_\_\_\_

Address \_\_\_\_\_

City \_\_\_\_\_

Zone Number \_\_\_\_\_ State \_\_\_\_\_



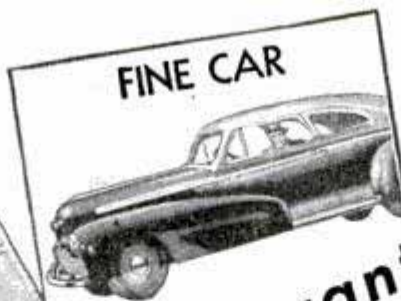

To the man who wants to enjoy  
**an ACCOUNTANT'S CAREER**



**IF** you're that man, here's something that will interest you. Not a magic formula—not a get-rich-quick scheme—but something more substantial, more practical.

Of course, you need something more than just the desire to be an accountant. You've got to pay the price—be willing to study earnestly, thoroughly.

Still, wouldn't it be worth your while to sacrifice some of your leisure in favor of interesting home study—over a comparatively brief period in your life? Always provided that the rewards were good—a salary of \$3,000 to \$10,000?

An accountant's duties are interesting, varied and of real worth to his employers. He has *standing!*

Do you feel that such things aren't for you? Well, don't be too sure. Very possibly they *can* be!

Why not, like so many before you, investigate LaSalle's modern Problem Method of training for an accountancy position?

Just suppose you were permitted to work in a large accounting house under the personal supervision of an expert accountant. Suppose, with his aid, you studied accounting principles and solved problems day by day—easy ones at first—then the more difficult ones. If you could do this—and if you could turn to him for advice as the problems became complex—soon you'd master them all.

That's the training you follow in principle under the LaSalle Problem Method.

You cover accountancy from the basic Principles right up through Accountancy Systems and Income Tax Procedure. Then you add C. P. A. Training and prepare for the C. P. A. examinations.

As you go along, you absorb the principles of Auditing, Cost Accounting, Business Law, Statistical Control, Organization, Management and Finance.

Your progress is as speedy as you care to make it—depending on your own eagerness to learn and the time you spend in study.

Will recognition come? The only answer, as you know, is that success *does* come to the man who is really *trained*. It's possible your employers will notice your improvement in a very few weeks or months. Indeed, many LaSalle graduates have paid for their training—with increased earnings—before they have completed it! For accountants, who are trained in organization and management, are the executives of the future.

### Write For This Free Book

For your own good, don't put off investigation of *all* the facts. Write for our free 48-page book, "Accountancy, The Profession That Pays." It'll prove that accountancy offers brilliant futures to those who aren't afraid of serious home study. Send us the coupon *now*.

Over 2300 Certified  
 Public Accountants among  
 LaSalle alumni

**G. I. APPROVED**

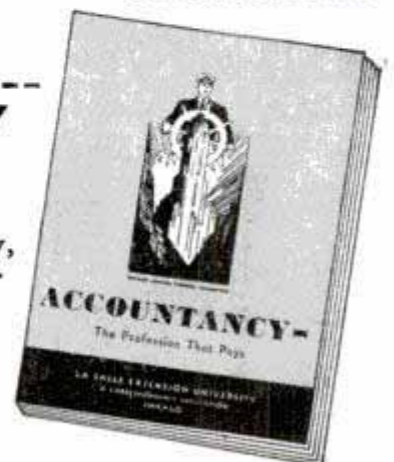

## LASALLE EXTENSION UNIVERSITY

### A CORRESPONDENCE INSTITUTION

417 South Dearborn Street, Dept. 264-H, Chicago 5, Illinois

I want to be an accountant. Send me, without cost or obligation, the 48-page book, "Accountancy, The Profession That Pays," and full information about your accountancy training program.

Name.....

Address..... City.....

Position..... Age.....



# PYROIL an old friend for your NEW CAR!



Automobiles get old first inside. Metal to metal contact of piston and cylinder means wear . . . corrosion . . . deterioration. Pyroil gives oil the quality of adhering to cylinder walls . . . of providing constant lubrication to prevent metal to metal contact and wear. Pyroil makes starting easier and reduces battery drain. Whether you are the proud owner of a new car or still driving a pre-war model . . . you will get added miles by adding Pyroil. Ask your gas station attendant.

## PYROIL FOR AIRCRAFT ENGINES

Use Aircraft Pyroil B for lubricating oil, Aircraft Pyroil A for gasoline.

Manufactured and Guaranteed by Pyroil Company,  
64 Pyroil Bldg., La Crosse, Wisconsin.

### PYROIL COMPANY

64 Pyroil Bldg., La Crosse, Wisconsin

I want my car to last and run properly. Please tell me more about Pyroil and how it can accomplish this for me.

Name.....

Address.....

City or Town..... State.....



*Jerry, the talking dog, is entertaining hospitalized veterans, by courtesy of the PYROIL Company. Picture of Jerry, sent on request.*

## TABLE OF CONTENTS (Continued)

### AUTOMOTIVE

Sedan and station wagon combined in De Soto car.....	95
New-type dolly for auto trailers.....	104
Tire carrier swings heavy spare into position for changing.....	112
Roll-over auto top protects race pilot.....	135
Electric pump cleans up dirty job of changing crankcase oil.....	136
Waterproof cover for pickup truck slips over aluminum frame.....	163
Three-wheel truck travels 65 miles on gallon of gas.....	174
Road tests simulated in laboratory to test gasoline.....	174
Portable test "lungs" measure air flow in crankcase.....	176
Safety locks prevent children from opening car doors.....	176

### AVIATION

Newcomers on the sky lanes.....	94
Hay bale "bombing" saves buffalo.....	104
Amphibian's rugged hull can make wheels-up emergency landing.....	122
Odd German helicopter has exhaust jets at tips of rotor blades.....	127
Small homemade biplane cruises at 160 m.p.h. over 500-mile area.....	136
Auto-plane sheds wings and propeller in five minutes.....	152
Largest bomber.....	158
Trainer has all-around visibility.....	158
Course under for lightplane pilots.....	159

### BOATS

"Turret-Control" tug turns in 28 inches.....	121
Truck salvages boat by hauling overland.....	130
Two-cylinder steamboat engine uses any kind of fuel.....	143
Self-propelled houseboat provides bunks for six.....	162

### FARM

Fluorescent lamps attract insects that threaten Japanese rice fields.....	115
Radio guided tractors make plowing by remote control possible.....	126
Chemical spares useful insects.....	159
Rear wheels of tractor adjust themselves automatically to contour of land.....	175

### HOUSE AND HOME

Heating-cooling unit uses temperature of earth as "fuel" source.....	126
Aluminum-plywood house built of salvaged materials.....	127
Inside stuff for your home.....	128
Stoker-fired water heater operates with sub-bituminous coal.....	136
House built of lightweight concrete slabs.....	146
Porcelain enamel house.....	168

### INDUSTRY

X-ray gauge for assembly line checks thickness of parts.....	112
Charcoal canisters keep apples fresh.....	121
Excavator steered from cab turns on dime.....	130
Glued cartons avert cargo shifting.....	135
Molded glass lenses eliminate grinding.....	135
Spraying rig follows row as driver dodges spray.....	163
Oil is produced from shale heated beneath the ground.....	170
Weasel fights fires in forest areas.....	167

### OUTDOOR RECREATION

Fish are unharmed by DDT spray used to kill mosquitoes on ponds.....	97
Balloon and parachute are used to cast fishing line.....	97
Adjustable rope clamp for tent holds canvas tight.....	142
Bicycle hub dynamo stores up power to carry rider over hills.....	152
Kerosene-heated stool keeps hunters warm.....	175

### RADIO AND ELECTRICAL

Control system prevents electrolytic damage to underground pipes.....	103
Earphones worn like stethoscope with speaker under chin.....	112
Radiotelephone service links remote western ranches to cities.....	113
Multiplug extension cord reel is self-retracting.....	142
10,000 messages in one tube promised by new amplifier.....	142
Atomic rifle shoots ultrashort radio waves through gas molecules.....	175

### TOYS AND NOVELTIES

Self-cleaning pipe has lighter.....	115
Costume jewelry made from surplus chains and gears.....	143
Spoon-fed iron horse.....	144
Framing the desert.....	160
"Art gallery" phonograph disk has picture under plastic.....	176

### TOOLS

Plastic level checks angles with six built-in bubbles.....	95
Spinning handle of screwdriver serves as hammer.....	96
Metal applicator provides short cut in filling engine block cracks.....	113
Tapered cones on stable end mill eliminate need for spring collets.....	115
Revolving rotor in protractor calibrated like transit.....	115
Oxyacetylene cutting torch can be carried like a pack.....	143
Ladder on wheels speeds job of painting.....	175

### MISCELLANEOUS

Atomic power plant.....	96
Seven-year snowmen.....	98
Elaborate hardwood desks for executive use.....	102
Why is the ocean blue?.....	113
Switzerland's new Alpine road.....	114
"Death ray" machines are harmless.....	115

(Continued to page 10)



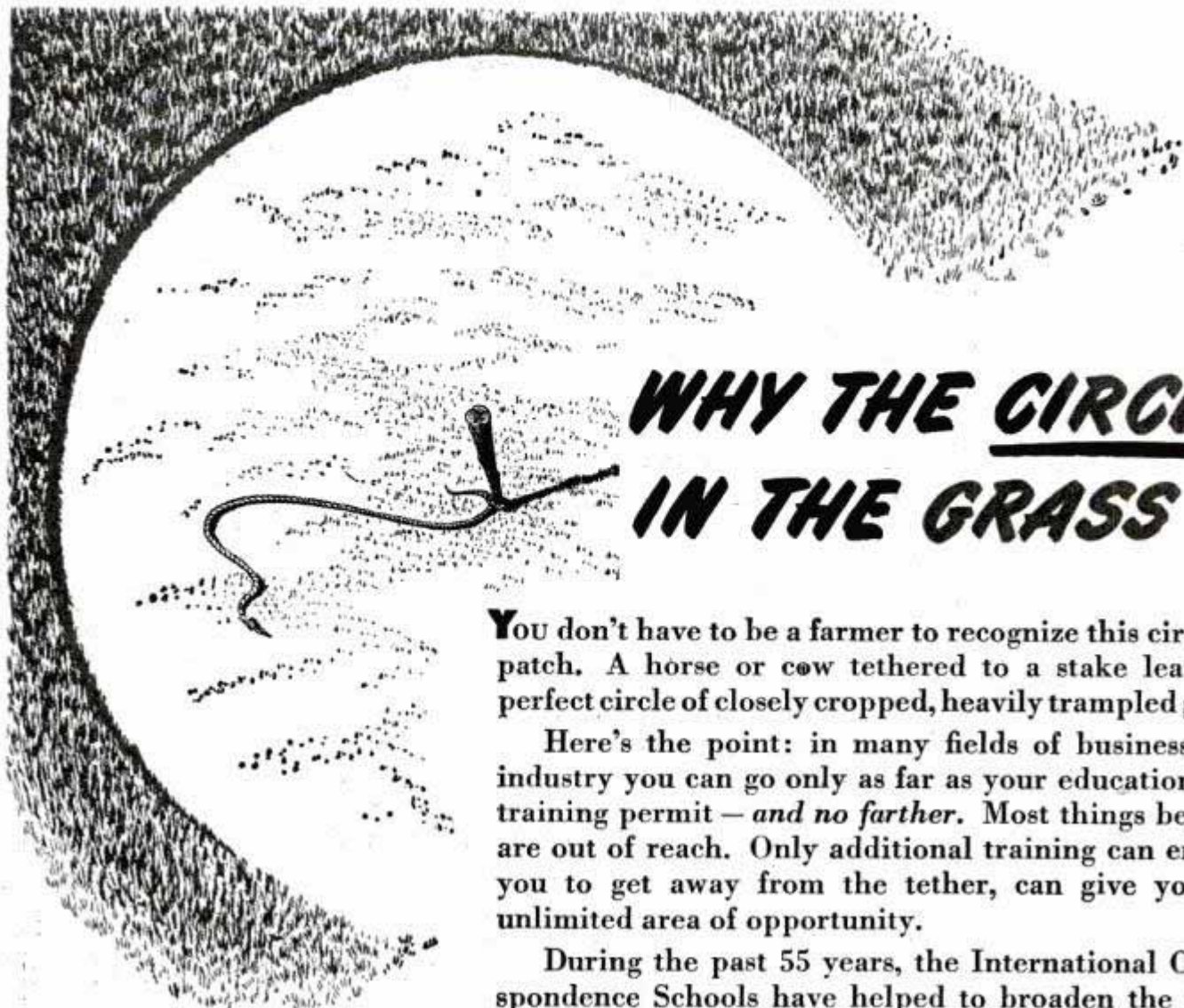

## WHY THE CIRCLE IN THE GRASS?

**YOU** don't have to be a farmer to recognize this circular patch. A horse or cow tethered to a stake leaves a perfect circle of closely cropped, heavily trampled grass.

Here's the point: in many fields of business and industry you can go only as far as your education and training permit — *and no farther*. Most things beyond are out of reach. Only additional training can enable you to get away from the tether, can give you an unlimited area of opportunity.

During the past 55 years, the International Correspondence Schools have helped to broaden the vocational scope for more than 5,000,000 men like yourself.

### INTERNATIONAL CORRESPONDENCE SCHOOLS



BOX 5597-K, SCRANTON 9, PENNA.

Without cost or obligation, please send me full particulars about the course *before* which I have marked X:

- Air Conditioning and Plumbing Courses
- Air Conditioning
- Heating  Plumbing
- Refrigeration  Steam Fitting
- Chemistry Courses**
- Chemical Engineering
- Chemistry, Analytical
- Chemistry, Industrial
- Chemistry, Mfg. Iron & Steel
- Petroleum Refining  Plastics
- Pulp and Paper Making
- Civil Engineering, Architectural and Mining Courses**
- Architectural Drafting
- Architecture
- Bridge and Building Foreman
- Building Estimating
- Civil Engineering
- Coal Mining
- Contracting and Building
- Highway Engineering
- Lumber Dealer
- Reading Structural Blueprints
- Sanitary Engineering
- Structural Drafting

- Structural Engineering
- Surveying and Mapping
- Communications Courses**
- Electronics
- Practical Telephony
- Radio, General
- Radio Operating
- Radio Servicing
- Telegraph Engineering
- Electrical Courses**
- Electrical Drafting
- Electrical Engineering
- Electric Light and Power
- Lighting Technician
- Practical Electrician
- Internal Combustion Engines Courses**
- Auto Technician  Aviation
- Diesel-Electric
- Diesel Engines  Gas Engines
- Mechanical Courses**
- Aeronautical Engineering
- Aircraft Drafting
- Flight Engineer
- Foundry Work
- Heat Treatment of Metals

- Industrial Engineering
- Industrial Metallurgy
- Machine Shop
- Mechanical Drafting
- Mechanical Engineering
- Mold-Loft Work
- Patternmaking—Wood, Metal
- Reading Shop Blueprints
- Sheet-Metal Drafting
- Sheet-Metal Worker
- Ship Drafting  Ship Fitting
- Tool Designing
- Toolmaking
- Welding—Gas and Electric
- Railroad Courses**
- Air Brake  Car Inspector
- Diesel Locomotive
- Locomotive Engineer
- Locomotive Fireman
- Railroad Section Foreman
- Steam Engineering Courses**
- Boilermaking
- Combustion Engineering
- Engine Running
- Marine Engineering
- Steam Electric  Steam Engines

- Textile Courses**
- Cotton Manufacturing
- Rayon Weaving
- Textile Designing
- Woolen Manufacturing
- Business and Academic Courses**
- Accounting  Advertising
- Arithmetic  Bookkeeping
- Business Correspondence
- Business Management
- Certified Public Accounting
- Commercial
- Cost Accounting
- Federal Tax
- First Year College
- Foremanship  French
- Good English  High School
- Higher Mathematics
- Illustrating  Motor Traffic
- Postal Service
- Salesmanship  Secretarial
- Sign Lettering
- Spanish  Stenography
- Traffic Management

Name \_\_\_\_\_ Age \_\_\_\_\_ Address \_\_\_\_\_

City \_\_\_\_\_ State \_\_\_\_\_ Present Position \_\_\_\_\_

Working Hours \_\_\_\_\_ A.M. to \_\_\_\_\_ P.M. Length of Service in World War II \_\_\_\_\_

Special tuition rates to members of the Armed Forces. Enrollment under the G.I. Bill of Rights approved for War II Veterans. Canadian residents send coupon to International Correspondence Schools Canadian, Ltd., Montreal, Canada.



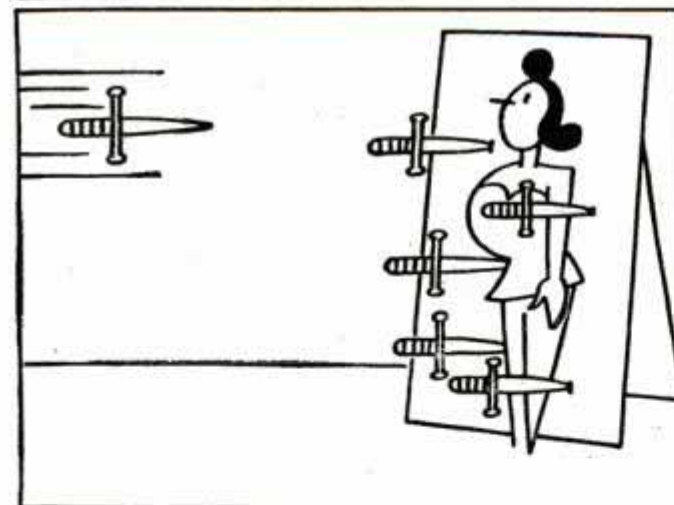
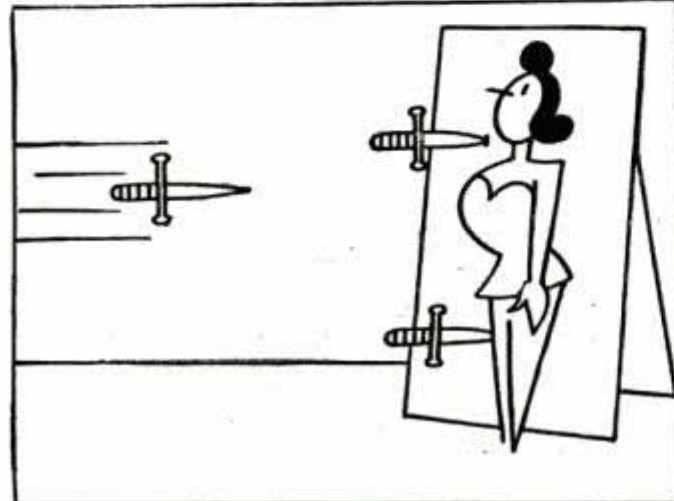

O. SOGLOW

(Continued from page 8)

Mobile traffic striper paints 25 miles a day.....	121
Dry ice "seeds" planted in a cloud produce a crop of artificial snow.....	122
Synthetic penicillin offers new chemical weapon against disease.....	126
Gas-powered tricycle from scrap parts.....	143
Stylus "reads" for the blind by scanning printed material.....	150
Easy-to-play "sweet-potato flute" has tone holes in keys.....	159
Photo lamp projects light patterns.....	167
Snow tank.....	169
French pump operated by crank produces 300 gallons per hour.....	170
Muscle grafting renews heart.....	174

## Craftsman and Shop Notes Index

### AUTOMOTIVE

Points to check in prolonging life of storage batteries.....	185
Car alarm in starter-horn circuit foils would-be thief.....	194
Safe driving.....	195
Tip on installing brake cylinder.....	216
"Flat" on outside wheel repaired.....	220
Reflectors on truck doors warn approaching motorists.....	221
Saving sidewalls on truck tires.....	221
Felt pad is convenient wiper for gas station attendant.....	227
Back of front seat holds shelf that serves as desk.....	228

### HOUSE AND HOME

T-plate reinforces broom handle.....	180
How to fix worn wringer rolls.....	180
Coil spring holds spoon on pan.....	180
Plant boxes made from empty milk cartons.....	181
Preserving finish on linoleum.....	181
Solving home problems.....	182
Dowel slipped over hanger bar prevents trouser creases.....	184
Presser foot clamps material when ripping cloth seam.....	197
Holes in sash make putty stick.....	200
Ventilator formed from plastic admits light and air.....	216
Metal guard for burner handles.....	216
Removing a fresh paint spot.....	216

### METAL WORKING

Enlarging holes in sheet metal.....	184
Tent stakes made from T-iron.....	184
Metal dispenser for cigarettes keeps them at hand.....	200

### PHOTOGRAPHY

Spotlight made from floodlamp and tin cans.....	213
Extension arms for projector.....	214
Frayed slide mounts repaired.....	214
Tilting head on camera tripod.....	214
Easily made floodlight deflector provides better diffusion.....	214
Focusing aid when enlarging.....	214

### RADIO AND ELECTRONICS

Equipment for demonstrating microwaves.....	229
How to build a converter for the new VHF amateur bands.....	230
Tuning-dial pointer and drive-cable repairs.....	232

### STORE AND OFFICE

Sealing of envelopes prevented.....	180
Method of proofreading stencils.....	193
Card indicates location of file.....	227
Papers clipped in spring rack are easy to locate.....	228

### TOOLS

Level equipped with adjustment measures angles accurately.....	184
Easier operation of tin shears.....	184
Auto light placed above jigsaw withstands heavy vibration.....	193
Curtain rod used as a rule.....	200
Bench vise for modelmakers holds small objects.....	200
Marking jig slips over work.....	207
Craft quiz.....	215
Tool head is secured to handle with wire mesh.....	216
Wood guard for double-bit ax protects cutting edges.....	220
Light reaches hard-to-see area.....	220
Boring-bar holder made in two operations.....	221

### TOYS AND NOVELTIES

Simple toy teaches child to spell elementary words.....	181
Steadiness of hand determined with testing instrument.....	197
Rack on scooter holds papers for newsboy.....	197
Jigsawed table novelties add color to luncheons.....	198
Trick matches that "burn" twice will amuse company.....	206
Sliding dovetail joints are secret of wood-block puzzle.....	207

### WOODWORKING

Unit end tables.....	178
Insulated plywood house for cat has automatically controlled heat.....	194
Collapsible cold frame stored when not used.....	207
Sawhorse is dismantled quickly and takes little storage space.....	228

### MISCELLANEOUS

"Sling" helps carry heavy boxes.....	180
Curing a leaking fountain pen.....	180
Flashlight used as egg candler.....	180
Getting the most out of your cigarette lighter.....	185
Extra storage space in garage provided by platform.....	193
Easily made scale permits fisherman to weigh catch on the spot.....	194
Test tubes warmed in reflector.....	197
Pull-out mailbox unit is tagged to aid distribution of mail.....	220
Clay used as balancing weight permits close adjustment.....	227

**IMPORTANT NOTICE**—It is the intention of this magazine to provide its readers with information regarding the latest developments in the mechanical arts. We take no responsibility as to whether the disclosures contained in our articles are covered by patents and advise readers to investigate this subject before making, using, or selling any of the products, machines, or processes described in order to avoid possible liability for patent infringements.



**AUDELS REFRIGERATION & AIR CONDITIONING GUIDE.....\$4**

New from Cover to Cover—1280 Pages, Fully Illus. Covering basic principles, servicing, operation & repair of household, commercial & industrial refrigeration & air conditioning. A gold mine of essential important facts for engineers, servicemen, users.

**AUDELS CARPENTERS & BUILDERS GUIDES—4 Vols. ....\$6**

A practical illustrated trade assistant on modern construction for carpenters, joiners, builders, mechanics and all woodworkers. 4 vols., 1800 pages, 3700 illustrations, flexible covers. Pocket size. Each volume sold separately \$1.50 a vol.

**AUDELS AUTOMOBILE GUIDE.....\$4**

A practical quick ready reference book for auto mechanics, service men, operators & owners. Explains theory, construction & servicing of modern motor cars, trucks, buses & auto type Diesel engines. 1540 pages, fully illustrated. 55 chapters. Indexed. A standard book for mechanics. New fluid drive covered.

**AUDELS DIESEL ENGINE MANUAL.\$2**

A practical, concise treatise with questions and answers on the theory, operation and maintenance of modern diesel engines including General Motors 2 cycle Diesel. 384 pages, fully illus., flexible binding, pocket size. All details plainly brought out, this book is of extreme value to engineers, operators & students.

**AUDELS WIRING DIAGRAMS.....\$1**

210 Pages, Illustrated. Gives practical facts on wiring of electrical apparatus. It shows clearly how to wire apparatus for practically all fields of electricity. Each diagram is complete & self-explanatory. Highly Endorsed Pocket Companion.

**AUDELS PLUMBERS & STEAMFITTERS GUIDES—4 Vols. ....\$6**

A Practical Trade Assistant & Ready Reference. Explains in plain language & by clear illustrations, diagrams, charts, graphs, pictures principles of modern plumbing practice including Marine Pipe Fitting and Air Conditioning. 4 Vols.—1870 Pages—3642 Diagrams. Pocket size. Each Vol. Sold Separately \$1.50 a Vol.

**AUDELS SHEETMETAL WORKERS HANDY BOOK.....\$1**

Practical inside information. Fundamentals of Sheet Metal Work. 388 pages, illustrated. 11 sections. Clearly written. Essential & important facts, figures, pointers in everyday language. Ref. Index.

**AUDELS SHEETMETAL PATTERN LAYOUTS.....\$4**

Developed by Experts for Sheet Metal Workers, Layout Men & Mechanics. A Practical Encyclopedia in 10 Sections, size 7 x 10 x 2—1125 Pages—350 Layouts—1600 Illustrations. 1001 Key Facts. Fully indexed for ready reference in answering your layout problems. Covers all phases of sheet metal work including Pattern Cutting, Pattern Development & Shop Procedure.

**AUDELS ANSWERS ON BLUE PRINT READING.....\$2**

For Mechanics & Builders. Covers all types of blue print reading including ship & airplane. 376 pages, fully illustrated.

**AUDELS NEW MACHINIST & TOOLMAKERS HANDY BOOK....\$4**

Covers modern machine shop practice in all its branches. 5 practical books in 1. New from cover to cover. Tells how to set up & operate lathes, screw and milling machines, shapers, drill presses and all other machine tools. 1600 pages, fully illustrated, 5 x 6 1/2 x 2. Indexed. 5 sections. 1—Modern Machine Shop Practice. 2—Blue Print Reading & How to Draw. 3—Calculations & Mathematics for Machinists. 4—Shop Physics. 5—How to Use the Slide Rule. 60 chapters. Easy to read and understand. A shop companion that answers your questions.

**AUDELS MATHEMATICS & CALCULATIONS FOR MECHANICS \$2**

Mathematics for home study or reference. 700 pages, 550 illus. Practical mathematics from beginning. How to figure correctly. Easy, correct methods covering a complete review. Ill. & Indexed.

**AUDELS HANDY BOOK OF PRACTICAL ELECTRICITY.....\$4**

For maintenance engineers, electricians & all electrical workers. 1440 Pages, 2600 Illus. Covers important electrical information in handy form—including Marine Wiring, Radio Principles, Welding. Indexed. A Key to a practical understanding of electricity.

**AUDELS RADIOMANS GUIDE.....\$4**

A key to the practical understanding of radio including Frequency Modulation, Television, etc., Aircraft & Marine Radio. For radio engineers, servicemen, amateurs. 773 pages, 400 illustrations & Diagrams. Photos. Review Questions & Answers, Reference Index. Authentic, clear, concise.

**AUDELS ELECTRONIC DEVICES....\$2**

Tells What You Want to Know About Electric Eye. Easily Understood. Covers photo-electric cells & their applications. Amplifiers, illumination, frequencies, voltage, photocell, tubes, Ohm's Law, wiring diagrams, etc.

**AUDELS WELDERS GUIDE.....\$1**

A concise, practical text on operation & maintenance of all welding machines for all mechanics. Over 400 pages, illustrated. Covers all methods of electric and acetylene welding including airplane work.

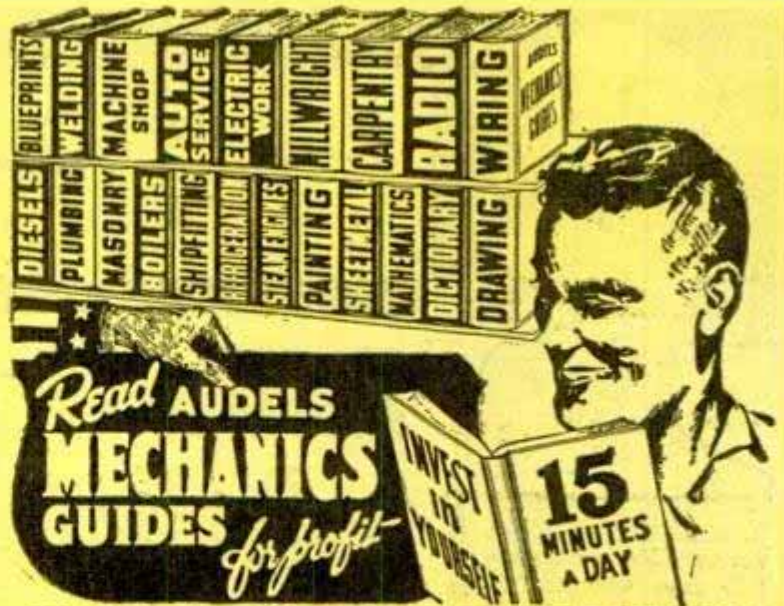

**AN AUDEL GUIDE IS A GOOD FRIEND!**

Use the brains and experience of others in these Guides of the Trades. Save time and money with right methods, short cuts, labor saving ideas. CHECK NOW! You can look over any Audel Guide in your home. Start the Easy Payments if satisfied.

**CUT HERE MAIL ORDER**

THEO. AUDEL & CO., 49 W. 23 St., New York 10, N.Y.

Please mail me for 7 days' free examination the books marked (X) below. I agree to mail \$1 in 7 days on each book or set ordered, and to further mail \$1 a month on each book or set ordered until I have paid purchase price. If I am not satisfied with Guides I will return them.

- Audels OIL BURNER GUIDE ..... \$1.
- Audels REFRIGERATION & Air Conditioning Guide. 4.
- Audels POWER PLANT ENGINEERS GUIDE 4.
- Audels PUMPS, HYDRAULICS & AIR COMPRESSORS 4.
- Audels WELDERS GUIDE 1.
- Audels BLUE PRINT READING ..... 2.
- Audels SHEET METAL WORKERS Handy Book ..... 1.
- Audels SHEET METAL PATTERN LAYOUTS ..... 4.
- Audels AIRCRAFT WORKER ..... 1.
- Audels MATHEMATICS and CALCULATIONS ..... 2.
- Audels MACHINISTS & TOOLMAKERS Handy Book 4.
- Audels MECHANICAL Dictionary ..... 4.
- Audels AUTOMOBILE GUIDE ..... 4.
- Audels DIESEL ENGINE MANUAL ..... 2.
- Audels MARINE ENGINEERS Handy Book ..... 4.
- Audels SHIPFITTERS Handy Book ..... 1.
- Gueths MECHANICAL DRAWING COURSE ..... 1.
- Rogers DRAWING and DESIGN ..... 2.
- Audels MILLWRIGHTS and Mechanics Guide ..... 4.
- Audels CARPENTERS and Builders Guides (4 vols.) ..... 6.
- Audels PLUMBERS and Steamfitters Guides (4 vols.) ..... 6.
- Audels MASONS and Builders Guides (4 vols.) ..... 6.
- Master PAINTER and DECORATOR ..... 2.
- Audels GARDENERS & GROWERS GUIDES (4 vols.) ..... 6.
- Audels ENGINEERS & FIREMANS EXAMINATIONS 1.
- Audels ENGINEERS and Mechanics Guides Nos. 1, 2, 3, 4, 5, 6, 7 and 8 complete ..... 12.
- Audels Answers on Practical ENGINEERING ..... 1.
- Audels ELECTRICIANS EXAMINATIONS ..... 1.
- Audels WIRING DIAGRAMS ..... 1.
- Audels Handy Book of PRACTICAL ELECTRICITY ..... 4.
- Audels ELECTRICAL POWER CALCULATIONS ..... 2.
- Audels ELECTRONIC DEVICES ..... 2.
- Audels ELECTRIC Dictionary ..... 2.
- Audels RADIOMANS GUIDE ..... 4.
- Audels NEW ELECTRIC LIBRARY at \$1.50 a Volume Vols. I, II, III, IV, V, VI, VII, VIII, IX, X, XI, XII

Name \_\_\_\_\_  
 Address \_\_\_\_\_  
 Occupation \_\_\_\_\_  
 Employed by \_\_\_\_\_

PM





# BE YOUR

*I will show you how to start  
a Radio Service Business  
Full Time or Spare Time without capital*

J. E. SMITH, President  
National Radio Institute  
The man who has directed the Home Study Training of more men for the Radio Industry than any other man in America.

## VETERANS!

You can get this training right in your own home under G.I. Bill. Mail coupon for full details.

## I Trained These Men



**\$50 A Month In Spare Time**  
"I have a spare time Radio and Electrical business of my own which has been very profitable, due to the efficient training I received from your Course. Last year I averaged over \$50 a month."—  
FRED H. GRIFFIE, Rt. 3, Newville, Pa.

### Fixing Radios Profitable Hobby

"I am doing Radio work in my spare time and find it a profitable hobby. My extra earnings run about \$10 a week. I certainly am glad I took your N. R. I. Course."—  
FERDINAND ZIRBEL, Chaseley, N. Dak.



**MY COURSE INCLUDES  
TELEVISION  
ELECTRONICS  
FREQUENCY MODULATION**

## SAMPLE LESSON FREE SEE OPPOSITE PAGE

Do you want a good-pay job in Radio—or your own money-making Radio Shop? Mail Coupon for a FREE Sample Lesson and my FREE 64-page book, "How to be a Success in Radio—Television, Electronics." See how N.R.I. gives you practical Radio experience at home—building, testing, repairing Radios with BIG KITS OF PARTS I send!

### Many Beginners Soon Make Good Extra Money In Spare Time While Learning

The day you enroll I start sending EXTRA MONEY JOB SHEETS. You LEARN Radio principles from my easy-to-grasp, illustrated lessons—PRACTICE what you learn with parts I send—USE your knowledge to make EXTRA money fixing neighbors' Radios in spare time while still learning! From here it's a short step to your own full-time Radio Shop or a good Radio job!

### Future for Trained Men is Bright in Radio, Television, Electronics

It's probably easier to get started in Radio now than ever before because the Radio Repair business is booming. Trained Radio Technicians also find profitable opportunities in Police, Aviation, Marine Radio, Broadcasting, Radio Manufacturing, Public Address work. Think of even greater opportunities as Television and Electronics become available to the public!

#### Find Out What N. R. I. Can Do For You

Mail Coupon for Sample Lesson and my 64-page book. Read the details about my Course. Read letters from men I trained, telling what they are doing, earning. See how quickly, easily you can get started. No obligation! Just MAIL COUPON NOW in an envelope or paste it on a penny postal. J. E. SMITH, President, Dept. 7BP, National Radio Institute, Pioneer Home Study Radio School, Washington 9, D. C.

Our 33rd Year of Training Men for Success in Radio

# A TESTED WAY



# OWN BOSS

## LEARN RADIO BY PRACTICING IN SPARE TIME with Big Kits of Radio Parts I Send You!

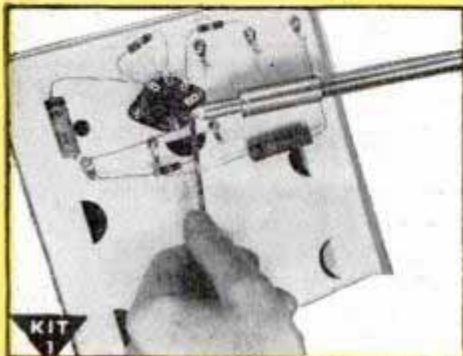

KIT 1

I send you Soldering Equipment and Radio Parts; show you how to do Radio soldering; how to mount and connect Radio parts; give you practical experience.



KIT 2

Early in my Course I show you how to build this N.R.I. Tester with parts I send. It soon helps you fix neighborhood Radios and earn EXTRA money in spare time.

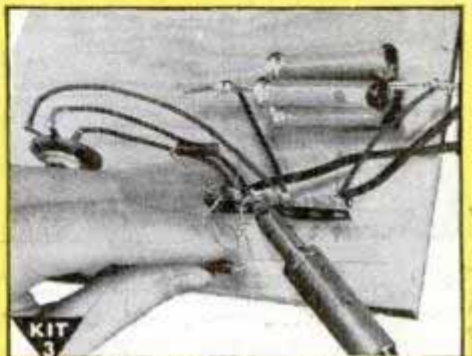

KIT 3

You get parts to build Radio Circuits; then test them; see how they work; learn how to design special circuits; how to locate and repair circuit defects.

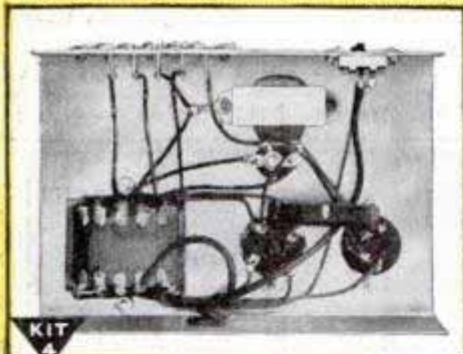

KIT 4

You get parts to build this Vacuum Tube Power Pack; make changes which give you experience with packs of many kinds; learn to correct power pack troubles.

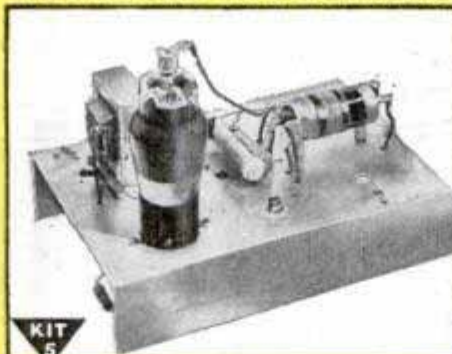

KIT 5

Building this A. M. Signal Generator gives you more valuable experience. It provides amplitude-modulated signals for many tests and experiments.

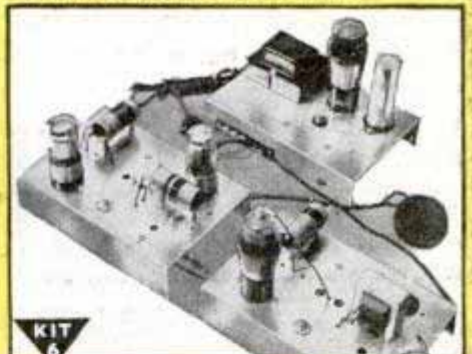

KIT 6

You build this Superheterodyne Receiver which brings in local and distant stations—and gives you more experience to help you win success in Radio.

## SAMPLE LESSON

### FREE

I will send you a FREE Lesson, "Getting Acquainted with Receiver Servicing," to show you how practical it is to train for Radio at home in spare time. It's a valuable lesson. Study it—keep it—use it—without obligation! Tells how Superheterodyne Circuits work; gives hints on Receiver Servicing, Locating Defects, Repair of Loudspeaker, I.F. Transformer, Gang Tuning, Condenser, etc. Thirty-one illustrations.



MAIL COUPON FOR FREE LESSON AND 64-PAGE BOOK

### Good for Both FREE

Mr. J. E. SMITH, President, Dept. 7BP  
National Radio Institute, Washington 9, D. C.  
Mail me FREE, without obligation, Sample Lesson and 64-page book about how to win success in Radio—Television, Electronics. (No salesman will call. Please write plainly.)

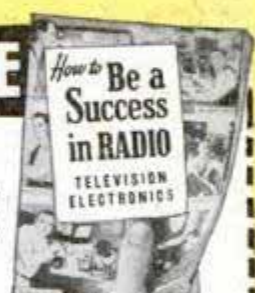

Age.....  
Name.....  
Address.....  
City..... Zone..... State.....

Approved for Training under GI Bill

TO GOOD PAY



**\$2000**  
of Old Line Legal Reserve  
**LIFE INSURANCE**  
(at age 21) \$ **1.78** A MONTH\*  
**ONLY** — Other ages  
in proportion  
\*One Half Permanent Rate in effect 5<sup>th</sup> year

Buy as little as \$1500. of this solid protection—or more—at proportionately low rates. *But buy your Postal Policy now!*  
Postal Life of New York has specialized for 40 years in insurance by mail and over the counter. The savings due to this direct dealing are passed on to policy holders. Current dividends 9½%. Further savings are made if premiums are paid quarterly, semi-annually or annually.

**POSTAL LIFE OF NEW YORK**  
operates under the rigid New York State Insurance Laws and has paid out over

**\$60,000,000.00**

to its Policy Holders and Beneficiaries.  
Postal issues all Standard Policies to men or women, from ages 10-60, at low cost.  
Send coupon today for rates on this Modified "4" Policy at your age and other details. *Life Insurance is vital!*

**CLIP AND MAIL COUPON TODAY**

**POSTAL LIFE INSURANCE COMPANY**  
511 Fifth Ave., Dept. M-668  
New York 17, N. Y.

Mail me without obligation complete information about your low-cost Modified "4" Policy at my age.

Name .....

Date of Birth .....

Occupation .....

Address .....

(Street and No., Zone, City and State)

**EASY to  
PLAY**



Pitched in G or C

**Order TO-DAY**

*The New Luellen*  
**HARMONICA**

Most wonderful pocket instrument ever made is the harmonica. Easy to master, fun for Everyone. The Luellen has 10 holes, 20 notes. Key of G or C (state choice). Brass reeds and plates. Postpaid Only..... **\$2.35**  
**INSTRUCTION BOOK.** Simple for youngest child. No notes, scales nor exercises. Lesson charts show everything. Includes popular songs. Price 35 cents. Here's our special introductory offer: The Instructor and the Harmonica, both postpaid, both for \$2.70. Send Check or Money Order Today.  
**JOHN LUELLEN & CO., 17034 Page Avenue, Dept. 203, Hazelcrest, Ill.**



**START  
SMALL  
GROW  
BIG**

**START YOUR OWN  
REFRIGERATOR  
REPAIR SHOP!**

Learn to install and repair all types of REFRIGERATION and AIR-CONDITIONING equipment. You can start your own shop with as little as \$50 worth of tools. We show you how. Our practical, shop-tested home-training prepares you quickly and easily during your spare time, for a job or your own business in this fast-growing profitable industry. Send for FREE BOOKLET today. No obligation.

**MECHANICS TRAINING SCHOOL**  
7217 S. Broadway, Dept. P102 Los Angeles 3



**AMAZING DISCOVERY!** Corrects poor penmanship in few days—big improvement in 3 hours. Write, Ozment, 34, St. Louis, Mo., IMMEDIATELY.

**PLAY GUITAR  
LIKE THE  
COWBOYS  
DO... 8 1/2¢  
A LESSON**



Just out—very latest guaranteed, simple, easy method. Play cowboy songs the Western way in a few minutes by ear. Surprise and amaze your friends. Be in big demand at parties, camps, public entertainments, on the radio, etc. 12 Complete Lessons. **SEND NO MONEY.** Pay postman only \$1.00 plus postage and C.O.D. charges, or send \$1.00 and get EXTRA SONGS all postpaid. (Canada, \$1.25 money order only.) Nothing else to buy. Positive money back guarantee. *Rush order today.*

**WESTERN RANGER STUDIOS, Dept. 152, Hutchinson, Kans.**



**LEARN PORTRAIT PAINTING  
AT HOME**

• Previous art training or talent NOT necessary. This new Stuart System teaches you, in 11 simple, easy-to-follow lessons, to make exact charcoal and oil likenesses. Guidance for your every step. Send for free book today.

**STUART STUDIOS.**  
121 Monument Circle, Room 62, Indianapolis 9, Ind.  
Please send me free book and outline of lessons.

Name.....  
Street.....  
City.....State.....



# INVENTORS

The patent laws provide that any new and useful art, machine, article of manufacture, composition of matter, or design, or any new and useful improvement thereof, may be patented if the act of invention is involved. Therefore, every inventor with a valuable invention should take advantage of the patent laws and proceed for patent protection in order to safeguard his rights.

A patent gives the inventor the exclusive right to prevent others from making, using, or selling the invention claimed in the patent for a period of 17 years.

The patent laws were enacted for the benefit of the inventor to give him protection for the features of his invention which are patentable. These features must be properly and concisely set forth and claimed in a formal application for patent in order to comply with the requirements of the U. S. Patent Office. For that reason, the Patent Office advises the inventor to engage a competent registered patent attorney to prepare his application for patent and represent him before the U. S. Patent Office Examiner.

A specially prepared booklet containing detailed information with respect to patent protection and procedure will be forwarded to you without obligation upon request.

**Patents**  
**Trademarks**  
**Copyrights**

*Registered Patent Attorneys*

**CLARENCE A. O'BRIEN**  
**& HARVEY B. JACOBSON**

71-B District National Building + Washington 5, D. C.

CLARENCE A. O'BRIEN & HARVEY B. JACOBSON  
Registered Patent Attorneys  
71-B District National Bldg., Washington 5, D. C.

Please send me booklet containing information regarding patent protection and procedure, and also "Record of Invention" form. This request does not obligate me.

Name \_\_\_\_\_

Address \_\_\_\_\_

City \_\_\_\_\_ State \_\_\_\_\_

(Please write or print plainly.)



# NOW SPRAYBERRY RADIO TRAINING

## GIVES YOU 8 BIG KITS OF RADIO EQUIPMENT

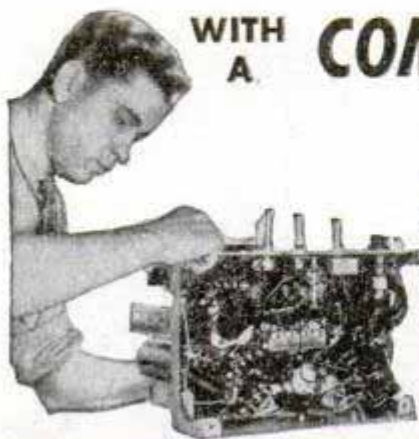

WITH A COMPLETE 6 TUBE SUPER-HETERODYNE RECEIVER

**YOU LEARN RADIO SERVICING THROUGH INTENSIVE "SHOP-BENCH" PRACTICE**

### YOU DO EXPERIMENTS, CONSTRUCTION, TROUBLE-SHOOTING

I'll show you how to perform over 175 instructive Experiments—how to build countless Radio Circuits. You'll learn a new, fast way to test Radio Sets without mfg. Equipment.



I give you a fine, moving-coil type Meter Instrument on Jewel Bearings—with parts for a complete Analyzer Circuit Continuity Tester. You learn how to check and correct Receiver defects with professional accuracy and speed.

You'll get valuable experience and practice building this Signal Generator and multi-purpose Tester. Makes a breeze out of fixing Radios and you don't have to spend money on outside, ready-made equipment.



Soldering, wiring, connecting Radio parts . . . building circuits with your own hands—you can't beat this method of learning. When you construct this Rectifier and Filter, Resistor and Condenser Tester, etc., you get a really practical slant on Radio that leads to a money-making future.

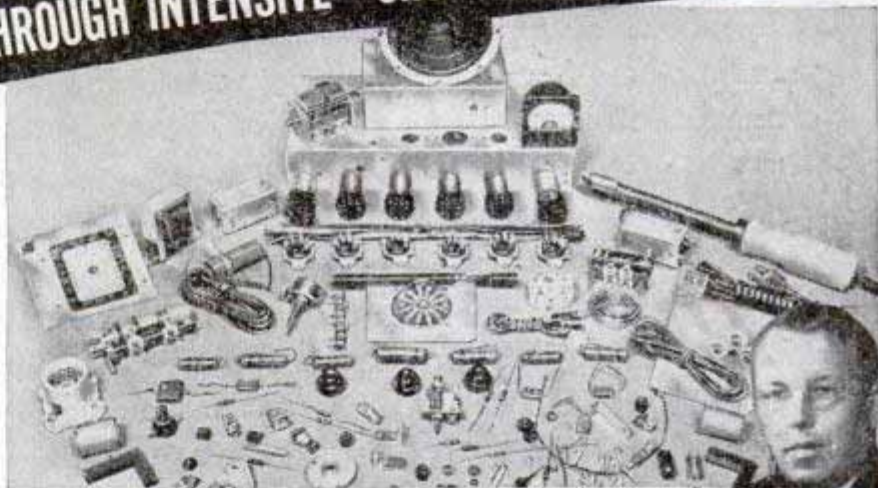

### HERE'S THE LATEST, SIMPLEST WAY TO TRAIN at HOME for a GOOD LIVING in RADIO-ELECTRONICS & TELEVISION

I train your mind by putting you to work with your hands on a big 6-Tube Superheterodyne Receiver. And, believe me, when you get busy with real Radio Parts—8 big Kits of them—you really LEARN Radio and learn it RIGHT! You get the practical stuff you need to be useful in Radio, and that's what it takes to make money. You don't have to worry about what to do with these 8 Kits of Parts. Step by step, I show you how to build circuits, test, experiment, trouble-shoot. And you don't need any previous experience. The Sprayberry Course starts right at the beginning of Radio! You can't get lost! Simplified lessons, coupled

with real "Shop" practice, makes every subject plain and easy to understand and remember.

#### A BUSINESS OF YOUR OWN . . . OR A GOOD RADIO JOB

Soon after you begin Sprayberry Training, I'll send you my sensational BUSINESS BUILDERS. You'll find out how to get and do neighborhood Radio repair jobs for nice profits and rich experience while learning. This sort of work can easily pave the way for a Radio Service business of your own. But with Sprayberry Training, you're not limited. You can swing into any one of the swiftly expanding branches of Radio-Electronics INCLUDING Radio, Television, FM, Radar, Industrial Electronics. Be wise! Decide now to become a fully qualified RADIO-ELECTRONICIAN. Get full details about my Training at once! Mail coupon below for my 2 big FREE Books.

### SEND FOR THESE FREE BOOKS



"How to Read Radio Diagrams and Symbols"

Here's a valuable and wonderfully complete new book which explains in simple English how to read and understand any Radio Set Diagram. Includes translation of all Radio symbols. Send for this volume at once! It's free! Along with it, I will send you another Big Free book describing in detail my Radio-Electronic Training.

#### SPRAYBERRY ACADEMY OF RADIO

F. L. Sprayberry, President, Room 1027, Pueblo, Colorado

Please rush my FREE copies of "How to MAKE MONEY in RADIO, ELECTRONICS and TELEVISION," and "HOW to READ RADIO DIAGRAMS and SYMBOLS."

Name ..... Age .....

Address .....

City ..... State .....

(Mail in envelope or paste on penny postcard)

**MAIL COUPON TODAY!**



# HOW JUST TWO WORDS TURNED MAC INTO A HE-MAN!

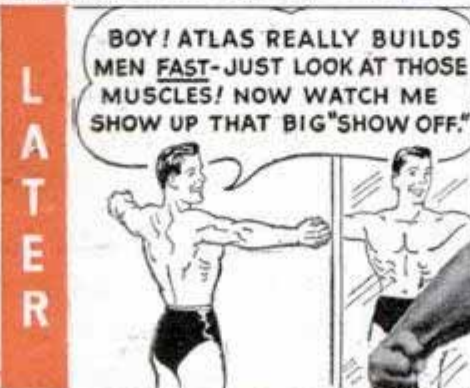
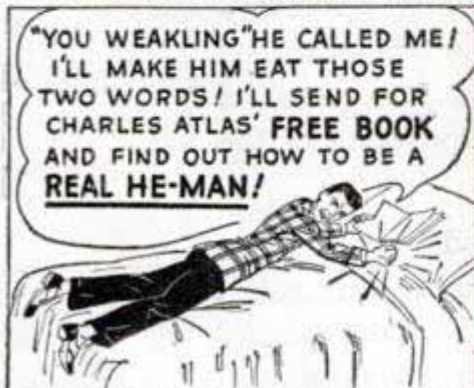

*Charles Atlas*  
— actual photo of Charles Atlas, winner and holder of the title, "The World's Most Perfectly Developed Man."

## I Can Make YOU a New Man, Too —in Only 15 Minutes a Day!

If you (like Mac) are fed up with being "pushed around"—if you're sick and tired of having the kind of a body that people PITY instead of ADMIRE—then give me just 15 minutes a day! That's all I need to PROVE I can make you a NEW MAN!

I know what I'm talking about. I was once a thin, peppy, 97-pound "bag of bones" myself. Then I discovered my now-famous secret, "Dynamic Tension." It turned me into "The World's Most Perfectly Developed Man." And I have used this secret to rebuild thousands of other scrawny, half-alive weaklings into perfect, red-blooded specimens of real HE-MANHOOD. Let me prove that I can do the same for YOU!

### "Dynamic Tension" Does It!

Using "Dynamic Tension" only 15 minutes a day, in the privacy of your own room, you quickly begin to put on muscle, increase your chest measurements, broaden your back, fill out your arms and legs. This easy, NATURAL

method will make you a finer specimen of REAL MANHOOD than you ever dreamed you could be!

I don't care how old or young you are, or how ashamed of your present physical condition you may be. If you can simply raise your arm and flex it I can add SOLID MUSCLE to your biceps—yes, on each arm—in double-quick time!

### FREE BOOK

Thousands of fellows have used my marvelous system. Read what they say—see how they look before and after—in my book, "Everlasting Health and Strength."

Send NOW for this book—FREE. It tells all about "Dynamic Tension." Shows you actual photos of men I've turned from puny weaklings into Atlas Champions. It tells how I can do the same for YOU. Don't put it off! Address me personally, Charles Atlas, Dept. 82, 115 East 23rd Street, New York 10, N. Y.



CHARLES ATLAS, Dept. 82  
115 E. 23rd Street, New York 10, N. Y.

I want the proof that your system of "Dynamic Tension" will help make a New Man of me—give me a healthy, husky body and big muscular development. Send me your free book, "Everlasting Health and Strength."

NAME.....  
(Please print or write plainly)

ADDRESS.....

CITY..... Zone No. .... STATE.....  
(if any)

Check here if under 16 for Booklet A.



# INVENTORS

## Patent Laws Encourage The Development Of Inventions

The Rules of Practice of the U. S. Patent Office advises—unless an inventor is familiar with such matters—that he employ a competent registered attorney, as the value of patents depends largely upon the skillful preparation of the specifications and claims.

The firm of McMorrow, Berman and Davidson is registered to practice before the U. S. Patent Office. Additionally, it maintains a staff of attorneys able to readily understand inventors' disclosures, to advise concerning patentability, and to prepare appropriate specifications and claims for filing with the Patent Office.

If an inventor believes he has an invention, a search of the most pertinent prior U. S. patents should be made and a report obtained relative to its patentability. Where such report indicates that the invention appears patentable, in order to secure protection, diligence should be exercised in making application for a patent.

## McMORROW, BERMAN & DAVIDSON

*Registered Patent Attorneys*

**PATENTS — TRADE MARKS — COPYRIGHTS**

1352 VICTOR BUILDING, WASHINGTON 1, D. C.

### McMORROW, BERMAN & DAVIDSON

*Registered Patent Attorneys*

1352 Victor Building, Washington 1, D. C.

Send me further particulars as to patent protection and procedure and "Invention Record" form at once. I understand that this request does not obligate me.

Name.....

Address.....

City..... State.....

(WRITE OR PRINT NAME CLEARLY)



# PUTTING THE WORLD ON WHEELS

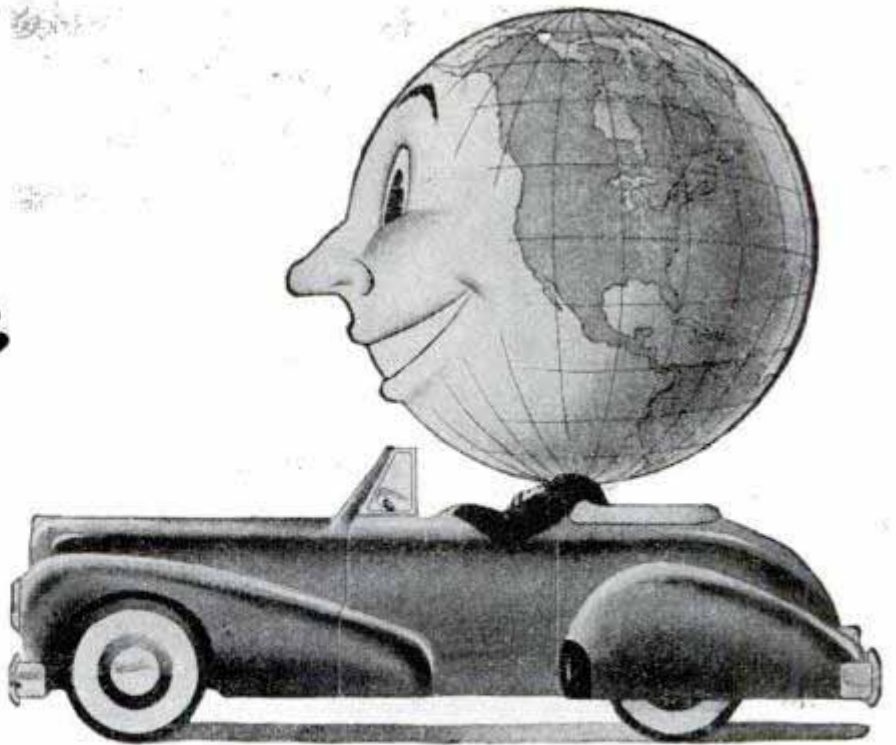

**T**HAT'S the achievement of the American motor car industry in little more than half a century. Graduates and students of 55-year-old I.C.S. have played quite a part in the whole dramatic story of automotive progress.

The I.C.S. contributors to the motor revolution include . . . the founder and builder of the second largest car manufacturing concern . . . a long-time production chief of another "Big 3" corporation . . . the chief engineer of an organization produc-

ing one of the most famous of the high-priced cars . . . the designer of the first all-steel body.

In every other leading industry, you'll find men who have studied I.C.S. Courses serving with equal distinction. They applied their ambition and intelligence to obtaining essential *training*. Do you have these qualities? Then I.C.S. can help you with the training you need to get to the top.

Mail the coupon—as so many successful men have done. Do it *now!*

## INTERNATIONAL CORRESPONDENCE SCHOOLS



BOX 5598-K, SCRANTON 9, PENNA.

Without cost or obligation, please send me full particulars about the course *before* which I have marked X:

### Air Conditioning and Plumbing Courses

- Air Conditioning
- Heating  Plumbing
- Refrigeration  Steam Fitting

### Chemistry Courses

- Chemical Engineering
- Chemistry, Analytical
- Chemistry, Industrial
- Chemistry, Mfg. Iron & Steel
- Petroleum Refining  Plastics
- Pulp and Paper Making

### Civil Engineering, Architectural and Mining Courses

- Architectural Drafting
- Architecture
- Bridge and Building Foreman
- Building Estimating
- Civil Engineering
- Coal Mining
- Contracting and Building
- Highway Engineering
- Lumber Dealer
- Reading Structural Blueprints
- Sanitary Engineering
- Structural Drafting

- Structural Engineering
- Surveying and Mapping

### Communications Courses

- Electronics
- Practical Telephony
- Radio, General
- Radio Operating
- Radio Servicing
- Telegraph Engineering

### Electrical Courses

- Electrical Drafting
- Electrical Engineering
- Electric Light and Power
- Lighting Technician
- Practical Electrician

### Internal Combustion Engines Courses

- Auto Technician  Aviation
- Diesel-Electric
- Diesel Engines  Gas Engines

### Mechanical Courses

- Aeronautical Engineering
- Aircraft Drafting
- Flight Engineer
- Foundry Work
- Heat Treatment of Metals

- Industrial Engineering
- Industrial Metallurgy
- Machine Shop
- Mechanical Drafting
- Mechanical Engineering
- Mold-Loft Work
- Patternmaking—Wood, Metal
- Reading Shop Blueprints
- Sheet-Metal Drafting
- Sheet-Metal Worker
- Ship Drafting  Ship-Fitting
- Tool Designing
- Toolmaking
- Welding—Gas and Electric

### Railroad Courses

- Air Brake  Car Inspector
- Diesel Locomotive
- Locomotive Engineer
- Locomotive Fireman
- Railroad Section Foreman

### Steam Engineering Courses

- Boilermaking
- Combustion Engineering
- Engine Running
- Marine Engineering
- Steam Electric  Steam Engines

### Textile Courses

- Cotton Manufacturing
- Rayon Weaving
- Textile Designing
- Woolen Manufacturing

### Business and Academic Courses

- Accounting  Advertising
- Arithmetic  Bookkeeping
- Business Correspondence
- Business Management
- Certified Public Accounting
- Commercial
- Cost Accounting
- Federal Tax
- First Year College
- Foremanship  French
- Good English  High School
- Higher Mathematics
- Illustrating  Motor Traffic
- Postal Service
- Salesmanship  Secretarial
- Sign Lettering
- Spanish  Stenography
- Traffic Management

Name \_\_\_\_\_ Age \_\_\_\_\_ Home Address \_\_\_\_\_

City \_\_\_\_\_ State \_\_\_\_\_ Present Position \_\_\_\_\_

Working Hours \_\_\_\_\_ A.M. to \_\_\_\_\_ P.M. Length of Service in World War II \_\_\_\_\_

Special tuition rates to members of the Armed Forces. Enrollment under the G.I. Bill of Rights approved for War II Veterans. Canadian residents send coupon to International Correspondence Schools Canadian, Ltd., Montreal, Canada.



# PATENT PROTECTION *for* INVENTORS

## A PATENT IS A VALUABLE RIGHT

On the basis of a constitutional provision Congress has established a system under which inventors may secure the exclusive right to prevent the unauthorized use, manufacture and sale of their inventions for periods of seventeen years. The inventor secures this protection by obtaining a patent from the United States Patent Office.

*The United States Patent Office*  
**RECOMMENDS**

in its Rules of Practice that "an applicant is advised, unless familiar with such matters to employ a competent registered patent attorney or registered patent agent, as the value of patents depends largely upon the skillful preparation of the specifications and claims."

*We*  
**RECOMMEND**

that you authorize us to conduct a search through the U. S. Patents pertinent to your invention and submit a report setting forth our opinion regarding its patentability.

**V**ICTOR J. EVANS & CO., has a staff of experienced registered patent attorneys, available to represent inventors in the preparation and prosecution of their cases before the Patent Office. Detailed information and the steps to be taken in obtaining patent protection will be furnished upon request.

FORM BELOW FOR MAILING CONVENIENCE

**VICTOR J.  
EVANS & Co.**

*Merlin M. Evans*  
REGISTERED PATENT ATTORNEY

230-B Merlin Building, Washington 6, D. C.

Please forward to me detailed information regarding procedure to obtain Patent Protection, together with your convenient "Evidence of Invention" form.

Name.....

Address.....

City and State.....

PATENTS

TRADEMARKS

COPYRIGHTS



# MEN! Whether You're 16 or <sup>up to</sup> 40.. *Learn* **ELECTRICITY**



A partial view of one of the Training Departments at Coyne

Get Ready quickly  
for the Field that offers  
**STEADY WORK and  
A REAL FUTURE!**

**FREE BOOK** shows how you can  
prepare for a **GOOD JOB NOW**

## "LEARN-BY-DOING" IN COYNE SHOPS

Start now to prepare for a Lifetime of Success. Get into Electricity, the essential field that will continue to offer good pay and a real future all through the years. Coyne trains you, **NOT** by correspondence, but by actual shop work right here in the Coyne Shops in Chicago on real electrical machinery. You get necessary theory in a practical way by lectures, blackboard illustrations and equipment demonstrations.

In the Big Coyne Shops you get practical "all-around" training . . . wiring, installing, operating, testing, repairing and servicing various types of Electrical and Electronic equipment . . . you work on real armatures, motors, generators, refrigerators, electronic controls, etc. No advanced education or previous electrical experience needed. Many of our students had no previous experience. Others had experience in one or two branches but realized they needed all-around training for the better jobs and advancement.

### Student Finance Plan

Don't let lack of money hold you back. Our "Pay-Tuition-after-Graduation" plan has helped thousands. Coupon brings details.

### Earn While Learning

Many earn while learning, to help take care of living expenses while here. When you have graduated, our Employment Department will give you Lifetime Employment Service.



### PREPARE FOR PERMANENT JOBS LIKE THESE

Light and Power Wiring  
Power Plant Work  
Armature Winding  
Substation Operator  
Maintenance Electrician  
Electrical Testing and Repair  
Signal Maintenance  
Industrial Electronics  
Electric Refrigeration  
and many others  
Our Employment Bureau for graduates gives FREE lifetime employment service.

### Industrial Electronics and Electric Refrigeration Training Now Included

Added training in these two great fields is now included with our Electrical Course. Industrial Electronics and Electric Refrigeration offer big opportunities. Get BOTH at Coyne!



*B.W. Cooke*

### MEN WITH PHYSICAL DISABILITIES—

We also have facilities for men with physical disabilities whether due to war or other causes. Check coupon for particulars if you have a physical disability of any nature.

### GET THE FACTS

Don't let lack of money keep you from sending in the Coupon now. Our Big FREE Book is full of facts and photographs which tell you about Coyne training. It also gives you the details of our "Student Finance" Plan, Part Time Employment Plan, Graduate Employment Service, Lifetime Membership, etc.

**OUR GRADUATE EMPLOYMENT SERVICE HAS LET-TERS FROM DOZENS OF FIRMS ASKING FOR COYNE TRAINED MEN FOR GOOD JOBS WITH A REAL FUTURE.**



This modern fireproof building is occupied entirely by the Coyne Electrical School.

### VETERANS

Coyne is also equipped to train those who qualify for training under the G. I. Bill of Rights. Check coupon for special G.I. Bulletin

**ADDED TRAINING IN  
INDUSTRIAL  
ELECTRONICS  
AND ELECTRIC  
REFRIGERATION  
Now Included!**

B. W. COOKE, Director

**COYNE ELECTRICAL SCHOOL**  
500 S. Paulina St., Dept. 27-72, Chicago, 12

**Send Today for  
this FREE Book!**

**B. W. COOKE, Director**  
**COYNE ELECTRICAL SCHOOL.**  
500 S. Paulina St., Dept. 27-72, Chicago 12, -IL.

Without obligation send big free illustrated book with facts about Coyne and details of "Student Finance" Plan and added training in Industrial Electronics and Electric Refrigeration you are now including.

- Send special G. I. Bulletin.
- Send physical disability details.

Name.....

Address.....

City.....State.....





**I'll PROVE I can make you, too, TOUGH as a MARINE**

..... and add Powerful POUNDS and Vital INCHES of DYNAMIC MUSCLE to your ARMS, LEGS, BACK, CHEST, and SHOULDERS

says **George F. Jowett**

**WORLD'S GREATEST BODY BUILDER**

**..OR IT WON'T COST YOU A CENT!**

Let me prove to YOU that you can put inches of dynamic muscles on your arms! Add inches to your chest! Broaden your shoulders and power-pack the rest of your body. I can do for you what I've done for thousands the world over, including many officers and men now in the U. S. and British Armed Forces!

**GIVE ME 10 MINUTES A DAY!**

**I'll Show You My Secrets Of Body Building**

I'll help you learn the "Progressive Power Method" through which I rebuilt myself from a physical wreck to the holder of more strength records than any other living athlete or teacher! No matter how skinny or flabby you are, you can learn my methods right in your own home. Through my proved secrets I show you how to develop your power, inside and out, until YOU are fully satisfied that you are the man you want to be. "The Jowett System," says R. F. Kelly, Physical Director of the YMCA, Atlantic City, "is the greatest in the world!"

If you want a physique that will inspire respect from men, and admiration from women... **ACT LIKE**

**A HE-MAN!** Decide at once! The famous book, "Nerves of Steel—Muscles Like Iron" will be included FREE! Priceless for the strength fan! Full of photos of marvelous power-bodied men who will show you what Jowett has done for them, and how he can do the same for you. Reach out... Grasp this Special Offer today!

**PROVE TO YOURSELF IN ONE NIGHT!**

Send only 25c for test Course, "Molding a Mighty Arm." Read it the evening it arrives—learn from experience the thrill you can give your muscles!

**SEND FOR THESE FIVE FAMOUS COURSES IN BOOK FORM ONLY 25c EACH or ALL 5 for \$1.00**

Jowett Institute of Physical Culture  
230 Fifth Avenue  
Dept. PM-72  
New York 1, N. Y.

*This Book Free!*



**BOOK WITH PHOTOS OF FAMOUS STRONG MEN MAIL COUPON NOW FREE**



Jowett Institute of Physical Culture  
230 Fifth Avenue, Dept. PM-72, New York 1, N. Y.  
George F. Jowett: Your proposition looks good to me. Send by return mail, prepaid, the courses checked below, for which I enclose ( ), include FREE book of PHOTOS.

- George F. Jowett Champion of Champions
- All 5 courses for... \$1
  - Molding a Mighty Arm 25c
  - Molding a Mighty Grip 25c
  - Molding a Mighty Back 25c
  - Molding a Mighty Chest 25c
  - Send all 5 C.O.D. (\$1 plus postage.) No orders less than \$1 sent C.O.D.

NAME ..... Age .....

(Please print plainly. Include Zone Number.)

ADDRESS .....

**Do You Make These Mistakes in English?**

MANY persons say "between you and I" instead of "between you and me"—or use "who" for "whom"—or don't know whether to spell certain words with one or two "e's" or "m's" or "r's," or with "ie" or "ei," etc. Every time you speak or write you show what you are. Mistakes in English reveal lack of education, refinement. Lack of language power prevents you from presenting your thoughts in the strongest way. Real command of English will help you reach ANY goal. Stop making mistakes in spelling, punctuation, pronunciation, grammar. Increase your vocabulary.



Sherwin Cody

**WONDERFUL INVENTION**

Only 15 minutes a day with Sherwin-Cody's new invention—and you can actually SEE your English improve. It teaches by HABIT—makes it easier to do the RIGHT way. Wonderful self-correcting lessons.

**FREE BOOK ON ENGLISH** Lack of language power may be costing you friendships, income, every year. See what Mr. Cody can do for you; it costs nothing to find out. Write this very minute for free book, "How You Can Master Good English in 15 Minutes a Day." It will prove a revelation. WRITE NOW. SHERWIN CODY SCHOOL OF ENGLISH, 52 B & O BLDG., Rochester 4, N. Y.

**LEARN MEAT CUTTING At Home—In Spare Time**



Get into the vital meat industry. Concise, practical Home Training based on 25 years proven instruction methods used at National's famous resident school. Prepares you for bigger pay as Meat Cutter, Supervisor, market manager or more money in your own store. Go as rapidly as your spare time permits. Diploma. Start NOW to turn your spare hours into money. Send for FREE bulletin today. No obligation.

National School of Meat Cutting, Inc., Dept. U-78, Toledo 4, Ohio

**LEARN MONEY-MAKING CARTOONING**

**IN SPARE TIME — by Easy Picture Chart Method**

Same Simplified Method that has helped train creators of "Terry & Pirates," "Freckles," "Out Our Way," "Winnie Winkle," "Regular Fellers," "Strange As It Seems," "The Neighbors," and many others. Earn while learning. Send 10c for Picture Chart (to test your ability), and full details. (State age.)



Landon School of Cartooning, Dept. 4792 Philadelphia 1 Pa.

*Learn Penmanship*

You can learn plain, rapid writing or fancy ornamental writing for social and business advancement, right in your own home during spare time by my Simplified Method. Write for my free book, "How to Become an Expert Penman," which shows what others have accomplished by taking my Courses. Send 10c for one of my favorite Pen Points and your name with a beautiful flourished bird written on a card. Write today. T. M. Tevis, Box 25K, Chillicothe, Mo.

**What Every Mason Wants**



We have important Masonic books for Blue Lodge, Chapter, Commandery, Scottish Rite, and Shrine.

Our Rituals Are Used the World Over. Send for free catalog of books and rituals for Masons, Odd Fellows, Knights of Pythias, Knights of Columbus, etc. EZRA A. COOK, Publisher, P. O. Box 796, PF, Chicago 90, Ill.

**Learn Public Speaking**

Learn theory and fundamentals at home—in spare time. Then acquire actual experience and practice. Send for FREE booklet "Power of Effective Speech." No obligation.

North American School, Dept. 1352  
1315 S. Michigan Ave., Chicago 5, Illinois

**MAKE MONEY AT HOME**

**RUBBER MOLDS** Low as 6¢ EA.



Amazing rubber mold-making outfit makes perfect flexible molds of plaques, ash trays, book-ends, etc. Molds cost 6c to 25c each. Each mold makes hundreds of novelties and gifts to sell for \$1.00 apiece and more! No experience necessary. Everything furnished. Quick and easy. Start profitable business in your home—sell to stores, gift shops, friends, resorts, road stands, by mail. Full or spare time. Write for complete FREE details and easy instructions.

SO-LO WORKS, Inc., Dept. R-800, Loveland, Ohio



# WHICH OF THESE *Opportunities* INTERESTS *You* MOST?

Accounting  
Air Conditioning  
Architecture & Building  
Automotive Engineering  
Aviation—Practical  
Aviation Drafting & Design  
Better Foremanship  
Bookkeeping  
Business Management

Contracting  
Diesel Engineering  
Drafting & Design  
Electrical Engineering  
Electricity—Practical  
Electronics, Industrial  
High School Courses  
Machine Shop Operations  
Mechanical Engineering

Plastics Engineering  
Plumbing—Practical  
Private Secretary  
Radio Operating & Servicing  
Railway Training  
Refrigeration  
Sheet Metal Pattern Drafting  
Shop Management  
Tool Making

## THINK! LOOK FORWARD!

Business is making big, new plans

Men and Women are preparing for the future

### WHAT ARE YOU DOING ABOUT YOUR TOMORROWS?

● Today, choose the job you want—and prepare for it. Or if you are already engaged in the work you like best, start training now for quicker promotion. Acquire the knowledge that will help you to get ahead faster, make more money and have greater security.

Invest part of your spare time in more rapid progress. Start training now, in spare time in your own home. Be ready to grasp your opportunity and step out ahead of those who lack the ability you have attained.

American School, founded in 1897 as an educational institution *not for profit*, can help you to reach your goal just as it has helped others during the past fifty years. Give serious thought to the list above. Pick one or more subjects that interest you. Then check the coupon at right, add your name and address and mail it at once. The school will send you details on its training plan and outline of study prepared by specialists. There is no charge, no obligation, so send the coupon immediately.

PRACTICAL, EFFECTIVE HOME - STUDY TRAINING SINCE 1897

Take This First Easy Step

**CHECK, CLIP AND MAIL COUPON NOW**

AMERICAN SCHOOL, Dept. G245, Drexel at 58th, Chicago 37, Ill.  
*Without obligation, Please send FREE and postpaid, bulletin and details of the Subject checked.*

- |                                                    |                                                |                                                                |
|----------------------------------------------------|------------------------------------------------|----------------------------------------------------------------|
| <input type="checkbox"/> PLASTICS ENG'R            | <input type="checkbox"/> Accounting            | <input type="checkbox"/> Drafting and Design for Men and Women |
| <input type="checkbox"/> Refrigeration             | <input type="checkbox"/> Electrical Engr.      | <input type="checkbox"/> Radio                                 |
| <input type="checkbox"/> Architecture and Building | <input type="checkbox"/> Electricity-Pract.    | <input type="checkbox"/> High School                           |
| <input type="checkbox"/> Contracting               | <input type="checkbox"/> Electronics, Industr. | <input type="checkbox"/> Air Conditioning                      |
| <input type="checkbox"/> Practical Plumbing        | <input type="checkbox"/> Bookkeeping           | <input type="checkbox"/> Mechanical Eng.                       |
| <input type="checkbox"/> Automotive Engineering    | <input type="checkbox"/> Private Secretary     | <input type="checkbox"/> Shop Management                       |
| <input type="checkbox"/> Aviation Drafting         | <input type="checkbox"/> Diesel Engineering    | <input type="checkbox"/> Tool Making                           |
| <input type="checkbox"/> Aviation                  | <input type="checkbox"/> Sheet Metal           | <input type="checkbox"/> Better Foremanship                    |
| <input type="checkbox"/> Business Mgmt             | <input type="checkbox"/> Pattern Drafting      | <input type="checkbox"/> Machine Shop Operations               |
| <input type="checkbox"/> Railway Training          |                                                |                                                                |

Name..... Occupation.....

Address..... Age.....

City..... State.....

**AMERICAN SCHOOL**

Dept. G245, Drexel at 58th Street, Chicago 37



Listen to this Record!

# SPEAK SPANISH

FRENCH, GERMAN, OR ITALIAN

BIG OPPORTUNITIES and JOBS awaiting Americans who speak Spanish. Learn as easily as a child learns—“BY LISTENING” to these NEW CORTINA recordings.

**Only 15 Minutes a Day**

The CORTINAPHONE Method FAMOUS FOR 60 YEARS teaches you to speak SPANISH LIKE A NATIVE—right in your own home, relaxed and at ease. THOUSANDS have found it the most fascinating, most satisfactory method. Here is the quick, easy way to learn Spanish for PLEASURE and BUSINESS. Investigate!

**Sent on 5 Days Approval**



“THE CORTINA SHORT-CUT” tells just what you want to know. Interesting. Get it!

**Write Today—NOW!**

CORTINA ACADEMY (Language Specialists for 60 Years) Dept. 642, 105 West 40th Street, New York 18, N. Y.

Please send me—without obligation—your free booklet, “The Cortina Short-Cut.” I am interested in (mark):

SPANISH  French  Italian  German

Name.....

Address.....

## AUDELS Carpenters and Builders Guides 4 vols. \$6

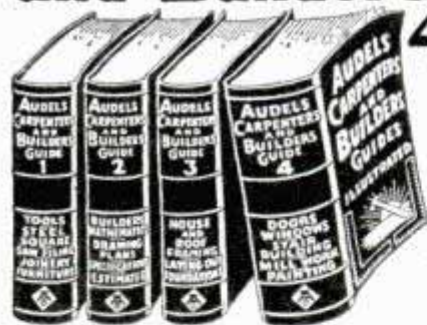

**Inside Trade Information** for Carpenters, Builders, Joiners, Building Mechanics and all Woodworkers. These Guides give you the short-cut instructions that you want—including new methods, ideas, solutions, plans, systems and money saving suggestions. An easy progressive course for the apprentice and student. A practical daily helper and Quick Reference for the master worker. Carpenters everywhere are using these Guides as a Helping Hand to Easier Work, Better Work and Better Pay. To get this assistance for yourself, simply fill in and mail the FREE COUPON below.

**How to use the steel square—How to file and set saws—How to build furniture—How to use a mitre box—How to use the chalk line—How to use rules and scales—How to make joints—Carpenters arithmetic—Solving mensuration problems—Estimating strength of timbers—How to set girders and sills—How to frame houses and roofs—How to estimate costs—How to build houses, barns, garages, bungalows, etc.—How to read and draw plans—Drawing up specifications—How to excavate—How to use settings 12, 13 and 17 on the steel square—How to build hoists and scaffolds—skylights—How to build stairs—How to put on interior trim—How to hang doors—How to lay floors—How to paint**



**THEO. AUDEL & CO., 49 W. 23rd St., New York City**

Mail Audels Carpenters and Builders Guides, 4 vols., on 7 days' free trial. If O.K. I will remit \$1 in 7 days, and \$1 monthly until \$6 is paid. Otherwise I will return them. No obligation unless I am satisfied.

Name.....

Address.....

Occupation.....

Reference..... PM

**SEND FOR THIS FREE!**

**HOW TO BREAK and TRAIN HORSES**

Make money with horses. Every farmer, every lover of horseflesh should have a copy of this booklet. If you want to know how to break, train and make money with horses, write today for full information FREE, together with my special offer of a course in Animal Breeding. If you are interested in Gaiting and Riding the saddle horse check here.  Do it today—now. You'll never regret it.

**BEERY SCHOOL OF HORSEMANSHIP**  
Dept. 1102-D Pleasant Hill, Ohio

## IMPROVE YOUR PLAYING



**PIANISTS**—Send for FREE Booklet showing how you may greatly improve your technique, accuracy, memorizing, sightreading and playing thru Mental-Muscular Coordination. Quick results. Practice effort minimized. Used by famous pianists, organists, teachers and students. No obligation.

BROADWELL STUDIOS, Dept. 157-B Covina, Calif.

## BOOKS LOCATED!

WHAT BOOKS DO YOU WANT?  
Out-of-Print and Hard-to-Find Books World-wide search service, sponsor or later locates almost any book ever printed. List your wants for all books, old or new. Prices reasonable. No obligation.

22 East 17th St., SEARCHLIGHT BOOK CLUB New York 3, N. Y.

**LAW**

STUDY AT HOME for PERSONAL SUCCESS and LARGER EARNINGS. 38 years expert instruction—over 108,000 students enrolled. LL.B. Degree awarded. All texts furnished. Easy payments. Send for FREE BOOK—“Law and Executive Guidance.”

**AMERICAN EXTENSION SCHOOL OF LAW**  
Dept. 74-M, 646 N. Michigan Ave., Chicago 11, Ill.

**THERE'S MONEY IN CARTOONS!**

RAYE BURNS will teach you HOW to CREATE ORIGINAL CARTOONS at home that you may SELL! Course contains 26 lessons and over 500 illustrations. All for Only..... **\$2.85**

Send name and address for free details.

RAYE BURNS SCHOOL, Dept. M, Box 3583, CLEVELAND, OHIO

## WATCHES WANTED Broken or Usable

All kinds. Highest Prices paid for jewelry, rings, spectacles, gold teeth, diamonds, Sterling Silver, etc. Cash mailed promptly. Write for free shipping container.

LOWE'S, Dept. PM, Holland Bldg., St. Louis 1, Mo.

SAY YOU SAW IT IN POPULAR MECHANICS

**APTITUDE TESTS** discover the kind of work or studies best for your success! You get a personal report—a guide for life—more happiness—more prosperity. For men, women, boys and girls. Write for complete facts.

**VOCATIONAL COUNSELING INSTITUTE**  
956 Maccabees Bldg., Detroit 2, Michigan

**MONEY for MEN ALL FREE**

THE PLASTEX Industry needs manufacturers on small scale and for big production of Lamp and Clock Stands, Art Goods and Novelties in Plaster and Marble imitation. Experience unnecessary. 3/4" material makes regular 10c store sellers. Rubber moulds furnished for speed production. Small investment brings good returns. Big chain store orders now being placed. Ambitious men have chance for real prosperity. Our Free booklet will interest and benefit you.

PLASTEX INDUSTRIES, Dept. P, 1085 Washington Ave., New York, N.Y.



# Selected as one of the Nation's Foremost

**RADIO-ELECTRONICS** courses  
of DeForest's Training, Inc.  
recommended by the New  
York Museum of Science  
and Industry

DeForest's Training, Inc. wins Museum's Certificate of Merit for Home Study and Residence courses... First school of its kind to be so honored



ELLERY L. PLOTTS,  
Nationally Known Radio  
Station Consulting Engineer



You can build 133 Modern Experiments from this Equipment

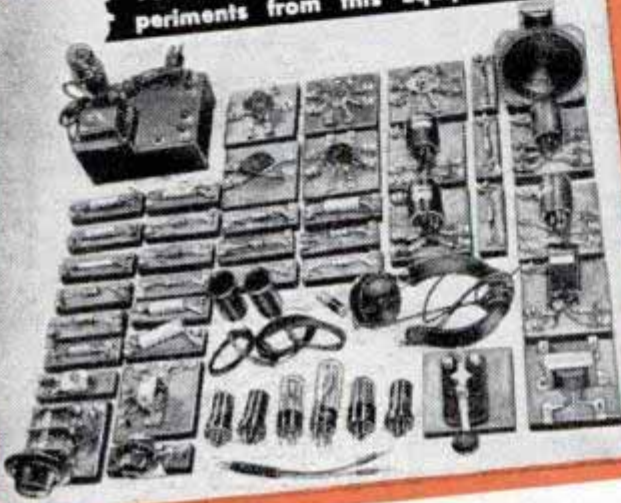

## Enjoy Real Movies at Home

Through the courses of DeForest's Training, Inc., you not only learn-by-doing and reading, but you also have the use of a motion picture projector and 12 reels of film. No other course affords this opportunity to learn important Radio fundamentals faster and easier at home. DeForest's Training, Inc., also includes instruction in Motion Picture Sound Equipment, FM Radio and Television.



## Says Course Is Worth Many Times Cost

"I think the visual training part of your course is 'tops'! I think your course is worth many times more than what you actually charge for it. I truly believe this is the field to get into for any man interested in a real future and the welfare of his family's peace and security."



HAROLD J. ELLIOTT,  
701 Miller Ave., Ann Arbor, Michigan

## Nationally Known Radio Engineer Endorses DeForest's Training, Inc.

"The Home Study course of DeForest's Training, Inc., is a short cut to the fascinating and profitable field of Radio and Electronics," says Ellery L. Plotts, nationally known radio station consulting engineer and former special research associate at Harvard University's Radio Research Laboratories.

"Now is the time . . . to prepare to enter the field of Radio and Electronics . . . No greater opportunity is afforded the high school student . . . the war veteran . . . or the man who wants to make more money," says Ellery L. Plotts, nationally known radio station consulting engineer and former special research associate at Harvard University's Radio Research Laboratories.

"Investigation reveals that these DeForest's Training, Inc., courses are as modern as they are thorough. Each home study student has the use of a motion picture projector, which gives advantages heretofore unknown in home study training. The comprehensive kits of Radio parts are unusually valuable inasmuch as they enable a man to get practical, on-the-job experience in his own home. Further study enables me to highly recommend either the home study or resident course," says Ellery L. Plotts.

## Choose This Selected Course for Radio-Electronic Training

DeForest's Training, Inc., only, gets you off to a brighter future by supplying "ALL 4" of these major training benefits AT HOME . . . (1) Learn-By-Seeing Movies, (2) Illustrated Loose-Leaf Lessons, (3) Learn-By-Doing Radio Equipment and (4) Employment Service.

8 Kits of quality Radio parts provide the practical experience you need . . . enabling you to build and operate SEVEN different Radio Receivers, a Radio Telephone, Wireless Microphone, Photo Electric Cell Devices and dozens of other marvels in this Electronic Age.

Get the complete facts now and see how quickly YOU may get started toward this field of outstanding opportunity. Mail the coupon today.

## WRITE TODAY FOR FREE INFORMATION

DeFOREST'S TRAINING, INC.  
2533-41 N. Ashland Ave., Dept. PM-D2  
Chicago 14, Illinois, U. S. A.

Send me your big book "VICTORY FOR YOU," showing how I may make my start in Radio-Electronics with your modern home training plan. No obligation.

Name..... Age.....

Address..... Apt.....

City..... Zone..... State.....

If under 16, check here for special information.

If a discharged veteran of World War II, check here.



**DeFOREST'S**  
TRAINING, INC.  
CHICAGO, ILLINOIS





## SO IT NEEDS FIXING

By S. T. CHRISTENSEN

*the "Fix-it Man"*

**W**ELL, I guess I'm the fellow to see, for I've repaired thousands of refrigerators (home and commercial both), vacuum cleaners, radios, washing machines, irons, fans, lamps, mangles, motors, etc. In fact, many of my customers call me their "electrical appliance doctor." And, "doctoring," I might add, has paid me a good substantial income for quite a few years. Funny, in a way, how I got started. Always liked to tinker and by experimenting around I found that most electrical appliances had many things in common. That, regardless of what the appliance was used for, or who the manufacturer was, the basic principles were much the same. From fixing my own appliances to fixing friends' and then for strangers at a fee, seems now to have been but a small step.

### What to Charge?

At first, I let the owner decide the charge and, frankly, I was amazed at what I earned per hour. But then, when one figures what initial costs are involved in buying most electrical appliances, one can readily see that spending extra dollars for repairs is well worth while. Before long I was making more in my spare time repairing than from my regular job. The result . . . I went into business for myself. When war came, business boomed, for new appliances were not available.

For a while, repair parts (needed on some

jobs) were a little difficult to get. But that situation quickly adjusted itself and many repair parts were given the high priority rating of AA2. After all, we had to provide for the health and well-being of our civilian population.

### The Future Offers

Friends ask me about my future. And, I think I've got a grand one. Age is no handicap in repairing. I have in my files enthusiastic letters from repairmen ranging in age from 18 to 79 years. Now the war is over we are certain to see hundreds of new products on the market . . . products that the average person never dreamt of. These new products and our old appliances are all going to need at some time or other "fixing." Well, I'll still be the fellow to do it. The field open for appliance repairmen is unlimited. I don't worry at all about too much competition.

### If You Are Ambitious

To the contrary, I've prepared a complete course, chuck full of simple, easy to understand photos and drawings and written in the same non-technical language as this article. I know the course is good, because I have hundreds of men all over the country writing to me telling me how the course has helped swell their pockets with cash. If you too want to prepare now for your future, I suggest you read the next page and send me the handy coupon."

Advertisement





**BIG MONEY  
INDEPENDENCE**

*A PROFITABLE  
LIFETIME  
BUSINESS  
OF  
YOUR OWN!*

# LEARN ELECTRICAL APPLIANCE REPAIRING

## PREPARE NOW FOR THE FUTURE

If now employed, start your home appliance repair business NOW in your spare time and be set with a business of your own no matter what happens. You don't need elaborate fixtures or expensive equipment to be a successful repairman. Operate from your garage, basement, vacant store, etc. Work as many hours as you wish—the home appliance repairman is his own boss. It is a profitable occupation for on many types of repairs it is not unusual for a repairman to charge on the basis of \$5.00 to \$6.00 per hour. Don't gamble with your future—learn a trade that will always support you. Remember, as long as electrical appliances are used, there will be a need for electrical appliance repairmen.

If you are at all mechanically inclined—can hold and use tools—then you have all of the qualifications required for becoming a big money earning home appliance repairman. It does not matter if you have not had a great deal of schooling or had previous experience along these lines—WE WILL TEACH YOU. Age should be no barrier—nor should any minor physical handicap.

### New Course Tells All

Profusely illustrated, our new course shows you in simple, easy to understand language and drawings how to make each repair on refrigerators, vacuum cleaners, washing machines, motors, etc. Explains and gives you a working knowledge of electricity, welding, nickel plating, etc. Shows you how to build the power tools you need and how to solicit and keep business coming to you. Not a theory course but an honest to goodness course written by and used by repairmen the country over. Price of course is so low that the savings on your own household appliance repairs will quickly pay for it. Act now! Mail the handy coupon below today.

#### Read What Our Students Say About Course

I really believe your course the best investment a mechanically minded man can make.—Claude E. Allen, Indianapolis, Ind.

I have received your Course in Appliance Repairing and I must say I am well pleased with same. I am only sorry I did not have said Course some years ago. I have learned so much more through this course I would not part with it.—Charles Schwarz, Hamilton, Ohio.

The Course in Appliance Servicing arrived a few days ago. Want to take out a few minutes of my valuable time to let you know that this is just what I have been looking for ever since I opened up my Fix-It shop. I must admit that you told the truth when you said that it contains quite a bit more information than I bargained for.—P. J. Brett, Sebring, Ohio.

I am a mechanic for the Western Union Telegraph Co. Three days after receiving the lessons in refrigeration I earned the exact cost of the course.—Henry S. Lee, Washington, D. C.

I work day times at the shipyard and after 4:00 P.M. I operate from my cellar and garage. I average \$10.00 to \$15.00 clear every day.—Walter Hanhy, Brockton, Mass.

### GET STARTED TODAY — MAIL THIS COUPON

**CHRISTY SUPPLY CO.**  
2835 N. Central Ave., Dept. D-4203  
Chicago 34, Illinois

Please send me free illustrated literature about America's Fastest Growing Industry — ELECTRICAL APPLIANCE REPAIRING.

Name.....

Address.....

City..... State.....



# Do you want

- ..to go to College?
- ..or to enter a Profession?
- ..or get an Office Position?

(Such as Accounting, Architecture, Nursing, Dentistry; Teaching, Social Work, Osteopathy, Beauty Culture, Optometry, Embalming, Chiropody, Law, Medicine, etc.)

To get anywhere, you practically **MUST** finish High School **FIRST**. You can complete our simplified High School Course in **SPARE** time at home, as **FAST** as your time and abilities permit. Equivalent to resident school work—prepares you for college, pre-professional examinations, business, industry. Standard texts furnished. Diploma. Credit for H. S. subjects already completed. Single subjects if desired. Low tuition, easy terms. American School, Chicago, est. 1897—endorsed by educators. Finish your high school education **NOW**, Write **TODAY!**

## High School Course at Home

Many Finish in 2 Years

American School, Dept. H-245, Drexel Ave. at 58th St., Chicago 37, Ill.

Gentlemen: Send me **FREE** information covering special training in subjects checked below. No obligation on my part.

- |                                                      |                                                              |
|------------------------------------------------------|--------------------------------------------------------------|
| <input type="checkbox"/> High School Course          | <input type="checkbox"/> Diesel Engineering                  |
| <input type="checkbox"/> Architecture and Building   | <input type="checkbox"/> Drafting and Design for Men & Women |
| <input type="checkbox"/> Automotive Engineering      | <input type="checkbox"/> Plastics                            |
| <input type="checkbox"/> Business Management         | <input type="checkbox"/> Private Secretary                   |
| <input type="checkbox"/> Electrical Engineering      | <input type="checkbox"/> Mechanical Engineering              |
| <input type="checkbox"/> Elec. and Gas Refrigeration | <input type="checkbox"/> Aviation                            |
| <input type="checkbox"/> Air Conditioning            | <input type="checkbox"/> Salesmanship                        |
| <input type="checkbox"/> Railway Training            | <input type="checkbox"/> Radio                               |
| <input type="checkbox"/> Electronics, Industrial     |                                                              |

Name.....

Address.....

## OIL BURNER INFORMATION IN A HANDY FORM

JUST OUT!



A POCKET COMPANION THAT ANSWERS YOUR QUESTIONS!

**AUDELS OIL BURNER GUIDE** — A new practical, concise treatise, 384 pages—31 Chapters — 321 Diagrams and Illustrations — covering Domestic and Industrial Oil Burners.

New from Cover to Cover, for mechanics interested in Oil Burners. Gives practical inside working knowledge of theory, construction, installation, operation, testing, servicing and repair of all types of oil burners. Includes electrical hook-ups and wiring diagrams of automatic control systems.

PRICE \$1 POSTPAID

Get this information for yourself. Mail coupon today. No obligation unless satisfied.

ASK TO SEE IT

**AUDEL, Publishers, 49 W. 23rd St., New York 10, N.Y.**

Please mail **AUDELS OIL BURNER GUIDE** (Price \$1). If satisfactory, I will remit \$1 on its safe arrival, otherwise I will return the book.

Name.....

Address.....

Occupation.....

Employed by.....

## How to Start YOUR OWN BUSINESS

Amazing Postwar Development Now Gives You the Opportunity to Make Money Fast!

Startling scientific discovery, just now becoming available for general use, will enable you to start your own business and reap great profits! **LIQUID MARBLE**, one of the most revolutionizing and rapidly expanding industries, offers a great opportunity to all enterprising men and women. This is one of the few industries in which home manufacturers thrive and prosper. You can start even on a spare time basis in your own home, and expand rapidly into a full time business, paying good profits.

Make **LIQUID MARBLE** the amazing Plastic, with a thousand uses. **LIQUID MARBLE** can be poured into **FLEXIBLE MOLDS** for casting all kinds of artistic and serviceable articles such as: ornaments, novelties, desk sets, paper weights, book-ends, souvenirs, statuary, toys, etc.

**FLEXIBLE MOLDS** Make your own **FLEXIBLE MOLDS**. The cost is low—in fact, a large sized mold costs but a few cents. Hundreds of casts can be taken from a single mold.

**NO EXPERIENCE NEEDED!** No skill or previous knowledge is necessary. All you do is follow our easy-to-understand instructions.

**UNLIMITED MARKET** The market is literally unlimited. You will find steady year-round demand in your own community. Your problem will not be in selling but in supplying the huge pent-up demand. Moreover, we supply you with names of big buyers for your finished products.

**WRITE TODAY** Bing Products will show you how to start with a small investment and build a permanent, independent, profitable business! Don't fail to grasp this opportunity! Write today for **FREE CATALOG**.

### BING PRODUCTS

Dept. A-15, 88 Broad Street

BOSTON 10, MASS.

## LAW...

**STUDY AT HOME** Legally trained men win higher positions and bigger success in business and public life. Greater opportunities now than ever before.

**More Ability: More Prestige: More Money** We guide you step by step. You can train at home during spare time. Degree of L.L.B. We furnish all text material, including 14-volume Law Library. Low cost, easy terms. Get our valuable 48-page "Law Training for Leadership" and "Evidence" books **FREE**. Send **NOW**. **G. I. APPROVED.** **LASALLE EXTENSION UNIVERSITY, 417 South Dearborn Street** A Correspondence Institution Dept. 264-L, Chicago 5, Ill.

## PRINTING PAYS BIG

"Make your future secure. Prepare for a highly paid position or a print shop of your own. Students throughout the world are enthusiastic in their praise of our training program and the personal attention given each student. Rush name today for free literature and sample lesson. No salesman will call. Write Dept. M-106.

International School of Printing, Box 334, Dayton, Ohio

## ARTISTS MAKE MONEY

Do you like to draw? Send name, address, age and occupation for **FREE ART TEST**, to find out your ability.

**ART INSTRUCTION, Inc.**

2137 ART INSTRUCTION BLDG., MINNEAPOLIS 15, MINN.

## Train Your Own HORSES!

Colts — Stock Horses — Circus Horses  
Gait Show Horses — Write for **FREE BOOK**  
**ANIMAL LOVERS' ASSOCIATION**  
Box KA-111, Tarzana, Calif.



## "MAGIC VANISHING CARD"

**THROW IT INTO THE AIR** — It completely disappears. Reproduce it later from spectator's pocket. It amuses and confuses all. Easy to do — 25c with **Amazing Catalog of 300 Tricks**.

THE MAGICIAN, Dept. 5, 2463 Kensington Ave., Philadelphia 25, Pa.

## MAKE YOUR OWN COSTUME JEWELRY

SPLENDID HOBBY OR VOCATION

Sea Shells • Pin Backs • Ear Screws • Screw Eyes  
Plastic Discs • Ear Clips • Floral Stones • Jump Rings  
Chains • Clasps • Wire • Boxes • Bracelets • Parts  
Bow Knots • Catches • Plexiglas • Cements • Dyes

WRITE FOR FREE CATALOGUE • DEPT. B

PHILADELPHIA BADGE CO., 1007 Filbert St., Phila 7, Pa.



# GET INTO RADIO

## TELEVISION ELECTRONICS NOW!

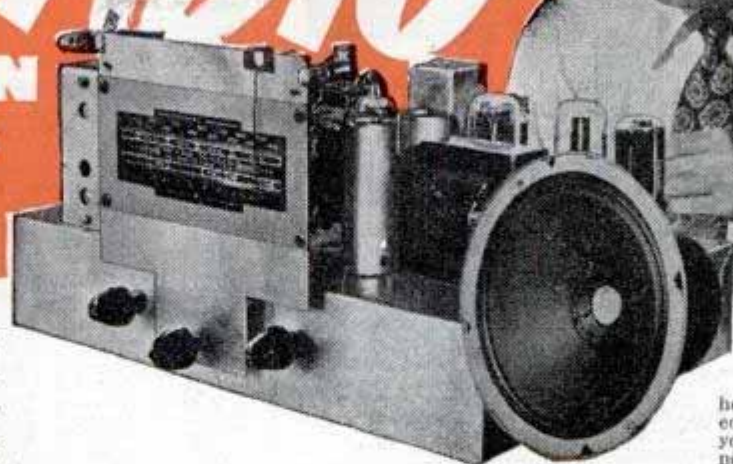

You build this complete, modern super-heterodyne receiver with the equipment that comes with your National Training at no cost.

This practical shop instruction system gives you actual experience with a Home Radio Laboratory—part of the

# SHOP METHOD HOME TRAINING

FOR YOU—A REAL HOME LABORATORY IN MODERN RADIO

from one of the world's Oldest and Largest Technical Trade Schools

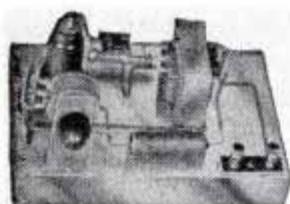

Your National Training Kits include equipment for over a hundred practical electronic experiments in your own home. You

get standard radio parts for this audio oscillator which you get to understand by building it yourself.

You learn modulation, beat frequencies, signal generation by a **actually** building this small radio transmitter with your National shop parts.

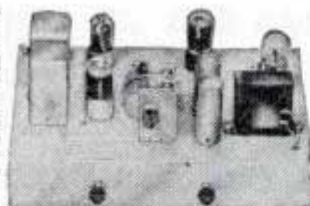

Your training outfits from National are made up of the most modern radio equipment—much of it just out of the experimental laboratory. You learn new ways of handling equipment by modern methods.



Get the details by mailing the coupon.

Send the coupon below immediately. Learn how this improved practical training can fit you for the **GREAT BUSINESS OF RADIO**—for the **NEW AND RAPIDLY EXPANDING FIELD OF FREQUENCY MODULATION (F.M.), TELEVISION AND ELECTRONICS.**

This is the thoroughly proved method used so extensively in wartime training—endorsed by the success of National men everywhere—a system by which you study in spare time—off hours, even minutes right in your home and yet have the **ADVANTAGE OF REAL SHOP EXPERIENCE** behind you.

### Trained Radio Men Wanted

The man who really knows modern Radio is in greater demand today than ever before—not only in Radio proper but in Television and Electronics—in Aviation, Transportation, Manufacturing, Communications. Good jobs

await the trained man, in the production, operation and maintenance of modern electronic equipment—in radio stations, in hundreds of industries—in homes, theatres and studios. Good sound training in this important field is absolutely necessary. And now, National Schools brings such training to you **no matter where you live or what you may be doing**—not only the fundamental theory but the actual experience that comes with knowing shop practice and working with real equipment—demonstrating each step with first-hand knowledge. This is true "learning by doing"—direct from the great shops and laboratories of National Schools where new developments in methods, equipment and applications are constantly going forward.

National offers you such practical training and National has the facilities. **Sample this training yourself. MAIL THE COUPON FOR A FREE LESSON.**

### SUCCESS and SECURITY FOR YOU

Radio is a Well-Established Business, Television and allied fields are just on the threshold of limitless expansion. Would you like to profit from these developments? An excellent job or perhaps into a business of your own? Answer these questions by reading the catalog sent you **FREE** from National Schools. Get the facts.

### Check the Job You Now Have With These Opportunities in RADIO

1. Financial Security Radio has grown from \$100 million to \$5 billion in past few years.
2. Limitless Future predicted by over 1,800 manufacturers of equipment.
3. Television promises unrealized opportunity.
4. Electronics opens wide new fields in home and industrial use.
5. Your Own Business with little capital.

Get the details. Use the coupon!

FREE GET THESE 2 BIG BOOKS

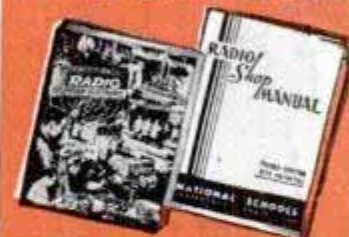

## NATIONAL SCHOOLS

LOS ANGELES 37, CALIFORNIA EST. 1905



### MAIL OPPORTUNITY COUPON FOR QUICK ACTION

National Schools, Dept. 2-PM  
4000 South Figueroa Street  
Los Angeles 37, California

(Mail in envelope or paste on penny post card)

Mail me **FREE** the books mentioned in your ad including a sample lesson of your course. I understand no sales-man will call on me.

NAME..... AGE.....

ADDRESS.....

CITY..... ZONE..... STATE.....

Check here if veteran of World War II

## NATIONAL TRAINING WINS BIG JOBS

You, too, can share the success of National graduates. Clifford Hannah, Portage La Prairie, Manitoba, Canada, writes: "My training has brought results as I'm in line for another raise, thanks to National's encouragement and thorough training. You can count on me as a real National booster and I am glad I used such good judgment in getting into a live and growing field."

While still a student of National training, I. Wilson of Vallejo, California, writes: "My pay has jumped from \$32.18 a week to \$72.65, and the end is not in sight. I am proud of my National Course."

Joseph Michel, Jr., Granite City, Illinois, writes: "I am enthused with National training. I am now earning \$225 a month as a radio operator and technician and \$20 a week more in my shop at home."



# 8 BIG BUILDING BOOKS

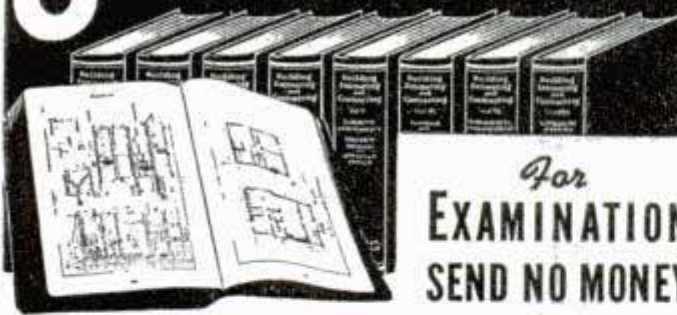

For  
**EXAMINATION**  
SEND NO MONEY

Learn to draw plans, estimate, be a live-wire builder, do remodeling, take contracting jobs. These 8 practical, profusely illustrated books cover subjects that will help you to get more work and make more money. Architectural design and drawing, estimating, steel square, roof framing, construction, painting and decorating, heating, air-conditioning, concrete forms and many other subjects are included.

## BETTER JOBS — BETTER PAY

The postwar building boom is in full swing and trained men are needed. Big opportunities are always for **MEN WHO KNOW HOW**. These books supply quick, easily understood training and handy, permanent reference information that helps solve building problems.

## Coupon Brings Eight Big Books For Examination

**AMERICAN TECHNICAL SOCIETY** Vocational Publishers since 1898  
Dept. G219 Drexel at 58th Street Chicago 37, Ill.

You may ship me the Up-to-Date edition of your eight big books, "Building, Estimating and Contracting," without any obligation to buy. I will pay the delivery charges only, and if fully satisfied in ten days, I will send you \$2.00, and after that only \$3.00 a month, until the total price of only \$34.80 is paid. I am not obligated in any way unless I keep the books.

Name .....

Address .....

City.....State.....

Please attach a letter stating your age, occupation, employer's name and address, and name and address of at least one business man as a reference. Men in service, also please give home address.

# LEARN TO DRAW... EARN BIG MONEY!



Now it's easy to be an artist! Famous Art Director's self-teaching home method offered for the first time! Discloses professional secrets of tremendous value! Sensational money-saving introductory offer!

1. Lessons 1 & 2 of 5-lesson Professional Artist Course (see below).
2. Genuine artists' models shown in professional art poses.
3. Two Self-Teaching Art Booklets authentically illustrated. Booklet 1: Figure drawing. 2: Cartooning.

Complete 5-lesson Professional Artist Course: Lesson 1. Adult Figures. 2. Line of Beauty & Action Lines. 3. Developing male & female figures; heads & hands. 4. Eyes, ears, nose & mouth. 5. Cartoons & caricatures.

Five authentically illustrated Art Booklets covering figure drawing, cartooning, oil painting, perspective, and water colors.

Convenient portfolio in which lessons, pictures, etc., may be kept.

**Professional Artist's Kit—everything needed to draw for real money.**

**MONEY BACK GUARANTEE!** Fill out coupon below, enclose in envelope with money or money order and mail to

**MOVIELAND ARTISTS**  
P. O. Box 2344, Los Angeles 54, California

PM-1

NAME .....

ADDRESS .....

CITY.....STATE.....

# ANALYZE HANDWRITING

Qualify for Certified Grapho Analyst Degree at home, spare time. Credit, Employment, Personnel Managers, Business, Professional men, women use **grapho-analysis in their work, earn substantial fees in spare time.** Many study solely for personal benefit, no desire to earn money, find it so fascinating they start using it to add to their incomes. Entertainment field pays well, up to \$100 a week reported. Others establishing profitable practices as Vocational and Family Problem Counselors, Personality Teachers, and lecturers.



## GROWING—UNCROWDED PROFESSION

More and more police use grapho analysis handling suspects and criminals. They understand how criminals think. Their handwriting tells. Men like Hugh Donlap, university student, Harry Allen, retired preacher, use it in court, win cases, earn fees even before graduation. **Only school in world devoted to teaching grapho analysis** offers thorough training to earnest, ambitious men and women regardless of where you live, small town, farm or city. Send for **GRAPHO ANALYST**, illustrated lesson, personal handwriting analysis offer, **ALL FREE.** Must be 21 or over. Address **A. I. G. A. Inc., 120. Noel, Missouri.**



## Get Started in Radio

### TEN "HOW-TO-DO-IT" BOOKS

Get a solid foundation in radio by means of these 10c timely text books. Each clearly written, profusely illustrated, contains over 15,000 words. You'll be amazed at the wealth of information packed into these handy books. Excellent for reference—ideal for technical library. Your money back if not satisfied.

**5 Books for 50c - 10 Books for \$1**  
SENT TO YOU POSTPAID



- |                                                                    |                                     |
|--------------------------------------------------------------------|-------------------------------------|
| No. 1—How To Make Four Doerle Short Wave Sets                      | No. 4—All About Aerials             |
| No. 2—How To Make The Most Popular All-Wave 1 and 2 Tube Receivers | No. 5—Beginners' Radio Dictionary   |
| No. 3—Alternating Current for Beginners                            | No. 6—How To Have Fun With Radio    |
|                                                                    | No. 7—How To Read Radio Diagrams    |
|                                                                    | No. 8—Radio for Beginners           |
|                                                                    | No. 9—Simple Electrical Experiments |
|                                                                    | No. 10—Television                   |
- Remit by check or money order—register letter if you send cash or stamps.  
**RADIO PUBLICATIONS, 23-W West Broadway, New York (7)**



Thomas E. Lattin  
President

## I WANT TO TRAIN YOU For A Big-Paying Job IN THE MEAT BUSINESS

Big-pay jobs go to expert Meat Cutters—essential trade—**PEOPLE MUST EAT!** Become Meat Cutting and Meat Merchandising expert in 6 weeks at Toledo. Learn easily, quickly. Actual practice. Training methods based on 30 years experience. Training for beginners or men with experience. Be own boss in profitable market. Diploma Approved for training under G. I. Bill. Write TODAY for FREE facts. No obligation.  
**National School of Meat Cutting, Inc., Dept. 34, Toledo 4, Ohio**

# INVENTING

**—FOR PROFIT!** If you have an inventive turn of mind, write for free 28-page booklet explaining how the Institute of American Inventors is helping inventors pre-test the profit possibilities of proposed devices to fill today's unprecedented demand for useful new inventions.

**INSTITUTE of AMERICAN INVENTORS**  
Dept. 4, 1926 Eye St., NW, Washington 6, D. C.

## Become a Doctor of PSYCHOLOGY

Win the degree of Ps.D. Teach the secret of contentment, happiness. Solve mental worries. Experience the revelation of truth. Chartered college. Individual help. Write for FREE book. **COLLEGE OF UNIVERSAL TRUTH, 5153-B North Clark St., Chicago.**

# GOV'T. JOBS

Inexpensive, Keyed Lessons prepare you for Exam. Write, Ozment School, 80, St. Louis, Mo. (Veterans get preference.)



## makes False Teeth TIGHT

Makes loose dental plates fit snugly and comfortably.  
**LASTS for MONTHS!**

Simply squeeze on dental plate and put it in your mouth. Hardens and becomes part of plate. Money-back guarantee.  
**FREE** Generous package of Dental Plate Cleanser with each order. Send \$1.00 or mailed parcel post collect.  
**Fit-Rite Co., 1557 Milwaukee Ave. Dept. 2-PM, Chicago, Ill.**





# AMERICA'S FOREMOST SCHOOL OF *PRACTICAL TRAINING!*

**WILL TRAIN YOU FOR KEY JOB OR BUSINESS OF YOUR OWN**

**IN**

# **REFRIGERATION AIR CONDITIONING**

- SPARE TIME HOME STUDY
- RESIDENCE SHOP TRAINING
- COMBINATION HOME AND RESIDENCE TRAINING

Here is an industry that offers every opportunity you could ask for. Good jobs—security—plenty of chance for advancement—a business of your own.

And here is a school equipped in every way to train you for Refrigeration and Air Conditioning work—one of the largest and most completely equipped schools of its kind in America—a school that already has trained thousands of men for just such opportunities.

### **GET READY NOW!**

Learn Refrigeration and Air Conditioning—now, while the time is ripe. You don't need any advanced schooling or previous experience. If you are at all mechanically inclined and have gone to high school for at least one year or have an equivalent education, we can teach you Refrigeration and Air Conditioning.

### **LEARN AT HOME OR COME TO OUR SCHOOL**

You can take most of your training at home, in your spare time—or you can come to Chicago and take your entire training in our completely equipped shops and laboratories. Either way you quickly acquire the fine points, practical skill, and broad, technical "know how" that makes the expert Refrigeration and Air Conditioning Technician.

*Get all the facts about the opportunities in this interesting field of work, and about the I. T. I. system of training that has helped so many men into key jobs in this industry. Fill out the information coupon below and mail it TODAY. You will be under no obligation whatsoever.*

**AUTHORIZED TO ACCEPT VETERANS FOR G. I. TRAINING**

### **FACTS ABOUT THE INDUSTRIAL TRAINING INSTITUTE**

Founded in 1916. Has trained more than 400,000 men for practical work in industrial fields. From 1942 through 1945 trained specialized technicians, exclusively, for the Army, Navy and Marine Corps. Now training thousands of veterans under the G.I. Bill, both in its Residence Schools and by home-study. Occupies five buildings of its own. Has over \$500,000 invested in training facilities, with an instruction staff of more than 100 men. Known everywhere as America's foremost school of practical training for industry.

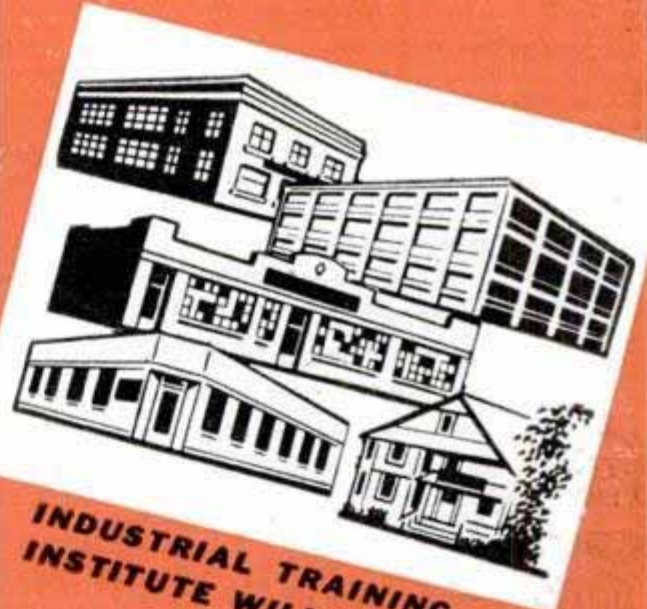

**INDUSTRIAL TRAINING  
INSTITUTE WILL TRAIN YOU**

**SEND FOR  
THIS  
BOOK  
FREE**



### **REGISTRAR P10**

### **INDUSTRIAL TRAINING INSTITUTE**

**2150 Lawrence Ave. • Chicago, 25, Ill.**

Please send me, FREE, your "Camera Visit" booklet and information about the opportunities for trained men in Refrigeration and Air Conditioning. It is understood that I will be under no obligation.

Name .....

Address .....

City ..... State .....

Are you a veteran? .....

**GET FACTS NOW**



# LOANS *by* MAIL

\$50 to \$300 *IN A HURRY*

## CONFIDENTIAL

Salaried people, men or women, married or single, loans on your own signature, or your own security. NO personal interview. NO co-signers needed. NO wage assignments. You mail the application to us... we mail the money to you.

FOR A LOAN OF	YOU CAN REPAY MONTHLY			
	IN 15 PAYMENTS	IN 12 PAYMENTS	IN 9 PAYMENTS	IN 6 PAYMENTS
\$ 50	—	\$ 5.03	\$ 6.43	\$ 9.24
100	8.40	10.07	12.87	18.48
150	12.60	15.10	19.30	27.73
200	16.75	20.09	25.68	36.91
250	20.85	25.02	32.02	46.05
300	24.93	29.94	38.33	55.17

The above payments made at regular monthly intervals will repay the entire loan and all charges in the time indicated. Charges are based on the monthly rate of three per cent on unpaid principal balances to \$150.00 and two and one-half per cent on that portion of unpaid balances in excess of \$150.00 but not exceeding \$300.00. "Loans by Mail" may be repaid in larger amounts, more frequent payments or repaid in full at further savings to you.

## CONVENIENT

Just write us how much money you need and how you wish to repay... there's no charge or obligation. Whatever your needs for cash now or in the future, write for your "Loans by Mail" plan, today.

### MERCHANTS INVESTMENT CO.

819-G 1st Nat'l Bldg., Omaha, Nebr.

Without obligation, rush complete details and all papers necessary

for a loan of \$\_\_\_\_\_ to be repaid at \$\_\_\_\_\_

on the \_\_\_\_\_ day of each month.

Name \_\_\_\_\_

Address \_\_\_\_\_

City \_\_\_\_\_ State \_\_\_\_\_

Occupation \_\_\_\_\_

**AIR RIFLES**

**BENJAMIN**

**AIR PISTOLS**

ARE IN PRODUCTION

ORDER BENJAMIN AIR RIFLES & BENJAMIN AIR PISTOLS from your DEALER. Send for our FREE FOLDER and Complete Specifications TODAY. Both Calibre Benjamin H-C Pellets are available now.

BENJAMIN AIR RIFLE CO., 812 MARION ST., ST. LOUIS 4, MO.

## STAMMER ?

This new 128-page book, "Stammering, Its Cause and Correction," describes the Bogue Unit Method for scientific correction of stammering and stuttering—successful for 46 years. Benj. N. Bogue, Dept. 1845, Circle Tower, Indianapolis 4, Ind.

GET THIS FREE BOOK!

**HUNTING and FISHING**



## HUNTING and FISHING

is a monthly magazine crammed full of hunting, fishing, camping, dog and boating stories and pictures, invaluable information about guns, fishing tackle, game law changes, best places to fish and hunt—countless ideas that will add more fun to your days afield.

### Special Trial Offer

Send 25c in stamps or coin and we will send you Hunting & Fishing for six months.

HUNTING & FISHING MAGAZINE

251 Sportsmen's Bldg., Boston, Massachusetts

## TRAIN FOR KEY JOB OR BUSINESS OF YOUR OWN

# REFRIGERATION and AIR CONDITIONING

Millions of Older Units Need Expert Service. Big After-the-War Expansion Will Create Even More Opportunities. Approved for Veterans "G. I." Training

A key job—a successful business of your own—you can have either in this vital, war-hit industry. A serious shortage of service-experts exists in every branch. Big post-war boom will open thousands of new opportunities. Get ready for your big chance. We'll give you the practical training you need—at home—and in our big Chicago shops, largest and most completely equipped in the country. No advanced schooling needed. Our unique methods make everything easy to grasp. We've trained thousands. Pay as you go. Quit when you want to. Get the full facts without obligation. Write TODAY.

## INDUSTRIAL TRAINING INSTITUTE

2150 Lawrence Avenue, Dept. P8b, Chicago 25, Ill.

# Be A MASTER PLUMBER

Earn \$15 To \$50 A Day

## DON'T ENVY THE PLUMBER — BE ONE

Every skilled workman will tell you that Plumbers have the best of it. WINTER and SUMMER the Plumber is busy at top wages. No skilled Plumber is ever out of a job—compare his opportunities with any trade, plus the opportunities of having your own shop. We teach you Plumbing with TOOLS (not books) under Licensed Master PLUMBERS in one of the finest equipped schools in America. We make you a Plumber, every branch is taught thoroughly—Lead Work—Blueprint for plan reading—all other tricks.

## LEARN IN 30 WEEKS WITHOUT PREVIOUS EXPERIENCE

If you like to work with tools you owe it to yourself to investigate. No need to ever work as an apprentice. Get free bulletin. Write now! G.I. APPROVED. Our 24th year.

### UNIVERSAL PLUMBING SCHOOL

815 HOLMES STREET KANSAS CITY, MO.

## TOOL ENGINEERING • MECHANICAL DRAFTING MASTER MACHINIST

Completely equipped shops and drafting rooms. directed by an accredited staff of engineers and practical instructors. 18 years of successful training of men for industry.

Days, Evenings • Approved for Veteran Training

BULLETIN ON REQUEST

ALLIED SCHOOL OF MECHANICAL TRADES, INC. 1330 SOUTH MICHIGAN AVENUE • CHICAGO 5, ILL.

## BOYS—IT'S FREE!

This exciting book "THE WONDERS OF CHEMISTRY"

Shows how to amaze your friends with chemical magic, describes many fascinating home experiments, tells of fun, thrills, adventure and big future opportunities for boys who know chemistry. Send today!

THE PORTER CHEMICAL COMPANY 44 Prospect Avenue Hagerstown, Md.



## INDIANA TECHNICAL COLLEGE

Engineering B.S. degree in 27 mos. Aeronautical, Chemical, Civil, Electrical, Mechanical and Radio Engineering. 2-yr. diploma. Air Conditioning and Refrigeration; Drafting, 1-yr. Gov't approved for G.I.'s. Low rate. Earn board. Large industrial center. Demand for graduates. Enter March, June, Sept., Dec. Catalogue. 527 E. Washington Blvd., Ft. Wayne 2, Ind.



Begin today. Write now for our Free Book, "How to Become a Good Penman." It contains specimens and tells how others learned to write in spare time. Enclose 10c for your name beautifully written and a pen point suitable for shaded writing. Write today.

THE TAMBLYN SCHOOL OF PENMANSHIP N-441 Ridge Building, Kansas City, Mo.

## SAY YOU SAW IT IN POPULAR MECHANICS

# INVENTORS

WITH GOOD INVENTIONS

Should write us without delay for FREE BOOKLET, Protective Disclosure Form and facts about The Inventor's Most Logical Markets. Patented, Unpatented inventions, all kinds, Cash, Royalty, needed by specific manufacturers. If your invention is for sale, write today for full particulars. A Post-Card will do! Address:

THE INVENTION REPORTER 5C-11106 South Longwood Drive Chicago 43, Illinois

POPULAR MECHANICS



How to equal the PHENOMENAL PHYSIQUE of...

# Mr. America!

## ALAN STEPHAN

official winner of the National A.A.U. title, "MR. AMERICA" offers you this **FREE BOOK**

This is an unretouched photograph

Small scale view of Alan Stephan's Mr. America trophies

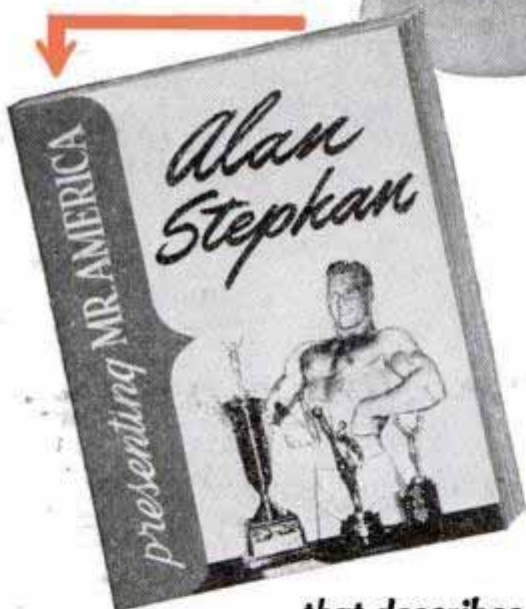

To possess the awe-inspiring, eye-catching body of a "MR. AMERICA," the revolutionary new Alan Stephan Course in Body Building speaks for itself as a builder of title-winning perfection. At 15 Alan Stephan was a skinny, gangling kid: anything but a physical marvel! Today he is officially recognized as the finest physical specimen in the nation. His progress in physical development was so rapid (he developed 70 additional pounds of muscle in the first year!) that he immediately became a physical training instructor when he enlisted in the United States Navy. By the phenomenal perfection of his own physique through a system perfected by himself, no man in America today is so well qualified to show you the way to achieve sparkling health, glowing vitality, vital power, increased pep.

### that describes **HIS** EASY-TO-FOLLOW PHYSICAL TRAINING PROGRAM

This vital new book will tell you about the physical training program followed by "MR. AMERICA"—Alan Stephan. It will explain how YOU can equal the phenomenal physique which has earned for him this official National A.A.U. title symbolic of physical perfection, the Finest Male Physique in America.

Alan Stephan's story should be an inspiration to every American. His miraculous body reveals positive proof of what proper training can do. As this book so clearly illustrates, his chest is super-impressive, his arms and back are amazing; his column-like neck, his waist, hips and legs blend in harmonious proportions—all of which go to make up the perfect physique! And what Alan Stephan has done, you, too, can do. Every secret of the physical training program perfected and practiced by Alan Stephan is now made available to YOU.

**Make the physical perfection of "Mr. America" your goal! Act now! Get the complete facts about body building from the most eminently qualified man in the nation.**

#### MAIL THIS COUPON NOW

Alan Stephan, Box Number 1080, Chicago 90, Illinois

Please send me absolutely FREE a copy of your book, "Presenting Mr. America... Alan Stephan."

Write for the **FREE** Book

NAME \_\_\_\_\_

ADDRESS \_\_\_\_\_

CITY \_\_\_\_\_ STATE \_\_\_\_\_

DATE OF BIRTH \_\_\_\_\_

"Presenting Mr. America... Alan Stephan"



# BUILD a TELEVISION SET

*To stimulate its radio and television training programs, this famous resident radio and television school is offering men interested in television this unusual opportunity.*



Instructor demonstrating rare

Schmitt Optical System, used in big picture, projection type, television receivers. At N.Y.T.I. of N.J. all types of television receivers are available for student study.

**I**F you are unable to leave home to go to a resident school, N.Y.T.I. of N.J. can supply you with parts to build a television chassis in your own home. You will be supplied with the same instructions and directions with which the school's resident students are equipped, when they reach the stage in their training that calls for television set construction. If you already have a sound radio background, with experience in building radio receivers, you will

be surprised to find how much you can learn about television by building this set.

N.Y.T.I. of N.J. is one of America's leading resident schools for men seeking dependable, thorough, up-to-the-minute training in the various fields of radio and television.

The schooling offered by N.Y.T.I. of N.J. is particularly useful to those who recognize the high-earning possibilities of technical training in radio and television and are willing to tackle the class and laboratory work offered, regardless of their previous education.

No high-school diplomas are needed for entrance. But N.Y.T.I. of N.J. requires that a student be earnest, sincere and radio-minded. Students without proper mathematical backgrounds are taught the radio and television mathematics they

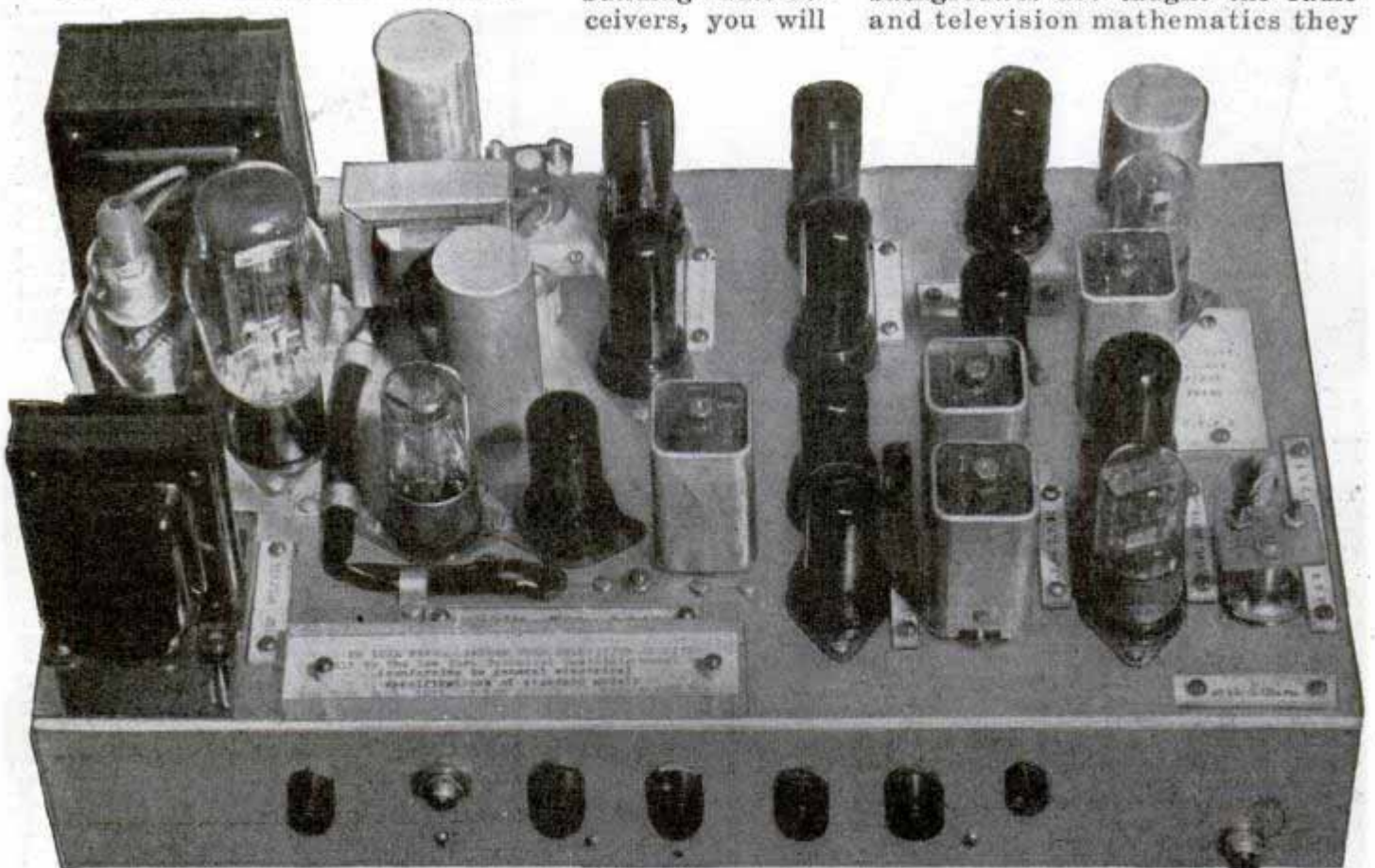

You can build a direct viewing television chassis similar to the one pictured above, right in your own home by following carefully the exact instructions sent to you by this famous television school, located

square in the HEART of America's television manufacturing and broadcasting industry. Mail the coupon at the right to get full details. It costs you nothing to learn about his big opportunity.

Advertisement



# RIGHT in YOUR OWN HOME!

need. Several students with only grammar school educations have successfully completed advanced technical television courses.

A considerable number of out-of-state students attend the school because of its excellent, practical type of radio and television courses, so difficult to get anywhere else in the world today. Living quarters are obtainable by single students.

## You Put Into Practice Everything You Learn

Students at N.Y.T.I. of N.J. particularly like the way the school puts into practice what it teaches. You may actually build a 17-tube television chassis. You also help build as many as 7 radio receivers of different types, a total of 75 electronic educational devices. Class study and laboratory study, in the proper combination, increase interest—and your hands get as smart as your head.

A 17-tube, experimental, television chassis may be built by all resident students of television, and may be kept as their own property, if they so choose.

## Located in the Heart of the Electronic Industry

The New York Technical Institute of New Jersey is in Newark, N. J., just across the river from New York City (only 20 minutes from Broadway by subway or train). The school is located in the heart of America's great radio and electronics industry. Such leading television, radio and electronics manufacturers as R.C.A. Western Electric, Du Mont, Federal and Edison are nearby. This means that the school offers numerous advantages, as it is in touch with the most recent developments in radio and television.

Highly qualified television and radio instructors are here in abundance. Equipment is easier to get. Television students are offered exceptional advantages in this great electronic center.

## Coupon Brings Full Information -- FREE

The school issues a special Bulletin which illustrates and describes its truly exceptional facilities and equipment. This Bulletin also describes classes that may be attended, housing conditions, costs, hours, etc. If you are interested in Television — you will want to read this Bulletin. You can have it *free*, merely by mailing the coupon at right.

The school will also be happy to send you complete information about the television kits and directions which are now available to you if you desire to build your own television chassis at home.

Just fill out the coupon at right and mail it NOW to: *New York Technical Institute of New Jersey, Dept. 22, 158 Market Street, Newark, N. J.*



Instructor demonstrating theory of light in connection with study of optical systems used in projection type television receivers.

Big picture television (16" x 21 1/4") in the flesh at N.Y.T.I. of N.J. All types of television receivers are available for student use and instruction at the school.

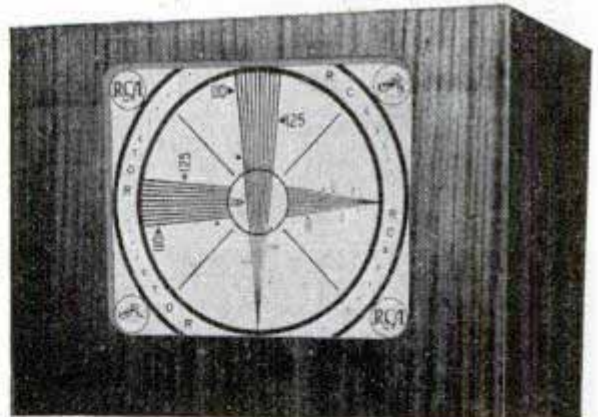

Standard laboratory type test pattern used for testing all types of television transmitters and receivers. (You can see it at N.Y.T.I. of N.J.)

New York Technical Institute of New Jersey, Dept. 22,  
158 Market Street, Newark, New Jersey

- Check here if you wish to receive the Special FREE Bulletin describing the resident school of the New York Technical Institute of New Jersey located in Newark, N. J.—including its facilities, equipment, courses offered, costs, hours, etc.
- Check here if you wish complete information about building a television chassis in your own home.
- Check here if you are a War Veteran.

NAME..... AGE.....

ADDRESS.....

CITY..... ZONE (if any)..... STATE.....

Advertisement



# THIS EASY WAY TEACHES PIANO

*Without Sheet Music*

**NEW SHORT-CUT  
PIANO METHOD**  
*Has No Scales  
No Conventional  
Notes...*



**TEACHES SIMPLE SONGS FROM FIRST LESSON**  
*Including Strong Left Hand Bass*

**25 LESSONS AT LESS THAN 6c PER LESSON**

If you think you must spend weeks and weeks learning note reading and scales to play piano, get ready for a big surprise. Dave Minor at last has perfected an original, different **SHORT CUT** way to piano playing that's the easiest to follow, simplest method you ever saw. Not one conventional music note or scale in the entire course. Mr. Minor first starts you playing simple melodies with the right hand, then easy chords with the left.

You have simple songs, often the very first day. Each lesson takes you step-by-step into piano playing the short-cut Dave Minor way. And while I won't pretend I'll make you a concert artist, I can and will make you this trial, inspection and approval offer. I don't care if you never played the piano before in all your life. If you can read simple English and put your fingers where my charts show you to put them, you'll agree that truly "music is fun for everyone"  
**THE DAVE MINOR WAY.**

**SEND NO MONEY**

**Make This Conclusive 10-Day Test**

Just write today. On arrival, deposit \$1.49 plus c.o.d. postage through postman. See how simple yet thorough course is. Keep 10 days. Then, if you don't agree that I've given you a short cut to piano playing worth to you far more than you paid, return and I'll refund your \$1.49. Without extra cost you receive the big 72-page Dave Minor Piano Song Book of 50 ever-popular songs, all charted for your right and left hands... waltzes, hymns, western songs, etc., for you to learn to play to your satisfaction. Cash orders sent prepaid on same money back guarantee. Get in on this 2 for 1 offer. Mail your order now to:

**DAVE MINOR, Room X-49B, 232 E. Ohio St., Chicago 11, Ill.**



**2 for 1 offer  
ONLY \$1.49**

**GLOWS  
IN THE  
DARK**

**WRITE FOR Free Sample**

★ ★ **Make Big Money** ★ ★

Be the first to sell luminous house numbers and light switch plates. Also luminous pictures, statues, etc. Religious, nursery, glamour and other subjects. Sell on sight.

Represent a Large Manufacturer Est. 1913  
**MADISON MILLS - 303 Fourth Ave. - New York 10, N. Y.**



**"The Book They're Talking About"**

Contains over 350 illustrations, charts and notes

## ART ANATOMY OF THE HUMAN FIGURE

For the amateur and professional artist and sculptor. Giving detailed study of every part of the body.

**MALE AND FEMALE, POSED AND IN ACTION**

(Sent in plain wrapper.) Outside U.S.A. send \$1.25.

**MAJOR BOOK CO., Dept. 320-D, 241 East Broadway, New York 2, N. Y.**

**ONLY  
\$100**

## Electric Heating Element

# FLUX

Repair burned out electric elements of coffee urns, electric stoves, flat irons, toasters, and other electrical appliances. Simply apply Christy Electric Heating Element Flux to the break, turn on the current and **PRESTO** the job is done and your appliance is ready again for years of satisfactory service. Generous size package (enough to repair 50 elements) sent postpaid for only \$1.00.

## ELECTRICAL APPLIANCE REPAIR PARTS

Renual Iron element. Guar. 1 year. Package of 6.....\$3.12  
Toaster element forms. Clear Mica. Fits most toasters. 10 for.. 1.80  
Heating element wire. 10 ft. coiled 1/4" O.D. #20..... 2.55  
Heating element wire. 10 ft. coiled 3/16" O.D. #22..... 1.77  
Hot plate bricks. 5 3/4" diameter. 6 for..... 1.62  
Appliance cord. Rubber covered. 20 ft. \$1.00; 100 ft..... 4.50  
Ribbon element heating wire. Std. size. 100 ft..... .75  
Percolator elements. Universal. Flat type. 1 yr. guar. 2 for... 1.20  
Element cement. Withstand 3000° F. 1 lb. pkg. \$1.00. 5 lb. pkg.. 3.50  
Lead wire. Asbestos covered heater hook-up wire. 10 ft..... 1.00  
Iron Cord Sets with complete plug attachments. 10 for..... 5.00  
Carbon brush set. Assorted. 104 brushes. 15 springs. Complete set 3.00

## HOW TO FIX IT BOOKS

Modern Electric & Gas Refrigeration.....\$5.00  
Practical Electricity & House Wiring..... 1.50  
Armature & Magnet Winding..... 1.50

Here is your opportunity to save on repairing your own appliances and to earn extra money repairing appliances for friends and neighbors.

## CHRISTY SUPPLY COMPANY

2835 N. Central Ave., Dept. T-550, Chicago 34, Ill.

Learn to **MOUNT BIRDS**

**Tan SKINS, make up FURS**

Be a Taxidermist. Double your hunting fun. We teach you at Home. Mount Birds, Animals, Fish, Heads, common specimens. Fun and profits. Decorate home and den **MAKE MONEY**. Mount game, tan for others. Big profits in spare time. **WRITE TODAY.**

**100 game pictures in FREE BOOK**  
Hunters, get your copy. It's **FREE**.  
Now Free. Send post card. State your AGE.  
**NORTHWESTERN SCHOOL OF TAXIDERMY**  
Dept. 3372 Omaha, Nebraska

**FREE BOOK**

## LEARN WATCH REPAIRING



**AT HOME.** By our modern and original system of instruction you can learn every part of the **WATCH REPAIRING TRADE AT HOME.** Prepare yourself for a well-paying position or start in business after completing our course of instruction. Good watch repairers are in demand and generally earn very good salaries. For particulars apply to the **Wisconsin School of Watch Repairing** 759 North Milwaukee St., Milwaukee 2, Wis.

**RADIO ENGINEERING,** Broadcasting, Servicing, Electronics, Aviation, Marine & Police Radio taught thoroughly. 48 weeks' Engineering course equivalent to 3 years' college radio work. Approved Veteran Training. Co-educational. Catalog free.  
**VALPARAISO TECHNICAL INSTITUTE, Dept. D, Valparaiso, Ind.**



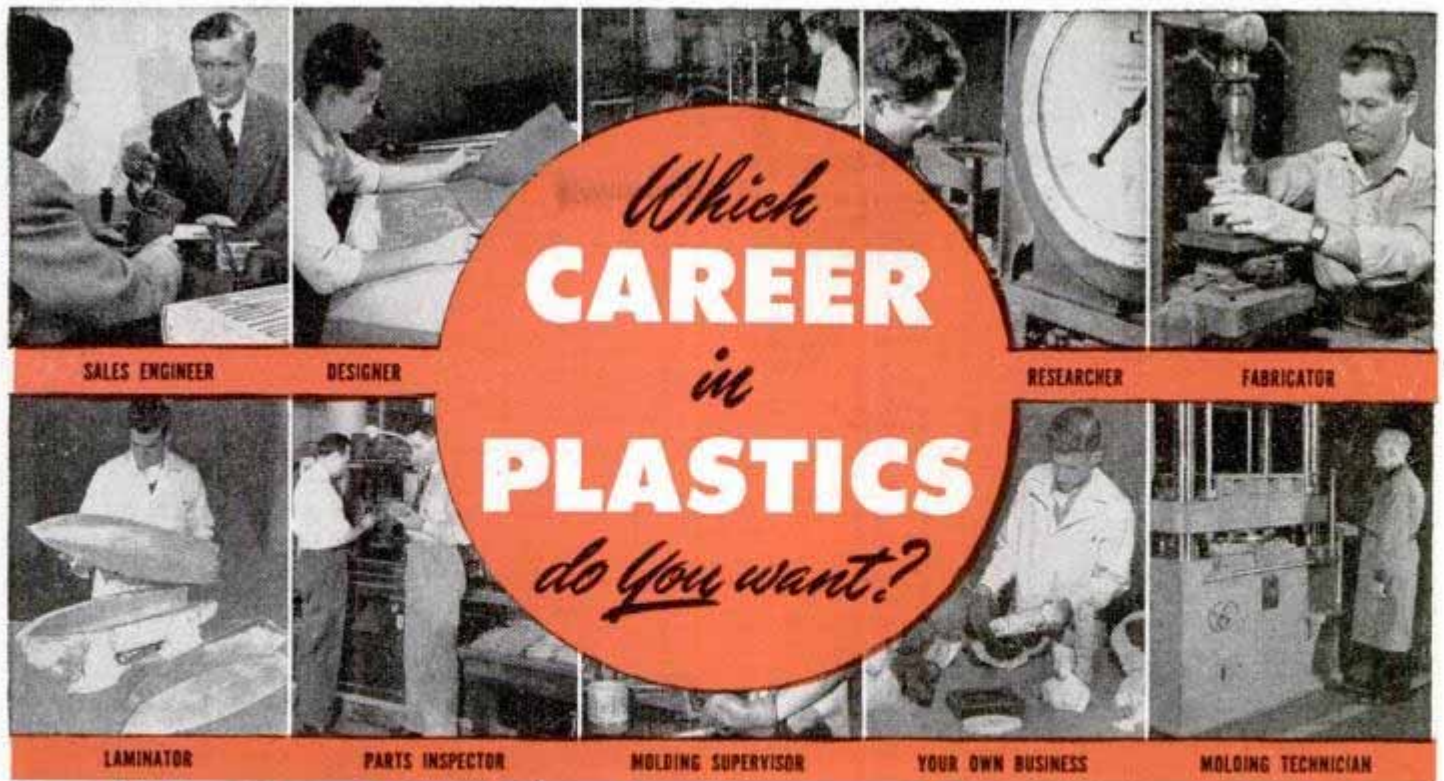

# The Plastics Industry is Growing Fast!

Every day you can read glowing descriptions of how plastics are improving old products and creating interesting new ones. Men who know plastics, who are trained in its many phases fill the important, well-paying positions. *You* can be one of them. **ACT NOW** to prepare yourself for a successful future in a *growing* industry... and all the security and satisfaction that such a future brings.

**PLASTICS EXCLUSIVELY—**Plastics Institute, America's oldest and largest plastics educational organization devotes its entire facilities to plastics instruction with no time spent on other subjects. **IMMEDIATE ENROLLMENT** can be arranged. Send for our interesting catalogue *today!*

Write Dept. PM-7-2 • 1601 S. Western Avenue • Los Angeles 6, California  
**Home Training Courses and Resident School APPROVED FOR VETERANS**

**A COMPLETE COURSE**—Everything you should know about plastics... materials, designing, molding, fabricating, laminating and testing. Acquire a basic knowledge of plastics... invaluable in getting a fine position in this great industry.

**START YOUR FUTURE TODAY**—Mail the coupon below, now! Get an interesting, illustrated free booklet about plastics. Get complete details about Plastics Institute Resident School, located in beautiful Southern California. Also learn about the comprehensive Plastics Home Training Course which prepares you for a future in plastics while you continue your present job. Clip the coupon and mail it **TODAY!**



### LEARN BY DOING

To give you practical experience we supply colorful plastics to make useful, attractive creations. You can also make and sell plastics articles to earn while learning.



**PLASTICS INSTITUTE** in the heart of sunny Los Angeles. Here modern laboratories and shops give Resident School students facilities for practice on the finest of industry-type plastics equipment. Also the headquarters for **HOME TRAINING.**

# Plastics

**INDUSTRIES TECHNICAL INSTITUTE**  
 NEW YORK CHICAGO LOS ANGELES

Plastics Industries Technical Institute  
 Dept. PM-7-2, 1601 S. Western Ave., Los Angeles 6, Calif. Mail in Envelope or  
paste on penny postcard

Gentlemen: Please send me the booklet "World of Plastics" and information on your Resident School Courses  Home Training Courses.  I understand there is absolutely no obligation.

Name (PRINT) ..... Occupation .....

Street (PRINT) ..... Age .....

City ..... Zone ..... State .....

Important: Please fill out coupon *completely*. If Veteran, please check.  If in Armed Services now, please check.

**FREE BOOKLET**  
**Send For It Today!**



# STUDY AT HOME

With An Educational Institution

Men with specialized training win higher positions, insure larger earnings, and are bigger successes in business and public life. Opportunities NOW greater than ever before. Send for our Catalog.

## ARTS and SCIENCES

Courses in Philosophy; Education; Letters; Public Health; Medical Jurisprudence; Psychology; Sociology; Physics; Chemistry; Plastics; Geology; Political Science; Theology; Business and Commerce; Accounting; Mathematics; Statistics; Agriculture.

## ENGINEERING

Courses in Electrical, Civil, Mechanical, Drafting, Architectural, Steam, Aeronautical, Radio, Structural, Mining, Industrial, Petroleum, Marine, Chemical, Diesel, Automobile, Refrigeration, and Air Conditioning Engineering.

## LAW

Complete Professional Law Course includes 18 Hornbook Series college grade textbooks. Courses also in Commercial Law, Patent Law and Medical Jurisprudence. McKinley-Roosevelt Incorporated, 4610-K, Sheridan Rd., Chicago 40, Ill.

# SHORTHAND in 6 Weeks at Home

Famous Speedwriting system. No signs or symbols; uses ABC's. Easy to learn; easy to write and transcribe. Fast preparation for a job. Surprisingly low cost. 100,000 taught by mail. Used in leading offices and Civil Service. Write for free booklet. **SPEEDWRITING, Dept. 1502-7, 55 West 42 St., N. Y. 18**

# "How to Make Money With Simple Cartoons"

A book everyone who likes to draw should have. It is free; no obligations. Simply address **CARTOONISTS' EXCHANGE**

Dept. 92-D

Pleasant Hill, Ohio

# Good Handwriting

HELPS YOU WIN SUCCESS!

It's so important to write a good hand for business and social advancement. Poor illegible penmanship often causes costly errors and marks you for failure. Why write a poor hand? It's so easy to learn at home in spare time. Write for our new free booklet today. If you wish, send 10c for a penpoint suitable for shaded writing and your name beautifully written.

**THE TAMBLYN SCHOOL OF PENMANSHIP**  
In Business Since 1895 H-441 Ridge Bldg., Kansas City, Mo., U. S. A.

# REFRIGERATION

Repair and improve all refrigerators. New manual tells how. Charts and pictures to help you. Price only \$1.00, postpaid. Money back guarantee. **Supreme Publications, 9 S. Kedzie Ave., Chicago 12, Illinois.**

# Photography

for

## PLEASURE or PROFIT



Learn at home. Spare time. Practical basic training. Long-established school. Many have earned while learning. Send coupon below for free booklet, "Opportunities in Modern Photography" and full particulars.

**AMERICAN SCHOOL OF PHOTOGRAPHY**

**1315 Michigan Avenue Dept. 1352 Chicago 5, Illinois**  
Send booklet, "Opportunities in Modern Photography," full particulars and requirements.

Name..... Age.....  
Address.....  
City..... Zone..... State.....

# Keep that "TICKING" Car

7 DAYS FREE TRIAL

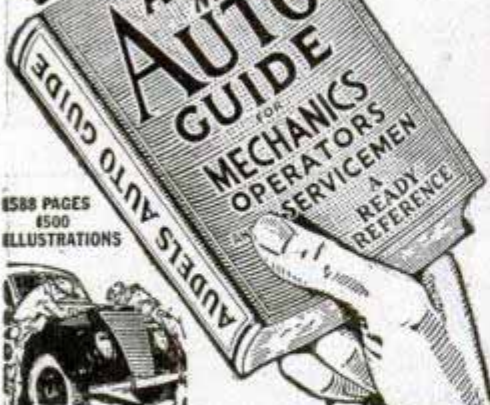

Every operator and mechanic needs AUDELS AUTO GUIDE.

This book saves time, money and worry. Highly endorsed. It presents the whole subject of auto mechanics:

- 1—Basic principles
  - 2—Construction
  - 3—Operation
  - 4—Service
  - 5—Repair
- Handy Size, Easily understood.

1588 PAGES  
1500 ILLUSTRATIONS



## NEW FLUID DRIVE, HYDRAULIC SHIFT AND DIESEL ENGINES FULLY COVERED

Over 1500 pages—1540 illustrations showing inside views of modern cars, trucks and buses with instructions for all service jobs.

ASK TO SEE IT!—To Get This Assistance for Yourself Simply Fill in and Mail Coupon Today.

**4 COMPLETE • PAY ONLY \$1. A MONTH ←**

**AUDEL Publishers, 49 West 23rd St., New York**  
MAIL AUDELS NEW AUTO GUIDE for free examination. If O.K. I will send you \$1 in 7 days; then remit \$1 monthly until price of \$4 is paid. Otherwise I will return it.

Name.....

Address.....

Occupation.....

Employed by..... P M



## START

**\$1756 to \$3021 YEAR**

Unusual Number of Examinations expected soon

Prepare NOW for Next Examinations

**MEN—WOMEN**

Veterans get preference.

**32-Page Civil Service Book**

—FREE

Mail Coupon Today—

SURE

**FRANKLIN INSTITUTE**

Dept. E87

Rochester 4, N. Y.

Gentlemen: Rush to me, FREE of charge, list of U. S. Government big pay jobs. Send me FREE 32-page book describing salaries, vacations, hours, work, and full particulars telling how to qualify for one of these jobs.

Name.....

Address..... Vet?.....





# To those who think LEARNING MUSIC is hard...

SEE HOW EASY IT IS!

MY COUNTRY 'TIS OF THEE,  
SWEET LAND OF LIBERTY



Strike these notes and you're playing "America." TRY IT — IT'S FUN



Enrolling for 3rd Course

"I learned more from your course than many of my friends who studied under private teachers have for years. The fact that I've already taken 2 courses and am now enrolling for a third should speak for itself."

\*F. A. S., Indiana



Plays from Start

"Your advertisements are true to the letter. I can actually play my favorite instrument even though I'm only at the beginning. How can I ever express my joyful gratitude."

\*F. R. O., Illinois

\*Actual names on request. Pictures by Professional Models.

## Easy as A·B·C this print and picture way

• Perhaps you think learning music is a tedious grind. It isn't any longer! Long hours of practicing humdrum scales and hard-work exercises are over and done with.

You have no excuses... no alibis whatsoever for not getting started toward musical good times *now!* For, through a new, easy, pleasant method, you can now learn to play right at home—without a private teacher—for only a few cents a day.

### Learn to Play by Playing

The lessons come to you by mail from the famous U. S. School of Music... complete instructions, large, clear diagrams and all the music you need. You study with a smile. You learn to play by playing real tunes by note. And it's all so easy to understand. First you are *told* how to do a thing. Then a picture *shows* you how. Then you do it yourself and *hear* it.

If you're tired of just looking on at parties—if you've envied those who could entertain others—if learning music has always been a never-to-come-true dream—let this time-tested home-study method come to your rescue.

Over 850,000 people have studied music this modern, easy as ABC way. And remember, no matter what instrument you choose, the cost will average only a few cents a day.

Our illustrated Free Booklet fully explains this remarkable course. It shows how you can learn to play quickly, and for a mere fraction of the cost of old, slow methods. So decide which instrument you want to play and mail the coupon today. The fascinating Free Booklet will be sent to you at once together with a "Print and Picture" Sample. U. S. School of Music, 72 Brunswick Bldg., New York 10, N. Y.

### FREE PRINT AND PICTURE SAMPLE

U. S. School of Music, 72 Brunswick Bldg., N. Y. 10, N. Y.  
Please send me Free Booklet and Print and Picture Sample.  
I would like to play instrument checked below.

(Do you have instrument \_\_\_\_\_)  
Piano      Accordion      Trumpet      Ukulele  
Violin      Mandolin      Trombone      Clarinet  
Guitar      Saxophone      Tenor Banjo      Other Instrument

Name \_\_\_\_\_ (PLEASE PRINT)

Street \_\_\_\_\_

City \_\_\_\_\_ State \_\_\_\_\_

Note! If you are under 16 yrs. of age parent must sign coupon

Save 2c—Stick Coupon on penny postcard





# YOU CAN LEARN TO BE AN ARTIST

Start DRAWING At Home in Your SPARE TIME!

Draw for Money! Trained Artists are capable of earning \$40, \$60, \$75 and more a WEEK!

Your future is in your own hands. Prepare yourself now in **COMMERCIAL ART, DESIGNING and CAR-TOONING**—all in ONE complete home study course. No previous art experience necessary—we teach you step-by-step for a fascinating hobby and a profitable career. For 32 years WSA graduates have been "making good"—**WHY NOT YOU?** FREE BOOK, "Art for Pleasure & Profit" fully describes course and commercial opportunities. **TWO ART OUT-FITS** included with training. Mail coupon today.

(VETERANS! Course available under G. I. Bill.)



**FREE BOOK** gives details!

WASHINGTON SCHOOL OF ART,  
Studio 122H, 1115 15th St., N. W., Washington, D. C.

NAME.....AGE.....

Street.....

City.....Zone ( ) State.....

## Learn this Profitable Profession



**IN 90 DAYS AT HOME**

## Money-Making Career Open to Men and Women, 18 to 50

Hundreds of men and women between 18 and 50 make \$10 to \$20 in a single day giving scientific Swedish Massage and Hydro-Therapy treatments. There is big demand from doctors, hospitals, sanatoriums and clubs. Graduates earn large full time incomes from these or in private practice in their own offices. Others make good money from home treatments given in spare time. Learn this interesting, money-making profession in your own home, through our home study course. Same instructors as in our nationally known resident school. You can win independence and prepare for future security by qualifying for your Diploma. Course can be completed in 3 to 4 months. Many earn while they learn. Begin your training at once.



### Anatomy Charts & Booklet FREE

Enroll now and we will include, at no extra cost, many needed supplies. Fit yourself to help meet growing demand for Scientific Swedish Massage. Send the coupon at once for complete details. Anatomy Charts and 32-Page Illustrated Booklet, FREE, postpaid.

THE COLLEGE OF SWEDISH MASSAGE  
Dept. 764-B, 100 East Ohio St., Chicago 11, Illinois

Please send me FREE and postpaid, "Anatomy Charts, 32-page Booklet and complete details on Home Training.

Name.....

Address.....

City.....State.....

# OSWALD RABBIT Home Movies

A Walter Lantz production

Young and old enjoy the thrilling escapades of Oswald Rabbit. Every film packed with laughs.

### OSWALD RABBIT FEATURES

- 50 Ft. 8 mm.....\$1.75
- 100 Ft. 16 mm.....\$3.00
- Bo Peep's Sheep.....14-A
- The Radio Bug.....18-A
- The Magic Wand.....21-A
- Remote Control.....23-A

Show also a Mickey Mouse, Donald Duck, and a Walter Lantz 3-Monkeys cartoon for a grand Home Movie show. At your Photo Dealer or direct. Write for complete list of films and prices.



HOLLYWOOD FILM ENTERPRISES, Inc.

6060 Sunset Blvd. Dept. 115 Hollywood 28, Calif.

## CONFIDENTIAL LOAN SERVICE

**Borrow \$50 to \$300<sup>00</sup>**

Need money? No matter where you live you can borrow **BY MAIL** \$50.00 to \$300.00 this easy quick confidential way.

**BY MAIL**

**IT IS EASY TO BORROW BY MAIL!**  
Completely confidential and private  
**CONVENIENT MONTHLY PAYMENTS**

**NO ENDORSERS NEEDED**  
EMPLOYED MEN and women of good character can solve their money problems quickly and in privacy with loans **MADE BY MAIL**. No endorsers or co-signers. We do not contact employers, friends or relatives. Convenient monthly payments. Send us your name and address and we will mail application blank and complete details **FREE** in plain envelope. There is no obligation.

## STATE FINANCE CO.

Southern Surety Bldg., Dept. H-107, Des Moines 8, Ia.

## FREE! 32-PAGE ILLUSTRATED BOOKLET ABOUT WORLD'S MOST FASCINATING HOBBY



You're invited to hours of satisfaction with skilled tradesmen, business and professional men. Build your own scale model railroad—easy, inexpensive—looks and performs like the real thing. **Get started now! Send for our FREE illustrated booklet—"Model Railroading For You."** Send us your name and address **TODAY!**

**MODEL RAILROADER MAGAZINE**  
DEPT. 724-B • MILWAUKEE 3, WISCONSIN

SAY YOU SAW IT IN POPULAR MECHANICS



## CODE-RECEIVING SPEED

Learn to send and receive Radio Code with greater speed. Stop nervous tension. Have confidence. Be proficient. Same system used by radiotelegraph specialists. Thousands of operators needed. Rush name for FREE book.

**CANDLER SYSTEM CO.**

Dept. 5-B, Box 928, Denver 1, Colo., U. S. A.



### NEW CHEMICAL MITT

Sensational! **DRY Window Cleaner!** Uses no water, no messy liquids. Chemically Treated. Simply glide over windows; leaves glass sparkling clear. No heating water, no heavy buckets to carry. No rags, powders, sponges, chemicals. No mess or fuss. No red chapped hands. Dust, dirt, grime, fog disappear like magic. *Wonderful for auto windows, windshields!*

**SAMPLES FOR AGENTS** Sample offer sent immediately to all who send name at once. A penny postal will do. **SEND NO MONEY—just your name.** KRISTEE CO., 683 Bar Street, AKRON, OHIO.





# NOW! Build Your Future On

# DIESEL

## OPPORTUNITIES

IN INDUSTRY

ON WATER

ON LAND



## DIESEL POWER IS GOING PLACES!

You don't have to look far to see Diesel Power in action these days. Trucks, buses, tractors, streamliners and switching engines, ocean-liners and small watercraft, power and lighting plants, farm and road equipment — more and more depend on Diesel each day. And now aircraft are experimenting with the lighter units. On the farm, in factories, in communities large and small — Diesel is growing as it proves to be efficient, economical, dependable, streamlined power.

### Diesel Knowledge is Earning Power

THE NEW AND INCREASING USES OF DIESEL open a broad field for trained men who can install, maintain, operate and repair DIESEL EQUIPMENT. Diesel engines need DIESEL-trained men! Now is the time to prepare for these opportunities.

### LEARN NOW WHILE YOU KEEP YOUR JOB Actual Shop Practice

If you are between 17 and 60 and mechanically inclined, you can get thorough, individual instruction right in your home. Through UEI balanced training, you learn first through home study the fundamentals of Diesel in all its phases, given to you in practical, easy to understand lessons from men with years of successful experience training this way. You will learn how Diesel Engines operate, how fuel systems work, how to make repairs, all about the latest accessories and auxiliary equipment, and a world of other Diesel basic "know how."

Then you get valuable practice in our big shop, working on costly equipment under Diesel men who really "know their stuff". This course is new and up to the minute, including latest techniques for handling new and old equipment under today's conditions. UEI offers placement service for graduates and has numerous other features which have contributed to the reputation of this outstanding school—now in its 20th success-making year. Coupon below brings complete information.

**DO IT NOW!** It costs you nothing to get all the facts about Diesel opportunities and training. Simply mail the coupon below. Time is important—and the time to begin is NOW! Make up your mind after you get the facts, but write for them at once. Send coupon today!

### COMPACT DIESEL TRUCK ENGINE

6 cylinders, 5 1/8" bore and 6" stroke, maximum horse power rating 200 H.P. at 2100 RPM.

### OTHER U.E.I. Training Opportunities

Practical Shop Training Follows Preliminary Home Study

#### AUTO BODY AND FENDER REPAIR

Includes Welding, Metal Work, Spray Painting and Refinishing.

#### MECHANICAL REFRIGERATION

Servicing and Installation for all commercial and domestic types.

#### WELDING

Are and Acetylene. With fundamentals of metallurgy and supervised welding practice.

#### AIR CONDITIONING

Installation, operation and maintenance of home and industrial equipment.

Founded 1927

Mail Coupon FOR FREE FACTS

UTILITIES ENGINEERING INSTITUTE, Dept. 127-D  
1314 W. Belden Avenue, Chicago 14, Illinois

Please send me FREE facts about UEI training and opportunities in the field checked below.

- DIESEL
- WELDING
- REFRIGERATION
- AIR CONDITIONING
- AUTO BODY AND FENDER REPAIR

Name \_\_\_\_\_ Age \_\_\_\_\_

Address \_\_\_\_\_

City \_\_\_\_\_ Zone or County \_\_\_\_\_ State \_\_\_\_\_

If World War II veteran give length of service \_\_\_\_\_  
 Check here for special information if you are under 17.

## UTILITIES ENGINEERING INSTITUTE

1314 W. Belden Ave., Dept. 127-D Chicago 14, Ill.





## HOW TO BUILD PERSONAL SUCCESS

**N**OW, in the privacy of your own home, you can have the skilled guidance of a famous counselor. Through 17 unusual tests you will learn your real talents. Then, step-by-step, Eugene J. Bengé will show you how to profit by your abilities and your limitations! You'll learn how to acquire confidence; give your efforts a sure sense of direction; improve your poise, reasoning, memory and initiative. It's all in Mr. Bengé's new book, **YOU - TRIUMPHANT!** More than a self-help book, it's a manual that helps you chart your progress as you go along. There is no other book like it; its tests and training aids enable you to fit the program to your own individual needs! Send for it today.

### MAIL THIS COUPON NOW

**READ IT  
10 DAYS  
FREE!**

**HARPER & BROTHERS, 637 Madison Ave., New York 22**  
Please send me a copy of **YOU - TRIUMPHANT!** Within ten days I will remit \$3.00, plus postage, or return the book undamaged.  Check here if you enclose \$3.00, publisher pays postage; return privilege guaranteed.

Name \_\_\_\_\_  
Address \_\_\_\_\_  
City \_\_\_\_\_ State \_\_\_\_\_ 3604Z

## VETERANS Learn WATCHMAKING

### A Lifetime Profession

Regardless of Conditions, Age, Sex, or Physical Limitations  
Veterans—Civilians!  
Your Opportunity—  
**LEARN WATCHMAKING**

Lift yourself from a futureless job into a position paying better than your present work. Fit yourself for the job that will permit you to establish your own shop, or be employed in a pleasant environment.

Watch Repairing—Jewelry—Engraving will always be in ever greater demand. Our graduates wanted everywhere. Dignified positions \$50-\$75-\$100 per week. Veterans write today for latest FREE enrollment requirements.



**Kansas City School of Watchmaking**  
Largest Horological School in America  
617-621 Wyandotte St. Kansas City 8, Mo.

# BE A BUILDING CONTRACTOR

### FREE FACTS: Use Our Training Plan to Learn at Home in Spare Time

Do you want to be on the inside in the building boom—where big money is made? Learn about opportunities for Building Contractors whether or not you have previous experience in this field. Millions of dollars are going to be made in home and farm buildings, in construction of stores, garages, small industrial buildings. The building industry uses men with organizing ability by thousands in construction, supervision, management, sales. Properly trained men needed in production, distribution, finance, installation, marketing. Government estimates housing demand at 40 billion dollars. Others are preparing to get in now! Act immediately—get the facts! Mail postcard today—no obligation.

**HOME BUILDERS TRAINING INSTITUTE, Dept. D22**  
7050 N. Glenwood Ave. Chicago 26, Illinois

## Have an OFFICE of YOUR OWN!

**LEARN NEW PROFITABLE PROFESSION**  
At Home in 60 Days, Men & Women, 18 to 70!

Be Your Own Boss and the Boss of Others. Be Respected. Meet Interesting People.

Earnings of men and women in this profession run as high as \$5,000-\$15,000 yearly. Others make good money in spare time. Little money needed to start. A business where your earnings begin sooner. Easy to learn. No selling or goods to buy. No experience necessary. A depression-proof business. A course of action to guide you step by step as you earn. All 53 lessons sent at once to use as operating manuals. Easy terms. Diploma. Money-back agreement. Write for **FREE BULLETIN.**



**FRANKLIN CREDIT SCHOOL**  
Dept. 75-B ROANOKE 7, VIRGINIA

**BY MAIL in Easy Lessons**

# BUILDING



Millions of homes needed. Nation wide call for builders. Big opportunities. Learn now in spare time, — at home. Practical training with blue prints. No books. Send for **FREE** Trial Lesson and blue print plans.

**CHICAGO TECHNICAL COLLEGE**  
B-151 Tech. Bldg., 2000 S. Mich. Ave. Chicago 16, Ill.

## LEARN MOVIE THEATRE MANAGEMENT

The Motion Picture Theatre Business offers big opportunities for trained men. Get into a fascinating field with a post-war future. Train at home in spare time. Free Catalog. Established 18 years.

**THEATRE INSTITUTE, 370 Washington St., Elmira, New York**

# GOV'T JOBS!

**VALUABLE INFORMATION FREE**  
Columbian Correspondence College, Dept. 7, Washington 2, D. C.

**CARTOON TO SUCCESS!**  
Learn cartooning from a **PROFESSIONAL!** Let me show you how to create **ORIGINAL** cartoons and **IDEAS.** Send for **FREE** details about course.  
Also **CARTOONIST'S MAGAZINE**—Lessons, plans and hints. Send 25c coin for copy.  
**CARTOONIST HARTMAN, 2776 California Court, LINCOLN 8, NEB.**

## 6 Interesting Mail Trade Magazines

Latest Issues. All Different. 16 to 72 Pages Each. Full Of **25c** Money Making Information. Excellent Advertising Mediums.  
**GIARD 1130 MADISON AURORA, MO.**

## SUIT YOURS AS A BONUS

**AND BIG MONEY IN SPARE TIME, TOO**  
We want you to wear this fine made-to-measure suit! Make it yours by sending a few orders, & earn **BIG CASH PROFITS** in spare time. Your suit will help you get more orders with scores of rich, quality fabrics, tailored-to-measure to newest styles. Also Ladies' Tailored Suits—complete line. Write today for **FREE SAMPLES**. **NO EXPERIENCE, no money needed.** For quick action tell us about yourself.  
**J. C. FIELD & SON, INC.**  
Harrison and Throop Sts., Dept. P-1716, Chicago 7, Ill.



# Now! NO AUTO REPAIR JOB IS TOO TOUGH FOR YOU!

Let this New Short-Cut Save You Time and Work!

Used by U. S. Army and Navy

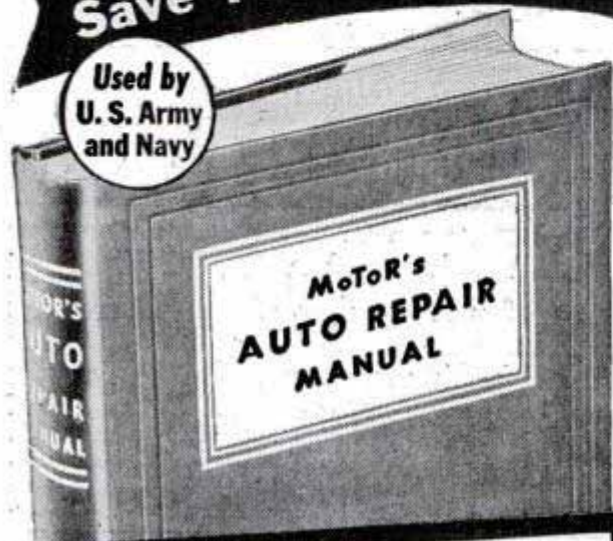

JOB ALL FINISHED IN ONLY HALF THE TIME!



Whether you do auto repairs either as full-time or as part-time work, no service or repair job can "throw" you when you've got MoToR's AUTO REPAIR MANUAL! Just look up make, model, and the job in the streamlined index—and you're ready to lick ANY job from carburetor to rear end, faster, easier, better!

Try it FREE for 7 Days!

## MoToR's AUTO REPAIR MANUAL Shows You How to Service and Repair ANY Part of ANY Car Built Since 1935!

Nearly 200,000 service and repair facts on all 31 makes. 856 big pages; including 50 pages of carburetor text, charts, illustrations, covering all models. Over 500 charts, tables; Tune-up Chart; Valve Measurements; Compression Pressure; Torque Wrench Reading; Starting Motor; Engine Clearances; Generator; Clutch & Brake Specifications; Front End Measurements, etc., Engines; Electric, Fuel, Cooling, Lubricating Systems; Transmissions; Universals; Front Ends; Wheels; Rear Ends, etc.

### Covers All These Makes!

American	Cord	La Salle	Packard
Bantam	Crosley	Lincoln	Pierce Arrow
Auburn	De Soto	Lincoln	Plymouth
Austin	Dodge	Zephyr	Pontiac
Buick	Ford	Mercury	Reo
Cadillac	Graham	Nash	Studebaker
Chevrolet	Hudson	Overland	Terraplane
Chrysler	Hupmobile	Oldsmobile	Willys
	Lafayette		

Try this great book for 7 days FREE! It's "headquarters" for 200,000 facts about service, repair, adjustment, replacement, and tune-up — on every car built from 1935 through 1946. The engineer-editors of MoToR Magazine built this Manual for YOU, by collecting and organizing all the vital information from 150 official factory shop manuals. Then they put ALL the facts into this ONE amazing workbook.

### More Than 1,000 Pictures!

MoToR's AUTO REPAIR MANUAL not only TELLS you clearly what to do. It SHOWS you, too! — in over 1,000 cut-away photos, diagrams, drawings. 856 BIG pages (8½x11 inches) put the complete "know-how" right at your fingertips! And the Fabric binding is strong, built for years of day-in-day-out service!

No wonder it is used by the U. S.

Army, Navy, trade and technical schools, thousands of auto servicemen and handymen everywhere! No wonder we're willing to have YOU try it, FREE, for 7 days! Once you use it—and see for yourself how much valuable time and hard work it saves—you'll never again want to be without it!

## SEND NO MONEY

### 7-Day Free Examination

Don't send any cash — unless you wish to do so in order to save postage charges! Simply mail coupon NOW. When postman brings your book, pay him nothing. First make the book show you what it does for you! Unless convinced it's the greatest time-saver and work-saver you've ever seen—return book in 7 days, pay nothing. Mail coupon NOW! Address: MoToR Book Dept., Desk 1-B, 572 Madison Avenue, New York 22, N. Y.

## Same FREE 7-Day Offer Applies on New MoToR's TRUCK REPAIR MANUAL

For mechanics, truck specialists, service stations, fleet owners. Covers EVERY job on EVERY truck made since 1936! 1400 pictures, 900 pages, 300,000 facts. Used by Armed Forces.

All types Gasoline Engines, Diesels, Hesselman, Fuel Systems, Governors, Lubrication Systems, Ignition Systems, Starters, Generators, Clutches, Transmissions, Axles, Torque Dividers, Transfer Cases, Brakes, Steering, etc.

ALSO SERVICES many buses, farm and industrial tractors, contractor and road building equipment, stationary power machinery, etc. (on all parts described in Manual.) Check box in coupon at right.



Published by MoToR, The Leading Automotive Business Magazine. MoToR's manuals assure high standard repair work.

## MAIL COUPON NOW FOR 7-DAY FREE TRIAL

MoToR Book Dept., Desk 1-B, 572 Madison Ave., New York 22

Rush to me at once; (check box opposite book you want).

MoToR's AUTO REPAIR MANUAL. If O.K. I will remit \$1 in 7 days (plus 35c delivery charge), then \$2 monthly for 2 months and a final payment of 95c a month later. (Book price \$3.95.) Otherwise I will return book postpaid in 7 days. (Foreign price, remit \$8 cash with order).

MoToR's TRUCK REPAIR MANUAL. (Described at left.) If O.K., I will remit \$2 in 7 days, and \$2 monthly for 3 months, plus 35c delivery charges with final payment (\$8.35 in all). Otherwise I will return book postpaid in 7 days. (Foreign price, remit \$11 cash with order).

Print Name..... Age .....

Print Address.....

City..... Zone No. (If any) .....

State..... Occupation .....

Save 35c! WE pay postage if you ENCLOSE full payment. (Check, M. O., postal note.) Same 7-day return-refund privilege.



# AVIATION Career

## MAXIMUM TRAINING IN MINIMUM TIME

CAL-AERO TECH TRAINING will add dollars to your pay check all the rest of your life. Specializing in AERONAUTICAL ENGINEERING and MASTER AVIATION MECHANICS since 1929, Cal-Aero Tech training is carefully designed for just one thing—TO MAKE MORE MONEY FOR YOU. An alumni of over 6000 successful graduates proves our career training is unsurpassed.

**VETERANS** —Write us about Aviation Training, as provided under "G.I. Bill of Rights."



**CAL-AERO TECHNICAL INSTITUTE**  
 MAJOR C. C. MOSELEY PRES. SINCE 1929  
 FORMERLY CURTISS-WRIGHT TECHNICAL INSTITUTE

GRAND CENTRAL AIR TERMINAL  
 GLENDALE 1, CALIFORNIA  
 LOS ANGELES COUNTY

### MAIL THIS COUPON TODAY!

Cal-Aero Technical Institute, Grand Central Airport, Glendale 1, California  
 Please send full information on Aviation Training FREE—without obligation. Dept. 135-2

Name \_\_\_\_\_ Birth Date \_\_\_\_\_  
 Street \_\_\_\_\_  
 City \_\_\_\_\_ State \_\_\_\_\_

No Waiting to LEARN

## START NOW TO EARN!

This BIG BOOK SHOWS HOW

### IF IT'S RESULTS YOU WANT—GET ACTION QUICKLY WITH THESE PRACTICAL IDEAS

Never before has a more helpful book been printed for those planning a business of their own. Gathered in this large illustrated volume are the formulas, recipes, facts and secrets that have contributed so largely to America's great industrial progress. Capitalize on this information for making most any conceivable product without experience, special equipment or previous knowledge of chemistry. Start at home, expand with profits—build for a profitable independence.

The experts who compiled this book are authorities, and present this information in simple, understandable language. They also give you wholesale supply sources for needed materials, short cuts and economy methods for the most profitable results. Hundreds of good paying businesses have been built on a product made from a simple

recipe. Opportunities in this field exist everywhere. Choose from any of the 162,000 facts and 10,000 formulas of which the following are only a very few: Adhesives, Alloys, Anti-Freeze Solutions, Cosmetics, Beverages and Liquors, Candy, Gum, Casein, Celluloid, Oils and Ointments, Paints, Paper, Perfumes, Photography, Polishes, Powders, Remedies for Man, Beast or Fowl, Rubber Products, Refrigerants, Soaps, Solder and Soldering, Tooth Cements, Transfers, Transparencies, Varnishes and Thousands of others for making all sorts of profitable and practical things.

**ALSO**  
 We include Free—our new book of helpful money-making information: —  
 "The More You Know the More You Can Earn—Easier and Quicker."

### FORTUNES MADE FROM A SINGLE IDEA!

This comprehensive book is an accepted authority by chemists, schools, industry, etc. and is the largest and most comprehensive book of its kind ever issued. Nothing else like it in existence. A single formula has been worth a thousand times this book's small cost to countless owners. Crammed with money-making ideas. Invaluable for reference. Ideal for Factory, Home, Farm, Office or Workshop. As necessary as the dictionary and more useful for manufacturers, chemists and salesmen who put up products for profit.

\$3.50 postpaid. Canada or Foreign, \$3.85 U. S. Funds. (C.O.D. shipments U.S.A. only.) Immediate Shipment—Safe Delivery Guaranteed.  
**ADAMS BROWN COMPANY BOOKS OF APPLIED SCIENCE**  
 Dept. 172, Chestnut Hill 67, Massachusetts, U. S. A.

POSTPAID!  
**\$3.50**  
 U.S.A.  
**\$3.85**  
 FOREIGN

**FOR PLEASURE OR PROFIT**

# PHOTOGRAPHY

**Train at HOME!**

Ideal as a joy-full hobby, photography also offers ever-increasing opportunities for sparetime earnings, a well-paid career or independence and profit as your own boss. Best of all, through N.Y.I.'s success-proved training, you can qualify at home without leaving job or family. FREE book gives fascinating details. Write TODAY. Also resident courses.

**New York Institute of Photography**

Dept. 49

10 West 33 St., New York 1, N. Y. (37th Year)

## Command a Substantial Salary

# BE AN ACCOUNTANT

**FREE WRITE TODAY**

Hill's, one of America's leading Business Schools, offers you the opportunity to advance yourself to a well paying accountant's job. Our FREE book, "Through Hill's to Success," tells how and where the best positions are found and how you can qualify for them by study at home or in our resident school. We have thousands of successful graduates and maintain nation-wide employment service. G. I. Approved.

**HILL'S EXTENSION SCHOOL and BUSINESS UNIVERSITY**  
 619 W. Main St. - Oklahoma City 2, Okla.

## TRAIN NOW FOR A WELL PAID JOB IN POST-WAR AVIATION!! AIRCRAFT INSTRUMENT MEN

will be needed by manufacturers, airlines, service organizations. Don't wait until competition gets tough! Be ready! Study now! Let Eastern's Home Study Course give you training in your own home. Actual instruments furnished. Send for folder now.

**EASTERN AIRCRAFT INSTRUMENT SCHOOL, Dept. PM**  
 Division of National Technical Institute, Inc.  
 116 Newark Ave. Jersey City 2, New Jersey

### FIGURE DRAWING WITHOUT A MODEL

This book brings famous art schools right to your home! Over 300 "real-life" drawings in this new Cliff Young book. Copy from them to guide your Art Career. Only \$1 postpaid. Order Now: Art Books list included FREE.



HOUSE OF LITTLE BOOKS, 80-A East 11th St., New York 3

SAY YOU SAW IT IN POPULAR MECHANICS

# RUPTURED?

## Get Relief This Proven Way

Why try to worry along with trusses that gouge your flesh—press heavily on hips and spine—enlarge opening—fail to hold rupture? You need the Cluthe. No leg-straps or cutting belts. Automatic adjustable pad holds at real opening—follows every body movement with instant increased support in case of strain. Cannot slip whether at work or play. Light. Waterproof. Can be worn in bath. Send for amazing FREE book, "Advice To Ruptured," and details of liberal truthful 60-day trial offer. Also endorsements from grateful users in your neighborhood. Write:

**CLUTHE SONS, Dept. 31, Bloomfield, New Jersey**



# Learn RADIO- ELECTRONICS- TELEVISION



ELECTRONIC CIRCUIT TESTING — Instructor showing students use of large Cathode Ray Oscilloscope.

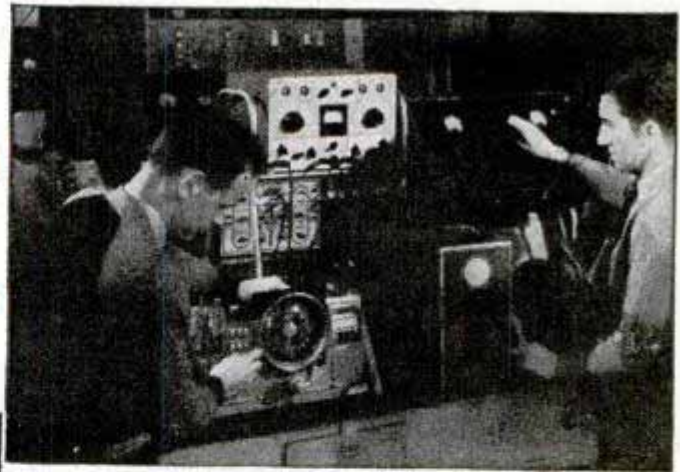

RADIO TESTING AND SERVICING—Students learning to locate troubles with modern radio analyzers.

**TRAIN FOR A GOOD  
JOB NOW** one that  
offers **STEADY WORK**  
with a **REAL FUTURE**

Don't be caught napping. Prepare for a good job now that will still be a good job with a real future when conditions change. If you are not a trained man you may have to compete with millions of other untrained men. Get into a field that offers real opportunities in good-times and bad-times. Tremendous expansion in Frequency Modulation and Television is predicted because of war time discoveries now being re-converted to civilian use. Radio-Electronics trained men are needed today—they will be needed in the years ahead!

### Real Opportunities for the Radio Trained Man

Prepare for jobs as assembler, inspector and tester—Radio sales or service and installation work, electronics, television, sound work, aircraft-radio, auto-radio, etc. Many opportunities in the vast Radio-Electronics field.

### GET OUR BIG NEW BOOK

It tells all about our big Chicago shops and our plans to help you get ahead. Packed with facts and pictures of students at work in our shops. Mail coupon for this Big New Book now! Coupon will also bring details on how we'll finance most of your tuition...facts on how we help you "Earn-While-Learning"...information on FREE EMPLOYMENT SERVICE FOR LIFE...and other plans to help you. ACT NOW TO MAKE SURE YOU GET OUR GENEROUS OFFER. Sending for this interesting free book can be your first big step to success. No obligation. No salesman will call. Mail coupon today. B. W. Cooke



# "Learn by Doing"

**RIGHT HERE** in the SHOPS of COYNE — in a Few Weeks  
*Student Finance Plan*

We train you on real Radio, Television and Sound equipment—RIGHT HERE IN THE COYNE SHOPS IN CHICAGO. Necessary theory is given in a practical way by practical lectures, blackboard illustrations and equipment demonstrations. Whether or not you have had Radio experience you need Coyne all-around Radio Electronics training. Many of our students had no previous experience. Others had experience in one or two branches but realized they needed all-around training for better jobs and advancement.

### EARN WHILE LEARNING

If you need part-time work to help pay living expenses while at school, we will help you get it. Coyne graduates also receive a Life Membership with Lifetime Employment Service.

**MEN WITH PHYSICAL DISABILITIES**—whether due to war or other causes—we also have facilities for you. Check coupon for particulars if you have a physical disability of any nature.

**PREPARE FOR  
JOBS LIKE THESE**

Radio Servicing  
Radio Sales  
Radio Manufacturing  
Factory Inspecting and Testing  
Auto Radio Installation & Servicing  
Sound and Public Address, etc.  
Your Own Radio Shop

**Electric Refrigeration  
Now Included**

**ADDED  
TRAINING**

This training included to help you get ready for the better jobs in this great field

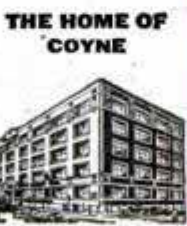

**VETERANS!** Coyne is also equipped to train those who qualify for training under the G. I. Bill of Rights. Check coupon for special G. I. Bulletin.

B. W. COOKE, Dir. Founded 1899  
**COYNE ELECTRICAL SCHOOL**  
**RADIO-ELECTRONICS DIV.**  
 500 So. Paulina Street Dept. 27-3H CHICAGO 12, ILLINOIS

B.W. COOKE, Dir., Radio-Electronics Div.,  
 COYNE ELECTRICAL SCHOOL  
 500 S. Paulina St., Dept. 27-3H  
 Chicago 12, Ill.

Dear Mr. Cooke, Send me your Big Free Radio-Electronics Book and all the facts... also full details of your "Student Finance" plan.  Send special G. I. Bulletin.  Send physical disability details.

NAME.....  
 ADDRESS.....  
 CITY.....STATE.....



# INVENTORS

The inventor who believes he has a new and useful invention, and finds himself in need of advice, should consult a competent registered patent attorney.

The question as to whether a subject matter is patentable can be substantially determined by a search of the United States Patent records.

Without obligation, write us for information as to what steps an inventor should take to secure a Patent.

## RANDOLPH & BEAVERS

Registered Patent Attorneys

11-D Columbian Bldg., Washington 1, D. C.

### RANDOLPH & BEAVERS

11-D Columbian Bldg., Washington 1, D. C.

Please send me full information on how to secure Patents & Trademarks.

Name.....

Street.....

City.....State.....



# AUTO BOOKS ON APPROVAL



### CAN YOU FIX IT?

These wonder books tell step by step HOW to make difficult repairs and adjustments, how to keep a car at maximum efficiency, including latest improvements in car design and operation. Engine troubles and how to correct them well covered.

**6 BIG VOLUMES**  
2800 pages, 2000 illustrations, wiring diagrams, etc., including Diesel engines. Beautiful modernistic, washable cloth binding.

**SEND NO MONEY.** Just mail the coupon for a complete set of Six Big Auto Books. 20th Edition. Whether you are a mechanic or helper, expert or apprentice, auto owner or driver, take immediate advantage of this FREE EXAMINATION OFFER.

**MAKE GOOD MONEY NOW HOLD A PERMANENT JOB**  
America wants its automobiles kept in good repair. Men with "know how" are in demand, at big pay. These books will help you get and hold an important job, or give you a chance to go into business for yourself now or later. Any man who half tries to improve himself can learn auto servicing and repairing by this quick reference method. Use the JIFFY INDEX to find easily understood answer to any auto problem. These wonder books prepared by eleven of America's great automobile engineers. Many hundreds of valuable illustrations. Send the coupon TODAY.

[A year's consulting privileges with our engineers now given with these books without extra charge.]  
Vocational Publishers Since 1898

**AMERICAN TECHNICAL SOCIETY, Dept. A219**  
Drexel Ave. at 58th St., Chicago 37, Ill.

I would like to examine your Six-Volume Set of Auto Books. I will pay the delivery charges only, but if I choose I may return them express collect. If after 10 days' use I prefer to keep them, I will send you \$2 and pay the balance at the rate of only \$3 a month until \$24.80 has been paid. Please include consulting service as offered above.

Name.....

Address.....

City.....State.....

Please attach letter stating age, occupation, employer's name and address and name and address of at least one business man as reference. Men in service, also please give home address.

# DOUBLE your INCOME IN YOUR SPARE TIME

## LEARN SILK SCREEN PROCESS

Jealously Guarded Trade Secrets NOW Available to You

Develop a Profitable Business of Your Own... or a Hobby

Prepare yourself for an interesting top paying position. Thousands of jobs open. Silk Screen Process signs, displays, Xmas cards, toys, etc. IN GREAT DEMAND THE WORLD OVER. You may make enough the second week to pay for the entire course. EASY TO DO... EASY TO LEARN. No education or mechanical knowledge required. BOOKLET with 3-color Silk Screen Processed cover and Samples sent FREE. Write NOW!

**CALIFORNIA SCHOOL OF SCREEN PROCESS**  
Dept. PM-27 3740 Overland Blvd., Los Angeles 34, California



**COURSE INCLUDES A COMPLETE KIT OF SUPPLIES**

# PATENTS AND TRADE MARKS

## C. A. SNOW & CO.

REGISTERED PATENT ATTORNEYS

WRITE FOR INFORMATION TO  
428 SNOW BUILDING, WASHINGTON 1, D. C.

# PATENTS "Proof of Invention"

Folder mailed without obligation.

**E. E. VROOMAN, Registered Patent Atty.**  
871 Woodward Building, Washington 5, D.C.

# TRAIN Your VOICE!

Results GUARANTEED

We build, strengthen the vocal organs—not with singing lessons—but by sound, scientifically correct silent and vocal exercises and absolutely guarantee complete satisfaction with results. Write for Voice Book, FREE. Sent to no one under 17 years old unless signed by parent.  
Perfect Voice Studios, Studio 1352, Kimball Hall Bldg., Chicago 4, Ill.

# FREE NEW HOBBY HANDBOOK

A Gold Mine of Information on Newest Equipment, Materials, Tools for HOME CRAFTSMEN AND MECHANICS

IF you work in metals, woods, plastics or glass, you need this Big, FREE Source Book of equipment, tools, parts and materials... including dozens of hard-to-get items you can't find in stores. Many things you must have for your home hobby or shop. Just loaded with ideas and illustrations.

**A WAREHOUSE OF THINGS YOU WANT**  
More than 100 items including: Portable Welder; Bench Tools; Plastic Molder; Telephone System; Chemical Sets; Spray Guns; Electroplater; Drills; Grinders; Tool Chests; Model Tools; Key Maker... everything you need for your hobby or craft. Send for this Big, FREE Book TODAY. Mail postcard or coupon below.

**WARNER ELECTRIC CO., 1512 Jarvis, Chicago 26, Dept. L-110**

**WARNER ELECTRIC CO., 1512 Jarvis, Chicago 26, Dept. L-110**  
PLEASE SEND BIG, FREE BOOK |

NAME.....

ADDRESS.....

CITY.....ZONE.....STATE.....



# NOW!

## You Can Make Your Present Radio Into An Advanced **F.M.** RECEIVER

with this Powerful New **1947**

# MIDWEST RADIO

**LOW**  
**FACTORY-TO-YOU**  
**PRICE**  
COMPLETE WITH  
SPEAKER

**SERIES 16\***  
**AM-FM**  
**CHASSIS**  
with  
**5 Wave Bands**

ONCE again Midwest demonstrates its 27 years of leadership with this powerful Super De Luxe Series 16\* 5-band world-ranging radio that brings you noise-free FM reception plus Standard Broadcast and 3 short wave bands. You'll be thrilled by its marvelous tone...its wealth of new post-war features...its world-ranging performance that brings you the finest programs with amazing clarity and strength. Send today for the new FREE 1947 Midwest Catalog before you buy any radio. Take advantage of our sensational Factory-to-you values and liberal 30 days Trial Offer.



**\*SERIES 16 CHASSIS USES ALL OF THESE LATEST TYPE TUBES**

**14 1/2"**  
**PANASONIC**  
**SPEAKER**

Plus the Exclusive **TRI-MAGNADYNE** Coil System — the Heart of Every **MIDWEST** in.

**30**  
**DAYS**  
**TRIAL**

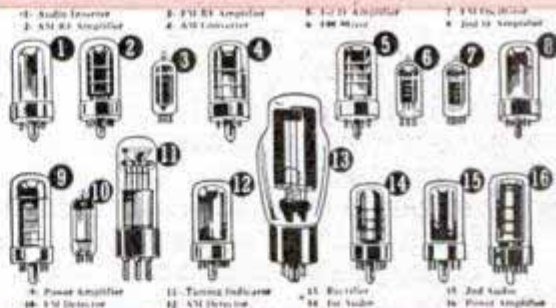

## THE MAGNIFICENT LINE OF BRILLIANT NEW CONSOLE AND TABLE MODEL RADIOS AND RADIO-PHONOGRAPHS



The **SYMPHONY GRAND SERIES 16\*** AM-FM RADIO-PHONOGRAPH CONSOLE with **NEW AUTOMATIC RECORD-CHANGER**

A REAL masterpiece of cabinet design and radio engineering... a luxurious musical instrument that brings you the newest marvels of radio science, including static free FM, automatic record changing, 5 wave bands and scores of new features and improvements for your listening pleasure. For complete details of this and other Midwest Radio models send for your copy of the 1947 Midwest Catalog today.

**Rush for Free Catalog!**  
FILL IN COUPON AND MAIL TODAY OR JUST SEND YOUR NAME AND ADDRESS ON 1c POSTCARD

**MIDWEST RADIO CORP.**  
Dept. 25-E, 909 Broadway  
Cincinnati 2, Ohio

Gentlemen: Please send me your new FREE catalog and details of your liberal 30 Days Trial.

Name \_\_\_\_\_ Zone \_\_\_\_\_ State \_\_\_\_\_  
Address \_\_\_\_\_  
City \_\_\_\_\_

**EASY TERMS**

**MIDWEST RADIO CORP.**  
Dept. 25-E • 909 BROADWAY • CINCINNATI 2, OHIO

**RADIO MANUFACTURERS**  
Since 1920



**"What's he got  
that I haven't got?"**

LOOK at the successful men you know. "What have they got" that you haven't?

Very little, probably. In most ways these men are no brighter or naturally more capable than average. Many of them probably have no more formal education or better natural aptitudes than you.

But that little extra they have is important. They have the special knowledge and ability for which business is glad to pay well—they know the what, why and how of business. They have also the confidence and aggressiveness which come from knowing that they know and can apply their knowledge.

You may add that extra—may get that same profitable knowledge and ability—that same confidence and aggressiveness—if you are willing to pay the price in earnest, necessary study. For LaSalle has spent 38 years developing, testing and proving, with over a million student members, spare-time success training in certain specialized business fields. What scores of thousands of men and women—many just like you—have done, you should be able to do.

You need not leave your home or interrupt your job; you need pay comparatively little money. But you must be ambitious and willing to study seriously. And soon after you start training, the results will begin to show up in your own confidence and in your work. For what you learn at home tonight is so practical that often you can apply it on the job tomorrow.

How much do you want success—more money, a promotion or a new job, prestige and responsibility? If you really want it, you will use the coupon below to find out what LaSalle training can do for you. It costs only a postage stamp, but a coupon like it has been the starting point to real success for scores of thousands—and can be for you.

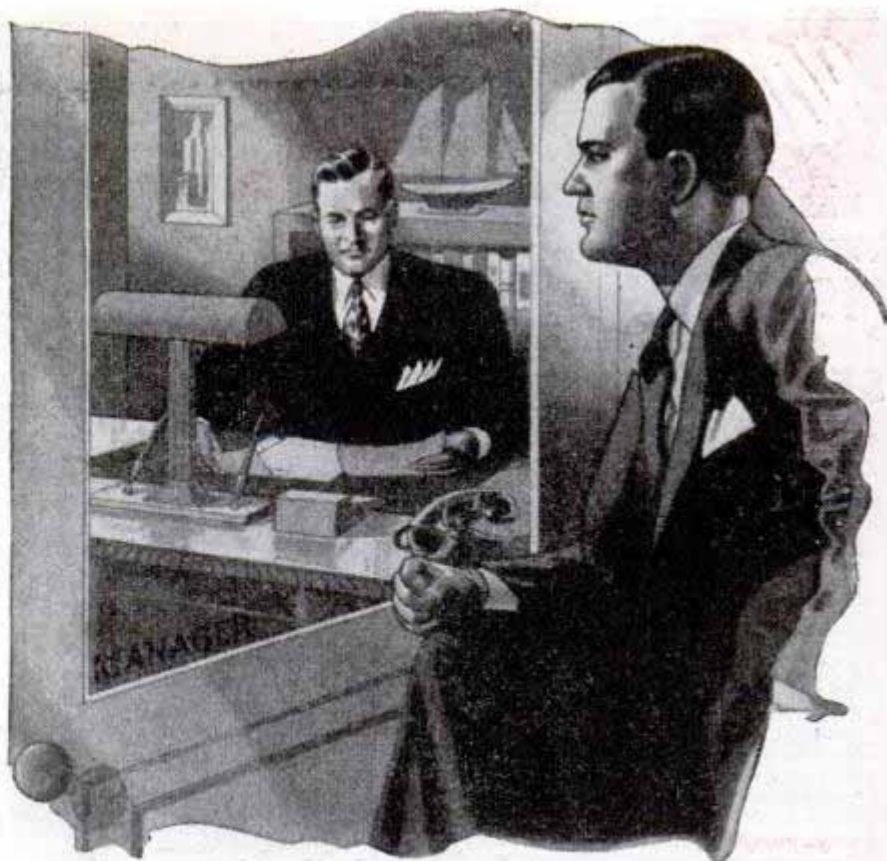

**G. I. APPROVED**

**LA SALLE Extension University**  
*A Correspondence Institution*

Dept. 264-R • 417 S. Dearborn • Chicago 5, Ill.

I want to know how LaSalle can help me win success in the field I have checked below. Please send me your free 48-page booklet about that field and your success training in it.

- |                                            |                                                        |
|--------------------------------------------|--------------------------------------------------------|
| <input type="checkbox"/> Accountancy       | <input type="checkbox"/> Salesmanship                  |
| <input type="checkbox"/> Bookkeeping       | <input type="checkbox"/> Effective Speaking            |
| <input type="checkbox"/> C.P.A. Coaching   | <input type="checkbox"/> Executive Management          |
| <input type="checkbox"/> Business English  | <input type="checkbox"/> Industrial Management         |
| <input type="checkbox"/> Law: LL.B. degree | <input type="checkbox"/> Traffic Management            |
| <input type="checkbox"/> Foremanship       | <input type="checkbox"/> Stenotypy (Machine Shorthand) |

Name..... Age.....

Position.....

Address.....

City, Zone and State.....

**LA SALLE** EXTENSION UNIVERSITY  
*A Correspondence Institution*



**WORLD'S  
BEST  
WANT AD  
MEDIUM**

# CLASSIFIED Advertisements



Advertisements in this section 60 cents per word, each insertion, minimum 10 words, payable in advance  
To be inserted under proper classification in March issue, copy should be in our office January 25th

March issue on sale March 1st

F. W. Johnson, Manager, Classified Advertising

Popular Mechanics Magazine, 200 East Ontario Street, Chicago 11, Illinois

## 1214 CLASSIFIED ADVERTISEMENTS 1214 OPPORTUNITIES FOR YOU

### AUTOMOBILES, MIDGET CARS

**MAKE** Your Ford fast! Complete details, photographs. How to construct 120 m.p.h. Hotrod. \$1 postpaid. California Bill, Eagle-rock Box L-1, Los Angeles 41, Calif.

**CLYMER'S** Motor Scrapbooks (old automobiles) Editions 1, 2, 3, each different, \$1.50 each. Motor History of America, \$3.00. Fastest on Earth racing book, \$2.00. Motor Racing With Mercedes-Benz, \$2.00. Book Steam Automobiles, \$2.00. Power & Speed, \$2.50. Henry Ford, His Life & Work, \$3.00. Midget Automobile Racing Book, \$1.10. Indianapolis "500" Race History book 1909-1946, \$3.50; 1946 only, \$1.00. All postpaid. Catalog free. See ad motorcycle section. Clymer, Dept. A23, 2125 W. Pico, Los Angeles 6, Calif.

**SPEED** And Mileage manual. Easily obtain greater speed, mileage, racing performance from any automobile! Includes simplified methods, speed tuning, gas saving secrets. Instructions on building economizers, speed equipment, dual carburetors, mufflers, superchargers, racing fuels, fast conversions. \$1.98. Alquist Engineering, 447 (G)—64 St., Brooklyn 20.

**DUALTONE** Crystalline packed twin muffler sets. Prices complete. V8's \$23.00, six cylinder cars \$33.00. Large chrome tail-pipe extensions \$3.30. Polished carburetor velocity stacks \$1.30. Replacement mufflers, prices on request. Dualtone Mufflers, 2636C India Street, San Diego 1, California.

**SEE** Our ad under Motorcycles for midget racer bargains. Midget Motors Directory, Athens, Ohio.

**R & R Mfg. Co.**, marine and auto division, Anderson, Indiana, Robert M. Roof, \$1.00 for our new 1947 speed and power equipment catalogue with price sheet—showing racing cars, midgets, speed boats with recommendations how to rebuild your motors for racing. Dual ignition racing cylinder heads for V-60-100 and Mercury Ford engines. Dual intake manifolds, racing pistons, camshafts, compound valve springs, Lynite flywheels, quick change gear boxes and numerous other supplies.

**SCOOTER-CAR** Runabout! Two passenger, three wheeled, motorized, speedy. Simple construction from available second hand parts. Detailed plans \$1.00. Plans for midget "Jeep" included free. Universal, 2671 Algonquin, Toledo 6, Ohio.

**"CUSTOM-STYLING"** Manual. Easily make car look Hollywoodized, custom built, ultra-beautiful! Streamlining suggestions, simplified restyling, refinishing, illustrations, plans, accessories, mufflers, model changes—convertibles, custom, sport, etc. \$2.00. Alquist Engineering, 447(G)—64 Street, Brooklyn, 20.

**GOGGLES**, Heavy duty Aero, \$4.50 pair. Summer helmets \$1.50 each. Winter leather helmets slightly used \$3.00 ea. New \$5.00 ea. Send payment with order. Western Aircraft, Hawthorne, California.

**RACING** Car performance for all cars. Increase power, speed. Special "custom-built" equipment. Free literature. Write Lee Motorcraft, 1412-A Great Northern Bldg., Chicago 4, Illinois.

**CUSTOMIZE** Your automobile. Illustrated, new restyling ideas, instructions, suggestions, specific model changes by simple methods. Postpaid \$1. Speedwheel, Box 723-E, Arcadia, California.

**BUILD** Speedy midget track racer from castoff parts! Plans, specifications, construction information, \$1.00. Motor Supply, Box 1682-CS, Toledo, Ohio.

**"STREAMLINED Roadster"**—America's lowest priced car! Speedy, two passenger, light, three wheeled, beautiful! Amazingly easy to build from inexpensive material—small motor. Instructions, drawings \$1.98. Alquist Engineering, 447(G)—64 Street, Brooklyn 20.

**MUFFLER** Manual. Convert easily to Hollywood, Laguna, Westwood, duals, etc. Includes construction details, regulations, diagrams. Postpaid \$1. Mellotone, Box 723E, Arcadia, California.

**PROFESSIONAL** Midget racer, motor-scooter, midget roadster, and midget motorcycle. Plans, specifications for all four contained in illustrated handbook, 25c. Big list bargain priced used motors, motorscooters, servicycles, etc., included free! Midwest, 3839 Drummond, Toledo, Ohio.

**AUTOMOBILE** Racing book, fifth edition, well illustrated. Instructions on building bodies, frames, engines. Ford A and B conversions. Plans. AAA rules, specifications. Roadster racing, Indianapolis cars. \$1.00 postpaid, \$1.30 C.O.D. Ray Kuns, Dept. 47, Madisonville, Cincinnati 27, Ohio.

### AUTO SUPPLIES AND EQUIPMENT

**TWIN-TONE** Mufflers for V-8 and Mercurys 35 to 47 models. Gives more mileage, without back pressure. Mufflers are straight through-type and produce deep mellow tone, \$20.00 a set. Single through-type mufflers for all cars \$6.50 ea. Chrome tail pipe extension 2½" dia. \$2.50 ea. Satisfaction guaranteed. Twin-Tone Mufflers, 139 East Manchester Ave., Los Angeles 3, Calif.

**"QUICK Start"** for your car in the coldest weather—relieves storage battery of long grinds. Booster battery with necessary accessories to give hot sparks to engine plugs. Complete with full instructions for installation. \$6.00 postpaid. R C H Engineering Co., Box 93, Riverside, Ill.

**OIL** Pumping motors—brought back to normal without ring job. Send address on post card for detail. Mullner, Box 3102, St. Paul 1, Minn.

**INTRODUCTORY** Offer—Kits all-bronze connecting rod bearings 75c. Dealers accommodated. Kit's Machine Co., Washington, N. J.

**BUILD** An a.c. battery charger. \$20 starts shop. Garland Enterprises shows how. Dept. 2-47, Box 186, Windsor, Ontario, Canada.

**AUTO** Parts, new and used. Bumper to bumper. Fast service. Describe needs. Arrow Auto Wreckers, 4128 Ogden Ave., Chicago 23, Ill.

**MANIFOLD** Whistles—Imitates many sounds, "wolf whistle," barking dog, etc. Connects to windshield wiper in 15 minutes. Send \$6 to Kivi Co., 4033 Windsor, Youngstown 7, Ohio.

**PLATINUM** Ignition points assure instant starting, positive sparking, smooth performance, eliminate costly tune-ups. Complete \$6.95. State car model—year. Jaco Industries, 3 Seaside Terr., Lynn, Massachusetts.

**GRILLES** For all cars. Meyers Auto Parts, 820 Dryades, New Orleans, La.

**DISTINCTIVE** Automobile seat covers individualized with your initials in gold. Perfectly tailored in tastefully colored fiber and leatherette with sturdy sailcloth or mercerized cotton. Reasonably priced. Hollywood-Craft Auto Seat Cover Co., 1948 Judson St., Los Angeles 33, Calif.

**33 MILES** Per gallon, Center Flow carburetor throttle. Walert Company, 3429 North Tenth St., Milwaukee 6, Wisconsin.

**HAVING** Car trouble? New, used, guaranteed auto, truck parts save money. Transmission specialists. Describe needs; immediate reply. Victory, 2930½ Northwestern, Chicago 18.

**AUTO** Parts for all autos and trucks. Trans., motors, differentials, fenders, carburetors. Also body parts. Security Auto and Truck Parts, 1941 BJ Eddy, Chicago 13.

**PLATING** Outfits for auto parts. Connect to a battery. No tanks used. Free particulars and proofs. Gunmetal Co., Ave. J, Decatur, Ill.

### AUTO TRAILERS

**TRAILER**, Streamliner has everything. Large manual drawings, instructions, parts list \$1.00. Circular 10c. Tandem 3 room trailer, 24x36" six views floor plans, principal dimensions, \$1.00. Craftsmann Books, Box 1153 P3, Milwaukee 1, Wis.

**VISIT** The trailercoach show, Navy Pier, Chicago, March 15-23. Subscribe to the personalized trailercoach journal, Trail-R-News, 1 year, \$1. Box 431, Glendale, Calif.

**SOFT** Tire indicators for trailers. Inquire. Laidlaw Mfg. Co., Box 1108, Pasadena 20, Calif.

**AUTO-TRAILER** Travel, monthly magazine, \$1 year. Magazine Mart, Plant City 8, Fla.

**BUILD** Your own trailer! Save money! Have every feature you want! Plans for house, sport, camp and utility trailers. Catalog describing 9 models 10c. 15c in Canada and overseas. Jim Dandy, Box 125-A, Wausau, Wisconsin.

### MOTORCYCLES, BICYCLES, MOTOR-SCOOTERS AND SUPPLIES

**CUSHMAN** Motorscooter \$25 complete; midget car \$28; midget car less motor \$10; midget motorcycle \$25, German Sachs motorcycle \$50, less motors; motors \$3 up. Over 5400 small balloon tires \$1.50 up, mailorder only. Send 25c for big War Bargain catalogue Number 17, listing the above and hundreds of other bargains in new and used motors, motorscooters, midget cars, motorcycles, outboards, etc. (35c by first class mail). Midget Motors Directory, Athens, Ohio.

**TIRES**, Inner tubes, wheels, for small trucks, wheelbarrows, midget cars, power scooters, farm equipment, carts, etc. Sizes 8" to 18" o.d. in 2, 4, and 6 ply first-line quality tires, with removable inner tubes and heavy duty demountable wheels. Also caster forks, straight or swivel types. Free circular and prices. Experienced tire engineers to advise on your special equipment problems. Jahant Co., 626 East Exchange Street, Akron 6, Ohio.

**NEW** Bicycles, tricycles. All makes, all sizes, also complete stock of accessories and parts. Send self-addressed stamped envelope for price list and details for free bicycle radio. Atlas Cycle Co., 3002 Broadway, Chicago 14, Illinois.

**MOTORBIKE** Manual containing easy to build motorbike and scooter plans, motor tune up information, \$1.00. Veco, A127 Box 124, Evansville 5, Ind.



**BICYCLES.** New Schwinn and Monarks. Wholesale and retail. Send dime for list. Century Cycle, 3447 Lawrence, Chicago 25, Illinois.

**BIKE** Trailer, sturdy made, beautiful finish. Also wheel kits—real snapshot and prices free. Wilber Mfg., Box 667, Kokomo, Ind.

**MOTORCYCLE** Parts, new and used. List 10c. Ballak, 811 N. 9th, St. Louis 1, Mo.

**WHEELS**—Steel disc, rubber tired, sizes 5"—6"—7"—8"—10". Available. United Wheels Mfg. Co., 11727 La Fayette Ave., Chicago 28, Ill.

**CLYMER'S** Motorcycle books. Speedway Motorcycle Racing, \$2.00. Motorcycle Speedway Annual, \$1.00. How to Manage Motorcycles, \$1.50. Motorcycling Manual, \$2.00. How to Obtain Speed, \$1.50. Motor Scooter Plans, \$2.00. Books on Ariel, BSA, Norton, Triumph, Villiers engines, \$1.50 each. English Motorcycle Magazine, 50c. All postpaid. See our ad automobile section. Catalog free. Clymer, Dept. A24, 2125 W. Pico, Los Angeles 6, Calif.

**MOTOR** Scooters, bicycle engines, 120 miles gallon. Dime for catalog. Clymer, Dept. A25, 2125 W. Pico, Los Angeles 6, Calif.

"**BICYCLE** Repair Manual." Illustrated booklet, tells how to repair bicycles. 65c. Robert Klausner, Shelbyville, Ill.

**RETREADING**—Top mid-west plant equipped to tread motorcycle tires, midget racing tires (all sizes) in famous Zook Armor Tread. All non-skid design. Substantial dealer discount. Send tires direct to Zook Tire Company, Denver, Colorado.

**MEAD** Ranger motor scooters, world's foremost power scooters are available once more. Ranger heavy duty models 541 and 543 are again offered for prompt shipment. Literature and prices on request. Mead Cycle Co., 4520 W. Madison St., Chicago 24, Ill.

**CUSHMAN** Motorscooter \$40. Briggs motor \$5, tires \$1.00! Send 25c for new bargain catalog packed with money saving buys in motorscooters, motorbikes, midget cars, motors, wheels, tires and parts. Gail and Company, 538 Erie, Toledo, Ohio.

**GOGGLES**, Heavy duty Aero, \$4.50 pair. Summer helmets \$1.50 each. Winter leather helmets slightly used \$3.00 ea. New \$5.00 ea. Send payment with order. Western Aircraft, Hawthorne, California.

**MOTORSCOOTER** \$10, Motor \$3, tires \$2! Send 25c for big new catalog Number 934 listing scores of other sensational bargains in motors, wheels, motorscooters, motorbikes, Servicycles, tires, etc. Associated, Box CS-1764, Toledo, Ohio.

**LARGE** Stock Indian parts. Expert motor rebuilding. New and rebuilt Chief motorcycle, motors only. Indian Motorcycle Sales, Kansas City 1, Mo.

**GENUINE** Moto-Scoot parts. Amsco centrifugal clutch, Windshields, sidecars. All other parts and accessories. Write for parts list. Also genuine engine parts for Briggs and Stratton, Lauson. American Moto-Scoot Co., 1313-23 Carroll Ave., Chicago 7, Ill.

**WHEELS!** Build wagons, scooters, mowers, trailers, wheelbarrows, grocery carts, baby carts, play pens, baby carriages. 4" to 16". Free list. Trulsen Mfg. Co., 811 E. 31, Kansas City, Mo.

**HARLEY-DAVIDSON** New and used 45" motors, service, parts, accessories. Send \$2.25 for army motorcycle manual, 10c for bulletins. Knuth's (Harley-Davidson factory dealer), 2491 Fondulac, Milwaukee, Wis.

**MOTORCYCLE** Cams ground for speed and power, carburetion. For information write Harold Schaller, 247 West Main, Turlock, Calif.

**BICYCLE** Book, how to buy, rebuild, sell used bicycles 50c. John Collett, Handley, Texas.

**TIRES** And industrial wheels, suitable for scooters, wheelbarrows, farm equipment, etc. All sizes. Bicycles and accessories. Largest assortment in America. Send dime for list. Cycle Transport Company, 1241 So. Michigan Ave., Chicago 5, Illinois.

**BUILD** America's lowest priced motor-scooter speedster! Complete plans, specifications, \$1.00. Big list bargain priced used motors, etc., included free! Motor Supply, Box 1682-CS, Toledo, Ohio.

**AUTO** Books. Up-to-date list free. Popular Mechanics Press, (C-43), 200 E. Ontario, Chicago.

## AVIATION

**JET** Propulsion experiments. New principle, drive boats, bicycles, model helicopters. Circular on plans. Rush name. Maupin, Tipp City 6, Ohio.

**PROPELLERS**—Correct type, size for sled, boat, plane. Exclusive manufacturers of Airliner 3 blade, also 2 blade. Either hardwood or all metal. Illustrated literature. Build your own motor, aircool diagrams 50c. Standard Aircraft, Ft. Worth, Texas.

**CUBS**, Wacos, Taylorcrafts, Aerocas. Big catalog, 25c, lists these and thousands of other sensational airplane bargains. Some are "easy to repair" crackups. National, Box 1682-CS, Toledo, Ohio.

## BATTERIES, GENERATORS

**BATTERY** Repairing, rebuilding, plate making plans. L. Wertz, Pekin, Illinois.

**EDISON** Batteries. Light. Power. Fifteen year life. Unconditionally guaranteed. Free literature. Seejay Company, 321 Yonkers Avenue, Yonkers, New York.

## ELECTRICAL SUPPLIES, EQUIPMENT

**NEW** Kohler electric plants a.c. and d.c. Other electric plants rebuilt. Bargain on Silvertron electric outboard motors. E. F. Schmaltz, 314 Wyoming Ave., Kingston, Penna.

**NEON** Window signs complete with transformers. Inter-State Laboratories, 4049 Minnehaha Avenue, Minneapolis 6, Minnesota.

**CONTROL** Garage doors from dashboard. "Build yourself" plans \$1.00, refundable. Vital parts available. Kaytor Laboratories, Lynwood, California.

**FREE** Catalog of welders, welding supplies, generators, fencers, and other electrical items. Write LeJay Company, Minneapolis 8, Minn.

**AMAZING** Value. New 110-volt sixty-cycle ball bearing precision motors. Operate grinders, fans, etc. With special mounting brackets. Cost government \$48.75. Sent express prepaid. Only \$3.99. Leco Engineering Company, 908-PM-13, Lincoln, Nebraska.

**EXPERIMENTERS**, Student scientists—Experimental Manuals: C-1, "Construction of Galvanometer," inexpensive applicable to chemical, electrical, thermal experiments in home-laboratory; E-1, "Experiments With Galvanometer," numerous applications. Each 50c. Queens Experimental Supply Co., 23-08 21st Avenue, Long Island City 5, New York.

**SILVER** Contacts — 1/4" diameter, pair mounted on sturdy brackets, 50c. "Sylvian," 4800 North Lawndale, Chicago 25.

**PRACTICAL** Winding of a.c. motors. A course of instruction on winding, connecting, and testing single, two, and three phase motors. Clearly written in everyday non-technical language. Illustrated throughout. This book is recommended for beginners interested in learning motor winding and repair. Satisfaction guaranteed or remittance refunded. \$2.00 prepaid. Educational Advancement Co., Dept. Y, Lakewood, New York.

**LAMPS**—All parts to build or repair. Catalog 10c. Gyro Lamps, 5416 Clark, Chicago 40.

**FLEXIBLE** Non metallic conduit. 1/2 inch to 2 inch. U.L. approved type. Is used to replace pipe. Also automotive loom. Large quantities at a bargain price. Send for price list. State Ignition, 2521 Indiana, Chicago 16, Ill.

**ELECTRIC** Pencil: Writes, engraves all metals. \$1.00 postpaid. Beyer Mfg., 4515-H Cottage Grove, Chicago 15.

**FLUORESCENT** Tubes burned-out? You can relight and use indefinitely. Complete instructions \$1.00. Wallingford, 121 Burlington, York, Nebr.

**ELECTRIC** Fan assemblies. Make your own. Ted Riseman, 425 East Jefferson, Springfield, Illinois.

## WELDING, SOLDERING, PLATING

**BUILD** Proven 10-250 amp. 220 volt a.c. welder that has been used successfully in industrial plants past seven years. Simple low cost. Complete instructions \$3.50. Westco Mfg. Co., Marshall, Tex.

**ACETYLENE** Welding outfits, new, consisting of 2 gauge regulators, torch, 3 tips, hose, lighter, \$54.50. Eagle Welding, Dept. PM, 5085 Broadway, Chicago 40, Ill.

**BUILD** Small, medium or large d.c. or a.c. arcwelder. Plans \$1.00 each. Welders Club, AB-3432, Chicago 54.

**WELD**, cut, braze with gasoline! Amazing new discovery shatters costs. Boosts profits. Important! Write Matthews Mfg. Co., Calgary 21, Canada.

**ELECTROPLATING** By battery. Illustrated instructions. \$1.00. Alvin, 553 William, Winnipeg, Manitoba.

**NEW** Model electric welder 110 volt a.c.-d.c.; will weld all metals; easy to use; full directions. Complete with power unit, flame and metallic arc attachments, carbons, fluxes, rods, mask; all for \$19.95. Used by the navy. Magic Welder Mfg. Co., 239-MP12 Canal St., New York City.

**WELDING**, Cutting, aircraft welding and soldering equipment. Electric arc welders. Superior Oxy-Acetylene Co., Hamilton, Ohio.

## MACHINERY, TOOLS AND SUPPLIES

**UNIVERSAL** Tools dandy 10 piece set: Rigid pipe wrench, channellock pliers, adjustable wrench. Ceetee pliers, diagonal cutter, ballpeen hammer, plastic screwdriver, waterpump pliers, hacksaw and blade, cold chisel, \$19.85. Universal Tool Company, 1527 Grand, PM-2, Kansas City, Missouri.

**INVENTION**. New principle. How to make portable power hammers. Any size. Tack hammer—pile driver. Electric, gasoline. Simple, easy. No gears, cranks. Circular on plans. Rush name. Maupin, Tipp City 4, Ohio.

**CEMENT** Equipment, low prices. Oil heat conversion units for coal heaters, furnaces. Blue Square, Excelsior, Minn.

**DRILLS**—1/4 in. Chicago Pneumatic, good condition, \$17.50 complete. Check or money order. Kleinschmidt Store, Cordeur, Missouri.

**LATHE** Milling attachment castings, 30 lbs. \$8.75. Angle Plates, V-Blocks, etc. Catalog 3c. Model Tool Service, Rock Falls, Ill.

**NEEDLEFILES**, Swiss, circular free. Harkay, 116 Nassau St., New York 7, N. Y.

**GEARS** For inventors, experimenters, model makers, schools, work shops, laboratories, etc. Government surplus made of brass, bronze, dural steel and stainless steel. 12 matched pairs; 24 gears, bevel, spur and ratchet. List price \$12.00, our price \$2.50. 25 matched pairs; 50 gears, includes larger gears, also sets of worm gears. List price \$30.00, our price \$5.00. Limited quantity. Order now. Write for our bulletins on ball bearings, rectifiers, relays, selsyns, horns and government surplus materials. Met Exchange, 323 Canal Street, New York.

**TABLE** Saws \$18.00, sanders, jigsaws, compressors, post drills, circulars, 3c. Sunshine, Berkshire Hghts., Penna.

**AIR** Cooled 4 cylinder air compressor complete with moisture trap, safety valve, fifteen feet 2 ply hose. Quart paint gun, tire chuck, blow gun. Ideal for painting, inflating tires, blowing air. Complete with 1/4 h.p. ball bearing motor \$96.50. Less motor \$66.50. Guaranteed. X-L Supply Company, 233 Main Street, Cincinnati 2, Ohio.

**TOOLS**, Brand new war surplus bargains. Stanley wood chisels 1/4" 89c, 1" 99c. Other good makes, 1/2" 79c, 3/4" 89c, 1 1/2" \$1.25, all with leather tipped handles. All five \$4.29. Mallets with hardwood handles and head 59c. Genuine Crescent hacksaws \$1.29. Millers Falls \$1.69. Millers Falls feeler gages, 9 leaf 59c. Millers Falls screw pitch gages (30 pitches) 89c. US standard sheet steel gages #0-36, \$2.79. Add 10c per item postage. Metal Materials Company, 5312 So. Broadway, Los Angeles 37, California.

**ELECTRIC** Strip heaters, 500 watt, 115 volt, 24" long, safe, for heating tanks, cabs, etc. \$1.30 each, any quantity, mail check. Also 1/2 HP., 12 volt DC motors \$12.00 each. M. C. Solon, 2410 East 8th St., Duluth, Minn.

**TWIN** Disc clutches and parts. Briggs and Stratton motor parts. Frank Johnson, 3426 Charles St., Omaha, Nebraska.

**LATHES**—Atlas watchmakers, Norton grinder. Millers, chucks, headstocks, compounds. Service, Newfane 2, Vermont.

**DRILL** Grinder for twist drills \$2.95. See ad on page 266.

**BALL-BEARINGS**, One-fourth list price. Free list. Burgess, Box 168, Ferguson, Mo.

**CEMENT** Brick machines \$85. Howe Brick Machine, Beaufort, N. C.

**CONCRETE** Block machine. Two blocks at time. No expensive pallets to buy. 200 to 240 blocks hour. Concrete mixers on wheels \$59.95. Other block machines 45 to 100 blocks hour. Brick machines, power or hand operated. Batch Mixers. Any size. Madison Equipment Co., Madison, Tenn.



**LATHE Chucks**—3 and 4-jaw threaded for 1½"-8 thread spindle. Other tools at bargain prices. Immediate delivery. Write for free catalog! Kacy Supply Co., 209 Sycamore St., Genoa, Illinois.

**CUT-OFF Tool holders**, non-chatter, for lathes and screw machines. Free circular. Gustin, High Hill, Missouri.

**SHARPEN** Dull pipe wrenches with new patent grinder. No competition. One operator made \$321 in one week. J. C. Moore Industries, Box 234, Fredonia, Penna.

**CONCRETE** Building block machines and molds. Catalog free. Concrete Machine Co., 5129 South Compton Ave., St. Louis 11, Mo.

### BOATS, OUTBOARD MOTORS, ETC.

**MARINE** Conversions for Ford and Jeep engines. Catalog 10c. Lehman Manufacturing Company, Department D, Newark 2, New Jersey.

**USED** Outboard motor parts. Outboard Exchange, 1194 Remsen Ave., Brooklyn 12, N. Y.

**PISTON** Rings for all outboard motors. Wilson Marine, 170 Terrace, Buffalo, N. Y.

**KAYAKS**. Rowboats, weldwood ready cut kits, booklet. E. J. Croot Co., #103-D, Basking Ridge, N. J.

**REBUILT** Tachometers 0-5000 and 0-8000 r.p.m. 4¾ diameter face. \$10.00 each, specify rotation. Zakarian Engineering, Box 416, East San Diego, Calif.

**REBUILT** Marine engines and outboard motors, propellers. Marine Supply catalogue 40c. Cruisers priced \$1980.00 and up. Data on request. W. L. Masters & Son, Est. 1906, 214 W. Chicago Ave., Chicago 10, Ill.

**MARINE** Power — Easily convert any Ford and Jeep motor (domestic and foreign) with Osco parts and kits. Complete catalogue 25c (coin). Osco Motors Corp., 2020B E. Orleans St., Philadelphia 34, Penna.

**PLYWOOD** Boat kits! Complete materials for building "Delta Craft," "Junior Dinghy," "Tadpole Skiff." Mahogany marine plywood and oak construction! Send 10c today for illustrated folder featuring these boat kits and other marine materials and supplies. Carmen-Bronson, Marine Department, Mount Vernon, N. Y.

**OUTBOARD** Motor parts, new and used, for all makes. Our stock of used parts is too large to list. Write giving us the model and motor no. New parts for Waterwitch, Seaking, Mercury, Wizard, Lauson, Neptune, etc. New standard and over-size outboard pistons. Outboard motor cylinders honed and re-bored. Outboard Motor Mart, Inc., 309 Atlantic Ave., Boston 10, Mass.

**ALL** Copper water jacketed exhaust manifolds for marine conversions of automobile and aviation engines and marine engine replacements; any make, model or age. Joseph Van Blerck & Son, 397 Woodcleft Avenue, Freeport, N. Y.

**BOATS** And all about them. How to select, build, repair and operate. For 40 years the leading practical boating magazine. Half price trial subscription. 12 issues for \$1.00. Motor Boat, 62 Gold Street, New York 7.

**TWENTY** Plywood boat plans \$1.00. Catalog boat building plans 10c. The Rudder, 15 Murray Street, New York.

**FORD-Mercury-Zephyr** marine conversions. Catalog 10c. Lehman Manufacturing Company, Dept. D, Newark 2, N. J.

**BOAT** Designers are highly paid professionals. Complete course by mail. Catalog. Westlawn, Montville, N. J.

**USED** Marine motors, propellers, marine fittings, conversion manifolds. Stokes Marine Supply, Coldwater, Michigan.

### ENGINES, MOTORS, DYNAMOS

**INSTANT**—Reverse your present capacitor split phase motor. Cost no more than good controller. Write for folder. The Enoch Co., 533 N.E. 78th Ave., Portland 16, Oregon.

**150 AMPERE** Generators for welding \$47.50. Extra flexible cable, 6 ft. lengths \$2.75. Other bargains. Butler Electric Company, 1885 Milwaukee, Chicago 47.

**HEAVY** Duty voltage control boxes: Cut-out, current and voltage control units with genuine silver contacts. Also large radio filter. All enclosed in a weather proof die-cast box. Like new condition. 24 volt-50 amp. Wt. 12½ lbs. Original cost \$140.90. \$5.95 each delivered. State Ignition, 2521 Indiana, Chicago 16, Ill.

**WINDING** Data listing 225 motors, single and three phase, \$1.00. Motor Data Co., Box 7631, Kansas City 3, Mo.

**"BUILD Your Own"** gas drive arc welder easily with Hobart Generator. Save \$300 to \$500, and need only add used auto engine and chassis to build portable gas drive welder that goes everywhere after profitable construction and repair jobs. Write for free instruction book, further details. Hobart Brothers Co., Box M-1066, Troy, Ohio.

### ATHLETIC EQUIPMENT, BODY BUILDING COURSES

**BARBELLS**, Olympic revolving sleeve, highest quality. Stamp for folders. Jackson Barbells, Springfield, N. J.

**BARBELLS**, Exercise equipment. Courses. Free booklet. Good Barbell Co., Reading, Penna.

**BUILD** Bulging muscles. Complete course \$1.00. Health-O-Matic System, Covington, Ky. YMCA.

**DEADLY** Judo—Fiercest fighting technique. Trick knockouts. (200 photographs—plus illustrations). Expert instructions. Three volumes. Complete \$2.25. Variety House, Box 46-BM, Wall Station, New York 5.

### SPORTING GOODS, GUNS, FISHING TACKLE, ARCHERY, TRAPPING

**AUTOMATIC** Lure—Positively weedless. Greatest invention in ages. Nothing like it. Circular free. Babcock Reel Co., Oak Harbor, Ohio.

**FINEST** Glass eyes; taxidermy supplies. Catalog free. Elwood Company, Department 234, Omaha 2, Nebr.

**SEND** 10c For list 100 used guns. Frayser's, Willmar, Minn.

**FISHING** Poles, canes, bamboos, casting rods, ferrules, guides, clamps, etc. Sample 3-piece native cane \$2.50. Sample 6' bamboo rod with guides, tip, etc., \$5.50. Baseball bats, softball bats of finest ash. Dealers only. Bob Pace, Combs, Ark.

**3000 BARGAINS**, Firearms, binoculars, war relics. Catalog 30c. Smith Firearms, Runnemeade, New Jersey.

**1947 ILLUSTRATED** Firearms collectors catalog 50c. "House of Guns," Kearny, New Jersey.

**BLUEING**, Cleaning, adjusting, "single" shotgun or rifle, \$6.50. Home blueing kits, \$2.50. Reimco, 310 Douglas, Freeport 3, Illinois.

**AMMUNITION**—New and used shotguns, rifles, handarms, fishing tackle. List 10c. Rudolph's, Atchison, Kansas.

**CARTRIDGES**, Shells, ammunition, guns, rifles, list 25c. Frank Farish, Vicksburg, Mississippi.

### FIELD GLASSES, MICROSCOPES, TELESCOPES, MAGNIFIERS

**MYSTERIOUS** Wonders! 50 power microscope. Heavy gauge aluminum, 2 lenses, adjustable reflector, specimen slides, instructions. \$2.98. Wardell, 2509 Clarendon Road, Brooklyn 26, N. Y.

**TELESCOPE**—59c Formerly \$1.49. No toy but a real telescope. Magnifies objects many times natural size. Brings everything right up close. Precision ground optical lens, plastic eyepiece, extends 15 inches, folds for easy carrying. Send 59c for one postpaid or \$1 for 2 postpaid. Satisfaction guaranteed. No c.o.d. at these low prices. Rush order today. Supply limited. Simmons Co., 30 Church St., Dept. L-91, New York 7, N. Y.

**TELESCOPES**, Microscopes, binoculars, barometers. Bought, sold, repaired. Lists 10c. Rasmussen & Reece, 41 Market, Amsterdam, N. Y.

**60 POWER** Telescope, \$2.95. 250 power microscope, \$2.45. Send for free catalog of telescopes, binoculars and microscopes. Brownscope Company, 24 West 45th Street, New York.

**REFLECTING** Telescopes, complete, 3½" diameter, equatorially mounted. View planets, stars, \$19.75. Write Sky-scope Company, 475-P 5th Ave., New York.

**BINOCULARS**, Telescopes, watches. Buy, sell, trade. Paul Schweer, Donnellson, Iowa.

### DOGS, PETS, BIRDS, RABBITS

**GENUINE** Chinchillas. Small payment plan and booklet of care. Send \$1.00. Mont. Fur Farm, Billings, Mont.

**RAISE** Guinea pigs. Make money at home. Big demand. Booklet free. Taylor, Box 426A, Hapeville, Georgia.

**PEDIGREED** Police pups, blacks, whites. Ansonia Kennels, Mose, N. Dak.

**RAISE** Registered rabbits under cooperative marketing. Small investment. Thomas Hall, Vernal, Utah, received \$603.00 for 21 rabbits produced from four rabbits in 3 months. Illustrated booklet tells how. 25c. Hansen's Rabbitry, 1347 Miller Ave., Salt Lake City 5, Utah.

**BEAUTIFUL**, Useful collie-shepherd pups \$12. Paul Schuitetus, New Liberty, Illinois.

**ENGLISH** Shepherds—border collie puppies, all ages, both sexes, choice colors. Faithful workers. Satisfaction guaranteed. Fairmont Farms, Cedar Falls, Iowa.

**GIGANTIC** Chinchilla giants—Really profitable. Demand strong. Free literature. Illustrated catalogue, 25c. Fur samples, 25c. Behrens Chin-Chin Farms, Pearl River 4, New York.

**RACCOONS**, Minks, foxes. Bred females. Baby skunks. Colored catalog, 25c. Shady Fur Farm, Springfield, Minnesota.

**RAISE** Money-making Angora rabbits. Wool \$15.00 pound. Plenty markets. Cash income. Future prospects bright. Particulars free. White's Rabbitry, Lawrence, Kan.

**60 VARIETIES** Pigeons, etc. Catalogue 10c. Jim Houck, Tiffin, Ohio.

**GUARANTEED** Chin-Chin giant Chinchilla rabbits. Greatest amount of delicious meat. Largest, finest, most valuable furs. Tremendous demand for breeding stock. We buy youngsters. Contact world's largest breeder. Willow Brook Farm, R15, Sellersville, Penna.

**ANGORAS**, Chinchillas, giant rabbits—finest pedigree! Catalogue free. Book "Profitable Rabbit Raising" tells everything \$1.00; scientific self-cleaning hutch plans \$1.00; automatic feeder plans \$1.00. All three \$2.50. Grinsteads, Dept. 15-E, Edwardsville, Illinois.

**ZOOLOGICAL** And pet animals for sale. Illustrated catalogue, literature, 25c. Trails End Zoo-5, St. Stephen, S. C.

**\$2000 PER** Year raising Angora rabbits. We buy your output. Contract particulars free. Wilsons, 1065 Shryer, St. Paul 8, Minn.

**RAISING** Rabbits, Cavies, Hamsters, Chinchillas is a growing and profitable industry. Magazine 10c. Descriptive book and magazine 25c. Book and magazine (monthly) one year \$1.00. Address Small Stock Farmer, Pearl River 15, N. Y.

**SPORTSMEN**: 200 Pointers, setters, straight cooners, combination hunters, rabbit and fox hounds. Reasonable. List free. Ramsey Creek Kennels, Ramsey 1, Illinois.

**RAISE** Guinea pigs. Profitable, low-cost feeding, small space required, small investment. Complete details 25c. Guinea Pig Farms, 3456 West 116th St., Chicago 43.

**ST. BERNARD** Pups: Champion sired beauties. Franklin Young, R4, Riverhead, Long Island, New York.

**STANDARD** Rabbit Journal, Milton, Pa. 3 years \$1.00, sample dime.

### SEEDS AND NURSERY STOCK

**DAHLIAS**. Ask for 1947 book. 400 varieties. Springhill Dahlia Farm, R. 2, Box P, Grand Rapids, Mich.

### FARMS, FARM LANDS, REAL ESTATE

**660 ACRES** Of farm land on paved road; 15 miles from city of Tampa. \$25.00 an acre. Owner: W. H. Hamiter, 104 N. Rome Avenue, Tampa, Florida.

**STROUT'S** Spring farm catalog just out! Bigger than ever—bargains galore! 136-page green book. 30 states—coast to coast. Write today for your copy. Mailed free. Strout Realty, 255 4th Ave., New York 10, N. Y., 20 W. 9th St., Kansas City 6, Mo., 453 So. Spring, Los Angeles 13, Calif.

**FLORIDA** Homesite \$250.00—Beautiful Tampa bay area. Close to city of Tampa. Owner: Ceasar Fernandez, 2822 Elmore Avenue, Tampa, Florida.

**WEST'S** 1947 Catalogue: Over one thousand farm and business bargains. Free copy, write Buck & West Realtors, HE-2, Pittsburgh 16, Penna.

**100 ACRES**, 10 Miles from city of Tampa \$30.00 an acre, good farm land. Owner: Raymond Sheldon, 608 Tampa Street, Tampa, Florida.

**HERE'S** A plan for your future! Write today for complete information on farming opportunities in Canada. Farms of all types, sizes, at low prices. Favorable terms. Be sure to indicate kind of farm and what province you are interested in. Address H. S. Cresswell, Canadian Pacific, Montreal.



**HOMESITES \$450**—Convenient payments. California's finest garden section. On Morro Bay's scenic shores. Wonderful fishing, hunting, boating, bathing. Fertile soil, softest water, temperate climate, congenial community. Free literature. Richard Motto, 6560 Hollywood Blvd., Hollywood 28, California.

**GOVERNMENT Lands** \$1.00 acre up. Information all states 25 cents. National Tax Service Bureau, 834A Majestic Building, Detroit.

**GOOD Farms—Ranches.** Washington, Minnesota, Montana, Idaho, Oregon, North Dakota. Dependable crops, favorable climate. Write for literature, lists describing typical postwar farm opportunities, specify which state. J. W. Haw, 119 Northern Pacific Ry., St. Paul 1, Minn.

**OZARK Magazine,** Eureka Springs, Arkansas. For homeseekers, tourists. Year, \$1.00.

**NEW Free catalog,** selected farm bargains, 16 states, sent to you free! Many equipped. Many illustrated with picture. Special service to those stating general location desired, and payment plan. Write today! United Farm Agency, 1684 Arcade Bldg. 1, St. Louis, Mo.

**\$5.00 MONTHLY Buys** 40 acres near town. Price \$200.00. Free list. Box 425-P, Carthage, Mo.

**OZARK Lands** for all purposes. Actual river frontages, 5 acres \$90.00 and upwards. Free list and literature. Hubbard, 424-I, Minnesota Ave., Kansas City 4, Kansas.

**FARMS, Ranches.** All kinds, sizes. Reasonable prices, terms. Wide variety locations, climates, recreational facilities. Free descriptive folders, price lists. Milwaukee Railroad territory; Washington, Idaho, Montana, the Dakotas, Minnesota, Iowa, Missouri, Indiana, Illinois, Wisconsin, Upper Michigan. R. W. Reynolds, 914, Union Station, Chicago 6, Illinois.

### POULTRY AND FARM SUPPLIES

**YOUR Greatest poultry problem** will look simple when you read American Poultry Journal regularly. 500,000 poultrymen do, why not you? 2 years 50c. 5 years \$1.00. American Poultry Journal, 537 So. Clark, Chicago.

**WHITE African guineas**—big profits. Chicks, stock. Illustrated catalogue free. Goshen Poultry Farm, Dept. A-17, Goshen, Indiana.

**MONEY-MAKING** Experimental farm poultry raising helps only 25c per year. Five years \$1.00. Early start increases profits. Order now! Poultry Tribune, Dept. 41, Mount Morris, Ill.

**RAISE Turkeys for profit!** Learn how others succeed with America's only all-turkey magazine. Experimental farm helps. Only \$2.00 per year. Subscribe now! Turkey World, Dept. 92, Mount Morris, Ill.

**BOTH Free!** Four color catalog with full page pictures. Valuable chick raising book. Rock bottom prices on all baby chicks. Colonial Farms, Pleasant Hill, Mo.

**RAISE Turkeys the new way.** Write for free information explaining how to make up to \$3000 in your own backyard. Address National Turkey Institute, Dept. 3, Columbus, Kans.

**POULTRY Pays!** Learn how. Production line methods. More money. Less work. Send postcard for free booklet "Seven Keys to Poultry Profits and Fryer Producers' Yardstick." to Poultry Advisory Service, Room 108, 1046 So. Olive St., Los Angeles 15, California.

**BABY Chicks,** champion mated. 52 varieties, 6 Hybrids, licensed inspected, blood-tested. Rush postal, large colored book free, low prices. Berry's Farm, Route 12, Clarinda, Iowa.

### PROFITABLE OCCUPATIONS

**FOR An extremely profitable lifetime business,** operate a collection agency—credit bureau. Easily learned. Write: Cole & Associates, Syracuse 2, New York.

**SCRAP Metal** costing 5c pound brings dollars in finished castings. Lifetime profits. Information, Fritz Foundry & Supply, 622 N. Fulton, Allentown, Penna.

**BIG Pay,** buying, selling, repairing motors, refrigeration, tavern equipment. Lists, wholesale suppliers, manuals, circulars (10c). Myers Electric, Manitowoc, Wis.

**SHELL Jewelry** profitable hobby. Illustrated booklet and sample kit, \$1.50. For instruction folder write, Sarasota Shell Shop, Box 2046, Sarasota, Florida.

**PROFITABLE Mail selling business.** Write, Parcell, 2701 Main, Elkhart, Indiana.

**TATTOOING Machines.** Worlds finest, supplies. Free catalogue. Jensen, 120 West 83rd Street, Los Angeles 3.

**STORY Writing** simplified by Simple Segment System. Complete, \$5.00. Free circular, Box 834, Spokane, Wash.

**SMALL Business** on less than \$100 capital. No selling, no manufacturing. Dignified business in or near your neighborhood. Earnings better than comfortable living. My treatise gives every detail, \$1.00. Satisfaction or refund. James K. Hollomon, Buell Post Office, Norfolk, Virginia.

**"Los Angeles Boom."** Job opportunities in nation's fastest growing industrial area. \$1.00 brings copyrighted booklet giving facts on expansion programs totaling \$80,000,000. Lists over 300 firms. Explains how—where to apply. Los Angeles Research Services, 507 N. Windsor Blvd., Los Angeles 4, Calif.

**NO Selling,** operate vendors, amazing profits, details free. Silver-King, 622 Diversey, Chicago 14, Ill.

**MAKE Seashell jewelry.** Illustrated instructions and catalog 10c. Beginners kit \$3.00. Frissells, Dept. C, 4627 Woodside Drive, Houston 3, Texas.

**"ALASKA—The Last Frontier"** offers thousands of excellent opportunities! \$1 brings official government map and 1947 copyrighted report describing potential opportunities in commercial fishing, mining, fur farming, prospecting, aviation, timber, agriculture, live stock raising, business enterprises, government homestead lands. Alaska Opportunist, 6417 Homewood Ave., Dept. PM, Hollywood 28, Calif.

**MAKE Money** at home. Write immediately. Duffy, 056, Covington, Ky.

**MECHANICALLY Inclined men**—Own and operate general appliance repair shop. Complete, illustrated course shows you how. Welding, refrigeration, motor repair, how to get business, etc., all phases covered. Free literature. Christy Supply, Dept. 473, 2835 N. Central Ave., Chicago.

**WOULD You pay 3%—first \$350 made?** Color-illustrated book "505 Odd, Successful Enterprises" free! Some offer occasional "day off." Work home. Expect something odd! Pacific, San Clemente, Calif.

**INTERESTED In Latin American** and foreign employment? \$1 brings 1947 Foreign Service Directory listing oil, aviation, mining, transportation, manufacturing, construction concerns with foreign interests and tips for immediate application. Global Reports, 6417 Homewood Ave., Dept. PM, Hollywood 28, Calif.

**GROW Bean sprouts** at home in spare time for profit and future. Year around without sun or soil. America's fastest growing industry. For complete simplified instructions send \$1.00 to Hydroponic Farms, 2656 Champa Street, Denver, Colorado.

**MAIL-ORDER Business,** how to build your own! Idea and plan book for beginners, mail dealers. 25c. Baker, 319R Tazewell, Knoxville 18, Tennessee.

**ANNOUNCING** Home study course in commercial baking. Practical basic training. Good field for those with aptitude. Nearly depression proof. Send for free booklet, "Opportunities in the Baking Industry." National Baking School, 1315 Michigan Ave., Dept 3431, Chicago 5, Ill.

**LOCKSMITHING**—Profitable business or hobby! New course teaches you lock secrets, how to fit keys, de-code, masterkey, etc. Easy self-instruction lessons. Bargain price. Fascinating 100-page illustrated catalog free! Write Nelson Company, Dept. 2-02, Chicago 5.

**QUICK Money!** "Repairing car batteries!" At home! Easy too! Write Batteryman, Grand Junction 6, Colorado.

**FASCINATING.** Small investment business. 25c. Parcell, 2701 Main, Elkhart, Ind.

**BE A Novelty manufacturer,** fascinating, interesting work. Exceptional profits. No expensive equipment needed, quickly learned. Use garage or basement. Successful manufacturer shows how, orders waiting. Write today. Plastex Products, 127 Clement, San Francisco (18).

**WASHING Machines.** Parts all makes. Northeast Burner, 1358 H St., Washington 2, D. C.

**PHOTO Stamps.** Illustrated instructions. \$1.00. Alvin, 553 William, Winnipeg, Manitoba.

**MUSHROOMS Grown.** Boxes. Barrels. Illustrated instructions 50c. Spawn \$1.00. Gordons, 553 William, Winnipeg, Manitoba.

**TYPEWRITER** Repairing instructions, standard typewriters. Webers', Box 1008, Canton, Ohio.

**\$3000 A YEAR**—Your own business, no boss, no time clock, independence. Complete details \$1.00. Satisfaction guaranteed. Home Industries, B1354 Hollywood, Columbus, Ohio.

**\$40.00 WEEKLY** Made growing mushrooms, fresh, dried. Dominion patent 331583. Free spawn. North American, 169P Yonge, Toronto, Canada.

**TADPOLES** Make frogs, tremendous demand. Both make you money. 25c brings tell-how information. Chariton Corporation, Century Building, Chicago 4.

**WELDING**—Electric arc. Learn profitable trade quickly through actual practice. Individual welder instructions at bare cost of materials. Full particulars free. Valuable welding lessons book 50c. Hobart Welding School, Box M-1064, Troy, Ohio.

**ELECTRIC Clocks** are every where you go, buildings, homes, parking lots, factories. Repairs increasing. Our easy to learn course with pictures and drawings teach you how to repair these clocks. Electronic Supply Co., P.O. Box 2350A, Houston 1, Texas.

**TYPEWRITER** Repairmen urgently needed. Earn \$40 to \$50 weekly spare time. Our easy to learn home study course teaches how to repair typewriters. Write for free information. Houston Typewriter Repair Service, P.O. Box 5357A, Houston 12, Texas.

### BOOKS, PERIODICALS, PICTURES, POSTCARDS

**WHAT Every Mason wants.** We have Masonic books for Blue Lodge, Chapter, Commandery, Scottish Rite and Shrine. Our rituals are used the world over. Send for free catalog of books and rituals for Masons, Odd Fellows, Knights of Columbus, etc. Ezra A. Cook, Publisher, P.O. Box 796-PF, Chicago 90, Ill.

**MAIL Order catalogs.** 10c each. Pera, 165 Chattanooga, San Francisco 14, Calif.

**100,000 PROBLEMS** Solved graphically, in mechanics, hydraulics, electricity, physics, shopwork, etc. Read off the answer instantly. Details free. Columbia Graphs, Columbia, Connecticut.

**OCCUPATIONAL Success chart,** How to Study Guide. Free. Prepared by college authorities. Learn how to make your own practical home study course of every text in big educational catalogue. Send for free chart and guide today. Central Educational Service, Dept. B-21, 6009 Belmont Avenue, Chicago, Illinois.

**MAGAZINES**—Business, trade, professional. Current copies. Choice over 800 publications. All fields. Free price-list. Commercial Engraving Publishing Co., 34C North Ritter, Indianapolis 1, Ind.

**POST Cards** of navy ships. Beautiful post cards of ships of the navy, all modern, all different, 20 for 25c, mailed post paid. Liberty Picture Co., Richmond, Calif.

**MAGAZINE Clearance sale.** (Catalog free.) All kinds. A-1 Book Store, 509 No. State, Chicago 10.

**BE First** to get amazing new plans for homecraft projects. Send 25c for first edition surprising new magazine Homecraft & Garden, 100 W. Chicago Ave., Chicago 10, Ill.

**NAVY Ship pictures.** Beautiful reproductions of Lowell Heckings pens and ink sketches, size 14x20 inches, each suitable for framing, 10 for \$1.00 mailed prepaid. Liberty Picture Co., Richmond, Calif.

**SUCCESS, Happiness, power,** by analyzing the other person's basic dream—two amazing new Pathway Lecturettes 25c each. Leaflet listing unusual booklets, biographies, unique lectures, free. New Method Lecture Service, 738-G Fifth St., N.W., Washington 1, D. C.

**DIVER'S Manual.** One dollar. Navy Diver, 31 Tyler, Vallejo, Calif.

**FIVE Or more opportunity publications** with valuable information 25c. Robert Dyer, Box 1608, March Field, California.

**FAST Selling merchandise, novelties, money-making ideas.** "Hows" given in large tabloid. Copy 10c; MMM-Magazine, Box 791, Chicago 90.

**SHIP Pictures** (World War II navy ships) reproduced in color, size 9 1/2 x 13 1/2 inches, suitable for framing, all different, 50 for \$1.00 mailed prepaid. Liberty Picture Co., Richmond, Calif.

**BOOKFINDERS.** Any book, new, used, any subject. Send wants, Charles Book Shop, Box 12C, Fordham Station, New York 58, N. Y.

**BOOKS! (Out-of-print, scarce):**—Quickly supplied. Send wants. Spotlight, 141 Broadway, New York.

**BACK-DATE Magazines,** books. Send wants. Arkell's, Box 744, Tarzana, Calif.



**GOOD "Used" self-instruction educational books on all subjects bought, sold, rented, exchanged. Satisfaction guaranteed. Complete information and 100-page illustrated bargain catalog free! Write—Nelson Company, Chicago 5.**

**SHIP'S Photographs, passenger, freighters, tankers, list 10c. Scozzafava, 1648 59th St., Brooklyn 4, N. Y.**

**SELF-EXPLAINING Bible: Illustrated circular free. Box 446-P, Minneapolis, Minn.**

**NATIONAL Geographic Magazine, 1888-1945, any issue. Periodical Service, Dept. PM. Swarthmore, Penna.**

**MACHINIST'S Compact reference book. Tables, drafting, tempering, shop trig. \$1.00 postpaid. G. A. Knudsen, 523-48th St., Brooklyn 20, N. Y.**

**TECHNICAL Books. We have latest on autos, electrical construction, diesel, aircraft, formulas, engineering, drafting, blueprints, accounting, welding, adhesives, rubber, horology, photography and many others. Information free. Edwards, 324 North 18th St., Quincy, Illinois.**

**UNUSUAL Books; hobby, money, sideline, sports, mystic. Large catalog 10c refunded. Stanley Service, 544 E. Jersey St., Elizabeth 1, N. J.**

**CASH In on our national advertising campaign. Fastest dollar seller ever offered. Marshall Adrian Company, 371 Colorado Building, Denver, Colorado.**

**STRANGE, Interesting and unusual books, write for free catalogue. Fuller Company, 201 Dewey Street, Newark 8, New Jersey.**

**MAGAZINE Export Sales Company, 2084 First Avenue, New York 29, N. Y. U. S. A. Over-issue popular American magazines and pocket-size novels. Comics, fashions, pictorials, romances, screens, pulps, many others. Export only.**

**BOOKFINDERS! (Scarce, out-of-print unusual books.) Quickly supplied. Send wants. Clifton, Box 1377PM, Beverly Hills, Calif.**

**BIG Profits taking subscriptions for all magazines. Agents' confidential catalog listing over 2500 periodicals and complete starting supplies free. Pines Subscription Agency, Flushing, New York.**

**MAGAZINES (Back dated)—foreign, domestic, arts, books, booklets, subscriptions, etc. Catalog 10c (refunded). Cicerone's, 863 First Ave., New York 17, N. Y.**

#### GAMES AND ENTERTAINMENT

**BOOKS! Magazines! Novelties! Money-making opportunities! Free lists! Hirsch's, Spring Valley, N. Y.**

**CHECKERBOARD Puzzle—Keeps you working hours to solve tricky, hair raising, greatest funmaker ever invented. 35c. Money back if dissatisfied. Farris, 1364 N. Sedgwick, Chicago 10.**

**CHESS Players! Contacts wanted for postal card matches. Information free. Pioneer Game Co., Pasadena 17, Calif.**

**CLEVER Novelty wood and metal puzzle baffles the experts. Mailed complete with solution, 50c. King, 5821 Rawles, Indianapolis, Indiana.**

#### MAGIC TRICKS, PUZZLES, JOKER NOVELTIES

**THRILL And mystify friends with performances of magic! Easily learned, splendid parlor entertainment, impressive program with equipment and instructions. Postpaid \$2.00. Holbrook, Box 3365, Terminal Annex, Los Angeles, California.**

**MASTER Cigarette vanisher will fool even your wife! 25c, including 1947 lists. Scheetz's, 98-(N) Branch, Sellersville, Penna.**

**MAGIC Tricks, books, jokes, novelties. Rex Magic Shop, 727 Union St., New Orleans 12, La. Free catalog.**

**PALMING. Shuffling, forcing cards. Illustrated instructions 25c. Bowman, 2319 Orchard, Chicago 14.**

**DOLLAR Magic set free with gigantic catalog 25c. Mysto, 4462-A Germantown, Philadelphia.**

**AMAZE Friends, be life of party. Make objects disappear, take rabbit from empty cabinet. Easy, yet baffling. Blue print, instructions \$2.00. House of Magic, 3051 Fillmore, Denver, Colo.**

**MAGIC Made easy, 250 tricks easy to do, 50c. Weston, Drawer F, Pacoima, California.**

**DANDY Big mail. Magical, hobbies, fun package! All postpaid 25c. Magic, Box 35A, Irvington 11, N. J.**

**BE A magician. Large professional magic catalogue of latest tricks 25c. Ireland, C-109 North Dearborn, Chicago 2.**

**WINNING Wagers. Magic memory. Chest mystery. Four 1947 plastic items, catalogue \$1.00. Ruby's Novelties, Bristol, Tenn.**

**SNEEZING Powder, itching powder, eighteen other tricks, free with mammoth joke magic catalog 25c. Factory, 2404-N, Fifteenth, Philadelphia.**

**MAGNETIC Tricky dogs. Amusing, unusual, instructive, mounted on strong Alnico magnets, \$1.00—four pair. Gross \$21.60. Auerbach, 14 East 34, New York City.**

**BALLOONS—3 Ft. targets 25c each in 30 lots. Sample 50c. Switch, Box 835, Newark 1, N. J.**

**VENTRILOQUISM. Complete course only \$1. LeSueur, 77 Wellesley, Toronto, Canada.**

**TRUE Secret of ventriloquism. First time published. Free booklet. Quackenbus, Big Flats, N. Y.**

**VANISHING Half dollar trick and catalog 25c. Sterling Magic Co., Royal Oak, Mich.**

**WORLD'S Largest professional magic shop. keeps you in touch with latest tricks. To receive mailings, send 35c for new catalog. Holden's, M220 West 42nd St., New York.**

**"MAGIC Vanishing card." Throw it into air, it completely disappears, reproduce it later from spectators pocket. Easy to do. Complete, 25c with magic catalog. The Magician, 2463-C Kensington Ave., Philadelphia 25, Penna.**

**200 ELECTRIC Stunts, 110 volts, \$1. Kutting Sons, Campbell, Calif.**

**500 TRICKS! New 1946-7 edition Douglas famous catalog now ready, only 10c. Brand new magic for pocket, parlor, club, stage, professional, amateur. America's fastest service to magicians everywhere for over 25 years. Send 10c today. Douglas Magicland, Dept. 1, Dallas, Texas.**

**EARN Money in any crowd. Call names of strangers, tell unspoken questions. Professional course mind reading, faked spiritualism, etc., \$1. Henderson, Box 341, San Bernardino, Calif.**

**AMAZE And mystify your friends with highest quality magic. New catalogue 25c coin. Mazda Magic Co., 1135 Westgate Ave., Oak Park, Ill.**

**LARGE Illustrated professional catalog 10c. Williams, 900 Plymouth, Ellwood City, Penna.**

**FREE! Large catalog of magical apparatus if you remit 25c for "Magic Is Fun" magazine. Robbins Co., 152-F West 42nd Street, New York.**

**ENTERTAIN! Mystify! New, bigger magic catalog and 4 secret tricks 25c. Herbert, P-192 N. Clark, Chicago 1.**

**MAGIC: Big 160 page Illustrated Catalog Latest Magic Goods, 25c. For over 1/3 century we have supplied Professional as well as Beginner. Chicago Magic Co., 2300 N. Mason, Chicago 39.**

**MAGIC Tricks, puzzles, books, cards, punch boards. Catalog 10c. Specialty, Box 671, St. Louis 1, Mo.**

#### COINS, TOKENS, CURRENCY

**JAP-PHILIPPINE Occupation currency. Seven denominations—\$4.00. Aquilino Domingo, Cabanatuan, Philippines.**

**\$2.00 TO \$100.00 Each paid for hundreds of coins. Indian, Lincoln and foreign coins wanted. Get posted. Send 20 cents for new illustrated coin value book. 4x6. Guaranteed prices. 40 years in business. Bargain circulars free with each book. Coin Exchange, (7), Le Roy, N. Y.**

**WORLD Coins—25 different \$1.00. Harry Elsholz, Box 9014, Pittsburgh 24, Penna.**

**INDIANHEAD Cents 7c each. Ritter, Box 1245, Corpus Christi, Texas.**

**OLD Money wanted. Do you know that coin collectors pay up to \$100.00 for certain U. S. cents? And high premiums for all rare coins? We buy all kinds. Send 4c for large coin folder. May mean much profit to you. Numismatic Co., Dept. 20, Fort Worth, Texas.**

**WILL Pay \$10.00 each for certain Lincoln pennies! Indianheads \$50.00; dimes \$1,000. Catalogue 10c. Federal Coin Exchange, 2-PM, Columbus, Ohio.**

**LINCOLN Cents—1931S 65c, 1909S 50c, 1914D \$2.50, 1922P \$2.00. All other dates, your pick, 10 different for \$1.00. Add 50% for extra choice coins. Wanted 1909-SVDB. Guarantee Coin Co., Box 6370A, Chicago 80, Ill.**

**GET Profit and pleasure in collecting old coins. Send 10c for 56 page illustrated coin catalog. You'll be delighted with it. Send for it now. B. Max Mehl, 370 Mehl Bldg., Fort Worth, Texas. Largest rare coin establishment in U.S. Established 47 years.**

**WANTED Liberty standing quarters. Free details. Myatt's, Pittsboro, N. C.**

**THIRTY Different coins and bills \$1.00. Oddehon, Box 482, St. Louis, Mo.**

**\$1500.00 FACE Value guaranteed in every mammoth packet of Japanese Philippine invasion currency. Large assortment. Hard-to-get 1,000 peso included! Price only \$1. Stewart Byers, Box 187, Rayville, La.**

**NEW Coin buying list 10c. 209 South Church, Rockford 27, Ill.**

**FOR Sale: 1893 Columbian half dollar, 60c; 50 assorted Indian head cents, \$1.00; 50 foreign coins, \$2.00; large coin price list, 10c. Ben's Coin Company, 72 West Washington, Chicago 2, Illinois.**

**FREE! Foreign coin, banknote and coin collectors illustrated catalog to approval service applicants. Send 3c postage. Tatham Coinco, Springfield-125, Mass.**

#### OLD STAMPS WANTED

**I WILL Pay \$100.00 each for 1924 1c green Franklin stamps, rotary perforated eleven (up to \$1,000.00 each unused). Send 6c today for large illustrated folder showing amazing prices paid. Vernon Baker, (PM-72), Elyria, Ohio.**

#### STAMP COLLECTING

**GREAT Britain mint peace set only 10c with request for mint British Colonies on approval. References please. Glen B. Wilson, 711 North A Street, Tampa 6, Florida.**

**UNEQUALLED Bargain. Stamps from over 25 countries including Fiji, Swaziland, Pitcairn, Tonga, Trinidad, etc. Everything 10c to approval applicants. Bennett's, Box 252, Terminal 'A', Toronto, Canada.**

**WHAT Have you to offer? A collection? A "shoe box" accumulation? Anything in stamps. We urgently need them. Spot cash paid. Cosmopolitan Stamp Co., 1457 Broadway, Dept. 2-E, New York.**

**VICTORY Packet free—Includes stamps from Tanganyika, British Cayman Islands, animal, scarce babyhead, coronation, early Victorian, airmail, map stamps, with big catalogue—all free. Send 5c for postage. Gray Stamp Company, Dept. PM, Toronto, Canada.**

**POSITIVELY Greatest free offer—Latest Scott's International \$5.00 stamp album, covering entire world, contains 36,000 illustrated descriptive spaces; Scott's 1947 Standard \$6.00 catalogues "Philately's Encyclopedia"—absolutely free to applicants for foreign approvals becoming customers. Plymouth Specialty Company, Dept. A-9, Bell, California.**

**RICH Man's approvals, poor man's prices. Grand value packet containing five foreign sets, free with approvals. Stoll Stamp Service, 2630B West Burnett, Louisville 10, Kentucky.**

**24c PRESIDENT Harrison. Don't miss this scarce stamp. Only 5c with United States and foreign approvals. Willett Stamps, Box 507, Port Chester, N. Y.**

**FREE—30 Different U. S. with approvals. Taubers, 1755 Ocean Parkway, Brooklyn, N. Y.**

**U. S. Stamps for collectors. New and used. H. Jacot, Greenwich, Conn.**

**APPROVAL Selections. Southern California Stamp Co., Box 158, Los Angeles 42, California.**

**PHILIPPINE Victory issue. 3 varieties 5, 1, 2 approvals. Harry Bradley, 580 North College, Bowling Green, Ohio.**

**FREE "U.S. Olympia poster set" to approval applicants. Wolf, 3202 Columbia Ave., Philadelphia 21, Penna.**

**COSTA Rican triangle and diamond stamps free to approval applicants. Jay-Dee Sales, 49 Chalmers, Youngstown, Ohio.**

**PRECANCELS: Two scarce defense bureau 10c. Approvals. Information. Klein Brothers, Vincennes, Ind.**

**50 DIFFERENT Used United States stamps 25c. Steger, 1165 Downing, Denver 3, Colorado.**

**STAMP Magazine—Chock-full information, news, bargain ads! Copy free! "Stamp Post," Station A, Pasadena, Calif.**

**EXCHANGE Your duplicates. Send 50 and 20c, receive 100 different, catalog \$3.00. Hobbyland, Nashua, N. H.**

**FREE—50 Different German, price list, album holding 500, handling 25c. Cut rate. Blue Springs (10), Missouri.**

**AROUND The world—30 different countries. Includes Basutoland, Nyassaland, Tangier, Cyprus, Ascension. 10c to approval applicants. Excello Stamps, P.O. Box #95, Hackensack, N. J.**



FREE Illustrated lists of new issues. Essex, Box 1214, Omaha 1, Nebraska.

95 DIFFERENT U. S.—25c. Satisfaction guaranteed. Approvals. Victor Logsdon, Hyndman, Pennsylvania.

50% DISCOUNT Approvals! Bargain general selections, Floyd Gaines, Shelbyville, Illinois.

CANADA War set 10c with attractive approvals. Rheume, 8949 Routhier, Montreal, Canada.

FREE! 33 Haiti! Inini! Philippines! Approvals. Stampco, Box 267, Forest Hills, New York.

DOLLAR Mixtures: 750 Australia, 2,000 Canada, 2,000 British. Seiden, 1331 Intervale, New York 59.

NEPAL 15-25 (11 Varieties) 65c. Approvals. Millhiser, 7724 Abbott, Pittsburgh 21, Penna.

50 DIFFERENT Belgium 10c. Swell approvals. Eric Kardell, 1175 Clay, San Francisco 8, California.

FREE 110 Different stamps to approval applicants. Postage appreciated. Barwis, 4748A Umbria, Philadelphia 27, Penna.

SAVE Money on our high quality low price approvals. Two beautiful sets 5c. Boyncoc, 3404 Cedar, Austin, Texas.

UNITED States. #282C, #283, #294, #372, #613, #873. Send 50c. Approvals accompany. Whiton-Stamps, Westport 4, Connecticut.

TWENTY Beautiful foreign pictorials free when requesting approvals. Getche, 1040 N.E. Eighteenth, Minneapolis 13.

50 DIFFERENT Commemoratives 25c. 50 different Central America 35c. 25 different Ceylon 45c. 100 different Yugoslavia 75c. 100 different Portugal 90c. 50 different Union South Africa \$1.00. 50 different Newfoundland \$1.25. 100 different Nicaragua \$1.85. Mission Mart, Washington 17, D.C.

400 DIFFERENT Precancels \$1.00. Beesley, 821 Lobdell, Los Angeles 26, Calif.

SENSATIONAL Offer! 55 different U. S. including \$1.00, \$2.00, \$4.00, \$5.00, \$10.00. Only 10c with approvals! Thrifty, 727 Silver, Silver Spring, Maryland.

300 DIFFERENT Given free with approvals. Postage 3c. Windsor Stamps, 1435 East 67th Place, Chicago 37.

HITLER, Vatican, French, Spanish, British Colonies, U.S. \$1, \$2, \$5, free to approval applicants. Middleton Stamp Co., 78-14 Woodside Ave., Elmhurst, N. Y.

GAMBLER'S Packet. Having decided to discontinue my DeLuxe Foreign approval service, I will close out entire stock of fine stamps. The contents of my entire stock is being made up into one-dollar packets containing no definite number of stamps but cataloging from about \$5.00 to as high as \$15.00 per packet—No junk in these packets, high grade stamps that will grace anybody's album pages or make fine approval material for dealers. Over \$10,000 worth of stamps in this stock, and in addition I am going to throw in my duplicates of old nineteenth century classics accumulated through 30 years of active collecting. I am personally making up these packets and making them such big values that every purchaser will order and reorder. Place a dollar bill in an envelope right now and get the surprise of a lifetime. Not much duplication. Dr. L. L. Doison, Guaranty Building, Cedar Rapids, Iowa.

UNUSED British Colonials, world wide beauties, including bi-colors Basutoland, Cyprus, Seychelles, 10c to serious approval applicants. Mutual Stamp Service, 5145R Village Green, Los Angeles 16, California.

MEXICO—Newest material, 200 mixed 35c. Biel, Apatado 2887, Mexico City, D. F.

FREE! 20 Mint recent Hungary to approval applicants. Quality Stamp Company, Box 202, Sta. F. Buffalo, N. Y.

MAGNIFYING Glass—50 different. 10c. Approvals. Buchanan, 307 East 23rd, New York 10.

FOUR Hundred different foreign 50c. Approvals. Lists. Neulotz Co., Box 12 Newlots Station, Brooklyn 8, N. Y.

FREE—50 Different including Argentine Roosevelt, Vatican, airmails, commemoratives. Approvals. Postage 3c. Chesapeake Stamps, 748 Overbrook, Baltimore 12, Maryland.

CHINA 20 Colorful historical stamps 10c with approvals. Collins', 71 Coleridge, San Francisco 10, Calif.

FREE—Beautiful new issues, Chinese, Hungarian, San Marino, Vatican, to approval applicants. Green & Company, Norwood 12, Ohio.

PHILATELIC Printing — Stockforms. Samples for postage. Acmeprint-6, East Flat Rock, North Carolina.

FREE! Complete Balkan aviation set with approvals. Beaman, Elliston, Virginia.

UNITED States Bargain. Here's an offer so stupendous that it is almost unbelievable: 50 different U. S. stamps ranging in age as far back as over sixty years and in face value as high as the dollar value composed entirely of face different postage, airmail and commemorative stamps, nothing else. In addition, we include 2 Japanese stamps of the Philippines. We will send all these for only 10c, but only for sincere approval applicants. In asking for approvals, please state whether you are interested in United States or foreign stamps or both. Approval Headquarters, Globus Stamp Company, 268 Fourth Ave., New York City 10, Dept. 201.

WORLD'S Largest Triangle Stamp, rare Russian set of picturesque designs, mammoth stamps. This complete set including giant triangle retails for \$3.00 but only 10c to approval applicants. West Coast Stamp Service, Box 344B Hollywood Station, Hollywood 28, California.

40 STAMPS Each from a different country 10c to approval applicants. Flamingo Stamp Co., P.O. Box 2835, Miami 18, Fla.

FREE! Tiny Chinese "midget" war set. Approvals. Seminole, Elliston, Virginia.

\$2,000 IN Stamps free to contest winners. Particulars, entry blank, to approval applicants enclosing only 10c for scarce Roosevelt Mourning stamps from Nicaragua, Greece and Argentina, plus photograph of "Roosevelt Collecting Stamps." National Stamp Sales, 276A West 43rd Street, New York 18, N. Y.

31 DIFFERENT With George Washington stamps from Brazil and Ecuador; Pirate Island; victory issue; medical set; others—all 4c with approvals. Grayson Company, Sherman, Texas.

"GOYA Nude" set complete genuine 30c. Approvals. Royal Stamp Company, Tamaqua, Penna.

4 SETS, Argentina Roosevelt, 3c with approvals. Mack Co., 2205 E. Mercer, Seattle 2, Wash.

188 U. S. Commemoratives, etc. 10c. Dorenbusch, 501 Ridgeway, Cincinnati 29, Ohio.

300 WORLD Wide. 87c; 150, 47c postage. Pacific, P.O. Box 5704, Los Angeles, Calif.

AGENTS Wanted, sell stamps, no investment. William Waugh, 2140 N St., N.W., Washington 7, D. C.

STAMPS From 40 countries, including Fiji 10c. Elsea, Bowling Green, Ohio.

FREE! 25 Different stamps with approvals. Wm. Harper, 1638 Harold St., Houston, Texas.

TWENTY-FIVE Cents brings 100 United States issued before 1920. Six months subscription to Lotus News, 50 assorted Switzerland, 25 Ireland, 30 Faroe Islands, 30 Argentine, one years membership Lotus Exchange. Our monthly pink sheet of bargains and approvals. The Lotus Concern, Kalamazoo 87, Mich.

FREE Illustrated album with box full stamps. Contains hundreds all different. Super grade catalogs over \$10.00. Everything \$1.00. Satisfaction guaranteed. Longacre Shop, 108-K West 42nd, New York City 18.

GET A flying start! Expand your collection with 1000 different worldwide—\$3.50; 2000 different \$8.25. Satisfying approvals. Kenneth Warrington, Greenwood, Delaware.

FREE Stamps premium to U. S. approval applicants. Frontier Co., 1280 (MP) Ocean Avenue, Brooklyn 30, N. Y.

FLAG Premiums, return postage approvals. George Warrell, 226 W. 5th, Albany, Oregon.

150 DIFFERENT, 5c. Approvals. Best Stamps, Box 139, Bangor, Maine.

500 MIXED Foreign including many large size stamps. Only \$1.00 postpaid. Roit, 4539 Bleigh Street, Philadelphia 36, Penna.

50 DIFFERENT French stamps and our price list, one silver dime. Stamp Sales, Box 1649P, Oakland 4, California.

CASH For accumulations and collections. Send insured with your offer. W. L. Bedard, Box 637, Detroit 31, Michigan.

73 U. S. Airmails, commemoratives 35c. Corryville Exchange, 119 St. Clair, Cincinnati, Ohio.

ROOSEVELT Nicaragua set of three 10c to approval applicants. Murray, 2152 Vogel Road, Evansville 14, Indiana.

FREE! Colorful pictorial French Coat of Arms set complete! To approval applicants. "PG," 195 Park, Lewiston, Maine.

FREE! The Stamp Finder! Send today for the big new edition, fully illustrated, enabling you instantly to identify all difficult stamps! Also fine packet strange, fascinating stamps from Bosnia-Herzegovina, Monaco, Patiala, Cyprus, etc., including maps, ships, animals and strange scenes. All free to approval applicants inclosing 3c postage. Garcelon Stamp Company, Box 900, Calais, Maine.

FREE—Ten Australian to approval applicants. Ivan Storbek, Kinde, Michigan.

THREE Sets 5c with approvals. Mallo, 767 Leith, Flint 5, Mich.

DANDY U. S. approvals; write immediately. Sullivan, Endicott Building, St. Paul, Minnesota.

CUBA'S Retirement set shows aged couple receiving pension check. This set sent to approval applicants for only 5c. Bryson Stamp Company, Drawer F-2, Rossford, Ohio.

WHOOPIE! Wowie! 25c worth of U. S. stamps free! No obligations! Write M & N Co., 742 Sheffield Ave., Brooklyn 7, N. Y.

ONE Cent each and up. Most ideal way to fill your album at low cost. Fine selection sent on request. Lange, Box 21, Station R, New York 55.

UNITED States, 150 all different, \$1.00 postpaid. Free premiums. Box 22, New York 34.

300 STAMPS, Album, hinges, 25c. Northeast, Box 6618, Kansas City, Mo.

FREE! 25 Beautiful pictorials to approval applicants. Streiner, 898 East 75, Cleveland 3, Ohio.

ROUND The world colonies—British, Dutch, French, Portuguese; strange little known countries, primitives, cannibals etc. All for 3c to approval buyers. Dixie Stamp Company, Dept. 10, Milwaukee 1, Wis.

VATICAN City! Four varieties of Vatican City (world's smallest country) including portrait of Pope Pius! Also stamps from Afghanistan, Cape Juby, Libya, Macao, Palestine, Syria, Liechtenstein, San Marino, and many other interesting countries. All together 48 different stamps, total catalog price over \$2.50!—only 10c to approval applicants! Methuen Stamp Service, Inc., Dept. 211, Lawrence, Mass.

FREE 18 Different Switzerland with approvals. Excel, Box 1315, Chicago 90.

118 DIFFERENT Stamps including commemoratives, charities, airmail, surcharges, sets, etc. Only 3c to approval buyers. Badger Stamp Company, Dept. M, Milwaukee 3, Wis.

ALL Different: 200, 25c; 500, 60c; 1000, \$1.50. Beacon Sales, Maynard, Mass.

FLAG Stamp free with U. S. approvals. Wenigman, 929 Oakdale, Chicago.

FREE Persia and China packet to approval applicants. Everglades Stamps, Box 3222, Station F, Atlanta, Georgia.

\$3.35 VALUE Only 10c. Gorgeous bi-colored Greece allegorical issue 12 values, (Scott 1946 catalog \$3.35). Send dime today, supply limited. Imperial Stamps, Box 1491, Tampa, Florida.

SMOKY Mountain souvenir commemorative sheet and 30 different U. S. stamps, including commemoratives, airmail, etc. (catalog value exceeds 65c) for 10c to approval applicants. Curhan Stamp Company, Dept. H, Gloucester, Mass.

FIRST Day covers on approval. Knobel, 1918 S.W. 12 St., Miami, Florida.

UNITED States approvals. Amazing variety and prices. Mohawk Stamp, Box 524, Albany, N. Y.

FREE! Airmail packet with approvals. Deane, Box 1002, Miami Beach 39, Florida.

COLLECTORS: Write today for famous "four star approvals." Nothing like them! Kessel's, Box 808, Tucson, Arizona.

FREE—The ever popular Famous Americans set of 35 stamps plus the just as desirable set of flags (13 stamps) plus the National Parks set (10 stamps), plus the complete set of Presidentials to the \$5.00 (32 stamps). A total of 90 of the most popular United States stamps will be given absolutely free to applicants for our brand new series of United States and foreign approval selections. Send 3c postage for 15 of the above mentioned stamps, plus full particulars. Do it now! Triboro Stamp Co., 145 Nassau St., New York City.

FREE Packet to approval applicants. Bloom, #13 Trailer Camp, New Ulm, Minn.

SPECTACULAR-THRILLING — You build fine collection with our U. S. Mint Stamps. Railroad, suffrage, steamship, telegraph, movie, Florida, Iwo Jima, Army, Navy, Coast-Guard, Marine, Hyde Park, Smith, Texas, Discharge, Tennessee, Iowa, Smithsonian, Santa Fe, Victory. Buy one or more, 5c each. All complete \$1.00, lists included. Frontier Stamp, 1280 Ocean Avenue, Brooklyn 30, N. Y.



GIVEN Seychelles "palm tree," Hitler, Petain portraits, Norway "Quisling" traitor, Jap issued Philippines, snake, lion, others. All given for 3c postage. Approvals. Premium Stamp Service, Hartland, Maine.

UNITED States collection. 104 different commemoratives including Columbians, Pan Americans, Pan Pacific, bicentennials, parks, famous Americans. Price \$1.00. Approval applicants only. Orange Stamp Company, Albany, New York.

FREE. Irish commemorative collection, including dramatic Easter Rebellion issue with approvals. Raymax, 123-Z William St., New York City.

10 DIFFERENT U. S. over 40 years old, 5c. Foreign, U. S. approvals. Scott, 30 Baker Ave., Lexington 6, Mass.

ILLUSTRATED Stamp Magazine, 26 weeks 25c. Stamp Journal, Kalamazoo, Michigan.

MONTENEGRO Colorful pictorial set, 10c with approvals. Vargo Stamps, 6044 South Fairfield, Chicago 29, Ill.

U. S. COLLECTION—Thirty different fine unused commemoratives before 1939 including Columbians, bicentennials, parks price \$1.00 approval applicants only. Fort Orange Stamps, Albany 7, New York.

BRITISH, Spanish, French Colonies, Vatican, Hitler heads, and airmail packet. Free with approvals. Pan-American Stamp Co., Box 145, New York 33, N. Y.

BERLIN Bears, complete set of eight and 100 different stamps only 10c to approval applicants. Reich Stamp Co., 4647 Kenmore, Chicago 40, Ill. Dept. M11.

20,000 VARIETIES 1c-5c each! Gordon Davison, Box 1019B, Manchester, N. H.

WORLDWIDE, 100 Different stamps, 5c with approvals. Boerger Stamps, 206 Main, Toledo 5, Ohio.

WOW! \$10.00 Worth of fun only 10c. What a treasure hunt! Big package 500 foreign stamps—just as received from foreign missions other sources. Includes stamps from Africa, South America, Philippines, Free French, Cape Juby, Palestine, etc., including airmails, commemoratives, and stamps worth up to 50c and 75c. This amazing offer is given for 10c to serious approval applicants only. One to a customer, money back if not more than delighted. Jamestown Stamp Co., Dept. 22, Jamestown, New York.

ROOSEVELT, Churchill, Stalin, Hitler and Vatican City stamps free to approval applicants. Eliot Stampco, 86-31 Eliot Avenue, Rego Park, N. Y.

ATTRACTIVE Packet free to approval applicants. Rare Stamp Service, P.O. Box 4077, Miami, Fla.

FIVE Vatican City stamps free to approval applicants. Florida Stamp Company, Box 807, Miami 5, Florida.

SOLOMON Islands, Grenada, Turks Caicos, Caymans, Dominica—everything 2c with approvals. Viking, 130-Z Clinton St., Brooklyn, N. Y.

PENNY Approvals by country. M. H. Hoerning, 115, Farmington, Ark.

STAMP Collections wanted. Complete collections, duplicate lots, surplus stock, mint and used. Prefer trade for printing or other items, buy outright if priced right. What have you, what's wanted? Vanroy Shirk, Lebanon, Penna.

1000 MIXED U. S. old and new—25c; 2 lb. \$1.25. Weatherby, Medina, Ohio.

YOUR Money's worth! Seychelles, Djibouti, Angola, Chinese hunger stamps and over 100 different other stamps. Everything 10c to approval applicants. Atlas Stamps, 4220 West 16th, Dep't L, Little Rock, Ark.

FREE! Rhodesian bi-colored waterfall; old El Salvador issues; plus 25 different worldwide stamps. All free to approval applicants. Pladon Stamps, 1717-M Idaho, Toledo 5, Ohio.

FREE—Abyssinia, Cayman Islands, Tuna triangle, Indochine, Syria, Ivoire, Philippines (Jap "shame" issue), Turkish harem, Damascus, Cambodia, African "beauty," Pirate Islands, Colonials, others—All free for 3c postage with approvals. Belmont Stamps, Washington 10, D. C.

AMAZING Offer! Assortment each of giant stamps, midget stamps, flag stamps, airmail stamps, Free French Colonies, U. S. commemoratives and numerous others. Everything only 10c to approval applicants. Simon, Box 608, Iraan, Texas.

PORTUGUESE Colonies, 25 different 5c with approvals. Lorane Brown, Marion, Michigan.

ADEN To Zanzibar! 40 different British Empire, including Cyprus, Malta, Dominica; 5c with approvals. Lyman Company, 95 Nassau Street, New York City 7.

U. S. Price list. Send postage. State Stamp Service, 1225 Park Building, Pittsburgh 22, Penna.

OLD Scarce U. S. seconds on approval. Slightly defective, nice appearance, bargain prices. Herfeld, 551 Clinton, Newark 8, N. J.

ZANZIBAR, Palestine, Manchukuo, Azerbaijan, Haiti, Iraq, Siam, Victoria, Hitler stamp 5c. Approvals. Postzegel, Windham, New York.

U. S. Price list. Send postage. Stanley Gibbons, 38-P Park Row, New York.

PENNY Approvals, that satisfy. Neil Gronberg, Box 5441-P, Philadelphia 43, Penna.

MINT Pictorials free to approval applicants. Surf Stamp Co., Box 2296, Miami Beach 40, Florida.

COMPLETE "United States" catalog with 1000 illustrations! Send 10c for mailing. Harris & Co., 137 Transit Building, Boston, Mass.

ZOWIE-E! A barrel of fun for only a dime. 500 United States stamps—absolutely unpicked and unsorted—just as received from church missions. Many varieties, including large commemoratives, airmails, high denominations up to \$5.00! Stampdom's biggest package of fun—and you might find something really valuable! Price only 10c to serious approval service applicants. Money back if not delighted. Illustrated bargain lists with each order. Mystic Stamp Company, Dept. 80, Camden, New York.

50 DIFFERENT United States, 10c. Price-list free. Seidenberg, Cassopolis, Mich.

CANADA—75c Diff. 25c. Approvals, Lists. Victoria Stamp Co., London 4, Canada.

FREE! Negro Triangle; Turks Islands "Cactus"; Dakar; Guinea; Palestine; "Fairy Tale," Pirate Chart, Map, Ship, Sea Lion and Snake stamps; French, British, Portugese Colonies, etc. Free for 3c postage. Approvals. Potomac Stamps, Washington 10, D. C.

FREE! Leeward Is., Cayman Is., Turks and Caicos plus 54 different mint World's Fair poster stamps, to approval service applicants sending 3c postage. Tatham Stamp Co., Springfield 30, Mass.

UNITED States approvals complete coverage, fine quality, attractive prices. Seminoe Stamps, Box 378, Coconut Grove, Florida.

50 DIFFERENT Including scarce diamond-shaped airmail 3c to approval service applicants. Avalon Stamp Co., Dept. M, Springfield 8, Mass.

1000 GRABAGS 15c Each. Super bags 25c. Zandy, 630 Bingham, Reading, Pa.

FREE U. S. price list. Postage 3c. Mark Hanna, 335 - 5th Avenue, Pittsburgh 22, Penna.

FREE—Pick 25c worth of stamps from our first U. S. approval selection. Approximately 100 stamps to choose from. Excellent value. No obligation to buy. Lists illustrating the most popular U. S. stamps—at prices you can afford—will be included. Don't miss this opportunity! Write today. S. C. Engel Co., 38 Park Row, New York City.

FREE! Canadian sets, royal visit, George VI, George V, coronation, jubilee, others, to approval applicants. Ensign, Box 118-M, South Orange, N. J.

WORLD'S Largest diamond and triangle stamps, free stamp magazine, stamps from fighting Free French, 20 stamps from 20 different countries, pictorials, airmails, big bargain 5c with approvals. Capital Stamps, Dept. 2, Little Rock, Ark.

DEALERS—Wholesale list. Postage 3c. Frank, 5031 Queensberry, Baltimore 15, Md.

25 DIFFERENT Swiss 10c—with 1/4, 1/2, 1c approvals. Carroll's, 4357A S. Hoover, Los Angeles 37, Calif.

#### HOBBIES AND COLLECTIONS

"GEM Cutting." Profitable, interesting hobby. Instructive illustrated booklet, one dollar. Mineral Specimens Company, Box 1191, Santa Monica, California.

SWAPPER? Collector? Send 25c for sample copy Hobbyswap Contacts, 1326 South 27th, Omaha, Nebraska.

SWAPPERS! Kollektors! Hobbyists! What'cha got? What'dye want? Three times two dimes. National Xchange Bulletin, Royal Oak, Mich.

WANTED: Old cigarette cards. Write Charles Bray, East Bangor, Penna.

COLLECTING Hobbyists! Exchange duplicates. "Hobbyswap Contacts" directory 10c. C. Bishop, Route 8, Kalamazoo 88, Michigan.

KLONDIKE! For hobby jewelry makers! Novelty jewelry findings from tables of large manufacturers—parts for bracelets, pins, earrings, etc. unfinished. Chains, rings, pins, stones, clips, beads, many other items—1 lb. bags, \$2.00 per bag in 5 bag lots. Sample bag, \$3.00. Prepaid only. Mdse. Distributing Co., 19 E. 16 St., New York 13.

296 COLORED Illustrations, new book "Foreign Medal Ribbons," \$1.00. Foreign campaign bars, insignia, lists, samples, 20c. Packets \$1.00. Insigniacrafts, 236-28th Ave. N.W., Calgary, Canada.

CAMPAIGN Ribbons—Beginner's package. Introductory price 50c, contains 15 assorted ribbons. Collectors desiring special ribbons specify your requirements. L. H. G. Company, 19 E. 16 St., New York 13.

INTRODUCTORY Offers—10 officers insignias 25c; 22 different American or 15 different foreign, \$1.00. Illustrated catalog 10c. Hobbyguild, 35P West 32nd St., New York.

EXCHANGE Your duplicate stamps, match covers, post cards, or any hobby, with collectors everywhere! Exchange register listing swappers, 10c. (Mention hobby). World Hobby House, Box 721-A, Olympia, Wash.

INVENTING Can be an interesting and profitable hobby. Write for complete particulars. Institute of American Inventors, Dept. 40-E, 1926 Eye St. N. W., Washington 6, D. C.

COLLECT Colorful Army patches. Pictures, prices and sample patch only 10c. Insignia Mart, 703 Broadway, N. Y.

UNUSED Match book covers. 100 all different \$1.00. 35 Royal Flash covers \$1.00. Free list. Charles Edelman, 13110 East 84, Cleveland 3, Ohio.

JEWELRY Stones removed from rings, etc., 100 assorted \$2.40; 50 large ones \$2.40. B. Lowe, Holland Bldg., St. Louis 1, Mo.

#### ANTIQUES, RELICS, INDIAN GOODS, CURIOS

4 FINE Ancient arrowheads \$1.00. Stone tomahawk \$1.00. List free. Lear's, Box 569, Galveston, Texas.

550 ANTIQUE Guns for sale. Catalogue 25c. Gil Hebard, Knoxville, Illinois.

SWORDS, Rapiers, daggers, pistols, armor. Illustrated catalog 50c. Robert Abels, 860-A Lexington Ave., New York.

#### PRECIOUS STONES, MINERALS

TEN Minerals, cutting or specimen, \$1.00. Tourmaline and list 20c. Plummer, 5068 Brighton, San Diego 7, Calif.

"GENUINE" Arizona rubies (garnets). Send quarter for packet Mineral Specimens Company, Box 2651, Phoenix, Ariz.

FOOL'S Gold from famous gold camp 10c per sample. Gold \$1. Others, Martin's, 506 Harrison, Leadville, Colorado.

#### CAMERAS AND PHOTO SUPPLIES

PRINT Your own pictures, kit \$1.00. Spada Enterprises, 10 Lexington, Wethersfield 9, Conn.

POLAROID Filters—\$1.75 for set of two in mount. Ideal for fade out for movies or as a single filter to cut glare. Price includes mailing. Associated Surplus Co., 10838 Ventura Blvd., North Hollywood, Calif.

SPEED-O-COPY Ground-glass focusing attachment for Leica, Contax Argus C-2 and C-3. Send for literature. D. Paul Shull, Dept. PM-2, 240 S. Union, Los Angeles, Calif.

CAMERAS. Films, enlargers, slide projectors, dark room supplies, chemicals, etc. Free new catalog. Also movie supplies and rental film library. The Dayton Film, Incorporated, 2227 Hepburn Avenue, Dayton 6, Ohio.

HAVE Fun and learn—Kayark Photo Developing & Printing Set, complete with all equipment and supplies, \$4.75. New Foto-Flex reflex camera, 12 exposures on 127 film, cerium polished lenses, instantaneous and time shutter, \$7.95. 3 rolls 127 film, special \$1. 620 Hollywood Reflex Camera, 12 negatives 2 1/4 x 2 1/4, aluminum body, \$19.95. Money-back guarantee. Order now from Onway Camera Co., 34 N. Clark, Chicago.

PHOTOGRAPHY For pleasure or profit. Learn at home. Practical basic training. Long established school. Write for booklet. American School of Photography, 1315 Michigan, Dept. 3431, Chicago 5.



CONCORD Camera (formerly Lafayette Camera). New catalog free! Movie and still cameras, accessories, photographic supplies, dark room equipment. We pay top dollar for used cameras and all types photographic equipment. Write, Concord Camera, Dept. CB-10, 901 West Jackson Blvd., Chicago 7, Ill.

COMPLETE Repairing on all types of foreign and domestic cameras. Factory trained specialist on Korable and Poth cameras. B. & V. Camera Repair Service, 22 East Van Buren, Chicago 5, Illinois.

OIL Coloring photographs can be a fascinating hobby or profitable sideline for those with artistic talent. Learn at home. Easy simplified method. Send for free booklet. National Photo Coloring School, 1315 Michigan, Dept. 3431, Chicago 5, Ill.

"HOLLYWOOD Glamour shots"—How to make them! Instructions, diagrams, sample 8 x 10 print, \$1.00. Bunnell Studio School, San Pablo, California.

PHOTO Printer developer. No experience required, complete with supplies and instructions, \$2.00. Homes, Box 12A, Oaklandon, Indiana.

CAMERAS, Enlargers, projectors, Lowest prices. Free catalog. Cavalier Camera, 1822 Center, Pittsburgh 19, Penna.

CASH! Spot cash for cameras, lenses, binoculars, movie and still equipment. Send full description for prompt cash offer. Over 36 years of dependability. Bass Camera Company, Dept. AG, 179 W. Madison St., Chicago 2.

BASS Says: Trade cameras? For 36 years Bass has satisfied thousands everywhere! Finest equipment available. Always satisfaction guaranteed or your money back! Bass buys 'em, sells 'em, trades 'em. Bass Camera Company, Dept. AG, 179 W. Madison St., Chicago 2.

USED Camera Directory, Box 1031-M, Canton, Ohio—lists hundreds of war-bargain used cameras—35mm., Speed Graphics, Kodaks, Rolleiflex—many others. Send 25c for latest issue.

HAVE You a camera? Improve your hobby of photography and learn how to make better pictures. Write today for our latest book catalog and sample copy of American Photography, containing articles and pictures by the world's foremost writers and photographers. Camera House, 601, 353 Newbury St., Boston 15, Mass.

### PHOTO FINISHING

ROLL Film developed. 8 oversize Velox prints from any size roll up to 116, 35c; reprints 4 cents each. Colonial Studio, Sta. A Box 85, Charleston, S. C.

CAMERA Fans—We can supply you with 116, 127, 120, 620, 616 films. Write for details Davis Specialty Shoppe, Box 213, Venice, Calif.

ROLLS Developed, eight prints 25c. 8" x 10" colored framed enlargement from negative or photo \$1.50. Promenade Photos, Sta. D, Box 198C, New York 3.

SENSATIONAL Introductory offer! Send snapshot or negative, this ad, and 3c. We'll send you a beautiful, 7" x 5" enlargement! Or, kodak rolls developed with 8 giant double-size prints, 25c. Special, from your negatives, 16 regular-size or 8 double-size reprints, 25c! Candid rolls—36 exp. 35mm. developed, vaporated, enlarged to 3x4, \$1.00! 18 exp. 50c. Reprints, 3x4, 3c each. We have new, perfect 35mm. film. Low prices. Free mailers, details on request. American Studios, Dept. 279, La-Crosse, Wis.

ROLL Developed, two prints each exposure 25c. Additional reprints 3c each. Skrudland, 6444Z Diversey, Chicago.

ENLARGEMENTS You'll be proud of, 5x7, 25c; 8x10, 45c. Doubleweight paper. Expert oil coloring 75c extra. Please remit with order. Photo-Lab, Box 791, Neenah, Wisconsin.

ENLARGEMENTS Of your prized negatives, 8x10, beautifully oil colored, \$1.00. Composed and colored as per your instructions. Sam Goldman, 1544 West First Street, Brooklyn 4, N. Y.

25 2½x3½ GLOSS Reproductions from favorite portrait (returned) \$2.00. Hansen, 4908 Ohio, Chicago.

NEW Color process makes full color prints from black and white film or negatives. Send dime for sample. We have films. Midwest Photo, Janesville 26, Wis.

CENTURY Delivers work and service that can't be beat. Sixteen famous Century-Tone prints each 8-exp. roll 30c. Free mailers. Century Photo Service, LaCrosse, Wis.

8 BEAUTIFUL Double size pictures and roll developed 30c. 8 hour service. Free mailers. Pacific Photo Service, Box 666, San Francisco, Calif.

PHOTOGRAPHY For pleasure or profit. Learn at home. Practical basic training. Long established school. Write for booklet. American School of Photography, 1315 Michigan, Dept. 3452, Chicago 5.

ROLL Developed and 8 prints 30c. Overnight service. Free mailers. Tri-Plex Photo Service, Box 375, San Francisco, Calif.

8 EXPOSURE Rolls developed, 1 print each and one enlargement coupon 25c. Two each and coupon 35c. 3 each and coupon 40c. Reprints 3c. Fred D. Eastman, Bode, Iowa.

PLASTIC Statuettes. New avenues of pleasure and profit if you can develop and enlarge. Illustrated folder free. Statuette Craft, 8448 Grand River, Detroit 4, Mich.

8 HOUR Service. Your 8 exposure roll printed jumbo or regular size, 25c; 12 exposures, 35c; 16 exposures, 50c; 3 exposures, \$1.00. Reprints jumbo or regular, 3c. Regular prints deckled. Fine grain developing. Send for free mailers. Quality Photo Service, Box 468, San Francisco 1, Calif.

FREE Price list on quality developing, printing, enlarging. Write for it today. Roy Photo Service, G.P.O. Box 644, New York (1), N. Y., Dept. M.

SPECIALIZING 35MM. fine grain developed. 36 big 3x4 enlargements, \$1.25. Photoshop, Linton, Indiana.

ROLL Developed, 8 brilliant fadeproof Velox prints and two professional enlargements 25c. Overnight service. Young Photo Service, 405-C, Albany 2, N. Y.

FREE—Set of filters for names and addresses of four camera owners. Photocraft, Canton 1, Ohio.

8 PRINTS, All enlarged to nearly postcard size, from your roll or negative, 25c. Willard Studios, Box 3535A, Cleveland 18, Ohio.

SPECIAL—50 Reprints \$1. Suburban Studio, 1410 Bond, Rockford, Illinois.

2 BEAUTIFUL Hi-Gloss prints each good negative and enlarging coupon with each 6 or 8 exposure roll developed 28c. Owlphoto Co., Weatherford, Oklahoma.

BIGGEST \$1.00 Value in 35mm. finishing today. 36 exposure fine grain 3¼x4½ enlargements; deckled, embossed margin and date. Eighteen exposures 75c; 16 exposure splits 55c; 36 exposure reloads 50c. Special: return this ad with \$2.00 and we will send five 36 exposure reloads. Free mailers. 8 exposure rolls in beautiful, deckled contact finish with embossed wide margin, 25c. Mailbag Film Service, Box 5440A, Chicago 80, Ill.

GLOSS Finish enlargements, 4 5x7 from negative 50c. 3 5x7 from photo 50c. Robert Renshaw, Jr., P.O. Box 478, Chester, Penna.

EVERY Picture an enlargement! 8 sparkling deckle-edge enlargements and roll developed 25c coin; 116 size or smaller; enlarge reprints 3c. Enlarge Photo, Box 791D, Boston, Mass.

### MOTION PICTURES AND SOUND EQUIPMENT

FAMILY 8MM.—16mm. movies; slides. Lists, dime. 2-scene Kodachrome sample, dollar. Campus Films, 668-F, Ithaca, N.Y.

RELIGIOUS—New sound prints only. Screenart, 723 7th Ave., New York.

MOVIE Projector, 16mm. sound, slightly used, bargain. 2407 Garrison Blvd., Baltimore 16, Md.

MAKE \$8 to \$10 net profit daily with your 8mm. or 16mm. projector. Details free. Metcalf, 10806 Glenroy Ave., Chicago 43, Ill.

8MM.—16MM. silent cameras and projectors also 16mm. sound equipment for immediate delivery. Large rental library of silent and sound films for rent. Free new catalog. Also kodaks, cameras and still photographic supplies. The Dayton Film, Incorporated, 2227 Hepburn Avenue, Dayton 6, Ohio.

GUARANTEED Fresh anti-halo outdoor movie film! Weston 12! Daylight loading! Processing free! Three spools double 8mm. \$3.45! Six single 8mm. for Univex, \$4.60! Postpaid! Catalog. Eso-S, 828-B West 39th, Kansas City 2, Missouri.

UNUSUAL Home movies. Free list. Loja, Box 74B, Station B, Brooklyn.

TITLES Expertly made to your specifications. Title Technicians, Department M, 3964 Ames N.E., Washington 19, D. C.

"THE World's Greatest Passion Play." all sizes sound and silent. Write Hemenway Film, 33-F Melrose St., Boston 16, Mass.

35MM. Sound features, westerns. C. Rogers, Box 26, East Atlanta, Ga.

"MISS America, 1946." Projection length kodachrome sample \$1.00. Complete editions, 8mm., 50 ft., \$2.00. Kodachrome, \$7.50; 16mm., 100 ft., \$4.00; Kodachrome, \$14.75. Catalog 25c. World in Color, Box 392-F, Elmira, N. Y.

FRESH Movie films, 100' 16mm. \$2.25, three rolls \$6.00, 25' double 8mm. \$1.25. Ambassador, 479-A Quincy Street, Brooklyn, N. Y.

I BUY, Exchange, swap movie films. Harvey Iris, Box 539, Brockton, Mass.

RENT 8MM.—16mm. and sound films by week. New catalogs. Lowest rates. Dayton Film, 2227 Hepburn, Dayton 6, Ohio.

FIVE Slide views—Oldest convict ship afloat 25c. Slide Supply Service, 3111 West Tuscarawas, Canton, Ohio.

TALKIES: Convert your silent 16mm. projector into sound with our guaranteed parts kit. Plays all 16mm. sound films. Quickly assembled at home. Special introductory offer: Send this ad now with \$19.95, check or money order, and we will include sound test film, instruction manual and full information on how to use with your radio. Kit includes photocell, exciter lamp, optic, which makes a sound head complete. Or send \$1.50 for complete blue prints showing how to make adapter yourself. Sound Tech, Box 3071, Hollywood 28, California.

UNUSUAL Home movies: Travel, adventure, sports, comedies. Silent-Sound. Many film bargains. Big illustrated 1947 catalog, sample—dime. Audet, Box 6520BG, Philadelphia 38, Penna.

8-16MM. Silent-sound films. Complete rental library. All latest subjects. Free catalogue (sample film 10c). Garden Film, 317 W. 50th, New York 19.

EXCITING Films—bullfights, movie stunts. Unusual subjects. Send only dime for sample film and special list. Exciting Films, 1071-F El Centro, Hollywood, Calif.

RENT 16mm. sound films 50c reel. Large selection; free catalog. Film Service, 128 Chestnut St., Roselle Park, N. J.

LEARN Professional motion picture technique at home. Approved for veteran training under G.I. Bill. Free catalog. Motion Picture Institute, Birmingham 4, Mich.

HOME Movies. Rent, buy, swap 8mm.-16mm. silent and sound at money-saving rates. Details for a dime. Midland, Box 429, Oak Park 4, Ill.

COMPLETE Stocks always of Castle, Official, Pictorial films, 8mm., 16mm., sound. Musicals, soundies, free catalogs. We exchange your films and equipment, or buy them for cash. Frank Lane, 5 Little Bldg., Boston, Mass.

MOVIE Camera films, 100' 16mm. \$2.50, 25' double 8mm. \$1.25. Free developing. Better Films, 742 NewLots, Brooklyn 7, N. Y.

BASS Says: 36 years of leadership in the motion picture equipment field. Sound projectors, 8 and 16mm. equipment, finest accessories. Bass buys 'em, sells 'em, trades 'em. Always satisfaction guaranteed or money refunded! Bass Camera Company, Dept. A, 179 W. Madison St., Chicago 2.

LEARN Movie projection, management. Free catalog. Theatre Institute, Elmira, N. Y.

### MUSIC AND MUSICAL INSTRUMENTS

ACCORDIONS. New or used, wholesale and retail, cash or terms. Our 57th year in business. Del Principe, 307 So. Wabash, Chicago, Ill.

NEW Italian accordions, all sizes. Wholesale prices. Free catalog. American Accordion Center, 39 So. Kedzie Ave., Chicago 12, Illinois.

POEMS Wanted to be set to music. Free examination. Send poems. McNeil, Master of Music, 510-PM S. Alexandria, Los Angeles, California.

SONGWRITERS — Free explanatory booklet, attractive offer. Song Service, 331-C West 46th, New York.

SONGWRITERS! Outstanding, ethical offer. Four of my songs alone sold over half million records, led by Victor. Be convinced! Hibbeler, C5, 2157 N. Avers, Chicago.

SONGWRITERS: Real opportunity. Commonwealth Conservatory, C-1, 423 E. 7th St., Boston 27, Mass.

POEMS Wanted for musical setting. Send poem for immediate consideration. Five Star Music Masters, 630 Beacon Building, Boston.

SONGWRITERS: Send poems for free examination and outstanding offer. United Music Service, 150, Salem, Indiana.



**PIANISTS** Acquire professional technique in quickest possible time. Most unique course ever put out. Low cost. Get literature. Wehner, 25 Fulda, Roxbury 19, Mass.

**HARMONICAS** \$2, \$2.90, \$5, \$7.75, \$9.75. All musical instruments sold. Price list 25c. Musician's Shop, 2 E. Centre Street, Baltimore 2, Maryland.

**CHURCH** Organist 35 years composes music and does music printing. Reginald Belcher, Florham Park, New Jersey.

**POEMS** Wanted for musical setting. Send poem for immediate consideration. Five Star Music Masters, 630 Beacon Building, Boston.

**FREE** Publication contract. For poem and song writers. 24 songs to be published during 1947. Two each month. \$2.00 for entry, examination and comment. This is no scheme. We want songs. Puritan Publishing Co., Inc., 343 South Dearborn, Chicago 4, Illinois.

**SONGWRITERS.** Send your songs or poems today. Music written for your words without charge. Records, copies, copyright furnished. We have helped many new writers find their first success. Let us try to help you. Hollywood Tunemasters, 1537 No. Vine St., Dept. N-1, Hollywood 28, Calif.

**ATTENTION** Songwriters. Music composed to your song poems. Send poems and complete songs for free examination. Our songs published by (ASCAP) publishers and featured by leading screen and radio stars. American Music Printers, Dept. 5, Atlas Bldg., Washington, D. C.

**PLAY** Music without study \$1.00 postpaid. Dr. P. Wilson, P.O. Box 3851, Station D, Philadelphia 46, Penna.

**DUO-FLEX** Reeds, for clarinets and saxophones. Eliminate your reed troubles. Circular free. Duo-Flex Reeds, 1204 First Ave., Evansville, Ind.

**SONG** Writers: Present your song to publishers and bandleaders on a professional recording. We furnish CBS talent, male or female. \$10.00 complete c.o.d. Write Music Dept., Buffalo Recording Co., 277 Delaware Ave., Buffalo 2, N. Y.

**MUSIC** Printing, \$5-100. Composing, complete service. Auto-Litho, Jensen, Fla.

**SONGWRITERS.** Submit songs for free analysis. Only worthy material accepted for development. Tommy Kilbourne, Box 1253, Bakersfield, Calif.

**SONGWRITERS**—Send poems for immediate examination and free book, "Your Future in Songwriting." Radio City Music Academy, 1674 Broadway, New York City 19.

**ACCORDIONS.** Wholesale prices. Request circular. New streamline accordions. All sizes and makes. Monarch Accordion Co., 44 N. Albany Ave., Chicago, Ill.

**MUSIC** Arranged. Songs printed. Frank Wildt, Music Publisher, Lancaster, Penna.

**WANTED!** Lyrics, melodies for songs. We arrange, publish, sell. Superior Song Studios, Passaic, N. J.

**SONG** Poems wanted. Free examination. McNeil, Master of Music, 510-PM South Alexandria, Los Angeles, Calif.

**WRITE** Songs. Big money and reputation. Write for information. J. Gordon Pub Co., 201 N. Hoyne Ave., Chicago.

**SONG** Writer's attention! The amazing demand for phonograph records, accelerated by more than 300,000 juke boxes and the hits popularized warrants your immediate consideration. We are offering song-poem writers the rare opportunity of having established composers collaborate on appealing material received this month. Recola Records, Box 987P, Hollywood 28, Calif.

**POEMS** Wanted for musical setting. Send poem for immediate consideration and free rhyming dictionary. Richard Brothers, 24 Woods Building, Chicago.

#### RADIOS, SUPPLIES, INSTRUCTIONS

**FREE** New radio catalog is ready! Radionic's catalog lists hard-to-get radio parts, books, amateur, test and P.A. equipment. All available for immediate shipment. Send today to: Radionic Equipment Co., Dept. SS-2, 170 Nassau St., New York 7, N. Y.

**LATEST** 1-Tube receiver. Illustrated instructions, 50c, postpaid. Hugh Gregg, 1424 Workman Mill, Whittier, Calif.

**WIRECORDERS**—Limited quantity precision built navy wire recorder magazines—new and in original boxes. Records 1/2 hour continuously, has level wind, erasing head, minute and second indicators, automatic stops, etc. Marvelous bargain at \$49.50 f.o.b. Detroit. Photographs on request. Shipped c.o.d., weight 25#. Richard H. Wann, 3000 East Jefferson Avenue, Detroit 7, Michigan.

**BUILD** Simplest one-tube a.c. radio. Instructions, 25c. "Loudest" crystal set instructions, 25c. "All About Crystal Sets," booklet, 50c. Amorose, Route Four, Richmond, Virginia.

**SECRETS** Of the radio serviceman's trade trouble located in 30 minutes with my "Simplified Radio Trouble Chart" \$2.00 postpaid. Shepard Lab., 1214 1/2 W. Washington Blvd., Los Angeles 7, California.

**"CRYSTAL DX-ER"**—Free literature. Radio, 1697 Lanier Drive, Atlanta, Georgia.

**150 FEET** Flexible fibreglass, plastic, varnished spaghetti tubing; \$1.00. "Sylmian," 4800 North Lawndale, Chicago 25.

**25 YEARS** Experience in radio repairing at your fingertips for \$1.00. I've repaired 45,000 radios and have perfected a system which you can follow step by step. My methods are far simpler than any other course on the market and require no calculations. Send \$1.00 to Ross Radio Company, 14615 Grand River, Detroit 27, Michigan.

**RADAR** Crystals. Supersensitive. Free details. Hayes, Box 636, Santa Barbara, California.

**PERSONAL** Extension speaker, smartly encased. May be used anywhere in your home. Ideal for personal use in den, bedroom, etc. Easily attached to any radio. With instructions, \$4.49 postpaid. Rocen Sound, 7124 South California, Chicago 29, Illinois.

**VEST** Pocket radio! What fun! Listen while strolling or cycling. Local or distant reception. Plans sold around the world. Kits available. Cheap, easy. Free photograph with plans. Rush \$1.00. United Manufacturing Associates, 3316 Ave. G, Fort Worth 5, Texas.

**FREE** New radio catalog is ready! Radionic's catalog lists hard-to-get radio parts, books, amateur, test and P.A. equipment. All available for immediate shipment. Send today to: Radionic Equipment Co., Dept. 7S2, 170 Nassau St., New York 7, N. Y.

**POWERFUL** 4-Tube A.C.-D.C. radio. Receives 550 to 1600 kc. New Alnico 5 speaker assure good tone. Polished walnut cabinet. Complete, ready to play, net \$10.95. Dal-Bar 5-tube superhet radio. Receives 550 to 1650 kc. Beautiful walnut cabinet. Complete \$18.95. McGee Radio Co., 1227 McGee St., Kansas City, Mo. Write for catalog.

**FM** Crystal set. Build this simple FM radio. Use as converter on broadcast receivers. Complete plans \$1.00. FM-4, 26 Rixey Drive, Alexandria, Va.

**HOW** To be a radio announcer. Send \$2.00 for complete book. Hollywood Radio Publishers, 5855-PM Hollywood Blvd., Hollywood 28, California.

**FAMOUS** "Allen" midget semi-fixed crystal detector. Set building plans and 100 late crystal set distance reports all for 50c postpaid. Allen, 427-2, Clinton, Mo.

**NEVADIUM** Super crystal. Write for details. Box 764, Elko, Nev.

**RADIO** Service men and experimenters send stamp for our giant radio catalogue. Save dollars. United Radio Co., (1000-V) Newark 1, N. J.

**MAKE** Simple, tubeless, batteryless, distance-getting crystal radios. Crystal and illustrated instructions 25c postpaid. Allen, 427-P, Clinton, Missouri.

**RADIO** Technician and radio service courses. Training for federal licenses. American Radio Institute, 101 W. 63 St., New York City. Approved under G. I. Bill of Rights.

**RADIO** tubes, parts, wholesale, retail large stock. Radio Mail Order Company, 46-13 188th St., Flushing, N. Y.

#### BUSINESS OPPORTUNITIES

**BUILD** Your own independent, fascinating and very profitable business at home, spare, or full time. \$75.00 and upwards weekly easily possible making beautiful brilliant, sparkling novelties and religious figures. Fast sellers through you, salesmen, stores. Quickly learned and few dollars starts you making real money. Successful manufacturer can tell you how and furnish everything. Start small, grow big. Write for full information and "amazing story of my success" at once. Inghram Company, 2845 Sixth Street, Detroit 1, Michigan.

**START** Selling costume jewelry \$2.00-\$5.00. Sellers send for \$25.00-\$50.00 assortment. Double your investment. Manufacturers, 264 5th Ave., New York.

**DOMESTICATED** Earthworms. Send \$1.00 for booklet. How to raise, use and sell them. Earthworm Farms Enterprises, Box 4, Lamoni, Iowa.

**MONEY-MAKING** Opportunities, exclusive supply sources, personal guidance guaranteed. For complete details, remit 25c. Winklepost, Box 517, Grand Central Annex, New York 17.

**PROFITABLE** Concrete block business. Details free. Wm. Horne, 206 West Wilder, Tampa 3, Florida.

**SELL** 3-Line, cushion mounted, index face rubber stamp 65c. Good commission. Write for agency. Velazquez, Box 55 Hamilton Grange, New York 31.

**MAKE** A hobby into a profitable business. Build miniature structures for architects, realtors and builders. Supplies and instructions available. For details write Min-A-Model Homes, 1204 18th Street, San Diego 2, California.

**315** MONEY-Making opportunities. Supply Sources, Neiman, 1136 Robeson, Reading, Pennsylvania.

**START** Home manufacturing business making Cleaning Compounds, Soaps, Insecticides (DDT), Cosmetics, Polishes. No machinery. Literature free. Kemix, Park Ridge, Ill.

**DOLLARS** Daily! Cleared \$1900 in two months. Details. Loeb, 7201-A-2 Montgomery, Cincinnati.

**GOT** \$24,500 Using schemes from "Schemer" Magazine, Alliance, Ohio. 49th year, \$1.00; 3 samples, 25c.

**MEN—Women—**"Everybody likes candy." Learn to manufacture professionally at home. (Our 36th year). Ragsdale Candies, Dept. 4, East Orange, N. J.

**OPPORTUNITIES.** Wholesale directory, \$2.00. Edward Reimer, C-1119 Chestnut, Saginaw, Michigan.

**SELL** By mail—Books, merchandise. Free literature. Goerke, Bell, Calif.

**BUILD** Your own mail order business. Free literature. Hamilton Service, Box 865-A, Waterbury 87, Conn.

**CO-OPERATORS** Wanted—for meritorious business project. Box 985, Los Angeles 53, Calif.

**GOLDEN** Magic embossing outfits. Establishes home business ten ways. Details free. Royal, Box 92-H, Station B, New York, N. Y.

**LIVE** Mailing list. 5000 mail order buyers on gum labels \$25.00 or \$6.00 per thousand. Guaranteed live for results. Ace-A, 4112 N. Menard, Chicago.

**BEST** Mail-order seller in years. Own your own business. Big profits. Box 27A, Ridgewood, New Jersey.

**OPERATE** Profitable mail order business. Splendid opportunity. For details, write, U. S. Specialty Co., Box 13, Patchogue 1, N. Y.

**"LUMINOUS** Paint." Resilvering Mirror formulas 25c each. "50 Single Ingredient Formulas" \$1.00. Ideal Service, 300, Park Ridge, Ill.

**CALIFORNIA** Motels. Pay well. For circulars write Frank Dykema, 813 Gretna Green Way, Los Angeles 24, Calif.

**POWERFUL** Program for achieving personal and business success; works without expense or guesswork. Applicable for you. Free literature. Menders, 15857-A Coram Ave., Detroit 5, Michigan.

**MONEY** Making opportunities. Tested plans, ideas galore for successful operation mail order business. Full or part time. Details free. Levand, 6410 Kenwood, Chicago 37.

**START** Your own advertising agency, in spare time at home. Opportunity for big earnings and permanent business. Complete operation revealed. No stock or equipment needed. Folder and proof free. P. Snyder, Box 4907-A, Philadelphia 19, Penna.

**OPERATE** Profitable mail order business. Tremendous profits. Patrick Service, Box 1322, Cleveland 3, Ohio.

**GROW**—Sell potted flowers, vegetable plants. Details and packet mixed flower seeds 10c. Bowers, Loyaltown, Penna.

**MAKE** Liquid marble, flexible molds, statuary, art goods, novelties, artificial marble flooring. Literature free. Kemico, Park Ridge 50, Ill.

**OPPORTUNITY** To build fast growing, high grade, business without capital. This plan is used by large business throughout the United States. Address, Roy Vail, La-Grange 6, Indiana.

**RUBBER** Molds, liquid rubber, statuary plaster, kits for beginners. Free instructions. "Everything for the plastercrafter." Blue Rapids Supply, Blue Rapids, Kansas.

**OPERATE** Profitable mail order business. Splendid opportunity. For details write: Fox, Rt. 1, Box 600, Aptos, Calif.



**EARN \$75-\$150 Weekly** operating "Merchants Advertising Service." Permanent employment, immediate earnings. No investment required. 3c stamp brings sealed information. National Sales, Gulfport 1, Burlington, Iowa.

**40 MAILORDER** Magazines, ad sheets and circulars. Opportunity unlimited for 25c. Theodore Gordon, Box 1223, New Haven, Conn.

**GET The facts.** Sell names by mail. Spare time. Big money making opportunity. Rush name for details. Forest Book Co., Box 297P, North Hollywood, Calif.

**DIRECTORY—3342** Business, trade, diversion magazines \$1.00. Commercial Engraving Publishing Co., 34C North Ritter, Indianapolis 1, Ind.

**OPPORTUNITY** Big mail 3c. Mallo, 767-PM Leith St., Flint 5, Mich.

**MAKE Strange plastic—1c** pound. Makes durable, attractive floors, walls. Build with waste. Save half. Bays Laboratory, Oklahoma City 9.

**LEARN** To metallize baby shoes \$1.00. Don Brady, 1618 Sage St., Topeka, Kan.

**MAIL Order** offers increased income, independence, unlimited possibilities, free literature. Manhattan House, 126-L, Lexington, New York 16.

**START Your own mail order business,** now! Free details. Stillman Taylor, Cologne, N. J.

**OPERATE Profitable mail order business.** Splendid opportunity. For details, C. Riekert, 22 Royal Road, Rockville Centre, N. Y.

**HANDYMEN—Earn money** home operating Community "Fix-It" Shop. Write Stafford, 708 Rawlings, Carbondale, Ill.

**SUPER X liquid molding rubber.** Sample jar 25c, quart \$3.00, gallon \$10.00. Free instructions. W. Wooley, 115-A Donald, Peoria, Ill.

**WANTED: Persons** willing to co-publish magazine. 10c for samples, details. Lannich's, 7145 Greenwood Ave., Chicago, Ill.

**HOME Business** on small capital, \$1.00 makes \$6.00. No canvassing. Details 10c. Full instructions, illustrations and sample \$1.00. Sample well worth charge. Hand-I-Work Shop, Route 9, Box 612, Portland 16, Oregon.

**MONEY Making Manual** outlines 7 sure-fire ways to start profitable home business. Copy 25c postpaid. Powell Publishing, Sampler Bldg., Cleveland 3, Ohio.

**EVERYBODY Eats.** How to make money in the restaurant business. Illustrated success stories. \$1.00 postpaid. Luckock Press, 1047 Irolo Street, Los Angeles 6, Calif., Dept. 5-A.

**APEX Plastic products** presents three types of liquid latex for flexible mold makers. Simple illustrated mold making instructions 50c. Advanced \$1.00. 1915 Lunt, Chicago.

**MAKE Plaster novelties.** Special molding rubber. Free sample. Quart \$3.00, gallon \$10.50. Free instructions. Universal Sales, Box 1076-A, Peoria, Ill.

**OPERATE Simplified appliance** and building repair business. Locally or by mail. Free information. Cline-Porter, Box 6346PM, Pittsburgh 12, Penna.

**DO It with sea shells.** Big profits. Werts, 1429 - 56th Avenue, Oakland 3, Calif.

**START A full or spare time** profitable mail order business at home. This is your opportunity. Particulars free. Vails Mail Service, 3201-C Harrison, Brookfield, Ill.

**OWN A mail-order paper products** business. Sell envelopes, tags, bags, boxes, by mail, wholesale. Tremendous demand. Steady profits. No capital necessary. Write Omaha Envelope Service, Dept. 188, 4721 California, Omaha 3, Nebraska.

**EXCLUSIVE Territory** to men who are capable of organizing a sales force to cover a state or several counties. Must have contacts with wholesale houses, jobbers, etc. Wonder Plastic Linoleum Finish and Wonder Plastic Wood Finish. Write Wonder Plastic Products Company, 2609 S. Kedvale Avenue, Chicago 23, Illinois.

**START Home plaster novelty business.** Amazing course tells how. Literature free. W. Belfort, Engineering Building, Chicago 6.

**MAIL Order business—Your opportunity.** Start small—Grow big. Literature free. C-Belfort, Engineering Building, Chicago 6.

**LIQUID Marble—Make in any color.** Soundproof plastic flooring. Flexible molds. Cast novelties, plaques, statuary. Big money—your own business. Catalog free. Write—Bing Products, 88-A2N Broad Street, Boston 10, Mass.

**YOUR Town is ripe** for a profitable Collection Agency. \$5,000 first year easily possible. We train you, coach you, get you started and help develop your business. Send \$1.00 for Starter Course, or ask for facts. American Collection Associates, 226 State Street, Schenectady 5, New York.

**MECHANICALLY Inclined men—Own** and operate general appliance repair shop. Complete, illustrated course shows you how. Welding, refrigeration, motor repair, how to get business, etc., all phases covered. Free literature. Christy Supply, Dept. 173, 2835 N. Central Ave., Chicago.

**500 GIGANTIC Money-Producing** ideas, plans, formulas. Build permanent business, limited capital. Manufacturing, mail order opportunities. Particulars free. National Enterprises-Z, 10 Waverly Place, New York 3.

**SELL By mail—Amazing new book** tells how. Literature free. M. E. Egan, 205-G W. Cherry St., Shenandoah, Penna.

**WOULD You pay 3¢—first \$350 made?** Color-illustrated book "505 Odd, Successful Enterprises" free! Some offer occasional "day off." Work home. Expect something odd! Pacific, San Clemente, Calif.

**WHOLESALE Distributor: Amazing patented** screw-holding screw drivers! Removes, holds, inserts screws hard-to-get places! Retail stores, mechanics, factories, buy quantities. Counter displays, advertising furnished. Fast sales, big profits, refundable trial offer! Millen Mfg., 457 Miller Bldg., Boston, Mass.

**OPERATE Big profit mailorder business** on shoestring! Details free. Schneider, 1038 Holland, Schenectady, N. Y.

**BRONZED Baby shoe mountings.** Beautiful all-metal bookends, onyx plaques, etc. Wholesale only. Write for list. Hollywood Bronze Supply, 1770 No. Vermont, Hollywood 27, Calif.

**EXTRA Dollars, or a good living,** with your typewriter. New, exclusive opportunity. Never before offered. Get details now. Schroder, 221 E. Bush, Covington, Ky.

**\$5,000 YEARLY Possible** in spare time selling by mail with expert assistance. Small investment. Details free. Diafas, 109 Mt. Hope, Dover 2, New Jersey.

**SUBSTANTIAL Mail order opportunities.** Oldest trade journal in the field shows you how. 54th year. Copy 25c. Veterans Publications, Charleston 1, Illinois.

**CATALOG Of business opportunities** free. Carr, 1600 Second Ave. S., Minneapolis 4, Minn.

**MAKE Big money** in your own sandwich shop. My copyrighted book, "Making Money In A Sandwich Shop," tells you how to get started. Money back guarantee. Price \$1.00. Dexter Pratt, Box 1361SSS, Springfield, Missouri.

**UNPAINTED Wall plaques 2½c up.** Beautiful designs. Easily painted. Illustrated list free. Write today. Omman, 642-M2 Broadway, St. Paul 1, Minnesota.

**BIG Money in vending machine.** Smallest capital start brings immediate profits that build permanent profitable business. Starting instructions free. Becker Vendors, 105 Dewey, Brillion, Wisconsin.

**COMPLETE Mail selling setups** built-to-order, for financially responsible mail order aspirants by leading mail order association. Descriptive booklet free! National Mail Dealers' Association, 46-P King, Dorchester, Mass.

**MAIL Order profits.** Oldest trade journal (54th year) shows how. Sample copy 25c. The Mail Order News, Somerville, New Jersey.

**OPERATE Profitable mail order business.** Splendid opportunity. For details write C. G. Gloger, 318 Green St., Watertown, Wis.

**OPERATE Own wholesale candy business.** Sell stores. Free list. Information. Sally Dee Candies, 142-Sims, Newport, R.I.

**EARN Up to \$500 month** part or full time keeping books for small firms. Simplified system. Write Tax-Saver System, Dept. K, Ft. Worth, Tex.

**YOUR Own business metallizing baby shoes.** Complete course \$3.50. Technical Aid and Supply Co., P.O. Box 668, Los Angeles 53, Calif.

**FORMULA Buyers,** join our new formula club, get valuable formulas free. Write Alliance Chemical, 415 Laramie, Alliance, Nebraska.

**ALL Types of businesses for sale,** Southern California. Send \$1.00 for listing giving complete information. Broker, 731 W. 9th, Los Angeles 15.

**COST 8c, Retail \$5.** Mfg. mail order. Car beauty preserver—used once year. New—different. Royalty basis. Grossed \$3,000 first month, at home. Plasticize, 2254 N.W. 62nd St., Miami, Fla.

**CASTONE—Hardest coldcasting composition** on earth. Any mold; white and colors; 10 pounds \$2.00. Hundred \$6.00. New Era, 1321-N Belmont, Chicago.

**TRAVEL Everywhere.** Be your own boss. Earn \$100.00 per week. I guarantee you can or refund your money. Complete plans \$1.00. Box 112, LaGrange 1, Indiana.

**100 PER Cent profit** selling unbreakable personalized ladies' comb in your mail order business. Future Products, Box 43 Gravesend, Brooklyn 23, N. Y.

**COLLECT Names** and addresses at home. Sell them to mail order dealers. Large profits. Write MacAndrews, Box 351, Calais, Maine.

**PLASTIC—Liquid glass, china glazes,** protects any plaster object. Pint, \$1.00; gallon \$3.00. New Era, 1321N Belmont, Chicago.

**SOAP Is scarce.** Complete plans for the manufacture of fine hand soap. Where to buy wrappers, materials, coloring and where to market your product. Materials and equipment amazingly inexpensive. Complete plans \$1.00. Better Business, 918 State Street, Racine, Wisconsin.

**10c BRINGS Mailorder's fastest dollar** puller. You keep dollars—orders filled free. Tiny investment returns, tremendous profits. Harrison, R2, Berrien Springs, Mich.

**RUBBER-AIRFLEX Liquid,** makes molds "overnight." Pint \$1.25; gallon \$7.00 with instructions. New Era Products, 1321-N Belmont, Chicago.

**PIPE Layout men** to demonstrate and sell new speedy practical pipe layout tool. Profits high. Write Henjum Tool Company, 3421 W. Pico Blvd., Los Angeles 6, California.

**LIQUID Rubber for molds.** Gal. \$10.00. Midwest Supply, Paulina, Iowa.

**SIGNS Made easily.** Instructions and ten sets modern alphabets, numerals, patterns. Sizes up to eight inches. All for \$1.00. Co-operative Business, 7 West Madison, Chicago, (2).

**PACKAGE, Sell amazing cleaners** under your name mail, local. Other products. Samples 25c. Linnell, Box 1720A, Cleveland, Ohio.

**PROFITABLE Business** or hobby in photo-printing, post-cards from negatives without dark room. Print advertising, souvenir or personal picture post-cards. Work in your kitchen. No experience needed. Automatic machine complete with supplies to print 50 picture cards \$5.98 tax-paid, postpaid. Order now, or send for free folder. Craftex Products, 6815 East End Ave., Dept. P-2, Chicago 49, Illinois.

**BOOKKEEPERS: General ledger** and tax report experience operate permanent, profitable accounting service for the smaller business. Part or full time. Simplified method. Write now! L. A. Bell, 1404 West 25th Street, Cleveland 13, Ohio.

**METALLIZE Baby shoes!** Learn this money making business from nationally recognized consultant. Get "know how" from outstanding authority! See Kushner ad, page 246.

**ACTION: Money making opportunity** unmatched. Big demand for electric appliances. Large source available. Good profits. Write letter for details. Soltz, Box 303, Silverton, Oregon.

**NEW Rubberized construction** excellent for removing lint from cloth and clothing, especially dark fabrics and suede shoes. Better than a brush. Sells quickly with good profit. Write for details. Henry M. Nagel, P.O. Box 125, Boulder, Colorado.

**BOOKKEEPERS—Operate your own** simplified "Dollar-A-Week" bookkeeping and tax service. Full or spare time. Details free. Ellis, Box 200, Cedar Grove, North Carolina.

**IF You would like to make \$5,000 yearly** in an easily learned office business of your own, send for free details immediately. G. H. Cole, Pres., Syracuse 2, New York.

**SELL By mail, 25 plans 25 cents.** Rex Newton, Loretto, Tenn.

**EXTRA Money!** Start profitable home mail business, sparetime. No experience. Edward Tana, 2-A Ogden Road, West Islip, N. Y.

**LOOKING For new opportunities?** Mail order and others? Get "The Practical Idea." Write: Veteran, Charleston 6, Illinois.

**MILLIONS Have been made** in real estate. Why not learn how? Send 25c for "Pointers on How to Make Money." Wm. M. Wells, 5115½ Monte Vista, Los Angeles 42, Calif.

**EARN \$100 Per day profit** with Master Concrete Tile Machine. Materials and markets everywhere. Descriptive literature free. Concrete Machinery Company, Box #2248-B, Hickory, N. C.



**MAIL** Order business course shows you how to make money, spare or fulltime. Teaches professional mail order technique—not penny-snatching schemes. Fascinating 100-page illustrated success-catalog free! Write, Nelson Company, Dept. 4-02, Chicago 5.

**BE** First with newest items—New Products Bulletin Service brings listing 100 newest products. Tells where to get them long before they're on open market. Sample bulletin only \$1.00, details free. American Enterprises, Box 595-P, Grand Central Station, New York 17.

**\$46 FROM** Square foot plywood. Jigsaw necessary. Write, Woodarts, Bridgewater, Mass.

**MAKE** Flexible molds! Few cents each! Cast plaques, novelties, bookends! Free sample! H. Tooker, Hamilton 44, Ohio.

**PLASTIC** Discs, shapes, metal findings, wholesale, free catalog. "Secors," Bradenton Beach, Florida.

**1000 CONTRACT** Bookkeepers needed. Start your own business. Part or full time. Information free. Write A. J. Hawthorne, Public Accountant, Decatur, Ala.

**RENT** Amidon scaffolds to contractors. Amidon Engineering Co., Elyria, Ohio.

**ELITE** Collection contains 137 practical money-making plans; local and mail order. New edition. Particulars free. Elite Co., 220 Grand St., New York 13.

**FORTUNES** In formulas and trade secrets. Practical, authentic, reliable. Details free. Stillman, 555 Kingston Ave., Brooklyn 3, N. Y.

**137 WAYS** To make money, in home or office, business of your own. Full particulars free. Elite Co., 220 Grand St., New York 13.

**OPERATE** Profitable home business. Levine's, Box 15-X, Boulevard Station, New York 59, N. Y.

**SELL** Lamswool lined slippers, men's, women's and children's. Sensational profits. Sell from illustrated catalog or samples. Write for full details today. Shepherd Products Company, Worcester, Massachusetts.

**ARE** You "fed up" working for bosses? Own permanent mail order business. Crompton, Box 2567, Hollywood 28, Calif.

**MAKE** Money making shell jewelry and novelties. Instruction book 75c. Kit \$5.00. Catalogue free. Palm Shellcraft Co., 220 W. 9th St., Sarasota, Fla.

**OPPORTUNITIES** Galore to operate own successful businesses. Manufacture own products. Establish yourself locally, statewide, nationally. No hokum. Serious-minded men invited to write Robert Avila, Isleton, Calif.

**BRONZING** And metallizing baby shoes! Gold, silver, copper, nickel, bronze, pearl, ivory, and "luminous glow" colors! Big profits! New field! Details free! Write R. O. Morgan, Box 349, Long Beach 2, Calif.

**BECOME** Independent! Rent New York office under your own name, and sell what you have to offer through world's greatest business center. Rates \$7.30 and \$14.60 yearly. Co-operative Offices, 126 Lexington Avenue, New York 16.

**BUILD** Miracle homes. For yourself, or sell others. Livable, lovable, durable. Facts free. Chamberlain Co., Fitzsimons Bldg., Pittsburgh 22, Penna.

**INVITATION** To income! Contact, Mib Associates, Fitzsimons Bldg., Pittsburgh 22, Penna.

**BELTS!** Make 'em and make money. No tools! Sample 50c. Artinc Leather, 411 Joseph Ave., Rochester 5, N. Y.

**ELECTROPLATE** Baby shoes. Complete instructions \$2.00. Creative Publishers, Winnetka 7, Illinois.

**\$15 TO \$20 Daily** if you can walk, talk, read and write. Elcom Service, Box 910, Tampa 1, Florida.

**VENDING** Machines. Be independent. Own a big money business operating coin machines. Earn as high as \$7.00 weekly on machine costing as low as \$11.75 each. Car and experience unnecessary. Routes can be operated either in your spare or full time. Act quickly. Write for details and catalogue showing our amusement games, postage machines, candy-gum-nut vendor and scales. Parkway Machine Co., 623J W. North Ave., Baltimore 17, Md.

**WHAT** Sells—How to start. 10c places your name many mailing lists. Zech, 7532 Buist, Philadelphia 42.

**"BULK** Vending" machines make easy steady income. Have you considered or would you like to learn this fascinating business. Post card brings free booklet. Vending, 1051 "L" St., San Bernardino, Calif.

**ANYONE** Can learn. Tune pianos by my system. \$12 lessons and chart. Oscar Fylling, 841 Robinson, Oroville, Calif.

**LIQUID** Marble—Colorful, glazed! Molded, brushed, sprayed! Composition floors. Rubberlastic molds. Particulars free. Marbleizing Service, Edwardsville, Ill.

**PLASTIC** Homes—Build yourself! Re-surface old buildings! Wonderful building material. Particulars free. Marbleizing Service, Edwardsville, Illinois.

**GOT** \$24,500 Using schemes from "Schemer" Magazine, Alliance, Ohio. 48th year, \$1.00; 3 samples, 25c.

**BRAND** New proposition. Extra money spare time. No selling. No canvassing. Absolutely different. You do it. Full particulars free. R. H. Callaway Specialty Co., P.O. Box 341, Fort Smith, Ark.

**LEARN** Shell jewelry manufacturing. No tools or experience needed. Learn-earn within a week! Complete home instruction course, beautifully photographed, shows how to make 75 styles of pins, earrings, brooches, hair ornaments, dress clips, necklaces, bracelets, candy dishes, wall plaques, ash trays, candle sticks, etc. Includes pearlizing, golding, dyeing, luminous methods. Illustrates 55 species of sea shells. Lists hundreds of raw materials with wholesale prices. Complete course \$1.00, postpaid. Beginner's kit, \$3.00. (\$3.50 in Canada). House of Gifts, Box 4550-RF, Coral Gables, Fla.

**EARN** \$2000 Or more during March 15th tax period. Be a tax consultant. Bookkeepers, etc. can qualify quickly. Details free. Edw. H. Smith, 17 Rockland Ave., Yonkers, N. Y.

**\$565.00 PROFIT** From every \$15.00 invested. Standard Service System, La Grange 1, Indiana.

**QUICK** Money! "Repairing car batteries." At home! Easy too! Write. Batteryman, Grand Junction 5, Colorado.

**"HOW** To Make Simple Molds and Plaster Plaques." Profitable business or hobby! Instructive booklet 25c. Plastercraft Supply Company, 1406 East 43rd Street, Cleveland 3, Ohio.

**OPERATE** profitable mail order business. Splendid opportunity. For details write Albert Tayes, Zolfo Springs, Fla.

**SELL** By mail!—Books and novelties! 35 different items! Large profits! Catalog free! Elco, 432 N. Wells, Chicago 10.

**FREE** Details—How to operate a profitable mail order business. Beier's, 837-A North Hoffert, Bethlehem, Penna.

**MAILING** List! 5000 women mailorder buyers, \$25.00; 3000, \$15.00; 1000, \$6.00. Guaranteed accurate! Try them! Woods Remnants, Bedford, Penna.

**ORGANIZE** Wholesale—retail—popcorn, potato chip shops. We sell beginner's outfits. Long-Eakins, 4760 Hi St., Springfield, Ohio.

**DO** You want to learn the how, what, and where of the mail selling business? Details free. Harold Eisert, 218 Beach 81st Street, Rockaway Beach, New York.

**EVERYBODY'S** Feet hurt. Sell guaranteed cream. Excellent repeater. Free advertising. Write IDI, Quakertown, Penna.

**START** Home business making statuary, plaques, novelties, garden furniture, artificial marble flooring, liquid marble. Make your own flexible molds. Amazing profits. Folder free. Creative Publishers, Box 236-L, Winnetka, Illinois.

**COLOR** Concrete with chemicals. Make Hollywood style pottery; home or shop. Marbling, water-paints, 10c brings sample, pictures. Hollywood Cementcraft, 8527 Wonderland, Hollywood 46, Calif.

**INTERESTED** In immediate mail order cash? Read "Advance"—Voice of mail order. Offers money-making opportunities. Personal guidance and benefits to all. Sample copy 25c. American Mail Trade Association, 313 East 21st Street, Dept. 400, New York 10, N. Y.

**WHY** Job worry? Learn electroplating. Highly paid, uncrowded, interesting business. Gold, silver, nickel, chromium, etc. Send postcard for free booklet and proof. Plater Hyde, Dept. MC, P.O. Box 176, National City, Calif.

**COPUBLISH** Leading m.o. paper. Latest copy Mail Sale Advertiser and proposition, commemorative stamp. Vanroy Shirk, Lebanon, Penna.

**START** Profitable mail order business. PMT lists new propositions available; products, sources, accurate methods. Covers ad writing, letter logic, trade information. Send 10c for copy and get free instruction folio offer. Progressive Magazine, Sheboygan, Wisconsin.

**HOW** And where to obtain capital. Fully explained. Particulars free. Star Service, Wapakoneta, Ohio.

**MAKE** Extra money now. Build to financial independence. Sell office supplies by mail from your home. I tell you how. Jo Troutwine, 8654 S.W. Ninth, Portland 1, Oregon.

**OPERATE** Profitable home business selling merchandise by mail. Fast sellers. Large profits. Powell Service, 5713 Euclid, Cleveland 3, Ohio.

**START** A home business in spare time. Make extra money. Experience unnecessary. Literature free. Ellmar Services, Muncy, Penna.

**LIQUID** Rubber, for making flexible molds, literature and sample free. H. Chaney, 1130 E. 16th St., Jacksonville 6, Fla.

**1946 GIGANTIC** Directory of opportunities, advertisers supplies, sources, trade information, mail order ideas, products, wholesalers, valuable tips—just published! Descriptive literature free. Wilkin & Co., 118-AP East Main St., Hillsboro, Ohio.

**BIG** Paying jobs in welding. Complete welding lessons and reference books, 516 pages, 41 lessons, \$2.00 copy. Money-back guarantee. Hobartweid, Box M-1065, Troy, Ohio.

**START** A clock shop. Fascinating, easily learned profitable business requiring little capital. We teach you how to repair all kinds of clocks. Information free. Houston Clock Shop, P.O. Box 5086A, Houston 12, Texas.

**SYNTHETIC** Latex with Neoprene base for making flexible molds! Quick drying! Safe! For home, classroom, or industry. Quart \$2.00. Gallon \$5.95. Full instructions. Plastercraft Supply Company, 1406 East 43rd Street, Cleveland 3, Ohio.

**200 MONEY** Making deals, Plans. Rare formulas. Schemes. Folio free. Formico Mart, Box 572, Dayton, Ohio.

**RAISING** Canaries pays good profits. Valuable bird book—"Its Care, Breeding and Training." Price \$1.00. American Canary, 2839 N. Halsted, Chicago.

**SPECIALTY** Manufacturing, the big money business that can be operated anywhere, start on a very small capital; we supply dependable formulas and complete instructions; get interesting free booklet, "Money-making Opportunities in Specialty Manufacturing." Howard Robinson, Ph.G., 1300-A South Ohio Street, Sedalia, Mo.

**MINK** Raising, information free. Complete Lake Superior Mink Farm, Superior, Ee, Wisconsin.

**TADPOLES** Make frogs, tremendous demand. Both make you money. 25c brings tell-how information. Chariton Corporation, Century Building, Chicago 4.

**COPERIZE** Baby-shoes, complete instructions, tested sales plan. Metalloids, Box 8087-b, Pittsburgh 16, Penna.

**MAKE** "DDT" Products. My ten master formulas show how. Literature free. Howard Robinson, Ph. G., 1302-A So. Ohio, Sedalia, Missouri.

**WE** Start you in business, at home, sparetime, earning \$10-\$30 weekly selling by mail. Stamp appreciated but not necessary. Driscoll Sales Service, Box 2771-A, Denver, Colo.

**YOUR** Own business. Big profits, very small capital. National organization teaches, helps, supplies everything. Interesting service business. Big demand everywhere. Americlean, 211 North 7th Street, St. Louis 1, Mo.

**COLORGLAZED** Concrete pottery made without molds. New, low cost, patented method. Cemetery products, novelties, tiles, floors, etc. Basement leaksealing. Other moneymaking projects. Booklet, details free. Men only. National Potteries Company, Fergus Falls, Minnesota.

**RECAST** Old batteries into new. Latest achievements. Battery Laboratories, Minneapolis.

**START** Mailorder bookshop—Everything furnished; publisher cooperation. 25c brings booklet, exclusive setup, samples, exciting ideas. General Publications, Ossining, N. Y.

**\$25 WEEKLY** Working two hours daily. No canvassing. No manufacturing. Lycke, Box 2471, Cleveland 12, Ohio.

**BRUSH** Plating outfits connect to a battery. No tanks necessary. Good paying business at home plating autoparts, bathroom fixtures, bicycles, reflectors, silvering mirrors. No shop or experience required. Outfits furnished. Free booklet. Gunmetal Co., Ave. H, Decatur, Ill.

**BABY** Shoes preserved. Complete instructions. Exclusive rights. M. E. Watson, Bellefontaine, Ohio.



**LATEX** For making flexible rubber moulds. Thoroughly tested. No shrinkage. Complete instructions with each order. Stoneham Rubber Co., Box 244, Stoneham 80, Mass.

**RUBBER** Moulds for casting novelties. Latex for making moulds. Use thoroughly tested and approved products. Eastern Latex Laboratories, Box 153, Mattapan 26, Mass.

**LEARN** Piano tuning, repairing, at home. Tremendous field! Piano parts, tools furnished. Established 1935. Empire School of Piano Tuning, 606-B East University Ave., Champaign, Ill.

**\$10,000 PROFIT.** Amazing new product. Gives new life to battery. \$1500.00 investment for district jobber. Exclusive territory. \$150.00 investment for used battery business. State distributor inquiries invited. California Sales & Equipment Company, 13550 Addison St., Van Nuys, California.

### MONEYMAKING OPPORTUNITIES

**START** Your own mail-order business on small capital. Big profits. Details free. Hadeland, Box 27A-2, Ridgewood, New Jersey.

**FREE "Prize Contest Bulletin"** describes many contests. Money making opportunity. Cash Register-G, 210 Fifth Ave., New York 10.

**GET** Dollar orders by mail. Keep 90c of each dollar. Easy, pleasant home business. Few dollars starts you. Start now. Details free. Roy H. Davidson, Box N640 Nots, Inyokern 3, Calif.

**RUBBER** Moulds for ash trays, lamps, etc. Vallance Art Products, 1873 East 70 Street, Cleveland 3, Ohio.

**THOUSANDS** Articles wholesale. "Supply Source Directory" 10c. Ideal Service, Park Ridge 40, Illinois.

**FLAT** Broke? Impossible! Here are the secret. "Seven cures for a lean purse," if it is wealth you desire. \$1.00 postpaid. Postcard brings descriptive information free. E. Kalb, General P.O. Box 553, New York 1, N. Y.

**YOUR** Shoe soles can wear 20 months. Details stamp. L. Brokaw, Carson City, Mich.

**HANDICRAFT** Folio, 10c. Other money-making books. Ralph Underhill, Beebe, Arkansas.

**MAKE** Rubber stamps. Complete instructions \$1.00. Th. Law, 54 East 99th, New York 29.

**PROFIT** 75c Or more per dollar. Postal brings literature. Trader, 216P Degraw, Brooklyn 2, N. Y.

**EARN** "Pin money" at home. Assemble colorful handmade jewelry. Free details. Beginner's outfit, \$1 (refundable). Plastic Works, 712 Kimball, Danville 3, Illinois.

**UNPAINTED** Figurines, plaques. List. Progress Company, 4033 Chown, Minneapolis 10, Minn.

**\$25 WEEKLY** Working two hours daily. No canvassing or manufacturing. Lycke, Box 2471, Cleveland 12, Ohio.

**YOUR** Backyard hobbies can pay off illustrated true stories of big business from backyard hobbies. \$1.00 postpaid. Luckock Press, 1047 Irolo Street, Los Angeles 6, Calif., Dept. 6-A.

**SELL** Books by mail. Large profits! Free! Information. Cline-Porter (Publisher), Box 6346-PB, Pittsburgh 12, Penna.

**YOU** Can earn real money by mail, thousands do. Particulars free. Thomasson's, Minneapolis 12, Minnesota.

**POWERFUL,** Order pulling sales letters, literature, and mail order campaigns prepared! Investigate! Joe Melton, 8902 Daytona, Dallas, Texas.

**CONVERT** Burnt out light bulbs into fire extinguishers for few cents each. Every home a prospect for several at your own price. Copyrighted instruction folio with fotos show you how. \$1.00. Fred A. Lewis, Box 104-A Kensington Station, Brooklyn 18, New York.

**EXPORTS** Are profitable. Send \$2.00 for list 50 Latin American firms interested trading with North America. Johnston, 5520 South Miro Street, New Orleans 15, Louisiana.

**WHOLESALE** Catalog, directory. 10c. Stafford Sales, Box 5211, Indianapolis 1, Indiana.

**SPARETIME** Dollars earned by mechanically inclined men. Amazing opportunity. Details free. Gruber, 1608½ Morton Ave., Los Angeles 26, California.

**MECHANICALLY** Inclined men — Own and operate general appliance repair shop. Complete, illustrated course shows you how. Welding, refrigeration, motor repair, how to get business, etc., all phases covered. Free literature. Christy Supply, Dept. 1173, 2835 N. Central Ave., Chicago.

**WOULD** You pay 3%—first \$350 made? Color-illustrated book "505 Odd Successful Enterprises" free! Proven! Work at home, office. Expect something odd! Pacific, San Clemente, Calif.

**START** Your own business! Big money manufacturing novelties, plaques, statuary. Free catalog. Write Bing Products, 88-A2M Broad Street, Boston 10, Mass.

**FIVE** Million jobs available! In postwar reconstruction program. Write for free details! Robert Dyer, Box 1608, March Field, California.

**\$40 WEEKLY,** Working part time only. Easy, too. Jones, Bethany 23, Okla.

**CONSTRUCTION** Workers attention! In Philippines, Hawaii, Okinawa, Alaska, South America, large construction contracts. Excellent opportunity. Send \$1.00 for details. Personnel Service, Box 949-B, Knoxville, Tenn.

**AMAZING** New salesboard. Legal anywhere. \$8.00 profit on \$10.00 sample. Dremaco, 911-W California, Oklahoma City 4.

**FREE** Literature describing many money making plans. William Woodrow Jenkins, Atmore, Alabama.

**VETERANS**—Start your own business, at home, making novelty plastic articles. \$100 outfits you completely. See ad page 266. Write NRK Mfg. and Engineering Co., 5648 North Western, Chicago, Illinois.

**SEWING** Machine repairmen make big money lifetime. Start neighborhood shop today. Our course repairs all makes. \$1.98 postpaid. Serviceman, Hamilton 9, Ohio.

**BUILD** Neon signs and neon lighting. Easy to learn. Very small capital required. McMaster Sign Co., 730 State St., Bellingham, Wash.

**WHY** Work for others? Make and sell household aluminum cleaner. Fast seller. Big profits. Easy to put up. Formula \$1.00. J. Williams, P.O. Box 399, Cranford, N. J.

**ELITE** Collection contains 137 separate proven moneymaking plans—home town and mail order. New edition. Information free. Pacific Distributors, Box 841, Oakland 4, Calif.

**MAKE** Photo-statues from snapshots. Simple, profitable reorders. Amazing details free. Brooklyn Model, 818-B Coney Island, Brooklyn 18, N. Y.

**EARN** Up to \$2,000 year, inventing simple items for special cash markets. Ideas only. No patents. Hendrickson, Argyle (7), Wisconsin.

**THERE'S** Big money in junk," and repairing batteries. Write, Batteryman, Grand Junction 5, Colorado.

**EARN** Money evenings, copying and duplicating comic cartoons for advertisers. Adservice, Argyle (1), Wisconsin.

**EARN** Money at home! Thousands do! "Home Worker Magazine" tells how. Sample, 25c (coin). Six issues, \$1.00. Arthur Sizemore, Pub., Box 870-M, St. Petersburg, Fla.

**\$246.50 MAKING** Unusual secret device without skill, machinery, from former war material costing \$1.50! Simple, baffling invention, unbelievably profitable! Illustrated proofs free. Rolls Enterprises, 115-D West 16th, New York 11.

**EARN** While you learn clock repairing. With our method your income can start immediately. Write Akron Clock Clinic, 964 Wye Drive, Akron 3, Ohio.

**SELL** By mail! Mail order business is shortest cut to profitable sales. Inspiring, constructive, instructive literature sent without obligation. Earl Cratty, 385 Lenzen Ave., San Jose 11, California.

**EARN** Money at home—steady income. Write Successful Income Builders, 508-A, Hollywood 28, California.

**LEARN** Metascience. Remarkable drugless healing. No manipulation. No apparatus. Unbelievable simplicity and results. Inexpensive correspondence course. Write Metascience, De Land, Florida.

**LEARN** Battery repairing, rebuilding. Engineer offers money making methods. Battery Bureau, 2225 North 44th St., Milwaukee, Wis.

**200 MONEY** Making deals, plans, rare formulas. Schemes. Folio free. Formico-Eng., Box 572, Dayton, Ohio.

**FORTIFY** The future! Start own business: home, office. Booklet describing "Collection of 137 Tested Plans" free. Elite Co., 220-A Grand St., New York 13.

**PUBLISH** Your own magazine. Handsome 52 page format, well edited, illustrated. Cost low as \$1.00 month. Brings you prestige, profits. 25c brings sample. details. National, Ord. Nebr.

**I MAKE** Big money in the mail-order business. You can do the same at home with my copyrighted system. Write me. I'll tell you how. F. Little, Box 8, Glen-shaw P.O., Pittsburgh, Penna.

### FORMULAS, PLANS, ETC.

**MANUFACTURE** Cleaners, flavors, cosmetics. Literature catalog free. Kemico, Park Ridge 20, Illinois.

**STRIP** Nickel from brass lamps, copper kettles, etc. No tanks or electricity. Almost instant. Simple. Cheap. Widely used written formula, directions \$2.00. Boone Products, 236 W. 63rd, Chicago 21, Ill.

**LARGE** Formula catalog. Valuable information 10c. Refunded. Obermeyer's, 358 Uneda, Fond du Lac, Wis.

**PURCHASE** Trade-secrets, formulas, processes, 30c thousand. Details for stamp. Home Education Service, 124-N. Austin, Wichita Falls, Texas.

**ROOFING** 100% Fireproof, low cost, lasts like slate. Insulates better. Apply like plaster. Formula \$1. Ray Roofing, Box 98, New Hyde Park, New York.

**6 HOME** Use and moneymaking formulas \$1.00. Kozyra, 2946 N. Meade, Chicago, Ill.

**10,000 FORMULAS** And trade secrets. Free literature. Stillman, 555 Kingston Ave., Brooklyn 3, N. Y.

**NEED** Chemists? Formulas? Analyses? Products duplicated, improved? Consulting Scientific Company, Swarthmore, Pennsylvania.

**REAL** Manufacturing formulas. Lists free. Cummings, Chemist, Gordon Ave., Syracuse 4, N. Y.

**FORMULAS** — Latest, best. Analysis. Giant formula catalog and chemical instruction sheet 10c. Refunded first order. Belfort, Engineering Building, Chicago 6.

### PLASTICS

**PLASTICS,** Accessories from "one-stop" store. Plexiglas, Lucite, Cellulose Acetate for hobbies, money-making opportunities, sheets, rods, tubes, clear or colored. Full range of sizes. Cements, dyes, polishing compounds, buffs. Send for free price list, also details. Burgess Vibro-Tool, Handee Moto-Tool, Plasticator Injection Molding Machine, molds novelties, toys, gifts, Plastic Parts & Sales, 1157 S. Kingshighway, Dept. H-2, St. Louis 10, Mo.

**KITS**—\$1.50 Each, Plexiglas tie-rack 18" or 8"x10" picture frame. Heah Manufacturing Co., 5115 N. Neenah Ave., Chicago 31, Ill.

**PLEXIGLAS**—Everything for the plastic craftsman. Free listings. Novalte Plastic, P.O. Box 106, Brooklyn 19, N. Y.

**LUCITE,** Ft.— $\frac{1}{8}$ " \$1.45,  $\frac{1}{4}$ " \$2.05. Catalog, special offer. Midwest Plastic, 1717 No. 66, Omaha 4, Nebr.

**PLEXIGLAS:** First grade.  $\frac{1}{8}$ " \$1.50,  $\frac{3}{16}$ " \$1.85,  $\frac{1}{4}$ " \$2.00 pr. sq. ft. Clear and colors. Clear scrap, 35c lb. Shipped postage express collect or c.o.d. Rainbow Plastic Company, Arlington, Texas.

**PLASTICS,** Supplies, internal carving drills, kits \$3.00, \$5.00, \$8.00. List. Plasmet Sales and Engineering, 4648 Shirley Place, St. Louis 15, Mo.

**PLASTICS,** Material and supplies. Information folio, list free. Art Plastics of Calif., 8127 East 14th St., Oakland 3, Calif.

**PLASTICS,** Shells, jewelry findings. Free listings. Craft Plastics, Box 129M, Somerville, N. J.

**PLASTICS**—Best materials, low prices. Send for free price list. Plastex Products, 533A W. Balto St., Baltimore 1, Md.

**LEARN** At home "Working With Plastics." Full information on sheets, blocks, rods, tubes, sizes, colors for fabrication. Designing, tooling, bending, cementing, polishing. Also for homeworkshop. Only \$1.25 postpaid. Money back guarantee. Lucite plastic hobby kits available. Price \$3.00 postpaid. Free literature. Modern Technical Book Co., Dept. MMC, 55 West 42nd St., New York 18.

**PLASTIC** Sets! Build streamlined HO gauge trains, reciprocating engine that runs, cigarette boxes, jewelry. Easy new method. Postage prepaid. Complete with tools. Small \$1.69, large \$4.95. Wm. Trumpler Co., Palmer Mill Road, Media, Penna.

**PLEXIGLAS** Lucite slashed, free listings. Douglas Home Craftsman, Dept. M, Stamford, Conn.



**LUCITE**—Get acquainted with the "gem of plastics." Write for illustrated booklet, complete fabricating instructions, wholesale, retail prices, sheets, rods, tubes, supplies. Booklet, sample, 35c; booklet, 10c. Gem-O-Lite. Post Office Box 686B, North Hollywood, Calif.

**MAKE Money** assembling our pre-fabricated plastic kits. Sample kit 50c. Catalog free. Fabros, Box 156, Station F-1, Buffalo 12, N. Y.

**SENSATIONAL Plastic injection molding machine.** Low price Plexiglas, dyes, cements, shellcraft kits; molding sets, polystyrene rods. Free literature. G. Baker Company, River Edge, New Jersey.

### CHEMISTRY

**THE House of Winn,** home of supplies for amateur chemists. See Winn's New Idea chemical kits and apparatus outfits for home experimenting. Send 10c for retail catalog. Established 1931. John H. Winn, Dept. 502, 124 West 23rd St., New York 11, N. Y.

**CHEMICALS—LAB. Supplies.** New catalog 10c. Mel-Glo Chemical Co., 258 Fourth Avenue, Brooklyn 15, N. Y.

**BIG Savings on laboratory supplies.** Catalogue 10c. National Scientific Company, 2204 W. North Ave., Chicago 47, Ill.

**HANDBOOK For chemical experimenters,** illustrated, hundreds of experiments, 50c. Experiment booklet 15c. Supply catalog 5c. Reading Scientific Company, Reading, Penna.

**APPARATUS. Chemicals,** ounce quantities, catalog 5c. Fleischer's Laboratories, Everett 49, Mass.

**CHEMICALS And apparatus for industrial, analytical, and private laboratories.** Complete supply service for correspondence school students. Send 3c for catalog. Dept. M-43, Biological Supply Co., 1176 Mt. Hope Ave., Rochester 7, New York.

**FREE Catalog. Chemistry, mineralogy, biology, optics.** Tracey Laboratories, Evanston, Illinois.

**LABORATORY Supplies. Chemicals and apparatus** all descriptions. 36 page book 10c. Standard Science Supply Co., 1232 N. Paulina St., Chicago 22, Illinois.

### HELP WANTED

**RELIABLE Man with car** wanted to call on farmers. Wonderful opportunity now. \$15-\$20 in a day. No experience or capital required. Permanent. Write today. McNess Co., Dept. 25, Freeport, Illinois.

**WANTED: Mechanical and chemical engineering** development help by reliable manufacturer—full or part time—give record or facilities. Arco-Ozark Co., Hot Springs, Arkansas.

**PARAMOUNT Atmospheric conversion gas burners.** Quickly installs into any heating plant. Blowers. Gas floor furnaces. Sell and install. Peerless Sales, 4322 Sheridan, Lincoln 6, Nebr.

### AGENTS WANTED

**"27" AGENTS.—Salesmen Wanted!** Liberal territory allotted. Demonstrate amazing "27 Second" eye glass cleaner. Whirlwind seller. Year's supply in compact only 59c. 2 for \$1.00. \$40.00 per gross—110% profit. 27 Second Cleaner Co., Dept. 192, 6337 N. Talman, Chicago 45.

**90c PROFIT Each \$1 sale.** Sell positive mothproofing solution to housewives, stores, agents. Experience unnecessary. Postal brings details. Kinford, Wayne 3, Penna.

**CALL On friends with greeting card assortments, Easter, birthday, other occasions.** Personal stationery, gift wrappings. Big profits. Experience unnecessary. Samples on approval. Wallace Brown, 225 Fifth Avenue, Dept. E-4, New York 10.

**AT Last! Something new and sensational in everyday cards.** Gorgeous satin and velour designs never before offered. Get orders fast. Big profits. 14 assortments for year 'round occasions retail 60c to \$1. Get samples on approval. Puro Co., 2801 Locust, Dept. 740-B, St. Louis 3, Mo.

**EARN Big money.** Sunshine everyday cards. Take orders galore from friends for America's most beautiful everyday assortment. 14 folders. Costs 50c. Sells \$1. Also 1947 Sunshine notes, birthday, convalescent, everyday gift wraps. Samples on approval. Write today. Sunshine Art Studios, 115 Fulton St., Dept. EE2, New York City.

**EARN Up to \$6.00 hourly,** selling history War 2. Gold mine for veterans. Free supplies. Start earnings immediately. Gillespie, 4503 Meadow Road, Norfolk 2, Virginia.

**WE Pay you \$25 for selling fifty \$1.00 assortments birthday, all occasion cards.** Tremendous demand. Sell for \$1.00—your profit 50c. It costs nothing to try. Write for samples. Cheerful Card Co., 28 White Plains, N. Y.

**NEW Sponge wall cleaner.** Erases dirt like magic. Wallpaper, painted walls, ceilings. Saves redecorating. Lightning seller. Samples sent on trial. Kristee 132, Akron, Ohio.

**\$1 STARTS You in business.** Sell deluxe ties, 100% wool interlining. Costs you only \$7 per dozen, you make \$5.00 dozen. Send \$1.00 for special introductory offer two deluxe ties. Catalog complete line free. Phillip's Neckwear, 20 West 22nd St., Dept. K-8, New York 10.

**SELL Greeting cards—Everyday, birthday, humorous, Easter assortments.** Wrappings, stationery, correspondence notes. Over 100 money-makers. Special offers. Fast sales, big profits, extra bonus. Experience unnecessary. Request \$1.00 everyday assortment on approval. Hedenkamp, 343 Broadway, Dept. F-21, New York 13.

**AGENTS. Substantial profits.** Repeat order products. Not mere "job" but opportunity establish steady income. Additive lubricant. Limitless field. Factories, autoists, service stations, fleet owners buy in huge quantities. Write Kidder Oil Company, LaCrosse 1, Wis.

**CANVASSERS Take orders—new electric product—everyone needs.** \$3.95. We deliver. Sample \$2. Sibert Co., East Orange, N. J.

**MEXICAN Feather pictures.** Unusual novelty. \$1.00 (stamps) bring \$2.00 worth samples, details. Refunded if unsatisfied. Aztec Art-P, Apartado 762, Mexico City.

**SELL Avronmelle personalized cosmetics.** Every woman a prospect. A. C. Tembro, 189D West Madison, Chicago.

**SOAP Powder for mechanic, factory, printing trades.** Ample supplies. Big opportunity. Profits selling users, retail stores. Schuitz Laboratories, Boone, Iowa.

**AGENTS: Stamping names on pocket-key protectors.** Sample check with your name, address. 25c. Stamping outfits. Emblem checks, check-fobs, name plates. Hart Mfg. Co., 303 Degraw St., Brooklyn, N. Y.

**NEW Cheap oil burner** sweeping the country! South Dakota manufacturer discovers how to cook, bake and heat the easy economical modern way by inventing a new low cost oil burner for coal or wood ranges, cook stoves, circulating heaters, heating stoves and laundry stoves. Larger size for furnaces. With its sensational Fuelizer Starter vaporizing system it turns cheap 130 flash furnace oil, distillate, diesel, range, kerosene and like oils into oil gas heat without clogging up the vaporizing system. No more shoveling coal or ashes—better heating, cooking and baking. Every burner has a lifetime guarantee against defects. New sales plan is one of today's most exceptional money makers and you can get your new Quik Heat for introducing in your territory. The manufacturers are so much sold on their new oil burner that they will offer you \$1.00 bonus for testing and will let you try it in your own stove, range or furnace for one month. Be first to cash in on the tremendous demand for this new oil burner by sending in your name today to North-west Mfg. Co., 416 C, Mitchell, S. Dakota.

**SIGNS. Metallic letters for store windows, trucks, etc.** Looks like gold leaf. 3 complete alphabets with numerals and catalog \$2.00. Globe, 61 W. Cordova, Vancouver, B. C., Canada.

**100% PROFIT On famous, popular Pines birthday, Christmas and all-occasion greeting cards.** Wonderful 12 to 24 card, boxed assortments sell on sight for \$1.00. Write today for information and extra bonus distributors' plan. R. Pines, Box 32, Flushing, N. Y.

**AT Home—Your own manufacturing business; making popular \$1.00 novelties.** Cost you 3c to 15c. Everything supplied. Write So-Lo Works, Dept. P-600, Loveland, Ohio.

**WONDERFUL Sideline.** America's fastest selling everyday greeting cards. Write, Zweifel's Shut-in Agency, Orangeville, Ill.

**EVERYDAY Cards.** Earn \$5.00 with every ten \$1.00 assortments you sell. Also wrappings and note paper. Unusual quality. Send for samples today. Howard P. Ellis, Dept. PM-2, Pitman, New Jersey.

**AGENTS: All ages, earn \$30 to \$50 weekly** selling for yourself, fibre brooms, mops, and floor dusters, start now. Write Burtz Fibre Broom Co., Columbia, Penna., Dept. A.

**A New outlook for 1947 with Silver Plating Liquid (NuSilver and Re-Plate-O Trademark Patents) and Lectrik Silver Kleener Atomic Metal Plates for de-tarnishing discolored silverware quick.** These are Demonstration products. No demonstrations, no sales. Lots of demonstrations, lots of sales. You are not supposed to be selling, just showing and demonstrating and explaining in order to get their honest opinion of the products. They will insist upon buying from you while you are demonstrating. Sells wholesale and retail. About 95% of sales are at retail prices, about 5% at wholesale. Can work business districts on retail prices in all places where they would use the products, or can work only the places where they would re-sell at wholesale prices. The better way is to work both plans and do a thorough job. Also a good-house-to-house seller for those who sell that way. We have several distributors who sell it exclusively that way and have made money for several years. One of the products is a good repeater seller. The profits are good, extra good, 3 for 1, 4 for 1, and 5 for 1. A car is not necessary, but is a big help if you cover territory. We have several distributors working without cars, one of them for over 7 years. We want exclusive, protected demonstrating sales distributors in all areas where no one is working now. You buy outright from us at low manufacturer prices. That is why your profits are big. You demonstrate and sell and deliver for cash as you work throughout your territory. You begin taking in fine cash profits for yourself within one hour after starting. You sell wholesale or retail or both. Both worked together will make you the most money. You may sell one product or both together. Both worked together we have found is the most profitable. You visit every City, Town and Village in your territory. You demonstrate and sell, appoint agents and dealers, and stock them at a good profit for yourself. Demonstrations in stores are particularly good in getting introduced into new localities. We refer all inquiries and orders from your territory back to you to handle while you are working it. We do not write to or answer anything from your territory while you are working it. Thus you are completely protected 100%. This is a good money-making appointment if you will work it energetically. Complete details will be sent by sealed letter mail upon request if your area is not being worked now. NuProcess Products Laboratories, Dept. 275, Aurora, Illinois.

**EXTRA Cash** quickly selling friends tremendous value 16 card \$1.00 all-occasion assortment; your profit as much as 50c per box. Also birthday, get-well, baby, humorous, gift wrapping, correspondence notes boxes 33-1/3c up. New 1947 line. Experience unnecessary. Extra bonus. Special money-saving offer. Request feature everyday assortment on approval and free personal stationery sample portfolio. Elmira Greeting Card Co., M-15, Elmira, N. Y.

**SELL New-Used clothing** from home, auto, store. Men's suits \$1.17. Leather jackets 85c. Overcoats 62c. Dresses 17c. Ladies' coats 38c. Other bargains. Catalog free. S & N, 565A Roosevelt, Chicago.

**AGENTS: Big profit selling unbreakable personalized ladies comb.** Special proposition for crew managers, distributors. Future Products, 1654 Dahill, Brooklyn 23, N. Y.

**WONDER Silver plating liquid.** (Plates metals without tanks or electricity.) Applied with cloth or by dipping. New, improved, concentrated, double-strength formula; plates larger surface with heavier coating. Good carded item for stores. Wonderful demonstration. Big profits. Free details. Wonder Products, 1265D Broadway, New York 1, New York.

**BIG Profits** selling used clothing, etc. Operate from home, auto, or store. Sensational low prices. Catalog free. Kadetsky & Son, 702 Barber Street, Dept. 52, Chicago 7, Illinois.

**OPERATE Profitable business** selling packaging products under your own name. Lyle A Products, 5 E. Spaulding, Wiloughby, Ohio.

**137 COMPLETE Plans** for starting own business: local—mail order. Particulars free. Elite Co., 220 Grand St., New York 13.

**COLLEGE Students! 100% profits** selling costume jewelry. Wm. Morris, Maywood, New Jersey.

**SELL Full, part time individualized belts, buckles, cap badges, tie holders.** 2,000 emblems to choose. Fast profits. Repeats. Write today special outfit offer. Hookfast Specialties, Box 1425, PM, Providence, Rhode Island.



NO Money or experience required. Spare or full time writing orders for guaranteed men's hosiery. We deliver and collect. Advance profit and 33% cash bonus. Huge demand everywhere. Steady repeat business. Write for free sales outfit containing everything needed to make money. Kentcraft, 44 Court Street, Department AM, Brooklyn 2, N. Y.

SELL Personalized soap. Name on every cake. Ideal for gifts. Get sample offer. Dunbar Soap, New Brunswick, N. J.

EXCELLENT Sideline for printing and advertising salesmen. Decalcomania name plates in small quantities. Great demand. Also make money applying initials on automobiles. Free samples. "Ralco" XL-Roxbury, Boston 19, Mass.

SELLING To housewives? Double your sales with inexpensive premiums. Postal brings interesting details. A. Kinford, Wayne, Penna.

HOUSE Numbers that glow in the dark. Luminous pictures, etc. Large mfr. wants factory representative. Wonderful new product. Fast seller. Free samples. Madison Mills, 303 4th Ave., New York City.

AGENTS—Big line including food products. Fast selling premium and bargain deals. Low prices. Send card for big profit offer with gift. Ho-Ro-Co, 2796 Dodier, St. Louis 7, Mo.

AMAZING Seller: "Soilless Garden Chemical." Grow plants, vegetables, fruits, flowers all year round without soil. In or outdoors. Tremendous demand. Excellent profits. Literature free. Nega & Co., 1824 W. Dickens, Chicago 14.

SCHOOL Seniors—Sell classmates America's most beautiful, distinctive graduation name cards. 40% commission. Largest selection. Lowest prices. Free cards and sample kit. Printcraft, 1425 E. Elm Street, Scranton 5, Penna.

AGENTS—300 % Profit selling genuine gold window letters; stores and offices. Free samples. Metallic Letter Co., 438-B North Clark, Chicago.

200 MONEY Making deals. Plans, rare formulas. Schemes. Folio free. Formico Service, Box 572, Dayton, Ohio.

\$3 FIRE Extinguisher; quick sales, wholesale or direct; liberal profits. "Fire-Killer," 109 N. Franklin, Syracuse 1, N. Y.

SCHOOL Seniors! Your postal will bring our wonder, Kwick-Sell Cardalog of popular graduation name cards. Biggest profits! Only firm giving free souvenir chest and card case. Don't miss out! Hurry that postal! Craftcards, Box 235(L), Pittsburgh 30, Pennsylvania.

PLATING Outfits for autoparts, reflectors. Connect to a battery. No tanks necessary. Free booklet and particulars. Gunmetal Co., Ave. N. Decatur, Ill.

FREE Water and our concentrates, makes flavors, lotions, shampoos, 72 products, labels, bottles furnished. Quaioco, E-20030 Russell, Detroit.

GOLD Lacquered window sign letters. Large sizes penny each. New foils. Absolutely beautiful. Free samples. Atlas, 544 W. 79th, Chicago 20.

WANTED Agents for house to house selling of plastic products including table cloth covers. Write for details. House of Schiller, Dept. P, 180 N. Wacker Drive, Chicago 6, Ill.

#### HIGH GRADE SALESMEN

AMAZING New zipper shoe sells on sight. Big profits for salesmen. Leads line 200 splendid styles. Territories open. Get free sample outfit. Write, Consolidated Shoe, Dept. S-754, Chippewa Falls, Wis.

START Your own business on our capital. Always your own boss. Hundreds average \$6,000 to \$25,000 annual sales. We supply stocks, equipment on credit. 200 home necessities. Selling experience unnecessary to start. Wonderful opportunity to own pleasant, profitable business backed by world-wide industry. Write Rawleigh's, Dept. B-U-PPM, Freeport, Ill.

ADVERTISING Book matches—World's largest direct selling mgr. of advertising book matches offers opportunity for profitable year 'round selling. Every business a prospect. No exp. needed to start. Full or part time. Factory service. Low prices for high quality. Repeats. Sales kit furnished. Match Corp. of America, 3433-43 W. 48th Place, Dept. E-7, Chicago 32, Ill.

FRANCHISE Available every city. Supervise sales, make surveys for management engineering firm. Valuable training given. Sims & Associates, 120-PS, LaSalle, Chicago.

SELL Gift shops, department stores, etc. Write Kimley, 103 Highland, Williamsville, N. Y.

OLD Toy, new idea. Good opportunity in your territory for an additional line. Excellent item mail order or premium house. 25c brings sample prepaid. Allied Metal Products Co., 85 Prescott St., Worcester, Mass.

LARGE Earnings! Your own business supplying household food and drug necessities to consumers! Free details. Hollenbush Products, Dept. PM, Pottsville, Penna.

\$6000 YEARLY Possible, calling on gift shops, dept. stores, etc. Amazingly new, different 15 key Tru-Tone baby grand piano. Territory going fast. Write, Presto Noveltoys Co., 1012 N. Marshfield, Chicago 22, Ill.

DEMONSTRATE Sell to taverns, amazing, original glass rinse. "Clear Glass." No toweling, no water spots. Guaranteed. Riesen Chemical, 419 Vliet, Milwaukee 12.

BIG Commissions—selling to stores celluloid pricing tickets, metal shelf moulding—to restaurants, menu covers, signs. Pricing Press, 124 White St., Dept. P, New York 13, N. Y.

POCKET Pal: The all-purpose cutting tool. Wagon jobbers-salesmen. Sell to retailers and jobbers. 50c seller. Steady repeat item. Exceptional profit. Sample 25c. Nelson Mfg. Co., 222 W. Kellogg, St. Paul 2, Minn.

WAGON—Jobbers, agents! Big profits selling stores, individuals sensational ball point pen. \$2.98 retailer. Free details; also list hundreds fast sellers. Salesmanager, Box 27, Atlanta, Georgia.

QUICK Profits with individualized belts, buckles, cap badges, tie holders, uniforms. Choice of thousand emblems. Sure repeat orders. Easy-selling outfit offer. Write Hook-Fast Company, Dept. 12, Roanoke, Virginia.

WAGON Salesman—Fast moving carded goods and 10c line. Long profit. Free facts. Peerless, 2717 Dodier, St. Louis 7, Mo.

FREE! Latest issue Opportunity Magazine. Salesman's Guide. Inspiring, constructive. Shows how to earn money selling for others or in your own business. Hundreds postwar opportunities. Send name and describe what you have sold or are selling. Illustrated copy sent free. Opportunity Magazine, 620 N. Michigan, Dept. 17, Chicago 11, Ill.

#### EDUCATIONAL AND INSTRUCTION

LEARN Trigonometry better than others. Master method instructions \$1. Guaranteed. J. Ziemba, 6123 Orchard, Dearborn, Mich.

LEARN Landscaping. Profitable, healthful career—absorbing hobby, for men, women. Thorough 45-lesson home-study course takes 8-12 months spare time. Hundreds of successful graduates. 31st year. Send for free catalog. American Landscape School, 6394 Grand Ave., Des Moines, Iowa.

"HOW To Break and Train Horses"—a book every farmer and horseman should have. It is free; no obligation. Simply address Beery School of Horsemanship, Dept. 1102C, Pleasant Hill, Ohio.

HAVE An office. Many earn up to \$5,000-\$15,000 annually. Learn credit-collection agency business by home study course. Write for free bulletin. Franklin Credit School, Dept. 202-C, Roanoke 7, Virginia.

HOME Study course, drugless therapy. Free literature. Institute of Drugless Therapy, Tama, Iowa.

AMAZE Others. Add faster than adding machine. Free details. Math Institute, Box 633, Mobile 4, Ala.

FREE Self-instruction book offer. Postcard brings list. Herbert Enstice, Box 353, Asbury Park, New Jersey.

WORK For "Uncle Sam!" Commence \$145-\$250 month. Men-women. Jobs without strikes. Prepare now at home for 1947 examinations. Vets get preference. Full particulars, list positions, sample coaching free! Write today. Franklin Institute, Dept. E24, Rochester, N. Y.

AMAZING Mathematics shortcuts \$1.00. Vocational Institute, Box 434B, Duluth, Minn.

ARE You satisfied with your life? Aptitude testing can give you more money and happiness. Free particulars. Dr. Smith, 5635 Nicollet, Minneapolis, Minn.

INVESTIGATORS—Men, women, learn the work of a department store investigator. Bogus checks, fraud accounts, etc. I'll instruct you. Over thirty years' experience. Write Shewbridge, 216 Valdez Avenue, San Francisco 12, Calif.

GOOD Jobs and a sound, substantial future await you in hotel and institutional field. Men and women—all ages—needed for well-paid positions that offer color, excitement, ever-new and fascinating duties. Record-breaking travel means even greater opportunities for trained men and women in hotels, clubs and institutions. Lewis School receiving calls for managers, assistant managers, stewards, hostesses, purchasing agents and 55 other types of important positions! From coast to coast there are important positions that offer splendid opportunities for advancement in a business where you are not dropped because you are over 40. Previous experience proved unnecessary! No need to leave your job to qualify. A good grade school education, plus Lewis Training qualifies you at home, in spare time. Our National Placement Bureau helps to place you—and our amazing Certified Job Plan—actually certifies you will "make good" when placed. Write today for free book! Veterans: This course approved for veterans' training. Lewis Hotel Training School, Room LB 368, Washington 7, D. C. (First and only school of its kind—now in its 31st year.)

YOUR Favorite subject in books: Mineral identifications Simplified—over 200 minerals \$3.50; Real Estate Dictionary and Appraisal Manual \$5.00; X-Ray Training illustrated \$6.00; Canaries at Work and Play illustrated \$2.50; Rockets, Jet Motors, Dynamotors—280 answers to questions \$2.50; Spanish-English Dictionary and Conversation, 400 pages \$1.00. Catalog. Will ship c.o.d. Wetzel Publishing Co., Inc., Dept. M, 524 South Spring Street, Los Angeles, California.

"JOBGETTER" Charts speed your employment prospects! \$1 cash. Furnish personal history. Hal Davis, X247, Seaford, N. Y.

GAIN Success through nerve force development. Instructions reveal all, tells how to overcome fear, nerves, worry obstacles; free details. O'Leary, Box 594-AI, Baltimore 3, Md.

GOOD "Used" self-instruction educational books on all subjects bought, sold, rented, exchanged. Satisfaction guaranteed. Complete information and 100-page illustrated bargain catalog free! Write—Nelson Company, Chicago 5.

USED Educational books on all subjects sold, rented, also bought and exchanged. Moneyback guarantee. Write today for free catalog and details. Lee Mountain, Pisgah, Alabama.

INVESTIGATOR Training. Phillips Secret Service, 1917B North Kenneth, Chicago 39, Ill.

ANALYZE Handwriting. Unlimited opportunities. Amateur or professional. Illustrated course including free individual analysis \$1.98. Mayer, 681-P Market, San Francisco 5, California.

LEARN Detective-Fingerprint work. Frank Mashak, 6419 Woodrow, St. Louis 20, Missouri.

DISTILLERS Correspondence course; formulas learned easily. Full course mailed at once. Six months to complete. \$50.00 cash. Instructor practical distiller for 37 years. McLanahan's Distillers' School, 639 Highland Avenue, Aliquippa, Pennsylvania.

SECRET Investigation. Experience unnecessary. Investigators particulars free. George Wagner, M 125 West 86th, New York.

BIG Money rebuilding shoes. Help needed everywhere or start big-income business of your own. Learn practical, sure, easy way in 3 months. Anyone from 18-60 years can learn easily. Approved for GI training. Rush postcard today. Modern Shoe Rebuilding School, Est. 1927, 2935 Belmont, Chicago 18, Illinois.

CHIROPODY, Evans Natural Therapeutics Home Study Course. Foot Correction Massage Supports. General Knowledge of Feet. Excellent for Shoe Salesmen, Assistants, etc. P.O. Box 1195, San Antonio 6, Texas.

29 LANGUAGES By Linguaphone. Russian, Spanish, Portuguese—Direct conversational method for mastering any language quickly, easily, correctly at home. Available under G.I. Bill of Rights. Send for free book. Linguaphone Institute, 83 RCA Bldg., New York 20.

MASSO-PHYSIO-THERAPY Home study course. Massage, diet, baths, etc. Dignified profession. Evans Nat'l Therapeutics Courses, P.O. Box 1195, San Antonio 6, Tex.

BRIEFSRIPT—Simple, speedy, ABC shorthand, 50c. Eastern Book Co., 203 E. 18 St., New York.

3800 USED Correspondence courses. Catalogue 25c. EG Mfg., Elmsford 1, N. Y.



**MODERN** Welding school gives thorough training for one of industry's best paid jobs. Experienced instructors. Individual attention. Non-profit institution. Qualified under G.I. Bill. Write for literature and details. Hobart Brothers Co., Box M-1067, Troy, Ohio.

**HOME** Bible course. Simple, helpful, instructive. Total cost \$3.00 includes textbooks, stationery, examinations, certificate. \$1.00 starts you, or simply request prospectus. The Bible Study School, Reverend Leslie Marshall, Secretary, 382 Van Houten Street, Paterson 1, N. J.

**LEARN** Photo-engraving at home or in oldest, largest school in America. Work for newspaper or establish own profitable business. New Tasope' Photo-Engraving equipment available soon. Write for information. Veterans ask about G.I. training. The Aurora School of Photo-Engraving, Tasope' Bldg., Aurora, Mo.

**MEDICAL** Laboratory technicians in great demand. We train you in your spare time, in your own home. You can practice while studying. Write for free catalogue. Imperial Technical Institute, Box 973-E, Austin, Texas.

#### PLAYS, STORIES, MANUSCRIPTS

**REJECTIONS** Converted into successes! Plots, situations, titles revitalized! Trial examination \$1. Register singly. Today! Hal Davis, X247, Seaford, N. Y.

**POEMS** Wanted for publication consideration, details free. J. Barnes, Publisher, Box 490 Times Sq. Station, New York 18, N. Y.

**I WANT** New writers to cash hundreds of checks for \$1 to \$100, offered each month. The easiest way to write for pay. No previous experience necessary. Send for free details. No obligation. Saunders M. Cummings, 467-M Independence Bldg., Colorado Springs, Colo.

**NEW** Writers needed to rewrite ideas in newspapers, magazines and books. Splendid opportunity to "break into" fascinating writing field. May bring you up to \$5.00 per hour spare time. Experience unnecessary. Write today for free details. No obligation. Postcard will do. Comfort Press, Inc., 210-P South Seventh St., St. Louis 2, Missouri.

#### BUSINESS SERVICE

**LETTERS** Forwarded 25c each. Box 133, Station D. Montreal 22, Canada.

**CHICAGO** Mail address. Suite 665, 120 S. La Salle, Chicago.

**CHICAGO** Trip unnecessary. We become your agent in buying, selling, securing information, collections, remailing, expedite business transactions. Chicago Personal Service, Box 145, Chicago 90.

**\$2.00 MONTHLY** Maintains Washington, D. C., "Capital address." Your business, personal mail reforwarded when wanted. "Hawkins," (established 1917), 1300-D Taylor.

**YOUR** Bookkeeping, accounting, taxes questions answered. \$1.00. Box 526, Jamaica, N. Y.

**TO** Whom it may concern: We will represent you in all principal cities of the world. Personal or business assignments \$1 per hour. James W. Parley, Citizens Bldg., Cleveland 14, Ohio. Note: Would appreciate hearing from someone who wishes to enter this business in your city. Will send you assignments immediately. References exchanged. State qualifications.

#### SPECIAL SERVICES

**HOW** To get your refund on income tax. Special worksheet and instructions with complete list of legitimate deductions. Easily understandable. Many save \$100 or more. Send \$1.00. Associated Merchants Board of Trade, 149-24 Jamaica Ave., Jamaica 2, N. Y.

**TOOL** Design, planning, product engineering. Hoover Engineering Service, P.O. Box 111, Harper, Kans.

**GLOBAL** Mail—Receive scenic viewcards or let us mail your letters from any spot on earth. Free particulars. Travelpost, Box 528, El Centro, California.

**MFG.**—Wholesale sources. Most any item. Write: "Service," 1332B Findlay, New York City 56.

**CIRCULARS** Mailed! Can handle 25,000 monthly at \$2.50 per 1000. San-Val, Box 202-A, North Hollywood, Calif.

**MAINTAIN** New York City mailing address, mail forwarded daily, \$2.00 monthly. J. Barnes Publisher, Box 490 Times Sq. Station, New York 18, N. Y.

**"ANALYSESER:"**—Wisdomer; occupation; admin.; economic efficiency; author; editor; marketer; researcher for readers, (publication) 7c postpaid. Instructor, Box 6, Syracuse 10.

**GOOD** "Used" self-instructional books on all subjects bought, sold, rented, exchanged. Satisfaction guaranteed. Complete information and 100-page illustrated bargain catalog free! Write—Nelson Company, Chicago 5.

**SURPRISE** Your friends from Miami Beach; 3 beautiful picture cards, 25c. You address and return, we mail. Letter mailing service \$2.00 monthly, 25c each. Title or tax search anywhere South Florida; reasonably done. "Raymond for Service," Box 2733, Miami 17, Fla.

#### CARTOONING, COMMERCIAL ART, SHOWCARD WRITING, SIGN PAINTING

**LEARN** Showcard writing at home, spare time. Fascinating lifetime business of your own. No special skill needed. Free information. Sherwood Publishing Co., Irvington 52, N. J.

**"HOW** To Make Money With Simple Cartoons"—a book everyone who likes to draw should have. It is free; no obligation. Simply address Cartoonists' Exchange, Dept. 92-C, Pleasant Hill, Ohio.

**BARGAINS**—Quick landscape painting, poster art-letting, art lessons. Free literature. Art Book Shop, Arnold 3, Mo.

**LEARN** Sign painting, be independent. Signways, 4933 Erie, Chicago 44, Illinois.

**SIGN** Painting course prepared by one of America's best sign artists. \$2.00 postpaid. Progressive Signs, 3607 Fifteenth Avenue, Chattanooga, Tennessee.

**EARN** Money evenings, copying and duplicating comic cartoons for advertisers. Adservice, Argyle (1-B), Wisconsin.

**MAKE** Signs. 9 complete alphabet pattern sets. 3 complete numeral pattern sets and catalog \$1.00. Sign Letter Distributors, P.O. Box 101, Mineola, N. Y.

**CHALK** Talks. Laugh producing program, \$1.00. Catalog 10c. Balda The Cartoonist, Oshkosh, Wisconsin.

#### ADVERTISING AGENCIES, LETTER WRITERS, FOR ADVERTISERS

**ADVERTISERS!** Publishers! Dudley Bunn, 126-PM Lexington Avenue, New York 16, will write or rewrite your books, folios, booklets, circulars, sales letters, etc., for only three dollars per typewritten page. For faster service, please give your exact needs in your first letter. Twenty years' experience. Satisfaction guaranteed. "Good advertising never costs; it pays!"

**WANT** Lists of large retail and DM users. What have you? Dunlop, 915-30th South, Seattle.

**24 WORDS** In 140 Canadian weeklies \$8.00. Lists free. Lever Advertising Agency, 109 PM LaSalle Avenue, Comeau Bay, P2 Canada.

**INCH** Display advertisement Mallorder World, year \$24. Wood's Popular Services, Atlantic City, New Jersey.

**ADVERTISERS:** Mail order ad covering United States—2,000,000 circulation—\$21.00 inch. Classified ad, 24 words, 20 metropolitan Sunday newspapers—\$25. Magazine, newspaper, mail-list ratebook, adwriting assistance—free. Chicago Advertising Agency, 20-PM West Jackson, Chicago 4.

**SEND** For prices on all types of mailing lists. All Types, 1412-13 Great Northern Building, Chicago 4, Illinois.

**EFFECTIVE** Copy written and placed. Cecil L. Clark, Advertising Agency, Wilmore, Kentucky.

**ADVERTISE:** 24 Words, 40 newspapers \$3.50. Lists free. Advertising Bureau, 4515-C Cottage Grove, Chicago 15.

**ADVERTISING** Service, art work, C. Sanford, 5029 Maple, St. Louis, Mo.

**ADVERTISERS!** Reach nearly 18,000,000 readers. 25 Sunday national key newspapers, 18 words, \$42.25. "Terrific pullers." 20 popular newspapers, \$8.50. "Free booklet." Special—One inch display 2,600,000 circulation, \$32.90. Newmark's Advertising Agency, (Established 1893) 217-7th Ave., New York 11.

**MAILING** Lists, certified, productive, inexpensive, \$5.00 1000. Homeworkers, agents, buyers, etc. Write Dixie Service, King, N. C.

**FREE!** 1946 Advertisers Rate & Data Directory. 52 pages! E. H. Brown Advertising Agency, 20 N. Wacker, Chicago 6.

**24 WORDS** In 64 weeklies \$4.96. H. J. Darnell, 730 Hays, Jackson, Tenn.

**ADS** Placed in out of town newspapers and magazines. Low rates. Catalogue free. Ideas that pay. Baker Advertising Agency, Successors Ankrum Agency, 189 W. Madison, Chicago 2.

#### TYPEWRITERS, DUPLICATORS, OFFICE DEVICES

**1946 WOODSTOCK** Standard typewriter, \$138 postpaid, Hewitt, 1478 Millar, Glendale 6, California.

**"PRINTOMATIC"** Selffeeding post card stencil printing duplicators \$9.50 up. Office size duplicators. Speedoprints, Hilco, Excellographs \$33.41 up. Literature free. Pittsburgh Typewriter Supply, 336-WK Fourth Avenue, Pittsburgh 22, Penna.

**RECONDITIONED** Typewriters, mimeograph, multigraph printing devices, appliances, supplies. Catalog. Dixiegraph Service, King, N. Carolina.

#### RUBBER STAMPS AND OFFICE SUPPLIES

**PROMPT** Service. Cushioned, indexed. Real quality guaranteed. 1 line 35c, 2 lines 45c, 3 lines 55c. Stampcraft, 1707 Virginia Street, Gary, Indiana.

**MAKE** Rubber stamps! Everything needed instructions—\$5.00. Steele, 296-PM New Main, Yonkers 2, N. Y.

**QUALITY** Rubber stamps, gold-indexed, cushioned, 35c line. 3 lines \$1. Bernell Products Co., 170 Broadway, New York 7.

**PICTORIAL** Rubber stamps, sample (flag) 25c. Stamporium, 8833M Quincy, Detroit 6, Mich.

**FAST** Service on rubber stamps. Send for literature. Lee-Vall Press, Box 1242, Indianapolis 6, Indiana.

#### PRINTING, MULTIGRAPHING, MIMEOGRAPHING, GUMMED LABELS

**1000 BUSINESS** Cards \$1.50 postpaid. Shufeldt, 10 Minerva Place, New York 58.

**75 HAMMERMILL** Letterheads and 75 envelopes, \$1.00 postpaid. Benneville Printing, Box 1931, Pittsburgh 30, Penna.

**GOOD** Printing, any amount. Estimates free. O'Reilly, 31027 Detroit, Pittsfield 3, Maine.

**250 8 1/2 x 11 HAMMERMILL** Letterheads \$2.00 postpaid; 500, \$3.75. Envelopes same. Veterans' Duplicating Service, 806 Roosevelt Bldg., Indianapolis, Ind.

**1000 FOUR** Line stickers, \$1.00. Printing, mimeographing, best and cheapest in the country. Imprint, Emporia, Kansas.

**THOUSAND #10** Envelopes \$6.95; 500 \$4.25. Thousand 6 3/4 or 6 1/4 envelopes \$4.25; 500 \$2.75. Williams Sales Company, Box 4100, Portland 8, Oregon.

**500 3/4 x 2 1/4 FOUR** Line gummed stickers, 35c. Moritz Printery, Saginaw, Mich.

**BETTER** Printing, attractively priced! Imitation letters, letterheads, envelopes, statements, booklets, cards, labels. Samples, estimate free. Lonelm Publishers, Paulding, Ohio.

**MIMEOGRAPHING**—Neat, accurate, speedy, inexpensive. Rizzo, 2051-P W. Forest, Detroit 8.

**250 8 1/2 x 11 LETTERHEADS** And 6 3/4 envelopes \$2.75. Advance, Strasburg, Ohio.

**1000 EMBOSSD** Business cards \$2.25 postpaid. Elmer Griffith, Sciotoville, Ohio.

**CUT** Printing costs. 1,000 offset 8 1/2 x 11 printed \$3.95; 5,000 \$15.75; larger quantities less. 48 hour service. Samples, price-list free. Fidelity Company, Parkersburg 14, W. Va.

**FACIMILETTERS:** With letterhead. New process. Absolutely beautiful. 500—\$6, 1,000—\$7.50. 937 Franklin, Johnstown, Penna.

**5000 GUMMED** Labels 2" x 1 1/2", \$5.50, postpaid, 25 words. J. Barnes, Publisher, Box 490 Times Sq. Station, New York 18, N. Y.

**250 LETTERHEADS** \$1.50. Envelopes same. Mallo, 767 Leith, Flint 5, Mich.

**1000 BUSINESS** Cards \$2.50. prepaid. Reliable Print Shop, 901 E. Jefferson, Louisville 6, Ky.

**MIMEOGRAPHING.** Highest quality. Reasonable. Letter Service, Box 1849, Chicago 90, Illinois.

**PHOTO-OFFSET.** Printing, multigraphing. 3-day service. Samples free. Mango, 555-A South 20th, Newark 3, N. J.

**SEND** 10c Now, for our 36-page 1947 pricelist—refunded first order. McCall Press, 1326 South 27th, Omaha, Nebraska.



**MIMEOGRAPHING** Specialists — Any copy. Reasonable. Mailers Service, Box 606-A, Chicago 90, Ill.

150-8½x11 **HAMMERMILL** Letterheads \$1.00 postpaid. Envelopes same. Race Printing, Hudson, New York.

**QUALITY** Printing: Business, personal stationery. Prepaid delivery. Samples free. Mero Products, 100 Morrison, Punxsutawney, Penna.

**BETTER** Grade printing reasonable. Estimates on anything. Economic Press, Leonia, N. J.

**MIMEOGRAPHING**—Letters, pricelists, formulas, instructions. Lowest prices. Lem's Letter Shop, 5710 Stanton, Detroit 8.

#### PRINTING OUTFITS AND SUPPLIES

**PRINTERS** Galley, quarterly magazine containing valuable information. Copy 10c, year 25c. Steiner, Rockwell Road, Danbury 21, Connecticut.

**PRINTERS** Manual—An instruction and ready reference book for amateur and apprentice printers. Completely indexed and illustrated. Send \$1.00. Weller-Craft, Telford, Penna.

**PRINTING** Equipment, type and supplies. Send stamp for details or dime for complete illustrated supply book. Kelsey Inc., X-11, Meriden, Conn.

**CUTS**—Make real halftones, line cuts yourself! Samples 25c. Particulars free. Rapid Chemical Service, Edwardsville, Ill.

**PRINTERS**, Make a quick-etch etcher for cuts, halftones. Details, Charles Medlock, Box 256C, Goodland, Indiana.

**PRINT** At home—Send 10c for catalogue—presses, type, supplies. Barnhard Co., 6 Columbia St., Newark 5, N. J.

**HOME-MADE** Presses. Proofs free. Riegel, 1111 Harrison, Phila. (24), Penna.

**INEXPENSIVE** Home-made printing press. Details free. Novelty Shop, Downsville, Louisiana.

#### PATENT ATTORNEYS

**INVENTORS**—Patent laws encourage the development of inventions. The Rules of Practice of the U. S. Patent Office advises—unless an inventor is familiar with such matters—that he employ a competent registered attorney, as the value of patents depends largely upon the skillful preparation of the specifications and claims. Write for further particulars as to patent protection and procedure and "Invention Record" form at once. No obligation. McMorror, Berman & Davidson, Registered Patent Attorneys, 134-B Victor Building, Washington 1, D. C.

**PATENT** Protection—The U. S. Patent Office recommends—"an applicant is advised, unless familiar with such matters, to employ a competent registered Patent Attorney, as the value of patents depends largely upon the skillful preparation of the specifications and claims." Steps to be taken in obtaining patent protection will be sent upon request, Victor J. Evans & Co., 231-B Merlin Building, Washington 6, D. C.

**INVENTORS**: Learn how to protect your invention. The patent laws were enacted for the benefit of the inventor to give him protection for the features of his invention which are patentable. The United States Patent Office advises the inventor to engage a competent, registered patent attorney to represent him. We offer inventors experienced, conscientious counsel and prompt, confidential service. A specially prepared booklet containing detailed information concerning patent protection and procedure with "Record of Invention" form will be forwarded to you upon request—without obligation. Clarence A. O'Brien & Harvey Jacobson, Registered Patent Attorneys, 71B-A District National Building, Washington, D. C.

"**PROOF** of Invention" folder mailed without obligation. E. E. Vrooman, Registered Patent Attorney, 871 Woodward Building, Washington 5, D. C.

**MEXICAN** Law. General practice attorney. 1203 Arizona Street, El Paso, Texas.

**PATENT** And Trade-Mark Practice before U. S. Patent Office. Validity and infringement investigations and opinions. Booklet and form "Evidence of Conception" forwarded upon request. Lancaster, Allwine & Rommel, Registered Patent Attorneys, Suite 411, 815-15th Street, N.W., Washington 5, D. C.

"**INVENTOR'S** Guide" free on request. Frank Ledermann, Registered Patent Attorney, 154 Nassau St., New York 7, N. Y.

**INVENTORS**: Write for free brochure "Evidence of Invention." Labiner, World Building, New York 7.

**C. A. SNOW & Co.**, M-427 Snow Bldg., Washington 1, D. C. Registered patent attorneys. Established 1875. Literature mailed on request.

**INVENTORS**: Without obligation, write us for information as to what steps an inventor should take to secure a patent. Randolph & Beavers, Registered Patent Attorneys, 21-C Columbian Bldg., Washington 1, D. C.

**PATENTS**—Trade marks. Irving L. McCathran, 315 McLachlen Bldg., Washington 1, D. C. Registered Patent Attorney.

#### FOR INVENTORS

**DRAWINGS** Of your ideas engineered to modern practices by experienced designer. Absolutely confidential. Free estimate of drawing charges by return mail. Machine Design Service, 416 Madison Avenue, Rahway, New Jersey.

"**CREATING** New Ideas," \$2.95 postpaid. Practical daily working methods for inventors, writers, opportunity seekers, others. Personal service coupon included. Satisfaction guaranteed. Order today! Dudley B. Bunn, 126-A Lexington Avenue, New York 16, N. Y.

**INVENTORS**: Let us handle your inventions. Polk, 4857 State St., Chicago 9, Ill.

**PROVE** Invention date, your problem? Adopt the Aabberly secret routine, using simple materials purchasable anywhere! Guaranteed second only to an application in safety, legality and all 'round dependability. By far, outranks registered letters, "copyrights," other dangerous makeshifts. Disclosure not even to me! Plain instructions—\$2. Need prelim. search, regulation drawing or actual patent application covering your invention? Or, your rough idea perfected? Rely on 31 yrs. "know how"! Nicholas Aabberly, Patent Engineer, 303 Woodward Building, Washington.

**INVENTORS**—Patent laws encourage the development of inventions. The Rules of Practice of the U. S. Patent Office advises—unless an inventor is familiar with such matters—that he employ a competent registered attorney, as the value of patents depends largely upon the skillful preparation of the specifications and claims. Write for further particulars as to patent protection and procedure and "Invention Record" form at once. No obligation. McMorror, Berman & Davidson, Registered Patent Attorneys, 134-A Victor Building, Washington 1, D. C.

**INVENTORS**—Victor J. Evans and Co., established 1898, has a staff of registered patent attorneys, available to represent inventors in the preparation and prosecution of their cases before the Patent Office. Detailed information and the steps to be taken to obtain patent protection will be furnished upon request, Victor J. Evans & Co., 232-B Merlin Building, Washington 6, D. C.

**INVENTORS**: Learn how to protect your invention. The patent laws were enacted for the benefit of the inventor to give him protection for the features of his invention which are patentable. The United States Patent Office advises the inventor to engage a competent, registered patent attorney to represent him. We offer inventors experienced, conscientious counsel and prompt, confidential service. A specially prepared booklet containing detailed information concerning patent protection and procedure with "Record of Invention" form will be forwarded to you upon request—without obligation. Clarence A. O'Brien & Harvey Jacobson, Registered Patent Attorneys, 71A-A District National Building, Washington, D. C.

**CASH** For practical ideas and inventions. Mr. Ball, AB-9441 Pleasant, Chicago.

"**INVENTOR'S** Guide" free on request. Frank Ledermann, Registered Patent Attorney, 154 Nassau St., New York 7, N. Y.

**SAVE** \$200 And 12 months time cashing in on your invention. Booklet written by experienced inventor gives complete details of tested system, 50c postpaid. W. Parry, 1503 Oxford, Berkeley, Calif.

**INVENTORS**: You save up to 300% when dealing with your patent searcher direct. Complete search with patent copies \$6.00. Reports mailed in 5 days. Invention protection forms free. Write Raymond L. Smith, Patent Searcher, 703-M Albee Building, Washington 5, D. C.

**I SELL** Patents. Established in 1900. Charles A. Scott, 773PM Garson Ave., Rochester, N. Y.

**INVENTORS**—Your commercially valuable invention, any kind, patented, unpatented, may have cash, royalty possibilities in today's markets. Write today. Explanatory booklet, disclosure form, references, free. Invention Reporter, 5A-11106 So. Longwood Drive, Chicago 43.

**THE** Inventor who believes he has a new and useful invention, and needs advice, should consult a competent registered patent attorney. Without obligation, write for full information on how to secure patents and trademarks. Randolph & Beavers, Registered Patent Attorneys, 11-E-Columbian Bldg., Washington 1, D. C.

**INVENTORS**: Avoid unnecessary expense. Write for free booklet explaining how our consulting and advisory service can assist you in deriving greatest profit from inventing. Institute of American Inventors, Dept. 40-A, 1926-Eye St. N.W., Washington 6, D. C.

**CASH** For your idea. 100 manufacturers need inventions, patented or unpatented. List free. Invention Bureau, 208 Clinton, Oak Park, Illinois.

#### INVENTIONS WANTED

**INVENTORS!** Save time, money, by reading the book "Selling Inventions With and Without Patents"; contains methods for selling before patenting, court rulings, mechanical principles; how to market, finance inventions successfully. \$1 prepaid. Metzler, 11 West 42nd, New York.

**INVENTIONS** Wanted. Patented or pending. Inventors Exchange, Dept. B, Hartford 1, Connecticut.

**WANTED**: Practical inventions by manufacturers, patented or unpatented. John D. & Son, Dept. PM-2, Box 3213, 285 Howard Ave., Bridgeport 5, Conn.

**ORIGINATORS**: Aggressive promotion salable products from your working models! Write fully. Hal Davis, X247, Seaford, N. Y.

**EARN** Up to \$2,000 year, inventing simple items for special cash markets. Ideas only. No patents. Hendrickson, Argyle (7-B), Wisconsin.

**WANTED**: Practical inventions for marketing through chain, drug, and cigar stores. Particularly desire lighters, smoker's articles, etc., in plastic, wood or metal. Write Matt, 1412-DN Great Northern Bldg., Chicago 4.

**CASH** For inventions, patented, unpatented. Mr. Ball, A-9441 Pleasant, Chicago.

**INVENTORS**: Hundreds of manufacturers have requested our assistance in locating marketable new products. Complete information, free. Institute of American Inventors, Dept. 40-D, 1926-Eye St. N.W., Washington 6, D. C.

**WANTED**—Patented, unpatented inventions having profit possibilities, all kinds. If will sell, reply immediately. Descriptive booklet, references, free. Invention Reporter, 5B-11106 So. Longwood Drive, Chicago 43.

#### PATENTS FOR SALE

**PATENT** No. 2355979. Expansion stopper for bathtubs. Cannot washout or dislodge. Chain Store Item. John Keyzer, 2049 So. 69th St., West Allis 14, Wis.

**HAVE** Several inventions for household use. Elizabeth Edmonds, 4626 Indiana, Chicago 15, Ill.

**INVENTORS**—Your patented, unpatented invention, if practical, may have specific cash, royalty value in correct markets. Find out now. Explanatory booklet free. Invention Reporter, 5D-11106 So. Longwood Drive, Chicago 43.

**INVENTORS**: Test the commercial value of your patented or unpatented inventions, quickly and inexpensively. Write for free information. Institute of American Inventors, Dept. 40-B, 1926-Eye St. N.W., Washington 6, D. C.

#### MANUFACTURING

**MODELS**—Small lot manufacturing. Metals, plastics, etc. Milburn, Burlington, Kentucky.

**MANUFACTURING**, Stamping, designing, developing and experimental work; tools, dies, jigs, fixtures. Models made by experts. A complete service available once again following interruption by war work. Technical Development Co., 157 Chambers St., New York City 7. (Dept. PM-2).



A BRAND New inventor's service. Write for information. J and M Company, Burlington, Kentucky.

MODELS Developed and built. Small run manufacturing. The Thompson Engineering Co., 206-C Winchester Bldg., Grand Rapids 2, Michigan.

NAME Plates for manufactured products. Etched metal. Ad-Craft, LaCrosse, Wis.

#### MODELS AND MODEL SUPPLIES

CATALOGS (Illustrated) for modellers! Airplanes, 60 page book on solids. Features construction data, specifications, camouflage 15c. Railroads: 128 page 'HO' guide. Equipment, accessories, fittings, 25c (includes refund coupon). Send coin or stamps for each profusely illustrated catalog desired. Polk's, "Nation's Leading Hobby House," 314-PM Fifth Ave., New York City 1.

WARSHIP Plans! Now available! Navy approved detailed scale drawings of battleships, carriers, cruisers, etc. Send 25c for list and sample destroyer plan! Edward Wiswesser, 2537 Cumberland Ave., Mt. Penn, Reading, Penna.

4 MASTED Ship 5 1/2" long, 2 3/4" high, in wine bottle, made by seaman \$5.00. Peters, 341 West 29, New York City.

"S" GAGE-3/16" Scale, 1/8" track. The size that popularized model railroading. 20c coin (refunded with order) for large illustrated equipment and data catalogue. Midgate Models, Inc., Box 1044 A, Portsmouth, Rhode Island.

WIZZ Electric motor: (1 1/2 x 2 1/2"). Small flashlight cell operates. Parts complete, plus illustrated instructions 35c. Two 65c. Immediate delivery. Send today! Eltro, Deer Park, N. Y.

SPEEDY 1" Motor, runs atop flashlight cell! Parts, instructions, 35c. Fonskov, 655-K Amboy, Perth Amboy, N. J.

DIESEL Model engine. Displacement .10 cubic inch. For model boats, race cars, airplanes, 4000 to 10,000 r.p.m. Weight 5 1/2 oz. No coil, condenser, spark plug or batteries. \$18.50. C.I.E., 11929 So. Western, Los Angeles 44.

PLASTIC Blocks and deadeyes retail from 10 cents per dozen up. Price list for stamp. Dealers wanted. Gullmars, Westhill, Ontario.

STAMPED Steel wheels for small toys, models, etc. Priced as low as 5 cents each. Send for list. Also small stampings made to your specifications. Richard C. Judson, 4554 Eastway, Toledo 12, Ohio.

SHIP Models and yacht supplies complete. Large 64 page catalogue 30c. Bill Wild's, 510 East 11 St., New York City 9.

BUILD Model gas and steam engines using our no casting plans. Very fast. Only lathe and scrap required. Illustrated folder 10c. Rowe Engineering, 8889 Appoline, Detroit 27, Mich.

MODEL Railroad fans—Now for the first time, make your own building materials for stations, tunnels, etc., out of beautiful plastics, 16 different colors, 12 different parts such as bricks, roof shingles, fences, windows, doors, etc.—all inter-locking, no pins necessary. Animals and other figures also available. See ad page 266. Write NRK Mfg. and Engineering Co., 5648 North Western, Chicago, Illinois.

SHIP Models, coaches, covered wagons, blueprints, supplies, catalog 25c coin. R. E. Hancock, 323 Douglas Ave., Portsmouth, Virginia.

LANDLOCKED Sailors! Here's a beautiful, richly illustrated, fully descriptive catalogue of famous model ships—whalers, slavers, corvettes, etc., authentic in every detail. Send for it today. Only 10c. Halesite Yacht Service, Inc., Halesite, Huntington, N. Y.

SHIP and Yacht model fittings; blueprints. Send 25c for illustrated catalog No. 20—listing hundreds of items. A. J. Fisher, 1002-1 Etowah Ave., Royal Oak, Mich.

MIDGET Steam engines \$2.98, boilers \$2.65. Stamp for literature. R. Looker, Box 105, Michigan City, Indiana.

BRASS Gears and model supplies for the inventors. Send 10c for catalog. Pierce Model Works, Tinley Park, Ill.

FREE Catalog of model trains, airplanes, ships, accessories and tools. Ben's Hobby Company, 72 West Washington, Chicago 2, Illinois.

BUILD Model ships, airplanes, railroads. Catalog 10c. Ideal, 21 West 18th Street, New York 11, N. Y.

ENGINE Castings. Supplies. Catalogue 10c. Howard A3, 2417 N. Ashland, Chicago, Ill.

RAILWAY Models, complete line, 128 page catalog, HO and O gauge 25c. Walthers, 247 Erie, Milwaukee 2, Wis.

BIG Illustrated model engine catalog 10c. Active Products & Supply Co., 53 W. Jackson, Chicago 4.

MINIATURE Steam locomotives, 1/4", 1/2", 3/4" scales. Castings, parts, rail! Thorough drawings with instructions. Catalog 25c. Little Engines, Wilmington, Cal.

#### HOME CRAFTSMEN

WHAT-NOTS Of scrap wood. 12 full size patterns \$1.00. Albright Service, M6901 Railroad Ave., Omaha 7, Nebr.

CELLULOID—New postwar, beautiful assortment. Mottles, opaques, onyx, pearls. Used by ring makers everywhere. One pound assortment—pieces approximately 30 sq. in. each. Price \$1.00. Please add 10c for postage. Craft Service, 337 University Ave., Rochester 7, New York.

MAKE Shell jewelry! Profit! Pleasure! Shellcraft instruction book free! Express your artistic inspiration! 450 Caribbean shells, including findings for making \$6 worth. \$1. Satisfaction guaranteed. Shell Company, Miami 36, Florida.

MAKE Your own jewelry! Findings in metal and plastic earwires, pinbacks, cameos, stones, beads, clasps, charms, sprays, combs, hairbars, chains, plastic and metal. Hobby Art Corp., P.O.B. 276, New York 18, N. Y.

RARE Wood—Selected burls and sections from rare Myrtlewood. Grows only in Oregon and bush form in Palestine. Ideal for lathe work. A hardwood which takes a beautiful finish. Jewel boxes, candlesticks, lamps and other articles sell for ten to fifteen times the cost of the Myrtlewood used. Send two dollars for a sample block. Let us give you a price on Myrtlewood for your requirements. Oregon Myrtlewood Company, 112 S.W. Pine Street, Portland 4, Oregon.

YOUR Dollar brings material for making cameo brooch, floral kits. Free illustrated catalogue. Dixie Shell Service, Lakeland, Fla.

LEATHER Designs for tooling, carving. Imprinted instantly. No tracing. Introductory set \$1.00. Three folios of designs available; fifty belts, twenty billfolds, ten handbags, \$1.00 each. Lampkin Artcrafts, Box 641, Culver City, Calif.

FREE Instructions, shell jewelry. Werts, 1429-56th Avenue, Oakland 3, Calif.

HARDEN All steels quickly, safely. Lasts indefinitely. Ingredients with instructions \$1. Roman Nejeski, Box 185, Dept. PHSM27, Fort Wayne 1, Indiana.

BE First to get amazing new plans for homecraft projects. Send 25c for first edition surprising new magazine Homecraft & Garden, 100 W. Chicago Ave., Chicago 10, Ill.

NEW Self-heating soldering iron. Copper tip heats in minute from built-in alcohol burner. Nothing to wear out. Send \$1.00 today for iron and holder-box postpaid. O'Toole Tools, 2409 First Ave. South, Minneapolis, Minnesota.

TURNING Squares and lumber—Honduras mahogany and Spanish cedar, plywood and veneers. Sedlo Company, P.O. Box 7161, New Orleans, La.

BAND Saw blades. Finest Swedish steel. 1/8" — 1/4" — 3/8" — 4/8" — 90c. 5/8" — \$1.00. 6/8" — \$1.10. Larger sizes and metal cutting saws. Price on request. T. Davison, 743 N. Parkside Ave., Chicago 44, Ill.

SHELLCRAFT Instructions free! Make beautiful seashell jewelry! Wholesale catalogue of complete line shells! Plastic discs! Animal shapes! Pinbacks! Earrings! Cameos! Etc. (Buy direct.) Pace's, Box 279, Bradenton, Florida.

MAKE \$5 Cameo, shell brooch, earrings, easily. Complete kit \$1. Wholesale jewelry supplies. Shelart, 3027 1/2 6th Street South, St. Petersburg, Fla.

JIG Saw patterns. Full size, ready to use. Artistic Gothic wall shelf 20" high; corner shelf 17". Both for 10c. Jig Saw Guild, 117-JS Worth Street, New York 13.

WHITTAKER'S Supplies, readicut blanks, special woods, knives. Old Whittaker, 1402 Charles, LaCrosse, Wis.

SHELLS, Plastics, findings. Lowest prices. Free catalog. Frances Jones, Box 251, Sarasota, Fla.

PIPE Makers supplies. Pipe Makers Manual \$1.00. Briar blocks, stems, rough pipes. Free price list. Harold Mangus, Rt. 3, Alliance, Ohio.

CRAFTSMEN—Lawn furniture plans, beautiful jigsaw designs. Illustrated folders 10c. Refunded with order. Summer-craft Studio, 42 Vernon St., Newton 58, Mass.

MASONITE Mill ends. 10# \$1.00, plus postage. Carl Sign Co., Wooster, Ohio.

CERAMIC Jewelry supplies, bar pins, ear screws, for ceramic and woodworkers; also glass and seashell assemblers. Free catalog. Philadelphia Badge Co., Dept. B-1, 1007 Filbert St., Philadelphia, Penna.

THE Craftmaster's Catalog lists one of the most extensive lines of quality jewelry findings in the country. Lucite, Plexiglas, all types of chemicals, ideas, for pleasure or profit—all in this big, new catalog. For values galore, send 25c (refunded on first order) now, don't wait, you can't do without it long. Pittshire Plastics, Box 90, Pittsfield, Mass.

LEATHERCRAFTERS! Send for free catalog listing leather, kits, supplies. Kit Kraft, 1607 S. Western, Los Angeles 6, California.

EXPERIMENTERS! Interested in electrical, mechanical devices from war surplus? List free. F. Siefke, Box 18, Station E, Buffalo 11, N. Y.

MAKE Shell jewelry—for gifts, as a hobby or start a business. Free catalogue and price list. Complete illustrated book of instructions 75c. Florida Shellcraft Company, Box 1840, Sarasota, Florida.

SHELLCRAFT Kits for beginners—shells and complete supplies for making pins, earrings, combs and novelties. Instructions free. Kits \$2.00 and \$5.00. Herbert Diamond & Co., 1121 North East First Avenue, Miami 36, Florida.

SHELL Jewelry supplies. Wholesale only. McFarland-Plastic Co., Sarasota, Fla.

CATALOG: Patterns plywood novelty furniture, letters, numerals, plaques, frames, weathervanes, silhouettes, lawn ornaments, 100 books and booklets on crafts and hobbies, picture frame mouldings, tools, large line decal transfers. Other lines. Hundreds articles finely illustrated. Write Wo-Met Shop, Ashburn, Ga.

KNOCKDOWN Cedar chest lumber veneers. Free price list. Giles-Kendall, Huntsville, Ala.

#### MAKE IT YOURSELF

BUILD Concrete block machine. 2 blocks per minute. Build concrete mixer. Easy, inexpensive. Details free. Horne, 206 West Wilder, Tampa 3, Florida.

FREEZER—Completely illustrated instructions show how to build any size food freezer from available material. \$1.00 postpaid. Anchorage Crafts, Marblehead, Mass.

BUILD A better tilting table circular saw. Details free. Ward Manufacturing Co., Walsenburg, Colo.

CONCRETE Block homes. 24 page booklet: Drawings and instructions, how to build \$1.00. H. C. Lightfoot, civil engineer, Richboro 1, Penna.

BUILD Your home as a hobby. No rent, no mortgage. Save 50%. Use spare time. No special skill required. Amazing facts sent free. H. C. Lightfoot, civil engineer, Richboro 1, Penna.

BUILD Real heavy duty machines, using our production tested plans. 30" bandsaw, 12" lathe, dowel machine, portable sawmill, planer, concrete block machines, dozens other machines for shop, farm, home. Free lists. Nichols Equipment Co., Purvis, Miss.

GRANDFATHER Clock building system, simple, shop-tested, thousands built, with weight movements pictured in production \$1. Kempel Clock Engineers, Minneapolis 16, Minn.

FLUORESCENT Lights. How to make your own 20 watt lights for less than \$1.00 each. Materials available. Complete, guaranteed, detailed instructions, \$1.00 cash or money order. Checks \$1.10. Specialty Sales, Box 1086, Muncie, Indiana.

AIRPLANE Jettison gasoline tanks, streamlined, ten foot six inches by two foot four inches, 165 gallon, twenty gauge terne coated steel. Ideal for making boats, bob sleds, midget auto, etc. Price \$10.00 per tank, \$7.50 per tank quantities of five or more. General Truck Sales, Inc., 205 Market S.W., Grand Rapids, Michigan.

#### WATCHES, OLD GOLD, JEWELRY, ETC.

FIX Alarm clocks. Instructions 50c. Jones, 1210P Dudley, Utica 3, N. Y.

WATCH Repairing. \$5.75 for complete overhauling. All work guaranteed. Over 45,000 satisfied customers. Carle Jewelers, 2211 Elmwood Ave., Springfield, Ohio.

WATCHES: Adjustment and Repair—Camm \$2.50. Other technical books at reduced prices. Catalog free. Engineers' Book Service, 19 West 44th St., New York City 18.



**WATCHES** Repaired, guaranteed. Correct time. P.O. Box 102, Brooklyn (Sta. P), New York.

**WATCHES** Cleaned, adjusted by experts, \$3.00 plus postage. 10 day service, pack securely, insure. Bezkor, 1491 Metropolitan Ave., Box 62, New York, N. Y.

**GUARANTEED** Watch repairing, all types, 8 day service. Mail to Rite Time, 1112 West 79th St., Chicago, Illinois.

**WATCH** And clock repairing—Complete practical course in modern horology. 66 illustrated self-instruction lessons. Just out! Low price. Fascinating 100-page illustrated catalog free! Write—Nelson Company, Dept. 3-02, Chicago 5.

**WATCHES**, Jewelry bought, sold, repaired. Catalogue. Justice, Box 6, Preuss Station, Los Angeles 35, California.

**OLD Gold**: Top price paid. Mail old or broken jewelry, rings, watches, gold teeth, silverware, diamonds. Receive cash immediately. 100% satisfaction or articles returned. Information free. The Old Gold Specialist, Robert Wyndham, 1035 East A Street, Ontario 1, California.

**GEMS**, Precious and semi-precious, all genuine, from world wide sources. Deal direct, no overhead, save money. Catalog 10c. Hill Co., Route 7, Salem, Oregon.

**WATCH** Repairing easy learned by our home study course. Watch repairers are in demand and are among the highest paid craftsmen today. Write for free information. Houston Chronometer & Watch Co., P.O. Box 1140A, Houston 1, Texas.

**GOLD** \$35.00 Ounce—Mail old gold teeth, diamonds, jewelry, watches—receive cash by return mail. Satisfaction guaranteed. Free information. Dr. Weisberg's Gold Refining Company, 1500-Q Hennepin, Minneapolis, Minn.

**WANTED**—Old, broken jewelry. Cash paid immediately. Mail gold teeth, watches, rings, silverware, diamonds, spectacles. Satisfaction guaranteed. Information free. Rose Smelting Co., 29-A East Madison, Chicago.

#### PLANS AND BLUEPRINTS

**CONCEALED** Storage space in your home! Many illustrations with detailed explanations, \$5 postpaid. C. F. Engineering Board, 303 Herald Place, Syracuse 4, N. Y.

#### TOBACCO, SMOKERS' SUPPLIES

**CIGARETTES**, Popular brands, \$1.59 per carton, postage included. Orders shipped immediately. No c.o.d.'s. Branford Mfg., 126 Branford Pl., Newark, N. J.

**SELL** Genuine briar pipes direct. All men prospects. 100% profit. Lightweight sales kit. Write Abbott Pipes, 62 East 87th, New York 28.

**CIGARETTES**—Popular brands; minimum 3 cartons. Price \$1.45 per carton; postpaid. Send check or money order. Ace Mail Order Co., East Orange 84, N. J.

**PIPE** Smokers valet, pipe smokers what you've been waiting for. The Travelers Pipe Valet. Beautiful lucite rack, holding two pipes, tobacco, matches. Fits on dashboard of car, plane, or cruiser with guaranteed rubber suction cups. Enables you to fill and light pipe with one hand. Write for free descriptive booklet. Dealers and jobbers protected. Jalouse Art Co., Dept. C, 173 Hobart St., Ridgefield Park, N. J.

**MAKE** Smoking pipes, briar blocks and stems. Send for circular. Michelson & Sternberg, 67 West 44th St., New York 18.

#### SURVEYING INSTRUMENTS

**GUARANTEED** Factory rebuilt transits and levels for sale (cash or terms) or rent (with purchase option). We will repair, trade, or buy old instruments. Ship prepaid for estimate and valuation. For complete information, write for list M-32. Warren-Knight Co., (Manufacturers of Transits and Levels), 136 N. 12th St., Philadelphia 7, Penna.

#### FOR SALE—MISCELLANEOUS

**SENSATIONAL Offer!** 12 neckties only \$2.00. Dry cleaned, pressed. Assorted styles and colors. Re-conditioned. Hard to tell from new ties. Original values up to \$3.00 each. Money back if not satisfied. Send \$1.00 with order. Balance c.o.d. plus postage. Reprocessed Tie Co., (Dept. 102), Box 31 Station E, Brooklyn 7, N. Y.

**MEN'S** Slacks, gabardines. Zipper pleats \$8.95. Give size, two choice colors. Send \$1.00. WHB Mfg. Co., 1395 Yosemite, San Jose, Calif.

**HARMONICAS** \$10.80, \$21.00 Dozen. Wholesalers, 11 E. Centre Street, Baltimore 2, Maryland.

**MECHANICAL** Drawing Instruments—Veeco, 4 piece, compact, precision set, brand new in lined case, value \$12.50, special, \$7.25, \$10.00-Charvos 9 piece set, \$8.50. Army surplus slide rules, slightly used, 75c each. Hull automobile compass, for accurate road direction, brand new, \$2.50. Brand new folding valise knapsacks made of heavy olive green duck, heavily bound and reinforced, repellent to fire or water. Inside 3 large snap fastened pockets, heavy webbed straps, hand and shoulder handles, size opened 22" x 54", closed 22" rolled. Useful to hunters, boy scouts, hikers and for all traveling use. A \$7.50 value, special \$2.25 postpaid. Prisms for 6 x 30 or 8 x 30 binoculars brand new \$1.50 each. Offset prisms to be attached to 7 x 50 B. & L. binoculars gives double the field of the ordinary 7 x 50 binocular. Cost \$98.00, special \$25.00. Green sunshades for binoculars size 6 x 30 and 7 x 50 snap on type value \$7.50, special \$1.25 per pair. Forward money order. No C.O.D. shipments. Public Sport Shops, 13 S. 16th St., Philadelphia, Penna.

**MODERN** Kitchen cupboard construction and planning made easy with our plans. Free information. Masterprint Company, White Building, Buffalo, N. Y.

**SURPLUS** Leather flying helmets \$1.00. Woolen army shirts \$3.00. Crestview Ice, Crestview, Fla.

**BUY! Sell! Swap!** On our capital! We make your deals on commission basis only. Swap ads. free! Listing forms, details, on request. Contact Brokers, 610-C Kirby Street, Raleigh, North Carolina.

#### WANTED MISCELLANEOUS

**ATTENTION** Novelty manufacturers. Wanted immediately for South Africa, novelties of all kinds, tricks, etc. Please send catalogues and price lists to Novelty, P.O. Box 6032, Johannesburg, South Africa.

**WANTED**—Precision machinist tools, micrometers, indicators, etc. Send tools, get appraisal, cash promptly. Wm. Gruer, 460 Ryerson Ave., Elgin, Illinois.

**WHOLESALE** Buyer for plastic jewelry, \$3.75-\$6.50. Bissell, Iron Belt, Wis.

**JUSTICE** Buys "Anything." List free. Box 6, Preuss Station, Los Angeles 35, California.

**MERCURY**—Highest prices. Free containers. Write. Wholesale Terminal, Norwood, Mass.

**MERCHANDISE** Of any kind. Paul, 425 E. Jefferson, Springfield, Illinois.

**MERCURY** (Quicksilver). Write for quotation stating quantity. Metallurgical Products Co., 35th and Moore Sts., Philadelphia, Penna.

#### PERSONAL

**STAMMER**? Maybe I can help. Sauers, Box 139-B, Mars, Penna.

**BORROW** By mail! Loans \$50.00 to \$1,000.00 to employed men and women. Easy, quick. Completely private, confidential. No endorsers. Repay in convenient monthly payments. Details free in plain envelope. Write First Loan Co., World Herald Bldg., Dept. H-20, Omaha, Neb.

**PICTURE** Postcards mailed from New York City, Atlantic City, or Asbury Park. 3 for 25c. You address, return. I mail free. Herbert Enstice, Box 353, Asbury Park, New Jersey.

**LAKE** Tahoe postcards, including beautiful Emerald Bay, three for 25c. You address, return, we mail. Tahoe Photo Service, King's Beach, Lake Tahoe, California.

**MAIL** Friends postal cards from Milwaukee, 25c for three. Address, return for mailing. Letters 25c. Slamka, Box 1243, Milwaukee 2, Wisconsin.

**SWAPPERS!** Traders!—Free information. "Swappers" Gazette," 2836-PM Slevin, Louisville 12, Kentucky.

**CREATE** Brushless pictures. No experience. Original art for everyone. Colorful details free. Weidler, 1321 Wellesley, Los Angeles 25, California.

**MAIL** Forwarded, 25c each letter. Acme, 3405 Lisbon, Milwaukee, Wis.

**NEWSPAPER** Clippings for your personal scrapbook. Amaze your friends. In your own words, with or without photo, clipped from real newspaper page. Details 10c. Bolduc Studio, 33 West 67 St., New York City.

**THREE** Beautiful St. Louis postcards 25c. Address, return, we mail. Letters forwarded 25c each. Clyde Price, 2331 Alblon Place, St. Louis, Mo.

**FLORIDA** Remail service. Mystify friends! Winter vacation land! Scenic tropical postcards 10c each. You address, return, I remail. Letters mailed 25c. 1176 N.W. 28 St., Miami 37, Fla.

**RUPTURED?** Beltless, bulbless, strapless truss. Brandon, 623 N. Quincy, Clinton, Ill.

**FALSE** Teeth wearers. If your dental plate is loose and uncomfortable I have good news for you. Send name on postcard. No obligation. Dr. Reese, Dentist, Box 268-X, Winnetka, Illinois.

**FALLING** Hair, its cause and prevention. An informative and educational pamphlet entitled "How To Keep Your Hair Till Ninety" mailed free. James Hilton, 4819 A Fourth Ave., Brooklyn 20, N. Y.

**RUPTURED?** Positive comfort, no understraps, no steel, no elastic. Write Smith Manufacturing Company, Preston, Ontario.

**HAIR** Falling? Dandruff? Write Trichologist, 137 Lewis St., Phillipsburg, N. J.

**HOW** You can find out! Information discreetly developed, any matter, person, problem, anywhere. Personal-business assignments, representations, undertaken. Nation-wide. Officially licensed and bonded service established 1922. Reasonable. All inquiries confidential. William Herman, 170 Broadway, New York.

#### MISCELLANEOUS

**PERSONALIZED** Poker chips! 150 plastic, unbreakable chips each stamped with your initials, complete with attractive plastic rack, \$5.95 postpaid. Herbert Sales Co., Box 1227, Detroit 31, Mich.

**PRINTED** Pressure sensitive tapes. Locker, electrical, cloth and paper tapes furnished. Write for samples. Print Tape Sales, Box 44, Peru, Ind.

**ARE** You tired of seeing ugly scratches on your furniture? Would you like to see them magically disappear with one stroke? For free details, write—Tibet Products, P.O. Box 415, Summit, N. J.

**CACTUS** Wood, window and home displays, desert plants. Free catalog. Natural Desert Displays, Box 876, Coolidge, Arizona.

**SAWS**, Scissors and knives sharpened and reconditioned. Expert work, fair price. Send to Overland's Saw Service, Independence, Iowa.

**NEW!** Personalized tooth brushes—your name stamped on handle of high quality nylon bristle brush. 40c each, 3 for \$1 postpaid. Herbert Sales Co., Box 1227, Detroit 31, Mich.

**RARE** Garden, field and tree seeds. Mexican Products Co., 126 N. Main, Tulsa 3, Okla.

**INFORMATION**. Any subject. The Roxbys, 747 S. New Hampshire, Los Angeles 5.

**BLUE** Plan booklet, 10 small houses, 10c. Model Service, 4302 Oak, Kansas City 2, Mo.

**BRAZILIAN** Orchids. Ask catalog. Orquideario Catarinense, Exporters, Corupa, Santa Catarina, Brazil.

**NAVY** Ship pictures. Any ship in the navy, size 8x10 inches, actual photo. Price \$1.00 each mailed post paid. Liberty Picture Co., Richmond, Calif.

**"HOW To Create New Ideas"**—Practical daily working plans for inventors, writers, business promoters, executives, advertisers, salesmen, students, others. Consultation service included. Satisfaction guaranteed. \$3.00 postpaid. Dudley B. Bunn, A-126 Lexington Avenue, New York 16, N. Y.

**MERCHANTS** Business Builder, sample 10c. Write James Lamont, Beacon, N. Y.

**ATOMIC** Weight gaining—through simple exercises and proper eating. No diet or apparatus necessary, also reducing. Send \$2.00 for booklet. Leonard Green, Box 123, Norwalk, Ohio.

**GIGANTIC** Malls, magazines, catalogs, listing 10c, three times 25c. Waddell's Directory, 341 East 76th, New York 21.

**DELICIOUS** Caramels, marshmallows, carmelcorn; three confectioners secret formulas, \$2.00, guaranteed. Frank Shilling, 1017-J Dueber, Canton 6, Ohio.

**MAGNET**, "Ainico" 4 oz. horseshoe, powerful (lifts about 5 lbs.), \$1.00, 8 oz. (lifts 10 lbs.), \$1.50 postpaid. Ross, 68C W. Broadway, New York, N. Y.

**POST** Card folders. Beautiful folders with the pictures of 16 navy ships, price 10c each, mailed post paid. Liberty Picture Co., Richmond, Calif.

**ROBALL** Pen—years of use without re-filling! Beautifully designed, accurately engineered, lifetime guaranteed. Writes smoothly, dries instantly, satisfies permanently. Send \$5 to Wardell, 2509 Clarendon Road, Brooklyn 26, N. Y.



**SAMPLE Billfold \$1.** Unlaced billfolds and leather articles. Free catalog. Wholesale Leathercraft, Statesan, Wis.

**PHOTOSTATS—75c** Per copy for 8 1/2 x 11 or smaller copies of all legal documents and valuable papers. Return postage paid. Icon-Photocopies, Athens, Ohio.

**THREE Pine ladies' handkerchiefs** hand made for \$5.00. Rafael Borges, Sancarlos #230, Cienfuegos, Cuba.

**IF You drive or own a taxicab** you are entitled to a free sample copy of Taxicab Operator. Send name and address to Taxicab Operator, 1621 N. California Ave., Chicago, Ill.

**PHILIPPINE Coins, guerrilla and occupation currencies;** twelve different, \$4.85 postpaid. Prima Morta, 44 Halcon, Manila.

**GOOD "Used" self-instruction educational books** on all subjects bought, sold, rented, exchanged. Satisfaction guaranteed. Complete information and 100-page illustrated bargain catalog free! Write—Nelson Company, Chicago 5.

**PURE Vermont maple sugar** postpaid in \$1, \$2 and \$5 lots. Eulalia Turner, Poulney, Vermont.

**"RECEIVE Mail."** Moneymaking offers, opportunities, catalogs. Name listed 10c. Ideal Service, 100, Park Ridge, Ill.

**SQUARE Dance instructions, 25 sets,** \$1.00. Rayburn, Eureka Springs, Arkansas.

**CALENDAR 1753 To 2152.** Shows actual calendar for each month. Accurate, simple and durable. 35 cents postpaid. Tracy Newton, Decatur, Georgia.

**STENCILS, Decalcomania letters.** Letter your own trucks, signs, store windows. We have weathervanes, housemarkers. Free folder. H. E. Sales, 3463 Itaska, St. Louis 11, Mo.

**70 BIBLE Lessons, 25c.** Bulletin, Box 87, Station H, New York 25.

**DARI-SPRED.** Delicious butter substitute, costs about 25c per pound. Can be made in 3 minutes from 5 simple ingredients available at every grocery store. Complete instructions \$1.00. Guaranteed. Household Research, 408 No. Solano, Albuquerque, New Mexico.

**M-SCOPE Metal, mineral locators** latest 1947 electronic type ready for immediate shipment. Fisher Research Laboratory, Inc. manufactured some of the finest metal-locators for the U. S. army. Experience gained is yours in the most efficient metal, mineral locator. Free 16-page booklet upon request. Credit plan available. Fisher Research Laboratory, Inc., Palo Alto, California.

**8 ALNICO Magnets plus 100 experiments,** \$2.00. Eljay, Box 891, Newark 1, N. J.

**MAKE Your own plastoplate printing cuts.** Simple, easy process. Plastoservice, Argyle 1, Wisconsin.

**BOOKFINDERS!** (Scarce, out-of-print unusual books.) Quickly supplied. Send wants. Clifton, Box 1377PMM, Beverly Hills, Calif.

**TATTOOING Outfits—engraving outfits.** Circulars free. Write, Zels Studio, 728 Lesley, Rockford, Illinois.

**RECEIVE Moneymaking opportunities,** mails, samples, catalogs, magazines. Your name in thousand mailing lists, 25c. Glassmine, 1654-MX Amsterdam Avenue, New York 31.

**MEDICAL Laboratory technicians** in great demand. We train you in your spare time, in your own home. You can practice while studying. Write for free catalogue. Imperial Technical Institute, Box 973-J, Austin, Texas.

**FREE—"Amazing New Book"—"Profits From Classified Advertising."** Tells how and what to advertise. Be sure to read this book before you invest one cent in advertising. Remember—it's free! Write for your copy now. F. W. Johnson, Classified Advertising Manager, 200 East Ontario Street, Chicago 11, Illinois.

## MAKE UP TO \$5.00 AN HOUR In Your Own YEAR ROUND Business!

**ONLY A FEW DOLLARS PUTS YOU IN BUSINESS!**

Many Clearing as High as \$20 to \$30 a Day **NET** Renewing Rugs, Carpets, Upholstery. New Method Now Used for Auto Upholstery. Write for Facts About Quick, Easy Way to Get Started

Here is the chance you've been looking for to step into a pleasant, dignified, big-pay business of your own that offers you a steady, year 'round income. Start on "a shoe-string," full or spare time, right from your own home. Equal opportunities for men and women, young or old, in small towns or big cities. No experience needed. Many making big money with new Americlean System just cleaning auto upholstery. Easy to learn. We send you complete instructions and quick-cleaning supplies so you can start making money the very first day! Quick method cleans upholstery, rugs and carpets like new without taking off floor! Tremendous demand in homes, apartments, hotels, stores, office and public buildings. Steady repeat business. Territories going fast. Write today for full FREE facts. No cost or obligation. Rush letter or postcard now to AMERICLEAN CO., Dept. G-2, St. Louis 1, Missouri.

**WRITE FOR FREE DETAILS NOW!**

## BE A RADIO ANNOUNCER

ENJOY BIG PAY AND PRESTIGE! BE IN THE SPOTLIGHT! MEET FAMOUS PEOPLE!

"HOW TO BECOME A RADIO ANNOUNCER," written by a top announcer at one of the country's leading radio stations. How to prepare yourself. Practice copy included. An invaluable guidebook for would-be radio announcers. \$1.00 postpaid. Send for copy today!

Converse Publications - Dept. PM 2, Box 311, Worcester, Mass.

## ELECTRICIANS' SCHOOL

PRACTICAL TRAINING IN

HOUSE AND COMMERCIAL WIRING • MOTOR REPAIR AND REWINDING • ELECTRIC REFRIGERATION, COMMERCIAL AND DOMESTIC.

Approved for Veterans Training

PENNSYLVANIA INSTITUTE SCHOOL OF ELECTRICITY

42nd and SPRUCE STS.

PHILADELPHIA 4, PENNA.

## PLASTIC KITS

Complete line of kits with full scale lay-outs for making your own items. Picture Frames, Jewelry and Cigarette Boxes, Tie Racks and numerous other articles from Sparkling Lucite and Plexiglas. Send today for free catalog of kits and supplies.

Home Craftsman Plastics, 1945 W. Harrison St., Chicago 12, Ill.

## HIGHWAY ENGINEERING

PRACTICAL TRAINING IN HIGHWAY DESIGN AND PRACTICE. HOME STUDY — BY MAIL ONLY — WRITE US NOW! SCHOOL OF HIGHWAY PRACTICE DEPT. A, 2161 SHATTUCK AVE. BERKELEY 4, CALIF.



**Announcement**  
A SOLID FOUNDATION TRAINING in **BAKING**

**Now Available in Spare Time Study at Home**

This is good news for ambitious men who realize that Baking is one of America's leading industries in wage and profit possibilities.

Yes—now you can get sound basic training in spare time at home! The N. B. S. Course thoroughly covers the various phases of baking—teaching fundamental principles by inspiring "learn-by-doing" method, step-by-step, under the guidance of a qualified instructor. With proper aptitude and application, our training should provide a solid foundation background which may open the door to the experience needed for worthwhile jobs or possibly your own business some day.

Baking is a steady, year 'round business . . . seldom affected by depressions. Top wages are paid key men. Promotion and increases are generally rapid to those who qualify. Privately owned bakeries, properly managed, are invariably profitable.

GET FREE BOOKLET: Send coupon today for free booklet, "Opportunities in the Baking Industry," and full particulars.

## NATIONAL BAKING SCHOOL

1315 S. Michigan Ave., Dept. 1352 Chicago 5, Ill.

## NATIONAL BAKING SCHOOL

1315 S. Michigan Ave., Dept. 1352, Chicago 5, Ill.

Please send me, without obligation, your FREE booklet, "Opportunities in the Baking Industry," and full particulars.

NAME \_\_\_\_\_  
ADDRESS \_\_\_\_\_  
City \_\_\_\_\_ Zone \_\_\_\_\_ State \_\_\_\_\_





Give yourself the Backing of a  
GREAT GROWING INDUSTRY



# REFRIGERATION AIR CONDITIONING

Refrigeration and Air Conditioning have leading place in fast growing fields of our time. Trained men paid well to service, install, maintain, repair, rebuild household and commercial refrigerators. Important new developments such as Frozen Foods and many new industrial uses. Demand for commercial installations in restaurants, butcher shops, taverns, florists, bakeries, etc. — air conditioning in homes, offices, shops.



## START NOW—Full and Part Time Earnings

There may never again be such opportunities for men who want better jobs or business of their own to get in on ground floor and go up fast! Many started with small investment who built good, growing business. If over 17 and under 60 learn how you can get started. **CONSULTATION AND PLACEMENT SERVICE WHETHER YOU ARE INTERESTED IN WORTHWHILE JOB OR SETTING UP YOUR OWN BUSINESS.**



### Begin Training at Home or Come Directly to Shops

Begin your training at home in spare time, finish in our big, modern shops, or come directly to shops. At home you get C.T.I.'s SHOP PROVED HOME STUDY instruction—actual shop experience has gone into the practical lesson assignments. That is why it is easy for mechanically inclined men to learn by our Home Study training and start on actual refrigeration work.



### A NATIONALLY KNOWN INSTITUTION

C.T.I. was only civilian school selected by Army to train service men for refrigeration. Same quality training available to you now. The method that has made rapid progress possible. Commercial Trades Institute has established its place in Air Conditioning and Refrigeration industries, and that is important to you in making your start.

### VETERANS

Veterans qualifying under "G.I. Bill" have tuition paid by Government plus monthly subsistence allowance while in school. Just mail coupon, we will handle all details. (LOW TUITION, EASY TERMS if you are not a veteran.)

COMMERCIAL TRADES INSTITUTE  
Dept. A22

1400 W. Greenleaf Ave., Chicago 26, Ill.

FREE — Important Information Telling How to Get Started



CUT OUT COUPON BELOW

Fill Out, Cut Out, Mail Today

FACTS FREE for Men Who Want to Get Ahead  
COMMERCIAL TRADES INSTITUTE, Dept. A22  
1400 W. Greenleaf, Chicago 26, Ill.

Send free Illustrated Brochures and other information about Refrigeration and Air Conditioning.

Veteran  Non Veteran

Name .....

Address .....

City ..... State .....

## LEARN WATCH REPAIRING AT HOME



Construction, repair, adjustment. New complete "PRACTICAL COURSE" for beginners and professional repairmen. All essential steps. Theory, operation. Many test cases. Full coverage of tools, materials. Fully illustrated. Only... **\$2.95** Post Paid  
(If C.O.D. plus C.O.D. fee.)  
**Money Back Guarantee**

### We Supply Tools, Materials at Lowest Cost

Please request PRICE QUOTATION on specific items of interest. We carry complete sets of TOOLS and MATERIALS for STUDENTS & PRACTICAL REPAIRMEN. Request folder.

MODERN TECHNICAL BOOK CO., Dept. MMC  
55 West 42nd St. New York 18, N. Y.

### JOIN our new TECHNICAL BOOK CLUB — free

We specialize in ALL BOOKS on Technics, Chemistry, Plastics, Refrigeration, Building, Radio, Automotives, Mathematics, Woodworking, Homecraft, Business, Farming, Sports, etc. Write for FREE LITERATURE. Please specify subject.

## MAKE MONEY WITH DOGS!



Start your own business. Cash in on man's love for dogs. \$10,000 yearly possible. \$60,000 from a single acre. No dog selling, breeding. We tell you how! Send for FREE folder, "MONEY IN DOGS."

THE DOG PRESS, Dept. A,  
St. Petersburg, Florida.

## WHY JOB WORRY? LEARN ELECTROPLATING

Highly paid, uncrowded, interesting business. Part or full time. Chromium, Nickel, Gold, Silver, etc. Send postcard for FREE booklet and proof.

PLATER HYDE, Dept. M Post Office Box 176  
National City, Calif.

## WHY DON'T YOU WRITE?

Writing short stories, articles on business, homemaking, travel, hobbies, shop crafts, local and club activities, etc., will enable you to earn extra money. In your own home, on your own time, the New York Copy Desk Method teaches you how to write—the way newspaper men learn, by writing. Our unique "Writing Aptitude Test" tells whether you possess the fundamental qualities essential to successful writing. You'll enjoy this test. Write for it, without cost or obligation.

Veterans: This course approved for Veterans' Training.

NEWSPAPER INSTITUTE OF AMERICA  
SUITE 559-B, ONE PARK AVENUE, NEW YORK 16, N. Y.

SAY YOU SAW IT IN POPULAR MECHANICS

## ELECTRICAL TRAINING

Intensive 32 weeks residence course in fundamentals of industrial electrical engineering, including radio, electronics. Prepares for technician, engineering aides. Approved for veteran training. 54th year. Catalog.

BLISS ELECTRICAL SCHOOL  
7626 Takoma Ave., Wash. 12, D.C.



A COMPLETE SERVICE

MANUFACTURING—STAMPING,  
DEVELOPING and  
EXPERIMENTAL WORK

Tools, Dies, Jigs, Fixtures,  
Models made by experts.  
Write for Details

TECHNICAL DEVELOPMENT CO., Inc. (Dept. M-2)  
157 Chambers Street New York 7, N. Y.



# WAR BARGAINS in LENSES and PRISMS

## ASSEMBLE YOUR OWN BINOCULARS!

Complete Optics! Complete Metal Parts!  
Save More Than 1/2 Regular Cost

### ARMY'S 7X 50 BINOCULARS

Here's an unusual opportunity to secure a fine set of Binoculars at a substantial saving of money. Offered here are complete sets of Optics and Metal Parts for the Army's M-16 7X 50 Binoculars (M-16 is not the waterproof model). These components are new and all ready for assembly. We supply full instructions. Limit—1 set of Metal Parts and 1 set of Optics to a customer.



**METAL PARTS**—Set includes all Metal Parts—completely finished—for assembly of 7X 50 Binoculars. No machining required. Bodies have been factory hinged and covered. A sturdy brown leather Binocular Carrying Case is included with each set of Metal Parts.  
Stock #824-H 7X 50 Metal Parts.....\$35.00 Postpaid

**OPTICS**—Set includes all Lenses and Prisms you need for assembling 7X 50 Binoculars. These Optics are in excellent condition—perfect or near perfect—and have new low reflection coating.  
Stock #5102-H 7X 50 Optics.....\$25.00 Postpaid

**NOTICE!** If you buy both the Binocular Optics and the Binocular Metal Parts, your purchase becomes subject to 20% Federal Excise Tax. Be sure to add amount covering tax to your remittance or your order cannot be filled.

### ARMY'S 6X 30 BINOCULARS

No Carrying Case with any Sets shown below. (None yet available in Surplus Market.) M-13A1 sets are waterproof model. M-3 sets are not waterproof. Limit—1 Set to a Customer on all Sets shown below.

**COMPLETE OPTICS & METAL PARTS**—Model M-13A1, 6X 30 Binoculars. Everything you need—ready for assembly. When finished will look like a regular factory job costing \$102 to \$120. The Optics are new, in perfect or near-perfect condition. Have new low reflection coating. Metal Parts are new and perfect, all completely finished. No machining required. Bodies factory hinged and covered. Complete assembly instructions included.  
Stock #830-H.....\$40.00 Postpaid,  
plus \$8.00 Tax—Total—\$48.00

**COMPLETE OPTICS & METAL PARTS**—Model M-3, 6X 30 Binoculars. The Optics in this set are new, perfect or near-perfect. Prisms have new low reflection coating. Factory mounted Eye Piece and Objective Assemblies not coated. Metal Parts are perfect, new, ready for assembly. When finished, this will look like a regular factory job, except a name has been filed off a cover plate. No machining required. Bodies factory hinged and covered.  
Stock #831-H.....\$35.00 Postpaid,  
plus \$7.00 Tax—Total—\$42.00

**METAL PARTS ONLY**—Model M-13A1, 6X 30 Binoculars. No Optics. Same Metal Parts as described for Stock #830-H.  
Stock #832-H 6X 30 Metal Parts.....\$25.00 Postpaid

**METAL PARTS ONLY**—Model M-3, 6X 30 Binoculars. No Optics. Some machining on these Metal Parts required. Bodies hinged and Prism Shelf holes placed, but you must tap them. Prism Shelves have been machined. Six lead spiral focusing threads have been cut. Some less difficult components you must thread and machine yourself, but all material you need is furnished except body covering material and Optics.  
Stock #833-H 6X 30 Metal Parts.....\$12.00 Postpaid

**METAL PARTS ONLY**—Model M-3, 6X 30 Binoculars. No Optics. All parts you need. You must do machining on most parts, but not all. No body covering material.  
Stock #834-H 6X 30 Metal Parts.....\$8.00 Postpaid

**OPTICS FOR 6X 30 BINOCULARS** (No Metal Parts). Slight seconds. Cemented but not coated.  
Stock #5123-H.....\$10.00 Postpaid

**SAME OPTICS AS ABOVE** (6X 30), but coated.  
Stock #5124-H.....\$12.75 Postpaid

If you buy both the Binocular Optics and the Binocular Metal Parts, your purchase becomes subject to 20% Federal Excise Tax. Be sure to add amount covering tax to your remittance or your order cannot be filled.

Optics and Metal Parts are Available for Monoculars (1/2 a Binocular). For Complete Details, Write for Bulletin #14-H.

SATISFACTION GUARANTEED

Order by Stock No.

# EDMUND SALVAGE CO. P. O. AUDUBON, NEW JERSEY

## YOU CAN EASILY MAKE

Telescopes, Magnifiers, Photographic Gadgets and  
Hundreds of Experiments with these Low Cost Lenses

**MOUNTED 35 MM. PROJECTING LENS SYSTEM** (May Also Be Used for Enlarging). Focal Length 91.44 mm. and speed of f 1.9. Outside dia. of mount at one end 60 mm. Length of mount 64 mm. May be used as Enlarging Lens by stopping down speed. Most useful for Portrait work. Less useful for pictures requiring perfect definition out to edges of print.  
Stock #4033-H.....\$3.00 Postpaid

**CONDENSING LENSES** for 35 mm. Projectors and Enlargers. Consists of set of 2 Lenses—diam. 2 3/8", F.L. 3" each.  
Stock #1077-H.....\$2.00 Postpaid

**MOUNTED KELLNER TELESCOPE EYE PIECE**—Perfect, coated, in Ordnance sealed boxes. F.L. 1 1/4 inches. Outside dia. of steel mount 40 mm.  
Stock #6198-H.....\$3.15 Postpaid

**OPTICAL BENCH KIT**—(Not a War Surplus Item). Everything you need, including four Lens Holders for checking Focal Lengths and setting up Lens Systems.  
Stock #53-H.....\$8.50 Postpaid

**35 MM. KODACHROME PROJECTING LENS SET**—Consists of Achromatic Lens for projecting, plus a Condensing Lens and piece of Heat Absorbing Glass with directions.  
Stock #4025-H.....\$1.95 Postpaid

**POLARIZING VARIABLE DENSITY ATTACHMENT FOR 7X 50 BINOCULARS**—An amazingly effective unit for controlling amount of light reaching your eyes. Cuts down glare in sky and overwater observations. Easily snapped on and off over the eye cups of American-made 7X 50 Binoculars. Govt. cost \$8.30 each.  
Stock #20,000-H.....\$2.00 Postpaid

**PRISM TELESCOPE**—All the Lenses You Need to build your own 20 power Telescope! No mounts. Has wide field of view.  
Stock #5012-H.....\$7.25 Postpaid

### GIANT SIZE RED AND AMBER FILTERS

Filter material is cemented between glass. All 3/8" thick.

Stock No.	Color	Diam.	Price
706-H	Red	7 1/2"	\$2.00
707-H	Red	5 1/2"	1.50
708-H	Amber	7 1/2"	1.50
709-H	Amber	5 1/2"	1.00

**USES:** For large camera filters, for large size spotlights, for darkroom lights (spectroscopically tested), for interior decorating, for display tray in home or store.

## AIR FORCES GUN SIGHT

With Polarizing-Variable Density Attachment

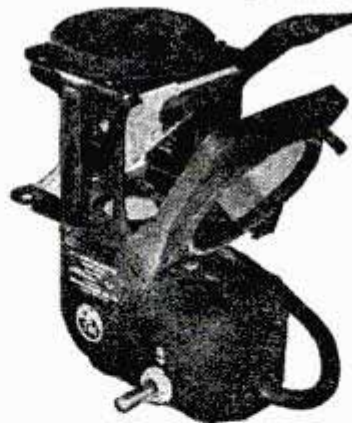

Can be used as Slide Viewer, or take it apart and you can get Polarizing Variable Density Attachment, Mangin Concave Mirror, Reflector Plate, Metal Reticule, Window, Lamp Housing, Ring and Bead Sight. The Polarizing attachment alone is worth many times the price of entire unit. Consists of 2 Polarizing Filters mounted with small handle which rotates one around the other. May be used in Photography, Research, Experiments, as Light Dimmer, etc.

Stock #908-H.....\$5.00 Postpaid  
Same Unit Without Polarizing Attachment

Stock #916-H.....\$2.50 Postpaid

**BOMBER SIGHTING STATION**—A double end Periscope Type Instrument of highest precision. Brand new and in perfect condition. 6 ft. tall, shipping wt. 360 lbs. Orig. cost \$9,850. Consists of numerous Lenses, Prisms, Mirrors, Gears, Motors, Metal Parts and Electrical Gadgets.  
Stock #914-H.....\$50.00 F.O.B. Oklahoma

**TANK PRISMS**—90-45-45 deg., 5 1/2" long, 2 1/2" wide, finely ground and polished.  
Stock #3004-H Silvered Prism (new & perfect).....\$2.00 Postpaid

Stock #3005-H Plain Prism (new & perfect).....\$2.00 Postpaid

Stock #3100-H Silvered Prism (Second).....\$1.00 Postpaid

Stock #3101-H Plain Prism (Second).....\$1.00 Postpaid

We have literally millions of war surplus lenses and prisms for sale at bargain prices. Write for Catalog "H" — Sent Free!



# Learn DRAFTING

I Will Train You at Home Until You Have a GOOD PAY JOB!

Engineer Dobe

Give Yourself a Chance to Make Good in this Big Opportunity Field

Don't be a fellow who "never had a chance"—for your big chance is right here now—in Drafting. The field for draftsmen is bigger now than ever before, for drafting is the basic profession and all new products start with the draftsman.

Get into Drafting now. I will train you at home, in your spare time and give you actual experience on actual work—the same kind of jobs you will do for the best paying firms. I will train you until you are competent, fully experienced and holding a position that will bring advancement and pay raises as deserved. Write me today!

## WORKING TOOLS INCLUDED

You get drafting instruments, table and other equipment when you start. Nothing for you to buy.

## EXPERIENCE WHILE LEARNING

Don't forget! I train you through practical jobs—I give you experience. And I list this experience as a reference to employers when you are ready to go to work. Lack of starting knowledge or higher education should not hold you back. Low cost—and monthly payments, if desired.

## ACT NOW!

Mail coupon to me today! No salesman will call, but you will get my big book and all details. Give your age to get reply.

## MAIL COUPON FOR VITAL FACTS

Engineer Dobe, Div. 12, Libertyville, Ill.

Send me the Vital Facts on Drafting and Industrial Designing, your Free Book and advertised list of positions for Draftsmen and Designers wanted.

Name..... Age.....  
Address.....  
City..... Zone..... State.....

## The Steady Pay Profession Good Times or Bad!

## SCIENTIFIC CRIME DETECTION

FOLLOW THIS MAN

Operator No. 38



### It Is Easy to Learn!

I will teach you this fascinating science during your spare time at home. It pays to be an expert in Finger Printing, Firearms Identification, Police Photography and Secret Service Methods. I have trained hundreds of men and women now successfully serving in identification bureaus throughout America. You, too, may quickly prepare yourself to become a well-paid valued officer of the law, often sharing in the generous rewards offered for wanted criminals.

## FREE! 53 PER CENT

### "BLUE BOOK OF CRIME"

This book is full of exciting information on scientific crime detection. It will show how You can get started in a grand career. Now, at amazingly low cost. Clip coupon Now... Mail it today.

of all Identification Bureaus in the U. S. employ students and graduates of I. A. S. A majority of these men are heads of Bureaus. Many of them knew nothing about crime detection before training with me. Now they have steady jobs, good salaries and a fine future. Write today for full particulars and free book. Give age.

## INSTITUTE OF APPLIED SCIENCE

1920 Sunnyside Ave., Dept. 1352, Chicago 40, Ill.

INSTITUTE OF APPLIED SCIENCE  
1920 Sunnyside Ave., Dept. 1352, Chicago 40

Gentlemen: Without any obligation on my part, send me the "Blue Book of Crime," and complete list of Identification Bureaus employing your students or graduates, together with your low prices and Easy Terms Offer. (Literature will be sent ONLY to persons stating their age.)

Name.....  
Address.....  
Age.....



## Learn to Repair ELECTRIC APPLIANCES

WRITE TODAY for FREE BOOK

Prepare now for a permanent future, independence and security with a business of your own. Our practical, easy-to-learn home course teaches you, during your spare time, how to repair washing machines, vacuum cleaners, electric ranges, lamps, motors, irons, etc., and do house wiring. Also how to get started on little capital. Write today for FREE BOOKLET. No obligation.

## PACIFIC TRAINING SCHOOL

7217 S. Broadway, Dept. P-102, Los Angeles 3

## LEARN AT HOME TO MOUNT BIRDS



Animals, Heads, Fishes, Pets; to TAN. Be a Taxidermist. Profit and FUN.

Hunters, save your valuable TROPHIES. Mount ducks, squirrels, everything. Learn to TAN for leather and furs. Wonderful HOBBY Have a HOME MUSEUM—BIG PROFITS mounting for others. INVESTIGATE NOW.

FREE BOOK With 100 fine game pictures. NOW absolutely FREE. Write TODAY.

Send Postal TODAY for FREE BOOK. State AGE. N. W. SCHOOL OF TAXIDERM, Dept. 3372, Omaha, Neb.



## LAW

STUDY AT HOME for PERSONAL SUCCESS and LARGER EARNINGS. 38 years expert instruction—over 108,000 students enrolled. LL. B. Degree awarded. All texts furnished. Easy payments. Send for FREE BOOK—"Law and Executive Guidance." AMERICAN EXTENSION SCHOOL OF LAW Dept. 74-M, 646 N. Michigan Ave., Chicago 11, Ill.



## CORRESPONDENCE COURSES IN RADIO and ELECTRICAL ENGINEERING

Tuition \$25

ELECTRICAL ENGINEERING. Get good grasp of wide electrical field. Modern. Very understandable. Theory made easy. RADIO ENGINEERING. Extra fine course in radio, public address, photo-electric work. Trains you to be super-service man, real vacuum tube technician. Tuition ONLY \$25, either course. Deferred payment plan. Servicemen needed badly. FREE Write for free copies of school catalogs, student magazines, etc. LINCOLN ENGINEERING SCHOOL, Box 931-P98, Lincoln, Nebr.

## TODAY... BUSINESS OF YOUR OWN

ORDER Now our BRAND NEW tested guides "FROM NOTHING TO INDEPENDENCE," only \$2.00—"THE SILVERSTREAK PLAN" only \$1.00—12 issues of "BUSINESS OPPORTUNITIES" monthly magazine, only \$2.50, all three \$5.00 postpaid FIVE DAYS examination and information free. Educational Book Co., 2907 Berwick Ave., Baltimore 14, Maryland

## Make Your Own RUBBER MOLDS

Amazing New Method!....

Now, an amazing new method to make your own flexible rubber molds to recast sculptured models or subjects. Duplicate singly or in quantity, expensive original subjects at amazing low cost. Reproduce statuettes, plaques or any other material—any surface—with this new liquid rubber material. Hundreds of other uses.



### PROFITABLE HOBBY!

Start this fascinating hobby that can lead to beginning of your own business. For only a few cents each, make hundreds of castings to resell at big profit prices. Easy to start. Big list of subjects you can reproduce.

### SEND NO MONEY!

Just your name and address for BIG INTRODUCTORY KIT containing 14 different items; everything you need to work with including famous Indian model. Pay postman only \$1.49 plus C.O.D. postage. Money back if not satisfied. Or save C.O.D. by sending \$1.49 with order and we pay postage. Write for FREE CATALOGUE!

RUBBER-FOR-MOLDS, 6044 N. Avondale, Dept. 49-B7, Chicago 31, Ill.



# Now While these Great Industries Go Forward

**AIM HIGH—PICK ONE OF THESE BIG FIELDS**

- REFRIGERATION AND AIR CONDITIONING
- AUTOMOTIVE MECHANICS
- BODY, FENDER REBUILDING
- ELECTRICITY

## Make Your Decision

For a Better Job  
or a  
**BUSINESS of YOUR OWN**  
**NOW'S the TIME**

**R**EFRIGERATION and Air Conditioning, the Automotive Field, the Electrical Industry are rapidly making up for lost time. There may never again be such opportunities for men who want better jobs or business of their own to get in on ground floor and go up fast! Yes—FOR MEN WHO ACT FAST, THINGS CAN HAPPEN FAST!

**YOU CAN'T AFFORD TO WAIT  
YOUR FUTURE DEPENDS  
ON WHAT YOU DO TODAY.**

## A Few Short Weeks Can Make All the Difference

**COMMERCIAL TRADES INSTITUTE** was only civilian school selected by Army to train service men for refrigeration. In motive trades our institute gained nationwide fame training Auto Mechanics for U.S. Army. Same quality training available to you now. If over 17 and under 60 learn how you can get started. **CONSULTATION AND PLACEMENT SERVICE WHETHER YOU ARE INTERESTED IN WORTHWHILE JOB OR SETTING UP YOUR OWN BUSINESS.**

**TRAIN AT HOME**  
IN SPARE TIME OR IN OUR  
**WELL EQUIPPED SHOPS**

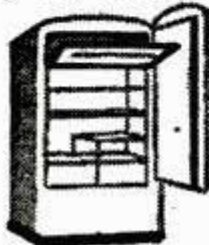

## REFRIGERATION *and* AIR CONDITIONING

Trained men paid well to service, install, maintain, repair, rebuild household and commercial refrigerators. Important new developments such as Frozen Foods, and many new industrial uses. Opportunities for full time, spare time earnings. Begin training at home in spare time, finish in our big modern shops, or come directly to shops.

At home you get C.T.I.'s SHOP PROVED HOME STUDY instruction—actual shop experience has gone into the practical lesson assignments. That is why it is easy for mechanically inclined men to learn by our Home Study training, and start on actual refrigeration work.

## AUTOMOTIVE MECHANICS • BODY & FENDER REBUILDING



Progress rapid by our learn-by-doing **SUPERVISED SHOP TRAINING**. Efficient auto mechanics get excellent pay. Learn to overhaul and repair engines, transmissions, differentials and other assemblies.

Body and Fender Rebuilding offers profitable work. Get good, practical "all-around" training—welding, aligning, mixing and matching colors, spray painting, power and hand tools. Values increased when used cars are made to "look like new."

**A NATIONALLY KNOWN AND RECOGNIZED INSTITUTION**



**HOME OF  
COMMERCIAL  
TRADES  
INSTITUTE**

## MODERN SHOP TRAINING **ELECTRICITY** ELECTRICAL SERVICING

### Modern Shop Training in Electricity

Get ready for good job or business of your own. Electricity is the heart of modern industry. Electricians always needed, earn higher pay, work year around. Make rapid progress in step-by-step practical shop training in Electrical Wiring and Circuits; Armature Winding; Electrical Appliance Repairs; Electro Plating and Welding. Rural Electrification, the Building Boom, many new uses of Electricity opening more opportunities in this vast field. Get training under thoroughly experienced instructors, be ready in few short weeks for Job Opportunities in Electricity.

**COMMERCIAL TRADES INSTITUTE, DEPT. E-22**  
1400 Greenleaf, Chicago 26, Ill.

**FREE**—IMPORTANT INFORMATION  
Telling HOW TO GET STARTED  
IN ONE OF THESE GREAT FIELDS

**VETERANS**—Veterans qualifying under "G.I. Bill" have tuition paid by Government plus monthly subsistence allowance while in school. Just mail coupon, we will handle all details. (LOW TUITION, EASY TERMS if you are not a veteran.)

**SEND THE COUPON NOW** ➔

## FILL OUT · CUT OUT · MAIL TODAY!

### FACTS FREE FOR MEN WHO WANT TO GET AHEAD

**COMMERCIAL TRADES INSTITUTE, Dept. E-22**  
1400 W. Greenleaf, Chicago 26, Ill.

Send free illustrated Brochures and other information about the field I have checked below.

- |                                                             |                                                   |
|-------------------------------------------------------------|---------------------------------------------------|
| <input type="checkbox"/> Refrigeration and Air Conditioning | <input type="checkbox"/> Automotive Mechanics     |
| <input type="checkbox"/> Electricity                        | <input type="checkbox"/> Body & Fender Rebuilding |

Name .....

Address .....

City..... State.....

Veteran  Non-Veteran



**NEW peacetime  
production plans  
mean**



## BIGGER PAY FOR MACHINISTS

Master shop work quickly with these books

This big home-study and reference course gives you the practical facts on machines and methods you need to advance in machine shop work. Take advantage of the other man's experience as found in books, to solve your problems, increase your efficiency, with

### The AMERICAN MACHINISTS' LIBRARY

6 volumes—2368 pages—2516 illustrations  
(A combined home-study course and reference library)

This library of machine shop practice was written for practical men. It gives you the best methods for every kind of machine shop work. It fully explains lathes, drills, and other machine tools and their operation, automatic screw machines, speeds and feeds, gear design and production, jigs and fixtures, punch and die work, metal surfacing, etc., etc. Plainly written—completely illustrated—the best kind of help to the machine shop man who wants to advance himself.

No money down—special price—easy payments.

#### EXAMINATION COUPON

McGraw-Hill Book Co., 330 W. 42nd St., N. Y. 18  
Send me for ten days' examination the American Machinists' Library. If satisfactory I will send you \$4.00 in 10 days and \$4.00 monthly until the price of \$20.00 is paid. If not wanted, I will return the books postpaid. (To insure prompt shipment write plainly and fill in all lines.)

Name.....  
Home Address.....  
City and State.....  
Company.....  
Position..... PM 2-47

## Learn WATCH REPAIRING

From An  
Approved School  
The Largest of Its Kind



EARN  
WHILE  
LEARNING

Spare Time Home Training  
Prepares You For Big Pay

**FREE WATCH** working tools and watch included as part of our Watch Repairing Course

The demand for skilled watch repairers—men and women—is increasing with the step-up in the manufacture of watches. Now is the time to prepare yourself in this fascinating profession with the aid of our highly practical HOME TRAINING COURSE—in your spare time at home. Start your own business or accept a big pay position.

**WRITE TODAY FOR FREE DETAILS**

Earn while you learn with an "approved" school.  
Get the facts—then judge.

**ILLINOIS SCHOOL OF WATCH REPAIRING**  
6312 Huntington Street, Dept. PM-2, Chicago 30, Illinois

# SUCCEED IN THE POULTRY BUSINESS!



**YOU CAN MAKE A  
Good, Comfortable  
LIVING WITH POULTRY**

Enjoy country life—grow your own food—and let poultry pay expenses

Get ready now—the easy, scientific, inexpensive way! For 26 years, we've been helping thousands to greater success. During 26 years we have trained thousands of students, showing them how to establish poultry farms—how to avoid mistakes—how to cut losses—how to increase profits on established plants—how to have their own small profitable breeding plant and make a good living at it.

Proper management and "know-how" makes profits ANY season, for life. Our courses cover all phases of poultry raising, including plans for buildings, breeding, hatching, culling, sexing, caponizing, marketing, judging, exhibiting, and many others, etc., as planned by Harry M. Lamon, former Senior Poultryman for the United States Dept. of Agriculture. Endorsed by leading colleges, poultrymen everywhere. Write today for this Catalog "How to Raise Poultry for Profit." It fully describes courses, methods, service, opportunities, and easy payment plan.

**National Poultry Institute**  
Dept. 50, Adams Center, N. Y.



**YOU CAN SUCCEED...**  
Send for this Prospectus TODAY

## NEW PLASTICS Fabricating MANUAL



Make beautiful objects of Plexiglas, Lucite, Catalin, Polystyrene a home. Jewelry, novelties, accessories. Send for new 10,000 word manual on how to fabricate, weld and form latest plastic materials in home workshop. Hundreds of practical suggestions. Written by leading plastics engineer. Price prepaid 25c (stamps or coin). Or get FREE information and price list covering transparent plastic sheets, rod, tubing cut to your size. Write today: **HOUSE BEAUTIFUL PLASTICS**, Dept. B3, 5534 W. Harrison St., Chicago 44, Ill.

## INVENTORS — RESEARCH ENGINEERS

Keep Up-To-Date on Technical Developments, Patents  
Subscribe to weekly report covering Technical advances, AVIATION—BUILDING, HEATING, VENTILATION — CERAMICS — CHEMISTRY—ELECTRICITY—ENGINEERING—FOODS—FUELS, LUBRICANTS—MEDICINE—INSECTICIDES—METALS—NUCLEONICS (Atomic Energy)—PAPER, PRINTING—PHOTOGRAPHY—PLASTICS—TEXTILES—TRANSPORTATION. Send for a sample copy and full information

**THE TECHNICAL SURVEY**  
790 BROAD ST. NEWARK 2, N. J.

## GET INTO MAIL ORDER BUSINESS

Get into Mail Order Business, anywhere: start small, grow fast from profits! "SIMPLIFIED SELLING BY MAIL," illustrated, fully outlined tested, winning methods, for building fascinating, successful business, full or spare time. Complete course in one inexpensive volume; purchase price refunded if not satisfied. Descriptive Prospectus FREE.  
**FRANK J. ARTZ** 10600 Harding Drive  
TOLEDO 9, OHIO

## Now You Can Join CLUB PLAN For BUSINESS SUCCESS

**FREE**  
Full Details and Illustrated Brochure

Club Plan of Practical Business Administration now offered men in business and industry who want to follow a program in order to move up to executive positions. Plan available to employed men who wish advancement with present employer or elsewhere. Program will not interfere with present job. Serious minded, ambitious men invited to send for free facts at once.

**AMERICAN TECHNICAL SOCIETY, Dept. 522**  
Drexel & 58th CHICAGO, ILL.



# 4 Career Ways to Security

APPROVED FOR TRAINING THE YOUNG MEN OF AMERICA—VETERAN AND NON-VETERAN

## PLASTICS — MAGIC WORD!



Here at Plastics Tech in Los Angeles, men are learning the secrets of this glamorous industry for which the future seems unlimited. Hundreds of new products are being made of plastics requiring trained men to develop and fabricate them. Plastics Tech is the pioneer and leader in the field of plastics instruction. Its faculty and directors are leaders in

the industry. Write for beautiful four-color catalog today. No obligation. Courses available either residential or study at home. Mail coupon in envelope or paste on penny postcard.

**PLASTICS INDUSTRIES TECHNICAL INSTITUTE,**  
Dept. PM7-2Q, 1601 S. Western Ave., Los Angeles 6, Calif.

Gentlemen: Please send me free booklet "World of Plastics" and information on your training.

Name (PRINT) .....  
Street ..... Age.....  
City ..... State.....  
Veteran..... Non-Veteran.....  
Residence School..... Home Study.....

## BE AN AIRCRAFT INSTRUMENT TECHNICIAN

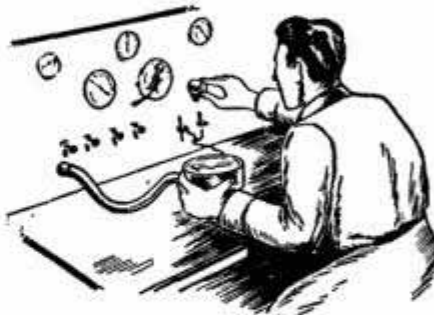

More than 750,000 trained men (CAA survey) will be needed to fill important jobs in the Aviation industry in next 10 years. All planes require delicate instruments. There must be trained men to service, maintain and repair them — Instruments must be right ALWAYS.

**AMERICAN SCHOOL OF AIRCRAFT INSTRUMENTS** teaches men to perform this important, interesting and well-paid work. The world's future depends on more Aviation—INSTRUMENTS. Write today for free booklet. Send coupon in envelope.

**AMERICAN SCHOOLS OF AIRCRAFT INSTRUMENTS,**  
Dept. P-27, 5145 W. San Fernando Rd., Los Angeles 26, Calif.

Gentlemen: Please send me free booklet and information on your training.

Name (PRINT) .....  
Street ..... Age.....  
City ..... State.....  
Veteran..... Non-Veteran.....



## AIRCRAFTSMANSHIP MODERN TRAINING



Aero Tech training will give you a better start for a well paid, responsible position. Thousands of successful AERO TECH graduates prove we have the knowhow to give leadership training. Now at our new location on huge Oakland Airport —Gateway to the Pacific. Write for catalog and full information on our

Aeronautical Engineering and Master Mechanics Course. Early enrollment assured. Mail coupon in envelope.

**AERO INDUSTRIES TECHNICAL INSTITUTE,**  
Dept. P-27, Oakland Municipal Airport, Oakland 14, Calif.

Gentlemen: Please send me free booklet and information on your training.

Name (PRINT) .....  
Street ..... Age.....  
City ..... State.....  
Veteran..... Non-Veteran.....

## WATCHMAKING— A CAREER FIELD!

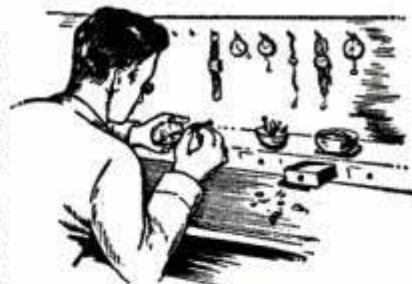

WORK — and plenty of it — Millions of watches and clocks need fixing. An interesting and needed service in the top-pay bracket, or start an independent business of your own. The AMERICAN SCHOOL OF WATCHMAKING

offers proven training under QUALIFIED watchmaker-instructors. Complete information free upon request. Enclose coupon in envelope or paste on penny postcard.

**AMERICAN SCHOOL OF WATCHMAKING,**  
Dept. P-27, 5145 W. San Fernando Rd., Los Angeles 26, Calif.

Gentlemen: Please send me free booklet and information on your training.

Name (PRINT) .....  
Street ..... Age.....  
City ..... State.....  
Veteran..... Non-Veteran.....

MEMBERS OF NATIONAL COUNCIL OF TECHNICAL SCHOOLS

CHOOSE THE ONE THAT FITS YOU BEST — SEND COUPON TODAY



**Pay Is Good**  
 in both these big Branches  
 of the Automobile Industry

LEARN IN A FEW  
 WEEKS IN OUR  
 BIG MODERN  
 TRAINING SHOPS

**AUTOMOTIVE  
 MECHANICS**

**BODY & FENDER  
 REBUILDING**

NOW IS THE TIME  
 TO PREPARE FOR  
 YOUR PLACE IN A  
 GIANT INDUSTRY

Automobile industry making up for lost time! There may never again be such opportunities for men who want better jobs or business of their own to get in on ground floor and go up fast! Yes — FOR MEN WHO ACT FAST. THINGS CAN HAPPEN FAST!

**TRAIN ON ACTUAL EQUIPMENT**

Chicago Motive Trades Institute makes rapid progress possible by Learn-By-Doing SUPERVISED SHOP TRAINING. In motive trades our institute gained nation wide fame training Auto Mechanics for U. S. Army. Same quality training available to you now. CONSULTATION AND PLACEMENT SERVICE. WHETHER YOU ARE INTERESTED IN WORTHWHILE JOB OR SETTING UP YOUR OWN BUSINESS.



**AUTOMOTIVE  
 MECHANICS**

Practical shop training on all types of equipment. Automotive mechanics needed to keep millions of cars, busses, trucks rolling. Efficient auto mechanics get fine pay. Can service, repair, install all mechanical and electrical parts of autos. Learn to overhaul and repair engines, transmissions, differentials, and other assemblies. Good pay, steady work, excellent opportunities for increased earnings for properly trained auto mechanics.

**BODY AND FENDER REBUILDING**



Body and Fender rebuilding one of best paid fields in automobile industry. Body and Fender Rebuilding makes good profits in garages, service stations. Get practical, all-around Shop Training—welding, aligning, mixing and matching colors, spray painting, power and hand tools. Values increased when used cars are made to "look like new."

**A NATIONALLY KNOWN INSTITUTION**

Rapid progress possible by supervised learn-by-doing SHOP TRAINING. C.T.I. is an old established school, backed by years of experience—with trained instructors—with completely equipped shops. VETERANS qualifying under "G.I. Bill" have tuition paid monthly subsistence allowance while in school. Just mail coupon, we will handle all details. (LOW TUITION, EASY TERMS if you are not a veteran.)



**CHICAGO MOTIVE TRADES INST.**  
 Dept. B22  
 Div. of Commercial Trades Inst.  
 1400 W. Greenleaf Ave., Chicago 26, Ill.  
**FREE—IMPORTANT INFORMATION**  
 TELLING HOW TO GET STARTED

CUT COUPON ALONG THIS LINE

**Fill Out, Cut Out, Mail Today**

FACTS FREE for Men Who Want to Get Ahead

**CHICAGO MOTIVE TRADES INSTITUTE, Dept. B22**  
 1400 W. Greenleaf, Chicago 26, Ill.  
 Send free illustrated Brochures and other information about the field I have checked below.

- Automotive Mechanics
- Body & Fender Rebuilding
- Veteran
- Non Veteran

Name.....  
 Address.....  
 City.....State.....

**NEW MIDGET ELECTRIC  
 ARC WELDER**

RETAILS  
 ONLY  
**\$3.95**

FULLY  
 GUARANTEED



**Plugs into Light  
 Socket—AC or DC**

It's new! It's handy! It's efficient! Use the Midget Electric Arc Welder for hundreds of light-metal jobs. Does comparable welding work with a 1/16 inch welding rod on thin metal as that of larger and higher priced welders. Operates on 15 ampere fuse, 110 volt 60 cycle A.C. or D.C. current, by use of our special standard-coated 1/16-inch welding rods. Generous supply of rods supplied with machine. Recommended for all light welding like automobile fenders, etc. Take the Midget Arc anywhere to the job. Sturdily built and fully guaranteed. Comes complete—ready to use. Nothing else to buy. No previous welding experience needed to strike an arc. In a short time, anyone mechanically inclined can learn to weld with this machine.

You'll find hundreds of money-saving, time-saving uses for the Midget Arc around your home, garage, or workshop. Also in garages, factories, repair shops, tin shops, mechanics, farmers, inventors, etc. Order a Midget Electric Arc Welder now! SEND NO MONEY. We'll rush one to you, complete with rods and helmet (equipped with APPROVED welding glass). Pay postman only \$3.95 plus postage charges. If not satisfied, return Midget Arc in 5 days from receipt and we'll refund your money immediately. RUSH YOUR ORDER NOW.

MIDGET ARC WELDER CO., Strader Ave., Dept. T-202, Cincinnati 26, Ohio

**MUFFLERS**

**STEELS and ALUMINUMS  
 with a motorboat tone**

SINGLES, Chev, V-8, Plymouth, Steels \$5.50, Aluminum \$6.50. Chry., Olds., Buicks, etc., Steels \$7.50, Aluminum \$8.50. V-8 and MERCURY DUALS, Steel \$17.50, Aluminum \$20.00. Aluminums are guaranteed for life of your car.

**DEALERS WANTED**

**SANDEE MUFFLER CO.**  
 7523 S. WESTERN AVE., LOS ANGELES 44, CALIF.

**CHICKS ON 30 Days Trial**

guarantee. Money refunded on any chicks not true to breed. No need to take chances. You get 30 days to make sure chicks are as represented. Male or pullet chicks furnished. Low prices. All varieties. Mo. Approved. Blood Tested. Easy buying plan. Bargain Prices and Chick Manual Free. MISSOURI STATE HATCHERY, Box 289, BUTLER, MO.

**SEXED**

**FREE MRS. BERRY'S POULTRY BOOK**

BABY CHICKS or STARTED, Champion-Mated, Licensed, Inspected, B.W.D. TESTED, 52 BREEDS, 6 HYBRIDS, Sexed or straight. Mature fowls, Hatching Eggs and Remedies. LOW PRICES. The ORIGINAL Berry's Farm—over 50 years' service. LARGE BEAUTIFUL BOOK FREE. Stamps appreciated. BERRY POULTRY FARM, Ex. 29, CLARINDA, IOWA

**Wonderful POULTRY BOOK**

**FREE LOW PRICES** 48 varieties SEX-LINKED and PUREBREDS; BABY CHICKS, Pullets or Cockerels, also STARTED CHICKS, BABY TURKEYS, Mature Fowls and Hatching Eggs. ALL FLOCKS BLOOD TESTED FOR B.W.D. Write quick for this fine free book. GREAT WESTERN HATCHERY, Box 15, Salina, Kans.



**Learn modern watch  
 and clock repairing**

At home, spare time. Good field now... security and contentment in future. Start part-time business and EARN while you learn. Horology is precision instrument work... a great and growing field, sensational opportunities. Easy self-instruction course. Low prices. Money-back guarantee. Write today for FREE Success-Catalog! NELSON CO., 1139 S. Wabash Ave. Dept. 80 2 Chicago 5, Illinois





**DO ANY JOB.. EASIER.. QUICKER**  
**MAKE MORE MONEY** in the  
**BIG OPPORTUNITY**  
**FIELDS**

**SEND NO MONEY**  
 Select the Books  
**YOU Need Now!**  
 We Ship C.O.D.  
 Anywhere in U. S.  
 and Will Refund  
 Amount Paid if  
 Not Satisfactory.

**Here's the Help You Need**  
**For Best Paying Jobs**  
**Right NOW!**

**FREE TRIAL**  
**IN YOUR OWN HOME**

Used by Army, Navy, Other Government  
 Depts., 200 Schools and Industrial Firms.

Do it now! Get the better pay that goes to men with specialized knowledge. Get into one of these big opportunity fields. Big money and many other advantages await you if you prepare now. Here is the help you need—EASY—QUICK—AT LOW COST. Thousands of men have already used these famous books. Beginners and experienced men alike have doubled and tripled their earnings with this help. You too, can now get the special knowledge you need for top pay, better jobs, or a business of your own. This is your GOLDEN OPPORTUNITY.

**AIR CONDITIONING**

Big air conditioning boom interrupted by war will be bigger than ever. It's ready to GO now! Get this non-technical book by international authority and be ready for your share of millions to be spent. Covers whole field. 450 pages. Illustrated. \$4.00.

**AIRPLANE WELDING**

All metal airplane building offers big peacetime opportunities. New 2nd edition of this famous book by J. B. Johnson, Materials Division, Wright Field. The authoritative and practical book on Airplane welding and materials brought right up to date. 420 pages, 193 pictures. \$3.50.

**BODY & FENDER REPAIR**

Owners will spend big money to keep their good older cars looking like the new ones coming out. This is a practical money-making guide, ideal for shop owners and every man who wants a share of the millions to be spent in keeping old cars looking new. Tells how to get a good job or start business of your own with small capital. 325 pages, 232 illustrations. \$3.50.



**DYKE'S FAMOUS CARBURETOR BOOK**

This famous book has been the standard guide in the best paying auto work for a generation. It has helped thousands of men make money. New edition covers engine tune-up, compression, ignition, carburetion, fuel pump valves, etc. Use this book to specialize in this big field. 244 pages, 549 illustrations. \$3.50.

**HOUSE WIRING**  
**NEW EDITION**

Get this new sixth edition of this standard and practical electrical wiring book. It gives complete practical instruction on every phase of house wiring in one handy volume. Goes further than most books on subject. Hand-book style. Gives National Electric Code, 400 pages, 669 illustrations. Electrical work will reach a new high with millions of new homes to be built. Get started now. \$3.00.

**15 Million Refrigerators**  
**Need Service and Repairs**

**REFRIGERATION—Book of the Hour!**  
**Biggest Opportunity in Many Years!**

**NEW PRINTING—ALMOST 1000 PAGES**  
**408 Pictures—17 Diagrams in Colors Makes All Refrigerator Service Maintenance, Repairs Simple as A. B. C.**

Thousands of Refrigerators need repairs! Owners will pay big for competent service which will be needed more and more. Get MODERN GAS AND ELECTRIC REFRIGERATION, the non-technical guide to all types of refrigerators and get your share of this new profit. Get a job or start your own service business. This book will help you make money anywhere. Price \$5.00.

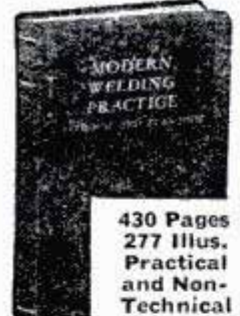

**MODERN WELDING PRACTICE**

Newest book on all types of welding and heat treatment of metals. Written by recognized specialists in training men for production jobs. Practical and Non-Technical.

430 Pages  
 277 Illus.  
 Practical and Non-Technical

Covers everything you need to know. Prepare for best pay jobs now. Price \$4.00.



**NEW 20th EDITION**  
**Leading Auto Book for Over 32 Years**

**World's Greatest AUTO BOOK**

**New Material on Transmissions, Trucks, Tractors, Diesels, Aircraft and Auto Engines**

Now with millions of cars needing repairs and thousands of men needed to do the work, you need the famous DYKE Auto Book more than ever before. Brand new 20th Edition covers all principles, construction, repair, adjustments, testing, troubles and remedies of all cars. Over a half million copies of 20 editions of Dyke's have been sold. Gives specifications of old and newer cars. World's biggest book value, \$7.00. This big book, a complete auto library in one volume, has 1483 pages—4600 illustrations and diagrams—weighs 6 lbs.—equal to 4 ordinary books.

**ENGINEERS HANDBOOK**

World famous Bailey's handbook of universal questions and answers for Stationary, Marine and DIESEL engineers and firemen. Prepares for any license examination. This is the one book that men should have if they want to reach the top in installation, maintenance and operation of Diesel and steam plants. Pocket size, \$2.00.

**Goodheart-Willcox Co., Inc.**  
 209 S. Michigan Ave., Dept. 12, Chicago 16, Ill.

**SEND NO MONEY! Mail Coupon**

**GOODHEART-WILLCOX CO.,**  
 209 S. Michigan Ave., Dept. 12, Chicago 16, Ill.

Send books checked, C.O.D. I will pay postman, plus few cents charges. If not satisfactory I will return books in 5 days and you will refund money paid. (Outside U.S. or possessions remit with order.)

- Gas & Electric Refrigeration . . . . . \$5.00
- Dyke's Auto Book . . . . . \$7.00
- Dyke's Carburetor Book . \$3.50
- Modern Welding . . . . . \$4.00
- Airplane Welding . . . . . \$3.50
- Sheet Metal Layout . . . \$3.50
- Air Conditioning . . . . . \$4.00
- Engineers Handbook . . . \$2.00
- Body and Fender Repair . \$3.50
- House Wiring . . . . . \$3.00
- Shop Math. (2 vols.) . . . \$3.00
- A.C. Power Wiring . . . . \$4.00
- D.C. Power Wiring . . . . \$4.00

If remittance accompanies order we will pay all postage charges under same return privilege.

Name . . . . .  
 Address . . . . .  
 City . . . . . State . . . . .



# HOW YOU CAN BUILD A MIGHTY BODY

Quickly! Easily! Pleasantly  
—in 10 minutes a day in your own home

"The World's greatest molder of men"—at last reveals to you in these five complete book-courses (value \$5 each).

## 1. How YOU Can Build a Mighty ARMI



**A. PASSAMONT**  
First prize for physical perfection.

Let me give YOU, TOO, such a pair of chain-breaking biceps. The strongest-armed man in the world, George F. Jowett, planned this course for you. His great experience stands as proof that YOU, TOO, can get the arms men respect and women admire.

**Complete Arm Course 25c**

## 2. How YOU Can Build a Mighty CHEST



**REX FERRIS**  
Champion of South Africa, says, "I owe everything to Jowett Methods."

Look at the Heroic Chest of this Jowett Pupil. A powerhouse of energy. Ferris writes, "I want to add my sincere gratitude to that of thousands of pupils for wonderful results from your course. Your course is by far the best." If you have a narrow, sunken chest I can improve it so that you will be proud to show it off.

**Complete Chest Course 25c**

## 3. How YOU Can Build a Mighty BACK



**CHAS. SCHAFER**  
an amazing Jowett product. Once a puny weakling. Now versatile athlete.

Look at his rock-like Back now! He says, "You have worked wonders for me. You are head and shoulders above the rest in your profession." Let me help YOU, TOO, build a back of power. Square shoulders with enviable military spread. A spine as strong as a steel shaft.

**Complete Back Course 25c**

## 4. How YOU Can Build a Mighty GRIP



**W. BURNS**  
A Jowett-made Olympic Strength Champion.

YOU, TOO, can have a Manly Grip like this Jowett pupil. What would you give for a forearm like that, with its bone-crushing grip? Fingers strong as steel pincers. A hand like an iron vise. YOU, TOO, can get these symbols of real manliness. I have proved to thousands this is no mere dream. Let me mold a pair of arms like this for you . . . with a grip of might. A handshake that will win friends—success.

**Complete Grip Course 25c**

## 5. How YOU Can Build Mighty LEGS



**BOB MITCHELL**  
A Jowett Champion—not in words but by ACTUAL RECORDS.

What would you give to have the all-round he-man strength of Bob Mitchell? It's reasonable to assume that what I have done for thousands, I can do for you. I myself increased my thighs by 8 inches, my calves by 5 inches, by this simple, unbeatable method. I'll help you build legs that are real props of leaping, tireless power!

**Complete Leg Course 25c**

**Last Chance! Get All 5 Picture Courses for \$100**

Send for them now and learn the "World's Greatest Secrets of Body Building." FREE! Marvelous Photo Book of Famous Strong Men, "Nerves of Steel—Muscles like Iron".

**RUSH COUPON NOW**

**BOOK WITH PHOTOS OF FAMOUS STRONG MEN MAIL COUPON NOW FREE**



**George F. Jowett**  
Champion of Champions

Jowett Institute of Physical Culture  
230 Fifth Avenue, Dept. PM-72A, New York 1, N. Y.  
George F. Jowett: Your proposition looks good to me. Send by return mail, prepaid, the courses checked below, for which I enclose ( ). Include FREE book of PHOTOS.

- |                                                                |                                                     |
|----------------------------------------------------------------|-----------------------------------------------------|
| <input type="checkbox"/> All 5 courses for . . . \$1           | <input type="checkbox"/> Molding Mighty Legs 25c    |
| <input type="checkbox"/> Molding a Mighty Arm 25c              | <input type="checkbox"/> Molding a Mighty Grip 25c  |
| <input type="checkbox"/> Molding a Mighty Back 25c             | <input type="checkbox"/> Molding a Mighty Chest 25c |
| <input type="checkbox"/> Send all 5 C.O.D. (\$1 plus postage.) | No orders less than \$1 sent C.O.D.                 |

NAME . . . . . Age . . . . .  
(Please print plainly. Include Zone Number.)

ADDRESS . . . . .

The great SUCCESS instruction for men and women now in business . . . or planning to get into PRODUCTIVE work . . . The PROFITABLE, EASY, SURE method . . . Get it NOW

# HOW TO MAKE MONEY BY MAIL

ENLARGED to 640 pages, 15th edition

Down-to-earth facts, directions (illustrated) for running business profitably, using expertly for YOUR good fortune the employees, trains, planes which Gov't places at your disposal CHEAP. Get orders by mail, ship by express or freight or mail, get out of the kindergarten . . . 15th edition, enlarged to 640 pages, now selling. It's YOUR winner. Make this year and the following years worth more. . . . . THIS knowledge really PAYS OFF.

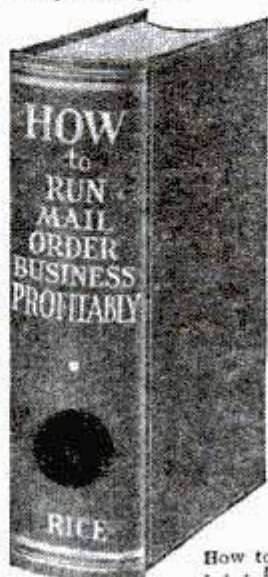

## THE EASY WAY to start new or expand your present occupation. Do it NOW.

Extraordinary plain, simple skill, know-how. No theory. Fact story of rich experience of author E. Rice day-by-day. How many times have we heard: "I wish I had some money, this patent would earn me a fortune," or "why can't my crop pay better?" or "I wish I knew how to sell this gadget myself," or "why should my boss alone do this when I too know how the money is made?" . . . Listen, YOU DO NOT NEED MONEY TO START THIS RICE WAY. His method automatically pays all bills same day rendered, no bank loans, pay as you go, no borrowing from relatives or friends, no salesmen. Also no worry, quickly a home of your own all paid for. Rice paid off \$5000 in mortgages a year after using this skillful idea.

### 46 Years of PROOF

Sounds fishy? Sure, but this has been done steadily for 46 years, depression or no depression, by the author; that is why he wrote this book, to pass the good word along. Make it go with anything you have which is salable, or with what you are now doing. Rice made his pay plan go from the start when living in one room in a city lodging house. Turn your city or country home, your work, your hobby, into money. How to get orders coming steadily at cost of only \$4 for each \$100 taken in. The popular error to avoid in trying for sales. Business won free while others have to pay for it. How to conceive the money-getting advertisement.

Profitable changes from ordinary ideas and methods. Not usual cut-and-dried pattern, 250 adventures, a dictated book in everyday talk by Rice doing day by day what he discloses in his book can be done by his method. No dictionary writing. . . . Read how others are profiting big.

Take a chance on this book being worth a fortune to you and yours and send \$2.95. Book mailed same day order is received. Hundreds of buyers whose letters we show you declare emphatically its superlative goodness. Follow its easy pattern for success. Cloth-bound, 640 pages, 6 1/2 by 5 1/2. Best seller, 15th edition now selling. Cut out the \$2.95 HOW BOX here, pin or stick it to sheet of paper bearing your name and address, mail in envelope with money order or check for \$2.95 to

**HOW**  
640 PAGES  
**\$2.95**

HOWARD ST. HOUSE, Melrose 76d, Massachusetts



## RAISE CHIN-CHINS

No experience needed. Just a few minutes daily and a few feet of backyard, garage or barn space. Several females and a male starts a large, profitable herd. WE FURNISH FREE INSTRUCTIONS. TREMENDOUS DEMAND for breeding and laboratory stock, meat, and world's most beautiful rabbit fur. Brokers, cut off from imported rabbit pelts by world famine. NEED CHIN-CHIN FURS NOW, and for years to come! Write for free illustrated catalog today.

WILLOW BROOK FARM • R-64, SELLERSVILLE, PENNA.



## RAISE TURKEYS THE NEW WAY!

Write for free information explaining how to make up to \$3000.00 in your own back yard. Address: NATIONAL TURKEY INSTITUTE, Dept. 275, Columbus, Kansas



## BIG Income Selling TAILORING

Do you want bigger earnings, a growing business, independence? Here's your opportunity. One of America's finest Made-to-Measure Tailoring Lines now available to a few more capable men.

**NO EXPERIENCE NECESSARY**  
Our men have been making big, steady incomes for years. We give selling helps and big sample line FREE to qualified men.

**Country's Greatest Fabric Selection**  
Sell from hundreds of choice fabrics—popular designs. Each garment hand cut. Union made. Turn the popular demand for tailoring into ready cash. Get started now. Write TODAY!

**FAIRBANKS TAILORING CO.**  
Oakley at Wabansia, Dept. PM 72, Chicago 47, Ill.

GET FREE OUTFIT





He's talking on a **BEAM OF LIGHT!**

**E**VER hear of the Optiphone? It's an ingenious device for telephone communication over a light-beam. The U. S. Army Signal Corps developed and improved it for military use.

With a daytime range of seven miles, the Optiphone has certain advantages over radio. Its path is so narrow that messages are almost wholly safe from interception. At night the beam is made invisible by infra-red filters.

The device has definite possibilities for civilian use, such as short-range communication on construction jobs, and temporary replacement of broken telephone lines during floods or other catastrophes.

New discoveries and inventions are constantly being developed in the peacetime Regular Army. Its research covers almost the whole range of modern science. For intelligent young men, eager to share in advances that will benefit all humanity, there's no finer place to get experience than in the Army. Radar and Electronics, Nuclear Energy, Jet Propulsion and Supersonic Flight are just a

few of the fields which offer promising careers to qualified young men.

There's good pay while learning; food, clothing, shelter and medical care provided; liberal leave, educational and retirement benefits. And on a 3-year enlistment you can *choose* your branch of service among those which have openings, and you'll be among the first chosen for the Army's splendid training schools. Ask for full details at your nearest U. S. Army Recruiting Station.

Listen to "Sound Off," "Warriors of Peace," "Voice of the Army," and "Proudly We Hail," on your radio.

A GOOD JOB FOR YOU  
**U. S. Army**  
 CHOOSE THIS  
 FINE PROFESSION NOW!

**YOUR REGULAR ARMY  
 SERVES THE NATION AND MANKIND  
 IN WAR AND PEACE**



# Learn Estimating AT HOME!



Building Contractors pay big salaries to good estimators! Learn the Tamblyn System of Estimating at Home! No lessons to mail! Extraordinarily simple—no theory—self-teaching! Look over entire course free!

## TAMBLYN SYSTEM

Johnson Building, PM2 • Denver, Colorado

Send Tamblyn System for 10 days free inspection. If satisfied, I will pay you \$5.00 per month until \$30.00 is paid. Otherwise I will return it.

NAME \_\_\_\_\_ AGE \_\_\_\_\_

ADDRESS \_\_\_\_\_

CITY \_\_\_\_\_ ZONE \_\_\_\_\_ STATE \_\_\_\_\_

**SEND NO MONEY • SEE IT FIRST**

**YOUR SKILL**

**DESERVES**

**THIS**

**Engineered Instrument!**

**NEW**

**BRUNING**

## Refillable Draftsman's Pencil

Designed by engineers for engineers and draftsmen, this new Bruning Draftsman's Refillable Pencil is built on an entirely new principle. No metal grip to nick or score leads—new type rubber clutch provides freedom from lead breakage! Pencil holds full length leads from .079" to .070"—including degrees HB to 9H of any popular drafting lead.

**A Fine Tool for Skilled Work**  
Precision built, this pencil is worthy of a place beside your finest drafting instruments! Adjustable cap provides easy identification of degree of leads most commonly used—just turn the cap to indicate degree desired. Knurled grip provides a firm hold, prevents slipping whether pencil is held close to or away from point. The all-plastic barrel is finished in an attractive rust red.

You'll want one or more of these Bruning Refillable Draftsman's Pencils—order now while the supply still lasts at this low price. Just mail the coupon!

**List Price Only \$1.00 Postpaid**

Charles Bruning Co., Inc.  
4722-24 Montrose Avenue  
Chicago 41, Illinois

Gentlemen: Please send me (indicate number of pencils wanted) \_\_\_\_\_ Bruning Draftsman's Refillable Pencils at \$1.00 each. Enclosed is (give amount) \$ \_\_\_\_\_ in payment.

Name \_\_\_\_\_  
Address \_\_\_\_\_  
City \_\_\_\_\_ State \_\_\_\_\_

# Radio Men Needed

## The Finest in Radio Training

Train for well-paid position in Radio Engineering, Television, Electronics. Thorough courses in frequency modulation, math, mechanical drawing, construction, repair, aviation and police systems, sales and service, broadcasting.

**APPROVED FOR VETERANS UNDER GI BILL**  
Low Tuition and Living Costs—Fine Climate—Hunting & Fishing. New Classes Start Each Month. Write  
COL. H. C. WASHBURN, Dept. 5, CLOVIS, NEW MEXICO

# Benson Radio Institute



## MAKE MORE MONEY BE YOUR OWN BOSS!

\$1.00 VALUE

**25¢**

**40,000  
WORDS**

IN TEXT

**MONEY BACK GUARANTEE**

**NATIONAL PLANS COMPANY**  
P.O. Box 26F, Ansonia Station, N.Y.C. 23, N.Y.

In "CASH IN" you now get THE real money-makers—dozens of profitable tested mail order plans, confidential business secrets, dozens of practical tested formulas, successful tested schemes—actual experiences of men who have started on a shoestring—with less than \$10 capital.

25c a copy postpaid. Send U.S. stamps, money order, or coin.

## BE A MANUFACTURER'S AGENT



## INCREASE YOUR INCOME! BE YOUR OWN BOSS!

Learn a business in which profits are limited only by your energy and ability—no heavy overhead cost! Write today for this valuable book. Learn the functions of an agent, how to contact manufacturers, select products and where to get leads on lines available. \$2.00 postpaid.

**VIMAR CO.** 536 H Andrus Bldg.  
Mpls. 2, Minn.

SAY YOU SAW IT IN POPULAR MECHANICS

**GET INTO**

## REFRIGERATION AND AIR-CONDITIONING

Build your future in fast-growing industry. Prepare for high pay jobs or get into your own business. M-2 Resident classes only.

Send ad with name and address for information. VETERANS Eligible for training under G. I. Bill. Check here

**BOSTON TECHNICAL INSTITUTE**  
School of Refrigeration, 4707 Euclid Ave., Cleveland 3, Ohio

# CHAPMAN CHINCHILLAS

The originator of the first Chinchilla Farm in the United States. For information on purchasing the finest, selected breeding stock of these aristocratic animals that were virtually trapped to extinction write or visit—

Established  
1919

**Chapman Chinchilla Farm**  
4957 West 104th Street  
Inglewood, California



## Thrilling Work COLORING PHOTOS

Fascinating vocation learned at home by those with aptitude. Thrilling pastime. National method brings out life-like colors. Free booklet.

**NATIONAL PHOTO COLORING SCHOOL**  
1315 S. Michigan, Dept. 1352, Chicago 5

**SUPER YOUR GREATEST ASSET!**  
**MEMORY** AMAZE... ASTOUND... Friends, Customers, with feats of memory thru the easy-to-study SUPER MEMORY COURSE. Write today. THOR BOOKS, Z-4, Box 1210, Chicago



# Find OPPORTUNITY Where DEMAND is Great!

# AUTO BODY and FENDER REPAIRING



You men who are tired of being rutted in your job should look into a field where demand is huge—and gives every indication of growing even larger! Such a field is **AUTO BODY and FENDER REPAIRING**. As long as there are cars on the road, there'll be dents and bumps to be fixed, body repairs to be made, replacements of worn or damaged parts! The more cars—the more **WORK!**

Millions of old cars are on the road today, with fenders and bodies in great need of repair and refinishing. Thousands are rolling off production lines now. Within a short time they'll be coming into shops for maintenance.

## Here is a Trade that Needs Manpower!

The man with ambition recognizes great opportunity here for lifetime work, either at a dependable job or in his own business. For **AUTO BODY and FENDER REPAIR** is the kind of business which can be started with small capital. And, what's more, **AUTO BODY and FENDER REPAIRING**, as taught by **UEI**, is easy to learn! No previous experience nor high school education is necessary—what's needed is a liking for mechanical work.

## Old Established School Offers Practical Training HOME STUDY AND SHOP PRACTICE

**UEI's** Course in *Auto Body and Fender Repairing* is arranged so you can begin your study in spare time, without interfering with your present job. You learn about auto body repairs and refinishing, body alignment, and many other subjects. Then, when you have completed your home study, you continue your course here in our well-equipped residential school where you receive practical experience in the repairing and refinishing of damaged bodies, tops, doors and fenders, the replacing of door panels and turret tops, use of tools, spray painting, acetylene welding, under personal supervision of capable instructors.

## GET FULL FACTS FREE!

Since 1927, **UEI** has trained thousands of men for new opportunity fields, and students are making good. If **you** want to get ahead, get full facts about **Auto Body & Fender Repairing**, and its opportunities. Don't wait—investigate now. Mail coupon today.

### OTHER U. E. I. TRAINING OPPORTUNITIES

Practical Shop Training after preliminary Home Study.

#### DIESEL

Engine Operation, fuel systems, auxiliary equipment, repairs and maintenance.

#### WELDING

Arc and Acetylene. With fundamentals of metallurgy and supervised welding practice.

#### REFRIGERATION

Servicing and installation for all commercial and domestic types.

#### AIR CONDITIONING

Installation, operation and maintenance of home and industrial equipment.

WRITE FOR FREE INFORMATION

**FILL OUT AND MAIL COUPON**

Founded 1927

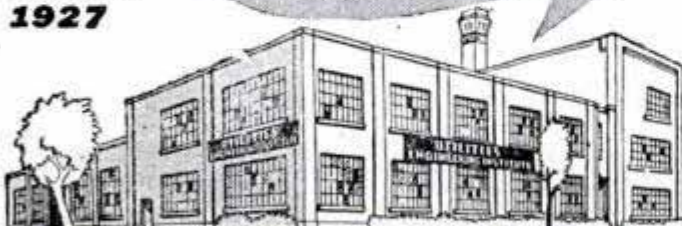

## UTILITIES ENGINEERING INSTITUTE

1314 W. Belden Ave., Dept. 127-X Chicago 14, Ill.

Utilities Engineering Institute, Dept. 127-X  
1314 W. Belden Ave., Chicago 14, Illinois

Yes! Send me the facts FREE about the field checked below.

- Auto Body and Fender  
 Diesel Engine       Refrigeration  
 Welding               Air Conditioning

NAME \_\_\_\_\_ Age \_\_\_\_\_

Address \_\_\_\_\_

City \_\_\_\_\_ ZONE or COUNTY \_\_\_\_\_ State \_\_\_\_\_

- If World War II Veteran give length of service \_\_\_\_\_  
 Check here for special information if you are under 17.



It's YOUR future — Make the most of it!



Start now to earn the bigger pay in electrical repair

WAS there ever such an opportunity to get started in electrical maintenance and repair—and at top-notch wages? Are you ready—with experience and ability—to cash in on it? Others are getting just the sort of background needed—quick! practical!—to handle the great variety of electrical maintenance and repair work TODAY—from this well-known electrical library. You can too!

## THE LIBRARY OF ELECTRICAL MAINTENANCE AND REPAIR

5 vols., 1826 pages, 1724 illustrations

Gives you the "know-how" to tackle any wiring or motor job. Five books show you HOW—to install all types of motor and generator units—to inspect and repair motor starters and generators—to diagnose motor and generator troubles—to figure new windings for old cores—DC and AC windings—to test armature windings—test induction motors, etc., etc. One book is full of trouble-shooting charts that show quickly symptoms, causes, specific remedies, etc.

Take the first step toward improving YOUR future—Mail this coupon TODAY

No money down—special price—easy payments—FREE trial

McGraw-Hill Book Co., 330 W. 42 St., New York 18, N. Y.

Send me for ten days' free examination the Electrical Maintenance and Repair Library. If satisfactory I will send you \$1.50 in 10 days and \$3.00 monthly until the price of \$16.50 is paid. If not wanted I will return books postpaid. (To insure prompt shipment write plainly and fill in all lines.)

Name .....

Home Address .....

City and State .....

Company .....

Position .....

PM 2-47

### SICKNESS or ACCIDENT can't rob me of my savings

I'VE A FAMILY MUTUAL HOSPITALIZATION POLICY

Costs only **3¢** A DAY · EACH ADULT  
1½¢ A DAY · EACH CHILD

- Benefits begin the day you enter a hospital FOR SICKNESS OR ACCIDENT
- Hospital Expenses paid, up to (beginning with the first day) **\$540.00**
  - FOR ACCIDENT
  - Doctor Expense paid, up to **\$135.00**
  - Loss of Wages reimbursed up to **\$300.00**
  - Loss of Life by Accident **\$1000.00**
  - WAR COVERAGE AND EXTRA BENEFITS
  - Childbirth Expense paid, up to **\$75.00**

Sickness or accident can easily wipe out, in a few weeks, savings it may have taken years to accumulate. Don't let this happen to you. With a Family Mutual Hospitalization policy you'll be able to pay your hospital bills. In case of accident, you will be reimbursed for your doctor expenses and for loss of time from work. You may choose any hospital in the United States and your own family doctor may attend you. Benefits applying to children are 50% of those paid adults.

MAIL COUPON TODAY—No Agent Will Bother You

FAMILY MUTUAL LIFE INSURANCE CO., WILMINGTON 99, DEL.

Family Mutual Life Insurance Co. PM-17  
601 Shipley St., Wilmington 99, Del.

Please send me, without obligation, complete information on your Economical Hospitalization Plan.

NAME .....

ADDRESS .....

CITY ..... STATE .....

BE A

# LANDSCAPE ARCHITECT

WORK OUTDOORS



Healthful, pleasant outdoor work in an uncrowded field.

The field of Landscape Gardening offers unusual opportunities for trained men... greatly augmented by the huge home-building and modernizing program ahead. We provide thorough, interesting home-training during your spare time... adapted to your regional conditions.

APPROVED for VETERANS

## BE YOUR OWN BOSS

A graduate says, "I finished the course about two months ago and now I average about \$2.00 per hour net for my time."

There are many employment opportunities in this profitable, uncrowded field or you can easily start your own business. Write today.

Service from Coast to Coast

NATIONAL LANDSCAPE INSTITUTE

DEPARTMENT P-2, 756 SOUTH BROADWAY — LOS ANGELES 14

# BUILD 15 RADIOS

ABSOLUTELY NO KNOWLEDGE OF RADIO NECESSARY YOU NEED NO ADDITIONAL PARTS OR TOOLS

A 36 page book written by expert radio instructors teaches you to build radios in a professional manner. You will start with a 1-tube receiver. Before you are done with this kit you will have built 11 receivers, 1 public address system and 3 transmitters.

The PROGRESSIVE RADIO KIT is the ONLY COMPLETE KIT Contains everything you need: instruction book, metal chassis, tubes, radio parts, soldering iron, pliers and cutters, screwdriver. Postage prepaid with check or M. O. **\$19.75**

PROGRESSIVE ELECTRONICS CO., Dept. 112PM  
22 Havemeyer St., Brooklyn 11, N. Y.

### NURSERY BOOK

Free THE EARL FERRIS 78th ANNIVERSARY BEAUTY EDITION!

Our finest catalog and guide in 78 years, more pages, more lovely colors—and more money-saving offers on FERRIS Northern Grown EVERGREENS, Shade Trees, Ornamentals, Flowers, Shrubs, Bulbs, Fruit Trees, Berry Plants, etc. Write—it's FREE!

EARL FERRIS NURSERY  
390 Bridge St. Hampton, Iowa

### WHY WEAR DIAMONDS

When diamond-dazzling Zircons from the mines of far-away mystic Sam are so effective and inexpensive! Thrilling beauty, stand acid, true backs, full of FIRE! Exquisite mountings. See before you buy. Write for FREE catalog.

National Zircon Co., Dept. 20  
Wheeling, W. Va. **Catalog FREE!**

AGENTS... Be First With Newest Products  
It means quick easy sales and large profits. Our monthly NEW PRODUCTS BULLETIN SERVICE lists 100 NEWEST products, where to buy them, long before they appear on the market. Sample Bulletin \$1.00. FREE information. HURRY—BE FIRST—BEAT COMPETITION.  
EDUCATIONAL BOOK CO., 2907 Berwick Ave., Baltimore 14, Md.

## TRI-STATE COLLEGE

B. S. Degree in 27 months in Engineering (7 branches); Bus. Admin., Acct and Sec. Science. 64th year. School now filled to capacity. No applications can be accepted until further notice.  
427 College Ave., Angola, Ind.

### Radio Parts BARGAIN

Amazing war-surplus radio parts bargain, with new Coils, Condensers, Transformers, Resistors, Controls, others. \$15 to \$25 value. Ideal for experimentors, amateurs, home shop men. Now only \$3.98.

MARKO SUPPLY, Dept. PM-2a, 2924 Logan Blvd., Chicago 47, Ill. **\$3.98 AMAZING VALUE**



# Electricity at your finger ends

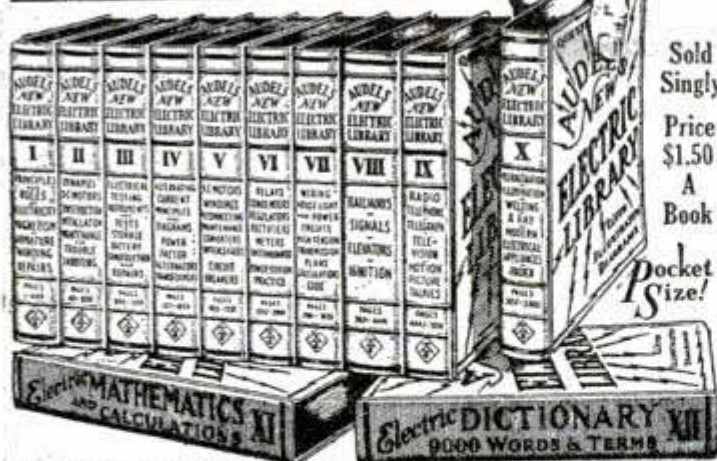

Sold Singly  
Price \$1.50  
A Book  
Pocket Size!

**AUDELS NEW ELECTRIC LIBRARY**—A progressive Home Study and Reference Course in applied electricity. Easy to understand. Questions and answers plainly written for a complete working knowledge of modern electrical practice, necessary to every electrician, engineer, mechanic and student.

**LEARN THE AUDEL WAY!** You ask the question—Audels New Electric Library gives the answer—9500 simplified outlines, graphic illustrations and precise explanations covering Construction, Operation and Machine Maintenance.

**BOOK A MONTH PLAN**—Order the volume that interests you—today! We will send that volume on 7 days' free trial. If the book helps you, send us \$1.50. If it does not help you, mail book back to us. On receipt of your first payment, we will send your second book. We allow 30 days to pay for this and for each following book until you complete the Series.

If you are not satisfied, you may cancel your subscription at any time.

**FREE EXAMINATION COUPON**

Theo. Audel & Co., 49 W. 23rd St., New York City  
Mail Vol. I, Electric Library on 7 days' free trial. If O. K. I will remit \$1.50, otherwise I will return it. I also request you to mail one book each month on same terms. No obligation unless I am satisfied.

Name .....  
Address .....  
Occupation ..... PM

## START NOW TOWARD A FUTURE IN REFRIGERATION and AIR CONDITIONING

Refrigeration and Air Conditioning are among the giant Industries of America. Such industries need men who KNOW. Many men servicing and installing equipment are making large incomes.

### Spare Time Training

If mechanically inclined, get the training you need to qualify for experience installing & servicing Refrigeration and Air Conditioning in stores, offices, homes.

Then you should have no difficulty getting started in these great industries. As experience, tools and a personal following are acquired; you may find it practical, later, to start your own REFRIGERATION and AIR CONDITIONING SHOP.



Approved for training under G. I. Bill

### Practical Interesting Training

You'll like our way of training—through capable home-study instruction followed by practice on actual equipment under watchful eyes of seasoned Refrigeration and Air Conditioning men in our shops. You'll get top-rate instructions—the easy way. So get the facts now—FREE of obligation. Write TODAY—SURE!

**UTILITIES ENGINEERING INSTITUTE**  
1314 W. BELDEN AVE., CHICAGO 14, ILL. Dept. 127  
Please send me the Free FACTS about opportunities in Air Conditioning and Mechanical Refrigeration. I marked the one that interests me most.

Air Conditioning     Mechanical Refrigeration

NAME ..... Age .....  
ADDRESS .....  
CITY ..... Zone ..... STATE .....

# BUSINESS SUCCESS At the Tip of Your Pen!

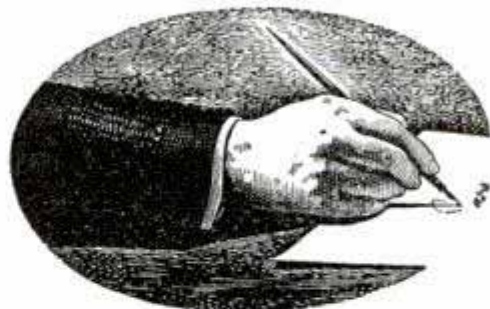

## Send for this Famous FREE Booklet!

"FORGING AHEAD IN BUSINESS" is a stimulating, 64-page booklet which describes the Alexander Hamilton Institute's executive training plan. If you are ambitious and really want to get ahead in the business and industrial world, you will find this one of the most stimulating pieces of literature you have ever read.

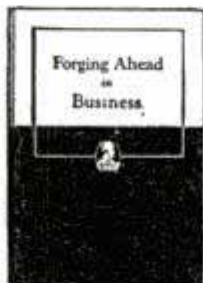

It is mailed to you absolutely FREE! Use the coupon!

**ALEXANDER HAMILTON INSTITUTE**  
Dept. 524, 71 West 23rd Street, New York 10, N. Y.  
In Canada:  
54 Wellington Street, West, Toronto 1, Ont.  
Please mail me, without cost, a copy of the 64-page book—"FORGING AHEAD IN BUSINESS."

Name .....  
Address .....

SAY YOU SAW IT IN POPULAR MECHANICS



## BEAUTIFUL IMPORTED SWISS WATCHES

ONLY \$8.18

- Sweep Second Hand
- Radium Dial
- Shock Resistant
- Unbreakable Crystal
- Plastic Straps

#700 — 7 Jewel watch, sweep second hand; steel back, expansion band. For professional people. A \$20 value at only \$15.95

#900 — Famous "Integra" watch, 15 Jewels, small second hand. Steel back. Water-thin model. Only \$16.50

"CHATON" — Nationally advertised Men's Dress Watch. 15 Jewels; square, Gold-filled case; simulated Diamond Dial; small second hand. Leather straps. Formerly \$36.00, now only \$29.50

Lady's Wrist Watch Jeweled Swiss Movement; radium dial; small second hand; fine chrome plated case, leather straps. A dainty and dependable Dress watch at only \$14.95

ADD 10% FED. TAX ON ALL WATCHES  
Money Back within 5 days if not delighted

Stainless Steel expansion Bands—For Men's only \$5.98. Watches formerly \$1.98 now

Gold-Plated, Expansion Bands formerly \$3.00. Now only \$2.49

Men's or Lady's Expansion Bracelets (as shown), silver-like, stainless steel, non-corrosive, formerly \$6.50, now only \$3.90

Same with Gold-filled top, steel back, formerly \$9.95 now only \$5.95

Send Money Order or Check, we pay postage; or order C.O.D. plus postage. C.O.D. orders U.S. only. No additional charges. Agents wanted. Inquiries invited for export and import orders.

**CEDO SALES SERVICE, 64 W. 36th St., Dept. 102, New York 18, N. Y.**



# DIESEL

## Shop Training

**FREE Illustrated Brochure**

**in a Nationally Known School**

Diesel engines are used in locomotives, ships, trucks, buses, power plants, tractors. Trained men are needed to repair, rebuild, install, maintain, operate equipment. A big field that promises even bigger things in the years right ahead. Get modern shop training on actual equipment under experienced instructors. Practical training makes rapid progress possible. Get benefits of services and training facilities of nationally known school.

### BETTER JOBS—BETTER PAY

Use of Diesels in automotive and railway industries, other widespread uses all indicate Diesel knowledge means more earning power. **LEARN DIESEL UNDER DIRECTION OF MEN WHO TRAINED DIESEL MECHANICS FOR U.S. ARMY.** Mail coupon today.



**Diesel Division, Motive Trades Institute, Dept. F 22, 1400 Greenleaf, Chicago 26, Illinois.**

**FREE—Important Information telling how to get started**  
**CUT OUT COUPON BELOW**



**Fill Out, Cut Out, Mail Today**

**FACTS FREE for Men Who Want to Get Ahead**  
Diesel Division, Motive Trades Institute, Dept. F22  
1400 Greenleaf, Chicago 26, Illinois

Send free illustrated Brochures and other information on modern Diesel training.

Veteran       Non Veteran

Name.....  
Address.....  
City.....  
State.....

## MAKE BIG MONEY— AS A REFRIGERATION SERVICE ENGINEER

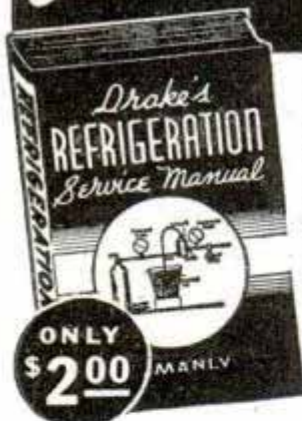

Drake's Refrigeration Service Manual gives you all the information you need. Explains fully all accepted methods of servicing and repairing refrigerators and refrigeration systems of all types, including installation, testing, troubleshooting, adjustment, removal, replacement, and repair. Complete—concise—easy to understand. 317 pages, 148 illust. Only \$2.00 (No. 1 in coupon).

**Also, note these other important Drake books**

- No. 2. Heating, Cooling, and Air Conditioning Handbook. A practical working manual and elementary instruction book fully covering the subject. 700 pages, 64 tables and charts, 350 illust. Only \$4.00.
- No. 3. Plumbing, Installation and Repair. For those with no previous experience or training. Complete and easy to understand. 250 pages, 162 illust. Only \$2.00.
- No. 4. Sheet Metal Workers' Manual. A complete handbook and instruction manual. Pocket size, 522 pages, 375 illust. Only \$3.00.

**Drake's books are sold on a money-back guarantee.**  
**USE THE COUPON . . . MAIL TODAY**

**Frederick J. Drake & Co., Dept. A-3**  
600 W. Van Buren St., Chicago 7, Ill.

Please send me the books checked below. If not satisfied I will return them in 5 days and money will be refunded.

1    2    3    4    (Circle numbers wanted)

Check or money order enclosed \$..... Send books postpaid.  
 Send C. O. D. plus postage.

Name.....

Address.....

City..... State.....

**Drake's Books Are Sold by Leading Booksellers**

1847 A CENTURY OF PUBLISHING 1947  
MERRIAM-WEBSTERS

## The Merriam-Webster Book of Biographies

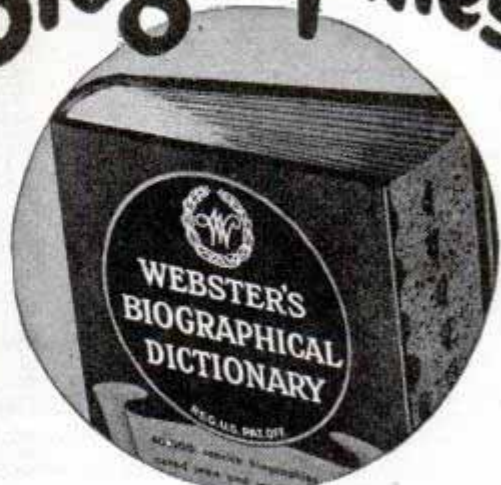

**Essential Facts About 40,000 Noted People**  
**WEBSTER'S BIOGRAPHICAL DICTIONARY** contains more than 40,000 concise biographies, with pronunciation of names and all essential facts. Includes scientists, statesmen, explorers, writers, painters, actors, eminent figures from every other field. Prepared by the expert staff of Webster's New International Dictionary, Second Edition. Valuable to writers, speakers, readers. 1,736 pages, thumb index. \$7.50. At your bookdealer, or from G. & C. MERRIAM Co., 652 Federal St., Springfield 2, Mass.

## ELECTRICIANS

Get this Great Book **FREE**

Book of 150 Shop Prints, Wiring Diagrams, Full Size 8 1/2" x 11"



For Merely Examining Coyne's NEW Pay Raising

## 7 Volume Set APPLIED ELECTRICITY

Here's a brand new set of electrical books to give you the "know how" on all branches of electricity from appliance repairing to D. C. and A. C. equipment, electrical refrigeration, etc. 3,000 subjects, 10,000 facts, latest methods all explained in easy to follow instructions. In order to prove how valuable and Practical this set of electrical books is I'm willing to give you a FREE copy of my book "150 Shop Prints and How to Read Them" just for looking over this set. Written by the Coyne Technical Staff and backed by 47 years' experience, this set has helped many ambitious electrical workers to bigger pay, better jobs & added opportunity.

**OFFER LIMITED • ACT NOW!** Here's my offer to you—if you act promptly, I'll send you the 7 volume set Applied Practical Electricity for 7 days FREE examination . . . together with the 150 Shop Print Book. Look the set over 7 days. If you like it send either \$19.75 cash or send \$3.00 after 7 days and \$3.00 per month until \$21 is paid. If you don't want the set, return it and YOU OWE NOTHING. In either event, however, you keep the 150 Shop Print Book absolutely FREE.

**SEND NO MONEY!** Coupon below is just a request to see the books free and to get my gift book for doing it. **ACT—Send coupon Today!** Technical Book Div., COYNE ELECTRICAL SCHOOL, 500 S. Paulina Street, Dept. 27-R6, Chicago 12, Ill.

**FREE BOOK Coupon**



**COYNE ELECTRICAL SCHOOL, Dept. 27-R6,**  
500 SOUTH PAULINA STREET, CHICAGO 12, ILLINOIS

Send me that 7 volume set APPLIED PRACTICAL ELECTRICITY and your FREE gift of a copy of "150 Shop Prints and How to Read Them". I'll either return the set in 7 days and owe nothing or send you either \$3 in 7 days and \$3 a month until \$21 is paid or \$19.75 cash. Regardless of whether or not I keep the 7 Volume Set the 150 Shop Prints is mine FREE as a Gift.

NAME..... AGE.....  
ADDRESS.....  
TOWN..... ZONE..... STATE.....



# Learn RADIO TELEVISION ELECTRONICS

I'LL TRAIN YOU AT HOME IN YOUR SPARE TIME

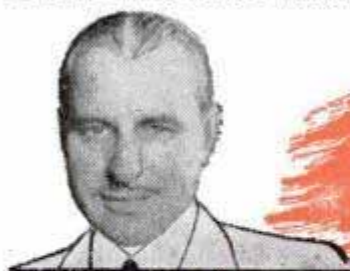

For a Good Pay Job or  
A BUSINESS OF YOUR OWN!

## My Proven 2-Way Method Helps You Get into Radio *Quicker!*

### HERE'S PROOF OF THE QUALITY OF H.R.T.I. TRAINING

1st, 2nd and 4th Prizes Won by  
H. R. T. I. Students In Open Contest

With over 250 students and graduates from many Radio schools, as well as experienced radio men, competing to find the best Radio Technicians in Cuba . . . 7 out of the first 10 prizes were won by H.R.T.I. Graduates! These **PROVEN RESULTS** speak for themselves! You can't afford to gamble with your future. Choose the Radio School with the success record . . . H.R.T.I.

#### WHAT WINNER OF FIRST PRIZE SAYS:



"Your training methods are so practical, and so clear, that no one should have difficulty in learning. I found everything so easy that it makes me feel that anyone who takes your course can be sure of success."

LUIS ILLADA, Havana, Cuba

#### WHAT SECOND PRIZE WINNER SAYS:

"I am very happy about my success, but it is to you and the H.R.T.I. staff that I owe my success. I am deeply grateful to H.R.T.I. for I have received all and MORE than you promised when I enrolled."



ALFREDO RODRIGUEZ, Oriente, Cuba

#### WHAT WINNER OF FOURTH PRIZE SAYS:

"The 1st, 2nd and 4th prizes were won by H.R.T.I. students! This shows that H.R.T.I. is one of the best schools! Over 250 radio technicians competed. Among them were real experts of established radio shops as well as students of nearly every known school. You will notice, from the enclosed newspaper, that the 4th prize was won by me, and I owe it all to your easy method of teaching."

GODFREDO REYES, Oriente, Cuba

Find out about the money-making opportunities Radio offers you. Learn how you can qualify for a good-pay job or start a business of your own *without capital*. Send below coupon for my big FREE book, "Your Opportunities in Radio & Television," which tells of radio's vast opportunities and how **HOLLYWOOD RADIO & TELEVISION INSTITUTE** has been training men for success in Radio for over 17 years, in over 40 different countries, through its proven **2-WAY METHOD—LESSONS PLUS HOME SHOP PRACTICE!**

#### YOU PERFORM OVER 300 RADIO TESTS AND EXPERIMENTS

I send you 9 kits of radio parts with which you make hundreds of interesting,

fascinating tests and experiments. You learn the "whys and hows" of radio *first hand, by doing*. Thus, you learn *more thoroughly, faster!*

#### MANY H.R.T.I. STUDENTS EARN MONEY IN SPARE TIME WHILE LEARNING

From the very start, through special "Spare Time Work Sheets," I show you how to earn money in spare time by doing good-pay radio jobs that abound in nearly every neighborhood. Many students earn \$5, \$10, and more a week while learning. A mighty good way to lay the foundation for a future radio business of *your own*.

Now is the time to start preparing for **YOUR** career in this fast-growing industry. Take the first step—send coupon for my big FREE Book today.

### YOU GET 9 KITS OF RADIO PARTS WITH WHICH YOU PERFORM OVER 300 EXPERIMENTS



Left: You build this transformer coupled audio stage. (Experiment No. 260)



Above: You build this tuned radio stage, regenerative detector and audio amplifier. (Experiment No. 329)



Left: You build this Multi-purpose Shop Test Panel. 5 Test instruments in one.



Left: You build this A. C. Power Supply.

#### YOU LEARN BY DOING

You build these and many other radio circuits and testers with the 9 kits I send you, to help you learn faster, more thoroughly. All kits become your property.



C. H. Mansfield, President, Dept. A1  
Hollywood Radio & Television Institute  
810 West 6th St., Los Angeles 14, Calif.

Send me your FREE book, "Your Opportunities in Radio, Television & Electronics" which explains your 2-way training method. (No salesman will call)

Name \_\_\_\_\_ Age \_\_\_\_\_

Address \_\_\_\_\_

City \_\_\_\_\_ Zone \_\_\_\_\_ State \_\_\_\_\_

**DON'T PUT IT OFF, MAIL THIS COUPON AT ONCE!**

## BIG FREE BOOK

### HOLLYWOOD IS A WORLD CENTER

of radio broadcasting and manufacture—television—motion picture production. Thus, H.R.T.I. is in an excellent location to bring you modern, up-to-the-minute instruction.

Before you decide on any course you owe it to your future to find out about H.R.T.I. training. Read what graduates in 40 different countries say about this famous course. Just paste coupon on a postcard or send in envelope. No salesman will call.

HOLLYWOOD RADIO & TELEVISION INSTITUTE  
810 West 6th Street, Los Angeles 14, California



# How to Write

For Extra Income or Full Time Career,  
Learn At Home To Write Articles,  
Mysteries, Short Stories



**Beginner Credits Success  
to Palmer**

"I had never written a single line before starting your course. Today I am unable to write fast enough to keep up with sales, all of which is entirely due to your coaching." Hugh G. Jarman, Montreal.

## Big New Opportunities Now

The public's new interest in technical, mechanical subjects offers big new opportunities for scientific minded writers who are trained to make dry facts interesting and exciting.

You don't have to be a great writer to make good money—using experiences of your own, of friends—or just your imagination. Many beginners start earning early in their training, selling short stories, articles of all kinds, which bring in small but welcome checks of \$25, \$50, \$100 and more. Such material may be turned out quickly once you acquire the proper technique. And now it's easier to learn than you may imagine, through Palmer's unique method of training—for NOT just one field of writing, but for all: Fiction, Article, Radio.

## You Learn To Write By Writing

You receive individual coaching by professional writers who go over your writing, giving you helpful suggestions and showing you how to correct weaknesses, how to capitalize on your good points. Thus your own individual writing style is carefully developed. Study fast or slow. Save time and effort. To find how you too may make money writing—part time or full time—send today for FREE illustrated book. Palmer Institute of Authorship (since 1917), 6362 Hollywood Blvd., Hollywood 28, Calif. Desk T13.

## FREE BOOK

**PALMER INSTITUTE OF AUTHORSHIP** Since 1917  
6362 Hollywood Blvd., Desk T13, Hollywood 28, Calif.

Please send me free illustrated book "The Art of Writing Salable Stories," explaining how your training helps new writers get started. This is confidential. No salesman will call.

Mr. \_\_\_\_\_  
Mrs. \_\_\_\_\_  
Miss \_\_\_\_\_  
Address \_\_\_\_\_  
City \_\_\_\_\_ Zone \_\_\_\_\_ State \_\_\_\_\_

## Play in One Hour by Ear and Note



**NEWLY INVENTED  
SLIDE-CHORD DEVICE**

Fits piano. Play any chord at once. Plink out tunes by ear and note and add chords to play beautiful 2-hand professional radio style at one sitting. Fun! A game! No exercise or drills. Startle your friends! **PLAY 27 COMPLETE SONGS WITH 4 CHORDS (SEND NO MONEY) (JUST 1c CARD)**. 25 lessons ABC METHOD, including many POPULAR SONGS and SLIDE-CHORD DEVICE ALL for \$2 plus C. O. D. Save C. O. D. Send \$2 cash, check, money order. **MONEY BACK GUARANTEE.**

**DALE SHEARS SCHOOL OF MUSIC**

Studio 4203 Struthers 3, Ohio

## HOME STUDY OR SHOP TRAINING

Learn Plastics, Refrigeration or Diesel. Study at home, shop work later. Also shop courses in Body and Fender, Machine Shop, Tool and Die. 41,000 graduates. Established 1902. Free booklet. Specify trade.  
**GREER SHOP TRAINING**, Dept. 127, 460 S. State St., Chicago

## FENCING HEALTHFUL SPORT

Keep fit and enjoy the exciting pastime of swordsmanship with our two 3 ft. Spring Steel Foils (swords) Safety Rubber buttons, hand guards and our Free Instruction manual—all available now for only \$1.98 payable by

CHECK or M. O. Add 28c for Foreign Postage.  
**LEE PRODUCTS, Dept. 23, 1613 First Ave., N.Y. 28, N.Y.**



## MAKE MONEY CASTING AT HOME FREE FACTS SENT



Cast thousands of perfect Plaques, Book Ends, Ash Trays, Etc. Plaster, Liquid Marble, Etc. **ENORMOUS PROFITS.** Start in basement or garage. **LITTLE CAPITAL NEEDED. QUICK, EASY, NO PREVIOUS EXPERIENCE NEEDED.** Rubber molds for speed production. **MAKE YOUR OWN. SAMPLE KIT \$1.00.**  
Plastic Arts Studio, Route 5, Dept. 29, Muncie, Ind.



## 48 PLANS

**\$100**

48 complete plans of toys, ash trays, garden ornaments, Dutch boys and girls, what-not shelves, and many other interesting projects. Finest selection available. Novel method allows you to make finished project any size desired. **PLUS FREE De-Luxe Plan of corner shelves.** Send only \$1 to  
Jackson, Dept. 1-5440 N. Shoreland Ave., Milwaukee 11, Wis.

## Learn CARTOONING



**HAVE FUN! MAKE MONEY!** Cash in on your sense of humor at HOME—BY MAIL. No experience needed to start. Write today for **FREE TRIAL LESSON** and full particulars.  
Moon Gag Cartoon School, Dept. P, Fall Creek, Wis.

## ● Earn HIGH SCHOOL DIPLOMA at Home ●

Guided study permits you to complete High School education in shortest possible time. Modern methods make it interesting, easier. Prepare for better jobs, pre-professional, college entrance exams. Recognition for H.S. credits already earned. Books supplied, low tuition, easy terms. Write for **FREE** information.  
**HOME STUDY INSTITUTE**, Dept. 12, 209 Vine Ave., Park Ridge, Illinois

## MIDGET AUTO RACING BOOK \$1.10



**45 FOTOS, History 1946 Calif. Racing, \$1.10. 1946 Indianapolis "500" Race Book, \$1.00. Mercedes-Benz book, \$2.00.** See our ad (Autos) Classified Section. Catalog free.  
CLYMER, Dept. A 2, 2125 W. Pico, Los Angeles 6, Calif.

## SAY YOU SAW IT IN POPULAR MECHANICS

# Get into ELECTRICITY Now! MODERN SHOP TRAINING

**START NOW — BE READY IN FEW WEEKS  
FOR BIGGER JOB OPPORTUNITIES  
LEARN ON ACTUAL EQUIPMENT  
IN NATIONALLY KNOWN SCHOOL**

Get ready for good job or business of your own. Electricity is the heart of modern industry. Electricians are always needed, earn higher pay, work year around. Make rapid progress in step-by-step practical shop training in Electrical Wiring and Circuits; Armature Winding; Electrical Appliance Repairs; Electro Plating and Welding. Rural Electrification, the Building Boom, many new uses of Electricity opening more opportunities in this vast field. Get training under thoroughly experienced instructors, be ready in few short weeks for Job Opportunities in Electricity.



**VETERANS** qualifying under "G.I. Bill" have tuition paid by Government plus monthly subsistence allowance while in school. Just mail coupon, we will handle all details. **LOW TUITION. EASY TERMS** if you are not a veteran.)  
**ELECTRICAL DIVISION  
COMMERCIAL TRADES INSTITUTE**, Dept. C22  
6312 N. Broadway, Chicago 40, Ill.  
**FREE** — Important Information Telling How to Get Started

## Fill Out, Cut Out, Mail Today

**FACTS FREE for Men Who Want to Get Ahead**  
**COMMERCIAL TRADES INSTITUTE**, Dept. C22  
6312 N. Broadway, Chicago 40, Ill.  
Send free illustrated Brochures and other information about your training in Electricity.  
 Veteran  Non Veteran

Name .....

Address .....

City ..... State .....



# TRAVEL On "Uncle Sam's" Payroll



## RAILWAY POSTAL CLERKS COMMENCE \$2300 YEAR

MANY U. S. GOVERNMENT JOBS  
AVAILABLE TO MEN—WOMEN 18 TO 50  
VETERANS GET SPECIAL PREFERENCE

**POST OFFICE CLERKS**    **CUSTOMS PATROL INSPECTORS**  
**CITY MAIL CARRIERS**    **MEAT INSPECTORS**  
**RURAL CARRIERS**        **ZONE DEPUTY COLLECTORS**

These are relatively secure positions. Strikes, poor business conditions, lockouts, or politics affect them less than the ordinary job. U. S. Government employees get their pay for full twelve months each year.

### RAILWAY POSTAL CLERKS

Railway Postal Clerks now get \$2300 the first year regular, being paid on the first and fifteenth of each month, \$95.84 each pay day. Their pay is increased annually, the maximum being \$3600 a year, \$150.00 each payday. They get extra allowance for hotel expenses when away from home.

### PAID VACATIONS

Railway Postal Clerks, like all Government employees, are given a yearly vacation of 15 working days (about 18 days). On runs they usually work three days and have three days off duty or in the same proportion. During this off duty and vacation, their pay continues just as though they were working. When they grow old, they are retired with a pension. As Railway Postal Clerks are continually traveling, they have an excellent chance to see the country.



## GOVERNMENT JOBS!

### CITY MAIL CARRIERS — POST OFFICE CLERKS

Clerks and Carriers commence at \$2100 a year and automatically increase \$100 a year to \$3100. They also have 15 days vacation. Men—Women 18 to 50 are eligible.

### CLERKS IN WASHINGTON

(Open to men or women 18 to 53)  
Salary \$1756 and \$1954 to \$3397 a year. Pleasant clerical work in the departments and offices at Washington, D. C. and throughout the country.

### WHAT WILL YOU EARN FIVE YEARS FROM NOW?

Compare these conditions with your present or your prospective condition, perhaps changing positions frequently, kicking around from post to pillar, no chance in sight for secure employment, frequently out of a position and the year's average salary very low. DO YOU EARN \$2300 EVERY YEAR? Have YOU ANY ASSURANCE THAT A FEW YEARS FROM NOW YOU WILL GET \$3100 OR MORE A YEAR — EVERY YEAR?

Rush to me entirely free of charge (1) a full description of the position checked below; (2) Free copy of illustrated 32-page book, "How To Get A U. S. Government Job"; (3) Tell me how to prepare for the position checked.

Railway Postal Clerk.....	(\$2300-\$3300)
Post Office Clerk.....	(\$2100-\$3100)
City Mail Carrier.....	(\$2100-\$3100)
Rural Mail Carrier.....	(\$2569)
Clerk.....	(\$1954)
Patrol Inspector.....	(\$3021)
Zone Deputy Collector.....	(\$2644)

**FRANKLIN INSTITUTE**  
Dept. E86  
ROCHESTER 4, N. Y.



### GET FREE LIST OF POSITIONS

Fill out the coupon. Tear it off and mail it today—now, at once. DO IT NOW—This investment of three cents for a postage stamp may result in your getting a U. S. Government Job.

Name \_\_\_\_\_

Address \_\_\_\_\_

Vet? \_\_\_\_\_

Use This Coupon Before You Mislaid It — Write or Print Plainly



FIND OUT WHY THE  
**DEAF**  
CALL IT A MIRACLE

THIS ONE  
TINY UNIT  
IS ALL  
YOU  
WEAR



About 1/3 size  
and weight of old-  
style hearing aids

You'd call this new Beltone Mono-Pac Hearing Aid a miracle, too, if you had been wearing a clumsy, annoying, battery pack strapped to your body with entangling wires, and then suddenly found the new Electronic Beltone. It's a single-unit hearing aid—so small you can hide it with the palm of your hand—so light you forget you are wearing it—so thin it is lost from sight—so efficient you bless the day you learned about it.

Those are a few of the reasons why more people are wearing Beltones than all other one-unit hearing aids combined.

GET FREE BOOK ABOUT HEARING PROBLEMS  
and about the

NEW  
**Beltone**  
MONO-PAC  
HEARING AID



FREE BOOK—MAIL COUPON

BELTONE HEARING AID CO., Dept. PM-72  
1450 West 19th Street, Chicago 8, Illinois

Please send me, without obligation, FREE information concerning the new Beltone with the amazing X-Cell which out-performs units 5 times its size.

Name.....

Address.....

Town..... Zone..... State.....

LEARN PIANO AT HOME WITH *Special*



**AMAZING!** SO FAST! SO SIMPLE!  
SO PRACTICAL!

With RECORDS it's Thrilling How Quickly and Easily you LEARN to play popular tunes, semi-classic, boogie woogie, western songs, hymns, most anything. You HEAR a gifted piano teacher right beside you . . . on records which never tire. Thru Records he repeats any portion of lessons, often as you wish. Set your own pace. Prints and pictures show you how. Then Tracy Teachers on records help you. No "ear" or number systems. No tiresome exercises. First lesson starts you reading real notes, playing actual pieces with both hands. This is the world's ONLY piano course with RECORDED lessons . . . yet costs no more! In ten days you play better than you dreamed possible in so short a time . . . or money back! Stop wishing! Write us today. **SEND NO MONEY—Mail coupon for full information kit! Act now. TRACY INSTITUTE OF MUSIC, Dept. P-1, 54 Holmehurst Ave., Baltimore 28, Md.**

MAIL COUPON TODAY  
TRACY INSTITUTE OF MUSIC, Dept. P-1, 54 Holmehurst Ave., Baltimore 28, Md.  
Please send me Free Full Information Kit showing how I can learn to play piano with print and picture lessons plus Records.

Name.....

Street.....

City..... State.....

SAY YOU SAW IT IN POPULAR MECHANICS



**LANGUAGE IS POWER**

... Forge ahead, win special assignments, promotion, better job in global peace time opportunities through ability to speak a foreign language.

MASTER A NEW LANGUAGE  
quickly, easily, correctly by

**LINGUAPHONE**

The world-famous Linguaphone Conversational Method brings voices of native teachers INTO YOUR OWN HOME. You learn the new language by LISTENING. It's amazingly simple; thousands have succeeded.

HOME-STUDY COURSES IN 29 LANGUAGES

Send for FREE book—

**LINGUAPHONE INSTITUTE**

98 RCA Building, New York 20, N.Y. • Circle 7-0830

Available under

GI BILL OF RIGHTS

Send for Information

State of GI

LINGUAPHONE INSTITUTE,

98 RCA Bldg., New York 20, N.Y.

Send me the FREE Linguaphone Book.

Name.....

Address..... City.....

Language Interested.....



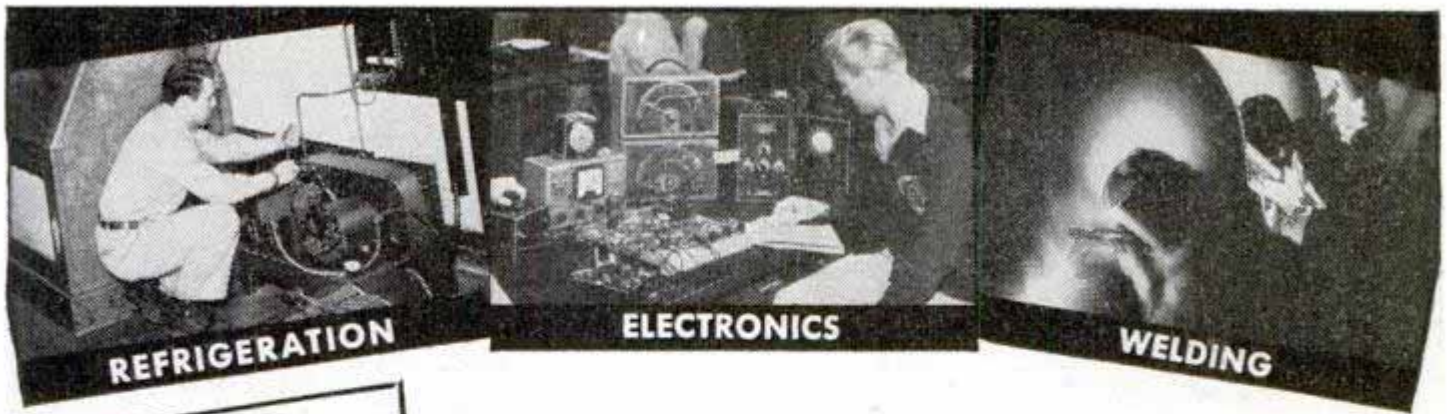

**REFRIGERATION**

**ELECTRONICS**

**WELDING**

Specialize in  
6 months to 3 years  
**COURSES**

**SERVICE—6 months**  
Practical Electricity  
Practical Welding  
Refrigeration Service  
Heating Service

**TECHNICIAN—1 Year**  
Electro Technician  
Radio Technician  
Electronics Technician  
Refrigeration, Heating  
and Air Conditioning  
Technician

**PROFESSIONAL—3 Years**  
Electrical Engineering  
B. S. Degree—Major in  
Machinery or Electronics

## PRACTICAL TECHNICAL TRAINING

Our time-tested **CONCENTRIC SYSTEM** enables you to build your career step by step. Each 6-month course is complete in itself. Stay as long as circumstances permit—until you reach your desired occupational objective. For 44 years this school has specialized in technical training. More than 35,000 former students in industries the world over. 1,248 students now enrolled from 46 states and 5 foreign countries. Faculty of 63 specialists. World-wide alumni counselor committee. *Terms start April, July, September.* **SEND COUPON TODAY!**

## MILWAUKEE SCHOOL OF ENGINEERING

A Technical Institute

Milwaukee School of Engineering, Dept. PM-247  
N. Broadway and E. State, Milwaukee, Wis.

Without obligation, send me free booklet "Career Building" and more details on course in .....

Name ..... Age .....  
Address .....  
City ..... State .....

 **GRASP THIS OPPORTUNITY**  
TO TRAIN YOURSELF  
FOR A WELL PAID JOB IN **ELECTRICITY**



This large, four-story building completely equipped with first class electrical equipment for *on-the-job, up-to-the-minute* methods of training in Armature and Motor Winding, Factory Wiring, House Wiring, Electrical Maintenance, Appliance Repair. Entire building—4 floors devoted exclusively to this one course. No crowding, plenty of space and light. Well staffed with instructors to give individual attention to students. Living quarters arranged for if desired.

*Pay after you graduate . . .* Lack of money need not hold you back. We will finance your training. After you graduate you can pay us back in small monthly payments.

## VETERANS!!!

School approved for training under the GI Bill. Take this course at no cost to you, and receive \$65 to \$90 per month while training. Complete details furnished.

—MAIL COUPON TODAY—

MICHIGAN TECHNICAL INSTITUTE, Dept. P-2  
2281 W. Fort St., Detroit 16, Michigan

- Please send me literature about your training.  
 I am a G.I.

NAME .....

ADDRESS .....

CITY ..... STATE .....

**MAIL COUPON today**





## **JUDGE BROWN'S CAR** ~~was~~ **must be ready at nine!**

Judge Brown is a fine man and I sure wanted to help him out.

But his old car, with 87,000 miles on it, had certainly seen better days. For one thing, she was really pumping oil.

He said, "Now, Frank, I've just got to have it Wednesday morning for a case in Kirby."

Boy, I really slaved over that car. Pulled the motor down, ground the valves, put in a set of Perfect Circle Piston Rings, new gaskets, and other things she'd needed for a long time.

Then I "sewed her up," so to

speak. I certainly felt as though I'd just performed a major operation —and I had!

Well, the way that car ran was a pleasant surprise to the judge. He should have brought it in long before he did and saved himself a lot of needless trouble and expense.

Anyway, that's my job. They call me a Doctor of Motors . . . and I guess I am.

### **NOTICE TO CAR OWNERS**

Perfect Circles are available at every automotive repair shop. Your favorite mechanic—your Doctor of Motors—recommends them.

THE PERFECT CIRCLE COMPANIES, HAGERSTOWN, IND., and TORONTO, ONT.

Your Doctor of Motors  
restores power . . . saves gas  
. . . saves oil with . . .

**PERFECT  
CIRCLE** PISTON  
RINGS



WRITTEN SO YOU CAN UNDERSTAND IT  
VOL. 87 NO. 2

**PART I**

**H**AVING lifted a tentative, probing finger above his head, man is preparing to spread his arms and explore farther into the space that surrounds his earth.

Today he is sending instruments 100 miles up into the electrified void that exists above him. He is creating his own meteors that streak through the upper air, and in the laboratory he has duplicated small wisps of the mysterious auroras that glow high above the poles.

He has snapped pictures of his own planet from 65 miles high and is wondering how soon he'll be able to obtain a moon's-eye view of half the earth on one negative. He plans to launch small satellite bodies out beyond his own atmosphere to revolve around the earth forever, and to fire rockets at the moon. He is even studying the navigation problems that must be solved if and when space ships are directed at other planets of the solar system.

These are some of the highlights of numerous kindred research programs that are under way. The whole subject of upper air investigation received a tremendous boost when German V-2 rockets became available for peaceful scientific

Technicians prepare a towering V-2 for flight to help solve mysteries of the upper atmosphere

# LABORATORY IN SPACE

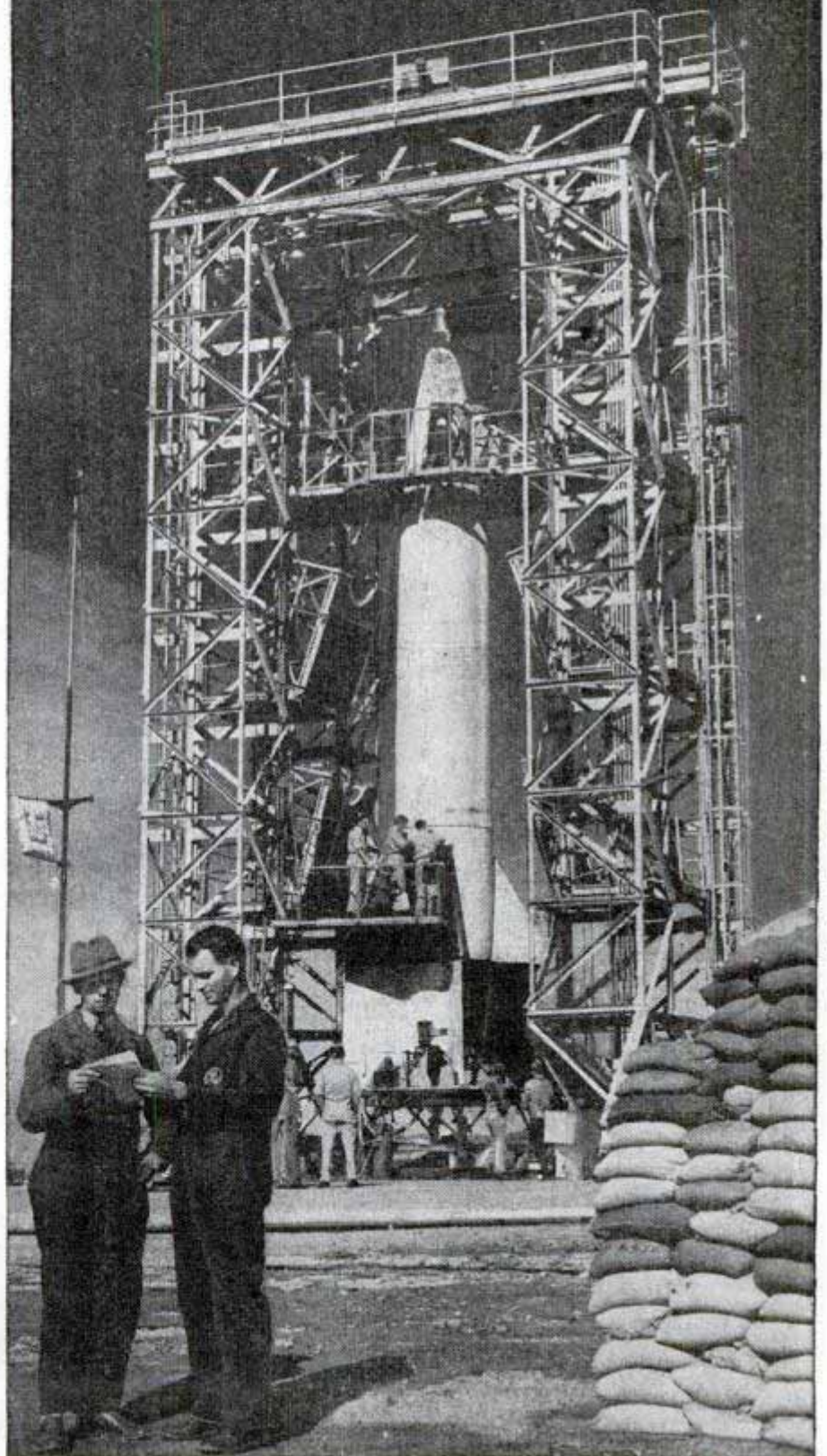



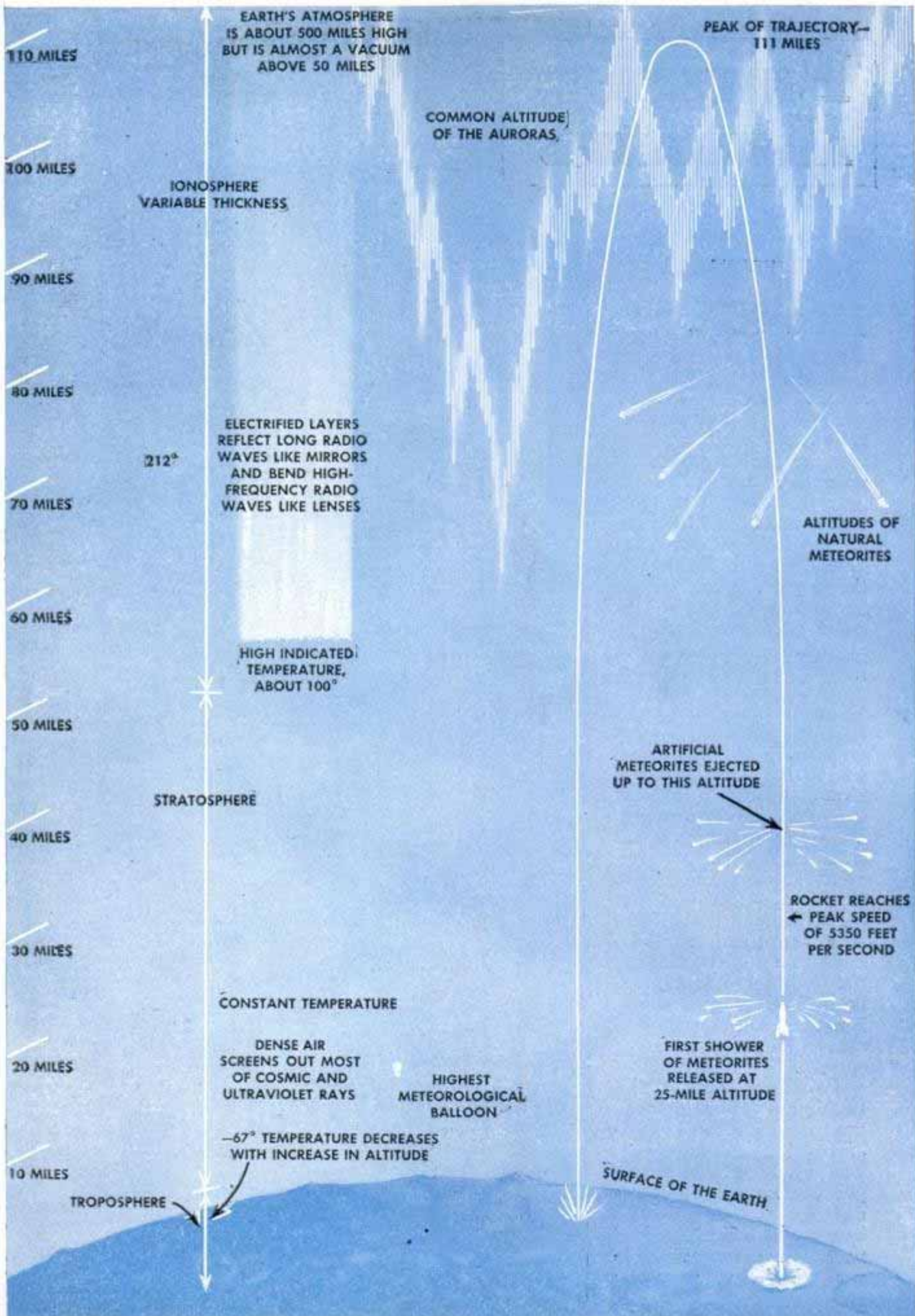

**TRAJECTORY OF THE RECORD-BREAKING ROCKET FIRED DECEMBER 17, 1946**



purposes. These for the first time provide man with vehicles that can rise high enough through the atmosphere to supply the answers to many perplexing questions.

Among other things, rockets that travel to the outer reaches of the atmosphere can carry instruments that will report on the nature of primary cosmic radiation and similar rays that sweep interstellar space. Ultraviolet and other wave lengths of light that are blocked by the atmosphere can be used in studying spectra of the sun and stars.

This year, at White Sands Proving Ground, N. Mex., the Army is firing about half of a total of 50 V-2s that are to be expended for scientific studies. The warheads are "farmed out" to research groups including the Naval Research Laboratory, Johns Hopkins University, Princeton University, the University of Michigan and California Institute of Technology. Specially and sturdily built, the warheads are crammed with instruments and radio reporting equipment.

In one spectacular series of experiments with the V-2s, swarms of artificial meteors are released at altitudes of 25 to 40 miles. First proposed by Dr. Fritz Zwicky of Cal Tech and Aerojet Engineering, the experiments may affect much of what is believed about the physical characteristics and chemical composition of the upper air.

The earth-launched meteorites are smaller than you might suppose. Of various predetermined materials such as steel, graphite or glass, most of them are about the size of a dime. Embedded in so-called "hollow charges" of a high explosive material that burns furiously when ignited, the slugs are spewed out horizontally from the body of the rocket. Their initial velocities are in excess of 2000 miles per hour. Twin showers are ejected simultaneously from opposite sides of the rocket to avoid any chance of disturbing the vehicle's flight.

Astronomical telescopic cameras with interrupting shutters are stationed within a 200-mile radius of White

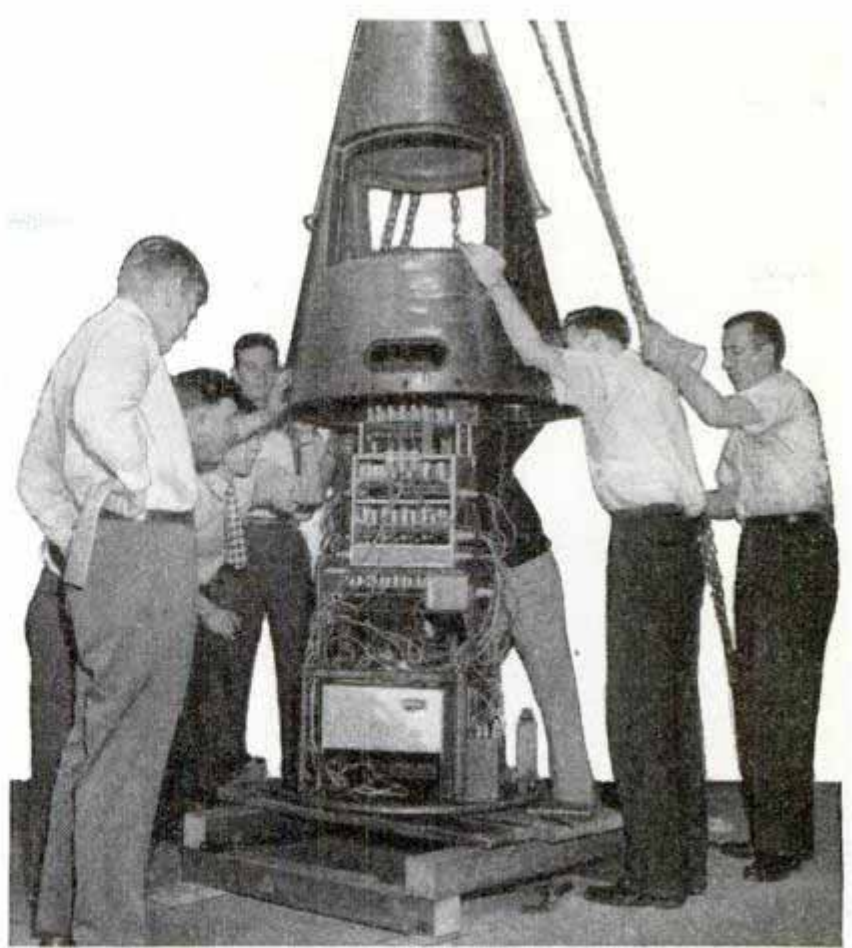

Warhead with hatch for ejection of meteorites is lowered over assembled scientific instruments including Geiger counters and recorders

Sands to photograph the meteor trails. Other pictures are taken by telescopes at MacDonald Observatory in Texas, at observatories in Flagstaff and Tucson, Arizona, and at the Palomar Observatory in California. Spectrographic observations of the meteor paths are to be made. Radar records of any ionization trails will be attempted.

The first experiment in tracing the artificial meteorites was made December 17,

Diagram shows interior arrangement of the instruments. Note the TNT charges that blow the warhead free of the rocket during the descent

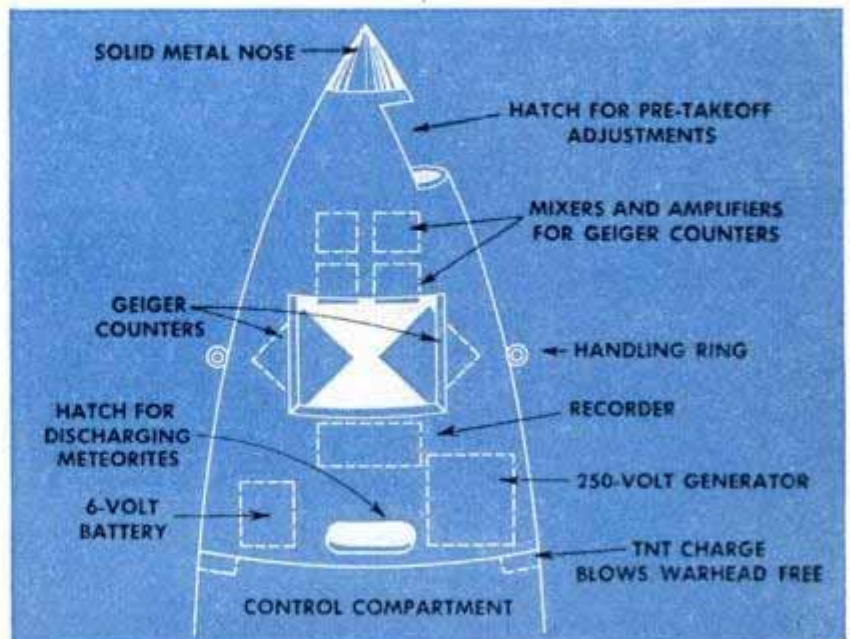





Cutaway V-2 motor shows double skin in which the fuel is preheated before entering the blast chamber

1946. Observers saw either the showers of slugs or flashes from the rifle grenades in which they were encased. Scientists hope that future experiments will prove even more successful, as the meteorites are calculated to produce a luminosity comparable to that of Venus when viewed directly from below. The December 17 rocket also was successful in setting a new altitude and speed record, soaring 111 miles into the air and reaching a speed of 5350 feet per second.

Some of the artificial meteorites that are created during the experiments may travel in just the right direction and with suffi-

Artificial meteors in rifle grenade cases are inserted in the warhead



cient velocity to take up orbits around the earth instead of falling into the lower atmosphere where they are consumed by friction. Under the right circumstances some of these might circle the earth in from 60 to 80 minutes, Dr. Zwicky believes.

A very few of the fastest particles may have enough speed to escape entirely from the earth's gravitational field, never to return. These would be the first missiles launched from the earth to reach interplanetary space. Systematic attempts to do just that are planned for later dates.

"In searching for the key to space travel," Dr. Zwicky says, "we first throw a little something into the skies, then a little more, then a shipload of instruments—and then ourselves."

The artificial meteorite program as viewed by Dr. Zwicky may require from 10 to 15 years to complete. Larger and still larger bodies will be launched from rockets as the program matures. When the supply of V-2 rockets is exhausted the meteorites may be launched from new high-performance rockets of the step type. A mother rocket, fired to a high altitude, at the peak of its flight releases a smaller rocket that ascends even higher.

In another recent experiment a camera installed in the rocket's fuselage instead of the warhead took a continuous motion picture of the earth's surface at altitudes from 100 feet to 65 miles. The film was made as part of an experiment to learn the roll and pitch of the missile—information required for interpretation of cosmic ray and spectrographic data. But prints of the film stole the show from the data itself.

Immediately after the rocket was launched the 50-foot film started recording the flight. The V-2 reached the 65-mile height in three minutes and the camera

continued to operate during the descent until the missile was 45 miles above the earth. After passing the peak of its trajectory, the rocket tumbled several times, giving the camera a telescopic glimpse of the horizon. At one point the horizon was theoretically 720 miles away and the camera saw 40,000 square miles of area. If there had been an observer in the rocket who could look in all directions he would have seen San Diego, Salt Lake City, Kansas City and San Antonio, or about 1,600,000 square miles of the earth's surface.

When the warhead containing scientific instruments was severed by an explosive





Photo taken soon after the rocket started its ascent looks much like an aerial photo taken from a plane

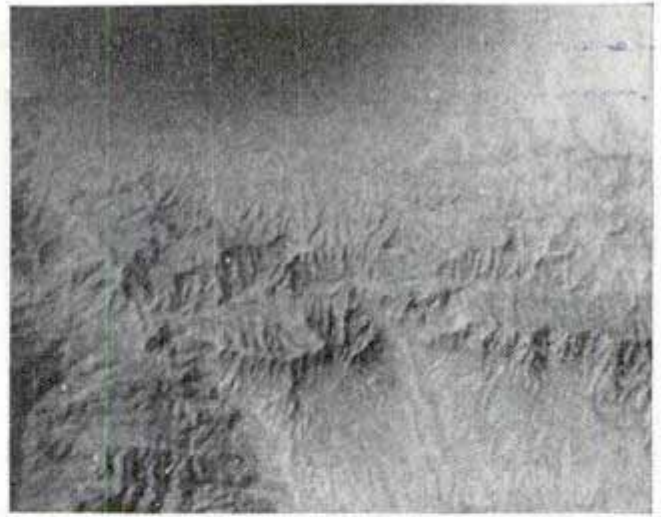

From altitude of 60 miles the earth's mountain ranges and valleys look like wrinkles to the rocket's camera



At 65-mile altitude the horizon is 720 miles away. Cloud layers seem to hug the earth. Right, drawing shows location of the rocket's fuel tank and motor

charge, the camera, too, was blown clear about 25,000 feet above the earth. It fell free the remaining distance, slowing down to a velocity of about 500 feet per second. Equipment from the rocket was scattered over an area of five square miles. When the duralumin camera box was found, the lens was broken, the batteries smashed and the camera damaged. But the magazine and film were recovered in perfect condition.

The pictures, although slightly blurred, show plainly many of the details of the earth's surface. Mountain ranges look like wrinkles and cloud formations seem to hug the earth from that height. The curve of the horizon can be seen easily.

In the meantime other instruments contained in the V-2s are studying special features of the upper air. One problem is the riddle of the ionized layers high in the atmosphere that behave like mirrors in reflecting low-frequency radio waves back to earth. High-frequency radio waves pass through the layers but are bent or refracted.

Complicated ground-to-rocket and rock-

(Continued to page 276)

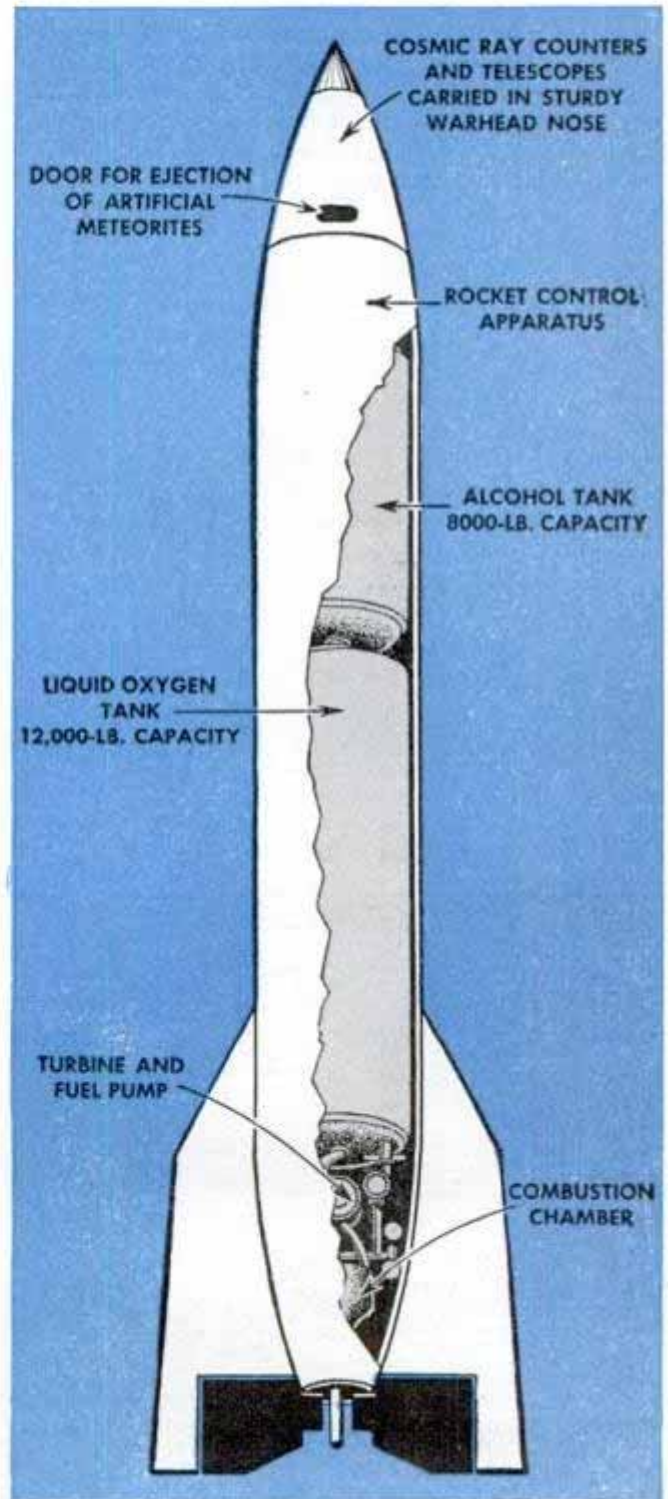



## NEWCOMERS ON THE SKY LANES



▲ Britain's Fairey Firefly, termed "world's fastest trainer," gets a maximum speed of 305 miles an hour from its 12-cylinder Rolls Royce Griffon XI engine

Built for cramped off-main-route airfields, the → Northrop Pioneer can take off with a 10,600-pound load in 700 feet and land in 750. Loading work is simplified by a very small floor-to-ground angle. Three-engined, its wing span is 85 feet, length 60 feet seven inches and gross weight 25,000 pounds

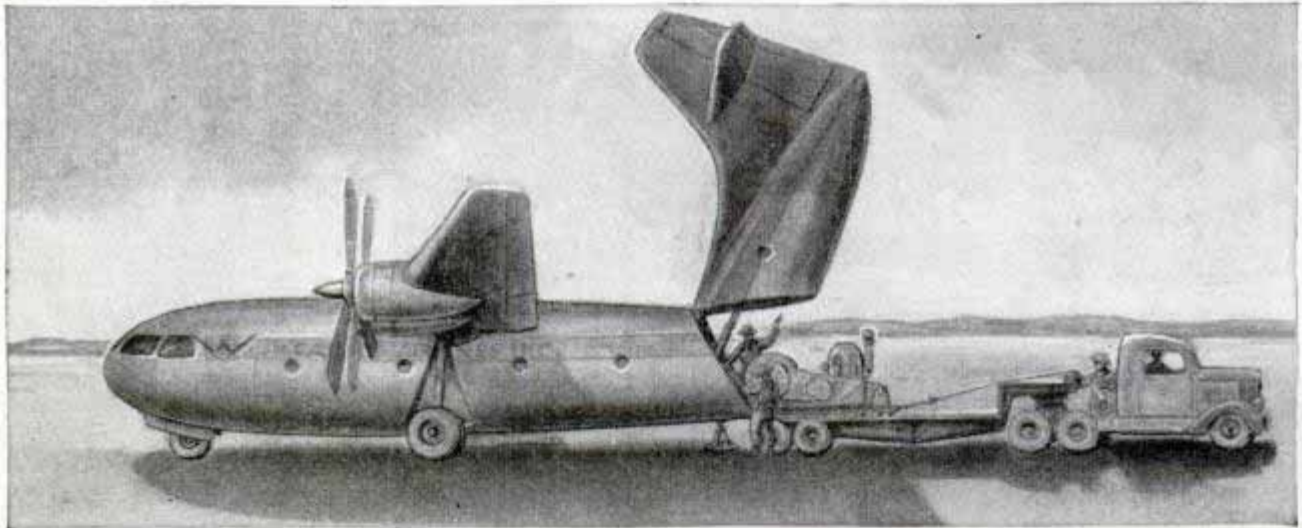
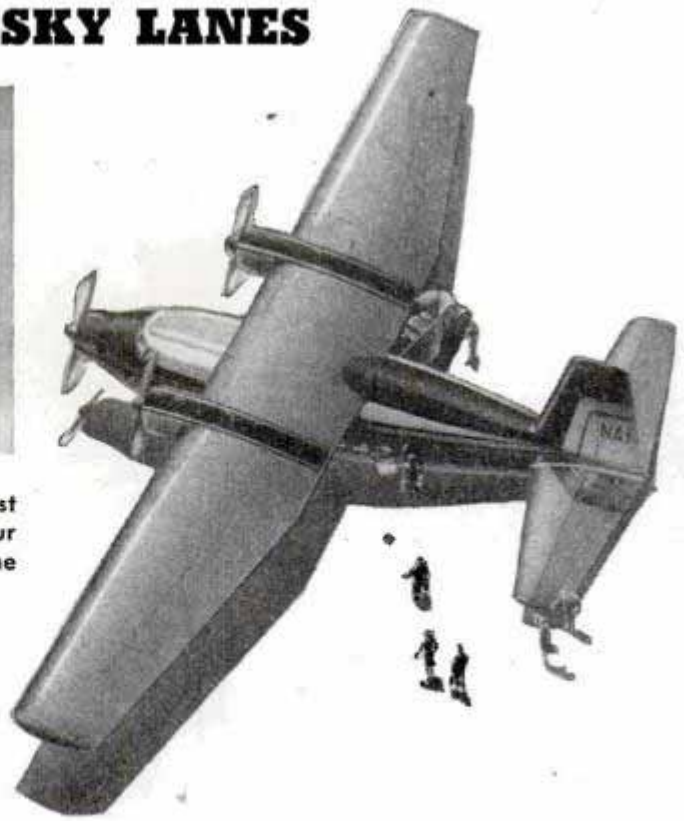

◆ By lifting the tail, bulky machinery and trucks can quickly be stowed in a cargo plane being built by Curtiss-Wright. It also has a low floor equal to truck bed height, 45 inches from the ground, and a nose door

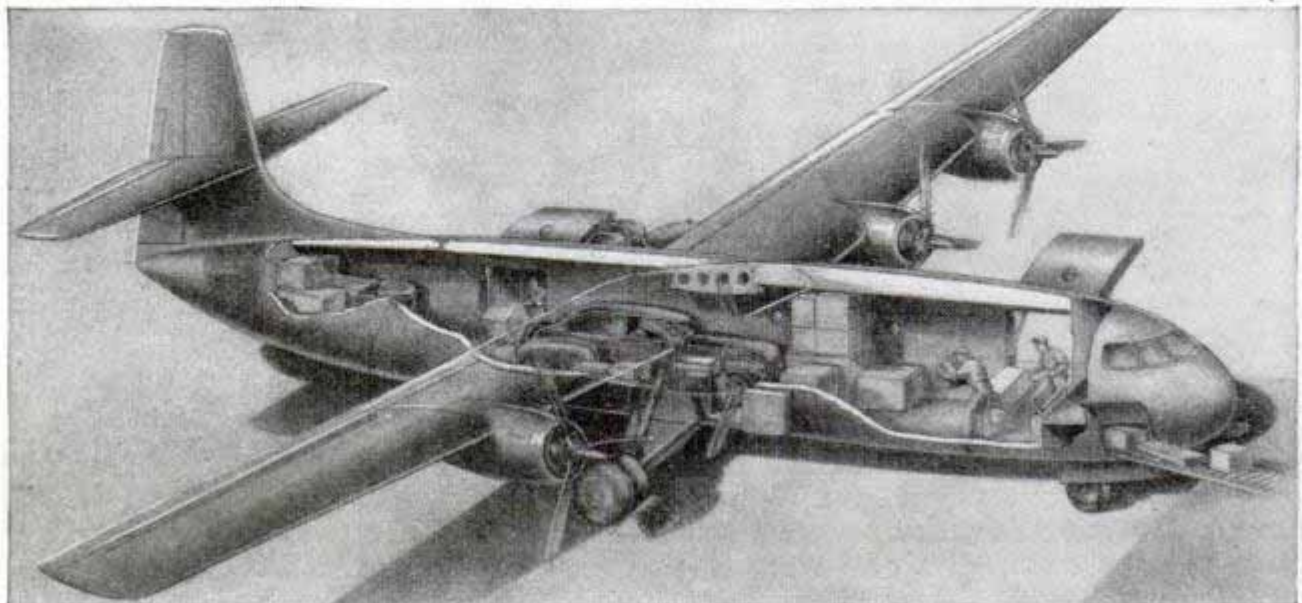



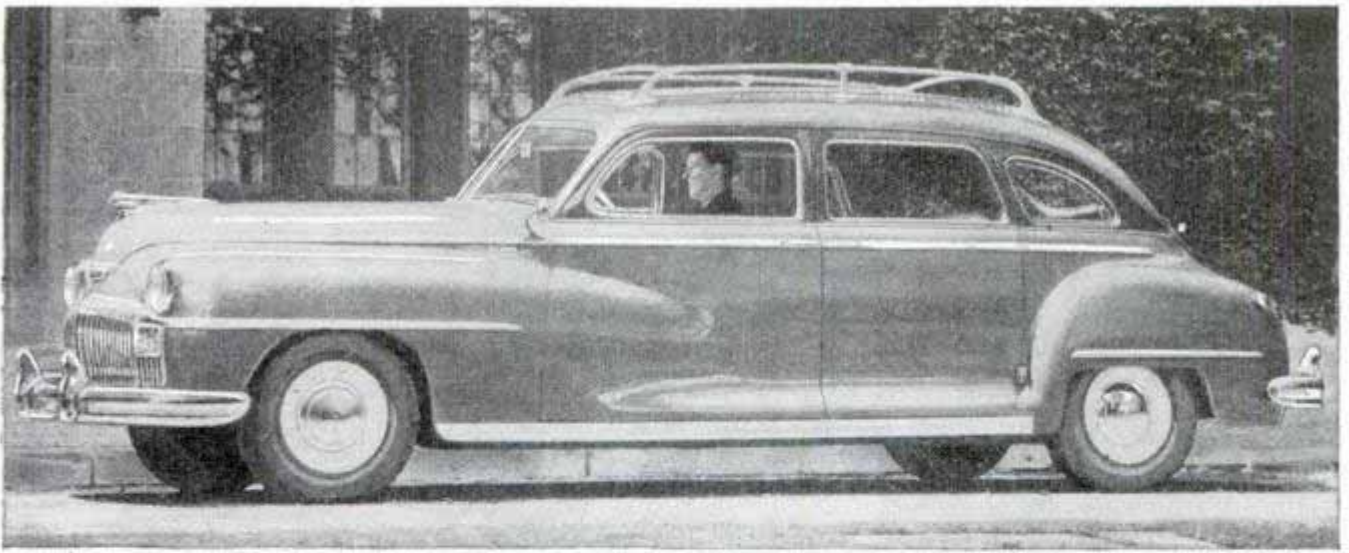

## Sedan and Station Wagon Combined in De Soto Car

Features of both a station wagon and sedan are combined in the De Soto Suburban which seats as many as nine persons and still leaves room for luggage inside the car. If additional space is required for hunting or camping equipment, virtually all of the interior can be so utilized without removing any seats. This flexibility is achieved by a three-position rear seat and adjustable front and center seats. The rear seat may be folded down to become part of the floor, and the other two seats moved forward. This arrangement creates six feet of luggage compartment space, enough for a full-size bed. The car has a 139½-inch wheelbase and oversize brakes, rear springs and tires. Attached to the top is a large luggage rack and chrome guard rail. Exterior color is a two-tone combination and the seats are covered with plastic fabric, available in several colors, which resembles leather. Plastic paneling in natural wood graining adds to the beauty of the interior, which is said to be practically scuffproof.

Three seats in De Soto Suburban are adjustable to → accommodate nine persons or allow six feet of space

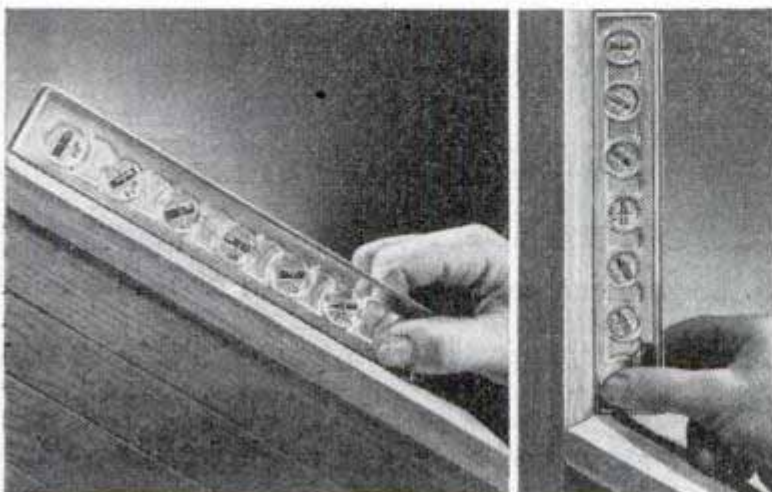
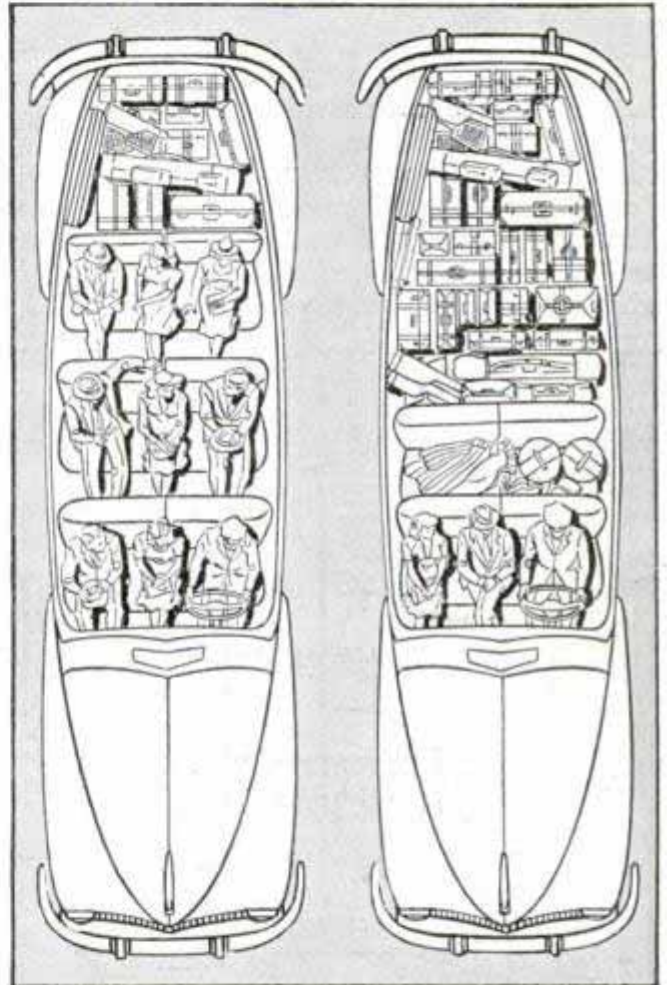

## Plastic Level Checks Angles With Six Built-in Bubbles

Surfaces at 180, 90, 60, 45, 30 and 22½ degrees can be checked with a plastic level. The tool has six leveling bubbles, each a different color. The degree of angle and a center leveling line are stamped over each bubble.

☞ "Auditioned" by a sound level meter, the circus gorillas Gargantua and Toto proved to have softer voices than a canary.



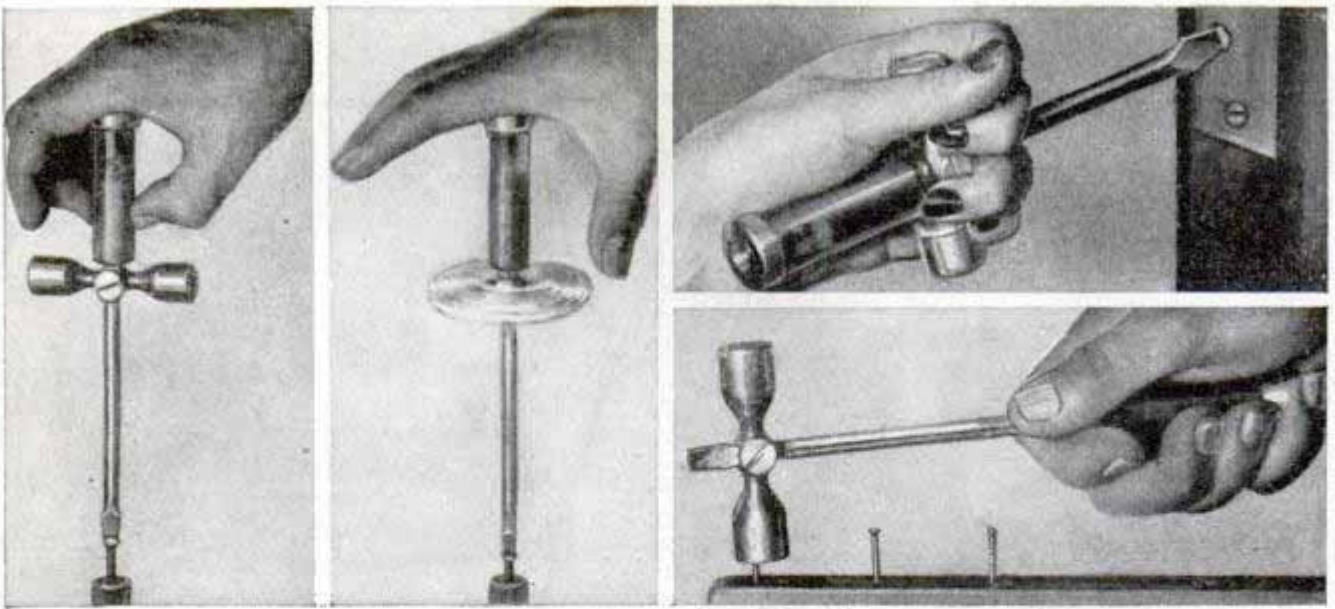

Loose-fitting machine screws can be "spun" in and out of place with a versatile tool that looks like a screwdriver and spins like a top. The operator's hand rests on a bearing on top of the handle. A heavy crossbar shaped like an hourglass is clamped half-

## Screwdriver-Hammer

way down the tool and acts as a flywheel. The same crossbar can be used as a power bar for increased leverage when the tool is applied to tight-fitting screws. The crossbar can be unclamped to slip down to the blade tip, thus converting the tool into a hammer.

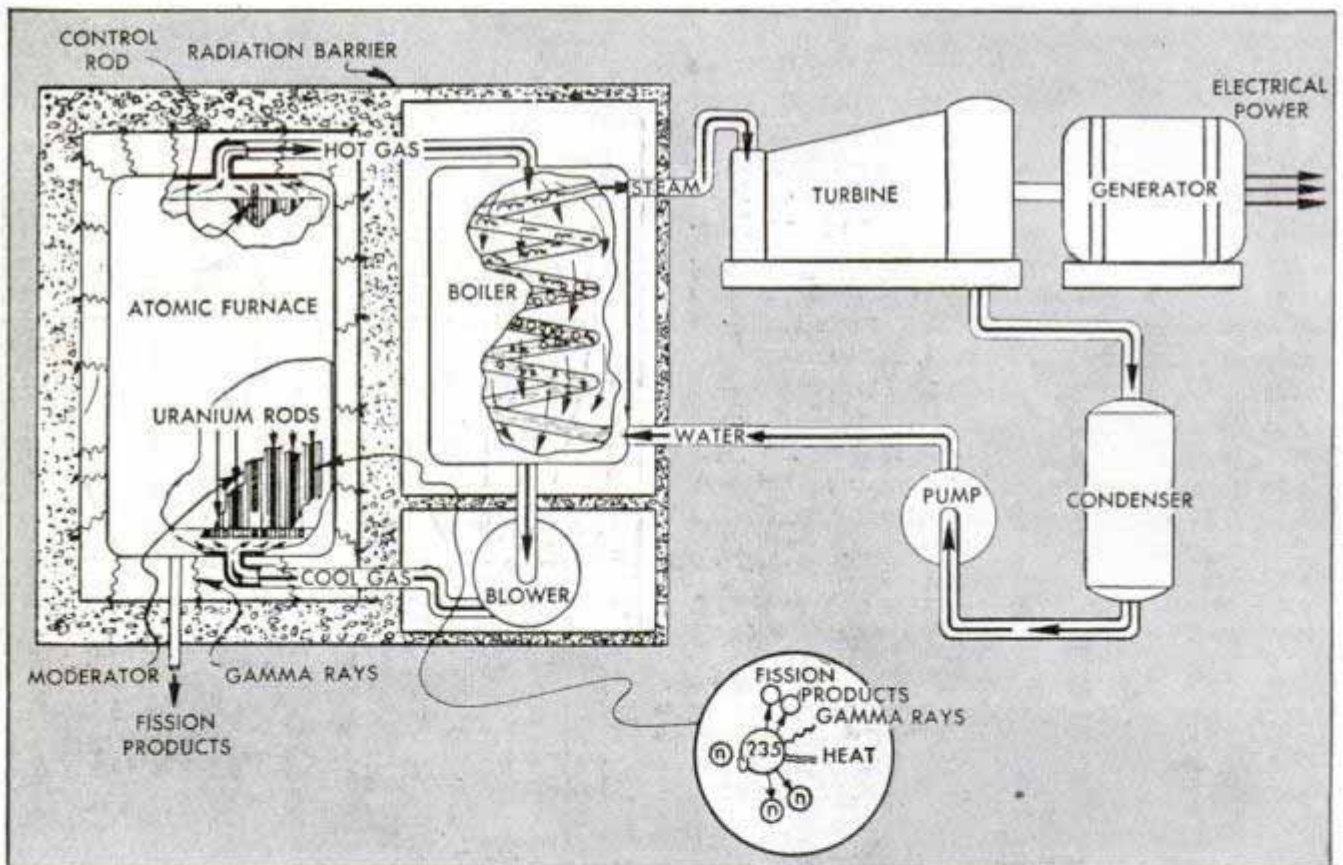

This diagrammatic sketch reveals the operating principle of an atomic power plant to be built this year at the Oak Ridge, Tenn., atom-bomb "factory." Marking man's first direct move to harness atomic energy as an aid to mankind, the plant was designed by Monsanto Chemical Company scientists. Gas will be heated through atomic re-

## Atomic Power Plant

action in the chamber at left. Then it will pass into the center chamber where it will come in contact with tubes carrying water. Steam thus generated will be conducted to a steam turbine which will operate a generator to produce electricity. After being used, the steam will be led to a condenser, converted to water and pumped back into the system.



# Balloon and Parachute Are Used to Cast Fishing Line

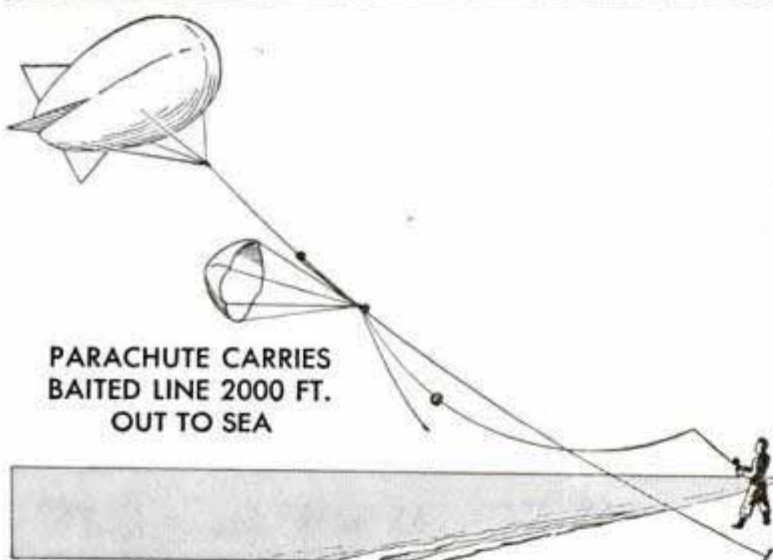
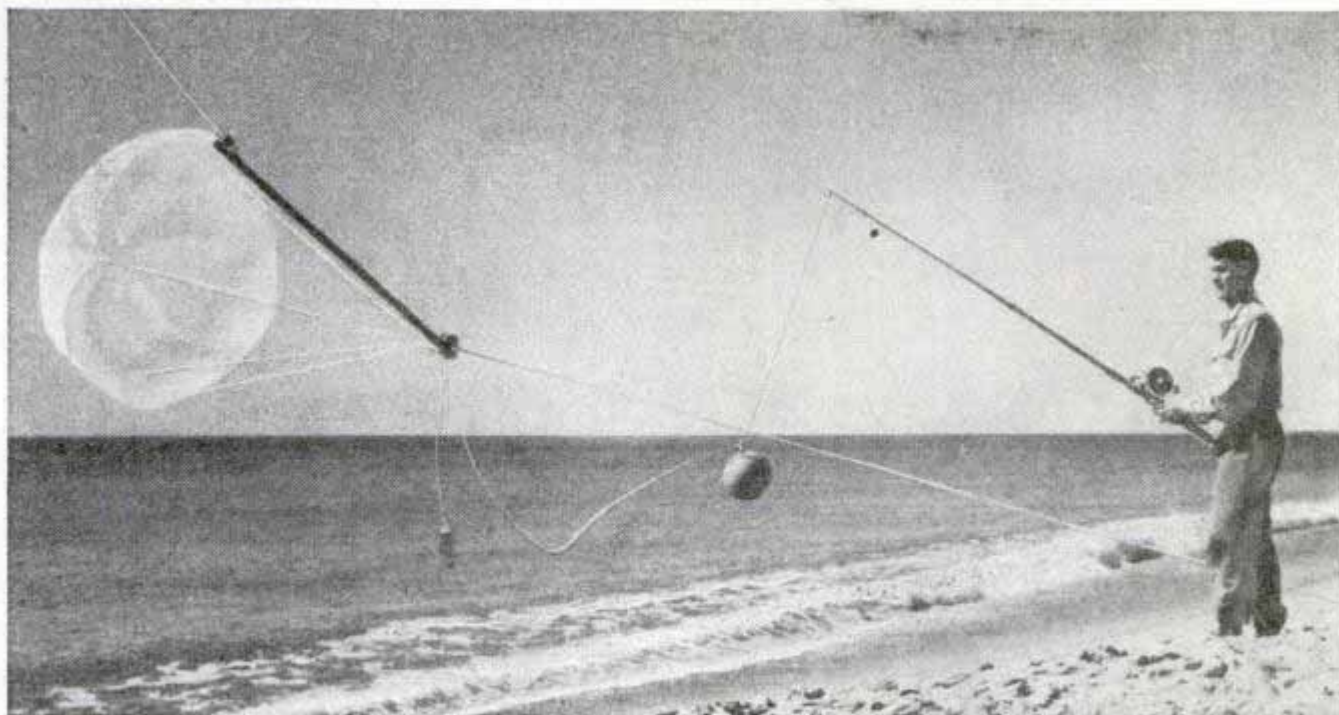

Scientific fishermen now use a "kytoon"—cross between a kite and balloon—to drop their line 2000 feet from shore in quest of striped bass weighing 20 pounds and up. Eighty yards is about the maximum for conventional surf casting. In this latest boon to fishermen, a six-foot-long balloon is floated out over the surf and then a parachute is hitched to the wire holding the balloon. With the fishline, bait and a rubber balloon float attached to it, the parachute catches the wind and heads for the balloon. A tripper stops the parachute near the balloon, and line, bait and float are dropped to the water. The parachute collapses and slides back to the fisherman.



Wind-filled parachute (top) carries fishing line toward balloon and tripper which lowers bait to water. Above, the gear is easy to carry

## Fish Are Unharmful by DDT Spray Used to Kill Mosquitoes on Ponds

Spraying of ponds and lakes with DDT to kill mosquitoes does not harm fish nor the small, water-inhabiting animal forms upon which fish feed. In tests, Tennessee Valley Authority biologists sprayed inland lake

areas 16 times from the air with DDT in an aerosol mist. Mosquitoes were almost eliminated but the fish and smaller water animals were not affected. Concentration of the DDT used was  $\frac{1}{10}$  pound to an acre.



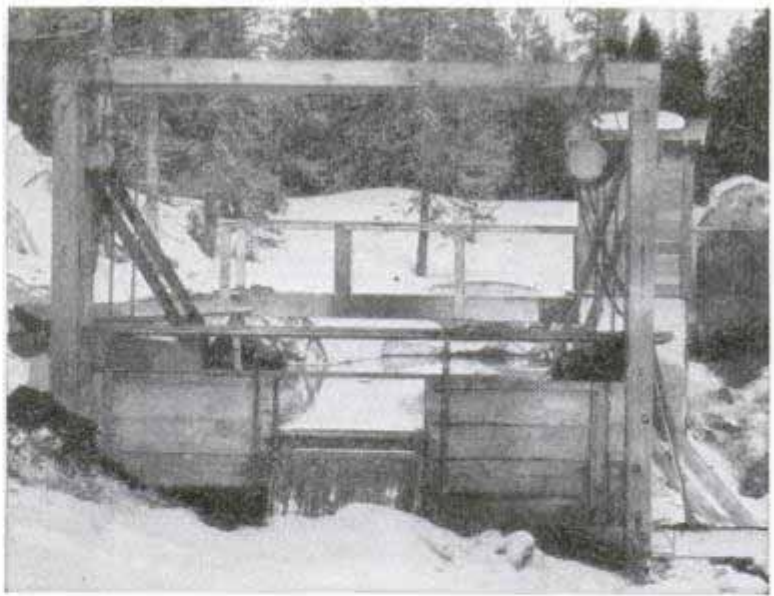
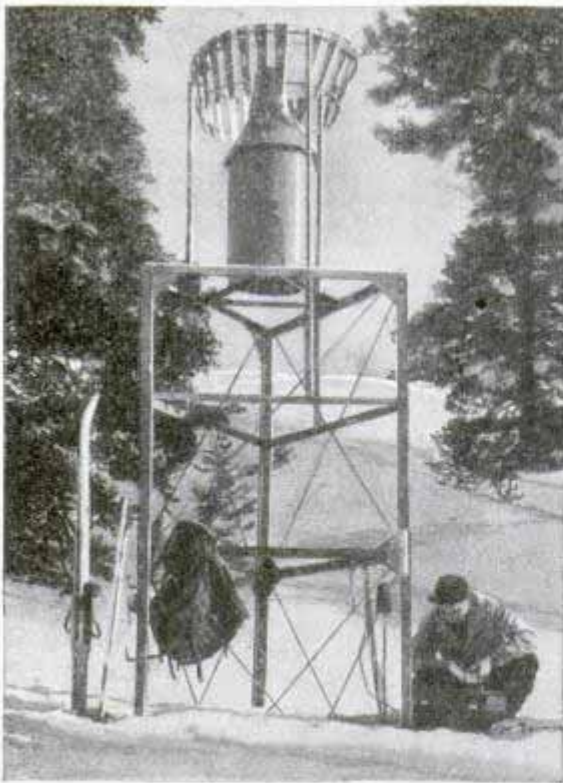

Snowfall is measured in terms of precipitation in tank at upper left and the volume of melted run-off from test basin is recorded at station above. Below, electric wires are plunged into the snow to measure its temperature. Ground and air temperature at 28 points register at one minute intervals on meters shown at bottom

## SEVEN-YEAR "SNOWMEN"

For seven years four men will huddle high in the Sierra Nevada Mountains to "count snowflakes and droplets." Representing the U. S. Engineer Department and the Weather Bureau, their job is to determine how much water flows, and how fast, from the snow-capped heights, information sorely needed by dam and reservoir engineers in northern California. The laboratory's facilities will include electrical resistance thermometers to measure snow temperature, storage gauges, a device recording duration of sunshine at one-minute intervals and a large run-off basin

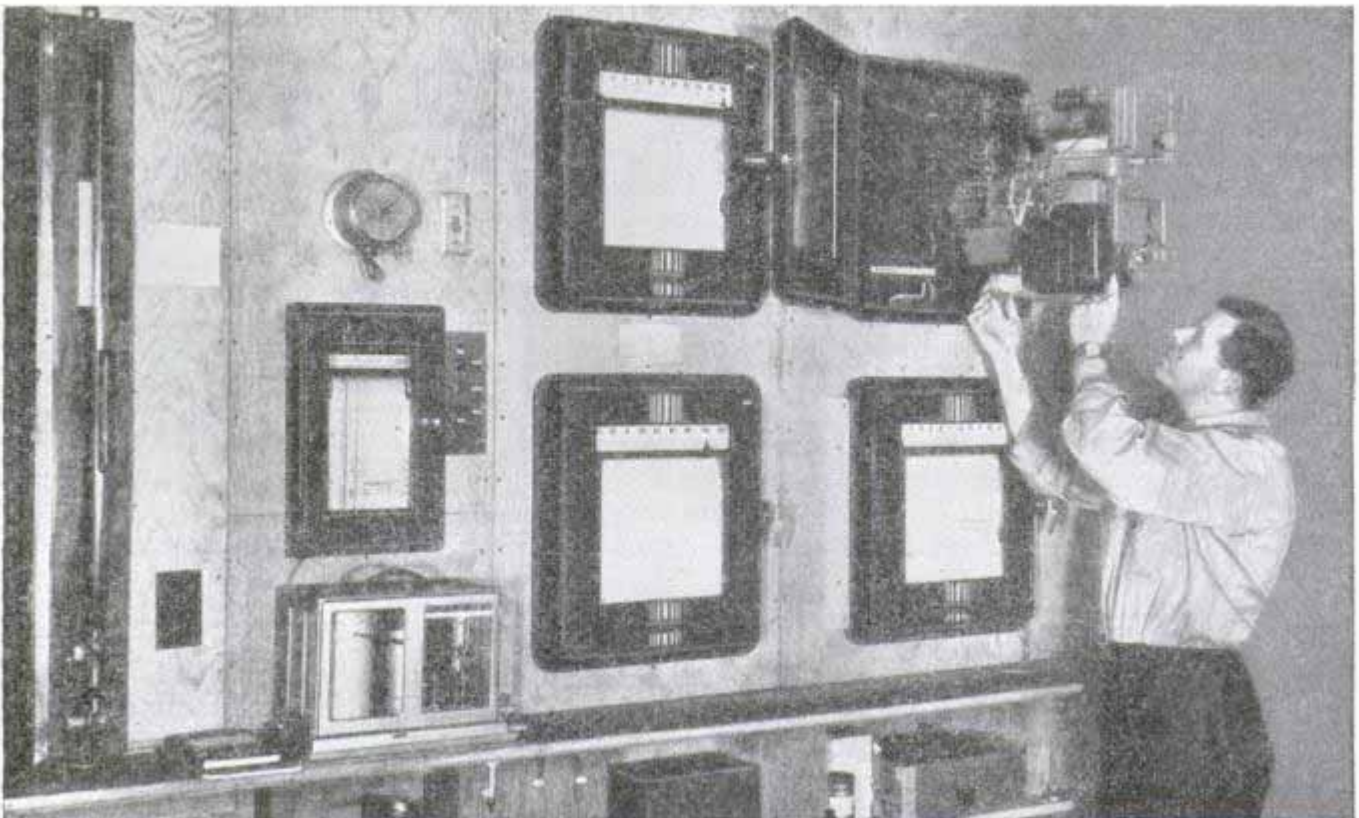



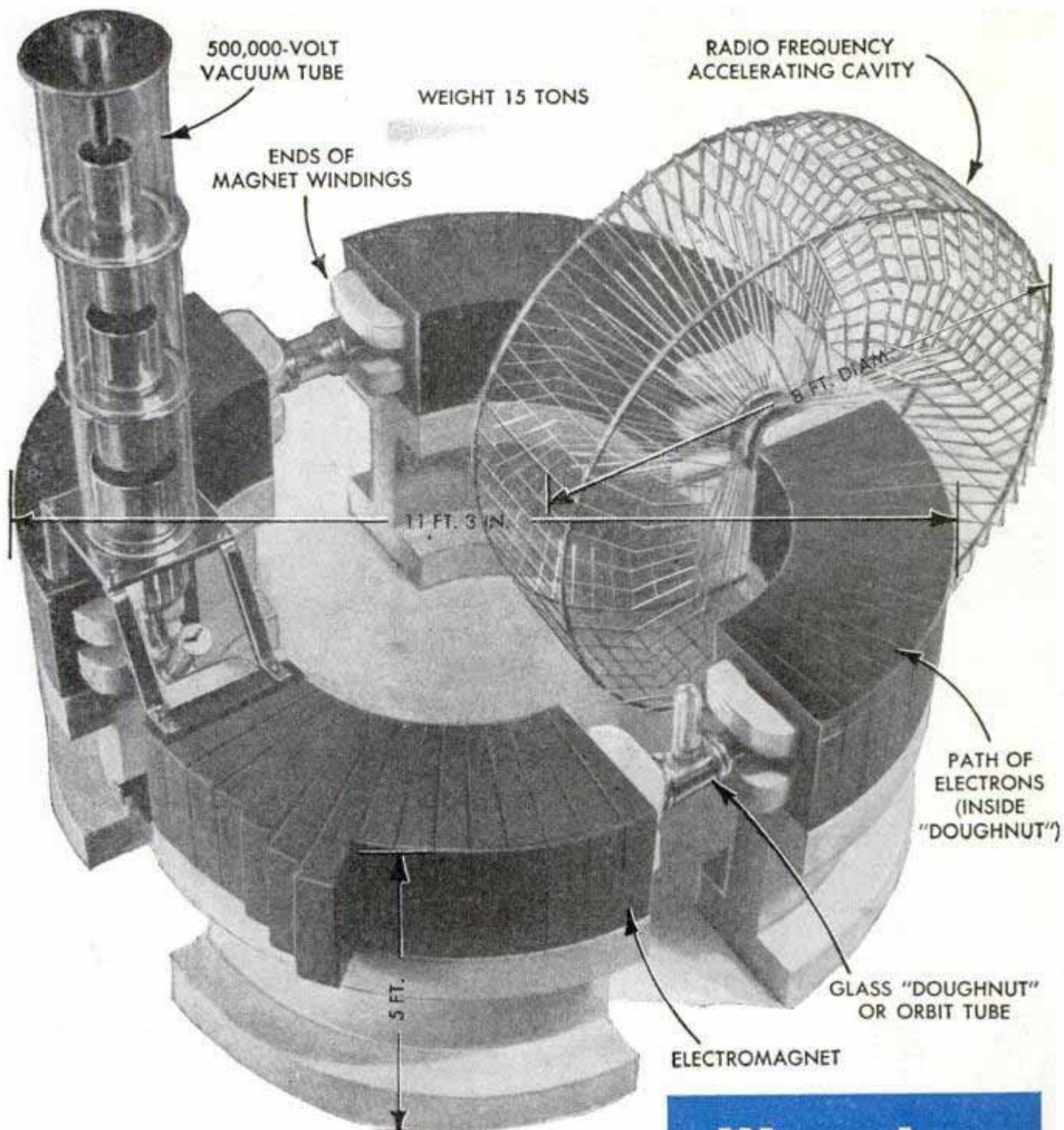

Model of 300-million-volt "race track" synchrotron now under construction at University of Michigan. This "atom buster" will produce energy similar to cosmic rays

By Daniel Wilkes

**T**HE ATOM—its structure and behavior—is as baffling to scientists today as it was 10 years ago. In view of the development of the atomic bomb and man's entrance into an Atomic Age, this may seem a surprising statement.

Yet it is an inescapable fact that the atomic bomb was only a stage in nuclear research. The men of the atom are just getting back to the main job of discovering the true nature of the atom, the basic piece of matter out of which the universe is built.

The first shot in the postwar attack on the atom has been fired—a 200-million electron volt barrage of atomic bullets—by the monster 4000-ton cyclotron just completed at the University of California

Waterloo  
for the  
ATOM



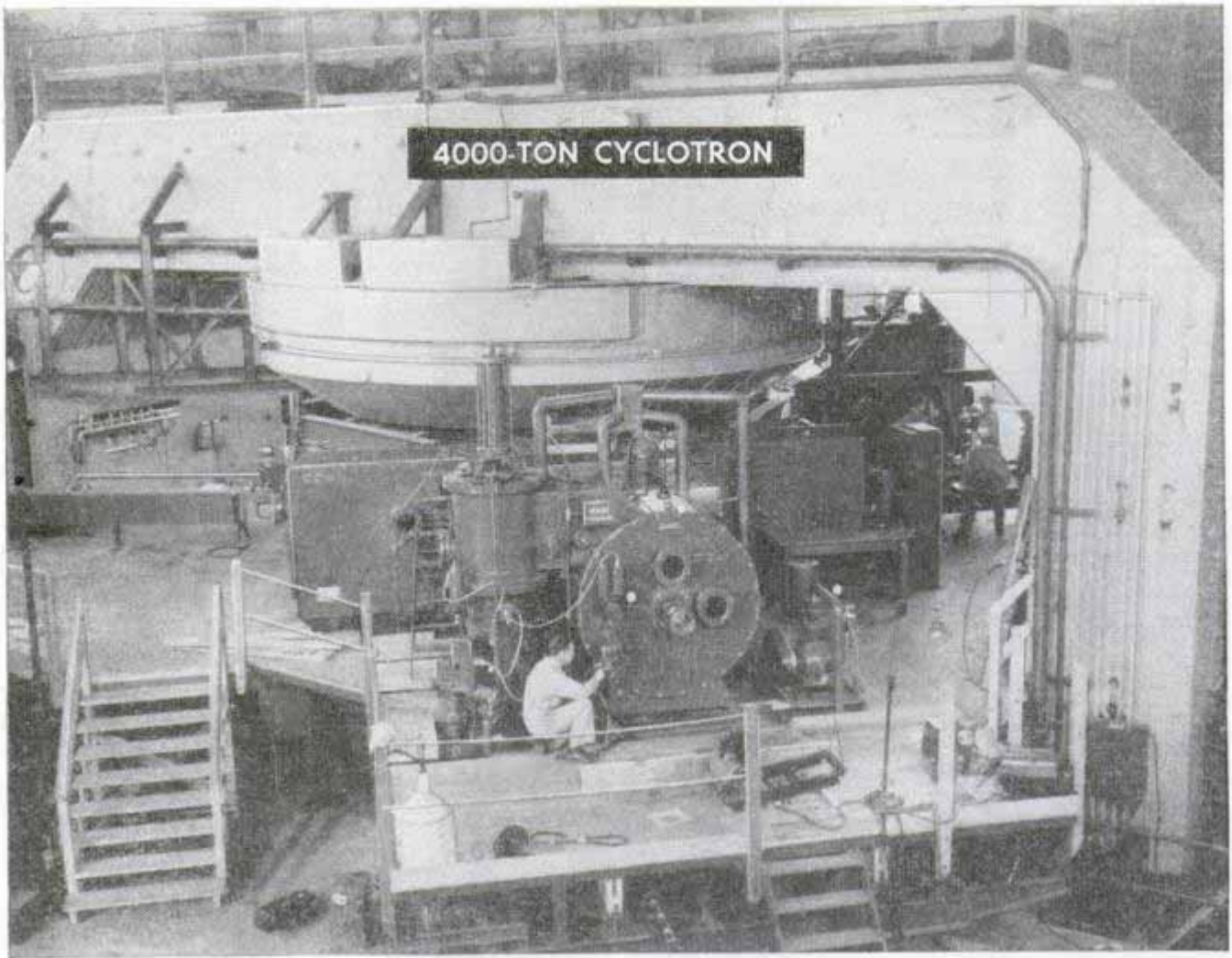

**4000-TON CYCLOTRON**

Most efficient all-around atom smasher is the 4000-ton cyclotron at the University of California. It discharges protons of about 350 million electron volts which cause complete disintegration of the nucleus of an atom

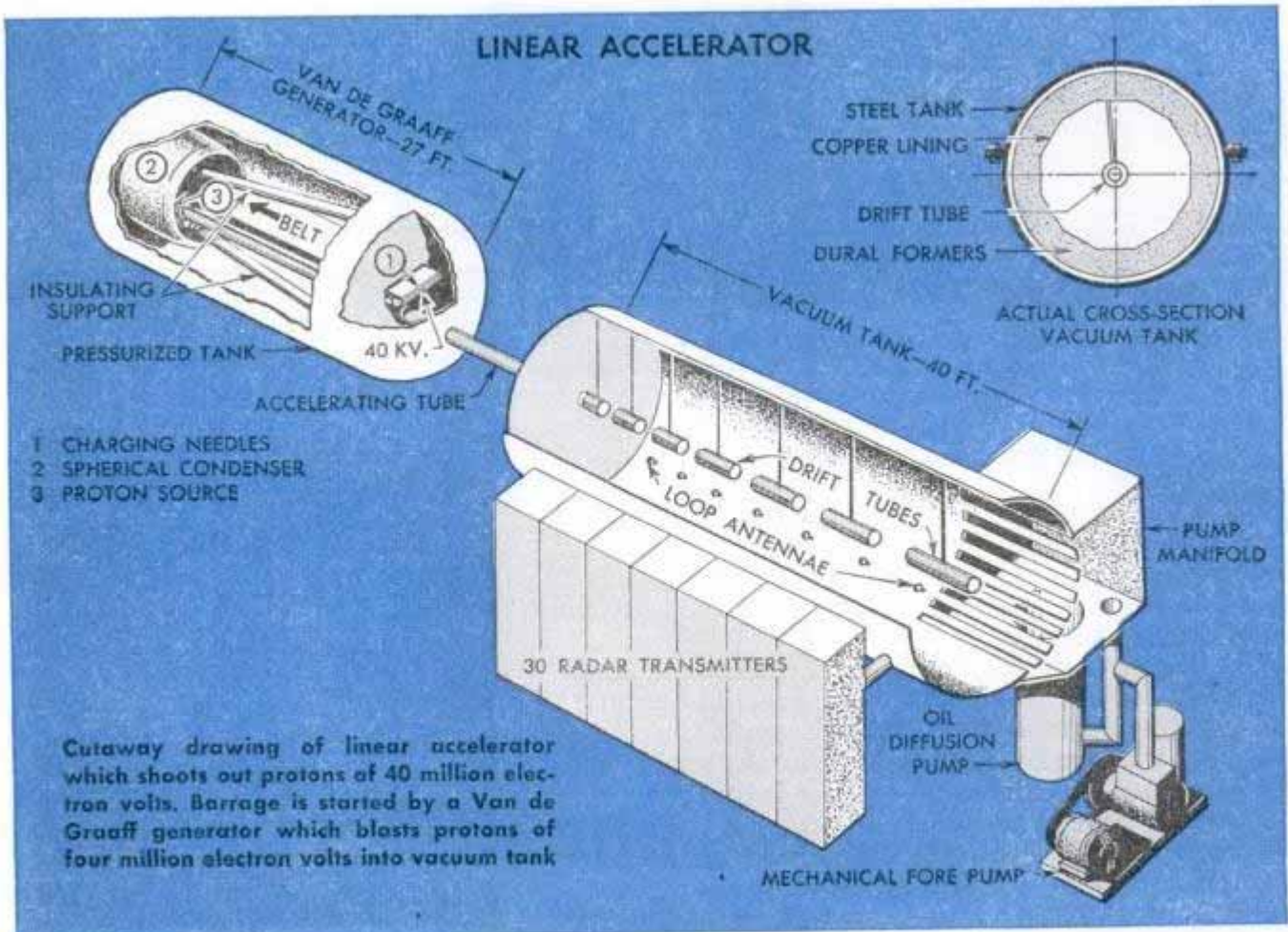



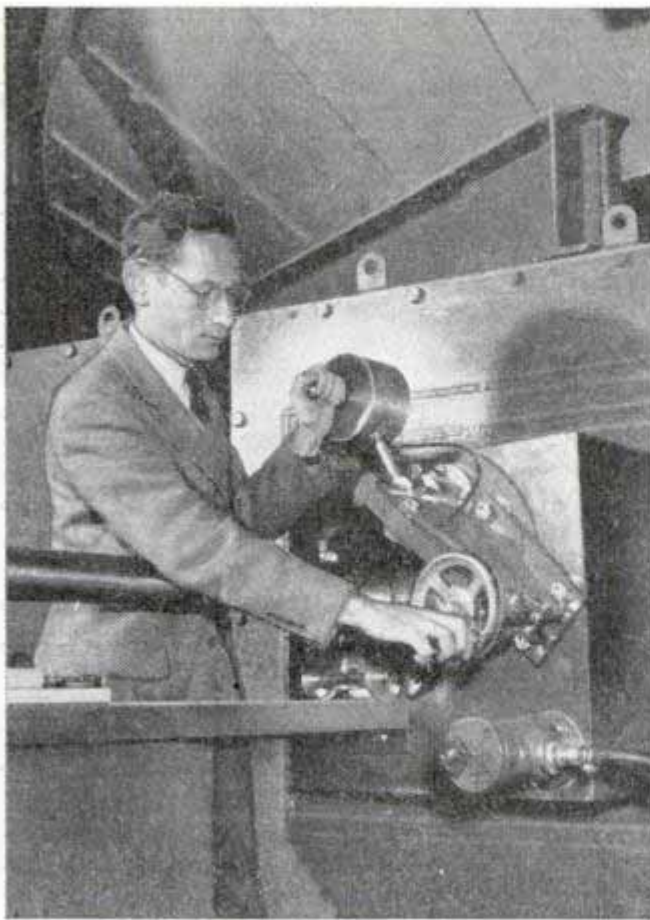

The target of the 184-inch cyclotron is operated by Professor Robert Serber at the University of California

by Professor Ernest O. Lawrence. In a few months two new machines, the synchrotron and the linear accelerator, designed for different types of atomic destruction, will join the barrage in the same laboratory. They will hurl atomic bullets from three to more than 20 times harder than have been shot before.

As the months tick by, more of the same type of atomic artillery, now on the drawing boards of America's laboratories, will step up the bombardment. Within 10 years scientists hope to be able to report that the atom has met its Waterloo.

This day will have arrived, says Professor Robert Oppenheimer, the University of California's eminent theoretical physicist, when scientists have laid bare the inner workings of the subatomic world; when they can say positively what particles make up the atomic nucleus, how they act on each other and what holds them together.

With this knowledge man may have entered an era in which it will be possible to take atoms apart and rebuild them at will; in other words, to alter man's environment to suit his wishes.

What is the atom holding out on nuclear scientists? Where do the scientists now stand? What tools will be used and how do they work?

First, draw a rough picture of an atom. Essentially, it consists of a tight, hard,

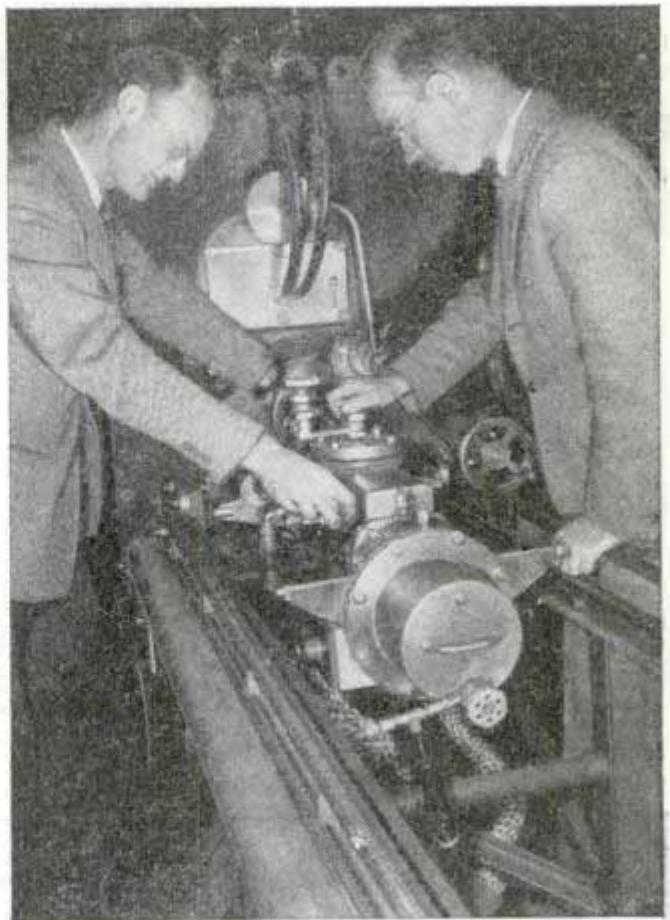

Professor Robert Thornton (left) and William Brobeck, mechanical engineer, regulate cyclotron's ion source

granulated core, the nucleus, made up of neutrons and protons. Around this nucleus, electrons circle in planetary orbits. Positrons, gamma rays and mesotrons are emitted by the nucleus when disturbed violently, as in a collision with a cosmic ray.

Scientists have identified all six of these atomic particles and are familiar with many of their characteristics. But they do not know what binds the particles of the nucleus together—surely the most powerful force in the universe. And they are fairly certain there are a couple more particles in the nucleus unaccounted for. The strategy by which they hope to find out about these things is to duplicate the atom smashing which occurs in nature. Atomic nuclei are constantly being exploded in collisions with high-speed particles in the atmosphere. From these explosions are liberated mesotrons, which are extremely penetrating high-energy cosmic rays, and other nuclear particles of lesser energy.

Scientists have photographed mesotrons zipping through Wilson cloud chambers, and wherever they have found an atomic explosion, mesotrons have popped out. They reason, therefore, that the mesotron is intimately connected with the energy which holds the nucleus together.

If they can hit the nucleus hard enough in the laboratory to make mesotrons pop out—in other words, duplicate nature's





Professor Ernest O. Lawrence, noted University of California physicist, adjusts the target area of a pilot model for the giant 184-inch cyclotron

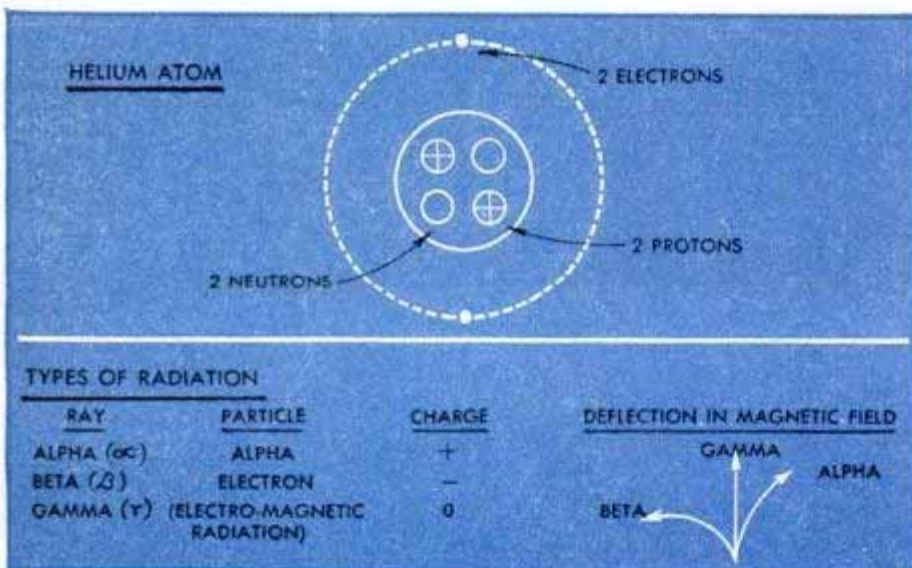

Composition of a helium atom is illustrated in the drawing, above a chart which lists various types of radiation and their characteristics. Below, every step in operating the powerful cyclotron is controlled from this room

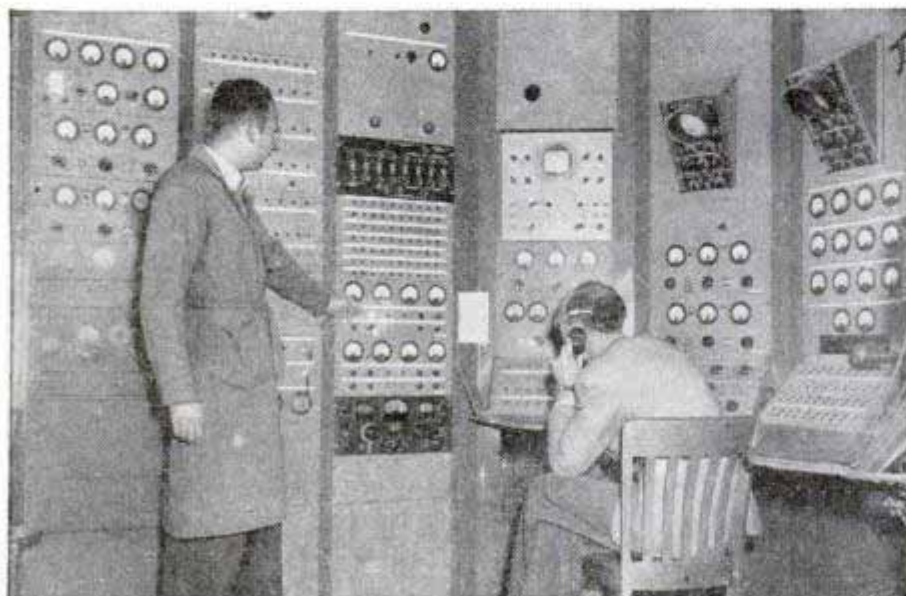

atom smashing — the atomic strategists believe they can learn what they need to know. Special equipment can be devised to observe everything that happens in these nuclear disintegrations.

This super atom smashing should not be confused with atomic bombardments to date. Until the 4000-ton cyclotron was turned on, it was possible only to jar neutrons and protons out of the nucleus—in effect, chip it. Super atom smashing involves the complete disintegration of the nucleus.

This is the job for the new giant atom busters. In addition to Professor Lawrence's three machines, atom smashers planned or under construction include a 700-million electron volt betatron for General Electric; a 500-million electron volt cyclotron for the Associated Universities; a 300-million volt synchrotron at the University of Michigan; a linear accelerator for Massachusetts Institute of Technology; and duplications or variations of these machines in institutions all over the nation. General Electric already has a small 70-million-volt synchrotron in operation.

A complete picture of this artillery can be obtained at the University of California, where the three basic types of super atom smashers have seen or will first see action. Each type is designed for a different kind of atomic destruction and uses different types of subatomic projectiles.

The 4000-ton cyclotron is the most efficient all-around atom buster. It shoots protons (the elementary nuclear particle which incidentally constitutes the nucleus of the hydrogen atom) of 350

(Continued to page 264)





Five o'clock shadow comes off to music, above. For refreshment of clients there are two trays of ice cubes in refrigerator built into the front side of all-electric desk below

## 'All But Kitchen Sink' In Desk for the Boss

Elaborate hardwood desks designed for executive use are complete office units. One has a flared burnproof top large enough for six people to be seated around it. Three sliding ash trays are concealed under its outer rim. It has no legs but rests on runners. The desk and the accompanying chair are adjustable in height for either tall or short men. Another is designed with sliding drawer panels on its working side. On the reverse side is a built-in refrigerator, office safe and bar. It also has two electric clocks, one on the working side and one on the reverse side.



Both desks have concealed automatic dictating machines, radios and electric razors. Special compartments in all drawers accommodate papers and working tools.

## Control System Prevents Electrolytic Damage to Underground Pipes

Stray electric current which damages underground pipes can be curbed by a new control system that connects the pipe with a nearby electrical conductor. Stray current is caused by trolley wires or third rails which use standard rails as a return circuit to the powerhouse. The current sometimes leaves these tracks and enters the ground where it travels to neighboring pipe lines. When it leaves the pipe line to enter the

ground again it causes electrolytic action which depletes the metal in the pipe. The control system weighs only 40 pounds and connects the offending rail with near-by pipes. When stray current leaves the pipe it travels harmlessly through the system rather than through the soil. It is estimated that preventable electrolysis causes more than \$50,000,000 damage annually in the gas, oil and water industries alone.





## Hay Bale "Bombing" Saves Buffalo

Army flyers, in an unusual mercy flight, "bombed" Montana buffalo with hay to prevent their starvation. When winter snowstorms buried the grassy feeding grounds and blocked truck roads into the reservation, the animals were without food. Flyers at the AAF base at Great Falls saved the herd, one of the last surviving large ones, by loading a C-47 transport with hay, flying over the feeding grounds and dropping bales of feed which burst open when they hit the ground.

**Snowbound buffalo on the Crow Indian Reservation in Montana are fed from the skies. Army transports were loaded with hay when it was reported the animals were starving and roads were blocked, then flew low over the herd while crewmen pushed the baled hay out through the cargo doors**

## Knee-Action Dolly on Trailer Turns at Same Angle as Auto Wheels

Knee action and improved steering are provided in a new-type dolly for automobile trailers. When the car wheels are turned to the left, the dolly wheels turn in the same direction and at the same angle. This is accomplished by an arm attached to a hitch ball installed on the auto alongside the trailer hitch. Heavy-duty steel coil springs support from 85 to 90 percent of the forward weight of the trailer and have a capacity of 8000 pounds.

☐ Airplanes can take off with a greater load when ammonium hydroxide is used as an internal cooling liquid in the engines.

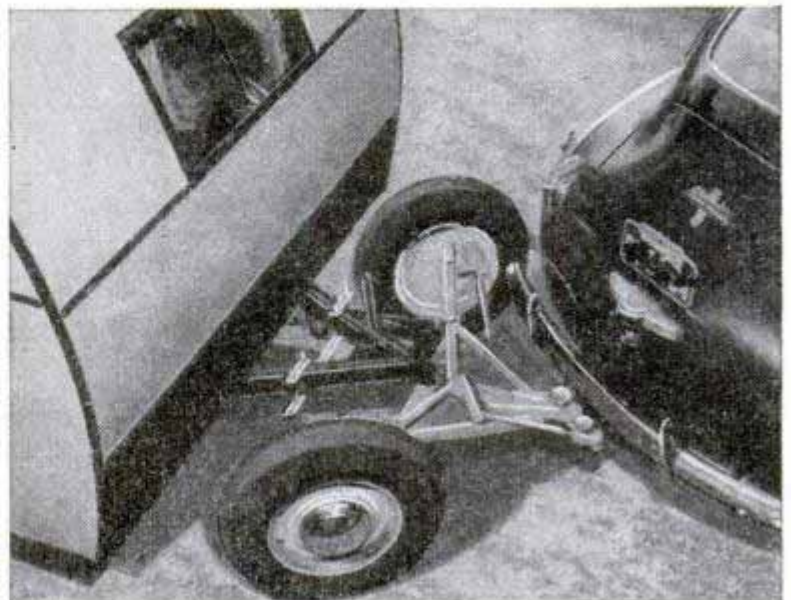



Cross-country driving requires both skill and stamina. It sometimes takes an hour and 200 shifts of gear to get a heavily loaded semitrailer up a mountain grade that pleasure cars climb easily in 15 or 20 minutes



## *Highballing the Highway Freight*

**A PLEASURE driver can climb the Cajon Pass north of San Bernardino in 20 minutes, but it was going to take Harry Karasick an hour and a quarter to reach the top of the 13-mile grade. With 20 tons of merchandise in the semitrailer, he would average 10 miles an hour on the uphill pull.** **By Thomas E. Stimson, Jr.**

Back in the cab he glanced at the air-pressure dial and eased the tractor into second gear direct. Under way, he tested the foot air brake and then, separately, the hand air brake connected to the trailer's rear duals. Everything was normal. By now the tachometer needle was hovering at 2000 r.p.m. and he shifted into second overdrive. A minute later he used both hands, one for each lever, to shift into third direct. This was the highest gear he would use until he reached the summit.

Karasick had left Los Angeles at 3:00 that afternoon. At 7:00 he would eat dinner at

First he made a routine safety stop. At the side of the road he checked the oil and water in the big 200-horsepower Diesel. Then, with a steel bar, he walked all the way around the rig, thumping each of the 19 huge rubber tires. The solid sound of the blows told him that none was soft.



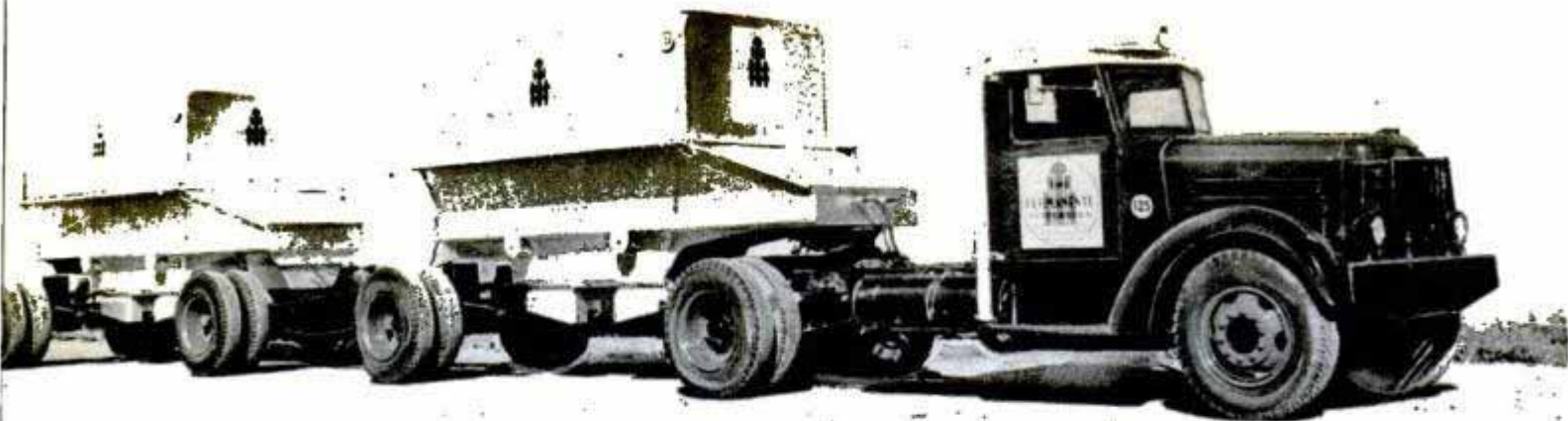

important weight savings have been made by building trailers entirely of magnesium. Because of that improvement this 60-foot truck train is permitted to haul three tons more cement than is legal with heavier equipment

the top of the grade and then highball at 50 miles an hour across the desert to Jean, Nevada. That was the division point where Bill Bethke would take over the load. Bethke would roll across most of Nevada in the moonlight and crawl up through the hills of southern Utah, reaching Cedar City at 8:00 in the morning. A third driver would take the rig into Salt Lake City. Four days later, five days out of Los Angeles, the load of merchandise would be in Chicago.

As Karasick left Los Angeles other units of the Pacific Intermountain Express fleet were leaving terminals in Chicago and St. Louis, westbound, and a tractor was moving a load east from San Francisco. Four

"Fifth wheel" of a tractor is the connection block upon which the front end of the semitrailer rests

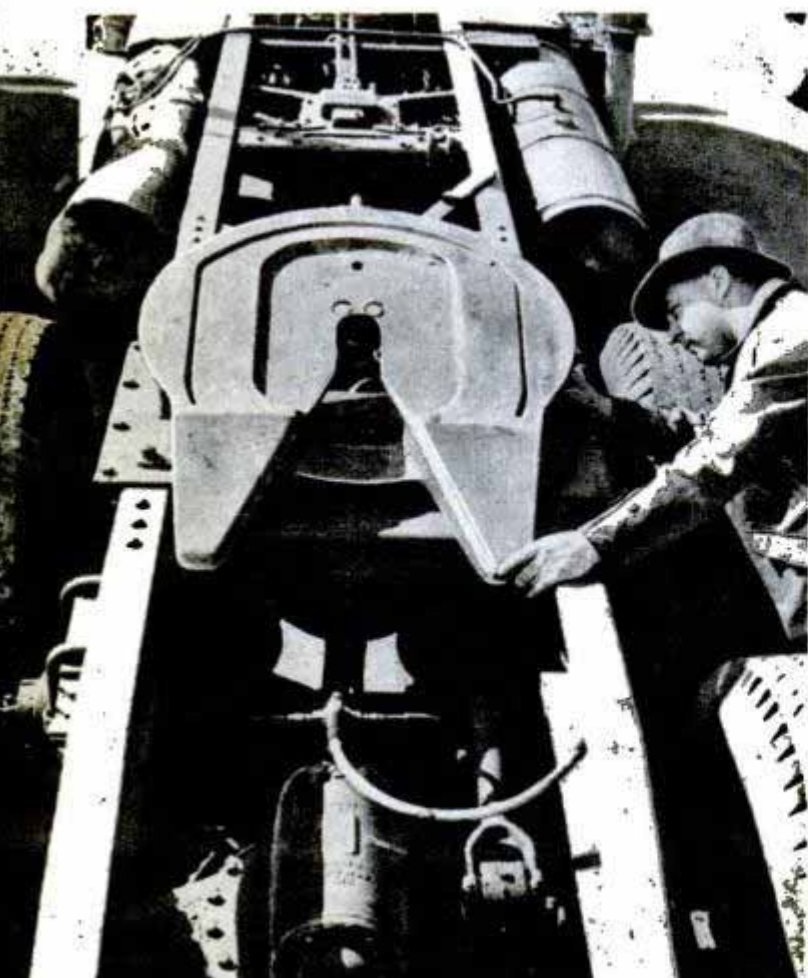

hours later other highway units would leave the same terminals on an around-the-clock schedule that keeps them rolling night and day. Between Denver and Salt Lake City as many as a dozen westbound and a dozen eastbound P.I.E. units are put on the road every 24 hours.

Handling one of the big highway rigs is no job for an average driver. In some respects P.I.E.'s physical standards are higher than the Army's. Driver applicants must pass rigorous intelligence, driving, and reaction time tests and those who are accepted are taken on student runs by Earl French, driver superintendent. All drivers must pass a yearly physical examination.

A new driver learns that he will have to make one or more changes of gear to climb a slight upgrade that is hardly noticeable in a pleasure car. Each shift must be timed just right and he trains himself in double clutching. To shift down, he practices accelerating the engine during the shift so that he can mesh gears without missing.

He learns to drive by the tachometer instead of the speedometer and he's taught that the engine operating range is from 1700 to 2000 r.p.m. When the tach needle creeps down to 1700 he shifts to a lower gear, when it climbs to 2000 he shifts up. His top road speed is 50 miles per hour in fourth overdrive at 2000 r.p.m.

His brake pedal supplies air to all wheel brakes and the hand air lever is connected to the rear duals alone. In slippery weather this separate rear-end brake can be used as a drag to keep the equipment in line. If the tractor starts to skid the driver uses the trailer brakes as an anchor. But if the trailer starts to slide it's best to use no brakes at all. Accelerating the tractor instead is recommended.

A light fall of dry snow is no special handicap and, if necessary, a big outfit can pull through dry snow a foot deep. Wet snow is different. The big 10.00-22 tires be-



Oil in can on running board is for emergency use when the crankcase level is low



gin to spin and the driver must chain up the eight traction wheels. Usually this is a 45-minute job. Icy pavement calls for the most caution of all and to be on the safe side the driver goes down to a low gear and grinds along at slow speed.

Wrestling with the gears keeps a man warm except in bitter weather and he has a heater in his cab when he needs it. Driver fatigue is reduced by a new soft seat equipped with built-in hydraulic shock absorbers. Much of the customary roar of the Diesel exhaust is eliminated by a new stainless steel muffler.

Each driver carries an operating manual that describes his route and the location of dangerous curves and grades. The booklet tells the procedures to be followed in overtaking other vehicles and in handling various traffic situations. It notes the three or four points along the route at which safety stops are to be made. These periodic checks are vitally important, for even a soft tire could cause a disaster. Undetected, the soft tire may become flat and then heat up and burst into flames. Such fires have spread to the cargo and consumed the entire unit.

Highway drivers work six days a week and average seven hours at the wheel in an eight-hour shift, during which they travel an average of 250 miles. Over flat country a man may do better than 45 miles an hour with hardly a change of gears;

climbing across a mountain range may slow him to a 15-mile average and he may have to shift gears 200 times in an hour's driving.

Truck drivers used to have poor reputations on the road but today most of them are courteous professionals who will pull over when they can to let you pass. They go out of their way to give others a hand. They can't stop to change a tire for an able-bodied man but they are glad to haul you back on the pavement, for example, if you have dug yourself in on the roadside. Pulling cars back on the road is a routine task almost every trip during the winter months.

Reading hub meter that registers total mileage. This affords check on need for inspections and overhauls







Easiest change is an outside tire. Driver can run inside wheel up on a wooden block and avoid using his 10-ton jack. At right, bumping each of the 19 giant tires with a steel bar to detect any sign of softness

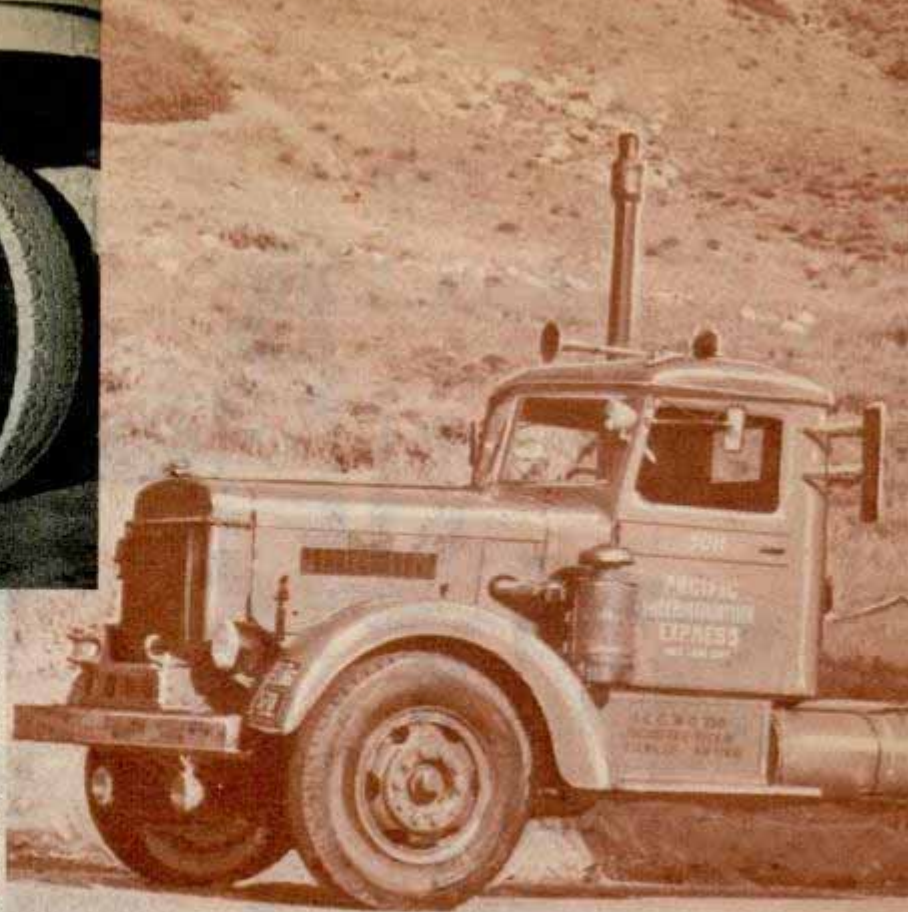

Scores of pleasure drivers who have been marooned in blizzards owe their lives to truck drivers who rescued them from their stalled cars. During one heavy snowstorm in the mountains one truck driver unhooked his tractor from the load and then used it as a taxi to haul the passengers of a wrecked bus to the warmth and safety of a service station seven miles away. He completed the rescue in a dozen round trips, then hooked on to his trailer again and kept going.

The fact is that the big highway trucking systems can't afford to employ poor or irresponsible drivers. "Mexican overdrive" (that means coasting down hill out of gear), speeding, "pinch" passing or any other reck-

less driving can cost a driver his job. He is under almost constant scrutiny on the road.

Supervisors in private cars trail the drivers to note how they obey traffic laws. Traveling engineers of the insurance companies prowl the truck routes to watch against unsafe driving practices. Each piece of P.I.E. equipment and its cargo, for instance, are insured up to a value of a million

dollars. On top of all this, truck lines employ outside road detectives who make complete reports of the good as well as the bad driving practices of drivers that they spot on the highways. Finally, the locked tachograph in the cab of every truck makes a record of road speeds, stops and the duration of the stops on every trip. Checked against the distance of the run, this record shows where the stops

Elevation scale showing heights on trucking run between San Francisco and Chicago

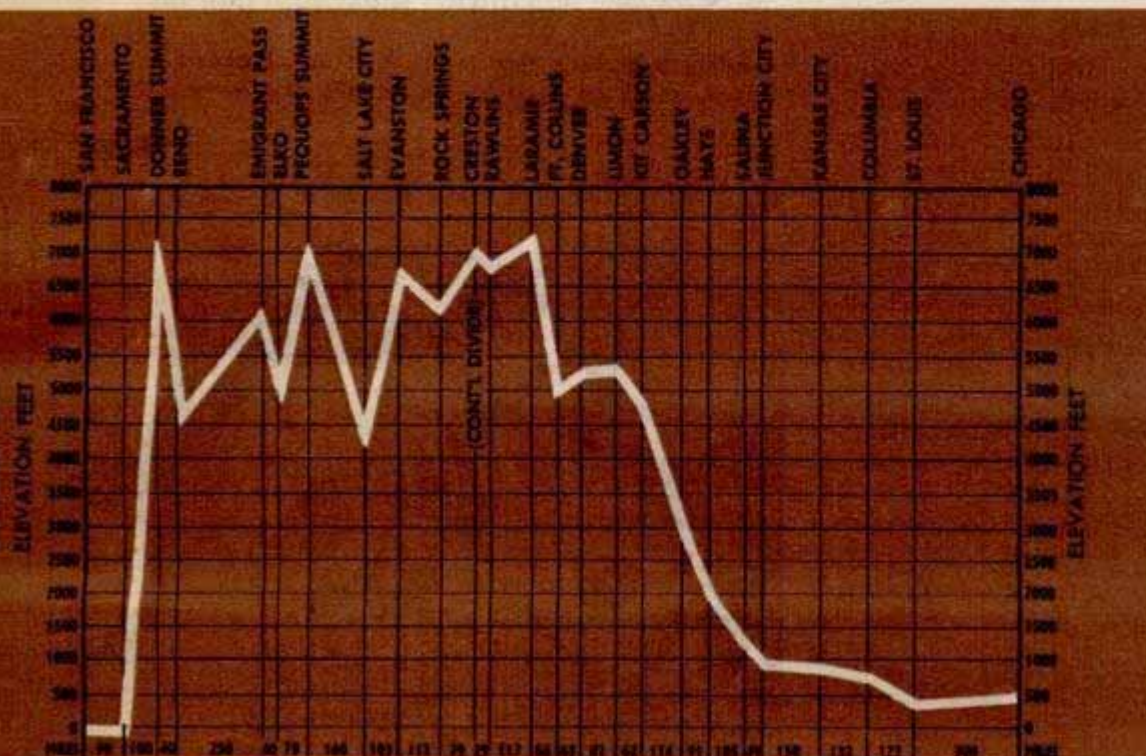





were made and the speeds that were maintained at all points.

P.I.E. uses Diesel tractors between Kansas City and the West Coast, and gasoline tractors in the flat territory from Kansas City to St. Louis and Chicago. Normally the intermountain run between Denver and Salt Lake City is made via the easy grades of Highway 30 through Wyoming. On tests, however, fully loaded vans have climbed up through the Rockies during blizzards, over the 11,314-foot summit of Berthoud Pass on Highway 40. P.I.E. has a corps of 275 "over the road" drivers and its rolling stock includes 136 power tractors and 221 semitrailers. Commodities of almost every description are carried between the nearly 200 cities and towns along its 12,000 miles of routes. By interconnections with other carriers it

picks up or delivers shipments in all parts of the country. The system hauls over 150,000 tons of cargo and its units travel 18,000,000 miles a year. The tractors are on the road 90 percent of the time and some accumulate 200,000 miles in a year.

To keep its units moving on schedule and to avoid breakdowns on the road, P.I.E. has big maintenance and overhaul shops at its Salt Lake City headquarters. Under the direction of Harry Larson, fleet maintenance

Lightweight truck refrigerating unit to be given desert tests this summer

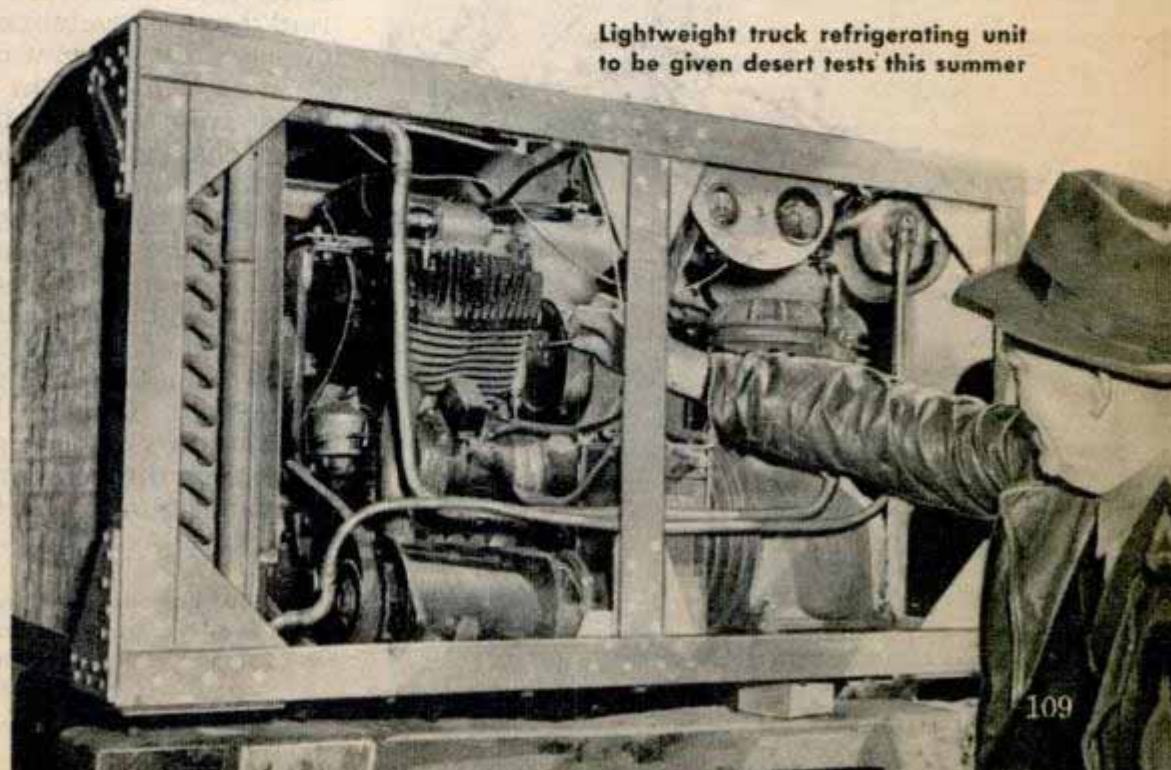



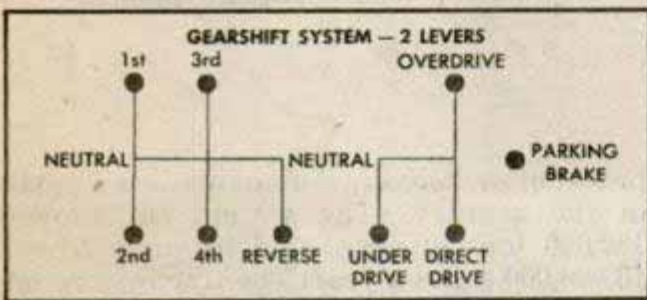
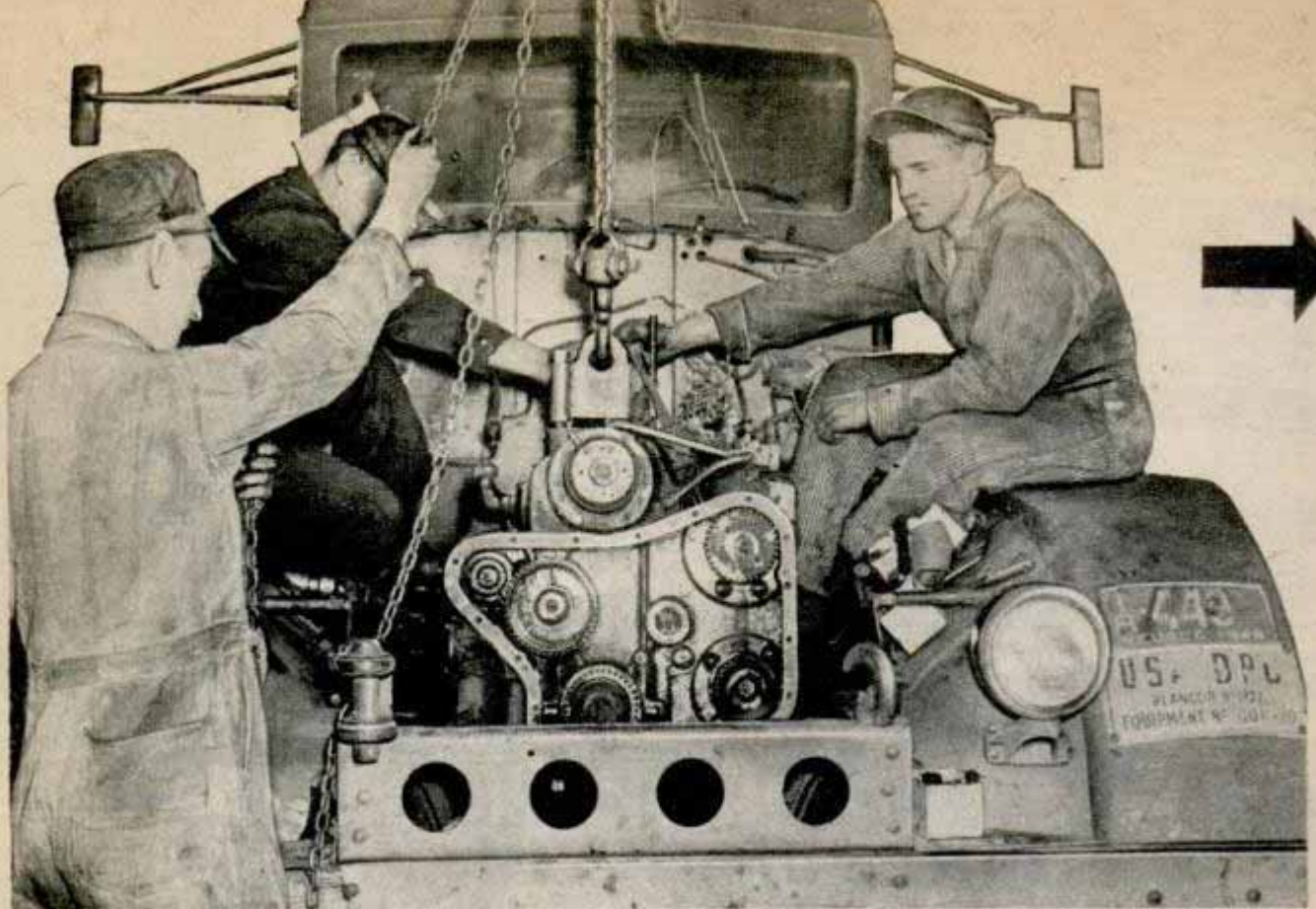

### Removing Diesel from a tractor for periodic overhaul

superintendent, a program of preventive maintenance is carried on so that all units receive inspections and overhauls based on mileage. Power plants, gearboxes, rear ends and accessory equipment are pulled out, according to mileages, to be restored to new condition, and are replaced from stock to keep the units moving. In effect, break-downs occur in the shop instead of on the road. "Squawk sheets" turned in by drivers are used as guides for incidental repairs.

The truck lines are as vitally interested in lightweight equipment as the air lines. Every pound that can safely be removed from the gross weight of a tractor or trailer increases the amount of pay load that can be carried. One weight-saving development is the frameless semitrailer that has no heavy chassis. The sides of the van themselves are the structural members, being engineered like bridges to support the weight of the cargo, carried on cross members between the two sides.

Lightweight semitrailers 35 feet long are being built of stainless steel, and other vans consist almost entirely of aluminum and magnesium. One of the latter can carry four times its own weight. A recent development in the cement-hauling field is an all-magnesium truck train built by Permanente Metals Corporation. The tractor,

Cab of 200-horsepower Diesel tractor, with a diagram of the two-lever gearshift system. The new-type seats are equipped with built-in hydraulic shock absorbers

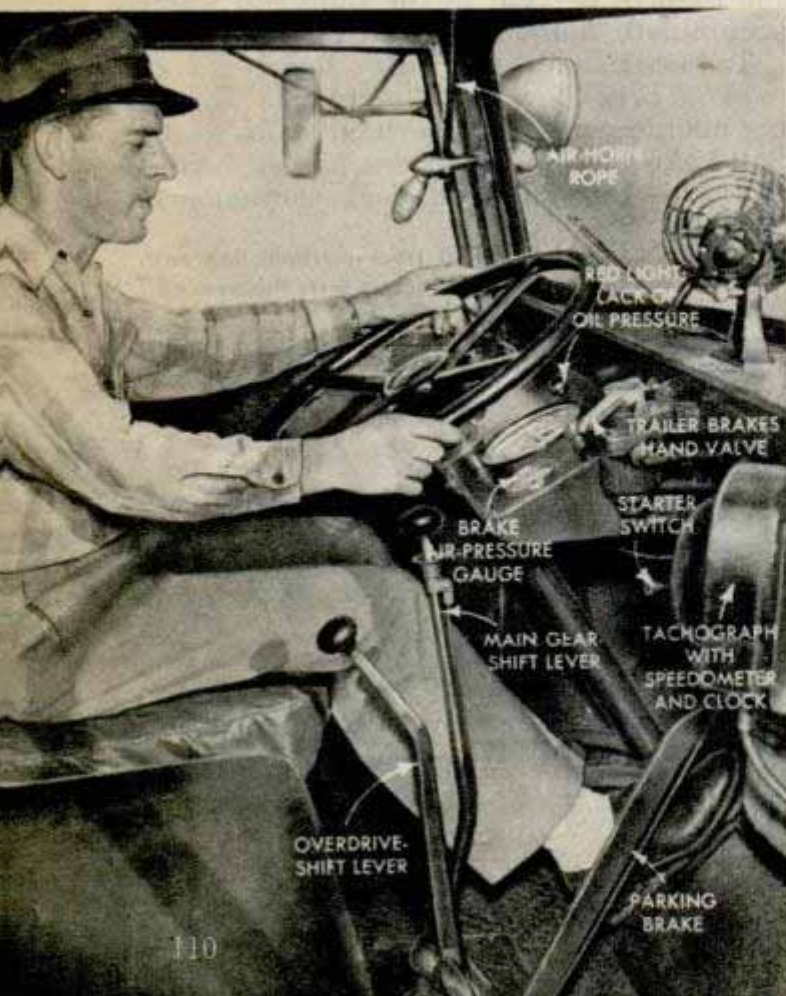



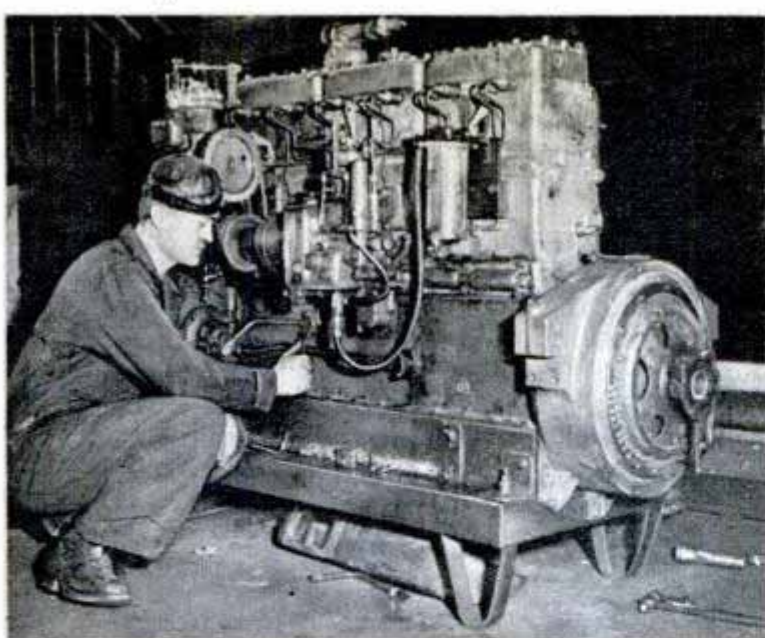

While another engine replaces it in the tractor, a Diesel starts disassembly for a complete overhaul

semitrailer and trailer have an over-all length of 60 feet and the unit can carry a pay load of 51,230 pounds under California highway laws, three tons more than usual.

In its campaign to save weight, Pacific Intermountain Express recently built in its own shops a big 200-horsepower tractor that weighs 14,000 pounds, two tons under the standard weight. This unit is to be the pilot model for an even lighter tractor that will weigh about 12,000 pounds. Designed by Harry Larson, the new unit will have aluminum axle housings, transmission casings, cab, fenders, running boards and engine hood.

Some time ago Larson cast a dissatisfied eye on the 1400-pound refrigeration plants that are used on the "reefer" trucks hauling frozen foods, whole sides of beef and other perishables. He redesigned the plant and brought its weight down to 700 pounds. Tested for months in temperatures as high as 120 degrees on the Nevada and California deserts, the lighter refrigeration plants have met all demands in maintaining an even zero temperature inside the insulated vans. Still dissatisfied, Larson has designed a new unit that weighs only 350 pounds and will be tested this summer.

Highway trucking was pretty much a hit-or-miss industry a decade or so ago. It had its origin in the teamster business that moved goods from point to point inside a city. The industry expanded to a city-to-city basis when reliable trucks were developed. Eventually the big highway cargo systems were formed on the basis of "express service at freight rates." They make door-to-door deliveries between cities a hundred miles or a whole continent apart. Today they are a major element in the nation's huge transportation picture.



Maintenance is an around-the-clock affair. Mechanic balances pistons to match weight of six in full set



Gearboxes and rear-end gear assemblies mounted on test stand for complete teardown and overhaul. Below, a special device for testing and adjusting fuel pumps

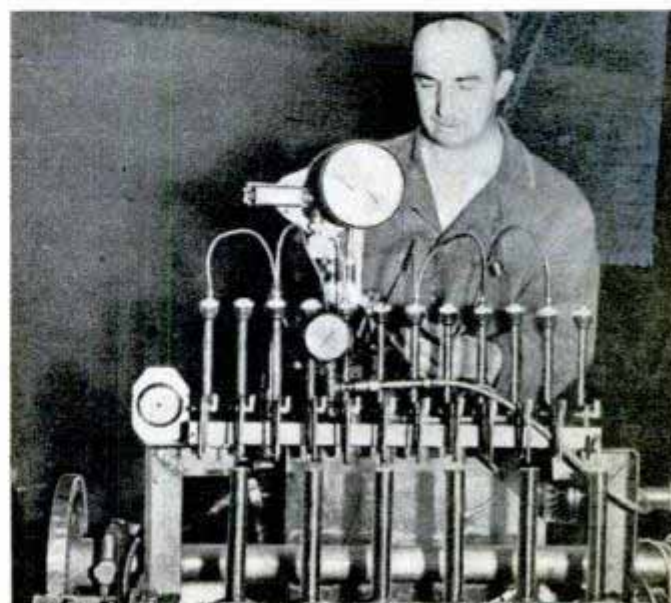





## Earphones Worn Like Stethoscope With Speaker Under Chin

← Lightweight earphones for aircraft and railroad communications can be worn under the chin instead of over the head. Designed like a stethoscope, the earphones include a tiny round speaker and two hollow tubes with earpieces on the ends. Made of Tenite plastic, the set weighs only 1.2 ounces including the speaker and a miniature plug-in attachment. It is said to produce high-fidelity reception with a minimum of ear pressure and head fatigue.

## Tire Carrier Swings Heavy Spare Into Position for Changing

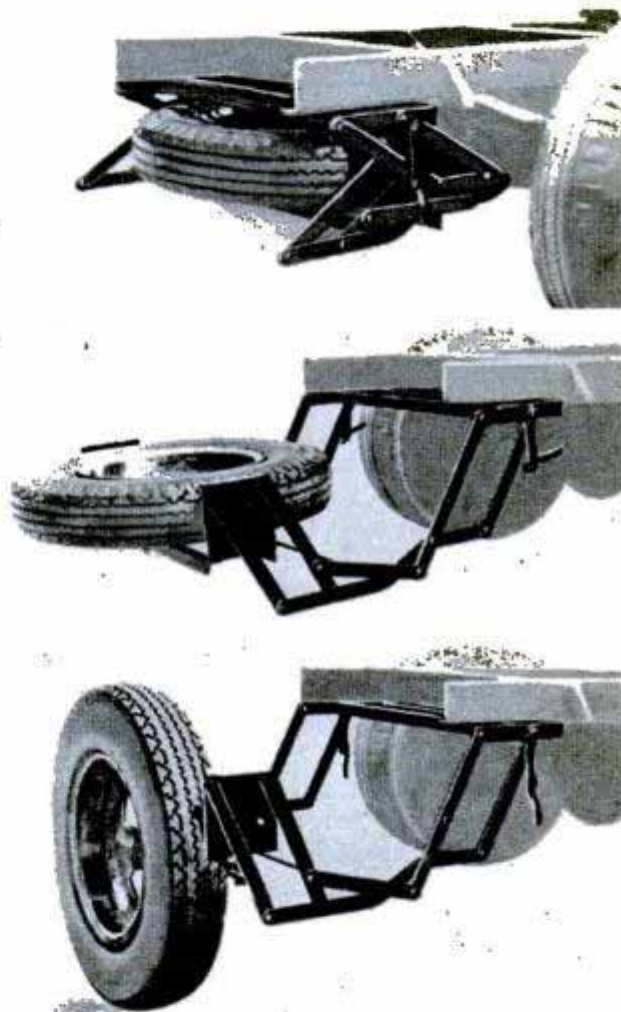

## X-Ray Gauge for Assembly Line Checks Thickness of Parts

Moving materials on production lines are measured for thickness with an X-ray gauge which does not touch the objects being manufactured. The gauge can be used on metals, paper, plastics, rubber or other material for continuous or spot-check measurements. It operates by comparing electronically the thickness of the material against a master sample with the required known dimensions. The thickness of metal tubing can be checked without cutting it.

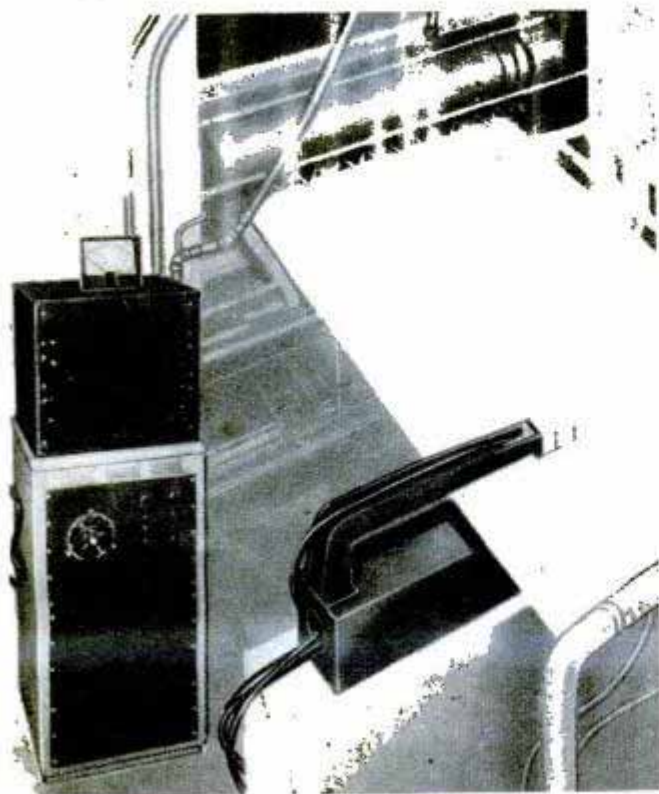

Spare truck or bus tires too heavy for one man to lift can be handled easily with the help of a tire carrier which clamps under the chassis. The carrier holds the tire out of the way under the body. When it is necessary to remove the spare, the carrier is pulled out and down so that the tire rests in an upright position ready to be detached and rolled into place. The replaced flat tire can be handled in the same way without lifting.

☛ Oatmeal porridge is now precooked and packed in hermetically sealed tin cans that need only to be heated before serving.



## Metal Applicator Provides Short Cut in Filling Engine Block Cracks

Cracked engine blocks are repaired speedily with a metal applicator that fills the crack with metal after alloy pins are put in place. Use of this electric tool eliminates the need for lining pins along the entire length of a channel, thus doing away with many drilling, tapping and peening operations. The applicator also is used to fill blow holes in castings and for brazing and soldering. Operated on 110-volt, 50-60-cycle power supply, the unit has a dual-purpose control switch which lowers the operating temperature in one position and raises the fusing temperature in another.

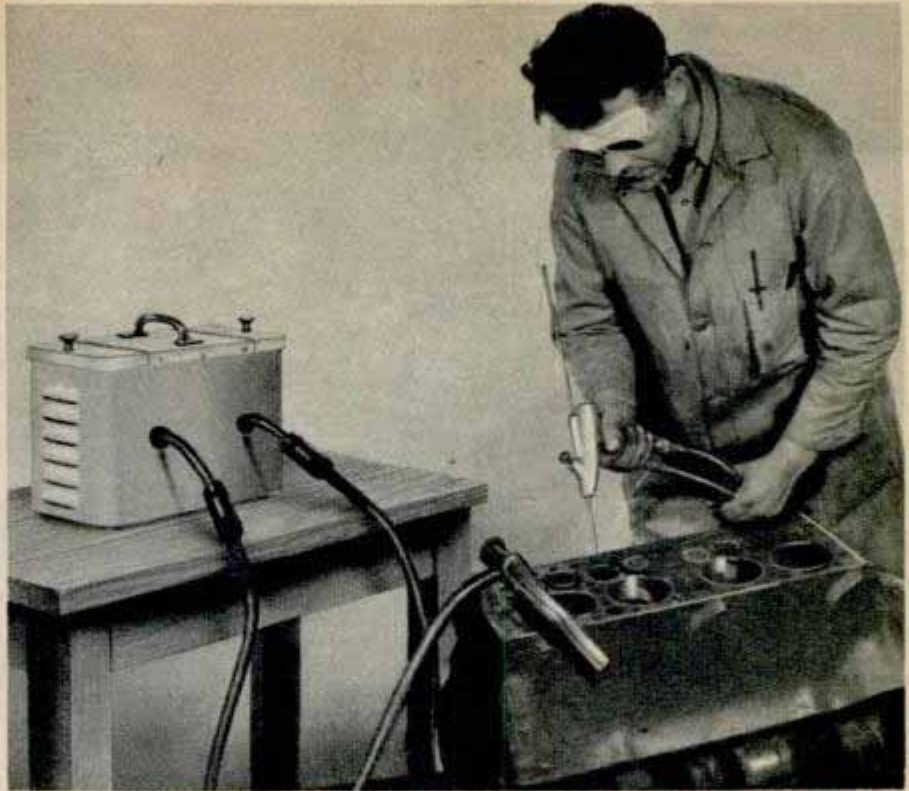

## Radiotelephone Service Links Remote Western Ranches to Cities

Several isolated western ranches are now linked by radiotelephone with the nation's local and long-distance circuits through the telephone exchange at Cheyenne Wells, Colo. On the ranches, a forked radiophone antenna is used. One side of the antenna broadcasts phone signals and the other receives them.

### Why Is the Ocean Blue?

Belief that the ocean is blue because it reflects the blue in the sky has been proved false by two scientists attempting to use light rays to detect submarines. They found that the millions of dirt particles in ocean water reflect sunlight back to the surface. But the light that gets back to the surface has been filtered through many feet of water. The water absorbs the red and yellow colors of light, leaving greens, blues and violets, which combined make up indigo blue, the usual color of deep ocean water. The scientists who discovered this were Dr. F. A. Jenkins, professor of physics at the University of California, and Dr. I. S. Bowen, director of Mount Wilson Observatory.







Europe's finest Alpine road—the 26-mile-long Sustenstrasse in

Switzerland—is now open to travel-hungry motorists. In 1938 the Swiss started carving this beautiful road through the Central Alps at an altitude of 7300 feet. Except for a short mobilization period, even the war failed to stop the construction work. Cold weather and snow were the main delayers, halting the project seven or eight months

## Switzerland's New Alpine Road

each year. Now the 22-foot-wide asphalt paving cushions the way for travelers from Wassen to Innertkirchen. There are well-banked, sweeping curves and the grade never exceeds 9.3 percent. Construction costs were approximately \$9,000,000. The photo above, taken at the highest point of the pass, shows the Alpine scenery typical of the area. Below, workmen complete the last section of the highway.

Authenticated News photos





## Tapered Cones on Stable End Mill Eliminate Need for Spring Collets

Two tapered cones on a new end mill fit into matching cones on the holder and cap to give the cutting tool greater rigidity and concentricity. A nut screws tightly over the conical surfaces to increase the stability. The novel holding arrangement eliminates the need for spring collets which sometimes cause ragged and uneven cutting. The tool will cut to a depth of  $1\frac{3}{4}$  inches, has a feed of  $5\frac{3}{4}$  inches per minute and a cutter speed of 202 r.p.m.



## Fluorescent Lamps Attract Insects That Threaten Japanese Rice Fields

Fluorescent lamps are now used by Japanese farmers to attract insects to death traps, replacing gasoline lights which have been blacked out by a severe fuel shortage. As dusk falls over the rice fields, the farmers turn on blue-colored fluorescent lights and leave them on all night.

## Self-Cleaning Pipe Has Lighter

For the convenience of pipe smokers a lighter is inserted in the bowl of a pipe, ready to ignite tobacco by a flick of the thumb. Another feature of the pipe is a special piston that can be pulled out of the pipe barrel easily, removing bitter tar oil and moisture and providing a sweet, cool smoke.



## Revolving Rotor in Protractor Calibrated Like Transit

Calibrated the same as a surveyor's transit, a plastic protractor has a rotor which revolves a full 360 degrees. With the device it is possible to calculate angles directly from bearings, eliminating the figuring of interior and exterior angles. It is easy to handle and reduces the time required by usual protractor methods. It is also useful in dead reckoning navigation problems.

## "Death Ray" Machines Are Harmless

Of the 25 or more "death ray" machines invented during World War II, not one proved effective, according to Dr. Albert F. Murray, formerly with the Office of Scientific Research and Invention, who investigated all of them. Dr. Murray's specifications for a successful death ray include: (1) Burn a half-inch hole through a four-inch plank in five seconds; (2) burn a live tree six inches in diameter at a distance of two miles in three minutes; (3) kill small animals, such as guinea pigs, rats and rabbits, at 5000 feet in three seconds.

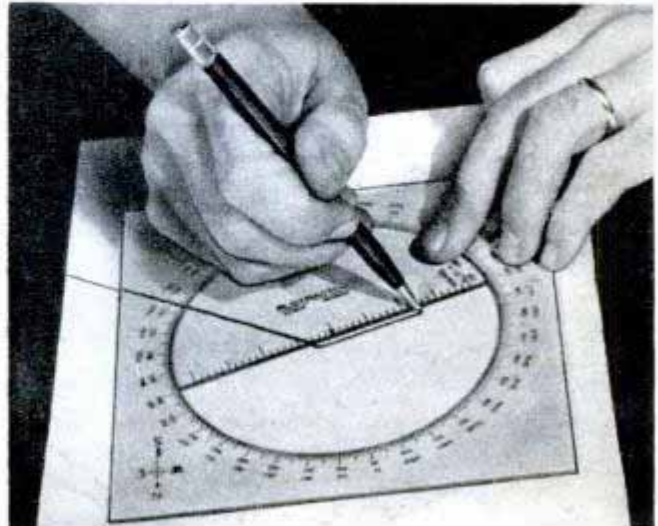



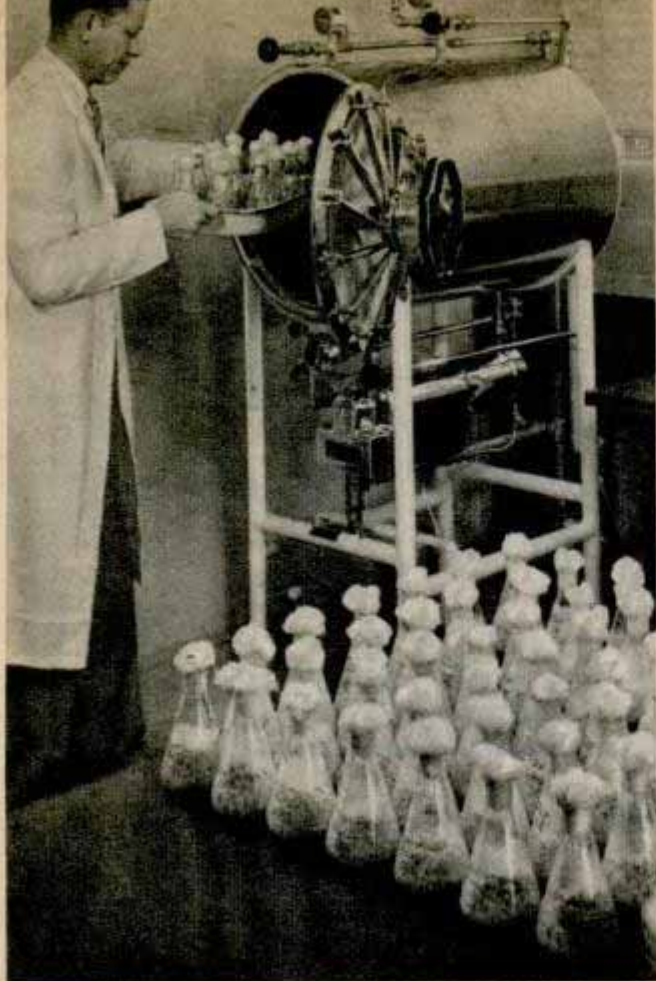

Barley used as food in insect control tests is sterilized in an autoclave similar to a pressure cooker

**B**IOLGICAL WARFARE has been opened against insect enemies of man. Taking advantage of the fact that bugs, like human beings, are subject to a variety of diseases, scientists have embarked upon a campaign to control the insects that destroy crops by spreading disease among them.

Why not annihilate a heavy infestation of codling moths in an apple orchard by starting a virus epidemic among them similar to influenza in man? How about broadcasting a deadly pestilence comparable to typhus that would decimate the chinch bugs in an area? Entomologists are seeking the answers to such questions because this kind of control would be cheap and automatic.

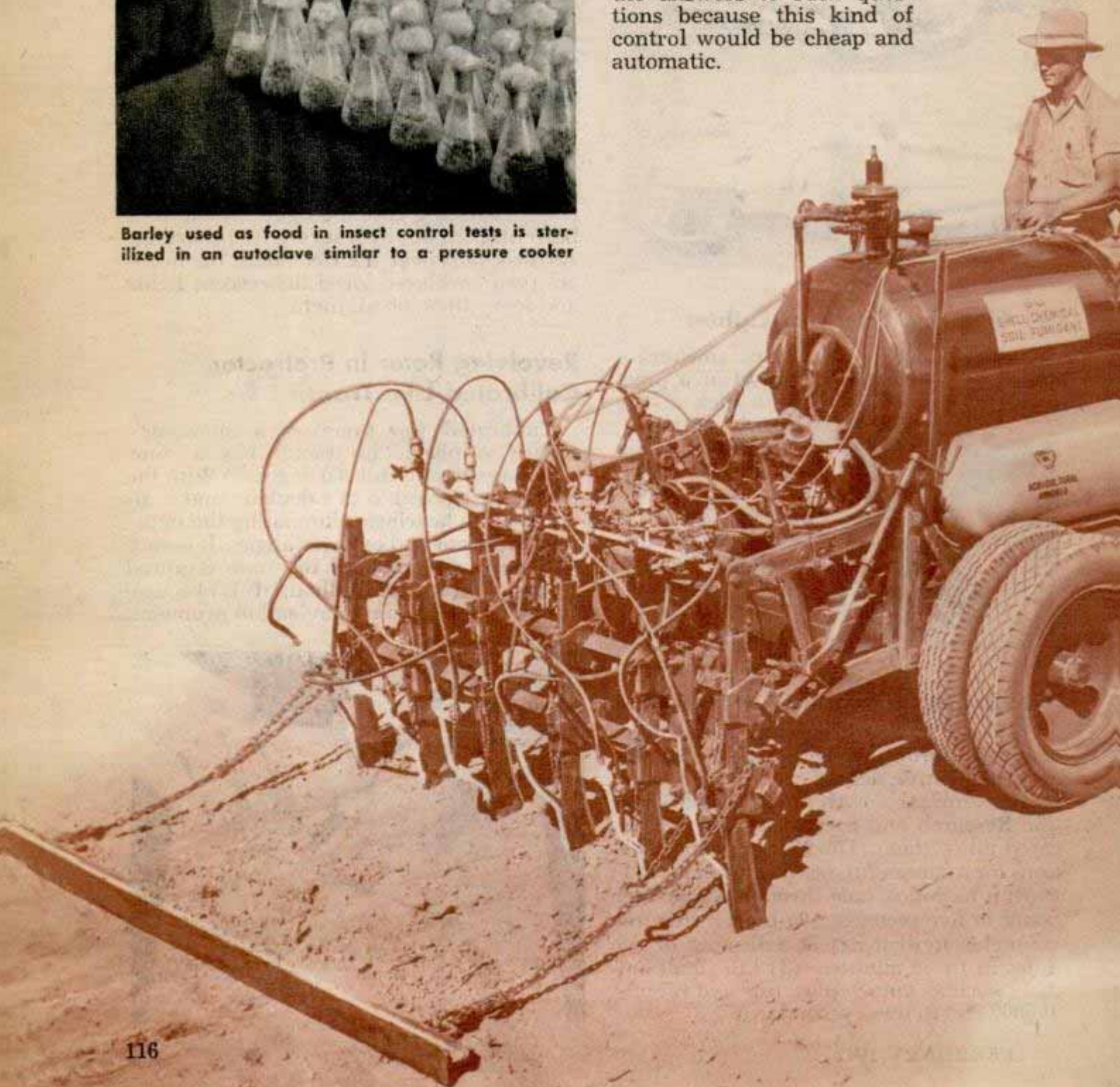



# WARFARE AGAINST BUGS

Biological warfare against insect pests has been an almost unexplored field in the past. Now it is receiving the full-time attention of a new insect pathology laboratory just established on the Berkeley campus of the University of California. Under the direction of Dr. Edward A. Steinhaus, a research group is seeking and testing microorganisms that are destructive to insects but harmless to man, animals and plants. Effective ways are being sought to make disease germs cause violent, devastating contagions among insect populations.

Such epidemics or epizootics occasionally

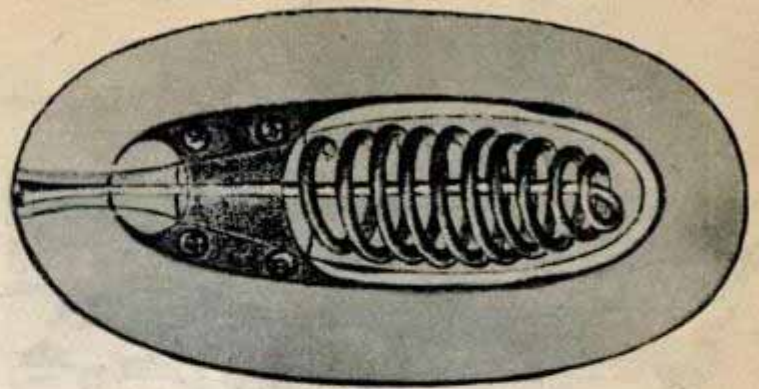

▲ Cutaway sketch shows filament coiled inside protozoan that attacks certain insects and causes disease



Photomicrograph by Dr. Edward A. Steinhaus

▲ Greatly enlarged photo of rodlike bacillus which induces disease in corn borers and cabbage butterflies

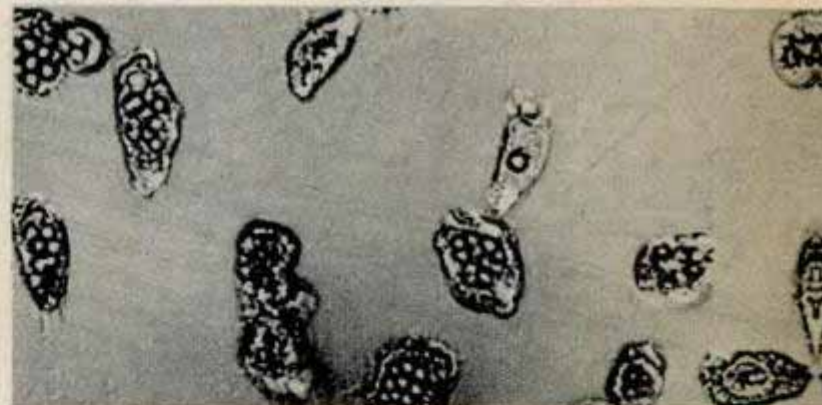

Photomicrograph by Dr. William Traeger

Virus injected into insect tissue cells causes the appearance of white dots. Below, parasitic wasps kill Oriental fruit moths and other insect pests

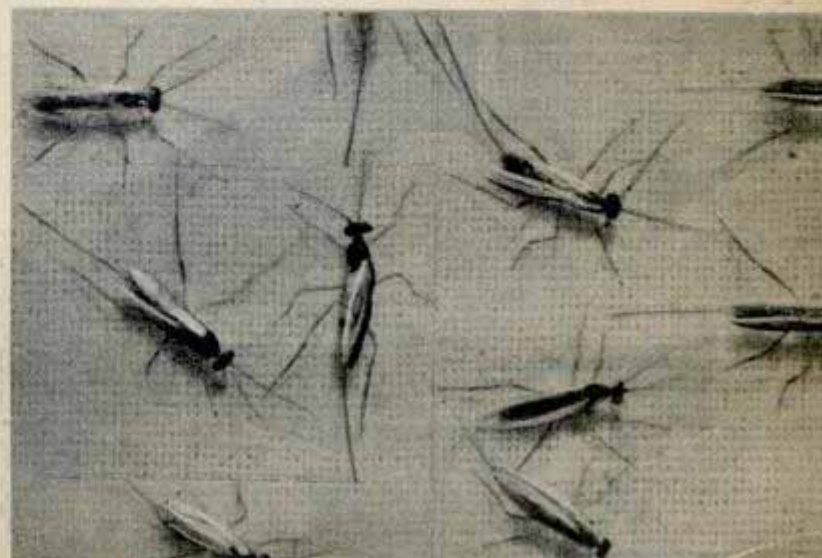

Double injection spreads fertilizer and kills destructive nematodes at same time. Expansion of liquid ammonia fertilizer has covered injector pipes with white frost





Studying effect of a new chemical on darkling ground beetles

occur in nature. Now and then a farmer whose alfalfa crop is about to be destroyed by the alfalfa butterfly suddenly finds that all the caterpillars have mysteriously died, ending the threat to his crop. Similarly, Canadian foresters have noted that a horde of spruce sawfly causing widespread ruin in a spruce forest may suddenly succumb to an unknown malady. These are only two of many instances.

Apparently each variety of insect is plagued by one or more diseases that afflict its kind. Just how or why such a disease suddenly flares up to epidemic proportions is unknown and, in many cases, not even the microorganism that is responsible has been determined. Only recently, for instance, was it discovered by Dr. Steinhaus that a certain virus is the deadly agent in California that attacks the alfalfa butterfly in its caterpillar stage.

Lack of enough knowledge may be the reason why some efforts at germ warfare have been unsuccessful in the past. Attempts to create artificial epidemics among swarms of locusts and grasshoppers have had only indifferent results although these insects are susceptible to diseases. Research workers are optimistic now about their chances of controlling these pests some time in the future.

The best-known example of successful biological control is the checking of the Japanese beetle along the Atlantic seaboard by a spore-forming bacterium that produces a so-called milky disease in the beetles. Once a fearsome threat to vegetation, the beetle to a large extent has been kept under control since the infectious agent was discovered and put to work.

Disease campaigns have been started in the University of California laboratory against scale insects that infest citrus groves, the codling moth that is found in



Potatoes are used at the University of California in production of parasitic wasps for insect control studies. Below left, inoculating test plates with plant disease organisms. Right, treating soil with a fumigant that destroys wire worms







**Nitrogen fertilizer is metered from tanks and added to water in irrigation ditch to kill certain earthworms**

some deciduous orchards, the alfalfa butterfly, and certain leaf-eating caterpillars that are classed as forest defoliators. Soil pests, including grubs and weevils, also will be investigated, and experiments conducted with bacteria, fungi, viruses and protozoa that have fatal effects on certain in-

sects. Quite possibly some of the germ-dispensing agents such as mists and smokes that were developed during the war will be useful in spreading diseases among insects.

Dr. Steinhaus stresses the facts that research has just been started, that much of it will be basic in nature for a time, and

**Healthy tomato plant has many hairlike feeding roots**

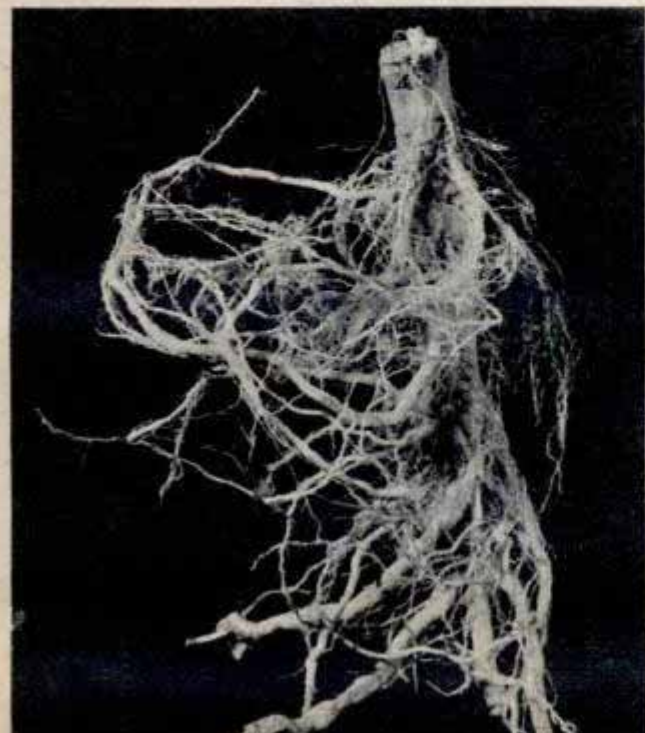

**Diseased tomato plant like this produces very little**







that immediate spectacular results are not anticipated. Biological control, he adds, will be attempted mainly against those agricultural pests that are not being satisfactorily controlled by other means. Some injurious insects are kept under control by the use of predator or parasite insects that are raised in insectaries and then released in the fields and orchards. Other pests are controlled by chemical warfare that employs various insecticides. There is no immediate need for biological warfare against flies and mosquitoes, for example, since these pests are easily controlled with DDT.

In the case of some pests the scientists expect that biological warfare might be useful in over-all long-range control and that insecticides could be used for immediate protection in case of local outbreaks. In the meantime several new insecticides, just discovered, are providing farmers with new weapons against some of their most destructive pests.

Biological warfare may also be a means of eradicating weeds, wiping out whole populations of undesired or noxious plants. That doesn't mean that disease germs or insects can be made to kill off all the miscellaneous weeds on a farm, leaving the crops untouched. The problem consists rather in finding and introducing diseases or insects that are selective against certain plants that need to be controlled. The Klamath weed that got a start on the West

(Continued to page 252)

Spraying deadly virus mist on alfalfa infested with caterpillars. The plant is not affected by the virus



## Turret-Control' Tug Turns in 28 Inches

Steering controls and power unit are enclosed in a cylindrical turret on a materials handling tug designed for greater maneuverability. The engine, automatic clutch, automatic transmission and driving wheel are mounted inside the turret. The entire assembly is turned to steer the vehicle or to back up, eliminating need for reverse gears or elaborate steering mechanism. The tug is powered by a six-horsepower engine and can travel eight miles an hour. It can turn in a 28-inch radius.



## Charcoal Canisters Keep Apples Fresh

Apples in storage stay fresh about 20 percent longer when containers of charcoal are hung in the storage room to delay ripening. Experiments at Cornell University show that if one percent of the apples in a storage chamber are riper than the rest they give off enough ethylene gas to ripen the others 25 percent faster. The charcoal canisters strain the gas out of the air in the same way a gas mask does its job. About 2½ pounds of charcoal will prolong the life of 250 bushels of apples, it is said. In addition to delaying the



ripening process, the charcoal helps prevent a storage disease called "scald" and absorbs all odors in the storage chamber.

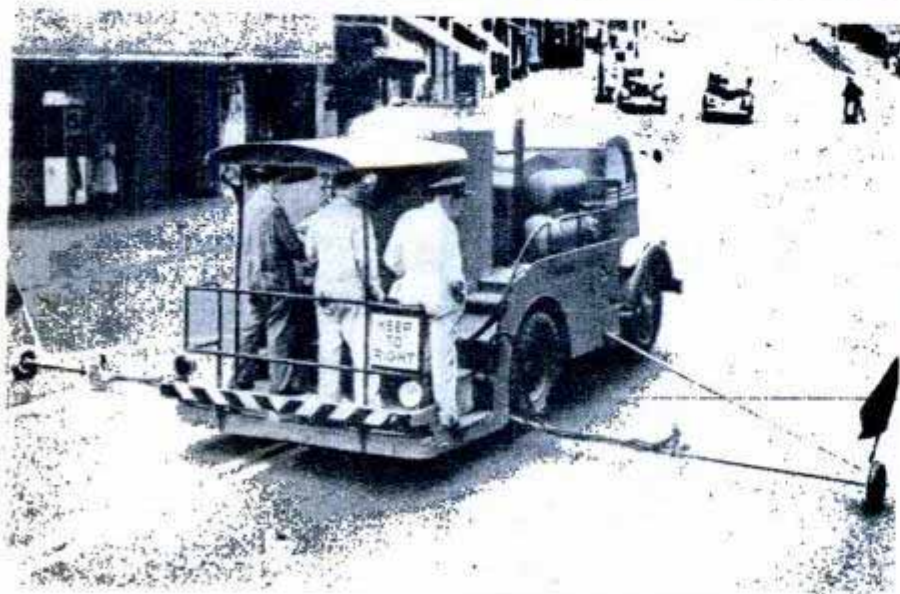

## Mobile Traffic Striper Paints 25 Miles a Day

Traffic stripes can be painted on 25 miles of highway in one day with a mobile striper designed and built by Carl Sohmer of Tacoma, Wash. Three men operate the machine. The paint is delivered through rolling power sprays. The power unit and compressor are mounted on a truck. The striper lines 12 blocks of city streets in 12 minutes, using 80 gallons of paint.



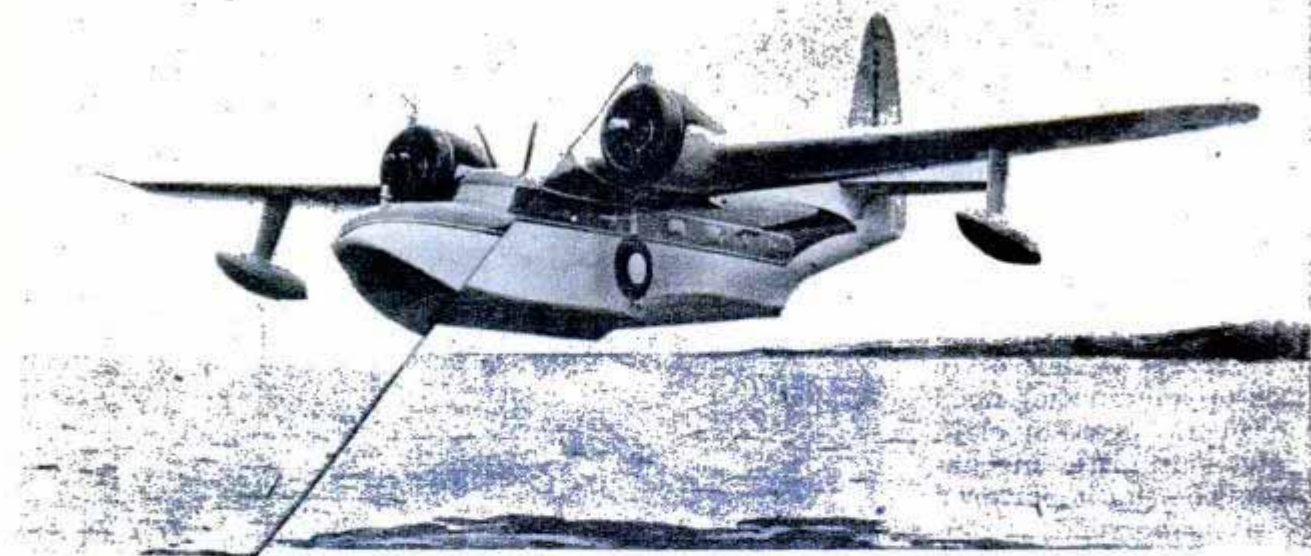

Safety is emphasized in the Grumman Mallard amphibian, with a rugged hull that can take wheels-up emergency landings on uneven ground with little or no damage. A deep flare in the hull bottom is designed for smoother water landings and quicker take-offs. The luxurious interior of the Mallard accommodates 10 in two compartments. Its cruising speed is 180 miles an hour, high for an amphibian, and range is over 1000 miles. Twin engined, the plane's wing span is 66 feet 8 inches, length 48 feet 4 inches and gross weight 12,500 pounds.



### Dry Ice "Seeds" Planted in a Cloud Produce a Crop of Artificial Snow

Snow for a white Christmas, winter sports or the storage of water for spring irrigation of crop land can be made to order with dry ice pellets and a cloud. In demonstrating the weather-making achievement for the first time, a three-mile-long cloud

was turned to snow with six pounds of pellets dropped into the cloud from an airplane flying at 14,000 feet. The dry ice serves as "ice seeds" which start to freeze the supercooled water droplets of the cloud. Once started freezing, the droplets grow

into snow crystals. In a few minutes the snow crystals replace all of the original droplets and the cloud becomes snow. Dr. Vincent J. Schaefer created the first artificial snow in a cold chamber at the General Electric Research Laboratory.

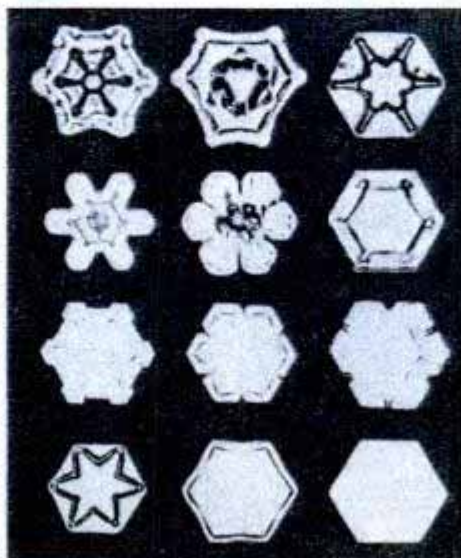

From the waters around Bikini, site of the atomic bomb test, a total of 39,000 fish representing about 250 species was obtained for the Smithsonian Institution.



# WHALE FACTORY

**W**HALING has gone modern in a big way aboard the Balaena (Latin for whale) which uses radar to dodge icebergs and three amphibian planes to spot its quarry. The planes, housed in a hangar on the stern and launched by catapult, radio the position of spouting whales to harpoon crews on smaller catching vessels which supply the factory ship. The Balaena, now operating in Antarctic waters, has a flensing, or blubber stripping, deck large enough to process four giants of the sea at once. Bulges to port and starboard give increased area to the deck.

The most modern machinery for utilizing every portion of the catch includes pressure boilers for treatment of blubber and bone, liver extraction plant, meat meal plant, deep-freeze lockers and other auxiliaries. The tanks in the hold (shown in the cutaway drawing by G. H. Davis, English artist, on the next two pages) have a capacity of 19,150 tons of purified whale oil. They are emptied from time to

No place for ancient mariners is the Balaena, new whaling ship equipped with radar and hangar for spotter planes. It carries crew of 430 men

time and the oil sent home in tankers. The British hope that a good whaling season will help ease the fat shortage. Also, experts from the Ministry of Food are on board the Balaena to study ways of making lean whale meat palatable. Fully equipped laboratories are available to chemists and other governmental researchers on the ship.

Ten catcher vessels with harpoon crews accompany the Balaena; they use humane type of explosive harpoon

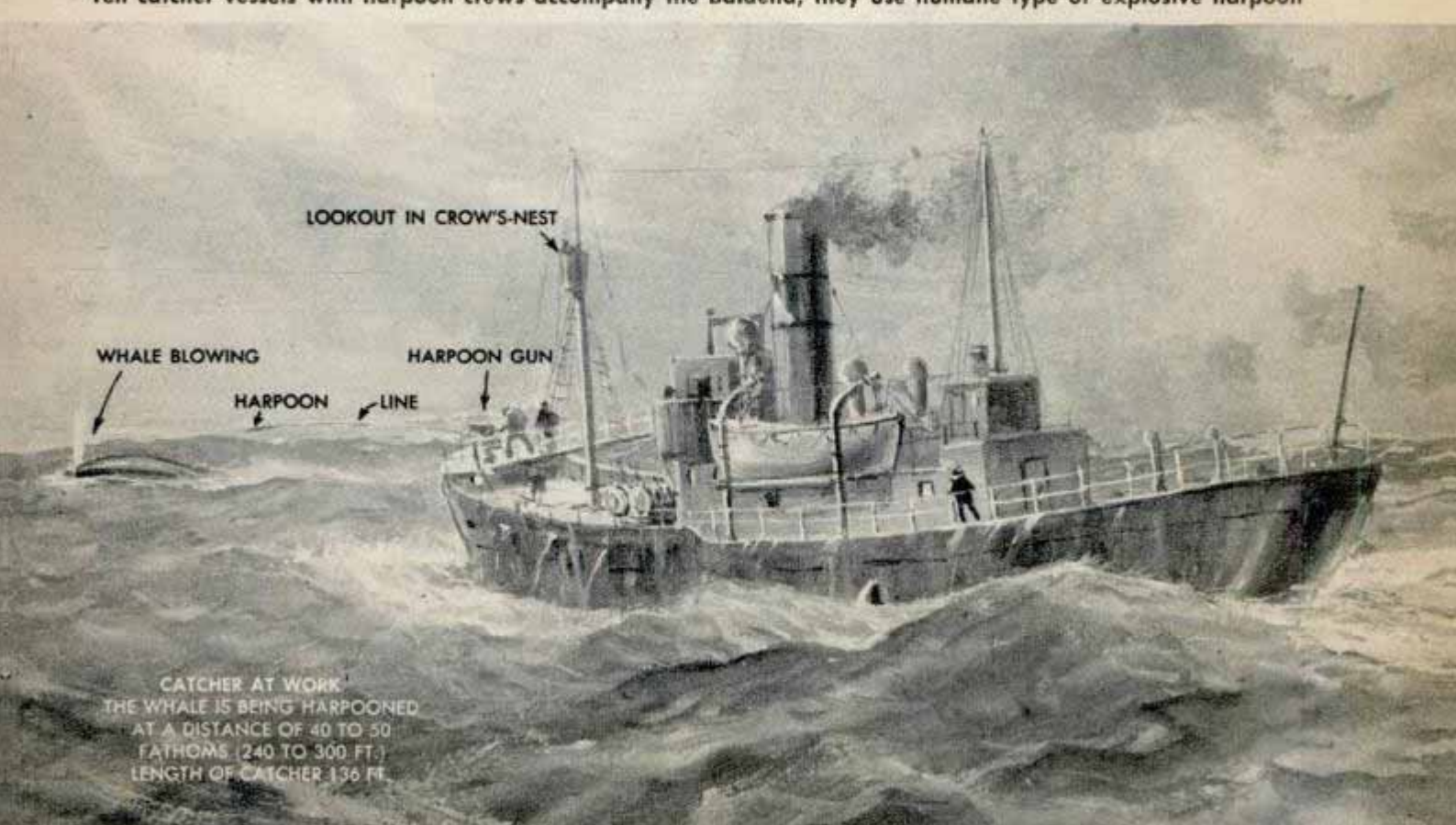

**CATCHER AT WORK**  
THE WHALE IS BEING HARPOONED  
AT A DISTANCE OF 40 TO 50  
FATHOMS (240 TO 300 FT.)  
LENGTH OF CATCHER 136 FT.



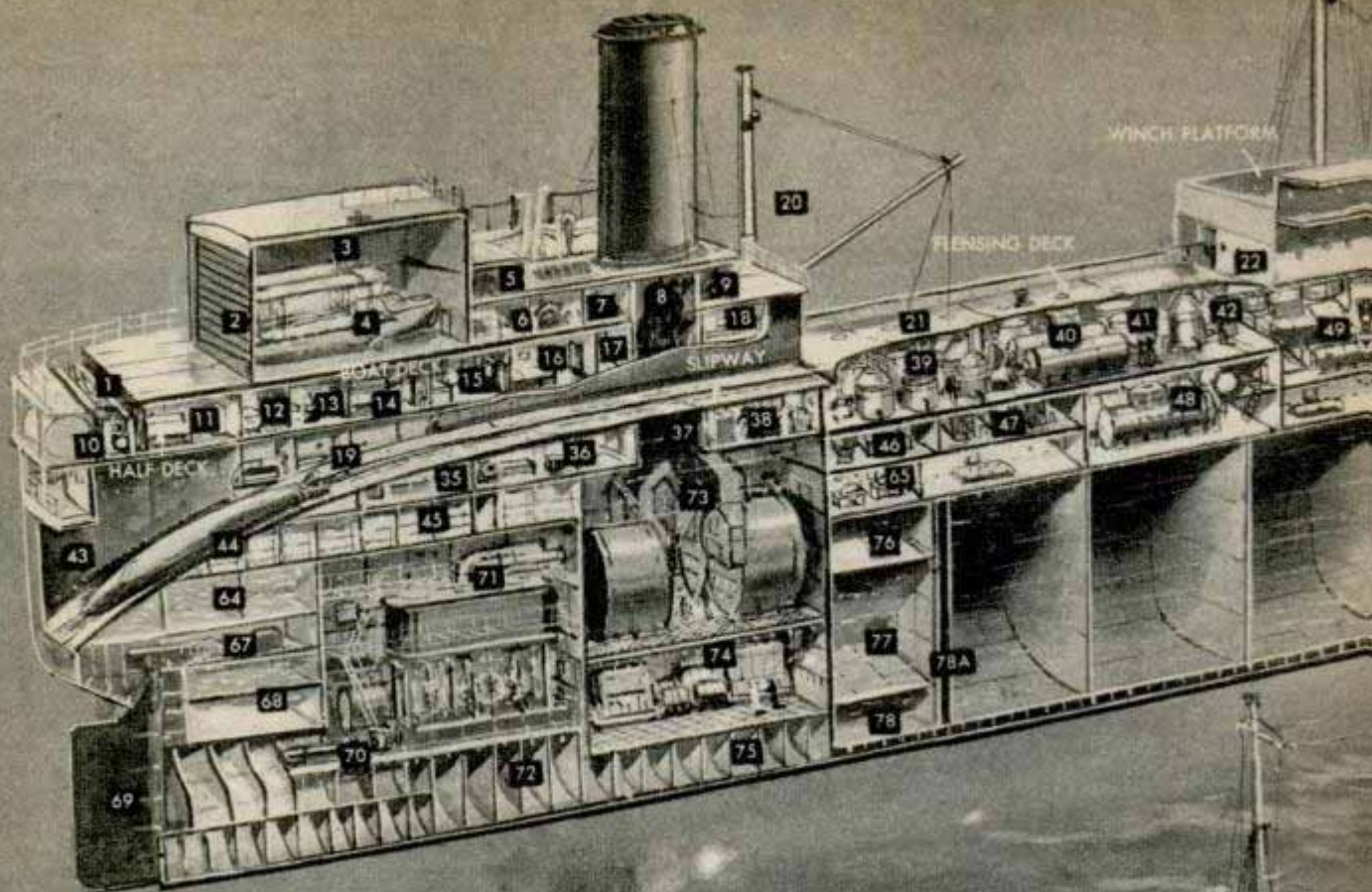

EXTERIOR VIEW  
 LENGTH, 535 FEET  
 BEAM, 74 FEET  
 DISPLACEMENT, 15,000 TONS  
 CARRY, 21,000 TONS  
 COMPLEMENT, 430 MEN

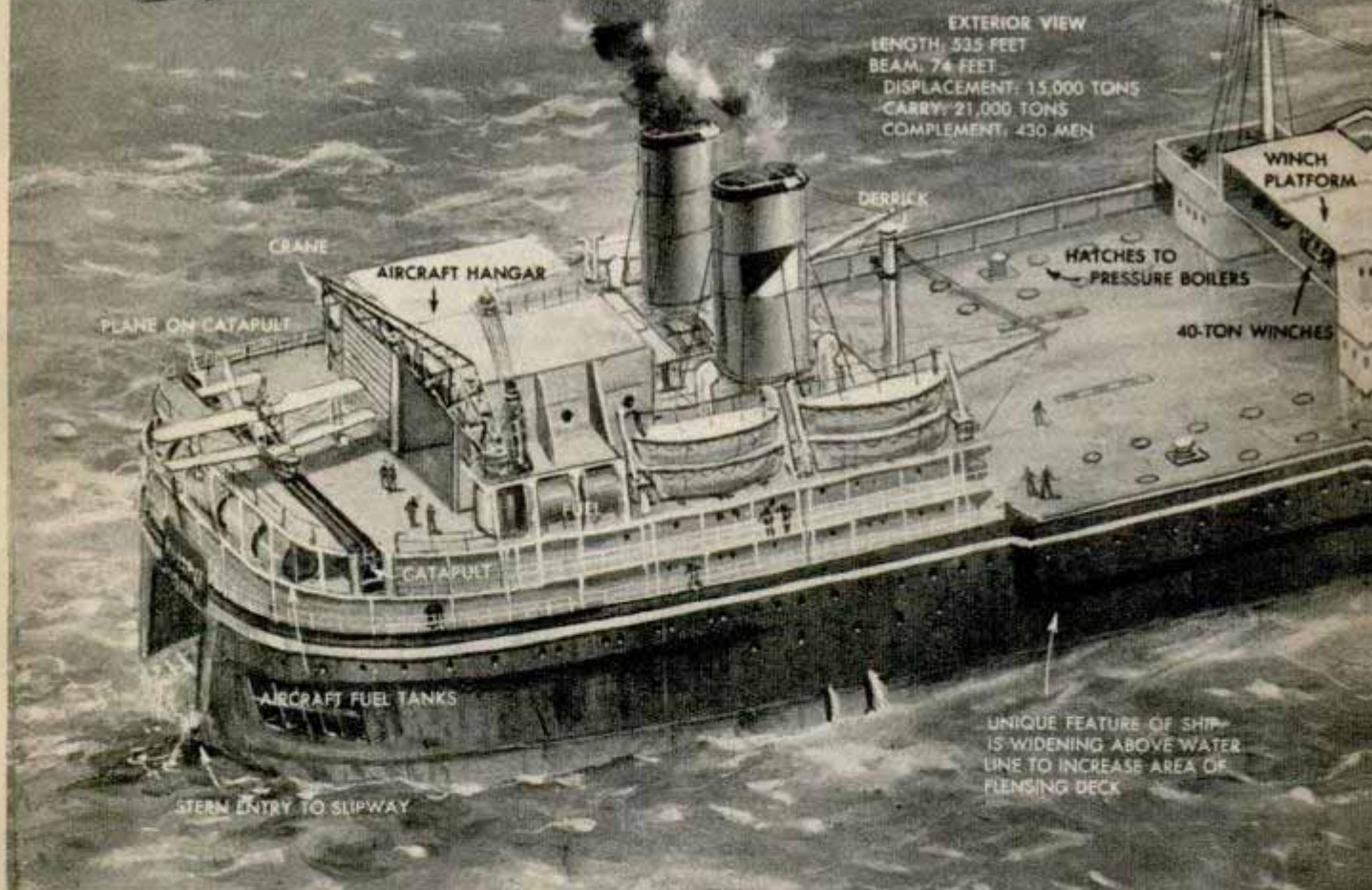

Sectional view of English whale factory ship shows, on boat deck: (1) aircraft catapult, (2) hangar roller shutter, (3) port hangar, (4) aircraft, (5) fans, (6) aircraft workshop, (7) fans, (8) port funnel uptake, (9) fans. On the halfdeck: (10) aircraft fuel tanks, (11) hospital, (12) bathrooms, (13) doctor's consulting room, (14) doctor's cabin, (15) dental surgery, (16) dental surgeon's cabin, (17) gangway, (18) assistant surgeons. On the flensing deck: (19) cookers' cabins, (20) derrick, (21) hatches to pressure boilers, (22) blacksmith shop, (23) carpenter shop,

(24) derrick and funnel, (25) lifeboat, (26) 40-ton winch, (27) electrical control room, (28) galley, (29) butcher shop, (30) pantry, (31) bakery, (32) hatch, (33) stewards' store, (34) boatswain's store. On upper flat: (35) seamen's laundry, (36) stewards' laundry, (37) funnel uptake, (38) bone drying plant, (39) blubber boilers, (40, 41 and 42) processing tanks. On the factory deck: (43) stern entrance to slipway, (44) whale being drawn up slipway, (45) cabins for workers, (46) drier, (47) meat meal plant, (48) separators, (49) liver plant, (50) mixture tanks,



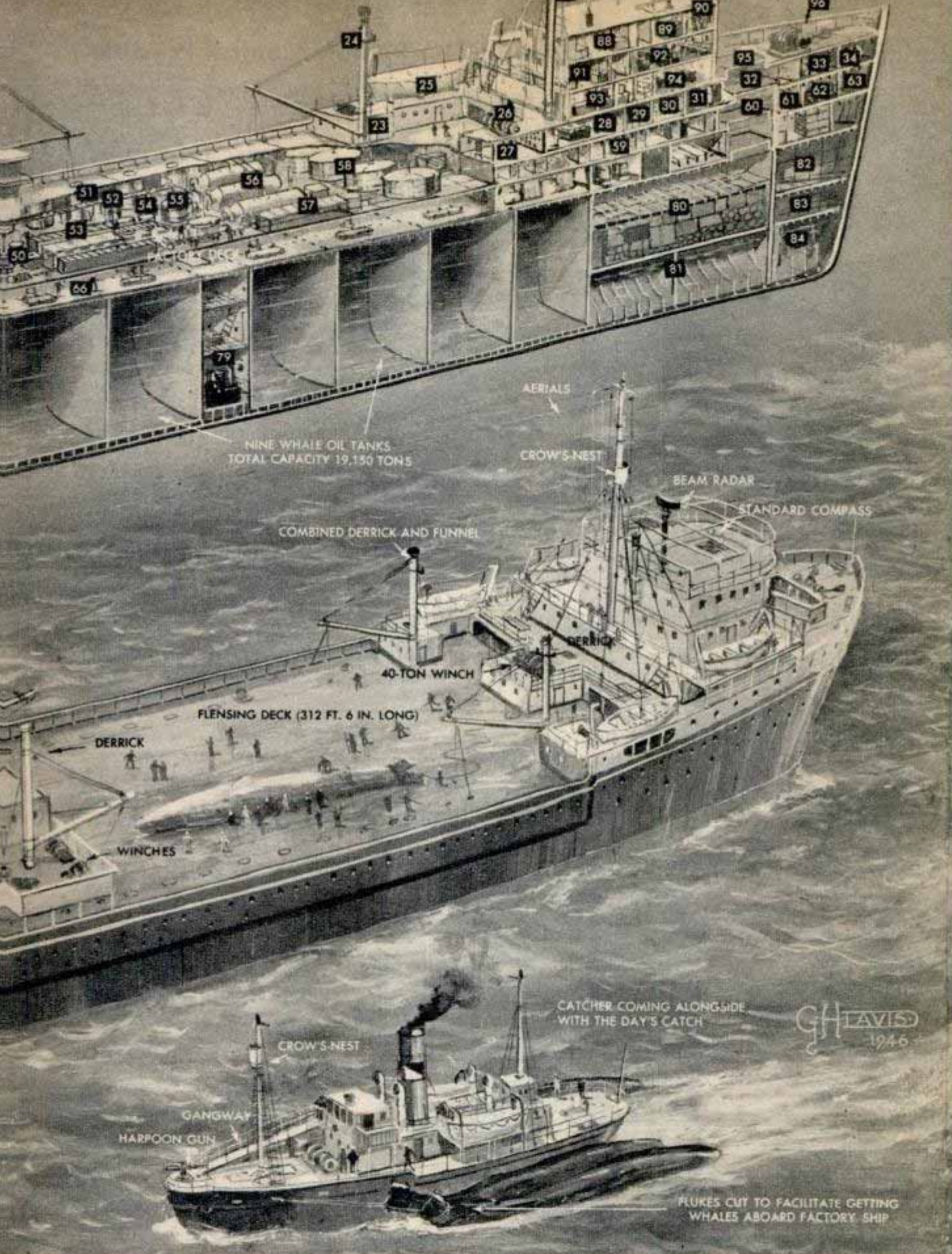

(51) pressure boilers, (52) conveyor, (53) driers, (54) settling tanks, (55) separators, (56) cookers, (57) cutting machinery, (58) driers, (59) freezing compartment, (60) hatch, (61) harpoon stores, (62) chain lockers, (63) stores. Lower flat: (64) fresh water tanks, (65) knife sharpening room, (66) tank tops. Lower hold: (67) steering gear, (68) water ballast tanks, (69) rudder, (70) propeller shaft, (71) triple expansion steam propulsion engine, (72) fresh-water tanks, (73) boiler room, (74) generators, (75) fuel tanks, (76) Diesel oil tanks, (77) settling

tank, (78) fuel tank, (79) pump rooms, (80) fore-hold, (81) fore deep tanks, (82 and 83) fresh-water or ballast tanks, (84) reinforced bow frames. Bridge and superstructure: (85) foremast, (86) beam radar, (87) master compass, (88) wireless cabin, (89) captain's chartroom, (90) wheelhouse, (91) officers' cabins, (92) dining room, (93) officers' and chief stewards' cabins, (94) mess and smoke rooms, (95) hatch, (96) windlass. This cutaway drawing was made of the new Balaena, 15,000-ton whaling ship built in Belfast for United Whalers Ltd. of London.



## Radio Guided Tractors Make Plowing by Remote Control Possible



One farmer soon may be able to plow a half dozen fields at the same time with radio controlled tractors. At Barnet, Hertfordshire, England, radio signals direct the tractor along a straight furrow, raise the plow when the end of the furrow is reached and cause the machine to turn either right or left. One man directs the tractor movements through a tiny master switch. The radio impulses operate electrical relays in the receiver. These, in turn, operate compressed air servomotors mounted on the tractor and controlling its movements.

## Heating-Cooling Unit Uses Temperature of Earth as "Fuel" Source

Year-round temperature control for homes is provided by a small unit that utilizes the moderate temperature of the ground below frost level as a "fuel" source to provide heat in winter and cool air in summer. A refrigerant, Freon, circulates through the unit which operates on the same principle as an electric refrigerator. Heart of the unit is a coil buried in the

ground outside the home. The refrigerant, in a cold liquid state in winter, circulates through the coil where it picks up heat from the comparatively warmer ground and is vaporized. The vapor passes through a compressor which boosts it to a higher pressure and temperature. When the hot vapor passes through an air coil, the heat is extracted by the air stream and circulated through the home.

The refrigerant, cooled by the air, condenses and passes through an expansion valve where pressure and temperature are reduced to make it a cold liquid again. From the valve it goes to the ground coil to complete the cycle. In summer the function of the ground coil and air coil are reversed to cool the house air. No chimney is required for the unit, which is about the size of a home refrigerator exclusive of the ground coil and air ducts.

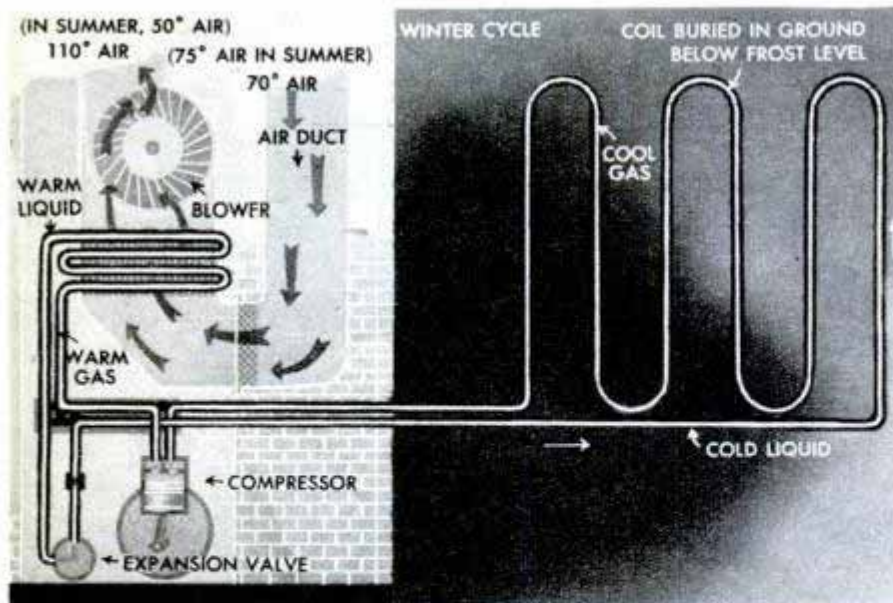

## Synthetic Penicillin Offers New Chemical Weapon Against Disease

Synthetic penicillin is providing medical science with a new weapon in its fight against disease. Produced for the first time at Cornell Medical College by Professor Vincent du Vigneaud and his associates, the

synthetic mold may prove to be superior to natural penicillin. Improvements in chemical makeup may offer remedies for such diseases as tuberculosis, the common cold, influenza and infantile paralysis.



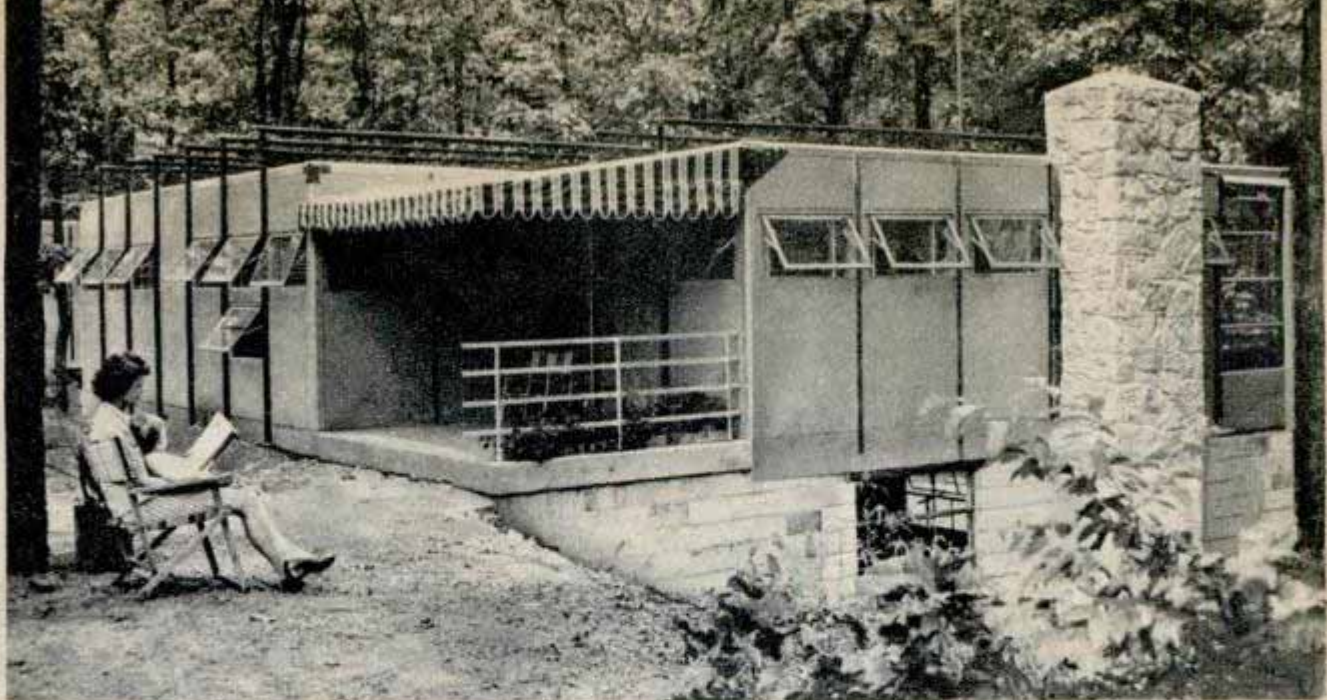

## Aluminum-Plywood House Built of Salvaged Materials

Salvaged aluminum and plywood were the major materials used by J. L. Blackshaw in building himself an attractive one-story home in Atlanta, Ga. All window frames and molding are made of salvaged aluminum, and the window sections are bolted to steel uprights. The wall sections are two quarter-inch thicknesses of plywood insulated with two inches of spun glass. Nine fellow employees gave him part-time help with the construction.

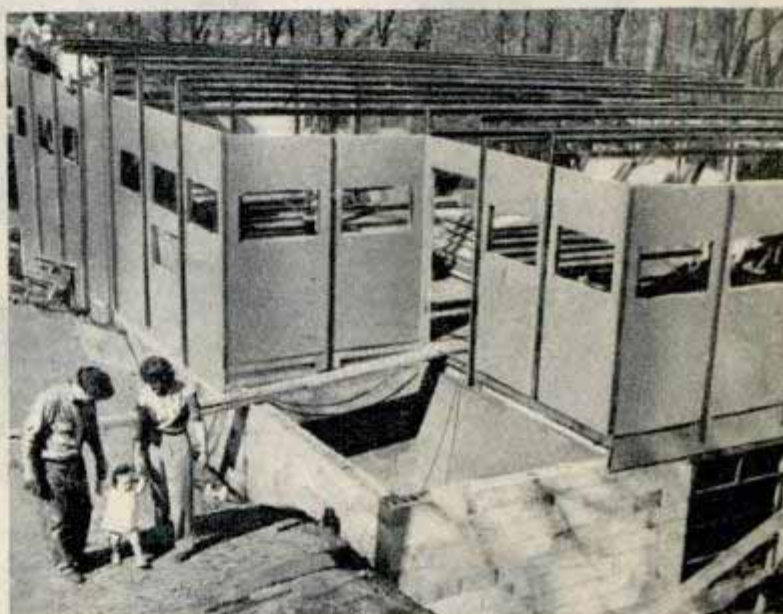

## Odd German Helicopter Has Exhaust Jets at Tips of Rotor Blades



Small exhaust jets are mounted at the tip of the rotor blades on a German jet-propelled helicopter. The craft, considered by aeronautical experts to be one of the oddest produced by the Nazis, is under study by the Army Air Forces at Wright Field, Dayton, Ohio.



Popular Mechanics is always ready to supply further information to readers about various products described in any issue. Just write to Bureau of Information, Popular Mechanics Magazine, 200 E. Ontario Street, Chicago 11, Illinois, for a prompt reply





*"Inside  
Stubb"*  
for  
Your Home

1

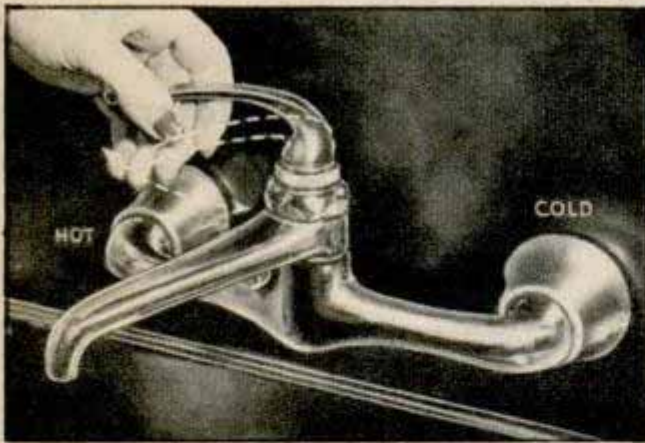

2

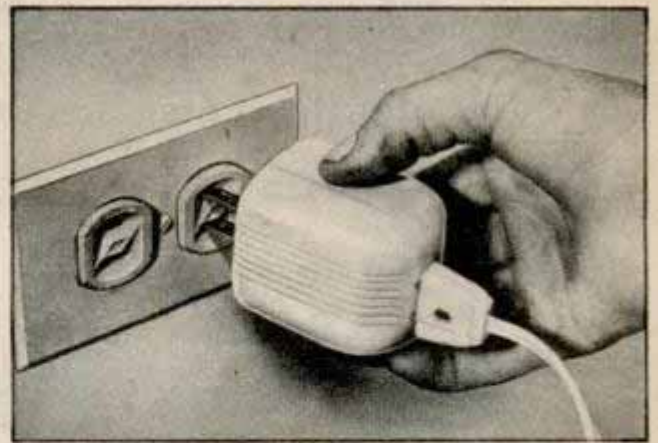

3

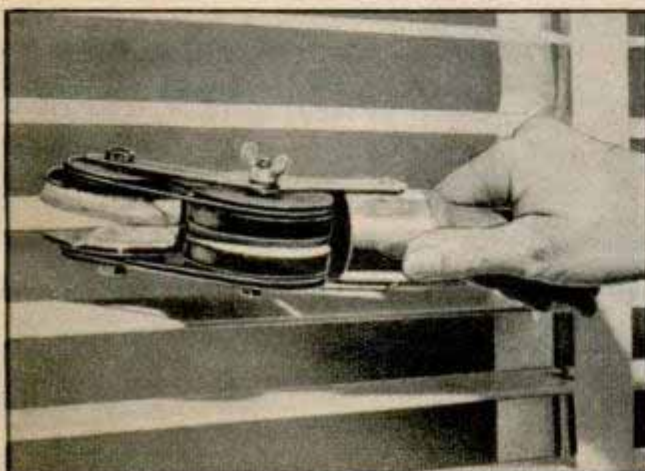

4



5





6



7

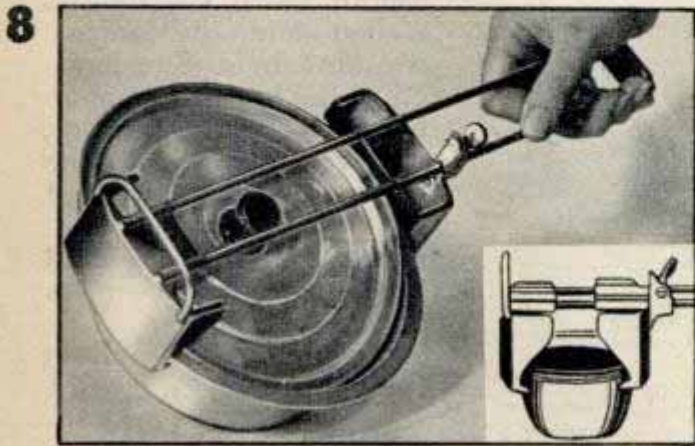

8



9

- 1 Oranges are juiced, potatoes sliced and steaks tenderized by a two-attachment kitchen utensil
- 2 Downward push on faucet handle regulates volume, sideways movement controls temperature
- 3 For electric razors working best on direct current, plug-in unit converts alternating current to d.c.
- 4 Venetian blind cleaner removes dirt from slats by rolling saturated pads across the surfaces
- 5 Like inverted pliers, a cap remover lifts jar lids by pushing down on the jar and up on the lid
- 6 Aluminum three-prong clothespin resists rust, holds clothes securely, is easy to apply and remove
- 7 Folding book and magazine stand has three-point base
- 8 Adjustable hot pan holder handles dishes of many sizes
- 9 Service tray holds 26 pieces of flatware, fits in drawer
- 10 Bagless vacuum cleaner picks up soap lather as well as dirt.

10







## Truck Salvages Boat By Hauling Overland

In a salvage operation at Daytona Beach, Fla., a stranded boat was rescued the "easy" way—by dragging it across two hills, loading it on a trailer and hauling it eight miles back to the water. The boat, a 10-ton cruiser 38 feet long, drifted ashore when the motors stalled and the anchor wouldn't hold. She landed on the beach during an unusually high tide and was well inland when the water receded. No boat could be chartered that was big enough to haul her back to the ocean, so an automobile salvage company was hired to do the job. A wrecking truck was placed 300 yards inland on the edge of a highway and its  $\frac{7}{8}$ -inch steel cable pulled across two sand dunes and wrapped around the boat's hull. The 100-hp. motor dragged the boat slowly across the dunes to the highway, where it was loaded on a long trailer. An inspection showed that the hull had scarcely been scratched.



## Excavator Steered From Cab Turns on Dime

Virtually turning on a dime, a crane-type excavator can be steered and brought into working position by the operator alone. It is unnecessary to block the crawlers in maneuvering. The crane is steered from the operator's cab by a system of sliding-jaw clutches and independently operated hydraulic brakes. It will make gradual or sharp turns, and in cramped quarters can be turned completely around. Separate crawler brakes prevent rollbacks or runaways.

☐ Ten matches per day for every man, woman and child in the United States are produced by the country's 24 major match companies, whose 28 factories turn out 500 billion matches each year.

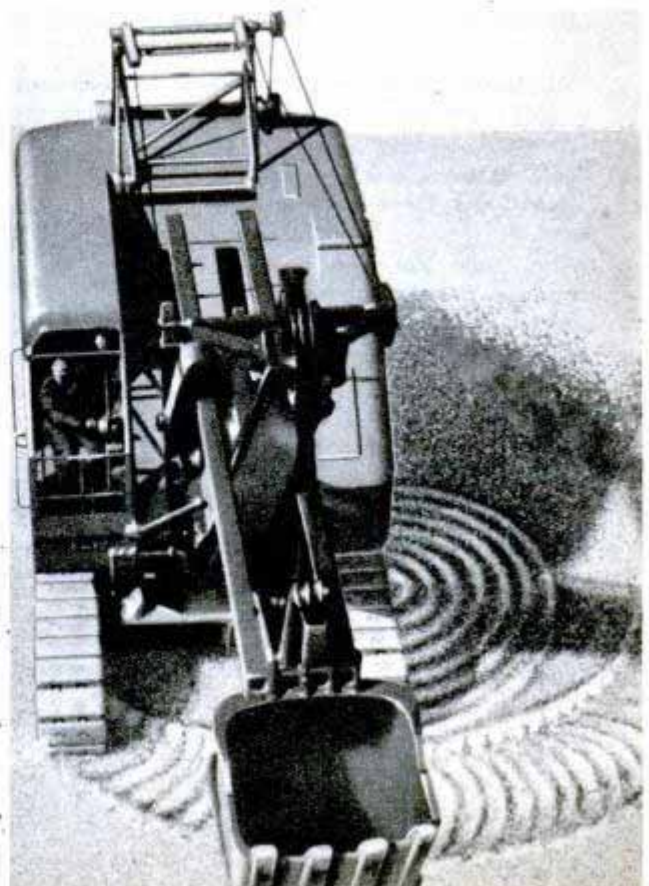





# RIGGERS RIDE HIGH

By Henry F. Unger

**F**OR RIGGERS, the first cable ride is a make-or-break event. Clinging to the chokers in whirring rides over canyon chasms at 1200 feet a minute, apprentices are made or broken in a year. Money alone isn't sufficient compensation for the daily dangerous work on the high line.

Riggers rarely rest. Without them today's huge dams wouldn't get beyond the blueprint stage, and 70 dams have been built in the last 10 years. Five were among the largest concrete dams in the world. Like circus performers, the riggers must often stand high above raging rivers and rocky embankments, without the reassuring presence of a net, and guide massive girders into place. Nerves can't misbehave at those dizzy heights.

Clambering all over the Davis Dam, on the Colorado River between Arizona and Nevada, they haul equipment and materials to workmen pushing the project to completion. Dams like the Davis, which is 200 feet high and 1600 feet long at its crest, are urgently needed for water power in the reconversion of industry.

For centuries, huge dams have been built to hold back

Iron-nerved rigger rides through space on a hook over the Grand Coulee Dam in Pacific Northwest. Drum gate and pier are in right foreground



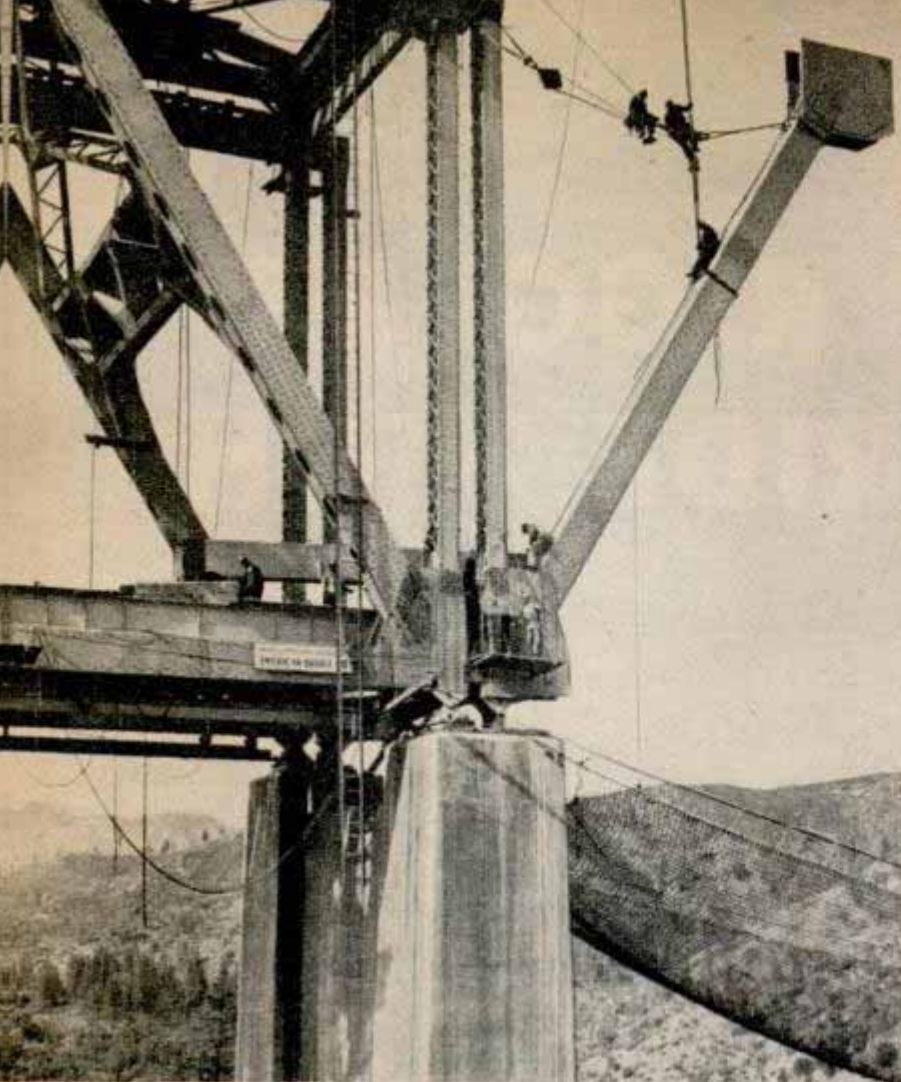

Views of riggers at work on huge Shasta Dam in California. During the past 10 years 70 dams have been completed, five of them among the largest concrete dam structures in the world

flood waters. A mighty masonry dam was begun at Assuan, Egypt, in 1898 and completed in 1902. Emperor Nero built a dam at Subiaco that lasted 1300 years and the Moors erected a dam at Elche, Spain, with a height of 52 feet and a base width of 159 feet.

But the touch of glamor came only with the advent of the modern rigger, who risks his life on every trip into high altitudes.

Even before a dam is begun, the riggers with a survey party will scale mountains, high above wild rivers, and place anchorages on the dangerous sloping sides. From there they often dangle by ropes while scaling down the walls of the canyon with jackhammers and pinch bars.

Following construction companies around the country, riggers live in barracks for the most part. Hard working and hard living constitutes their existence.

As the dam rises to completion, the role of the rigger becomes more important. He is constantly needed to carry tools and equipment to workmen laboring on the mushrooming dam. At some of the dams, like Grand Coulee, giant hammerhead T-shaped cranes were used. These ride over the steelwork and the riggers are dropped onto the steel trestles.

At the Boulder Dam, riggers rode on a railed timber platform hung from





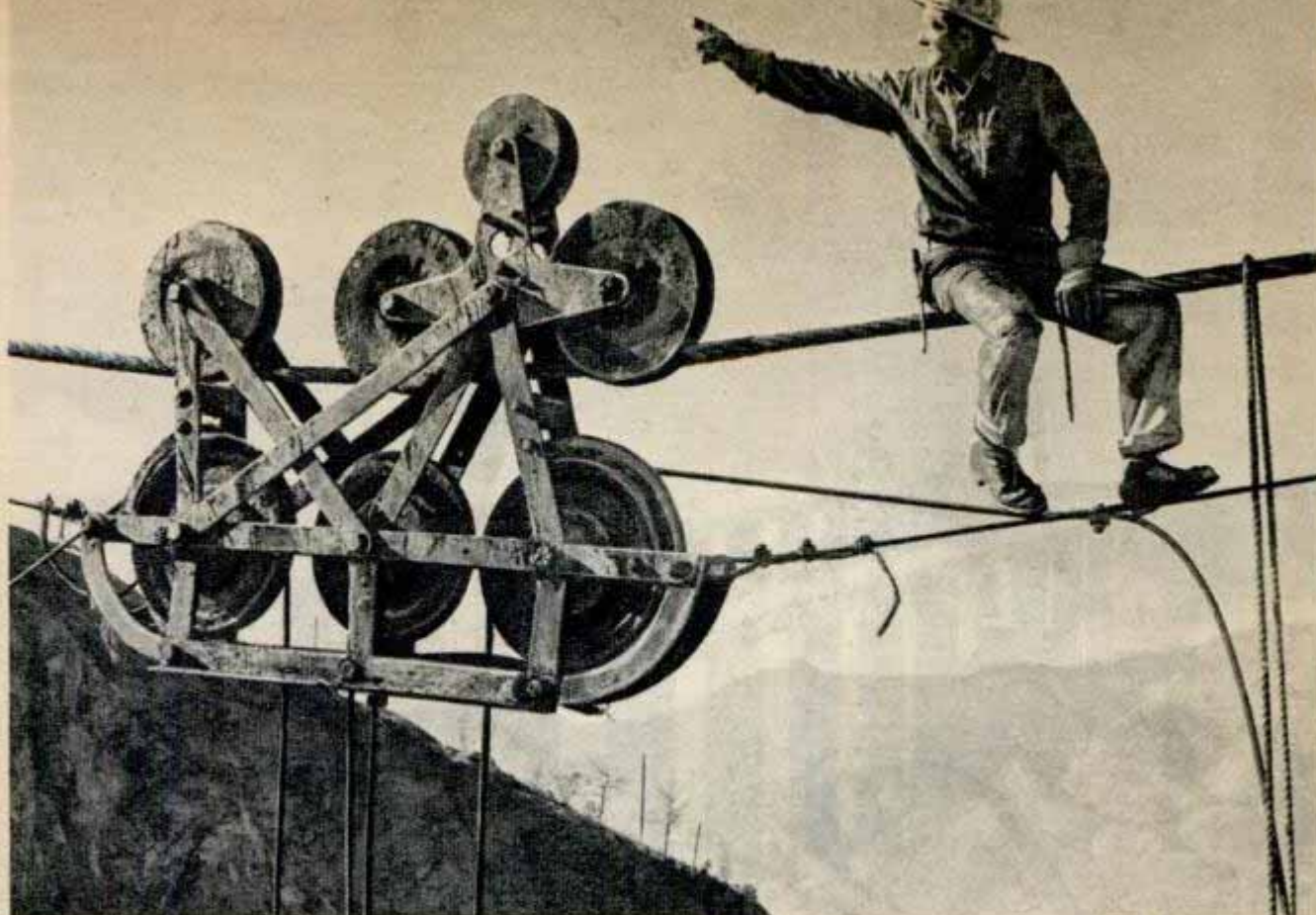

**"Joe McGee" rig used to remove excavated material**

an eight-wheel carriage. The cableway ship tender would wave a signal to the hoistman. The ship like a graceful bird would rise from the ledge, hesitate and then whip across the wide canyon chasm. At the end of the trip the tender waved a flag. The carriage stopped, swung like a pendulum and then dropped 700 feet to the canyon floor. Three minutes after leaving the Nevada rim of the canyon the rigger was on the floor of the Arizona side.

Riggers were kept on their toes hauling materials at Bartlett Dam, the world's highest multiple arch type. A suspension bridge had to be erected there to carry an eight-inch pipe, through which concrete was pushed by means of a two-cylinder pump. Three floods drowned the infant dam, sweeping away much equipment. Undisturbed, the riggers kept their schedule.

Working like beavers, riggers are almost seeing completion of the Anderson Ranch Dam in Idaho. With a height of 444 feet, a 1350-foot-long crest and width of 2650 feet at the base, the reservoir will hold 493,199 acre-feet of water. In conjunction with the Arrowrock, Deer Flat, Deadwood, Cascade, Black Canyon and Boise River Dams, it will provide water for lands in seven counties and incidental flood control in an area now subject to periodic inundation.

Without the riggers, dams now under construction by the Bureau of Reclamation would not be built. The Angostura Dam, 150 feet high, 1900 feet in length along the

crest, with a reservoir capacity of 220,000 acre-feet, is rising on the Cheyenne River. Kortes Dam in Wyoming on the North Platte River, 200 feet high, 440 feet long at the crest and with a reservoir capacity of 5000 acre-feet, is another in the chain of dams now being erected.

Once riggers have completed their task

**Setting reinforcing for walls and columns of a dam**





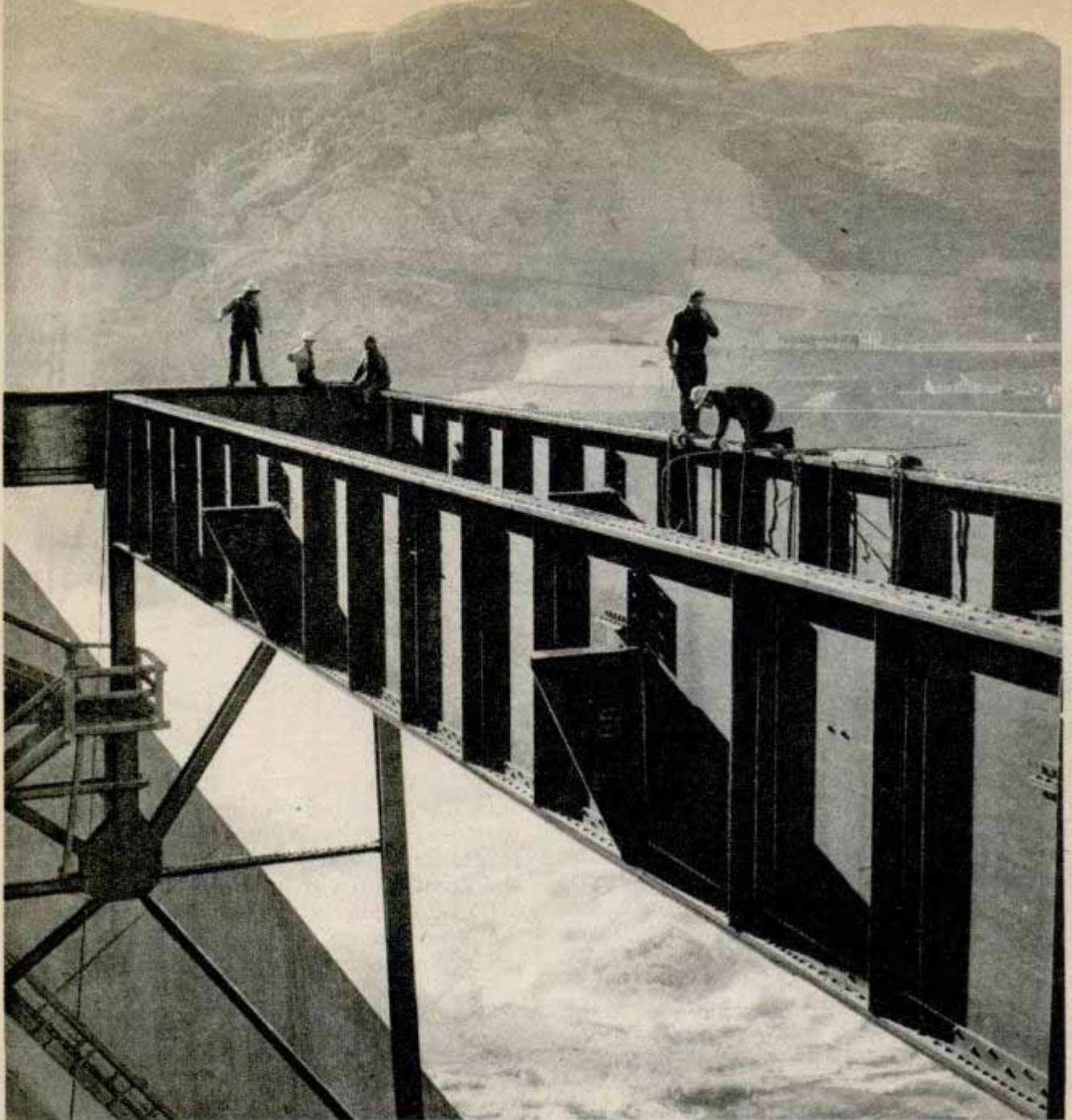

High over a raging river, riggers dismantle a construction trestle with same freedom of movement an average man has on the ground. Below, fastening cableway



on the huge Granby Dam, on the western slope of the Continental Divide, it will store water from melted spring snow that will eventually flow east under the Continental Divide through the 13-mile-long Alva B. Adams tunnel. From the tunnel outlet, the water will fall 2800 feet through six power plants to be built along Big Thompson Canyon, and finally flow into storage at Carter Lake and Horsetooth Reservoir, which will store irrigation water for 615,000 arid acres on Colorado's eastern slope.

Bridge Canyon Dam, just below Grand Canyon, to be the largest ever built, is now on the planning boards of engineers. The riggers already look upon it as their baby. In the 38 years during which 160 dams and reservoirs were built, the Bureau of Reclamation has called upon the riggers scores of times and each time a schedule was shattered. It won't be any different this time, for danger is the rigger's business.



## Glued Cartons Avert Cargo Shifting

Cardboard cartons containing glassware or bottled goods are glued together to prevent damaging contents during shipment by freight car. Gluing the cartons together keeps them from shifting around in transit. Two strips of glue are applied to the bottom of each carton by an applicator in the conveyor line leading into the car. Two large wheels of the applicator rotate in a tank of quick-drying glue and each carton is striped with glue as it moves along. In unloading, each box may be broken loose by a blow of the hand. A similar system for wooden boxes also is being tried by the Union Pacific Railroad.

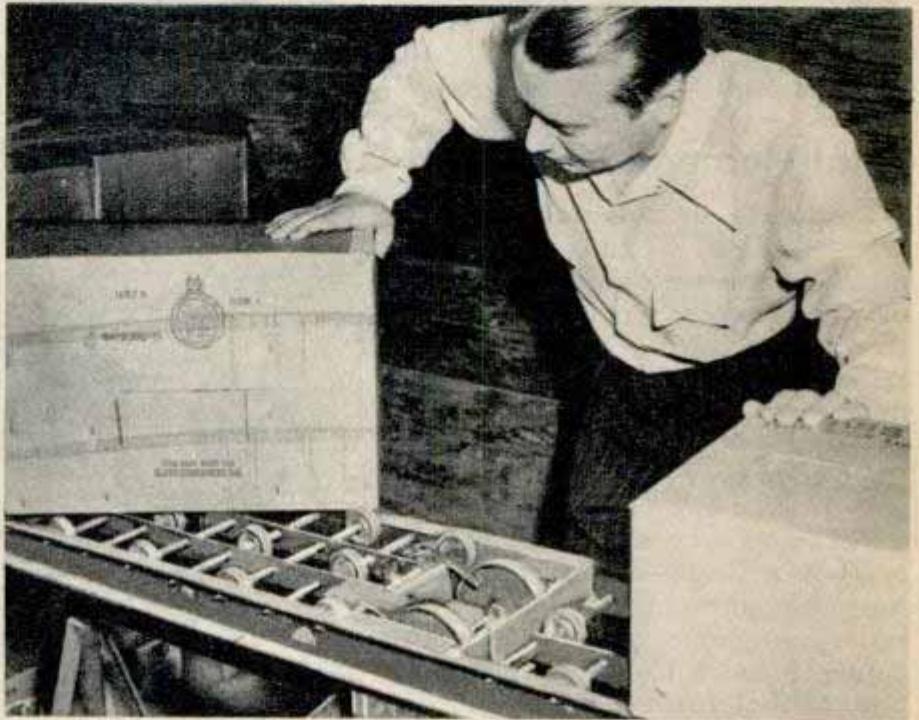

## Molded Glass Lenses Eliminate Grinding

Small optical lenses of eyeglass size can now be molded in quantity as finished articles without grinding or polishing.

The molding process is conducted in an atmosphere of hydrogen to prevent uneven chilling of the hot slug of glass on contact

with the mold. Lenses accurate enough for use in telescope systems are expected to be produced with improved presses.



## Roll-Over Auto Top Protects Race Pilot

One of the hazards of midget car racing has been lessened with a steel top which fits over the cockpit. Designed by "Doc" Shanebrook, a veteran race driver, the "roll-top" protects the driver if his car turns turtle. Value of the design was demonstrated at a race in Detroit when a midget racer, equipped with the top, made two complete rolls. The driver was uninjured and the car suffered only minor damage to its paint job in the mishap.



## Electric Pump Cleans Up Dirty Job of Changing Crankcase Oil

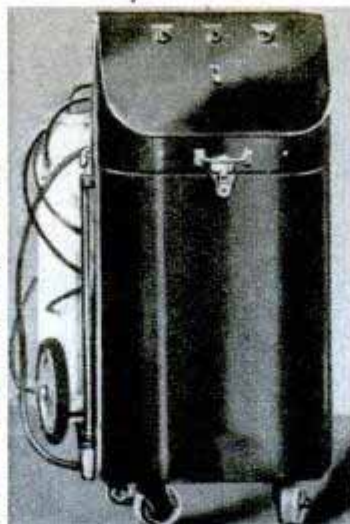

Changing crankcase oil—a dirty job that usually entails crawling under a car or driving it up on a ramp—is simplified with an electric pump. A long, thin, metal tube is inserted through the oil gauge hole to the lowest point in the crankcase. The pump sucks oil through the tube into a rubber hose and waste storage tank. The mouth of the tube is cut so it cannot become stopped by sludge.

## Small Homemade Biplane Cruises at 160 M.P.H. Over 500-Mile Area

Residents in the vicinity of Wichita Falls, Texas, have been puzzled over the identity of a small private plane. It's neither a Piper, Aeronca, Ryan nor any other familiar make. Neighbors of Ted Boden, former flight engineer with the AAF's 5th Ferry Group, call it the Boden Special. He built it himself in his back yard and the job took about a year. The finished craft is a single-seater cantilever wing biplane which cruises at 160 miles per hour over a 500-mile range. It has a 15-foot wingspread and 13-foot fuselage.



## Stoker-Fired Water Heater Operates With Sub-Bituminous Coal

U. S. Bureau of Mines photo

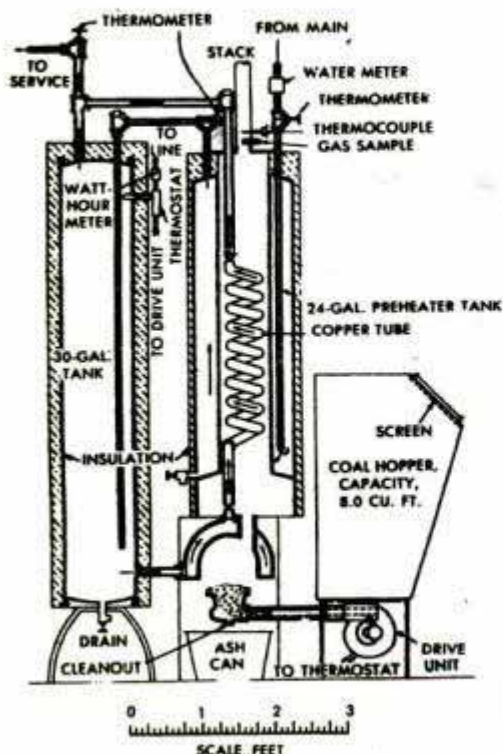

Sub-bituminous coal and other low-rank fuel can be used in a stoker-fired water heater developed by the U. S. Bureau of Mines at Golden, Colo. It consists of a coal hopper and constant-volume fan, feed screw, retort and preferably a double water-storage tank. When a thermal control regulator calls for heat, the driving mechanism moves coal into the retort, where it comes in contact with low temperature air circulated by the fan. The resulting small, steady flame is controlled by an adjusting vane.



Tires are being shipped to market today at a faster rate than ever before in the rubber industry's history

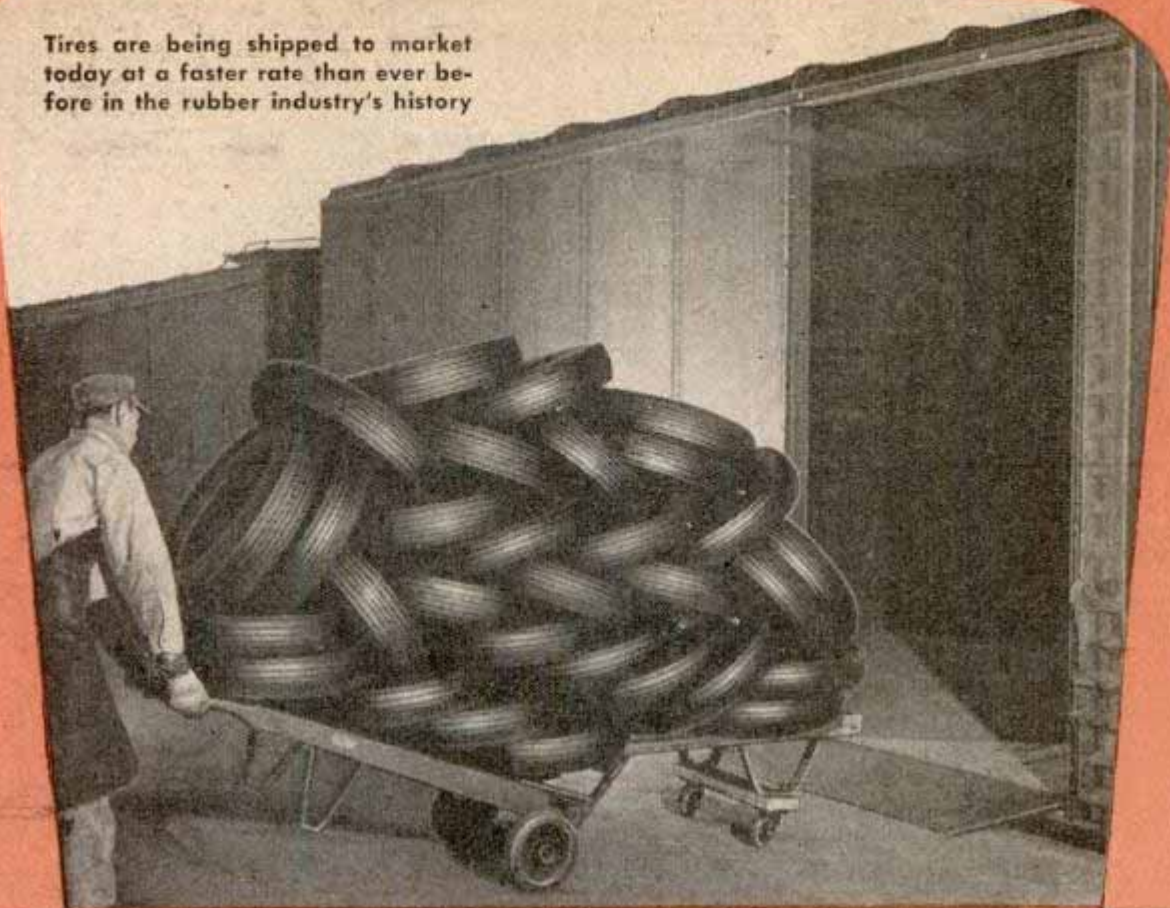

## *Your Next Tires... Synthetic or Natural?*

By Clifford B. Hicks

WHEN Uncle Sam put the bite on Great Britain recently for an extra 200,000 tons of natural rubber—and got it—the ring was dusted off for the biggest bout in rubber history. The surprise shipment foreshadowed the day when there'll be rubber to burn and when synthetic, an upstart contender with a brilliant war record, can take a shot at the title that natural rubber has held for a hundred years. Biggest question of the battle is whether natural will bounce back to its prewar prominence.

To the motorist who's fed up with the tire shortage this doesn't seem the important issue. He wants a rapid-fire answer to another question. When can he buy a new set of shoes for his prewar flivver? The question of what kind of rubber he'll have

Rubber worker rolls a strip of preformed tread around the carcass of a truck tire  
Firestone Tire and Rubber Co. photo







**BEFORE:** Hand-built casing is placed in vulcanizing machine where the heat molds it into its final shape

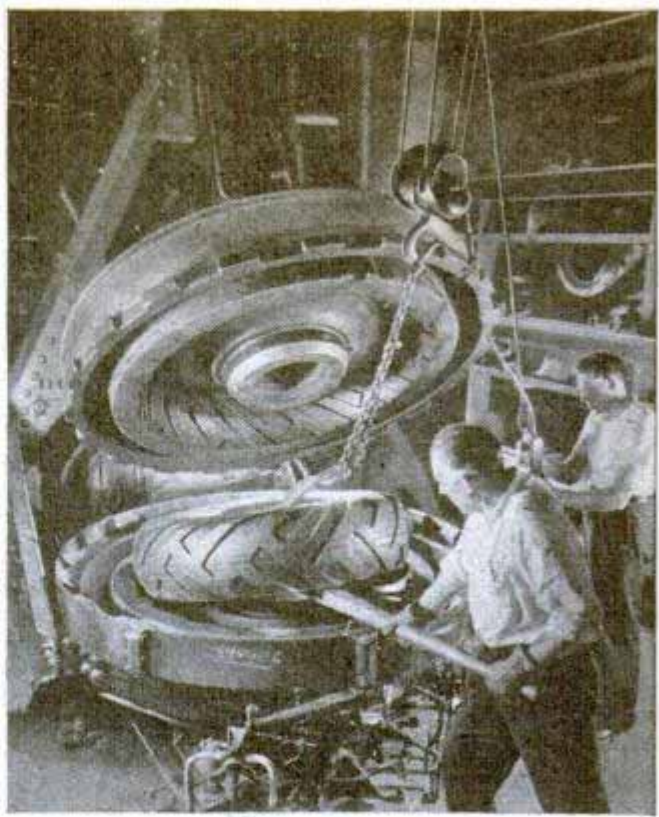

**AFTER:** Steam bag inside the tire has forced rubber into tread mold where heat caused vulcanization

on his car in the future is usually shoved into the background. Chalk up an optimistic answer from the major tire companies to his first question.

Best estimate is that the tire shortage definitely will end some time this spring with the most pessimistic answer putting tires on the shelves by the middle of the year. About 95,000,000 tires were needed in 1946 and less than 80,000,000 were built. But last year's production took the slack out of the pent-up demand and, with equal production this year, supply will almost certainly top demand within the first few months of this year. Last year's 80,000,000 tires, incidentally, beat all previous records.

In the scramble for new tires the possible revolution in rubber is often forgotten. But when the world's supply of rubber is more than the demand, the battle of synthetic vs. natural will start.

Rubber manufacturers point to an inevitable oversupply of rubber within a short time—maybe months. It's a boomerang of the near-disastrous war shortage. The United States was a "have not" nation in rubber when the war started, but when Japan folded, Uncle Sam had facilities to turn out more than 1,000,000 tons of synthetics a year. Before

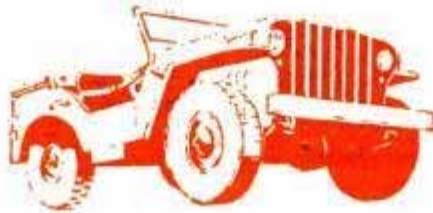

the war crude rubber was America's largest import. Obviously there'll be a rumble in the nation's economy because we can now produce at home the equivalent of our largest prewar import.

The world will find use for about 1,500,000 tons of rubber in 1947. There'll be a little less than 1,000,000 tons of natural to meet this demand. But the United States alone can more than take up the slack with test tube stuff. According to the Inter-Agency Policy Committee on Rubber the world's productive capacity will soon stretch to 3,000,000 tons of all kinds of rubber annually. With demand at 1,500,000 tons that means a serious surplus.

As soon as supply tops demand the rubber companies will have a choice of the two types. They'll make a selection after weighing two factors—the performance and price of each type. With a choice just around the corner there's many a weighty conference on records and costs to determine what kind of rubber will go into our tires and tubes, our baby pants and hot-water bottles.

Armchair experts have kicked around the relative merits of the two opponents since 1942 with an overwhelming decision in favor of natural rubber. But synthetic won't be

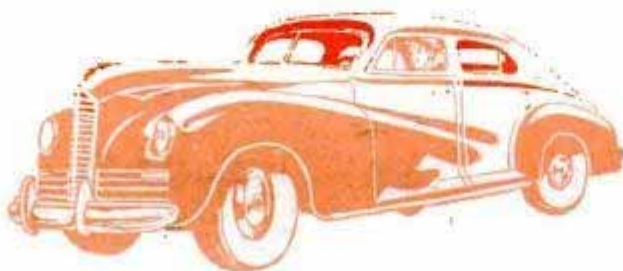



tossed into the heap of war relics. Not by a long shot.

There's many an indignant voice raised against the performance of synthetics. The antagonism goes back to the days when a few tires were made of reclaimed rubber and still more were made of test tube mixtures before the bugs were eliminated. Today's synthetics are far superior to those first wartime substitutes.

Tire engineers have discovered some surprising things in testing GR-S, the government-approved standard synthetic for tires. It usually wears longer than nature's product on the tread of a tire. It stays flexible at lower temperatures. It's slightly more resistant to chemical attack, one of nature's biggest drawbacks.

But you can't whitewash synthetic rubber on some counts and the big tire companies won't even try. Man-made rubber heats up more quickly and is therefore far inferior for truck tires. It's stiffer than natural rubber—harder and more costly to process. It's less resistant to bruising. It has four to six percent less skid resistance.

Many of these problems have been licked by tire engineers. They've improved the structure of the tire itself to counterbalance some of the drawbacks of synthetic rubber.

New tread designs have given these postwar synthetic-plus-natural tires a tread that most manufacturers claim will roll more miles than your prewar all-natural tires. Treads are wider and flatter and distribute the wear over a larger surface.

But the biggest change has come in the carcass of the tire. When synthetic rubber was first turned out in quantity, the test tube product was merely substituted for natural rubber in the old tire structure. The new tire heated and bruised more easily. Blowouts were much more frequent. It was obvious that changes must be made in the carcass rather than the synthetic.



▲ New waffle-pattern inner tube made by U. S. Rubber Company has extra rubber in square pockets which squeezes around puncture

▼ Heavy testing wheel is used to check strength of a big bomber tire. The tire is slammed against turning wheel to simulate landing shock

Westinghouse photo

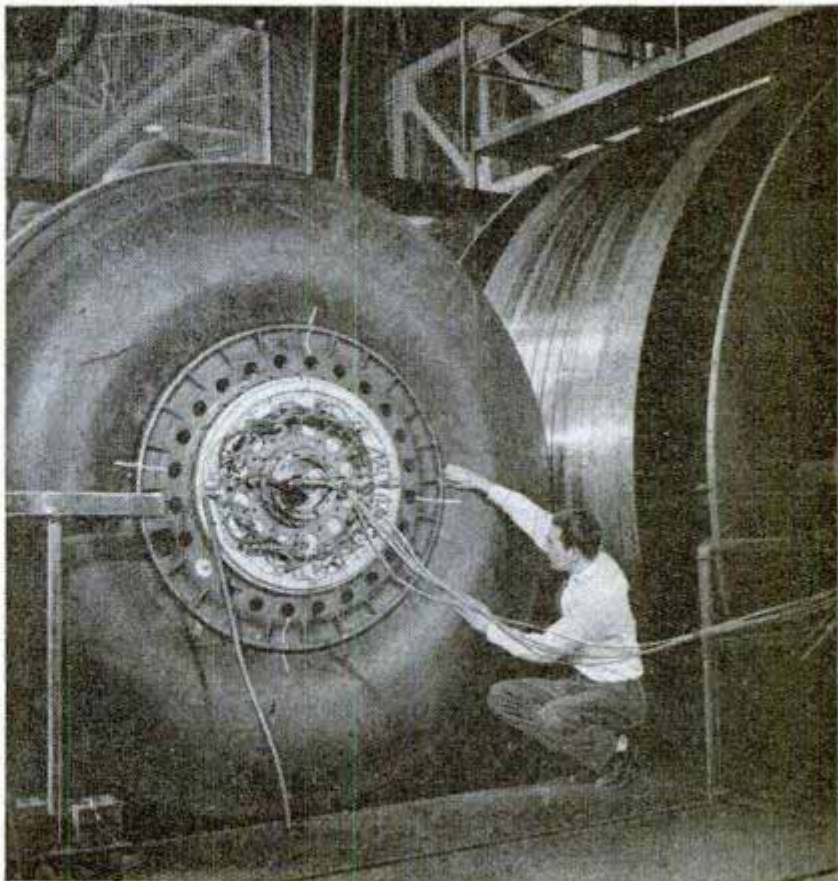



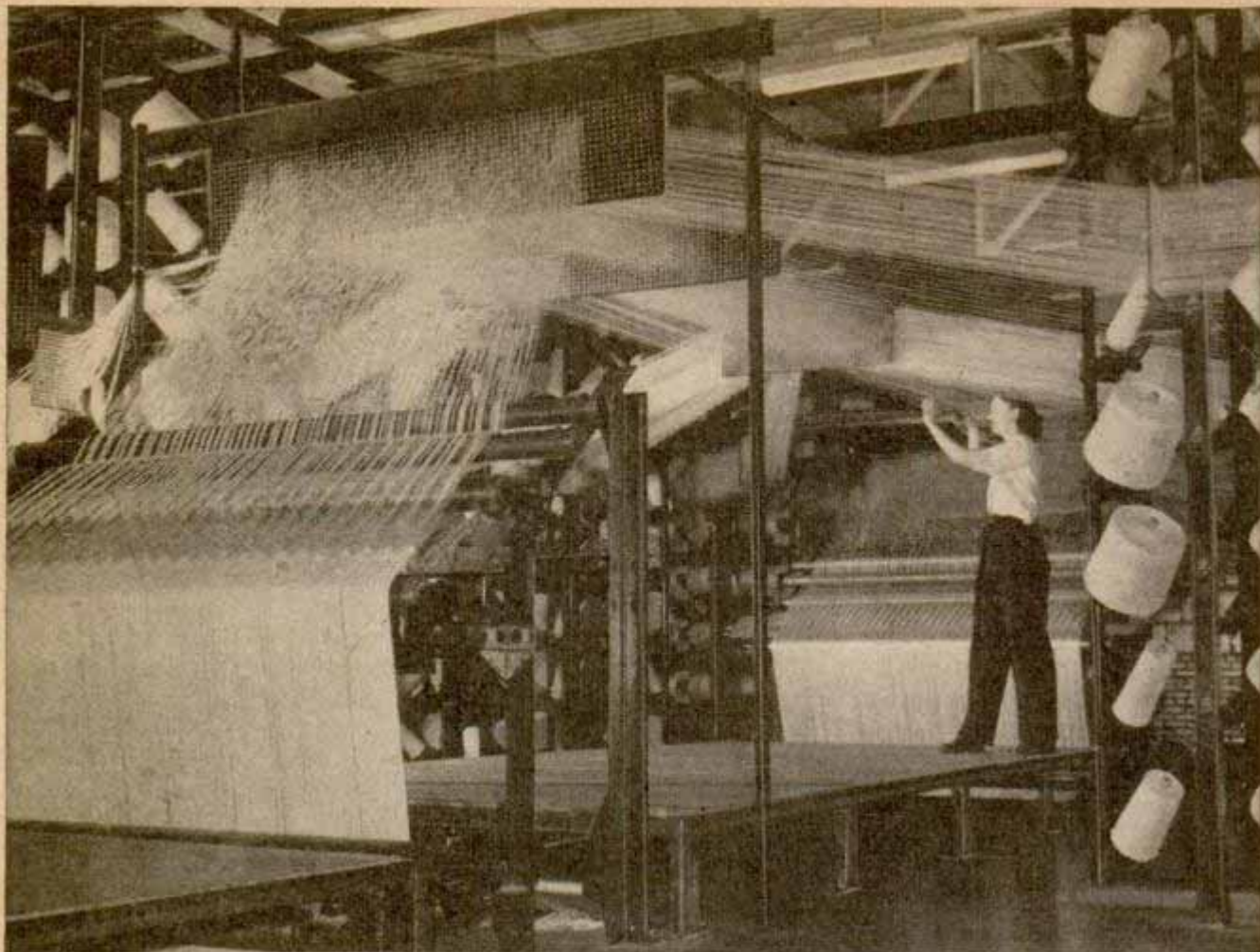

B. F. Goodrich Co. photo

▲ Maze of threads in the creel room is woven into sturdy fabric which is coated with rubber to be cut into individual tire plies

▼ Wires pulled through die are rubber-covered to become bead

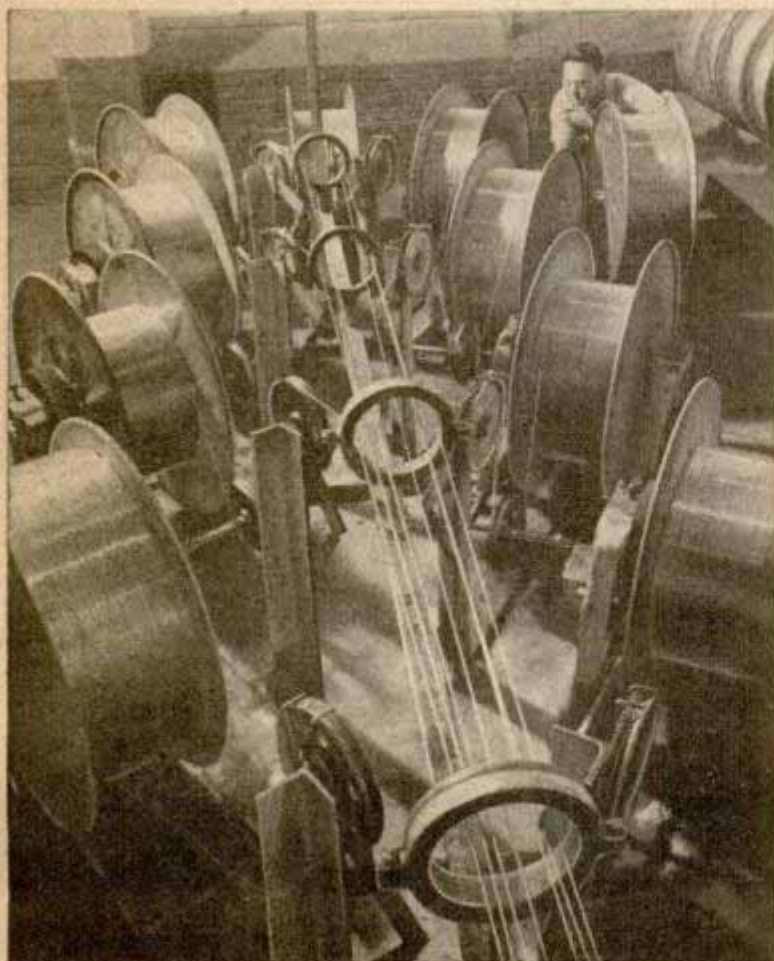

So engineers went to work on the fabric. A new type of cotton cord was developed that proved much stronger than the old type. Rayon, stronger than cotton, was also used.



Tests were made with Nylon but increased costs prohibit weaving Nylon into a passenger tire at present. Changes were made in the angle at which the plies were put on the tire. The amount of insulation between plies was increased as much as 30 percent to counteract the tendency of synthetic plies to pull apart.

Stronger carcasses were required and they were produced. Today's tires made of GR-S and some natural rubber have shown by test that they're as much as 55 percent stronger than prewar tires.

Man-made rubber's lower resistance to skid hasn't been overcome but there has been some improvement. New tread designs have given the ribs slightly more grip on pavement, snow and ice.



Biggest problem of all, the tendency of GR-S to heat up at high speed, was licked when the carcass was strengthened. But truck tires under heavy loads get too hot, so synthetic rubber isn't used to any great extent in new truck casings. Heat is the major cause of failure in truck tires, even with natural rubber.

The best postwar synthetics are no more dangerous at high speed than were prewar tires, although high speeds are dangerous at any time. Firestone has issued the following statement to allay the fears of those who creep along on their new tires: "Before the war when all tires were made of natural rubber we placed no restriction upon the car owner in the use of our tires other than the normal requirements of proper inflation and reasonable care. The same situation applies today to our new Firestone Deluxe tires made of synthetic rubber."

Just how good are postwar tires as a result of these improvements? The manufacturers stand pat behind the performance of today's synthetic-natural combinations.

Goodrich makes the flat statement that their best postwar passenger-car tire "will by all known tests outwear tires made of natural rubber." The top Firestone tire is "55 percent stronger and will give up to 32 percent longer mileage" than the same company's prewar natural rubber tire, according to spokesmen.

The U. S. Rubber Company's best tire of combined rubbers has a rayon cord that produces "a stronger, safer carcass than prewar tires." And a Goodyear executive refers to "the present 30,000 to 50,000-mile tire, depending upon operating conditions."

Because most of the improvements in the new casings have been made in the tire itself and not in the man-made rubber, it's a logical assumption that a tire made of today's carcass and yesterday's natural rubber would

(Continued to page 236).

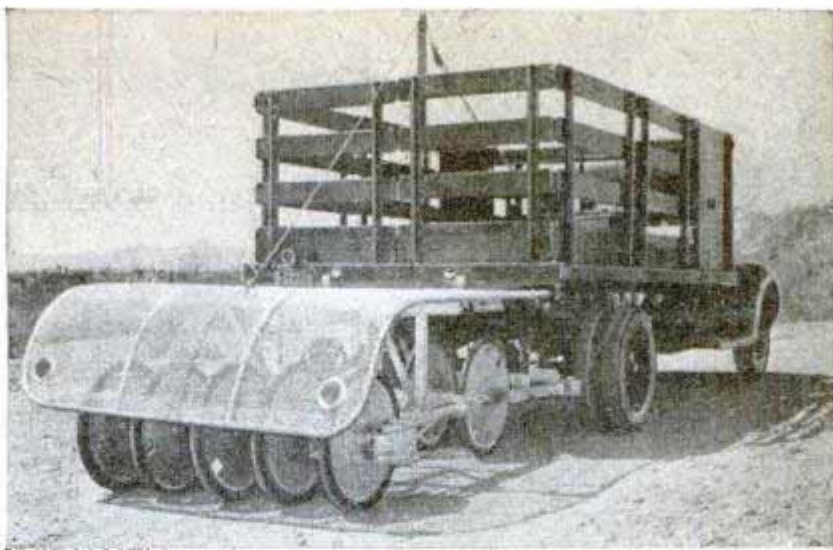

U. S. Rubber Co. photo

▲ Bicycle tires, tested over rough roads under a hot Arizona sun, are operated until they fail, then analyzed for weakness under stress

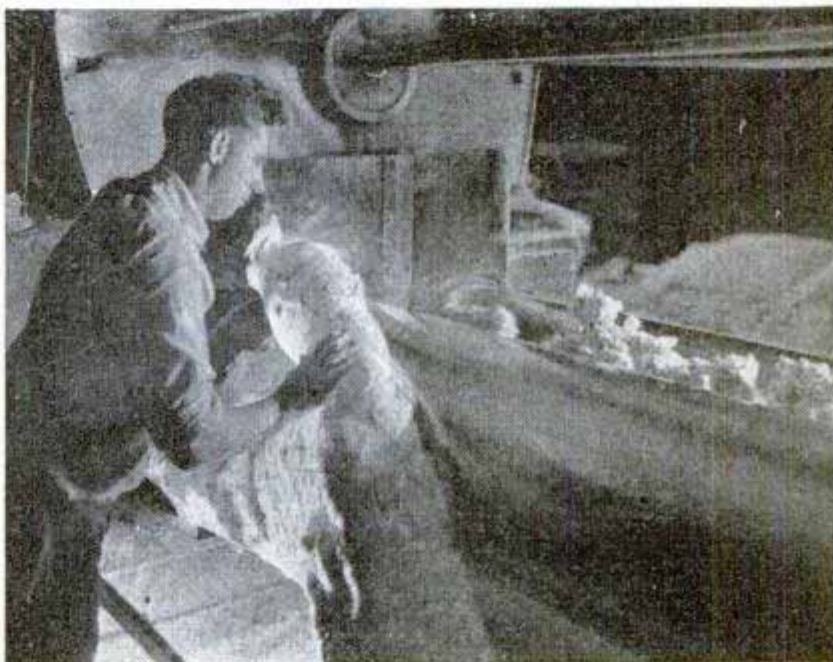

▲ Mill works like a giant wringer to mix synthetic rubber with sulphur and other chemicals. Plastic mass then is processed into tire fabric

▼ After crude rubber comes from mixer it is placed on conveyor to cool

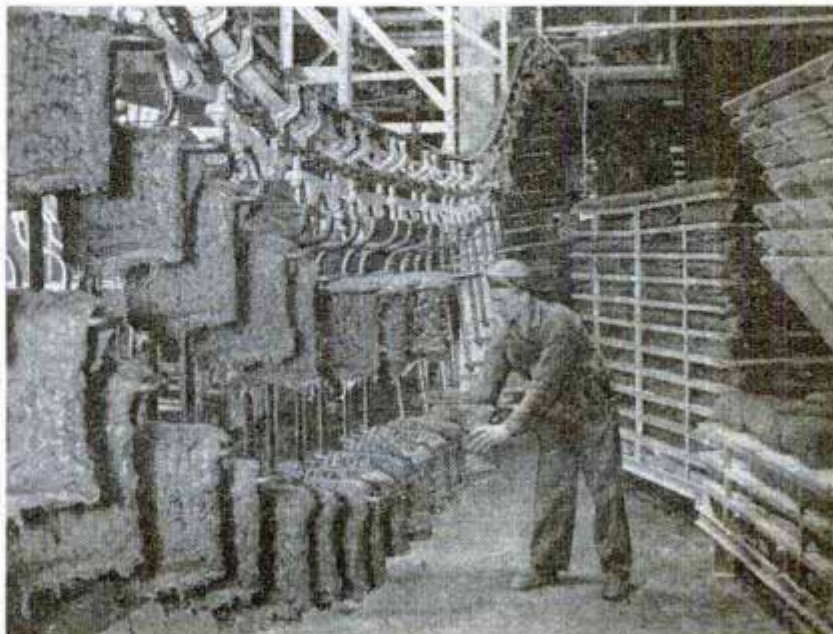



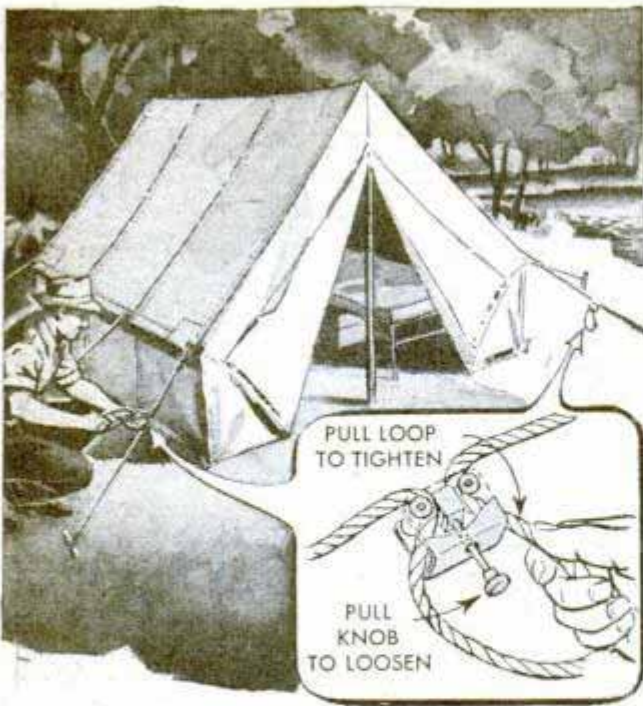

### Adjustable Rope Clamp for Tent Holds Canvas Tight

Tent ropes are held taut by a rustproof brass clamp equipped with teeth that grip the rope securely until a control pin is pulled when a camper desires to loosen the rope. To tighten the rope, the left or right side of the loop is pulled.

### Multiplug Extension Cord Reel Is Self-Retracting

Six prong-type connector plugs are accommodated in the plastic case of a multiple plug fixture. It is equipped with a 25-foot-long extension cord so that it can be moved about conveniently. The cord is rewound automatically on the reel in the base as the fixture is moved closer to the wall outlet.

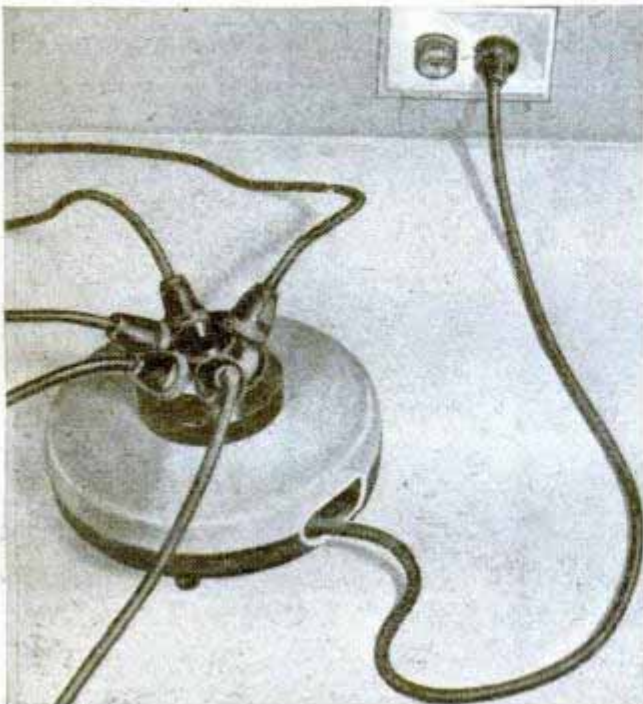

### 10,000 Messages in One Tube Promised by New Amplifier

Tests made with a new vacuum tube indicate that it may amplify dozens of full color or black and white television programs simultaneously. It may handle more than 10,000 simultaneous long distance telephone conversations or over a hundred million words a minute by telegraph. Developed in the Bell Telephone Laboratories, the tube is entirely different from earlier amplifiers. It consists of a narrow, foot-long glass stem which flares into a bulb at one end. Inside the stem a long coil of thin

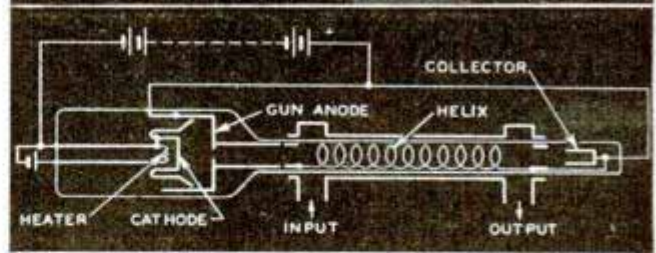

wire runs from one end to the other. The wave which is to be amplified is fed into the coil at the bulb end and is drawn off at the other end. As the wave travels along the coiled wire a beam of electrons is shot through the coil in the same direction but at a speed a little faster than the wave. The electrons give up some of their speed to the wave which becomes many times amplified. The effect is the same as that of a breeze on the ripples on a pond—the ripples grow larger as the breeze blows them along. In the tube, the electron beam “blows past” the wave on the coil and reinforces the wave by transferring energy to it.





Since building a 1½-horsepower tricycle from scrap, 87-year-old Marshall Pressley finds it easier to get around. The machine is driven by a belt transmission

Any kind of fuel serves in a two-cylinder steamboat engine built by three Manitowoc, Wis., men from a furnace boiler. The hull is an abandoned steel lifeboat



Surplus brass sprocket chains and aluminum gears, designed for use in bombsights and range finders, become costume jewelry with polishing and gold plating

All the equipment needed with an oxyacetylene cutting torch can be carried like a pack. The outfit, with oxygen and acetylene tanks, weighs 55 pounds





# SPOON-FED IRON HORSE

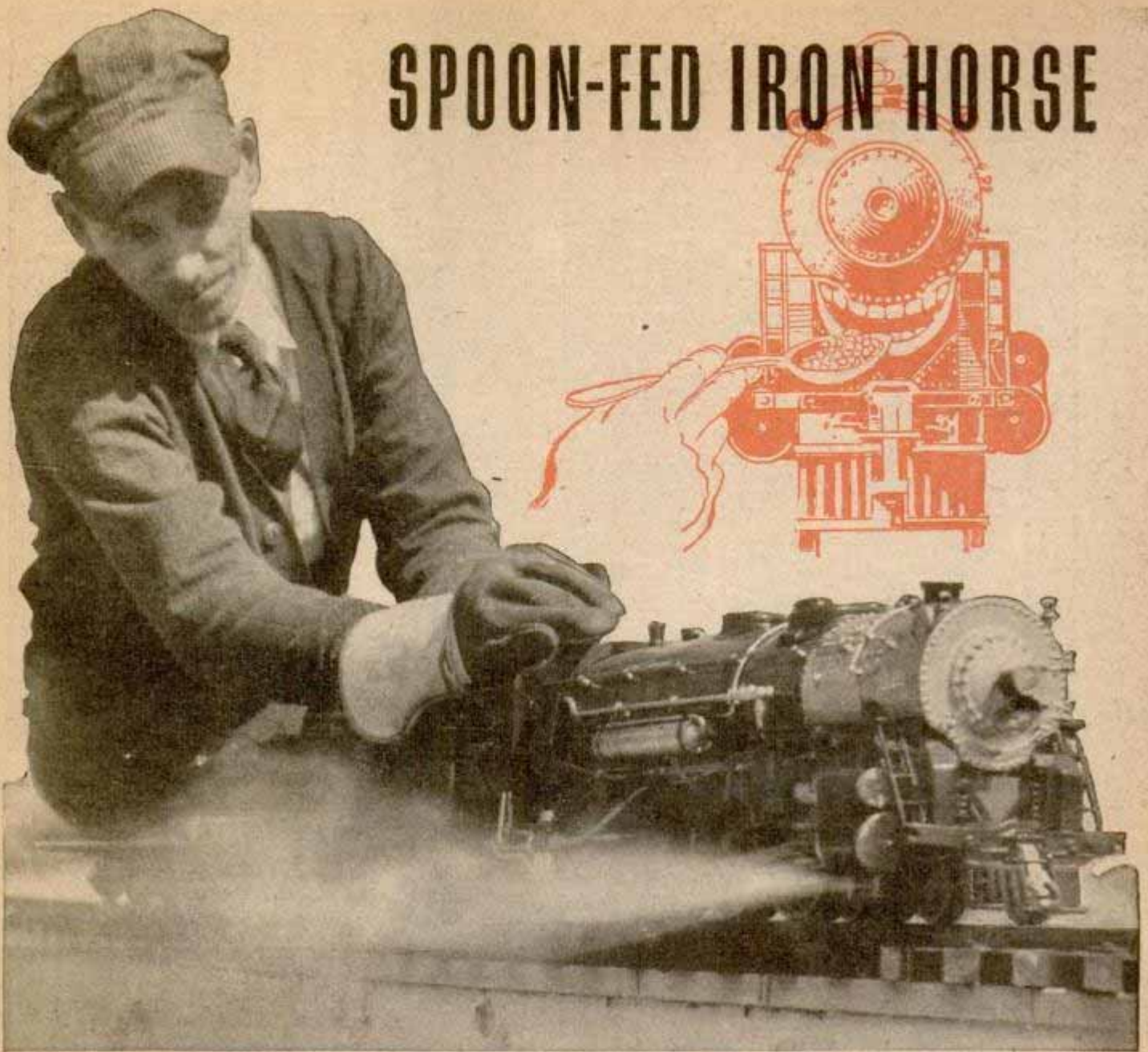

William Michael at the throttle of a live steamer built in his Racine, Wis., home shop. Below, he compares cylinder cast with scale drawing. The locomotives are built on a scale of about a half inch to the foot



**I**N A LITTLE home machine shop in Racine, Wis., William E. Michael builds midget steam locomotives from thousands of tiny parts that he makes.

His engines are working units equipped with water injectors, mechanical lubricators, safety valves, cylinder cocks, whistles and full reverse gear. They are incredibly perfect, down to the last wheel and shaft, tiny copper tube, baffle board on the firebox door, bell and cowcatcher. The small pressure gauge is scarcely a half inch in diameter. Rivets in the boiler and brass tender are escutcheon pins. Each finished model takes three to four years' spare time, rep-



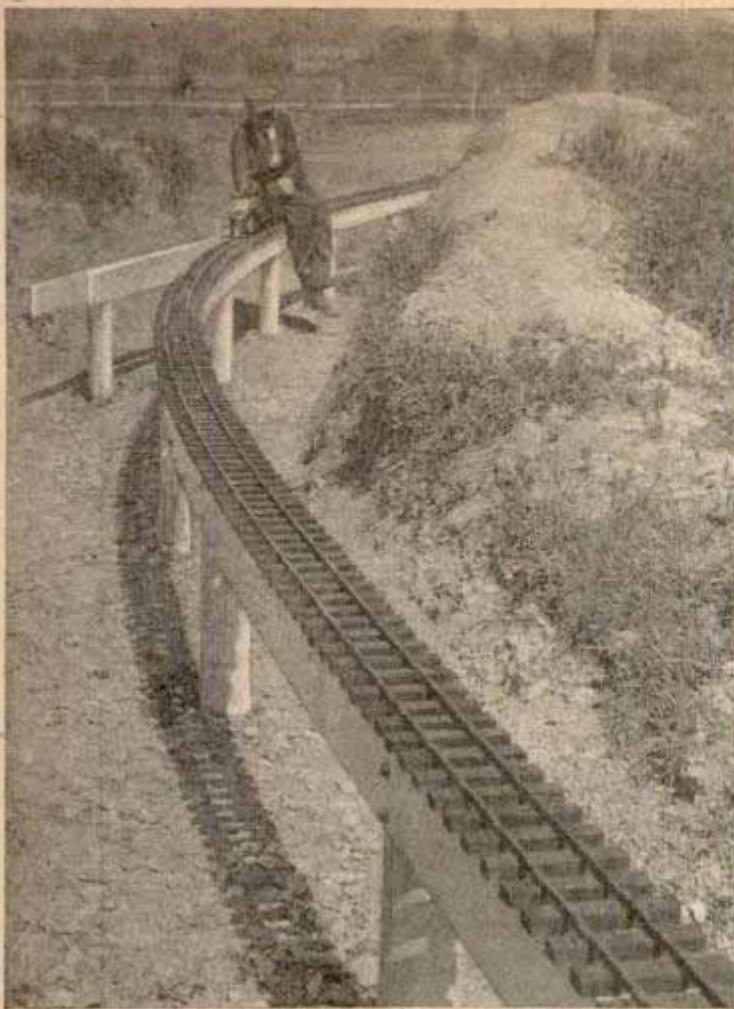

The model locomotives travel over 140 feet of track

representing about 1000 hours of patient work.

Michael's Hudson-type engines, which are 28½ inches long and weigh about 60 pounds, are built on a scale of slightly more than one half inch to the foot. He works with tolerances of 1/1000 and 1/2000 inch. He has drills no bigger than a needle, and he makes many of his own tools.

In addition, he makes his own blueprints, his own wooden patterns and castings, and does the machining to complete each part. His machinery includes a lathe and small drill press, a milling machine, larger drill presses, planer, air compressor and brazing equipment—all insured for \$3000.

Michael's hobby of building model live-steam engines began in 1929 and since then he has built four locomotives and has the beginnings of two more.

In order to watch his handiwork in action, Michael purchased five acres of land near his home and built 140 feet of 2½-inch-gauge winding track. He sank cedar posts into the sandy soil and laid a platform on them for his winding track. The track has a 1½-percent grade, but on a level stretch one engine pulls four persons.

Each tender holds about four pounds of buckwheat size coal, but one locomotive will consume about 10 pounds a day if it is kept going.

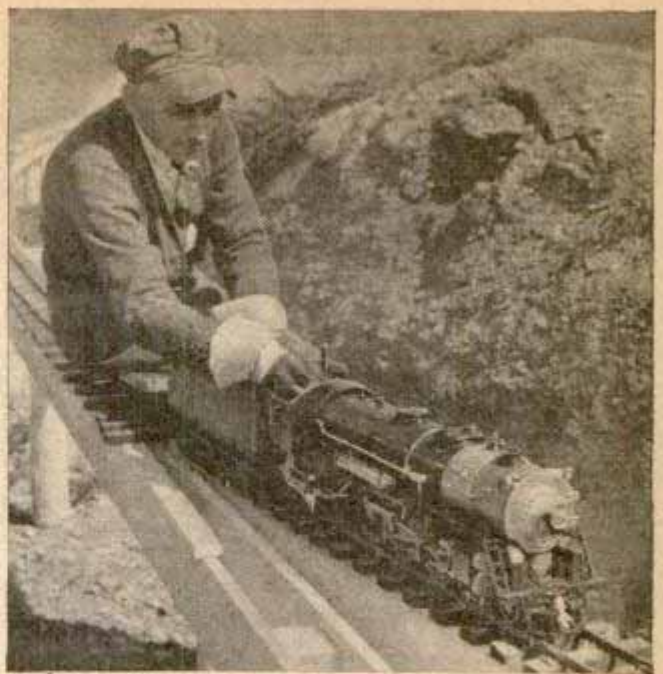

Through cuts and up and down hills, the engines cavort on 2½-inch-gauge track on elevated platforms which are mounted on cedar posts sunk into sandy soil

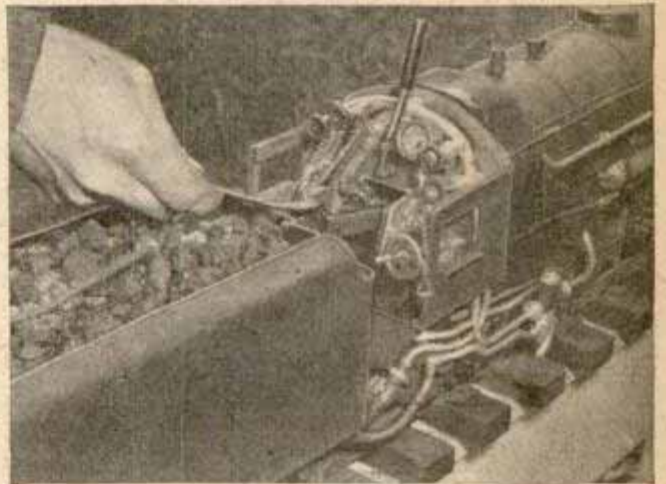

Coal is fed to the tiny firebox with a spoon. Below, tire pump is used to create a draft to start boiler





# House Built of 64 Lightweight Concrete Slabs

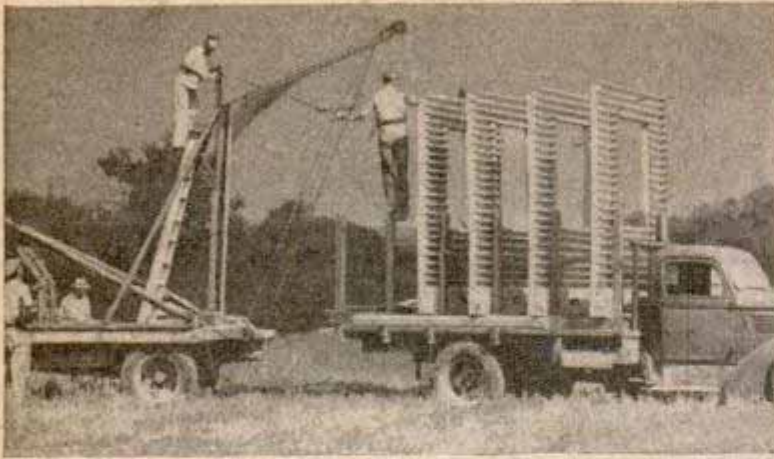

Completed concrete sections are trucked to the homesite where a portable crane lowers them to workmen who put them together

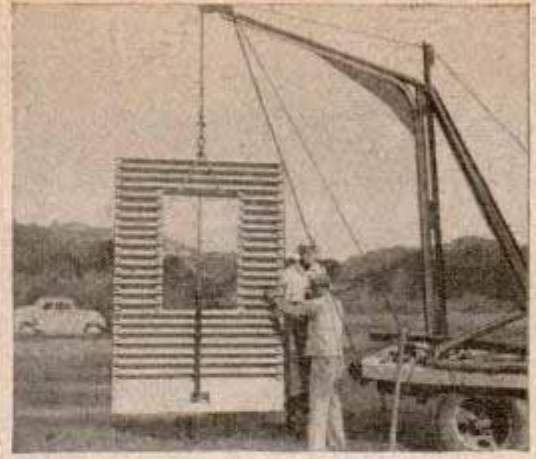

Prefabricated concrete block, six feet by nine feet, is lowered into foundation slot

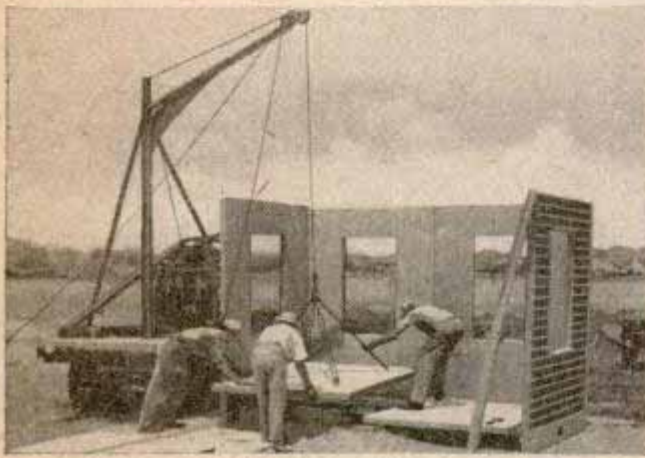

Floor slab is guided into place. Slab is attached to the crane by angle irons fitted when slab is poured



Roof section is added. House has a ceiling ventilator which circulates air in all rooms and closets

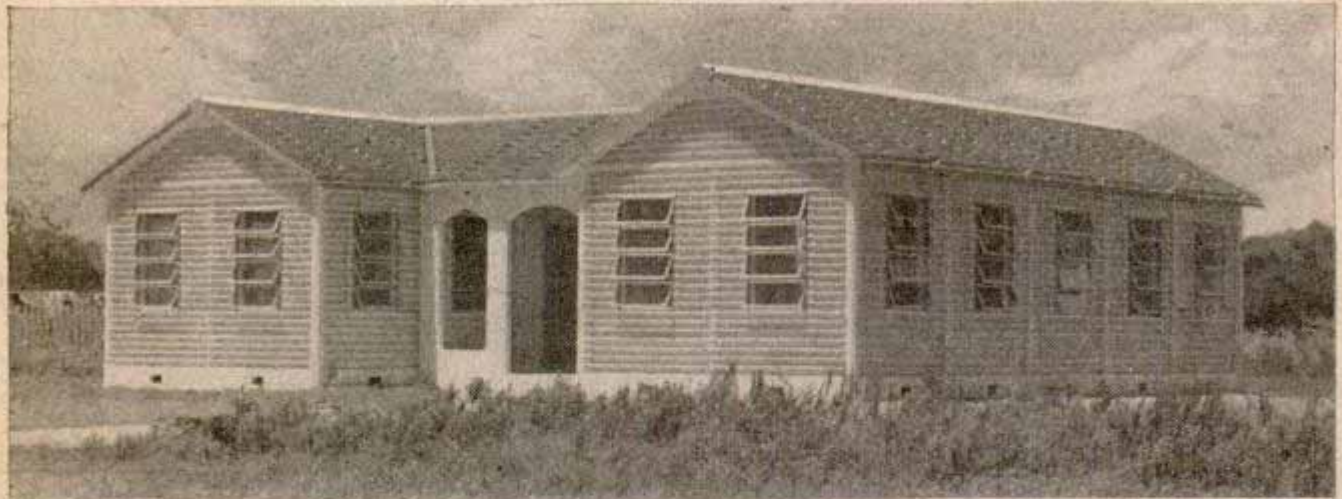

The finished house. It has two bedrooms and bath on the left and kitchen and living-dining room on the right

**D**OWN IN TEXAS they're building houses that consist of 64 prefabricated concrete slabs, with window and door openings cut out. The special concrete is strong, yet it weighs 40 percent less than ordinary concrete.

When finished, the house is H-shaped, 36 feet wide and 30 feet deep, and it sells for a little less than \$4000. There are four rooms, plus bathroom and a connecting section

that can be used as a sleeping porch. Plywood partitions are employed to form the bathroom and closets.

Four-inch fins extend from the outer walls and roof to shade the house. These fins prevent the sun from shining directly against the walls except at sunrise and sunset. The roof is two thirds shaded all during the day. The walls of the concrete house are painted white and the roof red.



# Filming the Sun's Diary

Photo of artificial eclipse of sun, taken at Mount Wilson observatory, shows thin fringe of circling atmosphere

**A** PERPETUAL ECLIPSE of the sun, maintained by an around-the-world chain of high-altitude observatories equipped with coronagraphs, may be the next step in extracting useful information from our nearest star.

New facts about the atom can be anticipated from coronagraph observations, as well as information that will help us understand the solar disturbances that cause magnetic storms on earth. Improvement of long-range weather forecasting is another possibility.

The coronagraph is a new kind of solar telescope, the invention of Dr. Bernard

Lyot of France. It permits direct observations of the solar corona, the vast nebulous "atmosphere" that surrounds the sun. Light from the corona is 1/600,000th as bright as light from the sun itself and until now has been visible only during total eclipses.

The coronagraph produces an artificial eclipse by the use of a brass cone exactly the size of the sun's image. The cone, in the instrument's optical system, blanks out all direct sunlight. At the same time the instrument is designed to eliminate practically all of the scattered light and reflections that occur in most optical systems. The result is that the dim light of the corona

Twin mirrors in dome of 60-foot solar tower at Mount Wilson reflect image of sun through tower shaft to observer







Testing 10½-inch refracting telescope at Climax, Colo., observatory. Below, coronagraph photo of 50,000-mile-high prominence flaring above sun's chromosphere (thin white line). Bottom, dome of Climax observatory



may be viewed. Since the atmosphere itself scatters some light the coronagraph is best used at high altitudes.

With this device the spectral lines of the corona may be analyzed. The solar prominences and flares that extend out into the corona may be studied against the coronal background. A movie camera that is set to expose one frame of film every 10 seconds makes a record of the observations.

The only coronagraph in the United States is a five-inch instrument installed five years ago at a high-altitude station at Climax in the Colorado Rockies by Commander Donald H. Menzel and Dr. Walter O. Roberts of Harvard College Observatory. Elevation of the station is 11,520 feet.

Artificial eclipses of the sun are nothing new in themselves. Daily records of prominences, made by artificially eclipsing the sun, are chronicled by the Mount Wilson (California) Observatory of the Carnegie Institution of Washington, D. C. The spectroheliographs that Dr. Seth B. Nicholson and the other Mount Wilson "sun men" use to study prominences do not, however, eliminate sufficient scattered light to reveal the dim corona. That is why the new coronagraph has become an important research tool.

The astronomer's sun is a very complicated body. The layman sees only the photosphere, the gaseous body of the sun itself. When magnified by a telescope the surface of the sun has a rice grain appearance, caused probably by the turbulence of its flaming gases. On this surface appear sunspots (dark) as well as bright spots known as faculae.

The visible photo-



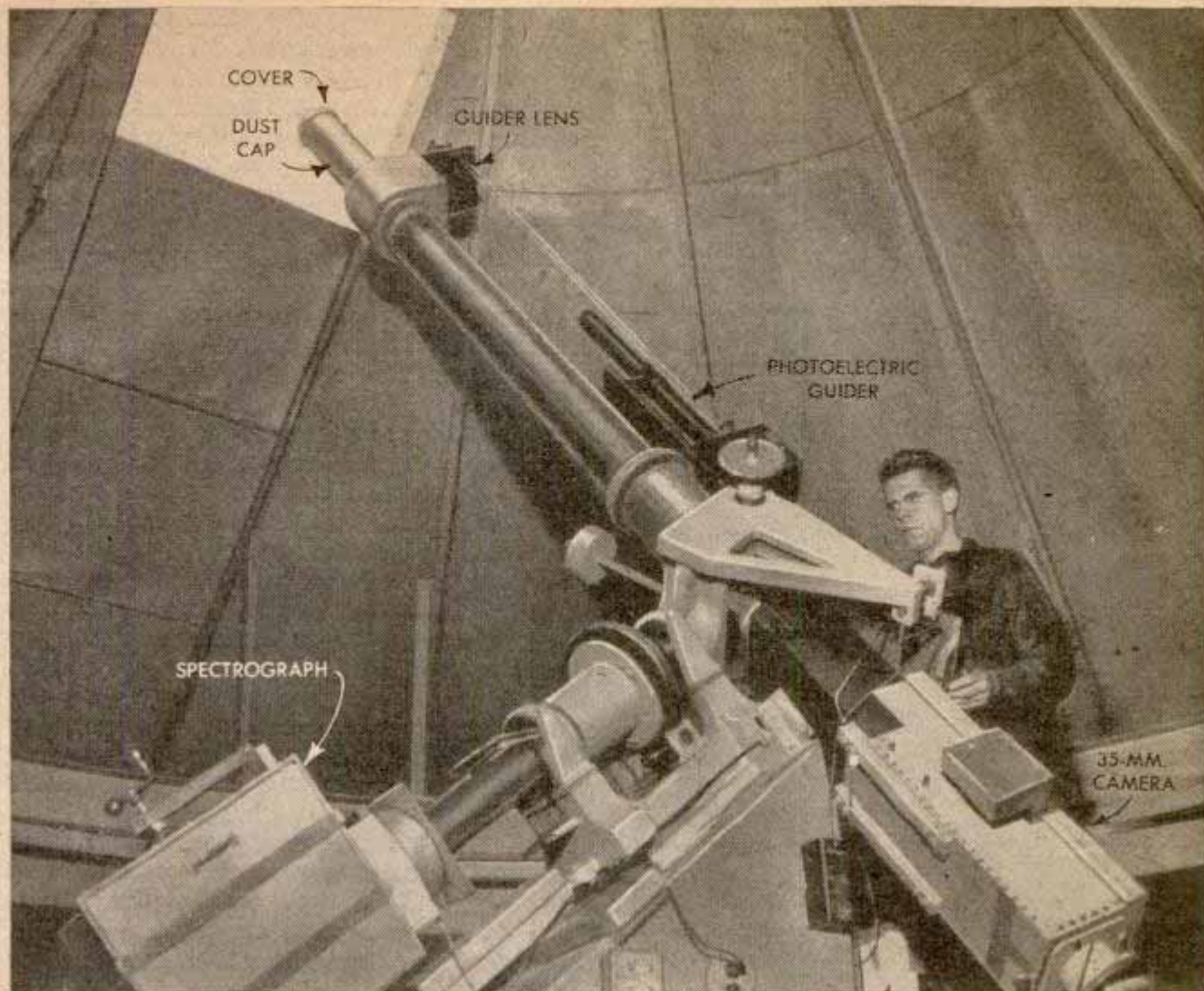

The coronagraph resembles a long-barrel field gun. Its photoelectric guider keeps it pointed toward the sun



sphere is surrounded by the chromosphere, a thin layer of dynamic gas that presents a spiky appearance almost like a head of hair. Outside of the chromosphere is the corona. It has no definite limits and often shows wispy streamers that project far out into space. It is visible as pearly light to the naked eye during a total eclipse.

Solar astronomers are concerned at present about the prominences that appear in the corona. These flares seem to be directly related to magnetic storms on the earth.

Astronomers have known for a long time that there is some general connection between sunspots and the upsets that affect the earth's magnetic field from time to time.

During periods of intense sunspot activity, tremendous electrical forces are released toward the earth. Practically all communication channels are disturbed.

Long-range radio communication becomes impossible. Airway radio beams can't be trusted and plane-to-ground voice communication is difficult. False signals may occur in long-distance telegraph circuits, producing garbled messages. To avoid this, the most widely used telegraph carrier circuits are protected by supplementary parallel wires that neutralize the effect of the undesired currents. Even power transmission lines are affected by the surging solar radiations.

In spite of the general connection between sunspots and magnetic storms, it has been impossible to predict all such storms on the basis of sunspot observations. Several years ago, however, it was discovered that there appeared to be definite relationship between the occurrence of solar flares, usually associated with active sunspots,





Two sun towers (150-foot unit at left and 60-foot tower at right) are used in solar studies at Mount Wilson

and the magnetic storms. Crippled communication channels can be anticipated on earth one or two days after large flares appear on the sun.

This was important military knowledge during the war. Reports concerning flares and prominences were telegraphed to Washington daily by Climax, Mount Wilson, and the McMath-Hulbert Observatory of Michigan. From such data, forecasts were made of the times when our communication channels might be faulty and, which was of even greater importance, of the periods during which the enemy would be having communication difficulties.

With the coronagraph it is hoped that more can be learned about the nature of prominences and flares. Both sunspots and prominences are thought to be manifestations of some solar condition that is not yet understood.

The physical connection between the sun and the earth that leads to magnetic disturbances seems to be via the ultraviolet rays and the soft X-rays that are emitted by the sun. These radiations have an effect on the atmosphere and are responsible for the so-called ionosphere, the layer of charged particles high in the atmosphere that re-

flects most radio waves back to earth instead of allowing them to travel straight out into space. It is because of the ionosphere that long-distance radio communication is possible. Disturbances on the sun, however, push the ionosphere down to a lower altitude. With the increase in pressure the particles lose their reflecting quality. Instead of bouncing back to earth the radio waves escape.

One of the possibilities now being explored is the chance that not all radio frequencies are affected alike by this condition. It may be that the ionosphere retains its reflecting ability for some precise wave lengths during the disturbances. If these channels exist and can be found, it may be practical to shift to them when normal frequencies are blacked out.

Directly or indirectly, all of the present research is likely to bring us additional knowledge about atomic processes. The sun is a vast atomic laboratory in which nuclear reactions are occurring constantly on a gigantic scale. Much of what we know about the atom originated from solar studies and our harnessing of atomic power stems directly from this knowledge.

Matter in the sun is being converted at the rate of four million tons per second, each gram of which produces one hundred thousand billion kilowatts of power. So far, scientists have been able to extract power only from the heavier elements. Further solar studies may suggest ways of putting some of the lighter elements to work.

The Climax coronagraph has been used as an exploratory instrument to determine both its value and the advantages of the Climax site. Now plans are under way for a new and larger high-altitude observatory to be constructed in adjacent forest land. Two 15-inch coronagraphs that will permit the making of detailed pictures of prominences are to be used, together with auxiliary apparatus for studying spectral lines in the corona. A one-ton 10½-inch Bausch & Lomb refracting telescope will be employed for studying the solar photosphere. The new observatory will be operated jointly by Harvard University and the University of Colorado.

The present coronagraph automatically turns itself to remain pointed at the sun by means of an improved electronic sight invented by Dr. Roberts. An image of the sun is centered between four Lucite rods in the sight or pointer, each rod being connected to a photoelectric cell. When the sun's image moves off center, one of the Lucite rods receives more light than the others and this fact is transmitted via its photoelectric cell to an electrical brain that supplies power to electric motors guiding the instrument.

An elaborate filter has been designed by



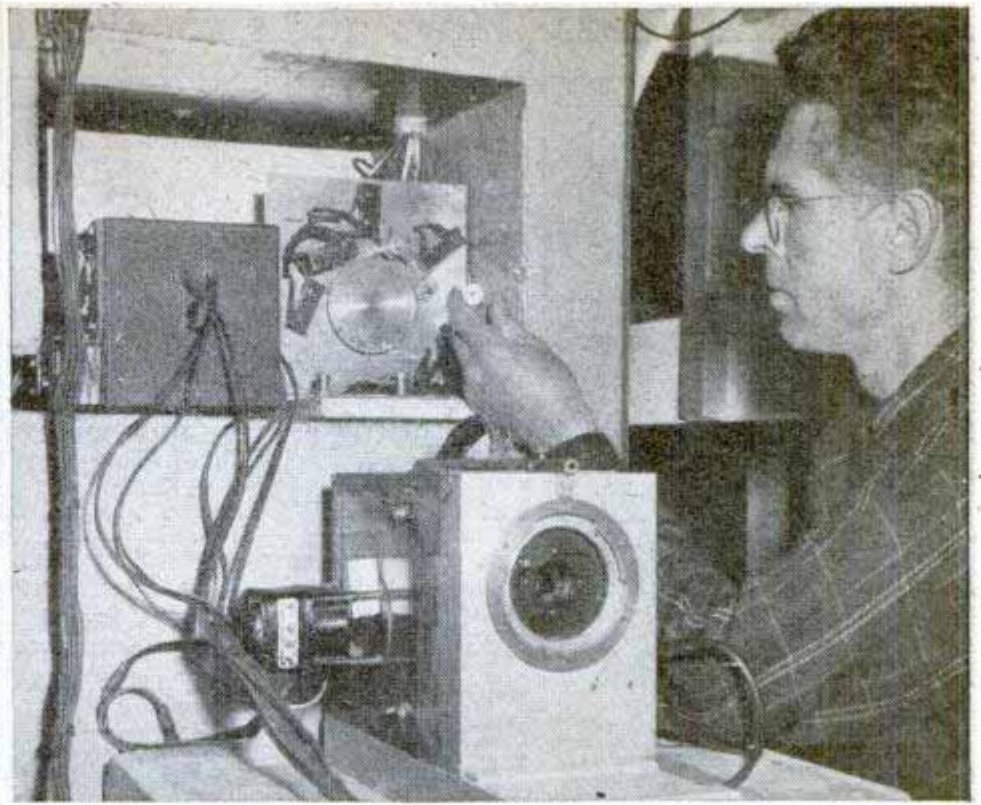

Sun's image is studied as it falls on white disk (left) at base of Mount Wilson's 150-foot tower. Right, electrically driven time clock automatically exposes frame of motion picture film in the Climax coronagraph

Dr. J. W. Evans of the Climax staff for use with the new coronagraphs. The filter will screen out all except a thin slice of visible light, permitting accurate studies of the corona's spectrum. The filter will consist of 16 layers of polaroid crystal and 15 layers of quartz and will contain heating units and sensitive thermostats so that a uniform

temperature may be maintained automatically. A slice of light only two fifths as wide as an Angstrom unit will pass through the filter. The human eye is sensitive to light ranging from 4500 to 8000 Angstrom units. Light passing through the filter will be recorded on special high-speed film several times more sensitive than usual films.

The sun is more than a fiery blob. This sketch shows the various components of Old Sol and their relationship

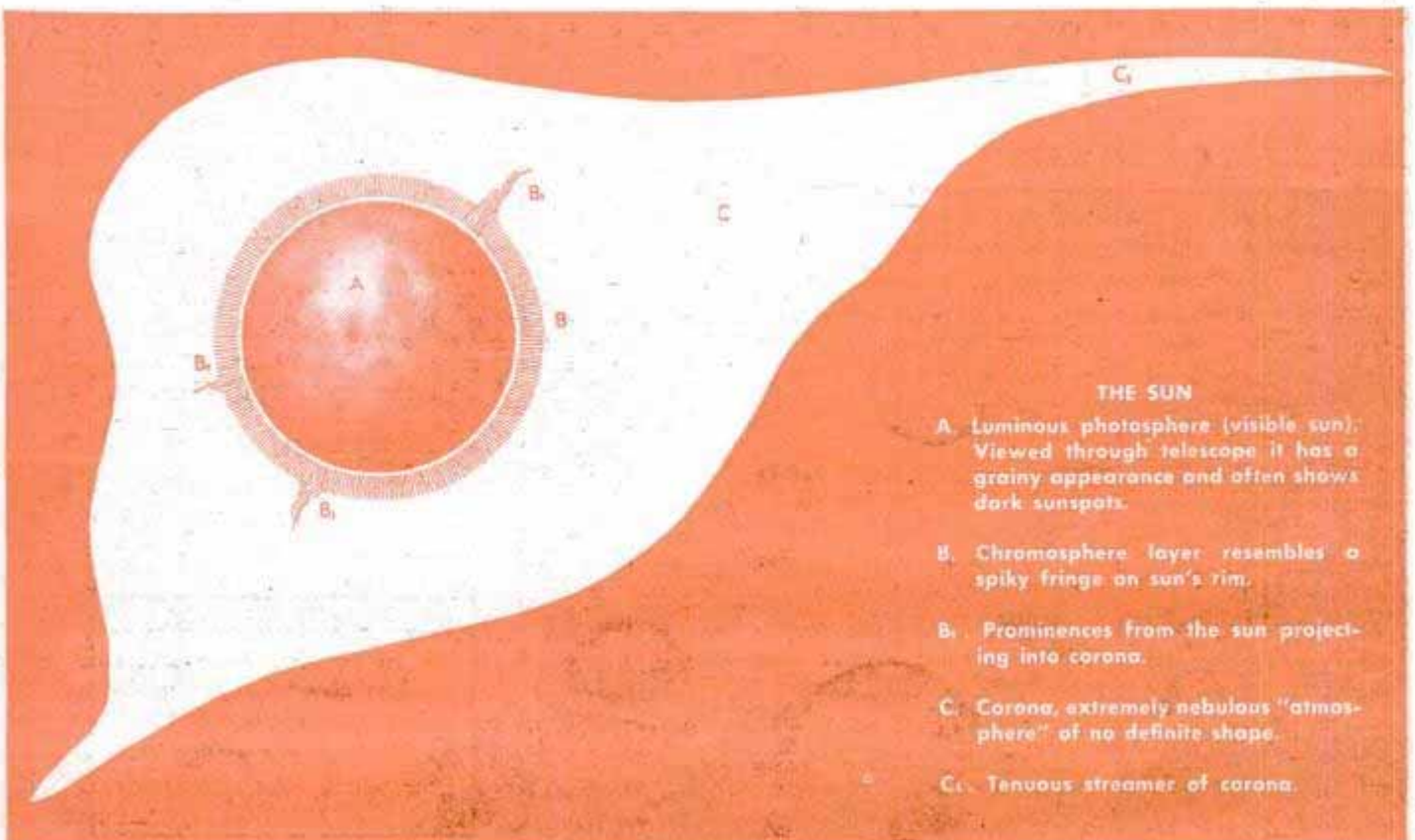

#### THE SUN

- A. Luminous photosphere (visible sun). Viewed through telescope it has a grainy appearance and often shows dark sunspots.
- B. Chromosphere layer resembles a spiky fringe on sun's rim.
- B<sub>1</sub>. Prominences from the sun projecting into corona.
- C. Corona, extremely nebulous "atmosphere" of no definite shape.
- C<sub>1</sub>. Tenuous streamer of corona.



## Auto-Plane Sheds Wings and Propeller in Five Minutes



As a two-passenger automobile, left, the Airphibian can go 750 miles on a tank filled with 30 gallons of gasoline. Converting it from air to road use requires disconnecting two locks and takes five minutes. The silver colored, aluminum bodied coupe has a roll-back canvas top

Five minutes' time to disconnect two locks is all that's needed to convert the Airphibian into a two-passenger automobile. A 150-horsepower, six-cylinder, air-cooled engine propels the craft about 125 miles an hour in the air and 45 miles an hour on the ground. The plane weighs 2200 pounds fully loaded and goes 400 miles on 30 gallons of gasoline. On the road it has shown mileage of 25 miles per gallon. It carries 50 pounds of baggage as well as pilot and passenger. The three-blade propeller is removed by turning one lock and another unhinges the



wings and three-wheel fuselage. Wings span 33 feet 6 inches and the coupe's overall dimensions are 7 by 4½ feet. The same steering wheel is used at all times.

## Bicycle Hub Dynamo Stores Up Power to Carry Rider Over Hills

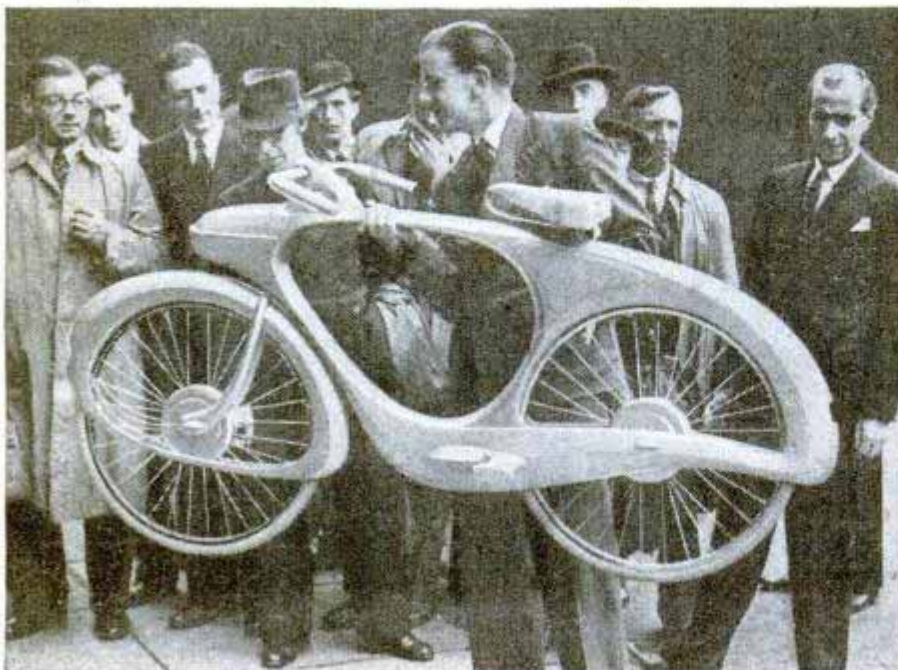

Coasting down one hill on an "electric" bicycle stores up power for climbing the next. Power is stored by a hub dynamo which releases it to aid the cyclist as he pedals. The streamlined "electric" bicycle was designed by B. G. Bowden of Leamington Spa, Warwickshire, England.

Popular Mechanics will supply further information to readers about various products described in any issue. Write to Bureau of Information, Popular Mechanics, 200 E. Ontario St., Chicago 11, Ill.





# Edison Started Something

Edison's lamp lighted the world. His phonograph, below, right, was the first to capture sound

By Maston M. Jacks

WHEN Thomas A. Edison discovered electricity leapfrogging from the filament of his lamp to another wire he couldn't explain why nor did he know of any way to use it. Even if someone had told him that his discovery—known as the Edison Effect—would usher in radio and electronics he probably wouldn't have been impressed because such things then had no practical value.

The results of Edison's work are as close today as the nearest light switch. Snap on the light, answer the telephone,







Outdoor sports events are televised by NBC with a 40-inch focal length lens, the longest ever used. Television and other electronic miracles stem from Edison's discovery of the Edison Effect which he found while working with externally wired lamps, right



play a record on your phonograph and you realize how his inventions reach into the everyday lives of almost every American.

This month the country observes the 100th anniversary of Edison's birth at Milan, Ohio, February 11, 1847. The whole world honors his persistent tinkering that created millions of jobs and raised living standards everywhere. Motion pictures and electric light and power, only two among many puzzles his genius solved, today employ 455,000 persons in this country alone. They pay nearly \$1,000,000,000 a year in salaries. Statisticians reckon their total capitalization at nearly \$19,000,000,000. Even the 400,000 juke boxes now in use are descendants of Edison's penny-in-the-slot machine. They spread 2,000,000,000 nickels a year among nearly 75,000 people.

He invented the incandescent electric lamp and wasn't satisfied with it. Particles

of the carbon filament (one came from a strip of bamboo torn from a palm-leaf fan found in the living room of his home) blackened the inside of the bulb. He wanted to know why and discovered the Edison Effect. This led Dr. Lee De Forest, 23 years later, to make the vacuum grid tube needed in electronics.

What Edison found is that electrons are emitted from the heated filament of an electric lamp. He put a cold metal plate near the filament inside the bulb and wired the plate to the positive terminal of a battery. Current jumped from the filament to the plate and passed along the wire. With the plate connected to the negative battery terminal, the electrons didn't hop the gap.

De Forest added the light metal "screen" or grid between plate and filament. The grid controls the flow of electrons from filament to plate with miraculous accuracy



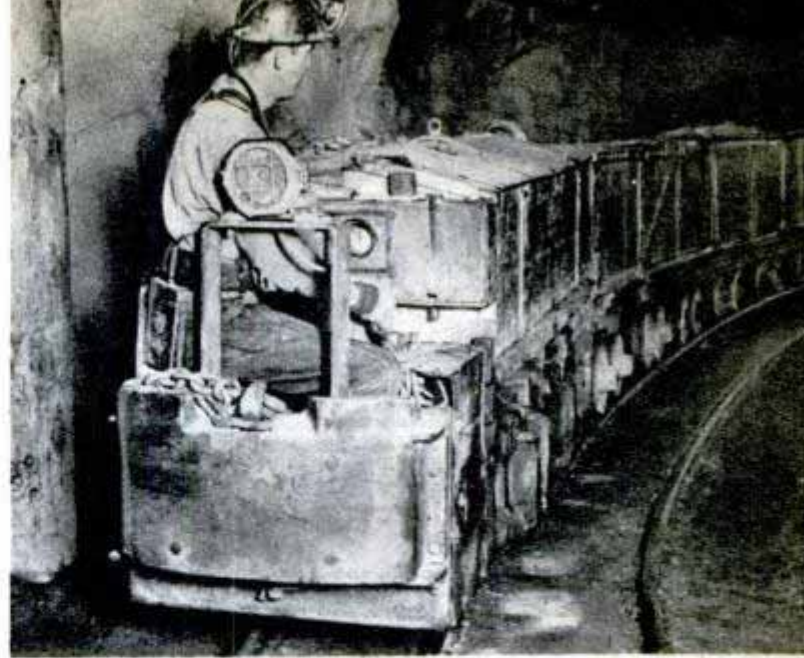

**Edison's alkaline battery for electric autos today lights miners' safety lamps and drives mine locomotives**

and speed. It can change stop-and-go signals on electric current more than a billion times a second.

Under control in a small portable radio, for example, the Edison Effect makes it possible for four tubes no bigger than a cigarette to multiply the power of an incoming radio signal 25,000,000,000 times between antenna and speaker.

The importance of Edison's discovery is reflected by a still growing \$6,000,000,000-a-year electronics industry. It is responsible for radio, television, radar, the electron microscope and scores of other technical changes further transforming the living habits of the world.

Industrial research projects are commonplace today. Large companies regularly spend millions to improve their products. Only a few weeks ago General Electric scientists, seeking artificial means to control weather, turned a three-mile-long cloud into snow. About the same time, Bell Telephone laboratories announced the development of a vacuum-tube amplifier that handles more than 10,000 long-distance telephone conversations simultaneously, and the Johns-Manville Company disclosed that it is planning a multimillion dollar building material research center.

It was the establishment of Edison's laboratory at Menlo Park, N. J., in 1876 that forced industry to recognize industrial research. Until then the quest for applied scientific knowledge was haphazard and spasmodic. Edison organized the effort. While he knew little of scientific theory, he surrounded himself with trained assistants who did.

Edison invented by sheer persistence, using the tools of science in innumerable combinations whether they had any obvious connection or not. Menlo Park itself was an experiment for him. Like many oth-

ers of his combinations, it worked. An example of his method is his pursuit of a suitable lamp filament. After he finally happened upon carbonized bamboo, he spent \$100,000 testing 6000 different specimens before he isolated three that were satisfactory.

He liked to think of himself as a practical man, although he frequently spent all his funds on experiments. At one time he was paying a New Jersey sheriff \$15 a day to withhold execution of a court order attaching his equipment until he could raise the money to pay a judgment against him.

**Radar is development of Edison Effect. Triple antennas of mobile trailer set aim and fire antiaircraft guns**

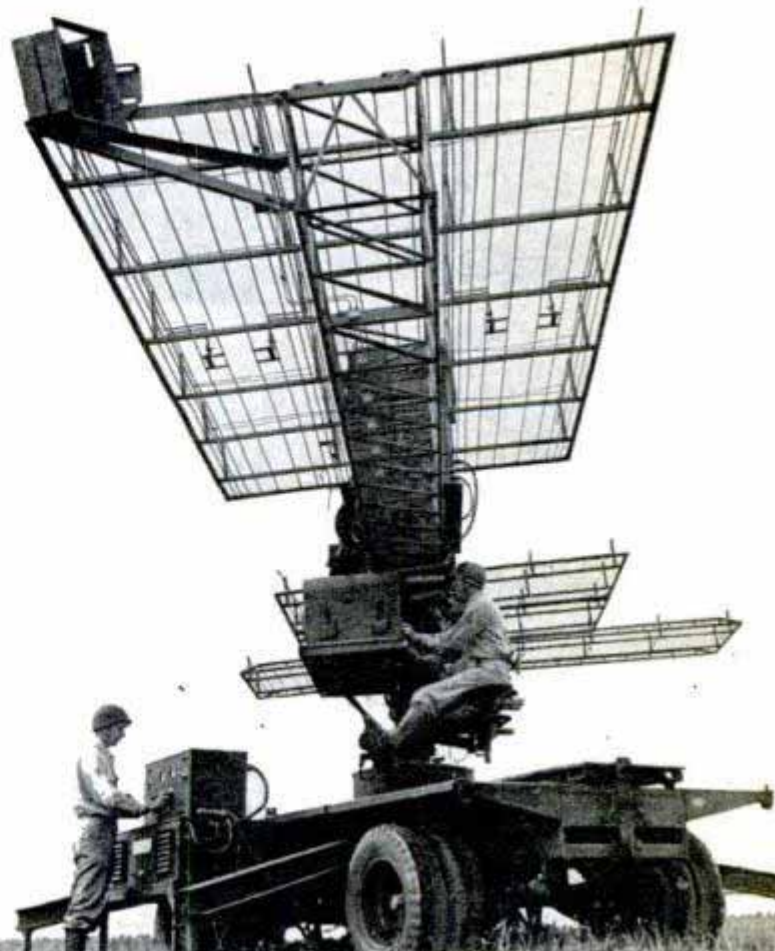



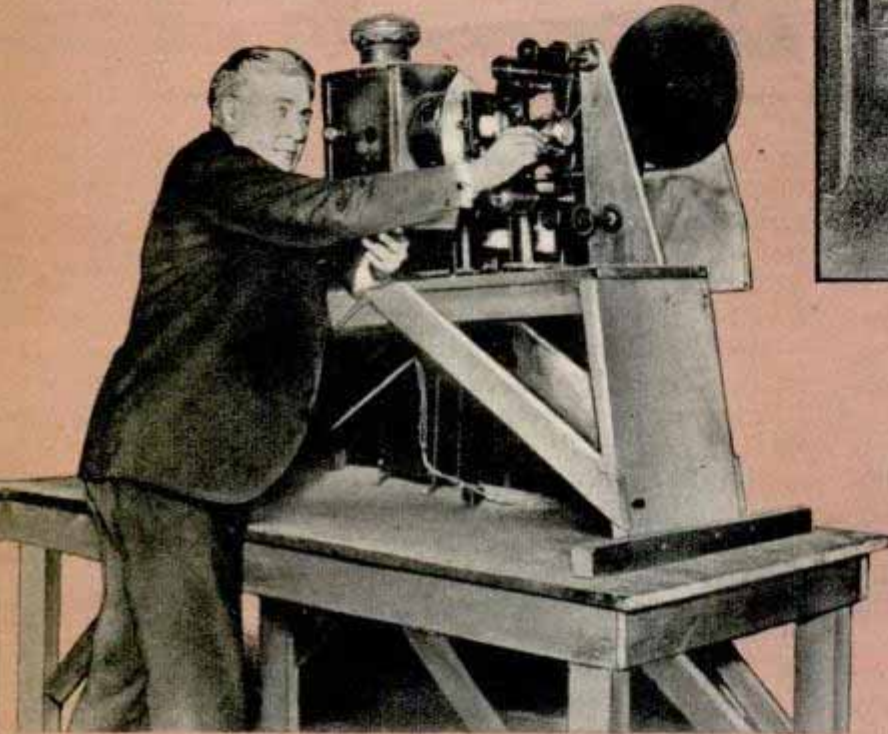
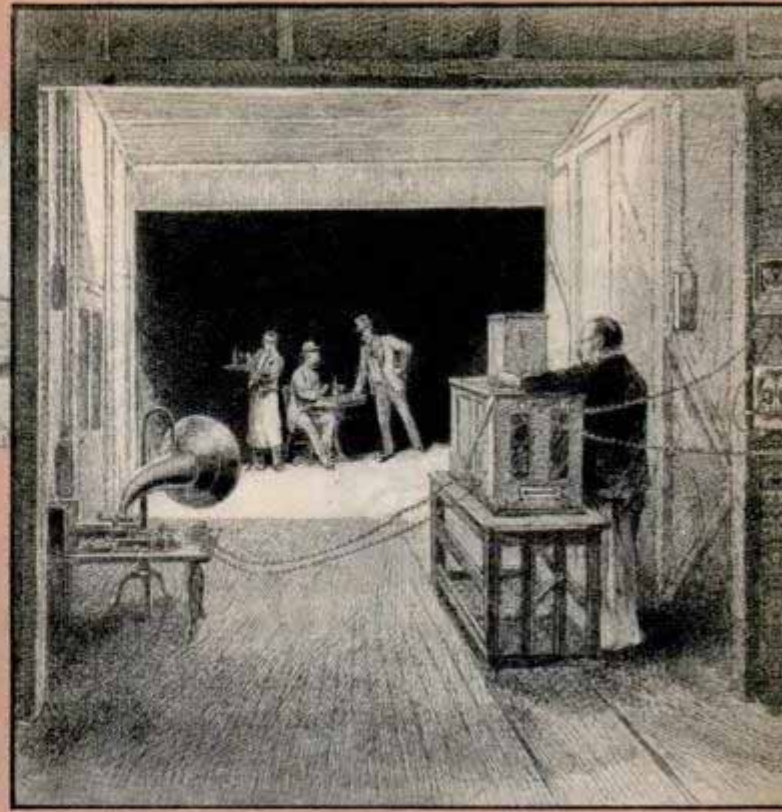

The grandpappy of Hollywood's multimillion-dollar studios was the tar-paper shack, top left, which Edison built on a circular track to take advantage of sunlight both morning and afternoon. Inside, motion picture camera devised by Edison filmed action while synchronized phonograph recorded the sound. Edison then worked with another inventor to contrive a practical projector, left, for use in nickel-odeons of the period. Modern motion picture industry is built upon Edison's foundation. Elaborate sound stage, below, for Warner Bros. film, "Night and Day," took thousands of dollars worth of equipment and many technicians





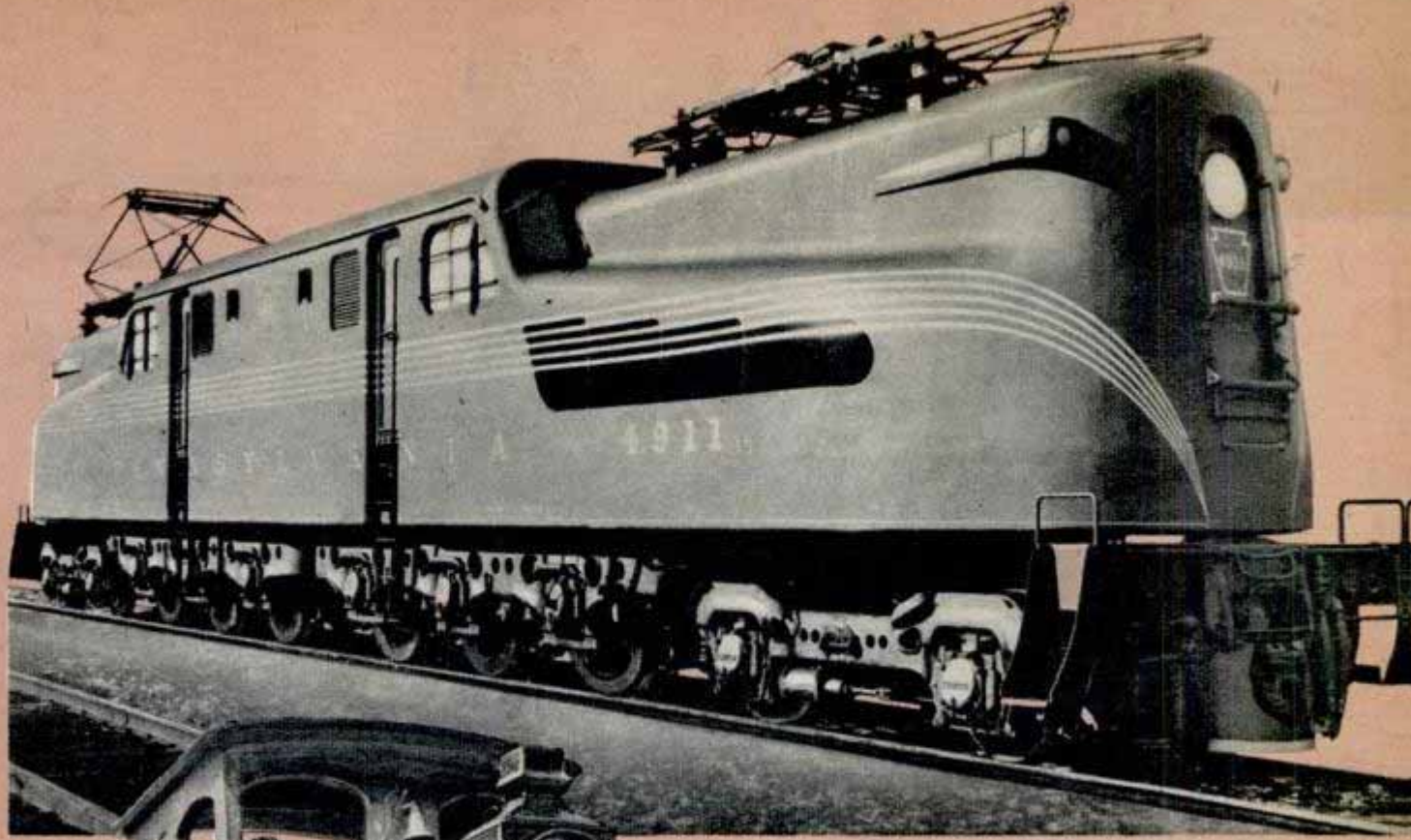

Edison devised third-rail system for electric traction and from his early model, left, electric locomotives capable of 100 m.p.h. have been evolved

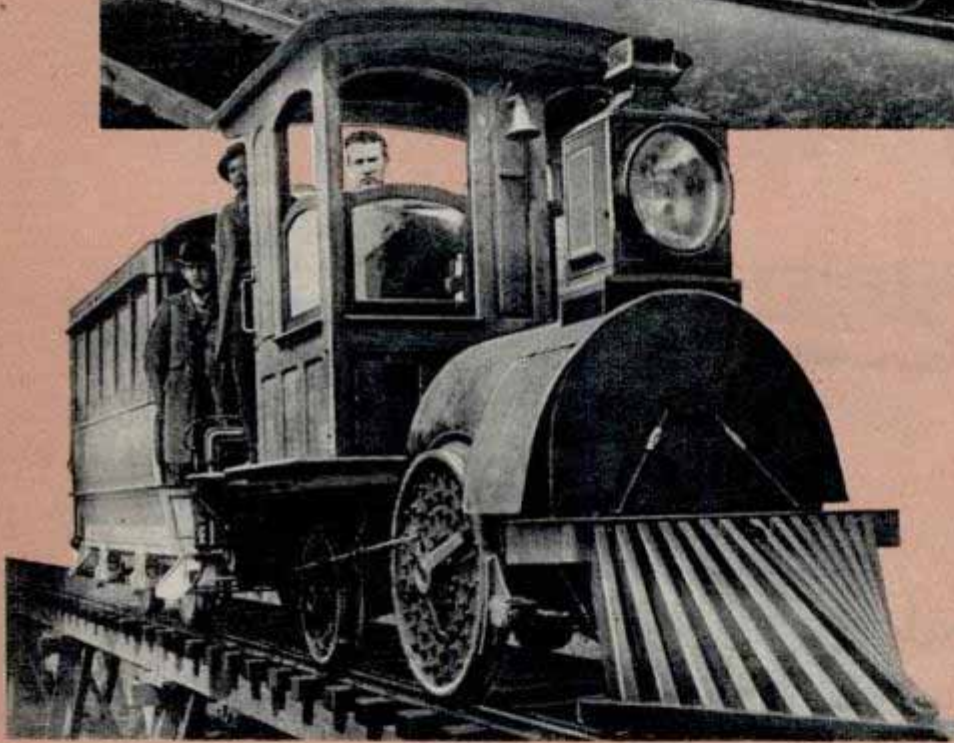

the sound vibrations of the transmitter I could reverse the process and reproduce the sounds."

How well he succeeded is shown by the fact that his first crude model was a complete success. Only a little later Edison predicted how the world would use the machine. On his list are its uses for reproduction of music, for musical toys, teaching elocution and languages, preservation of speeches,

Many legends linger about him; one, that he had invented a 365-layer shirt that could be worn all year-round simply by peeling off the outer layer each day.

He once lectured a scientist for failure to appreciate commercial problems. The scientist countered by asking Edison what he had received for his lamp. Edison said he had gotten nothing. The scientist pointed out that it was Edison who failed to understand business—that for the manufacturing rights to an article not nearly so much in demand as the Edison lamp he had received \$250,000.

The phonograph was Edison's most original and his favorite invention. He said, "I got the idea while working on a telephone carbon transmitter. It occurred to me that if I could indent a yielding substance with

production of phonographic books for the blind, a recording device in connection with the telephone, an office dictation instrument and as a coin-in-the-slot juke box.

But his experience with the phonograph disclosed that he was never quite the "practical" man he insisted the inventing business needed. After he had invented it, he discarded the machine for 10 years until a rival company began to manufacture it. Then both Edison and the rival company manufactured phonographs as penny arcade juke boxes. The phonograph was not recognized as a musical instrument. A music merchant would have been insulted if he had been asked to sell it. Hardware stores and toy shops were the sales outlets.

Next the flat disk record was devised.

(Continued to page 260)



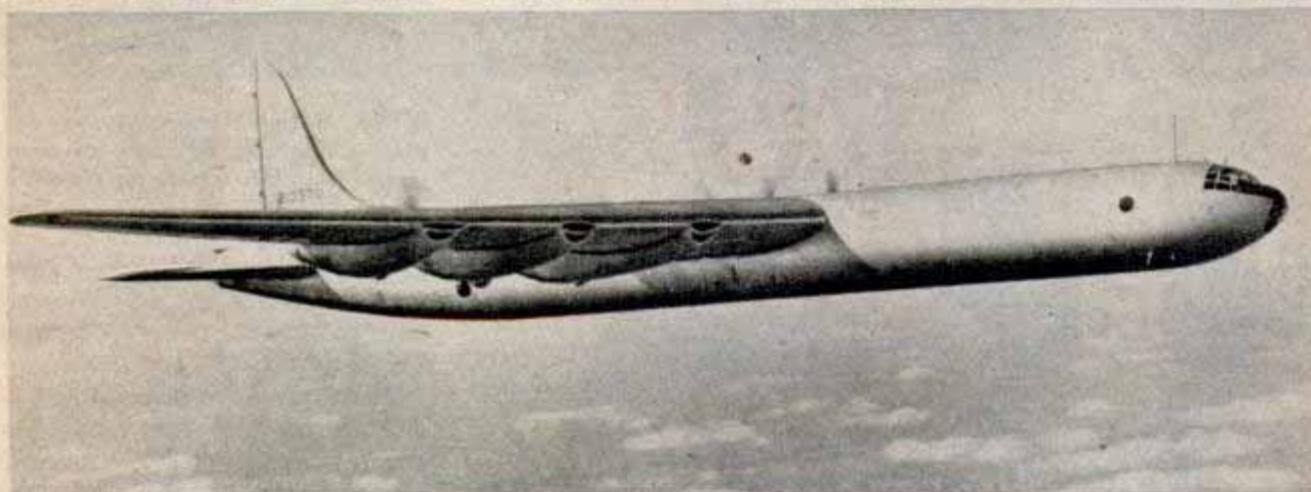
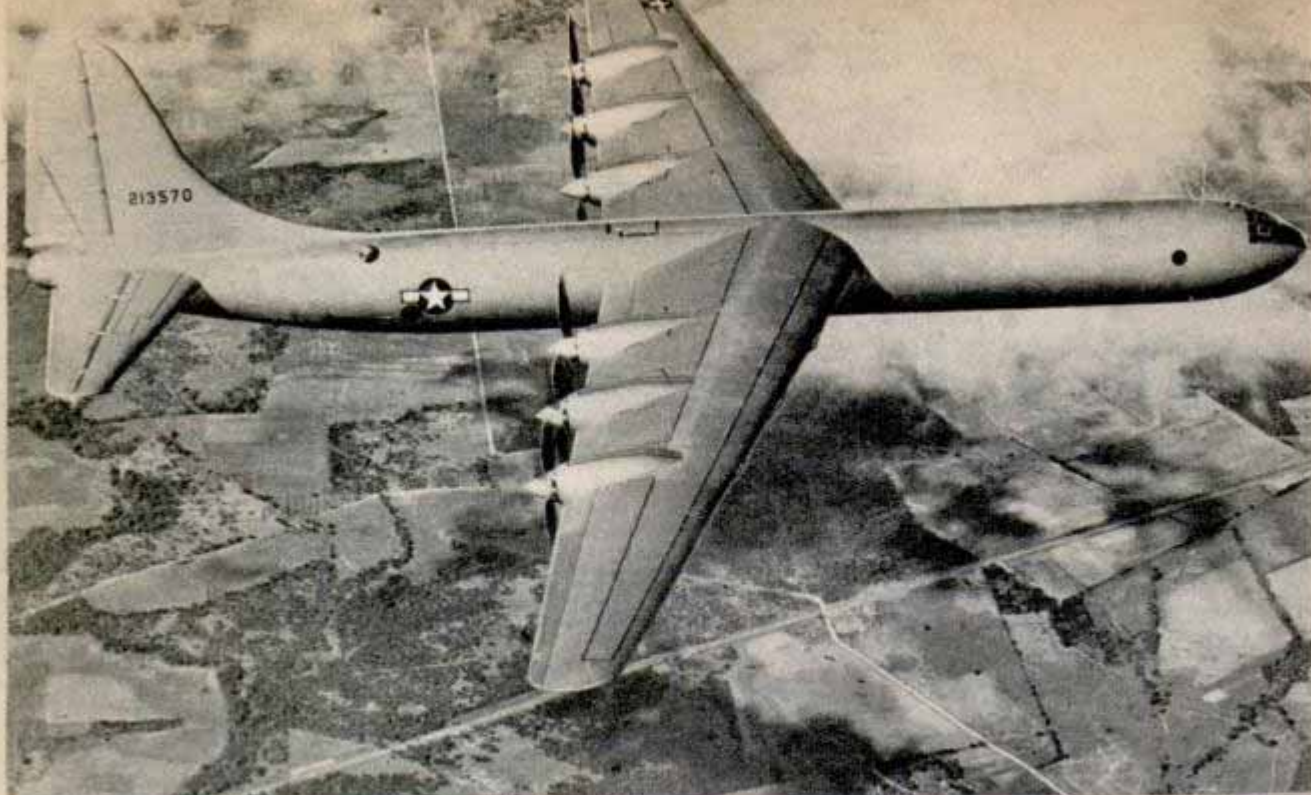

Consolidated-Vultee photos

## Largest Bomber

Eight 56-inch landing wheels are being substituted for two 110-inch wheels to support the 278,000 pounds of the Army's B-36. Arranged in four-wheel trucks, they distribute the weight of the largest bomber ever flown better than the two wheels used in test flights and are nearly a half ton

lighter. This improvement, coupled with the shortened landing runs resulting from reversible pitch propellers, permits use of a greater number of airfields. The pressurized bomber, with six pusher-type engines, has a 40,000-foot ceiling and a range of 10,000 miles with 10,000 pounds of bombs. The wing tanks hold 21,116 gallons of gasoline and 1200 gallons of oil, more than an ordinary motorist uses in 20 years.

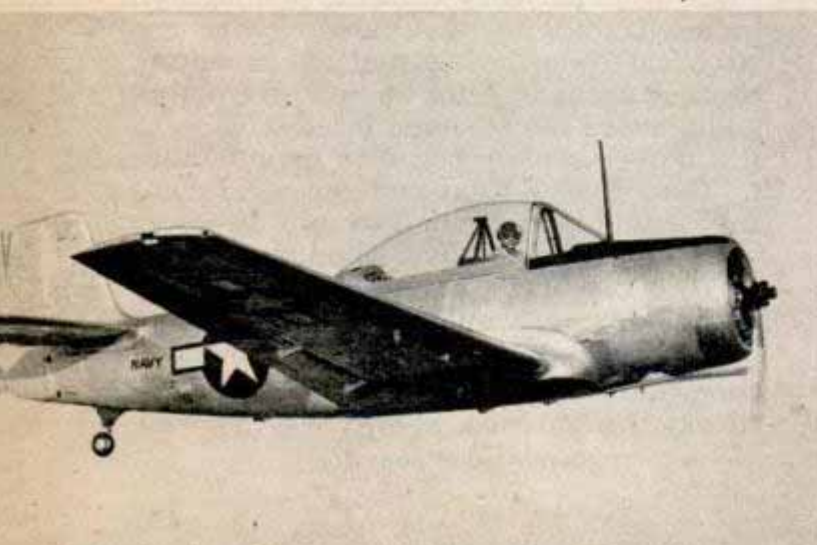

## Trainer Has All-Around Visibility

Instructor and student have the safety advantages of all-around visibility beneath a one-piece bubble canopy in the Navy's latest primary trainer, the Fairchild XNQ-1. It has a top speed of 170 miles an hour, climbs over 1000 feet a minute and weighs 3700 pounds. The nine-cylinder Lycoming engine spins a controllable pitch propeller.

☐ Filament wire used in electric lamps is so strong that a three-inch length will support 200,000 times its own weight.



## Stylus "Reads" for the Blind By Scanning Printed Material

Ten words or more per minute can be "read" by blind persons using an electronic hand-held stylus to scan printed material. No raised type, as employed in Braille, is required. The stylus is moved horizontally across a line of type, letter by letter. A beam of light directed through a narrow slit in the face of the stylus scans the print vertically, 30 times per second, indicating the presence and extent of black portions of each letter by a warbling tone which becomes audible through headphones. Ultimate speed expected with the instrument, developed by RCA Laboratories, is 60 words a minute. If the reader gets off the line, the device transmits no sound.



## Easy-to-Play "Sweet-Potato Flute" Has Tone Holes in Keys

Music that sounds like a cross between flute and "sweet-potato" (ocarina) tones is produced by an easy-to-play woodwind instrument designed for beginners. Equipped with a simplified mouthpiece that requires no reeds, the sweet-potato flute has a complete fingering system that incorporates tone holes in the keys, thus reducing the number of mechanical parts.



## Course Finder for Lightplane Pilots

With a unique transparent plastic protractor, course plotting for flights under contact conditions is simplified for light-

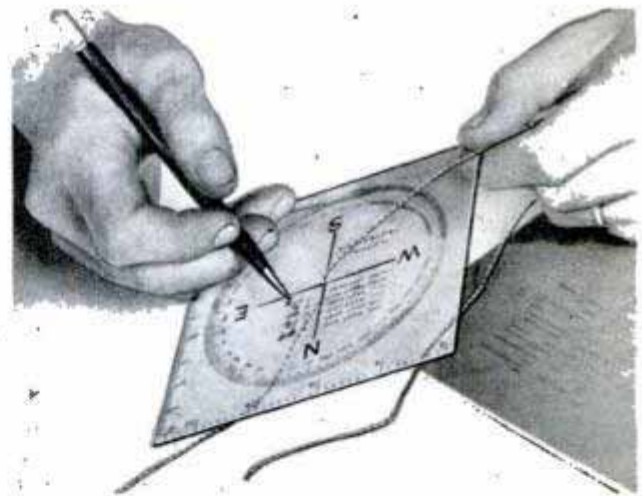

plane pilots. The protractor has a cord attached which is laid out between points on a strip-map for determination of the true course. True course, variation, magnetic course, deviation and wind velocity figures needed to determine the correct compass course can be jotted down in pencil on a frosted section of the protractor.

## Chemical Spares Useful Insects

Useful insects may be spared with a chemical which kills the codling moth, a pest that destroys apples and other orchard crops. Phenothiazine, used to control internal parasites in animals, is combined with lead arsenate to destroy the moth. It was developed by Du Pont chemists, who report it is less harmful to useful insects.



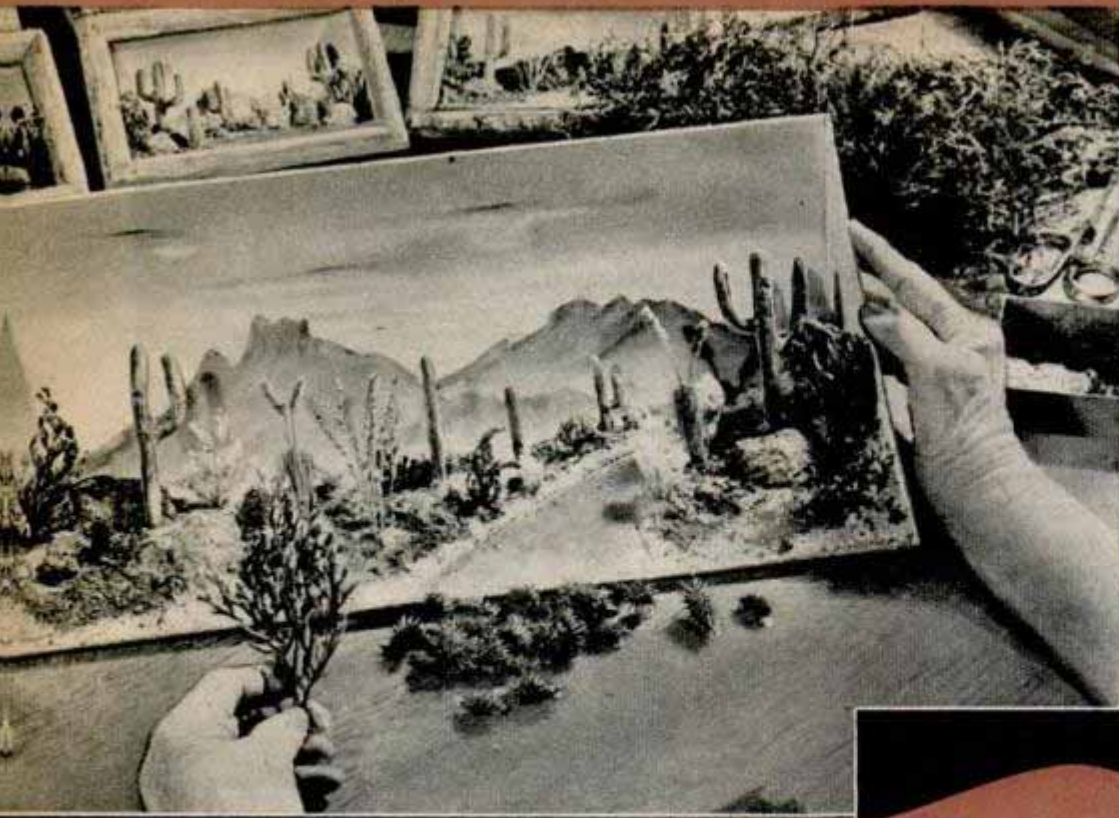

# FRAMING the DESERT







**C**OLORFUL Arizona desert scenes are reproduced in painstaking detail in dioramas made by the Guy Knauff family in Tucson. In their home shop they have constructed 46,000 of the three-dimension pictures. Most materials used are fragments of vegetation which the Knauffs gather from the desert near their home. The boxed scenes vary in size from 3 by 4 inches to 18 by 66 inches. All are made with concave background to give the illusion of horizon and sky. Some are so deep that lights can be placed between cutout mountains and the background wall to simulate a sunset

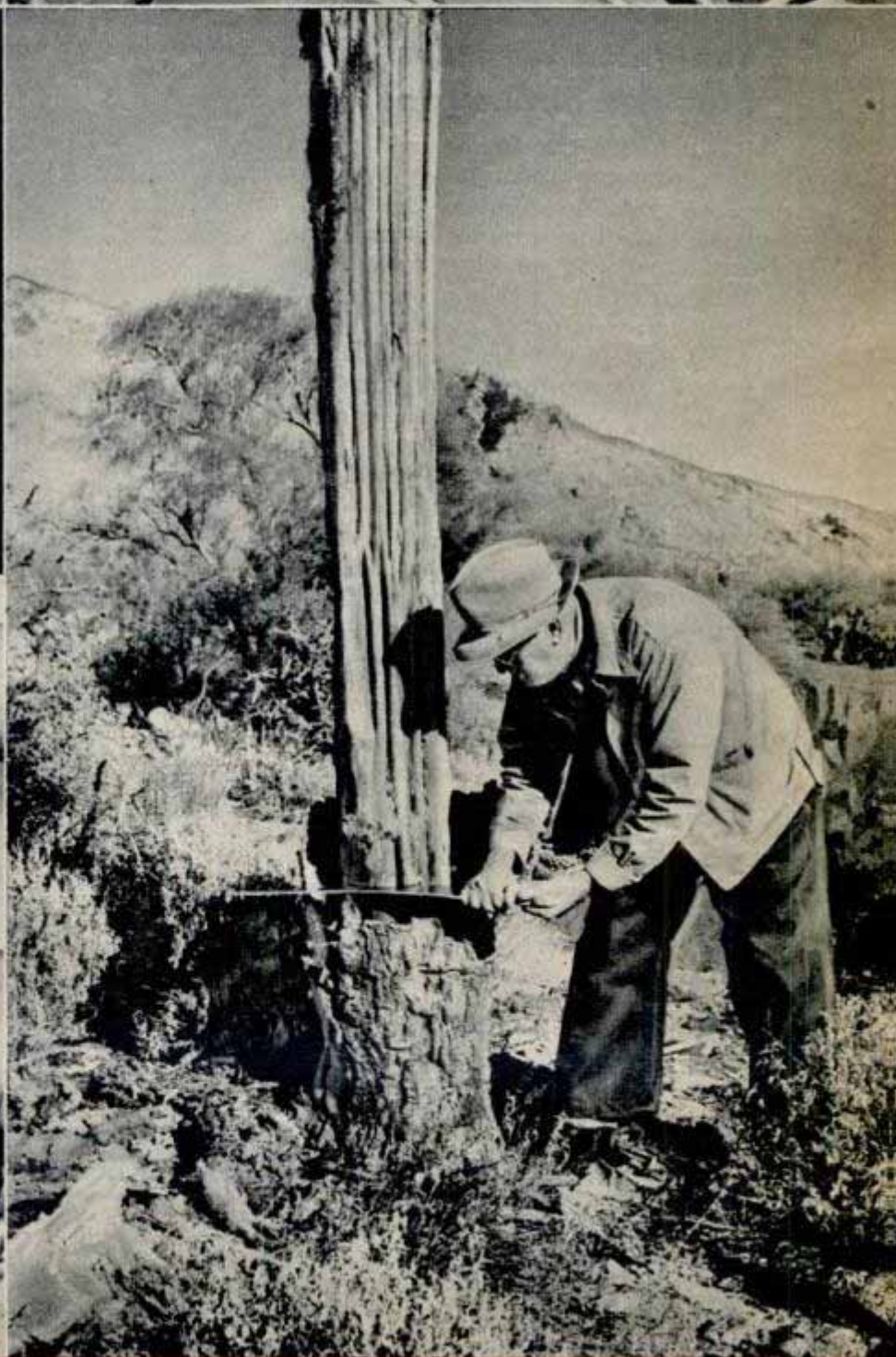

Clay saguaro is painted green and "planted" in desert. Ribs of real saguaro, right, will become diorama frames





## Self-Propelled Houseboat Provides Bunks for Six

One answer to the housing shortage—and moving day worries, too—is a new 36-foot steel-hull houseboat with lines like an assault boat and a cruising speed of seven miles an hour. The craft is fireproof, waterproof, insulated with mineral wool and has a draft of only two feet. Its accommodations include a stateroom with two single and one double bunk and a lounge which can be converted into a double bedroom. The galley has a double sink, an icebox, a four-burner stove, four built-in cabinets and a drop-leaf table. The tiled bathroom has a stall shower and even boasts a medicine cabinet. The boat is equipped with 110-volt current. Powered by a 45-hp. engine, the craft is priced at \$9990.

Left, awning-shaded afterdeck of the houseboat has a built-in seat where the owner can lounge or fish in comfort. Right, the cozy living room can be converted into an extra double bedroom



▲ In the galley are a double sink, a four-burner bottled-gas stove and an apartment-size refrigerator. Below, the sturdy boat, powered by a 45-horsepower engine, resembles a wartime landing craft

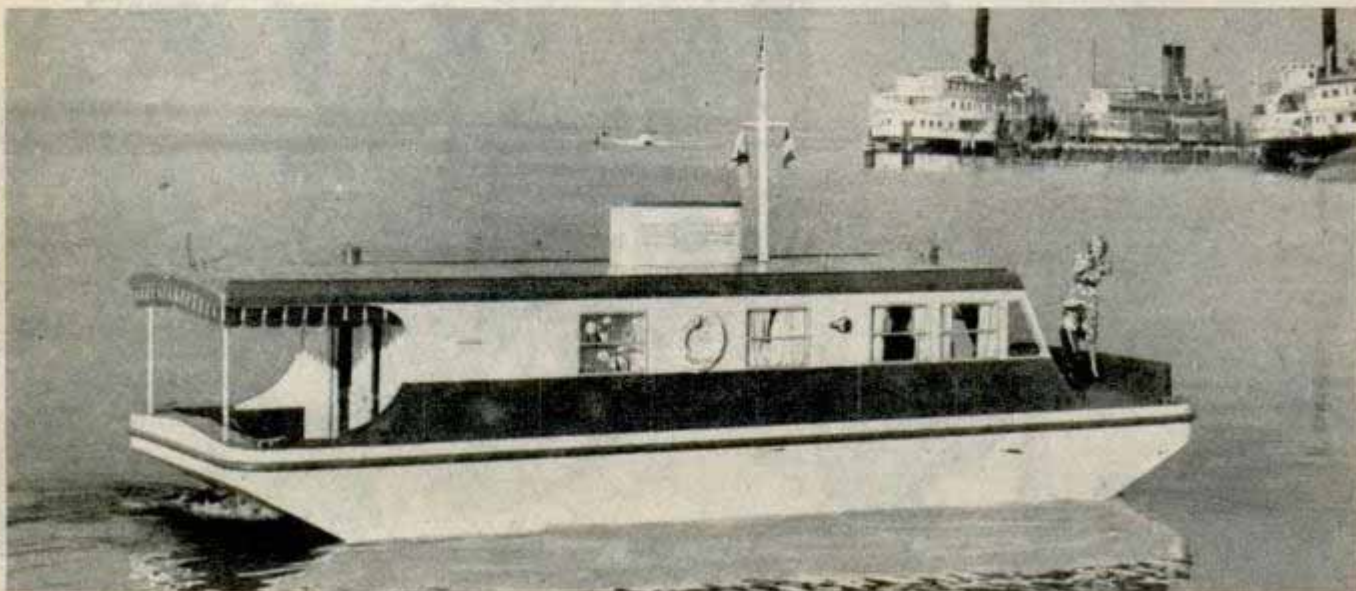



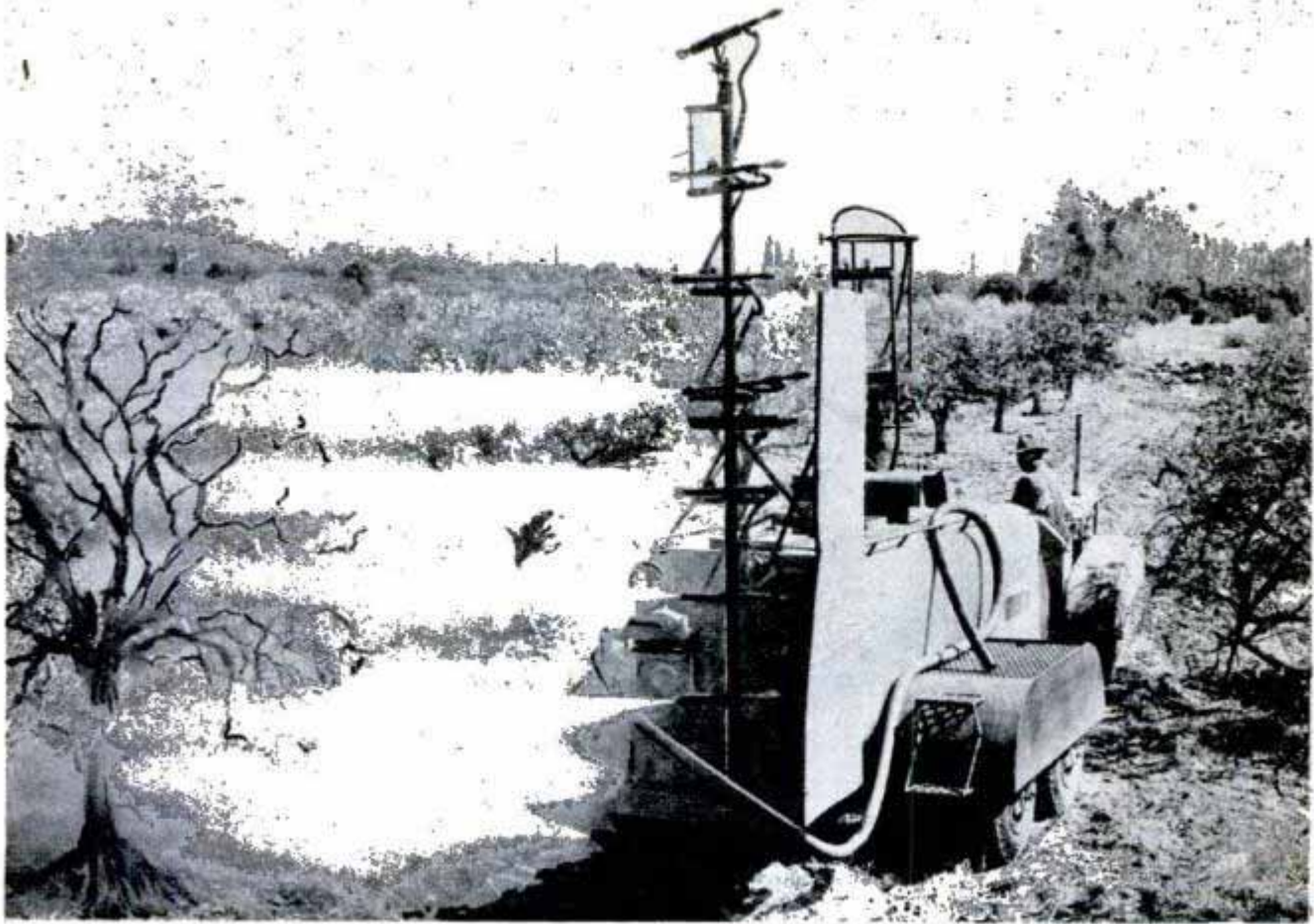

When the wind blows spray over the driver of the spraying rig used in the lemon groves of the Sespe Land and Water Company at Fillmore, Calif., the driver dismounts. While he walks along in the next row to avoid the spray, the driverless Diesel track-type

### Spraying Rig Follows Row As Driver Dodges Spray

Caterpillar tractor pulls the rig straight down the work row. The automatic rig is equipped with nine spraying nozzles that are mounted so that they swing back and forth by power from the sprayer motor. The spray tank holds 800 gallons of material.

### Waterproof Cover for Pickup Truck Slips Over Aluminum Frame

Conventional pickup trucks can be converted into waterproof vehicles with a heavy duck cover that fastens over an aluminum frame. Trim lines of the cover minimize wind resistance. The canvas across the rear can be opened easily by a zipper along each side and rolled to the roof. The unit fits most  $\frac{1}{2}$  to  $1\frac{1}{2}$ -ton pickup trucks built from 1940 to 1946 as well as many built before 1940.



Records of television programs will be made on 16-mm. motion picture film much as transcriptions are now used in radio.



Glowing man-made gems are physically and chemically the real thing, yet they cost but a fraction of the price of natural stones

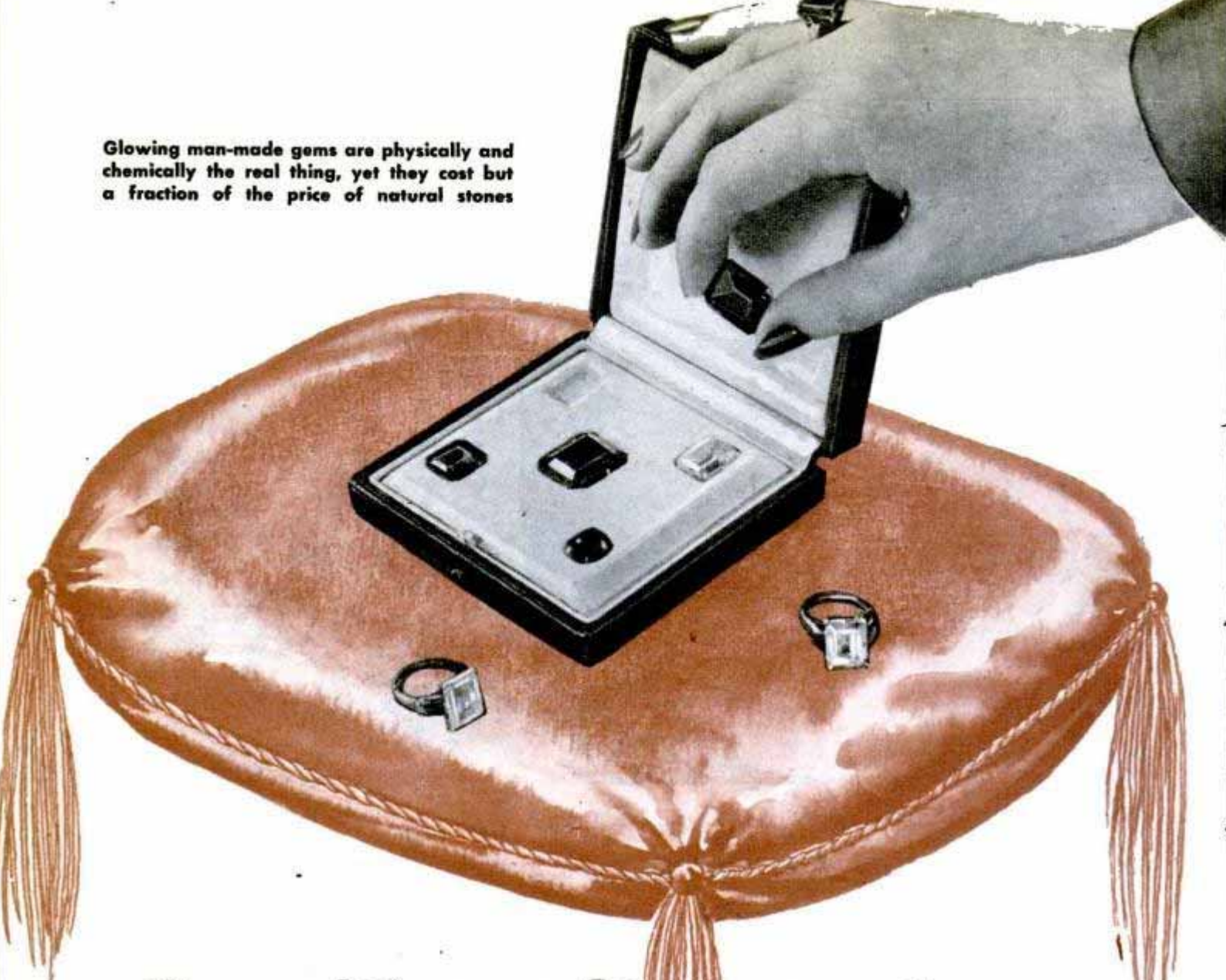

## *Oven-Baked Gems for Industry*

**A**LCHEMISTS of the Middle Ages searched for centuries to find the "philosopher's stone"—a mystic substance that would transform everyday materials into gold and silver—but ultimately gave up their search. More recently, men have tried sealing lumps of carbon inside iron balls, heating the balls white-hot, then dropping them in ice water. The sudden change of temperature was supposed to change the carbon into diamonds, but these experiments failed, too.

But where alchemy failed, modern industrial science has triumphed. Today, synthetic sapphires and rubies—identical in chemical and physical properties with natural gems—are being produced in America in commercial quantities. The secret of the process is controlled heat, which transforms a feathery powder into beautiful crystals, red rubies, or sapphires of many colors.

The development of man-made sapphire is significant to industry as well as the jewelry trade, for the substance has a combination of hardness and uniformity of structure which makes it ideal for bearings that wear indefinitely. Even before the war every Army or Navy plane required between 75 and 100 sapphires for instrument bearings. Range finders and other military instruments that had to be accurate contained large numbers of sapphire bearings.

Before the war the United States was able to get all the synthetic sapphires it needed—in the form of finished jewel bearings at the rate of some 30 millions a year—from Switzerland. The war ended this source of supply. American industry had to produce synthetic sapphire quickly for bombsights, speedometers, chronometers, compasses, airmeters, voltmeters, altimeters, gyroscopes, electric and fire control



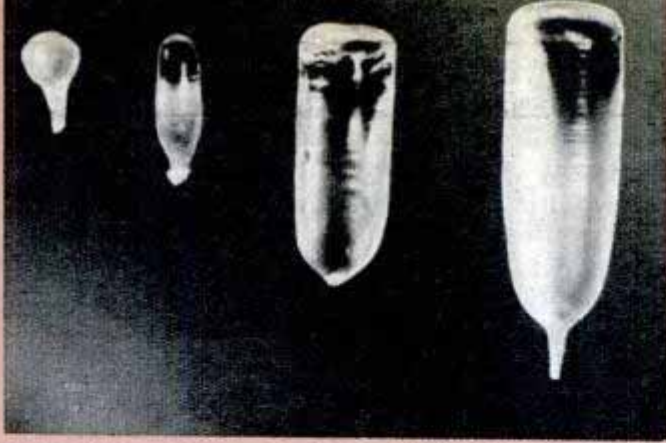

Left, the first "boule" ever made; right, the most recent

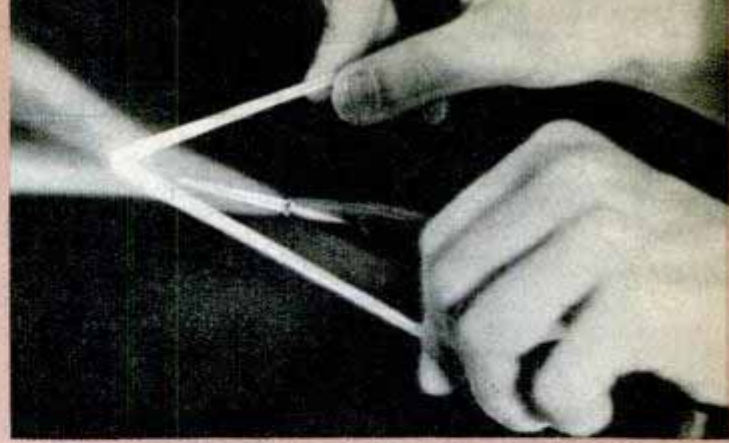

Sapphire rod torch-heated to 3100 degrees F. is bent by hand

instruments and naval instruments. Within two years engineers and chemists developed and produced synthetic corundum, a mineral family which includes sapphires, rubies and common emery.

After 16 months of intensive research the first American plant for the production of synthetic sapphire turned out the first gems. From then until the end of the war there was no scarcity of the material. A stream of synthetic jewels poured from the ovens of the Linde Air Products Company, General Synthetics Corporation and the Bulova Watch Company.

Modern alchemists start their production of sapphires and rubies by roasting pure alum crystals in a furnace at 2400 degrees F. The product is a feathery white powder—aluminum oxide. This material melts at 3750 degrees F. and the temperature range in which it can be worked is quite narrow.

The size of the particles of this powder influences the quality of the finished product. At present, particles measuring  $\frac{1}{10}$  micron are producing the purest and best synthetic gems. These particles are so small that if one of them were enlarged 50,000 times it would be about the size of a pinhead.

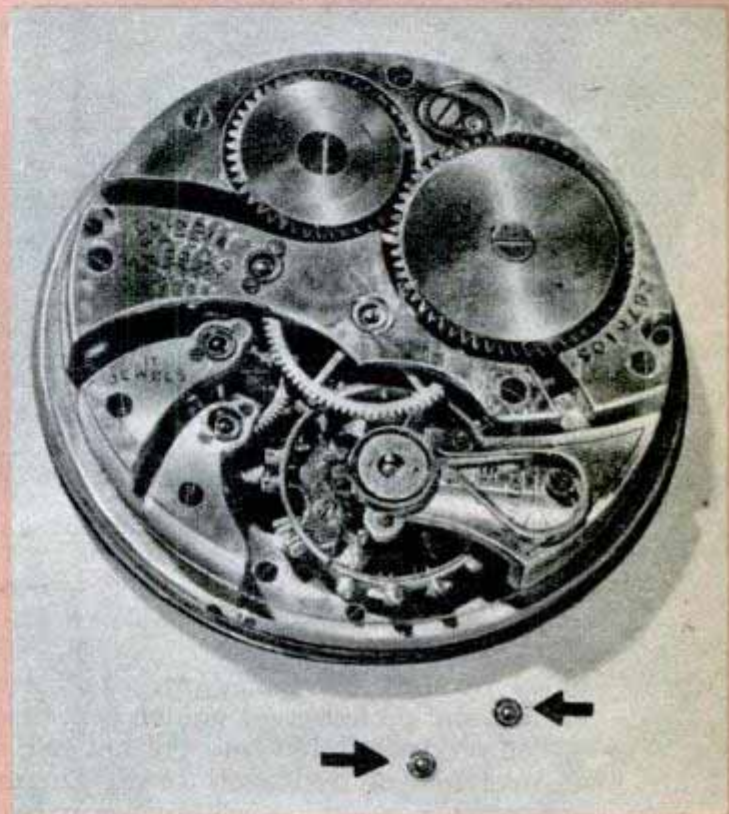

▲ Major field for man-made sapphires is in jeweled watches  
 ▼ Precision gauges made with synthetic sapphire surfaces outlast steel gauges and maintain their accuracy indefinitely  
 Linde Air Products Company photos



▼ Gems are made in the form of rods, then sliced into disks

Looped rod is durable thread guide for textile industry

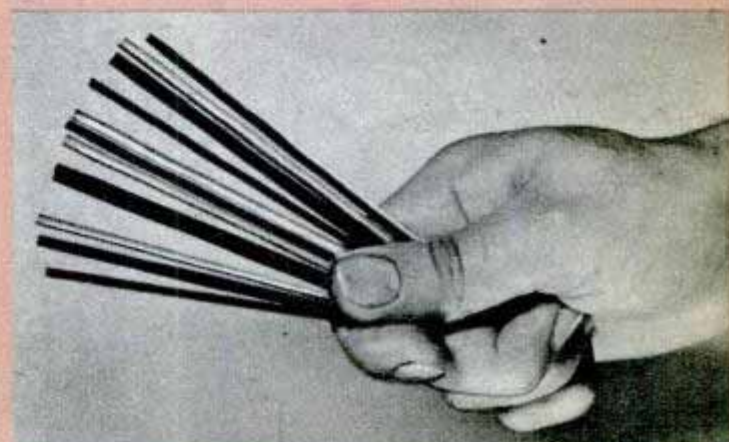
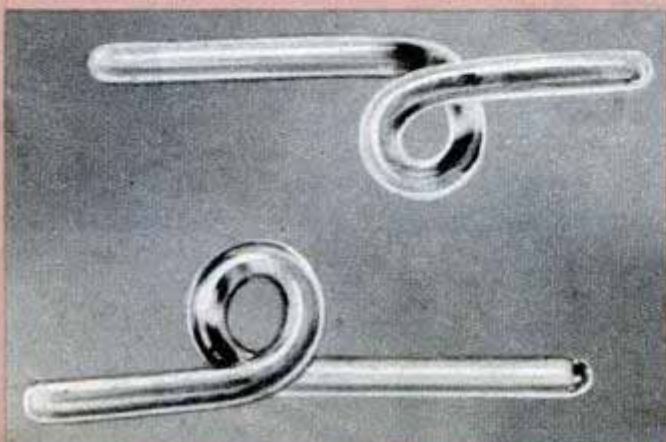



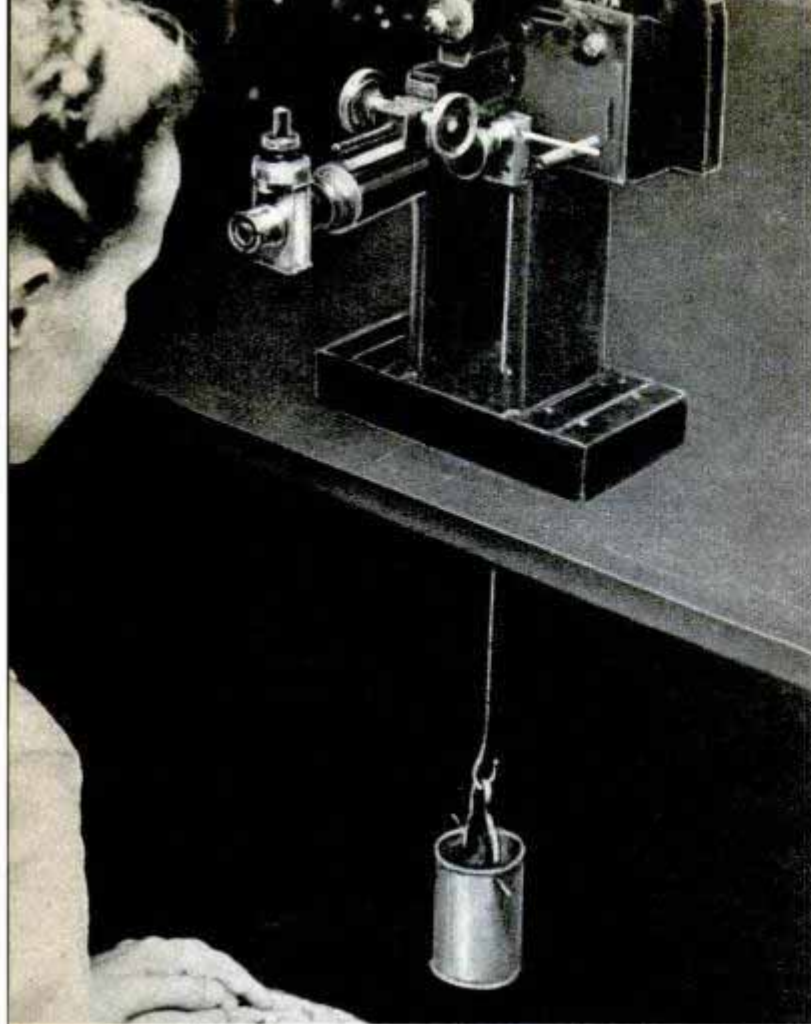

**Test instrument checks tensile strength of sapphire rod**

To this powder is added any coloring matter desired. A little chromic oxide gives rubies; titanium and iron give blue sapphires; cobalt and vanadium produce emeralds, and nickel gives golden sapphire.

The mixture is fed into the hot flame of an inverted oxyhydrogen torch. The mass of molten material resulting from the fusion of the powder is deposited on a fireclay

**Rod is given a strength test at white-hot temperatures. It maintains its hardness up to 2912 degrees F.**

pedestal. Here the mixture piles up, shimmering with its own intense heat, to form a carrot-shaped mass known as a "boule." This boule is actually a single crystal.

As the crystal grows it develops stresses. The boule is split to relieve these stresses. Before the splitting the boule weighs about 300 carats, is about  $\frac{3}{4}$  inch in diameter and two inches long. Crystals have been produced weighing up to 800 carats.

Most bearings are made from small disks, and several expensive steps formerly were required to work such disks from a boule. Research workers decided to produce the gem material in the form of small-diameter rods, although European experts concluded years ago that this was impossible.

Today American sapphire is produced in rods varying from 0.065 inch to 0.125 inch in diameter and up to 30 inches in length. The rods are sliced off into disks of the required size with diamond-impregnated saws. It is estimated that this one improvement has cut waste in working with synthetic sapphire from 91 percent, as it was with boules, to only 40 percent.

Now that the wartime demand for thousands of precision bearings has dropped, man-made gems have had an enthusiastic reception in the jewelry field. Synthetic sapphire and its close relative, spinel, are made in deep colors and delicate tints that make attractive accessory jewelry. The variety of colors is increasing rapidly, and soon any desired color should be in the showcases of your nearest jewelry store. Both sapphire and spinel have superior hardness ratings that allow them to take and keep a brilliant polish.

These synthetics fill a long-felt need for jewelry materials that are above the level

(Continued to page 248)

**Rotating rod is polished by gas flame. Surface will show no scratches even under high-power microscope**

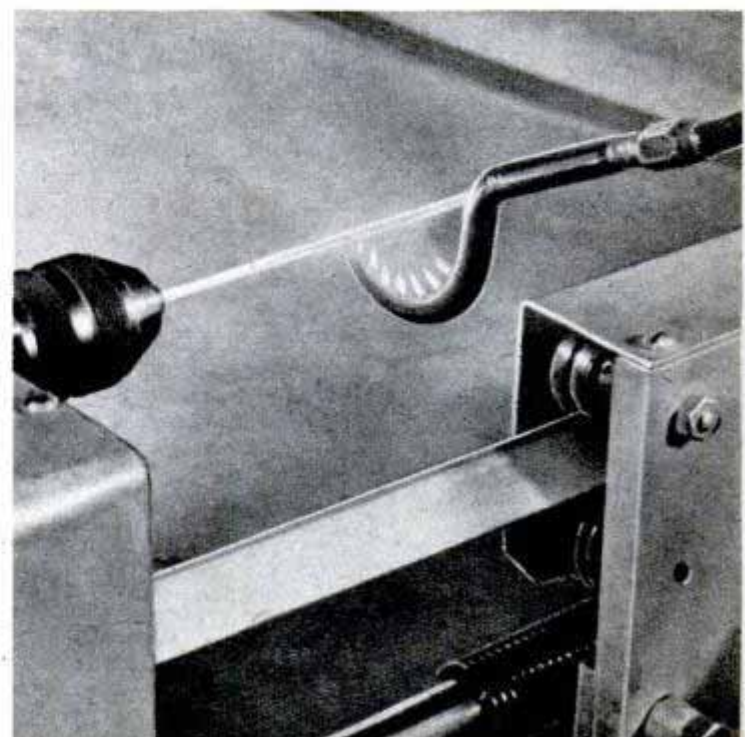
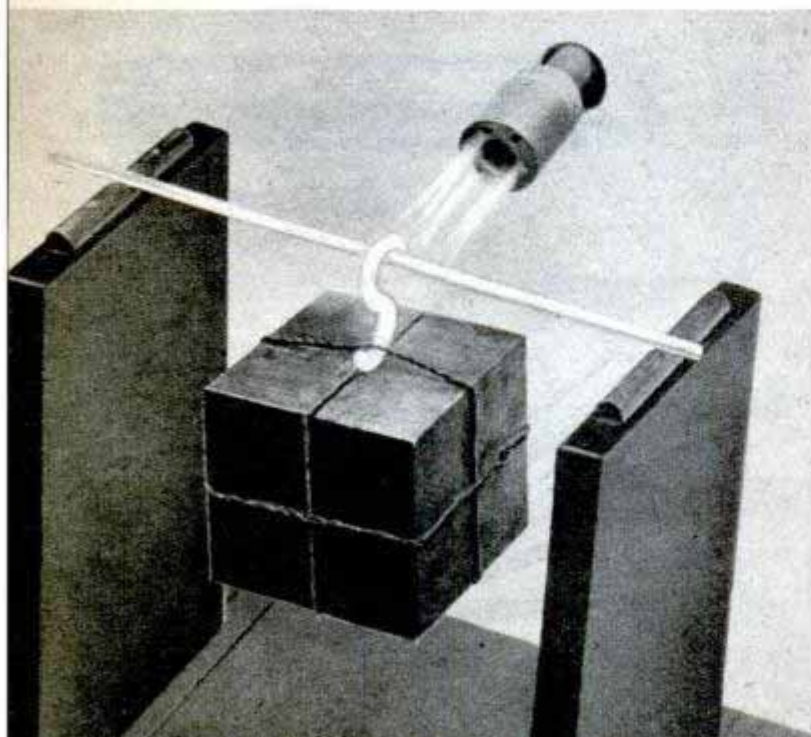



## Weasel Fights Fires In Forest Areas

Fighting fires is the latest assignment for the Weasel, the Army's amphibious twin-track cargo carrier which goes almost anywhere on land or sea. Equipped with a powerful pump, several hundred feet of 1½-inch hose, shovels, axes and fire extinguishers, a Weasel now aids in combating forest fires in the heavily wooded mountains in San Gabriel Canyon near Arcadia, Calif. Loaded with equipment, the craft can speed along on roads at 36 miles an hour and, when a fire is spotted, it can be guided into water to begin pumping. Ira C. Funk, supervisor of the Arcadia Fire Control District of the U. S. Forest Service, who converted the Weasel into a fire fighter, believes it will become widely used for this job, particularly in muddy, swampy areas.



## Photo Lamp Projects Light Patterns

Unique lighting effects for photography are possible with a new spotlight-floodlight combination. Accessories for the light include four disks for special designs, four color filters, one square and two round apertures and two glass disks. The accessories make possible special effects such as clouds, lattice light, single lines of light, silhouette lighting and novel light patterns.

Information, including manufacturers' names, concerning products described in this issue may be obtained by writing Bureau of Information, Popular Mechanics, 200 East Ontario St., Chicago 11, Ill.





- ▲ Living room features built-in bookcases and picture window
- ▼ Finished five-room house is fireproof and weather resistant



Steel wall frame is bolted to foundation

# Porcelain Enamel House



Trim bungalows made of steel with a porcelain enamel finish are being factory-built by the Lustron Corporation of Chicago for assembly on the site. Steel structural members replace two-by-fours in the house frame and the walls are made of steel panels. A variety of exterior appearances and room arrangements is possible.

Below left, a factory-built wall section is raised into place. Below, the outside panels are tailor-made to fit into the wall structure

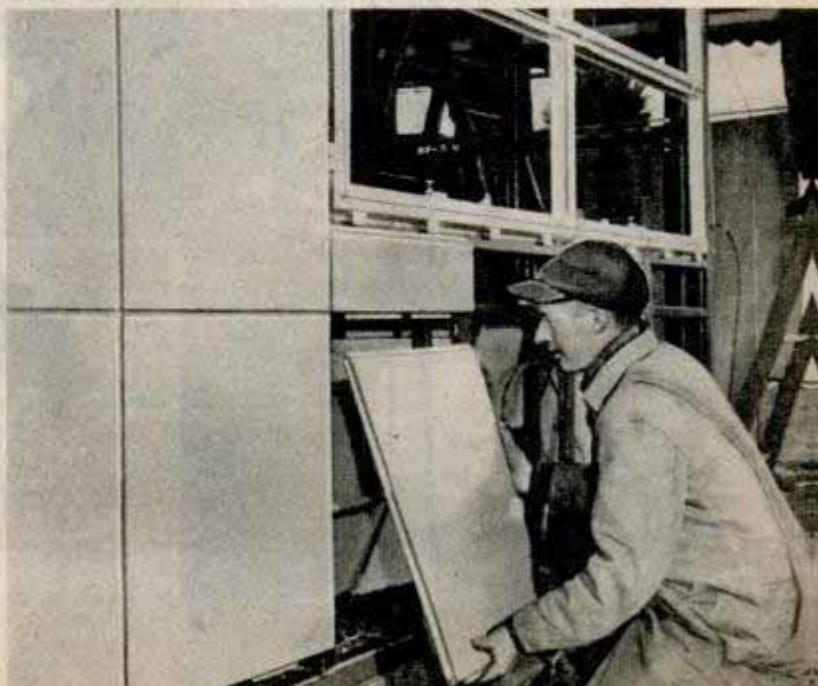
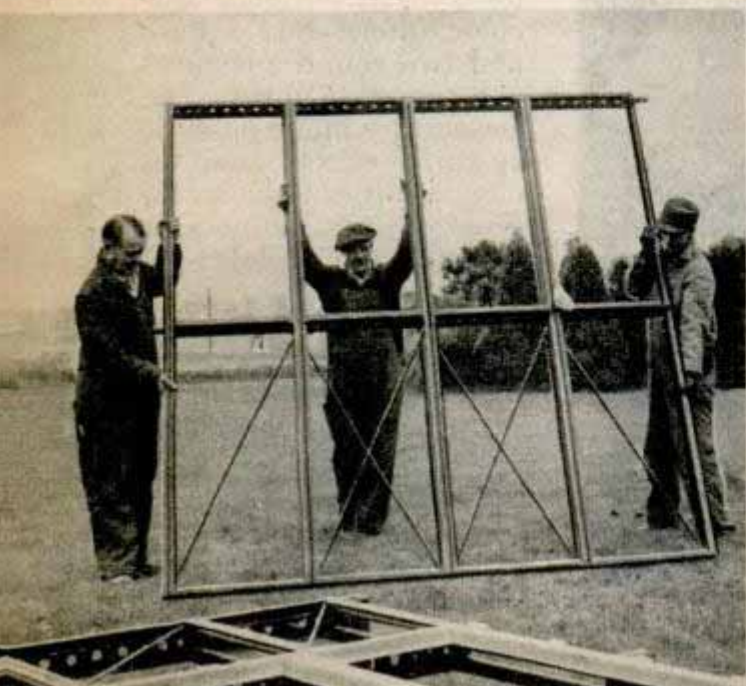





# SNOW TANK

▲ Vehicle's bogie wheels work like those on a tank, forcing the track to hug the surface and distributing total weight over a large area

▼ Single passenger balances the driver's weight by riding in the front seat. A cabin model is planned that will carry four persons

Snow banks and sheets of ice offer no barrier to the snow tank, a little vehicle that may replace the dog team as transportation in the Far North. Designed as a fast, reliable carrier for hunters, trappers, game wardens and other snow travelers, it is powered by a self-starting air-cooled 15-horsepower motor and has a top speed of 25 miles per hour. Wide tracks distribute the weight over a large area. The snow tank steers like any other track-type vehicle and turns in its own length. It pulls a sled loaded with gas, food and camping gear. A commercial model equipped with a cabin, heater, lights and seats for four passengers may be in production soon.



Indian princess and her companion enjoy their first ride in the Far North's snow vehicle. The cleats on the broad flat tracks give traction in softest snow

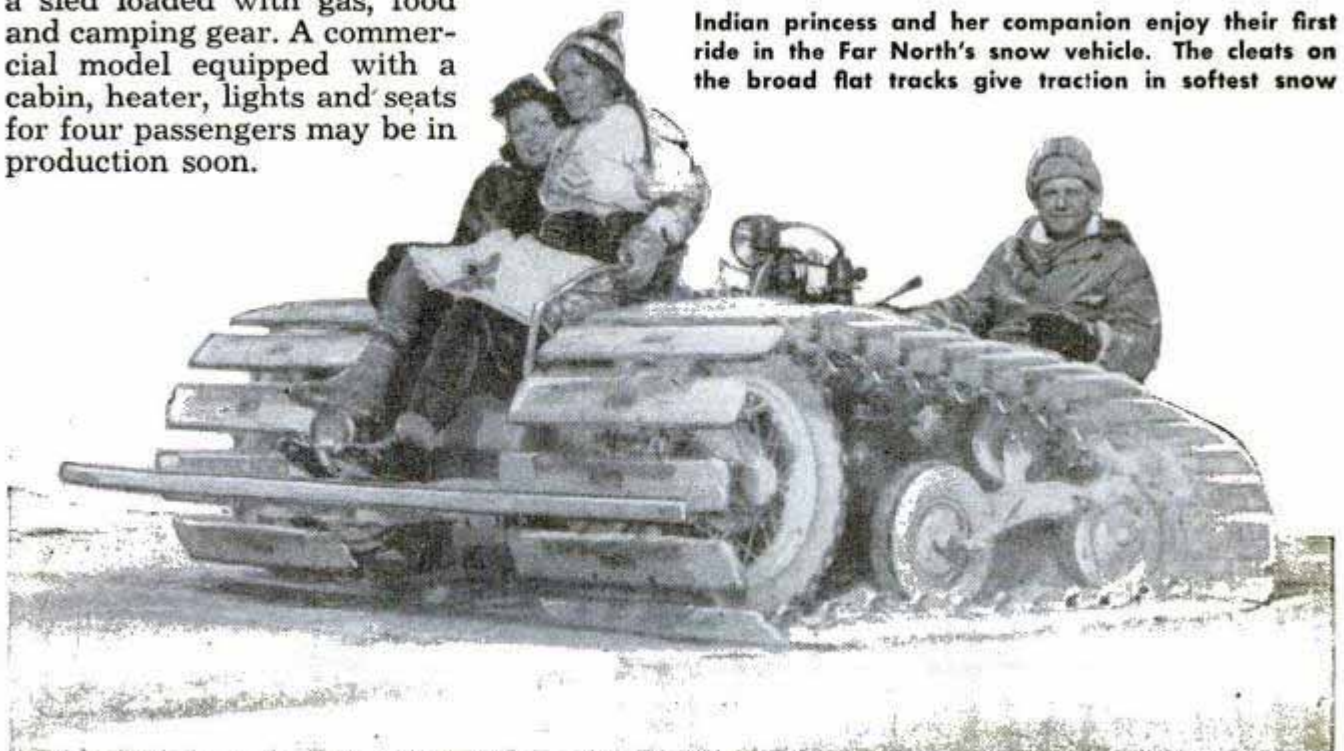



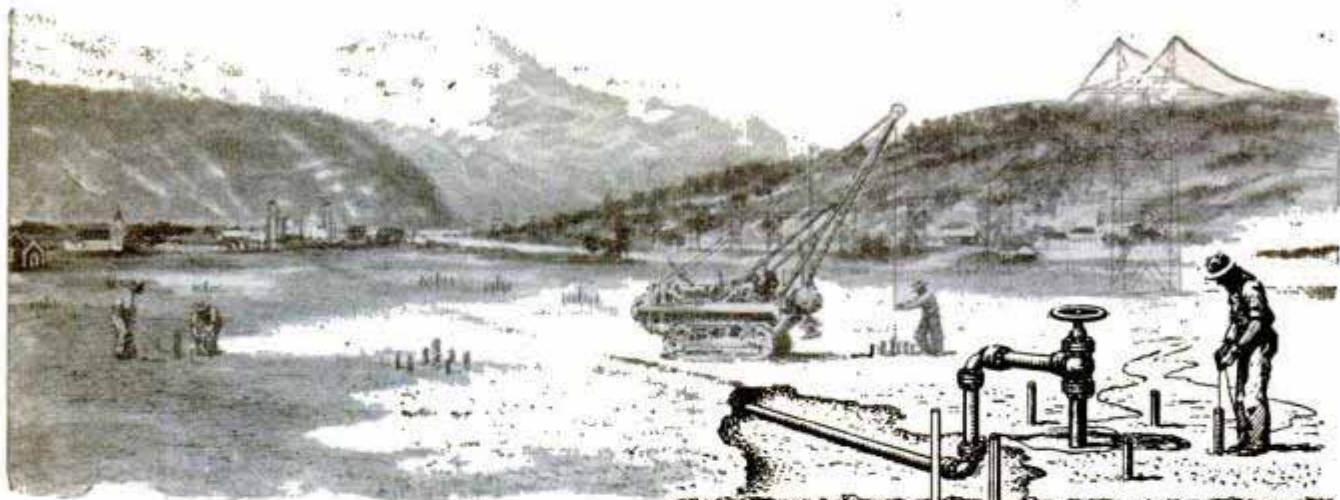

## Oil Is Produced From Shale Heated Beneath the Ground

Sweden gets much of its oil by heating shale 75 feet beneath the ground, drawing off the vapors and converting them by distillation into various petroleum products. Holes about two inches in diameter are drilled into the earth so that electric heaters can be lowered to heat the shale to 1000 degrees Fahrenheit. This temperature releases oil from the shale in the form of vapor which rises through the holes. A cooling process converts the vapor to liquid which is piped to refineries for distillation.

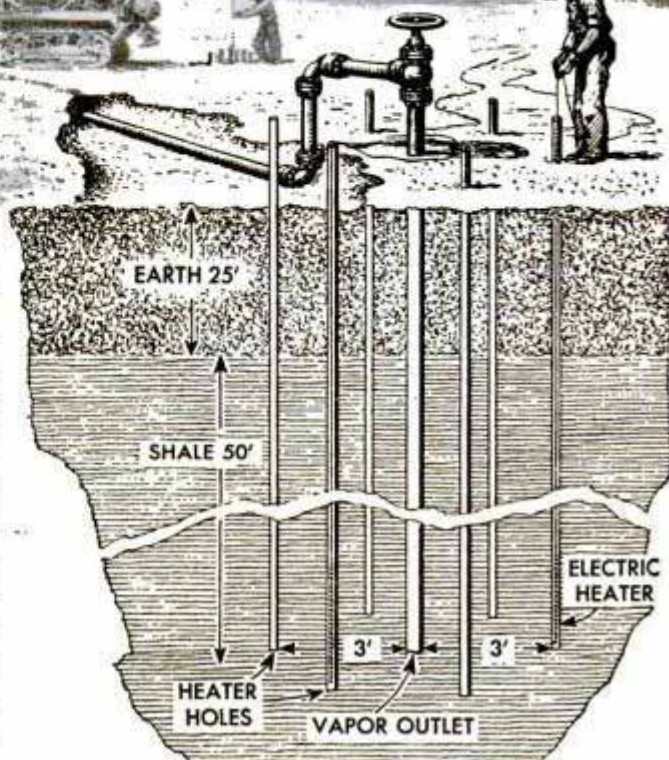

Sweden launched this unusual oil production project during the war when it became almost wholly dependent upon wood from its forests for heat and power. Dr. Gustav Egloff, petroleum engineer with Universal Oil Products Company, reported recently on returning from Europe that Sweden's wartime oil production by the underground heating method was 2000 barrels per day. An interesting by-product of the Kvarntorp oil shale project is the growth of oversized tomatoes and other

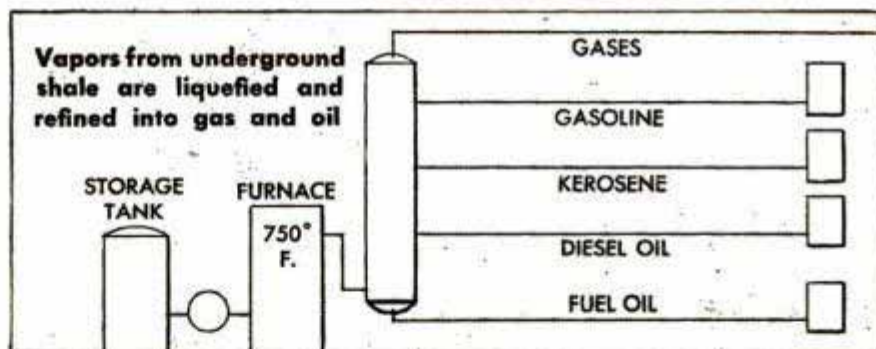

vegetables on the soil above the heated shale. Dr. Egloff said such soil probably will retain some heat for 30 years, during which improved fertility will be noted.

## French Pump Operated by Crank Produces 300 Gallons Per Hour

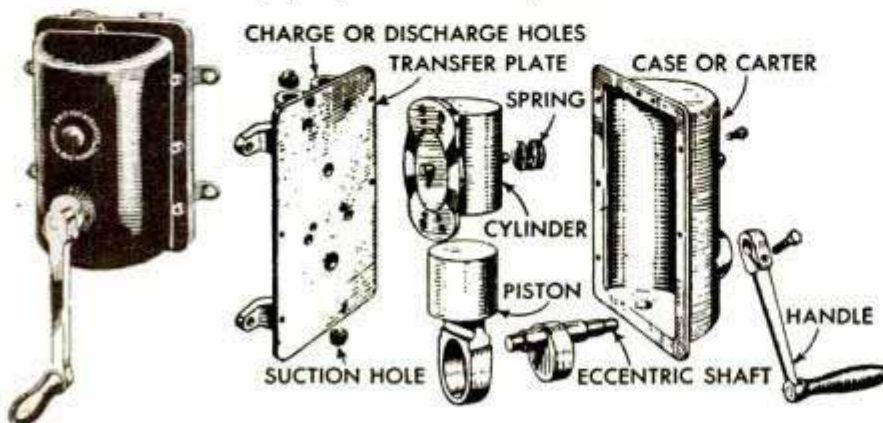

Instead of the usual up and down motion, the handle of a pump developed by a French inventor is operated with the same movement used in turning the crank of a grind organ. A steady stream of water is produced at the rate of 300 gallons per hour. The pump is suitable for farm use in connection with wells 25 feet deep or less.





Wind power turns the large wooden gears that run the machines in Dutch flour mills

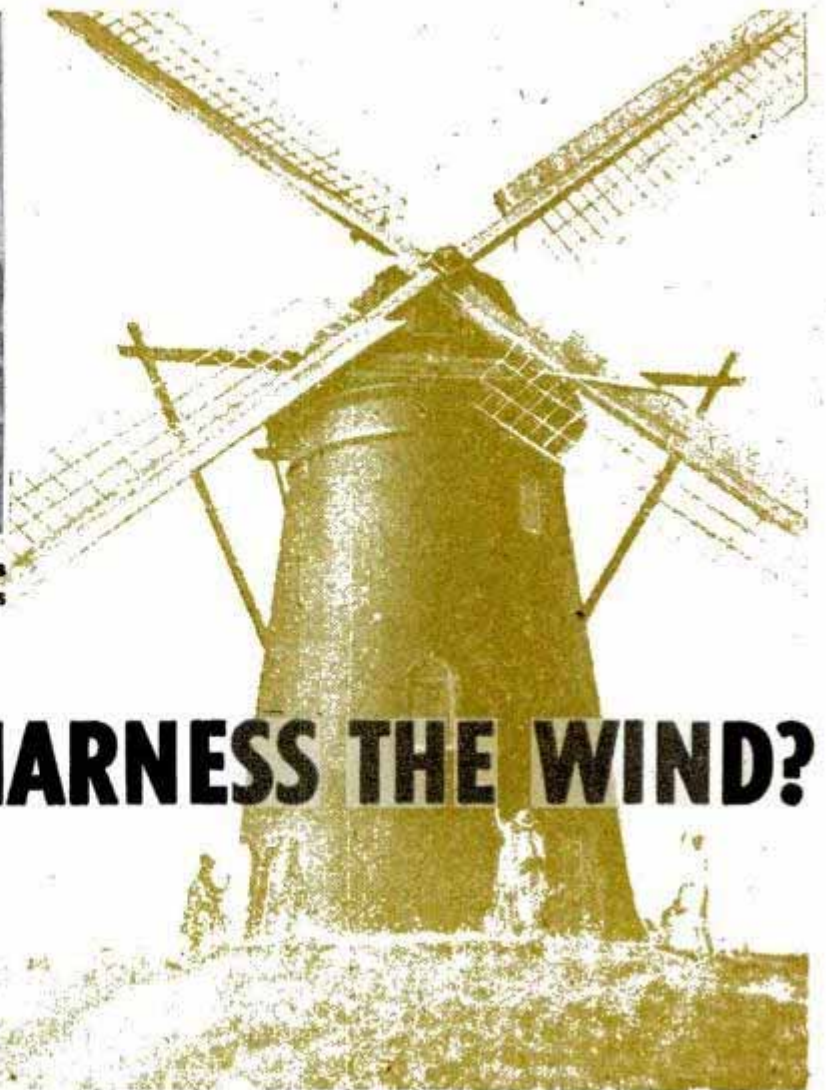

# CAN CITIES HARNESS THE WIND?

By John L. Kent

**E**LECTRIC POWER almost as free as the wind is the possibility inherent in a newly designed wind-driven generator. Mounted atop a 475-foot tower, the electric generator would be turned by two wind turbines or propellers, each with three 80-foot-long blades swinging in a circle 200 feet in diameter.

The two wind turbines would be mounted on opposite ends of a 225-foot-long steel bridge, supported on a central turntable. Propellers, gears, generator and controls, weighing more than 750 tons, would be free to swing into the wind atop the tower.

Brain child of Percy H. Thomas, engineer on the staff of the Federal Power Commission, the giant aerogenerator is estimated to produce enough electricity to supply 10,000 homes. It is the newest attempt to get electricity from the wind.

Wind and tides have been the subject of much study in the search for cheap power. For centuries, windmills have raised water, ground flour and furnished power to drive simple devices. In Belgium and the Netherlands they still grind flour just as they have done for more than 700 years. American wind-

▼ For inexpensive power, Percy H. Thomas, right, would harness the wind to a 47-story-high version of his model aerogenerator

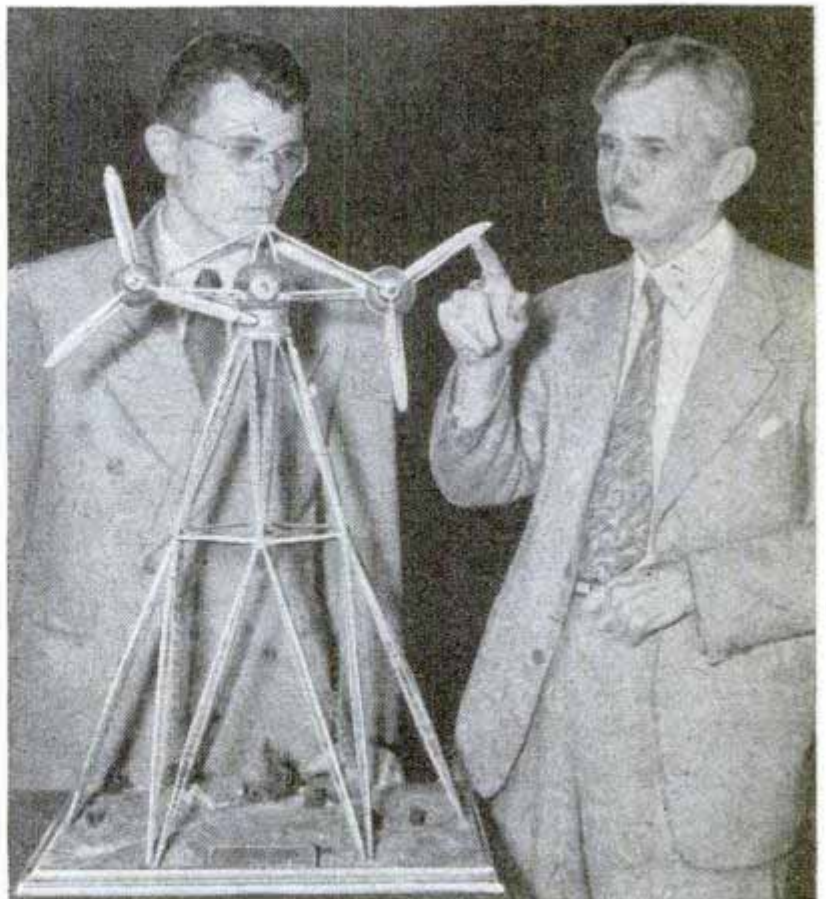



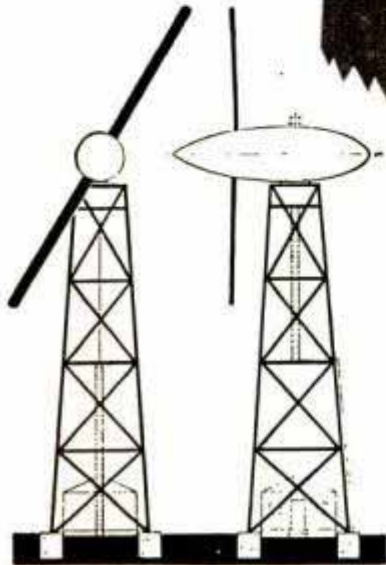
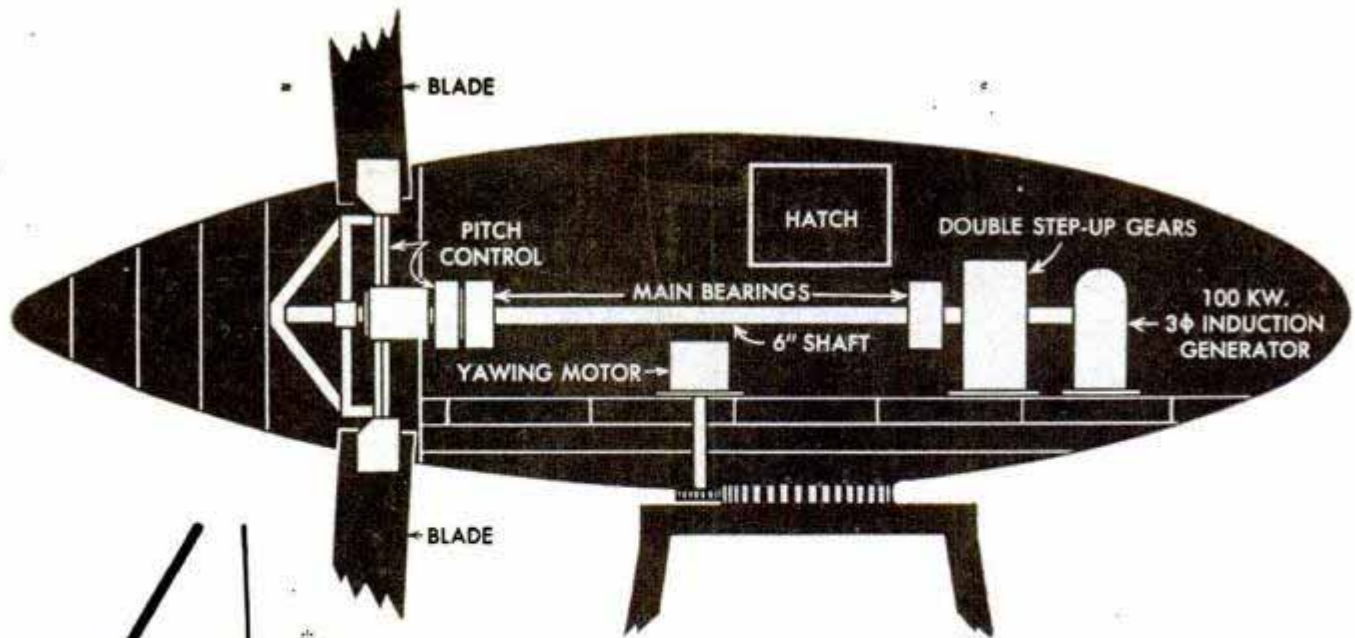

Army considered using 100-kw. wind generators, above, to supply power at its overseas bases. First practical generator was erected in 1941 on top of a 100-foot tower on a Vermont hillside, below. Its blades were 65 feet long

S. Morgan Smith Co. photo

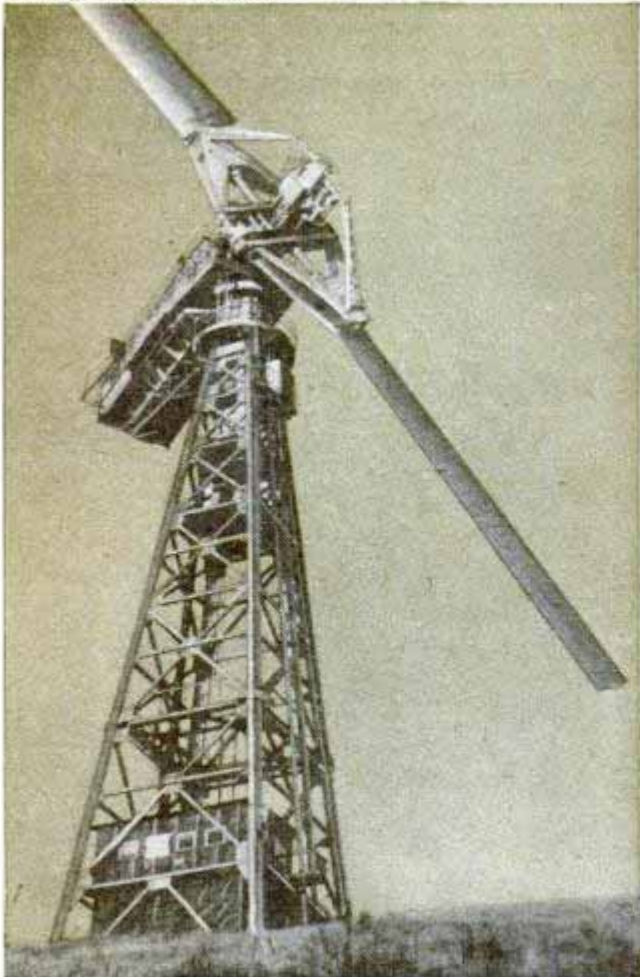

mills with many short blades or slats instead of the four large sails of the Dutch mill, find great use on farms, especially in pumping water. A newer type equipped with a regular aviation-type propeller is used to charge storage batteries.

One of the earliest attempts to transform wind power into electric energy was made about 1880 by Moses G. Farmer. His model employed three solid wind wheels driving the armatures of three dynamos in circuit with a small storage battery.

In 1934 the Russians built an experimental wind turbine generator in the Balaclava region of Crimea. It generated 100 kilowatts. Then in 1941 an American company built the first practical aerogenerator atop a 110-foot tower on a hill near Rutland, Vermont.

Designed by Palmer C. Putnam, a Boston engineer, its two rectangular blades, each 11 feet wide and 65 feet long, generated 1000 kilowatts. Although a practical success, it was recently dismantled and may be re-erected at another location.

The Thomas aerogenerator is based in part on experiences encountered in the operation of the Vermont windmill. But the new design provides for a generator five times as large, producing up to 10,000 kilowatts. Thomas has planned two different machines. One, for a maximum rated wind of 34 miles per hour, has capacity of 7500 kilowatts. Two-blade propellers, each 14 feet wide and swinging in a 200-foot circle, rotate the two turbines.

But since many desirable sites have average wind velocities of only 20 miles per hour, a second design provides for a maximum rated wind capacity of 28 miles per hour. This one uses three-blade propellers nine feet wide and 200 feet from tip to tip. The twin turbines are to have a capacity of 6500 kilowatts.



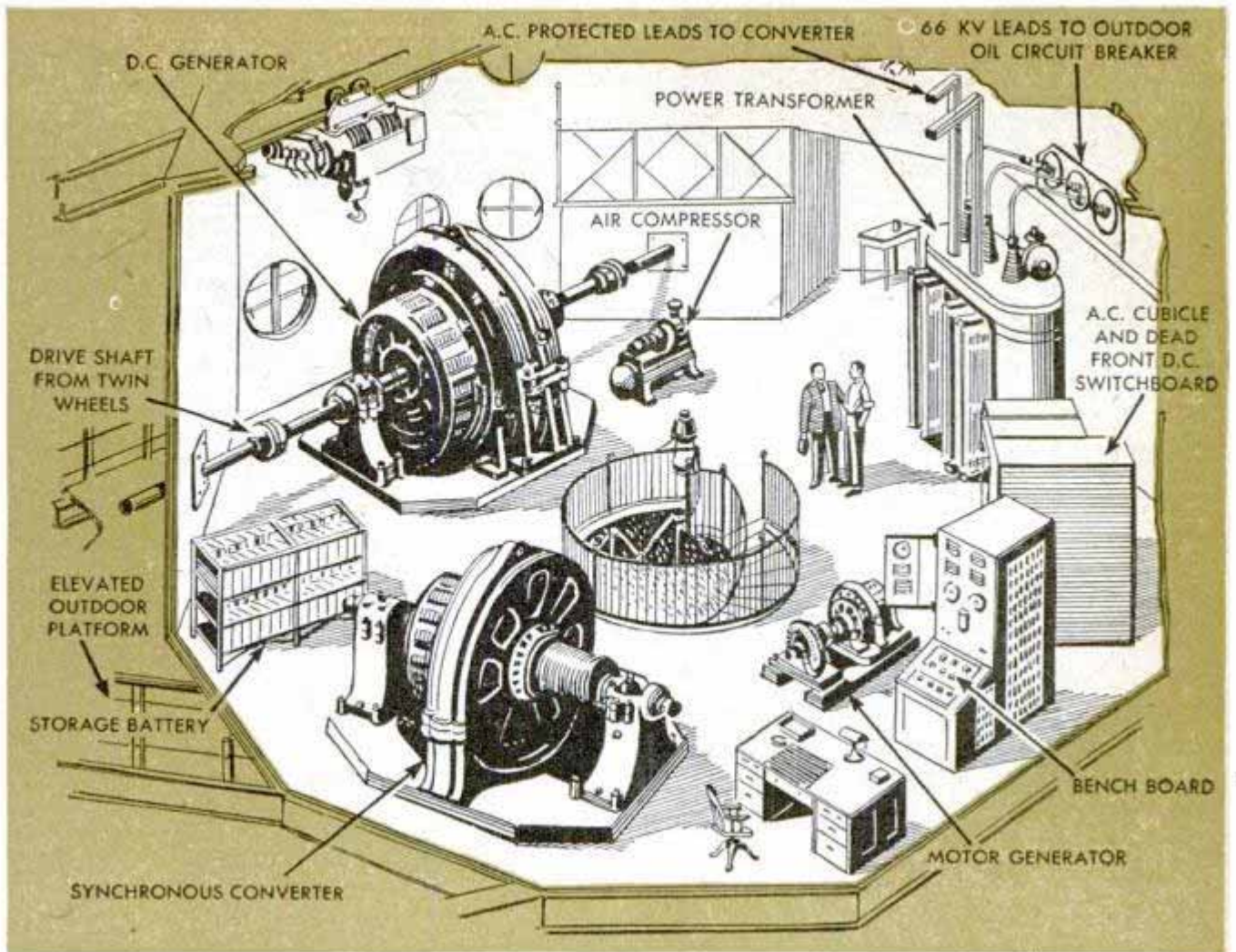

**Generating station located at top of turbine tower**

The blades of the propeller are each 80 feet long. The streamlined hub to which they are attached is 40 feet across. Making  $47\frac{1}{2}$  revolutions per minute, the turbine's blade tips will travel 340 miles an hour. To

(Continued to page 244)

**Battery of wind turbines proposed to power a city**

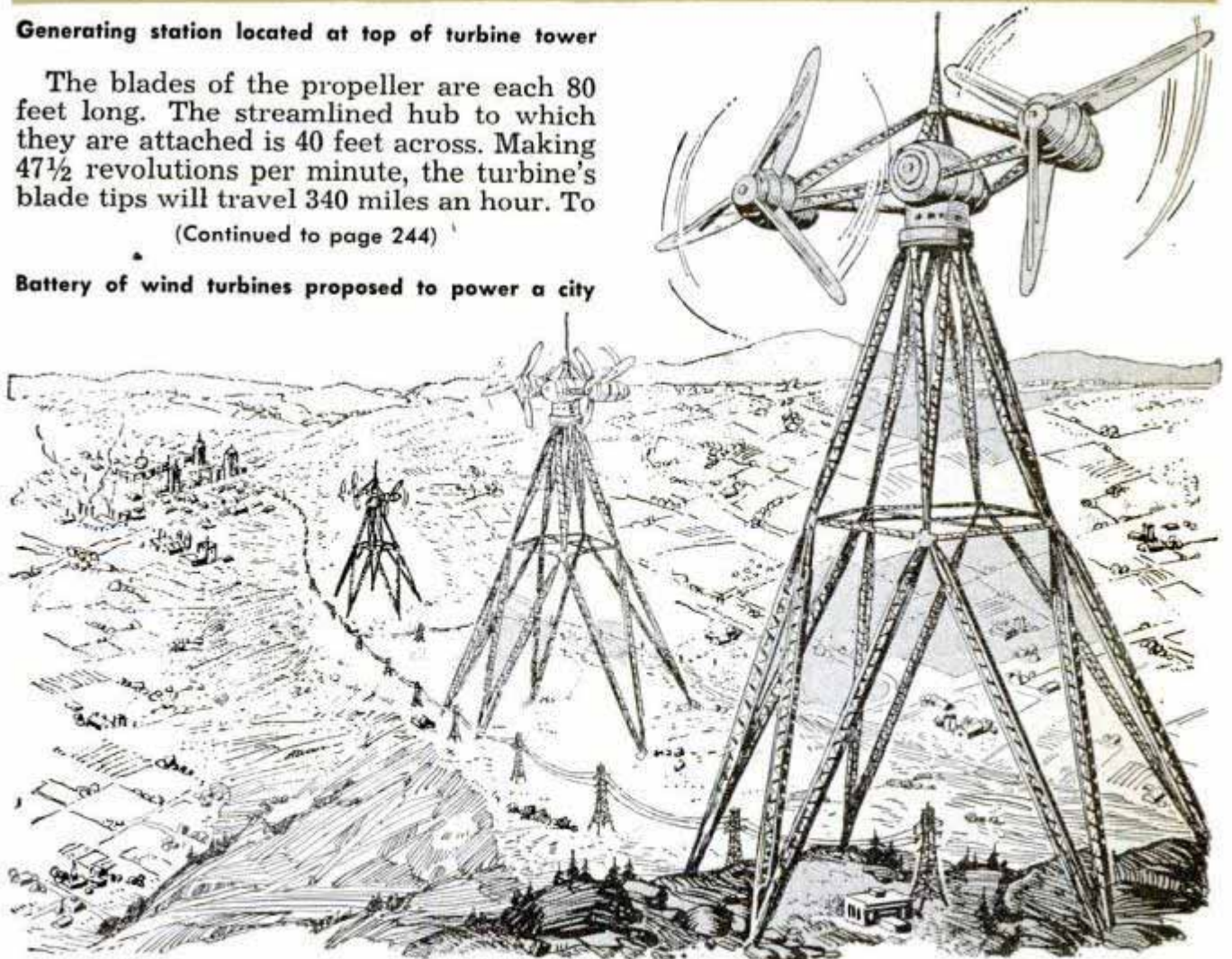



## Three-Wheel Truck Travels 65 Miles on Gallon of Gas

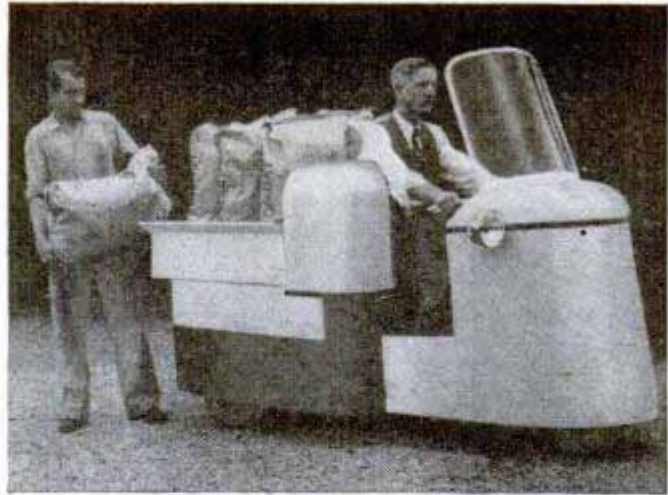
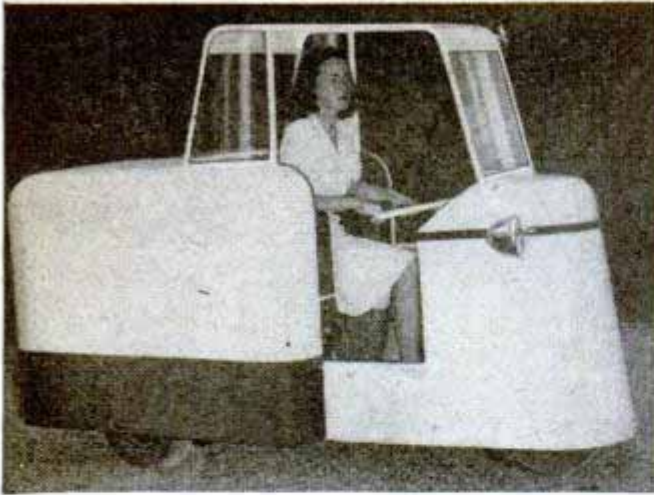

Sixty-five miles on a gallon of gasoline is the economical performance mark of a new three-wheel light delivery truck. The vehicle turns in its own space and doesn't require a gearshift lever, so the brake and accelerator are the only pedal controls. Its

10-horsepower two-cylinder motor has a top speed of 35 miles an hour. An enclosed body model is made for deliveries requiring weather protection and an open-deck type for general purposes. The load carrying capacity of each is 500 pounds.

## Road Tests Simulated in Laboratory to Test Gasoline

All sorts of conditions encountered in driving automobiles are simulated in a machine developed by the Gulf Oil Corporation to test new gasolines. The rear wheels of the laboratory car run on iron rollers

attached to intricate machinery which, by push-button control, gives the effect of going up or down hills, speeding or slowing down and stopping. Air blasts directed against the front of the tester duplicate wind resistance on highways. With a minimum of noise in the indoor tests, engineers can detect engine knocks with greater accuracy than during actual road tests.

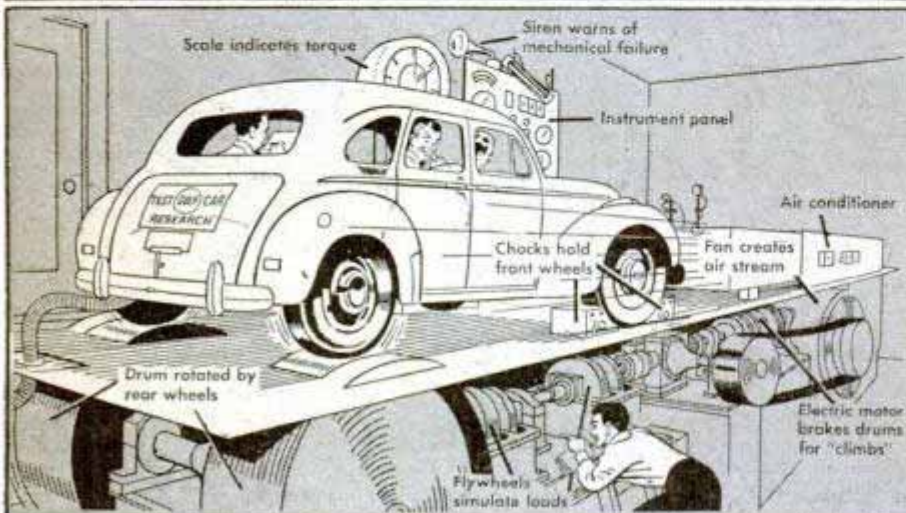

## Muscle Grafting Renews Heart

Living muscles from other parts of the body may be used to replace dead bits of heart muscles in heart disease victims. The new muscle-grafting operation, offering hope to sufferers, already has been successfully completed on dogs. Drs. M. Weinstein and B. G. Shafiroff, of New York University College of Medicine, developed the technique. In the operation, muscle strips taken from the abdomen and legs of dogs were grafted to heart muscles. Within two or three days, the dogs were up and about their kennels.





**TRACTOR** has rear wheels which automatically adjust their height to contour of land to keep machine level

**ATOMIC "GUN"** shoots ultrashort radio waves through gas molecules in an examination of their behavior

Westinghouse photo

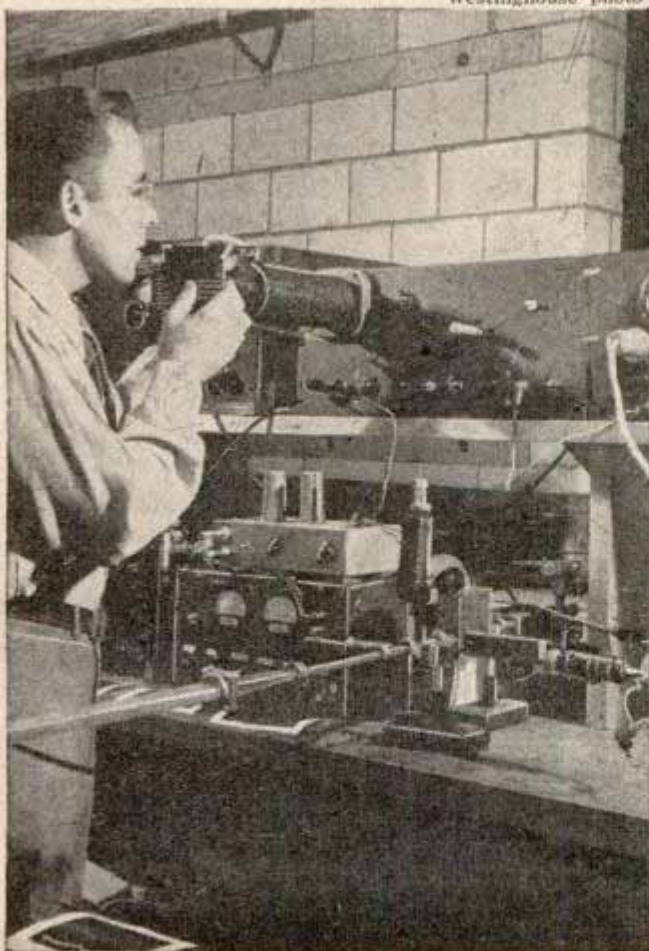

FEBRUARY 1947

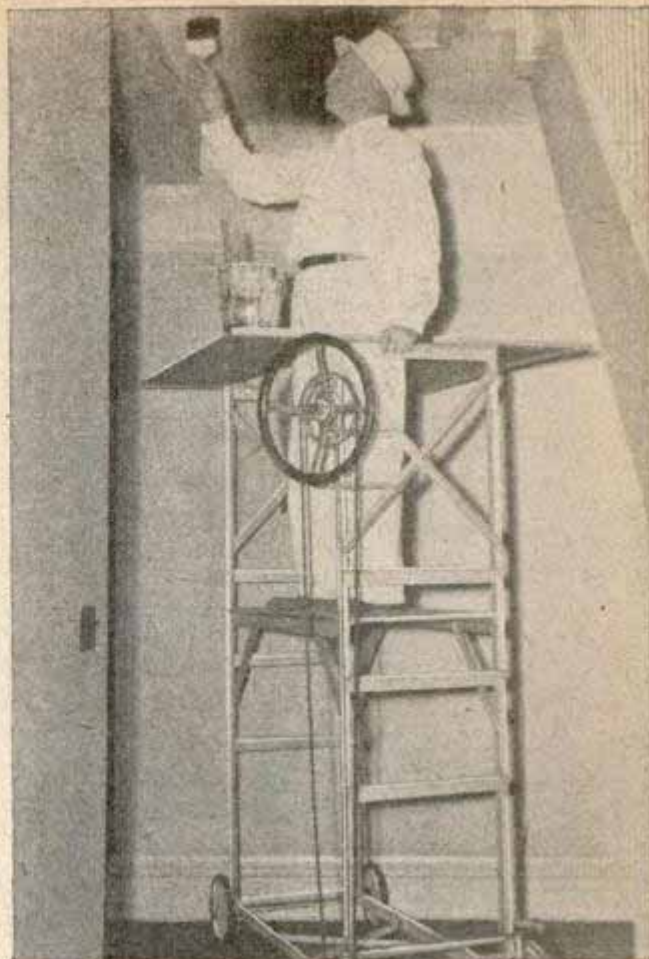

**LADDER ON WHEELS** enables painter to move to new location by operating large wheel while on the ladder

**KEROSENE-HEATED STOOL** keeps hunters warm while they wait for game to appear. Fuel supply lasts 36 hours





## Portable Test "Lungs" Measure Air Flow in Crankcase

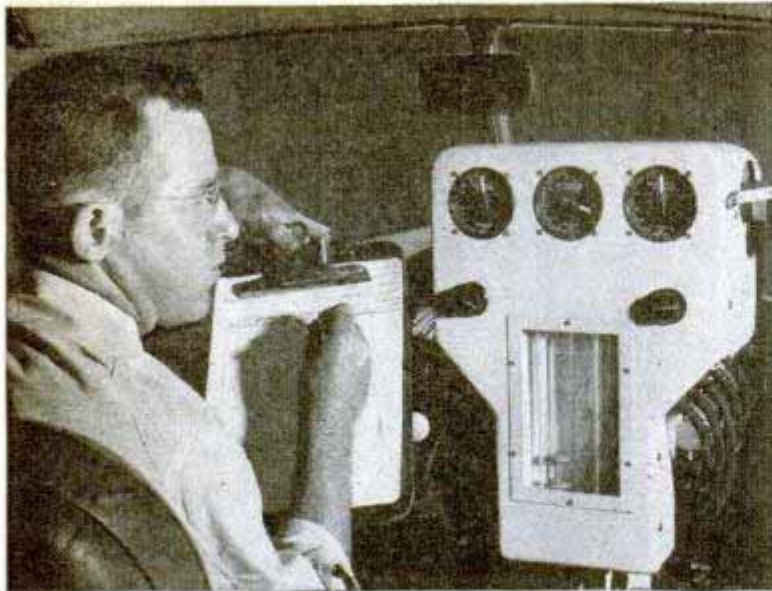

Testing "lungs" measure crankcase ventilation under various speeds and conditions to aid research on auto lubrication. The tester consists of two air flow measuring tubes. One shows the flow of air into the engine and the other measures the outflow of gases. The equipment also checks "blow-by," the flow of gases forced from the combustion chamber past the piston rings into the crankcase. The portable "lungs," developed by the Ford Motor Company, may be installed in a few minutes on any car and provide an instantaneous, direct reading of the air and gas flow.

## "Art Gallery" Phonograph Disk Has Picture Under Plastic

Novel phonograph records that have eye as well as ear appeal are covered with colorful pictures and cartoons. The illustrations reflect the theme of the recording and cover the entire surface except for a small border. The records are made in layers with an aluminum disk in the center that makes them warp-proof and shatterproof. A sheet of paper printed with a four-color illustration is fastened to the aluminum disk. The top layer of the record is a coating of transparent Vinylite plastic upon which the recording is cut. The eye-catching illustration can be seen through the layer of plastic.



## Safety Locks Prevent Children From Opening Car Doors

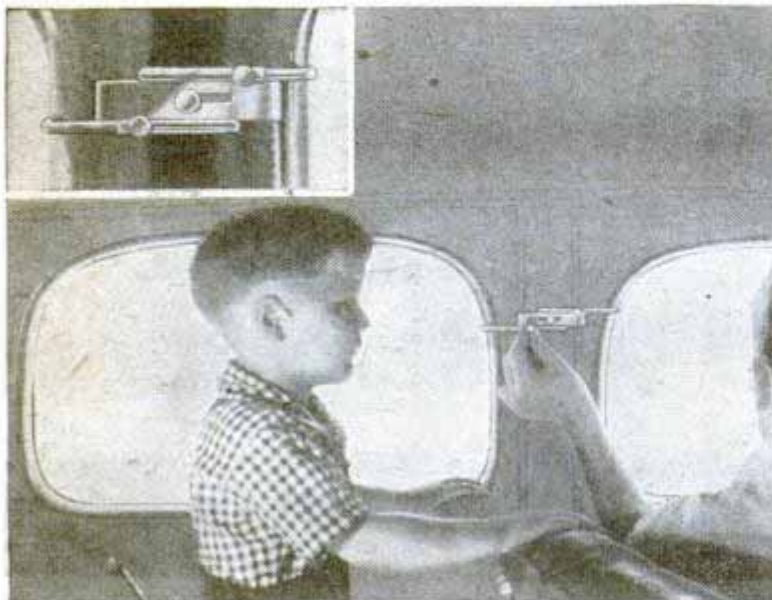

Danger of children opening or falling out of automobile doors while the car is in motion is eliminated by a safety lock. One clamp holds both front and rear doors shut and is operated by the turn of a thumb nut. The chromium steel lock is adjustable for quick installation on any car make or model and does not affect the operation of doors or windows.

You may want additional information about new products described in Popular Mechanics. For the name of the manufacturer or distributor, write to Bureau of Information, Popular Mechanics, 200 E. Ontario St., Chicago 11, Ill.



# The CRAFTSMAN

Yes, we've been asked for it many times—a complete how-to-build story on a deep-freeze unit. And—after taking time for designing, building and testing just to make sure—here it is, roughly 20 cu. ft. of storage capacity in two compartments, with a temperature range from zero to 30 below. Building the cabinet, less whatever refinements you might wish to add, has purposely been kept within the limits of hammer-and-saw carpentry. The story, opening on page 186, also goes into the technical problems that come up and tells how to connect the condenser unit and prepare it for service. For the shop man there's an informative discussion on cutting multiple threads on page 222, and the colorful item in craftsman-built furnishings turns up on page 178. Just build a bookcase and end tables around your studio couch and you have something decorators talk about even after hours. And finally, on page 198, there's a story giving some new angles in jigsawed novelties which will be of interest to homecrafters



CUTTING  
MULTIPLE THREADS



UNIT END TABLE

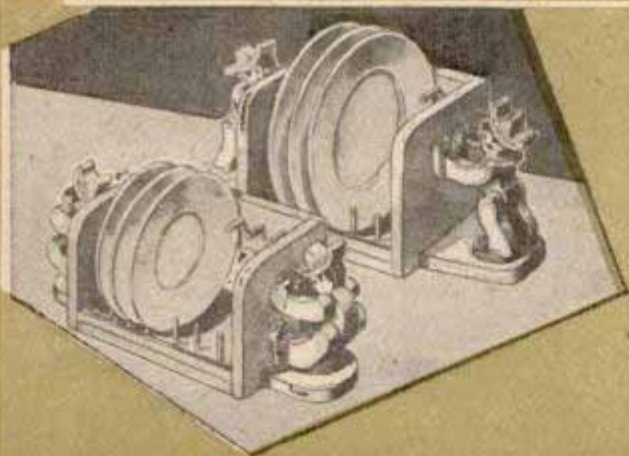
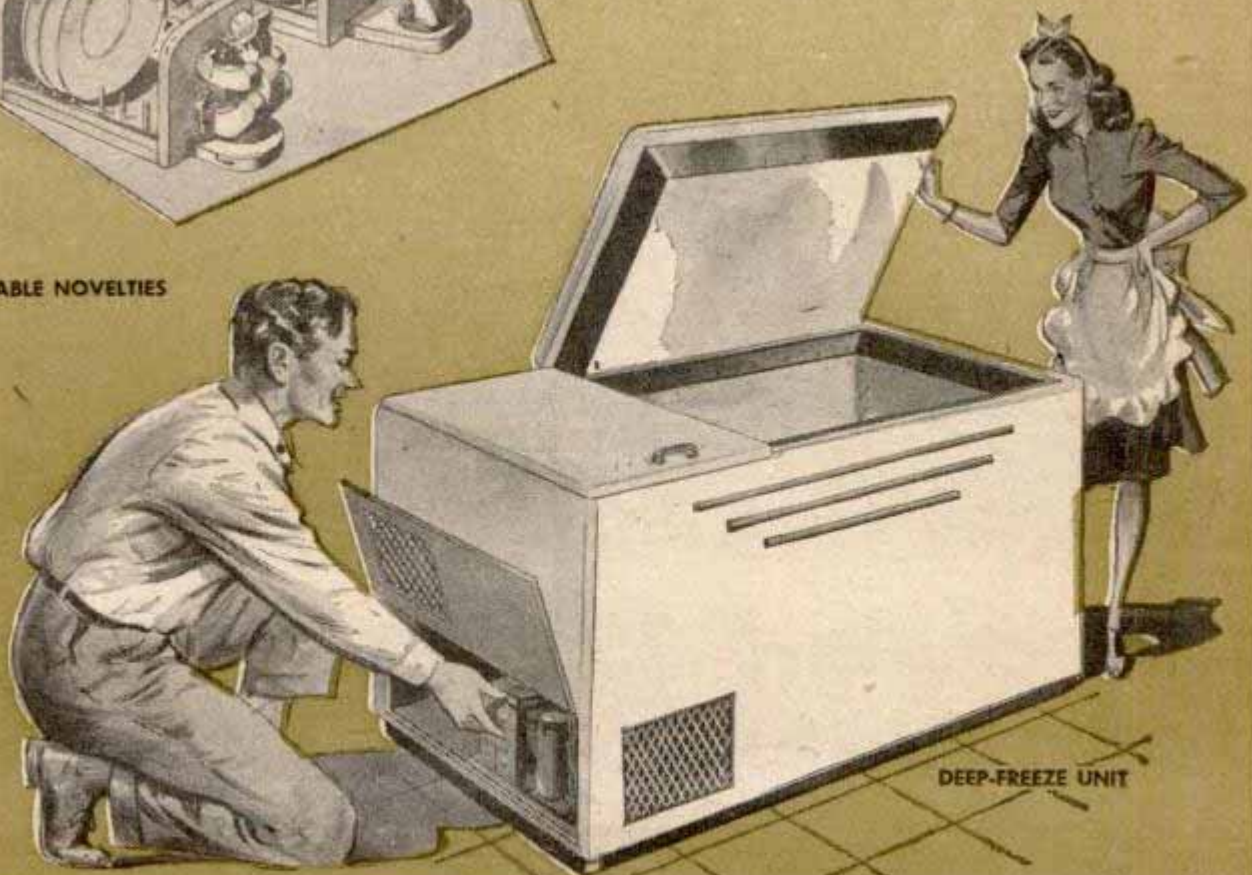
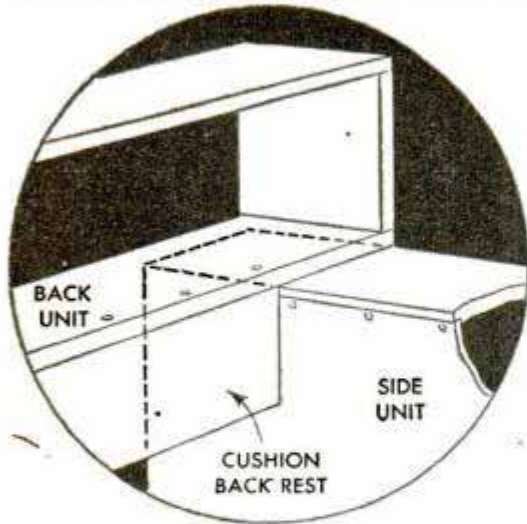

TABLE NOVELTIES



DEEP-FREEZE UNIT





For the connecting bookshelf idea the stepped tops of the end tables are omitted as shown above. The separate book section simply sets in place, making the whole thing easily portable and especially suitable for small apartment use. Although shown open, the back of the top unit can be closed with plywood. Arm and back cushions are tailored to come flush with the tables, and twin lamps matching the fluting on the base can be attached permanently in place

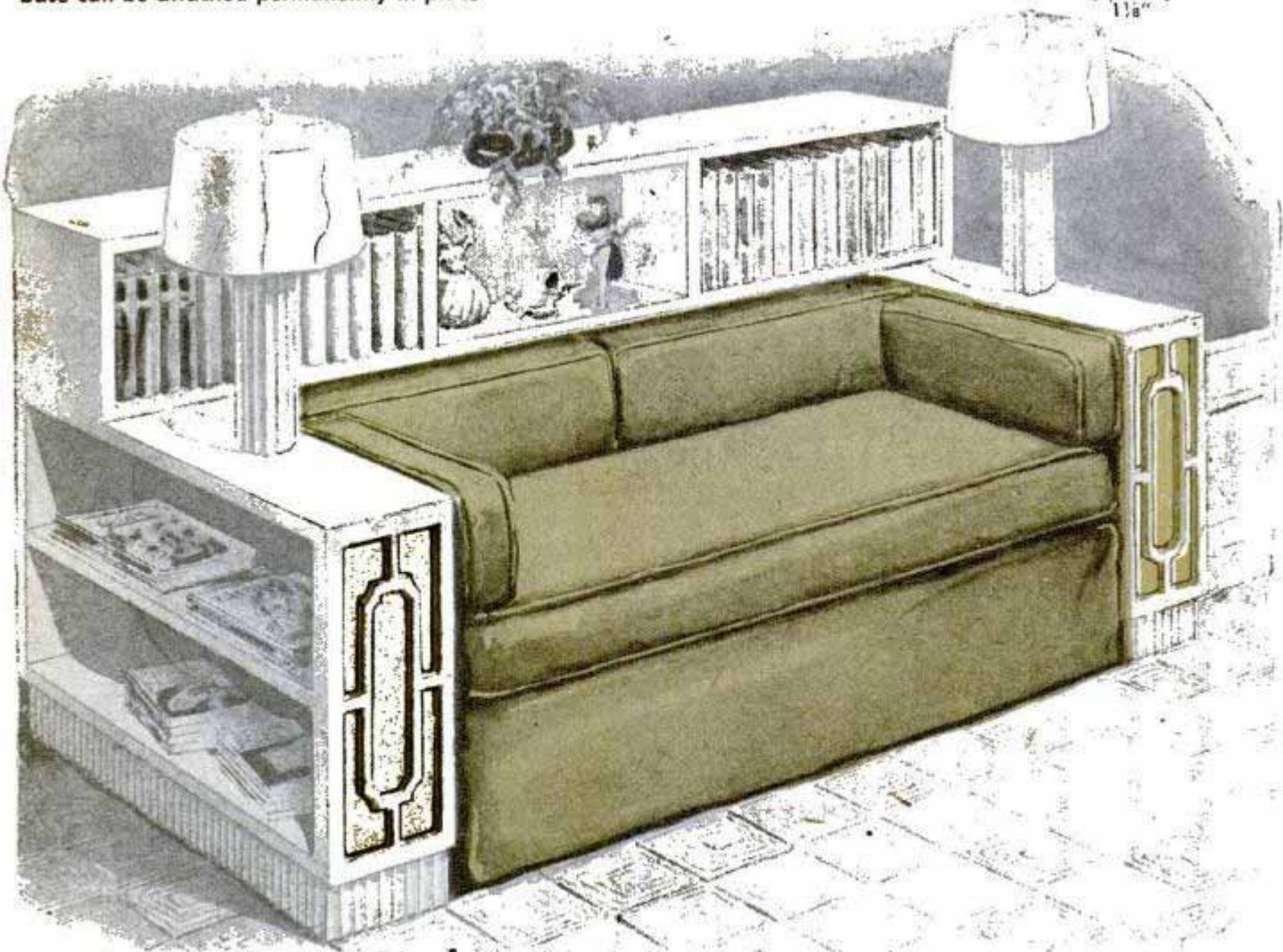
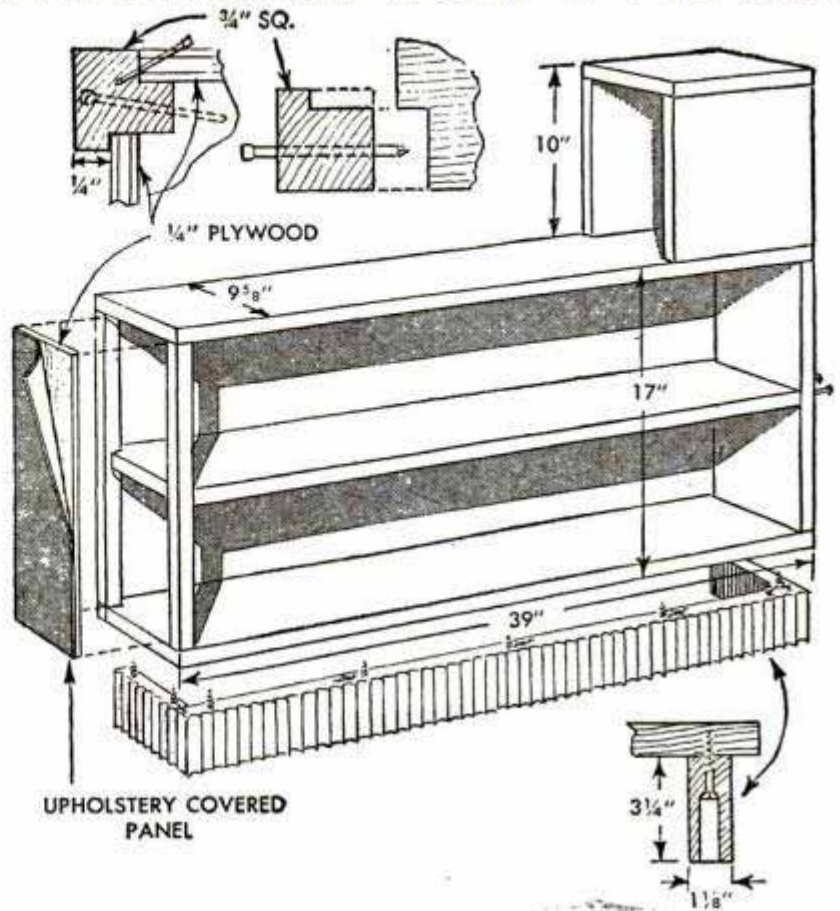



# TABLES

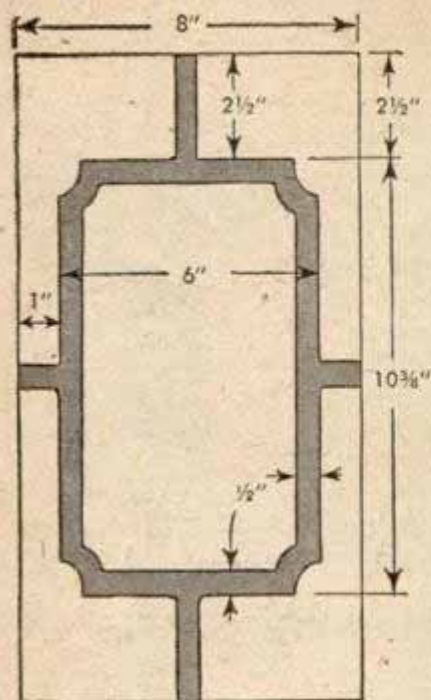

FRETWORK PATTERN



SHAPE OF CUTTER BLADE



By Wayne C. Leckey

USE them at each end, or join them across the back with a book shelf and see what a lift these unit end tables give that dated studio couch. Pine will do for a painted finish and you can "upholster" the fronts to either match or contrast with the couch covering. The couch at hand will determine the size of the tables. Using common 1 by 10 lumber (actually  $\frac{3}{4}$  in. by  $9\frac{3}{4}$  in.), you'll only have to cut the pieces to length. Two  $\frac{3}{4}$ -in.-square posts form the fretwork opening, these being rabbeted as shown to take plywood panels. The cloth-covered panel must be slipped in place before the top board is fastened and is held with small brads. Then the facing fretwork is fitted flush in the opening. The base is built up of random widths of  $1\frac{1}{8}$ -in. stock with the grain running up and down. If you don't have a molding head, the fluting can be done by hand with a 1-in. gouge and then smoothed with a sandpaper block. Screws in counterbored holes are used to attach the base to the table,  $\frac{3}{4}$  in. in from the edge.

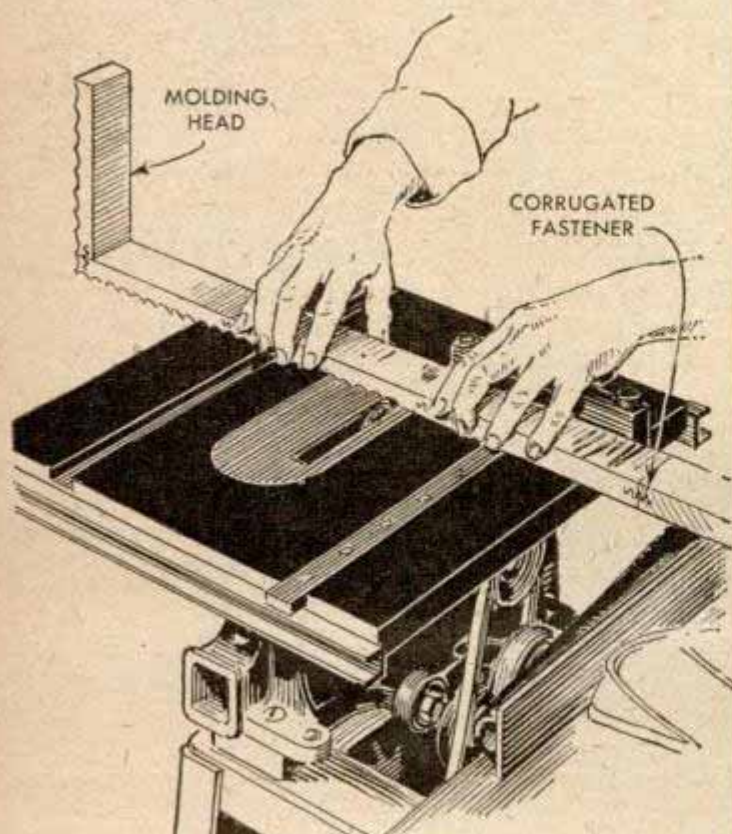

HOW BASE BAND IS FLUTED



## Curing a Leaking Fountain Pen



nib. Cleaning the holes with a pipe cleaner or toothpick will remedy the trouble.

Kenneth Murray, Colon, Mich.

## Coil Spring Holds Spoon on Pan

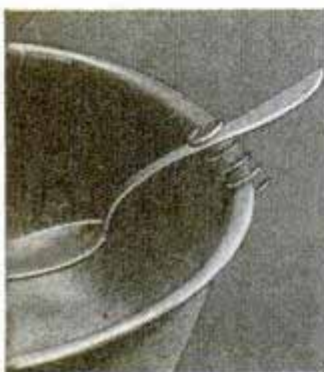

inserted between the coils. This will keep the spoon, or other cooking instrument, at a reasonable temperature.

## Sealing of Envelopes Prevented

When supplies of envelopes are stored in a damp place where the flaps are apt to be sealed accidentally, place a strip of waxed

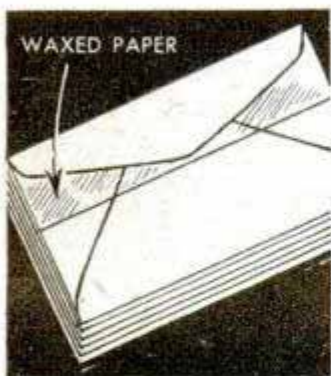

paper between each flap and its envelope. This will prevent the flap and envelope from sticking together due to the moisture in the air. The paper is removed, as envelopes are used.—J. Young, Altoona, Pa.

## How to Fix Worn Wringer Rolls

Should the wringer rolls on your washing machine become worn and uneven, with no replacements available, try restoring them with bicycle balloon-tire inner tubes. Select portions that do not have

patches and cut them so that, when installed, they will overlap each end of the roll about  $\frac{1}{4}$  in. Because of the tight fit in many cases, the tube is worked over the roll gradually.—Martin J. Gresbo, Chicago.

## "Sling" Helps Carry Heavy Boxes

Here's a rope sling that will come in handy when carrying a large box or carton. The ends are tied and knots are made at three equidistant points. The four loops thus formed slip over the corners of the container and the looped ends are grasped as a handle. A detachable wooden handle will make it easier to carry parcels.

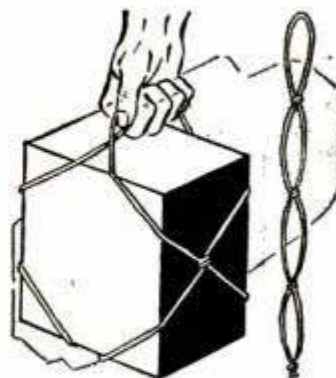

C. L. Meehan, Lakeview, Ont., Can.

## Flashlight Used as Egg Candler

If you have occasion to candle eggs and don't have the proper equipment, you can use a flashlight to do the job. Take a piece of lightweight cardboard several inches wide and wrap it around the lens end to form a tube. Secure it with a rubber band. The egg is held



against the tube for inspection when the light is on.—Opie Read, Jr., Chicago.

## T-Plate Reinforces Broom Handle

It's easy to twist or break the handle of a push broom at the point where it fastens to the brush. To prevent this, or to make a repair after it has happened, screw a T-shaped metal brace to the broom. This increases the strength of the handle at its weakest point and prevents it from twisting.—A. Vena, Philadelphia, Pa.



When paper has stuck to a varnished surface, apply olive oil, let it soak in thoroughly and you can remove the paper easily.



# Plant Boxes Made From Empty Milk Cartons

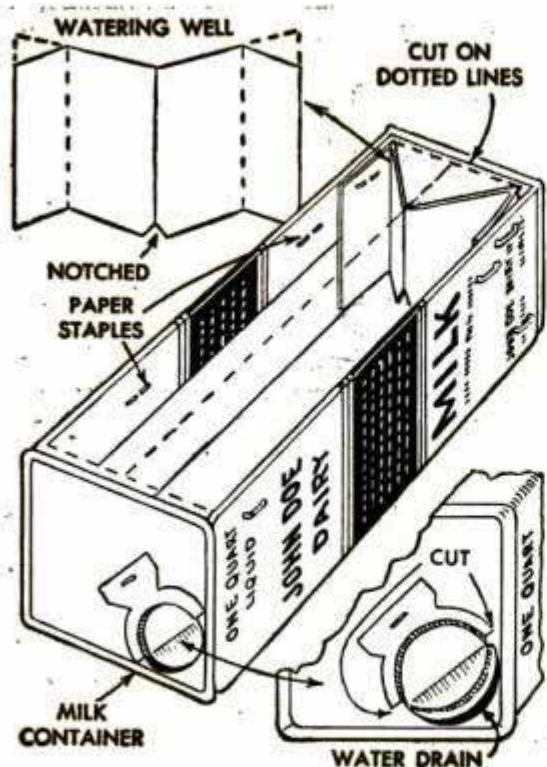

If you want to give those seedlings the proper start in life, plant them in these window-sill boxes that are self-watering and have a drain port for excess water. Paper milk cartons are used to make the containers. After the carton has been washed, place it with the opening down, center detail, and cut slits through the center and across the ends. Fold the flaps and fasten them with staples. To make the drain port, cut the lip on the cap at opposite points and fold the lower half of the cap inside the box so that the weight of the soil placed in the box will not force the cap out; see lower

right-hand detail. The watering well is cut, folded and notched as shown in the upper left-hand detail. It is held in place with staples. In filling the box, use coarse soil in the bottom and pack it carefully so the weight will not cause the box to bulge. Any excess water in the soil will drain through the opening in the side of the box. Provision should be made to catch this water in a dish or pan. When ready for transplanting, cut off both ends of the container, fold the sides down and remove the soil and plants.

J. O. E. Dieterich, Sr., Jamaica, N. Y.

## Simple Toy Teaches Child to Spell Elementary Words

This is a simple toy, but it is effective in teaching small children to spell three-letter words. All that is needed to make the device is an ordinary thread spool and three strips of cardboard. A complete alphabet is lettered on each strip, and the strips are fastened on the spool so they can be rotated. By turning the bands, many three-letter words can be spelled.

### Preserving Finish on Linoleum

To preserve the finish on linoleum, lacquer it as soon as it is laid. This is true particularly of enameled linoleum. It should be lacquered once a year, or as soon as signs of wear appear. Before applying the lacquer, the linoleum should be washed and allowed to dry thoroughly.

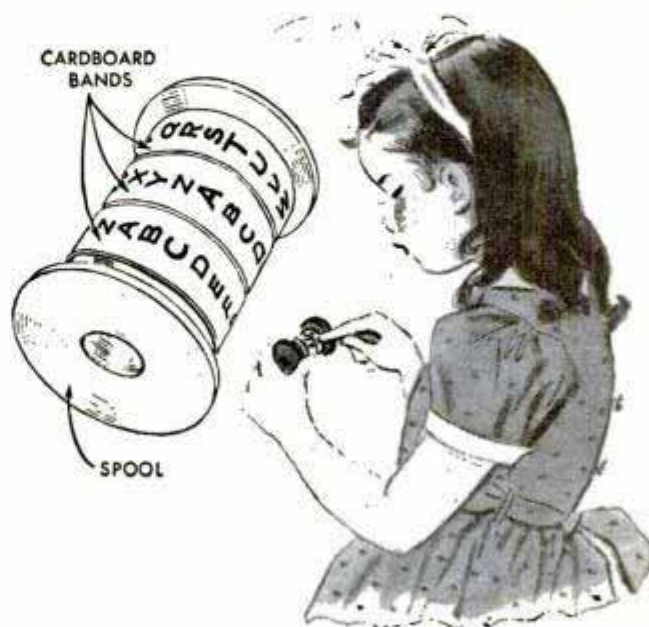





When fagoting tape to the edge of a piece of cloth, holes for the stitching are made by running the material through a sewing machine. Then the hand work is done. For large, open fagoting, use alternate holes



Rubber bands, slipped over spools of thread, keep the ends of the thread from unwinding and cluttering the sewing basket or drawer



## Solving



For darning fingers in gloves, a dowel inserted in a thimble is handy. Withdraw slowly so the thimble will not catch in the glove

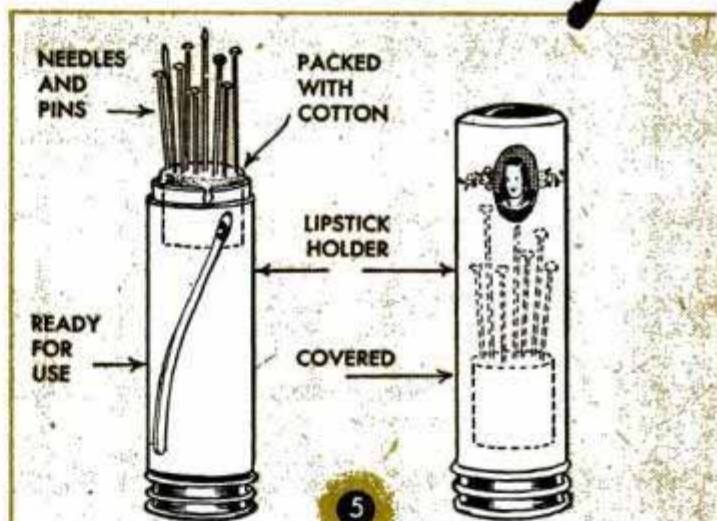

An empty lipstick container can be converted into a pin-and-needle case. Remove lipstick and pack the holder with cotton for a cushion



Instead of putting a shopping list inside your purse, fasten it on the outside where it can be referred to very easily

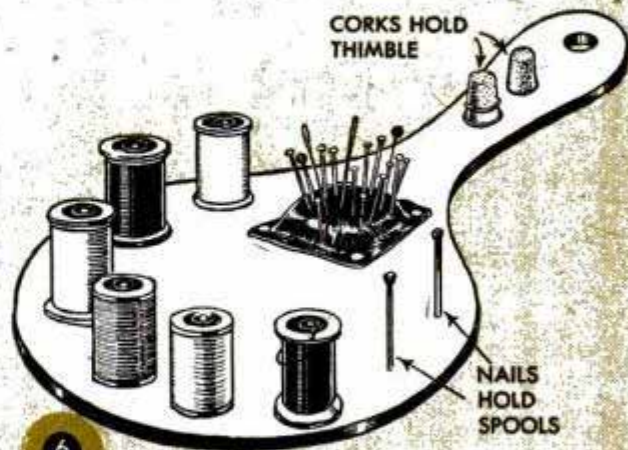

This paddle-shaped piece of plywood is ideal for sewing equipment. Finishing nails hold spools, and thimbles are slipped over corks



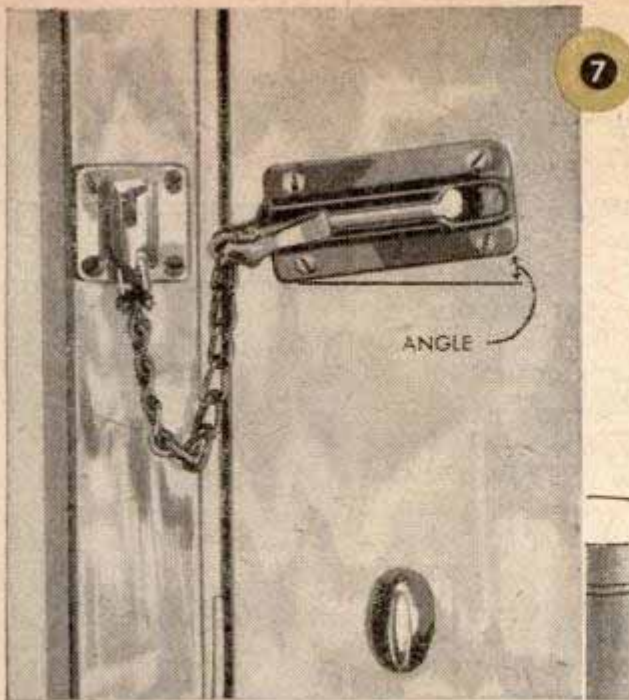

# HOME PROBLEMS

**7** If a chain-latch plate is installed at an angle, as indicated, any attempt on the part of an intruder to open the door after the lock has been forced will cause the chain to slide to the closed end of the plate and no amount of shaking will move it to the other end where it is unhooked

**8** Powdered glue and similar materials that come in tin cans with a flanged lid can be measured and poured much more accurately if the lid and the top of the can are notched. Merely align the notches to pour the powder. The size of the opening will control the amount that is poured

**9** Housewives can save many steps while cooking if the condiments are kept on a small tray that is fastened to the back of the stove. The tray, which is made of sheet metal, is about 4 in. wide and 15 in. long, having the edges bent up in order to prevent the articles from slipping off

**10** To save space when storing bottles in the refrigerator, make two wire hooks that fit between the shelves to form a separate compartment in which the bottles are stacked. The hooks should be about 1 in. longer than the space between the shelves and, of course, they can be set at any necessary width

**11** Worn casters on a washing machine can be replaced with roller-skate wheels if other replacements are lacking. Remove the old casters, substitute the wheels and use a 1/4-20 bolt to serve as an axle. Trim the end of the bolt and flatten it to keep the nut from working loose and coming off

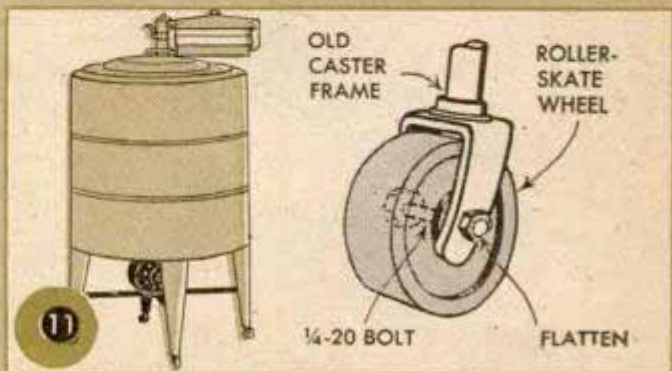
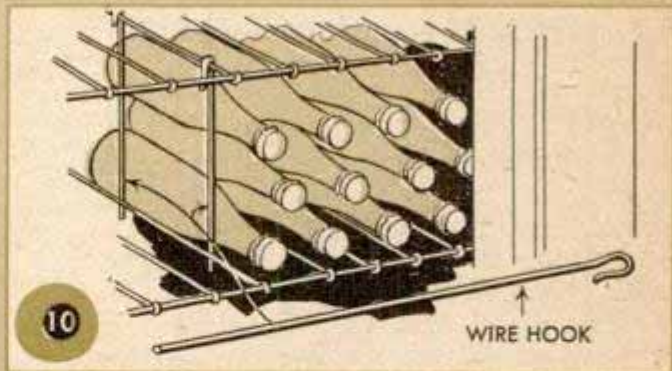
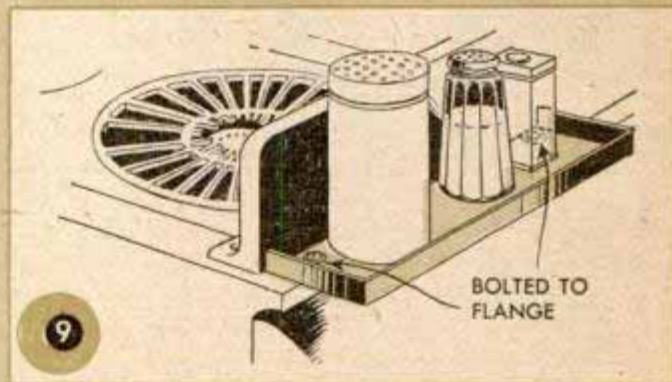



## Level Equipped With Adjustment Measures Angles Accurately

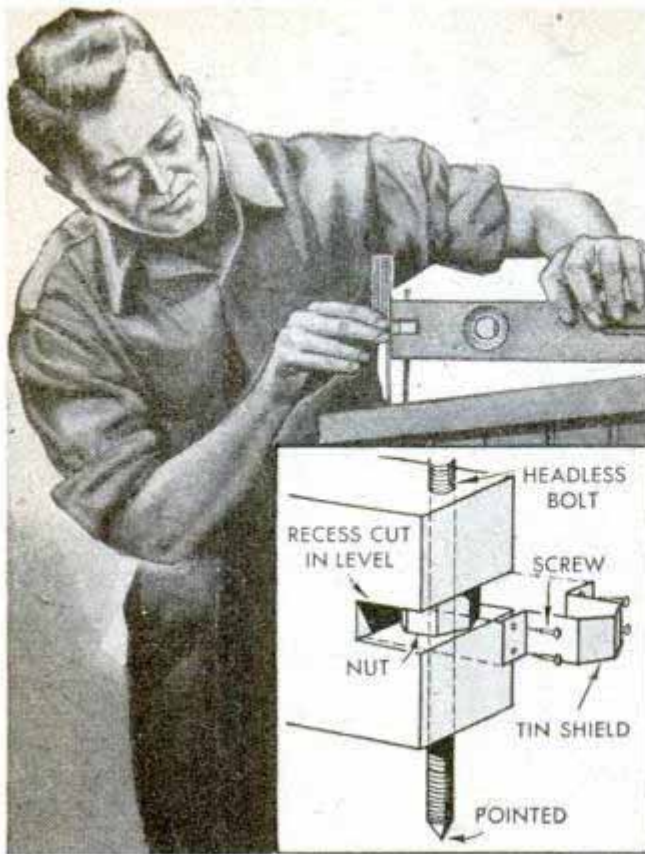

Measuring the angle or pitch of an object with an ordinary level is difficult because it is hard to hold the level steady while taking a reading with a rule. With this adjustment, which is removable, the job is easy. A recess or slot is cut in one end and a vertical hole is drilled to take a headless bolt. A nut fits into the recess and permits adjustment of the bolt. When the level is not used to measure angles, the bolt is removed. A tin shield holds the nut in place.

## Tent Stakes Made From T-Iron

Strong and serviceable tent stakes can be made from odd lengths of T-iron. Pieces 8 in. long will do for smaller tents and 10 or 12-in. lengths are about right for larger ones. Detail A shows the iron before it has been shaped and detail B shows how the stake is cut and notched. The cutting may

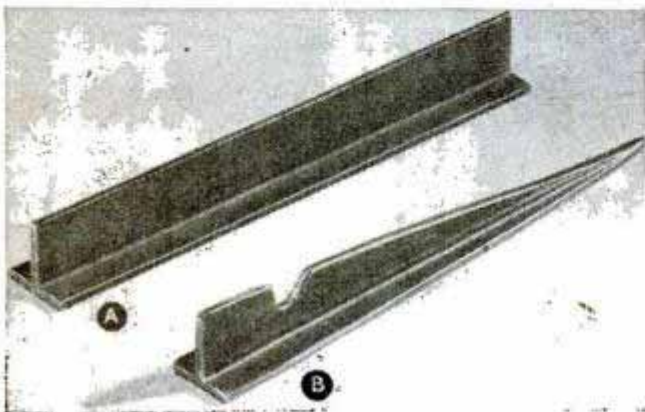

be done with a saw or a cutting torch. All rough edges should be ground smooth.

D. E. Horn, River Forest, Ill.

## Enlarging Holes in Sheet Metal

When it's necessary to drill a hole in lightweight sheet metal and a drill of the exact size is not at hand, you can use the next smaller size and countersink the hole with a slightly larger drill. Then you can enlarge the hole to the exact size with a round file; the countersinking operation will have removed most of the metal so the filing can be done easily.

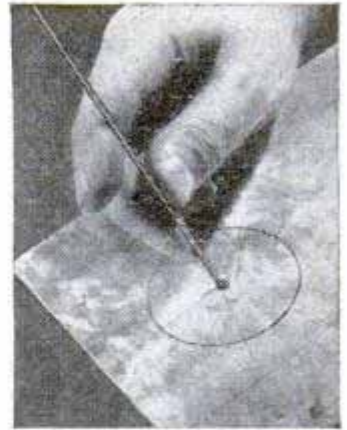

## Dowel Slipped Over Hanger Bar Prevents Trouser Creases

Creases in trousers caused by hanging them over the bar of a wire coat hanger can be avoided by cutting a lengthwise slot halfway through a piece of  $\frac{3}{8}$ -in. dowel. The rod should be a little shorter than the crossbar. After the dowel is slipped in place, put a drop of cellulose cement at each end to hold it. Dowels may be used to cover the arms of the hanger as protection for coats.

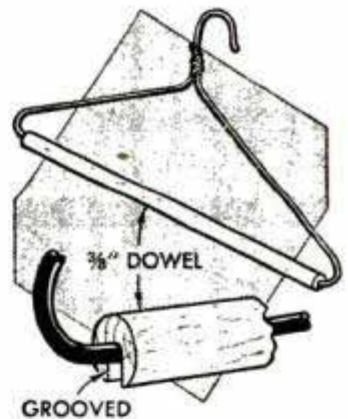

## Easier Operation of Tin Shears

Tin shears will operate easier if graphite is blown around the screw that joins the halves. Care should be taken to see that the powder penetrates thoroughly. Graphite will not pick up dust easily.

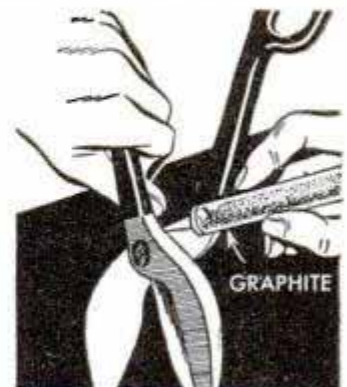

❑ Instead of throwing a ball to your dog, let him play with a rubber closet-tank ball. The double-cone shape limits the roll of the ball to a wide circle and prevents it from being lost easily.



# Getting the Most Out of Your Cigarette Lighter



Like any other piece of mechanical equipment, a cigarette lighter demands a certain amount of maintenance and repair if it is to operate at fullest possible efficiency



A flick of the thumb, and you get a clean, well-adjusted flame every time. There's no trick to it—all that's necessary for satisfactory lighter operation is to follow a few simple checks. First, of course, the lighter must be kept properly fueled. Use any of the fuels on the market and refuel at night so that any flooding of the mechanism will have evaporated by morning. Always keep the file wheel clean; this may be done by rubbing with a toothbrush and scraping the grooves with a pin. Also brush the wick if it is charred. Sometimes it will help to clip the top of the wick square across with shears. The flint should always line up with the file wheel as in detail A. If it tips as in details B or C, it should be replaced with one that is properly adjusted. The flint tube in many lighters can be cleaned with a pipe cleaner. Another check is to test the tension of the flint spring to be sure that it exerts the proper pressure on the flint. If the spring becomes too weak, you may be able to correct this condition by stretching it slightly, and if this does not work, a replacement part should be obtained



A large lighter with a heavy base is ideal for the house



When you carry a lighter outdoors, use a windproof type

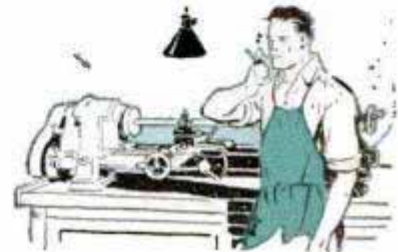

A flip-action unit protects the file wheel from greasy thumbs



Remember that sand on a beach clogs complicated mechanisms

## Points to Check in Prolonging Life of Storage Batteries

There are a few, simple checks that will do much to keep your battery operating at peak efficiency. Examine the case for cracks or leaks at the top where the cells are sealed, and then test the battery for charge. Make sure the battery cables are not frayed or corroded and the insulation is not eaten away. Be sure the generator commutator is clean and the brushes seating properly. To reduce the current required to start the car, clean the plugs and set the gaps to manufacturer's recommendations. Examine the spark-plug cables to see that the insulation is not oil-soaked or spongy. If it is, some of the current that should be going to the plugs will be lost

on the way. Distributor points that are pitted and burned will rob the battery of more of its needed energy. Remove drag in the engine and transmission by using the proper grade of oil. While not necessarily a cold-weather driving practice alone, remember to start the car with the clutch disengaged so the battery won't have to turn transmission gears as well as the engine. Don't start the car with the lights turned on, and always keep the battery filled to the correct level, using only approved electrolyte or water. In freezing weather, use the car immediately after adding water to insure mixture with the electrolyte and eliminate the possibility of freezing the battery.



*Rep. farm ...*  
*out of print -1090 809*  
**DEEP-FREEZE UNIT**

**30° Below**

Ordinary hand tools were used in building this deep-freeze unit, which has 18 cu. ft. of storage space and a 2-cu.-ft. deep-freeze compartment that has a separate control valve

*Rep. WTM '49*



You can make the unit smaller by reducing dimensions and size of condensing unit proportionately



Trouble-free operation is the result of following the few simple service routines that are given

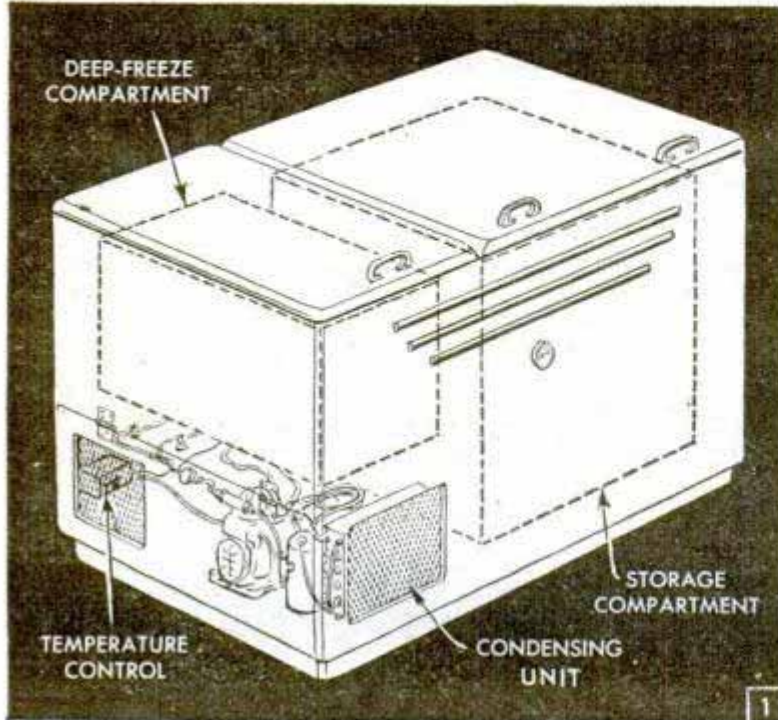

By John F. Shrock  
 3146 SHERIDAN RD., CHICAGO, ILL.

**B**UILDING your own deep freezer is not a difficult job, especially this one; it's nothing more than a well-insulated plywood box or cabinet in which a purchased refrigerating unit is installed. The freezer has been tested in actual use and also in a laboratory, Fig. 8. The deep-freeze and storage compartments can be separately controlled by shutoff valves and the deep-freeze compartment can be brought down to about 30 deg. below zero for quick freezing of meats and vegetables before putting them in the storage compartment. The latter is held at a temperature of approximately zero. When not in use, the deep-



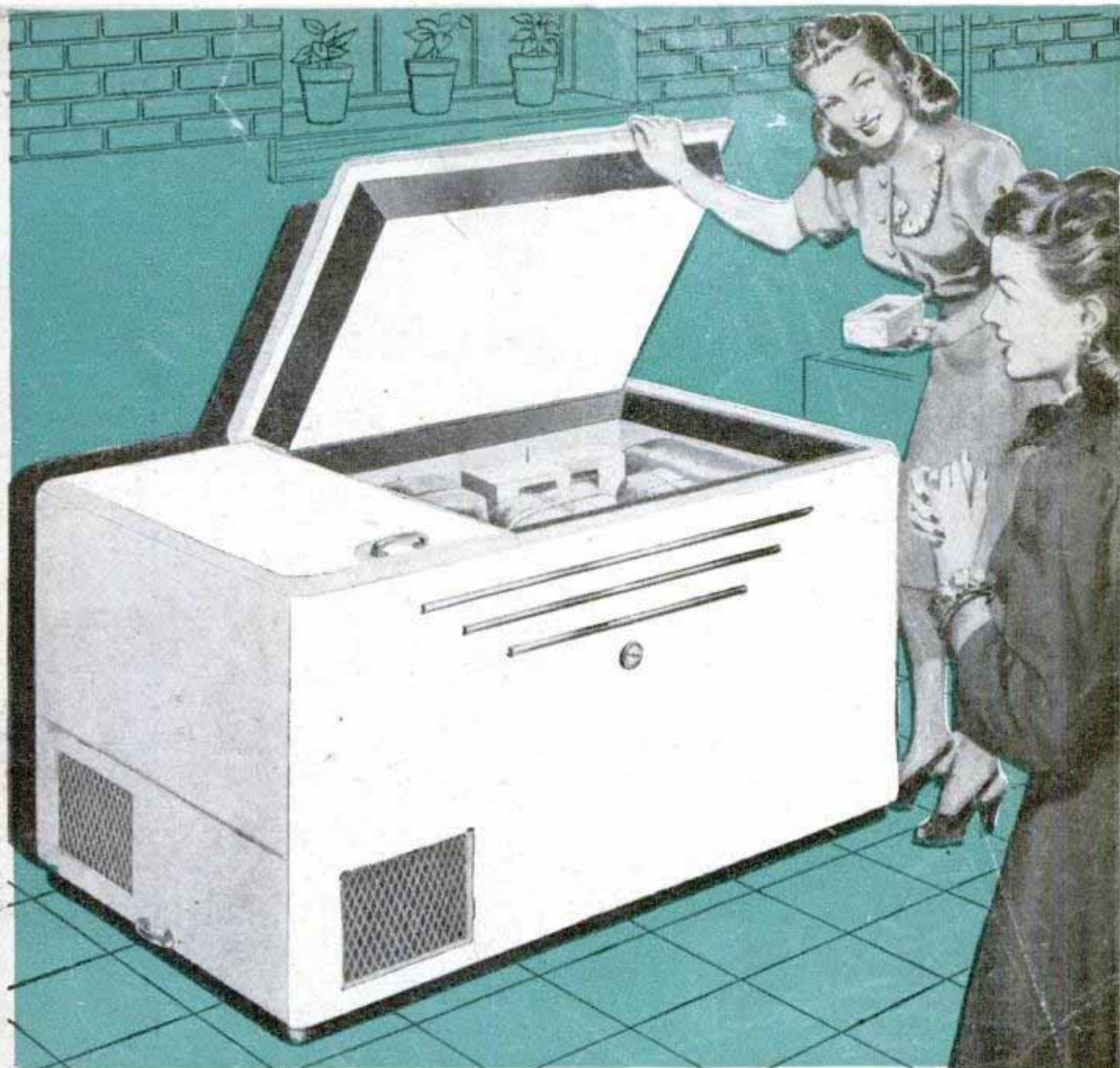

freeze compartment may be shut off to ease the load on the compressor. It's best to use a new refrigeration or condensing unit, which comes charged with refrigerant and only has to be connected to the freezer or evaporator coils inside the compartments.

Construction begins with the cabinet, Fig. 1, which is divided into three parts: a deep-freeze compartment, a storage compartment and the space for the condensing unit. Refer to Fig. 2 for the general dimensions. Since the over-all size of condensing units varies with different makes, this will affect the dimensions of the compartments because space allotted for the unit will vary. There should be several inches clearance on both sides and above the condensing unit. The dimensions given are for a hermetic  $\frac{1}{8}$ -hp. unit.

After the base is cut, a 2 by 4-in. kick board is screwed to the underside 2 in. from the edges as shown in the lower right-

hand detail of Fig. 2. The corners are mitered. The frame is of glued-and-screwed butt construction and all members are common 2 by 2 in. stock, actually  $1\frac{5}{8}$  by  $1\frac{5}{8}$  in. dressed. They are glued and screwed, using No. 14 screws 3 in. long. The screws, of course, are countersunk so the plywood panels will fit flush against the frame. The platform that forms the base of the deep-freeze compartment is cut next and screwed to the supporting members. This is  $\frac{3}{4}$ -in. waterproof plywood, the width of which is determined by the space allotted for the condensing unit. To provide a partition and backing for the insulation for adjoining walls of the storage and deep-freeze compartments, as well as to form one side of the condensing unit compartment, a  $\frac{1}{4}$ -in. waterproof plywood panel is used. This extends the full width and height of the box and is fastened to the frame members against which it rests.



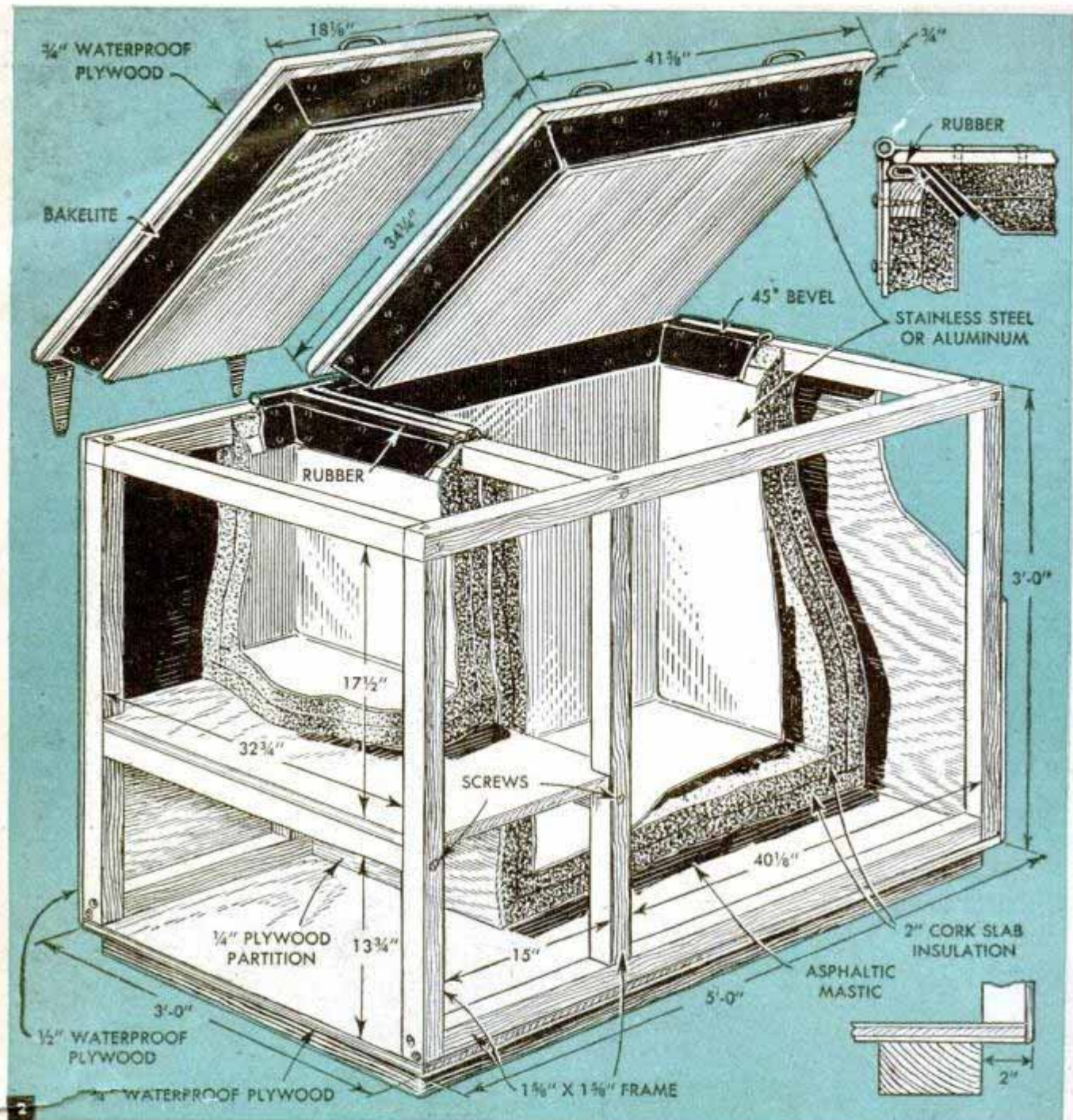

Next, the plywood sides, back and front are fitted to the frame. These are all  $\frac{1}{2}$ -in. waterproof plywood, although hard-pressed board of a suitable thickness would do equally well. Before installing the front panel, cut an opening in it over the condensing unit compartment and nail expanded metal over the inside of the opening. Any decorative grillwork can be used; but it must be remembered that air passing over the condenser enters through this opening and its area should not be restricted to retard movement of air as this would affect the efficiency of the refrigerating unit. That portion of the end panel covering the unit is hinged to provide a door for access to the unit. The door should be large enough to provide easy access to all parts of the com-

partment it covers. Toward the rear end of the door an opening is cut equal in area to the one in the front panel. This is the exhaust outlet for the condensing unit and remarks concerning the type of grille apply here as well as to the front panel.

After the panels have been fitted and assembled, they are screwed to the frame. Use flathead screws and countersink the holes so they can be filled. If the panels are cut so that one end comes flush with a corner frame member and the end of the adjoining panel extends slightly beyond the post, nicely rounded corners can be made. To do this, round the corners to the approximate curve desired with a plane or saw. Then use a sanding block that has the face cut to the desired contour to finish the curve. The lids for the deep-freeze and storage compartments should extend over



the openings about  $\frac{3}{4}$  in. on all sides, with very little clearance between the inner edges of the two lids. Approximate overall dimensions are given in Fig. 2. After the lids have been cut to size, the corners and edges are rounded in the same manner as was done previously.

The next step is the application of the insulation and sheet-metal lining. A double layer of 2-in. compressed-cork slab, which is cut easily with a handsaw, is applied to the bottom and sides of both compartments and to the undersides of the lids. An asphaltic-mastic compound, which is a neat emulsified asphalt, is used as the bonding medium. Figs. 3 and 4 show how the mastic is troweled on. When applying the two layers of cork, spread mastic on all joining surfaces of the plywood and cork. After insulating the compartments and undersurfaces of the lids, roughly bevel the insulation at the upper edges of the compartments at a 45-deg. angle, using a saw to cut them. Then bring the bevels to a perfect 45-deg. angle by troweling on a mixture of ground cork and mastic, using a template as in Fig 5.

The metal lining is next. Either stainless steel or aluminum is used. A medium-gauge aluminum will prove very satisfactory. Before the metal is cut to shape, paper patterns should be fitted against the cork to determine the exact dimensions so the joints will be a perfect fit. This is necessary since the joints are not soldered, but depend on the mastic to hold the lining in place. The upper edges of the metal should overlap the bevels about 1 in. After the lining has been applied, using mastic to bond it to the cork, a Bakelite edging is cemented and screwed over the bevels. Again, paper patterns should be cut and tried to assure a perfect fit. After completing the compartments, bevel the insulation of the lids to fit the beveled surfaces of the compartments and apply metal and Bakelite as for the compartments. When preparing the lids it's a good idea to try them on the compartments frequently as the work progresses to compensate for any error that may have been made when beveling the compartments. A refrigerator cover-seal gasket of rubber, upper right-hand detail of Fig. 2, is screwed to the frame members before the Bakelite is attached. After the lids have been fitted, the hinges and handles are screwed in place. Chromium-plated hardware is used and the hinges should be attached firmly to the frame members and lids. A refrigerator dial thermometer, flush mounted, connects to the storage compartment. Any holes that are drilled are sealed with cork and mastic.

A  $\frac{1}{8}$ -hp. condensing unit is used for a

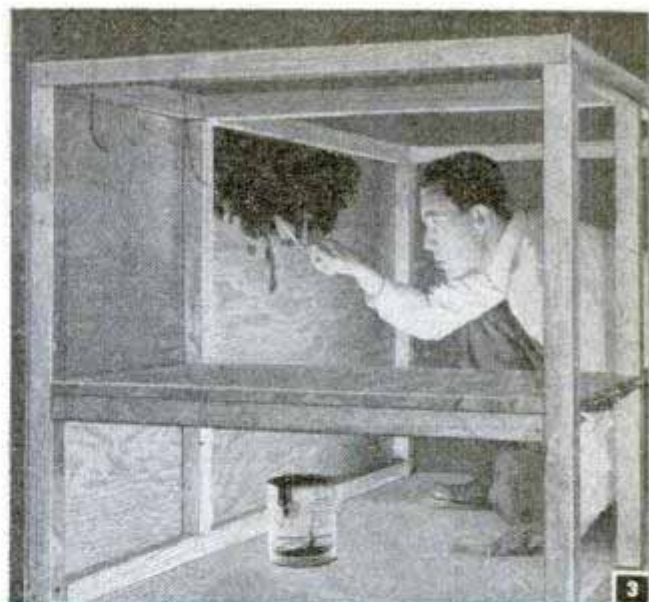

Troweling the asphaltic mastic that forms a bonding medium between the cork and plywood



Here the final coating which forms a seal between the sheet metal and the cork is applied



A template must be used to gauge the correct bevel between the sides and lid of the unit





A cool corner of your basement is best for the deep-freeze unit, but it may be kept in a spare room, on a closed porch, or even in the garage

cabinet of this size, although smaller units can be used if the size of the compartments is reduced proportionately. The so-called "open" type consists of a compressor, condenser, receiver, motor and fan, the compressor being driven by a V-belt. Hermetic units have the motor connected directly to the compressor and a separate motor is used to drive the fan. If a rebuilt unit is used, be sure that the compressor valves are not leaking, as this will affect the operating efficiency considerably. Freon 12 is the refrigerant gas commonly used. Other required parts for the refrigeration system are a dehydrator, sight glass, two shutoff valves, two tees, two thermostatic expansion valves and a check valve, or a two-temperature valve if available. Flare fittings are used throughout. About 100 ft. of  $\frac{3}{8}$ -in. and 8 to 10 ft. of  $\frac{1}{4}$ -in. dehydrated copper tubing, as used for refrigeration work, are required. For this particular unit all parts are for  $\frac{1}{4}$ -in. connections except one tee, which is  $\frac{3}{8}$  in., as is the check valve. The expansion valves, which have  $\frac{1}{4}$ -in. inlets and  $\frac{3}{8}$ -in. outlets, must be for a  $\frac{1}{2}$ -hp. unit. A pneumatic temperature-control unit of suitable range is used to start and stop the motor. The connections to be made are shown in color.

Fig. 7 shows the complete refrigeration system installed. When making a flare joint, upper left-hand detail, the end of the tube is compressed against the seat of the fitting by screwing down the nut. The end of the tube must be perfectly round and cut off square. Carefully remove all burrs and chips of metal and keep all filings and chips out of the tube to prevent them from getting into the refrigeration system. Form the end of the tube with a flaring tool, making certain that the flare is the right length. If it is too short, it will not seat fully and the tube will pull out of the flare nut, while if the flare is too long it will not permit the nut to seat properly.

The manner in which the connections are made is indicated in Figs. 7, 9 and 10. The condensing unit, which is mounted on an integral base, is placed toward the front end of the compartment with the condenser against the grille in the front panel. The outlet connection from the receiver, which is for  $\frac{1}{4}$ -in. tubing, runs to the dehydrator, the sight glass and through a tee to the shutoff valves and the expansion valves. All these are  $\frac{1}{4}$ -in. fittings. All bends should have as large a radius as possible so the tubing is not compressed. The shutoff valves are made so they can be screwed to



the top of the compartment. The evaporator coils, which are the coils inside the compartments, are  $\frac{3}{8}$ -in. tubing. They connect to the outlets of the expansion valves and are secured with clips to the walls of the metal lining as shown in Fig. 9. About 50 ft. of tubing is required for each compartment. From the storage compartment, the line runs to a check valve and then to a  $\frac{3}{8}$ -in. tee. The return from the deep-freeze compartment goes directly to the same fitting from which a common return goes to the suction valve of the compressor, Fig. 7. Bending tools are used when making the evaporator coils, which should be formed before they are screwed to the metal lining. Two holes are drilled in each compartment, one for the  $\frac{1}{4}$ -in. inlet tubing and the other for the  $\frac{3}{8}$ -in. outlet. In the case of the storage compartment, the outlet hole should be large enough to accommodate the capillary or temperature-control tubing which connects to the temperature control. The holes are hermetically sealed with the mastic-and-cork mixture. The bulb for the control is clamped to the evaporator coil, as indicated in Fig. 7. The control tubing for the expansion valves is clamped to the coils at a point about 2 ft. from where the coil leaves the compartment. The exact spot will have to be determined by experiment. After the system is in operation, there should be no frost on the suction-side

tubing outside the compartments. If there is, the control-tubing clamp should be moved farther back from the outlet. If a satisfactory adjustment does not result, the setting of the expansion valve will have to be changed. However, this is set at the factory and should be reset by a refrigeration serviceman. The manner of adjustment varies with the different makes of valves. The completed unit is then painted and finished with metal trim, Fig. 6.

If you are unfamiliar with refrigeration work, it's best to have a serviceman connect the condensing unit to the coils and put the system in operation. This includes purging the tubing of air, checking the suction and discharge pressures, and testing for refrigerant leakage. This work can be done for a nominal sum. It is necessary that there be no air in the system because air is much less compressible than Freon and, for that reason, may ruin the valves of the compressor. The simplest way to purge the coils of air is as follows: after the connections have been made and tightened, a standard refrigeration suction gauge is installed in the port provided on the suction valve, which is then opened slightly; open the receiver outlet valve and both shutoff valves to admit refrigerant to the evaporator coils. When the gauge pressure rises to about 20 lbs., close the suction valve on the compressor and the valve on the re-

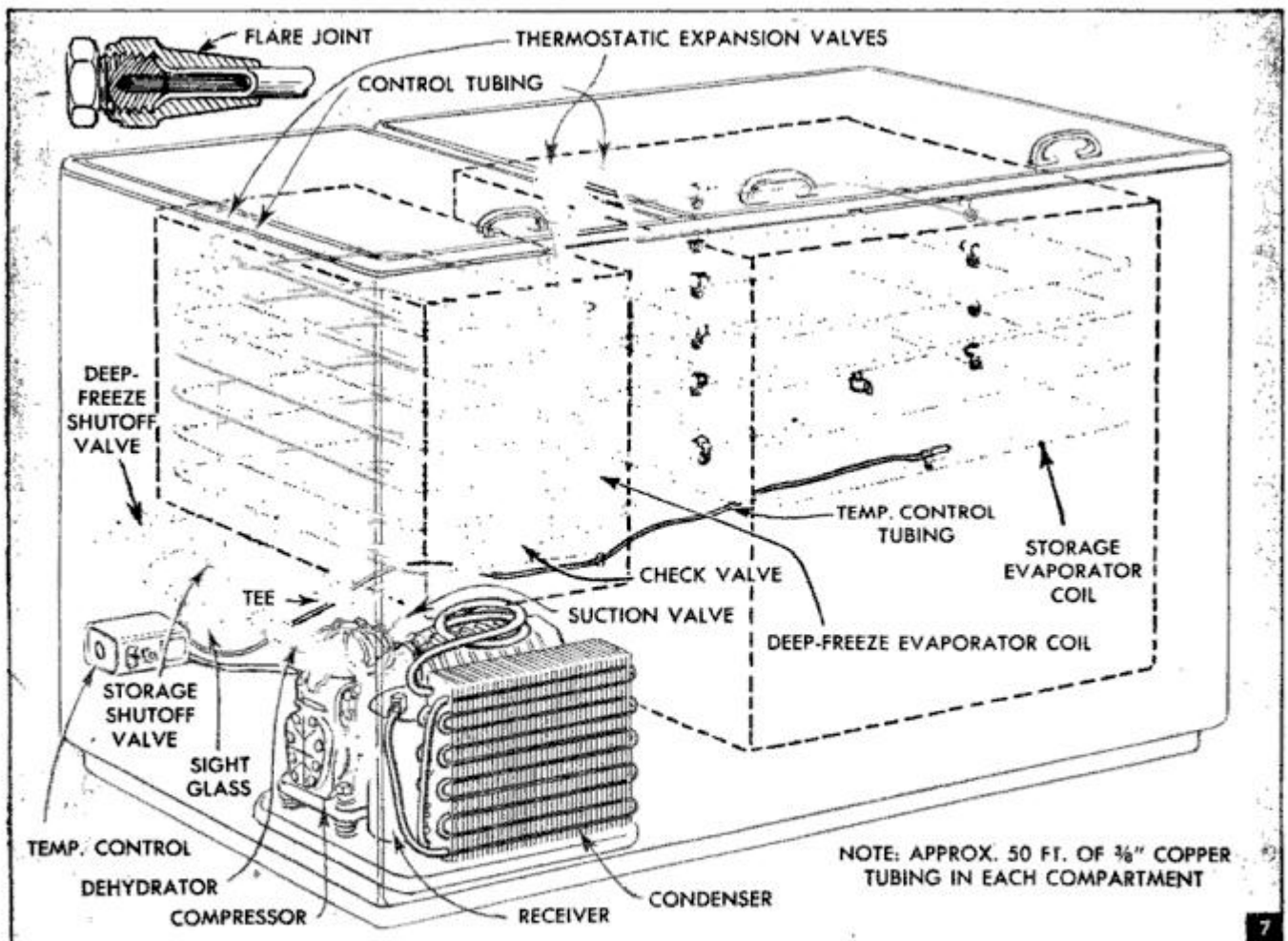





Temperature readings are being taken with a thermocouple during the initial test of this deep-freeze unit

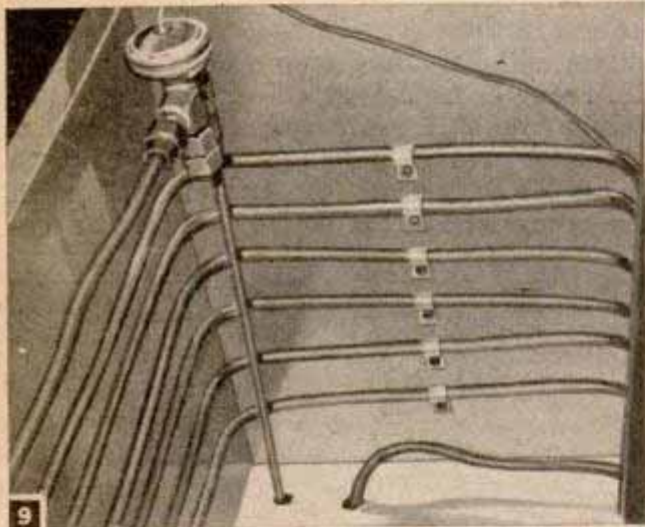

Above: The evaporator coil is attached to the side-walls of the deep-freeze compartment with small metal clips. Below: Arrangement of the condensing unit, valves, sight glass and dehydrator is shown here

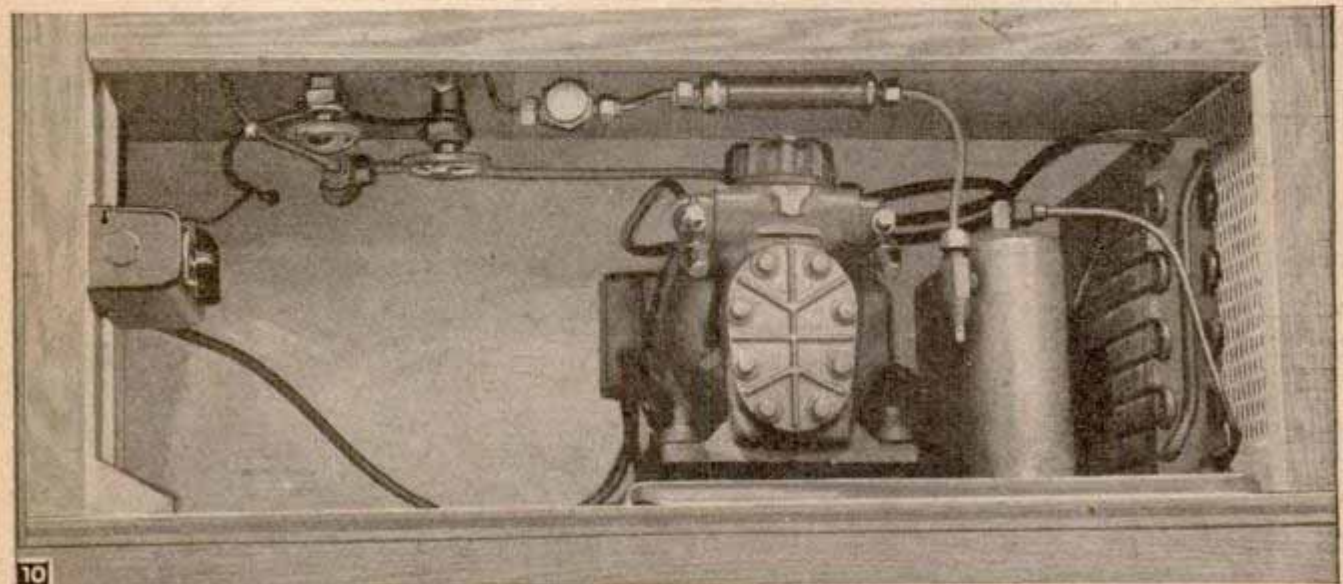

ceiver outlet. The coils now contain a mixture of refrigerant and air; loosen the flare nut that connects the tubing to the suction valve to purge the tubing of this mixture, then tighten the nut again. It will be necessary to repeat the operation about three times. Care must be taken when purging the lines. Not following the proper sequence might result in excessive loss of refrigerant or cause damage to the condensing unit when it is put into operation.

After the system has been purged, all valves are opened and the motor is connected to a power source to put it into operation. All valves should be opened fully, otherwise damage may result. The temperature of the storage compartment is regulated by the temperature control. When it is not desired to use the deep-freeze compartment, close the shutoff valve to put it out of service.

Since the deep-freeze unit is not opened as frequently as a refrigerator, it will not require defrosting as often. However, when the coils are heavily frosted, the frost should be removed with a wire brush to keep the unit operating at its highest efficiency. For easy access, food should be kept in wire baskets, or dividers should be used.

A few of the common troubles experienced in the operation of refrigeration systems follow, together with the cause and correction. (When working around a condensing unit, always disconnect the motor as the operation is automatic and the unit may start at any time.) If the compressor runs in short cycles, it may be due to the fact that the suction and discharge valves are partially closed when they should be wide open and in the back-seated position. Obstructions over the grilles may cause insufficient ventilation. Periodically the grilles should be cleaned and the condenser gone over with a brush to be sure that there are no obstructions. A low charge of



refrigerant will also cause the unit to run too frequently; if bubbles show in the sight glass or the liquid appears cloudy, this indicates the need of additional refrigerant. It should be noted that when food is put into the deep-freeze compartment, there will be a heavy load placed on the refrigeration system and it will run more frequently than when in normal operation.

If the compressor knocks, it may be due to air in the system which should be purged, or in open models it may be due to a lack of oil in the crankcase. If the latter is true, a refrigeration serviceman should add the proper kind of oil. Frost on the compressor head is an indication that the suction pressure is too high and this is corrected by adjusting the control tubing on the expansion valves. As a general rule, there should be no frost on the lines after they leave the deep-freeze and storage compartments. Compressors that are driven through a V-belt should have the drive tested for tension and alignment if belt slippage is suspected. When lubricating a unit, remember that oil deteriorates V-belts and avoid dropping any on the belts.

Moisture is seldom found in a properly maintained refrigeration system, and no system will function correctly if there is moisture in it because the water will freeze at the expansion valve and then be blown free by accumulated refrigerant pressure, resulting in erratic suction pressure. If replacing the dehydrator fails to correct this condition, the expansion valve may have to be removed and dried out as well. In either case, it's best to have a serviceman do the work since the refrigerant must be exhausted from the evaporator coils and pumped into the receiver and condenser.

Should it become necessary to take the unit out of service, or should there be an extended power failure, dry ice can be put in the storage compartment to hold the temperature, or the food can be moved to a locker plant. However, care must be taken when using dry ice as its temperature is 110 deg. below zero and it may reduce the temperature in the box too far. The ice should not be handled with bare hands as this may result in a "burn."

## Method of Proofreading Stencils

One simple way to proofread mimeograph stencils is to insert a sheet of carbon paper between the cushion sheet and the backing sheet before the stencil is cut. The inked side of the carbon is against the backing sheet. When the stencil is finished, read on the backing what you have written. Or a sheet of bond paper under the carbon will give you an excellent copy.

Lt. Alvin R. New, Rantoul, Ill.

## Extra Storage Space in Garage Provided by Platform

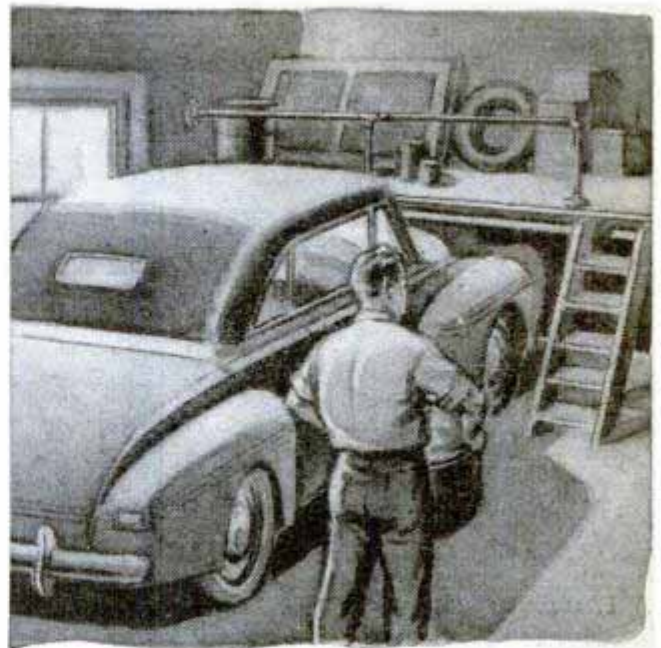

Having a number of articles to store and no available storage space, one car owner built a platform at the end of his garage just high enough for the hood of the car to fit under. A protective railing was bolted to the platform, and a stair ladder was placed at one side. With this arrangement, none of the space needed for the car was taken, but former waste space was put to use.—E. W. Moses, Jr., Blacksburg, Va.

## Auto Light Placed Above Jigsaw Withstands Heavy Vibration

Because the filament in an automobile bulb will stand more vibration than an ordinary 110-volt one, a craftsman found that, after he mounted one above his jigsaw, replacements were not needed as frequently. The bulb was connected to a bell transformer wired to a 110-volt line.—Guy E. McAllan, North Vancouver, B. C., Can.

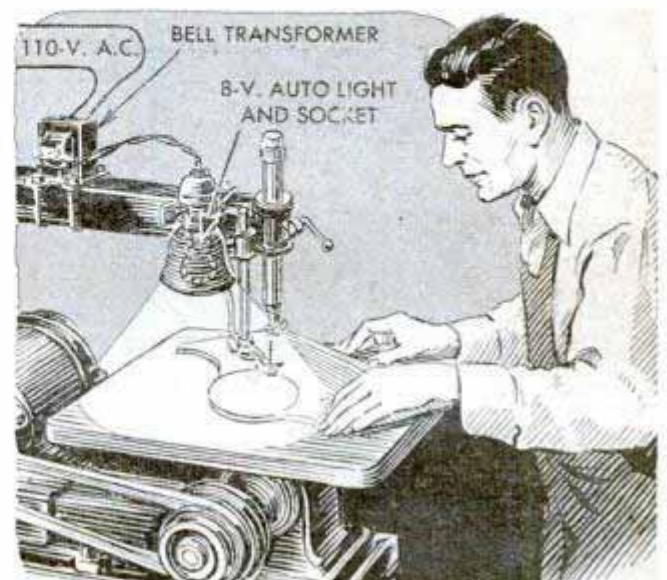



## Insulated Plywood House for Cat Has Automatically Controlled Heat

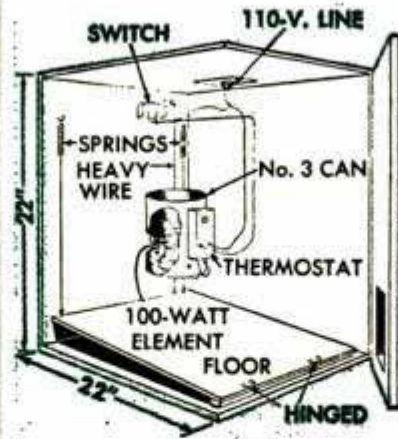

about 2 ft. square, or a little under, is ideal. As the right-hand detail indicates, there is a false floor which is hinged at one end and slightly suspended at the other by means of wire and springs. Also attached to the free end is another wire that is fastened to the arm of a micro switch. Connected to the switch in series is a thermostat set to close at 40 deg. F. and a 100-watt heating element. When the cat steps into the house, his weight causes the false floor to sink, and this closes the micro switch so

The last word in outdoor shelter for a cat, this house is insulated, lined with plywood and has automatic heat. Although the dimensions can be varied, a house that is

that if the temperature is below 40 deg. F., the heating element will turn on. A self-closing door is necessary.

Dawson G. Womeldorff, Wheaton, Ill.

## Easily Made Scale Permits Fisherman to Weigh Catch on the Spot

This combination balance scale and rule is made for the fisherman who wants to weigh his catch on the spot, and he can use it also to measure fish of a doubtful legal length. A one-foot ruler made of hardwood will serve as the beam. The end which has the 12-in. mark should be counterweighted with 1 lb. of lead or sheet metal so the scale will balance when a 1-lb. weight is hung from the opposite end. The fulcrum is made of sheet metal with a steel balance pin. Steel rod or a nonrusting material can be used to form the scale hook. Location of the notches is determined by using weights from a regular scale.—Albert M. Lindner, Jr., Cold Springs, N. Y.

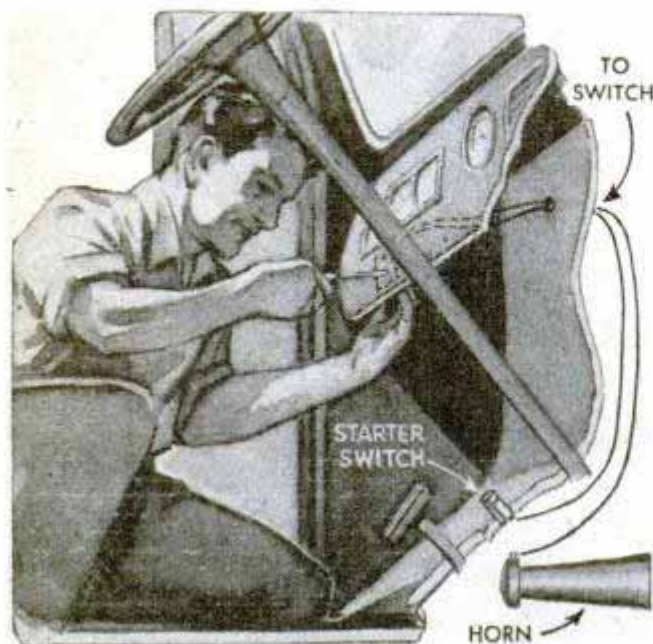
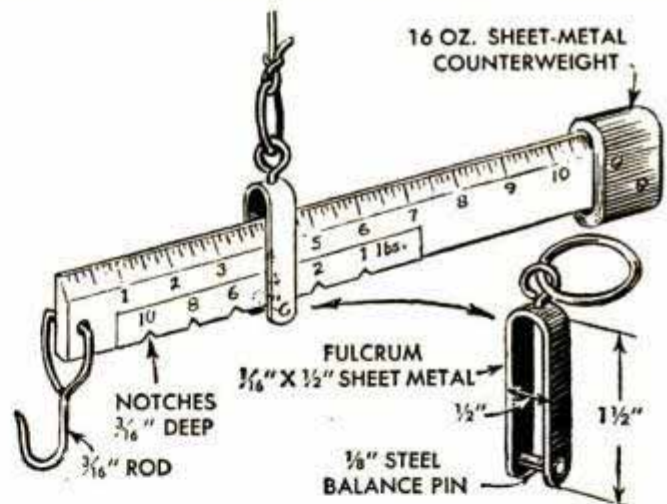

## Car Alarm in Starter-Horn Circuit Foil Would-Be Thief

By connecting the starter switch of his car to the horn, in series with a switch, one motorist is able to foil would-be car thieves. A wire runs from the "cold" side of the starter switch through a toggle switch mounted on the back of the instrument panel and then to the "hot" side of the horn. When the toggle switch is left closed, anyone who forces his way into the car and tries to use the starter will sound the horn at the same time, thus attracting attention.

☐ A good protective finish for window screens consists of a mixture of varnish, 2 parts, linseed oil, 1 part, and turpentine, 1 part, which can be applied with a piece of carpet tacked to a wood block.



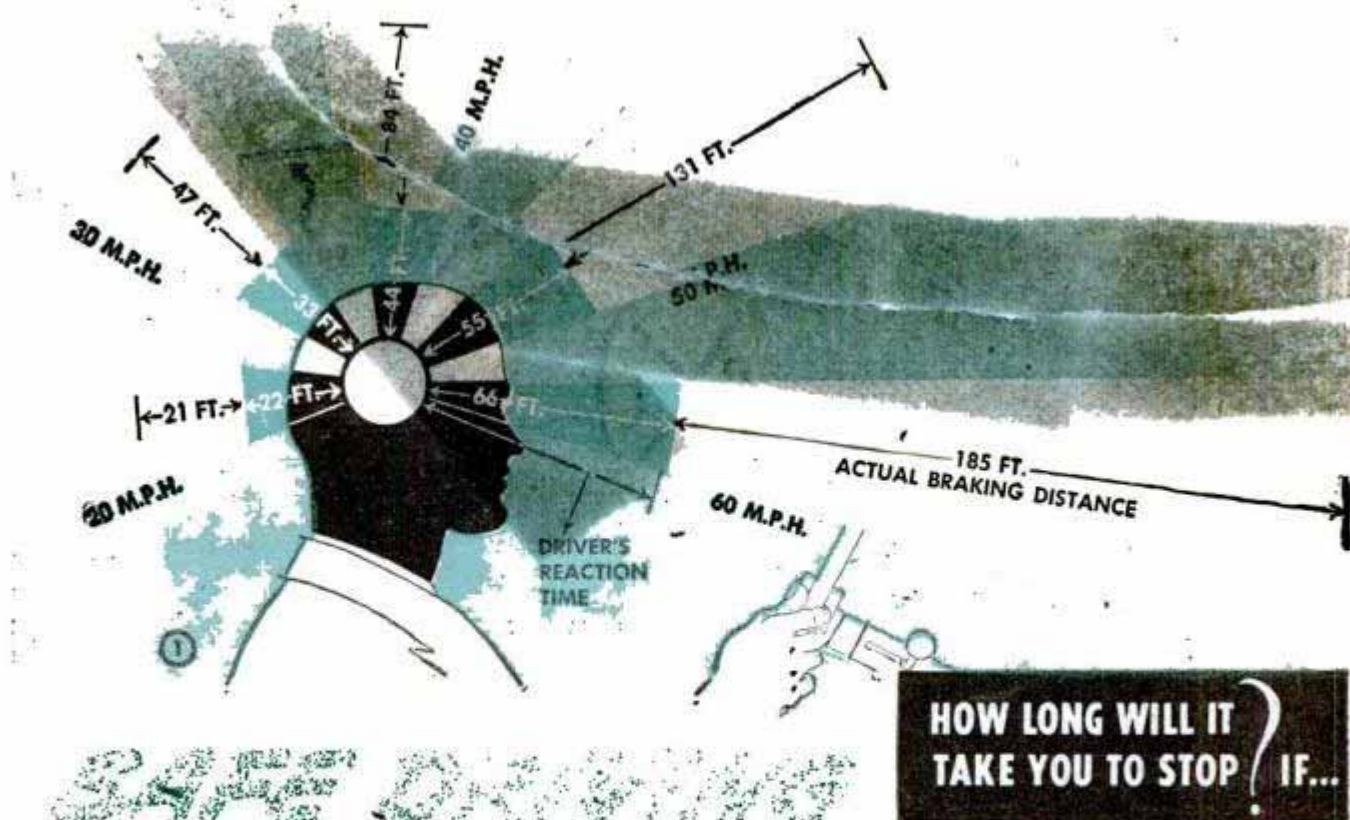

By Phil Ruskin

ONE of the major factors in the safe operation of a car is knowing how far it will travel before coming to a stop after the brakes have been applied. Knowledge of this fact is important if the car is to be kept under complete control. The distance required to stop a car on a good, dry pavement is surprising, especially at higher speeds, and this may account for many of the accidents that occur. As shown in Fig. 1, at 20 m.p.h. the average car in good condition will come to a standstill after traveling 43 ft. from the time the driver receives a signal to stop. The signal may be a car dashing out from a side street; a child running out from between parked cars or, in the country, it may be a car on the wrong side of the road when rounding a blind curve. At 40 m.p.h., 128 ft. of clear space is required to stop the car, and at 60 m.p.h., a total of 251 ft. is required.

Of course, the brakes are not actually applied from the moment you receive a signal to stop. There is a period, generally called reaction time, which is the interval required to act after you receive a warning to "step on the brakes." This time varies from driver to driver, but it is estimated at approximately  $\frac{3}{4}$  second. This means that at 20 m.p.h. a car will travel 22 ft. before the brake pedal is touched. At higher speeds the car will travel even greater distances before the brakes are set. For example, at 40 m.p.h. the car will travel 44 ft. and at 60 m.p.h. the distance is 66 ft. before the driver applies the brakes. These figures apply to cars in good condition traveling on well-paved, dry roads. Under poor conditions, much more allowance should be made for stopping the car.

Another factor in safe driving is the recognition of signs giving directions, Fig. 2. Rectangular signs are used to give traffic directions, round signs indicate a railroad crossing and a diamond-shaped sign means that the driver is to slow down. A square sign contains either information or a warning and an octagonal sign means a stop. Knowing what the shape of the sign means helps

**HOW LONG WILL IT TAKE YOU TO STOP? IF...**

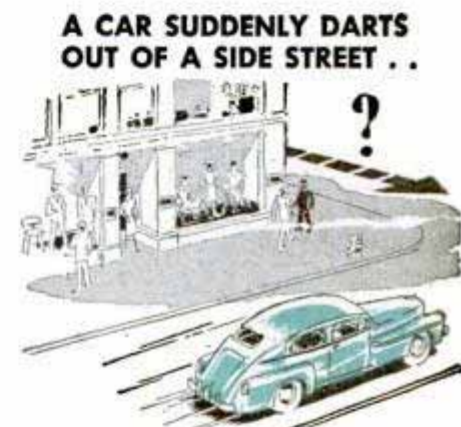



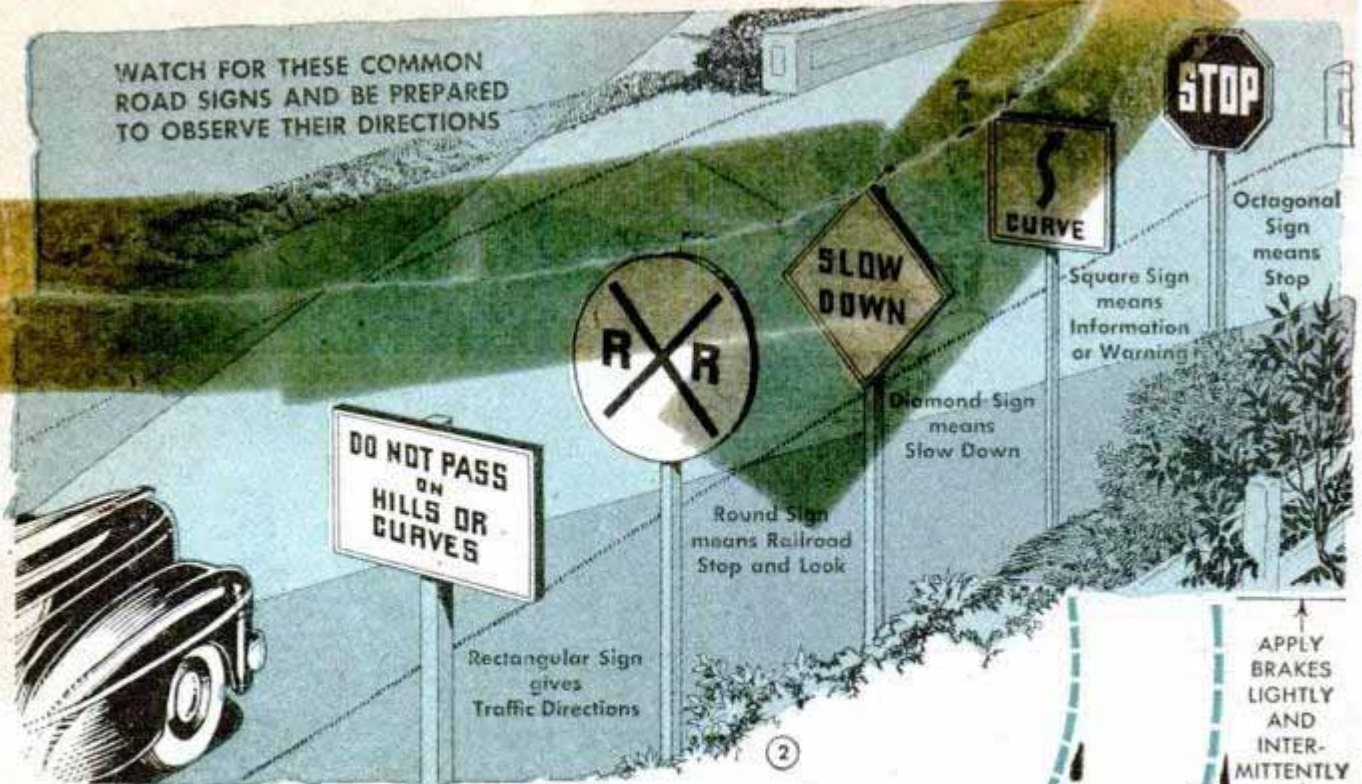

the driver prepare to act before he is close enough to read the lettering.

Knowing how to pull a car out of a skid, Fig. 3, may prevent serious or fatal injuries as well as save the owner a considerable sum of money. Always turn the front wheels in the direction of the skid and do not apply the brakes immediately. Instead accelerate slightly, and after the skid is nearly under control, apply the brakes lightly and intermittently. The natural reaction is to "freeze" on the brakes at first instead of accelerating. It might be well to practice skidding the car in some unobstructed area, and then bring it out by using the accelerator. In case there is a blowout, or the car runs off the shoulder of the road, don't try to steer back to the original line of travel by turning the wheel sharply. Accelerate lightly to keep the car under control, and in the case of a blowout bring it to a stop. Always leave the clutch engaged while the car is moving. The retarding action of the engine will save wear on the brakes and is helpful in making safe turns at faster speeds, when descending grades and on slippery roads. There is no danger of "locking" the wheels and making them slide instead of rotate when engine braking is used. The lower the gear ratio employed, the greater the engine-braking action. Thus, it is advisable to shift into first or second gear when descending hills or on icy stretches of road.

Tires and brakes suffer much from fast driving. The friction and heat generated by quick starting and stopping wear the rubber and brake lining rapidly. Making turns "on two wheels" and speeding over bumpy roads not only rubs valuable mileage off the tires but may also cause damage to the sidewalls where the rim cuts in. This is especially true if the tires are underinflated. Making a fast start away from a traffic light is not only a poor practice, it's an expensive one. Tires suffer considerably from this type of driving.

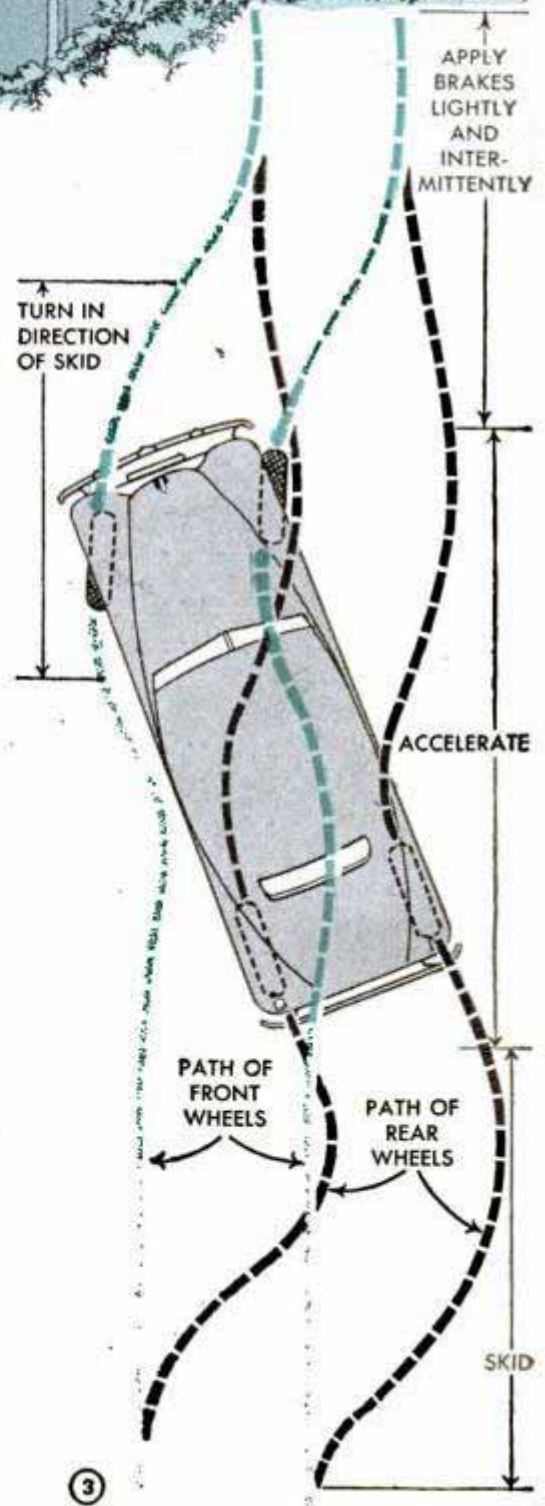



# Rack on Scooter Holds Papers for Newsboy

Made from a box of suitable size, this rack for holding newspapers is mounted on a scooter to enable a newsboy to whiz over his route. The box is divided into sections spaced so that each will take a single row of rolled newspapers. The dividers should slant downward slightly to prevent the papers from falling out. There is a "stand" which pivots to one side of the box. When standing still, the stick swings out and the scooter is leaned against it. A restraining chain holds the stick. The box top is used as a desk to hold the route book.

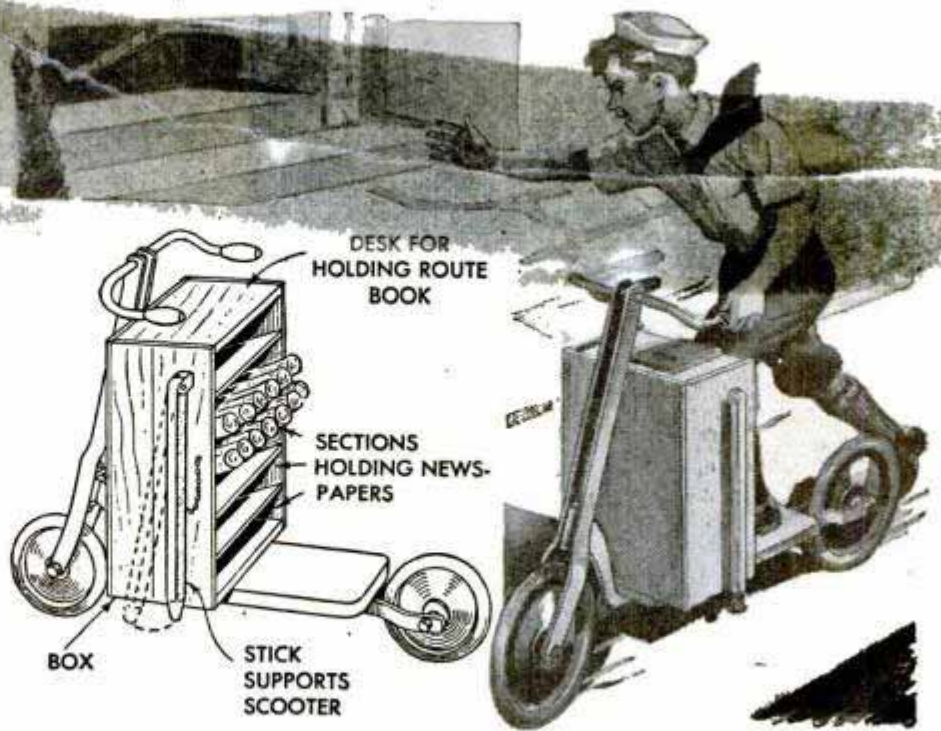

## Steadiness of Hand Is Determined With Testing Instrument

Young and old alike will enjoy this testing device which is used to determine the steadiness of your hand. The upper right-hand diagram shows the way in which the circuit is connected. Insulated wire is run from one terminal out of the box and through a wooden handle where it terminates in a loop. The insulation is removed from the loop. A wire from the other battery post is connected to one terminal of an electric bell, as shown. Wire connected to the other terminal runs out through the box, where it is bent in an irregular shape

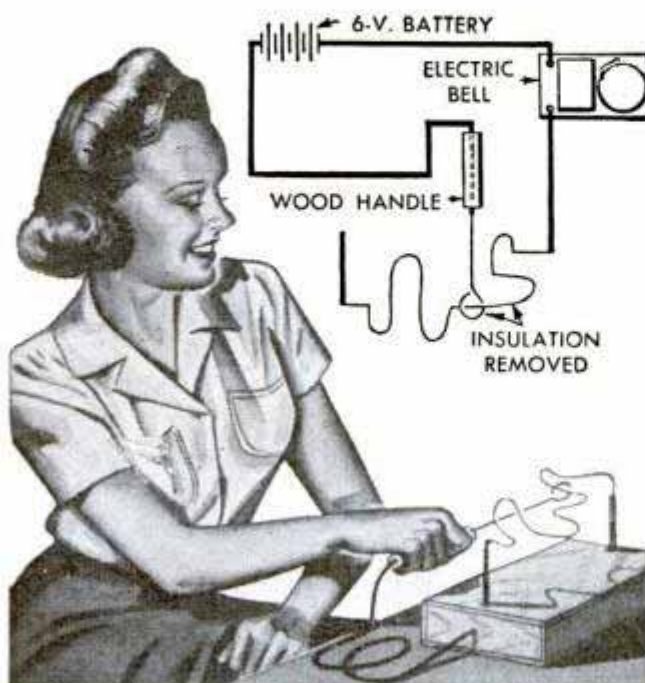

and fastened between two dowels. Insulation also is removed from the part between the dowels. The trick is to run the loop over the exposed wire without touching it. If the loop touches the wire, the bell rings.

F. Toors, Utrecht, Netherlands.

## Presser Foot Clamps Material When Ripping Cloth Seam

When ripping a seam, the task is made easier if one end of the cloth is clamped under the presser foot on the sewing machine. This leaves one hand free to do the cutting while the other hand pulls the cloth apart.



## Test Tubes Warmed in Reflector

Desiring to keep test tubes warm, one teacher reversed the reflector on his desk lamp and nested the tubes around the light bulb. Heat was sufficient to maintain the proper temperature.

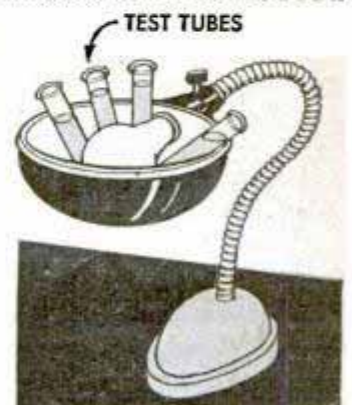



# Jigsawed TABLE

By R. L. Fairall



CHEERY luncheons will be made even gayer by these amusing table novelties, and breakfast will be an event when your soft-boiled egg comes to you in such an unusual cup as that shown in Fig. 1. To make the cup, the base sections are cut to shape and assembled, after which the rim is jigsawed and nailed to the base. In jigsawing, either by hand or with the power saw, a little extra care in following the pattern lines will save a lot of time in hand sanding.

The egg server, Fig. 4, is shown in detail in Fig. 2. Two disks of wood are sawed and drilled as shown. One has 12 holes for a dozen eggs, and the other has one large center opening. Four wooden plugs glued to the lower disk space the assembly to hold the eggs. A large cut-out of the world's most famous egg server not only as a decoration but also as a handle. Humpty Dumpty's body is screwed to the upper disk and his arms and legs are glued in holes drilled in the body. The tie is painted on, but you may glue a strip of narrow ribbon around his collar for added novelty.

Napkin and place-card holders are

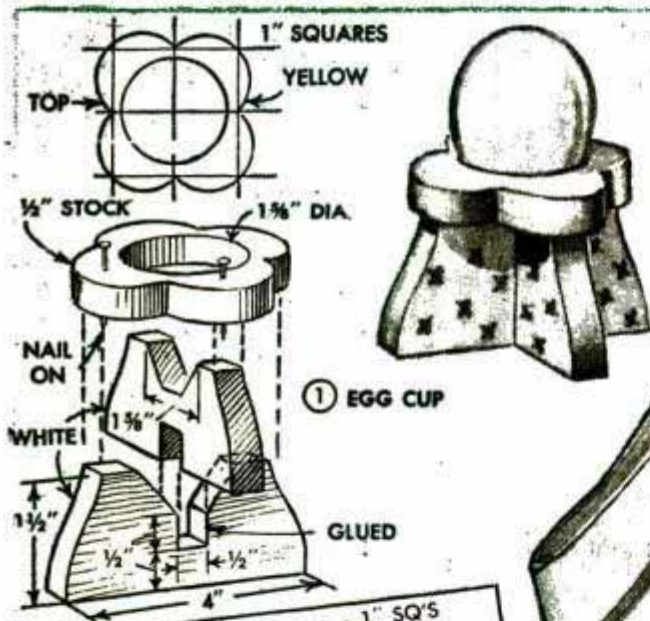

③ NAPKIN AND PLACE CARD HOLDER

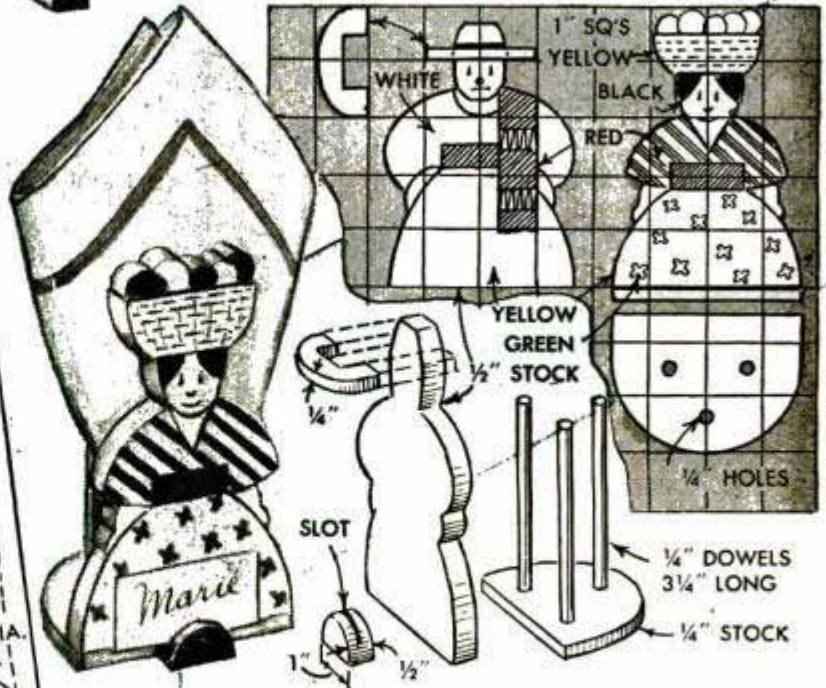
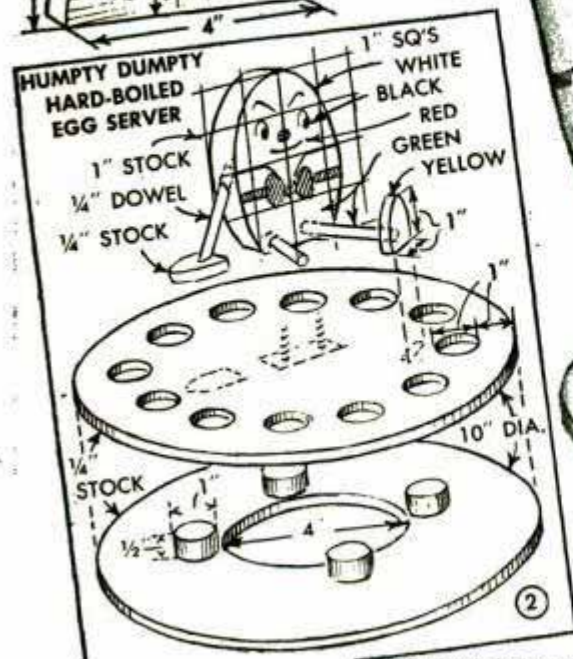

shown in Fig. 3. The figures are jigsawed to the cross-hatched pattern and nailed or glued to semicircular bases of lighter stock which are drilled for three short



# MELTIES

add color to luncheons



④  
HARD-BOILED  
EGG SERVER

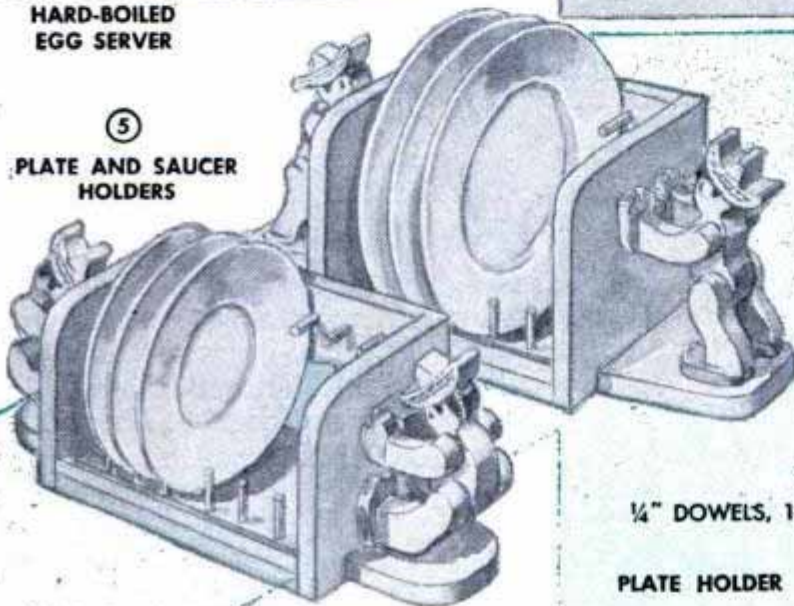

⑤  
PLATE AND SAUCER  
HOLDERS

dowels to hold napkins. One half of a small disk cut from a length of dowel is slotted to hold a place card and glued to the front of each figure to represent a foot. In addition, the little man's hat brim is glued in place as shown.

Plates and saucers are held ready for use in holders supported by sturdy figures that seem to be working hard in the performance of their duty, Fig. 5. Each holder, made as detailed in Fig. 6, consists of a base, two endpieces and a backstrip, short lengths of dowel being inserted in the base and backstrip to hold the dishes. The figures, diagrammed in the cross-hatched detail, are assembled and mounted on the ends of the holder bases. Blocks of wood glued to the ends of the saucer holder give the figures a better grip on their burden and help steady them.

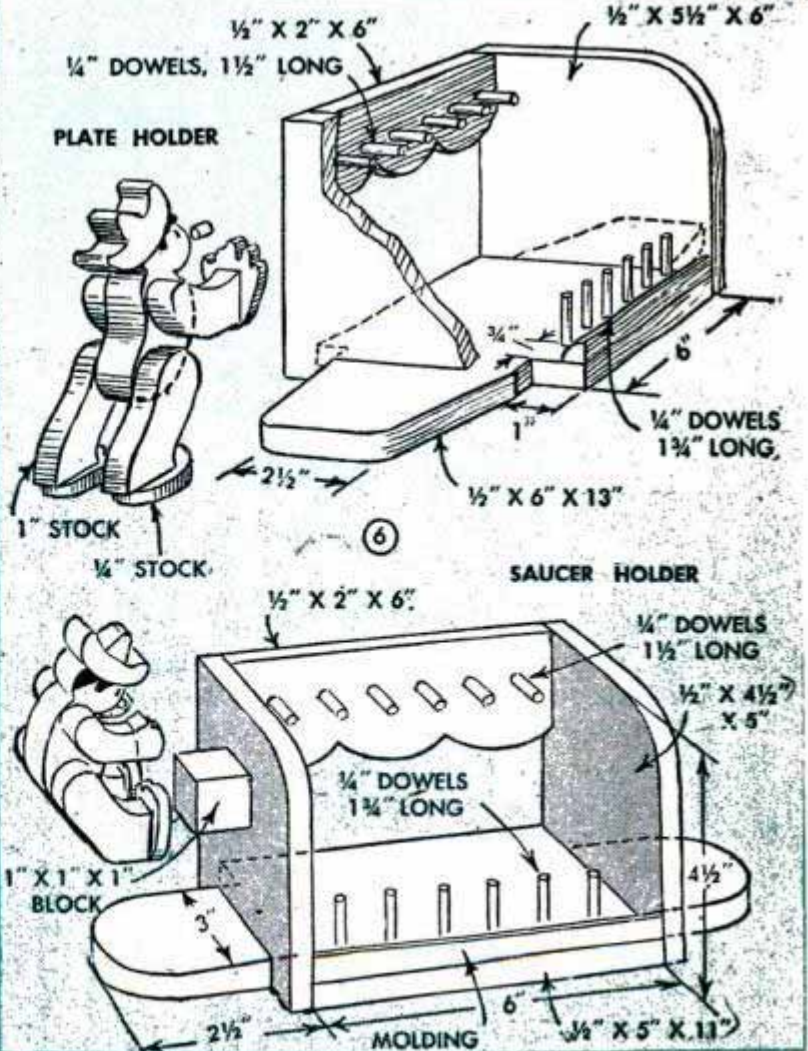
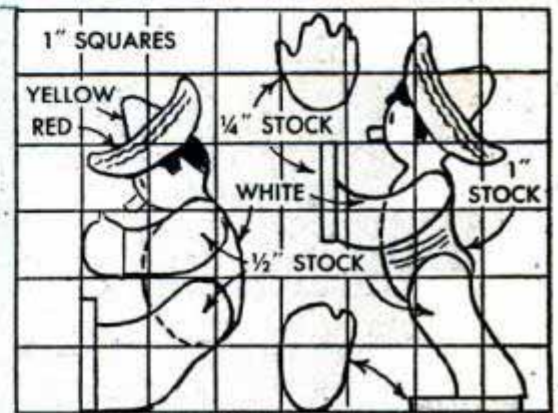



## Metal Dispenser for Cigarettes Keeps Them at Hand

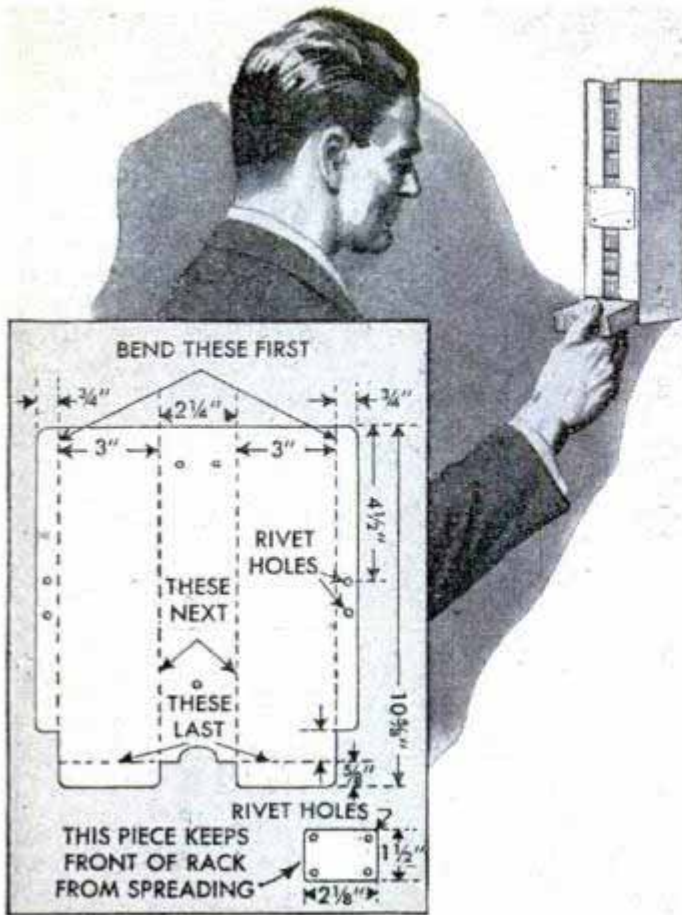

Instead of searching through a drawer every time you want a package of cigarettes, keep them in a dispenser like this one and they will always be at hand. The dispenser, of any lightweight metal, can be mounted in a closet, in a cabinet, behind a door or in some other inconspicuous place if you want to keep it out of sight yet readily accessible. Dimensions given here are for the standard size package, but if you like the "king" size, increase the 3-in. dimension to 3 1/2 in. Dimensions for cutting and instructions for bending are given on the drawing. The front piece, which is to keep the sides from spreading, furnishes space for your monogram or some other decorative design.—M. W. Jeronimus, North Hollywood, Calif.

## Curtain Rod Used as a Rule

Handy for measuring inside dimensions where an ordinary yardstick cannot be used, an expanding curtain rod can be made into a rule to serve this purpose. The

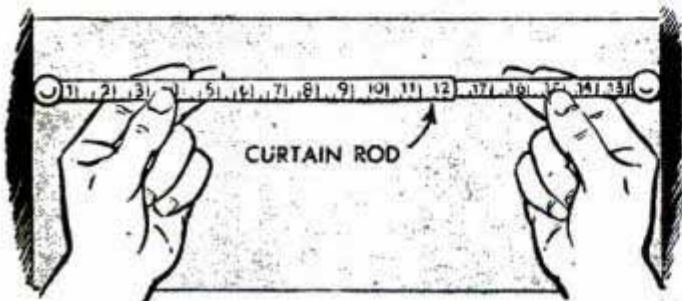

left half of the rod is marked with numbers in their regular sequence and the other half, which pulls out, has the numbers in reverse order. This is necessary to obtain a correct reading.

## Holes in Sash Make Putty Stick

When setting a pane of glass, after the glaziers' points are driven punch a row of holes in the wood next to the glass with an icepick or other pointed instrument. Then apply the putty in the usual manner.

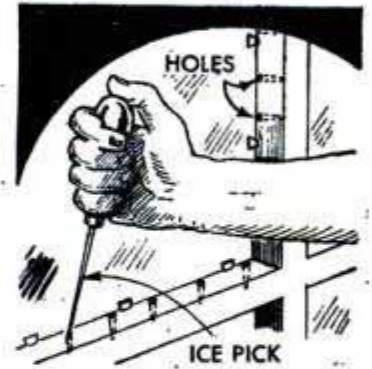

Some of it will be pressed into the holes you have punched and serve to anchor the putty better.

A. H. Waychoff, Phoenix, Ariz.

## Bench Vise for Modelmakers Holds Small Objects

Here's a lightweight vise that's ideal for modelmakers and others who work with small objects. The two jaws are made of flat iron, the rigid half being bent so that it can be bolted to the workbench. The halves

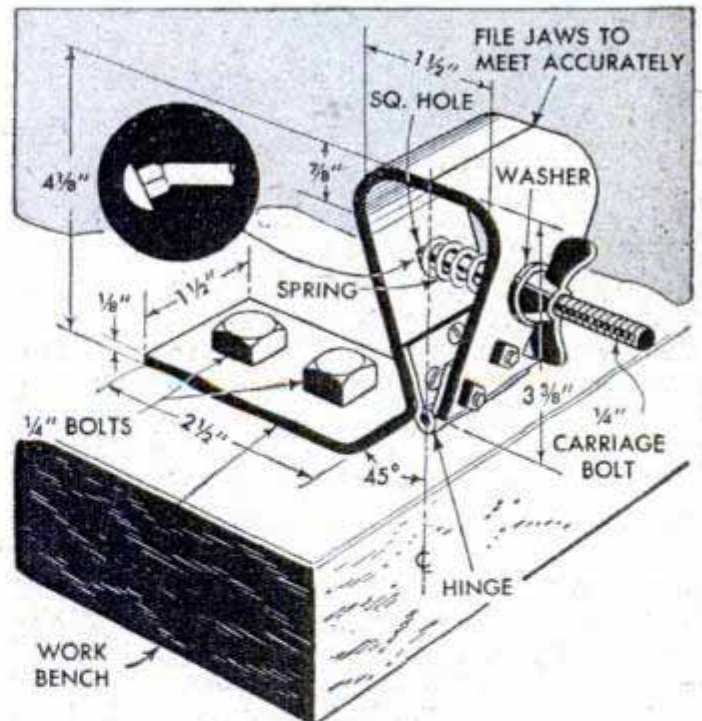

are joined with a butt hinge. A square hole is cut in the rigid piece and a round hole in the other for a carriage bolt that serves to open and close the jaws. Bend the head of the bolt so it will fit properly. Note that a compression spring is used to furnish tension on the jaws of the vise. A wing nut and washer are threaded on the bolt. After the unit is assembled, dress the jaws to fit.



# STAGE YOUR OWN SHOW

## PART III

By Kenneth Murray

**M**OVEMENTS of marionettes on the stage are really projections of the actor-personality of the puppeteer—the fellow pulling the strings. Thinking that over, it won't take you long to conclude that marionettes will capture instantly the skills and emotions of the manipulator and convey these to the audience. The puppeteer then is the real actor, although of course the attention of the audience is always centered on the marionettes, for in a well-conducted marionette show the customers never are intentionally made aware of the puppeteer during the actual performance. All this means that one must practice until the controllers and strings perform as extensions of the muscles and nerves and impulses of the operator. Only in this way can the puppeteer acquire that smooth proficiency and sense of complete control which gives a marionette show its appealing reality.

At first you use a mirror as in Fig. 36 where the operator is demonstrating the correct position to take for early practice. The mirror should be as large, or larger, than the one shown and should be placed at the correct angle so that the manipulator can watch every movement of the puppet. The purpose of the mirror, of course, is to enable you to see the puppet just as the audience sees it. The figure must stand, walk and gesture with perfect naturalness. And right here is where you begin to think puppeteer-wise, keeping both your mind and your eyes on the doings of the miniature figure whose movements you are originating and directing. When it commits an error, an unnatural pose, gesture or method of walking, you can detect it instantly in the mirror. During the first few hours of practice, you should list all errors immediately they are made, writing these in detail on a sheet of paper for later reference. Then, during subsequent practice sessions, go through each bit of movement in which an error was committed time after time, on succeeding days, until you are sure that the corrected movements have become quite automatic to your fingers. Like the music student, you should allot yourself a regular daily practice period.

A practice stage is next set up as in Fig. 37, the purpose of this being to give one



Above, the operator is demonstrating a practice position before a mirror. Mirror enables you to see the puppet actor just as your audience will see it. Below, the operator is working a marionette on a practice stage

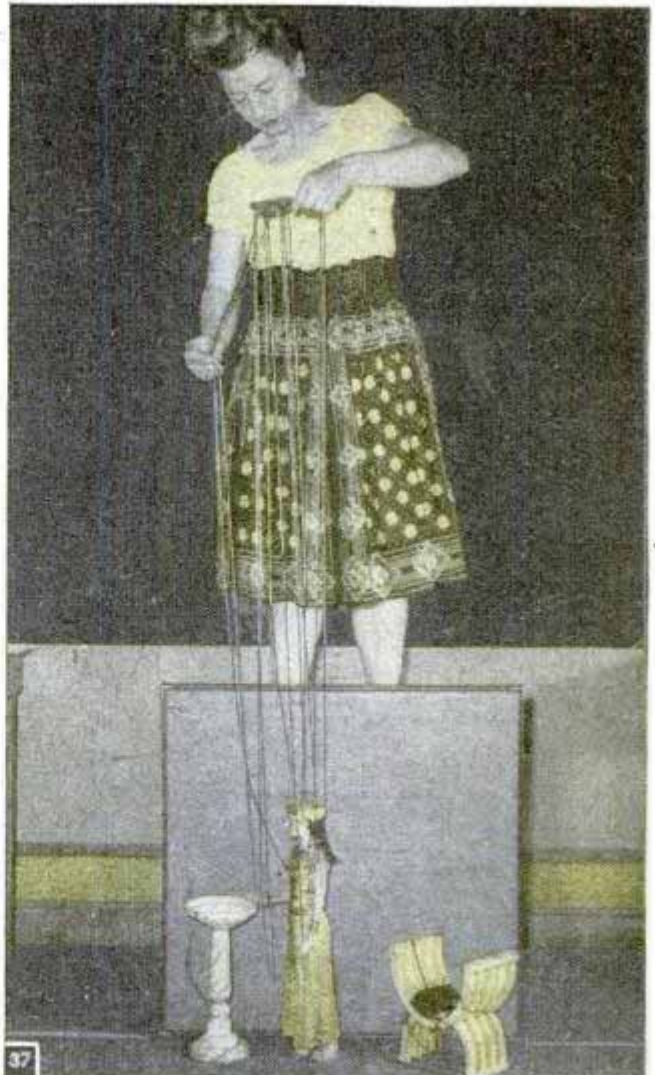



NORMAL STANDING POSITION—  
CONTROLLER NORMAL



SHOULDER STRING  
SUPPORTS FIGURE

HAND STRINGS TAUT  
KEEP HEAD ERECT

LEG STRINGS  
LOOSE

NORMAL AND  
WALKING POSITIONS



SHOULDER STRING  
REMAINS TAUT

WALKING POSITION—  
CONTROLLER HORIZONTAL

HEAD STRING

LEG STRINGS—  
GRASPED AT X  
TO CONTROL MOVEMENT OF FEET

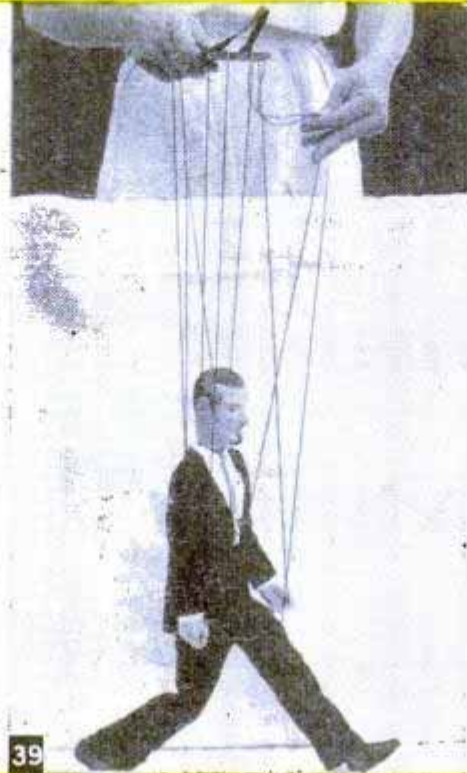
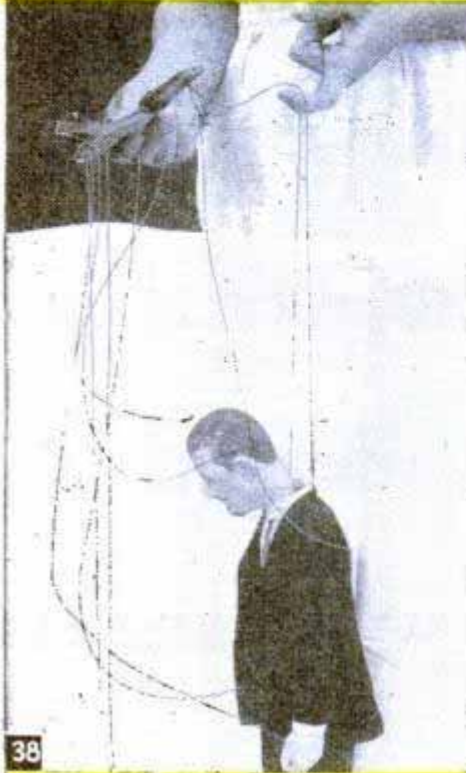

GRASP ARM STRINGS  
AT X FOR HAND  
GESTURES

X

SHOULDER STRING  
REMAINS TAUT

GESTURES



GRASP BACK STRING AT X  
AND LOWER CONTROLLER

X

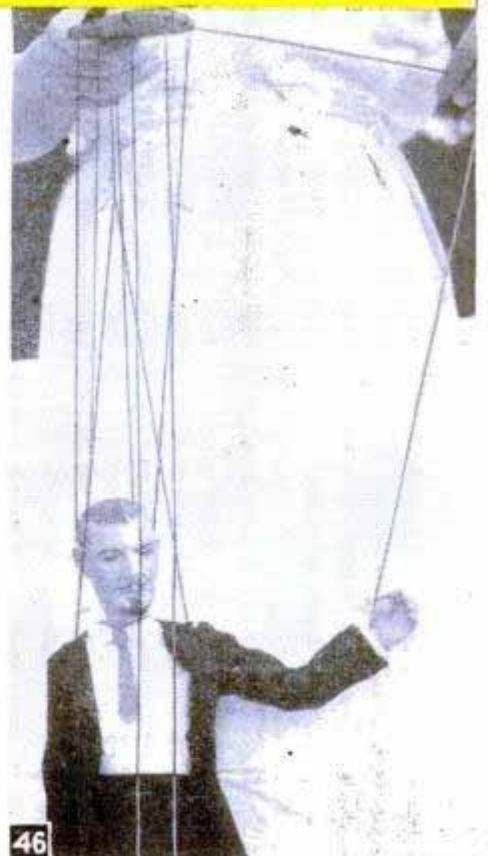
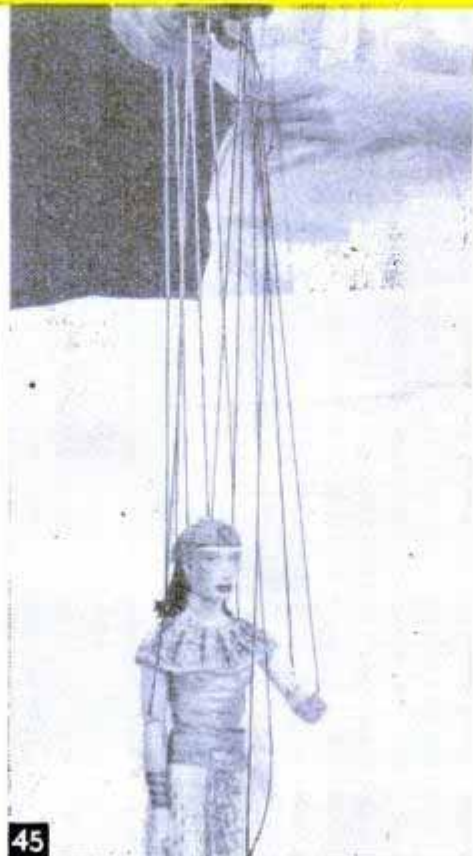
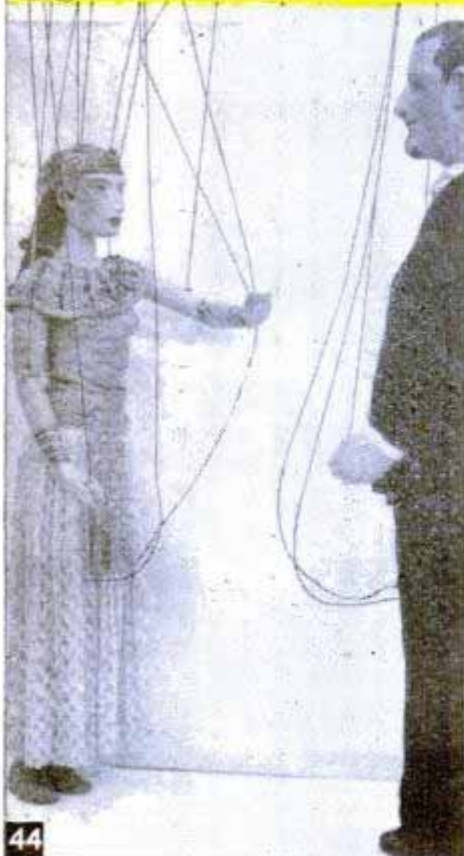



HEAD MOVEMENT

SHOULDER STRINGS  
REMAIN TAUT

FORWARD TILTING OF  
CONTROLLER LOOSENS  
HEAD STRINGS, AT LEFT,  
ALLOWING HEAD TO NOD  
FORWARD

CONTROLLER TILTED TO RIGHT  
CAUSES HEAD TO TURN LEFT  
CONTROLLER TILTED TO LEFT  
CAUSES HEAD TO TURN RIGHT

HEAD STRINGS

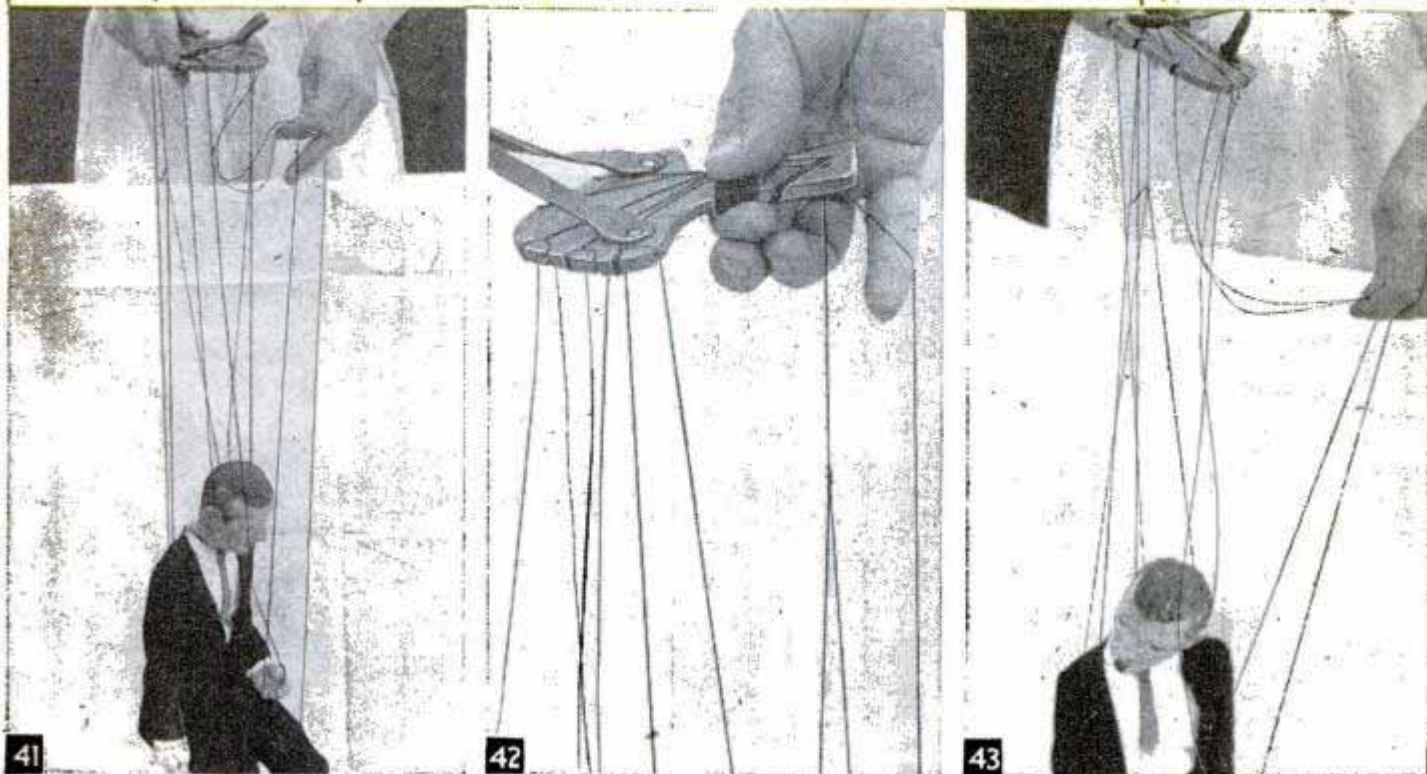

new at the trade the "feel" of the height and width of a marionette stage. Use a low bench on which to stand, and before it set an unopened card table on edge to serve as a background. If you wish you can still use the mirror in front of this informal setup. Mark off the stage dimensions on the floor with chalk or tape. Small wood or cardboard boxes can be substituted for props such as chairs or benches.

**With this advanced setup,** you work for the first time with full-length strings and enter puppets from the stage "wings," have them sit down, bow, gesture, talk and walk. From this you gain a feeling of proper distances, the stage size will become familiar and you'll get onto the trick of keeping the figures in a standing posture without sagging or "flying," a term puppeteer pros use to describe some of the grotesque positions the puppet may assume if you let things get out of hand.

**Voice of the puppet** is your voice, for you are the voice as well as the action of your marionette show. It is assumed that you will either use a professionally prepared script or write your own, which is preferable, as this makes the entire drama, comedy or other type of production entirely and originally yours. The script should feature the usual "sides," parts and cues, and particularly the different character-

izations. From this point on you become an actor or actress on your own, with your own script. It is not difficult to learn to change your voice to distinguish one character from another. Practice this with a friend acting as your audience and mentor. Yours is the inspiration but in the end the marionettes do your acting before the customers. Only consistent practice can perfect the illusion but once you've convinced your audience that you've mastered the art of puppetry, they'll forget all about you, and they'll enjoy your show.

**Now the mechanics of the thing:** To begin with, study the steps demonstrated in Figs. 38 to 53 inclusive. Notice Fig. 38 particularly, and the detail of the controller directly above it. Remember, of course, that the operator is only demonstrating the more common movements and, besides, is using shortened strings. Because of this the hand positions cannot be shown exactly as they would appear in normal manipulation from the puppeteer's bridge. Fig. 38 reveals the real inside trick in stage-managing a puppet actor. The string yoke, looped over the operator's left forefinger, is attached to the handle or "heel" of the controller by a single cord as you see in the detail. Thus, even though all the other strings go slack for any reason, the figure will remain upright so long as you hold the controller in



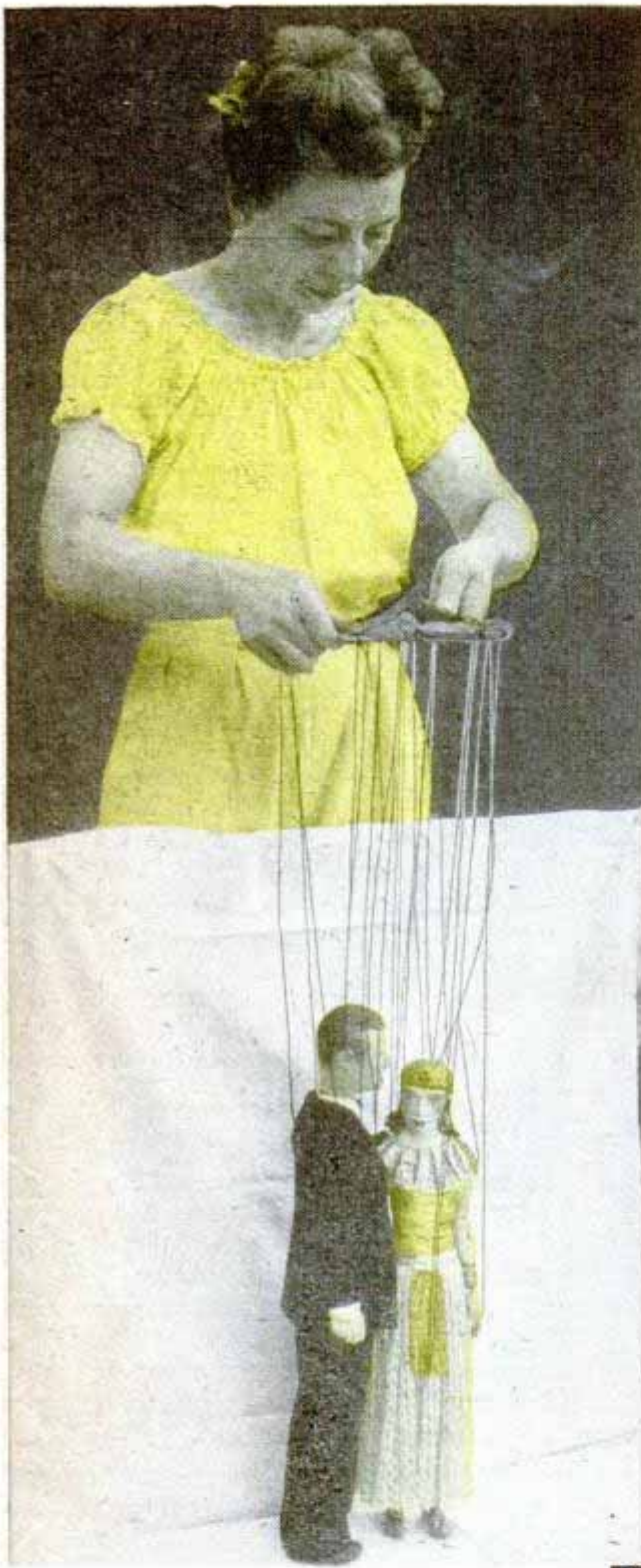

Puppeteers learn to be ambidextrous, that is, they become equally proficient with the right and left hand. Here the operator is working two puppet actors

a horizontal position. The important thing to learn is to keep the controller always a given height above the stage while your actor is going through his lines. These two simple rules take care of the fundamental mechanics of puppeteering. The rest is merely an elaboration of procedures. Figs. 39 and 40 are examples of this. In Fig. 39 the dapper puppet gentleman is being put through an undignified "bounce," as the puppeteers call it, which is an approved

method of practicing the walk. Here the "lift" of the normal walk is purposely exaggerated. The controller is lifted slightly while at the same time the controlling fingers are "teetered" or alternated in height, which causes the legs to reverse position, spreading on the downstroke of the controller and reversing on the upstroke. Lessen the exaggeration until the bounce of the torso is scarcely perceptible, then take the slack out of the strings and you have the gentleman strolling casually across the stage as in Fig. 40. That's all there is to it, in essential. The naturalness comes with prolonged practice. Always the figure should have the feet on the stage floor with just enough weight to give a slight drag to each foot. Actually the walk is little more than a shuffle. Puppeteers refer to the advanced leg as the "lead" leg, the other as the "lag" leg.

**When more puppets** than you can handle are on the stage at one time, those not performing are suspended by attaching the controllers to the puppeteer's bar. Hooks are provided for both sitting and standing distances and you have to determine the positions by trial after studying the set required by the script.

**Bowing is one** of the easiest practice movements and is accomplished by hooking your little finger underneath the string attached to the back of the actor as in Fig. 42. Support the figure with the shoulder string, as usual, while allowing it to take a bow. With each of these actions, practice until you can make the required movements with the fingers while keeping attention on the puppet.

**Actors are made** to kneel by grasping the leg strings with the fingers of one hand as in walking, advancing the lead leg and permitting the lag leg to bend by slightly lowering the controller heel. At the same time the controller is tilted forward as in Figs. 41 and 51. Fig. 41 is mentioned in this connection because of the head movement required in the kneeling procedure. Be careful not to allow the head to fall too far forward at the start of the maneuver. However, it should be inclined slightly as in Fig. 41. Complete the kneeling position by lowering the figure to the stage. These movements are indicated in Fig. 51. They are reversed to raise the figure to its feet.

**The head pivot** permits the head to swing in either direction while you are maintaining support of the body with the shoulder string. If you tilt the controller forward there will be sufficient slack in the head strings to permit the head to nod. Tilting the controller to either side will cause the head to turn in the opposite direction, Fig. 43. Practice until the movements are familiar, as they will be used frequently.





48



49



50



51



52



53

Gestures are used to indicate the speaker. A slight movement or gesture by a puppet indicates that it is speaking or as a sign to the audience that the speech is to be passed on to another actor. A natural, modified gesture, Fig. 45, is usually the practice. This consists of a gentle movement and is accomplished by lifting the string close to the controller. In general, you avoid a wide, sweeping gesture, Figs. 44 and 46, unless the figure is making a speech of such outstanding importance that it requires special oratorical or dramatic emphasis. Remember that only the puppet which is speaking should ordinarily show movement, as this bit of business focuses attention on the speaker and excites the imagination of an audience by its unexpected touch of realism.

**Puppeteers experienced in the trade** learn to be ambidextrous, which means that you must know how to handle actors with both hands, Fig. 47, even though simultaneous movement of more than one figure is rarely required. Learn to exchange controllers with an assistant so that an actor can move from one side of the stage to the other when the script calls for it. Usually it is considered bad stage practice to

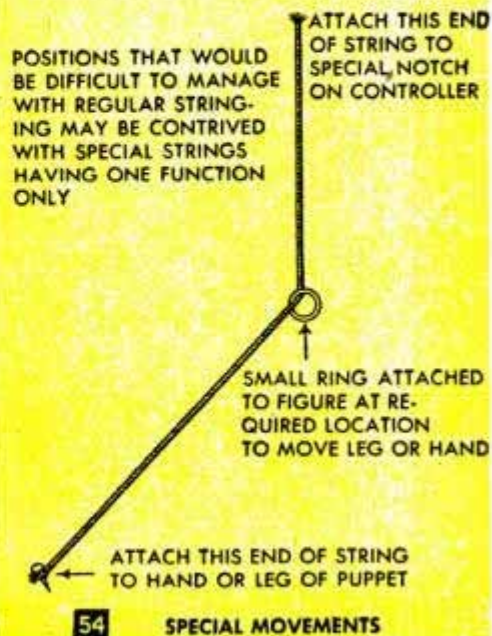

54

SPECIAL MOVEMENTS





If marionettes are to make a well-groomed appearance on stage they must be stored between shows in cloth bags to protect costumes from grime and wrinkles

stand one actor in front of another and, unless required by the script, the performers never turn their backs to the audience.

**Allow your actors** to sit down occasionally during a show. People tire of watching a play in which the actors are always standing. Everybody relaxes when a player walks to a chair or bench and seats himself naturally without a flourish or fault. Figs. 48, 49 and 50 show the procedure. Of course, miniature chairs and benches, instead of practice props, are desirable for a public performance. After maneuvering your actor easily and naturally into position before a seat, tilt the controller sharply forward, holding leg strings slack so that the figure bends over. Then bend the knees by lifting on the leg strings as in Fig. 49. Lower the controller until the figure is almost level with the seat, then gently drop

him into it. If the performer is to remain seated for any length of time, fasten the controller on a hanger. A slight tug at one of the strings will effect any bit of movement that may be called for meantime.

**A lying-down procedure** is seldom resorted to unless essential to carry part of the story. Although marionettes are constructed with the balance required to simulate the movements of a human being, they lack muscles and it is difficult for them to lie flat on the stage floor, or to arise naturally from this position. Moreover, you always risk the clatter of a loosely-assembled mechanical device. The rule is, generally: Don't try it. However, in rare cases where it must be done, puppeteers use a compromise, providing a miniature couch or divan. Figs. 52 and 53 show the use of such a prop. Begin with the sitting posture and seat the actor at a slight angle. Then allow the figure to relax slowly backward by lowering the controller until the strings are slack. As you see in Fig. 53, the gentleman is in position to arise when you reverse these movements and the action will seem perfectly natural. Sometimes the script will call for movements of the puppet-actor's legs or arms that are difficult to manage with the regular stringing. Fig. 54 shows how this usually is handled by means of a special extra string. Extra stringing, however, should always be kept to the minimum. More than two extras are difficult to handle at best and you should practice handling even one until you feel complete confidence.

**Marionettes must have good care** between performances if they are to make a fresh, crisply pressed appearance on the stage. Experienced puppeteers store them in heavy cloth bags fitted with drawstrings like that in Fig. 55. After the marionette is gently dropped into the bag and the drawstring pulled, excess string is wrapped around the handle of the controller so that it will not become tangled. Both the controller and bag are marked with the name of the performer. Bags should be sufficiently large to avoid cramping and possible loosening of joints. They can be stored in a trunk or hung on wall hooks.

THE END

## Trick Matches That "Burn" Twice Will Amuse Company

The next time you have guests at your home, you can amuse them with matches that apparently burn twice. Pick up from an ash tray several matches that appear to have been burned. These are the wooden, strike-anywhere type that are commonly used around the house. After asking the guests whether they have ever seen such a match burn twice, and receiving negative

replies, strike the match on a rough surface and it will burst into flame. The secret, of course, lies in the fact that the match had been prepared beforehand. The heads of unburned matches were dipped in black ink and allowed to dry thoroughly before placing them in the ash tray. Be careful not to stain the stick.

Waldemar J. Gydesen, Milwaukee, Wis.



# Collapsible Cold Frame Stored When Not Used

After they have served their purpose in the spring, most cold frames become filled with weeds and detract from the well-ordered appearance of the garden. Here's a frame that is quickly disassembled after it has served its purpose, and can be stored out of the way until needed again. The lower detail shows the method of assembly and construction. The exact size of the frame will be governed by the size of the sash that is used. In this case, it is two four-light barn sash with 10 by 12-in. glass panes. The four sides are held together with a hook and screw eye at each corner. Loose-pin hinges are used to fasten the sash to the frame as this permits easy removal. Either 2 by 4-in. lumber or bricks can be used as a base.—Harold Jackson, Kankakee, Ill.

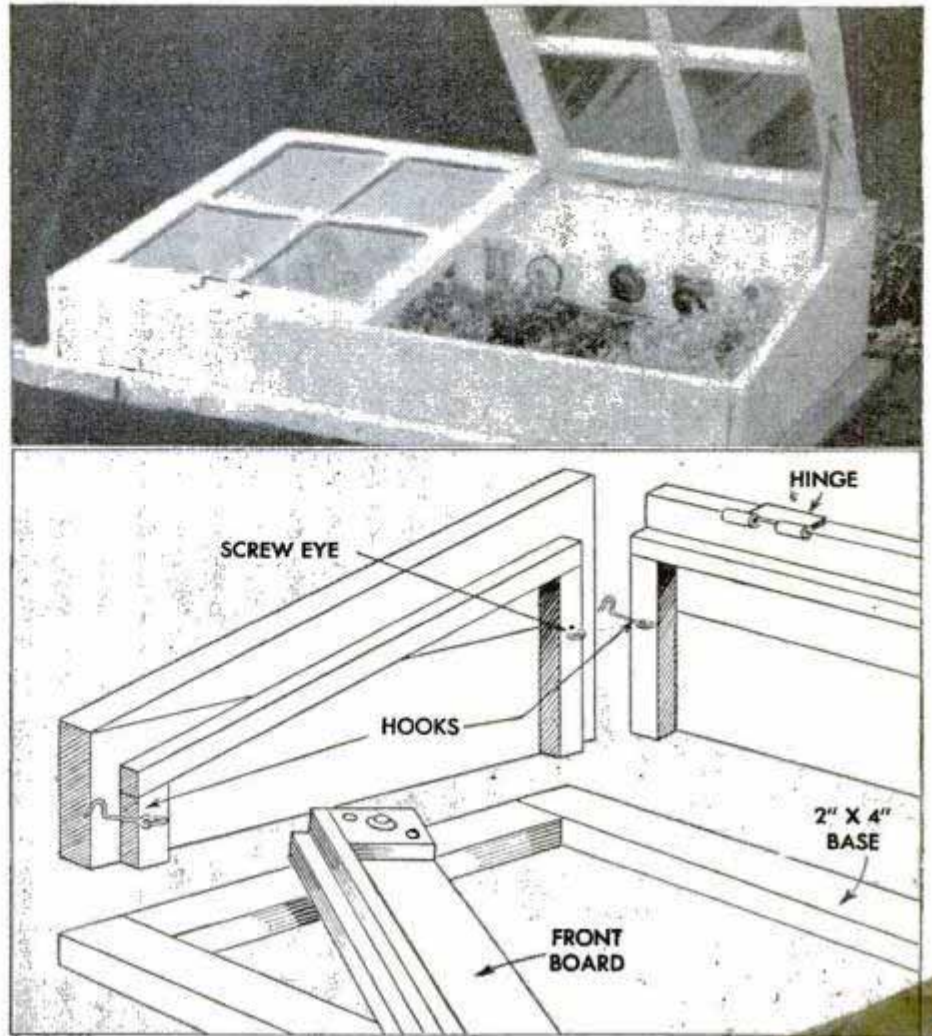

# Sliding Dovetail Joints Are Secret of Wood-Block Puzzle

If the cuts are made as pictured, these two blocks slide together smoothly and seemingly make a single block that cannot be separated. The secret is the sliding dovetails and, as you can see, they separate by

sliding along the diagonal. Maple is a good wood from which to make the puzzle and care should be taken that the grain matches in both pieces. The inside surfaces should be waxed so they will slip together easily. The outside is finished with a clear lacquer that will not mar the natural beauty of the grain.

Sgt. Emil Gaynor, San Francisco, Calif.

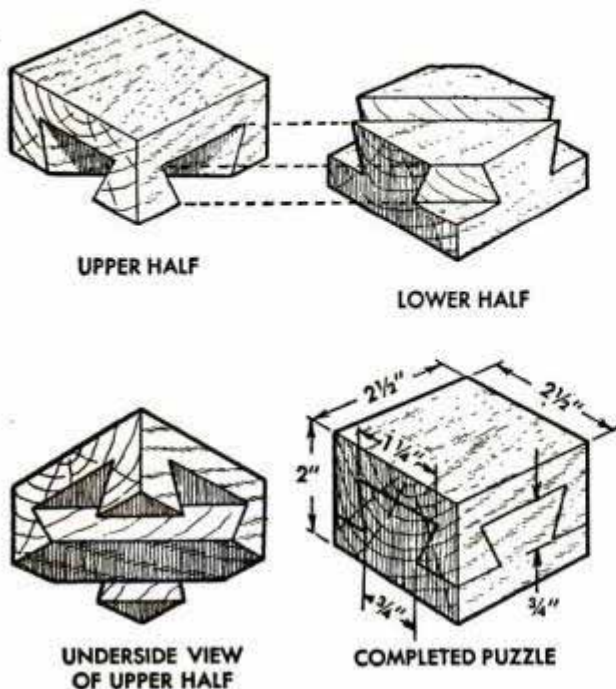

# Marking Jig Slips Over Work

Formed from 22-ga. sheet metal, this marking gauge will aid in scoring mortises quickly on flat-surface work. The two sides are bent to fit over the work and the top must be wide enough to accommodate work of standard dimensions. The unit can be slotted at the angles that are most common to the user's needs.

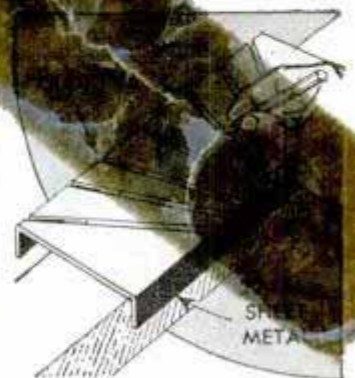



# Transparency Projector

NOW that you have the frame, blower and synchronized shutter details worked out as in Part I, you're ready for the controlling mechanism and other items. A solenoid—called a solenoid motor here because of its application—is quite powerful, and with it a comparatively heavy body can be moved a short distance quickly. When the power thrust against the plunger is equalized, there is a braking action, Fig. 16, at which time power should be cut off. This occurs when the plunger reaches the center of its travel. By removing power from the carriage motor, the carriage, Fig.

19 and Photo F, is carried clear across on momentum, but by holding power on the shutter motor, the shutter is held in front of the lens until the carriage has moved over. A push-button switch on the control panel, Fig. 26, permits both of these operations to be done simultaneously with a single button.

Winding of the solenoids, detailed in Fig. 17, is done on a lathe. Set the lathe for 72 threads per inch. A wire leader or guide is made by drilling a  $\frac{1}{16}$ -in. hole lengthwise through a short length of metal rod. This is clamped in an offset tool holder, Photo E. The wire is fed through the guide and sol-

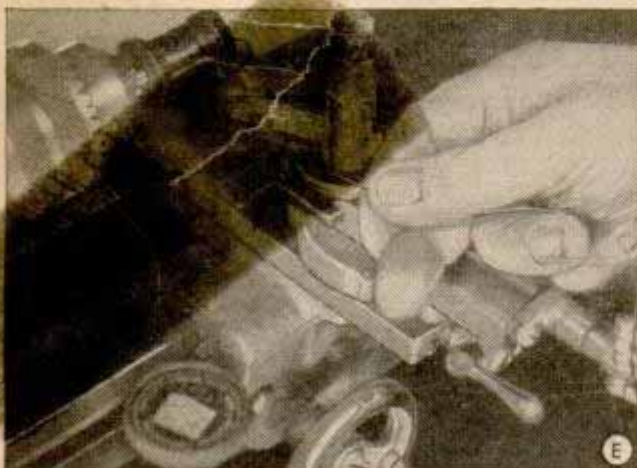
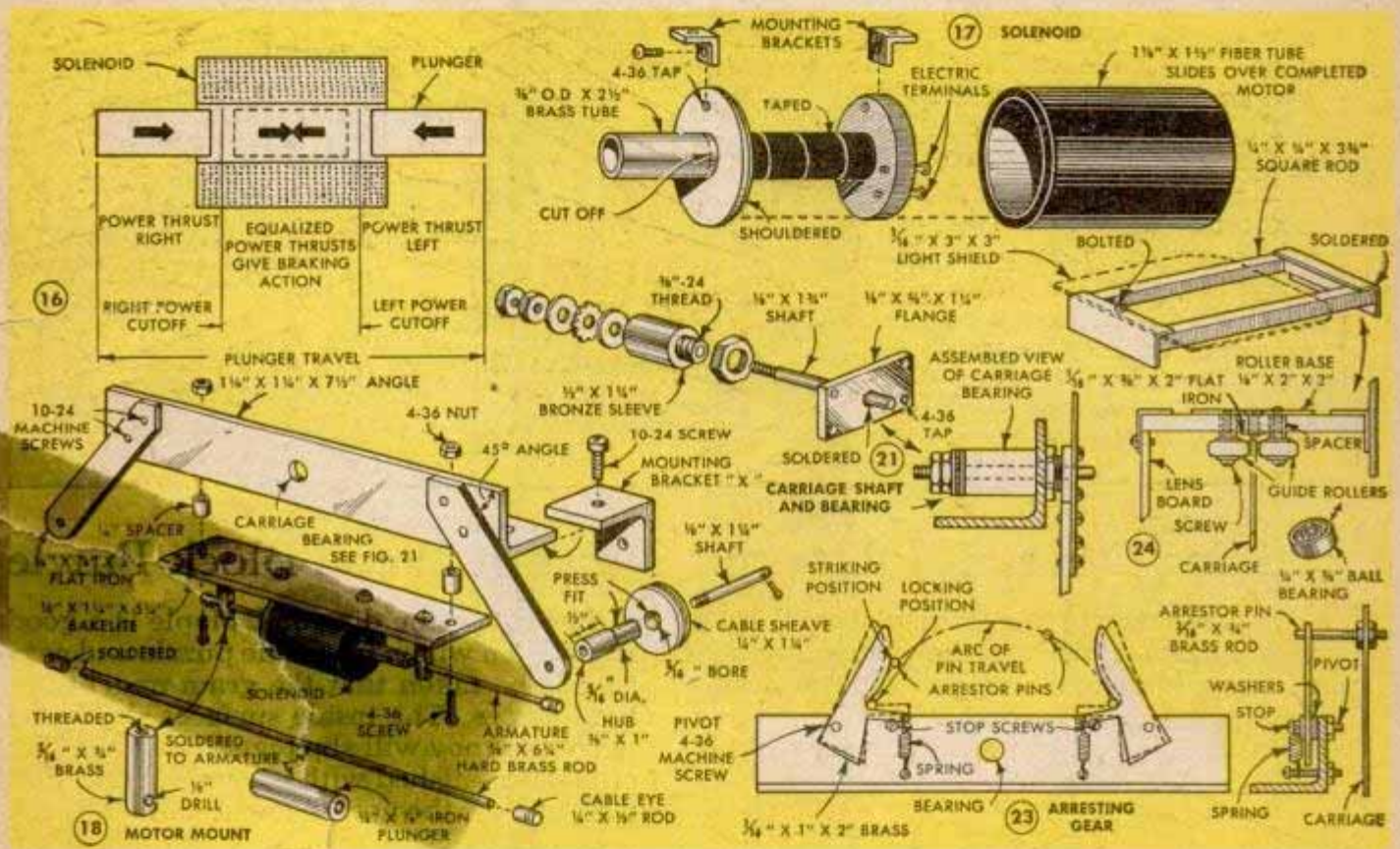

In winding solenoid coils wire is passed through a hollow guide held in an offset tool holder. Use back gears and set the lathe for 72 threads to the inch

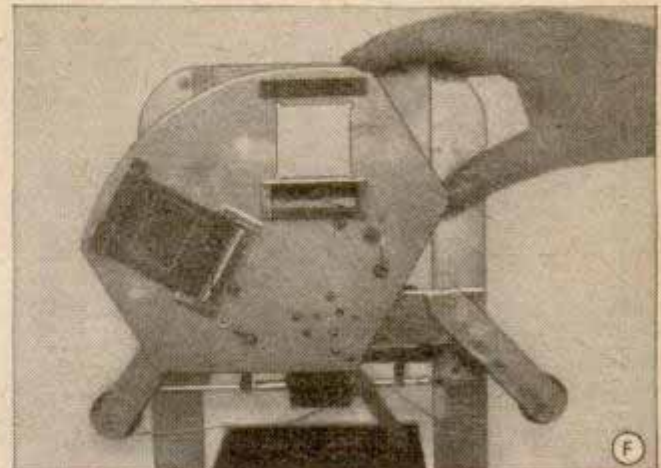

Slide holder is driven by solenoid motor controlled by a rheostat switch. Although the slide runs free, movement is snubbed at limits of travel by an arrester



## PART II

By Alexander Maxwell

dered to the inner terminal of the solenoid drum. Then, with the lathe set at lowest back-gear speed, you're ready for winding. By changing the feed from right to left, the entire coil can be wound without stopping. Each coil requires 800 turns of No. 28 enameled wire. When testing the coils, do not apply 110 volts directly, but use a resistance unit in the test circuit, Fig. 28. The solenoid motor which actuates the carriage is mounted in the subassembly shown in Fig. 18. The carriage shown in Photo F and detailed in Fig. 19 is made from sheet aluminum. The slide holder

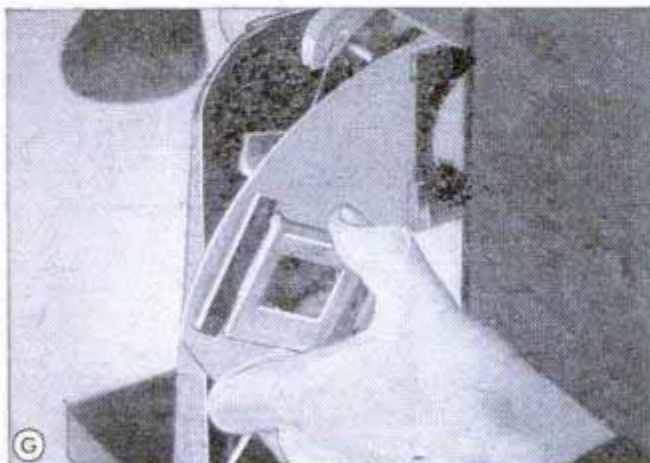
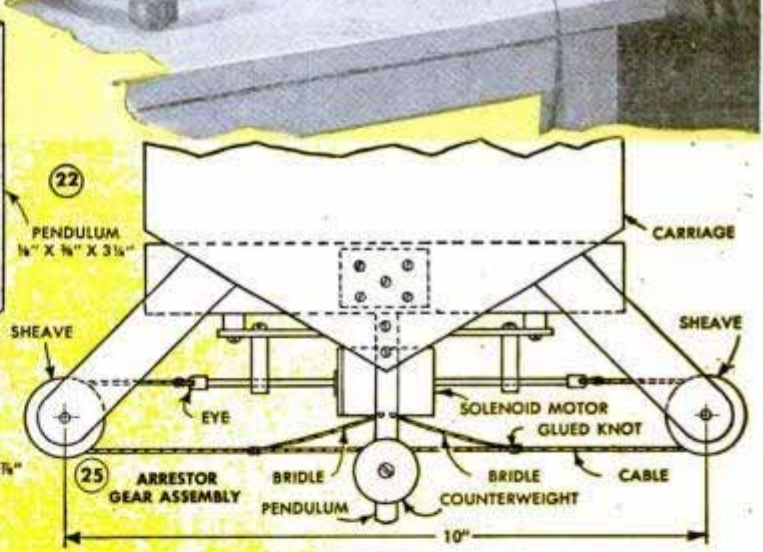
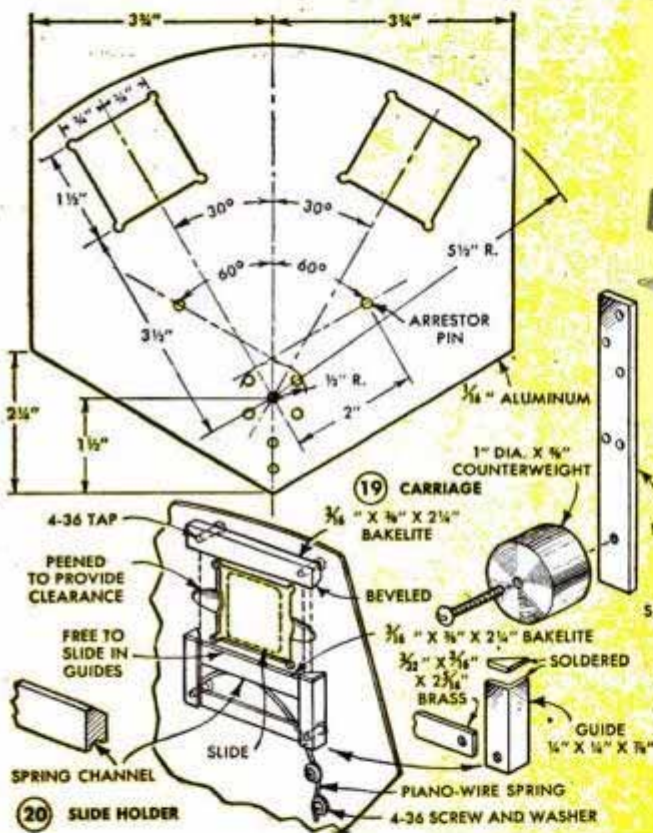

Holder is made so that slides can be held between the thumb and first finger and snapped in place. Both holders are brightly illuminated from the condenser

detailed in Fig. 20 is made so that the slide can be held between thumb and first finger and snapped in place, Photo G. Slides can be inserted and removed rapidly because the holder is brightly illuminated by light from the condenser.

Linen fishline is best for the slide-holder drive cable, Fig. 25, as this cord does not stretch. The carriage shaft and bearing are shown in Fig. 21. A pendulum and counterweight, Fig. 22, and an arresting gear, Fig. 23, bring the carriage to an easy stop at the limits of travel. The rheostat is adjusted so just enough power is applied to pull the carriage past dead center. The carriage is guided by two rollers, Fig. 24. When the carriage and motor assembly has been completed, as in Fig. 25, it is



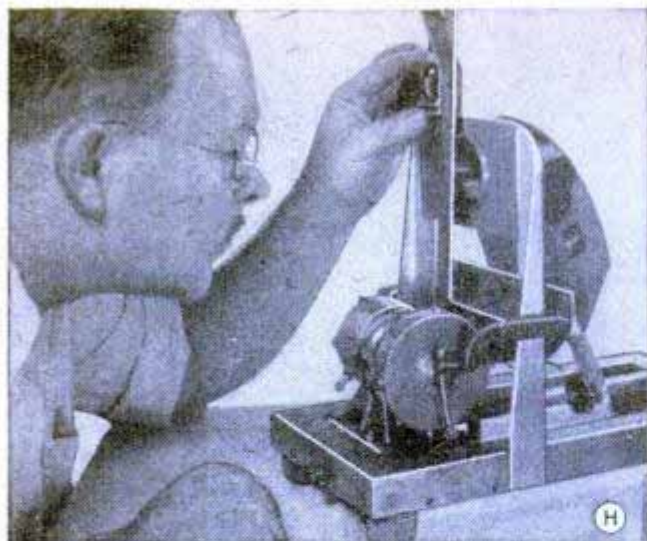

lined up with the lens tube. The assembly is clamped in place while testing as shown in Photo H. Do not drill holes in frame uprights for mounting bracket "X," Fig. 18, until you are sure the unit is in proper position. Fig. 28 gives the wiring diagram for the push-button control and Fig. 29 shows the parts in perspective. Also, you see the same thing in Photo J. The snap switches and 250-ohm resistor are mounted under the frame while the rest is located on the control panel, Fig. 26. Note carefully how the push button, Fig. 27, actuates the two snap switches. As it is pressed, the shutter switch closes first and the shutter covers the lens. There it remains until the button is pressed all the way down. The shutter does not drop until the button is released. As the shutter cuts off the light the audience doesn't see the slide change.

Switches on the control panel also turn on the blower motor and projection lamp, Fig. 29. Ordinarily the solenoid motors are turned on first and regulated. The shutter rarely needs adjustment but, when it does, the resistor slide, Fig. 29, is relocated. The carriage adjustment is somewhat more critical but usually is necessary only when the voltage supply varies. The rheostat knob provides for this adjustment which may have to be made whenever you plug into a new current supply. Turn on the blower before you switch on the lamp and when you have finished a run of slides, turn off the lamp first.

The condenser, Fig. 30, should be the 35-mm. enlarger type in a barrel mounting. However, the lower efficiency of the two-element condenser is largely offset by the fact that it is self-contained. Heat-absorbing glass is essential and must be placed inside the barrel between the two lenses. The condenser unit must be a definite distance from the slide. This is determined by experiment so don't bolt down the lamp-house standard, Fig. 30, until lamp, reflector and condenser are all lined up.

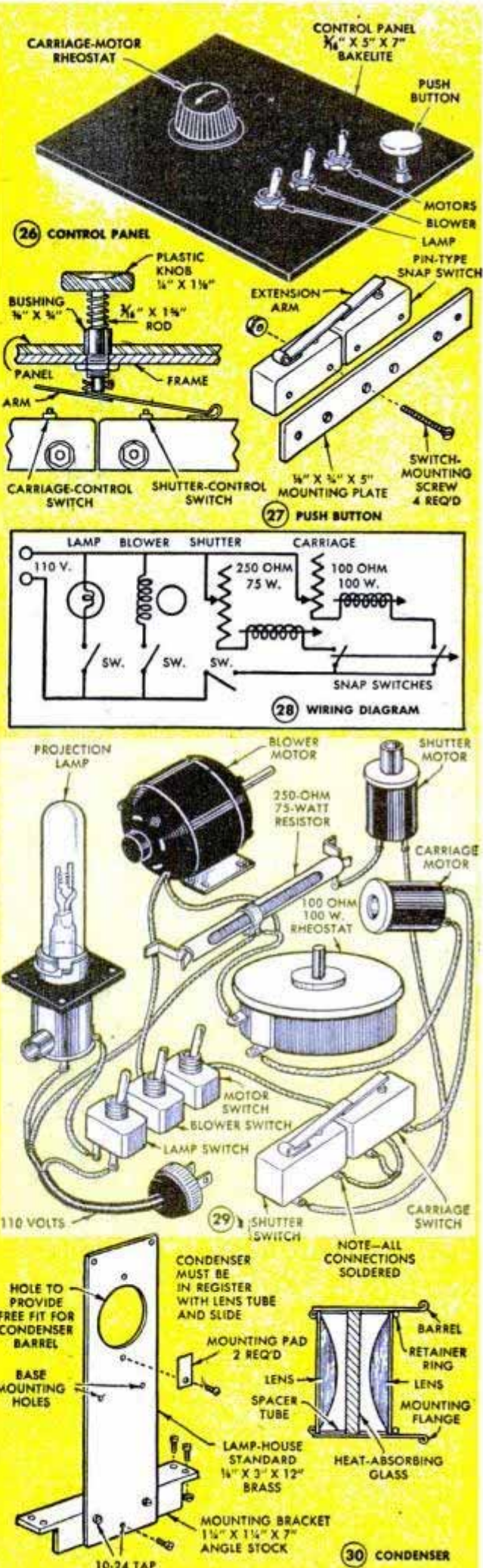



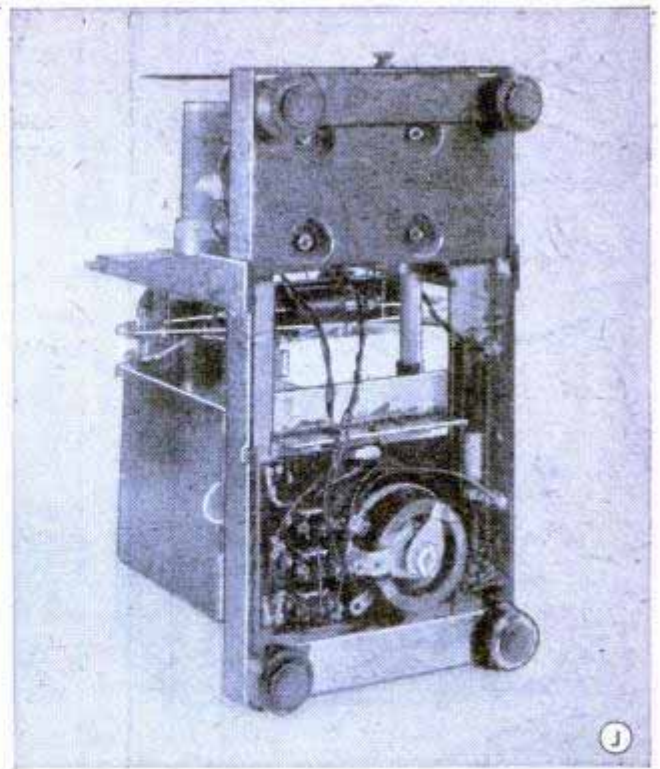
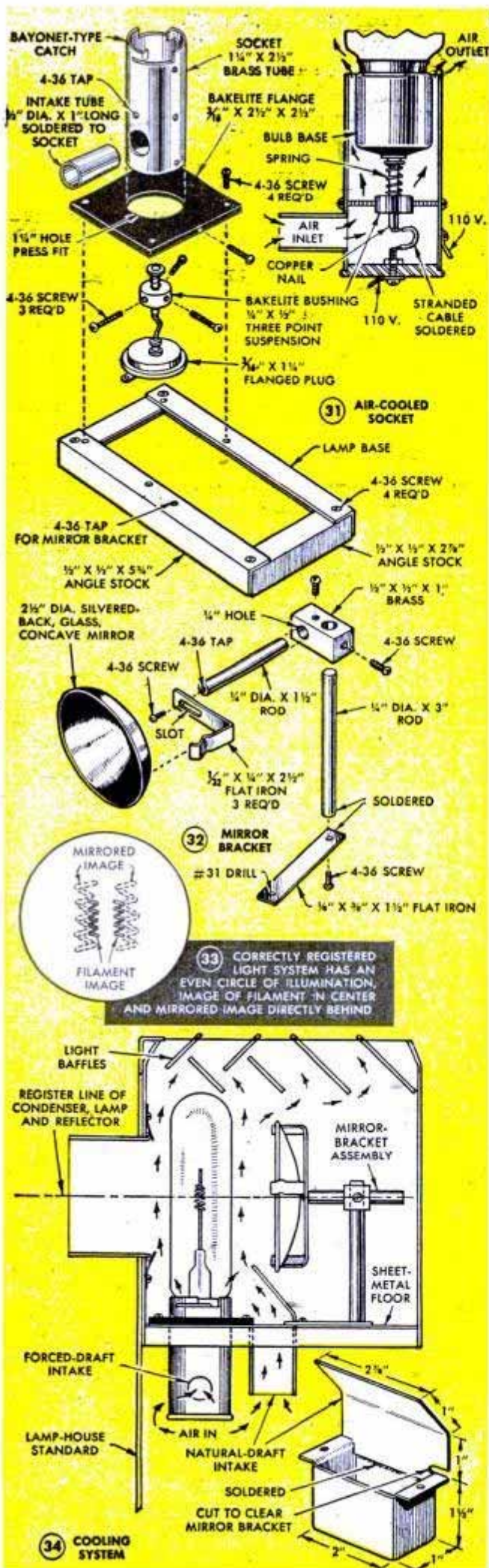

An air-cooled socket, Fig. 31, directs the blast of injected air directly against the tube itself. The lamp filament must be on a plane with the slide, and the base is so designed that the tube will fit in the socket in only one way. Although this is known as a prefocused bulb, you will have to do your own prefocusing in this case. The socket is designed so that it can be elevated, rotated or moved back and forth as well as sideways, until the filament is exactly in line. A good mirror is important, for it collects a large percentage of lost light and directs it into the condenser. The best are of optically ground glass flashed with vaporized aluminum. The mirror is mounted on a bracket as in Fig. 32.

When focusing the optical system, use an electric heater or toaster in series with the lamp as a resistor. Adjust the lamp until it appears correctly centered, remove the mirror, then move the standard back and forth until the light on the screen shows uniform coverage. Unscrew the focusing lens and you'll see that the condenser throws a magnified image of the lamp filament on the screen. Center the filament image. Replace the mirror and adjust until a reflected image looms directly behind the filament, Fig. 33. This simple procedure will line up the units. Replace the lens and move the mirror backward and forward and watch for dark or bright spots. There will be one critical point where the entire screen is lighted with a uniform brilliance.

The filament of a projection bulb is heated to a temperature of about 6000 deg. F. and getting rid of this heat requires a specially designed lamp house with a system of baffles and light traps. As you can't rely



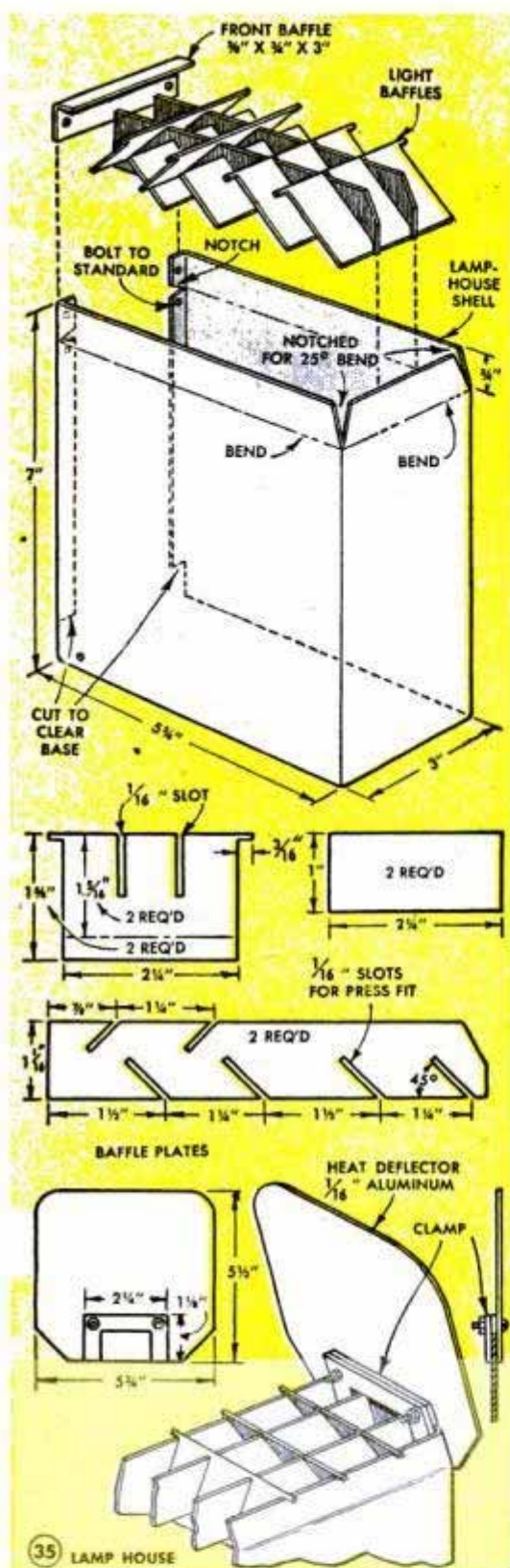

35 LAMP HOUSE

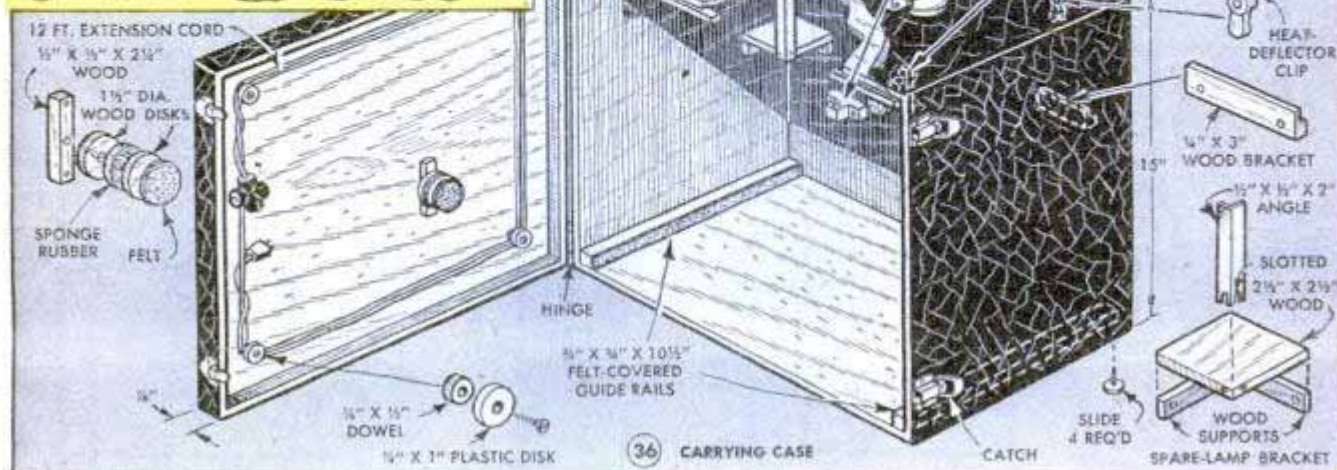

on natural draft for proper cooling, the pressure air line, Fig. 34, is coupled to the socket with a rubber hose. The lamp house itself is made of copper or aluminum as either of these metals dissipates heat more efficiently than steel. A deflector directs the heated air away from the operator. The shell, or housing, Fig. 35, is made in one piece with the front edges crimped so it can be bolted to the standard without light spill. As the housing must be removed to reach the condenser and mirror, which should be wiped periodically, the screws are located so they are easily accessible. The light baffle, Fig. 35, rests on lugs and is retained by the front baffle which bolts to the housing. Paint the inside of shell and baffle a flat black. The entire projector is given a coat of black crystal lacquer which air-dries with a crystal-figured surface. This projector is worth the little extra trouble it takes to get a real professional finish. The best way to do this is to lacquer each piece separately before assembling. In order to get a good lacquer job all surfaces must be clean, and there must be no dust about to get onto the brush or be raised by the air blast from the spray gun. Spraying lacquer is heavy-bodied and sets so quickly that it cannot be satisfactorily applied with a bristle brush, but the so-called "brush" lacquers work very well. When you use the type which dries with a crystal surface the brush marks do not show. However, once you have applied this material don't brush back over it as this will destroy the crystals which form quickly after application. Use a brush with fine bristles to get a uniform application.

The carrying case, Fig. 36, serves a dual purpose. It houses the projector and acts as a pedestal to raise it to operating position. Made of 1/4-in. plywood, it is covered with sample-case leatherette using sodium silicate, or water glass, as an adhesive. To make the unit self-contained, provide facilities for carrying an extension cord, spare lamp and screwdriver. The heat deflector must be demounted when the projector is placed in the case.

THE END





## FLOODLAMP PLUS TIN CANS EQUALS SPOTLIGHT

Often a spotlight is used to increase the snap and brilliance of portraits, provide back lighting, illuminate table-top scenes and serve a variety of other purposes. Here's one way to convert a floodlamp and reflector so it can be used as a focusing spotlight without marring it for its regular uses. Only a few simple materials are needed: three tin cans, some paper clips and a positive lens. As for the tools required, a pair of tin snips and a soldering iron are about all that you will need to complete the job.

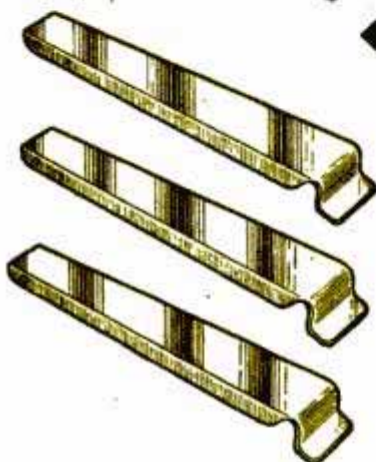

Three tin arms are required to fasten the central tube to the reflector. The arms are tapered and the edges are bent to form a channel. A clip is formed at one end to slip over the reflector and holes for hinge pins are punched in the other. The tube consists of two tin cans with the ends removed. They are soldered together and ventilating louvers are cut where the tube fits over the lamp. Hinge pins on which the arms pivot are made by bending wire paper clips as indicated and then soldering them on the can

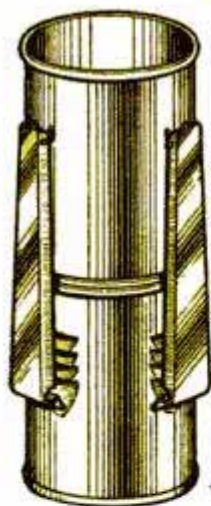
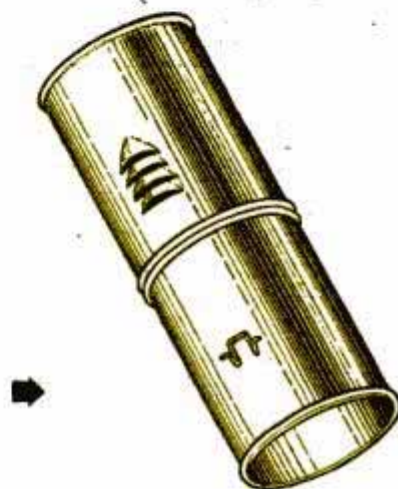

Here is the assembled tube ready to slip over the lamp and clip onto the reflector. When in place, the arms should extend at about a 45-degree angle. The lens mount at the right is a smaller tin can having a diameter somewhat larger than that of the lens used. Three metal strips are bent to form lens-holding clips and are soldered to the sides of the can. Two wings are fastened to the sides of the mount and serve to hold it in place in the central tube. The mount slides back and forth so the light can be focused

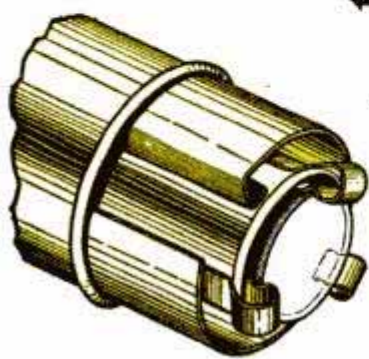
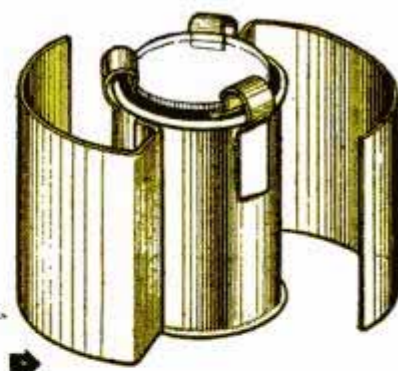

Here the manner in which the mount fits into the tube is illustrated. Right: the completed spotlight clamped to a floodlamp reflector is ready for use. Although a spotlight effect is obtained with the use of the tube alone, the intensity of the light is greatly increased by a positive lens. If you have several lenses, it might be well to try them all to determine which one gives the best results. The insides of the mount and tube are finished with aluminum paint and the outsides have a dull finish to minimize light reflections

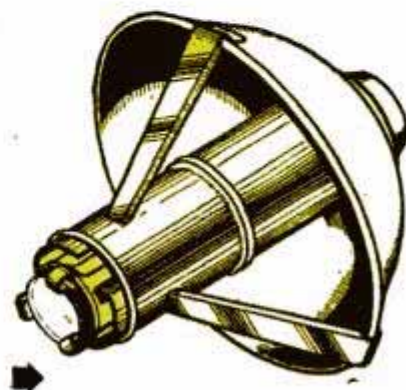



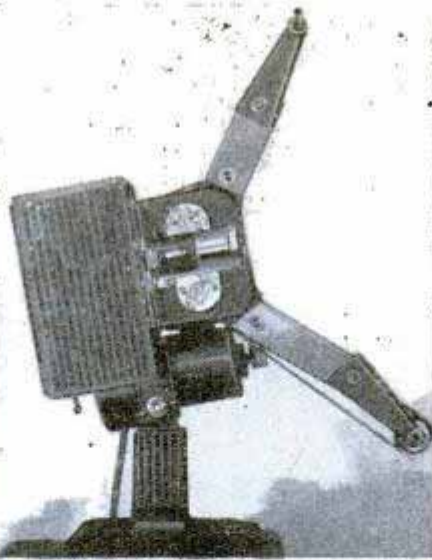

## Extension Arms For Projector

At a moderate cost you can bring your projector up to date by fitting it with extension arms that take larger size reels. Dimensions shown in the lower detail will not apply to all projectors and it may be necessary to alter them. Locate the extension pieces so the film will be in alignment. It will be necessary to install new spring winding belts and these should be checked carefully for tension.—Robert E. Merriman, Battle Creek, Mich.

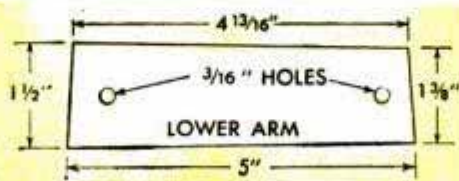
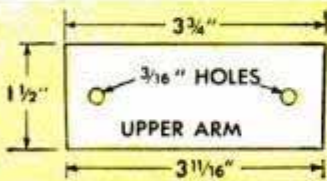

## Frayed Slide Mounts Repaired

Cardboard mountings used for 35-mm. and 2 by 2-in. color transparencies often become frayed after being used in a projector or viewer. This trouble may be prevented if the edges are coated with colorless fingernail polish before the slide is used. Another way to protect the edges is to cover them with cellulose tape.

## Tilting Head on Camera Tripod

In order to point a camera up or down when you have no tilting head, it is necessary only to swing one leg of the tripod inward between the other two. This results in a support about as stable as that when the tripod is in the normal position. Don't shorten a leg as this will cause unbalance.

Fred G. Korth, Chicago.

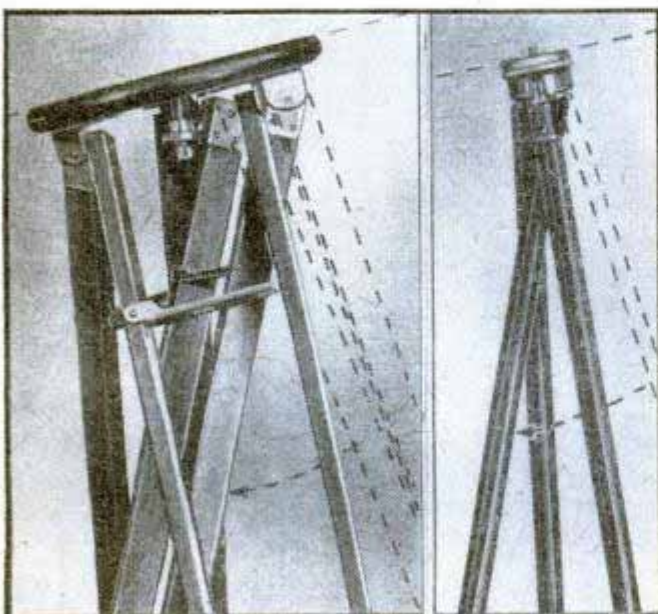

## Easily Made Floodlight Deflector Provides Better Diffusion

With this deflector you will obtain better diffusion when using floodlights. It is a disk of light metal, approximately 3 1/2 in. in diameter, with two arms that extend out and clip over the rim of the reflector. The arms are channel shaped

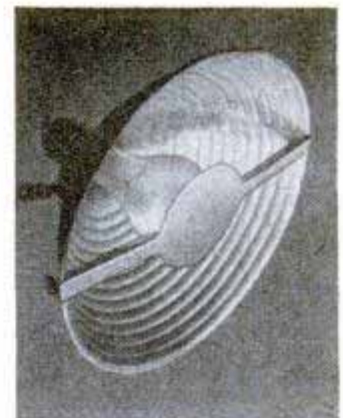

and the ends are rounded. Use an exposure meter to check the over-all diffusion. It may be necessary to alter the size of the disk.

Robert Scott, Saltsburg, Pa.

## Focusing Aid When Enlarging

To save the time required to slip a special negative into the enlarger every time it is necessary to refocus, use this aid. Make a cardboard mount to slip over the lens and paste another strip of cardboard about 1/2 in. wide across the center of the mount. When the outline of the strip is projected sharply on the easel, the negative will be in focus.



H. Klein, Pittsburgh, Pa.



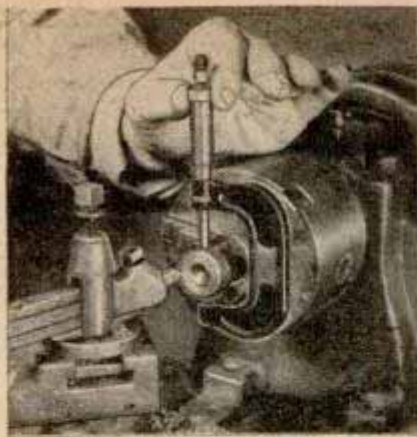

# Craft QUIZ

1. This instrument is a—  
 (A) Ring gauge (C) Micrometer  
 (B) C-clamp (D) Vernier caliper

2. Scoring represents—  
 (A) Furring (C) Planking  
 (B) Battens (D) Breaching

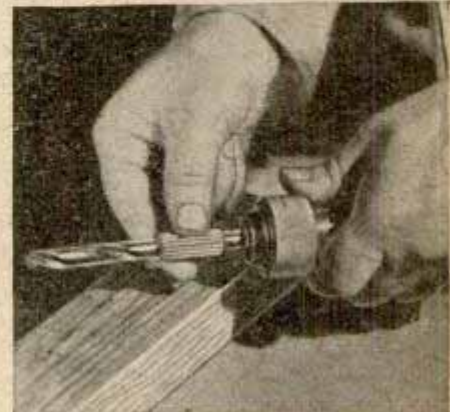

3. Rubber tubing serves as—  
 (A) Chip remover (C) Shock absorber  
 (B) Depth Stop (D) Finger grip



4. Woodworkers call this a—  
 (A) Trimming board (C) Shoulder stop  
 (B) Hold down (D) Bench hook

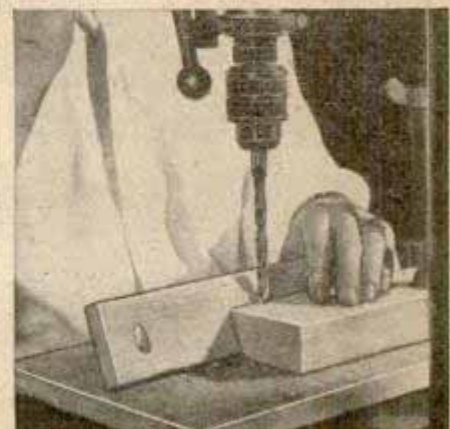

5. With this setup you can cut—  
 (A) Screw pockets (C) Fillets  
 (B) Rosettes (D) Gains

ANSWERS: 1—C; 2—C; 3—B; 4—D; 5—A  
 WHAT'S WRONG: 1—Saw blade is too high (should just clear thickness of work); 2—Stop rod is in line of cut; 3—Table insert is missing; 4—Blade is mounted backwards; 5—Dangling necktie (dangerous practice); 6—Guard is not in place on revolving jointer head; 7—Hands holding work in wrong position; 8—Wrench on saw table; 9—Rear hold-down not clamping work



## Ventilator Formed From Plastic Admits Light and Air

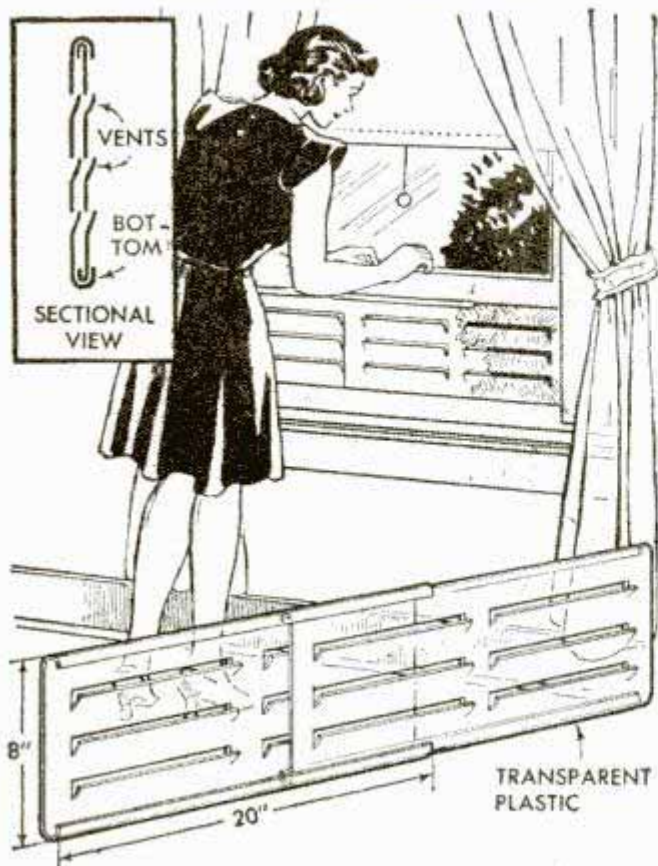

Novel because it is made of transparent plastic that will admit light, this ventilator can be made to fit almost any window. One half is formed to slide inside the other with the tops and bottoms curved as shown in the detail. The louvers are bent in to provide protection from rain and snow, and this also serves to direct drafts upward.

E. B. Wiggins, Tampa, Fla.

## Metal Guard for Burner Handles

Since children have a curiosity that may get them into trouble, a metal guard over the burner handles of a gas stove will elim-

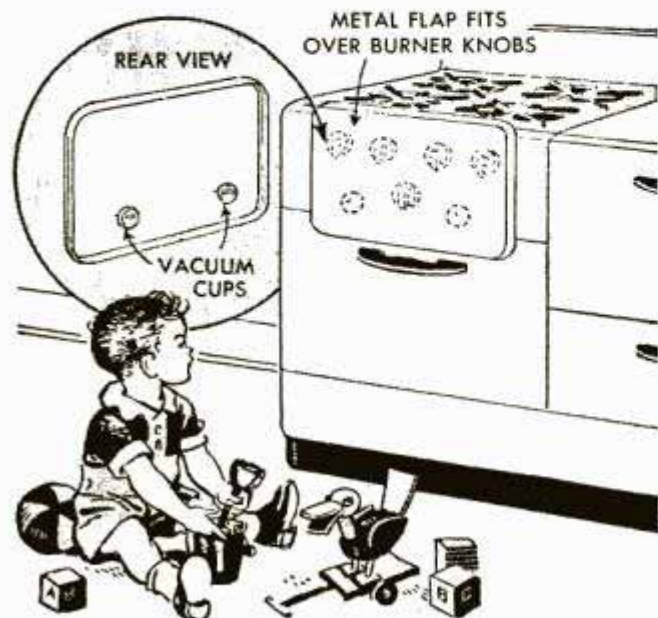

inate the possibility of an accident. This is merely a piece of sheet metal to which two vacuum cups are attached near the bottom edge. The shield is held in place by pressing the cups against the smooth surface of the stove. When the stove is to be used, it's an easy matter to remove the shields.

## Tool Head Is Secured to Handle With Wire Mesh

The head on a hammer or other tool may be fastened securely if the end of the handle that fits into the head is wrapped with wire mesh. Ordinary fly screen will serve to make a tight union.

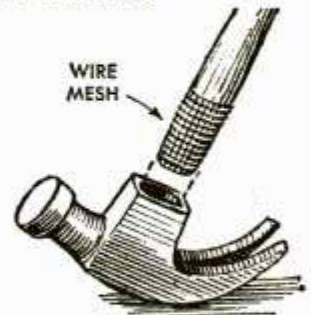

When the handle is driven in place the mesh bites into the wood and has firm contact with the metal of the hammer head.

## Tip on Installing Brake Cylinder

When installing the master cylinder on a hydraulic-brake system after rebuilding it, frequently it is found that air is admitted to the lines, resulting in "spongy" brake action or no braking power at all. To correct this, I use the following method of installing the cylinder: After it has been honed and the new piston and cups are in place, I fill the reservoir to the correct level. Then, with the cylinder clamped in a vise, I pump the plunger arm until a steady stream of liquid is discharged. Following this, the cylinder is installed, the connection to the line being left somewhat loose. The brake is pumped until fluid comes out of the connection, which then is tightened with the pedal held down. Finally the unit is filled to the proper level. The brake can be worked from beneath the hood or under the car while watching the connection.

Robert Brunt, Rocky River, Ohio.

## Removing a Fresh Paint Spot

Next time you have occasion to remove a spot of fresh paint from furniture while doing a painting job, try rubbing it with a soft cloth that has been dipped in lemon oil. One craftsman found that the oil leaves the surface of the furniture glossy and is easy on the finish.



Frank Shore, New York.



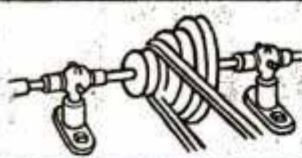

# Shop Notes



## MECHANICAL "Hired Man"

Designed and built by Herschel Huss of Indiana, this electrically driven farm elevator handles both grain and baled hay

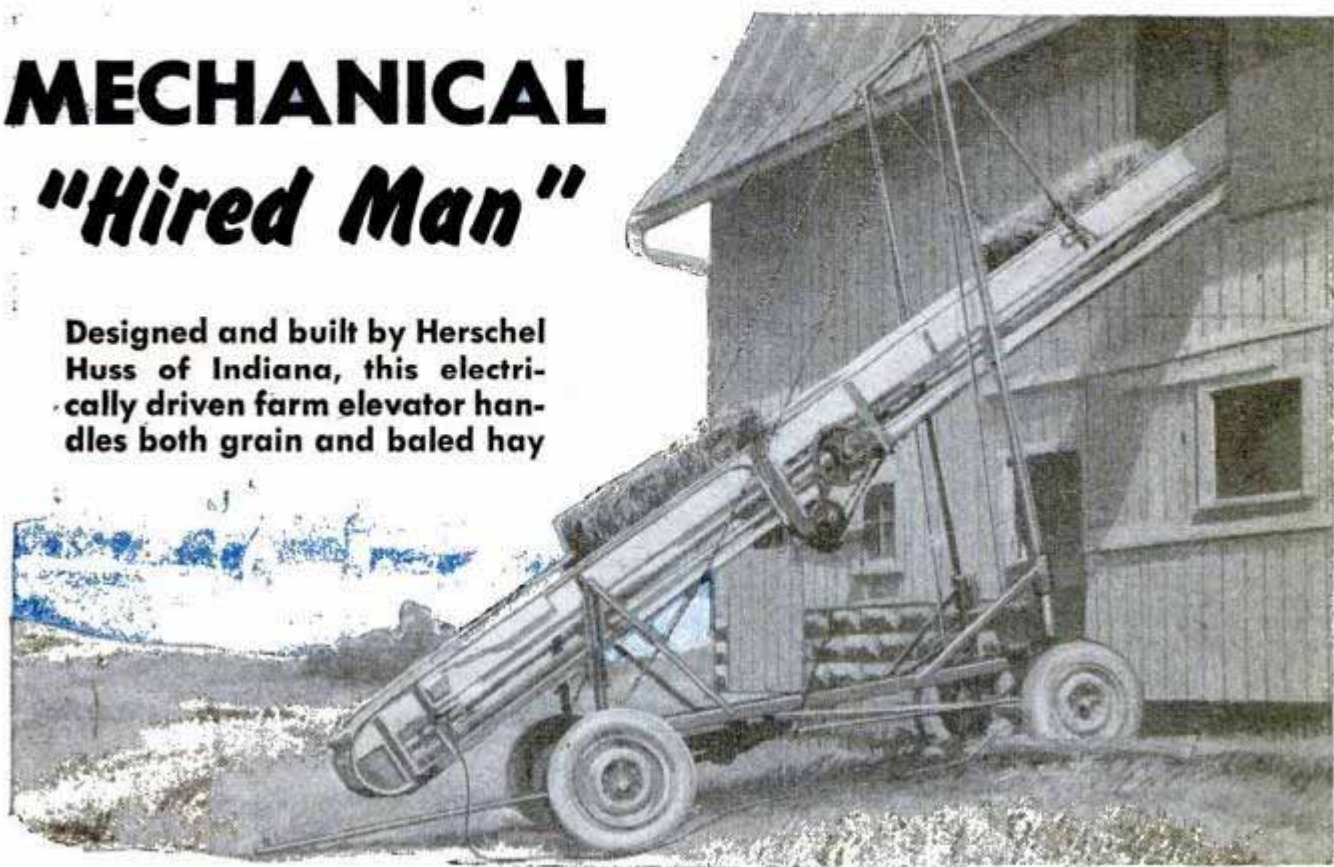

By A. E. Holden

**T**OSSING bales of hay around or scooping grain from truck to bin is a dusty, tiring job, as every farmer knows. And always, during the harvest season, every minute counts. That's why elevators like the one pictured are so popular as farm helpers. This one is especially handy because it's a self-contained unit mounted on a rubber-tired trailer truck and fitted with a raising mechanism and a built-in motor drive. All that's necessary is to back it up to the barn or granary, raise the conveyor leg to the proper height to deliver the hay or grain where you want it, plug the motor into the power source and you're ready for work, all in a matter of minutes.

The builder of this particular unit used the angles from old windmill towers for the conveyor frame, the trailer or truck was made up by working over a Ford Model-T chassis, and for the balance of the construction he used salvage from the farm scrap pile and purchased, new, such parts as sprockets, shafts and pulleys. With this method of building, the unit can be put together for only a few dollars cash exclusive of the motor or engine. Wherever practical, the parts are arc-welded for greater strength and rigidity.

Fig. 3 details the whole thing. Construction

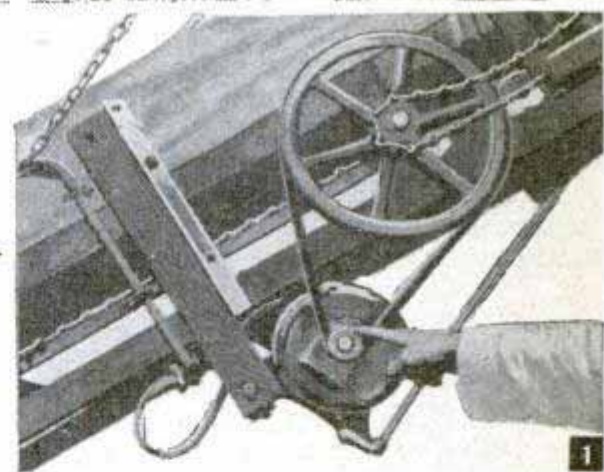

Above, motor mount is adjustable for proper belt tension. Below, raising cables wind on steel drums

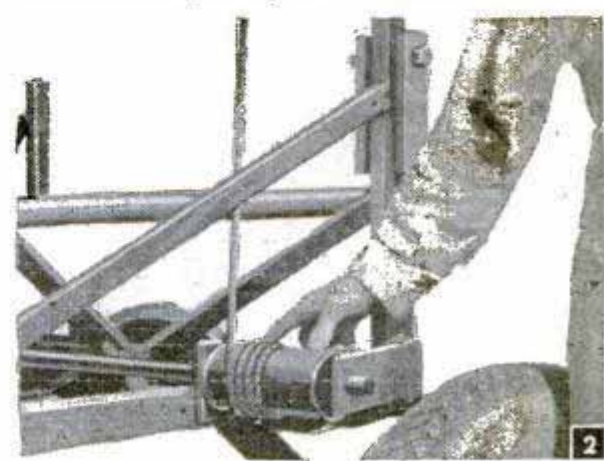



can start with either the truck or the conveyor leg, which in this case is 22 ft. long. Any changes in the length will require that the truck chassis be lengthened correspondingly, and that the driving motor be larger to handle the extra load. Notice in the front view, Fig. 3, that the forward end of the conveyor is adjustable for height. Although ordinary pillow-block bearings are shown carrying the sprocket shafts at both ends of the conveyor you can purchase standard elevator parts which consist of bearing fixtures with sliding adjustments for tightening the chain to the proper tension. You can readily see how the conveyor lift operates from study of the details in Fig. 3. The raising mechanism, or winch, is a stock item but the worm gear can usually be obtained from the scrap pile. Winding drums are made up by welding ends into sections of 3-in. pipe and then welding the drums onto a suitable shaft, Fig. 2. Other parts of the raising mechanism can be almost anything you have at hand that will serve the purpose.

The construction of the conveyor calls for a little more care. It should be of exact width throughout the length, otherwise the chain may bind. Also, the angle-iron conveyor lifts or drags should be cut to exact length for the same reason. Drags are 3 ft. apart, a distance convenient for handling baled hay but a little slow for ear corn and, of course, not suitable for small grain, except possibly an occasional job. More drags can be added to give a spacing of 1 ft. or so if you handle grain principally. Even with the narrow spacing of the drags, the elevator will handle hay bales quite well. Although not detailed, many farmers fit this type of elevator with a small sheet-metal hopper with flared sides. The hopper makes it easier to handle fine material or small grains. As shown in Fig. 1 and a detail in Fig. 3, the motor is mounted on a pivot arrangement provided with a screw for adjusting tension of the V-belt. Although a 1/2-hp. motor is specified, a 3/4 or 1-hp. motor will drive the elevator at maximum capacity. The motor should be of the repulsion-induction type to handle a heavy starting load.

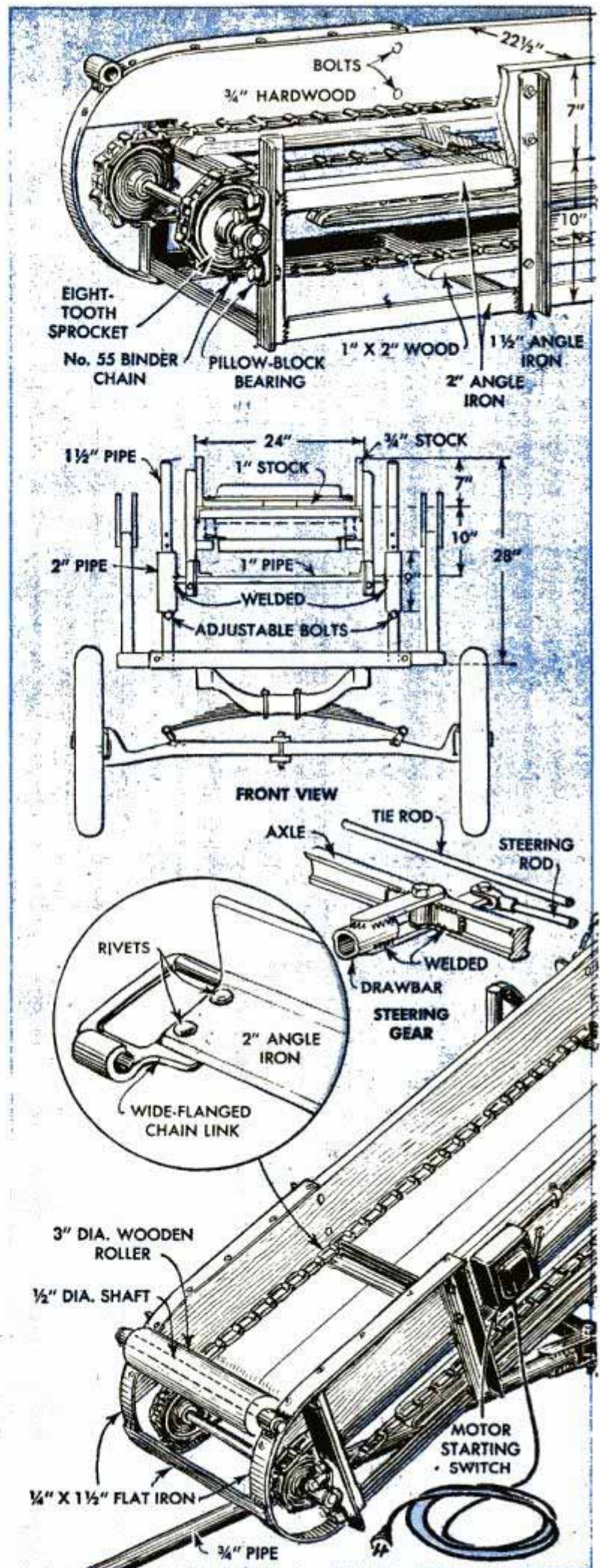



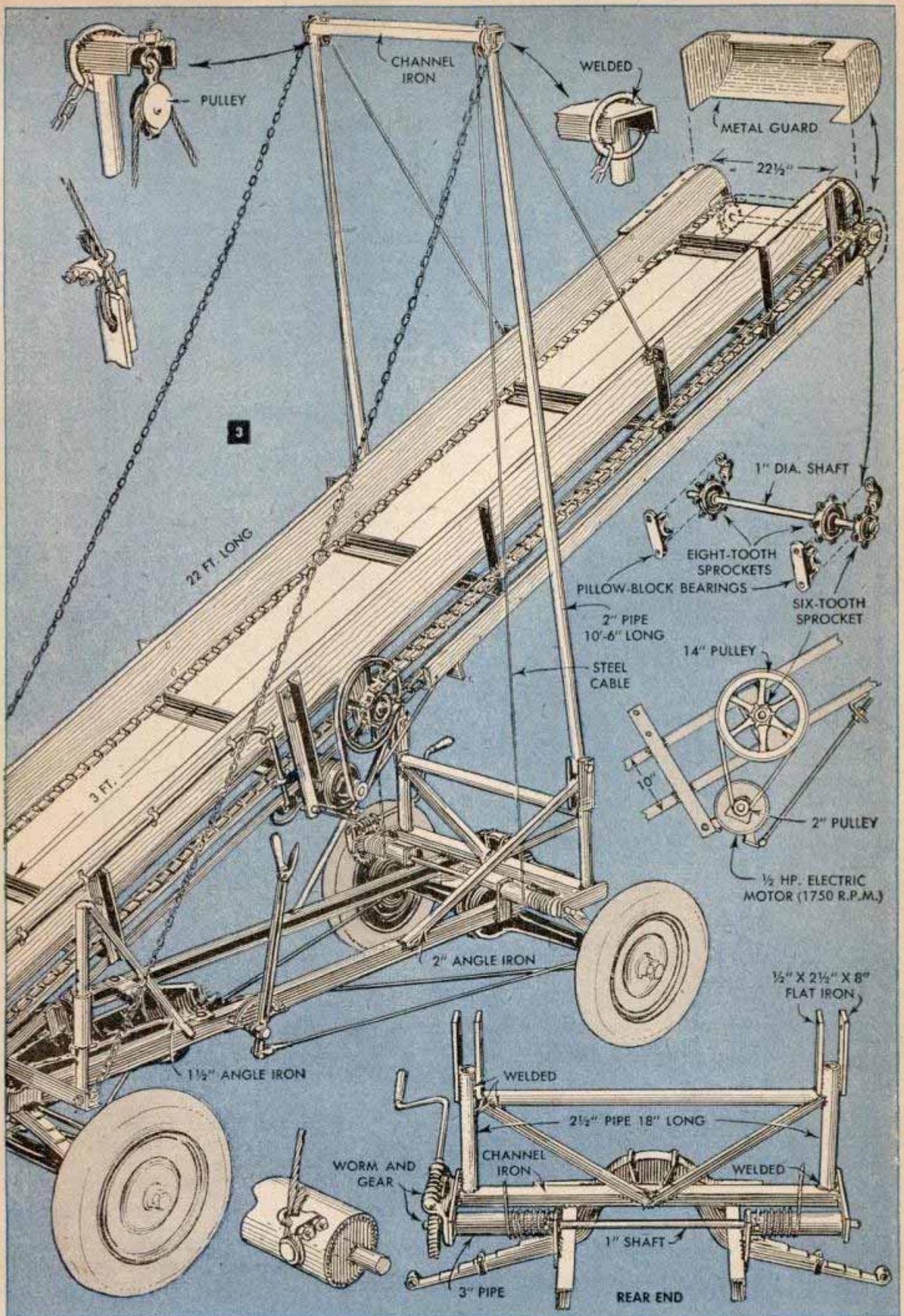



## Wood Guard for Double-Bit Ax Protects Cutting Edges



If two pieces of wood are grooved to fit over the blades of a double-bit ax and held in place with a rubber band cut from an inner tube, the cutting edges will be protected when the ax is not in use. The guard is put on easily and when removed is compact enough to fit into the pocket. The same idea may be applied to an ax with a single bit except that it may be necessary to cut out a section of the inner tube and patch it to make a rubber band of the proper length.

George T. Hewett, Salem, Ore.

## Light Reaches Hard-to-See Area

Often it is difficult to illuminate the interior of small gear boxes and housings with an ordinary flashlight. This difficulty may be eliminated by adding a plastic rod to direct the light beam. The lens and its ferrule are replaced by the end cap taken from another light of the same size. First, the cap is modified by inserting a piece of

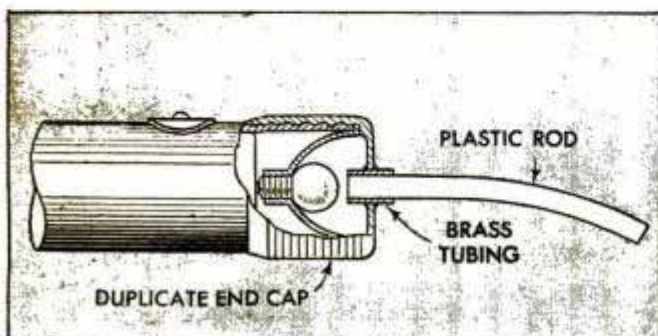

plastic rod of the kind used by dentists to direct light into a patient's mouth. The rod is bent to the desired shape and held in place with brass tubing that is soldered to the cap.—B. L. DeMare, Aberdeen Proving Grounds, Md.

## 'Flat' on Outside Wheel Repaired

When you have a puncture in the outside tire of a dual-wheel truck, you can change it without using a jack. Simply run the inner wheel onto a large wooden block to get the required lift. The block should be tapered at one end to avoid bruising the tire when you drive onto it. Once the brake is set, you won't have to worry about the truck rolling off the jack.

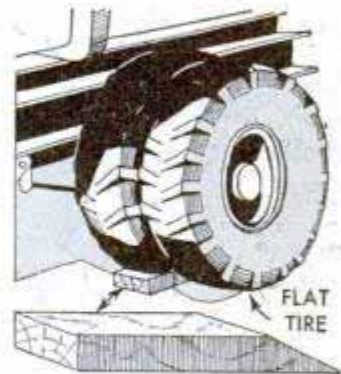

## Pull-Out Mailbox Unit Is Tagged To Aid Distribution of Mail

SOLDERED OR BOLTED TO MAIL COMPARTMENT



To aid in the distribution of mail, one apartment manager whose building was equipped with boxes of the pull-out type had metal pieces soldered to the top of each box to hold cards. The name of each tenant was lettered on the proper card. Then, after the box was opened, the postman could read the names and distribute the mail without having to stoop and get the names from the front of the box.



# Boring-Bar Holder Made in Two Operations

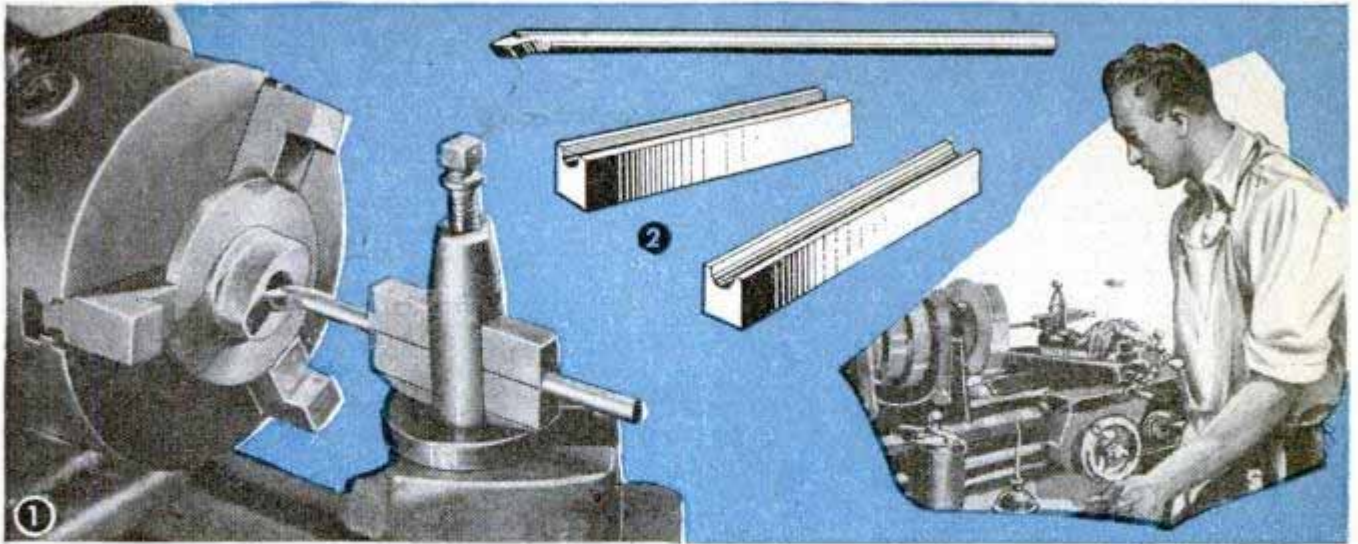

Just two drilling operations are required to make this holder: one, the pilot hole; the other, drilling to the finish diameter. The holder you see in Fig. 1 was made from two short lengths of  $\frac{3}{8}$  by  $\frac{1}{2}$ -in. cold-rolled steel. Of course this size can be varied as required to suit the boring bar being used. The two pieces are clamped together as in Fig. 3, making sure that the edges are exactly flush, and are held for drilling in the drill-press vise. Drill the pilot hole first, centering on the joining line, then follow with a drill bit of the same diameter as the boring bar. What you get is shown in Fig. 2. Draw-file the edges of the two pieces slightly so that they do not touch when clamped over the boring-bar shank as in Fig. 1. This finishes the holder ready for use.

Gary Moore, East Aurora, N. Y.

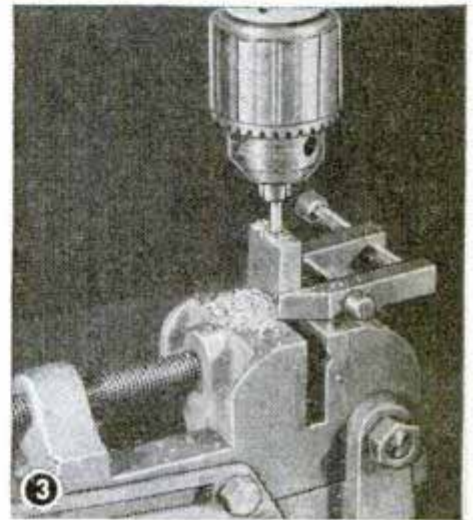

## Reflectors on Truck Doors Warn Approaching Motorists

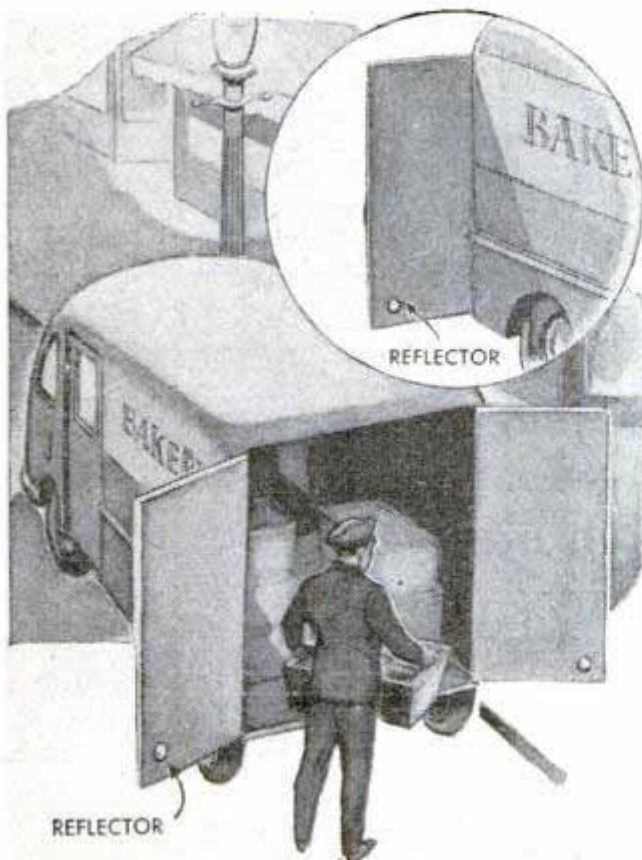

One firm that had a fleet of trucks with doors that swung outward mounted reflectors on both sides of each door for night deliveries. Thus, when the doors were opened, as well as when they were closed, approaching motorists' headlights would be reflected to furnish warning.

## Saving Sidewalls on Truck Tires

A tire guard cut from a piece of sheet metal will serve to protect the sidewalls of truck tires from being scuffed when rubbing against curbstones or other obstructions. The guards are made in the shape shown and are attached to the regular mounting lugs. Heavy sheet metal is used and the parts are welded.—G. H. Danzberger, West Chester, Pa.

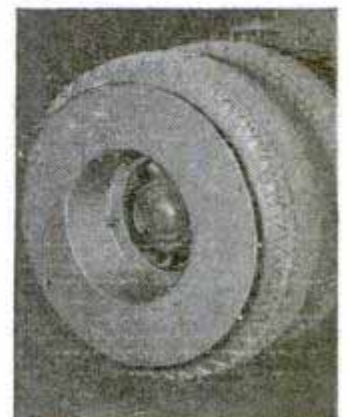



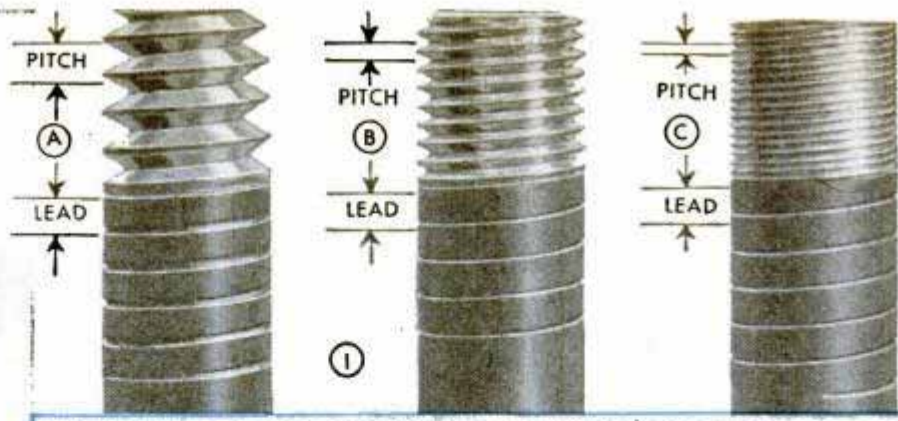

1 START (SINGLE THREAD) 2 STARTS (DOUBLE THREAD) 4 STARTS (QUAD THREAD)

# MULTIPLE

By Sam Brown

WHEN you want fast travel with a fine thread, you use a multiple thread, breaking the original lead distance into two, three or more threads as desired. The cap of a fountain pen is a good example—you want the cap to screw on quickly and a coarse thread is not satisfactory. Focusing devices on cameras and binoculars offer another everyday example of the use of multiple threads.

**General terms:** Fig. 1 illustrates the two terms used to describe any thread—lead and pitch. Lead is the distance the thread advances in one revolution; pitch is the distance between threads. In a single thread, detail A, Fig. 1, lead and pitch are the same. The second detail, B, shows the original lead broken into two threads so that the pitch is one half the lead. Detail C shows a quad or 4-start thread, where the pitch is one fourth of the lead. In all multiple



*Spacing with Dog on Faceplate*

DOG PLACED IN OPPOSITE SLOT

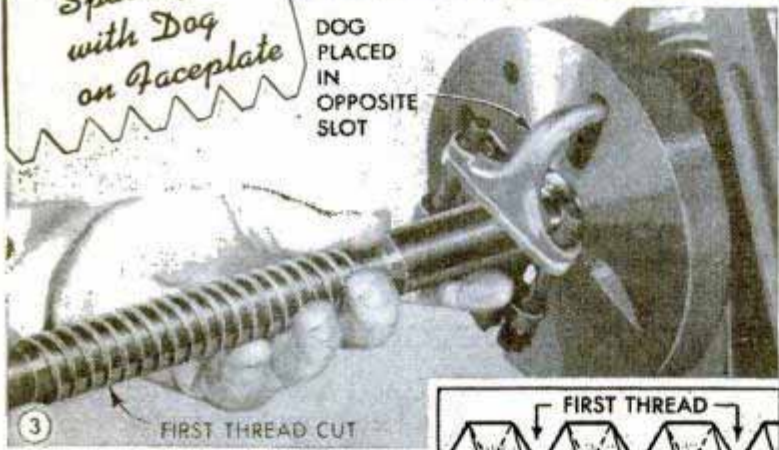

FIRST THREAD CUT

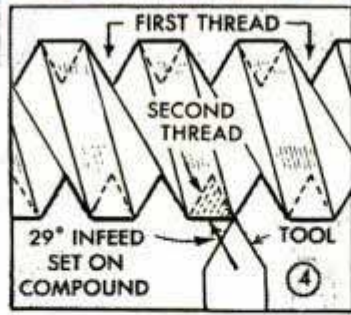

SPACING MULTIPLE THREADS BY PLACING DOG IN VARIOUS SLOTS IS USEFUL METHOD OF WORKING. PHOTOS SHOW DOUBLE THREAD. THREE STOPS ARE USED FOR TRIPLE THREAD

TABLE 1

USEFUL RANGE OF MULTIPLE THREADS

NUMBER OF STARTS	LEAD (NUMBER OF TURNS PER INCH OF SINGLE THREAD)																						
	1½	2	2½	3	3½	4	4½	5	5½	6	6½	7	8	9	10	11	11½	12	13	14	16	18	20
2 STARTS	3	4	5	6	7	8	9	10	11	12	13	14	16	18	20	22	23	24	26	28	32	36	40
3 STARTS	4½	6	7½	9	10½	12	13½	15	16½	18	19½	21	24	27	30	33	34½	36	39				
4 STARTS	6	8	10	12	14	16	18	20	22	24	26	28	32	36	40								
5 STARTS	7½	10	12½	15	17½	20	22½	25	27½	30	32½	35	40										
6 STARTS	9	12	15	18	21	24	27	30	33	36	39												
8 STARTS	12	16	20	24	28	32	36	40															
10 STARTS	15	20	25	30	35	40																	
12 STARTS	18	24	30	36																			

FIGURES IN BODY OF TABLE GIVE PITCH OF THREAD (NUMBER OF THREADS PER INCH)

NOTES

1. FIGURES IN SHADED BOXES CAN BE CUT WITH USE OF THREAD DIAL
2. FAST LEADS FROM 1½ TO 3½ ARE NOT USUALLY SHOWN ON GEAR CHARTS BUT CAN BE SET UP WITH REGULAR GEARS



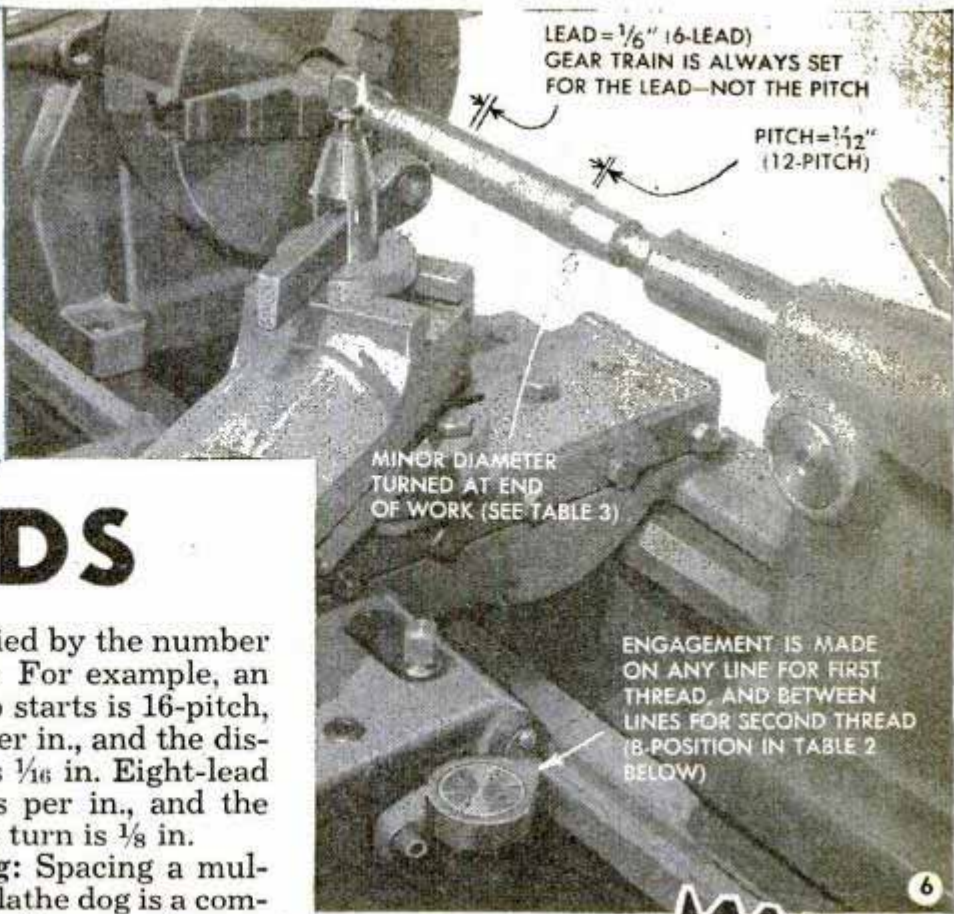
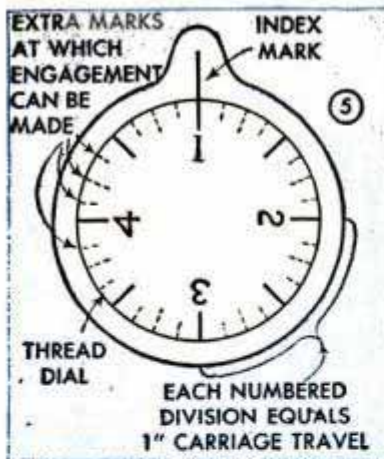

# THREADS

threads, the lead multiplied by the number of starts gives the pitch. For example, an 8-lead thread having two starts is 16-pitch, or there are 16 threads per in., and the distance between threads is  $\frac{1}{16}$  in. Eight-lead means there are 8 turns per in., and the distance advanced in one turn is  $\frac{1}{8}$  in.

**Spacing with lathe dog:** Spacing a multiple thread by using the lathe dog is a common method of working. Suppose, for example, you want to cut a double thread of 8-lead and 16-pitch. Set up the gear box or gear train for the lead. Always gear for the

PHOTO SHOWS HOW THE THREAD DIAL IS USED TO CUT A DOUBLE THREAD OF 6-LEAD, 12-PITCH

*Using the Thread Dial*

TABLE 2

THREAD DIAL SETTING FOR MULTIPLE THREADS

STARTS	LEAD																				
	4	12	20	2	6	10	14	18	3	5	7	9	11	13	1½	2½	3½	4½	5½	6½	11½
2 STARTS	8 (A)	24 (A)	40 (A)	4 (B)	12 (B)	20 (B)	28 (B)	36 (B)	6 (C)	10 (C)	14 (C)	18 (C)	22 (C)	26 (C)	3 (D)	5 (D)	7 (D)	9 (D)	11 (D)	13 (D)	23 (D)
4 STARTS	—	—	—	8 (B)	24 (B)	40 (B)	56 (B)	72 (B)	12 (C)	20 (C)	28 (C)	36 (C)	44 (C)	52 (C)	6 (D)	10 (D)	14 (D)	18 (D)	22 (D)	26 (D)	46 (D)
8 STARTS	—	—	—	—	—	—	—	—	24 (C)	40 (C)	56 (C)	72 (C)	88 (C)	104 (C)	12 (D)	20 (D)	28 (D)	36 (D)	44 (D)	52 (D)	92 (D)

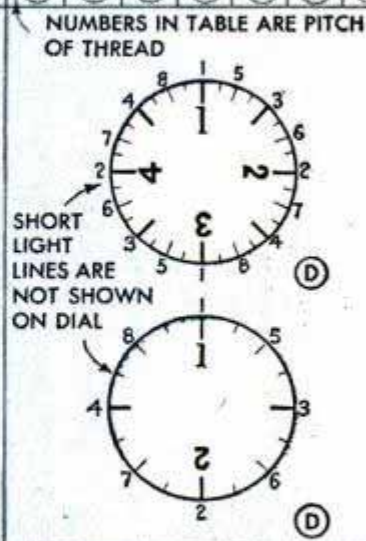
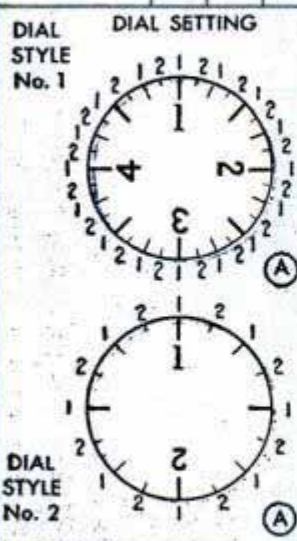

FOR DOUBLE THREAD, ENGAGE AT ANY POINT MARKED 1 (ON OUTSIDE RIM OF DRAWING) FOR FIRST THREAD AND AT ANY POINT MARKED 2 FOR SECOND THREAD. IF A QUAD THREAD IS DESIRED, ENGAGE AT 1-2-3-4 FOR THE RESPECTIVE THREADS. FOR 8 STARTS, ENGAGE AT 1-2-3-4-5-6-7-8 AS MARKED.



# Step-by-Step Example of Threading

QUADRUPLE THREAD  
4½-LEAD  
18-PITCH  
THREAD DIAL-D-POSITION

1.181" MINOR  
+ .020"  
1.201"

BORE  
1.201"

1.181"

MAJOR DIA.  
1¼"

1¼" = 1.265"  
DD = .084 (FROM TABLE 3)  
1.181 IS MINOR DIA.

7

MAKE A ROUGH DRAWING LIKE THIS BEFORE YOU START

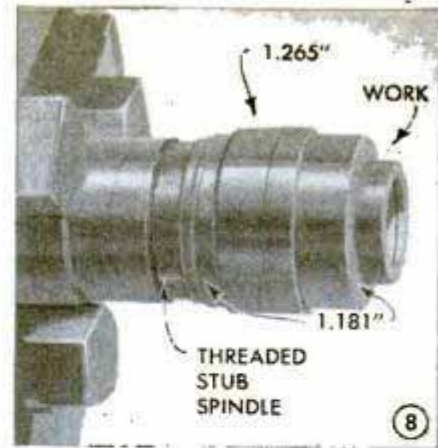

8

First the work is mounted on a threaded stub spindle. Then major and minor diameters are turned

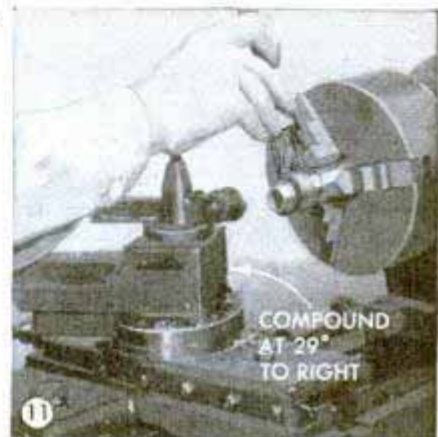

Set the gear train for 4½-lead and make the first cut using the thread dial, as is indicated by D in Table 2

Engaging the dial as outlined produces four starts which are finally deepened to finish the threads

Note that the compound is in the 29-deg. position, swung to the right. Always use plenty of cutting oil

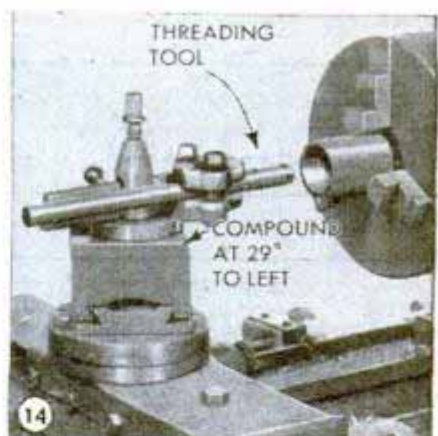
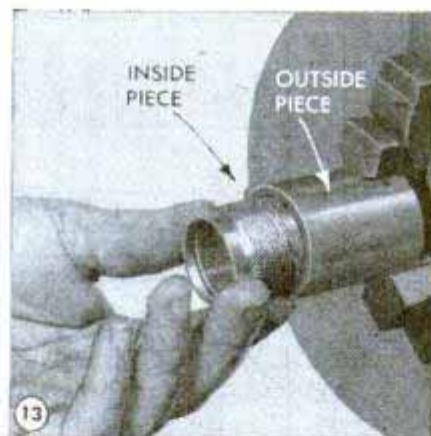
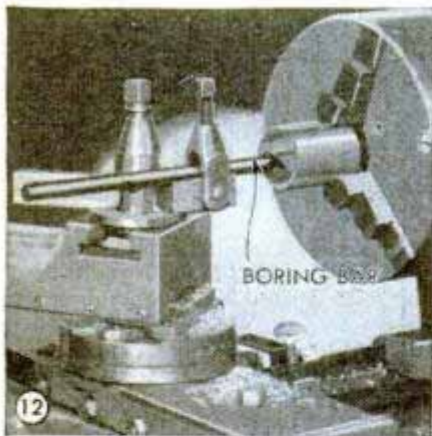

The outside piece is started by boring the hole to the required minor diameter, plus the proper clearance

The clearance allows minor diameter turned on the inside piece to fit loosely inside the bored hole

Cut internal thread same as external except compound is swung to left. Check frequently for size

lead you want, not the pitch. Proceed as for any single thread, but cut only to the depth of a 16-pitch thread. Table 3 shows this to be .047 in. or, if you use regular 29-deg. angle feed on the compound, the compound infeed is .054 in. Fig. 2 shows the first thread being cut. After cutting the first thread to full depth, back up the tailstock and fit the tail of the dog in a slot opposite to the one used for the first thread, Fig. 3. Back the compound to the original starting position

and cut the second thread just the same as the first. If you are using 29-deg. compound feed, the second thread will start along by the first thread, as shown in Fig. 4, and successive cuts will complete the thread. With the four slots of the faceplate you can cut a quad thread. If a triple or 3-start thread is desired, tap three equally spaced holes in the faceplate for studs and use a straight-tail dog.

Using thread dial: Most small lathes are



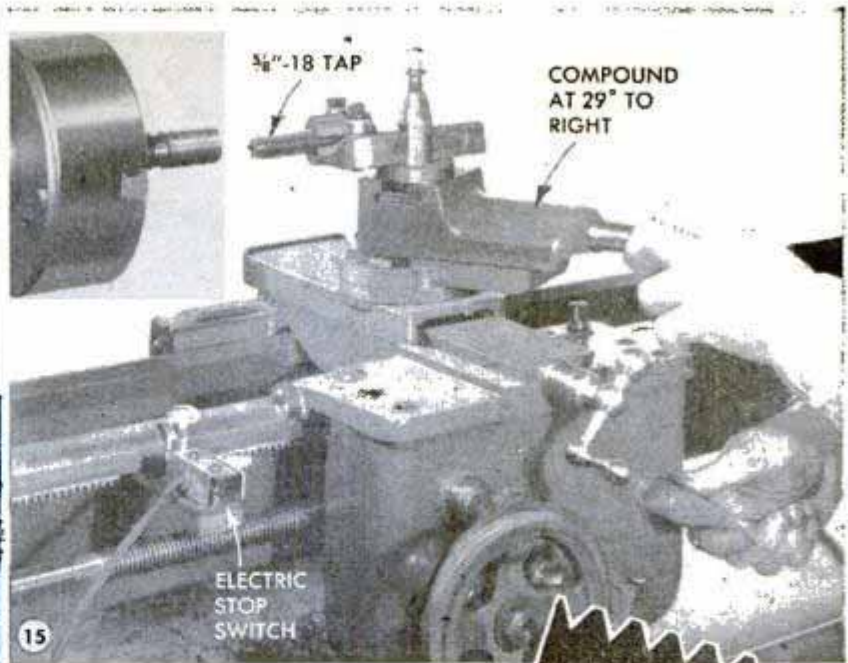
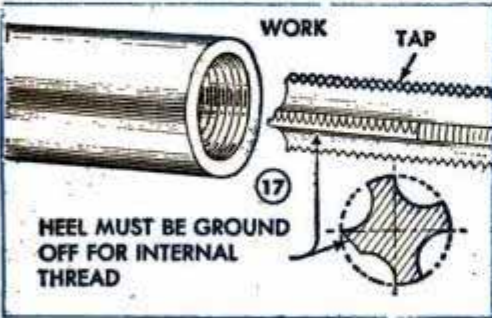
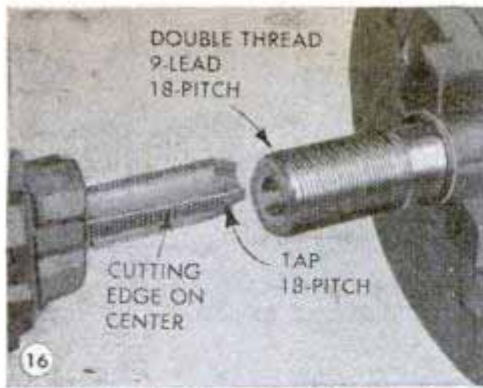

*How to Use Taps*

IF LATHE IS GEARED FOR 1/2 THE PITCH OF A TAP THE TAP WILL CUT A DOUBLE THREAD

fitted with a thread dial, and this can be employed for a wide range of multiple threads. Table 1 shows the complete useful range of multiple threads, with pitches that can be cut using a thread dial indicated by shaded boxes. A typical dial is shown in Fig. 5. In addition to the engagement points marked, you can also engage at the points indicated by the dotted lines. Table 2 shows threads that can be cut and dial settings for cutting them. Two different standard types of dials are shown. The table is based on an 8-pitch lead screw, standard on most small lathes.

As an example of threading, consider Fig. 6. This shows a double thread of 6-lead, 12-pitch being cut. Refer to Table 2 and you will note this requires engagement similar to the B position. Gear for 6-lead and cut the first thread by engaging the dial at any point marked 1 on the outside rim of the drawing. Without changing the compound infeed, engage at any point marked 2. That's your double thread. Make successive cuts at each compound setting until the double thread is complete. With this method, no attention need be given the minor diameter since you simply go on turning until the crest of thread is sharp. However, as a matter of convenience, it is always good practice to turn the minor diameter. This can be determined by noting the double depth of thread in Table 3 and subtracting this figure from the full diameter of the work.

**How thread dial works:** It's a good idea to understand just why the thread dial splits the thread. On any such dial, numbered divisions indicate 1 in. of carriage travel. One half of a numbered division is 1/2 in. of carriage travel, etc. Fig. 5 shows that the dial can be subdivided to 1/8 in. of

TABLE 3 DEPTH OF THREADS

Pitch	Pitch Inches	Single Depth of Thread	Double Depth of Thread	Infeed at 29 Degrees
3	.333	.253	.506	.292
4	.250	.190	.380	.216
4½	.222	.169	.338	.192
5	.200	.152	.304	.174
6	.167	.127	.254	.146
7	.143	.108	.216	.124
7½	.133	.101	.202	.114
8	.125	.095	.190	.108
9	.111	.084	.168	.096
10	.100	.076	.152	.087
10½	.095	.072	.144	.082
11	.091	.069	.138	.079
12	.083	.063	.126	.072
13	.077	.059	.118	.068
13½	.074	.058	.116	.067
14	.071	.054	.108	.062
15	.067	.051	.102	.057
16	.063	.047	.094	.054
16½	.061	.046	.092	.053
18	.055	.042	.084	.047
19½	.051	.039	.078	.045
20	.050	.038	.076	.043
21	.048	.036	.072	.041
22	.045	.035	.070	.039
23	.043	.033	.066	.037
24	.042	.032	.064	.036
25	.040	.030	.060	.035
26	.038	.029	.058	.034
27	.037	.028	.056	.032
28	.036	.027	.054	.031
30	.033	.025	.050	.029
32	.031	.024	.048	.027



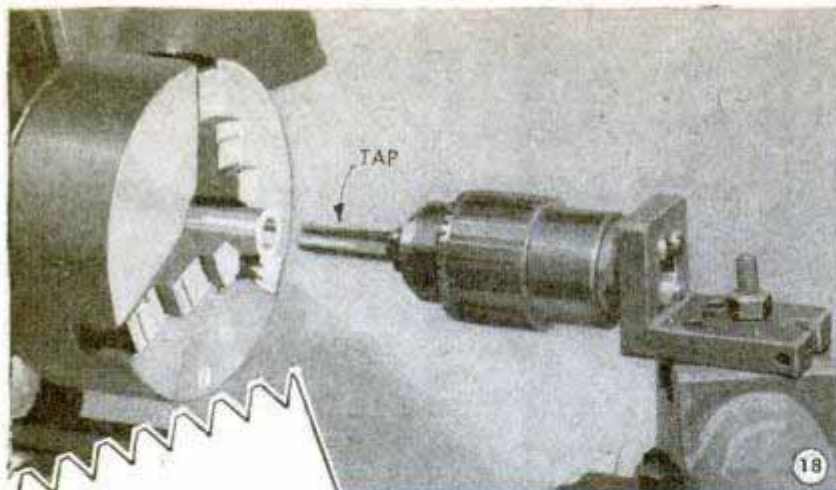

More on  
Use of Taps

REGULAR TAPPING TECHNIQUE CAN BE USED FOR SMALL HOLES. USE A TAP OF THE LEAD YOU WANT. SPLIT THE THREAD BY USING THREAD DIAL

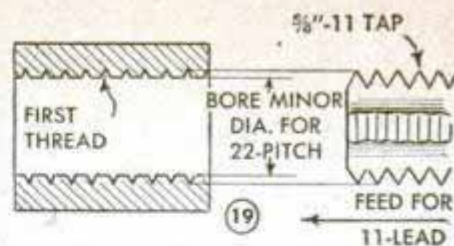

FIRST STAGE OF 11-LEAD 22-PITCH DOUBLE THREAD

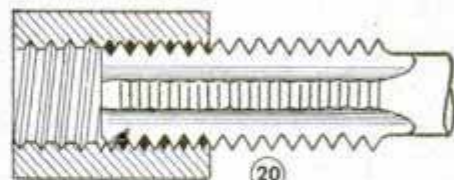

SECOND STAGE—THREAD DIAL IS ENGAGED TO SPLIT AN 11-LEAD THREAD. RESULT IS DOUBLE THREAD OF 22-PITCH

carriage travel. Now, consider the previous example of a 6-lead thread. In 1 in. of carriage travel, the tool will engage at the first and the sixth threads. At  $\frac{1}{2}$  in. of carriage travel, the tool will "hit" the third thread, but if you engage at  $\frac{1}{4}$  in. of carriage travel, the tool will hit at  $1\frac{1}{2}$  threads and will split the thread. Engagement at  $\frac{1}{8}$  in. of carriage travel will again split it producing a quad thread. This is as far as this particular lead can be split, but other leads, C and D positions, Table 2, can be split into 8 starts. Triple threads cannot be cut because the number of striking points (32) cannot be divided by 3.

**Example of threading:** Figs. 8 through 14 show both external and internal thread cutting for the work detailed in Fig. 7. The external thread usually is cut first because this commonly carries the major diameter. In boring for the internal thread, use Table 3 to find minor diameter and then add to this about one fourth of the double depth of thread. Always allow this clearance as a full thread cannot be cut. In boring the hole oversize, you are not presetting a loose thread because the fit of any thread comes from the angular contact, not the crests.

**How to use taps:** The use of taps for cutting single threads is an old lathe trick, and it can be used just as well for multiple threads. What happens here is that you have a multiple-point threading tool which will cut two, three or more threads in one operation. The example, Fig. 15, shows an 18-pitch tap being used. If you want to cut

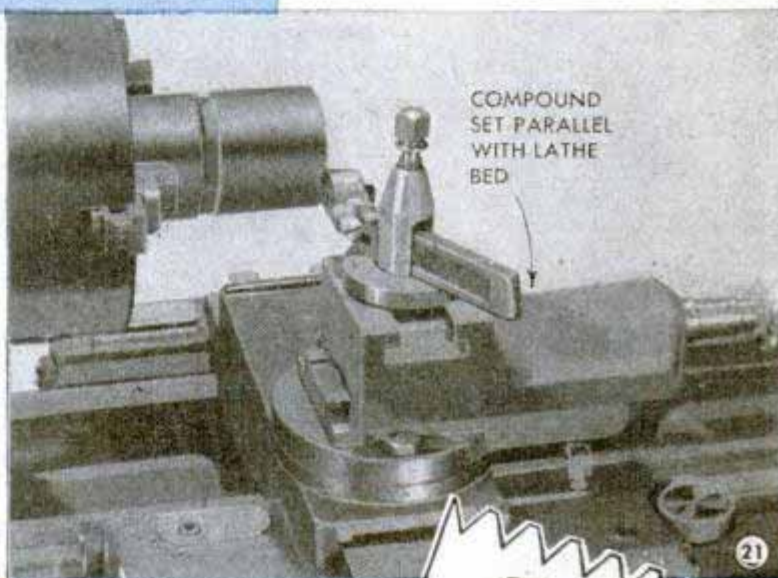

COMPOUND SET PARALLEL WITH LATHE BED

IN THIS SETUP, THREAD DIAL IS USED AS FOR SINGLE THREAD. THE THREAD IS SPLIT BY MOVING THE COMPOUND BACK  $\frac{1}{2}$  OR  $\frac{1}{3}$  OF THE LEAD DISTANCE FOR DOUBLE OR TRIPLE THREAD RESPECTIVELY

Setting Threads with Compound

a double thread, the gear box or train is set for 9 threads, not 18. Engagement of the thread dial is normal for a 9-thread and the tap catches both threads of the double thread in one operation. Successive in-feeds are made at the compound until the thread is complete, Fig. 16. With the same tap, a triple thread would be cut with the gear train set for 6-lead; a quad thread would be cut with gear train set for  $4\frac{1}{2}$ -lead. In all cases, the pitch is the same as the tap, which in this case is 18-pitch.

If a tap is used to cut an internal thread, it will be necessary to grind away the heel of the cutting teeth, as shown in Fig. 17, in order to get needed clearance. Taps are not good for heavy cutting—use a light feed



and plenty of oil. In this setup, the tap is smaller than the hole in the work and only one set of teeth does the cutting.

Another method of using a tap is shown in Fig. 18. In this instance a tap having the desired lead is used and the thread dial is employed to split the thread. This method is handy for small holes where a single-point tool could not be used. The original tap thread can be split into double or quad thread, but not triple. The example shown in Figs. 19 and 20 uses an 11-thread, or lead, tap. Splitting the 11-lead gives a double thread of 22-pitch. The bore diameter should be for 22-pitch thread, with due allowance for clearance. In this setup, all teeth of the tap cut.

**Setting threads with compound:** This method is sometimes useful, especially for roughing the thread for 3, 5 and 6 starts which are cleaned up later by chasing with a tap of proper pitch. As shown in Fig. 21, the compound is set parallel. Assuming 6 starts and 4-lead, the thread will be 24-pitch. Gear for a 4-lead and cut a single thread to the depth of a 24-pitch thread, making successive plunge cuts by infeeding the cross slide. Then move the compound back a distance equal to the pitch, in inches, of a 24-pitch thread. Table 3 shows this to be .042 in. Make the second thread and proceed with remaining threads in the same manner. Threads cut by this method may show a slight variation in pitch, but this is equalized readily by running a few chasing cuts with a 24-pitch tap.

### Card Indicates Location of File

In locating papers that have been removed from a file case, one firm uses cards that are slipped into the file when a folder is removed. Space is provided on the card for the name of the file, the person who removed it and the date it was taken. Any person seeking papers that are not in the file has only to look at the file card to see who has them.

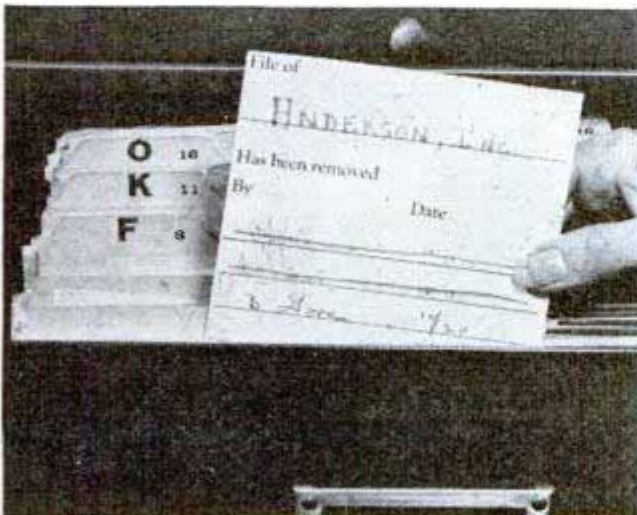

### Clay Used as Balancing Weight Permits Close Adjustment



To balance accurately the weight of an empty container, which is often difficult with the graduated weights on hand, one laboratory worker uses modeling clay. After the container is balanced, it is filled and the contents weighed in the regular manner.

### Felt Pad Is Convenient Wiper For Gas Station Attendant

A pad made of several pieces cut from a felt hat is handy at filling stations for wiping the oil-gauge stick. The leaves are bolted in a clamp that has a hook to fasten to the attendant's belt.





## Sawhorse Is Dismantled Quickly And Takes Little Storage Space

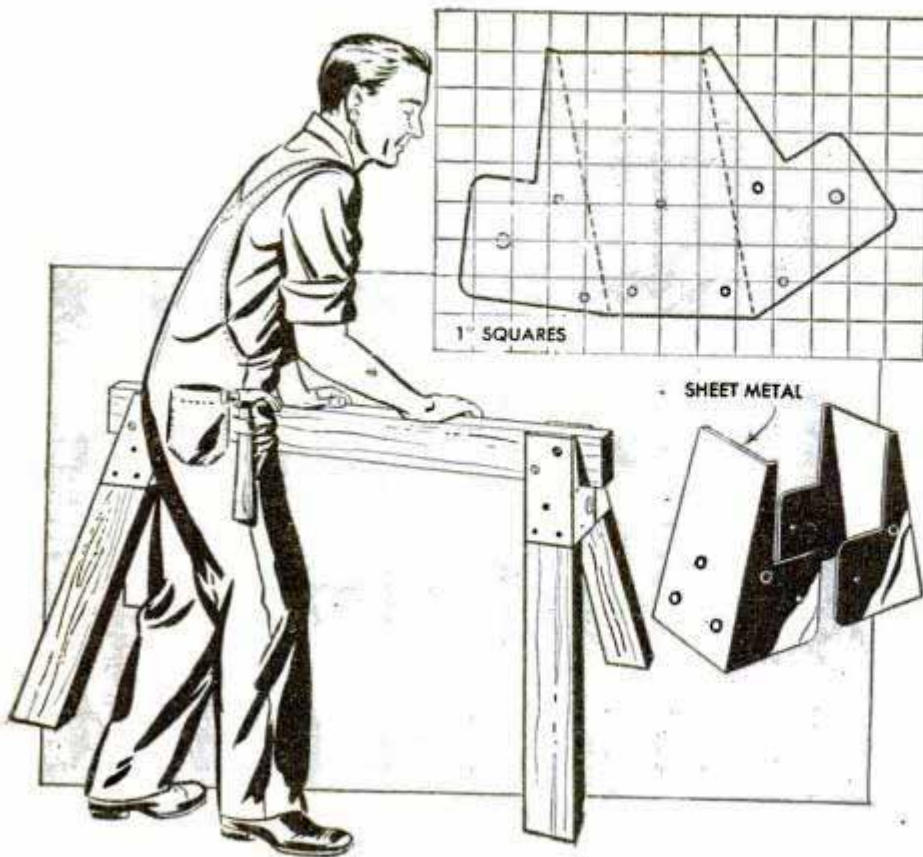

Here's a collapsible sawhorse for the carpenter who doesn't have a lot of space in his car and must carry several horses from job to job. To dismantle the unit, lift the crosspiece and fold the legs. Galvanized sheet metal is used to form the hinged pieces, which are cut as shown in the upper right-hand detail. After they are bent, they are riveted together as indicated by the lower right-hand detail. When bending, remember that the facing parts are bent in opposite directions. The legs are then inserted in the hinges and fastened with screws. Both legs and crosspiece are 2 by 4-in. lumber. One outstanding feature of this device is that the harder you bear down on the sawhorse, the tighter the legs will grip the crosspiece.

## Back of Front Seat Holds Shelf That Serves as Desk

Made of 1/4-in. plywood and fitted with flat-iron hooks to fit over the back of the front seat, this shelf serves as a small desk for your car. Several compartments are added to keep paper, envelopes and records. The size of the shelf is determined by the dimensions of the car and the size of the papers that are carried.

Wm. P. Houser, Organ, N. Mex.

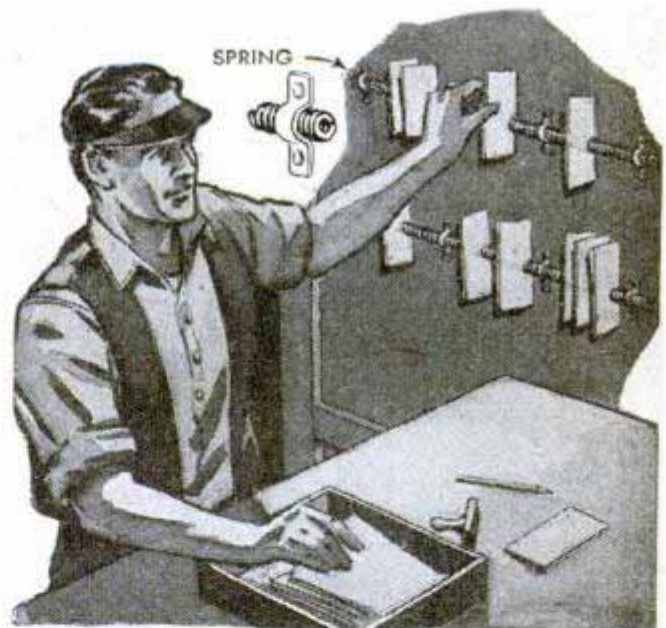
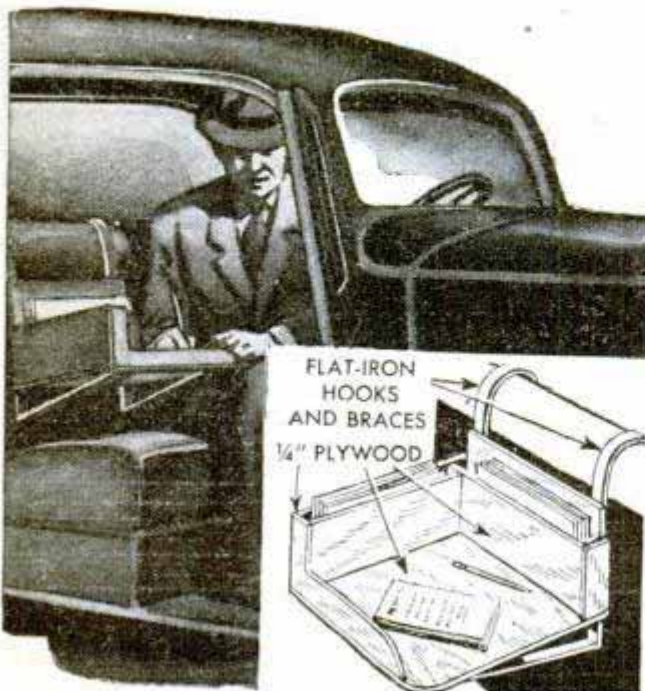

## Papers Clipped in Spring Rack Are Easy to Locate

Suggested here is a simple holder for keeping receipts, orders and other records visible and within easy reach. A screen-door spring is fastened to the wall with clamps and the papers are placed in the coils. The spring should be stretched only slightly or the papers may drop out.

ⓘ Overinflation of more than 3 lbs. in automobile tires is uncomfortable for passengers and detrimental to the tires.





## Equipment For Demonstrating Microwaves

By F. L. Brittin

THE history of electronics in industry indicates that years have usually elapsed before some new device or application progresses from the demonstration stage to active use. Therefore engineers of the General Electric Company decided it would be desirable to shorten this interval for microwaves by demonstrating with simple equipment some of their useful properties.

During the war there were many effective applications of these extremely high frequencies—between 2000 and 30,000 megacycles (corresponding to wave lengths between about 6 in. and  $\frac{1}{2}$  in.). Obvious industrial control uses are interception, or reflection, of beams of these radiations for the purpose of counting and sorting; for such purposes microwaves can do things that are not possible with photoelectric relays.

Classroom demonstrations at about 2400 megacycles are made with the simple oscillator shown in photo 2. A disk-seal-type triode tube, photo 3, commonly known as the "lighthouse" tube, is employed.

The circuit diagram appears in Fig. 1. To focus the microwave beam, a parabolic reflector is used; the reflected beam is picked up by means of an intensity meter illustrated in photo 4. It will be noted that this meter unit also employs a tiny half-wave dipole antenna; the received microwave energy is fed to a silicon crystal detector. Photo 1 shows a demonstration transmission through a hollow flexible-pipe wave guide. In photo 5, classroom demonstrators are locating standing waves found by direct and reflected radiations.

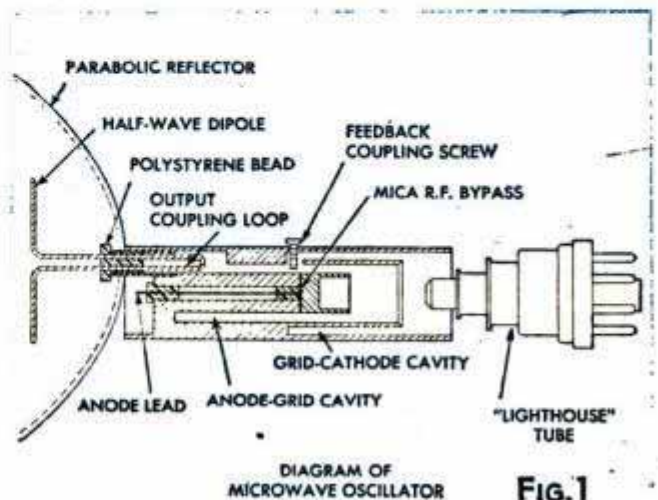
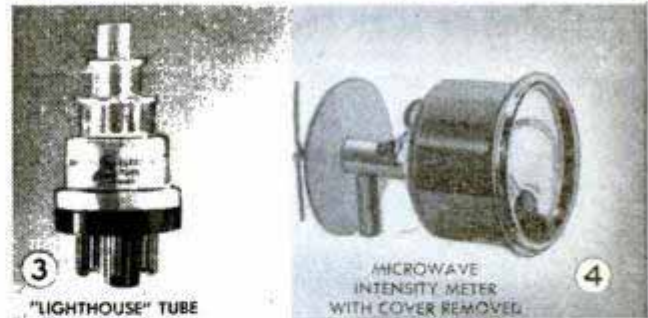
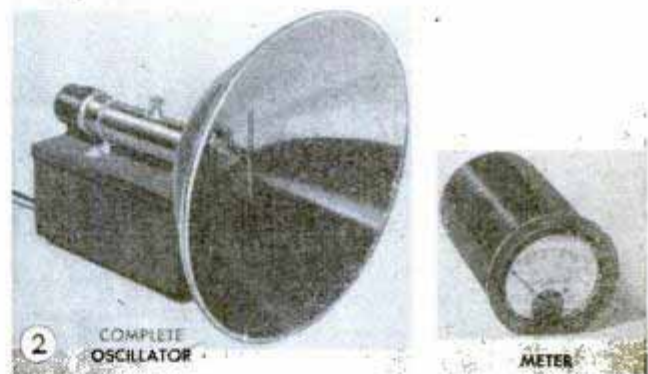
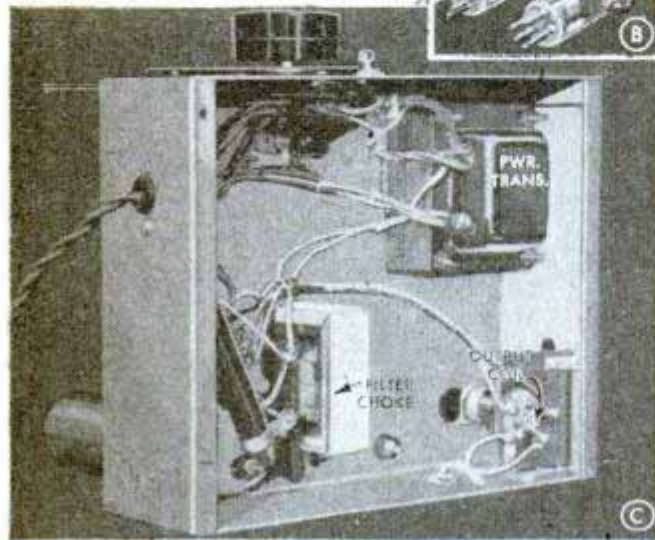
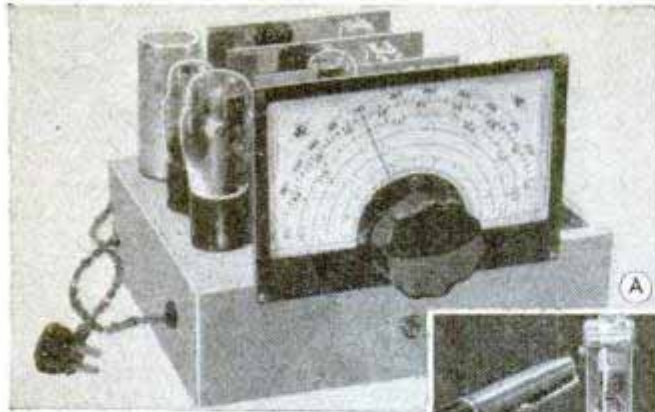

FIG. 1



# HOW TO BUILD A CONVERTER FOR

By George D. Hansen—W9FFD



Now you can build a converter so that you can tune in the 11, 10, 6 and 2-meter bands on any standard communication receiver, including war surplus receivers such as the BC-342 and similar types that are limited to 18 megacycles at the high-frequency end of the tuning scale.

The compact self-powered converter unit illustrated consists of an R.F. stage, a mixer stage and an oscillator, ganged together under a single control. Type 6AC7 tubes are employed in the R.F. and mixer stages and the oscillator is a type 6J5. Filling the average ham's need and extending the tuning range of the short-wave listener's communications-type receiver, this VHF converter employs standard parts and the coils are all hand wound. It is designed to work its output into a receiver set at approximately 10,100 kilocycles, or at a spot where no extraneous signals appear. In this manner your receiver becomes the I.F. section of the arrangement.

All three midget variable condensers are ganged together and shielded from each other, as will be noted in photos D, E, and F. Tube sockets for the three stages and the 5-prong coil forms are mounted on the shelf above the variable condensers as illustrated in photo D. The tube sockets are of the

### CONDENSERS

- 2—(C1), (C3) 10 mmfd. variable condensers, (Cardwell type ZR-10-A5)
- 1—(C5) 15 mmfd. variable condenser (Cardwell type ZR-15-A5)
- 11—3(C2), 3(C4), 3(C6), 1(C7), 1(C8) (Bud type MT833) 2-36 mmfd. trimmers
- 6—(C9), (C10), (C11), (C13), (C14), (C18) .0005 mfd. mica fixed condensers, midget size (Aerovox type 1467)
- 1—(C12) .01 mfd. 400-volt paper type fixed condenser
- 1—(C15) .00005 mfd. silver mica fixed condenser (Aerovox type 1469)
- 1—(C16) .002 mfd. mica fixed condenser
- 1—(C17) .0001 mfd. mica fixed condenser
- 2—(C19), (C20) 8 mfd. electrolytic filter condensers 600-v. (Aerovox G1)

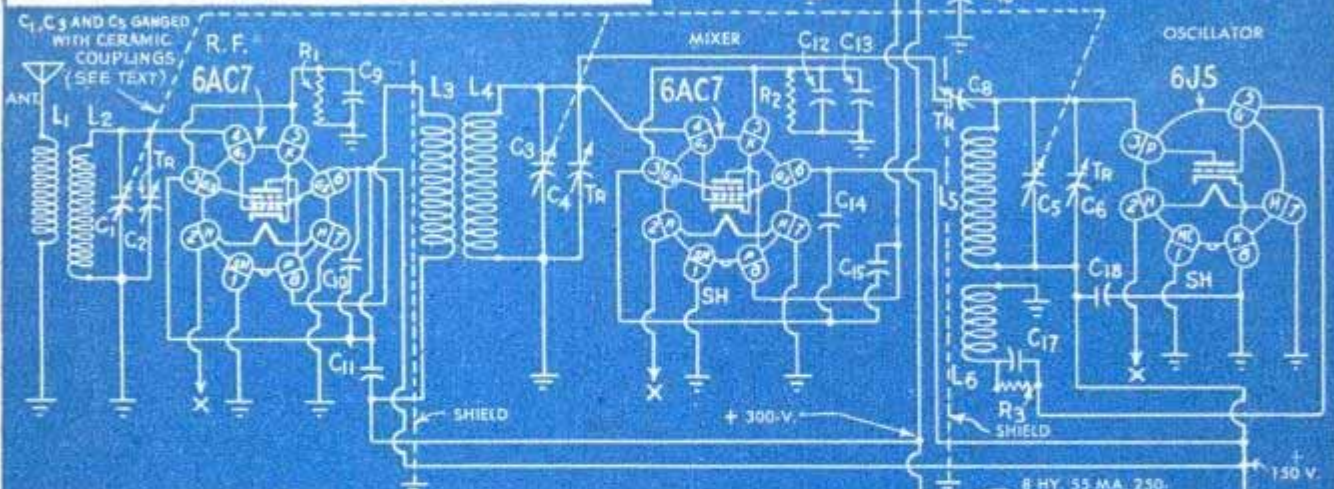

### RESISTORS

- 1—(R1) 1200-ohm 1/2 watt carbon type fixed resistor
- 1—(R2) 10,000-ohm 1/2 watt carbon type fixed resistor
- 1—(R3) 50,000-ohm 1/2 watt carbon type fixed resistor
- 1—(R4) 6,000-ohm 25 watt wire-wound resistor

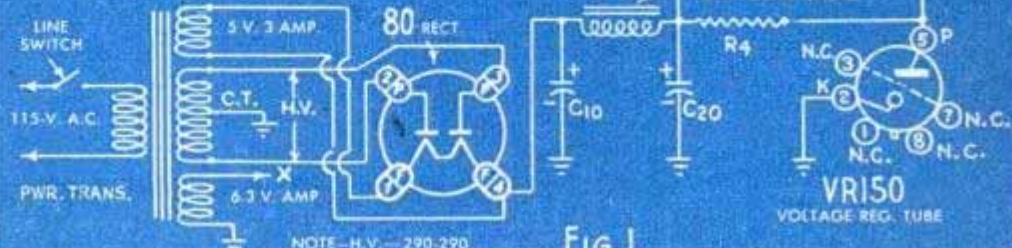

NOTE—H.V.—290-290

FIG. 1



# THE NEW VHF AMATEUR BANDS

conventional chassis type and made of Amphenol polystyrene material for low-loss insulation. The plug-in coils are of the same material and all soldered connections must be carefully made; clean all points to be soldered and apply heat for as short a time as possible because of the low melting point of the polystyrene material. This converter unit is not intended for beginners and reasonable care must be taken to keep all connecting leads as short as possible.

The schematic circuit diagram is given in Fig. 1 and the coil winding details appear above the coil chart. In order to make the necessary change of coil forms for the various bands with no readjustment in each case, every coil form is provided with a small trimmer condenser, mounted across the top of the coil form by means of two short self-tapping screws, for fine and permanent alignment. The coils are in groups of three and their comparatively small size is indicated by the pen in photo B. Photo C shows the underside of the chassis base and it will be noted that output coil L<sub>7</sub> and L<sub>8</sub> is mounted on a small shelf made of 1/8-in. hard-pressed wood. The power transformer, filter choke and resistor R<sub>4</sub> are also under the chassis base. The full-wave rectifier tube and a voltage regulator tube are mounted on the chassis base.

The 3-stage tuning unit is shown in photo F; each stage is identified and all dimensions given. Short lengths of 1/4-in. square brass rod were drilled and tapped to mount the partitions; angle brackets may be substituted if desired.

In ganging the variable condensers it is very important that the shafts be in exact alignment. The middle, or mixer stage,

(Continued to page 240)

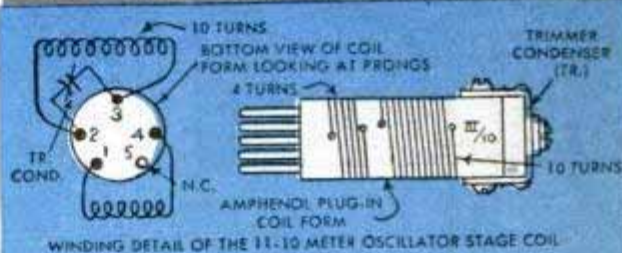
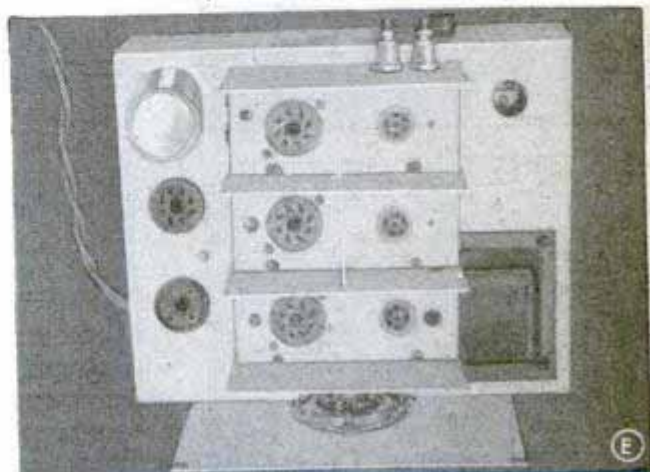

COIL WINDING CHART						
Band	Coil	Turns or In. of Wire	Wire Size Enameled	Space Between Turns	Space Between Windings	Diameter of Form or Coil
CHART No. 1 11 and 10 meters 27-30 MC	Form No. 1 L1	4 turns	No. 22	1/16"	1/8"	1/2" on outside of form
	L2	6 turns	No. 22	1/16"	1/8"	
	Form No. 2 L3	4 turns	No. 22	1/16"	1/8"	
	L4	6 turns	No. 22	1/16"	1/8"	"
	Form No. 3 L5	10 turns	No. 22	1/16"	1/8"	"
	L6	4 turns	No. 22	1/16"	1/8"	"
CHART No. 2 6 meters 50-54 MC	Form No. 1 L1	2 turns	No. 20	1/8"	1/4"	"
	L2	3 turns	No. 20	1/8"	1/4"	
	Form No. 2 L3	1 turn	No. 20	1/8"	1/4"	
	L4	3 turns	No. 20	1/8"	1/4"	"
	Form No. 3 L5	4 1/2 turns	No. 20	1/8"	1/4"	"
	L6	1 1/2 turns	No. 20	1/8"	1/4"	
CHART No. 3 2 meters 144-148 MC	Form No. 1 L1	Wire Length 1 1/2"	No. 20	1/8"	1/8"	Coil 1/2" in diameter wound inside form
	L2	1 1/2"	No. 18	3/16"	1/8"	
	Form No. 2 L3	1 1/2"	No. 20	1/8"	1/8"	
	L4	1 1/2"	No. 18	3/16"	1/8"	"
	Form No. 3 L5	1"	No. 18	1/8"	1/8"	"
	L6	1 1/2"	No. 20	1/8"	1/8"	
Permanent coil used for all bands	L7	19 turns	No. 22	Close wound	1/8"	Wound on 1/2 in. coil form
	L8	8 turns	No. 22	Close wound	1/8"	

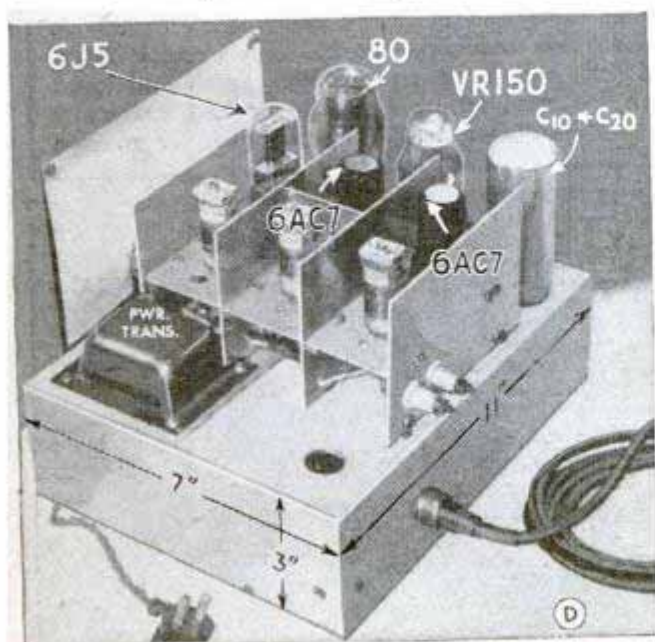



# Tuning-Dial Pointer and Drive-Cable Repairs

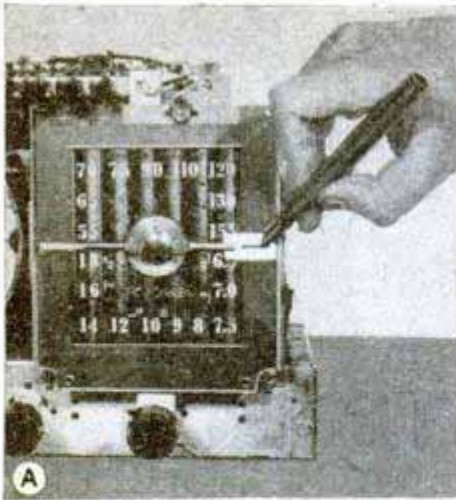

Tuning dial repairs are not difficult if proper precautions are taken to avoid disturbing the calibration of the dial and pointer. A convenient method of marking the pointer position before removing it from the shaft is illustrated in photo A. With the variable condenser plates fully meshed, place a small strip of adhesive tape on the dial and make a mark directly opposite the end of the pointer. It is then a simple matter to replace the pointer in the same position after the repairs have been made.



After removing the pointer and dial plate a new drive cable may be indicated if it is badly worn or too loose. If so, make a diagram of the dial-drive cable assembly, tracing the cord wrapped around the tuning shaft and drum as shown in photo B, before removing the dial cord; this will save time and avoid errors.

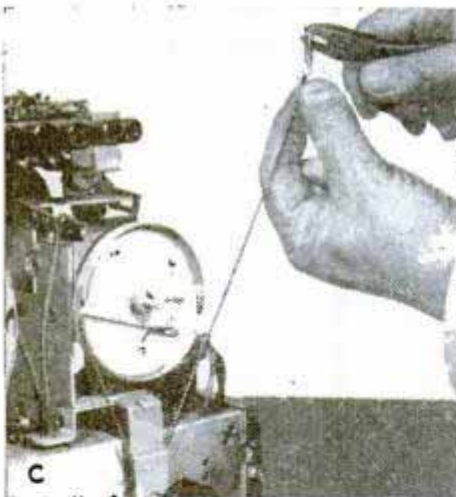

Even if the cord is broken it is often possible to determine its operation before removing the old cord. The system shown is fairly simple; others are more involved. If the dial cord merely is loose and slipping, a repair may sometimes be made by cutting off a small portion of one of the springs as indicated in photo C. When this spring on the end of the cord is reconnected to its hook on the dial drum, more tension will be placed on the cord. Another temporary repair is to apply rosin or a kitchen cleanser powder to the cord. Heavy fishline will often make an emergency cord or cable repair if standard dial cable is not available. Some receivers use special stranded phosphor bronze cable, others heavy linen cord. Permanent repairs on such receivers can be made by any good radio service man.

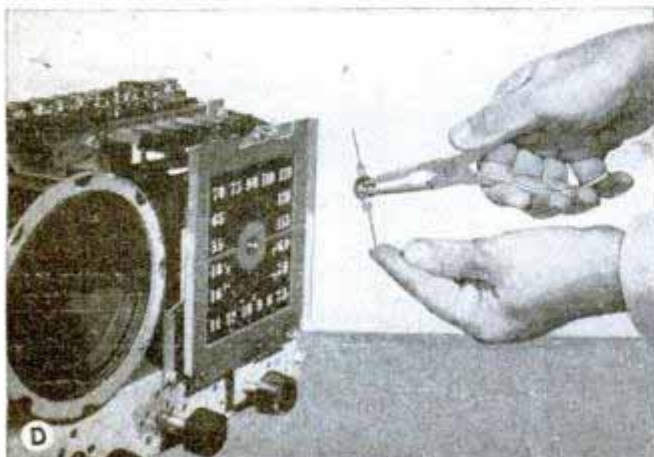

Loose dial pointers or indicators may be repaired by bending the clasps which fit over the shaft with a pair of long-nose pliers, as illustrated in photo D, to obtain a tight fit. Sometimes a light application of service cement, of the type used to repair speaker cones, is necessary, as indicated in photo E. In all cases when the pointer is replaced on the shaft make certain that the condenser plates are fully meshed and that the pointer is lined up with the guide mark. Install the set in its cabinet carefully and make sure that all chassis mounting screws under the cabinet are replaced correctly.

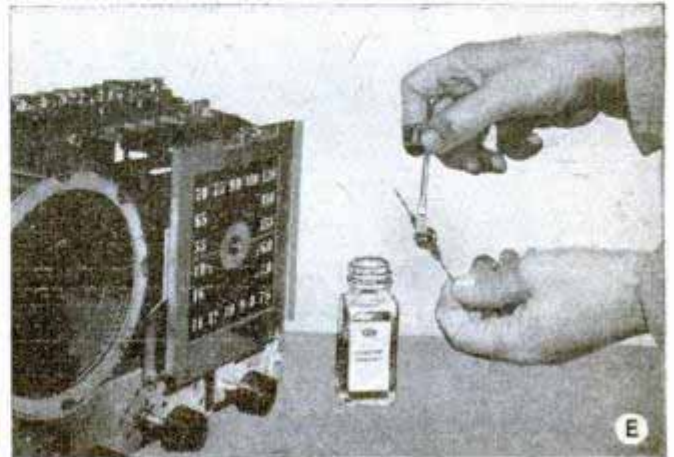

Blueprints covering radio and electronic construction articles in this and past issues are available for 25 cents each; detailed student material lists, additional general information and latest blueprint list can be obtained from our Radio and Electronics department without charge on receipt of ordinary letter postage





Television camera, receiving tube, all-electronic receiver and radio relay equipment—  
are the result of pioneering and research at RCA Laboratories.

## Behind every big stride in Television—RCA Laboratories!

From the scene of action—to your own living room—these RCA developments based upon research at RCA Laboratories mean *television at its finest*:

RCA Image Orthicon Camera sees whatever the eye sees, even in the light of a match! Sports events on cloudy days or in twilight do not fade because this camera eliminates the need for strong lighting.

RCA Mirror-backed Kinescope—All the lifelike realism and detail caught by the super-sensitive RCA Image Orthicon Camera is reproduced by this new receiving tube.

RCA Victor Television Receiver—with the new RCA exclusive "Eye

Witness" feature that "locks" the picture in tune with the sending station.

RCA Radio Relay equipment enables television stations to broadcast events taking place at a considerable distance from the studio, and eventually may link television stations in networks.

In television, as in radio, records or tubes, if it bears the name RCA or RCA Victor it is one of the finest instruments of its kind science has achieved.

Radio Corporation of America, RCA Building, Radio City, New York 20. Listen to the RCA Victor Show, Sundays, 2 P.M., Eastern Time, over NBC.



RCA Victor table model television receiver with the exclusive "Eye Witness Picture Synchronizer" that assures you *brighter, clearer, steadier pictures*.



**RADIO CORPORATION of AMERICA**



# NEW!



## NO. 77 X-ACTO WOODCARVING SET

### Contains:

6 different chisel and gouge blades, scalpel-sharp, of high carbon surgical steel. Flat, "U" and "V" shapes.

4 assorted regular blades.

2 three-inch blades.

1 specially designed handle, to take all blades.

Complete, with hardwood block and transparent acetate cover . . . Only **\$3**

## THE

# PERFECT TOOLS

for carving wood, plastics, linoleum or what have you—with special rigidity for heavy cutting

This is it! The sweet and handy set you woodcarvers, model builders and artists have been clamoring for . . . the super-topnotch job you expect and get from X-acto.

Six scalpel-sharp, new chisel and gouge blades, each a different shape, each designed with an ingenious architectural rib in the tang end to give you the special rigidity you need for deep cuts, curves and angles. Plus a

half-dozen other X-acto blades and a specially designed X-acto handle into which all blades fit interchangeably.

What versatility! You can use this new No. 77 for anything from a life-size statue to a tiny scale-model plane . . . and know you'll do a better, quicker job, as *always* with X-acto!



### Have you seen "The Big Shot?"

It's got everything! Knives, plenty of blades, specially designed hobbycraft tools for every exacting job. Contains: 3 X-acto Knives; complete assortment of blades; stripper; sander; planer; saw; drills and holders; ruler. Complete in desk-drawer size wooden chest **\$12.50**

# X-acto

## KNIVES & TOOLS



Singly or in sets, 25c to \$45.  
At hobby, gift and hardware shops

X-acto Crescent Products Co., Inc., 440 Fourth Av., N. Y. 16  
In Canada: Handicraft Tools, Ltd., Hermant Bldg., Toronto  
\*Reg. U. S. Pat. Off.



# NEW

# "EVEREADY" FLASHLIGHT BATTERY LASTS 93% LONGER!

**Tiny cell packs  
enough ENERGY to  
bowl one full game!**

You could send that 16-pound ball crashing into the pins time after time ... actually bowl one full game with two balls to a frame ... if you could properly apply the foot-pounds of electric energy in *one* great new "Eveready" flashlight cell. Think of this dynamic power turned to light in *your* "Eveready" flashlight ... and giving brilliant white light nearly *twice as long*.

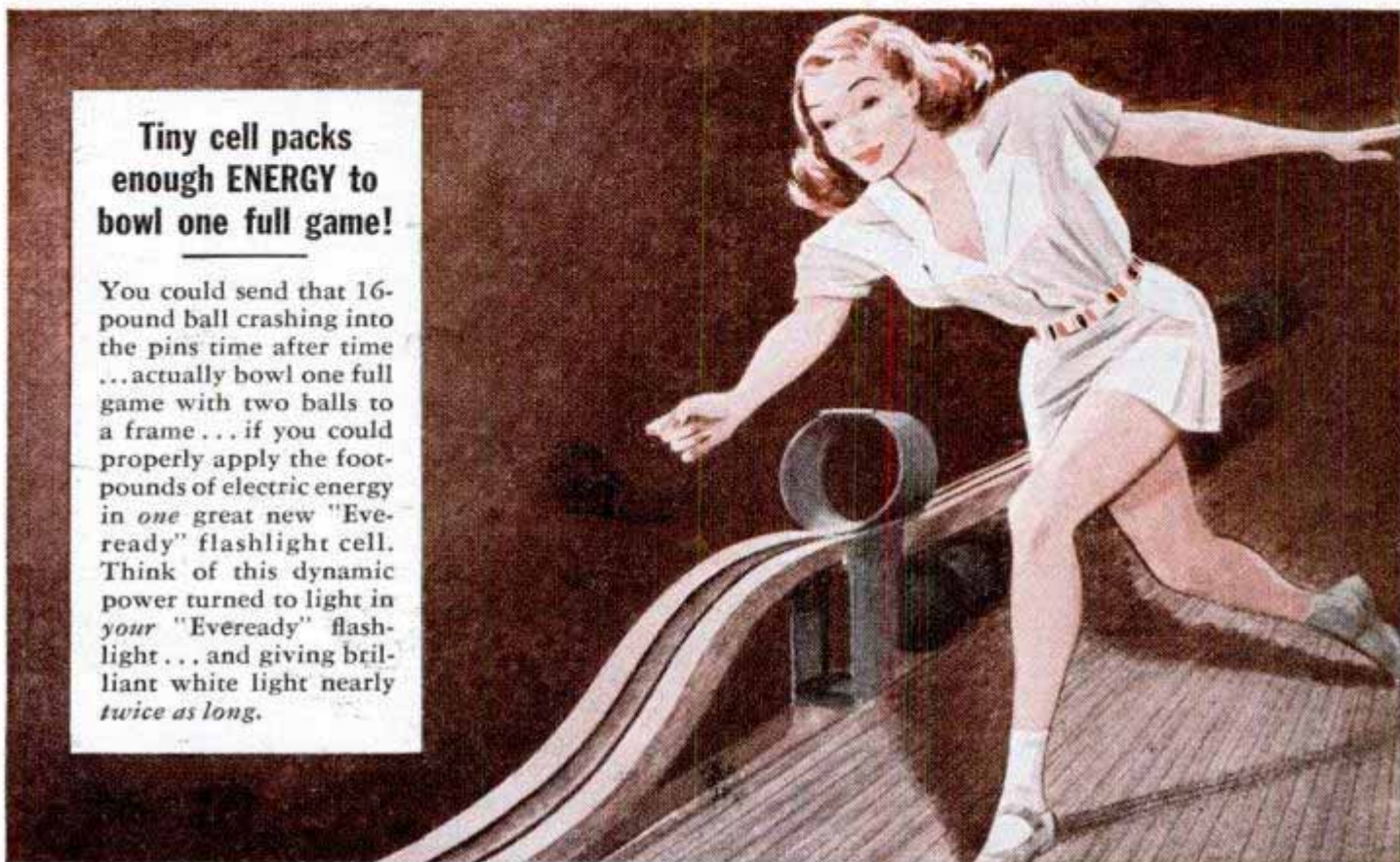

**Y**OUR flashlight is nearly *twice* as useful to you today. Because **NOW** you can get revolutionary new "Eveready" flashlight cells, power-packed with 93% **MORE ENERGY!** That's *nearly double* the amount of energy that famous pre-war "Eveready" flashlight batteries gave you ... nearly two times the wonderful service that made them famous for a *longer life of brighter light*. Ask for them by the famous brand name ... "Eveready."

The registered trade-mark "Eveready" distinguishes products of

**NATIONAL CARBON COMPANY, INC.**

30 East 42nd Street, New York 17, N. Y.

Unit of Union Carbide  and Carbon Corporation

Nearly *twice* the electric energy ... almost *two times longer life* of brilliant white light than even famous pre-war "Eveready" flashlight batteries. That's today's *high-energy* "Eveready" battery, as proved by the "Light Industrial Flashlight" test devised by the American Standards Association.

**93% MORE ENERGY**

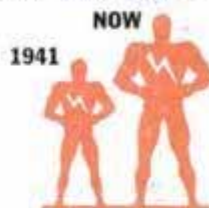

*High Energy* **MEANS**  
**BRIGHTER LIGHT, LONGER LIFE**

**EVEREADY**  
TRADE-MARK  
**FLASHLIGHT BATTERIES**





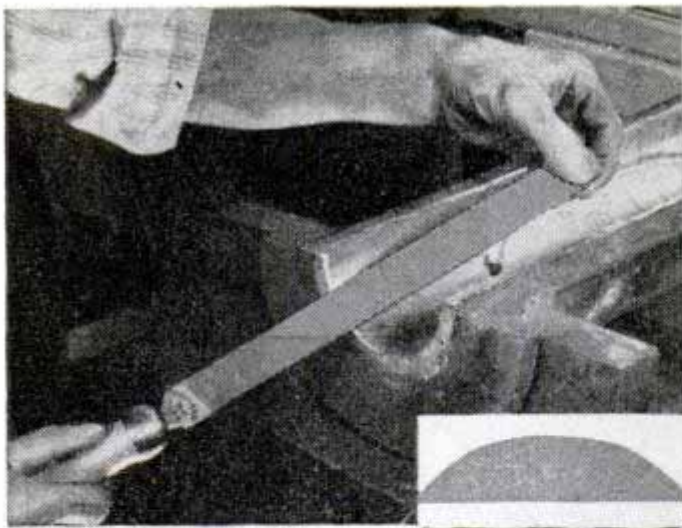

**A "SMOOTH  
SHAVE" FOR  
SOFT METALS**



**Y**ES, the Nicholson or Black Diamond Lead Float File actually "shaves" thin slices from such extra-soft metals as lead and babbitt. Its coarse, short-angle teeth or "blades" cut away stock rapidly under normal pressure. Yet the same file—used with a lighter touch—produces a smooth finish.

Lead Float files are made in both Flat (rectangular cross-section) and Half Round shapes. In the above illustration, the Half Round back of a Lead Float file is being used to smooth up the concave edge of a babbitted bearing. This shape is also useful in reaming lead-pipe fittings and finishing off solder joints.

Nicholson or Black Diamond Lead Float Files—both Flat and Half Round—are widely used by industrial plants and machine shops on soft bearings and moulded parts; and by plumbers and home craftsmen.

**FREE — 48-PAGE BOOK — "FILE PHILOSOPHY"**



**NICHOLSON FILE CO.**  
22 Acorn St., Providence 1, R. I.  
(In Canada, Port Hope, Ont.)



**NICHOLSON  
FILES** FOR EVERY PURPOSE

## Your Next Tires . . . Synthetic or Natural?

(Continued from page 141)

outwear the new synthetics. Most rubber manufacturers, despite the highly touted synthetics, look back with nostalgia on the days of natural rubber.

With performance of synthetics adequate, the big tire companies will choose future rubber on the basis of price.

The cost of natural rubber in its hundred-year history has bounced like a rubber ball. Nothing in industry has been as unpredictable. In 1925 the price of rubber inflated to an all-time high of \$1.25 a pound. The depression pricked the price balloon and it collapsed to three cents a pound in 1932. The wobbly price factor is important when you consider that a one-cent variation means twenty million dollars to the American public.

Last year the government gave 23½ cents for the first shipment of natural rubber. In October, surprise negotiations with Great Britain resulted in delivery of the additional 200,000 tons at 20¼ cents a pound. Whether the price will continue to bounce and fall no one seems to know.

The price of GR-S can be predicted with reasonable accuracy. The wartime cost was about 40 cents a pound, but experts believe that new manufacturing methods and cheaper materials will reduce the postwar cost to 15 cents or lower. Synthetic rubber can and will compete with natural in price.

As a result the companies that turn out tires for your car will soon choose between the two types after evaluating prices quoted at that time. They'd rather use natural rubber but if the cost makes tire prices exorbitant they'll turn to synthetics.

Research men say that tomorrow's tires will be a combination of the two and far superior to today's synthetics.

John W. Thomas, chairman of Firestone, speaking for the industry as a whole, says "it is no trade secret that we expect ultimately to produce a tire that will last 100,000 miles. And it may be made of a substitute for natural rubber." Recently the Society of Automotive Engineers was told that the 100,000-mile tire is already being produced, provided it is given proper maintenance. In two or three years you may be able to buy a set of tires that will last as long as your new car.

The price of natural rubber within the next few months will determine whether we'll be riding on natural or synthetic tires. Today's synthetics have proven to be good performers. If natural rubber is too costly we'll continue to ride the test tube stuff.



Dependable

# CHAMPION

AMERICA'S FAVORITE SPARK PLUG

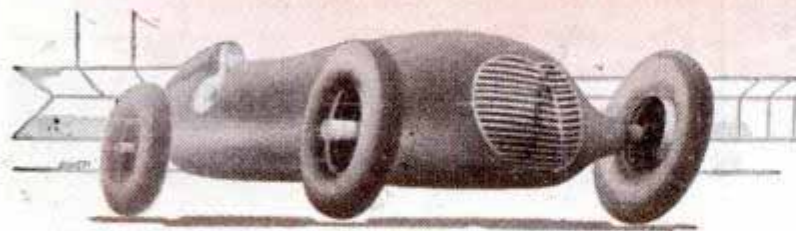

The reason why Champion is America's favorite spark plug is because of better performance and greater dependability. Proof of this is in the continuing use of Champions by those who seek and win championship events. A current outstanding example is the 1946 AAA National Championship won by Ted Horn, master mechanic, master race driver. Champion Spark Plug Company, Toledo 1, Ohio.

***FOLLOW THE EXPERTS***

DEMAND DEPENDABLE CHAMPIONS FOR YOUR CAR

Listen to the CHAMPION ROLL CALL, Harry Wismer's fast sportscast every Friday night, 9:55 EST over the ABC network.



# NEW SHAVER GIVES "SIMPLEST SHAVES OF YOUR LIFE!"

Special Offer Introduces New  
Enders Speed Shaver Now  
at Local Drug Stores

## SAFER...SMOOTHER ...SWIFTER

Mystic, Conn., Jan. 16, 1947.  
It's here at last! Today the Dur-  
ham-Enders Corp., announced  
the simplest of all razors—the  
new Enders—the world's most  
modern razor.

It's new in every way—but  
its big feature is its extreme sim-  
plicity. You simply click the  
blade in *and shave*. Only one  
piece, no moving parts, no extra  
"gadgets." And it's  
light in your hand and swift and keen on your face. You  
get an extra-smooth shave, an extra-safe shave, an extra-  
swift shave. Already chosen as "the razor of the airlines."

And here's the offer: don't risk a penny. Get the new  
Enders at your local drug store—introduction price  
only 49¢ with 5 double-thick deluxe speed blades. Your  
*money back* if Enders Shaving isn't the swiftest and  
easiest in your life! (Order direct if your druggist  
doesn't have it yet.)

Durham-Enders Razor Corp., Dept. 103, Mystic, Conn.

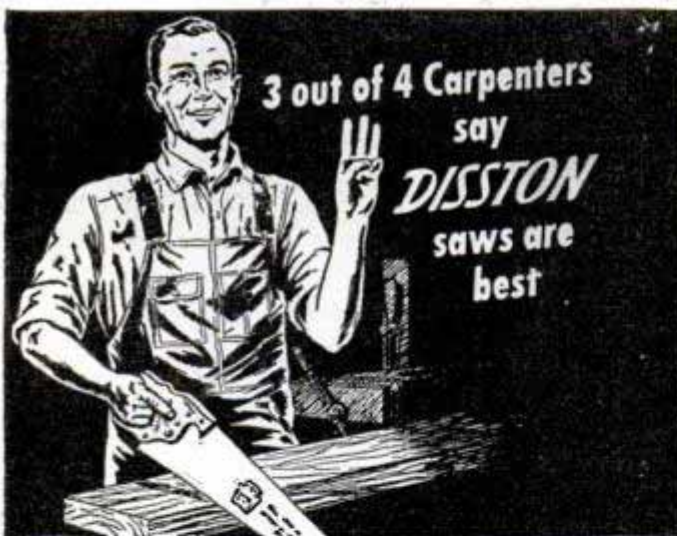
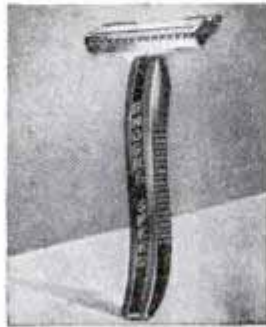

"In your opinion, which make of handsaw is highest  
in quality?" Thousands of carpenters were asked that  
question. Three out of four replied, "Disston saws"  
... a high tribute indeed, for it comes from men  
who know saws best.

The reasons for this preference may be summed up in  
what one carpenter says, "You can't beat a Disston  
for good, clean cutting and long life."

Ask your Hardware Retailer for a fine  
looking, fine performing Disston Saw.  
Also ask him for a FREE copy of "The  
Disston Saw, Tool and File Manual," or  
write to us direct.



**HENRY DISSTON & SONS, INC.**

211 Tacony, Philadelphia 35, Pa., U. S. A.

**DISSTON** The saw most  
Carpenters use

Electrically Welded Endless

# Paramount

**BAND  
SAW  
BLADES**



Made in widths from 1/8" to 1-3/4"

Make your band saw do more work for you. The proper  
width of blade will extend the scope of this important ma-  
chine. Burrill's Paramount Blades are made from tough  
Nickel Alloy Steel properly tempered. Teeth accurately set  
and filed, and all saws carefully straightened. Send order  
and check today. Delivery will be made as promptly as con-  
ditions permit, from a few days to a week or two. You can  
obtain these saws at the following prices:

1/8"-3/16"-3/4"-3/8" wide, 5'6" long.....\$ .90 each  
3/8"-3/16"-3/4"-3/8" wide, 6'6" long..... .95 each  
1/8"-3/16"-3/4"-3/8" wide, 7'6" long..... 1.10 each

Other sizes at proportional prices

**ALSO METAL CUTTING BAND SAWS**

Made in widths from 1/8" to 3/4"

Your satisfaction is guaranteed

**BURRILL SAW & TOOL WORKS**

407 E. Main St., Ilion, N. Y.

What gives each file  
a guiding mark  
Like lighted street  
signs, after dark?

## Dennison

**INDEX TABS**  
At Stationery Departments Everywhere

# LAW

STUDY AT HOME for PERSONAL SUCCESS  
and LARGER EARNINGS. 38 years expert instruc-  
tion—over 108,000 students enrolled. L.L. B. Degree  
awarded. All texts furnished. Easy payments. Send  
for FREE BOOK—"Law and Executive Guidance."  
**AMERICAN EXTENSION SCHOOL OF LAW**  
Dept. 74-M, 646 N. Michigan Ave., Chicago 11, Ill.

SAY YOU SAW IT IN POPULAR MECHANICS

## BRUSH PLATING OUTFITS

for re-plating articles in the home and  
shop. No tanks necessary. Free particulars.  
**GUNMETAL CO., AVE. M, DECATUR, ILLINOIS**

## NUMBERALL Rotary Stamp

(Patented)

### 1 Tool Instead of 12

For stamping figures and letters on  
metal, etc. One stamp does away with  
12 individual hand stamps. Changes of  
characters are quickly made merely by  
rotating the indexed wheel. Wheel is  
made of finest tool steel. Sizes 1/16"  
to 3/16" figures can be furnished at  
\$5.00 each in pouch. Larger sizes and  
alphabet at higher prices. Write for  
Catalog.

**NUMBERALL STAMP & TOOL CO.**  
HUGUENOT PARK STATEN ISLAND 12, N. Y.



*"Just look at that paint!"*



**BILL:** Yeah, it *is* kind of cracking up.

**MIKE:** And I painted this garage the same time you did yours—last May.

**BILL:** What kind of paint did you use?

**MIKE:** Regular house paint. I don't remember the name. It's a brand I hadn't heard of.

**BILL:** There's your answer, Mike. You're always better off buying a *well-known* brand—with a name you can trust. Not only in paint but in tools and hardware, too.

**MIKE:** Well, maybe—but they always cost more.

**BILL:** Sure about that? Look—I won't have to paint my garage again for two or three years, but yours needs repainting right now. This time, take a tip from me and buy branded paint at the hardware store. Then you'll *know* it's good.

*Your HARDWARE DEALER  
sells QUALITY tools and  
hardware. Buy from HIM.*



**POPULAR MECHANICS**



# ANCO RAIN-MASTER

## "Dead-Locker"

### WINDSHIELD WIPER ARMS and BLADES

BLADE SNAPS ON...  
STAYS PUT

FINGER-  
TIP  
RELEASE



CAN'T FALL OFF  
CAN'T BLOW OFF

(A war-born invention—by ANCO—first  
for military aircraft—now for your car.)

## DON'T SHOOT YOUR GAS-PUMP MAN!

He's doing the best he can. Sure, he knows how dangerous it is for you to drive your car... in stormy weather... with your dull old windshield wipers that smear and smear. He'd gladly put on for you quickly a pair of keen new ANCO RAIN-MASTER Wiper Blades and Arms. He has them—Newest Models! But he forgets to remind you? Too busy? You can't shoot him for that!



PATENTS  
MAKE JOBS

After all, it's *your* car to protect. So *you* remind *him*. Get RAIN-MASTERS... patented features... original equipment on many makes of high grade cars and trucks... used in war—on our fighting tanks and trucks and ships and bombers too... because ANCO RAIN-MASTERS clean quicker, clean cleaner... last longer. May save you a costly smashup.

Ask for RAIN-MASTER Windshield Wiper Arms and Blades next time you buy gas.

## THE ANDERSON COMPANY

Established 1918

GARY, INDIANA

## How to Build a Converter for The New VHF Amateur Bands

(Continued from page 231)

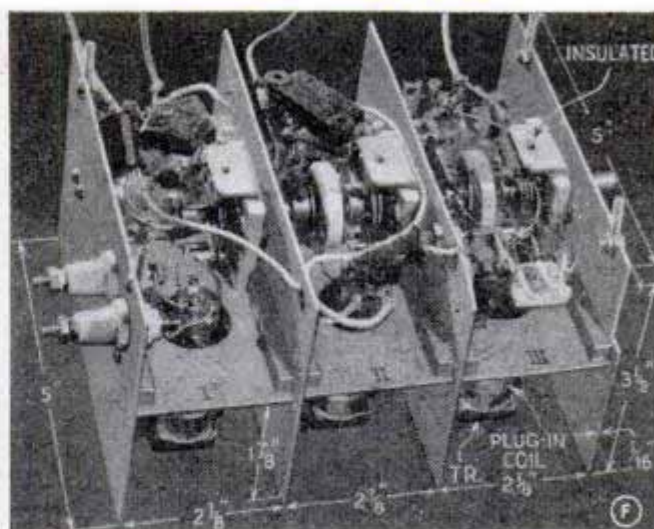

variable condenser is separated from the oscillator and R.F. stage by means of flexible insulated couplings. The rotors of the mixer and R.F. stages are at ground potential while, on the other hand, the oscillator variable condenser is completely insulated, as indicated on photo F. The tuning control is a National-type ACN dial, photo G, which provides suitable space for hand calibration. Note, in coil chart No. 3, the length of wire is given in inches instead of turns.

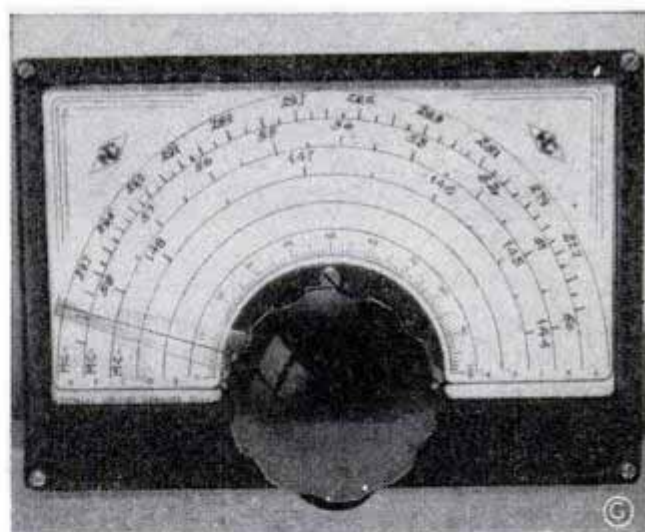

To align the converter: with the oscillator tube and coil in position, adjust the frequency to the one in the coil group selected, less the I.F. frequency of 10,100 k.c. used. This can be done with a receiver or other measuring means, and the range should be at least from 15 to 85 on the dial. Alignment is similar to that of any superheterodyne after this I.F. frequency is set up. Detailed alignment steps are included in the student material list R-352 which is available from Popular Mechanics Radio and Electronics department upon receipt of ordinary letter postage.



Presenting...



REGAL  
TREASURE  
CHEST  
NO. 130  
Price \$10.00

★  
KNIVES  
BLADES  
CARVERS  
ROUTERS  
PUNCHES  
SAWS  
SPOKESHAVES  
PLANES  
AND COMPLETE  
KITS

# King Kut

*The Royalty of*

**KNIVES, TOOLS AND BLADES  
FOR HOBBY-CRAFT AND HANDICRAFT**

● These amazing new precision cutting tools, so expertly designed, so flawlessly made, so perfect in performance, will gladden your craftsman's heart. AT LAST . . . new blade shapes, new carvers, new routers, new punches (some never before available) . . . 22 in all—and each one different.

Each fits the simple yet skillfully designed aluminum handle featuring the tapered chuck with a vise-like grip. Plus King Kut's plane, curved and flat spoke shaves—all aluminum bodied. King Kut's cutting edges are made of the finest steel, expertly hardened, tempered, ground, honed and buffed to razor sharpness.

King Kut tools meet the same high standard of design and performance that champion hobbycrafters demand of themselves.

See your Hobby, Sporting Goods, Hardware, Art and other Stores for King Kut Tools.



HOBBY TOOL SET NO. 120  
... 6 blades, 6 carvers, 6 routers, 3 punches,  
1 saw, 1 handle and plastic knob. Price \$5.00

King Kut Products are covered by  
Fair Trade Agreements.

King Kut Tool Sets range in price...  
\$1.00 to \$10.00

ADDRESS DEPT. KK 131

THE  PARTS CORPORATION • TOLEDO, OHIO

Manufacturers of the famous  
AP Mileage Getting Mufflers



# RANGE

# RELIABILITY

# RESEARCH



Flick the switch and turn the dial. Instantly you'll begin to sense how the "Three R's" combine in the 12-tube National NC-2-40D to bring you truly matchless performance. Range... to pick up station half a world away. Reliability... proved by the record of National sets on three-fourths of the Navy's warships. Research... untiring, never-ending, to bring you at last a thrilling new experience in radio reception. Hear the NC-2-40D for yourself. Write today for name of your nearest dealer.

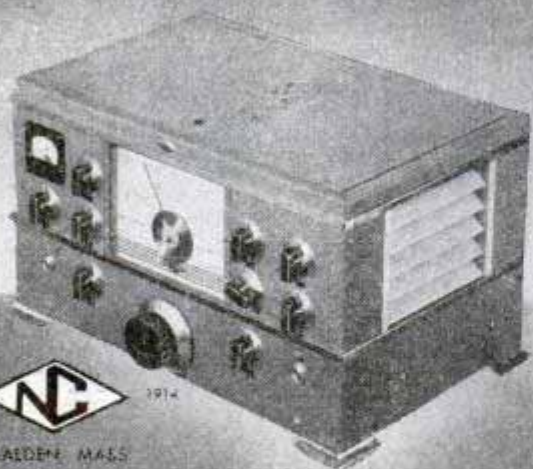

# NATIONAL

COMPANY, INCORPORATED

THE MOST DISTINCTIVE NAME IN RADIO COMMUNICATIONS

## Limited Stock! New, 27-Volt AC-DC AIR COMPRESSORS

• 1/3-HP 3-stage Motor

• 4500 RPM

• Weighs 38-Lbs.



• COMPRESSOR OUTPUT is 1500 Lbs. High Pressure Low Volume

• IDEAL for Low Pressure Spray Gun

Precision built...hook up furnished. Convert with transformer or 4-1000-watt heating elements. Individually packed in wooden boxes and wrapped in plicofilm for double protection. Simple diagram describing hook-up included. Hush us your order, today.

Cost the Government over \$200 to build  
**BARGAIN \$15** for you

### General Surplus Stores

1439 Grand Avenue

Kansas City, Missouri

## CROSMAN Silent RIFLES



**NOW AVAILABLE**

America's favorite compressed air rifles for indoor or outdoor shooting are back again! Available in .22 Cal. Single Shot and Magazine Loading types. At your dealer—or order direct. Ask for Crosman SUPERPELLS too—the better ammunition for all compressed air rifles: .177 Cal.—\$2.25 per M; .22 Cal.—\$2.50 per M.

CROSMAN ARMS CO., INC. ROCHESTER 7, N. Y.

## MARCOT KEY MACHINE

Immediate Delivery



Marcot No. 8 Key Machine Mounted on Cabinet.....\$ 75.00  
Book on Modern Locksmithing. 3.95  
Auto Code Book and Auto Depth Keys ..... 12.50  
162 Doz. Popular Key Blanks.. 77.76  
Set Key Files, Tools, Pins, Springs, Thimble ..... 10.50

\$179.71

A. J. MARCOTTE CO., DEPT. PM, CHICAGO 51, ILL.

SAY YOU SAW IT IN POPULAR MECHANICS

## ONE-MAN SAWMILL LESS THAN \$200<sup>00</sup>

Easy To Turn Trees Into Money

Makes lumber, ties, shingles, crates, lath, studding, siding.



Belsaw Models

in 10 to 24 foot sawing lengths. MECHANICAL FEED, accurate set works and positive dogs. Use tractor or old auto engine for low cost power.

Thousands used for commercial sawing. Pays for itself quickly. Send post card today for FREE booklet, "How To Make Lumber" and Catalog of Woodworking Equipment.

BELSAW MACHINERY CO., 2811-H Field Bldg. 315 Westport Road Kansas City 2, Mo.

## WALKIE SIREN

Formerly \$15<sup>00</sup> - Now Only \$3<sup>95</sup>



GOV'T SURPLUS. A precision instrument. Easy turn of crank produces CLEAR, FULL SIREN TONE. Can be heard for great distance. Ideal for Boats, Autos, Schools, Sporting Events, etc. Dimensions 7" x 8" x 5". Wt. 4 1/2 lbs. Price includes shoulder strap and waterproof cover. SEND NO MONEY. Just name and address. We'll ship C.O.D. for \$3.95 plus postage, or send money in advance, we'll ship prepaid. Canadian price \$4.50. ILLINOIS MERCHANT MUSE MART, Dept. 400, 1227 Loyola Ave., Chicago 26, Ill.



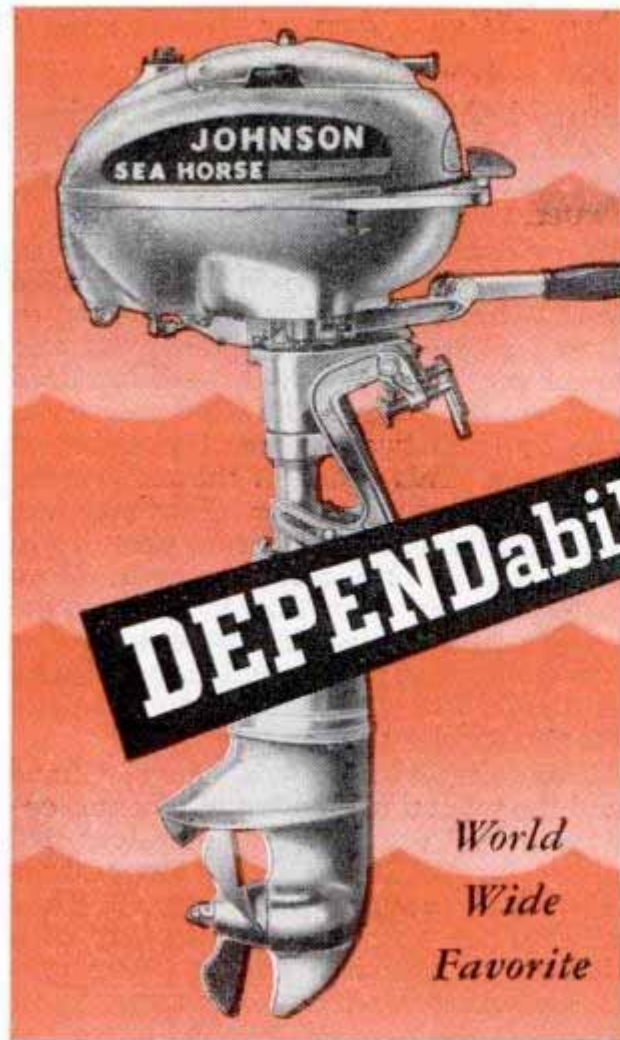

JOHNSON is the outboard motor that leaves its wake around the world! Wherever men use boats the Johnson Sea-Horse is a familiar sight—because it is **DEPENDABLE**.

It offers users the simplicity and reliability of twin cylinder construction. It has all features that contribute to brilliant performance. Remember, outboard motoring's great improvements (Alternate Firing, Reverse, Dual Carburetion and others) are JOHNSON developments.

**DEPENDABILITY**

*World  
Wide  
Favorite*

**FREE HANDY CHART:** New. Describes the 1947 line. Write for it. See your Johnson dealer about delivery. Look for his name under "Outboard Motors" in your classified phone book.

JOHNSON MOTORS, 400 Pershing Rd., Waukegan, Ill.

**1947 SEA-HORSE MODELS**

Small Alternate Firing Twin . . . 31 lbs. . . . 2.5 H.P.  
 Medium Alternate Firing Twin . . 44 lbs. . . . 5.0 H.P.  
 Large Alternate Firing Twin . . 70½ lbs. . . . 9.8 H.P.  
 Super Alternate Firing Twin . . 92½ lbs. . . 16.0 H.P.  
 Heavy Duty Opposed Twin . . 115¼ lbs. . . 22.0 H.P.

All H.P. ratings above are O.B.C. Certified Brake Horsepower at 4000 r.p.m.

**THERE IS NO SUBSTITUTE FOR EXPERIENCE**

**BUILD YOUR OWN FAST FREEZER** PLANS \$1.00

It's easy to build this household appliance and profitable to use. Save up to 75%. Operates on 110 or 32 volts. Plans show 5 sizes and are easy to follow. **ENJOY MAKING ONE OF** these freezers from new or used parts. No expert knowledge needed. Mail \$1.00 bill or check for complete plans and catalog.

**LE JAY MFG., 447 LeJay Bldg., Minneapolis 8, Minn.**

5 sizes  
8 to 40 cu. ft.

**Test-O-Lite** the MODERN TROUBLE SHOOTER

**THE NEON GLOW** . . . LOCATES TROUBLE INSTANTLY in electric circuits, fuses, cut-outs, motors, radios, appliances. Tests everything electrical from 100 to 550 volts. Indicates hot or grounded wires. Tells AC from DC. Engineers prefer it because it has patented safety features.

**PUTS "FINGER" ON THE TROUBLE SPOT -- QUICKLY**

Far superior to ordinary clumsy test bulb. Saves precious time. Indispensable in shop or home. Vest pocket size. Lifetime guarantee. (Pat. No. 1,778,883) Purchase through regular electrical dealers.

**L.S. BRACH MFG. CORP.**  
200 Central Ave. Newark, N. J.

FUSES  
MOTORS  
OUTLETS

**USE YOUR LEISURE TIME PROFITABLY with a BURGESS vibro-tool**

Decorate plastics (illustrated) in any form . . . trays, boxes, bracelets, etc. Tool leather, emboss metals, engrave jewelry, cut out cardboard signs; with a Vibro-Tool it's easy to make varied types of unusual gifts.

**Vibro-Tool with Engraving Needle \$7.50**  
(110 V. AC 60 Cycles)

Tool and 22 accessories, with sharpening stone, in handsome hinged hardwood box, complete for only **\$16.50**

**SEE YOUR DEALER or Order Direct**

**HANDICRAFT DIVISION  
BURGESS BATTERY COMPANY**  
166 N. WABASH AVE. • CHICAGO 1, ILL.





# Sweeping the Country



**Speed Sweep**  
**THE BRUSH WITH  
THE STEEL BACK**

Speed-Sweep brushes are replacing old style brushes in thousands of factories, warehouses, and stores because they sweep faster, cleaner and easier. Speed Sweep brushes also outlast ordinary brushes 3 to 1. There is a Speed Sweep to meet every requirement. Write for styles, sizes and prices today.

Milwaukee Dustless Brush Co.  
530 North 22nd Street  
Milwaukee 3, Wis.

Please send me complete information about Speed Sweep brushes.

Name \_\_\_\_\_

Address \_\_\_\_\_

City \_\_\_\_\_ State \_\_\_\_\_

## Can Cities Harness the Wind?

(Continued from page 173)

withstand this speed, each of the three blades is supported by two braces. The propeller shafts will be geared to a centrally mounted generator.

The question of the pessimistic observer—"What will happen when the wind dies down?"—has been anticipated. The entire unit is free to swing atop the tower and face the prevailing wind. Several hundred feet above the ground, the wind velocity is generally from two to three times that at the surface. This is one of the reasons for an extremely high tower. Furthermore, the aerogenerator can operate usefully in wind as low as 12½ miles per hour. More important, however, is the plan to have the wind generator "tied in" with hydro or steam generating plants, which would take over should the wind become too weak to drive the turbines.

All investigators of wind power have found the wind undependable. Thomas envisions a "battery" of aerogenerators tied together, so that if one should stop, others will continue to supply electricity. Located several miles apart, the probability of a sudden calm descending upon every generator at one time would be remote.

There is the opposite problem—how to slow down the generator in a high wind. In the Vermont generator, the blades could be "feathered" like an airplane propeller. The speed of the propeller could be kept almost constant, no matter how high the wind velocity, by changing the pitch.

Since the blades on the new aerogenerator are fixed, and the turbine speeds will vary with the wind, a flexible electric link with the cooperating utility circuit was decided upon. This would control the speed of the turbine through automatic adjustment of the load on the generator according to the velocity of the wind.

Safety devices are provided to protect the aerogenerator from damage in heavy winds. To prevent overloading the electric apparatus the turbine will slow down automatically in "over winds," and the entire unit will turn out of the wind when the velocity becomes excessive.

The War Production Board in 1944 authorized a research project at New York University based on Thomas' early reports. Four different two-blade wind-rotor models were tested in a 7 by 10-foot tunnel at the university. The researchers also designed their own 100-kilowatt wind turbine to enable the U. S. Army to determine the utility of such equipment as fuel savers.

(Continued to page 248)



IT'S A GRAND FEELING,  
TO BUILD A MODEL  
THAT FLIES...

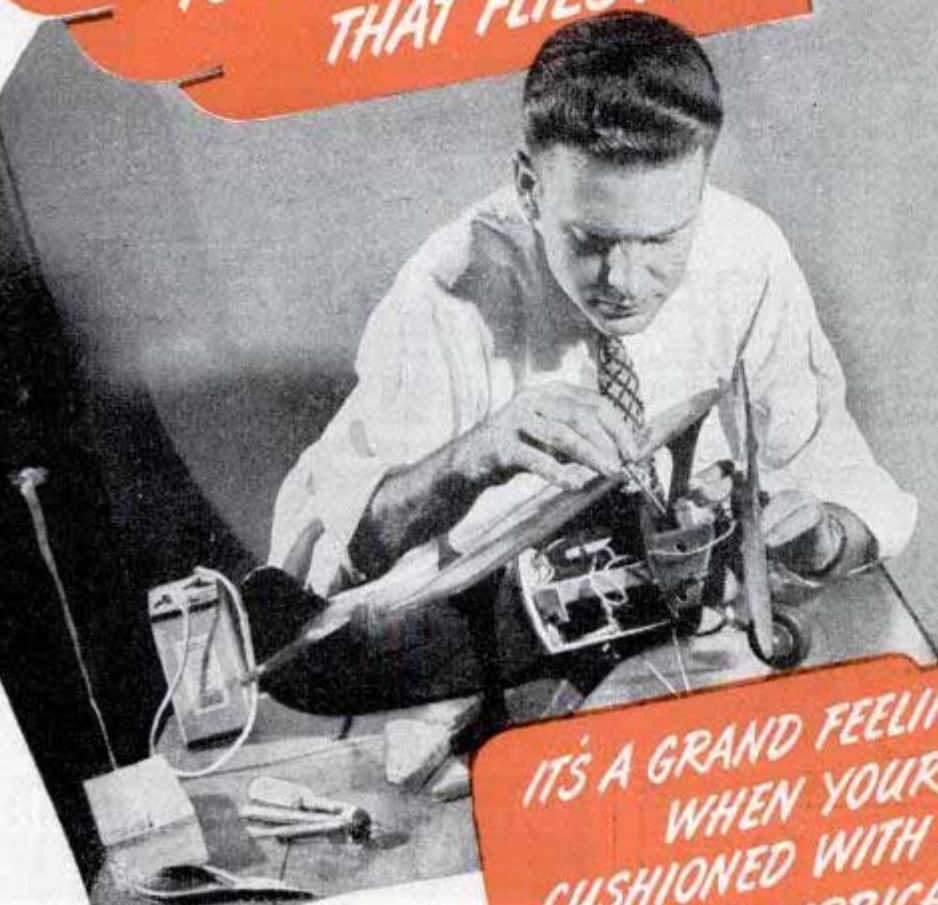

IT'S A GRAND FEELING, TOO,  
WHEN YOUR CAR IS  
CUSHIONED WITH MARFAK  
CHASSIS LUBRICATION

... AND **MARFAK'S** CUSHIONY FEELING LASTS LONGER

It's a grand feeling to have an interesting hobby... the same grand feeling you get from your smooth riding *Marfak* lubricated car.

*Marfak* is scientifically designed to cling to bearing surfaces, resist wash-out, jar-out and squeeze-out and stick to the job for a thousand miles and more. See your Texaco Man today, and say: "*Marfak*, please!"

**TEXACO DEALERS**

in all 48 states



THE  
TEXAS  
COMPANY

Tune in: { TEXACO STAR THEATRE presents the Eddie Bracken show every Sunday night.  
METROPOLITAN OPERA broadcasts every Saturday afternoon. See newspapers for time and stations.



**GO PLACES!  
DO THINGS with**

**Cushman**  
MOTOR SCOOTER

9 out of 10  
Motor Scooters used by  
U. S. Armed Forces  
were Cushman



Solo-seat Tandem,  
Side Kar Package-  
Kar Models

On highways, in town, on the farm, at the factory, for deliveries, service calls . . . go the Cushman modern and economical way. Cushman Motor Scooters are speedy, safe. Park anywhere. "Eye-dropper" gas economy. Ruggedly built with automatic clutch, two-speed transmission, 4 H.P. Cushman "Husky" engine. Balloon tires and knee-action springing give easy riding, load carrying capacity. Convenient luggage compartment.

**FREE** Send for literature and name of your nearest Cushman dealer. Write post card today.

**CUSHMAN MOTOR WORKS, INC.**  
Dept. M-200 Lincoln, Nebr.

UP TO  
**400 MILES**  
ON A  
**\$100**  
WORTH OF  
GAS

**BACKED BY 45 YEARS OF  
QUALITY ENGINE BUILDING!**

**IMMEDIATE  
DELIVERY!**



**\$19.95**

F. O. B.  
ROYERSFORD, PA.

**8 in. BENCH SAW**

COMPLETE AS SHOWN

**TABLE SEGMENT**—Shows degree of table tilt—graduated. **SPLITTER**—Hard temper cold rolled steel. **GUARD**—Aluminum. **MITER GAUGE**—Aluminum. Accurately graduated 45° each side of center. **BEARINGS**—(2) Oil-ite bronze. **CAPACITY**—0 to 2 3/4". **TABLE** 12"x14". **SHIPPING WEIGHT**—44 lbs.

This Price is Below the Authorized O.P.A. Ceiling

**AMERICAN MACHINE & TOOL CO., Inc.**

DEPARTMENT 100 • ROYERSFORD, PA.

## FLUID PUMP

At last, a dependable, low priced coolant pump for machine tools. Fully guaranteed by old, reliable manufacturer.

Constructed of non-corrosive materials. Plastic screen quickly removed for cleaning. With this pump and small pan for fluid you obtain same results as with expensive equipment.

May be used for Evaporative Coolers, Fountains, Displays, etc.

DEPT. M **\$19.50** POSTPAID

JOBBER AND DEALER INQUIRIES INVITED

**AMERICAN  
METAL PRODUCTS CO.**  
FORT WORTH 9, TEXAS



## FIND UNDERGROUND MINERALS and METALS with M-SCOPE

Employs same principle as Army Mine Detector. Unsurpassed in Efficiency. Write for Free 16 page booklet.

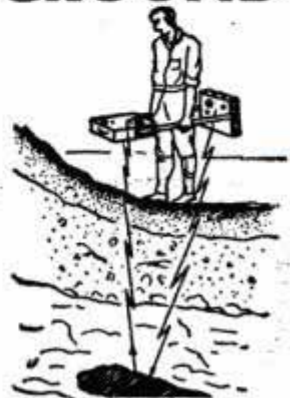

**FISHER RESEARCH LABORATORY**  
PALO ALTO CALIFORNIA

## Big Money for Workers In Home or Shop



Licensed Concrete Specialists wanted. No experience needed. Make *Colorglazed* concrete pottery without molds. New, low cost, patented method. Cemetery products, novelties, tiles, etc. Basement leaksealing. Other big pay projects. Booklet, details free. Men only.

**NATIONAL POTTERIES COMPANY**  
542 Lincoln Avenue Fergus Falls, Minnesota

## METALLIZE BABY SHOES

Learn this easy, money making business from nationally recognized consultant. Small investment; perpetual market. For free details write Joseph B. Kushner, B.S. Ch.E., Metal Finishing Consultant, Stroudsburg, Pennsylvania, RD3V.

SAY YOU SAW IT IN POPULAR MECHANICS

## BUILD ARC WELDER PLANS 35¢

We Show You How to build this new powerful welder without rewinding. For light or heavy work. Uses coils taken from old auto generators. Works on 110 or 220 volts A. C. Has 20 different heats. Send 35¢ for complete PLANS and valuable Catalog. Write today. **LEJAY MFG. CO., 1347 LeJay Bldg., Minneapolis 8, Minn.**



## MACHINE SHOP EQUIPMENT



Just off the press!—Every man who owns a workshop should have a copy of the new, up-to-the-minute, 200 page catalog of Machine Shop Equipment—the latest tools made by the biggest manufacturers in the U. S. Replete with illustrations, descriptions, prices. Prompt delivery on most tools listed in this book. Available at cost of printing—50¢ a copy—get yours today! **Price of Catalog Refunded on First Order over \$5.00.** Send check or Money Order to

**CENTER TOOL CO., 154 Centre St., New York 13, N. Y.**



# AMAZING NEW TRAP

CATCHES ALL KINDS OF ANIMALS.  
CAN'T HARM CHILDREN, PETS, BIRDS OR POULTRY

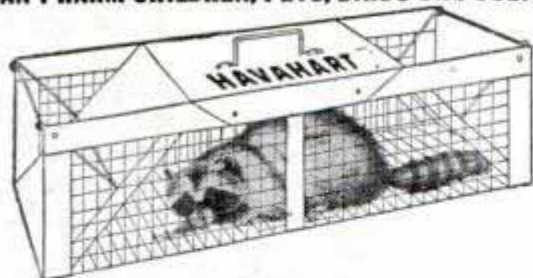

Amazing all metal galvanized "Havahart" traps beat snap traps all hollow for farm and estate use. Your good dog can't lose a toe in these traps and it's easy to return the neighbor's cat or turn your own loose unhurt.

This trap works like the old box trap except it opens at both ends so the animals can see all the way through and get a feeling of confidence.

No springs to break. Some have given continuous service for over ten years.

A trap set continuously near the chicken coop will pay for itself very quickly.

Send card today for illustrated price list.  
HAVAHAART, 407 Water St., Ossining, N. Y.

## New THOR "B" ENGINE-\$6.95

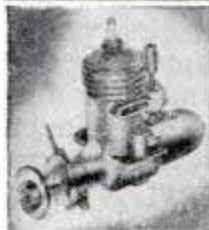

The new THOR "B"—Sensational miniature gasoline engine that really works. Super-power performance. Smooth, velvety power that roars into action with a "twist of the wrist." Over 20,000 already sold. 1/6 H.P. Complete with coil and condenser. Ready to run, only \$9.95. In KIT form, fully machined, 5 minutes to assemble, \$6.95, without coil and condenser. Powers all models. Fully illustrated instructions. Send \$1.00—shipped collect same day C.O.D. or send full price plus 25c extra and we ship parcel post insured.

FREE. SEND FOR 32-PAGE ILLUSTRATED HOBBY CATALOG.  
AMERICA'S HOBBY CENTER  
DEPT. B27, 156 WEST 22ND STREET, NEW YORK 11, NEW YORK

# LEPAGE'S GLUE

LEPAGE'S MODEL AEROPLANE GLUE

LEPAGE'S LIQUID SOLDER

## BOILS WATER IN 3 MINUTES



Wonderful for Homes,  
Cabins... Trailers...  
Wherever hot water  
is wanted QUICKLY

### ELECTRIC WATER HEATER

Immersion type... drop it into the water... it heats a basin or a sinkful pronto. 110 volts AC-DC. Comes with extra long heavy duty water-proof cord. Weighs 11lb. We'll mail it C.O.D.

**\$245**

Plus C. O. D.  
and postage

Write for Big free Trailer Parts Catalog

### NATIONAL TRAILER STORES

Dept. 10, Box 2353 Terminal Annex  
LOS ANGELES 54, CALIF.

# For Cabinet Finishing

use **PLASTIC WOOD**



in your  
**HOME WORKSHOP!**

If you'd like a satiny smooth, professional finish on your next cabinet job—use Plastic Wood! It's an ideal filler for cracks or rough grains, dries tight and hard, sands to a swell finish and takes paint, lacquer or varnish perfectly. Here's an extra hint—knot holes or gouges just disappear when this handiest filler is used! Handles like putty—hardens into wood!

... dozens of other uses

FOR FILLING...

FOR REPAIRING...

- Countersunk screws
- Chipped furniture
- Nail and screw holes
- Loose casters
- Broken balusters
- Broken furniture

- You'll want Plastic Wood SOLVENT, too. Get both at one time. It is made especially to control the consistency of Plastic Wood... useful also in removing dried Plastic Wood from tools and fingers.

T. M. Reg. U.S. Pat. Off.

At all Hardware,  
Paint and 10c Stores



# PLASTIC WOOD

Tube or Can

A CELLULOSE FIBRE FILLER



**Now, Simoniz  
in Colors . . .  
TO MATCH YOUR  
FURNITURE AND WOODWORK**



**Easily Applied With A Cloth. Quickly  
Rubs Up To Rich Luxuriant Luster**

See how Household SIMONIZ brings out the radiant, satiny luster. A protective beauty for furniture and woodwork that helps cover scratches, lasts so much longer, requires so little care. Apply in the shade that matches the finish. Then soiled spots, spilled things, fingerprints . . . all disappear with the swish of a damp cloth. Never an oily film or stickiness to attract dust and dirt. Try this new, improved care that matches the beauty of your finest finishes . . . Household SIMONIZ in Colors.

*Household*  
**SIMONIZ**  
*in Colors*

**FOUR BEAUTIFUL COLORS  
TO MATCH ALL FINISHES**

- NEUTRAL** . . . For bleached and light woods
- MAPLE** . . . Also for light oak, birch, pine
- WALNUT** . . . Also for dark mahogany, oak
- MAHOGANY** . . . Also for cherry, redwood

THE SIMONIZ CO., CHICAGO 16, ILL.  
"SIMONIZ" . . . Trade Mark Reg.  
U.S. Pat. Off. & Foreign Countries



From these studies it was concluded that wind turbines of about 100-kilowatt capacity would save 150,000 pounds of fuel oil per year at overseas military bases, or up to 250,000 pounds under favorable wind conditions.

The war's end, however, stopped further consideration of wind-power turbines for our overseas forces. The proposed overseas wind generator was to be mounted at the top of a steel tower about 72 feet high. Two blades, each 23 inches wide and 24 feet long, sweeping a circle 60 foot in diameter, would drive the generator.

The Thomas plan for commercial power production calls for a supplementary Diesel engine driving a 100-kilowatt synchronous generator matched to the induction generator atop the tower. This synchronous generator would furnish excitation current to the induction generator. It would also pick up the load as the wind decreased and power furnished by the induction generator fell off.

Operating constantly when there is sufficient wind, the Thomas generator will save coal or water of the cooperating power plant. If the wind dies down to a point where the aerogenerator cannot function properly, the stand-by plant will take over.

Although this would appear as a rather expensive approach to getting low-cost power, the abundance of wind—which is free—makes the aerogenerator economically feasible. The United States Weather Bureau and the Bureau of Reclamation are preparing studies of wind characteristics at certain locations, so that the generator can be placed most efficiently.

**Oven-Baked Gems for Industry**

*(Continued from page 166)*

of glass or imitation stones and still within the reach of those for whom natural stones are a financial impossibility. Physically and chemically identical with the natural materials, synthetics are far above the ordinary run of "costume" gems and can be purchased for a fraction of the cost of the real thing.

If you've been proud of a sapphire ring in the past, how would you like to own an entire watch crystal of pure sapphire? Such crystals have been produced in both clear and tinted shades. Before the war they sold for about five dollars.

There's a wide field for the gems in industry. In hardness, synthetic sapphire approaches diamond, the peer of the mineral kingdom. Man-made sapphire has a tensile strength equal to that of mild steel

*(Continued to page 252)*



Lots of FUN  
AHEAD on a  
**HARLEY-DAVIDSON**

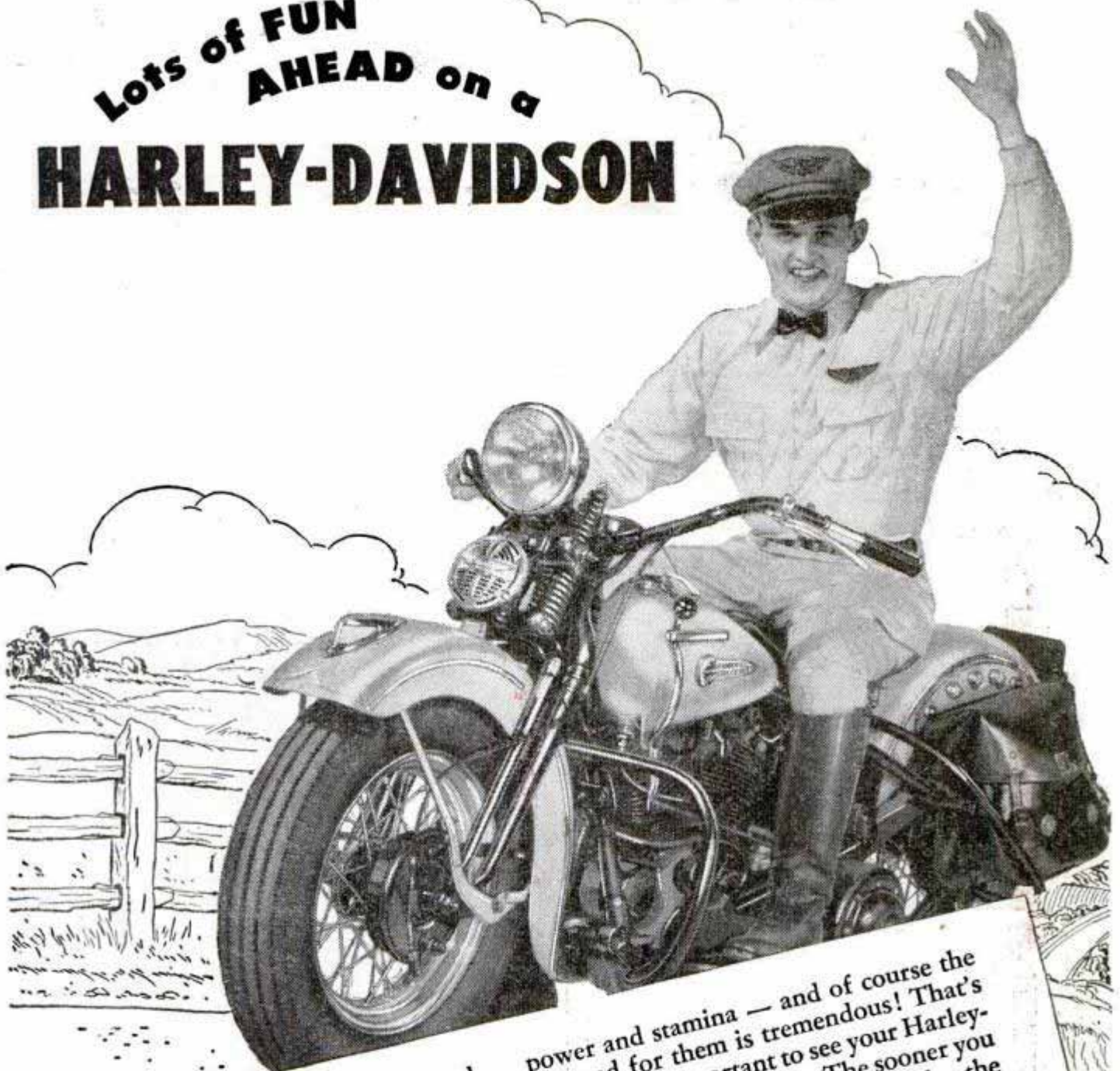

Sure thing — you want all the fun and excitement of motorcycling during the months to come! Life will be a continuous round of pleasure — when you own a Harley-Davidson. The new 1947 models have thrilling beauty, speed,

power and stamina — and of course the demand for them is tremendous! That's why it's all-important to see your Harley-Davidson dealer *at once*. The sooner you do, the earlier you'll be "all set" for the thrill-packed good times of motorcycling!

**HARLEY-DAVIDSON**  
*Motorcycles*

HARLEY-DAVIDSON MOTOR COMPANY, Dept. P, Milwaukee 1, Wisconsin

Please send at once free copy of 24-page "Enthusiast" Magazine, filled with motorcycle action pictures and thrilling stories.

Name.....

State.....

Address.....

City.....





Give Your Home Cleaner, Better Heat

prevent clogged lines!

# SILOO

## FUEL OIL TANK SOLVENT



**\$1.25**  
QUART

Harmful sludge can partially or wholly clog burner mechanisms and screens—cause shut down or loss of heat, wasted fuel, sooty burners that ruin curtains, drapes and furniture.

A simple, economical **SILOO** treatment clears and cleans the entire system. Just pour it in your tank. **SILOO FUEL OIL TANK SOLVENT** is completely harmless. Used by thousands of satisfied customers for more than eight years. Write for **FREE** pamphlet.

**PETROLEUM SOLVENTS CORPORATION**  
331 Madison Ave., N. Y. 17 • Plant: Port Reading, N. J.  
Petroleum Solvents Corp. of Canada, Ltd., Montreal

## RADIO Builders, Experimenters



ONLY  
**\$5.88**

Own this valuable  
Test Instrument!

Here's a wonderful value in an AC-DC Volt-Ohm-Milliammeter! This wide-coverage test unit with 2" moving-vane type meter reads: AC-DC volts, 0-25-50-125-250; AC-DC ma., 0-50; Resistance, 0-100,000 ohms, 2400 ohms center scale; Capacitance, .05-15 mfd. Jacks provide range selection. In black bakelite case with cord and plug. No. 84-306. *Special Price* . . . **\$5.88**

### GET THESE HELPFUL ALLIED RADIO BOOKS!

- Radio Formulas & Data No. 37-752 . . . 10c
- Dictionary of Radio Terms No. 37-751 . 10c
- Radio Circuit Handbook No. 37-753 . . 10c
- Radio Builders' Handbook No. 37-750 . 10c
- Simplified Radio Servicing No. 37-755 . 10c
- Radio Data Handbook No. 37-754 . . . 25c
- ALL SIX BOOKS No. 37-799 . . . . . 75c

Parallel-Resistance and Series Capacitance Calculator, No. 37-960 . . . 25c

R-F Resonance and Coil Winding Calculator, No. 37-955 . . . . . 25c

### ALLIED RADIO

833 W. Jackson Blvd. • Dept. 5-B-7 • Chicago 7

ORDER FROM

## ALLIED RADIO

See your ALLIED Catalog for Everything in Radio

## Can You Equal This Home for 2250

Shipped Direct from Our Mill



Save 30% to 40% on Your New Home..

Act Now!

Don't pay several hundred dollars more than necessary when you build a home! Buy it direct from our mill at our low factory price. We ship you the materials—lumber cut-to-fit, ready to erect. Paint, glass, hardware, nails, etc., all included in the price—no extra charges. Plans furnished—also complete building instructions. No wonder our customers write us that we saved them 30% to 40%. Prices subject to change without notice.

BIG BOOK of House Plans in Colors 25¢

### Handsome Big CATALOGUE

Pictures wonderful homes in colors at money-saving prices. Designs to suit everyone. Send 25c for catalogue today.

### LEWIS MANUFACTURING CO.

1272 Lafayette Ave., Bay City, Michigan

## Here YOU ARE WOODWORKERS

### THE NEW CONSTANTINE MASTER MANUAL

Bigger and better with more new pages of helpful articles and information on materials and supplies. Hundreds of familiar items back again; dozens of new additions including lumber, veneers, inlays, plywood, tools and finishing materials. The greatest 25c worth ever offered craftsmen and woodworkers. In addition, without charge, a year's subscription to Chips & Chats to keep you up to date on craftsmen's activities and many bargains. Send 25c now to **ALBERT CONSTANTINE & SON, INC.** 791-B East 135th St., New York 54, N.Y.



**FREE**  
1 YR. SUBSCRIPTION TO  
**CHIPS & CHATS**



### IMMEDIATE SHIPMENT

The angle you want when you want it  
• **Universal Ball Positioner and Vise** •  
Jaw width 2" • Jaw Opening 2 1/4" • Positive Simple lever lock and release. No lost motion

SEE YOUR DEALER OR WRITE  
**Reypo CORPORATION**

9900 Lincoln Blvd., Los Angeles 45, Calif.

### COLOR CONCRETE WITH CHEMICALS

Get into business on small capital working at home, or shop. Start small grow big. There is real money in making Hollywood style pottery and birdbaths without moulds. Our instructions cover a large variety of designs. Washing-wells, benches, garden light-houses, stucco-rock, imitation marble, cement water-paints and many more. 10c brings sample, details and pictures. Hollywood Cementcraft, 8529 Wonderland Ave., Hollywood 46, Calif.

### NU-WAY Lawn Mower

Write for Free Circular

PRICE  
**12.50**

WHY PAY MORE?

### BUILD YOUR OWN ROTARY TYPE LAWN MOWER

We Supply Cutting Unit Complete

No Increase in Price

Tractor-Lite Mfg. Co.  
Spirit Lake, Iowa





# Luther

HAND AND POWER GRINDERS

# HAND GRINDERS

**FAMOUS FOR FIFTY YEARS**

Precision-built to exact specifications—proudly offered by dependable dealers—carefully chosen by those who demand fine tools. Select your new hand or power grinders from Luther's complete line At Your Hardware Dealer

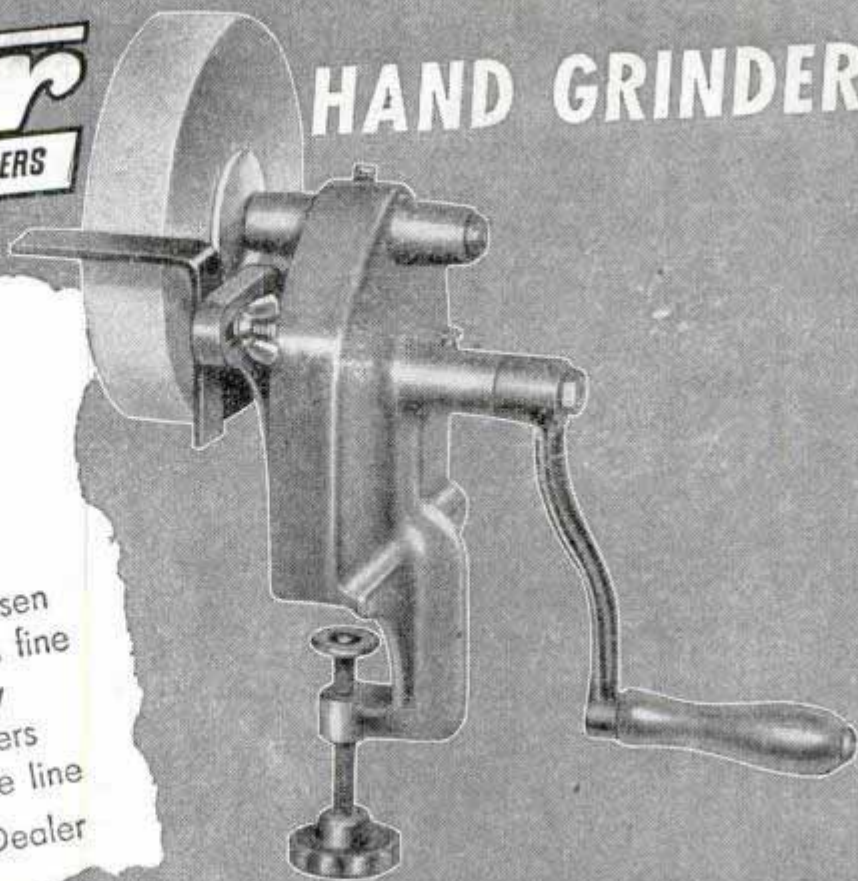

**LUTHER GRINDER & TOOL CO.**

(Established 1896)

SHEBOYGAN, WISCONSIN

## JET PROPULSION



### GAS TURBINE Model Engine

★ ★ Be one of the first to build a real Turbo-Jet Model Engine. Single-stage centrifugal compressor and turbine. This is a real engine, easily made with ordinary home workshop equipment. Complete plans for construction . . . design formulas and curves for checking performance and testing.

**\$2.00**  
Post paid

**THE ROTOJET CO.** Department 11  
BOX 757 • LOS ANGELES 25 • CALIFORNIA



Balance 4" x 9" Base. With either \$6.00 Metric or Avoirdupois Weights . . .

Catalog with 3000 Illustrations of laboratory apparatus, and over 10,000 prices sent for \$1.00. Catalog of 80 Scientific books. Price \$1.10.

**LABORATORY MATERIALS CO.**  
7321 Vincennes Ave. Chicago 21, Ill.

Sand Casting—Forging—Heat Treating—Case Hardening

## BRONZE FOUNDRY



is again available in limited quantity without priority. Orders filled in sequence as received. INVENTORS—SCHOOLS—CRAFTSMEN use FOUNDRYETTE for making castings quickly for new inventions, for instruction, and general purpose. Order now for early delivery. Three sizes are available capable of making bronze castings of 1½, 3, and 6 pounds weight, aluminum, copper, brass, etc. Domestic gas supply and 110 volt AC or DC energy required for operation.

Write for circular.

**KANSAS CITY SPECIALTIES CO.**  
Box 6022, Dept. P-75 Kansas City, Mo.

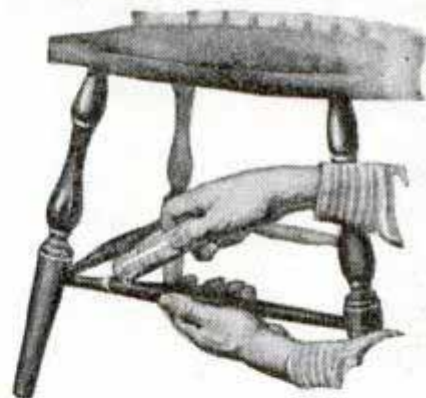

## REPAIRS FURNITURE, TOYS

... also broken china, glassware, torn luggage and books. This handy adhesive is waterproof, transparent and flexible. Get a tube today!



**DU PONT**  
**DUCO CEMENT**  
REG. U. S. PAT. OFF.



**IT'S  
NEW!**



**DUMORE**

**DUPLEX GRINDER**

**More Power—More Capacity  
More Durability and Utility  
than any other homeshop handgrinder!**

Now you can have—for your workshop—the high-quality tool used by industry, at the price of an ordinary homeshop handgrinder. The Duplex Grinder is made by a famous manufacturer of precision industrial tools. Actually it's an industrial grinder modified for home workshop use, without sacrificing the extra power, endurance, capacity, and utility required by industry. Hobbyists in wood, metal, and plastics welcome this new tool. It makes their work easier, faster, better — and twice the fun. Lightens the job of the "handyman" around the home or farm.

**Full Power to Handle 1/4" Shank Tools**

You can do a countless variety of jobs with the Duplex—sanding, sharpening, grinding, sawing, and many more. Its chuck takes tools with 3/4", 1/2", and 3/32" shank — ordinary handgrinders usually handle only up to 3/16" shank tools. A full 1/14 HP motor has plenty of power for heavier jobs. Long-life bearings guarantee trouble-free service.



The Deluxe Duplex Grinder Kit (illustrated above) includes the Duplex Grinder and 27 different tools and accessories, packed in a permanent case of handsome polished wood. Complete as described — \$27.50. Standard, 9-accessory kit, without case — \$19.75.

With a simple, easy-to-use attachment your Duplex becomes a flexible-shaft tool. Write for information on this kit, and other attachments which convert the Duplex into a lathe- and bench-grinder.

**Money-Back Guarantee—10-Day Trial**

Take advantage of our 10-day Trial Money-Back Guarantee — prove to yourself that the Duplex Grinder is the best hobby-tool value on the market today. Production is still too limited to stock your dealer, but while the supply lasts, we can accept direct orders for immediate delivery.

H-1 **Tear out and mail this coupon today!**

THE DUMORE COMPANY, Dept. B-51, Racine, Wisconsin

Please send me —

- One Deluxe Dumore Duplex Grinder Kit .....Price \$27.50 } Check
- One Standard Dumore Duplex Grinder Kit .....Price \$19.75 } One

Enclosed is my check (or money order) for \$.....

Please ship C.O.D. plus postage and insurance.....

If not completely satisfied with my Duplex, I can return it within 10 days for a complete refund of the purchase price.

Please send complete information on the Dumore Duplex Grinder.

Name.....

Street Address.....

City.....(.....) State.....

and a resistance to crushing loads exceeding that of steel. It takes a more-than-mirrorlike polish, does not scratch easily and is not subject to the corrosive effects of most acids.

It's long been a saying in the synthetic jewel industry that "wherever there's friction there should be a sapphire." Fine watches, of course, will account for thousands of jewels every year. In addition, thread guides for the rayon industry are already being made of sapphire. The guides last indefinitely and don't develop the ragged spots that cut down the efficiency of steel guides.

Synthetic sapphire is also winning a place in the medical field. It aids in the ultraviolet treatment of blood plasma and serums because it transmits ultraviolet rays more efficiently than any other known material.

Sapphires are used in inexpensive master gauges for checking the accuracy of other gauges. Sapphire gauges maintain an accuracy of 0.00001-inch tolerance and outlast glass, tool steel and other materials.

The synthetic gems are going into extrusion dies, long-life tools for the precision machining of metals, phonograph needles with long-run performance and bearings of all kinds. Wherever a smooth, ultrahard, long-lasting, wear-resistant substance is needed you'll soon find synthetic sapphire.

**Germ Warfare Against Bugs**

(Continued from page 120)

Coast and was then checked by the artificial spreading of a beetle that attacks only that plant is an illustration of what is possible. Scientists are going after the prickly pear cactus with good results, and they hope additional research will help in the control of other weeds, particularly those affecting range lands and pastures.

In the chemical warfare field, one important development is a new soil fumigant that kills off wire worms and other nematodes in most soils. Nematodes are among the most widely spread of all agricultural pests and have been difficult to control. They attack some 1500 plant species, including cabbages, potatoes, tomatoes, corn, rice, citrus, peanuts, tobacco, pineapples and sugar beets. They are found in practically all tropical and semitropical regions and are a serious pest in the southern and southwestern parts of the United States.

Produced by Shell Chemical Corporation, the new soil fumigant is injected into the soil in spoonful quantities. The fumigant spreads through the earth, killing

(Continued to page 256)



EASY with one hand  
and a

**"YANKEE"**

Quick-Return Spiral  
Screw Driver



Got to drive screws where it's hard to use both hands? Easy with a "Yankee" 130A Spiral Driver. "Quick-return" spring in handle keeps bit in slot, returns handle after each push.

Write for the "Yankee" Tool Book.

YANKEE TOOLS NOW A PART OF

**STANLEY**

THE TOOL BOX OF THE WORLD

**NORTH BROS. MFG. CO.**

Division of The Stanley Works  
Philadelphia 33, Pa.

Save  
with  
**LARSON**  
Leathercraft

For  
Pleasure and Profit

Send ten cents to Leathercraft Headquarters for 16-page catalog describing all necessary materials for making belts, moccasins, purses, gloves and many other practical items. Easy to assemble. Instructions come with materials.

Send  
for this  
Catalog



**J. C. LARSON & COMPANY**  
176 N. Wacker Drive • Chicago 6, Illinois

## Steel Wheels

To Build Your Own Wagon, Cart, Toy, etc.

Sturdy, rubber tired pressed steel wheels with red enamel finish. Ready to use axles—threaded at both ends. Acorn nuts supplied. Order today, or send stamp for catalog.

**WHEELS WITH SOLID RUBBER TIRES**  
4" Wheels, 1/4" bearing, Steel Disc..... \$ .75  
6" Wheels, 3/8" bearing, Steel Disc..... 1.00

**WHEELS WITH SEMI-PNEUMATIC TIRES**  
6" x 1.50 with 3/8" Oilite Bearing..... 1.75  
8" x 1.75 with 3/8" Oilite Bearing..... 2.25

**AXLES, COLD ROLLED STEEL**  
1/4" x 14" long, Nickel Cap Nuts..... .40  
3/8" x 10" long, Nickel Cap Nuts..... .60  
1/2" x 18" long, Nickel Cap Nuts..... .80

Sent postpaid in U. S. on receipt of price.

**CIRCLE METAL MANUFACTURING COMPANY**  
4266 E. PACIFIC WAY LOS ANGELES 23, CALIF.



New  
**MIRACLE WALL CLEANER**

Saves Costly Redecorating!

AMAZING INVENTION. Banishes old-style housecleaning mess and fuss. No tags—no sticky "dough"—no red, swollen hands. No more dangerous stepladders. Literally erases dirt like magic from walls, ceilings, window shades, upholstered furniture, etc. **Endadadners!** SAVES REDECORATING!

**SAMPLES FOR AGENTS** Sample offer sent immediately to all who send name at once. A penny postal will do. **SEND NO MONEY—** just your name. **KRISTEE CO., 682 Bar Street, AKRON, OHIO.**

*Logan*

A NAME TO REMEMBER  
WHEN YOU THINK OF **BETTER LATHES**  
AND SHAPERS

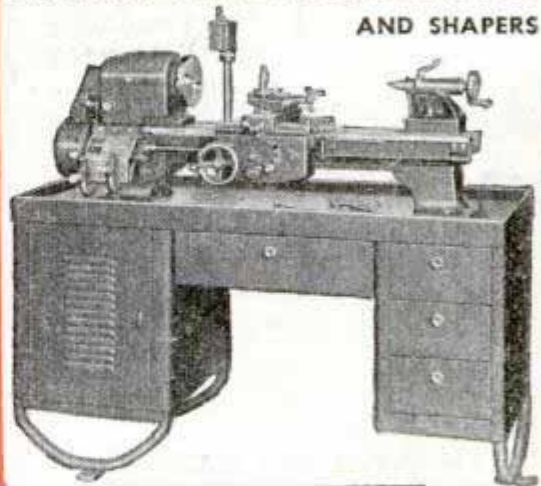

the **LOGAN** lathe

### Widens the Scope of Small Shops

The variety of jobs a Logan Lathe handles with speed and precise accuracy is an asset as important to small work shops as it is to industrial tool rooms. Reaming, taper cutting, turning, facing, boring, and threading of steel, cast iron, non-ferrous metals and plastics are every-day Logan Lathe operations. For even further versatility, a hexagonal turret assembly is available to make your Logan Lathe a high speed production tool.

**WRITE FOR THE LOGAN CATALOG...** complete, illustrated descriptions of Logan Lathes, Shapers and Accessories.

### 9 REASONS why LOGAN Lathes are BETTER lathes

- 1 **BALL BEARING HEADSTOCK** for sustained accuracy.
- 2 **RUGGED, ACCURATE BED** within .0005" of parallelism.
- 3 **SELF-LUBRICATING BEARINGS** at vital points lengthen life.
- 4 **BACK GEARS ENCLOSED IN HEADSTOCK** with shifter rack safely and conveniently at your finger-tips.
- 5 **RUBBER CUSHIONED COUNTERSHAFT** for smoothness and accuracy in working area.
- 6 **THREE POINT SUPPORT** Steadies the countershaft, prevents rocking.
- 7 **ENCLOSED BELTS, GEARS, PULLEYS** Prevents accidents. Keeps lathe clean.
- 8 **AUTOMATIC BELT TENSION RELEASE** Makes belt changing easy and safe.
- 9 **PRECISION BUILT THROUGHOUT** For tool room accuracy in your shop.

**LOGAN ENGINEERING CO.,**  
DEPT. B-2, 4901 LAWRENCE AVE., CHICAGO 30, ILL.



**FREE** ASK FOR YOUR COPY—  
**LATEST CAMERA CATALOG**

CAMERAS • MOVIE EQUIPMENT • ENLARGERS

IMMEDIATE DELIVERY — GUARANTEED

**ARGUS C3**

35mm CANDID CAMERA  
with FLASHGUN and CASE

Shoot pictures indoors and outdoors, day and night. Excellent for color. F3.5 coated lens. Shutter speeds from 1/5 to 1/300 sec. stops fast action. Built-in coupled range-finder. Easy to operate.



**\$69<sup>58</sup>** Complete with Flashgun and Leather Case



**MICRO-16 CAMERA**

Slip into your pocket and carry it anywhere for fast, candid shooting. Provides more pictures at less cost. All metal case, handsomely finished.

Smaller than a Pack of Cigarettes!

**PEERLESS WILL ALLOW YOU**

**\$500** or more on your present exposure meter (regardless of make, condition or where it was bought), toward the purchase of one of these photo-electric exposure meters.

- WESTON MASTER II.....\$29.67
- G.E. DW-58.....\$26.95
- DeJUR AUTOCRITIC.....\$23.75

ORDER NOW!

Write to  
DEPT. 24

**PEERLESS**  
CAMERA STORES

133 E. 43rd ST., NEW YORK 17, N. Y.

**GREAT NEW TOOL!**

The world-famous Mead Bandsander is ideal for home workshop use! This remarkable machine quickly shapes, sands, carves and polishes wood, metal, plastics! Works equally well on inside cutout openings or irregular outside edges. Gets at places no other can! Tilting table for bevelling, chamfering. Rust-and-sweat proof top. Ball bearings. Saves time, labor, money on jobs in any home or industrial shop. **Invaluable** to home-craftsmen, makers of patterns, tools, dies, signs, costume jewelry, castings, forgings, ornaments, radio and electrical parts, stampings, etc. Nothing else like it. Sold on 5 Day Trial, money back guarantee. Circular Free! Cuts Fast and Clean... Saves Filing, Sanding Work.



Shows use on inside cut-out openings

*Bandsander*  
**THE MACHINE THAT AMAZED THE EXPERTS!**



**WRITE for FREE Circular**

Send for free details on "the machine that amazed the experts!" Rush a post-card today for Circular, surprisingly low price. Hurry!

**MEAD SPECIALTIES CO.**  
41 14 N. Knox Ave., Dept. 127, Chicago 41, Ill.

**PERFECT DOWELS**

... easily made



**ON YOUR LATHE OR DRILL PRESS**

Use a SPEE-DOWL and you can work wonders with wood. Quickly and easily you'll make dowels of any wood... perfect burnished dowels for furniture, toys and thousands of other projects. You merely push SPEE-DOWL on wood—the lathe or drill press does the

work! Cast aluminum body, tool steel blade. SIZES: 2, 3, 4, 5, 6, 7 and 8/16". Only \$1 ea. Special—any 4 of above for \$3.50; complete set of 7 for \$6. Also sizes 9 to 20/16" \$2.65 each. SPEE-DOWL is Unconditionally Guaranteed. Send postal note or check—we pay postage in North America.

FREE Literature.

JOHNS MFG. CORP., DEPT. C-5  
DUNELLEN, N. J.

**PLEXIGLAS**

VERSATILE, CRYSTAL-CLEAR PLASTIC!

for hobbyists and use on home equipment

• Transparent • Sparkling • Strong and Durable • Lightweight • Can be machined, sawed, drilled, threaded • Easily formed and molded—can be bent or twisted by hand to almost any shape • Will not warp, craze or discolor in sun or weather • Bends light around corners, curves, angles • Perfect for lamp shades, bookends, tables, candlesticks, tableware, jewelry and novelties of all kinds!

**SHEETS • RODS • TUBES • ODD SHAPES**

ALSO dyes, cements, buffing compounds

Franklin Plexiglas Anti-Static Wax, Burnisher & Cleaner

**CADILLAC PLASTIC COMPANY**

655 WEST BALTIMORE

DETROIT 2, MICHIGAN

Portable—"NEW ELECTRIC TOOL GRINDER"—Stationary. 6000 RPM Delco 115 V AC.DC. Motor. Norton longlasting grinding wheel—A SHARP EDGE IN SECONDS—grinds cool. Guide forms beveled edge on any size knife or scissors. Ideal for chisels, plane blades, drill bits, metal parts, cutters, Etc. A real **TIMESAVER** for butchers, restaurants, tailors, barbers, jewelers, model makers, craftsman. "FIXIT SHOPS"  
—Every housewife has dull knives & scissors. Pays for itself. Guaranteed. Order today \$14.95 POSTPAID. Send check or M.O.



MORGAN GRINDER MFG. CO., 810 So. 31 St., Omaha 5, Nebr.

**MEGOW SHIP MODELS...**  
with Carved Balsa Hulls

Each kit contains accessories costing more than the price of kit if bought separately

- GS-1 Submarine.....\$4.95
- GS-2 Destroyer Pillsbury... 8.00
- G-4 Great Republic..... 2.50
- G-5 Bounty..... 2.50
- G-12 Xebec..... 2.50
- G-15 Arabella..... 2.50
- G-16 Seabird..... 2.50
- G-17 Bear of Oakland..... 2.50
- HC-1 H.M.S. Bounty..... .75
- HC-8 U.S.S. Niagara..... .75
- HC-9 H.M.S. Queen Mary..... .75
- HC-14 Cabin Cruiser..... .75
- HC-15 U.S.S. New York..... .75
- HC-16 Pensacola..... .75
- HC-21 Hispanola..... .75



Bounty

See them at your dealers.

MEGOW CORP., Philadelphia 22, Pa.



# MIRACULOUS OPTICAL GYROSCOPE!

The Famous Mark 18 Gyro-sight...

New—Ready to Run—For Only \$12<sup>95</sup>!

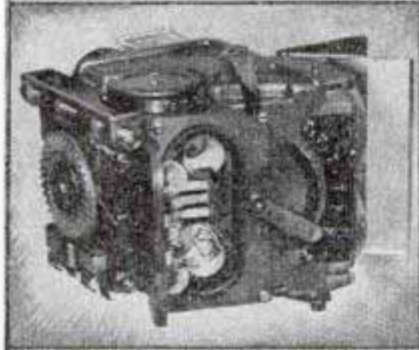
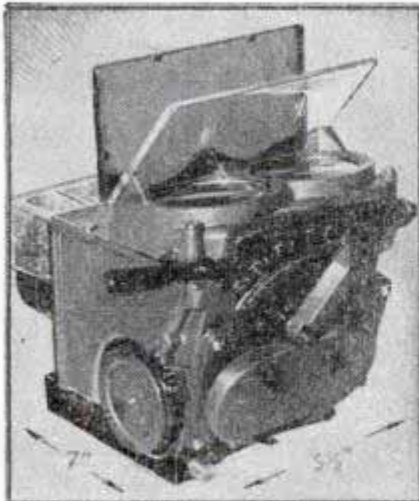

THIS magnificent precision instrument is a triumph of Applied Physics. Its breathtaking ingenuity fascinates every engineer who sees it. **IT WORKS!** Operate this inspired aircraft gunsight that measures and computes automatically—see how sheer designing genius made gear-trains and amplifiers unnecessary. **GYRO UNIT COMES OUT** easily with all wires intact. Remove it and see how tiny ball-bearing motor's clever governor maintains constant speed from 14-22 V. **at only 1/10 amp.** AC or DC (no 3-phase or 400 ~ stuff!) You'll marvel at the precision-balanced gyro, its beautiful yoke and special bearings. Demonstrate how **GYRO MAINTAINS FIXED POSITION IN SPACE**, and this one has a hand figured *spinning mirror* supporting a perfect optical image at full speed! Energizing 6 electromagnets with DC will show erection rate or compute lead and deflections.

Light up the twin projection systems and see both images fuse into one. One fixed, one moving and variable, demonstrate *virtual images* **TWO SUPERB ACHROMATS** in threaded brass cells, cemented doublets, 2" dia. 7/4 c.f.l. *tested perfect for telescope objectives!* (Unusual—see instructions.) 3 Precision first surface flats, aluminized, one 2 1/4" x 4 1/4". Reflecting glass, sun filter. Two 22v. lamps in door, changeable if another voltage is desired; no rewiring. Two reticles, glass enclosed. Stainless gears. **PLASTIC GEL CELL DEHYDRATOR** with tell-tale colored silica gel. Die-cast aluminum case **HERMETICALLY SEALED.** 24" cable, 10 coded wires. Detailed instruction sheets. Detachable recoil shock base, 25-leaf spring, bronze slide on **PRECISION STAINLESS** ground rods, azimuth clamp, bolted to wood shipping base. Elegant padded cover for complete unit—brand new, original package. Cost Navy hundreds of dollars. **What a Buy at Only \$12.95.** Send check or money order, no C.O.D.'s. Ship. wt. 13 lbs. Express Collect.

**COLUMBO TRADING CO., Inc.**  
304 Canal Street, New York 13, N. Y.  
25 years on Canal St.—Five Floors of bargain values.

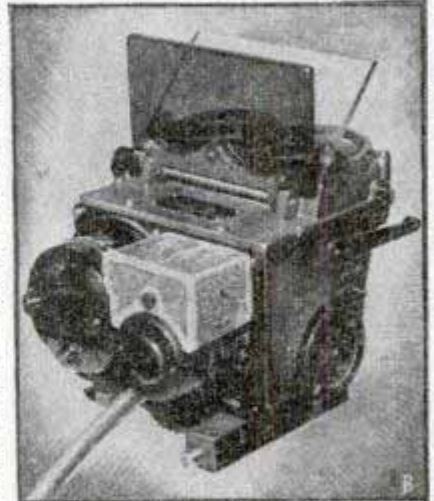

## PHOTOGRAPHERS:

PRINT PHOTOS  
ON

BOOK COVERS!



CHINAWARE!



RECORD  
ALBUMS!



GLASS  
SILHOUETTES!



WOODEN  
JEWELRY!



PHOTO MURALS  
DEN WALLS!



Now You CAN PRINT PHOTOS  
ON PRACTICALLY ANY SURFACE!

EASY TO USE — BY CONTACT, BY PROJECTION  
— ON METAL, GLASS, PAPER, PLASTICS, WOOD, ETC.

Get This  
Free Booklet  
From Your  
Dealer!

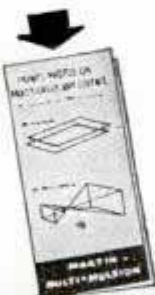

Let your imagination go! Find new uses for your photographic hobby! Put those pictures you prize most on display in hundreds of interesting ways. It's all possible with the new Martin Multi-Mulsion—a simple, practical emulsion which sensitizes almost any surface for photographic reproduction. Ready to use. Applied in one coating with a brush or cloth. Works with ordinary darkroom equipment.

The Glenn L. Martin Co., Baltimore 3, Md.  
ASK YOUR DEALER ABOUT

GLENN L.

*Martin*

**MULTI-MULSION**





# BRIGHT STAR

## BATTERIES

**GIVE MORE  
BRIGHT LIGHT  
LONGER  
FOR YOUR 10¢**



**HERE IS PROOF! BASED ON TESTS CONDUCTED UNDER GOVERNMENT STANDARDS**

THREE LEADING BRANDS TESTED	BRIGHT STAR	BATTERY A	BATTERY B
<b>VERY BRIGHT LIGHT</b>			
<b>GOOD LIGHT</b>			
<b>FAIR LIGHT</b>			

Each column adds up to 10 cents, but **BRIGHT STAR** leads the field with 70% **VERY BRIGHT LIGHT**.

And that's not all... Bright Star batteries give 150% of the Light Industrial Test requirements as specified by the U. S. Gov't Bureau of Standards.

*... and there are more  
BRIGHT STAR FLASHLIGHTS  
sold than any other make.  
they, too, have been  
best since 1909!*



BRIGHT STAR BATTERY CO.  
CLIFTON, N. J.

soil pests and some few weed seeds. Within two weeks the fumigant has disappeared and the soil may be cultivated and seeded.

Results of the treatment in nematode-infested areas are spectacular. Soil that formerly produced 816 pounds of sweet potatoes to the acre produced 13,860 pounds after fumigation. Sugar beet production jumped from an original three tons to 17 tons per acre. Peach trees increased their yield 10 times. Lettuce, lima beans, carrots, beets and squash multiplied their yield by an average of six times.

Known as D-D, the fumigant is a by-product in the manufacture of certain plastics and is technically a mixture of dichloropropane and dichloropropylene. A few dollars' worth is enough for treating a 2000-square-foot plot. A stick for making a hole in the ground every 15 inches and a spoon are the only tools needed, or a special injection device that resembles a giant syringe may be used. Large acreages are disinfected by means of tractor-drawn equipment that makes the injections at the proper spacings. Often the tractor equipment does two or more jobs at the same time, such as fumigating the soil with D-D and also making injections of liquid or gaseous ammonia, now used as a fertilizer because of its high nitrogen content.

Interested in finding new uses for petroleum by-products, Shell has established a modern \$500,000 agricultural laboratory at Modesto, Calif., where it is testing the possible uses in agriculture of a wide range of organic and synthetic chemicals. The D-D soil fumigant is one such product. Continued research may produce other fumigants to destroy plant disease organisms in the ground, as well as destroying many kinds of weed seeds.

Dr. Roy Hansberry, director of Shell's new laboratory, is optimistic about a new group of oil-type vapor sprays for use against agricultural pests. The oil vapors are simply an improved vehicle for carrying pyrethrum, rotenone, DDT or other insecticides to crops that are threatened by insects. The oil particles in the vapor adhere to plant surfaces for a minimum of a week and in some cases are effective up to several months. The spray may be used effectively in wind conditions that limit dusting or the use of aerosols. It needs no bulky admixture such as water. From four to seven gallons per acre are effective for most crops, as against some 300 gallons of water spray per acre in the case of potatoes.

Among other implications, this means that the costs of applying insecticides by the use of aircraft can be slashed to the

(Continued to page 260)





# OWN A "POCKET SIZE" MACHINE SHOP

## IMPROVED MOTO-TOOL

APPROXIMATELY  
27,000 R.P.M.  
CUTS CLEANER;  
SAVES CUTTERS

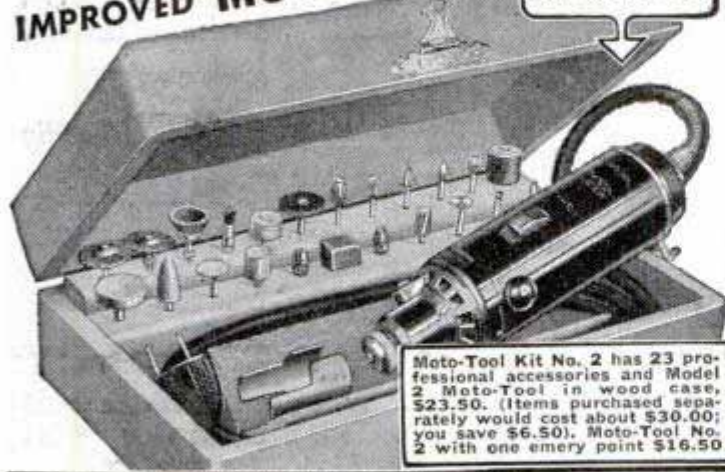

Moto-Tool Kit No. 2 has 23 professional accessories and Model 2 Moto-Tool in wood case, \$23.50. (Items purchased separately would cost about \$30.00; you save \$6.50). Moto-Tool No. 2 with one emery point \$16.50

## "MAN...WHAT A POWERHOUSE!"

### A TOOL THAT PACKS YEARS OF PLEASURE

Here's a tool to please a man's heart. A gleaming "powerhouse" that holds promise of endless creative hours. This "pocket-size machine shop" is a war veteran... used by all branches of the armed forces in far flung repair bases... and it helped set production records at General Electric, Westinghouse, Remington Arms, Ford and other plants. Hobby enthusiast or expert craftsman... first choice is Model 2 "Moto-Tool" kit, with its handsome, felt-lined, highly finished wood case... with rows of tools begging to be put to work. The usefulness of "Moto-Tool" for precision work is increased by two versatile attachments now available at slight additional cost (see below).

### Look For These

#### Moto-Tool Features

- Housing has "pencil-type" finger grip
- Instant-action, wrenchless chuck
- Oil-less, sealed, trouble-proof bearings
- Patented automatic chuck lock pin
- Oversize armature shaft, hardened, ground and polished
- 110 volt, universal type motor
- Easily replaced commutator brushes
- Sliding snap type switch
- Handy hanger hook
- Cord protector
- Sturdy, shockproof bakelite housing
- Dust-filtered, air-cooling system
- Weighs only 13 oz. . . . shaped to fit the hand
- Dynamically balanced for vibrationless operation.

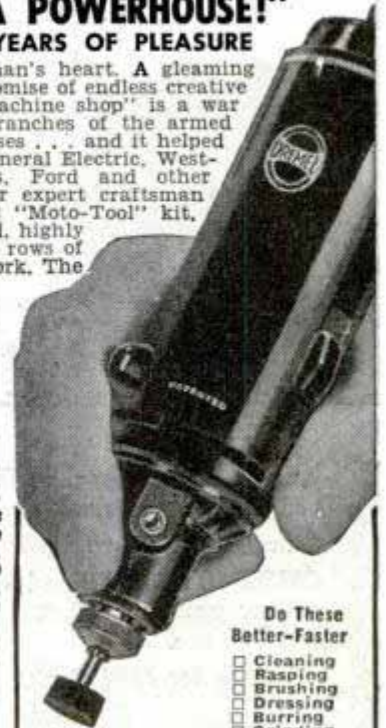

#### Do These Better-Faster

- Cleaning
- Rasping
- Brushing
- Dressing
- Burring
- Grinding
- Routing
- Sanding
- Drilling
- Inlaying
- Sawing
- Scoring
- Cutting
- Carving

### Free Both Hands With Moto-Tool Attachments



Moto-Tool Stand (left), made of heavy cast iron, holds Moto-Tool at any position or angle. \$4.50



Moto-Tool Shaping Table \$2.50. (Shown with stand, right). Aids accuracy in routing and grinding.

### MONEY BACK GUARANTEE

Buy Dremel "Moto-Tool" and Accessories from your dealer. If he does not handle them, order direct from the factory on a 10 day trial, money back guarantee.

DREMEL MFG. CO., DEPT. 117-B, RACINE, WISCONSIN



## Appliance \$10<sup>95</sup> Tester

### LOCATES TROUBLE INSTANTLY IN ALL ELECTRICAL DEVICES

In this single unit are all the necessary tests for examining every appliance. Checks thermostats under working conditions. Tells instant if opens or closes. Controls heat on soldering irons. Prevents over-heating. Tests continuity, open circuits, automatic irons, vacuum cleaners, motors, coin machines, bulbs, 3-way switches, etc. Great time and money saver! ONLY \$10.95 COMPLETE. POST-PAID. NO C.O.D.'s. MONEY-BACK GUARANTEE.

FREE with each Tester. New, Complete Practical Course in electrical appliance repairing. WRITE FOR CIRCULAR. HANLAN CO., 1419-A, West Jefferson, Los Angeles 7, Calif.

## Skilled Hands Need PRECISION TOOLS

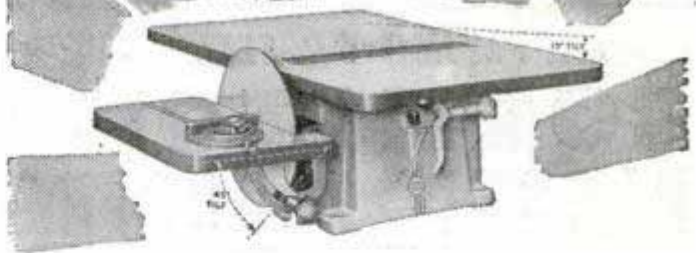

In the Drum and Disc SANDMASTER, Darra-James brings your shop more precision, more accuracy, more speed for your sanding operation... at a moderate price. Uses easily obtained standard size sandpaper.

Outstanding features include lever controlled depth of cut; graduated quadrant; 1/2" shaft extension for accessory connections; "sealed for life" ball bearings; structural aluminum alloy construction to assure long rustproof life.

If your dealer is temporarily out of the D-J Power tool you want, please wait. You'll be glad you did.

*Darra-James*

CORPORATION

WATERBURY 91, CONN.

## FINE TOOLS NEED FINE OIL!



• Lubricates



• Prevents Rust

• Cleans • Polishes

SOLD EVERYWHERE

**3-IN-ONE** Oil



**Time & Date AT A GLANCE**

**BELL**  
GUARANTEED  
**CALENDAR WATCH**

Tells time, name of day and date.  
Day name changes automatically.

No. JX382 - 17 jewels, waterproof, shock-proof, anti-magnetic, radium dial and hands, stainless steel back **\$49.75**

Other fine ladies' and men's watches from **\$24.75**

**ORDER BY MAIL:** Send check, money order or pay postman C.O.D. Prices Incl. Fed. Tax and Postage.

Write for **FREE** illustrated booklet "JX"

**Repair Service**

All types and makes of quality watches repaired expertly and promptly. **FREE** estimate on request.

**BELL WATCH COMPANY, INC.**  
Time and Life Bldg., Rockefeller Center, New York 20, N. Y.

# MAKE MORE MONEY

APPLYING OR SELLING

# CORKSTONE PLASTIC FLOORING



**EASY TO APPLY**

Here's your opportunity to get into business for yourself applying or selling Corkstone, the economical, top-grade plastic flooring. Plenty of profit. Act without delay!

**Dealers & Agents Wanted**  
WRITE FOR DETAILS  
**LASTING PRODUCTS COMPANY**  
FRANKLINTOWN ROAD PLANT, BALTIMORE 23, MARYLAND

## Ball-Bearing — SPEED WHEELS —

with semi-pneumatic Tires



12" x 1.75" wheel.....\$4.25  
10" x 1.75" wheel.....\$3.25  
8" x 2" wheel.....\$2.25

— AXLES —

24" Steel axle.....75c

— Solid Tire WHEELS —

7" wheel .....60c  
6" wheel .....50c  
4" wheel .....30c

**ORDER NOW FOR PROMPT DELIVERY**  
**10% REQUIRED WITH C.O.D.'S**

**JIM BROWN TOY COMPANY**  
1097 Home Ave. Akron 10, Ohio

### NEW! 12" SHEET METAL BRAKE Only \$10

Fits in bench vise. Quickly, easily forms all kinds of angles in sheet metal, strap iron and aluminum, wire and plastic. Use it to make useful articles, experimental research work, patent models, etc.,

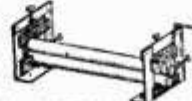

simple gages made for quantity duplicating. Now available. Send for details, or order direct. \$10.00 PP. C.O.D. \$2.00 deposit. Wt. 10 lbs.

**VISE FORMING TOOL.** Makes cylinders, ovals, cones and round corners in sheet metal, wire and 1/8" steel strap, 2" to 60" in dia., 16" wide. \$7.50 PP.

**VISE IRON BENDER.** Easily bends 1/4" square or round; 1/4" up to 2" wide. Makes hooks, rings, hoops, etc. All steel. Price, \$7.50 PP. Immediate delivery.

**SHEET METAL PLIERS.** Forms any length, angles, channels, and crimps in sheet metal. jaws 3 1/2" wide. Price, \$2.00. All items guaranteed.

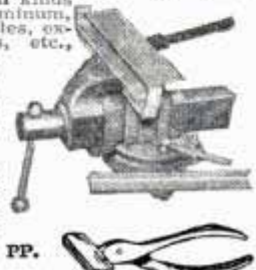

**VISE BRAKE MFG. CO., 1318 So. 30th Ave., Omaha 5, Nebr.**



**MASTER CHAMPION LAWN MOWER SHARPENER**

Also Mfg., Saw Sharpening & Key Machines

**FRANK'S MFG. CO.**

Dept. PM8  
2501 E. Imperial Highway  
Los Angeles 2, Calif.

SAY YOU SAW IT IN POPULAR MECHANICS

## WOOD WORKERS

**LUMBER — PLYWOOD AVAILABLE**

Harold Hunt wants to send new No. 15 catalog. Over 148 pages of woodworking ideas. **UNEQUALLED BARGAINS** in imported and American woods, supplies, hard-to-find hardware. Send only 15c to cover postage and handling.

**CRAFTSMAN WOOD SERVICE CO.**  
2729 S. Mary St., Dept. A-78, Chicago 8, Ill.

only 15¢

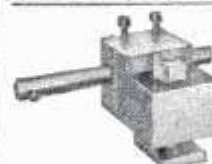

**Own a BOR-RITE TOOL HOLDER**

**BOR-RITE** is a real tool holder. Designed by a skilled machinist for 6" to 9" metal lathes. Adjustable but rigidly built for precision work. Will send postpaid complete for \$8.50. Money back guaranteed.

**\$8.50**

For further particulars write The Rugg Engineering Co., So. Coventry, Conn.



**FEET HURT? Try Dr. Barron's New Foot Cushion**

Do you suffer from metatarsal callouses, corns, weak arch foot pains? Try Dr. Barron's New Foot Cushions. **LIKE WALKING ON A PILLOW!** Soft, Spongy, Air-ventilated. Fits all shoes. Cushions your arches and feet from heel to toes. Dr. Barron says: "Wonderful for tired, aching feet!" Send only \$2.98 for **A PAIR**, or C.O.D. plus postage. State shoe size and if man or woman. **30-DAY TRIAL GUARANTEE.** Money back if no blessed relief. **ORTHO CO., 111 W. 83 ST., Dept. 49B, N.Y.C. 24**



**THE IRON HAMMER WAS ON THE SPOT, TOO, WHEN WE LEFT THE STONE AGE**

Our machine is made to fit into standard, open-head 11 1/4 in. (3 1/2 & 5 gallon) steel cans. We will make a unit for open-head 13 1/2" Id, 100# drums

How to fill all makes of Grease & Calking guns

No more air pockets or dirt in your Calking or Grease-guns

How to change from empty can. Traffic dents Ok.

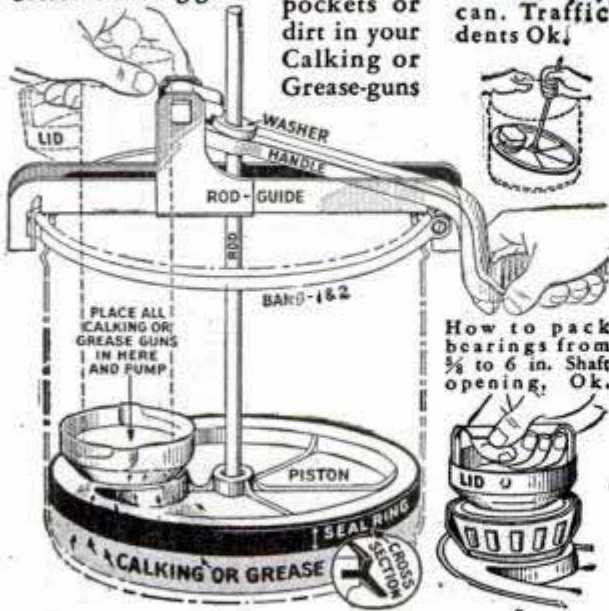

How to pack bearings from 3/8 to 6 in. Shaft, opening, Ok.

Cut this ad out, hand to the man you buy your Calking or Grease products from, he will demonstrate to you Free HK9-621 Fullerton Pky. Chicago 14, Ill. Patent No. 2,224,509 Trade Mark Reg.

**HERE THEY ARE**

**THE ORIGINAL**

*Paratroop Hunting Boots*

Here are the ideal boots for all kinds of outdoor wear. Same design, construction and quality as famous Paratrooper Boots. Soft, rugged, unusually comfortable and heavy-oil-treated to keep your feet dry and warm.

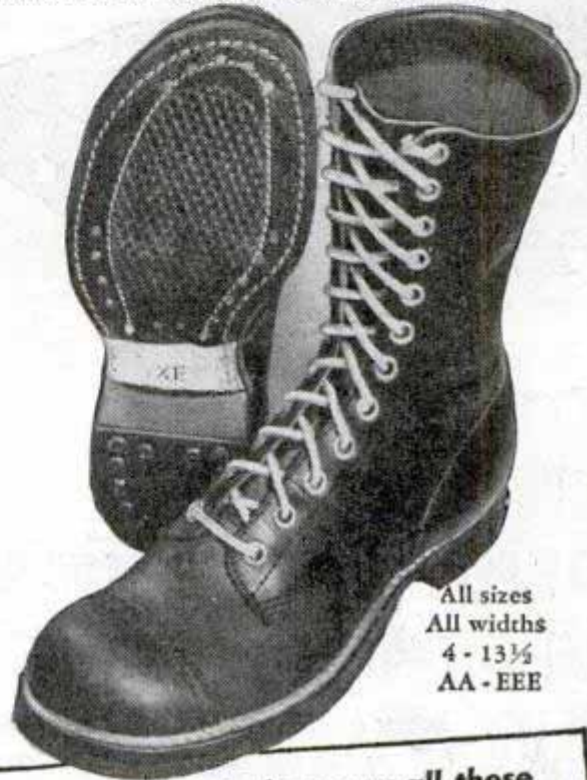

All sizes  
All widths  
4 - 13 1/4  
AA - EEE

**No other boot gives you all these EXCEPTIONAL FEATURES**

- Made of soft, pliable leather with extra heavy oil water-proofing.
- Full 10 inch height gives proper support.
- Balanced construction gives ideal walking comfort.
- Special heel and toe construction prevents tiring.
- Counter, box toe and bottom filler all leather. Shank is made of steel.
- Heavy reinforcing tape on sides of instep prevents stretching and assures good snug fit.
- Middle sole is leather of outersole quality. Outside tap is rubber, sewed to middle sole in two places and nailed clear through to insole to prevent ripping off.
- Special Goodyear rubber heel gives maximum springiness and reduces hazard of tripping.

**At this Amazing Low Price**

These boots are not government surplus stock. We can offer them at this unusual low price only by selling direct to you. Money back if not satisfied on receiving them.

**ONLY \$9.87 Plus Postage**

Postage only is C.O.D.

**CORCORAN INC., STOUGHTON, MASS.**

Please rush a pair of Paratroop Hunting Boots. Check  Money Order  for \$9.87 is enclosed. I will pay postage C.O.D.

Name \_\_\_\_\_

Address \_\_\_\_\_

Size and width of Shoe \_\_\_\_\_

PM-2

TEMPLE PIPES with **GOO TRAP** and REMOVABLE PLUG FOR CLEANING

A patented pipe individually made with extra sturdy stem. Smokes dry and sweet—never hot.

**TEMPLE PIPECRAFTERS**  
Temple, Pennsylvania

SOLD ONLY BY MAIL  
\$2 POST PAID  
CASH OR C. O. D.  
MONEY - BACK GUARANTEE

U. S. PAT. # 142093

**TINY TIM \$14.95**  
COMPLETE WITH BOILER AND BASE

Single cylinder Oscillating Steam Engine. A rugged high-speed precision-built engine made of highest quality material. Equipped with safety valve, throttle control and two fly wheels. Base 7" x 4". Boiler height 7 1/2". Satisfaction or money back guarantee. Order now. Supply limited. Cash orders prepaid or C.O.D.

**THE THOMPSON ENGINEERING CO.**  
405 Winchester Bldg., Grand Rapids 2, Mich.

SAY YOU SAW IT IN POPULAR MECHANICS

**START A BATTERY FACTORY**

—at home; the latest achievement; re-cast junk batteries into new. Complete instructions. We supply everything. Big Profits!

**THE BATTERY LABORATORIES**  
Dept. PM Minneapolis 13, Minn.

**EXPERIMENT WITH LUMINOUS PAINT**

See story "It glows in the dark" page 214 June issue of Popular Mechanics for many ideas on how to use our three color kit — contains one of each of 3 colors—LUMI BLUE, GARDENIA and CHARTRUSE. One ounce sealer. Guaranteed best quality.

**COMPLETE KIT WITH 3 COLORS AND SEALER \$4.25**

New Address F.O.B. Chicago  
**BLACK LIGHT PRODUCTS • 67 E. Lake St. • Chicago 1, Illinois**



# Performance

# goes up

# in smoke...



## when worn connecting rod bearings cause oil pumping

Every engine opened up to correct oil pumping should have new bearings installed. Worn bearings let excess oil burn to carbon on new piston rings, pistons, spark plugs, valves. New bearings protect you against comebacks on overhauls and cost little more at the time of overhaul. Federal-Mogul bearings are your best bet, because they are engineered for the job of oil control!

**FEDERAL-MOGUL SERVICE**  
DIVISION OF FEDERAL-MOGUL CORPORATION  
COLDWATER, MICHIGAN



Replace in sets with Genuine  
**FEDERAL-MOGUL**  
Oil-Control Bearings



bone. Carrying the concentrated oil vapor spray, an airplane can cover far greater acreage per trip than has been possible in the past. One pilot can spray 20 acres in five minutes, in one short trip, as against several trips for reloading that he formerly needed to make.

Application costs, in fact, are so low that for the first time it is economical to conduct chemical warfare against destructive pests that infest forests, swamps, range lands and huge grain fields.

## Edison Started Something

*(Continued from page 157)*

Then, in 1906, the Victor company made the first Victrola with the horn inside and cabinet styled as a fine piece of furniture.

Edison resisted these changes. He refused to put the awkward horn inside the cabinet and he held out for the clumsy cylinder records. As a result, sales of the Edison phonograph dropped out of sight. It was not until 1914, eight years after his competitors, that Edison agreed to restyle his machine. He agreed then only because he needed revenue to pursue new experiments and the only way to get money was to increase almost nonexistent Edison phonograph sales.

His invention of the incandescent electric lamp on October 21, 1879, is generally regarded as his greatest achievement. After he had produced the lamp, he had to devise an electrical distribution system for it. This he did, complete with dynamos, conductors, fuses, meters and sockets. More than a third of his many patents dealt with electric lighting and power distribution.

Because the first Edison electric company did not expand rapidly enough to suit him, he organized a pioneering department. His department paid for installation of lighting in small communities and then sold the system to local management. Illuminating gas companies fought with advertising pointing out that electric lamps could not be "turned down like a gas jet." Edison countered with the argument that electric lamps could not be blown out. Near all open illuminating gas jets there was a printed warning, "Don't blow out the gas." Too often just the opposite happened with the result that the person who disregarded the warning usually "went out," permanently, a few hours later.

In manufacturing lamps, Edison set standards for mass production methods acclaimed as the basis of American economy. He estimated that quantity manufacture of lamps at 40 cents each should yield a sub-

*(Continued to page 264)*



# Closing Out All Used WAR SURPLUS

all in good useable condition

**ARMY TRUNKS:** regulation size, made of durable plywood, extra tray, \$9.00 value.....\$3.98  
**METAL BOXES:** extra heavy gauge, well built, 14x17x23 inches, fine for tool box, storage, etc.....\$1.98  
**NEW STRONG BOX:** for valuable papers, jewelry, small tools, has 4 liftout compartments.....\$6.49  
**WHEEL CHAIRS:** new, original crates \$75 value....\$24.50  
**ROPE new:** 1/2 inch government specifications, 3c pr. ft.—1200 ft. roll, cheaper.  
**SCREW JACKS:** Contractors Bell Bottom, 12 ton capacity .....\$6.49

**QUANTITY DISCOUNTS — ORDER NOW**

Write us your wants. Thousands of other items.

**MIDWEST BUY ANYTHING CO.**

1515 Locust St.

Kansas City, Mo.

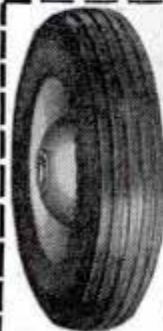

## WHEELS AT BARGAIN PRICES

**WE ARE OVERSTOCKED AND MUST MOVE THIS SUPPLY OF De Luxe BALL BEARING WHEELS**

---- 8x2" Semi Pneumatic Tire, 7/16" Ball Bearing, \$2.75 ea.  
 ---- 10x1.75" Semi Pneumatic Tire, 7/16" Ball Bearing 3.25 ea.  
 (Price each Complete Wheel and Tire)

**BUILD YOUR OWN Wagons—Scooters—Soap Box Racers — Baby Pens — Wheelbarrows — Welding Carts—Etc.**

To order above wheels write number wheels wanted in space provided, tear out and mail this ad with check or money order and your name and address. If other sizes are wanted write for FREE LIST.

**TRULSON MANUFACTURING CO.**

811 E. 31 Street, Dept. M. 1, Kansas City 3, Mo.

**WRITE FOR FREE LIST OF 4 to 16 inch WHEELS**

Start a NEW BUSINESS

## Sharpen Dull Pipe Wrenches

Industries save hundreds of dollars. Some "wrench shops" make \$50 a day.

Write for information.

**J. C. MOORE INDUSTRIES P. O. BOX 234 FREDONIA, PA.**

## NEVERSLIP PULLEY

Transmits more power with less belt wear, unaffected by weather. No pulley covering, no belt dressing required. Replace troublesome pulleys with NEVERSLIPS. All sizes. Money-back guarantee. Ask for NEVERSLIP Pulleys on ALL power machinery you buy. Write for folder and prices.

**ROSENTHAL CORN HUSKER CO. Box 16-147 Milwaukee, Wisconsin**



Send 10c Today to Dept. G for Catalog of 45 Kits  
**MEIER BRASS & COPPER CO.**  
 1155 Bellevue, Detroit 7, Mich.

## BRASS RODS For Home Work Shops

For use on model boats, airplanes, etc., keep a supply of these free-turning brass rods on hand. Each kit contains a complete assortment of sizes.

## CORROSION TROUBLE?

Use an oil that prevents rust while it lubricates  
 —shop appliances  
 —household devices  
 —mechanic's tools

Hardware and Sports Dealers

It's THE Triple Action Oil Lubricates Prevents Rust Cleans

3-oz. SPOUT CAN 40¢

# FIENDOIL

## A TOOLSHOP IN YOUR HAND!

- GRIND • DRILL • ROUT
- POLISH • ENGRAVE
- CUT • SAND • SAW, etc.

Make Things From  
 Wood—Plastics—Metals—Glass—Linoleum—Leather—Alloys—Horn—Stone—Bone, etc.

**HANDEE TOOL OF 1001 USES**

Smooth, steady power at your fingertips! Perform precision operations not possible with any other portable tool! With a Handee you can turn out professional looking projects for pleasure or profit—ship, plane and train models, costume jewelry, wood carvings, puppets, initialed tumblers, etc. AC or DC. 25,000 r.p.m. Wt. 12 oz.

USE THE RIGHT ACCESSORIES! Choose them from the most complete line . . . more than 300 made right in the Handee plant.

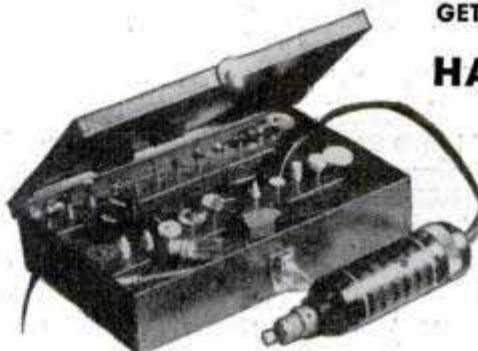

## GET A GOOD START GET THE HANDEE KIT

HANDEE Tool and 45 most popular accessories packed in compact steel carrying case. You'll be amazed at what you can accomplish!

Postpaid, \$27.50

Handee, with 7 accessories, \$20.50

FOR YOURSELF OR A FRIEND... THE GIFT OF A LIFETIME!

## NEW PRECISION ATTACHMENTS

Fit Handee only; enable novice or craftsman to do perfect work. Magically, easily, your offhand carving, routing, shaping will be exact as to depth of cut, accuracy of line. Set of 6 attachments with instructions, postpaid, \$7.95

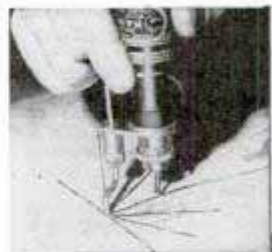

ORDER NOW. SATISFACTION GUARANTEED!

FREE! NEW 52-PAGE MANUAL

## CHICAGO WHEEL & MFG. CO.

1101 W. Monroe St., Dept. PM  
 Chicago 7, Ill.

Send  Handee Kit  Handee Tool  Precision Attachments  
 C.O.D.  Remittance enclosed  Send Manual

Name.....

Address.....



**KEEP WARM!  
SAVE FUEL!**

**Mortite**  
**BETWEEN YOU AND THE COLD**

A pliable, plastic weather-stripping, easily, quickly applied to windows, doors, baseboards. Stops expensive heat leaks. Keeps out dust and dirt.

Just press into place. Use inside or outside. Can be painted. Mortite does not shrink or crack. Also plugs cracks around drainboards, bathtubs, etc.

Roll covers about 80 feet, enough for 5 windows.



**\$1.25** AT HARDWARE, PAINT, DEPT. STORES AND LUMBERYARDS

Higher west of Rockies and Canada

Ask for Mortite Booklet!

**J. W. MORTELL CO.**

522 Burch St. Kankakee, Illinois

**RIDE-RITE**

NEW TYPE — LIGHTWEIGHT — HEAVY-DUTY STRENGTH

**UTILITY TRAILER AXLES**

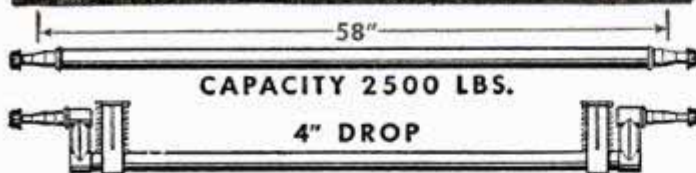

CAPACITY 2500 LBS.

4" DROP

EITHER TYPE AXLE AVAILABLE WITH OR WITHOUT SPRING SUSPENSION (Pat. Appl. For)



Build your own utility trailer and equip it with a Ride-Rite axle. Get the advantage of its new lightweight, heavy-duty tubular construction. Available with or without patented double-coil spring suspension. Straight axle has standard 58" tread; drop axle has 60" tread. Distance between spring hangers 48" on both axles. **BIG CAPACITY:** Axles made of 1 1/2-inch O.D. steel tubing have tested load capacity of 2500 pounds. Coil springs, four per axle, have minimum capacity of 650 pounds each. Ride-Rite axles will fit hubs and wheels made by Motor Wheel Corp., Kelsey Wheel Co., Ford Motor Co., and Industrial Machine Tool Co.

PRICED LOW AS  
**\$6.75**  
PRICES F.O.B. FENTON, MICH.

Remittance with order —No C.O.D.	Axle Only	Axle with Springs
Straight Axle, Std. Tread	\$ 6.75	\$19.70
Drop Axle, Std. Tread (Springs fit Ride-Rite axles only)	12.50	25.45
Axles can be furnished any tread desired for slight additional cost.		

Write for descriptive literature  
QUANTITY LOT PRICES  
FURNISHED ON REQUEST  
WRITE ON YOUR LETTERHEAD

MANUFACTURED BY

**INDUSTRIAL MACHINE TOOL CO., INC.**  
200 S. LEROY STREET FENTON, MICHIGAN

**MANUFACTURERS AND DEALERS!**

**READY CUT HOMES**

Order Now

Homes \$1365.00 and up, freight paid. Orders filled in order received. Save \$500 at least on modern production homes. Much more compared with builders' prices. Anyone can assemble with simple plans furnished. Complete, including paint, hardware, roofing, glass, nails, etc. Send 35c in coin for full color catalogue showing 57 modern low-priced homes and floor plans. Complete building plans ready for filing at low cost. Sold separately if desired.



NEW COLOR CATALOG FOR ONLY 35c

Dept. PM-27  
**INTERNATIONAL MILL & TIMBER CO.**  
Bay City, Mich.



**Thompson BEATS the World on BOATS**



**Better Built Lower Prices**

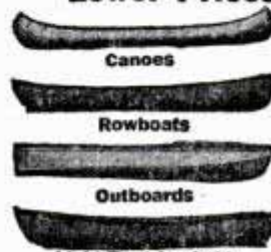

**Safe Boats With Full Length Spray Rails**  
Keep passengers perfectly dry—even at high speeds. Catalog also shows two new models of "Take-Along" Boats. Two big factories—save you freight.

**CATALOG FREE**  
Write for your copy. State kind of boat in which you are interested.  
**THOMPSON BROS. BOAT MFG. CO. (161)**  
213 Ann St. PESHYGO, Wis. (Write to either place)

Light Boat for Auto  
113 Elm St. CORTLAND, N.Y.

**THE GEM MAKER**



Amateurs or professionals . . . hobbyists or jewelers . . . Polish your own gems with a B&I Gem Maker. You will find this a profitable adventure. All necessary lapidary equipment is furnished, including a super-charged diamond blade for sawing, and all wheels for grinding, shaping and polishing, also complete instructions. The complete equipment as shown, less motor and belt, for only \$29.50, f.a.b., Burlington, Wis. Write today for information and literature on the Gem Maker and accessories.  
**B&I MFG. CO., Dept. S, Burlington, Wis.**

**YOUR ELECTRIC DRILL**

**Has 100 Other Uses**

when used with K-Jax attachments  
**METAL SAWING . . . SHEARING  
RIVETING ATTACHMENTS**

Ask your Hardware dealer or write for illustrated circular  
**K-JAX, 2600 Canton St., Dallas, Texas**

**LAWN ORNAMENT-NOVELTY PATTERNS**

28 Lawn Ornament Patterns, 25c. Other patterns; 15-20" high; Dutch Girl, Dutch Boy, Pirate, Bull Terrier, Mexican Girl, Mexican Boy, Dwarf, Penguin, Flower Girl, 10c each. 25 Novelty Patterns, 30c. All 62 Full Size Patterns, \$1.00 Postpaid. Strother Pattern Service, Dept. S-8, Box 383, Belington, W. Va.

**8000 OHM HEADPHONE**

Army surplus at 1/10 original cost. Very sensitive. Built on hearing aid principle, shuts out outside noise. No. 17A420  
Every One Brand New, **\$2.95**  
Plus 25c each for Postage.



**BURSTEIN-APPLEBEE CO.**  
1012 McGee, Kansas City 6, Mo.



CUT OUT THIS BAND TO FIND RING SIZE

AUTHENTIC WESTERN  
**SADDLE RING**  
FOR MEN!  
& WOMEN!

PURE  
STERLING  
SILVER

Only  
\$4.95

Postpaid  
We Pay Tax



First time at anywhere near this low price! Authentic replica of romantic western saddle. Hand-somely formed from solid Sterling Silver by Navajo Indian craftsmen. Massive style for men, dainty style for women. A gift of distinction. A pleasure to wear. Sent on approval.

**SEND NO MONEY!** Just clip this ad and mail with your name and address. Pay postman only \$4.95 plus few cents postage on arrival; or send cash and we pay postage. Wear this sensational ring for 10 days. If not delighted, return for full refund. Specify for **MAN** or **WOMAN** and **RING SIZE**. Use cut-out band to determine size.

**ARIZONA CRAFTSMEN** Room 272, 1904 Farnam  
Omaha 2, Nebraska

## Portable Paint Sprayers

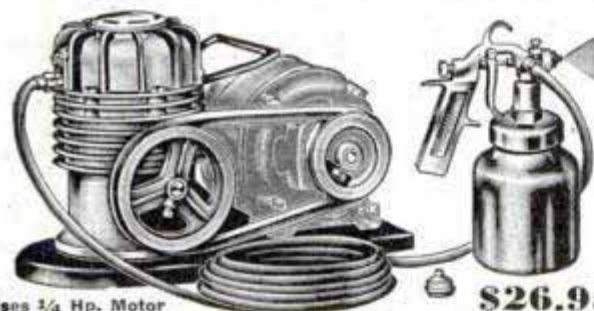

Uses 1/4 Hp. Motor

**\$26.95**

Complete as illustrated, less motor. Outfit consists of, compressor, 15 ft. hose, Spray Gun with qt. cup, "V" belt and drive pulley for motor. Sprays any kind of paint, lacquer, varnish.

SPRAY GUNS—PT. CUP—4.95

25' AIR HOSE—2.90

### INDIANA APPLIANCE CO.

20 East Sycamore

Evansville 9, Ind.



#### A MUST TOOL FOR FINE CRAFTSMEN

Jewelers • Technicians • Hobbyists  
A dual purpose precision built vise. Can be used as a hand or bench vise. With swivel base . . . A quality tool.

SEE YOUR DEALER OR WRITE

**Reypo CORPORATION**

9900 Lincoln Blvd., Los Angeles 45, Calif.

**AMAZING SELLS LIKE LIGHTNING!**

**NEW ZIPPER SHOE**



**ZIPS ON... ZIPS OFF**

● Here's your chance to start a fine, solid, profitable business right among your friends and neighbors. Tie up with the **LEADER** in the direct-to-wearer shoe industry, established 42 years. Just rush postcard NOW for **FREE SAMPLE OUTFIT**, Free 10-Second Air Cushion Demonstrator, Free Automatic Selling Plan. Learn how you can start making money very **FIRST DAY** with over 200 fast-selling Feature Style and Comfort Shoes.

**Victor Thomas Shoe Co.**  
Dept. V-799, 610 W. Van Buren St., Chicago 7, Ill.

# PRAC TO

## U-BUILD-'EM SETS

Life-size everyday utility vehicles for boys who love to make things with their own hands. **NOT A TOY!** ALL FULL SIZE, serviceable, dependable, sturdy!

### U-BUILD-'EM BIKE TRAILER



Tru-Ball Bearing, steel welded rubber-tired wheels. Holds heavy loads. Complete with nuts, bolts and chassis. Attach box for a sturdy **BIKE TRAILER**.

No. 88 . \$8.00  
complete with  
detailed in-  
struction sheet.

### U-BUILD-'EM WHEELBARROW

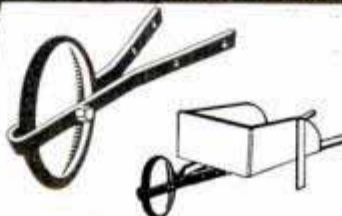

9" steel-welded wheel . . . rubber tires. All metal parts . . . you supply the wood for rugged **WHEELBARROW**.

No. 68 Ball Bearings \$3.50

### U-BUILD-'EM SPEED MOBILE

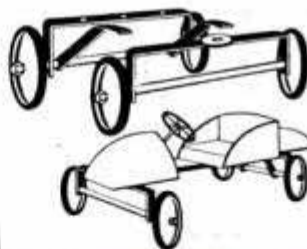

Everything but the wood . . . 9" steel-welded wheels . . . rubber tires. Complete with bolts, nuts, washers.

No. 10B Ball Bearings \$10.50

### U-BUILD-'EM EXPRESS CART

Complete metal parts. 9" wheels, steel welded, rubber tired . . . bolts, nuts, washers, sturdy chassis. 500 lb. capacity. You supply wood.

No. 9B . \$11.00

Make a business of building Practo vehicles for resale. **SPECIAL DISCOUNT** for 6 units or more. Write at once!

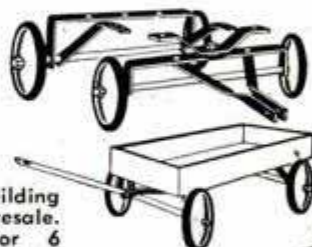

It may be difficult to get these U-BUILD-EM sets at your dealer. **SEND CHECK** or **MONEY ORDER** and order direct. Sent express paid

**INTERNATIONAL MFG. CO.**

712 BEACON ST., BOSTON 15, MASS.

Reference: National Shawmut Bank, Boston, Mass.



**MAKE PRECISION WORK**  
*easier with*  
**these dependable tools**



Combination Set  
No. 391

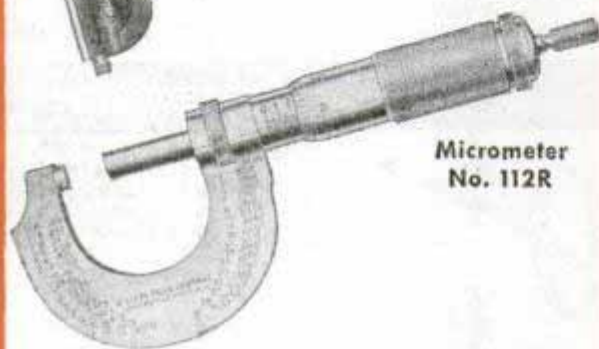

Micrometer  
No. 112R

Here are two of the finest and most useful precision tools in the Millers Falls line—tools with many special features to simplify your work. Like all Millers Falls products, they are quality-built throughout and assure precision accuracy.

The combination set (No. 391) has a beam, a center head and a protractor. The blades are tempered steel.

The micrometer (No. 112R) has a cut-away frame to permit measurements impossible with regular frames, a lock ring, and a speeder. Decimal equivalents are etched on the frame. Measures by 1/1000 of an inch from 0 to 1".

Millers Falls also makes steel rules, thickness and screw pitch gauges, calipers, dividers, depth and surface gauges, and many other machinists' tools. See your dealer.

**One Thing In Common - Quality!**



MILLERS FALLS COMPANY  
 GREENFIELD • MASSACHUSETTS

stantial profit. The first ones cost him \$1.25 each and he lost 85 cents on each of 20,000. The next year he lost 30 cents on each and the third year, 10 cents. By the fourth year, production was so high that he made a profit of three cents on each and sold enough to repay all losses. Soon he made them for 22 cents and earned a profit of 18 cents on each of millions.

Time has wrought many changes in the descendants of inventions that first saw the light in Edison's workshop. Science and industry have moved ahead at a fast clip in the search for perfection. But there is one Thomas A. Edison record which no one has improved upon: the 1097 patents granted him are by far the greatest number ever awarded to one individual.

## Waterloo for the Atom

(Continued from page 102)

million electron volts; deuterons (the nuclei of heavy hydrogen atoms, consisting of a proton and a neutron) of 200 million electron volts; and alpha particles (the nuclei of helium atoms, consisting of two neutrons and two protons) of 400 million electron volts.

In each case this is about 10 times greater than the previous high. Deuterons and alpha particles have proved most useful in the transmutation of atoms and in the discovery of new elements, such as plutonium, americium and curium. Protons of high energy have not been widely used, since they have been difficult to manage in a cyclotron. However, a new principle upon which the 4000-ton cyclotron was built makes it a simple matter for this machine to shoot protons of 350 million electron volts. Protons are the most promising projectile for causing the complete disintegration of the nucleus because they create the greatest subatomic earthquake on collision.

The synchrotron will shoot electrons only. Betatrons and the "racetrack" synchrotron also are electron accelerators. The 300-million electron volt electrons which will be produced by the Berkeley synchrotron may be in themselves electron cosmic rays, cousins to the mesotron. With the synchrotron, scientists hope to determine a most important point: are the known particles of the nucleus really basic, or can they be broken down into smaller, now unknown units? If the splitting of neutrons, protons and other nuclear particles can be accomplished, the high-energy electrons have the best chance of doing the job.

The linear accelerator will shoot protons only. The 4000-ton cyclotron will hit an up-

(Continued to page 268)



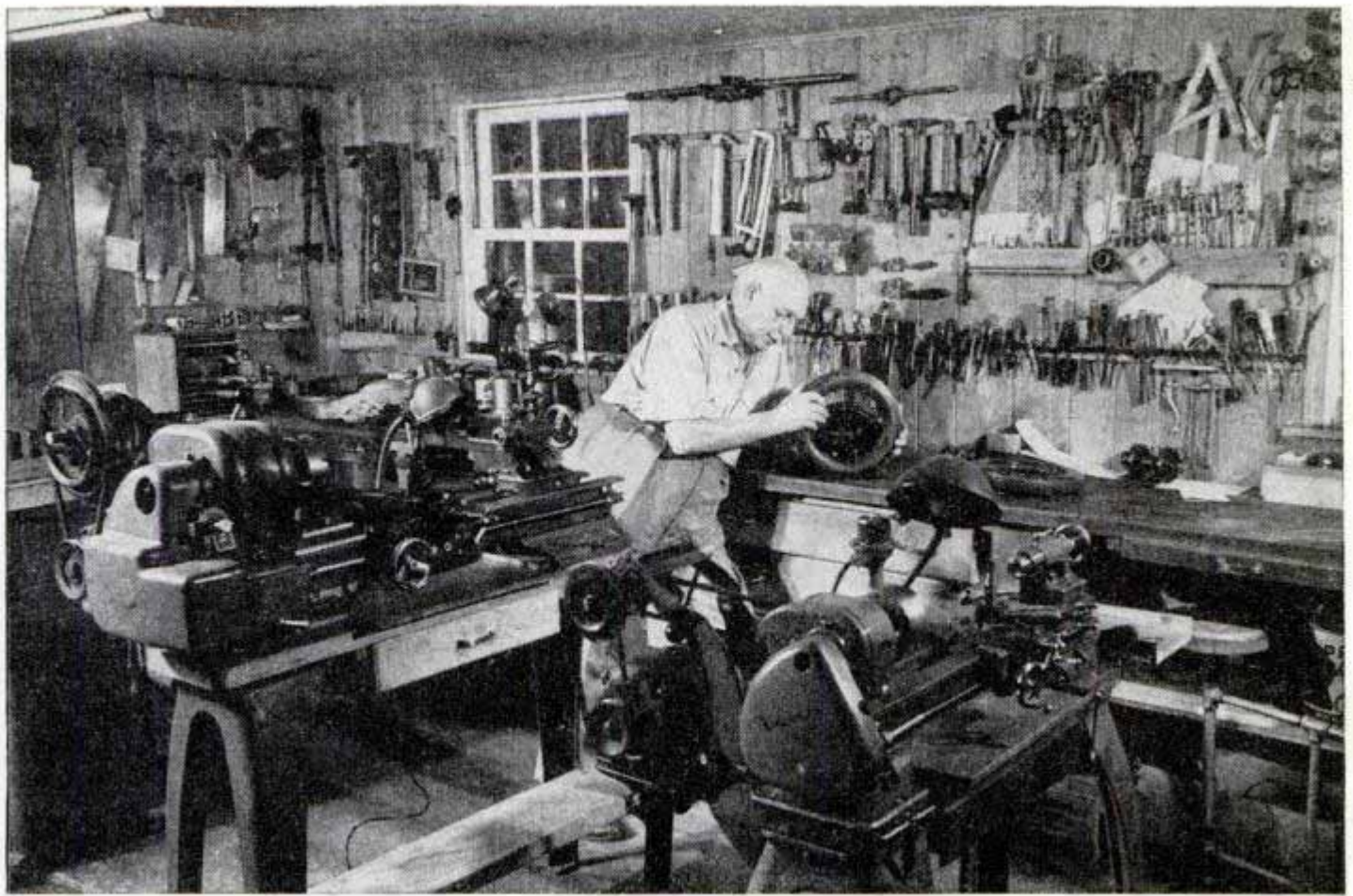

## Far from Broadway . . . Arthur Hammerstein Keeps Young . . . and Busy . . . in his Atlas Equipped Shop

With the beautiful melodies of his 31 musical triumphs still echoing, famed producer Arthur Hammerstein, at 73, continues an active vigorous life on his 300 acre dairy farm near Chicago.

His love of tools carries over from boyhood days in his father's shop. Now he is happiest in his Atlas-equipped workshop, repairing farm and home equipment and working on unique inventions, which include a non-clogging salt shaker soon to be sold nationally.

For practical relaxation after busy days, or an interesting hobby with future commercial possibilities, nothing quite compares with a home workshop. And you'll

find Atlas industrial tools ideal for such a shop — *compact, powerful, accurate, and low cost.*

They help you master any machining need that develops as you repair home equipment or work on ambitious projects. Ask your Atlas distributor to give you the complete details about their many performance features.

### Free — "SUCCESS STORIES"

An interesting collection of photographs and stories of men who built businesses of their own with Atlas tools. Send for your copy today. Atlas Press Company, 243 North Pitcher St., Kalamazoo 13D, Michigan.



**Atlas 4 TOOL TEAM**

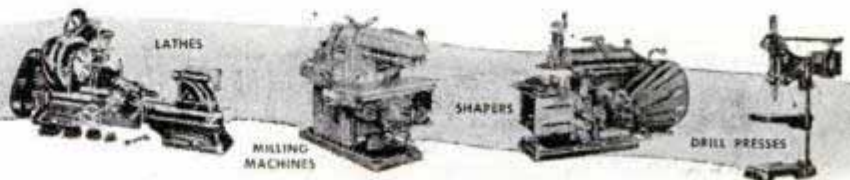



# FUN and PROFIT with PLASTICS

Now you can get a plastic injection molding machine to cast plastic parts right in your own work-shop. You can make an endless variety of jewelry novelties, true-scale building materials, model parts, poker chips, golf tees, buttons, etc., quickly and inexpensively. You'll find it a fascinating new handicraft, and you can make it a profitable business.

There are 22 different stock molds already available, and more will be offered regularly. You can make scale models of homes, railroad stations, tunnels, etc.—there are 9 molds for bricks, roof tiles, and other building materials. The skilled man can make his own molds with Plasticor easy-to-work die blanks. And there are 16 beautiful colors of plastic available, in 1/2, 1, 5 and 10 lb. packages.

**IMPORTANT:** NRK service continues, after you buy Plasticor, with the Plasticor News, a planned educational program in plastics that reports regularly what's new, what's fun and what's profitable.

**N. R. K. MFG. and ENGINEERING CO.**  
5646 North Western Avenue Chicago 45, Illinois

THE NEW  
IMPROVED 1947  
**Plasticor**  
JUNIOR

a miniature plastic molding machine, built like a fine machine tool, yet so simple and safe a child can operate it.

Price only **\$54.00**  
(F.O.B. Chicago)  
Molds (22 diff.) each .....\$1.50



## WALKIE-TALKIES!

**Complete Army Sets Ready to Operate**

Portable radio telephone sends and receives 10 to 15 miles! Used by the Army with great success. Ideal for amateurs, police, explorers, airports, utilities, boat owners, Government services, etc. Operates anywhere in the 28 to 52 MC band. Renewed by the Government and guaranteed. Shipped, ready to operate, complete with tubes, microphone, telescope antenna and new batteries. Price—only **\$45.00** each.

Extra batteries (80 hours continuous service) .....\$4.75 each

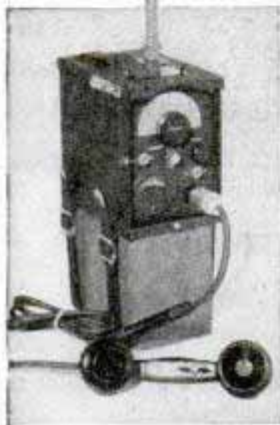

### Radio-Telegraph Sending Keys

Real S-37 Signal Corps keys for your radio or telegraph set or for code practice. They have coin silver contacts and full adjustments. Valued at 3 times our low price. Send \$1.00 plus 20c for postage anywhere in U. S. Guaranteed.



**WELLS SALES, INC.**

4717 W. Madison St., Dept. P-2  
Chicago 44, Illinois

SAY YOU SAW IT IN POPULAR MECHANICS

## SUPER DRILL GRINDER

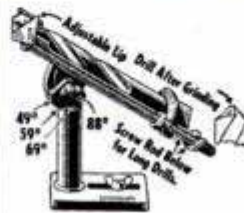

Sharpens round shank drills from 3/32" to 1-1/16" diameter. Grinds Old Drills like new in 4 different drill point angles. Grinds Short, Medium and Long Twist Drills from 1 1/2" up to 11" long, for hand or power grinding wheels.

**200,000 IN USE!**

Grinds your drills like factory in 25 seconds. Gives perfect center and clearance. Saves drills, time and money. No shop should be without the Super Drill Grinder. Guaranteed to do the work or money back. The Grinder that gives a rounded point!

Only **\$2.95**

At Your Dealer's or Postpaid  
**CRANDALL MFG. CO.**

1512 West Slauson, Dept. FA-14

Los Angeles 44, Calif.



Beautiful brass Social Security plates (illustrated 1/2 actual size), priced at only 50c. Please print your name & number plainly.

**ACME**

Stamping Service  
Box 836  
Davenport, Iowa



**Send for Free List of Leading Books and Catalog of Tools For Watch and Clock Repairing—Engraving, Aircraft Instruments Etc. Address Dept. 12. Use Letterhead.**

**HENRY PAULSON & CO.**

37 SO. WABASH AVE., CHICAGO 3, ILL.

## WRITE FOR YOUR FREE COPY OF THE NEW KRW HYDRAULIC PRESS BOOK

Describes all manner of Production and Shop Work on KRW Hydraulic and Bench Type Arbor Presses. 32 pages illustrating the new KRW Hand-operated, Electric-operated and Air-operated Hydraulic Presses. Write for your copy today.

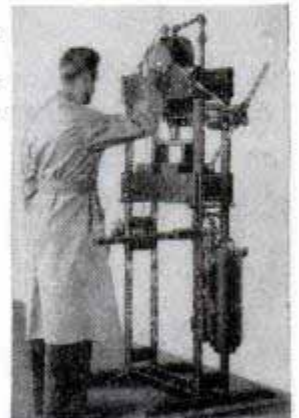
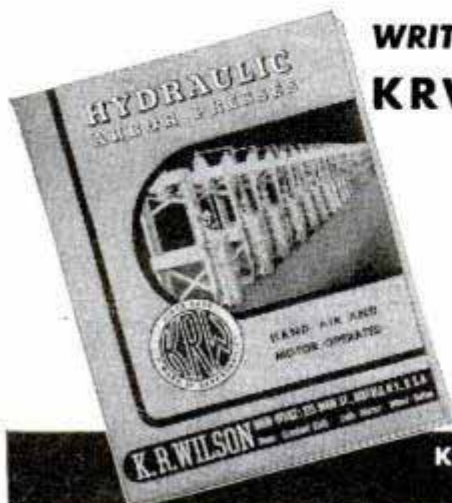

**K. R. WILSON, DEPT. 17, 215 MAIN ST., BUFFALO 3, N. Y.**

Builders of Shop Equipment for Ford Dealers Since 1916



# THIS

is the  
**CRESCENT\***  
Wrench  
There is no other



**Because** it is made *by* the Crescent Tool Company.

**Because** the name Crescent\* which is forged into the handle is a registered trade mark of the Crescent Tool Company and the rights to its exclusive use have been upheld by the courts.

**Because** for forty years it has been the *leader* of adjustable wrenches.

And it leads now in every respect. Better steel, more accurate machining, uniform hardening, superior strength and toughness.

Most good hardware stores have sold Crescent\* Wrenches for many years—ask for them by name, then you will know you have bought the best.

**CRESCENT TOOL CO.**  
JAMESTOWN, N. Y.

\*"CRESCENT" is our trade mark in the United States and foreign countries for wrenches and other tools.  
"Crescent" tools are made only by Crescent Tool Company of Jamestown, N. Y.





# AMAZING MONEY MAKER!

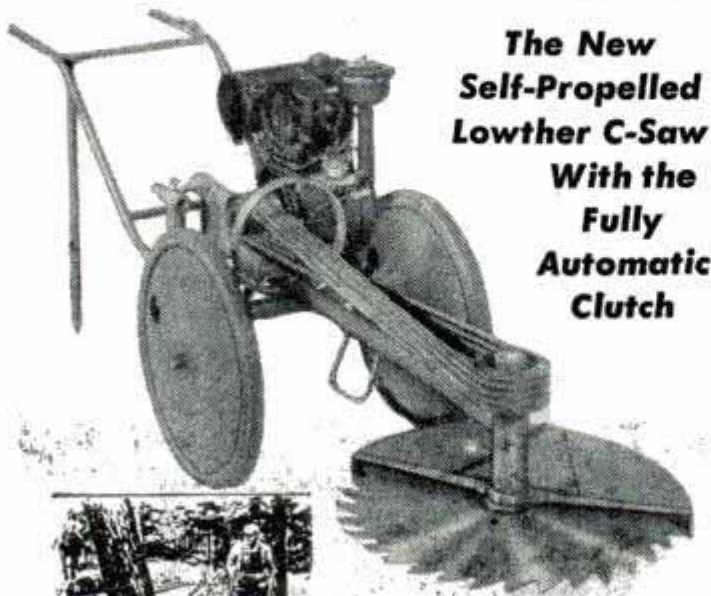

**The New  
Self-Propelled  
Lowther C-Saw  
With the  
Fully  
Automatic  
Clutch**



## FELLING TREES

30" Oak felled in two minutes and fifty-two seconds with the Lowther C-Saw—11" Pine in fifteen seconds.



## CUTTING LOGS

Cutting 10 to 20 cords of wood a day—on only 3 gallons of gasoline.



## CLEARING LAND

Transforms brush covered wasteland into valuable pasture—Quickly and Easily.



Turn that standing timber on your farm and your neighbor's into cash with the Lowther C-Saw—the one-man portable power saw that has been proved in 478 Lumber Camps, in the production of millions of cords of wood!

Reap these big profits while prices are high—Do it quickly and easily—the Lowther C-Saw way!

### New Operating Ease!

Now your Lowther C-Saw may be equipped with the fully automatic Lowther C-Saw Clutch\*—so your saw is easy to start—will produce more—and eliminate the hazard of the "pinch."

Your C-Saw can be self-propelled, too! The NEW Lowther Power Drive\*—ends pushing . . . solves the cutting problem where the going is tough.

Some one near you is making money cutting wood with the Lowther C-Saw—Write us—We'll tell you where he is! He'll tell you the whole story!

\*Optional equipment

### HARRY A. LOWTHER COMPANY

141 West Jackson Boulevard

Chicago 4, Illinois

Send Me Circular No. 927

Name \_\_\_\_\_

Address \_\_\_\_\_

per limit for protons of 350 million electron volts, and the linear accelerator may push the figure above a billion.

How do the new juggernauts work?

The 4000-ton cyclotron and the synchrotron are based upon a new principle called the "theory of phase stability," developed independently and simultaneously by Professor Edwin M. McMillan, one of Professor Lawrence's young associates, and a Russian physicist. It was calculated specifically to cheat the theory of relativity. Einstein's theory indicates that as a particle gains energy, it also gains weight. As it gains weight, it can be shoved up to a higher energy, but only at a slower rate. This was beginning to set a limit to the power of cyclotrons.

In a cyclotron, particles are whirled around a circular chamber placed between sections of an electromagnet. The magnet forces the particle to stay in a circular path. One or two electrodes, called "dees," are placed in the chamber; the 4000-ton cyclotron has one electrode. High-frequency alternating radio waves are transmitted to the "dee."

Particles to be speeded up as bullets begin at the center of the chamber and are whammed twice by an alternating electrical roundhouse every time they go around. The shock of the electrode on the atomic bullet is delivered at regular intervals. As the particle makes a half circle, its arc becomes wider, but its increased speed enables it to travel the longer distance in the same length of time. Thus it always makes the half circle just in time to receive a new high-frequency "hot foot." Eventually the circle is so wide that the particle emerges from a slit in the side of the chamber.

That works fine in a cyclotron up to about 100-million electron volt deuterons and 200-million electron volt alpha particles. There, relativity lays down the law. The particle has been gaining weight all the time, although not perceptibly. But at this point the particle becomes so "fat" it begins to lag noticeably. It slows down enough so that it arrives too late to receive its electrical shove. Then it is out of step and can't be accelerated any more.

Thinking of some way to circumvent this limitation, McMillan reasoned as follows: instead of keeping the particle in step with the alternating electrical charge, why not keep the electrical charge in step with the particle? When the particle begins to slow down, why not slow down the frequency of the electrical shock to wait for it?

Using the 85-ton cyclotron at the University of California as a pilot model, the

(Continued to page 272)



# AMAZING NEW SAFE MAGNETIC SAW!

READY FOR IMMEDIATE DELIVERY!

## SYNGRO

DELUXE JIG SAW

For Hobbyists, Craftsmen and Light Production

ONLY  
**\$17.50**

FOB FACTORY

Shpg. Wt. 18 lbs.  
Complete with cord, 3 blades

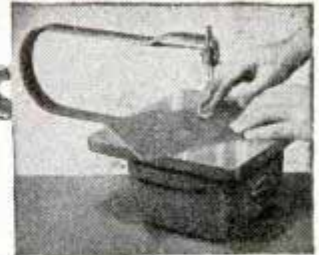

MODEL NO. 2000

**NO MOTOR NEEDED—JUST PLUG IN!  
PORTABLE . . . SAFE . . . CUTS CLEAN  
AND SMOOTH—NO SANDING NECESSARY!**

ANNOUNCING a remarkable, PATENTED, MAGNETIC Jig Saw—better-performing, better-quality than famous PRE-WAR SYNCROS—now ready for immediate shipment anywhere! SYNCRO needs NO belt, NO gears, NO oiling, NO motor to buy. The high-speed, short stroke action, and freedom from belts, makes SYNCRO so SAFE even small boys and girls may operate it. Get this husky, powerful, 18 pound saw . . . so easily portable . . . you can use it anywhere—even on the kitchen table . . . so smooth-cutting no sanding is necessary! Cuts intricate designs on 3/4" soft wood, 1/2" plywood and thinner hardwoods, plastics, thin metals. Leaves NO ragged undersides on plywood or heavy cardboard. The rapid action blade cuts to the center of a 27" circle. SYNCRO is a rugged, powerful power tool for exceptionally high quality work but is not for ordinary lumber cutting. Ideal for hobbyists, craftsmen, light production. Perfect for models, displays, puzzles, inlays, silhouettes, toys, marquetry, games, what nots, etc. Order yours NOW on our 10 Days Money Back Trial offer—enjoy a LIFETIME of use!

### 15 Outstanding Syncro Features

(1) **WORLD'S SAFEST SAW.** (2) **PORTABLE** . . . plugs in to 60 cycle A.C. 110-130 volt wall outlet. (3) **NO ROTATING MOTOR NEEDED.** Syncro's self-contained magnetic power unit transmits A.C. magnetic impulses to armature diaphragm—power transferred to saw blade. **COIL** contains 1 1/4 lbs. No. 19 insulated copper wire, completely taped, impregnated, baked. **Guaranteed** not to burn out! **MAGNET CORE** contains 58 layers of metal. **DIAPHRAGM** of spring steel, heat-treated under special process, suspended on L-I-V-E rubber mounting cartridges. (4) **14,400 STROKES PER MINUTE!** (5) **NO RECIPROCATING OR ROTATING PARTS TO WEAR OUT!** (6) **NEVER NEEDS OILING.** (7) **TABLE TOP** 10" x 10", a heavy, thick, durable alloy die casting 3/8" thick, ribbed base. **Surface** smooth for easy sliding. (8) **BASE** 7 1/2" x 6 3/4". . . a heavy, durable die casting. (9) **ARM** is of specially formed steel stamping 3/8" x 1". **Return Spring** of heavy duty steel. **Guide**

**Slide** of plated steel and adjustable to varying wood thicknesses. **Adjustment Screw** permits easy, quick changes in length of saw blade stroke to compensate for voltages of 110 to 130 A. C. (10) **THROAT CLEARANCE** 13 1/2" permitting work on square sheet of wood, metal, plastic. 27" on the diagonal. (11) 5' cord . . . extension **Underwriter's approved** electric cable with molded rubber plug. (12) **BLADES** are 5", pin end style, of finest steel, 18 teeth per inch. (13) **NO-MAR, NON-SLIP RUBBER FEET.** (14) **DURABLE**—will last a lifetime. (15) **HIGHEST QUALITY**—guaranteed by the trademark name "SYNGRO."

### "FAMILY SAW"

"The SYNCRO POWER SAW ordered from you in 1940 is still sawing merrily away. My son (then 8) has used it in the attic, kitchen, his room, and basement shop. I use it too. We never worry about accidents due to its MAGNETIC SAFETY STROKE feature. It's truly a family saw."—Mr. B. H. Smith, Rexburg, Idaho

### SAFEST!

SYNCRO has No continuous cutting blade nor "Long stroke" blade to pull fingers into teeth—instead there are 14,400 strokes per minute—7,200 short cutting strokes plus 7,200 upward NON-CUTTING, REPELLING strokes! (Fig. 1) SYNCRO will not even CUT wood unless piece is pushed FIRMLY DOWNWARD AGAINST blade and FIRMLY FORWARD at SAME time! SYNCRO blade teeth cut ONLY on DOWN stroke. (Fig. 2) Teeth raise, repel, push away any object on UP stroke. (Fig. 3) When blade moves UP it KICKS finger away free. On down stroke, blade does not move far enough to accidentally cut finger unless finger is intentionally, deliberately fed into blade like wood is fed in Figure 1. No wonder SYNCRO is the world's SAFEST saw . . . a feature old and young users acclaim!

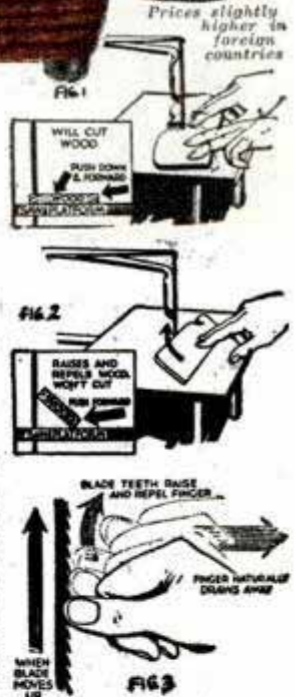

Prices slightly higher in foreign countries

### ORDER on 10 DAYS TRIAL!

So you may order with complete confidence, read this SYNCRO TRIAL OFFER: When you get your saw, plug it into any 60 cycle A. C. 110-130 volt outlet and saw according to instructions. Then, if it does not satisfy you perfectly in every way, return it postpaid within 10 days of delivery date, and we will refund your \$17.50 promptly without questioning.

### HOW TO ORDER—DO IT NOW!

Mail Coupon with Postal Note, Money Order or check for only \$17.50 plus Parcel Post or Express carrying charges . . . or . . . send \$17.50 only and we will ship saw collect for Parcel post or Express carrying charges only. Specify type of delivery on Coupon. Shipping weight, packed, 18 lbs. Hurry! Act promptly—order—we'll ship same day order is received. (No complete COD orders accepted.) Add state sales tax (if any) to saw price.



EXPORT ADDRESS . . . 120 Wall St., New York City, U. S. A.  
DEPT. A-27  
ROCHESTER, MICHIGAN

WORLD'S LARGEST MAKERS OF ELECTRIC JIG SAWS

### SYNGRO SAW CORPORATION, Dept. A-27 ROCHESTER, MICHIGAN

EXPORT ADDRESS: 120 Wall St., N. Y. City

Gentlemen: Here's my order for one SYNCRO MAGNETIC JIG SAW, Model No. 2000, shpg. wt. packed, 18 lbs., \$17.50 FOB Factory. Please send it complete with electric cable and plug, 3 blades, on your 10 Days Money Back Trial Offer. I enclose \$17.50, plus state sales tax, if any, as payment. Please ship saw:

- Express charges collect or  Parcel Post charges collect.
- Express, for which I enclose an extra \$\_\_\_\_\_
- Parcel Post, for which I enclose an extra \$\_\_\_\_\_

NAME.....

ST. & NO.....

CITY..... STATE.....

I enclose no money—send FREE SYNCRO CIRCULAR.



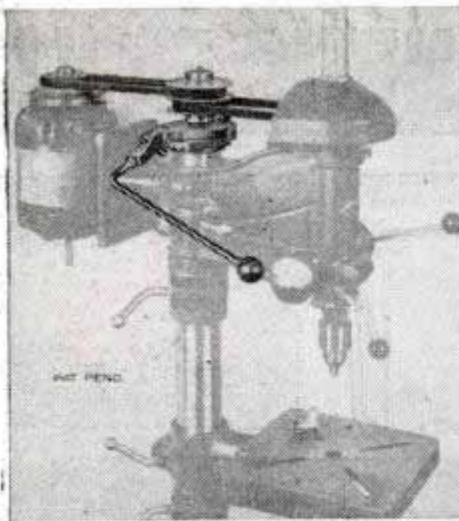

## VARIABLE SPEED DRIVE ATTACHMENT FOR DRILL PRESSES

The Era Variable Speed Drive enables the operator to provide correct speed for large or small drills by a convenient method of shifting a lever.

Designed to fit all popular makes of presses. Installed in a few minutes, without drilling of holes or changing present equipment.

Furnished with either bronze or ball bearing pulley, complete with belts.

When ordering be sure to specify make and model of press, also type of pulley desired.

WRITE FOR INFORMATION on other makes of presses

Minimum and Maximum range of speeds obtainable, as follows:

Atlas 15 or Craftsman	330/7780	Buffalo 18	260/4400
Boice Crane 15	275/10000	Delta 17" L. S.	320/2400
Buffalo 15	310/9300	Old Model	320/2400
Canedy-Otto 16	410/9250	Delta 17" L. S.	230/4100
Delta 14" L. S.	350/2240	New Model	230/4100
Delta 14" H. S.	670/5500	Delta 17" H. S.	640/5000
Walker Turner 14" L. S.	360/3100	Old Model	640/5000
Walker Turner 14" H. S.	670/5500	Delta 17" H. S.	460/6450
Price—above Bronze bearing, \$39.50; Ball bearing, \$45.50		New Model	460/6450
		Walker Turner	168/2880
		D-1100 H. S.	168/2880
		Price—above Bronze bearing, \$45.00; Ball bearing, \$51.00	

Special Model for Light Duty \$27.50 and Home Workshop . . . . .

**ERA METER COMPANY**

3942 N. Kilpatrick Avenue  
CHICAGO 41, ILL.

## G&E Craftsmen's Bargains

### ELECTRO MAGNETIC LIFT

An important labor-saver every repairman will use in many handy ways. For momentary work: Plug in any AC socket. 110 volt, 60 cycles; size 4 3/4" diam. by 3", with 22" cord and plug attached. Complete with instructions. Ship. Wt. 5 1/2 lbs. No. 7618—only . . . . .



**\$7.35** each

### FULFLO Heavy Duty FILTERS

Famous Fulflo Filter is ideal for gas, air or oil. Stands 250 lbs. pressure. Has 1/4" inlet and outlet I.P.T. Heavy bracket attached for mounting. Complete, ready to install. Overall size 3-9/11" diam., 5" high. Ship. Wt. 4-3/4 lbs. No. 4753—only . . . . .



**\$1.95** each

Lots of Ten \$1.85

### SANDING CLOTH 3-M-I.T.E.



The perfect abrasive for metal and wood. Extra tough-grained. Grit 150 x (4/0); 12" diam., 3" hole. Use on disc or cut up as emery cloth. Made by Minnesota Mining and Mfg. Co. Ship. Wt. 2 lbs. While supply lasts. No. 2908—25 discs for only

**\$1.25**

Send check or money order, including postage. No C.O.D.'s

### FREE CATALOG

New! Lists hundreds of hard to get Electrical & Refrigeration parts. Wholesale only. Write Today!



## G & E EQUIPMENT SUPPLY CO.

Dept. PM-14 400 N. SANGAMON ST., CHICAGO 22, ILL.



• Test ALL Home Outlets  
• Find Open Circuits

## STAR TEST-PLIERS

• Locate Blown Fuses  
• Remove Fuses SAFELY

A must tool for electricians, maintenance men, home owners. Replaceable lamp inside Plier tests 110 to 250 Volts. Plier pulls fuses from 10 to 100 Amperes. Shockproof. Requires the use of only one hand. Can be obtained from General Electric or Westinghouse stores, or from local electric dealers.

Order one TODAY

Price \$2.75 without Leads, \$1.50 additional for Leads

STAR FUSE CO., 233 Canal St., New York 13, N. Y.

## SAVE MONEY ON GASOLINE

### FITS ALL CARS



Now you can get up to 30% extra gasoline mileage with a Vacu-matic on your car. Quicker pick-up, smoother running, added power saves money every day. Guaranteed. **Automatic Supercharge Principle** Vacu-matic is entirely different! Operates on the Supercharge principle. Saves gas. Automatically provides a better gas mixture. Guaranteed to give up to 30% extra gas mileage, more power and better performance.

### SALESMEN WANTED

Big profits. Every Car a Prospect. Send name and address for FREE PARTICULARS and how you get yours for introducing.

Vacu-matic Co., 7617-1301 W. State St., Wauwatosa 13, Wis.

## NOW AVAILABLE

## Famous Gleason JUMBO Deluxe Semi-Pneumatic Rubber Tired WHEELS for Homecraft, Farm, Shop USE!

Air-cushion, puncture-proof tires on welded steel discs engineered for industry now available at your hardware store. If your dealer can't supply you, order direct from factory. No COD's. Send money with order. Dealers, Manufacturers write for information.

**CHECK THESE Gleason Features**

- Heavy, thick walled tires
- Hardened roller bearings
- Specially designed hub
- Fits all 1/2" axles



## Gleason

CORPORATION

2401 N. Maryland Ave., Milwaukee 11, Wis.

### BUILD YOUR OWN

Trailers, farm carts, wagons, carry-alls, trucks, special wheeled equipment.

**Gleason Wheel Prices**

8x1 3/4 ea. \$2.80 4-\$10.80  
8x2 ea. \$2.90 4-\$11.00  
10x1 3/4 ea. \$3.60 4-\$14.00  
10x2 3/4 ea. \$7.10 4-\$28.00

FOB Milwaukee, Wisconsin



# SAFE-T-PLANE

CUTS WOOD, METAL, PLASTICS  
FITS ANY DRILL PRESS!

Positive cutting action eliminates scraping or tearing in hard, medium or soft woods, including balsa, irrespective of grain position. A special cutter is available for making square-shouldered cuts, another for work in non-ferrous metals and many plastic products.



Features: single cutting blade; "one-spot" blade adjustment; polished bell guard protects eyes and hands, directs flying chips downward; vibrationless precision operation, rugged strength, versatility and long working life.

Only \$5.95  
fully guaranteed.

At Your Dealer—or Postpaid.  
Literature available

A. D. McBURNEY, 939 W. SIXTH STREET,  
DEPT. PM-2, LOS ANGELES 14, CALIF.

# EXHAUST BLOWER

NEW! IMPROVED  
FOR MANY USES

- Ventilators for office, kitchen, attic, cellar, etc.
- Darkroom exhaust fans
- X-ray and sterile rooms
- Photographic booths, commercial, etc.

Motor—Continuous, quiet, ball bearing, 110 volt A.C., 50-60 cycle. Capacity 100 cu. ft. per minute. Motor casing black crackle finish. Ends heavy cast aluminum.

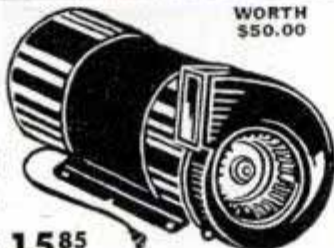

WORTH  
\$50.00

1585

Built for Long Life, Trouble Free Performance.

Send Check or Money Order. No C.O.D.'s. West of Mississippi—Add 1.00 for mailing and handling.

IMMEDIATE DELIVERY

UNIVERSAL YONKERS CORP., 41-P Locust St., Yonkers 2, N. Y.

# Grinding Wheels at LOW PRICES WHILE THEY LAST

CARBORUNDUM—NORTON—BAY STATE—MACKLIN, ETC.

6" x 1 1/4" x 1" 36 Grain Gr-R.....	EACH	75c
8" x 1" x 3/8" 60 Grain Gr-M.....	EACH	\$1.10
12" x 1 1/2" x 1 1/4" 24 Grain Gr-P.....	EACH	\$4.00
12" x 2" x 1 1/4" 46 Grain Gr-N.....	EACH	\$5.00

ORDER TODAY . . . F.O.B. Chicago

D. SCHUPACK, 2256 E. 75th St., Dept. P-W, Chicago 49

SAY YOU SAW IT IN POPULAR MECHANICS

# "Professional Finishes"

Every Craftsman should have our price list on: Electroplating chemicals and supplies, wood and metal finishes; shop chemicals; industrial and novelty finishes. CRAFT FINISHES, Box M-467, Arlington, Virginia.

# NEW CHEAP OIL BURNER

FOR COOKING & HEATING STOVES-FURNACES  
HEAT YOUR HOME, COOK YOUR MEALS  
WITH CHEAP FURNACE OIL



NO MORE SHOVELING COAL OR ASHES. A New Fuelizer Starter Vaporizing System turns Cheap 130 Flash Furnace Oil, Distillate, Kerosene etc. into Oil Gas heat without clogging up. LIFETIME GUARANTEE against defects. \$1.00 Bonus Offer for Testing. We will let you try it in your own stove or furnace for one month. Get yours for introducing. Big Profits QUICK. Be first. Send in your name TODAY.

NORTHWEST MFG. CO., 567-B 5th, Mitchell, So. Dakota

# HOBART arc welders are money makers for YOUR SHOP or GARAGE



prompt action means money to you...  
use the coupon

## Start Your Own Business!

Here's your best opportunity to be your own boss and get into the big money! Start your own welding shop—minimum investment required. Hobart offers 1000 welding combinations with Multi-Range Control for better welds—Hobart's Remote Control speeds up work—makes you more profit!

## You Can "Build Your Own" HOBART

Save hundreds of dollars, build your own gasoline drive Hobart arc welder. You need only a Hobart generator, a used auto engine and chassis. With this portable gasoline drive welder, you can go any place. Free booklet tells you how. Write for details.

## The Finest A. C. Welder Ever Built

Hobart A. C. Arc Welder for single phase lines. Handles auto repairs economically—ideal for all types of light metal work. Use coupon for details.

## HOBART WELDING SCHOOL

Individual instruction, expert instructors, low cost. Qualified under G. I. Bill of Rights.



• Electric Drive



• Build Your Own



• A. C. Welder

Welders' Vest  
Pocket Guide

**Hobart** Brothers Co., Box M-27

Troy, Ohio "One of the World's  
Largest Builders of Arc Welders"

Free!

I'm interested in Hobart Arc Welding. Send my free book, details on items checked.

- |                                           |                                         |
|-------------------------------------------|-----------------------------------------|
| <input type="checkbox"/> Gas Drive Welder | <input type="checkbox"/> Build Your Own |
| <input type="checkbox"/> A. C. Arc Welder | <input type="checkbox"/> Welding School |

NAME \_\_\_\_\_

ADDRESS \_\_\_\_\_

Hobart Bros. Co., Box M-27, Troy, Ohio



# AMAZING NEW JET IMPELLED SPEED GRINDER



Another Quality Product from the House of Hudson

## The HUDSON TURBO GRINDER

**SHARPENS  
Everything for  
Home and Shop**

Simplest operation possible. Just attach to any ordinary faucet, turn on the water and the sensational patented Hudson turbo-jet impeller spins the wheel at more than 3,000 revolutions per minute—almost twice the speed of a standard electric motor. Adjustable to 10,000 RPM, depending on water pressure. Ideal for the handy man, housewife, hobbyist, mechanic, farmer. Precision built, quality throughout. Super-hard silicon carbide wheel. Stainless steel shaft. Chrysler Oilite bearings (never need oiling). All metal parts gleaming chrome. Colorful vinylite tubing.

Sharpens knives, scissors, skates, lawn mowers, wood planes, bits, chisels, axes, hatchets and all edged tools.

**FULL MONEY BACK GUARANTEE**  
See Your Hardware Dealer

**HUDSON PRODUCTS CO.**  
4402 ST. AUBIN AVENUE  
DETROIT 7, MICHIGAN

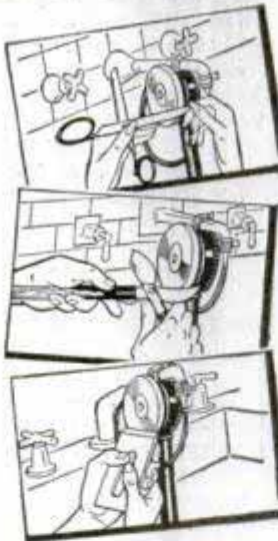

**IF YOUR DEALER DOESN'T  
HAVE THE HUDSON TURBO  
GRINDER SEND COUPON  
TODAY**

**HUDSON PRODUCTS CO.**  
4402 St. Aubin Ave., Detroit 7, Michigan

Enclosed is a \$8.95 ( ) check, ( ) money order for which rush to me, postpaid, one Hudson Turbo Grinder with full instructions for use. I understand the Grinder carries a full, money back guarantee.

Name.....  
Address.....  
City..... State.....  
Name of Hardware Dealer.....  
Address.....

new theory worked like a charm. Protons were marched around the chamber in perfect step. A cyclotron built on this principle is called a "frequency-modulated cyclotron" or "synchro-cyclotron." Its chief advantage is that a particle can be whirled around the chamber an almost indefinite number of times, and smaller amounts of energy can be applied to it to achieve a higher ultimate energy of atomic bullet.

The synchrotron is a cross between a betatron and a cyclotron. Professor McMillan is supervising the construction of the 300-million electron volt synchrotron on the Berkeley campus. The tank and magnet of the synchrotron will be doughnut-shaped, hollow in the center. An electron is very light, and when it is speeded up it will stay in one orbit rather than continue in widening circles as do the heavy particles used in the cyclotron. Therefore, the accelerating chamber, about a yard in diameter, is ring-shaped.

The synchrotron will operate as a betatron up to two million electron volts, the electrons being "muscled" around the orbit by the strength of the magnet. At this point it begins to operate as a synchrotron.

McMillan's theory is applied to the synchrotron differently from the frequency-modulated cyclotron. The spacing of the alternating charges on the one accelerating electrode is regular and unchanged, where it is slowed down in the cyclotron. However, the strength of the magnetic field is altered to keep the electrons in step. As the electrons being whirled around the doughnut slow down with increasing weight, the magnetic field is increased slightly, jerking the lagging particles up to the point where the next electrical push is applied. This change in the field is continued to the limit of the magnet's strength, when it can no longer compensate for the lagging particles.

With the 135-ton laminated steel magnet of McMillan's machine, this point is expected to be reached at about 300 million electron volts. McMillan says that, theoretically, with a stronger magnet a synchrotron could produce electrons of a billion electron volts.

The third of the new atom smashers at Berkeley is the linear accelerator, the modern version of which is the brain child of Professor Luis Alvarez, another young associate of Professor Lawrence. Professor Lawrence and D. H. Sloan built a linear accelerator in 1930, but it was capable of speeding up particles to only about two million electron volts. Alvarez and other young scientists now have revived the lin-

(Continued to page 276)



# 2 NEW WAR SURPLUS RELEASE SCOOPS

**GENUINE  
BULOVA**  
17-JEWEL (RUBIES)



With  
Army  
Air Force  
Nomen-  
clature  
on Back



**TYPE A-11  
U. S. ARMY  
AIR FORCE  
BULOVA  
WRIST WATCH**

- The Watch that Timed Air Corps Pilots, Navigators, and Bombardiers!
- Non-Magnetic Hair Spring
- Unbreakable Crystal
- Stainless Steel Case
- Sweep Second Hand
- Shock-absorbent, Water-repellent
- Flexible Metal Band
- 17-Jewel Movement
- Used—Reconditioned like New for Re-Issue.

Now . . . at About **\$19<sup>95</sup>**  
One-Third Regular  
Market Price, Only  
DELIVERED ANYWHERE IN U. S. A. Plus 10%  
Fed. Excise Tax **TOTAL \$21.95**

**BRAND  
NEW!**

**LEATHER  
FLIGHT  
JACKET**



- Full Zipper Front
- Invisible Knit Wristlets
- Waist Take-Up Straps
- Ventilated Under Sleeves
- Two Huge Button-Down Pockets
- Sheep Shearling Lined Throughout, Including Sleeves
- Elbows and All Seams Reinforced
- Sizes 38 to 48

**OFFICIAL NAVY  
AIR CORPS**

Now . . . at Less **\$24<sup>95</sup>**  
Than Two-Thirds  
Gov't. Cost, Only  
DELIVERED ANYWHERE IN U.S.A.

If this merchandise is not all that we say it is, return it within 48 hours of receipt and your money will be fully refunded.

*The Great*  
**WAR SURPLUS  
DEPARTMENT STORES, Inc.**  
1395 Milwaukee Avenue, Chicago 22, Illinois  
The Largest stock of war surplus merchandise in America

**MAIL COUPON TODAY FOR PROMPT DELIVERY TO:**

*The Great* **WAR SURPLUS DEPT. STORES, Inc.**  
1395 Milwaukee Ave., Chicago 22, Illinois

Please send me these items in the following quantities:

—Watches at \$19.95 ea. (plus 10% Fed. Excise Tax) Total \$21.95

—Jackets, sizes, —, —, —, — at \$24.95 each

(No C. O. D.'s. Send P. O. Money Order or Check. Illinois Residents Add 2% Retailers' Occupational Tax.)

Name \_\_\_\_\_

Address \_\_\_\_\_

City \_\_\_\_\_ State \_\_\_\_\_



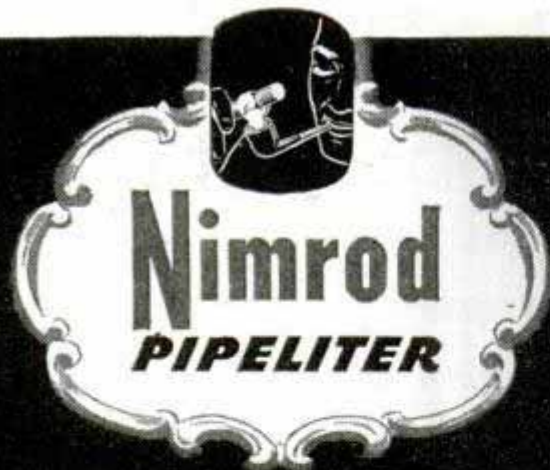

# Nimrod PIPELITER

THE ONLY DOWN-DRAFT CHIMNEY-ACTION LIGHTER  
MADE. DESIGNED EXCLUSIVELY FOR PIPE SMOKERS.



**\$3.50** AT YOUR  
DEALER

- WINDPROOF
- LIGHTWEIGHT
- LARGE FLAME

A perfect lighter for pipes, cigarettes  
or cigars too. Unconditionally guaranteed. If your  
dealer cannot supply you, send \$3.50 direct to  
us. Include your dealer's name.

WARD-NIMROD COMPANY

Dept. 35-A, 2968 Jessamine St., Cinti. 25, Ohio



# Aladdin's Tool

THE "GENI" OF  
A THOUSAND AND ONE USES !!!

**\$5.95**

all types of  
WOOD SHAPING

Routing  
Tongue & Groove  
Fluting  
Notching  
Inlay  
cuts any type of joint

use in any standard type chuck  
HIGHEST QUALITY HIGH SPEED TOOL STEEL  
6 blades will make 12 different cuts

IF YOUR DEALER DOES  
NOT STOCK THIS ITEM  
SEND \$5.95 IN CHECK  
OR MONEY ORDER  
FOR PREPAID SHIPMENT  
OR C.O.D.

The DESIGN CO  
326 LAW BUILDING  
KANSAS CITY 6, MO.

# MORE PROFITS

with

## MODERN LAWN MOWER SHARPENER



SHARPEN ANY LAWN MOWER from 5-inch  
Edger to 36-inch Power Mower in ten to twenty  
minutes with a MODERN LAWN MOWER SHARP-  
ENER because dismantling is unnecessary — neither  
handle, roller, wheels nor motor need be removed  
when sharpening any mower. . . . the MODERN  
SHARPENER eliminates all hand filing; it precision  
grinds to the extreme ends of both left or right reel  
blades. Bottom knife is held in same brackets for  
sharpening. NO EXTRA ATTACHMENTS! Order  
today! Price \$241.50 (less motor) f.o.b. Pasadena.  
(1/3 or 1/4 H.P. single phase motor recommended.)

Modern Mfg. Co., 156 N. Fair Oaks, Pasadena 1, Calif.

### ATTENTION AUTO OWNERS!

#### New Power, Pickup, Pep!

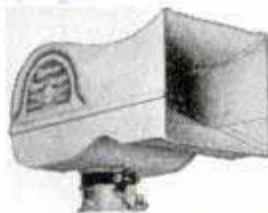

Amazing TYPHOON SUPERCHARGER  
is back again, ready to put new life  
into old motors, add to power, pickup,  
pep! 41,000 users find gas economy,  
you will, too. Motor knock vanishes,  
grease bath air cleaning keeps harm-  
ful dust out. Takes 5 minutes to in-  
stall with screw driver on carburetor,  
replacing old air cleaner. Order to-  
day, mention make and model of car.  
Only \$5.95.

(Ohio orders add 3% sales tax, West of Rockies, add 10%)  
10 Day Money Back Guarantee!

TYPHOON PRODUCTS CO. 507-W Engineers Bldg.  
Cleveland 14, Ohio

THE SCOUT,  
a high pres-  
sure steam  
engine with  
silver soldered boiler for  
boats 20" long and larger. Burns alcohol.  
Runs 30 min. Drives a 2 1/4" propeller. Price complete ready \$8.95  
to run with 70-lb. safety valve and accessories as shown...  
Postage extra, shipping wt. 4 lb. Distributors and dealers write for terms.  
PHILIP STEVENSON CO., Box 162, Station D, Cincinnati 6, Ohio

# PLASTICS!

Fabricating plastics offers you a fasci-  
nating hobby or a  
profitable business.  
New Carmen-Bronson Plastics Handbook tells you how; gives con-  
struction plans. New Carmen-Bronson Catalog lists all needed materi-  
als—Plexiglas, Lucite, Bakelite, Lignolite, Tenite II, Lumarith in  
sheets, rods, tubes, special shapes—clear and glowing colors. Also  
plastic dyes, cements, accessories and supplies. 10c brings you both  
catalog and handbook. Send for them today.

**CARMEN-BRONSON COMPANY**  
165 EAST 3RD STREET, DEPT. 2-B, MOUNT VERNON, N. Y.

## ELECTRIFY your LAWNMOWER

Battery Operated . . .  
SELF-CONTAINED • SELF-PROPELLED

We show you how to convert your own lawn  
mower for use with a car battery. Save energy,  
labor and time with this self-propelled unit.  
Our simplified plans make it easy.



LEJAY MFG. CO

247 LeJay Bldg.

Complete Plans \$1.00  
Minneapolis 8, Minn.

POPULAR MECHANICS



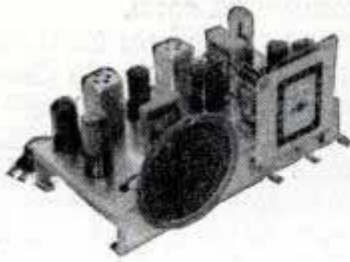

# BUILD YOUR OWN RADIO

*It's Easy* WITH THESE NEW KITS

**NEW BARGAINS  
AT NEWARK**

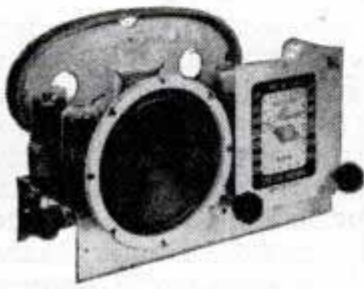

Mail Orders Filled From  
Either New York or Chicago

Here they are, beginners! Two new kits. Build your own radio in jig time. It's simple with these special Meissner jobs.

• 5 tube superhet, all stations on broadcast band. Your favorite programs over a receiver you have built yourself. COMPLETE ..... **\$18.75**

• 6 tube superhet, gets Europe and America! A real job, but easy to build. Fun, experience galore. COMPLETE ..... **\$25.20**  
Cabinet ..... \$5.95 extra

Both sets are complete, easy to build, fine performers. These as well as many other bargains are available now at Newark. Write for our Super Bargain Bulletins. Visit our stores, talk "shop" with our personnel, and see some great radio and electronic equipment.

NEW YORK  
Offices & Warehouse  
242 W. 55th St., N.Y. 19

**NEWARK**  
ELECTRIC COMPANY, INC.

CHICAGO  
323 W. Madison St.  
Chicago 6, Ill.

New York City Stores: 115-17 W. 45th St. & 212 Fulton St.

C4

## New "THERMO-SAW"

Cuts Rapidly & Cleanly  
No Noise—No Sawdust  
BOYS & MECHANICS  
thrill over the many  
interesting things they  
can make with this  
NEW ALL-STEEL  
THERMOSAW. Diff-  
cult patterns are made  
QUICK and EASY.  
ORDER TODAY.

\$1.75 in Canada & Mexico, \$5 Elsewhere.  
BOISSELIER MFG. CO., Dept. P-2, GLEN ELLYN, ILLINOIS

**CUTS  
WITH  
HEAT**

Note—  
Operates  
on 110 volt  
Alternating  
Current; 50  
to 60 cycle

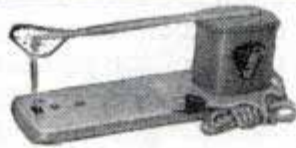

Machine Measures 11x4x 3 1/2" High, Throat 7" Deep. PATTERN FREE. Postpaid  
**ONLY \$4.50**

## IT'S EASY PICKING FROM A HUOT DRILL INDEX

A handy container for indexing and filing twist drills. All steel—ten sizes. Correct drill always at your fingertips.

SEND \$1 for No. 13 holds drills from 1/16" to 1/4" by 64s. (Or see dealer) Order Today.

**HUOT MFG. CO.**

Foot, Schultz Bldg., St. Paul 1, Minn.



## LIQUID MARBLE COLORED POTTERY



Different! Marvelous! Color-glazed, Brush, spray, mold files, table-tops, ornaments! **SANITARY COMPOSITION FLOORING**—Dustless, noiseless; put on like plaster, plain or tile designs; yielding as cork;



lasting as stone. **RUBBERLASTIC Mold Compound**—For plaster casting, novelties, statuary, toys, plaques, dolls. **TILEX Colored Roofing**. Build Modern **PLASTIC HOMES**. Illustrated literature free. **RAPID MARBLEIZING SERVICE**, Dept. 10-A, Edwardsville, Illinois

## OTTAWA TRACTOR SAW



**350 Cuts Per Minute**—cuts them down, saws them up, one man operates. Thousands in use, stiff heavy blade, built to last, safety clutch control, uses power take-off any tractor. Low price. **OTTAWA MFG. CO.**, D-227 Forest Avenue, OTTAWA, KANSAS

## CROP-CONDITION YOUR SEEDBED with a SEAMAN TILLER

USED FOR MANY YEARS BY  
U. S. DEPT. OF AGRICULTURE

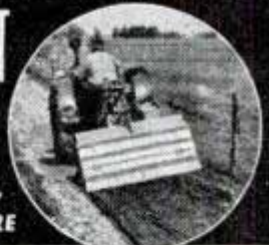

This is how the farm-size SEAMAN ROTARY TILLER actually "crop-conditions" your seedbed for more profitable yields:

- ... Increases nitrogen through soil aeration.
- ... Conserves and holds moisture by complete and uniform pulverization of soil.
- ... Provides more available plant food by milling cover crops and fertilizer into the GROWING AREA of seedbed.
- ... Helps to destroy weeds and most crop pests.
- ... Helps to reduce soil erosion.
- ... Promotes earlier and more complete germination of seed by maintaining higher temperatures in seedbed.
- ... Enables you to get on land sooner and get crops in while weather is right.

Let us tell you about the many new improvements in the construction and operation of SEAMAN TILLERS. There is a size to fit your farm and your tractor . . . 36-inch to 72-inch, power-take-off and motorized models. SEE YOUR LOCAL IMPLEMENT DEALER and write for literature today!

DEALERS: Write us on your business letterhead if interested in handling SEAMAN TILLERS.

**SEAMAN MOTORS, Inc.**

341 NO. 25TH STREET, MILWAUKEE 3, WISCONSIN



**"It's a  
MONEY  
MAKER  
for me"**



● "Yes, my American floor sander has been a steady money-maker. Both new and old floors have kept me busy with good-paying work. And there are plenty of jobs ahead all the time!"

This is typical of the experience of American owners everywhere!

Throughout America, thousands find that American floor sanding machines make profits for them that consistently exceed their original expectations.

There's REAL MONEY for you in floor surfacing! Send today for "tell-all" booklet entitled "Opportunities in Floor Surfacing". Not a catalog—it's a general introduction to getting into something for yourself...being your own boss. Use coupon and enclose 25c in coin or stamps to cover handling.

## AMERICAN FLOOR SANDERS

● American Floor Surfacing Machine Co.  
● 535 So. St. Clair St., Toledo 3, Ohio

● Enclosed find 25c in stamps or coin for booklet  
● "Opportunities in Floor Surfacing", telling me how  
● I can be my own boss.

● Name \_\_\_\_\_  
● Street \_\_\_\_\_  
● City \_\_\_\_\_ State \_\_\_\_\_

ear accelerator idea and a 40-foot section capable of hurling 40-million electron volt protons will be completed soon.

To get the protons started on their way in the linear accelerator, a Van de Graaff generator, a potent atom smasher itself by prewar standards, will shoot four-million electron volt protons into the new gun. Attached to this generator, which looks like a tank on its side, will be a long, hollow, copper cannon. Down the center of this cannon will run a rifelike tube cut up into sections. These are called "drift tubes." The first tube is a few inches from the entrance to the cannon. On each side of the cannon is a row of obsolete radar sets. These sets, 15 on each side of the 40-foot section, pump alternating high-frequency radio waves into the copper cannon, trapping a tremendous power within it.

As a proton is shot into the cannon it receives a terrific electrical shock which speeds it even faster into the first drift tube. While it is in the drift tube the proton is protected from any effect of the electrical charge in the cannon, and advantage is taken of this period to reverse the electrical field. Just as the proton emerges from the tube, the field is once again reversed, clipping the proton another electrical blow and sending it into the next tube. This process continues until the proton emerges from the tube. Each successive tube is longer, which compensates for the increased speed of the proton as it is kicked along.

Alvarez estimates that it should be possible to get one million electron volts per foot for the machine. To get greater energy a new section will be added. After the pilot model 40-foot section has proved itself, a 240-foot model will be built later. The young scientist says that it should be possible eventually to accelerate protons to a billion electron volts with the new machine.

## Laboratory in Space

(Continued from page 93)

et-to-ground radio circuits that produce oscillograph pulse measurements are being used to study the thicknesses of the ionized layers, their up-and-down movements during night and day, and their refractive effects. Accurate radio refraction indexes will be necessary for precise radio control of high-altitude rocket vehicles or weapons.

Other instruments carried by the V-2s have confirmed previous ideas that parts of the upper atmosphere are boiling hot. This, however, doesn't mean what one might suppose. High temperatures in the thin upper air mean that the relatively few

(Continued to page 280)



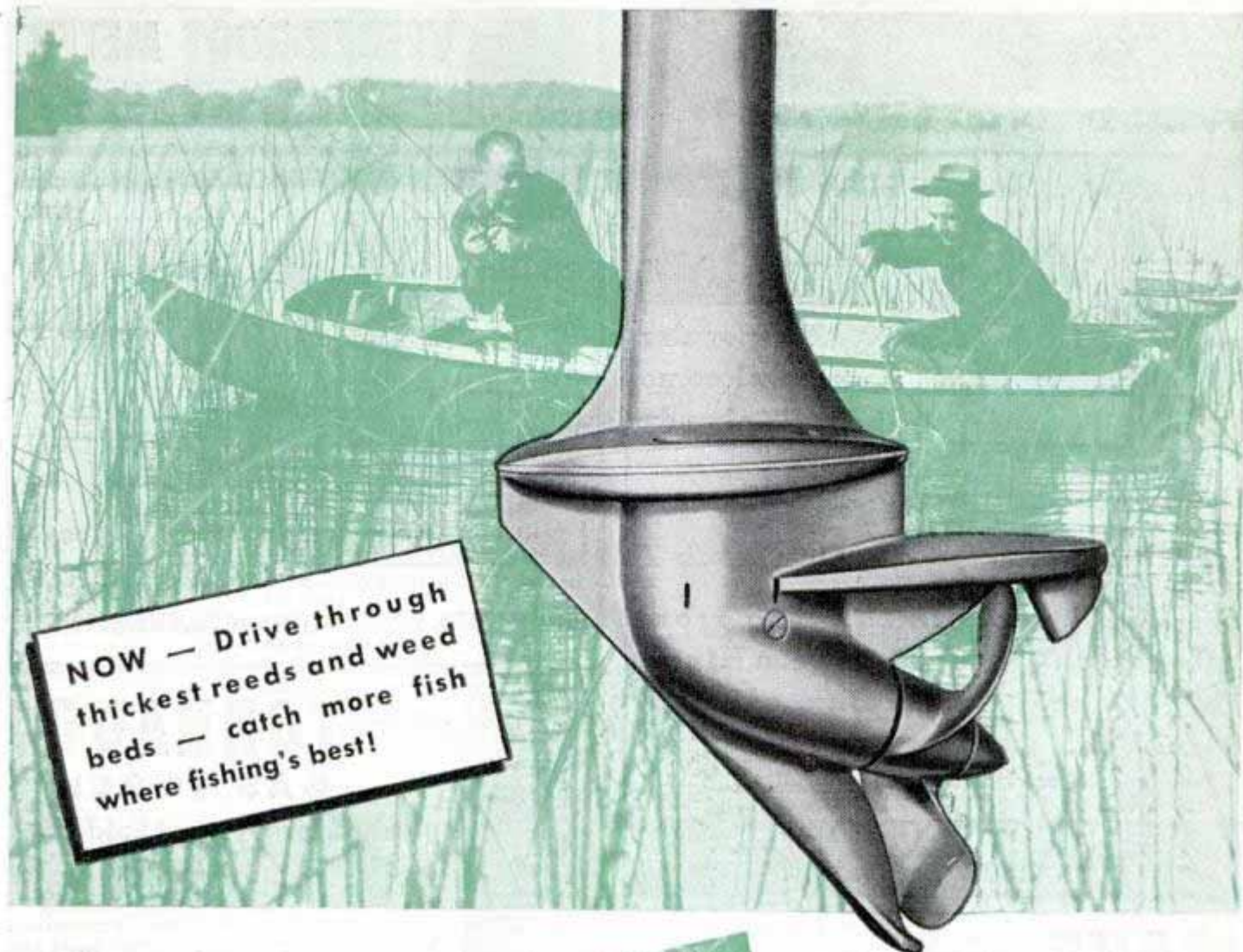

**NOW — Drive through  
thickest reeds and weed  
beds — catch more fish  
where fishing's best!**

# Evinrude announces the revolutionary new Weedless Drive



Now you can enjoy a new "freedom of the water". Drive full power, non-stop, through thickest reeds or dense carpets of water hyacinth or lotus. Slash confidently through water growths you would not dream of tackling with any conventional drive. Go where you wish . . . catch more fish where fishing's best!

Fully tested and amazingly effective the WEEDLESS DRIVE is the result of long experiment to perfect a drive equally efficient in weeds *and in open water*. Tremendously rugged . . . built to take the banging over rocks and dead heads. Equipped with new type propeller slip clutch that practically eliminates need for shear pin replacement.

The WEEDLESS DRIVE is now standard on two of Evinrude's most popular light motors, Sportsman and Sportwin. See your Evinrude dealer — look for his name in your classified telephone directory under "Outboard Motors." The Evinrude catalog is free— send for your copy today.



**EVINRUDE**  
OUTBOARD MOTORS



**SEND FOR FREE CATALOG —**  
Complete catalog of 7 Evinrude models sent free — write for it today! EVINRUDE MOTORS, 5433 N. 27th St., Milwaukee 9, Wisconsin. In Canada: Evinrude Motors, Peterboro, Ontario.



## Useful Tools



This popular Set will come in mighty handy

if you work on an  or a  or a  Contains 7 thin wall sockets ranging from  $\frac{1}{8}$ " to  $\frac{3}{4}$ " with  $\frac{1}{4}$ " square drive, a Hinge Handle and Cross Bar, all in a Steel Box.

Ask your jobber or dealer for the 40-T set.

**WALDEN**  
WORCESTER  
WRENCHES

**STEVENS WALDEN, INC.**

WORCESTER, MASSACHUSETTS

# MAKE MONEY

*Selling*

## FLUORESCENT

## SAVES

# 1/2

on Electric Light Bills

## INTO SOCKET JUST LIKE BULB!

## SALESMEN!

Once expensive—once costly to install—out of the reach of most people, Fluorescent Lights still sold in millions. Experts now predict war starved market of  $3\frac{1}{2}$  BILLION, and with invention of fixture that screws in like an ordinary light bulb, a fixture that can be installed in an instant, a fixture that sells complete with tubes at a new low price—the most spectacular sales opportunity of the decade has been opened up for salesmen and distributors. Enormous advance commissions. Exceptional factory co-operation includes financing big orders by shipping open account to your customers.

## FREE

If earnings of \$5,000, \$10,000 and \$15,000 a year don't scare you, rush your name by fastest way for sensational facts—sales plans—complete line with pictures and prices. This is the hottest item in direct selling today. Even if you don't answer another ad in this magazine, rush your name on this proposition—right now.

North American Mfg. Co., 5042 Cottage Grove, Dept. 32, Chicago 15, Ill.



## VEEDER-ROOT METER

Counts no. of ft. of trailing wire antennae; no. turns when winding on coil applicable for many uses; flexible shaft can be attached and connected to another device for counting without direct attachment; speed 300 ft. per minute for reeling out; beautiful bakelite case, jeweled dialite, pilot light enclosed, 3 position switch, counts up to 1000. EACH..... **95c**

## ARMY AIRCRAFT RECEIVERS

BC-946-B

Broadcast band from 520 to 1500 Kc, tube complement — 3-12SK7, 1-12SR7, 1-12A6, 1-12K8 can be used with 24V dynamotor supplying A & B power; can be converted to AC or DC or 32 volt sets 3 stages of IF used. Uses 3 gang condenser. Complete with **\$12.95** tubes and schematic, each.... Dynamotor DM-32A, each..... **\$4.95**

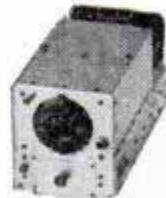

## SUPREME FOUNDATION METER

40 Micro Amps. 25,000 ohms per volt  $4\frac{1}{2}$ " square. **\$8.95**  
Manufactured by Supreme Instruments Corp. Each...

Hickok  $2\frac{1}{2}$ " 0-150 AC Voltmeter, each..... **\$2.49**  
Dept. PM

ARROW SALES, INC., 59 W. Hubbard St., Chicago 10, Ill.  
SUPERIOR 5575



## TORNADO GAS TORCH

*The Modern Way of Soldering*

Ideal for hard and soft soldering. Will heat quickly; solder will flow freely and smoothly. No compressed air required. Nothing to pump. Self-adjusting. Safe. Economical. Can be used for annealing small parts and bending metal parts. Generates a heat of 1700° Fahrenheit. Simply connect to any illuminating gas jet with a rubber hose and

operate. Tornado Torch No. 119 comes with three (3) tips, ( $\frac{1}{8}$ ",  $\frac{1}{4}$ ",  $\frac{3}{8}$ " blast).

The Tornado Gas Torch No. 119, complete with three tips, is \$2.95. See your dealer or order direct. Send check or money order—post paid.

Robco Corporation, 202 E. 44th Street, New York 17, N. Y.

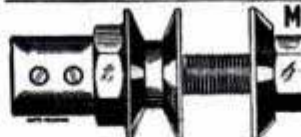

## Motor Arbor and Combination V Pulley

$\frac{1}{2}$ " right, .65c —  $\frac{1}{2}$ " left, .75c  
 $\frac{3}{8}$ " &  $\frac{1}{4}$ " right and left... **\$1.00**



Spindle to Fit **35c**



## SAW MANDRELS

$\frac{1}{2}$ " ..... **\$2.95** —  $\frac{3}{8}$ " ..... **\$3.45**

ADD 10% FOR POSTAGE U. S. A.  
SEND 3c STAMP FOR CIRCULAR.

B. DOWICK, Dept. P, 584 Communipaw Ave., Jersey City 4, N. J.



**RUMIN**  
Gold-Coated FLINTS  
and LIGHTER FLUID

For all Lighters  
**RUMIN**  
LIGHTER FLUID

gold-coated  
FLINTS

Rumin Gold-Coated Flints... the only gold-coated flints made... plus Rumin blue-flame Lighter Fluid are a sure fire combination that make every lighter spark quicker, light brighter!

**SOLD WHEREVER CIGARETTES, CIGARS AND TOBACCO ARE SOLD**

**ROCK FLINT CO., 123 Doughty Blvd., Far Rockaway, N. Y.**







# Only

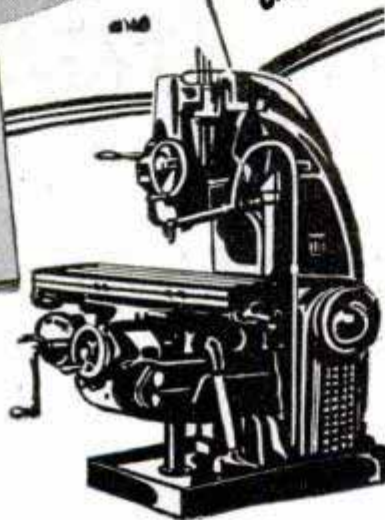

UNDER NEW  
 WAA  
 25%

## "BELOW-MARKET" PRICE SCHEDULE

Here is a real bargain in surplus machine tools for general production purposes. 31 major types of tools—in all makes and models have been recently repriced to an average of 25% under the open market for the same machines—in order to clean government warehouses faster of this surplus property. The tools average less than 3 years old. Few need rebuilding but when necessary it can be done at a cost within the large price differential allowed. Find out today about these bargains for yourself or your company. Write, wire or phone any of the WAA offices listed below for your copy of the fixed price Machine Tool Catalog—issued October 1, 1946 . . . or ask your regular machine tool dealer to show you his copy.

## WAR ASSETS ADMINISTRATION

Offices located at: Atlanta • Birmingham • Boston • Charlotte • Chicago • Cincinnati • Cleveland • Dallas • Denver • Detroit • Fort Worth • Helena • Houston • Jacksonville • Kansas City, Mo. • Little Rock



Los Angeles • Louisville • Minneapolis • Nashville • New Orleans • New York • Omaha • Philadelphia • Portland, Ore. • Richmond • St. Louis • Salt Lake City • San Antonio • San Francisco • Seattle • Spokane • Tulsa

686-2-A

air molecules present have very high kinetic energy. An object in the upper air is not heated by conduction; it becomes very hot on the side exposed to solar radiation and bitterly cold on its shady side because of its own radiation into space.

Man's knowledge about cosmic rays and their relation to the energy that runs the universe may be multiplied many times by studies that are being conducted at moderate altitudes by converted B-29s and at extreme altitudes by rockets.

Important new data about these powerful rays already have been obtained by means of cosmic ray telescopes placed in the warheads of V-2s by the applied physics laboratory of Johns Hopkins. Showers of the rays have been recorded up to 350,000 feet. The telescopes consist of sets of Geiger-Mueller counters placed between lead plates so that only the particles that strike from certain directions can be recorded. Additional counters alongside the telescopes make general records of all the charged particles encountered.

Unique methods are employed for transmitting this information to the earth. Various objections precluded the detaching of the instruments from the V-2 at high altitude and lowering them by parachute. Instead, the cosmic ray counters are hooked up through amplifiers to a radio telemetering system in the rocket that uses 16 channels in instantaneously sending the information back to earth. Mechanical recorders inside the warhead meanwhile punch out duplicate records on brass tape. This permanent record, if the recorders are found in good condition, is a check on the accuracy of the telemetering system.

Dr. J. A. VanAllen of Johns Hopkins reports that on the basis of V-2 research it appears that cosmic ray showers are 300 times more plentiful in the upper atmosphere than at ground level. They increase in frequency up to about 200,000 feet and then continue to increase at a reduced rate for as high as instruments have been carried. Mesotrons, secondary particles generated by primary rays, are recorded in greatest numbers at about 100,000 feet. Radioactive and self destructive, few mesotrons "live" long enough to reach the earth.

One of the reasons why cosmic rays are the subject of widespread research today is that the energy of these particles is millions of times greater than can be produced by nuclear fission. This has very important implications in the field of atomic energy. It is entirely possible that in his upper air research man will find the key to a power plant by which he can travel even farther into space.



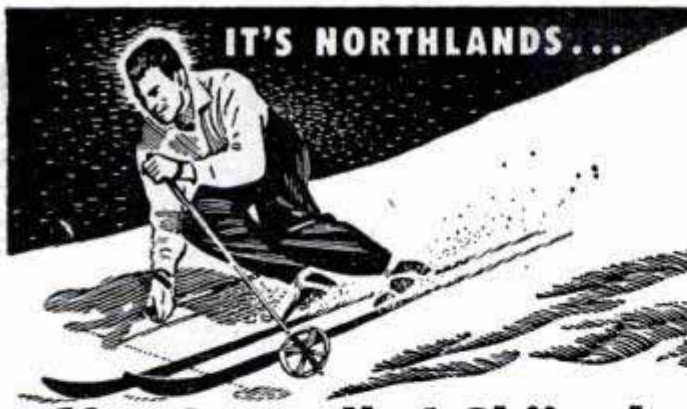

IT'S NORTHLANDS...

**for Controlled Skiing!**

For better ski control, new skiing pleasure, choose Northlands. They're hand-crafted skis designed to make your skiing surer—safer.

LOOK FOR THE DEERHEAD TRADEMARK

★ Send 15c for the Northland Ski Manual, a guidebook to better skiing edited by Hannes Schneider. Or, write for free booklet. Offer does not apply in Canada.

**NORTHLAND SKI MFG. COMPANY**  
95 Merriam Park St. Paul 4, Minnesota

WORLD'S LARGEST SKI MANUFACTURERS

● **POWER LAWN MOWER**

**BUILD ONE YOURSELF FROM YOUR OLD MOWER**

We supply complete attachments that fit any make or size of mower, with or without 1 1/2 H.P. gas engine. Easy to install in less than an hour. No more back breaking mower pushing. Immediate delivery, at low prices, express prepaid.

**MONEY BACK GUARANTEE**

You'll be delighted! Complete satisfaction or your money back. Write for

**FREE FOLDER**  
Dealers Wanted.

**ROYAL OAK LAWN MOWER SHOP**  
431 N. Main St., Royal Oak, Mich.

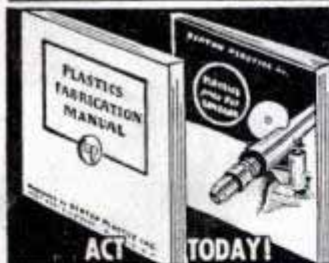

**BIG MONEY FOR YOU IN PLASTICS**

SEND **10¢** Offer includes 2 books: New Fabrication Manual & Giant Catalog, listing the most complete stock of Plastic Materials, Accessories, Tools.

**BERTON PLASTICS, INC.**  
19 W. 21st St., N. Y. 10, N. Y.

ACT TODAY!

**STOP FAUCET LEAKS**  
with "Pignose" faucet washers

They outwear, outlive, outperform ordinary washers. If your dealer can't supply you, we'll send 3 samples **FREE** to prove "PIGNOSE" are best.

Just fill in coupon and mail to



★ **REFUND OF MONEY**  
Guaranteed by **Good Housekeeping**  
IF DEFECTIVE OR NOT AS ADVERTISED THEREIN

**KIRK HILL INC., 6828 MCKINLEY AVE.**  
**LOS ANGELES 1, CALIF.**

Your name .....

Address .....

Your dealer .....

it's NEW...

it's **BIG**

it's **FREE**



**LAFAYETTE'S**  
latest, greatest,  
**Radio Catalog**

Mail  
**Coupon Below**

**YES**, here it is at last — the most complete catalog ever offered by Lafayette — world's largest radio supply house. And what a catalog it is! Pages are brimming with an amazing display of radio parts, build-it-yourself kits, microphones, record changers—and hundreds of other items. All the tried-and-tested standard equipment is listed—also many items so recently developed that they're shown for the first time. Everything in stock. Be among the first to get this, America's greatest radio catalog — **FREE**.

**TYPICAL LAFAYETTE**

**BARGAIN**

Each unit individually measured with maximum capacity marked on end plate. Average maximum capacity 120 mmfd. 96-to-1 backlash-free worm drive. Order NOW. No. HR 175. Your Cost Only 98¢.

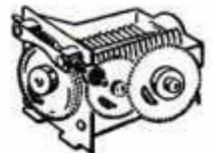

**PRECISION VARIABLE CONDENSER**

*Lafayette Radio*

RADIO WIRE TELEVISION INC.

100 SIXTH AVE. NEW YORK 2

110 FEDERAL ST. BOSTON 10

24 CENTRAL AVE. NEWARK 2

**LAFAYETTE RADIO Dept. BL-7**  
100 Sixth Avenue, New York 13, N. Y.

Rush my free copy of your big new catalog.

Name.....

Address.....

City..... State.....



# 'QUICK-CHANGE' GEAR BOX

CUT THREADS — 4 TO 224 PER INCH

Approximately .003 feed, for fine turning.  
New reverse furnished with box for Atlas.  
Bronze bearings throughout entire unit.  
Aluminum casting — All steel gears.  
Maintained accuracy.  
Speeds up production.  
Easy to install.  
Simple to set.  
Immediate delivery.

Only **\$75<sup>00</sup>**

F.O.B. Chicago  
Guaranteed

**FOR-** Atlas, Logan, Craftsman  
and Power-Kraft Lathes

Write for information or order direct. Full instructions with shipment.  
O'BRIEN MACHINE CO., Sales Dept. A. 1620 Highland Ave., Chicago, Ill.

Fill Holes, cracks, dents, gouges . . .

## These **BETTER FILLERS**

- HARDEN FASTER
- SHRINK LESS
- STAY IN!

FILLS HOLES  
IN ONLY  
APPLICATION



Duratite Wood Dough will fill rough or irregular cavities in wood, metal, plastic or plaster in one application. (Duratite Surfacing Putty for shallow cavities). Can be sawed, cut, milled, sanded; are waterproof, fire resistant. Seven wood colors, in tubes or cans, at Hardware and Paint stores. Made by Manufacturers of famous Arrowhead Cement.

### WEBB PRODUCTS CO.

228 South G Street, San Bernardino, California  
or Webb Company - Dept. M - Norcross, Georgia.



## DURATITE

WOOD DOUGH AND SURFACING PUTTY

## Have Your Own **ELECTRO-PLATING** Business

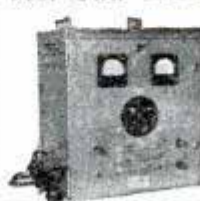

Profitable - Simple - Pleasant

The VARI-PLATER—110 V. A.C.—plus a glass or rubber tank and chemicals, which are always available, and accompanying handbook, that is illustrated and easy to understand, will give you many money making opportunities.

You can **PLATE** Gold—Silver—Chromium—Nickel—Copper—Cadmium, etc. on metals and non-metals with the VARI-PLATER.

**FREE** Write today for descriptive literature and price list.  
**LEWIS ELECTRICAL MFG. CO.** 1266P Gun Hill Rd. New York 67, N. Y.

## NEW! **DECAL-CRAFT** FULL COLOR TRANSFERS

Make circus wagons, animals, miniature streamliner train. Easy to use—stick 'em on—saw 'em out, or use to decorate children's furniture. All for \$2.00 postpaid. Instructions included.

**DECAL-CRAFT, 1112 BIRCH ST., EAU CLAIRE, WIS.**

## **AUTOMATIC RETOOTHER**

Makes New Profits

Cuts new teeth in 50 seconds! Any size tooth 4 to 16 points. Old teeth fall off as chips. Simple to operate. A perfect job.

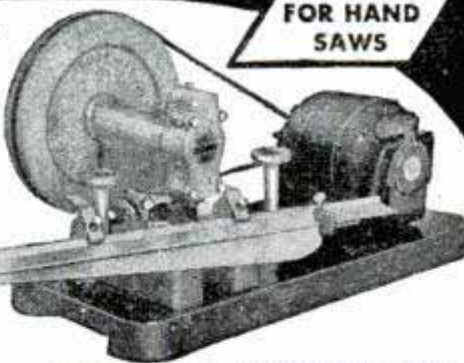

FOR HAND  
SAWS

IMMEDIATE  
DELIVERY

**BURR MFG. COMPANY** 8933-A Venice Blvd. Los Angeles 34, Calif.

The Chief

# WORK BENCH

*Built to Last a Lifetime!*

With Bottom Shelf and 18" Sq. Drawer. 2"x6", Solid Plank, Grooved and Dovetailed Top and 1"x8" Back Rail, Shellacked to a Smooth, Sat'ny Finish.

MOHAWK LUMBER CO. Dept. 32  
14525 W. Chicago Blvd. Detroit 27, Mich.  
Enclosed  Check  Money Order for \$  
Ship  CHIEF WORK BENCHES at  
Quantity  
\$16.95 each, F.O.B. Detroit, Mich.  
 Send C.O.D., \$5 Deposit Enclosed.

NAME .....

ADDRESS .....

CITY ..... STATE .....

No Priority Necessary!

• 6 Ft. Long • 34" High • 26" Deep. Shipped Knock-down, with Bolts, Nuts and Screws and ABC Chart for Quick, Simple Assembly.

*Prompt Delivery*  
**MOHAWK LUMBER CO.**

14525 W. Chicago Boulevard  
DETROIT 32, MICHIGAN



**\$16<sup>95</sup>**  
F.O.B. DETROIT

Send Check or Money Order, or Will Ship C. O. D. (\$5 Deposit)



## SAMSON 10" LEVER-JAW WRENCH

OVER 1,000,000 IN USE



**\$1.75** All Steel Construction; Cadmium Plated; Postpaid to Harden Jaws Open to 1 1/4 Inches, Can Be Anywhere In U.S.A. Locked in Any Position at 1/2-Ton Jaw Pressure.

- Breaks loose and turns stubborn, rounded nuts.
- Sure grip, fast action pipe wrench.
- Secure clamp for welding, soldering, drilling, etc.
- Portable vise for holding small or irregular shapes for grinding or drilling.

Satisfaction Guaranteed or Your Money Refunded.

SEND ORDERS TO **WM. TRUMAN TOOL CO.** 153 S. YORK ST. ELMHURST, ILL.

## TURNER

### VT-73

### DESK MICROPHONE

Here's the mike you want for your rig. It's got looks, it's tough, and man, oh man how it performs. It's a TURNER! Ask your dealer or write for Free Literature on other low cost Turner Microphones.



THE TURNER COMPANY

921 17th St., N.E., Cedar Rapids, Iowa

## ONLY ELECTRIC MOTOR

### 60c

CONSTRUCTION KIT  
EASY TO ASSEMBLE  
FUN—EDUCATIONAL

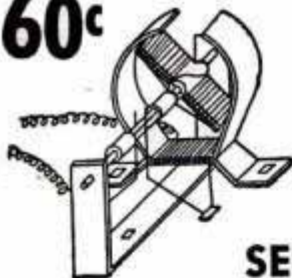

IDEAL GIFT

Runs on a Single Dry Cell (not included). Use it to run Toy Pumps, Pulleys, Etc.

SEND CHECK—MONEY ORDER or CASH (at your own risk) to

THE HAYDN CHEM. CO., Dept. C 2, Box 27, Kenmore 17, N. Y.

## New Self-Locking Cutting Tool

Cuts holes, discs, washers, and rings—1/8" to 6". Cuts steel, brass, dural, bakelite, etc. Locks in position when pressure is applied to bits. No Tools needed for adjusting is Hand adjusted. A handy, time-saving tool for production shops or hobby shops. Complete \$5.95. Manufacturing rights for sale to any capable firm.

W. D. BELL, Pickwick Hotel, Kansas City 6, Mo.

## SHAW and "Peppy-Pal" DU-ALL GARDEN TRACTORS

1 to 9 H.P. Circulars on request. Building more now. We supply repairs for all SHAW Tractors sold in our 42 years in business.

### BUILD YOUR OWN RIDING TRACTOR—"WAR HORSE"

using old auto parts, powered by 2 H.P. or larger air-cooled engine; or walking type Garden Tractor 1/2 to 3 H.P. or convert truck or auto into Farm Tractor. Each with steel or rubber tires; will plow, cultivate. Plans for building, in few hours, any one of above, postpaid for \$1.00 (state which wanted) or all 3 for \$2.00. Money Back Guarantee.

SHAW MFG. CO., 4502 Front St. Galesburg, Kansas

6686 North 4th St., Columbus, Ohio

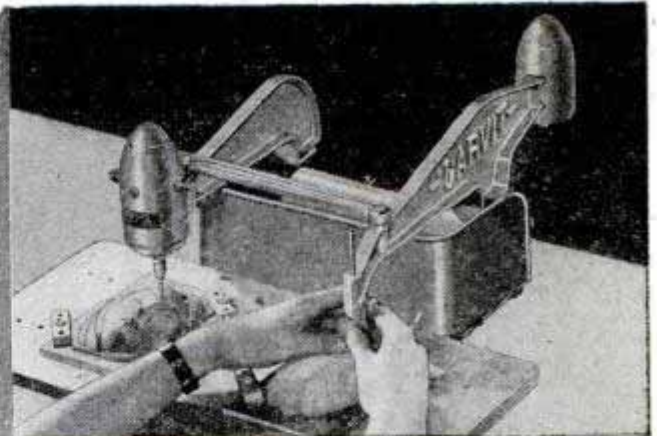

## Amazing New DUMORE "CARVIT" Makes You a Skilled WOOD CARVER in Twenty Minutes!

A fascinating new hobby, complete in 1 tool!

Making fine wood carvings with a Carvit is so simple a child can do it! You can amaze your friends with finished work on your very first attempt. You can add a "professional" touch to other woodworking projects by embellishing them with fine carvings.

### Fascinating Fun—and Profitable!



The Carvit is a duplicating tool, made by a famous manufacturer of precision industrial tools. With it you can carve dozens of beautiful and useful objects in mahogany, ebony, and other fine woods. For models, you can use plaques, costume jewelry, ash-trays, and a wide variety of other inexpensive objects of plaster, metal, glass and plastic. Your carvings are many times more beautiful and valuable than your models!

Think of the useful and ornamental things you can make for your own home — think of the distinctive gifts you can make for your friends!

### You are an expert at once—with a Carvit!

Here's how the easy-to-use Carvit works: You clamp a model to the table below the tracer, and a wood block below the cutter. Then you switch on the motor and guide the tracer over the raised contours of your model. The cutter moves with the tracer to carve an exact duplicate of your model. That's all there is to it!



With a center attachment you can carve objects in the round—statuettes, busts, and figures. The Carvit comes complete with cutters, wrenches, and instructions, ready to use, for \$48.50. Center attachment extra.

Production is too limited to supply your local dealer, but while our stock lasts we can accept your direct order for immediate delivery. To avoid waiting for your new Carvit,

H-2

tear out this coupon and mail today!

THE DUMORE COMPANY, Dept. B-51, Racine, Wis.

10 DAYS

FREE TRIAL

Please send me —

- One Carvit complete as described above.  
 Complete information on the Dumore Carvit.

(If I am not completely satisfied with my Carvit, I can return it in 10 days for a complete refund of the purchase price.)

- Enclosed is my check or money order, in the amount of \$.....  
 Ship C.O.D. plus insurance and postage.

Name.....

Street Address.....

City.....(.....) State.....



# SPEED LINER

Fishing Boats and Runabouts

**Your DREAM BOAT!**

The boat you've dreamed of owning ... a SPEED LINER. And you have seven super models from which to choose ... for fishing, fun and family pleasure. Precision-built, streamlined design ... for attractive appearance, durability, maneuverability and seaworthiness.

Place your order with your dealer now to be assured of delivery in 1947. If no dealer near you, write us.



"TROPHY" MODEL

**GENERAL MARINE COMPANY**  
ST. JOSEPH 25, MISSOURI

## Inflates Tires Instantly!



# Tirex

### SENSATIONAL NEW AUTO ACCESSORY

Enjoy new freedom from driving worries. Carry a Tirex in your car. Soft or flat tires are inflated in 3 seconds. Just attach the convenient steel bottle to your tire valve, turn the handle and the tire is filled instantly! No pumping. Avoids most roadside tire changing. Ideal for areas where air pressure is not available. Enough pressure for 3 tires. Completely safe.

#### Tirex Puts Out Fires, Too!

The Tirex is filled with carbon dioxide under pressure. It is the perfect fire extinguisher for small gasoline or electrical fires. It smothers the flames without harming the car. Tirex gives you double protection—pressure for tires—safety from fires. A lifetime accessory. Tirex may be refilled for 75c. Send check (or M.O.) for \$5.95. Money refunded if not satisfied. *Distributor Inquiries Invited*

**\$5.95**

POSTPAID  
IN U.S.

**BREAKSTONE & CO.**

2155 W. Harrison St. Chicago 12, Illinois



**Say Goodbye to Backaches!**

LOHRMAN "SNOW-GLIDE" **SNOWPLOW**

**Removes Snow Without Effort!**

Cleans snow as fast as you can walk! No bending or lifting. Sturdy all-metal construction, rubber-tired wheel, rubber handle grips. Cleans 21" path with straight blade. 18" with V-blade. Money-back guarantee. Send check or money order and plow will be sent postpaid same day order received. Sorry, no C.O.D's

**LOHRMAN SEED CO.**  
Room 107, 1300 Brush  
Detroit 26, Michigan

Only **\$79.95** Postpaid

Our 55th Year in Business

Adjusts to V or Straight Blade

**10¢ FOR THIS PLAN (and four others!)**

**STANLEY**

**PLAN SET No. 19**

—easy to make, useful objects for home or gifts. Set No. 19 includes: Child's Rocker — Bedside Chest — Dressing Glass — Portable Towel Rack — Sewing Kit.

Yours, postpaid, for only 10¢ — send today! Or write for free list of all Stanley Plan Sets. **STANLEY TOOLS**, 127 Elm St., New Britain, Connecticut.



## PERISCOPE SIGHTING STATION

Bausch & Lomb & Eastman — new — contains 32 coated lenses & prisms, selsyns, gears, motors, etc. **\$49.50**  
Cost over \$10,000.00

Navy battle lanterns—7" x 7" with 4" lens— **\$5.50**  
new

Shipped prepaid anywhere in U. S.

**ASSOCIATED SURPLUS** 10838 Ventura Blvd. North Hollywood, Calif.

**\$24.95** Full Set

## MICROMETERS

Six piece set, in velvet lined leather case. Special price, only \$24.95. Precision machined in one thousandths, up to 4" outside and 3/4" inside measurements. Guaranteed accurate, easy to read and adjust. Satisfaction guaranteed or money back. Also indicators and gauges. Shipped prepaid on receipt of remittance. On C.O.D. shipments, send deposit of \$2.00.

**FREE FOLDER**

**MICRO PRODUCTS**, 8655 E. Jefferson, Detroit 14, Mich.

SAY YOU SAW IT IN POPULAR MECHANICS

## 3 in 1 OTTAWA SAW

THE WORLD'S FASTEST.

**6-H. P. EASY TO MOVE**

**FELLS TREES, SAWS BIG LOGS, SMALL LOGS, LIMBS**

One motor performs all three operations. Furnished with or without attachments shown below. Thousands in use. Make **BIG** profits in the ever increasing wood business. Pulley for belt work. Fully guaranteed. Low direct-to-user prices. **FREE** details—write **TODAY**.



**OTTAWA MFG. CO.**, 227 Pine St., Ottawa, Kansas





## AUTHENTIC GUN MODELS



Beautiful, accurately detailed models of famous Naval Guns. Easy to build. Become real collector's items.

No. 1103—SEA MORTAR—An authentic reproduction 4" long, accurately detailed in every respect. Complete kit, \$4.25.

No. 1104—ONE POUNDER—Modeled after one of our famous Revolutionary War Guns. 4 1/2" long. Complete kit. \$4.25

Address Dept. PB

HALESITE YACHT SERVICE, INC., Halesite, L. I., N. Y.

## DIE-LESS DUPLICATING

Many small parts can be formed without dies, to duplicated accuracy of .001" with DI-ACRO Precision Machines. — Benders, Brakes, Shears. Save die expense and time delay. Ideal for experimental and research work, making samples, models, etc., as well as regular production runs. Write for descriptive literature.

O'Neill-Irwin Mfg. Company

341 8th Ave.  
Lake City, Minnesota



SHEAR

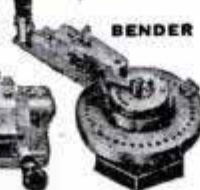

BENDER



BRAKE



## BUILD YOUR OWN TRAILERS

Build this new, modern, stream-line trailer.

Complete detail plans and building instructions sent postpaid for only \$2.50. Send postoffice money order to

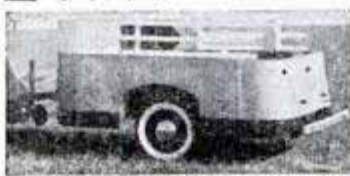

MITCH-CRAFT PLANS, P.O. Box 362, McCook, Nebraska

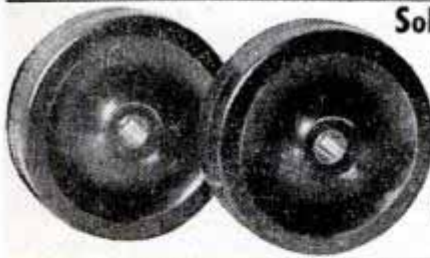

## Solid Rubber Wheels

Build your own hand cart and trucks with solid rubber wheels.

These wheels are 5" Diameter 1 1/2" thick with 5/8" hole and Brass bushing.

\$3.25 per pair Post-paid in U.S.A.

Backlin Mfg. Company

Box 426  
Burlington, Wisconsin

## A "TREASURE CHEST" OF PARTS

### 2-Motor Gyroscope Stabilizer

Consists of two 1/50 H.P. 12 V. motors high speed to 10,000 r.p.m. removable for separate use. Variable resistor assembly. Vibrator dampener. Small condenser. Coils. Springs. Sus-

pension system. Made by Westinghouse for government use. Many valuable parts.

Free Catalog . . . Rush Order!

Only \$12<sup>50</sup> F.O.B. Chicago

B & B PRODUCTS CO., Dept. PM, 111 W. Jackson Blvd., Chicago

SAY YOU SAW IT IN POPULAR MECHANICS

## MAKE 200% to 1000% PROFIT AT HOME

in your own business preserving Baby Shoes in REAL metal, pearl, gold, silver, bronze and colors. Lifetime opportunity. America's biggest paying home business. This is YOUR big chance for independence and big money. Write for free details.

**KIKTAVI COMPANY** 8620 S. Ruthelen, Dept. 2  
Los Angeles 44, California

New LOW COST "CHIEF"

## PORTABLE ELECTRIC ARC WELDER



A COMPLETE WELDING SHOP IN 1 CASE • CARRY IT ANYWHERE • VERY SIMPLE TO OPERATE

SPECIALLY DESIGNED FOR EASY PORTABILITY AND GENERAL PURPOSE

## WELDING BRAZING SOLDERING

HARD SURFACING • PRE-HEATING



Works On Iron, Steel, Aluminum, Brass, Bronze, Copper and Alloys. Excellent Results Achieved On Thin Gauge Metals

The "CHIEF" is a remarkably efficient new low-cost Electric Arc Welder that brings easier portability and greater simplicity of operation than ever before. Its wide range of application makes it ideal for all-around use in home workshops, welding shops, farms, garages, machine, auto and general repair shops. Lightweight, easily carried. Accessories fit into a tray on bottom of case, providing a complete welding outfit all in ONE compact portable unit.

### Amazingly Simple Low Cost Operation

Very simple to operate. Even inexperienced workers can achieve good results right from the start. Does high-grade work you would think only possible with larger, more expensive outfits. The Hy-Flash Arc Torch included, simplifies welding of all light and medium gauge metals, as well as brazing, soldering and heating operations. 110 or 220 volt models. Complete, as illustrated. The greatest welder value in America today!

SEND COUPON FOR FREE DETAILS NOW!

CHICAGO PRECISION MACHINE CO.  
926 S. Michigan Ave., Chicago 5, Illinois  
Send free details on Chief Welder. No obligation.

Name \_\_\_\_\_  
Street \_\_\_\_\_  
City \_\_\_\_\_ State \_\_\_\_\_



# PLAN YOUR NEW HOUSE *Before You Build*

BY CONSTRUCTING AN ACTUAL MINIATURE MODEL

ALL MATERIALS & TOOLS INCLUDED

4 KITS TO CHOOSE FROM

NO. 1—FIVE ROOM CAFE COD BUNGALOW WITH 2 UNFINISHED ATTIC ROOMS

1/4 INCH SCALE — \$4.95

NO. 1A—SAME AS ABOVE 1/4" SCALE \$7.95

NO. 2—SIX ROOM, THREE-LEVEL COLONIAL HOUSE, BUILT IN GARAGE,

1/4 INCH SCALE — \$6.95

NO. 2A—SAME AS ABOVE 1/4" SCALE — \$11.95

VARIED CONSTRUCTION POSSIBLE WITH KIT

PLEASE STATE MODEL WANTED

FROM COMPLETE KIT

EACH KIT COMPLETE • NO EXTRAS TO BUY

- Workable blue prints of an actual house.
- Direction sheets — easy to follow.
- Sufficient Balsa wood of all sizes to change the plan to suit your needs.
- Paper design flooring, shingles and siding.
- All other tools to construct your model home, such as glue, paint, wallpaper, knife, etc.

EASY TO MAKE • NO NAILS NEEDED

MAIL ORDERS PROMPTLY FILLED • SEND CHECK, MONEY ORDER OR C.O.D.



**MARSHALL HOMES**

BUILDERS OF SCALE MODEL HOUSES  
6535 RISING SUN AVENUE, PHILADELPHIA 11, PA.

## ROTO-ETTE

Reg. U. S. Pat. Off.

### THE ALL-PURPOSE POWER GARDENER

ROTARY TILLAGE PLUS

Ideal for Small Farms Gardens, Grounds

See this new ROTO-ETTE. Does outdoor jobs faster, easier, better. Tills a deep, finely pulverized seed bed, ready for planting; cultivates, hills. Quickly converted to lawn or field mower, hay rake, seeder, furrower, spray, snow plow, power unit.



**NOTE THESE FEATURES**  
**ROTO-BUSTER:** Greatest improvement since invention of rotary tillage. Licks hard or stony ground. Permits complete tillage entire width of unit without "dead spots."

**STABILIZER:** Automatically holds machine in balance; adds new ease to operation.

**ANTI-SHOCK MECHANISM:** Improved cushioning in drive absorbs shocks of stones and hard ground. Protects tines against breakage; operator against fatigue.

Write Dept. N for literature

**ROTOTILLER, INC. TROY, N.Y.**

### ASSEMBLE KING MIDGET

Practical highway racer runabout. We supply all parts. Just bolt together. Low cost. Ready for delivery NOW. One or two cylinder, 40 m.p.h., up to 100 miles per gallon. Send 25c for complete literature with large picture, 3-view drawings, price of parts, or send \$1 for the above plus 4 actual photographs, plans for snow and ice conversion, catalogue of new and used motors, motorscooters, transmissions, clutches, other offerings, etc.

MIDGET MOTORS, Athens 1, Ohio

## Auto Battery Chargers

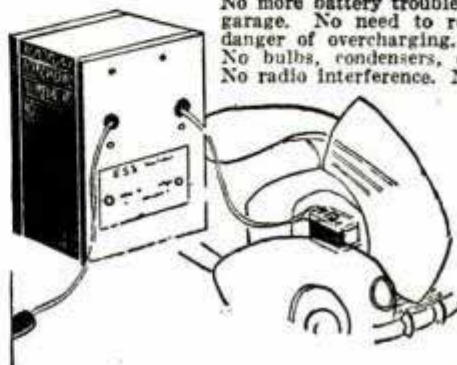

No more battery trouble. Simple to use in garage. No need to remove battery. No danger of overcharging. No moving parts. No bulbs, condensers, or liquids to spill. No radio interference. Noiseless. Will save you many garage bills. Operates on 110 volts A.C. 50-60 cycles. **FULLY GUARANTEED.** Order today. Send check, money order or pay Postman

**\$12.95**

plus a few cents postage

MART DISTRIBUTORS, Dept. B, P. O. Box No. 6, Evanston, Ill.

**FEW EXCLUSIVE TERRITORIES AVAILABLE! DISTRIBUTORS WANTED!**

**Nationally Advertised Brand AUTO ACCESSORIES**

**\$500 TO \$600 SUPPLY LASTS ONLY WEEK TO 10 DAYS**

Have your own big business in a territory that is exclusively yours. Year around steady demand; national advertising to back you up. Write today for catalog, information and territories available . . . give age, experience, and complete background in first letter.

KNICKS MEND-RITE CO. 1443-47 Gentry, N. Kan. City, Mo.

**ACE**  
LATHE TOOL SET

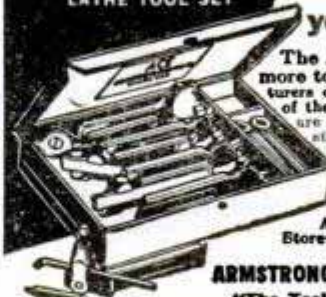

**Be permanently tooled-up for every operation on your Metal Cutting Lathe**

The ACE Set is complete—there's nothing more to buy. Drop forged by the manufacturers of cutting tools used by 96 per cent of the plants and shops in industry they are correctly designed, are of special steel, are finely finished, are stronger—will last a lifetime. You can cut easier, faster and more accurately with ACE TOOLS.

At your Hardware Store

**ARMSTRONG BROS. TOOL CO.**

"The Tool Holder People"

368 N. Francisco Ave., Chicago 12, U.S.A.

1 Turning Tool, 2 Cutting Tools, 3 Knurling Tools, 4 Boring Tools, 5 Threading Tools, High Speed Steel Cutters and Blades, and 2 Wrenches in Filled Steel Case.

## COMPRESSED AIR INSTANTLY, Anywhere!!

Portable Air Compressor and storage tank. Ruggedly built of best materials using lifetime lubricated ball-bearing on connecting rod and oil impregnated main bearing on shaft. Unusual design forever eliminates valve trouble, the most common fault in air compressors. **PATENTED** unique air intake system increases efficiency tremendously over other compressors so that air output is much greater than that from larger compressors powered by heavier motors. Will deliver approximately 3500 cu. inches of air per minute at maintained pressure of 30 lbs., or will inflate a 90 lb. truck tire in less than one minute. Comes complete with 100 lb.

gauge, although finger-tip adjustment allows setting of output pressure at any value, which will automatically be maintained. Works from any 1/4 H.P. motor. Useful for spraying paints or lacquers, disinfectants, insecticides, annealing or brazing with natural gas, inflating tires, etc. Price \$14.50 postage prepaid anywhere in the U. S. Efficient, completely adjustable syphon type spray gun complete with 12 ft. of 100 lb. tested hose available for only \$7.75 with pint container, also prepaid. 25% required on all C.O.D. orders. Send for free catalogs of radio parts and surplus items.

**BUFFALO RADIO SUPPLY, 219-221 GENESEE ST., DEPT. M-2, BUFFALO, N. Y.**

POPULAR MECHANICS



**Handy Joe** *Portable* AIR COMPRESSOR

• Now, here it is! The All-Purpose Air Compressor you have been waiting for!

Fills a long felt need for Home Craftsmen, Model Builders, Hobbyists, etc. Handy Joe is a small and inexpensive compressor that will handle 1001 jobs around the home, garage, shop, farm and factory... gives compressed air instantly and priced so amazingly low that you can't afford to be without it. Delivers approx. 2 cu. ft. at maintained pressure of 30 lbs. Weighs only \$14.50 7½ lbs., height 9 in. Each

Satisfaction Guaranteed

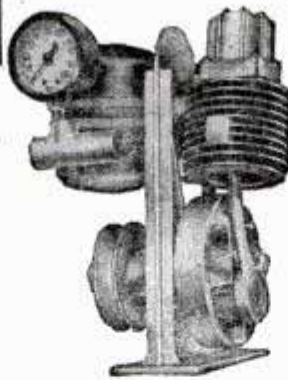

**SPRAY GUN**

A precision made, syphon type gun that operates smoothly with any kind of paint, lacquer, oil, gasoline, varnish, insecticide, etc. Adjustable to fine or heavy spray. **\$4.90** Each



**RUBBER HOSE**

80 lbs. pressure tested. ½ inch fitting on one end. 12½ ft. long, each. 1.70 23½ ft. long, each. 3.00

**EARL A. RUSSELL & CO.**

1118 So. Michigan Avenue

Chicago 5, Illinois

**V-8  
DUALS  
& SINGLES**

**MUFFLERS  
STEELS and ALUMINUMS  
with a motorboat tone**

SINGLES, Chev. V-8, Plymouth, Steels \$5.50, Aluminum \$6.50. Chry., Olds., Buicks, etc., Steels \$7.50, Aluminum \$8.50. V-8 and MERCURY DUALS, Steel \$17.50, Aluminum \$20.00. Aluminum are guaranteed for life of your car. **DEALERS WANTED**

**SANDEE MUFFLER CO.**

7523 S. WESTERN AVE., LOS ANGELES 44, CALIF.

**TRAILER AXLES, HITCHES, AND PARTS**

• If you are interested in purchasing trailer axles, hitches, and other trailer parts, contact us promptly. **Write for free literature.**



HAMMER BLOW TOOL COMPANY, Dept. 114, WAUSAU, WIS.

**PRESTO! ANYONE CAN MASTER GLAZE**

LEAVES HARD GLASS-LIKE FINISH  
EASY TO APPLY  
PROTECTS THE SURFACE  
NO SMEAR OR STREAKS AS WITH WAX  
LASTS SIX MONTHS TO A YEAR



SAVES YOU MONEY

Car Owners! Meet Master Glaze—the sensationally different luster for new and used cars! Not a wax—not an oil polish—not a paint!—nothing that “smears” over the surface.

**MASTER GLAZE** is a unique discovery—a creamy liquid—quick and easy to apply! Gives a hard, glass-like surface. Even gasoline cannot dull it! Lasts six months to a year! Amazing luster—beautiful, sparkling clean and brilliant! Doesn't finger-mark—doesn't smear! A match box full glazes an entire car. Seals the pores—protects! **NOTHING LIKE IT!**

**AGENTS**

An unusual opportunity! Quick, flashy demonstrator. Big profits. Good territory. Write today!

**FREE SAMPLE**

Just send your name and address to **MASTER GLAZE CO., 7720-570 W. Harwood Ave., Milwaukee, Wis.**

**PUTS PROFIT in Your POCKET**

**BIG OPPORTUNITY BUILDING BLOCKS of CONCRETE CINDERS**

Men of Vision and Modest Capital See Prosperity and Independence in This Big Field Today. Read Offering Below and Then MAIL COUPON.

**NEEDED EVERYWHERE** for Every Kind of Building to be Done



**BIG DEMAND FOR QUALITY BLOCKS  
BIG PROFITS**

Yes, here's a manufacturing opportunity never before equaled. Our complete concrete block unit consists of mixer, material elevator, hopper and famous proven Blocker Vibrator Machine. Turns out 130 blocks an hour. Needs only 3 people to operate. This unit has been paying for itself in six months so **IT PAYS FOR ITSELF QUICKLY**—and from then on you **KEEP FULL PROFITS**. One user says:

“We are operating your machine at Junction City. Easy to maintain production of **ONE HUNDRED CONCRETE BLOCKS PER HOUR PER MACHINE**—often producing as high as one hundred thirty units per hour. Your Blocker Vibrator has no complicated parts. We recommend your product as a **REAL practical MONEY MAKER**.”—Concrete Products Co. of Junction City.

Limited amount at special price to get these operating in many different localities at once. **RUSH COUPON BELOW** for money making facts and details about our unit—**DO IT NOW**.

**Concrete Block Equipment Co., Inc.**

920 Central, Dept. 104-B

Kansas City 6, Mo.

**MAIL COUPON for DETAILS!**

Concrete Block Equipment Co., Inc.  
920 Central, Dept. 104-B, Kansas City 6, Mo.

Please send me details and “How to Start and Operate a Concrete and Cinder Block Plant—a New Local Business Rich in Opportunity.”

Name.....

Address.....



**DAD'S LOTS MORE FUN SINCE HE GOT THAT WESTERN ELECTRIC HEARING AID!**



**There is a difference in Hearing Aids**

● Western Electric Hearing Aids are made by the nation's largest producer of communications and electronic equipment. They are the *only* hearing aids designed by the famous Bell Telephone Laboratories.

So, Western Electric is a name you can trust . . . for better hearing. Your hearing aid is a companion you'll rely on for a long time; it had better be the best. Ask about the new Model 64 Hearing Aid.

**Western Electric**

Dept. 380-PM2, 195 Broadway, New York 7, N. Y.

Please send your free guides to better hearing and information about Model 64.

Name \_\_\_\_\_

Address \_\_\_\_\_

City \_\_\_\_\_ Zone \_\_\_\_\_ State \_\_\_\_\_

Distributed in Canada through Northern Electric Co., Ltd.

you'll do faster, better work with this  
**EFFICIENT SHOP TOOL**

**THE Bantam GRINDER**



- ★
- Polishing
- Grinding
- Carving
- Drilling
- Buffing
- Plastic
- Glass
- Metal
- Wood
- Bone

You'll enjoy doing many shop jobs with the Bantam Grinder. Correctly balanced for easy handling. Precision-built of quality materials for dependable, long-life service. Operates on 110-115 Volt AC-DC. Speed approx. 20,000 R.P.M. Internal ventilating fan. Fingertip switch. Weight—15 oz. With 8-ft. cord and plug, 23 accessories, substantial gift box... **\$25**

If your dealer doesn't have it, write us.

**Small Motors, Inc.**

Dept. 80, 2068 Elston Ave. ● Chicago 14  
Manufacturers of special small universal, fractional H. P. motors, shaded pole motors, heater motors for industrial and appliance uses.

**SMALL EFFICIENT SPEED REDUCER**



**\$18.56**  
NET — POSTPAID

Just the thing for the Home Work Shop, Hobby Shop, Bench Work, Animated Displays, Light Production work. Used daily in thousands of homes and shops. Sturdy, compact, (see dimensions). Case of heat treated aluminum. Gears, SAE 65 (British) Gear Bronze. Worm of case hardened steel. Timken Bearings throughout. Torque capacity 100 inch pounds. Available in 4 different assemblies (shown below) and in these standard ratios:

4-1	25-1	64-1	200-1
8-1	30-1	75-1	300-1
10-1	40-1	80-1	400-1
16-1	50-1	100-1	600-1
20-1	60-1	150-1	800-1

When ordering be sure to specify assembly and ratio required. Shipping weight in carton, 8 lbs. Full money back guarantee. Prompt deliveries.

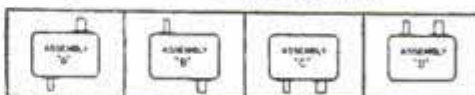

**THE OHIO GEAR CO.**

1402 EAST 179th ST. ● CLEVELAND 10, OHIO

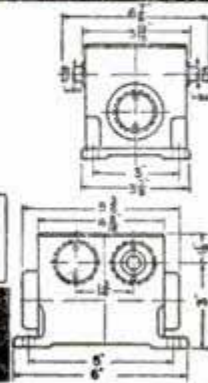

**AMAZING MYSTERY BUTTON**

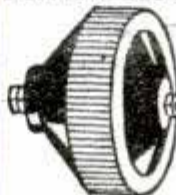

Startles Everybody. With this *Electronic Button* you can make your own Telephone-Amplifier—Detectophone. Attach this button to piece of cardboard—transmit conversation to another room. Music also transmitted to distant places. Most interesting electrical apparatus ever discovered. Enables you to perform hundreds of experiments. So tiny it can be concealed in dozens of places. A Pre-War Product. *Electronic Button* including 5000 word instruction booklet with 50 illustrated experiments, postpaid, only \$1.00

**SUPER MYSTERY BUTTON**

Many times as sensitive as our regular mystery button. Can be used for the same experiments and uses as the mystery button but with far better results. Needs no diaphragm of any kind. Ideal for musical instruments, intercommunication, recording, talking thru radio, and many other uses. When used with small head phone it makes an ideal inexpensive hearing aid. Shipped with 5000 word, 12 page booklet showing diagrams for dozens of uses, postpaid \$2.00.

Electronic Products Company  
Saint Charles 1, Ill., U.S.A.

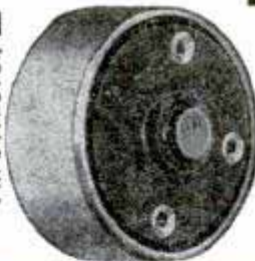

**While They Last--Supply Limited**

**1 1/2" PARALLEL BARS: 3 3/8" PARALLEL DISCS**  
Soft Cold Rolled Steel — Surfaces Ground Parallel  
Parallel 1 1/2 x 1 1/2 x 3 1/4" Long. Discs 3 3/8 x 1 1/8" Thick  
ONLY \$1.50 A fortunate opportunity to Discs 3 3/8 x 5/8" Thick  
Postpaid at LESS THAN COST. ONLY \$1.25 & \$1.00  
MECHANICAL PRODUCTS CORP'N ● ORDER TODAY ● U. S. A.  
168 No. Ogden Ave. Dept. P-G CHICAGO 7, ILL.

**SIGNS EASILY AND EXPERTLY**  
PAINTED WITH LETTER PATTERNS

AND SHOWCARDS ● MANY SIZES & STYLES ● WRITE FOR FOLDER!  
JOHN F. RAHN  
1330-31 N. Central Ave  
CHICAGO 31, ILL.

SAY YOU SAW IT IN POPULAR MECHANICS

**BUILD YOUR OWN MACHINE TOOLS!**  
Blueprints \$1.00 - Catalog FREE

Detail construction Blueprints on 6 Lewis metal and wood-working tools postpaid for \$1.00. Includes prints for Lewis 10" Shaper, Milling Machine, Drill Press, Vise, 8" Circular Saw, 6" Jointer. Castings for these tools save up to 80% of comparable new tool cost.

Illustrated 32-page Catalog—sent free with Blueprint Order—describes 21 Lewis tools. WRITE TODAY!

LEWIS MACHINE TOOL CO.  
P. O. Box 7446, Sta. L, Dept. M, Los Angeles 23, Calif.





# Redecorating?

A single coat of Luminall paint, in the rich, new colors, will work wonders in your home. Use over wallpaper... dries in 40 minutes. There's a dealer near you.

Luminall Paints, Chicago 9.



**Use Luminall**  
for brighter interiors

## GET THE BEST IN MUFFLERS V-8 DUALS & SINGLES

Finest Norman custom-built muffler sets - steel pack - torpedo type - heavy, perforated steel cores - chrome enamel finish - mellow, deep tone (improves with use) - designed to fit - all ways superior - double economy.

DUALS.....\$17.50 SINGLES.....\$7.50

V-8 Ford-Mercury Buick, Olds., Chrys.  
SINGLES.....\$5.50 ORDER TODAY! Will outlast three ordinary mufflers.

Chev., Ford, Plym. Dealers—Write Today for Full Details

## NORMAN'S MUSICAL MUFFLERS

Dept. PM-5, 1216 W. Slauson Ave., Los Angeles 44, Calif.

## HULL AUTOMOBILE COMPASS



A travel companion that shows directions anywhere, any time.

Write for Circular

At your dealer's.

Price \$3.95

HULL MFG. CO.

WARREN, OHIO



P. O. BOX 246-D2

## PILOT'S JACKET

BRAND NEW B-15 army style Jacket. Warm, sturdy, comfortable. Dark brown sail cloth; sheds water; alpaca wool lining; genuine Mouton fur collar with storm tab; elastic knit wool cuffs and waist; zipper front; 2 slash pockets plus 2 inside pockets. Sizes 34-46.....\$13.75

Write for full illus. list Army surplus pants, etc. Orders sent postpaid except C. O. D.

Complete satisfaction or money back.

CONSUMERS CLOTHING CO., INC.

Box 17, 2066 First Ave., New York 29, N. Y.



**STOP LOOKING... START LIVING!**



## SCHULT OFFERS FULL VALUE IN A FURNISHED HOME

The Schult Luxury Liner built to quality standards by pioneers of the trailer coach industry offers you an unbeatable combination of living comfort and value, available right now!

In one package you get well heated, well insulated mobile housing, ingeniously designed furniture, a kitchen equipped with refrigerator, oven range and double sink.

### EVERY FACILITY OF A 3-ROOM HOME

The Luxury Liner contains three separate rooms... sleeps four comfortably... provides all the wardrobe, closet, and drawer space you need... is luxuriously furnished and decorated, includes vanity with built-in lavatory or toilet room.

See a Schult! Write today for dealer's name; we'll send latest catalog, too.

## SCHULT CORPORATION

DEPT. 3202 • ELKHART, INDIANA

In Canada, John Inglis Co., Ltd., Toronto



SEE SCHULT AT THE SHOW!  
Attend National Trailer Coach Show, Navy Pier, Chicago, March 15 to 23

## SCHULT Trailer Coaches

6 handy tools in ONE!

- 1 MITERING GUIDE
- 2 DIAMETER GAGE
- 3 ACCURATE SQUARE
- 4 MARKING GAGE
- 5 CENTER FINDER
- 6 CONVENIENT RULER



\$2.00

POSTPAID

# MITER-MASTER



Miter Master takes the place of an expensive miter box accurately set to any angle. Scale marked for mitering 5, 6, and 8-sided frames. Steel construction. Built to last a lifetime. If your dealer can't supply you we will send it postpaid anywhere in the U. S. for \$2.00. (Foreign \$2.25.) Unconditional guarantee. If not satisfied within ten days for any reason whatsoever, your money will be refunded.

## MASTER SPECIALTY COMPANY

3018 EAST LAKE STREET • MINNEAPOLIS 6, MINN.



**Make Up To \$600  
An Hour!**



**Operate Your OWN Home-Weaving Business With AMAZING New DEEN Power Loom!**

Make yourself financially independent! Start a steady business of your own . . . right in your home! Earn **BIG PROFITS** by weaving thousands of different designs of rugs on the new easily operated Deen Power Loom. Machine will automatically weave ten yards of beautiful intricate designs every hour.

**DEEN LOOM TAKES UP LITTLE SPACE.** You can put this marvelous weaving machine in a corner of your living room, basement, garage, or spare bedroom. Then later on, as your business expands, you can move into regular business establishment.

**IDEAL BUSINESS FOR HANDICAPPED PEOPLE** such as veterans and persons handicapped by loss of sight or limbs, and those unable to do strenuous labor. Loom is simple to operate . . . a child can run it. Any rug design you wish can be woven by merely changing paper guide pattern.

**ORIGINAL INVESTMENT CAN BE RETURNED IN THIRTY DAYS.** A small investment gets you started in your own business right away. Deen Loom has capacity of from eighty to one-hundred yards a day . . . in only one month it is possible to get back your original investment. Demand for home-woven rugs is **GREATEST IN HISTORY. DON'T DELAY . . .** start making plans for your own business NOW. Write today for free descriptive booklet and full information. Address **THE GIBSON COMPANY, DEEN LOOM DIVISION, HARLAN, IOWA.**

*Distributorships Still Available in Some States*

**"Makers of DEEN Looms — FAMOUS Since 1895"**

**REMOVES ALL FINISHES**



New type semi-paste remover quickly lifts off paint, enamel, varnish, shellac, lacquer, bakelite and other synthetic resin finishes. (Removes emulsified resin water paints, too.) Stays wet longer — stays put on upright or overhead surfaces — strips clean, quick. One coat usually enough (apply with brush or spray). Contains no benzol, acid, caustic, alkali, or wax — harmless to hands, bristles, surface stripped. All sizes (pint 65c) at paint and hardware stores.

**FREE CIRCULAR**

"How to Remove Paints, Varnishes, Lacquers, etc." Also describes other Savogran Products: Heavy Duty Cleaner, Crack Filler, Wood Putty, Remover & Bleacher (renews floors), Paint Brush Cleaner, Coldfoam Soapless Soap Powder.

*It's Orange!*



**THE SAVOGRAN CO.  
DEPT. 38, BOSTON 10, MASS.**

**SAVOGRAN  
STRYPEEZE**

*IN EVERY WELL-EQUIPPED HOME WORKSHOP*



**NOW!  
PAINT  
STRIPING  
MADE  
EASY!**

**PAINTERS'  
STRIPING TOOL**

Easy to use as a pencil! Draws parallel lines, straights, curves, circles with paint, enamel, lacquer, etc. Do your own striping on autos, furniture, toys, bikes, model planes, signs, linoleum . . . make wall board look like tile. Painters — craftsmen, order today! Type "M" Master Painters' Striping Tool complete with tip for 1/16" stripe, \$1.00, Extra tips 1/64", 1/32", 3/64", 1/16", 5/64", 3/32", 1/8" — 75c each. Tool with complete set of 7 tips \$5.00. (C.O.D. orders 25c extra.) Dealers write!

**WENDELL MFG. CO.**  
4234-B Lincoln Ave., Chicago 18, Illinois

**Special - METERS**

**SURPLUS — NEW — GUARANTEED — GOV'T. INSPECTED**

ANOTHER OF OUR POPULAR METER COMBINATIONS. Five different brand new, accurate Gov't. Inspected Surplus meters which anyone can use for many purposes: experimenting, laboratories, testing and repairing.

**A.C. VOLTMETER** Weston, Model 517, 2 1/2" round, flush mounting 0-150 volts A.C. Black scale. Suitable for use from 25 to 400 cycles.

**D.C.-A.C. VOLTMETER** Sterling, 2" ring mounted, stamped metal case, polarized vane type, 0-250 volts, Direct Current and Alternating Current, 5% accuracy.

**D.C. MILLIAMMETER** General Electric, DW-51, 2 1/2" round flush mounted 0-1 Milliampere, 100 Millivolt movement, 100 ohms resistance. Scale marked 0-50 M.A. COMPLETE WITH PAPER VOLT-OHM-MILLIAMMETER SCALE.

**RADIO FREQUENCY AMMETER** General Electric, DW-52, 2 1/2" round flush mounting 0-1.5 Amperes R. P. Black scale, complete with external thermocouple.

**D. C. MILLIAMMETER** General Electric, Type G-1, 1 3/4" Square, 1.35 M. A. movement. Black scale, luminous markings.

ALL FIVE of these meters can now be had AT ONLY A SMALL FRACTION OF GOVERNMENT COST. **Only \$9.90** Postage Paid anywhere in the U. S. and Canada for . . .

**MARITIME SWITCHBOARD**

Dept. PM6 336 Canal Street New York 13, N. Y.

**WINDOW SIGN LETTERS**

For Store Fronts and Office Windows. Anyone can put them on. Samples furnished. Genuine Gold and Silver. **METALLIC LETTER CO., 430 N. Clark St., Chicago 10**

SAY YOU SAW IT IN POPULAR MECHANICS

**CHANITE SELF-WELDING FLUX**

REPAIRS ALL ELECTRIC HEATING ELEMENTS

So simple anyone can make repairs in your broken or burnt-out electrical appliances—irons, toasters, stoves, etc. Guaranteed nothing like it. From our mines to your appliances. \$1.00 per package. \$7.50 per doz. Stick form 25c. \$2.00 per doz. **CHANITE SALES COMPANY, 914 So. Main, Fort Worth 4, Texas**

**Cut NEW TEETH in 3 Min.**

**With FOLEY RETOOTHER**

**For All HAND SAWS**

No need to grind off old teeth — cut new ones over them. Fast, accurate, no eye-strain. Cuts filing time in half.

Cuts 20 sizes of teeth from 4 to 16 points per inch. Immediate delivery



**FOLEY MFG. CO.**  
290-7 Foley Bldg., Minneapolis 13, Minn.  
Send full details on Foley Retoother.

Name . . . . .  
Address . . . . .



**Now Ready FOR BOAT and MODEL BUILDERS!**

**South Coast Company MARINE HARDWARE CATALOGUE**

New, revised edition of the famous South Coast Marine Hardware Catalogue with which is combined "Racing Rules" and "Tuning Your Boat," by the late Walton Hubbard, Jr., famous boat builder and International Star Boat champion, is now ready.... Completely illustrated, this book contains a wealth of information on boat racing and rigging and the description and prices of racing hardware for sail boats of every size. An invaluable aid to the sail boat builder and a source of reference for the model maker.

SEND \$1.00 FOR YOUR COPY TODAY!

**South Coast Company** BOX M • 23rd and Central Newport Beach, California



**AAF-B-3 FLYING JACKET**

Leather, sheepskin lined, zipper front, reclaimed for reissue like new. The perfect coat for all outdoor sports and outdoor work. Takes the toughest wear. It's warm as toast. All sizes. Other surplus bargains: D-1 Jacket \$10.95; Navy alpaca jackets \$3.95 up; all sizes. Send check, Money Order, or Sent C. O. D.; Free Catalogue. **SURPLUS MERCHANDISE DEALERS, Dept. P, 408 Communipaw Ave. Jersey City 4, N. J.**

**FLYING GOGGLES \$3.95**

Clear lens type, adjustable width, Rubber face mask which is chamois lined. For aviators, motor-cyclists, hot-rod pilots, etc. A \$15.00 value postpaid anywhere in the U.S. **ONLY \$3.95.**

**AIR PARTS INC., 723 Sonora St., Glendale 1, Calif.**

**Raise GOLDEN HAMSTERS**

The new wonder animals. Look like toy bears. Delightful pets. Everybody wants them. Thousands needed by laboratories. Make money, get started now. Send 10c for illustrated literature, or send \$5 for a pair of hamsters and literature.



**GULF HAMSTERY, 1536 BASIL ST., MOBILE 17, ALA.**

SAY YOU SAW IT IN POPULAR MECHANICS



**your way to BETTER PICTURES**

with this fine precision-built photoelectric Exposure Meter

**\$14.95 WITH CASE**  
including tax on meter



The Sign of Precision



Get more from your camera—indoors or outdoors, day or night, stills or movies, black-and-white or color. SKAN gives you correct exposure under all light conditions... enables you to get that better picture every time. Simple to use. A fitting companion for the finest camera. Sold at camera counters everywhere. For free literature write: G-M Laboratories Inc., 4290 N. Knox Ave., Chicago 41, Ill.

**SKAN PHOTOELECTRIC EXPOSURE METER**

**SPEEDGRIP**

**JUST FLIP YOUR THUMB AND THE JAW IS SET!**

Simple one-hand operation makes "SPEEDGRIP AUTOMATIC" ideal for every mechanic's tool box, for every motorist's car. Wrench has 1 5/16" jaw opening, 8" length. SAE 1045 steel, precision tooled, heat treated, and Rockwell tested. Order from your dealer or direct. No C.O.D.s.

Manufactured by **POLARIS PRODUCTS, INC.**

**AUTOMATIC WRENCH**



**\$5.80**

POST PAID

642 North 5th Street Milwaukee 3, Wisconsin



**SCOUTS!  
SPORTSMEN!  
CAMPERS!**

**Own this Precision-Built  
U. S. AIR FORCES  
COMPASS**

Made by Famous Watch-Craftsmen  
**Longines-Wittnauer**

**Declared  
U. S.  
SURPLUS**

All Metal  
Pocket  
Watch  
Type



Photo  
Approx.  
1/3 Actual Size

A really fine instrument made by Longines, used by U. S. Air Forces. Sealed-in rust-proof, smooth metal case with automatic locking lid. Compass needle floats on watch jewel. Engraved dial gives accurate 360° direction finding. Can be attached to chain or carried in watch pocket. Sturdy construction. Shipped post-paid, in fabric cover and original box. Ideal gift for outdoor men, women, boys and girls.

**\$1.55**  
Now Only **1** POST PAID  
(Check or Money Order)  
Worth Much More!

USE 10 DAYS WITH OUR GUARANTEE If not completely satisfied return within 10 days and get your money back.

MAIL COUPON  
TODAY TO

**Lansburgh's** DEPT. STORE  
Dept. P—Washington 4, D. C.

Please rush postpaid ..... LONGINES-WITTNAUER  
AAF Pocket Compasses @ \$1.55 EA.

Check  Money Order for \$..... is enclosed.

Name.....

Street.....

Town..... Zone..... State.....

**15 JEWEL MILITARY  
WRIST WATCH  
Complete with New Style  
EXPANSION BAND**

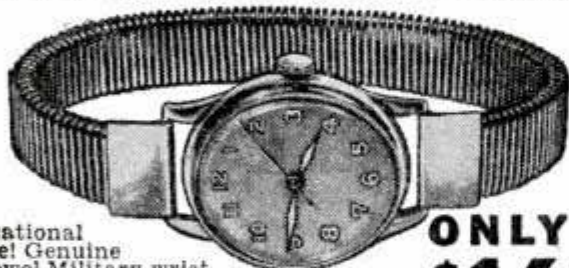

Sensational value! Genuine 15 jewel Military wrist watch, precision built, split-second time-keeper, for ONLY \$16.95 plus tax! Water-proof, shock-protected, anti-magnetic. Radium dial and hands, easily read in the dark, unbreakable crystal, red sweep second hand. Handsome, non-corrosive stainless steel case. Genuine non-corrosive stainless steel expansion bracelet fits all wrists. Order yours today!

**SEND NO MONEY!** Rush order now! Pay postman only \$16.95 plus postage and 10% Fed. tax. If not delighted, return within 10 days for refund.

**BURTON SALES COMPANY**

809 W. Madison St. Dept. B-84 Chicago 7, Ill.



**NOW! EASY-TO-MAKE  
HOMECRAFT NOVELTIES  
FOR PLEASURE AND PROFIT!**

**FREE! NEW 40-PAGE CATALOG**

Our new book is crammed with money-making facts about Leather Craft, Wood Carving, Clay Modeling, Lacing and Braiding, Wood Burning (Pyrography), Showcard Lettering, Ready-to-Finish Woodcraft, Plastics, Marbleite Molding, and much more. Send for FREE copy TODAY!

**SPECIAL! EASY MONEY-MAKER!**

Newest fashion idea. Leather Link Belts. Very smart for both men and women. Kit including everything for six easy-to-make belts (2 white, 2 black, 1 brown, 1 natural) to sell at \$2 each (\$12 total) sent to you complete for only \$3.50 postpaid. Or C.O.D., you pay postage. (No Canadian C.O.D.'s and no foreign shipments made.) Money back if not delighted. Sample Kit (1 belt) \$1.

Make  
BEAUTIFUL  
Hand-Tooled  
BILLFOLDS  
CLAY MODELS  
WOOD CARVINGS  
POTTERY  
SPATTER CRAFT  
BOOK ENDS  
BRACELETS

DWINNELL CRAFT SHOP, Dept. P-72, Elm Grove, Wheeling, W. Va.

**New PERSONAL RADIO... Pocket Size**



This little radio is substantially built and is so constructed that, if dropped, it will not break. It has a beautiful red leatherette case. May be carried in your pocket wherever you go. Reception is guaranteed when used according to instructions.

There is no cost in operating this radio as there are no tubes and no batteries to buy, and no electricity needed. Instead, the new "Crystal diode" rectifier same as used in Army and Navy ultra hi-frequency radar sets is being employed. It is not a toy, but a practical little radio for football or baseball games, news reports, or your favorite program. It is especially good to listen to in bed, or in hospitals, dormitories, barracks, and offices because it is not heard by anyone but yourself.

Send only \$1.00 (check, money order, cash) and pay postman \$3.95 plus delivery fees, or send \$4.95 for postpaid delivery.  
SHEESS MFG. CO., LAKE GENEVA, WIS.

**SAY YOU SAW IT IN POPULAR MECHANICS**

Build Your Power Tools With  
**OUR BALL BEARING ARBORS**

New Departure  
Self Lubricating  
Bearings  
L. H. T. 1's  
Also

15,000 R.P.M.  
CS-5/8 Pictured

Full stock of V belts and pulleys for immediate delivery. P. P.

B33—\$4.95 PP.  
3/8 x 4 1/2 Spindle  
B15 Plain Spindle \$3.45

CS-5/8 x 12 1/2 spindle, housing 2x8, \$8.25 PP.  
CS-3/4 x 12 1/2 spindle, housing 2 1/2 x 8, \$9.25 PP.  
CS-1 x 17 1/2 spindle, housing 2 5/8 x 11 \$16.95 PP.

1 INCH BETWEEN WASHER AND COLLAR

POLY PRODUCTS, Dept. M1, 406 S. Chester Ave., Ct. 1, Pasadena 5, Calif.

**SILVER SOLDER KITS!  
For Silver Soldering ALL METALS**

SOMETHING NEW. For Electricians, Jew-  
elers, dentists, garages, field service re-  
pair men, plumbers, farmers, refrigerator,  
and all types of brazing and fix-it-shops.

**\$2.50** POST-PAID

**KIT INCLUDES:**  
One 3 oz. Tube XCEL-FLUX "SS" Silver Solder Paste.  
Twenty 5-inch lengths (total 100 inches) of SILFOS  
and EASY-FLO Silver Brazing Alloy—1/8" - 1/16"  
and 1/32" wires, and one EASY-FLO .005" x 1" strip.  
(Jobbers write for Quantity Discounts.)  
Use your own torch or write for torch prices.  
American Products Corp., 817 Lowell Bldg., Chicago 5, Ill.

**COMB-A-TRIM  
THE NEW QUICK TRIMMER**

Something New! Trim your hair without any experience. It's easy! The excess hair comes off smoothly and easily by just pulling trimmer through hair like an ordinary comb. Also removes hair from legs—armpits. Save on hair-cut bills... Trim your own hair or the whole family's. Send 59c and your Comb-A-Trim will be sent at once.



59c

**SPECIAL OFFER**  
Send \$1.00 for 2  
Comb-A-Trims  
and save 18c. **2 for \$1**

5 Extra Blades (Year's Supply) 25c  
COMB-A-TRIM CO.  
Dept. R-16 Cincinnati, O.

1734 Carew Tower



Amazing New KLIK-RITE

# BALL PEN

GUARANTEED to Write for Years Without Refilling Name in 23K Gold FREE

CLICK THE BUTTON

A real BALL PEN! Works and performs exactly like highest-priced pens—PLUS amazing new "click-it-to-write" . . . "click-it-to-park-it" feature—PLUS your name in 23K gold—all for only \$2.98! Writes dry with water-proof ink—no blotter needed. Cannot leak. Writes anywhere . . . even under water. One piece—no cap to fuss with or lose. Touch the button on top & ball point "clicks" out to write. Another touch and the point "clicks" back into the barrel. A slim streamlined beauty—lightweight . . . **COMPACT!** Factory guaranteed.

Only \$2.98

Send No Money!

Rush order today. PRINT NAME to be stamped in 23K Gold. Pay postman only \$2.98 plus few cents postage on delivery. Or send \$2.98 with order and save postage. If you are not delighted, return pen within 10 days for your money back. Order today!

KLIK-RITE PEN CO., Dept. D-69  
215 W. Ontario Street, Chicago 10, Ill.

**NEW-CONVERT** FROM GASOLINE TO BOTTLEGAS

USING OUR MODEL HP REGULATOR YOU CAN CHANGE OVER GASOLINE STOVES, HEATERS, MELTING POTS, PAINT BURNERS, ETC.

FOR ANY 100# CYLINDER

FOR PARTICULARS AND PRICES DROP A CARD TO—  
**APPLIANCE SERVICE CO.**  
BOX 275 VIRGINIA, MINNESOTA

## MELT CAST IRON

For the first time you can now melt fine gray cast iron on a small scale at home. Produce cast iron at a profit from scrap. Use castings in design problems.

Fourteen detailed blueprints of a proven small cupola and complete text of instructions for \$4.85. Also a complete line of sands, flasks, metals, crucibles, etc. Send 10c for complete catalog and preliminary instructions. **KEN PARR**, Box 637-P, West Lafayette, Indiana.

## REFRIGERATION and AIR CONDITIONING

APPROVED GI TRAINING

Train where the Army trained. Learn at home or in our big shops. Expert instructors—real machines. Easy to learn. Write for big FREE catalog today. No obligation. **COMMERCIAL TRADES INSTITUTE**, 1400 W. Greenleaf (Dept. X-22), Chicago 26, Ill.

VETERANS ASK FOR GI PLAN

## A WATER VAPOR INJECTOR

Car owners at last a water vapor injector within the reach of all. Same principle used by planes during the war. Increases power • Quicker pickup • Extra power on grades. Simple installation in all cars • Literature on request.

\$4.95

Check or M.O. \$4.95 postpaid  
Harmonic Radio Co., 580 Rogers Ave., Brooklyn 25, N.Y.



## Profit by the Building Boom!

Start your own business manufacturing concrete building block and brick. Use Economy hand moulds. Make true, straight, easy-to-lay units which will pass any building code. Small investment, high production, big profits. One \$30.00 mould will make 1,000 5"x8"x12" blocks per day. Letters and repeat orders tell how pleased our customers are.

WRITE FOR FOLDER

**Economy Manufacturing Company**  
Dept. P Stone Mountain, Georgia

FEBRUARY 1947



"For 35 years it has been my dream to build a fine, light car. Here it is—smart, fast, economical."

Powell Crosley, Jr.

PRESIDENT CROSLLEY MOTORS, INC.

WEIGHING about 1/3 as much and operating for approximately 1/3 the cost, the new fine CROSLLEY reverses the trend towards heavier, more cumbersome and expensive automobiles!

Created by America's leading light car exponent, today's modernly streamlined fine CROSLLEY comfortably accommodates 4 big huskies like its 6' 4" builder, plus baggage. Compared with midget foreign cars, it's a big automobile—in all but weight and price!

Revolutionary new 4-cylinder, valve-in-head, CROSLLEY COBRA (Copper BRAZED) engine is the most talked-of technical improvement in internal combustion engines in 40 years—gives 35-50 miles per gallon of ordinary gasoline; speeds to 60-plus. Steel engine weighs but 59 lbs., yet delivers 26.5 H.P. See—drive—this new, fine CROSLLEY before buying any car!

### CHECK THESE FEATURES

ALL STEEL Construction, low center of gravity, great safety factors • MODERN Streamlining, the "aircraft flavor," gives extraordinary beauty • CAR WEIGHS only 1150 lbs., curbside, perfectly balanced, weight-to-power • EASY DRIVING, virtually "parks on a dime"; oversize shock absorbers • MORE MANEUVERABLE in traffic; 20 inches narrower than most cars • ECONOMY that's almost unbelievable; instant pick-up, speeds to 60-plus • DELIVERS for less than \$1000 in the U. S. A.

For Information and literature write:  
Crosley Motors, 2537 Spring Grove Ave., Cin'tl 14, O.



## STOP LEAKS!

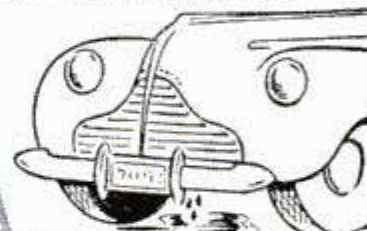

Cooling Systems Made Leak-Proof QUICKLY

WARNER LIQUID SOLDER—Non-Metallic—Deposits Tiny Fibers to Repair Leaks Anywhere in Cooling Systems. Simply pour in! Finds and REPAIRS every crack or hole. Do it yourself—or see your service man.

Warner-Patterson Co., 920 S. Michigan Ave., Chicago 5



# Larson

"MAKE YOUR OWN"

## FOLDING SAW-HORSE SET



IN USE

A brand new LARSON construction set, with copyrighted instruction sheet for easy assembly. Set makes two complete Folding Saw Horses,

that can't be beat for general household use. They are rigid yet light in weight and fold compactly for storage. Can be made to any reasonable height or length. Lumber not included in set.



FOLDED

Prepaid \$2.50

CHAS. O. LARSON CO., BOX 358, STERLING, ILLINOIS

## A TREASURE CHEST FOR MECHANICS GARAGEMEN—FARMERS—EXPERIMENTERS



**100 POUND HANDY ASSORTMENT \$8.95**  
SCREWS—NUTS—BOLTS  
WASHERS—RIVETS—SPRINGS

Think of it—this popular assortment specially priced at less than 9¢ a pound! Chest filled with 100 pounds of clean, new fasteners, mostly 1/4" and larger diameters—bound to come in handy in shops, garages, on farms, or wherever a large variety is needed. Chest, too, is valuable for many uses after original contents have been used. Shipping wt. 115 lbs. Price only \$8.95. Enclose remittance and shipping charges when ordering.

HUDSON TRADING CORP.

FA-1521 N. Wells St.

Chicago 10, Ill.



## SPECIAL HUNTER'S COMPASS

Hunting Case,  
Watch Type,  
All Metal,  
Jeweled Waltham

\$1.95

## SPORTSMEN'S RUBBER GOGGLES

White Plastic Lens and Extra green Polarizing Lens. Plastic Lens are shatterproof, Polarizing Lens a protection against reflected glare, excessive light, dust and wind. Ideal for industrial use, Motoring, skiing and all kinds of outdoor use. Value \$3.50.

SPECIAL \$1.50

Engineers All Metal Army Type Hand-Sighting

## LEVELS

\$2.00

PRECISION  
QUALITY



WHEATSTONE BRIDGES Used in excellent condition. Mfg. by Thompson Lever Mfg. Co., Philadelphia. Value \$150.00. SPECIAL \$49.50

PUBLIC SPORT SHOPS

13 S. 16th St., Phila. 2, Pa.

No COD's



PRECISION VISE

## QUICK ACTING PRECISION VISE 1/4" JAWS OPENING 1 1/2"

WITH SWIVEL BASE  
Removable jaws • Gibbed for accuracy  
Machined dovetail base  
Push! It's closed • Flick! It's open

SEE YOUR DEALER OR WRITE  
**Raypo CORPORATION**  
9900 Lincoln Blvd., Los Angeles 45, Calif.



## New Designs in FRANZITE GRIPS

Modernize Your Gun! Improve Your Score!  
Most durable grips made. Positively unbreakable! For Colt, Smith & Wesson, Hi-Standard, Ortgies, Luger & Mausers in a wide choice of beautiful designs in ivory, pearl, walnut, onyx, etc. Low prices. FREE CATALOG. Dealers Wanted.

SPORTS, INC., (Mfrs.) 5501 Broadway, Dept. P-2, Chicago 40, Ill.

## Power Hacksaw \$44.75 Cap. 4" x 4" Swivel Vise

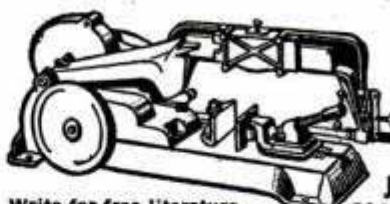

F.O.B. Kalamazoo, Mich.  
NO OTHER SAW LIKE IT for the price. Cast iron, ruggedly constructed. Quick action vise, jaws swivel to 45°. Bronze bearings. Draw cut action, saw lifts on return stroke. Automatic cut-off switch.

JOHN E. KANDLER—Machinery  
214 N. Rose St., Kalamazoo 12, Mich.

Write for free literature

## Quick Help for RUPTURE!



Learn About This Perfected Invention

Light, cool, comfortable. Durable, cheap. GUARANTEED instant relief for reducible ruptures in men, women and children. Not sold in stores. No agents. You deal direct! Correspondence confidential.

Sent on Trial!  
Made-to-measure and sent on no-risk actual wearing test. Act NOW.



Ordered by 18,278 Doctors!

Send Postcard for FREE Rupture Book  
BROOKS CO., 359-C State St., Marshall, Mich.



# WANTED MAN WITH CAR

## No Time Like Now to Get In McNess Business

It's no trick to make good money when you use your car as a McNess "Store on Wheels." Farmers buy everything they can from McNess Men because McNess Products are tops in quality, represent extra values. Attractive business-getting prizes and premiums; also money-saving deals to customers make selling McNess daily necessities a snap. **We Supply Capital—Start Now!** There's no better work anywhere. Pays well, permanent, need no experience to start, and we supply capital to help you get started quick. You begin making money first day. Write at once for McNess Dealer Book. It's FREE. Tells all—no obligation. (1)  
**THE McNESS CO., 391 Adams St., Freeport, Ill.**



**Use Your  
CAR  
to Raise  
Your  
PAY**

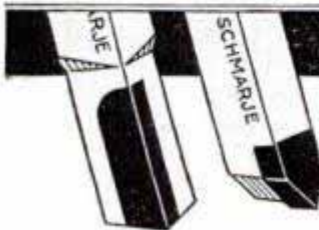

## SPECIAL SET \$2.00

### GENUINE CARBOLOY-TIPPED TOOLS

Same as used by the big factories. Long life, high production. Designed to perform home workshop jobs on metal, wood and plastic. Shipped in pairs as shown, either 1/4 or 5/16". Only \$2 cash with order, postage paid.

**SCHMARJE TOOL & ENGINEERING CO., MUSCATINE, IOWA**



## SWISS MUSICAL UNITS

Ready to install in your own box. Choice of waltz, operatic or classical. \$4.50 each. Postpaid if cash with order. Literature on request.

Music box repairs invited.

**Assembly & Repair Co.**  
Dept. PM, 582 Third Ave., N. Y. C. 16

\$4.50 ea.

## PLATE USERS! Give Your Mouth A Treat! "CAMCO" Dental Plate Reliner.

Restores original comfortable fit. Odorless. Tasteless. Not \$2.00 post-an adhesive. Will not dissolve in mouth. Easy to apply. \$2.00 paid  
**CATHAY AMERICAN CO., San Francisco 11, Calif.**

# AUTO ENGINE SPEED CONTROL GOVERNORS

Give constant or changeable speed to any auto or truck engine, when used for power. Guaranteed. Instructions. Oil ring bearing, \$14.25. Full ball bearing, \$21.75. Postage, 50c, east of Miss., 85c. COD, or— Postage any country \$1.00 each.



These valves used where carburetors have outside attachments.

State size of opening and distance between bolt holes.

1", \$3.75; 1 1/4", \$5.25; 1 1/2", \$6.50; 1 3/4", \$7.50; V8, \$8.00. Mailing weight, 3 lbs. If remitting, enclose for postage.

Stocks carried: In Canada, Montreal 15: 7546 Wiseman St. In Skaneateles, N. Y.: Horle Welding Supply. Circulars.

**CANDEE, Dept P, 2641 S. Hill, Los Angeles 7, Calif.**



**AGENTS WANTED**  
Parts and Implement Dealers,  
Garages, Welders, Wreckers,  
Catalog and Mailing List  
Houses, etc.

## The Finest Rotary Tool Kit Ever Sold By Mail—A BARGAIN

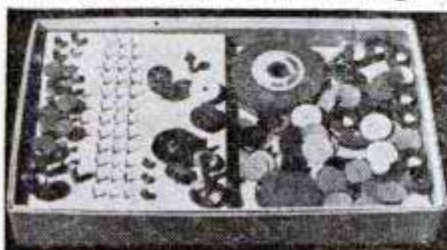

**COMPLETE KIT**  
**102 Grinding, Cutting**  
**and Polishing WHEELS**  
**PLUS 150 assorted items**  
**for Home or Shop**  
**ONLY \$9.75**  
Postpaid in U.S.A.

**RUSH ORDER TODAY**

**D. SCHUPACK • 2256 E. 75th St., Dept. P-2 • CHICAGO 49**

- 2 Grinding Wheels 3" and 2" dia.
- 2 Rotary Files, High Speed Steel.
- 6 Rotary Cutters 1/8" Shank.
- 3 Rotary Cutters 3/32" Shank.
- 6 Mounted Grinding Wheels 1/8" Shank.
- 6 Mounted Grinding Wheels 3/32" Shank.
- 4 Speed Drills 3/32" Shank.
- 36 Rotary Cutting Burs 3/32" Shank.
- 2 Mandrels 3/32" Shank.
- 1 Mandrel 1/8" Shank.
- 1 Screw Type Mandrel 3/32" Shank.
- 3 Rotary Bristle Brushes 3/32" Shank.
- 1 Rotary Wire Brush 3/32" Shank.
- 1 Circular Saw 1 1/2" dia.
- 1 Mandrel for Circular Saw 1/8" Shank.
- 1 Rubber Cylinder Mandrel 3/32" Shank.
- 1 Rotary Drum Sander 1/4" Shank.
- 10 Bands for Rotary Drum Sander.
- 15 Rotary Feit Wheels 1" dia.

Plus 150 Ass't Items for Home or Shop



# 4 Points TO REMEMBER FOR BETTER SOLDERING

Skillfully designed for versatility in soldering, this rugged pencil iron tackles those big jobs with ease, yet has that light magic touch so necessary in delicate precision soldering.

## More Points to Remember

QUICK HEATING . . . 90 SECONDS  
LIGHTWEIGHT . . . 3.6 OUNCES  
HANDY SIZE . . . . . 7 INCHES  
SAVES ELECTRICITY . . 20 WATTS

## Perfect Balance

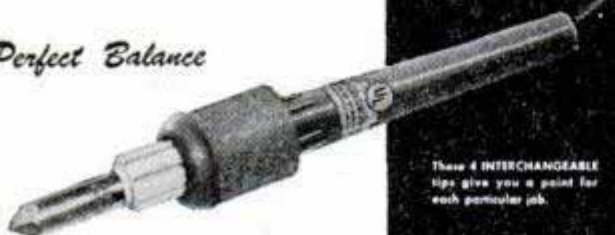

SEE YOUR NEAREST RADIO, HARDWARE OR HOBBY DEALER

**WILGHE Electric Tools**

BOX 2255, TERMINAL ANNEX LOS ANGELES 54, CALIF.



These 4 INTERCHANGEABLE tips give you a point for each particular job.

SAY YOU SAW IT IN POPULAR MECHANICS



# VETERANS!

You Earned Your War Decorations

Now you can get them and keep them proudly

Here's your chance to get complete sets of authentic U. S. and foreign ribbons, professionally mounted by experts in proper official order. Kassin-Stein, licensed distributor, has

**COMPLETE STOCKS OF EVERY AUTHORIZED U. S. RIBBON AND MINIATURE—Plus More Than 300 Foreign Decorations.**

## THREE TYPES OF RIBBONS

**Kwikset** (uncovered ribbons mounted on clutch-bar).  
**Ever-Clean** (protective plastic covering, mounted on clutch-bar).

**Sew-on** (uncovered ribbons reinforced with buckram, to sew on uniform).

Single Ribbon Bar, 50c; double, 75c; triple, \$1. Foreign ribbons each 25c extra. Bronze stars 10c; other attachments, 25c each additional.

## CIVILIAN MINIATURES

**Individual plastic**—lustrous, true reproductions of U. S. ribbons, with clutch-type fastener, 50c ea.  
**Metal Multiples**—bases for 1 to 6 "ribbons", mounted as single unit screw-back lapel button. Each "ribbon", 25c, plus 25c for base.

ORDERS FILLED SAME DAY RECEIVED

Postage prepaid. Enclose check or money order—or send for order blank. Your service serial number must be included (required by govt. reg.)

**KASSAN-STEIN** • Dept. H

510 11th St., N. W., Washington 4, D. C.

★ Complete Military Outfitters ★

MODEL 350-B (11 boring heads) \$5.95

# FASTER, EASIER WOOD-BORING with this BRUNO AUGER BIT SET \$3.95

Complete with 6 boring heads (5/8" to 1-1/4") in plastic case



Now you can bore many different size holes with one auger bit...exclusive Bruno Quick-Change Boring Heads cut tool costs in half! Boring heads of finest high carbon tool steel have special extra long cutting edge...require no forward pressure, turn easily in toughest woods. No flutes to bind or clog, bores all the way without cleaning. **MONEY BACK GUARANTEED.** See your dealer or write direct, Dept. PM2

Tool No.	Boring Heads	Cutting Diameters	Shank Length	Price
340-B*	6	5/8" to 1 1/4" by 8ths	8-1/16"	\$3.95
350-B*	11	5/8" to 1-1/4" by 16ths	8-1/16"	5.95

\*Square shanks for use in hand brace. Nos. 340, 350 straight shanks for use in bench drill, drill press, or portable drill.

# BRUNO The BIG BUY in TOOLS

BRUNO TOOLS 9330 SANTA MONICA BLVD. BEVERLY HILLS, CALIFORNIA

## BE A PERFUME DISTRIBUTOR

The most sensational profit possibilities in the whole field of selling; 100% year-round demand, liberal distributor discounts. Sell consumers or dealers, or both. Employ sub-salesmen. No experience needed; we'll tell you how. Finest perfumes made, exquisite, long lasting fragrances women just can't resist at your low prices. Men big buyers for gifts. Beautifully packaged. Write TODAY for free sample and details of tested sales plan.

DUDAN PARFUMS, 21-P West Illinois St., Chicago 10, Ill.

## 12 lbs. SURPLUS RADIO PARTS \$2.00

A gold mine of parts for repairmen, amateurs, and experimenters... relays, condensers, resistors, transformers, coils, hardware, wire, etc. An outstanding bargain in usable parts! Send \$2.00 cash, check or M.O. today! (Pay small express charges on receipt.)

**ELECTRONIC PARTS, Inc.** Dept. M2 622 W. Randolph St., Chicago 6, Ill.

## A. C. CURRENT ANYWHERE!

With KATOLIGHT PLANTS.

Furnish the same kind of Current as the highlines. Sizes 500 watt to 50 KW. Also Manufacturers of Rotary Converters, Frequency Changers. D.C. Motors 1/4; 1/2; & 1/2 hp.; A.C. Motors, single phase in 2, 3, and 5 hp.

**KATOLIGHT** 1402 First Avenue MANKATO, MINN.

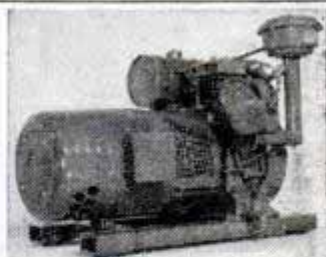

WAKE UP YOUR Scalp

**BE FAIR TO YOUR HAIR** Want better looking hair? Embarrassed by falling dandruff, itching scalp? Then try VITABRUSH, new electric driven scalp brush that gives your scalp a vigorous and invigorating "workout" in just three minutes of fun. Cleans scalp. Stimulates blood supply. Restful. Pleasant. Write today for complete information and satisfaction-guaranteed offer. Hershey Mfg. Co., 3755 Field Bldg., Chicago 3

POPULAR MECHANICS



● Our hobbyist is using a scroll saw. Other famous Delta Homecraft tools include: lathe, saw-jointer, band saw, drill press, and sander.



# The Happiness you Seek...

## may lie in a hobby: Try woodworking with Delta Homecraft\* Power Tools



● Delta tools are typical products of the American way of doing business. In America we use tools to create more and better things at lower cost than in any other country, and in this way provide better living — for only as people work together to produce more can they have more to enjoy.

Call it contentment — peace-of-mind — escape. A lot of folks are finding it in the popular woodworking hobby.

You get a thrill when you discover and use the inborn skill of your hands. Medical men say manual activity is good for you.

You find that your hobby draws the family closer together, as you share in this fun.

There's nothing hard about woodworking, especially when you use Delta Homecraft Power Tools. These famous tools are known the country over for their

superb quality, which is another way of saying that they are so *accurate*, so *dependable*, so *safe* that even a beginner can turn out attractive projects to be proud of.

When Delta tools become available in quantity, you can see for yourself why they are first choice in so many home shops, as well as in schools and industrial plants.

Get acquainted with your Delta dealer, let him help you plan. And send the coupon today for *free* copy of "Happiness Herald," the introduction to woodworking.



Delta Manufacturing Div.  
Rockwell Manufacturing Co.  
Milwaukee 1, Wisconsin

### "Happiness Herald"

— a complete introduction to the woodworking hobby

**Free!** Pages of helpful information showing how to get started in woodworking and what to make. Pictures of interesting shops and projects. Tips on selection of tools. Send the coupon now.

### Plans for an easy-to-make Doll House

Complete plans and instructions for making the attractive doll house shown above. Plans — easy to follow — include clear photographs and detailed drawings, with a full-sized sectional view. Send coupon today for Plan No. 4649. Only \$1.00.



### Tear Out Coupon — Mail Today!

DELTA MANUFACTURING DIVISION  
Rockwell Manufacturing Company  
680B E. Vienna Avenue, Milwaukee 1, Wisconsin

Send me *free* "Happiness Herald"

Send me the Doll House plan, No. 4649. \$1.00 enclosed.

Name.....

Address.....

City..... (.....) State.....



**"Mr. Walker"**  
THE FASCINATING  
ACTION TOY  
FOR YOUNGSTERS  
AND ADULTS



**WALKS DOWNSTAIRS!**  
America's greatest post-war Action Toy. It walks down a flight of stairs! Fascinating and exciting. Nothing to get out of order. No winding, no motor. Just set it on the top step, flip it and plop, plop, plop, it goes down stairs automatically like a giant night-crawler. Be the first to amaze your friends with this toy sensation. Fun galore! Sent anywhere in the U. S. Postpaid for..... **\$1**

See story page 127 in December issue of Popular Mechanics



**AGENTS WANTED**—Easy to demonstrate, easy to sell. Write for special agents deal.

**Travis Products Co.**  
Dept. 20, 224 W. Huron St.  
Chicago 10, Ill.

**PRESSURE QUEEN**  
FOUR CYLINDER  
PORTABLE AIR COMPRESSOR  
SPRAY PAINTING OUTFIT



**\$69<sup>75</sup>**  
(WITHOUT MOTOR)

**COMPACT • RUGGED • POWERFUL**  
The ideal air supply for home and farm workshop, machine shop, garage and contracting painter; for product finishing, inflating tires, painting automobiles, trucks, machinery, etc. Indispensable for building maintenance, interior and exterior. Handles any paint, insecticide or disinfectant.

This 4 cylinder compressor has drop forged crankshaft, stainless steel, heat treated valves; bronze bearings and positive forced feed lubrication. Maximum pressure 50-60 lbs., free from pulsation. Standard equipment includes the compressor mounted on steel base with carrying handle, belt, compressor pulley, air chamber, air gauge, 15-ft. hose, spray gun. Requires 1/2 or 1/3 h.p. motor or gas engine, not included.

If your dealer does not sell Pressure Queen write direct

**THE CAMPBELL-HAUSFELD CO.**  
1046 RAILROAD AVE., HARRISON, OHIO

**SPECIAL! GOV'T SURPLUS SPECIAL!**

**HI-SPEED ROTARY FILES**  
3 pc. set. Heads threaded, with 1/4" mandril ..... **\$4.00**

**6 PC. SET ASS'T FILES**  
all with 1/4" shaft..... **\$5.00**

**ONE HI-SPEED MILLING CUTTER** with 1/4" shaft..... **\$1.25**

**6 PC. SET SPIRAL FLUTED ROUTER AND MILL END BITS** 1/8" to 1/2" ..... **\$5.00**

**MICRO SWITCH** — normally open or can be reversed to close. Works on slightest touch. Has more than 100 uses..... **\$1.00**

**DELCO Permanent Magnet Motor** — 27v (DC) also runs off a 6v battery for miniature or model trains, boats, etc. .... **\$3.00**

**EYE LEVELS** — completely assembled, well constructed, handy for many uses ..... **\$1.00**

ALL PRICES INCLUDE PACKING & POSTAGE IN U. S. A. PLEASE REMIT IN U. S. POSTAL NOTES OR MONEY ORDERS.

**Holland Hardware Co., Inc.**  
24 VESEY ST., New York 7, N. Y.

**SAY YOU SAW IT IN POPULAR MECHANICS**

**ARMY-NAVY SURPLUS BY MAIL CATALOG FREE**

Now you can buy Genuine Brand New Surplus Clothing by mail at enormous savings. Trousers, jackets, shirts, rain coats, blankets, arctics, shoes, socks, gloves, underwear etc. Mail post card today for your FREE CATALOG sent promptly.

**J. R. ADDISON UNIFORM CO. CAMBRIDGE, OHIO**

**PRACTICAL BOOKS ON HOME PLANNING BUILDING · REPAIRS**



MAIL ORDER TODAY Plan Now—Build When You Can Books Sent C.O.D. Anywhere in U.S.A.

Select from this list of helpful books. In U. S. books sent postpaid if remittance accompanies order. Outside U. S. include 15% extra for shipping charges.

- How to Plan a House.....\$4.50
- House Construction Details .....\$3.00
- Painting, Decorating.....\$1.50
- Carpentry .....\$2.00
- Painting, Furniture Finishing and Repairing Includes floor renewal .....\$1.50
- How to Remodel a House Complete, practical.....\$4.75
- Building Insulation.....\$3.50
- Concrete Handbook Do work for yourself, others .....\$1.50
- Blueprint Reading for Building Trades.....\$1.25
- Practical Bricklaying.....\$1.75
- Simplified Carpentry Estimating .....\$3.00

**FAMOUS PLAN BOOKS**

- Books contain floor plans, photos, descriptions of homes.
- AMERICA'S BEST LOW COST HOMES.** 125 designs. ....\$1.00
- DE LUXE SMALL HOMES.** 210 designs. ....\$1.00
- OUR FUTURE HOME.** Wide selection of residences, summer homes, garage apartments. \$1.00
- MODERN HOME & GARDENING.** 42 popular designs. Improvements, garden shortcuts, etc. ....50c

**Set of Four Books \$3.50**

**Stair Building \$2.00**



**POPULAR MECHANICS PRESS**  
Dept. 000 • 200 E. Ontario St., Chicago 11



# WAR SURPLUS!

## Winter Clearance Sale

BARGAINS FOR ALL AT A FRACTION OF GOVERNMENT ACQUISITION COST



### AAF FLIGHT PANTS

These garments made for extreme sub-zero weather. Ideal for all winter outdoor wear. Alpaca-lined, used, **\$5.95** perfect. Special .....

Down-filled, new, \$30 value.....**\$11.95**

Alpaca-lined, featherweight, zippered, new .....**\$7.95**

Leather, sheep-lined, zippered, new .....**\$7.95**

### AAF FLIGHT COVERALLS

All wool, gabardine, zippered, new. Made for the Army Air Forces. Extra strong, reinforced crotch, buttons, adjustable. Two breast pockets and 2 knee pockets. Here's a buy you can't miss! It's **\$6.95** a real value at only.....



### WHITE NYLON PARACHUTES

Over 50 square yards of slightly used sturdy white nylon fabric. You'll find numerous uses for it in shop, home and on the farm. There's a real buy in these parachutes, priced **\$12.95\*** at only .....

### WOOL-LINED SLEEPING BAGS

Two-piece, water-repellent cover, lightweight. Perfect for **\$6.95** campers and hunters. New!..

Used, perfect condition..**\$4.95**

Bed-Roll Covers, water-proof. Approximate size, 7x9 feet. A fine utility cover. New...**\$4.95**



### TARPAULINS

New, rubberized, water-proof, roped and grommeted, complete, 14 ft. x 20 ft. ....**\$14.95\***  
10 ft. x 14 ft. (Same tarp, but one unfinished edge.) New.....**\$7.50\***

### NAVY SISAL ROPE

One-half inch, mildew-resistant, 100-foot lengths and over...**3c per foot\***

### HATCHETS

Hardwood handle, extra fine steel, new .....**\$1.45**

### MESS KITS

Ideal for picnicking, camping, etc. New .....**89c**

### ARMY B-4 BAGS

A perfect man's traveling bag. Zipper closing, 2 outside pockets, good condition .....**\$5.95**

### MOUNTAIN TENTS

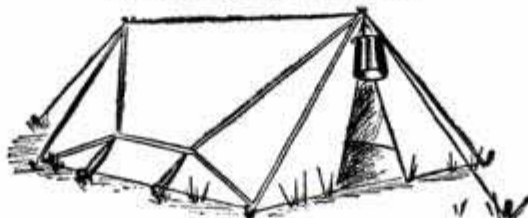

Two-man; wind, water, insect proof. Sewed-in floor. Complete with ropes, poles and stakes. **\$7.89\***

Weights only 10 lbs.! Excellent condition...**\$3.95**

### SHIRTS and PANTS

O.D., all-wool, excellent condition. Ready for reissue. **Shirts**, sizes 13 to 15; **pants**, sizes 28 to 32, each .....**\$2.95**

Same shirts described above in maroon or autumn brown, dyed .....**\$4.89**

**Suntan Pants**, sizes 28 to 32, excellent condition .....**\$1.98**

**Suntan Shirts**, sizes 13 to 15, excellent condition .....**\$1.59**

**Trousers**, civilian cut, blue, all-wool Navy Melton cloth. New! A real buy at only.....**\$6.95**

## EXCELLENT COLD WEATHER FOOTWEAR



### FLIGHT BOOTS

AAF, sheeplined, with zipper, new.....**\$9.95**

Government reconditioned for reissue. An excellent **\$6.95** buy!.....



**SHOE PACS**  
10-inch leather tops, rubber bottoms, new .. **\$6.50**

**OVERSHOES**  
All-rubber, 4-buckle, excellent condition.... **\$1.98**

All-rubber, 5-buckle, new!... **\$3.95**



### SKI BOOTS

Just the thing for winter sports, also for farm use. Warm, comfortable. Regular \$15 value, only.... **\$7.95**

Slightly used.... **\$6.95**



### COMBAT JACKETS

Water-proof O.D. poplin; 4 large pockets. Trimly tailored with poplin inner lining. For work and sportswear. Used, but in excellent condition. With draw-string, as shown..... **\$4.85**

### MACKINAWS

O.D., poplin, water-repellent shell; blanket-wool lined, ready for reissue..... **\$7.45**

### NAVY BOOT SOX

Extra heavy, 75% wool, new.....**99c**

### WAC SKIRTS

Cotton Suntan, ready for reissue.....**\$1.59**

WAC Poplin Shirts, ready for reissue.....**\$1.29**

### ARMY OVERCOATS

All wool, excellent condition, only.....**\$5.95**

### BLANKETS



All-wool Army O.D., used, some minor defects, **\$3.33**

Only.....**4.89**

Used, excellent condition.. **7.45**

New.....**7.45**

Maroon dyed, excellent condition..... **7.50**

25% wool, Army O.D., new. **3.95**

WHITE VIRGIN WOOL NAVY BLANKETS, new.....**\$10.95**

### CANVAS FOLDING COTS

Complete with mosquito bar. Excel-**\$4.45\*** lent condition  
Mosquito bar only...**\$1.95**



Mattresses to fit folding cot, used, **\$5.45** sterilized, hair filled .....

### 5-MAN RUBBER LIFE RAFTS

AAF, new .....**\$29.50\***

### ALASKAN BOOTS

Sheeplined, knee-high, rubber bottoms, \$30 value, new .....**\$9.95**

### TYPHOON SUITS

Navy style, waterproof. Two-piece bib coverall and parka jacket. Ideal for all outdoorsmen, new .....**\$5.95**

ORDER FROM EITHER OF THESE CONVENIENT LOCATIONS

## MIDWEST

WAR SURPLUS DIVISION

54-A SOUTH 3RD STREET  
MINNEAPOLIS 1, MINN.

### ORDER INSTRUCTIONS

Send check or money order plus 25c for postage and handling. Items marked \* are shipped collect.

## PACIFIC

WAR SURPLUS DIVISION

101 K. STREET, DEPT. 10  
SACRAMENTO, CALIF.



# BOYS LIKE THESE LARGE 10" x 1.75 WHEELS

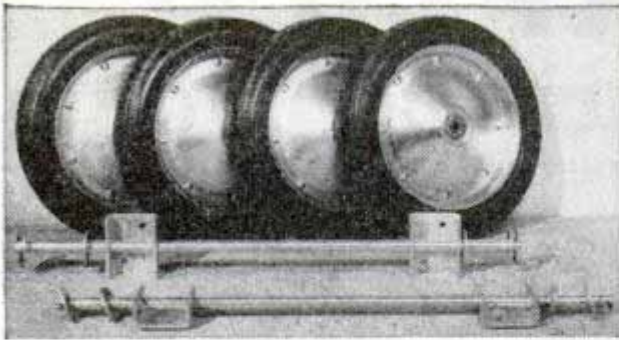

**BUILD YOUR OWN RACER**  
with Genuine GATES  
Style 508 and GOODYEAR  
Style 19 DEEP TREAD  
PUNCTURE PROOF SEMI-  
PNEUMATIC TIRES.

also HEAVY DUTY  
12"x2 1/2" SUPER DELUX  
All Purpose Wheels  
(See Price List Below)

NOTE: these ARE  
NOT the toy tires  
used by most wheel  
manufacturers.

## BUDD HEAVY STEEL WHEELS

Bright Zinc Plated . . . With Arguto Lifetime Oilless  
Bearings or Kilian Ball Bearings. **4 FOR \$10.00**  
For 1/2" or 5/8" Axles. . . . .  
With 2 . . . 1/2" dia. Axles 20" long hangers, washers, cotter pins, Ready To Use. . . . . **ONLY \$13.50**

Here It Is . . . Combination V Belt Pulley Drive  
First Again— . . . and Brake Drum



Securely Held To Wheel . . . **READY TO USE.** Smart Design in Sturdy Pure Cast Aluminum . . . Precision Machined.

One Combination Drive and 10" x 1.75 Wheel Assembled. . . . . **PRICE \$5.50**

One Combination Drive Wheel and three without (set of 4). **PRICE \$13.00**

Same as above with 2-20" x 1/2" axles, 4 hangers, washers, cotter pins. **READY FOR USE. . . . . PRICE \$16.50**

Same as above with 24" long x 5/8" dia. axles, 4 hangers, washers and cotter pins. **READY FOR USE . . . . . PRICE \$19.00**

Combination V Pulley Drive and Brake Drum, without wheel. . . . . **PRICE \$3.50**

F.O.B. Doylestown, or, add 10% for Prepaid Shipment anywhere in U.S.A.

Write For **FREE Circular on OUR NEXT SURPRISE — ELECTRIC and GASOLINE MOTORS**



### Model "A" Racer Chassis FOR POWER OR PUSH

Again we are **FIRST** with a sturdy built All-Purpose Chassis. Miles of pleasure, for any age, little ones or adults. This racer chassis engineered into the finest design for electric, gasoline or push power, giving you the choice of body design to build yourself. Equipped with Genuine Arguto Oil-Less Lifetime Bearings or Kilian Ball Bearings. Ready to roll and steer. **COMPLETE \$46.00**  
A.S. ABOVE, ONLY  
F.O.B. Doylestown or, add 15% for Prepaid Shipment in U.S.A.

65 Inches Long  
24 Inches Wide  
Weight  
Approx. 55 Pounds

**RUSH YOUR ORDER TODAY**



Super DeLux  
12x2 1/2" Wheels  
for 1/2" or 5/8" Axles  
Wheels Complete With Tire  
1 ONLY . . . . . \$ 5.50  
2 ONLY . . . . . \$10.00  
4 ONLY . . . . . \$18.00  
Plus 10% for  
Prepaid Shipment

Designed To Carry  
2,000 Pounds

## OSBORN WHEEL COMPANY

115 So. Main St., Dept. P-2

DOYLESTOWN, PENN.

# SAWS ANY PATTERN



**CUTS DESIGNS NEVER BEFORE POSSIBLE**

Here's a fast-cutting precision tool that simplifies intricate jobs in wood, plastics or light metals. Long-lasting spiral blade cuts in any direction—without binding or breaking. Lustrous baked enamel steel frame, with new lever-action blade adjustment, provides right tension constantly. Complete saw, with 3 extra blades, only 95¢. (Blades only, 3 for 25¢) — Get yours — today!

ENLARGED SECTION OF BLADE

AT YOUR NEAREST HARDWARE STORE  
or send \$1 direct for sample to

**TYLER MANUFACTURING COMPANY**  
938 Pico Boulevard — Santa Monica, California

## U-MAK-IT New AQUAMOBILE V-18



Cut-to-Fit—for quick Home Assembly. Get used Ford motors A. B. V8, Chevrolets, etc. for trike. Adjustable motorbeds fit all. Assembled frames ready for installation. Fast VEE bottom Marine Plywood hulls.

**SEND 25c** (coin) for 3 **MONEY SAVING CATALOGS** also showing Kits & Construction Details for **KAYAKS, ROWBOATS, OUTBOARDS, DINGHIES & RUNABOUTS**  
**KAYAK BOAT CO., 154P East 129th St., New York 35, N. Y.**

NO EXPERIENCE NECESSARY

## RISCO SERVICEMEN'S SPECIALS!

**RADIO TUBES AT DEALER DISCOUNTS ALL TYPES IN STOCK**

100 Asst. Insul-Resistors. . . \$1.95  
Alliance Phono Motors. . . . 3.75  
25 Asst. Mica Condensers. . . .89  
5" Alnico V P.M. Speaker 1.75  
PL-55 Microphone Plugs. . . .20



Astatic L-70 & Shure Glider Crystal \$2.15 ea.  
Pickups 10 at \$1.95

**RECORD PLAYER** Complete with 3 Tube Amplifier & 5" Spk. Walnut cabinet. Plays 10" and 12" rec-ords. . . **\$16.95**

Maguire 2 Post Automatic Record Changer—Plays 10" and 12" Records. . . . . \$15.50

25% Required on COD Orders — Free Catalog  
**RISCO SALES CO., 22 Warren St., N. Y. 7**

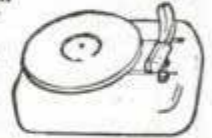

## MAKE MAGIC YOUR HOBBY

**BE A MAGICIAN FOR FUN OR PROFIT!**

Rush 25c for first issue of "MAGIC IS FUN," new magazine that teaches how to do tricks with coins, cards, ropes, etc. **FREE**, with order, large catalog of magical apparatus. **D. Robbins & Co., Dept. M69, 152 W. 42 St., N.Y. 18, N.Y.**

**BE YOUR OWN BOSS**  
Men and women make up to \$100.00 or more a week! Design and fit corrective arch supports by the time-tested Stephenson Method. A profitable, full or part-time, profession. Train at home; pay as you go. No costly equipment to buy. No capital needed. Send for **FREE** booklet today. Get into uncrowded dignified work. Be your own boss.  
**STEPHENSON METHOD, 5-28 Irvington St., Boston, Mass.**



**New Advertising Machine**



**Prints & Illustrates 1¢ Post Cards**

**FREE!** Learn how thousands of merchants and business men are boosting sales in spite of product shortages with 1¢ messages—printed in a few minutes on gov't postcards—with amazing new, patented **CARDMASTER**. Your "todays" ideas for specials, read by prospects next morning. Not a toy, but a sturdy, advertising machine, built to last many years. Low price, sold direct. Guaranteed, five years.

**SEND NAME** We'll send free illustrated book of money-making ideas for your business and complete, unique advertising plans. Rush your name today.

**CARDMASTER COMPANY**  
4546 Ravenswood Dept. 132 Chicago 40, Ill.

**U. S. SURPLUS SIGNAL CORPS CARRYING CASE**



A handsome durable fiber-oid case 19" x 12" x 6" with genuine leather inside trim. Handy for traveling, photographers, home craftsmen, mechanics, plumbers, tradesmen. Makes an exceptional tool case. Has 2 leather snap pockets and 17 tool holders and 8 large sectional divided compartments, each rigidly reinforced. Sturdy hardware including Yale lock and keys. Yours for only

**\$5.00** plus postage

**MATT COIL-LESS BURNER CO.**

4015 W. LAKE ST.

CHICAGO 24, ILL.

**FLEXIBLE MOLDS**

**MAKE YOUR OWN COST 10¢ EA.**

**FREE SAMPLE**

Cast plaques, novelties, book ends! Make concrete garden furniture, vases, bird baths—without molds! Send post card for FREE sample!  
**H. TOOKER, 630-N CHESTNUT ST., HAMILTON, OHIO**

**NEW Liquid PLASTIC**

Hobbyists, art fans, craftsmen, home money-makers, here's a great discovery. Castolite, amazing new liquid plastic, gives beautiful effects never before possible. Now you can embed photos, flowers, coins, insects in clear liquid plastic and harden to any size or shape. Castolite comes clear or can be colored. Pours without heat. Use home tools: spoon, glass tumbler, ash tray, saucer. Saw, drill or carve. Make 1001 objects: book ends, buttons, jewelry, toys. Have pleasure; gain profit.

**Makes 1001 OBJECTS**



**SPECIAL CASTO-KIT**  
Starts You at Home — \$2.95

Start with instant-use CASTO-KIT. Includes pound liquid Castolite, vial of hardener, test tube, flower castings, buffing compound, measuring dropper, abrasives, complete instructions. Make useful objects first day. Send \$2.95 plus 20¢ postage. Or order shipped C.O.D. Or send 25¢ (stamps or coin) for illustrated instruction manual only. The Castolite Co., Dept. B1, Box 211, Kenilworth, Illinois.

**HERE'S REAL FUN and PROFIT for**

Shows How to Build: **ONLY \$150**

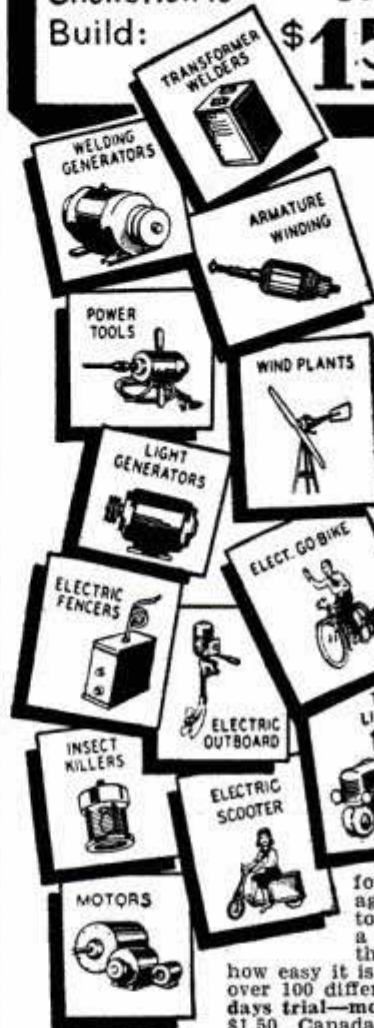

**SIMPLE PLANS for PRACTICAL PROJECTS**

You will have no trouble in working out the plans detailed in the LeJay Manual and you will get a lot of enjoyment from them. Whether or not you are mechanically inclined, the projects in these plans will appeal to you for their usefulness and practicality. They will save you money and make money for you, too, in jobs and repairs for neighbors and friends, because the plans embody all kinds of electrical devices.

**NO EXPENSIVE TOOLS NEEDED**

The tools you have around the house are all you need for these projects and most of the necessary material can be

found around workshops, garages and scrap yards. Being able to make your own welder helps a lot in doing other jobs, and the LeJay Manual shows you how easy it is to do this; also, how to make over 100 different items. . . . Sent on three days trial—money back if not satisfied. Only \$1.50, Canada, \$1.75.

**BUILD THIS FAST FREEZER**

PLANS ONLY \$100

**FROZEN STORAGE**

For Fish, Meat, Fruit, etc.  
From 5° above to 10° below zero.

5 SIZES—8 to 40 Cubic Feet Capacity

**NO KNOWLEDGE OF REFRIGERATION REQUIRED**

—Plans are easy to follow and you may have much of the material at hand. **FAST FREEZERS** made from these plans have been in use since 1938.

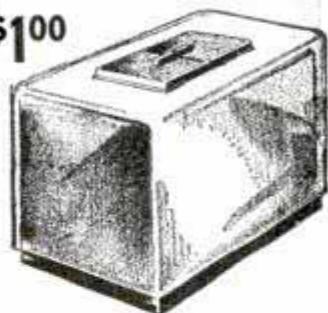

**MILK COOLER PLANS, too,** are included at no extra cost. Send only \$1.00 for the **FAST FREEZER** plans — or save 25¢ and send \$2.25 for both these plans and the LeJay Manual.

**BOTH for only \$2.25**

**LEJAY MFG. CO**

747 LeJay Building,  
**MINNEAPOLIS - 8 - MINN.**



# U. S. WAR SURPLUS



## EYE GUARD GOGGLES

For industrial, farm, welding, and general use. Made by Amer. Industrial Safety Equip. Co. Comes with extra set of mountable lenses. Sent postage collect. **\$2.25**

## ADJUSTABLE STENCIL SET

Set contains complete interlocking alphabet, including numerals, of durable metal, 3" high. Also ink and brush. A handy item for home and farm use. Also industrial. Shipped in original government airtight package. **\$2.00**

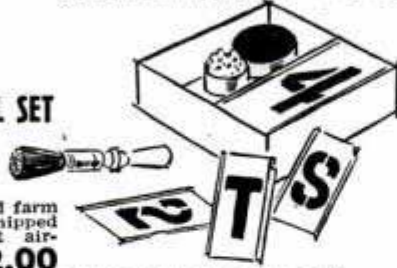

## MACHINE GUN OIL

An extra high grade machine oil used by U.S. Air Force. An all-purpose oil for farm and machine shop—firearms. 24 qt. cans in original cartons. Pour-point 50° below zero. **\$4.00**  
Sample qt. can. **.35**

## GRAPHITE GREASE

In original government 5 lb. can. **\$.75**

**Extra Heavy Tow Chain**  
For logging, tractor use, and extra heavy towing. 14 ft. length with ring and hook. Links 5/8" stock. Each **\$10.00**

or **3 for \$27.00**

**WRECKING BAR**  
Made to government specifications. 5 ft., 18 lb. of 3/4" stock. Has chisel end. **\$2.00**

**1 QT. PYRENE FIRE EXTINGUISHER**  
With wall bracket. **\$8.00**  
No discount. ....  
20% discount for orders of \$100.00 or more. All items shipped F. O. B. Chicago

**GEAR OIL**  
A low temperature all-purpose oil with a 30° below zero pourpoint. For farm equipment. Used in airplane gear boxes. Case of 6 gal. **\$3.00**  
1 gal. sample. **\$1.00**

**Wheel Bearing Grease**  
Of fine quality. For farm and industrial use. 5 lb. **\$.75**

## SCHAFFER SALES

3423 W. Lawrence Ave.

Chicago 25, Illinois

# AMMCO 7" SHAPER

"A Precision Machine of a Thousand Uses"

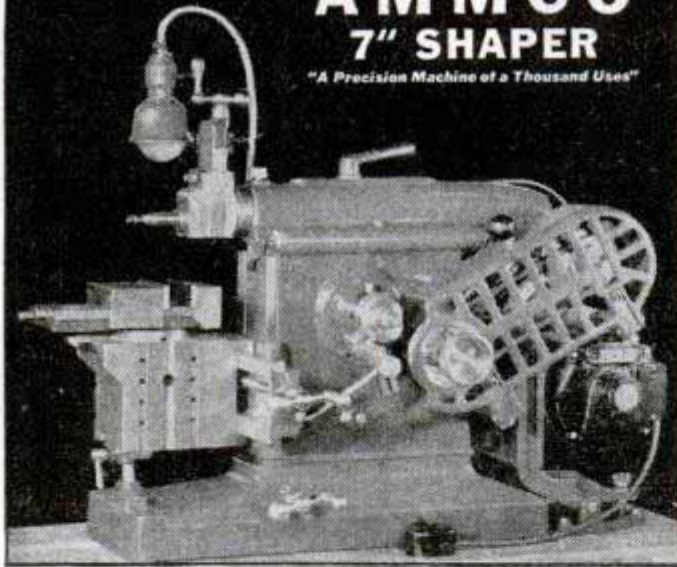

A wide variety of jobs can be done accurately, quickly, easily, and economically on the AMMCO Shaper (7" stroke).

Construction incorporates many features you would expect to find only in larger, more expensive machines... For example: WAYS of ram, tool head, and front face of the main frame are of the "VEE" type, hand scraped to insure accuracy and long life. Available for stationary installation or as portable unit.

Write today for specifications and prices

## AMMCO TOOLS, INC.

COMMONWEALTH  
AVENUE



NORTH CHICAGO  
ILLINOIS

(Formerly Automotive Maintenance Machinery Co.)

# PAY-RAISING — EXTRA MONEY BOOKS

Use these books to prepare for a better job—bigger pay—to start a profitable spare time or full time business of your own, improve your home, start a hobby. Popular Mechanics specializes in supplying outstanding self-help books on many subjects. Send for our FREE catalog.

- How to Remodel a House**  
Nothing is omitted. **\$4.75**
- Painting, Furniture Finishing & Repairing**  
New self-help book for craftsmen, home owners. **\$1.50**
- Shop Notes for 1947**  
New ready. For every man who uses tools. **.60c**
- Shop Notes Library**  
5 Vols.—1946, 45, 44, 42, 41. (No Dup. Mat.) **\$3.00**
- Welding, Brazing & Soldering**  
How to build own equipment and use it effectively. **\$1.25**
- Garden Book**  
Build own trellises, lawn furniture, fireplaces, ornaments, etc. **\$1.00**
- Forty Power Tools**  
Build own saw, drill, lathe, sander, etc., from scraps—save money. **\$1.25**
- Rewinding & Servicing Electric Motors (No. 75)** **.25c**
- Turn Scrap Into Money**  
Convert old auto generators into motors, welders, etc. **\$1.00**
- House Wiring (No. 89)**  
All information needed to do complete job. **.25c**
- Modern Refrigeration**  
Electric, Gas. Be service expert. **\$5.00**
- Dyke's Auto Ency. (includes Diesels, airplane engines)**  
New 20th Ed. World's greatest book for mechanics. **\$7.00**
- Sheet Metal Work**  
Self instruction in all phases. **\$2.50**
- Tool & Saw Sharpening (No. 92)** **.25c**
- Armature Winding**  
Construction, winding, repairing AC & DC Motors, generators. **\$2.00**
- Build Your Own Boat**  
Describes 17 popular boats—rowboats, sailboats, plywood outboard, etc. 192 pages **\$1.50**
- Forging Practice** **\$1.50**
- Toys You Can Make of Wood** **\$2.50**
- Carpentry**  
Learn modern methods. **\$2.00**
- Foundry Work** **\$2.00**
- Pattern Making**  
Wood, metal. **\$2.00**
- Action Toys (No. 66)**  
Plans for 21 easy-to-make toys. **.25c**
- The Young Craftsman**  
Over 450 things boys can make. **\$1.50**
- Five Acres and Independence**  
How to make money on small farm. **\$2.50**
- Modern Welding Practice**  
Useful data on welding of all kinds. Simplified, non-technical, easy-to-understand. **\$3.50**
- How to Plan a House**  
Every detail carefully explained. 525 pages. **\$4.50**
- A Small Store and Independence**  
Guide to successful retailing. **\$2.00**
- Modern Gas Turbine**  
Complete up-to-date information on uses as supercharger and prime mover. Includes jet propulsion. **\$4.00**
- A.B.C. of Poultry Raising** **\$2.50**
- How to Build Violin, Pipe Organ, Banjo-Uke** **\$1.00**
- Knots, Ties, Splices**  
For everyone who uses rope. **\$1.25**
- Plastics**  
Latest information on manufacture and use. **\$4.00**
- Workbenches & Tool Cabinets You Can Build (No. 47)** **.25c**

- Concrete Handbook**  
New book on using concrete around home, garden, farm. **\$1.50**
- Oil Burner Handbook** **\$2.50**
- Photo Guide**  
Construct own equipment, gadgets. Make better photos. **\$1.50**
- Welding, Electric** **\$1.25**
- Welding, Oxy-Acetylene**  
Welding, cutting. **\$1.25**
- Metallurgy** **\$2.50**
- Ropp's Calculator**  
Figuring made easy. **.50c**
- Plumbing Installation & Repair**  
For those without previous training. **\$2.00**
- Judo, 30 Lessons in Modern Jiu-Jitsu** **\$2.50**
- Tool Making** **\$3.50**
- Tool Design** **\$4.50**
- Mechanism** **\$3.50**
- Air Conditioning—Heating and Ventilating**  
Principles and general applications of steam, hot water, vapor and vacuum heating. **\$4.00**
- Audels Sheet Metal Pattern Layout** **\$4.00**
- Estimate for the Building Trades**  
How To: Material and labor costs for masonry, plumbing, electricity, carpentry, heating, hardware, painting, etc. 629 pp. **\$4.75**
- Audels Masons and Builders Guides**  
For Bricklayers, Cement workers, Plasterers, Tile Setters and Stone Masons. 4 Vols. **\$1.50 each**
- Lejay Manual of Homemade Electric Equipment**  
How to construct 100 items that are scarce and valuable. **\$1.50**
- Drake's Refrigeration Service Manual** **\$2.00**
- Slide Rule Simplified** **\$2.50**
- Mathematics for Ready Reference**  
Covers all phases of mathematics. **\$2.00**
- Mechanical Drawing Self-Taught**  
With 21 simple step-by-step exercises, 56 pages of illustrations showing how to do it. **\$1.00**
- Audels' New Automobile Guide**  
1600 pages. **\$4.00**
- New Small Homes**  
62 practical and popular designs. **.50c**
- The Vegetable Growing Business** **\$3.50**
- Rabbits for Food and Fur** **\$2.50**
- Furniture Joinery** **\$2.50**
- Principles of Woodworking**  
Tools, processes, materials, projects. **\$2.00**
- Pottery Made Easy** **\$2.50**
- The Art of Wood Turning** **\$2.00**
- Essentials of Upholstery** **\$2.75**
- Radio Physics Course** **\$5.00**  
A thorough training in radio fundamentals.
- Bookkeeping for Personal and Business Use** **\$2.25**
- The Art of Inventing and What to Invent** **\$3.00**

## MAIL THIS COUPON TODAY

Check the books you want, write your name and address below, and mail this advertisement with money order or check. Outside U. S. A. include 15% additional for shipping charges.

Books selected will be mailed promptly on our "money back if you're not entirely satisfied" guarantee.

Name .....

Address .....

City ..... State .....

Mail to **POPULAR MECHANICS PRESS.**

Dept. 604—200 East Ontario St., Chicago 11, Ill.

**SAY YOU SAW IT IN POPULAR MECHANICS**



# ELECTRICITY *Anywhere*

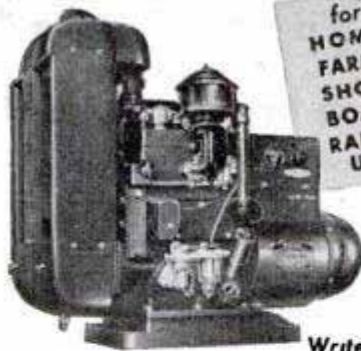

for  
**HOMES  
FARMS  
SHOPS  
BOATS  
RADIO  
USE**

● Onan gasoline-engine-driven Electric Plants supply reliable, economical electric service for any use Portable, stationary or stand-by models. Water or air-cooled, compact and rugged.

A.C.: 350 to 35,000 watts in all standard voltages and frequencies. D.C.: 600 to 10,000 watts, 115 and 230 volts. BATTERY CHARGERS: 500 to 3,500 watts; 6, 12, 24, 32 volts.

Write for folder

**D. W. ONAN & SONS INC.**  
2526 Royalston Ave., Minneapolis 5, Minn.



## Plastics Supplies

Everything in plastics — Lucite, Plexiglas, Dyes, Rods, Sheets. Lowest prices. Send 3c stamp with name, address and this ad for catalog.

**PLASTICS MFG. & SUPPLY CORP.**

Dept. M-2, 4707 Euclid Ave.

Cleveland, Ohio

## RADIO PARTS GRAB BAG!!

\$25 value assortment of Coils, Condensers, Transformers, Resistors, Controls, etc. An experimenter's dream. Order today! Only.....

**MARKO SUPPLY, Dept. PM-2**  
2924 Logan Blvd. Chicago 47, Ill.

**\$3.98**

## C-THRU-MIRRORS

See thru one side. Mirror on other side. Leisurely watch others at close range who imagine themselves unseen. Loads of fun. Lasts a lifetime. 3"x4" or 2"x6" sizes only. \$2.95 postpaid. No C.O.D. One day shipment. Beeler Enterprises, Dept. 21-B, North Hollywood, Calif.

ENSHRINE THEIR MEMORIES WITH



**U.S. MONUMENTS** \$14. UP

There is none better. Our free catalog is ready for you. Write today. A-18 U. S. Marble & Granite Co., Oneco, Fla.



**MACHINISTS — TOOLMAKERS  
PATTERNMAKERS**

Choose Gerstner Tool Chests for complete Satisfaction. Free Catalog.  
**GERSTNER TOOL CHESTS**  
447 Columbia St., Dayton 7, Ohio

## 2 Bushels of Ripe TOMATOES from ONE VINE



2 or 3 vines will produce enough tomatoes for the average family.

### New BURGESS CLIMBING TRIP-L-CROP

TOMATO rapidly grows to a height of 10 to 18 feet. Grow on trellis, side of house or barn or as a bush in garden. Beautiful crimson, solid, meaty fruits of best quality, some weighing over 2 lbs. each. The most productive of all tomatoes. Trial packet 10c—3 for 25c, postpaid.

**CASH PRIZE CONTEST**  
Send for FREE Garden Book giving full details about CASH PRIZES to growers of this wonderful tomato.

**BURGESS SEED & PLANT CO.**  
217 C.T., GALESBURG, MICH.



**A WHOLE SHOP  
FULL OF TOOLS  
IN ONE!**

Use it for grinding, routing, drilling, sawing, polishing, carving, sanding and 9,994 other uses. Increases your skill and your scope. Precision-engineered, AC-DC. More exclusive features than any other tool.

Exclusive Safety Fingergrip for fine detail work

**\$22.50**

COMPLETE WITH 36 ACCESSORIES IN FITTED STEEL CASE

\$31.75 Value if Purchased Separately

Works Wood, Metal, Glass, Plastics

**CASCO ELECTRI-CRAFT TOOL KIT**  
CASCO PRODUCTS CORPORATION, BRIDGEPORT 2, CONN.

## All Leather Shearling Lined FLYING JACKET

*Famous Army Air Force B-3*  
1/3 ORIGINAL PRICE  
**only \$14.95**



RECLAIMED FOR RE-ISSUE TOUGH Outside-WARM Inside

A rich looking, sturdy jacket made originally for the toughest assignment of all, the Army Air Forces. Complete protection against wind, rain, snow. Finest leather and best shearling available. For every type of outdoor activity, work or play. Resistant to scuff and hard wear, flexible. Neat appearance, combined with greatest warmth possible in a jacket. Far better than any civilian jacket because the Government demands and receives the best. Greatest value ever offered. Order today, while choice sizes are still available. Sizes: small—medium—large.



Order Direct and SAVE

Please send check or money order for \$14.95. Pay few cents express charges on delivery.

**BENNETT MARSHALL**

2801 UNION CENTRAL BLDG. Dept. 412  
CINCINNATI 12, OHIO



FOR STEADY-VOLTAGE POWER...  
FREE FROM OUTSIDE INTERFERENCE

DIESEL'S THE POWER...

*Sheppard's the Diesel*

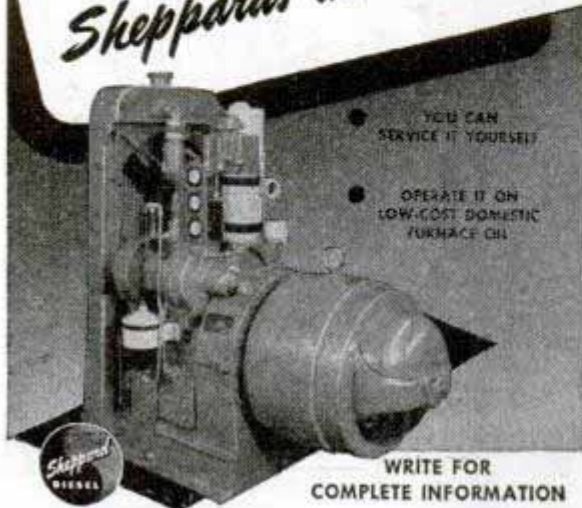

YOU CAN  
SERVICE IT YOURSELF

OPERATE IT ON  
LOW-COST DOMESTIC  
FURNACE OIL

WRITE FOR  
COMPLETE INFORMATION

Generating Sets... 2,000 to 36,000 Watts

Power Units... 3 1/4 to 56 continuous H. P.

Marine Engines... 3 1/4 to 62 continuous H. P.

R. H. SHEPPARD COMPANY, INC., 48 Middle St., Hanover, Pa.

## New MILLING ATTACHMENT

Sizes for 8" to 16" metal lathes

BUILD IT YOURSELF from our sets of semi-machined castings and save \$\$\$. Can be finished on your lathe alone. Complete working drawings and step-by-step machining instructions furnished with castings.

Mill keyways, slots, splines, dovetails, flutes in reamers, taps, hobs, and special cutters; produce spur, bevel, mitre and worm gears, ratchets and racks; mill flat surfaces, square shafts, mill hexes, spot face, drill spaced holes, bore, etc. on your lathe with this precision attachment. It has a T-slotted table, a vise which swivels for angular milling, a gear cutting fixture and dividing centers.

**FREE!** Illustrated folder and price list. Mention your lathe. Write today.

**HURON MACHINE AND TOOL CO.**  
YALE 4, MICHIGAN



# FIVE ACRES AND INDEPENDENCE

*A Practical Guide to the Selection and Management of the Small Farm*

By M. G. Kains



This book is a complete, practical guide to the selection and management of a small farm. It explains how a small farm can be self-supporting. What farms not to buy. How to choose the right farm, based on proper soil, location, irrigation, elevation, climate, etc. Then a detailed explanation of what crops to plant and how to make them yield results, sure-fire methods of grafting, rotation, transplanting, etc. Finally, how to make a profit by selling your excess crops, livestock and preserves. Written by an expert who has made a

real success with many small farms. Revised, enlarged edition. 413 pages, profusely illustrated. Price \$2.50

Only \$2.50, Postpaid in U.S.A. (Outside U.S. \$2.75). Order Today

**POPULAR MECHANICS PRESS** Room 490 • 200 East Ontario St., Chicago



## BUILD A BOAT

Row Boat—12 Foot  
Dinghy—8 Foot  
Dinghy—14 Foot Sailing  
Training Ship—6 Foot  
Sea Sled—9 Foot  
Outboard—12 Foot  
Cruiser—18 Foot  
Bicycle Boat—Kayak  
Row Boat—Sectional  
Dinghy—Sailing  
Canoe—16 Foot  
Sailing—12 Foot  
Outboard—12 Foot  
Outboard—Runabout  
Pontoon—Ice Yacht

FOR PLEASURE OR PROFIT DESCRIBES 17 LOW COST BOATS Get this outstanding book and build a boat at home for your own use or to sell at a profit. You can do it. Just the boat you've always wanted—power, sail or row boat—17 different kinds and sizes.

Order BUILD A BOAT on postal card and pay only \$1.50 plus postage on delivery. Return in 5 days if not pleased and get money back. Or send \$1.50 with order and we'll pay postage. (Outside U.S. \$1.70 with order.) Order today.

**POPULAR MECHANICS PRESS**  
Dept. 598, 200 E. Ontario, Chicago 11

## Cigarette Smokers The Perfect Gift

New, modern, compact "PAK-LITE"... a Combination Unit—fits the pocket—fits the purse! Holds a full pack of regular size cigarettes—with handy, convenient Lighter built right into the handsome Case. Has one hand cigarette lighting action, strong flame, large fuel chamber and new safety fire-guard. Case is durably constructed of virgin plastic. A beauty Unit that saves time hunting for cigarettes and a lighter. Order now for your own use or as the perfect Gift.

**SEND NO MONEY**—Just pay postman only \$1.49, plus postage. Or enclose \$1.49 with order for postpaid delivery. **SATISFACTION GUARANTEED OR RETURN IN 10 DAYS FOR REFUND.** Order extra "PAK-LITES" for gifts.

**Pak-lite**  
LIGHTER and CIGARETTE CASE

**\$1.49**

POSTPAID

2 Extra  
FLINTS  
Included



**BALL PRODUCTS CO., 737 W. RANDOLPH ST., DEPT. 6, CHICAGO 6, ILLINOIS**



# NEW PATENTED WAR DEVELOPED TOOL

**HOME CRAFTSMEN**—Amazing new tools, heretofore used in important war work of motor transport and aircraft plants, now available to you for first time. These patented, new war-developed tools—wheels, points, cones—scientifically made of soft, flexible, abrasive fabrics. Cut, shape, grind, and polish in one operation. Save time, labor, do precise work. Designed to fit all standard rotary power units; like Handee, Freedom, Crandall, others. Get useful Practo-Kit of 12 assorted wheels, points, cones, "pencils" and mandrel for low price of \$1.95. Big Master Kit with mandrel and 26 assorted wheels, points, cones and "pencils" only \$2.95. Send check for either Kit, prepaid. Or you can order either Kit shipped COD, regular price plus small delivery charge. Satisfaction guaranteed. Time-Test Co., Dept. B-1, 8324 W. Grand Avenue, Chicago (River Grove), Ill.



**\$1.95**  
SPEC. ASS'T.

**SEND NO MONEY!**

**TALK-SING thru your own radio with RADIO MICROPHONE**

Be the life of the party. Put on your own broadcasts at home. Talk-Sing make announcements from any room. Wonderful voice practice. Microphone easily attached to any radio. Follow enclosed instructions. **SEND NO MONEY**—pay postman \$1.98 plus postage. Send Money Order or check and save postage.

**EMPIRE RADIO & TELEVISION CO.** (Dept. R2) 1521 Bedford Ave. Brooklyn 16, N. Y.

**SELL MERCHANDISE by mail**

OPERATE Profitable Lifetime Business Selling Merchandise by Mail. Large Profits on Fast Selling \$1.00 Items. **WRITE TODAY!**

**POWELL CO. DEPT. A** SAMPLER BLDG., CLEVELAND 3, OHIO

**MICROSCOPES SUPPLIES-ACCESSORIES & SCIENTIFIC INSTRUMENTS**

SELL SPENCER NEW & USED BOUGHT-SOLD EXCHANGED-REPAIRED

LEITZ ZEISS MEDICAL INDUSTRIAL AMATEUR

Send for FREE LIST NATIONAL SCIENTIFIC INSTRUMENT CO. 119 CHAMBERS ST. N.Y.

**FIBRE ARMS AND LEGS!**

Light, correctly fitted, strong and comfortable. Natural appearance. Braces for all deformities. Scientific design. Fair Terms.

**BUCHSTEIN-MEDCALF** 223 S. 6th St., Minneapolis, Minn.

## Ugly BLACKHEADS OUT IN SECONDS



Keep your complexion free of Blackheads this new way—look attractive instantly!

### Try VACUTEX Blackhead-Remover

The amazingly effective Vacutex extracts Blackheads automatically—WITHOUT squeezing the skin or injuring tissues. Easy to use with three fingers. It reaches Blackheads anywhere. Try it 10 days and if not delighted, return VACUTEX and your money will be refunded.

**\$7.00**

**AT YOUR DEALER OR USE COUPON 10 DAY TRIAL COUPON**

**BALLCO PRODUCTS CO., Dept. A-3202**  
19 West 44th St., New York 18, N. Y.

Enclosed find \$1. Send postpaid.  
 Send C.O.D. I will pay postman \$1 plus postage; \$1 refund if not delighted.

**SORRY. NO C. O. D.'s OUTSIDE U. S. A.**

## WAR SURPLUS BARGAIN SPECIAL

### BRAND NEW! VACUUM-AIR HYDRAULIC FUEL PUMP

Original Cost \$45.00  
Now Only **\$9.95**

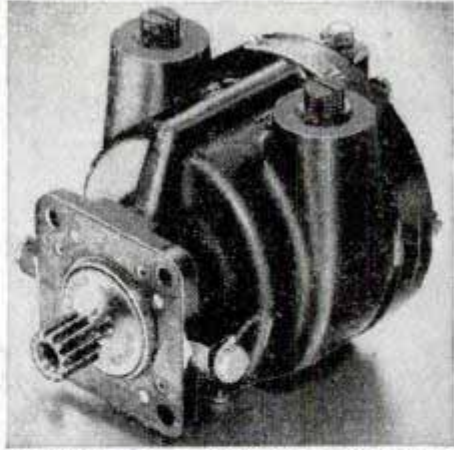

Postpaid in U.S.A.

Adaptable for use on Home Oil Burners, Spray Machines, Milking Machines, Compressors, Vacuum Pumps, Hydraulic Systems, Presses, etc. Originally cost \$45.00. Used by the Air Corps to drive bomber de-icer boots, gyroscopes, automatic pilots, etc. May be used as air or fluid pump—for pressure or vacuum. Standard 3/4 inch pipe thread with interchangeable ports. Will pump 7 1/2 gal. SAE 30 oil per minute at 300 RPM. Builds air pressure of 30 lbs. per sq. in. at 1000 RPM. Vacuum will draw 26 inches of mercury at 1750 RPM. Runs forward or reverse. Self aligning shaft. Die cast aluminum housing 6x4x4 inches. Has stainless alloy steel vanes and impeller. Made by Bendix Avia. Corp. Spline terminal for direct drive—readily replaced with a pulley. Recommend a 1/4 H. P. or stronger electric motor as source of power. Rated capacity 1500 RPM with high overload factor. Special price for quantity users. Send check or money order today. Postpaid in U.S.A.

**GROBAN SUPPLY CO.** 1522 So. Michigan Avenue Dept. PM2, Chicago 5, Ill.

## GRINDING WHEELS • ABRASIVES •

# 305 FOR ONLY \$9.95

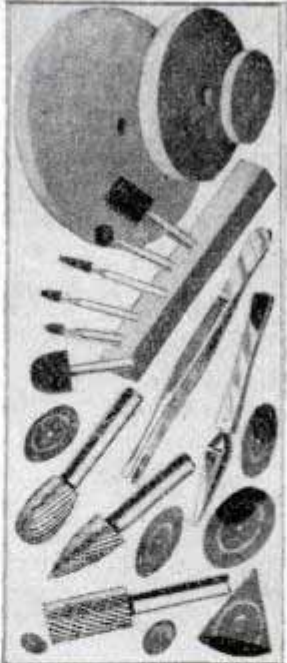

**REGULAR \$50.00 VALUE**  
Nationally Advertised Brands Including  
**NORTON — CARBORUNDUM**  
**MANHATTAN — MACKLIN**

Every possible type of grinding job can be handled quickly and easily with this huge assortment of nationally known makes of grinding wheels—NORTON—MACKLIN—CARBORUNDUM and others ranging in size from 3/4" to 6" in diameter. Only because they are War Surplus and only because we have bought in such large quantities are we able to make this amazing offer. Think of it . . . 305 items in all! Little more than 3 cents apiece! A sensational value! Every hobbyist—every farmer—every craftsman will find in this assortment the answer to every grinding need . . . for little more than 3 cents per item.

#### HERE IS WHAT YOU GET

- 10 Grinding wheels from 3/4" to 6" in diam., 1/4 to 1 1/4 Face 1/8 to 1 1/2 Holes
- 5 Cut off wheels from 2 to 4 inch, 1/8 to 1/4 hole
- 5 Mounted Grinding Wheels 1/2 inch shank.
- 3 Mounted Grinding Wheels 1/4 inch shank.
- 3 Rotary files 1/4 inch shank high speed
- 1 India oil stone 4x3 1/2
- 1 Pr. nickel plated forceps
- 1 Pr. spring back pliers
- 1 Grinding wheel 6 1/2 x 1 1/2
- 1 Grinding wheel 6 x 1 1/4 x 1
- 1 Grinding wheel 6 x 1 1/2 x 1 1/4
- 1 Grinding wheel 7 x 1 1/2 x 1 1/4
- 1 Grinding wheel 10 x 3/4 x 3
- 1 Cut off wheel 10 x 060 x 5/8
- 1 Cut off wheel 10 x 1 1/4 x 1 1/2
- 1 Sander wheel
- 1 Flaring cup
- 1 Cloth abrasives
- 100 Sanding strips up to 10x2
- 2 Felt hobs 1x2 1x1 1/2 to 1/2
- 5 Felt wheels 1x1 1/2
- 100 7/8 Paper abrasive discs
- 50 3-inch Butterfly crocus cloths
- 10 Abrasive cones

**A TOTAL OF 305 PIECES**  
**A \$50.00 VALUE**  
**\$9.95**

**ORDER NOW**  
**GROBAN SUPPLY CO.** 1522 So. Michigan Ave. Dept. PM2, Chicago 5, Ill.



# NEW Tool!

for  
HOME • SHOP • FARM  
TOOL CHEST

THE DAY TOOL DRIVER is the first practical improvement in screwdrivers for years. CARPENTERS, MECHANICS, MACHINISTS and HANDYMEN need never be without the right size screwdriver with the DAY TOOL DRIVER... 8 different-sized blades with just 2 convenient automatic locking handles. Blades and locking nuts made of high quality steel. Handles moulded from tough plastic. A press of the thumb unlocks the old blade—another press of the thumb locks the new blade securely in place. It's quick, practical, more convenient and unconditionally guaranteed... 8 screwdrivers in ONE THIRD THE SPACE! Dealer inquiries invited.

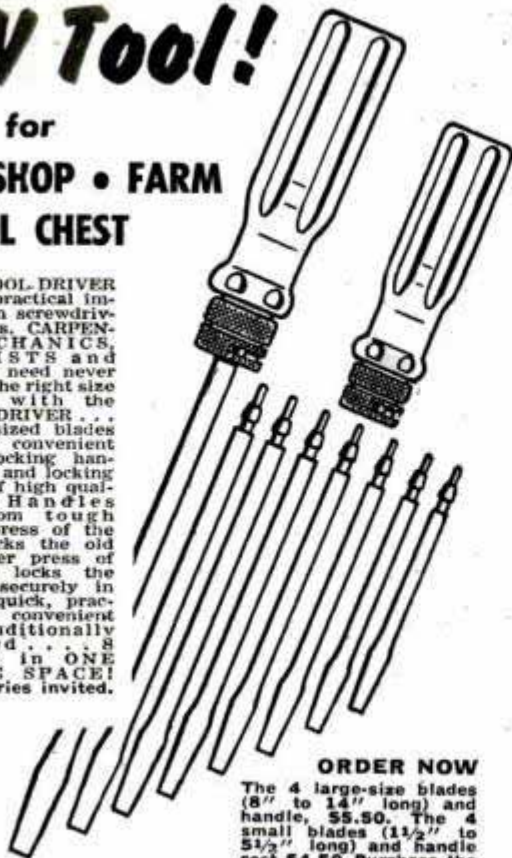

2 HANDLES  
8 BLADES

**ORDER NOW**  
The 4 large-size blades (8" to 14" long) and handle, \$5.50. The 4 small blades (1 1/2" to 5 1/2" long) and handle cost \$4.50. Purchase the COMPLETE COMBINATION SET of 8 blades and 2 handles for \$9.50 and save. Immediate shipment, postage prepaid.

THE CONWAY COMPANY, 953 So. Grand Ave., Los Angeles 15, Calif.

## Tire Changing Tool Lifts Wheel To Align Bolts With Holes

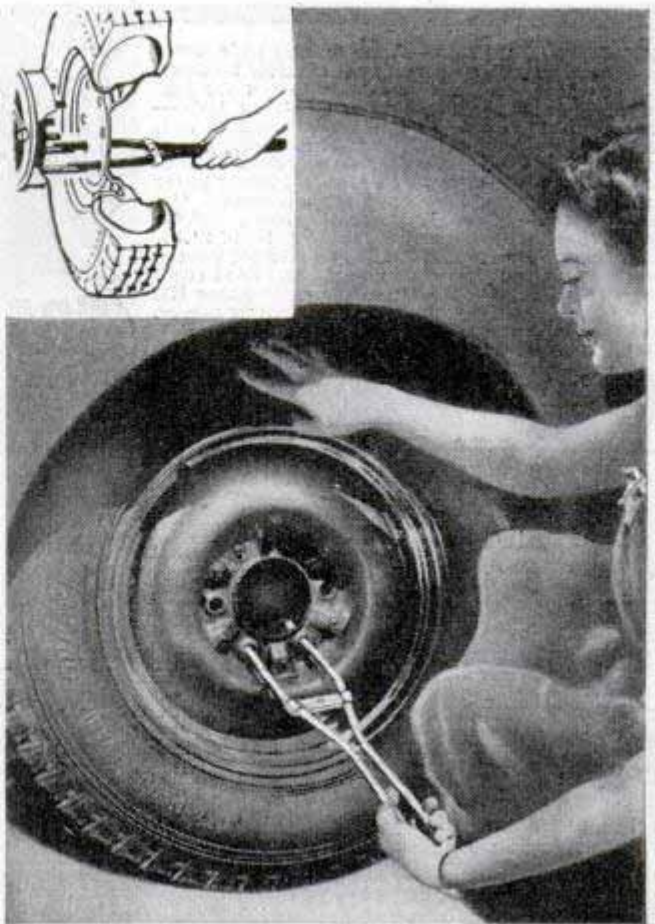

Changing tires on an automobile becomes a relatively simple job with a tool which helps lift the wheel to the hub and aligns the lug bolts with the holes. Prongs of the tool, which fit either lug or bolthole-type drums, can be adjusted to slide easily through the holes of any wheel. The prongs are passed through the bottom holes and the grooved ends fit over the tips of the bottom lug bolts. By lifting the handle of the tool, the wheel automatically drops into place on the top lug bolts.

## Nazis Made Glycerin From Sugar

While American housewives were saving fats to make glycerin for use in explosives, the Germans were producing their glycerin from sugar. Postwar studies of German industry reveal that glycerin was produced by the following process: sugar was placed in a weak solution of oxalic acid at 75 degrees Centigrade and then neutralized with calcium carbonate. When the solids settled, the solution was treated with charcoal and distilled. The resulting product contained about 40 percent glycerin, 40 percent propylene glycol and 20 percent alcohol. The purified glycerin was as good as that obtained from fats, according to the U. S. Department of Commerce.

# Start a SAW REPAIR BUSINESS!

MAKE A GOOD LIVING IN YOUR OWN BUSINESS—sharpening saws with the Foley Automatic Saw Filer. It makes old saws cut like new again. All hand saws, also band saws and cross-cut circular saws can be filed on this ONE machine.

THERE ARE HUNDREDS OF SAWS TO BE FILED in your own neighborhood, used by farmers, carpenters, homes, schools, factories, etc. W. L. Tarrant writes: "I left my old job last September and in 10 months have filed 2,159 saws. We have a lovely business worked up and cannot keep up with the work."

SEND FOR FREE PLAN—Shows how to start this steady cash business. No experience needed, no eyestrain, no canvassing. Send coupon today.



## FOLEY Automatic SAW FILER

FOLEY MANUFACTURING CO.  
216-7 Foley Bldg., Minneapolis 13, Minnesota  
Send Free Plan on Saw Filing business, no obligation

Name \_\_\_\_\_

Address \_\_\_\_\_





**NEW  
CONCORD  
RADIO  
Bargain  
Catalog**



Brand new—48 exciting pages of radio parts, equipment, and supplies for experimenting, building, testing, repair, maintenance—Big feature sections of Ham Gear, Radio Sets, Communications Receivers, Amplifiers, Record Players and Portables, Record Changers, complete Sound Systems. Pages and pages of top-quality standard-make radio and electronic parts—plus scores of special value bargains. Thousands of items NOW IN STOCK and ready for IMMEDIATE SHIPMENT! Write TODAY for your FREE COPY. Please address Dept. P-27

**CONCORD RADIO CORP.**

LAFAYETTE RADIO CORPORATION

**CHICAGO 7**

**ATLANTA 3**

901 W. Jackson Blvd.

265 Peachtree Street

*Your Rust Troubles are Over*

**THE WAR-TIME MIRACLE LIQUID** which cleaned millions of parts during war effort. **CORODEX** positively removes **RUST** and **CORROSION** regardless of depth, from iron, steel, brass, bronze, copper, chromium and nickel. Cleans tools, hardware, sports equipment, household utensils, etc., for a few cents a piece. No **RUBBING** or hard work.

**CORODEX IS GUARANTEED TO REMOVE RUST.**

Valuable Manual of Rust Control free with order.

On sale at all Sears Retail Stores in **HARDWARE DEPTS.** 50c and \$1.00 in Mid-West (Slightly higher elsewhere)

**SEARS, ROEBUCK AND CO.**  
CHICAGO, ILLINOIS

(Corodex is made by Allied Products Co., 1133 Newport Ave., Chicago)

**Genuine full-color  
KODACHROME PRINTS**

Now available at new low quantity prices.  
Order through your Kodak dealer.

**EASTMAN KODAK CO., Rochester 4, N. Y.**



*Make Your Own*  
**RUBBER  
MOLDS**

with **RED LATEX**

**MOLDING COMPOUND**

Earn money, have fun; make your own molds for plater objects. Produce novelties and gifts for home and to sell to friends. **RED LATEX MOLDING COMPOUND** (60% density) now available in quart and gallon quantities. Gives perfect results, easy to apply. Send for complete information and prices.

**FRANCIS SUPPLY CO., Dept. B-2, 1836 E. Fulton St., Columbus 9, O.**



**UMBRELLA HAT COVER**  
*Smart Hollywood Creation*

EASY TO MAKE AT HOME with light weight plastic film and cement. Clear or opaque material may be used.

**VERY SIMPLE:** All around tubular border (A) gets rigid and expands the brim when inflated by mouth through valve (B) easily made with a piece of rubber tube. Deflate said tubular border and the whole thing may be folded like a handkerchief and carried in the pocket as an insurance against expected or unexpected bad weather or burning sun. Excellent for city or country, for football games, etc.

**MORE PRACTICAL** than the ordinary umbrella (frequently lost), or than the raincoat (frequently forgotten). And the Umbrella Hat Cover leaves your hands free for work or play.

**A FORTUNE FOR YOU!**

Life is short. Why work hard for an uncertain **FUTURE?** Take advantage of the booming **PRESENT.** No expensive equipment or studies necessary. Just a pair of scissors and a few dollars of materials. Start small and grow big before the next depression comes.

*Millions of Customers Waiting*

This product is not limited to a group or class or age of people. Millions will buy it at sight. Its novelty and true service attracts the crowds. Without offering it for sale the inventor sold for five dollars the first Umbrella Hat Cover made with his own hands at a cost of a few cents. But he cannot cover the whole world; there is plenty of room for other manufacturers. **BE ONE YOURSELF** and let us help each other to make this article the most popular novelty of the epoch.

**GET THE "KNOW HOW" from the inventor for only one dollar. Nothing more to buy from him. Everything is told clearly.**

Make Today Your Independence Day. Send the Coupon Now.

**H. RAMIREZ, 4969 Sunset Boulevard, Hollywood 27, California**

I enclose one dollar, for which send me **AIR MAIL** confidential instructions and drawings for making the Umbrella Hat Cover. **MY MONEY TO BE REFUNDED** if I ask for it within 5 days.

Name \_\_\_\_\_

Address \_\_\_\_\_

City \_\_\_\_\_ State \_\_\_\_\_

**SAY YOU SAW IT IN POPULAR MECHANICS**



Handy?



Like Gadgets?

## FOR ONE DOLLAR

You get a superb tachometer mechanism — completely assembled — precision built for airplanes. 350 to 3500 RPM — Adaptable to other counts — Design your own dial.

Check what YOU can make:—



Engine RPM Counter for Boats



Speedometer for Bikes and Motorcycles



Revolution Counter for Lathes and Machines



YOUR OWN IDEAS!

Send

\$1.00

FOR ONE TACHOMETER MECHANISM

\$10.00

FOR 12 MECHANISMS

Postpaid in USA

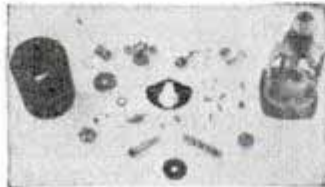

**KENYON INSTRUMENT CO., Inc.**  
1345 New York Avenue      Huntington Station, L. I., N. Y.

## AMAZING VALUES!

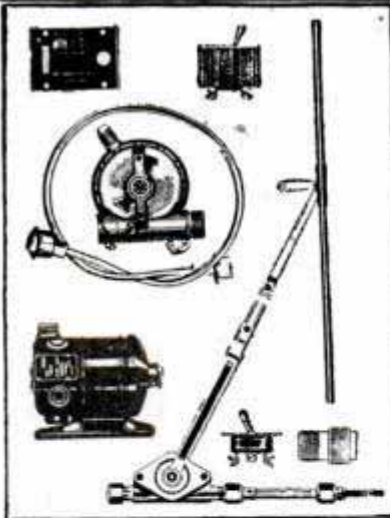

### HUNDREDS OF PARTS!

K3 GUNSIGHT UNIT contains fascinating array of parts useable in 1001 ways! Amazing 1/50th H.P., 24 V. D.C. High-Speed Motor. Many regular and bevel gears, switches, shafts, lenses, bearings and various other parts too numerous to mention. Original cost approx. \$3000.00. You pay only..... **\$17.50**

SHIPPED PREPAID ANYWHERE IN CONTINENTAL U. S. A.

CASH WITH ORDER

24 V. quilted electric Bomb-Sight heating pad, 5 ft. cord, twist-lock connector, thermostat, 20" zipper, No. HP 10, **\$1.49** only.....

WRITE FOR LIST OF OTHER WAR SURPLUS VALUES

**WARSHAWSKY & LAZAR**  
2126 S. Michigan, Chicago 16

## Trap to Catch Minnows for Bait Collapses Into Flat Disk

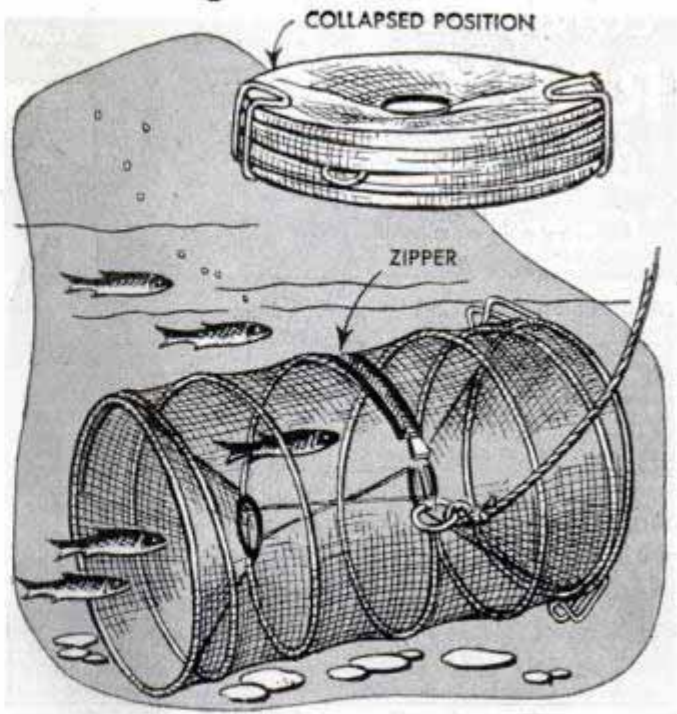

Minnow traps that collapse into flat disks save space on fishing trips. The trap's frame is a wire bent in a spiral to form a large spring. The net is fastened around the frame with a funnel-shaped opening at each end. When the trap is collapsed, two hooks hold the ends together. When the trap is to be used, the hooks are released and the spring action of the wire frame snaps it into shape. A slide fastener that runs halfway around the center provides an opening for baiting the trap and removing the minnows. The trap is suspended in the water by a cord fastened to a ring in the center of the frame.

## Heavier Machine Gun for Planes Is One of Navy's Late Weapons

Machine guns of .70 caliber are listed among improved weapons recently announced by the Navy. They will replace .50-caliber armament on Navy planes. The heavier guns will be radar controlled, firing bullets 3/4 inch in diameter. Another new Navy weapon is an automatic three-inch antiaircraft cannon that will replace the present twin-mounted 40-millimeter Bofors gun. The cannon will fire proximity-fused shells nearly double the caliber and five times the weight of Bofors projectiles. An automatic ramp that launches 40 five-inch rockets a minute has also been perfected. The rate of fire of a heavy cruiser's eight-inch guns will soon be boosted by a completely automatic loading mechanism that will replace the present mechanism, which is operated partly by hand.



# Proves Wonderful For Itching Skin!



## Also Aids Healing

Here's a Doctor's anti-septic formula — Zemo — a stainless liquid which is invisible on skin — yet so soothing and highly medicated that first applications promptly relieve itching, burning of Eczema, Psoriasis and similar skin and scalp irritations due to external cause. Zemo ALSO aids healing.

Apply clean, stainless invisible Zemo at any time. It won't show on skin. In 3 sizes. For severe cases ask for super Extra Strength Zemo.

# ZEMO

500,000!!!!

# LENSES

Send 3 cent stamp for "BARGAIN" list.

**A. JAEGER'S**

BOX 84P

SO. OZONE PARK 20, N. Y.



## "LITTLE WONDER" Crystal Radio

NO ELECTRIC—NO BATTERIES—NO TUBES

One of the smallest genuine crystal radio sets in the world. Slider-contact tuning, binding posts for aerial and ground. Extra long range. SEND NO MONEY. Just send your name and address and when your "Little Wonder" arrives simply pay the postman \$1.99 plus a few cents postage. Sent prepaid if you enclose check or money order with your order.

MART DISTRIBUTORS, Dept. MP-2, P.O. Box 6, Evanston, Ill.

## B-M MOWERS

NOW AVAILABLE! Newest type, three-wheel, whirling blade mower.

The perfect answer to grass and weed cutting problems. Choose from two models of assembled mowers (with motors) or build-it-yourself kit of parts.

Write for literature. B-M MOWER COMPANY, Box 66, Blue Mound, Kansas



## WANTED

### DISTRICT PURCHASING AGENTS

No experience or money required. Exceptional opportunity for those who want to establish themselves in a steady, year 'round, well paying business.

For details: Write

### PURCHASING MANAGER, DEPT. C

2719 LAWRENCE AVE.

CHICAGO 25, ILL.

## HOW TO CUT RAFTERS

New vest pocket book gives lengths, side cuts, Plumb cuts. Deductions. For all rafters for any building from one inch to forty feet wide. Gives numbers to cut on square. Also degrees for same cuts for Radial Saws. All standard pitches from 1/8 to 3/4. Just open book to pitch page and there are your lengths, side cuts, etc. Anyone who knows what a jack rafter is can frame a roof if he has this great book. Price one dollar prepaid. BUILDERS' TOPICS, Dept. M, Lock Box 828, Seattle, Washington. Original teachers of the square in five easy lessons by mail. SEND FOR FREE LIST OF TECHNICAL BOOKS. Learn to read blueprints etc.

FEBRUARY 1947

## A PENNY BUYS



Go places for pennies . . . with a Whizzer Motor on your bike! This sturdy, modern motor fits any balloon tire bike . . . takes you 125 miles per gallon, at speeds up to 35 m.p.h. It's America's thriftiest power transportation, engineered for years of trouble-free performance! Get in the Whizzer Parade!

## A 6-MILE RIDE

RIDE ONE AND YOU'LL BUY ONE!



ONLY \$97.55 PLUS TAX

FACTORY PRICE

# ON A WHIZZER

Whizzer Motor Company, Dept. 522, Pontiac, Michigan. Enclose \$99.97, which includes \$2.42 Federal Excise Tax ( ) check or ( ) money order. Send me one Whizzer Motor complete, ready for installation. If descriptive literature only is desired, check here ( ).

Name \_\_\_\_\_ City \_\_\_\_\_

Street \_\_\_\_\_ State \_\_\_\_\_

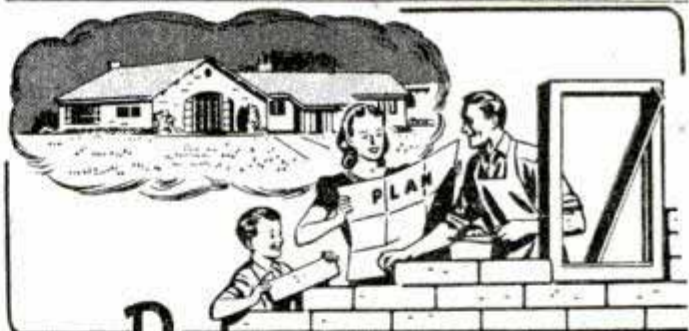

# Build it Yourself

Send for booklet showing how to make your own bricks of Cemadobe and build an attractive low cost home yourself. Amazing discovery in soil stabilization. Bricks of earth and cement. Attractive; heat and cold resisting. Easy to make. A Godsend to anyone who needs a home. Now being used by hundreds of satisfied home builders. Acceptable to loan agencies. Complete instructions in attractive, easy-to-understand booklet entitled "Cemadobe". 50 illustrations and 40 chapters. Money back guarantee of satisfaction. Send \$1.00 to Cem-Adobe Company, Box 81, Dept. PM-27, West Los Angeles Station, Los Angeles 25, California.

SAY YOU SAW IT IN POPULAR MECHANICS



# MILL IT ON YOUR LATHE



## WITH A PALMGREN

### MILLING ATTACHMENT



No. 250

#### IMMEDIATE DELIVERY

No.	Width Jaws	Depth Jaws	Jaws Open	Weight Pounds	Base Opening	Price F. O. B. Factory
150	1 1/2"	1"	1 1/2"	6 1/2	1"	\$18.75
250	2 1/2"	1 1/4"	2 1/4"	11	1 1/2"	24.75
400	4"	1 1/2"	4"	25	2"	39.75

Order from your dealer or jobber. Write for circular No. 349

#### JUST A FEW OPERATIONS YOU CAN DO ON YOUR LATHE!

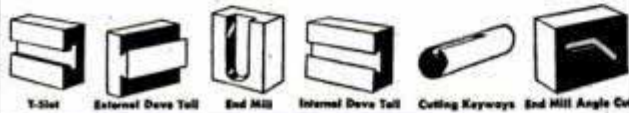

## CHICAGO TOOL AND ENGINEERING CO.

Mfrs. of PALMGREN PRODUCTS for Over 28 Years

8365 South Chicago Avenue • Chicago 17, Illinois

## Extra Special BARGAIN MEN'S Wrist Watch

### Year's Greatest Value!

Here at last is that watch you have been waiting for! Now you can fulfill your desire to own a fine imported SWISS WRIST WATCH. The exact watch you've been wanting at a price you can afford to pay. Our direct-to-you, no-middle-man, mail order plan, makes this low price possible. We import our own watches direct from Switzerland and only have a limited number available to offer.

SEND NO MONEY ORDER NOW!

Never mind paying now. Upon delivery, pay postman only \$8.49 plus 85c Fed. Tax and C.O.D. charges, or send \$9.34 (tax included) with order and we pay postage. WRITTEN GUARANTEE WITH EVERY WATCH. If not delighted, return within 10 days for refund, providing watch has not been tampered with. Hurry—order now—supply limited!

#### Style!

1947 Streamlined Model. Genuine Imported Swiss movement—All with Sweep second hands—Ideal for professional use—Smart—easy to read—dial. Chrome plated. Unbreakable crystal. Complete with leather band.



Written Guarantee with every watch

Limited Special Price

**\$8.49**

Plus 10% FED. TAX

RUSH!

A fortunate purchase makes this amazing offer possible. They won't last long at this sensational low price. We urge you to order now while the supply lasts. Prices are going up, up and up every day—order now—this offer is made only for quick action sales!

## AMERICAN MERCHANDISING CO., Inc.

Dept. PM W-48 12 Adams Avenue Montgomery 4, Alabama

## Weight Shift on Platform Causes Scooter to Turn



By shifting weight on the platform, a youngster can cause a four-wheel scooter to bank and turn. Shifting weight to the left causes the scooter to turn left and reversing the weight shift causes it to turn right. An upright handle is moved right or left as the turn is made.

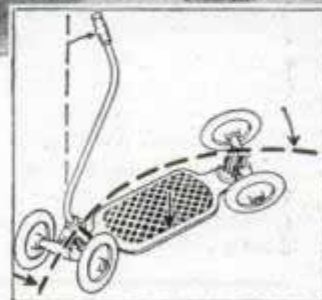

## Metallic Window Glass Glazer Replaces Putty

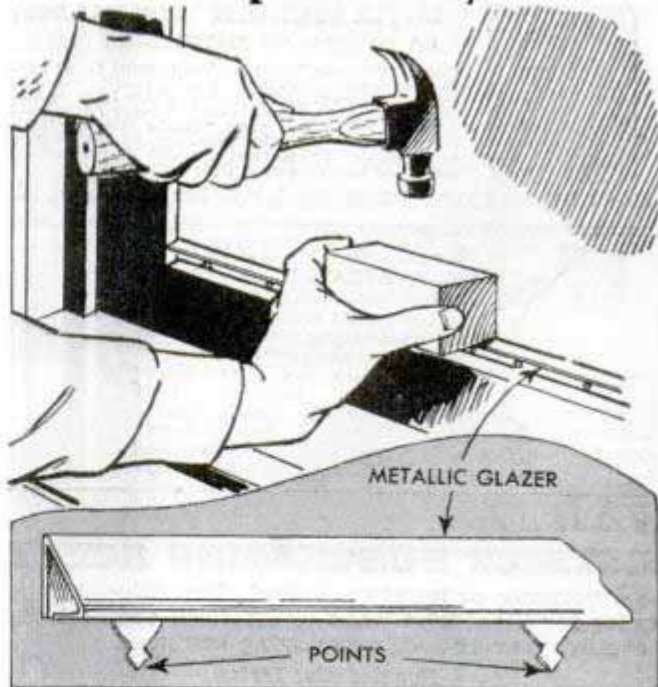

Loose window glass resulting from the drying and cracking of putty used as a glazing material is prevented by a permanent metallic glazer. If the glass is broken the metallic glazer can be removed and used again. Waterproof, it protects the sash from rotting. It is made of rust-resistant iron with a copper base.



## Handy Mail Order List

Little Library of Useful INFORMATION

5 for \$1.00  
12 for \$2.00  
25¢ Each

Here at amazingly low cost is the practical help and information you have always wanted. Articles in previous issues of Popular Mechanics have been classified according to subject and are now available in these handy reprint booklets.

- How to Use Measuring Tools—Micrometers, Calipers, etc.—106.
- Power Driven Saws—74.
- Drill Presses, Grinders, Etc.—79.
- Wood, Metal Turning Lathes—81.
- Filing Machine, Hacksaw, Cutoff Wheel, Shaper—82.
- Lathe Tools You Can Make—101.
- Workbenches—Tool Cabinets—47.
- Spray Painting—94.
- From Pattern to Casting—91.
- Tool and Saw Sharpening—92.
- Sharpening Drills, Wood Bits—90.
- Successful Wood Turning—32.
- How to Read Blueprint—71.
- Metal Turning Lathe, Kinks—99.
- Operating a Metal Lathe—100.
- Heat Treating, Hardening—102.
- Working With Glass—103.
- Servicing Elec. Motors—75.
- Electromagnets & Solenoids—44.
- Transformer Construction—41.
- The Boy Electrician—43.
- Soldering and Brazing—17.
- Arc and Spot Welders—5.
- Electroplating With Nickel, Chromium, Cadmium, Etc.—86.
- Plating Leather, Wood, etc.—87.
- Lower Your Fuel Costs—31.
- Curing Leaky Basements—45.
- Fitting Home Game Room—55.
- Indoor & Outdoor Fireplaces—88.
- Backyard Gardening—39.
- Lawn and Garden Novelties—72.
- Trellises, Pergolas, Fences—76.
- Lawn and Garden Furniture—77.
- Playground Equipment—73.
- Concrete Garden Furniture—6.
- Making Serving Trays—53.

- Knots and Ropework—105.
- Working With Plastics—61.
- Simple Home Improvements—104.
- Ridding Home of Insect Pests—107.
- Children's Room Furniture—51.
- Jigsawed Novelties—57.
- Doll House & Doll Furniture—60.
- 25 Shelves You Can Make—64.
- Novelties Turned on Lathe—62.
- Inlay Pictures—Veneering—63.
- Wood, Soap Carving—65.
- Windmills & Weathervanes—68.
- Lamps from Wood, Metal—69.
- Rustic Furniture—18.
- Wood Finishing—40.
- Boats—14 ft. Outboard—2.
- Boats—14 ft. Sail Dinghy—26.
- Boats—21 ft. Sloop—46.
- Rowboats, Small Dinghy—83.
- Small Sail Boats—84.
- Two Outboard Runabouts—85.
- Build Own Canoe, Kayak—30.
- Build Class-E Ice Yacht—22.
- Auto Kinks, Shortcuts—10.
- Building Trailers—27.
- Motor-Driven Midget Cars—34.
- Stop Auto Elect. Troubles—95.
- Photo Printers and Dryers—25.
- Photo Darkroom Equipment—96.
- Trick and Table Top Photos—97.
- Cosmetic Formulas—12.
- Poultry Houses—108.
- Guns and Decoys—109.
- Re-Silvering Mirrors—70.
- Chemical Experiments—93.
- Log Cabins, Tourist Houses—14.
- Trapping Small Animals—33.
- Farm and Garden Tractors—8.
- Building Extra Attic Rooms—23.
- Attractive Basement Rooms—24.

- Sanders—80.
- House Wiring—89.
- Treasure Finders—13.
- Hanging Wallpaper—38.
- Built-in Fixtures—78.
- Bird Houses—7.
- Magazine Racks—49.
- Clock Cases—50.

- Book Ends—52.
- Small Tables—54.
- Smoking Stands—56.
- Desks—58.
- Book Cases—59.
- Action Toys—66.
- High Flying Kites—67.
- Telescopes—20.
- Metal Craft—28.

- Small Looms—37.
- Gem Cutting—42.
- Photo Enlargers—1.
- Photo Kinks—98.
- Cleaning Formulas—11.
- Taxidermy—9.
- Magic—29.
- Training Dogs—35.
- Small Furnaces—36.

Check Titles Wanted, Clip, Mail with Remittance to

POPULAR MECHANICS PRESS, Dept. 635, 200 E. Ontario, Chicago 11

★ ★ ★

MAKE YOUR OWN  
**POWER TOOLS**  
at Low Cost  
from old Auto Parts, etc.

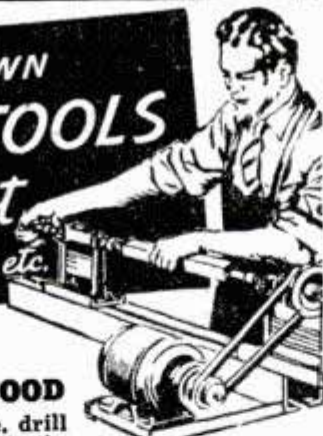

### A New Edition Featuring TOOLS of WOOD

Now you can have a good lathe, drill press, circular and band saw and other power tools in your home workshop, at a cost of only a few dollars each. Make them yourself from old auto parts, discarded sewing machines and other odds and ends that cost little or nothing. Get this new book—"Forty Power Tools You Can Make." Costs only \$1.25 postpaid. This book gives every detail in plain language you can understand and follow. Hundreds of pictures and plans show every step to follow in making the power tools you want. Actual photographs of finished machines included. Send \$1.25 today. Money back if not satisfied.

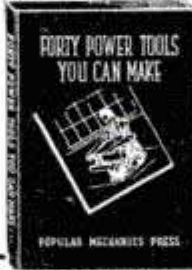

### MAKE EVERY POWER TOOL NEEDED IN YOUR HOME WORKSHOP

- |                                           |                              |
|-------------------------------------------|------------------------------|
| Some of the power tools you can make are: |                              |
| 2 Band Saws                               | 2 Drill Presses              |
| 9 Sanding Machines                        | 1 Scroll Saw                 |
| 2 Circular Saws                           | 2 Wood Turning Lathes        |
| 1 Metal Lathe                             | 3 Grinders                   |
| 1 Power Hack Saw                          | 1 Shaper or Moulding Machine |
| 1 Jig Shears                              | 1 Vibrating Pencil           |
| 1 Cut-Off Wheel                           | and others                   |

Information too, about pulleys, belts, motors and drive methods. Just published. No other book like it. Order today.

**POPULAR MECHANICS PRESS**

Dept. 621 • 200 E. Ontario Street, Chicago 11

# RATS

## K-R-O Kills 'em or Your Money Back

"With my last can of K-R-O Powder, I killed 43 rats in one night—" reports Mr. George Ripper, Lanark, Illinois, farmer. K-R-O is guaranteed to kill rats. Red squill, its active ingredient, makes K-R-O safer to use around farm animals. Economical! Two-ounce package at 75c will make 200 death-dealing baits. At most drug, feed, and seed stores. Get K-R-O today!

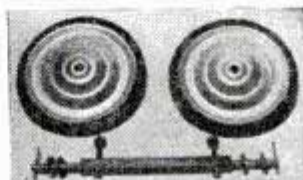

## WHEEL KITS

Two 6" wheels with 3/8" rubber tires (tested load capacity of 245 lb. per wheel). One 1/2" square axle, 18" long with ends turned down to fit the wheel, with 2 1/4" holes for screws to be bolted to the body of the vehicle.  
Complete kit with cotter pins, washers, screws, lock washers, and nuts, only \$2.50  
Two kits \$4.50  
Individual wheel \$1.00  
All prices postpaid; no C. O. D.

LEO KARTNER  
210 Centre Street  
New York 13, New York

# Now for EVERY WORK SHOP! NEW Invention Electroplates by BRUSH



## Easy to Plate CHROMIUM GOLD, SILVER, NICKEL, COPPER . . . For Pleasure and Profit!

If you have a workshop—at home or in business—you need this new Warner Electroplater. At the stroke of an electrified brush, you can electroplate models and projects—you can replate worn articles, faucets, tools, fixtures, silverware, etc. with a durable, sparkling coat of metal . . . Gold, Silver, Chromium, Nickel, Copper or Cadmium. Method is easy, simple, quick. Everything furnished—equipment complete, ready for use. By doing a bit of work for others, your machine can pay for itself within a week. So make your shop complete by getting a Warner Electroplater right away. Send today for FREE SAMPLE and illustrated literature. ACT AT ONCE! Mail Coupon.  
**WARNER ELECTRIC CO., DEPT. L-17**  
1512 Jarvis Avenue, Chicago 26, Ill.

## FREE Details & Sample!

WARNER ELECTRIC CO., 1512 Jarvis Avenue, Chicago 26, Dept. L-17  
Gentlemen: Send Free Sample and Details to:

Name \_\_\_\_\_  
Address \_\_\_\_\_  
City \_\_\_\_\_ State \_\_\_\_\_





## RUGGED! COMPACT! HANDLES BIG WORK

Thousands of owners find fun and profit with the Universal. Patented design gives you the five most useful power tools in one HEAVY fabricated-steel frame. Runs free in bronze bearings. Ideal for home or small shop.

**LATHE**—30" between centers. Face plate, spur center, tool rest included. **SANDER**—cuts fast and clean. 8-in. diam. disk takes any kind abrasive. **CIRCULAR SAW**—taking 6" to 8" blade. Arbor takes moulding cutters, scratch wheels, buffing wheels. **EMERY WHEEL**—5"—furnished. **DRILL PRESS**—pulls up to 1/2-in. drill in steel. 2" travel.

Write for literature. Shipping weight, 65 lbs. \$17.50 down, balance C. O. D. Ten day trial—prompt shipment. (Motor and saw blade not included.)

EMRICK INC., 1724H Clinton St., KALAMAZOO 24, MICH.

## PLASTICS ... At New Low Prices

Grade 1 Plexiglas — no seconds — no scraps—big full sheets. Complete instructions and cement included. Big bargains. Kit No. 22, \$3.95—Kit No. 33, \$5.70—Kit No. 55, \$9.20. Permanent dyes also available. Save money—Order your kits now. Send check or money order today. Add 10% for postage and handling. Catalog available.

JACKSON STUDIO, Dept. 2  
5440 N. Shoreland Ave., Milwaukee 11, Wis.

Free Project Sheets!

## All CARLSON RULES

have this

**10-SECOND  
BLADE CHANGE  
FEATURE**



WITHOUT OPENING THE CASE, you can quickly replace the blade. Keep a spare Replacement Blade on hand. Models in 6, 8 and 10-foot lengths. SOLD BY LEADING HARDWARE DEALERS

## Paint Thoroughly Mixed in Can With Perforated Paddle Wheel

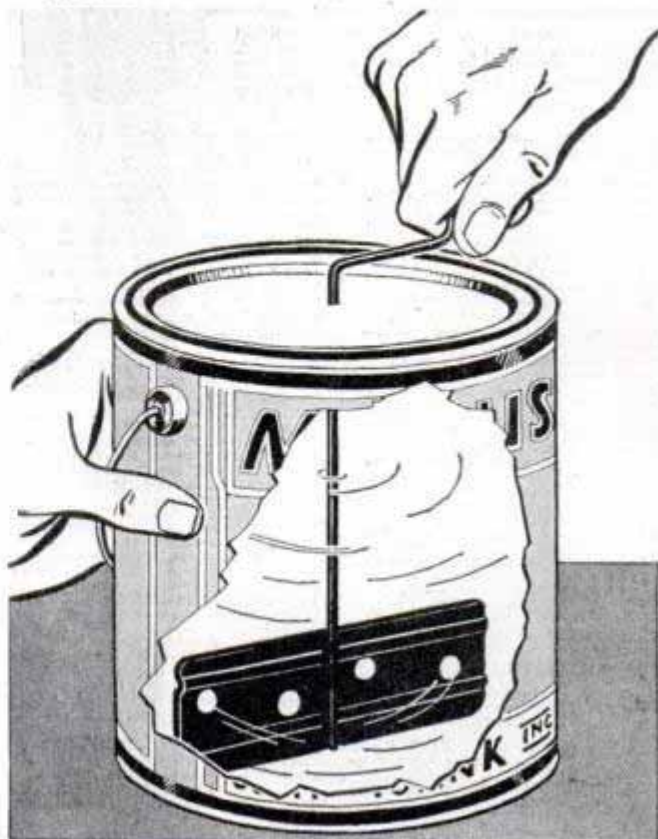

Paint is thoroughly mixed by a perforated paddle wheel turned by a handle extending through the lid of a can. The handle end is pointed for punching the lid at the center. The mixer comes in sizes for gallon or quart cans.

## Motor Supplies Fluid Power

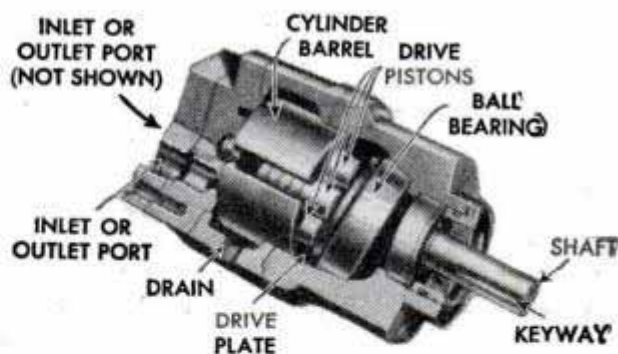

No mechanical linkages or connecting rods are used in a fluid motor designed to supply rotary power with controlled variable speeds. Available in three and five-horsepower models, the motor is the axial-piston type equipped with floating drive which maintains constant pressure between the driving pistons and the parts that turn the shaft. The motor is self-starting and it operates efficiently in either direction. When a speed control valve is added, the motor can be preset to operate at any speed within its capacity.

501 W. F. THILL BLVD  
MONTROVIA, CALIF.



**VEST POCKET SIZE!**

**WORLD'S  
LOWEST  
PRICED  
ADDING  
MACHINE**



Fits vest pocket or purse. Guaranteed Accurate. Operated as easily, and as reliable, as machines costing many times as much. NOT A TOY OR GADGET. Substantially made of 28-gauge steel — guaranteed for life against defects in construction. Beautiful looking, modernized design. Finished in Black, Silver and Red. You positively can't buy a Calculator of equal quality for as little money. **ACCEPTED AS THE FINEST LOW PRICED CALCULATOR FOR OVER 30 YEARS!** Operates with a flick of your finger. Adds, subtracts, multiplies, divides—counts up to ten million. Pays for itself over and over in mistakes avoided, and time saved.

**MAKES IDEAL GIFT** Baby Calculator makes an ideal gift for every Gift occasion. Birthday — Graduation — Christmas — Anniversaries. For men, women, children—teachers, business people, home or shop use. **COMES PACKED READY FOR GIFT WRAPPING.**

**TEN DAY TRIAL Money Back Guarantee** Because we know that our machine is the very best calculator to be obtained at this low price, we make this 10 Day Trial offer on a positive money back guarantee!! Don't buy ANY Calculator without this guarantee! Send only name and address, pay postman \$2.50 plus postage (if cash is sent, we pay postage—you save up to 40c. (If outside U. S., send \$3.00). Money back within 10 days if not delighted.

**AGENTS WANTED**

**CALCULATOR MACHINE CO. (Mfrs.)**  
DEPT. 187, P. O. Box 248 GLENVIEW, ILL.

**Free Trial** ONLY **\$2.50** TOTAL COST  
Each Baby Calculator enclosed in beautiful rich-looking Leatherette Case — at no extra cost. **SEND NO MONEY**

**USE COUPON**

**CALCULATOR MACHINE CO., (Mfrs.)**  
P.O. Box 248, Dept. 187, Glenview, Ill.  
Your Calculator is just what I've been looking for. Send one at once (C.O.D.) or (I am enclosing \$2.50).

Name.....  
Address.....  
City..... State.....

**U. S. Army RADIO PHONES**



(Water, Shock and Weather Proof) Made to U.S. Army specifications, passed by Signal Corps Inspectors. Dynamic Microphone and Dynamic Receiver of Finest Quality—Water, Shock, Weather and Altitude Proof, used on tank and aircraft (B9) intercom systems. For recording, for battery-less telephone. **TALK THROUGH YOUR RADIO SET OR USE EARPHONES FOR POCKET-SIZE SET OR LOUD SPEAKER.** Complete two receiver, cord set, head band, and dynamic hand microphone including special connecting cord set. **A REAL BARGAIN AT THIS LOW PRICE. Postpaid WHILE THEY LAST.**

ONLY **\$8.95**



**ELECTRIC SWITCH**  
VERSATILE SWITCH...MILLIONS IN POST WAR APPLICATIONS... Floodlight your porch when the door is opened... Sounds alarm when window is opened... Signals arrival of mail... Controls heating of furnace... Filling of water tank... these and many other services are performed by this **VERSATILE SWITCH.** Shipped with instruction sheet showing numerous illustrated uses. **EXCEPTIONAL LOW PRICE.**

ONLY **\$1.00**  
Postpaid

**SATILE SWITCH. GET YOURS NOW.**  
**KING PRODUCTS CO., Dept. P-4, BATAVIA, ILL.**

**WINNERS ALL... BASS OUTDOOR FOOTWEAR**



**WEEJUNS**  
FOR  
LEISURE  
COMFORT



**QUAL HUNTERS**  
FOR  
FIELD AND  
STREAM



**SKI BOOTS**  
FOR  
SMOOTHER  
SKIING



**SPORTOCASINS**  
THE  
GOLFERS' DELIGHT  
**G. H. BASS & CO.**  
60 MAIN STREET  
WILTON, MAINE

**Now You Can - GET THOSE NEEDED AUTO PARTS and SAVE MONEY**

Make the old car run longer and faster with **REBUILT UNITS** and **NEW PARTS.** We are specialists in Rebuilding used **UNITS** to work **Good As New.** Our experts turn out only the highest quality work. All parts thoroughly degreased and rebuilt with precision for perfect performance. Our workmanship **ABSOLUTELY GUARANTEED.** Due to the tremendous volume of business we handle you will find our **PRICES THE LOWEST.** We Ship Anywhere in the U.S.A.—**Get Our Prices.**

- **AUTO PARTS REBUILDERS**
- **REBUILT UNITS EXCHANGED**

All rebuilt units are sold on an exchange basis. You simply ship us your unit and we will **PROMPTLY** ship you a **REBUILT UNIT** plus a nominal charge. Or we will rebuild your unit... Put it in **FIRST CLASS CONDITION** and return it to you **C.O.D.** All Exchanged Units Shipped the Same Day received.

**LOCAL AGENTS WANTED EVERYWHERE**

**MECHANICS AUTO PARTS, 3807-11 No. Ashland Ave., Dept. PM, CHICAGO 13, ILL.**

**Just to Get Acquainted GET YOURS TODAY**

**6 Piece IGNITION TOOL SET \$1**  
**4 OPEN END WRENCHES (4 sizes) ONLY**  
**1 ADJUSTABLE PAIR PLIERS Postpaid**  
**1 Top Quality POINT FILE**

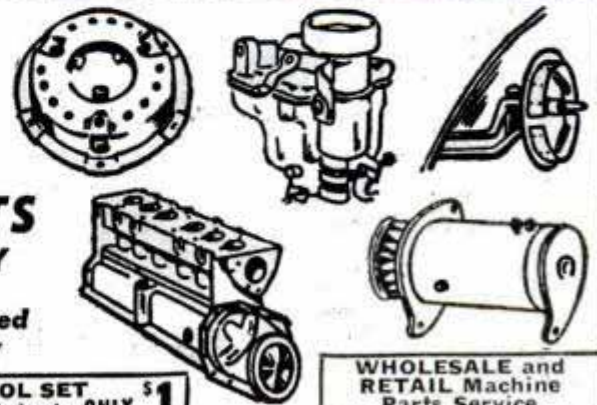

**WHOLESALE and RETAIL Machine Parts Service**

• **ESTABLISHED 1920** •



# FOR CARE-FREE NIGHT DRIVING

## Get TRAV-A-LITE

The Modern Automobile TROUBLE LIGHT

Fits any auto cigar lighter socket. 12 ft. cord reaches all parts of car. Brilliant 18 C. P. light.



Rubber suction cup permits hanging any place on car.

Instant light for all night driving emergencies.

PRICE

**\$2.49**

Post Paid Remit with order

NOTE: For cars, trucks and tractors not equipped with cigar lighter, we have an adapter available at 5c. Please specify if adapter is needed.

INTERCONTINENTAL INDUSTRIES, INC.  
FAIRBANKS-MORSE BLDG.  
CHICAGO 5, ILL.

## ARMY RADIO PHONES

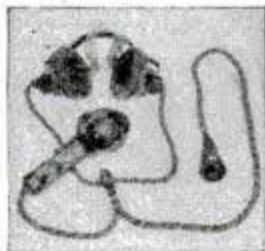

They're Weather - Water and Shock Proof

When we say they are made to Army specifications, that's enough assurance they must be of best quality. These Army Radio Phones are perfect and were O.K.'d by Signal Corps Inspectors. These Dynamic Mikes and Receivers, were used on aircraft and tank inter communication systems. Use them for recording, for battery-less phone, for pocket size set loud speaker or talk through your radio set. We bought a good many of these Radio Phones, they are brand new, and cost a great deal more than you can get them for. A complete dynamic hand mike, 2 earphones, headband, cord set. A wonderful buy for only... **\$3.45**

Send check or Money Order. FOB warehouse

**LEEDS RADIO CO.**

75 Vesey St. Dept. MP New York City 7

## GUM GRIPPER

### Tightens FALSE TEETH or NO COST



Lasts from 3 to 6 Months!

New discovery makes loose dental plates fit snug and comfortable for months—almost like having your own teeth again. For uppers and lowers, **Easy to Apply at Home**... Simply squeeze some "GUM GRIPPER" evenly on your denture, put plate in your mouth where it sets and hardens in few minutes. No heat—no fuss—no muss. Will not harm any denture.

**SEND NO MONEY...**

Order a tube today, for only \$1.00 (deposit with your own postman). Each application of "GUM GRIPPER" guaranteed to last from 3 to 6 months and delight you completely or your money will be cheerfully refunded.

**GUM GRIPPER, INC.**  
127 N. Dearborn St., Dept. 71P, Chicago 2, Ill.

## New Glider-Kite TOWS AUTO OR LIFTS LIGHT PERSON

LIFTING WING AREA EQUAL TO SMALL PLANE

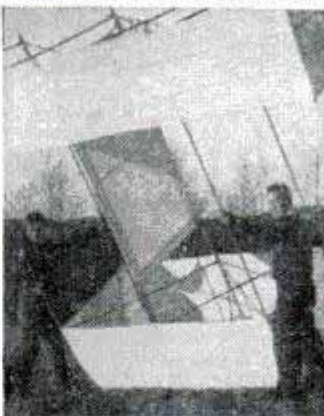

Cost Government \$108  
Yours for \$34.50

Not a toy for youngsters. Men with scientific or aeronautical turn of mind get thrill of lifetime with this genuine Barrage Glider-Kite. A "natural" for sky advertising. Took 12 years to perfect. Hundreds used during war to shield convoys. 134 sq. ft. special aircraft fabric. 10' long x 14' wide double wing and tail. Gives enough pull to move car on level ground. Act quick if you mean business. Cost Government \$108. You send only \$34.50 and we ship F.O.B. complete with spare parts and repair material. Ready made. Assembles easily in 15 minutes. Dismantle in 5 minutes. Or send \$10 and we ship C.O.D. for balance. Write Great Northern Kite Mart, Dept. PM, North Adams, Mass. (Dealers letterhead inquiries invited.)

## PLYWOOD

Beautiful cabinet and paneling stock. Perfect for many projects, and for general construction and cabinet work. Thicknesses 1/32" through 3/4"; panels 6" x 6" through 48" x 96". Birch, Gum, Oak, Mahogany, Walnut, Maple, Basswood. Send 10 cents today for complete Plywood Catalog.

**Carmen-Bronson Corporation**

165 East 3rd Street, Dept. 2-B, Mount Vernon, N. Y.

## Blow Sawdust Away From Your Circular Saw

Comet Saw Fan whisks sawdust out of chute. Keeps sawdust off table top, operator. Improves vision, safety. Quickly attaches to 8" and 10" circular saw with 5/8" arbor. **SEND NO MONEY!** Send only name, address. Pay postman \$1 plus C.O.D. Or, save C.O.D. by sending \$1 with order. Money back Guar. **SCHARF MFG. CO., 4626 Dodge, Omaha, Nebr.**

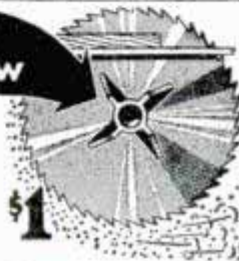

## BABY FEEDER SET

The Baby Feeder Set every parent wants. Patent feature permits liquid to flow from cup only as baby drinks. Prevents "Dribbling" from corners of mouth. Teaches baby to drink at moderate speed. If accidentally tipped over, only a few drops will be spilled before the cup can be righted. Saves feed. Sanitary. Order one or more sets @ **\$1.95 each. SEND ONLY \$1.00.** We ship COD for Bal. & Postage.



F. A. PRIEBE P. O. BOX 90 KEARNEY, NEBR.

## LAW

STUDY AT HOME for PERSONAL SUCCESS and LARGER EARNINGS. 38 years expert instruction—over 108,000 students enrolled. LL. B. Degree awarded. All texts furnished. Easy payments. Send for FREE BOOK—"Law and Executive Guidance."

**AMERICAN EXTENSION SCHOOL OF LAW**  
Dept. 74-M, 646 N. Michigan Ave., Chicago 11, Ill.

## Say you saw it in POPULAR MECHANICS

Beautiful Modern SIGN LETTERS  
Signs anywhere, quickly, easily... Write for money making-saving plan... Samples  
**PINNACLE SIGN LETTERS, Mound City, Ill.**

## BRONZE BUSHING STOCK

Cast in solid and cored bars 12 inches long  
WRITE FOR LIST OF SIZES AND PRICES  
**SALEM BRASS FOUNDRY, 3220 State St., Salem, Oregon**

## Stromberg WINTER LAYERS

**DARK CORNISH.** Breeders are U. S. AP-PROVED PULLORUM TESTED. Specializing in Large Type, Pedigreed Sired WHITE LEG-HORNS and High Production WHITE ROCKS. 26 leading varieties & crosses. Also START-ED CHICKS & Ducklings. FREE CATALOG. Stromberg Hatchery, Dept. 813, Ft. Dodge, Iowa



## Big Profit AUSTRA-WHITES

Sensational MONEY MAKING HYBRID. Customers report broilers 8 weeks, laying 4 1-2 mos. Disease resistant. **Hardy Layers.** 60,000 chicks weekly. Started pullets. Profit Sharing Plan. FREE Book. Write today. **BERRY BROS. FARMS, Box 582, ATCHISON, KANS.**



**HAND MICROPHONE**



Top quality hand microphone with control button in handle. Highly sensitive. Has rubber covered cord and tel. plug. Fine for use on home recorders, public address systems, etc. Brand new—perfect. Shp. wgt. 2 lbs. Stock No. 170. Each... **\$1.95**

**Shatterproof Goggles**



All purpose type. Sponge rubber frame. Red shatterproof flexible lens. Adj. head band. With case. New. Wgt. 1 lb. No. 139—Each... **39c**

# WAR SURPLUS AND HUNDREDS OF OTHER BARGAINS

**LEVEL WIND ANTI BACK LASH REEL**

Highest quality with chrome plated frame. 3 piece take down design. 4x gears. Bronzed bearings and jeweled spool caps. Spool diameter 1 1/2 ins.; pillar lengths 1 1/2 ins. Capacity 100 yard line. Onyx head ring. Shp. wgt. 1 lb. No. 450F—Each only... **\$8.55**



**RAIN SUITS**

New 2 piece rain suits. Of durable wear resistant, repelling water and wind repellent OD fabric. Bib style pants, zipper fly. Jacket has parka attached. Guaranteed 100% weatherproof. Small, medium and large sizes. Shp. wgt. 3 lbs. No. R549. Ea. **\$4.95**



**TELE-SCOPING BAIT AND FLY ROD**

Combination 4 piece telescoping bait and fly casting rod. Screw locking reel seat. Cork grip. Snake guides. Extends to 9 feet, telescopes to 38 inches. Shp. wgt. 1 lb. No. F411—Each... **\$3.65**

**BAYONET BLADE**

Fine forged steel. Ground but not polished. May be made into throwing or hunting knife or spear. Blade 6 3/4 x 7/8 inches, 1 1/4 inches overall. Will take and hold a fine edge. Shp. wgt. 1 lb. No. 664-R—Each... **49c**

**7 LB. EXPERIMENTER PARTS ASSORT. KIT**



A "gold mine" for the radio serviceman. Hundreds of valuable radio parts, new radar and electronic parts and subassemblies, coils, resistors, trimming condensers—worth many times this low price. A130R—7 lbs... **\$1.79**

**U.S. Govt. BOLO KNIFE**



Extra heavy. For farm, home or jungle use. Blade of Gov't. formula cutlery steel. Walnut riveted handle. 3 1/2 inch hilt. 10 1/2 inch blade. You'll find hundreds of uses for a Bolo knife. Blade will take and hold a keen cutting edge. Wt. 2 lbs. A112—with Army Sheath... **\$4.95**

**POPULAR RECORD ASSORTMENT**



Fifty records of modern dance, race, blues and hillbilly selections. No two alike. Famous name bands and artists included. Used in juke boxes, but guar. perfect. Shipped exp. collect only—no exchanges or refunds. Wgt. 28 lbs. No. A303—50 records... **\$9.64**

**PROF. TELEGRAPH KEY**

Purchased from the gov't. Finest design and construction. Base measures 3 x 4 1/4 inches. Original value \$2.50. All parts of instrument brass. Adjustable. A-147. **98c**



**No. A300—25 records. All Dance. Wgt. 14 lbs. \$4.88**

**No. A301—25 Records. Hillbilly, Race and Blues. Wgt. 14 lbs. Set. \$4.88**

**No. 302—25 Records. All Hillbilly numbers. Wgt. 14 lbs. Set. \$4.88**

**SATCHEL POUCH**

Heavy canvas pouch. Ideal for touring lunches, shopping, books, etc. Has three 1 1/2 inch pockets. Brand new, guaranteed perfect. Has over-size flap with single strap fasteners. A113—EACH... **\$1.69**



**2 Man Mountain Tent**

Regulation Army type two man mountain tent, complete with poles, guy ropes, etc. Of durable nylon with reinforced seams. Ideal for outdoorsmen, campers, etc. Shp. wgt. 10 lbs. A splendid value. Stock No. 202—Each... **\$9.95**



**6x30 PRISM BINOCULARS**

Bausch & Lomb make. Prism type individual eye focus. With leather case. Power 6x30. Used but perfect. \$100 value. Wgt. 5 lbs. No. 503 — Price \$37.50 plus \$7.50 tax. Total... **\$45.00**



**BOMB PARACHUTE**

Of white nylon 5x8 feet in diameter. Split seam for directional dropping of bombs, emergency rations, etc. Each packed in a metal container. Material alone worth more than price quoted. Wgt. 6 lbs. No. 162. Each... **\$1.95**



**PUP TENTS**

Regulation Army Pup Tents of durable, brown canvas. Used, but in good condition. Fine for campers, outdoorsmen, boy scouts, etc. Grand Xmas gift for children. Wgt. 8 lbs. A1—Tent only... **\$3.95**  
A110—Tent, new... **\$7.95**  
A101—Ropes, wooden poles and stakes for above. Per set **\$1.00**



**RADIO HEAD-PHONES**

Extremely sensitive with 4000 ohms resistance. Brand new and fully guaranteed. With moisture-proof cord and phone plug. A splendid value for the radio serviceman and experimenter. A106—PAIR... **\$2.95**  
A108—Pair... **\$5.95**



**Plastic 8 oz. Flask**

For hunters, scouts, fishermen. Waterproof and transparent. Use it for liquids. Use it for matches, flies, bait, etc. Has screw cap top for liquids, plus full open top. Size 5 1/2 x 4 1/2 x 1 1/2 ins. Has hundreds of other uses. Wgt. 1 lb. No. A347. Each... **29c**



**OXYGEN TANKS**

A shatterproof, welded seam oxygen tank. Fits gauge listed above. Measures 5 1/2 x 8 in. Internal volume 104 cu. in. Square inch pressure 1.4 cu. ft. Has 3/8 inch pipe thread vent. Shp. wgt. 2 lbs. No. 537. **49c**  
Each... **\$1.41**  
Same as above but 6x1 1/2 inches. Internal volume 280 cu. in. Takes pressure up to 3.8 cu. feet. Shp. wgt. 5 lbs. No. 538—Each... **\$2.00**



**WOOL SLEEPING BAG**

G.I. type 100% wool with 30 inch Talon zipper. Used but renovated for reuse. Shp. wgt. 3 lbs. No. 165. Each... **\$3.95**



**MESS KITS**

Regulation two-piece Army Mess Kits with folding handle. Used, but perfect. Weight 2 lbs. No. A116—Ea. **69c**



**CANTEENS**

Reg. U. S. issue canteens. Plastic screw top chained to body. Slightly used but perfect. Wgt. 1 lb. 117—Metal **69c**  
118—Plastic—Ea. **69c**



**CANTEEN CUPS**

All metal. Folding handle. Wgt. 1 lb. No. A120—Each... **25c**

**CANTEEN COVERS**

Heavy canvas. Button fastener. New No. 530—Each... **69c**  
Used No. 119—Each... **35c**



Of fine heavy khaki. Big roomy pockets with snap button fasteners. Fine for hunters, campers, boy scouts, etc., also for shop work in carrying small parts, etc. Material alone is worth this price. Shp. wt. 1 lb. 11 Pocket Type No. 49c  
5 Pocket Type No. 110 Each... **79c**

**Wool Blanket**

Full size and 100% wool. Used but renovated for reuse. Use for camping, etc. Shp. wgt. 3 lbs. No. 233—Each... **\$4.89**



**LIFE PRESERVER BELTS**

Right from the invasion beaches. Consists of two air chambers. May be inflated automatically with "sparklet" cartridges or manually by attached hose. Adjustable in waist size. One air chamber guaranteed air tight—other may need a tire patch. All belts are used and slightly soiled but a bargain at this low price. No. 1261—Each... **\$1.00**



**SPARKLET CARTRIDGES**

May be used with above belts. In boxes of 10. Stock No. 254. **50c**

**ORDER DIRECT FROM THIS AD**

Values galore! Hundreds of hard-to-find items for home, shop and outdoors. Make remittances by money-order, bank draft or personal check. Send 25% deposit on C.O.D. orders. No C.O.D.'s on orders for less than \$5.00. Include sufficient postage on parcel-post orders—any overage will be promptly refunded. All quotations F.O.B. Chicago. Used items and materials are guaranteed serviceable and as described. Your money back if not more than satisfied.

**Big Illustrated Catalog Free**

**STARK'S** Dept. PM247  
509 So. State St.  
CHICAGO 5, ILL.

**BRONSON FISHING REEL**



New! Level winding, 100 yd. capacity. Quadruple multiplying. Bright nickel finish. New improved click. Shipping wgt. 8 ozs. No. F1133 Each... **\$2.35**

**WIRE PLIER**



Genuine Bernard 6 1/2 inch wire cutting plier. Parallel opening jaws. Reg. \$3.00 value. Wgt. 1 lb. No. 168—Each... **\$1.29**



102 Booklets filled with Money and Time-Saving Helps

# Little Library of Useful INFORMATION

Here at amazingly low cost is the practical help and information you have always wanted. Articles in previous issues of Popular Mechanics have been classified according to subject and are now available in these handy reprint booklets. Check Titles wanted, clip ad and mail today.

## BOOKLETS ON WORKSHOP EQUIPMENT

**Power-Driven Saws—74:** Complete details on scrollsaw, two circular saws, sliding cut-off saw, bandsaw.  
**Drill Presses, Plane, Grinders—79.**  
**Sanders—80:** Complete constructional details on 8 useful machines.  
**Wood & Metal-Turning Lathes—81:** Two wood lathes, small metal-turning lathe.  
**Filing Machine, Hacksaw, Cutoff Wheel, Shaper—82.**  
**Metal Lathe Tools You Can Make—101.**  
**Workbenches & Tool Cabinets—47.**  
**Spray Painting—94:** Constructing spray guns, compressor, using spray gun.  
**From Pattern to Casting—91:** How to make your own patterns and small castings.

## BOOKLETS ON SHARPENING—USING TOOLS

**Correct Measurement—106:** How to use micrometers, gauges, calipers, etc.  
**Tool and Saw Sharpening—92.**  
**Using & Sharpening Drills & Wood Bits—90.**  
**Successful Wood Turning—32:** All the information you need to master this art.  
**How to Read Blueprints—71:** Tells you how to understand signs, symbols, and lines.  
**Metal Turning Lathe Kinks—99:** Simple homemade tools, time and labor-saving shortcuts you can use.  
**Operating a Metal Turning Lathe—100.**  
**Heat Treating & Case Hardening—102.**  
**Working with Glass—103:** Cutting, drilling, etching, blowing.

## ELECTRICAL BOOKLETS

**Rewinding & Servicing Electric Motors—75:** Repairing and rewinding a.c. and d.c. motors. Locating trouble. Converting auto generators into 110 v. a. c. motors.  
**House Wiring—89:** All the information you need to do a complete wiring job or install extra outlets.  
**Electromagnets & Solenoids—44:** Designing and building.  
**Transformer Construction—41:** Easy-to-understand instructions for all kinds of transformers.  
**The Boy Electrician—43:** Easy-to-build motors, experiments.  
**Soldering & Brazing—17.**  
**Arc & Spot Welders—5:** Building and operating 110 v. a. c. arc and spot welders.  
**Treasure Finders—13:** Build your own treasure finder and metal locator. Details for both large and small radio types.

## ELECTROPLATING BOOKLETS

**Electroplating with Copper, Nickel, Chromium, Lead, Zinc, Cadmium—86.**  
**Plating Leather & Other Non-Metallic Objects—Plating with Gold, Silver, Alloys—87.**

## HOME IMPROVEMENT BOOKLETS

**Simple Home Improvements—104:** Modernizing; making storm sash, ironing boards, etc.  
**Building Extra Rooms in Attic—23.**  
**Attractive Basement Playrooms—24.**  
**Lower Your Fuel Cost—31:** Practical kinks that will save you hundreds of dollars.  
**Hanging Wallpaper—38:** Tricks of hanging wallpaper, removing old paper, etc.  
**Curing Leaky Basements—45.**  
**Fitting Home Game Room—55:** Construct own game & tennis tables, shuffleboard court, action game, portable playrooms.

**Ridding the Home of Insect Pests—107:** Exterminating and protecting against moths, flies, termites, mosquitoes, etc.  
**Built-in Fixtures—78:** Step and space-saving kitchen units, built-in beds, corner cabinets, vanities, linen chest.  
**Constructing Indoor & Outdoor Fireplaces—88:** Stone fireplaces, portable mantels, garden fireplaces.

## GARDENING BOOKLETS

**Backyard Gardening—39:** Selecting, planning and getting the best results.  
**Lawn & Garden Novelties—72:** Jig-sawed ornaments, parkway numbers, sundials, flower boxes.  
**Trellises, Pergolas, Fences—76.**  
**Lawn & Garden Furniture—77:** Modern bent-tube furniture, arbor and seat combinations, swings, lawn chairs.  
**Playground Equipment—73:** Two playhouses, ferris wheel, roller coaster, treadmill, play store, slide, two merry-go-rounds.  
**Colored Concrete Garden Furniture—6:** Garden benches, pottery, flower boxes, bird baths and sundial pedestals in colored concrete. How to build small concrete mixer.  
**Bird Houses—7:** Easy to build homes for all kinds of birds.  
**Farm & Garden Tractors—8:** Two tractors you can build from old automobile parts.

## CRAFT WORK—HOBBY BOOKLETS

Complete how-to-make-it instructions for hundreds of practical projects.

**Working with Plastics—61:** Using brilliantly-colored plastics in craftwork.  
**Magazine Racks—49:** Ten attractive racks.  
**Clock Cases—50:** Large Hall, Colonial wall and mantel, ship's wheel, miniature grandfather, desk, Spanish style banjo.  
**Serving Trays for Every Occasion—53:** Fourteen different designs.  
**Children's Room Furniture—51:** Twelve attractive pieces.  
**Book Ends—52:** Ten designs offer good selection.  
**Small Tables—54:** Modern and colonial styling.  
**Smoking Stands—56:** Seven designs given.  
**Jigsawed Novelties—57:** Sewing kits, string holders, place-card holders, plywood kitchenware, plant and flower holders, coin banks, door stops, drawer pulls.  
**Desks—58:** Colonial writing desk, two modern-type desks, student's study desk of plywood, combined chest and writing desk.  
**Book Cases—59:** Eight designs.  
**Doll House & Doll Furniture—60.**  
**25 Shelves You Can Make—64.**  
**Novelties Turned on Lathe—62.**  
**Inlay Pictures—Veneering—63.**  
**Whittling and Wood & Soap Carving—65.**  
**Action Toys—66:** 21 easy-to-make toys.  
**High Flying Kites—67.**  
**Windmills & Weathervanes—68.**  
**Lamps in Wood, Metal, Plastic—69:** Selection of 14 designs.  
**Metal Craft—28:** Brass tapping and making of novelties both decorative and useful.  
**Small Looms—37:** Building hand looms for weaving rugs, etc.; leather novelties.  
**Plain & Novelty Wood Finishing—40.**  
**Gem Cutting—42:** How to cut and polish semi-precious stones.  
**Rustic Furniture—18:** How to build chairs, benches, tables, gates, summer house, etc.

5 for \$1.00  
 12 for \$2.00  
 25¢ Each

## BOAT BUILDING BOOKLETS

Build a boat at home—you can do it

**14 Ft. Outboard Runabout—2:** Here is a fast 14 foot V-bottom boat. Suitable for motors of 4 to 24 hp., estimated cost, \$30 to \$40.  
**14 Ft. Sailing Dinghy—26:** This 14-foot boat combines strength and light weight. It carries 140 sq. ft. of canvas and weighs about 350 pounds. Actual photographs and diagrams illustrate every detail.  
**21 Ft. Sloop—46:** Every fact needed by the amateur boat builder to construct this craft which carries eight to ten persons.  
**Rowboats, Bicycle Boat, Small Dinghy—83:** All the information you need to construct four low-cost boats.  
**Small Sail Boats—84:** 12-ft. sailing dinghy, 6-ft. "training ship" for young sailors, how to sail a boat.  
**Two Outboard Runabouts—85:** 14-Ft. family outboard weighs about 400 lbs. and 12-ft. plywood outboard weighs about 110 lbs. Both are V-bottom type.  
**Build Your Own Canoe, Kayak, Surfboard—30:** Complete details on 16-ft. Canadian-type canoe, 17-ft. kayak, and 12-ft. hollow surfboard.  
**Fast Class-E Ice Yacht—22:** Build your own Class-E ice yacht. Every detail of construction carefully explained.

## AUTOMOBILE BOOKLETS

**Automobile Kinks and Shortcuts—10:** Money-saving hints on upkeep, operation.  
**Building Trailers—27:** Small Streamlined house trailer; several utility trailers.  
**Motor-Driven Midget Car & Scooter—34:** Both use gas engine of washing machine type.  
**Curing Auto Electrical Troubles—95.**

## PHOTOGRAPHY BOOKLETS

Save Money by constructing your own photo equipment.

**Photo Enlargers—1:** Condenser lens type; simple vertical; horizontal.  
**Photo Printers & Dryer—25:** Describes three practical printers, timer and negative dryer.  
**Photo Darkroom Equipment—96:** Cabinets, light-tight box, timer, agitator, washer.  
**Picture Projector, Trick & Table Top Photography—97:** Projectors that enlarge magazine illustrations and shop drawings. Tips for table toppers, photomontages, tricks.  
**Photo Kinks—98:** 63 time and money-saving ideas you can use.

## FORMULA BOOKLETS

**Cleaning Preparations—11:** Easy-to-make cleaners for walls, glass, etc. Removing fabric stains.  
**Cosmetic Formulas—12:** Hand lotions, creams, rouge, bath salts, beauty clay, lipsticks, etc.  
**Re-Silvering Mirrors—70:** Formulas for silvering and coloring.

## MISCELLANEOUS BOOKLETS

**Knots and Ropework—105.**  
**Chemical Experiments—93:** Easy-to-perform experiments. Inexpensive lab.  
**Taxidermy—9:** How to prepare skins and obtain life-like poses.  
**Log Cabins & Tourists Cottages—14:** Year-round log cabins; inexpensive tourists' cabin.  
**Magic for Everybody—29:** Simple tricks to puzzle your friends.  
**Trapping Small Animals—33:** How to lure fur bearers, prepare bait and traps, dress skins.  
**Tricks of Training Your Dog—35.**  
**Small Furnaces—36:** Build own gas or electric.  
**Telescopes—20:** Design and construction.  
**Poultry Houses—108:** Structures, brooders and incubators.  
**Guns and Decoys—109:** Cleaning, shooting; making decoys.

POPULAR MECHANICS PRESS,  
 200 E. Ontario St., Chicago 11, Ill.

I enclose ..... (U. S. bills may be mailed if carefully wrapped)  
 for "Little Library" booklets numbers:

.....  
 Name .....  
 Address ..... Zone .....  
 City ..... State .....



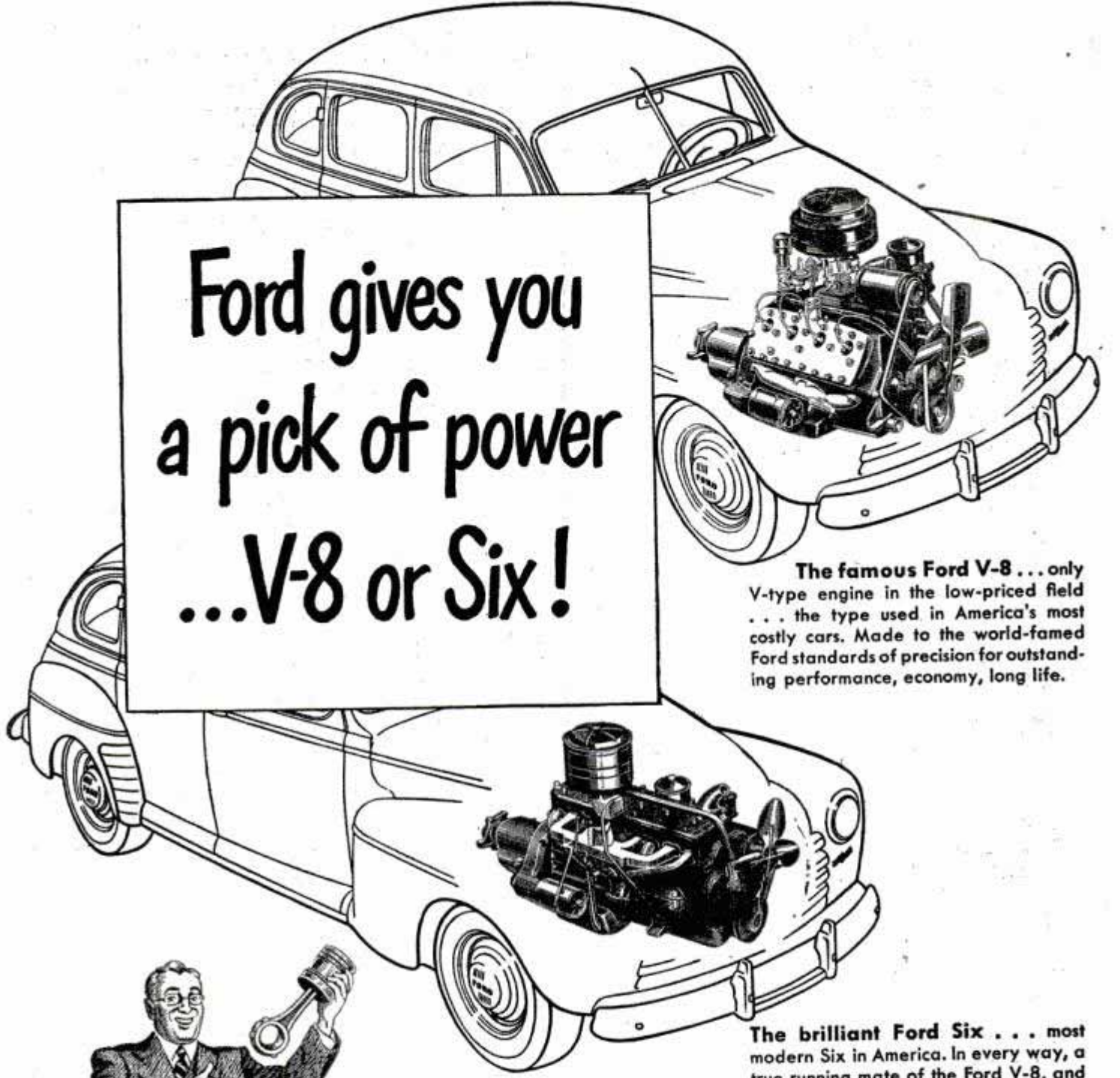

# Ford gives you a pick of power ...V-8 or Six!

The famous Ford V-8 . . . only V-type engine in the low-priced field . . . the type used in America's most costly cars. Made to the world-famed Ford standards of precision for outstanding performance, economy, long life.

The brilliant Ford Six . . . most modern Six in America. In every way, a true running mate of the Ford V-8, and backed by fifty years of automotive engineering experience. Now—more important advancements than ever . . . a spirited, pepful performer that's top value in every way.



Both have balanced carburetion—one big reason why both great Ford engines are so thrifty on gasoline. Plus dual automatic spark control (centrifugal and vacuum) for greater mileage, maximum smoothness wherever and whenever you drive.

Both have new 4-ring pistons that save on oil. Lightweight aluminum alloy construction gives higher heat conductivity, reduces bearing loads. That means better performance, less wear.

And both engines "loaf" while the car "hustles." Yes, both V-8 and Six lead their class with fewer engine revolutions . . . as much as two-and-a-quarter-million less in 10,000 miles. These slower engine speeds mean less wear, longer life for moving parts. No wonder—Six or V-8—Ford's Out Front!

There's a  in your future



Plane · Rabbet · Groove  
Rout · Panel · Tenon  
on Your Drill Press



This exclusive tool fits any drill press, simultaneously planes, panels, rabbets, routs, tenons, beads, grooves. No extra blades to buy. Over fifty thousand now in use by hobbyists, pattern and cabinet workers, etc. Satisfaction guaranteed or your money back. Complete **\$7.50**

**ALL-METAL DRILL PRESS TABLE**

Solid Alcoa aluminum heavily ribbed. Blanchard ground top and bottom. Equipped with Barron adjustable steel fence. Extra large working surface 13" x 18". Fits all standard drill presses. Instantly mounted or removed. **\$9.85**

**SPIRAL FLUTE ROUTER BITS**

New 45° hex angle tool steel design for smoother, faster, accurate routing, grooving, carving, mortising. Extra long cutting flutes. Individual sizes 1/8" to 1/2". Prices on application. Complete set of six graduated sizes. **\$9.50**



**ROTARY SURFACE SANDER**

Fits chuck of any drill press. Provides satin smooth, even, accurate surfacing of woods, plastics and metals. No ridges, no striations. Original in design, a great labor saver. Complete with 20 sanding discs. Fully guaranteed. **\$5.95**

Liberal 10 Day Money Back Guarantee

Workshop Guide FREE

**BARRON TOOL CO.**

469 Architects Bldg., Detroit 1, Mich.



**BARRON PRECISION TOOLS**  
WORK SHOP

**BOWS & ARROWS**

Write for 94 page illustrated instruction Hand Book 50c; 20 page catalog 5c; stamps or coin. LE STEMLER CO. QUEENS VILLAGELINE

**Here they are STAINLESS STEEL PLUMB BOBS**

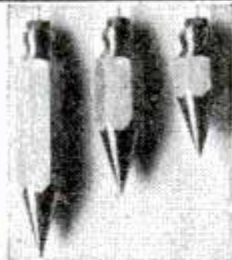

With Removable Screw End For Holding String

- Solid
- Stainless
- Steel will

for: CARPENTERS, BRICK LAYERS, PLUMBERS, MACHINISTS, ELECTRICIANS, MILLWRIGHTS, MASONS, ETC., ETC.

never rust COMBINATION OFFER

ALL 3

4" \$2.50  
3" \$2.25  
2 1/2" \$2

Postpaid

ful HIGH LUSTRE . . . will never rust or tarnish . . . The pride of any mechanic . . . An indispensable MUST HAVE in every tool chest . . . Removable Screw End For Holding String means a perfect true line . . . At this low cost it will save you considerable to buy the Combination Set of 3 FOR ONLY \$5.50 . . . You SAVE \$1.25 . . . Better order your supply TODAY.

ONLY \$5.50  
Postpaid

DEALERS Write for Discounts

**MECHANICAL PRODUCTS CORPORATION**

168 No. Ogden Ave. Dept. PM CHICAGO 7, ILL.

MECHANICAL PRODUCTS CORP'N  
168 No. Ogden Ave. Dept. PM  
CHICAGO 7, ILL.

• RUSH THIS ORDER TODAY •

Am enclosing \$ . . . . . send immediately COMBINATION OFFER ( )

Am enclosing \$ . . . . . send immediately SIZE . . . . . inch ( )

NAME . . . . .

ADDRESS . . . . .

TOWN . . . . . STATE . . . . .

**Start a PLASTIC BUSINESS**

this Marvelous Machine  
NOW PAVES THE WAY  
TO BIG PROFITS

Opportunity is all around this excellent machine. This S-K-W Press is ideal for manufacturers, custom molders, laboratories, home workshops, colleges, etc. Operates hydraulically, quickly, accurately, economically. Pays big dividends in a hurry. Electrically controlled heat under varying degrees of pressure and temperature. Platen area approx. 20 sq. in. Size of press 9 1/2 x 14 x 26". Ram pressure to 8 tons.

Make Your Own Plastic Parts This

Quick Easy Way for Production or Experimental Work

**PRODUCES BOTH PLASTIC and RUBBER PARTS**

NOW you can make your own plastic or rubber parts from your own mold, material can be secured in most localities. We can also save you money on any molds you desire. The plastic industry offers great opportunities for those who get into it TODAY.

USED FOR HUNDREDS of MOLDING NEEDS This Machine offers an excellent start in this Big Money-Making Industry. Make YOUR OWN PRODUCTS. Establish YOUR OWN BUSINESS. ORDER TODAY. ONLY . . . . .

Wt. Approx. 100 lbs. COMPLETE

**\$160.00**

IMMEDIATE DELIVERY

F.O.B. Chicago

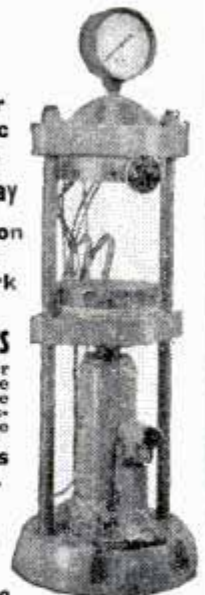

CLARENDON MFG. CO., Dept. P-2, 176 Adams St., Chicago 3, Ill.

**Electric Slide and Film Viewer**

3 1/2" Plastic lens — Battery operated. Handles 35 mm., 2 1/4 x 2 1/4, and 2 1/4 x 3 1/4 color transparencies. Complete with batteries and 35 mm. adapter.

**\$2.95** parcel post prepaid

G. & S. FOTO SALES, 6040 BROADWAY, CHICAGO 40, ILL.

**BUILD YOUR OWN ZEOLITE WATER SOFTENER**



Save up to 50%. Pays for itself. Fun to build. Only a wrench required. All materials available. Send \$1.00 check or money order for simple and complete plans and operating instructions.

BOX 2732-P BODEY MFG. CO. MINNEAPOLIS 7, MINN.

**FREE Bikini Crossroads Patch**



Send only \$1.00 for our beautiful selection of 20 different Flight Squadron and Shoulder Insignia and receive the RARE BIKINI BOMBER leatherette breast patch absolutely FREE. Tremendous value. Colored insignia book with your order at no cost. Send to-day. Offer limited.

THE INSIGNIA MART, Dept. EE  
703 Broadway, New York 3, N. Y.



**Say You Saw It in POPULAR MECHANICS**

**TOOLS — PLASTICS — SUPPLIES — ETC.**

New Decorative Plastic Panels for table tops, etc. also aluminum trim, Plexiglas, Plastic Screws, Cement, Drills, Taps, Dies, Milling Cutters, Torches, Flux, Brazing Wire, Screws, Aluminum, Shafting, Bearings, Pulleys, Mandrels, Machine Handles, Flexible Shaft Tools, Electric Drills, etc. Many other items. 70% in stock. New Illustrated Catalog E-15c. Metiplas Supply Co., 1420 South 16th Avenue, Maywood, Illinois.

**Ottawa Self-Propelled Buzz Master**

CLEARs LAND FAST! Powerful 6-HP motor with friction clutch for safe operation. Cuts down timber, brush and hedge; turn blade vertically and saw logs to length. Can be equipped to fell largest trees. Has clutch pulley for belt work. Is fully guaranteed.



OTTAWA MFG. CO., 227 Brush Ave., Ottawa, Kansas



An Ideal and Practical Gift For Any Man!

# Now A DYNAMIC HEAVY DUTY INDUSTRIAL WELDER

## Available Now—Immediate Deliveries

### Designed to Do High-Grade Welding *Inexpensively*

Maintenance men, farmers, mechanics, machine shops, foundries, auto, general repair and job welding shops using the DYNAMIC WELDER find it so indispensable and useful that they cannot afford to be without it. If inexperienced you can easily learn to do a variety of high-grade welding jobs by following the practical, simplified operating and welding instructions furnished.

### WORKS ON IRON, STEEL, BRASS, BRONZE and OTHER METALS

Has eight metallic and carbon arc welding heat stages. Does work you would think only possible with a larger, more expensive machine.

### READ WHAT USERS SAY...

**Repair Shop Owner says, "It will do more than you say"**

"I want to say I operate a repair garage and am more than satisfied with the welder. It will do more than you say." C. P., Butler, Ohio

**It's the Greatest Portable Outfit**

"Now I am equipped for all kinds of welding and I must say it's the greatest portable outfit for welding any man could ever wish to own. I wouldn't sell mine for the cost of plenty welders I have seen which were very high in cost but not in convenience. You may put me on file as a booster of your wonderful welding product." W. J. B., St. John, N. B., Canada

**Better Than I Expected**

"I have done quite a little welding with my welder and will say it is better than I expected. The price, convenience, and variety of work that can be done with the Dynamic are the attractive points." W. R. P., Portland, Ore.

## EASY TO OPERATE!

# DYNAMIC SUPERCHARGED WELDER

Once you see a DYNAMIC in operation you won't want to be without it. Its simplicity will amaze you. In a year the DYNAMIC only costs you about 6c a day. COMES COMPLETE, READY TO OPERATE, WITH HELMET, RODS, CABLES, ELECTRODE HOLDER AND OPERATING INSTRUCTIONS, ETC. NOTHING ELSE TO BUY. Write today for Free particulars. Act now and get details on our amazingly low-priced Dynamic Welder and 10-day trial offer.

**DYNAMIC WELDER CO.**

13 East 23rd Street FS, Chicago 16, Ill.

## MAIL COUPON FOR FREE DETAILS

### 10-DAY TRIAL OFFER

**DYNAMIC WELDER CO.**

13 East 23rd Street FS, CHICAGO 16, ILL.

Send me free details of your 10-DAY trial offer.

Name.....

Address.....

City.....Zone.....State.....



FOR ONLY  
**\$23<sup>50</sup>**  
COMPLETE

### AMAZINGLY SIMPLE TO OPERATE!

This portable Dynamic Welder, easily carried right to the job, can be operated from any convenient, properly wired 110 Volt 60 cycle line. Can also be supplied for 220 Volt 60 cycle operation and for other voltages and cycles at slight additional cost.







9" Bench Lathe

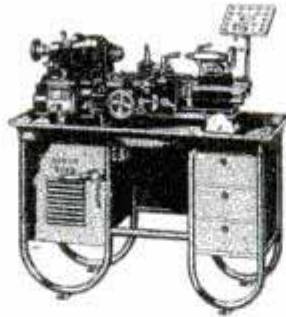

10" Bench Lathe

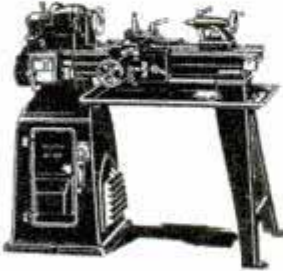

10" Engine Lathe

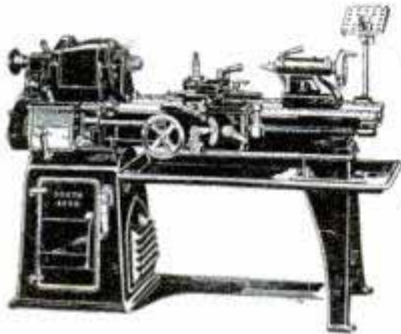

13" Toolroom Lathe

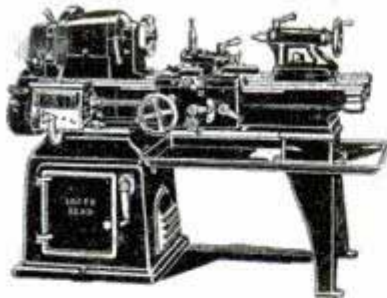

14 1/2" Engine Lathe

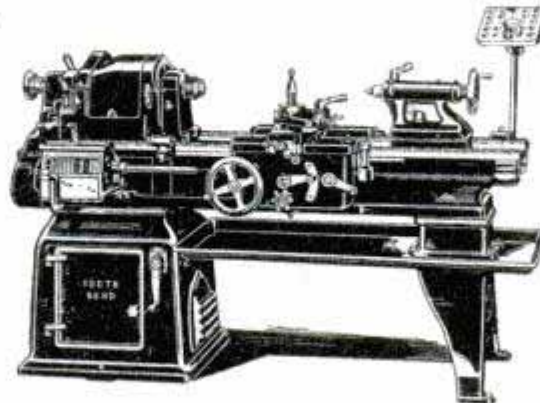

16" Toolroom Lathe

**SOUTH BEND LATHES** for accurate production operations and exacting toolroom work. Engine Lathes and Toolroom Lathes with 9", 10", 13", 14 1/2", and 16" swings. Precision Turret Lathes with 1/2" and 1" collet capacities. Write for Catalog 100-F.



**SOUTH BEND LATHE WORKS**  
 LATHE BUILDERS SINCE 1906 • 455 EAST MADISON STREET, SOUTH BEND 22, INDIANA

Printed by Popular Mechanics Company, Chicago, Ill., U. S. A.



# FASTEST BLADES ON EARTH by FRANK WILLIAMS

## IRVING JAFFEE

...UNDEFEATED  
WORLD'S SPEED  
ICE-SKATING  
CHAMPION.

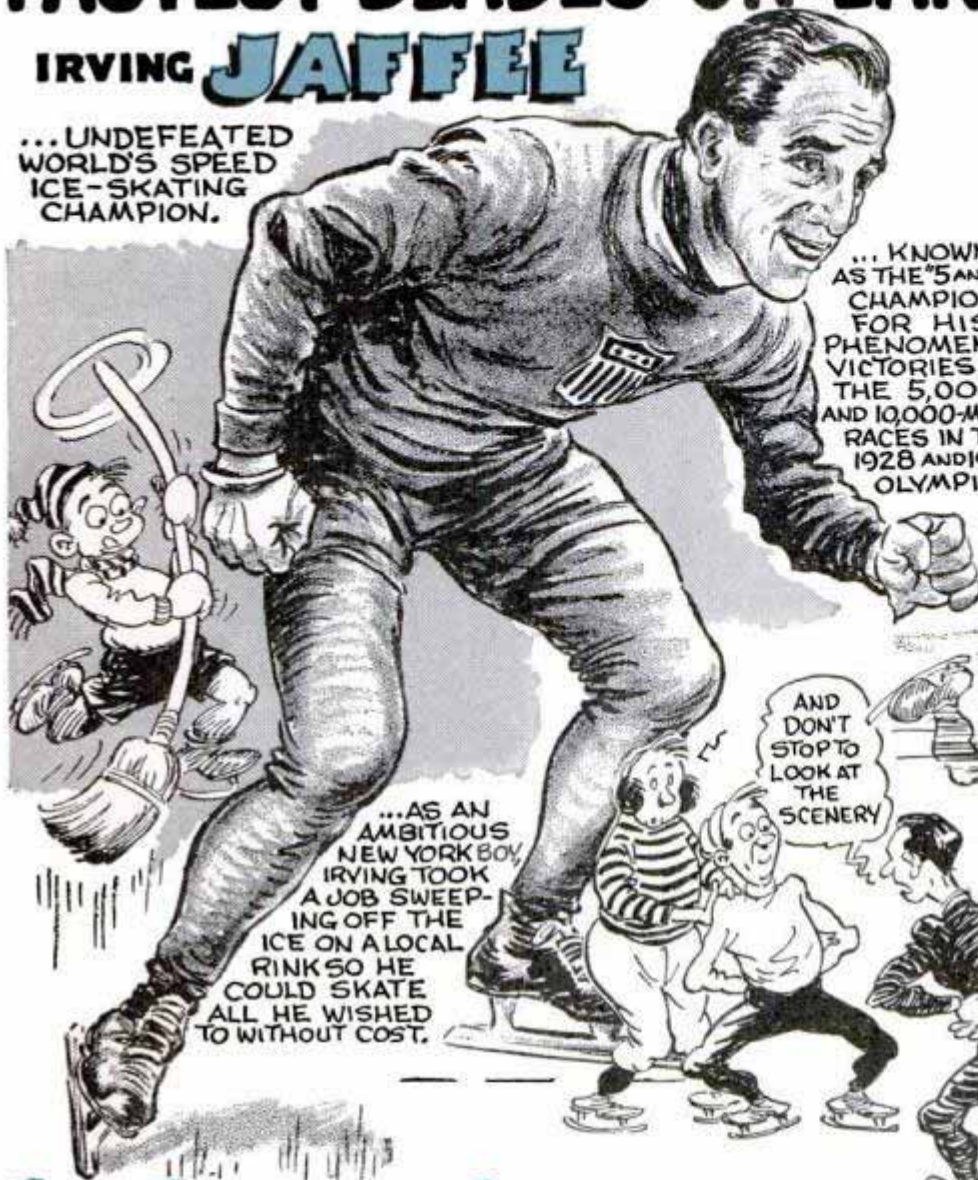

... KNOWN  
AS THE "5 AND 10"  
CHAMPION  
FOR HIS  
PHENOMENAL  
VICTORIES IN  
THE 5,000  
AND 10,000-METER  
RACES IN THE  
1928 AND 1932  
OLYMPICS...



JAFFEE  
ALSO HOLDS  
THE  
WORLD'S  
AMATEUR  
SPEED  
RECORDS FOR  
ONE, TEN  
AND 25  
MILES!

HE LOOKS  
**SHARP!**

...AS HE SKIMS DOWN THE ICE...



...AS AN  
AMBITIOUS  
NEW YORK BOY,  
IRVING TOOK  
A JOB SWEEP-  
ING OFF THE  
ICE ON A LOCAL  
RINK SO HE  
COULD SKATE  
ALL HE WISHED  
TO WITHOUT COST.

AND  
DON'T  
STOP TO  
LOOK AT  
THE  
SCENERY

...FLASHING  
FARTHER AHEAD  
OF THE PACK WITH EACH  
TIRELESS STROKE!

HE FEELS  
**SHARP!**

...COACHING FUTURE AMERICAN  
SKATING GREATS FOR THE POST-  
WAR WINTER SPORTS OLYMPIC  
GAMES AT ST. MORITZ,  
SWITZERLAND IN 1948.

look **SHARP**  
feel **SHARP**  
be **SHARP**

use  
**Gillette**  
**Blue Blades**  
with the **SHARPEST** edges  
ever honed!

● You look sharp for you enjoy the swellest shaves ever. You feel sharp because they're refreshing and give you a lift. You are sharp for you get far more shaves per blade and save money. Ask for Gillette Blue Blades.



5 for  
25¢

ENJOY BOXING

FRIDAYS AT  
10 PM EST OVER ABC NETWORK. GILLETTE'S CAVALCADE OF  
SPORTS ALSO AIRS WORLD SERIES AND OTHER CLASSICS YEAR ROUND.

HE IS **SHARP!**

...JAFFEE GETS THE BEST-LOOKING  
SHAVES A MAN CAN ENJOY BECAUSE  
HE ALWAYS USES  
**GILLETTE BLUE BLADES**  
WITH THE SHARPEST EDGES EVER  
HONED! WISE TO SAVING MONEY  
IRVING KNOWS THAT  
**DOUBLE EDGES MEAN  
DOUBLE ECONOMY!**

Gillette Safety Razor Company, Boston 6, Mass.

Copyright, 1947, by Gillette Safety Razor Company



# YOUR "T-ZONE" WILL TELL YOU!

**T** for Taste...

**T** for Throat...

That's your own proving  
ground for any cigarette

YES, the "T-Zone" is your own critical laboratory for any cigarette. That's where you learn by actual smoking experience the particular cigarette that suits you best.

For your taste and your throat are individual to you. Only your taste and throat can decide which cigarette tastes best to you . . . and how it affects your throat.

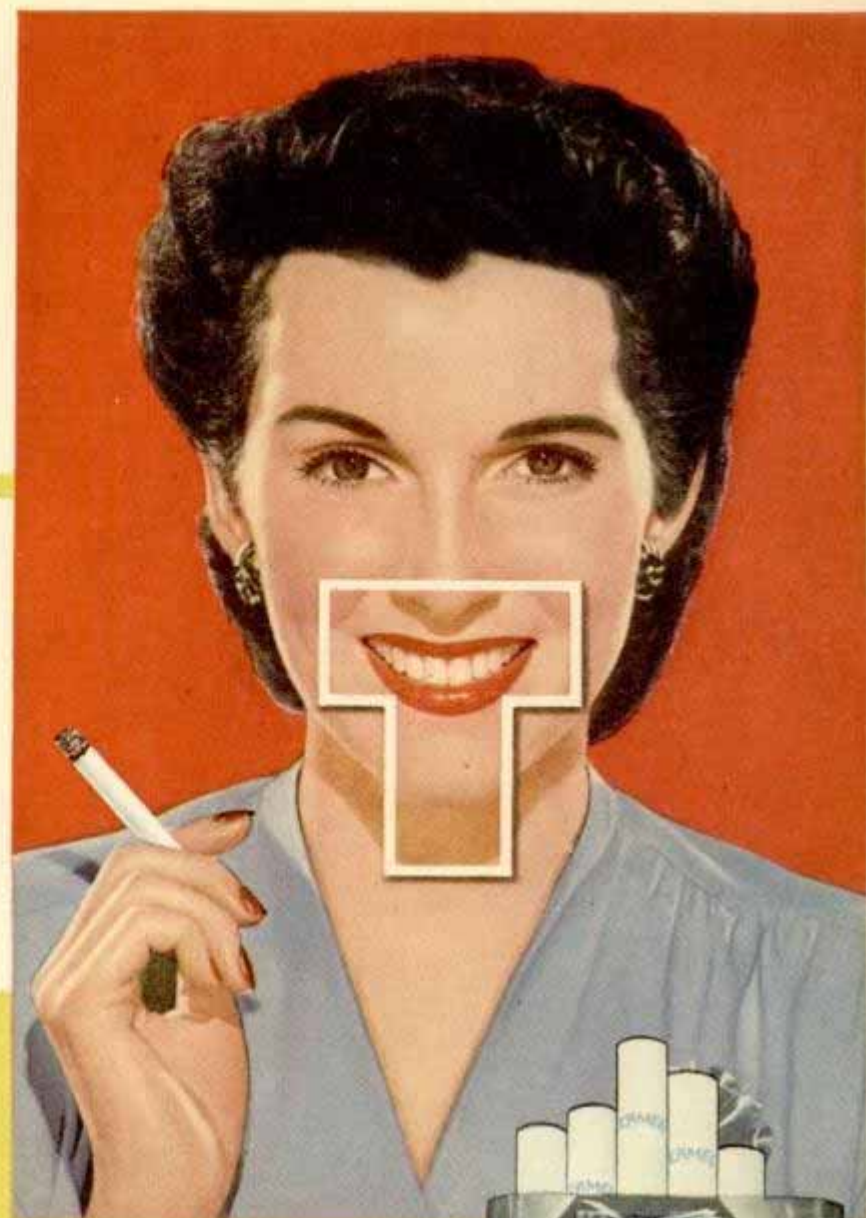

Try Camels. See how your taste responds to the rich, full flavor of Camel's choice, properly aged tobaccos. See how your throat reacts to the delightfully cool mildness of Camels.

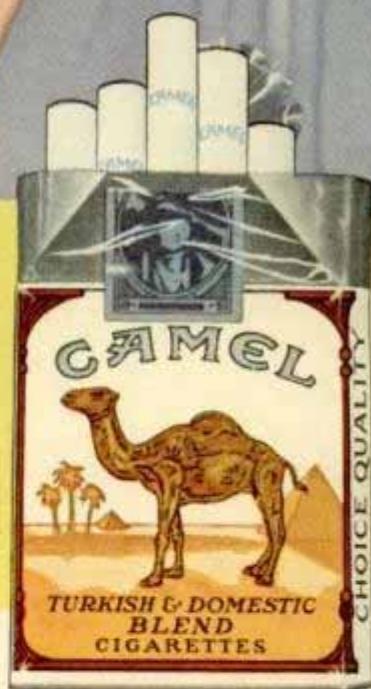

*According to a recent Nationwide survey:*

# More Doctors smoke Camels than any other cigarette

When 115,597 doctors were asked by three independent research organizations to name the cigarette they smoked, more doctors named Camels than any other brand.