

POPULAR MECHANICS

MAGAZINE

WRITTEN SO YOU CAN UNDERSTAND IT

REG. TRADE MARK, GREAT BRITAIN, No. 40424

REG. U.S. PAT. OFF.



LEADS YEAR AFTER YEAR by FRANK WILLIAMS

NAT HOLMAN-

...BRILLIANT BASKETBALL COACH OF CITY COLLEGE OF N.Y.

...ONE OF THE BEST BALL HANDLERS OF ALL TIME!

HE LOOKS **SHARP!**

...MAKING STARS OF RAW RECRUITS

NOW-SHOOT!

...NAT HAS MORE PROTEGES IN PRO BASKETBALL THAN ANY OTHER COACH!

HE FEELS **SHARP!**

...GUIDING HIS FLASHY TEAMS TO ONE VICTORY AFTER ANOTHER.....

HIS 27-YEAR RECORD AT C.C.N.Y. IS 308 WINS AND 111 LOSSES !!!

look **SHARP**
feel **SHARP**
be **SHARP**

use
Gillette
Blue Blades
with the **SHARPEST** edges ever honed!

● You look sharp for you enjoy the swellest shaves ever. You feel sharp because they're refreshing and give you a lift. You are sharp for you get far more shaves per blade and save money. Ask for Gillette Blue Blades.



ENJOY BOXING FRIDAYS AT

10 PM EST OVER ABC NETWORK. GILLETTE'S CAVALCADE OF SPORTS ALSO AIRS WORLD SERIES AND OTHER CLASSICS YEAR 'ROUND.

HE IS **SHARP!**

...NAT ALWAYS GETS A FACEFUL OF SHAVING SATISFACTION BY INSISTING ON **GILLETTE BLUE BLADES** WITH THE SHARPEST EDGES EVER HONED. HE NOT ONLY ENJOYS FAST, GOOD-LOOKING SHAVES BUT SAVES MONEY, TOO! YES SIR, **DOUBLE EDGES MEAN DOUBLE ECONOMY!**

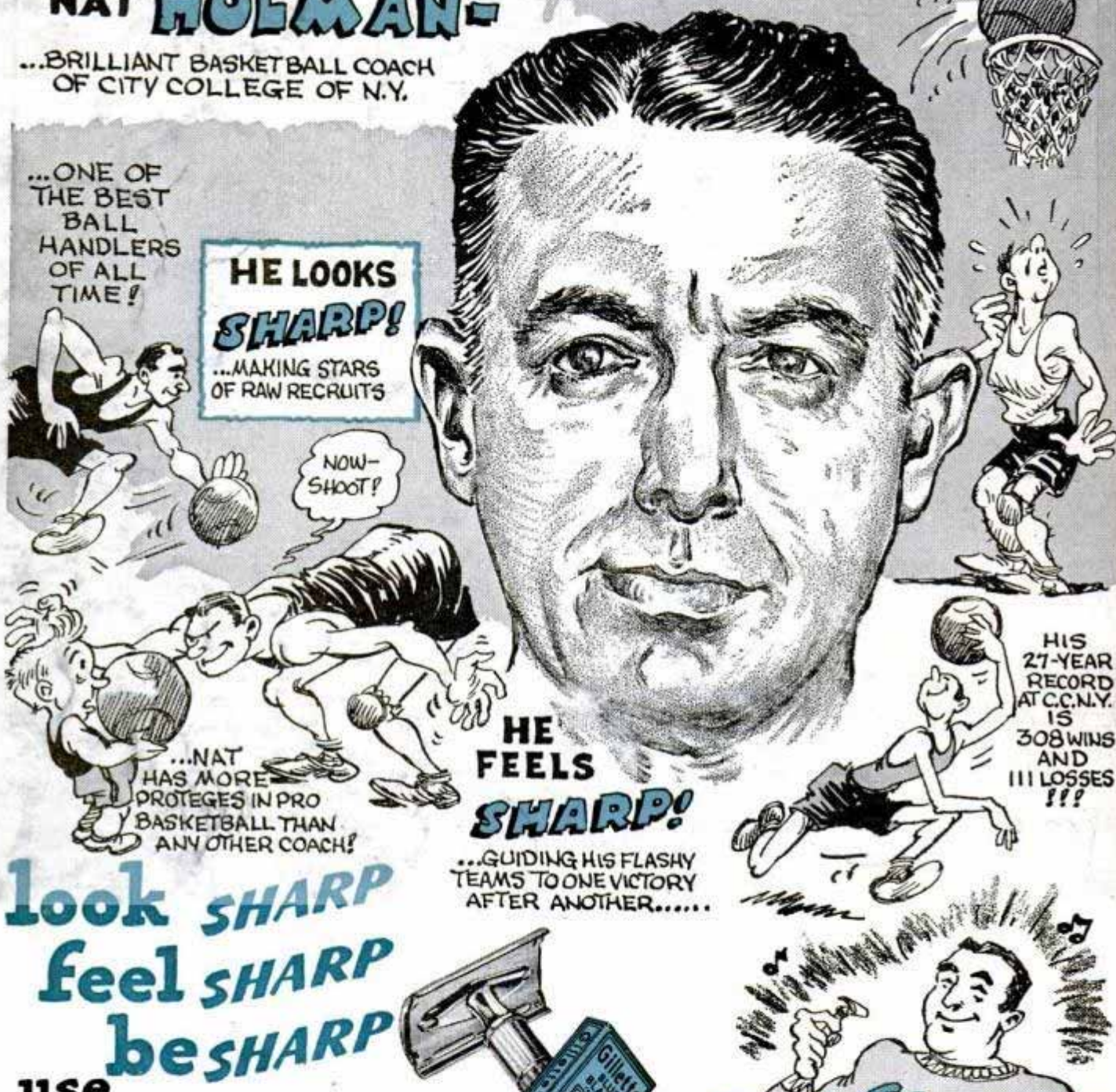

Gillette Safety Razor Company, Boston 6, Mass.



TYPICAL EXAMPLE: THE NEW TIRE THAT OUTWEARS PREWAR TIRES

PICTURED above is E. B. Palmer of Denver, Colorado, a traveling salesman, who writes:

"Last January I was fortunate enough to obtain one of your B. F. Goodrich tires from the Waco dealer. The same day that I mounted the tire, I put on three of a competitive brand.

"I am a traveling salesman and I drive many thousands of miles, over all types of roads at comparatively high speeds. This B. F. Goodrich Silvertown tire has been 36,664 miles, most of which time it was on the right rear wheel.

"It still has a good tread and apparently a number of safe miles left. The three competitive tires

have long since been discarded. *It has given me better service than any prewar tire that I have ever used.*"

Many letters like this—from owners of taxi fleets, passenger car drivers, police departments and commercial car owners—are coming in every week to tell us that the new B. F. Goodrich Silvertown tires stand up better than the tires of prewar days.

Supplies of tires are still limited, of course. Even today's increased production cannot keep up with the demand. This is particularly true of the B. F. Goodrich tire that outwears prewar tires. It's best to check your needs with your B. F. Goodrich dealer well in advance. He'll do his best to keep you rolling until he can get new tires for you. *The B. F. Goodrich Co., Akron, Ohio.*

B.F. Goodrich

FIRST IN RUBBER

HAWAIIAN WIGGLERS

Get Bass in "Tough Spots!"



F. C. Johnson with bass caught from Moon Lake, Miss., on No. 1 Hawaiian Wiggler

Dear Fred:

"I caught these 11 bass and one crappie with your No. 1 Deep Running Hawaiian Wiggler from Moon Lake, Miss. The No. 1 and the No. 2 Hawaiian Wigglers are both excellent lures to cast and very effective for the 'tough spots' as this picture proves."

—*F. C. Johnson, Lula, Miss.*

Hawaiian Wigglers

All five members of the Hawaiian Wiggler family are specialized bass baits. No. 1 runs deep and is for rocky streams, lakes and dams. No. 1½ runs medium; No. 2, shallow. No. 2½ sputters on the surface. No. 3, the most weedless, wiggles right through gooey weeds and moss.

Write for Free Catalog

Gives all information on Hawaiian Wigglers; also Jitterbug, my famous surface bait, and my new Hula Dancers. It contains scores of letters from fishermen all over the country telling of their experiences with these popular baits. For a free copy of my catalog, write

FRED ARBOGAST & CO., 1601 North St., Akron 3, Ohio



Deep Running
No. 1 Hawaiian
Wiggler, \$1.10

Popular Mechanics Magazine

Registered in U. S. Patent Office and Canada

H. H. WINDSOR, Founder

H. H. WINDSOR, Jr., Editor and Publisher



THERE are questions galore about television these days. How soon? How good? How expensive? We've written, produced and televised our own show to discover some of the answers. You'll find the story of this special telecast in a behind-the-scenes article on page 89.

NEXT MONTH'S issue is crammed with outstanding features including an article on those puzzling sun spots that make the headlines whenever they scramble radio reception. There'll also be a timely answer to the question "Your Next Tire—Natural or Synthetic?" and an exciting trip in a semitrailer truck highballing 20 tons of freight over mountain highways at 50 miles an hour.

SHOPPING for the evening meal can be a lot of fun if you do it in your own deep-freeze unit. Next month's Craftsman section will give complete information on building an 18-cubic-foot cold-storage unit with a separate compartment to freeze your favorite foods in a hurry. Another article tells how to build matching end tables that will give a lift to the living room of even the smallest home or apartment. Ever notice how few turns it takes to screw a cap on a fountain pen or focus cameras and binoculars? That's because they have multiple threads; a February article tells how to cut them.

HAMS and S-W listeners can tune in the 11, 10, 6 and 2-meter bands on communications receivers with the converter detailed in next month's Radio and Electronics section.

Volume 87

JANUARY 1947

Number 1

Managing Editor.....	Roderick M. Grant
Assistant Managing Editor.....	Wayne Whittaker
Shop Notes and Crafts Editor.....	James R. Ward
Radio and Electronics Editor.....	Frank L. Brittin
Aviation Editor.....	Aubrey O. Cookman, Jr.
Associate Editor.....	John R. Kinsey
Eastern Editor.....	Bill Reiche
Western Editor.....	Thomas E. Stimson, Jr.
Art Director.....	Frank Beatty

Assistant Editors

Donald R. Brooks Clifford B. Hicks Maston M. Jacks Virgil T. Swanson

Assistant Editors, Shop Notes and Crafts

W. Clyde Lammey Wayne C. Leckey John F. Shrock A. E. Youngquist

In This Issue

<i>Popular Mechanics Presents</i>	
<i>An Original Television Production</i>	89
<i>Electric Tools Aid Medical Science</i>	99
<i>Dangerous Business, Farming</i>	105
<i>European Auto Show</i>	116
<i>Jet Black Bonanza</i>	122
<i>Task Forces Against the Arctic</i>	131
<i>Racing the Hot Rods</i>	138
<i>Uncle Sam's Private Fur Crop</i>	148
<i>Clocking the Jets at Muroc</i>	153
<i>American Rice Feeds the Orient</i>	164
<i>Silhouettes for Salons</i>	171

For the Craftsman

<i>Stage Your Own Marionette Show</i>	185
<i>Chip Carving Is Easy</i>	201
<i>Transparency Projector</i>	206
<i>Auto-Transformer Construction</i>	213
<i>Experimental Biology-Lab Incubator</i>	217
<i>Good Pruning Aids Nature</i>	225
<i>Radio and Electronics</i>	229

Table of Contents Continued on Page 8

Published monthly by POPULAR MECHANICS COMPANY, 200 East Ontario Street, Chicago 11, Ill. H. H. Windsor, Jr., president; Paul H. Dunakin, vice president and general manager; D. F. Windsor, vice president and secretary-treasurer; William Harrison Fetridge, vice president and assistant to the publisher; Clover L. Perkins, advertising manager; Alan M. Deyoe, circulation manager. Single copy in the United States and Canada, 25 cents; subscription rates in United States and possessions, Canada, and countries of the Pan-American Postal Union, 1 year, \$2.50; 2 years, \$4.50; 3 years, \$6.00. To all other countries add \$1.00 a year over United States prices for overseas postage. If you plan to move, notify us at least 60 days in advance so you will not miss an issue. Give both old and new addresses. Entered as Second Class Matter, September 15, 1903, at the Post Office at Chicago, Illinois, under Act of March 3, 1879. Entered as Second Class Matter at Post Office Dept., Canada. Copyright 1946, by Popular Mechanics Company, Copyright under International Copyright Union. Copyright in France. All rights reserved under Pan-American Copyright Union. Printed in the United States of America.

Ingenious New Technical Methods

To Help You
Simplify Production

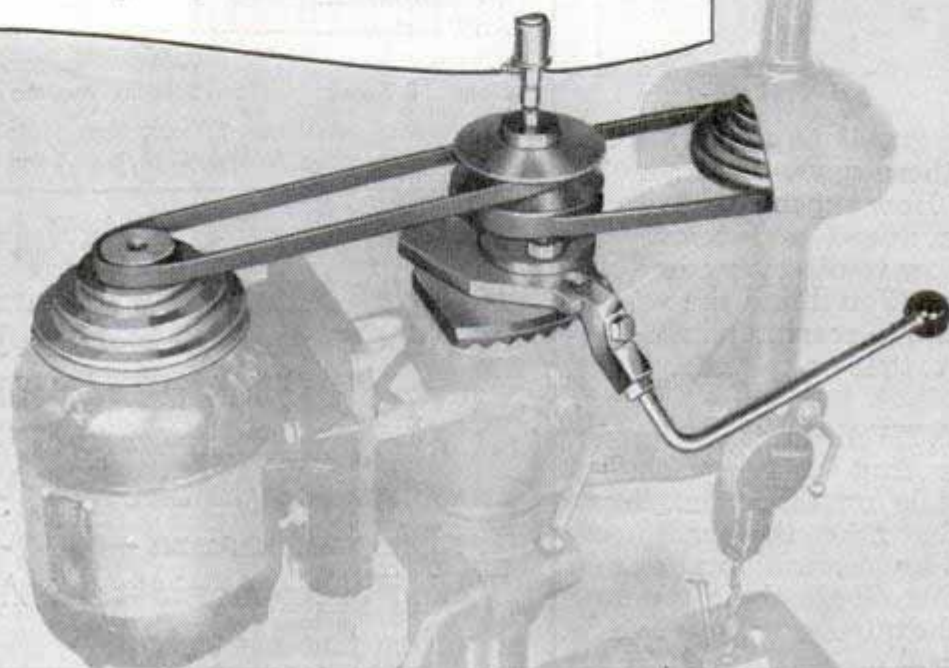

Variable Speed Drive Attachment Offers Instant Speed Control for Drill Press Work!

Now you can adjust drill press speeds from high to low—or any intermediate speed—as easily as shifting gears in your car! The Era Variable Speed Drive Attachment enables the operator to provide the correct speed for large or small drills by merely moving a lever. This saving in time results in greater work volume, better work, and lower production cost.

The Era Attachment fits all popular makes of drill presses, and is easily installed without the necessity of drilling holes or changing present equipment.

To also help save time on the job, many plant owners make chewing gum available to workers. Chewing gum seems to make work go easier, time go faster. Wrigley's Spearmint Gum may be used even when both hands are busy, eliminating work interruptions, and thus promoting greater safety for the operator.

*You can get complete information from Era Meter Co.
3940 N. Kilpatrick Ave., Chicago 41, Ill.*

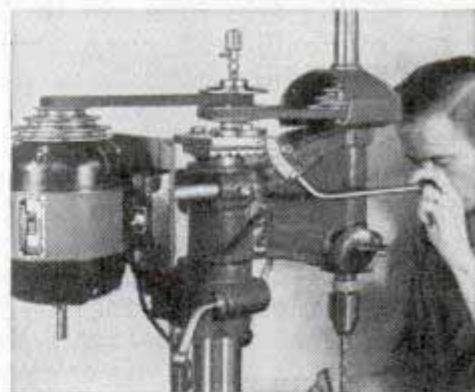

Era Variable Speed Drive



AA-206

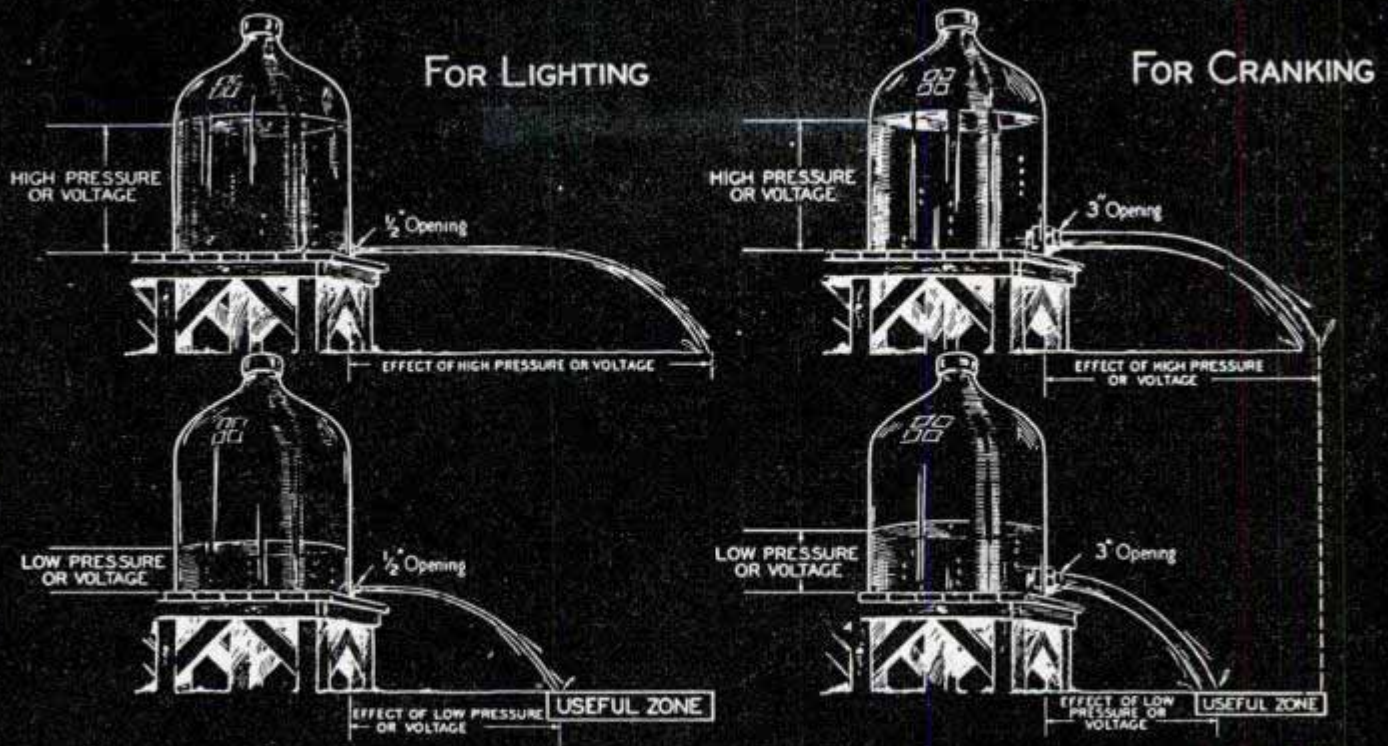

WHAT MAKES A BATTERY "RUN DOWN"

A storage battery, like a water tank, can deliver only what it contains. The quantity of current it can supply is gauged by its capacity—voltage multiplied by amperage.

VOLTAGE means pressure of electric current, just as "pounds per square inch" indicate water pressure. **AMPERAGE** measures the flow of electric current per hour, just as "gallons per minute" measures water flow. **CAPACITY** means the quantity of electricity delivered in a definite time.

The faster a battery is discharged, the quicker the pressure drops. More current is consumed in cranking (starting) than in lighting, and power

is more quickly exhausted. This is clearly shown in the illustrations above.

Thus capacity is an important factor in determining the power and quality of a storage battery . . . and the kind of service it gives you.

Exide Batteries are noted for their high capacity, long-life, low cost per mile of operation and strong starting power.

"WHEN IT'S AN EXIDE YOU START"

Would you like to know more about batteries? The complete story is told in a booklet, "THE STORAGE BATTERY, Its Fundamentals, Use and Maintenance." Mail a postal card today for a FREE copy.

Exide

BATTERIES

THE ELECTRIC STORAGE BATTERY COMPANY, Philadelphia 32

Exide Batteries of Canada, Limited, Toronto

In Your Mind's Eye

The Secret of MENTAL CREATING

IF you just like to dream, read no further. There comes a time when your fancies *must be* brought into light—and stand the test of every-day, hard realities. Are you one of the thousands—perhaps millions—whose thoughts never get beyond the stage of *wistful wishing*? Do you often come to from a daydream with the sigh, "If only I could bring it about—*make it real*?"

All things begin with thought—it is what follows that may take your life out of the class of those who hope and dream. Thought energy, like anything else, can be dissipated—or it can be made to produce actual effects. *If you know how to place your thoughts* you can stimulate the creative processes within your mind—through them you can assemble things and conditions of your world into a happy life of accomplishment. *Mental creating* does not depend upon a magical process. It consists of *knowing how* to marshal your thoughts into a power that draws, compels and organizes your experiences into a worth-while design of living.

ACCEPT THIS *Free* BOOK

Let the Rosicrucians tell you how you may accomplish these things. The Rosicrucians (not a religious organization), a world-wide philosophical fraternity, have preserved for centuries the ancients' masterful knowledge of the functioning of the inner mind of man. They have taught men and women how to use this knowledge to *recreate their lives*. They offer you a free copy of the fascinating book, "The Mastery of Life." It tells how you may receive this information for study and use. Use coupon opposite.

The ROSICRUCIANS
(AMORC)

SAN JOSE

CALIFORNIA

SCRIBE: V. B. X.
The Rosicrucians (AMORC),
San Jose, California.

Please send free copy of "The Mastery of Life,"
and I shall read it as directed.

Name.....

Address.....

City.....



6

KEYS TO OPPORTUNITY for Men and Women

They have helped over a million toward their ambition... **THEY CAN HELP YOU!**

The great barrier to realizing ambition is the question "HOW?"

For the past 39 years more than a million ambitious men and women have found the "HOW" to greater success in business in one of the free 48-page books illustrated above.

These books are more than catalogues—they give you the facts about the field of your choice, tell you of the opportunities in that field, its demands, and how our training fits you for the field. They'll answer questions that may have bothered you.

We have perfected Home-Study Training—made it interesting and practical through the problem method. You train under specialists, men who have achieved success in their chosen field—you study principles and solve problems without any loss of time, pay or interference with your present job.

Our training is tried and proven—and what you study at home you can use on the job right away. Perhaps right in your own company there is a great opportunity to advance—to get an executive job with the prestige and money that go with such advancement.

The way to success is not magic. It requires study, and you will have to be willing to work earnestly—thoroughly.

But wouldn't it be worth your while to trade some of your leisure over a comparatively brief period for a bigger job and more money?

Why not be somebody in the business world—why be satisfied to go through life in a small job at small pay when the way to success is clearly marked. The years are going by very fast—and it's high time you did something concrete about your future.

The coupon below will bring you complete information about the field of your choice. **SEND IT TODAY.** Don't delay—it can be the turning point in your career to a better job and more money.

G. I. APPROVED

LASALLE Extension University
a Correspondence Institution

Dept. 164-R Chicago 5, Ill.

I want to better my position—make more money. Send me your free booklet on the field I have checked below.

- | | |
|--|--|
| <input type="checkbox"/> Higher Accountancy | <input type="checkbox"/> Traffic Management |
| <input type="checkbox"/> Industrial Management | <input type="checkbox"/> Foremanship |
| <input type="checkbox"/> Executive Management | <input type="checkbox"/> Law L. L. B. Degree |

This One



XU6T-DZO-ZASX



use PYROIL...

Pyroil gives oil the property of clinging to metal surfaces, thus providing . . .

- protection against corrosion while your car is not running.
- starting ease without battery drain.
- protection against undue cylinder wear while your car is running.

Ask your gas station attendant to add PYROIL . . . and add life to your car.

PYROIL FOR AIRCRAFT ENGINES

Use Aircraft Pyroil B for lubricating oil, Aircraft Pyroil A for gasoline.

Manufactured and Guaranteed by Pyroil Company, 63 Pyroil Building, La Crosse, Wisconsin.



PYROIL COMPANY
63 Pyroil Bldg., La Crosse, Wisconsin

I want my car to last and run properly. Please tell me more about Pyroil and how it can accomplish this for me.

Name.....

Address.....

City or Town.....State.....



Jerry, the talking dog, is entertaining hospitalized veterans, by courtesy of the PYROIL Company. Picture of Jerry, sent on request.

TABLE OF CONTENTS (Continued)

AUTOMOTIVE

Aircraft-type auto jack works on six-pound pressure.....	111
Electric brakes for big trucks.....	121
Hospital "car" for handicapped men travels at walking speed.....	143
Inflator valve for spare tire extends through trunk side.....	163

AVIATION

Aeronca Chum has top speed of 118 m.p.h.....	94
How fast can we go?.....	96
Air-freighter load computer records change in weight.....	115
First American jet bomber expected to exceed 500 m.p.h.....	115
Two wide nose doors facilitate loading in Bristol air freighter.....	130
Revolutionary wing.....	144
Planes land in cross winds with swivel-wheel gear.....	147
Land-bound "flight deck" training being given Navy helicopter pilots.....	147
"Guinea pig" glider led to buzz bomb.....	151
Portable electric winch and hoist speed loading of air cargo.....	159
Superservice ramp truck.....	175

BOATS

Windmill bilge pump for small boat.....	94
Automatic hoist on tuna clipper.....	115
Outboard jet engine for boats.....	152

FARM

Farm horse population falling.....	137
Plow guard pins down trash for cutting by disk.....	152
Imported beetles eat weeds to aid crop cultivation.....	162

HOUSE AND HOME

Paper-hanging frame holds strip to ceiling.....	95
Horse collar makes unique mirror frame.....	98
Gripper spring holds shoe for shine.....	111
Inside stuff for your home.....	112
Aluminum houses—by the truck load.....	127
Dial telephone lock limits calls.....	146
Faucet filter uses charcoal to purify water.....	163
Temperature within electronic blanket controls flow of warmth.....	168
Glass fibers vs. goose feathers.....	174

INDUSTRY

Opinion meter for business conferences.....	115
First all-aluminum bridge span.....	115
Boxcar ramp and turntable ease tractors to top deck.....	126
"Lazy" helium gas checks oil level.....	137
Earthquakeproof building "floats" on rollers.....	176

MILITARY

Super-tank for Army weighs nearly 100 tons.....	98
Submarine leap.....	169
Midget switchboard handles six lines.....	170

OFFICE

Interoffice communications system blocks out interruptions.....	143
Rotary opener for letters clips envelope without damaging contents.....	143
Snap-back typewriter eraser fits in platen knob.....	163

PHOTOGRAPHY

Film holder prevents finger marks.....	111
Photo easel has movable platen.....	111
Odd-shaped enlarging masks help prevent fogged edges.....	142
Army movies at 1500 miles an hour.....	158
16-mm. camera weighs only seven ounces.....	174

RECREATION

Portable aluminum oven and grill folds into flat package.....	97
Plate glass screen shields hockey fans.....	104
Electric beach-car is toe-controlled.....	137
Game carrier worn over clothing has pouches and rubberized lining.....	159
Pocket-size blowtorch cooks meals for camper.....	162

TOOLS

Speed changer for drill press operates by hand lever.....	104
Magnetism holds metal tools on wall rack in workshop or kitchen.....	121
Tool operates like wall-type can opener to crimp heavy sheet metal.....	121
Automatic coil and loop winder records number of turns on counter.....	130
Mobile hoist for shop work is operated by a handwheel.....	142
Safety reel for bandsaw coil holds loose end with clip.....	152
Glass tongs resist acid solution in production of quartz crystals.....	158
Eight-blade revolving "hoe" mulches soil and cuts weeds.....	158
Plastic rule doubles as compass in compact four-tool kit.....	174
Tool for flaring metal tubing fits most sizes of pipe.....	174
Filing attachment clamps on lathe.....	176

TOYS AND NOVELTIES

Flying model helicopter rises 100 feet.....	95
Model engines drive iceboats 130 m.p.h.....	97
Youngsters wagon can be converted into sled.....	115
"Child's paradise" in Dallas built as engineer's hobby.....	126
Beach digger for youngsters operates like steam shovel.....	137
Midget piano with three octaves has special alloy rods instead of strings.....	143
Whittler carves intricate chains with 53-year-old knife.....	146
"Two-mile" trolley runs in basement.....	168

MISCELLANEOUS

Silencer guards telephone conversations.....	97
Rockets give added boost to speedy English motorcycle.....	98
Power-packed motor develops more power than earlier motors.....	98
Flowers form giant clock.....	104
Master timekeeper.....	114
Navigating by star teams.....	128
Scientists find rare anesthetic in search for airsickness cure.....	130
Chemical put in gasoline mixes water and fuel.....	142

(Continued to page 10)

NOT BACK HERE!

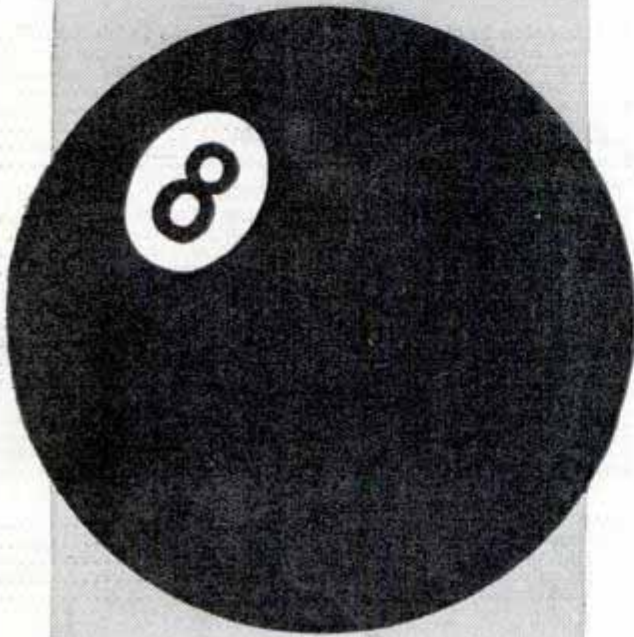

I. C. S. graduates turn up in lots of places — but not “behind the 8-ball.” You’ll find thousands of them in *top* executive posts . . . hundreds of thousands holding good positions and regularly collecting promotions and pay raises.

They realized that the advancements go to the trained men . . . and that practical, authoritative I.C.S. training is just as close to any one as the nearest letter-box. Many of them started drawing the dividends of larger pay checks and increased responsibilities *before* they completed their I.C.S. Courses.

The road they followed to success is open to you. I.C.S. Courses cover more than 400 business and technical subjects. You study in your spare time . . . at low cost . . . in a class by yourself.

If you’re as smart as we think you are, you won’t be caught “behind the 8-ball” with the untrained. You’ll mail the coupon today for full information on how to join the trained men rewarded by this modern world.

INTERNATIONAL CORRESPONDENCE SCHOOLS



BOX 5595-K, SCRANTON 9, PENNA.

Without cost or obligation, please send me full particulars about the course *before* which I have marked X:

- | | | | |
|---|--|--|--|
| <p>Air Conditioning and Plumbing Courses</p> <ul style="list-style-type: none"> <input type="checkbox"/> Air Conditioning <input type="checkbox"/> Heating <input type="checkbox"/> Plumbing <input type="checkbox"/> Refrigeration <input type="checkbox"/> Steam Fitting <p>Chemistry Courses</p> <ul style="list-style-type: none"> <input type="checkbox"/> Chemical Engineering <input type="checkbox"/> Chemistry, Analytical <input type="checkbox"/> Chemistry, Industrial <input type="checkbox"/> Chemistry, Mfg. Iron & Steel <input type="checkbox"/> Petroleum Refining <input type="checkbox"/> Plastics <input type="checkbox"/> Pulp and Paper Making <p>Civil Engineering, Architectural and Mining Courses</p> <ul style="list-style-type: none"> <input type="checkbox"/> Architectural Drafting <input type="checkbox"/> Architecture <input type="checkbox"/> Bridge and Building Foreman <input type="checkbox"/> Building Estimating <input type="checkbox"/> Civil Engineering <input type="checkbox"/> Coal Mining <input type="checkbox"/> Contracting and Building <input type="checkbox"/> Highway Engineering <input type="checkbox"/> Lumber Dealer <input type="checkbox"/> Reading Structural Blueprints <input type="checkbox"/> Sanitary Engineering <input type="checkbox"/> Structural Drafting | <ul style="list-style-type: none"> <input type="checkbox"/> Structural Engineering <input type="checkbox"/> Surveying and Mapping <p>Communications Courses</p> <ul style="list-style-type: none"> <input type="checkbox"/> Electronics <input type="checkbox"/> Practical Telephony <input type="checkbox"/> Radio, General <input type="checkbox"/> Radio Operating <input type="checkbox"/> Radio Servicing <input type="checkbox"/> Telegraph Engineering <p>Electrical Courses</p> <ul style="list-style-type: none"> <input type="checkbox"/> Electrical Drafting <input type="checkbox"/> Electrical Engineering <input type="checkbox"/> Electric Light and Power <input type="checkbox"/> Lighting Technician <input type="checkbox"/> Practical Electrician <p>Internal Combustion Engines Courses</p> <ul style="list-style-type: none"> <input type="checkbox"/> Auto Technician <input type="checkbox"/> Aviation <input type="checkbox"/> Diesel-Electric <input type="checkbox"/> Diesel Engines <input type="checkbox"/> Gas Engines <p>Mechanical Courses</p> <ul style="list-style-type: none"> <input type="checkbox"/> Aeronautical Engineering <input type="checkbox"/> Aircraft Drafting <input type="checkbox"/> Flight Engineer <input type="checkbox"/> Foundry Work <input type="checkbox"/> Heat Treatment of Metals | <ul style="list-style-type: none"> <input type="checkbox"/> Industrial Engineering <input type="checkbox"/> Industrial Metallurgy <input type="checkbox"/> Machine Shop <input type="checkbox"/> Mechanical Drafting <input type="checkbox"/> Mechanical Engineering <input type="checkbox"/> Mold-Loft Work <input type="checkbox"/> Patternmaking—Wood, Metal <input type="checkbox"/> Reading Shop Blueprints <input type="checkbox"/> Sheet-Metal Drafting <input type="checkbox"/> Sheet-Metal Worker <input type="checkbox"/> Ship Drafting <input type="checkbox"/> Shipfitting <input type="checkbox"/> Tool Designing <input type="checkbox"/> Toolmaking <input type="checkbox"/> Welding—Gas and Electric <p>Railroad Courses</p> <ul style="list-style-type: none"> <input type="checkbox"/> Air Brake <input type="checkbox"/> Car Inspector <input type="checkbox"/> Diesel Locomotive <input type="checkbox"/> Locomotive Engineer <input type="checkbox"/> Locomotive Fireman <input type="checkbox"/> Railroad Section Foreman <p>Steam Engineering Courses</p> <ul style="list-style-type: none"> <input type="checkbox"/> Boilermaking <input type="checkbox"/> Combustion Engineering <input type="checkbox"/> Engine Running <input type="checkbox"/> Marine Engineering <input type="checkbox"/> Steam Electric <input type="checkbox"/> Steam Engines | <p>Textile Courses</p> <ul style="list-style-type: none"> <input type="checkbox"/> Cotton Manufacturing <input type="checkbox"/> Rayon Weaving <input type="checkbox"/> Textile Designing <input type="checkbox"/> Woolen Manufacturing <p>Business and Academic Courses</p> <ul style="list-style-type: none"> <input type="checkbox"/> Accounting <input type="checkbox"/> Advertising <input type="checkbox"/> Arithmetic <input type="checkbox"/> Bookkeeping <input type="checkbox"/> Business Correspondence <input type="checkbox"/> Business Management <input type="checkbox"/> Certified Public Accounting <input type="checkbox"/> Commercial <input type="checkbox"/> Cost Accounting <input type="checkbox"/> Federal Tax <input type="checkbox"/> First Year College <input type="checkbox"/> Foremanship <input type="checkbox"/> French <input type="checkbox"/> Good English <input type="checkbox"/> High School <input type="checkbox"/> Higher Mathematics <input type="checkbox"/> Illustrating <input type="checkbox"/> Motor Traffic <input type="checkbox"/> Postal Service <input type="checkbox"/> Salesmanship <input type="checkbox"/> Secretarial <input type="checkbox"/> Sign Lettering <input type="checkbox"/> Spanish <input type="checkbox"/> Stenography <input type="checkbox"/> Traffic Management |
|---|--|--|--|

Name _____ Age _____ Address _____
 City _____ State _____ Present Position _____

Working Hours _____ A.M. to _____ P.M. Length of Service in World War II _____

Special tuition rates to members of the Armed Forces. Enrollment under the G.I. Bill of Rights approved for War II Veterans.
 Canadian residents send coupon to International Correspondence Schools Canadian, Ltd., Montreal, Canada.

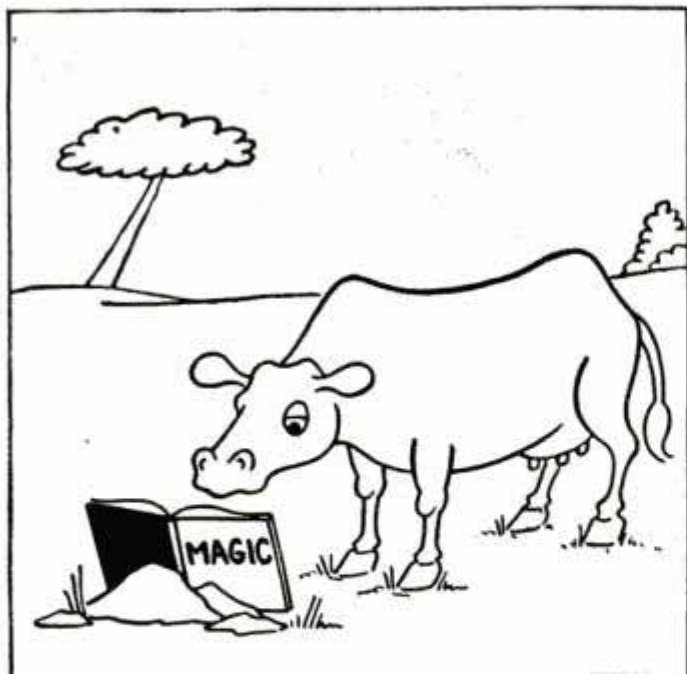

(Continued from page 8)

Hook lift on truck makes loading easy.....	151
Mild malaria cured by war-born drug.....	151
Chemical prolongs battery life.....	152
Vaccine injected into chicken eggs tests effectiveness on disease.....	158
Man-made mountain holds back river.....	160
Stroller doubles as car seat.....	162
Homemade telescope required 20 years to build.....	170
Versatile movie amplifier talks to crowd or takes sound off film.....	175

Craftsman and Shop Notes Index

AUTOMOTIVE

Paper roll in glove compartment is handy memo pad.....	184
Rubber-hose clip holds ticket on steering column.....	192
Indicator light for automobile.....	200
Tire spreader simplifies task of locating nail.....	220
Plastic hand scraper cleans windshield of sleet and ice.....	223

FARM

Wiring electric-fence gate.....	223
Sliding door on poultry house operated from outside.....	224
Keeping stock out of culverts.....	224

HOUSE AND HOME

Folding step in clothes closet provides access to high shelf.....	180
Solving home problems.....	182
Sliding pole in closet makes clothes easy to reach.....	184
Shell serves as flower vase.....	192
Oil-soaked corncocks thaw pipe.....	194
Strong fastening for doorknobs.....	194
Forced air unit removes soot from boiler.....	198
Drawer under baby's high chair keeps utensils handy.....	212

PAINT AND PAINTING

Egg beater mixes enamel in small cans quickly.....	180
Ends of scaffold painted red as safety precaution.....	194
Paint spray mask is made using cloth strainer.....	194
Preparing painted and varnished surfaces for refinishing.....	195

RADIO AND ELECTRONICS

Seeing signals with a panoramic adapter.....	229
One-tube dual regenerative set operates a loud speaker.....	230
Automatic temperature control for soldering iron.....	232
How to add extension speakers to your receiver.....	232

RECREATION

Hiker's handy water canteen.....	180
Plywood guard for bike sprocket.....	181
Locking pin for tennis-net tightener.....	204

STORE AND OFFICE

Shot used as scale weights.....	180
Decorative borders on stencils.....	216
Display promotes metal cleaner.....	216
Shipping tag lifts sales slips.....	224
Support holds envelopes upright.....	224

TOOLS

Bolts used to make set of taps for soft materials.....	191
Dust collector for circular saw.....	192
Window-crank device on saw provides height adjustment.....	198
Cleaning caulking-gun nozzle.....	198
How to measure speed of shaft without using counter.....	199
Small drills kept in test tubes.....	200
Coil spring formed in vise jaws.....	204
Metal box holds burning tools.....	204
Battery clip serves as vise.....	204
Craft quiz.....	211
Substitute clamp for gluing.....	212
Clamp holds small model parts.....	212
Combination tape and compass performs dual function.....	215
Two-line plumb bob is stable.....	216
One man can lift oil drum with this hoist.....	220
Wrench for socket-head screws.....	220
Driving pitchfork on new handle.....	220
Hand-powered drill press.....	221
Improvised tool-post grinder.....	222
How to sharpen bandsaw blades by coiling in vise.....	224

TOYS AND NOVELTIES

Toy walkie-talkie.....	181
Novel decorations for the aquarium.....	184
Steam jet propels speedy toy airplane.....	191
Footrests on boys' stilts raised while in use.....	192
Desk stamp box of contrasting woods.....	193
Plastic plant trellises.....	197
Slip-on identification bracelet of metal and plastic.....	200

MISCELLANEOUS

Modernize your bed.....	178
Holder for thread and needle.....	180
Emergency handle for suitcase.....	184
Reinforcing broken pipe shank.....	184
Lead strip fixes crack in drum.....	194
How to start a fire in the rain.....	198
Bowling "dice" are scored like real game.....	199
Renewing surface of hectograph.....	204
High-speed cleaner for movie film.....	205
Garden hose and barbed wire protect tree from animals.....	212
Improvised mousetrap requires no setting.....	212
Fishing creel acts as container for visitors' tags.....	216
Solder cut in measured lengths when duplicating work.....	216

IMPORTANT NOTICE—It is the intention of this magazine to provide its readers with information regarding the latest developments in the mechanical arts. We take no responsibility as to whether the disclosures contained in our articles are covered by patents and advise readers to investigate this subject before making, using, or selling any of the products, machines, or processes described in order to avoid possible liability for patent infringements.

AUDELS REFRIGERATION & AIR CONDITIONING GUIDE....\$4

New from Cover to Cover—1280 Pages, Fully illus. Covering basic principles, servicing, operation & repair of household, commercial & industrial refrigeration & air conditioning. A gold mine of essential important facts for engineers, servicemen, users.

AUDELS CARPENTERS & BUILDERS GUIDES—4 Vols.\$6

A practical illustrated trade assistant on modern construction for carpenters, joiners, builders, mechanics and all woodworkers. 4 vols., 1600 pages, 3700 illustrations, flexible covers. Pocket size. Each volume sold separately \$1.50 a vol.

AUDELS AUTOMOBILE GUIDE....\$4

A practical quick ready reference book for auto mechanics, service men, operators & owners. Explains theory, construction & servicing of modern motor cars, trucks, buses & auto type Diesel engines. 1540 pages, fully illustrated. 55 chapters. Indexed. A standard book for mechanics. New fluid drive covered.

AUDELS DIESEL ENGINE MANUAL.\$2

A practical, concise treatise with questions and answers on the theory, operation and maintenance of modern diesel engines including General Motors 2 cycle Diesel. 384 pages, fully illus., flexible binding, pocket size. All details plainly brought out, this book is of extreme value to engineers, operators & students.

AUDELS WIRING DIAGRAMS.....\$1

210 Pages. Illustrated. Gives practical facts on wiring of electrical apparatus. It shows clearly how to wire apparatus for practically all fields of electricity. Each diagram is complete & self-explanatory. Highly Endorsed Pocket Companion.

AUDELS PLUMBERS & STEAMFITTERS GUIDES—4 Vols.\$6

A Practical Trade Assistant & Ready Reference. Explains in plain language & by clear illustrations, diagrams, charts, graphs, pictures principles of modern plumbing practice including Marine Pipe Fitting and Air Conditioning. 4 Vols.—1679 Pages—3642 Diagrams. Pocket size. Each Vol. Sold Separately \$1.50 a Vol.

AUDELS SHEETMETAL WORKERS HANDY BOOK.....\$1

Practical inside information. Fundamentals of Sheet Metal Work. 388 pages. Illustrated. 11 sections. Clearly written. Essential & important facts, figures, pointers in everyday language. Ref. Index.

AUDELS SHEETMETAL PATTERN LAYOUTS.....\$4

Developed by Experts for Sheet Metal Workers, Layout Men & Mechanics. A Practical Encyclopedia in 10 Sections, size 7 x 10 x 2—1125 Pages—350 Layouts—1600 Illustrations. 1001 Key Facts. Fully indexed for ready reference in answering your layout problems. Covers all phases of sheet metal work including Pattern Cutting, Pattern Development & Shop Procedure.

AUDELS ANSWERS ON BLUE PRINT READING.....\$2

For Mechanics & Builders. Covers all types of blue print reading including ship & airplane. 376 pages, fully illustrated.

AUDELS NEW MACHINIST & TOOLMAKERS HANDY BOOK...\$4

Covers modern machine shop practice in all its branches. 5 practical books in 1. New from cover to cover. Tells how to set up & operate lathes, screw and milling machines, shapers, drill presses and all other machine tools. 1600 pages, fully illustrated, 5 x 6 1/2 x 2. Indexed. 5 sections. 1—Modern Machine Shop Practice. 2—Blue Print Reading & How to Draw. 3—Calculations & Mathematics for Machinists. 4—Shop Physics. 5—How to Use the Slide Rule. 60 chapters. Easy to read and understand. A shop companion that answers your questions.

AUDELS MATHEMATICS & CALCULATIONS FOR MECHANICS \$2

Mathematics for home study or reference. 700 pages, 550 illus. Practical mathematics from beginning. How to figure correctly. Easy, correct methods covering a complete review. Ill. & Indexed.

AUDELS HANDY BOOK OF PRACTICAL ELECTRICITY.....\$4

For maintenance engineers, electricians & all electrical workers. 1440 Pages, 2600 illus. Covers important electrical information in handy form—including Marine Wiring, Radio Principles, Welding. Indexed. A Key to a practical understanding of electricity.

AUDELS RADIOMANS GUIDE.....\$4

A key to the practical understanding of radio including Frequency Modulation, Television, etc., Aircraft & Marine Radio. For radio engineers, servicemen, amateurs. 772 pages. 400 Illustrations & Diagrams. Photos. Review Questions & Answers, Reference Index. Authentic, clear, concise.

AUDELS ELECTRONIC DEVICES...\$2

Tells What You Want to Know About Electric Eye. Easily Understood. Covers photo-electric cells & their applications. Amplifiers, illumination, frequencies, voltage, photocell, tubes, Ohm's Law, wiring diagrams, etc.

AUDELS WELDERS GUIDE.....\$1

A concise, practical text on operation & maintenance of all welding machines for all mechanics. Over 400 pages, illustrated. Covers all methods of electric and acetylene welding including airplane work.

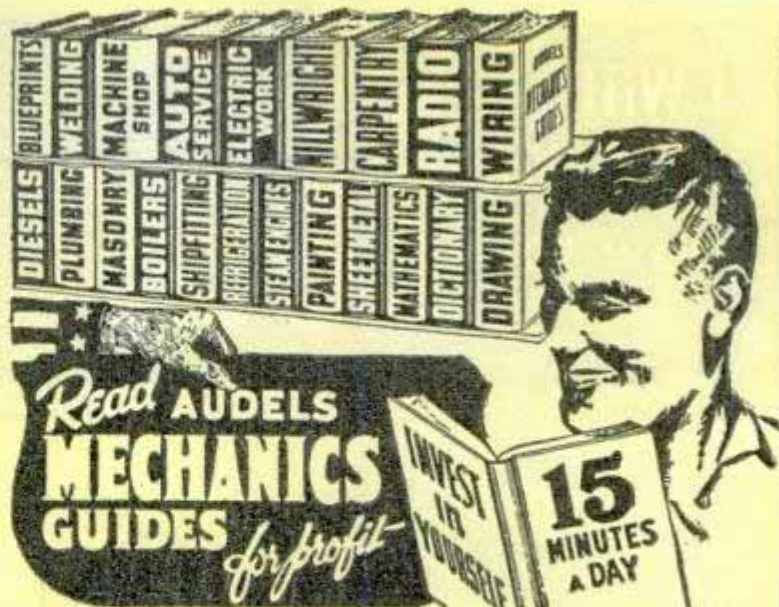

AN AUDEL GUIDE IS A GOOD FRIEND!

Use the brains and experience of others in these Guides of the Trades. Save time and money with right methods, short cuts, labor saving ideas. CHECK NOW! You can look over any Audel Guide in your home. Start the Easy Payments if satisfied.

CUT HERE MAIL ORDER

THEO. AUDEL & CO., 49 W. 23 St., New York 10, N.Y.

Please mail me for 7 days' free examination the books marked (X) below. I agree to mail \$1 in 7 days on each book or set ordered, and to further mail \$1 a month on each book or set ordered until I have paid purchase price.

If I am not satisfied with Guides I will return them.

- Audels OIL BURNER GUIDE \$1.
- Audels REFRIGERATION & Air Conditioning Guide. 4.
- Audels POWER PLANT ENGINEERS GUIDE 4.
- Audels PUMPS, HYDRAULICS & AIR COMPRESSORS 4.
- Audels WELDERS GUIDE 1.
- Audels BLUE PRINT READING 2.
- Audels SHEET METAL WORKERS Handy Book 1.
- Audels SHEET METAL PATTERN LAYOUTS 4.
- Audels AIRCRAFT WORKER 1.
- Audels MATHEMATICS and CALCULATIONS. 2.
- Audels MACHINISTS & TOOLMAKERS Handy Book 4.
- Audels MECHANICAL Dictionary 4.
- Audels AUTOMOBILE GUIDE 4.
- Audels DIESEL ENGINE MANUAL 2.
- Audels MARINE ENGINEERS Handy Book 4.
- Audels SHIPFITTERS Handy Book 1.
- Gueths MECHANICAL DRAWING COURSE 1.
- Rogers DRAWING and DESIGN 2.
- Audels MILLWRIGHTS and Mechanics Guide 4.
- Audels CARPENTERS and Builders Guides (4 vols.) 6.
- Audels PLUMBERS and Steamfitters Guides (4 vols.) 6.
- Audels MASONS and Builders Guides (4 vols.) 6.
- Master PAINTER and DECORATOR 2.
- Audels GARDENERS & GROWERS GUIDES (4 vols.) 6.
- Audels ENGINEERS & FIREMANS EXAMINATIONS 1.
- Audels ENGINEERS and Mechanics Guides Nos. 1, 2, 3, 4, 5, 6, 7 and 8 complete 12.
- Audels Answers on Practical ENGINEERING 1.
- Audels ELECTRICIANS EXAMINATIONS 1.
- Audels WIRING DIAGRAMS 1.
- Audels Handy Book of PRACTICAL ELECTRICITY 4.
- Audels ELECTRICAL POWER CALCULATIONS 2.
- Audels ELECTRONIC DEVICES 2.
- Audels ELECTRIC Dictionary 2.
- Audels RADIOMANS GUIDE 4.
- Audels NEW ELECTRIC LIBRARY at \$1.50 a Volume Vols. I, II, III, IV, V, VI, VII, VIII, IX, X, XI, XII

Name _____
 Address _____
 Occupation _____
 Employed by _____ PM

AUDEL, Publishers, 49 W. 23 St., N. Y. 10

I Will
Show You
How to

Learn RADIO

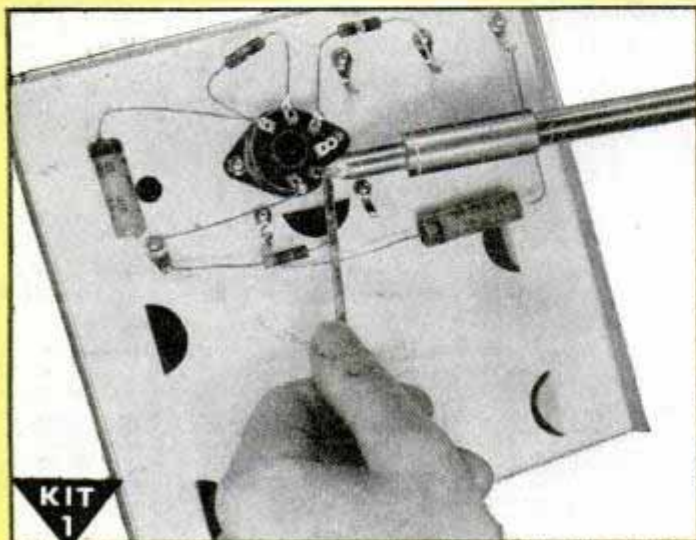

KIT 1

I send you Soldering Equipment and Radio parts; show you how to do Radio soldering; how to mount and connect Radio parts; give you practical experience.



KIT 2

Early in my course I show you how to build this N.R.I. Tester with parts I send. It soon helps you fix neighborhood Radios and earn EXTRA money in spare time.

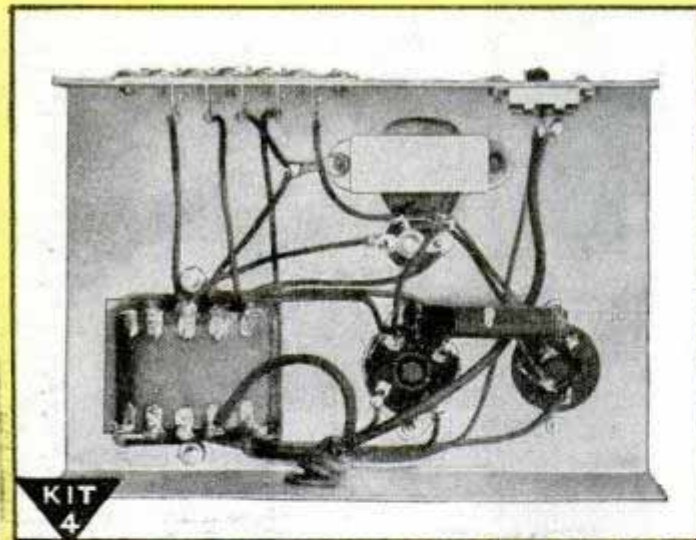

KIT 4

You get parts to build this Vacuum Tube Power Pack; make changes which give you experience with packs of many kinds; learn to correct power pack troubles.

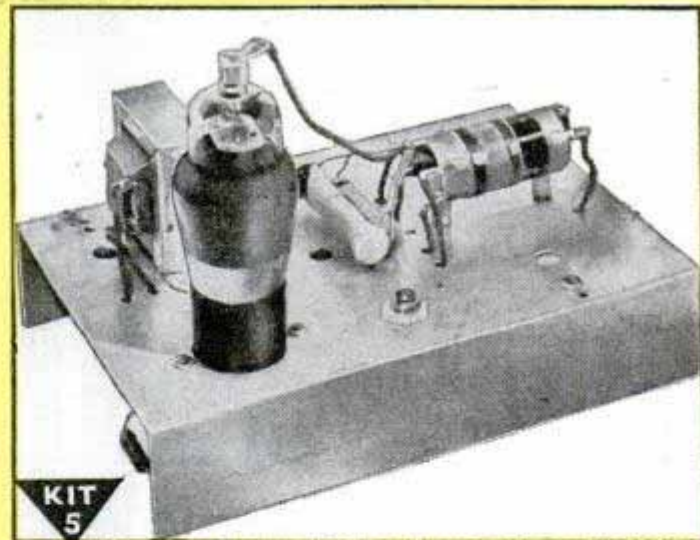

KIT 5

Building this A. M. Signal Generator gives you more valuable experience. It provides amplitude-modulated signals for many tests and experiments.

MEN I TRAIN AT HOME GET GOOD JOBS LIKE THESE

**\$50 a Week
From Own Shop**

"Am making over \$50 a week profit from my own shop. Have another N.R.I. graduate working for me. I like to hire N.R.I. men because they know radio." — **NORMAN MILLER**, Hebron, Neb.



**Fixing Radios
Profitable Hobby**

"I am doing radio work in my spare time, and find it a profitable hobby. My extra earnings run about \$10 a week. I certainly am glad I took your N.R.I. Course." — **FERDINAND ZIRBEL**, Chaseley, North Dakota.



**Chief Engineer
Station KWLM**

"Am now Chief Engineer of Station KWLM and in charge of maintenance of Police Station KRIN, County Highway Dept. Also have my own business. Mighty glad to be in radio." — **LLOYD V. STENBERG**, 516 Litchfield Ave., W., Willmar, Minn.



**Still Climbing in
Air-craft Radio**

"I am still climbing as a result of my N.R.I. training. I now do aircraft radio work at Greenwood Army Air Field, and operate a radio shop in my spare time." — **JAMES L. BOYETT**, P.O. Box 218, Greenwood, Miss.



by Practicing in Spare Time

I Send You
Big Kits
of Radio Parts

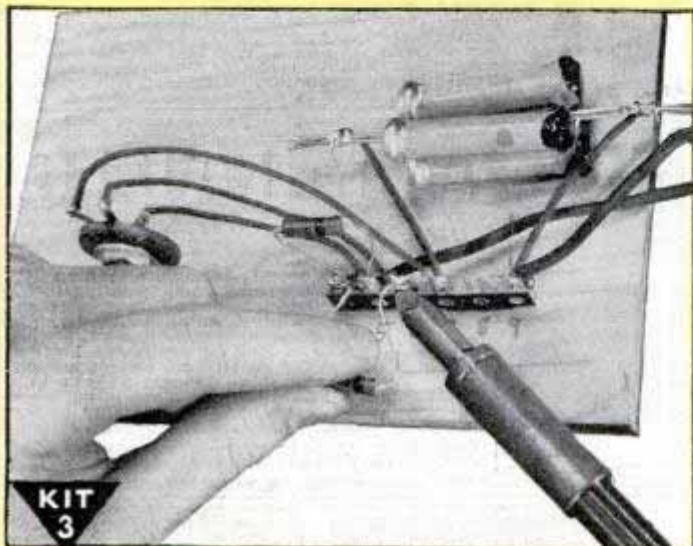

KIT
3

You get parts to build Radio Circuits; then test them; see how they work; learn how to design special circuits; how to locate and repair circuit defects.

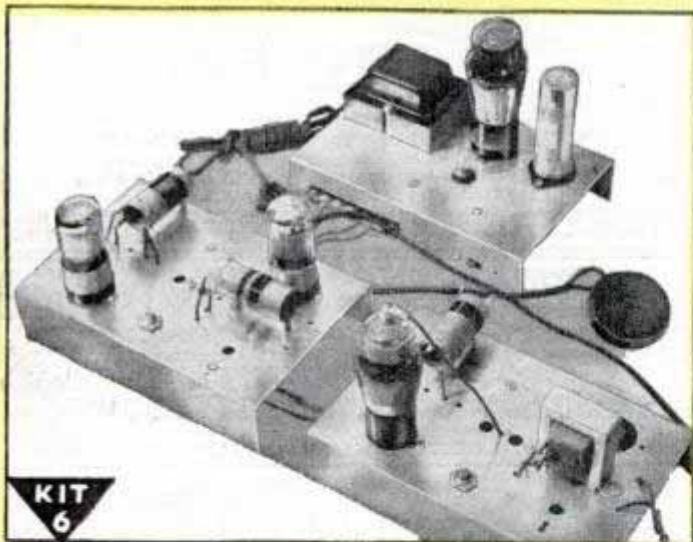

KIT
6

You build this Superheterodyne Receiver which brings in local and distant stations — and gives you more experience to help you win success in Radio.

SAMPLE LESSON

FREE

Gives hints on Receiver Servicing, Locating Defects, Repair of Loudspeaker, I.F. Transformer, Gang Tuner, Condenser, etc. Mail Coupon.

GETTING ACQUAINTED WITH
RECEIVER SERVICING

My Radio Course Includes
TELEVISION • ELECTRONICS
FREQUENCY MODULATION

KNOW RADIO *Win Success* I Will Train You at Home

APPROVED
for training
under
G.I. BILL

Do you want a good-pay job in the fast-growing Radio Industry—or your own Radio Shop? Mail the Coupon for a Sample Lesson and my 64-page book, "How to Be a Success in RADIO — Television, Electronics," both FREE. See how I will train you at home—how you get practical Radio experience building, testing Radio circuits with **BIG KITS OF PARTS** I send!

Many Beginners Soon Make Extra Money in Spare Time While Learning

The day you enroll I start sending **EXTRA MONEY JOB SHEETS** that show how to make **EXTRA MONEY** fixing neighbors' Radios in spare time, while still learning! It's probably easier to get started now than ever before, because the Radio Repair Business is booming. Trained Radio Technicians also find profitable opportunities in Police, Aviation, Marine Radio, Broadcasting, Radio Manufacturing, Public Address work. Think of even greater opportunities as Television, FM, and Electronic devices become available to the public! Send for **FREE** books now!

Find Out What NRI Can Do For You

Mail Coupon for Sample Lesson and my **FREE 64-page** book. Read the details about my Course; letters from men I trained; see how quickly, easily you can get started. No obligation! Just **MAIL COUPON NOW** in envelope or paste on penny postal. **J. E. SMITH, President, Dept. 7AP, National Radio Institute, Pioneer Home Study Radio School, Washington 9, D. C.**

Our 33rd Year of Training
Men for Success in Radio

MAIL NOW!

Mr. J. E. SMITH, President, Dept. 7AP
National Radio Institute,
Washington 9, D. C.

Mail me **FREE**, your sample lesson
and 64-page book. (No salesman will
call. Please write plainly.)

Age.....

Name.....

Address.....

City..... State.....
(Please include Post Office zone number)



Approved for Training under GI Bill



AUTO

BOOKS ON APPROVAL



SEND NO MONEY. Just mail the coupon for a complete set of Six Big Auto Books, 20th Edition. Whether you are a mechanic or helper, expert or apprentice, auto owner or driver, take immediate advantage of this FREE EXAMINATION OFFER.

MAKE GOOD MONEY NOW HOLD A PERMANENT JOB
America wants its automobiles kept in good repair. Men with "know how" are in demand, at big pay. These books will help you get and hold an important job, or give you a chance to go into business for yourself now or later. Any man who half tries to improve himself can learn auto servicing and repairing by this quick reference method. Use the JIFFY INDEX to find easily understood answer to any auto problem. These wonder books prepared by eleven of America's great automobile engineers. Many hundreds of valuable illustrations. Send the coupon TODAY.

[A year's consulting privileges with our engineers now given with these books without extra charge.]
Vocational Publishers Since 1898

CAN YOU FIX IT?

These wonder books tell step by step HOW to make difficult repairs and adjustments, how to keep a car at maximum efficiency, including latest improvements in car design and operation. Engine troubles and how to correct them well covered.

6 BIG VOLUMES
2800 pages, 2000 illustrations, wiring diagrams, etc., including Diesel engines. Beautiful modernistic, washable cloth binding.

AMERICAN TECHNICAL SOCIETY, Dept. A119
Drexel Ave. at 58th St., Chicago 37, Ill.
I would like to examine your Six-Volume Set of Auto Books. I will pay the delivery charges only, but if I choose I may return them express collect. If after 10 days' use I prefer to keep them, I will send you \$2 and pay the balance at the rate of only \$3 a month until \$24.80 has been paid. Please include consulting service as offered above.

Name

Address

City State

Please attach letter stating age, occupation, employer's name and address and name and address of at least one business man as reference. Men in service, also please give home address.

Electricity at your finger ends



Sold Singly
Price \$1.50 A Book

Pocket Size!

AUDELS NEW ELECTRIC LIBRARY—A progressive Home Study and Reference Course in applied electricity. Easy to understand. Questions and answers plainly written for complete working knowledge of modern electrical practice, necessary to every electrician, engineer, mechanic and student.

LEARN THE AUDEL WAY! You ask the question—Audels New Electric Library gives the answer—9500 simplified outlines, graphic illustrations and precise explanations covering Construction, Operation and Machine Maintenance.

BOOK A MONTH PLAN—Order the volume that interests you—today! We will send that volume on 7 days' free trial. If the book helps you, send us \$1.50. If it does not help you, mail book back to us on receipt of your first payment, we will send your second book. We allow 30 days to pay for this and for each following book until you complete the Series.

If you are not satisfied, you may cancel your subscription at any time.

FREE EXAMINATION COUPON

Theo. Audel & Co., 49 W. 23rd St., New York City
Mail Vol. I, Electric Library on 7 days' free trial. If O. K. I will remit \$1.50, otherwise I will return it. I also request you to mail one book each month on same terms. No obligation unless I am satisfied.

Name

Address

Occupation PM

Do You Make These Mistakes in English?

MANY persons say "between you and I" instead of "between you and me"—or use "who" for "whom"—or don't know whether to spell certain words with one or two "e's" or "m's" or "r's," or with "ie" or "ei," etc. Every time you speak or write you show what you are. Mistakes in English reveal lack of education, refinement. Lack of language power prevents you from presenting your thoughts in the strongest way. Real command of English will help you reach ANY goal. Stop making mistakes in spelling, punctuation, pronunciation, grammar. Increase your vocabulary.



Sherwin Cody

WONDERFUL INVENTION

Only 15 minutes a day with Sherwin Cody's new invention—and you can actually SEE your English improve. It teaches by HABIT—makes it easier to do the RIGHT way. Wonderful self-correcting lessons.

FREE BOOK ON ENGLISH Lack of language power may be costing you friendships, income, every year. See what Mr. Cody can do for you; it costs nothing to find out. Write this very minute for free book, "How You Can Master Good English in 15 Minutes a Day." It will prove a revelation. WRITE NOW. SHERWIN CODY SCHOOL OF ENGLISH, 51 B & O Bldg., Rochester 4, N. Y.

FIX ANY RADIO

Amazing New Invention



PRICE ONLY \$1.50 COMPLETE

Learn quickly to repair all radio sets. New, different Comparison method. No previous radio knowledge needed. Introductory training included. Simple, picture suggestions tell you where to look for faults and how to make the repair. No testers needed for most jobs. Manual 8 1/2 x 11 in., 63 job-sheets, 24 blueprints. Many hints. New edition. Order manual 3-P. Price only \$1.50 postpaid. Satisfaction guaranteed or money back.

SUPREME PUBLICATIONS 9 S. Kedzie Ave. Chicago 12, ILL.

GOVT. JOBS

Inexpensive, Keyed Lessons prepare you for Exam. Write. Ozment School, 80, St. Louis, Mo. (Veterans get preference.)

LEARN MOVIE THEATRE MANAGEMENT

The Motion Picture Theatre Business offers big opportunities for trained men. Get into a fascinating field with a post-war future. Train at home in spare time. Free Catalog. Established 18 years.

THEATRE INSTITUTE, 370 Washington St., Elmira, New York

LEARN MONEY-MAKING CARTOONING

IN SPARE TIME — by Easy Picture Chart Method
Same Simplified Method that has helped train creators of "Terry & Pirates," "Freckles," "Out Our Way," "Winnie Winkle," "Reg'lar Fellers," "Strange As It Seems," "The Neighbors," and many others. Earn while learning. Send 10c for Picture Chart (to test your ability), and full details. (State age.)

Landon School of Cartooning, Dept. 4701 Philadelphia (1) Pa.

TRAIN Your VOICE!

Results GUARANTEED

We build, strengthen the vocal organs—not with singing lessons—but by sound, scientifically correct silent and vocal exercises and absolutely guarantee complete satisfaction with results. Write for Voice Book, FREE. Sent to no one under 17 years old unless signed by parent.

Perfect Voice Studios, Studio 1351, Kimball Hall Bldg., Chicago 4, Ill.

Fit-Rite makes False Teeth TIGHT

Makes loose dental plates fit snugly and comfortably. **LASTS for MONTHS!**

Simply squeeze on dental plate and put it in your mouth. Hardens and becomes part of plate. Money-back guarantee.

FREE Generous package of Dental Plate Cleanser with each order. Send \$1.00 or mailed parcel post collect.

Fit-Rite Co., 1557 Milwaukee Ave. Dept. 1-PM, Chicago, Ill.



INVENTORS

The patent laws provide that any new and useful art, machine, article of manufacture, composition of matter, or design, or any new and useful improvement thereof, may be patented if the act of invention is involved. Therefore, every inventor with a valuable invention should take advantage of the patent laws and proceed for patent protection in order to safeguard his rights.

A patent gives the inventor the exclusive right to prevent others from making, using, or selling the invention claimed in the patent for a period of 17 years.

The patent laws were enacted for the benefit of the inventor to give him protection for the features of his invention which are patentable. These features must be properly and concisely set forth and claimed in a formal application for patent in order to comply with the requirements of the U. S. Patent Office. For that reason, the Patent Office advises the inventor to engage a competent registered patent attorney to prepare his application for patent and represent him before the U. S. Patent Office Examiner.

A specially prepared booklet containing detailed information with respect to patent protection and procedure will be forwarded to you without obligation upon request.

Patents
Trademarks
Copyrights

Registered Patent Attorneys

CLARENCE A. O'BRIEN
& HARVEY B. JACOBSON

71-A District National Building + Washington 5, D. C.

CLARENCE A. O'BRIEN & HARVEY B. JACOBSON
Registered Patent Attorneys

71-A District National Bldg., Washington 5, D. C.

Please send me booklet containing information regarding patent protection and procedure, and also "Record of Invention" form. This request does not obligate me.

Name _____

Address _____

City _____ State _____

(Please write or print plainly.)

NOW SPRAYBERRY RADIO TRAINING

GIVES YOU 8 BIG KITS OF RADIO EQUIPMENT

WITH A COMPLETE 6 TUBE SUPER-HETERODYNE RECEIVER

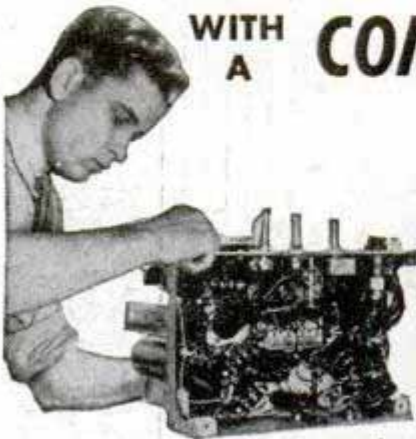

YOU LEARN RADIO SERVICING THROUGH INTENSIVE "SHOP-BENCH" PRACTICE

YOU DO EXPERIMENTS, CONSTRUCTION, TROUBLE-SHOOTING

I'll show you how to perform over 175 instructive Experiments—how to build countless Radio Circuits. You'll learn a new, fast way to test Radio Sets without mfg. Equipment.



I give you a fine, moving-coil type Meter Instrument on Jewel Bearings—with parts for a complete Analyzer Circuit Continuity Tester. You learn how to check and correct Receiver defects with professional accuracy and speed.

You'll get valuable experience and practice building this Signal Generator and multi-purpose Tester. Makes a breeze out of fixing Radios and you don't have to spend money on outside, ready-made equipment.



Soldering, wiring, connecting Radio parts . . . building circuits with your own hands—you can't beat this method of learning. When you construct this Rectifier and Filter, Resistor and Condenser Tester, etc., you get a really practical slant on Radio that leads to a money-making future.



HERE'S THE LATEST, SIMPLEST WAY TO TRAIN at HOME for a GOOD LIVING in RADIO-ELECTRONICS & TELEVISION

I train your mind by putting you to work with your hands on a big 6-Tube Superheterodyne Receiver. And, believe me, when you get busy with real Radio Parts — 8 big Kits of them — you really LEARN Radio and learn it RIGHT! You get the practical stuff you need to be useful in Radio, and that's what it takes to make money. You don't have to worry about what to do with these 8 Kits of Parts. Step by step, I show you how to build circuits, test, experiment, trouble-shoot. And you don't need any previous experience. The Sprayberry Course starts right at the beginning of Radio! You can't get lost! Simplified lessons, coupled

with real "Shop" practice, makes every subject plain and easy to understand and remember.

A BUSINESS OF YOUR OWN . . . OR A GOOD RADIO JOB

Soon after you begin Sprayberry Training, I'll send you my sensational **BUSINESS BUILDERS**. You'll find out how to get and do neighborhood Radio repair jobs for nice profits and rich experience while learning. This sort of work can easily pave the way for a Radio Service business of your own. But with Sprayberry Training, you're not limited. You can swing into any one of the swiftly expanding branches of Radio-Electronics INCLUDING Radio, Television, FM, Radar, Industrial Electronics. Be wise! Decide now to become a fully qualified **RADIO-ELECTRONICIAN**. Get full details about my Training at once! Mail coupon below for my 2 big **FREE** Books.

SEND FOR THESE FREE BOOKS



"How to Read Radio Diagrams and Symbols"

Here's a valuable and wonderfully complete new book which explains in simple English how to read and understand any Radio Set Diagram. Includes translation of all Radio symbols. Send for this volume at once! It's free! Along with it, I will send you another Big Free book describing in detail my Radio-Electronic Training.

SPRAYBERRY ACADEMY OF RADIO

F. L. Sprayberry, President, Room 1017, Pueblo, Colorado

Please rush my **FREE** copies of "How to **MAKE MONEY** in RADIO, ELECTRONICS and TELEVISION," and "HOW to READ RADIO DIAGRAMS and SYMBOLS."

Name Age

Address

City State

(Mail in envelope or paste on penny postcard)

MAIL COUPON TODAY!

15 Minutes a Day!

Give me just this
and I'll prove I can make you
A NEW MAN!

I'M "trading-in" old bodies for new! I'm taking men who know that the condition of their arms, shoulders, chests and legs—their strength, "wind," and endurance—is not 100%. And I'm making NEW MEN of them. I'm giving them the kind of powerful, healthy HE-MAN build that spells SUCCESS in life and business.

Only 15 Minutes a Day!

Are you ALL MAN—tough-muscled, on your toes every minute, with all the up-and-at-'em that can lick your weight in wildcats? Or do you need the help I can give you—the help that has already worked such wonders for other fellows, everywhere?

All the world knows I was ONCE a skinny, scrawny 97-lb. weakling. And NOW it knows that I am the holder of the title, "The World's Most Perfectly Developed Man." How did I do it? How do I work miracles with the bodies of other men in only 15 minutes a day? The answer is "Dynamic Tension," the amazing method I discovered and which changed me from a 97-pound weakling into the champion you see here!

In just 15 minutes a day, right in the privacy of your own home, I'm ready to prove that "Dynamic Tension" can lay a new outfit of solid muscle over every inch of your body. Let me put new, smashing power into your arms and shoulders—give you an armor-shield of stomach muscle—strengthen your legs into real columns of surging stamina. If lack of exercise or wrong living has weakened you *inside*, I'll get after that condition, too, and show you how it feels to LIVE!

FREE This Famous Book that Tells You How to Get a Body that Men Respect and Women Admire

My book, "Everlasting Health and Strength," tells you exactly what "Dynamic Tension" can do. And it's packed with pictures that SHOW you what it does. RESULTS it has produced for other men. RESULTS I want to prove it can get for YOU! If you want to learn how you can actually become a NEW MAN, right in the privacy of your own home and in only 15 minutes a day, then man!—get this coupon into the mail to me as fast as your legs can get to the letterbox! CHARLES ATLAS, Dept. 81, 115 East 23rd St., New York 10, N. Y.

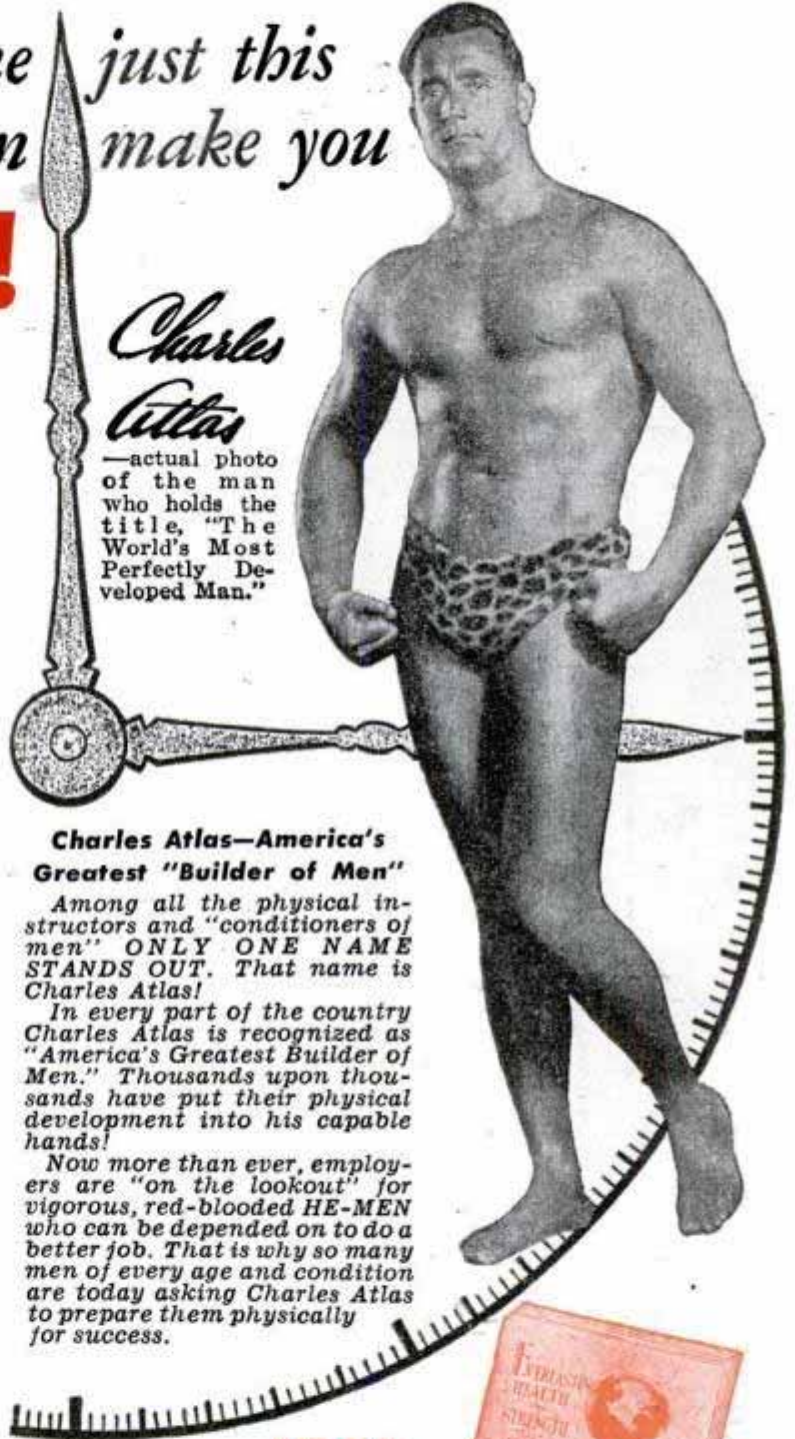

Charles Atlas

—actual photo of the man who holds the title, "The World's Most Perfectly Developed Man."

Charles Atlas—America's Greatest "Builder of Men"

Among all the physical instructors and "conditioners of men" ONLY ONE NAME STANDS OUT. That name is Charles Atlas!

In every part of the country Charles Atlas is recognized as "America's Greatest Builder of Men." Thousands upon thousands have put their physical development into his capable hands!

Now more than ever, employers are "on the lookout" for vigorous, red-blooded HE-MEN who can be depended on to do a better job. That is why so many men of every age and condition are today asking Charles Atlas to prepare them physically for success.

MAIL THIS COUPON NOW!

CHARLES ATLAS, Dept. 81

115 East 23rd St., New York 10, N. Y.

I want the proof that your system of "Dynamic Tension" will help make a New Man of me—give me a healthy, husky body and big muscular development. Send me your free book, "Everlasting Health and Strength."

Name.....
(Please print or write plainly)

Address.....

City..... Zone No. State.....
(if any)

Check here if under 16 for Booklet A.



INVENTORS

Patent Laws Encourage The Development Of Inventions

The Rules of Practice of the U. S. Patent Office advises—unless an inventor is familiar with such matters—that he employ a competent registered attorney, as the value of patents depends largely upon the skillful preparation of the specifications and claims.

The firm of McMorrow, Berman and Davidson is registered to practice before the U. S. Patent Office. Additionally, it maintains a staff of attorneys able to readily understand inventors' disclosures, to advise concerning patentability, and to prepare appropriate specifications and claims for filing with the Patent Office.

If an inventor believes he has an invention, a search of the most pertinent prior U. S. patents should be made and a report obtained relative to its patentability. Where such report indicates that the invention appears patentable, in order to secure protection, diligence should be exercised in making application for a patent.

McMORROW, BERMAN & DAVIDSON

Registered Patent Attorneys

PATENTS — TRADE MARKS — COPYRIGHTS

1351 VICTOR BUILDING, WASHINGTON 1, D. C.

McMORROW, BERMAN & DAVIDSON

Registered Patent Attorneys

1351 Victor Building, Washington 1, D. C.

Send me further particulars as to patent protection and procedure and "Invention Record" form at once. I understand that this request does not obligate me.

Name.....

Address.....

City..... State.....

(WRITE OR PRINT NAME CLEARLY)



Reports on



"Conscientious study of I. C. S. Courses proves their value beyond doubt."

R. D. CHARLES
Maintenance Superintendent
Africa-Orient Division
Pan American World Airways

RECORDS of Pan American World Airways tell you plenty about the value of I. C. S. Aviation Courses. They show that hundreds of Pan American pilots, co-pilots, flight engineers and maintenance men have taken I. C. S. Courses.

Now flying for just one division of the airline — Latin American — are 336 pilots and co-pilots who are holders of I. C. S. diplomas.

What better endorsement could there be of any institution offering training for Aviation careers?

If *you* are planning for a place in Aviation, you owe it to yourself to mail the coupon today for full information on the famous I. C. S. Courses. Do it *now!*

INTERNATIONAL CORRESPONDENCE SCHOOLS



BOX 5596-K, SCRANTON 9, PENNA.

Without cost or obligation, please send me full particulars about the course *before* which I have marked X:

Air Conditioning and Plumbing Courses

- Air Conditioning
- Heating Plumbing
- Refrigeration Steam Fitting

Chemistry Courses

- Chemical Engineering
- Chemistry, Analytical
- Chemistry, Industrial
- Chemistry, Mfg. Iron & Steel
- Petroleum Refining Plastics
- Pulp and Paper Making

Civil Engineering, Architectural and Mining Courses

- Architectural Drafting
- Architecture
- Bridge and Building Foreman
- Building Estimating
- Civil Engineering
- Coal Mining
- Contracting and Building
- Highway Engineering
- Lumber Dealer
- Reading Structural Blueprints
- Sanitary Engineering
- Structural Drafting

Structural Engineering

- Surveying and Mapping

Communications Courses

- Electronics
- Practical Telephony
- Radio, General
- Radio Operating
- Radio Servicing
- Telegraph Engineering

Electrical Courses

- Electrical Drafting
- Electrical Engineering
- Electric Light and Power
- Lighting Technician
- Practical Electrician

Internal Combustion Engines Courses

- Auto Technician Aviation
- Diesel-Electric
- Diesel Engines Gas Engines

Mechanical Courses

- Aeronautical Engineering
- Aircraft Drafting
- Flight Engineer
- Foundry Work
- Heat Treatment of Metals

Industrial Engineering

- Industrial Metallurgy
- Machine Shop
- Mechanical Drafting
- Mechanical Engineering
- Mold-Loft Work
- Patternmaking—Wood, Metal
- Reading Shop Blueprints
- Sheet-Metal Drafting
- Sheet-Metal Worker
- Ship Drafting Ship Fitting
- Tool Designing
- Toolmaking
- Welding—Gas and Electric

Railroad Courses

- Air Brake Car Inspector
- Diesel Locomotive
- Locomotive Engineer
- Locomotive Fireman
- Railroad Section Foreman

Steam Engineering Courses

- Boilermaking
- Combustion Engineering
- Engine Running
- Marine Engineering
- Steam Electric Steam Engines

Textile Courses

- Cotton Manufacturing
- Rayon Weaving
- Textile Designing
- Woolen Manufacturing

Business and Academic Courses

- Accounting Advertising
- Arithmetic Bookkeeping
- Business Correspondence
- Business Management
- Certified Public Accounting
- Commercial
- Cost Accounting
- Federal Tax
- First Year College
- Foremanship French
- Good English High School
- Higher Mathematics
- Illustrating Motor Traffic
- Postal Service
- Salesmanship Secretarial
- Sign Lettering
- Spanish Stenography
- Traffic Management

Name _____ Age _____ Home Address _____

City _____ State _____ Present Position _____

Working Hours _____ A.M. to _____ P.M. Length of Service in World War II _____

Special tuition rates to members of the Armed Forces. Enrollment under the G.I. Bill of Rights approved for War II Veterans.
Canadian residents send coupon to International Correspondence Schools Canadian, Ltd., Montreal, Canada.

ADVICE *for the* INVENTOR

The United States Patent Office advises the inventor, unless he is familiar with such matters, to employ a competent, registered patent attorney since the value of a patent depends largely upon the skillful preparation of the specifications and claims set forth in his application.

PRELIMINARY STEPS *toward* PATENT PROTECTION

The Evidence of Invention form mentioned below is offered as a convenience to the inventor in making his disclosure of invention. The inventor should date and sign his disclosure and have it witnessed by two or more persons who are capable of understanding his invention. The disclosure should then be mailed together with the inventor's authorization to conduct a pre-

liminary search at the U. S. Patent Office among previously granted U. S. Patents for similar types of invention. A report is then prepared on the probable patentability of his invention and a recommendation made as to the further course he should take in regard to his invention, provided that the patentability report indicates possible patentability.

Victor J. Evans & Co., has a staff of experienced, registered patent attorneys available to represent inventors in the preparation and prosecution of their cases before the Patent Office.

The **COUPON BELOW** is suggested as a convenience to the inventor in starting action on his invention.

**VICTOR J.
EVANS & Co.**

Merlin M. Evans

REGISTERED PATENT ATTORNEY

230-A Merlin Building, Washington 6, D. C.

PLEASE SEND DETAILED PATENT INFORMATION TOGETHER WITH CONVENIENT "EVIDENCE OF INVENTION" FORM.

Name.....

Address.....

City and State.....

PATENTS

TRADEMARKS

COPYRIGHTS

MEN! Whether You're 16 or ^{up} to 40..

Learn ELECTRICITY

Get Ready quickly
for the Field that offers
**STEADY WORK and
A REAL FUTURE!**

FREE BOOK shows how you can
prepare for a **GOOD JOB NOW**



A partial view of one of the Training Departments at Coyne

"LEARN-BY-DOING" IN COYNE SHOPS

Start now to prepare for a Lifetime of Success. Get into Electricity, the essential field that will continue to offer good pay and a real future all through the years. Coyne trains you, **NOT** by correspondence, but by actual shop work right here in the Coyne Shops in Chicago on real electrical machinery. You get necessary theory in a practical way by lectures, blackboard illustrations and equipment demonstrations.

In the Big Coyne Shops you get practical "all-around" training... wiring, installing, operating, testing, repairing and servicing various types of Electrical and Electronic equipment... you work on real armatures, motors, generators, refrigerators, electronic controls, etc. No advanced education or previous electrical experience needed. Many of our students had no previous experience. Others had experience in one or two branches but realized they needed all-around training for the better jobs and advancement.

Not a Correspondence Course

This is not a home-study or correspondence school training. You go right into the great Coyne Shops and handle full-size electrical equipment, just like you will later use on the job.

Earn While Learning

Don't let shortage of money hold you back. Many earn while learning, to help take care of living expenses while here. When you have graduated, our Employment Department will give you Lifetime Employment Service.



PREPARE FOR PERMANENT JOBS LIKE THESE

Light and Power Wiring
Power Plant Work
Armature Winding
Substation Operator
Maintenance Electrician
Electrical Testing and Repair
Signal Maintenance
Industrial Electronics
Electric Refrigeration
and many others

Our Employment Bureau for graduates gives FREE lifetime employment service.

Industrial Electronics and Electric Refrigeration Training Now Included

Added training in these two great fields is now included with our Electrical Course. Industrial Electronics and Electric Refrigeration offer big opportunities. Get BOTH at Coyne!



B. W. Cooke

MEN WITH PHYSICAL DISABILITIES—

We also have facilities for men with physical disabilities whether due to war or other causes. Check coupon for particulars if you have a physical disability of any nature.

GET THE FACTS

Don't let lack of money keep you from sending in the Coupon now. Our Big FREE Book is full of facts and photographs which tell you about Coyne training. It also gives you the details of our Part Time Employment Plan, Graduate Employment Service... Lifetime Membership, etc.

OUR GRADUATE EMPLOYMENT SERVICE HAS LETTERS FROM DOZENS OF FIRMS ASKING FOR COYNE TRAINED MEN FOR GOOD JOBS WITH A REAL FUTURE.



This modern fireproof building is occupied entirely by the Coyne Electrical School.

VETERANS

Coyne is also equipped to train those who qualify for training under the G. I. Bill of Rights. Check coupon for special G.I. Bulletin

**ADDED TRAINING IN
INDUSTRIAL
ELECTRONICS
AND ELECTRIC
REFRIGERATION
Now Included!**

B. W. COOKE, Director

COYNE ELECTRICAL SCHOOL
500 S. Paulina St., Dept. 17-72, Chicago, 12

**Send Today for
this FREE Book!**

B. W. COOKE, Director
COYNE ELECTRICAL SCHOOL,
500 S. Paulina St., Dept. 17-72, Chicago 12, Ill.

Without obligation send big free illustrated book with facts about Coyne and details of added training in Industrial Electronics and Electric Refrigeration you are now including.

- Send special G. I. Bulletin.
 Send physical disability details.

Name.....

Address.....

City.....State.....



**"I'll show YOU
how to make yourself
COMMANDO-TOUGH**

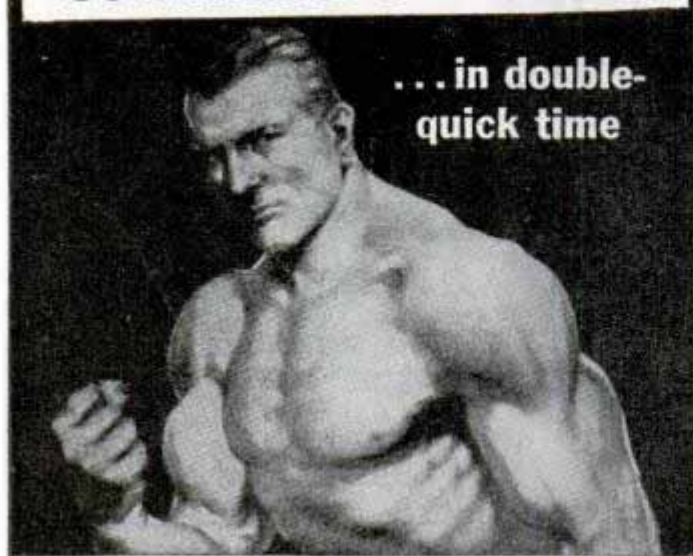

**...in double-
quick time**

**...OR IT WON'T COST YOU A CENT!"
says George F. Jowett**

WORLD'S GREATEST BODY BUILDER

Let me prove to YOU that you can put inches of dynamic muscles on your arms! Add inches to your chest! Broaden your shoulders and power-pack the rest of your body. I can do for you what I've done for thousands the world over, including many officers and men now in the U. S. and British Armed Forces.

GIVE ME 10 MINUTES A DAY!

I'll Show You My Secrets Of Body Building

I'll help you learn the "Progressive Power Method" through which I rebuilt myself from a physical wreck to the holder of more strength records than any other living athlete or teacher! No matter how skinny or flabby you are, you can learn my methods right in your own home. Through my proved secrets I show you how to develop your power, inside and out, until YOU are fully satisfied that you are the man you want to be. "The Jowett System," says R. F. Kelly, Atlantic City, Physical Director, "is the greatest in the world!"

If you want a physique that will inspire respect from men, and admiration from women... ACT LIKE A HE-MAN! Decide at once! The famous book, "Nerves of Steel—Muscles Like Iron" will be included FREE! Priceless for the strength fan! Full of photos of marvelous power-bodied men who will show you what Jowett has done for them and how he can do the same for you. Reach out... Grasp this Special Offer today!

Jowett Institute, Dept. PM-71
230 Fifth Ave., New York 1, N.Y.

**PROVE TO YOURSELF
IN ONE NIGHT!**

Send only 25c for test Course, "Molding a Mighty Arm." Read it the evening it arrives—learn from experience the thrill you can give your muscles!

**SEND FOR THESE FIVE FAMOUS
COURSES IN BOOK FORM**

**ONLY 25c EACH
or ALL 5 for \$1.00**

QUICK ACTION BRINGS

**THIS
BOOK
FREE!**



PHOTO BOOK OF FAMOUS STRONG MEN FREE



Jowett Institute of Physical Culture
230 Fifth Avenue, New York 1, N. Y. DEPT. PM-71

George F. Jowett: Your proposition looks good to me. Send by return mail, prepaid, the courses checked below, for which I enclose (). Include FREE book of PHOTOS.

- George F. Jowett Champion of Champions
- All 5 courses for.... \$1
 - Molding a Mighty Arm 25c
 - Molding a Mighty Back 25c
 - Send all 5 C.O.D. (\$1 plus postage.) No orders less than \$1 sent C.O.D.
 - Molding Mighty Legs 25c
 - Molding a Mighty Grip 25c
 - Molding a Mighty Chest 25c

NAME..... Age.....
(Please print plainly. Include zone number.)

ADDRESS.....

**Learn PHOTOGRAPHY
at Home Now—Portraiture, Press,
Commercial or Hobby**



Whether it's for a full-time career or just plain fun, you'll enjoy learning photography this new, easy way. Every phase of photography is carefully covered, with the latest techniques and methods fully explained. There are thousands of opportunities in photography as a career, and hours of pleasure as a hobby, so make the most of them today.

12-Month Home Study Course

Written and directed by expert photographers with years of teaching experience at one of America's leading educational institutions. A really THOROUGH education in photography, taught in easy steps and simple terms. Write today for complete information.

MOODY EDUCATIONAL INSTITUTE, Inc.

208 E. Wisconsin Ave. Dept. 11-B6 Milwaukee 2, Wis.

**LEARN Accounting
AT HOME - IN SPARE TIME**

Bookkeepers, accountants, and secretaries are in great demand. Now is the time to prepare for the many opportunities open to business-trained men and women.

Write today for FREE copy of interesting new booklet, "Through Hill's To Success," which tells where the best positions are found and how you may train for them quickly at home in your spare time or in resident school.

Hill's is rated as one of America's leading business schools. Thousands of successful graduates. Nationwide Employment Service.

**Hill's EXTENSION SCHOOL
And Business University**
619 West Main St., Oklahoma City 2, Okla.



WHAT BOOKS DO YOU WANT?

We quote the lowest market prices. No charge for locating Hard-to-Find and Out-of-Print Books. All books, OLD or NEW, mailed POST-FREE.

SEARCHLIGHT BOOK CLUB, 22 East 17th St., New York City

Learn Penmanship

You can learn plain, rapid writing or fancy ornamental writing for social and business advancement, right in your own home during spare time by my Simplified Method. Write for my free book, "How to Become an Expert Penman," which shows what others have accomplished by taking my Courses. Send 10c for one of my favorite Pen Points and your name with a beautiful flourished bird written on a card. Write today. T. M. Tevis, Box 25K, Chillicothe, Mo.

PRINTING PAYS BIG

"Make your future secure. Prepare for a highly paid position or a print shop of your own. Students throughout the world are enthusiastic in their praise of our training program and the personal attention given each student. Rush name today for free literature and sample lesson. No salesman will call. Write Dept. M-106.

International School of Printing, Box 334, Dayton, Ohio

WHICH OF THESE *Opportunities* INTERESTS *You* MOST?

Accounting
Air Conditioning
Architecture & Building
Automotive Engineering
Aviation—Practical
Aviation Drafting & Design
Better Foremanship
Bookkeeping
Business Management

Contracting
Diesel Engineering
Drafting & Design
Electrical Engineering
Electricity—Practical
Electronics, Industrial
High School Courses
Machine Shop Operations
Mechanical Engineering

Plastics Engineering
Plumbing—Practical
Private Secretary
Radio Operating & Servicing
Railway Training
Refrigeration
Sheet Metal Pattern Drafting
Shop Management
Tool Making

THINK! LOOK FORWARD!

Business is making big, new plans

Men and Women are preparing for the future

WHAT ARE YOU DOING ABOUT YOUR TOMORROWS?

● *Today*, choose the job you want—and prepare for it. Or if you are already engaged in the work you like best, start training *now* for quicker promotion. Acquire the knowledge that will help you to get ahead faster, make more money and have greater security.

Invest part of your spare time in more rapid progress. Start training now, in spare time in your own home. Be ready to grasp your opportunity and step out ahead of those who lack the ability you have attained.

American School, founded in 1897 as an educational institution *not for profit*, can help you to reach your goal just as it has helped others during the past fifty years. Give serious thought to the list above. Pick one or more subjects that interest you. Then check the coupon at right, add your name and address and mail it at once. The school will send you details on its training plan and outline of study prepared by specialists. There is no charge, no obligation, so send the coupon immediately.

PRACTICAL, EFFECTIVE HOME - STUDY TRAINING SINCE 1897
Take This First Easy Step

CHECK, CLIP AND MAIL COUPON NOW

AMERICAN SCHOOL, Dept. G-145, Drexel at 58th, Chicago 37, Ill.
Without obligation, Please send FREE and postpaid, bulletin and details of the Subject checked.

- | | | |
|--|---|--|
| <input type="checkbox"/> PLASTICS ENG'R | <input type="checkbox"/> Accounting | <input type="checkbox"/> Drafting and Design for Men and Women |
| <input type="checkbox"/> Refrigeration | <input type="checkbox"/> Electrical Engr. | <input type="checkbox"/> Radio |
| <input type="checkbox"/> Architecture and Building | <input type="checkbox"/> Electricity-Pract. | <input type="checkbox"/> High School |
| <input type="checkbox"/> Contracting | <input type="checkbox"/> Electronics, Industr. | <input type="checkbox"/> Air Conditioning |
| <input type="checkbox"/> Practical Plumbing | <input type="checkbox"/> Bookkeeping | <input type="checkbox"/> Mechanical Eng. |
| <input type="checkbox"/> Automotive Engineering | <input type="checkbox"/> Private Secretary | <input type="checkbox"/> Shop Management |
| <input type="checkbox"/> Aviation Drafting | <input type="checkbox"/> Diesel Engineering | <input type="checkbox"/> Tool Making |
| <input type="checkbox"/> Aviation | <input type="checkbox"/> Sheet Metal Pattern Drafting | <input type="checkbox"/> Better Foremanship |
| <input type="checkbox"/> Business Mgmt | | <input type="checkbox"/> Machine Shop Operations |
| <input type="checkbox"/> Railway Training | | |

Name..... Occupation.....

Address..... Age.....

City..... State.....

AMERICAN SCHOOL

Dept. G-145, Drexel at 58th Street, Chicago 37

OIL BURNER

INFORMATION IN A HANDY FORM

JUST OUT!

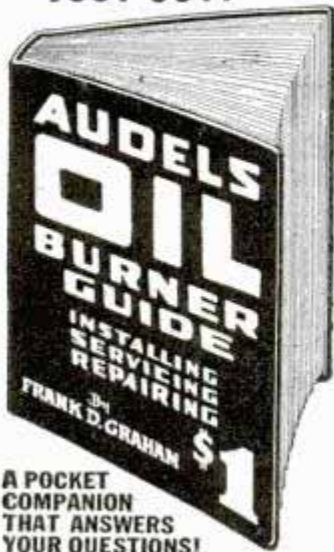

A POCKET COMPANION THAT ANSWERS YOUR QUESTIONS!

AUDELS OIL BURNER GUIDE

- A new practical, concise treatise, 384 pages-31 Chapters - 321 Diagrams and Illustrations - covering Domestic and Industrial Oil Burners.

New from Cover to Cover, for mechanics interested in Oil Burners. Gives practical inside working knowledge of theory, construction, installation, operation, testing, servicing and repair of all types of oil burners. Includes electrical hook-ups and wiring diagrams of automatic control systems.

PRICE \$1 POSTPAID

Get this information for yourself. Mail coupon today. No obligation unless satisfied.

ASK TO SEE IT

AUDEL, Publishers, 49 W. 23rd St., New York 10, N.Y.

Please mail AUDELS OIL BURNER GUIDE (Price \$1). If satisfactory, I will remit \$1 on its safe arrival, otherwise I will return the book.

Name _____

Address _____

Occupation _____

Employed by _____ PM

STUDY AT HOME

With An Educational Institution

Men with specialized training win higher positions, insure larger earnings, and are bigger successes in business and public life. Opportunities NOW greater than ever before. Send for our Catalog.

ARTS and SCIENCES

Courses in Philosophy; Education; Letters; Public Health; Medical Jurisprudence; Psychology; Sociology; Physics; Chemistry; Plastics; Geology; Political Science; Theology; Business and Commerce; Accounting; Mathematics; Statistics; Agriculture.

ENGINEERING

Courses in Electrical, Civil, Mechanical, Drafting, Architectural, Steam, Aeronautical, Radio, Structural, Mining, Industrial, Petroleum, Marine, Chemical, Diesel, Automobile, Refrigeration, and Air Conditioning Engineering.

LAW

Complete Professional Law Course includes 18 Hornbook Series college grade textbooks. Courses also in Commercial Law, Patent Law and Medical Jurisprudence. McKinley-Roosevelt Incorporated, 4610-K, Sheridan Rd., Chicago 40, Ill.

LEARN WATCH REPAIRING



AT HOME. By our modern and original system of instruction you can learn every part of the **WATCH REPAIRING TRADE AT HOME.** Prepare yourself for a well-paying position or start in business after completing our course of instruction. Good watch repairers are in demand and generally earn very good salaries. For particulars apply to the Wisconsin School of Watch Repairing 759 North Milwaukee St., Milwaukee 2, Wis.

Learn NOVELTY MANUFACTURING!!



Today's best bet for a business of your own starting with little money is the Casting of Wall Plaques, Book Ends and other Novelties. Large orders and profits waiting. Start in garage or basement, quickly learned. **NO EXPENSIVE MOLDS TO BUY.** Our system has started many on the road to a splendid financial future. Write today for free particulars.

PLASTEX PRODUCTS, 127 Clement St. San Francisco (18), Calif.

ANY BOOK IN PRINT

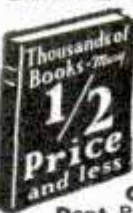

Delivered at your door. We pay postage. Standard authors, new books, popular editions, fiction, reference, medical, mechanical, children's books, etc. **Guaranteed savings.** Send for Clarkson's 1947 catalog.

FREE Write for our great illustrated book catalog. A short course in literature. The buying guide of 800,000 book lovers. The answer to your Christmas gift problem. **Free if you write now-today!**

CLARKSON PUBLISHING COMPANY
Dept. PM471, 1257 So. Wabash Ave., Chicago, Ill.

INVENTORS

WITH GOOD INVENTIONS

Should write us without delay for **FREE BOOKLET**, Protective Disclosure Form and facts about The Inventor's Most Logical Markets. Patented, Unpatented inventions, all kinds. Cash, Royalty, needed by specific manufacturers. If your invention is for sale, write today for full particulars. A Post-Card will do! Address:

THE INVENTION REPORTER
5C-11106 South Longwood Drive Chicago 43, Illinois

ELECTRICIANS

Get this Great Book

FREE

For Merely Examining
Coyne's NEW Pay Raising

7 Volume Set
APPLIED ELECTRICITY

Here's a brand new set of electrical books

to give you the "know how" on all branches of electricity from appliance repairing to D. C. and A. C. equipment, electrical refrigeration, etc. 3,000 subjects, 10,000 facts, latest methods all explained in easy to follow instructions. In order to prove how valuable and Practical this set of electrical books is I'm willing to give you a **FREE** copy of my book "150 Shop Prints and How to Read Them" just for looking over this set. Written by the Coyne Technical Staff and backed by 47 years' experience, this set has helped many ambitious electrical workers to bigger pay, better jobs & added opportunity.

OFFER LIMITED - ACT NOW! Here's my offer to you - If you act promptly, I'll send you the 7 volume set Applied Practical Electricity for 7 days **FREE** examination . . . together with the 150 Shop Print Book. Look the set over 7 days. If you like it send either \$19.75 cash or send \$3.00 after 7 days and \$3.00 per month until \$21 is paid. If you don't want the set, return it and **YOU OWE NOTHING.** In either event, however, you keep the 150 Shop Print Book absolutely **FREE.**

SEND NO MONEY! Coupon below is just a request to see the books free and to get my gift book for doing it. **ACT - Send coupon Today!**

FREE BOOK
Technical Book Div., COYNE ELECTRICAL SCHOOL,
500 S. Paulina Street, Dept. 17-R4, Chicago 12, Ill.

COYNE ELECTRICAL SCHOOL, Dept. 17-R4,
500 SOUTH PAULINA STREET, CHICAGO 12, ILLINOIS

Send me that 7 volume set APPLIED PRACTICAL ELECTRICITY and your **FREE** gift of a copy of "150 Shop Prints and How to Read Them". I'll either return the set in 7 days and owe nothing or send you either \$3 in 7 days and \$3 a month until \$21 is paid or \$19.75 cash. Regardless of whether or not I keep the 7 Volume Set the 150 Shop Prints is mine **FREE** as a Gift.

NAME _____ AGE _____

ADDRESS _____

TOWN _____ ZONE _____ STATE _____

ELECTRICIANS

Get this Great Book

FREE

Book of 150 Shop Prints, Wiring Diagrams, Full Size 8 1/2" x 11"

NEW EDITION!

150 SHOP PRINTS

For Merely Examining
Coyne's NEW Pay Raising

7 Volume Set APPLIED ELECTRICITY

to give you the "know how" on all branches of electricity from appliance repairing to D. C. and A. C. equipment, electrical refrigeration, etc. 3,000 subjects, 10,000 facts, latest methods all explained in easy to follow instructions. In order to prove how valuable and Practical this set of electrical books is I'm willing to give you a **FREE** copy of my book "150 Shop Prints and How to Read Them" just for looking over this set. Written by the Coyne Technical Staff and backed by 47 years' experience, this set has helped many ambitious electrical workers to bigger pay, better jobs & added opportunity.

OFFER LIMITED - ACT NOW! Here's my offer to you - If you act promptly, I'll send you the 7 volume set Applied Practical Electricity for 7 days **FREE** examination . . . together with the 150 Shop Print Book. Look the set over 7 days. If you like it send either \$19.75 cash or send \$3.00 after 7 days and \$3.00 per month until \$21 is paid. If you don't want the set, return it and **YOU OWE NOTHING.** In either event, however, you keep the 150 Shop Print Book absolutely **FREE.**

SEND NO MONEY! Coupon below is just a request to see the books free and to get my gift book for doing it. **ACT - Send coupon Today!**

FREE BOOK
Technical Book Div., COYNE ELECTRICAL SCHOOL,
500 S. Paulina Street, Dept. 17-R4, Chicago 12, Ill.

COYNE ELECTRICAL SCHOOL, Dept. 17-R4,
500 SOUTH PAULINA STREET, CHICAGO 12, ILLINOIS

Send me that 7 volume set APPLIED PRACTICAL ELECTRICITY and your **FREE** gift of a copy of "150 Shop Prints and How to Read Them". I'll either return the set in 7 days and owe nothing or send you either \$3 in 7 days and \$3 a month until \$21 is paid or \$19.75 cash. Regardless of whether or not I keep the 7 Volume Set the 150 Shop Prints is mine **FREE** as a Gift.

NAME _____ AGE _____

ADDRESS _____

TOWN _____ ZONE _____ STATE _____

B. W. Cooke
Director

COYNE ELECTRICAL SCHOOL, Dept. 17-R4,
500 SOUTH PAULINA STREET, CHICAGO 12, ILLINOIS

Send me that 7 volume set APPLIED PRACTICAL ELECTRICITY and your **FREE** gift of a copy of "150 Shop Prints and How to Read Them". I'll either return the set in 7 days and owe nothing or send you either \$3 in 7 days and \$3 a month until \$21 is paid or \$19.75 cash. Regardless of whether or not I keep the 7 Volume Set the 150 Shop Prints is mine **FREE** as a Gift.

MONEY for MEN ALL FREE

ALL DATA

THE PLASTEX Industry needs manufacturers on small scale and for big production of Lamp and Clock Stands, Art Goods and Novelties in Plastex and Marble imitation. Experience unnecessary. Use material makes regular 10c store sellers. Rubber moulds furnished for speed production. Small investment brings good returns. Big chain store orders now being placed. Ambitious men have chance for real prosperity. Our Free booklet will interest and benefit you.

PLASTEX INDUSTRIES, Dept. P, 1055 Washington Ave., New York, N.Y.

Now IN YOUR OWN HOME Learn

RADIO ELECTRONICS

The Practical
"HOME-TESTED"
Modern "A-B-C" Way



YOU USE ALL OF THESE RADIO PARTS
TO BUILD
AND OPERATE
7
DIFFERENT RADIO
RECEIVING CIRCUITS

WITH THE HELP OF

A EIGHT Big Kits of Actual "Learn-by-Doing" Radio Parts and Assemblies with which you make 133 fascinating SHOP METHOD EXPERIMENTS in your own home! Imagine building 7 different Radio Receivers that operate!

B A 16 mm Home Movie Projector and Twelve Reels of "Learn-by-Seeing" Home Movie Films . . . for picture-clear, fast understanding of Radio Fundamentals!

C Modern, well-illustrated, Loose-leaf Lessons, prepared in clear, simple, understandable language . . . to guide you throughout your training!

NO PREVIOUS RADIO OR ELECTRICAL EXPERIENCE NECESSARY

DeForest's Training, Inc. provides every major home study aid to help you learn Radio-Electronics rapidly and thoroughly . . . to give you the *experience* and *confidence* needed for a responsible, Good-Pay Job, or to Start a Business of Your Own! Here is a REAL opportunity field for YOU . . . when you are a trained Radio-Electronics man! Just think of the tremendously exciting future ahead of FM Radio, Aviation and Broadcast Radio, Sound Motion Picture Equipment, Servicing and Sales of Radio Equipment, etc. Put *yourself* in this picture . . . See how you can benefit from a PRACTICAL training in this fascinating work! Think, too, of the coming possibilities ahead of Radar, Facsimile and Television. Send TODAY for the interesting, opportunity-revealing book, "Victory for You!" See how others probably no more talented or ambitious than you, have advanced in earning power after this training . . . how YOU can do it too! Mail the coupon NOW!

INCLUDING:

1. Simple Receiver
2. Two Tube Receiver
3. Tuned Radio-Frequency Receiver
4. Short Wave Receiver
5. Aviation Band Receiver
6. 4-Tube Superheterodyne
7. 5-Tube Superheterodyne with Magic Tuning Eye

... PLUS SCORES OF OTHER FASCINATING, INSTRUCTIVE RADIO-ELECTRONIC EXPERIMENTS

THEN GET THE HELP OF OUR EFFECTIVE EMPLOYMENT SERVICE

VETERANS!

Big things are happening at DeForest's Training, Inc. for veterans! See how you can prepare yourself WITHOUT COST for a GOOD JOB or a BUSINESS OF YOUR OWN in the vast Radio-Electronic opportunity field.

16 MM MOVIE PROJECTOR
YOU USE "LEARN-BY-SEEING" MOVIES



DEFOREST'S TRAINING, INC. INCLUDES INSTRUCTION IN MOTION PICTURE SOUND EQUIPMENT, FM RADIO AND TELEVISION . . . RESIDENTIAL TRAINING IN OUR MODERN CHICAGO LABORATORIES ALSO AVAILABLE—ASK US FOR INFORMATION!

DeFOREST'S TRAINING, INC.
CHICAGO 14, ILLINOIS



E. B. DEVRY, President
DeFOREST'S TRAINING, INC.
2535-41 North Ashland Ave., Dept. PM-D1
Chicago 14, Illinois, U.S.A.

Send FREE "VICTORY FOR YOU!" BOOK, showing how I may make my start in Radio Electronics.

Name _____ Age _____

Address _____ Apt. _____

City _____ Zone _____ State _____

If under 16, check here for special information.

If a discharged Veteran of World War II, check here.



SO IT NEEDS FIXING

By S. T. CHRISTENSEN
the "Fix-it Man"

WELL, I guess I'm the fellow to see, for I've repaired thousands of refrigerators (home and commercial both), vacuum cleaners, radios, washing machines, irons, fans, lamps, mangles, motors, etc. In fact, many of my customers call me their "electrical appliance doctor." And, "doctoring," I might add, has paid me a good substantial income for quite a few years. Funny, in a way, how I got started. Always liked to tinker and by experimenting around I found that most electrical appliances had many things in common. That, regardless of what the appliance was used for, or who the manufacturer was, the basic principles were much the same. From fixing my own appliances to fixing friends' and then for strangers at a fee, seems now to have been but a small step.

What to Charge?

At first, I let the owner decide the charge and, frankly, I was amazed at what I earned per hour. But then, when one figures what initial costs are involved in buying most electrical appliances, one can readily see that spending extra dollars for repairs is well worth while. Before long I was making more in my spare time repairing than from my regular job. The result . . . I went into business for myself. When war came, business boomed, for new appliances were not available.

For a while, repair parts (needed on some

jobs) were a little difficult to get. But that situation quickly adjusted itself and many repair parts were given the high priority rating of AA2. After all, we had to provide for the health and well-being of our civilian population.

The Future Offers

Friends ask me about my future. And, I think I've got a grand one. Age is no handicap in repairing. I have in my files enthusiastic letters from repairmen ranging in age from 18 to 79 years. Now the war is over we are certain to see hundreds of new products on the market . . . products that the average person never dreamt of. These new products and our old appliances are all going to need at some time or other "fixing." Well, I'll still be the fellow to do it. The field open for appliance repairmen is unlimited. I don't worry at all about too much competition.

If You Are Ambitious

To the contrary, I've prepared a complete course, chuck full of simple, easy to understand photos and drawings and written in the same non-technical language as this article. I know the course is good, because I have hundreds of men all over the country writing to me telling me how the course has helped swell their pockets with cash. If you too want to prepare now for your future, I suggest you read the next page and send me the handy coupon."



**BIG MONEY
INDEPENDENCE**
*A PROFITABLE
LIFETIME
BUSINESS
OF
YOUR OWN!*

LEARN ELECTRICAL APPLIANCE REPAIRING

PREPARE NOW FOR THE FUTURE

If now employed, start your home appliance repair business NOW in your spare time and be set with a business of your own no matter what happens. You don't need elaborate fixtures or expensive equipment to be a successful repairman. Operate from your garage, basement, vacant store, etc. Work as many hours as you wish—the home appliance repairman is his own boss. It is a profitable occupation for on many types of repairs it is not unusual for a repairman to charge on the basis of \$5.00 to \$6.00 per hour. Don't gamble with your future—learn a trade that will always support you. Remember, as long as electrical appliances are used, there will be a need for electrical appliance repairmen.

If you are at all mechanically inclined—can hold and use tools—then you have all of the qualifications required for becoming a big money earning home appliance repairman. It does not matter if you have not had a great deal of schooling or had previous experience along these lines—WE WILL TEACH YOU. Age should be no barrier—nor should any minor physical handicap.

New Course Tells All

Profusely illustrated, our new course shows you in simple, easy to understand language and drawings how to make each repair on refrigerators, vacuum cleaners, washing machines, motors, etc. Explains and gives you a working knowledge of electricity, welding, nickel plating, etc. Shows you how to build the power tools you need and how to solicit and keep business coming to you. Not a theory course but an honest to goodness course written by and used by repairmen the country over. Price of course is so low that the savings on your own household appliance repairs will quickly pay for it. Act now! Mail the handy coupon below today.

Read What Our Students Say About Course

I really believe your course the best investment a mechanically minded man can make.—Claude E. Allen, Indianapolis, Ind.
I have received your Course in Appliance Repairing and I must say I am well pleased with same. I am only sorry I did not have said Course some years ago. I have learned so much more through this course I would not part with it.—Charles Schwarz, Hamilton, Ohio.

The Course in Appliance Servicing arrived a few days ago. Want to take out a few minutes of my valuable time to let you know that this is just what I have been looking for ever since I opened up my Fix-It shop. I must admit that you told the truth when you said that it contains quite a bit more information than I bargained for.—P. J. Bretl, Sebring, Ohio.

I am a mechanic for the Western Union Telegraph Co. Three days after receiving the lessons in refrigeration I earned the exact cost of the course.—Henry S. Lee, Washington, D. C.
I work day times at the shipyard and after 4:00 P.M. I operate from my cellar and garage. I average \$10.00 to \$15.00 clear every day.—Walter Hanhy, Brockton, Mass.

GET STARTED TODAY — MAIL THIS COUPON

CHRISTY SUPPLY CO.

2835 N. Central Ave., Dept. D-4103
Chicago 34, Illinois

Please send me free illustrated literature about America's Fastest Growing Industry — ELECTRICAL APPLIANCE REPAIRING.

Name.....

Address.....

City..... State.....

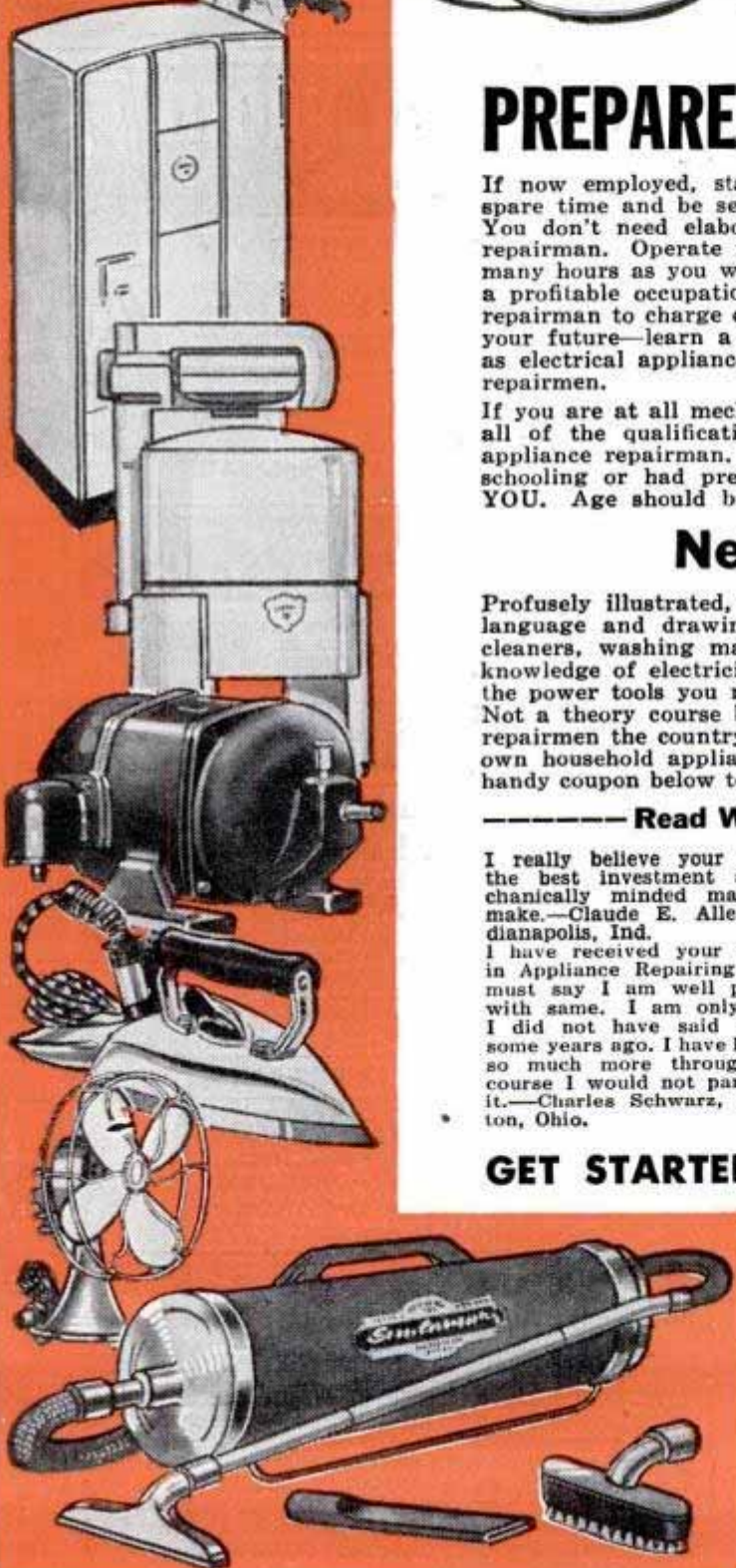

**NEW peacetime
production plans
mean**



BIGGER PAY FOR MACHINISTS
Master shop work quickly with these books

This big home-study and reference course gives you the practical facts on machines and methods you need to advance in machine shop work. Take advantage of the other man's experience as found in books, to solve your problems, increase your efficiency, with

**The AMERICAN
MACHINISTS' LIBRARY**

6 volumes—2368 pages—2516 illustrations

(A combined home-study course and reference library)

This library of machine shop practice was written for practical men. It gives you the best methods for every kind of machine shop work. It fully explains lathes, drills, and other machine tools and their operation, automatic screw machines, speeds and feeds, gear design and production, jigs and fixtures, punch and die work, metal surfacing, etc., etc. Plainly written—completely illustrated—the best kind of help to the machine shop man who wants to advance himself.

No money down—special price—easy payments.

EXAMINATION COUPON

McGRAW-HILL BOOK CO., 330 W. 42nd St., N. Y. 18

Send me for ten days' examination the American Machinists' Library. If satisfactory I will send you \$4.00 in 10 days and \$4.00 monthly until the price of \$20.00 is paid. If not wanted, I will return the books postpaid. (To insure prompt shipment write plainly and fill in all lines.)

Name.....

Home Address.....

City and State.....

Company.....

Position..... PM 1-47

**AUDELS Carpenters
and Builders Guides**
4 vols. \$6



Inside Trade Information for Carpenters, Builders, Joiners, Building Mechanics and all Woodworkers. These Guides give you the short-cut instructions that you want—including new methods, ideas, solutions, plans, systems and money saving suggestions. An easy progressive course for the apprentice and student. A practical daily helper and Quick Reference for the master worker. Carpenters everywhere are using these Guides as a Helping Hand to Easier Work, Better Work and Better Pay. To get this assistance for yourself, simply fill in and mail the FREE COUPON below.

Inside Trade Information On:

How to use the steel square—How to file and set saws—How to build furniture—How to use a mitre box—How to use the chalk line—How to use rules and scales—How to make joints—Carpenters arithmetic—Solving mensuration problems—Estimating strength of timbers—How to set girders and sills—How to frame houses and roofs—How to estimate costs—How to build houses, barns, garages, bungalows, etc.—How to read and draw plans—Drawing up specifications—How to excavate—How to use settings 12, 13 and 17 on the steel square—How to build hoists and scaffolds—skylights—How to build stairs—How to put on interior trim—How to hang doors—How to lay floors—How to paint



THEO. AUDEL & CO., 49 W. 23rd St., New York City

Mail Audels Carpenters and Builders Guides, 4 vols., on 7 days' free trial. If O.K. I will remit \$1 in 7 days, and \$1 monthly until \$6 is paid. Otherwise I will return them. No obligation unless I am satisfied.

Name.....

Address.....

Occupation.....

Reference..... PM

AVIATION

Aeronautical University Approved Training meets exacting standards of aviation industry, prepares for key positions, big opportunities.

Courses in:

AERONAUTICAL ENGINEERING. B.S. degree.
AERONAUTICAL ENGINEERING DRAFTING
CERTIFIED ENGINE MECHANICS
ADMINISTRATION—including sales

PRE-ENGINEERING: Special course for high school graduates and veterans deficient in math and science.

Also refresher courses for Gov't Airplane and Engine Mechanics Licenses for those with aviation experience.

Oldest fully approved aviation school. Outstanding faculty, modern equipment, outside employment, placement service. Day, evening. Approved for Veterans. Send today for FREE catalog "Opportunities in Aviation."

AERONAUTICAL UNIVERSITY
Dept. 77, 116 S. Michigan Ave., Chicago 3, Ill.

**FOUNDED
BY
CURTISS-
WRIGHT**

PRINT ANY PHOTO
on Paper, Cloth, Leather or Wood

SIMPLE, EASY TO USE

Magic liquid takes only 2 minutes to reproduce any snapshot you have on to stationery, handkerchiefs, ties, scarfs, etc. Won't wash off. Won't hurt negative or fabric it's used on. Personalize your belongings! An ideal gift. Complete outfit enough to transfer 100 photos—only \$1.00 postpaid. Sent C.O.D. for \$1.21.

CHRISTY PHOTO SUPPLY, Dept. 2410
2835 N. Central, Chicago 34



**BUILDING
HUMAN STATURE**

"I grew 6 inches during a year I followed instructions given in 'BUILDING HUMAN STATURE,'" says the younger man at left. "Now I am a head taller than my father."

If you wonder why you are short send for FREE outline of this remarkable book loaded with practical information.

CARILLON BOOKS, Dept. 93, Boerne, Tex.

INVENTING

—FOR PROFIT! If you have an inventive turn of mind, write for free 28-page booklet explaining how the Institute of American Inventors is helping inventors pre-test the profit possibilities of proposed devices to fill today's unprecedented demand for useful new inventions.

INSTITUTE of AMERICAN INVENTORS

Dept. 4, 1926 Eye St., NW, Washington 6, D. C.

SAY YOU SAW IT IN POPULAR MECHANICS

Train Your Own HORSES!

Colts — Stock Horses — Circus Horses
Gait Show Horses — Write for FREE BOOK

ANIMAL LOVERS' ASSOCIATION
Box KA-111, Tarzana, Calif.



FALSE TEETH

KLUTCH holds them tighter

KLUTCH forms a comfort cushion; holds dental plates so much firmer and snuggler that one can eat and talk with greater comfort and security; in many cases almost as well as with natural teeth. Klutch lessens the constant fear of a dropping, rocking, chafing plate. 25c and 50c at druggists... If your druggist hasn't it, don't waste money on substitutes, but send us 10c and we will mail you a generous trial box. © I. P. INC.

KLUTCH CO. Box 4793-A ELMIRA, N. Y.

GET INTO THE NEW FIELD OF

INDUSTRIAL

Electronics



THRILLING NEW FRONTIER OF OPPORTUNITY



AMERICA'S FOREMOST SCHOOL OF PRACTICAL TRAINING

Here is a **NEW** Industry—one that points the way to a vast new field of opportunity—Opportunities that beckon alike to men looking for new fields, and to experienced electrical men seeking a way to bigger earnings and a more secure future.

Industrial Electronics is *not* Radio. It has nothing to do with radio transmitters and receivers. It is a totally new application of electric power, applied to modern production by means of the magic of the vacuum tube. Everywhere industrial electronic devices are replacing the old-time electrical controls, and processes. Industrial Electronics is *Modern Industrial Electricity*.

GET READY NOW!

Now is the time to get into Industrial Electronics, while the field is in its infancy . . . and while it is rapidly developing a need for thousands of trained experts. Tomorrow's leaders are training today.

And here is a School equipped in every way to train *you* for Industrial Electronics work—one of the largest and most completely equipped, and one of the few of its kind in America—a School that already has trained thousands of men for industrial opportunities.

LEARN AT HOME OR COME TO OUR SCHOOL

Learn Industrial Electronics—now, while the time is ripe. You don't need any advanced schooling or previous experience. If you are at all mechanically inclined and have gone to highschool for at least one year or have an equivalent education, we can teach you Industrial Electronics.

You can take most of your training at home, in your spare time—or you can come to Chicago and take your entire training in our completely equipped shops and laboratories. Either way you quickly acquire the fine points, practical skill, and broad, technical "know how" that makes the expert Industrial Electronics Technician.

"Every electrician should know — must know — Industrial Electronics." That's what many Union leaders are telling their members today. They know that the use of Industrial Electronics devices is growing by leaps and bounds. They know that to install and service this equipment, even the best of present-day electricians must first have had special

FACTS ABOUT THE I. T. I.

Founded in 1916. Has trained more than 400,000 men for practical work in industrial fields. From 1942 through 1945 trained specialized technicians, exclusively, for the Army, Navy, and Marine Corps. Now training thousands of veterans under the G. I. Bill, both in its Residence Schools and by home-study. Occupies five buildings of its own. Has over \$500,000 invested in training facilities, with an instruction staff of more than 100 men. Known everywhere as America's foremost school of practical training for industry.

training.

Get all the facts about the opportunities in this interesting field of work and about the I.T.I. system of training that has helped so many men into key jobs in industry. Fill out the information, coupon below and mail it **TODAY**. You will be under no obligation whatsoever.

AUTHORIZED TO ACCEPT VETERANS FOR G. I. TRAINING



GET THE FACTS ABOUT AMERICA'S FOREMOST SCHOOL OF PRACTICAL TRAINING

REGISTRAR, PIN

**INDUSTRIAL TRAINING INSTITUTE,
2150 LAWRENCE AVE., CHICAGO 25, ILL.**

Please send me, **FREE**, your "Camera Visit" booklet and information about the opportunities for trained men in **INDUSTRIAL ELECTRONICS**. It is understood that I will be under no obligation.

NAME.....

ADDRESS.....

CITY.....STATE.....

ARE YOU A VETERAN?.....

8 BIG BUILDING BOOKS

For
**EXAMINATION
SEND NO MONEY**

Learn to draw plans, estimate, be a live-wire builder, do remodeling, take contracting jobs. These 8 practical, profusely illustrated books cover subjects that will help you to get more work and make more money. Architectural design and drawing, estimating, steel square, roof framing, construction, painting and decorating, heating, air-conditioning, concrete forms and many other subjects are included.

BETTER JOBS — BETTER PAY UP-TO-DATE EDITION

The postwar building boom is in full swing and trained men are needed. Big opportunities are always for MEN WHO KNOW HOW. These books supply quick, easily understood training and handy, permanent reference information that helps solve building problems.

These books are the most up-to-date and complete we have ever published on these many subjects.

Coupon Brings Eight Big Books For Examination

AMERICAN TECHNICAL SOCIETY Vocational Publishers since 1898
Dept. G119 Drexel at 58th Street Chicago 37, Ill.

You may ship me the Up-to-Date edition of your eight big books, "Building, Estimating and Contracting," without any obligation to buy. I will pay the delivery charges only, and if fully satisfied in ten days, I will send you \$2.00, and after that only \$3.00 a month, until the total price of only \$34.80 is paid. I am not obligated in any way unless I keep the books.

Name

Address

City.....State.....

Please attach a letter stating your age, occupation, employer's name and address, and name and address of at least one business man as a reference. Men in service, also please give home address.

Keep that "TICKING" Car

7 DAYS FREE TRIAL

AUDELS NEW AUTO GUIDE
OR
AUDELS AUTO GUIDE
MECHANICS
OPERATORS
SERVICEMEN
A READY REFERENCE

Every operator and mechanic needs AUDELS AUTO GUIDE.

This book saves time, money and worry. Highly endorsed. It presents the whole subject of auto mechanics:

- 1—Basic principles
- 2—Construction
- 3—Operation
- 4—Service
- 5—Repair

Handy Size, Easily understood.

1588 PAGES
1500 ILLUSTRATIONS

NEW FLUID DRIVE, HYDRAULIC SHIFT AND DIESEL ENGINES FULLY COVERED

Over 1500 pages—1540 illustrations showing inside views of modern cars, trucks and buses with instructions for all service jobs.

\$4 ASK TO SEE IT!—To Get This Assistance for Yourself Simply Fill in and Mail Coupon Today.

4 COMPLETE • PAY ONLY \$1. A MONTH ←

AUDEL Publishers, 49 West 23rd St., New York
MAIL AUDELS NEW AUTO GUIDE for free examination. If O.K. I will send you \$1 in 7 days; then remit \$1 monthly until price of \$4 is paid. Otherwise I will return it.

Name.....

Address.....

Occupation.....

Employed by..... P M

CAUGHT BY THEIR FINGER PRINTS

YOU Can Become a **CRIMINAL INVESTIGATION and FINGER PRINT EXPERT AT HOME!**

During the past 30 years the L. A. S. has trained hundreds of men at home to fill positions of responsibility and steady pay as finger print experts. This fascinating, profitable profession can be learned at home during spare time. More than 800 American Identification Bureaus employ I.A.S. graduates or students. Write today for complete list of these Bureaus.

Send Now for "BLUE BOOK OF CRIME" Thrilling, inspiring, helpful. Be sure to state your age when sending for book. **FREE!**

INSTITUTE OF APPLIED SCIENCE
Dept. 1351, 1920 Sunnyside Ave., Chicago 40, Ill.

SEND FOR THIS FREE!

HOW TO BREAK and TRAIN HORSES

Make money with horses. Every farmer, every lover of horseflesh should have a copy of this booklet. If you want to know how to break, train and make money with horses, write today for full information FREE, together with my special offer of a course in Animal Breeding. If you are interested in Gaiting and Riding the saddle horse check here. Do it today—now. You'll never regret it.

BEERY SCHOOL OF HORSEMANSHIP
Dept. 1101-D Pleasant Hill, Ohio

IMPROVE YOUR PLAYING

PIANISTS—Send for FREE Booklet showing how you may greatly improve your technique, accuracy, memorizing, sightreading and playing thru Mental-Muscular Coordination. Quick results. Practice effort minimized. Used by famous pianists, organists, teachers and students. No obligation.

BROADWELL STUDIOS, Dept. 157-A Covina, Calif.

THERE'S MONEY IN CARTOONS!

RAYE BURNS will teach you HOW to CREATE ORIGINAL CARTOONS at home that you may SELL. Course contains 25 lessons and over 600 illustrations. All for Only..... **\$2.85**

Send name and address for free details.

RAYE BURNS SCHOOL, Dept. M, Box 3583, CLEVELAND, OHIO

Learn to Write

Begin today. Write now for our Free Book, "How to Become a Good Penman." It contains specimens and tells how others learned to write in spare time. Enclose 10c for your name beautifully written and a pen point suitable for cursive writing. Write today.

THE TAMBLYN SCHOOL OF PENMANSHIP
N-441 Ridge Building, Kansas City, Mo.

Store Route Plan PAYS BIG MONEY

SELL COUNTER CARD PRODUCTS

Build a good-paying business of your own. Call on dealers of all kinds; show nationally-advertised Aspirin, Vitamins, Cosmetics and 200 other necessities. Big 5c and 10c retail packages, high quality. Attractive counter displays sell goods fast. Free book gives amazing facts. Write!

World's Products Co., Dept. 10-J, Spencer, Ind.

GET INTO RADIO

TELEVISION ELECTRONICS NOW!



You build this complete, modern super-heterodyne receiver with the equipment that comes with your National Training at no cost.

This practical shop instruction system gives you actual experience with a Home Radio Laboratory—part of the

SHOP METHOD HOME TRAINING

FOR YOU—A REAL HOME LABORATORY IN MODERN RADIO

from one of the world's Oldest and Largest Technical Trade Schools

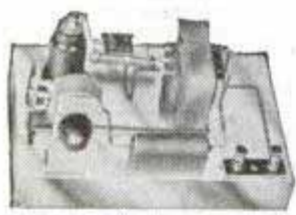

Your National Training Kits include equipment for over a hundred practical electronic experiments in your own home. You

get standard radio parts for this audio oscillator which you get to understand by building it yourself.

You learn modulation, beat frequencies, signal generation by actually building this small radio transmitter with your National shop parts.

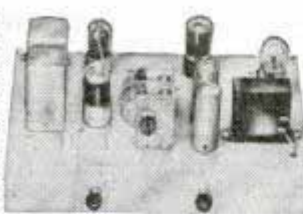

Your training outfits from National are made up of the most modern radio equipment—much of it just out of the experimental laboratory. You learn new ways of handling equipment by modern methods.



Get the details by mailing the coupon.

Send the coupon below immediately. Learn how this improved practical training can fit you for the GREAT BUSINESS OF RADIO—for the NEW AND RAPIDLY EXPANDING FIELD OF FREQUENCY MODULATION (F.M.), TELEVISION AND ELECTRONICS.

This is the thoroughly proved method used so extensively in wartime training—endorsed by the success of National men everywhere—a system by which you study in spare time—off hours, even minutes right in your home and yet have the ADVANTAGE OF REAL SHOP EXPERIENCE behind you.

Trained Radio Men Wanted

The man who really knows modern Radio is in greater demand today than ever before—not only in Radio proper but in Television and Electronics—in Aviation, Transportation, Manufacturing, Communications. Good jobs

await the trained man. In the production, operation and maintenance of modern electronic equipment—in radio stations, in hundreds of industries—in homes, theatres and studios. Good sound training in this important field is absolutely necessary. And now, National Schools brings such training to you no matter where you live or what you may be doing—not only the fundamental theory but the actual experience that comes with knowing shop practice and working with real equipment—demonstrating each step with first-hand knowledge. This is true "learning by doing"—direct from the great shops and laboratories of National Schools where new developments in methods, equipment and applications are constantly going forward.

National offers you such practical training and National has the facilities. Sample this training yourself. MAIL THE COUPON FOR A FREE LESSON.

SUCCESS and SECURITY FOR YOU

Radio is a Well-Established Business, Television and allied fields are just on the threshold of limitless expansion. Would you like to profit from these developments? An excellent job or perhaps into a business of your own? Answer these questions by reading the catalog sent you FREE from National Schools. Get the facts.

Check the Job You Now Have With These Opportunities in RADIO

1. Financial Security Radio has grown from \$100 million to \$5 billion in past few years.
2. Limitless Future predicted by over 1,800 manufacturers of equipment.
3. Television promises unrealized opportunity.
4. Electronics opens wide new fields in home and industrial use.
5. Your Own Business with little capital.

Get the details. Use the coupon!

FREE GET THESE 2 BIG BOOKS

NATIONAL TRAINING WINS BIG JOBS

You, too, can share the success of National graduates. Clifford Hannah, Portage La Prairie, Manitoba, Canada, writes: "My training has brought results as I'm in line for another raise, thanks to National's encouragement and thorough training. You can count on me as a real National booster and I am glad I used such good judgment in getting into a live and growing field."

While still a student of National training, I. Wilson of Vallejo, California, writes: "My pay has jumped from \$52.18 a week to \$72.65, and the end is not in sight. I am proud of my National Course."

Joseph Michel, Jr., Granite City, Illinois, writes: "I am enthused with National training. I am now earning \$225 a month as a radio operator and technician and \$20 a week more in my shop at home."

NATIONAL SCHOOLS

LOS ANGELES 37, CALIFORNIA EST. 1905

MAIL OPPORTUNITY COUPON FOR QUICK ACTION

National Schools, Dept. 1-PM
4000 South Figueroa Street
Los Angeles 37, California

(Mail in envelope or paste on penny post card)

Mail me FREE the books mentioned in your ad including a sample lesson of your course. I understand no salesman will call on me.

NAME..... AGE.....

ADDRESS.....

CITY..... ZONE..... STATE.....

Check here if veteran of World War II

Do you want

- .. to go to College?
- .. or to enter a Profession?

(Such as Accounting, Architecture, Nursing, Dentistry; Teaching, Social Work, Osteopathy, Beauty Culture; Optometry, Embalming, Chiropody, Law, Medicine, etc.)

- .. or get an Office Position?

To get anywhere, you practically MUST finish High School FIRST. You can complete our simplified High School Course in SPARE time at home, as FAST as your time and abilities permit. Equivalent to resident school work—prepares you for college, pre-professional examinations, business, industry. Standard texts furnished. Diploma. Credit for H. S. subjects already completed. Single subjects if desired. Low tuition, easy terms. American School, Chicago, est. 1897—endorsed by educators. Finish your high school education NOW, Write TODAY!

High School Course at Home

Many Finish in 2 Years

American School, Dept. H-145, Drexel Ave. at 58th St., Chicago 37, Ill.

Gentlemen: Send me FREE information covering special training in subjects checked below. No obligation on my part.

- | | |
|--|--|
| <input type="checkbox"/> High School Course | <input type="checkbox"/> Diesel Engineering |
| <input type="checkbox"/> Architecture and Building | <input type="checkbox"/> Drafting and Design for Men & Women |
| <input type="checkbox"/> Automotive Engineering | <input type="checkbox"/> Plastics |
| <input type="checkbox"/> Business Management | <input type="checkbox"/> Private Secretary |
| <input type="checkbox"/> Electrical Engineering | <input type="checkbox"/> Mechanical Engineering |
| <input type="checkbox"/> Elec. and Gas Refrigeration | <input type="checkbox"/> Aviation |
| <input type="checkbox"/> Air Conditioning | <input type="checkbox"/> Salesmanship |
| <input type="checkbox"/> Railway Training | <input type="checkbox"/> Radio |
| <input type="checkbox"/> Electronics, Industrial | |

Name.....

Address.....

Learn this Profitable Profession



IN 90 DAYS AT HOME

Money-Making Career Open to Men and Women, 18 to 50

Hundreds of men and women between 18 and 50 make \$10 to \$20 in a single day giving scientific Swedish Massage and Hydro-Therapy treatments. There is big demand from doctors, hospitals, sanatoriums and clubs. Graduates earn large full time incomes from these or in private practice in their own offices. Others make good money from home treatments given in spare time. Learn this interesting, money-making profession in your own home, through our home study course. Same instructors as in our nationally known resident school. You can win independence and prepare for future security by qualifying for your Diploma. Course can be completed in 3 to 4 months. Many earn while they learn. Begin your training at once.



Anatomy Charts & Booklet FREE

Enroll now and we will include, at no extra cost, many needed supplies. Fit yourself to help meet growing demand for Scientific Swedish Massage. Send the coupon at once for complete details. Anatomy Charts and 32-Page Illustrated Booklet, FREE, postpaid.

THE COLLEGE OF SWEDISH MASSAGE
Dept. 764-A, 100 East Ohio St., Chicago 11, Illinois

Please send me FREE and postpaid, Anatomy Charts, 32-page Booklet and complete details on Home Training.

Name.....

Address.....

City..... State.....

ANALYZE HANDWRITING

Qualify for Certified Grapho Analyst Degree at home, spare time. Credit, Employment, Personnel Managers, Business, Professional men, women use grapho-analysis in their work, earn substantial fees in spare time. Many study solely for personal benefit, no desire to earn money, find it so fascinating they start using it to add to their incomes. Entertainment field pays well, up to \$100 in a week reported. Others establishing profitable practices as Vocational and Family Problem Counselors, Personality Teachers, and lecturers.



GROWING—UNCROWDED PROFESSION

More and more police use grapho analysis handling suspects and criminals. They understand how criminals think. Their handwriting tells. Men like Hugh Dunlap, university student, Harry Allen, retired preacher, use it in court, win cases, earn fees even before graduation. Only school in world devoted to teaching grapho analysis offers thorough training to earnest, ambitious men and women regardless of where you live, small town, farm or city. Send for GRAPHO ANALYST, illustrated lesson, personal handwriting analysis offer, ALL FREE. Must be 21 or over. Address A. I. G. A. Inc., 120, Noel, Missouri.



Mickey Mouse Cartoon Home Movies



Always popular among all Home Movie fans everywhere.

Get These Features
100 Ft. 8mm.....\$3.00
200 Ft. 16mm.....\$6.00

Hired and Fired....1402-B
Wild Party.....1403-B
Mechanical Boxer ..1404-B
Wild Dream.....1405-B

Show also a Donald Duck and the Walter Lantz cartoons, 3 Monkeys and Oswald Rabbit.

Get at your Photo Dealer or order direct. For complete lists and prices, write to—

HOLLYWOOD FILM ENTERPRISES, Inc.

6060 Sunset Blvd. Dept. 115 Hollywood 28, Calif.

LAW...

STUDY AT HOME Legally trained men win higher positions and bigger success in business and public life. Greater opportunities now than ever before.

More Ability: More Prestige: More Money We guide you step by step. You can train at home during spare time. Degree of LL.B. We furnish all text material, including 14-volume Law Library. Low cost, easy terms. Get our valuable 48-page "Law Training for Leadership" and "Evidence" books FREE. Send NOW. G. I. APPROVED. LASALLE EXTENSION UNIVERSITY, 417 South Dearborn Street A Correspondence Institution Dept. 164-L Chicago 5, Ill.

BUILDING

Millions of homes needed. Nation wide call for builders. Big opportunities. Learn now in spare time. — at home. Practical training with blue prints. No books. Send for FREE Trial Lesson and blue print plans.

CHICAGO TECHNICAL COLLEGE
A-151 Tech. Bldg., 2000 S. Mich. Ave. Chicago 16, Ill.

Correspondence Courses in RADIO and ELECTRICAL ENGINEERING

LOW AS \$25

ELECTRICAL ENGINEERING. Get good grasp of wide electrical field. Modern. Very understandable. Theory made easy.
RADIO ENGINEERING. Extra fine course in radio, public address, photo-electric work. Trains you to be super-service man, real vacuum tube technician. Tuition ONLY \$25, either course. Deferred payment plan. Servicemen needed badly.
FREE Write for free copies of school catalogs, student magazines, etc.
LINCOLN ENGINEERING SCHOOL, Box 931-P97, Lincoln, Nebr.

LEARN MEAT CUTTING At Home — In Spare Time



Get into the vital meat industry. Concise, practical Home Training based on 25 years proven instruction methods used at National's famous resident school. Prepares you for bigger pay as Meat Cutter, Supervisor, market manager or more money in your own store. Go as rapidly as your spare time permits. Diploma. Start NOW to turn your spare hours into money. Send for FREE bulletin today. No obligation.

National School of Meat Cutting, Inc., Dept. U-77, Toledo 4, Ohio

MR. AMERICA!

Would You Trade **5** Minutes Reading Time for

NEW *Vigor
Strength
Vitality*



ALAN STEPHAN—officially recognized by the National A.A.U. as "MR. AMERICA"—is the physical phenomenon of the day. A physical training instructor in the United States Navy during the war, he is an unprecedented example of what perseverance, plus the rigid adherence to sound, logical principles of physical training, can do for you. At the age of 15, Alan Stephan was anything but a physical marvel. He was a skinny, gangling, underweight blond kid. Today, at 22, he stands six feet, weighs 205 pounds, and is officially recognized as the possessor of the best physique in America! Today, after competing against the finest physical specimens in the nation, he is "MR. AMERICA"—extraordinarily qualified by the personal development of his own physique to show you how you can attain *new vigor—new strength—new vitality.*

ACCEPT THIS SPECIAL FREE OFFER FROM "MR. AMERICA"

If you act promptly, Alan Stephan will send you a FREE copy of his booklet, "Presenting Mr. America . . . Alan Stephan," giving you complete facts about his miraculous physical development, plus full details about the revolutionary new Alan Stephan Course in Body Building. Just off the press, this revealing new booklet about "MR. AMERICA" and his personal recommendations for attaining new vigor will show you the way to new youth, sparkling health, glowing vitality, vital power, increased pep. Less than 5-minutes reading will tell you how.

ACT NOW! GET THE COMPLETE FACTS ABOUT THIS AMAZING NEW BODY BUILDING COURSE BY THE MOST EMINENTLY QUALIFIED MAN IN THE NATION—ALAN STEPHAN—"MR. AMERICA."

FREE!

CLIP AND MAIL NOW!



Alan Stephan

Post Office Box 1080, Chicago 90, Illinois

Gentlemen: Please send me absolutely FREE a copy of the booklet, "Presenting Mr. America—Alan Stephan."

Name Date of Birth

Address

City State

BUILD a TELEVISION SET

To stimulate its radio and television training programs, this famous resident radio and television school is offering men interested in television this unusual opportunity.



Instructor demonstrating rare Schmitt Optical System, used in big picture, projection type, television receivers. At N.Y.T.I. of N.J. all types of television receivers are available for student study.

IF you are unable to leave home to go to a resident school, N.Y.T.I. of N.J. can supply you with parts to build a television chassis in your own home. You will be supplied with the same instructions and directions with which the school's resident students are equipped, when they reach the stage in their training that calls for television set construction. If you already have a sound radio background, with experience in building radio receivers, you will

be surprised to find how much you can learn about television by building this set.

N.Y.T.I. of N.J. is one of America's leading resident schools for men seeking dependable, thorough, up-to-the-minute training in the various fields of radio and television.

The schooling offered by N.Y.T.I. of N.J. is particularly useful to those who recognize the high-earning possibilities of technical training in radio and television and are willing to tackle the class and laboratory work offered, regardless of their previous education.

No high-school diplomas are needed for entrance. But N.Y.T.I. of N.J. requires that a student be earnest, sincere and radio-minded. Students without proper mathematical backgrounds are taught the radio and television mathematics they



You can build a direct viewing television chassis similar to the one pictured above, right in your own home by following carefully the exact instructions sent to you by this famous television school, located

square in the HEART of America's television manufacturing and broadcasting industry. Mail the coupon at the right to get full details. It costs you nothing to learn about his big opportunity.

Advertisement

RIGHT in YOUR OWN HOME!

need. Several students with only grammar school educations have successfully completed advanced technical television courses.

A considerable number of out-of-state students attend the school because of its excellent, practical type of radio and television courses, so difficult to get anywhere else in the world today. Living quarters are obtainable by single students.

You Put Into Practice Everything You Learn

Students at N.Y.T.I. of N.J. particularly like the way the school puts into practice what it teaches. You may actually build a 17-tube television chassis. You also help build as many as 7 radio receivers of different types, a total of 75 electronic educational devices. Class study and laboratory study, in the proper combination, increase interest—and your hands get as smart as your head.

A 17-tube, experimental, television chassis may be built by all resident students of television, and may be kept as their own property, if they so choose.

Located in the Heart of the Electronic Industry

The New York Technical Institute of New Jersey is in Newark, N. J., just across the river from New York City (only 20 minutes from Broadway by subway or train). The school is located in the heart of America's great radio and electronics industry. Such leading television, radio and electronics manufacturers as R.C.A. Western Electric, Du Mont, Federal and Edison are nearby. This means that the school offers numerous advantages, as it is in touch with the most recent developments in radio and television.

Highly qualified television and radio instructors are here in abundance. Equipment is easier to get. Television students are offered exceptional advantages in this great electronic center.

Coupon Brings Full Information -- FREE

The school issues a special Bulletin which illustrates and describes its truly exceptional facilities and equipment. This Bulletin also describes classes that may be attended, housing conditions, costs, hours, etc. If you are interested in Television—you will want to read this Bulletin. You can have it *free*, merely by mailing the coupon at right.

The school will also be happy to send you complete information about the television kits and directions which are now available to you if you desire to build your own television chassis at home.

Just fill out the coupon at right and mail it NOW to: *New York Technical Institute of New Jersey, Dept. 21, 158 Market Street, Newark, N. J.*



Instructor demonstrating theory of light in connection with study of optical systems used in projection type television receivers.

Big picture television (16" x 21 1/4") in the flesh at N.Y.T.I. of N.J. All types of television receivers are available for student use and instruction at the school.

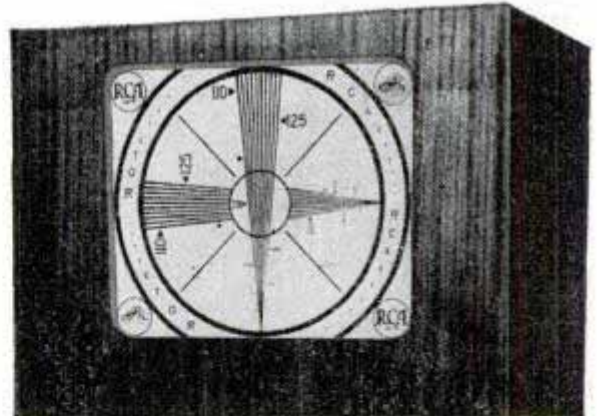

Standard laboratory type test pattern used for testing all types of television transmitters and receivers. (You can see it at N.Y.T.I. of N.J.)

**New York Technical Institute of New Jersey, Dept. 21,
158 Market Street, Newark, New Jersey**

- Check here if you wish to receive the Special FREE Bulletin describing the resident school of the New York Technical Institute of New Jersey located in Newark, N. J.—including its facilities, equipment, courses offered, costs, hours, etc.
- Check here if you wish complete information about building a television chassis in your own home.
- Check here if you are a War Veteran.

NAME..... AGE.....

ADDRESS.....

CITY..... ZONE (if any)..... STATE.....

Advertisement

**Carry 5000
ELECTRICAL FACTS
in Your Pocket!**



**ELECTRICIANS
HANDBOOK
Helps You on the Job!**

The handiest electrical reference book on the market... a "library" of 5,000 facts, wiring diagrams, formulas, charts, tables, rules—condensed into one pocket-size, 4½ x 7" volume, weighing slightly more than your steel rule... Take it with you on the job—have the answers to daily problems always on hand. Saves you time—earns you more money. Flexible leatherette cover to withstand hard usage. Get this book on **FREE TRIAL** basis today! **Get this book for 7 days FREE!** Try it on the job—see how often you refer to it—how much time it saves you. Then, if not satisfied, return to us. If you keep the book, you pay only \$2.75, after 7 days.

350 PAGES
INDUSTRIAL
ELECTRONICS
WIRING METHODS
MOTORS
ILLUMINATION
SWITCHING
AND CONTROL
... and thousands
of other facts!

SEE IT FREE

Technical Book Division
**COYNE ELECTRICAL SCHOOL, Dept. 17-R6,
500 SOUTH PAULINA STREET, CHICAGO 12, ILLINOIS**

FREE TRIAL COUPON

Technical Book Div., Coyne Electrical School, Dept. 17-R6,
500 SOUTH PAULINA STREET, CHICAGO 12, ILLINOIS
Please send Electricians Handbook on 7 days' Free Trial. If satisfied after
7 days, I will pay you only \$2.75—if not, I will return book to you.

Name _____ Age _____

Address _____

City _____ Zone _____ State _____

CHECK HERE if you want to pay postman \$2.75 on delivery. Same
7 days' trial arrangement and money-back guarantee

**START YOUR OWN
REFRIGERATOR
REPAIR SHOP!**



**START
SMALL
GROW
BIG**

**Learn at Home
In Your Spare Time**

Our practical, shop-tested home-training teaches you quickly and easily how to repair and install all types of REFRIGERATION and AIR-CONDITIONING. No experience is needed. A grade school education is enough. You may either take a well-paid job or start your own shop with as little as \$50 worth of tools. The opportunities are endless in this huge, well-paid, expanding field. Let us tell you all about it with no obligation. Mail coupon now.

**WRITE FOR OUR
FREE BOOK**



MECHANICS TRAINING SCHOOL

7217 So. Broadway, Dept. P-101, Los Angeles 3, Calif.

Dear Sirs: Please send me without obligation, your free book giving full details about your training.

Name _____

Address _____

City _____ State _____

Amazing New KLIK-RITE

BALL PEN

**GUARANTEED to Write for
Years Without Refilling
Name in 23K Gold FREE**

**CLICK
THE
BUTTON**

A real BALL PEN! Works and performs exactly like highest-priced pens—PLUS amazing new "click-it-to-write"... "click-it-to-park-it" feature—PLUS your name in 23K gold—all for only \$2.98! Writes dry with water-proof ink—no blotter needed. Cannot leak. Writes anywhere... even under water. One piece—no cap to fuss with or lose. Touch the button on top & ball point "clicks" out to write. Another touch and the point "clicks" back into the barrel. A slim streamlined beauty—lightweight... **COMPACT!** Factory guaranteed. Comes in attractive GIFT BOX.



**Only
\$2.98**

Send No Money!

Rush order today. **PRINT NAME** to be stamped in 23K Gold. Pay postman only \$2.98 plus few cents postage on delivery. Or send \$2.98 with order and save postage. If you are not delighted, return pen within 10 days for your money back. Order today!
**KLIK-RITE PEN CO., Dept. C-69
215 W. Ontario Street, Chicago 10, Ill.**



make dreams come true!

SUCCESS FORMULA

tells you what to do!
tells you how to do it!

Happiness, prosperity, health—all can be yours! You too can climb the heights to shining success—achieve your greatest desires—simply by following this easy Success Formula! Just one dollar can start you on the road to success now! Send for your Success Formula TODAY.

THE CIRCLE P.O. Box 503 Dept. PM-17
Riverside • California

FENCING

HEALTHFUL SPORT

Keep fit and enjoy the exciting pastime of swordsmanship with our two 3 ft. Spring Steel Foils (swords) Safety Rubber buttons, hand guards and our Free Instruction manual—all available now for only \$1.98 payable by CHECK or M. O. Add 28c for Foreign Postage.



LEE PRODUCTS CO. Dept. 20 1413 FIRST AVE. N.Y. 28 N.Y.

**"How to Make Money
With Simple Cartoons"**

A book everyone who likes to draw should have. It is free; no obligations. Simply address
CARTOONISTS' EXCHANGE

Dept. 91-D Pleasant Hill, Ohio

INDIANA TECHNICAL COLLEGE

Engineering B.S. degree in 27 mos. Aeronautical, Chemical, Civil, Electrical, Mechanical and Radio Engineering. 2-yr. diploma, Air Conditioning and Refrigeration; Drafting, 1-yr. Gov't approved for G.I.'s. Low rate. Earn board. Large industrial center. Demand for graduates. Enter March, June, Sept., Dec. Catalogue. 517 E. Washington Blvd., Ft. Wayne 2, Ind.



**LEARN PORTRAIT PAINTING
AT HOME**

• Previous art training or talent NOT necessary. This new Stuart System teaches you, in 11 simple, easy-to-follow lessons, to make exact charcoal and oil likenesses. Guidance for your every step. Send for free book today.

**STUART
STUDIOS.**

121 Monument Circle, Room 61, Indianapolis 9, Ind.

Please send me free book and outline of lessons.

Name _____

Street _____

City _____ State _____



Have you
considered a
career in
PLASTICS?



A job with a promising future goes a long way toward making you happy —at work and at home.

Do you know of the fine opportunities for advancement that are available in the plastics industry? Do you want to share in the development of a great new plastics era? *Trained men*, who have plastics know-how, will fill the well-paying positions in the industry. If YOU want to be one of them act NOW to prepare yourself.

Every day you can read glowing descriptions of how plastics are improving old products and creating new ones. Learn the hundreds of interesting phases of the plastics industry and be ready for the position that will give you the security and satisfaction you want.

EXCLUSIVELY PLASTICS—Plastics Institute is America's oldest and largest educational organization which devotes all of its facilities exclusively to plastics. **IMMEDIATE ENROLLMENT** can be arranged. Write for information *today!*

COMPLETE COURSES—You learn the various phases of plastics from these courses... materials, designing, molding, fabricating, laminating

Write Dept. PM7-1, 1601 S. Western Ave., Los Angeles 6, California

Home Training Courses and Resident School APPROVED FOR VETERANS

and testing. You acquire a basic knowledge of plastics that can be invaluable to you in acquiring the type of position you want.

YOU MAKE THINGS—We supply materials. To give you practical experience in working with plastics, we supply handsome, colorful rods, sheets and tubes of plastics from which you make useful, attractive creations. You form, dye, decorate, cast and laminate various types of plastics. You also design and develop your own ideas. You can make and sell plastics articles to earn while learning.

START YOUR FUTURE TODAY—Mail the coupon below, now! You will get an interesting, illustrated, free booklet with valuable information about plastics. Get complete details about the world renowned Plastics Institute Resident School, located in beautiful Southern California. Also learn about the comprehensive Plastics Home Training Course, which prepares you for a future in plastics while you continue your present job. Clip this coupon and mail it TODAY!

Plastics

INDUSTRIES TECHNICAL INSTITUTE
NEW YORK CHICAGO LOS ANGELES



PLASTICS INSTITUTE in the heart of sunny Los Angeles. Here modern laboratories and shops give Resident School students facilities for practice on the finest of industry-type plastics equipment. Also the headquarters for HOME TRAINING.

Plastics Industries Technical Institute
Dept. PM7-1, 1601 S. Western Ave., Los Angeles 6, Calif.

Gentlemen: Please send me the booklet "World of Plastics" and information on your Resident School Courses Home Training Courses. I understand there is absolutely no obligation.

Name (PRINT) Occupation.....
Street (PRINT) Age.....
City Zone State.....

Important: Please fill out coupon *completely*. If Veteran, please check. If in Armed Services now, please check.

FREE BOOKLET
Send For It Today!

It's YOUR future — Make the most of it!



Start now to earn the bigger pay in electrical repair

WAS there ever such an opportunity to get started in electrical maintenance and repair—and at top-notch wages? Are you ready—with experience and ability—to cash in on it? Others are getting just the sort of background needed—quick! practical!—to handle the great variety of electrical maintenance and repair work TODAY—from this well-known electrical library. You can too!

THE LIBRARY OF ELECTRICAL MAINTENANCE AND REPAIR

5 vols., 1826 pages, 1724 illustrations

Gives you the "know-how" to tackle any wiring or motor job. Five books show you HOW—to install all types of motor and generator units—to inspect and repair motor starters and generators—to diagnose motor and generator troubles—to figure new windings for old cores—DC and AC windings—to test armature windings—test induction motors, etc., etc. One book is full of trouble-shooting charts that show quickly symptoms, causes, specific remedies, etc.

Take the first step toward improving YOUR future—Mail this coupon TODAY

No money down—special price—easy payments—FREE trial

McGraw-Hill Book Co., 330 W. 42 St., New York 18, N. Y.

Send me for ten days' free examination the Electrical Maintenance and Repair Library. If satisfactory I will send you \$1.50 in 10 days and \$3.00 monthly until the price of \$16.50 is paid. If not wanted I will return books postpaid. (To insure prompt shipment write plainly and fill in all lines.)

Name.....
 Home Address.....
 City and State.....
 Company.....
 Position..... PM-1-47

AVIATION Career

MAXIMUM TRAINING IN MINIMUM TIME

CAL-AERO TECH TRAINING will add dollars to your pay check all the rest of your life. Specializing in AERONAUTICAL ENGINEERING and MASTER AVIATION MECHANICS since 1929, Cal-Aero Tech training is carefully designed for just one thing—TO MAKE MORE MONEY FOR YOU. An alumni of over 6000 successful graduates proves our career training is unsurpassed.

VETERANS —Write us about Aviation Training, as provided under "G.I. Bill of Rights."



GRAND CENTRAL AIR TERMINAL
 GLENDALE 1, CALIFORNIA
 LOS ANGELES COUNTY

MAIL THIS COUPON TODAY!

Cal-Aero Technical Institute, Grand Central Airport, Glendale 1, California
 Please send full information on Aviation Training FREE—without obligation. Dept. PM-1

Name..... Birth Date.....
 Street.....
 City..... State.....

How to Start YOUR OWN BUSINESS

Amazing Postwar Development Now Gives You the Opportunity to Make Money Fast!

Startling scientific discovery, just now becoming available for general use, will enable you to start your own business and reap great profits! Plastics, one of the most revolutionizing and rapidly expanding industries, offers a great opportunity to all enterprising men and women. This is one of the few industries in which home manufacturers thrive and prosper. You can start even on a spare time basis in your own home, and expand rapidly into a full time business, paying good profits.

LIQUID MARBLE
 Make LIQUID MARBLE the amazing Plastic, with a thousand uses. LIQUID MARBLE can be poured into FLEXIBLE MOLDS for casting all kinds of artistic and serviceable articles such as: ornaments, novelties, desk sets, paper weights, book-ends, souvenirs, statuary, toys, etc.

FLEXIBLE MOLDS
 Make your own FLEXIBLE MOLDS. The cost is low—in fact, a large sized mold costs but a few cents. Hundreds of casts can be taken from a single mold.

NO EXPERIENCE NEEDED!
 No skill or previous knowledge is necessary. All you do is follow our easy-to-understand instructions.

UNLIMITED MARKET
 The market is literally unlimited. You will find steady year-round demand in your own community. Your problem will not be in selling but in supplying the huge pent-up demand. Moreover, we supply you with names of big buyers for your finished products.

WRITE TODAY
 Bing Products will show you how to start with a small investment and build a permanent, independent, profitable business! Don't fail to grasp this opportunity! Write today for FREE CATALOG.

BING PRODUCTS
 Dept. A-14, 88 Broad Street BOSTON 10, MASS.

Be A MASTER PLUMBER

Earn \$15 To \$50 A Day

DON'T ENVY THE PLUMBER — BE ONE
 Every skilled workman will tell you that Plumbers have the best of it. WINTER and SUMMER the Plumber is busy at top wages. No skilled Plumber is ever out of a job—compare his opportunities with any trade, plus the opportunities of having your own shop. We teach you Plumbing with TOOLS (not books) under Licensed Master PLUMBERS in one of the finest equipped schools in America. We make you a Plumber, every branch is taught thoroughly—Lead Work—Blueprint for plan reading—all other tricks.

LEARN IN 30 WEEKS WITHOUT PREVIOUS EXPERIENCE
 If you like to work with tools you owe it to yourself to investigate. No need to ever work as an apprentice. Get free bulletin. Write now! G.I. APPROVED. Our 24th year.

UNIVERSAL PLUMBING SCHOOL
 815 HOLMES STREET KANSAS CITY, MO.

"MAGIC VANISHING CARD"
THROW IT INTO THE AIR — It completely disappears. Reproduce it later from spectator's pocket. It amuses and confuses all. Easy to do — 25c with Amazing Catalog of 300 Tricks.
 THE MAGICIAN, Dept. 5, 2463 Kensington Ave., Philadelphia 25, Pa.

APTITUDE TESTS
 discover the kind of work or studies best for your success! You get a personal report—a guide for life—more happiness—more prosperity. For men, women, boys and girls. Write for complete facts.

VOCATIONAL COUNSELING INSTITUTE
 956 Maccabees Bldg., Detroit 2, Michigan

OPTICAL ILLUSION
 makes any view or object you wish to draw appear on the drawing paper in rich detail. Low-cost invention makes drawing simple tracing. Educates and amuses children and adults. Practical for artists. Free details. Dept. 21-A, Beeler Enterprises, No. Hollywood, Calif.

SAY YOU SAW IT IN POPULAR MECHANICS

CARTOON TO SUCCESS!
 Learn to cartoon! Big pay! Easy, enjoyable work! Cartoon course, gag course, anatomy course and business course full of plans, markets, ideas. Drawing set and criticisms. All one low price! Rush card for details!
 HARTMAN SCHOOL, 2776 California Court, Lincoln 8, Nebraska

MAKE YOUR OWN COSTUME JEWELRY

SPLENDID HOBBY OR VOCATION

Sea Shells • Pin Backs • Ear Screws • Screw Eyes
 Plastic Discs • Ear Clips • Floral Stones • Jump Rings
 Chains • Clasps • Wire • Boxes • Bracelets • Parts
 Bow Knots • Catches • Plexiglas • Cements • Dyes

WRITE FOR FREE CATALOGUE • DEPT. B
 PHILADELPHIA BADGE CO., 1007 Filbert St., Phila. 7, Pa.



H. T. ARMSTRONG
General Manager

**START YOUR OWN
APPLIANCE REPAIR SHOP
Be Independent!**



**YOUR JOB IS SAFE
IF YOU HAVE
YOUR OWN SHOP**

No new-fangled machine can ever take your place in this work . . . for it takes hands to fix appliances. So you will never be out of a job. Further, everyone needs a repair man from time to time . . . so everyone is literally a potential customer. Yes, and everyone respects and admires a man who can fix things . . . so there is a lot of satisfaction being in this business. But there's even more satisfaction in knowing you and your family will never be out on a limb . . . because you will never be out of a job. Let's talk it over by mail.

**NEW BOOK
"HOW TO START YOUR
OWN BUSINESS"**

**Sent at No Extra Cost
If You Act Promptly**

This valuable book covers locating your shop, contains drawings of how to build and wire work-benches, where and how to advertise, what to charge, how to hire solicitors, etc. Sent to students who enroll promptly.

**FREE BOOKLET
MAIL THIS COUPON
TODAY**

Learn at HOME in
Your Spare Time
**How To REPAIR & SERVICE
ELECTRICAL
APPLIANCES**

Our practical, thorough course teaches you this interesting, good-paying business AT HOME, DURING YOUR SPARE TIME. A grade school education is all you need. We teach repairing electrical appliances, motors and house wiring. And from long, daily experience we know how to make our lessons understandable and easy to grasp . . . and how to give you the answers to the questions you'll want to ask. For the man who is handy with tools, and likes to work with his hands as well as his head, there is a WIDE OPEN OPPORTUNITY today, in this great growing field.

**YOU CAN PAY FOR YOUR TRAINING
WITH JUST ONE GOOD REPAIR JOB**

It's a fact! One good repair job can more than pay the cost of the entire course of training. And here's a business you can start as small as you like, in your basement or garage . . . work when you want to . . . and grow as big as you like. Or, you can take a well paid job most anywhere, to start . . . as the need for service mechanics is tremendous in this field and will grow bigger as more and more appliances are released.

AN INDUSTRY WITH A FUTURE

Just think! Despite war, shortages, priorities and restrictions, nearly 3,000,000 more U. S. homes were wired for electricity for the first time . . . since 1940. It's almost like discovering a new continent filled with customers . . . added to the millions already here. And electrification is in for a big boom with government projects in plan for all over the nation.

H. T. ARMSTRONG, General Manager,
**PACIFIC TRAINING SCHOOL, Dept. P-101,
7217 So. Broadway, Los Angeles 3, Cal.**

Dear Sirs: Please send me, without obligation, your FREE BOOK-LET, and full details.

Name

Address

City State



LANGUAGE IS POWER

... Forge ahead, win special assignments, promotion, better job in global peace time opportunities through ability to speak a foreign language.

MASTER A NEW LANGUAGE quickly, easily, correctly by

LINGUAPHONE

The world-famous Linguaphone Conversational Method brings voices of native teachers INTO YOUR OWN HOME. You learn the new language by LISTENING. It's amazingly simple; thousands have succeeded.

HCME-STUDY COURSES IN 29 LANGUAGES

Send for **FREE** book—

LINGUAPHONE INSTITUTE

98 RCA Building, New York 20, N.Y. • Circle 7-0830

Available under
GI BILL OF RIGHTS

Send for Information
State of GI

LINGUAPHONE INSTITUTE,
98 RCA Bldg., New York 20, N.Y.
Send me the **FREE** Linguaphone Book.

Name
Address..... City.....
Language Interested.....

SAY YOU SAW IT IN POPULAR MECHANICS



HUNTING and FISHING

is a monthly magazine crammed full of hunting, fishing, camping, dog and boating stories and pictures, invaluable information about guns, fishing tackle, game law changes, best places to fish and hunt—countless ideas that will add more fun to your days afield.

Special Trial Offer

Send 25c in stamps or coin and we will send you **Hunting & Fishing** for six months.

HUNTING & FISHING MAGAZINE

251 Sportsmen's Bldg., Boston, Massachusetts

BECOME A SERVICE EXPERT

REFRIGERATION and AIR CONDITIONING

Millions of Older Units Need Expert Service. Big After-the-War Expansion Will Create Even More Opportunities

Approved for Veterans "G.I." Training

Now, not "next week," is the time to start training for a top-pay job in this vital field. A drastic shortage of trained service experts exists. Many thousands more will be needed for big post-war expansion caused by new industrial uses. Train NOW to get your pick of best jobs. We will give you the practical training you need. For 2 years we trained men and women for the Army and Navy only, in fine-precision aircraft instrument work. So our methods must be right. Common schooling is all you need. Our unique system makes everything easy to grasp. You can train at home and in our big Chicago shops. Write for full facts TODAY, without obligation.

INDUSTRIAL TRAINING INSTITUTE

2150 Lawrence Avenue, Dept. P8a, Chicago 25, Illinois



WHY WEAR DIAMONDS

When diamond-dazzling Zircons from the mines of far-away mystic Siam are so effective and inexpensive! Thrilling beauty, stand acid, true backs, full of FIRE! Exquisite mountings. See before you buy. Write for **FREE** catalog.

National Zircon Co., Dept. 20
Wheeling, W. Va.

Catalog FREE!

ARTISTS MAKE MONEY

Do you like to draw? Send name, address, age and occupation for **FREE ART TEST**, to find out your ability.

ART INSTRUCTION, Inc.

1137 ART INSTRUCTION BLDG., MINNEAPOLIS 15, MINN.

FREE MRS. BERRY'S POULTRY BOOK

BABY CHICKS or **STARTED**, Champion-Mated, Licensed-Inspected, B.W.D. TESTED, 32 BREEDS, & HYBRIDS, Sexed or straight. Mature fowls, Hatching Eggs and Remotes. **LOW PRICES**. The **ORIGINAL Berry's Farm**—over 50 years' service. **LARGE BEAUTIFUL BOOK FREE**. Stamps appreciated. **BERRY POULTRY FARM, Bx. 29, CLARINDA, IOWA**



CHICKS on 30 Days Trial

SEXED!
guarantee. Money refunded on any chicks not true to breed. No need to take chances. You get 30 days to make sure chicks are as represented. Male or pullet chicks furnished. Low prices. All varieties. Mo. Approved. Blood Tested. Easy buying plan. **Bargain Prices and Chick Manual Free.** MISSOURI STATE HATCHERY, Box 189, BUTLER, MO.

RAISE CHIN-CHINS



No experience needed. Just a few minutes daily and a few feet of backyard, garage or barn space. Several females and a male starts a large profitable herd. **WE FURNISH FREE INSTRUCTIONS.** TREMENDOUS DEMAND for breeding and laboratory stock, meat, and world's most beautiful rabbit fur. Brokers, cut off from imported rabbit pelts by world famine. **NEED CHIN-CHIN FURS NOW**, and for years to come! Write for free illustrated catalog today.

WILLOW BROOK FARM • R-64, SELLERSVILLE, PENNA.

DRAW for MONEY... Be an ARTIST!



TRAINED ARTISTS ARE CAPABLE OF EARNING

\$50, \$60, \$75 and MORE a WEEK!

You can learn to draw at home in your spare time the well-known WSA way. **COMMERCIAL ART, DESIGNING, CARTOONING** all in **ONE** complete course. No previous Art experience necessary—we teach you step-by-step. Prepare for a fascinating hobby or profitable career. For 32 years WSA graduates have been making good—**WHY NOT YOU?**



VETERANS! WSA Approved for Training Under G. I. Bill. Write for **FREE BOOK**, "Art for Pleasure & Profit," fully describes course and commercial opportunities for you. **TWO ART OUTFITS** included with training.

Washington School of Art, Studio 121H

1115—15th St., N.W., Washington 5, D. C.

Please send me full information and your Free Book, "Art for Pleasure and Profit."

Name.....AGE.....

Street.....

City.....Zone.....State.....

They're Back! **BETTER THAN EVER BEFORE!**

The New
1947

MIDWEST POST-WAR ENGINEERED RADIOS

Featuring this Powerful
SERIES 16*
AM-FM
CHASSIS

AT SENSATIONAL
**FACTORY-TO-YOU
PRICES**



ONCE again Midwest demonstrates its 27 years of leadership with this powerful Super De Luxe Series 16* 5-band world-ranging radio that brings you noise-free FM reception plus Standard Broadcast and 3 short wave bands. You'll be thrilled by its marvelous tone... its wealth of new post-war features... its world-ranging performance that brings you the finest programs with amazing clarity and strength. Send today for the new FREE 1947 Midwest Catalog before you buy any radio. Take advantage of our sensational Factory-to-you values and liberal 30 days Trial Offer.

***SERIES 16 CHASSIS USES ALL OF THESE LATEST TYPE TUBES**

Now Offering
FREQUENCY MODULATION

PUT THIS WORLD RANGING CHASSIS IN YOUR PRESENT CABINET OR SELECT A NEW **MIDWEST** FROM

**30
DAYS
TRIAL**



THE MAGNIFICENT LINE OF BRILLIANT NEW CONSOLE AND TABLE MODEL RADIOS AND RADIO-PHONOGRAPHS



The **SYMPHONY GRAND SERIES 16*** AM-FM RADIO-PHONOGRAPH CONSOLE with **NEW AUTOMATIC RECORD-CHANGER**

A REAL masterpiece of cabinet design and radio engineering... a luxurious musical instrument that brings you the newest marvels of radio science, including static free FM, automatic record changing, 5 wave bands and scores of new features and improvements for your listening pleasure. For complete details of this and other Midwest Radio models send for your copy of the 1947 Midwest Catalog today.

EASY TERMS

Rush for Free Catalog!
FILL IN COUPON AND MAIL TODAY OR JUST SEND YOUR NAME AND ADDRESS ON 1c POSTCARD

MIDWEST RADIO CORP.
Dept. 25-C, 909 Broadway
Cincinnati 2, Ohio

Gentlemen: Please send me your new FREE catalog and details of your liberal 30 Days Trial.

Name _____
Address _____
City _____ Zone _____ State _____

MIDWEST RADIO CORP.

Dept. 25-C • 909 BROADWAY • CINCINNATI 2, OHIO

No Waiting to **LEARN**
START NOW TO EARN!
 This **BIG BOOK** SHOWS HOW



IF IT'S RESULTS YOU WANT—GET ACTION QUICKLY WITH THESE PRACTICAL IDEAS

Never before has a more helpful book been printed for those planning a business of their own. Gathered in this large illustrated volume are the formulas, recipes, facts and secrets that have contributed so largely to America's great industrial progress. Capitalize on this information for making most any conceivable product without experience, special equipment or previous knowledge of chemistry. Start at home, expand with profits—build for a profitable independence.

The experts who compiled this book are authorities, and present this information in simple, understandable language. They also give you wholesale supply sources for needed materials, short cuts and economy methods for the most profitable results. Hundreds of good paying businesses have been built on a product made from a simple

recipe. Opportunities in this field exist everywhere. Choose from any of the 162,000 facts and 10,000 formulas of which the following are only a very few: Adhesives, Alloys, Anti-Freeze Solutions, Cosmetics, Beverages and Liquors, Candy, Gum, Casein, Celluloid, Oils and Ointments, Faints, Paper, Perfumes, Photography, Polishes, Powders, Remedies for Man, Beast or Fowl, Rubber Products, Refrigerants, Soaps, Solder and Soldering, Tooth Cements, Transfers, Transparencies, Varnishes and Thousands of others for making all sorts of profitable and practical things.

ALSO
 We include Free—our new book of helpful money-making information:—
 "The More You Know the More You Can Earn—Easier and Quicker."

FORTUNES MADE FROM A SINGLE IDEA!

This comprehensive book is an accepted authority by chemists, schools, industry, etc. and is the largest and most comprehensive book of its kind ever issued. Nothing else like it in existence. A single formula has been worth a thousand times this book's small cost to countless owners. Crammed with money-making ideas. Invaluable for reference. Ideal for Factory, Home, Farm, Office or Workshop. As necessary as the dictionary and more useful for manufacturers, chemists and salesmen who put up products for profit.
\$3.50 postpaid. Canada or Foreign, \$3.85 U. S. Funds. (C.O.D. shipments U.S.A. only.) Immediate Shipment—Safe Delivery Guaranteed.
ADAMS BROWN COMPANY BOOKS OF APPLIED SCIENCE
 Dept. 171, Chestnut Hill 67, Massachusetts, U. S. A.

POSTPAID!
\$3.50 U.S.A.
\$3.85 FOREIGN

AIR RIFLES BENJAMIN AIR PISTOLS
ARE IN PRODUCTION

ORDER BENJAMIN AIR RIFLES & BENJAMIN AIR PISTOLS from your **DEALER**. Send for our **FREE FOLDER** and **Complete Specifications TODAY**. Both Calibre Benjamin H-C Pellets are available now.
BENJAMIN AIR RIFLE CO., 812 MARION ST., ST. LOUIS 4, MO.



FREE NEW HOBBY HANDBOOK

A Gold Mine of Information on Newest Equipment, Materials, Tools for **HOME CRAFTSMEN AND MECHANICS**
 IF you work in metals, woods, plastics or glass, you need this Big, **FREE** Source Book of equipment, tools, parts and materials . . . including dozens of hard-to-get items you can't find in stores. Many things you must have for your home hobby or shop. Just loaded with ideas and illustrations.

A WAREHOUSE OF THINGS YOU WANT
 More than 100 items including: Portable Welder; Bench Tools; Plastic Molder; Telephone System; Chemical Sets; Spray Guns; Electroplater; Drills; Grinders; Tool Chests; Model Tools; Key Maker . . . everything you need for your hobby or craft. Send for this Big, **FREE** Book **TODAY**. Mail postcard or coupon below.
WARNER ELECTRIC CO., 1512 Jarvis, Chicago 26, Dept. L-109

WARNER ELECTRIC CO., 1512 Jarvis, Chicago 26, Dept. L-109
 PLEASE SEND BIG, FREE BOOK
 NAME.....
 ADDRESS.....
 CITY..... ZONE..... STATE.....

PHOTOGRAPHY

offers
OPPORTUNITIES
 for **TODAY**
 and **TOMORROW**

- NEWS
- COLOR
- PORTRAIT
- ADVERTISING
- COMMERCIAL
- FASHION

Train at HOME

As a hobby, career or a shortcut to independence in your own profitable studio—photography offers more opportunities today than ever before. You can quickly qualify through N. Y. I.'s success-proved home study training. Previous experience unnecessary. **FREE** Book tells why photography is "going places"—how you can take advantage of these ever-increasing opportunities. Write **TODAY**. Also resident courses.

NEW YORK INSTITUTE OF PHOTOGRAPHY
 Dept. 49 10 West 33 St.,
 New York 1, N. Y.
 (37th Year)

ELECTRICAL TRAINING

Intensive 32 weeks residence course in fundamentals of industrial electrical engineering, including radio, electronics. Prepares for technician, engineering aides. Approved for veteran training. 54th year. Catalog.

BLISS ELECTRICAL SCHOOL
 7624 Takoma Ave., Wash. 12, D. C.

BE A BUILDING CONTRACTOR

FREE FACTS: Use Our Training Plan to Learn at Home in Spare Time

Do you want to be on the inside in the building boom—where big money is made? Learn about opportunities for Building Contractors whether or not you have previous experience in this field. Millions of dollars are going to be made in home and farm buildings, in construction of stores, garages, small industrial buildings. The building industry uses men with organizing ability by thousands in construction, supervision, management, sales. Properly trained men needed in production, distribution, finance, installation, marketing. Government estimates housing demand at 40 billion dollars. Others are preparing to get in now! Act immediately—get the facts! Mail postcard today—no obligation.

HOME BUILDERS TRAINING INSTITUTE, Dept. D21
 7050 N. Glenwood Ave. Chicago 26, Illinois

WATCHES WANTED Broken or Usable

All kinds. Highest Prices paid for jewelry, rings, spectacles, gold teeth, diamonds, Sterling Silver, etc. Cash mailed promptly. Write for free shipping container.

LOWE'S, Dept. PM, Holland Bldg., St. Louis 1, Mo.

RADIO PARTS GRAB BAG!!

\$25 value assortment of Coils, Condensers, Transformers, Resistors, Controls, etc. An experimenter's dream. Order today! Only.....
MARKO SUPPLY, Dept. PM-1
 2924 Logan Blvd. Chicago 47, Ill.

SAY YOU SAW IT IN POPULAR MECHANICS

Photography
 for



PLEASURE or PROFIT

Learn at home. Spare time. Practical basic training. Long-established school. Many have earned while learning. Send coupon below for free booklet, "Opportunities in Modern Photography" and full particulars.

AMERICAN SCHOOL OF PHOTOGRAPHY
 1315 Michigan Avenue Dept. 1351 Chicago 5, Illinois
 Send booklet, "Opportunities in Modern Photography," full particulars and requirements.
 Name..... Age.....
 Address.....
 City..... Zone..... State.....

Learn RADIO- ELECTRONICS- TELEVISION



ELECTRONIC CIRCUIT TESTING — Instructor showing students use of large Cathode Ray Oscilloscope.



RADIO TESTING AND SERVICING—Students learning to locate troubles with modern radio analyzers.

**TRAIN FOR A GOOD
JOB NOW** one that
offers **STEADY WORK**
with a **REAL FUTURE**

Don't be caught napping. Prepare for a good job now that will still be a good job with a real future when conditions change. If you are not a trained man you may have to compete with millions of other untrained men. Get into a field that offers real opportunities in good-times and bad-times. Tremendous expansion in Frequency Modulation and Television is predicted because of war time discoveries now being re-converted to civilian use. Radio-Electronics trained men are needed today—they will be needed in the years ahead!

"Learn by Doing"

RIGHT HERE in the SHOPS of COYNE — in a Few Weeks
Student Finance Plan

We train you on real Radio, Television and Sound equipment—RIGHT HERE IN THE COYNE SHOPS IN CHICAGO. Necessary theory is given in a practical way by practical lectures, blackboard illustrations and equipment demonstrations. Whether or not you have had Radio experience you need Coyne all-around Radio Electronics training. Many of our students had no previous experience. Others had experience in one or two branches but realized they needed all-around training for better jobs and advancement.

EARN WHILE LEARNING

If you need part-time work to help pay living expenses while at school, we will help you get it. Coyne graduates also receive a Life Membership with Lifetime Employment Service.

MEN WITH PHYSICAL DISABILITIES—whether due to war or other causes—we also have facilities for you. Check coupon for particulars if you have a physical disability of any nature.

PREPARE FOR JOBS LIKE THESE

Frequency Modulation (FM)
Radio Manufacturing
Radio Set Serviceman
Television Servicing
Electronics Maintenance
Public Address Systems, etc.
Your Own Radio Shop
**Electric Refrigeration
Now Included**

**ADDED
TRAINING**

This training included to help you get ready for the better jobs in this great field.

THE HOME OF
COYNE



VETERANS!
Coyne is also equipped to train those who qualify for training under the G. I. Bill of Rights. Check coupon for special G. I. Bulletin.

Real Opportunities for the Radio Trained Man

Prepare for jobs as assembler, inspector and tester—Radio sales or service and installation work, electronics, television, sound work, aircraft-radio, auto-radio, etc. Many opportunities in the vast Radio-Electronics field.

GET OUR BIG NEW BOOK

It tells all about our big Chicago shops and our plans to help you get ahead. Packed with facts and pictures of students at work in our shops. Mail coupon for this Big New Book now! Coupon will also bring details on how we'll finance most of your tuition...facts on how we help you "Earn-While-Learning"...information on FREE EMPLOYMENT SERVICE FOR LIFE...and other plans to help you. ACT NOW TO MAKE SURE YOU GET OUR GENEROUS OFFER. Sending for this interesting free book can be your first big step to success. No obligation. No salesman will call. Mail coupon today. B. W. Cooke



B. W. COOKE, Dir., Radio-Electronics Div.,
COYNE ELECTRICAL SCHOOL
500 S. Paulina St., Dept. 17-3H,
Chicago 12, Ill.

Dear Mr. Cooke, Send me your Big Free Radio-Electronics Book and all the facts... also full details of your "Student Finance" plan. Send special G. I. Bulletin. Send physical disability details.

NAME.....

ADDRESS.....

CITY..... STATE.....

B. W. COOKE, Dir.

Founded 1899

COYNE ELECTRICAL SCHOOL
RADIO-ELECTRONICS DIV.

500 So. Paulina Street Dept. 17-3H CHICAGO 12, ILLINOIS

ELECTRICIANS! RADIO MEN!

Earn More Money!

Get this new
GIANT SIZE

**ELECTRICAL
and RADIO
TROUBLE
SHOOTING
MANUAL**
GUARANTEED BY
COYNE

Yours 10 Days Free

Needed by **was** workers, maintenance men, beginners, old timers! Nothing else like it. Saves time, helps boost your pay... **4 GREAT BOOKS IN ONE!** 1. New Step-by-Step Trouble Shooting Course. 2. 500 Shop Prints. 3. Elec.-Radio Dictionary. 4. Spare Time Jobs.

FREE! 1 yr. Technical Counsel by mail from COYNE staff, on trouble-shooting problems.

SEND NO MONEY! See offer below. Satisfaction guaranteed by famous COYNE "Learn-by-Doing" Electrical School. Rush coupon now!

OVER 500
Large Size
Electrical
and Radio
Shop Prints
-How to read
and use them

Book Division, Dept. 17-R5
COYNE ELECTRICAL SCHOOL
500 S. Paulina St., Chicago 12, Ill.

Send, with all shipping charges paid, your new COYNE Electrical and Radio Trouble Shooting Manual. Within 10 days after getting it I'll either return it or send \$3, then \$3 monthly until total of \$8.95 is paid. [] Cash price \$1.00—you save over 10%. Same 10-day free trial and return privilege.

NAME _____ Age _____
ADDRESS _____
CITY _____ Zone _____ STATE _____

FREE TRIAL COUPON

★ TRAIN for SUCCESS in the Poultry Business



Study at home in spare time. Earn extra while learning.

YOU CAN MAKE A Good, Comfortable LIVING WITH POULTRY

Enjoy country life—grow your own food—and let poultry pay expenses

Get ready now—the easy, scientific, inexpensive way! For 25 years, we've been helping thousands to greater success. During 25 years we have trained thousands of students, showing them how to establish poultry farms—how to avoid mistakes—how to cut losses—how to increase profits on established plants—how to have their own small profitable breeding plant and make a good living at it.

Proper management and "know-how" makes profits ANY season, for life. Our courses cover all phases of poultry raising, including plans for buildings, breeding, hatching, culling, sexing, caponizing, marketing, judging, exhibiting, and many others, etc., as planned by Harry M. Lamon, former Senior Poultryman for the United States Dept. of Agriculture. Endorsed by leading colleges, poultrymen everywhere. Write today for this Free Catalog "How to Raise Poultry for Profit." It fully describes courses, methods, service, opportunities, and easy payment plan.

National Poultry Institute
Dept. 50, Adams Center, N. Y.



YOU CAN SUCCEED....
Send For this Book Today

DOUBLE your INCOME IN YOUR SPARE TIME

LEARN SILK SCREEN PROCESS

Jealously Guarded Trade Secrets NOW Available to You

Develop a Profitable Business of Your Own... or a Hobby

Prepare yourself for an interesting top paying position. Thousands of jobs open. Silk Screen Process signs, displays, Xmas cards, toys, etc. IN GREAT DEMAND THE WORLD OVER. You may make enough the second week to pay for the entire course. EASY TO DO... EASY TO LEARN. No education or mechanical knowledge required. **BOOKLET** with 3-color Silk Screen Processed cover and **Sample** sent FREE. Write NOW!



COURSE INCLUDES A COMPLETE KIT OF SUPPLIES

CALIFORNIA SCHOOL OF SCREEN PROCESS
Dept. PM-17 2710 So. Spaulding Avenue, Los Angeles 16, California

BOYS-IT'S FREE!

This exciting book "THE WONDERS OF CHEMISTRY"

Shows how to amaze your friends with chemical magic, describes many fascinating home experiments, tells of fun, thrills, adventure and big future opportunities for boys who know chemistry. Send today!

THE PORTER CHEMICAL COMPANY
43 Prospect Avenue Hagerstown, Md.



48 PLANS

\$100



48 complete plans of toys, ash trays, garden ornaments, Dutch boys and girls, what-not shelves, and many other interesting projects. Finest selection available. Novel method allows you to make finished project any size desired. **PLUS FREE** Deluxe Plan of corner shelves. Send only \$1 to Jackson, Dept. PM-5440N, Shoreland Ave., Milwaukee 11, Wis.

FREE Bikini Crossroads Patch



Send only \$1.00 for our beautiful selection of 20 different Flight Squadron and Shoulder BOMBER leatherette breast patch absolutely FREE. Tremendous value. Colored insignia book with your order at no cost. Send to-day. Offer limited.

THE INSIGNIA MART, Dept. DD
703 Broadway, New York 3, N. Y.

GOV'T JOBS!

VALUABLE INFORMATION FREE
Columbian Correspondence College, Dept. 7, Washington 2, D. C.

SUPER YOUR GREATEST ASSET!

MEMORY Facts, figures, faces, **STICK LIKE BURRS** with new improved **SUPER-MEMORY** Course.

THOR BOOKS, Z3, Box 1210, Chicago

TRI-STATE COLLEGE

B. S. Degree in 27 months in Engineering (all branches); Bus. Admin., Acc't and Sec. Science. 63rd year. School now filled to capacity. No applications can be accepted until further notice.
417 College Ave., Angola, Ind.



CARTOONING

HAVE FUN! MAKE MONEY! Cash in on your sense of humor **AT HOME—BY MAIL.** No experience needed to start. Write today **FOR FREE TRIAL LESSON** and full particulars.
Moon Gag Cartoon School, Dept. B, Fall Creek, Wis.

STAMMER?

This new 128-page book, "Stammering, Its Cause and Correction," describes the Bogue Unit Method for scientific correction of stammering and stuttering—successful for 46 years. **Benj. N. Bogue, Dept. 1844, Circle Tower, Indianapolis 4, Ind.**

GET THIS FREE BOOK!

Now Any AUTO REPAIR JOB Can Be a "Push-Over" for You!

**IN LESS TIME —
WITH LESS WORK —
AND MORE PROFITS!**

MoToR's new AUTO REPAIR MANUAL shows you how to service and repair ANY part of ANY car! Now you can lick even the toughest jobs when you have this amazing Manual to make your work easier!

Every job on every car built since 1935 is explained as simply as A-B-C. Clear, illustrated instructions lead you step by step. NOW you can tackle ANY job from carburetor to rear end—and do it quick, easy, right, the FIRST time! Just look up make, model, and the job in the quick index of MoToR's AUTO REPAIR MANUAL—and go to work!

ONLY Manual of Its Kind

No wonder this manual is used by the U. S. Army, Navy, trade and technical schools everywhere, and thousands of successful auto servicemen!

To make this great book possible, the engineer-editors of MoToR Magazine condensed all the meat from 150 official factory manuals for you. They dug out all the information you need; made sure *every word* is crystal-clear; and put "the whole works" into this one great, handy book!

MoToR's AUTO REPAIR MANUAL is a big book: 764 large pages, 8½ x 11 inches, bound in sturdy covers. Nearly 200,000 ser-

vice, repair, adjustment, replacement, tune-up facts on every car built from 1935 through 1946!

Over 1,000 Pictures!

More than 1,000 cutaway photos, diagrams, drawings, charts, SHOW you what the clear text TELLS you! No wonder thousands of men call this amazing book their Auto Repair "Bible"! No wonder it will save YOU countless hours of work—and help you make MORE MONEY from auto repairs!

See for yourself—without cost!—what a work-saver, time-saver, and "life-saver" MoToR's AUTO REPAIR MANUAL will be for you! TRY it FREE—for 7 days. Learn first-hand how it can pay for itself the first few times you use it!



Clear, Pictured Facts on Every Job on Every Car Built Since 1935!

Nearly 200,000 service and repair facts on all these makes:

American Crosley	La Salle	Packard
Bantam De Soto	Lincoln	Pierce
Auburn Dodge	Lincoln	Arrow
Austin Ford	Zephyr	Plymouth
Buick Graham	Mercury	Pontiac
Cadillac Hudson	Nash	Reo
Chevrolet Hupmobile	Oldsmobile	Studebaker
Chrysler Lafayette	Overland	Terraplane
Cord		Willys

764 big pages; including 50 pages of carburetor text, charts, illustrations covering all models. Over 500 charts, tables: Tune-up Chart; Valve Measurements; Compression Pressure; Torque Wrench Reading; Starting Motor; Engine Clearances; Generator; Clutch & Brake Specifications; Front End Measurements, etc.; Engines; Electric, Fuel, Cooling, Lubricating Systems; Transmissions; Universals; Front Ends; Wheels; Rear Ends, etc.

**FREE
7-DAY OFFER
SEND NO MONEY**

Just mail coupon below—without money! When the postman brings your book, examine it thoroughly. Make it show you what it's got! Unless you agree this is the greatest time-saver and work-saver you've ever seen—return book in 7 days and pay nothing. Mail coupon today! Address: MoToR Book Department, Desk 1-A, 572 Madison Ave., New York 22, New York.



Same FREE 7-Day Offer Applies on MoToR's Truck Repair Manual

For mechanics, truck specialists, service stations, fleet owners. Covers EVERY job on EVERY truck made since 1936! 1400 pictures, 914 pages, 300,000 facts. Used by Armed Forces. Warranted to contain every essential fact you need to know. Strong binding, size 8½x11.

Covers all types Gasoline Engines; Diesels and Hesselmanns. Fuel Systems, Governors. Lubrication Systems, Ignition Systems, Starters, Generators, Clutches, Transmissions, Axles, Torque Dividers, Transfer Cases.

Brakes, Steering, etc., etc. Also services buses, farm and industrial tractors, contractor and road building equipment, stationary power machinery, etc. (on all parts described in Manual.)

Offered on same FREE 7-Day examination as Auto Repair Manual. Check box in coupon at right.



Published by MoToR, The Leading Automotive Business Magazine. MoToR's manuals assure high standards of repair work.



Used by
U.S. Army
and Navy

MoToR Book Dept., Desk 1-A, 572 Madison Ave., N. Y. 22

Rush to me at once: (Check box opposite book you want)

MoToR's AUTO REPAIR MANUAL. If O.K. I will remit \$1 in 7 days, plus 35c delivery charges; \$2 monthly for 2 months and a final payment of 95c a month later (Price \$5.95). Otherwise I will return book postpaid in 7 days. (Foreign price, remit \$8 cash with order.)

MoToR's TRUCK REPAIR MANUAL. (Described at left.) If O.K. I will remit \$2 in 7 days, and \$2 monthly for 3 months, plus 35c delivery charge with final payment (\$8.35 in all). Otherwise I will return book postpaid in 7 days. (Foreign price, remit \$11 cash with order.)

Print Name..... Age.....

Print Address.....

City..... (if any).....

State..... Occupation.....

SAVE 35c SHIPPING CHARGE! ENCLOSE full payment (check, money order, or postal note) and we pay postage. Same 7-day return-refund privilege.

Give yourself the Backing of a
GREAT GROWING INDUSTRY



REFRIGERATION AIR CONDITIONING

Refrigeration and Air Conditioning have leading place in fast growing fields of our time. Trained men paid well to service, install, maintain, repair, rebuild household and commercial refrigerators. Important new developments such as Frozen Foods and many new industrial uses. Demand for commercial installations in restaurants, butcher shops, taverns, florists, bakeries, etc. — air conditioning in homes, offices, shops.



START NOW—Full and Part Time Earnings

There may never again be such opportunities for men who want better jobs or business of their own to get in on ground floor and go up fast!



Many started with small investment who built good, growing business. If over 17 and under 60 learn how you can get started. **CONSULTATION AND PLACEMENT SERVICE WHETHER YOU ARE INTERESTED IN WORTHWHILE JOB OR SETTING UP YOUR OWN BUSINESS.**

Begin Training at Home or Come Directly to Shops

Begin your training at home in spare time, finish in our big, modern shops, or come directly to shops. At home you get C.T.I.'s SHOP PROVED HOME STUDY instruction—actual shop experience has gone into the practical lesson assignments. That is why it is easy for mechanically inclined men to learn by our Home Study training and start on actual refrigeration work.



A NATIONALLY KNOWN INSTITUTION

C.T.I. was only civilian school selected by Army to train service men for refrigeration. Same quality training available to you now. The method that has made rapid progress possible. Commercial Trades Institute has established its place in Air Conditioning and Refrigeration industries, and that is important to you in making your start.

VETERANS

Veterans qualifying under "G.I. Bill" have tuition paid by Government plus monthly subsistence allowance while in school. Just mail coupon, we will handle all details. (LOW TUITION, EASY TERMS if you are not a veteran.)

COMMERCIAL TRADES INSTITUTE
Dept. A21

1400 W. Greenleaf Ave., Chicago 26, Ill.

FREE — Important Information Telling How to Get Started



CUT OUT COUPON BELOW

Fill Out, Cut Out, Mail Today

FACTS FREE for Men Who Want to Get Ahead
COMMERCIAL TRADES INSTITUTE, Dept. A21
1400 W. Greenleaf, Chicago 26, Ill.

Send free Illustrated Brochures and other information about Refrigeration and Air Conditioning.

Veteran Non Veteran

Name

Address

City State

5 lbs. **HANDY ASSORTMENT** \$1.98

For Mechanics — Garages
— Workshops — Home Use

SCREWS • NUTS • BOLTS • WASHERS
RIVETS • SPRINGS • BRACKETS • MISC.



MORE THAN 1,000 PIECES—5 full pounds—a veritable treasure chest of fastening devices for every practical use. Satisfaction guaranteed. Order now \$1.98
SPECIAL—2 assortments, over 2,000 pieces, for \$3.69.

Get on our FREE Bargain Mailing List—Many other valuable assortments to meet every need!

HUDSON TRADING CORPORATION
11521 N. Wells St.
Chicago 10, Ill.

Play in One Hour by Ear and Note



NEWLY INVENTED
SLIDE-CHORD DEVICE

Fits piano. Play any chord at once. Plink out tunes by ear and note and add chords to play beautiful 2-hand professional radio style at one sitting. Fun! A game! No exercise or drills. Startle your friends! **PLAY 27 COMPLETE SONGS WITH 4 CHORDS (SEND NO MONEY) (JUST 1¢ CARD).** 25 lessons ABC METHOD, including many POPULAR SONGS and SLIDE-CHORD DEVICE ALL for \$2 plus C. O. D. Save C. O. D. Send \$2 cash, check, money order. **MONEY BACK GUARANTEE.**

DALE SHEARS SCHOOL OF MUSIC

Studio 4202

Struthers 3, Ohio

Be Your Own Boss — In Your Own Business

LEARN

PLASTICS

PLASTICS TECH

School of America, Inc.

5200 Euclid Avenue

Dept. M-17, Cleveland 3, Ohio

Start at home . . . small capital needed . . . prepare for exciting plastics jobs or Your Own Plastics Business. We teach you Fabrication and Casting right in your own home. All materials furnished. Send ad with name and address for information. **VETERANS:** Eligible for resident training under G. I. bill, Check here

FIGURE DRAWING WITHOUT A MODEL

This book brings famous art schools right to your home! Over 300 "real-life" drawings in this new Cliff Young book. Copy from them to guide your Art Career. Only \$1 postpaid. Order Now; Art Books list included FREE.

HOUSE OF LITTLE BOOKS, 80-A East 11th St., New York 3



AMAZING DISCOVERY! Corrects poor penmanship in few days—big improvement in 3 hours. Write, Ozment, 34, St. Louis, Mo., IMMEDIATELY.

RUPTURED?

Get Relief This Proven Way

Why try to worry along with trusses that gouge your flesh—press heavily on hips and spine—enlarge opening—fail to hold rupture? You need the Cluthe. No leg-straps or cutting belts. Automatic adjustable pad holds at real opening—follows every body movement with instant increased support in case of strain. Cannot slip whether at work or play. Light. Waterproof. Can be worn in bath. Send for amazing FREE book, "Advice To Ruptured," and details of liberal truthful 60-day trial offer. Also endorsements from grateful users in your neighborhood. Write:

CLUTHE SONS, Dept. 31, Bloomfield, New Jersey

Why be a BOOKKEEPER?

...When Accountancy offers more Money and Success...

If you are a bookkeeper, you are right on the threshold of a profession that pays far above average—where there's real opportunity to get ahead and move up fast.

Why not step UP from bookkeeping—be an accountant—make *real* money!

You can learn Accountancy by the interesting LaSalle Problem Method—in your convenient spare time, at home, without losing a day from your work. You learn by *doing*... you study Accounting principles and solve Accounting problems under the clear guidance of experienced C.P.A.'s. You cover Accountancy from the basic principles right up through Accounting Systems and Income Tax Procedure—to advanced training for the C.P.A. degree if you so desire. And as you go along step-by-step, you master the principles of auditing, business law, statistical control, cost accounting, organization, management, finance, etc.

You go as fast or as slowly as you choose. And you may start "cashing in" on your new ability long before you complete the training—as thousands of others have proved. Many advance quickly to better positions, even before they are half way through. And that is only the *beginning* of a growing and continuing success for the rest of your business life.

Why remain "just a bookkeeper" when Accountancy holds so much for you? Our free 48-page booklet, "ACCOUNTANCY, THE PROFESSION THAT PAYS," tells you what you must know to be an Accountant, and how you can prepare in your leisure time, at moderate cost and on easy terms.

Send the coupon today. Get all the facts and judge for yourself. There is no obligation. You are already started in this field...find out how you can rapidly go to the top! Mail coupon NOW!

FREE BOOKLET

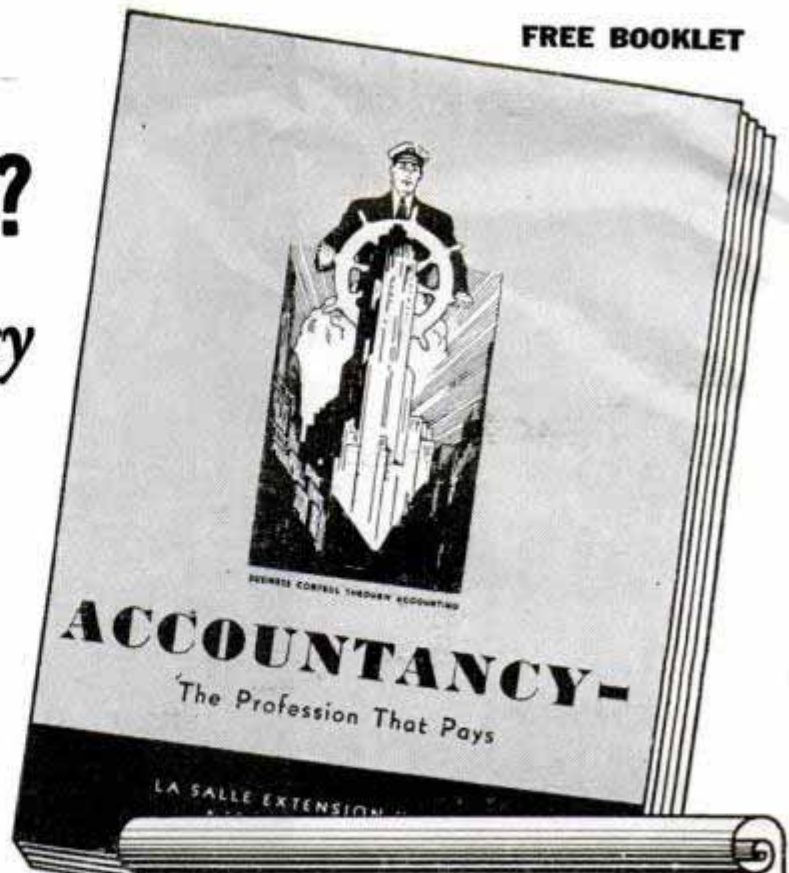

G. I.
APPROVED

LA SALLE Extension University

A Correspondence Institution

Dept. 164-H • 417 S. Dearborn • Chicago 5, Ill.

I'd like to know more about your home study program to help me prepare for an accounting career. Please send me your free 48-page booklet, "Accountancy, the Profession That Pays."

Name

Position..... Age.....

Address.....

City, Zone and State.....

"I'm **GOING**
to be an
ACCOUNTANT!"



LASALLE

EXTENSION UNIVERSITY

A Correspondence Institution

**WORLD'S
BEST
WANT AD
MEDIUM**

CLASSIFIED Advertisements



Advertisements in this section 60 cents per word, each insertion, minimum 10 words, payable in advance
To be inserted under proper classification in February issue, copy should be in our office December 26th

February issue on sale February 1st

F. W. Johnson, Manager, Classified Advertising

Popular Mechanics Magazine, 200 East Ontario Street, Chicago 11, Illinois

1347

CLASSIFIED ADVERTISEMENTS

1347

OPPORTUNITIES FOR YOU

AUTOMOBILES, MIDGET CARS

SCOOTER-CAR Runabout! Two passenger, three wheeled, motorized, speedy. Simple construction from available second hand parts. Detailed plans \$1.00. Plans for midget "Jeep" included free. Universal, 2671 Algonquin, Toledo 6, Ohio.

DUALTONE Crystalline packed twin muffler sets. Priced complete, V8's \$23.00, six cylinder cars \$33.00. Single mufflers. Large chrome tailpipe extensions \$3.30. Polished carburetor velocity stacks \$1.30. Dualtone Mufflers, 2636C India Street, San Diego 1, California.

R & R Mfg. Co., marine and auto division. Anderson, Indiana, Robert M. Roof. \$1.00 for our new 1947 speed and power equipment catalogue with price sheet—showing racing cars, midgets, speed boats with recommendations how to rebuild your motors for racing. Dual ignition racing cylinder heads for V-60-100 and Mercury Ford engines. Dual intake manifolds, racing pistons, camshafts, compound valve springs, Lynite flywheels, quick change gear boxes and numerous other supplies.

NEW Racing books. Dick Seaman, Racing Motorist, \$3.50. Road Racing, \$3.50. Wheels at Speed, \$3.50. Wheelspin, \$3.50. Midget Automobile 1946 Racing Year Book, \$1.10. All postpaid. Clymer, Dept. A-12, 2125 W. Pico, Los Angeles 6, Calif.

RENAULT Automobile, descriptive booklet, 26 illustrations, models 1924-1938, 50c. R. W. Pratt, 245 North Street, Dalton, Mass.

CLYMER-Tone finest California style dual mufflers, V-8 Ford, Mercury. Increases power, reduces back pressure. \$20.00 complete with pipes. Fast installation. Specify model car. Clymer, Dept. A-17, 2125 W. Pico, Los Angeles 6, Calif.

"STREAMLINED Roadster"—Speedy, small two passenger automobile! Beautiful three wheel sport style. Easily constructed for \$75 from available material. Small motor. Instructions, plans \$1.98. Almqvist Engineering, 447 (B) 64 Street, Brooklyn 20.

MIDGET Automobile Racing Book. 45 photos. Complete history 1946 California racing. \$1.10 postpaid. Clymer, Dept. A-16, 2125 W. Pico, Los Angeles 6, Calif.

SEE Our ad under motorscooters for midget car bargains. Midget Motors Directory, Athens, Ohio.

HENRY Ford. His life—His Work, book, 384 pages, 50 photographs. Complete, detailed history book of Ford Motor Company and founder, genius Henry Ford. Revised to date. \$3.00; De Luxe Clothbound, \$4.00, postpaid. Clymer, Dept. A-15, 2125 W. Pico, Los Angeles 6, Calif.

550 DIFFERENT Photos, race cars, drivers. List, sample 10c. Frank Smith, Midland Park, N. J.

FLOYD Clymer's Motor books: Power & Speed, \$2.50—Motor Racing With Mercedes-Benz, \$2.00—Motor History of America, \$3.00—Speed, How to Obtain It, \$1.50—Ab Jenkins' Racing Book, \$1.50—Fastest on Earth racing book, \$2.00—Clymer's Motor Scrapbooks (old cars) Editions 1, 2, & 3 each different, \$1.50 each—Steam Automobile Book, \$2.00—Motorcycling Manual, \$2.00—Motorcycles, How to Manage Them, \$1.50—Full Throttle, \$3.50—Indianapolis Race History Book 1909-1946, \$3.50—1946 Indianapolis Racing Book, \$1.00; postpaid. Motorbook catalog free. See our ad Motorcycles classification. Clymer, Dept. A-11, 2125 W. Pico, Los Angeles 6, Calif.

"CUSTOM-STYLING" Manual—Easily make any car Hollywoodized, custom, newer, streamlined! Beautifying suggestions, simplified restyling, illustrations, plans, accessories, California mufflers, refinishing, model changes—convertibles, custom, sport, etc. \$2.00. Almqvist Engineering, 447 (B) 64 St., Brooklyn 20.

FREE Catalog describes racing, historical, automobile, motorcycle books, 25 titles. Write Clymer, Dept. A-13, 2125 W. Pico, Los Angeles 6, Calif.

INDIANAPOLIS 1946 Race History, including 80 illustrations, charts, drawings. World famous car, driver data. Highlights George Robson career; \$1.00. Complete Indianapolis Race History every Speedway race since 1909, including 1946, 1100 illustrations, 352 pages, \$3.50 postpaid. Clymer, Dept. A-10, 2125 W. Pico, Los Angeles 6, Calif.

SPEED And Mileage Manual—Easily obtain greater speed, mileage, racing performance, any car! Simplified speed tuning includes gas saving secrets. Instructions on building speed equipment, economizers, mufflers, superchargers, fast conversions. \$1.98. Almqvist Engineering, 447 (B) 64 Street, Brooklyn 20.

"FASTEST On Earth" history book every World's Straightaway Speed Record. 200 pages. 70 illustrations world famous drivers, cars. \$2.00 postpaid. Clymer, Dept. A-14, 2125 W. Pico, Los Angeles 6, Calif.

RACING Fuels; six tested guaranteed auto racing formulas. \$1.00 postpaid. Formula Research, 481 Pacific, San Luis Obispo, Calif.

GOGGLES, Heavy duty Aero, \$4.50 pair. Summer helmets \$1.50 each. Winter leather helmets slightly used \$3.00 ea. New \$5.00 ea. Send payment with order. Western Aircraft, Hawthorne, California.

1947 **SUPER** Ignitioniter \$5.50. Atomic starting, pep, mileage. EG Mfg., 355A East 149th, New York 55.

RACING Car performance for all cars. Increase power, speed. Special "custom-built" equipment. Free literature. Write Lee Motorcraft, 1412-A Great Northern Bldg., Chicago 4, Illinois.

CUSTOMIZE Your automobile. Illustrated, new restyling ideas, instructions, suggestions, specific model changes by simple methods. Postpaid \$1. Speedwheel, Box 723-E, Arcadia, California.

BUILD Speedy midget track racer from castoff parts! Plans, specifications, construction information, \$1.00. Motor Supply, Box 1682-CS, Toledo, Ohio.

MUFFLER Manual. Convert easily to Hollywood, Laguna, Westwood, duals, etc. Includes construction details, regulations, diagrams. Postpaid \$1. Mellotone, Box 723E, Arcadia, California.

PROFESSIONAL Midget racer, motorscooter, midget roadster, and midget motorcycle. Plans, specifications for all four contained in illustrated handbook, 25c. Big list bargain priced used motors, motorscooters, serviceclcs, etc., included free! Midwest, 3839 Drummond, Toledo, Ohio.

AUTOMOBILE Racing book, fifth edition, well illustrated. Instructions on building bodies, frames, engines. Ford A and B conversions. Plans, AAA rules, specifications. Roadster racing. Indianapolis cars. \$1.00 postpaid, \$1.30 C.O.D. Ray Kuns, Dept. 47, Madisonville, Cincinnati 27, Ohio.

AUTO SUPPLIES AND EQUIPMENT

HYDRAULIC Bumper jacks fit all makes of cars. Lifting range 17 inches. Send \$7.95 postpaid. S. & P. Merchandise, 12199 Flanders, Detroit 5, Mich.

FORGET Battery troubles. Build an a.c. charger. Start a shop on small capital. We show how. Write, Garland Enterprises, Box 186, Dept. I-47 Windsor, Ontario, Canada.

PROTECT Battery with anti-corrosion washers, 25c set. Send coin. Battery Washer Co., 6210 S. Mason, Chicago 38.

DUAL Carburetors fit any year. Blueprints \$1.00. Corcraft, 80 Maxwell, Rochester 11, N. Y.

NEW Auto parts. Advise needs. Eddy, 1516 169th, Hammond, Ind.

GRILLES For all cars. Meyers Auto Parts, 820 Dryades, New Orleans, La.

INTRODUCTORY Offer—Kit's all-bronze connective rod bearings 75c. Dealers accommodated. Kit's Machine Co., Washington, N. J.

ATTENTION, Pistons, cast, Lynite, Std, os, semi. 1916 to 1946 cars, trucks and tractors. Also rings. Zrubek Tractor and Supply, 509-11 So. Main St., Pratt, Kansas.

NEED Auto parts? We have them. New or rebuilt. Ready to deliver. Prompt shipments. Write requirements. Save money—buy direct. Factory warehouse. Mechanics Auto Parts, 3807 North Ashland, Chicago 13.

DISTINCTIVE Automobile seat covers individualized with your initials in gold. Perfectly tailored in tastefully colored fiber and leatherette with sturdy sailcloth or mercerized cotton. Reasonably priced. Hollywood-Craft Auto Seat Cover Co., 1948 Judson St., Los Angeles 33, Calif.

QUICKLY! Start any automobile in zero weather. Results guaranteed. Formula 25c. Industrial Laboratory, Box 1726, Portland 7, Oregon.

33 MILES Per gallon. Center Flow carburetor throttle. Walert Company, 3429 North Tenth St., Milwaukee 6, Wisconsin.

HAVING Car trouble? New, used, guaranteed auto, truck parts save money. Transmission specialists. Describe needs; immediate reply. Victory, 2930½ Northwestern, Chicago 18.

AUTO Parts for all autos and trucks. Trans., motors, differentials, fenders, carburetors. Also body parts. Security Auto and Truck Parts, 1941 BJ Eddy, Chicago 13.

PLATING Outfits for auto parts. Connect to a battery. No tanks used. Free particulars and proofs. Gunmetal Co., Ave. J, Decatur, Ill.

AUTO TRAILERS

SOFT Tire indicators for trailers. Inquire. Laidlaw Mfg. Co., Box 1108, Pasadena 20, Calif.

AUTO-TRAILER Travel, monthly magazine, \$1 year. Magazine Mart, Plant City 8, Fla.

TRAILER, 17 Foot Streamliner has everything. Large manual, drawings, instructions, parts list \$1.00. Illustrated circular 10c. Tudor Tandem 24 foot 3 room trailer. Large 24x36" six views floor plans giving principal dimensions \$1.00. Craftsmann Books, Box 1153-P3, Milwaukee 1, Wis.

BUILD Your own trailer! Save money! Have every feature you want! Plans for house, sport, camp and utility trailers. Catalog describing 9 models 10c. 15c in Canada and overseas. Jim Dandy, Box 125-A, Wausau, Wisconsin.

MOTORCYCLES, BICYCLES, MOTOR-SCOOTERS AND SUPPLIES

MODERN Motorcycle Mechanics Manual, 560 pages, 300 illustrations, covers Harley, Indian and English makes. The most complete motorcycle book published. \$3.00 postpaid. Nicholson Bros., Motorcycle Engineers, Saskatoon, Sask., Canada.

BICYCLES, Balloon, Schwinn and Monark. New \$43.37. Send dime for list. Century Cycle, 3447 Lawrence, Chicago 25, Illinois.

"**BICYCLE Repair Manual**." Illustrated booklet, tells how to repair bicycles. 65c. Robert Klausner, Shelbyville, Ill.

RETREADING—Top mid-west plant equipped to tread motorcycle tires, midget racing tires (all sizes) in famous Zook Armor Tread. All non-skid design. Substantial dealer discount. Send tires direct to Zook Tire Company, Denver, Colorado.

MOTORCYCLE News—monthly. Yearly subscription \$1.00. Sample copy 10c. Anniversary number 25c. Buzzzz The Motorcycle News, 5424 N. Sawyer, Chicago 25.

MOTORBIKE Manual containing easy to build motorbike and scooter plans, motor tune up information \$1.00. Veco, A117 Box 124, Evansville 5, Indiana.

NEW Bicycle engines, 120 miles gallon. Easy installation any bicycle. Send dime for folder. Clymer, Desk 10, 2125 W. Pico, Los Angeles 6, Calif.

MEAD Ranger motor scooters, world's foremost power scooters are available once more. Ranger heavy duty models 541 and 543 are again offered for prompt shipment. Literature and prices on request. Mead Cycle Co., 4520 W. Madison St., Chicago 24, Ill.

MOTORCYCLE Racing books: Speedway History, 356 pages, 50 photos, world famous riders, machines, \$2.00—Stenner's Motorcycle Speedway Annual, 46 photos, complete history English, Australian racing, \$1.00 postpaid. Clymer, Desk 11, 2125 W. Pico, Los Angeles 6, Calif.

MOTOR Scooters, bikes, valuable addresses, 23 manufacturers, \$1.50. Merchandise Mart, 519 Main St., Jacksonville, Florida.

FLOYD Clymer's popular motorcycle books: Motorcycles, How to Manage Them, \$1.50—Motorcycling Manual, \$2.00—English Motorcycle Service Manual, \$1.50—Speed, How to Obtain It, \$1.50—Sample English Motorcycle Magazine, 50c—Plans build attractive motor scooter, \$2.00—Plans Electric Bicycle, \$1.50. Prices postpaid. See our classified advertisement under "Automobiles." Motorbook catalog free. Clymer, Dept. A-19, 2125 W. Pico, Los Angeles 6, Calif.

CUSHMAN Motorscooter \$25 complete; midget car \$28; midget car less motor \$10; midget motorcycle \$25. German Sachs motorcycle \$50, less motors; motors \$3 up. Over 5400 small balloon tires \$1.50 up, mailorder only. Send 25c for big post War Bargain catalogue Number 17, listing the above and hundreds of other bargains in new and used motors, motorscooters, midget cars, motorcycles, outboards, etc. (35c by first class mail). Midget Motors Directory, Athens, Ohio.

FLOYD Clymer publications—Book of Ariel, BSA, Norton, Triumph, Villiers Engine. Complete authentic service manuals, \$1.50 each, postpaid. Specify title wanted. Motorcycle Speedway Racing, 256 pages, \$2.00 postpaid. Clymer, Dept. A-18, 2125 W. Pico, Los Angeles 6, Calif.

HARLEY-DAVIDSON Parts, repairs, batteries and tires, 24 hour service. Special polaroid motorcycle goggles with extra green lens, \$1.29 postpaid. Authorized dealer. Philadelphia Harley-Davidson Company, 857 North Broad Street, Philadelphia 23, Penna.

BUILD Scooter, midgets, Diesel conversion, motorcycle trailers, etc. Illustrated circular dime. Craftsmann Books, Box 1153-P2, Milwaukee 1, Wis.

DISTRIBUTORS Of English motorcycles. Preston Motors, Inc., 1327 South Calhoun St., Fort Wayne, Indiana. Complete accessory line for all makes and models. Write for free list. New streamlined chrome mufflers, fit all makes and models of motorcycles, removable insides, complete with mounting brackets, \$9.50 chrome, \$7.50 black.

CUSHMAN Motorscooter \$40. Briggs motor \$5, tires \$1.00! Send 25c for new bargain catalog packed with money saving buys in motorscooters, motorbikes, midget cars, motors, wheels, tires and parts. Gail and Company, 538 Erie, Toledo, Ohio.

GOGGLES, Heavy duty Aero, \$4.50 pair. Summer helmets \$1.50 each. Winter leather helmets slightly used \$3.00 ea. New \$5.00 ea. Send payment with order. Western Aircraft, Hawthorne, California.

MOTORSCOOTER \$10, Motor \$3, tires \$2! Send 25c for big new catalog Number 934 listing scores of other sensational bargains in motors, wheels, motorscooters, motorbikes, Servicycles, tires, etc. Associated, Box CS-1764, Toledo, Ohio.

LARGE Stock Indian parts. Expert motor rebuilding. New and rebuilt Chief motorcycle, motors only. Indian Motorcycle Sales, Kansas City 1, Mo.

GENUINE Moto-Scoot parts. Amsco centrifugal clutch. Windshields, sidecars. All other parts and accessories. Write for parts list. Also genuine engine parts for Briggs and Stratton, Lauson, American Moto-Scoot Co., 1313-23 Carroll Ave., Chicago 7, Ill.

WHEELS! Build wagons, scooters, mowers, trailers, wheelbarrows, grocery carts, baby carts, play pens, baby carriages, 4" to 16". Free list. Trulsen Mfg. Co., 811 E. 31, Kansas City, Mo.

HARLEY-DAVIDSON New and used 45" motors, service, parts, accessories. Send \$2.25 for army motorcycle manual, 10c for bulletins. Knuth's (Harley-Davidson factory dealer), 2491 Fondulac, Milwaukee, Wis.

MOTORCYCLE Cams ground for speed and power, carburetion. For information write Harold Schaller, 247 West Main, Turlock, Calif.

BICYCLE Book, how to buy, rebuild, sell used bicycles 50c. John Collett, Handley, Texas.

TIRES And industrial wheels, suitable for scooters, wheelbarrows, farm equipment, etc. All sizes. Bicycles and accessories. Largest assortment in America. Send dime for list. Cycle Transport Company, 1241 So. Michigan Ave., Chicago 5, Illinois.

BUILD America's lowest priced motor-scooter speedster! Complete plans, specifications, \$1.00. Big list bargain priced used motors, etc., included free! Motor Supply, Box 1682-CS, Toledo, Ohio.

AVIATION

PROPELLERS—Correct type, size for any motor. Exclusive manufacturers of Airliner 3 blade, both wood and all metal. Latest thing in ice-snow sled and boat propulsion. Build your own motor, we furnish. Illustrated literature. Standard Aircraft, Ft. Worth, Texas.

PLANES, Gliders, autogiros, helicopters made of paper, toothpicks, pins and glue. Easily assembled by anyone in ten minutes. Fly in living room, cannot harm furniture. Fun for grownups and kids alike. Plans can be used many times. Booklet containing twenty plans and complete instructions, \$1.00 postpaid. Dent, Box 262, Starkville, Mississippi.

VOLTAGE Regulator, 24 volts, aeroplane generator Automatic by Westinghouse, \$3.95 each, 3 for \$10.00. Postpaid. Lyell Hdw. Co., Box 5, Rochester, N. Y.

JET Engines. See Dyna-Jet advertisement under Models classification this issue.

LIGHTPLANES. All about them. Large manual \$1.00. Illustrated circulars on Scout, Eaglet, Seaplanes, etc., 20c. Craftsmann Books, Box 1153-P1, Milwaukee 1, Wis.

B-29 COMPUTERS, Dynamotors, amplidyne, auto pilots, amplidyne servo-amplifiers, compressors, gun chargers, turret drives, generators, starters, Flexiglas domes, oxygen cylinders, sighting stations, etc. Write for details and prices. Erec, 1006 Hewitt, Everett, Wash.

VETERANS: Flight training under G.I. bill. Private, commercial, and flight instructor ratings. Write for information. Gottschalk School of Aeronautics, Adrian, Michigan.

CUBS, Wacos, Taylorcrafts, Aerocas. Big catalog, 25c, lists these and thousands of other sensational airplane bargains. Some are "easy to repair" crackups. National, Box 1682-CS, Toledo, Ohio.

BATTERIES, GENERATORS

BATTERY Repairing, rebuilding, plate making plans. L. Wertz, Pekin, Illinois.

ELECTRICAL SUPPLIES—EQUIPMENT

PRACTICAL Winding of alternating current motors. A course of instruction on winding, connecting, and testing single, two and three phase motors. Written in clear, understandable language. Illustrated throughout. This book recommended for beginners interested in learning electrical motor rewinding. Money-back guarantee. \$2.00 prepaid. Educational Advancement Co., Dept. P-1, Lakewood, New York.

BORCELAIN Tubes 11½ and 12 inches long, ID ¾", OD 1", Postpaid \$5.00 per dozen. Allmands, Holdrege, Nebraska.

AVAILABLE For sale neon display signs and clocks. Write for particulars. General Sales Service, Box 1092, Roswell, N. M.

LAMPS—If you build or repair and have trouble finding parts—your search is ended! We carry practically every part necessary. Harps, finials, vase caps, etc. Illustrated catalog 10c. Gyro Lamps, 5416 Clark, Chicago 40.

FLEXIBLE Non metallic conduit, ½ inch to 2 inch, U.L. approved type. Is used to replace pipe. Also automotive loom. Large quantities at a bargain price. Send for price list. State Ignition, 2521 Indiana, Chicago 16, Ill.

ELECTRIC Pencil: Writes, engraves all metals. \$1.00 postpaid. Beyer Mfg., 4515-H Cottage Grove, Chicago 15.

ELECTRIC Meters, prompt shipments, any quantity, all sizes, D.C. or A.C. New and used. Ditto Pyrometers, Thermocouples. Service on all types. Write Cleveland Electric Laboratories, 1988 E. 66 St., Cleveland 3, Ohio.

STARTER Relay solenoids, 6, 12, 24 and 32 VDC, 1000 A. Silver contacts, \$2. New. Postpaid. Quantity discounts. Erec, 1006 Hewitt, Everett, Washington.

FLUORESCENT Tubes burned-out? You can relight and use indefinitely. Complete instructions \$1.00. Wallingford, 121 Burlington, York, Nebr.

ELECTRIC Fan assemblies. Make your own. Ted Riseman, 425 East Jefferson, Springfield, Illinois.

TOASTERS; Clocks; mixers, irons; other appliances. Immediate delivery. Price list. Mail Order Electric, 713 South Dearborn, Chicago.

WELDING, SOLDERING, PLATING

A.C. Welders, 110 v., welds ½" steel, \$29. Money back guarantee. Paul Morris, 1850 State St., Schenectady 4, N. Y.

ACETYLENE Welding outfits, new, consisting of 2 gauge regulators, torch, 3 tips, hose, lighter, \$49.50. Eagle Welding, Dept. PM, 5085 Broadway, Chicago 40, Ill.

BUILD Small, medium or large d.c. or a.c. arcwelder. Plans \$1.00 each. Welders Club, AB-3432, Chicago 54.

WELD, cut, braze with gasoline! Amazing new discovery shatters costs. Boosts profits. Important! Write Matthews Mfg. Co., Calgary 21, Canada.

ELECTROPLATING By battery. Illustrated instructions, \$1.00. Alvin, 553 William, Winnipeg, Manitoba.

NEW Model electric welder 110 volt a.c.-d.c.; will weld all metals; easy to use; full directions. Complete with power unit, flame and metallic arc attachments, carbons, fluxes, rods, mask; all for \$19.95. Used by the navy. Magic Welder Mfg. Co., 239-MP12 Canal St., New York City.

WELDING, Cutting, aircraft welding and soldering equipment. Electric arc welders. Superior Oxy-Acetylene Co., Hamilton, Ohio.

MACHINERY, TOOLS AND SUPPLIES

LATHE Chucks—3 and 4-jaw threaded for 1½"-8 thread spindle. Other tools at bargain prices. Immediate delivery. Write for free catalog! Kacy Supply Company, 211 Sycamore St., Genoa, Ill.

CEMENT Brick machines \$85. Howe Brick Machine, Beaufort, N. C.

CONCRETE Mixers—World's best farm size. Folders. Wettschurack's, Montmorenci, Indiana.

COLLETS, Drawbars and stepchucks all machines. Forst Sales, Box 909, Pasadena 20, California.

UNIVERSAL Tools dandy 10 piece set: Rigid pipe wrench, channellock pliers, adjustable wrench, Cetee pliers, diagonal cutter, ballpein hammer, plastic screwdriver, waterpump pliers, hacksaw and blade, cold chisel, \$19.85. Universal Tool Company, 1527 Grand, PM-1, Kansas City, Missouri.

GEARS For inventors, experimenters, model makers, schools, work shops, laboratories, etc. Government surplus made of brass, bronze, dural steel and stainless steel. 12 matched pairs; 24 gears, bevel, spur and ratchet. List price \$12.00, our price \$2.50. 25 matched pairs, 50 gears, includes larger gears, also sets of worm gears. List price \$30.00, our price \$5.00. 50 matched pairs; 100 gears better assortment, including worm sets. List price \$75.00, our price \$10.00. Limited quantity. Order now. Write for our bulletins on ball bearings, rectifiers, relays, selsyns, horns and government surplus materials. MET Exchange, 323 Canal Street, New York.

OVER 100 Brand new finely machined and fabricated parts of stainless steel, brass, bronze, dural, etc. Including matched gears, clamps, knobs, pulleys, springs, bearings, etc., \$3.00. Value over \$20.00. Kensington, P.O. Box 91, Brooklyn 18, New York.

JUMBO Assortment screws, nuts, washers, rivets, etc. 10 pounds, \$2.50. Crown, 4842 North Spaulding, Chicago 25.

CONCRETE Block machine. Two blocks at time. No expensive pallets to buy. 200 to 240 blocks hour. Concrete mixers on wheels \$59.95. Other block machines 45 to 100 blocks hour. Brick machines, power or hand operated. Batch Mixers. Any size. Madison Equipment Co., Madison, Tenn.

MATISON Automatic turning lathe, No. RKS. Turns legs 40 in. long. Abe Miller, Plain City, Ohio.

ANGLE Plate 4" x 3" x 3" ribbed machined (4) sides \$2.00, unfinished 75c. V-blocks, surface plates, vises, lathe milling attachments. Catalog 3c. Model Tool Service, Rock Falls, Ill.

TABLE Saws \$18.00, sanders, jigsaws, compressors, post drills, motors, circulars, 3c. Sunshine, Berkshire Heights., Penna.

SHEBEL Saw filer, \$7.50. Files all saws. Free trial. Circular, 730B So. 2nd St., Milwaukee 4, Wis.

LABEL Your cigar boxes, drawers, bins, cans, jars, bottles. Increase storage space and save hours of valuable time. A necessity in every small shop. 100 assorted labels of excellent quality printed in extra large type with all necessary titles including all classes of tools, hardware, liquids, electrical supplies, machine screws, etc. \$1.00 postpaid, sample 10 cents. Money refunded if returned within 5 days. Dept. 1, Hinds Manufacturing Company, 223 Second Street, Niagara Falls, N. Y.

LATHE Chucks—3 and 4-jaw threaded for 1½"-8 thread spindle. Other tools at bargain prices. Immediate delivery. Write for free catalog! Kacy Supply Co., 209 Sycamore St., Genoa, Illinois.

CUT-OFF Tool holders, non-chatter, for lathes and screw machines. Free circular. Gustin, High Hill, Missouri.

WRENCH-HANDLE. Only one now available for socket-screw wrenches, keys. New invention. For details of free trial, write Wittie Manufacturing Company, 1041 Lititz Avenue, Lancaster, Penna.

DRILL Grinder for twist drills \$2.95. See ad on page 266.

FINE Combination saws 8"x½" arbor, \$4.50. Small quantity. Others available monthly. L. Rix, Ballston Lake, N. Y.

RIVET Guns—aluminum, air driven. Perfect condition. Famous makes. Limited quantity. Immediate delivery. \$9.95 postpaid. Free bargain catalog. Art's Surplus Mart, 1329 W. Florence Ave., Dept. M, Los Angeles 44, California.

SPECIAL Dies, jigs, fixtures, tools, designed, manufactured. Free estimates. Colman Company, 204 North Buchanan, Amarillo, Texas.

MAGNETIC Chucks, indicator bases, \$3.45! Unbelievable? Write, Eyrich, Box 849-B, Milwaukee 1.

HOBBYISTS! You can equip your workshop at a fraction usual cost by building your own mill, shaper, drillpress and other shop tools for metal and woodworking from Lewis castings, materials and blueprints. Easy to complete, and ideal for home use. Send 10c to cover cost of mailing latest catalog describing 21 items. Lewis Machine Tool Co., 3217 Union Pacific Ave., Dept. M, Los Angeles 23, Calif.

WAR Surplus in small tools for machine shop. Send 10c for bulletin. Travers Tool Company, Dept P, 5 Court Square, Long Island City, N. Y.

SHARPEN Dull pipe wrenches with new patent grinder. No competition. One operator made \$321 in one week. J. C. Moore Industries, Box 234, Fredonia, Penna.

CONCRETE Building block machines and molds. Catalog free. Concrete Machine Co., 5129 South Compton Ave., St. Louis 11, Mo.

INDEX Heads for sale. Very inexpensive. Sixty-two different divisions. Used on small lathes, drill press, milling machines, etc. Make gears, hobs, cutters, etc. Very accurate, and durable. Not a toy. Used by defense schools and hobbyists. Write for free folder. Long's Index Heads, 2117 East B St., Torrington, Wyo.

BOATS, OUTBOARD MOTORS, ETC.

MARINE Power—Easily convert any Ford and Jeep motor (domestic and foreign) with Osco parts and kits. Complete catalogue 25c (coin). Osco Motors Corp., 2020B E. Orleans St., Philadelphia 34, Penna.

PLYWOOD Boat kits! Complete materials for building "Deltacraft," "Junior Dinghy," "Tadpole Skiff," Mahogany marine plywood and oak construction! Send 10c today for illustrated folder featuring these boat kits and other marine materials and supplies. Carmen-Bronson, Marine Department, Mount Vernon, N. Y.

REBUILT Tachometers 0-5000 and 0-8000 r.p.m. 4¾ diameter face. \$10.00 each, specify rotation. Zakarian Engineering, Box 416, East San Diego, Calif.

OUTBOARD Motor parts, new and used, for all makes. Our stock of used parts is too large to list. Write giving us the model and motor no. New parts for Waterwitch, Seaking, Mercury, Wizzard, Lauson, Neptune, etc. New standard and over-size outboard pistons. Outboard motor cylinders honed and re-bored. Outboard Motor Mart, Inc., 309 Atlantic Ave., Boston 10, Mass.

ALL Copper water jacketed exhaust manifolds for marine conversions of automobile and aviation engines and marine engine replacements; any make, model or age. Joseph Van Blerck & Son, 397 Woodcleft Avenue, Freeport, N. Y.

BOATS And all about them. How to select, build, repair and operate. For 40 years the leading practical boating magazine. Half price trial subscription. 12 issues for \$1.00. Motor Boat, 62 Gold Street, New York 7.

TWENTY Plywood boat plans \$1.00. Catalog boat building plans 10c. The Rudder, 15 Murray Street, New York.

FORD-Mercury-Zephyr marine conversions. Catalog 10c. Lehman Manufacturing Company, Dept. D, Newark 2, N. J.

BOAT Designers are highly paid professionals. Complete course by mail. Catalog. Westlawn, Montville, N. J.

USED Marine motors, propellers, marine fittings, conversion manifolds. Stokes Marine Supply, Coldwater, Michigan.

ENGINES, MOTORS, DYNAMOS

GENERATORS By Bendix P.2. New. 200 amps. 5,000-10,000 speed rating. \$20.00 each. Lyell Hardware, Box 5, Rochester 11, N. Y.

HEAVY Duty voltage control boxes: Cut-out, current and voltage control units with genuine silver contacts. Also large radio filter. All enclosed in a weather proof die-cast box. Like new condition. 24 volt-50 amp. Wt. 12½ lbs. Original cost \$140.90. \$5.95 each delivered. State Ignition, 2521 Indiana, Chicago 16, Ill.

½ H. P. Motor d.c. 27 volts—New \$4.95. 4,000 r.p.m. or converted to a.c. \$9.95. Small Delco motor with gear box 120 r.p.m., \$2.50; also G.E. 8 oz. small motor a.c. or d.c., \$2.50; all three \$10.00 postpaid. Outstanding value 1000 uses shop or home. Lyell Hardware, Box 5, Rochester 11, N. Y.

150 AMPERE Generators for welding \$47.50. Extra flexible cable, 6 ft. lengths \$2.75. Other bargains. Butler Electric Company, 1885 Milwaukee, Chicago 47.

DYNAMOTORS, 27 v. d.c. to 110 v. a.c. 485 watts, 400 cycle. Will operate ordinary 110 v. a.c. receivers. New postpaid. \$12.50. Ereco, 1006 Hewitt, Everett, Washington.

IT Can be done. Instant reverse your present split phase motor. Cost no more than good controller. Write for information. The Enoch Co., 533 N.E. 78th Ave., Portland 16, Oregon.

"BUILD Your Own" gas drive arc welder easily with Hobart Generator. Save \$300 to \$500, and need only add used auto engine and chassis to build portable gas drive welder that goes everywhere after profitable construction and repair jobs. Write for free instruction book, further details. Hobart Brothers Co., Box M-1066, Troy, Ohio.

WINDING Data, listing 225 motors, single and three phase, \$1.00. Motor Data Co., Box 7631, Kansas City 3, Mo.

ATHLETIC EQUIPMENT, BODY BUILDING COURSES

TRAINING Bags, to develop punch and body speed. Circular 10c. Andre's Gym, 3466 Mt. Elliott, Detroit, Mich.

JIU Jitsu. Fear no one. Be tough. Disable any attacker with bare hands. Beat bullies easily. Taught by George Bothner, champion of the world for 20 years; conqueror of greatest Japanese jiu-jitsu experts. Send \$1 for course to George Bothner, 6471 Broadway, N. Y. City, P.O. Box 3.

BARBELL Plates 20, 35 and 50's, 9c lb. Texas Barbell Co., Pine Street, Palestine, Texas.

DEADLY Judo—Fiercest fighting technique. Trick knockouts. (200 photographs—plus illustrations). Expert instructions. Three volumes. Complete \$2.25. Variety House, Box 46-BM, Wall Station, New York 5.

HE-MAN Muscles make you popular, increase your self-reliance. Write for free information. Key Institute of Physical Culture, Dept. B, Miami, Florida.

BARBELLS. Exercise equipment. Courses. Special offers! Free booklet! Good Barbell Co., Reading, Penna.

SPORTING GOODS, GUNS, FISHING TACKLE, ARCHERY, TRAPPING

DELUXE Casting rod, sensational design; lifetime guarantee. Goff, 5017¼ Cermak, Cicero 50, Illinois.

AUTOMATIC Bait—Positively weedless. Greatest invention in ages. Nothing like it. Circular free. Babcock Reel Co., Oak Harbor, Ohio.

FINEST Glass eyes; taxidermy supplies. Catalog free. Elwood Company, Department 234, Omaha 2, Nebr.

AMMUNITION—New and used shotguns, rifles, handarms, fishing tackle. List 10c. Rudolph's, Atchison, Kansas.

BASEBALL Bats, softball and boys' bats, finest quality. All kinds fishing poles and rods. Sample 6' bamboo wrapped, \$5.50 prepaid. Dealers only. Bob Pace, Combs, Ark.

BISH Shotgun rearsite, a new shooting aid for shotguns. It's a distinct innovation and aid for better shooting accuracy. Adjustable ring clamps rigidly on all single barreled guns. \$1.10 postpaid. Send payment with order. K. W. Watkins Co., Box 85, Providence, Utah.

CARTRIDGES. Shells, ammunition, guns, rifles, list 25c. Frank Parish, Vicksburg, Mississippi.

FIELD GLASSES, MICROSCOPES, TELESCOPES, MAGNIFIERS

MYSTERIOUS Wonders! 50 power microscope. Heavy gauge aluminum. 2 lenses, adjustable mirror, specimen slides, instructions. \$2.98. Wardell, 2509 Clarendon Road, Brooklyn 26, N. Y.

TELESCOPES. Microscopes, binoculars, barometers. Bought, sold, repaired. Lists 10c. Rasmussen & Reece, 41 Market, Amsterdam, N. Y.

60 POWER Telescope, \$2.95. 250 power microscope, \$2.45. Send for free catalog of telescopes, binoculars and microscopes. Brownscope Company, 24 West 45th Street, New York.

REFLECTING Telescopes, complete. 3½" diameter, equatorially mounted. View planets, stars. \$19.75. Write Sky-scope Company, 475-P 5th Ave., New York.

FIELD Glasses. High powered, case. \$35.00 cash. Frank Payne, Route 5, Kansas City 3, Kansas.

BINOCULARS. Telescopes, watches. Buy, sell, trade. Paul Schweer, Donnellson, Iowa.

DOGS, PETS, BIRDS, RABBITS

GIGANTIC Chinchilla giants—Really profitable. Demand strong. Free literature. Illustrated catalogue. 25c. Fur samples, 25c. Behrens Chin-Chin Farms, Pearl River 4, New York.

RACCOONS, Minks, foxes. Bred females. Baby skunks. Colored catalog. 25c. Shady Fur Farm, Springfield, Minnesota.

RAISE Money-making Angora rabbits. Wool \$15.00 pound. Plenty markets. Cash income. Future prospects bright. Particulars free. White's Rabbitry, Lawrence, Kan.

60 VARIETIES Pigeons, etc. Catalogue 10c. Jim Houck, Tiffin, Ohio.

ANGORA Wool spinners, shearing tables, breeding stock. House of Angora, Springfield, Illinois.

GUARANTEED Chin-Chin giant Chinchilla rabbits. Greatest amount of delicious meat. Largest, finest, most valuable furs. Tremendous demand for breeding stock. We buy youngsters. Contact world's largest breeder. Willow Brook Farm, R15, Sellersville, Penna.

ANGORAS, Chinchillas, giant rabbits—finest, pedigreed! Catalogue free. Book "Profitable Rabbit Raising" tells everything \$1.00; scientific self-cleaning hutch plans \$1.00; automatic feeder plans \$1.00. All three \$2.50. Grinsteads, Dept. 15-E, Edwardsville, Illinois.

DOBERMAN Pinscher puppies: champion sired. Willfocal Kennels, East Berlin, Penna.

HUNTING Hounds: Straight Cooners, Combination Hunters, Foxhounds, Beagles, Bluebacks, Redbones, Blacktans. Reasonable. Trial. Free list. Echo Valley Kennels, Herrick, Illinois.

FOR Sale — Coonhounds, Foxhounds, Rabbits, Blacktans, Combination Hunters, Blacktans, Redbones, Bluebacks, Spotted, Reasonable. Trial allowed. Literature free. Wildwood Kennels, Herrick, Illinois.

ZOOLOGICAL And pet animals for sale. Illustrated catalogue, literature, 25c. Trails End Zoo-5, St. Stephen, S. C.

BUY Diamond seal rabbits. We pay up to \$50.00 each for the offspring. Continuous market price guaranteed. Prefabricated hutches, \$5.50 each. Illustrated booklet 25c with hutch plans, \$1.00. Completely automatic. Hansens Rabbitry, 1347 Miller Ave., Salt Lake City 5, Utah.

\$2000 PER Year raising Angora rabbits. We buy your output. Contract particulars free. Wilsons, 1065 Shryer, St. Paul 8, Minn.

RAISE Guinea pigs. Make money at home. Big demand. Booklet free. Taylor's Guinea Pig Farm, Hapeville, Georgia.

RAISING Rabbits, Cavies, Hamsters, Chinchillas is a growing and profitable industry. Magazine 10c. Descriptive book and magazine 25c. Book and magazine (monthly) one year \$1.00. Address Small Stock Farmer, Pearl River 15, N. Y.

SPORTSMEN: 200 Pointers, setters, straight cooners, combination hunters, rabbit and fox hounds. Reasonable. List free. Ramsey Creek Kennels, Ramsey 1, Illinois.

RAISE Guinea pigs. Profitable, low-cost feeding, small space required, small investment. Complete details 25c. Guinea Pig Farms, 3456 West 116th St., Chicago 43.

ST. BERNARD Pups: Champion sired beauties. Franklin Young, R4, Riverhead, Long Island, New York.

STANDARD Rabbit Journal, Milton, Pa. 3 years \$1.00, sample dime.

SEEDS AND NURSERY STOCK

DAHLIAS. Ask for 1947 book, 400 varieties. Springhill Dahlia Farm, R. 2, Box P, Grand Rapids, Mich.

FARMS, FARM LANDS, REAL ESTATE

CHOOSE A good farm in Canada! Information about excellent opportunities in farms to fit your needs and capital will be sent to you promptly. State your preferences in size and kind of farm, and in what province you are interested. Address inquiry to H. S. Cresswell, Canadian Pacific, Montreal.

GOOD Farms—Ranches. Washington, Minnesota, Montana, Idaho, Oregon, North Dakota. Dependable crops, favorable climate. Write for literature, lists describing typical postwar farm opportunities. Specify which state. J. W. Haw, 119 Northern Pacific Ry., St. Paul 1, Minn.

WEST'S 1947 Catalogue: Over one thousand farm and business bargains. Free copy, write Buck & West Realtors, HE-1, Pittsburgh 16, Penna.

OZARK Magazine, Eureka Springs, Arkansas. For homeseekers, tourists. Year, \$1.00.

NEW Free catalog, selected farm bargains, 16 states, sent to you free! Many equipped. Many illustrated with picture. Special service to those stating general location desired, and payment plan. Write today! United Farm Agency, 1684 Arcade Bldg. 1, St. Louis, Mo.

\$5.00 MONTHLY Buys 40 acres near town. Price \$200.00. Free list. Box 425-P, Carthage, Mo.

OZARK Lands for all purposes. Actual river frontages. 5 acres \$90.00 and upwards. Free list and literature. Hubbard, 424-I, Minnesota Ave., Kansas City 4, Kansas.

CALIFORNIA Motels. Pay well. For circulars write Frank Dykema, 813 Gretna Green Way, Los Angeles 24, Calif.

FARMS, Ranches. All kinds, sizes. Reasonable prices, terms. Wide variety locations, climates, recreational facilities. Free descriptive folders, price lists. Milwaukee Railroad territory; Washington, Idaho, Montana, the Dakotas, Minnesota, Iowa, Missouri, Indiana, Illinois, Wisconsin, Upper Michigan. R. W. Reynolds, 914, Union Station, Chicago 6, Illinois.

HOMESITES \$450—Convenient payments. California's finest garden section. On Morro Bay's scenic shores. Wonderful fishing, hunting, boating, bathing. Fertile soil, softest water, temperate climate, congenial community. Free literature. Richard M. Otto, 6560 Hollywood Blvd., Hollywood 28, California.

STROUT'S Blue farm catalog—27 states—coast to coast—over 1300 bargains, money-makers—132 pages. Write today. Mailed free. Strout Realty, 255-P 4th Ave., New York 10, N. Y. 7 So. Dearborn St., Chicago 3, Ill. 453 So. Spring, Los Angeles 13, Calif.

POULTRY AND FARM SUPPLIES

POULTRY Raisers—Increase poultry profits with experimental farm advice. Latest tested helps. Subscribe now! One year 25c; five years \$1.00. Poultry Tribune, Dept. 41, Mount Morris, Illinois.

BOTH Free! Four color catalog with full page pictures. Valuable chick raising book. Rock bottom prices on all baby chicks. Colonial Farms, Pleasant Hill, Mo.

RAISE Turkeys the new way. Write for free information explaining how to make up to \$3000 in your own backyard. Address National Turkey Institute, Dept. 3, Columbus, Kans.

MAKE Money with turkeys. Magazine with Experimental Farm explains how. Early start increases profits. Subscribe now! Twelve big issues, \$2.00. Turkey World, Dept. 92, Mount Morris, Ill.

YOUR Greatest poultry problem will look simple when you read American Poultry Journal regularly. 500,000 poultrymen do, why not you? 2 years 50c, 5 years \$1.00. American Poultry Journal, 535 So. Clark, Chicago.

POULTRY Pays! Learn how. Production line methods. More money. Less work. Send postcard for free booklet "Seven Keys to Poultry Profits and Fryer Producers' Yardstick." to Poultry Advisory Service, Room 108, 1046 So. Olive St., Los Angeles 15, California.

BABY Chicks, champion mated, 52 varieties, 6 Hybrids, licensed inspected, blood-tested. Rush postal, large colored book free, low prices. Berry's Farm, Route 12, Clarinda, Iowa.

PROFITABLE OCCUPATIONS

ANNOUNCING Home study course in commercial baking. Practical basic training. Good field for those with aptitude. Nearly depression proof. Send for free booklet, "Opportunities in the Baking Industry." National Baking School, 1315 Michigan Ave., Dept 3431, Chicago 5, Ill.

RAISE Domestic rabbits! Interesting. Pleasant. Profitable. Instruction folio \$1.00. Odette Rabbitry, PO. Box 5642-MP, Dallas 2, Texas.

LOCKSMITHING—Profitable business or hobby! New course teaches you lock secrets, how to fit keys, de-code, masterkey, etc. Easy self-instruction lessons. Bargain price. Fascinating 100-page illustrated catalog free! Write Nelson Company, Dept. 2-02, Chicago 5.

STORY Writing simplified! Home study. Free circular. New Segment System, Box 834, Spokane, Wash.

SHELL Jewelry. All materials furnished, \$2.60 and \$1.00 kits, with instructions. Postpaid. Earn while you learn. Catalogue free. Shell-O-Craft Co., Box 365, Station A, St. Petersburg, Fla.

FOR An extremely profitable lifetime business, operate a collection agency-credit bureau. Easily learned. Write: Cole & Associates, Syracuse 2, New York.

SCRAP Metal costing 5c pound brings dollars in castings. Lifetime profits. Information. Fritz Foundry & Supply, 622 N. Fulton, Allentown, Penna.

ALASKA Opportunities. The Last Frontier offers many job and business opportunities. \$1.00 brings 1947 report, explaining how to apply for spring openings in commercial fishing, mining, forestry, aviation etc. Information on Homestead lands and free Government map of Alaska. Alcan Pub. Co., 1663 N. Highland Ave., Hollywood 28, Calif.

A SMALL Business on less than \$100 capital. No selling, no manufacturing. A dignified business in or near your neighborhood. Earnings; better than comfortable living. My treatise gives every detail, only \$1.00. Satisfaction or refund. James K. Hollomon, Buell Post Office, Norfolk, Virginia.

QUICK Money! "Repairing car batteries!" At home! Easy too! Write Batterymen, Grand Junction 6, Colorado.

MAKE Strange plastic—1c pound. Makes durable, attractive floors, walls. Build with waste. Save half. Bays Laboratory, Oklahoma City 9.

INTERESTED In Latin American and Foreign Jobs? \$1.00 brings copyrighted report listing specific firms with interests in mining, aviation, oil etc., and explains how to apply. Pan Americana, 1663 No. Highland Ave., Hollywood 28, Calif.

FOR An extremely profitable lifetime occupation operate a commercial employment agency, easily learned. Details free. Hunt, Box 308, Burlingame 15, Calif.

PANNING Gold—Learn how. Free illustrated booklet, "How to Get Started." Old Prospector, A-26, Dutch Flat, Calif.

FASCINATING. Small investment business. 25c. Parcell, 2701 Main, Elkhart, Ind.

MECHANICALLY Inclined men—Own and operate general appliance repair shop. Complete, illustrated course shows you how. Welding, refrigeration, motor repair, how to get business, etc., all phases covered. Free literature. Christy Supply, Dept. 472, 2835 N. Central Ave., Chicago.

\$15 DAILY Reconditioning butchers', cooks', knife sharpening steels. Home. Traveling. Pays \$1. Takes 15 minutes. Secret method. Pocket kit. Free material. Illustrated instructions \$2. Arcaj Service, 7601-R Dudley, Cleveland, Ohio.

MIRRORS From window glass at 3c per foot. Formula and silvering data \$1.00. Metallize baby shoes for big profits. Several methods \$1.00. Tes-Co, P.O. Box 189-MC, Wilkes Barre, Penna.

RUBBER Moulds for ash trays, lamps, etc. Vallance Art Products, 1873 East 70 Street, Cleveland 3, Ohio.

BE A Novelty manufacturer, fascinating, interesting work. Exceptional profits. No expensive equipment needed, quickly learned. Use garage or basement. Successful manufacturer shows how, orders waiting. Write today. Plastex Products, 127 Clement, San Francisco (18).

WASHING Machines. Parts all makes. Northeast Burner, 1358 H St., Washington 2, D. C.

SHELL Jewelry—This is the place for beginners to get samples and instructions for making shell jewelry and novelties by sending \$1.00 to Shell Mart, 165-9th St. North, St. Petersburg, Fla.

PHOTO Stamps. Illustrated instructions. \$1.00. Alvin, 553 William, Winnipeg, Manitoba.

MUSHROOMS Grown. Boxes. Barrels. Illustrated instructions 50c. Spawn \$1.00. Gordons, 553 William, Winnipeg, Manitoba.

ANALYSER; (Wisdomer; "Occupation") (Publication-serial.) Postpaid 7c. Box 6, Syracuse 10, N. Y.

ELECTROPLATE With sponge, using charger or battery. Instructions \$1.00. Mintel, Box 921, Pawtucket, R. I.

\$3000 A YEAR—Your own business, no boss, no time clock, independence. Complete details \$1.00. Satisfaction guaranteed. Home Industries, B1354 Hollywood, Columbus, Ohio.

REFRIGERATION: Big profits. Easy to learn servicing, selling, buying at home. Send dime for lists of wholesale suppliers, manuals, circulars. Myers Electric, Manitowoc, Wis.

"Los Angeles boom." Post-war industrial expansion creates thousands of job opportunities at good pay. Los Angeles workers enjoy year-round delightful climate near the ocean, mountains and desert. Our copyrighted booklet lists over 300 firms. Gives data on expansion programs. Includes sample application letter telling how and where to apply. Also up-to-the-minute bulletin listing best job chances, newest projects, housing tips. \$1.00. Refund if not satisfied. Los Angeles Research Services, 507 N. Windsor Blvd., Los Angeles 4, Calif.

LEARN Gagwriting. Profitable new field. Free particulars. Frankel, 1508 South Homan, Chicago 23.

RAISE Earthworms, complete instructions \$1.00. W. L. Huffman, 391 Pleasant Lake, Rives Junction, Mich.

\$40.00 WEEKLY Made growing mushrooms, fresh, dried. Dominion patent 331583. Free spawn. North American, 169P Yonge, Toronto, Canada.

TYPEWRITER Repairing instructions, standard typewriters. Webers', Box 1008, Canton, Ohio.

LEATHERCRAFT Supplies, Catalog 10c. Art Craft Supply Company, 1205 Throckmorton, Fort Worth, Texas.

SHELL Jewelry, novelties. Easy to make at home as hobby or to sell. Beginners kit \$1.00. Catalog 5c. Burton, Box 27, Station A, St. Petersburg, Fla.

TADPOLES Make frogs, tremendous demand. Both make you money. 25c brings tell-how information. Chariton Corporation, Century Building, Chicago 4.

WELDING—Electric arc. Learn profitable trade quickly through actual practice. Individual welder instructions at bare cost of materials. Full particulars free. Valuable welding lessons book 50c. Hobart Welding School, Box M-1064, Troy, Ohio.

WOULD You pay 3%—first \$350 made? Color-illustrated book "505 Odd, Successful Enterprises" free! Some offer occasional "day off". Start at home, office. Expect something odd! Pacific, 2207 1/2 Cloverfield, Santa Monica, Calif.

ELECTRIC Clocks are every where you go, buildings, homes, parking lots, factories. Repairs increasing. Our easy to learn course with pictures and drawings teach you how to repair these clocks. Electronic Supply Co., P.O. Box 2350A, Houston 1, Texas.

TYPEWRITER Repairmen urgently needed. Earn \$40 to \$50 weekly spare time. Our easy to learn home study course teaches how to repair typewriters. Write for free information. Houston Typewriter Repair Service, P.O. Box 5357A, Houston 12, Texas.

BOOKS, PERIODICALS, PICTURES, POSTCARDS

MAGAZINES—Business, trade, professional. Keep informed on developments, opportunities, etc. Current copies. Choice over 800 publications. All fields. Free price-list. Commercial Engraving Publishing Co., 34C North Ritter, Indianapolis 1, Ind.

GOOD "Used" self-instruction educational books on all subjects bought, sold, rented, exchanged. Satisfaction guaranteed. Complete information and 100-page illustrated bargain catalog free! Write—Nelson Company, Chicago 5.

AMAZING New book gives instant solutions to 100,000 practical problems. Details free. Columbia Graphs, Columbia, Connecticut.

VETERANS—Beautiful South Sea Island photographs. Tropical scenes, native life. Twelve 4x6 Hi-gloss \$1.00, fifty \$4.00. Kin-nicutt's International Foto Service, 3537 Fruitvale Ave., Oakland 2, California.

BOOKS, Hard to find and out of print our specialty. Any book. Banker Book Co., 13518 Contour Dr., Sherman Oaks, Calif.

UNUSUAL Books. Catalogue free! Wilborn, 706-P Judson Rives Bldg., Los Angeles 13.

WHAT Every Mason wants. We have Masonic books for Blue Lodge, Chapter, Commandery, Scottish Rite and Shrine. Our rituals are used the world over. Send for free catalog of books and rituals for Masons, Odd Fellows, Knights of Columbus, etc. Ezra A. Cook, Publisher, P.O. Box 796-PJY, Chicago 90, Ill.

BEAUTIFUL Scenic art pictures, 6" x 8", 10 for 50c. Renfro, 2533 University, San Diego, Calif.

THE World's largest collection of science fiction and books. Julius Unger, 6401-24 Avenue, Brooklyn 4, New York.

SHIP'S Photographs, passenger, freighters, tankers, list 10c. Scozzafava, 1648 59th St., Brooklyn 4, N. Y.

SELF-EXPLAINING Bible: Illustrated circular free. Box 446-P, Minneapolis, Minn.

NATIONAL Geographic Magazine, 1888-1945, any issue. Periodical Service, Dept. PM, Swarthmore, Penna.

MACHINIST'S Compact reference book. Tables, drafting, tempering, shop trig. \$1.00 postpaid. G. A. Knudsen, 523-48th St., Brooklyn 20, N. Y.

FREE—100 Page catalog of new and used college and home study text and reference books at a saving. Est. 1902. Long's College Book Co., Dept. M, Columbus 1, Ohio.

TECHNICAL Books. We have latest on autos, electrical construction, diesel, aircraft, formulas, engineering, drafting, blueprints, accounting, welding, adhesives, rubber, horology, photography and many others. Information free. Edwards, 324 North 18th St., Quincy, Illinois.

"30,000 JOB And Business Opportunities in Alaska"—Based on two years' Alaskan experience, this 15,000-word copyrighted report gives latest facts on fur farming, mining, agriculture, lumbering, transportation, commercial fishing, construction, business opportunities. Special section on climate, homesteading, mineral resources, rights, etc. Private firms and government projects listed—tells how, when, where to apply. \$1.00. Return for refund in 7 days if not satisfied. Pacific Industrial Research Bureau, Dept. 2D, 907 Terminal Sales Building, Portland 5, Oregon.

BACK-DATE Magazines, books. Send wants. ARK's, Box 744, Tarzana, Calif.

3 CALIFORNIA Post cards 20c. Address return. Letters mailed 10c. Box 524, Bell Gardens.

"100,000 POST-WAR Jobs Abroad"—South America, China, India, Burma, Japan, Russia, Malaya. How, when and where to apply. U. S. participation in world reconstruction and trade demands thousands of American-trained mechanics, salesmen, technicians, engineers, foremen, laborers and business representatives—every trade needed. Our 15,000-word copyrighted report—compiled from business, professional and government sources—lists over 200 big U. S. firms with foreign interests, gives job information, salary brackets, contract tips, application letters, passport information, climatic conditions, etc.—everything needed for your immediate application. \$1.00. Return for refund in 7 days if not satisfied. Pacific Industrial Research Bureau, 907-E Terminal Sales Building, Portland 5, Oregon.

BOOKS! (Out-of-print, scarce); quickly supplied. Send wants. Spotlight, 141 Broadway, New York 6.

ATOM Bombed Nagasaki, 15 photographs, \$1.00. 12 Aleutian photographs, \$1.00. Makins Pictures, 538 1/2 Washington, Bremerton, Washington.

UNUSUAL Books; hobby, money, sideline, sports, mystic. Large catalog 10c refunded. Stanley Service, 544 E. Jersey St., Elizabeth 1, N. J.

CASH In on our national advertising campaign. Fastest dollar seller ever offered. Marshall Adrian Company, 371 Colorado Building, Denver, Colorado.

STRANGE, Interesting and unusual books, write for free catalogue. Fuller Company, 201 Dewey Street, Newark 8, New Jersey.

MAGAZINE Export Sales Company, 2084 First Avenue, New York 29, N. Y. U. S. A. Over-issue popular American magazines and pocket-size novels, Comics, fashions, pictorials, romances, screens, pulps, many others. Export only.

BOOKFINDERS! (Scarce, out-of-print unusual books.) Quickly supplied. Send wants. Clifton, Box 1377PM, Beverly Hills, Calif.

BOOKS, (Out-of-print, new, used) quickly supplied. Many 35c bargains. Catalogue. Mid-West Book Service, 18870 Marx Ave., Detroit 3, Mich.

BIG Profits taking subscriptions for all magazines. Agents' confidential catalog listing over 2500 periodicals and complete starting supplies free. Pines Subscription Agency, Flushing, New York.

MAGAZINES (Back dated)—foreign, domestic, arts. Books, booklets, subscriptions, etc. Catalog 10c (refunded). Cicerone's, 863 First Ave., New York 17, N. Y.

"TRUE Christian Religion." To obtain a free copy of an 80-page digest of this remarkable work by the famous scientist, philosopher and theologian, Emanuel Swedenborg, send your name and address to Swedenborg Foundation, Inc., Room 1649, 51 East 42 Street, New York 17.

GAMES AND ENTERTAINMENT

MAKE Your own photos of movie stars and bandleaders. No chemicals, darkroom or experience required. Fun for all. Complete outfit \$1.00. You can use your own negatives also. Arden Specialties, 2147 86th St., Brooklyn, N. Y.

"84 CARD Tricks." 25c! Free: Money-making opportunities! Hirsch's, Spring Valley, N. Y.

NEW Exciting cribbage scoring. Fast streamlined rules for experts and advanced players only. Full instructions, almost 200 examples \$1.00. Mr. Fud, Room 528, 333 North Michigan, Chicago 1, Illinois.

PLAY Football on checkered 15" x 26" matboard field. Adjustable goals, 23 characterized wood counters, 50 pages of instructions, games, plays, diagrams, \$1.65 post paid. Nat'l Scrimmage Club, 2320 North 33rd Avenue, Omaha 10, Nebraska.

MAGIC TRICKS, PUZZLES, JOKER NOVELTIES

VENTRILOQUISM Taught. 3c stamp bring particulars. Smith, 801 Bigelow, Peoria 5, Ill.

VANISHING Half dollar trick and catalogue 25c. Sterling Magic Co., Royal Oak, Mich.

MASTER Cigarette vanisher—Will fool even your wife! 25c, including 1947 catalogue. Scheetz's, 98-N Branch, Sellersville, Penna.

MINDREADING, Ventriloquism. Instructions \$1.00. Alvin, 553 William, Winnipeg, Manitoba.

SO Different it amazes professionals! No switch, codes, assistants, impressions, one ahead, memory work. Sensational mind reading instructions \$1. Nationwide. 706 Judson Rives Building, Los Angeles 13.

STARTLING, Bewildering Hindu mystic trick 10c. Postways, Box 5325-A, Philadelphia 42.

VENTRILOQUISM, Complete course only \$1. LeSueur, 77 Wellesley, Toronto, Canada.

CHECKERBOARD Puzzle—Keeps you working hours to solve tricky, hair-raising, greatest funmaker ever invented. 35c. Money back if dissatisfied. Farris, 1364 N. Sedgwick, Chicago 10.

TRUE Secret of ventriloquism. First time published. Free booklet. Quackenbus, Big Flats, N. Y.

HAVE Fun with Plasty Mystery compact puzzle Pup lucky charm key chain, 75c. Key Box 124, Station P, Brooklyn, N. Y.

BREAK Pencil with "dollar bill." Instructions 25c. Rosa, 907 Adams, Brownsville, Texas.

ATTRACTIVE Magic kit of 10 tricks (\$2.50 value) \$1.00. Playing cards containing over 12,000 secret marks, \$1.00. Kogels Magic Novelty Co., 6751-A Colbert St., New Orleans 19, La.

DANDY Big mail—only 25c. Postpaid! Magical, funny, entertaining. Magic. Box 35A, Irvington 11, New Jersey.

DOLLAR Magic set free with gigantic catalog 25c. Mysto, 4662-A Germantown, Philadelphia.

"I'LL Bet you can't!" Sure-fire challenge tricks with pocket objects. You can do them—but the other fellow can't! No skill, no make-ready, 120 show-how pictures. At leading bookstores, or \$1.00 postpaid. Lewis Kohrs Company, 2208-M Stuart Street, Berkeley 5, California.

FOAMING Sugar. Slip into your guest's coffee or other beverage and observe the volcano of foam rapidly grow. Harmless. Liberal supply with instructions 25c. Pioneer Publications, Box 1402, Philadelphia 5, Penna.

BAFFLING Svengali trick deck. Does 10 tricks, \$1.00. Free price list. DeLuxe Magic Studio, 739 Poydras, New Orleans, La.

WORLD'S Largest professional magic shop, keeps you in touch with latest tricks. To receive mailings, send 35c for new catalog. Holden's, M220 West 42nd St., New York.

ENTERTAINING Card deck routine The Auction, \$1.00. Ehbör, Box 6837, Philadelphia 32, Penna.

"MAGIC Vanishing card." Throw it into air, it completely disappears, reproduce it later from spectators pocket. Easy to do. Complete, 25c with magic catalog. The Magician, 2463-C Kensington Ave., Philadelphia 25, Penna.

200 ELECTRIC Stunts, 110 volts, \$1. Kutting Sons, Campbell, Calif.

UNTIE Knot in human hair. Instructions, 50c. Details, listings, free. Newton Company, Bonham, Texas.

500 TRICKS! New 1946-7 edition Douglas famous catalog now ready, only 10c. Brand new magic for pocket, parlor, club, stage, professional, amateur. America's fastest service to magicians everywhere for over 25 years. Send 10c today. Douglas Magicland, Dept. 1, Dallas, Texas.

EARN Money in any crowd. Call names of strangers, tell unspoken questions. Professional course mind reading, faked spiritualism, etc., \$1. Henderson, Box 341, San Bernardino, Calif.

AMAZE And mystify your friends with highest quality magic. New catalogue 25c coin. Mazda Magic Co., 1135 Westgate Ave., Oak Park, Ill.

LARGE Illustrated professional catalog 10c. Williams, 900 Plymouth, Ellwood City, Penna.

FREE! Large catalog of magical apparatus if you remit 25c for "Magic Is Fun" magazine. Robbins Co., 152-F West 42nd Street, New York.

ENTERTAIN! Mystify! New, bigger magic catalog and 4 secret tricks 25c. Herbert, P-192 N. Clark, Chicago 1.

MAGIC: Big 160 page Illustrated Catalog Latest Magic Goods, 25c. For over 1/3 century we have supplied Professional as well as Beginner. Chicago Magic Co., 2300 N. Mason, Chicago 39.

MAGIC Tricks, puzzles, books, cards, punch boards, Catalog 10c. Specialty, Box 671, St. Louis 1, Mo.

COINS, TOKENS, CURRENCY

OLD Money wanted. Will pay fifty dollars for nickel of 1913 with Liberty head (no buffalo). We pay cash premiums for all rare coins. Send 4c for large coin folder. May mean much profit to you. Numismatic Co., Dept. 20, Fort Worth, Texas.

WANTED Liberty standing quarters. Free details. Myatt's, Pittsboro, N. C.

WILL Pay \$10.00 each for certain Lincoln pennies! Indianheads \$50.00; dimes \$1,000.00. Catalogue 10c. Federal Coin Exchange, 1-PM, Columbus, Ohio.

GET Profit and pleasure in collecting old coins. Send 10c for 56 page illustrated coin catalog. You'll be delighted with it. Send for it now. B. Max Mehl, 370 Mehl Bldg., Fort Worth, Texas. Largest rare coin establishment in U.S. Established 47 years.

THIRTY Different coins and bills \$1.00. Oddehon, Box 482, St. Louis, Mo.

\$1500.00 FACE Value guaranteed in every mammoth packet of Japanese Philippine invasion currency. Large assortment. Hard-to-get 1,000 peso included! Price only \$1. Stewart Byers, Box 187, Rayville, La.

SOUTH African coins, complete set. Send \$3.00. McDonald, 30 Rosetta Street, Regents Park, Johannesburg, South Africa.

UNITED States coin collections bought. Excellent prices paid. Send 25c for buying-price list. Rockhill, Jamaica, N. Y.

\$2.00 TO \$100.00 Each paid for hundreds of coins. Indian, Lincoln and foreign coins wanted. Get posted. Send 20 cents for new illustrated coin value book. 4x6. Guaranteed prices. 40 years in business. Bargain circulars free with each book. Coin Exchange, (3), Le Roy, N. Y.

NEW Coin buying list 10c. 209 South Church, Rockford 27, Ill.

FOR Sale: 1893 Columbian half dollar, 60c; 50 assorted Indian head cents, \$1.00; 50 foreign coins, \$2.00; large coin price list, 10c. Ben's Coin Company, 72 West Washington, Chicago 2, Illinois.

WORLD Coins—List free. Harry Elsholz, Box 9014, Pittsburgh 24, Penna.

COMMEMORATIVE \$1/2, Oregon, Texas, Kentucky, Cleveland, Long Island, \$2.00 ea. Illustrated catalogue 25c. Norman Shultz, Salt Lake 9, Utah.

FREE! Foreign coin, banknote and coin collectors illustrated catalog to approval service applicants. Send 3c postage. Tatham Coinco, Springfield-125, Mass.

OLD STAMPS WANTED

I WILL Pay \$100.00 each for 1924 1c green Franklin stamps, rotary perforated eleven (up to \$1,000.00 each unused). Send 6c today for large illustrated folder showing amazing prices paid. Vernon Baker, (FM-71), Elyria, Ohio.

STAMP COLLECTING

10 DIFFERENT Mauritius 25c. 50 different Paraguay 40c. 100 different Argentine 50c. 50 different Australia 75c. 100 different Brazil 85c. 50 different Dominican Republic \$1.00. 100 different China \$1.10. 500 different Hungary \$2.00. 150 different Denmark \$2.25. Mission Mart, Washington 17, D. C.

FREE! Absolutely free! Mutiny Island! Fabulous bird, sword and shield, pirate map, wingless bird, Sun-Yat-Sen, schooner and others! Free premiums! Approvals. Star Stamp Co., Dept. M, Lakewood, New York.

FANTASTIC Nepal, scarce country, picturing dread five-headed, four-handed Hindu god, Siva the destroyer, wearing necklace of human skulls. 5 different Nepal, catalog price 68c, our regular price 50c, only 10c to approval applicants. Littleton Stamp Co., Littleton 42, New Hampshire.

FREE! Swell stamps with guaranteed catalog value over 75c. Just send 3c postage. Includes airmails, pictorials from Grenada, Dominica, San Marino, etc. Bargain approvals. Al. Johnson, 727 North Foote, Colorado Springs, Colorado.

WHAT Have you to offer? A collection? A "shoe box" accumulation? Anything in stamps. We urgently need them. Spot cash paid. Cosmopolitan Stamp Co., 1457 Broadway, Dept. 1-E, New York.

POSITIVELY Greatest free offer—Latest Scott's International \$5.00 stamp album, covering entire world, contains 36,000 illustrated descriptive spaces; Scott's 1947 Standard \$5.00 catalogues "Philately's Encyclopedia"—absolutely free to applicants for foreign approvals becoming customers; Bargain Stamp Service, Palm Springs, California.

FREE! The Stamp Finder! Send today for the big new edition, fully illustrated, enabling you instantly to identify all difficult stamps! Also fine packet strange, fascinating stamps from Bosnia-Herzegovina, Monaco, Patiala, Cyprus, etc., including maps, ships, animals and strange scenes. All free to approval applicants enclosing 3c postage. Garcelon Stamp Company, Box 900, Calais, Maine.

FREE Roosevelt Colombia issue to approval applicants. Blatt, 1015 Pine, Philadelphia 7, Penna.

CHEAPEST Buys from only Canadian dealer in S. America. Send dollar for super lot and lists. Robinson, Casilla Correo 781, Buenos Aires, Argentina.

1500 BETTER Grade foreign mixture \$1.00. Central Stamps, New Providence 1, New Jersey.

50 DIFFERENT Belgium 10c. Approvals 1/2c up. Kardell, 1175 Clay, San Francisco 8, California.

FREE—Commemoratives, airmails, pictorials. Approvals. H. P. Wisehart, Frankfort 1, Ohio.

FREE—Beautiful new issues, airmails, triangle to approval applicants. Green & Company, Norwood 12, Ohio.

ROOSEVELT Nicaragua set of three 10c to approval applicants. Murray, 2152 Vogel Road, Evansville 14, Indiana.

FREE! U. S. \$1.00, \$2.00, \$4.00, \$5.00, \$10.00 stamps with approvals! Postage 3c. Thrifty Stamps, 727 Silver, Silver Spring, Maryland.

FREE—Ten Australian to approval applicants. Ivan Storbeck, Kinde, Michigan.

THREE Sets 5c with approvals. Mallo, 767 Leith, Flint 5, Mich.

FREE! Colorful pictorial French Coat of Arms set complete! To approval applicants. "PG," 195 Park, Lewiston, Maine.

ATTRACTIVE Foreign sets sent on approval. Maurice Rouillard, 181 Chestnut St., Holyoke, Mass.

UNITED States approvals. Fine quality. Klein, Box 22, Robinson, Illinois.

DANDY U. S. approvals; write immediately. Sullivan, Endicott Building, St. Paul, Minnesota.

CUBA'S Retirement set shows aged couple receiving pension check. This set sent to approval applicants for only 5c. Bryson Stamp Company, Drawer F-2, Rosford, Ohio.

FREE Pictorial packet to approval applicants. Getche, 1040 N.E. Eighteenth, Minneapolis 13.

1000 DIFFERENT Worldwide approvals, 1c each or less. Jones, 1942 Wallace, Philadelphia 30, Pennsylvania.

WHOOPIE! Wowie! 25c worth of U. S. stamps free! No obligations! Write M & N Co., 742 Sheffield Ave., Brooklyn 7, N. Y.

MEXICO Mixture—Plenty of pictorials, 400 for \$1.00. Biehl, Apatado 2887, Mexico City.

ADULTS Only! Pictorial set free. Approvals. Davis, 810 North 31st, Waco 4, Texas.

VATICAN City #77-79, cat. 46c, only 10c with approvals. Reasonable prices. Neuen-dorf, 22 W. Florida, Evansville 11, Ind.

FREE! 12 West Indies. Approvals. Super Stamp Shop, 2 S. Madison, Greencastle, Indiana.

FREE Economical packet list. Stanley Rumont, P.O. Box 996, Mobile 6, Ala.

SWITZERLAND 25 Different, 25c. Satisfaction guaranteed. Approvals. Boesch, 2049 East 35 Street, Brooklyn, N. Y.

ONE Cent each and up. Most ideal way to fill your album at low cost. Fine selection sent on request. Lange, Box 21, Station R, New York 55.

FREE—World's only octagonal (eight-sided) stamp and 70 year old Turkey set to approval applicants. Charles Cleaveland, 806 North Humphrey, Oak Park, Illinois.

SEND 8 Cents to 8 dollars for new Canadians at face with approvals. London Stamp House, London, Canada.

FREE—Liberia, Triangle, Hitler stamps, half-stamp triangle, Devil's Island, others. Approvals. Postage 3c. Pilgrim Co., 6406 Old Hartford, Baltimore 14, Md.

UNITED States, 150 all different, \$1.00 postpaid. Free premiums. Box 22, New York 34.

300 STAMPS, Album, hinges, 25c. Northeast, Box 6618, Kansas City, Mo.

FREE! 25 Beautiful pictorials to approval applicants. Streiner, 898 East 75, Cleveland 3, Ohio.

"JUST What I want!" Choose premiums from illustrated lists. Write for United States approvals. Jarr, Box 217-E, Madison Square, New York 10.

ROUND The world colonies—British, Dutch, French, Portuguese; strange little known countries, primitives, cannibals etc. All for 3c to approval buyers. Dixie Stamp Company, Dept. 10, Milwaukee 1, Wis.

25 DIFFERENT Guaranteed stamps—10c with approvals. Midwest Stamp Company, Box 4847, Kansas City, Missouri.

25 DIFFERENT U. S. commemoratives 10c, with bargain approvals. Specify countries desired. Cripe, 1922 Ohio, Anderson, Ind.

FORTY Stamps from forty countries 10c. Approvals. I. Tesmer, 218 Carlton St., Buffalo 4, N. Y.

VATICAN City 12 different beautiful pictorials to approval applicants 10c. G. A. Hegenbarth, 1545 Ardmore Ave., Chicago 26, Ill.

ROCK Of Gibraltar packet free. A nice collection of stamps from Gibraltar, the mightiest fortress in the world—also New Zealand Centennial, British Uganda, French Colonials, early British Colonial, West Indies, South American and war stamps plus sample copy Philatopic Monthly Magazine. Send only 5c for postage. Empire Stamp Company, Dept. PM, Toronto 5, Canada.

VATICAN City! Four varieties of Vatican City (world's smallest country) including portrait of Pope Pius! Also stamps from Afghanistan, Cape Juby, Libya, Macao, Palestine, Syria, Liechtenstein, San Marino, and many other interesting countries. All together 48 different stamps, total catalog price over \$2.50!—only 10c to approval applicants! Methuen Stamp Service, Inc., Dept. 211, Lawrence, Mass.

TWENTY-FIVE Airmails, commemoratives, etc. Approvals. Postage. O. Burgett, Lima 2, Ohio.

U.S. Price list. Send postage. Steger, 1165 Downing, Denver 3, Colorado.

FREE 18 Different Switzerland with approvals. Excel, Box 1315, Chicago 90.

55 DIFFERENT United States 10c, approval applicants. Standard, 3817 Sackett, Cleveland 9, Ohio.

118 DIFFERENT Stamps including commemoratives, charities, airmail, surcharges, sets, etc. Only 3c to approval buyers. Badger Stamp Company, Dept. M, Milwaukee 3, Wis.

EXCHANGE The modern way. Send 60 different and dime, receive 60 in exchange. Modern, Box 995, New Haven 4, Conn.

FREE—Send 10c and keep 25c from our approvals. Winklers' Stamps, East Hale St., Bushnell, Ill.

GENEROUS Packets: Each 10c (11 for \$1.00). 20 Africa; 12 Airmail; 25 Argentina; 30 Asia; 15 Australia; 30 Belgium; 25 Brazil; 50 British Colonies; 30 Canada; 25 China; 15 Colombia; 20 Chile; 20 Cuba; 25 Czech; 50 Denmark; 25 Ecuador; 25 Finland; 15 Greece; 15 Guatemala; 40 Hungary; 30 India; 50 Italy; 25 Mexico; 10 Newfoundland; 15 New Zealand; 25 Netherlands; 25 Norway; 10 Paraguay; 25 Peru; 25 Portugal; 15 Russia; 25 Spain; 30 So. America; 30 Sweden; 15 Turkey; 40 U. S.; 25 Uruguay; 15 West Indies. No approvals sent. Longacre Shop, 108 West 42, New York City.

ALL African bargain! Includes Gold Coast, Swaziland, Seychelles, Rhodesia, Libia, Eritrea, Angola, Mozambique, Djibouti, etc. Everything 10c with approvals. Bolger, 1510 W. York St., Philadelphia, Penna.

ALL Different: 200, 25c; 500, 60c; 1000, \$1.50. Beacon Sales, Maynard, Mass.

FREE! Philippines, Japanese occupation, pictorials. Approvals. Stamp Co., Miami Springs, Florida.

4 INDIA Temple issues, plus 50 different, 15c with approvals. L. Margolin, 52 Highview Ave., Woodmont, Conn.

CASH For accumulations and collections. Send insured with your offer. W. L. Bedard, Box 637, Detroit 31, Michigan.

HUNGARY 300 Different, principally newer, \$2.25; other packets. Stempel, 5410 Vliet, Milwaukee 8, Wis.

FLAG Stamp free with U. S. approvals. Wenigman, 929 Oakdale, Chicago.

SOUTH African stamps. Send \$1.00. McDonald, 30 Rosetta Street, Regents Park, Johannesburg, South Africa.

EXCHANGE—Send 200 mixed United States commemoratives—receive 200 varieties foreign. Grampp, 1133 Kensington, Buffalo, N. Y.

DOLLAR Each—1200 better U. S.; 2,000 Britain; 2,000 Canada. Seiden, 1331 Intervale, New York 59.

FREE Persia and China packet to approval applicants. Everglades Stamps, Box 3222, Station F, Atlanta, Georgia.

UNITED STATES. #94, #146, #157, #225, #402, #427, #490. Send 50c. Approvals accompany. Whiton-Stamps, Westport 4, Connecticut.

HITLER Heads, used, 30 varieties \$1.00. Kraus, 1721 Juneau, Milwaukee 3, Wis.

FREE! 50 Diff. with approvals. R. Miller, Sta. P., Box 89, Brooklyn, N. Y.

PRECANCELS: Two scarce defense bureau 10c. Approvals. Information. Klein Brothers, Vincennes, Ind.

FREE! Four Hungarian 1/2c up, approvals. Marjay's, Box 14, Station B, Brooklyn 16, New York.

SEND Me \$1.25 and return mail will bring you scarce Pony Express stamp, national park philatelic sheet and 100 other different United States stamps, some dating back to Civil War. Fred Coops, Box 215, Fontana, California.

400 DIFFERENT Precancels \$1.00. Beesley, 821 Lobdell, Los Angeles 26, Calif.

STAMPS From 40 countries, including Fiji 10c. No approvals. Elsea, Bowling Green, Ohio.

15 MINT Blocks—world, catalogs almost \$4. Stampette, 2518 Tunlaw Rd., Washington, D. C. \$1.00 postpaid.

AUSTRALIA. All issues. List free. 50 different \$1. Burnett, R. 2, Vernon, B. C., Canada.

FREE Mint Greek glory set with first foreign approvals. 20th Century, P.O.B. 3413, Philadelphia 22, Penna.

\$3.35 VALUE Only 10c. Gorgeous bi-colored Greece allegorical issue 12 values. (Scott 1946 catalog \$3.35). Send dime today, supply limited. Imperial Stamps, Box 1491, Tampa, Florida.

CROATIA—Legionnaire set 5c to approval applicants. Irving Solomon, 3716 Kings Highway, Brooklyn 10, N. Y.

SMOKY Mountain souvenir commemorative sheet and 30 different U. S. stamps, including commemoratives, airmail, etc. (catalog value exceeds 65c) for 10c to approval applicants. Curhan Stamp Company, Dept. H, Gloucester, Mass.

SUPERB Approvals, net prices. Stamps 1/3 to 1/2 catalog. P. G. Beals, 170A Tremont St., Boston, Mass.

FREE: United States Olympic poster set. Request approvals. Wolf's, 3202 Columbia, Philadelphia 21, Penna.

EGYPT Collection. 50 different 75c. Foreign approvals accompany. Yokum's, Box 1327, San Antonio 6, Texas.

FREE! Cayman Island stamp with approvals. Illustrated price list and philatelic grabbag 10c. Herget, Buffalo 15, N. Y.

FIRST Day covers on approval. Knobel, 1918 S.W. 12 St., Miami, Florida.

FRESHLY Mounted foreign on approval to dependable beginners and advanced collectors. Also new issue service. References. Wlaschim, 55 Nagle Ave., New York 34.

UNITED States approvals. Amazing variety and prices. Mohawk Stamp, Box 524, Albany, N. Y.

FREE! Airmail packet with approvals. Deane, Box 1002, Miami Beach 39, Florida.

COLLECTORS: Write today for famous "four star approvals." Nothing like them! Kessel's, Box 808, Tucson, Arizona.

FREE—The ever popular Famous Americans set of 35 stamps plus the just as desirable set of flags (13 stamps) plus the National Parks set (10 stamps) plus the complete set of Presidentials to the \$5.00 (32 stamps). A total of 90 of the most popular United States stamps will be given absolutely free to applicants for our brand new series of United States and foreign approval selections. Send 3c postage for 15 of the above mentioned stamps, plus full particulars. Do it now! Triboro Stamp Co., 145 Nassau St., New York City.

NEWEST Roosevelt Cuba honors Roosevelt. Sent for only 5c to approval applicants. Thiem, 1100 1/2 St. Paul Street, Rochester, New York.

2 NEW Zealand triangles, 5c with approvals. Philip Mandel, 1912 N. Kimball Ave., Chicago 47, Ill.

BARGAINS. Selling stamp collection cheap. Zaporowski, 4360 Edgemont, Philadelphia, Penna.

EXCLUSIVELY Styled approvals for collectors using International junior or modern albums. Batema, Holland, Mich.

FREE Packet to approval applicants. Bloom, #13 Trailer Camp, New Ulm, Minn.

WANT Precancelled stamps. Write Louis Atwater, Box 952, Bridgeport, Conn.

SPECTACULAR-THRILLING—You build fine collection with our U. S. Mint Stamps. Railroad, suffrage, steamship, telegraph, movie, Florida, Iwo Jima, Army, Navy, Coast-Guard, Marine, Hyde Park, Smith, Texas, Discharge, Tennessee, Iowa, Smithsonian, Santa Fe, Victory. Buy one or more, 5c each. All complete \$1.00, lists included. Frontier Stamp, 1280 Ocean Avenue, Brooklyn 30, N. Y.

SORDID Story told—Japanese occupation of Philippines stamps. Beautiful Victoria Falls of Rhodesia, 10 large unusual Portuguese commems. 25 different Uruguay. Land of mystery, Iraq, exciting set, high catalog. All only 10c to approval applicants. R. S. Rabois Co., 3631 Corlear Ave., New York 63, N. Y.

SALE Attractive 10c sets 8c, 5c sets 4c. Ecuador airmail set free to approval applicants. Write today. Socher, 1508 Dickinson Street, Philadelphia 46, Penna.

GIVEN Seychelles "palm tree," Hitler, Petain portraits, Norway "Quisling" traitor. Jap issued Philippines, snake, lion, others. All given for 3c postage. Approvals. Premium Stamp Service, Hartland, Maine.

PICTORIAL Stamps of the world on approval. Barrington Smith Co., Halfwaytree, Jamaica, B. W. I. (Postage 5c).

FREE Magazine for stamp collectors! Send today for sample copy of the new weekly stamp magazine—Philately. Complete and up-to-date U. S. and foreign stamp news and features. Modern format, excellently illustrated. Philately, 200-PM So. 7th St., St. Louis 2, Mo.

LESS Than 300 U. S. in your collection? You need my progressive U. S. approvals. Precancel selections also available. Cole, 43 Rinewalt, Williamsville, N. Y.

UNITED States collection. 104 different commemoratives including Columbians, Pan Americans, Pan Pacific, bicentennials, parks, famous Americans. Price \$1.00. Approval applicants only. Orange Stamp Company, Albany, New York.

FREE. Irish commemorative collection, including dramatic Easter Rebellion issue with approvals. Raymax, 123-Z William St., New York City.

10 DIFFERENT U. S. over 40 years old. 5c. Foreign, U. S. approvals. Scott, 30 Baker Ave., Lexington 6, Mass.

ILLUSTRATED Stamp Magazine, 26 weeks 25c. Stamp Journal, Kalamazoo, Michigan.

MONTENEGRO Colorful pictorial set, 10c with approvals. Vargo Stamps, 6044 South Fairfield, Chicago 29, Ill.

SPAIN'S "Nude Goya" set complete 30c. Approvals. Royal Stamp Company, Tamaqua 1, Penna.

U. S. COLLECTION—Thirty different fine unused commemoratives before 1939 including Columbians, bicentennials, parks price \$1.00 approval applicants only. Fort Orange Stamps, Albany 7, New York.

BRITISH, Spanish, French Colonies, Vatican, Hitler heads, and airmail packet. Free with approvals. Pan-American Stamp Co., Box 145, New York 33, N. Y.

THIRD Philatelic exhibition sheet 25 cents. Approvals sent. Louis Merrill, 1623 5th, Portsmouth, Ohio.

25 DIFFERENT Peru 10c with approvals. Batch Stamp Service, Box 294, Elmhurst 1, Illinois.

BERLIN Bears, complete set of eight and 100 different stamps only 10c to approval applicants. Reich Stamp Co., 4647 Kenmore, Chicago 40, Ill. Dept. M11.

NETHERLANDS War set 10c with interesting approvals. Rheaumet, 8949 Routhier, Montreal, Canada.

20,000 VARIETIES 1c-5c each! Gordon Davison, Box 1019B, Manchester, N. H.

WORLDWIDE, 100 Different stamps, 5c with approvals. Boerger Stamps, 206 Main, Toledo 5, Ohio.

ROOSEVELTS Nicaragua (2), 5c to approval applicants. Collins', 71 Coleridge, San Francisco 10, Calif.

BEAUTIFUL Collections wholesale \$1.00, \$2.00, \$5.00; approvals. Ehde, Amiret, Minnesota.

WOW! \$10.00 Worth of fun only 10c. What a treasure hunt! Big package 500 foreign stamps—just as received from foreign missions other sources. Includes stamps from Africa, South America, Philippines, Free French, Cape Juby, Palestine, etc., including airmails, commemoratives, and stamps worth up to 50c and 75c. This amazing offer is given for 10c to serious approval applicants only. One to a customer, money back if not more than delighted. Jamestown Stamp Co., Dept. 22, Jamestown, New York.

100 DIFFERENT Hungary. New material 50c. Jem Stamps, Port Jefferson, N. Y.

ROOSEVELT, Churchill, Stalin, Hitler and Vatican City stamps free to approval applicants. Eliot Stampco, 86-31 Eliot Avenue, Rego Park, N. Y.

PHILATELIC Printing—stockforms. Samples. Acmeprint, Box 245, East Flat Rock, N. C.

WORLD'S Largest triangle stamp, included in rare Russian set of picturesque designs, mammoth stamps. This complete set including giant triangle retails for \$3.00 but only 10c to approval applicants. West Coast Stamp Service, Box 344, Hollywood Station, Hollywood 28, California.

ATTRACTIVE Packet free to approval applicants. Rare Stamp Service, P.O. Box 4077, Miami, Fla.

WE Buy desirable stamp collections, and accumulations Top prices. National Stamp Sales, 276 West 43rd St., New York City.

MINTS Famous Americans, etc. Get list. Marion Slikes, 1831 E. Allegheny, Philadelphia 34, Penna.

FIVE Vatican City stamps free to approval applicants. Florida Stamp Company, Box 807, Miami 5, Florida.

SOLOMON Islands, Grenada, Turks Caicos, Caymans, Dominica—everything 2c with approvals. Viking, 130-Z Clinton St., Brooklyn, N. Y.

PENNY Approvals by country. M. H. Hoerning, 115, Farmington, Ark.

STAMP Collections wanted. Complete collections, duplicate lots, surplus stock, mint and used. Prefer trade for printing or other items, buy outright if priced right. What have you, what's wanted? Vanroy Shirk, Lebanon, Penna.

MAGNIFYING Glass, all plastic, non breakable, 50 different Italy, 50 different Sweden. All for 30c with approvals. Bradford, Box 636, G.P.O., Brooklyn 1, N. Y.

1000 MIXED U. S. old and new—25c; 2 lb. \$1.25. Weatherby, Medina, Ohio.

30 BEAUTIFUL Airmails, 10c. Selected approvals. Louis Morrison, Milmont Park 1, Penna.

NEW Zealand, 60 varieties plus Airmail, Coronation, and Health sets. \$1.00. Lovell, Taupiri, New Zealand.

YOUR Money's worth! Seychelles, Djibouti, Angola, Chinese hunger stamps and over 100 different other stamps. Everything 10c to approval applicants. Atlas Stamps, 4220 West 16th, Dept L, Little Rock, Ark.

FREE! Rhodesian bi-colored waterfall; old El Salvador issues; plus 25 different worldwide stamps. All free to approval applicants. Pladon Stamps, 1717-M Idaho, Toledo 5, Ohio.

MIXTURES. Worldwide accumulations 1,500 for \$1. Missions Outlet, Rev. Marshall, Paterson 1, N. J.

FREE—Abyssinia, Cayman Islands, Tuna triangle, Indochine, Syria, Ivoire, Philippines (Jap "shame" issue), Turkish harem, Damascus, Cambodia, African "beauty," Pirate Islands, Colonials, others—All free for 3c postage with approvals. Belmont Stamps, Washington 10, D. C.

EXCELLENT Pictorial approvals. Reasonably priced. Crown Stamp Company, Box 331, Toronto, Canada.

AMAZING Offer! Assortment each of giant stamps, midget stamps, flag stamps, airmail stamps, Free French Colonies, U. S. commemoratives and numerous others. Everything only 10c to approval applicants. Simon, Box 608, Iraan, Texas.

PORTUGUESE Colonies. 25 different 5c with approvals. Lorane Brown, Marion, Michigan.

ADEN to Zanzibar! 40 different British Empire, including Cyprus, Malta, Dominica; 5c with approvals. Lyman Company, 95 Nassau Street, New York City 7.

U. S. Price list. Send postage. State Stamp Service, 1225 Park Building, Pittsburgh 22, Penna.

OLD Scarce U. S. seconds on-approval. Slightly defective, nice appearance, bargain prices. Hernfield, 551 Clinton, Newark 8, N. J.

25 DIFFERENT Swiss 10c—with 1/4, 1/2, 1c approvals. Carroll's, 4357A S. Hoover, Los Angeles 37, Calif.

ONE, Two, four, five dollar U. S. stamps free to approval applicants. United Stamp Service, Box 1789-M, Miami 10, Florida.

ZANZIBAR, Palestine, Manchukuo, Azerbaijan, Haiti, Iraq, Siam, Victoria, Hitler stamp 5c. Approvals. Postzegel, Windham, New York.

U. S. Price list. Send postage. Stanley Gibbons, 38-P Park Row, New York.

PENNY Approvals, that satisfy. Neil Gronberg, Box 5441-P, Philadelphia 43, Penna.

MINT Pictorials free to approval applicants. Surf Stamp Co., Box 2296, Miami Beach 40, Florida.

COMPLETE "United States" catalog with 1000 illustrations! Send 10c for mailing. Harris & Co., 137 Transit Building, Boston, Mass.

ZOWIE-E! A barrel of fun for only a dime. 500 United States stamps—absolutely unpicked and unsorted—just as received from church missions. Many varieties, including large commemoratives, airmails, high denominations up to \$5.00! Stampdom's biggest package of fun—and you might find something really valuable! Price only 10c to serious approval service applicants. Money back if not delighted. Illustrated bargain lists with each order. Mystic Stamp Company, Dept. 80, Camden, New York.

50 DIFFERENT United States, 10c. Price-list free. Seidenberg, Cassopolis, Mich.

CANADA—75c Diff. 25c. Approvals. Lists. Victoria Stamp Co., London 4, Canada.

FREE! Negro Triangle; Turks Islands "Cactus"; Dakar; Guinea; Palestine; "Fairy Tale." Pirate Chart, Map, Ship, Sea Lion and Snake stamps; French, British, Portuguese Colonies, etc. Free for 3c postage. Approvals. Potomac Stamps, Washington 10, D. C.

FREE! Leeward Is., Cayman Is., Turks and Caicos plus 54 different mint World's Fair poster stamps, to approval service applicants sending 3c postage. Tatham Stamp Co., Springfield 30, Mass.

UNITED States approvals complete coverage, fine quality, attractive prices. Seminole Stamps, Box 378, Coconut Grove, Florida.

50 DIFFERENT Including scarce diamond-shaped airmail 3c to approval service applicants. Avalon Stamp Co., Dept. M, Springfield 8, Mass.

1000 GRABAGS 15c Each. Super bags 25c. Zandy, 630 Bingaman, Reading, Pa.

FREE U. S. price list. Postage 3c. Mark Hanna, 335 - 5th Avenue, Pittsburgh 22, Penna.

FREE—Pick 25c worth of stamps from our first U. S. approval selection. Approximately 100 stamps to choose from. Excellent value, no obligation to buy. Lists illustrating most popular U. S. stamps—at prices you can afford—will be included. Don't miss this opportunity! Write today. S. C. Engel Co., 38 Park Row, New York City.

FREE! Canadian sets, royal visit, George VI, George V, coronation, jubilee, others, to approval applicants. Ensign, Box 118-M, South Orange, N. J.

WORLD'S Largest diamond and triangle stamps, free stamp magazine, stamps from fighting Free French, 20 stamps from 20 different countries, pictorials, airmails, big bargain 5c with approvals. Capital Stamps, Dept. 2, Little Rock, Ark.

DEALERS—Wholesale list. Postage 3c. Frank, 5031 Queensberry, Baltimore 15, Md.

MINT George VI eight crown colony pictorials including bi-colors 10c to serious approval applicants. Mutual Stamp Service, 5145P Village Green, Los Angeles 16, California.

HOBBIES AND COLLECTIONS

KLONDIKE! For hobby jewelry makers! Novelty jewelry findings from tables of large manufacturers—parts for bracelets, pins, earrings, etc. unfinished. Chains, rings, pins, stones, clips, beads, many other items—1 lb. bags, \$2.00 per bag in 5 bag lots. Sample bag, \$3.00. Prepaid only. Mdse. Distributing Co., 19 E. 16 St., New York 13.

296 COLORED Illustrations, new book "Foreign Medal Ribbons." \$1.00. Foreign campaign bars, insignia, lists, samples, 20c. Packets \$1.00. Insigniacrafts, 236-28th Ave. N.W., Calgary, Canada.

CAMPAIGN Ribbons—Beginner's package. Introductory price 50c, contains 15 assorted ribbons. Collectors desiring special ribbons specify your requirements. L. H. G. Company, 19 E. 16 St., New York 13.

HOBBIES And Collectors Swapper's Hobby Bulletin: Three times two dimes. Royal Oak, Mich.

TEN Unusual rocks \$1.00; twenty-five fine mineral specimens \$2.00. Bjork, 1434 1/2 Larimer, Denver 2, Colorado.

INTRODUCTORY Offers—10 officers insignias 25c; 22 different American or 15 different foreign, \$1.00. Illustrated catalog 10c. Hobbyguild, 35P West 32nd St., New York.

EXCHANGE Your duplicate stamps, match covers, post cards, or any hobby, with collectors everywhere! Exchange register listing swappers, 10c. (Mention hobby). World Hobby House, Box 721-A, Olympia, Wash.

WANTED: Old cigarette cards. Write Charles Bray, East Bangor, Penna.

INVENTING Can be an interesting and profitable hobby. Write for complete particulars. Institute of American Inventors, Dept. 40-E, 1926-Eye St. N. W., Washington 6, D. C.

COLLECT Colorful Army patches. Pictures, prices and sample patch only 10c. Insignia Mart, 703 Broadway, N. Y.

UNUSED Match book covers, 100 all different \$1.00. 35 Royal Flash covers \$1.00. Free list. Charles Edelman, 1311C East 84, Cleveland 3, Ohio.

JEWELRY Stones removed from rings, etc., 100 assorted \$2.40; 50 large ones \$2.40. B. Lowe, Holland Bldg., St. Louis 1, Mo.

ANTIQUES, RELICS, INDIAN GOODS, CURIOS

COINS, Minerals, glass, Indian relics. Catalogue 5c. Cowboy Lemley, Las Cruces, New Mexico.

50,000 INDIAN Arrows, tools, rainbow variations. Don McKillop, Regina, Sask.

500 RARE Guns for sale. Catalogue 25c. Gil Hebard, Knoxville, Illinois.

SWORDS, Rapiers, daggers, pistols, armor. Illustrated catalog 50c. Robert Abels, 860-A Lexington Ave., New York.

4 FINE Ancient arrowheads, \$1.00. Stone Tomahawk, \$1.00. Flint knife, 50c. List free. Lear's, Box 569, Galveston, Texas.

PRECIOUS STONES, MINERALS

ASSORTMENT Of local minerals for cutting or specimens \$1.00. State which. Plummer, 5068 Brighton, San Diego 7, Calif.

"GENUINE" Arizona rubies (garnets). Send quarter for packet. Mineral Specimens Company, Box 2651, Phoenix, Ariz.

TEN Minerals, cutting or specimens, \$1.00. Price list and sample 25c. Plummer, 5068 Brighton, San Diego 7, Calif.

FIFTY Mineral specimens, boxed, mounted, identified, described. Postpaid \$4.00. Old Prospector, A-27, Dutch Flat, Calif.

FOOL'S Gold from famous gold camp 10c per sample. Gold \$1. Others. Martin's, 506 Harrison, Leadville, Colorado.

CAMERAS AND PHOTO SUPPLIES

SPARTUS 35MM. candid camera. For color or black and white. F7.7 Achromatic 50mm. lens. 3 lens openings, F16, F11, F7.7. 2 shutter speeds. Daylight loading. 35mm. cartridges, black and white or colored. Built-in tripod socket. Modern black case, chrome fittings. Automatic exposure counter. Price \$11.75. Case, \$4.75. 20 exp. Kodachrome, \$2.77. 36 exp. Kodachrome, \$4.77; 36 exp. B & W, \$1.05. 6 rolls for \$5.00. Immediate delivery. Conway Camera Co., 34 N. Clark St., Chicago 2, Ill.

PHOTOGRAPHY For pleasure or profit. Learn at home. Practical basic training. Long established school. Write for booklet. American School of Photography, 1315 Michigan, Dept. 3431, Chicago 5.

ROLL Film, any quantity, 6 rolls 127, \$1.65; 120-620, \$1.98; 116-616, \$2.30. postpaid. Imperial Foto, 122 Sharon, Glendale, Ohio.

COMPLETE Repairing on all types of foreign and domestic cameras. Factory trained specialist on Korelle and Poth cameras. B. & V. Camera Repair Service, 23 East Van Buren, Chicago 5, Illinois.

CONTACT Paper, 10 x 10 single weight no. 2. Government surplus, guaranteed good or money refunded, \$2 per gross. Mid-West Photo, 3824 W. Florissant, St. Louis 7, Mo.

OIL Coloring photographs can be a fascinating hobby or profitable sideline for those with artistic talent. Learn at home. Easy simplified method. Send for free booklet. National Photo Coloring School, 1315 Michigan, Dept. 3431, Chicago 5, Ill.

F 1.9 Anastigmat achromatic lens assy, 91.44 mm. Complete in gun sight \$4.50 postpaid. Associated Surplus, 10838 Ventura Blvd., North Hollywood, Calif.

SPEED-O-COPY Ground-glass focusing attachment for Leica, Contax, Argus C-2 and C-3. Send for literature. D. Paul Shull, Dept. PM-1 240 S. Union, Los Angeles, Calif.

AMATEUR, Camera portrait lenses, state distance and size. \$1.75 prepaid. William E. Hill, 1516 Jefferson Ave., Des Moines 14, Iowa.

"HOLLYWOOD Glamour shots"—How to make them! Instructions, diagrams, sample 8 x 10 print, \$1.00. Bunnell Studio School, San Pablo, California.

GET Your copy of the "Surplus News Letter" for photographic "plus-values." No charge—from Sterling Howard, Dept. PM-2, 1900 Monterey Avenue, New York 57.

4x5 MASTERLITE Diffusion or condenser enlargers. Postwar sensation \$163.70. Circular on request. Mayfair Camera, 4011 Shelmire, Philadelphia 36, Penna.

PHOTO Printer developer. No experience required, complete with supplies and instructions, \$2.00. Homes, Box 12A, Oaklandon, Indiana.

ELECTRIC Magnified 35mm. color slide viewer. Materials cost only few cents. Complete plans \$1.00. Mr. Fud, Room 528, 333 North Michigan, Chicago 1, Illinois.

CAMERAS, Enlargers, projectors. Lowest prices. Free catalog. Cavalier Camera, 1822 Center, Pittsburgh 19, Penna.

CASH! Spot cash for cameras, lenses, binoculars, movie and still equipment. Send full description for prompt cash offer. Over 36 years of dependability. Bass Camera Company, Dept. AG, 179 W. Madison St., Chicago 2.

BASS Says: Trade cameras? For 36 years Bass has satisfied thousands everywhere! Finest equipment available. Always satisfaction guaranteed or your money back! Bass buys 'em, sells 'em, trades 'em. Bass Camera Company, Dept. AG, 179 W. Madison St., Chicago 2.

USED Camera Directory, Box 1031-M, Canton, Ohio—lists hundreds of war-bargained used cameras—35mm., Speed Graphics, Kodaks, Rolleiflex—many others. Send 25c for latest issue.

HAVE You a camera? Improve your hobby of photography and learn how to make better pictures. Write today for our latest book catalog and sample copy of American Photography, containing articles and pictures by the world's foremost writers and photographers. Camera House, 601, 353 Newbury St., Boston 15, Mass.

PHOTO FINISHING

8 BEAUTIFUL Double size pictures and roll developed 30c. 8 hour service. Free mailers. Pacific Photo Service, Box 666, San Francisco, Calif.

CENTURY Delivers work and service that can't be beat. Sixteen famous Century-Tone prints each 8-exp. roll 30c. Free mailers. Century Photo Service, LaCrosse, Wis.

ENLARGEMENTS From your negative—8 x 10-40c; 5 x 7-25c. Mass. Photo, 581 Mass. Ave., Boston, Mass.

PHOTOGRAPHY For pleasure or profit. Learn at home. Practical basic training. Long established school. Write for booklet. American School of Photography, 1315 Michigan, Dept. 3452, Chicago 5.

ROLL Developed and 8 prints 30c. Overnight service. Free mailers. Tri-Plex Photo Service, Box 375, San Francisco, Calif.

20 REPRINTS 25c With this ad. Photographer, River Grove, Ill.

8"x10" HAND Colored framed enlargement from negative or photograph, \$1.50. Promenade Photos, Sta. D, Box 198-X, New York 3, N. Y.

8 EXPOSURE Rolls developed, 1 print each and one enlargement coupon 25c. Two each and coupon 35c. 3 each and coupon 40c. Reprints 3c. Fred D. Eastman, Bode, Iowa.

5 x 7 ENLARGEMENTS, 25c Ea., five—\$1.00. Send negatives. Herman Neely, Somerset, Kentucky.

ANY Offer 35c—8 x 10 framed enlargement. Three 8x6 enlargements, 12 prints plus one 8 x 6 enlargement. Six 4 x 6 enlargements. Roll developed, 16 prints plus one 8 x 6 enlargement. Photo album plus 100 art corners. Prompt, guaranteed. Lifetime Photo Co., Dept. 139, Des Moines, Iowa.

PENNY Photos—Marvelous machine brings top quality, lowest prices. 20 reprints 25c; 50 or more 1 cent each. Penny Photos, Box 904, Des Moines, Iowa.

PLASTIC Statuettes. New avenues of pleasure and profit if you can develop and enlarge. Illustrated folder free. Statuette Craft, 8448 Grand River, Detroit 4, Mich.

AT Last! We have films: 116 and 616—38c ea., 120 and 620—33c ea., 127—27c ea. 8 exposure roll developed, all your snapshots hand-colored as beautiful as most actual colored photography—50c. Hand-colored reprints—6c each. 8 exposure roll developed and black and white prints—35c. Reprints—4c each. Midwest Photo, Janesville 26, Wis.

ROLL 6 or 8 Exposure. 1 print each, 30c. James V. Johnson, Fremont, Mich.

8 HOUR Service. Your 8 exposure roll printed jumbo or regular size, 25c; 12 exposures, 35c; 16 exposures, 50c; 36 exposures, \$1.00. Reprints jumbo or regular, 3c. Regular prints deckled. Fine grain developing. Send for free mailers. Quality Photo Service, Box 468, San Francisco 1, Calif.

FREE Price list on quality developing, printing, enlarging. Write for it today. Roy Photo Service, G.P.O. Box 644, New York (1), N. Y., Dept. M.

BEAUTIFUL 4" x 6" Enlargements. A 75c value for 30c a complete roll. Photo Service, 107 Dewey St., Newark, N. J.

GORGEOUS Color prints from your transparencies, 4x5, \$1.00; 5x7, \$1.98; 8x10, \$2.98. Broad Camera, 953 Broad St., Newark, N. J.

SPECIALIZING 35MM. fine grain developed. 36 big 3x4 enlargements, \$1.25. Photoshop, Linton, Indiana.

ROLL Developed. 8 brilliant fadeproof Velox prints and two professional enlargements 25c. Overnight service. Young Photo Service, 405-C, Albany 2, N. Y.

FREE—Set of filters for names and addresses of four camera owners. Photo-Craft, Canton 1, Ohio.

8 PRINTS. All enlarged to nearly postcard size, from your roll or negative, 25c. Willard Studios, Box 3535A, Cleveland 18, Ohio.

SPECIAL—50 Reprints \$1. Suburban Studio, 1410 Bond, Rockford, Illinois.

2 BEAUTIFUL Hi-Gloss prints each good negative and enlarging coupon with each 6 or 8 exposure roll developed 28c. Owlphoto Co., Weatherford, Oklahoma.

BIGGEST \$1.00 Value in 35mm. finishing today. 36 exposure fine grain 3 1/4 x 4 1/2 enlargements; deckled, embossed margin and date. Eighteen exposures 75c; 16 exposure splits 55c; 36 exposure reloads 50c. Special: return this ad with \$2.00 and we will send five 36 exposure reloads. Free mailers. 8 exposure rolls in beautiful, deckled contact finish with embossed wide margin, 25c. Mailbag Film Service, Box 5440A, Chicago 80, Ill.

GLOSS Finish enlargements. 4 5x7 from negative 50c. 3 5x7 from photo 50c. Robert Renshaw, Jr., P.O. Box 478, Chester, Penna.

EVERY Picture an enlargement! 8 sparkling deckle-edge enlargements and roll developed 25c coin; 116 size or smaller; enlarge reprints 3c. Enlarge Photo, Box 791D, Boston, Mass.

SENSATIONAL Introductory offer! Send snapshot or negative, this ad, and 3c. We'll send you a beautiful 7" x 5" enlargement! Or, Kodak roll developed with 16 guaranteed deckled-edge velox fade-proof prints or 8 double-size prints, 25c! Special! From your negatives, 16 regular-size or 8 double-size reprints, 25c! Candid rolls—36 exp. 35mm. developed, vaporated, enlarged to 3x4, \$1.00! 18 exp. 50c. Reprints, 3x4, 3c each. We have new, perfect 35mm. film. Low prices. Free mailers, details on request. American Studios, Dept. 279, LaCrosse, Wis.

MOTION PICTURES AND SOUND EQUIPMENT

16-MM. Sound films. Complete subjects, good condition, often as low as \$1.95 per 400' reel. Write for list of over 200 available titles. Blackhawk Films, Davenport, Iowa.

"HOME Movies"—We exchange 8-16mm. films, sound-silent, comedy, etc. Send your reel and 75c. We send different subject of same value for each reel. Simons & Hunt's Film Exchange Club, 3046 Strong Hgts., Flint 7, Michigan.

FAMILY Movies. 8mm.-16mm. Projection length Kodachrome sample—dollar. Kodachrome sample, lists—dime. Campus Films, 668-F, Ithaca, N. Y.

I BUY, Exchange, swap movie films. Harvey Irls, Box 539, Brockton, Mass.

RENT 16mm. Sound films from newest, finest in the field. Schools—roadshowmen, send letter for new catalogue. Popular Pictures Exchanges, Traverse City, Mich.

GUARANTEED Fresh anti-halo outdoor movie film! Daylight loading! Processing free! Three spools double 8mm. \$3.45! Six single 8mm. for Univex, \$4.60! Postpaid! Catalog, Eso-S, 828-B West 39th, Kansas City 2, Missouri.

JOIN World's largest cinematographic society. Details free. International Cinematographers Society, Suite 118, 6770 Hollywood Blvd., Hollywood 28, Calif.

FREE, 1947 Catalog. Movies, cameras, projectors, films, samples 10c. Everything photographic. Goodwill Company, Jackson, Tennessee.

FILM—100 Ft. 16mm. \$2.25, 25 ft. 8mm. \$1.25, processing included. Free accessory with order. Movie Shop, Box 3877, Kirkwood, Mo., Dept. A.

FREE—8mm.-16mm. movie titles. Details 3c stamp. Peerless Service, Suite 118, 6411 Hollywood Blvd., Hollywood 28, Calif.

RENT 8MM.—16mm. and sound films by week. New catalogs. Lowest rates. Dayton Film, 2227 Hebburn, Dayton 6, Ohio.

DISTRIBUTORS Wanted. Make big money selling our new 16-mm. sound specialties. Send \$10 for sample movie and our free wholesale price list. Standard Pictures Corp., Dept. A, Universal City, Calif.

FIVE Slide views—Oldest convict ship afloat 25c. Slide Supply Service, 3111 West Tuscarawas, Canton, Ohio.

FRESH Movie camera films 100'—16mm. \$2.25, three rolls \$6.00. 25' double 8mm. \$1.25 developing included. Ambassador, 479-A Quincy Street, Brooklyn, N. Y.

MAKE Your own 2x2 slides. Less than 3 cents each. Sample slide and particulars 10 cents. Sanford Film Company, Phelps Road, Honeoye Falls, N. Y.

16MM. Films. Lists. Sam's Electric Shop, 35 Monroe Street, Passaic, New Jersey.

TALKIES: Convert your silent 16mm. projector into sound with our guaranteed parts kit. Plays all 16mm. sound films. Quickly assembled at home. Special introductory offer: Send this ad now with \$19.95, check or money order, and we will include sound test film, instruction manual and full information on how to use with your radio. Kit includes photocell, exciter lamp, optic, which makes a sound head complete. Or send \$1.50 for complete blue prints showing how to make adapter yourself. Sound Tech, Box 3071, Hollywood 28, California.

UNUSUAL Home movies: Travel, adventure, sports, comedies. Silent-Sound. Many film bargains. Big illustrated 1947 catalog, sample—dime. Audet, Box 6520BG, Philadelphia 38, Penna.

NEW 400 Ft. 16mm. motor driven projectors. \$25.95, \$40.95 postpaid. Sterling's, 679 Northampton, Easton, Pennsylvania.

8-16MM. Silent-sound films. Complete rental library. All latest subjects. Free catalogue (sample film 10c). Garden Film, 317 W. 50th, New York 19.

FILM—Movetone is back. It's Weston 12, nonhalation. Free processing—100 ft. 16mm. \$3.25; 25 ft. Double 88, \$1.50. Bulk film without processing—100 ft. 16mm. \$2.25; Double 88, \$2.45. Free circulars. Fromader Genera, Davenport 7, Iowa.

TITLES Of quality give your movies that professional touch. Write for prices. Title Technicians, 3964 Ames St. N.E., Washington 19, D. C.

16-35MM. Silent, sound films, projectors. Bedner, 5300 So. Talman, Chicago.

CLUB Plan 16 mm. sound rentals. Lowest rates. Details dime. R. A. Dechene, 90 State St., Albany 7, N. Y.

*** EXCITING Films — bullfights, movie stunts.** Unusual subjects. Send only dime for sample film and special list. Exciting Films, 1071-F El Centro, Hollywood, Calif.

RENT 16mm. sound films 50c reel. Large selection; free catalog. Film Service, 128 Chestnut St., Roselle Park, N. J.

"The World's Greatest Passion Play," all sizes sound and silent. Write Hemenway Film, 33-F Melrose St., Boston 16, Mass.

LEARN Professional motion picture technique at home. Approved for veteran training under G.I. Bill. Free catalog. Motion Picture Institute, Birmingham 4, Mich.

UNUSUAL 8-16 mm. Film subjects. Big catalog with sample film, 10c. National Film Exchange, Broadway, Sta. E, Tolcdo 9, Ohio.

HOME Movies. Rent, buy, swap 8mm.-16mm. silent and sound at money-saving rates. Details for a dime. Midland, Box 429, Oak Park 4, Ill.

COMPLETE Stocks always of Castle, Official, Pictorial films, 8mm., 16mm., sound. Musicals, soundies, free catalogs. We exchange your films and equipment, or buy them for cash. Frank Lane, 5 Little Bldg., Boston, Mass.

MOVIE Camera films, 100' 16mm. \$2.50, 25' double 8mm. \$1.25. Free developing. Better Films, 742 NewLots, Brooklyn 7, N. Y.

BASS Says: 36 years of leadership in the motion picture equipment field. Sound projectors, 8 and 16mm. equipment, finest accessories. Bass buys 'em, sells 'em, trades 'em. Always satisfaction guaranteed or money refunded! Bass Camera Company, Dept. A, 179 W. Madison St., Chicago 2.

LEARN Movie projection, management. Free catalog. Theatre Institute, Elmira, N. Y.

MUSIC AND MUSICAL INSTRUMENTS

PIANISTS Popular music chord chart: Shows names; symbols; readings; enharmonics; notation; 648 treble, 180 bass positions. Sensational! Desirable! Practicable! Only \$1.00. Carol Music Chart Co., Box 21 PM-Lefferts, Brooklyn 25, N. Y.

SONGWRITERS—Piano, orchestral arrangements. Your poem set to music. Popular records, send for price list. Cy Gaster, 134 Beech 62 St., Arverne, L. I., N. Y.

NEW Song released! Oh! Mother Cabrini. Publisher Johnny Smolen, 1837 Cuyler, Chicago.

DUO-FLEX Reeds, for clarinets and saxophones. Eliminate your reed troubles. Circular free. Duo-Flex Reeds, 1204 First Ave., Evansville, Ind.

CHURCH Organist 35 years, composes good music to good words, 200 copies printed, recording made. Reginald Belcher, Florham Park, New Jersey.

SONGWRITERS—Free information how to develop hit songs. Writer of "Kilroy was here." Dixon, 634 Common, New Orleans.

SONG Writers: Present your song to publishers and bandleaders on a professional recording. We furnish CBS talent, male or female, \$10.00 complete c.o.d. Write Music Dept., Buffalo Recording Co., 277 Delaware Ave., Buffalo 2, N. Y.

BEFORE Sending your poem to be set to music, know your composer. Free folder. Al. Moquin, 5333 La Cresta Court, Hollywood 38, Calif.

MUSIC Printing, \$5-100. Composing, complete service. Auto-Litho, Jensen, Fla.

SONGS And poems arranged, printed, published. National Songwriters, 1587 Broadway, New York City.

PIANO—Play immediately with Latom System of piano playing. Melody and chords, including Boogie Woogie. No notes, no scales, no exercises, no tedious practicing. Not a picture or ear method. Free trial. Play popular standard songs immediately or pay nothing. Send \$2.00 for your copy. If not completely satisfied return within 5 days for refund. Latom Music Publishing Co., 2147A-86th Street, Brooklyn 14, N. Y.

LEARN Songwriting quickly — easily. Previous training or talent not necessary. Al Jolson chairman of board, says, "Don't envy successful songwriters. Be one." Folio Fifteen gives practical basic training—reference book for songwriters. Send no money. Pay postman only \$2.00 plus postal charges. Song Hit Guild, Hollywood 46, Calif.

"EXPOSING The song shark!" Free details. Barry, 5 Park Square, Boston 16.

HAWAIIAN Guitar playing made easy! New picture method teaches you to play beautiful Hawaiian music on any guitar. Send only \$1.00 for complete instructions. (Money back guaranteed.) Zetco Products Company, (Dept. C.) Bellefontaine, Ohio.

SONGWRITERS: Publishing information free. Stuckmann Music Press, 5426 Broadway, Chicago 40.

SONGWRITERS! Amazing, ethical offer. Hibbler, C5, 2157 N. Avers, Chicago.

FUNNY Book with crazy song, 10c. 4 books 35c, 12 books \$1. None alike. Wood Publisher, 921 Jackson, Tulsa 5, Okla.

SONGWRITERS, Submit songs for free analysis. Only worthy material accepted for development. Tommy Kilbourne, Box 1253, Bakersfield, Calif.

SONGWRITERS—Send poems for immediate examination and free book, "Your Future in Songwriting." Radio City Music Academy, 1674 Broadway, New York City 19.

LEARN To play the piano by ear in one week. The quick easy way. Write. E. Morrison, Box 9312-N, Station S, Los Angeles 5, Calif.

ACCORDIONS. Wholesale prices. Request circular. New streamline accordions. All sizes and makes. Monarch Accordion Co., 44 N. Albany Ave., Chicago, Ill.

MUSIC Arranged. Songs printed. Frank Wildt, Music Publisher, Lancaster, Penna.

WANTED! Lyrics, melodies for songs. We arrange, publish, sell. Superior Song Studios, Passaic, N. J.

SONG Poems wanted. Free examination. McNeil, Master of Music, 510-PM South Alexandria, Los Angeles, Calif.

WRITE Songs. Big money and reputation. Write for information. J. Gordon Pub Co., 201 N. Hoynes Ave., Chicago.

SONG Writer's attention! The amazing demand for phonograph records, accelerated by more than 300,000 juke boxes and the hits popularized warrants your immediate consideration. We are offering song-poem writers the rare opportunity of having established composers collaborate on appealing material received this month. Recola Records, Box 987P, Hollywood 28, Calif.

POEMS Wanted for musical setting. Send poem for immediate consideration and free rhyming dictionary. Richard Brothers, 24 Woods Building, Chicago.

RADIOS, SUPPLIES, INSTRUCTIONS

RADIO Crystal detector kit, complete with crystal, parts and base. Illustrated instructions and 40-page radio beginners booklet. Only \$1.00. Easily assembled and ready to get reception with headphones and aerial. We can supply headphones for \$2.50. Aerial \$1.95. Al Hawkins and Company, Box 1285-P, Sioux City 7, Iowa.

FM Crystal set. Build this simple FM radio. Use as converter on broadcast receivers. Complete plans \$1.00. FM-4, 26 Rixey Drive, Alexandria, Va.

LOUDER. Simpler crystal set just developed. Instructions, 20c. "All about crystal sets," booklet, 45c. Amorose Radio, Route Four, Richmond, Virginia.

1947 REVISED "Plans 18 long distance crystal sets," catalog, "Radiobuilder"—25c, 6 issues "Radiobuilder"—\$1.00. Laboratories, Box I-c, San Carlos, California.

HOW To be a radio announcer. Send \$2.00 for complete book. Hollywood Radio Publishers, 5855-PM Hollywood Blvd., Hollywood 28, California.

FREE New radio catalog is ready! Radionic's catalog lists hard-to-get radio parts, books, amateur, test and P.A. equipment. All available for immediate shipment. Send today to: Radionic Equipment Co., Dept. SS-1, 170 Nassau St., New York 7, N. Y.

SPECIAL Sale Signal Corps product—With leather adjustable head bands \$2.95, without bands \$1.45. Make a crystal radio with them. Add 25c mailing. Send check or money order. Nico Supply Co., 540 N. 17th Street, Philadelphia 30, Penna.

50 PAPER And mica condensers \$1.00. Brand new. Fine assortment. Popular sizes. Balzer, Box 91, Brooklyn 18, N. Y.

KITS, Phones, surplus items. "C" list free. John Barron, Box 128, Ft. Hamilton Sta., Brooklyn 9, N. Y.

RADAR Crystals. Super-sensitive. Free details. Hayes, Box 636, Santa Barbara, California.

LEARN Radio at home. Earn money. Have fun building our "educational radio kits." We teach you every step. Simple, easy to understand instructions. Free literature. Write immediately. Chapin Electronics, Inc., Dept. A., 134 W. Onondaga, Syracuse, New York.

WESTERN Electric fixed crystal, no adjusting, loud, steady signal. Government release. Cost originally over five dollars, prepaid 99c. Excellent for crystal sets. List Z. Radio City Lab., 30 Church Street, New York 7, New York.

KITS. Television, amplifier, record changers, receivers, crystals. Engineering products. Anyone can build. Free list 8. Electronics Laboratories of America, P.O. Box 394, New York 8, N. Y.

RADIO Kit. Build real vacuum tube set yourself! No soldering or special tools required. Powerful, selective, simple. Kit with complete instructions, \$4.95. Headset, \$2.00. Elec-Rad Radio, Box 2030, Tampa, Florida.

CRYSTAL Radio \$2.00 complete, earphones \$2.00. Radar crystal 75c. Write for surplus bargain list. Ruben Radio, Shrewsbury, N. J.

RADIO Tubes—Attention radio repair service men. For satisfaction in radio tubes. Le-Hi Electrical Co., Dept. PM-1, 660 Broadway, Newark 4, N. J. Distributors of guaranteed radio tubes.

FAMOUS "Allen" midget semi-fixed crystal detector. Set building plans and 100 late crystal set distance reports all for 50c postpaid. Allen, 427-2, Clinton, Mo.

NEVADIUM Super crystal. Write for details. Box 764, Elko, Nev.

SELSYN Beam rotation kit complete, 110 VAC operated. Includes pair selsyns, motor, drive gears, switches, etc. \$22.50. Postpaid. Ereco, 1006 Hewitt, Everett, Washington.

SPECIAL \$7.00 Complete ready to operate crystal radio in plastic case, station selector, crystal, official A & N headphones 8,000 ohm, 100 feet 7 x 22 aerial wire, 50 feet rubber covered lead-in and ground wire, insulator and ground strap. Postpaid \$7.00. Radio City, Fifth and Ash, San Diego 1, Calif.

ELECTRONIC Organ easily constructed from radio parts. Plans \$1.00. Quaker Radio, Box 68, Salem, Ohio.

RADIO Service men and experimenters send stamp for our giant radio catalogue. Save dollars. United Radio Co., (1000-V) Newark 1, N. J.

LOUD Speaking crystal radio, improved design. Illustrated plans 25c. Radio Clinic, 10631-C Euclid, Cleveland 6, Ohio.

MAKE Simple, tubeless, batteryless, distance-getting crystal radios. Crystal and illustrated instructions 25c postpaid. Allen, 427-P, Clinton, Missouri.

RADIO Technician and radio service courses. Training for federal licenses. American Radio Institute, 101 W. 63 St. New York City. Approved under G. I. Bill of Rights.

BUSINESS OPPORTUNITIES

WANTED Men to operate sound movie circuits. Make big money. We furnish machines, films, etc. \$19.50 starts you. Write for particulars. Southern Visual Films, Shrine Bldg., Dept. B, Memphis, Tenn.

"KEMO-PLASTIK"—Amazing new rubber molding liquid. Dries quickly. Easy to apply. Quart \$3.00. Gallon \$6.95. Mold-making instruction included free. B. Belfort, Engineering Bldg., Chicago.

GO Into rug and upholstery cleaning and mothproofing business. Extra double profits selling these two professionally used products to stores and homes. Russell-Johnson Company, Clarkfield, Minn.

ACTION: Money making opportunity unmatched. Big demand for electric appliances. Large source available. Good profits. Write letter for details. Soltz, Box 303, Silverton, Oregon.

SELL 3-Line, cushion mounted, index face rubber stamp 65c. Your commission 35%. Write for agency. Velazquez, Box 55, Hamilton Grange, New York.

UPHOLSTERING Pays. Course \$2.50. Slip covers course \$2.25 prepaid. Educational Service, Box 385-A, Lombard, Illinois.

"PREPARE To Meet Thy God!" Delay means disaster! Free Bible course—Voice of Prophecy, Box 55, Los Angeles.

START Home manufacturing business making Cleaning Compounds, Soaps, Insecticides (DDT), Cosmetics, Polishes. No machinery. Literature free. Kemix, Park Ridge, Ill.

UNPAINTED Wall plaques 2½c up. Beautiful designs. Easily painted. Illustrated list free. Write today. Omman, 642-M1 Broadway, St. Paul 1, Minnesota.

MAIL Order business at home. Large profits. Interesting work. Write today for free details. G. R. Remson, 158-10 Sanford Ave., Flushing, N. Y.

START Selling costume jewelry. \$2.00, \$5.00 sellers. Send for \$25.00, \$50.00 assortment. Manufacturers, 264-5 Ave., New York.

OPERATE Profitable business at home by mail. Write F. Webster, Box 1553B, Sacramento, Calif.

NEW Rubberized construction excellent for removing lint from cloth and clothing, especially dark fabrics and suede shoes. Better than a brush. Sells quickly with good profit. Write for details. Henry M. Nagel, P.O. Box 125, Boulder, Colorado.

BOOKKEEPERS—Operate your own simplified "Dollar-A-Week" bookkeeping and tax service. Full or spare time. Details free. Ellis, Box 200, Cedar Grove, North Carolina.

HOW To sell through agents by mail. Pleasant. Profitable. Small investment. Literature free. Guernsey Mail Service, 518-X South Ninth Street, Cambridge, Ohio.

FIFTY Prize-winning plans for mail order operation. Guides you to a profitable business. Free details. Deeley Business Service, 126 Lexington Ave., New York 16.

TATTOOING Machines. Worlds finest, supplies. Free catalogue. Jensen, 120 West 83rd Street, Los Angeles 3.

IF You would like to make \$5,000 yearly in an easily learned office business of your own, send for free details immediately. G. H. Cole, Pres., Syracuse 2, New York.

SELL By mail—Amazing new book tells how. Literature free. M. E. Egan, 205-F-W Cherry St., Shenandoah, Pennsylvania.

SELL By mail. 25 plans 25 cents. Rex Newton, Loretto, Tenn.

METALIZING Baby shoes, instructions \$1.00. Wilborn, 706-P, Judson Rives Bldg., Los Angeles 13.

FAST-SELLING Patriotic book, just published; with free deal \$1. 100% profit. Working samples 50c, refundable first order. Portent, Box 62, New York 67.

MAKE Liquid marble, flexible molds, statuary, art goods, novelties, artificial marble flooring. Literature free. Kemico, Park Ridge 50, Ill.

OPERATE Profitable mail order business. Tremendous profits. Patrick Service, Box 1322, Cleveland 3, Ohio.

LEARN To metallize baby shoes \$1.00. Don Brady, 1618 Sage St., Topeka, Kansas.

MAKE Money at home. Small capital. No canvassing. Details free. Superior Distributors, 916 Hayes St., San Francisco 17, Calif.

EXTRA Money! Start profitable home mail business, sparetime. No experience. Edward Tana, 2-A Ogden Road, West Islip, N. Y.

LOOKING For new opportunities? Mail order and others? Get "The Practical Idea." Write: Veteran, Charleston 6, Illinois.

MILLIONS Have been made in real estate. Why not learn how? Send 25c for "Pointers on How to Make Money." Wm. M. Wells, 5115½ Monte Vista, Los Angeles 42, Calif.

DOLLARS Daily! Cleared \$1900.00 in two months. Details. Duffy, M56, Covington, Ky.

PROFITABLE Home mail order business. Details free. George Gundrum, LeRoy, Michigan.

MAIL Order business course shows you how to make money, spare or fulltime. Teaches professional mail order technique—not penny-snatching schemes. Fascinating 100-page illustrated success-catalog free! Write, Nelson Company, Dept. 4-02, Chicago 5.

START Profitable home business absolutely new. Particulars free. Parrott Enterprises, Box 296, Kingston-1, New York.

MAKE \$5000 Yearly selling "specialties." I do. Carylon, Bethany, Okla.

FIX Alarm clocks. Instructions 50c. Clifford Jones, 1210P Dudley, Utica 3, N. Y.

LIQUID Marble—Make in any color. Soundproof plastic flooring. Flexible molds. Cast novelties, plaques, statuary. Big money—your own business. Catalog free. Write—Bing Products, 88-A2H Broad Street, Boston 10, Mass.

MAKE Soap at home. No machinery. Profitable. Literature free. Kemico, Park Ridge 60, Ill.

40 MAILORDER Publications. Magazines, ad-sheets, circulars, etc. A barrel of opportunity for 25c. Theodore Gordon, Box 1223, New Haven, Conn.

BE First with newest items—New Products Bulletin Service brings listing 100 newest products. Tells where to get them long before they're on open market. Sample bulletin only \$1.00, details free. American Enterprises, Box 595-P, Grand Central Station, New York 17.

CAPITAL Raising—Through loans or securities. Complete instructions. Suite 665, 120 S. La Salle, Chicago.

OPERATE Profitable mail order. Harry Punch, 1329 Grace, Cincinnati 8, Ohio.

EARN \$100 Per day profit with Master Concrete Tile Machine. Materials and markets everywhere. Descriptive literature free. Concrete Machinery Company, Box #2248-B, Hickory, N. C.

MECHANICALLY Inclined men—Own and operate general appliance repair shop. Complete, illustrated course shows you how. Welding, refrigeration, motor repair, how to get business, etc., all phases covered. Free literature. Christy Supply, Dept. 172, 2835 N. Central Ave., Chicago.

IDEAL Business stamping metal key protectors, social security plates. Information upon request. General Products, 11 No. Pearl (M), Albany, N. Y.

WONDER Plastic wood and metal finish now ready for state or county distributors. Also have some territory available for wonder plastic linoleum finish. Exclusive sales contract for live wires. Write Wonder Plastic Products Company, 2609 South Kedvale Avenue, Chicago 23, Illinois.

PROFIT By co-publishing magazine. 16-page booklet 10c (refundable). Goldenberg, 5209-K Lindsay, Houston 3, Texas.

\$46 FROM Square foot plywood. Jigsaws necessary. Write, Woodarts, Bridgewater, Mass.

MAKE Flexible molds! Few cents each! Cast plaques, novelties, bookends! Free sample! H. Tooker, Hamilton 44, Ohio.

FREE Literature. New type air curing rubber latex for flexible molds. Illustrated simple mold making instructions 50c. Advanced instructions \$1.00. Apex Plastic Products, 1915 Lunt Ave., Chicago 26.

MAKE Money helping us, free information. Distributors, Box 67, Sebastopol, Calif.

WORK Evenings at home collecting names and addresses. Sell them by mail. Details free. MacAndrews, 8 Buick Street, Calais, Maine.

PLASTIC Discs, shapes, metal findings, wholesale, free catalog. "Secors," Bradenton Beach, Florida.

1000 CONTRACT Bookkeepers needed. Start your own business. Part or full time. Information free. Write A. J. Hawthorne, Public Accountant, Decatur, Ala.

BIG Money in vending machines. Small investment. Start route spare time. Build full time dependable cash business. Free details. Becker Vending, Brillion, Wisconsin.

RENT Amidon scaffolds to contractors. Amidon Engineering Co., Elyria, Ohio.

OPERATE America's lowest price precision penny venders. Stock shipments. Write for bulletin and prices. Fielding Company, Dept. PM-1, Jackson, Michigan.

ELITE Collection contains 137 practical money-making plans; local and mail order. New edition. Particulars free. Elite Co., 220 Grand St., New York 13.

INFORMATION For plastic novelties. 10c. None free. Pinetree, 1037 Elm, Manchester, N. H.

MEN, Make regular income collecting and selling us old used spark plugs. Every garage accumulates large amounts. Carl, 7927 Paseo, Kansas City, Mo.

FORTUNES In formulas and trade secrets. Practical, authentic, reliable. Details free. Stillman, 555 Kingston Ave., Brooklyn 3, N. Y.

OWN A mail-order paper products business. Sell envelopes, tags, bags, boxes, by mail, wholesale. Tremendous demand. Steady profits. No capital necessary. Write Omaha Envelope Service, Dept. 181, 4721 California, Omaha 3, Nebraska.

137 WAYS To make money, in home or office, business of your own. Full particulars free. Elite Co., 220 Grand St., New York 13.

OPERATE Profitable home business. Levine's, Box 15-X, Boulevard Station, New York 59, N. Y.

START Profitable home mail order business. For details. Ernest Weed, 772 Cleveland Ave., Bridgeport, Conn.

METALLIZE Baby shoes! Learn this money making business from nationally recognized consultant. Get "know how" from outstanding authority! See Kushner ad, page 259.

DOLLARS Daily! Cleared \$1900 in two months. Details. Loeb, 7201-A-1 Montgomery, Cincinnati.

START Profitable business, sell merchandise under your name, mail-local. Samples 25c. Linnell Co., Box 1720A, Cleveland, Ohio.

COSTS 8c Retail \$5. Mfg. mail order. Car beauty preserver—used once year. New, different. Royalty basis. Grossed \$3,000 first month, at home. Plasticize, 2254 N.W. 62nd St., Miami, Fla.

OPERATE Own wholesale candy business. Sell stores. Free list. Information. Sally Dee Candies, 124-Sims, Newport, R. I.

10 MODERN Mail order boosters. 25c. Tony Camillo, 1412 Great Northern Building, Chicago 4, Illinois.

DISTRIBUTORS—Nut vending machines, nationwide. Acme, 3405 Lisbon, Milwaukee, Wisconsin.

SELL Lamswol lined slippers, men's, women's and children's. Sensational profits. Sell from illustrated catalog or samples. Write for full details today. Shepherd Products Company, Worcester, Massachusetts.

START In mail order. No stock necessary. Free details. Self-Helps, Box 426-C, Buffalo 5, N. Y.

HOME Mail business, unlimited earnings. Copyrighted instructions \$1.00. Write, Edwin Garske, 3407 Fullerton Ave., Chicago 47, Ill.

ARE You "fed up" working for bosses? Own permanent mail order business. Crompton, Box 2567, Hollywood 28, Calif.

MAKE Money making shell jewelry and novelties. Instruction book 75c. Kit \$5.00. Catalogue free. Palm Shellcraft Co., 220 W. 9th St., Sarasota, Fla.

MAKE \$100.00 Per week, and more on old Singer sewing machines. Write for circular. Essex Vacuum Shop, 172 Washington St., Newark 2, N. J.

LATEX For making flexible rubber molds. Thoroughly tested. No shrinkage. Complete instructions with each order. Stoneham Rubber Co., Box 244, Stoneham 80, Mass.

ACHIEVE Success and financial independence in your own business by "turning ideas into cash." 176 page book, \$1.00 postpaid. M. A. Copeland, Box 645, Elsinore, California.

PROFITABLE Business of your own. Local or mail order. Write Tes-Co Enterprises, Wilkes Barre, Penna., Box 189-MA.

OPPORTUNITIES Galore to operate own successful businesses. Manufacture own products. Establish yourself locally, statewide, nationally. No hokum. Serious-minded men invited to write Robert Avila, Isleton, Calif.

RUBBER Moulds for casting novelties. Latex for making moulds. Use thoroughly tested and approved products. Eastern Latex Laboratories, Box 153, Mattapan 26, Mass.

OPERATE Profitable mail order business. Splendid opportunity. For details write H & T Service, Box 841, Wichita, Kansas.

MAKE Big spare or full time earnings in mail order. Easy pleasant work. Small capital. Interesting details free. Holden's, Dept. 227, 4903 Rhodes Avenue, North Hollywood, California.

BRONZING And metallizing baby shoes! Gold, silver, copper, nickel, bronze, pearl, ivory and "luminous glow" colors! Big profits! New field! Details free! Write R. O. Morgan, Box 349, Long Beach 2, Calif.

ACCOUNTANTS—Bookkeepers operate our system at any locality. Forms furnished. Professional assistance. Barnhart & Kennedy, Public Accountants, Chambersburg, Penna.

BECOME Independent! Rent New York office under your own name, and sell what you have to offer through world's greatest business center. Rates \$7.30 and \$14.60 yearly. Co-operative Offices, 126 Lexington Avenue, New York 16.

OPERATE Fast home business, new, small capital, no soliciting, no machinery, not mailorder, repeats. Full instructions, illustrations, 50c. Hand-I-Work Shop, Route 9, Box 612, Portland 16, Oregon.

EARN Up to \$500 month part or full time keeping books for small firms. Simplified system. Write Tax-Saver System, Dept. J, Fort Worth, Tex.

MAIL Order opportunities. Read oldest trade journal. 53rd year. Copy 25c. Mail Order News, Somerville, N. J.

SUPER X liquid molding rubber. Sample jar 25c, quart \$3.00, gallon \$10.00. Free instructions. W. Wooley, 115-A Donald, Peoria, Ill.

DO You want a permanent business profession of your own? Learn the Stephenson Method of making and fitting corrective arch supports. Earnings of men and women in this profession run as high as \$50 to \$100 weekly. Not medical or chiropody—easy terms for home training—no further capital needed, no goods to buy, no agency. Write for free booklet. 51 years in business. Stephenson Method, 11 Back Bay, Boston, Mass.

WHOLESALE Catalog, directory 10c. Thousands of articles. Stafford, Box 5211, Indianapolis 1, Ind.

BUILD Year round business, by mail or direct contact. Everyday necessities, easy repeats. Excellent profits. Full time or side line business. Sample 10c. Lytle Supply Co., Avenue 15, Fredericksburg, Ohio.

RUBBER-AIRLASTEX Mold making liquid; extra heavy "pre-war" quality. Sample pint with instructions, \$1.25. New Era Products, 1321-N Belmont, Chicago.

PLASTIC-INTERMIX, Makes ordinary plaster 10 fold harder. Gallon develops 100 pounds. Pint \$1.50. Gallon \$4.00. New Era Products, 1321-N Belmont, Chicago.

MONEY-MAKING Opportunities. Tested plans, ideas galore for successful operation mailorder business. Full or sparetime. Details free. Levand, 6410 Kenwood, Chicago 37.

BUILD Miracle homes. For yourself, or sell others. Livable, lovable, durable. Facts free. Chamberlain Co., Fitzsimons Bldg., Pittsburgh 22, Penna.

FIFTY Tested mail order plans for profitable, fascinating home-operation, details free. Manhattan House, 126-M Lexington, New York 16.

AT Home—Your own manufacturing business; making popular \$1.00 novelties. Cost you 3c to 15c. Everything supplied. Write So-Lo Works, Dept. N-600, Loveland, Ohio.

INVITATION To income! Contact. Mib Associates, Fitzsimons Bldg., Pittsburgh 22, Penna.

METALLIZE Baby shoes! Easily learned. Universal Sales, Box 1076-A, Peoria, Ill.

MAIL Order offers increased income, independence, unlimited possibilities. Free literature. Manhattan House, 126-L, Lexington, New York 16.

BELTS! Make 'em and make money. No tools! Sample 50c. Artnc Leather, 411 Joseph Ave., Rochester 5, N. Y.

LIQUID Marble, plastics, marblite, plasters, make your own. Universal Sales, Box 1076-A, Peoria, Ill.

ELECTROPLATE Baby shoes. Complete instructions \$2.00. Creative Publishers, Winnetka 7, Illinois.

\$15 TO \$20 Daily if you can walk, talk, read and write. Elcom Service, Box 910, Tampa 1, Florida.

VENDING Machines. Be independent. Own a big money business operating coin machines. Earn as high as \$7.00 weekly on machine costing as low as \$11.75 each. Car and experience unnecessary. Routes can be operated either in your spare or full time. Act quickly. Write for details and catalogue showing our amusement games, postage machines, candy-gum-nut vendor and scales. Parkway Machine Co., 623J W. North Ave., Baltimore 17, Md.

WHAT Sells—How to start. 10c places your name many mailing lists. Zech, 7532 Buist, Philadelphia 42.

MAKE Big money. Get started in tire business. Up to \$20.00 in 3 hrs. Send \$1.00 for details. "Tireman," 1515 E. Virginia, Phoenix, Arizona. Less than \$50.00 capital.

OPERATE Profitable mail order business. Splendid opportunity. For details write: Fox, Rt. 1, Box 600, Aptos, Calif.

"BULK Vending" machines make easy steady income. Have you considered or would you like to learn this fascinating business. Post card brings free booklet. Vending, 1051 "L" St., San Bernardino, Calif.

ANYONE Can learn. Tune pianos by my system. \$1 2 lessons and chart. Oscar Fylling, 841 Robinson, Oroville, Calif.

BOOKKEEPERS: General ledger and tax report experience, operate permanent, profitable accounting service for the smaller business. Part or full time. Simplified method. Write now! L. A. Bell, 1404 West 25th St., Cleveland 13, Ohio.

RUBBER Molds. Make big money duplicating hundreds of items, own your own business, start in spare time, make your own genuine rubber production molds, duplicate expensive molds for only a few dollars cost. Latest factory and shop methods. Also molds made to order. Get our prices. Information free. Write Shop Technician, 1832 E. 9th Street, Kansas City, Mo.

WANTED: Persons willing to co-publish magazine. 10c for samples, details. Lanich, 7219 Woodlawn Ave., Chicago, Ill.

MONEYMAKING Mailorder business. Sparetime. Details free. Jajuk, B445, Sallina, Kans.

BIG-PAYING Home mailorder business. Literature free. Jackson, Newfoundland 3, Kentucky.

AGENT Or exclusive distributor for cigarette lighter mfg. Box 9, Tarzana, Calif.

LIQUID Marble—Colorful, glazed! Molded, brushed, sprayed! Composition floors. Rubberlastic molds. Particulars free. Marbleizing Service, Edwardsville, Ill.

PLASTIC Homes—Build yourself! Resurface old buildings! Wonderful building material. Particulars free. Marbleizing Service, Edwardsville, Illinois.

GOT \$24,500 Using schemes from "Schemer" Magazine, Alliance, Ohio. 48th year, \$1.00; 3 samples, 25c.

MECHANICALLY Inclined? Here's a real opportunity! Your own profitable interesting business. Full information dime. River Workshop, 170 East 51st Street, New York 22.

BRAND New proposition. Extra money spare time. No selling. No canvassing. Absolutely different. You do it. Full particulars free. R. H. Callaway Specialty Co., P.O. Box 341, Fort Smith, Ark.

PRINT Colorful signs and posters. Experience unnecessary. Simple home-made equipment. Complete instructions \$1.00. Signographer, 1 Benson Avenue, Elmont, N. Y.

LEARN Shell jewelry manufacturing. No tools or experience needed. Learn-earn within a week! Complete home instruction course, beautifully photographed, shows how to make 75 styles of pins, earrings, brooches, hair ornaments, dress clips, necklaces, bracelets, candy dishes, wall plaques, ash trays, candle sticks, etc. Includes pearlizing, golding, dyeing, luminous methods. Illustrates 55 species of sea shells. Lists hundreds of raw materials with wholesale prices. Complete course \$1.00, postpaid. Beginner's kit, \$3.00. (\$3.50 in Canada). House of Gifts, Box 4550-RP, Coral Gables, Fla.

EARN \$2000 Or more during March 15th tax period. Be a tax consultant. Bookkeepers, etc. can qualify quickly. Details free. Edw. H. Smith, 17 Rockland Ave., Yonkers, N. Y.

DO It with sea shells. Attractive jewelry. Big profits. Free instructions. Werts, 1429 56th Avenue, Oakland 3, Calif.

\$665.00 PROFIT From every \$15.00 invested. Standard Service System, La Grange 1, Indiana.

QUICK Money! "Repairing car batteries." At home! Easy too! Write. Batteryman, Grand Junction 5, Colorado.

"HOW To Make Simple Molds and Plaster Plaques." Profitable business or hobby! Instructive booklet 25c. Plastercraft Supply Company, 1406 East 43rd Street, Cleveland 3, Ohio.

LEARN Piano tuning, repairing, at home. Tremendous field! Piano parts, tools furnished. Established 1935. Empire School of Piano Tuning, 606-B East University Ave., Champaign, Ill.

OPERATE Profitable appliance and building repair business. Information free. Cline-Porter, Box 6346D, Pittsburgh 12, Penna.

OPERATE profitable mail order business. Splendid opportunity. For details write Albert Taves, Zolfo Springs, Fla.

SELL By mail!—Books and novelties! 35 different items! Large profits! Catalog free! Ellico, 432 N. Wells, Chicago 10.

PROFITABLE Home sparetime business, making wallets, belts, other fast-selling leather novelties. Simple to make. Tools not necessary. Amazing opportunity. Send for free catalog. Gold Leathercraft, 632 Desplaines, Forest Park, Ill.

FREE Details—How to operate a profitable mail order business. Beier's, 837-A North Hoffert, Bethlehem, Penna.

SOAP Powder for mechanic, factory, printing trades. Ample supplies. Big opportunity. Profits selling users, retail stores. Schultz Laboratories, Boone, Iowa.

MAILING List! 5000 women mailorder buyers, \$25.00; 3000, \$15.00; 1000, \$6.00. Guaranteed accurate! Try them! Woods Remnants, Bedford, Penna.

ORGANIZE Wholesale—retail—popcorn, potato chip shops. We sell beginner's outfits. Long-Eakins, 4760 HI St., Springfield, Ohio.

BABY Shoes preserved. Formulas, instructions, \$1.00. Novelty Bronzing, Box 56, Hyde Park 36, Mass.

PLASTIC—Liquid glass; China glazes, protects plaster objects, seals wood. Pint \$1.00, gallon \$3.00. New Era Products, 1321-N Belmont, Chicago.

DO You want to learn the how, what, and where of the mail selling business? Details free. Harold Eisert, 218 Beach 81st Street, Rockaway Beach, New York.

CASTONE—Hardest coldcasting composition on earth, any mold. White and colors, 10 pounds assorted colors, \$2.00; hundred pounds, \$6.00. New Era Products, 1321-N Belmont, Chicago.

EVERYBODY'S Feet hurt. Sell guaranteed cream. Excellent repeater. Free advertising. Write IDI, Quakertown, Penna.

START Profitable concrete block business. Details free. Wm. Horne, 206 West Wilder, Tampa 3, Florida.

METALLIZE Baby shoes and plaster casts! New, easily followed complete step by step instructions. Written by a plating engineer. Electroplating by brush included. Make own equipment. Complete instructions \$2.00. H. C. Pedrick, 1419 West Ontario Street, Philadelphia 40, Penna.

START Home business making statuary, plaques, novelties, garden furniture, artificial marble flooring, liquid marble. Make your own flexible molds. Amazing profits. Folder free. Creative Publishers, Box 236-L, Winnetka, Illinois.

COLOR Concrete with chemicals. Make Hollywood style pottery; home or shop. Marbling, water-paints. 10c brings sample, pictures. Hollywood Cementcraft, 8527 Wonderland, Hollywood 46, Calif.

20th CENTURY "business opportunities book." 144 pages of formulas, mailorder, homeworkers plans. \$1.00 postpaid or c.o.d. plus postage. Money back guarantee. Silver Crest Products, Dept. 1A, 3040 North Ave., Chicago 47.

EARN Up to \$400.00 monthly. Details free to mail order beginners only. F. C. Bradford, P.O. Box 246, Morenci, Arizona.

INTERESTED In immediate mail order cash? Read "Advance"—Voice of mail order. Offers money-making opportunities. Personal guidance and benefits to all. Sample copy 25c. American Mail Trade Association, 313 East 21st Street, Dept. 400, New York 10, N. Y.

WHY Job worry? Learn electroplating. Highly paid, uncrowded, interesting business. Gold, silver, nickel, chromium, etc. Send postcard for free booklet and proof. Plater Hyde, Dept. MC, P.O. Box 176, National City, Calif.

COPUBLISH Leading m.o. paper. Latest copy Mail Sale Advertiser and proposition, commemorative stamp. Vanroy Shirk, Lebanon, Penna.

GO Into the mail order business. My 32 years' experience tells how. Send 25 cents for instructions. Mail Order Institute, Box 1902, Cleveland 6, Ohio.

START Profitable mail order business. PMT lists new propositions available; products, sources, accurate methods. Covers ad writing, letter logic, trade information. Send 10c for copy and get free instruction folio offer. Progressive Magazine, Sheboygan, Wisconsin.

MERCHANTISE At half the standard advertised price. Ken Solomon Company, 813 Broadway, New York 3, N. Y.

MAKE Extra money now. Build to financial independence. Sell office supplies by mail from your home. I tell you how. Jo Troutwine, 8654 S.W. Ninth, Portland 1, Oregon.

ESTABLISH Own specialized, profitable advertising business. Make big money practically giving away advertising. E. J. Matteson, P.O. Box 580, Hanford, Calif.

OPERATE Profitable home business selling merchandise by mail. Fast sellers. Large profits. Powell Service, 5713 Euclid, Cleveland 3, Ohio.

START A home business in spare time. Make extra money. Experience unnecessary. Literature free. Elmar Services, Muncy, Penna.

LIQUID Rubber, for making flexible molds, literature and sample free. H. Chaney, 1130 E. 16th St., Jacksonville 6, Fla.

HOW And where to obtain capital. Fully explained. Particulars free. Star Service, Wapakoneta, Ohio.

ASTOUNDING Modern mailorder plans bring quick profits. Darrah, Orono, Maine.

AMAZE Others. Add faster than adding machine. Free details. Math Institute, Box 633, Mobile 4, Ala.

1946 GIGANTIC Directory of opportunities, advertisers supplies, sources, trade information, mail order ideas, products, wholesalers, valuable tips—just published! Descriptive literature free. Wilkin & Co., 118-AP East Main St., Hillsboro, Ohio.

BIG Paying jobs in welding. Complete welding lessons and reference books, 516 pages, 41 lessons, \$2.00 copy. Money-back guarantee. Hobartweld, Box M-1065, Troy, Ohio.

START A clock shop. Fascinating, easily learned profitable business requiring little capital. We teach you how to repair all kinds of clocks. Information free. Houston Clock Shop, P.O. Box 5086A, Houston 12, Texas.

MEN, Women, "Everybody Likes Candy." Learn to manufacture professionally at home. (Our 36th year.) Ragsdale Candies, East Orange 2, N. J.

SYNTHETIC Latex with Neoprene base for making flexible molds! Quick drying! Safe! For home, classroom, or industry. Quart \$2.00. Gallon \$5.95. Full instructions. Plastercraft Supply Company, 1406 East 43rd Street, Cleveland 3, Ohio.

PARATOL—Amazing new rubber latex moulding compound for perfect detail castings of all kinds tested and approved in long service. No worries—easy to apply, quick drying, maximum strength and long life. Why pay more—buy direct! Quarts—\$1.60, 1 gal.—\$4.90, 5 gals. \$4.45 gal. 4 oz. samples on request. Send 25c to cover mailing and handling charges. Full instructions sent with each order. Testworth Laboratories, Inc., Manufacturers of coating and adhesive products of all kinds, 407 S. Dearborn Street, Chicago 5, Illinois.

200 MONEY Making deals. Plans. Rare formulas. Schemes. Folio free. Formico Mart, Box 572, Dayton, Ohio.

WOULD You pay 3%—first \$350 made? Color-illustrated book "505 Odd, Successful Enterprises" free! Some plans offer occasional "day off." Start at home, office. Expect something odd! Pacific, 2207½ Cloverfield, Santa Monica, Calif.

RAISING Canaries pays good profits. Valuable bird book—"Its Care, Breeding and Training." Price \$1.00. American Canary, 2839 N. Halsted, Chicago.

INCORPORATE Your business, Delaware laws. Many advantages, free details. Tax Research Bureau, Inc., Delaware Trust Building, Wilmington, Delaware.

SPECIALTY Manufacturing, the big money business that can be operated anywhere, start on a very small capital; we supply dependable formulas and complete instructions; get interesting free booklet, "Moneymaking Opportunities in Specialty Manufacturing." Howard Robinson, Ph.G., 1300-A South Ohio Street, Sedalia, Mo.

FELLOW Workers—Down with bosses—Start own business—Be independent—Booklet describing 137 tested plans, free. F. Padney, 307 York St., Jersey City, N. J.

MINK Raising, information free. Complete. Lake Superior Mink Farm, Superior, EE, Wisconsin.

PROFITABLE Mailing merchandising business. Write Riegel, 1111 Harrison, Phila. (24), Penna.

TADPOLES Make frogs, tremendous demand. Both make you money. 25c brings tell-how information. Chariton Corporation, Century Building, Chicago 4.

COPPERIZE Baby-shoes, complete instructions, tested sales plan. Metaloids, Box 8087-b, Pittsburgh 16, Penna.

MAKE "DDT" Products. My ten master formulas show how. Literature free. Howard Robinson, Ph. G., 1302-A So. Ohio, Sedalia, Missouri.

WE Start you in business, at home, sparetime, earning \$10-\$30 weekly selling by mail. Stamp appreciated but not necessary. Driscoll Sales Service, Box 2771-A, Denver, Colo.

COLORGLAZED Concrete pottery made without molds. New, low cost, patented method. Cemetery products, novelties, tiles, floors, etc. Basement leaksealing. Other moneymaking projects. Booklet, details free. Men only. National Potteries Company, Fergus Falls, Minnesota.

YOUR Own business. Big profits, very small capital. National organization teaches, helps, supplies everything. Interesting service business. Big demand everywhere. Americlean, 211 North 7th Street, St. Louis 1, Mo.

HANDY Men—Earn money home operating Community "Fix-It" Shop. Write Stafford, 708 Rawlings, Carbondale, Ill.

RECAST Old batteries into new. Latest achievements. Battery Laboratories, Minneapolis.

START Mailorder bookshop—Everything furnished; publisher cooperation. 25c brings booklet, exclusive setup, samples, exciting ideas. General Publications, Ossining, N. Y.

\$25 WEEKLY Working two hours daily. No canvassing. No manufacturing. Lycke, Box 2471, Cleveland 12, Ohio.

BRUSH Plating outfits connect to a battery. No tanks necessary. Good paying business at home plating auto parts, bathroom fixtures, bicycles, reflectors, silvering mirrors. No shop or experience required. Outfits furnished. Free booklet. Gunmetal Co., Ave. H, Decatur, Ill.

BABY Shoes preserved. Complete instructions. Exclusive rights. M. E. Watson, Bellefontaine, Ohio.

MONEYMAKING OPPORTUNITIES

SEWING Machine repairmen make big money lifetime. Start neighborhood shop today. Our course repairs all makes. \$1.98 postpaid. Serviceman, Hamilton 9, Ohio.

EARN Money spare time mailing circulars for mail dealers. Pioneer, 404-P, Yonkers 1, N. Y.

SELL Personalized book matches. Beautiful line; excellent commission. Details free. Hall's, Iowa City, Iowa.

500 GIGANTIC Money-producing ideas, plans, formulas. Build permanent business, limited capital. Manufacturing, mail order opportunities. Particulars free. National Enterprises-Z, 10 Waverly Place, New York 3.

START Your own business! Big money manufacturing novelties, plaques, statuary. Free catalog. Write Bing Products, 88-A2K Broad Street, Boston 10, Mass.

THOUSANDS Of modernized formulas. Everything; beauty preparations, cleaners, antiseptics, polishes. Write Helle, 11714 E. Jefferson, Detroit 14, Mich.

SMALL Capital "moneymaker." New. Unusual. Hurry. Jones 112, Bethany, Okla.

FLAT Broke? Impossible. Here are the secret "Seven Cures for a Lean Purse" if it's wealth you desire. \$1.00 postpaid. E. Kalb, 114-40 138th St., Jamaica 4, L. I., N. Y.

MAGIC Stone plastic flooring offers lifetime profitable business. Write, Palmer Company, Station A, Berkeley, California.

NOW Is the time to get good jobs in Florida. Bumper citrus and vegetable crops. Big tourist season. Free booklet. Florida Businessmen's Service, Box 767-B, Panama City, Florida.

THOUSANDS Articles wholesale. "Supply Source Directory" 10c. Ideal Service, Park Ridge 40, Illinois.

EMBOSS Letterheads, cards, announcements, invitations yourself. Easy. Details free. Dexter, 45-A Pleasant, Battle Creek, Mich.

BUILD Neon signs and neon lighting. Easy to learn. Very small capital required. McMaster Sign Co., 730 State St., Bellingham, Wash.

OPERATE Profitable home mail order business. Progressive, 64 PP. Magazine tells how. Sample 10c. Publisher, Box 1302-P471, Detroit 31.

HOMECRAFT Folio, 25c. Moneymaking book list. Ralph Underhill, Beebe, Arkansas.

SELL Personalized gifts by mail. Sample and details 25c. Danbros Jewelers, Dept. M, 3530 South Hanover, Baltimore 25, Maryland.

MECHANICALLY Inclined men — Own and operate general appliance repair shop. Complete, illustrated course shows you how. Welding, refrigeration, motor repair, how to get business, etc., all phases covered. Free literature. Christy Supply, Dept. 1172, 2835 N. Central Ave., Chicago.

WHY Work for others? Make and sell household aluminum cleaner. Fast seller. Big profits. Easy to put up. Formula \$1.00. J. Williams, P.O. Box 399, Cranford, N. J.

ELITE Collection contains 137 separate proven moneymaking plans — home town and mail order. New edition. Information free. Pacific Distributors, Box 841, Oakland 4, Calif.

BEAUTIFUL Mirrors from ordinary glass. Complete instruction folio \$1.00. Tes-Co., P.O. Box 189-MB, Wilkes Barre, Penna.

CONVERT Burnt out light bulbs into fire extinguishers for few cents each. Every home a prospect for several at your own price. Copyrighted instruction folio with fotos show you how. \$1.00. Fred A. Lewis, Box 104 Kensington Station, Brooklyn 18, New York.

METAL Chips for gaming machines. Reasonable prices. Write Main Service, Box 82, Bushnell, Ill.

READ, Educational folios, home work, etc. New read-study plan saves money. Phil Bruce, Box 341-EB, Palo Alto, Calif.

PROFITABLE Mail business; we'll start you. Immediately enormous profits. 25c refundable. Tuff, 429 Robison Court, Pittsburgh 19, Penna.

BRONZE Baby shoes in your spare time. Deluxe kit, material, instructions \$2.98. Baby Art Studio, 8245 S. Rhodes, Chicago 19, Illinois.

YOUR Own Boss. Large profits. Free details. Business Men's Foundation, G-7553 Elmhurst St., Detroit 4, Mich.

NEED Extra money? Get our offer. Strictly spare time work. No canvassing, no experience. Write for free particulars. Can Do Corner, 1919 Coleman Street, Brooklyn 10, New York.

EARN "Pin money" at home. Assemble colorful handmade jewelry. Free details. Beginner's outfit, \$1 (refundable). Plastic Work, 712 Kimball, Danville 3, Illinois.

MAKE Photo-statues from snapshots. Simple, profitable reorders. Amazing details free. Brooklyn Model, 818-B Coney Island, Brooklyn 18, N. Y.

DOLLARS Daily! Learn how. Read "Timely Tips Magazine." Paulding, Ohio. 19th year. \$1.00. Three copies, 25c.

TREMENDOUS Demand for new remarkable inexpensive treatment which makes coal burn hotter, longer. Formula \$1 (refundable). Brokaw, Carson City, Mich.

PLANS And instructions for manufacturing cement laundry tubs. Grannen, 619 Dufferin Ave., London, Ont., Can.

EARN Up to \$2,000 year, inventing simple items for special cash markets. Ideas only. No patents. Hendrickson, Argyle (7), Wisconsin.

THERE'S Big money in junk," and repairing batteries. Write, Batteryman, Grand Junction 5, Colorado.

EARN Money evenings, copying and duplicating comic cartoons for advertisers. Adservice, Argyle (1), Wisconsin.

EARN Money at home! Thousands do! "Home Worker Magazine" tells how. Sample, 25c (coin). Six issues, \$1.00. Arthur Sizemore, Pub., Box 870-M, St. Petersburg, Fla.

\$246.50 MAKING Unusual secret device without skill, machinery, from former war material costing \$1.50! Simple, baffling invention, unbelievably profitable! Illustrated proofs free. Rolls Enterprises, 115-D West 16th, New York 11.

SELL Books by mail. Large profits! Details free. Cline-Porter (Publisher), Box 6346-H, Pittsburgh 12, Penna.

EARN While you learn clock repairing. With our method your income can start immediately. Write Akron Clock Clinic, 964 Wye Drive, Akron 3, Ohio.

NYLONS—Supply sources, 50 manufacturers. \$1.00. Bonafide information. Enterprises, 578N Prospect, New York 55.

MAKE, Sell over 100 fast repeating products under your name without machinery. Kohen, 506 W. 45th St., Chicago 9.

EARN Extra cash—full time or spare time—selling Pines' 1947 Greetings. Profits over 100% for producers. These sensational easy-selling boxed assortments must be seen to be fully appreciated. The complete line includes over 100 different moneymaking assortments for all occasions—birthdays, anniversary, convalescent, congratulations, announcements, invitations, gifts, special occasion and holiday cards; distinctive social stationery for men and women. Climb this big-profit band wagon by sending \$3.00 now for your saleable samples (value \$6.00) of six different current feature dollar box assortments together with full details of our no-risk money back guarantee on our complete line. Just print your name and address, attach \$3.00, and mail to: Pines, Box 32, Flushing 1, New York.

SELL By mail! Mail order business is shortest cut to profitable sales. Inspiring, constructive, instructive literature sent without obligation. Earl Cratty, 385 Lenzen Ave., San Jose 11, California.

"LUMINOUS Paint." Resilvering Mirror formulas 25c each. "50 Single Ingredient Formulas" \$1.00. Ideal Service, 300, Park Ridge, Ill.

EARN Money at home—steady income. Write Successful Income Builders, 508-A, Hollywood 28, California.

LEARN Metascience. Remarkable drugless healing. No manipulation. No apparatus. Unbelievable simplicity and results. Inexpensive correspondence course. Write Metascience, De Land, Florida.

LEARN Battery repairing, rebuilding. Engineer offers money making methods. Battery Bureau, 2225 North 44th St., Milwaukee, Wis.

200 MONEY Making deals, plans, rare formulas. Schemes. Folio free. Formico-Eng., Box 572, Dayton, Ohio.

WOULD You pay 3%—first \$350 made? Color-illustrated book "505 Odd, Successful Enterprises" free! Proven by "Little Fellows." Start at home, office. Expect something odd! Pacific, 2207½ Cloverfield, Santa Monica, Calif.

FORTIFY The future! Start own business; home, office. Booklet describing "Collection of 137 Tested Plans" free. Elite Co., 220-A Grand St., New York 13.

PUBLISH Your own magazine. Handsome 52 page format, well edited, illustrated. Cost low as \$1.00 month. Brings you prestige, profits. 25c brings sample, details. National. Ord. Nebr.

I MAKE Big money in the mail-order business. You can do the same at home with my copyrighted system. Write me. I'll tell you how. F. Little, Box 8, Glenshaw P.O., Pittsburgh, Penna.

FORMULAS, PLANS, ETC.

MANUFACTURE Cleaners, flavors, cosmetics. Formula catalog 10c. Kemico, Park Ridge 20, Illinois.

ANY Manufacturing formula \$1 or money back, including war-born items, DDT, etc. Material sources, labels and circular copy furnished. Gigantic list 25c. Refunded first order. Universal, 162 N. State, Chicago.

SPECIAL Two new mail order postal card propositions. 13 new easily prepared beauty formulas. Vitamin cosmetic Complexion Cream. 24 firms offering moneymaking opportunities. Money selling names. Famous "It." All 50c. Coin or money order. Satisfaction guaranteed. Teycer, Chemist, Box 1287, Chicago 90.

924 PAGE Illustrated giant book containing 10,000 helps, scientific formulas, secrets, ideas, offers genuine, successful opportunities for own business. Exceptional bargain \$2.89 postpaid. (C.o.d. accepted). Continental Publications, 79-02m Woodside, Elmhurst, New York.

10,000 FORMULAS And trade secrets. Free literature. Stillman, 555 Kingston Ave., Brooklyn 3, N. Y.

NEED The advice of a professional chemist? Ideas. Formulas. Research. Chemical Consulting Co., East Marion, L. I., N. Y.

CONTEMPLATING Mfg. frozen custard? One dollar brings you full instructions. Several years experience. B. C. Stroud, Tallmadge, Ohio.

NEED Chemists? Formulas? Analyses? Products duplicated, improved? Consulting Scientific Company, Swarthmore, Pennsylvania.

21 POPCORN, Candy apple, etc. formulas. All money-makers. \$1.00. We can supply equipment. Concession Supply Co., Dept. "A," Box 133 Sta. "B," Toledo, O.

REAL Manufacturing formulas. Lists free. Cummings, Chemist, Gordon Ave., Syracuse 4, N. Y.

FORMULAS—Latest, best. Analysis. Giant formula catalog and chemical instruction sheet 10c. Refunded first order. Belfort, Engineering Building, Chicago 6.

PLASTICS

LUCITE—Get acquainted with the "gem of plastics." Write for illustrated booklet, complete fabricating instructions, wholesale, retail prices, sheets, rods, tubes, supplies. Booklet, sample, 35c; booklet, 10c. Gem-O-Lite, Post Office Box 686B, North Hollywood, Calif.

LUCITE, Plexiglas sheets, rods, dyes, cement, cheap. Free price list. Thomas Cavaliere, 2141 So. Beechwood St., Phila. 45, Penna.

MAKE Money assembling our pre-fabricated plastic kits. Sample kit 50c. Catalog free. Fabros, Box 156, Station F-1, Buffalo 12, N. Y.

PLASTIC Lamination agents wanted. No expense; free particulars. Universal Electronics, Plastic Division, P.O. Box 1015, Kansas City, Missouri.

MAKE \$15.00 Daily in plastics. How? Send your favorite snap shot and \$1.00 for sample and complete details. Plexart, Box 1976, San Antonio, Texas.

PLEXIGLAS Sheets 10"x12"x12" 78c; 12"x15" 96c; 1/8"x11 1/2"x12" 98c; 9"x11" 75c; 10"x12" 84c; 13"x16 3/4" \$1.60. Ten colors in 12" rod assortment \$4.00. Julian Rhodes Muench Co., 1527 W. Alabama, Houston 6, Texas.

PLEXIGLAS Masked sheets 12"x12"—1/16"—\$1.00, 1/8"—\$1.25, 3/16"—\$1.55; 1/4"—\$1.85. Include 10% postage. Dyes, rods, cements, shells, buffing compounds, jewelry findings, tools. Free listings. Craft Plastics, Box 129-P, Somerville, New Jersey.

PLASTICS. 10c Brings illustrated 1947 catalog. Contains plastics, kits, bulk-assortment, national contest. Bellico Plastics, 98-P Gramatan, Mt. Vernon, N. Y.

HEMOCRAFTERS! Plastic formula and instructions \$1.00. Box 84, Station K, Toronto, Canada.

PLASTICS And supplies—New Plexiglas, Lucite, Catalin sheet, rods, tubes, etc. Attractive prices. Exceptional kits \$2.00, \$5.00, \$8.00. Internal floral carving drill. We pay postage. Free list. Plas-met Sales & Engineering, 4648 Shirley Place, St. Louis 15, Mo.

PLEXIGLAS, First grade 1/8" 12"x12" \$1.40. 10 lbs. assorted sizes \$4.95. Crowe, Bluff City, Tenn.

NEW Liquid plastic. Clear, colors. Cast without heat. Embed flowers, insects, coins. Saw, drill, carve. Manual tells how. Send \$2.95 plus 20c postage for complete kit including one pound liquid Castolite, Dept. A21, Castolite, 211, Kenilworth, Ill.

PLEXIGLAS Lucite—4 pound assortment. Approximately 5 square feet. Cement included, \$4.95 postpaid. Mayfair Plastics Co., 8125-P Frankford Ave., Philadelphia 36, Penna.

PLEXIGLAS Lucite slashed, free listings. Douglas Home Craftsman, Dept. M, Stamford, Conn.

SENSATIONAL Plastic injection molding machine. Low price Plexiglas, dyes, cements, shellcraft kits; molding sets, polystyrene rods. Free literature. G. Baker Company, River Edge, New Jersey.

MONEY In plastics! Lucite plastic hobby kit. Two pounds Lucite materials, coloring dye, cement. Instructions. Send \$2.50 to Plastic Specialty Co., (Dept. M), 192 Lexington Ave., New York 16. Also Swiss music movements, \$3.50 each.

LEARN At home "Working With Plastics." Full information on sheets, blocks, rods, tubes. Trade names, sizes, colors for fabrication. Designing, tooling, bending, cementing, polishing. Also for homework-shop. Only \$1.25 postpaid. Money back guarantee. Modern Technical Book Co., Dept. MMC, 55 West 42nd St., New York 18.

CHEMISTRY

THE House of Winn, home of supplies for amateur chemists. See Winn's New Idea chemical kits and apparatus outfits for home experimenting. Send 10c for retail catalog. Established 1931. John H. Winn, Dept. 501, 124 West 23rd St., New York 11, N. Y.

BIG Savings on laboratory supplies. Catalog 10c. National Scientific Co., 2204 W. North Ave., Chicago 47, Ill.

CHEMICALS, Formulas, apparatus, any quantity. Catalogue 5c. Helett Products, 1305 Sheridan Ave., New York 56.

HANDBOOK For chemical experimenters, illustrated, hundreds of experiments, 50c. Experiment booklet 15c. Supply catalog 5c. Reading Scientific Company, Reading, Penna.

STUDENTS' Laboratory supplies. Send 5c for catalog. Mel-Glo Chemical Co., 258 Fourth Ave., Brooklyn, N. Y.

APPARATUS, Chemicals, ounce quantities, catalog 5c. Fleischer's Laboratories, Everett 49, Mass.

CHEMICALS And apparatus for industrial, analytical, and private laboratories. Complete supply service for correspondence school students. Send 3c for catalog. Dept. M-43, Biological Supply Co., 1176 Mt. Hope Ave., Rochester 7, New York.

FREE Catalog, Chemistry, mineralogy, biology, optics. Tracey Laboratories, Evanston, Illinois.

LABORATORY Supplies, Chemicals and apparatus all descriptions. 36 page book 10c. Standard Science Supply Co., 1232 N. Paulina St., Chicago 22, Illinois.

HELP WANTED

KNITTERS—Top earnings, steady employment with experience on any of these machines: Circular Links and Links, Wildman, Brinten, Dubied. State age, experience in detail. All replies confidential. Our employees know of this advertisement. Gantner & Mattern Co., 1453 Mission St., San Francisco.

AGENTS WANTED

EARN Big money. Sunshine everyday cards. Take orders galore from friends for America's most beautiful everyday assortment. 14 folders. Costs 50c. Sells \$1. Also 1947 Sunshine notes, birthday, convalescent, everyday gift wraps. Samples on approval. Write today. Sunshine Art Studios, 115 Fulton St., Dept. EE1, New York City.

FEATHERBIRD Pictures, wonderful works of art from Mexico made with real colored feathers. Send \$1.00 for beautiful sample pictures and wholesale price list. Westland Sales Co., P.O. Box 1931, El Paso, Texas.

CALL On friends with greeting card assortments, Easter, birthday, other occasions. Personal stationery, gift wrappings. Big profits. Experience unnecessary. Samples on approval. Wallace Brown, 225 Fifth Avenue, Dept. D-4, New York 10.

A BUSINESS Of My Own with good earnings, my own boss, working as I please, in my own allotted exclusive territory, with cash profits coming in each day I work, and starting within one hour after I first begin. That's it. Yours if you want it and will do the demonstrating. We want area distributors where none are working now. Do you have a car? And can you demonstrate and show 2 interesting products? The daily cash profits are really big. Silver Plating Liquid (NuSilver and Replate Patent Trademarks) which silverplates onto Sterling and plated silverware, and also onto brass, copper, bronze, etc. Lectrik Silver Kleener Atomic Metal Plates for de-tarnishing silverware quick by the catalytic electrolysis magnetic process. 2 thrilling demonstrator products. Can you show and demonstrate them and take in the profits for yourself? Can you finance your starting stock order to work with? Then write to the NuProcess Products Laboratories, Dept. 268, Aurora, Illinois, for full and free particulars by return sealed mail.

\$1 STARTS You in business. Sell deluxe ties, 100% wool interlining. Costs you only \$7 per dozen, you make \$5.00 dozen. Send \$1.00 for special introductory offer two deluxe ties. Catalog complete line free. Philip's Neckwear, 30 West 22nd St., Dept. K-7, New York 10.

AMAZING New chemical discovery keeps trousers creased entire month for 4c. Gives crease knife-like edge. Write for sample and details. Sta-Rite Products, 355 Imperial Street, Youngstown 9, Ohio.

BALLOON Squawker combination \$8.00 gross. Five cent retail. Balloons \$3.55 gross. Ellsworth Balloon Headquarters, La Junta, Colorado.

BIG Bargains for big profits. Over 100 sensational values. Men's suit suits \$2.00, pants 35c, topcoats \$1.25, overcoats \$2.00, shoes 20c. Experience unnecessary. Free wholesale catalog. Superior, 1250-B Jefferson, Chicago 7.

OPERATE Profitable business selling packaging products under your own name. Lyle A Products, 5 E. Spaulding, Wiloughby, Ohio.

SENSATIONAL "Chrom-Kleen" triple action polish. Liberal profits. Sure repeats. Rabiro, 228B E. 2nd St., New York 9, N. Y.

TRIM Hair at home. Save barber bills. New invention. Simple. Easy lightning seller. Samples sent on trial. Kristee, 131, Akron, Ohio.

VETERANS—A business of your own. \$500.00 monthly possible. For proof, write Gillespie, Meadow Road, Norfolk 2, Va.

137 COMPLETE Plans for starting own business: local—mail order. Particulars free. Elite Co., 220 Grand St., New York 13.

SENSATIONAL. Send \$5 and will receive free (except duty) 52 splendid featherbird pictures (12 calling-; 13 postcards; 12 pictures 4x7"; 10 pictures 5x9"; 6 pictures 7x15"). All Mexican curiosities. G.I.E.D.A., Lucerna 63 - 8, Mexico City.

NO Money or experience required. Spare or full time writing orders for guaranteed men's hosiery. We deliver and collect. Advance profit and 33% cash bonus. Huge demand everywhere. Steady repeat business. Write for free sales outfit containing everything needed to make money. Kentcraft, 44 Court Street, Department AM, Brooklyn 2, N. Y.

SELL Liberty cigarette lighters wholesale and retail, quality product, good profit. Navy anchor, air corps wings, liberty bell emblems. Send \$1 for sample. Specify emblem desired. Ozone Sales Company, 2306 Lambert Dr., Pasadena 8, Calif.

MEXICAN Feather pictures. Unusual novelty. \$1.00 (stamps) brings \$2.00 worth samples, details. Refunded if unsatisfied. Aztec Art, Apartado 762, Mexico City.

PLASTONE—Amazing new polishes for floors, furniture, autos. Beautifully packaged. Low priced. Whirlwind seller to stores, gas stations, homes. Fast repeater. Big profits. Unconditional money back guarantee. Write for free samples offer now! Plastone Company, 2207-PM-1 West Chicago Ave., Chicago 22, Ill.

160% PROFIT: "Mirror Shadow Box," novelties, jewelry. No risk, investment. Illustrated money making, free details. Hayner House, (2) Ballston Spa., New York.

AGENTS, Distributors. \$28.00, \$140.00 per day. Flo-Glo plastic linoleum finish. Write, Acme, Box 404, Mount Vernon, N. Y.

AGENTS, Substantial profits. Repeat order product. Not mere "job" but opportunity establish steady income. Additive lubricant. Limitless field. Factories, auto-ists, service stations, fleet owners buy in huge quantities. Write Kidder Oil Company, La Crosse 1, Wis.

SELL Finger-Saddles, a necessity to beauty parlors and every woman in the country. Samples 10c. Product Specialties Co., 5220 Fischer Ave., Detroit 13, Michigan.

COLLEGE Students! 100% profits selling costume jewelry. Wm. Morris, Maywood, New Jersey.

LIVE-WIRE Agents wanted for new fast-selling household items. Big profits, easy sales, plenty of repeat business. Write at once for full particulars. E. H. Weber's Mailing Agency, Cameron 13, O.

\$15.00 TO \$25.00 A day selling stool covers to restaurants, taverns, drugs, lunchrooms, factories, etc. Write today for selling outfit. Moore's Stool Covers Mfg. Co., Kent, Ohio.

NEW Cheap oil burner sweeping the country! South Dakota manufacturer discovers how to cook, bake and heat the easy economical modern way by inventing a new low cost oil burner for coal or wood ranges, cook stoves, circulating heaters, heating stoves and laundry stoves. Larger size for furnaces. With its sensational Fuelizer Starter vaporizing system it turns cheap 130 flash furnace oil, distillate, diesel, range, kerosene and like oils into oil gas heat without clogging up the vaporizing system. No more shoveling coal or ashes—better heating, cooking and baking. Every burner has a lifetime guarantee against defects. New sales plan is one of today's most exceptional money makers and you can get your new Quik Heat for introducing in your territory. The manufacturers are so much sold on their new oil burner that they will offer you \$1.00 bonus for testing and will let you try it in your own stove, range or furnace for one month. Be first to cash in on the tremendous demand for this new oil burner by sending in your name today to Northwest Mfg. Co., 416 A. Mitchell, S. Dakota.

MYSTERY Drinking bird. Drinks constantly. Super attraction. \$3.00 prepaid. Box 1D, Blue Earth, Minnesota.

RUBERLYKE Plastic foneholder. New, novel, fast selling. Retail, 60c. Fair-traded. Everybody a prospect. You also sell retail outlets. Fits all phones. Telephone rests on shoulder. Leaves hands free. Sample 50c. Reyam Plastic Co., 1525-A-East 53rd St., Chicago 15.

A GOLD Mine selling magic needle threaders. 50 on approval \$2.00. Sell for \$5.00. Easy-PM, 712 Case Building, Rochester 4, N. Y.

AMAZING New liquid rust remover actually "foams" off rust. Works fast. Easy to use. Safe to hands. Odorless. Works miracles on cars, tools, firearms, household fixtures, towels, shirts—anything. Gold mine for agents. Over 100% profit. Whirlwind seller. Simple demonstration convinces most skeptical. Write for free details. D. M. Scott, 958 Pine St., Winnetka, Illinois.

START The new year right—get our free catalog now on hard to get merchandise. Do it now! American Merchandising, Dept. PMWC-3, 12 Adams, Montgomery, Alabama.

AT Last! Something new and sensational in everyday cards. Gorgeous satin and velour designs never before offered. Get orders fast. Big profits. 14 assortments for year 'round occasions retail 50c to \$1. Get samples on approval. Puro Co., 2801 Locust, Dept. 740-A, St. Louis 3, Mo.

SELL Full, part time individualized belts, buckles, cap badges, tie holders. 2,000 emblems to choose. Fast profits. Repeats. Write today special outfit offer. Hookfast Specialties, Box 1425, PM, Providence, Rhode Island.

EARN Money quickly, easily, pleasantly showing greeting cards, stationery, wrappings. No experience needed. Up to 100% profit. Send today for everyday assortment on approval. Free personal stationery folder. Thomas Terry Studios, 32 Union Avenue, Westfield, Mass.

100% PROFIT. History World War II. Tremendous seller. Schlake, Box 813, Cincinnati 1, Ohio.

SELL Personalized soap. Name on every cake. Ideal for gifts. Get sample offer. Dunbar Soap, New Brunswick, N. J.

FREE—Mexican novelty curiosities. Fastest selling items. Biggest profits. "Productos." Apartado 9218, Mexico City.

LOOK: Agents. Golden rays kit. New, different. Fast seller, big profits. Sample kit \$1.00. Clinton Sales Co., 237 So. 4th St., Hamburg, Penna.

EXCELLENT Sideline for printing and advertising salesmen. Decalomania name plates in small quantities. Great demand. Also make money applying initials on automobiles. Free samples. "Ralco" XL-Roxbury, Boston 19, Mass.

SELLING To housewives? Double your sales with inexpensive premiums. Postal brings interesting details. A. Kinford, Wayne, Penna.

HOUSE Numbers that glow in the dark. Luminous pictures, etc. Large mfr. wants factory representative. Wonderful new product. Fast seller. Free samples. Madison Mills, 303 4th Ave., New York City.

AGENTS—Big line including food products. Fast selling premium and bargain deals. Low prices. Send card for big profit offer with gift. Ho-Ro-Co, 2796 Dodier, St. Louis 7, Mo.

SELL Books by mail. Mammoth sales and huge profits. Everything furnished. Send 10c for complete details. Business Plans Foundation, Box 56-R, New York 10.

AMAZING Seller: "Soilless Garden Chemical." Grow plants, vegetables, fruits, flowers all year round without soil. In or outdoors. Tremendous demand. Excellent profits. Literature free. Nega & Co., 1824 W. Dickens, Chicago 14.

SCHOOL Seniors—Sell classmates America's most beautiful, distinctive graduation name cards. 40% commission. Largest selection. Lowest prices. Free cards and sample kit. Printcraft, 1425 E. Elm Street, Scranton 5, Penna.

SCHOOL Seniors! Your postal will bring our wonder, Kwick-Sell Cardalog of popular graduation name cards. Biggest profits! Only firm giving free souvenir chest and card case. Don't miss out! Hurry that postal! Craftcards, Box 235(L), Pittsburgh 30, Pennsylvania.

AGENTS—300 % Profit selling genuine gold window letters; stores and offices. Free samples. Metallic Letter Co., 438-B North Clark, Chicago.

200 MONEY Making deals. Plans, rare formulas. Schemes. Folio free. Formico Service, Box 572, Dayton, Ohio.

AGENTS: Stamping names on pocket-key protectors. Sample check with your name, address, 25c. Stamping outfits. Emblem checks, check-fobs, name plates. Hart Mfg. Co., 303 Degraw St., Brooklyn, N. Y.

\$3 FIRE Extinguisher; quick sales, wholesale or direct; liberal profits. "Fire-Killer," 109 N. Franklin, Syracuse 1, N. Y.

PLATING Outfits for autoparts, reflectors. Connect to a battery. No tanks necessary. Free booklet and particulars. Gunmetal Co., Ave. N. Decatur, Ill.

FREE Water and our concentrates, makes flavors, lotions, shampoos, 72 products, labels, bottles furnished. Qualco, E-20030 Russell, Detroit.

GOLD Lacquered window sign letters. Large sizes penny each. New foils. Absolutely beautiful. Free samples. Atlas, 544 W. 79th, Chicago 20.

HIGH-GRADE SALESMEN

SALESMEN Sell service stations new, amazing, fast chemical auto upholstery cleaner. Rub on with brush, wipe off dirt with rag. Removes oil, grease spots. Large profit for station—excellent earnings and repeat business for you. Write General Sales Co., 6655 Berthold Ave., St. Louis 10, Mo.

AMAZING New zipper shoe sells on sight. Big profits for salesmen. Leads line 200 splendid styles. Territories open. Get free sample outfit. Write, Consolidated Shoe, Dept. S-753, Chippewa Falls, Wis.

START Your own business on our capital. Always your own boss. Hundreds average \$6,000 to \$25,000 annual sales. We supply stocks, equipment on credit. 200 home necessities. Selling experience unnecessary to start. Wonderful opportunity to own pleasant, profitable business backed by world-wide industry. Write Rawleigh's, Dept. A-U-PPM, Freeport, Ill.

POSTWAR Opportunity: Sell calendars and advertising specialties. New line—25% commission plus bonus of scarce merchandise prizes such as refrigerators, washing machines and radios. Exclusive territories open. Write Texas Calendar & Specialty Co., P.O. Box 1028, Port Arthur, Texas.

SPORTING Goods salesmen make extra money by taking orders for a collapsible golf bag carrier. Write United Tool, 1795 Pasadena Ave., Los Angeles 11, Calif.

ORANGES, Most delicious, bursting full with health giving juice and vitamins, from our famous Indian River groves direct to consumers. Employers are placing now gift orders for employees and customers. Salesmen earn over \$100.00 commission weekly. Sunset Valley, Oak Hill 7, Florida.

BIG Commissions—selling to stores celluloid pricing tickets, metal shelf moulding—to restaurants, menu covers, signs. Pricing Press, 124 White St., Dept. P, New York 13, N. Y.

POCKET Pal: The all-purpose cutting tool. Wagon jobbers-salesmen. Sell to retailers and jobbers. 50c seller. Steady repeat item. Exceptional profit. Sample 25c. Nelson Mfg. Co., 222 W. Kellogg, St. Paul 2, Minn.

WAGON—Jobbers, agents! Big profits selling stores, individuals sensational ball point pen. \$2.98 retailer. Free details; also list hundreds fast sellers. Salesmanager, Box 27, Atlanta, Georgia.

TIRE Reliners. Every filling-station a prospect. Hottest item in years. Allied Rubber Company, East St. Louis, Illinois.

SELL Record of Service certificates. All data from discharge paper may be copied on certificate for framing. Sales made easily. Sample \$1. Wilbur Sales Company, Box 451, Plymouth, Mass.

QUICK Profits with individualized belts, buckles, cap badges, tie holders, uniforms. Choice of thousand emblems. Sure repeat orders. Easy-selling outfit offer. Write Hook-Fast Company, Dept. 12, Roanoke, Virginia.

EXCELLENT Sideline for printing salesmen. 300% profit. Samples 25c. "Acme," Oblong, Illinois.

WAGON Salesman—Fast moving carded goods and 10c line. Long profit. Free facts. Peerless, 2717 Dodier, St. Louis 7, Mo.

FREE! Latest issue Opportunity Magazine. Salesman's Guide. Inspiring, constructive. Shows how to earn money selling for others or in your own business. Hundreds postwar opportunities. Send name and describe what you have sold or are selling. Illustrated copy sent free. Opportunity Magazine, 620 N. Michigan, Dept. 17, Chicago 11, Ill.

AGENCIES WANTED

HARDWARE Agency wanted for Quebec and Ontario, Canada. 27 years experience. Henry Lefebvre, 4766 Notre-Dame Street West, Montreal, Que., Canada.

EDUCATIONAL AND INSTRUCTION

GOOD Jobs and a sound, substantial future await you in hotel and institutional field. Men and women—all ages—needed for well-paid positions that offer color, excitement, ever-new and fascinating duties. Record-breaking travel means even greater opportunities for trained men and women in hotels, clubs and institutions. Lewis School receiving calls for managers, assistant managers, stewards, hostesses, purchasing agents and 55 other types of important positions! From coast to coast there are important positions that offer splendid opportunities for advancement in a business where you are not dropped because you are over 40. Previous experience proved unnecessary! No need to leave your job to qualify. A good grade school education, plus Lewis Training qualifies you at home, in spare time. Our National Placement Bureau helps to place you—and our amazing Certified Job Plan—actually certifies you will "make good" when placed. Write today for free book! Veterans: This course approved for veterans' training. Lewis Hotel Training School, Room LA 368, Washington 7, D. C. (First and only school of its kind—now in its 31st year.)

DRAFTING: Learn mechanical drafting. Set of six prints 12" x 15" with instruction notes. Prints taken from same drawing as drafting progressed from start to finish. Showing the six steps for making a drawing. Price \$3.00. Vincent B. Southard, Box 361, Worcester, Mass.

"INDUSTRIAL Engineering the sure road to success." Learn this profitable profession now under personal supervision of internationally known professional engineer. Write for free copy of "Your Start in Industrial Engineering." Herbert G. Heckatsweiler, 3355 North Olcott Avenue, Chicago 34, Illinois.

LEARN Landscaping. Profitable, healthful career—absorbing hobby, for men, women. Thorough 45-lesson home-study course takes 8-12 months spare time. Hundreds of successful graduates. 31st year. Send for free catalog. American Landscape School, 6393 Grand Ave., Des Moines, Iowa.

"HOW To Break and Train Horses"—a book every farmer and horseman should have. It is free; no obligation. Simply address Beery School of Horsemanship, Dept. 1101C, Pleasant Hill, Ohio.

HAVE An office. Many earn up to \$5,000-\$15,000 annually. Learn credit-collection agency business by home study course. Write for free bulletin. Franklin Credit School, Dept. 202-A, Roanoke 7, Virginia.

GOOD "Used" self-instruction educational books on all subjects bought, sold, rented, exchanged. Satisfaction guaranteed. Complete information and 100-page illustrated bargain catalog free! Write—Nelson Company, Chicago 5.

GET Gov't job! Inexpensive, keyed lessons, prepare you for examination. Write, Ozment School, 75, St. Louis, Mo.

USED Educational books on all subjects sold, rented, also bought and exchanged. Moneyback guarantee. Write today for free catalog and details. Lee Mountain, Pisgah, Alabama.

INVESTIGATOR Training. Phillips Secret Service, 1917B North Kenneth, Chicago 39, Ill.

ANALYZE Handwriting. Unlimited opportunities. Amateur or professional. Illustrated course including free individual analysis \$1.98. Mayer, 681-P Market, San Francisco 5, California.

PREPARE For civil service examination Pay for course after securing position. Write Free School, Dept. PM-3 Kokomo, Ind.

RESORT Hotel positions. Summer, winter. Travel. Beginners trained. Lee Institute, Winthrop Building, Boston 9.

MASTER Success secret revealed. Magnetic, compelling speech gets you what you want. Guaranteed instructions now yours, only \$2. Exciting details free. Trissell-Heymann, Box 896, Mason City 1, Iowa.

WRITERS! Want to sell? Experienced editor, author, teacher works with you. Free details. Studio Story Method, Dept. PM2, Box 1046, Spokane 4, Wash.

3800 DIFFERENT Correspondence courses. Catalogue 10c. EG Co., Elmsford 1, N. Y.

\$1756-\$3021 YEAR! U. S. Government jobs! Permanent. Dependable. Liberal vacations with pay. Men-women. Prepare immediately for 1947 examinations. 32-page civil service book—sample coaching—list positions free. Write today. Franklin Institute, Dept. D24, Rochester, N. Y.

LEARN Detective-Fingerprint work. Frank Mashak, 6419 Woodrow, St. Louis 20, Missouri.

DISTILLERS Correspondence course; formulas learned easily. Full course mailed at once. Six months to complete. \$50.00 cash. Instructor practical distiller for 37 years. McLanahan's Distillers' School, 639 Highland Avenue, Aliquippa, Pennsylvania.

WRITE For details of mail carrier, railway mail, forestry and park exams. \$2,100-\$3,000 year. Delmar Institute, M-11, Denver, Colo.

TYPEWRITING Learned in 10 lessons guaranteed (your home); Also: shorthand, bookkeeping including accounting—ninety hours each; low rates, secret of "Psycho-Method," either course \$2. Osborne College of Short Methods, 212 West Third Street, Los Angeles 13, California.

BECOME A Doctor of Psychology or Metaphysics. Teach secret of contentment, happiness. Win degree of Ph.D. or Ms.D. Solve mental worries. Free book. College of Universal Truth, 5153-B North Clark, Chicago.

ACCOUNTANTS Make big pay. We will train you for one of these good paying positions at home in your spare time. No previous knowledge or experience necessary. Write today for free information and aptitude test. Modern School of Accounting, Dept. P.M., 735 No. Throop St., Chicago 22, Ill. A Correspondence Institution.

LEARN Radio at home. Earn money. Have fun building our "educational radio kits." We teach you every step. Simple, easy to understand instructions. Free literature. Write immediately. Chapin Electronics, Inc., Dept. A., 134 W. Onondaga, Syracuse, New York.

LEARN Magic shorthand and typewriting. Complete home study course, 50c. Efficiency, Box 167, Los Angeles 53, Calif.

USED Correspondence courses and educational books bought, sold, rented; catalog free. Educational Exchange, Henagar, Ala.

BUSINESS College home courses. Speedy mathematics, bookkeeping, accounting, shorthand, typewriting, business law. \$1.00 each. Four for \$2.98. Government service information free. Vocational Institute, Box 434C, Duluth, Minn.

SECRET Investigation. Experience unnecessary. Investigators particulars free. George Wagner, M 125 West 86th, New York.

LEARN Commercial and domestic sewing machine repairing. Big demand for trained men in men's wear, ladies' wear, shoe factories etc. Complete home study course, \$25.00. Easy terms. Write for free particulars. Sullivan, Box 286, Ilion, N. Y.

BIG Money rebuilding shoes. Help needed everywhere or start big-income business of your own. Learn practical, sure, easy way in 3 months. Anyone from 18-60 years can learn easily. Approved for GI training. Rush postcard today. Modern Shoe Rebuilding School, Est. 1927, 2935 Belmont, Chicago 18, Illinois.

SENSATIONAL New magic shorthand and typing course, even a ten year old child can understand it. 25c postpaid. Streamline leather zipper wallets. Detail for stamp. Falk, McCarty, Rt. 6, Waco, Texas.

ANALYZE Handwriting for fun, knowledge, and profits! Full instructions. \$1.95. Details free. N. W. Oliver, Box CB, Mansfield, Tenn.

SELL Real estate. We teach you. R. J. Anderson, 551 Dickinson E., Grand Rapids 7, Mich.

CHIROPODY Evans Natural Therapeutics Home Study Course. Foot Correction Massage Supports General Knowledge of Feet. Excellent for Shoe Salesmen. Assistants, etc. P.O. Box 1195, San Antonio 6, Texas.

29 LANGUAGES By Linguaphone. Russian, Spanish, Portuguese—Direct conversational method for mastering any language quickly, easily correctly at home. Available under G.I. Bill of Rights. Send for free book. Linguaphone Institute, 83 RCA Bldg., New York 20.

LEARN Appliance and building repair business. Simplified Free literature Cline-Porter, Box 6346F, Pittsburgh 12, Penna.

MASSO-PHYSIO-THERAPY Home study course. Massage, diet, baths, etc. Dignified profession. Evans Nat'l Therapeutics Courses, P.O. Box 1195, San Antonio 6, Tex.

HOW To tri-sect an angle by geometry. Copyrighted instruction and geometric proof \$1.00. Novel Products, 60 E. Marion, Youngstown 2, Ohio.

STUDY Real estate at home. Free bulletin. DeVoto Realty Schools, 35 Vicente, San Francisco 16, Calif.

BRIEFSRIPT—Simple, speedy, ABC shorthand, 50c. Eastern Book Co., 203 E. 18 St., New York.

MODERN Welding school gives thorough training for one of industry's best paid jobs. Experienced instructors. Individual attention. Non-profit institution. Qualified under G.I. Bill. Write for literature and details. Hobart Brothers Co., Box M-1067, Troy, Ohio.

HOME Bible course. Simple, helpful, instructive. Total cost \$3.00 includes textbooks, stationery, examinations, certificate. \$1.00 starts you, or simply request prospectus. The Bible Study School, Reverend Leslie Marshall, Secretary, 382 Van Houten Street, Paterson 1, N. J.

LEARN Photo-engraving at home or in oldest, largest school in America. Work for newspaper or establish own profitable business. New Tasope' Photo-Engraving equipment available soon. Write for information. Veterans ask about G.I. training. The Aurora School of Photo-Engraving, Tasope' Bldg., Aurora, Mo.

MEDICAL Laboratory technicians in great demand. We train you in your spare time, in your own home. You can practice while studying. Write for free catalogue. Imperial Technical Institute, Box 973-E, Austin, Texas.

PLAYS, STORIES, MANUSCRIPTS

WRITE Stories that sell. Learn how. Free particulars. Herbert Enstice, Dept. A, Box 353, Asbury Park, N. J.

POETS. We want your poems for publication consideration. Details free: J. Barnes Publisher, Box 490, Times Sq. Station, New York 18, N. Y.

LEARN To write stories (The Short Line Way). Complete instructions, \$1.00. Mastercrafter, Box 2667, New Orleans, La.

I WANT New writers to cash hundreds of checks for \$1 to \$100, offered each month. The easiest way to write for pay. No previous experience necessary. Send for free details. No obligation. Saunders M. Cummings, 467-M Independence Bldg., Colorado Springs, Colo.

WIN Fame, success, security writing short stories, newspaper features. New, easy plan shows you how. Write today for exclusive details. Writer's Institute, 4-M So. 15th St., Philadelphia 2, Penna.

NEW Writers needed to rewrite ideas in newspapers, magazines and books. Splendid opportunity to "break into" fascinating writing field. May bring you up to \$5.00 per hour spare time. Experience unnecessary. Write today for free details. No obligation. Postcard will do. Comfort Press, Inc., 210-P South Seventh St., St. Louis 2, Missouri.

BUSINESS SERVICE

BUSINESS And personal representation in world's principal cities. Associates wanted everywhere. Suite 665, 120 S. La Salle, Chicago.

YOUR Bookkeeping, accounting, taxes questions answered. \$1.00. Box 526, Jamaica, N. Y.

LOS Angeles and California questions answered regarding employment, climate, business conditions, property prices, rentals, etc., answered completely \$1.00. Ranthum, 731 W. 9th St., Los Angeles, California.

\$2.00 MONTHLY Maintains Washington, D. C., "capital address." Your business, personal mail reforwarded when wanted. "Hawkins," (Established 1917), 1300-C Taylor.

TO Whom it may concern: We will represent you in all principal cities of the world. Personal or business assignments \$1 per hour. James W. Farley, Citizens Bldg., Cleveland 14, Ohio. Note: Would appreciate hearing from someone who wishes to enter this business in your city. Will send you assignments immediately. References exchanged. State qualifications.

SPECIAL SERVICES

GOOD "Used" self-instructional books on all subjects bought, sold, rented, exchanged. Satisfaction guaranteed. Complete information and 100-page illustrated bargain catalog free! Write—Nelson Company, Chicago 5.

YOUR Baby's shoes beautifully preserved in bronze plasticized finish. \$2.85 pair, \$1.50 single shoe. Baby Art Studio, 8245 S. Rhodes, Chicago 19, Ill.

DRAFTING, Mechanical, supervision licensed engineer. Reasonable. Engineering Institute, 7805 M Essex, Chicago.

GLOBAL Mail—Travel on beggar's pittance. Confidential information 3c postage. Travelpost, Box 1449, Palm Springs, Calif.

SURPRISE Your friends from Miami Beach; 3 beautiful picture cards, 25c. You address and return, we mail. Letter mailing service \$2.00 monthly, 25c each. Title or tax search anywhere South Florida, reasonably done. "Raymond for Service," Box 2733, Miami 17, Fla.

CARTOONING, COMMERCIAL ART, SHOWCARD WRITING, SIGN PAINTING

"HOW To Make Money With Simple Cartoons"—a book everyone who likes to draw should have. It is free; no obligation. Simply address Cartoonists' Exchange, Dept. 91-C, Pleasant Hill, Ohio.

SELL Your cartoons—"Cartoonists Sales Guide" tells how! Where! Lists highest paying cartoon markets today. Cash in now, send \$1.00. Cartoonists' Counsel, 4622 W. 61st Street, Mission, Kans.

EARN Money evenings, copying and duplicating comic cartoons for advertisers. Adservice, Argyle (1-B), Wisconsin.

MAKE Signs. 9 complete alphabet pattern sets. 3 complete numeral pattern sets and catalog \$1.00. Sign Letter Distributors, P.O. Box 101, Mineola, N. Y.

ARTISTS—Students: Auto-scale saves half time copying, enlarging, reducing drawings. Guaranteed. \$3. Particulars free. Disco, Box 761, Glendale 5, Calif.

CHALK Talks. Laugh producing program, \$1.00. Catalog 10c. Balda The Cartoonist, Oshkosh, Wisconsin.

ADVERTISING AGENCIES, LETTER WRITERS, FOR ADVERTISERS

EFFECTIVE Sales letters and booklets written on any subject, \$3.00 per page. Satisfaction guaranteed. Dudley Bunn, 126-PM Lexington Avenue, New York 16.

ADVERTISE Profitably: \$20.00 reaches 5,000,000 Sunday newspaper readers with 24-word ad. Newspaper, magazine, mailing-list ratebook free. Chicago Advertising Agency, 20-PA W. Jackson, Chicago 4.

GUARANTEED Successful mailorder letters, circulars, complete campaigns, developed. Long, successful experience. Investigate! Finkle Advertising, 408-P South Spring, Los Angeles, California.

SALES Letters rewritten into result getters! \$5 page. Universal, 162 N. State, Chicago.

HOW To write letters that sell—\$2.00 postpaid. Satisfaction guaranteed. Free details. Letter Company, 109P East Ninth, Ft. Worth 2, Texas.

INCH Display advertisement, Mailorder World Year \$24. Wood's Popular Services, Atlantic-City, N. J.

ADVERTISE: 24 Words, 40 newspapers \$3.50. Lists free. Advertising Bureau, 4515-C Cottage Grove, Chicago 15.

ADVERTISING Service, art work, C. Sanford, 5029 Maple, St. Louis, Mo.

MAKE Much more money from classified advertising. We show you how. Booklet free. Machen & Co., Station "F," Toledo, Ohio.

ADVERTISERS! Reach nearly 18,000,000 readers. 25 Sunday national key newspapers, 18 words, \$42.25. "Terrific pullers." 20 popular newspapers, \$8.50. "Free booklet." Special—One inch display 2,600,000 circulation, \$32.90. Newmark's Advertising Agency, (Established 1893) 217-7th Ave., New York 11.

AMERICAN Advertisers—Your 24 words ad in 140 Canadian Weeklies once \$8.00, three times \$16.00. Circulation over million. Proofs sent. J. M. Lever, P.O. Box 38, Dept. PM, Baie Comeau, Que., Can.

MAILING Lists, certified, productive, inexpensive, \$5.00 1000. Homeworkers, agents, buyers, etc. Write Dixie Service, King, N. C.

FREE! 1946 Advertisers Rate & Data Directory. 52 pages! E. H. Brown Advertising Agency, 20 N. Wacker, Chicago 6.

24 WORDS in 64 weeklies \$4.96. H. J. Darnell, 730 Hays, Jackson, Tenn.

ADS Placed in out of town newspapers and magazines. Low rates. Catalogue free. Ideas that pay. Baker Advertising Agency, Successors Ankrum Agency, 189 W. Madison, Chicago 2.

TYPEWRITERS, DUPLICATORS, OFFICE DEVICES

"PRINTOMATIC" Selffeeding post card stencil printing duplicators \$9.50 up. Office size duplicators, Speedprints, Hilcos, Excelligraphs \$33.41 up. Literature free. Pittsburgh Typewriter Supply, 336-WK Fourth Avenue, Pittsburgh 22, Penna.

NEW, Lightning portable adding machine, \$12. Romme, Office Equipment, 109 Atlantic, Stamford, Conn.

RECONDITIONED Typewriters, mimeograph, multigraph printing devices, appliances, supplies. Catalog. Dixiegraph Service, King, N. Carolina.

RUBBER STAMPS & OFFICE SUPPLIES

RUBBER Stamps, all kinds, Catalogue 10c. Print & Stamp Co., Box 172, Boston 1, Mass.

PICTORIAL Rubber stamps, sample (flag) 25c. Stamporium, 8833M Quincy, Detroit 6, Mich.

KNOB Handle, 1 line 35c, 2-45c, 3-55c. Stamp Works, Centerport, N. Y.

RUBBER Stamps, 3 lines 40c. Signatures \$1.75; pads 25c. Stamprite, Wauwatosa 13, Wis.

FAST Service on rubber stamps. Send for literature. Lee-Vall Press, Box 1242, Indianapolis 6, Indiana.

PRINTING, MULTIGRAPHING, MIMEOGRAPHING, GUMMED LABELS

5000 GUMMED Labels 2" x 1 1/4", \$5.50, postpaid, 25 words. J. Barnes, Publisher, Box 490 Times Sq. Station, New York 18, N. Y.

75 HAMMERMILL Letterheads with envelopes \$1.00. Price list. Benneville Printing, Box 1931, Pittsburgh 30, Penna.

250 LETTERHEADS \$1.50. Envelopes same. Mallo, 767 Leith, Flint 5, Mich.

3 x 6 CIRCULARS 2,000 \$3.00 Postpaid, 100 words. Schultheis, Box 449, Irwin, Penna.

PRINTING, Mimeographing. Best and cheapest in the country. Imprint, Emporia, Kansas.

1000 BUSINESS Cards \$1.25 postpaid. Shufeldt, 10 Minerva Place, New York 58.

1000 FOUR Line stickers, \$1.00. Imprint, Box 361, Emporia, Kansas.

1000 BUSINESS Cards \$2.50 postpaid, samples. Cressman, Washington, New Jersey.

500 REGAL Quality business cards \$3.50 postpaid. Regal, 747 1/2 So. 12th St., Salem, Oregon.

SALES Books, prompt delivery, free sample. Doerr Printing, Lewiston, N. Y.

1000 BUSINESS Cards \$2.50, prepaid. Reliable Print Shop, 901 E. Jefferson, Louisville 6, Ky.

100—8½ x 11 LETTERHEADS And 6¼ envelopes, \$1.25. Sturgill's, Arno, Va.

500 VICTORIA Laid, two color, letterheads, 500 envelopes \$8.55. Guaranteed. Lighthouse Press, 3404 S. Figuerora St., Los Angeles 9, Calif.

MIMEOGRAPHING. Highest quality. Reasonable. Letter Service, Box 1849, Chicago 90, Illinois.

SPECIAL Offer: 250 fine quality business cards. Unequaled in value for only \$1.00 prepaid. Prompt service. Satisfaction guaranteed. Acme Press, Box 264, Elkhart, Ind.

PHOTO-OFFSET. Printing, multigraphing. 3-day service. Samples free. Mango, 555-A South 20th, Newark 3, N. J.

QUALITY Printing, reasonably priced. Send copy, free estimates. Wood, 9 Arapahoe, West Hartford, Conn.

SEND 10c Now, for our 36-page 1947 pricelist—refunded first order. McCall Press, 1326 South 27th, Omaha, Nebraska.

MIMEOGRAPHING Specialists— Any copy. Reasonable. Mailers Service, Box 606-A, Chicago 90, Ill.

150—8½x11 HAMMERMILL Letterheads \$1.00 postpaid. Envelopes same. Race Printing, Hudson, New York.

QUALITY Printing: Business, personal stationery. Prepaid delivery. Samples free. Mero Products, 100 Morrison, Punxsutawney, Penna.

BETTER Printing, attractively priced! Letterheads, envelopes, booklets, cards, labels. Samples, estimate free. Lonelm Publishers, Paulding, Ohio.

BETTER Grade printing reasonable. Estimates on anything. Economic Press, Leonia, N. J.

500 ¾x2¼ FOUR Line gummed stickers, 25c. Moritz Printery, Saginaw, Mich.

MIMEOGRAPHING— Letters, pricelists, formulas, instructions. Lowest prices. Lem's Letter Shop, 5710 Stanton, Detroit 8.

PRINTING OUTFITS AND SUPPLIES

PRINTING Equipment, type and supplies. Send stamp for details or dime for complete illustrated supply book. Kelsey Inc., X-11, Meriden, Conn.

PRINTERS Galley, small printers magazine. Interesting informative articles. Copy 10c. Steiner Publications, Rockwell Road, Danbury, Connecticut.

CUTS— Make real halftones, line cuts yourself! Samples 25c. Particulars free. Rapid Chemical Service, Edwardsville, Ill.

MAKE Your own printing press, cuts, halftones easily. Pilgrim, Box 194, Springfield, Mass.

PRINTERS, Make a quick-etch etcher for cuts, halftones. Details. Charles Medlock, Box 256C, Goodland, Indiana.

PRINT At home—Send 10c for catalogue—presses, type, supplies. Barnhard Co., 6 Columbia St., Newark 5, N. J.

HOME-MADE Presses. Proofs free. Riegel, 1111 Harrison, Phila. (24), Penna.

INEXPENSIVE Home-made printing press. Details free. Novelty Shop, Downsville, Louisiana.

PATENT ATTORNEYS

INVENTORS: Learn how to protect your invention. The patent laws were enacted for the benefit of the inventor to give him protection for the features of his invention which are patentable. The United States Patent Office advises the inventor to engage a competent, registered patent attorney to represent him. We offer inventors experienced, conscientious counsel and prompt, confidential service. A specially prepared booklet containing detailed information concerning patent protection and procedure with "Record of Invention" form will be forwarded to you upon request—without obligation. Clarence A. O'Brien & Harvey Jacobson, Registered Patent Attorneys, 71B-A District National Building, Washington, D. C.

INVENTORS— Patent laws encourage the development of inventions. The Rules of Practice of the U. S. Patent Office advises—unless an inventor is familiar with such matters—that he employ a competent registered attorney, as the value of patents depends largely upon the skillful preparation of the specifications and claims. Write for further particulars as to patent protection and procedure and "Invention Record" form at once. No obligation. McMorror, Berman & Davidson, Registered Patent Attorneys 1349 Victor Building,

PATENT Protection—The U. S. Patent Office recommends—"an applicant is advised, unless familiar with such matters, to employ a competent registered Patent Attorney, as the value of patents depends largely upon the skillful preparation of the specifications and claims." Steps to be taken in obtaining patent protection will be sent upon request. Victor J. Evans & Co., 231-A Merlin Building, Washington 6, D. C.

"PROOF Of Invention" folder mailed without obligation. E. E. Vrooman, Registered Patent Attorney, 871 Woodward Building, Washington 5, D. C.

MEXICAN Law. General practice attorney. 1203 Arizona Street, El Paso, Texas.

PATENT And Trade-Mark Practice before U. S. Patent Office. Validity and infringement investigations and opinions. Booklet and form "Evidence of Conception" forwarded upon request. Lancaster, Allwine & Rommel, Registered Patent Attorneys, Suite 411, 815-15th Street, N.W., Washington 5, D. C.

"INVENTOR'S Guide" free on request. Frank Ledermann, Registered Patent Attorney, 154 Nassau St., New York 7, N. Y.

INVENTORS: Write for free brochure "Evidence of Invention." Labiner, World Building, New York 7.

C. A. SNOW & Co., M-427 Snow Bldg., Washington 1, D. C. Registered patent attorneys. Established 1875. Literature mailed on request.

INVENTORS: Without obligation, write us for information as to what steps an inventor should take to secure a patent. Randolph & Beavers, Registered Patent Attorneys, 21-C Columbian Bldg., Washington 1, D. C.

PATENTS— Trade marks. Irving L. McCathran, 315 McLachlen Bldg., Washington 1, D. C. Registered Patent Attorney.

FOR INVENTORS

INVENTORS— Patent laws encourage the development of inventions. The Rules of Practice of the U. S. Patent Office advises—unless an inventor is familiar with such matters—that he employ a competent registered attorney, as the value of patents depends largely upon the skillful preparation of the specifications and claims. Write for further particulars as to patent protection and procedure and "Invention Record" form at once. No obligation. McMorror, Berman & Davidson, Registered Patent Attorneys, 1348 Victor Building, Washington 1, D. C.

"HOW To Create New Ideas." \$3.00, postpaid. Practical daily working plans for inventors, writers, advertisers, business executives, others. Consultation service included. Satisfaction guaranteed. Dudley B. Bunn, 126-A Lexington Avenue, New York 16.

INVENTORS: Learn how to protect your invention. The patent laws were enacted for the benefit of the inventor to give him protection for the features of his invention which are patentable. The United States Patent Office advises the inventor to engage a competent, registered patent attorney to represent him. We offer inventors experienced, conscientious counsel and prompt, confidential service. A specially prepared booklet containing detailed information concerning patent protection and procedure with "Record of Invention" form will be forwarded to you upon request—without obligation. Clarence A. O'Brien & Harvey Jacobson, Registered Patent Attorneys, 71A-A District National Building, Washington, D. C.

INVENTORS! Have you good, patentable ideas? Write Patent Agent Metzler, 11 West 42nd, New York.

INVENTIONS Wanted—Patented, unpatented. Cash waiting. Royalty or outright. Complete inventor's service. Financial assistance to those starting own company. Suite 665, 120 S. La Salle, Chicago.

CASH For practical ideas and inventions. Mr. Ball, AB-9441 Pleasant, Chicago.

INVENTORS— Victor J. Evans and Co., established 1898, has a staff of registered patent attorneys, available to represent inventors in the preparation and prosecution of their cases before the Patent Office. Detailed information and the steps to be taken to obtain patent protection will be furnished upon request. Victor J. Evans & Co., 232-A Merlin Building, Washington 6, D. C.

INVENTORS— See advertisement Carson Consultants page 262. New booklet "What An Inventor Should Know" wealth of reliable, concise, essential information about patents, expenses, models, manufacturer contacts sales potentials of inventions.

INVENTORS:—Six monthly installments pays preparation, filing, etc., United States Patent Application by my Washington, D. C. Registered Patent Attorney. Inventions sold, patented, unpatented. Have buyers waiting. Yours may fit one of 500 classifications. Details free. Charles R. Morton, Patent Broker, 11 West 42nd St., New York.

PATENTED, Unpatented inventions promoted. M. Joyce Humphries, 1424 Landtitle, Philadelphia 10, Penna.

"INVENTOR'S Guide" free on request. Frank Ledermann, Registered Patent Attorney, 154 Nassau St., New York 7, N. Y.

SAVE \$200 And 12 months time cashing in on your invention. Booklet written by experienced inventor gives complete details of tested system, 50c postpaid. W. Parry, 1503 Oxford, Berkeley, Calif.

INVENTION Date proof—Aabberly Routine \$2. Guaranteed safer, stronger than registered letter or "copyrighting." Secret—even from me! Nicholas Aabberly, Patent Engineer, Woodward Building, Washington.

A LIST Of 100 manufacturers used by an inventor who has invented over 80 new articles this year, also advice on unpatented inventions. Only \$1.00. 6537 20th N.E., Seattle 5, Wash.

INVENTORS: Don't put the cart before the horse. Before investing money in models, patents, etc., find out about your invention's commercial possibilities. New free bulletin "A 12 Point Program for Inventors," explains expertly developed marketing, merchandising, sales and protection service covering both patented and unpatented ideas. Write: Room 412c, Abbott Bldg., 28 E. Huron St., Chicago 11, Ill.

MANUFACTURING. Stamping, designing, developing and experimental work; tools, dies, jigs, fixtures. Models made by experts. A complete service available once again following interruption by war work. Technical Development Co., 157 Chambers St., New York City 7. (Dept. M-12).

INVENTORS: You save up to 300% when dealing with your patent searcher direct. Complete search with patent copies \$6.00. Reports mailed in 5 days. Invention protection forms free. Write Raymond L. Smith, Patent Searcher, 703-M Albee Building, Washington 5, D. C.

INVENTORS— Your commercially valuable invention, any kind, patented, unpatented, may have cash, royalty possibilities in today's markets. Write today. Explanatory booklet, disclosure form, references, free. Invention Reporter, 5A-11106 So. Longwood Drive, Chicago 43.

I SELL Patents. Established in 1900. Charles A. Scott, 773PM Garson Ave., Rochester, N. Y.

THE inventor who believes he has a new and useful invention, and needs advice, should consult a competent registered patent attorney. Without obligation, write for full information on how to secure patents and trademarks. Randolph & Beavers, Registered Patent Attorneys, 11-E-Columbian Bldg., Washington 1, D. C.

INVENTORS: Avoid unnecessary expense. Write for free booklet explaining how our consulting and advisory service can assist you in deriving greatest profit from inventing. Institute of American Inventors, Dept. 40-A, 1926-Eye St. N.W., Washington 6, D. C.

INVENTIONS WANTED

INVENTORS! Have you good, patentable ideas? Write Patent Agent Metzler, 11 West 42nd, New York.

WANTED: Practical inventions by manufacturers, patented or unpatented. John D. & Son, Dept. PM-1, Box 3213, 285 Howard Ave., Bridgeport 5, Conn.

EARN Up to \$2,000 year, inventing simple items for special cash markets. Ideas only. No patents. Hendrickson, Argyle (7-B), Wisconsin.

WANTED: Practical inventions for marketing through chain, drug, and cigar stores. Particularly desire lighters, smoker's articles, etc., in plastic, wood or metal. Write Matt, 1412-DN Great Northern Bldg., Chicago 4.

CASH For inventions, patented, unpatented. Mr. Ball, A-9441 Pleasant, Chicago.

INVENTORS: Hundreds of manufacturers have requested our assistance in locating marketable new products. Complete information, free. Institute of American Inventors, Dept. 40-D, 1926-Eye St. N.W., Washington 6, D. C.

WANTED—Patented, unpatented inventions having profit possibilities, all kinds. If will sell, reply immediately. Descriptive booklet, references, free. Invention Reporter, 5B-11106 So. Longwood Drive, Chicago 43.

PATENTS FOR SALE

LIGHT Draft implement that will kill weeds after furrow drills. Patent pending. Will sell for part cash and royalty basis. Frank Rada, Box 735, Great Falls, Montana.

HAVE Several inventions for household use. Write, Elizabeth Edmonds, 4626 Indiana, Chicago 15, Ill.

HAVE Small item, keyhole illuminator, want someone to manufacture and distribute, royalty basis, patent pending. Frank Amico, 108 Pershing Dr., Rochester 9, New York.

JUST Patented. Card game for chain store business. Royalty basis. Information to manufacturers only. Oh-Kay Games, Box 127, Wilkes-Barre, Penna.

INVENTORS—Your patented, unpatented invention, if practical, may have specific cash, royalty value in correct markets. Find out now. Explanatory booklet free. Invention Reporter, 5D-11106 So. Longwood Drive, Chicago 43.

INVENTORS: Test the commercial value of your patented or unpatented inventions, quickly and inexpensively. Write for free information. Institute of American Inventors, Dept. 40-B, 1926-Eye St. N.W., Washington 6, D. C.

MODELS—Small lot manufacturing. Metals, plastics, etc. Milburn, Burlington, Kentucky.

MANUFACTURING

A BRAND New inventor's service. Write for information. J and M Company, Burlington, Kentucky.

MODELS Developed and built. Small run manufacturing. The Thompson Engineering Co., 206-C Winchester Bldg., Grand Rapids 2, Michigan.

MANUFACTURERS What have you to sell? I'll sell in Washington state. Lou Curtis, Manufacturer's Agent, 214 East 17th, Olympia, Washington.

NAME Plates for manufactured products. Etched metal. Ad-Craft, LaCrosse, Wis.

PLASTIC Molding and fabricating. Any quantity. Quick service! Plastic Products Co., 211-7th St. S. E., Canton, Ohio.

INVENTORS. Precision lathe work our specialty. Send sketch. Ideal, Box 142, N. Hackensack, N. J.

MODELS AND MODEL SUPPLIES

IT Sails! Beautiful, 3 masted schooner, coasting type with 2 realistic holds. Not built the usual tedious manner, uses scrap materials. 2 large plans and full instructions. \$1.00. Milton Sailing Models, Box 466, Rye, New York.

CATALOGS (Illustrated) for modellers! Airplanes, 60 page book on solids. Features construction data, specifications, camouflage, 15c. Railroads: 128 page "HO" guide. Equipment, accessories, fittings, 25c (includes refund coupon). Send coin or stamps for each profusely illustrated catalog desired. Polk's, "Nations Leading Hobby House," 314 PM Fifth Ave., New York City 1.

WORLDS Greatest rotary valve high speed model steam engine literature free. Amstoy Mfg. Co., Box 2638, Gravois Station, St. Louis, Mo.

WIZZ Electric motor. Flashlight cell operates. Parts plus instructions 35c. "Mighty Midget" model 30c. Eltro 171B, Deer Park, N. Y.

DYNA-Jet famous miniature jet gasoline engine for planes, boats, cars. Guaranteed deliver 3 pounds thrust. \$24.50 ready to run. Aeromarine, 5201 Old Springfield Pike, Dayton, Ohio.

SHIP Modellers should use the new superior molded plastic blocks, deadeyes. Dealers wanted. Send for price list. Gullmars, Westhill, Ontario.

MAGNESIUM Dowmetal for light weight construction now available in miniature extrusion structural shapes and .032" and .064" flat stock. If your dealer or jobber cannot supply you, write for size and prices to Sims & Associates, 464 Neff Road, Grosse Pointe, Michigan.

SHIP Models, coaches, covered wagons, blueprints, supplies, catalog 25c coin. R. E. Hancock, 323 Douglas Ave., Portsmouth, Virginia.

SHIP Model kits and fittings, most complete stock in New England. Boucher, Fisher, Marine Model and Model Shipways fittings, blueprints and model yacht equipment at standard prices. Send 25c for new illustrated 1947 catalog and price list. Dept. M, James Bliss & Co., Inc., 220 State Street, Boston, Mass.

LANDLOCKED Sailors! Here's a beautiful, richly illustrated, fully descriptive catalogue of famous model ships—whalers, slavers, corvettes, etc., authentic in every detail. Send for it today. Only 10c. Halesite Yacht Service, Inc., Halesite, Huntington, N. Y.

SHIP and Yacht model fittings; blueprints. Send 25c for illustrated catalog No. 20—listing hundreds of items. A. J. Fisher, 1002-1 Etowah Ave., Royal Oak, Mich.

STEAM Engines, boilers, castings. Catalog 25c. Anton Bohaboy, 2297 Price, Rahway, New Jersey.

BALSA Wood. Ideal for modelers, craftsmen. Sample carving block, 25c. List free. Sanlader, Manitowoc, Wis.

MIDGET Electric motors, 145 or 250 r.p.m., 27 v. d.c. Reversible. \$2.35. With gear reduction to 2 r.p.m., \$5. Postpaid. Eresco, 1006 Hewitt, Everett, Washington.

MIDGET Steam engines \$2.98, boilers \$2.65. Stamp for literature. R. Looker, Box 105, Michigan City, Indiana.

REMEMBER. When selecting model equipment at GMCO, you will find a complete stock of model airplanes, gas engines, ship models, railroads, race cars, supplies and tools. Chances are we have just what you want in stock. Send 25c for your copy of our new catalogue to GMCO Modelcraft Hobbies, 91-17 (M11) 173rd St., Jamaica 3, New York.

BRASS Gears and model supplies for the inventors. Send 10c for catalog. Pierce Model Works, Tinley Park, Ill.

FREE Catalog of model trains, airplanes, ships, accessories and tools. Ben's Hobby Company, 72 West Washington, Chicago 2, Illinois.

BUILD Model ships, airplanes, railroads. Catalog 10c. Ideal, 21 West 18th Street, New York 11, N. Y.

ENGINE Castings. Supplies. Catalogue 10c. Howard A3, 2417 N. Ashland, Chicago, Ill.

RAILWAY Models, complete line, 128 page catalog, HO and O gauge 25c. Walthers, 247 Erie, Milwaukee 2, Wis.

BIG Illustrated model engine catalog 10c. Active Products & Supply Co., 53 W. Jackson, Chicago 4.

MINIATURE Steam locomotives, 1/4", 1/2", 3/4" scales. Castings, parts, rail thorough drawings with instructions. Catalog 25c. Little Engines, Wilmington, Cal.

HOME CRAFTSMEN

LEATHERCRAFTERS: Perfect ending for Double Cordova stitch, no bulges, no splices. Practically undetectable. Workable sample and instructions, \$1.00. Palm Springs Leathercraft, Box 1034, Palm Springs, Calif.

SHELLS, Plastics, findings. Lowest prices. Free catalog. Frances Jones, Box 251, Sarasota, Fla.

PIPE Makers supplies. Pipe Makers Manual \$1.00. Briar blocks, stems, rough pipes. Free price list. Harold Mangus, Rt. 3, Alliance, Ohio.

FREE. Descriptive circular on toy plans. Production Engineering, 403-C City Hall Bldg., Rockford, Ill.

PROFITABLE Ideas on punch press scrap. Details 10c. Henry Mueller, R.R. 12 Box 136 A, Indianapolis, Ind.

ATTENTION Home craftsmen, I buy for cash small artistic wood carvings, ceramics, statuettes, castings. Brener, 522 5th Ave., New York City.

PLYWOOD Cabinet kitchen plans 25c. Playne Cabinets, 4617 Johnson Avenue, Western Springs, Illinois.

CRAFTSMEN—Lawn furniture plans, beautiful jigsaw designs. Illustrated folders 10c. Refunded with order. Summercraft Studio, 42 Vernon St., Newton 58, Mass.

MASONITE Mill ends, 10# \$1.00, plus postage. Carl Sign Co., Wooster, Ohio.

MAKE Your hobby pay. Fascinating game for two to six players all ages, easily made from plywood. You'll keep first one but sell others at big profit. Clear detailed plans and instructions for \$1.00. Send now—valuable bonus free with first 100 orders this month. Plancraft, Box 372, Danville, Illinois.

LEATHER Scraps for hobbyist. Six pounds \$2.00. Northern Supply Co., Dept.

SHELLCRAFTERS—Approx. 2 lbs. assorted Pacific Coast shells \$2.00. Eric Lee, Box 245, P.O. San Anselmo, Calif.

FINISHING Materials: Electroplating chemicals and supplies, wood and metal finishes; shop chemicals; industrial and novelty finishes. Write for price list. Craft Finishes, Box M-467, Arlington, Virginia.

CERAMIC Jewelry supplies, bar pins, ear screws, for ceramic and woodworkers; also glass and enamel assemblers. Free catalog. Philadelphia Badge Co., Dept. B-1, 1007 Filbert St., Philadelphia, Penna.

SHELLCRAFTERS! Why pay retail prices for seashells, findings, plastics? Send for free wholesale catalog and compare. Beachcomber Novelty Co., Box 551, Fort Myers, Fla.

JIG Saw patterns. Full size, ready to use, Artistic Gothic wall shelf 20" high; corner shelf 17". Both for 10c. Jig Saw Guild, 117-JM Worth Street, New York 13.

DOLLAR Brings shellcraft material for pins and earrings. Free catalogue. Shell Hunter, 241 1st Ave. N., St. Petersburg, Fla.

PATTERNS: 70 Lawn ornaments and novelties, \$1.00. Milne's Hardware, Saginaw, Michigan.

SCENEX—You will like this new mineral pulp in sheets. 1001 uses. Easy to use. Mold pike scenery, fire safes, vases, fire stops, jigs for welding and soldering, etc. 10 sq. ft. \$2.50. Trial package \$1.00. Hardmite Company, Box 352, Springfield, Illinois.

LEATHERCRAFT Tools. Kit of 10 includes background beveler, 2-hole punch, basketweave, etc., \$6.50 prepaid. W. McClelland, 2552 Marcy, Omaha, Nebr.

THE Craftmaster's Catalog lists one of the most extensive lines of quality jewelry findings in the country. Lucite, Plexiglas, all types of chemicals, ideas, for pleasure or profit—all in this big, new catalog. For values galore, send 25c (refunded on first order) now, don't wait, you can't do without it long. Pittshire Plastics, Box 90, Pittsfield, Mass.

SPECIAL Offer: 70 full size toy, novelty and lawn ornament patterns only \$1.00. Lynds, Medway, Mass.

UNPAINTED Statuettes and plaques. Perfect models. Free list. Edison, 710 Weiser St., Reading, Penna.

YOUR Dollar brings shell material for butterfly brooch, bracelet, floral spray. Illustrated catalogue free. Dixie Shell Service, Lakeland, Fla.

LEATHERCRAFTERS! Send for free catalog listing leather, kits, supplies. Kit Kraft, 1607 S. Western, Los Angeles 6, California.

RARE Wood—Selected burls and sections from rare Myrtlewood. Grows only in Oregon and bush form in Palestine. Ideal for lathe work and carving. A hardwood which takes a glass like finish. Make jewel boxes, candlesticks, plaques, lamps, of rich and fine appearance. All pieces have good pattern and color. Piece suitable for lamp or pedestal, \$2.00. Larger sizes up to \$10.00. State approximate size desired. Oregon Myrtlewood Company, 112 SW Pine Street, Portland 4, Oregon.

EXPERIMENTERS! Interested in electrical, mechanical devices from war surplus? List free. F. Siefke, Box 18, Station E, Buffalo 11, N. Y.

LEATHER Craftsmen—Hand engraved plastic transfers imprint design instantly for tooling. Sample 10c. Introductory set \$1.00. Lampkin Artcrafts, Box 641-M, Culver City, Calif.

MAKE Shell jewelry—for gifts, as a hobby or start a business. Free catalogue and price list. Complete illustrated book of instructions 75c. Florida Shellcraft Company, Box 1840, Sarasota, Florida.

SHELLCRAFT Kits for beginners—shells and complete supplies for making pins, earrings, combs and novelties. Instructions free. Kits \$2.00 and \$5.00. Herbert Diamond & Co., 1121 North East First Avenue, Miami 36, Florida.

35 PATTERNS Of action pull toys, trucks, carts, toy furniture, etc., \$1.00. Continental Homecraft, 907 Birch, Eau Claire, Wisconsin.

SHELL Jewelry supplies. Wholesale only. McFarland Plastic Co., Sarasota, Fla.

CATALOG: Patterns plywood novelty furniture, letters, numerals, plaques, frames, weathervanes, silhouettes, lawn ornaments. 100 books and booklets on crafts and hobbies, picture frame mouldings, tools, large line decal transfers. Other lines. Hundreds articles finely illustrated. Write Wo-Met Shop, Ashburn, Ga.

KNOCKDOWN Cedar chest lumber veneers. Free price list. Giles-Kendall,

SHELL Jewelry profitable hobby. Illustrated booklet and sample kit, \$1.50. For instruction folder write, Sarasota Shell Shop, Box 2046, Sarasota, Florida.

MAKE IT YOURSELF

RACE Horse cribbage, fascinating game, played with either dice or cards. Colored playing design 12 x 12 inches, 25c postpaid. McGonigle, Box 163P, Point Richmond, Calif.

CONCRETE Block homes, 24 page booklet: drawings and instructions, how to build, \$1.00. Build your home as a hobby. No rent. No mortgage, save 50%. Use spare time. No special skill required. Amazing facts sent free. H. C. Lightfoot, Civil Engineer, Richboro 1, Penna.

MAKE Seashell brooches, earrings, Free catalogue. Whyteson, Little River, Florida.

BALL Bearing wheels, 12 x 1.75", \$3.75; 10 x 1.75", \$3.25; 8 x 2", \$2.25. Jim Brown Toy Company, 1094 Home Avenue, Akron, Ohio.

HOT Water free—from sunlight. System efficient any locality year 'round. Standard materials, easily built, low cost. Facts free. Solar Water Co., Box 175, Dept. B, Coral Gables, Florida.

BUILD Real heavy duty machines, using our production tested plans. 30" bandsaw, 12" lathe, dowel machine, portable sawmill, planer, concrete block machines, dozens other machines for shop, farm, home. Free lists. Nichols Equipment Co., Purvis, Miss.

BUILD Concrete block machine. Vibrator or hand. Easy. Economical. 150 blocks per hour. Build house, shop, garage, or other buildings. Save half. Sell blocks. Make money. Free details. Clyde Lee, Mountain View, Dept. A, Oklahoma.

GRANDFATHER Clock building system, simple, shop-tested, thousands built, with weight movements pictured in production \$1. Kempel Clock Engineers, Minneapolis 16, Minn.

MECHANICS — Craftsmen. Revolutionary spring winder from scrap in any shop. Springs any length, lead, diameter. Compression, tension. Hand, power. Guaranteed plans \$1. Nedco Products, 1614 Shortridge Ave., San Jose, Calif.

FLUORESCENT Lights. How to make your own 20 watt lights for less than \$1.00 each. Materials available. Complete, guaranteed, detailed instructions. \$1.00 cash or money order. Checks \$1.10. Specialty Sales, Box 1086, Muncie, Indiana.

BUILD Concrete mixer. Power driven, simple, inexpensive. Details free. Horne, 206 West Wilder, Tampa 3, Florida.

BUILD Concrete block machine. Vibration and hand operated types. 100 blocks per hour. Easy, inexpensive. Sell blocks, build home, garage, barn at low cost. Details free. Horne, 206 West Wilder, Tampa 3, Florida.

AIRPLANE Jettison gasoline tanks, streamlined, ten foot six inches by two foot four inches, 165 gallon, twenty gauge terne coated steel. Ideal for making boats, bob sleds, midget auto, etc. Price \$10.00 per tank, \$7.50 per tank quantities of five or more. General Truck Sales, Inc., 205 Market S.W., Grand Rapids, Michigan.

MAKE Your own "Rustic Furniture." Our "Easy to Understand" plans tell how. You can make chairs, benches, tables, lamps, bird houses, summer house, and scores of other things. Our complete plan booklet only 25c. (Worth dollars.) Ask for Booklet No. 18. Popular Mechanics Press, 200 East Ontario St., Chicago 11, Illinois.

BLUEPRINTS AND PLANS

FORGET Battery troubles. Build an a.c. charger. Start a shop on small capital. We show how. Write Garland Enterprises, Box 186, Dept. 1-47, Windsor, Ontario, Canada.

DESIGNING, Remodeling home? Complete set latest illustrations on interior development \$6 postpaid. C. F. Engineering Board, 303 Herald Place, Syracuse 4, N.Y.

WATCHES, OLD GOLD, JEWELRY, ETC.

WATCH And clock repairing—Complete practical course in modern horology. 66 illustrated self-instruction lessons. Just out! Low price. Fascinating 100-page illustrated catalog free! Write—Nelson Company, Dept. 3-02, Chicago 5.

WATCHES, Jewelry bought, sold, repaired. Catalogue, Justice, Box 6, Preuss Station, Los Angeles 35, California.

PRESERVE Lustre. Silver, brass, all bright metals. Easy to apply. \$1.00 postpaid. Madison Laboratories, Box 41, Madison, Wis.

OLD Gold: Top price paid. Mail old or broken jewelry, rings, watches, gold teeth, silverware, diamonds. Receive cash immediately. 100% satisfaction or articles returned. Information free. The Old Gold Specialist, Robert Wyndham, 1035 East A. Street, Ontario 1, California.

GENUINE Diamonds, out-of-pawn low prices, wonderful values. Unredeemed loans and big buying power enable us to offer beautiful gems at prices far less than original cost. Shipped free for inspection, appraisal. Send for big free list showing fine diamonds at startling low prices. Lloyd J. Butler, President, Prudential Loan Association, 133-VA North Clark St., Chicago 2.

SEND Your discarded jewelry, watches, crowns, bridges, spectacles, silver, etc., for cash offer. Goods returned promptly if offer unsatisfactory. Old State Metal Co., 812 Erie, San Antonio, Texas.

WATCH Repairing estimates furnished. International Watch, Box 229 Grand Central, New York.

GEMS, Precious and semi-precious, all genuine, from world wide sources. Deal direct, no overhead, save money. Catalog 10c. Hill Co., Route 7, Salem, Oregon.

WATCH Repairing easy learned by our home study course. Watch repairers are in demand and are among the highest paid craftsmen today. Write for free information. Houston Chronometer & Watch Co., P.O. Box 1140A, Houston 1, Texas.

GOLD \$35.00 Ounce—Mail old gold teeth, diamonds, jewelry, watches—receive cash by return mail. Satisfaction guaranteed. Free information. Dr. Weisberg's Gold Refining Company, 1500-Q Hennepin, Minneapolis, Minn.

WANTED—Old, broken jewelry. Cash paid immediately. Mail gold teeth, watches, rings, silverware, diamonds, spectacles. Satisfaction guaranteed. Information free. Rose Smelting Co., 29-A East Madison, Chicago.

TOBACCO, SMOKERS' SUPPLIES

PIPE Smokers valet, pipe smokers what you've been waiting for. The Travelers Pipe Valet. Beautiful lucite rack, holding two pipes, tobacco, matches. Fits on dashboard of car, plane, or cruiser with guaranteed rubber suction cups. Enables you to fill and light pipe with one hand. Write for free descriptive booklet. Dealers and jobbers protected. Jalouise Art Co., Dept. C, 173 Hobart St., Ridgefield Park, N. J.

HAND Grenade table lighter. The body is an actual United States Army Hand Grenade. All parts fabricated to the highest standards of precision. Olive drab, 5" high. \$3.00 postpaid. Send payment with order. K. W. Watkins Co., Box 85, Providence, Utah.

FREE To pipe smokers—For new pipe smoking thrills, write us your brand of tobacco and get free package mild, tasty "Green River." Pete Moberly, Box 997, Owensboro, Kentucky.

MAKE Smoking pipes, briar blocks and stems. Send for circular. Michelson & Sternberg, 67 West 44th St., New York 18.

FOR THE HOME

"STOKER-OLA" Stokers, gearless, 3 year guarantee, prices, write. Howard Hall, 8501 W. Howard Ave., Milwaukee 14, Wisconsin.

CONVERT To oil heat with pot burners. Also cement mixers, block machines. Blue Square, Excelsior, Minn.

GRATES, firepots, linings, fireplastic, wringer rolls. Majprudax, Royal Oak, Mich.

HUMIDIFIER — Vigorously healthful cheaper heat. Simple, easy directions, 25c. Freeman Engineering, 519 Main, Cincinnati 2, Ohio.

FIREPLACE Owners: Are you proud of your fireplace? Add beauty with Sunset Glow, exclusive fire color. \$1.00 per box. Free sample. Amity Products Co., Box 207A, Waltham 54, Mass.

FOR SALE—MISCELLANEOUS

MODERN Kitchen cupboard construction and planning made easy with our plans. Free information. Masterprint Company, White Building, Buffalo, N. Y.

ARMY Clothing bargains—Leather pants, jackets, vests, raincoats, field jackets, etc. Free catalogue. New York Clothing Co., Dept. P.M., 2079 Second Ave., New York 10, N.Y.

SURPLUS Leather flying helmets \$1.00. Woolen army shirts \$3.00. Crestview Ice, Crestview, Fla.

REYNOLDS Rocket pen—writes 15 years without refilling—on paper, cloth, wood, makes 6 carbons. \$3.99 prepaid. \$4.25 C.O.D. Peerless, 2726 Sturtevant, Detroit 6, Mich.

MECHANICAL Drawing instruments—Veeco, 4 piece, compact, precision set, brand new in lined case, value \$12.50, special, \$7.25, \$10.00—Charvos 9 piece set, \$8.50. Army surplus slide rules, slightly used, 75c each. Hull automobile compass, for accurate road direction, brand new, \$2.50. Brand new folding valise knapsacks made of heavy olive green duck, heavily bound and reinforced, repellent to fire or water. Inside 3 large snap fastened pockets, heavy webbed straps, hand and shoulder handles, size opened 22" x 54", closed 22" rolled. Useful to hunters, boy scouts, hikers and for all traveling use. A \$7.50 value, special \$2.25 postpaid. Prisms for 6 x 30 or 8 x 30 binoculars brand new \$1.50 each. Offset prisms to be attached to 7 x 50 B. & L. binoculars gives double the field of the ordinary 7 x 50 binocular. Cost \$98.00, special \$25.00. Green sunshades for binoculars size 6 x 30 and 7 x 50 snap on type value \$7.50, special \$1.25 per pair. Forward money order. No C.O.D. shipments. Public Sport Shops, 13 S. 16th St., Philadelphia, Penna.

DRAFTSMEN, Architects, engineers: Adjustable quadrangle draws any angle, pitch, slope; sine scale. Draw pentagon quickly. Free circular. S & J Specialties, Box 513, Berkeley, California.

PUTTYLESS Windows. Metallic glazer for permanent puttyless windows. New patented glazer, fits any window, easily installed. Every home a prospect. Sells on sight. No competitors. Repeater. \$1.00 money order brings demonstrator, postpaid. Metallic Glazer, 1825 Ward St., Warren, Ohio.

AIRPLANE Oxygen tanks, (used) like new. Light weight, 4½ lbs., non-rusting stainless steel. Suitable for air pressure, bottled gas or any kind of liquids. Up to 400 lbs. pressure. Ideal for house trailers and other purposes. 6.9 cu. ft. \$2.98, 24" long x 6" diameter. Midwest Buy Anything, 1515 Locust, Kansas City, Mo.

GOVERNMENT Surplus, Sperry S-1 bomb sights consisting of hundreds of precision built parts, gears, lenses, roller brgs., shafts, motors, switches, relays—ideal for experimenters, inventors, hobbyists, \$49.50 each. Three or more, \$42.50 ea. With metal container and lock ideal for strong box, \$9.50 extra. Oxygen masks. Can be used for spraying, electric welding, painting, grinding, by farmers for tree spraying. Made of genuine rubber with sponge filters. 1 to 5, \$2.75 ea., 6 to 11, \$2.50 ea., 11 to 24, \$2.25 ea., 25 to 50, \$2.00 ea. B-11 safety belts for many uses on farms, homes and industrial. Also safety belts on jeeps, 1 to 11, \$2.00 ea., 12 to 24, \$1.75 ea., 25 to 50, \$1.50 ea. Cash with order, shipped prepaid anywhere in U.S.A. Ace Surplus Sales Co., 1449 W. 69th St., Chicago 36, Ill.

BUY! Sell! Swap! On our capital! We make your deals on commission basis only. Swap ads. free! Listing forms, details, on request. Contact Brokers, 610-C Kirby Street, Raleigh, North Carolina.

FREE—"Amazing New Book"—"Profits From Classified Advertising." Tells how and what to advertise. Be sure to read this book before you invest one cent in advertising. Remember—it's free! Write for your copy now. F. W. Johnson, Classified Advertising Manager, 200 East Ontario Street, Chicago 11, Illinois.

WANTED MISCELLANEOUS

JUSTICE Buys "Anything." List free. Box 6, Preuss Station, Los Angeles 35, California.

DO You want to swap, buy or sell anything? Get The National Swapper's Guide! It contains hundreds of swappers, buyers and sellers from coast to coast who list thousands of items they want to swap, buy and sell. Send \$1.00 and we'll mail you this valuable guide postpaid and list what you want to swap, buy or sell in the next issue absolutely free. National Swapper's Guide, P.O. Box 415, Evansville, Ind.

MERCURY—Highest prices. Free containers. Write. Wholesale Terminal, Norwood, Mass.

MERCANDISE Of any kind. Paul, 425 E. Jefferson, Springfield, Illinois.

MERCURY (Quicksilver). Write for quotation stating quantity. Metallurgical Products Co., 35th and Moore Sts., Philadelphia, Penna.

PERSONAL

"HOW To Create New Ideas," \$3.00, postpaid. Practical daily working plans for inventors, writers, advertisers, business executives, others. Consultation service included. Satisfaction guaranteed. Dudley B. Bunn, 126-A Lexington Avenue, New York 16.

POOR Penmanship corrected—few hours. New-way. Ozmest, 9, St. Louis, Mo.

MAIL Forwarded. Reliable. 25c each letter. 1621-8th St., Anderson, International Falls, Minn.

NEWSPAPER Clippings for your personal scrapbook. Amaze your friends. In your own words, with or without photo, clipped from real newspaper page. Details 10c. Bolduc Studio, 33 West 67 St., New York City.

VISIT Miami Beach. "Millionaires Playground," by mail. 3 romantic colorful postcard views 25c. You address, return, I remail free. Letters forwarded, 25c ea. P.J.D., Box 1547, Miami 9, Florida.

MAIL Forwarded from Ohio. Letters 25c. Special quantity prices. Sports, B-127 Station E, Columbus 5.

PRETEND Visiting California. 3 postcard views 25c. Address, return, free remailing. Letters mailed 15c. Free information. Smith, 708 Ellis, San Francisco 9, Calif.

BORROW By mail! Loans \$50.00 to \$1,000.00 to employed men and women. Easy, quick. Completely private, confidential. No endorsers. Repay in convenient monthly payments. Details free in plain envelope. Write First Loan Co., Dept. G-20, Omaha, Nebr.

TRAVEL By proxy. Hollywood. Two post cards 25c. We remail. Letters 15c each. Susan Mack, 535 Pioneer Drive, Glendale 3, Calif.

FLORIDA Remail service. Mystify friends! Winter vacation land! Scenic tropical postcards 10c each. You address, return, I remail. Letters mailed 25c. 1176 N.W. 28 St., Miami 37, Fla.

THE Laugh of a nation! Screwball key chains, ideal gifts, personal use. 50c each, 3 for \$1.00 postpaid. Gale, 4842 North Spaulding, Chicago 25.

SHAVING Sensation! Up to 50% less blade pressure on face. "Face saver" 25c. Inventor Brown, 35P 9th St., Columbus, Ohio.

POSTCARDS Your hobby? Samples, dime. Wilkins, 417 Hill, London, Canada.

CREATE Brushless pictures without previous experience. Original art for everyone. Colorful details free. Weidner, 1321 Wellesley, Los Angeles 25, Calif.

CHOOSE Your favorite movie stars, beautiful, interesting, genuine photos. None better. 9 for 50c, 20 for \$1.00. Samples and lists 25c. Satisfaction guaranteed. Oscar P. Meyers, Box 246, Glendale 5, California.

PRETEND Visiting Providence—3 cards 25c (no stamps), address, return, I remail. W. Ogden, 106 Whitehall St., Providence, R. I.

MAIL Forwarded, 25c each letter. Acme, 3405 Lisbon, Milwaukee, Wis.

RUPTURED? Beltless, bulbless, strapless truss. Brandon, 623 N. Quincy, Clinton, Ill.

STAMMER? Maybe I can help. Sauers, Box 139-A, Mars, Penna.

LIVE Longer, feel better, enjoy life. Free information. Fairchild Company, Mt. Vernon, Ohio.

HAIR Falling out? Use scalp stimulator. Amazing new method helps promote hair growth. Particulars free. L. Shields, 1024 Cavalry, Detroit 9, Mich.

SWAPPERS! Traders! Free list "Swappers" Gazette," 2836-PM Slevin, Louisville 12, Kentucky.

THREE Beautiful St. Louis postcards 25c. Address, return, we remail. Letters forwarded 25c each. Clyde Price, 2331 Albin Place, St. Louis, Mo.

GOT Words for a song? I'll write music! Ahlstrand, Box 1056, Port Orchard, Washington.

PHOTOSTAMPS. Details free. Pera, 165 Chattanooga, Dept. A1, San Francisco 14, Calif.

POWERFUL Prescription for achieving personal and business success; works without expense or guesswork. You can use it. Write for free literature. Menders, 15857-A Coram Ave., Detroit 5, Michigan.

FALSE Teeth wearers. If your dental plate is loose and uncomfortable I have good news for you. Send name on postcard. No obligation. Dr. Reese, Dentist, Box 268-X, Winnetka, Illinois.

FALLING Hair, its cause and prevention. An informative and educational pamphlet entitled "How To Keep Your Hair Till Ninety" mailed free. James Hillton, 4819 A Fourth Ave., Brooklyn 20, N.Y.

RUPTURED? Positive comfort, no understraps, no steel, no elastic. Write Smith Manufacturing Company, Preston, Ontario.

HAIR Falling? Dandruff? Write Trichologist, 137 Lewis St., Phillipsburg, N. J.

HOW You can find out! Information discreetly developed, any matter, person, problem, anywhere. Personal-business assignments, representations, undertaken. Nation-wide. Officially licensed and bonded service established 1922. Reasonable. All inquiries confidential. William Herman, 170 Broadway, New York.

MISCELLANEOUS

GOOD "Used" self-instruction educational books on all subjects bought, sold, rented, exchanged. Satisfaction guaranteed. Complete information and 100-page illustrated bargain catalog free! Write—Nelson Company, Chicago 5.

PURE Vermont maple sugar postpaid in \$1, \$2 and \$5 lots. Eulalia Turner, Poultney, Vermont.

SEPTIC Tank problems solved. "What To Do and What Not To Do." A booklet compiled from years of experience. Order now! \$1.00 per copy. Reuben Selfridge, Septic Tank Engineer, Dept. M, Clymer, N. Y.

MAGNET. "Alnico" 4 oz. horseshoe, powerful (lifts about 5 lbs.). \$1.00. 8 oz., (lifts 10 lbs.), \$1.50 postpaid. Ross, 68C W. Broadway, New York, N. Y.

RAT And snake control kill more pests and safer, with rat bombs—squill's, gases—Antu. "Kildonan Rat Program." A system of successful pest control. Send \$1.00. Kildonan Pest Control, Highwood, Illinois.

"RECEIVE Mail." Moneymaking offers, opportunities, catalogs. Name listed 10c. Ideal Service, 100, Park Ridge, Ill.

HERBALISM—Complete course in 2 volumes. 1,000 recipes. Particulars free. Home Service, Forrestville 2, Va.

SQUARE Dance instructions, 25 sets, \$1.00. Rayburn, Eureka Springs, Arkansas.

5 PAIR Men's first grade mill run cotton sox, \$1.00 prepaid. Arch Williams, Cemetery, Columbia, Tenn.

SENSATIONAL Buy. A new and safe collar clip for men. Keeps collar securely in place. Price \$1.50. General Post Office Box 512, Washington St., Brooklyn, N. Y.

CHINAWARE, Dozen cups, saucers, \$2.00, etc. Send \$1.00 for samples, list. Garcia, 516 West 51 St., New York City 19.

CALENDAR 1753 To 2152. Shows actual calendar for each month. Accurate, simple and durable. 35 cents postpaid. Tracy Newton, Decatur, Georgia.

STENCILS, Decalcomania letters. Letter your own trucks, signs, store windows. We have weathervanes, housemarkers. Free folder. H. E. Sales, 3463 Itaska, St. Louis 11, Mo.

PERSONALIZED Decal transfers for sports, photo, hobby, office, shop equipment and products. $\frac{1}{8}$ " gold letters. For wood, metal, glass, plastic. Fifty personal I-D-Cals, one name (middle initial only)—\$2.00. Remit with order. I-D-Cal Company, 451C West Fairview, Inglewood, Calif.

ETCHED Decimal chart for drafting machines. Free circular. Enterprise Products, Freeport, Illinois.

BARTOLET'S 1947 Almanac 25c. 9 East 7th St., Williamsport 10, Penn.

70 BIBLE Lessons, 25c. Bulletin, Box 87, Station H, New York 25.

LUCKY Coin—Lord's Prayer, Ten Commandments, or Crucifixion on a penny. Send 25c for one (state which)—50c for all three. Peerless, 2726 Sturtevant, Detroit 6, Mich.

DARI-SPRED. Delicious butter substitute, costs about 25c per pound. Can be made in 3 minutes from 5 simple ingredients available at every grocery store. Complete instructions \$1.00. Guaranteed. Household Research, 408 No. Solano, Albuquerque, New Mexico.

PRETEND Visiting picturesque California. Send 20c for 3 colorful postcards. You address, I remail. J. Carn, 4740 Bal-

22K CHINAWARE Gold. Pen permanently names on vases, banks, mugs, baby-plates, cups, ashtrays, gifts, etc. Simple home method. \$2.50 per dram. Beautiful named sample 50c. Larsen Kilns, Box 236, Wellsville, Ohio.

PERMANENT-GLOW House numbers—collects light during day, shines at night. No batteries. 1 number 35c, 3 for \$1.00, 5 or more 30c each. Don Kimbrough, Tullahoma, Tennessee.

ALL Concerned: Puerto Rico. American territory, active market of two million people, waiting for your products. Comprehensive directory of interested, dependable local agents, representatives and salesmen sent for one dollar. Enterprises, Box 654, San Juan, Puerto Rico.

DOG, Pet and identification tags 75c. Samples free. Agents wanted. Singer, 413 Pedretti Road, Cincinnati, Ohio.

NYLONS! \$1.00 brings valuable sources. (Guaranteed legitimate.) Renschler's, Carrollton 2, Kentucky.

WHOLESALE Radio service. Any radio repaired. Ship via express. Satisfaction guaranteed. Elkins Radio, Elkins, W. Va.

LOTS of mail from everywhere! Receive free samples, magazines, catalogues, literature, moneymaking opportunities! Mails galore! Your name listed in over 15,000 "surefire" mailing directories. \$1.00. 5000 listings, 50c; 2000, 25c. Stanford, 6220-M 16th, Philadelphia 41.

GENUINE Alligator hand bag, 10 $\frac{1}{2}$ " x 8 $\frac{3}{4}$ ". \$25.00. Moises Rodriguez, Box 2497, Havana, Cuba.

M-SCOPE Metal, mineral locators latest 1947 electronic type ready for immediate shipment. Fisher Research Laboratory, Inc. manufactured some of the finest metal-locators for the U. S. army. Experience gained is yours in the most efficient metal, mineral locator. Free 16-page booklet upon request. Credit plan available. Fisher Research Laboratory, Inc., Palo Alto, California.

DIAMOND Dust cuts anything. Three grades for cutting and polishing of metals, minerals and plastics. Kit, three dollars. K. Youngdahl, 9333 Carleton, Detroit 13, Michigan.

ETCH Glass easily, safely. Monograms, designs, signs. \$1.50. Escovill, 5 Cornelia, New York City.

SQUARE Dance instructions, 40 dances \$1.00. Wesley Rader, YMCA Educational Dept., 25-E 16th Ave., Denver, Colo.

NEW Edition simplified bookkeeping and income tax record for small business, postpaid \$3.75. S&A Bookkeeping Systems, 8858 Ladue, St. Louis 5, Mo.

8 ALNICO Magnets plus 100 experiments, \$2.00. Eljay, Box 891, Newark 1, N. J.

MAKE Your own plastoplate printing cuts. Simple, easy process. Plastoservice, Argyle 1, Wisconsin.

LARGE Hand tooled leather purses, Zipper style. Made by hand the slow, sure way. A product of the great southwest. Wonderful selection. Scores of styles. Last a lifetime. Free catalog. Star Drug, 619 N. Fillmore, Amarillo, Tex.

FREE—"Amazing New Book"—"Profits From Classified Advertising." Tells how and what to advertise. Be sure to read this book before you invest one cent in advertising. Remember—it's free! Write for your copy now. F. W. Johnson, Classified Advertising Manager, 200 East Ontario Street, Chicago 11, Illinois.

PERFUMES, 1 Dram bottle, metal cap, American Beauty rose, \$1.00 plus federal tax 20c. Lincoln Laboratories, 7528 Sheridan Road, Chicago 26, Ill.

BOOKFINDERS! (Scarce, out-of-print unusual books.) Quickly supplied. Send wants. Clifton, Box 1377PMM, Beverly Hills, Calif.

TATTOOING Outfits—engraving outfits. Circulars free. Write, Zels Studio, 728 Lesley, Rockford, Illinois.

MERCHANTS Bookkeeping system \$3.50 postpaid. James Lamont, Distributor, Beacon, New York.

THE Lord's coming! Get free undeniable proofs today. Write International Evangelism, Box 263, Duluth, Minn.

RECEIVE Moneymaking opportunities, mails, samples, catalogs, magazines. Your name in thousand mailing lists, 25c. Glassmine, 1654-MX Amsterdam Avenue, New York 31.

MEDICAL Laboratory technicians in great demand. We train you in your spare time, in your own home. You can practice while studying. Write for free catalogue. Imperial Technical Institute, Box

WAR BARGAINS in LENSES and PRISMS

ASSEMBLE YOUR OWN BINOCULARS!
Complete Optics! Complete Metal Parts!
 (Delivery on Binocular Sets Beginning January 30th)
Save More Than 1/2 Regular Cost

ARMY'S 7X 50 BINOCULARS

Here's an unusual opportunity to secure a fine set of Binoculars at a substantial saving of money. Offered here are complete sets of Optics and Metal Parts for the Army's M-16 7X 50 Binoculars (M-16 is not the waterproof model). These components are new and all ready for assembly. We supply full instructions. Limit—1 set of Metal Parts and 1 set of Optics to a customer.



METAL PARTS—Set includes all Metal Parts—completely finished—for assembly of 7X 50 Binoculars. No machining required. Bodies have been factory hinged and covered. A sturdy brown leather Binocular Carrying Case is included with each set of Metal Parts.
Stock #824-H 7X Metal Parts \$35.00 Postpaid

OPTICS—Set includes all Lenses and Prisms you need for assembling 7X 50 Binoculars. These Optics are in excellent condition—perfect or near perfect—and have new low reflection coating.
Stock #5102-H 7X 50 Optics..... \$25.00 Postpaid

NOTICE! If you buy both the Binocular Optics and the Binocular Metal Parts, your purchase becomes subject to 20% Federal Excise Tax. Be sure to add amount covering tax to your remittance or your order cannot be filled.

ARMY'S 6X 30 BINOCULARS

No Carrying Case with any Sets shown below. (None yet available in Surplus Market.) M-13A1 sets are waterproof model. M-3 sets are not waterproof. Limit—1 Set to a Customer on all Sets shown below.

COMPLETE OPTICS & METAL PARTS—Model M-13A1, 6X 30 Binoculars. Everything you need—ready for assembly. When finished will look like a regular factory job costing \$102 to \$120. The Optics are new, in perfect or near-perfect condition. Have new low reflection coating. Metal Parts are new and perfect, all completely finished. No machining required. Bodies factory hinged and covered. Complete assembly instructions included.
Stock #830-H..... \$40.00 Postpaid,
 plus \$8.00 tax—Total—\$48.00

COMPLETE OPTICS & METAL PARTS—Model M-3, 6X 30 Binoculars. The Optics in this set are new, perfect or near-perfect. Prisms have new low reflection coating. Factory mounted Eye Piece and Objective Assemblies not coated. Metal Parts are perfect, new, ready for assembly. When finished, this will look like a regular factory job, except a name has been filed off a cover plate. No machining required. Bodies factory hinged and covered.
Stock #831-H..... \$35.00 Postpaid,
 plus \$7.00 Tax—Total—\$42.00

METAL PARTS ONLY—Model M-13A1, 6X 30 Binoculars. No Optics. Same Metal Parts as described for Stock #830-H.
Stock #832-H 6X 30 Metal Parts..... \$25.00 Postpaid

METAL PARTS ONLY—Model M-3, 6X 30 Binoculars. No Optics. Some machining on these Metal Parts required. Bodies hinged and Prism Shelf holes placed, but you must tap them. Prism Shelves have been machined. Six lead spiral focusing threads have been cut. Some less difficult components you must thread and machine yourself, but all material you need is furnished except body covering material and Optics.
Stock #833-H 6X 30 Metal Parts..... \$12.00 Postpaid

METAL PARTS ONLY—Model M-3, 6X 30 Binoculars. No Optics. All parts you need. You must do machining on most parts, but not all. No body covering material.
Stock #834-H 6X 30 Metal Parts..... \$8.00 Postpaid

OPTICS FOR 6X 30 BINOCULARS (No Metal Parts). Slight seconds. Cemented but not coated.
Stock #5123-H \$10.00 Postpaid

SAME OPTICS AS ABOVE (6X 30), but coated.
Stock #5124-H..... \$12.75 Postpaid

If you buy both the Binocular Optics and the Binocular Metal Parts, your purchase becomes subject to 20% Federal Excise Tax. Be sure to add amount covering tax to your remittance or your order cannot be filled.

Optics and Metal Parts are Available for Monoculars (1/2 a Binocular). For Complete Details, Write for Bulletin #14-H.

SATISFACTION GUARANTEED

YOU CAN EASILY MAKE
 Telescopes, Magnifiers, Photographic Gadgets and
 Hundreds of Experiments with these Low Cost Lenses

MOUNTED 35 MM. PROJECTING LENS SYSTEM (May Also Be Used for Enlarging). Focal Length 91.44 mm. and speed of f 1.9. Outside dia. of mount at one end 60 mm. Length of mount 64 mm. May be used as Enlarging Lens by stopping down speed. Most useful for Portrait work. Less useful for pictures requiring perfect definition out to edges of print.
Stock #4033-H..... \$3.00 Postpaid

CONDENSING LENSES for 35 mm. Projectors and Enlargers. Consists of set of 2 Lenses—diam. 2 3/8", F.L. 3" each.
Stock #1077-H..... \$2.00 Postpaid

MOUNTED KELLNER TELESCOPE EYE PIECE—Perfect. coated, in Ordnance sealed boxes. F.L. 1 1/4 inches. Outside dia. of steel mount 40 mm.
Stock #6198-H..... \$3.15 Postpaid

OPTICAL BENCH KIT—(Not a War Surplus Item). Everything you need, including four Lens Holders for checking Focal Lengths and setting up Lens Systems.
Stock #53-H..... \$8.50 Postpaid

35 MM. KODACHROME PROJECTING LENS SET—Consists of Achromatic Lens for projecting, plus a Condensing Lens and piece of Heat Absorbing Glass with directions.
Stock #4025-H \$1.95 Postpaid

POLARIZING VARIABLE DENSITY ATTACHMENT FOR 7X 50 BINOCULARS—An amazingly effective unit for controlling amount of light reaching your eyes. Cuts down glare in sky and overwater observations. Easily snapped on and off over the eye cups of American-made 7X 50 Binoculars. Govt. cost \$8.30 each.
Stock #20,000-H \$2.00 Postpaid

PRISM TELESCOPE—All the Lenses You Need to build your own 20 power Telescope! No mounts. Has wide field of view.
Stock #5012-H \$7.25 Postpaid

GIANT SIZE RED AND AMBER FILTERS

Filter material is cemented between glass. All 3/4" thick.

Stock No.	Color	Diam.	Price
706-H	Red	7 1/2"	\$2.00
707-H	Red	5 1/2"	1.50
708-H	Amber	7 1/2"	1.50
709-H	Amber	5 1/2"	1.00

USES: For large camera filters, for large size spotlights, for darkroom lights (spectroscopically tested), for interior decorating, for display tray in home or store.

AIR FORCES GUN SIGHT

With Polarizing Variable Density Attachment



Can be used as Slide Viewer, or take it apart and you can get Polarizing Variable Density Attachment, Mangin Concave Mirror, Reflector Plate, Metal Reticule, Window, Lamp Housing, Ring and Bead Sight. The Polarizing attachment alone is worth many times the price of entire unit. Consists of 2 Polarizing Filters mounted with small handle which rotates one around the other. May be used in Photography, Research, Experiments, as Light Dimmer, etc.

Stock #908-H..... \$5.00 Postpaid
 Same Unit Without
 Polarizing Attachment
Stock #916-H..... \$2.50 Postpaid

BOMBER SIGHTING STATION—A double end Periscope Type Instrument of highest precision. 6 ft. tall, shipping wt. 360 lbs. Orig. cost \$9,850. Consists of numerous Lenses, Prisms, Mirrors, Gears, Motors, Metal Parts and Electrical Gadgets.

Stock #914-H..... \$50 F.O.B. Oklahoma
TANK PRISMS—90-45-45 deg., 5 3/4" long, 2 1/2" wide, finely ground and polished.

Stock #3004-H Silvered Prism (new & perfect) \$2.00 Postpaid
Stock #3005-H Plain Prism (new & perfect)..... \$2.00 Postpaid
Stock #3100-H Silvered Prism (Second)..... \$1.00 Postpaid
Stock #3101-H Plain Prism (Second)..... \$1.00 Postpaid

We have literally millions of war surplus lenses and prisms for sale at bargain prices. Write for Catalog "H" — Sent Free!

● Order by Stock No.

EDMUND SALVAGE CO. P. O. AUDUBON, NEW JERSEY

INVENTORS

The inventor who believes he has a new and useful invention, and finds himself in need of advice, should consult a competent registered patent attorney.

The question as to whether a subject matter is patentable can be substantially determined by a search of the United States Patent records.

Without obligation, write us for information as to what steps an inventor should take to secure a Patent.

RANDOLPH & BEAVERS

Registered Patent Attorneys

11-D Columbian Bldg., Washington 1, D. C.

RANDOLPH & BEAVERS

11-D Columbian Bldg., Washington 1, D. C.

Please send me full information on how to secure Patents & Trademarks.

Name.....
Street.....
City.....State.....

VETERANS Learn WATCHMAKING

A Lifetime Profession

Regardless of Conditions, Age, Sex, or Physical Limitations
Veterans—Civilians!
Your Opportunity—
LEARN WATCHMAKING



Lift yourself from a futureless job into a position paying better than your present work. Fit yourself for the job that will permit you to establish your own shop, or be employed in a pleasant environment.

Watch Repairing—Jewelry—Engraving will always be in ever greater demand. Our graduates wanted everywhere. Dignified positions \$50-\$75-\$100 per week. Veterans write today for latest FREE enrollment requirements.

Kansas City School of Watchmaking
Largest Horological School in America
617-621 Wyandotte St. Kansas City 6, Mo.



NOW! EASY-TO-MAKE HOMECRAFT NOVELTIES

FOR PLEASURE AND PROFIT!

FREE! NEW 40-PAGE CATALOG

Our new book is crammed with money-making facts about Leather Craft, Wood Carving, Clay Modeling, Lacing and Braiding, Wood Burning (Pyrography), Showcard Lettering, Ready-to-Finish Woodcraft, Plastics, Marbleite Molding, and much more. Send for FREE copy TODAY!

SPECIAL! EASY MONEY-MAKER!

Newest fashion idea. Leather Link Belts. Very smart for both men and women. Kit including everything for six easy-to-make belts (2 white, 2 black, 1 brown, 1 natural) to sell at \$2 each (\$12 total) sent to you complete for only \$3.50 postpaid. Or C.O.D., you pay postage. (No Canadian C.O.D.'s and no foreign shipments made.) Money back if not delighted. Sample Kit (1 belt) \$1.

DWINNELL CRAFT SHOP, Dept. P-71, Elm Grove, Wheeling, W. Va.



PATENTS

AND TRADE MARKS

C. A. SNOW & CO.

REGISTERED PATENT ATTORNEYS

WRITE FOR INFORMATION TO

428 SNOW BUILDING, WASHINGTON 1, D. C.

PATENTS

"Proof of Invention"
Folder mailed without obligation.

E. E. VROOMAN, Registered Patent Atty.

871 Woodward Building, Washington 5, D.C.

MUFFLERS

STEELS and ALUMINUMS
with a motorboat tone

SINGLES, Chev, V-8, Plymouth, Steels \$5.50, Aluminum \$6.50. Chry., Olds., Buicks, etc., Steels \$7.50, Aluminum \$8.50. V-8 and MERCURY DUALS, Steel \$17.50, Aluminum \$20.00. Aluminums are guaranteed for life of your car.

DEALERS WANTED

SANDEE MUFFLER CO.
7523 S. WESTERN AVE., LOS ANGELES 44, CALIF.

NEW PLASTICS

Fabricating MANUAL

HOW TO USE Plastic AT HOME

NOW ONLY 25c

Make beautiful objects of Plexiglas, Lucite, Catalin, Polystyrene at home. Jewelry, novelties, accessories. Send for new 10,000 word manual on how to fabricate, weld and form latest plastic materials in home workshop. Hundreds of practical suggestions. Written by leading plastics engineer. Price prepaid 25c (stamps or coins). Or get FREE information and price list covering transparent plastic sheets, rod, tubing cut to your size. Write today: **HOUSE BEAUTIFUL PLASTICS**, Dept. A3, 5534 W. Harrison St., Chicago 44, Ill.

START HOME MAIL ORDER BUSINESS

Start small—grow big. Amazing new course shows you the way. Rush your name and address today for full particulars. No obligation.

BELFORT (Dept. A) Engineering Bldg. Chicago 6, Ill.

SUIT YOURS

AS A BONUS

AND BIG MONEY IN SPARE TIME, TOO

We want you to wear this fine made-to-measure suit! Make it yours by sending a few orders, & earn BIG CASH PROFITS in spare time. Your suit will help you get more orders with scores of rich, quality fabrics, tailored-to-measure to newest styles. Also Ladies' Tailored Suits—complete line. Write today for **FREE SAMPLES**. NO EXPERIENCE, no money needed. For quick action tell us about yourself.

J. C. FIELD & SON, INC.
Harrison and Throop Sts., Dept. N-1716, Chicago 7, Ill.



DO ANY JOB.. EASIER.. QUICKER
MAKE MORE MONEY *in the*
BIG OPPORTUNITY
FIELDS

SEND NO MONEY
 Select the Books
YOU Need Now!
 We Ship **C.O.D.**
 Anywhere in **U. S.**
 and Will Refund
Amount Paid if
Not Satisfactory.

Here's the Help You Need
For Best Paying Jobs
Right NOW!

FREE TRIAL
IN YOUR OWN HOME

Used by Army, Navy, Other Government
Depts., 200 Schools and Industrial Firms.

Do it now! Get the better pay that goes to men with specialized knowledge. Get into one of these big opportunity fields. Big money and many other advantages await you if you prepare now. Here is the help you need—**EASY—QUICK—AT LOW COST.** Thousands of men have already used these famous books. Beginners and experienced men alike have doubled and tripled their earnings with this help. You too, can now get the special knowledge you need for top pay, better jobs, or a business of your own. This is your **GOLDEN OPPORTUNITY.**

AIR CONDITIONING

Big air conditioning boom interrupted by war will be bigger than ever. It's ready to GO now! Get this non-technical book by international authority and be ready for your share of millions to be spent. Covers whole field. 450 pages. Illustrated. \$4.00.

AIRPLANE WELDING

All metal airplane building offers big peacetime opportunities
 New 2nd edition of this famous book by J. B. Johnson, Materials Division, Wright Field. The authoritative and practical book on Airplane welding and materials brought right up to date. 420 pages, 193 pictures. \$3.50.

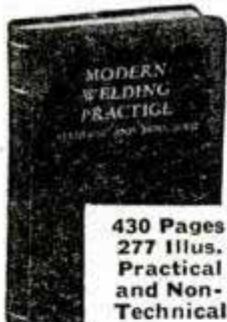

MODERN WELDING PRACTICE

Newest book on all types of welding and heat treatment of metals. Written by recognized specialists in training men for production jobs. Practical and Non-Technical.

430 Pages
 277 illus.
 Practical and Non-Technical

Covers everything you need to know. Prepare for best pay jobs now. Price \$4.00.

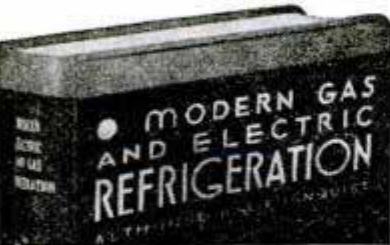

REFRIGERATION—Book of the Hour!
Biggest Opportunity in Many Years!

NEW PRINTING—ALMOST 1000 PAGES

408 Pictures—17 Diagrams in Colors Makes All Refrigerator Service Maintenance, Repairs Simple as A. B. C.

Thousands of Refrigerators need repairs! Owners will pay big for competent service which will be needed more and more. Get **MODERN GAS AND ELECTRIC REFRIGERATION**, the non-technical guide to all types of refrigerators and get your share of this new profit. Get a job or start your own service business. This book will help you make money anywhere. Price \$5.00.

BODY & FENDER REPAIR

Owners will spend big money to keep their good older cars looking like the new ones coming out. This is a practical money-making guide, ideal for shop owners and every man who wants a share of the millions to be spent in keeping old cars looking new. Tells how to get a good job or start business of your own with small capital. 325 pages, 232 illustrations. \$3.50.

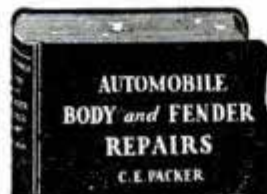

DYKE'S FAMOUS CARBURETOR BOOK

This famous book has been the standard guide in the best paying auto work for a generation. It has helped thousands of men make money. New edition covers engine tune-up, compression, ignition, carburetion, fuel pump valves, etc. Use this book to specialize in this big field. 244 pages, 549 illustrations. \$3.50.

HOUSE WIRING
NEW EDITION

Get this new sixth edition of this standard and practical electrical wiring book. It gives complete practical instruction on every phase of house wiring in one handy volume. Goes further than most books on subject. Hand-book style. Gives National Electric Code. 400 pages, 669 illustrations. Electrical work will reach a new high with millions of new homes to be built. Get started now. \$3.00.

15 Million Refrigerators
Need Service and Repairs



NEW 20th EDITION
Leading Auto Book for Over 32 Years

World's GREATEST AUTO BOOK

New Material on Transmissions, Trucks, Tractors, Diesels, Aircraft and Auto Engines

Now with millions of cars needing repairs and thousands of men needed to do the work, you need the famous DYKE Auto Book more than ever before. Brand new 20th Edition covers all principles, construction, repair, adjustments, testing, troubles and remedies of all cars. Over a half million copies of 20 editions of Dyke's have been sold. Gives specifications of old and newer cars. World's biggest book value. \$7.00. This big book, a complete auto library in one volume, has 1483 pages—4600 illustrations and diagrams—weighs 6 lbs.—equal to 4 ordinary books.

ENGINEERS HANDBOOK

World famous Bailey's handbook of universal questions and answers for Stationary, Marine and DIESEL engineers and firemen. Prepares for any license examination. This is the one book that men should have if they want to reach the top in installation, maintenance and operation of Diesel and steam plants. Pocket size, \$2.00.

Goodheart-Willcox Co., Inc.
 209 S. Michigan Ave., Dept. 11, Chicago 16, Ill.

SEND NO MONEY! Mail Coupon

GOODHEART-WILLCOX CO.,
 209 S. Michigan Ave., Dept. 11, Chicago 16, Ill.
 Send books checked, C.O.D. I will pay postman, plus few cents charges. If not satisfactory I will return books in 5 days and you will refund money paid. (Outside U.S. or possessions remit with order.)

- Gas & Electric Refrigeration \$5.00
- Dyke's Auto Book \$7.00
- Dyke's Carburetor Book . \$3.50
- Modern Welding \$4.00
- Airplane Welding \$3.50
- Sheet Metal Layout . . . \$3.50
- Air Conditioning \$4.00
- Engineers Handbook . . . \$2.00
- Body and Fender Repair . \$3.50
- House Wiring \$3.00
- Shop Math. (2 vols.) . . . \$3.00
- A.C. Power Wiring \$4.00
- D.C. Power Wiring \$4.00

If remittance accompanies order we will pay all postage charges under same return privilege.

Name
 Address
 City State

NEW AUTOMOBILE ENGINE MANUAL



JUST OFF THE PRESS

Drake's Automobile Manual helps you keep your own car running smoothly or qualifies you to earn big money as an automobile engine expert. 300 pages of sound information and instruction. Over 200 illustrations. Teaches you how to service all types of auto engines. Covers ignition, carburetion, etc. Order today. No. 1 on coupon.

ALSO—note these other big value books:

- No. 2—Drake's CYCLOPEDIA OF RADIO and ELECTRONICS—NEW 12th Edition. 764 pages. 1400 headings. 90 illust. Only \$6.00.
- No. 3—HOUSE WIRING MADE EASY. 96 pages. Over 100 illust. Only \$1.50.
- No. 4—Drake's REFRIGERATION SERVICE MANUAL. 317 pages. 148 illust. Only \$2.00.
- No. 5—Drake's HEATING, COOLING, and AIR CONDITIONING HANDBOOK. 700 pages. 64 tables and charts. 350 illust. Only \$4.00.

DRAKE BOOKS ARE SOLD BY LEADING BOOKSELLERS
USE THE COUPON — MAIL TODAY

Fred'k J. Drake & Co., Dept. A-2, 600 W. Van Buren St., Chicago 7, Ill.
Please send me the books checked below. If not satisfied I will return them in 5 days and my money will be refunded.

1 2 3 4 5 (Circle numbers wanted)

Check or money order enclosed \$..... Send books postpaid.
 Send C.O.D. plus postage.

Name.....

Address.....

City..... State.....

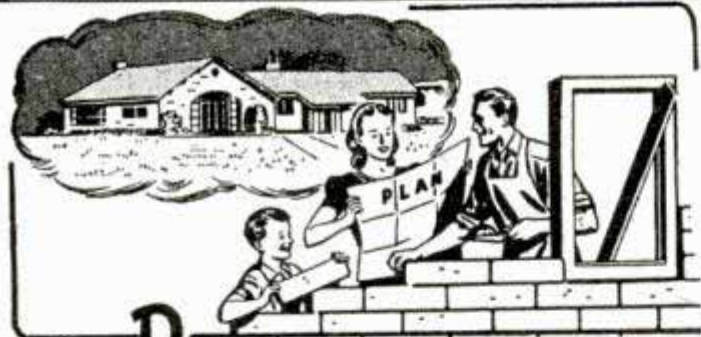

Build it Yourself

Send for booklet showing how to make your own bricks of Cemadobe and build an attractive low cost home yourself. Amazing discovery in soil stabilization. Bricks of earth and cement. Attractive; heat and cold resisting. Easy to make. A Godsend to anyone who needs a home. Now being used by hundreds of satisfied home builders. Acceptable to loan agencies. Complete instructions in attractive, easy-to-understand booklet entitled "Cemadobe". 50 illustrations and 40 chapters. Money back guarantee of satisfaction. Send \$1.00 to Cem-Adobe Company, Box 81, Dept. PM-17, West Los Angeles Station, Los Angeles 25, California.

LEARN WATCH REPAIRING AT HOME



Construction, repair, adjustment. New complete "PRACTICAL COURSE" for beginners and professional repairmen. All essential steps. Theory, operation. Many test cases. Full coverage of tools, materials. Fully illustrated. **\$2.95** Post Paid Only..... (If C.O.D. plus C.O.D. fee.) Money Back Guarantee

We Supply Tools, Materials at Lowest Cost

Please request Price Quotation on specific items of interest.—We carry complete sets of TOOLS and MATERIALS for Students & Practical Repairmen. Request folder.

MODERN TECHNICAL BOOK CO., Dept. MMC
55 WEST 42ND ST. NEW YORK 18, N. Y.

JOIN our new TECHNICAL BOOK CLUB—free

Members receive current literature, guidance on all book problems, premiums. No obligation. ALL BOOKS: Technics, Chemistry, Physics, Plastics, Refrigeration, Air-conditioning, Building, Construction, Electricity, Radio, Television, Electronics, Automotives, Mathematics, Woodworking, Homecraft, Business, Languages, Farming, Sports, Photography, etc. — Write for free literature, please specify subject.

BAND
INSTRUMENT
REPAIR
MANUAL
Only \$2.00

Learn quickly to become a band instrument repairman by our original simplified method. Write for yours today. Send money order only. Address

ALBERT ROBERTSON 768 N. Water St.
Milwaukee 2, Wis.

What Every Mason Wants



We have important Masonic books for Blue Lodge, Chapter, Commandery, Scottish Rite, and Shrine.

Our Rituals Are Used the World Over. Send for free catalog of books and rituals for Masons, Odd Fellows, Knights of Pythias, Knights of Columbus, etc. EZRA A. COOK, Publisher, P. O. Box 796, P.J.Y. Chicago 90, Ill.

TOOL ENGINEERING • MECHANICAL DRAFTING MASTER MACHINIST

Completely equipped shops and drafting rooms, directed by an accredited staff of engineers and practical instructors. 18 years of successful training of men for industry.

Days, Evenings • Approved for Veteran Training
BULLETIN ON REQUEST

ALLIED SCHOOL OF MECHANICAL TRADES, INC.
1330 SOUTH MICHIGAN AVENUE • CHICAGO 5, ILL.

RADIO ENGINEERING, Broadcasting, Servicing, Electronics, Aviation, Marine & Police Radio taught thoroughly. 48 weeks' Engineering course equivalent to 3 years' college radio work. Approved Veteran Training. Co-educational. Catalog free.

VALPARAISO TECHNICAL INSTITUTE, Dept. D, Valparaiso, Ind.

Beautiful Modern ★ **SIGN LETTERS**
Signs anywhere, quickly, easily... Write for money making-saving plan... Samples
PINNACLE SIGN LETTERS, Mound City, Ill.

LAW STUDY AT HOME for PERSONAL SUCCESS and LARGER EARNINGS. 38 years expert instruction—over 108,000 students enrolled. LL.B. Degree awarded. All texts furnished. Easy payments. Send for FREEBOOK—"Law and Executive Guidance."
AMERICAN EXTENSION SCHOOL OF LAW
Dept. 73-M, 646 N. Michigan Ave., Chicago 11, Ill.

Big Profit AUSTRA-WHITES
Sensational MONEY MAKING HYBRID. Customers report broilers 8 weeks, laying 4 1-2 moe. Disease resistant. Hardy Layers. 50,000 chicks weekly. Started pullets. Profit Sharing Plan. FREE Book. Write today.
BERRY BROS. FARMS, Box 582, ATCHISON, KANS.



The GLENWOOD MEMORIAL
Freight Paid Anywhere in U.S.A.

In all its beauty and durability is pictured in our free catalog of genuine Marble and Granite. Write for yours today.
U. S. MARBLE & GRANITE CO., A-18, Oneco, Fla.

HUNDREDS OF THOUSANDS OF MEN



**Make
This
Test**

**with your own hands
and feel what we mean**

**The Secret of the
"Interlocking Hands"**

Only COMMANDER contains this New principle. A porous non-stretch material is built into the special stretchy body of the COMMANDER . . . In the outline of two interlocking hands for EXTRA DOUBLE SUPPORT where you need it most. NO BUCKLES, LACES or STRAPS.

Commander Wearers All Over America Say—

"I am sure you will be pleased to know that it is by far the best and most practical supporter I have ever had. I have been pleased to show it to several of my friends and they are likewise impressed with it. You shall probably hear from some of them in the future."
—Dr. A. M. S. Standish, Mich.

supporter for ten times what it costs."
—Dr. G. C. S., St. Charles, Ill.

"I recommend the Commander for what it is made for. It sure has been a great help to me. I want to thank you for what it has done. I might add it has helped me more than anything I have ever tried."
P. N., Fort Knox, Ky.

"Enclosed find order for another belt. I wouldn't be without this

Above are just a few of the many unsolicited testimonials for the Commander that we receive regularly. Originals of these and others are on file.

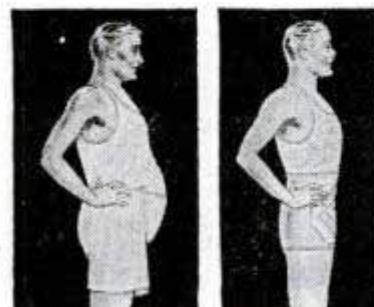

BEFORE

AFTER

**FREE
10 DAY TRIAL!**

If it fails to do all we say, send it back and the purchase price will be promptly refunded.

ONLY \$2.98

Special Large Sizes, 48 to 60, \$3.98 **SIZES** 28 to 47

Appear

SLIMMER . . .

FEEL BETTER, LOOK YOUNGER

with **COMMANDER**

The Amazing NEW Abdominal Supporter

Yes, instantly, you, too, can begin to feel ALIVE . . . ON TOP OF THE WORLD by joining the Parade of Men who are marching up the highway of happier living with the COMMANDER, the amazing new Men's Abdominal Supporter.

**GET "IN SHAPE" INSTANTLY
AND ENJOY A HAPPY STREAMLINED APPEARANCE**

The COMMANDER presents the exclusively designed "INTERLOCKING HANDS" principle for extra support where you need it most. It flattens the burdensome sagging "corporation" and restores to the body the zestful invigorating feeling that comes with firm, sure "bay window" control. Order this new belt today and begin enjoying the pleasure of feeling "in shape" at once.

BREATHE EASIER — TAKE WEIGHT OFF TIRED FEET

The helpful uplifting EXTRA SUPPORTING power of the COMMANDER firmly supports abdominal sag. The instant you pull on the belt you breathe easier . . . your wind is longer . . . you feel better!

YOUR BACK IS BRACED —

YOUR CLOTHES FIT BETTER — YOU APPEAR TALLER

The COMMANDER braces your figure . . . you look and feel slimmer . . . your clothes fit you better. Your friends will notice the improvement immediately.

COMMANDER IS NEW AND MODERN!

The absence of gouging steel ribs, dangling buckles and bothersome laces will prove a joy. COMMANDER has a real man's jock type pouch. IT GIVES GENUINE MALE PROTECTION. Try this amazing new belt with full confidence . . . and at our risk. SEND FOR IT NOW!

MAIL THIS COUPON TODAY

INTRODUCTORY TEN-DAY TRIAL OFFER

**WARD GREEN CO., DEPT. T131
113 WEST 57TH STREET, NEW YORK 19, N. Y.**

Send me the "COMMANDER" for ten days Trial, I will pay postman the special price of \$2.98 plus postage. If not satisfied after wearing it ten days, I may return it and the purchase price will be promptly refunded.

My waist measure is.....My height is.....

NAME

ADDRESS

CITY STATE

Check here if you enclose \$2.98 with this order and we will pay postage charges. The same refund offer holds.

Pay Is Good
in both these big Branches
of the Automobile Industry

LEARN IN A FEW
WEEKS IN OUR
BIG MODERN
TRAINING SHOPS

AUTOMOTIVE MECHANICS

BODY & FENDER REBUILDING

NOW IS THE TIME
TO PREPARE FOR
YOUR PLACE IN A
GIANT INDUSTRY

Automobile industry making up for lost time! There may never again be such opportunities for men who want better jobs or business of their own to get in on ground floor and go up fast! Yes—FOR MEN WHO ACT FAST. THINGS CAN HAPPEN FAST!

TRAIN ON ACTUAL EQUIPMENT

Chicago Motive Trades Institute makes rapid progress possible by Learn-By-Doing SUPERVISED SHOP TRAINING. In motive trades our institute gained nation wide fame training Auto Mechanics for U. S. Army. Same quality training available to you now. CONSULTATION AND PLACEMENT SERVICE WHETHER YOU ARE INTERESTED IN WORTHWHILE JOB OR SETTING UP YOUR OWN BUSINESS.



AUTOMOTIVE MECHANICS

Practical shop training on all types of equipment. Automotive mechanics needed to keep millions of cars, busses, trucks rolling. Efficient auto mechanics get fine pay. Can service, repair, install all mechanical and electrical parts of autos. Learn to overhaul and repair engines, transmissions, differentials, and other assemblies. Good pay, steady work, excellent opportunities for increased earnings for properly trained auto mechanics.

BODY AND FENDER REBUILDING



Body and Fender rebuilding one of best paid fields in automobile industry. Body and Fender Rebuilding makes good profits in garages, service stations. Get practical, all-around Shop Training—welding, aligning, mixing and matching colors, spray painting, power and hand tools. Values increased when used cars are made to "look like new."

A NATIONALLY KNOWN INSTITUTION

Rapid progress possible by supervised learn-by-doing SHOP TRAINING. C.T.I. is an old established school, backed by years of experience—with trained instructors—with completely equipped shops. VETERANS by Government plus monthly subsistence allowance while in school. Just mail coupon, we will handle all details. (LOW TUITION, EASY TERMS if you are not a veteran.)

CHICAGO MOTIVE TRADES INST.

Dept. B21
Div. of Commercial Trades Inst.
1400 W. Greenleaf Ave., Chicago 26, Ill.

FREE—IMPORTANT INFORMATION
TELLING HOW TO GET STARTED



CUT COUPON ALONG THIS LINE

Fill Out, Cut Out, Mail Today

FACTS FREE for Men Who Want to Get Ahead

CHICAGO MOTIVE TRADES INSTITUTE, Dept. B21
1400 W. Greenleaf, Chicago 26, Ill.

Send free illustrated Brochures and other information about the field I have checked below.

- Automotive Mechanics Body & Fender Rebuilding
 Veteran Non Veteran

Name.....

Address.....

City.....State.....

SAY YOU SAW IT IN POPULAR MECHANICS

NEW MIDGET ELECTRIC

ARC WELDER

RETAILS
ONLY
\$3.95

FULLY
GUARANTEED



Plugs into Light Socket—AC or DC

It's new! It's handy! It's efficient! Use the Midget Electric Arc Welder for hundreds of light-metal jobs. Does comparable welding work with a 1/16-inch welding rod on thin metal as that of larger and higher priced welders. Operates on 15 ampere fuse, 110 volt 60 cycle A.C. or D.C. current, by use of our special standard-coated 1/16-inch welding rods. Generous supply of rods supplied with machine. Recommended for all light welding like automobile fenders, etc. Take the Midget Arc anywhere to the job. Sturdily built and fully guaranteed. Comes complete—ready to use. Nothing else to buy. No previous welding experience needed to strike an arc. In a short time, anyone mechanically inclined can learn to weld with this machine.

You'll find hundreds of money-saving, time-saving uses for the Midget Arc around your home, garage, or workshop. Also in garages, factories, repair shops, tin shops, mechanics, farmers, inventors, etc. Order a Midget Electric Arc Welder now! SEND NO MONEY. We'll rush one to you, complete with rods and helmet (equipped with APPROVED welding glass). Pay postman only \$3.95 plus postage charges. If not satisfied, return Midget Arc in 5 days from receipt and we'll refund your money immediately. RUSH YOUR ORDER NOW.

MIDGET ARC WELDER CO., Strader Ave., Dept. S-202, Cincinnati 26, Ohio



Thomas E. Lattin
President

I WANT TO TRAIN YOU For A Big-Paying Job IN THE MEAT BUSINESS

Big-pay jobs go to expert Meat Cutters—essential trade—PEOPLE MUST EAT! Become Meat Cutting and Meat Merchandising expert in 6 weeks at Toledo. Learn easily, quickly. Actual practice. Training methods based on 30 years experience. Training for beginners or men with experience. Be own boss in profitable market. Diploma. Approved for training under G. I. Bill. Write TODAY for FREE facts. No obligation.

National School of Meat Cutting, Inc., Dept. 33, Toledo 4, Ohio



BE A RADIO ANNOUNCER

ENJOY BIG PAY AND PRESTIGE! BE IN THE SPOTLIGHT! MEET FAMOUS PEOPLE!

"HOW TO BECOME A RADIO ANNOUNCER," written by a top announcer at one of the country's leading radio stations. How to prepare yourself. Practice copy included. An invaluable guidebook for would-be radio announcers. \$1.00 postpaid. Send for copy today!

Converse Publications - Dept. PM-1, Box 311, Worcester, Mass.

REFRIGERATION and AIR CONDITIONING

REFRIGERATION
TRAINING
Since 1927

Mechanical units everywhere need servicing. Be ready with reliable pay-knowledge. Unique home study—actual practice plan. Train now for servicing and installing jobs or business of your own.

Get The Facts FREE Now! Write Today!

Approved under G. I. Bill UTILITIES ENGINEERING INSTITUTE
1314 W. Bolden Ave., Dept. 117, Chicago 14, Ill.

MAKE MONEY AT HOME

RUBBER
MOLDS

Low as
6¢ EA.



Amazing rubber mold-making outfit makes perfect flexible molds of plaques, ash trays, bookends, etc. Molds cost 6c to 25c each. Each mold makes hundreds of novelties and gifts to sell for \$1.00 apiece and more! No experience necessary. Everything furnished. Quick and easy. Start profitable business in your home—sell to stores, gift shops, friends, resorts, road stands, by mail. Full or spare time. Write for complete FREE details and easy instructions.

SO-LO WORKS, Inc., Dept. P-800, Loveland, Ohio



THIS ingenious device is a rocket-driven projectile about 16 feet long and a foot in diameter. Developed by the Army Ordnance Department, it is used by the Signal Corps to obtain accurate data on weather conditions 30 to 50 miles up in the ionosphere—far beyond the range of aircraft observation or radiosonde.

The projectile is powered to reach altitudes as high as 250,000 feet. There it releases parachutes and equipment capable of recording temperature, barometric pressure, humidity, electrical conductivity and other characteristics while dropping slowly to earth.

Long-range weather forecasting is only one of the fascinating fields of research being explored in the new Regular Army. The place

HOW'S THE WEATHER UP THERE?

for keen young men, eager for experience in such promising careers as Advanced Electronics, Radar, Nuclear Energy, Jet Propulsion and Supersonic Flight is here—in the front line of scientific advance.

Excellent pay—the equivalent of more than \$3000 a year in a civilian job—liberal leave, educational and retirement benefits, and the chance a 3-year enlistment gives you to *choose* your arm or service among those still open—make this the opportunity of a lifetime! Get full details at your nearest U. S. Army Recruiting Station.

• Listen to "Sound Off," "Warriors of Peace," "Voice of the Army" and "Proudly We Hail" on your radio.

★ ★ ★

**YOUR REGULAR ARMY SERVES THE NATION
AND MANKIND IN WAR AND PEACE**

A GOOD JOB FOR YOU
U. S. Army
CHOOSE THIS
FINE PROFESSION NOW!

U.S. GOVERNMENT JOBS

\$1,756 to \$3,021 a Year
(Veterans Get Special Preference)
Get Ready Now for 1947 Examinations

Railway Postal Clerks

Railway Postal Clerks get \$2,300 the first year of regular employment, being paid on the first and fifteenth of each month. (\$95.84 each pay day.) Their pay is automatically increased yearly to \$3,400 and \$3,600 in large organizations. Advance may be had to Chief Clerk at \$5,400 a year. Men 18 to 35.

3 Days On—3 Days Off—Full Pay

Railway Postal Clerks on long runs usually work 3 days and have 3 days off duty or in the same portion. During this off duty their pay continues just as though they were working. They travel on a pass when on business. When they grow old, they are retired with a pension.

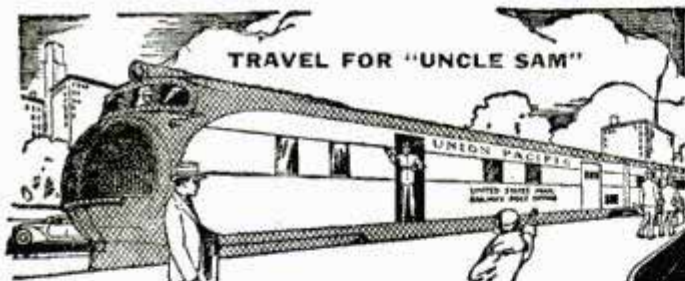

City Mail Carriers, Post Office Clerks

Clerks and Carriers now get \$2,100 the first year of regular employment and automatically increase \$100 a year to \$3,100. Open to Men—Women 18 to 50.

Many Other Positions

Many other positions are obtainable. Rural Carriers—Stenographers—Typists—Patrol Inspectors—Assistant Statistical Clerks—etc. Those wishing these positions should qualify at once.

Get Free List of Positions

Fill out the following coupon. Tear it off and mail it today—NOW, at once.

This investment can result in your getting a big-paid government job.

FRANKLIN INSTITUTE, Dept. D86, Rochester 4, N. Y.

Rush to me, entirely free of charge (1) a full description of U. S. Government Jobs; (2) Free copy of illustrated 32-page book, "How to Get a U. S. Government Job" with (3) List of U. S. Government Jobs; (4) Tell me how to prepare for one of these jobs.

Name.....

Address..... Veteran?.....

Use This Coupon Before You Mislaid It. Write or Print Plainly.

CONFIDENTIAL LOAN SERVICE
Borrow \$50 to \$300
 Need money? No matter where you live you can borrow **BY MAIL** \$50.00 to \$300.00 this easy quick confidential way.

IT IS EASY TO BORROW BY MAIL! Completely confidential and private CONVENIENT MONTHLY PAYMENTS

NO ENDORSERS NEEDED EMPLOYED MEN and women of good character can solve their money problems quickly and in privacy with loans **MADE BY MAIL.** No endorsers or co-signers. We do not contact employers, friends or relatives. Convenient monthly payments. Send us your name and address and we will mail application blank and complete details **FREE** in plain envelope. There is no obligation.

STATE FINANCE CO.
 Southern Surety Bldg., Dept. G-107, Des Moines 8, Ia.

MAKE MORE MONEY BE YOUR OWN BOSS!

Cash In!
 MAIL ORDER PLANS
 TESTED MONEY MAKERS
 BUSINESS SECRETS
 SUCCESS SCHEMES

\$1.00 VALUE 25¢
40,000 WORDS
 IN TEXT

In "CASH IN" you now get THE real money-makers—dozens of profitable tested mail order plans, confidential business secrets, dozens of practical tested formulas, successful tested schemes—actual experiences of men who have started on a shoestring—with less than \$10 capital.

25¢ a copy postpaid. Send U. S. stamps, money order, or coin.

MONEY BACK GUARANTEE
NATIONAL PLANS COMPANY
 P. O. Box 26Z, Ansonia Station, N. Y. C. 23, N. Y.

Learn modern watch and clock repairing

At home, spare time. Good field now... security and contentment in future. Start part-time business and **EARN while you learn.** Horology is precision instrument work... a great and growing field, sensational opportunities. Easy self-instruction course. Low price. **Money-back guarantee.** Write today for **FREE Success-Catalog!**

NELSON CO., 1139 S. Wabash Ave., Chicago 5, Illinois

Learn BAKING At Home

Baking is one of America's high industries in wages. Nearly depression-proof. Thorough basic home course lays sound foundation. If you have aptitude, write for **FREE BOOKLET.** "Opportunities in Commercial Baking."

National Baking School, 1315 Mich. Ave., Dept. 1351, Chicago 5

MAKE MAGIC YOUR HOBBY

BE A MAGICIAN FOR FUN OR PROFIT!

Rush 25¢ for first issue of "MAGIC IS FUN," new magazine that teaches how to do tricks with coins, cards, ropes, etc. **FREE**, with order, large catalog of magical apparatus.

D. Robbins & Co., Dept. M-57, 152 W. 42 St., N. Y. 18, N. Y.

PLATE USERS! Give Your Mouth A Treat!

"CAMCO" Dental Plate Reliner

Restores original comfortable fit. Odorless. Tasteless. Not an adhesive. Will not dissolve in mouth. Easy to apply.

\$2.00 post-paid

CATHAY AMERICAN CO., San Francisco 11, Calif.

FIBRE ARMS AND LEGS!

Light, correctly fitted, strong and comfortable. Natural appearance. Braces for all deformities. Scientific design. Fair Terms.

BUCHSTEIN-MEDCALF 223 S. 6th St., Minneapolis, Minn.

MAKE THIS SUIT YOURS NEW PLAN

EARN CASH SHOWING TO FRIENDS!

Write at once if you want this fine made-to-measure suit! You can get it by taking a few orders from friends, and earn up to \$10, \$12 in a day. Your bonus suit helps you take more orders with latest style, made-to-measure **guaranteed** suits at amazingly low prices. Also complete line of Ladies' Tailored Suits. No experience, no money needed. Write **TODAY** for **FREE SAMPLES**—telling about yourself—age, etc. No obligation!

PIONEER TAILORING CO. Congress and Throop Streets, Dept. N-1116, Chicago 7, Ill.

4 Career Ways to Security

APPROVED FOR TRAINING THE YOUNG MEN OF AMERICA—VETERAN AND NON-VETERAN

PLASTICS — MAGIC WORD!



Here at Plastics Tech in Los Angeles, men are learning the secrets of this glamorous industry for which the future seems unlimited. Hundreds of new products are being made of plastics requiring trained men to develop and fabricate them. Plastics Tech is the pioneer and leader in the field of plastics instruction. Its faculty and directors are leaders in

the industry. Write for beautiful four-color catalog today. No obligation. Courses available either residential or study at home. Mail coupon in envelope or paste on penny postcard.

PLASTICS INDUSTRIES TECHNICAL INSTITUTE,
Dept. PM7-1Q, 1601 S. Western Ave., Los Angeles 26, Calif.

Gentlemen: Please send me free booklet "World of Plastics" and information on your training.

Name (PRINT)
Street Age.....
City State.....
Veteran..... Non-Veteran.....
Residence School..... Home Study.....

BE AN AIRCRAFT INSTRUMENT TECHNICIAN

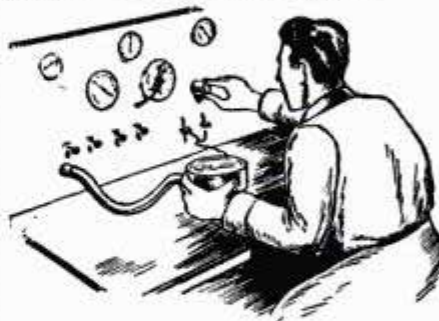

More than 750,000 trained men (CAA survey) will be needed to fill important jobs in the Aviation industry in next 10 years. All planes require delicate instruments. There must be trained men to service, maintain and repair them — Instruments must be right ALWAYS. AMERICAN SCHOOL OF AIRCRAFT INSTRUMENTS teaches men to perform this important, interesting and well-paid work. The world's future depends on more Aviation—INSTRUMENTS. Write today for free booklet. Send coupon in envelope.

AMERICAN SCHOOLS OF AIRCRAFT INSTRUMENTS,
Dept. P-17, 5145 W. San Fernando Rd., Los Angeles 26, Calif.

Gentlemen: Please send me free booklet and information on your training.

Name (PRINT)
Street Age.....
City State.....
Veteran..... Non-Veteran.....



AIRCRAFTSMANSHIP MODERN TRAINING



Aero Tech training will give you a better start for a well paid, responsible position. Thousands of successful AERO TECH graduates prove we have the knowhow to give leadership training. Now at our new location on huge Oakland Airport —Gateway to the Pacific. Write for catalog and full information on our

Aeronautical Engineering and Master Mechanics Course. Early enrollment assured. Mail coupon in envelope.

AERO INDUSTRIES TECHNICAL INSTITUTE,
Dept. P-17, Oakland Municipal Airport, Oakland 14, Calif.

Gentlemen: Please send me free booklet and information on your training.

Name (PRINT)
Street Age.....
City State.....
Veteran..... Non-Veteran.....

WATCHMAKING— A CAREER FIELD!



WORK — and plenty of it — Millions of watches and clocks need fixing. An interesting and needed service in the top-pay bracket, or start an independent business of your own. The AMERICAN SCHOOL OF WATCHMAKING

offers proven training under QUALIFIED watchmaker-instructors. Complete information free upon request. Enclose coupon in envelope or paste on penny postcard.

AMERICAN SCHOOL OF WATCHMAKING,
Dept. P-17, 5145 W. San Fernando Rd., Los Angeles 26, Calif.

Gentlemen: Please send me free booklet and information on your training.

Name (PRINT)
Street Age.....
City State.....
Veteran..... Non-Veteran.....

MEMBERS OF NATIONAL COUNCIL OF TECHNICAL SCHOOLS

CHOOSE THE ONE THAT FITS YOU BEST — SEND COUPON TODAY

MY DOBE TRAINING WAS ALL PRACTICAL EXPERIENCE!

I WILL TRAIN YOU AT HOME UNTIL YOU GET A GOOD PAY JOB!

Get Started NOW in DRAFTING



EXPERIENCE WHILE LEARNING

Your training will be experience because I give you practical jobs to do. And I list your experience and send it to employers as a reference when you are ready. All Dobe trained men start out with experience. You will too, because I will train you until you get a good pay job in drafting.

Take the first step now and step into Drafting—the big opportunity field—as an experienced, well paid draftsman. Act now for a better job, better pay and better working conditions. The field for draftsmen is bigger now than ever before for all new products, machines, construction start with the draftsman. Get into drafting now. I will train you at home in your spare time, and give you actual experience on actual work—the same kind of jobs you will do with the best paying firms. I will train you until you are competent, fully experienced, and holding a position that will bring advancement and pay raises. Write me today.

WORKING TOOLS SENT WHEN YOU START
All drafting instruments and table and other needed equipment sent when you start. Nothing to buy. Act today. Mail coupon to me now and be sure to give age.



MAIL COUPON FOR VITAL FACTS

Engineer Dobe, Div. 11, Libertyville, Ill.

Send me the Vital Facts on Drafting and Industrial Designing, your Free Book and advertised list of positions for Draftsmen and Designers wanted.

Name..... Age.....
Address.....
City..... Zone..... State.....

NOW! Build Your Future On DIESEL Opportunities



LOOK around you. See the way tractors, trucks, buses, railroads, ships, power plants and equipment of many kinds are "going Diesel." Every day new opportunities are opening—in industrial and farming communities—for trained men who can install, maintain, operate and repair Diesel engines. Plan now to build your future in this growing field.

Diesel Knowledge is Earning Power

You don't have to give up your present job. Now, you can begin learning DIESEL in spare time at home. UEI practical training teaches you, step by step, how Diesel engines operate, how fuel systems work, repairs, accessories and auxiliary equipment; a world of Diesel "know how." Includes actual practice on Diesel equipment in our shop under expert guidance. UEI training methods are successful. For 20 years they have helped mechanically inclined men better themselves.

NOW IT'S UP TO YOU!

Coupon below brings you all the facts without cost or obligation. Get going today! MAIL COUPON NOW.

UTILITIES ENGINEERING INSTITUTE
Diesel Division
1314 W. Belden
Dept. 117-D,
Chicago 14, Ill.

Founded 1927



UTILITIES ENGINEERING INSTITUTE, Diesel Division
1314 W. Belden Ave., Dept. 117-D, Chicago 14, Ill.
Please send me Free Facts about Diesel opportunities and training.

NAME..... Age.....
ADDRESS.....
CITY..... Zone or County..... STATE.....
 Check here for special information if you are under 17.
 Check here if Veteran of World War II.

Send Coupon for FREE FACTS

INVENTORS
A New Kind of Service
PRODUCTS AND IDEAS INVESTIGATED

INVENTORS—don't put the cart before the horse. Before you spend money on models, Patents, etc., find out whether your idea has any commercial value. Get full facts on new, modern Market Analysis and Investigation plan. We check markets, analyze sales possibilities, contact manufacturers, conduct sales negotiations. Help you get top prices. Service applies to both Patented and Unpatented inventions. Send at once for new FREE booklet, "A 12 Point Program for Inventors." NATIONAL MERCHANDISERS, Room 412, Abbott Building, 28 East Huron Street, Chicago 11, Ill.

NEW FREE BOOKLET

TRAIN NOW FOR A WELL PAID JOB IN POST-WAR AVIATION!! AIRCRAFT INSTRUMENT MEN

will be needed by manufacturers, airlines, service organizations. Don't wait until competition gets tough! Be ready! Study now! Let Eastern's Home Study Course give you training in your own home. Actual instruments furnished. Send for folder now.

EASTERN AIRCRAFT INSTRUMENT SCHOOL, Dept. PM
Division of National Technical Institute, Inc.
118 Newark Ave. Jersey City 2, New Jersey

AGENTS... Be First With Newest Products
It means quick easy sales and large profits. Our monthly NEW PRODUCTS BULLETIN SERVICE lists 100 NEWEST products, where to buy them, long before they appear on the market. Sample Bulletin \$1.00. FREE information. HURRY—BE FIRST—BEAT COMPETITION. EDUCATIONAL BOOK CO., 2907 Berwick Ave., Baltimore 14, Md.

● Earn HIGH SCHOOL DIPLOMA at Home ●
Guided study permits you to complete High School education in shortest possible time. Modern methods make it interesting, easier. Prepare for better jobs, pre-professional, college entrance exams. Recognition for U.S. credits already earned. Books supplied, low tuition, easy terms. Write for FREE information. HOME STUDY INSTITUTE, Dept. 11, 209 Vine Ave., Park Ridge, Illinois

6 Interesting Mail Trade Magazines
Latest Issues. All Different. 16 to 72 Pages Each. Full Of Money Making Information. Excellent Advertising Mediums. 25c
GIARD 1130 MADISON AURORA, MO.

Thrilling Work COLORING PHOTOS
EASY TO LEARN
Fascinating vocation learned at home by those with aptitude. Thrilling pastime. National method brings out life-like colors. Free booklet. NATIONAL PHOTO COLORING SCHOOL 1315 S. Michigan, Dept. 1351, Chicago 5

SAY YOU SAW IT IN POPULAR MECHANICS

COMB-A-TRIM
THE NEW QUICK TRIMMER

Something New! Trim your hair without any experience. It's easy! The excess hair comes off smoothly and easily by just pulling trimmer through hair like an ordinary comb. Also removes hair from legs—armpits. Save on hair-cut bills... Trim your own hair or the whole family's. Send 59c and your Comb-A-Trim will be sent at once.

59c

SPECIAL OFFER
Send \$1.00 for 2 Comb-A-Trims and save 18c. **2 for \$1**

5 Extra Blades (Year's Supply) 25c
COMB-A-TRIM CO.
1734 Carew Tower Dept. R-15 Cincinnati, O.

Learn by Mail to Mount Birds

Animals, Game-Heads, Fish, Pets, to Tan Skins

Men, Boys! Be a Taxidermist. Learn at home in spare time. Easily, quickly learned. Grand Fun. A wonderful, profitable hobby, for expert hunters, also for amateurs, even young boys. Mount wild-game, although wild-game is not necessary. Use common, domestic specimens, squirrels, pigeons, even frogs. This famous, reliable school in business more than 35 years. More than 300,000 delighted students. Think of that!

Hunters Save Your Trophies — Have a Home-museum Be a Taxidermy Artist

You will be THRILLED and DELIGHTED. You learn QUICKLY, easily AT HOME. Your friends will be amazed. Hunters from near and far will bring their TROPHIES to be mounted. You can earn fine profits in spare time. Many students earn \$60 to \$100 a month, in season. Rush the coupon today, and learn all about wonderful taxidermy. **DO IT NOW!**

Save your own hunting trophies. Have a lifelong hobby. Have a home museum that you are proud of, and that makes you popular and well-known far and wide. **BOYS, wild-game is not necessary.** Use common specimens, squirrels, pigeons, owls, domestic birds and animals. **It's wonderful. Inquire today. Kill fewer game-birds. Double your fun and pleasure.**

Fun — Fascination — Profit

And so easily learned in spare time. Wild-game is growing scarcer. Help preserve it. Shoot only a FEW fine ducks and other game-birds, MOUNT THEM for home and den, and have MORE FUN and PLEASURE than killing the legal limit every day. **Help preserve the wild-game.**

Remember you learn to mount expertly, birds, animals, game-heads, fish, pets, to tan skins and furs. Investigate! You will be delighted. Send for free book today. "Eat your trophies and have them too."

THE N. W. SCHOOL OF TAXIDERMISTRY, 3371 Elwood Bldg., Omaha 8, Nebr.

FREE BOOK!

Yes FREE, 44 pages, with 100 unique pictures of taxidermy work. No other book in the world like this. It will amaze and thrill you. Ask today for your free copy. State your AGE.

Send the Coupon!

Write name plainly in coupon or margin, or a post card will do. Rush your request, as free books may be exhausted quickly. Decide now. Don't wait a moment. State your age.

FREE BOOK

Northwestern School of Taxidermy, 3371 Elwood Bldg., Omaha, Neb. Send me your free illustrated book, "How to Mount Game". Also tell me how I may learn this fascinating art easily and quickly by mail. No obligation. State your age.

Name Age

Address

REFRIGERATION **ELECTRONICS** **WELDING**

COURSES

SERVICE—6 months
 Practical Electricity
 Practical Welding
 Refrigeration Service
 Heating Service

TECHNICIAN—12 months
 Electro Technician
 Radio Technician
 Electronics Technician
 Refrigeration, Heating
 and Air Conditioning
 Technician

PROFESSIONAL—36 months
 Electrical Engineering
 Major in Machinery
 or Electronics

PRACTICAL TECHNICAL TRAINING

Our time-tested *CONCENTRIC SYSTEM* enables you to build your career step by step. Each 6-month course is complete in itself. Stay as long as circumstances permit—until you reach your desired occupational objective. For 44 years this school has specialized in technical training. More than 35,000 former students in industries the world over. 1,248 students now enrolled from 46 states and 5 foreign countries. Faculty of 63 specialists. World-wide alumni counselor committee. Terms start January, April, July, September. **SEND COUPON TODAY!**

MILWAUKEE SCHOOL OF ENGINEERING

A Technical Institute

Milwaukee School of Engineering, Dept. PM-147
 N. Broadway and E. State, Milwaukee, Wis.

Without obligation, send me free booklet "Career Building" and more details on course in

Name Age

Address

City State

Bigger Opportunities Than Ever in . . .



AUTO BODY AND FENDER REPAIR

● THE FIELD IS STILL GROWING after more than 40 years . . . expanding with the giant auto industry! Millions of new cars are getting to market, millions of old ones are still on the road—THE NEED for MAN-POWER in the service field is INCREASING!

TRAIN NOW . . . FOR THE OPPORTUNITIES AHEAD!

Don't be stuck in a low-pay job! Opportunity here is big enough for thousands to find big-pay work either in a reliable job or in their own shops. UEI teaches Auto Body & Fender Repairing the *easy* way. No special education or experience needed . . . you can start in your spare time, right at home . . . keep your job while you learn. Then, when home study is finished, you continue at the well-equipped UEI shops getting practical experience. Fix and refinish damage, replace panels and tops. Learn up-to-date methods in use of tools, spray painting, welding, metal work—all under expert supervision.

GET THE FACTS . . . FREE!

UEI HAS TRAINED THOUSANDS for opportunity fields, and students are making good. If you want to get ahead, send coupon today for free facts on AUTO BODY AND FENDER REPAIRING. Don't delay!

**AUTOCRAFTS DIVISION
UTILITIES ENGINEERING
INSTITUTE**

1314 Belden Avenue, Dept. 117-X,
Chicago 14, Illinois

Approved for
training under
G. I. Bill

Founded
1927



FILL OUT AND MAIL . . . TODAY!

Autocrafts Division
Utilities Engineering Institute, Dept. 117-X,
1314 Belden Avenue, Chicago 14, Ill.

Yes, I'm interested! Send me those Free Facts about Auto Body and Fender Repairing.

NAME _____ Age _____

ADDRESS _____

CITY _____ Zone or County _____ STATE _____

If veteran of World War II check here
 Check here for Special Information if under 17.



SALESMEN FOR CITY AND COUNTY Nationally Known Manufacturer

Build up a business of your own with Nationally Advertised Products bearing Underwriters' label. Sell to schools, factories, service stations, warehouses, hotels, restaurants, public institutions, truck and bus companies, grain elevators, house trailers, autos, farms, homes, etc. Capable man can earn real money. Established in 1916. Write letter with details, age, experience, etc.

Dept. 90-25 FYR-FYTER CO., Dayton 1; Ohio

Now You Can Join CLUB PLAN For BUSINESS SUCCESS FREE

Full Details and Illustrated Brochure

Club Plan of Practical Business Administration now offered men in business and industry who want to follow a program in order to move up to executive positions. Plan available to employed men who wish advancement with present employer or elsewhere. Program will not interfere with present job. Serious minded, ambitious men invited to send for free facts at once.

AMERICAN TECHNICAL SOCIETY, Dept. S21
Drexel & 58th CHICAGO, ILL.

MAKE MONEY CASTING AT HOME FREE FACTS SENT



Make hundreds of Plaster Casts, quick, easy. Sell output to stores, novelty shops, etc. Enormous profits. No experience. Very little capital needed. Start in basement, garage or workshop. Complete, simple instructions anyone can follow. Start now while merchants are begging for merchandise to sell. Rush.
PLASTIC ARTS STUDIOS, R. R. 5, Dept. 29, Muncie, Ind.

HIGHWAY ENGINEERING PRACTICAL TRAINING IN HIGHWAY DESIGN AND PRACTICE. HOME STUDY — BY MAIL ONLY — WRITE US NOW! SCHOOL OF HIGHWAY PRACTICE DEPT. A, 2161 SHATTUCK AVE. BERKELEY 4, CALIF.

HOME STUDY OR SHOP TRAINING

Learn Plastics, Refrigeration or Diesel. Study at home, shop work later. Also shop courses in Body and Fender, Machine Shop, Tool and Die. 41,000 graduates. Established 1902. Free booklet. Specify trade.

GREER SHOP TRAINING, Dept. 117, 460 S. State St., Chicago

WAR SURPLUS

Lathes, Milling Machines, Drill Presses, Sawing equipment, Motors and thousands of miscellaneous items. Also information on Helicopters, Sleeper Trailers, Garden Tractors, Power Lawn Mowers, Welders, Jet Impulsion for Cars and Tractors etc. Rush name for free literature.
THE WAYNE ENGINEERING CO., DEPT. 1115, GREENVILLE, OHIO

CODE SPEED SHORT CUT

Be an expert. Learn to be a Telegraph or Radio Operator. Thousands of men needed. Intensely interesting work—good pay. Learn at home or wherever you are, quickly, easily with the famous Candler Speed System. Book of particulars Free.
CANDLER SYSTEM CO., Dept. 5-A, Box 928, Denver 1, Colo. U.S.A.

Now
MIRACLE WALL CLEANER

Saves Costly Redecorating!
AMAZING INVENTION. Banishes old-style housecleaning mess and mud. No rags—no sticky "dough"—no red, swollen hands. No more dangerous stepladders. Literally erases dirt like magic from walls, ceilings, window shades, upholstered furniture, etc. *Ends rudeness!* SAVES REDECORATING!

SAMPLES FOR AGENTS Sample offer sent immediately to all who send name at once. A penny postal will do. **SEND NO MONEY—** just your name. KRISTEE CO., 681 Bar Street, AKRON, OHIO.

The great **SUCCESS** instruction for men and women now in business . . . or planning to get into **PRODUCTIVE** work . . . The **PROFITABLE, EASY, SURE** method . . . **Get it NOW**

HOW TO MAKE MONEY BY MAIL

ENLARGED to 640 pages, 15th edition

Down-to-earth facts, directions (illustrated) for running business profitably, using expertly for **YOUR** good fortune the employees, trains, planes which Gov't places at your disposal **CHEAP**. Get orders by mail, ship by express or freight or mail, get out of the kindergarten . . . 15th edition, enlarged to 640 pages, now selling. It's **YOUR** winner. Make this year and the following years worth more. . . . **THIS** knowledge really **PAYS OFF**.

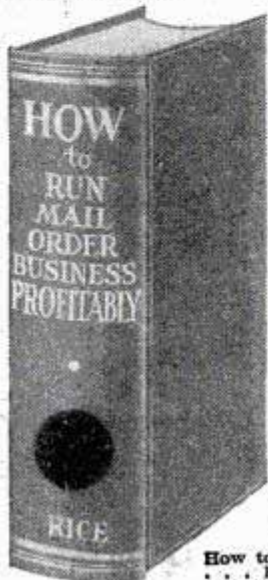

THE EASY WAY to start new or expand your present occupation. **Do it NOW.** Extraordinary plain, simple skill, know-how. No theory. Fact story of rich experience of author E. Rice day-by-day. How many times have we heard: "I wish I had some money, this patent would earn me a fortune," or "why can't my crop pay better?" or "I wish I knew how to sell this gadget myself," or "why should my boss alone do this when I too know how the money is made?" . . . Listen, **YOU DO NOT NEED MONEY TO START THIS RICE WAY.** His method automatically pays all bills same day rendered, no bank loans, pay as you go, no borrowing from relatives or friends, no salesmen. Also no worry, quickly a home of your own all paid for. Rice paid off \$5000 in mortgages a year after using this skillful idea.

46 Years of PROOF

Sounds fishy? Sure, but this has been done steadily for **46** years, depression or no depression, by the author; that is why he wrote this book, to pass the good word along. Make it go with anything you have which is salable, or with what you are now doing. Rice made his pay plan go from the start when living in one room in a city lodging house. Turn your city or country home, your work, your hobby, into money. How to get orders coming steadily at cost of only \$4 for each \$100 taken in. The popular error to avoid in trying for sales. Business won free while others have to pay for it.

How to conceive the money-getting advertisement. Profitable changes from ordinary ideas and methods. Not usual cut-and-dried pattern, 250 adventures, a dictated book in everyday talk by Rice himself, he discloses in his book can be done by his method. No dictionary writing. . . . Read how others are profiting big.

Take a chance on this book being worth a fortune to you and yours and send \$2.95. Book mailed same day order is received. Hundreds of buyers whose letters we show you declare emphatically its superlative goodness. Follow its easy pattern for success. Cloth-bound, 640 pages, 5 1/2" by 5 1/2". Best seller, 15th edition now selling. Cut out the \$2.95 **HOW BOX** here, pin or stick it to sheet of paper bearing your name and address, mail in envelope with money order or check for \$2.95 to

HOW
640 PAGES
\$2.95

HOWARD ST. HOUSE, Melrose 76d, Massachusetts

Wonderful POULTRY BOOK

FREE LOW PRICES 48 varieties **SEX-LINKED** and **PUREBREDS**; **BABY CHICKS**, Pullets or Cockerels, also **STARTED CHICKS**, **BABY TURKEYS**, Mature Fowls and Hatching Eggs. **ALL FLOCKS BLOOD TESTED FOR BWD**. Write quick for this free book. **GREAT WESTERN HATCHERY, Box 15, Salina, Kans.**



Stromberg WINTER LAYERS

SILVER SPANGLED HAMBURGS. Breeders are U. S. APPROVED PULLORUM TESTED. Specializing in Large Type, Pedigreed Sired **WHITE LEGHORNS** and High Production **WHITE ROCKS**, 22 leading varieties. Also Started Chicks & Ducklings. **FREE CATALOG**. Stromberg Hatchery, Dept. 813, Ft. Dodge, Iowa



LEARN AT HOME TO CLEAN WATCHES. Pays wonderful profits. Our "easy-to-understand" Instruction Course tells how. Amazing spare-time moneymaker. Act quickly. **WRITE NOW.** Eastern Horological Enterprises, Box 213, Toronto, Ont., Canada.

Say You Saw It in POPULAR MECHANICS

NOW 93% MORE ENERGY, LONGER LIFE

Get the New "Eveready" Flashlight Batteries
The word "Eveready" is a registered trade-mark of National Carbon Co., Inc.

TALK-SING thru your own radio with RADIO MICROPHONE

Be the life of the party. Put on your own broadcasts at home. Talk-Sing make announcements from any room. Wonderful voice practice. Microphone easily attached to any radio. Follow enclosed instructions. **SEND NO MONEY**—pay postman \$1.98 plus postage. Send Money Order or check and save postage.

EMPIRE RADIO & TELEVISION CO. (Dept. R2) 1521 Bedford Ave. Brooklyn 16, N. Y.

NOW! The ONE-UNIT HEARING AID

Thousands Have Waited for

The New ONE-UNIT **Beltone** MONO-PAC HEARING AID



THIS IS ALL YOU WEAR

No Separate Battery Pack
No Dangling Battery Cords

The tiny new BELTONE Mono-Pac is about 1/2 size and weight of old-style hearing aids, yet so powerful you hear even *whispers!* Get helpful facts about this new "MIRACLE" aid in valuable **FREE** book about deafness.

BELTONE HEARING AID CO.
1450 W. 19th St., Dept. PM71, Chicago 8, Ill.

FREE BOOKLET

Beltone Hearing Aid Co.

Dept. PM71, 1450 W. 19th St., Chicago 8, Ill.

Please send me **FREE** booklet about deafness and what can be done to overcome it.

Name _____
Address _____
Town _____ Zone _____ State _____

LEARN RADIO BROADCASTING WRITE FOR FREE FACTS

THIS PROFESSIONAL WAY—ACTUAL BROADCASTING MATERIALS SUPPLIED YOU IN YOUR OWN HOME

Opportunities for men and women. Train with America's foremost school of broadcasting. Fascinating field, good pay. Excellent training in preparation for professional productions, and for teachers, club members, social groups. Broadcast stations need qualified people. You receive actual equipment in own home including microphone, recordings, scripts, etc. You may follow home study course with intensive short period of instruction in our well equipped Chicago Studios. Get facts about this fascinating training program today. Send for **FREE FACTS** and full information. No obligation. Write today. Broadcast Productions, Dept. 11, 25 E. Jackson Blvd., Chicago, Ill.

NEW OHMITE Ohm's Law Calculator

25c

New Pocket Size Computing Scales on One Side Gives Composition Resistor Color Code

Figures Ohms, Watts, Amperes, Volts... Quickly!

Here's a new and improved version of the famous Ohmite Calculator. Handy pocket size—9" x 3". Solves any Ohm's Law problem with one setting of the slide. No slide rule knowledge necessary. Send 25c in coin for your Calculator.

OHMITE MFG. CO., 4939 Flournoy Street, Chicago 44, Illinois

Get into ELECTRICITY Now!

MODERN SHOP TRAINING

**START NOW — BE READY IN FEW WEEKS
FOR BIGGER JOB OPPORTUNITIES
LEARN ON ACTUAL EQUIPMENT
IN NATIONALLY KNOWN SCHOOL**

Get ready for good job or business of your own. Electricity is the heart of modern industry. Electricians are always needed, earn higher pay, work year around. Make rapid progress in step-by-step practical shop training in Electrical Wiring and Circuits; Armature Winding; Electrical Appliance Repairs; Electro Plating and Welding. Rural Electrification, the Building Boom, many new uses of Electricity opening more opportunities in this vast field. Get training under thoroughly experienced instructors, be ready in few short weeks for Job Opportunities in Electricity.



VETERANS qualifying under "G.I. Bill" have tuition paid by Government plus monthly subsistence allowance while in school. Just mail coupon, we will handle all details. (LOW TUITION. EASY TERMS if you are not a veteran.)

**ELECTRICAL DIVISION
COMMERCIAL TRADES INSTITUTE,
Dept. C-21
6312 N. Broadway, Chicago 40, Ill.**



FREE — Important Information Telling How to Get Started

Fill Out, Cut Out, Mail Today

FACTS FREE for Men Who Want to Get Ahead

**COMMERCIAL TRADES INSTITUTE, Dept. C-21
6312 N. Broadway, Chicago 40, Ill.**
Send free illustrated Brochures and other information about your training in Electricity.

Veteran Non Veteran

Name

Address

City State

ELECTROPLATING OUTFIT

**BRUSH ON
SILVER, COPPER**

Only
\$3.95
COMPLETE



Comes Ready to Use—Nothing Else to Buy!
Here's the Handy ELECTRO-PLATER outfit for your home-workshop or business! Only \$3.95 complete! Puts a smooth, shining, silver or copper plating on silverware, toys, models, doorknobs, auto accessories, home fixtures . . . everything with a conductive surface! Simple, easy to use! Complete instructions furnished. Just brush on silver or copper plating! Comes complete—ready to use—with liberal jars of silver and copper plating materials, cleaner, two brushes, battery power unit . . . everything you need to start plating at once! Nothing else to buy.

SEND NO MONEY! GUARANTEED!

Rush order today—a postcard will do. Electro-Plater shipped direct to you by express. Pay only \$3.95, plus express charges, on delivery—or send \$4.45 with order and we ship prepaid. Use 10 days, if not completely satisfied, return outfit and your money will be refunded. Order now.

**HANDY ELECTRO-PLATER • Dept. A-413
259 Strader Avenue Cincinnati 26, Ohio**

GENUINE MILITARY WRIST WATCH Complete with New Style EXPANSION BAND



Sensational value! Genuine Military wrist watch, precision built, split-second timekeeper, for ONLY \$13.95 plus tax! Water-protected, shock absorber. Radium dial and hands, easily read in the dark, unbreakable crystal, red sweep second hand. Handsome, non-corrosive stainless steel case. Genuine non-corrosive stainless steel expansion bracelet fits all wrists. Order yours today!

ONLY \$13.95 PLUS TAX

SEND NO MONEY! Rush order now! Pay postman only \$13.95 plus postage and 10% Fed. tax. If not delighted, return within 10 days for refund.

**CORONA WATCH SALES COMPANY
809 W. Madison St. Dept. A-84 Chicago 7, Ill.**

SONGWRITERS

Do your words need music? We supply the best music . . . written for you by a composer of HITS! Recordings made. Send for free booklet.

**TIP TOP TUNES DEPT. PM-17
BOX 309 • HOLLYWOOD 28, CALIF.**

Say You Saw It in POPULAR MECHANICS

BIG MONEY FOR YOU IN PLASTICS

SEND Offer includes 2 books: New Fabrication Manual & Giant Catalog, listing the most complete stock of Plastic Materials, Accessories, Tools.

10¢

**BERTON PLASTICS, INC.
19 W. 21st St., N. Y. 10, N. Y.**

ACT TODAY!

WILL'S Pioneer SEEDS

Many amazing offers celebrating our 65 years' developing and perfecting WILL'S hardy, dependable Pioneer Seeds and Plants. They inherit the wild beauty and sturdy vigor of the Northern Plains country. They grow anywhere!

FREE Big New 1947 Catalog. Wonderfully beautiful 65th edition—pictures, color, rotogravure. Everything in Flowers, Fruits, Vegetables, Nursery Stocks, Farm Seeds, etc. It's FREE. Write—

**New Hampshire
VICTOR TOMATO**

A Prof. Yeager original. Rich red, firm, delicious fruits, Early. Disease resistant. Post-paid.

BIG 15¢ PKT.

**OSCAR H. WILL & CO.
Box 745, Bismarck, N. D.**



IS THE WRONG JOB KEEPING YOU AT THE BOTTOM OF THE LADDER?

Are you wasting your life in work not suited to you? Out of every 100 people, 85 are doing just that! Why remain at the foot of the ladder, when there is a direct route to success? Thousands are turning to Vocational

Analysis for help. Vocational Analysis points out the formula for your success by scientific measurement of your abilities, interests and talents . . . shows you what *your* work should be.



No need to drift from job to job looking for your RIGHT career. Modern, scientific vocational testing will direct you to it. Send for our free booklet FORMULA FOR SUCCESS, telling you the simple steps YOU can take to SUCCEED. Write today to

Personnel Division M-9

VOCATIONAL TESTING LABORATORY

2019 Main Street

Dallas, Texas



Make Your Own RUBBER MOLDS

with RED LATEX MOLDING COMPOUND

Earn money, have fun; make your own molds for plaster objects. Produce novelties and gifts for home and to sell to friends. RED LATEX MOLDING COMPOUND (60% density) now available in quart and gallon quantities. Gives perfect results, easy to apply. Send for complete information and prices. FRANCIS SUPPLY CO., Dept. A-2, 1836 E. Fulton St., Columbus 9, Ohio.

CHAPMAN CHINCHILLAS

The originator of the first Chinchilla Farm in the United States. For information on purchasing the finest, selected breeding stock of these aristocratic animals that were virtually trapped to extinction write or visit—

Established 1919

Chapman Chinchilla Farm
4957 West 104th Street
Inglewood, California

BUILDING CONSTRUCTION



with composition cement and cheap wood builds 3 room house low as \$250, farm buildings low as \$50. Homemade forms make blocks, panels and tiles in color, and wallboard of sawdust and other compositions. Wall-high blocks, insulated, with finished sides. Stream-lined roof and walls. Cement gutters, troweled roofs and floors. Ten formulas. Cabins, stores and sectional. 100 money and labor saving ideas. Mixer and saw easily made from an old auto. Make doors and windows. 50 proved ways to earn \$10.00 to \$15.00 a day. Guaranteed, book, 100 illustrations, \$1.00.

MAKE FURNITURE OF COMPOSITION cement, sawdust, asbestos, paper. Some part scrap wood and metal. Illustrated instructions to make tables, cabinets, chests, racks, shelves, inclosed sinks, lawn novelties and toys. 500 per cent profit. 50c.

HOW TO MAKE ACCURATE SHOP MACHINES: Band, Jlg. and circular saws, electric drills, sanding wheels, forge, tools, electric weed cutters and many other things from old auto parts and washing machine motors. Illustrated. 50c.

HOME MFG. ENTERPRISES. 50 selected home shop projects, illus., 50c. Special: All four booklets described above, \$2.00 postpaid. No C.O.D. HOME INDUSTRIES, 1318 So. 30th Ave., Dept. PM, Omaha 5, Nebr.

SAY YOU SAW IT IN POPULAR MECHANICS



STUDY AT HOME for PERSONAL SUCCESS and LARGER EARNINGS. 38 years expert instruction—over 108,000 students enrolled. LL.B. Degree awarded. All texts furnished. Easy payments. Send for FREE BOOK—"Law and Executive Guidance."

AMERICAN EXTENSION SCHOOL OF LAW
Dept. 73-M, 646 N. Michigan Ave., Chicago 11, Ill.

BOWS & ARROWS

Write for 94 page Illustrated Instruction Hand Book 50c; 20 page catalog 5c; stamps or coin.

LE STEMLER CO. QUEENS VILLAGE, N.Y.

BRUSH PLATING OUTFITS

for re-plating articles in the home and shop. No tanks necessary. Free particulars.

GUNMETAL CO., AVE. M, DECATUR, ILLINOIS

LOANS by MAIL

\$50 to \$300 IN A HURRY

CONFIDENTIAL

Salaried people, men or women, married or single, loans on your own signature, or your own security. NO personal interview. NO co-signers needed. NO wage assignments. You mail the application to us... we mail the money to you.

FOR A LOAN OF

YOU CAN REPAY MONTHLY

	IN 15 PAYMENTS	IN 12 PAYMENTS	IN 9 PAYMENTS	IN 6 PAYMENTS
\$ 50	8.40	\$ 5.03	\$ 6.43	\$ 9.24
100	12.60	10.07	12.87	18.48
150	16.75	15.10	19.30	27.73
200	20.85	20.09	25.68	36.91
250	24.93	25.02	32.02	46.05
300		29.94	38.33	55.17

The above payments made at regular monthly intervals will repay the entire loan and all charges in the time indicated. Charges are based on the monthly rate of three per cent on unpaid principal balances to \$150.00 and two and one-half per cent on that portion of unpaid balances in excess of \$150.00 but not exceeding \$300.00. "Loans by Mail" may be repaid in larger amounts, more frequent payments or repaid in full at further savings to you.

CONVENIENT

Just write us how much money you need and how you wish to repay . . . there's no charge or obligation. Whatever your needs for cash now or in the future, write for your "Loans by Mail" plan, today.

MERCHANTS INVESTMENT CO.

819-G 1st Nat'l Bldg., Omaha, Nebr.

Without obligation, rush complete details and all papers necessary

for a loan of \$_____ to be repaid at \$_____

on the _____ day of each month.

Name _____

Address _____

City _____ State _____

Occupation _____

PRESTO! MASTER GLAZE

ANYONE CAN



Car Owners! Meet Master Glaze—the sensationally different luster for new and used cars! Not a wax—not an oil polish—not a paint!—nothing that "smears" over the surface.

MASTER GLAZE is a unique discovery—a creamy liquid—quick and easy to apply! Gives a hard, glass-like surface. Even gasoline cannot dull it! Lasts six months to a year! Amazing luster—beautiful, sparkling clean and brilliant! Doesn't finger-mark—doesn't smear! A match box full glazes an entire car. Seals the pores—protects! NOTHING LIKE IT!

AGENTS

An unusual opportunity! Quick, flashy demonstrator. Big profits. Good territory. Write today!

FREE SAMPLE

Just send your name and address today to

MASTER GLAZE CO., 7720-566 W. Harwood Ave., Milwaukee, Wis.

NOW! Enjoy Learning to Speak SPANISH AT HOME

FRENCH-GERMAN-ITALIAN

BIG opportunities and jobs waiting for those who can speak Spanish. Millions of dollars being invested in Mexico, Central and South America — business and travel increasing every day. Now the ability to speak Spanish will mean more to you than ever before.



Only 15 Minutes a Day

The **CORTINA METHOD**, famous for **OVER 60 YEARS**, teaches you to speak Spanish **LIKE A NATIVE**. Right in your own home, relaxed and at ease, you learn as easily as a child learns—**BY LISTENING** to native instructors on these 30 new, easy-to-understand **CORTINA** recordings. **EVERY WORD CLEAR AS A BELL.**



Sent on 5 Days Approval

THOUSANDS have learned Spanish, this quick, easy way for **PLEASURE** and **BUSINESS**. Why not you? Free, 32-page book, "The Cortina Short-Cut," describes this famous method fully and tells how you can try it in your own home for 5 days. **NO COST IF NOT DELIGHTED.** Mail coupon for free book.



Write Today-NOW!

CORTINA Academy (Established in 1882)
Dept. 641, 105 W. 40th St., New York 18, N. Y.

Please send me—without obligation—your free book. I am interested in (check)

SPANISH French Italian German

Name

Address

City State

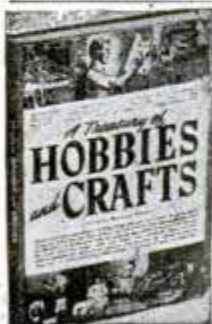

FREE
with this
Amazing
Offer →

A Book That Tells You the Working Procedure of 14 Handicrafts and Includes Over 200 Make-It-Yourself Projects

A goldmine of fun and craft instructions for both the beginner hobbyist and the expert. Here are more things to make and do than have ever before been crammed into a single volume at this low price. From a simple ash-tray to a breakfast-table-and-bench set, over 200 projects are explained, with tools and equipment needed, simplified working drawings, pictures and step by step directions that make it easy to turn out finished handicrafts that everyone will admire.

This Book Will Show You How To Make:—

- | | | |
|---------------------|-------------------|---------------|
| Costume Jewelry | Basketry | Stuffed Dolls |
| Book Ends | Photography | Wooden Toys |
| Soap Sculpture | Indoor Gardening | Rings |
| Leather Accessories | Plastic Craft | Earrings |
| Albums | Portrait Drawing | Pendants |
| Letter Openers | Whittling | Trays |
| Metal Vases | Metal Craft | Wallets |
| Miniature Furniture | Model Railroading | Dog Leashes |
| Candy Dish | Magic | Book-Cases |

and many, many, more things

A CRAFTSMAN'S KIT OF OVER 100 DESIGNS

All Full-Size and easy to trace or copy. Ornaments, monograms, geometric silhouette, fraternal, religious, floral, animal, border, and other decorative devices, forms and designs. For craftwork in Leather, Metal, Plastic, Wood, Textile, Cork, Paper, Glass, etc.

Floyd Clymer's Popular MOTOR BOOKS

1946 INDIANAPOLIS \$1.00

"500" RACING BOOK
80 ILLUSTRATIONS, drawings, charts. World famous driver, car data on 1946 race and highlights George Robson racing career, \$1.00. Large 320-page Indianapolis Race History every race since 1909, 1000 illustrations. Includes 1946 book, \$3.50.

FASTEST ON EARTH, by George Eyston, a racing history book of all world's straightaway land speed records since 1898, \$2.00. **MERCEDES-BENZ** Grand Prix race book, 176 pages, 93 photos, \$2.00.

Famous Motor Scrapbooks

Nos. 1, 2 & 3 available, \$1.50 each; cloth-bound, \$2.50 each. **Power & Speed**, \$2.50. **Ab Jenkins' Race History Book**, \$1.50. **Speed—How to Obtain It**, \$1.50. All books postpaid. See our ad under Autos, Classified section.

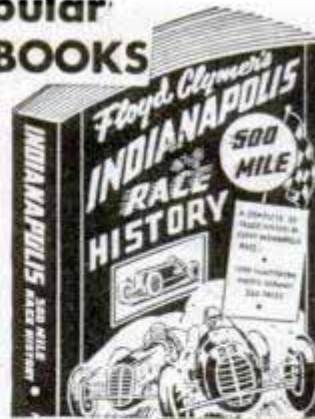

Send for **FREE** Motor Book Catalog

CLYMER MOTORS, Dept. A-1
2125 W. Pico St. LOS ANGELES 6, CALIF.

DUAL GYROSCOPE STABILIZER UNIT

Made by Westinghouse for Gov't costing hundreds of dollars. The 2 motors are worth the price of unit: 12 Volt high speed to 10,000 r.p.m. Among parts are Capacitors, Condensors, Coils, Springs, Suspension System and other valuable parts. **ALL NEW in METAL CASE.** Excellent for Precision workers, Hobbyists, Inventors, Home Craftsmen, etc.



Free Catalog — Rush Order

B & B PRODUCTS CO., Dept. PM-1 ONLY \$12.50 F.O.B. Chicago
111 W. Jackson Blvd. CHICAGO FOR COMPLETE UNIT

SAY YOU SAW IT IN POPULAR MECHANICS

EXPERIMENT WITH LUMINOUS PAINT

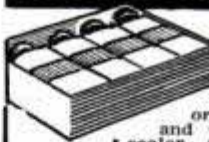

See story "It glows in the dark," page 214 June issue of **POPULAR MECHANICS** for many ideas on how to use our three color kit — contains one of each of 3 colors—**LUMI BLUE, GARDENIA** and **CHARTRUSE**. One ounce * sealer. Guaranteed best quality.

COMPLETE KIT WITH 3 COLORS AND SEALER
\$4.25

New Address

F.O.B. Chicago

BLACK LIGHT PRODUCTS • 67 E. Lake St. • Chicago 1, Illinois

HOLLYWOOD PLASTIC KIT

Make Plastic Novelties. 2 lbs. Lucite and Plexiglas, 3 colors dye, 1 bottle cement and complete instructions. Postpaid \$3.25. **HOLLYWOOD ITEMS CO., Box 1151, Dept. PM, Hollywood 28, Calif.**

Each craft and each project **COMPLETELY EXPLAINED** in this **BRAND NEW** book—"A TREASURY OF HOBBIES AND CRAFTS" edited by Michael Estrin. There is a unique enjoyment in making something with your own hands. If you have made it yourself, it will give you more pleasure than anything like it that you can buy. Send for this "Hobbyist Heaven" now. Just \$1.98 postpaid (for c.o.d. plus postage). Money back guarantee if not delighted.

HOBBY BOOK MART, Dept. H-20
150 Nassau St., New York 7, N. Y.

Send me a copy of "A Treasury of Hobbies and Crafts". If not delighted, I can return book and get my money back.

I enclose \$1.98, send book postpaid.
 Send book c.o.d. for \$1.98 plus postage.

Name

Address

City & Zone State

ELECTRIFY YOUR LAWNMOWER

Battery Operated

COMPLETE PLANS

ONLY \$100

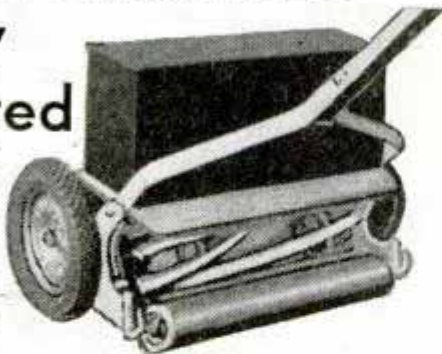

SELF-CONTAINED and SELF-PROPELLED

We show you how to convert your own lawnmower for use with an ordinary car battery. Save energy, labor and time with this self-propelled unit. Our simplified plans make it easy.

Makes Grass-Cutting Easy

Operates quietly on any ordinary auto battery, which is easily charged from house service. Our plans make it simple to convert almost any hand mower to power operation. Be the envy of your neighbors with a quietly propelled mower.

WRITE TODAY FOR PLANS

LEJAY MFG. CO

247 LeJay Bldg.

MINNEAPOLIS - 8 - MINN.

PLASTIC HOMES



New Building Material! Resurface old homes; build new ones. Colorful. Beautiful! **LIQUID MARBLE-COMPOSITION FLOORING**—Dustless, poiseless; put on like plaster; resilient—yielding as cork; lasts like stone; plain or marked in tile design. **RUBBERLASTIC Mold Compound**—Mold novelties, statuary, toys, gifts, plaques, plaster animals. **COLORLED POTTERY**—Birdbaths, garden furniture, vases. **TILEX** colored roofing. Illustrated literature FREE. **RAPID MARBLEIZING SERVICE**, Dept. 10-B, Edwardsville, Illinois

WINDOW SIGN LETTERS

For Store Fronts and Office Windows. Anyone can put them on. Samples furnished. Genuine Gold and Silver. **METALLIC LETTER CO.**, 430 N. Clark St., Chicago 10

Is Your Rupture HERE?

Why continue to suffer with an uncomfortable truss if we can help you? Relief **GUARANTEED** or it costs you nothing. Send for the facts about my perfected truss invention—the Brooks Appliance for reducible rupture—with the patented **AIR-CUSHION** support that works silently with **Nature** to give protection. Thousands bought by doctors.

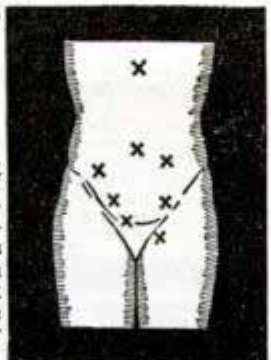

Sent on Trial—Made-to-measure, individual fitting for man, woman or child. Low-priced, sanitary, durable. No obnoxious springs or hard pads; no metal girdle to rust. Light weight, neat and comfortable. Not sold through stores or agents—beware of imitations. Write today for full information sent free in plain sealed envelope.

BROOKS APPLIANCE CO. 359-B State St. Marshall, Mich.

You Can Build Your Own **ARC WELDER...**



with this **MULTI-RANGE HOBART arc welding generator**

Saves Hundreds of Dollars!

You need only this Hobart Generator, a used auto engine and chassis to build your own Hobart gasoline drive portable arc welder—saving from \$150 to \$300! Send coupon for free book telling you how, no obligation.

Profitable Business!

An Arc Welding Job Shop is one of the most profitable businesses today, especially when one considers the minimum investment required. People bring auto and farm equipment for repair; construction jobs are countless—all bring you big profits!

Easy Operation!

Only Hobart can offer you the time and money saving advantages that guarantee extra profit! You get 1000 combinations of welding heat—the right heat for every job.

The Hobart Welding School!

A non-profit institution teaching every phase of welding. Modern building, expert instructors. Veterans—enroll under G. I. Bill. Check coupon for free book.

HOBART BROTHERS COMPANY
Box M-17, Troy, Ohio



Gasoline Drive Arc Welder



Electric Drive Arc Welder



A. C. Arc Welder



Hobart



"One of the World's Largest Builders of arc welders"

HOBART BROTHERS COMPANY, BOX M-17, TROY, OHIO
Free! Send me this "Welders' Guide," full of handy standard welding information.
Also send details on: "Build Your Own"
 Electric Drive Gasoline Drive
 A. C. Arc Welder Welding School

NAME _____
ADDRESS _____

W. A. A. ANNOUNCES NEW LOW PRICES for surplus MACHINE TOOLS



For details of the new "25% below market" price policy read this advertisement in December issues of technical magazines reaching the Metal Working Industries.

It describes the 31 types of surplus production machine tools newly repriced—tells how and where you may purchase them—gives detailed information on the policies *behind* these amazing new prices.

For even *quicker* action use this coupon to get the new price catalog. Send it to The Machine Tool Division of your nearest W.A.A. office listed below.

PRICE CATALOG—FREE
Machine Tool Division
.....Office, W.A.A.

Without obligation, please mail me your new machine tool price catalog. Part I.

Name.....Title.....
Firm.....
Address.....
City.....State.....

686-1-A

WAR ASSETS ADMINISTRATION

GOVERNMENT OWNED SURPLUS

Office located at: Atlanta • Birmingham • Boston • Charlotte • Chicago • Cincinnati • Cleveland • Dallas • Denver • Detroit • Fort Douglas, Utah • Fort Worth • Helena • Houston • Jacksonville • Kansas City, Mo. • Little Rock

Los Angeles • Louisville • Minneapolis • Nashville • New Orleans • New York • Omaha • Philadelphia • Portland, Ore. • Richmond • St. Louis • San Antonio • San Francisco • Seattle • Spokane • Tulsa

SAY YOU SAW IT IN POPULAR MECHANICS

**I Make More Money
Than Many Bankers
Without a Cent Invested**



MIDDLE-AGED BUSINESS MEN or SALESMEN

... you are wanted in various parts of country for a healthful, fascinating occupation. G. A. Bushman, new man, in first 6 months earned \$6,332.00. In same period—H. A. Fahlander, \$5,559.00. H. A. Murler got \$2,881.20 in 1 month. Bill Ladley earned \$8,121.00 in 10 months. In last 12 months, W. F. Berry received \$17,742.00; J. L. McCullough, \$14,064.00; J. A. Tucker, \$12,320.00. In 5 years, C. H. Solberg earned young fortune of \$54,125.64 (working only 8 or 9 months a year). \$31,320.50 went to N. E. Crist in 3 years. Over 150 of our men have earned \$400 to \$3,000 in one month—many beginners. (ALL FIGURES CERTIFIED). These gross earnings are, of course, exceptional—they are *not* average. But with peacetime activity restored, they will be better. Men once bankrupt now have home, car, college education for children, security for future. Openings now in fixed territories—also for those able to travel few weeks at a time. Our product (U.S. Pat. No. 2,392,813) sold on long credit terms, no down-payment, to high-grade dignified men—manufacturers, business officials, merchants, large farm and ranch owners. Wartime shortages, not expected to terminate soon, greatly increase demand. Earnings advanced weekly. Big season just ahead. Rush name, age for full details.

Vice-President, P.O. Box 711, Dept. PM, Fort Worth 1, Tex.

WANTED DISTRICT PURCHASING AGENTS

No experience or money required. Exceptional opportunity for those who want to establish themselves in a steady, year 'round, well paying business.

For details: Write **DEPT. C**
PURCHASING MANAGER
2719 LAWRENCE AVE. CHICAGO 25, ILL.

WANT TO BE INDEPENDENT?

You can go into business for yourself. Learn the Stephenson Method of making and fitting corrective arch supports. Not medical—not chiropody. Men and women earn \$50-\$100 weekly in this respected profession. Learn at home on easy terms, no other capital needed. No goods to buy, no agency, you become your own boss at once. Write for our free booklet! 51 years in business.

THE STEPHENSON METHOD
281 BACK BAY, BOSTON, MASS.



COLLECT U. S. ARMY Shoulder Patches

Send \$1 for sample selection of patches and PATCH CATALOGUE.

SPRINGER'S

EL PASO, TEX.

**20
for
\$1**

GRASP THIS OPPORTUNITY

TO TRAIN YOURSELF
FOR A WELL PAID JOB IN **ELECTRICITY**

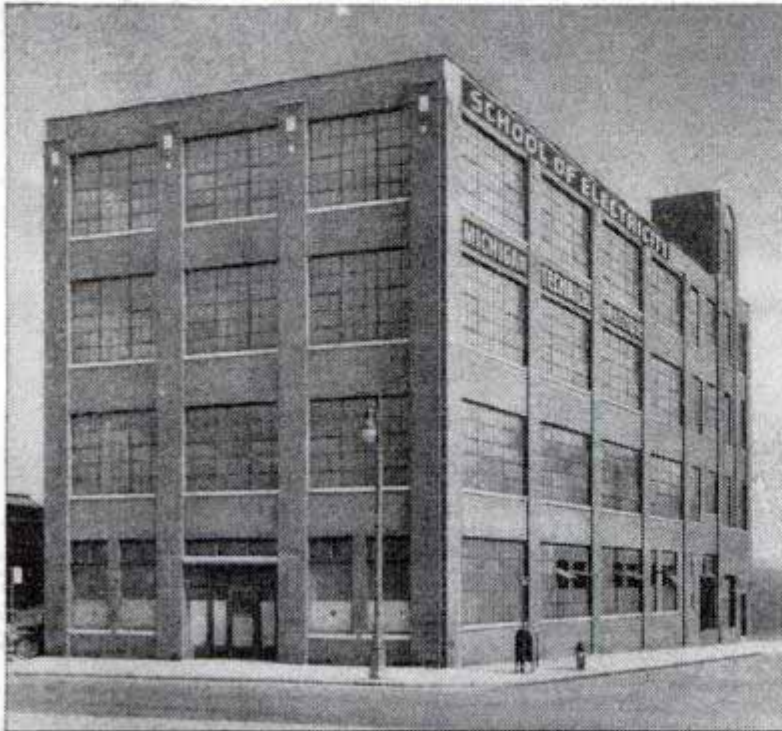

This large, four-story building completely equipped with first class electrical equipment for *on-the-job, up-to-the-minute* methods of training in Armature and Motor Winding, Factory Wiring, House Wiring, Electrical Maintenance, Appliance Repair. Entire building—4 floors devoted exclusively to this one course. No crowding, plenty of space and light. Well staffed with instructors to give individual attention to students. Living quarters arranged for if desired.

Pay after you graduate . . . Lack of money need not hold you back. We will finance your training. After you graduate you can pay us back in small monthly payments.

VETERANS!!!

School approved for training under the GI Bill. Take this course at no cost to you, and receive \$65 to \$90 per month while training. Complete details furnished.

MAIL COUPON TODAY

MICHIGAN TECHNICAL INSTITUTE, Dept. P-1
2281 W. Fort St., Detroit 16, Michigan

- Please send me literature about your training.
 I am a G.I.

NAME

ADDRESS

CITY..... STATE.....

MAIL COUPON *today*

MAKE UP TO \$5⁰⁰ AN HOUR In Your Own YEAR 'ROUND Business!

ONLY A FEW DOLLARS PUTS YOU IN BUSINESS!

Many. Clearing as High as \$20 to \$30 a Day NET Renewing Rugs, Carpets, Upholstery. New Method Now Used for Auto Upholstery. Write for Facts About Quick, Easy Way to Get Started

Here is the chance you've been looking for to step into a pleasant, dignified, big-pay business of your own that offers you a steady, year 'round income. Start on "a shoe-string," full or spare time, right from your own home. Equal opportunities for men and women, young or old, in small towns or big cities. No experience needed. Many making big money with new Americlean System just cleaning auto upholstery. Easy to learn. We send you complete instructions and quick-cleaning supplies so you can start making money the very first day! Quick method cleans upholstery, rugs and carpets like new without taking off floor! Tremendous demand in homes, apartments, hotels, stores, office and public buildings. Steady repeat business. Territories going fast. Write today for full FREE facts. No cost or obligation. Rush letter or postcard now to AMERICLEAN CO., Dept. G-2, St. Louis 1, Missouri.

WRITE FOR FREE DETAILS NOW!

BUILD ARC WELDER PLANS 35c

We Show You How to build this new powerful welder without rewinding. For light or heavy work. Uses coils taken from old autogenerators. Works on 110 or 220 volts A. C. Has 20 different heats. Send 35c for complete PLANS and valuable Catalog. Write today. LEJAY MFG. CO., 1347 LeJay Bldg., Minneapolis 8, Minn.



Learn Public Speaking

Learn theory and fundamentals at home—in spare time. Then acquire actual experience and practice. Send for FREE booklet "Power of Effective Speech." No obligation.

North American School, Dept. 1351
1315 S. Michigan Ave., Chicago 5, Illinois

SAY YOU SAW IT IN POPULAR MECHANICS

MANLY Makes it easy TO INSTALL AND REPAIR PLUMBING SYSTEMS



Manly's complete, easy-to-understand book . . . Plumbing Installation and Repair . . . quickly shows how to do your own work or earn big money working for others. Huge demand for plumbing experts created by housing shortage. Start today . . . order this new book. Complete instructions on estimating, roughing-in, fixtures, vents, drains, etc. Covers the whole field. 256 pages. 162 illustrations. Cloth bound. Only \$2.00 (Check No. 1 on coupon)

Here are other Manly books it will pay you to own.

- No. 2. Heating, Cooling and Air Conditioning Handbook. 317 pages. 148 illust. 64 charts and tables. Cloth bound. Only \$4.00
No. 3. Refrigeration Service Manual. 317 pages. 148 illust. Cloth. Only \$2.00
No. 4. Cyclopedia of Radio and Electronics. (12th Edition) 764 pages. 900 illust. Cloth \$6.00

All Drake's Books Sold on a Money-Back Guarantee

USE THE COUPON . . . MAIL TODAY

Frederick J. Drake & Co., Dept. A-2,
600 W. Van Buren St., Chicago 7, Ill.

Please send me the books checked below. If not satisfied I will return them in 5 days and money will be refunded.

1 2 3 4 (Circle numbers wanted)

- Check or money order enclosed \$..... Send books postpaid.
 Send C.O.D. plus postage.

Name.....

Address.....

City..... State.....

Drake's books are sold by leading booksellers.

How does he do it?

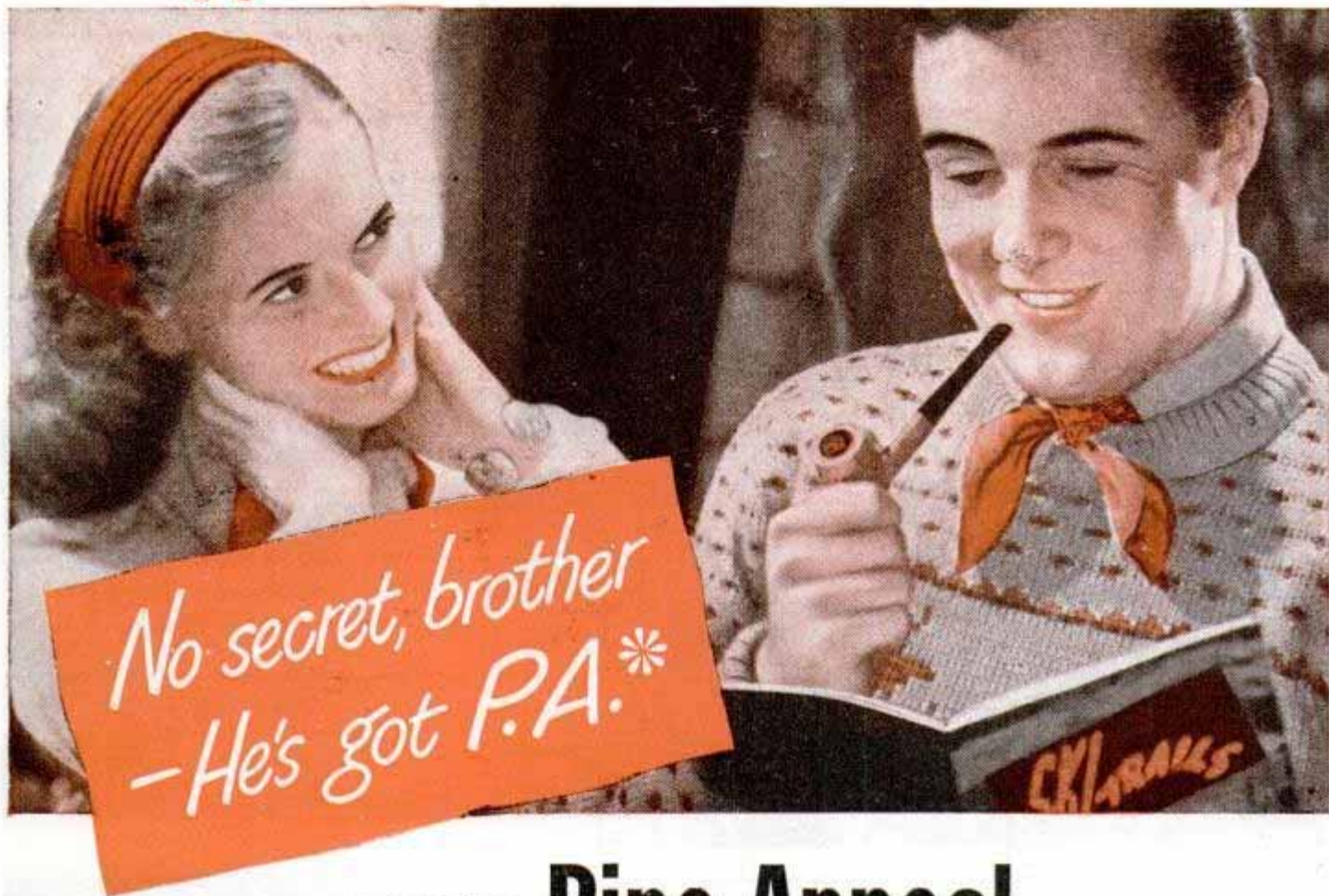

means **Pipe Appeal** —

P.A.*

Pipe Appeal is the rugged, masculine look of the man who smokes a pipe. Women go for it—just as you'll go for the comfort and joy of fine Prince Albert Tobacco.

means **Prince Albert**

FOR RICH TASTE AND
TONGUE-EASY PIPE
COMFORT, THERE'S NO
OTHER TOBACCO LIKE P.A.



P. A. stands for choice smoking tobacco—Prince Albert. Fine, rich flavor that pipe smokers go for . . . specially treated to remove harshness . . . easy on the tongue! P. A. is crimp cut for easy packing, easy drawing.

Roll-your-owners find Prince Albert's famous crimp cut perfect for smooth, easy cigarette "makin's."

R. J. Reynolds Tobacco Co., Winston-Salem, N. C.

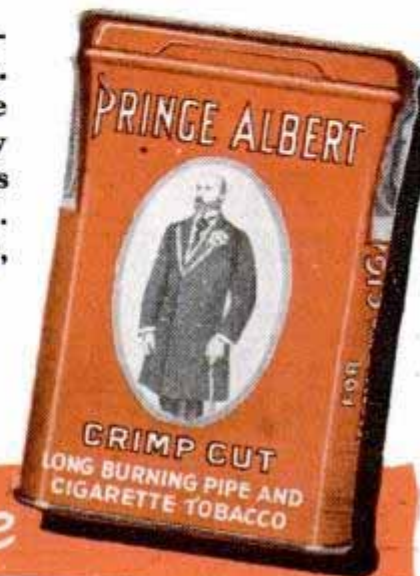

The National Joy Smoke

POPULAR JANUARY 1947 MECHANICS

WRITTEN SO YOU CAN UNDERSTAND IT
VOL. 87 NO. 1

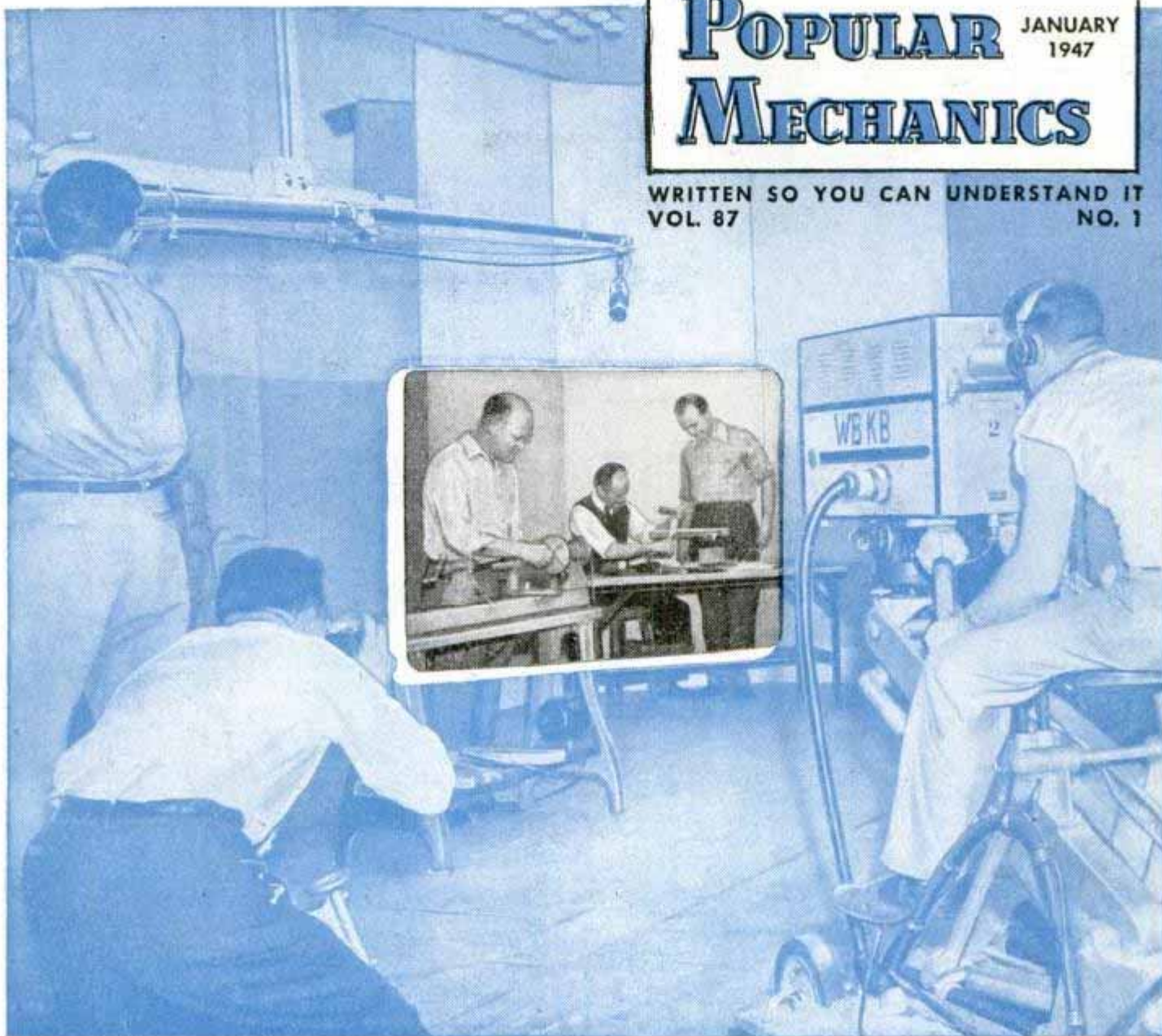

POPULAR MECHANICS PRESENTS *An Original Television Production*

By Clifford B. Hicks

"PLACES!" calls the director, her voice rising above the flurry of last-minute preparations in the big television studio.

Actors step quickly to the three sets, muttering their lines in a final rehearsal. Technicians inspect the cameras and sound boom. Overhead, an electrician adjusts banks of bright lights that wipe every shadow from the big room.

The director peers critically at five small television screens along one wall. "No. 1



dolly in!" she says into her mike.

Her words travel through a network of wires to the dolly-pusher's earphones. He shoves the heavy dolly toward one of the sets, while atop the dolly the cameraman squints into the eyepiece of the big

camera, focusing on one of the actors.

"No. 2 pan left!" orders the director. Immediately there is a flurry of movement toward the second set in the bright studio.

"Sound boom on the living room set!" The sound engineer turns a crank to twist

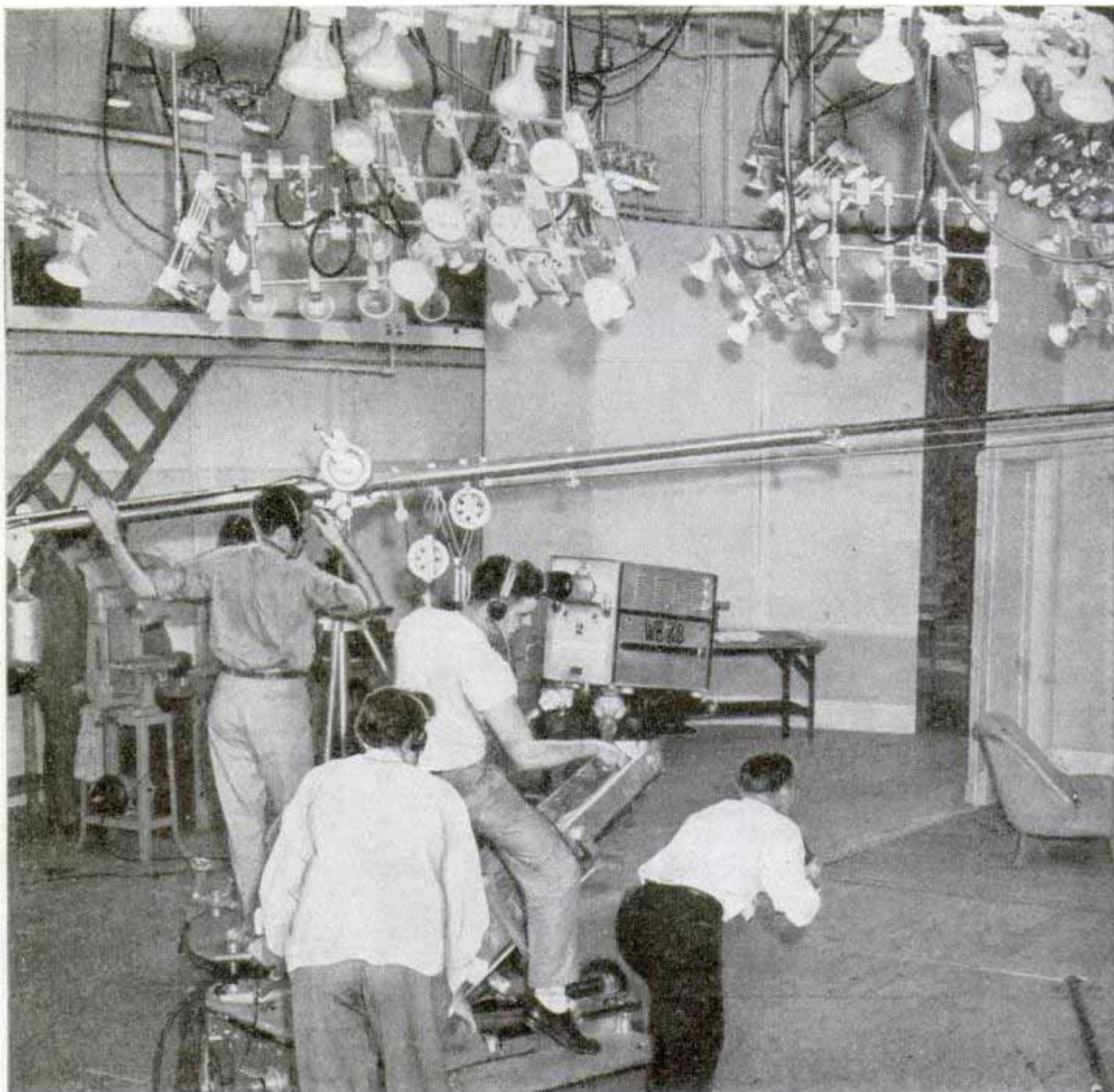

Sound engineer runs out the mike while the cameraman at left adjusts his camera for a long view. Camera at right is equipped with a telescopic lens and can take continual close-ups without obstructing other cameras

the long boom across the room and over the set. He runs out the mike until it dangles just above an actor's head.

At one end of the big studio two actors take their places in a living room complete with furniture, lamps, draperies and a rug. Along another wall a third character putters around a workbench in a cluttered basement scene. An actor on the third set stands in a model workshop, power tools grouped around him.

"Watch the red light!" The big studio instantly becomes quiet. Only 10 seconds to go.

A bulb on the front of No. 1 camera glows red, the actors start well-rehearsed movements and the show is on the air.

That was the minute-before-performance scene when POPULAR MECHANICS recently

broadcast an original television play, "Mr. Fix-It Earns a Holiday," over Station WBKB in Chicago. The show was one of the first to be produced in WBKB's new studio, a soundproof room big enough to hold a dozen sets at a time.

POPULAR MECHANICS wrote, produced and broadcast the show to get inside, straight-from-the-shoulder answers on postwar television. Tossing a moving image into the atmosphere and snaring it on a receiving screen 50 miles away is a magic trick that was oversold to the public a decade ago. Yet not one person in 100,000 knows just how a program is televised or how good postwar television is. Getting your feet wet in television is a novel experience confirming optimistic reports that have circulated for

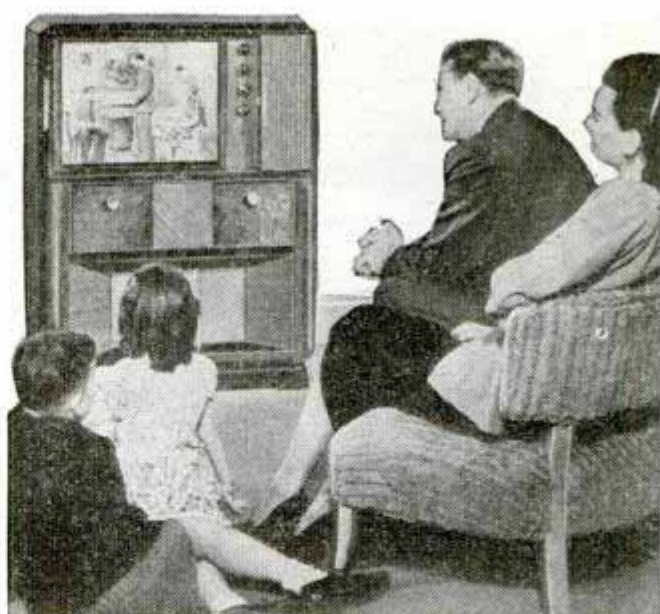

↑ Image is reflected by mirrors to a screen almost as large as a newspaper page in the RCA Victor console

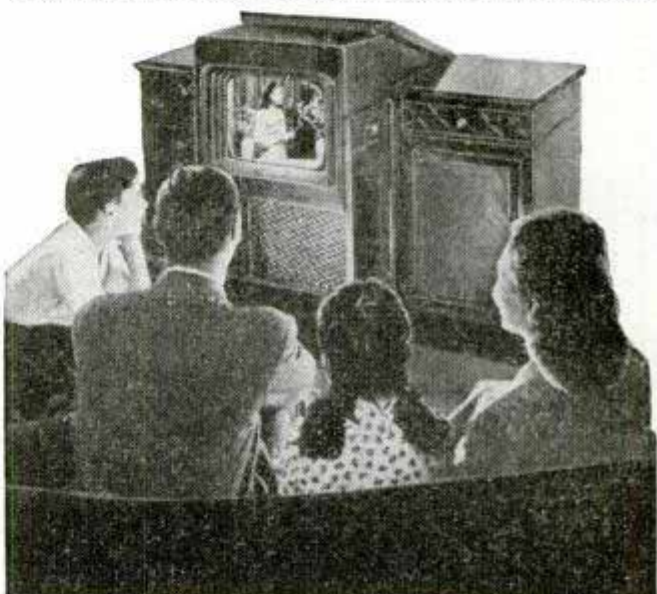

↑ Westminster teleset by DuMont has a large cabinet

↓ Experimental Philco receiver uses direct-view screen



Small Farnsworth set includes television and standard radio, phonograph and record cabinet

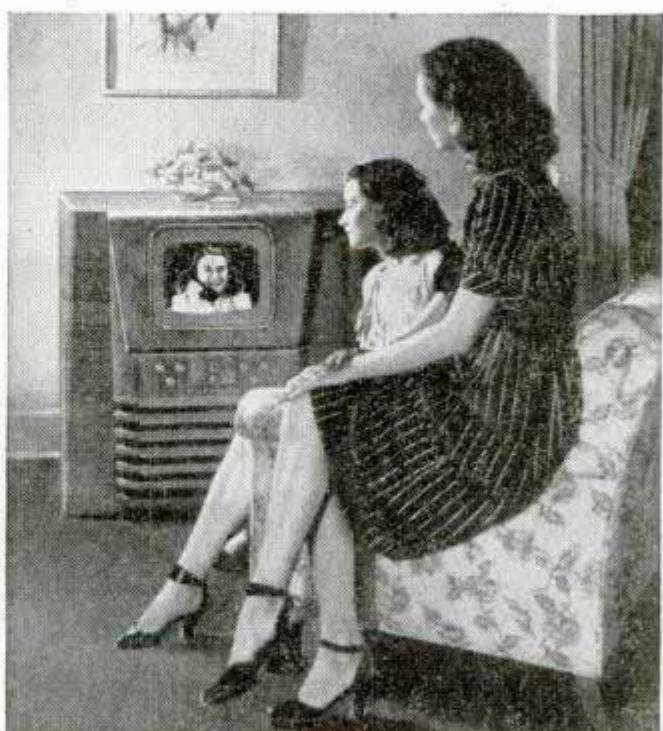

SCENES FROM THE SHOW

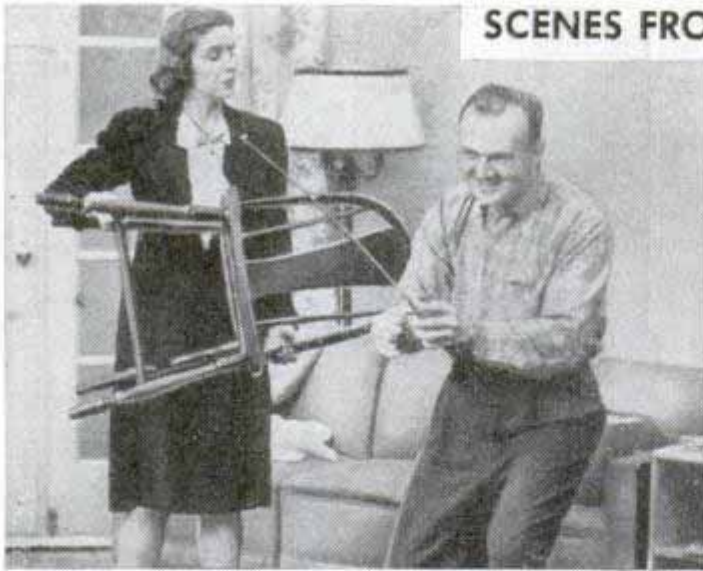

Bill Jones plans next day's fishing trip but his wife insists that he fix a broken chair before he can leave

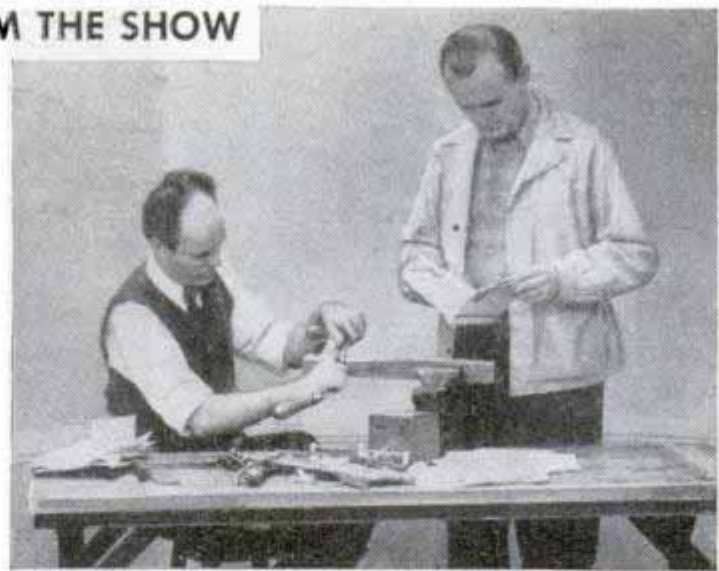

Bill goes to friend's home where they attempt to carve new chair leg with hand tools, finally give up in despair

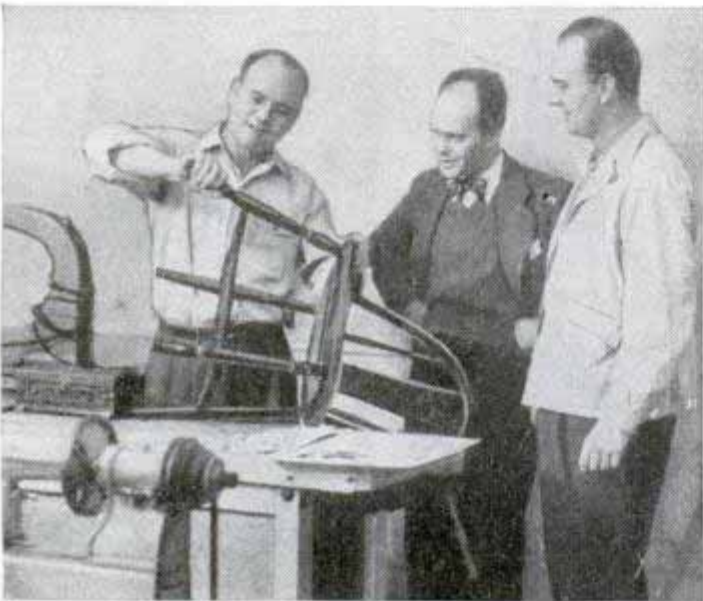

Worried about fishing trip, they take chair to Jim Ward, Craftsman editor, who's amused at wood carving efforts

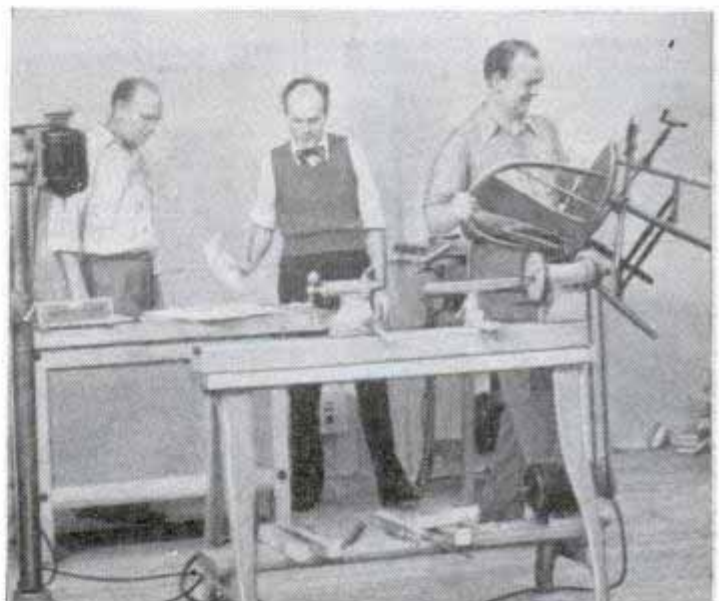

Jim salvages Bill's trip by turning new leg in his model workshop. Bill leaves, elated that he can please his wife

When he returns home he finds his wife in tears because she can't fit his fishing rod into suitcase for the trip



With chair fixed, luggage packed, and fish waiting they read copy of Popular Mechanics that Jim has given Bill





Director supervises broadcast from booth at left. Screen at far left is reserved for remote pickups, the second is a movie film, the two at right show what studio cameras see, and center screen shows what's on the air

years that video is ready to meet the public.

There's a scarcity of good television writers during these pioneer days in video so the **POPULAR MECHANICS** staff decided to write its own show. Radio authors, accustomed to writing "blind" programs, tend to forget the eyes of the audience in scripting a television program.

Production personnel of Station **WBKB** took charge of the program after the script was written. Captain William C. Eddy, di-

rector of the station, named Kit Carson producer-director of the show. Miss Carson is a television pioneer who helped video weather the war years when growth was impossible because improved equipment could not be manufactured.

The wire from the director's mike carries the pulse of any telecast. All production personnel except actors wear earphones and the director can personally instruct the

(Continued to page 260)

Color television is now possible with all-electronic equipment that does not make black-and-white receivers obsolete. In a recent demonstration the Radio Corporation of America used a new television camera to broadcast still pictures in full natural colors. When the electronic equipment is used a light beam is focused through the picture and then separated into component colors. Rapid-fire electrons then scan three colors—red, blue and green—and transmit 30 pictures a second for each of the color images. At the receiving set the three images are projected on a screen to reproduce a single full-color picture. Today's black-and-white sets will receive transmissions from future color stations by the addition of a converter, but the pictures will not be in color. Company officials say that years may pass before electronic color television is perfected for widespread use.

↓ Orthicon is general-purpose camera. Iconoscope gets more detail, image orthicon makes remote pickups

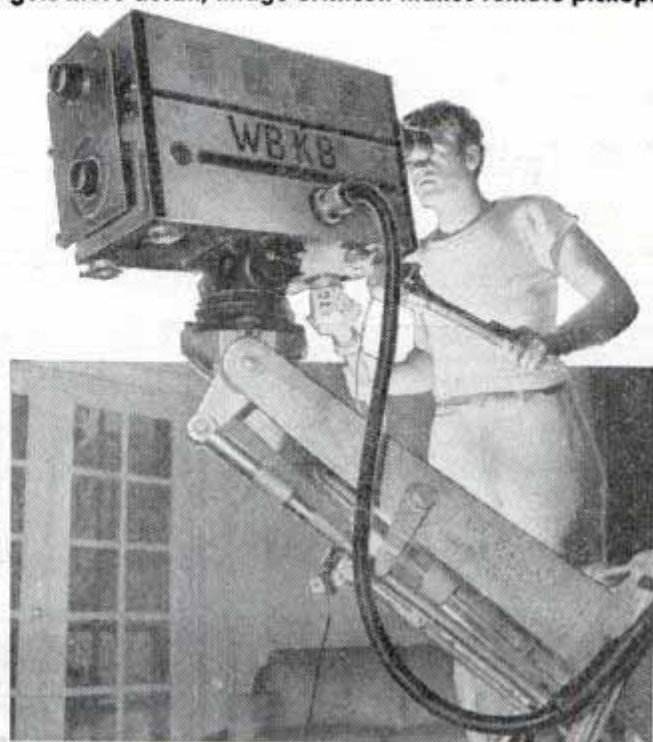

Two-Place Aeronca Chum Has Top Speed of 118 M.P.H.



Visibility of 360 degrees is provided in the new two-place 85-horsepower Aeronca Chum. The plane has a top speed of 118 m.p.h., lands at 49 m.p.h. and carries two persons with 60 pounds of baggage at a cruising speed of 108 m.p.h. Its 22-gallon wing fuel tanks give a range of 400 miles. The 42-inch-wide cabin is completely soundproofed. The Chum is spinproof and is steered like an automobile on the ground and in the air by the control wheel without the use of rudder pedals.



Windmill Bilge Pump for Small Boat Lifts Pint of Water Per Minute

Wind powers a small pump designed for boat owners who do not like the task of pumping out rain water. A two-blade 20-

inch plywood propeller drives the pump, which requires no priming and can run dry without damage. It operates in winds of 12 to 15 miles an hour and pumps about one pint of water per minute. It is made with tube length up to seven feet to lift water five feet. In addition to driving the pump, the propeller scares away seagulls.

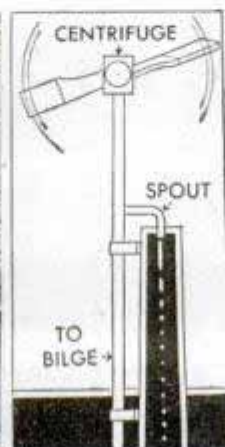
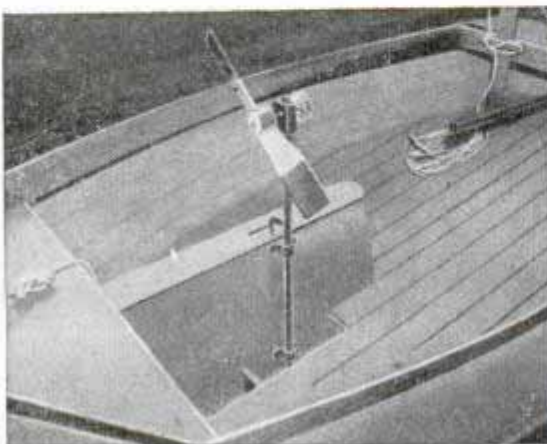

You may wish to obtain additional information about new products described each month in *Popular Mechanics*. If you want to know the name and address of the manufacturer or distributor, just write to Bureau of Information, *Popular Mechanics*, 200 E. Ontario St., Chicago 11.

Paper-Hanging Frame Holds Strip to Ceiling

Paper hanging in the home is made easier by a frame and brush set just introduced. It consists of a wooden frame 16 inches by 24 inches and two 16-inch brushes. One of the brushes forms one end of the frame, which holds the paper in place against the ceiling while the free brush is used to lift and paste the paper smoothly in place. With the frame one person can hang long strips as easily as short ones. The brushes and frame are narrower than the paper to prevent tearing.

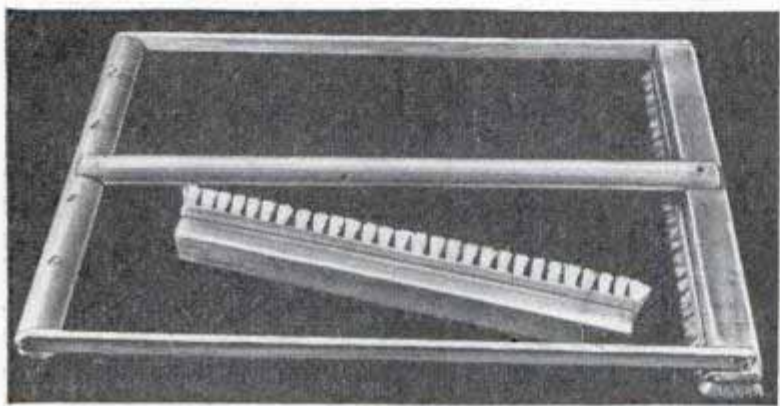

Brushes smooth paper against ceiling so that it dries without wrinkles

Flying Model Helicopter Rises 100 Feet in Air on Gyroscopic Power

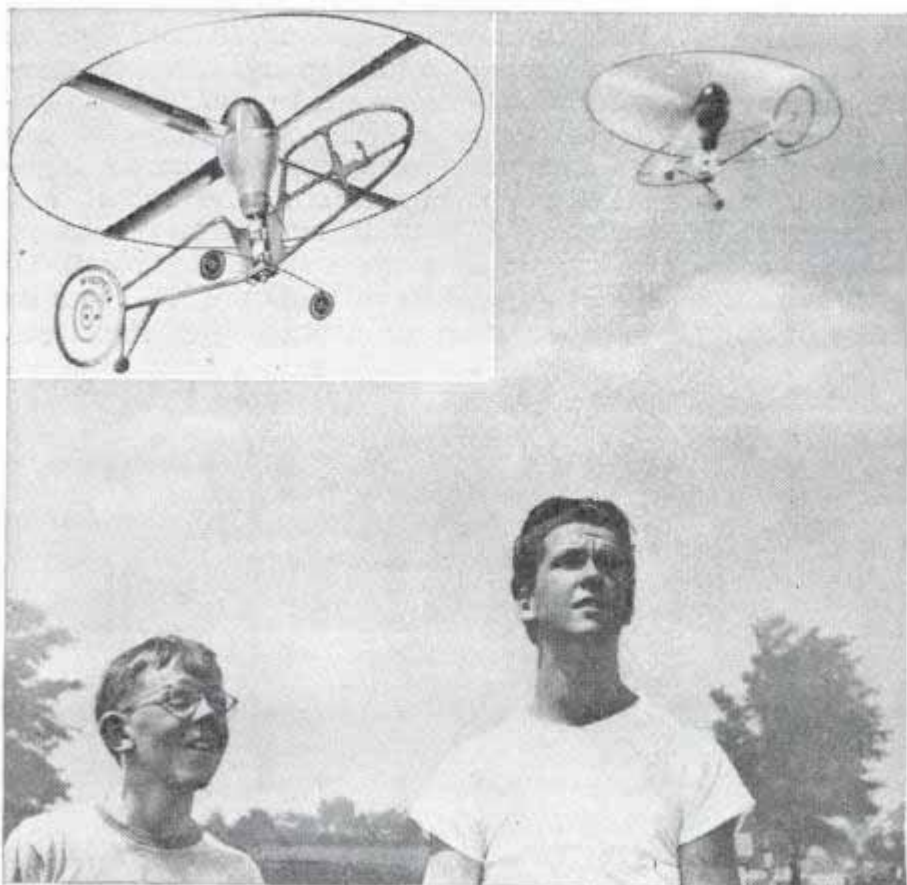

Toy helicopters that rise more than 100 feet in the air employ the principles of a gyroscope for stabilization and lifting power. Made of plastic and aluminum, they weigh less than two ounces. The rotor is spun in the same way a toy gyroscope is started: by winding a cord around the hub and pulling it quickly. A wire band around the rotors serves as a flywheel to sustain momentum after the rotors are turning. Even though the toy is tilted when released it will level off in flight and always land right side up. By hanging weights on the tail, nose or wheels the operator can make the plane circle in either direction or fly straight ahead.

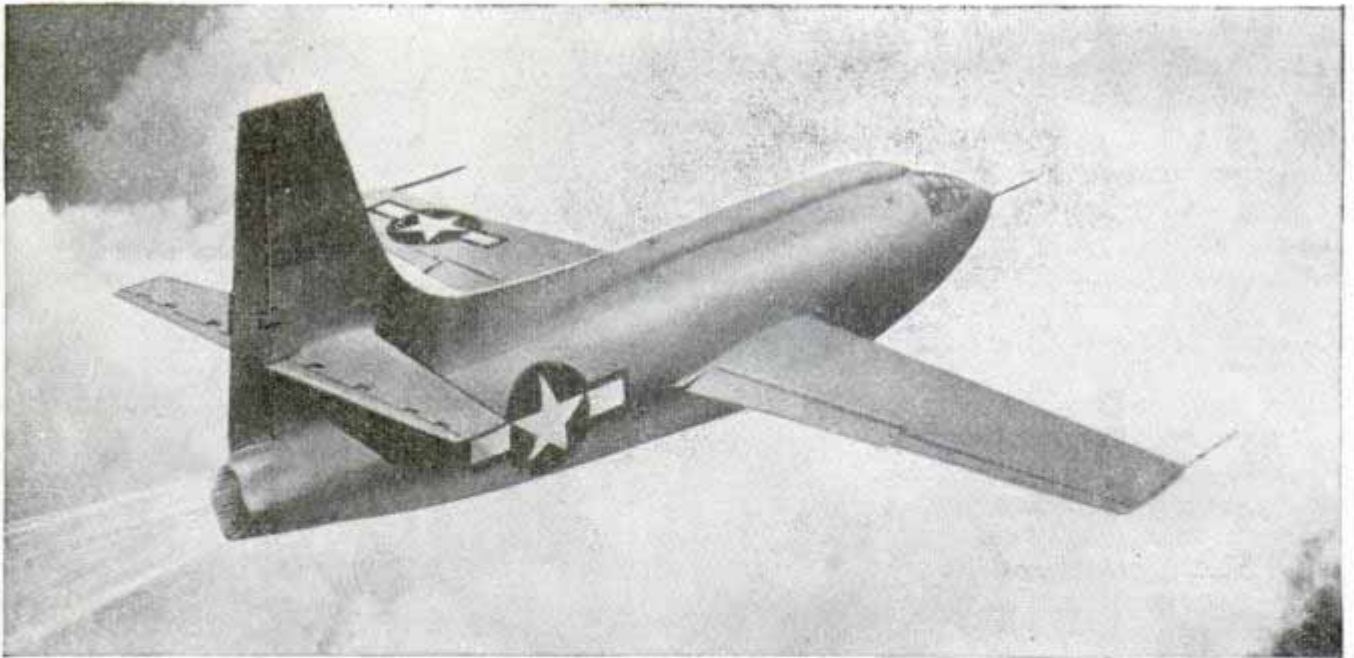

How Fast Can We Go?

FROM test dashes of the rocket-powered XS-1 we'll soon learn how close we are to 1500-2500-mile-an-hour speeds and beyond. No plane has ever been thought more likely to break the sonic barrier.

Designed to fly almost three times as fast as sound travels, it has the most rugged airframe ever built, capable of withstanding a force 18 times the pull of gravity. It will be brought along slowly, with flights at only 80 percent of the speed of sound as the first goal. The XS-1 represents joint efforts of the Army Air Forces, the Bell Aircraft Corporation and the National Advisory Committee for Aeronautics.

Though highly streamlined, the pressurized rocket ship has a reasonably conventional configuration. It has a very thin wing with an aluminum alloy skin machined out of solid stock that permits a thickness at the butt of a half inch, tapering to slightly more than an eighth at the tip.

The rocket engine's four units, burning

alcohol and liquid oxygen, each produce 1500 pounds of thrust, or a total of 6000 pounds. The power output increases with the velocity of the engine itself. A pound of thrust equals one horsepower at 375 miles an hour, for example, and two horsepower at 750 miles an hour. This power is controlled by selection of the number of cylinders to be fired, so the pilot can use 1500, 3000, 4500 or 6000 pounds thrust at his own choice. While a specially designed turbopump is being completed, an alternate, and somewhat slower, power plant will be used.

The plane is 31 feet long, 10 feet 10 inches from ground to tail top and has a comparatively small wing span of 28 feet. Its unloaded weight is 4892 pounds, 526 of which are accounted for by instruments for high-speed flight research. The rocket fuel weighs 8177 pounds, more than one and a half times as much as the empty plane. To save fuel, a B-29 will tow the XS-1 and its pilot to starting altitude for the tests.

Believed to be three times as fast as the speediest fighters today, the XS-1 operates best at 80,000 feet
Official AAF photos





Model Engines Drive Iceboats 130 Miles Per Hour

Speeds up to 130 or 140 miles per hour over ice and snow are standard for racing model iceboats. The propeller-driven craft, mounted on four steel runners, are a cross between racing cars and model airplanes. They are powered by model gasoline airplane engines. In competition they are attached to the end of a steel cable and raced against time over a circular course. Some of the speedy boats have been equipped with radio controls for straightaway races.

Silencer Guards Phone Talks

Private telephone conversations are guarded by an attachment that transmits the speaker's voice even when at a very low pitch. The device, an enlarged mouth-piece, can be installed on desk phones or the hang-up type. It transmits the important speech frequencies—those between 88 and 2000 cycles per second—with improved volume, while lower frequencies that produce blasting and distortion are reduced in intensity. The troublesome tones are conducted into an absorbing chamber filled with millions of glass fibers that absorb the sound. The silencer also cuts off surrounding noises so only the speaker's voice can be heard at the other end of the line.



Aluminum Oven and Grill Folds Into Flat Package

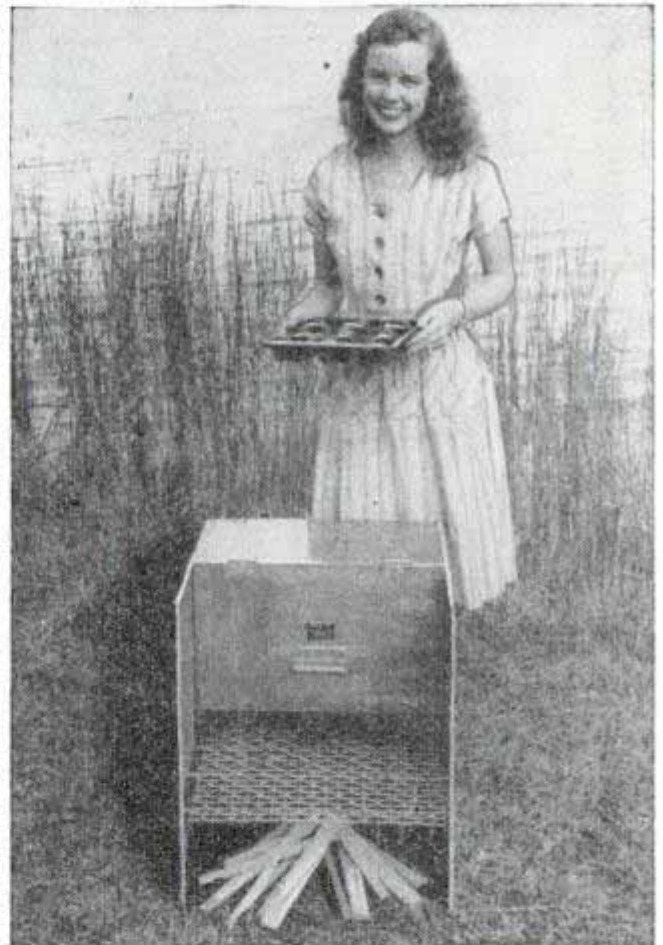

Barbecue grill and oven are combined in a rustproof outdoor stove constructed of aluminum for easy cleaning. Supporting rods for the grill and oven are adjustable in height for faster or slower cooking. Casserole and baked dishes can be prepared in the oven. The unit weighs only 23 pounds and is easily set up without tools. Knocked down for carrying or storage it forms a package 24 inches square and only two inches thick.

☐ In continuous operation since 1848, the Royal Scot of the London and Scottish Railroad claims the distinction of offering scheduled service for more years than any other train in the world.



HORSE COLLAR, polished to a high luster, makes a unique mirror frame. "Dude" seems to find it pleasing

SUPERTANK for the Army weighs nearly 100 tons and carries a 105-mm. gun that dwarfs a jeep in length. The Army says it's the heaviest vehicle ever built



FOUR ROCKETS controlled by switches on handlebars give an added boost to a speedy English motorcycle

POWER-PACKED MOTOR develops up to 134 percent more power per pound than earlier motors. Developed by Westinghouse, it's covered by an all-steel frame



Electric Tools Aid Medical Science

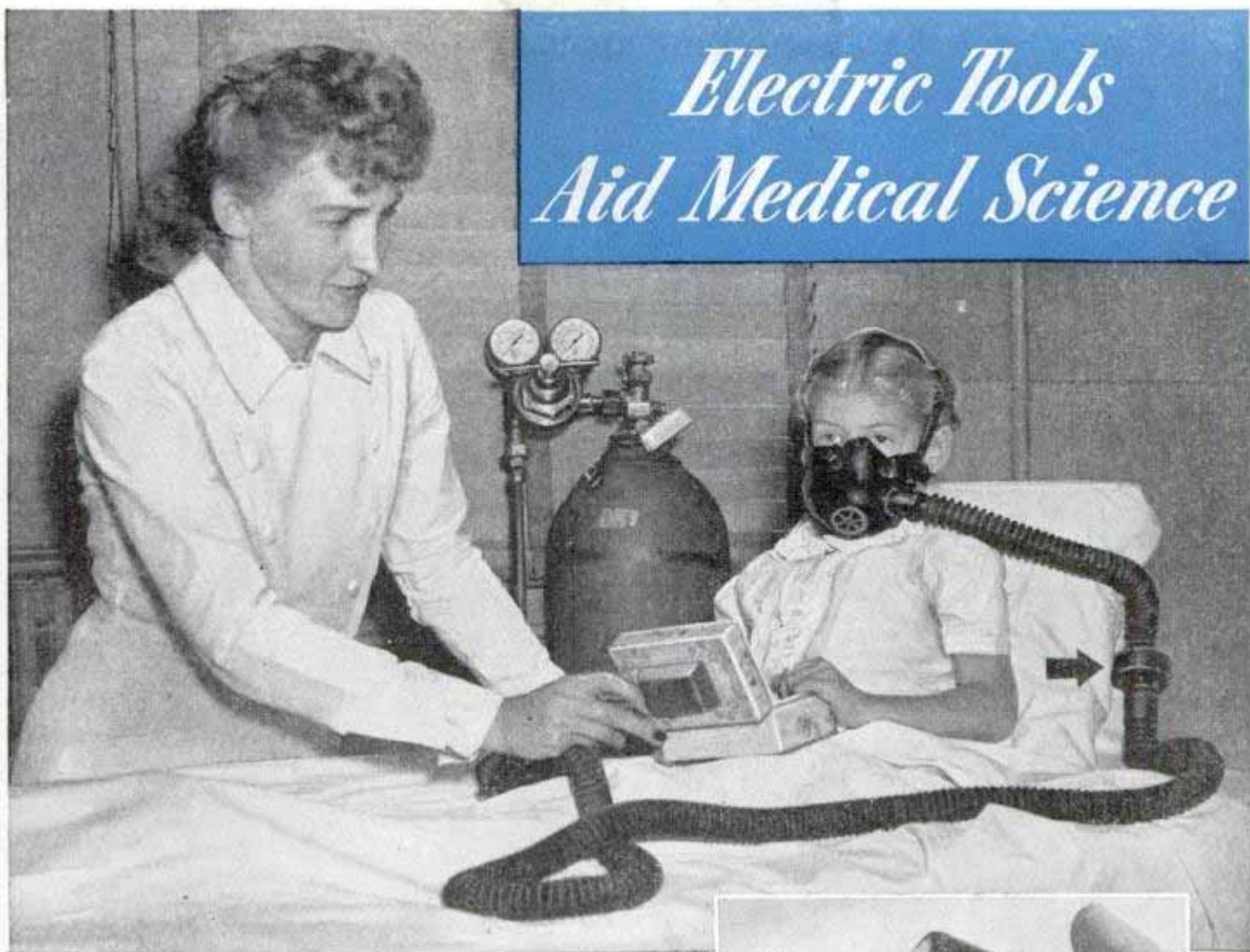

By John R. Kinsey

A 15-YEAR-OLD GIRL—winner of a 4H health contest—walked into a southern hospital last fall to cheer up her sister and nephew who were undergoing treatment for infantile paralysis.

Suddenly she collapsed. Her legs were paralyzed. Then dreaded respiratory paralysis set in, almost stopping her breathing.

But she didn't die, and she has a good chance to walk again.

Physiotherapists said she was saved by a little valve that automatically supplied the right amount of oxygen, through a mask, to restore breathing. This made it possible for immediate treatment to be applied to the girl's paralyzed limbs.

The all-important valve—described by a woman physiotherapist as a “little old 50-cent gadget”—was developed at the Army Air Forces' Aero-Medical Laboratory at Wright Field.

One of the numerous devices designed to make high-altitude flying safer, the oxygen regulator was perfected too late to be used in the war. It fits on an oxygen bottle and allows oxygen to flow through a mask to a person's lungs. When pressure in the lungs has reached the point where normally the

“Baby lung” has valve (shown by arrow and in inset) which automatically supplies the right amount of oxygen for victims of polio

person would stop inhaling, the valve automatically shuts off. When the oxygen has been exhaled from the lungs, the valve automatically opens again.

Tests at Bellevue Hospital in New York demonstrated the usefulness of the valve in treating polio victims, so the AAF made it available to doctors and hospitals throughout the nation.

Development and use of this little valve to combat a dreaded disease is typical of the increasingly important service being performed by mechanical and electrical devices to aid the medical profession. Polio patients, in particular, are benefiting from treatments by new and improved physiotherapy equipment.



← Whirling knife cuts tissue in millionth-of-an-inch slices for microscopic examination (inset)

Heat is applied to a patient's arm with short-wave diathermy machine

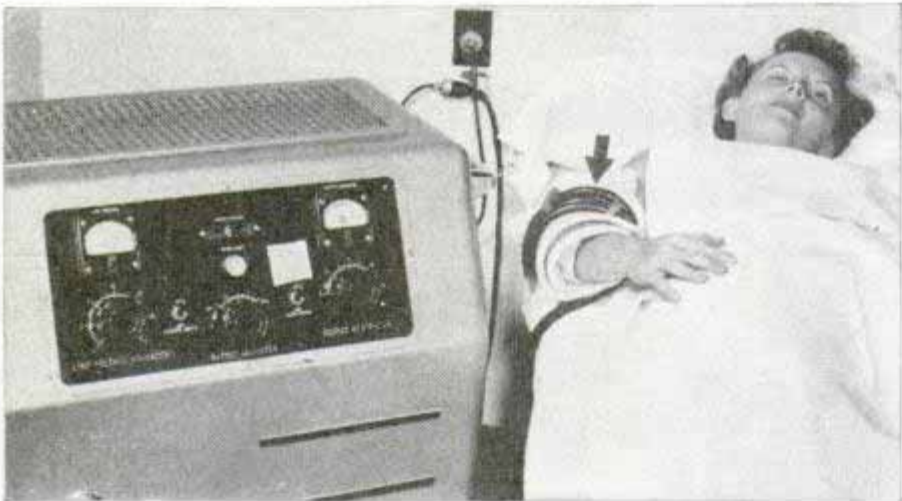

↓ Bottom, phase microscope equipped with light-controlling diffraction plate (upper inset) clearly reveals mold fragments (white objects below)

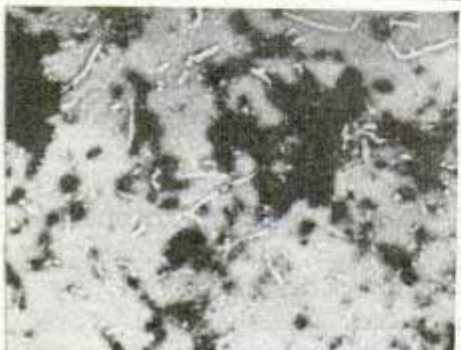
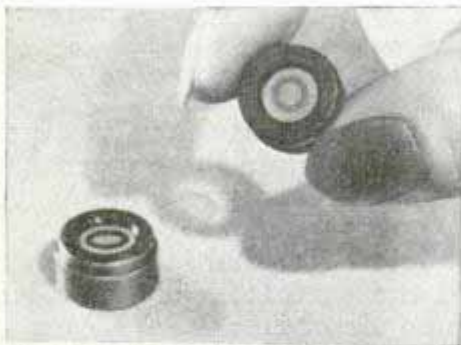

At Northwestern University's Medical School the muscles of infantile paralysis victims are stimulated by a variable-frequency generator. Electric current from the machine, simulating impulses from the brain, flows into a muscle at rates that can be varied from one impulse per minute to 120 per second.

Muscles, instead of wasting away, retain much of their strength by periodic stimulation with the generator, according to Dr. Stafford L. Osborne, associate professor of the department of physical medicine. Experimental use of the muscle stimulator is part of an extensive polio research program at Northwestern made possible by a grant of \$156,000 from the National Foundation for Infantile Paralysis, Inc.

Even special hot-pack washing machines have been designed to battle the spread of polio. The General Electric Company designed the machines and sent eight by plane last summer to hospitals in Colorado, gripped by the worst polio epidemic in its history.

The machines facilitate the heating and wringing of woolen packs which are applied to the bodies of polio victims. In place of the agitator in a standard washing machine, the polio hot-pack washer has an immersion heating unit. The heater is capable of raising water temperature to 180 degrees, which permits use of the machine in heating packs used in contagious cases.

In the treatment of tuberculosis of the skin, germ-killing light rays are utilized by a special ultraviolet lamp. The essential



part of this lamp is a capillary tube not much larger than an ordinary kitchen match.

Withstanding mercury vapor pressures up to 117 pounds per square inch, the tiny tube throws out ultraviolet rays which Dr. Osborne describes as the "closest approach to sunshine ever produced by a lamp."

Developed by the General Electric X-Ray Corporation, the lamp is placed within a few inches of diseased skin for 20 to 30-minute treatments. It provides the most effective remedy available for tuberculosis of the skin, Dr. Osborne reports.

The most modern method for heating tissues in treating arthritis, fractures and sprains is induction heating, the same method that industry has used for years in such processes as heat-treating metals.

In medical use, a cable is wound around a person's body or limb, or shaped into a coil and placed flat on that part of the body to be treated. Eddy currents induce heat in the most conductive tissues, the ones that require heat.

In artificial fever cabinets the induction-heating principle is utilized to induce controlled temperature between 104 and 107 degrees in a patient. Some eye diseases, syphilis of the brain, gonorrhoea, arthritis, asthma and chorea (St. Vitus's dance) are treated by this method.

Before artificial fever cabinets were developed, doctors increased a patient's temperature by inoculating him with germs or by administering foreign proteins. There was no certainty of getting the desired temperature or of controlling it.

Medical equipment described thus far

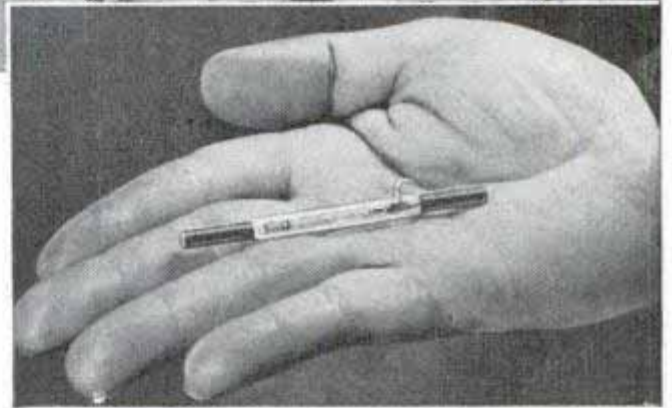

"Heart" of ultraviolet lamp (top) which treats tuberculosis of the skin is a small capillary tube (held in hand). Below, special General Electric washing machine washes hot packs used for victims of polio



Energy output measured in bicycle tests helps determine food requirements for combat soldiers and workers



was designed to assist physicians in treating diseases. Now let's examine a device which helps doctors check effects of various treatments.

A movie camera equipped with specially designed attachments takes colored pictures of a patient's throat, larynx, windpipe and esophagus. Two methods are followed: direct and indirect photography.

In direct photography the patient is placed on his back and his head is tilted back so that a tube, from 7 to 13 inches long, can be inserted in his throat. The camera then photographs the area seen through the tube.

In the indirect method a mirror attached to the camera lens is placed in the patient's mouth and the pictures are taken by reflection.

The University of Illinois College of Medicine uses a Bell and Howell 141-A camera, operating at 12 or 16 frames per sec-

↓ Leg muscles of polio patient are stimulated by variable-frequency generator. Right, colored movies of patient's throat are taken with camera equipped with special attachments. The parts are displayed below

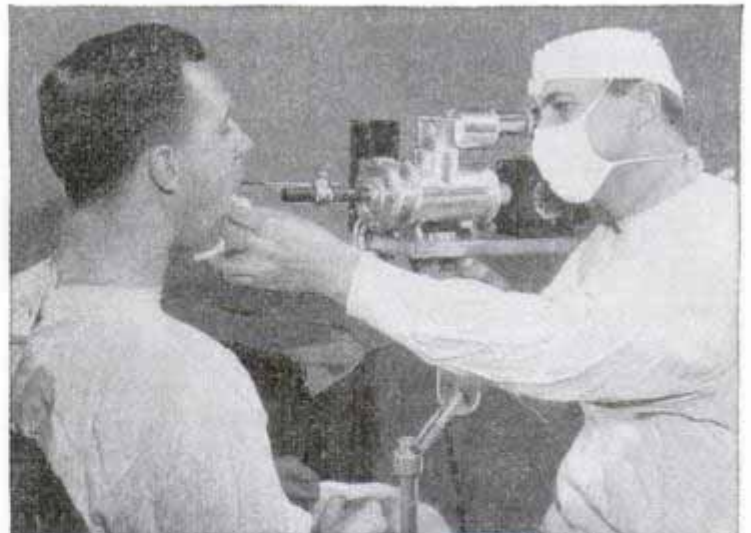

ond, to study the effects of various treatments and as an aid in instructing medical students.

Another "gauge" that medical science employs in research is the decompression chamber which simulates atmospheric pressure at heights up to 50,000 feet. It was used extensively during the war to study the effects of high altitudes on flyers.

Today, Northwestern University is studying the results of decompression chamber "flights" in treating sinus trouble. Dr. Robert Pittenger reports that sinus patients treated once a week "are obtaining considerable relief, with complete cure in some cases." Lowering air pressure in the chamber to duplicate atmospheric pressure at 10,000 feet permits sinuses to drain.

Improved scientific equipment helps man's war against disease in chemical analysis of blood and other fluids. The photoelectric colorimeter, for example, determines the concentration of sugar, hemoglobin or other constituents in blood by registering the precise color of the test sample. Filtered light passes through the blood in a test tube and strikes a photocell which generates a small amount of current, depending on the intensity of the light. Since substances of a certain color absorb certain known parts of the visible spectrum, the amount of light reaching the photocell reveals the exact shade of the liquid. Comparison of the reading with a table discloses what chemical is present, and how much.

One attachment developed by the American Optical Company for medical laboratories transforms an ordinary light microscope into an instrument that greatly extends the visual range. A new type of light-controlling diffraction plate, when placed in an objective lens system, makes visible minute details of cells and tissues.

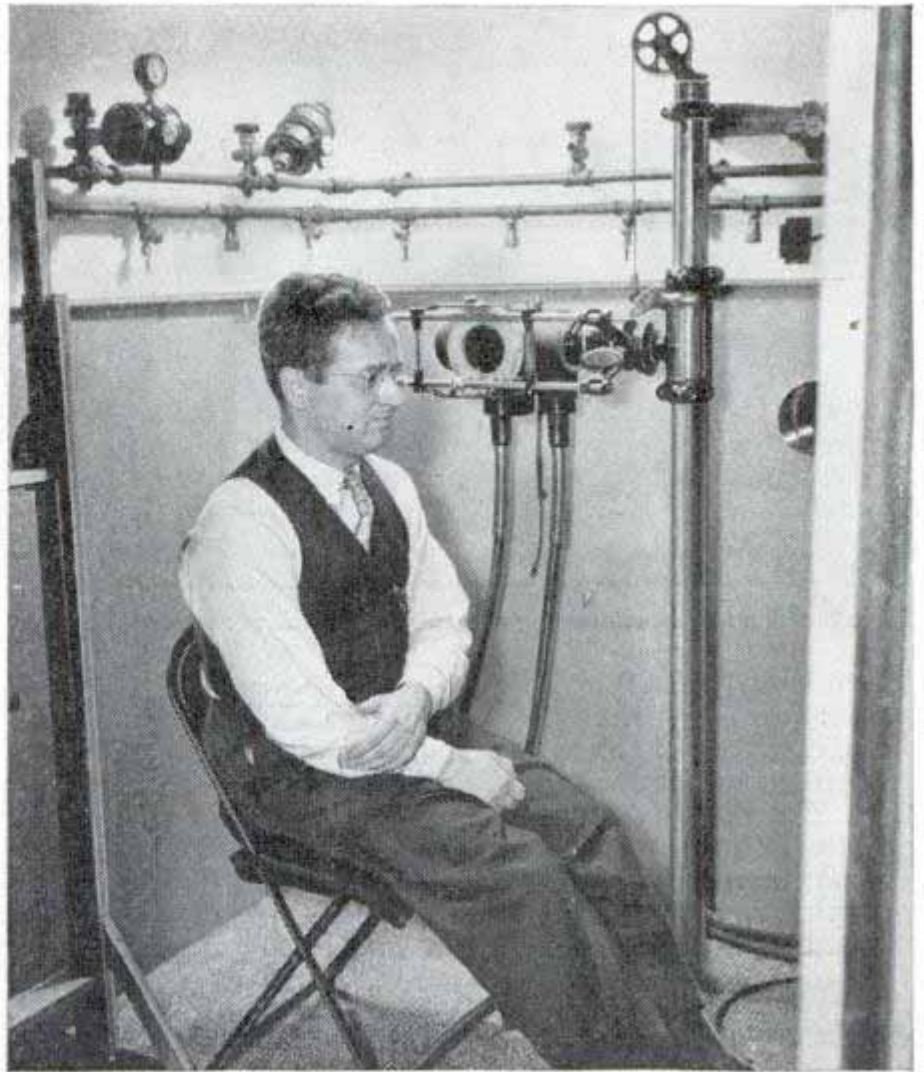

Sinus sufferer gets relief from treatment in decompression chamber at the Northwestern University Medical School. Below, exterior of chamber

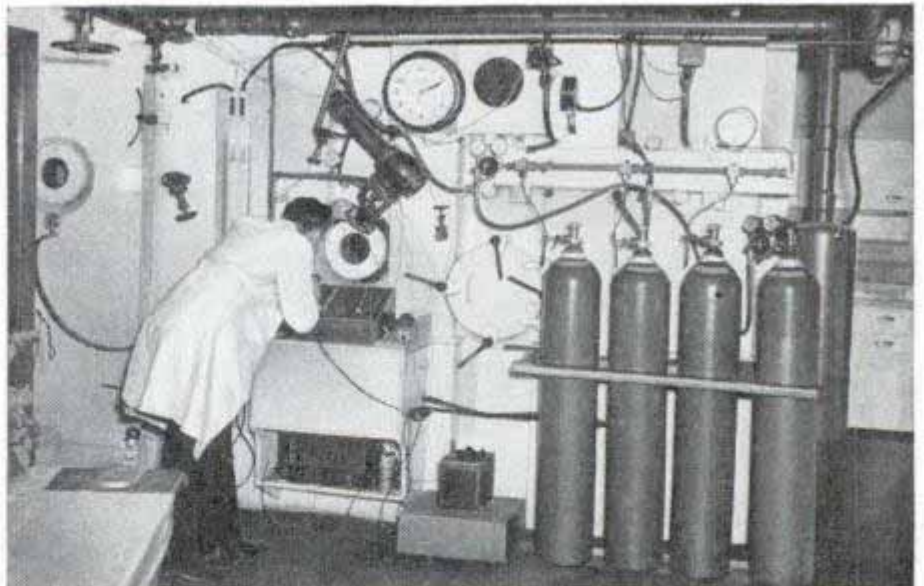

Another device—a ball-bearing razor-blade knife—cuts tissue into slices about a millionth inch "thin" for study under electron microscopes. Developed by the Interchemical Corporation Research Laboratories, the knife produces a cross section of tissue sufficiently thin to allow the complete cell and its nucleus to be examined at 20,000 magnifications under ultrapowerful electron microscopes.

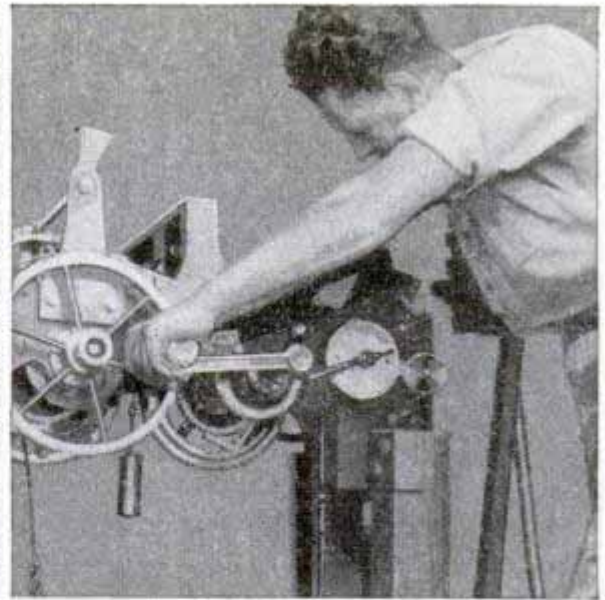

Huge dial is made of contrasting plants. Right, gardener winds the weight-powered mechanism every 24 hours

More than 100,000 plants form a giant floral clock at the zoo in Sydney, Australia, to surpass the animals as the main attraction. The clock's dial is 18 feet in diameter and the minute hand is eight feet long. The Roman numerals are formed of green carpet plants, contrasting sharply with the rust-colored background. Hour and minute hands, planted with moss, are carefully balanced with lead weights after each planting. Another 100,000 plants are used in near-by flower beds to depict the royal crown and a Maltese cross. One gardener devotes full time in summer to tending the clock and clipping the plants. The clock mechanism is powered by weights.

Speed Changer for Drill Press Operates by Hand Lever

Changing the belt of a drill press in order to change its speed is unnecessary when a new lever-operated speed changer is used.

A special pulley attached to the motor shaft changes in size as the lever is opened or closed, altering the ratio of the motor pulley to the driving pulley. In addition to the varying speeds possible with this pulley, conventional four-step pulleys can be used to give the drill press an even wider range of speeds, from 435 to 4550 r.p.m.



Glass Screen Shields Hockey Fans

Tempered plate glass screens protect New York hockey spectators from flying pucks and swinging sticks. Surrounding the entire playing surface, they extend two feet above the 3½-foot boards along the sidelines and are five feet high behind the goals. The specially hardened glass is 5/8 inch thick and built in five-foot panels. It is supported by metal clasps which do not project above the boards.

Dangerous Business, Farming

IN A SINGLE American industry during the next 24 hours about 45 people will be killed. Making munitions is far safer than this occupation. Blasting, mining and construction work aren't as perilous. Surprisingly, this most hazardous of jobs is plain old-fashioned dirt farming.

Favorite dream of city dwellers is to move to a farm, far from the noise and dangers of city streets. Few realize that farming is a down-



ACCIDENTS UNLIMITED
- Statement of Account -
To Mr. American Farmer, per year
16,000 deaths
1,500,000 injuries
55,000 permanent disabilities
1,000,000,000 dollars



↑ Mishandled tools often strike back. Blades should be carried away from body to avoid cuts in case of a fall
 ↓ Pitchforks against the wall can't harm anyone. The farmer who builds an implement rack has a safer farm

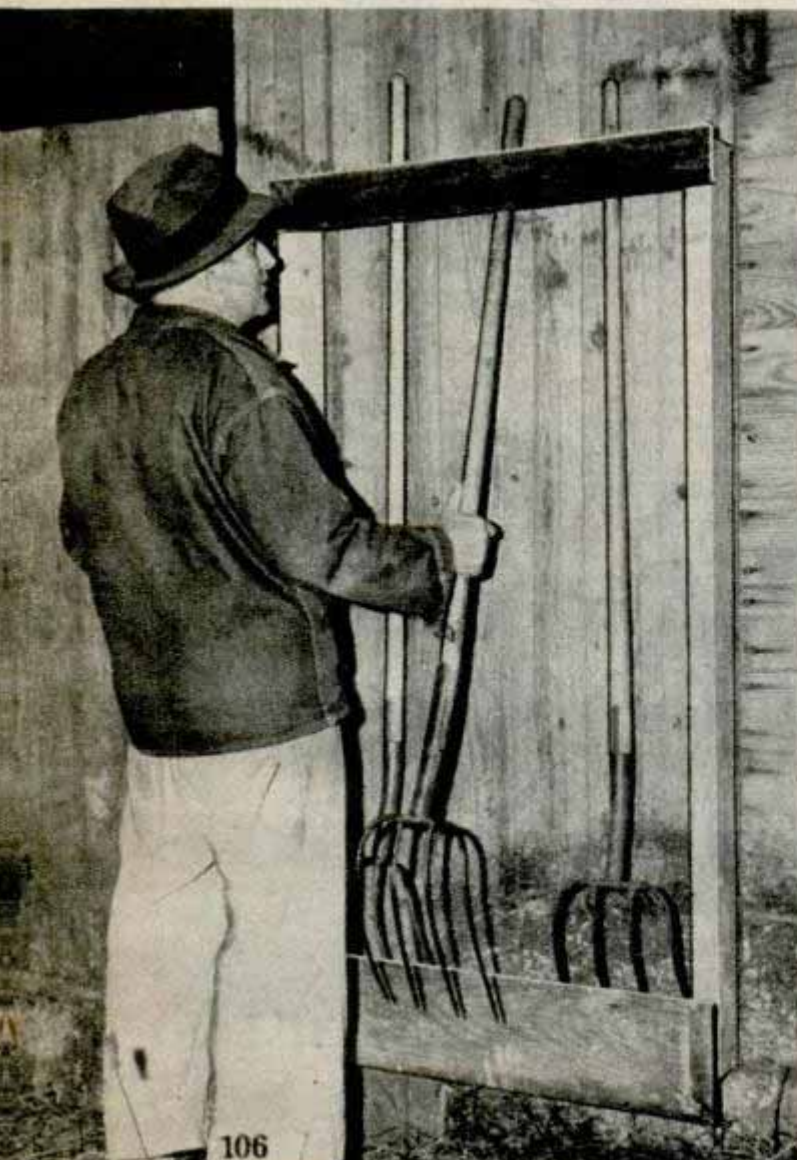

Tools left in the grass can be as dangerous as rattlesnakes. They should be safely stored when not in use

right dangerous business. Accidents reap a grim harvest on the nation's farms every year. The farmer runs a 1½-times greater risk with his life than the worker in the average industry, according to the Department of Agriculture. And playing on a farm can be more dangerous for kids than roving city streets, when safety takes last place instead of first.

Every minute, day and night, three farm people in the United States are seriously injured.

In Minnesota a farmer loaded hay with the help of two hired hands who stood on the rack above him. The farmer called for a pitchfork. One of the men handed down a fork and the farmer began spearing grass. The other helper threw down another fork, working-end first. The tines struck the farmer in the back, killing him within a few minutes.

The National Safety Council estimates that 16,000 farm residents will be killed within the next 12 months, 1,500,000 injured and 55,000 disabled for life. The total cost of farm accidents including fire will rise above a billion dollars.

These are sobering facts but they tell only part of the story. The victims themselves pay most of the cost of these accidents. The farmer races against time—if he loses a day of work he may lose a hay crop. Viewed against the backdrop of a billion dollar loss, individual accidents seem insignificant. But to the injured farmer an accident may mean debts that will take years to repay, or even the loss of his farm.

A Wisconsin farmer tossed the last corn-stalk into the shredder. His mittened right hand was caught and dragged between the rollers. A half hour later his hand was re-

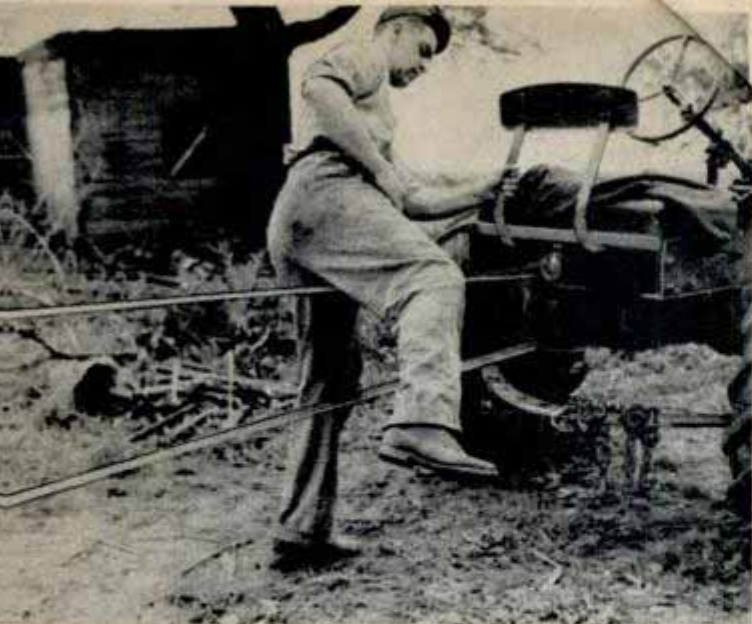

Climbing over belt may be a short cut—to the hospital

leased. The farmer paid \$500 to save his fingers and an equal amount was cut from his net income because of poor farm management during his recovery. Milk production on the farm dropped 10 percent. A litter of pigs was lost. Another \$200 was paid in wages to a hired hand. The debts were settled but the farmer still pays for his carelessness in moments of embarrassment when his coffee cup slips from nerveless fingers, or in lost efficiency when he drops his tools.

Trouble began for another Wisconsin farmer when his barn burned down recently. Tons of new hay were lost, but he was able to save most of his animals. After driv-

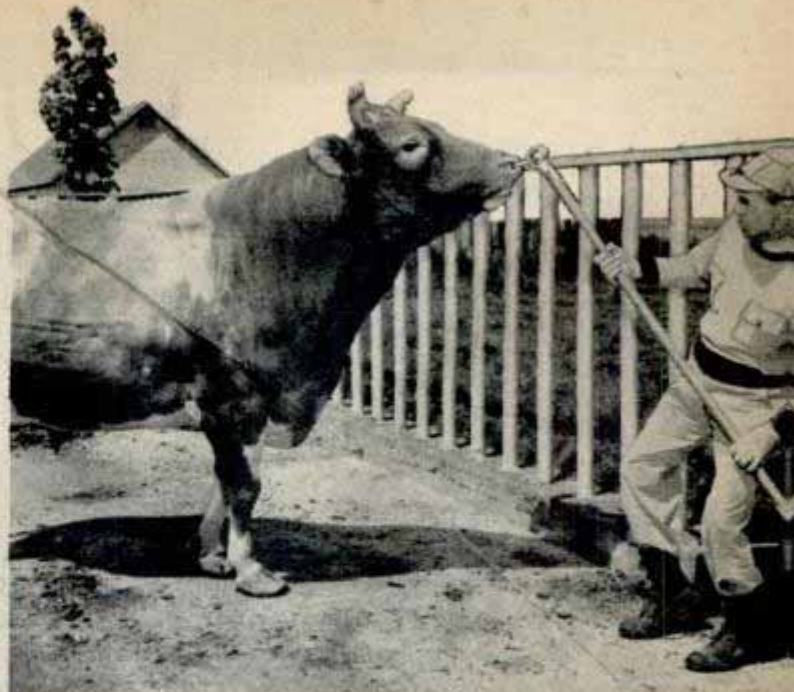

Only a staff can keep you on the safe side of a bull

ing them from the blazing barn he climbed to the roof of his house to drench sparks that threatened to spread the fire. He slipped from the roof, shattering his heel on the concrete below. Nearly a week passed before a surgeon capable of repairing the injury could be reached.

Why is farming more dangerous than any other occupation? Unlike most industries, farming has no elaborate safety devices, safety engineers, periodic inspections of equipment or coordinated safety programs. Almost every accident is a direct result of carelessness. And if carelessness is the cause, education is the cure.

Many agencies cooperate in telling the



Tragedy rides beside this child hitching ride on disk

National Safety Council photo

farmer the woeful tale of what will happen to him if he does his job the easy way instead of the right way. State colleges, universities and farm safety divisions in the state departments of health sell safety to the American farmer. But the agency fighting for old age for farmers on a national scale is the farm division of the National Safety Council.

The council aims its campaign at 26,000,000 people living on the nation's 6,000,000 farms. It works through organizations that honeycomb rural life. High school classes, extension services, 4H clubs and Grange units carry the campaign banner. The aim of the entire program is to make every farm resident realize the bitter truth that accidents don't always happen to someone else.

In an analysis of the 1945 farm accident fatalities the council points out the surprising fact that more deaths are caused in farm homes than at work. Much literature therefore is aimed at eliminating home hazards.

All farm residents spot and sometimes correct obvious hazards around the home—pouring gasoline or kerosene on a wood fire, climbing a weak ladder or chopping wood without protection for the feet. But some of the less evident perils pass by unnoticed—faulty electrical connections, weak treads in the basement steps or a clogged chimney.

A day spent in a thorough inspection of every farm building is a day well spent. The farmer may spot a surprising number of hazards and correct them before they put him on crutches or in the hospital. Guard rails should be built around hay chutes, weak floor boards

Farm welding operations require glasses for the eyes; gas tanks must be kept away from the sparks



If the doors should open suddenly this farmer would disappear. The walkway should be three feet beneath door level with a handrail

HOW TO CHOP WOOD

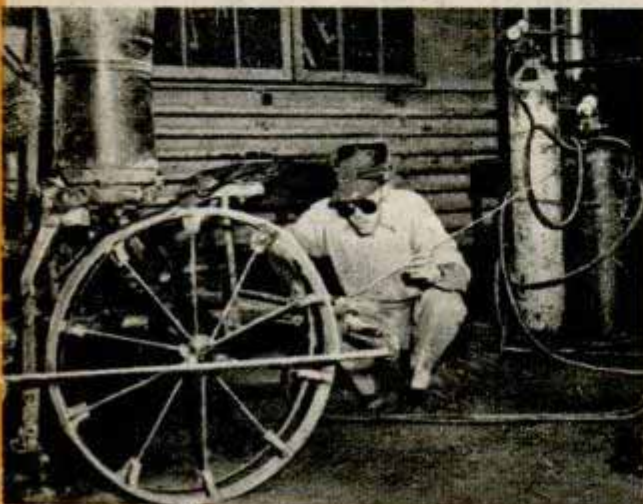
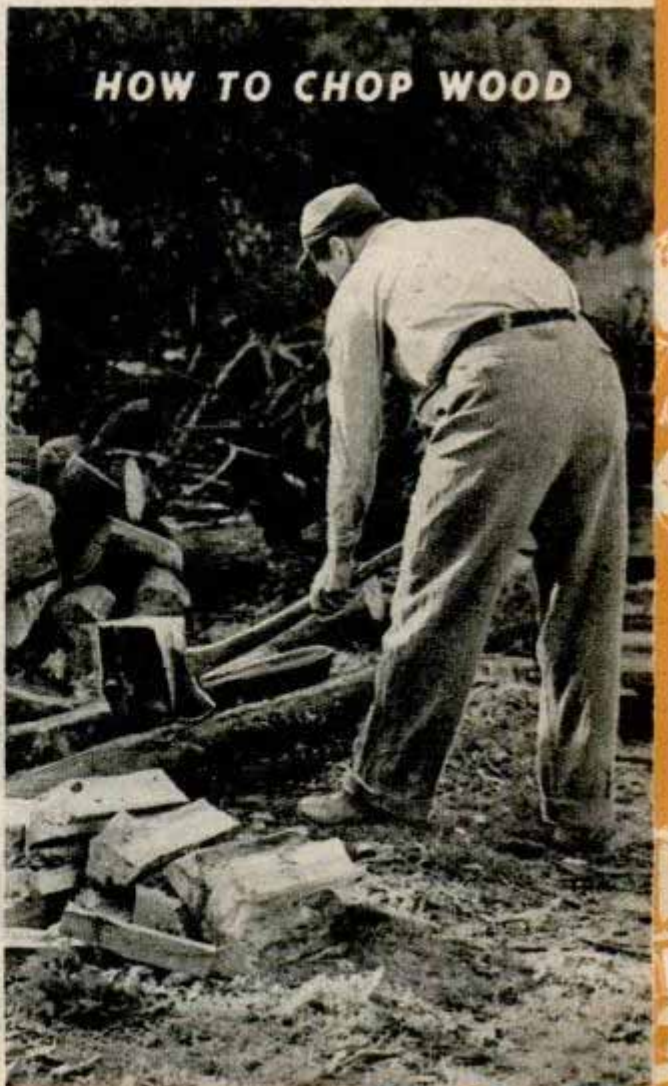

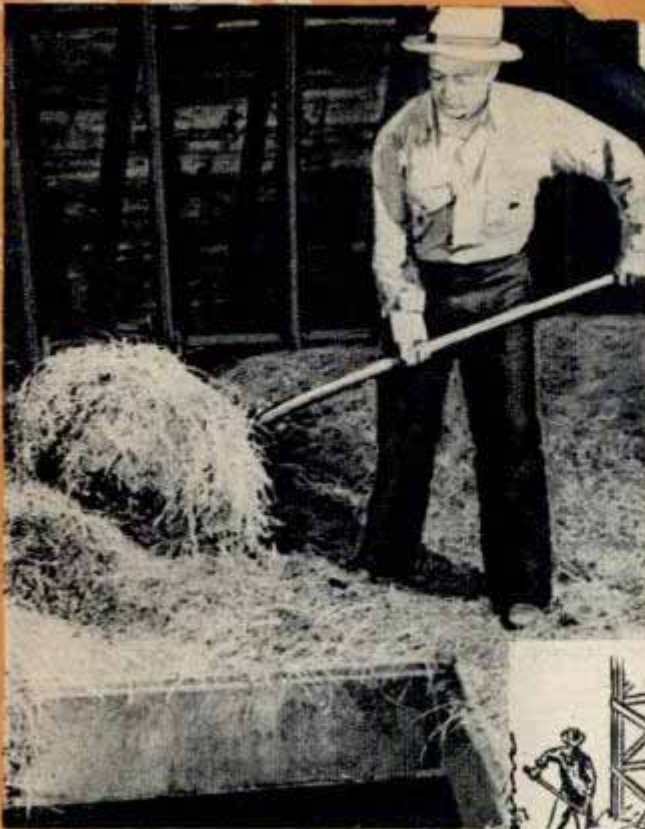

Open hay chutes can mean a quick, unexpected trip to ground level. A framework like the one drawn at right will protect the farmer

National Safety Council photos



and steps repaired. If lanterns are used instead of electric lights they must be hung on safe hooks. Platforms for servicing hayloft doors should be below the door level to prevent falling. Covered stairway entrances mean clean, safe steps. Cluttered work areas are annoying and dangerous—litters of glass and barbed wire scraps are easier to clean up than step over.

At least 30 percent of all fatal farm work accidents involve machinery and equipment. The nation's 2,000,000 tractors often rebel when mistreated by their owners. Cranking a tractor while it's in gear is not a healthy way to start the day's work, yet thousands of farmers do it each year through carelessness. Driving a tractor too close to the edge of a ditch is a short cut to the hospital. And speeding over a rough furrow may flip a farmer beneath the slashing blades of a disk.

The power takeoff shaft is another major cause of accidents with machinery. This shaft revolves behind the tractor, to

transmit power to towed machinery. All such shafts are provided with a shield by equipment manufacturers. Yet many farmers gamble the loss of a limb against the few seconds required to fasten the shield in place. The whirling shaft catches loose clothing and an arm or leg is drawn into the gears. It's an easy way to a long, maybe a permanent, vacation.

Major equipment manufacturers have banded together in the Farm Equipment Institute with a program which includes the development of high standards for farm machinery. One of the reasons that takeoff shields formerly

It's easy to get clothes tangled in a power take-off shaft when the shield is not fastened in place

HOW TO CHOP YOUR FOOT





Careless farmer works on the wrong side of a mower's cutter bar

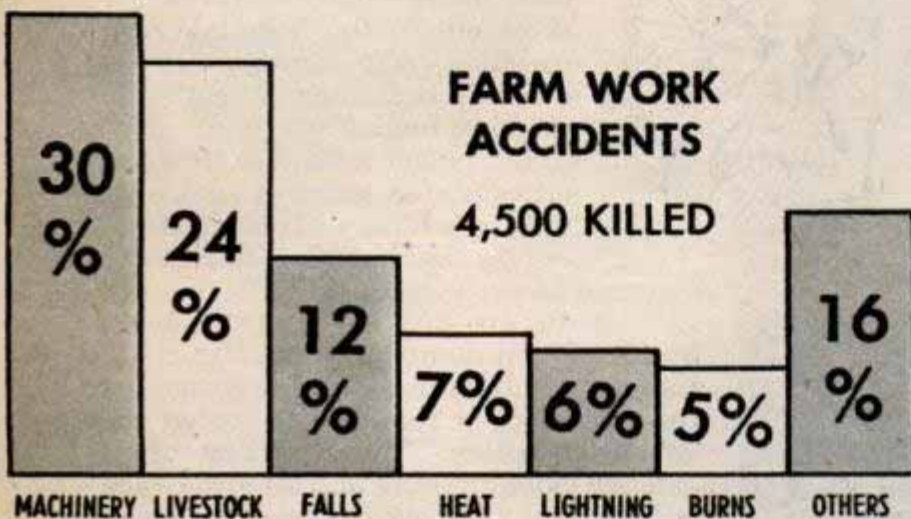

Remote control clutch (inset and below) helps farmer make tractor hitches safely. The tractor stops immediately when lever is released

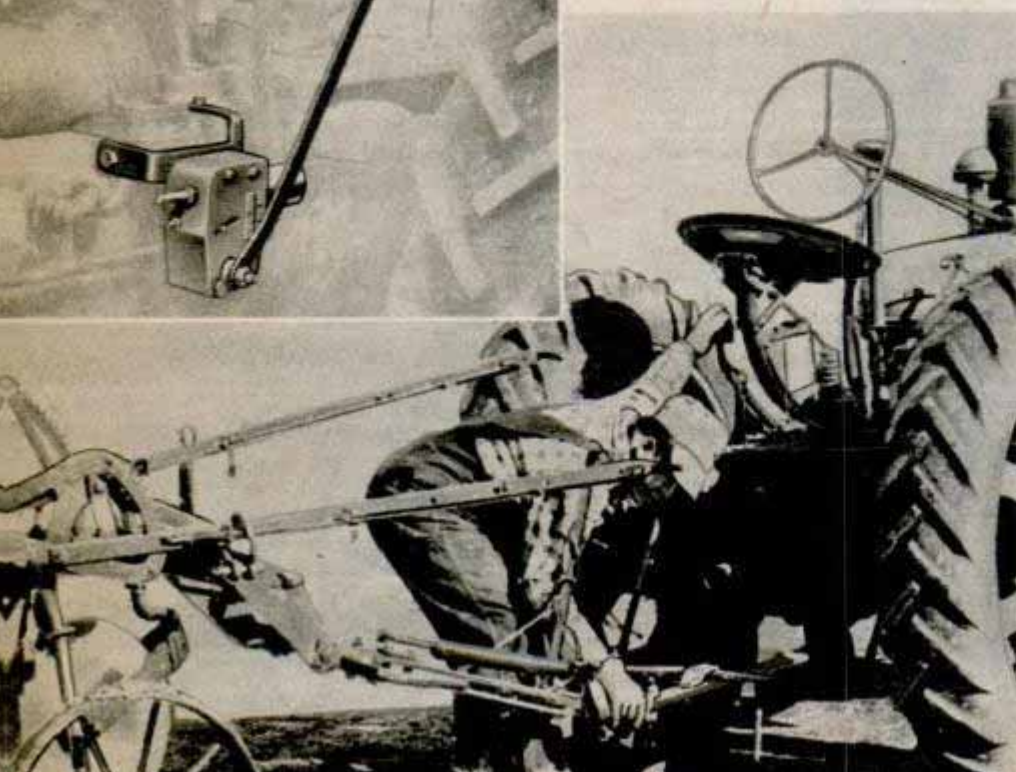

were taken off and left off was that equipment from one manufacturer didn't match the tractor of another. The American Society of Agricultural Engineers, following recommendations of the Farm Institute, proposed standard specifications for the takeoff shaft that are being adopted by every major manufacturer.

The "do's and don'ts" of handling equipment are plain common sense. Jumping off a tractor isn't a daring feat. It's a downright foolish one, especially when the tractor is pulling an implement. Standing behind a wire stretcher when repairing fences isn't exactly healthy, either. If the wire breaks, the barbs can whip through flesh like the teeth of a saw. And speaking of saws, the farmer who operates one without a guard may soon be operating without a finger.

Careless parents who permit children to drive the tractor, ride double on it or hitch a ride on a piece of equipment often pay high doctor bills for childish accidents.

Farmers grow old but sometimes forget that their equipment ages with them. An Indiana farmer was hauling a load of hay when a rusted bolt in the tractor seat gave way. He fell. The load of hay kept moving. The farmer died within a half hour.

An idling tractor is always potentially dangerous. A Colorado farmer stopped his tractor to put on warmer clothing. His open jacket caught the clutch lever as he jumped to the ground. The tractor climbed across his body. He was lucky to be alive to pay a bill for a long hospitalization.

The problem of hitching a heavy implement to a tractor is an annoying detail of farm work. Trying to operate the clutch to back up the tractor while standing directly behind it is an easy way to commit suicide. A "remote control" clutch is a recent innovation that may take guesswork and danger out of operating the tractor from behind. The

(Continued to page 248)

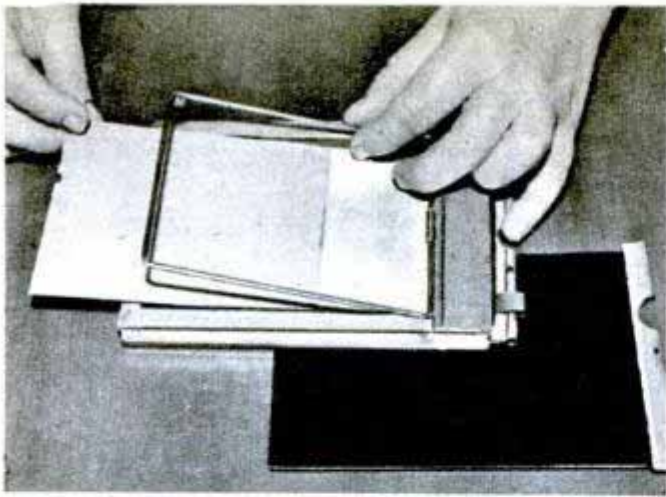

Film Holder Prevents Finger Marks

Finger marks on film are eliminated by an all-metal cut-film holder with a wire frame for holding the film in place instead of the grooves of the conventional type. The film is dropped into the holder and the frame swung down to clamp it tightly in place. The holder's light trap has no felt slide to spread accumulated dust over the film. Metal numbers that clip to the wire frame are available for identification.

Photo Easel Has Movable Platen

Sensitized photographic paper can be inserted in a new all-steel easel without lifting or disturbing the masks. The platen itself is depressed by a lever and the paper inserted through the guide from the right-hand side. A wide cutaway permits easy insertion of the paper in total darkness. The easel is three to five inches smaller than most other easels but accommodates prints up to 11 by 14 inches.

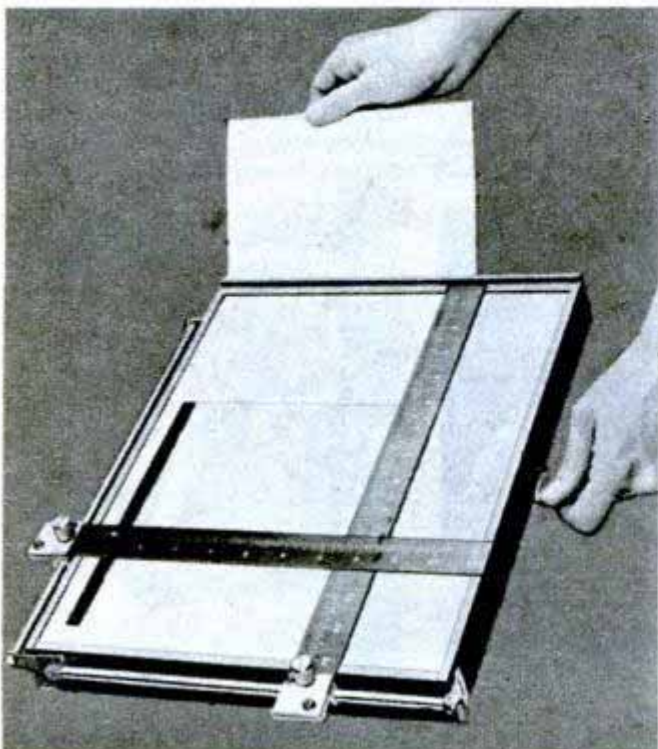

Aircraft-Type Automobile Jack Works on Six-Pound Pressure

Six pounds of energy applied to a jack patterned after aircraft bomb-bay openers will raise an automobile. A wide base and a sturdy bracket which fits under a bumper make the jack firm and solid. Danger of the handle spinning when the car is let down is eliminated by a special regulator.

Gripper Spring Holds Shoe for Shine

Shoes to be shined are held firmly in position by a self-adjusting spring in a holder which leaves the shoe top completely exposed. No shoe tree is necessary because the gripper spring pulls the sole down flat and removes all toe wrinkles. Rubber pads protect heel and toe. When not in use, the holder can be removed from its wall bracket for easy storage.



*"Inside
Stubb"*
for
Your Home

Kitchen table with double electric outlet has two padded benches that fold beneath the porcelain top



Top hood of electric broiler can be used as heater and bottom section doubles as aluminum serving tray



Three-section Tenite plastic roller on lawn mower makes it easy to turn machine without damage to the sod

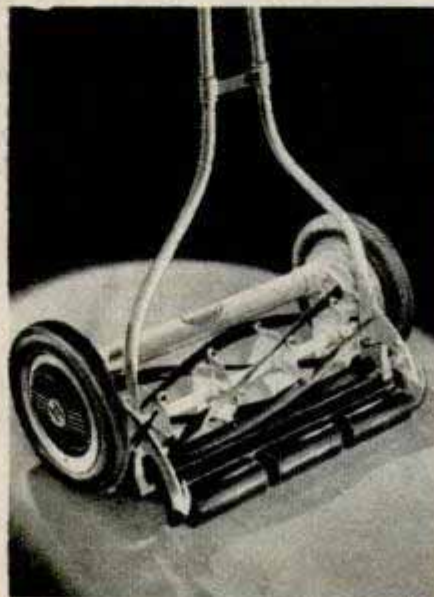

Heavy coiled extension cord makes ironing easier. It shortens itself and doesn't become looped over iron



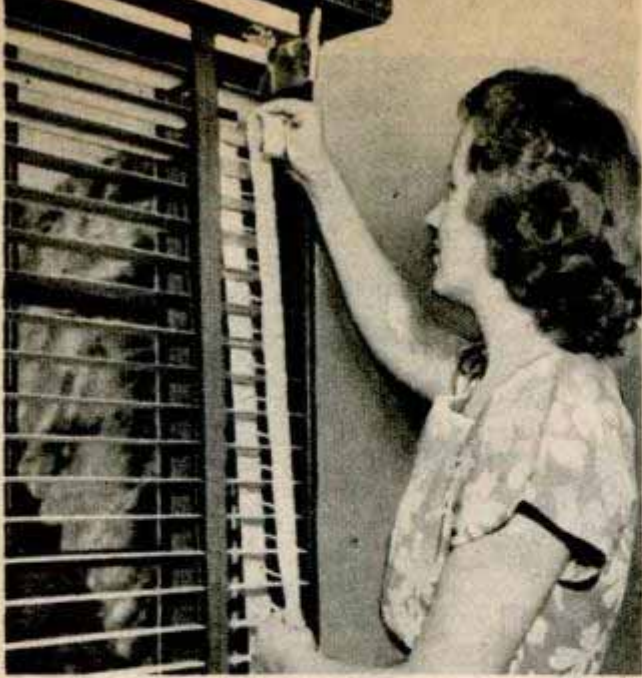

Replaceable tape for venetian blind is slipped over the end of the blind and into position of old tape



Home freezer has folding table attached which serves as dinette or work space in preparing frozen foods

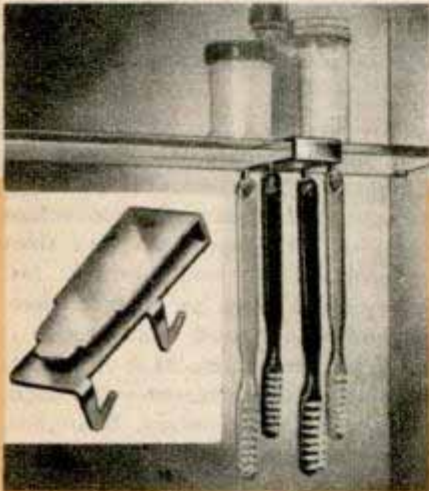

Toothbrush holder of flat aluminum slips over the medicine cabinet shelf without disturbing any other articles

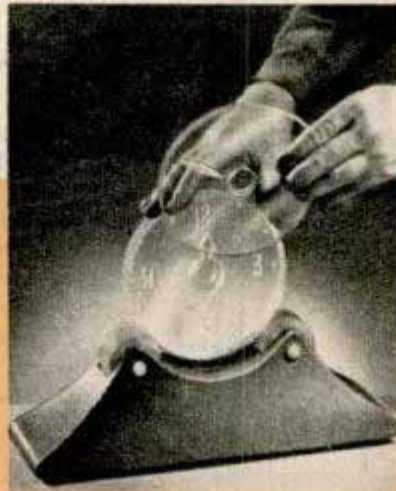

Rotating plastic gears of an electric clock turn plastic disks that show hour and minute hands



Suction cups on novel soap holder hold soap above the lavatory and prevent it from becoming soggy

Form-fitting chair adjusts itself for the comfort of the occupant. System of balances controls position changes



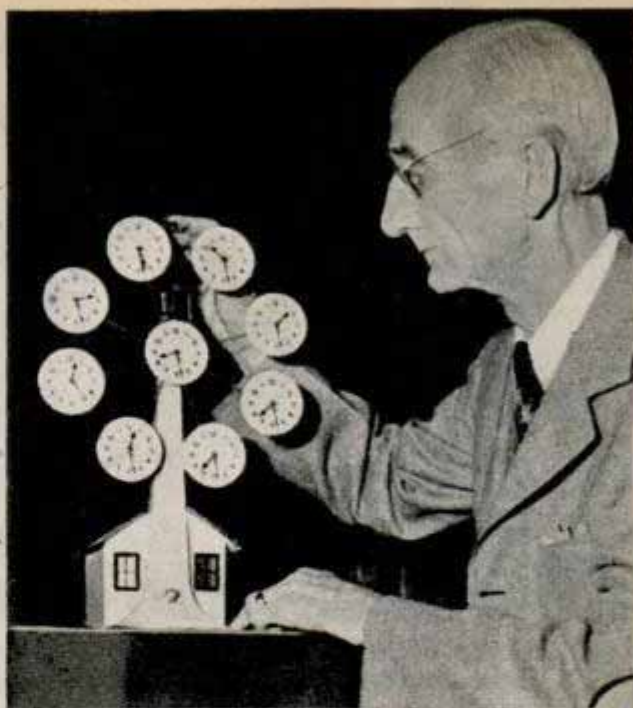

Master Timekeeper

Time passes quickly in the office of William H. Samelius at Elgin, Illinois, where the 72-year-old director of the Elgin Watchmakers College keeps his valuable collection of clocks. The collection includes timepieces of all types, ages and sizes and contains several that he built himself. Mr. Samelius was a boy of 13 when he started tinkering with springs and wheels and has been at it ever since. One of his famous clocks is the lighthouse (above) that tells the correct time in Chicago, New York, London, Moscow, Bombay, Shanghai, Yokohama, Hawaii and San Francisco. At left he winds the glass clock that he built for the Century of Progress Exposition. His collection of alarm clocks includes a tiny bedside timepiece and an old-fashioned giant alarm (lower left). His most unusual clock has an antique movement powered by leaves from an old wagon spring (below)



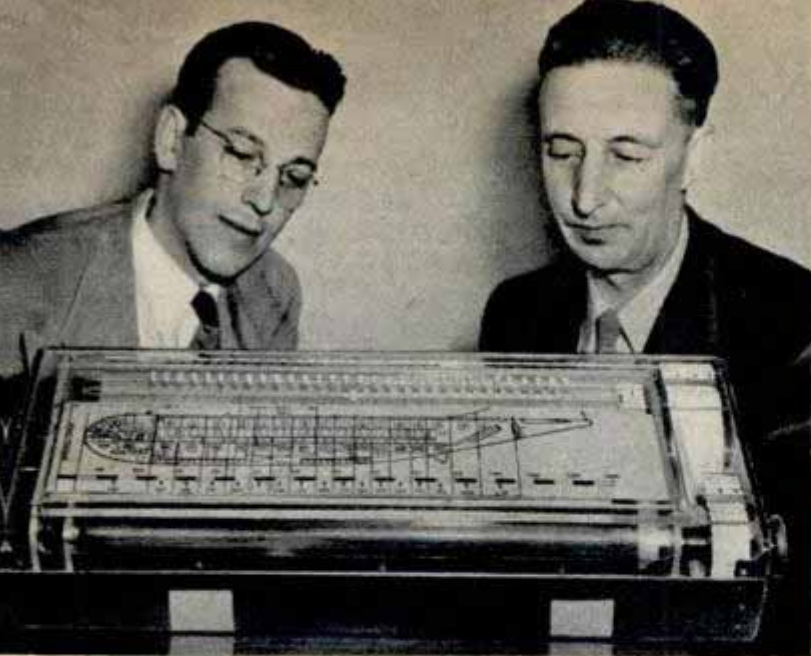

Boeing's air-freighter load computer instantly records change in weight or shift in center of gravity during loading. On its face is a profile of the Stratofreighter

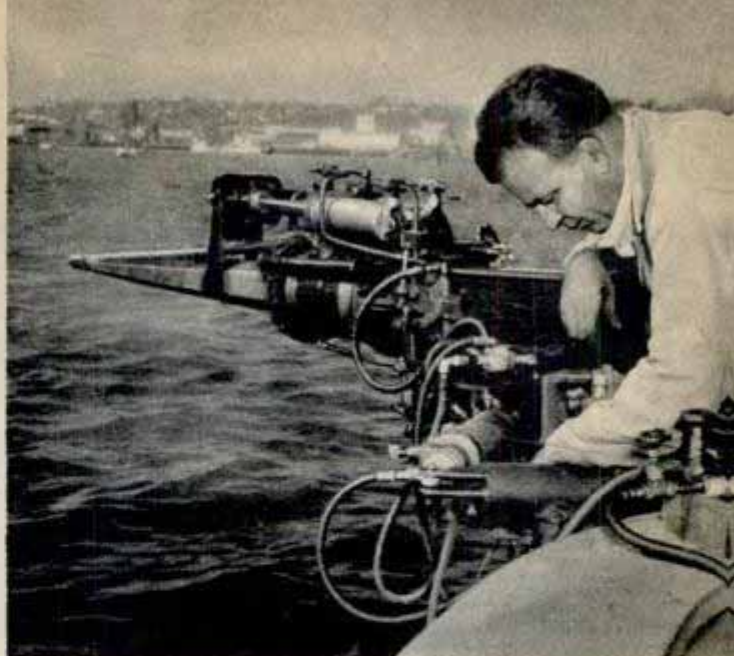

Automatic hoist on tuna clipper takes over fisherman's backbreaking job of heaving a 100-pound tuna from sea to upper deck. It is powered by compressed air



First all-aluminum bridge span swings into place across Brasse River at Massena, N. Y. It weighs 53,000 pounds. Same size steel span weighs 128,000 pounds

Youngsters get year-round use from all-steel wagon which can be converted into sled by removing wheels and substituting sturdy, streamlined steel runners

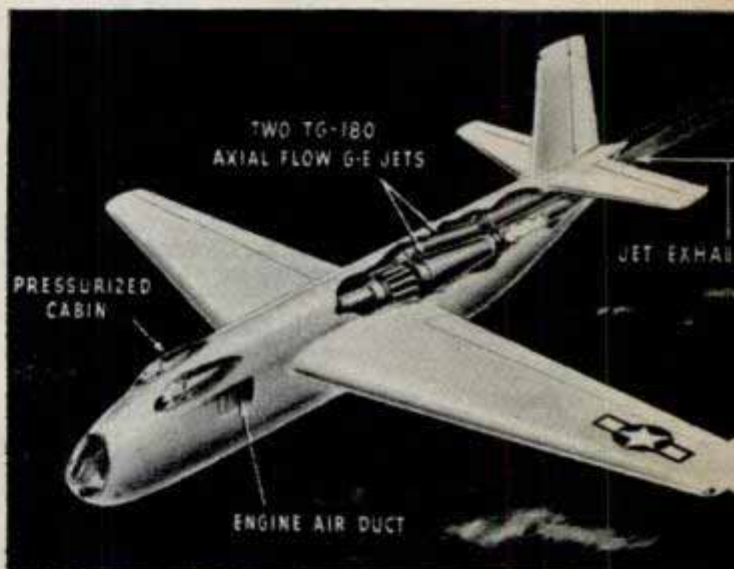

First American jet bomber, AAF's XB-43 is expected to exceed 500 m.p.h. Built by Douglas, plane has two GE jet engines. Each delivers 4000 pounds thrust

Individual opinions are recorded electrically and combined into group reaction by opinion meter designed for business conferences or motion picture previews



European Auto Show

POSTWAR models of sporty British runabouts and shining Russian limousines are rolling off Europe's assembly lines. Production is limited but England alone is turning out 28 different kinds of cars and more than 100 models. Few Europeans can find an automobile to buy, but a few new cars were in the hands of eager buyers before American autos were available.

Switzerland beat both America and Great Britain in bringing cars to market. A French automobile show was held in Paris last October; there hasn't been a show in the United States since 1941. England has edged out Detroit in export trade in line

Recognize a few familiar names? The Paris automobile show last October was the first exhibition since 1939



with her "austerity" program to boost her exports. She ships more than 50 percent of her motor cars to 70 different countries and for the first time in history leads the world in automobile shipments. A few British cars are even finding their way to American dealers.

Despite Great Britain's top exports of new models, the average Englishman has more trouble buying a motor car than his American counterpart. Put yourself in the Englishman's brogues. Imag-

Motor Cars in England

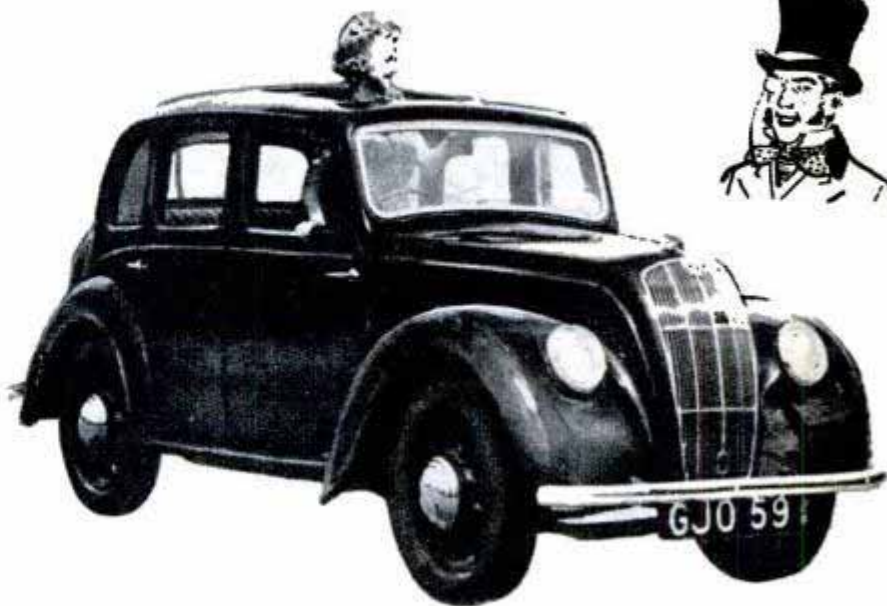

↑ Morris Eight has sky panel for view and air, costs about \$1400



↑ Four-cylinder Standard Fourteen has top speed of 68 m.p.h.

↓ Four forward gears are feature of this Austin export model

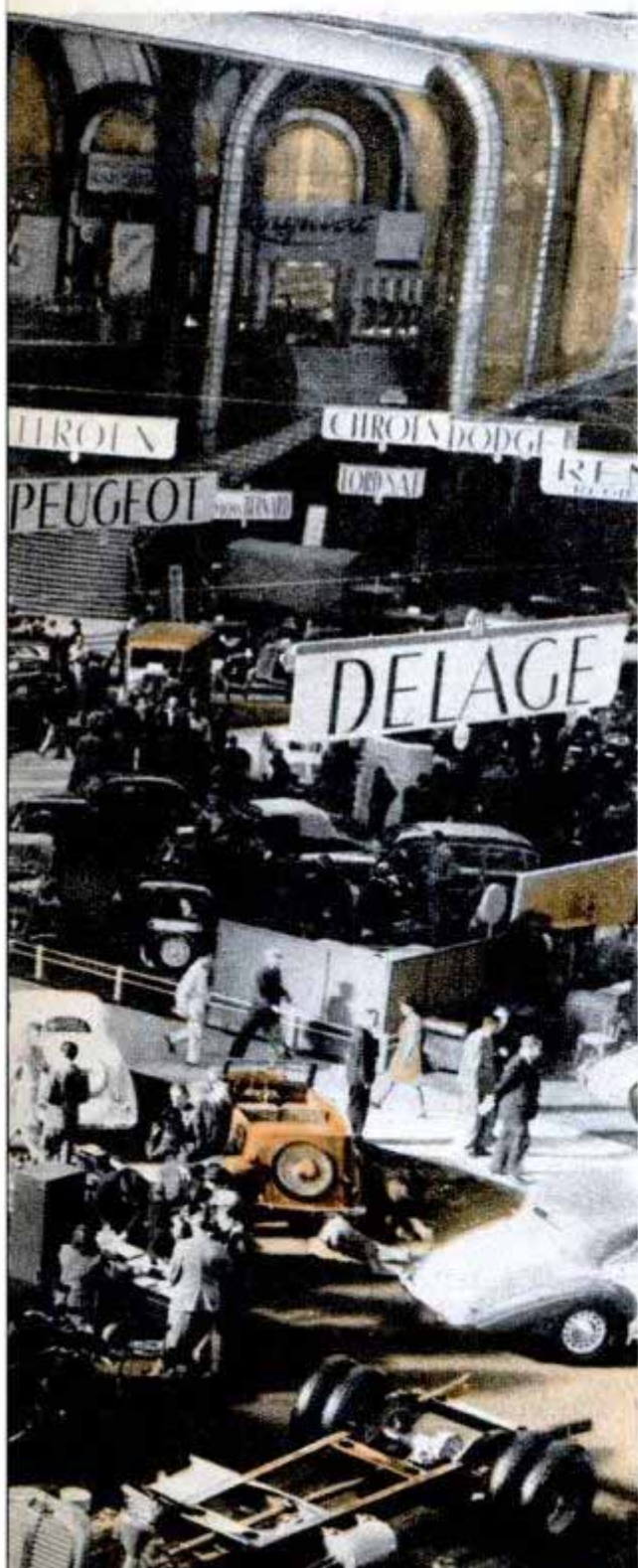
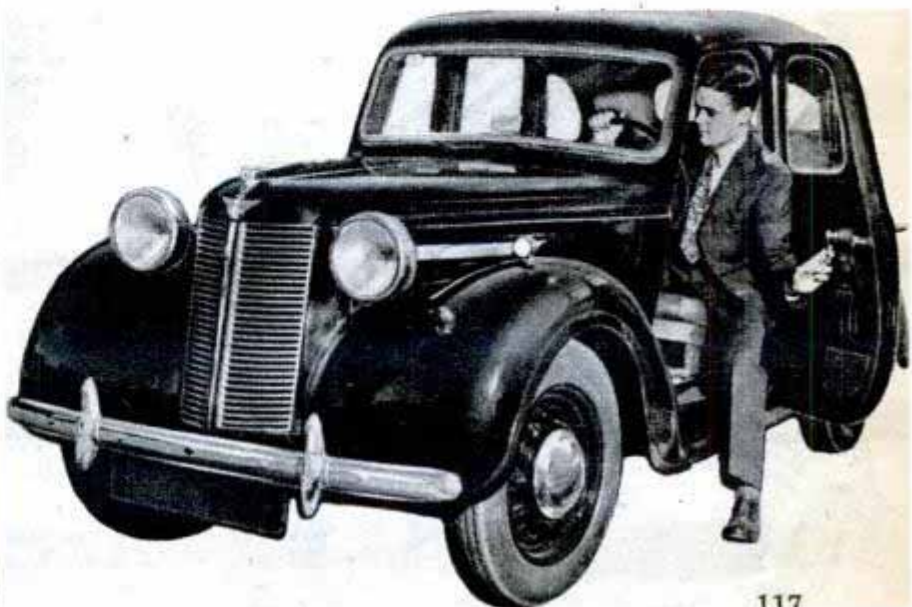

Motor Cars in England (CONT'D)

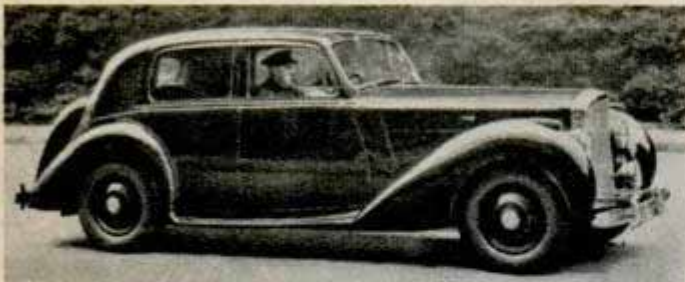

One of Britain's heaviest, most expensive cars is this Bentley made by Rolls Royce. It sells for about \$12,000



Triumph with its tubular chassis and "knife-edge" lines is one of the few entirely new models built in England
British Information Service photos

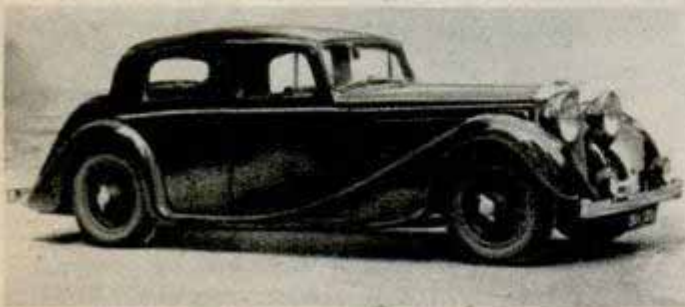

Flowing lines give a distinctive appearance to the six-cylinder Jaguar 2½-Litre Saloon. It costs about \$4000

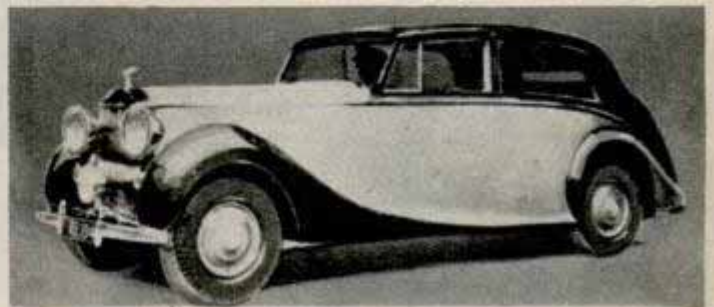

Engine of Rolls Royce Silver Wraith is said to be designed to run more than 100,000 miles without attention

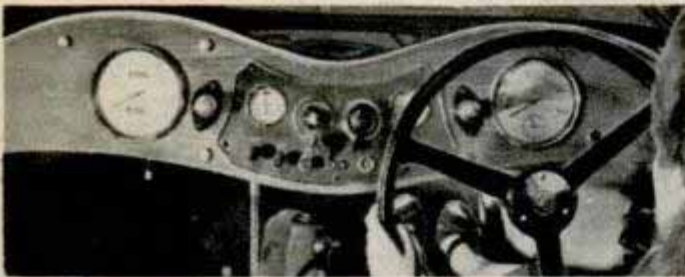

Driver of sporty M. G. Midget sits with legs straight out in front. Position of the steering wheel can be adjusted



One of Britain's fastest cars, the M. G. Midget has a road speed of about 80 m.p.h. Only one body style is available

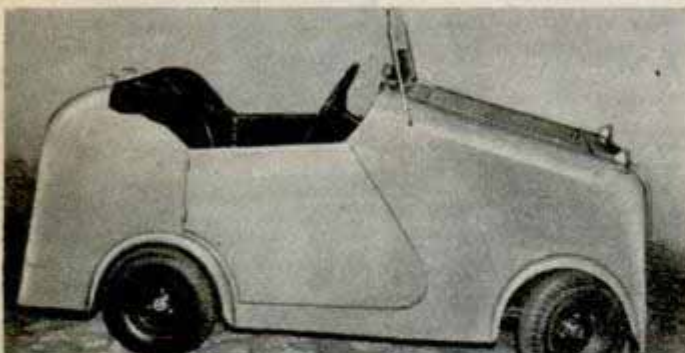

Lamar one-seater designed for the disabled can be fitted with all-hand controls. It travels 35 miles to the gallon

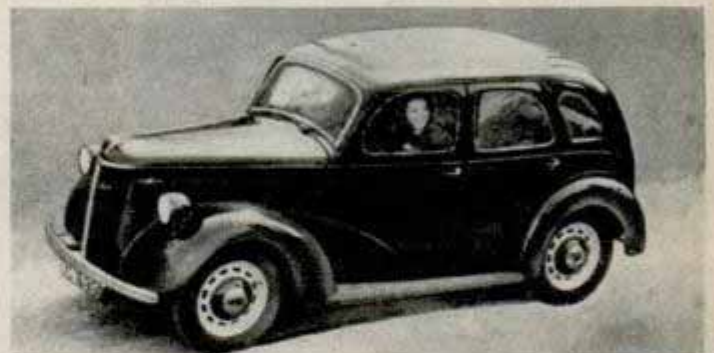

Here's the English model of the familiar Ford. Called the Prefect, it costs the Briton about \$1400 with tax

Standard Eight convertible goes 45 miles on a gallon of "petrol"



ine that your country stopped producing civilian cars in 1939 instead of 1941. Then suppose that manufacturers were shipping to foreign countries every other car that rolls off the line. That's the situation that faces the Briton who wants to buy a car to replace his prewar runabout.

America has no monopoly on inflated



Les Autos in France

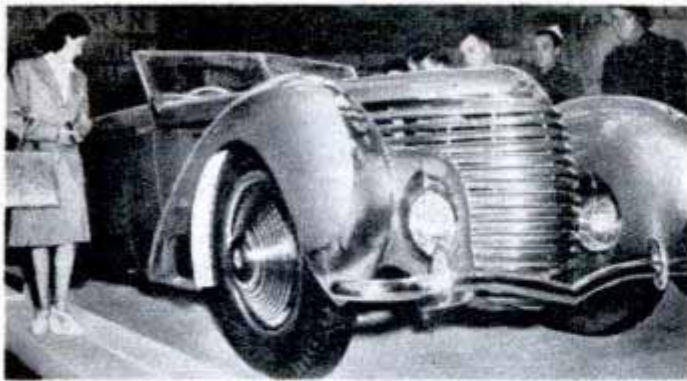

One of France's elaborate new cars is the low-slung Delahaye Competition. Note built-in headlights, fancy grille



Renault Eight, a popular French model, has a detachable aluminum cylinder head, will go about 50 miles per gallon



Smallest of cars displayed at the Paris automobile show was the light Deux Chevaux (two horsepower) Julien



French mademoiselle tries out the four-horsepower Panhard. The running board is eliminated because of the car's size

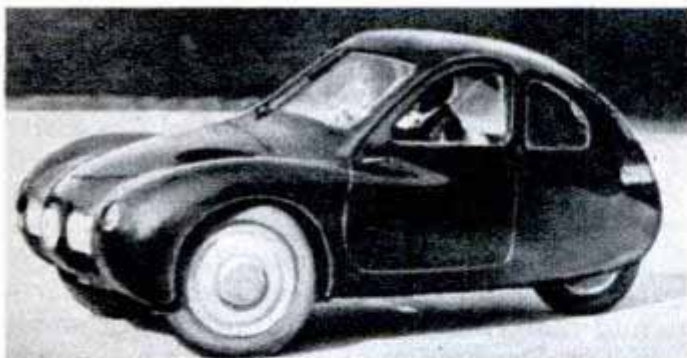

Result of restrictions on material is this three-wheel French model with a tapering body and sloping windshield



Gregoire has 100-pound chassis, air-cooled engine and front-wheel drive

prices, either. If you lived in England you'd pay about \$1400, including tax, for the lowest-priced car—a light English model of our own Ford. But the prices on strictly English makes range up to around \$12,000, tax included, for the Bentley, one of the more costly limousines. In general you'd pay \$1500 to \$3500 for a car that's smaller and less powerful than most American autos. The average British runabout costs approximately twice as much per pound as an American make.

English cars have always been lighter

and less powerful than those made in this country. A different type of service is required in England, and the English system of taxation discourages a large powerful motor beneath the "bonnet." Like most American models the postwar English autos are substantially prewar models with improvements. Some trends follow American design—built-in headlamps, lower center of gravity and independent wheel suspension.

The popular British car generally weighs 40 percent less than our own "Big Three" light cars, it has a four-cylinder engine

АВТОМОБИЛИ in Russia

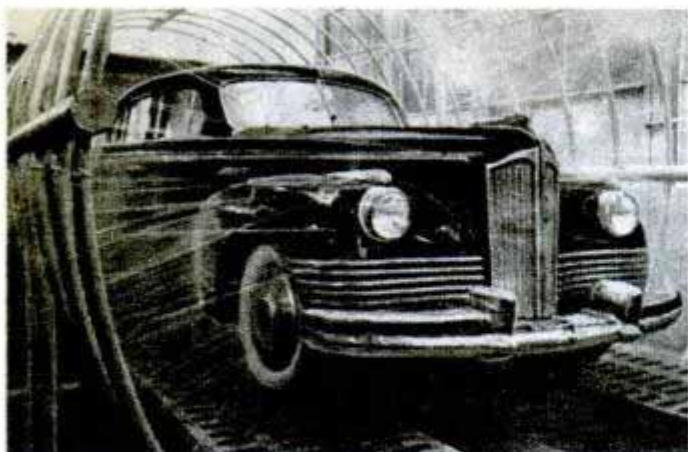

Eight-cylinder Russian limousine is tested for leaks in the "shower room." Note similarity to American autos



Victory car with four-cylinder engine follows American trends. Headlamps are built into long sweeping fenders

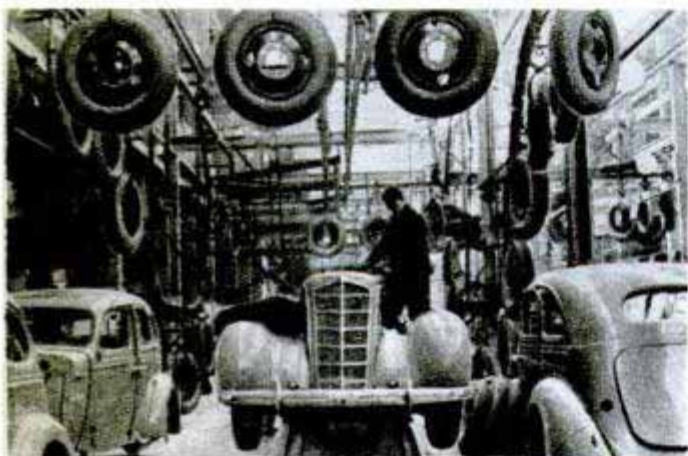

Stalin plant in Moscow makes over 200 cars and trucks a day. Russian assembly line resembles Detroit factory

that's 60 percent smaller, and has a top speed of about 60 m.p.h. Its four forward speeds compensate for its smaller power plant. But it rolls 30 to 50 miles on a gallon of gas. The car is well-tailored to the type of service required in England.

Heavier, more expensive cars are manufactured, too. The wealthy Briton is now looking over England's first gearless, clutchless car which appeared recently. An automatic torque-converter, working on the turbine principle, replaces the clutch and gearbox. The car is powered by a six-cylinder engine and sells for about \$9000 plus purchase tax.

British factories haven't reached full re-conversion yet. Production stopped short of the 1946 goal—400,000 automobiles. British manufacturers haven't been plagued with the major strikes that crippled our production, but an antiquated supply system has held down potential output. A British motor car is assembled from parts and materials made by hundreds of small firms. Production of one British make was

held down to eight cars in one week recently through lack of parts. Each of the eight, according to company figures, cost £200,000 or about \$804,000. The same supply system dragged down production before the war. The U. S. with only twice as many workers in prewar days turned out 15 times as many cars as England.

France has bounced in-to limited production

(Continued to page 252)

Bil in Sweden

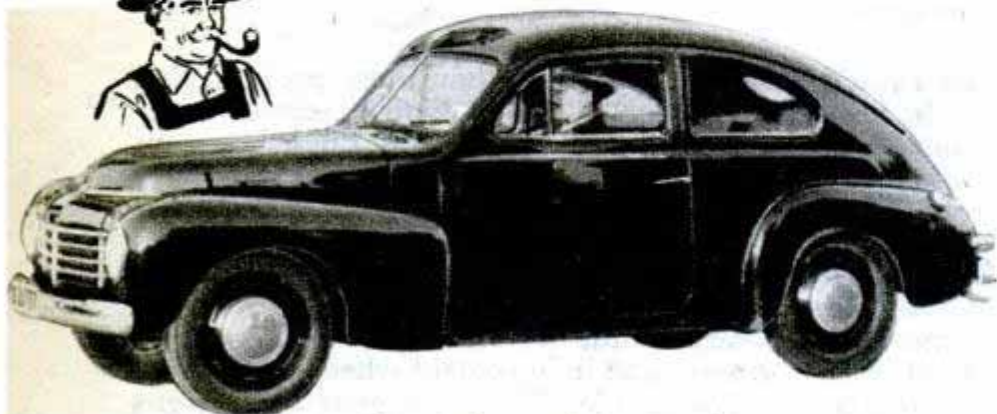

Small Swedish car sells for about \$1200, runs 24 miles per gallon of gas, looks like light American makes

Magnetism Holds Metal Tools on Wall Rack in Workshop or Kitchen

Magnetism holds tools and metal implements in place on a steel rack designed for use in homes, workshops, garages and factories. Knives, scissors, can openers, pliers, wrenches, screwdrivers—heavy or light—are simply held against the rack and then released.

Electric Brakes For Big Trucks

Safe control of heavy trucks at higher speeds is promised with a dual electrical braking system which has been adapted for use on tractor-trailer trains. It employs conventional shoe brakes on all wheels of tractor and trailer plus an electric retarder mounted on the drive shaft of the tractor and on a live axle of the trailer. The retarder, a simplified form of electric generator, can be preset on a dial in the driver's cab for speeds between 14 and 44 m.p.h.

It produces a braking effect by generating electric current. The current is converted into heat which is dissipated by the cooling fins of the retarder rotor. When pressure on the accelerator is released, the retarder goes into action and holds the loaded tractor-trailer within the limits of the desired speed. In tests, a loaded tractor-trailer with a gross weight of 42,000 pounds was



driven down a two-mile-long eight-percent grade. With the engine in high and without the use of the foot brakes, the retarder held speed below 35 m.p.h. The system, designed by the Warner Electric Brake Company, also uses shoe-type wheel brakes operated by an electromagnet. Cab dials give the driver fingertip control over brakes on each axle to balance brake action while in motion.

Tool Operates Like Wall-Type Can Opener to Crimp Heavy Sheet Metal

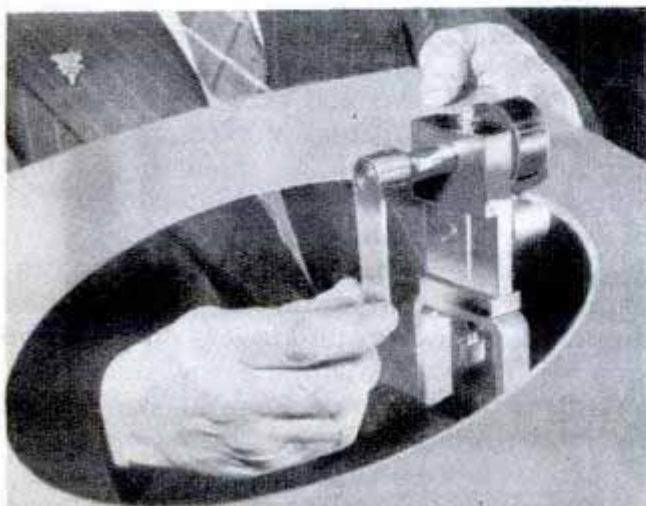

Sheet metal up to 16 gauge is crimped by a tool that operates like a wall-type can opener. The tool crimps straight-edged or curved material as well as blanked-out holes. Turning a crank pulls the sheet metal between two round dies that are under spring tension. Held firmly against a guide, the edge of the metal is crimped to the desired shape. A wheel substituted for the conventional handle allows the tool to be used on work already installed.

☞ Sweet corn retains its freshness for a week if wrapped in Cellophane and kept at about 40 degrees F., according to experiments by Ohio State University.



JET BLACK BONANZA



Photos by Marty Anderson

↑ Mined ore is piled high in a glistening mountain to await transportation by mine cars to plant where it goes through a separation and pulverization process
← One of principal uses is in asphalt for pavement

By Estey I. Reed

MESQUITE and rocks dominate the terrain out in Uintah County, a desolate area in northeastern Utah. Most travelers look on that part of the scenic West as "picturesque," but they can see nothing of value in the bleak land. Yet it's the only area in the world that produces in commercial quantities one of the raw materials that goes into the storage batteries of the cars they're driving.

If any of the travelers picked up a chunk of the glasslike rock, shiny and black, they'd probably think it was as useless as the mesquite. But they'd be looking at gilsonite—and the hard black lumps pay off.

Gilsonite was almost unheard of by many geologists until recent years. Even those who now know of it have different ideas as to its origin. Some believe it was liquid pe-

troleum in the days of the dinosaurs and was hardened by the glacier that passed over that section of the country years ago. They say the glacier caused an upheaval with sufficient heat to draw off the liquid and leave solid material. Others believe that over a period of centuries it seeped into the narrow fissures in which it's found and eventually hardened.

The story of the discovery of the valuable stuff is a thread in the history of the West. In 1885 prospectors penetrated every part of the Utah hills. One of them was Captain Samuel H. Gilson, explorer, soldier and law officer. In his travels in the hills just east of Fort Duchesne he noticed that the red ants that swarmed over the area were packing bits of glistening black rock. With his prospector's pick he unearthed a few lumps of the hard, brittle material.

The rock resembled the jet jewelry worn by the ladies of that day. Further explorations showed that nature apparently had tipped the underground layers on edge, the deposits running in long narrow streaks.

Gilson had an experimental streak and decided to find a use for the strange substance. When he tried burning it he found that it produced a flame hotter than coal.



Gilsonite is used in some phonograph records. Right, miner takes big chunk of "black gold" from a surface vein

Another experiment showed that it blended easily with clay or fiber and could be hot-molded. His tests proved that the ore was a solid bitumen, easily crumbled or reduced to powder. It had an extremely high melting point.

When the news of the discovery appeared in St. Louis papers an organization that had been importing rock asphalt from Sicily asked Gilson to come east. A conference resulted in the purchase of his rights and the founding of the Gilson Asphaltum Company. Because of Gilson's intense interest in the ore, settlers jokingly referred to it as "gilsonite" and it's been called that ever since.

When the area was first mined, gilsonite was loaded into ox-carts and hauled over

Processed ore is used in varnishes and some paints. Below, processing plant removes impurities, pulverizes the ore



125 miles of barely passable road to Rifle, Colorado, where it was shipped by rail to the East. In those days it sold for \$125 a ton.

Today, after 40 years of mining, the area has an annual output of 60,000 tons. The Barber Asphalt Company of New Jersey, which bought out the original company, sold half its interest to the Standard Oil Company of California last January. Standard Oil agreed to furnish research laboratory facilities to develop new uses for gilsonite and to use its sales department to sell the novel



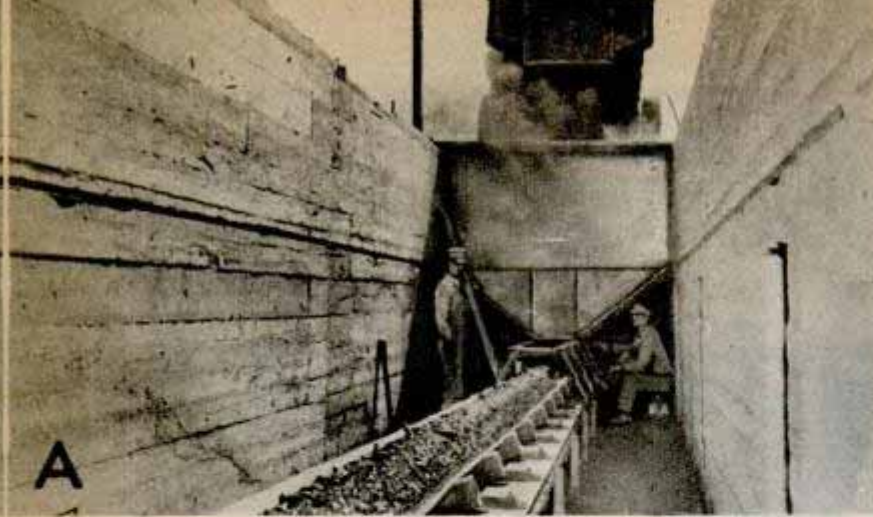

A

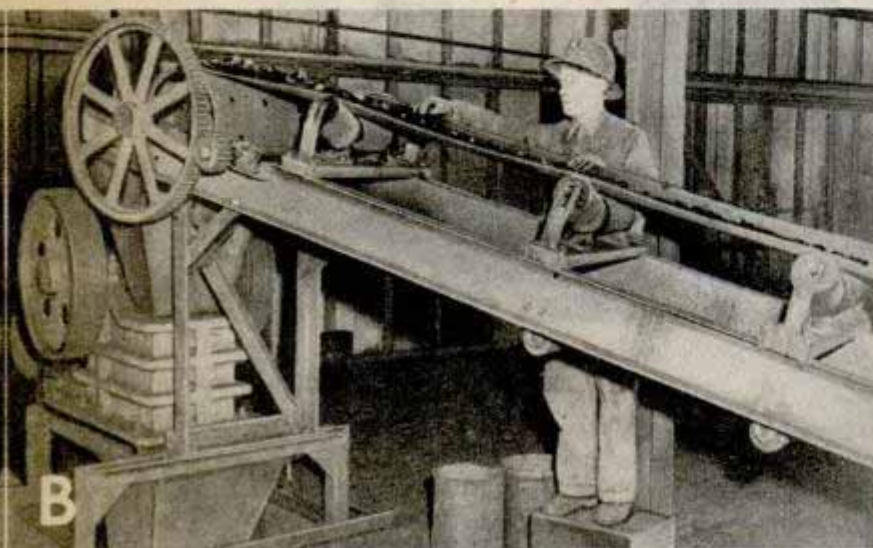

B



C



D



Gilsonite is used in mouth and ear pieces of switchboards and in many telephone receivers

stuff to new manufacturers. The new organization hopes to increase production to 200,000 tons a year and if possible to locate new veins in the area. Before the war the output averaged 20,000 tons yearly. The increased demand during the war doubled production, and widespread use since the war has further boosted it to today's 60,000 tons.

The nearly vertical fissures vary from a few inches to over 18 feet in width and from a few hundred feet to more than nine miles in length. Many are more than 1700 feet deep. Because of the nature of the fissures gilsonite is mined in deep trenches.

Until about four years ago gilsonite was mined and processed by old-fashioned methods. Then Sewell Thomas, a prominent engineer, was called in to modernize the mines. Thomas designed a mechanical plant that removes all rock and other foreign substances from the ore. He introduced the "shrinkage stope" type of mining now in use. The ore travels progressively from the vein through a chute to the tram cars. Thomas recently designed a ripping machine to break up the gilsonite and thereby save many man-hours. Tests of the new machine have proved satisfactory and soon it may be used throughout the mines. Another of his innovations is a boiler that burns gilsonite to provide power for the plant, saving the time and expense required to bring in coal.

After it's mined gilsonite is freed of rocks and other foreign material, graded and sacked. Most of it is trucked to Craig, Colorado, and shipped by rail to the East. The remainder is trucked to Salt Lake City.

Research has found widespread use

A—Conveyor belt takes ore from truck to plant
B—Crusher pulverizes biggest chunks of ore
C—Ore is separated from rock by air pressure
D—Processed gilsonite is sacked for market



Floor coverings and asphalt cement are among the many uses found for the jet black substance

for the ore. It's now being used in high-grade paints and varnishes, lustrous ink for rotogravure printing, rubber substitutes, storage battery cases, waterproof packaging, felts, roofing papers, floor coverings, japanning material, electric insulation, phonograph records and telephone receivers. A big chunk of the production still goes into asphalt. During the war 1500 tons were shipped to India for the Navy, presumably for aircraft runways.

As a result of the hot flame produced when gilsonite is burned, the ore is being used to make crude oil by high temperature distillation. A ton produces three or four barrels, which is refined in the usual way. Gilsonite also makes a top-notch coke which burns with practically no ash.

Principal town of the mine area is Bonanza, a sprawling village of 300 people, 90 of whom are employed in the mines. They work eight hours a day six days a week, starting before dawn during the cold winter months.

It's an eerie sight when the miners report for work in the morning. They look like ghosts, their faces, hands and necks coated with a white protective ointment. When they return from the mines they're as black as the ore. Gilsonite dust can't be washed off like coal dust. It's removed when the protective ointment is wiped off. Shirt collars are grimy for weeks if the ointment isn't used.

Right, asphalt made of gilsonite is poured into storage battery cases. Below, gilsonite is one of the ingredients used in lustrous printing inks

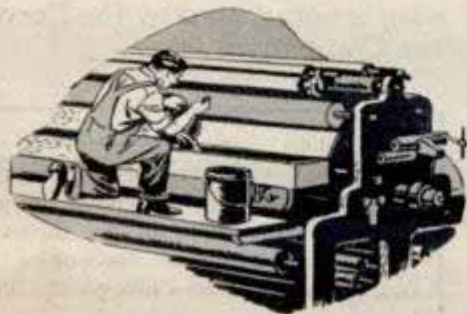

After applying protective ointment miners look like ghosts. Gilsonite dust won't wash off but wipes off with ointment

There's not much chance that the ore will be depleted for a long time yet. There are at least 30 million tons in known deposits and probably a lot more in the surrounding area that hasn't been discovered yet. Multiply the known reserves by \$25 a ton which the jet black wealth brings on a ready market. Subtract a depletion figure of 50 cents a ton in evaluating the reserve supply. The result is an industry with almost a billion-dollar stake.

With the research program intensified there'll be a lot more uses found for the strange stuff. All because a curious prospector wondered what the red ants were packing across the hills of Utah.





"Child's Paradise" in Dallas Built as Engineer's Hobby

Thanks to the ingenuity and generosity of a civil engineer in Dallas, Texas, children from all over the city have a gay time riding a miniature train and roller coaster built from junk-yard material. Both were erected on what was once a hilly and weed-grown lot divided by a creek which presented some interesting engineering problems. Everett T. Jones, the engineer, built his not-for-profit Child's Paradise as a hobby. He transformed old motors, discarded rails and other odds and ends into some thrill-dispensing equipment. The train is operated by an electric motor which pulls six small coaches as it winds through the one-acre tract on 600 feet of narrow-gauge rail. The roller coaster scoots through tunnels

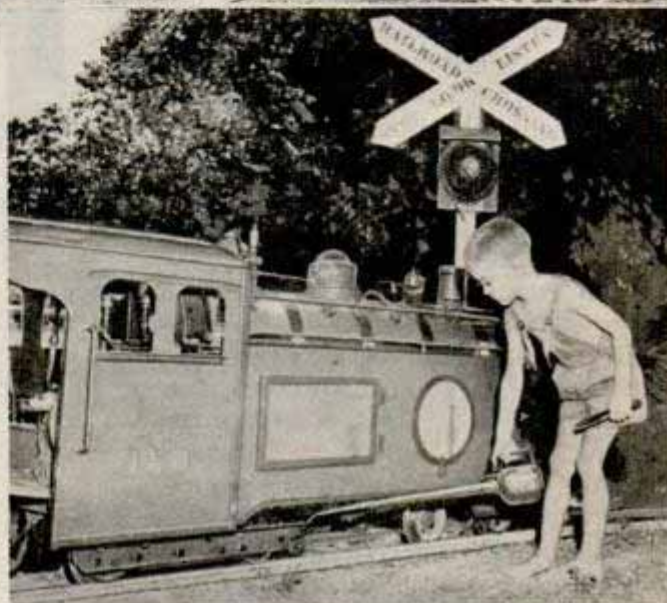

and up and down hills. Several hundred weekly visitors to "paradise" also enjoy its picnic grounds, for which Jones has built rustic seats and a barbecue pit.

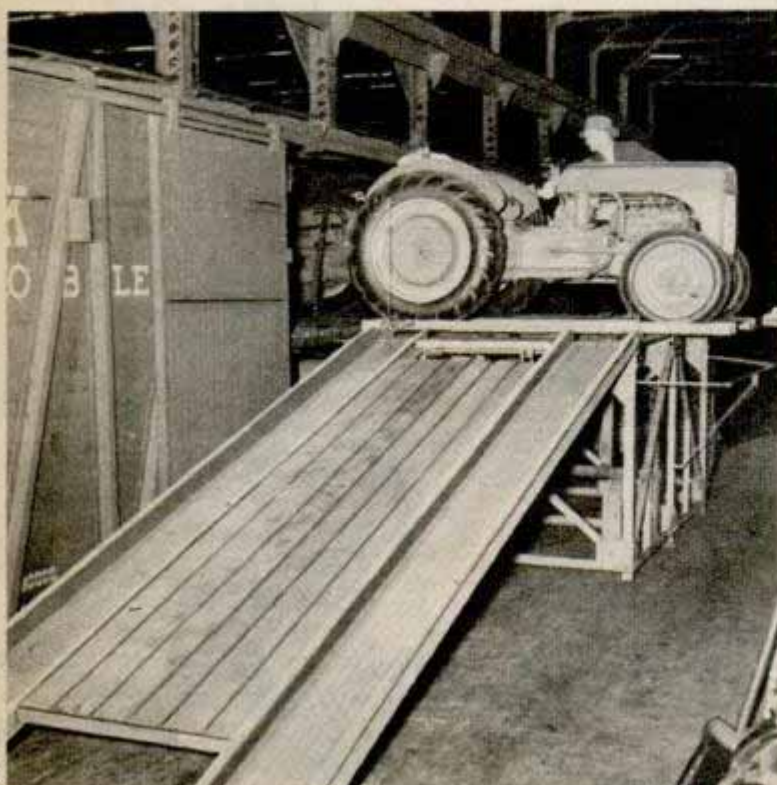

Boxcar Ramp and Turntable Ease Tractors to Top Deck

Time required to load tractors into a boxcar is reduced with a loading ramp and turntable. The tractors are run under their own power up a steel ramp to the turntable which swings them into position to be moved into the upper deck of the cars. Fourteen tractors are loaded in each car, seven up and seven down. The loading device is being used by the Ford Motor Company.

Information, including manufacturers' names and addresses, concerning products described in this issue may be obtained by writing to the Bureau of Information, Popular Mechanics, 200 East Ontario Street, Chicago 11, Illinois

Aluminum Houses—By the Truckload

Just three weeks are required to erect an aluminum two-bedroom house which sells for approximately \$7000, not including lot, garage or breezeway. Measuring 24 by 33 feet, the home is assembled from die-formed aluminum panels which can be painted any color the owner desires. Window space takes up 25 percent of the exterior wall area, with both bedrooms and the dining area having corner windows. The Butler Manufacturing Company, Kansas City, Mo., producer of the home, reports it is cool in summer and requires little fuel in winter, partly because of the reflective insulation provided by the outside walls.



Aluminum panels for the house walls and roof arrive at the building site in shipping crates. Below, in two days three fourths of the house walls are up as are the walls and girders for garage

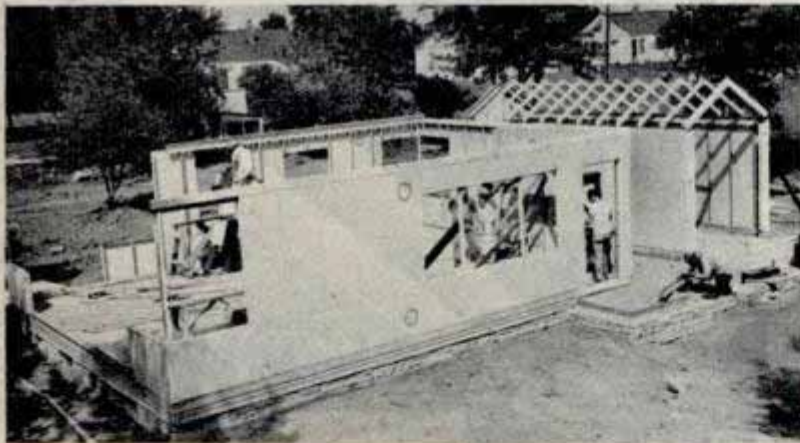

↓ Although this is the standard size for the Butler aluminum house, a complete wall panel can be removed in a few hours and extra panels added to both walls and ceiling to increase the size of a room or the entire home

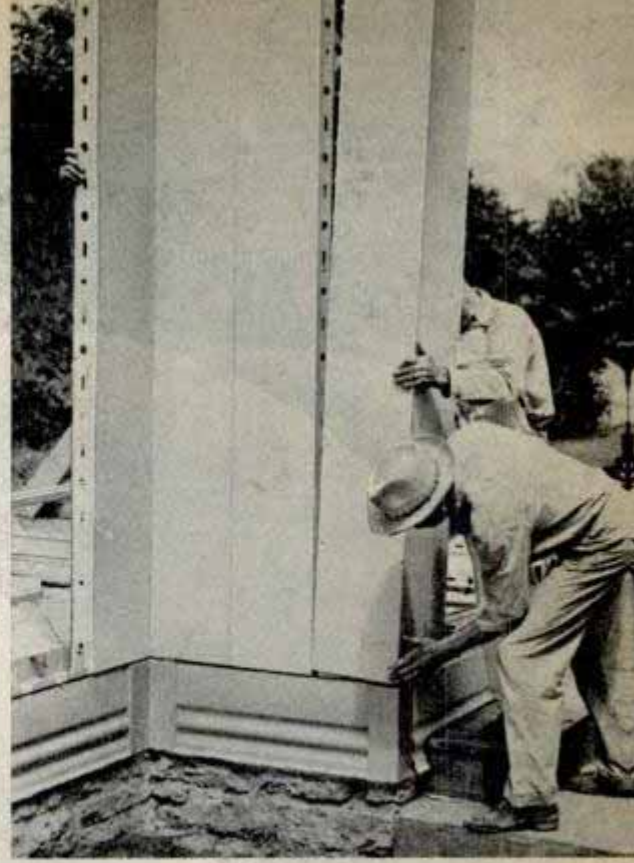

Fast-erected walls and roof are aluminum panels which are easily fitted into place. The panels will not shrink, burn, warp, rot or rust. Below, key-lock panel assures sturdiness of construction. The H-shaped key is fitted into a slot and turned with a hammer to lock the panels



NAVIGATING

CELESTIAL SPHERE

PREDETERMINED FIXED CIRCLE

OVERHEAD FIX

FIX

HERE is how the Collins system works: An airplane navigator moving through the night skies of the Atlantic determines his location, or fix, by shooting in rapid succession two pairs of stars at the same horizontal altitude, or two pairs of stars directly above each other. Then, by noting the time of observation with an ordinary watch, he determines latitude by referring to Collins' table, which shows where the fixed great circles cross latitude lines everywhere on the globe at every instant of time. Longitude is determined in terms of times at which specific stars are in alignment at moment of observation

BY STAR TEAMS

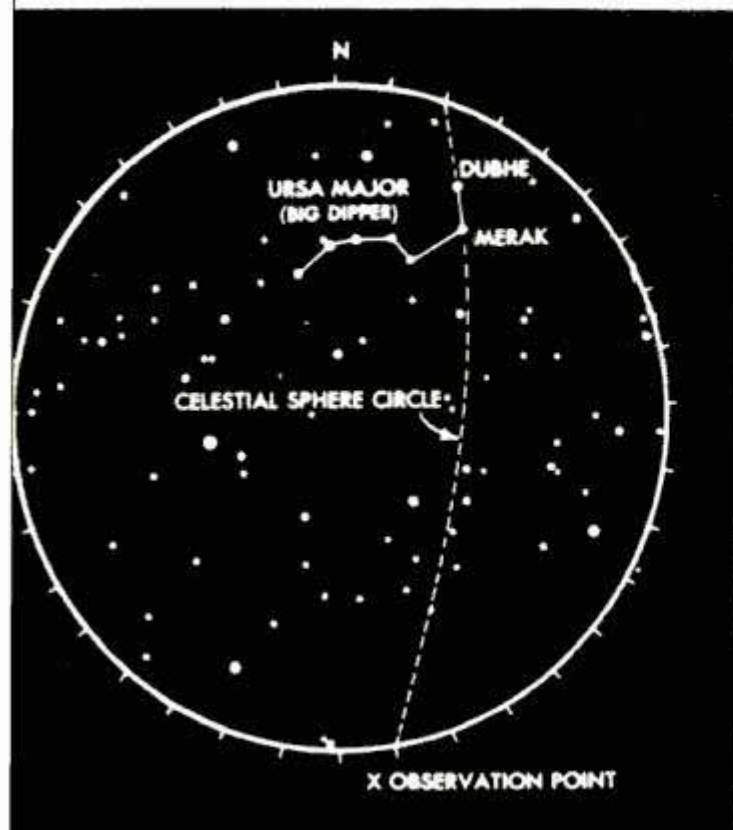

Observer at X (left) sees the stars, Dubhe and Merak, apparently one above the other. Several hours later, from the same observer's post (right), the two stars appear to be at the same altitude. These alignments describe permanently fixed celestial circles which are the basis of Professor Collins' system of navigation

A new system of celestial navigation has been devised by Professor O. C. Collins, University of Nebraska astronomer, which represents the first major change in "steering by the stars" in over a century.

The system, currently being tested by both the Army and the Navy, reduces computation time 60 percent and offers the navigator an effective way of solving navigational instrument problems encountered while crossing the polar regions.

Knowing that the "fixed" stars and constellations remain in the same relative position in the heavens, and that they appear to move from east to west, Professor Collins took note that the stars also appeared to change the angle of position to one another; that is, sometimes they appeared to be directly above one another, at other times exactly at the same altitude. The 55 brightest or navigational stars, he calculated, combine into 1485 such pairs.

The pairs determine two lines: one runs through the two-star position; the other forms a perpendicular to this line and equidistant between them. These imaginary lines, when projected, are great circles which do not change their positions relative to the stars.

By Bruce H. Nicoll

As the navigator of an airplane moves through the night skies, his zenith (directly overhead) crosses these great circles and it is at that moment he is able to observe two bright stars either at the same apparent altitude or vertical to each other. An airplane at the equator crosses one of these circles every 60 seconds, an interval that grows progressively longer as he moves north or south. At the Arctic Circle the interval is 2½ minutes.

By checking two such pairs of stars in rapid succession, noting the time of observation with an ordinary watch, latitude is determined by reference to a table prepared by Professor Collins which shows (a) where the great circles cross latitude lines everywhere on the globe at every instant of time, and (b) the longitude in terms of times at which specific stars are in alignment at that particular instant.

Professor Collins says his system (1) is accurate; (2) reduces calculation time to less than two minutes; (3) eliminates mathematical computations now necessary; (4) enables a navigator to determine his position within a circle of two-mile radius and before he leaves it; (5) can be operated with the bubble sextant, obviating need for new equipment.

Two Wide Nose Doors Facilitate Loading in Bristol Air Freighter

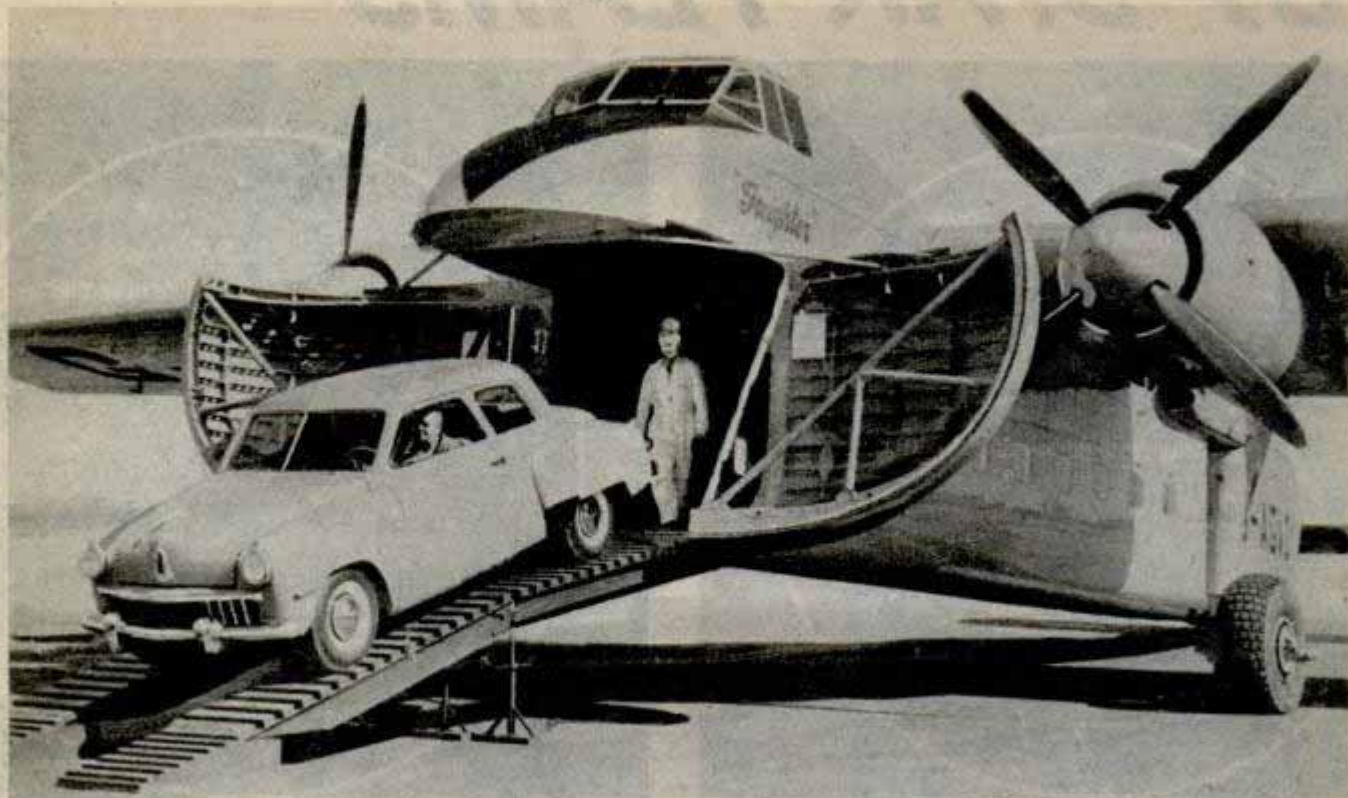

Two extra-wide nose doors speed cargo handling in one version of the Bristol Freighter, a twin-engine British transport with a capacity of six tons. The floor, which

has built-in rollers, supports 200 pounds per square foot. The plane has a maximum range of just over 1000 miles and cruises around 150 miles an hour.

Automatic Coil and Loop Winder Records Number of Turns on Counter

Field and armature coils can be wound on an automatic winder that records the number of revolutions on an odometer-type counter. The unit also winds loops with diamond, round, square and rectangu-

lar cores. A dial on the front of the machine permits regulation of speeds from 41 to 410 r.p.m. and a convenient clutch pedal is used to start and stop the winder. A $\frac{1}{2}$ -horsepower motor furnishes the power. Backlash is eliminated and the unit winds all types of coils evenly and accurately, according to the manufacturer.

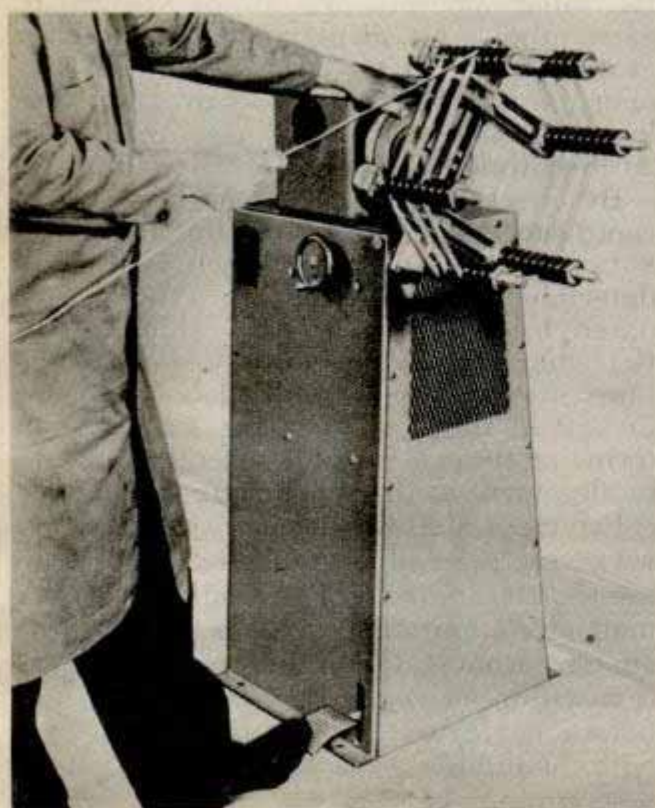

Scientists Find Rare Anesthetic In Search for Airsickness Cure

Xenon, one of the rarest of gases, may be used as a nonexplosive anesthetic as a result of wartime research at the University of California. Scientists studying high-altitude sickness discovered that a mixture of oxygen and krypton, an inert gas related to xenon, produced dizziness and numbness at high altitudes. Because xenon is even more soluble in the human body than krypton, research pointed to it as a possible anesthetic at sea level. Experiments on mice showed that a mixture of 70 percent xenon and 30 percent oxygen produced temporary staggering, stupor and paralysis.

☞ Low-grade potatoes are dehydrated and used by North Dakota farmers as a substitute for corn in feeding sheep.

TASK FORCES AGAINST THE POLES

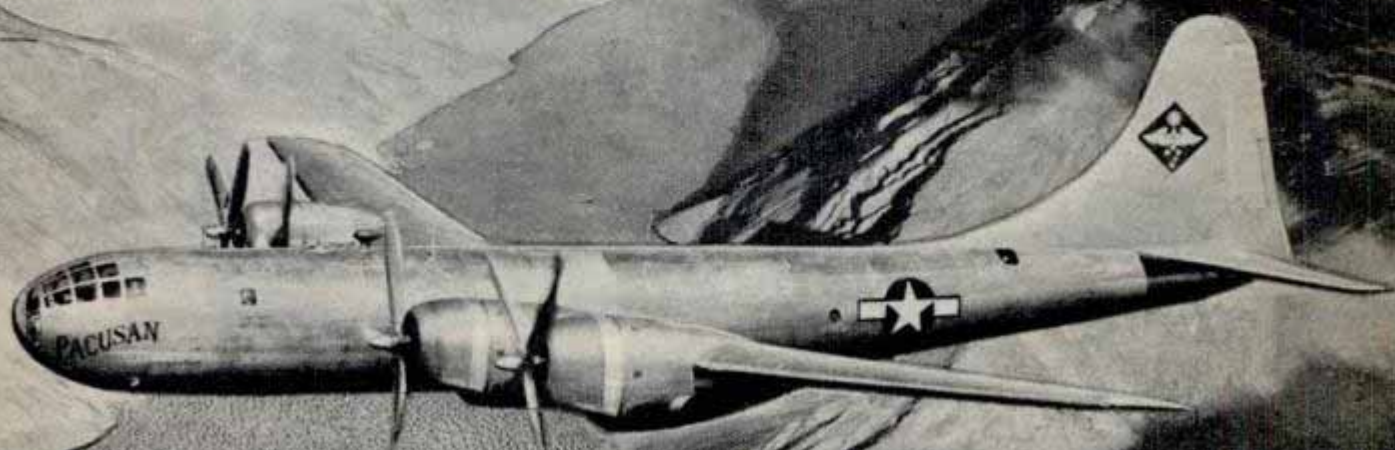

THE DREAMBOAT blazed a 10,000-mile sky path over the "top of the world." Three U. S. Army task forces, numbering 4500 men, are pushing through ice-crusts Alaska, the Aleutians and northern United States right now to learn more about extremely cold weather. Rear Admiral Richard E. Byrd, famed antarctic explorer, is heading a U. S. Navy expedition of 12 ships, 20 planes and 4000 men to the South Pole. He hopes to chart at least half of the antarctic's unexplored 4,000,000 square miles.

The polar regions, shut off from the world for centuries by a forbidding curtain of subzero weather and great distances, now promise to become our "back yard" and yield long-sought information of commercial and strategic importance.

Our armed forces are determined to find out the best methods for protecting them-

Arctic storms and icing conditions were no barrier to AAF's B-29 Pacusan Dreamboat, above, on its nearly 10,000-mile flight. Below, snowmobile pulling experimental radio shed over Army testing ground in Maine

AAF photos





AAF photo

Crew of the Pacusan Dreamboat examining arctic gear prior to the takeoff on their Honolulu-to-Cairo flight

selves in below-zero temperature, how best to safeguard mechanical and electrical equipment against breakdowns, and how to design new equipment that will work better in cold weather.

Important data came out of the Army Air Forces' 39½-hour flight of the B-29 Pacusan Dreamboat from Honolulu to Egypt. For one thing, Colonel C. S. Irvine, the pilot, reported that the North Magnetic Pole

apparently is 200 miles closer to the North Pole than previously was believed.

"We deliberately passed north of the point believed to be the North Magnetic Pole to check its apparent location and its effects on magnetic compasses," he explained. "In the position we crossed, our magnetic compasses pointed left toward the pole."

The flight proved that communications can be carried on from plane to plane and from plane to ground in the arctic regions, and that aircraft manned by experts can navigate in the arctic.

Colonel Irvine also said that the Dream-

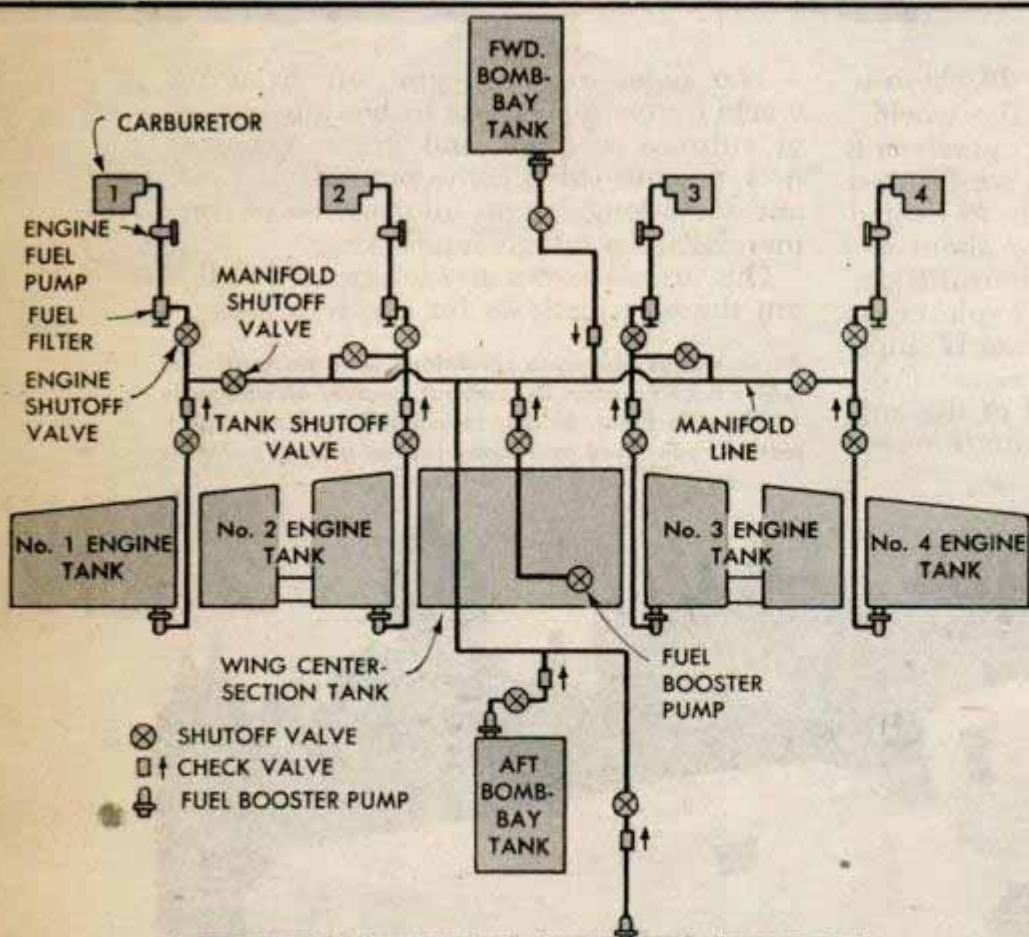
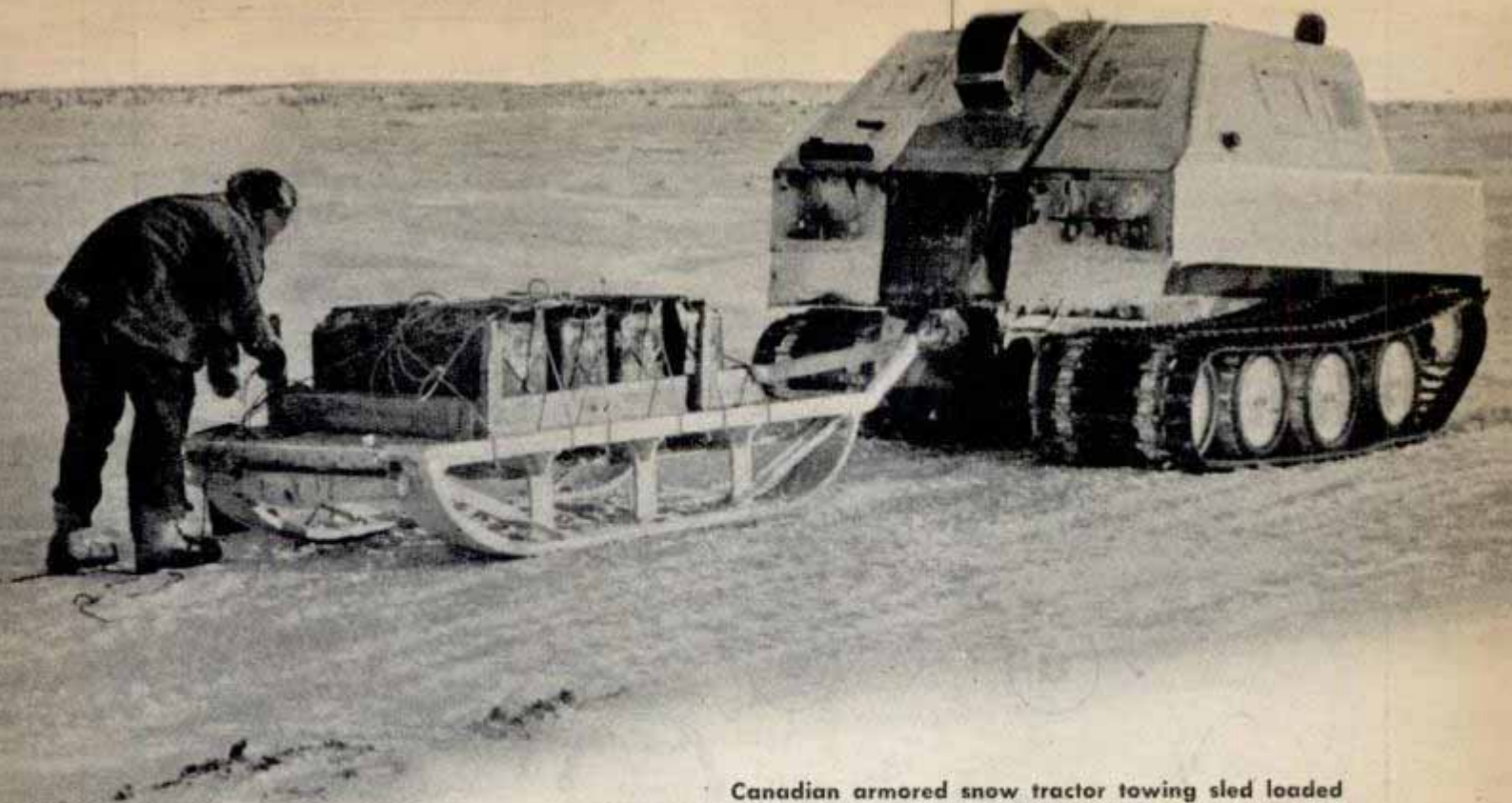

Diagram of the Dreamboat's fuel system. It held 13,000 gallons of gas at the takeoff

Boeing photo



Canadian armored snow tractor towing sled loaded with gasoline drums. Navy patrol planes, like PBM below, flew near pole for photos and weather data

boat's flight convinced him that the Army's new bomber, the B-36, could make an 11,000-mile trip over the top of the world with a bomb load—just as his B-29 accomplished the jaunt with only the necessary gasoline as cargo.

"The difference is," Irvine pointed out, "that the B-36 was designed for a range of 10,000 miles with a load, while the B-29 has a range, with load, of 7000 miles."

The men who today are continuing the search for cold weather data include scientists and experts in dietetics, transportation and arctic clothing. From now until April or May they will assemble facts that would help Uncle Sam protect our northern approaches against any enemy.

Task Force Frigid, which is stationed at Ladd Field, an Army air base near Fairbanks, Alaska, left San Francisco early last September. Task Force Frost remained in the United States and is operating at Camp McCoy, Wisconsin. Task Force Williwaw is on Adak Island in the Aleutians. Each of the three locations presents a different type of cold. Fairbanks was chosen because of extremes of prolonged arctic cold. Temperatures have reached 66 degrees below zero and blizzards occur all winter.

While not anticipating the extremes of subzero temperature found at Fairbanks, Task Force Williwaw on Adak is functioning under almost constant rain, fog and daily freezing and thawing. It is subject to the sudden freakish storms occurring in the Aleutians, known as williwaws, for which the task force is named. These storms generate with great suddenness. They have ter-

rific winds carrying snow, sleet and rain, and are described as blowing in all directions at once. Wind velocities of 110 miles an hour have been recorded.

Camp McCoy, 95 miles northwest of Madison, Wisconsin, is the scene of tests for equipment under heavy temperate climate winter conditions. Weather there is that which can be anticipated in the north-



U. S. Navy photo

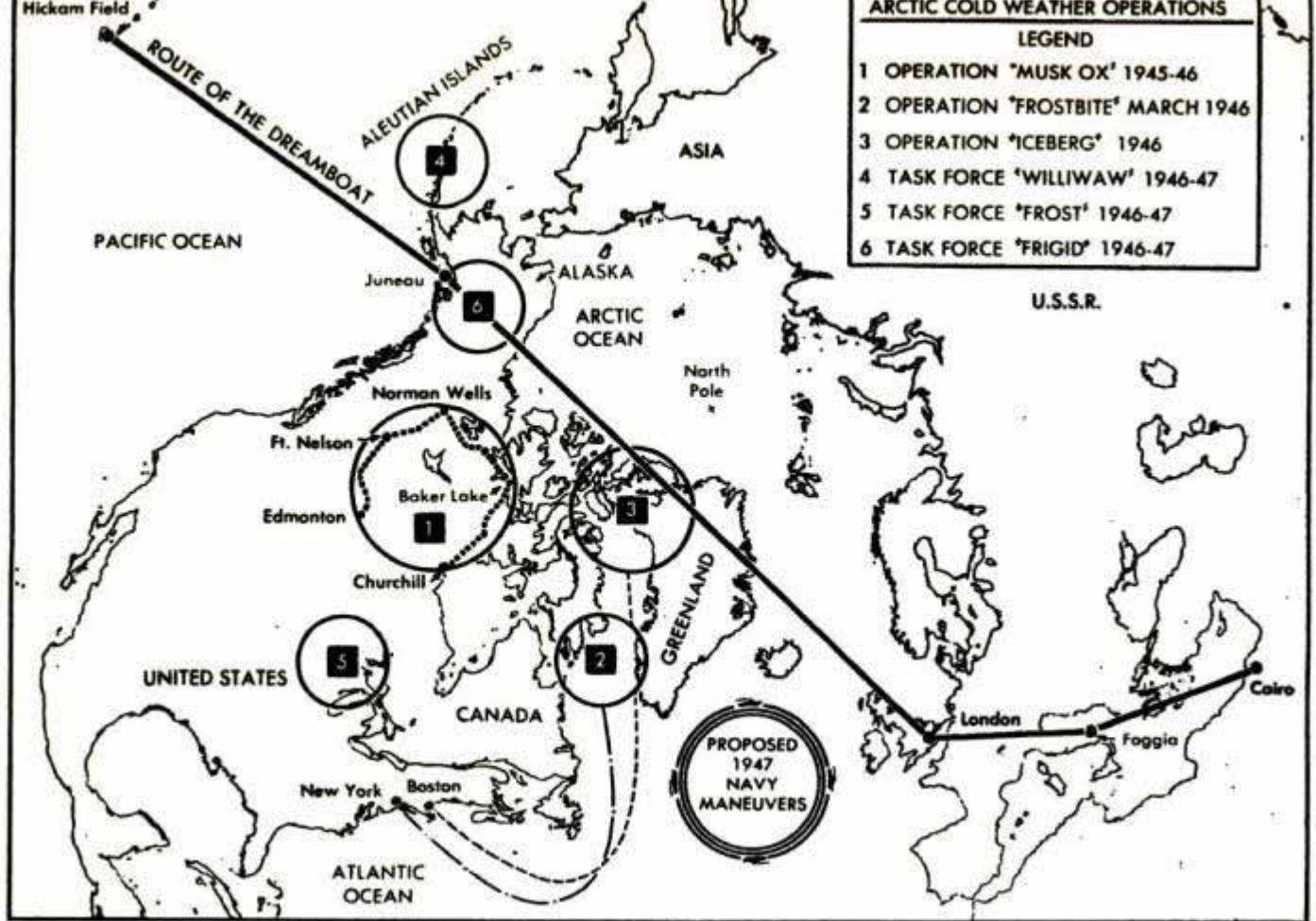

Bases for principal 1945-47 arctic weather operations

ern zones during the winter and similar to that experienced in the Ardennes offensive.

The three task forces will test all types of Army Ground Forces equipment, including tanks, self-propelled guns, radar, special snow vehicles, new rations, kitchens and clothing. The clothing will include new types of jackets, parkas, boots and mittens lined with fiber glass. These experimental types of arctic apparel, designed by the Army's Quartermaster Corps, employ a one-inch layer of fiber glass batting in place of the wool and pile linings used in standard cold weather clothing. The fiber glass batting is quilted in small squares on Nylon mesh and inserted between the outer shell and inner lining of the garment.

Medical personnel will play an important part. In addition to gaining firsthand knowledge of first-aid and evacuation problems in frozen countries, medical teams plan to study the effects of temperature variations on ground troops.

Army Air Forces equipment will also be tested in an attempt to determine the limit of human and equipment endurance in cold weather. From these experiments it is expected that weapons, aircraft and guided missiles will be perfected for arctic operations, as well as new types of clothing.

All of the resulting new information and knowledge will be added to that brought back by United States Army observers at the Canadian Army's Exercise Musk Ox, and two recent American expeditions, Op-

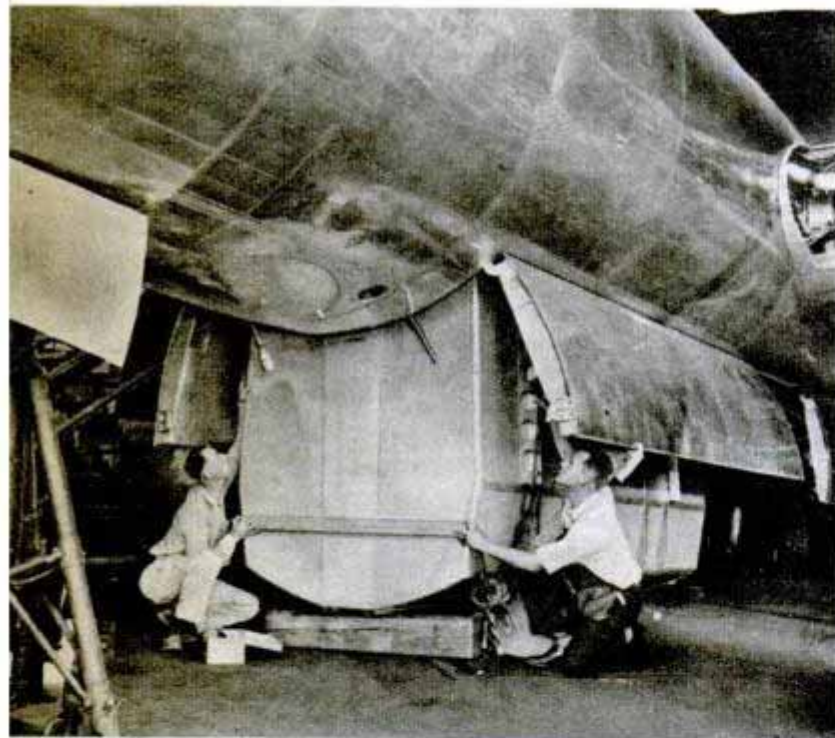

AAF photo

Installing 2500-gallon bomb-bay gasoline tank in the Dreamboat. Below, warming front axle of jeep with slave-kit heat, a frequent service in the bitter cold

Boeing photo

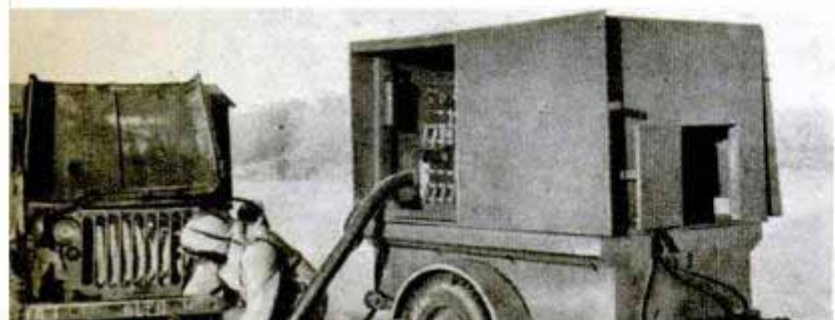

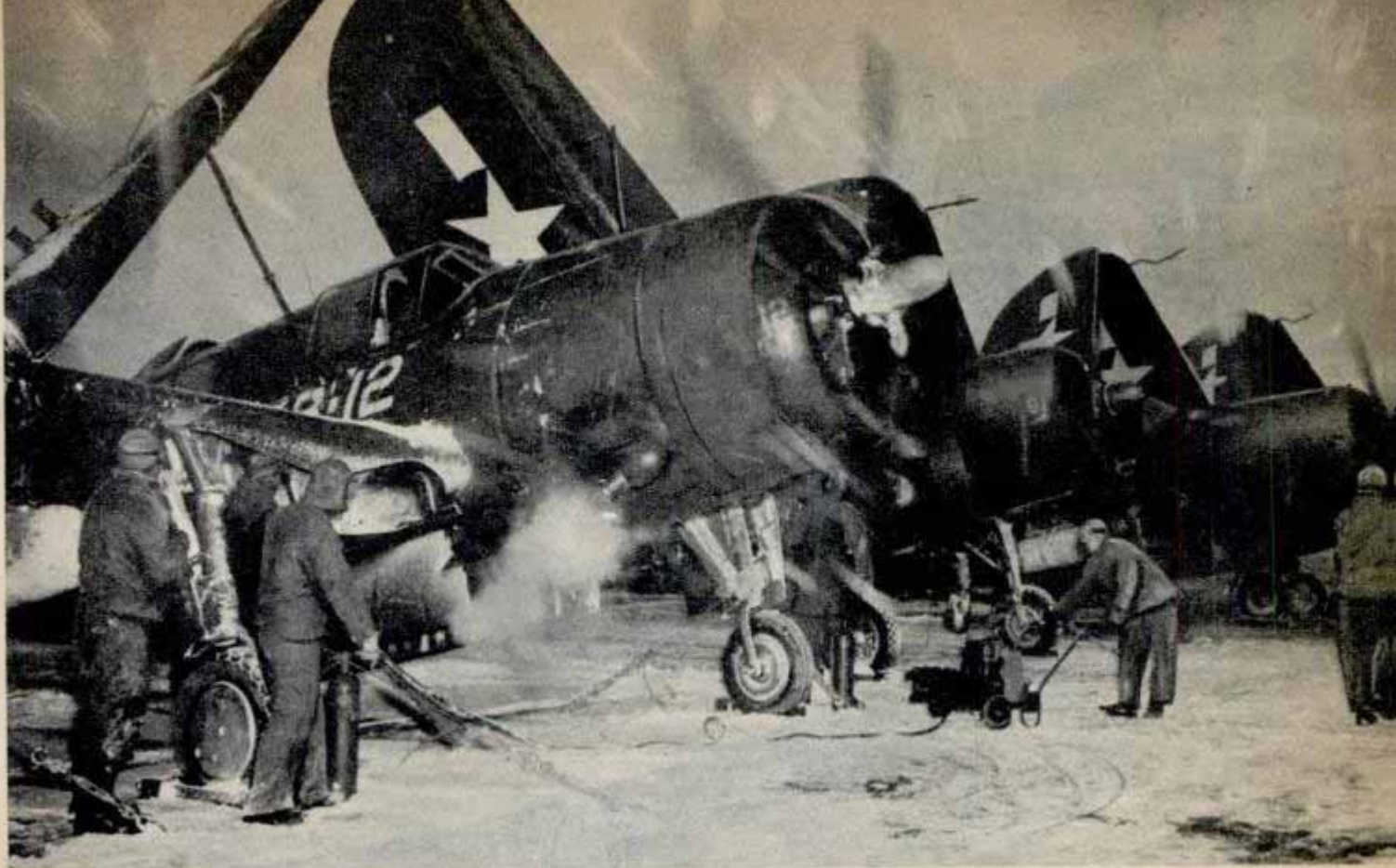

Operation Frostbite aircraft warming up on the deck of the Navy carrier Midway while a snowstorm blows. Air line type planes will make carrier takeoffs, aided by JATO bottles, during the Byrd Navy expedition

U. S. Navy photo

eration Frostbite and Operation Iceberg.

Exercise Musk-Ox, which included a 3000-mile trek through Canada's northern territory by a dozen armored snowmobiles, was strictly a fact-finding expedition. Its purpose was to test mechanized equipment under arctic conditions, to give radar navigators a test and to study clothing and food requirements. Because the exercise was directed toward a study of peacetime problems, only 50 men made the 3000-mile journey across the frozen wastes from Churchill, on Hudson Bay, to Edmonton.

During their 81 days out, the party was supplied by five C-47s of the Royal Canadian Air Force, specially equipped with Loran, which proved invaluable for navigation in the frozen country. In addition, the ground forces, too, used Loran to take directional readings, relaying this information to supply ships by radio.

Paradropping, a technique perfected by the Americans during the war, was used extensively to supply the land force. A variety of items were dropped by parachute. It is estimated that by the time the party reached its goal at Edmonton, some 345,000 pounds of air supply had been provided. Most of the fuel for the caches dotting the 3000-mile route was dropped in 40-gallon 400-pound drums, painted bright red for contrast against the snow. Two 28-foot parachutes were used for each drum.



Repairing the landing gear on a ski-equipped plane. Below, line maintenance men cover a transport's wings after landing as an extra cold weather precaution

AAF photos



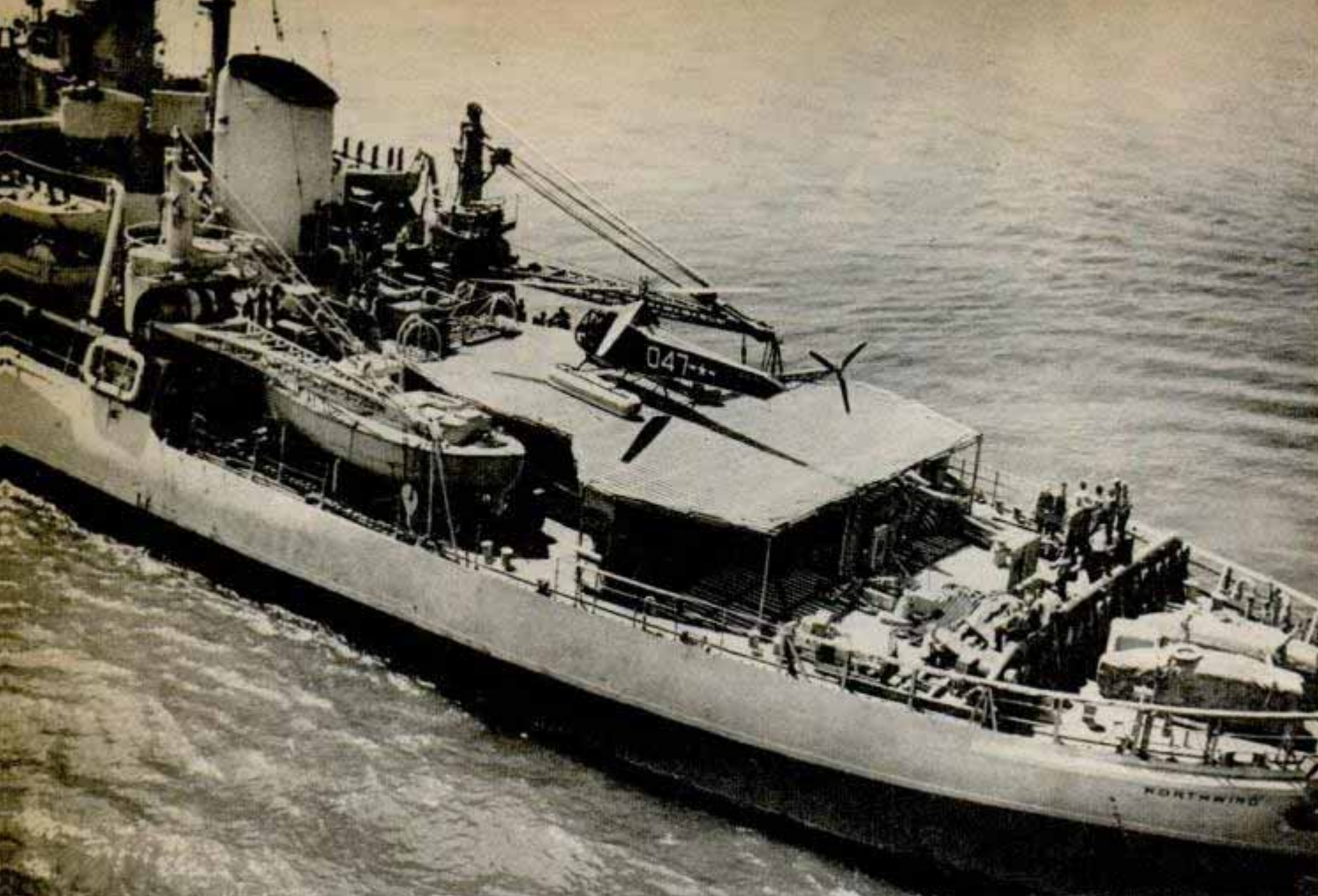

U. S. Coast Guard photo

Vital to polar work, helicopters take off from small flight decks like this one on the icebreaker Northwind

A 1300-pound snowmobile engine was also dropped with the help of four parachutes.

Discoveries by an Army Quartermaster Corps observer at the Musk Ox operation, William P. House, are expected to prove valuable to both the Army and to civilians living in the extreme climates of the northern United States. Mr. House made on-the-spot changes in types of American clothing, food and equipment. On the basis of his recommendations special equipment was developed in the United States and flown to the Canadian arctic to be tested under the same conditions as those which caused the recommendations to be made.

One of the early modifications was on 15 Yukon-type stoves. Designed to burn wood, the stoves were unsuitable after the expedition passed the timber line. Mr. House telegraphed Washington, requesting modification for oil consumption. Two weeks later, 15 modified stoves were parachuted to a campsite 550 miles north of Churchill and immediately put to use.

Several hundred miles northwest of the most northern camp of the Musk Ox expedition, at the Naval Petroleum Reserve No. 4, at Umiat, Alaska, the Navy's Sea Bees have been putting a great quantity of construction equipment through its paces since 1944. Today, tractor trains, bringing supplies from Point Barrow to Umiat, operate in temperatures as low as minus 40 degrees

Fahrenheit. All motorized equipment has heating coils to keep oil fluid, and metal ducts to circulate heated air around vital parts of engines.

Last March, the giant carrier USS Midway headed a five-ship task group into the icy north Atlantic between Greenland, Labrador and Hudson Strait. Known as Operation Frostbite, the cruise tested the Navy's carrier-borne air power in "ice-box" battle conditions.

Planes were catapulted aloft from the Midway two miles inside a Labrador ice field. Air-sea rescue experiments were made, with Commander Barry King of the Naval Medical Institute going into 38-degree water in a Navy Mark II immersion suit. He was "rescued" in four minutes with the use of a new basket and boom device which is now being installed on destroyers. During the frequent storms, the carrier's snow plows had to be used to clear the flight deck. Preheaters and motor covers were used to warm up engines before the takeoff from the icy deck.

Operation Iceberg was a three-month scientific study of weather and navigation hazards in the Far North. It was a joint Navy-Coast Guard effort in which officers of the Canadian Army, Navy and Air Force participated. Spearheaded by the Navy icebreaker USS Whitewood, the Coast Guard

(Continued to page 276)

Electric Beach-Car Is Toe-Controlled

With no noise, no fumes and no gas to buy, a touch of the toe on the controls of an electric beach-buggy sends it cruising over the hard-packed beach sands at Daytona, Florida. It is powered by two six-volt storage batteries. The wooden platform is mounted on bicycle wheels. An adjustable top helps users regulate their exposure to the sun.

"Lazy" Helium Gas Checks Oil Level

Because it is a poor mixer, helium is being used to chart underground movements of oil and gas. Injected through intake wells into oil sands, it travels in the underground pool with oil or other gases and returns to the surface through output wells. By noting the length of time required for the helium to reach the surface, engineers can determine underground reservoir conditions. Helium is used because it is an inert gas which does not combine with the

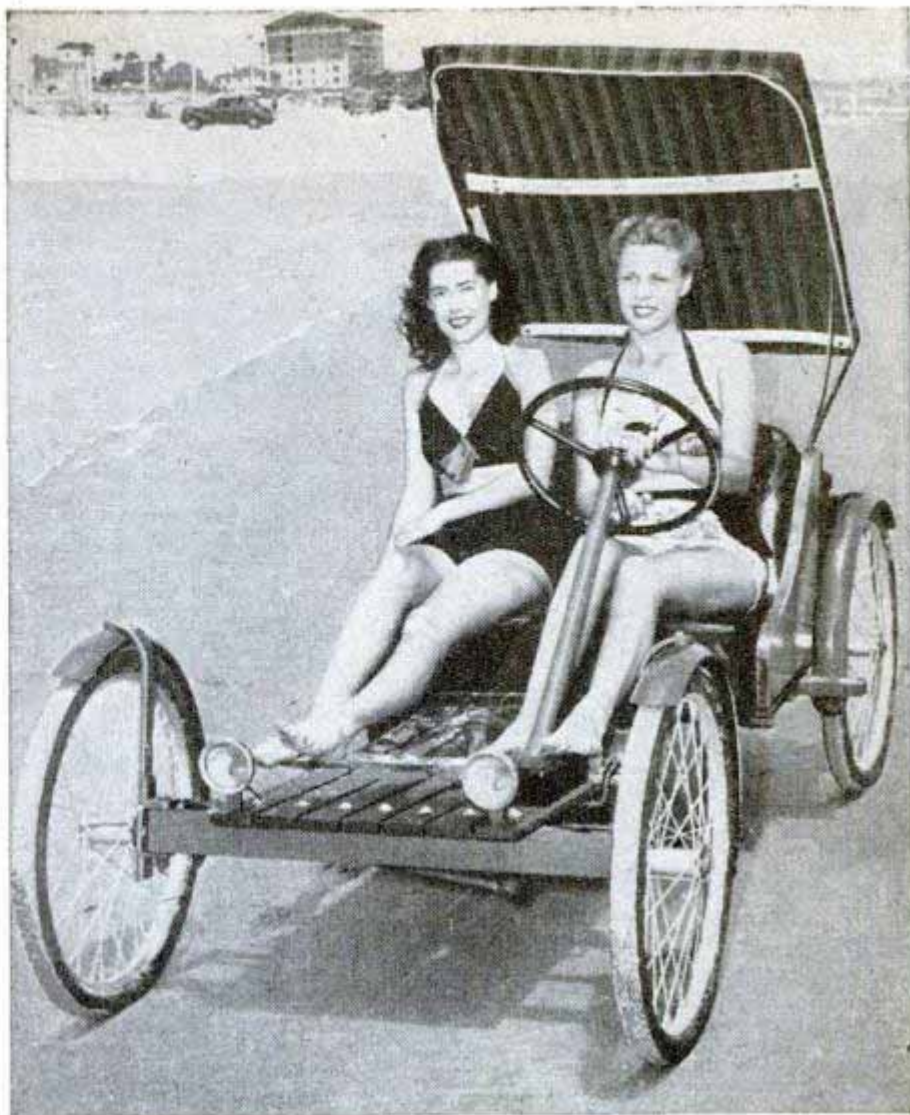

oil, but retains its identity. It can be separated from the oil well fluids and gas when it again reaches the surface.



Beach Digger for Youngsters Operates Like Steam Shovel

Children can excavate for their own construction jobs with a beach digger that operates just like a big steam shovel. The operator sits on a swivel seat and manipulates two control handles that push the scoop into the sand, raise the boom and dump the load. By rotating the seat the operator can dump the sand wherever he wishes. The steel toy can be used indoors to pick up marbles and building blocks.

Farm Horse Population Falling

Power-driven farm machinery continues to displace work animals on the farm. The total number of horses and mules on farms at the beginning of 1946 was 11,455,000, far less than the total of 14,481,000 on January 1, 1940. Farm animal population will continue declining, according to the Department of Agriculture, because farm wages and feed costs are high. Many horses have been shipped to Europe for farm work.

RECORD-HOLDING RACERS

ROADSTER

128.09 M.P.H.



Randy Shinn set present roadster record in a Model T Ford powered by a Mercury motor

MODIFIED

133.30 M.P.H.

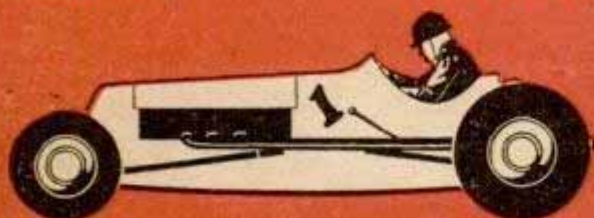

Best modified car is Karl Orr's Ford V-8
Brass plate awarded Orr for past record



STREAMLINER

140.00 M.P.H.



Teardrop design of his 1928 Chevrolet gave Bob Ruff top speed in the streamliner class

UNLIMITED

137.24 M.P.H.

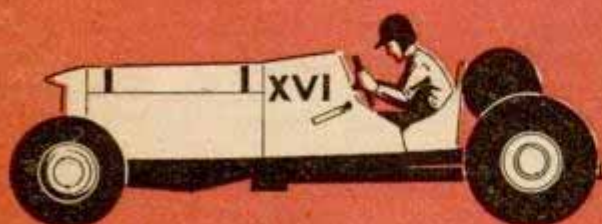

Tony Capanna set the record for the unlimited class in his 16-cylinder Marmon "rig"

By **ANDREW HAMILTON**

BUDDING Barney Oldfields are toiling over 20-year-old jalopies in southern California this month in preparation for another season of "hot-rod" racing. Come next April about 5000 drivers—"hop-ups"—from in and around Los Angeles will gather on dried-up lakes to zip across alkali bottoms smooth and hard as concrete.

They're working the kinks out of ancient cars to get a final burst of secondhand speed. When the season starts, drivers will "run the trap" at 140-mile-an-hour speeds while officials check timing devices and ambulances stand by to pick up accident victims. Hot-rod

RACING



This "rig's" starter has been removed to save weight so car must be pushed to turn over the motor



THE HOT RODS





Hot rod roars toward the finish line in the first of two record runs through the quarter-mile "trap"

racing, originally a popular southern California sport, is spreading to other parts of the United States. New drivers are stepping in every year to challenge "veterans" still in their teens. Clubs are flourishing in Denver, Indiana, Texas, Washington and small local areas throughout the country. Wherever high school and college kids gather to race stripped-down jalopies you've got the makings of a hot-rod club.

A hot rod in the jargon of speed demons is a standard make of automobile with enormously increased power and speed. It's also known as a "jalopy," "hot iron," "rig" or "outfit." There's a lot more double talk in the racing vocabulary, too. Exhaust pipes are called "stacks," the carburetor is a "jug" or a "pipe," the pistons are "slugs" and the tires are "boots" or "skins."

To soup up a car a speed demon usually starts with a cheap vintage model. Secondhand dealers call these old cars "junkers." About 90 percent of the hot rods are built from Ford V-8s and Mercurys, although a few Chevrolets, Cadillacs, Hudsons, Buicks, Marmons and foreign makes

have made good racers. The Ford V-8 with its individual fuel intake ports offers the greatest opportunity for increased speed. The r.p.m. are often increased from 3000 to 5600 or more.

The secondhand car is stripped of its fenders, headlights, top, running boards and all other "unnecessary" equipment. The chassis is strengthened and worn-out parts replaced. Then the car is rebuilt—engine, transmission and gears.

That's where the hop-up spends his money. A high-compression cylinder head to increase speed and power costs about \$50. A dual or triple manifold which feeds more gas to an already hopped-up engine sells for another \$45. Special camshafts range from \$30 to \$40. Custom-made parts run into a lot more money—\$45 for an aluminum flywheel, \$20 to \$50 for high-speed gears, \$45 for dual distributors, and cast aluminum pistons at \$45 a set.

Ready for its first race, a hot rod that originally cost a couple of hundred dollars may represent an investment of \$800 to \$1200. One or two run as high as \$5000.

Spectators huddle under blankets in the cold desert air as drivers line up cars for first morning race

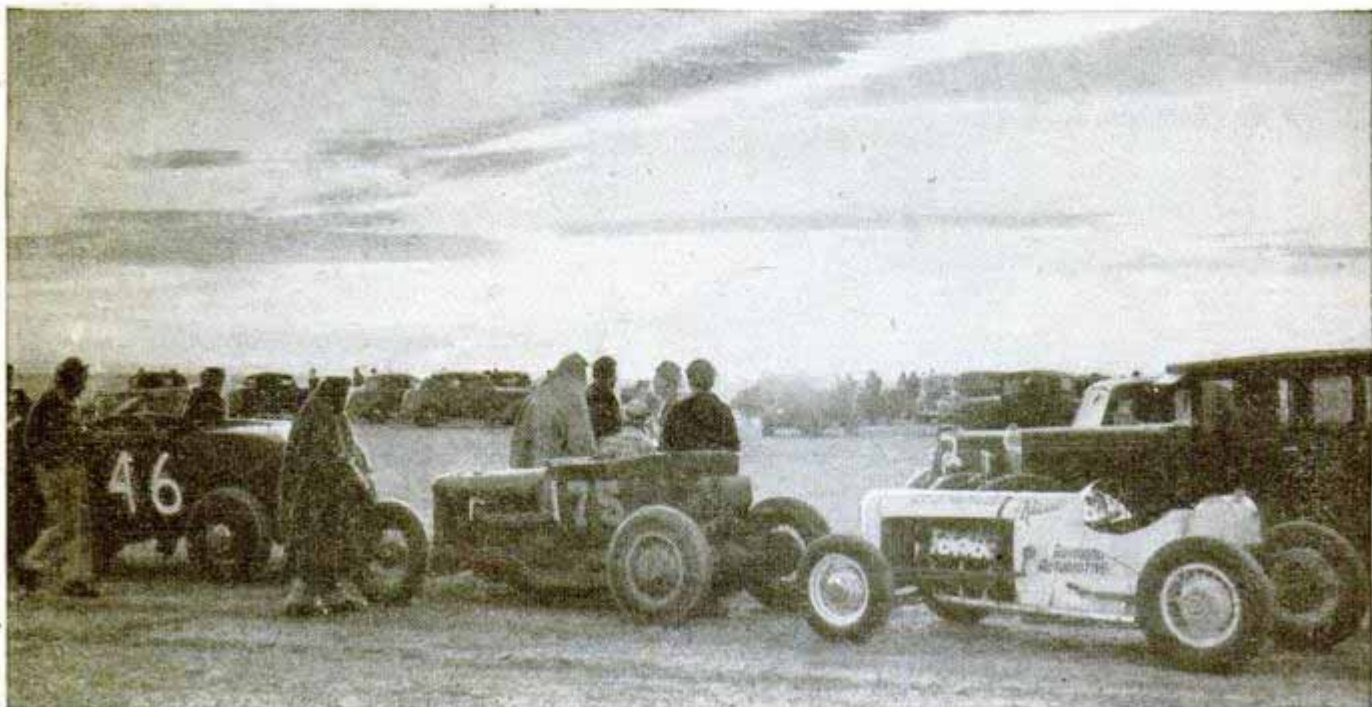

Hot-rod racing was born in southern California in the 1920s when youngsters in their teens were sure they could improve on Detroit's finest products. Soon they formed clubs and in 1938 they organized the Southern California Timing Association to supervise and regulate the fast-growing sport.

Today the SCTA includes about 30 clubs with such fancy names as Gophers, Road Runners, Lancers, Centuries, Albatas and Outriders. The association conducts time trials of important races (it's the only such association in the West recognized by the American Automobile Association), sets up rules for racing and administers the affairs of racing clubs.

Muroc Dry Lake, 125 miles north of Los Angeles, is the most popular track but some races are run on Harper Dry Lake, El Mirage Dry Lake and Rosamond Dry Lake. Time trials are held from dawn to 10 or 11 a.m. There's little wind during those hours and the heat is less intense than later in the day.

Cars are divided into four different classifications for the time trials. "Roadsters" are regular stock models with only the motors pepped up. "Modifieds" are cut-down stock models but with no streamlining of the rear end. "Streamliners" are models with teardrop or racing body designs. Cars in these three classifications must have less than 260-inch engine displacement. "Unlimiteds" include models of any design which have motors of more than 260-inch engine displacement or with supercharging devices.

Every trick in the book is used to increase speed. Ancient models are rebuilt to cut down resistance. Some drivers even fasten a tarpaulin to

(Continued to page 240)

Top, electric timer clocks racers within 1/100 second. Center, motors need constant tinkering to get extra speed. Bottom, driver waits turn at "trap." Note how car frame is stripped down

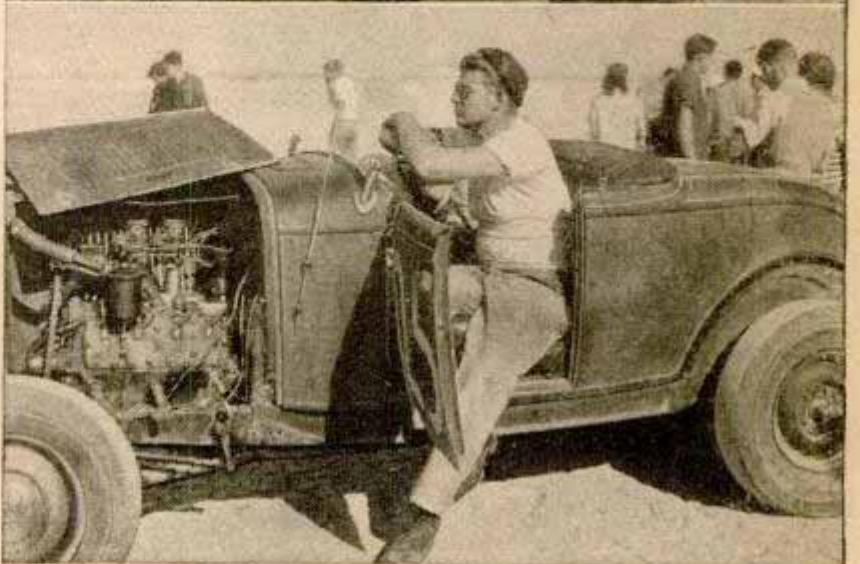
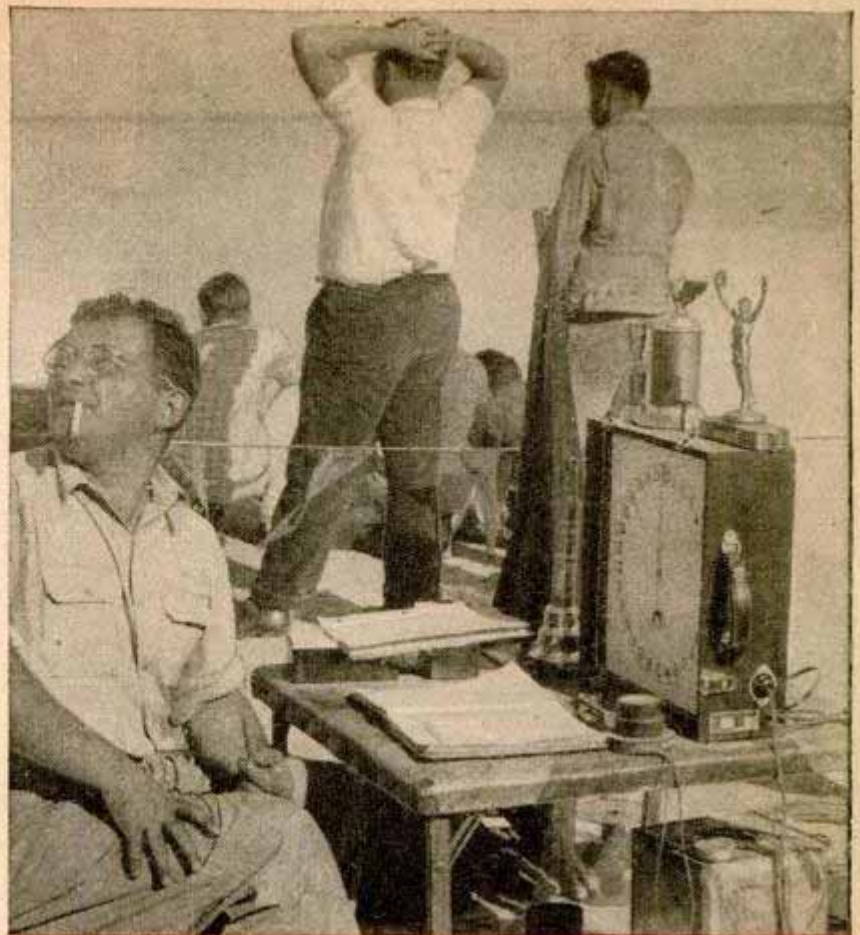

Odd-Shaped Enlarging Masks Help Prevent Fogged Edges

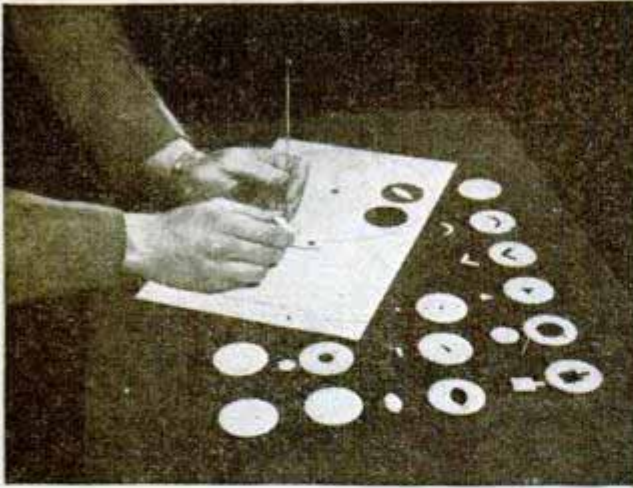

Portions of photographs needing more exposure in enlarging can be darkened without danger of fogging edges or corners of printing paper. Helpful devices contained in one kit are a spot printer with rotating disk, an aperture panel of 16 precision-cut disks and a wire holder with 12 different shapes for holding back exposure during printing. The upper side of the spot printer is white so that negative detail may be seen clearly and the underside is gray to prevent reflection. The disks of the aperture panel fit the rotating disk of the spot printer so that any

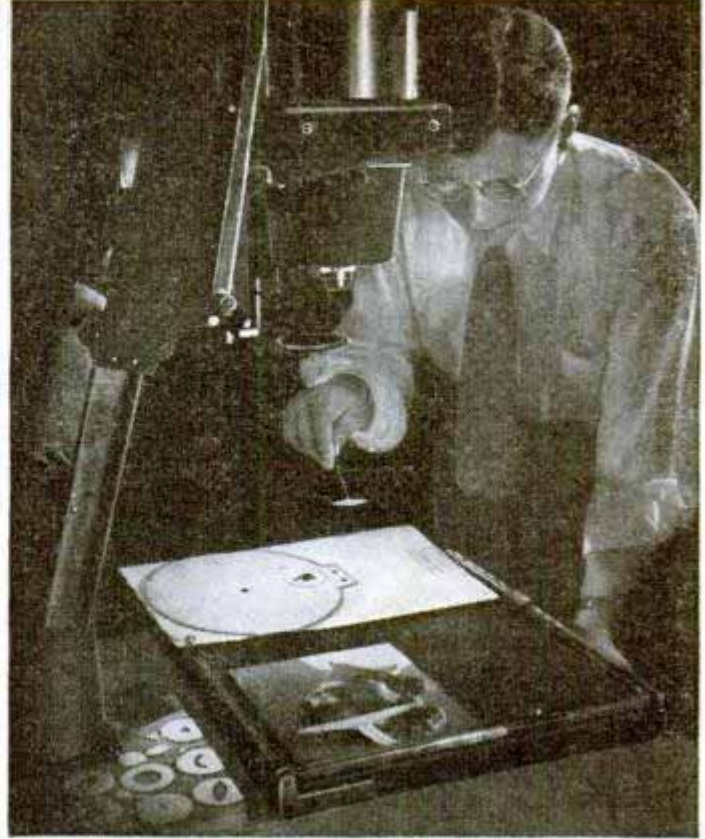

area in the print can be matched. Used in the holder, the aperture panel disks give a wide variety of shapes for matching areas.

Mobile Hoist for Shop Work Is Operated by a Handwheel

Mounted on steel casters so that it can be moved around the shop, a lifting hoist and handler can be operated by one man.

It can carry loads, such as automobile engines, weighing up to 2500 pounds. Its lifting beam lowers to within 16 inches of the floor or rises to a maximum height of eight feet. It is useful for removing motors, transmissions or other heavy units from trucks and tractors, as well as other hoisting jobs.

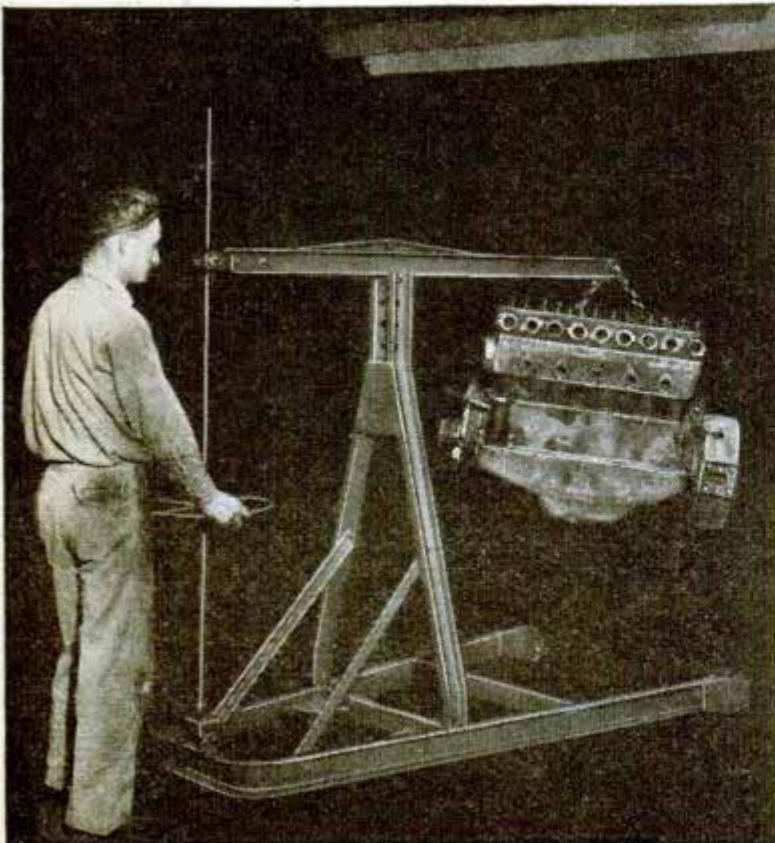

Chemical Put in Gasoline Mixes Water and Fuel

By adding a special chemical to the gasoline in tanks containing a small amount of water caused by moisture condensation, the water is absorbed by the chemical and dispersed throughout the gas to prevent carburetors from freezing. The chemical—similar to those in jellied gasoline for flamethrowers—may be used to absorb water in underground gasoline tanks.

□ A patent has been issued on a magnesium alloy containing .001 percent of lithium to reduce the fire risk in working with the highly inflammable magnesium.



INTEROFFICE communications system blocks out interruptions and prevents conversations from being overheard. Automatic testing device determines which lines are busy and refuses circuit until line is free

HOSPITAL "CAR" for handicapped men travels at walking speed. Built of surplus airplane parts, the vehicle has a camera, radio, horn and light. It runs on electric current and is operated by push buttons

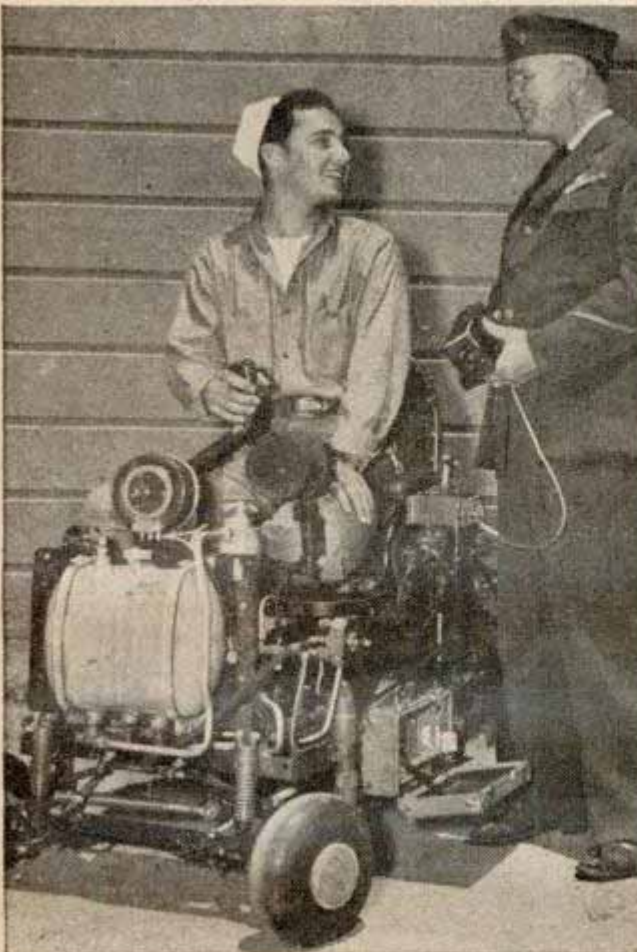

MIDGET PIANO with three octaves has special alloy rods instead of strings. Plastic case acts as a sounding board. The instrument, invented by Harold Rhodes of Los Angeles, has tones similar to harpsichord

ROTARY OPENER for letters clips the envelope without damaging the contents. To open an envelope the operator inserts it in a slot beneath a roller and pulls a convenient lever to shear off the edge



On Trial—

By
John C. Ross

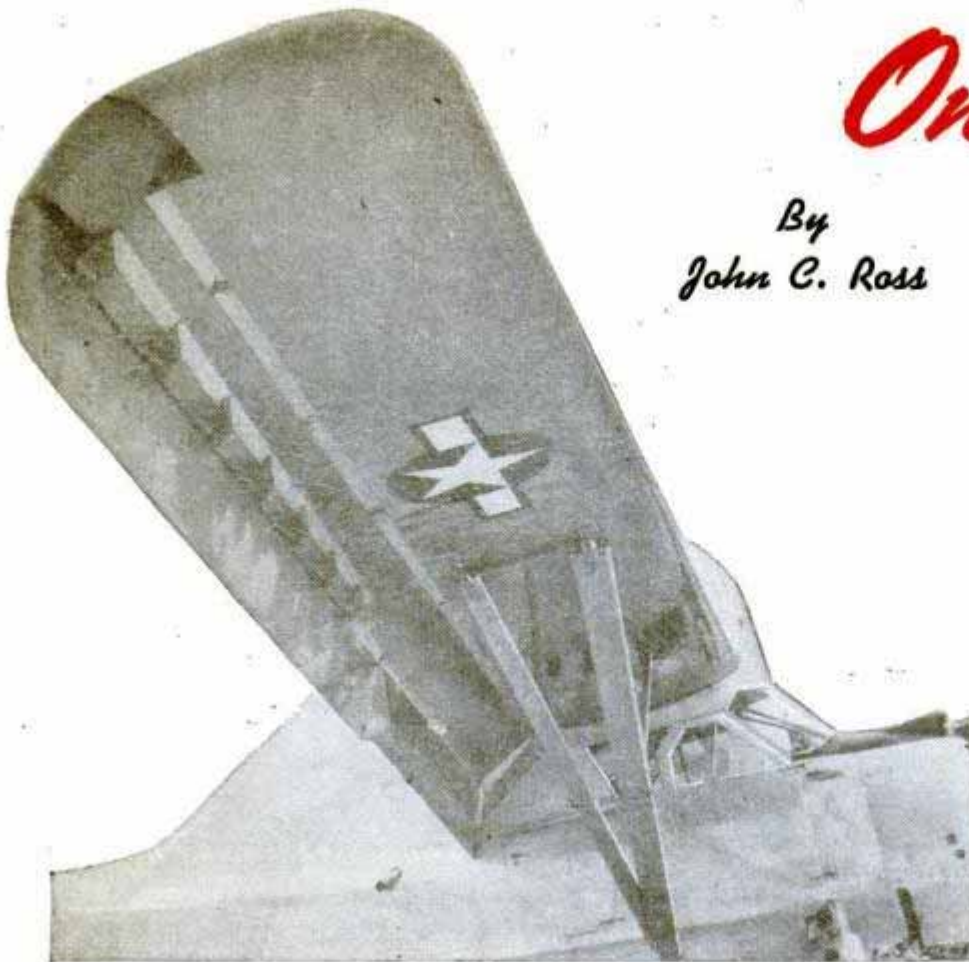

In boundary layer control tests with an L-1, a large blower above and behind the cabin sucked air off the wing's top surface through three induction slots

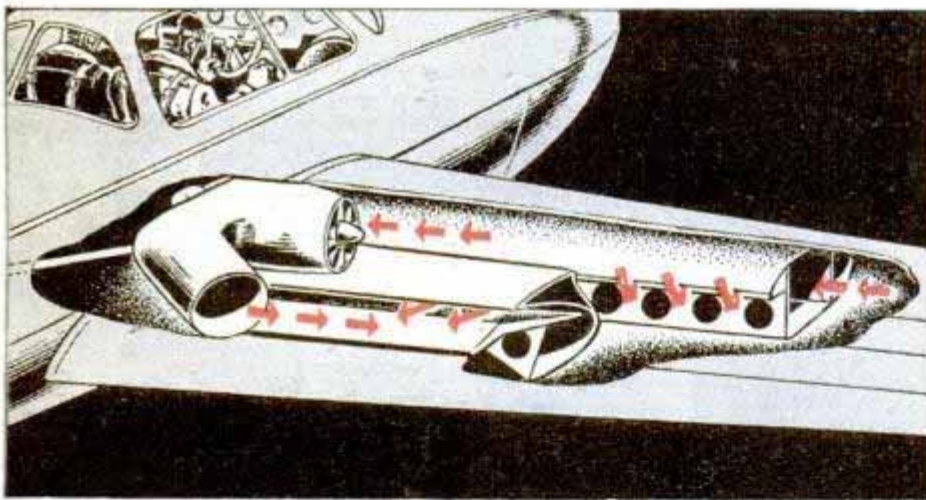

↑ This proposed lightplane wing has a flap with an induction slot near its forward edge and discharge slots at the rear. An engine-operated blower draws air in through the forward slot and pushes it out behind. Below is shown side view of full-length induction slots on experimental L-1 plane

ALREADY at an advanced stage is a revolutionary aeronautical improvement which increases lift, reduces drag and uses entirely new principles to make planes spinproof. It is called "boundary layer control."

Douglas Aircraft Company engineers have already put the basic principle into preliminary designs for an 85-ton transport powered by six turbojets. It is expected to use 20 percent less takeoff run than present transports of the same size and show gains of 50 percent in cruising speed, 32 percent in fuel economy and 22 percent in useful load.

Personal aircraft using boundary layer control wings are even farther along. One model is expected to fly soon.

Elimination of "dead air" from the surfaces of an airplane is a problem that has baffled aerodynamicists for years. Not only is it the source of much drag, but it also lessens efficiency of wing and control surfaces.

The basic idea isn't new. The Army recently told of a secret experimental boundary layer control plane built during the war, a rad-

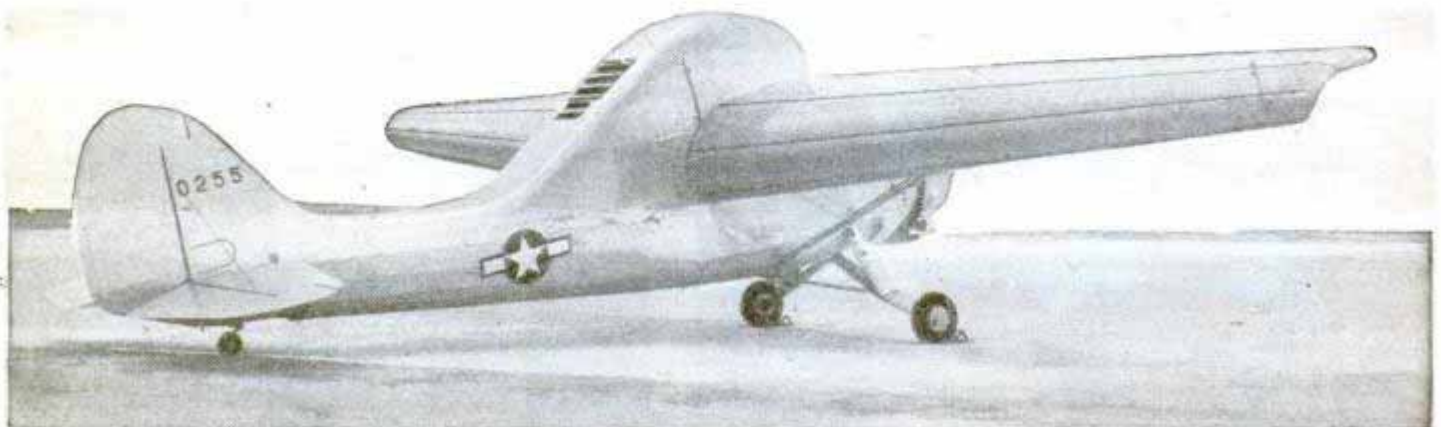

a Revolutionary Wing

ically modified Vultee Vigilant (L-1) with a great hump over the cockpit and the strangest wing ever put on an airplane.

What made the wing different was a row of three induction slots running the full length of each wing. Air was sucked in through these slots by a large blower in the hump run by an 80-horsepower engine in the fuselage. This air was blown out at the rear, though some was also jetted out through a duct just ahead of the aileron when the flaps were down.

The reason for this odd and cumbersome arrangement is that there are two movements of air over a wing, not one as commonly supposed. One mass moves across the wing from front to rear as the plane flies. A second, and counter, movement runs close to the wing's surface. This is a movement toward the great suction which exists at the leading edge of the wing.

The first movement is stronger, but in the second, close to the surface, some air is slowed by friction with the wing. This forms a thin boundary layer, increasing gradually from front to rear. It slows up so markedly that air begins to move forward toward the nose suction.

When this movement clashes with the main flow from front to rear the whole may tear loose, with resultant turbulence. Loss of lift and increased drag result. If the layer can be controlled so that it remains thin and doesn't clash with the main flow, lift can be tripled.

There are two ways to control the layer. One is a jet of air over the wing surface to speed up the layer so it can't move forward against the main flow, though this affects only part of the wing. Another is to suck air off into the wing. That was the purpose of the blower assembly on the Vigilant.

Wind tunnel tests had verified the second theory but the Vigilant was modified to see how it actually worked. When the air was sucked into the wing, the high-speed air layer above the boundary layer replaced it. The result was a delay in separation of the airflow from the wing which gave al-

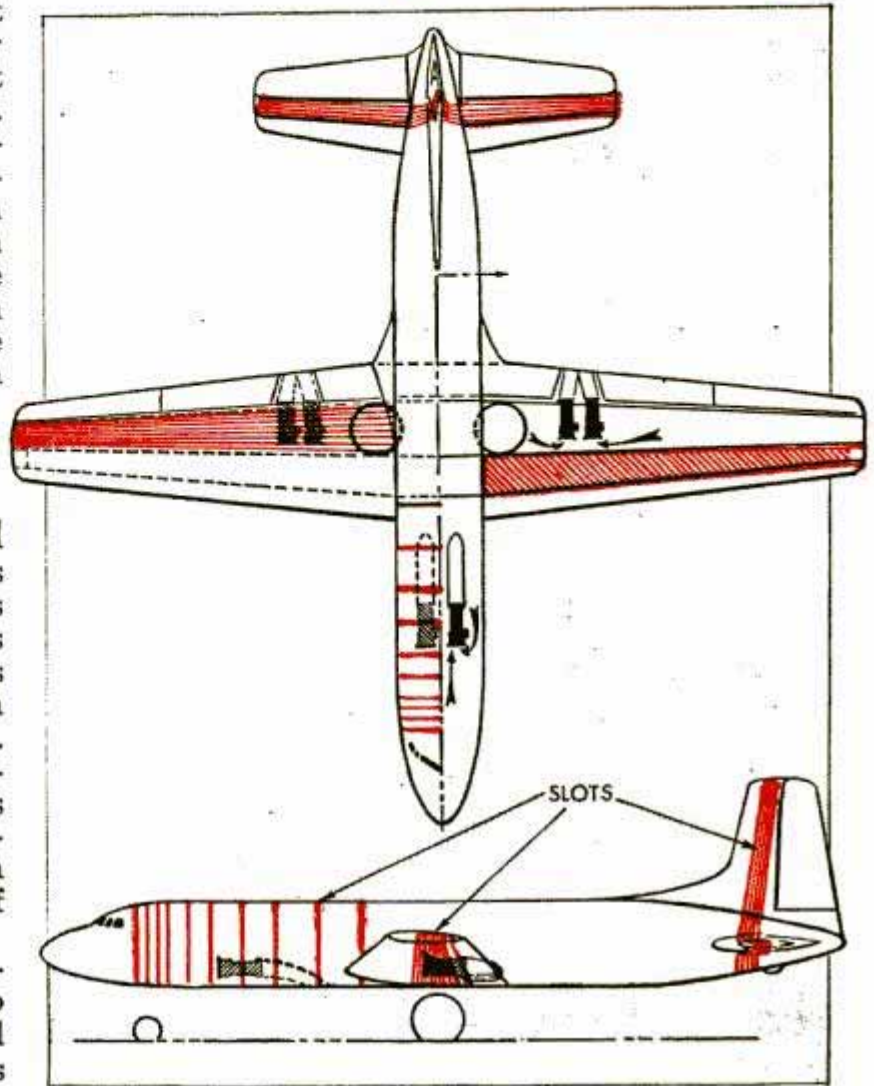

Four jets in the wing and two in the fuselage of a suggested 85-ton transport would operate on air sucked through induction slots shown by broken lines. Cross-hatched lines on the right wing indicate a porous material to accomplish the same purpose

most the entire wing effective lift. Flight tests indicated the plane developed a maximum lift coefficient of 3.6, compared with about 2.5 for conventional aircraft.

The Douglas-designed transport plane would use suction slots only. On the fuselage, as well as the wings, they'd serve as air intakes for the jet engines, requiring no added power source to control the boundary layer by suction.

Though it is far from perfected, some aerodynamicists believe boundary layer control may revolutionize future aircraft. In high-speed planes it has the advantages of smaller control surfaces, high-lift wings, lower climbing angles, greater speed and a solution to the air intake problem. In personal planes it has these advantages, plus those of slow flying, more positive control, nonspin characteristics and, most important, greater flying safety.

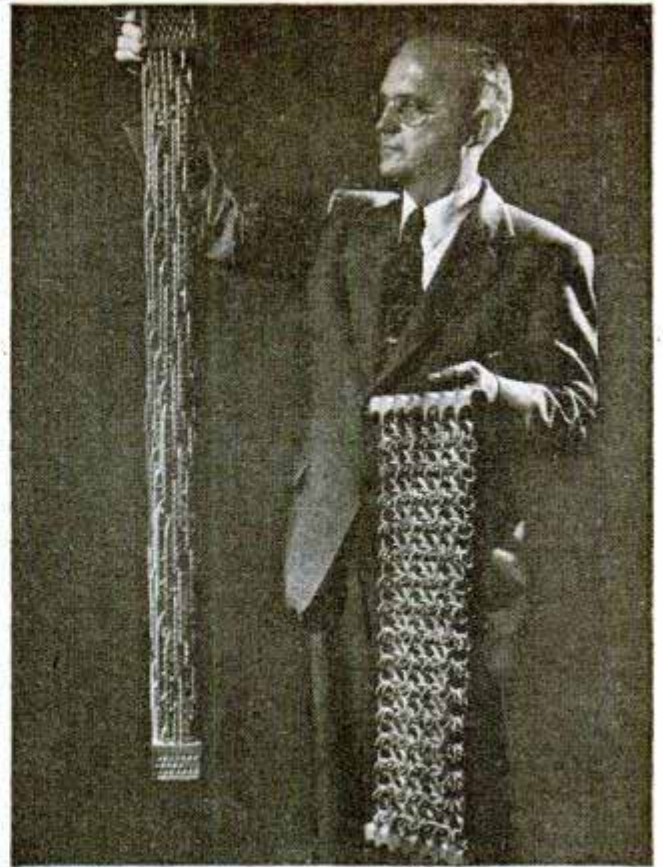

Whittler Carves Intricate Chains With 53-Year-Old Knife

Carving an unbroken chain from a single piece of wood seems such a simple feat to David A. Strausser, of Shoemakersville, Pa., that it offers no challenge. Mr. Strausser, whose carvings are known throughout the country, has carved 10 chains from one piece of wood, each chain connected with the others at top and bottom, and each having double links of different types. He spent more than a year completing it, but the complicated chain is just one of hundreds of pieces he has carved in 53 years devoted to his hobby. Another carving consists of 279 intertwined rings, each ring connected with three or four others, cut from a single piece of hardwood. He has carved seven intricate lattice-work balls, each inside the next larger size. Among his other pieces are endless chains, neck chains with lockets

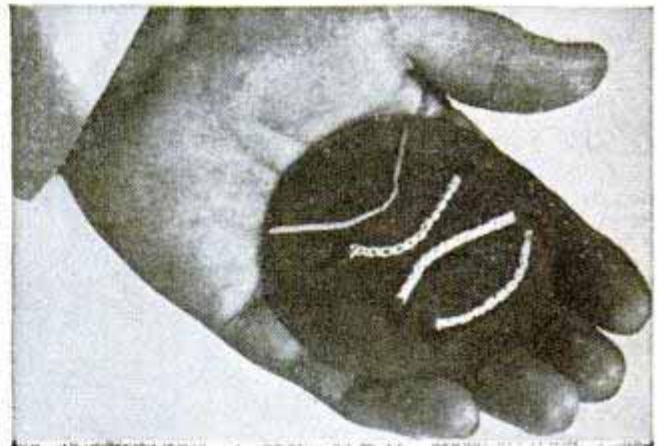

and tiny chains carved from matchsticks and toothpicks. Mr. Strausser, who began carving wood as a boy, has been employed 45 years repairing machinery used in manufacturing clothing. But during his spare time he pulls from his pocket the same jackknife he used 53 years ago and whittles away at his latest project.

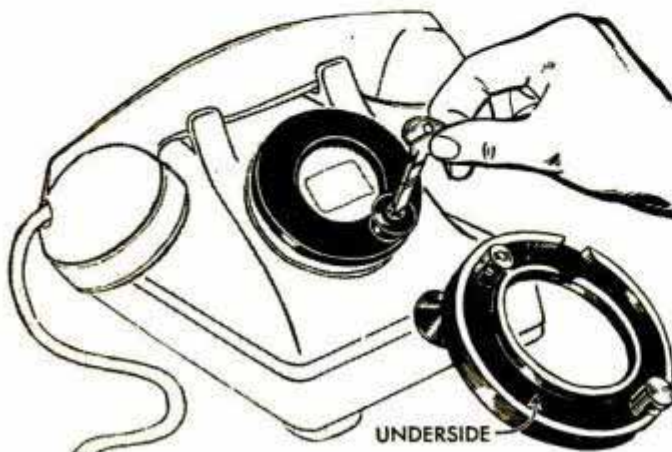

Dial Telephone Lock Limits Calls

To lock a dial phone so that outgoing calls cannot be placed over it, a ring lock which snaps on the dial is available. A key slot is located in a protruding knob. To unlock it, it is necessary only to press down on the key.

Names and addresses of manufacturers of new products featured in this issue will be supplied promptly by the Bureau of Information, Popular Mechanics Magazine, 200 E. Ontario St., Chicago 11.

Planes Land in Cross Winds With Swivel-Wheel Gear

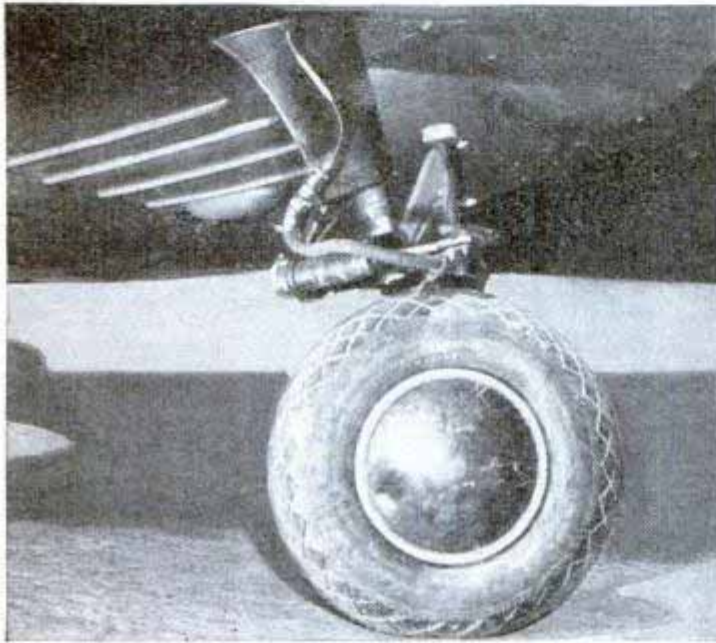

Swivel wheels working on the same principle as furniture casters allow a plane to land on the bias and remain headed into the wind while landing on a runway going in another direction. Cross-wind test landings and takeoffs have been made with pri-

mary training planes equipped with the swivel gear, but taxiing problems remain to be solved. Aircraft manufacturers believe the castered gear will increase the utility of small airports by permitting planes to land on one-strip fields in strong cross winds.



LAND-BOUND "FLIGHT DECK" training is being given Navy helicopter pilots, who can get their sea legs now without seeing water. The 40 by 60-foot deck simulates the roll of a ship by rocking back and forth 10 to 15 degrees on its supports. It is used for both takeoff and landing practice drills at Floyd Bennett Field

Uncle Sam's Private Fur Crop



Photo courtesy of Russeks, Chicago
Silky-smooth sealskin coats are available in black
and two shades of brown. They cost from \$700 up

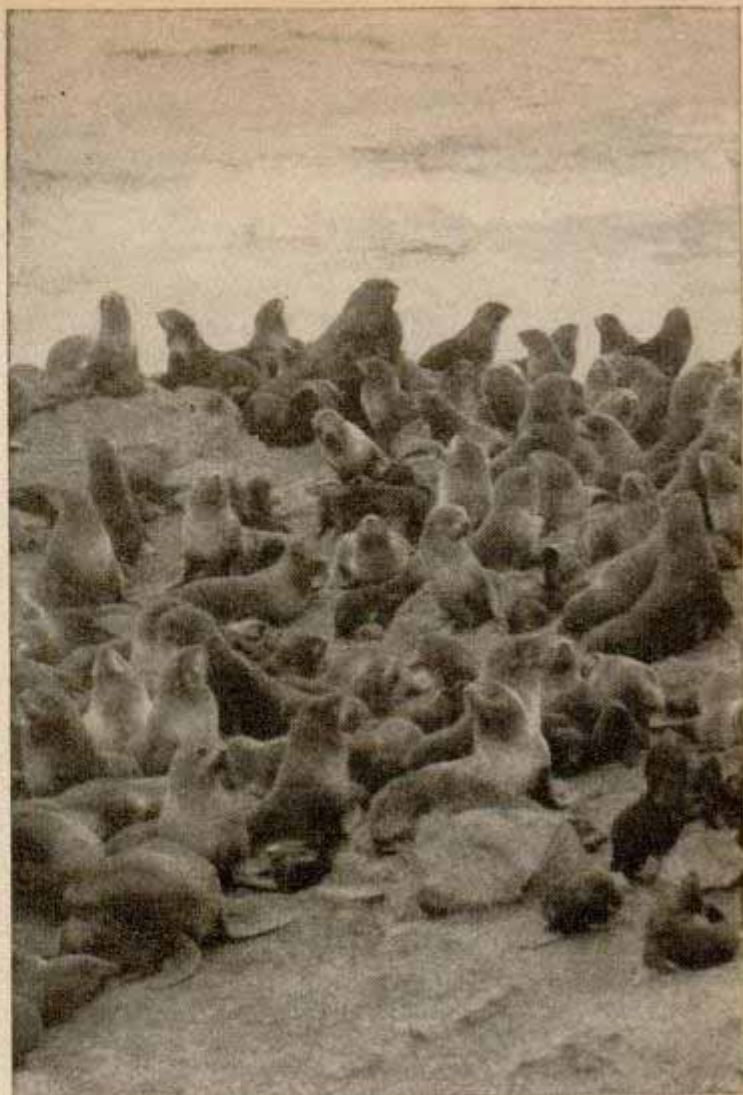

↓ Coarse guard hair is removed from sealskins by a two-handed knife deftly moved across the surface. The blade is kept dull so that no fine fur will be cut





↑ Luxurious pelts from fur seals on the Pribilof Islands, off the Alaskan coast, netted the U. S. about \$2,500,000 in 1946—at approximately \$100 per skin

UNCLE SAM became \$2,500,000 richer several months ago as the result of a sea-going mammal's attempt to keep warm by growing a fur coat. This unique money-maker is the fur seal, a distant cousin of the trained seal of circus fame. The \$2,500,000 was the proceeds of a public auction of 28,000 government-owned sealskins. An unusual government monopoly depending upon this fur-covered animal has resulted in a government income of some \$20,000,000 since 1867.

Once almost depleted by imprudent exploitation, the fur-seal herd is now estimated to be worth \$100,000,000. The entire industry is run by the U. S. Fish and Wildlife Service. It is centered on several small islands in the north Pacific where the seals come up from the water, and in St. Louis where a government contractor processes the sealskins for sale to furriers.

In order to prevent the extinction of seals by indiscriminate killing at sea, the United States entered into a conservation agreement in 1911 with Great Britain, Japan and Canada. Thus protected, the seal herds increased. In 1940 the Japanese government gave a notice of abrogation, and the agreement was terminated on October 23, 1941. Under a provisional agreement entered into in 1942, Canada now receives 20 percent of the total number of fur sealskins taken on the Pribilof Islands, the re-

↓ Native workmen on St. Paul Island in the Pribilofs remove blubber from the skins. Then the pelts are sent to a St. Louis fur plant for further processing



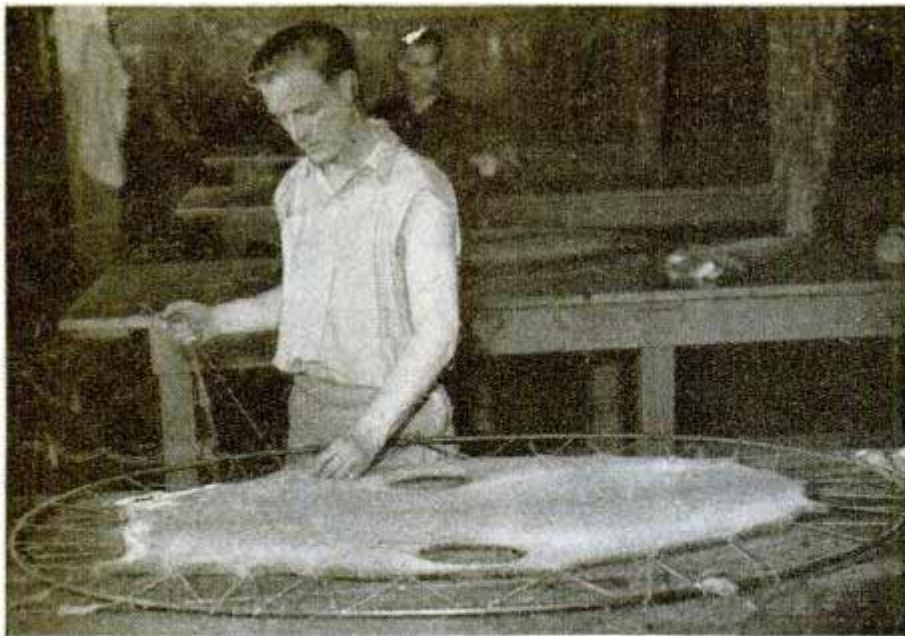

Before being dried, the skins are laced into hoops to maintain proper shape

mainder being kept by the United States.

Comparatively few persons have had an opportunity to observe fur seals, and the term "seal" is usually associated with the hair seals kept in zoological parks and elsewhere for exhibition purposes.

The fur seal is different from the hair seal and is believed to be of different ancestral origin. From an economic standpoint the chief difference is the character of the pelt. Underneath the coarse outer hair, the fur seal has fine fur highly prized for its utility and beauty in garments. The hair seals lack this fur.

Although widely scattered throughout the world, about 80 percent of the fur seals have their breeding grounds on the Pribilof Islands in the Bering Sea. The Pribilofs include five small islands about 300 miles off the mainland of Alaska. Villages located

rival is amazing. The mature males, called bulls, arrive around May 1, taking definite places on the breeding grounds, and await the arrival of the females. About June 1 the mature females begin to arrive and the young are born usually within a few days thereafter.

The immature males, called bachelors, also come to the Pribilofs at this time, but herd by themselves near the breeding grounds. It is from this class of animals that killings are made. Since the value of male pelts varies with their age, killings are confined to the age at which the most valuable pelt is produced. It has been found that it is most profitable to take the pelts of three-year-olds. The polygamous nature of the Pribilof fur seals makes it possible to kill a very considerable percentage of the males without interfering with natural increase

in the herd. When seals are to be killed, a group of young males is spotted and native sealers noiselessly take positions along a line between the water and the seals. At a signal, the men start beating clubs on the ground and shouting as they move toward the seals. The seals, finding their way to the water cut off, become frightened and head inland. It is then an easy matter to drive the seals to any ground that may be selected.

Skins obtained at the Pribilof Islands are cured in salt before they are

(Continued to page 236)



Skins are cured in salt at St. Paul Island before being shipped to U. S.

Hook Lift on Truck Makes Loading Easy

It is not necessary to lift heavy tote boxes to load a hand truck equipped with a hook device on the handle. The truck is backed up to the load and the hook is pushed up and into the tote box handle hole. A forward pull slides the boxes onto the bed, ready to be moved. The hook can be adjusted for various box sizes.

Mild Malaria Cured By War-Born Drug

Cure for the commonest and mildest form of malaria (plasmodium vivax) is claimed for a yellowish chemical called pentaquine. Dr. R. F. Loeb, chairman of the Board for Coordination of Malarial Studies, reported that experiments with 171 white persons revealed that a daily dose of 60 milligrams of pentaquine and two grams of quinine is required. Administered concurrently in divided doses every four hours for 14 days, this treatment is sufficient to produce "radical cure of severe infections due to plasmodium vivax," Dr. Loeb explained. Studies are now being made to determine whether the drug can be given safely to members of dark-skinned races or

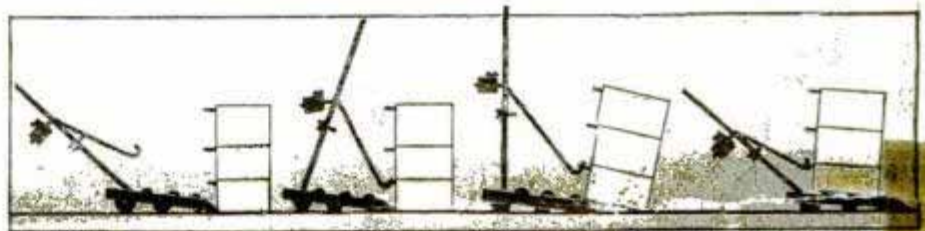

whether, like another antimalarial drug called pamaquine, it will cause severe anemia. Pentaquine was known as SN 13,276 during the secret wartime search for drugs to protect our fighting men against malaria.



"Guinea Pig" Glider Led to Buzz Bomb

Direct ancestor of both a twin-jet buzz bomb and the AAF's huge XB-35 was a tiny glider with a wing span of less than 30 feet. Built by Northrop Aircraft to test the basic design, the pilot's seat and canopy were eliminated in the bomb, which carries no pilot.

☐ An atomic bomb generates a temperature of 100,000,000 degrees Fahrenheit when detonated, according to scientists.

Outboard Jet Engine for Boats Develops Three Horsepower

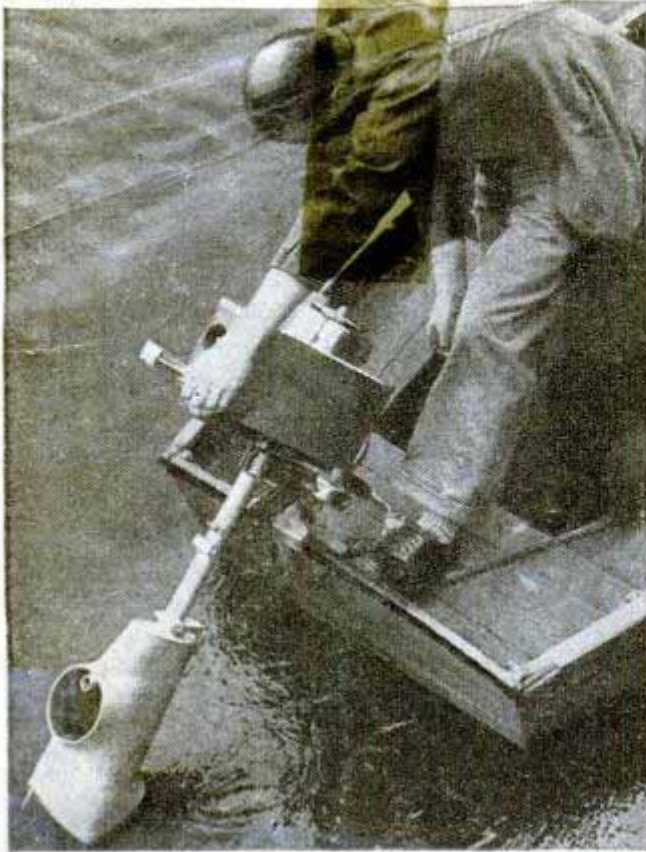

One gallon of fuel keeps an outboard jet engine, tested recently on the Thames River in England, running for 3½ hours. Weighing only 55 pounds, it develops three horsepower and will drive a boat at speeds up to eight miles an hour.

Safety Reel for Bandsaw Coil Holds Loose End With Clip

Safety reels eliminate the danger of metal-cutting bandsaw coils springing loose and cutting the operator or becoming tangled. A clip, fastened to the center of the

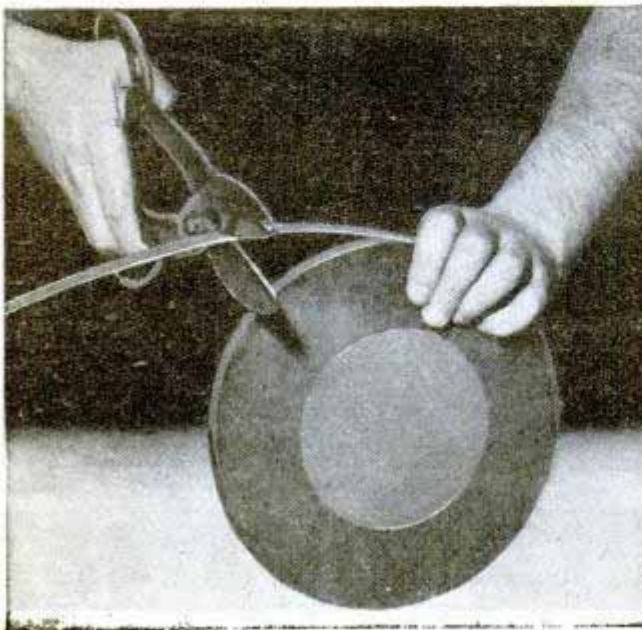

reel, holds the steel coil securely on the reel. To remove a length of bandsaw from the coil, the clip is held with the left hand while the coil is pulled out by the right hand to the desired length and cut. Then the clip is pushed back to hold the loose end of the coil remaining on the reel.

Plow Guard Pins Down Trash For Cutting by Disk

Plowing is made easier by a trash guard which automatically turns heavy trash into the ground and eliminates having to stop and remove debris from the plow. The guard, fastened to the coulter disk, holds trash close to the ground for cutting by the disk. The attachment is useful for burying corn stalks deep in the ground to eliminate corn borers and for turning heavy sweet clover under topsoil to serve as fertilizer.

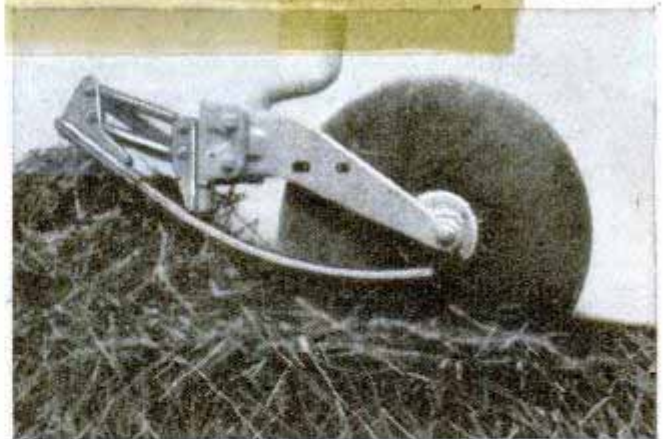
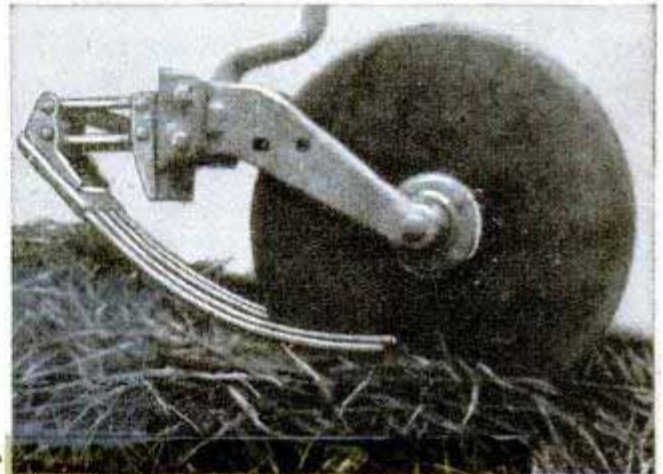

Chemical Prolongs Battery Life

Life of storage batteries can be prolonged with a powdered chemical compound which hinders the formation of deposits on the plates. The powder also shortens the time needed to recharge old batteries. The chemical reduces internal corrosion, restores activity in the electrolyte fluid and rebuilds the lead oxide plate. Developed by a California chemist, the compound has been given extensive tests by AAF engineers at March Field.

Clocking the Jets at Muroc

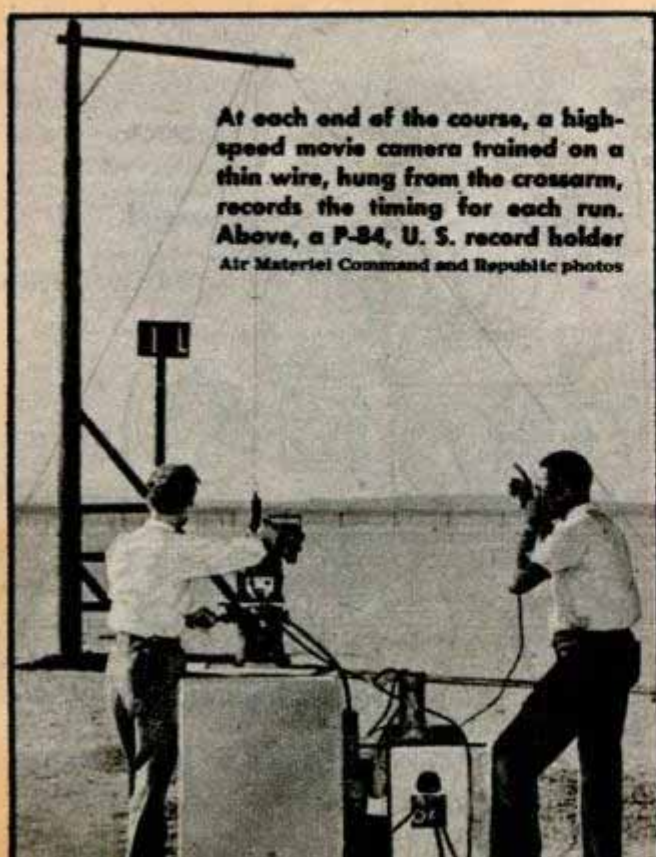

At each end of the course, a high-speed movie camera trained on a thin wire, hung from the crossarm, records the timing for each run. Above, a P-51, U. S. record holder
Air Materiel Command and Republic photos

SOMEONE shouts: "Here he comes!" You squint into the clear desert air and see a tiny black dot, trailing a thin ribbon of smoke. With magical speed the speck becomes a silvery jet plane. Roaring like a blast furnace, it levels off, holds its yammering course for a few seconds and then swoops up into the blue again.

Around you are technicians, fiddling with cameras and high-speed timing equipment, almost too busy to glance at the 600-mile-per-hour plane. They are already preparing for the next run.

You are surprised that the official time is not announced immediately. Technicians have to develop film, check timing apparatus and analyze the recorded information with slide rule and comptometer before they can confirm, perhaps 24 hours later:

"An official new world's record."

That, in brief, is how airplane speed



Lockheed photo

Strong contender for the world's speed crown is Lockheed's sleek P-80 fighter

records are clocked on the Army Air Forces' measured course at Rodgers Dry Lake, Muroc, Calif., on the Mojave Desert 125 miles north of Los Angeles. The area was chosen by the Air Materiel Command because of clear visibility and constant daytime temperatures and humidity. Split-second timing with latest photographic and electronic devices is essential when airplanes approach the speed of sound.

In a short span of 40 years, the world has come a long way in terms of speed—in particular, aircraft speed.

In 1906 a French pilot, M. Santos Dumont, sailed around a three-kilometer course at Bagatelle, France, at slightly more than 25 miles per hour. A long step forward was

taken in 1939 when Fritz Wendel, a Nazi pilot, went 469 miles per hour in his low-winged, streamlined Messerschmitt.

That mark stood until November 7, 1945, when the British recaptured the record. A Gloster Meteor IV, first jet plane to try for the title, zoomed over a course at Horne Bay, England, at 606 miles per hour. Eleven months later the Meteor IV bettered its own time with a new mark of 616 miles per hour.

And that's the official world's record American pilots are shooting at.

America's best official record is 611 miles per hour, set at Muroc in Sep-

tember 1946 in an Army P-84, Republic Aircraft's new Thunderjet. Best single run during the official test performance was slightly over 617 miles per hour. During the previous week the P-84 had made a single pass at 619 miles per hour.

Airplane speed tests are conducted under strict regulations of the Federation Aeronautique Internationale, a world body. Its rules provide that a plane must make four passes over the three-kilometer (1.863-mile) course. Two consecutive runs must be made in opposite directions to nullify wind advantage and the official time is the average of the four passes. To be credited with a new record, a pilot must exceed the old speed by at least 5 miles an hour.

Hurting along at nearly 10 miles a minute, a P-80 pilot has this array of instruments on the panel before him

Lockheed photo

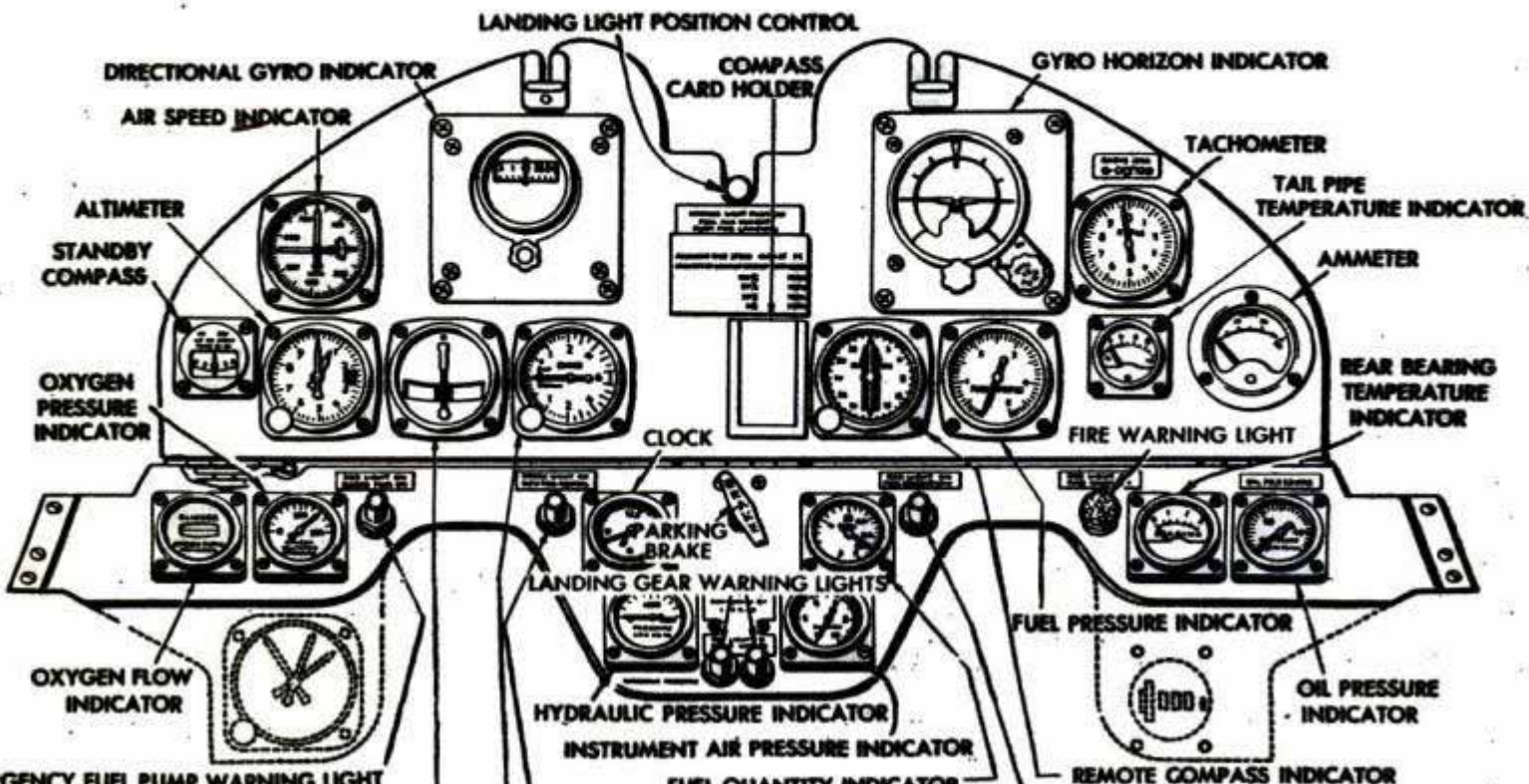

Air Materiel Command photo

Jet photographed just after crossing one of the vertical datum wires after a speed trial at Muroc. The cameras and auxiliary clocks are bolted on concrete bench marks. Below, tail end view of a P-84 Thunderjet

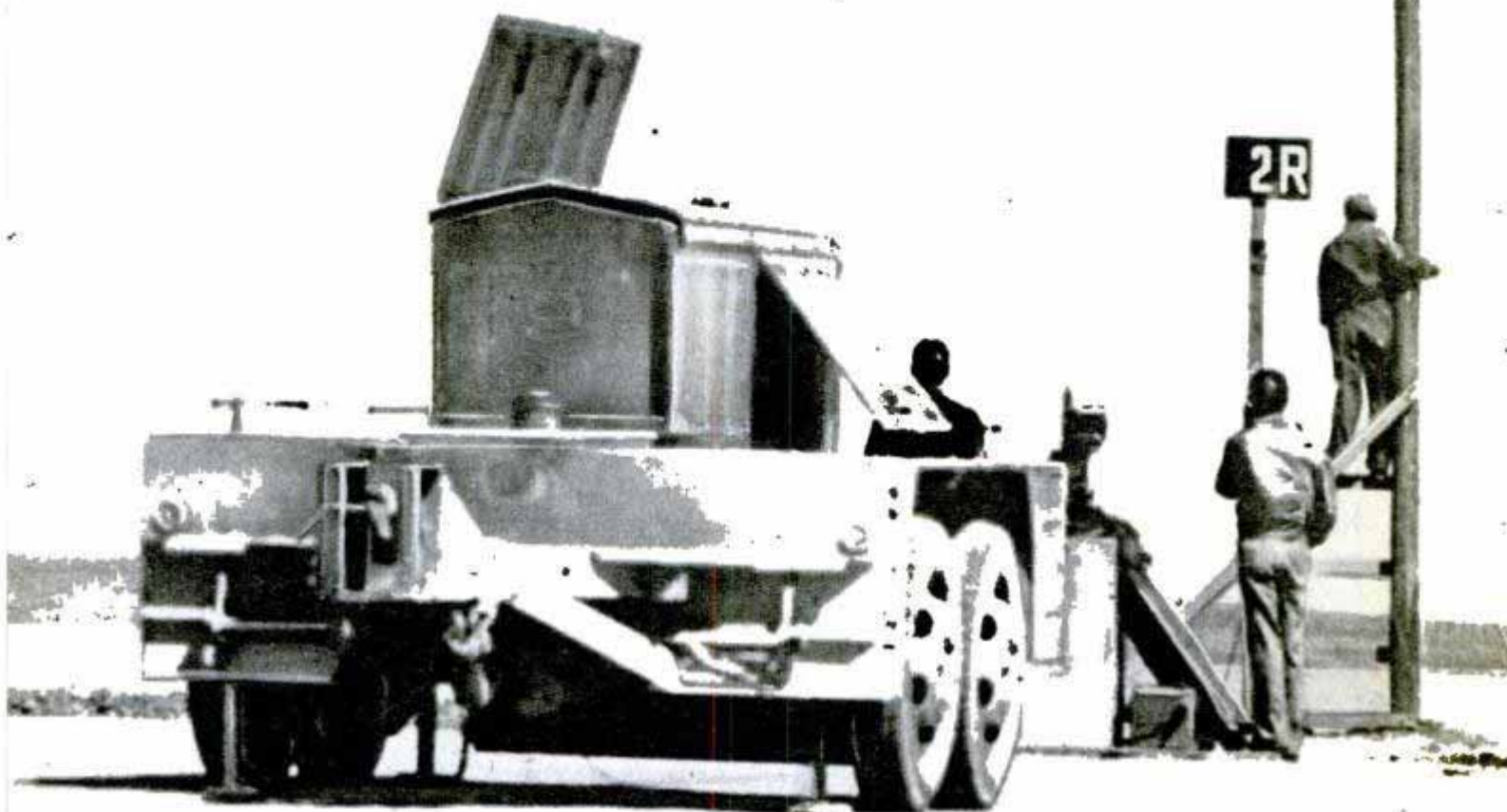

Such tests put pilot and plane through a grueling performance, even though completed in 20 to 25 minutes.

Let's go up with a jet jockey as he tries to crack the record. His plane has been groomed and adjusted to perfection by his ground crew. He doesn't need his "G suit" to prevent blacking out. His turns and dives are going to be gentle. With a noisy swish his sleek, powerful plane almost leaps from the runway into the air. Jet planes need no warming up so he immediately radios to the technicians on the ground to stand by for his first pass.

On the tawny desert sand below he spots the 12-foot-wide, 9842-foot-long black asphalt strip marking the three-kilometer course. It looks like a very

long, very narrow landing strip. He sees huge circles on the ground that will guide his approach and the pink smoke flares at each end of the asphalt. He knows that he has 25 to 35 miles in which to make his turns, but he can't go above 1312 feet altitude. Observers in pylon planes will disqualify him should he go higher.

"Let her rip!" he shouts into his throat mike and pushes his plane's nose down.

The shallow dive he's permitted can't help him pick up much speed. In his approach to the course he must be flying no higher than 246 feet from the ground. And as he roars directly above the black asphalt strip he must be skimming along at 200 feet or less to be within range of the camera speed-recording equipment.



British Official photo
Britain's jet Meteor IV averaged
616 miles an hour in setting the
present world's air-speed record

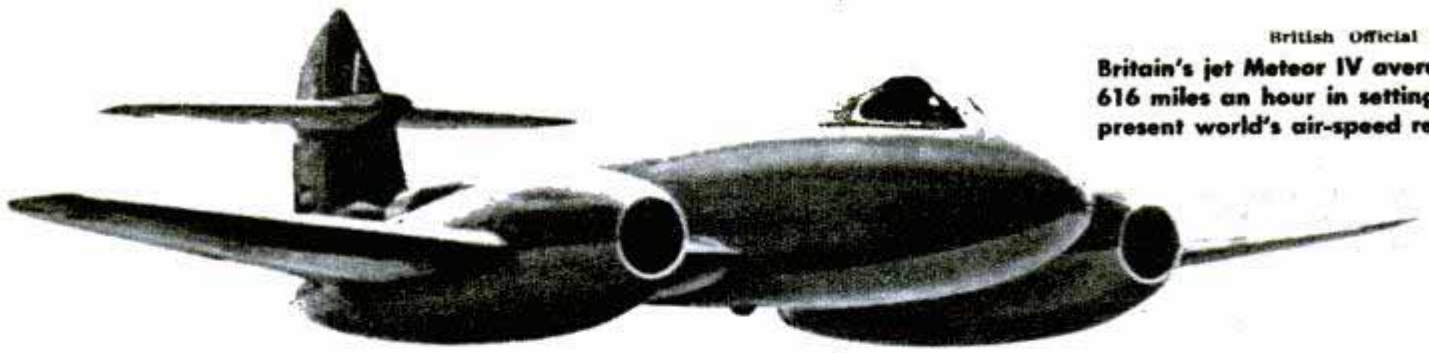

While the pilot is gunning his powerful plane across the test course, technicians are "sweating out" the runs below. They are all pulling for him, but it's hard to estimate that kind of whiplash speed. Optical illusions play strange tricks and the fastest runs do not always appear to be fastest.

A stop watch, graduated in tenths of a second, has been found sufficient to measure man's speed in a 100-yard dash. But

considerably more precision is involved in clocking the human comets that streak through the air in excess of 600 miles per hour. Two factors are stressed: (1) the accuracy and alignment of the course and (2) the precision of the timing devices.

The three-kilometer course at Muroc has been surveyed by the United States Coast and Geodetic Survey to an accuracy of one part in 600,000. Each end of the course is

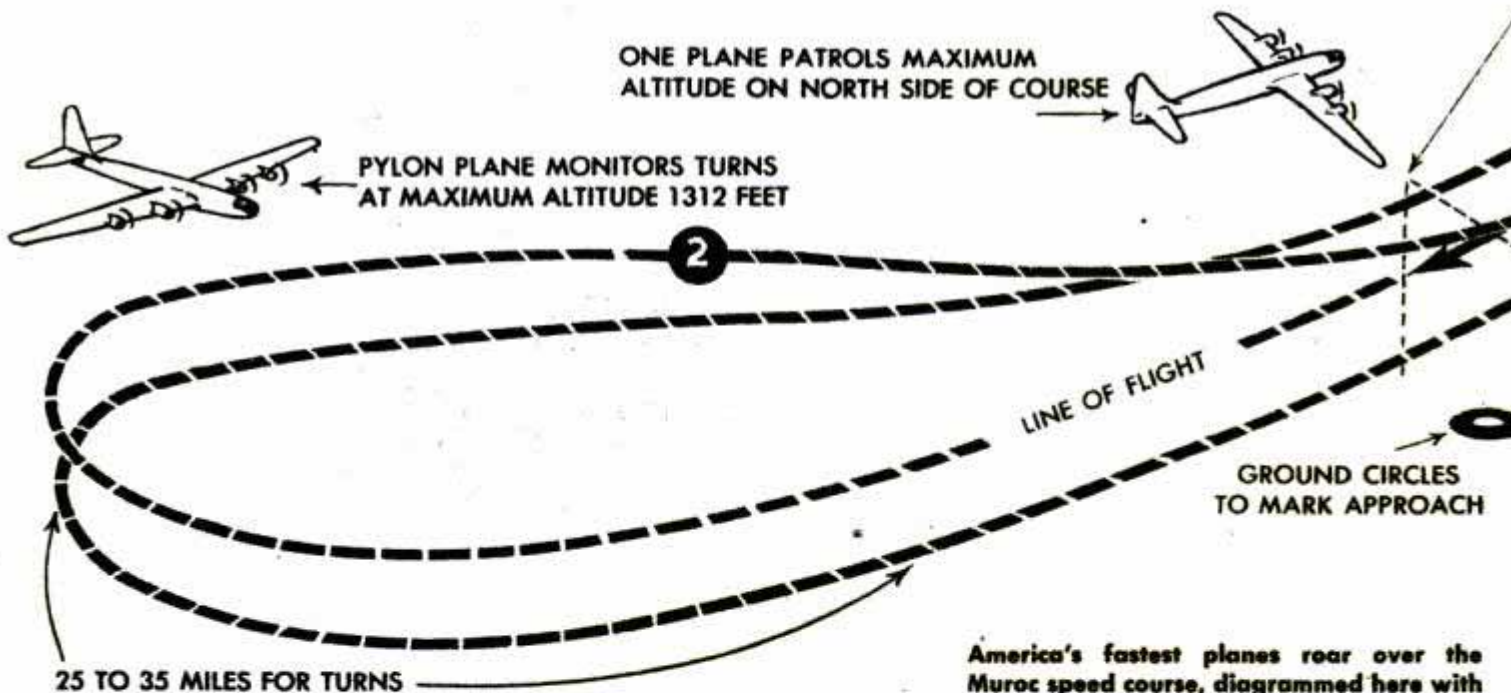

America's fastest planes roar over the Muroc speed course, diagrammed here with measurements and principal requirements for official tries at the world's mark

PYLON PLANE MONITORS TURNS
AT MAXIMUM ALTITUDE 1312 FEET

25 TO 35 MILES
FOR TURNS

PLANE MUST FLY AT 246 FEET
OR BELOW BETWEEN THESE POINTS

3 KILOMETERS
(1.863 MILES)

GROUND CIRCLES
TO MARK APPROACH

PINK SMOKE FLARES TO
MARK SPEED COURSE
ENTRY AND EXIT

HIGH-SPEED CAMERAS
PHOTOGRAPH AND TIME
PLANE AT EACH END OF COURSE

12-FOOT BLACK TAR
STRIP MARKS
MEASURED COURSE

SECOND PLANE PATROLS MINIMUM
ALTITUDE ON SOUTH SIDE OF COURSE

indicated by bench marks set in concrete.

Three inches behind these bench marks concrete bases have been built. They stand three feet high and are used to mount high-speed motion-picture cameras. Camera mounting bolts are located on the concrete bases with a transit and set so as to require only a small final adjustment. By dropping a plumb bob, the center of each camera lens is located directly over a bench mark.

Exactly 35 feet in front of each camera 1/4-inch wire cables are stretched from telephone pole crossarms to the ground and held taut with 100-pound pressure. These cables, like the cameras, are accurately surveyed and checked for alignment before each record try. Thus the camera lens centers and the vertical cables form perpendic-

ular datum planes which mark the exact beginning and end of the course.

In the actual timing, photography and electronics make up a well-coordinated precision team. High-speed motion-picture cameras, winding 16-millimeter film through at the rate of 500 exposures per second, record in almost infinitesimal steps the flight of the speeding craft as it cuts the datum plane at each end of the course. At this frame-exposure frequency the actual position of an aircraft traveling up to 650 miles an hour may be determined photographically to a plus or minus three inches.

The precision "heartbeats" of such a timing system are 100 and 200-cycle tuning forks (calibrated by the Bureau of Stand-

(Continued to page 268)

Vaccine Injected Into Chicken Eggs Tests Effectiveness on Disease



Live chicken embryos in eggshells are used to study animal disease viruses and vaccines for diseases. U. S. Department of Agriculture veterinaries drill two small holes in a shell which causes the air sac to move to the top of the egg. This leaves a large area within easy reach. Then, with an electric needle, the veterinary punctures the inner membrane and injects the virus just over the growing embryo in the shell. Both holes are covered with iodine.

Glass Tongs Resist Acid Solution In Production of Quartz Crystals

Glass tongs fashioned from solid glass rod are used in the production of quartz crystals. The tongs resist the effect of acid

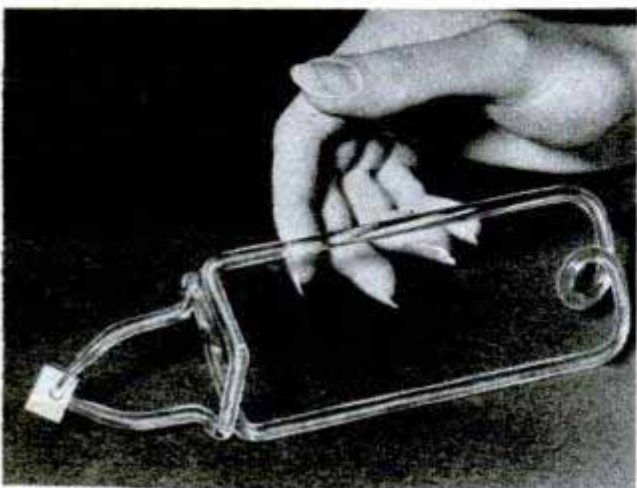

into which crystals are dipped for an etching bath. In normal position the tongs are closed but a slight pressure of the hand releases the crystal after it has been dipped.

Eight-Blade Revolving "Hoe" Mulches Soil and Cuts Weeds

Resembling a lawn mower, and operated in the same way, a gardening tool mulches soil 10 times faster than a hoe. Eight revolving blades break up the soil and at the same time cut weeds. The weed roots are cut below the surface and are scattered on the ground to wither. Simultaneously, the soil is chopped and lifted in a layer to mix with air before it settles to the ground. Air in the dust mulch promotes bacteria growth which is necessary to good cultivation. The tool is available with two attachments to convert it into a hilling or furrow plow.

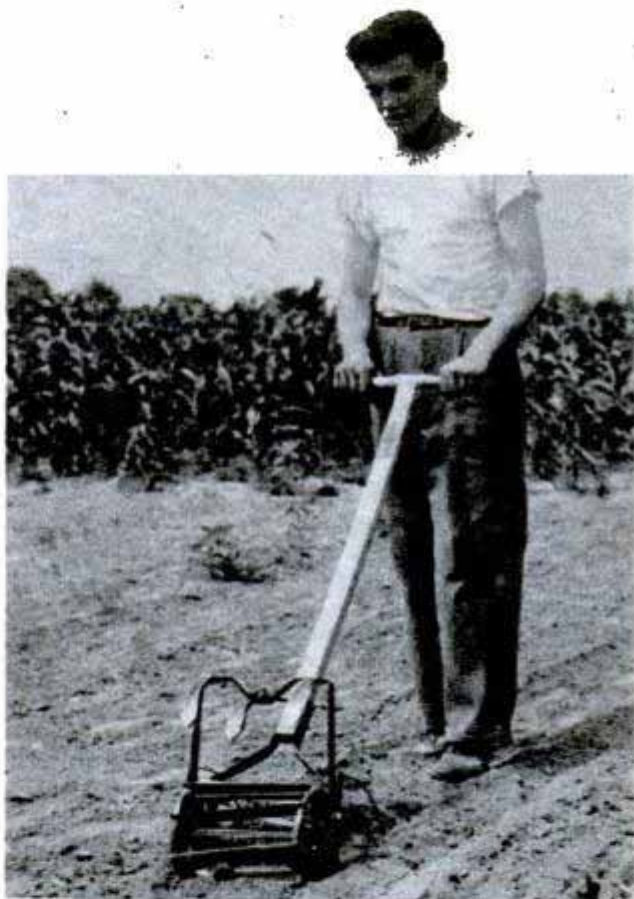

Army Movies at 1500 Miles an Hour

Three wartime cameras may be improved to meet the Army's need for taking clear motion pictures of the earth's surface from planes 20 miles high traveling at 1500 miles an hour. One of the cameras, according to Colonel George W. Goddard of Wright Field, Ohio, is a radar recording unit that tracks guided missiles. Another is especially suited to high-altitude photography and the third is a color camera that takes continuous strip pictures showing heights and depths of the earth's surface.



United Air Lines photos

Portable Electric Winch and Hoist Speeds Loading of Air Cargo

Air freighters are speeding the handling of heavy cargo with a portable electric winch and four-foot hoist boom that can lift 2500 pounds at 30 feet a minute. It is especially useful at fields with only a minimum of loading equipment. The winch can also be attached to tie-down points inside the plane and used to move heavy objects to and from stowage points. An auxiliary gasoline-driven power unit in the forward section of the plane operates the winch where outside power is not available. The boom is hinged to the upper aft corner of the door and the winch can be plugged into any of the plane's electrical outlets.



Game Carrier Worn Over Clothing Has Pouches and Rubberized Lining

← Worn over a hunting garment a featherweight harness-type game carrier has two shell pouches, a game pouch with rubberized lining and two nonrust metal game loops. The carrier is adjustable to fit men of various sizes and to locate the pouches in the most convenient position.

☞ University of Calcutta scientists have developed a new material similar to coarse wool from jute fiber.



World's highest earth dam is under construction on Boise River in Idaho. It will measure 456 feet to top. U. S. Bureau of Reclamation photos



MAN-MADE MOUNTAIN

SO SOLIDLY compacted are the 8,650,000 cubic yards of earth going into the Anderson Ranch Dam in southwestern Idaho that the man-made mountain weighs almost as much as if it were solid concrete. When completed in late 1947 it will be the world's highest earth dam, measuring 456 feet from bottom to top.

Half a million acre-feet of water for irrigation and development of electric power will be held behind it on the south fork of the Boise River.

The dam has an impervious central core consisting of a mixture of clay, sand and gravel. Huge sheepsfoot rollers make 12 trips over each layer, compacting it under

450 pounds pressure per square inch. Upstream, semipervious material prevents erosion or slippage. Downstream, a zone of compacted sand and gravel, held in place by a rock and cobble fill, backs up the core. The streamwise base is 2350 feet long. Upstream and downstream faces slope gently to the 1400-foot-long streamwise crest, forming a river barrier as immovable as the earth hills adjoining it.

Earth for the dam's great bulk is transported two miles to the site by conveyor belts. Big 150-horsepower electric motors start the conveyors. After that the weight of the load keeps the belts moving while the motors serve as generator brakes.

For the center core of the dam, 4,500,000 cubic feet of clay fill are being hauled two miles to the site by conveyor belts

Half a million acre-feet of irrigation water will be stored behind the dam when completed

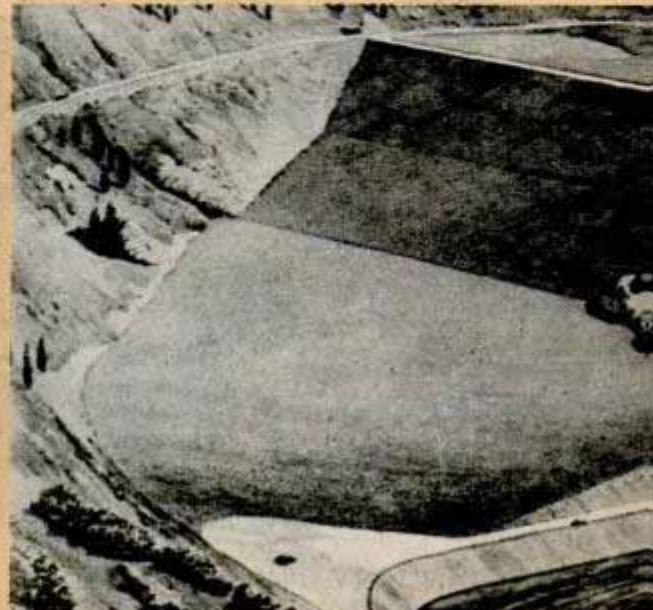
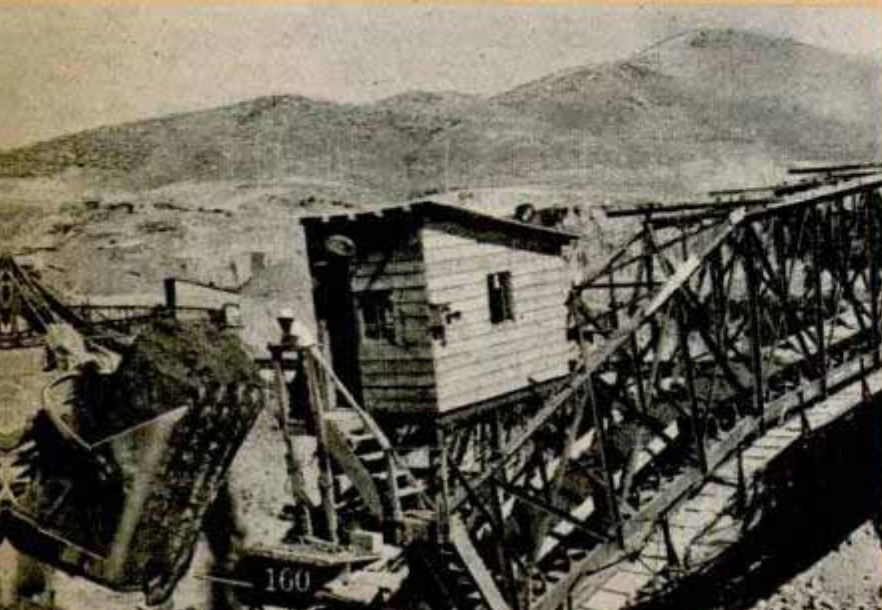

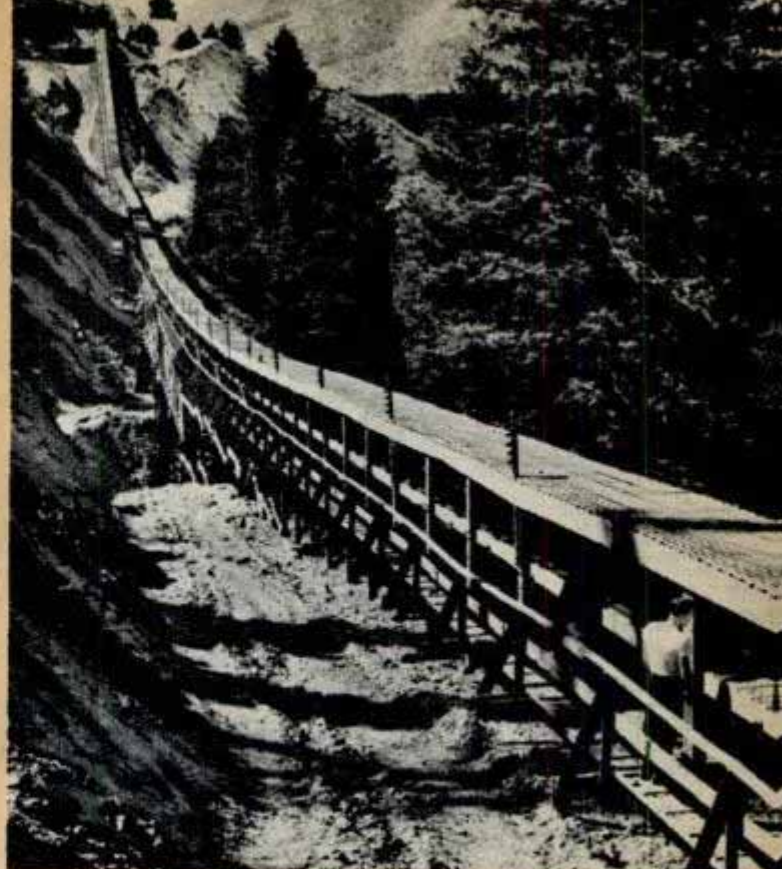

HOLDS BACK RIVER

Semitrailer carryalls haul clay from conveyor belt stockpile, left. Conveyor system crosses two bridges and goes through three tunnels

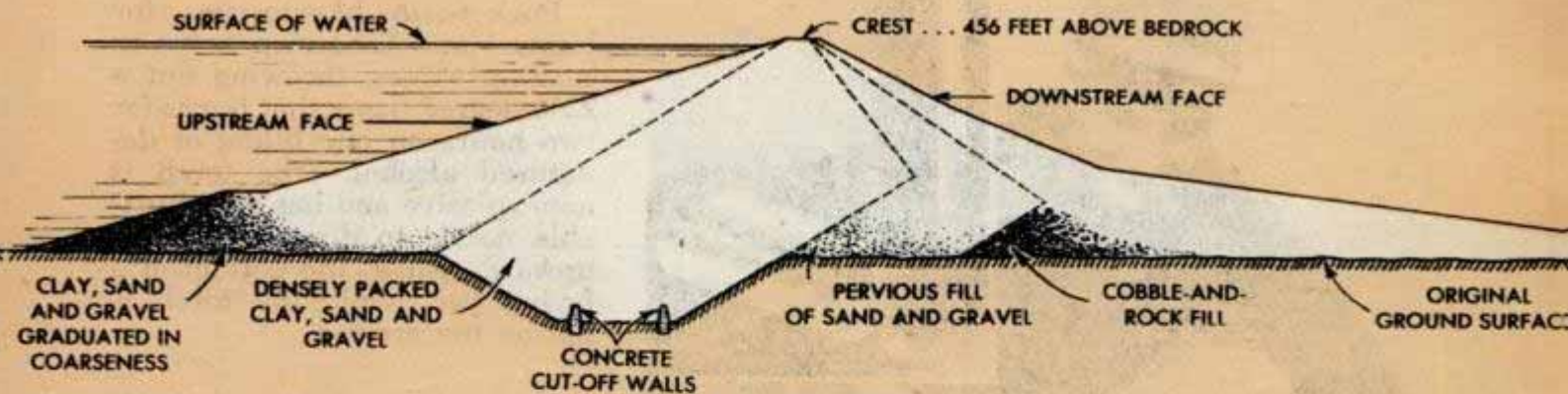

Power generating station at downstream base will supply electricity for farms in Boise River valley

Sheepsfoot rollers compact the clay fill so tightly that it weighs almost as much as solid concrete

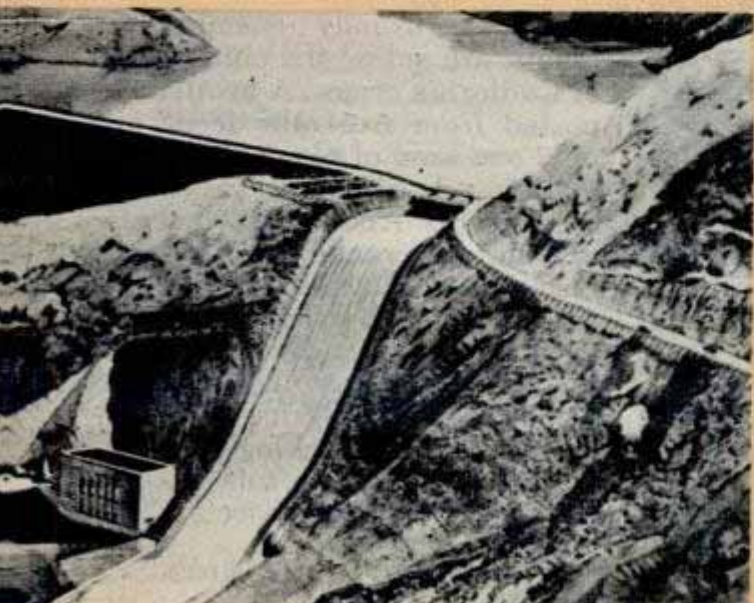



A combination stroller and car seat for a child are contained in a compact carrying case weighing less than 15 pounds. Each of the eight-inch rubber-tired wheels has individual compression springing for shock-

Stroller Doubles as Car Seat

absorber action. The wheels and the tubular handle of the stroller fold into the bottom of the case. The seat and back are fully cushioned and the sectional aluminum handle is adjustable for length.



Pocket-Size Blowtorch Cooks Meals for Camper

Pocket-size blowtorches for hunters and fishermen serve as cooking stoves, throwing out a 2200-degree flame that burns for two hours on one filling of denatured alcohol. The torch is nonexplosive and has an adjustable nozzle to direct the flame upward against the bottom of a frying pan while the torch is flat on the ground.

Imported Beetles Eat Weeds To Aid Crop Cultivation

Beetles, usually enemies of plants, are aiding the cultivation of California crops. A beetle imported from Australia feeds on only one kind of plant—the Klamath weed, sometimes called St. John's wort. About 100,000 acres of California range lands are infested with Klamath weed, and the imported beetles are being propagated as rapidly as possible to be released over large areas. Department of Agriculture entomologists are working with the University of California in experiments with the insects.

Inflator Valve for Spare Tire Extends Through Trunk Side

Checking spare tires is made easy with a valve which extends through the side of the trunk. An inflator, consisting of a 48-inch rubber hose with two brass valve connectors, is attached to the spare tire. Also, if a running tire is going flat from a slow leak, enough air can be transferred through the inflator from the spare to permit limited driving.

Faucet Filter Uses Charcoal To Purify Water

Equipped with a removable filter containing activated charcoal, a filtering device for the kitchen or bathroom faucet provides pure water. The activated charcoal removes bad taste, odors and dirt from the water.



Each filtering disk is sufficient for about 500 glasses of water. Replacement disks are available at low cost. The lower part of the device is removable to provide a large soft spray for washing fruits and vegetables.

☐ If a generator rotor is off balance by so much as the weight of a single wisp of lint it can be detected and the area of unbalance isolated by a microbalancing tool developed by Westinghouse.

Snap-Back Typewriter Eraser Fits in Platen Knob

There's no need for fumbling around and searching for a typewriter eraser that never seems to be where you left it. The eraser now has been made part of the typewriter. It is contained in a knob intended to replace the right-hand platen knob and is tied to a Nylon cord fastened to a spring reel. When the eraser is no longer needed, it is released and automatically reeled back into its position inside the knob.

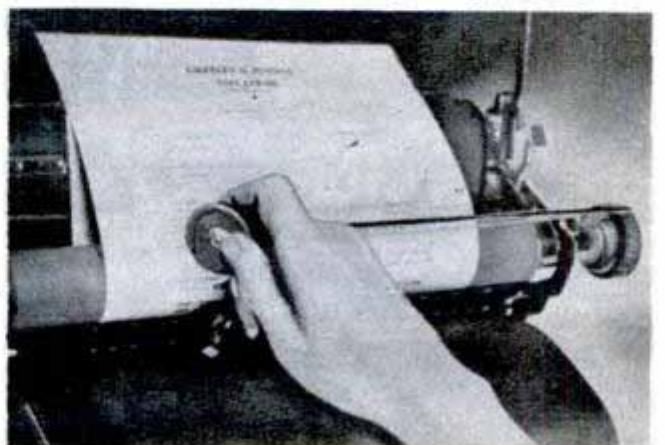
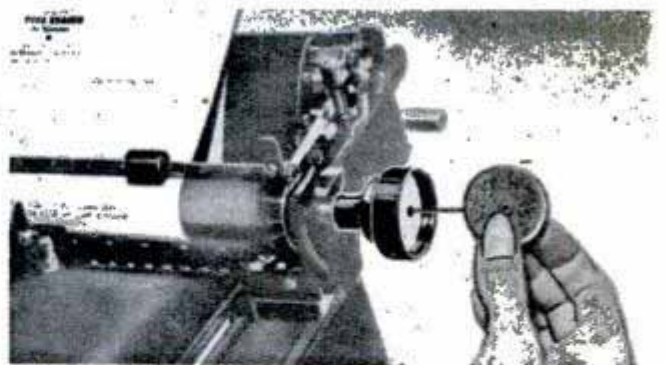

American Rice Feeds the Orient

By John L. Kent

UNDER the impact of war and floods, the primitive rice growing methods of the Orient have broken down and American farmers are shipping 1,200,000,000 pounds of rice to Asia this year to relieve shortages and prevent widespread starvation.

Over half the earth's population calls rice, rather than wheat, the staff of life. Most of these people are in the East. But while the crop there has dropped sharply, mechanized farming has pushed production in the United States ahead so rapidly that this country is now the second greatest rice producing nation in the world.

Two thirds of the American rice goes to the Orient where it is greatly needed. The worst floods in 20 years washed out 20 percent of the 1946 rice crop in Korea. In Burma, Siam and French Indo-China, the 1945-46 harvest was only 40 to 70 percent of normal. But the largest deficit is in China, which produced 35 percent of the world's crop before the war. The 1945-46 yield was 460 million bushels under the average 2620-million-bushel prewar production. In two Chinese provinces, Kwangsi and South Hunan, some 16,000,000 people face starvation. The UNRRA reports that only 25 percent of the normal crop land is planted.

The United States is second to China in world production. Our 1946 harvest was 2,100,000,000 pounds, about 15 pounds per person, but our consumption is one third of



American rice growers seed their fields by plane and combine harvesting, threshing and drying in one operation





that. We export the balance. Louisiana, Texas, Arkansas and California are the principal rice producing areas.

Rice originally was foreign to the United States but Americans have worked wonders with it. California growers developed airplane seeding of rice on water, and harvesting by the combine-drier method, giving the area the most highly mechanized rice fields in the world. In Asia, rice growing and harvesting and its subsequent processing are done almost entirely by hand. Although often favored with a good climate, the yield per acre is very low. The rice growers seldom have a surplus large enough to sell. So many people are employed in its production and they consume so much of what they grow that little is left for the rest of the population not engaged in rice growing.

From planting to harvesting, the inefficiency of oriental hand methods compared with ordinary American practice is evident at every instance.

To prepare the seedbed, the California rice grower uses a gang spike-tooth harrow, pulled by a tractor, covering a swath perhaps 30 feet wide. But in the Philippines and in India, the rice farmer uses a water buffalo hitched to a primitive tooth plow no more than 8 feet wide. Those having no water buffaloes or other animals hitch

Modern versus primitive methods of rice threshing. Louisiana grower, top, uses a power thresher. Korean farmers use a foot-powered drum studded with wire loops to knock rice from stalks



another human being to a plow as primitive as that used by the first farmer who used a forked stick to turn the soil.

Since rice fields must be irrigated, the oriental rice grower directs water to his field through elaborate dikes and flumes. Often he must pump water out of wells or lower rivers, using animals or human beings to supply power for chain buckets. In California, the rice grower merely opens a valve on the main irrigation line and water floods his field.

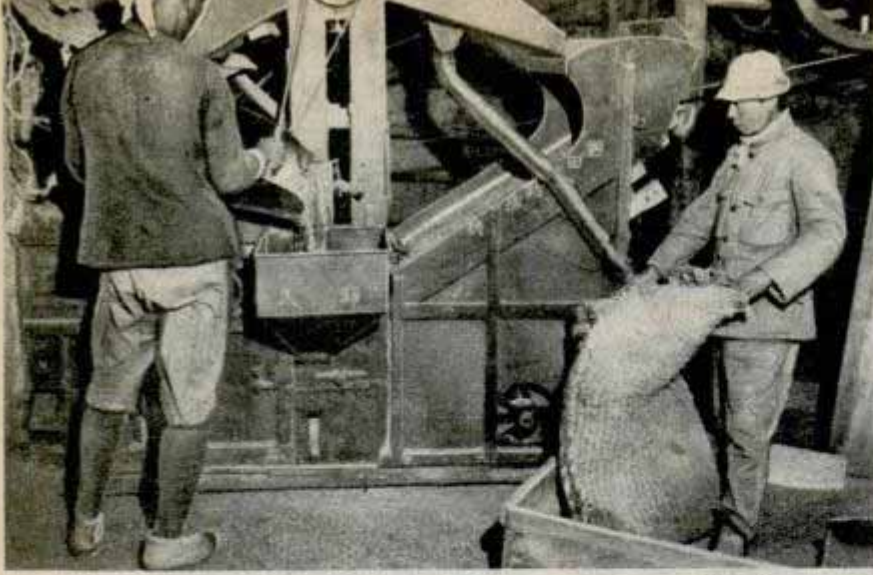

In Japanese rice mill, husked rice pours from machine into rope bag. Below, steel disks separate kernel from rough outer husk in modern machine used in rice milling operations in Louisiana
Farm Security Administration photo



Complete water control makes it possible for the American grower to control weeds, which during the early years of American rice production caused serious difficulties. In California, rice lands are now continuously submerged from planting time until shortly before harvest. The discovery that continuous submergence will control weeds was made by Jenkin W. Jones, a U. S. Department of Agriculture agronomist, 20 years ago.

Jones, working at the Biggs Rice Field Station, Biggs, California, discovered that barnyard grass and other weeds could be stopped either by seeding rice on a well-prepared seedbed and immediately submerging the land, or by first submerging the land and seeding broadcast on the surface of the water. The water, ranging in depth from 4 to 7 inches, is held on the land continuously from seeding time until the fields are drained preceding the harvest.

Rice seed on the surface of the soil germinates beneath the water, the roots penetrate the soft mud, and the first leaf stretches up through and often floats on the surface of the water. While the leaves of the rice plant emerge through the water and remain erect, barnyard grass seedlings are unable to emerge, and eventually die. It cost from \$3 to \$5 per acre to weed rice fields by hand. The

Sinuuous pattern of dikes marks rice fields in Korea





Korean farmers, top, blow small pieces of straw from threshed rice with foot-powered propeller. In modern method, vacuum tubes suck up all the unwanted chaff

Farm Security Administration photo

continuous submergence method of irrigation has resulted in an estimated annual saving of from \$500,000 to \$1,000,000 to the rice growers of California.

In Asia, the rice is cut by hand and stacked in fields or carried to another location to dry before it is threshed. Rice should be threshed only when the grain is hard and the straw reasonably dry. This usually requires from 7 to 14 days.

In early years, harvesting in California was done mainly by binders, which required shocking the rice and later hauling it to the stationary thresher. This was costly in labor. Now rice can be harvested and threshed in the field, even when it is much too moist to store well, and then dried to a 14.5-percent moisture content. This method favors production of high quality rice and reduces hand labor to a minimum. In recent years, with labor scarce, some Arkansas, Texas and Louisiana acreage also has been harvested by combine driers.

A few American rice growers have installed on their threshers an aspirator which removes weed seeds and other foreign material from the rice before it enters the sack. This improves the quality of the rice, and in damp weather tends to reduce the percentage of moisture. The materials removed are not sacked unless saved for feed, resulting in a saving in the sack bill.

In Japan and Korea the thresher consists of a wooden drum, studded with wire loops and turned by a foot treadle. The stalks are held on the drum and the wire loops knock the rice off. To separate the kernels



from the chaff and broken straws, hand sieves are commonly used, the grain falling through the holes. Sometimes a foot-operated propeller is used to blow the lighter pieces of straw away. In the more primitive areas, hand fans serve the same purpose.

After the rice grains have been separated from all foreign matter, they must be husked. Rice kernels, in common with other grains, have a thick outer shell which must be removed. In the United States

(Continued to page 276)

"Two-Mile" Trolley Runs in Basement

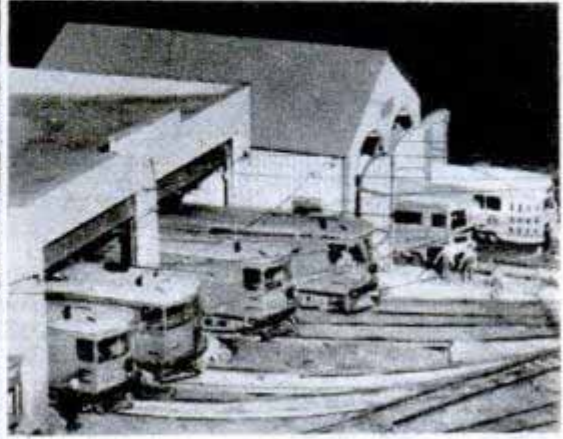

Model trolleys and interurban cars roll along 250 feet of miniature track in the basement of the Richard Wagner residence in Cincinnati, Ohio. Mr. Wagner chose to build trolleys instead of trains because they could negotiate the sharp curves of his limited layout which includes freight cars and depots, power lines and yard workers. Movies of his Rocky River Traction Com-

pany are so realistic they often mislead strangers into believing they are watching real trolleys. The 250-foot track that winds through the basement represents two scale miles of a trolley system. The trolleys roll through tunnels and across drawbridges, coming to rest in a model car barn. All the trolley cars are on separate tracks but move in unison when Wagner throws the switch.

Temperature Within Electronic Blanket Controls the Flow of Warmth

Desired temperatures are maintained to plus or minus one degree beneath a new electronic blanket. It is the first in which temperature is measured in the blanket itself rather than by a mechanical thermostat. A flexible wire consisting of two par-

allel conductors runs throughout the interior of the blanket and connects to a small bedside control unit, containing three electronic tubes, which regulates the flow of warmth. One conductor serves as a warming element and the other, known as a "feeler" wire, governs the degree of heat in the blanket. When the temperature goes above that dialed by the user, electronic impulses from the "feeler" wire cut off the current. If it drops below the preset figure, impulses start the flow of heat again. The blanket has an all-wool facing and is washable. As an added safety precaution all wiring is triple insulated and a special electronic tube in the control shuts off current under abnormal conditions.

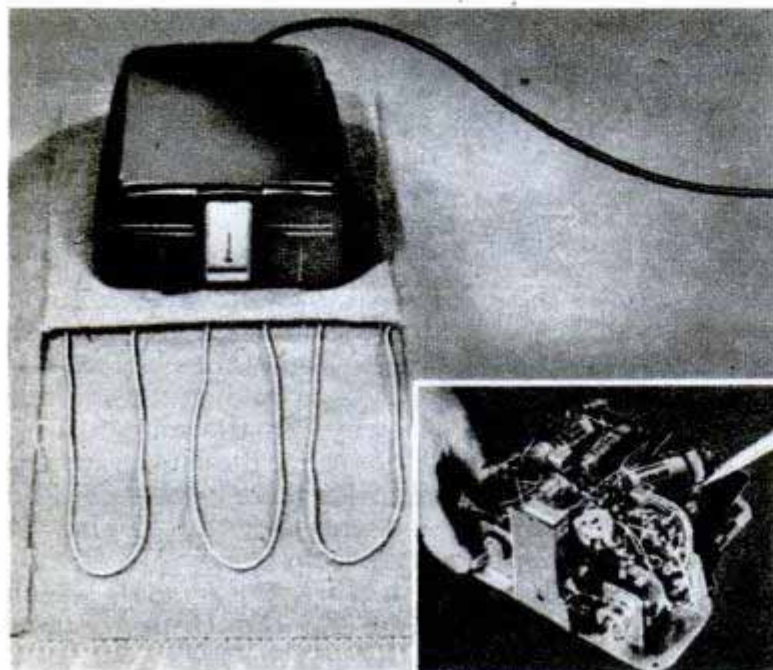

Popular Mechanics is always ready to supply further information to readers about various products described in any issue. Just write to Bureau of Information, Popular Mechanics, 200 E. Ontario St., Chicago 11, Ill., for a prompt reply.

Submarine Jeep

JEEPS protected by "submarine" kits now can plow through water approximately six feet deep, with the entire body and most of the windshield submerged. The depth of water they can negotiate is limited only by the height of the driver whose head sticks up above the surface. Developed for the Navy for amphibious operations, the seagoing jeep is equipped with 125 special parts, including waterproof ignition system and extensions to the exhaust pipe and "breather" pipe which protrude above the water surface. Drivers wear diving suits, minus the headpiece. The jeep is operated on four-wheel drive. Navy spokesmen say the water jeep, if available during the war, would have saved many lives in beach invasions. It also permits jeep-borne soldiers to ford rivers.

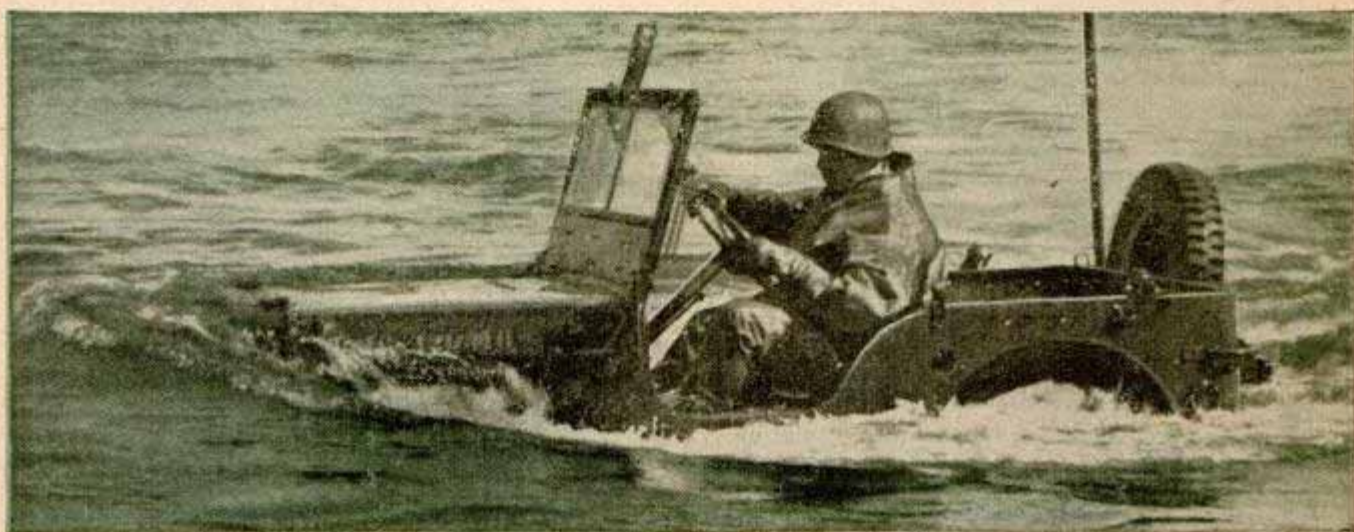

In the pictures at the top the amphibious jeep is shown splashing into water and settling down to the job of plowing into deeper water. At right, it purrs along with only the steering wheel, windshield, breather and exhaust pipes—and the driver from the waist up—extending above the water. The picture at bottom, right, gives a "back seat" view of the vehicle pushing through water. Waterproofing equipment for the engine (below) weighs approximately 117 pounds. The jeep can operate for 15 minutes in water more than a foot above the hood

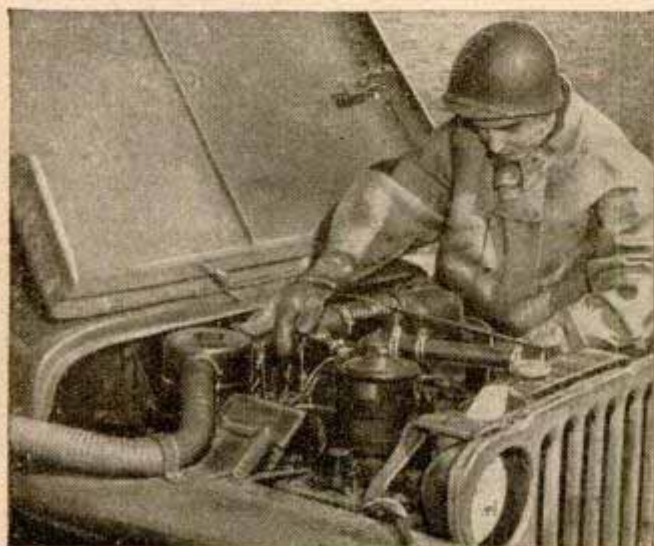



Midget Switchboard Handles Six Lines

Vest-pocket switchboards weighing only two pounds have been developed by the Army for use in the field. The unit replaces the standard six-line switchboard that weighed 60 pounds and was much more bulky. Seven transparent cubes in the switchboard are attached to incoming lines. Each cube has a two-prong plug on one side similar to an ordinary electric plug and slots on the opposite side into which the



prongs of a similar plug can be inserted when a call is switched between lines. A tiny neon light inside the cube signals the operator when one of his "customers" wants to place a call. The switchboard was developed by Kenneth Way, a civilian engineer employed by the Signal Corps.

Homemade Telescope With 14-Inch Lens Required 20 Years to Build

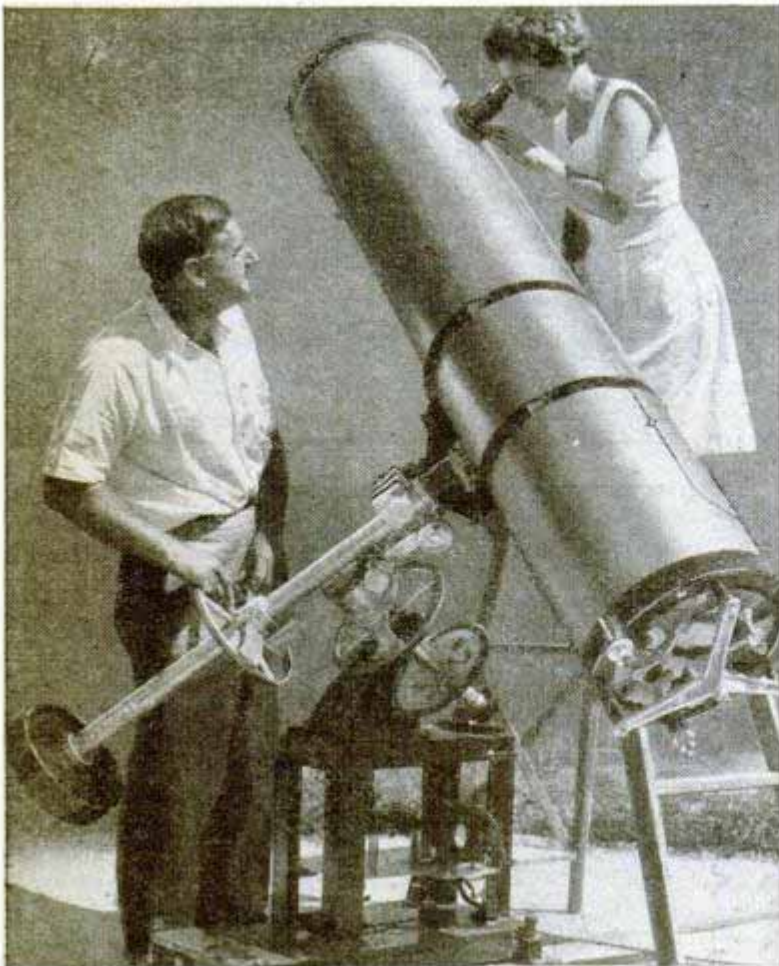

In 1926, John R. Cartlidge started to grind a telescope lens. Now finished, it is mounted in a 14-inch telescope set on a nine-ton rock and cement base embedded in his back yard in Cincinnati, Ohio. Mechanical engineer by day, amateur astronomer by night, Cartlidge has been watching the stars as long as he can remember. He ground the lens from a battleship porthole glass. In addition, he made all the parts of the telescope and assembled the mount and its 84-inch fixed barrel. The mount has a clock drive, which Cartlidge designed, to follow the path of a star under observation. It has an error of only 11 seconds per year and can follow a star or planet for five years without adjustment. Total cost of the 1500-pound instrument was \$600 plus, Cartlidge says, "about \$5000 worth of work."

☐ Setting a new American distance record for gliders, a two-place sailplane was flown 314 miles from Prescott, Arizona, to Governorador, New Mexico.



Silhouettes for Salons

By Paul Hadley

TRY simple silhouettes if you'd like to see your pictures win places in photographic salons. Although such scenes may appear difficult, even the beginner can shoot strikingly beautiful pictures of his subject silhouetted against a light background of landscape or sky. But first it is necessary to discard—with reservations—one of the oldest guides of conventional picture making: "Always keep the sun at your back." In making silhouettes you aim your camera toward the light source.

Many outstanding commercial photos and magazine illustrations are made this way and in almost all prize contests some of the winning prints are silhouettes with subject posed between sun and camera lens.

Any type of camera may be used, even the inexpensive box camera

Perfect silhouette results when sun is hidden behind large object such as Washington Monument

which gives splendid results when properly handled. Of course, with the silhouette picture as with any other kind of photograph, the better the camera, the better the picture, the writer preferring the type which has a ground glass focusing screen on which the picture can be composed and focused before the shutter is snapped.

Some of the pictures here shown were made with a view-type camera, while others were made with an ordinary folding hand camera and eye level view finder.

Outdoor silhouettes use the sky or water, or both, as a white or light colored background against which the main object of the picture stands out in sharp relief. To get this brilliant contrasty result, it is necessary to "shoot against the light," having the camera pointing toward the sun (with the lens shielded from the direct rays) and the subject of the picture be-

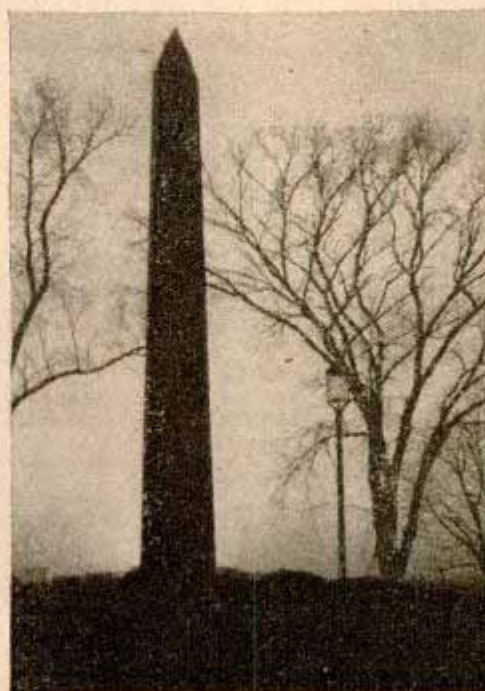



The arresting window pattern, above, and the light sky and water provide an excellent background frame for the figure. The arch and grillwork, below, make pleasing picture despite an uninteresting background



tween the camera and the sun. The best way to do this is to make the pictures either very early in the morning or very late in the afternoon, with the sun low in the sky, or even below the horizon. Excellent pictures can be taken just after the sun has set. If the sky is somewhat clouded, especially pictorial results can be attained. A file of cloud negatives, which every serious worker should have, provides an easy way to double print a clouded sunset sky in a picture where no clouds were present at the time of taking.

Most of the illustrations shown here were made at sunset. One shot, that of the statue of the Indian on his horse, was made on a cloudless day, and the clouded sky added from another negative. In all the other shots the sky is shown as it was at the time of taking. The "moonlight" picture of the children in the water was made at $\frac{1}{100}$ second at f:32 through a "G" filter, using superpan film. The sun was hidden behind clouds. This photo has won several prizes in contests. It was made with a view camera.

City sky lines and monuments lend themselves to the silhouette technique. With the sun behind a building, a short exposure may be given, thus insuring that all except the sky will be so much underexposed as to print out a solid black. Shooting from inside some building through a gate, a doorway or an arch, with a figure or two standing near the camera, will give a pleasing result. The background, though having detail, merely serves to accentuate the silhouetted figures and arch or gateway in the foreground. This type of



One picture results from two good negatives by double printing of silhouetted statue and cloud-filled sky

picture can be made at any time of day.

Shooting from the inside toward the outdoors may also be done by a window, if an attractively framed window is available. One example is shown here. In this case, sky and water beyond the window provided the light background which is necessary to all silhouette pictures. To obtain maximum contrast in making indoor shots, as much light as possible from other windows or doors must be kept from the figure by shutting doors or pulling down shades.

One print is shown that, while a true silhouette, was made by an artificial process. This is the picture of the boy running with his kite against a clouded sky. The sky itself is authentic, but the figure of the child and the kite are drawn in black ink on a print from a cloud negative. While unusual and pictorial results may be obtained in this manner, it requires some amount of artistic skill to achieve and, after all, is not true

On a print from a cloud negative the photographer inked in the figure of the boy and his kite to produce this silhouette

photography. For best effect, the finished photo-drawing is copied with a camera to produce a new negative from which the final print is made. In such copy work, one should use the commercial, or copy film, which is made especially for copy work and has much more contrast than ordinary film.

In developing silhouette pictures, it is necessary to produce negatives with much more contrast than is ordinarily desirable. Using a contrasty developer and then making the print on a contrast grade of paper will give best results.



Plastic Rule Doubles as Compass In Compact Four-Tool Kit

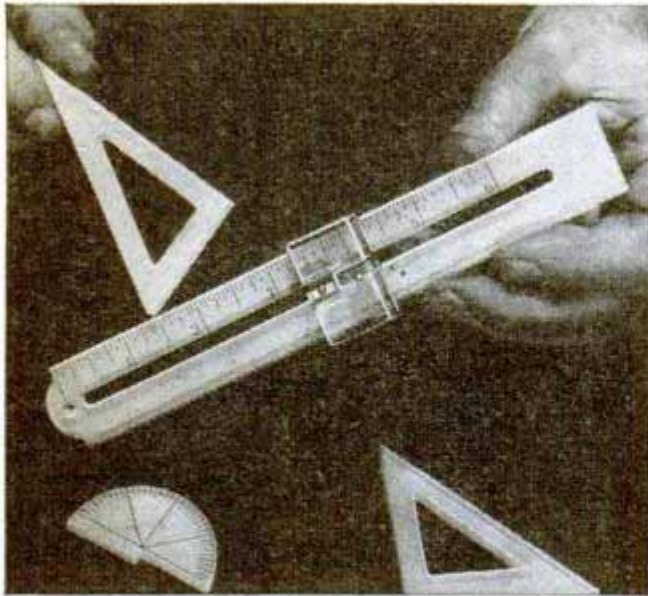

Two triangles and a protractor are included with a six-inch rule in an all-plastic kit for craftsmen. The rule also may be used as a compass, slide caliper or T-square. A pencil is inserted in the end loop of the rule for drawing circles. The radius is governed by an adjustable slide. The triangles are regular 45 and 60-degree pieces. They can be used in combination with the rule to form a T-square.

16-mm. "Vest Pocket" Camera Weighs Only Seven Ounces

Smaller than a package of cigarettes, a pocket camera is now available for fans who like to carry a camera wherever they go. The 16-mm. midget weighs only seven ounces, yet it is equipped with a precision-ground lens. The lens opening is controlled by an adjusting lever that has three positions, "bright," "dull" and "color." The shutter, also lever operated, has a fixed speed that will stop normal motion. The



camera's fixed focus gives sharp images from three feet to infinity, according to the manufacturer. Film is loaded by dropping it into a well in the camera. Pushing a plunger changes the frame and brings up the next number on an automatic frame counter. The finder is built into one side of the little camera.

Tool for Flaring Metal Tubing Fits Most Sizes of Pipe

Short pieces of tubing can be utilized for coupling when they are flared with a spreading tool which fits most sizes of pipe. Designed for the plumber, the tool simplifies sweat soldering and eliminates tedious coupling fitting. The swedging is accomplished by inserting the tool in the tubing and hammering the tool until the tube flares out over the shoulder of the proper diameter. It can be used on all lengths of tubing.

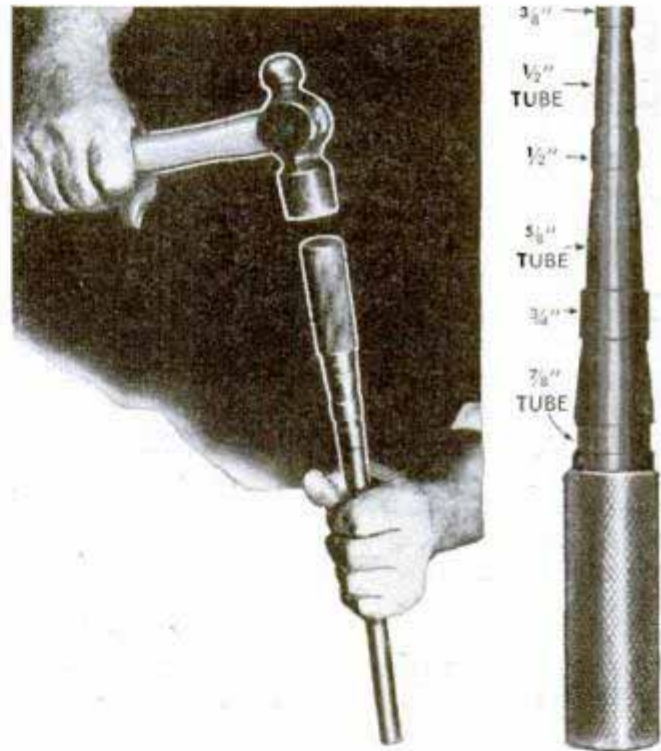

Glass Fibers vs. Goose Feathers

Pillows filled with Fiberglas instead of goose down offer relief to victims of feather allergy. Containing no allergenic protein, the lightweight fibers are moisture-resistant and fluff back into shape. In one test, a 16½-pound bowling ball was placed on a glass-filled pillow 50,000 times (for 20-second intervals) and inspection revealed that no glass fiber penetrated the pillow ticking.

Information, including manufacturers' names, concerning products described in this issue may be obtained by writing Bureau of Information, Popular Mechanics, 200 E. Ontario St., Chicago 11, Ill.

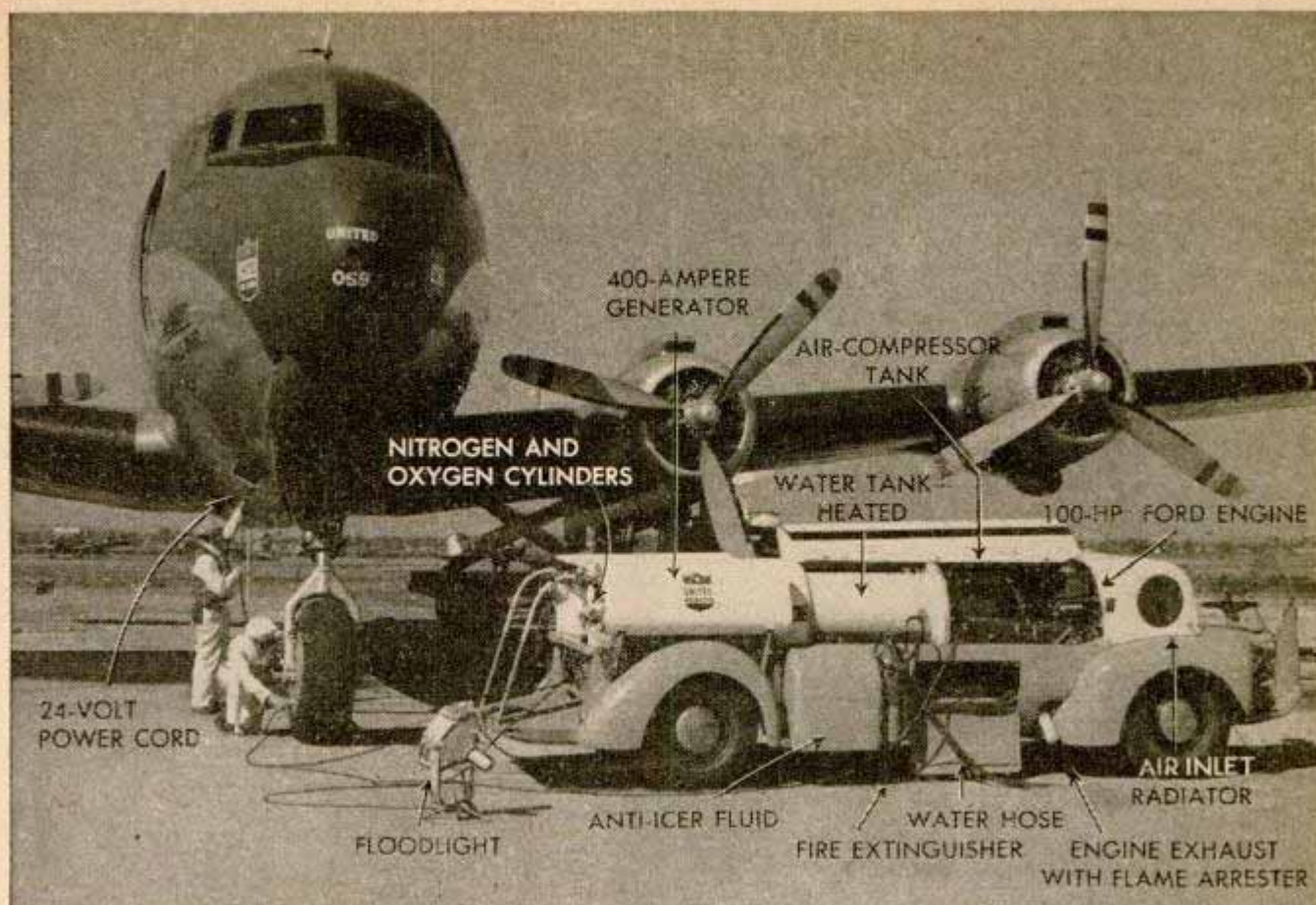

For speeding up the ground servicing of big transport planes, one air line has developed a superservice ramp maintenance truck for one-stop care of tires, landing gear, wash water tanks, propeller de-icing and hydraulic and oxygen systems. The unit incorporates a motor generator with a capacity of 400 amperes, a normal operating load, to 800 amperes for momentary peak loads required in starting engines. Other equipment includes a 20-gallon water tank and heater to supply hot water for lounge facilities aboard the planes; 50-gallon alco-

Superservice Ramp Truck

hol tank for servicing the propeller anti-icing system; 20 gallons of hydraulic fluid; a 100-cubic-foot cylinder of nitrogen to maintain pressure in the oleo struts in the landing gear; oxygen tank; two 12-volt floodlights with extension cables; fire extinguishers and aircraft towing equipment. The truck, operated by two men, is built so low to the ground that it can be driven underneath four-engine planes. It is powered by a Ford V-8 engine. The body is of lightweight metal and the front and rear halves can be separated for shipment or overhaul.

Versatile Movie Amplifier Talks to Crowd or Takes Sound Off Film

Dual roles are filled by a versatile movie projector amplifier which provides sound for the showing of 16-mm. film and also can be used with a microphone for a public address system. When used as a sound ampli-

fier for such activities as physical education demonstrations or speeches at civic gatherings in large parks, the unit makes use of its 15-watt power output to carry the speaker's voice to every listener.



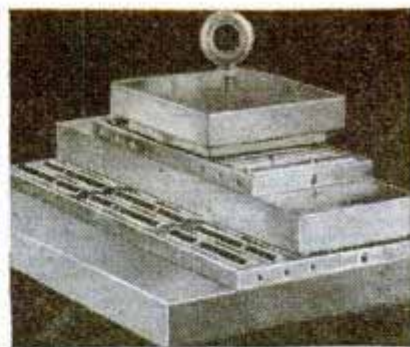
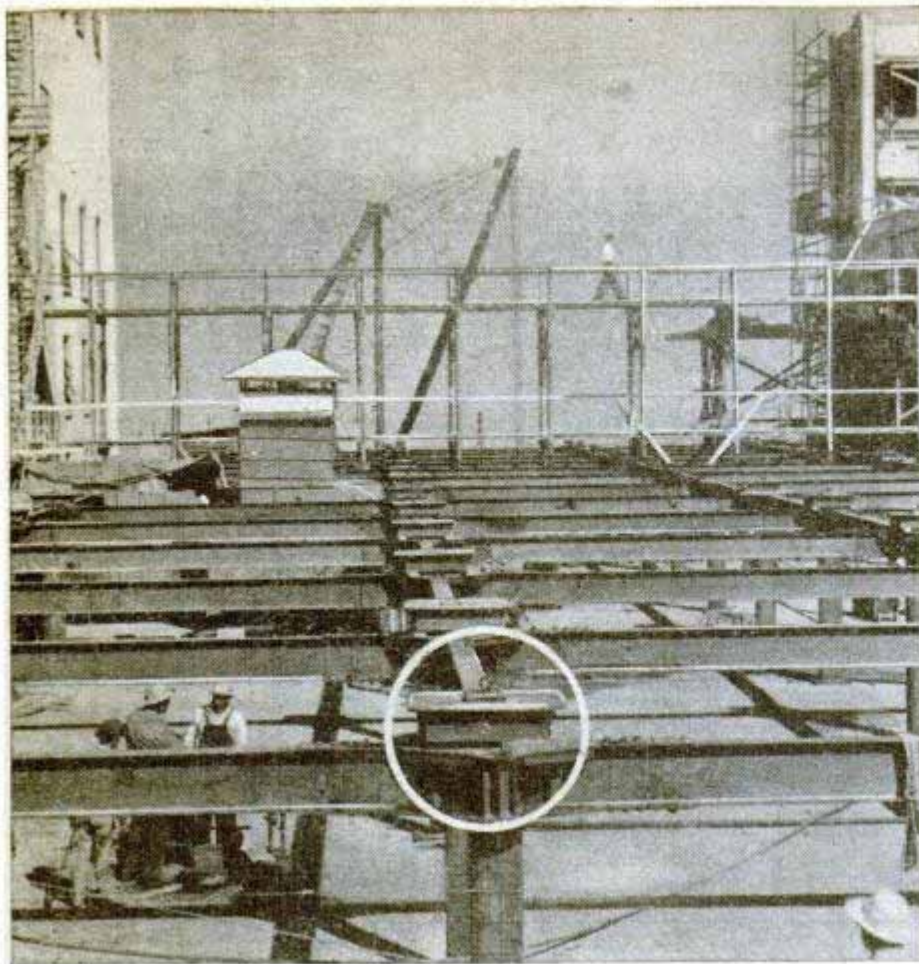

pensive, so engineers decided to "float" the additional floors on rollers placed under the girders and cross members. The structure rests on 65 roller bearing units, each designed to support 240,000 pounds. Each unit weighs 600 pounds and consists of three steel plates and two layers of rollers. The rollers between the bottom and center plate roll in a north-south direction, while those above move east-west. In the event of an earthquake the building can move six inches in any direction, sliding on both sets of rollers if the shock moves diagonally. Each of the roller units is hermetically sealed so no foreign matter can enter the bearing, and is lubricated with a nondeteriorating type of oil.

Earthquakeproof Building "Floats" on Rollers

Three top floors of a Los Angeles building will resist earthquake tremors by rolling six inches in any direction. This three-story addition now being built atop a six-story department store is the only structure in the world to rest on roller bearings. The store was built in 1929 before the earthquake code was enacted. Conventional earthquake-proof construction for the addition would have been too ex-

Filing Attachment Clamps on Lathe

Wood or metal lathes are converted into filing machines by a simple attachment that is small enough to be kept in a workbench drawer. A tapered arbor is slipped into the tailstock and the shaft of the attachment is clamped into a three-jaw chuck or collet. A block pivoted off center to the arbor fits into a slot on the reciprocating member to move the file up and down. The attachment has a circular table for bracing the work. It will file most materials, including metal, wood, hard rubber and plastics.

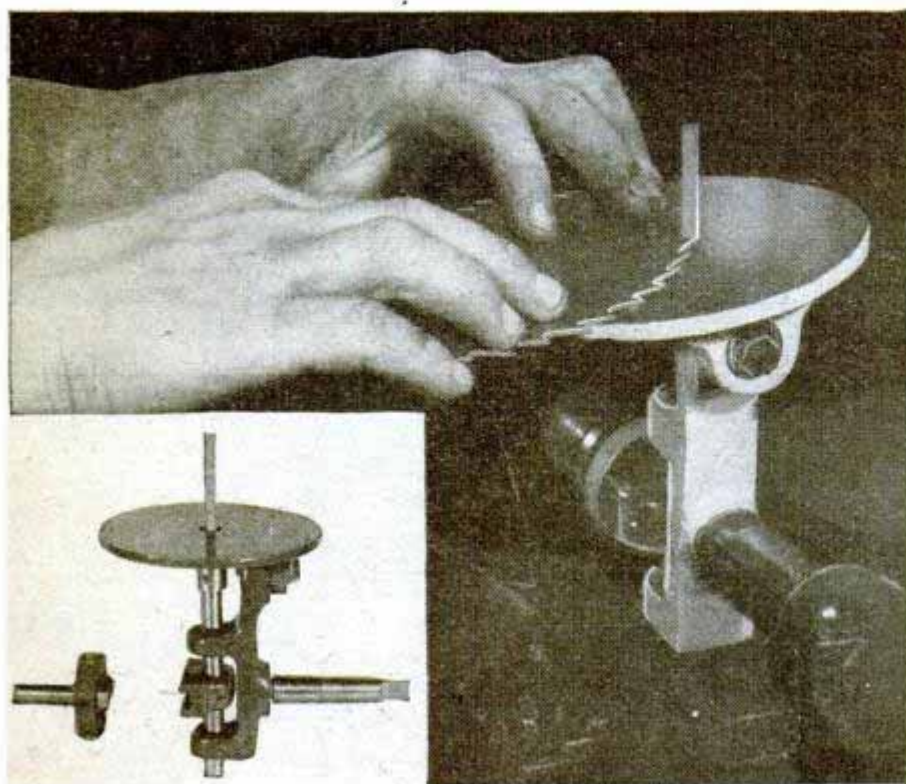

The CRAFTSMAN

We're not trying to "get you up in the air" but that's the only way to trim those "shaggy" trees. If pruning is unfamiliar, there's an article on page 225 that tells how to do it and keep your trees healthy and good-looking. In the meantime there is another type of cutting: chip carving. With two knives you can produce intricate designs that will equal the work of the old masters. Drawing and cutting the patterns are relatively simple. See page 201 for an explanation of this unusual art. The world of little things that are visible only through a microscope is a fascinating field for study. And with the experimental incubator described on page 217 the biology student will be able to cultivate many kinds of specimens. You don't have to wait any longer—this is it: the super de luxe color slide projector that features five-second sequence, push-button control, injector cooling, instant changeover, a snap-on holder and electric shutter. Instructions for building this unusual projector are on page 206

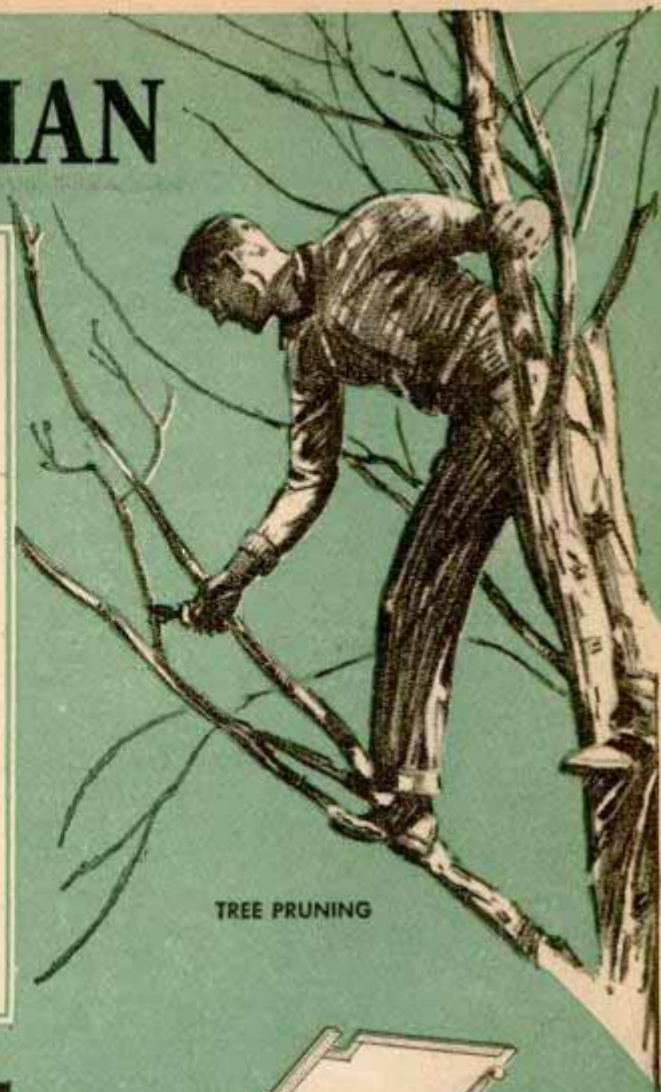

TREE PRUNING



CHIP CARVING

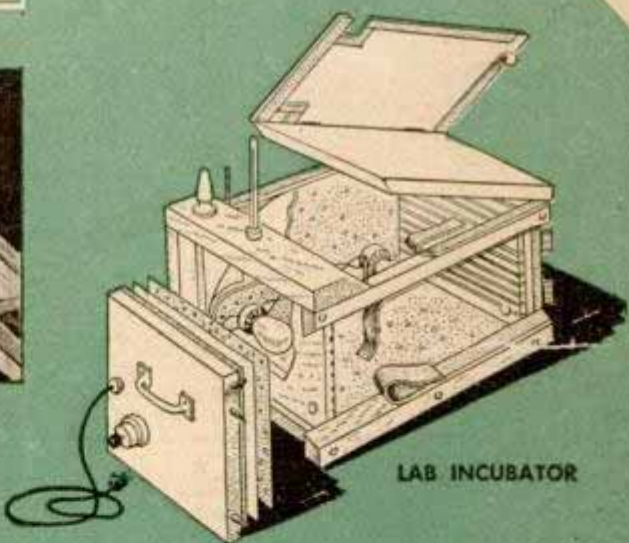

LAB INCUBATOR

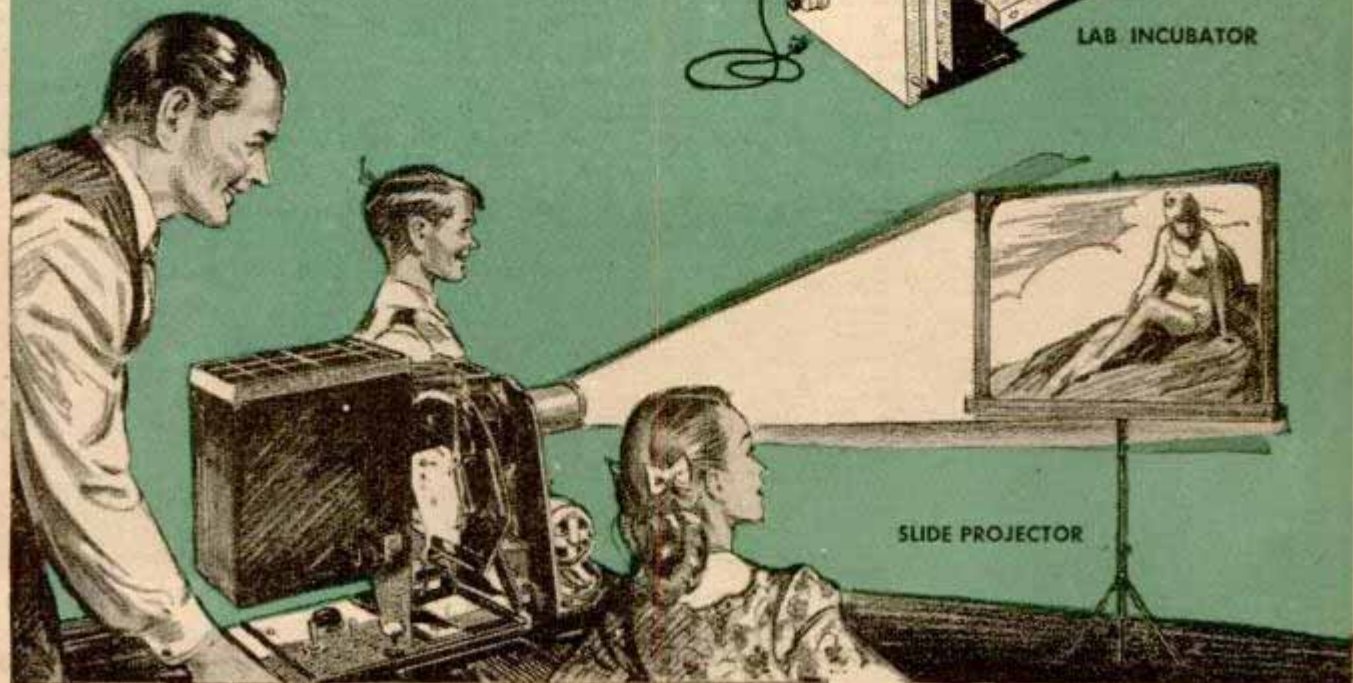

SLIDE PROJECTOR

REMODEL YOUR BED

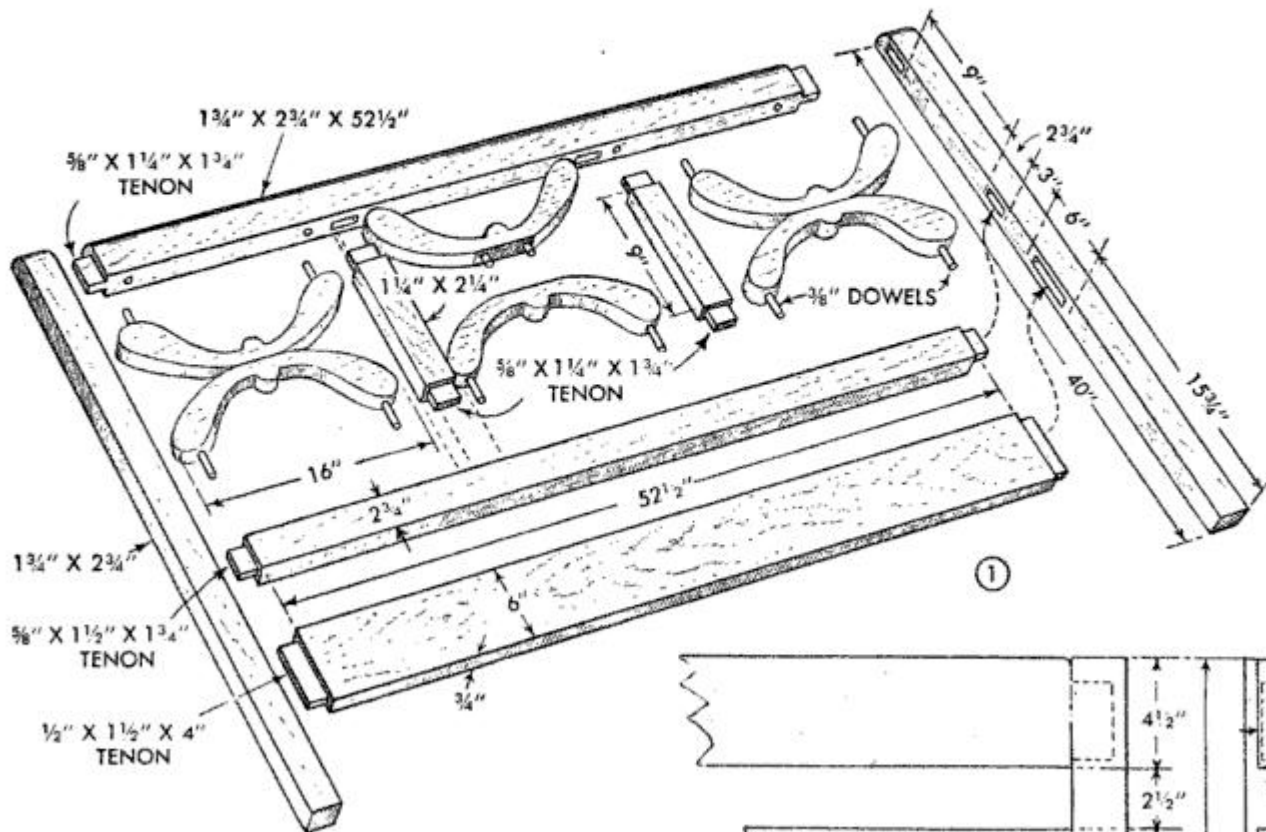

①

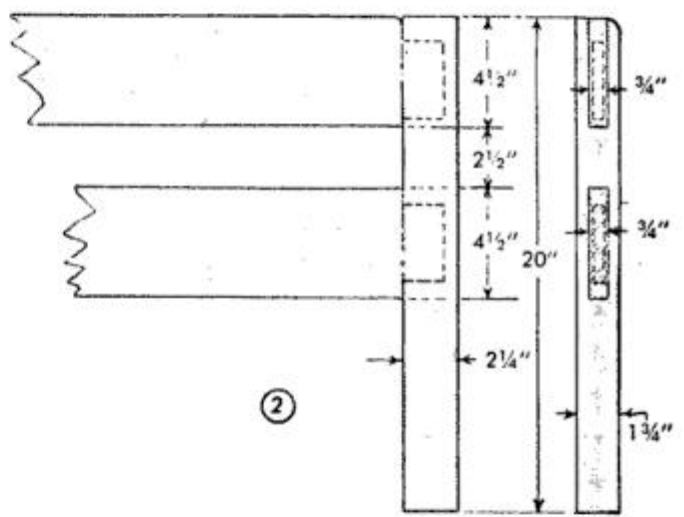

②

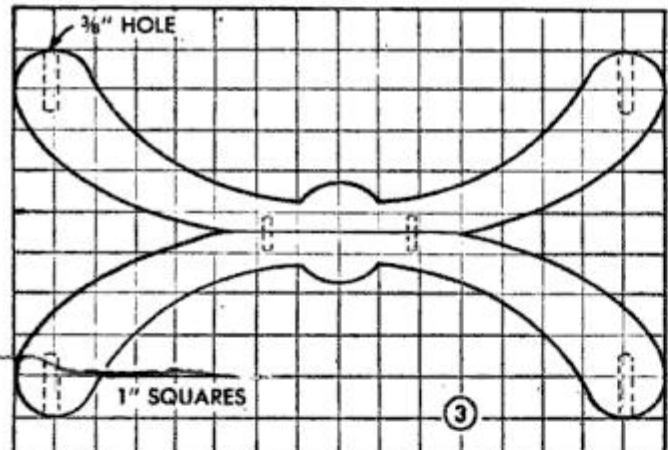

③

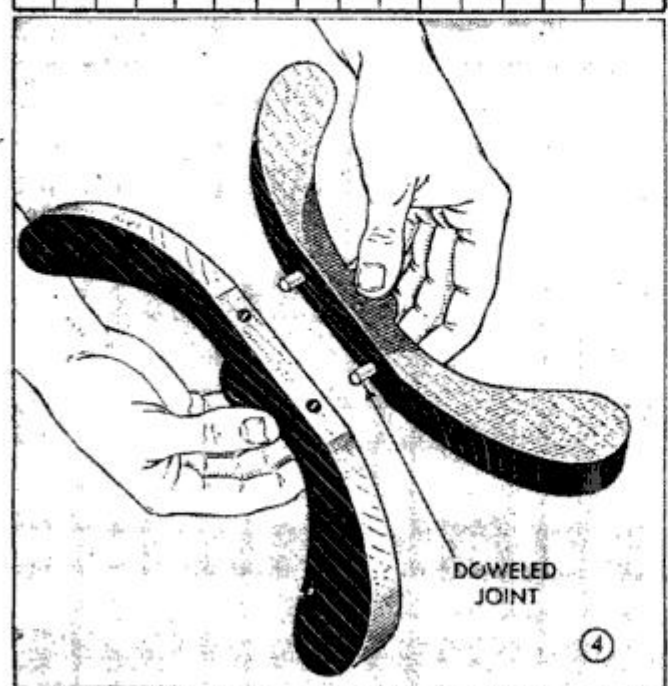

④

By Benjamin Nielsen

HERE you have the choice of remodeling an old bed, using the original side rails and other material if suitable, or starting from scratch and making an entirely new bed. The illustrations show the result of a remodeling job using original side rails and making the head and foot pieces from new material. Walnut was used for all parts, although any suitable cabinet wood such as oak, maple, birch or mahogany will do. The posts are made 1 3/4 in. thick, 2 3/4 in. wide and 40 in. long for the head, and 20 in. long for the foot piece. These are common proportionate heights. For the head, three stretchers are needed, two measuring 1 3/4 in. thick and 2 3/4 in. wide, the other 3/4 in. thick and 6 in. wide. Length will depend on the bed size—whether single or double. The width of this one is standard for a double bed. When slotting the posts for the side rails, be sure the centers are the correct distance apart



so the spring and mattress will fit. The uprights between the decorative sections are cut $1\frac{1}{4}$ in. thick by $2\frac{1}{4}$ in. wide. These are mortised into the stretchers as in Fig. 1. The three decorative sections are cut from stock a full 1 in. thick to the pattern given in Fig. 3 and, as you can see from the shape of these parts, it is necessary to do a thorough job of finishing before assembly. The two parts of each ornament are doweled and glued together as in Fig. 4. Be careful to wipe off all the excess glue before it dries. Join the parts of the head and foot pieces with mortise-and-tenon joints as shown in Figs. 1 and 2. Ornamental parts in the headpiece must be fitted into the assembly at the same time. Use glue in all joints and clamp until dry. Rounding off the top and front edge of the top stretcher is best done after the assembly is completed, as the square edges make the clamping operations easier and there is always the possibility of having to remove marks or scratches made by the clamp jaws.

The foot piece consists of two posts and two stretchers which are $\frac{3}{4}$ in. thick and $4\frac{1}{2}$ in. wide. Study of the drawings will show how these are mortised together.

Careful sanding of all the straight parts comes next. Good wood deserves a top-notch finish. Many craftsmen prefer the soft quality of a waxed surface to the hard gloss of a rubbed-varnish finish. If you have used an open-grain wood such as oak or walnut, then a filler is necessary. First stain the wood to the desired color, then add the same stain to the filler and apply the latter with a coarse cloth. Rub across the grain and then allow plenty of time to dry. Sand the surfaces lightly once again. Then follow with a sealer. When this is dry, rub smooth with fine steel wool. This simple treatment leaves an excellent base for a first-class wax finish.

Attaching the side-rail hooks or irons completes the job. If the available side rails have the type of hooks which fit into slots in the posts, this slotting and insertion of pins should be done before the parts are assembled. If it is necessary to make the side rails, use the length and cross-sectional size of a standard wood bed rail. No casters are used, the ends of the posts being rounded, smoothed and waxed. However, if casters are desired, the posts should be made approximately $1\frac{1}{2}$ in. shorter.

Folding Step in Clothes Closet Provides Access to High Shelf

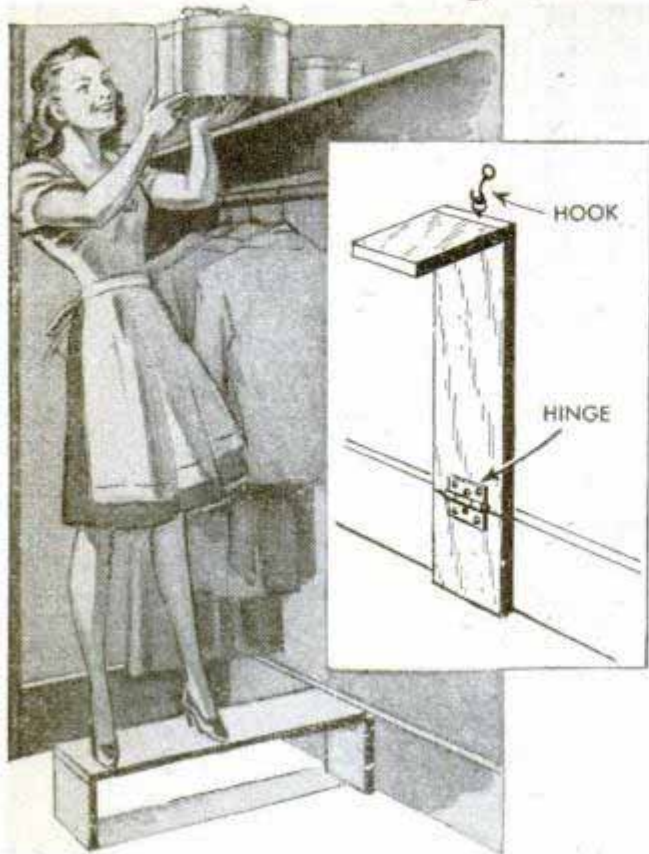

When a closet shelf is so high that a stool or chair is required to reach it, this step will be a great convenience. One end is nailed or screwed to the wall and is hinged so that it can be folded against the wall and held with a hook when not in use.

Ronald Eyrich, Milwaukee, Wis.

Shot Used as Scale Weights

BB shot can be used as weights for your scale. Each new pellet weighs alike for all practical purposes, as they are made to close tolerances in the manufacturing process. You can learn the weight of one or more by checking on a druggist's scale. It is then an easy matter to calculate the number you will need for any given weight.

Herman Klein, Pittsburgh, Pa.

Hiker's Handy Water Canteen

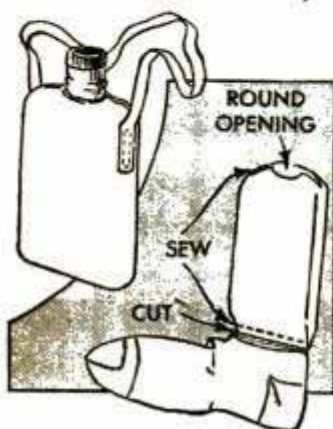

Made from a flat bottle with a plastic top, this canteen will carry water to quench your thirst on those long hikes. The cover is a heavy woolen sock that is cut off at the ankle and slipped over the bottle. Sew the

sock together at the bottom and the top, leaving the neck of the bottle projecting. Add a shoulder strap and the canteen is complete. If the cover is kept moist, the water in the bottle will be cooler because of evaporative cooling.

Holder for Thread and Needle

If you have an empty glass dental-floss container, it will serve as a holder for thread and needles and take little space in your purse. Thread is wound on a short length of drinking straw, and it and the needles then are slipped into the container. One end of the thread projects through the hole in the lid which functions as a thread cutter.

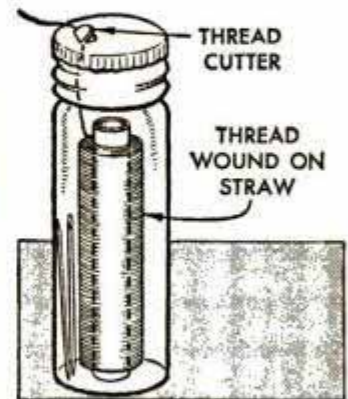

Frank Shore, New York.

Egg Beater Mixes Enamel In Small Cans Quickly

Instead of throwing away an old egg beater, cut it down so you can mix small cans of paint and enamel quickly and thoroughly. As indicated, the revolving vanes are cut down and the center rod is left a little longer to keep the vanes off the bottom of the can. A piece of wire wound around the vane stems will hold them.

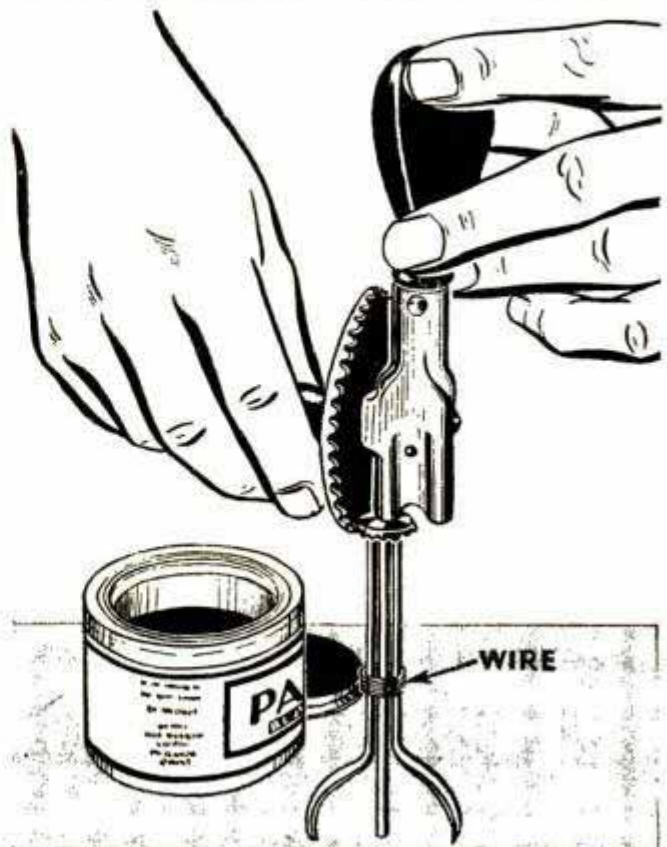



TOY WALKIE-TALKIE



Every child is familiar with the walkie-talkie developed during the war, and possession of a toy one will do much to keep him amused when the weather is bad outdoors. Odds and ends of scrap lumber can be used to make the toy. Overall dimensions given on the drawing will make an instrument of just about the right size for the average child. The box is assembled with countersunk screws and it is provided with a hinged access door. By way of ornamentation, call letters or numbers are nailed to the sides of the box and two drawer pulls are fastened on to provide carrying handles. If desired, a cord may be

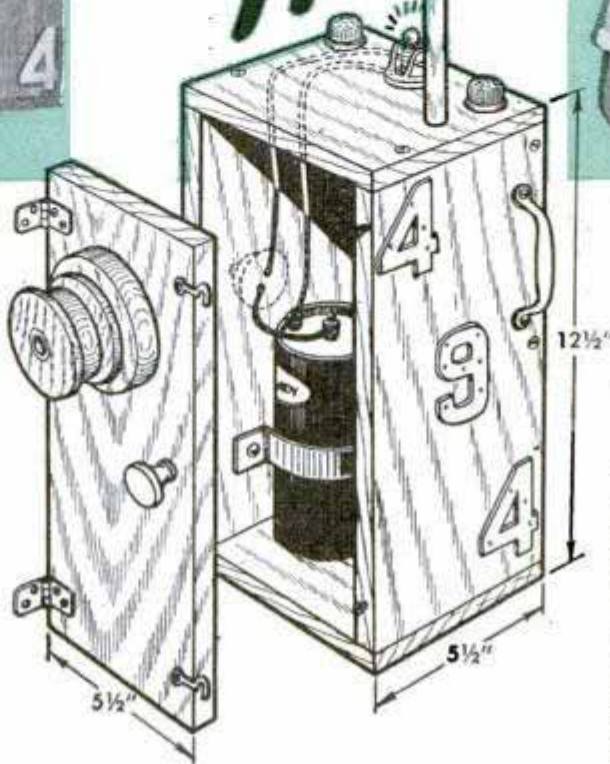

tied to the handles to serve as a shoulder strap. A fishing-line spool and several disks are the mouth-piece. On top are the dowel antenna, two radio knobs to make the walkie-talkie look real, and the blinker light and socket. The bulb should be of the same voltage as the dry cell. A doorbell push button on the side operates the light which is used to flash signals.

Harold Gluck, Bronx, N. Y.

Plywood Guard for Bike Sprocket Protects Leg of Trousers

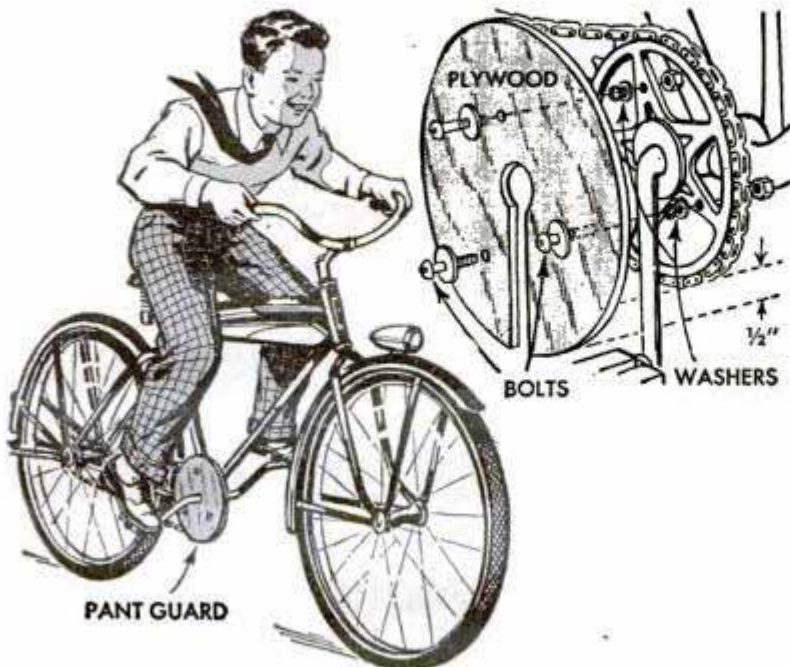

Here's an easily made guard that will prevent your pants leg from being caught between the chain and sprocket of your bicycle. Saw a circular piece of plywood about 1 in. larger in diameter than the sprocket so there will be an overlap of $\frac{1}{2}$ in. and cut a slot for it to slip over the crank. The pants guard is held in place with bolts and washers. Finish the wood the same color as your bike.—G. K. Ursenbach, Toronto, Ont., Can.

Pastry dough can be rolled easily by placing a sheet of waxed paper on the board and another piece on top of the dough. When rolling, additional flour is not required as the pastry will not stick and the board remains clean.

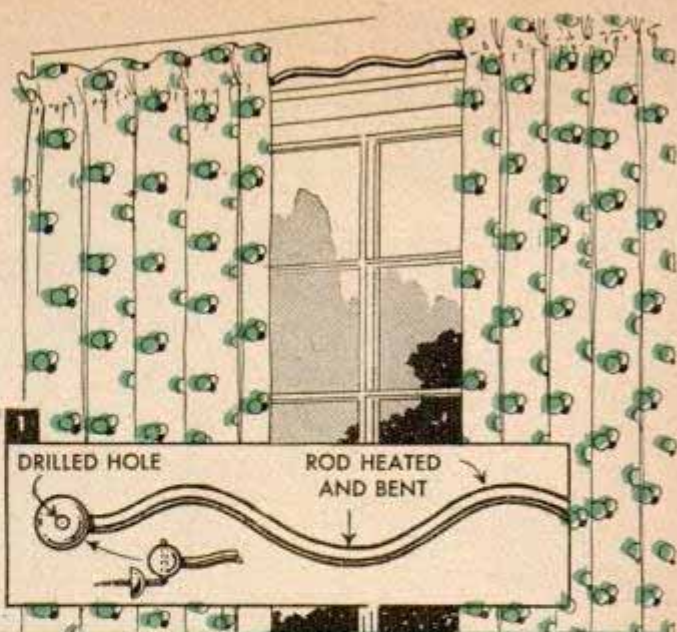

Solving HOME

1 You can hang curtains in uniform, well-spaced folds without adjusting them by using rods that are made of plastic. Select a piece that is longer than the finished article as bending may shorten it considerably. After the rod has been heated and bent, attach drilled knobs to the ends of the rod and slip in place over screw hooks

2 An old discarded alarm clock will serve to indicate when it's baby's feeding time, or for that matter can be used as any kind of time reminder, such as when it's necessary to take medicine. Merely set the hands of the clock ahead for the hour when the infant is to be fed or the time when medicine is to be taken

3 Some glove materials will shrink or change shape when being dried if they are washed in the usual manner with soap and water. However, if the gloves are of the right size, this shrinking can be prevented by inserting ordinary clothespins in the fingers. After the gloves are dried thoroughly, then the pins can be removed

4 When making frozen desserts, a small red paper flag attached to a toothpick and fastened to the cold-control knob of your refrigerator will serve as a reminder to turn the control back to its normal position when the dessert is removed. Otherwise more current than is necessary will be consumed

5 Lacking a stand to hold the top part of a glass coffee maker, one housewife used a quart fruit jar as a substitute holder. After the coffee has been brewed and is ready to be poured, the top half of the coffee maker that contains used grounds is set on the jar. This keeps drainings from soiling the top of the table or stove





6



7

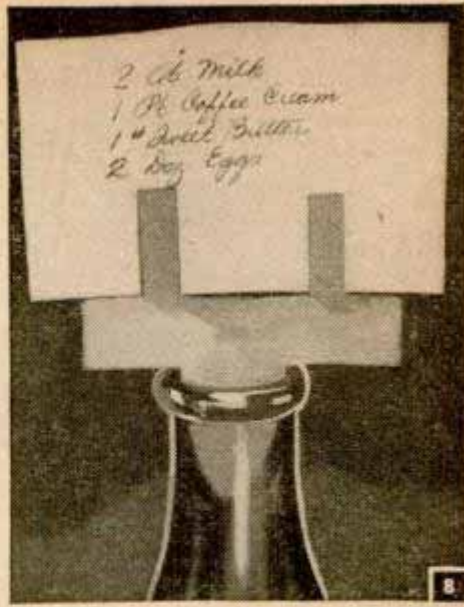

8

PROBLEMS

6

Moistening the gummed surfaces of envelopes and stamps is not an unpleasant task with this liquid applicator. The reservoir is a small test tube, which can be obtained at a drugstore. The end of the tube is stoppered with sponge rubber. To use, fill the tube and press the sponge against the stamp or envelope

7

To avoid having to unscrew the cap from a bottle of furniture polish each time it is used, punch a hole in the center of the top with an ice pick. Then the polish can be shaken onto the polishing or dustcloth easily. Although not necessary if the bottle is stored upright, the hole may be plugged with a match

8

Instead of losing notices to the milkman because they blow away or become illegible when water-soaked, use this handy note holder. It is made of waterproof cardboard with one end cut to fit snugly into the mouth of the bottle, and the section extending outside is slotted to hold the note or the ticket



9

9

One way to guard against taking the wrong bottle from the medicine chest in the dark is to insert pins in the cork. Poisons can be identified this way so that anyone taking such a bottle would know it was poison when he attempted to remove the cork. Even if the pins were trimmed somewhat so they projected only a slight distance, the warning would be ample

10

It's easy to find a screw of the right size if you keep them in rolls of transparent tape. Take the box of miscellaneous screws on hand and separate them into lots of similar size. Lay each lot in a row on a strip of cellulose tape with the tacky side up and then make a roll of them. When you want any particular kind of screw, you can take it from the roll



10

It's Easy to Reach Your Clothes With Sliding Hanger Pole

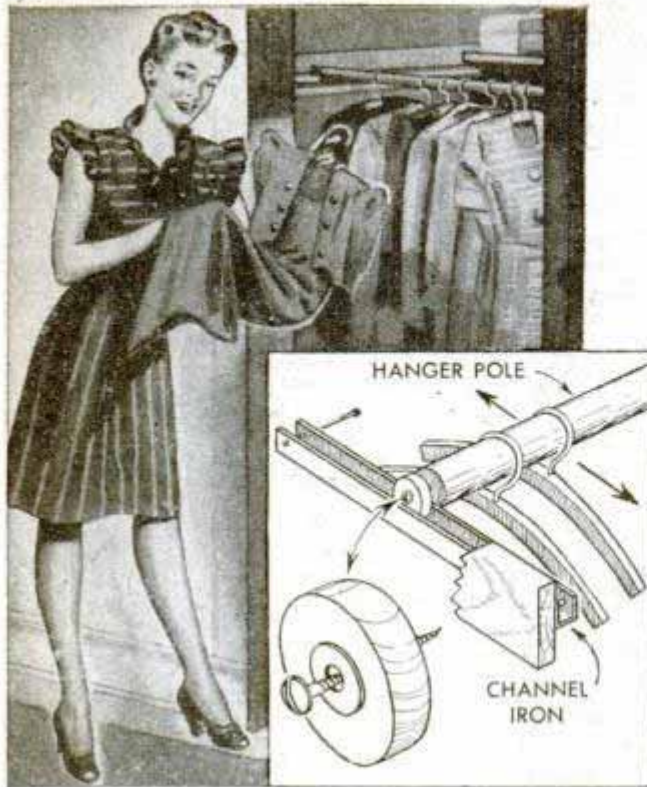

Instead of digging at the back of your closet to get clothing on a hanger, make this sliding pole that will enable you to pull the entire rack forward. A length of channel iron is fastened to each side of the closet and rollers screwed to the ends of the pole ride in the channels.

Novel Decorations for Aquarium Will Attract Attention

Here are two novel items that will draw attention to your aquarium. They are made of table-tennis balls. The prongs on the mine are simulated by cementing tubular rivets with china cement, taking care to space them equally over the surface of the ball. Paint one half of the mine black

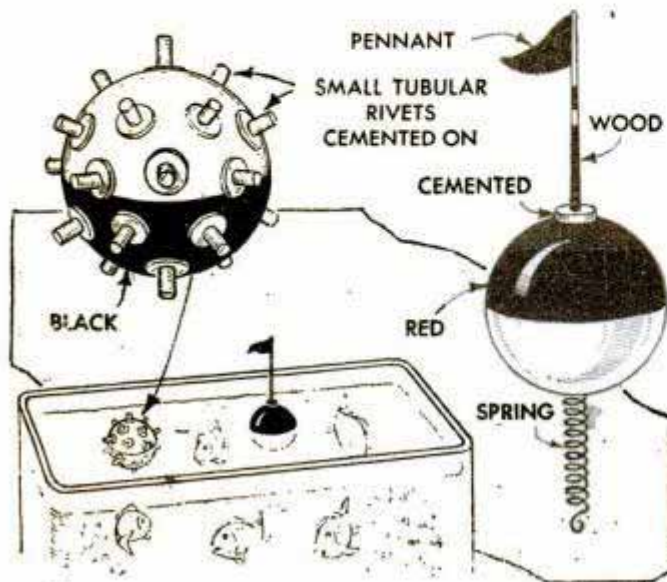

for a better effect. The buoy is made by painting one half of the ball red and cementing a small pennant on a pole to the center of this half. To keep the flag erect, a spring or other weight is fastened to the bottom to act as a counterbalance.

Emergency Handle on Suitcase

If you've broken the handle on your suitcase, here's an emergency repair that is sturdy and long-wearing. Cut a section of an auto tire, making it about $\frac{3}{4}$ in. wide. Wrap it with rubber insulating tape to make a smooth grip. Then spread it so that it has the proper shape and fasten to the suitcase with U-bolts. Large washers should be used on the bolts so the nuts will not pull through the case when it is heavily packed.

M. C. Fredrickson, Davenport, Iowa.

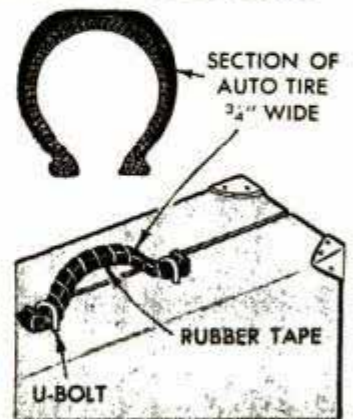

Reinforcing Broken Pipe Shank

When a smoker's pipe splits at the point where the stem or bit joins the shank, it's possible to reinforce the break with a ferrule made from the base of a single-contact automobile light bulb. The glass is broken and the base is set on a solid surface with the contact point up. A slight blow on the contact point will loosen it for removal; after this the remainder of the filament and insulating compound is scraped out. Then the ferrule is slipped over the shank and driven home. It may be necessary to dress the shank to obtain a fit.

J. A. Thompson, Harrison, Ark.

Paper Roll in Glove Compartment Is Handy Memo Pad

Salesmen and those who travel will find that a roll of adding machine tape is a handy thing to have in a glove compartment. The roll is held in place on a bolt and fastened with a wing nut to the side of the compartment. A metal channel that is soldered to the back of the lid serves to guide and hold the strip of paper flat.

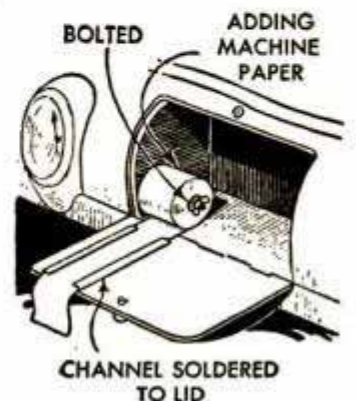

L.L.L.S.

STAGE YOUR OWN SHOW

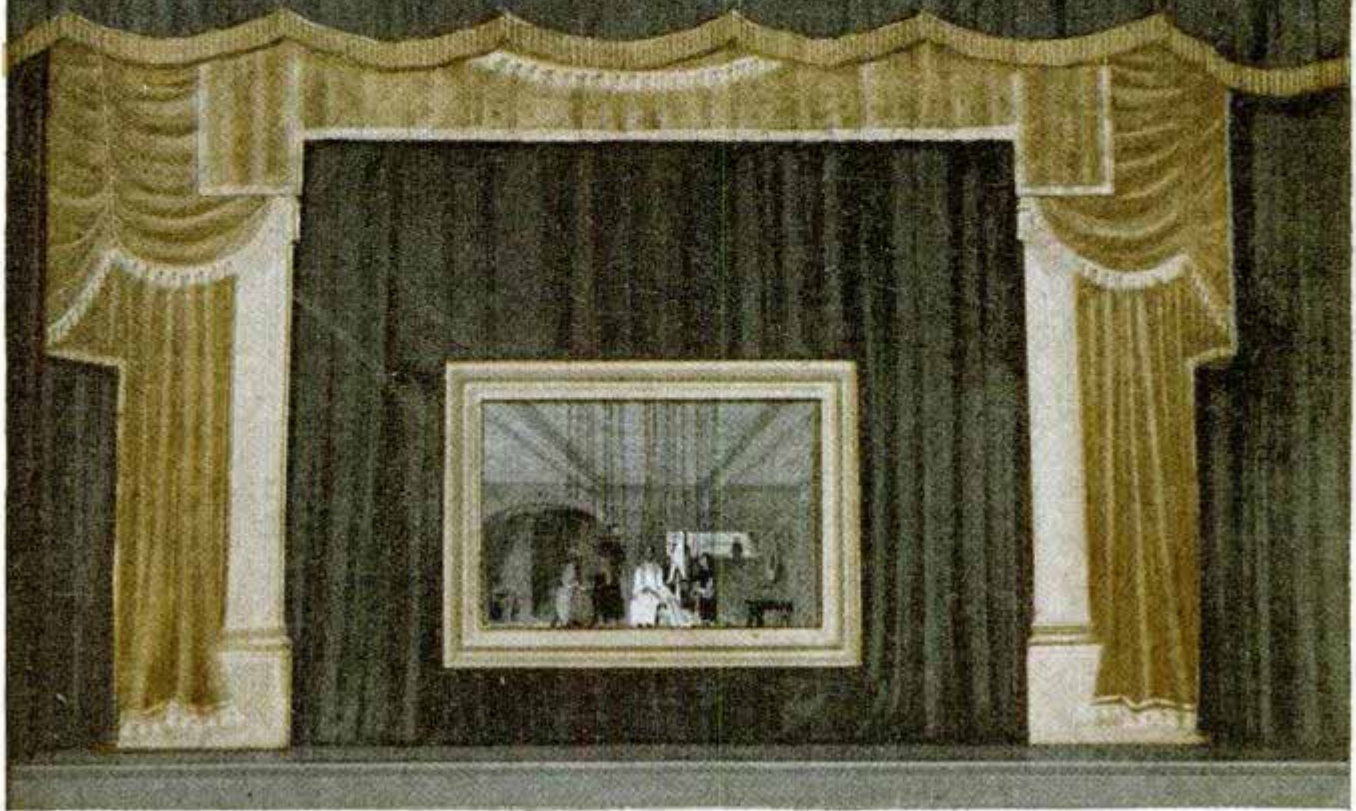

MARIONETTE stages designed for amateurs will give more satisfaction if the stage and accessories are modeled after those of the professional. This stage, which was designed for Martin and Olga Stevens of the Stevens Marionette Team, is compact and portable, and is equipped to handle complete dramatic productions. The area about the proscenium is masked with a grand drape, with an overhead drape and traveler drapes at each side, the whole arrangement being similar to valance and side drapes of a window. There also is a short drape underneath, and the drape support has a track for stage curtains. Then there is the stage for the marionettes, and back of it the puppeteer's bar, which also supports the backdrop or background. The bridge, with ladders at each end, is somewhat higher and has guard rails on three sides. The marionettes are controlled by operators standing on the bridge. Figs. 19, 20, 22 and 23 show how the stage and bridge are set up from a single folding unit.

Bridge. The top of 1/2-in. plywood and the 3/4-in. wood rails or stiffeners, to which the top is screwed, form a packing case for other members of the bridge and stage when the unit is folded. End supports, Fig. 21, are merely braced frames, each hinged

PART II SETTING UP THE STAGE By Kenneth Murray

at the top with 3/8-in. tie rods which pass through the sides of the bridge, the ends of the rods being peened over. Braces are on the inside to allow the supports to fold into the bridge. A ladder is hinged to the top cross member of each end support, a piece of 1/2-in. plywood separating two sets of hinges on each, this arrangement permitting the ladders to fold inside. A 13-in. length of chain secures the center step of the ladder to the middle of the support cross brace. The center support is somewhat narrower and is attached with piano hinges. Flat-iron braces hold the supports in position while the bridge is in use. Lower ends of the braces are attached with bolts and wing nuts on the inside, while bolts securing the upper ends to the bridge are peened over.

The stage. Fig. 24 details construction. Most of the parts in Fig. 21 are shown by dotted lines in Fig. 24. Stage top is of 1/2-in. plywood 24 in. wide and in three sections so that the end sections can fold back on the center. Piano hinges are used for the top sections and two of the 1/2-in. plywood supports. These two are hinged to supports for the bridge. The center support is somewhat shorter so that it will fold inside. A piece of plywood to make up the difference in height is hinged to the underside of the



19

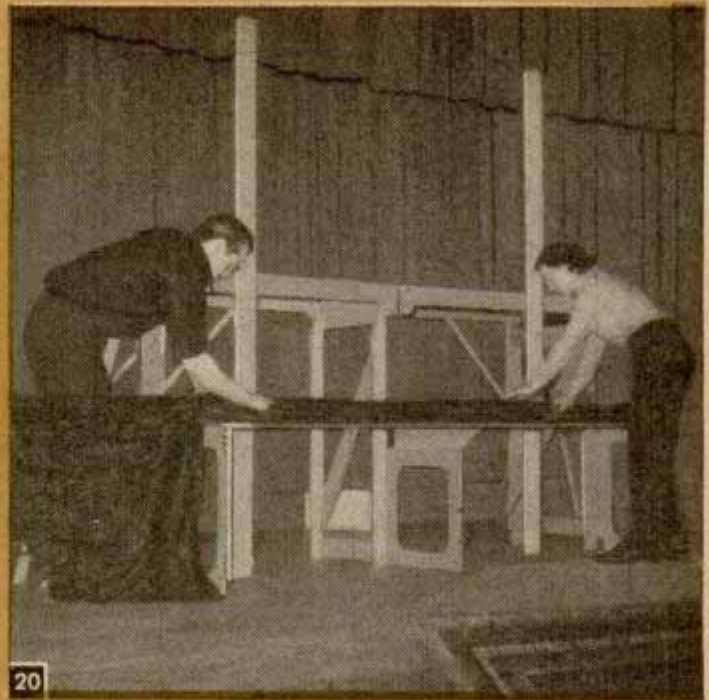

20

Here's the bridge being unfolded. Unfolding begins with the "package" upside down. Notice that the puppet stage is attached to one support, or leg, of the bridge for folding

Bridge unfolded and right side up with the stage in place and the grand drape going up. Note extra piece of plywood attached to support under the center of the stage

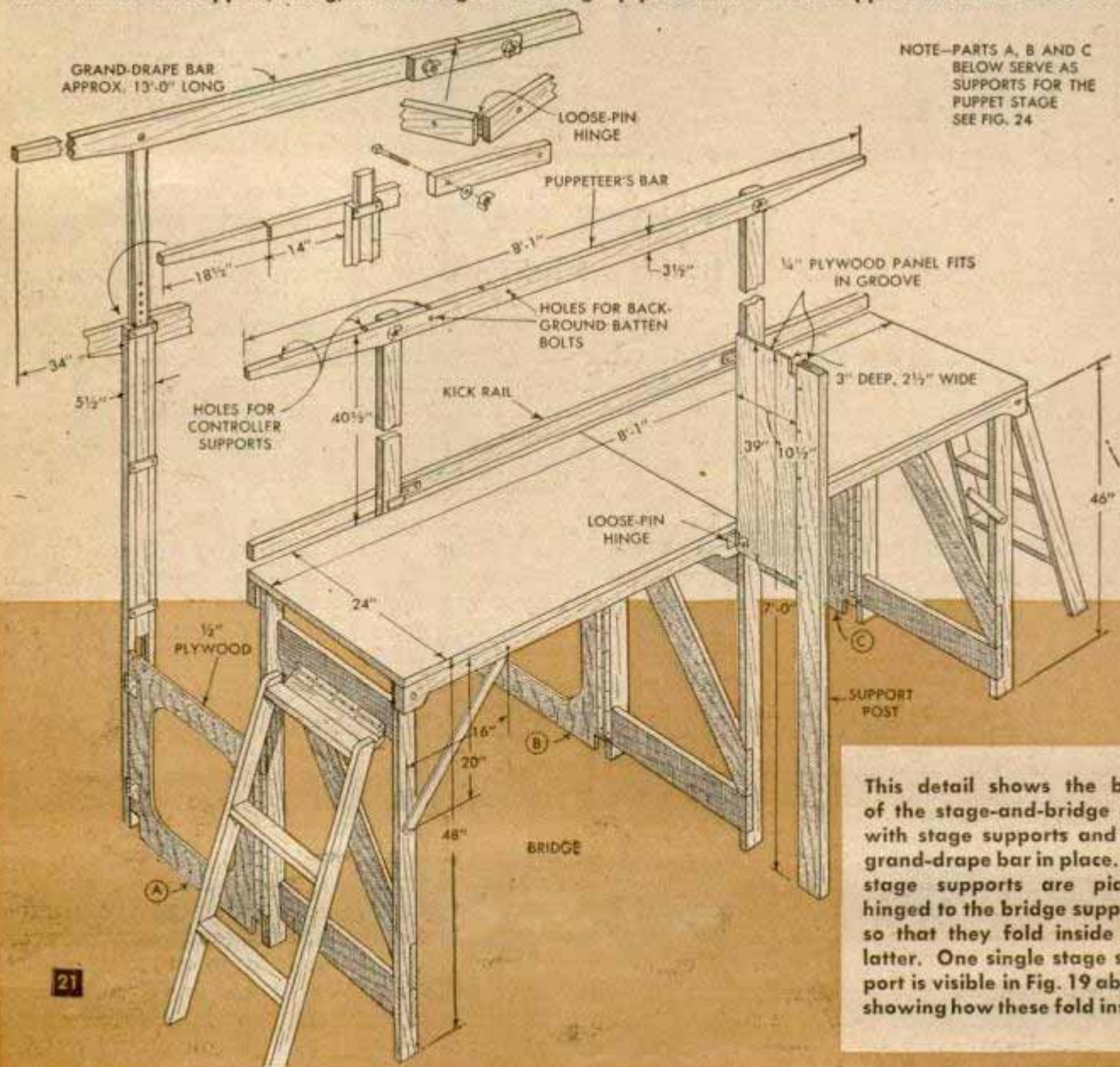

21

This detail shows the back of the stage-and-bridge unit with stage supports and the grand-drape bar in place. The stage supports are piano-hinged to the bridge supports so that they fold inside the latter. One single stage support is visible in Fig. 19 above showing how these fold inside

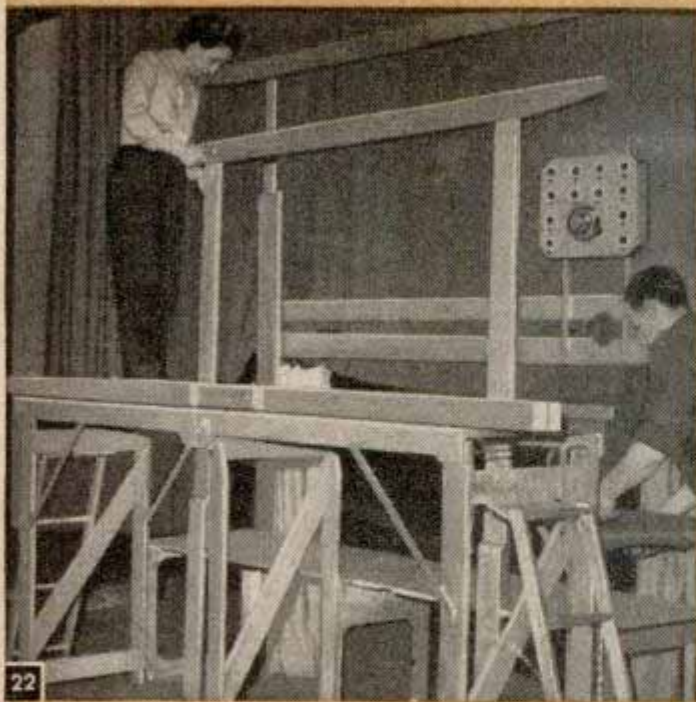

22



23

In just a few minutes more the stage-bridge unit will be ready for the show. Here the puppeteer's bar is being bolted in place. Setting up takes about 30 minutes

Guard rail comes last. This serves the dual purpose of preventing operators from accidentally stepping off the bridge and as a hanger bar for "actors" awaiting cues

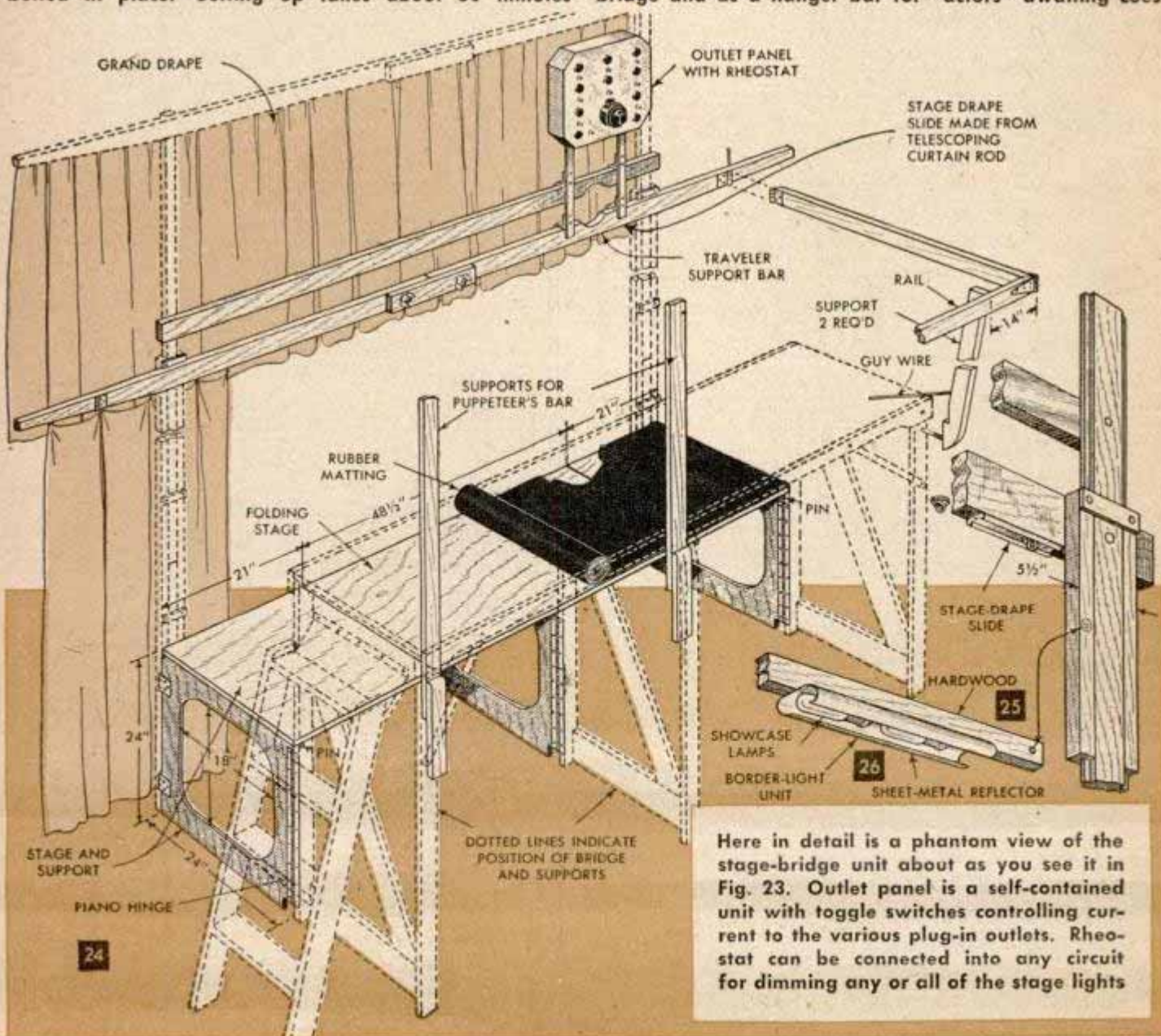

24

Here in detail is a phantom view of the stage-bridge unit about as you see it in Fig. 23. Outlet panel is a self-contained unit with toggle switches controlling current to the various plug-in outlets. Rheostat can be connected into any circuit for dimming any or all of the stage lights

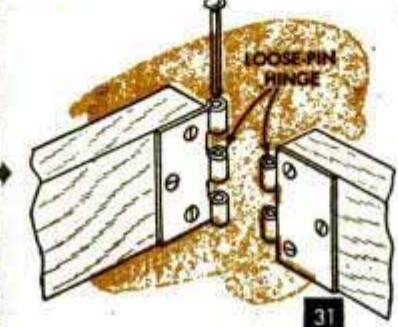
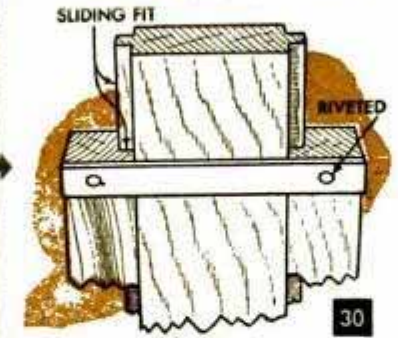
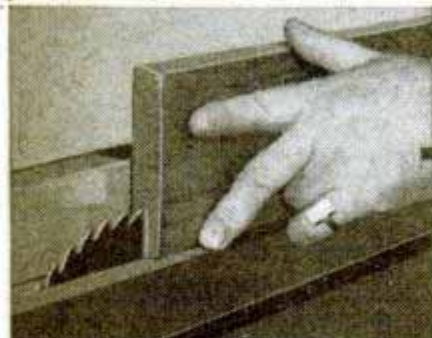
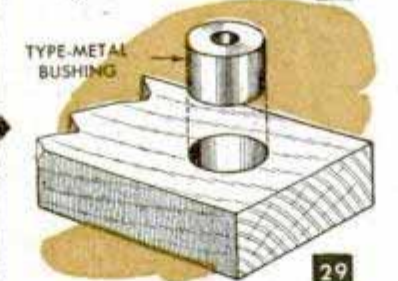
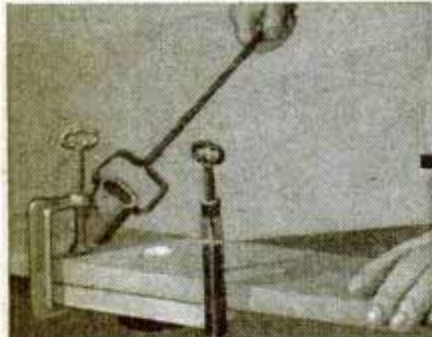
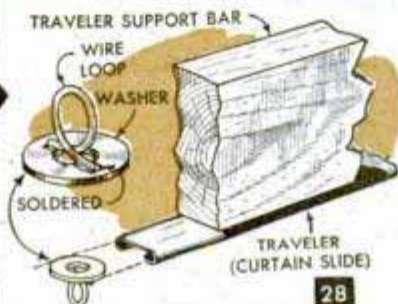
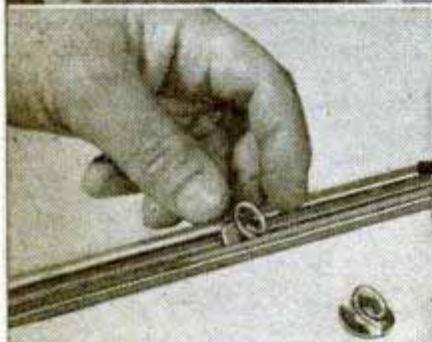
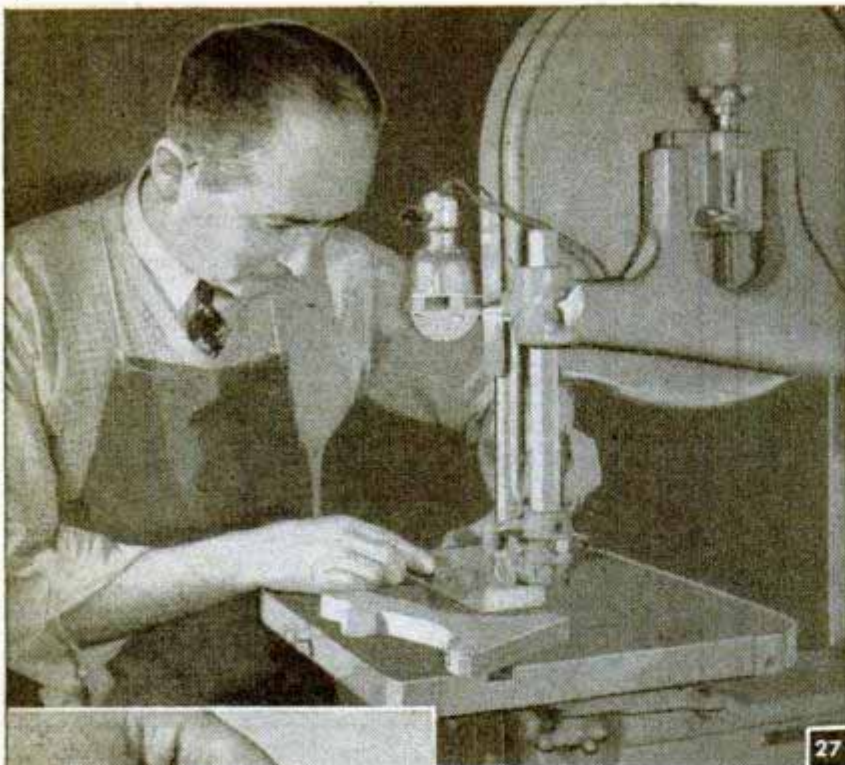

stage, and in turn is pin-hinged with loose-pin butts to the center support when the stage is set up. This part will be seen in place in Fig. 20. Each end support is pinned by means of loose-pin hinges to those on the traveler support uprights, Figs. 21 and 24. The puppeteer's bar, Fig. 21, is bolted to the front of the bridge and fits between it and the stage. Uprights supporting the bar are lap-jointed 24 in. from the floor to fold. A row of $\frac{3}{8}$ -in. holes is drilled in the upper edge of the bar for insertion of bent rods, which support the puppet controllers when not in use, Fig. 35.

Masking. Picture frame of the performance is the masking or proscenium, detailed in Fig. 34. In four parts, it is cut from a sheet of plywood. Three of the 45-deg.-angle joints are piano-hinged, but the fourth is attached with a butt hinge having a removable pin. The stage supports or brackets, Figs. 27 and 34, are hinged and fold flat. Legs are permanently attached with $\frac{3}{8}$ -in. bolts, the ends being peened over. Angle braces or clips in the upper corners attach to the traveler upright, and there is a strip of cloth tacked to the bottom to which the lower drape is hooked. Removal of the hinge pin permits the frame to fold flat.

Bushings. At all bolted joints where the parts are separated for packing, and on the parts permanently hinged, holes in wood members will eventually wear loose. To prevent this, drill the holes in the wood twice as large as required for the bolt, then fill with molten type metal, as in Fig. 29. Drill holes for the pivot pins or bolts in the metal.

Grand drape and traveler. The grand drape is attached with wire hooks over the supporting bar, Figs. 21 and 24. The drape is 162 in. wide and 55 in. deep, with allowance for fullness and hems. Side or traveler drapes are 37 in. wide and 75 in. long. Any dark, heavy material that does not

permit light to shine through from the back is suitable. As can be seen from Figs. 21 and 24, the drape bars fold in the middle for packing. The grand-drape bar is adjustable for height on a support which is tongued and grooved, Figs. 21 and 30. The three sections of each support are held in place with metal plates on each side, and at the bottom of each support are loose-pin hinges for pinning the parts to the stage supports, Fig. 24. Although screws will serve, it's perhaps better to rivet the hinge butts in place, as in Fig. 31. Similar hinges are riveted to the traveler bar to fasten ends of the rail, Fig. 24. Tracks for the stage drape slides are screwed underneath the traveler bar, Fig. 25. The slides are made from telescoping curtain rod.

Curtains may be of a lightweight material, as compared with the drapes, but should be lightproof. They are about 57 in. long and with sufficient width for pleated fullness. A hook is sewed in each pleat for attaching to the homemade slides, Fig. 28. Side-by-side lapping of the slides or tracks will bring the curtains together for a complete closure. They are controlled with a continuous cord which passes over a pulley at each side. The border light strip, Fig. 26, consists of a curved sheet-metal reflector mounted on a batten bolted between the traveler supports. Tubular showcase lamps, lacquered in different colors as well as clear, are turned on according to the color desired by means of separate switches on the outlet panel, Fig. 24. This is a self-contained unit with switches controlling current to plug-in outlets and arranged so that the rheostat may be connected into any circuit for dimming any or all of the lights. General overhead illumination is also provided by a 50-watt lamp in a painted reflector made from a No. 2½ tin can. A similar lamp mounted on a music stand provides any degree of flood-lighting from the side. It also can be covered with colored Cellophane for special effects. It has been found that a 50-watt lamp is ideal as a stronger illumination overlights the puppet characters and "washes out" detail and color. Footlights are not used.

Backdrops. These are of unbleached muslin, 5 by 8 ft., held on a curtain stretcher while the scenery is painted on. Use oil colors thinned with gasoline as this mixture will not stiffen the cloth or crack after repeated use. A hem at the bottom of each drop permits insertion of a narrow piece of

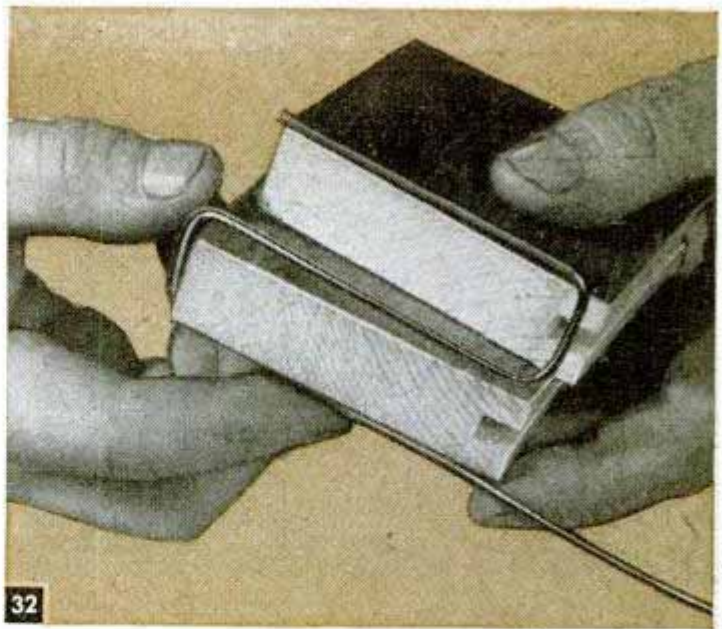

32

Above, the jig for forming the wire hangers which support members of puppet cast on the guard rail while awaiting their cues. Below, loops of leather attached to the controllers are slipped over the wire hooks to hold the figures securely



33

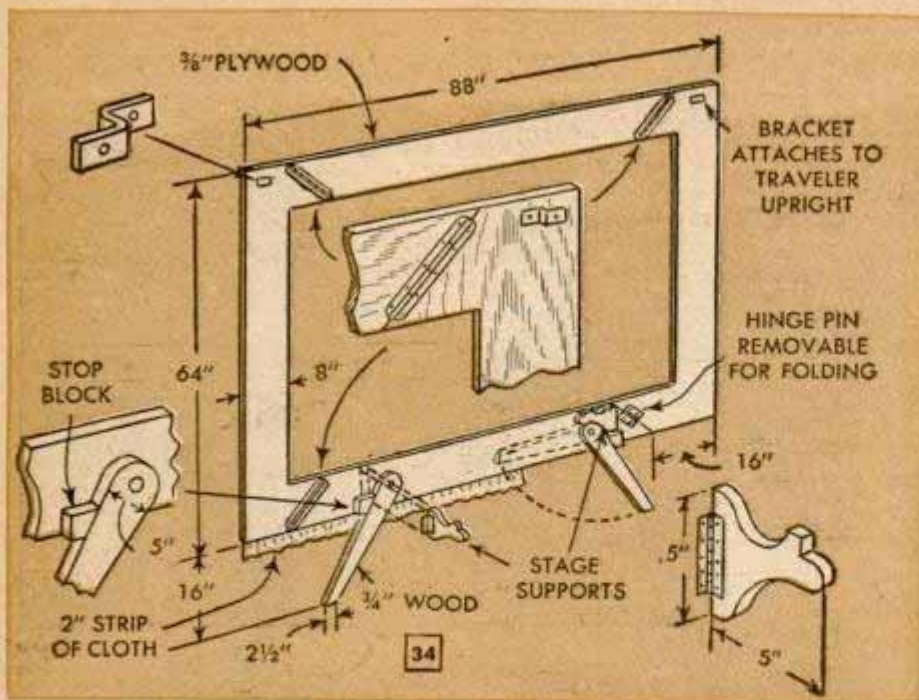

Above, the proscenium or masking frame which is placed directly in front of the stage. It's made of plywood and hinged at four points so that it folds. Below, the whole affair all set up complete and ready for the show

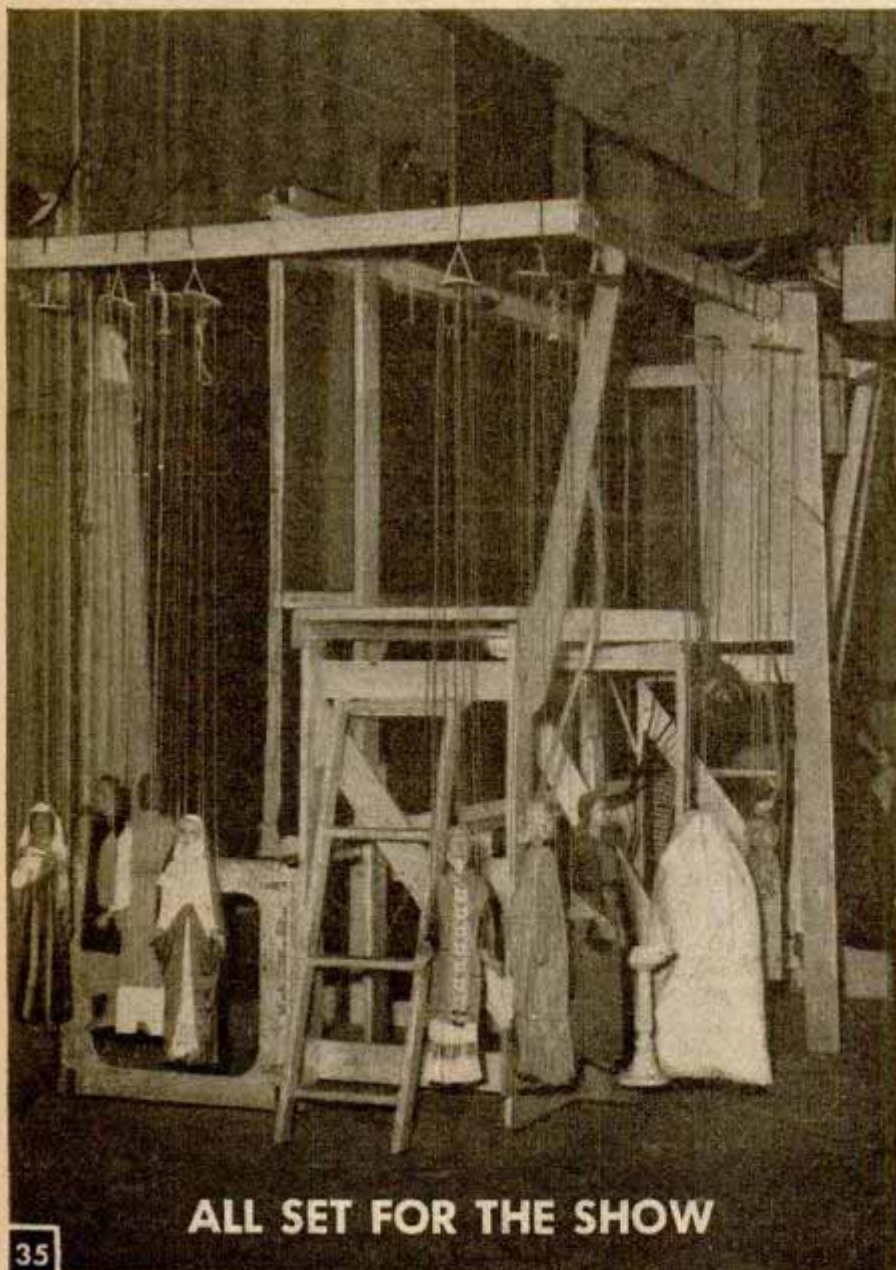

ALL SET FOR THE SHOW

wood which will serve as a weight to hold the drop taut. The top of each drop is fastened to a batten, the last scene being on top. Before the performance each drop is rolled up and fastened to the bar with lengths of cloth tape tied in bow knots. Then when changing between scenes, the operator pulls the free ends of the tapes and the drops fall into place. A kick rail, Fig. 21, prevents the operator pushing a foot into the scenery during a performance. Clips made from flat iron hold the rail in place.

The guard rail. Figs. 23 and 24 show how the guard rail is fitted to the puppeteer's bridge. This rail keeps the operator from accidentally stepping off the edge of the bridge and also serves as a hanger for the marionettes awaiting cues, Fig. 33. Wire hooks for hanging the puppets are formed as in Fig. 32. Back section of the guard rail is in two parts, with a lap joint so that the entire unit will fold. Two vertical supports hold the back section in place, the lower end of the supports being bolted to the bridge as in Fig. 24. Professionals generally use a sound system such as a record player with a loud-speaker located under the stage. If you use this added refinement, then the support post shown in Fig. 21 will be necessary. A piece of plywood is grooved into the upright and fastened to the bridge with a loose-pin hinge. Back section of the guard rail fits in the notch cut in the plywood, and the whole thing is held rigidly in place with guy wires fitted with turnbuckles. This simple arrangement takes little space and supports the record player securely.

(To be continued)

Steam Jet Propels This Speedy Toy Airplane

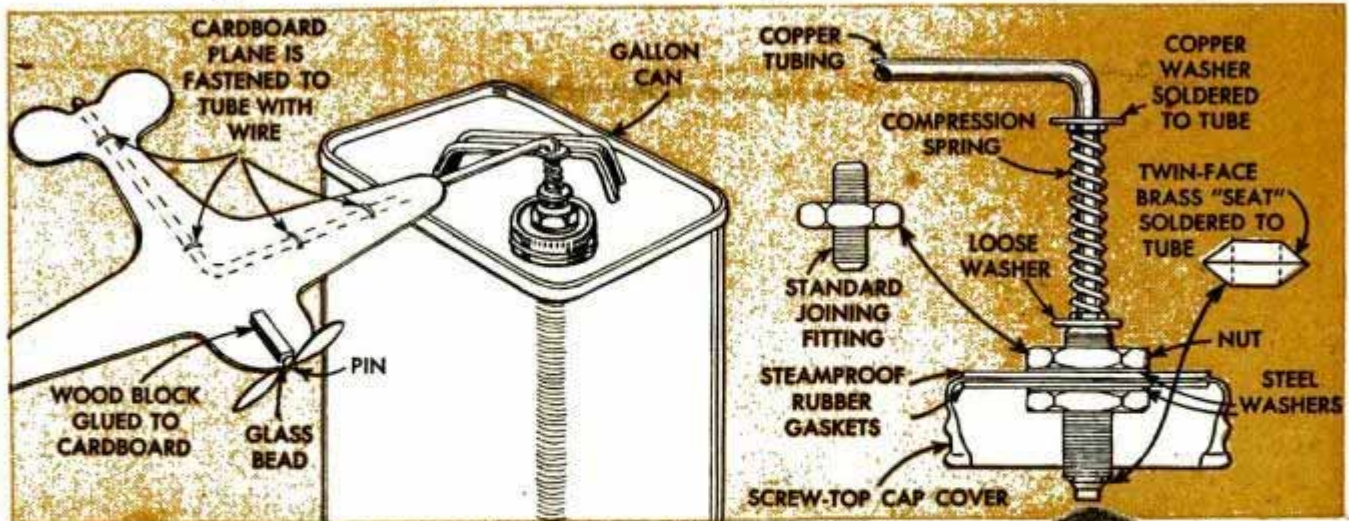

Heart of this "jet" job is the rotating steam seal on which it pivots and the $\frac{1}{8}$ -in. copper tubing through which steam is exhausted to power the plane. Construction of the seal is shown in the upper right-hand detail. The spring should be just strong enough to keep the seal properly seated. Too much pressure may cause the assembly to bind. If you find that the tube does not turn freely, it may be necessary to sand the outside down a bit. The mouth of the joining fitting will have to be reamed out to accommodate the brass "seat." The propeller, as well as the plane, is made of cardboard. After it has been cut out, spread glue over both sides, twist it to the proper shape and fasten in this position until it is dry. Paint the plane a bright color. When flying the jet, be careful about how much heat is applied. Steam should not be gen-



erated faster than it can be vented safely. Also, keep the can almost full of water to provide a substantial base for the plane. Before using the toy, always blow through the copper tube to be sure that the passage is clear.

C. L. Meehan, Lakeview, Ont., Can.



Bolts Used to Make Set of Taps For Soft Materials

You can make your own set of taps with various sizes of bolts that are found in your workshop. First grind a taper on the end of the bolt at a 5-deg. angle. This should be about $\frac{3}{4}$ in. long but will vary with the length of the bolt, larger bolts requiring a longer taper. When this is done, file two V-notches on opposite sides of the bolt to give the threads cutting edges. Carefully remove any burrs caused by grinding or filing. These taps are suitable for cutting threads in plastics, wood and soft metals.

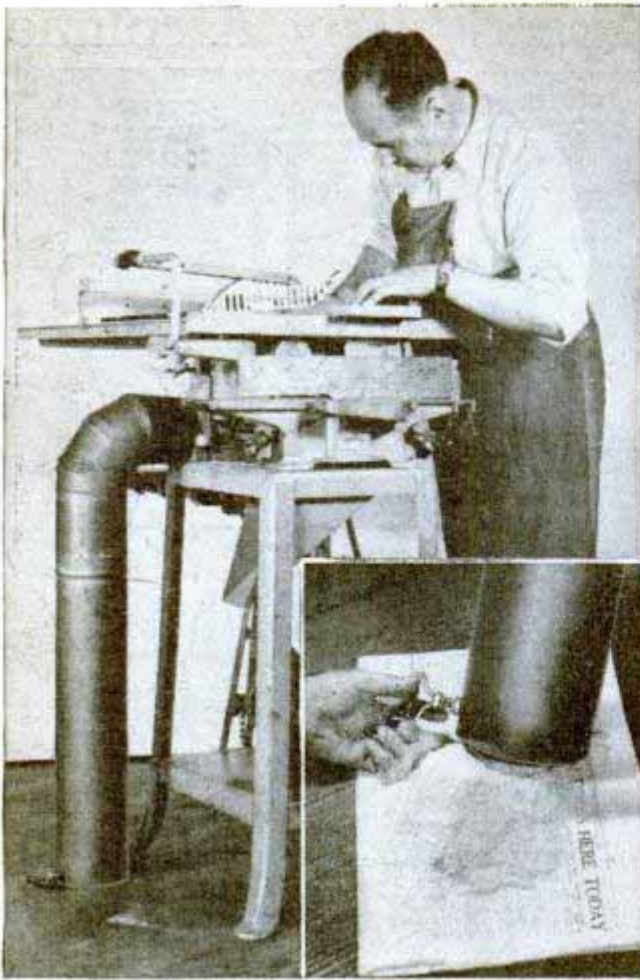

Dust Collector for Circular Saw Made From Stovepipe

With an ordinary 5-in. stovepipe, elbow and a damper, you can make a dust collector for a circular saw. When in position, the pipe should be high enough so the elbow will cover the dust outlet on the saw. The damper is kept closed and the openings for it in the pipe are sealed with adhesive tape. To empty the container, hold it over a newspaper or box and give the damper handle a quarter turn.

Footrests on Boys' Stilts Raised While They Are Used

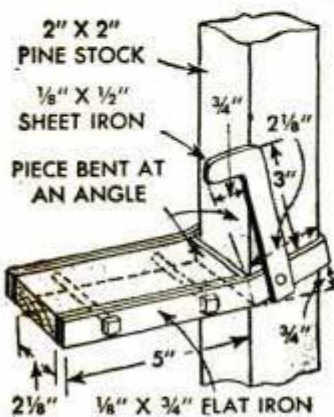

Footrests on most boys' stilts are fixed so that it is difficult to raise or lower them. Here's a pair which has rests that can be raised while walking on them. Details of construction are shown in the illustration. In use, the rest is raised by engaging the toe of the shoe in the hooked arm and lifting. An advantage of this type

is that a high perch is not needed to start from, since you can begin with the rests a foot or so off the ground and gradually increase the height as you walk.

Rubber-Hose Clip Holds Ticket

To avoid delay caused by searching for his return ticket at a toll bridge over which he passed every day, one motorist cut a short piece of rubber hose to make a ticket clip. The hose was slit lengthwise so it would slip over the steering column and a lip was formed on one end to act as a holder. Any small piece of paper could be held in the clip and be ready for quick reference.

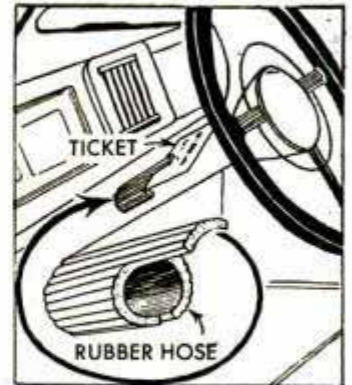

Shell Serves as Flower Vase

An attractive flower vase can be made from a conch shell supported on a wooden base. The base, which should conform roughly to the contour of the shell, is band-sawed from walnut or a similar wood. After the edge is shaped, it should be given a waterproof finish. A good bonding glue is needed to hold the shell on the base.

William H. Freeman, Baldwin, N. Y.

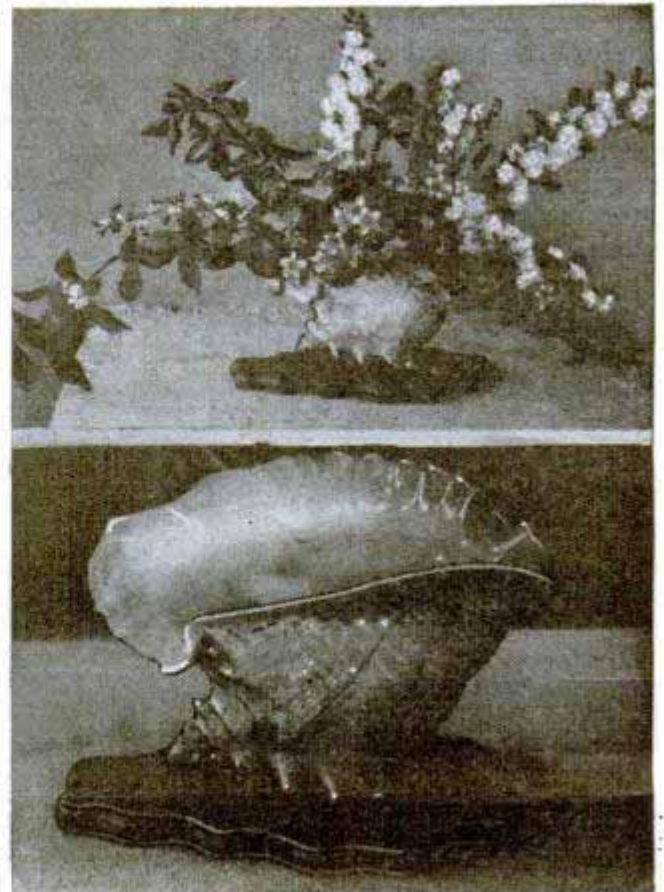

DESK STAMP BOX of contrasting woods

By Charles and Bertram Brownold

YOU WON'T have to search high and low for stamps if they're kept in this attractive box. The top is made of laminated woods in contrasting colors. Wide strips of walnut and narrow lengths of maple are ideal.

Details of assembly for the base are given in the lower half of Fig. 1. The compartment dividing strips are assembled with half-lapped joints and the filler blocks and ends are glued on. This assembly is glued to the base. In the upper part of Fig. 1 is shown the profile for the pieces that comprise the top. Jigsaw these so the grain is horizontal in the maple and vertical in the walnut. File any irregularities in the inside of the top, Fig. 2, assemble with the end pieces and glue together as in Fig. 3. A cleat nailed to the supporting surface will aid in aligning the pieces. After the top is dry, smooth the outside with a strip of sanding belt, Fig. 4. A waxed finish will bring out the grain nicely.

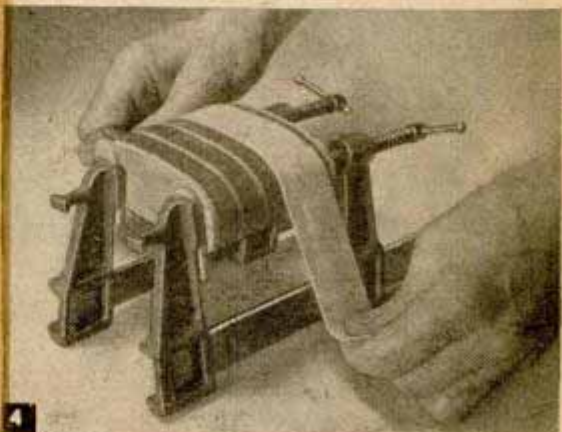
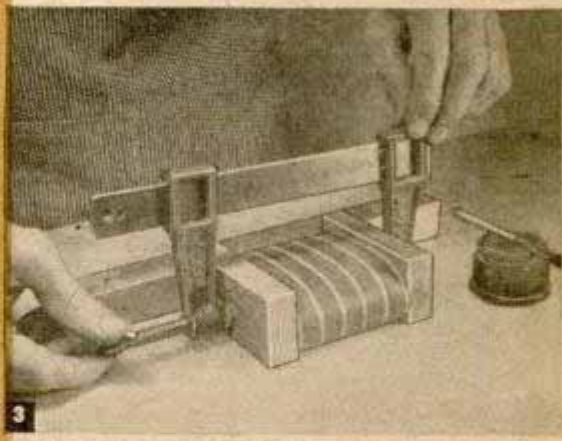
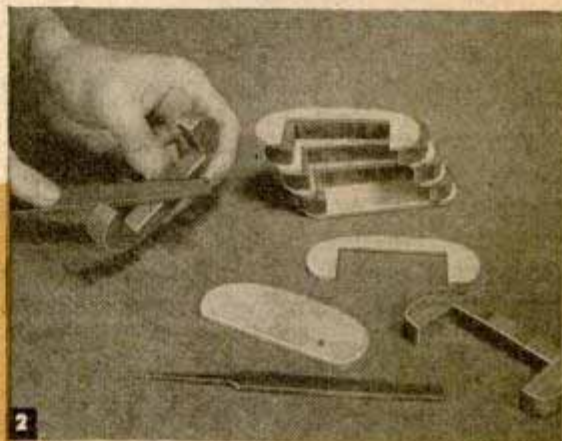
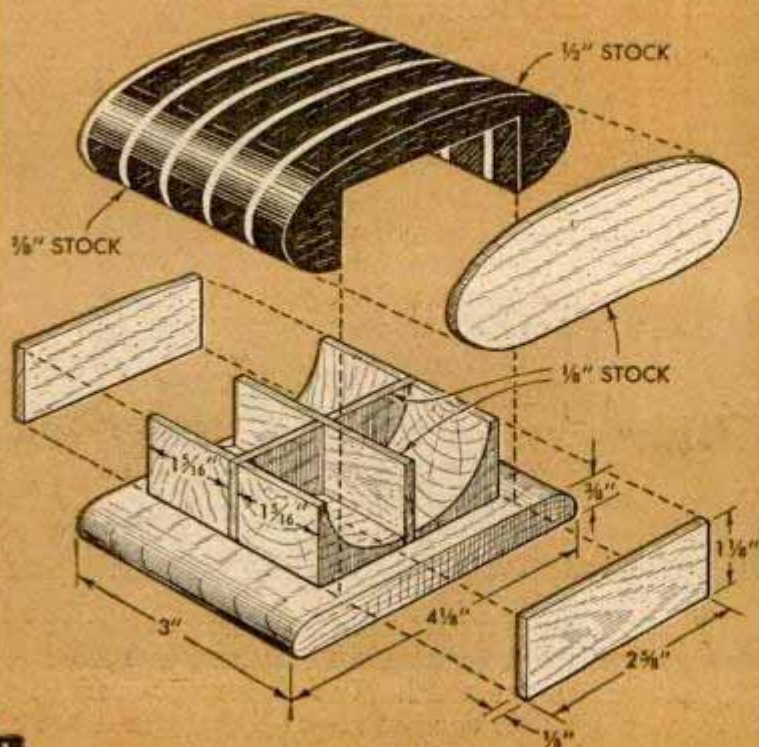
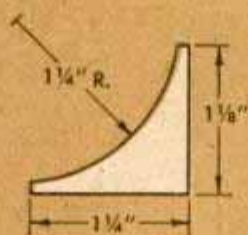
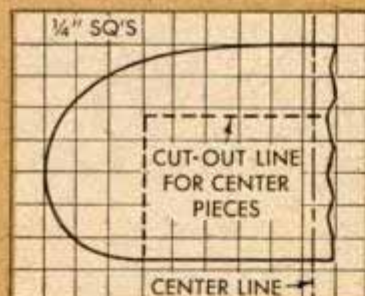
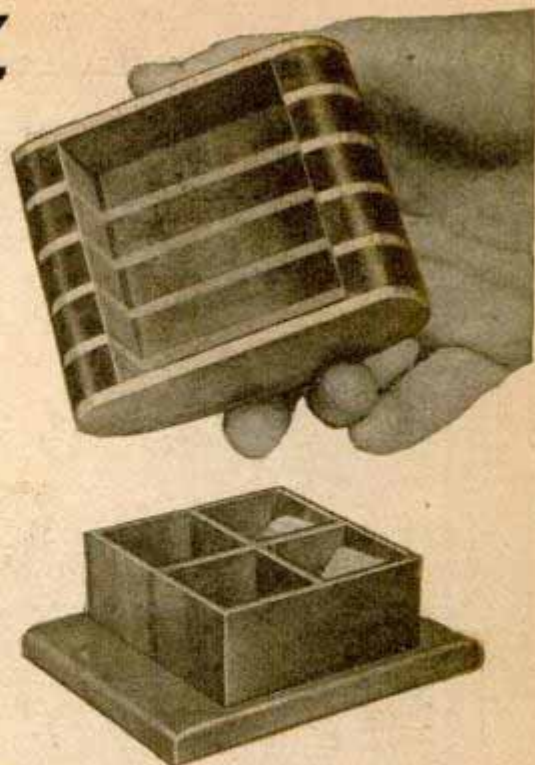

Ends of Scaffold Are Painted Red As Safety Precaution

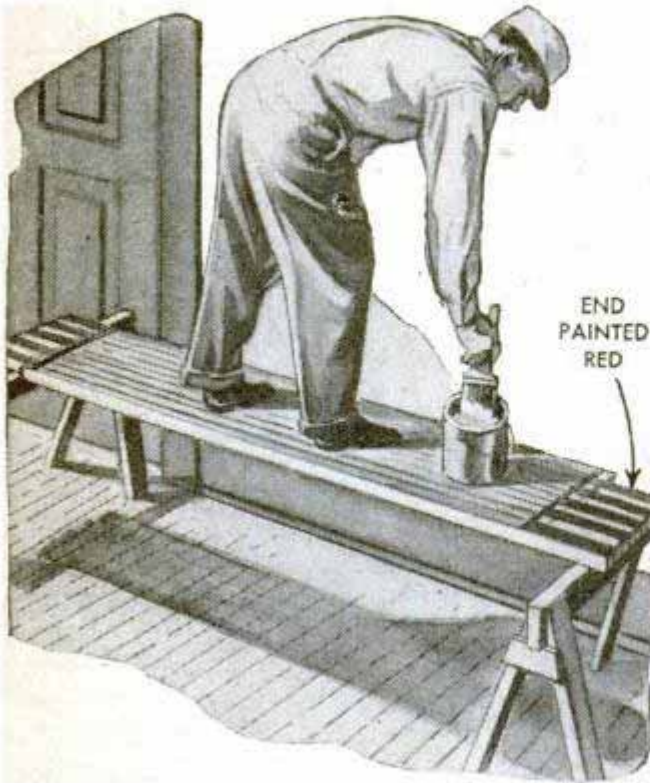

An accident may occur when the occasional painter, working on a scaffold, gets too near the end and loses his balance. If the ends of the scaffold are painted red, it will serve as a warning to the user that he is past the safe limit.—Adam Szczepanowski, Michigan City, Ind.

Paint Spray Mask Is Made Using Cloth Strainer

When you're working with a paint spray gun in a closed area where you might inhale paint "mist," here's an emergency mask you can use that will act as a filter. Take a conical paint strainer and trim



away most of the top edge. Fasten masking tape around it, allowing about ½ in. overlap. Then place cotton in the strainer and fit it to your face. Ear cords and the tape will hold it in place.

Russell L. Card, Tweed, Ont., Can.

Strong Fastening for Doorknobs

Since the set-screws that hold doorknobs have a tendency to work loose and eventually drop out, one person overcame this difficulty by using a copper split rivet and a BB shot from an air rifle.

The shot is dropped in the hole and the rivet tapped down over it until the head is flush with the doorknob handle. The BB spreads the rivet into the threads of the handle.—O. D. Cowles, Battle Creek, Mich.

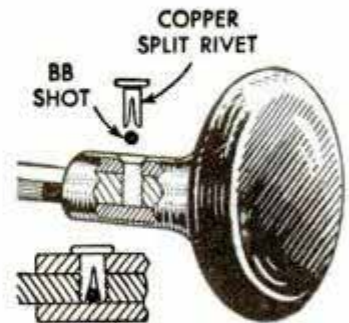

Lead Strip Fixes Crack in Drum

If you have an oil drum or other metal container that has a crack, it can be repaired quickly using a strip of lead. First bend the strip so it will slip into the crack. After inserting it, flatten it

on both sides to seal the opening. If the container is a closed one, the strip could be flattened on one side only.



Oil-Soaked Corncobs Thaw Pipe

To thaw frozen water pipes, touch a match to two oil-soaked corncobs that are fastened to the ends of a U-shaped wire and hung on the pipe. This should not be attempted, however, where there is a danger of setting fire to objects near the pipe.



☞ You can shine black or tan leather shoes with a banana skin if you have no shoe polish on hand. Rub the inner surface of the skin over the shoes lightly, and the oil in the skin will impart a polish.

OFF WITH THE OLD

Three methods of preparing painted and varnished surfaces for refinishing

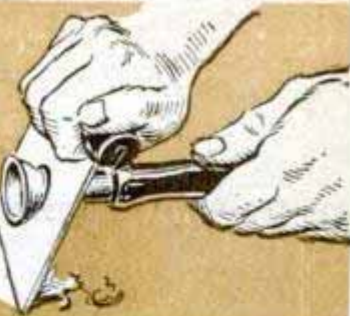

SCRAPING — SANDING

is one of the most common methods used in removing either paint or varnish, but efficient use of a scraper depends on several factors, such as age of the varnish or paint and the wood underneath. If the finish has aged to the point of being dry and brittle, a sharp scraper may be used if the wood is hard. However, a scraper in the hands of an inexperienced person is likely to result in digs and gouges in the surface of softwoods. Grinding off the

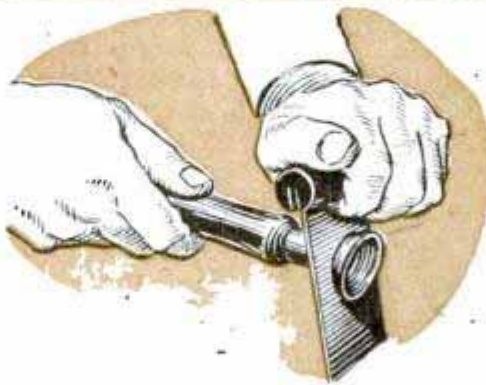

corners of the scraper will help some. The blade must be kept sharp by filing and turning the edge with a burnishing tool while the blade is held in a vise. It may be necessary to sharpen the scraper every few minutes while it is in use. If scrapers are used on rounded surfaces, even though the wood is hard, great care must be taken. The point of contact will be small and the pressure will be on a very small area. On some work the cutting edge should be slightly curved.

BLOWTORCH BURNING

is another method often used, especially where paint is to be removed from large areas, such as porch floors or sides of buildings on which several coats have been applied over a period of years. However, you must handle the torch carefully to avoid a fire. The torch should never be used on furniture and you should not attempt to remove varnish in this manner. When using a blowtorch most amateurs make the

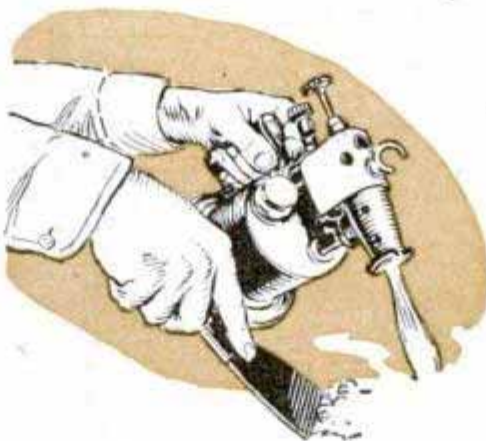

mistake of burning the paint too deeply. This scorches the wood underneath and does little to speed the work. Instead of trying to soften the entire paint film with one application of the torch, it's better to remove it momentarily as soon as the paint softens on top and then go over the surface with a scraper to cut off the softened paint. Repeat this operation until the wood surface appears, after which the use of the torch is discontinued.

CHEMICAL REMOVERS

are the best for use by inexperienced workmen. Although their use may raise the grain of the wood, which can be sanded down when dry, there is less chance of damaging the wood by nicking and gouging.

While not especially quick acting, trisodium phosphate, costing a few cents a pound, makes a safe remover for paint. It is not a corrosive agent, but rather a powerful alkaline solvent. Simply



make up a saturated solution in a pail of hot water. This is brushed or "mopped" onto the surface to be treated, which should be flat and horizontal so that the solution will not drain off. Repeated applications usually must be made. The operation may be speeded up if a stiff scrubbing brush is used while the solvent is at work. At the end of a half hour or so, a scraper is employed. If all of the paint does not come off at this



1 Only small areas at a time should be treated and a brush should be used to keep the solvent active

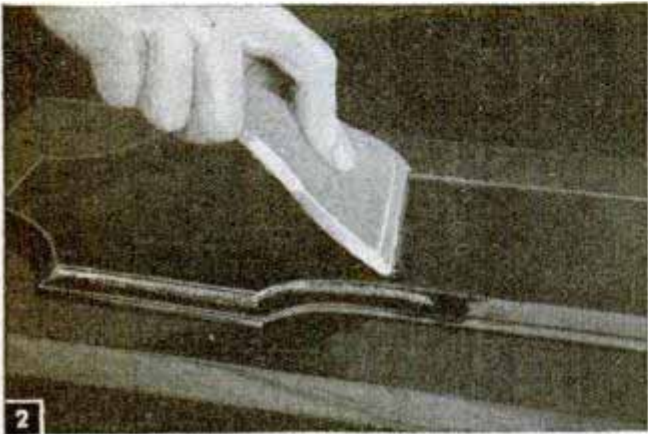

2 When removing varnish from veneers, use a scraper cut from hardwood and beveled on the scraping end

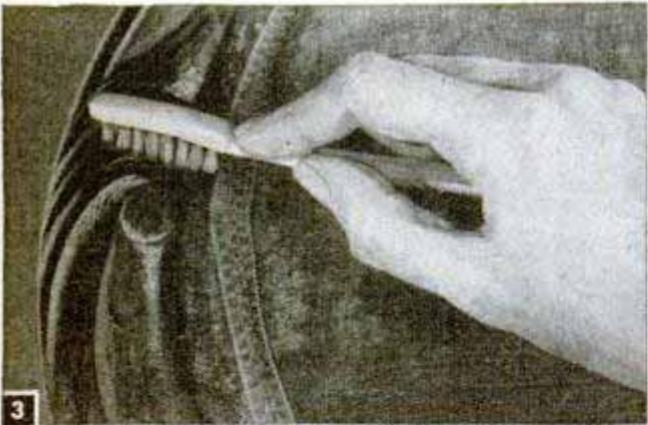

3 An old toothbrush is helpful in removing softened varnish from carved and other decorative surfaces



4 A hardwood dowel cut off at a sharp angle and then sharpened is ideal for cleaning varnished grooves

time, the applications are repeated until the paint film is softened through to the wood. A complete rinsing in warm, clean water follows and the bare wood is wiped dry to prevent warping.

Sodium metasilicate is another cheap chemical that performs much like trisodium phosphate. Although thorough and sure, both these materials are very slow acting. If you want speed, then prepared paint and varnish removers are best, although the precautions listed on the containers should be followed carefully in every detail. These removers usually contain dissolved wax or paraffin which slows down evaporation and protects the exposed wood. They should never be used in direct sunlight, which will cause them to evaporate with twice the normal speed. One should not make the mistake of trying to cover too much surface at once. A square foot, or even less, at a time is quite sufficient. For vertical or overhead surfaces where the material will run downward, a semipaste remover should be used. This type not only will stay put but also will stay wet a longer time. Paste removers are applied with a heavily loaded brush, using a flowing stroke. Lay on the paste with the flat of the brush rather than the tip, Fig. 1. Don't brush out as you would paint and don't brush back over material already applied. Allow 20 to 30 min. to penetrate, then scrape. If this doesn't expose bare wood another application is required. Allow time to penetrate and the finish then usually will come off. The job may be compared with taking off wallpaper. If there are several layers to be removed, it takes considerably more time and soaking.

When varnish is to come off, coarse rags may be employed after the solvent has had a chance to work for 8 or 10 min. Another application of remover is then made and followed by wiping. A final application of either turpentine or benzene stops action of the solvent. If rags are not sufficient on veneered surfaces, a scraper cut from hardwood may be used. This should be sharpened by beveling one end as in Fig. 2. If veneered drawer fronts have been covered with several applications of both paint and varnish, repeated applications of solvent usually are necessary for complete removal of the old finish. Removal from grooves will be aided greatly by several scrapers cut from dowels of various sizes. Any varnish-removal kit should have a set of all sizes along with several old toothbrushes to help in dealing with carved sections, Figs. 3 and 4. Such sections may require as many as ten applications of solvent before they are finally cleaned out. Be careful to prevent the staining of uncovered portions of furniture.

Plastic PLANT TRELLISES

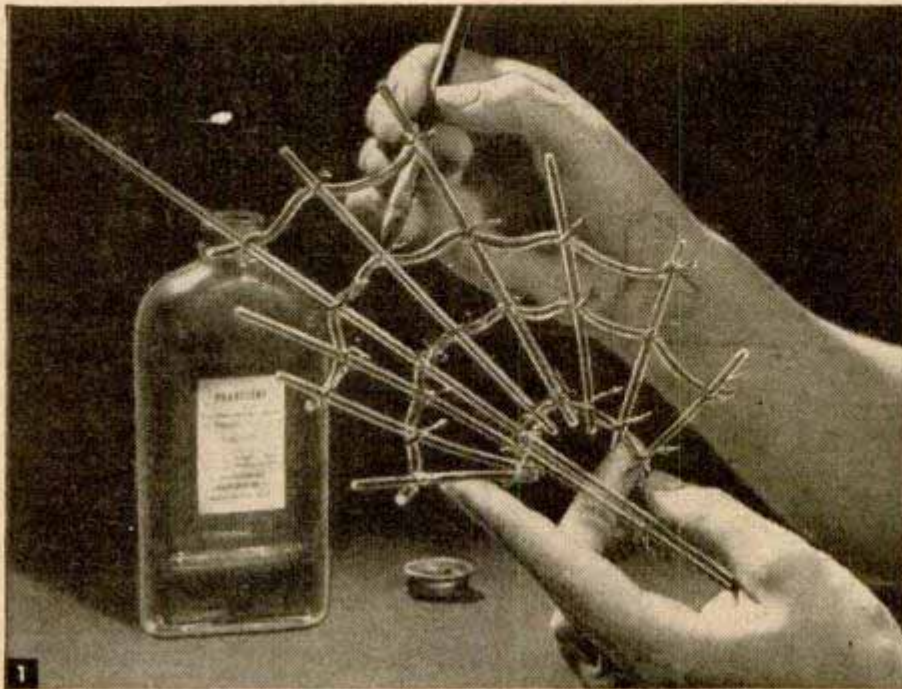

EASILY made in a short time, these plastic plant trellises are ideal for small house vines. One-eighth-inch thermoplastic rod is used and it can be formed in one of two ways. Fig. 2 shows how one section at a time is heated and then bent. However, for more intricate shapes, such as Fig. 3, a template is used. This is double corrugated cardboard with a design drawn and cut into the board. The lines should be about $\frac{3}{16}$ in. wide. The heated rod is pressed into the pattern for forming. After the rods are formed, tie them together with light copper wire and place a drop of quick-setting cement at each point where there is an intersection, Fig. 1. With a little practice this can be done quite easily and the cemented joint will not show. Allow plenty of time, at least 30 minutes, for the cement to set before the wire is removed. By doing this, you will be sure of strong joints.

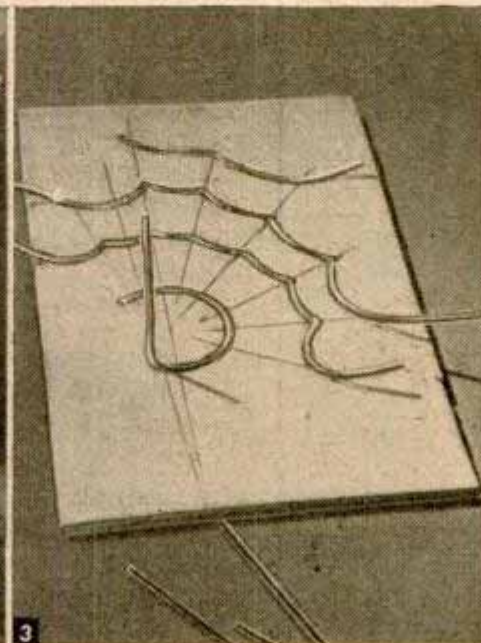

Forced-Air Unit Removes Soot

Much of the muss is eliminated from the task of cleaning the water jacket in your boiler if you use this modified vacuum cleaner. The blower, taken from a cleaner, is mounted in a sheet-metal housing which is attached to the beams with short lengths of flat iron. A screened opening in one side of the housing serves as an intake to admit air. A suitable hose is connected to the discharge outlet of the cleaner and the end is fitted with a flattened length of large-size tubing that serves as a nozzle. To keep the nozzle and hose out of the way when not

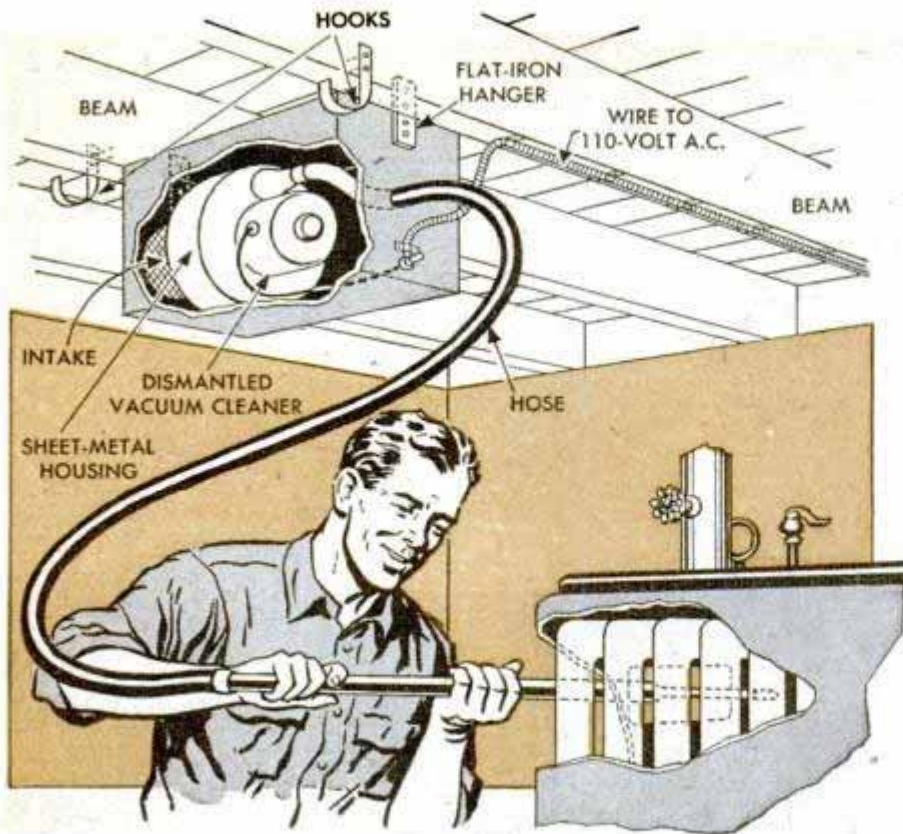

in use, two flat-iron hooks are bolted to the beams. The nozzle rests in these. The motor, of course, is connected to the house current with a switch in the line. To use the unit, insert the nozzle through the cleanout door, turn on the motor and blow the soot up the chimney. A hot fire is required as a strong draft action is necessary to do the job properly.

David B. Clapp, Livingston, N. J.

Window-Crank Device on Saw Provides Height Adjustment

Taken from a junked car, a window-crank mechanism provides a very satisfactory device to raise and lower a circular saw. The saw mandrel and motor are attached to a frame that is hinged to one end of the saw table. The other end is screwed to a lever which, in turn, is fastened to the regulator as shown. It may be necessary to shorten the arm on the crank mechanism.

Ralph S. Wilkes, Elbridge, N. Y.

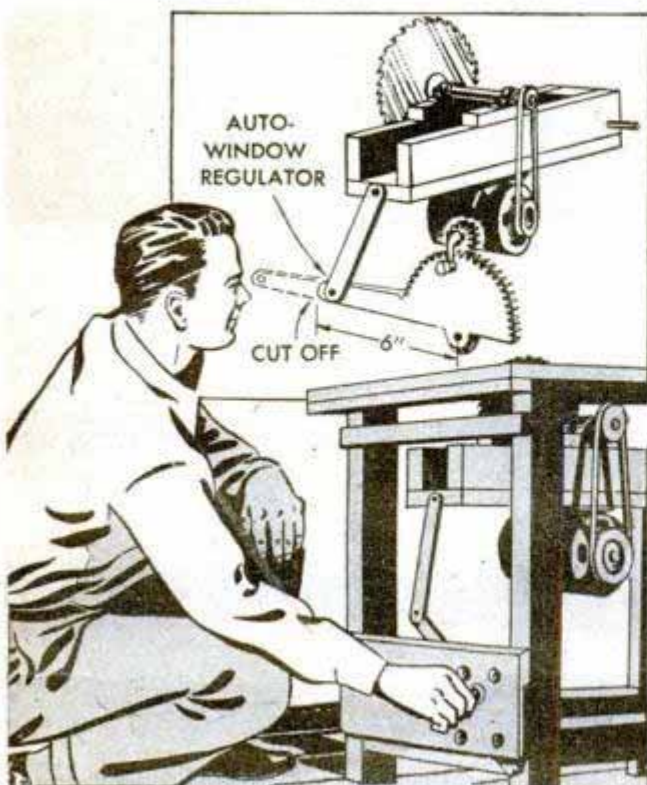

Cleaning Caulking-Gun Nozzle

If a long, narrow brush of the type used to clean coffee percolators is used, it will not be difficult to remove the compound from a caulking-gun nozzle. The nozzle is removed from the gun to do this. The brush is ideal for this service because it has short, stiff bristles that will clean the nozzle thoroughly. Clarence Brichetto, Detroit, Mich.



How to Start a Fire in the Rain

To start a fire in the rain or snow, I carry a tube of rubber cement which is highly inflammable. It will light instantly in a downpour and, unlike many other materials used for the same purpose, it can be carried easily in the pocket.

R. A. Jenkins, Los Angeles, Calif.

Bowling "Dice" Are Scored Like Real Game



Bowling fans will enjoy playing with these dice, which are scored like the real game. To make the dice, cut ten $\frac{5}{8}$ -in. hardwood cubes and draw pins on two opposite sides of each one. Also, number the pins from 1 to 10 consecutively. Then cover with a coat of transparent varnish for protection. A painted tin can or other similar

receptacle will serve as a cup. Any number of people can play the game. A player throws the dice and leaves any that show face up on the table, returning the rest to the cup. After the second throw, score all dice that are face up in the same manner in which you would when bowling. All bowling rules that can be applied are followed.

How to Measure Speed of Shaft Without Using Counter

If you have occasion in your home workshop to measure the r.p.m. of slow-speed shafting, here are several ways to do it. One method involves the use of a pencil with a rubber eraser and some string. The rubber is held against the center hole in the shaft and a piece of hardwood is pressed against the lead to hold it, detail A. Then, as the shaft turns, string is wound around the pencil. At the end of a predetermined period, say 6 seconds, the pencil is removed and the number of turns are counted. If, for example, there are 20 turns around the pencil in 6 seconds, in one minute there would have been 200 turns, or 200 r.p.m. In detail B, a pencil is moved along the shaft leaving a spiral mark. The number of turns is computed and translated into r.p.m. In detail C, a small notch is filed in the end of a shaft and a strip of cardboard is moved so as to leave nicks. The number of nicks is used to figure r.p.m.

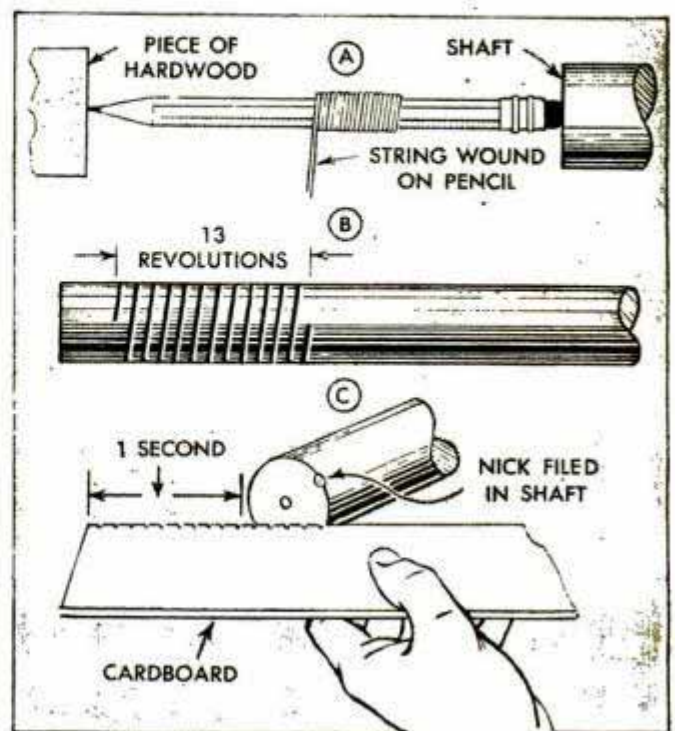

Slip-On Identification Bracelet Is Made of Metal and Plastic

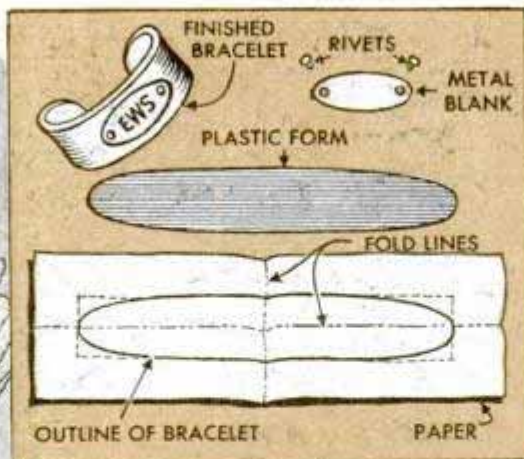

As a personalized gift, this slip-on identification bracelet is hard to beat. It's formed from odds and ends of plastic and metal that are not difficult to obtain. If the plastic you use is a dark color, select a highly polished metal, but if the plastic is light or transparent, the metal should have a dull finish.

Outline the bracelet on a piece of paper, shaping it somewhat like the sketch in the lower right-hand detail. Fold the paper horizontally and vertically and draw one quarter, transferring the

Indicator Light for Automobile

Owners of the earlier makes of automobiles that do not have a bright-light indicator can install one in their car easily. A steel clamp with a thumbscrew is formed to fasten to the lower edge of the dashboard or instrument panel. The light is mounted on this bracket and it can be one you have purchased or it can be made as indicated in the right-hand detail. A plastic cover for the light will mean less danger of breakage. To connect the unit, turn the headlights on bright and fasten the wire from the indicator to the terminal on the dimmer switch that will cause it to go on and off with the bright lights.

Arthur W. Clifford, Portsmouth, N. H.

line to the other quarters by pressure on the pencil. Then fill in the lines. Cut out the pattern and paste it on a sheet of $\frac{1}{8}$ -in. or $\frac{3}{16}$ -in. plastic, using rubber cement. Saw out the contour, file to the outline and finish with increasingly fine grades of sandpaper. Remove the scratches by rubbing carefully with a pumice-and-oil paste. Finally, buff it with tripoli and then rouge to obtain a glossy finish.

Cut and smooth the metal blank to the shape indicated in the upper right-hand detail and drill $\frac{3}{16}$ -in. rivet holes in each end. The name or monogram may be engraved, etched or stamped on the metal. You can bend the plastic strip by immersing it in boiling water and then forming it to shape. If necessary, repeat the heating process. Then shape the metal to conform to the curvature of the bracelet; drill rivet holes in the bracelet corresponding to those in the metal piece, using the latter as a template, and rivet in place.

Simon S. Palestrant, Bronx, N. Y.

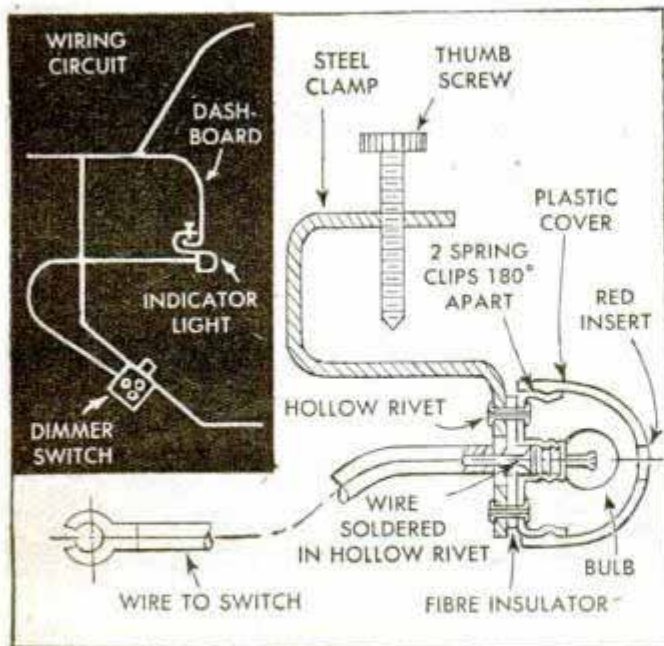

Put a key ring on each section of your clothesline and a harness snap on the clothespin bag and you can readily slide the bag along the line and have the pins handy when you are hanging up clothes.

Small Drills Kept in Test Tubes Mounted on Panel

Small drills, which are easily lost, are always at hand when kept in this test-tube rack. Using small test tubes obtained at a drugstore, mount them on a board in a suitable location by tacking a strip of canvas belting around them. As an additional protection, the tubes should be corked. Labels pasted on the glass will serve to identify the drill size.

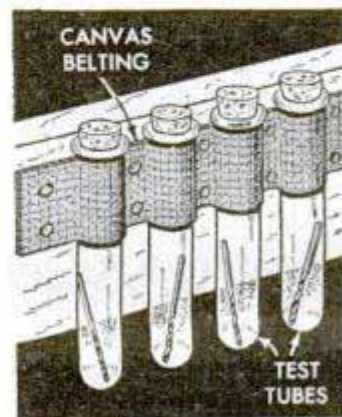



Chip Carving Is Easy



Notch carving is another name for it and its beauty is in the characteristic precision and repetition of the detail



By Hi Sibley

CHIP CARVING that equals the work of the old masters sounds like a big order, but study the step-by-step procedure beginning with Fig. 1 and you'll see that it's just as the title of the story says—easy. There are reasons, too. In the first place, to do simple chip carving you need only two knives with blades shaped as shown above. Just the shape of the blades alone is of the greatest aid in doing the work for no matter how you hold the knives the cutting edges are designed to give clean, shearing cuts. Another reason why chip carving is easy is the layout of the pattern full size directly on the wood. Because of this you don't have to depend on accuracy of eye alone, you have a line to follow, and, as most of the beauty of chip carving is in its geometric symmetry of arrangement, about all that's left in the way of requirements is care in handling the knife and in following the lines of the pattern. Fig. 8, A to F inclusive, suggests some of the basic patterns of chip-carved decoration.

In addition, Figs. 7 and 13 show a six-pointed star and a spiral design that work in well with other patterns laid out by means of straight lines on flat surfaces. In a gen-

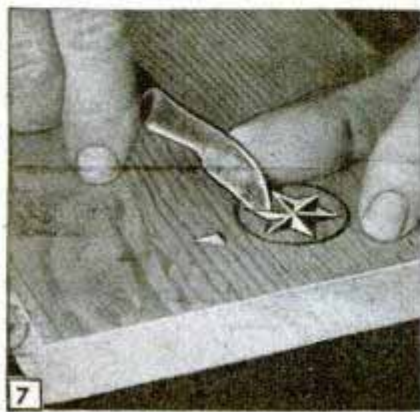
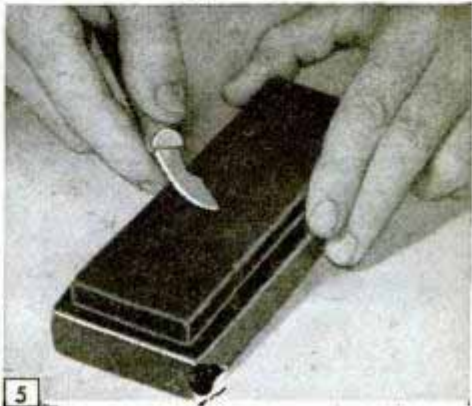
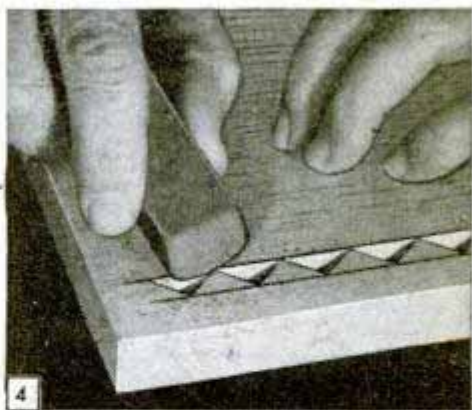
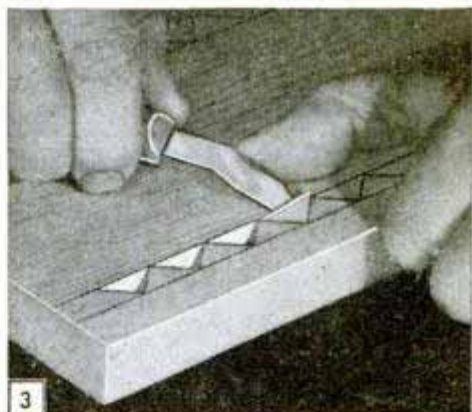
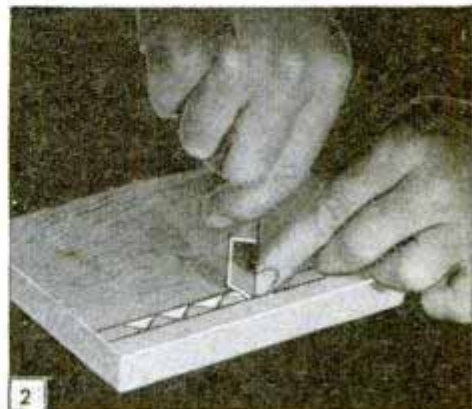
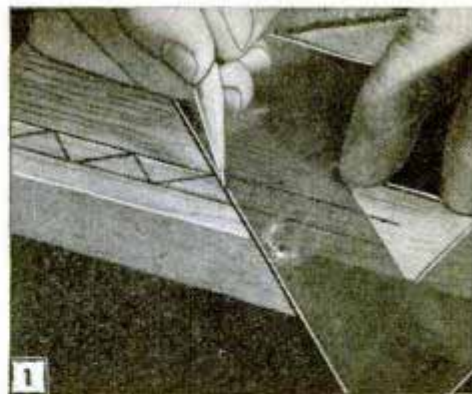

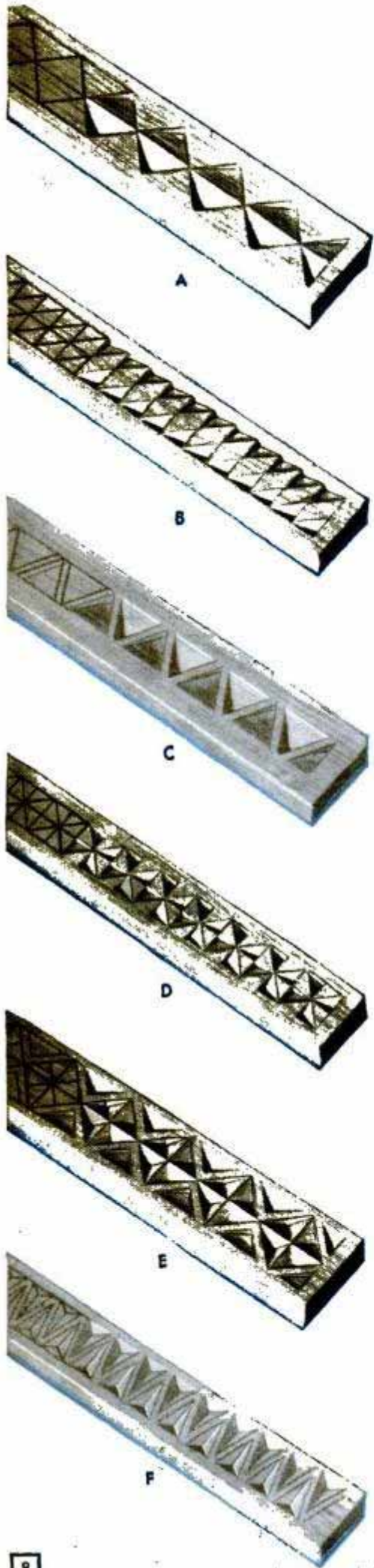

eral way, the whole ornamentation of any object by means of chip carving consists of an arrangement of small triangular shapes, squares and diamonds cut into the surface of the wood either in an all-over pattern or as centerpieces and borders. No matter what degree or extent of ornamentation you decide on, the procedure is very much the same. It begins with the layout of the pattern, Fig. 1. Then, with the design shown, the next step is the two vertical cuts with the bevel-edged knife blade. These are quite generally called "stabbing" cuts and special care is taken to see that the cutting edge follows the pattern line as it enters the wood. The next and final cut with the slitting knife is shown in Fig. 3. This merely lifts out the chip and, of course, must be done with care so that the wood is not torn or splintered. The pattern pictured is merely a repetition of these three cuts. To finish up, you erase those parts of the pattern lines that remain after the cuts are made over the whole area.

Figs. 5 and 6 show how to sharpen the knife on an oilstone and whet the edge on the palm of your hand. In sharpening, use a fine oilstone and if you should nick the edge grind out the nick on a wet grindstone. Avoid a short bevel as this causes the blade to lift the chip too quickly, splintering the wood ahead of the cutting edge. It's almost impossible to control a blade sharpened with a short bevel because the cutting edge acts as a wedge. Rather, the bevel of a blade used in carving should extend from the back of the blade to the cutting edge and should be flat, not curved. The best procedure in renewing the cutting edge when there are no nicks is to sharpen on the oilstone, hone the edge lightly on a hard slipstone, then finish on the palm of your hand or on a piece of full-grain leather.

Figs. 9 to 12 inclusive show the layout and carving of a design essentially the same as that already described except that there are three stabbing cuts instead of two. If you study the six suggested designs in Fig. 8 you will see that there is a basic similarity between all of them although no two of them appear alike in over-all pattern. One of the best and simplest ways to finish chip carving is to apply successive coats of furniture wax and polish with a soft bristle brush. Don't use shellac or varnish because such finish would destroy the beauty of the carving.

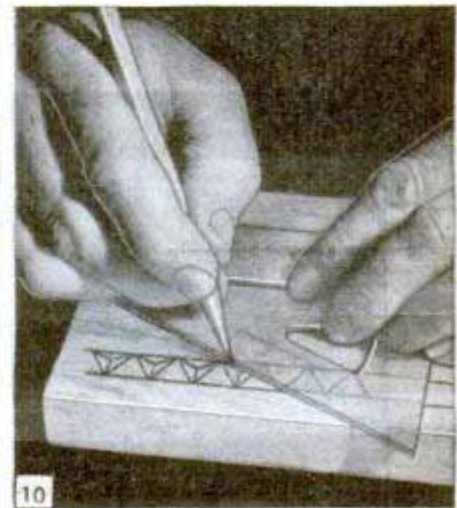
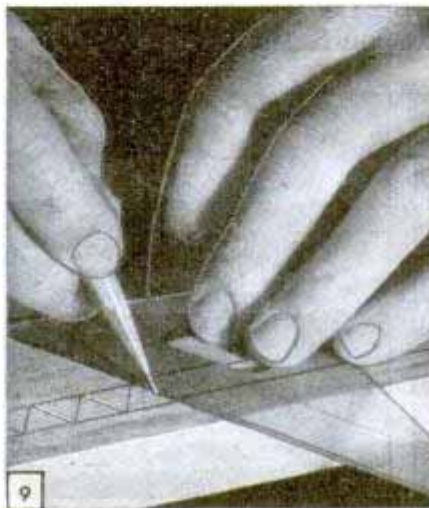

Picture Frame

You won't find this picture frame on every store counter. It's different because it has a hand-carved base. First there's the selection of wood, then a little sawing, grooving and sanding to do. Of the soft, close-grained woods choose white pine, basswood, poplar or red gum, the latter being the choicest of all. Maple, birch and cherry are perhaps the choice among the hardwoods suitable for chip carving

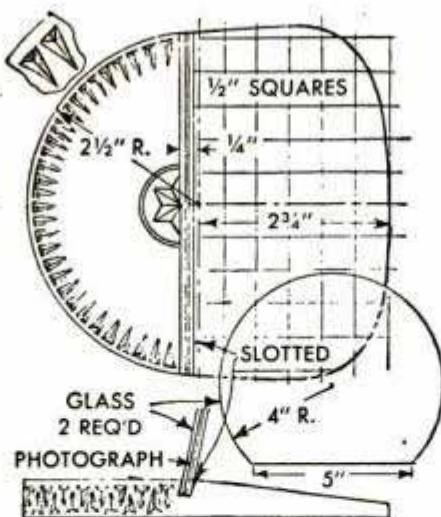

Book Ends

Book ends always show skillful handcraft to the best advantage. Everybody sees them at some time or other and you can always be casual about mentioning that you made them. That's usually enough, that is, if you did a good job. One thing about chip carving, especially on curved surfaces such as you have here: The layout should be exact, for the beauty of chip carving is in its precision of detail and design

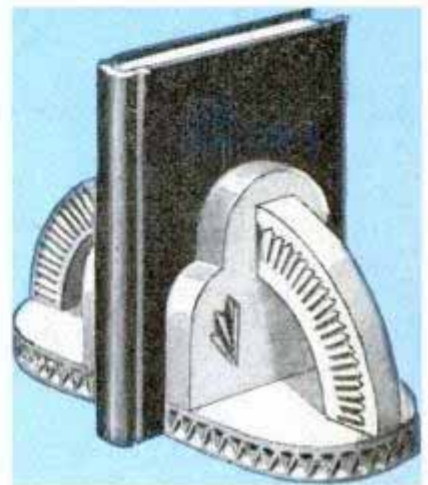
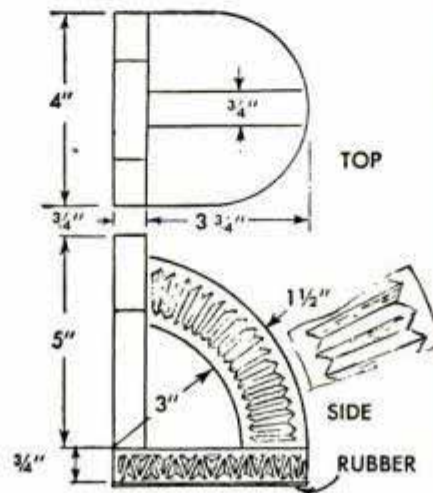

Pipe Rack

A chip-carved pipe rack is really something but practice a little on simpler work before you tackle this one. Choose a finer wood such as cherry or red gum and make the pattern layout with the greatest care because it really pays off in the finished job. Complete all hole drilling and sanding on the separate parts before assembling the rack. Finish with several coats of wax and polish lightly with a soft bristle brush

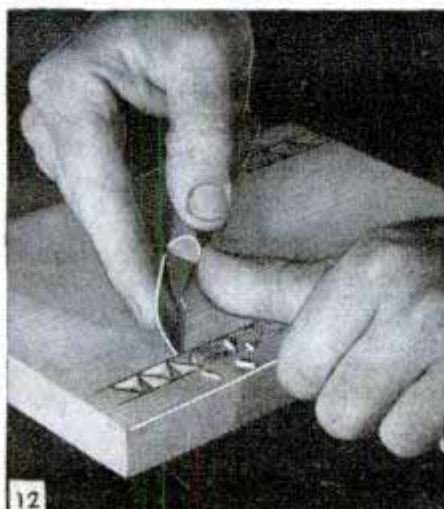
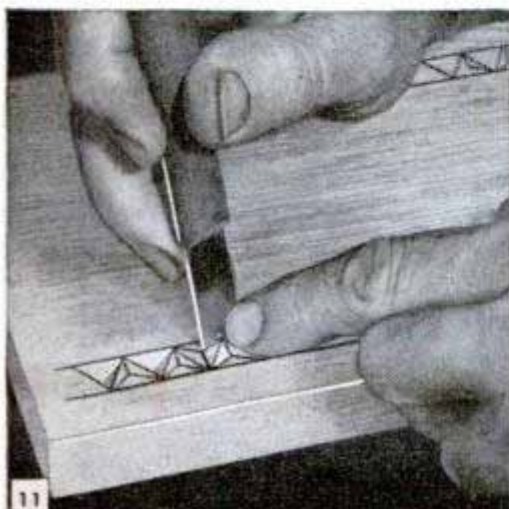
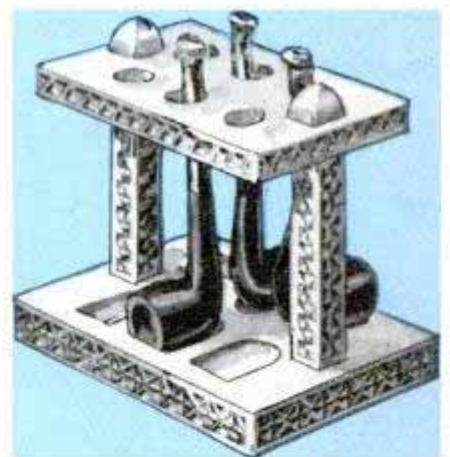
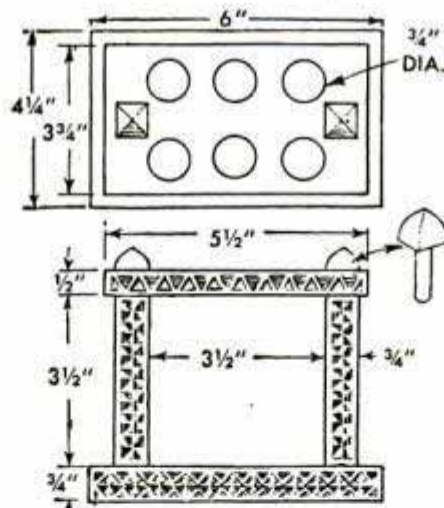

Coil Spring Formed in Vise Jaws With Belting Guide

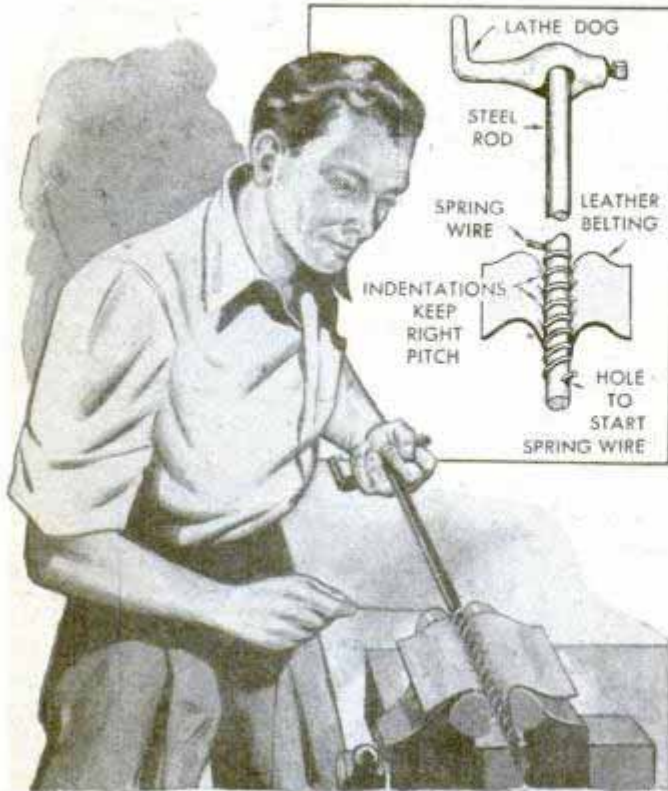

When properly started, you can wind small coil springs in a vise to almost any desired pitch. A piece of leather belting is inserted between the vise jaws and a rod of the proper diameter is used as the form. The rod is drilled at one end to hold the spring wire and a small lathe dog fastened on the other to serve as a handle. When winding the spring, the wire will make grooves in the leather that serves as guides. Therefore, care must be taken to get the right pitch when beginning.

William D. Evans, Glendale, Calif.

Metal Box Holds Burning Tools

If you have a small metal box, it may be just the thing to hold your burning pencil and accessories. Cut a wood block that will cover about half of the bottom and

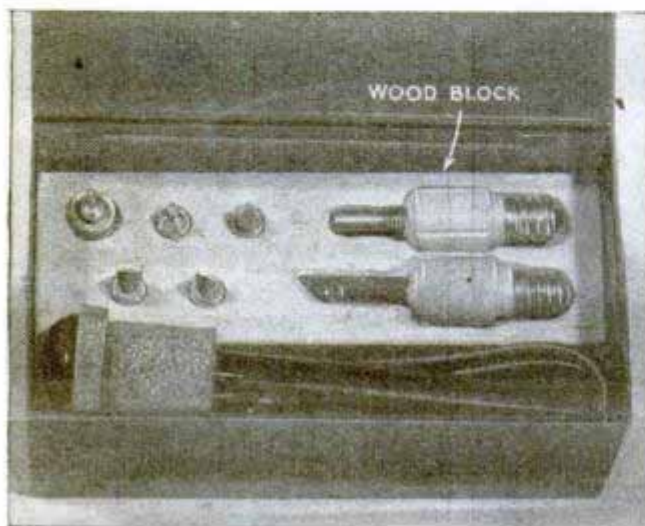

come halfway up to the top. In this block drill holes for the tips and cut recesses for the heating elements. The rest of the space is taken up with the holder and extension cord.—D. E. Horn, River Forest, Ill.

Locking Pin for Tennis Crank

With this crank and locking pin arrangement you will be able to tighten a tennis net and hold it securely without having to bother with knots that are hard to tie and apt to slip. The windlass on which the rope is wound is placed between two side plates that are screwed to the post. The plates are drilled to take a pin which projects and prevents the crank from unwinding.

M. S. Hunter, Orangeburg, S. C.

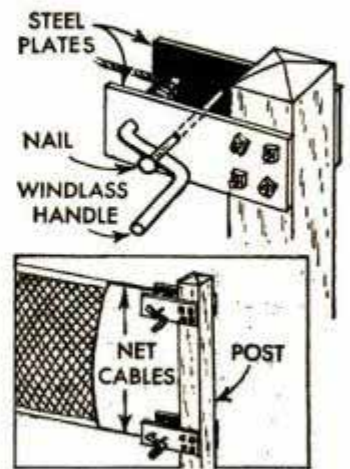

Renewing Surface of Hectograph

After a hectograph has been used for a length of time, the gelatinous compound becomes pitted and uneven. Melting the compound is not always successful as bubbles may develop in the solution. One way to resurface the composition is to pour alcohol over it and then burn the liquid off. After it has hardened again, the hectograph is ready for use.

Wilford Leach, Williamsburg, Va.

Battery Clip Serves as Vise

A heavy duty battery clip, if the ends are bent up and the points filed off as indicated in the illustration, will serve as a modelmaker's vise for small work. The clip is attached to the end of the workbench with a screw through the hole to which the cable was attached. Work is removed and clamped in the vise quickly and easily.

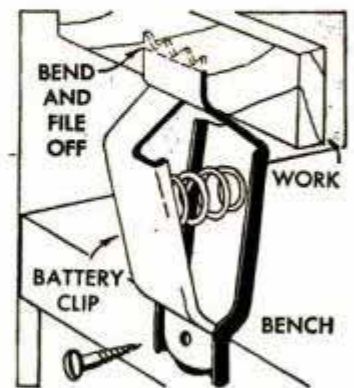

ⓘ Don't paint directly over a new plaster patch before shellacking it, especially if it is to be enameled. It will "flat out." Also, don't use oil putty under flat paint; there is danger that the oil will make a glossy spot on an otherwise flat surface.

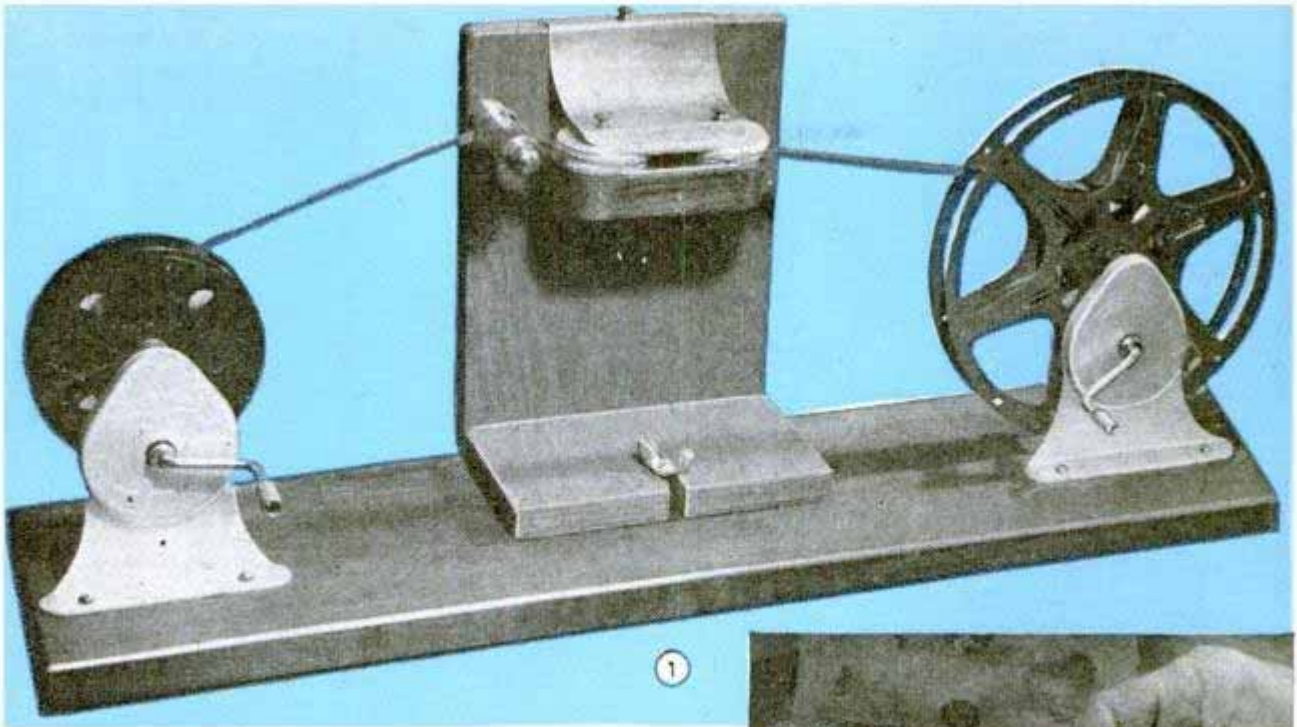

HIGH-SPEED CLEANER FOR MOVIE FILM

By Walter E. Burton

MOVIE FILM passing between four small powder puffs mounted in pairs between the rewinding reels on an 8 or 16-mm. editing board is cleaned rapidly with this attachment. The puffs are moistened with carbon tetrachloride or other film cleaner, or the first pair may be moistened with cleaner and the second pair used as drying pads. The puffs or pads shown are $1\frac{3}{4}$ in. in diameter. Fig. 1 gives the general idea. An L-shaped support about 6 in. wide is made of wood and the puffs attached to it in pairs by means of brackets. The upper puffs are held in place by a piece of sheet aluminum, which in turn is screwed to a spring-brass bracket. Fig. 2 shows how the puffs are fastened to the aluminum with small bolts.

The lower puffs are similarly bolted to a piece of aluminum, which is then fastened to a wooden bracket. This bracket can be seen in Fig. 3, which also shows a roller that guides the film between the puffs. The roller, turned from brass or stainless steel, has two grooves about $\frac{1}{16}$ in. wider than the film. In this case, the recesses are for 8 and 16-mm. film. When mounting the roller, the center division between the grooves should line up with the bolts that hold the puffs. The roller rotates on a bolt projecting from the support where it is retained by nuts and washers. A slot 2 in. long cut in the base block permits the cleaning unit to be fastened to the editing board or bench with a bolt and wing nut. When one half of each pad surface is dirty, the second half may be presented to the film by shifting the whole unit forward or backward, or the pad plates may be turned around. Always wind the film slowly.



Four miniature powder puffs are used as cleaning pads. Small bolts hold them in place

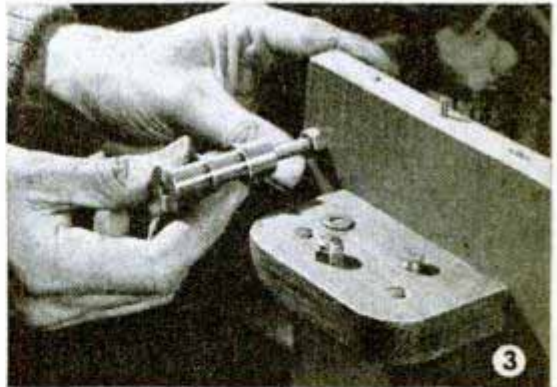

A grooved metal roller, mounted on the upright, guides the film between the cleaning pads



A few drops of carbon tetrachloride, or film conditioning agent, are used to moisten pads

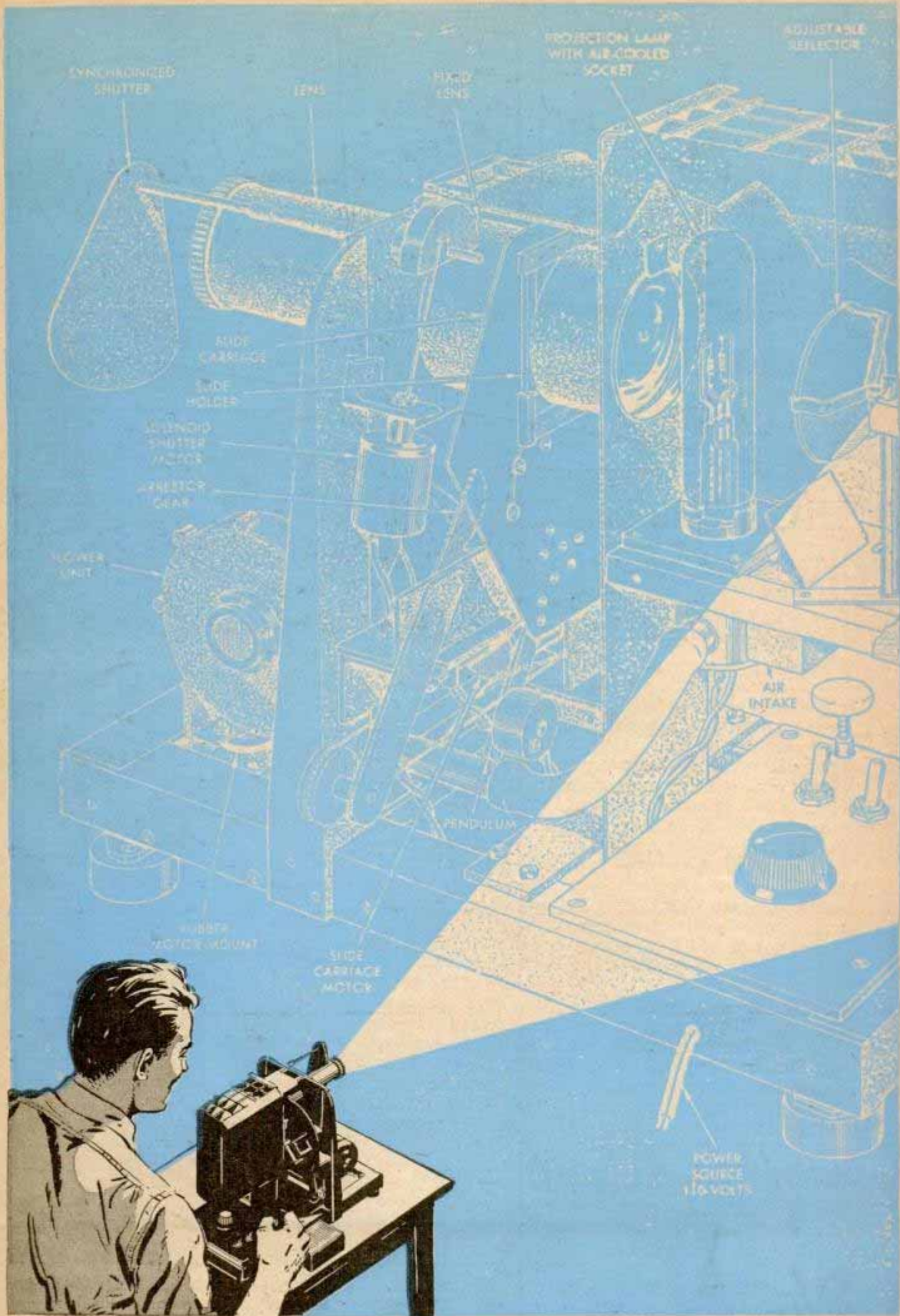

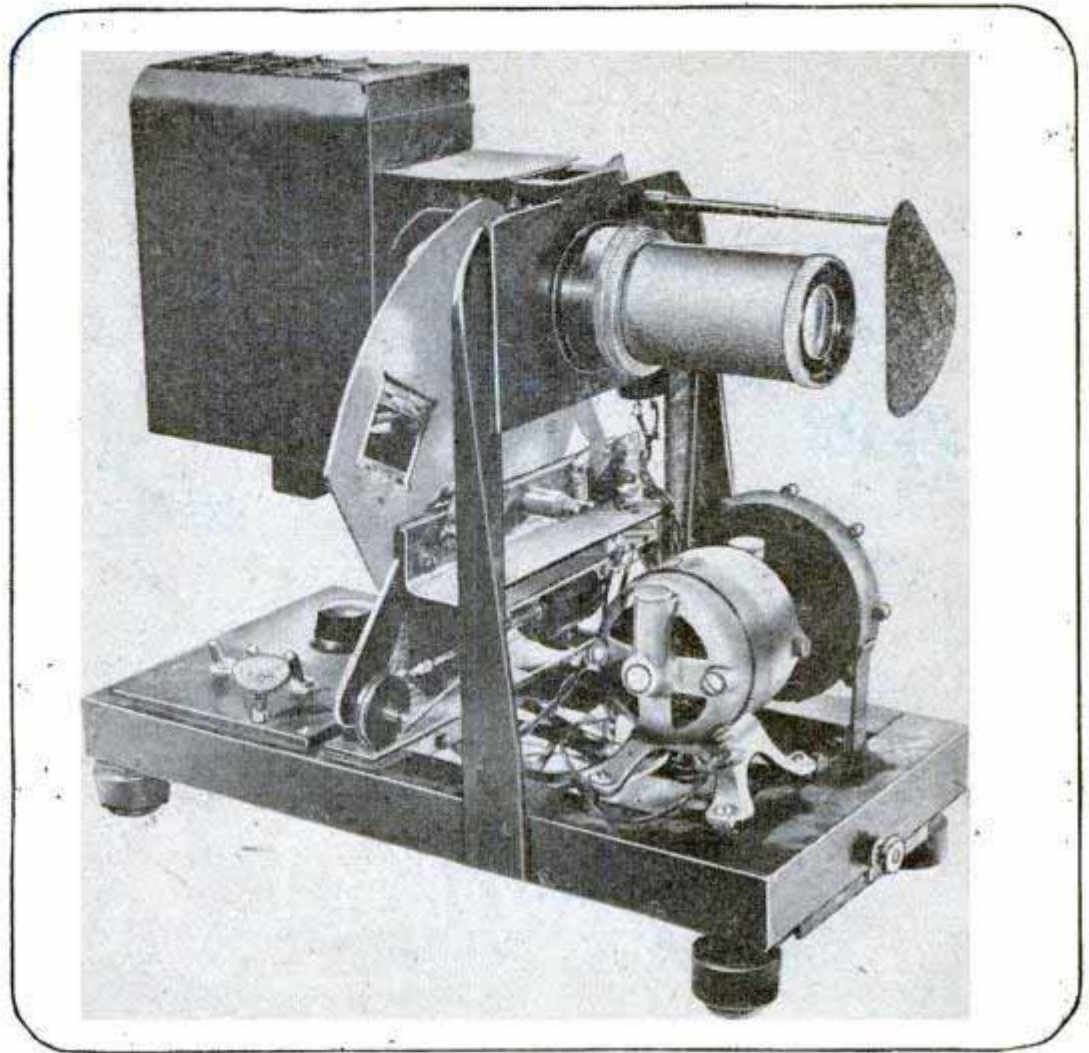

Transparency Projector

Features

**Five-Second Sequence
Push-Button Control
Injector Cooling**

**Instant Changeover
"Snap-On" Holder
Electric Shutter**

PART I

By Alexander Maxwell

AFTER going over the six features listed above you'll know this is no ordinary projector. A fully corrected lens gives brilliant, needle-sharp images which are clear right up to the edges. An electrically operated synchronized shutter makes it easy to change slides with eyewink speed, just like the change of scenes in the movies. A motor-driven rubber-mounted blower unit cools the lamp house with an ingenious "air-siphon" arrangement by means of which air is forced into the lamp house through the lamp socket. In this way no heat waves are picked up by the projection lens and there is no danger of heat damage to choice transparencies. Fig. 1 shows the assembly complete, and the photo at the upper right gives you a view of the opposite side of the instrument.

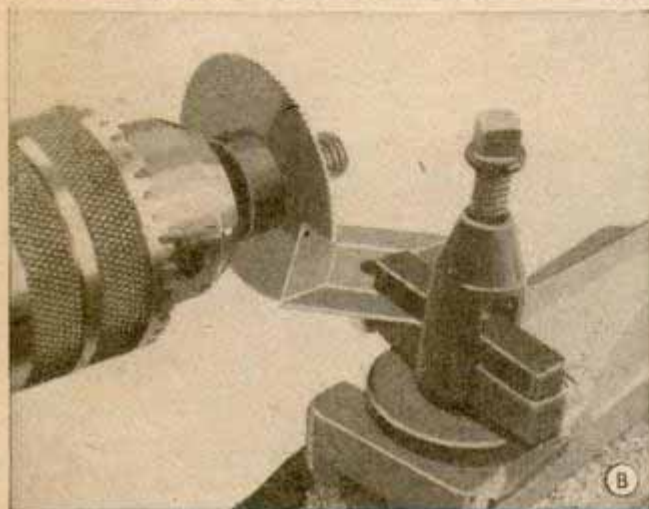
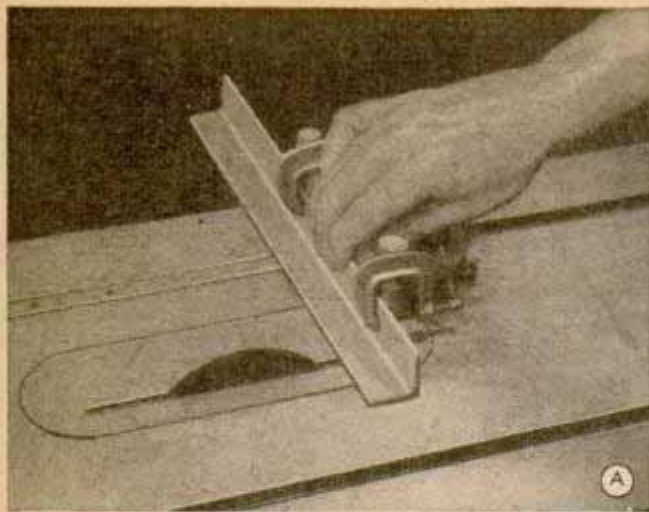

The frame, Fig. 2, consists mostly of 1 1/4-in. aluminum angle stock although 3/4-in. brass angles can be used without decreasing the rigidity. Cutting square ends is simple if one uses an abrasive wheel on the saw arbor and clamps the work to the guide as in Photo A. Machine screws are used for fastening. Thread the inner member of each joint and use lock washers. The larger-size screws can be seated with a ratchet screwdriver and there's no danger of them working loose. Drive the screws from the inside, Fig. 3, and file flush on the outside. As an added precaution it is a good idea to put an adhesive compound on the screwhead. The back foot is rigid, but the front foot can be elevated 3/4 in. to center the picture on the screen. Corner joints, Fig. 4, are made of four pieces. Use care when drilling and seat each screw before drilling for the next one. The uprights, Fig. 5, are tapered to decrease weight and improve appearance. Rough them to shape on a grinder and finish with a file.

Blower unit, Fig. 6, is purposely made as light as possible. It's driven by a 1725-r.p.m. motor. A minimum of blades insures quiet operation of the fan, and radio shock mounts, Fig. 7, float the motor and blower unit so that you hear only a gentle purr. Mahogany or gumwood is suitable for the

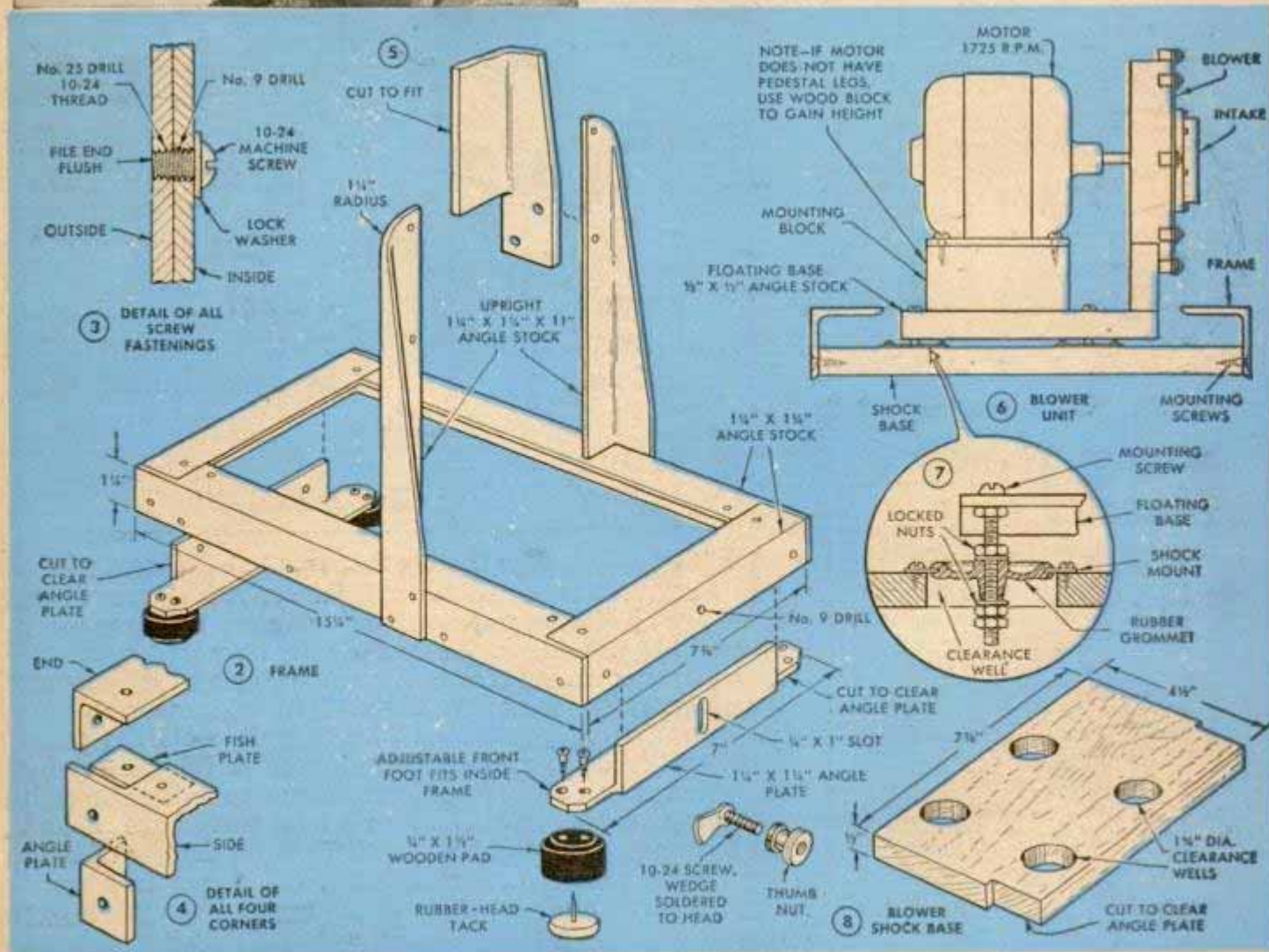

base, shown in Fig. 8, which is screwed inside the frame.

The blower housing, Fig. 9, requires careful lathe work and expert soldering. The impeller or fan is light but must be carefully balanced and must run with minimum clearance in the housing. The web is slotted, Photo B, by holding it in the lathe tool post. Solder by staking with a center punch, heating over a gas stove and then flowing solder along the well-fluxed seams. Wash clean and file smooth. The fan blades are cut to length and width on the lathe, using a tool-post grinder instead of a cutting tool and rotating the work slowly by hand. Aligning is best done with a jig, Fig. 10. The housing, floating base and supports are all clamped in place, then the setup is manipulated until the jig shows clearance zero in all positions, after which the joints are soldered one by one as in Photo C. A carbon arc is best for soldering such close work as it localizes the heat. Recheck after each joint. After soldering, drill for mounting screws. Installing the cover plate, Photo D, is the final step.

The lens must be purchased and the size needed depends upon where the picture is to be projected. As a 40-in. picture is more or less standard, Fig. 13 shows the distance of throw of the three standard lenses. A

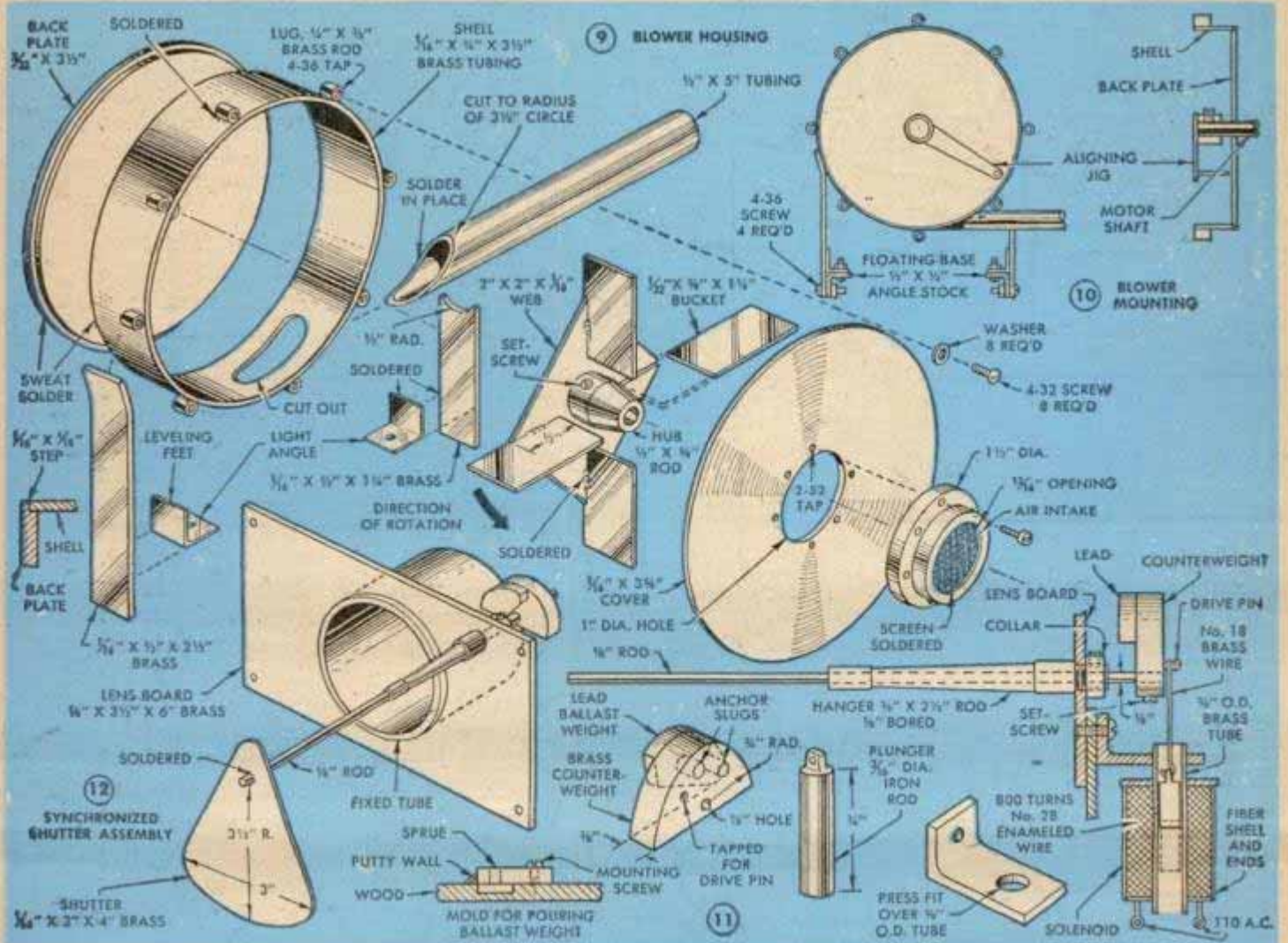
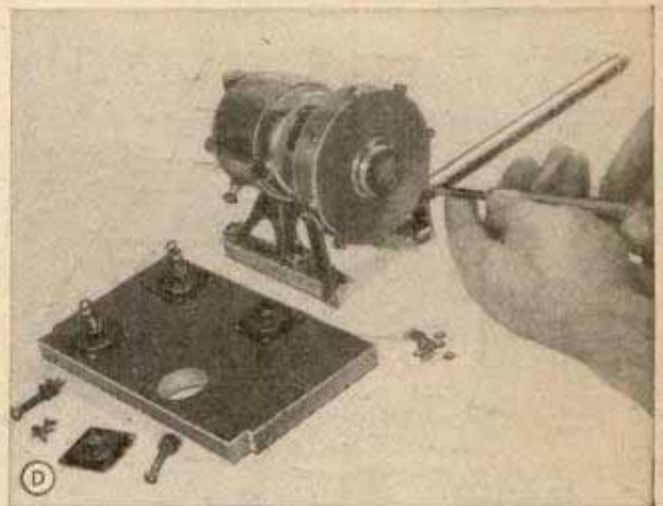
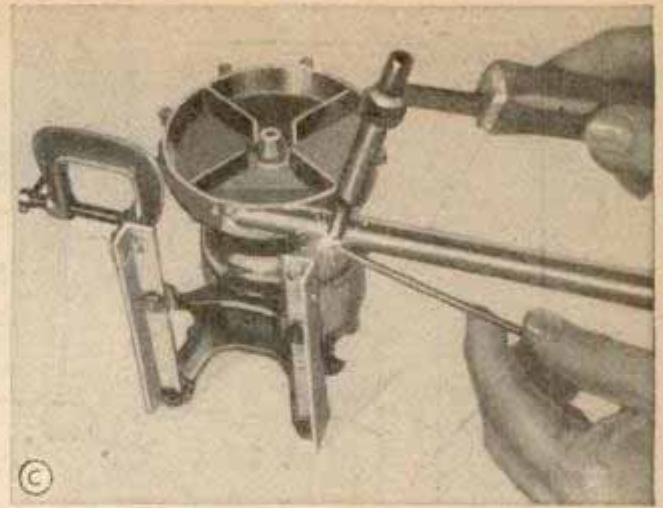

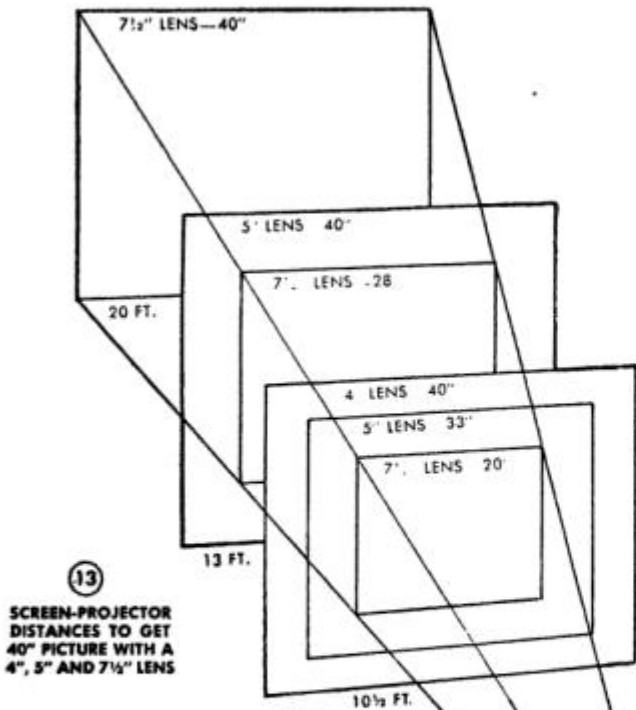

13 SCREEN-PROJECTOR DISTANCES TO GET 40" PICTURE WITH A 4", 5" AND 7 1/2" LENS

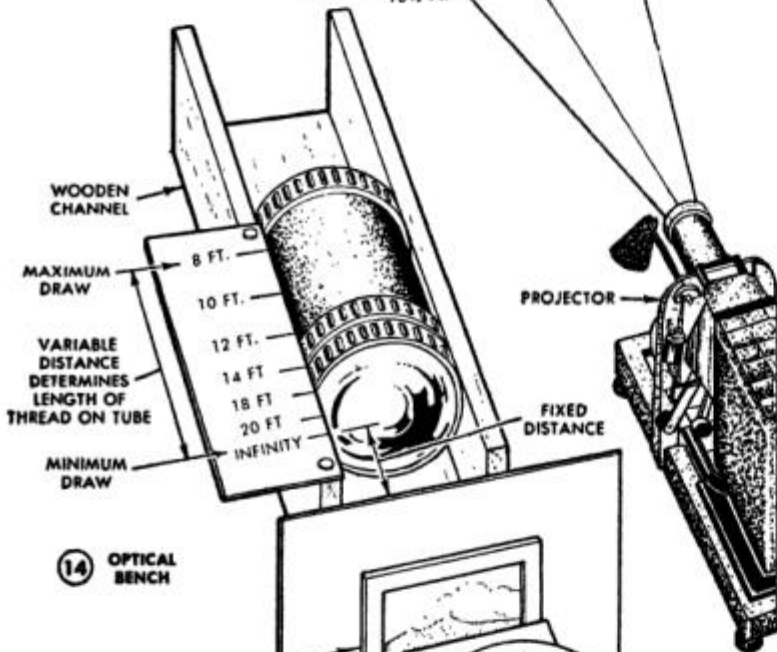

14 OPTICAL BENCH

VARIABLE TUBE 1 1/4" LONG
OUTSIDE DIA. .01" LESS THAN
INSIDE DIA. OF FIXED TUBE

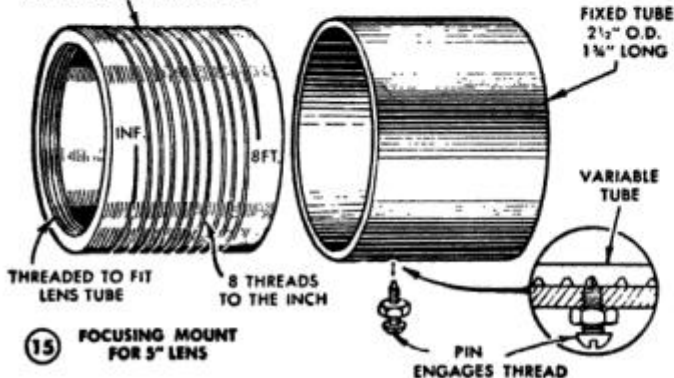

15 FOCUSING MOUNT FOR 5" LENS

5-in. lens is a happy medium and best for the average living room. Some lenses come complete with focusing mount, others screw into a barrel. They are all quite heavy and need a substantial support. Determining the length of the focusing helix requires an optical bench, Fig. 14. Set up the screen at all distances possible and mark the spots on the scale. Some lenses go from 48 in. to infinity in less than 1/2 in. of barrel travel. Others require as much as 4 in.

The lens tubes also are an individual problem for they must fit your lens and so far there is no standard mounting available. The one illustrated requires machining and was made from bronze refrigerator pipe. That is the only really suitable standard material thick enough to be threaded on both the inside and outside. The fixed tube is merely a length of seamless brass tubing. Bronze can be threaded by grinding the tool bit to a negative rake and turning the lathe by hand. This takes off a tightly curled shaving and a number of passes will result in a satisfactory thread, Fig. 15, which gives a precise lens setting. Simply rotate the barrel until the picture is sharp. So critical is the setting that when paper and glass mounts are mixed the lens must be rotated a quarter turn or so to bring each into focus.

Electrically operated shutter. Seeing one picture slide off the screen and another slide on gets monotonous but a synchronized shutter, Fig. 11, that blocks off the light for the split second during which the picture is changed is no more trying than the changing of scenes in a movie. The heart of the shutter is a solenoid which pulls down the plunger, Fig. 12, and swings the shutter over the lens. Smooth action is obtained only by balancing the shutter against the combination of counterweight and plunger so it will swing up instantly and drop back without rocking. This is accomplished by adding lead to the counterweight and regulating the voltage to the solenoid. It is extremely critical but holds adjustment well when once set. Care must be taken not to bend these parts.

(To be continued)

CRAFT QUIZ



1. Correct heat to form plastics is—
 (a) 110° (c) 800°
 (b) 250° (d) 350°

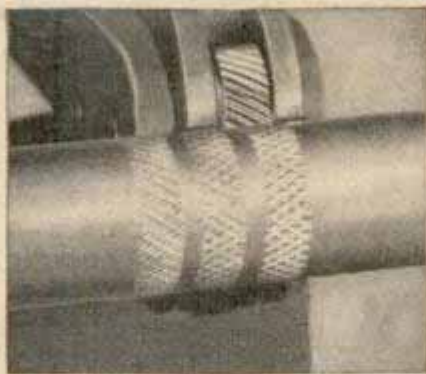

2. This lathe operation is—
 (a) Corrugating (c) Burling
 (b) Roughing (d) Knurling



3. Lacewood is also called—
 (a) Curtainwood (c) Silky oak
 (b) Fancy oak (d) Bubinga

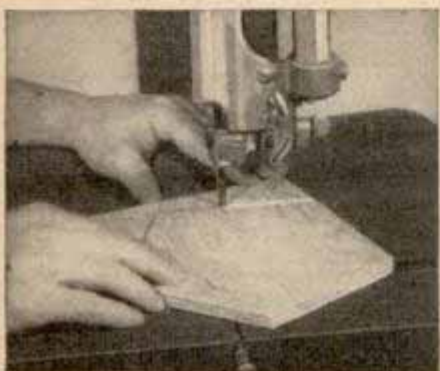

4. He is cutting a—
 (a) Pentagon (c) Nonagon
 (b) Hexagon (d) Decagon



5. Rough buffing on plastics is—
 (a) Ashing (c) Coloring
 (b) Scouring (d) Scratching

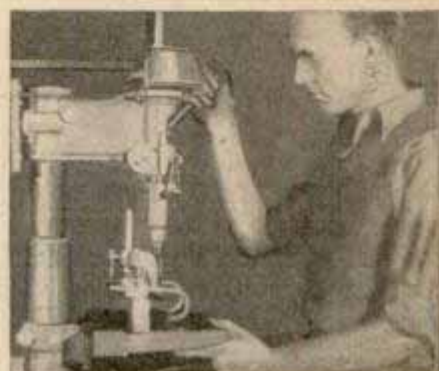

6. You can see he is—
 (a) Routing (c) Sanding
 (b) Mortising (d) Shaping

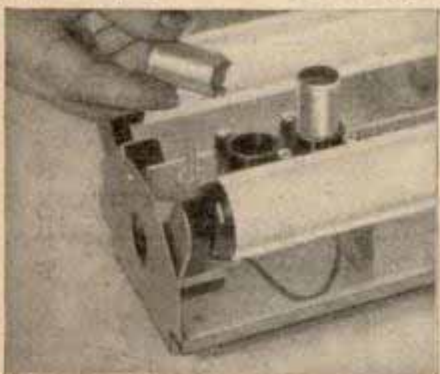

7. In a fluorescent lamp this is a—
 (a) Switch (c) Ballast
 (b) Transformer (d) Choke coil



8. Good bristle brushes have—
 (a) Flag ends (c) Single rows
 (b) Long handles (d) Chisel points

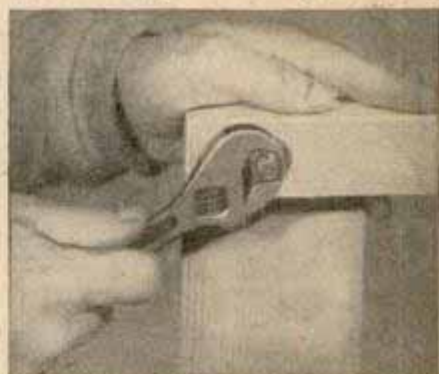

9. Wrong in tightening this nut is—
 (a) Rotation (c) Jaw opening
 (b) Kind of wrench (d) Jaw position

ANSWERS: 1-b, 2-d, 3-c, 4-a,
 5-b, 6-c, 7-a (starter switch),
 8-a (bristles brush, only 9-d
 points should be turned over
 to put brush against fixed part),
 9-d (wrench is wheel wrench, 11-b



10. He is headed for the—
 (a) Grinder (c) Lathe
 (b) Shaper (d) Bandsaw



11. These circular gadgets are—
 (a) Posettes (c) Curlicues
 (b) Rosettes (d) Swiss dots

Drawer Under Baby's High Chair Keeps Utensils Handy



To keep her youngster's plates and silver separate from the rest of the family's and to have them conveniently at hand, one housewife made a drawer to fit under the seat of a high chair. Guide strips are screwed to the underside for the drawer to slide in and a stop is provided at the back.

Garden Hose and Barbed Wire Protect Tree From Animals

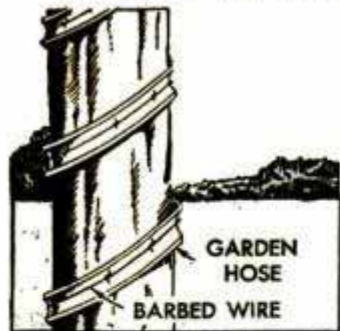

As protection for the bark of that carefully nurtured tree, wrap split garden hose, split side out, about it spirally and then nail barbed wire to the inside of the hose. Some animals will

be stopped by the hose and the wire will keep off cats. It is not necessary for the hose and wire to extend to the branches.

Substitute Holder for Gluing



Not having enough small C-clamps on hand to complete a gluing job, one woodworker found that the toe clamp taken from a roller skate was an excellent substitute. The curved parts that fit the sole of

the shoe were straightened so they would not dig into the wood. The regular skate key or a small wrench will tighten the clamp.—Earl B. Schenk, Astoria, Ore.

Clamp Holds Small Model Parts

This clamp will hold small parts while working with them. Body of the unit is a hexagon nut that has been drilled and tapped to receive the two clamping screws. Small handles welded to the nut make it easy to use.

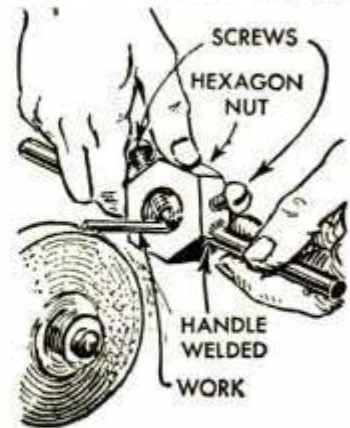

Easily Improvised Mousetrap Requires No Setting

Here's a mousetrap that's easy to make and requires no setting after it has been baited. Any large glass jar will do for the body of the trap, but the wider the mouth the better the chances of catching mice. Cover the mouth with stiff brown paper which is held in place by a rubber band around the neck. Cross slits are cut in the paper so the mice drop through it into the jar, which is half-filled with water. To suspend the bait over the jar, bend a piece of wire to fit around the neck and extend up and over the mouth. A runway is made with a piece of light wood which has a bent nail in one end to hook over the lip, as shown in the circular detail. Mice, catching the scent of the bait, will go up the runway and while attempting to get the bait, will drop through the paper into the jar of water and drown.

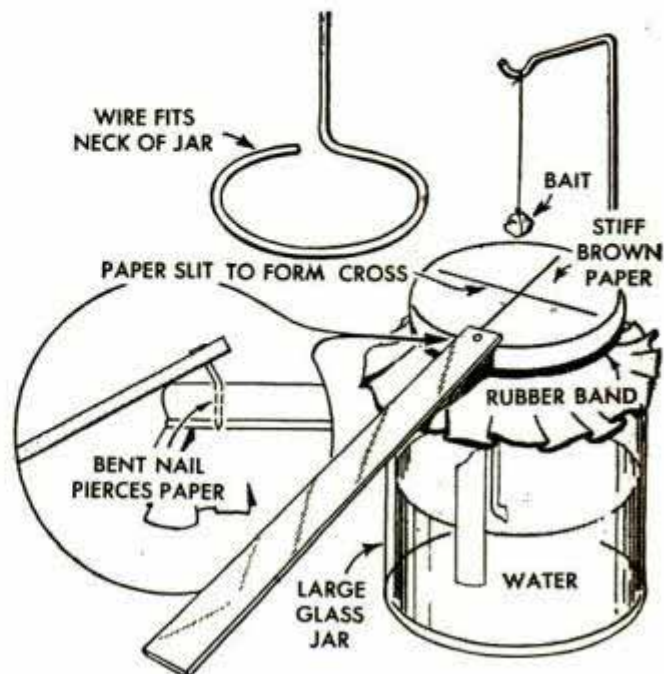

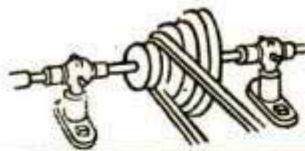

Shop Notes



Auto-Transformer Design and Construction

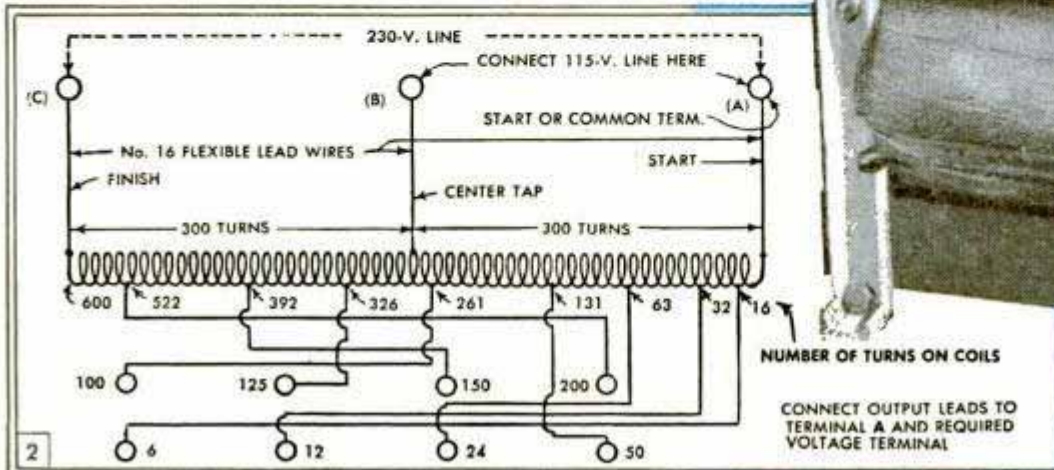
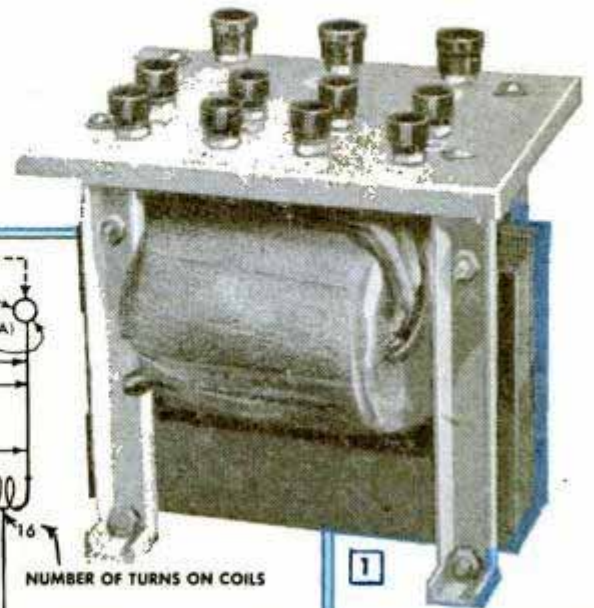

By Harold P. Strand

AN AUTO-TRANSFORMER that will provide a wide selection of voltages and have enough capacity to care for reasonably heavy loads is a handy piece of equipment to have around the workshop. The one illustrated in Fig. 1 is designed for such service and will be found easy to build, requiring a minimum of materials. If 115 volts are supplied, 6, 12, 24, 50, 100, 125, 150, 200 and 230 volts can be taken off. For 230 volts, connect the output leads to terminals A and C, Fig. 2. Otherwise connect to terminal A and the required voltage terminal. These are no-load voltages, and if it is desired to maintain this potential at load conditions, about 2 or 3 percent can be added to the specified turns for each tap. You can apply 230 volts across the full winding also. In this case reduced voltages are delivered down to 6 volts.

The winding is done with No. 16 enameled or double cotton-covered wire. This will handle loads of 3 to 4 amperes, or higher for short periods. If greater capacity is desired, add about 25 percent to the cross-sectional area of the core and use No. 14 wire for the coil. This will result in a larger coil, however, and the core will have to be altered to accommodate it.

In figuring the number of turns per volt, it will be noted that the 115-volt line is across 300 turns. Therefore, dividing 300 by 115 gives 2.6 turns per volt. For the first tap, 6 volts, there should be 6 times 2.6

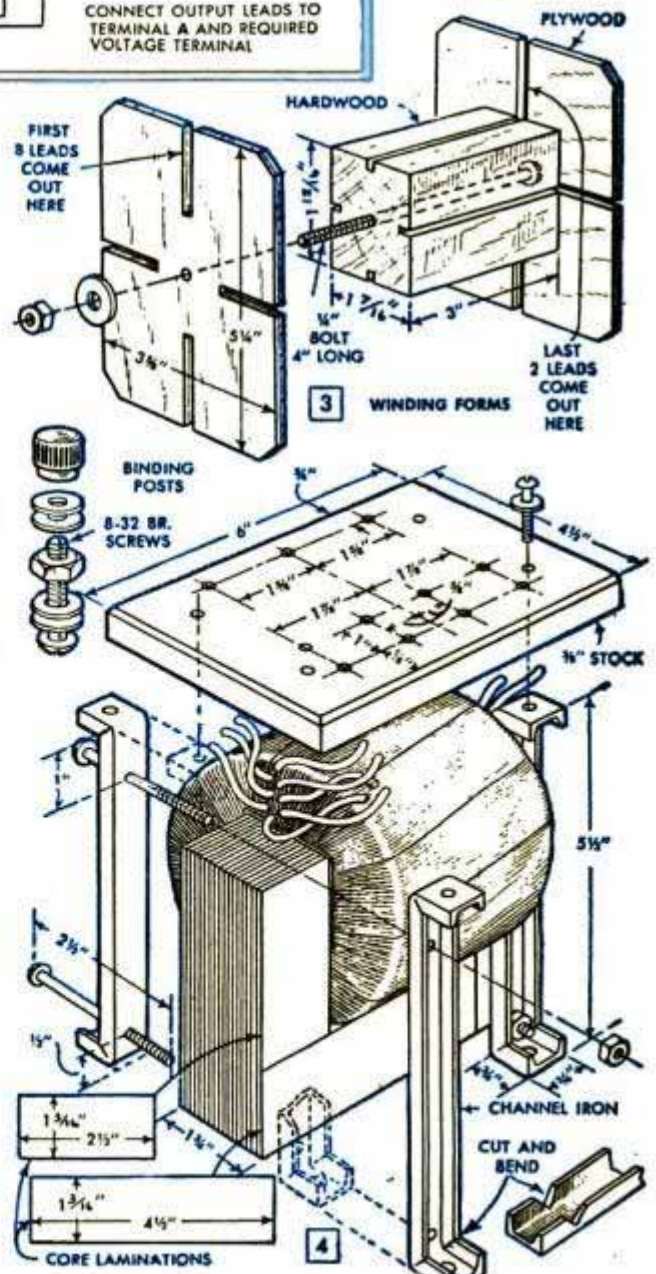

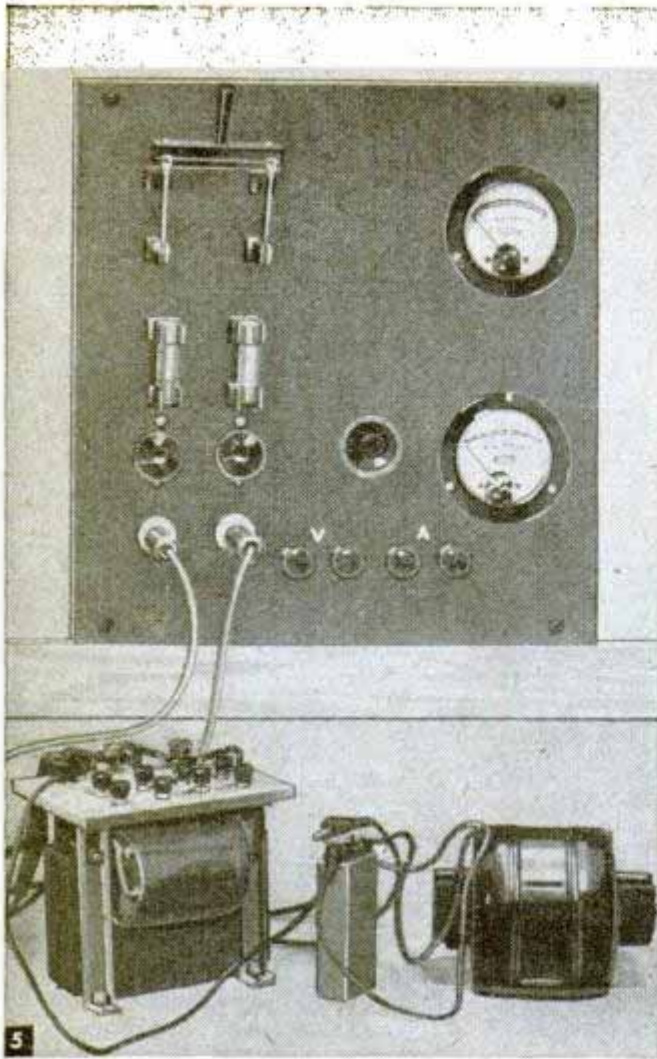

5 Here the transformer is being used on a test bench to check an electric motor that has been repaired

which equals 15.6 or 16 turns. This is the way in which all the taps are figured and it thus is possible to design the transformer to deliver any special voltages desired.

To make the coil, the form shown in Fig. 3 is used. The center is hardwood and the sides are plywood. The slots are used as channels through which string is passed to tie the coil. A $\frac{1}{4}$ -in. bolt holds the form together, the end being chucked in a lathe for winding. Wrap 2 turns of armature paper around the center, allowing it to lap over the sides about $\frac{1}{8}$ in. Secure the paper in place with cellulose tape.

When winding, use a very slow speed and be prepared to stop quickly. To start the coil, solder and tape a length of No. 16 flexible insulated lead wire to the end of the coil wire and place this in the slot next to the chuck. The first tap is made at the sixteenth turn, Fig. 6. No. 16 magnet wire is used and a cotton sleeve is placed over it. After taping, place a small piece of varnished cambric under the connection and another one over it, using cellulose tape to hold the cloth in place. Bring the lead out the same slot as the original one. Continue the winding, making the taps at the required number of turns. When you have

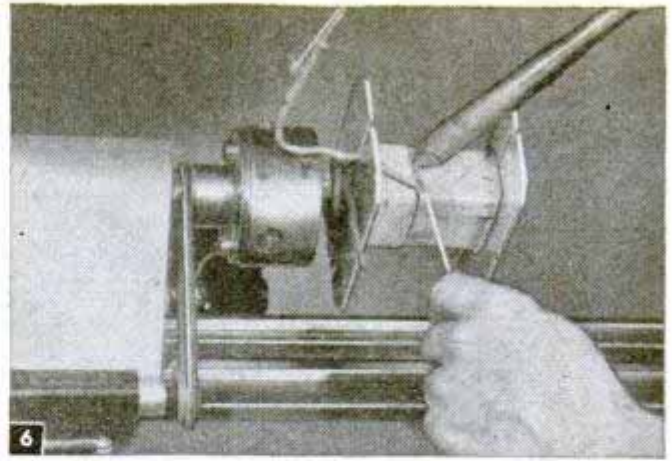

6 Soldering the tap for 6 volts after 16 turns. Note the sleeve on the length of wire used for the tap

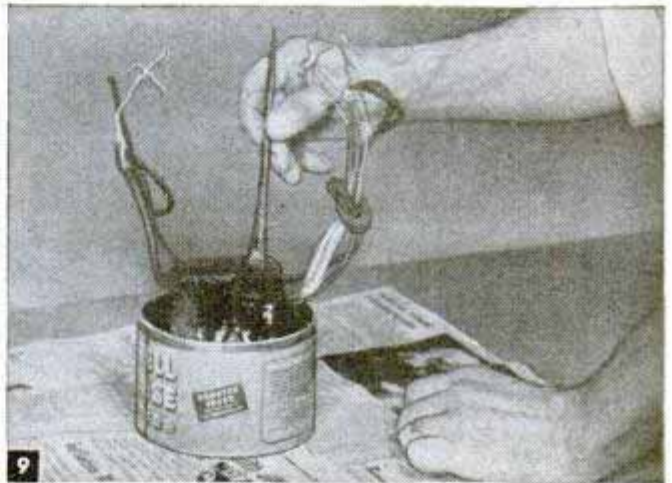

9 After the coil has been taped, it is impregnated with insulating varnish and baked for several hours

made 300 turns, again use flexible insulated wire for the lead. All taps so far, including the one made at 392 turns, are brought out the same slot. The last two connections are brought out the corresponding slot in the opposite side. The lead connecting to the end of the wiring, after soldering and taping, is fastened to the body of the coil with cellulose tape. This last lead is, of course, flexible insulated wire. A total of 600 turns is required.

Four strings are passed through the channels in the form and the coil is tied tightly, Fig. 7. Taping is done with white cotton coil tape, which is wrapped tightly and evenly, as in Fig. 8. The completed coil is dipped in insulating varnish and baked in an oven at 200 to 275 deg. F. for 2 or 3 hours. If such facilities are not available, pour the varnish in a coffee can and use a brush to impregnate the coil thoroughly, Fig. 9. Then let it drain for about half an hour and suspend it over a stove until thoroughly dry.

The core is made from strips of 26-gauge silicon, transformer grade, steel. All strips are cut $1\frac{3}{16}$ in. wide. They are cut in $2\frac{1}{2}$ and $4\frac{1}{2}$ -in. lengths. All duplicate pieces should match exactly and the ends must be

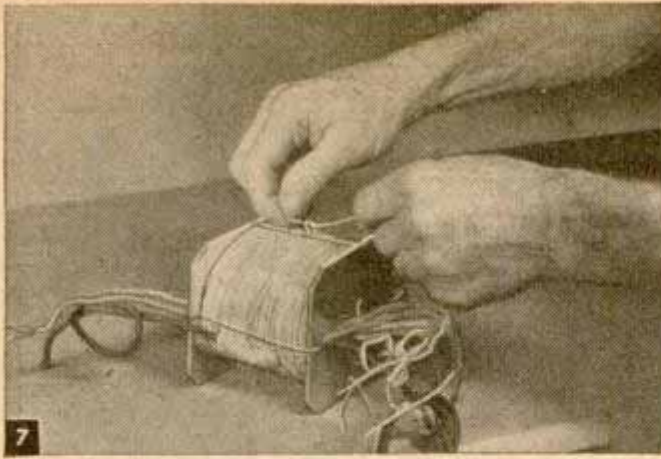

7 Before the coil is removed from the form, it is tied tightly with string to hold it while being taped

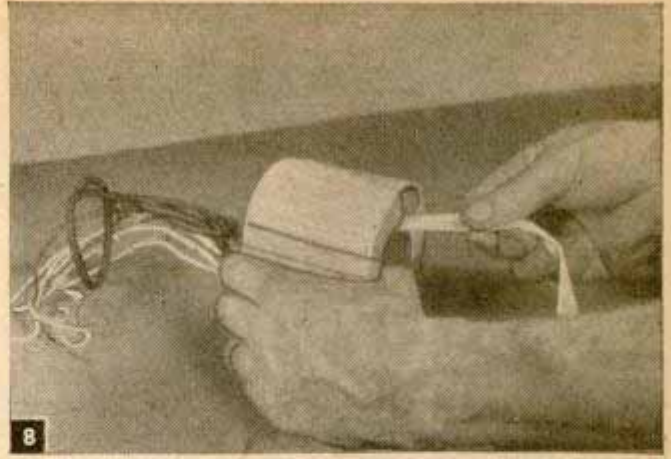

8 The coil is wound with white cotton tape. During this process, the string is removed from the wire

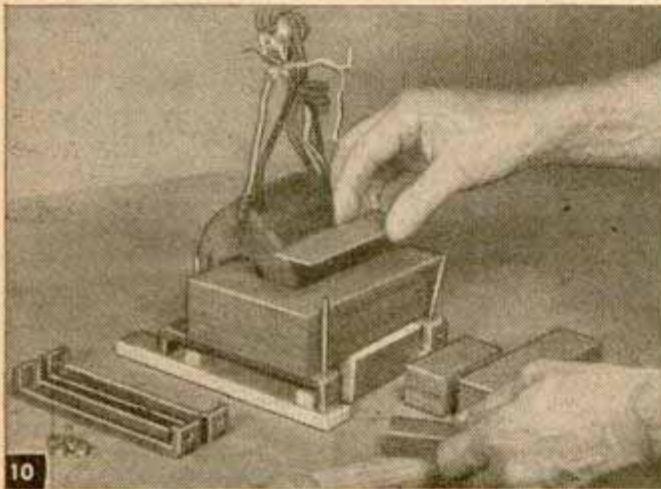

10 When assembling the core, be sure that the laminations are perfectly flat and that the ends are square

square. It might be well to check the dimensions of the coil to see that the core pieces, cut to these dimensions, will fit the coil. Make two piles of each length and when the stacks measure $1\frac{3}{4}$ in. high, tightly compressed, you have enough. The laminations must be absolutely flat to make a core that will work well.

Details of the channel-iron brackets, panel and method of assembly are given in Fig. 4. The laminations are assembled as in Fig. 10. Overlapping of the pieces should be alternated for each layer. After the brackets

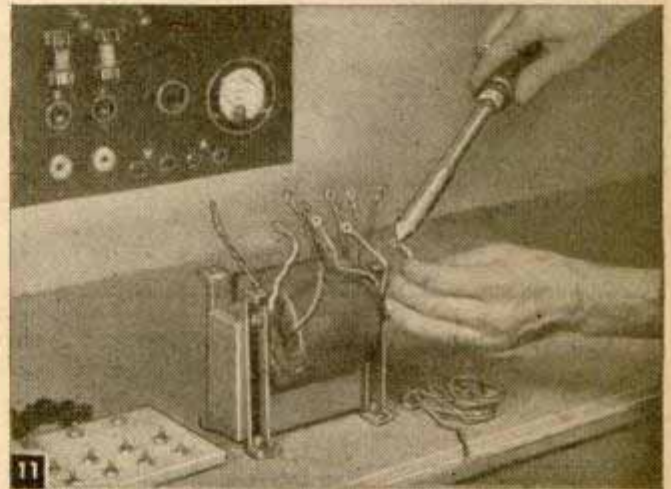

11 Next, terminal clips are soldered to all the leads after they have first been cut to the proper length

are assembled, the core can be squared up by laying the three exposed sides on a metal plate and tapping with a hammer. Terminal lugs are soldered to the leads from the coil, Fig. 11, and fastened to binding posts on the instrument panel. The leads are connected in the sequence shown in Fig. 2. It would be well to letter and number the terminals as indicated on this same drawing. All metal parts and the panel should be given several coats of enamel. Fig. 5 shows the completed unit in service, ready to test a motor that has been repaired.

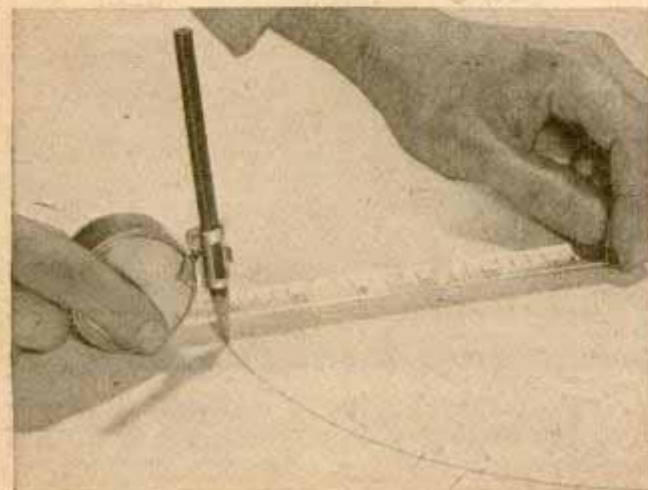

Combination Tape and Compass Performs Dual Function

If you have a steel measuring tape, make it do double duty by adding a compass attachment. With this improvised instrument you can draw large circles and do other layout work that ordinarily requires a beam compass. Secure the pencil clip from an inexpensive compass of the type used by students and solder it to the case in such a position that the pencil will be at right angles to the tape when it is extended as shown in the illustration.

Orville Buser, Kankakee, Ill.

Fishing Creel Acts as Container For Visitors' Tags



One plant uses a fishing creel, placed at the entrance, to hold visitors' tags or badges. It's an easy matter for the visitor going through the plant to drop the badge in the container provided as he leaves. Then at the end of the day the tags are collected. The basket is kept locked.

Solder Cut in Measured Lengths When Duplicating Work

Before starting to solder a number of duplicate pieces, cut enough lengths of solder that are just the right size for each

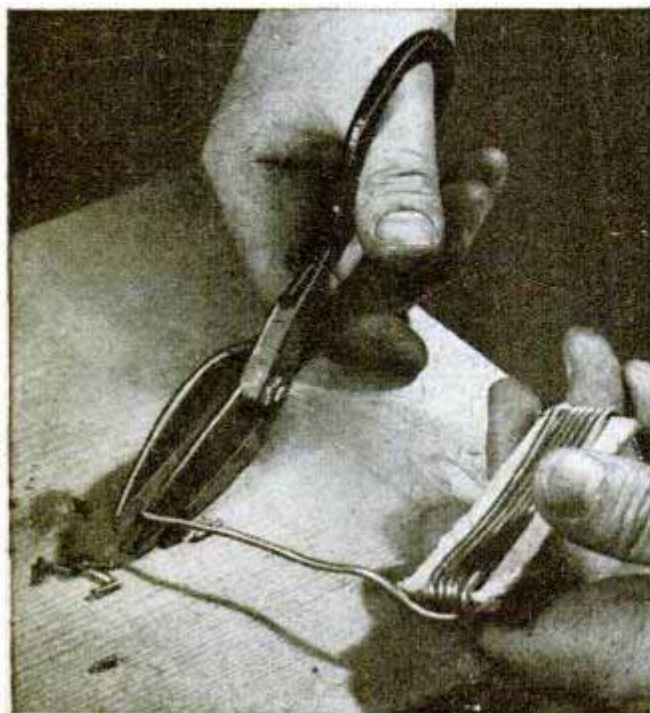

operation. Then each piece will have the same amount and the finished product will be neat and workmanlike in appearance.

Kenneth Murray, Colon, Mich.

Decorative Borders on Stencils

With some watch gears, knurled nuts and a spring-type clothespin, you can make a tool that will cut decorative borders on mimeograph stencils. A hole is drilled through the ends of the clothespin and

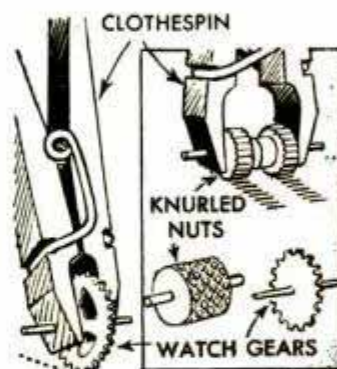

small axles are fitted to the gears, which then are slipped into the clothespin. Varying widths can be accommodated because the pin can be expanded considerably.

A. H. Waychoff, Phoenix, Ariz.

Display Promotes Metal Cleaner

To promote the sale of metal cleaner, one dealer used a display showing a jar of brightly polished pennies. Two cans of the cleaner were glued to the background of the display in an inverted position to simulate pouring the liquid into the jar. To indicate the flow of polish, rubber tubing connected the cans and the jar.

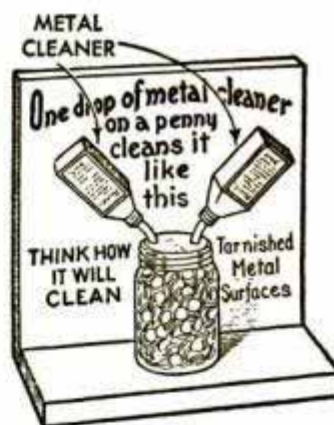

Opie Read, Jr., Chicago.

Two-Line Plumb Bob Is Stable

Twisting and spinning of a plumb bob is controlled better if the bob is suspended from two lines. Cut two triangular pieces of sheet metal and attach one to the tripod and the other to the plumb bob.

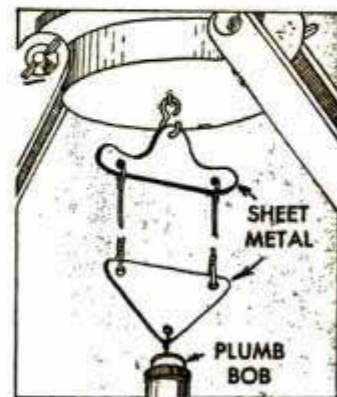

When each coat of house paint is allowed to dry thoroughly for at least ten days before the next coat is applied, the resulting finish will last longer and stay brighter.

Experimental Incubator For the Biology Lab

It also doubles in educational value when built as a school workshop project

By Edgar Watts

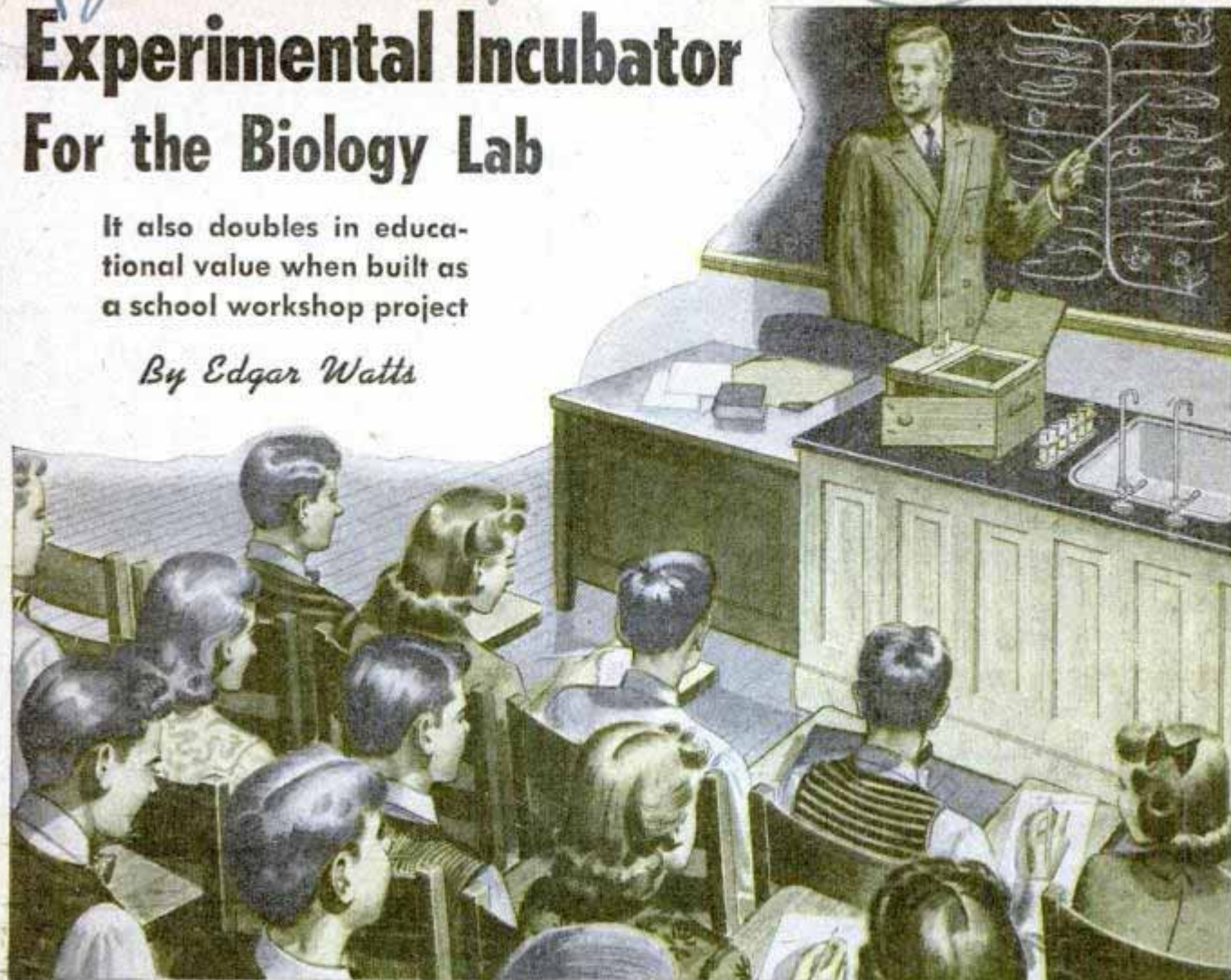

BUILDING apparatus for the incubation of microorganisms and cultivation and study of microscopy specimens, or even hatching an egg, sounds like quite an undertaking, but give the details on the construction of this laboratory incubator the once-over and it looks a lot easier. Not only that, but this type of incubator beats any temporary setup you can make because it's self-regulating, the temperature being controlled within limits of 0.5 deg. C. by an aquarium thermostat. Many experimenters in the field of amateur microscopy have use for this type of incubator, and it's an essential piece of equipment in the school lab. Boys taking courses in wood-working will jump at the chance to make it in the school workshop because of its educational value.

It consists of an insulated box containing three adjustable shelves, the interior being heated by two 25-watt electric lamps. Specifications are given in Figs. 1 to 3 inclusive and the dimensions make an allowance of $\frac{1}{8}$ in. for felt lining wherever it appears.

Building the box. Although seasoned hardwoods such as oak can be used, it will be found that medium-grade white pine will be most suitable as it is inexpensive and easy to work. Flathead screws are

recommended for all joints. Heads of the screws should be countersunk flush. Door and window frames should be beveled to an angle and cushioned with felt as shown in Figs. 2 and 3. The bolt used to fasten the door, window and cover is known as a "hanger" bolt, also sometimes called a "closet" screw. Wing nuts are used to facilitate tight closing, with washers under them to prevent the nuts from sinking into the wood. Both holes may be counterbored, the larger diameter being the same as that of the washer and the depth being the same as the thickness. The washer is cemented in place. Thickness of wood used for the box should be at least $\frac{3}{4}$ in. since thinner material is apt to be checked or warped. The 1-in. hole for the thermometer should be drilled before the box lining is applied.

Building the window and cover. The window frame consists of four separate pieces, each with two parallel grooves about $\frac{1}{2}$ in. apart to hold the glass. Ordinary window glass is suitable. The size of the glass given in Fig. 2, $7\frac{1}{2}$ by 9 in., refers only to the visible portion. As bolts used to clamp the window will interfere with the closing of the cover, small notches are cut from the cover to provide clearance for the wing nuts. Line the window casing and the edges

of the cover with felt. Use wood screws to join the parts of the window frame and set the glass in a thin line of glazier's putty.

Lining the box. Furnace cement is spread on the inside surfaces of the box to a depth of about $\frac{1}{4}$ in., covering all surfaces except the door. Keep the thermometer hole clear. After the furnace cement has dried, sheet asbestos is cut to size and laid in place, covering the same areas as the cement. Then sheet cork, of the type used for making gaskets, is carefully cut to size and nailed, together with the asbestos, to the box. Small nails or brads will pierce the furnace cement without cracking it if driven carefully. The cork also may be applied to the inside of the door, with sufficient margin to clear the edges of the box. Finish the lining with sheets of celluloid, tacked into place over the cork. This facilitates cleaning and further improves the appearance, besides providing a shiny surface for the reflection of heat waves, thus materially increasing the effectiveness of the insulation.

The shelves. To provide shelf adjust-

ment within $\frac{1}{2}$ in. of any desired level, two pieces of $\frac{3}{8}$ -in. plywood are cut to fit the sides of the box and grooved to a depth of $\frac{1}{8}$ in. on one side. The grooves are spaced $\frac{1}{2}$ in. apart and cut with one pass over the circular saw which makes them about $\frac{1}{16}$ in. wide. The grooved pieces are then nailed to the box as in Fig. 2. Shelves are cut to fit with a little clearance. Metal strips about $\frac{1}{16}$ in. thick are fastened to the bottom of each shelf, with enough of the strip projecting to enable the shelf to be pushed along the grooved sides without binding. The projecting ends of the metal strips should be slightly rounded. Grooves are cut in the shelves to prevent round objects, such as eggs, from rolling. Cutouts in the bottom shelf only prevent interference with the light bulbs.

Electrical work. It is neatest and safest to do all wiring on the inside of the box and no wire smaller than 18-gauge should be used. Two 25-watt bulbs provide sufficient heat for most work. A seven-watt bulb in a small socket on top of the box serves as an indicator signal. All these

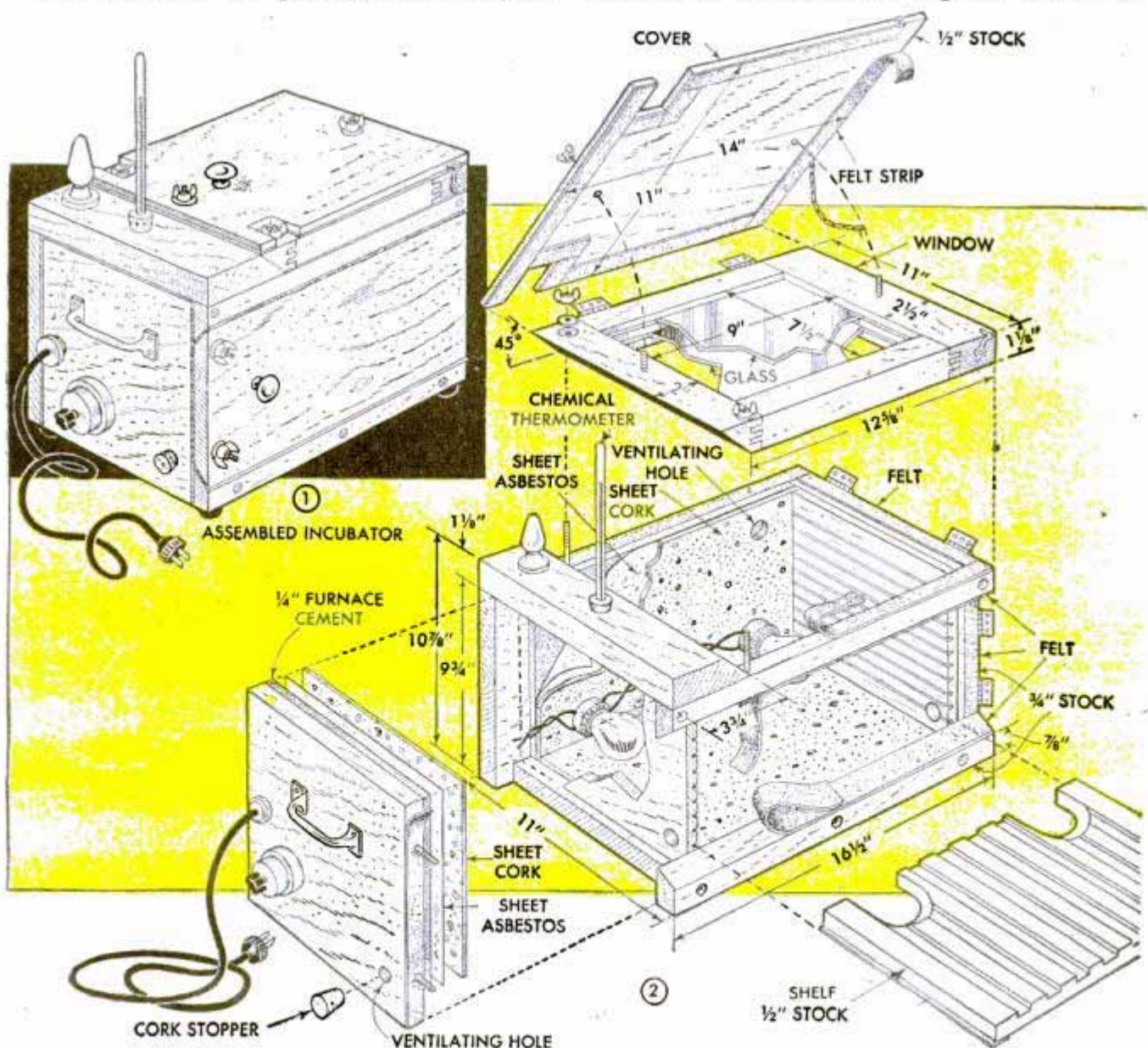

bulbs are wired in parallel as in Fig. 3. The thermostat is placed with the adjusting screw near the hole in the thermometer so that it may be adjusted by removing the thermometer and extending a screwdriver through the hole. The thermostat must be wired in series with a 1 mfd. 400-volt (paper-type) condenser connected across the terminals to prevent sparking which would affect the operation of the thermostat. Unless the latter is wired in series a short circuit will result. The current switch on the outside of the box is also wired in series. An extension cord and cap to plug into the house current completes the electrical work.

Finishing. Small chains may be attached to the window and cover to hold them open in position, reducing strain on the hinges. A handle on each side of the incubator makes

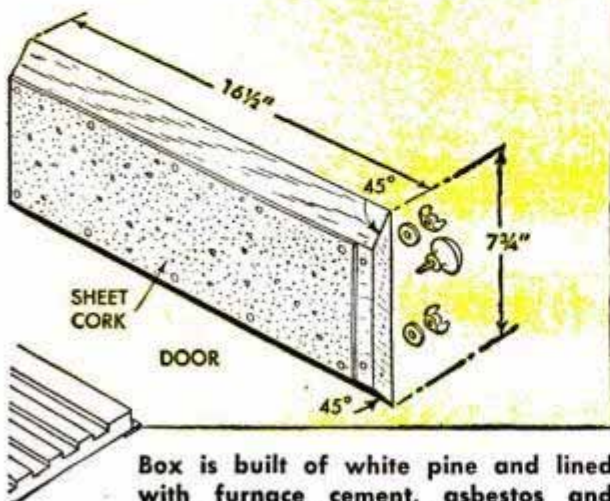
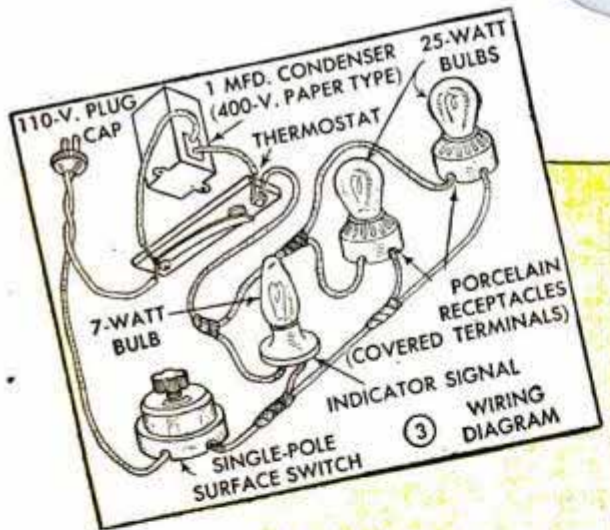
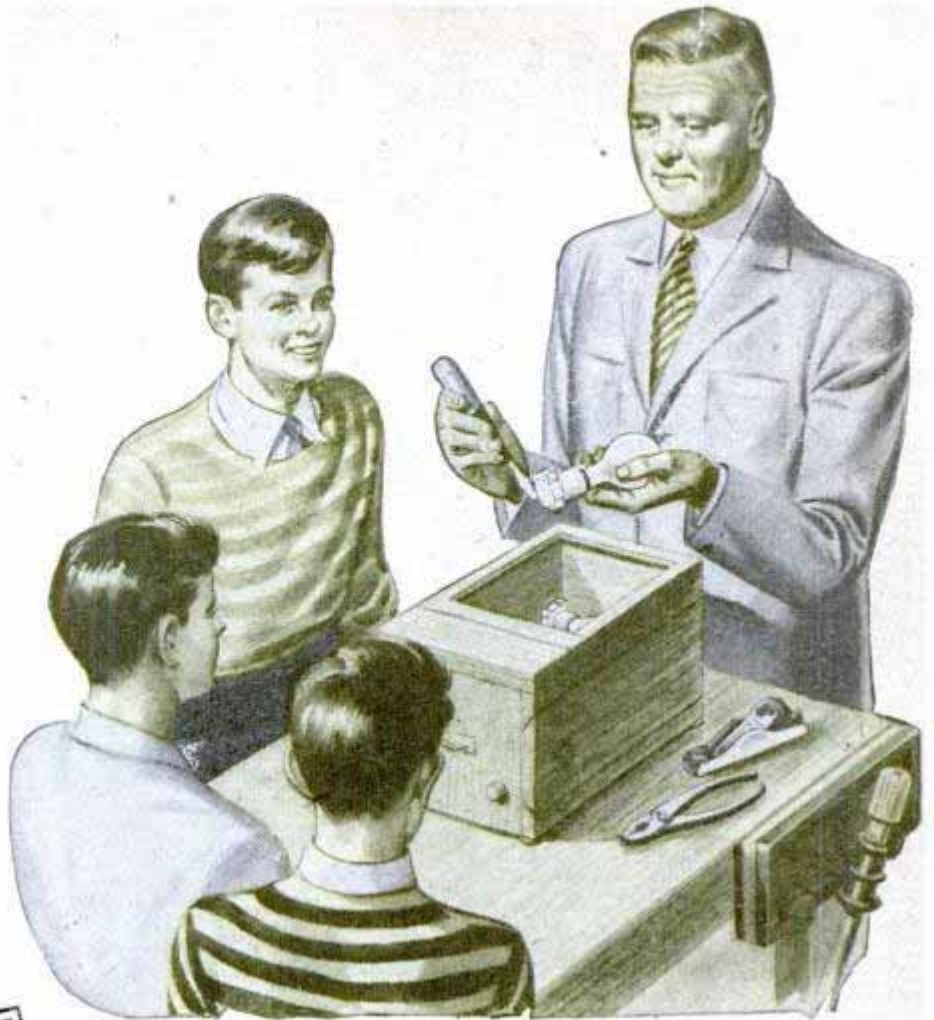

Box is built of white pine and lined with furnace cement, asbestos and cork. Sheet celluloid finishes the interior and two 25-watt lamps controlled by an aquarium thermostat supply heat

the unit easier to move about. Use wooden knobs on the door and cover and attach rubber feet to the bottom of the incubator. A chemical thermometer, preferably with both centigrade and Fahrenheit scales, is pushed about 2 in. through a hole bored in a cork which is forced into the hole in the top of the incubator as in Fig. 1. It is advisable to provide some means of ventilation. Bore four 3/4-in. holes, one on each side toward the front and bottom and two in the back toward the top, to provide ventilation. With the incubator heated and the holes open, air will enter the side holes and leave through the other two, providing a steady current of fresh air. Corks may be used to close the holes when ventilation is not required. Place a nonflammable shield around each of the bulbs and just below the thermostat and thermometer. The radiated heat of unshielded bulbs may cause the thermometer to give a falsely high reading while the thermostat will turn off the current before the temperature is as high as it should be. Although the outside of the box may be finished in any way desired, a coat of orange shellac followed by clear varnish will produce an excellent effect.

Before putting specimens into the incubator, allow it to warm up for about two hours in order to stabilize the temperature. Until all parts of the interior have been raised to the same temperature, the thermostat will turn off the current at a temperature varying from that for which it is set.

One Man Can Lift Oil Drum With This Hoist

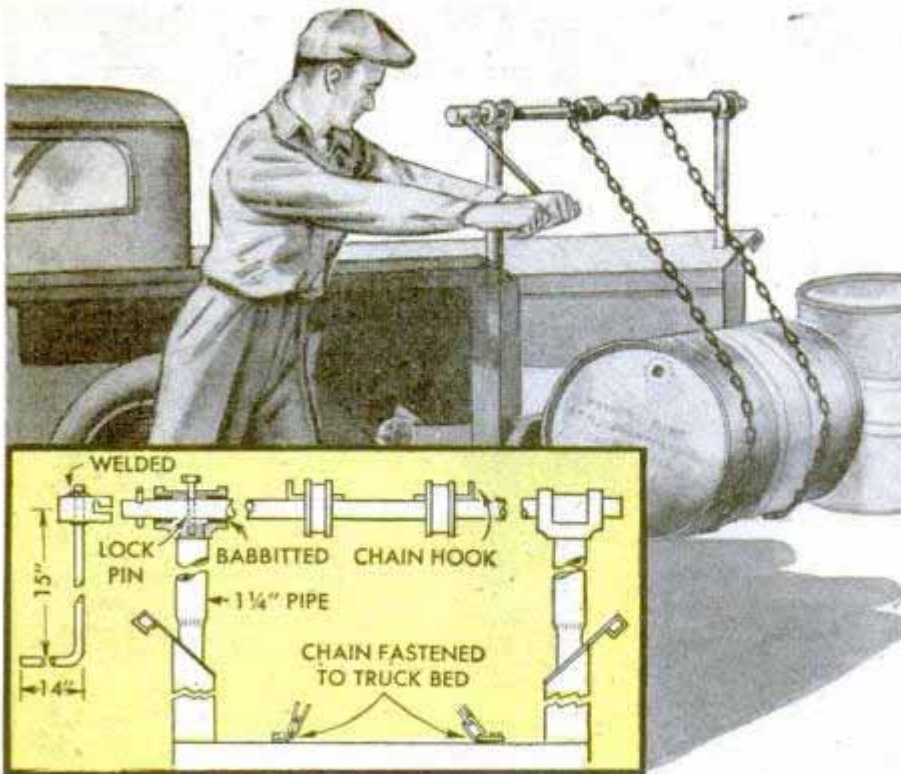

With this hoist attached to the rear of a truck, one man can load and unload oil drums with a minimum of effort, and since it isn't necessary to come in contact with the drum, clothes are kept cleaner. Pipe is used for the uprights with one end squared to fit into the stake sockets. Babbitted pipe tees serve as bearings for the shaft which has two set collars with hooks to anchor the chain. One bearing and the shaft are drilled for a lock pin. The crank is detachable so that it can be carried in the truck cab when not in use. One end of each chain is fastened to the truck bed. To load a drum, place it on the

chains after the hoist has been unwound and turn the crank until the drum rolls onto the truck. The procedure is reversed for unloading.

Walter P. Fuchs, Evansville, Ind.

Tire Spreader Simplifies Task Of Locating Nail

When trying to locate a nail or break in the fabric of a tire, this spreader simplifies the task. Four spools are riveted between two sheet-metal plates cut to the dimensions given. The rivets must be loose enough so the spools will roll easily and not bind in any way. In use, the spreader is inserted in the casing so that the spools ride on the beads.

Nathan Bogoch, Winnipeg, Man., Can.

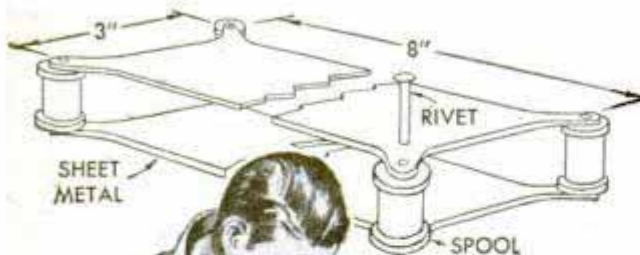

Wrench for Socket-Head Screws

If the ends of a socket-head wrench are beveled it will slip into the head of the screw easily. These wrenches are a fairly tight fit and the bevel allows movement. —Victor H. Heffel, Saginaw, Mich.

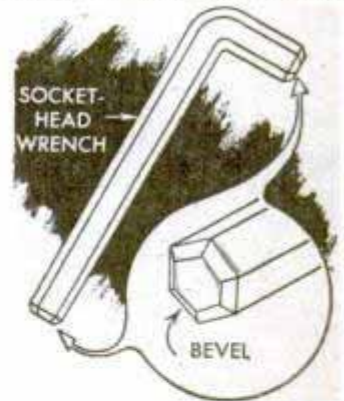

Driving Pitchfork on New Handle

Driving a three-tine pitchfork on a new handle is simplified if there is a length of large-diameter pipe at hand. Place the fork on the handle and slip the pipe over the center tine. Then hammer the pipe to secure the fork in place.

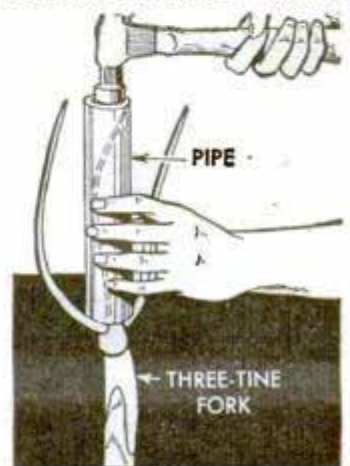

Hand-Powered DRILL PRESS

By Arthur W. Howe

THERE'S no need to place work on the floor or climb up on the bench to put enough pressure on the drill if you have a hand-operated drill press. This particular one, Fig. 1, is made from a 1/2-in., 2-speed breast drill, although other sizes may be substituted. Either wood or metal is used for the base. The column is a 36-in. length of 1 1/2-in. pipe. One end is threaded for a floor flange and the other end is notched for the operating lever. The pipe should be dressed so the two tees will be a smooth fit. These tees are reamed also and the backs are drilled and tapped for a 1/2-in. thread. Nuts are brazed in place in the following manner: thread them onto 1/2-in. bolts and turn the bolts into the tees until the nuts are flush against the tees. Then braze and remove the bolts. This will align the threads. Bend and thread short lengths of rod to make the adjusting screws.

The drill-press table is assembled as shown in Fig. 2. A short length of 1 1/2-in. pipe is screwed to the tee on the column and an identical tee is fastened to the free end. A short nipple screws to this tee and connects to a floor flange and the table. For the upper assembly, bush the tee down for 3/4-in. pipe. The nipple and tee here should center over the drill-press table. The upper left-hand detail shows how the 3/4-in. tee is assembled with the 5/8-in. rod. If you have a drill with a removable handle, you may be able to insert the rod and lock it with a setscrew, or you may have to braze it to the drill. The lever is a length of flat iron with a wooden handle riveted on. A linkage connecting the lever to the rod is held with locked nuts and washers. Fig. 3 shows an easy way to make a foot-feed drill.

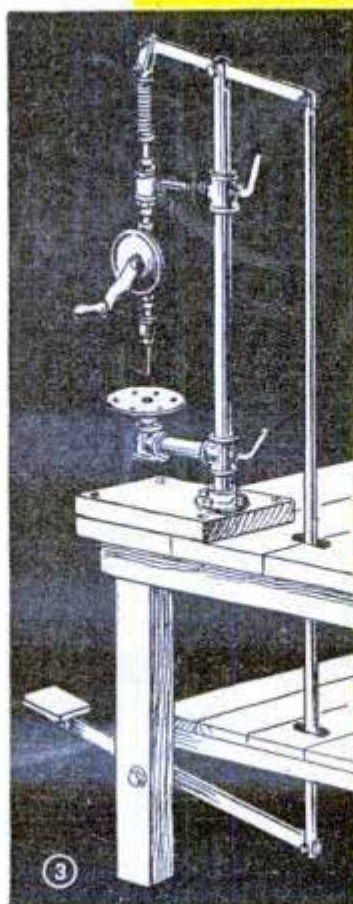
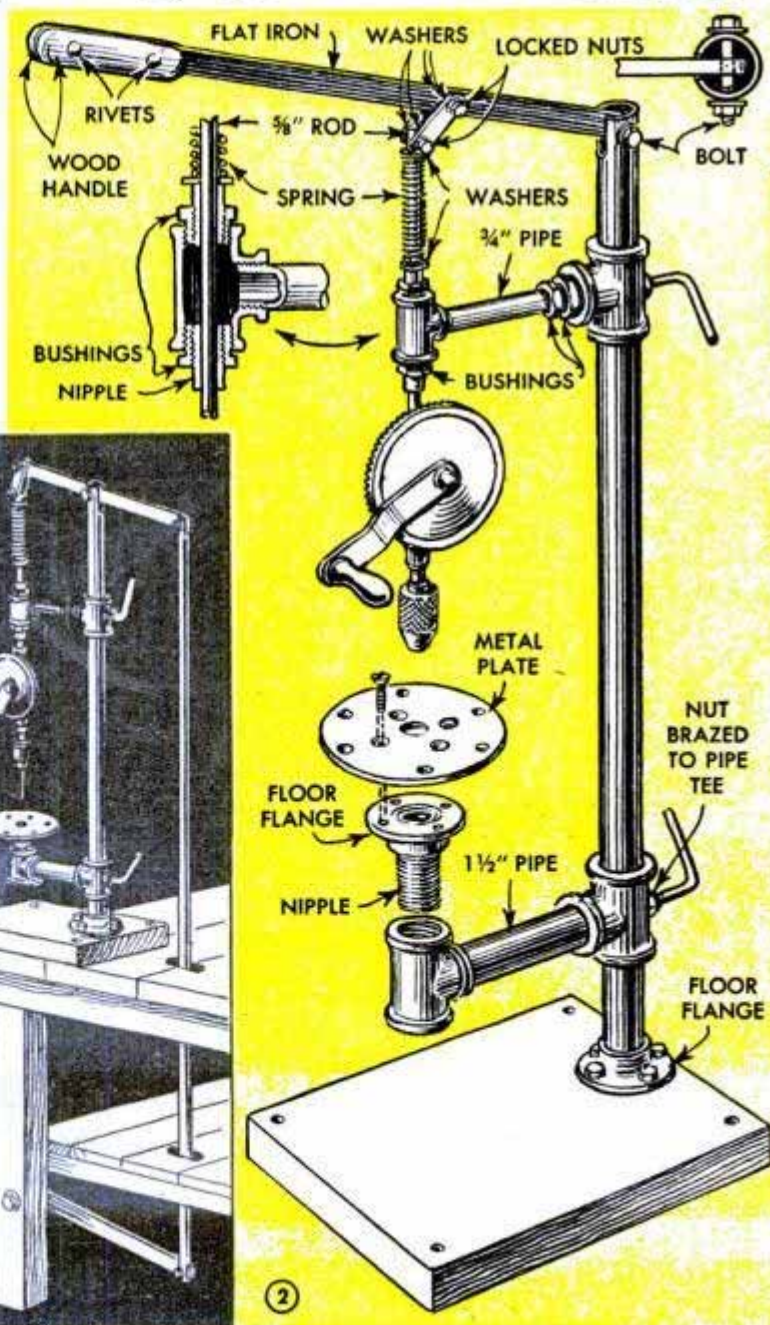
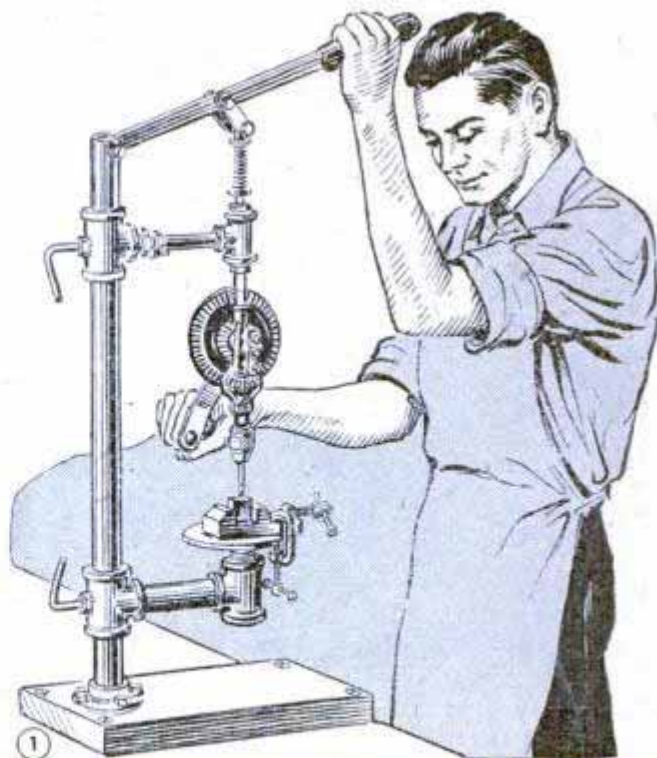

Improved TOOL-POST GRINDER

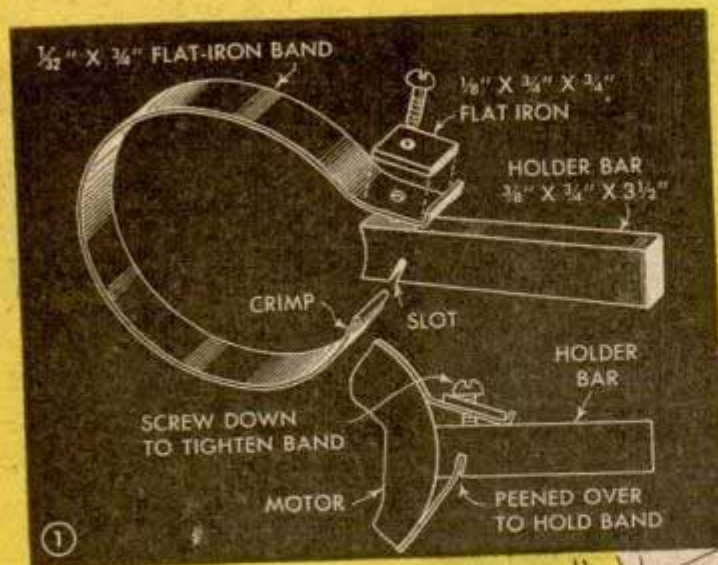

WHERE surface smoothness is more important than accuracy on small parts, high-speed grinding is often the answer. Most small grinders of the type ordinarily held in the hand are equipped either with a conventional drill chuck or with a collet-type chuck and make excellent tool-post grinders when fitted into a suitable holder. Many of these tiny motors are designed for speeds up to 20,000 r.p.m., which makes them especially suited to light grinding operations where a mirror finish on round work is the thing. A holder is made as detailed in Fig. 1, the trick being to get the compression band just the right length.

An example of work on which these improvised grinders do a first-class job is making a mandrel, Fig. 2. Select a length of steel rod and turn it until the working diameter is .001 in. greater than the hole it is to fit. Set the compound rest to about .5 deg., Fig. 2, and feed the grinder along the work cutting a taper of about .01 in. per foot. Make another pass of the grinding wheel at the same carriage setting and then lap the surface of the work with a hard slipstone and oil. On a mandrel, smoothness is more important than hardness, but if it is to be used for production runs, caseharden the center bearing surfaces of both ends. The mandrel can be pressed in and out of the work with an arbor press and being highly polished it will not freeze in the work.

Slicing glass tubing into spacer rings, Fig. 3, is a simple and rapid operation. An abrasive disk scores the glass and the heat snaps it off. Certain types of glass are a bit more involved. A diamond disk is used and the tube is cut all the way through.

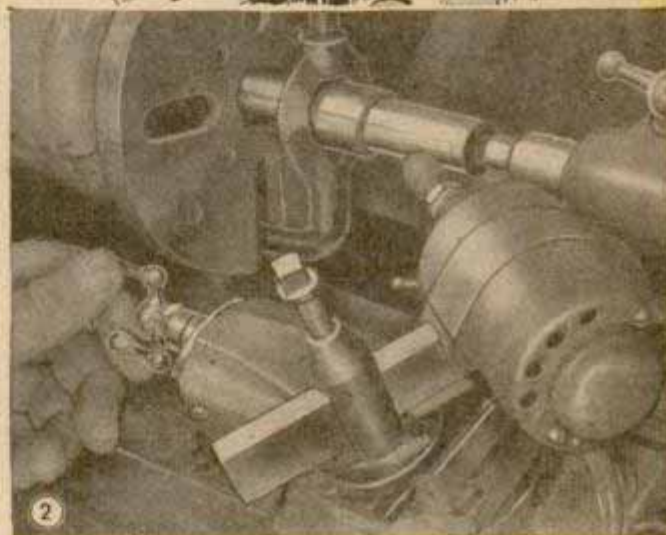

Glass-smooth finish on a lathe mandrel is possible with a small high-speed grinder set up like this. Speeds up to 20,000 r.p.m. are common

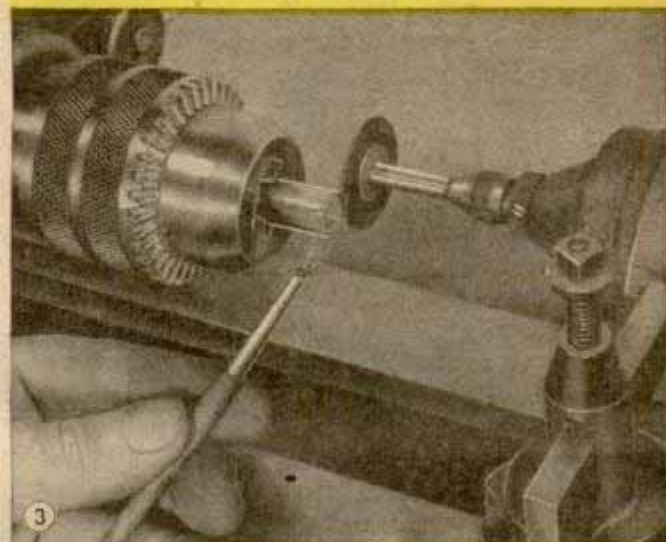

Spacers are cut from glass tubing in a jiffy with this setup. The wheel scores the glass and a brush dipped in ice water snaps off the ring

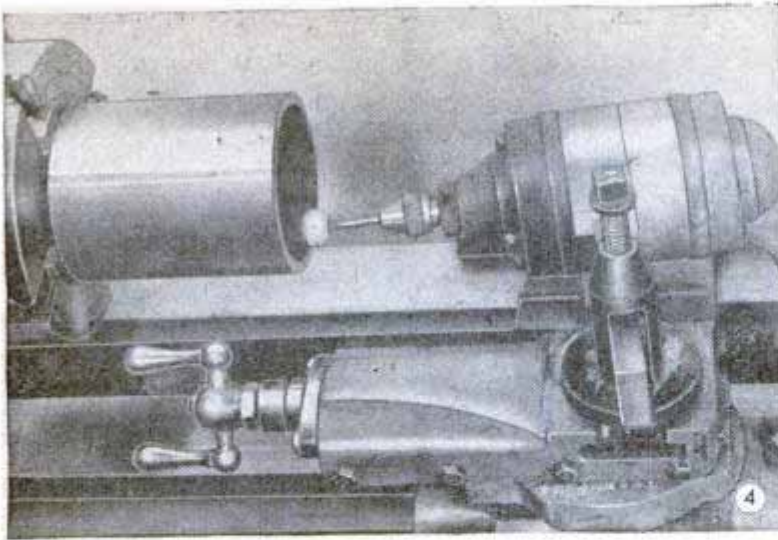

How to Select Grinding Wheels

Use aluminum-oxide wheels for high tensile strength materials

Carbon Steels	Malleable Iron
Alloy Steels	Wrought Iron
High-Speed Steels	Tough Bronze

Use silicon-carbide wheels for low tensile strength materials

Gray Iron	Aluminum
Chilled Iron	Copper
Brass	Rubber
Bronze	Leather

Use soft wheels on hard materials

Use hard wheels on soft materials

Use coarse wheels for rapid removal of stock

Use fine-grained wheels for a smooth finish

5

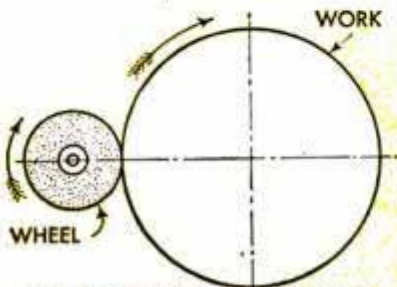

FOR EXTERNAL GRINDING, WHEEL ROTATES IN SAME DIRECTION AS THE WORK

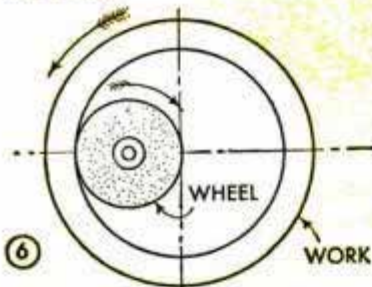

FOR INTERNAL GRINDING, WHEEL ROTATES IN DIRECTION OPPOSITE THAT OF THE WORK

Diamond disks must run in thick soapsuds. If the tube resists breaking, touch it with a brush dipped in ice water.

Seamless tubing seldom is truly circular, but it can easily be trued up by dressing lightly with the wheel as in Fig. 4. For much of this work it is important to select a wheel that cuts without clogging or heating unduly, Fig. 5. Shellac-bonded wheels are generally used, but fine rubber wheels will do almost as well. The diamond disk is a wafer of soft iron or copper in which diamond dust is embedded.

Work is rotated in the direction opposite to wheel travel for internal grinding, Fig. 6. Correct cutting speed is about 5000 surface ft. per min. with most wheels. Hence speed of the grinder should be about 15,200 r.p.m. with a 1-in. wheel. As most grinders turn 20,000 r.p.m. they are designed to run with a smaller wheel on stationary work. When the work rotates, Fig. 6, an allowance must be made. Small wheels require faster work rotation and large wheels slower. Before using a large wheel in a constant-speed grinder, check with the wheel speed recommended by the manufacturer.

Plastic Hand Scraper Cleans Windshield of Sleet and Ice

This scraper is handy when cleaning sleet or ice from auto windshields because it will not scratch the glass. The blade is made of plastic or fiber material and when worn can be discarded and a new one substituted. Over-all dimensions of the blade and handle are given in the illustration.

A. E. Fenn, Chicago.

Wiring Electric-Fence Gate

To eliminate devices requiring extra attention when opening and closing the gate of an electric fence, one farmer ran the wire in underground tile and connected it to the fence on both sides of the gate. The wire, of course, must be a type suitable for underground service.

Concrete can be prevented from freezing by adding a pound or two of salt to each sack of cement used.

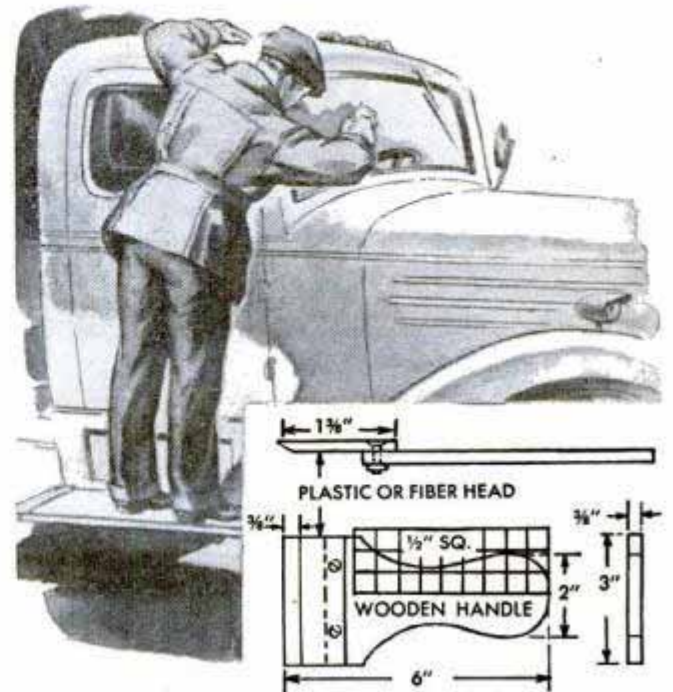

Sliding Door on Poultry House Operated From Outside

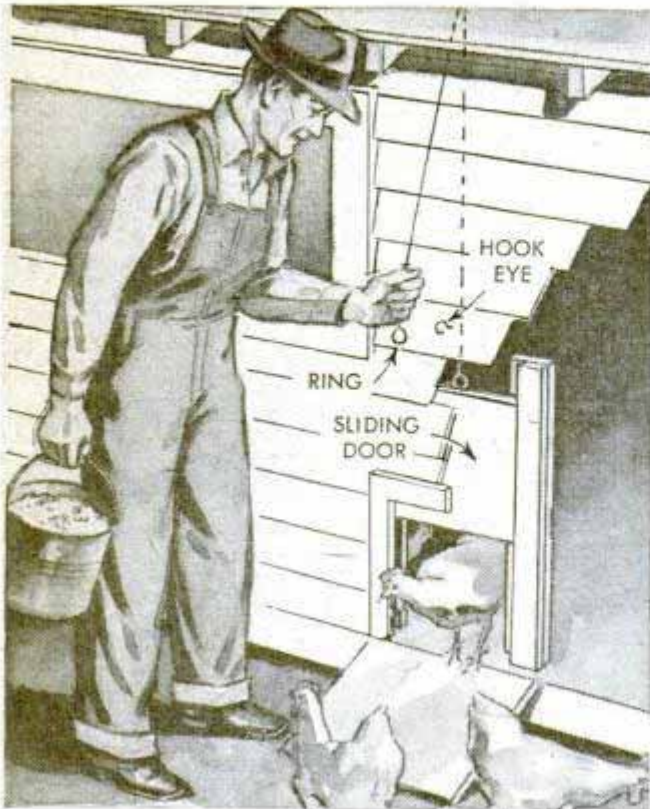

Saving many steps, this sliding door may be fitted easily on any poultry house. Just cut an opening of the desired size, screw two slides in place on the inside of the house and fit with a board to serve as a door that will drop down freely and cover the opening. A small rope attached to the door by means of a screw eye runs through a second screw eye in the ceiling or roof boards and then down the outside of the building where it terminates in a ring. The latter slips into a hook eye on the side of the building to hold the door in an opened position.—Don Brooks, Chicago.

Shipping Tag Lifts Sales Slips



To lift sales slips from a spindle without tearing them, simply drop a shipping tag over the spindle before the papers are placed on it. By pulling up on the tag, the slips will be removed quickly.

Keeping Stock Out of Culverts

Where a culvert or drain runs under a fence, and small livestock, such as hogs and sheep, are to be kept on one side of the fence, a farmer found that if a discarded

wheel of the proper size is set at the upstream end of the culvert, the animals cannot pass from one field to another. Periodically it is necessary to clean the wheel, but most twigs and plants will wash through with the water, leaving only the larger brush to be removed.

Support Holds Envelopes Upright

After a carton of envelopes has been partly used, those remaining fall forward and become mixed up. To prevent this, use a sheet-metal book end of the type found in libraries and schools. One part of the base slides under the envelopes and the upright keeps them in place. As the envelopes are removed, the book end is advanced.

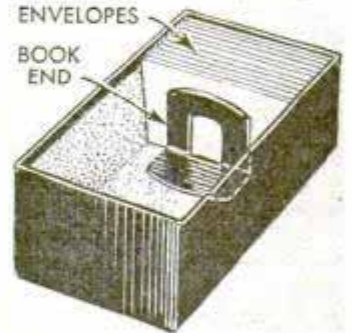

W. R. Black, Contact, Nev.

How to Sharpen Bandsaw Blades By Coiling in Vise

Usually the difficult and tedious task of sharpening a bandsaw blade can be simplified greatly by coiling the blade, as in Fig. 1, so that three teeth can be sharpened at one time. With the teeth lined up and clamped in a vise, they are filed across, as in Fig. 2. New blades will perform well if filed lightly in this manner before use.

Henry Hanscom, Elmhurst, Ill.

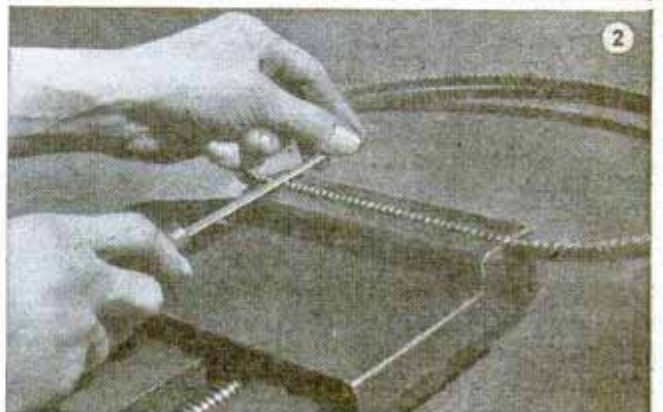
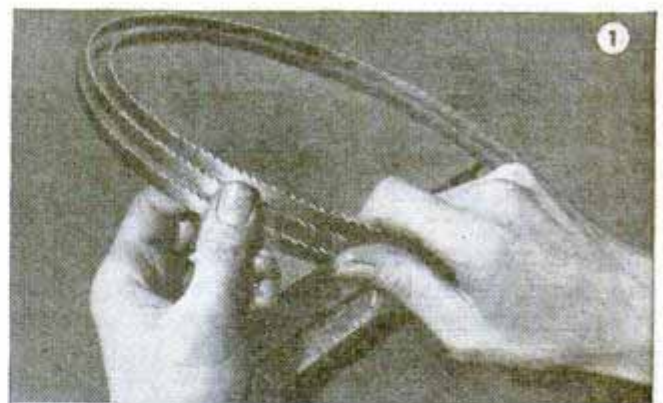

Good Pruning Aids Nature

By H. F. Roberts

PRUNING trees or shrubs is more than merely cutting off a few limbs or twigs here and there. Knowing what to take out and what to leave is the important thing, and this requires a careful study of each individual plant, taking into account its age, species and location. The time to prune varies with the locality. Some trees and shrubs can be pruned at almost any season while others will suffer extensive damage unless you do the job at precisely the right time. Experienced gardeners and orchardists say that dormant pruning is done best during January, February and March, but that the later it can be done during the dormant season the better, as the wounds will heal more quickly.

Except for formal treatment, the natural shape of the tree should be given every consideration. Each type has a typical form and pruning should emphasize this. The elm, for example, generally has a loose-growing vase shape; the Norway maple has a dense oval and almost formal one, and the pin oak has a pyramid shape with horizontal branching. Any tree will attempt to regain its normal form, regardless of trimming done to change it.

Most shade trees require relative-

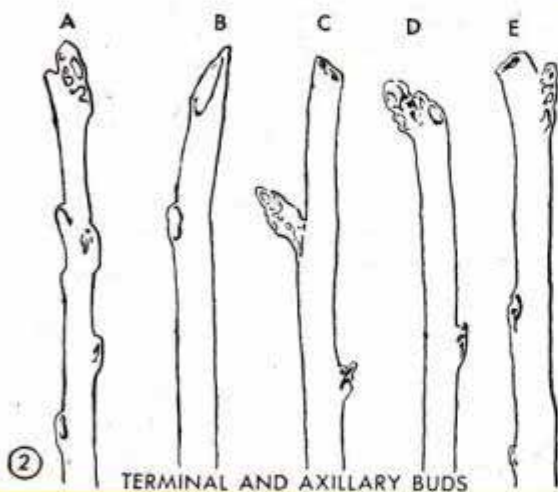
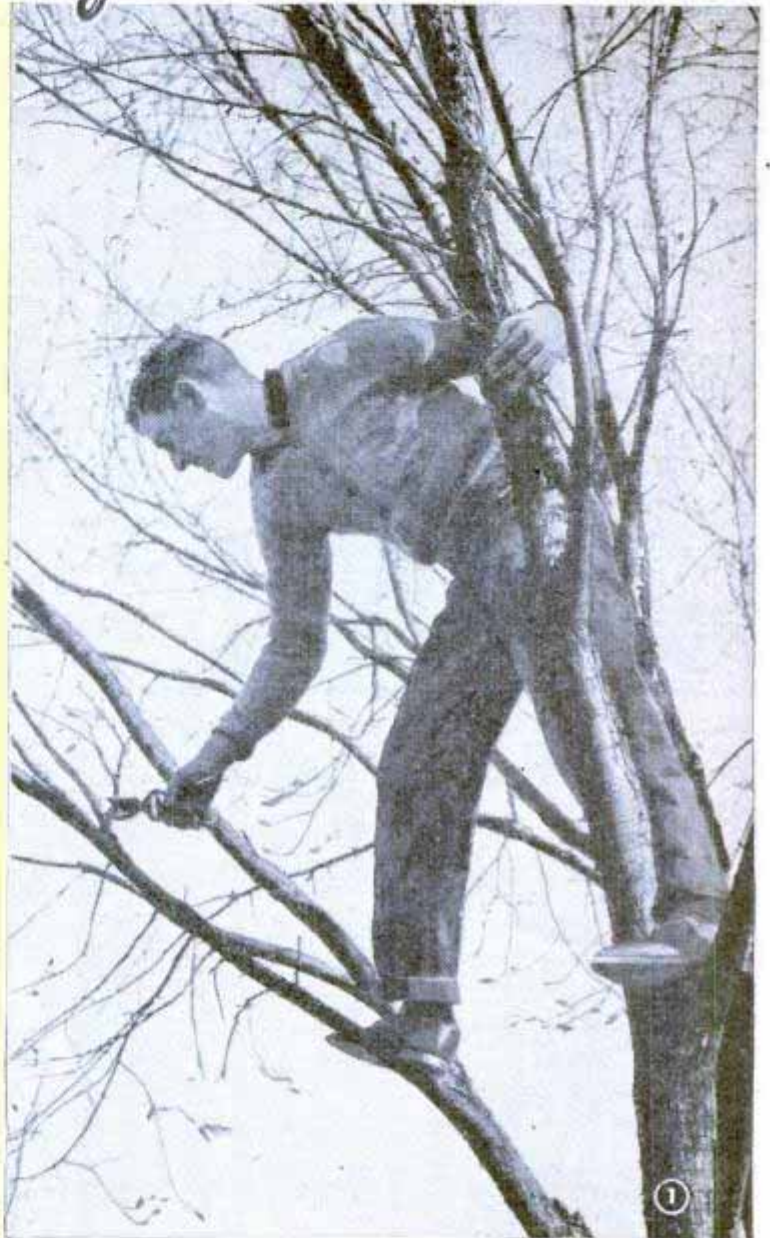

TERMINAL AND AXILLARY BUDS

ly little pruning. Removal of dead, interfering and injured branches usually is all that is needed. All cuts should be made with a sharp saw as close to the crotch as possible





bottom and the top, is to remove the stub. Very small branches are trimmed with a snap-cut pruner, Fig. 1. Any jagged edges should be shaved off, Fig. 4, and the wound painted thoroughly with tree paint, Fig. 7. Painting seals the cut and prevents moisture and decay from setting in before live wood covers the wound. Larger cuts should be painted each year because the cut portion may have a tendency to dry and crack. Some of the lower and inner branches of a tree usually die each year due to lack of sunshine. Also, some trees have a tendency to produce more branches than the roots can support and the weaker ones die off. These dead and dying branches should be removed regularly.

Frequently a tree will be found to possess a number of interfering branches which endanger the health of others by causing a crowded condition. Parallel branches too close together fall in this class also. Keep parallel branches at least a foot apart, and in removing interfering

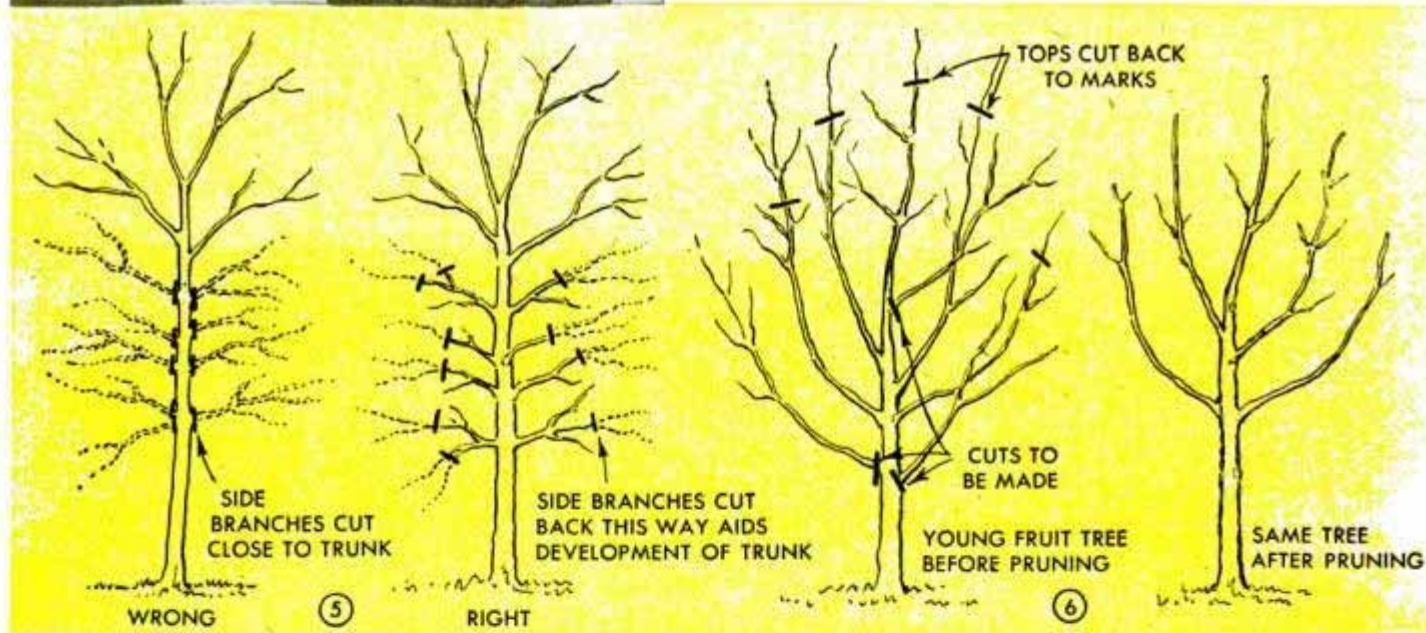

and parallel with the adjoining trunk or branch, Fig. 3. Leaving even a short stub will make proper healing of the cut difficult or impossible and may result in decay. Fig. 14 illustrates an incorrect cut where a stub has been left. Note that the live wood has been unable to cover the end and has receded, leaving a projection of dead wood which is ideal for decay. On smaller branches, the first cut should be made part way up from the bottom and then the second cut made from the top down, Fig. 13. If the cuts are not made in this manner, a tear that is very difficult to heal may result. Larger branches should be given even more care. A safe policy to follow is the one shown in Fig. 12. The first and second cuts are made as indicated to drop the limb, and the final cut, which is made from the

branches, study the over-all arrangement to maintain good balance. Worn spots caused by rubbing branches are likely to develop decay which may, in time, spread to other portions. Rubbing is due frequently to crowded or parallel branches that are too close together. One should be removed to allow more freedom. Another point of interference is at a crotch. Fig 15 illustrates a poor crotch caused by three branches coming out at the same point, forming sharp angles. Removal of the middle branch allows room for the others to spread without crowding. When a branch is torn off by wind, ice or snow, a jagged wound often results. Such an area should be cleaned until only firm wood is left and then painted. This may require lengthening the gash considerably, but that is better than leaving rough,

frayed portions that will collect moisture. Paint for several consecutive seasons until the wound heals.

It's important to prune young trees because faulty branching can be corrected while the limbs are small. A good main crotching arrangement can be trained either high or low, depending on the tree's location. Street trees should be high so they will not interfere with traffic. Most lawn trees in city and suburban areas also should be "headed up" to permit circulation of air through the yard and to allow sunshine on the lawn. Where space is not at a premium, low trees add to the appearance of the yard. When training young trees, the side branches are sometimes completely removed up to the desired height, as in the left-hand detail of Fig. 5, which makes the trunk weak. The right-hand detail of Fig. 5 shows the same tree properly trimmed.

When pruning, the location of the cut in relation to the buds is important. Detail A

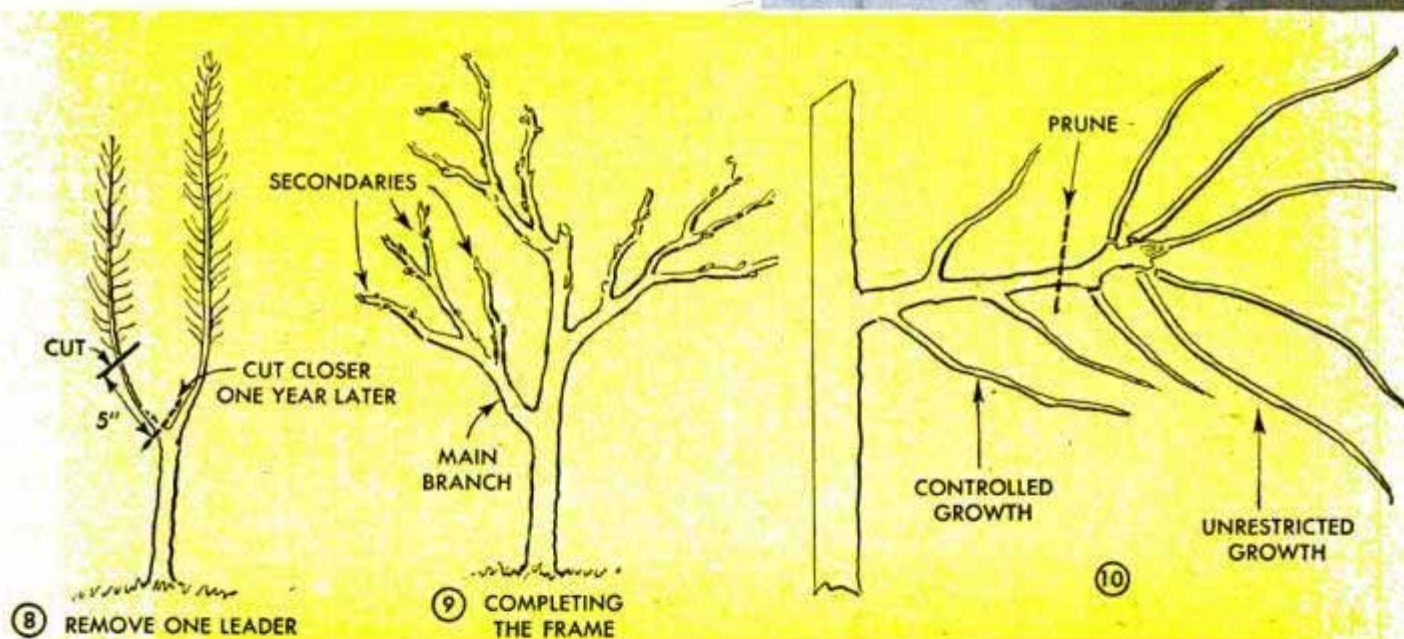

of Fig. 2 shows an unpruned branch. The terminal bud is at the tip with cluster buds at the base; farther down are axillary buds, which may be found in pairs. In detail B the cut is long and slanting, causing the wound to dry too slowly. Detail C shows a cut too far ahead of the bud and the stub may rot. The cut is too close to the bud in detail D and it may dry and drop off. The correct way is shown in detail E where the cut has a slight slant and is about $\frac{1}{4}$ in. above the bud.

If young trees have been planted, during the third year, or the second year if two-year trees were planted, shape the tree as in Fig. 9, treating each main branch as though it were an individual tree, except that the buds on it are not spaced around the branch, but should lie fanwise and par-

allel with the ground. Fig. 10 shows how growth is likely to develop if not cut back. This cutting forces the weaker buds below the cut to grow and form a well-knit frame. A newly planted tree, if it has developed two leaders, should have one cut, Fig. 8.

Fruit trees require a treatment slightly different from shade trees, although the method of pruning and the tools used, Fig. 16, are the same. Young fruit trees just being planted should be pruned to develop proper crotching and branching. The leader and three or four of the side branches should be retained. Both the leader and the remaining side branches should be cut back so the leader is 4 to 6 in. longer, left-hand detail of Fig. 6. The right-hand detail shows the same tree after pruning. When fruit trees begin to bear, their annual growth

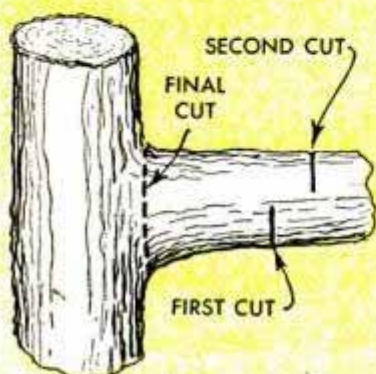
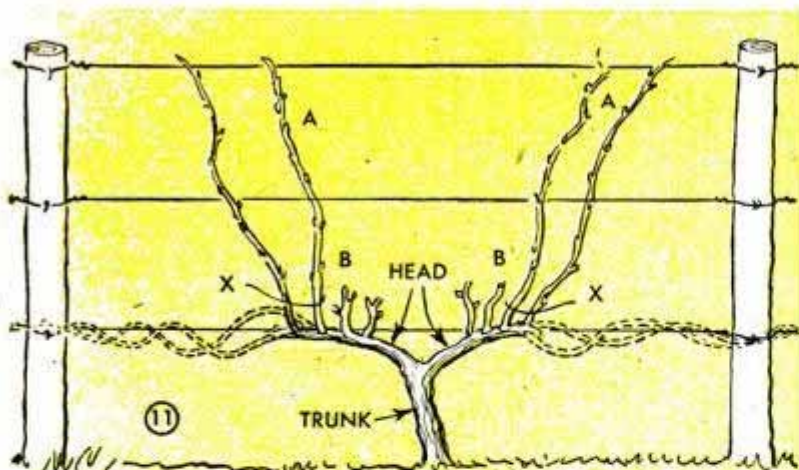

12 LARGE LIMBS

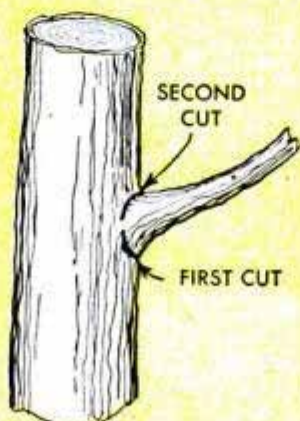

13 SMALL BRANCHES

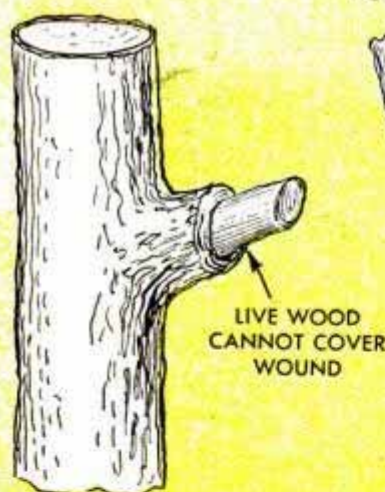

14 WRONG WAY

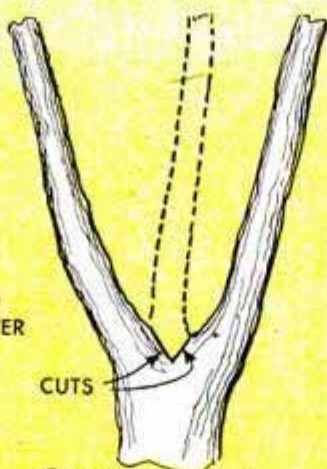

15 BRANCH REMOVED TO DEVELOP STRONG CROTCH

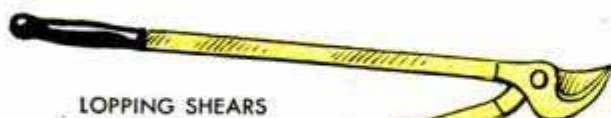

LOPPING SHEARS



SAW



SNAP-CUT PRUNER

generally lessens because of the strength required to develop fruit. As a rule-of-thumb, the need for pruning is limited usually to the removal of dead, interfering, diseased or damaged branches. There is one type of branch found on fruit trees that is not often encountered elsewhere. Sometimes this is called a "sucker" or "water" branch and will not bear fruit, but due to its rapid growth it will have a tendency to sap the strength from other branches. Most of these spring from the main branches and grow in an upright position. This type of growth should be removed.

Among the several systems used for pruning grape vines, the one illustrated in Fig. 11 is widely chosen because it is simple and produces renewal canes that are close to the head. During the latter part of each winter, but not when the vines are frozen, leave two or more long canes, AA, having five to ten buds each, and cut a similar number of canes, BB, back to spurs having one or two buds each. Then cut away all other growth. In effect, the long canes will produce shoots on which grow the following summer's crop, while the short canes become renewals that will bear the crop of the second summer. Early in spring, bring the long canes down and tie them as indicated by the dotted lines. Later reduce each short cane to a single strong shoot and tie to the upper supports. This process is repeated each season. When selecting renewals always select those as close to the head as possible. In many cases these may be coming from the trunk. The total number of buds that the long canes will carry depends upon the soil, vigor of the plant and similar factors. When well established, the popular Concord grapes can carry 50 to 60 buds to a vine, whereas less vigorous varieties should be held to a maximum of 25 to 30 buds to obtain the best yield. Like trimming trees, this type of work requires only a few simple tools. Lopping shears and a snap-cut pruner are all that are required in most cases.



Seeing Signals with a Panoramic Adapter

ATTACHED to any good communications receiver having an intermediate frequency of 450 to 470 kilocycles, this adapter for "panoramic reception" shows visually a wide panorama of signals 100 kilocycles each side of the frequency to which the receiver is tuned. The short-wave listener will find this "Panadaptor" useful for spotting weak or shifting stations and for identifying types of signals before tuning them in, since phone and key pips look entirely different on the screen of the cathode-ray tube.

The amateur and experimenter uses it for detecting frequency shift, monitoring either AM or FM, tracking down key clicks, checking modulation and other useful purposes. The band width may be changed instantly, by adjusting a knob on the panel, so that the band covered is from 200 kilocycles to any width down to zero. This means that the signal characteristics of an individual station to which the receiver is tuned may be studied in detail. As the receiver is tuned, new signal pips appear and old ones go off the screen. In actual practice the operator often watches the screen rather than the dial. Transient signals and short calls, which would be missed in dial tuning, are seen instantly and the receiver can be shifted to them before they disappear.

Photo A shows the adapter in a typical amateur radio station; a close-up view of the controls appears in photo B. Fig. 1 is self explanatory. Fig. 2 is a clear picture of an overmodulated tone signal visible in single-signal operation; note that the lower peaks are clipped. An unmodulated carrier appears in Fig. 3 as a deflection of fixed height; Fig. 4 shows an amplitude modulated carrier at reduced sweepwidth.

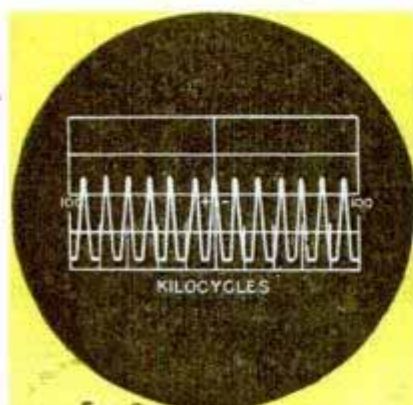
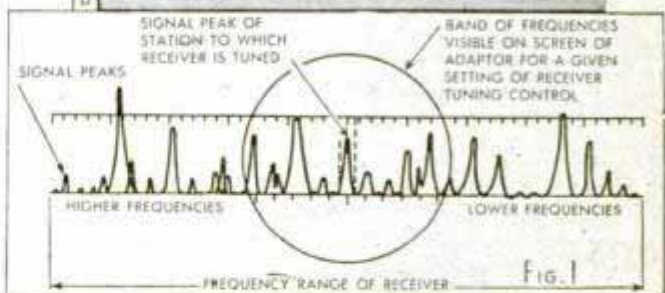
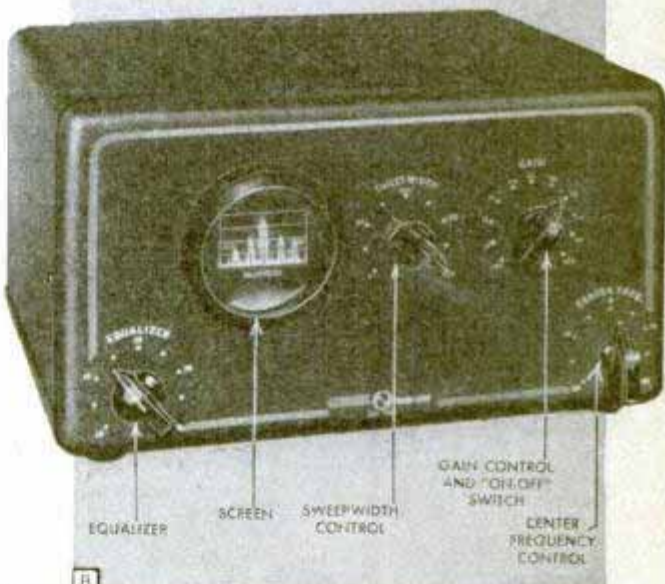

FIG. 2

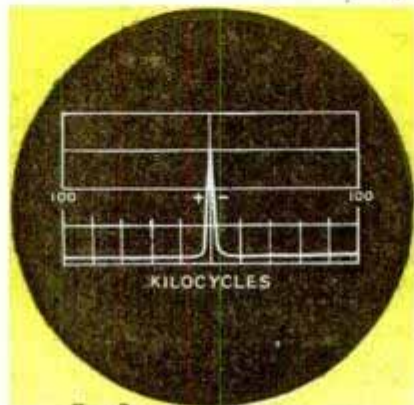

FIG. 3

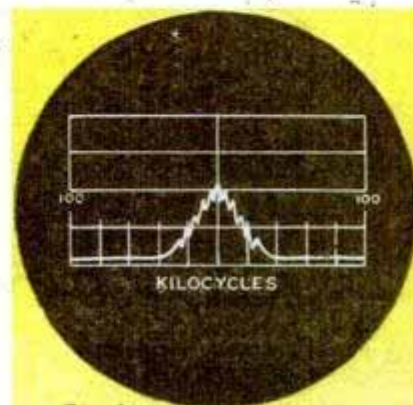

FIG. 4

ONE-TUBE DUAL REGENERATIVE

By M. P. Langendorf

BECAUSE of the unique design of the detector circuit, which features dual regeneration, enough power is available from this simple student set to operate a 5-in. permanent-magnet (PM) speaker and a pair of headphones. The volume from the loud-speaker, on strong local broadcasting stations, is sufficient for any room in the home.

The frequency range of the receiver is from 550 to 1200 kilocycles in the broadcast band. This slightly limited range was selected for simplicity and to enable the builder to find the component parts in current radio catalogs. The vacuum tube used is a combination rectifier-beam-power-amplifier which operates directly off a standard 115 to

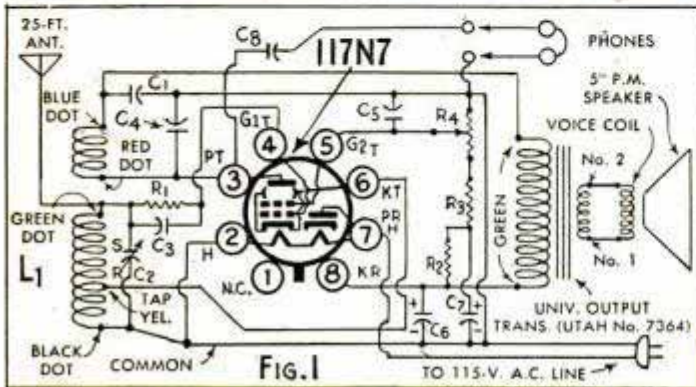
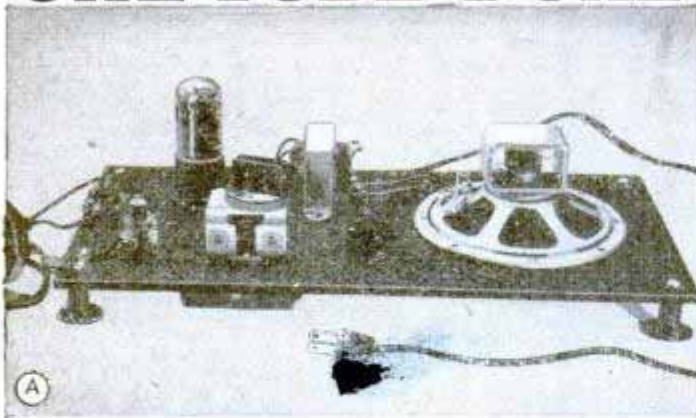

RESISTORS

- R1 1.5 megohm 1/2 watt carbon resistor
- R2 1,000 ohm 1/2 watt carbon resistor
- R3 39,000 ohm 1/2 watt carbon resistor
- R4 25,000 ohm potentiometer (audio taper)

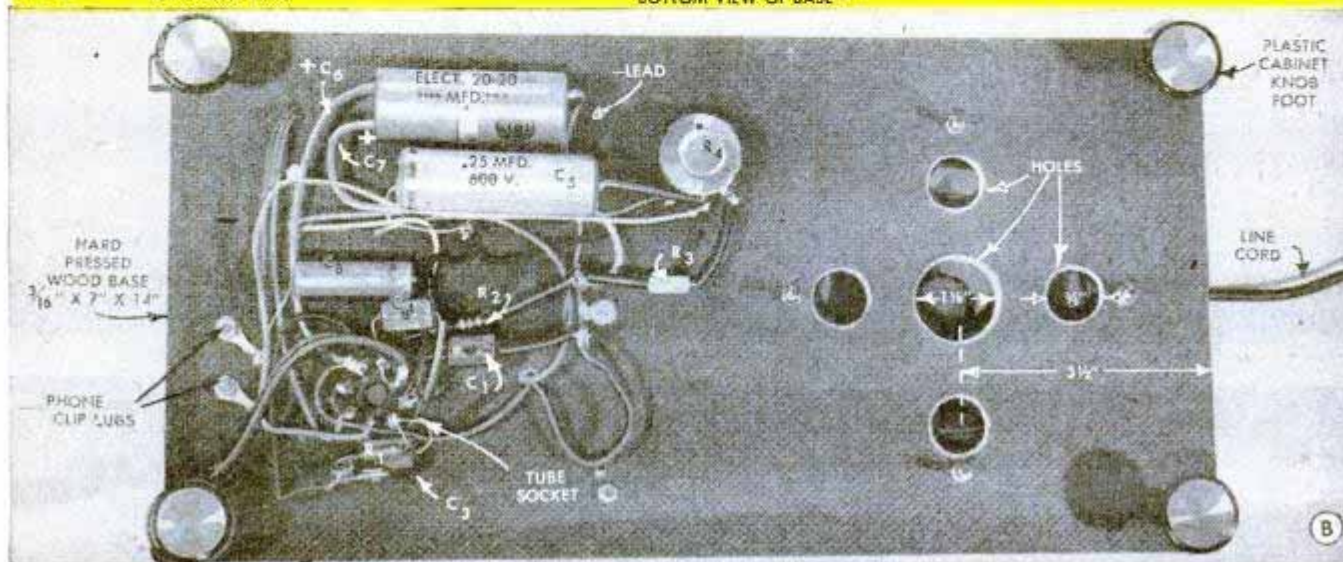
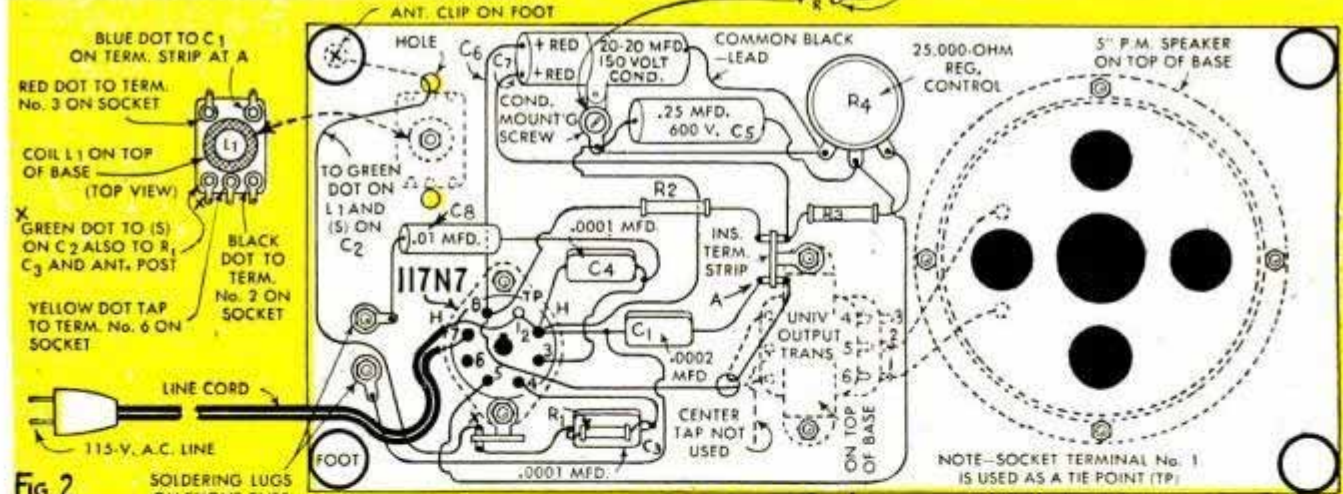
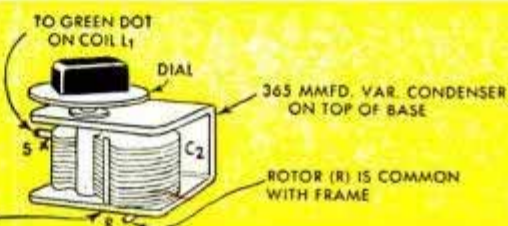

SET OPERATES A 5-IN. SPEAKER

117-volt line. The rectifier section provides d.c. voltage for the pentode section of the tube. There are no coils to wind as a standard oscillator coil (L_1), such as used in commercial superheterodyne receivers, is employed as an antenna coil. All coil connections are clearly marked and color coded in the schematic circuit diagram Fig. 1 and the pictorial wiring diagram Fig. 2. In Fig. 2 it will be noted that a top view of the coil is shown at the left of the baseboard, and its position on top of the hard-pressed-wood base is indicated by dotted lines.

It is important that all coil connections be followed carefully. For example, the green dot terminal on the Carron No. S472 coil (L_1) is a common connection at all points marked X in Fig. 2. On top of the base it goes to a soldering lug on the antenna clip and to S, the stator of variable condenser C_2 ; it also runs down through the hole in the base to the insulated terminal strip marked X. The blue dot lead at A runs down through one of the holes in the base to the point marked A on the 2-lug insulated terminal strip. Photos A, B and C show various views of the completed unit.

The output transformer is a Utah No. 7364 universal type; the center-tap lead is not used. The two green leads run down through the hole to terminal A and to terminal No. 8 on the tube socket as shown in Fig. 2; terminals Nos. 1 and 2 on the transformer are connected to the speaker voice coil. Variable condenser C_2 is fastened by the mounting screw which is a common terminal and grounds rotor R.

Drill all holes before mounting the parts. The baseboard is supported by four plastic cabinet knobs; keep all fixed condensers



and wiring as flat as possible against the underside as shown in photo B. The speaker is mounted directly over the holes that form the grille and the baseboard acts as a speaker baffle. The parts on top of the base should be mounted as shown in photo C; however, the arrangement is not critical.

Dual regeneration is obtained by use of an electron-coupled oscillator and a plate feedback winding in the antenna coil. A 30-ft. antenna will give best results. No line switch is used; merely plug the set in and out of the wall socket. To tune receiver, turn the regeneration control fully in and tune in a station, then slowly back off the regeneration control for maximum volume and clarity. Detailed student material list R-351 is available from Popular Mechanics Radio and Electronics department upon receipt of ordinary letter postage.

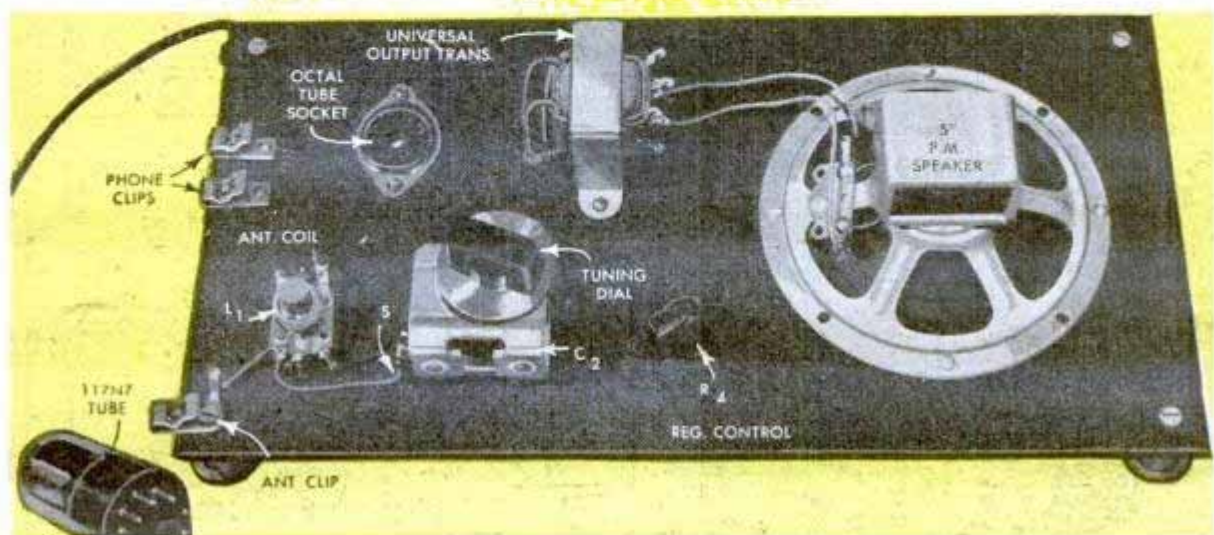

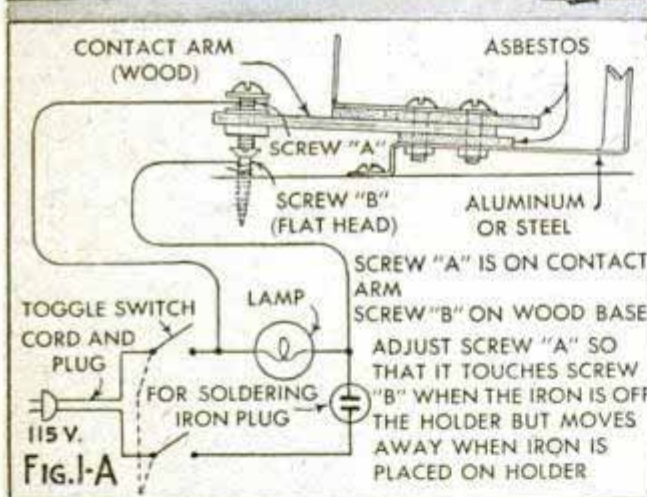
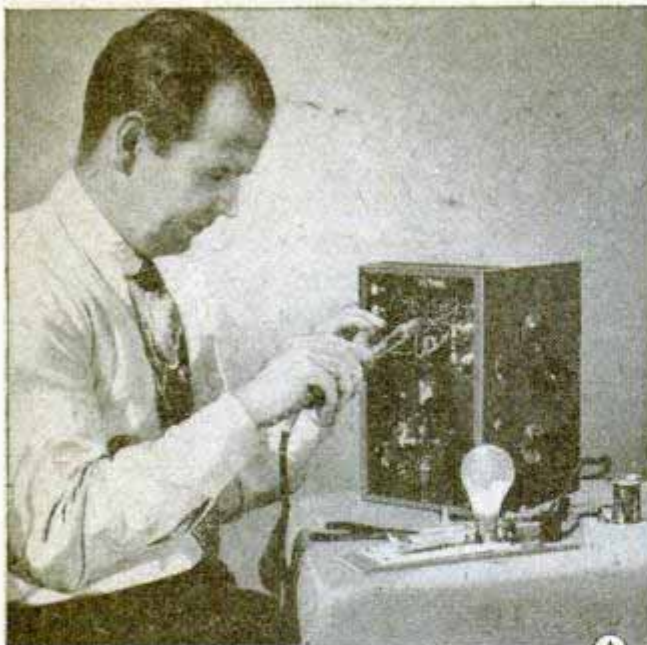

PRACTICAL RADIO SUGGESTIONS

YOUR soldering iron tips will last longer and require less filing and tinning if you use an automatic temperature control. The inexpensive homemade unit illustrated in photo A and detailed in Fig. 1-A cost less than one dollar. It employs a lamp of the same wattage as your iron connected in series to provide the necessary resistance to lower the voltage while the soldering iron is in the holder; when the iron is removed for use, the contact arm applies full voltage for quick heating.

The base is a strip of wood $\frac{1}{2}$ by $2\frac{3}{4}$ by $10\frac{1}{2}$ in. A sheet-metal spring arm and stop on which the iron rests is insulated from the circuit by means of two strips of asbestos cut from a "dime-store" hot dish pad. Dimensions of the bracket and spring rest will depend upon the size of the iron used. All circuit details are given in Fig. 1-A. The d.p.s.t. switch and a Bakelite receptacle for the soldering iron line plug complete the unit.

Extension speakers permit folks in other rooms of the house to enjoy programs from the radio set in the living room. A simple and efficient hookup for 2 speakers is detailed in photo B and Fig. 1-B; the diagram shows individual volume controls in the form of 8-ohm "L" pads. These pads maintain a constant load on the radio set speaker. Their adjustment will not affect the volume of the receiver. The Utah-type LA-8 "L" pad and PM wall speakers are available from radio parts houses. If only one extension speaker is used it is connected in the same manner. Cable connections may be made directly to the "L" pad speaker control, eliminating the connector.

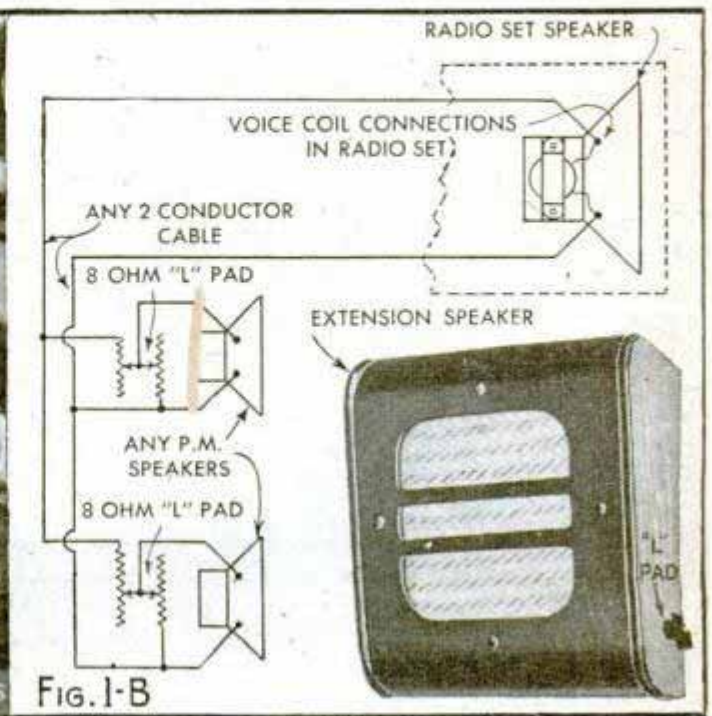
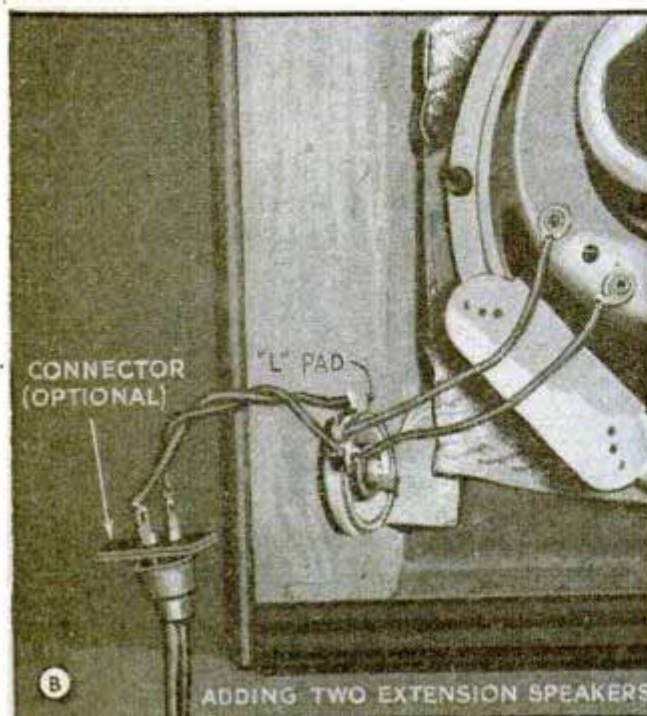

Brownie Reflex— for good snapshots night or day . . . indoors or out



Snapshots anywhere, anytime . . . in sun or shadows . . . inside or at night. Attach an accessory Flashholder to a Brownie Reflex, Synchro Model—insert a bulb—and you're ready to go. One button to push for both shutter and flash. Big brilliant finder previews your picture in actual size before you snap it.

Kodak Flashholder teams with new shutter on Kodaks, to insure accurate synchronization with the flash peak of the lamp you use . . . "fast" Class F or "slow" Class M. Light and strong, equipped with anodized aluminum reflector and button-operated ejector. Socket accepts either Class F or Class M midget bulbs.



Ejector button on Kodak Flashholder saves you finger burns

Mount your valuable prints this safe and convenient way . . .

Here's a way to prevent curling and buckling of prints mounted in albums. Use Kodak Thermount Tissue and Kodak Thermount Iron. You fasten the entire back of print to the page—securely, evenly. This method is recommended for Kodachrome and Kodacolor as well as black-and-white prints . . . EASTMAN KODAK COMPANY, ROCHESTER 4, N. Y.

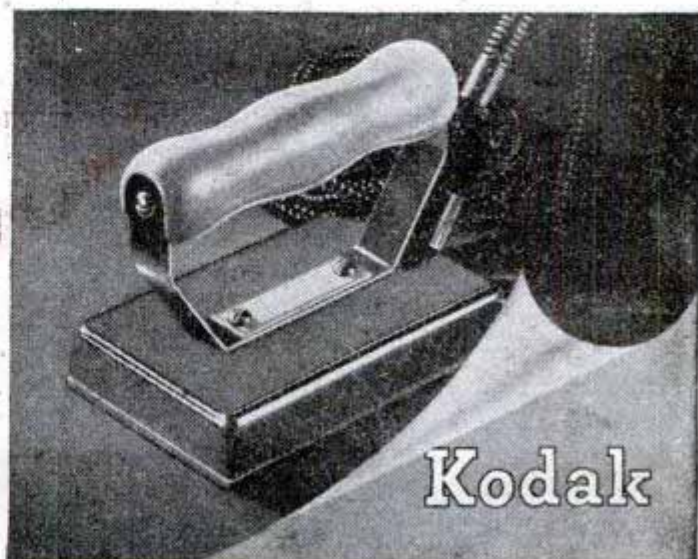

Kodak

"Pete will never learn, I guess!"



TIM: What's he done now?

TOM: This time it was his wrench that broke. He came over this morning and borrowed mine.

TIM: Funny how he keeps throwing money away on those "no-name" tools.

TOM: Yeah. I've tried to tell him that the only *good* tools are *branded* ones—with names you can trust.

TIM: I've mentioned it, too, but he still falls for that bargain counter stuff.

TOM: Thinks he's saving money, but

I'll bet he actually spends more on tools and hardware than you and I do.

TIM: Sure he does. He ought to start buying from the hardware store, where a man knows what he's getting.

Your **HARDWARE DEALER**
sells **QUALITY** tools and
hardware. Buy from **HIM**.



POPULAR MECHANICS

**"For exacting work
give us X-acto Tools!"**

... say professional model builders

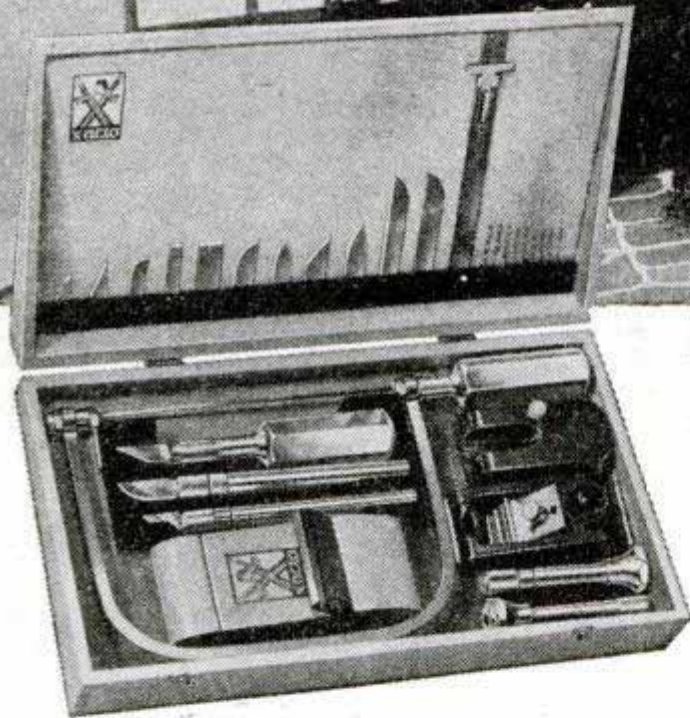
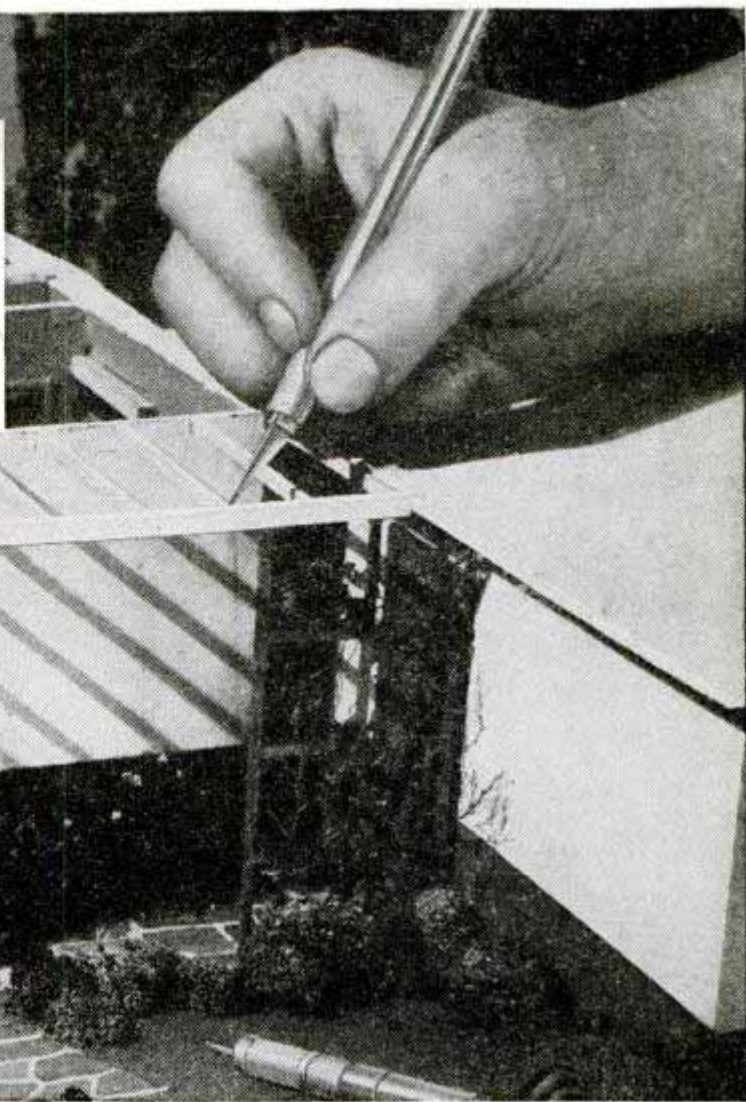

THE BIG SHOT—No. 85 X-acto Tool Chest. A knife, a tool for every job. Designed for safety and sure control. Includes: 3 X-acto Knives; complete blade assortment; sander; stripper; planer; saw; drills and holders; ruler. Complete in desk-drawer-size wooden chest . . . \$12.50.

Scale models for the Hollywood Bowl, Sam Goldwyn Studio props, Shell Oil Company models, are only a few of the big miniature jobs for which the firm of *Models and Miniatures* in Los Angeles uses X-acto tools. Knives, pin vises, mat cutters, strippers, planes, sanders . . . they use them all — and say, "as the details on our models are most exacting, we find the versatile X-acto tools *indispensable!*" Here modelmaker uses No. 2 Knife (\$1.00 complete with 5 assorted blades).



Thomas Galloway, model consultant, working on detail of scale-model miniature. "A No. 85 X-acto Tool Chest for every new employee's work bench" is on the schedule for this busy studio.

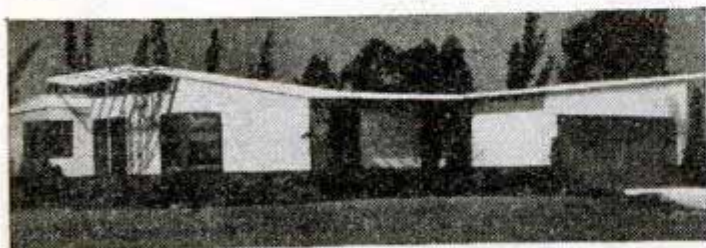

Models and Miniatures specializes in architectural layout, city planning and landscape models . . . often to as small a scale as one inch equals 16 feet. "X-acto is a must for every model builder," they say.

X-acto^{*}
KNIVES & TOOLS



*Singly or in sets, 25c to \$12.50
At hobby, gift and hardware shops*

X-acto Crescent Products Co., Inc., 440 Fourth Av., N. Y. 16
In Canada: Handicraft Tools, Ltd., Hermant Bldg., Toronto
^{*}Reg. U. S. Pat. Off.

RELIABILITY

UNSURPASSED

Hear it for yourself. Try it under any conditions and you'll find the National NC-2-40D turning in a kind of performance no radio receiver can surpass. Stations half a world away come in like those around the corner—thanks to the selectivity and sensitivity that made Nationals the Navy's choice for three-fourths of its warships. See and hear it for yourself today. Write for the name of your nearest dealer.

EST.  1914
MALDEN, MASS



NATIONAL

COMPANY, INCORPORATED

THE MOST DISTINCTIVE NAME IN RADIO COMMUNICATIONS

Uncle Sam's Private Fur Crop

(Continued from page 150)

shipped to the mainland. When the skins are removed there remains attached to them a layer of blubber or fat. While it is not necessary to remove this layer unless it is too thick to permit curing at the islands, most of the skins now are freed of blubber prior to being cured.

All the work is of an exacting nature, and efficient seal workers cannot be recruited and trained in a single season, but must be born to the trade and spend a youth-long apprenticeship in it. When the Army inducted a number of the Pribilof Aleuts during the war, conditions became such that 27 of them were given 90-day furloughs in 1945 to work at their trade.

After the skins are cured, they are packed in barrels and sent to the St. Louis plant of the Fouke Fur Company, which dresses and dyes them under government contract.

More than 100 distinct processes are involved in the dressing and dyeing of each skin, and the minimum time required is approximately 60 days. It is no wonder, then, that certain processes and formulas are closely guarded secrets.

Upon arrival in St. Louis, the blubbered skins go directly to the washing machines, while the unblubbered ones are first cleaned of blubber and then washed. After being washed, they are freed of excess moisture by running them through a wringer. Each skin is then laced to an oval iron hoop where it is stretched to its proper size and shape before being hung in a heated room to dry. This allows the skins to dry evenly without wrinkling or shrinking.

The next major step is the removal of the coarse guard hair which grows over and protects the fur. To do this the skin is first subjected to dry heat in a specially designed oven until the guard hair is loosened and can be removed without damage to the fur. The operator lays the skin over a curved

(Continued to page 240)



Model Builders Attention!

	V	V-2	V-3
Hex	1/2"	3/8"	5/16"
Thread	3/8"-24	1/4"-32	1/4"-32
Thread Length	7/32	7/32	5/32
Weight, Grams	8	3 1/2	2 1/2

Actual Size V-Plug

Champion spark plugs for model gas engines give the same dependable performance as regular Champions. Sillment sealed. Sillimanite insulator. Alloy needlepoint electrodes for easy starting. One piece construction.

CHAMPION

SPARK PLUG COMPANY • TOLEDO 1, OHIO

IN EVERY FIELD
AMERICA'S FAVORITE SPARK PLUG!



BUS AND TRUCK

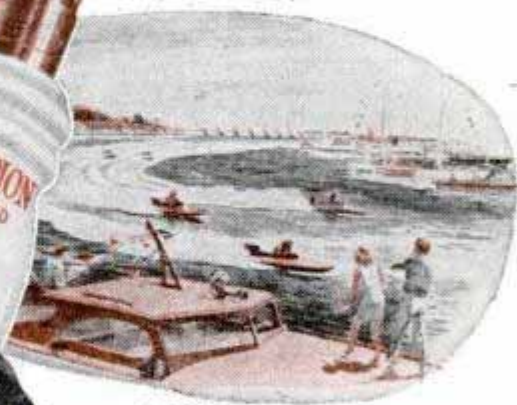

MARINE

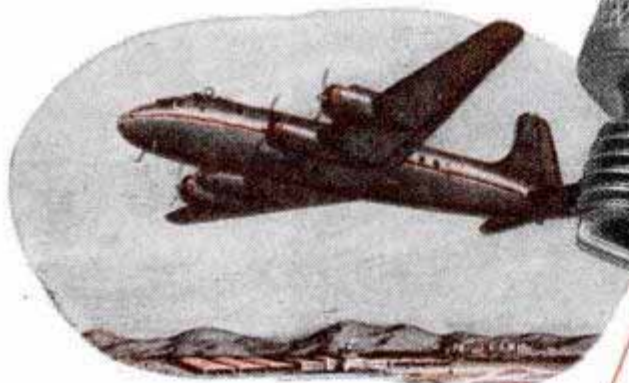

AVIATION

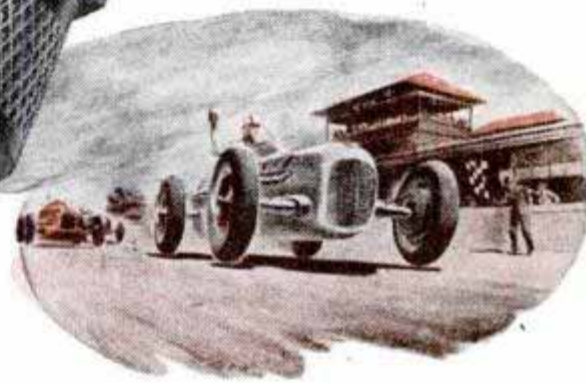

RACING



AUTOMOTIVE



FARMING

FOLLOW THE EXPERTS DEMAND *DEPENDABLE*

CHAMPIONS

Listen to the CHAMPION ROLL CALL, Harry Wismer's fast sportscast every Friday night, 9:55 EST over the ABC network.

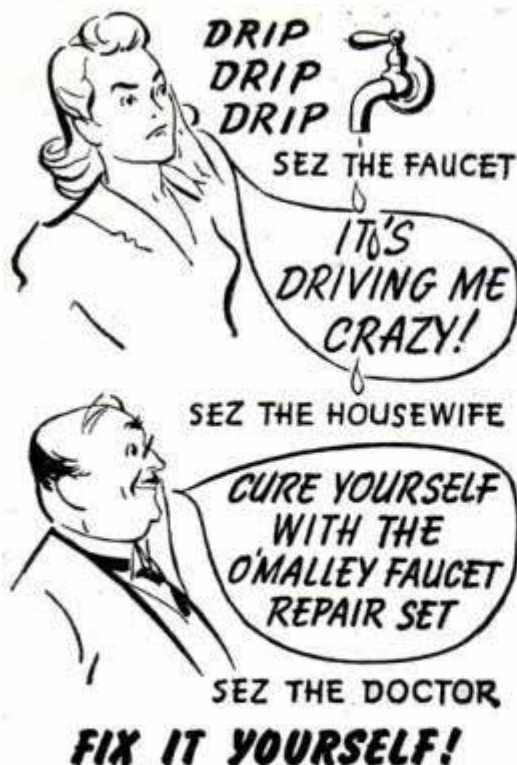

You don't even have to be handy with tools . . . just get an O'MALLEY FAUCET REPAIR SET . . . read the simple directions . . . and in a few minutes you can cure your faucet of its messy, water-wasting, nerve-devastating Drip-Drip-Drip. Costs less than a dollar, depending on the size you require, wherever hardware is sold.

EDWARD O'MALLEY VALVE CO., Chicago 19

O'MALLEY FAUCET REPAIR SET

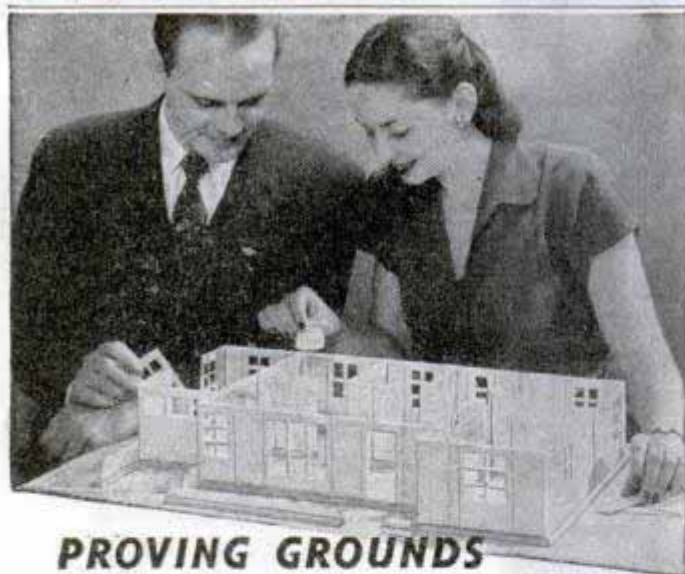

PROVING GROUNDS

For your home building ideas

Play safe—try your ideas on a model, before you build. Making a scale model is easy—no tools needed—with a PLAN-A-HOME Model Kit. Simply insert pre-cut wall sections in slotted wood footings. Change as often as you like. Furniture cut-outs for every room. Thousands of satisfied users.

Send today for 315 piece kit. 3-day inspection privilege. Postpaid, \$4.75 (\$5 west of Rockies and Canada). PLAN-A-HOME Model Co., Elkhart 6, Indiana.

PLAN-A-HOME MODEL KIT

Makes a model of any 4 to 9 room plan

Do a Better Job

WITH ONE OF THESE EMPIRE LEVELS

EMPIRE TORPEDO LEVEL
Smallest, most handy and accurate Level made. "Cigar-shaped"—no sharp corners to tear pocket. Aluminum stock. Only 3 oz. wgt. 9" long. Has Level, Plumb, 45° Vials.
No. 26\$1.75



ALUMINUM LEVEL — No. 151
Cast and Machined, a Beautiful Tool, with Patented, Removable Level and Vial.
With 2 Plumb, 2 Levels, 2 — 45° Vials. 18"\$5.00
24"\$5.50 28"\$6.25
Order EMPIRE LEVELS from your local dealer.
Write direct for literature.

EMPIRE LEVEL MFG. CO.
717 S. 6th St. Dept. P-244 Milwaukee 4, Wis.

JET PROPULSION



GAS TURBINE Model Engine

★ ★ Be one of the first to build a real Turbo-Jet Model Engine. Single-stage centrifugal compressor and turbine. This is a real engine, easily made with ordinary home workshop equipment. Complete plans for construction . . . design formulas and curves for checking performance and testing.

\$2.00
Post paid

THE ROTOJET CO. Department 11
BOX 757 • LOS ANGELES 25 • CALIFORNIA

LEPAGE'S PAPERHANGER'S PASTE

LEPAGE'S GLUE

LEPAGE'S PAPERHANGER'S WALL SIZE

WELD ANYTHING ANYWHERE ANYTIME



ALL PURPOSE ARC WELDER

9 Models . . . 32 Volt D.C., 110 to 440 A.C.
A complete workshop in itself! Weld, cut, braze or solder any type metal; iron, castings, aluminum, steel, bronze . . . in any gauge or weight, with equal ease. Compact, complete, sturdy as the Rockies. Formed steel and cast aluminum case, welded steel base, 4" cast wheels. Built with voltage control. Better on R.E.A. lines. No training needed. Sold throughout the world. Unconditionally guaranteed for 2 years. Fully equipped—ready to use.

FORNEY MFG. CO.
FORT COLLINS 2, COLORADO

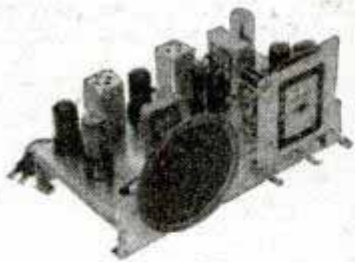

**NEW BARGAINS
AT NEWARK**

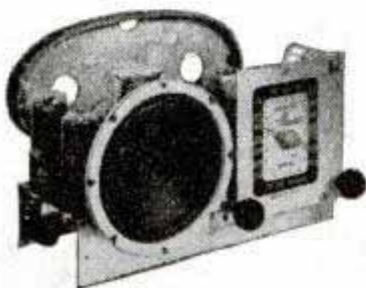

BUILD YOUR OWN RADIO

It's Easy WITH THESE NEW KITS

Here they are, beginners! Two new kits. Build your own radio in jig time. It's simple with these special Meissner jobs.

• 5 tube superhet, all stations on broadcast band. Your favorite programs over a receiver you have built yourself. **COMPLETE \$18.75**

• 6 tube superhet, gets Europe and America! A real job, but easy to build. Fun, experience galore. **COMPLETE \$25.20**
Cabinet \$5.95 extra

Both sets are complete, easy to build, fine performers. These as well as many other bargains are available now at Newark. Write for our Super Bargain Bulletins. Visit our stores, talk "shop" with our personnel, and see some great radio and electronic equipment.

NEW YORK
Offices & Warehouse
242 W. 55th St., N.Y. 19

NEWARK
ELECTRIC COMPANY, INC.

CHICAGO
323 W. Madison St.
Chicago 6, Ill.

New York City Stores: 115-17 W. 45th St. & 212 Fulton St.

C3

PLASTICS SUPPLIES AND MANUFACTURING

At last, under one roof, your complete source for supplies and for contract manufacturing service. Check list below and send this ad to us for full information at once.

SUPPLIES DEPT.

- Plastics (Lucite, Plexiglas, etc. — sheets, rods)
- Supplies (Cements, Dyes, Buffing Compounds, etc.)
- Casting Resins (Mold Materials, Fillers, etc.)

CHECK YOUR INTEREST AND SEND THIS AD WITH NAME, ADDRESS AND 3c STAMP FOR FREE SUPPLY CATALOG

MANUFACTURING DEPT.

- Molding (Injection, Compression of small parts)
- Fabrication (Complete production facilities)
- Resin Casting (Low mold cast. Small or large pieces)
- Surplus Plastics (We purchase large and small lots)

NO JOB TOO SMALL OR TOO LARGE. SEND SKETCHES FOR FREE ESTIMATE!

PLASTICS MFG. AND SUPPLY CORP.
DEPT. M-1, 4707 EUCLID AVE. CLEVELAND 3, OHIO

BUILD YOUR OWN POWER LAWN MOWER

WHY BREAK YOUR BACK MOWING FIELD OR LAWN?



IT'S FUN TO BUILD

WRITE FOR
FREE
LITERATURE
The Rite-Way
Mower
Attachment
Ball Bearing



SAVE MONEY
SAVE TIME

Now anyone can save time and effort mowing field or lawn by building their own whirl type power mower. Build according to your own ideas and needs at small cost. Cut close to fences, walks, buildings, etc. Build in short time with parts and instructions we furnish. Save hours of time and back breaking labor. Write today for FREE information.

T & H MFG. CO., Dept. PMI
811 E. 31, Kan. City 3, Mo.



**A MILLION
Happy
Moments
WITH A
BURGESS
vibro-tool**



The Vibro-Tool, 22 accessories and sharpening stone, in handsome hinged polished wooden box, complete for only \$16.50

Have loads of fun... spend leisure time profitably making unusual gifts with this unusual tool. Cuts out linoleum blocks (illustrated), tools leather, engraves metals, plastics, jewelry. Does craft and shop work electrically, easier, faster! 110 V. 60 cycle A. C.

Tool with engraving needle, \$7.50
See your dealer or order direct

HANDICRAFT DIVISION

BURGESS BATTERY COMPANY
166 N. WABASH AVE. • CHICAGO 1, ILL.

ANCO RAIN-MASTER

"Dead-Locker"

WINDSHIELD WIPER
ARMS and BLADES

BLADE SNAPS ON...
STAYS PUT

FINGER-
TIP
RELEASE

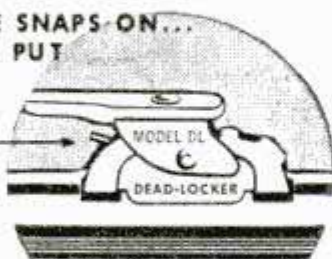

CAN'T FALL OFF
CAN'T BLOW OFF

(A war-born invention—by ANCO—first)
for military aircraft—now for your car.)

DON'T SHOOT YOUR GAS-PUMP MAN!

He's doing the best he can. Sure, he knows how dangerous it is for you to drive your car... in stormy weather... with your dull old windshield wipers that smear and smear. He'd gladly put on for you quickly a pair of keen new ANCO RAIN-MASTER Wiper Blades and Arms. He has them—Newest Models! But he forgets to remind you? Too busy? You can't shoot him for that!



After all, it's *your* car to protect. So *you* remind *him*. Get RAIN-MASTERS... patented features... original equipment on many makes of high grade cars and trucks... used in war—on our fighting tanks and trucks and ships and bombers too... because ANCO RAIN-MASTERS clean quicker, clean cleaner... last longer. May save you a costly smashup.

Ask for RAIN-MASTER Windshield Wiper Arms and Blades next time you buy gas.

THE ANDERSON COMPANY

Established 1918

GARY, INDIANA

board and with a deft movement of a two-handled curved knife pulls out the unwanted hairs. The edge of the knife is just dull enough to prevent cutting the fur.

After the guard hair is removed the skins are given a dressing and cleaned with fine hardwood sawdust. Then follows the dyeing process. Formerly, all fur sealskins were dyed black, but two shades of brown, safari brown and matara brown, are now also available.

The dyed skins are next machined, or put through a process to remove any short guard hairs which may have been left.

The skins are drawn tight over an iron bar with the fur side up directly below the narrow opening of a bellows extending the full length of the bar. A blast of air from the bellows blows the pliable fur down, in which position it is held by long combs, leaving the stiff hair standing. In this position, the hair is cut close to the skin by shears passing across the full length of the bar without injury to the fur. With each repetition of this operation the skin moves ahead a short distance until it has been entirely covered.

Following this, any excess of leather is removed on emery-covered rollers. The skins then are given a final cleaning and inspection and are graded.

The graded skins are sold at the annual spring auction in St. Louis. Sealskin fur is much in demand and at the 1946 auction more than 100 buyers were present and the bidding was spirited. All the 28,000 fur sealskins sold were taken on the Pribilof Islands during 1943.

Sealskins are not cheap. The matara brown dyed skins brought an average of \$92 each, with some selling as high as \$114. The high for safari brown was \$108.50, and for black \$103.

Next year the sealskins, made into women's coats, may be seen on the streets of New York, Chicago and Hollywood. It will be the end of a long series of events which began when frightened seals on the Pribilofs found their way to the water cut off.

Racing the Hot Rods

(Continued from page 141)

the dashboard, poke their heads through a slit and let the canvas stream out behind. Anything to smooth out air currents.

Speeds within each classification often depend upon the fuel used. Postwar drivers are experimenting with 90-100-octane aviation gasoline and with gasoline-alcohol mixtures. Formulas for fuel are concocted secretly and guarded jealously.

(Continued to page 244)



on NORTHLANDS!

America's number one winter sport is slalom, or downhill skiing. And America's number one choice in ski equipment is Northlands. That's because Northlands have the design, durability, controllability that mean better skiing—greater skiing pleasure. Quantity limited, look for the Deerhead trademark.

★Send 15c for Northland's Ski Manual edited by Hannes Schneider. Write for booklet. Offer not valid in Canada.

NORTHLAND SKI MFG. CO.

World's Largest Ski Manufacturers

95 Merriam Park St. Paul 4, Minnesota

CROSMAN *Silent* RIFLES



NOW AVAILABLE

America's favorite compressed air rifles for indoor or outdoor shooting are back again! Available in .22 Cal. Single Shot and Magazine Loading types. At your dealer—or order direct. Ask for Crosman SUPERPELLETS too—the better ammunition for all compressed air rifles: .177 Cal.—\$2.25 per M; .22 Cal.—\$2.50 per M.

CROSMAN ARMS CO., INC. ROCHESTER 7, N. Y.

BUILD Boucher MODELS

CLIPPER TANKER FREIGHTER
Everything for the Model Ship Builder Since 1905

34 DIFFERENT MODEL KITS \$5 to \$35

Send 35c for 96 PAGE ILLUSTRATED CATALOGUE

BOUCHER SHIP MODELS 36 EAST 12TH ST. NEW YORK, 3, N.Y.

MARCOT KEY MACHINE

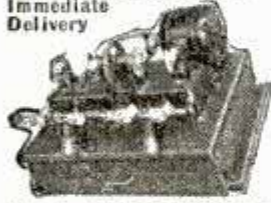

Marcot No. 8 Key Machine Mounted on Cabinet.....\$ 75.00
Book on Modern Locksmithing. 3.95
Auto Code Book and Auto Depth Keys 12.50
162 Doz. Popular Key Blanks.. 77.76
Set Key Files, Tools, Pins, Springs, Thimble 10.50
\$179.71

A. J. MARCOTTE CO., 1200 N. KEDZIE AVE. DEPT. PM, CHICAGO 51, ILL.

"WONTWIST" ANIMAL TETHER

AT LAST YOU CAN TIE-OUT YOUR ANIMAL SAFELY!

SAFE FOR ALL ANIMALS, BALL REVOLVES IN ALL DIRECTIONS.

STRONG EFFICIENT

DEPT. P-6

Send Check or Money Order \$2.95
Price Includes Delivery Charges

THE HAYDEN CO., Bryn Mawr, Pa.

PRACTO

U-BUILD-'EM SETS

Life-size everyday utility vehicles for boys who love to make things with their own hands. NOT A TOY! ALL FULL SIZE, serviceable, dependable, sturdy!



U-BUILD-'EM BIKE TRAILER

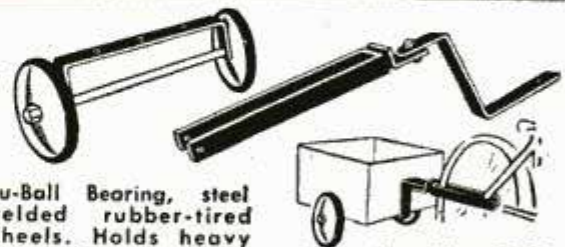

Tru-Ball Bearing, steel welded rubber-tired wheels. Holds heavy loads. Complete with nuts, bolts and chassis. Attach box for a sturdy BIKE TRAILER.



No. 8B \$8.00 complete with detailed instruction sheet.

U-BUILD-'EM WHEELBARROW

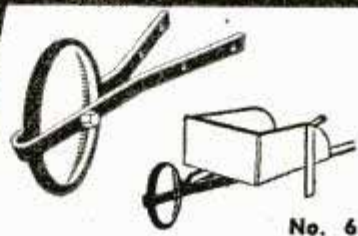

9" steel-welded wheel . . . rubber tires. All metal parts . . . you supply the wood for rugged WHEELBARROW.

No. 6 Tru-Bearings \$3.00
No. 6B Ball Bearings \$3.50

U-BUILD-'EM SPEED MOBILE

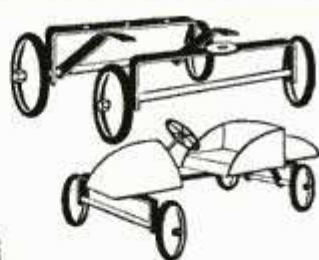

Everything but the wood . . . 9" steel-welded wheels . . . rubber tires. Complete with bolts, nuts, washers.

No. 10 Tru-Bearings \$8.50
No. 10B Ball Bearings \$10.50

U-BUILD-'EM EXPRESS CART

Complete metal parts. 9" wheels, steel welded, rubber tired . . . bolts, nuts, washers, sturdy chassis. 500 lb. capacity. You supply wood. No. 9 . . . \$9.00
No. 9B . . . \$11.00

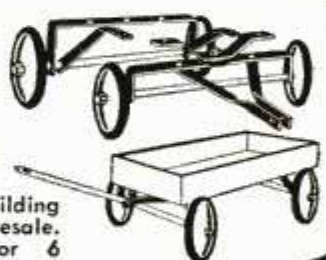

Make a business of building Practo vehicles for resale. SPECIAL DISCOUNT for 6 units or more. Write at once!

It may be difficult to get these U-BUILD-EM sets at your dealer. SEND CHECK or MONEY ORDER and order direct. Sent express paid

INTERNATIONAL MFG. CO.

712 BEACON ST., BOSTON 15, MASS.
Reference: National Shawmut Bank, Boston, Mass.

NOW AVAILABLE
Pressure stat
 FOR
PASSENGER CARS!

\$5.00 SET OF FIVE
 POST PAID



Protect yourself and passengers with Pressure-Stat and prolong the life of your tires! The same automatic safety valve used by high speed, cross-country trucking fleets is now available for passenger cars. The new Pressure-Stat weighs only 1/2 ounce and will not disturb wheel balance at any speed.

Blowouts due to destructive pressure buildup cause thousands of accidents. Pressure-Stat eliminates this deadly over-inflation hazard. And Pressure-Stat makes any tire last longer under all driving conditions.

A Pressure-Stat is easily installed on each wheel without the use of special tools and left on for the life of the tube. Pressure-Stat not only prevents excessive pressure buildup but also eliminates the use of an air-gauge when inflating tires. Send in the coupon for your set today.

Richardson Regulator, Inc.

4712 Chene Street, Detroit 7, Michigan

DEPT. PM-1

I enclose \$5.00 for which send me one set of 5 Pressure-Stats. It is agreed that I may return them within 10 days and my money will be refunded.

My Pressure-Stats should be set for:

28 lbs. 32 lbs. 35 lbs.

I'd like to know more about Pressure-Stat and am enclosing a 3c stamp. Please send me your illustrated descriptive folder.

Name _____

Street _____

City _____ Zone _____ State _____

**MONEY BACK
 GUARANTEE**

SAY YOU SAW IT IN POPULAR MECHANICS



In a nation-wide survey among carpenters, 92 out of every 100 reporting said they owned Disston saws. The reasons these experts give for such outstanding preference are that Disston saws are faster cutting, do finer work, require less frequent sharpening and last longer.

Ask your Hardware Retailer to show you Disston Hand Saws—you will see why they are the choice of the men who use them in their trade.

Also ask your Hardware merchant for a FREE copy of the Disston Saw, Tool and File Manual which tells how to use and care for tools, or write to us direct.



HENRY DISSTON & SONS, INC.

111 Tacony, Philadelphia 35, Pa., U. S. A.

DISSTON The saw most
 Carpenters use

**A COMPLETE
 SERVICE**

**MANUFACTURING—STAMPING,
 DEVELOPING and
 EXPERIMENTAL WORK**

Tools, Dies, Jigs, Fixtures,
 Models made by experts.
 Write for Details

TECHNICAL DEVELOPMENT CO., Inc. (Dept. M-1)
 157 Chambers Street New York 7, N. Y.

OTTAWA TRACTOR SAW



350 CUTS PER MINUTE

Make money sawing wood. Use Ottawa—fastest cutting. Cuts large, small logs easiest way. Fells trees. One man operates. Thousands in use. Built to last with heavy, stiff saw blade. Positive safety clutch control; uses power take-off any tractor.
OTTAWA MFG. CO., D127 Forest Ave., Ottawa, Kan.

AMAZING SELLS LIKE LIGHTNING!

**NEW
 ZIPPER
 SHOE**



**ZIPS
 ON...
 ZIPS OFF**

● Here's your chance to start a fine, solid, profitable business right among your friends and neighbors. Tie up with the LEADER in the direct-to-wearer shoe industry, established 42 years. Just rush post-card NOW for FREE SAMPLE OUTFIT, Free 10-Second Air Cushion Demonstrator, Free Automatic Selling Plan. Learn how you can start making money very FIRST DAY with over 200 fast-selling Feature Style and Comfort Shoes.

Mason Shoe Mfg. Co.
 Dept. M-713, Chippewa Falls, Wis.

POPULAR MECHANICS



USE OUR CAPITAL

NO SALES EXPERIENCE NEEDED

The biggest opportunity ever, to quickly establish a money-making, lifetime business, now awaits you as a McNeess Dealer. Sell things farmers need and use up. Serve same families year after year. Pleasant work--no bosses--easy to do. We supply capital to work on. Also provide offers--advertising--premiums and trade secrets that bring sales.

First to apply get best trading areas. Don't wait--write us today for McNeess proposition. Tell us county and state you want to serve. Ask for free McNeess Book.

THE McNEESS CO., 390 Adams St., Freeport, Ill.

BOILS WATER IN 3 MINUTES



UNCONDITIONALLY GUARANTEED

Wonderful for Homes, Cabins... Trailers... Wherever hot water is wanted QUICKLY

ELECTRIC WATER HEATER

Immersion type... drop it into the water... it heats a basin or a sinkful pronto. 110 volts AC-DC. Comes with extra long heavy duty waterproof cord. Weighs 11lb. We'll mail it C.O.D. **\$245**

Write for Big free Trailer Parts Catalog

Plus C. O. D. and postage

NATIONAL TRAILER STORES

Dept. 10, Box 2353 Terminal Annex LOS ANGELES 54, CALIF.

COLOR PLASTICS

The very latest and most practical for craftsmen's projects. Gem-like beauty--as easy to work with as wood. In five rich colors--mottled opaques and translucent. All new stock with masked polished surfaces. In 3/16" and 3/8" sheets, 6x6" to 12x24" and 1" and 1 1/2" diam. rods 10" and 20" long. Write for low price list.

SPECIAL INTRODUCTORY OFFER

Kit for matched set of cigarette box, ashtray and matches holder complete with plans and adhesive, shipping wt. 2 lbs., only \$3.80. Set is easily worth \$20.00 retail. Specify choice of marble-tone green or translucent tortoise shell. Send \$3.80 on money back satisfaction guarantee and we'll pay postage. Or send no money and pay postman C.O.D. plus postage.

HANSON PLASTICS, 7625 South Park Ave., Dept. 11, Chicago 19, Illinois

Appliance \$10.95 Tester

LOCATES TROUBLE INSTANTLY IN ALL ELECTRICAL DEVICES

In this single unit are all the necessary tests for examining every appliance. Checks thermostats under working conditions. Tells instant it opens or closes. Controls heat on soldering irons. Prevents over-heating. Tests continuity, open circuits, automatic irons, vacuum cleaners, motors, coin machines, bulbs, 3-way switches, etc. Great time and money saver! **ONLY \$10.95 COMPLETE. POST-PAID. NO C.O.D.'s. MONEY-BACK GUARANTEE.**

FREE with each Tester. New, Complete Practical Course in electrical appliance repairing. **WRITE FOR CIRCULAR.** HANLAN CO., 1419-A, West Jefferson, Los Angeles 7, Calif.

HERE THEY ARE

THE ORIGINAL

Paratroop Hunting Boots

The uppers are *waterproof elk*... for greater hunting, fishing and general outdoor utility. That's the only difference between these boots and the famous rugged and comfortable Paratrooper Jump Boots, made by Corcoran during the war.



All sizes
All widths
4 - 13 1/2
AA - EEE

No other boot gives you all these EXCEPTIONAL FEATURES

- Made of soft, pliable elk with extra heavy oil waterproofing.
- Full 10 inch height gives proper support.
- Balanced construction gives ideal walking comfort.
- Special heel and toe construction prevents tiring.
- Counter, box toe and bottom filler all leather. Shank is made of steel.
- Heavy reinforcing tape on sides of instep prevents stretching and assures good snug fit.
- Middle sole is leather of outersole quality. Outside tap is rubber, sewed to middle sole in two places and nailed clear through to insole to prevent ripping off.
- Special Goodyear rubber heel gives maximum springiness and reduces hazard of tripping.

At this Amazing Low Price

These boots are not government surplus stock. We can offer them at this unusual low price only by selling direct to you. Money back if not satisfied on receiving them.

ONLY \$9.87 Plus Postage

Postage only is C.O.D.

CORCORAN INC., STOUGHTON, MASS.

Please rush a pair of Paratroop Hunting Boots. Check Money Order for \$9.87 is enclosed. I will pay postage C.O.D.

Name _____

Address _____

Size and width of Shoe _____

PM-1

THE ONLY BRUSH THAT

*Keeps the Air Clear
as it Cleans the Floor*

Also Eliminates
Sweeping Compound!



Arbitrin Sweeping fluid is put into a steel reservoir in the back of the Dustless brush.

As you sweep Arbitrin fil- ters through the tufts — surrounds particles.

The dust itself is converted into sweeping compound— cannot rise into the air.

Dustless brushes used with Arbitrin sweeping fluid are 100 times more effective in controlling dust than ordinary floor brushes used with sawdust. When used daily, Dustless brushes actually reduce bacteria, normally in the air between sweepings, as much as 97%. These facts have been proved in tests made by independent health authorities. Dustless brushes are used in thousands of stores, factories, offices, schools, and institutions. They are unconditionally guaranteed to meet your requirements. Write today for sizes, styles, and prices.

MILWAUKEE DUSTLESS
BRUSH COMPANY

530 North 22nd Street • Milwaukee 2, Wisconsin

MANUFACTURERS OF DUSTLESS, SPEED SWEEP AND SPEED WASH BRUSHES

Milwaukee Dustless Brush Co., 530 N. 22nd St., Milwaukee 2, Wis.
Please send complete information about Dustless brushes and Arbitrin sweeping fluid.
Name.....
Address.....
City and State.....

106

Contestants are allowed a three-mile running start on the dry lakes and are timed over a carefully measured quarter mile. If a driver is shooting at a new record he "runs the trap" twice—in opposite directions—and an average time is computed.

Randy Shinn, a Pasadena lawyer, holds the roadster record at 128.09 m.p.h. in a 1927 Model-T Ford with a Mercury engine. Karl Orr copped the modified title in his Ford V-8 at 133.30 m.p.h. In the unlimited class Tony Capanna, a shipyard worker, and Babe Ouse, a mechanic, ran the trap at 137.24 m.p.h. in a 16-cylinder Marmon. Fastest speed of all was chalked up in the streamliner class by Bob Rufi, a carpenter, who set a record of 140 m.p.h. in a teardrop-design car with a four-cylinder 1928 Chevrolet motor mounted in the rear.

In addition to the time trials there are a number of "drag races" between two or more cars. They are run, not for record, but to satisfy the desire of most Americans to see who can get from here to there in the fastest time.

About the only reward a winning driver gets is the knowledge that his car will go faster than the other guy's. Very few trophies are awarded. The SCTA gives each registered contestant a brass plate engraved with his name and the data concerning his time trial. Occasionally a tire, gasoline or parts manufacturer will offer prizes. But mostly the competition is on an amateur basis.

Many celebrities in aviation and the sports world first became famous among hop-ups. Major Ted Lawson of "Thirty Seconds Over Tokyo" fame raced hot rods before the war and is still active. Tommy Lee, Los Angeles millionaire sportsman and radio network owner, races a high-powered foreign car across the lake beds. Rex Mays, 1940-41 AAA racing champ and Army Air Forces captain, started on dirt tracks near Riverside, California. And Eddie Meyer, who holds many records as a speedboat racer, was once a hot-rod driver.

There were several women drivers a few years ago, but the SCTA has discouraged the weaker sex from racing the souped-up cars. The only woman member today is Mrs. Veda Orr, wife of record-holding Karl Orr. She has driven her husband's racing car more than 130 m.p.h. She edits the mimeographed monthly publication which carries racing news to association members.

Hot-rod drivers have a code as rigid as that of any other sport or profession. They are highly annoyed when an outsider breaches this code. For example, it's unhealthy when conversing with a hop-up to

(Continued to page 248)

**STRIPE
WITH
PAINT
EASY
AS
USING
A
PENCIL**

PAINTERS' STRIPING TOOL

NOW you can do your own expert striping on furniture, bikes, model planes, bulletins, autos, toys, signs, linoleum, wall board . . . make plain walls look like tile! It's easy to paint straight, curved, circular, even parallel lines with any color. Handiest paint tool in your workshop! Type "M" Master Painters' Striping Tool complete with tip for 1/16" stripe, \$1.00. Extra tips 1/64", 1/32", 3/64", 1/16", 5/64", 3/32", 1/8"—75c each. Tool with complete set of 7 tips \$5.00. (C.O.D. orders 25c extra.) WENDELL MFG. CO., 4234 -1¹/₂ Lincoln Ave., Chicago 18, Ill.

**A TOOL . . .
NOT A BRUSH**

Dealers
Write
Today!



**\$1.00
POST
PAID**

15 JEWEL SWISS

\$17.50

MEN'S SUPERB WATCH

15 jeweled movement insures accuracy, dependability. Radium dial and hands. Regular second hand. Unbreakable crystal. Stainless steel back. The Swiss master watch craftsmen put these superb movements in handsome, lustrous, chrome cases. Truly a distinctive watch priced to sell quickly.

WRITTEN GUARANTEE WITH EACH WATCH!

Wear for 10 days at our risk and expense. SEND NO MONEY. Simply pay postman \$17.50 plus 10% tax and postage on delivery. Cash orders sent postpaid. Limited supply.

United Products Co., 7941 S. Halsted St., Dept. RR-254, Chicago 20, Ill.



QUICK-GLANCE Driving Directions

HULL STREAMLINE AUTOMOBILE COMPASS users like the easy readability of its magnified, ball-type dial,

visible from angles. Twelve-year reputation for accuracy and dependability. Price \$3.95. At your dealer's. Write for circular.

HULL MFG. CO., P. O. Box 246-D1, Warren, Ohio



FREE Catalog

Class pins, club pins, rings and emblems. Finest quality. Reasonable prices from 30c up. Write today. Dept. N, Metal Arts Co., Rochester, N. Y.



HOLD-E-ZEE AUTOMATIC GRIP SCREWDRIVERS

Hold-E-Zees do the job better, faster. They excel wherever screwdrivers are used. Gripper instantly released by spring action, sliding up out of way when not in use. Highest quality materials throughout.

Upton Bros., Inc.
86 Exchange St.
Rochester 4,
N. Y.



PATENTED

At
Leading
Dealers Everywhere

A TOOLSHOP IN YOUR HAND!

- GRIND • DRILL • ROUT
- POLISH • ENGRAVE
- CUT • SAND • SAW, etc.

Make Things From
Wood—Plastics—Metals—Glass—Linoleum—Leather—Alloys—Horn—Stone—Bone, etc.

HANDEE TOOL OF 1001 USES

Smooth, steady power at your fingertips! Perform precision operations not possible with any other portable tool! With a Handee you can turn out professional looking projects for pleasure or profit—ship, plane and train models, costume jewelry, wood carvings, puppets, initialed tumblers, etc. AC or DC. 25,000 r.p.m. Wt. 12 oz.

USE THE RIGHT ACCESSORIES! Choose them from the most complete line . . . more than 300 made right in the Handee plant.

GET A GOOD START GET THE HANDEE KIT

HANDEE Tool and 45 most popular accessories packed in compact steel carrying case. You'll be amazed at what you can accomplish!

Postpaid, \$27.50

Handee, with 7 accessories, \$20.50



FOR YOURSELF OR A FRIEND . . .
THE GIFT OF A LIFETIME!

NEW PRECISION ATTACHMENTS

Fit Handee only; enable novice or craftsman to do perfect work. Magically, easily, your offhand carving, routing, shaping will be exact as to depth of cut, accuracy of line. Set of 6 attachments with instructions, postpaid, \$7.95



ORDER NOW. SATISFACTION GUARANTEED!

FREE! NEW 52-PAGE MANUAL

CHICAGO WHEEL & MFG. CO.

1101 W. Monroe St., Dept. PM
Chicago 7, Ill.

Send Handee Kit Handee Tool Precision Attachments
 C.O.D. Remittance enclosed Send Manual

Name.....

Address.....

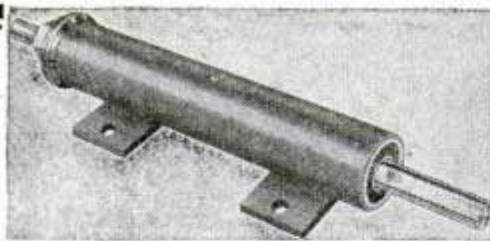

HEAVY DUTY, BALL BEARING, ALL PURPOSE MANDREL SHIELD PROTECTED

BALL BEARINGS . . . Ground precision type. Smooth running, vibrationless, long life. Completely shielded on exterior side.

SHAFT . . . True running, high quality Bessemer stock. Ends machined to accept bearings and eliminate longitudinal play. Work end has die-cut U. S. Standard threads. Pulley end machined and provided with milled flat to accept Standard size pulleys.

RIGID BODY . . . One piece heavy gauge SEAMLESS STEEL TUBING with welded-on mounting brackets. Ends internally machined to provide solid thrust supports for bearings.

WASHERS . . . Machined inside to provide firm grip on saw-blade, emery wheel, etc., and outside to provide hub, contracting inner bearing race transferring thrust to bearing only.

FINISH . . . Yes, it has "EYE APPEAL!" Body and brackets of lustrous, gray enamel. Hex nut and washers cadmium plated. Completely in harmony with any and all other fine equipment.

Now in use in thousands of workshops, machine shops, garages, hobby shops and on farms for saws, emery wheels, pulleys, buffing wheels, brushes, etc.

In ordering be sure to specify shaft size desired. Send money order or certified check.

STURDY STEEL CONSTRUCTION

Length Overall: 14"
Diameter: 1 3/4" OD
Lugs: 1/4" x 1 3/4" x 3 3/8"
Shaft: 1/2" or 3/8" Optional

POST PAID
\$800
IN U.S.

If Your Dealer Cannot Supply You Write **TRIO MACHINE CO., Box 187, Willoughby, O.**

RADIO Builders, Experimenters



ONLY
\$588

Own this valuable
Test Instrument!

Here's a wonderful value in an AC-DC Volt-Ohm-Milliammeter! This wide-coverage test unit with 2" moving-vane type meter reads: AC-DC volts, 0-25-50-125-250; AC-DC ma., 0-50; Resistance, 0-100,000 ohms, 2400 ohms center scale; Capacitance, .05-15 mfd. Jacks provide range selection. In black bakelite case with cord and plug. No. 84-306. Special Price . . . **\$5.88**

GET THESE HELPFUL ALLIED RADIO BOOKS!

Radio Formulas & Data No. 37-752 . . . 10c
Dictionary of Radio Terms No. 37-751 . . . 10c
Radio Circuit Handbook No. 37-753 . . . 10c
Radio Builders' Handbook No. 37-750 . . . 10c
Simplified Radio Servicing No. 37-755 . . . 10c
Radio Data Handbook No. 37-754 . . . 25c
ALL SIX BOOKS No. 37-799 . . . 75c

Parallel-Resistance and Series Capacitance Calculator. No. 37-980 . . . 25c
R-F Resonance and Coil Winding Calculator. No. 37-955 . . . 25c

ALLIED RADIO

833 W. Jackson Blvd. - Dept. 5-A-7 - Chicago 7

ALLIED RADIO

See your ALLIED Catalog for Everything in Radio



ORDER FROM

FIND UNDERGROUND MINERALS and METALS with M-SCOPE

Employs same principle as Army Mine Detector. Unsurpassed in Efficiency. Write for Free 16 page booklet.

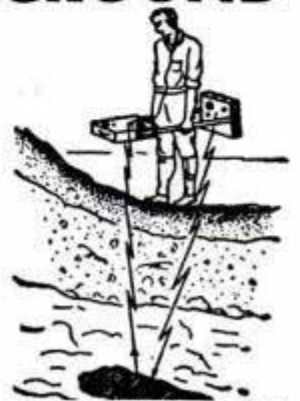

FISHER RESEARCH LABORATORY
PALO ALTO CALIFORNIA

CORROSION TROUBLE?

Use an oil that prevents rust while it lubricates
—shop appliances
—household devices
—mechanic's tools

Hardware and Sports Dealers

It's THE Triple Action Oil! Lubricates Prevents Rust Cleans

3-oz.
SPOUT
CAN
40c

FIENDOIL



Beautiful brass Social Security plates (illustrated 1/2 actual size), priced at only 50c. Please print your name & number plainly.

ACME

Stamping Service
Box 836
Davenport, Iowa

ONE TOOL WITH 6 USES!



- Mitering Guide
- Diameter Gage
- Accurate Square
- Marking Gage
- Center Finder
- Handy Ruler

It's a universal tool for the hobby shop and for carpenters because it has so many uses. Miter-Master takes the place of an expensive miter box, with scale marked to miter 5, 6, and 8-sided frames. Rugged steel construction. Full directions for use. Ask your dealer, or we will send it postpaid for \$2.00 (foreign \$2.25). Satisfaction guaranteed, or your money back.

MITER-MASTER

Enclosed is \$2.00 for Miter-Master, postpaid, (Foreign \$2.25)

PRINT NAME
ADDRESS

\$2.00
POSTPAID

MASTER SPECIALTY COMPANY
3018 E. LAKE ST. MINNEAPOLIS 6, MINNESOTA



HUNTER'S
COMPASS
Hunting Case,
Watch Type, **\$2.50**
All Metal, Jeweled

RUBBER SPORT GOGGLES

White Plastic Lens and Extra green Polarizing Lens. Plastic Lens are shatterproof, Polarizing Lens a protection against reflected glare, excessive light, dust and wind. Ideal for industrial use, Motoring, skiing and all kinds of outdoor use. Value \$3.50. **SPECIAL \$1.50**
Per pair

Engineers All Metal Army Type Hand-Sighting

LEVELS

\$2.00

PRECISION
QUALITY



WHEATSTONE BRIDGES Used, in excellent condition. Mfg. by Thompson Lever Mfg. Co., Philadelphia. Value \$150.00. **SPECIAL \$49.50**

PUBLIC SPORT SHOPS

13 S. 16th St., Phila. 2, Pa.

No COD's

Sand Casting—Forging—Heat Treating—Case Hardening

BRONZE FOUNDRY



is again available in limited quantity without priority. Orders filled in sequence as received. **INVENTORS—SCHOOLS—CRAFTSMEN** use **FOUNDRYETTE** for making castings quickly for new inventions, for instruction, and general purpose. Order now for early delivery. Three sizes are available capable of making bronze castings of 1½, 3, and 6 pounds weight, aluminum, copper, brass, etc., \$17.50, \$24.00, \$34.50, f.o.b. Kansas City. Domestic gas supply and 110 volt AC or DC energy required for operation. Write for circular.

KANSAS CITY SPECIALTIES CO.

Box 6022, Dept. P-74

Kansas City, Mo.

IRON CORE TUNERS

For Broadcast Band Superhets. Replace 2-gang condenser and oscillator. One compact tracked unit. Includes hook-up diagrams and instructions.

Only \$4 Postpaid

Send for **FREE** price list of Standard radio coils

MAGNA-METAL PRODUCTS CO.

Dept. A, 70 E. 45 St.

New York 17, N. Y.

LAWN ORNAMENT-NOVELTY PATTERNS

28 Lawn Ornament Patterns, 25c. Other patterns: 15-20" high; Dutch Girl, Dutch Boy, Pirate, Bull Terrier, Mexican Girl, Mexican Boy, Dwarf, Penguin, Flower Girl, 10c each. 25 Novelty Patterns, 30c. All 62 Full Size Patterns, \$1.00 Postpaid. Strother Pattern Service, Dept. R-8, Box 383, Belington, W. Va.

3 in 1 OTTAWA SAW

THE WORLD'S FASTEST.

6-H. P.
EASY TO MOVE

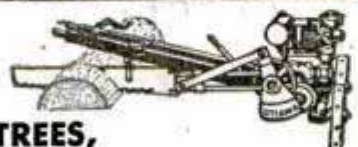

**FELLS TREES,
SAWS BIG LOGS, SMALL LOGS, LIMBS**

One motor performs all three operations. Furnished with or without attachments shown below. Thousands in use.

Make **BIG** profits in the ever increasing wood business. Pulley for belt work. Fully guaranteed. Low direct-to-user prices. **FREE** details—write **TODAY**.



OTTAWA MFG. CO., 127 Pine St., Ottawa, Kansas

For Cabinet Finishing
use **PLASTIC WOOD**

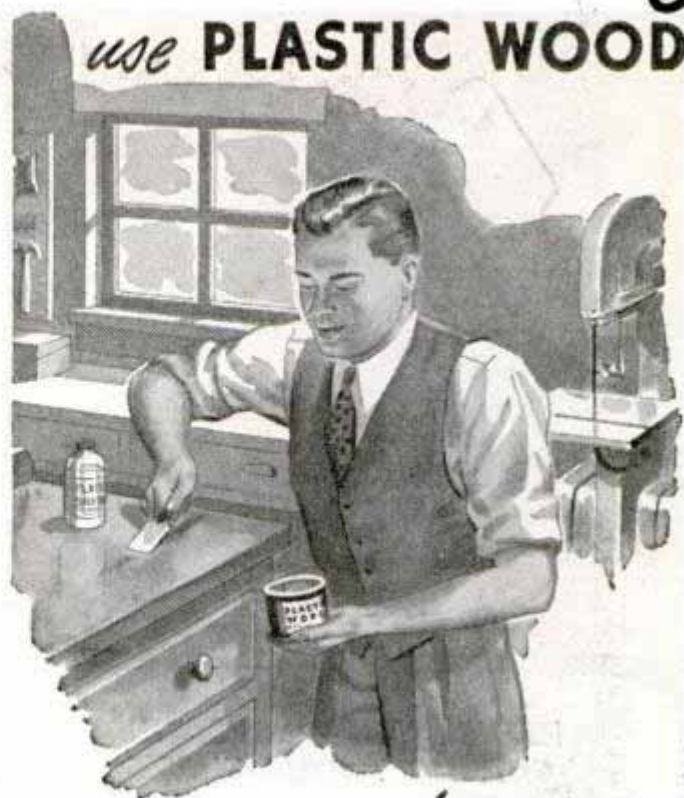

in your
HOME WORKSHOP!

If you'd like a satiny smooth, professional finish on your next cabinet job—use Plastic Wood! It's an ideal filler for cracks or rough grains, dries tight and hard, sands to a swell finish and takes paint, lacquer or varnish perfectly. Here's an extra hint—knot holes or gouges just disappear when this handiest filler is used! *Handles like putty—hardens into wood!*

... dozens of other uses

FOR FILLING ...

FOR REPAIRING ...

- Countersunk screws
- Chipped furniture
- Nail and screw holes
- Loose casters
- Broken balusters
- Broken furniture

- You'll want Plastic Wood **SOLVENT**, too. Get both at one time. It is made especially to control the consistency of Plastic Wood... useful also in removing dried Plastic Wood from tools and fingers.

T. M. Reg. U.S. Pat. Off.

At all Hardware,
Paint and 10c Stores



PLASTIC WOOD

Tube or Can

A CELLULOSE FIBRE FILLER

NEW CUTTING TOOLS . . .

RAZOR SHARP!



KEENER, MORE VERSATILE
CUTTING TOOLS—THAT'S

GENIE TOOL

Home craftsmen prefer GENIE TOOLS—for a special manufacturing process keeps blades free from wire edges. Is the GENIE TOOL versatile? You bet! A simple turn or two—and you have a knife, drill, saw, or whatever the need. Yes, GENIE TOOL has rightfully earned its slogan "Magic at Your Fingertips." Find out for yourself today.

Set #95

\$9.95



SEND FOR
FOLDER
TODAY!

DEPT. D1

MODEL TOOLS
BOX 30 • BURBANK, CALIF.

confuse hot rods with "pretty stuff" or "gook wagons." The latter are cars with mirror-bright polish, chrome fittings, fender skirts, radios, trick horns and twin exhaust pipes. A hop-up considers himself an engineer.

One of the aims of the SCTA is to encourage members to develop automotive parts and mechanical improvements which can be used by large automobile manufacturers. Hot-rod drivers were using high-compression heads and dual carburetors long before they were adopted by Chrysler and Buick.

Despite their 100-mile-an-hour-plus speeds on the tracks, youthful members of the SCTA are pledged to careful driving on the highways. Penalties for dangerous driving range all the way from suspension for a week to dismissal from the organization with the result that the offender can never again race on the dry lakes.

Racing drivers of the SCTA are burned up, therefore, when some California newspapers label every ancient car involved in an accident a hot rod. Really, say the drivers, the cars are "crocks," "goats," "dogs" or "crutches."

A few of the hop-ups did invite trouble once when they blocked off a Los Angeles street to run a private race. The offenders were haled into court and given proper punishment. Wiser heads in the SCTA pointed out the error of their ways to the young speed merchants and they have since refrained from unauthorized racing.

Traffic police, educators, social workers and juvenile authorities are behind hot-rod racing—properly controlled and regulated. It's a fine outlet for youthful drive and enthusiasm. And in the mass-produced world of the future, young minds and hands that understand machinery will be a valuable asset to the United States.

Dangerous Business, Farming

(Continued from page 110)

clutch is operated by a lever located beneath the seat. When the lever stands upright the tractor stands still. By pulling the lever back the farmer inches the tractor to the rear and into position for hitching. The awkward, dangerous stretch for the clutch pedal is eliminated. If the farmer should stumble or slip the lever springs back to its upright position and the tractor stops instantly.

Most farm residents are aware of the risks they take. Carelessness or the temptation to do a job the easy way is difficult to cure. When a farmer has worked the

(Continued to page 252)

Atlas

MILLING MACHINE

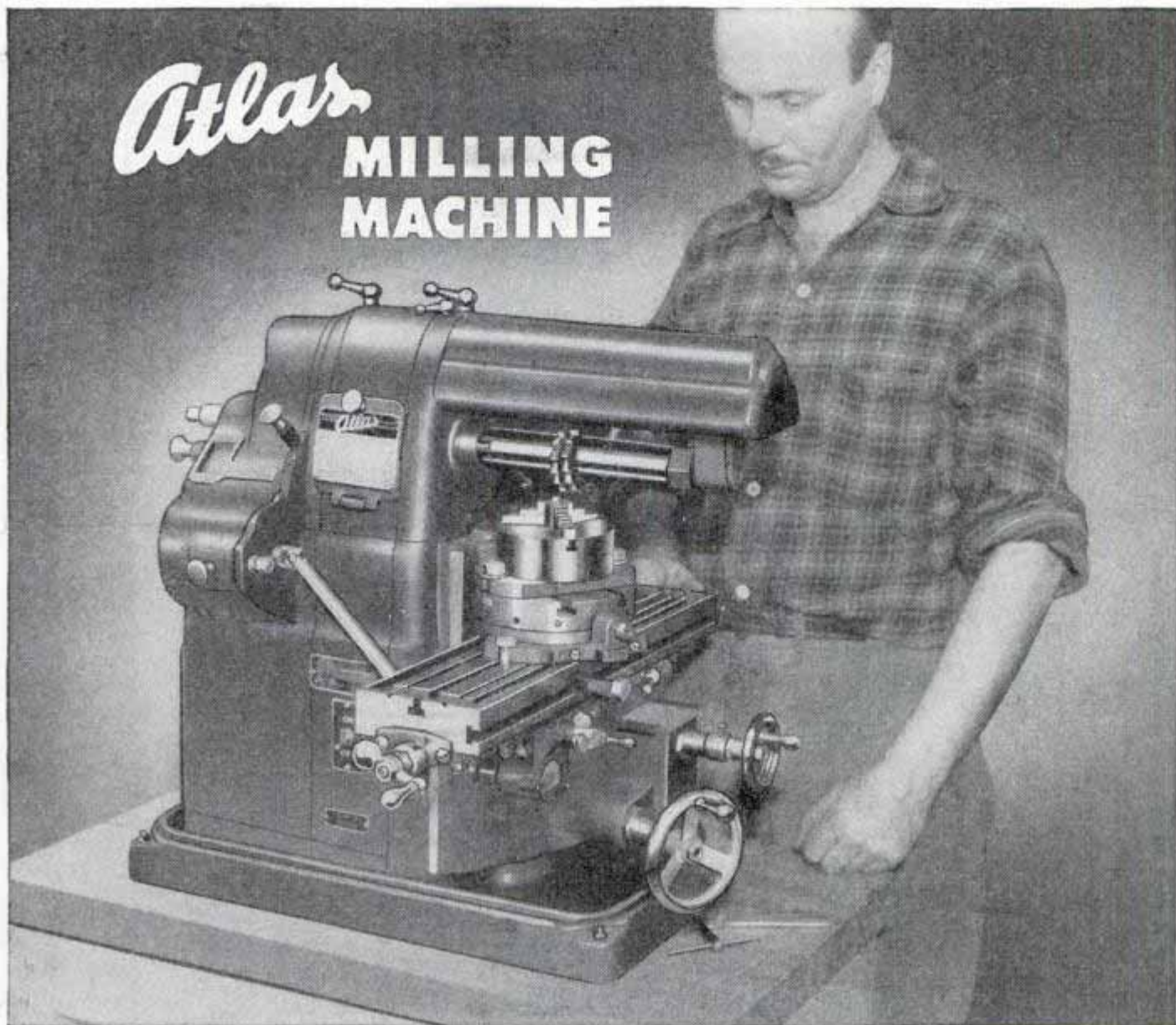

THE HOBBY THAT PAYS FOR ITSELF

MOST PRACTICAL of all winter hobbies is a well-equipped home work shop.

It's a quick, sure way for business and professional men to get away from daily cares, relaxing to the restful hum of busy tools. Most valuable, too, in repairing home equipment and making useful articles for home or business.

For inventive men—with commercial ventures in mind—an Atlas-equipped shop helps you make working models of your ideas, and go into production on them when they prove practical.

The ideal precision tool for all types of milling operations is the Atlas miller. Its table travels 10" horizontally, 3½" cross, 6" vertically. Spindle speeds from 62 to 2870 RPM. Back-gearred power, V-belt drive, Timken bearings. Operates from ⅓ HP motor. See one at your Atlas distributors.

"SUCCESS STORIES"—FREE

Reports of personal progress and success of men from coast to coast who have built profitable businesses starting with one or two Atlas tools. Sent free with latest Atlas catalog. Write Atlas Press Co., 143 North Pitcher St., Kalamazoo 13D, Mich.



Atlas 4 TOOL TEAM

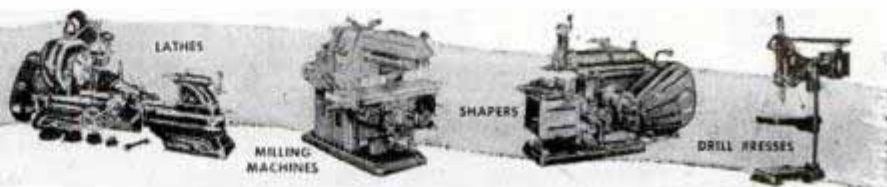

A Fine, Precision
EXPOSURE METER



The Sign of Precision

Make your camera take better, sharper photos. Eliminate guess-work, lost pictures and wasted film with a precision-built SKAN Exposure Meter. A *must* for color—still or movies. Be right in *any* light—day or night. Simple to use.

So... at camera counters everywhere. For free literature write: G-M Laboratories Inc., 4290 N. Knox Ave., Chicago 41, Ill.

SKAN

EXPOSURE METER

THE UNIVERSAL LIQUID CEMENT
The "Mr. Fix-it" for "a million things"

Tops in quality for 37 years. Uses unlimited . . . sticks and mends permanently. Waterproof . . . quick drying. Keep a tube on hand always. Extra quality . . . extra strength. Ready to use. **LOOK!** Get acquainted with Ambroid quality. At your dealers or send 25c for big 2-oz. tube postpaid (U.S.A. only). Money back guarantee. **25¢**

AMBROID CO.
303 Franklin St., Boston 10, Mass.

Also 50c 4-oz. tube. Pts., qts., gals. for industrial use.

New MILLING ATTACHMENT

Sizes for 8" to 16" metal lathes

BUILD IT YOURSELF from our sets of semi-machined castings and save 8\$. Can be finished on your lathe alone. Complete working drawings and step-by-step machining instructions furnished with castings.

Mill keyways, slots, splines, dovetails, flutes in reamers, taps, hobs, and special cutters; produce spur, bevel, mitre and worm gears, ratchets and racks; mill flat surfaces, square shafts, mill hexes, spot face, drill spaced holes, bore, etc. on your lathe with this precision attachment. It has a T-slotted table, a vise which swivels for angular milling, a gear cutting fixture and dividing centers.

FREE! Illustrated folder and price list. Mention your lathe. Write today.

HURON MACHINE AND TOOL CO.
YALE, MICHIGAN

BUILD these ENGINES

GAS and STEAM
NO CASTINGS!
NO SPECIAL TOOLS!

All you need is a small lathe and some scrap shafting. Plans and detailed instructions for these and other high speed engines available. Illustrated literature sent for 10c. Write today.

SEND 10c for illustrated CATALOG

R. W. ROWE ENGINEERING
DEPT. B, 8889 APPOLINE DETROIT 27, MICH.

NEW OTTAWA Wood Saw

FOR TRACTORS Makes wood sawing fast; easy. Cuts enough wood to pay for itself quickly. Easily moved while attached. Big blade; *free* details.

LOW PRICE

OTTAWA MFG. CO., W-127 Oak Ave., Ottawa, Kans.

"I'LL TAKE THE WHITE ONE EVERY TIME!"

WYTEFACE
TRADE MARK
STEEL MEASURING TAPES

KEUFFEL & ESSER CO.

PHOTOGRAPHERS:

PRINT PHOTOS
ON
BOOK COVERS!



CHINAWARE!



RECORD
ALBUMS!

GLASS
SILHOUETTES!



WOODEN
JEWELRY!



PHOTO MURALS
DEN WALLS!

Now You CAN PRINT PHOTOS
ON PRACTICALLY ANY SURFACE!

EASY TO USE — BY CONTACT, BY PROJECTION
— ON METAL, GLASS, PAPER, PLASTICS, WOOD, ETC.

Get This
Free Booklet
From Your
Dealer!



Let your imagination go! Find new uses for your photographic hobby! Put those pictures you prize most on display in hundreds of interesting ways. It's all possible with the new Martin Multi-Mulsion—a simple, practical emulsion which sensitizes almost any surface for photographic reproduction. Ready to use. Applied in one coating with a brush or cloth. Works with ordinary darkroom equipment. The Glenn L. Martin Co., Baltimore 3, Md.

ASK YOUR DEALER ABOUT

GLENN L.

Martin



MULTI-MULSION

a real professional microphone
TURNER CHALLENGER



MODEL BX
\$10.85
LIST

for hams and home recording. Reproduces voice or music crisp and clear. Precision built with moisture proofed crystal. Works indoors or out. Beautifully finished in rich bronze enamel.

Ask your dealer

Write for Free Literature describing Turner Microphones.

THE TURNER COMPANY

921 17th Street, N. E., Cedar Rapids, Iowa

Crystals licensed under patents of the Brush Development Co.

SAY YOU SAW IT IN POPULAR MECHANICS

• Test ALL Home Outlets
• Find Open Circuits

STAR TEST-PLIERS

• Locate Blown Fuses
• Remove Fuses SAFELY

A must tool for electricians, maintenance men, home owners. Replaceable lamp inside Plier tests 110 to 250 Volts. Plier pulls fuses from 10 to 100 Amperes. Shockproof. Requires the use of only one hand. Can be obtained from General Electric or Westinghouse stores, or from local electric dealers.

Order one TODAY

Price \$2.75 without Leads, \$1.50 additional for Leads

STAR FUSE CO., 233 Canal St., New York 13, N. Y.

*This is the way
to Make Money!*

MACHINE SAW FILING with the Foley Automatic Saw Filer is the modern way to recondition saws. Anyone can do the work—no experience needed—no eye-strain. Start in spare time—Foley-filed saws cut so smooth and fast, they will advertise for you, bring you new customers and a steady repeat cash business.

The Foley is the ONLY machine that files all hand saws, also band and cross-cut circular saws—enables you to handle work from schools, shops and factories as well as farmers, carpenters, etc.

Send for
FREE PLAN

Shows how to start—no canvassing. Send coupon today.

"I bought a Foley Saw Filer, one year later had all debts paid and also \$400 on a new home. Many days I earn as much as \$16," says J. H. Kellogg

W. L. Tarrant writes: "I left my old job last September and in 10 months have filed 2,159 saws. We have a lovely business worked up and cannot keep up with the work."

Thor Nedribe, Iowa, says: "I have filed 550 saws, made \$350. As I'm a carpenter, I just file saws in spare time—have more than I can take care of."



FOLEY Automatic SAW FILER

FOLEY MANUFACTURING CO.

116-7 Foley Bldg., Minneapolis 13, Minnesota

Send Free Plan on Saw Filing business, no obligation

Name _____

Address _____



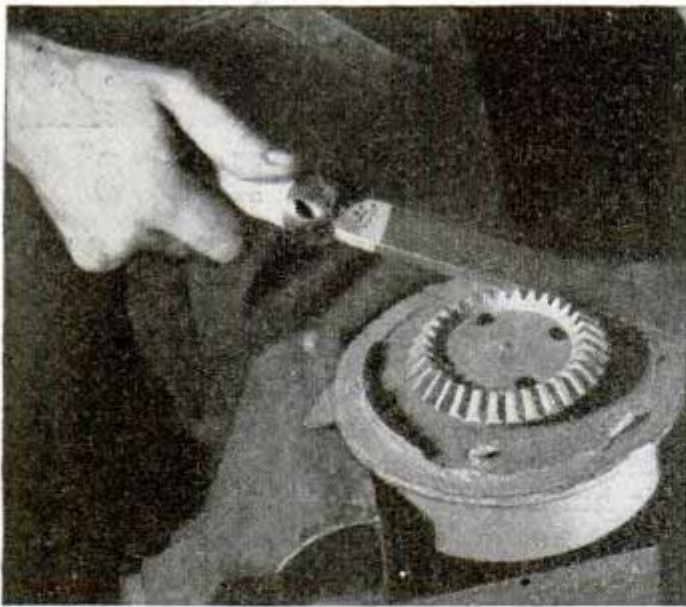

ROUGH FILING calls for TOUGH FILES

SNAGGING a rough casting with an ordinary file is a sure invitation to headaches—and "toothaches." Hard projections and sharp edges put a severe strain on regular file teeth—often cause them to shell or break out under pressure. Roughing-down calls for a file with an exceptionally strong tooth construction.

The right file for the job is the Nicholson or Black Diamond Special-Purpose Foundry File, with extra-sturdy teeth designed to absorb shock and resist breaking. Specializing in rough use—like knocking fins and sprues off foundry castings or filing the narrow edges and sharp corners of dies—this "bruiser" of the file family continues to give efficient service long after regular files are discarded.

• **OTHER NICHOLSON AND BLACK DIAMOND SPECIAL-PURPOSE FILES** of interest to mechanics and home craftsmen include files for: Aluminum, Stainless Steel, Brass, Lead, Die Castings, Die Making, Lathe Filing, plus milled Curved Tooth files and a wide range of Swiss Pattern precision files. Obtainable through industrial distributors and good hardware dealers.

FREE BOOK, "FILE PHILOSOPHY," on kinds, uses and care of files.



NICHOLSON FILE CO.
22 Acorn St., Providence 1, R. I.
(In Canada, Port Hope, Ont.)



NICHOLSON FILES

FOR EVERY PURPOSE

same way for 25 years he may be slow to change his habits. Stepping over or reaching through a moving belt seems simpler to a tired farmer than walking around the equipment. He saves a few seconds but he's living on borrowed time. The belt may snag his clothing and drag him into the machine.

Farm parents sometimes deny their children firearms, yet tools are scattered on the ground, poisons lie within reach and bull pens near farmyards are flimsy. In northern Illinois last year one of three youngsters splashing water from a farm stock tank was electrocuted by an unsafe electric fence that bordered the tank.

"Horse sense" around livestock is an easy thing to forget when you've grown up with animals. Standing on the tongue between a team of horses is a movie stunt but it's always done by a stand-in because of the danger. Reins and lines passed around the body or wrist are an invitation to disaster. Even steady old Dobbin can be frightened into bolting. A farmer often stands too close to the horses when harnessing his team. The Safety Council recommends that he stand well back and lean forward, so a hoof can't smack down on top of his arch. And old MacDonald may have the gentlest bull in the county, but if he handles the animal with a rope instead of a staff he may also have a funeral.

If you know five farm families, the chances are that one of those families will suffer a disabling injury this year. Using common sense in fighting farm hazards is the only way these accidents can be reduced.

European Auto Show

(Continued from page 120)

much faster than was anticipated. She now produces autos at about 70 percent of the prewar rate. As part of a vigorous export program, two thirds of all vehicles are sold abroad, some in the United States.

In the past, French designers have developed several improvements that were copied in other countries. They have an excellent record in designing automobiles, but can't mass produce their designs to compete with American cars either in quantity or price. Prices have jumped to six times the prewar level because of increased costs.

Novel French designs appeared again in the 1946 Paris show. One of the postwar models is an 800-pound Gregoire with a chassis that weighs only 100 pounds, an air-cooled engine and front-wheel drive. Another pocket automobile cuts total weight to 500 pounds. A freak of postwar restrictions may become popular. It's the "3-3"

(Continued to page 256)

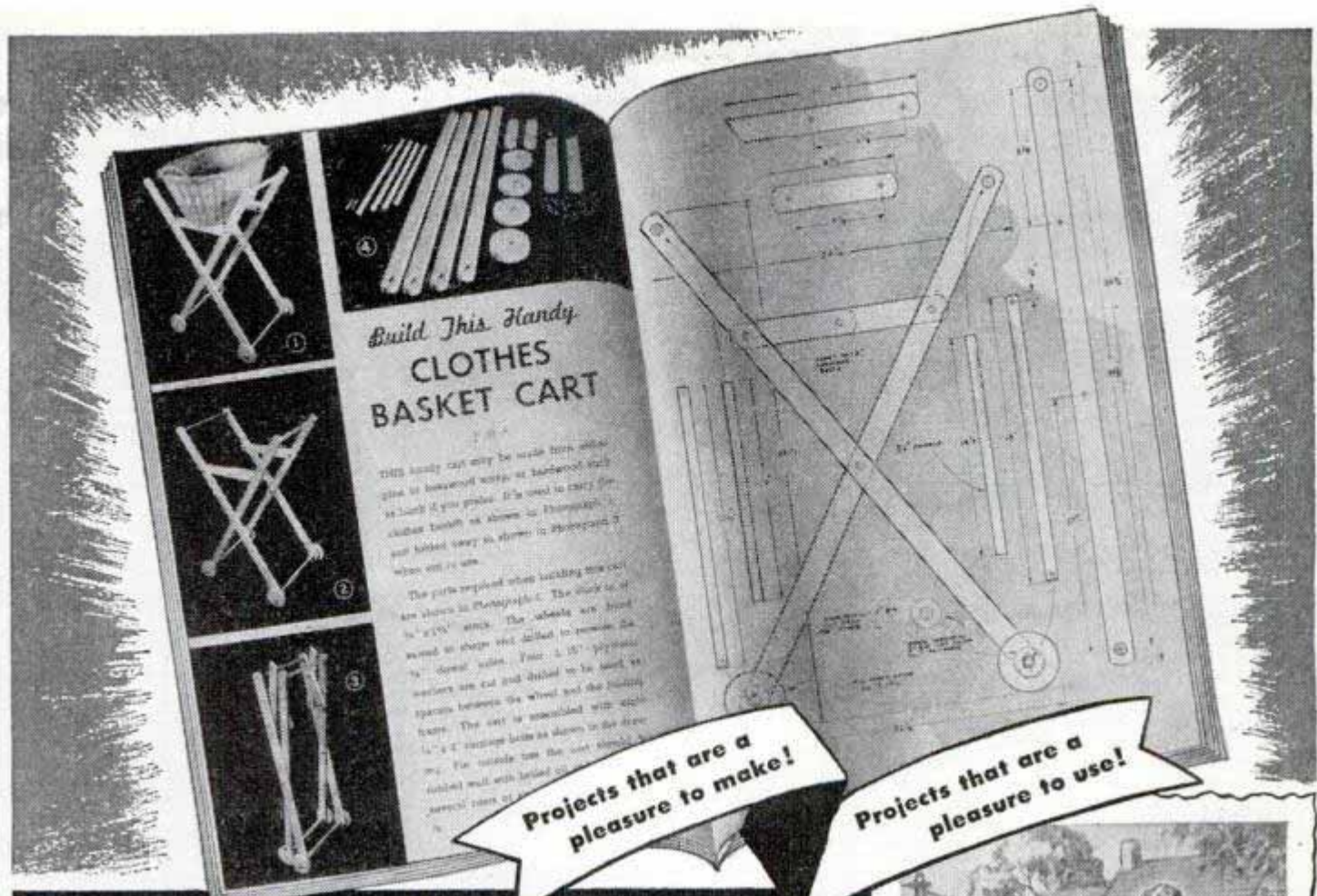

Clear, Detailed Plans that leave nothing to guesswork

— the kind of helpful project material you get in

THE *Deltagram**

... popular woodworking hobbyists' magazine

Step-by-step directions for making exciting Deltagram projects are complete and easy to understand. They are made that way by the use of clear pictures, detailed working drawings, and common, every-day words.

Even a beginner can follow Deltagram instructions without waste of time and costly materials.

Everything Shop-Tested!

All plans, projects, designs, and shop hints are shop-tested, before being shown in The Deltagram.

Thus, you can count on their being a big help to you, in producing good-looking results that win admiration . . . in performing tool operations more easily, more quickly, more safely.

Subscribe Now!

Let The Deltagram give you enough plans and ideas for two whole years of woodworking fun. Get your subscription in now!

Paper shortages permit us to print only a limited number of Deltagrams. So to avoid disappointments, fill out the coupon below now. Then mail it today with a one-dollar bill or money order.



DELTA
MILWAUKEE
MFG. CO.

Delta Manufacturing Division
Rockwell Manufacturing Company
Milwaukee 1, Wisconsin

2 Years' Subscription only \$1!

Right to your mailbox — in 12 big Deltagrams — comes page after page of how-to-do-it information for making furniture, lamps, toys and games, other thrilling projects!

HM-45A

Tear out coupon and mail today!

DELTA MANUFACTURING DIVISION
680A E. Vienna Ave., Milwaukee 1, Wisconsin

Enclosed is \$1.00 in full payment for two whole years' subscription to The Deltagram. (12 issues)

Name.....

Address.....

City..... (.....) State.....



PRESSURE QUEEN

FOUR CYLINDER
PORTABLE AIR COMPRESSOR
SPRAY PAINTING OUTFIT

\$64.60

(WITHOUT MOTOR)



COMPACT • RUGGED • POWERFUL

The ideal air supply for home and farm workshop, machine shop, garage and contracting painter; for product finishing, inflating tires, painting automobiles, trucks, machinery, etc. Indispensable for building maintenance, interior and exterior. Handles any paint, insecticide or disinfectant.

This 4 cylinder compressor has drop forged crankshaft, stainless steel, heat treated valves; bronze bearings and positive forced feed lubrication. Maximum pressure 50-60 lbs., free from pulsation. Standard equipment includes the compressor mounted on steel base with carrying handle, belt, compressor pulley, air chamber, air gauge, 15-ft. hose, spray gun. Requires 1/2 or 3/4 h.p. motor or gas engine, not included.

If your dealer does not sell Pressure Queen write direct

THE CAMPBELL-HAUSFELD CO.

1046 RAILROAD AVE., HARRISON, OHIO

**A TREASURE CHEST FOR MECHANICS
GARAGEMEN—FARMERS—EXPERIMENTERS**



100 POUND HANDY ASSORTMENT \$8.95
SCREWS—NUTS—BOLTS
WASHERS—RIVETS—SPRINGS

Think of it—this popular assortment specially priced at less than 9¢ a pound! Chest filled with 100 pounds of clean, new fasteners, mostly 1/4" and larger diameters—bound to come in handy in shops, garages, on farms, or wherever a large variety is needed. Chest, too, is valuable for many uses after original contents have been used. Shipping wt. 115 lbs. Price only \$8.95. Enclose remittance and shipping charges when ordering.

HUDSON TRADING CORP.

JA-1521 N. Wells St.

Chicago 10, Ill.

READYCUT HOMES

Order Now

Homes \$1365.00 and up, freight paid. Orders filled in order received. Save \$500 at least on modern production method of homes. Much more compared with builders' prices. Anyone can assemble with simple plans furnished. Complete, including paint, hardware, roofing, glass, nails, etc. Send 35c in coin for full color catalogue showing 57 modern low-priced homes and floor plans. Complete building plans ready for filing at low cost. Sold separately if desired.



NEW COLOR CATALOG FOR ONLY

Dept. PM-17
INTERNATIONAL MILL & TIMBER CO.
Bay City, Mich.

35c



Have trouble finding the right Nipple?



The Wing Nipple-guide

will make that nipple in a hurry! An easy tool. With your threader you can thread:
• Long pipe • Short pipe
• Next a wall • AND

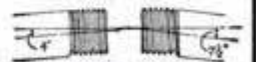

• Up to 15° angle per pair of threads

\$2.45 1/2" Wing Nipple-guide (above). 1/4" thru 1". Hardened, Electroplated.

Fast Simple Accurate

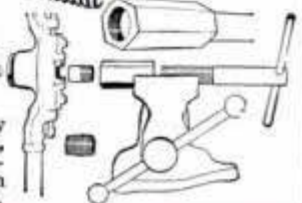

or drop card for information. Made by Wing S. Laboratory, 127 Water St., Grass Lake, Michigan. Sales organization being built. Applicants with character will be wanted in home office.

8000 OHM HEADPHONE



Army surplus at 1/10 original cost. Very sensitive. Built on hearing aid principle, shuts out outside noise. No. 17A420

Every One Brand New. **\$2.95**
Plus 25c each for Postage.



BURSTEIN-APPLEBEE CO.
1012 McGee, Kansas City 6, Mo.

500,000!!!!

LENSES

Send 3 cent stamp for "BARGAIN" list.

A. JAEGER'S

BOX 84P

SO. OZONE PARK 20, N. Y.



DRILL-INDEX A compact container for indexing and filing twist drills. Eliminates search. Made entirely of steel in nine sizes. See your dealer or write to **HUOT MFG. CO.**

Foot Schultz Bldg. St. Paul 1, Minn.

SAY YOU SAW IT IN POPULAR MECHANICS

Big Money for Workers In Home or Shop



Licensed **Concrete Specialists** wanted. No experience needed. Make **Colortazed** concrete pottery without molds. New, low cost, patented method. Cemetery products, novelties, tiles, etc. Basement leaksealing. Other big pay projects. Booklet, details free. Men only.

NATIONAL POTTERIES COMPANY
542 Lincoln Avenue Fergus Falls, Minnesota



OWN A "POCKET SIZE" MACHINE SHOP

IMPROVED MOTO-TOOL

APPROXIMATELY
27,000 R.P.M.
CUTS CLEANER;
SAVES CUTTERS

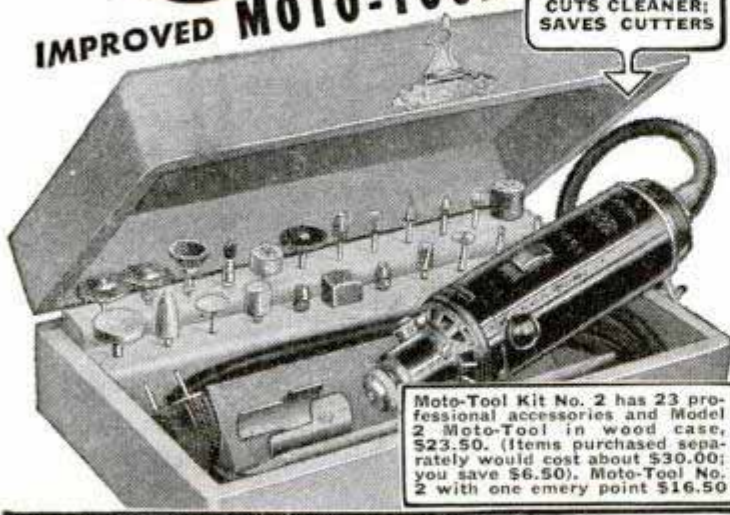

Moto-Tool Kit No. 2 has 23 professional accessories and Model 2 Moto-Tool in wood case, \$23.50. (Items purchased separately would cost about \$30.00; you save \$6.50). Moto-Tool No. 2 with one emery point \$16.50

HERE'S A CRAFTSMAN'S GIFT THAT PACKS YEARS OF PLEASURE

Here's a gift to please a man's heart. A gleaming "powerhouse" that holds promise of endless creative hours. This "pocket-size machine shop" is a war veteran . . . used by all branches of the armed forces in far flung repair bases . . . and it helped set production records at General Electric, Westinghouse, Remington Arms, Ford and other plants. Hobby enthusiast or expert craftsman . . . first choice is Model 2 "Moto-Tool" kit, with its handsome, felt-lined, highly finished wood case . . . with rows of tools begging to be put to work. The usefulness of "Moto-Tool" for precision work is increased by two versatile attachments now available at slight additional cost (see below).

Look For These

Moto-Tool Features

- Housing has "pencil-type" finger grip
- Instant-action, wrenchless chuck
- Oil-less, sealed, trouble-proof bearings
- Patented automatic chuck lock pin
- Oversize armature shaft, hardened, ground and polished
- 110 volt, universal type motor
- Easily replaced commutator brushes
- Sliding snap type switch
- Handy hanger hook
- Cord protector
- Sturdy, shockproof bakelite housing
- Dust-filtered, air-cooling system
- Weighs only 13 oz. . . . shaped to fit the hand
- Dynamically balanced for vibrationless operation.



Do These Better-Faster

- Sharpening
- Burnishing
- Engraving
- Touching Up
- Mortising
- Polishing
- Finishing

- Cleaning
- Rasping
- Brushing
- Dressing
- Burring
- Grinding
- Routing
- Sanding
- Drilling
- Inlaying
- Sawing
- Scoring
- Cutting
- Carving

Free Both Hands With Moto-Tool

Attachments

Moto-Tool Stand (left), made of heavy cast iron, holds Moto-Tool at any position or angle. \$4.50

Moto-Tool Shaping Table \$2.50. (Shown with stand, right). Aids accuracy in routing and grinding.



MONEY BACK GUARANTEE

Buy Dremel "Moto-Tool" and Accessories from your dealer. If he does not handle them, order direct from the factory on a 10 day trial, money back guarantee.

DREMEL MFG. CO., DEPT. 117-A, RACINE, WISCONSIN

Steel Wheels

To Build Your Own Wagon, Cart, Toy, etc.

Sturdy, rubber tired pressed steel wheels with red enamel finish. Ready to use axles—threaded at both ends. Acorn nuts supplied. Order today, or send stamp for catalog.



- | | |
|---|--------|
| WHEELS WITH SOLID RUBBER TIRES | |
| 4" Wheels, 1/4" bearing, Steel Disc | \$.75 |
| 6" Wheels, 3/8" bearing, Steel Disc | 1.00 |
| WHEELS WITH SEMI-PNEUMATIC TIRES | |
| 6" x 1.50 with 3/8" Oilite Bearing | 1.75 |
| 8" x 1.75 with 3/8" Oilite Bearing | 2.25 |
| AXLES, COLD ROLLED STEEL | |
| 1/4" x 14" long, Nickel Cap Nuts | .40 |
| 3/8" x 16" long, Nickel Cap Nuts | .60 |
| 1/2" x 18" long, Nickel Cap Nuts | .80 |
- Sent postpaid in U. S. on receipt of price.

CIRCLE METAL MANUFACTURING COMPANY
4266 E. PACIFIC WAY LOS ANGELES 23, CALIF.

1947 HARLEY-DAVIDSONS



They're tops for beauty and performance—pack a mighty wallop in power, speed and stamina! No wonder the demand is so great! The sooner you see your Harley-Davidson dealer, the earlier you will enjoy the exciting good times of motorcycling. Write today for free copy of "ENTHUSIAST" Motorcycling Magazine.

HARLEY-DAVIDSON MOTOR CO., Dept. P, Milwaukee 1, Wis.

110 VOLT 60 CYCLE A-C MOTOR GENERATOR UNITS

TWO BRAND NEW COMPLETE UNITS COST NAVY '97 50

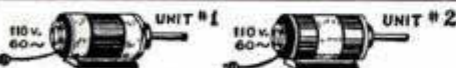

Amazing value! You get two separate units. Will operate as two AC motors or as an AC generator. Precision built with ball bearings, polished aluminum housings. Operate small grinders, fans, polishing heads, etc. Students, schools can use to experiment with fascinating AC phenomena. Generate AC electricity, operate as rotary converter, synchronous motor-generator, use as phase shifter, variable transformer, etc. Free with each order—manual of interesting experiments and full instructions. Send money order, personal check, currency or will send C.O.D. Order today or send card for more details.

LECO ENGINEERING CO., Box 908-PM-1, Lincoln, Nebr.

YOUR COST
Only \$6.99
EXPRESS PAID

Be Your Own Boss



There's a great feeling to being in something for yourself, where all the profits go into your own pocket. American floor sanders make it possible for you to realize this ambition without special schooling or a big investment. Begin small and work up to as large an enterprise as you desire . . . It all depends on your ambition to get ahead. Ask for "tell-all" booklet entitled "Opportunities in Floor Surfacing". Use coupon and enclose 25 cents in coin or stamps to cover handling.

AMERICAN FLOOR SURFACING MACHINE CO.

535 So. St. Clair St. • Toledo 3, Ohio
Gentlemen:
Enclosed find 25c in stamps or coin for booklet "Opportunities in Floor Surfacing," telling me how I can start my own floor sanding business.

Name _____
Street _____
City _____ State _____



IS YOUR FURNACE A SPENDTHRIFT? FUEL-MIZER

Guaranteed to:

- Save 1 Ton of Coal out of 6
- Give 20% More Heat
- Eliminate Coal Gas Odors
- Reduce Chimney Smoke
- Reduce Attention to Furnace
- Permit Use of Cheaper Fuel

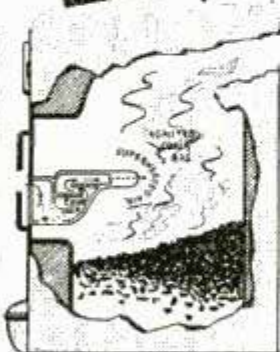

FUEL-MIZER attaches to your furnace door, preheats air in box A, passes it over baffles, and sprays superheated air over the coal bed. Fuel-Mizer burns the dangerous coal gases, reduces smoke and gives you more complete combustion. Fuel-Mizer holds your fire better. Less ash, less work. Fits any coal or coke burning furnace. Works equally well with hard or soft coal!

Send for Fuel-Mizer NOW. Shipped complete with simple installation instructions **\$34.50**

Dealerships Available in West and Midwest. Write or Wire.



THE FUEL-MIZER CORP.

1529 MAIN ST., BUFFALO 8, NEW YORK

Send me one Fuel-Mizer at \$34.50 with simple Installation Directions and One Year Money-Back Guarantee. Check or money order enclosed.

Name _____

Address _____

Look! CUTS IN ANY DIRECTION

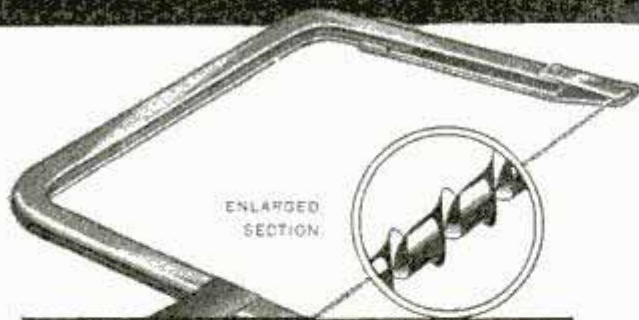

TRY THE NEW REVOLUTIONARY
Tyler Spiral Saw

Now! Saw wood, plastics or light metals as never before. Backwards, sideways—any direction. It's the only saw that cuts difficult curves, square corners—any pattern—without shifting work. The sharp, long-lasting blades *won't break*. And the new Snap-On frame holds the right tension constantly.

Get yours today! Frame, with four blades that also fit most jig saws—only 95c.

AT YOUR NEAREST HARDWARE STORE

or send \$1.00 direct for sample, to

TYLER MANUFACTURING CO. • 938 Pico Blvd. • Santa Monica, Calif.

model with a three-horsepower engine, only three wheels, and gasoline consumption of three liters per 100 kilometers or about 80 miles to the gallon.

The Netherlands buys cars from other countries. The Ford assembly plant in Amsterdam has resumed limited operations, but no strictly Dutch autos are being produced.

Neutral Switzerland jumped into the postwar market before either England or America. A 1946 exposition was held in Basel, Switzerland. Among the popular Swiss cars are those produced at the Willy Bernath factory at La Chaux-de-Fonds.

Sweden's cars compare favorably in price, size and style with American makes. Sweden has concentrated on trucks and larger autos for some time but Volvo, the passenger car company, recently turned to a four-passenger model that sells for about \$1200 and runs 24 miles to the gallon. A six-passenger car with a six-cylinder engine is also manufactured. Both cars are strikingly similar to American makes.

Russia is expanding her factories rapidly in line with a new five-year plan calling for doubled automobile production by 1950. The most important Russian plants are the Stalin factory in Moscow and the Molotov plant in Gorky. Another large factory in the Urals began to turn out automobiles in July 1944. Construction has been started on still another huge plant in the Volga area.

Most Russian cars are heavier than other European makes and compare in size and power with American autos. A new model, the ZIS-110, is an eight-cylinder seven-passenger limousine with a top speed of 87 m.p.h. A lighter Victory car is following the same trends in design as the postwar American models with fenders that merge with the body and with more passenger space. It has a four-cylinder motor and a top speed of about 70 m.p.h.

Germany is back in automobile production, too, but it's strictly limited. A small rear-engine Mercedes is being built with a novel rear-wheel suspension system. Without a load the wheels slant slightly with their lower edges toward each other. Under a normal load they're parallel, but under a heavy load they spread apart at the bottom.

Makers of the Mercedes are also turning out a four-cylinder car with the engine in the front and independent suspension for all four wheels. The Bavarian Motor Works is said to be turning out medium-size cars for the Russians at a rate of about 40 a day.

Europe raced her cars to the postwar market but her capacity for production is far short of the clamoring demand. Europeans no doubt will travel by foot or bicycle for a long time yet.

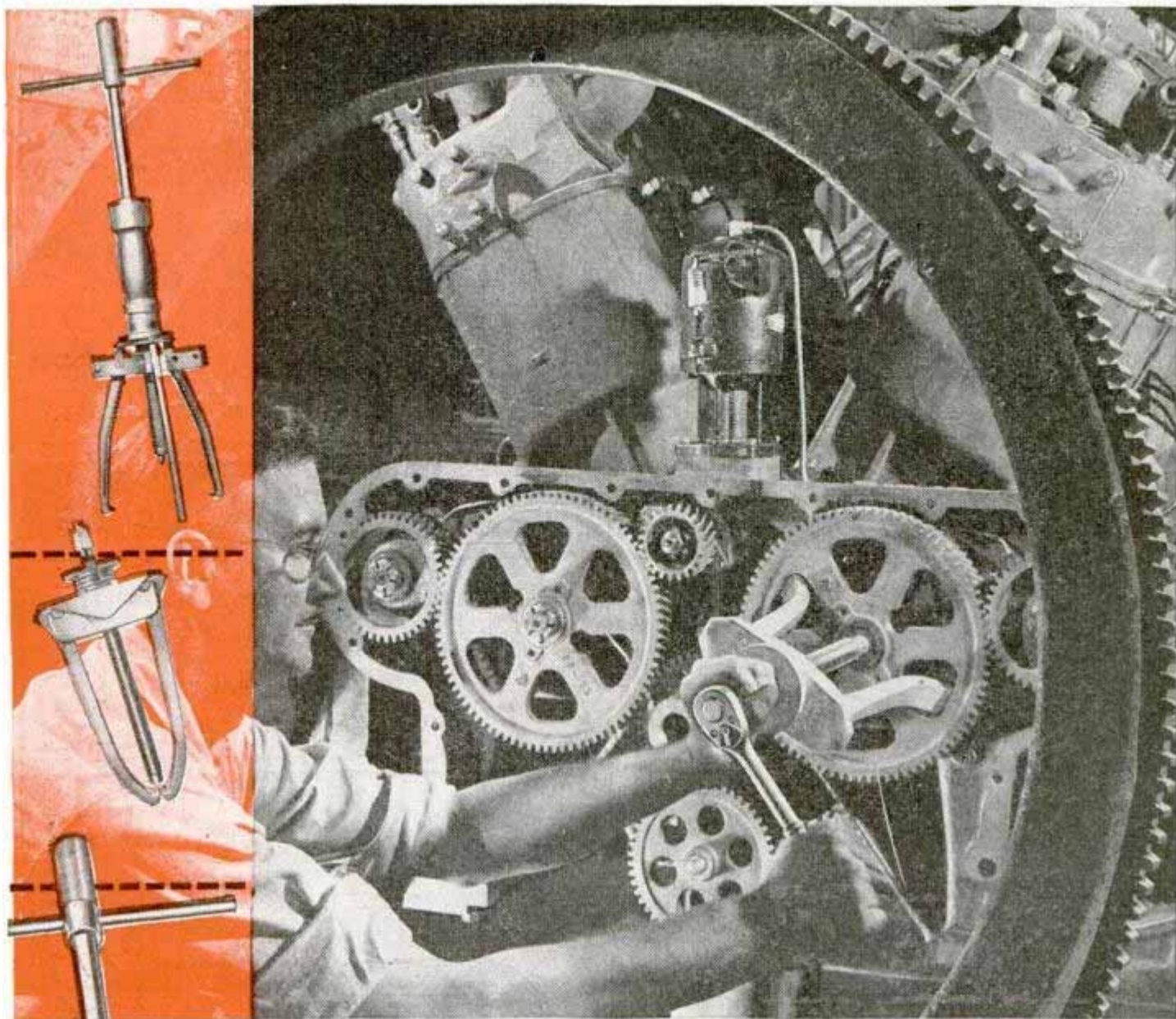

Snap-on Gear Pullers

give you safe, uniform power over entire range

On the testing floor... in maintenance operations... wherever there is a need for gear pullers, Snap-ons are favored by men who know good tools. There are four definite reasons for this popularity: (1) Snap-ons have more "locking power" for added safety. (2) They give you a "tip-less" pull that prevents binding. (3) You enjoy smooth uniform power for easy pulling over the entire range; (4) Snap-on pullers are available in a wide range of types and sizes. You'll like the comfortable, well-balanced feel of Snap-on pullers. They have the ruggedness and

stamina that make easy jobs out of the tough ones.

Snap-on pullers are part of a complete line of 4,000 tools available through Snap-on's nationwide, direct-to-user tool service. Write for free catalog.

Snap-on Tools
THE CHOICE OF BETTER MECHANICS



SNAP-ON TOOLS CORPORATION • 8062-A 28th Avenue, Kenosha, Wisconsin



FIXES

BROKEN CHINA

... also glassware, luggage, toys and furniture. It's transparent and waterproof. Makes models, too.



DUCO CEMENT

REG. U. S. PAT. OFF.

FREE

It's NEW, it's BIG, it's COMPLETE: It's Lafayette's latest, greatest catalog brimming with ALL that you want in Radio and Electronics. Radiomen and servicers, hams and dealers, hobbyists and experimenters. *Send for it.*

BIG NEW LAFAYETTE CATALOG



It's crammed with standard as well as new items—they're all in stock—they're ready for super-speed delivery—they're priced for super-economy. If radio's your hobby, if radio's your business, if you're mild about it or wild about it—this is the book for YOU. *It's yours, FREE.*

Lafayette Radio

RADIO WIRE TELEVISION INC.

NEW YORK 13
100 6th Ave.,

BOSTON 10
110 Federal St.,

NEWARK 2
24 Central Ave.,

■ LAFAYETTE RADIO, Dept. LA-7
■ 100 Sixth Avenue, New York 13, N. Y.
■ RUSH new big radio catalog to:

Name _____
Address _____
City _____ State _____

FINE TOOLS NEED FINE OIL!



• Lubricates

• Prevents Rust

• Cleans • Polishes

SOLD EVERYWHERE

3-IN-ONE Oil

Build Inlaid Smoking Accessories
and Useful Household Items

with the New WOODCRAFT CATALOG & MARQUETRY KIT

Catalog just off the press! Only 25c. Contains photographs with accurate shop drawings and all instructions needed to construct de luxe inlaid Cigarette Boxes, Book Ends, Silent Butlers, Serving Trays, Tobacco Humidors, etc. Kits equipped with all necessary materials, including genuine black American walnut for base, and completely laminated marquetry (inlaid wood) walnut panel in authentic natural colors. Subjects—Pheasant, Horse, Duck, Dog, etc. Send 25c for your catalog today!

WOODCRAFT MARQUETRY KITS CO.

DEPT. A17, 302 OAKLAND ST.

BROOKLYN 22, N. Y.

REFRIGERATION and AIR CONDITIONING



Train where the Army trained. Learn at home or in our big shops. Expert instructors—real machines. Easy to learn. Write for big FREE catalog today. No obligation. COMMERCIAL TRADES INSTITUTE, 1400 W. Greenleaf (Dept. X21), Chicago 26, Ill.



VETERANS ASK FOR GI PLAN

FREE PLASTICS CATALOG

Tells about a new source of supply for everything you need to make beautiful projects of crystal-clear Plexiglas. Included is a fine assortment of ready-made kits based on what the craftsman needs. Available also are permanent dyes for coloring, polishing rouges, and a quick-setting special cement. You also get complete instructions on how to cut, drill, form, and polish. There's also a big "grab bag" kit out of which you can make hundreds of projects. Send for your free copy today.

Jackson Studio, Dept. M, 5440 N. Shoreland Ave., Milwaukee 11, Wis.

SAY YOU SAW IT IN POPULAR MECHANICS

LAW

STUDY AT HOME for PERSONAL SUCCESS and LARGER EARNINGS. 35 years expert instruction—over 108,000 students enrolled. LL.B. Degree awarded. All texts furnished. Easy payments. Send for FREE BOOK—"Law and Executive Guidance." AMERICAN EXTENSION SCHOOL OF LAW Dept. 73-M, 646 N. Michigan Ave., Chicago 11, Ill.

New THOR "B" ENGINE—\$6.95

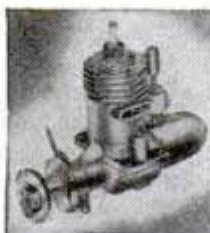

The new THOR "B"—Sensational miniature gasoline engine that really works. Super-power performance. Smooth, velvety power that roars into action with a "twist of the wrist." Over 15,000 already sold. 1/8 H.P. Complete with coil, condenser, and fully illustrated instructions, ready to run, only \$9.95. In KIT form, fully machined, 5 minutes to assemble, \$6.95, without coil and condenser. Powers all models. Send \$1.00—shipped collect same day C.O.D. or send full price plus 25c extra and we ship parcel post insured.

FREE. SEND FOR 32-PAGE ILLUSTRATED HOBBY CATALOG.

AMERICA'S HOBBY CENTER, INC.

DEPT. B17, 156 WEST 22ND STREET, NEW YORK 11, NEW YORK

ONE TOOL . . .
THE SEAMAN TILLER
DOES COMBINED WORK OF

PLOW DISC HARROW

Saves time and labor. Tears up and pulverizes soil in one trip over field under favorable conditions. Increases yields. Mixes nutrient elements into seedbed, assuring better availability of plant food; aids production of nitrogen by aerating soil; takes up and holds more moisture . . . protects against drought. Kills weeds. The most efficient tool ever developed for eradicating quack grass and other crop-choking weeds.

Write for Seaman Tiller Circular

SEAMAN MOTORS 327 No. 25th St., MILWAUKEE 3, WIS.

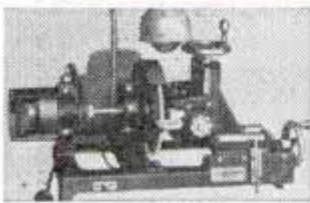

Start a NEW BUSINESS
Sharpen Dull
Pipe Wrenches

Industries save hundreds of dollars. Some "wrench shops" make \$50 a day.

Write for information.

J. C. MOORE INDUSTRIES P. O. BOX 234 FREDONIA, PA.



LIVE

CENTER & STOP

INDUSTRIAL & HOME USE

A. Center—No. 1 or 2 Morse

Taper \$6.50

B. Center—No. 2 Morse Taper \$10.50

Dept. 3 C. Live Stop \$3.50. Check or M.O.

Mechanical Research Lab., 57 Bergen Turnpike, Little Ferry, N. J.

CLEAN SMOOTH HANDS

OR YOUR MONEY BACK

Use amazing K-B Hand Cleaner for one week. If you don't agree K-B cleans and conditions hands better than any other hand cleaner, return bottle and we'll refund money. New, postwar formula removes paint, grease, dirt like magic. Don't let job-stained hands spoil your chances! Write today for 8-oz. bottle. Send 50c in coin, print name, address.

K-B Detergent Products Co. - P.O. Box 3084, San Francisco 19

ONE-MAN SAWMILL LESS THAN \$200.00
Easy To Turn Trees Into Money

Makes lumber, ties, shingles, crates, lath, studding, siding.



Belsaw Models

In 10 to 24 foot sawing lengths.

MECHANICAL FEED, accurate set works and positive dogs. Use tractor or old auto engine for low cost power.

Thousands used for commercial sawing. Pays for itself quickly. Send post card today for FREE booklet, "How To Make Lumber" and Catalog of Woodworking Equipment.

BELSAW MACHINERY CO., 2811-G Field Bldg. Kansas City 2, Mo.

315 Westport Road

TRAILER AXLES, HITCHES, AND PARTS

● If you are interested in purchasing trailer axles, hitches, and other trailer parts, contact us promptly. **Write for free literature.**



HAMMER BLOW TOOL COMPANY, Dept. 113, WAUSAU, WIS.

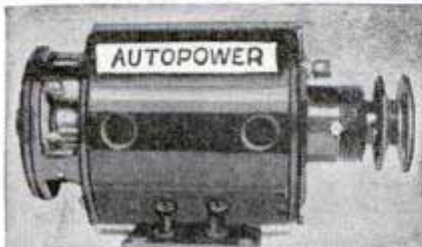

TURN SCRAP INTO MONEY

AUTOPOWER tells you how in plain, easy, simple, and illustrated instructions that anyone can follow. Change auto generators into useful, practical AC and DC generators and motors with voltage from 2 to 1,000 volts, for power, light, welding, radio, sound, etc. No previous experience nor special tools needed. Generators can be driven by wind, water, fan belt, etc. Already used and endorsed by thousands. Send for your copy of "AUTOPOWER." Only \$1.00 postpaid.

AUTOPOWER INC., 2118 Pine St., St. Louis 3, Mo.



now
WATER & OIL INJECTION
for ALL AUTOS · TRUCKS
 BUSES · INTERNAL
 COMBUSTION ENGINES



Gasolizer



\$12.95
 and
 \$15.95

PATENT PENDING
 USA & FOREIGN

SALESMEN & DISTRIBUTORS
BIG PROFITS!
 TAKING ORDERS FOR UNITS
Exclusive territories still available



✓ CHECK THESE FEATURES:

- ✓ ADDED POWER
- ✓ CARBON ELIMINATION
- ✓ UPPER CYLINDER LUBRICATION
- ✓ REDUCED GASOLINE CONSUMPTION
- ✓ LONGER ENGINE LIFE

Using principle successfully employed on military aircraft during the war

Gas Unit
 6-8 Locke St., Buffalo 2, N. Y.



• WRITE US FOR COMPLETE DETAILS •

METALLIZE BABY SHOES

Learn this easy, money making business from nationally recognized consultant. Small investment; perpetual market. For free details write Joseph B. Kushner, B.S. Ch.E., Metal Finishing Consultant, Stroudsburg, Pennsylvania, RD3U.

BOICE-CRANE POWER TOOLS

for shop men and
homecraftsmen.



Write for literature on this
versatile, low-cost,
sturdy line.

BOICE-CRANE COMPANY
943 Central Ave., Toledo 6, Ohio

Popular Mechanics Presents An Original Television Production

(Continued from page 93)

cameraman to move forward for a close-up or tell the production engineer to swing the sound boom farther on stage.

In front of the director are five monitoring screens. One of these screens carries a motion picture film that can be switched on the air at any time, another shows nothing during studio broadcasts but is connected with a remote control pickup camera for outside programs. A third, the screen in the center, shows the picture that is on the air and the remaining two show what each camera is picking up. By flicking switches the director can put on the air the picture appearing on any of the screens, varying the angle and distance of view.

James R. Ward, Craftsman editor, was one of the leading characters and played his own part in the show. Professionals were hired to play the other three parts. In years to come when more programs are broadcast the professional player will need the memory of an elephant. A telecast is a one-shot show. The actor must memorize two or three scripts at a time, then two or three more the following week. Mr. Ward learned firsthand all the problems of professional players. The overhead lights make the studio as hot as a summer day in the tropics. And during these frontier days in video the actors are sometimes neglected in the preoccupation to "get a good image."

Some strange quirks in telecasting were discovered in producing the POPULAR MECHANICS show. A few colors don't appear on the screen in their usual black-and-white values. Red usually goes much lighter than it would in a photograph, while any black material with a sheen appears silvery and sometimes white on the screen.

The camera often goes beneath the surface to produce startling effects. For example, all three male characters in the show were clean-shaven, yet the screen showed a dark shadow on each chin. In the first teleshows this effect was even worse and some romantic leads appeared on the screen with dark beards. Natural tears won't register so milk is used sometimes. Occasionally an actor dressed to contrast with the background dissolves into it and only his head shows on the screen. Some synthetic materials practically disappear in the camera and it's been reported that a bathing beauty show early in television history was quickly canceled when the bathing suits looked like Cellophane.

These peculiarities result from the cam-

(Continued to page 264)



STOP LEAKS!

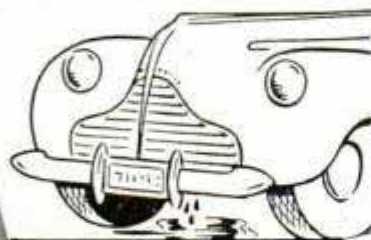

Cooling Systems
Made Leak-Proof QUICKLY

WARNER LIQUID SOLDER—Non-Metallic—
Deposits Tiny Fibers to Repair Leaks Any-
where in Cooling Systems. Simply pour in!
Finds and REPAIRS every crack or hole. Do
it yourself—or see your service man.

Warner-Patterson Co., 920 S. Michigan Ave., Chicago 5

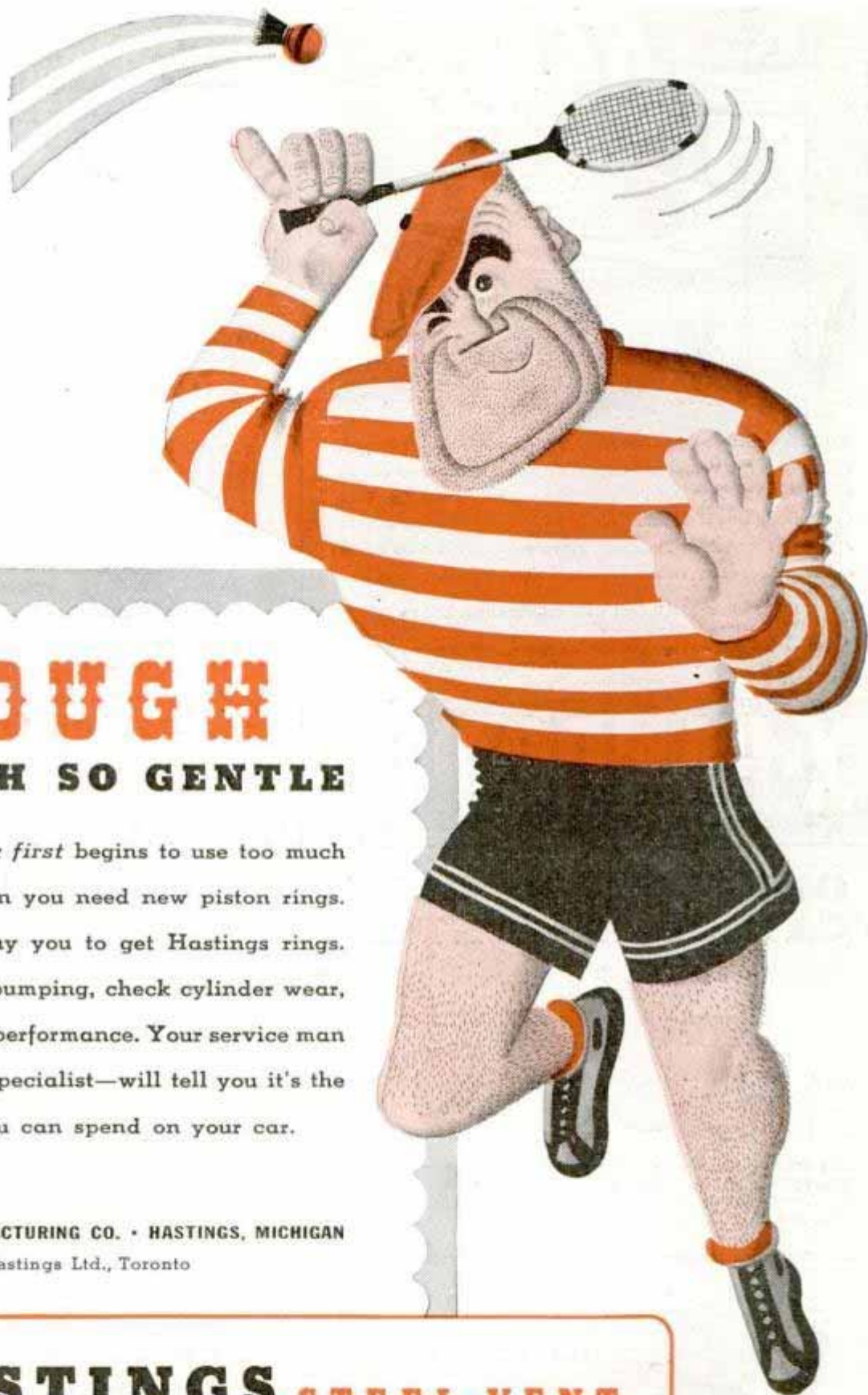

TOUGH

BUT OH SO GENTLE

When your car *first* begins to use too much oil, that's when you need new piston rings. And it will pay you to get Hastings rings. They stop oil-pumping, check cylinder wear, restore engine performance. Your service man—your motor specialist—will tell you it's the best money you can spend on your car.

HASTINGS MANUFACTURING CO. • HASTINGS, MICHIGAN
Hastings Ltd., Toronto

HASTINGS STEEL-VENT

PISTON RINGS



TOUGH ON OIL-PUMPING GENTLE ON CYLINDER WALLS

NEW...
EXPANDS AS IT SETS



THE ONLY HOUSEHOLD REPAIR CEMENT WITH THIS ADVANTAGE...

You'll be amazed by the sensational new mortar-like repair cement, that's so easy to use. Mixed only with water, X-Pandotite can be applied with a putty knife, or table knife. It's the permanent fixer for cracks, joints, loose fixtures, tile and 1001 other things that need repairing. For anchoring and molding purposes: X-Pandotite can be colored before using; stained or painted after hardening.

X-Pandotite is sold at leading hardware and paint-stores at 35¢ for a ½ lb. can — 60¢ for a one lb. can.
If your dealer can't supply, send 50¢ for a ½ lb. or \$1.00 for 1½ lbs. to the X-Pando Corp., 43-15 Thirty-Sixth St., Long Island City, N. Y. The X-Pandotite will be sent prepaid.

X-PANDOTITE

OLD AUTOMOBILE CATALOGS WANTED



A scientific museum wants authentic automobile catalogs and sales literature issued between 1890 and 1925. Will pay reasonable prices. Write full description to Museum, Dept. PM, 140 W. Ontario Street, Chicago.

STOKER EMPTIES OWN ASH!

A remarkable stoker already used by thousands of home owners—fits into any furnace or boiler. Manufactured since 1934. So automatic it takes the coal from your present coal bin through a pipe to the furnace, going around corners if necessary. Keeps house at even temperature, empties its own ash in sealed containers, no coal to shovel, no clinkers to dig, only bituminous stoker of its kind on the market. Send for full information NOW!

POCAHONTAS FUEL COMPANY INCORPORATED
344 EAST 131st STREET • CLEVELAND 8, OHIO

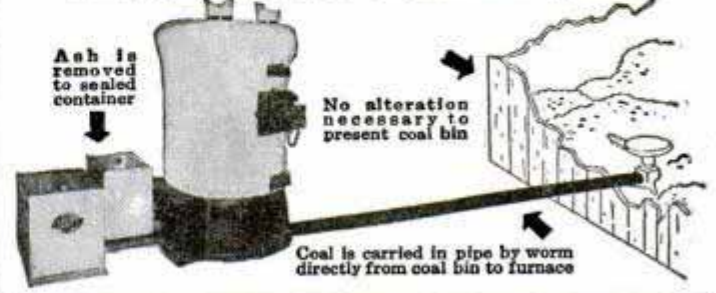

YOUR ELECTRIC DRILL

Has 100 Other Uses
when used with K-Jax attachments
METAL SAWING . . . SHEARING
RIVETING ATTACHMENTS

Ask your Hardware dealer or write for illustrated circular
K-JAX, 2600 Canton St., Dallas, Texas

INVENTORS' ADVISORY SERVICE

Before spending time and large sums of money on final development and patent, get reliable impartial advice and constructive criticism from qualified technicians on the practicability, manufacturing problems and possible sales demand of your invention. SEND POSTCARD FOR FULL INFORMATION.
CARSON CONSULTANTS, Dept. PM, 30 W. Washington St., Chicago 2, Ill.

SAY YOU SAW IT IN POPULAR MECHANICS

HOW TO CUT RAFTERS

New vest pocket book gives lengths, Side cuts, Plumb cuts, Deductions. For all rafters for any building from one inch to forty feet wide. Gives numbers to cut on square. Also degrees for some cuts for Radial Saws. All standard pitches from ¼ to 5/8. Just open book to pitch page and there are your lengths, side cuts, etc. Anyone who knows what a jack rafter is can frame a roof if he has this great book. Price one dollar prepaid. **BUILDERS' TOPICS, Dept. M, Lock Box 828, Seattle, Washington.** Original teachers of the square in five easy lessons by mail. SEND FOR FREE LIST OF TECHNICAL BOOKS. Learn to read blueprints etc.



HYDRAULIC ARBOR PRESSES
K. R. WILSON
HAND, AIR AND MOTOR OPERATED

WRITE FOR YOUR **FREE** COPY OF THE NEW **KRW HYDRAULIC PRESS BOOK**

Describes all manner of Production and Shop Work on KRW Hydraulic and Bench Type Arbor Presses. 32 pages illustrating the new KRW Hand-operated, Electric-operated and Air-operated Hydraulic Presses.
Write for your copy today.

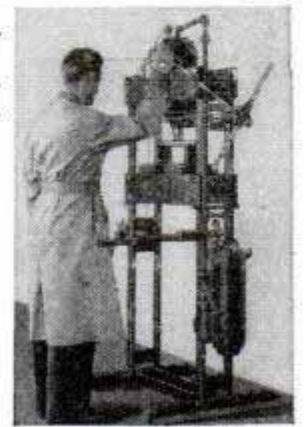

K. R. WILSON, DEPT. 17, 215 MAIN ST., BUFFALO 3, N. Y.
Builders of Shop Equipment for Ford Dealers Since 1916

MORE PROFITS

with

MODERN LAWN MOWER SHARPENER

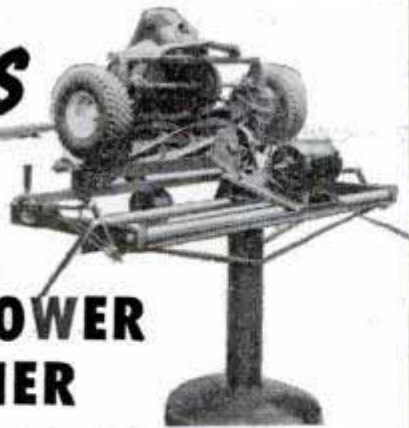

Dealers wanted

SHARPEN ANY LAWN MOWER from 5-inch Edger to 36-inch Power Mower in ten to twenty minutes with a **MODERN LAWN MOWER SHARPENER** because dismantling is unnecessary—neither handle, roller, wheels nor motor need be removed when sharpening any mower. . . . the **MODERN SHARPENER** eliminates all hand filing; its precision grinds to the extreme ends of both left or right reel blades. Bottom knife is held in same brackets for sharpening. **NO EXTRA ATTACHMENTS!** Order today! Price \$241.50 (less motor) f.o.b. Pasadena. (1/3 or 1/4 H.P. single phase motor recommended.)

Modern Mfg. Co., 156 N. Fair Oaks, Pasadena 1, Calif.

NEW SHAVER GIVES "SIMPLEST SHAVES OF YOUR LIFE!"

Special offer introduces new Enders Speed Shaver now at local drug stores

SAFER...SMOOTHER...SWIFTER

Mystic, Conn., Jan. 16, 1947. It's here at last! Today the Durham-Enders Corp., announced the most modern of all razors—the new Enders—the world's most modern razor.



It's new in every way—but its big feature is its extreme simplicity. You simply click the blade in *and shave*. Only one piece, no moving parts, no extra "gadgets." And it's light in your hand and swift and keen on your face. You get an extra-smooth shave, an extra-safe shave, an extra-swift shave. Already chosen as "the razor of the airlines."

And here's the offer: don't risk a penny. Get the new Enders at your local drug store—introduction price only 49¢ with 5 double-thick deluxe speed blades. Your *money back* if Enders Shaving isn't the swiftest and easiest in your life! (Order direct if your druggist doesn't have it yet.)

Durham-Enders Razor Corp., Dept. 103, Mystic, Conn.

REPAIR CRACKED BLOCKS AND HEADS—

External and internal leaks in blocks, cylinders and valve ports quickly and easily with **LUSCO PLASTIC SEAL**. 90 day Service Guaranteed or your money back. Send money order or check for full pint—more than sufficient for average repair. . . . **\$3.00** Postpaid

C. F. LUSK CO., 5915 BONNA AVE., CLEVELAND 3, OHIO

MIKE Jr. NOW ONLY \$1.49

SING—TALK—AMUSE YOUR FRIENDS— through your own radio set. Practice to become an announcer. Simple to install—Not a Toy. **SEND NO MONEY—WRITE TODAY**

Just send your name and address and when your **MIKE Jr.** arrives, pay postman \$1.49 plus few cents postage. Sent postpaid if check or money order accompanies your order. No stamps.

MART DISTRIBUTORS, Dept. M-4, P. O. Box 6, Evanston, Ill.

Assemble King Midget

Practical highway racer runabout. We supply all parts. Just bolt together. Low cost. Ready for delivery **NOW**. Send 25c for complete literature with large picture, 3-view drawings, price list of parts, or send \$1 for the above plus 4 actual photographs, plans for snow and ice conversion, catalogue of new and used motors, motorscooters, transmissions, clutches, other offerings etc.

MIDGET MOTORS, Athens 1, Ohio

MODEL AIRPLANE KITS

"THE ATOMIC." Control line model uses Class B Engine. Greater speed with lower price. Complete kit includes rubber wheels—\$3.95. **"THE CYCLONE."** This U-control model flies 60-90 MPH. Wing span 36"; length 28 1/2"; uses B or C Engine. Excellent stunt flying. Complete kit with rubber wheels—\$4.95. Money orders only; add 25c for postage.

ATLAS MODEL DISTRIBUTORS, 1511 E. Third Street, Bklyn. 30, N. Y.

NEW CHEAP OIL BURNER

FOR COOKING & HEATING STOVES-FURNACES
HEAT YOUR HOME, COOK YOUR MEALS WITH CHEAP FURNACE OIL

NO MORE SHOVELING COAL OR ASHES. A New Fuelizer Starter Vaporizing System turns Cheap 130 Flash Furnace Oil, Distillate, Kerosene etc. into Oil Gas heat without clogging up. **LIFETIME GUARANTEE** against defects. **\$1.00 Bonus Offer** for Testing. We will let you try it in your own stove or furnace for one month. Get yours for introducing. Big Profits **QUICK**. Be first. Send in your name **TODAY**.

NORTHWEST MFG. CO., 567-A 5th, Mitchell, So. Dakota

KEEP WARM! SAVE FUEL!

Mortite

BETWEEN YOU AND THE COLD

A pliable, plastic weather-stripping, easily, quickly applied to windows, doors, baseboards. Stops expensive heat leaks. Keeps out dust and dirt.

Just press into place. Use inside or outside. Can be painted. Mortite does not shrink or crack. Also plugs cracks around drainboards, bathtubs, etc.

Roll covers about 80 feet, enough for 5 windows.

\$1.25 AT HARDWARE, PAINT, DEPT. STORES AND LUMBERYARDS

Ask for Mortite Booklet!

J. W. MORTELL CO.
522 Burch St. Kankakee, Illinois

Higher west of Rockies and Canada

Larson

"MAKE YOUR OWN" CARPENTERS' SAW-HORSE SET

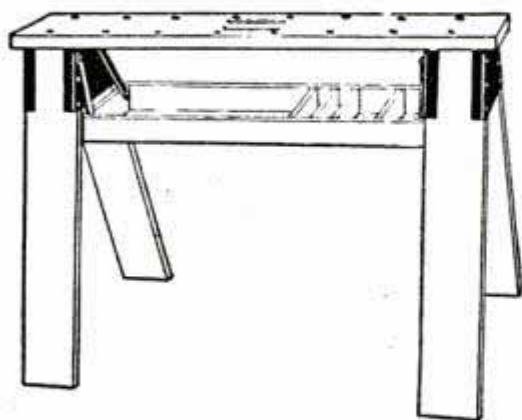

Makes a rigid saw horse that is actually a **PORTABLE HOME WORK BENCH** with many uses. Has a novel **SWINGING TOOL TRAY**. Complete hardware and copyrighted instruction sheet for easy assembly. Lumber is not included.

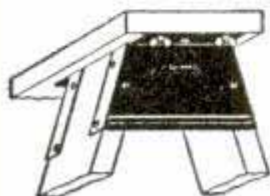

Prepaid \$1.35

CHAS. O. LARSON CO., BOX 358, STERLING, ILLINOIS

IMMEDIATE DELIVERY!



\$19.95

F. O. B.
ROYERSFORD, PA.

8 in. BENCH SAW

COMPLETE AS SHOWN

TABLE SEGMENT—Shows degree of table tilt—graduated. **SPLITTER**—Hard temper cold rolled steel. **GUARD**—Aluminum. **MITER GAUGE**—Aluminum. Accurately graduated 45° each side of center. **BEARINGS**—(2) Oil-ite bronze. **CAPACITY**—0 to 2 1/4". **TABLE**—12"x14". **SHIPPING WEIGHT**—44 lbs.

This Price is Below the Authorized O.P.A. Ceiling

AMERICAN MACHINE & TOOL CO., Inc.

DEPARTMENT 100 • ROYERSFORD, PA.

era's ability to photograph invisible as well as visible light. Infrared rays go beneath the surface to find pictures that aren't meant to be shown. An improved camera has been developed by RCA that filters out infrared light. The same camera will filter out visible light and photograph only by infrared rays. With such a camera the recent show could have been produced in total darkness and still appeared bright and clear on the screen.

Most of the other technical problems have been licked, too. Pictures of the **POPULAR MECHANICS** show on receiver screens were more distinct than home movies. The days have passed when actors looked like reflections in a fun-house mirror or disappeared in video snowstorms. For remote control broadcasts the new image orthicon camera will pick up anything that the unaided eye can see, will broadcast a scene lighted only by candles or the flare of a match, and can follow a baseball out of the park on a cloudy day.

Postwar receivers are keeping pace with other improvements. Direct-view screens of the new receivers average about six by eight inches in size with reflected images much larger than that. Manufacturers are tapping the working man's pocketbook with prices down to about \$200 to \$350 for table models, although you can sink as much as \$2400 in a fancy console. A spokesman recently set the industry's production goal at "not less than 750,000 and if possible 1,000,000 receivers in 1947."

To a public sold on television a decade ago it's a distinct disappointment that telecasting, despite technical improvements, is still in the barnstorming phase. There are a few good programs today but much of the time the air is filled with second-rate entertainment. Some authorities estimate that five years will pass before high-class visual entertainment will flood the air waves.

Why will there be a lag in good programs, now that good pictures can be broadcast? Video is chasing its own tail in a vicious circle. Sponsors won't invest big money in first-rate entertainment until there are several million receivers in the hands of the public. And a penny-wise public won't buy many sets until entertainment is first-rate.

From the sponsor's standpoint it's just poor advertising to spend as much as \$14,000 on a lavish show that will reach only 1400 people. Several large companies have spent thousands of dollars on telecasts for much the same reason that this magazine broadcast its show—to discover video's possibilities. One spokesman says "as far as we can tell in our company, our hours

(Continued to page 268)

FIRST IN WAR! FIRST IN PEACE!

Cushman
MOTOR SCOOTER

9 out of 10 Motor Scooters used by U. S. Armed Forces were Cushman

On the highway, in town, on the farm, at the factory, for deliveries, service calls... for work or play... go the Cushman modern and economical way. Cushman Motor Scooters are speedy, safe, park anywhere and have "eye dropper" gas economy. They are ruggedly built with automatic clutch, two-speed transmission, powered with the famous 4 H.P. Cushman "Husky" engine. Equipped with balloon tires and knee-action springing for ease of riding and load carrying capacity... have convenient luggage compartment. Dealers everywhere assure nation-wide service. For full details mail postcard to

CUSHMAN MOTOR WORKS, INC.
Dept. M100 Lincoln, Nebraska



Solo-Seat,
Tandem, Side Kar,
Package-Kar Models

FREE!

Descriptive literature and name of your nearest Cushman dealer sent on request. Write today.

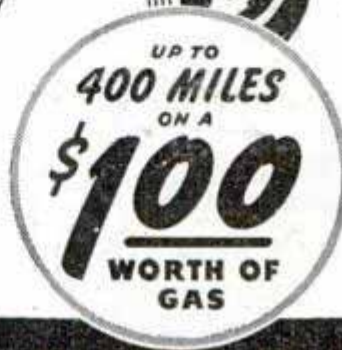

BACKED BY 45 YEARS OF QUALITY ENGINE BUILDING!

NEW! 12" SHEET METAL BRAKE Only \$10

Fits in bench vise. Quickly, easily forms all kinds of angles in sheet metal, strap iron and aluminum, wire and plastic. Use it to make useful articles, experimental research work, patent models, etc. simple gages made for quantity duplicating. Now available. Send for details, or order direct. C.O.D. \$2.00 deposit. Wt. 10 lbs.

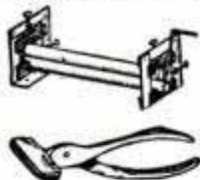

FORMING MACHINE. Bends sheet metal and wire in curves 2" to 10" in diameter, 18" wide. Screws to bench, or board. Price \$12.00, P. P.

SHEET METAL PLIERS. Forms any length, angles, channels, and crimps in sheet metal. Jaws 2 1/2" wide. Price, \$2.00. All items guaranteed.

WISE BRAKE MFG. CO., 1318 So. 30th Ave., Omaha 5, Nebr.

Ball-Bearing

SPEED WHEEL

Construction Sets

Including blueprints for making



ORDER NOW FOR PROMPT DELIVERY
10% required with C.O.D.'s



Build Your Own—

- Express Wagons \$13.20**
(Includes four 8" x 2" Tires, Wheels, Axles, etc.)
- Midget Racers \$17.70**
(Includes four 10" x 1.75" Tires, Wheels, Axles, etc.)
- Wheelbarrow Sets \$4.85**
(Includes one 10" x 1.75" Tire, Wheel, Axle, etc.)
- Bicycle Trailers \$7.80**
(Includes two 8" x 2" Tires, Wheels, Axles, etc.)

JIM BROWN TOY COMPANY

1097 Home Ave.

Akron 10, Ohio

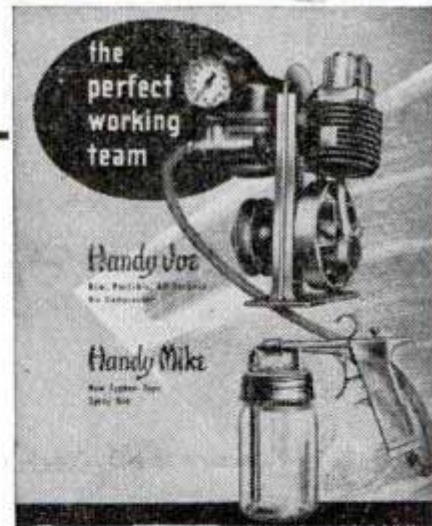

Here at Last Is a Mechanic's Dream
COME TRUE!

The all-purpose compressor-sprayer with 1001 uses

Here are just a few of the uses: Painting, spraying deodorants, drying hair and blowing away loose hair in barber shops, beauty parlors, etc., removing wall paper, applying paste to paper, applying stencil designs, etc., decorating, dyeing, lacquering shoes, spraying synthetic leather, operating laboratory burners in dental offices, cleaning clocks and watches, operating brazing and soldering torches in jewelry shops, pumping up tires, etc.

Compressor \$14.50 Gun \$4.90 Hose \$1.50

TRADE DISCOUNTS TO DEALERS

MIRACLE RADIO SHOP

675 Courtlandt Ave.

Bronx, N. Y.

BELT SANDER AND TOOL GRINDER

WOODS MODEL 40—For home work shop woodworking and machine shop production



HORIZONTAL OR VERTICAL OPERATION—5" x 8 1/2" CAPACITY

Husky sander for metal, plastics, wood, glass and rubber; perfectly-balanced completely machined pulleys (4" dia.) . . . ball-bearing thruout . . . drive shaft supported on both ends. These features assure maximum efficiency, smooth operation and long life. Tested to 5000 rpm. . . . easy adjustment for horizontal or vertical operation . . . reversible platen usable on either face.

Extra belts, 5" x 6" work table, and other accessories available from stock.

Order from your dealer or shipped FOB direct from our S. Norwalk Plant

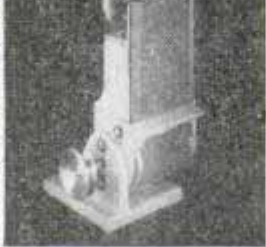

SPECIFICATIONS

Abrasive Belt	4" X 38"
Bench Space	9" X 15"
Motor Recommended	1/3 hp.
Net Weight	17 1/2 lb.
Shipping Weight	22 lb.

ATTENTION DEALERS!

A limited number of dealer territories are still open; write for information.

WOODS ENGINEERING CO.
NORWALK 11, CONN.

SANDER COMPLETE WITH BELT AND WORK DAM
\$39.95

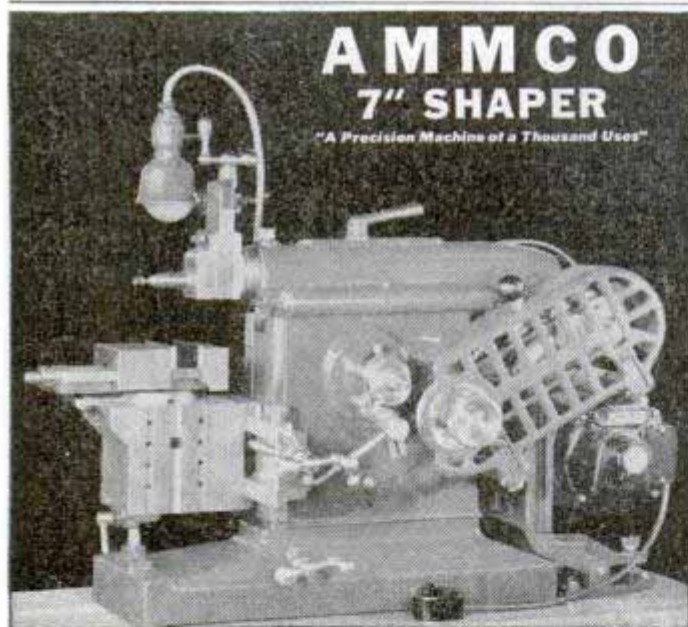

AMMCO 7" SHAPER

"A Precision Machine of a Thousand Uses"

A wide variety of jobs can be done accurately, quickly, easily, and economically on the AMMCO Shaper (7" stroke).

Construction incorporates many features you would expect to find only in larger, more expensive machines . . . For example: WAYS of ram, tool head, and front face of the main frame are of the "VEE" type, hand scraped to insure accuracy and long life. Available for stationary installation or as portable unit.

Write today for specifications and prices

AMMCO TOOLS, INC.

COMMONWEALTH
AVENUE



NORTH CHICAGO
ILLINOIS

(Formerly Automotive Maintenance Machinery Co.)

SUPER DRILL GRINDER

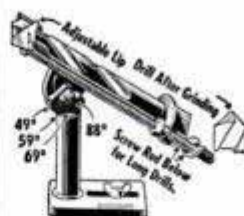

Sharpens round shank drills from 3/32" to 1-1/16" diameter. Grinds Old Drills like new in 4 different drill point angles. Grinds Short, Medium and Long Twist Drills from 1 1/2" up to 11" long, for hand or power grinding wheels.

200,000 IN USE!

Grinds your drills like factory in 25 seconds. Gives perfect center and clearance. Saves drills, time and money. No shop should be without the Super Drill Grinder. Guaranteed to do the work or money back. The Grinder that gives a rounded point!

Only
\$2.95

At Your Dealer's or Postpaid
CRANDALL MFG. CO.

1512 West Slauson, Dept. FA-13

Los Angeles 44, Calif.

Hunting
for Real

BUYS

Send for **FREE**
G&E PARTS CATALOG

Hundreds of hard-to-find items . . . available at America's lowest wholesale prices!

- Electrical Parts
- Refrigerator Parts
- Fractional H.P. Motors
- Switches
- Stove Parts
- Cabinet Hardware
- Wire; Tools

G & E has 'em, and lots more! Largest stock of everything for Service Men, Dealers, Builders—every item GUARANTEED. Now—write for handy G & E 1947 Catalog of values!

G & E EQUIPMENT SUPPLY CO.

Dept. PM-13 400 N. SANGAMON ST., CHICAGO 22, ILL.



**V-8
DUALS
& SINGLES**

MUFFLERS
STEELS and ALUMINUMS
with a motorboat tone

SINGLES, Chev, V-8, Plymouth, Steels \$5.50, Aluminum \$6.50. Chry., Olds., Buicks, etc., Steels \$7.50, Aluminum \$8.50. V-8 and MERCURY DUALS, Steel \$17.50, Aluminum \$20.00. Aluminums are guaranteed for life of your car.

DEALERS WANTED

SANDEE MUFFLER CO.
7523 S. WESTERN AVE., LOS ANGELES 44, CALIF.

CHANITE SELF-WELDING FLUX REPAIRS ALL ELECTRIC HEATING ELEMENTS

So simple anyone can make repairs in your broken or burnt-out electrical appliances—irons, toasters, stoves, etc. Guaranteed nothing like it. From our mines to your appliances. \$1.00 per package. \$7.50 per doz. Stick form 25c. \$2.00 per doz.

CHANITE SALES COMPANY, 914 So. Main, Fort Worth 4, Texas

SAY YOU SAW IT IN POPULAR MECHANICS

BUILD THESE PROJECTS

For garden or lawn. Easy to build. Easy to sell. Detailed Blueprints Model B-25 Dutch Windmill 50c; Model OM-60 Old Mill, 85c. Lawn Figure Patterns—Sunbonnet Girl, Dutch Boy, Tulip Girl, Holland Pair, 35c each, all 4—\$1. Catalog illustrating many models, send 10c, today.

CRAFTSMAN'S MODEL CO., Dept. P-99, 2030 N. 41st St., Milwaukee, Wis.

START A BATTERY FACTORY

—at home; the latest achievement; re-cast junk batteries into new. Complete instructions. We supply everything. Big Profits!

THE BATTERY LABORATORIES
Dept. PM Minneapolis 13, Minn.

SELL MERCHANDISE BY MAIL

Operate profitable home business selling merchandise by mail. 75c profit on fast selling \$1 items. Write TODAY.
POWELL CO., Dept. A, Sampliner Bldg., Cleveland 3, Ohio

ELECTRICITY FOR ANY JOB ANYWHERE

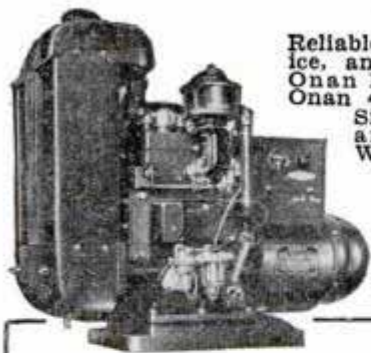

Reliable, economical electric service, anywhere, anytime, with an Onan Electric Plant. Driven by Onan 4-cycle, gasoline engines. Single-unit, compact design and sturdy construction. Water or air cooled.

Capacity range: 350 to 35,000 watts; 115 to 660 volts A.C., 50 to 800 cycles; 6 to 800 volts D.C. Combination A.C.-D.C. types. 65 different models

WRITE FOR FOLDER

ONAN

D. W. Onan & Sons, 2525 Royalston Ave., Minneapolis 5, Minn.

Portable Paint Sprayers



Uses 1/4 Hp. Motor

24.85

Complete as illustrated, less motor. Delivers 2 cu. ft. air per minute at 30 to 40# pressure. Sprays any kind of paint, lacquer, varnish.

SPRAY GUNS — 4.95

25' AIR HOSE — 2.90

INDIANA APPLIANCE CO.

20 East Sycamore

Evansville 9, Ind.

TOOLS SHARPENED...

Saws, knives, scissors, drills refinished like new. Any type or size. Prices reasonable. Work returned C.O.D.

A. D. MAST MACHINE WORKS
606 Marietta Ave., Lancaster, Pa.

MAST
PRECISION
FACTORY
METHODS



Send 10c Today to Dept. G
for Catalog of 45 Kits

MEIER BRASS & COPPER CO.
1155 Bellevue, Detroit 7, Mich.

BRASS RODS For Home Work Shops

For use on model boats, airplanes, etc., keep a supply of these free-turning brass rods on hand. Each kit contains a complete assortment of sizes.

Cut NEW TEETH in 3 Min.

With FOLEY RETOOTHER

For All
HAND SAWS

Cuts 20 sizes of teeth from 4 to 16 points per inch. Immediate delivery



No need to grind off old teeth — cut new ones over them. Fast, accurate, no eye-strain. Cuts filing time in half.

FOLEY MFG. CO.
190-7 Foley Bldg., Minneapolis 13, Minn.
Send full details on Foley Retoother.

Name.....

Address.....

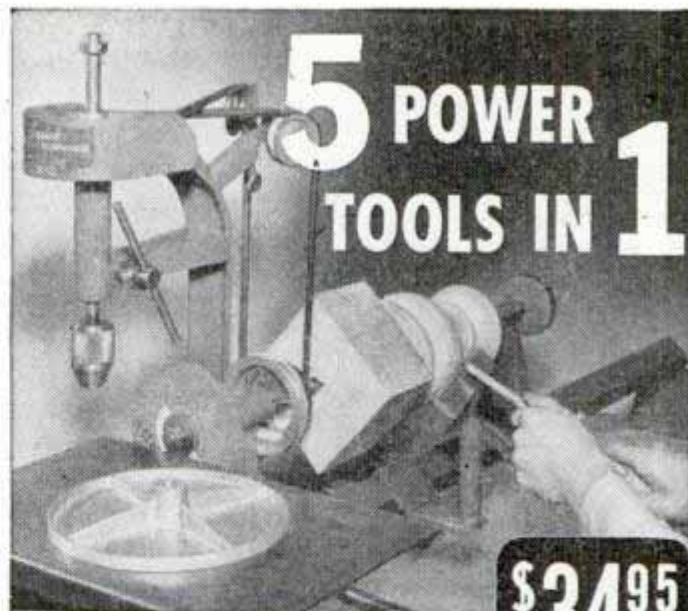

5 POWER TOOLS IN 1

\$34⁹⁵

RUGGED, COMPACT HANDLES BIG WORK

Thousands of satisfied users find fun and profit with the Emrick Universal Woodworker. Patented design gives you the five most useful power tools in one HEAVY fabricated steel frame. Free-running in bronze bearings. A lot of tool value for the money.

It's a LATHE—precision-built and easy-running. 10" swing over bed, 30" between centers. Face plate, spur center and tool rest included.



It's a DISC SANDER that cuts fast and clean, on edges or surface of any stock. 8" diameter disc takes any type of abrasive.



It's a CIRCULAR SAW taking 6" blade. Arbor takes dado saws, moulding cutters, scratch wheels or buffing wheels.

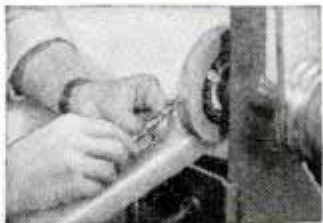

A good quality EMERY WHEEL is furnished. 4-step cone pulley gives choice of running speed. 1/2" shaft takes all standard grinding wheels.

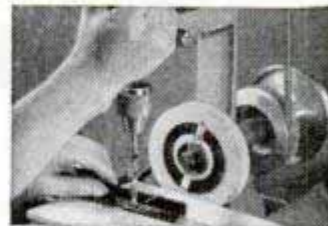

It's a DRILL PRESS that pulls 1/2" drill in steel. Chuck takes drills up to 1/2". 2" travel. 1/2" spindle. Drills to center of 12" circle.

The UNIVERSAL is available on ten-day trial. Prompt shipment. Write for literature. Uses 1/4 H. P. motor. (Motor and saw-blade not included in price quoted.) Shipping weight, 65 lbs. WRITE FOR FREE LITERATURE AND ACCESSORY LIST.

EMRICK INC.

1724A CLINTON STREET • KALAMAZOO 24, MICHIGAN

SAY YOU SAW IT IN POPULAR MECHANICS



ADD

MOTOR RYTHM and start faster in cold weather!

Pour a pint of MOTOR RYTHM into your crankcase *now*—add a pint with every oil change—and be sure of fast, easy starting on the coldest day! Save your battery, save your car, save your temper—a touch on the starter and the coldest motor springs to life with MOTOR RYTHM in the crankcase! Ask for MOTOR RYTHM at your garage or service station. *R. M. Hollingshead Corporation, Camden, N. J.; Toronto, Canada.*

**KEEP YOUR
MOTOR YOUNG
WITH
MOTOR RYTHM!**



A PRODUCT OF

Hollingshead

LEADER IN MAINTENANCE CHEMICALS

and dollars in television have not yet made a ripple in our total sales."

Coaxial cables may help television stand on its own feet. They make network broadcasts possible, opening promising new fields where no television receivers can now operate. Last October there were 2700 miles of coaxial cable already in the ground. Coast-to-coast links by 1950 are planned. Transmitters without studios can be set up anywhere along these cables and programs piped to areas outside the 50-mile broadcasting radius of present telestations.

But old-timers at Station WBKB say there's only one way that television can emerge from its vicious circle and climb into an upward spiral. Broadcasting stations themselves must lift the industry out by its bootstraps. They must provide the finest possible entertainment despite penny-pinching budgets. When programs are a little better a few more people will want receivers. When a few more receivers have been sold, advertisers will invest a few more dollars in better programs.

Will television ever replace radio and moving pictures? Experts doubt that any present form of entertainment will be outmoded. The housewife can listen to the radio while she works, but she can't watch a telecast. Television programs will be extremely popular in the evening and open broad opportunities for mass education. But most "television families" still will seek entertainment elsewhere. Half the fun of attending a movie or a stage show is "going out" for the evening. Television is a spanking new and different medium cutting across every field of entertainment but traveling its own road.

Clocking the Jets at Muroc

(Continued from page 157)

ards, Washington, D. C.) and square wave generators. The 100-cycle fork is the primary timing standard and produces a series of light streaks at the side of the film, with an accuracy of one part in 500,000.

A secondary timing device is a system of synchmotor clocks, mounted on the base of each motion picture camera so as to be photographed on each frame of film. They provide readings of $\frac{1}{1000}$ -second intervals and are coordinated with the light streaks on the film every 5 seconds.

Careful checking and analyzing of the photographed position of the aircraft, light streaks at the edge of the film and readings of the synchmotor clocks provide the official timers with information as accurate as the human brain can devise.

(Continued to page 272)

Save with LARSON Leathercraft

For Pleasure and Profit

Send ten cents to Leathercraft Headquarters for 16-page catalog describing all necessary materials for making belts, moccasins, purses, gloves and many other practical items. Easy to assemble. Instructions come with materials.

Send for this Catalog

J. C. LARSON & COMPANY
176 N. Wacker Drive • Chicago 6, Illinois

CALLING ALL BOYS!

Yes, we're **CALLING ALL BOYS**, and we're calling **YOU**, too. Tune in on an interesting hobby that pays big returns in fun and interest. Even helps to prepare you for a career in radio. Learn how to make your own simple, tubeless, batteryless crystal radio. Just send 25c. We will send you postpaid by return mail a genuine Melomite crystal with complete illustrated instructions for making your very own set. Then you will enjoy competing with others for long-distant reception. With crystal and instructions we send **The Magic Crystal**, our own publication chock-full of news, diagrams, questions and answers of interest. Don't delay! Send 25c today!

ALLEN RADIO, Dept. PM-1 Clinton, Missouri

BUILD YOUR OWN MACHINE TOOLS!

Blueprints \$1.00 - Catalog FREE

Detail construction Blueprints on 6 Lewis metal and wood-working tools postpaid for \$1.00. Includes prints for Lewis 10" Shaper, Milling Machine, Drill Press, Vise, 8" Circular Saw, 6" Jointer. Castings for these tools save up to 80% of comparable new tool cost. Illustrated 32-page Catalog—sent free with Blueprint Order—describes 21 Lewis tools. **WRITE TODAY!**

LEWIS MACHINE TOOL CO.
P. O. Box 7446, Sta. L, Dept. M, Los Angeles 23, Calif.

Build Your Power Tools With OUR BALL BEARING ARBORS

L. H. Th'ds Also

C5 $\frac{1}{2}$ —\$8.25 PP.
C6 $\frac{3}{4}$ —\$9.25 PP.

Spindle 12 1/2 Long
Housing 2 1/4 x 8
Heavy Duty Ball Bearing Saw Arbors
Dealers Wanted

B33—\$4.95 PP.
5/8 x 4 1/2 Spindle Only
B15 Plain Spindle \$3.45 PP.
Also Flange Models

**POLY PRODUCTS, Dept. M1,
406 S. Chester Ave., Ct. 1, Pasadena 5, Calif.**

MOLD PLASTICS

Something New, **THE PLASTICOR**, Plastic Injection Molding Machine, Molds Toys, Jewelry, Novelties. Small investment. Send name for complete details.

GRAY MODELS, Dept. PM, P.O. Box 1234, Syracuse 1, N. Y.

WOOD WORKERS

LUMBER—PLYWOOD AVAILABLE

Harold Hunt wants to send new No. 15 catalog. Over 148 pages of woodworking ideas. **UNEQUALED BARGAINS** in imported and American woods, supplies, hard-to-find hardware. Send only 15c to cover postage and handling.

CRAFTSMAN WOOD SERVICE CO.
2729 S. Mary St., Dept. A-77, Chicago 8, Ill.

only 15¢



STOP FUEL AND OIL LOSSES; GET BURD "GRAF-FLOX" PISTON RINGS

Budget-conscious car owners find added pleasure in driving, after a re-ringing job with Burd "Graf-Flox" Piston Rings . . . they appreciate the worth-while savings of gas and oil. There's a bonus of fun from hearing the sweet sound of a smooth running engine, too . . . and from feeling the instant response at the touch of the accelerator. Try a set of Burd "Graf-Flox" Piston Rings . . . they're quicker-seating, longer-lasting because they're made of electric-furnace iron, precision finished and "Graf-Flox" treated. Mail the coupon today for two FREE booklets.

BURD PISTON RING CO.
Dept. PM • Rockford, Ill.



THIS COUPON BRINGS FREE BOOKS

BURD PISTON RING CO., DEPT. PM
Rockford, Illinois

Gentlemen:

I'd like copies of your "Servicemen's Handy Handbook," which tells how to keep my car in good working order, and the booklet "No Job For A Dub."

Name

Address

City State

Handy Hand Book

No Job for a Dub

FLO-CO..

THE ENAMEL YOU APPLY LIKE POLISH



No Brush!
No Primer!
No Spray Gun!
Factory Guaranteed
Lasting "Factory-Like" Finish
Drive Your Car 4 Hours After Painting

Look for this display card at your local Service Station

The Greatest Advancement in Auto Refinishing!

Imagine repainting your car by hand in only 3 hours for \$6.00, without the use of primer or sealer, using a cheese cloth pad and obtaining a smooth "factory-like" finish... that's the FLO-CO way. It's the miracle paint of the century. Sold by reliable service station dealers everywhere. If your dealer cannot supply, write factory direct.

FLO-CO PRODUCTS, INC.

DETROIT 12

MICHIGAN

GREAT NEW TOOL!

The world-famous Mead Bandsander is ideal for home workshop use! This remarkable machine quickly shapes, sands, carves and polishes wood, metal, plastics! Works equally well on inside cutout openings or irregular outside edges. Gets at places no other can! Tilting table for bevelling, chamfering. Rust-and-sweat proof top. Ball bearings. Saves time, labor, money on jobs in any home or industrial shop. Invaluable to home-craftsmen, makers of patterns, tools, dies, signs, costume jewelry, castings, forgings, ornaments, radio and electrical parts, stampings, etc. Nothing else like it. Sold on 5 Day Trial, money back guarantee. Circular Free! Cuts Fast and Clean... Saves Filing, Sanding Work.

Shows use on inside cut-out openings



Bandsander
THE MACHINE THAT AMAZED THE EXPERTS!



WRITE for FREE Circular

Send for free details on "the machine that amazed the experts!" Rush a postcard today for Circular, surprisingly low price. Hurry!

MEAD SPECIALTIES CO.
4114 N. Knox Ave., Dept. 117, Chicago 41, Ill.

SMALL EFFICIENT SPEED REDUCER



\$18.56
NET - POSTPAID

Just the thing for the Home Work Shop, Hobby Shop, Bench Work, Animated Displays, Light Production work. Used daily in thousands of homes and shops. Sturdy, compact, (see dimensions). Case of heat treated aluminum. Gears, SAE 65 (British) Gear Bronze. Worm of case hardened steel. Timken Bearings throughout. Torque capacity 100 inch pounds. Available in 4 different assemblies (shown below) and in these standard ratios:

4-1	25-1	64-1	200-1
8-1	30-1	75-1	300-1
10-1	40-1	80-1	400-1
16-1	50-1	100-1	600-1
20-1	60-1	150-1	800-1

When ordering be sure to specify assembly and ratio required. Shipping weight in carton, 8 lbs. Full money back guarantee. Prompt deliveries.

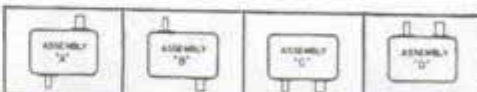

THE OHIO GEAR CO.
1401 EAST 179th ST. - CLEVELAND 10, OHIO

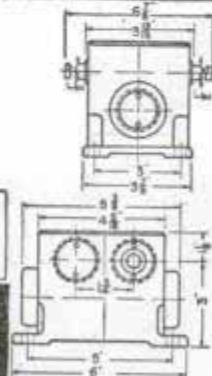

60 POWER TELESCOPE \$2.95

VARIABLE EYEPIECE 20X-40X-60X

NEW! Three telescopes in one. 3 different magnifications. 20 power for ultra-bright images with 40 and 60 power for extra long range. Guaranteed to bring distant objects, people, sports events, ships, moon, stars, etc., 60 times as close.



Most powerful made for any length. Multiple lens system. 30 mm. objective lens. 5 sections. Can be used as a compound & lens microscope. American made. Prompt shipment guaranteed. We pay postage. Only \$2.95. **BROWSCOPE CO., Dept. 1M, 24 W. 45th St., N. Y. 19, N. Y.**

DOWEL TROUBLES?



Now you can make dowels that match your wood! Amazing new SPEE-DOWL makes perfect, burnished dowels for arrows, cabinet work or other projects.

Simply rotate wood in lathe or drill press and push on SPEE-DOWL like pencil sharpener. Cast aluminum body, tool steel blade. A necessity for fine craftsmanship. Available in 2, 3, 4, 5, 6, 7, and 8/16" sizes. Only \$1! Special—any 4 sizes \$3; complete set of 7 for \$5. SENIOR MODEL.

9/16" to 1 1/4" only \$2.65 ea. Send postal note or check NOW for your SPEE-DOWL. Unconditionally guaranteed. Free literature.

JOHNS MFG. CORP., Dept. C-4 501 Bound Brook Rd. Dunellen, N. J.

150 MPH MODEL AIRPLANE

Improve your kit model or design and calculate your own prizewinning plane. Simplified scientifically correct aerodynamic charts. Complete easy to use instructions. \$2.00 POSTPAID.

INTERNATIONAL RESEARCH

P.O. Box 988

Los Angeles 53, Calif.

PLASTIC KITS

Complete line of kits with full scale lay-outs for making your own items. Picture Frames, Jewelry and Cigarette Boxes, Tie Racks and numerous other articles from Sparkling Lucite and Plexiglas. Send today for free catalog of kits and supplies.

Home Craftsman Plasties, 1945 W. Harrison St., Chicago 12, Ill.



NUMBERALL Rotary Stamp (Patented)

1 Tool Instead of 12

For stamping figures and letters on metal, etc. One stamp does away with 12 individual hand stamps. Changes of characters are quickly made merely by rotating the indexed wheel. Wheel is made of finest tool steel. Sizes 1/16" to 3/16" figures can be furnished at \$5.00 each in pouch. Larger sizes and alphabet at higher prices. Write for Catalog.

NUMBERALL STAMP & TOOL CO.
HUGUENOT PARK STATEN ISLAND 12, N. Y.

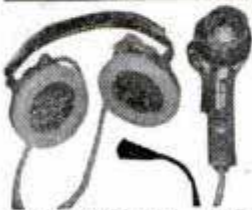

U. S. Army RADIO (Water, Shock and Weather Proof) PHONES

Made to U. S. Army Specifications, passed by Signal Corps Inspectors. Dynamic Microphone and Dynamic Receiver of Finest Quality—Water, Shock, Weather and Altitude Proof, used on tank and aircraft (B19) intercom systems. For recording, for battery-less telephone, talk through your radio set or use earphones for pocket-size set loud speaker. Complete two receiver, cord set, head band, and dynamic hand microphone including special connecting cord set. A REAL BARGAIN AT THIS PRICE.

ONLY \$995 post paid
Order yours today

HERE IT IS: ELECTRIC SWITCH

VERSATILE SWITCH—MILLIONS IN POST WAR APPLICATIONS—Floodlight your porch when the door is opened—sounds alarm when window is opened—signals arrival of mail—controls heating of furnace—filling of water tank; these and many other services are performed by this versatile switch. Shipped with instruction sheet showing numerous illustrated uses. EXCEPTIONAL LOW PRICE. ONLY \$1.00 post paid King Products Co., Dept. P-3, Batavia, Ill.

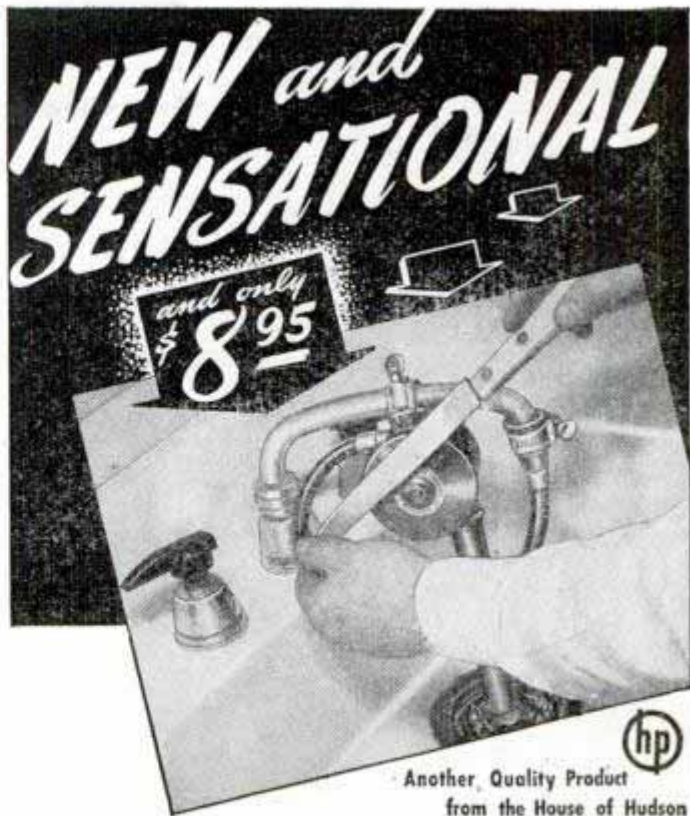

Another Quality Product
from the House of Hudson

The HUDSON TURBO GRINDER

The Amazing New Convenience for Home and Shop

Sharpens Everything Fast

Most useful accessory ever offered for the handy man, housewife, hobbyist, shop and auto mechanic, farmer...every-one who uses knives and tools. Fits any ordinary faucet. Just turn on the water and the patented Hudson jet-impeller drives the grinding wheel at speeds over 3,000 RPM. Adjustable to 10,000 RPM, depending on water pressure. Precision built, quality throughout. Super-hard silicon carbide wheel, stainless steel shaft, Chrysler Oilite Bearings. All metal parts gleaming chrome. Colorful vinylite tubing.

Sharpens knives, scissors, lawn mowers, skates, wood planes, chisels, bits, axes, hatchets and all edged tools.

FULL MONEY BACK GUARANTEE
See Your Hardware Dealer

HUDSON PRODUCTS CO.
4401 ST. AUBIN AVENUE
DETROIT 7, MICHIGAN

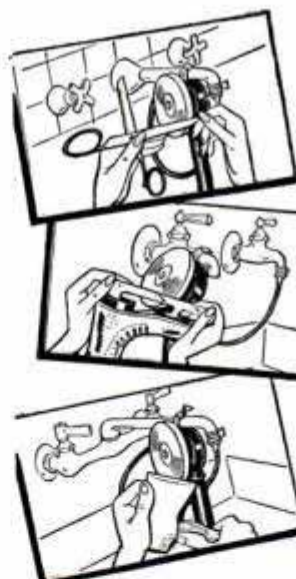

IF YOUR DEALER DOESN'T
HAVE THE HUDSON TURBO
GRINDER YET—SEND
COUPON TODAY

HUDSON PRODUCTS CO.
4401 St. Aubin Ave., Detroit 7, Michigan

Enclosed is a \$8.95 () check, () money order for which rush to me, postpaid, one Hudson Turbo Grinder with full instructions for use. I understand the Grinder carries a full, money back guarantee.

Name.....
Address.....
City..... State.....
Name of Hardware Dealer.....
Address.....

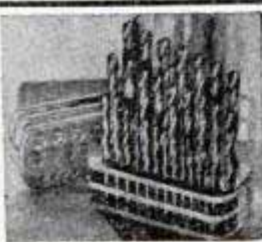

Why Hunt for Drills?

These Complete High Speed Drill Sets Now Available at Low Prices
#1 to 60 Drills.....\$12.95 Per Set
1/16-1/2 by 64ths....\$16.95 Per Set
Drill Sets A-Z.....\$15.50 Per Set
(Drill Stands Free)
Send For Free Circular

SID TOOL CO.
MACHINE SHOP SUPPLIES
183 Grand St., New York 13, N. Y.

SHALLOW WATER DIVING UNIT



For salvage, rescue, exploration dives and pool cleaning. Comfortable and efficient; seals absolutely. Low cost with long life. Also, complete line deep-diving gear. Write for details.

- Mask
- Weighted Belt
- Air Hose
- Portable Compressor

DESCO CORPORATION
1119 N. Water Street Milwaukee 2, Wis.

EXHAUST BLOWER

NEW! IMPROVED FOR MANY USES

- Ventilators for office, kitchen, attic, cellar, etc.
- Darkroom exhaust fans
- X-ray and sterile rooms
- Photographic booths, commercial, etc.

Motor—Continuous, quiet, ball bearing, 110 volt A.C., 50-60 cycle. Capacity 100 cu. ft. per minute. Motor casing black crackle finish. Ends heavy cast aluminum.

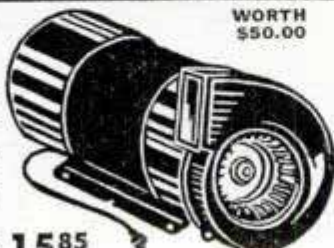

1585

WORTH \$50.00

Built for Long Life, Trouble Free Performance.
Send Check or Money Order. No C.O.D.'s. West of Mississippi—Add 1.00 for mailing and handling.

IMMEDIATE DELIVERY
UNIVERSAL YONKERS CORP., 41-P Locust St., Yonkers 2, N. Y.

HERE'S ACCURACY

in its handiest form...a Stanley Zig-Zag Rule



• Unfolding quickly to the length the job requires—from a 6-inch rule to a 6-foot stick—a Stanley Zig-Zag Rule will be your constant helper.

Many craftsmen like the famous "Green End" Zig-Zag with large, easy-reading vertical figures. Sticks of selected rock maple—concealed joints, tips and strike plates of rustproof metal. Put skill into your hands with Stanley Tools.

THE TOOL BOX OF THE WORLD



HARDWARE · HAND TOOLS · ELECTRIC TOOLS

Own these two Stanley Books

The first book is free... textbook, "How to Work with Tools and Wood", recently revised, fully illustrated. The cost is only \$1.00 postpaid. The second is the famous



Stanley Tools, 127 Elm St., New Britain, Connecticut. Please send by return mail:

- The FREE booklet: "The Joy of Accomplishment".
- 188-page book, cloth cover: "How to Work with Tools and Wood". \$1.00 enclosed.

(In Canada: Send order to Stanley Tool Co. of Canada, Ltd., Roxton Pond, Quebec.)

Name.....
 Address.....
 City..... State.....

The AAF believes it has two types of planes capable of breaking the existing world's airspeed record. One is Lockheed's P-80 Shooting Star. When first flown in 1944 it broke all existing American speed records and at the end of the war the Army had a fighter squadron of P-80s almost ready for combat. It has a wing span of 39 feet and an over-all length of 34 feet, 6 inches. Its engine fuel is kerosene, which has more energy per gallon than gasoline.

The other is the P-84 Thunderjet. It was originally conceived when the Army Air Forces asked Republic to redesign the famous P-47 Thunderbolt to test General Electric's newest axial-flow jet engine.

The Thunderjet is a sleek midwing job with a wing span of 36 feet, 5 inches and an over-all length of 37 feet, 3 inches. Its service range is more than 1000 miles and its service ceiling is above 40,000 feet. The most striking difference between the Republic P-84 and the Lockheed P-80 is that the former's air scoop is located in the nose instead of at the sides.

Pilots and planes are getting closer and closer to the speed of sound—which is 770 miles per hour at sea level, 650 miles per hour at 40,000 feet. And that's the big question mark of aviation today. Can the human body and man's most skillfully designed aircraft withstand the hammering sound wave that builds up on wings and fuselage?

The P-80 and the P-84 are among the most streamlined aircraft that fly. Leading edges of the wings are razor-sharp and fuselages are wax-smooth. In spite of this, compressibility building up on the surface of the plane at speeds of 600 miles per hour or more threatens to tear it to pieces.

Aeronautical engineers think that the critical speed for aircraft lies between 85 and 120 percent of the speed of sound. A case in point is Geoffrey de Havilland, a British pilot, who lost his life recently while attempting to crack the world's speed record. He is thought to have achieved a speed of 650 miles per hour when a sound wave tore his plane apart in mid-air.

At speeds of 1000 miles per hour or more, aircraft will leave sound waves harmlessly behind as do bullets and rockets. The answer to aviation's major problem may lie in building planes that will accelerate or decelerate quickly through the supersonic region between 600 and 1000 miles per hour.

But the looming peril of the sound wave hasn't yet frightened any of the leading American jet pilots. An adventurous breed of men, they're still making preparations to take a crack at the record. Flying a jet, they say, is the most exciting experience in this modern, mechanical world.



8" WHEELS

8"x1" SOLID RUBBER TIRES
STAMPED HEAVY GAUGE STEEL
Spotwelded — Completely Assembled

Unpainted; for carts, trucks, scooters, etc. Carry up to 500 lbs. per wheel. 3/4" dia. hub doubly reinforced with seamless tubing spun in place. Hubcaps, 10c ea. extra. Satisfaction guaranteed. Send PO order or check today.

\$1 EA.
Plus 15c ea. Parcel Post

SHARON CRAFT CO., PHOENIX, N. Y.

10" WHEELS, unpainted, 10"x1.75" semipneumatic tires, 1 3/4" thru hub with 1 1/2" hole, \$2.25 ea. \$8.50 set of 4, plus 25c ea. postage east of Miss. River, 40c ea. west of Miss. ALSO, 5" rubber tired, painted wheels, .75c ea. plus 10c ea. postage; hubcap not needed.

NEW Liquid PLASTIC

Hobbyists, art fans, craftsmen, home money-makers, here's a great discovery. Castolite, amazing new liquid plastic, gives beautiful effects never before possible. Now you can embed photos, flowers, coins, insects in clear liquid plastic and harden to any size or shape. Castolite comes clear or can be colored. Pours without heat. Use home tools: spoon, glass tumbler, ash tray, saucer. Saw, drill or carve. Make 1001 objects: book ends, buttons, jewelry, toys. Have pleasure; gain profit.

Makes 1001 OBJECTS



SPECIAL CASTO-KIT
Starts You at Home — \$2.95

Start with instant-use CASTO-KIT. Includes pound liquid Castolite, vial of hardener, test tube, flower castings, buffing compound, measuring dropper, abrasives, complete instructions. Make useful objects first day. Send \$2.95 plus 20c postage. Or order shipped C.O.D. Or send 25c (stamps or coin) for illustrated instruction manual only. The Castolite Co., Dept. A-1, Box 211, Kenilworth, Illinois.

ATTENTION AUTO OWNERS!

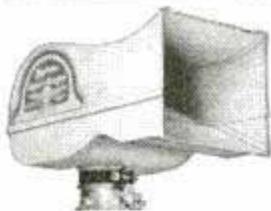

New Power, Pickup, Pep!

Amazing TYPHOON SUPERCHARGER is back again, ready to put new life into old motors, add to power, pickup, pep! 41,000 users find gas economy, you will, too. Motor knock vanishes, grease bath air cleaning keeps harmful dust out. Takes 5 minutes to install with screw driver on carburetor, replacing old air cleaner. Order today, mention make and model of car. Only \$5.95.

(Ohio orders add 3% sales tax, West of Rockies, add 10%)
10 Day Money Back Guarantee!

TYPHOON PRODUCTS CO. 507-T Engineers Bldg. Cleveland 14, Ohio

COLOR CONCRETE WITH CHEMICALS

Get into business on small capital working at home, or shop. Start small grow big. There is real money in making Hollywood style pottery and birdbaths without molds. Our instructions cover a large variety of designs. Washing-wells, benches, garden light-houses, stucco-rock, imitation marble, cement water-paints and many more. 10c brings sample, details and pictures. Hollywood Cementcraft, 8529 Wonderland Ave., Hollywood 46, Calif.



WAKE UP YOUR Scalp

BE FAIR TO YOUR HAIR Want better looking hair? Embarrassed by falling dandruff, itching scalp? Then try VITABRUSH, new electric driven scalp brush that gives your scalp a vigorous and invigorating "workout" in just three minutes of fun. Cleans scalp. Stimulates blood supply. Restful. Pleasant. Write today for complete information and satisfaction-guaranteed offer. Hershey Mfg. Co., 3735 Field Bldg., Chicago 3

NEWEST RIDING

Sensation!

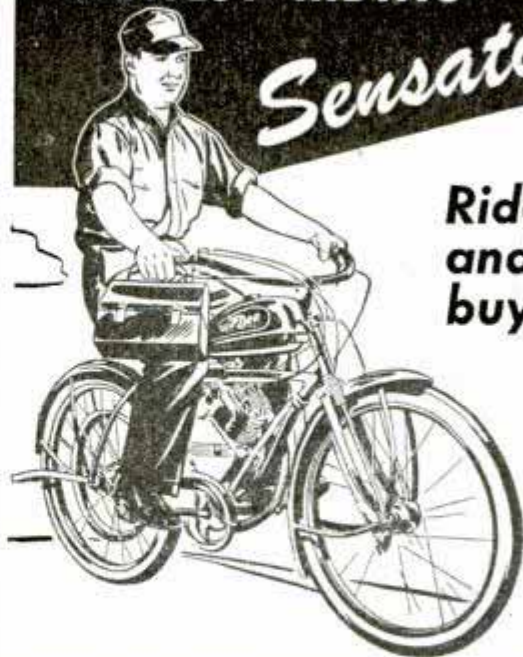

Ride one and you'll buy one!

WHIZZER BIKE MOTOR FITS ANY BALLOON-TIRED BIKE

The real answer to dependable, low cost transportation. Fits any balloon-tired bike. Built by automotive craftsmen in the heart of the auto industry, the Whizzer bike motor installs easily and will carry you fast (5 to 35 miles per hour) and far (125 miles or more on a gallon of gas). Enjoy new freedom and adventures with your Whizzer. Use it for errands, shopping, business, recreation and work. Whizzer's 2 1/2 h.p. will take you there and bring you back! Does not interfere with normal pedaling of bike. Put a Whizzer on your bike now. WHIZZER MOTOR CO., Pontiac 15, Michigan.

FACTORY PRICE

\$97.55
PLUS TAX

Simple, positive controls. Easy to ride, too . . . Whizzer doesn't change balance or riding qualities of bike!

See your WHIZZER dealer today

IF NO LOCAL DEALER, USE COUPON

WHIZZER MOTOR COMPANY
Dept. 173, Pontiac 15, Mich.

I enclose \$99.97, which includes \$2.42 Federal Excise Tax, () check or () money order. Send me one Whizzer motor, complete, with full installation instructions. Written guarantee with every motor.

If descriptive literature only is desired, check here ().

NAME _____

ADDRESS _____

CITY _____ STATE _____

TORNADO BURNER

**A Flame for Every
Laboratory Need**

The Tornado Burner No. 140 is equipped with three interchangeable brass tips giving three sizes of flame (approx. $\frac{1}{8}$ " , $\frac{3}{4}$ " and $\frac{3}{8}$ " blast). The easy interchange of these tips enables the burner to perform virtually any laboratory job where a narrow or wide, hot or soft, flame is needed.

No air adjustment is necessary; the burner is self-adjusting. The brass needle valve regulator, conveniently located on the side of the burner, regulates the flow of gas and is a gas shutoff, eliminating the necessity of turning off the gas at the supply source.

The steel base, constructed with two side holes, makes it simple to attach to a work bench or table.

Due to a patented feature, the Tornado Burner will, without the necessity of using grids, create a flame in which the heat is evenly distributed, thereby giving a faster and better heat.



TORNADO GAS TORCH

The Modern Way of Soldering

Ideal for hard and soft soldering. Will heat quickly; solder will flow freely and smoothly. No compressed air required. Nothing to pump. Self-adjusting. Safe. Economical. Can be used for annealing small parts and bending metal parts. Generates a heat of 1700° Fahrenheit. Simply connect to any illuminating gas jet

with a rubber hose and operate. Tornado Torch No. 119 comes with three (3) tips. ($\frac{1}{8}$ " , $\frac{1}{4}$ " , $\frac{3}{8}$ " blast).

The Tornado Gas Torch No. 119, or the Tornado Burner, complete with three tips, is \$2.95. A combination of the Tornado Gas Torch and Burner, with three tips which are interchangeable, is \$4.50. See your dealer or order direct. Send check or money order—post paid.

Robco Corporation, 202 E. 44th St., New York 17, N. Y.

MILL IT ON YOUR LATHE

WITH A PALMGREN

MILLING ATTACHMENT

Now — you can do milling, slotting, grinding, grooving, squaring shafts, sawing at angles, and many other important operations on your lathe. PALMGREN MILLING ATTACHMENT is a necessary fixture for small shops, schools and emergency work in large plants. Fits South Bend, Atlas, Craftsman, Logan, Sheldon and all other makes. It has graduation for rotary angle adjustments, also graduated feed and adjustment screw. Easily mounted by straddling lathe's regular tool post. Try one—it will quickly pay for itself.

IMMEDIATE DELIVERY

No.	Width Jaws	Depth Jaws	Jaws Open	Weight Pounds	Base Opening	Price F. O. B. Factory
150	2 1/2"	1"	1 3/4"	6 1/2	1"	\$18.75
250	3 1/2"	1 1/4"	2 1/4"	11	1 1/2"	24.75
400	4"	1 1/2"	3"	25	2"	39.75

Order from your dealer or jobber. Write for circular No. 349

CHICAGO TOOL AND ENGINEERING CO.

Mfrs. of PALMGREN PRODUCTS for Over 28 Years

8365 South Chicago Avenue • Chicago 17, Illinois

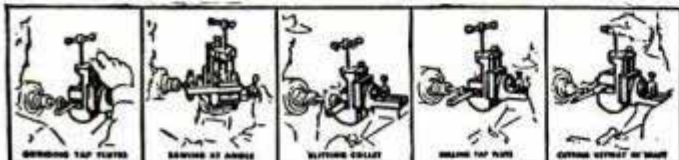

Start a PLASTIC BUSINESS

**this Marvelous Machine
NOW PAVES THE WAY
TO BIG PROFITS**

Opportunity is all around this excellent machine. This S-K-W Press is ideal for manufacturers, custom molders, laboratories, home workshops, colleges, etc. Operates hydraulically, quickly, accurately, economically. Pays big dividends in a hurry. Electrically controlled heat under varying degrees of pressure and temperature. Platen area approx. 20 sq. in. Size of press 9 1/2 x 14 x 26". Ram pressure to 8 tons.

PRODUCES BOTH PLASTIC and RUBBER PARTS

NOW you can make your own plastic or rubber parts from your own mold, material can be secured in most localities. We can also save you money on any molds you desire. The plastic industry offers great opportunities for those who get into it TODAY.

USED FOR HUNDREDS of MOLDING NEEDS

This Machine offers an excellent start in this Big Money-Making Industry. Make YOUR OWN PRODUCTS. Establish YOUR OWN BUSINESS. ORDER TODAY. ONLY IMMEDIATE DELIVERY

Wt. Approx. 100 lbs.
COMPLETE

\$160.00

F.O.B. Chicago

Make Your Own Plastic Parts This Quick Easy Way for Production or Experimental Work

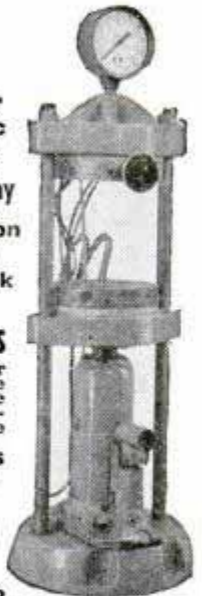

CLARENDON MFG. CO., Dept. P-1, 176 Adams St., Chicago 3, Ill.

NOW—IT'S EASY TO DRILL CONCRETE!

Slip a Carbide Masonry Drill into your Rotary Drill, Hand Brace or Drill Press — and drill holes



4 TIMES FASTER!
—Here's the "secret"—super-hard tip of Carbide Cemented Carbide (developed to cut hardest steel) "breezes through" softer masonry!
• Stays Sharp Up To 50 Times Longer!
• Drills Clean-edged Circular Holes!
• Eliminates Costly Breakage!

ALL MASONRY—BRICK, SLATE, ASPHALT, PLASTER, ETC.

Goodbye to back-breaking masonry drilling! Here's the easy way!—the precision way!—the speedy, professional way! Drill holes 1/8" apart without breakthrough! Drill any masonry. 15 popular drill sizes—ask about Handy 6-Drill Set (sturdy canvas case, free)! See your dealer, or write today for FREE LEAFLET SA-225.

CARBOLEY COMPANY, INC., 11185 E. 8 Mile St., Detroit 32, Mich.

Make Hundreds of Fascinating RADIO ELECTRICAL EXPERIMENTS WAR SURPLUS EXPERIMENTAL KIT

Only \$4.99
POST PAID U.S.A.

50-Piece Genuine New War Surplus Electronic Apparatus Super-Bargain—worth \$25. Includes neadphone, capacitors, potentiometers, resistors, fuses, sockets, wire switches, etc. Build hundreds fascinating circuits. Learn electronics. 50-piece kit with complete instructions, also plans for home laboratory.

Send only \$4.99 today, or will ship C. O. D.

LECO ENGINEERING CO.

Box 931-PM4

Lincoln, Nebr.

QUICK! "REPAIRING CAR BATTERIES" MONEY. At Home! Easy Too!

Write, BATTERYMAN, Grand Junction 6, Colorado



MASTER CHAMPION LAWN MOWER SHARPENER

Also Mfg., Saw Sharpening & Key Machines

FRANK'S MFG. CO.

Dept. PM7
2501 E. Imperial Highway
Los Angeles 2, Calif.

ARMY AIRCRAFT RECEIVERS

BC-946-B

Broadcast band from 520 to 1500 Kc, tube complement — 3-12SK7, 1-12SR7, 1-12A6, 1-12K8 can be used with 24V dynamotor supplying A & B power; can be converted to AC or DC or 32 volt sets 3 stages of IF used. Uses 3 gang condenser. Complete with **\$12.95** tubes and schematic, each...
Dynamotor DM-32A, each.....\$4.95



SUPREME FOUNDATION METER

40 Micro Amps. 20,000 ohms per volt. 4 1/2" square. **\$8.95**
Manufactured by Supreme Instruments Corp. Each...

Hickok 2 1/2" 0-150 AC Voltmeter, each.....\$2.49
Dept. PM

ARROW SALES, INC., 59 W. Hubbard St., Chicago 10, Ill.
SUPERior 5575

MODERNIZE YOUR GARDEN TOOLS WITH

TUG-O-WHEEL COMPLETE GARDENING OUTFIT

Does away with slow, back-breaking spading. Ideal equipment for vegetable gardens. Improved all steel Gardening Outfit plows 5" deep, marks, hills and cultivates rows 12" to 36" wide. Fast, efficient, easy to use. Cultivator and many other practical attachments.



Thousands of satisfied users. Material and workmanship fully guaranteed. Write today for information.

TUG-O-WHEEL HAND PLOW CO.
Dept. P Ballston Spa, New York

Leaking Boiler MADE TIGHT

IN 1 1/2 HRS.



"A hot water boiler section cracked at the lower nipple joint, causing a bad leak. The water level was lowered below the leak. The 3-inch crack was filled with Smooth-On No. 1, as was the space between the sections.

"A 3/8-inch-thick plate, long enough to cover the crack, was bent to conform to the casting surface and placed under the nearby pull-up bolt. The space between plate and casting was caulked full of Smooth-On No. 1. The plate could have been held by wire run thru the space between the sections if necessary. It took 1 1/2 hours to make the repair.

"The next day the boiler was filled with water. The repair was tight, so the boiler was put in operation and the system filled with water. It has been operating ever since, and is perfectly tight."

H. T., New Jersey

Always keep Smooth-On No. 1 on hand, for stopping leaks, sealing cracks, tightening loose parts and fixtures. Get it in economical 1 3/4-oz., 7-oz. or larger size at your hardware store. If they haven't it, write us.

FREE REPAIR HANDBOOK

Shows many home repair jobs as effective as the above. 40 pages. 170 diagrams. Pocket size. Easy-to-follow instruction. Paste coupon on postcard and mail today.

SMOOTH-ON CEMENTS



For the Motor Car and Boat, Home, Factory and Power Plant

—Sign and Send Now—

Smooth-On Mfg. Co., Dept. 37
570 Communipaw Ave., Jersey City 4, N. J.
Please send me a Smooth-On Repair Handbook.

Name.....

Address.....

1-47.....

Do it with **SMOOTH-ON** IRON CEMENT

AGENTS SALES-MEN

FOR IMMEDIATE DELIVERY

\$2.40 Doz.

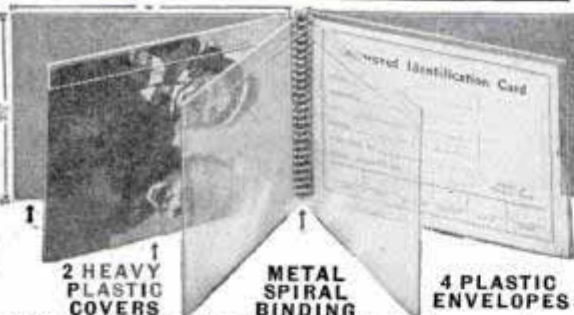

2 HEAVY PLASTIC COVERS
METAL SPIRAL BINDING
4 PLASTIC ENVELOPES

Timely fast selling Specialty—easy to carry. Everybody buys our Clear View Identico Case. The perfect Wallet Insert—fits into wallet, vest or blouse pocket and Ladies' purse. Sells like "Hot Cakes." Price 50c ea. Cost you \$2.40 Doz. Postpaid. Order trial Dozen today. GUARANTEE Sale of 1st order or money refunded for unsold portion. FREE 3 color display card, sample attached, with 1st order.

BEACON SALES CORP. Dept. PM-10, 37 S. Wabash, Chicago 3

TOOLS — PLASTICS — SUPPLIES — ETC.

New Decorative Plastic Panels for table tops, etc. also aluminum trim, Plexiglas, Plastic Screws, Cement, Drills, Taps, Dies, Milling Cutters, Torches, Flux, Brazing Wire, Screws, Aluminum, Shafting, Bearings, Pulleys, Mandrels, Machine Handles, Flexible Shaft Tools, Electric Drills, etc. Many other items, 70% in stock. New Illustrated Catalog E-15c, Metiplas Supply Co., 1420 South 16th Avenue, Maywood, Illinois.

SAY YOU SAW IT IN POPULAR MECHANICS

MACHINE SHOP EQUIPMENT



Just off the press!—Every man who owns a workshop should have a copy of the new, up-to-the-minute, 200 page catalog of Machine Shop Equipment—the latest tools made by the biggest manufacturers in the U. S. Replete with illustrations, descriptions, prices. Prompt delivery on most tools listed in this book. Available at cost of printing—50c a copy—get yours today! Price of Catalog Refunded on First Order over \$5.00. Send check or Money Order to

CENTER TOOL CO., 154 Centre St., New York 13, N. Y.



More Power—More Capacity —More Flexibility than any other homeshop handgrinder!

You want three things in your workshop handgrinder — POWER; CAPACITY; FLEXIBILITY. Look how you get these in the New Dumore Duplex! Powered with the famous Dumore motor, full 1/14 HP, to handle "heavy" jobs. Equipped with 3/4" chuck for extra capacity. Practical attachments to convert instantly for bench, lathe, and flexible-shaft work. Think what you can do with this extra power, capacity, and flexibility, in wood, metal, and plastics! Easier, better, faster work — twice the fun — and at no higher price than an ordinary handgrinder!

Full Power to Handle 1/4" Shank Tools

You can do a countless variety of jobs with the Duplex — sanding, sharpening, grinding, sawing, and many more. Its chuck takes tools with 3/4", 1/2", and 3/32" shank — ordinary handgrinders usually handle only up to 3/8" shank tools. A full 1/14 HP motor has plenty of power for heavier jobs. Long-life bearings guarantee trouble-free service.



The Deluxe Duplex Grinder Kit (illustrated above) includes the Duplex Grinder and 27 different tools and accessories, packed in a permanent case of handsome polished wood. Complete as described — \$27.50. Standard, 9-accessory kit, without case — \$19.75.

With a simple, easy-to-use attachment your Duplex becomes a flexible-shaft tool. Write for information on this kit, and other attachments which convert the Duplex into a lathe- and bench-grinder.



Money-Back Guarantee—10-Day Trial

Take advantage of our 10-day Trial Money-Back Guarantee — prove to yourself that the Duplex Grinder is the best hobby-tool value on the market today. Production is still too limited to stock your dealer, but while the supply lasts, we can accept direct orders for immediate delivery.

H-1A **Tear out and mail this coupon today!**

THE DUMORE COMPANY, Dept. A-51, Racine, Wisconsin

Please
send
me —

- | | | |
|---|--|--------------------------|
| <input type="checkbox"/> | One Deluxe Dumore Duplex
Grinder KitPrice \$27.50 | } Check
One |
| <input type="checkbox"/> | One Standard Dumore Duplex
Grinder KitPrice \$19.75 | |
| Enclosed is my check (or money order)
for \$..... | | <input type="checkbox"/> |
| Please ship C.O.D. plus postage
and insurance..... | | <input type="checkbox"/> |

If not completely satisfied with my Duplex, I can return it within 10 days for a complete refund of the purchase price.

Please send complete information on the Dumore Duplex Grinder.

Name.....
Street Address.....
City.....(.....) State.....

American Rice Feeds the Orient

(Continued from page 167)

husking is done by machinery and the Orientals, too, use simple machines for the job. They consist of two or more drums that rotate and rub the rice kernels against each other and against the drums, removing the thick skin. In Korea, small mills are sometimes operated by water wheels.

After the rice is husked, it must be polished or "peeled" to remove a very thin brown coat. Power-driven machines are used for this purpose, both in Asia and in the United States. Unfortunately, in removing the brown coat or bran, important vitamins, like thiamin, and minerals are also removed. The bran is usually thrown away. In the Orient, rice may be put through the "peeler" as often as three times. The peeling process breaks additional kernels which have remained whole through sifting and husking. Unprotected by the natural skin, the white rice turns rancid sooner.

In 1944, in an attempt to devise a peeling method which would not break as many kernels, and also preserve more of the minerals, the War Production Board sponsored research at the University of Arkansas on an experimental machine known as the Earle Rice Peeler. A model was built and tested. It consisted of a tubular mill about two feet in diameter by 10 feet long. The lining of this mill was rubber, about 1/4 inch thick. Inside the mill were five or six steel rods two inches in diameter. These rods rotate at different speeds both in relation to themselves and to the mill shell. As the motion is entirely one of gentle rubbing, less kernels are broken than in regular milling. Results also showed that rice milled with the new peeler retained a higher percentage of thiamin and minerals.

Although not the first time that American ingenuity has improved a foreign grain, American methods have so increased rice production that we can export a great part of it to the famine areas of the world — where the rice originally came from.

Task Forces Against the Poles

(Continued from page 136)

icebreaker USS North Wind and the naval seaplane tender USS Norton Sound left Boston in July, bound for the northwest coast of Greenland. The Norton Sound carried two PBM patrol planes and the North Wind carried a helicopter, which during the experiments took off and landed from a small specially built platform.

The cruise demonstrated the indispensa-

(Continued to page 280)



World's Finest Hand Tool Has Never Been Duplicated

Gripping power exceeds a ton! Does more things—easier and quicker—than any other tool. Remains locked to work with hands removed. Adjusts to super-plier action (handle opens automatically when grasp is released.) Greater range of jaw-adjustment than any other type of toggle-wrench.

There is only one Vise-Grip—it's the original toggle-wrench and has never been duplicated in strength or utility. Ask for Vise-Grip by name. Don't accept an imitation.

Built of fine alloy steel. Nickel plated.

Invented, Developed and Made World Famous by
PETERSEN MFG. CO., Dept. 27, DeWitt, Nebr.



**INSIST
On The Genuine**

UTMOST VALUE:

**7", \$1.65
10", \$1.95**

Sold through
**TOOL JOBBERS
and DEALERS**

WISE-GRIP

The Original Toggle Wrench

Double Lever
Action
Gives 1 Hand
Ton-Grip

DO YOUR OWN
Beautiful PLATING

It's EASY
with the aid of this
PLATING RECTIFIER



This unit is complete. Just plug into your 110V. A.C. no moving parts to get out of order. Only additional material required to do fine plating is glass or rubber tank and chemicals, which are readily available. . . . Any required voltage may be had by simply rotating large knob. Outputs are instantly read on large (2 1/4") voltmeter and ammeter on panel. . . . Economical to operate.

FREE WITH ORDER: Authoritative Book on Electroplating; 256 pages of information on methods, materials, solutions, currents and voltages required for plating with gold, silver, copper, etc.

SEND FOR DESCRIPTIVE FOLDER E.

ELECTRO-TECH EQUIPMENT CO., 1178 Lafayette St., New York 13, N.Y.

FREE WITH ORDER 256p BOOK TELLS NOW

SAY YOU SAW IT IN POPULAR MECHANICS
**Harley-Davidson U. S. Gov't
Surplus Used Motorcycle Engines**

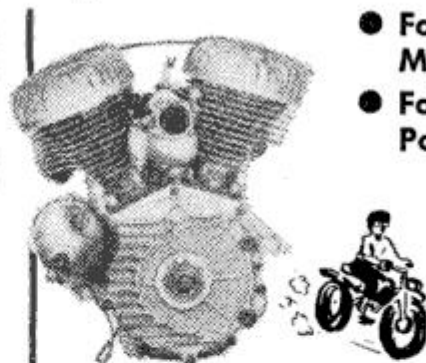

- For '37 to '46 H-D Motorcycles!
- For Economical Portable Power!

59⁹⁵

**Immediate Delivery
Write for
Credit Terms**

Worth \$265 when new! Completely inspected and OK'd! The replacement parts alone are worth more than you'll pay for the complete engine! Use it as a motor replacement on your 1937 to 1946 Harley-Davidson motorcycle. Use it on the farm or in the factory as a source of economical portable power or as inboard motor on boats, 2-cylinder, V-type, I-head engine, N.A.C.C. Horsepower rating is 6.05. Mail the coupon TODAY!

Goldblatt's

Clip This Coupon

Goldblatt Brothers, 333 S. State St., Chicago 4, Ill.
State, Jackson, Van Buren Sts., Chicago 4, Ill.

Please Send Me Harley-Davidson Used Motorcycle Engines at \$59.95 each.

Name

Address

City State Zone

Charge Money Order \$10 Deposit on C.O.D.

Illinois Residents Add 2% Occupational Tax. Extra Freight Charge for Shipping Outside of Regular Delivery Zone.

**Here you ARE
WOODWORKERS**

**THE NEW
CONSTANTINE
MASTER MANUAL**



Bigger and better with more new pages of helpful articles and information on materials and supplies. Hundreds of familiar items back again; dozens of new additions including lumber, veneers, inlays, plywood, tools and finishing materials. The greatest 25c worth ever offered craftsmen and woodworkers. In addition, without charge, a year's subscription to Chips & Chats to keep you up to date on craftsmen's activities and many bargains. Send 25c now to

**ALBERT CONSTANTINE & SON, INC.
791-A East 135th St., New York 54, N.Y.**

**FREE
1 YR. SUBSCRIPTION TO
CHIPS & CHATS**

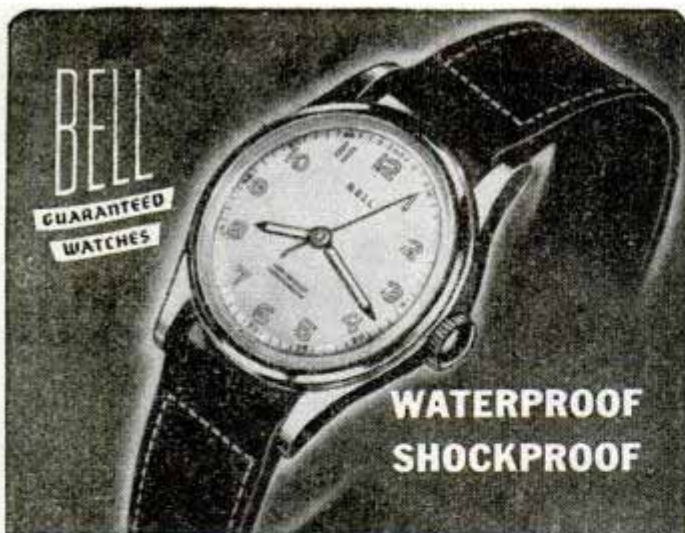

BELL
GUARANTEED
WATCHES

**WATERPROOF
SHOCKPROOF**

NOW AVAILABLE! Sturdy, handsome, reliable—backed by the famous BELL guarantee. Anti-magnetic, radium dial and hands, unbreakable crystal, sweep second hand, precision tested.

No. YG 197
17 jewels, stainless steel back..... \$29.75

No. YG 188
17 jewels, all stainless steel case..... \$47.50

No. YG 328 SELF-WINDING
17 jewels, all stainless steel case..... \$59.75

ORDER BY MAIL: Send check, money order, or pay postman C.O.D. Prices Incl. Fed. Tax & Postage. Gift Box. Wide choice of fine watches for men and women. Write for **FREE** Illustrated Booklet "YG"

Repair Service

All types and makes of watches repaired expertly and promptly. Free estimate on request.

BELL WATCH COMPANY, INC.

Time and Life Bldg., Rockefeller Center, New York 20, N. Y.

P-1 Generator Bracket

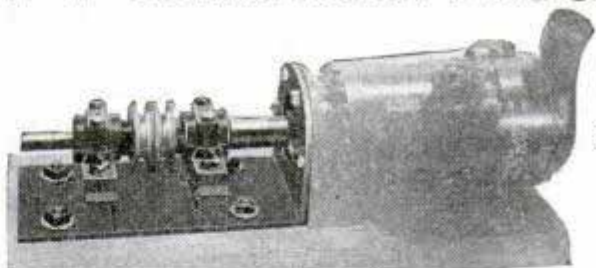

ONLY
\$ **8** 95

Ideal for either Delco or Westinghouse Generator

Made of 1/4" Welded Steel. For use with 2 "B"-V Belts. Can be used for combinations of 1 or 2 generators. Takes up the "Play" in the generator shaft. A Must for every generator user for longer life of the unit.

GOVERNMENT SURPLUS & HARDWARE SALES

1627 North Damen Ave., Chicago 47, Ill.

Telephone Arm. 2518



NEW! CLEAN POWDER LUBRICANT
WILL NOT SOIL CLOTHING!

Grafize
PACKAGE REG. U.S. PAT. OFF.

**FOR CARS, HOME,
OFFICE, WORKSHOP**

Positive lubrication in fine, clean, non-soiling powder form—in handy small bellows dispenser—blown by finger tip pressure—forms lasting lubricating film. No grit or abrasives.

Does away with squeaky hinges, bearings, casters. Frees sticking door locks, windows, etc. Lubricates working parts of over 1000 items. Get GRAFIZE now at hardware stores, auto accessory stores, filling stations. If your dealer cannot supply, write us for **FREE SAMPLE** giving dealer's name.

Schmidgall Manufacturing Co.
341 CASS STREET PEORIA 2, ILLINOIS



Shoots Light 800 Ft!

A genuine Delta for home and away. Spotlight and floodlight. 80-100 hrs. on a 6-volt battery. At hardware, sport, electrical stores. Less battery **\$3.95**



Delta ELECTRIC CO.
MARION, INDIANA

POWERlite 2-LITE ELECTRIC LANTERN



Profit by the Building Boom!

Start your own business manufacturing concrete building block and brick. Use Economy hand moulds. Make true, straight, easy-to-lay units which will pass any building code. Small investment, high production, big profits. One \$30.00 mould will make 1,000 5" x 8" x 2" blocks per day. Letters and repeat orders tell how pleased our customers are.

WRITE FOR FOLDER

Economy Manufacturing Company
Dept. P Stone Mountain, Georgia

CRESCENT TOOLS

Give Wings to Work

ASK YOUR
HARDWARE
DEALER



SPEED UP HARD-TO-DO JOBS

**WITH
AIR-SPEED SAW and FILE!**

Simplifies Difficult Sawing or Filing Jobs

**LIGHT
COMPACT
POWERFUL**

DEPENDABLE air-powered saw and file—Weight: 3½ pounds — Operating speed and cutting stroke adjustable — Ideal for key hole, dead-end and scroll cutting in iron, steel, aluminum, copper, plastics, brass, wood, hard fibre and other materials — File can be inserted in chuck for all filing operations — Only two moving parts guarantee long life — Fully warranted — Retail for \$44.50 — Immediate deliveries — See your Dealer.

AIR-SPEED TOOL COMPANY

1500 W. Slauson Ave., Dept. PM-1, Los Angeles 44, Calif.



WAR SURPLUS BARGAIN SPECIAL

**BRAND NEW!
VACUUM-AIR
HYDRAULIC**

FUEL PUMP

Original Cost
\$45.00
Now Only
\$9.95

Postpaid in U.S.A.

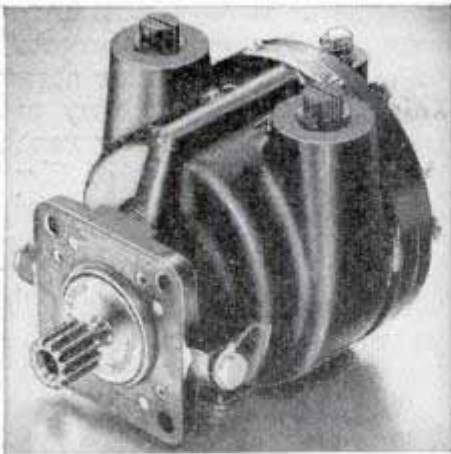

Adaptable for use on Home Oil Burners, Spray Machines, Milking Machines, Compressors, Vacuum Pumps, Hydraulic Systems, Presses, etc. Originally cost \$45.00. Used by the Air Corps to drive bomber de-icer boots, gyroscopes, automatic pilots, etc. May be used as air or fluid pump—for pressure or vacuum. Standard 3/4 inch pipe thread with interchangeable ports. Will pump 7 1/2 gal. SAE 30 oil per minute at 300 RPM. Builds air pressure of 30 lbs. per sq. in. at 1000 RPM. Vacuum will draw 26 inches of mercury at 1750 RPM. Runs forward or reverse. Self aligning shaft. Die cast aluminum housing 6x4x4 inches. Has stainless alloy steel vanes and impeller. Made by Bendix Avia Corp. Spine terminal for direct drive—readily replaced with a pulley. Recommend a 1/4 H. P. or stronger electric motor as source of power. Rated capacity 1500 RPM with high overload factor. Special price for quantity users. Send check or money order today. Postpaid in U.S.A.

GROBAN SUPPLY CO. Dept. PMJ, Chicago 5, Ill. 1522 So. Michigan Avenue

AMAZING MYSTERY BUTTON

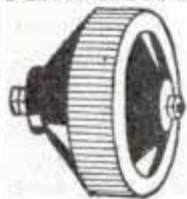

Startles Everybody. With this *Electronic Button* you can make your own Telephone—Amplifier—Detectphone. Attach this button to piece of cardboard—transmit conversation to another room. Music also transmitted to distant places. Most interesting electrical apparatus ever discovered. Enables you to perform hundreds of experiments. So tiny it can be concealed in dozens of places. A Pre-War Product. *Electronic Button* including 5000 word instruction booklet with 50 illustrated experiments, postpaid, only **\$1.00**

SUPER MYSTERY BUTTON

Many times as sensitive as our regular mystery button. Can be used for the same experiments and uses as the mystery button but with far better results. Needs no diaphragm of any kind. Ideal for musical instruments, intercommunication, recording, talking thru radio, and many other uses. When used with small head phone it makes an ideal inexpensive hearing aid. Shipped with 5000 word, 12 page booklet showing diagrams for dozens of uses, postpaid \$2.00.



Electronic Products Company
Saint Charles 1, Ill., U.S.A.

New Designs in

FRANZITE GRIPS

Modernize Your Gun! Improve Your Score!
Most durable grips made. Positively unbreakable! For Colt, Smith & Wesson, Hi-Standard, Ortigues, Luger & Mausers in a wide choice of beautiful designs in ivory, pearl, walnut, onyx, etc. Low prices. FREE CATALOG. Dealers Wanted.

SPORTS, INC., (Mfrs.) 5501 Broadway, Dept. P-1, Chicago 40, Ill.



**The Modern PLASTIC
for lasting Home Repairs**

PERMANENTLY mends cracks or holes in wood, tile, stone or plaster. Sticks and stays put—Does not chip, shrink or fall out. Easy to use. Economical. Mold it, chisel it, polish or paint it. If unobtainable from your lumber, paint or hardware dealer, the big 4-lb. can will be sent you postpaid (in U.S.) for only \$1. Full money-back guarantee, order now.

DONALD DURHAM CO.
Box 894-A, Des Moines, Iowa



**A WHOLE SHOP
FULL OF TOOLS
IN ONE!**

Use it for grinding, routing, drilling, sawing, polishing, carving, sanding and 9,994 other uses. Increases your skill and your scope. Precision-engineered, AC-DC. More exclusive features than any other tool.

Exclusive Safety Fingergrip for fine detail work

\$22.50

**COMPLETE WITH 36 ACCESSORIES
IN FITTED STEEL CASE**

Works **Wood, Metal,
Glass, Plastics**

\$31.75 Value if Purchased Separately

CASCO ELECTRI-CRAFT TOOL KIT
CASCO PRODUCTS CORPORATION, BRIDGEPORT 2, CONN.

RIDE-RITE

NEW TYPE—LIGHTWEIGHT—HEAVY-DUTY STRENGTH
UTILITY TRAILER AXLES

58" CAPACITY 2500 LBS.
4" DROP

EITHER TYPE AXLE AVAILABLE WITH OR WITHOUT SPRING SUSPENSION (Pat. Appl. For)

SIDE VIEW SPRING SUSPENSION

Build your own utility trailer and equip it with a Ride-Rite axle. Get the advantage of its new lightweight, heavy-duty tubular construction. Available with or without patented double-coil spring suspension. Straight axle has standard 58" tread; drop axle has 60" tread. Distance between spring hangers 48" on both axles. **BIG CAPACITY:** Axles made of 1 1/2-inch O.D. steel tubing have tested load capacity of 2500 pounds. Coil springs, four per axle, have minimum capacity of 650 pounds each. Ride-Rite axles will fit hubs and wheels made by Motor Wheel Corp., Kelsey Wheel Co., Ford Motor Co., and Industrial Machine Tool Co.

PRICED LOW AS
\$6.75
PRICES F.O.B. FENTON, MICH.

Remittance with order —No C.O.D.	Axle Only	Axle with Springs
Straight Axle, Std. Tread	\$ 6.75	\$19.70
Drop Axle, Std. Tread	12.50	25.45
(Springs fit Ride-Rite axles only)		
Axles can be furnished any tread desired for slight additional cost.		

**MANUFACTURERS
AND DEALERS!**

Write for descriptive literature
QUANTITY LOT PRICES
FURNISHED ON REQUEST
WRITE ON YOUR LETTERHEAD

MANUFACTURED BY
INDUSTRIAL MACHINE TOOL CO., INC.
200 S. LEROY STREET FENTON, MICHIGAN

PUTS PROFIT in Your POCKET

BIG OPPORTUNITY BUILDING BLOCKS of CONCRETE CINDERS

Men of Vision and Modest Capital
See Prosperity and Independence in
This Big Field Today. Read Offer-
ing Below and Then MAIL COUPON.

NEEDED EVERYWHERE
for Every Kind of Building
to be Done



BIG DEMAND FOR QUALITY BLOCKS
BIG PROFITS

Yes, here's a manufacturing opportunity never before equaled. Our complete concrete block unit consists of mixer, material elevator, hopper and famous proven Blocker Vibrator Machine. Turns out 130 blocks an hour. Needs only 3 people to operate. This unit has been paying for itself in six months so **IT PAYS FOR ITSELF QUICKLY**—and from then on you **KEEP FULL PROFITS**. One user says:

"We are operating your machine at Junction City. Easy to maintain production of **ONE HUNDRED CONCRETE BLOCKS PER HOUR PER MACHINE**—often producing as high as one hundred thirty units per hour. Your Blocker Vibrator has no complicated parts. We recommend your product as a **REAL practical MONEY MAKER**."—Concrete Products Co. of Junction City.

Limited amount at special price to get these operating in many different localities at once. **RUSH COUPON BELOW** for money making facts and details about our unit — **DO IT NOW**.

Concrete Block Equipment Co., Inc.

920 Central, Dept. 104

Kansas City 6, Mo.

MAIL COUPON for DETAILS!

Concrete Block Equipment Co., Inc.
920 Central, Dept. 104, Kansas City 6, Mo.

Please send me details and "How to Start and Operate a Concrete and Cinder Block Plant—a New Local Business Rich in Opportunity."

Name.....

Address.....

bility of radar to Arctic mariners by spotting icebergs in the vicinity during fog and darkness. It was not uncommon for as many as 30 iceberg "targets" to appear at one time on the radar screen of a single ship. Picking their way among the icebergs, the ships finally reached Thule, on the northwest coast of Greenland. From here the PBMs flew out and brought back the first photographs of this glacier-laden land. One flight carried the planes within 450 miles of the North Pole. The planes also reported movements of the ice pack to guide the ships in their trek northward.

The weather data brought back by the Frostbite and Iceberg expeditions will be of value during the full-scale maneuvers which the Navy is reported to be planning in the north Atlantic in 1947. The carriers and large warships are the last of war equipment to be tested against the arctic. Most of man's machines have already been tried out and, with appropriate modifications, found to function in the cold.

Last July a B-29 Superfortress with a pressurized cabin made a flight of more than 5000 miles from Edmonton, Canada, over the North Pole and back. Carrying a crew of 12, the plane stopped at Fairbanks to refuel and then went over the pole and returned to Fairbanks in about 23 hours.

The combination of air power and the short arctic routes have a new significance. Lieutenant General George E. Stratemyer, commanding general of the Air Defense Command, recently warned that another war, spearheaded by an unannounced air assault over the pole, would not give us the time advantage we had in World War II.

Formerly, Canada was a natural defense area for the United States, as no nation would ever attack it because of cold and inability to supply its divisions. Now, with the airplane functioning in the arctic, Canada is open territory. Canada has almost 3,000,000 square miles of unoccupied arctic and subarctic territory to defend.

In addition, ever since we bought Alaska from the Russians we maintained only a token garrison force there. It wasn't until the Japs threatened it, and finally made comparatively small landings on Attu and elsewhere, that the United States decided to defend it. To do it properly requires not only defense forts, but men and machines. And the men and machines must be able to operate in bitter cold.

The accelerated arctic tests during 1945 and 1946 have already shown that most machines can take it. The Army's two task forces in Alaska should now determine whether man can function in the intense cold as well as the machines he built.

CUT OUT THIS BAND TO FIND RING SIZE

AUTHENTIC WESTERN SADDLE RING

FOR MEN! & WOMEN!

PURE STERLING SILVER

Only \$4.95

Postpaid We Pay Tax



First time at anywhere near this low price! Authentic replica of romantic western saddle. Handsomely formed from solid Sterling Silver by Navajo Indian craftsmen. Massive style for men, dainty style for women. A gift of distinction. A pleasure to wear. Sent on approval.

SEND NO MONEY! Just clip this ad and mail with your name and address. Pay postman only \$4.95 plus few cents postage on arrival; or send cash and we pay postage. Wear this sensational ring for 10 days. If not delighted, return for full refund. Specify for MAN or WOMAN and RING SIZE. Use cut-out band to determine size.

ARIZONA CRAFTSMEN Room 272, 1904 Farnam Omaha 2, Nebraska



TINY TIM \$14.95

COMPLETE WITH BOILER AND BASE

Single cylinder Oscillating Steam Engine. A rugged high-speed precision-built engine made of highest quality material. Equipped with safety valve, throttle control and two fly wheels. Base 7" x 4". Boiler height 7 1/2". Satisfaction or money back guarantee. Order now. Supply limited. Cash orders prepaid or C.O.D.

THE THOMPSON ENGINEERING CO.
405 Winchester Bldg., Grand Rapids 2, Mich.

NEW! DECAL-CRAFT FULL COLOR TRANSFERS

Make circus wagons, animals, miniature streamliner train, many others. Easy to use—stick 'em on—saw 'em out. Mail \$2.00 TODAY for all of these plus patterns and instructions.

DECAL-CRAFT, 1112 BIRCH, EAU CLAIRE, WIS.

SAY YOU SAW IT IN POPULAR MECHANICS

Hobbywoods

FOR IMMEDIATE DELIVERY!

Thousands of feet of Fine Cabinet Woods in sizes and grades to exactly meet your home-craft or woodshop needs. Bargains in Turning Blocks, Picture Frame Mouldings, Plywoods, Veneers,

CATALOG OFFER: (U. S. A.)

HOBBYWOODS,
Eastern Ave. and Cedar,
Baltimore 3, Md.

Send me complete Hobbywoods Catalog with periodic supplements plus a twenty-five cent size Waterproof VeriPLY (urea resin) Glue. Enclosed is 25c for both, prepaid.

Name

Address

Town Zone State.....

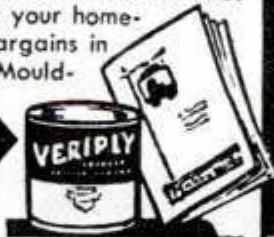

At Last..

AVAILABLE AGAIN!!

Genuine STAINLESS STEEL

30 PIECE SET



Make Your "Little Lady" Happy With This Ever-Gleaming Tableware



Includes

- 12 Teaspoons
- 6 Tablespoons
- 6 Forks
- 6 Knives

\$6.95

NO PLATING TO WEAR OFF

Requires No Polishing

For a long time the use of stainless steel was highly restricted. Now WE CAN SUPPLY this gleaming, never-staining, never-tarnishing tableware again.

There's NOTHING ELSE to compare with STAINLESS STEEL. It can serve a lifetime. It is SOLID—the same metal and color all the way through—like sterling silver.

ORDER ONE OR MORE SETS—for yourself or for gifts—today!

Guaranteed

- Never to Rust!
- Never to Stain!
- Never to Tarnish!

SEND NO MONEY

Just mail coupon and pay postman on delivery. Or SAVE postage and C.O.D. fees by sending remittance with order.

FREE

with every set—while they last—
—Velour Lined Leatherette Case!
ORDER TODAY! .

MAIL COUPON NOW

UNITED SILVERWARE, Dept. PM-1,
Box 3620 Mdse. Mart, Chicago 54, Ill.

Please send me sets of your 30-piece set of Stainless Steel Tableware.

- I am enclosing \$.....herewith. Send postpaid.
- Send C.O.D. I will pay postman plus postal charges.

NAME.....

ADDRESS.....

CITY..... STATE.....

Please print clearly with pencil

Power . . .
*independent of
 outside interference*

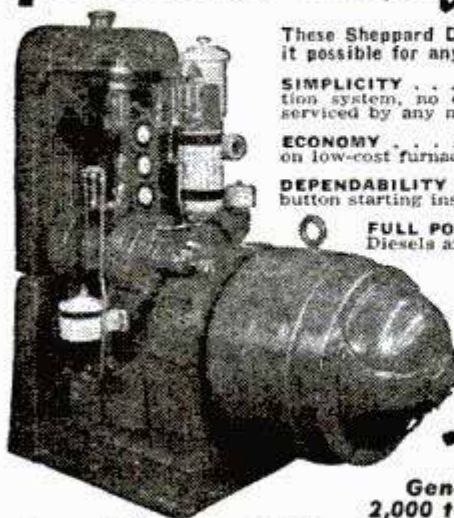

These Sheppard Diesel features make it possible for anyone . . . anywhere.

SIMPLICITY . . . no electrical ignition system, no carburetor. Can be serviced by any mechanic.

ECONOMY . . . starts and operates on low-cost furnace oil.

DEPENDABILITY . . . electric push button starting insures instant power.

FULL POWER . . . Sheppard Diesels are rated on their actual continuous power output while operating with full equipment.

SAFETY . . . no explosive fuel to handle and store.

**Generating Sets
 2,000 to 36,000 Watts**

Power Units 3 3/4 to 56 H.P. • Marine Engines 3 3/4 to 62 H.P.
 R. H. Sheppard Company, Inc., 48 Middle St., Hanover, Pa.

DIESEL'S THE POWER . . .

Sheppard's the Diesel

**MAKE MORE
 MONEY**

APPLYING OR SELLING

**CORKSTONE
 PLASTIC FLOORING**

**EASY
 TO
 APPLY**

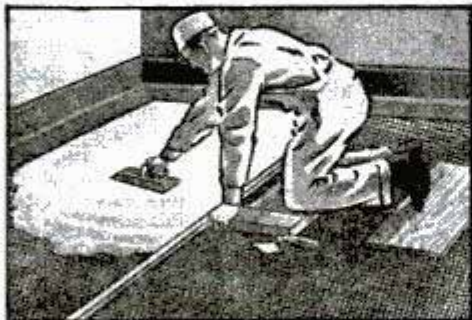

Here's your opportunity to get into business for yourself applying or selling Corkstone, the economical, top-grade plastic flooring. Plenty of profit. Act without delay!

Dealers & Agents Wanted

WRITE FOR DETAILS

LASTING PRODUCTS COMPANY
 FRANKLINTOWN ROAD PLANT, BALTIMORE 23, MARYLAND

**MULTI-PURPOSE, RUGGEDLY CONSTRUCTED
 FLEXIBLE SHAFTS**



\$575
 Plus Postage

Sealed Against Dust & Dirt

53 1/2" Length, 3/8" Diameter (O.D.)
 These SHAFTS can be used on 1/2" motor shaft, or by removing the coupling, in a chuck up to 3/8" capacity. Shaft size on operating end is 3/8" diameter. 24 threads per inch. Speed range 1725 RPM to 3600 RPM. Can be bent or looped to small radius for working in hard-to-get-at places. Outer covering of oil-resistant Neoprene. Useful for many purposes, including Buffing, Grinding, Drilling, Polishing, Rotary Filing and Transmission of Power.

U. S. Navy Battle Lantern

Throws strong 500 ft. light beam. With on-off switch. Waterproof and weather-proof. Steel case, sturdy. Neat in Battleship Grey. Convenient handle. Useful in automobile, boat, garage, shop, factory, home and farm; at work or at play. (10 1/2" high x 7 1/2" wide x 4" deep.) Requires 2 Standard Dry Cell Batteries. Price, Less Batteries



\$575
 Plus Postage

Complete with batteries . . . \$6.40

ELECTRIC TRADING CO.

313 CANAL ST. NEW YORK 13, N. Y.
 Electric Fans and Blowers in most sizes for every Industrial, Commercial and Domestic use. Table Saws—Air Compressors—Electrical Tools and Paint Spray Equipment in stock.

WRITE FOR CATALOG "M"

"International" Tractor Model

EASY TO BUILD—MOVABLE TRACKS
 Construct this fascinating 1/2-inch scale, authentic model of a famous crawler tractor. Wood parts cut to shape—die-cut plastic track shoes—18 finished, turned wheels—detailed, full-size drawings—simple instructions—colored name transfers.



SENT POSTPAID \$1.50
 (CASH—MONEY ORDER—CHECK)

*"Be The First One In Town
 To Own This New Model!"*

R. D. DELANEY, 27 Champion Place, Alhambra, California

BENCH DRILL PRESS

With 1/2" Chuck. Less Motor **\$2750**

LIVE CENTERS

Ball Bearing. #2 M. T. Shank **\$650**

DAVIS MACHINERY CO.

(Rated Dun & Bradstreet)

126 N. CLINTON ST. CHICAGO (6), ILL.

Immediate Delivery: Mail Orders

**BUILD a
 BOAT**



- New Boat—12 Foot
- Dinghy—8 Foot
- Dinghy—14 Foot Sailing
- Training Ship—6 Foot
- Sea Sled—9 Foot
- Outboard—12 Foot
- Cruiser—18 Foot
- Bicycle Boat—Kayak
- Row Boat—Sectional
- Row Boat—Sailing
- Dinghy—16 Foot
- Canoe—16 Foot
- Sailing—12 Foot
- Outboard—12 Foot
- Pontoons—Runabout
- Ice Yacht

**FOR PLEASURE OR PROFIT
 DESCRIBES 17 LOW-COST BOATS**

Get this outstanding book and build a boat at home for your own use or to sell at a profit. You can do it. Just the boat you've always wanted—power, sail or row boat—17 different kinds and sizes.

Order **BUILD A BOAT** on postal card and pay only \$1.50 plus postage on delivery. Return in 5 days if not pleased and get money back. Or send \$1.50 with order and we'll pay postage. (Outside U. S. \$1.70 with order.) Order today.

POPULAR MECHANICS PRESS
 Dept. 598, 200 E. Ontario, Chicago, 11

Limited Stock! New, 27-Volt AC-DC AIR COMPRESSORS

- 1/2-HP 3-stage Motor
- 4500 RPM
- Weighs 38-Lbs.



- COMPRESSOR OUTPUT is 1500 Lbs. High Pressure Low Volume
- IDEAL for Low Pressure Spray Gun

Precision built... hook up furnished. Convert with transformer or 4-1000-watt heating elements. Individually packed in wooden boxes and wrapped in plicofilm for double protection. Simple diagram describing hook-up included. Rush us your order, today.

Cost the Government over \$200 to build
BARGAIN \$15 FOB for you

General Surplus Stores

1439 Grand Avenue Kansas City, Missouri



MIDGET WATER HEATER FOR GARAGES, WORKSHOPS, COTTAGES, GAS STATIONS

This compact automatic electric water heater supplies hot water 24 hours a day. Easily installed; just two simple pipe connections—then plug into regular 110 Volt A.C. outlet. Two sizes, 3 gallon capacity (Vertical or Horizontal) and 6 1/2 gallon capacity (Vertical only).

Horizontal Model
3 gal. capacity
Casing size 12x17"
\$42.50 FOB Chicago
(6 1/2 gal. 10 1/2 x 32")
\$57.50 FOB Chicago

See your dealer or write
Dept. 110, 7405 Stony Island Ave.
Chicago 49, Illinois

POLAROID FILTERS!!! \$1.75 set

SPERRY K-3 COMPUTING SIGHT contains hundreds of precision bearings—gears—electronic parts—motor—clutches—shafts—optical system... **\$12.50**
BOMBER SIGHTING STATION. A double-end periscope instrument containing recticles—selsyns—Vacuum pump—motors—gears... **\$49.50**
—etc. Original cost over \$10,000.
Shipped prepaid anywhere in U. S.

ASSOCIATED SURPLUS 10838 Ventura Blvd.
North Hollywood, Calif.

Say You Saw It in POPULAR MECHANICS

Radio Parts BARGAIN

Amazing war-surplus radio parts bargain, with new Coils, Condensers, Transformers, Resistors, Controls, others. \$15 to \$25 value. Ideal for experimenters, amateurs, home shop men. Now only \$3.98. **\$3.98** AMAZING VALUE
MARKO SUPPLY, Dept. PM-1a, 2924 Logan Blvd., Chicago 47, Ill.

ONLY
\$1.00
Postpaid



Electric Motor CONSTRUCTION KIT Easy to Assemble Fun—Educational

Runs on a single dry cell (not included). Rugged construction, use it to run fans—pumps—pulleys, etc.

Send Check—Money Order or Cash (at your own risk) to

THE HAYDN CHEMICAL CO., Dept. C1, Box 27, Kenmore 17, N. Y.

New LOW COST "CHIEF"

PORTABLE ELECTRIC ARC WELDER



A
COMPLETE
WELDING
SHOP
IN
1 CASE
•
CARRY IT
ANYWHERE
•
VERY
SIMPLE
TO
OPERATE

SPECIALLY DESIGNED
FOR EASY PORTABILITY
AND GENERAL PURPOSE

WELDING BRAZING SOLDERING

HARD SURFACING · PRE-HEATING



Works On Iron, Steel, Aluminum, Brass,
Bronze, Copper and Alloys. Excellent
Results Achieved On Thin Gauge Metals

The "CHIEF" is a remarkably efficient new low-cost Electric Arc Welder that brings easier portability and greater simplicity of operation than ever before. Its wide range of application makes it ideal for all-around use in home workshops, welding shops, farms, garages, machine, auto and general repair shops. Lightweight, easily carried. Accessories fit into a tray on bottom of case, providing a complete welding outfit all in ONE compact portable unit.

Amazingly Simple Low Cost Operation

Very simple to operate. Even inexperienced workers can achieve good results right from the start. Does high-grade work you would think only possible with larger, more expensive outfits. The Hy-Flash Arc Torch included, simplifies welding of all light and medium gauge metals, as well as brazing, soldering and heating operations. 110 or 220 volt models. Complete, as illustrated. The greatest welder value in America today!

SEND COUPON FOR FREE DETAILS NOW!

CHICAGO PRECISION MACHINE CO.
926 S. Michigan Ave., Chicago 5, Illinois
Send free details on Chief Welder. No obligation.

Name _____
Street _____
City _____ State _____

START YOUR OWN CONCRETE BLOCK MANUFACTURING BUSINESS



The Flam Challenger Concrete Block Machine is simple and easy to operate. No special training required. This machine incorporates the Flam patented "UNDIRECTIONAL" vibration. Get In Now! A small investment will set you up in this rapidly growing industry. Write for detailed information TODAY!

STEPHEN FLAM Inc.
15026 Oxnard St. • Van Nuys, Calif.

Now for EVERY WORK SHOP! NEW Invention **Electroplates** by BRUSH



Easy to Plate CHROMIUM GOLD, SILVER, NICKEL, COPPER . . . For Pleasure and Profit!

If you have a workshop—at home or in business—you need this new Warner Electroplater. At the stroke of an electrified brush, you can electroplate models and projects—you can replate worn articles, faucets, tools, fixtures, silverware, etc. with a durable, sparkling coat of metal . . . Gold, Silver, Chromium, Nickel, Copper or Cadmium. Method is easy, simple, quick. Everything furnished—equipment complete, ready for use. By doing a bit of work for others, your machine can pay for itself within a week. So make your shop complete by getting a Warner Electroplater right away. Send today for FREE SAMPLE and illustrated literature. ACT AT ONCE! Mail Coupon. **WARNER ELECTRIC CO., DEPT. L-16** 1512 Jarvis Avenue, Chicago 26, Ill.

FREE Details & Sample!

WARNER ELECTRIC CO., 1512 Jarvis Avenue, Chicago 26, Dept. L-16
Gentlemen: Send Free Sample and Details to:

Name _____
Address _____
City _____ State _____

The Wheel of 1001 USES!



Rugged steel disc wheel, solid rubber tire. Electrically welded. Ideal for building or repairing "Tiny-Tot" vehicles. A light wheel with great strength for countless other uses. 4 1/2" dia., 3/8" steel bushing. Bright red enamel.

IMMEDIATE DELIVERY ON THIS DELUXE WHEEL

For craftsmen wanting a better wheel . . . here's a beauty! Air-cushion, puncture proof rubber tire . . . 2" thick . . . 8" diam. The famed Walton 8x2 wheel equipped with a precision type 1/2" roller bearing. Only \$11.60 for 4. Send money with order. No COD's.

PRICES
4 1/2" steel Wheel
ONLY 75c each.
\$8.40 a doz.
POSTPAID

WALTON WHEEL CO.
Dept. 78, Box 432, Milwaukee, Wis.
Dealers, Jobbers, Salesmen Wanted

METERS SPECIAL OFFER

An ideal combination of FOUR USEFUL METERS for repair shops, laboratories, home and farm at a SENSATIONAL NEW LOW PRICE.

- A. C. VOLTMETER—W.H. 2 1/2" Aircraft type, 0-150 volt A.C. bk sc, lum mkgs, suitable for use from 25 to 125 cycles.
- A. C. AMMETER—Simpson 3 1/2" square, 0-60 self contained.
- D. C. VOLTMETER—Gruen 2 1/2", 150 volt.
- D. C. VOLT-AMMETER—W.H. 2 1/2" Aircraft type 0-120 Amp & 30 volts D.C. black scale, luminous mkgs with external shunt.

ALL FOUR of these meters can now be had **ONLY \$9.00** postage paid anywhere in the U. S. for

MARITIME SWITCHBOARD

Dept. PM6 336 Canal Street New York 13, N. Y.

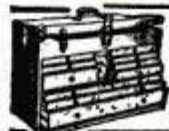

GERSTNER Tool Chests

Modern in every detail, and attractive in finish. Free catalog for machinists and toolmakers.

GERSTNER TOOL CHESTS
447 Columbia St., Dayton 7, Ohio



"LITTLE WONDER" Crystal Radio

NO ELECTRIC—NO BATTERIES—NO TUBES

One of the smallest genuine crystal radio sets in the world. Slider-contact tuning, binding posts for aerial and ground. Extra long range. **SEND NO MONEY.** Just send your name and address and when your "Little Wonder" arrives simply pay the postman \$1.99 plus a few cents postage. Sent prepaid if you inclose check or money order with your order.

MART DISTRIBUTORS, Dept. MP, P.O. Box 6, Evanston, Ill.

SPECIAL PLASTIC SHEETS

New stock, masked, clear, plexiglas. **\$2.50**
A-1 grade. Special Size 1/4" x 9" x 20". each postpaid

Write for quantity price.

Full stock of standard sheets, rods, cements, etc. Complete price list sent on request.

CRAFT SERVICE
Over a DECADE of Service

337 University Ave.
Rochester 7, N. Y.

SAY YOU SAW IT IN POPULAR MECHANICS



Old Dangerous Way

TOOL HOLDER
for
**Chisels—Punches
Star Drills**



New Safe Way

Send \$1.25 To **BERGGREN, Mfr., Wadena, Minn.**

BUILD PRACTICAL THINGS for FUN and PROFIT!

YOU HAVE TOOLS
and MATERIAL HANDY

The tools you have around the house are all you need and much of the necessary material can be found in workshops, garages and scrap yards. If you need a welder, these plans will show you how easy it is to build one. They will enable you to make money in building or repairing things for others. Send for this Manual today—Cash or C.O.D.



ONLY \$1.50 POSTPAID
PLANS ARE SIMPLE — EASY TO FOLLOW
The simple plans in the LeJay Manual are a source of enjoyment to non-experts in the electrical field. They are easy to follow, do not call for expensive equipment and produce practical results. A few of the many interesting projects are illustrated here.

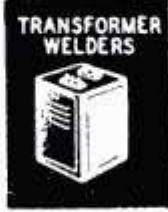

ORDER NOW BOTH FOR \$2.25

LEJAY MFG. CO

747 LeJay Building,
MINNEAPOLIS - 8 - MINN.

BUILD A LEJAY FAST FREEZER

No Knowledge of Refrigeration Required

A handy addition to every home which gives you frozen storage from 5° above to 10° below zero. Can be made in 5 sizes, from 8 to 40 cubic feet capacity. You don't have to be a refrigeration expert or a cabinet maker to build this LEJAY FAST FREEZER, and in these days of meat shortages and high prices, it will effect quite a saving in your household economy. Its sturdy simplicity and ease of construction appeal to every man who likes to make things. Free plans for a Milk Cooler are also included. Only \$1.00—cash or C.O.D. A Special offer—The LeJay Manual and Fast Freezer Plans Combination for \$2.25.

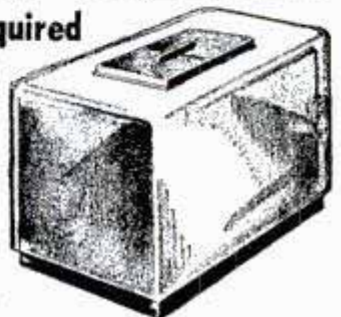

"SAWZIT"—A Tool of 1000 Uses. Handles Like Knife. Cuts Like a Hack Saw

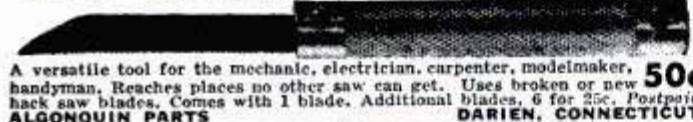

A versatile tool for the mechanic, electrician, carpenter, modelmaker, handyman. Reaches places no other saw can get. Uses broken or new hack saw blades. Comes with 1 blade. Additional blades, 6 for 25c. Postpaid **50c**
ALGONQUIN PARTS DARIEN, CONNECTICUT

SAY YOU SAW IT IN POPULAR MECHANICS

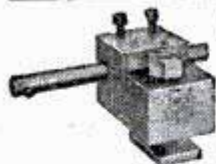

Own a BOR-RITE TOOL HOLDER

BOR-RITE is a real tool holder. Designed by a skilled machinist for 6" to 9" metal lathes. Adjustable but rigidly built for precision work. Will send postpaid complete for \$8.50. Money back guarantee.

For further particulars write
The Rugg Engineering Co., So. Coventry, Conn.

\$8.50

Aluminum Rivet Assortment \$1.00 Postpaid

This assortment includes 2 pounds of round head, flat head, oval head and brazier head body types. The sizes are from 1/16" diameter x 1/8" long to 3/8" diameter x 2 1/2" long. They are excellent stock for making model parts and fastenings. (Approximately 2,000 pieces in assortment.) You cannot touch an assortment of this type anywhere else. Send remittance to Model Engineering Corporation, P. O. Box 635, Bristol, Tennessee.

INVEST XMAS CASH IN THESE TOOLS YOU'VE ALWAYS WANTED



**SCHERR
"Ten-Thousandths"
MICROMETER**

Without extra price, this mike has sharp, accurate vernier on the barrel giving readings to "tenths" in 1", 2" and 3" sizes. Exceptionally long accuracy-life and uniformly smooth "feel" throughout entire length of spindle because of Scherr process burnish-hardened micrometer screw. Here is the mike you have been looking for—a tool that will give you modern measuring to 1/10,000", that will serve you indefinitely, and be a treasured addition to your tool equipment. 1" size, plain model (as shown) \$6.75. With locknut and ratchet \$8.25.

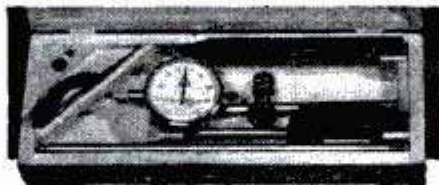

PRECISION DIAL INDICATOR

Complete set, in hardwood box, includes the Scherr precision-built dial indicator with universal ball-joint back, three contact points, inside measuring attachment, clamp and tool-fast holder. Reads to .001". A sensitive tool, widely popular for the long-lived and uniform accuracy of its readings, due to exceptionally few moving parts, positive needle action, absence of backlash, and ease of adjustment for any required use, with its ball-joint back. A tool that will justify its cost many times in truing up work for machining and other uses. Complete set, \$19.75.



SINE BAR for accurate angles

You have always wanted one. Here it is, with the Scherr guarantee for accuracy, thoroughly normalized against warp, 1" x 3/8" x 5", at the more than reasonable price of \$22.20.



**INTERNAL GAGE
5/16" to 2-1/8"**

With this set of four telescoping gages you can gage any inside dimension to 2 1/8" and read it in ten-thousandths with the Scherr Micrometer. A Scherr precision tool for only \$9.10, including leatherette case.

10-DAY MONEY-BACK OFFER means every Scherr tool has to make good or you return it in 10 days for full refund. Send check or money order or we will ship C.O.D. Quick delivery on all tools.

GEO. SCHERR COMPANY, Inc. 200-A LAFAYETTE STREET
NEW YORK 12, N. Y.

THE IRON HAMMER WAS ON THE SPOT, TOO, WHEN WE LEFT THE STONE AGE

Our machine is made to fit into standard, open-head 11 1/4 in. (3 1/2 & 5 gallon) steel cans. We will make a unit for open-head 13 1/2" Id, 100# drums

How to fill all makes of Grease & Calking guns

No more air pockets or dirt in your Calking or Grease-guns

How to change from empty can. Traffic dents Ok.

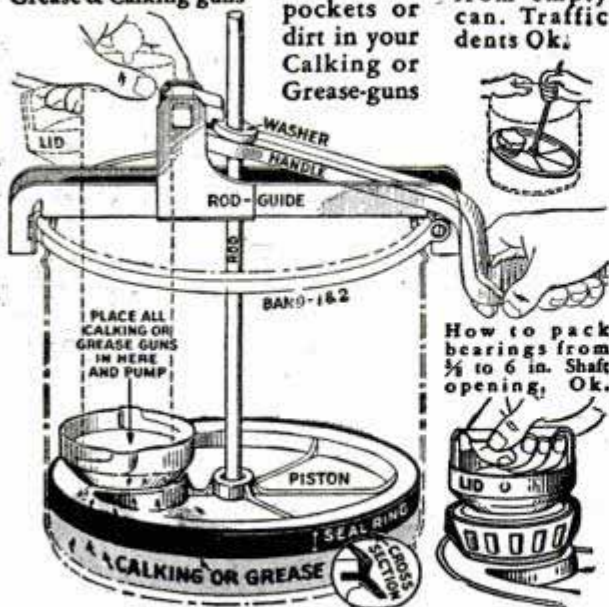

PLACE ALL CALKING OR GREASE GUNS IN HERE AND PUMP

How to pack bearings from 1/2 to 6 in. Shaft opening, Ok.

Cut this ad out, hand to the man you buy your Calking or Grease products from, he will demonstrate to you Free HK9-621 Fullerton Pky. Chicago 14, Ill.

Patent No. 2,224,509 Trade Mark Reg.



SPEAK THROUGH ANY RADIO

WITH A "Real Mike"

It's **GUARANTEED** to Work! Not A Toy But a "Real Mike" Broadcast personal messages, Birthday greetings, etc. from another room. Fun at parties Tell the kiddies stories, etc. Easy to connect. Instructions included.

\$1.95

Mail Orders Direct to **UTILITY STORES** 117 So. Wabash, Dept. NN-12, Chicago 3, Ill.

GET THE BEST IN MUFFLERS V-8 DUALS & SINGLES



Finest Norman custom-built muffler sets - steel pack - torpedo type - heavy, perforated steel cores - chrome enamel finish - mellow, deep tone (improves with use) - designed to fit - all ways superior - double economy.

DUALS.....\$17.50 **SINGLES.....\$7.50**
 V-8 Ford-Mercury Buick, Olds., Chrys.
SINGLES.....\$5.50 **ORDER TODAY!** Will outlast three ordinary mufflers.
 Chev., Ford, Plym. Dealers—Write Today for Full Details

NORMAN'S MUSICAL MUFFLERS

Dept. PM-5, 1216 W. Slauson Ave., Los Angeles 44, Calif.

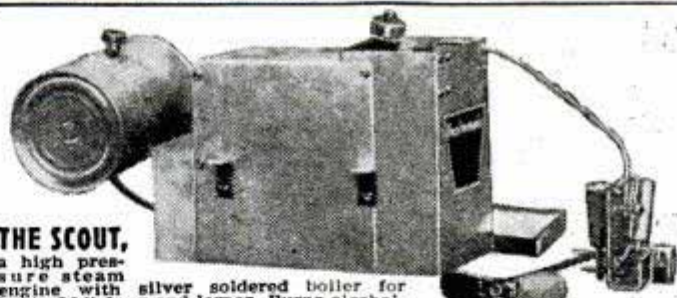

THE SCOUT, a high pressure steam engine with silver soldered boiler for boats 20" long and larger. Burns alcohol. Runs 30 min. Drives a 2 1/4" propeller. Price complete ready to run with 70-lb. safety valve and accessories as shown... **\$8.95** Postage extra, shipping wt. 4 lb. Distributors and dealers write for terms. **PHILIP STEVENSON CO.,** Box 162, Station D, Cincinnati 6, Ohio

START HOME NOVELTY MFG. BUSINESS

New course tells in simple language how to make plaster novelties of many kinds at home. Descriptive folder free.

W. BELFORT

Engineering Building

Chicago 6, Illinois

BEAT THE WIRE SHORTAGE! FIRST OFFER OF THIS KIND EVER MADE!

REPAIR YOUR OWN WINDOW SCREENS WITH ACE SCREEN PATCHES

PATCH SIZE 2x2 1/2"
 6 PATCHES - 10¢
 3 PACKAGES - 25¢
 AHEAD

Enclosed Please Find _____ For _____
 CHECK ONE
 GUARANTEED NAME _____
 BLACK ADDRESS _____
 BRONZE CITY _____ ZONE _____ STATE _____

Mail to

ACE WINDOW SCREEN CO.
 1634 S. PULASKI RD. CHICAGO (23) ILLINOIS



FRESH EGG STANDS ON END

— ORIGINAL — AMAZING —

\$1 SENDS INSTRUCTIONS MONEY BACK GUARANTEE **ANTONIO** 922 Blaine St., Los Angeles 15, Calif.

Quick, Easy, Lasting REPAIRS!

Cracks, holes, dents in wood, plaster, concrete, metal, etc. — loose handles, rungs, knobs, screws — mistakes in carpentry, etc. — fix them all with Savogran Crack Filler (hard as stone) or Savogran Wood Putty (easily tooled). Just mix with water, press into place. Stays put, hardens quickly, will not shrink! Can be painted, pre-colored. Ideal for models, inlays, etc. Patented! Big 1-lb. can only 30c at hardware and paint stores.

FREE CIRCULAR

Describes these and other Savogran Products: Heavy Duty Cleaner, Remover & Bleacher (renews floors), Paint Brush Cleaner, Strypeeze (removes all finishes), Coldfoam Soapless Soap Powder.

THE SAVOGRAN CO.
 Dept. 36, Boston 10, Mass.



SAVOGRAN

CRACK FILLER · WOOD PUTTY

IN EVERY WELL-EQUIPPED HOME WORKSHOP

BOYS LIKE THESE LARGE 10" x 1.75

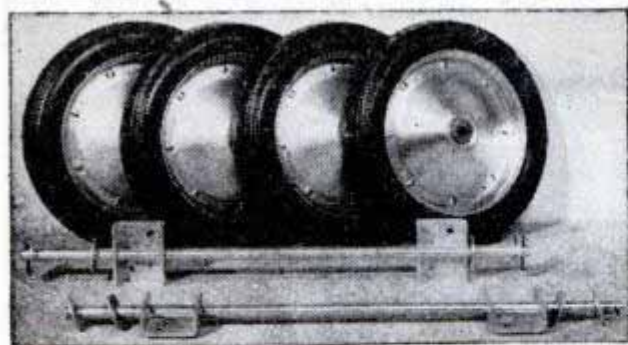

BUILD YOUR OWN RACER
with Genuine GATES
Style 508 and GOODYEAR
Style 19 DEEP TREAD
PUNCTURE PROOF SEMI-
PNEUMATIC TIRES.

WHEELS

Made to Outlast
Any Other Type
Wheels—And They Do

NOTE: these ARE
NOT the toy tires
used by most wheel
manufacturers.

BUDD HEAVY STEEL WHEELS

Bright Zinc Plated . . . With Arguto Lifetime Oilless
Bearings or Kilian Ball Bearings. **4 FOR \$10.00**
For 1/2" or 5/8" Axles.
With 2 . . . 1/2" dia. Axles 20" long hangers, **\$13.50**
washers, cotter pins, Ready To Use. . . ONLY

Here It Is . . . Combination V Belt Pulley Drive
First Again— . . . and Brake Drum



Securely Held To Wheel . . . READY TO
USE. Smart Design in Sturdy Pure Cast
Aluminum . . . Precision Machined.
One Combination Drive and 10" x 1.75
Wheel Assembled. **PRICE \$5.50**
One Combination Drive Wheel and
three without (set of 4). **PRICE \$13.00**
Same as above with 2-20" x 1/2"
axles, 4 hangers, washers, cotter pins.
READY FOR USE. **PRICE \$16.50**

Same as above with 24" long x 5/8" dia. axles, 4
hangers, washers and cotter pins. **READY FOR
USE PRICE \$19.00**
Combination V Pulley Drive and Brake Drum, with-
out wheel. **PRICE \$3.50**

F.O.B. Doylestown, or, add 10% for Prepaid Shipment
anywhere in U.S.A.

Write For FREE Circular on OUR NEXT SURPRISE—
—12" x 2 1/2" SUPER DeLUX WHEELS

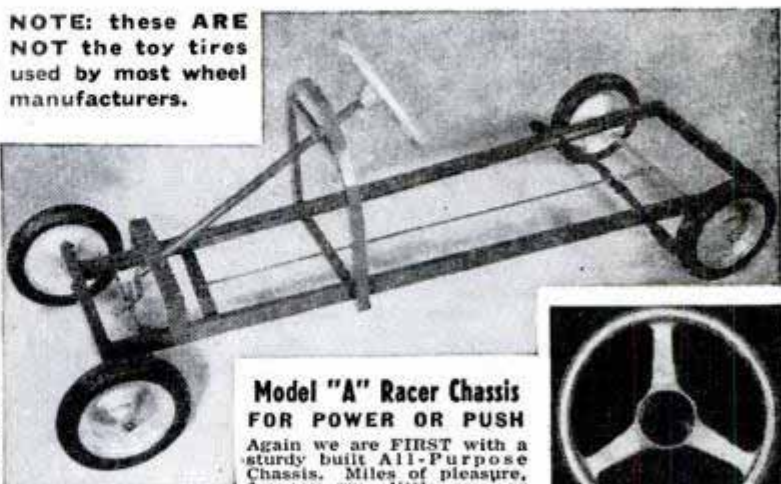

Model "A" Racer Chassis FOR POWER OR PUSH

Again we are FIRST with a
sturdy built All-Purpose
Chassis. Miles of pleasure,
for any age, little ones or
adults. This racer chassis
engineered into the finest de-
sign for electric, gasoline or
push power, giving you the
choice of body design to
build yourself. Equipped
with Genuine Arguto OIL-
LESS LIFETIME BEARINGS
or Kilian Ball Bearings.
Ready to roll and
steer. COMPLETE **\$46.00**
AS ABOVE, ONLY
F.O.B. Doylestown or, add 15%
for Prepaid Shipment in U.S.A.

65 Inches Long
24 Inches Wide
Weight
Approx. 55 Pounds

**RUSH YOUR
ORDER
TODAY**



12 in. deluxe all
weather steering
wheel complete with
steering rod. Hang-
ers and jam nut as-
sembly. **ONLY \$8.75**

OSBORN WHEEL COMPANY

115 So. Main St., Dept. P-1

DOYLESTOWN, PENN.

AMAZING NEW JIG SAW Ready For Delivery!



\$17.50
Postpaid

At last! Here is the new, deluxe,
magnetic, powerful SYNCRO JIG
SAW—ready at the factory for
prompt shipment to craftsmen,
hobbyists. This remarkable, pat-
ented saw has a 10" x 10" Table
Top with 13 1/2" arm clearance.
It cuts 3/4" soft and 1/2" hard wood,
also plastics, thin metal—smoothly,
quickly, safely. Needs no motor—
needs no oiling. No rotating parts to
wear. Lasts a lifetime! Portable.

Just plug it into electric outlet in wall—
and saw! 14,400 Strokes Per Minute—
7200 down-cutting and 7200 upward, non-
cutting, REPELLING SAFETY strokes.
SYNCRO DELUXE is far superior to
famous pre-war SYNCROS. Comes with
6 blades, cord with plug, ready to use.
Sold direct from factory for only \$17.50 postpaid or \$17.50 plus post-
age, COD fee. SATISFACTION GUARANTEED OR MONEY RE-
FUNDED. Order NOW. Rush check or Money Order. Production
limited. First come, first served. Hurry! (Free Circular).
SYNCRO SAW CORP., Dept. A-17, ROCHESTER, MICHIGAN, U.S.A.

SYNCRO WORLD'S SAFEST SAWS

Sold direct from factory for only \$17.50 postpaid or \$17.50 plus post-
age, COD fee. SATISFACTION GUARANTEED OR MONEY RE-
FUNDED. Order NOW. Rush check or Money Order. Production
limited. First come, first served. Hurry! (Free Circular).
SYNCRO SAW CORP., Dept. A-17, ROCHESTER, MICHIGAN, U.S.A.

12 lbs. SURPLUS RADIO PARTS...\$2.00

A gold mine of parts for repairmen, amateurs, and experi-
menters . . . relays, condensers, resistors, transformers, coils,
hardware, wire, etc., etc. An outstanding bargain in usable
parts! Send \$2.00 cash, check or M.O. today!
(Pay small express charges on receipt.)

ELECTRONIC PARTS, Inc. Dept. M1, 622 W. Randolph St.
CHICAGO 6, ILL.

Low Price The OTTAWA "Buzz" Master



CLEAR LAND FAST! Powerful 6-HP motor
with friction clutch for safe operation.
Cuts down timber, brush, hedge; turn blade
vertically and saw logs to length. Can be
equipped to fell largest trees. Clutch
pulley for belt work. Guaranteed.

FREE
Details

OTTAWA MFG. CO., 127 Brush Ave., Ottawa, Kansas

NEW-ALL QUICK CHANGE GEAR BOX Increases Production up to 1000%

NEW IMPROVED MODEL!



**PAYS
FOR
ITSELF
in
30
DAYS!**

30-DAY Money-Back Guarantee!

Drastically Cuts LABOR COSTS!

NO TIME LOST FINDING GEARS! Inexperienced workmen easily
produce top output. Easy to install. You simply drill and tap
four holes. **Guaranteed Accuracy!**

IS GUARANTEED TO CUT ACCURATE THREADS from 4 to 224
per inch with approximately 3/1000 lead for fine turning. It
safeguards entire production in process throughout the complete
operation. **Precision Constructed**

PRECISION CONSTRUCTED THROUGHOUT with gears of quality
hobbed steel. Gear Box housing is made of high grade aluminum
alloy casting—with replaceable bronze bearings.

NEW LOW PRICE . . . \$89.50 F.O.B. Los Angeles
For ATLAS, CRAFTSMAN, LOGAN, POWERKRAFT and
SOUTH BEND 9-in., B & C.—Use Your Own Lead Screw.

Write Div. PM-1

WESTERN AIRCRAFT TOOL CO.
2505 North Ontario St., Burbank, Calif., Charleston 6-7750

INSIST ON CONGRESS DIAMOND BORED PULLEYS

• When you need pulleys for your power equipment or home appliances be sure they are Congress Pulleys. They are made of the finest alloys under conditions that assure highest quality, perfect balance, long life and satisfaction to you, as evidenced by the fact that leading appliance manufacturers have now standardized on Congress Drives. Each Congress V-belt pulley, variable speed and flexible coupling has been factory tested and individually packaged for your protection.



Sign of an Authorized Congress Dealer

At Your Local Dealer

You can get Congress Drives at all leading hardware stores. Look for the sign at the left. It shows a store that carries a complete stock of all the popular sizes, available to you at the low prices made possible by our vast production and our policy of specializing on drives alone. For America's biggest value in pulleys go to your hardware dealer and say "Congress, please."

CONGRESS DIAMOND BORED DRIVES
3750 EAST OUTER DRIVE DETROIT 12, MICHIGAN

PARTS FOR MODEL MAKERS



ELECTRICAL "BUGS" INVENTORS AND MECHANICAL WIZARDS

TEST YOUR WITS! Create gadgets, electrical devices, etc. Great gifts for budding geniuses, mechanics, shut-ins, schools, etc. Perfect war souvenirs!

HUNDREDS OF PARTS

K3 GUNSIGHT UNIT contains fascinating array of parts usable in 1001 ways! Amazing 1/50th H.P. 24 V. D.C. High-Speed Motor. Many regular and bevel gears, switches, shafts, lenses, bearings and various other parts too numerous to mention. Original cost approx. \$3000.00. You pay only.....

\$17.50

1/50th H.P. Gyro Motor

No. GM7 - 24 V. High-Speed D.C. motor revs up to 10,000 R.P.M. Use for precision grinders, buffers, dental, jewelry, model work, etc. 2 1/2" dia. Gyro flywheel. Rare buy at.....

\$4.95



400 Lb. Sq. In. Pressure Tank

No. PT4 - Original oxygen container for aviators. 5 1/2" dia., 14" long. 1/2-gal. capacity. Fine as air or gas tanks, floats, liquid containers, etc. Painted bright yellow. Only

\$1.49



SHIPPED PREPAID ANYWHERE IN CONTINENTAL U.S.A.

CASH WITH ORDER

24 V. quilted electric Bomb-Sight heating pad, 5 ft. cord, twist-lock connector, thermostat, 20" zipper, \$1.49
No. HP 10, only.....
Electric gyro heating pad complete with cord and twist-lock plug, No. GC 1, only.....\$1.00 Carton of 4 pads.....\$3.00

WRITE FOR LIST OF OTHER WAR SURPLUS VALUES

WARSHAWSKY & LAZAR
2126 S. Michigan, Chicago 16

Vaughan's Gardening Illustrated

265 FLOWERS IN FULL COLOR

More than 2500 new varieties and old favorites are listed in this beautiful catalog—roses, dahlias, gladioli, annuals, perennials—265 in full color!

Vegetables, too, of the luxury quality which only home gardeners can enjoy, are offered in this annual, which is packed with information invaluable to amateurs. It tells how to grow everything listed, and all about the new weed killers, insecticides, fertilizers and post-war tools and gadgets. FREE on request.

SPECIAL FOR 1947. Rated by many of the most beautiful of cut flowers, the gold-veined *Salpiglossis* can be grown in any garden by the simple culture included with this offer. Packet of seed including all colors sent with catalog for 10c.



VAUGHAN'S SEED STORE, Dept. 271

10 W. Randolph, Chicago 1 • 47 Barclay, New York City 7

BRAND NEW PLEXIGLAS DOME \$6.95

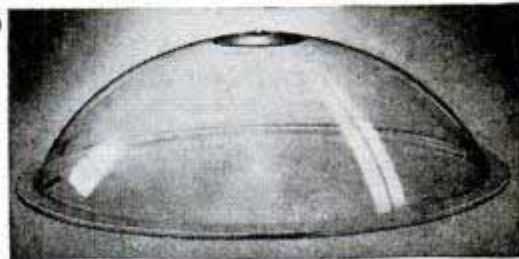

19" dia., 8" deep, 3/16" thick

CRYSTAL CLEAR PLEXIGLAS-MASKED

Surplus Navigation Astro-Dome purchased from U. S. Govt. Scores of purposes. NEW! Makes Motor Cycle or Boat Windshield, House Trailer Observation Window, or Hanging Garden, Philodendron Bowl, Flower Bowl, or can be decorated for Lamp Shade or other decorative or architectural uses or what-you-will. Shatter-proof; rimmed; drills easily. Has 3" center metal disk with screw closure, leak proof. Postpaid in U.S.A.....

\$6.95

GROBAN SUPPLY COMPANY

1522 SO. MICHIGAN AVE.

CHICAGO 5, ILL.

Say You Saw It in POPULAR MECHANICS

Build and Fly CLEVELAND MODELS



36" Douglas D-C3

Industrial Training Model, Dry Kit IT-165.....

\$100

70% Master Flying Model, Complete Kit SF-165.....

\$1450

ALSO: 30" IT Kits of Ercoupe, P-39 Airacobra, Culver V, Curtiss P-40, Shooting Star, Ryan Fireball, Globe Swift, Helicat, Stinson 150, Taylorcraft, Silvaire. All dry Kits. Each.....

\$100

N. AMER. P-51 MUSTANG

36" Industrial Training model, Dry Kit T-91.....

\$150

ALSO: Dry Kits for Lockheed P-38, Lightning, Black Widow, Piper Cub—all 36" span. Each only

\$150

SEE your dealer first. In ordering direct, include 25c extra for packing-postage. Get our jumbo folder (Kits 25c \$15.00)—send stamp.....

3c

Cleveland Model & Supply Co.

4513A21 Lorain Ave.



Cleveland 2, Ohio, U.S.A.

Have Your Own ELECTRO-PLATING Business Profitable-Simple-Pleasant



The VARI-PLATER—110 V. A.C.—plus a glass or rubber tank and chemicals, which are always available, and accompanying handbook, that is illustrated and easy to understand, will give you many money making opportunities.

You can PLATE Gold—Silver—Chromium—Nickel—Copper—Cadmium, etc. on metals and non-metals with the VARI-PLATER.

FREE Write today for descriptive literature and price list.

LEWIS ELECTRICAL MFG. CO. 1266 Gun Hill Rd. New York 67, N. Y.

The **PRECISION**
Lawn Mower Sharpener



Only **\$37.50**
Less Motor
F.O.B. Rock Island

EXTRA DOLLARS IN YOUR SPARE TIME...

Looking for an extra income sideline? Install a Precision Lawn Mower Sharpener in your workshop and turn your spare time into dollars. Sturdily constructed - Easy to operate.

QUAD-CITY PRODUCTS CO. - P.O. Box 42, Rock Island, Ill.

BOILING HOT WATER IN A JIFFY!!



Place the Jiffy Electric Water Heater into the water and insert the plug in the nearest electric wall or light plug. You will have hot water in less than five minutes for baby's bath, your washing, shaving and a great many other uses in the home, camping, business, and on the farm. Mailed complete, including six feet of rubber covered wires and plug. One year guarantee. **JIFFY ELECTRIC COMPANY, 21321 Stephenson Highway, Hazel Park, Mich.**

Only **\$2.95**
plus twenty five cents for postage

New Welding Outfit



Complete like picture
\$54.50

Electric Welding Outfits from \$39.00 up. International Distributor Inquiries Invited.

EAGLE WELDING EQUIP. CO.
Dept. 40
5085 Broadway, Chicago

ACE
LATHE TOOL SET



Be permanently tooled-up for every operation on your Metal Cutting Lathe

The ACE Set is complete—there's nothing more to buy. Drop forged by the manufacturers of cutting tools used by 90 per cent of the plants and shops in industry they are correctly designed, are of special steel, are finely finished, are stronger—will last a lifetime. You can cut easier, faster and more accurately with ACE TOOLS.

At your Hardware Store—

ARMSTRONG BROS. TOOL CO.
"The Tool Holder People"
368 N. Francisco Ave., Chicago 12, U.S.A.

1 Turning Tool, 2 Cutting Tool, Knurling Tool, Boring Tool, Threading Tool, High Speed Steel Cutters and Blades, and 7 Wrenches in Filled Steel Case.

PHONO-AMPLIFIER



\$3.25 3-TUBE AC-DC—IMM. DEL. Volume and tone controls. Complete wired.

PHONO AMP. KIT

With 3 tubes and 5" speaker..... \$7.95
less tubes or speaker..... 5.95
Complete kit wired & tested..... 8.50
Alliance Phono motors and T.T. at..... 3.95
Astatic curved arm pickup..... 2.25

Uses—12SQ7-50L6-35Z3

25% required on COD orders.
FREE CATALOG—M1

RISCO SALES — WHOLESALE RADIO DISTRIBUTORS
414-2ND AVE. AT 23RD ST. NEW YORK 10, N. Y.

It's an O'BRIEN!

HYDRAULIC BUMPER JACK



Designed for any make and model automobile

Newest and finest Engineered — Most ruggedly constructed on the market

NOTE THESE UNSURPASSED FEATURES

1. ALL STEEL CONSTRUCTION THROUGHOUT, with a large SOLID STEEL base that holds car rigid.
2. SOLID STEEL PISTON ROD, 3/4" thick, surrounded and fortified by 3 columns of TELESCOPING HEAVY STEEL TUBES.
3. ADJUSTABLE STEEL HOOK, shaped for any bumper, with unprecedented ADJUSTMENT RANGE OF 15 INCHES. Quickly adjusted to any bumper height.
4. SAFE LOAD ON HEAD OF COLUMN 6000 lbs. An easy, PRESSURE, hydraulic stroke.
5. SAFE LOAD ON ADJUSTABLE HOOK 2000 lbs.

ALSO FOR
Trailers
Tractors
Farm Machines
Shops and Industrial Plants

For Lifting
Supporting
or Spreading

POWERFUL... SAFE... RUGGED... EASY

List **\$17.50**

Money back guarantee against defective material and workmanship.

Ask your nearest dealer or mail coupon today!

Gentlemen: Please send me _____ O'BRIEN Bumper Jacks.

Enclosed find check _____ money-order _____ or send C.O.D.

Name _____ Address _____

City _____ Zone _____ State _____

O'BRIEN MACHINE COMPANY
1620 Highland Ave. Chicago 26, Ill.

Solid Rubber Wheels

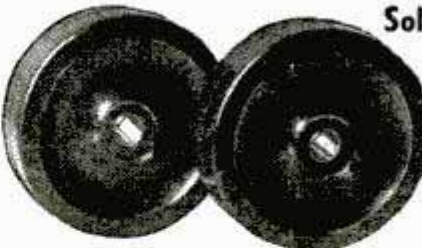

Build your own hand cart and trucks with solid rubber wheels.

These wheels are 5" Diameter 1 1/2" thick with 5/8" hole and Brass bushing.

\$3.25 per pair Post-paid in U.S.A.

Backlin Mfg. Company
Box 426
Burlington, Wisconsin

SAY YOU SAW IT IN POPULAR MECHANICS

AUTO ENGINE SPEED CONTROL GOVERNORS

Give constant or changeable speed to any auto or truck engine, when used for power. Guaranteed. Instructions. Oil ring bearing, \$14.25. Full ball bearing, \$21.75. Postage, 50c; east of Miss., 85c. COD, or—Postage any country \$1.00 each.



These valves used where carburetors have outside attachments.

State size of opening and distance between bolt holes.

1", \$3.75; 1 1/4", \$5.25; 1 1/2", \$6.50; 1 3/4", \$7.50; V8, \$8.00. Mailing weight, 3 lbs. If remitting, enclose for postage.

Stocks carried: In Canada, Montreal 15: 7546 Wiseman St. In Skaneateles, N. Y.: Horie Welding Supply. Circulars.

CANDEE, Dept. P, 2641 S. Hill, Los Angeles 7, Calif.



AGENTS WANTED
Parts and Implement Dealers, Garages, Welders, Wreckers, Catalog and Mailing List Houses, etc.

Feather Action Miniature Switch



You'll find dozens of practical home and shop uses for this miniature switch that opens or closes with the slightest pressure yet handles all normal 110 volt currents. Can be used for burglar alarms, automatic door lights, signal systems, relays, etc. Mailed Parcel Post prepaid complete with instructions for \$1.00. Fully guaranteed.

Finest Quality Magnetic Relay Assortment

An assortment of 7 magnetic relays obtained from the nation's leading manufacturers is now available to you for a fraction of the original price. Relays may be connected to miniature switches for signal systems, pinball machines, model railroad controls and hundreds of other fascinating and useful devices. Send check (or M.O.) for \$4.85 and we will ship 7 fully guaranteed relays by prepaid express.



Hundreds of Radio-Electric Values

Our new Catalog contains many pages of just the type of equipment that radio amateurs and home experimenters want. Everything has been carefully selected from Government contract sources and is guaranteed to be of top quality. Prices represent tremendous savings. Send a dime today for your copy of Catalog H 200.



4717 W. Madison St., Dept. P-1
Chicago 44, Illinois

Write for FREE Evinrude Catalog



Completely describes 1947 line of Evinrude outboard motors — light "singles", smooth "twins" and 3 thrilling four-cylinder models. Gives helpful information on boats, speeds, etc. Profusely illustrated. Address, EVINRUDE MOTORS, 5407 N. 27th St., Milwaukee 9, Wis.

EVINRUDE



New! Complete!
RADIO CATALOG

READY NOW! Send For Your FREE Copy!

Radio sets...radio kits (including 19 Popular Mechanics Kits)...radio parts...electronic equipment...amplifiers...complete, standard lines of post-war designed equipment and supplies; pages and pages of what you've been waiting for...in the new Concord Catalog, ready now! Rush coupon for your copy...sent FREE!

CONCORD RADIO CORP.

LAFAYETTE RADIO CORPORATION
CHICAGO 7, ILL. 901 W. Jackson Blvd. • 265 Peachtree St. ATLANTA 3, GA.

CONCORD RADIO CORPORATION, Dept. P-17
901 W. Jackson Blvd., Chicago 7, Ill.
Rush FREE copy of new, complete Concord Catalog.

Name.....
Address.....
City..... State.....



PLASTIC INSULATED WIRE

200 feet of 20 gauge stranded insulated wire on two 100 Ft. reusable Handee Bakelite spools, 2 colors. Just the thing for Experimenters, Inventors, Radio Set Builders, Toys and many other wiring applications. This modern wire has a plastic insulation that is highly resistant to cold, heat, oil and grease, abrasion, water and many other normally destructive factors.

SENSATIONAL OFFER FOR ONLY \$1.35
Two 100 Foot Spools

Postage prepaid anywhere in U.S. if remittance is made with order.

PARKSIDE WIRE COMPANY

Parkside & Elston Avenues

Chicago 30, Illinois

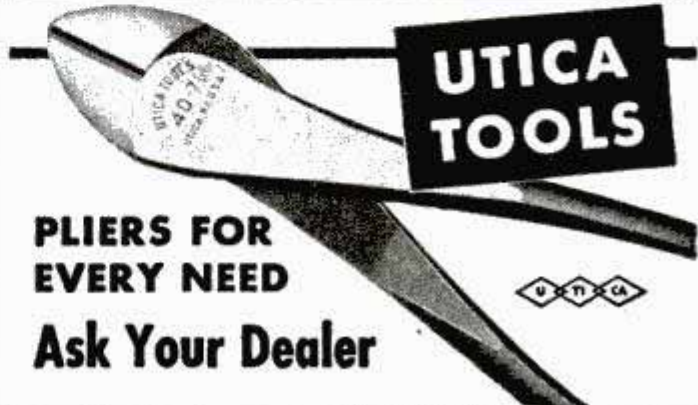

PLIERS FOR EVERY NEED

Ask Your Dealer

UTICA DROP FORGE & TOOL CORP.
UTICA 4, NEW YORK

LAW

STUDY AT HOME FOR PERSONAL SUCCESS and LARGER EARNINGS. 38 years' expert instruction—over 108,000 students enrolled. LL.B. Degree awarded. All texts furnished. Easy payments. Send for FREE BOOK—"Law and Executive Guidance."

AMERICAN EXTENSION SCHOOL OF LAW
Dept. 73-M, 646 N. Michigan Ave., Chicago 11, Ill.

SAY YOU SAW IT IN POPULAR MECHANICS



SUPERCHARGERS

Aircraft surplus, turbo type, complete. Can be converted into blowers, turbines, etc. Cost to Gov't approximately \$3,000. Sale price \$15.00 each while they last. FOB, Harrisburg, Pa. No COD. Send check or money order to: **INDUSTRIAL SALES CO., ATLANTIC BLDG., WASHINGTON, D. C.**

MAKE THIS PRECISION TOOLMAKERS VISE IN YOUR SPARE TIME



Inspectors, Toolmakers and Machinists need this fine precision tool. Can be used to obtain surface dimensions from all sides. Accurate, hardened parts are ground to your own satisfaction. "V" grooves in opposite jaws at 90° to each other and parallel to vise permit holding round parts. Dimensions are 2 3/8" wide, 1 1/2" deep, 3/4" opening. Drawings and complete instructions for building this fine tool for your tool box, including a dimension chart to inscribe your name, \$2.00. Postpaid U.S.A. only.

MECHANICAL ENGINEERING CO., Dept. PM-1
208 N. Wyman St. Rockford, Illinois, U.S.A.



THE GEM MAKER

Amateurs or professionals... hobbyists or jewelers... Polish your own gems with a B&I Gem Maker. You will find this a profitable adventure. All necessary lapidary equipment is furnished, including a super-charged diamond blade for sawing, and all wheels for grinding, shaping and polishing, also complete instructions. The complete equipment as shown, less motor and belt, for only \$29.50, f.o.b., Burlington, Wis. Write today for information and literature on the Gem Maker and accessories.

B&I MFG. CO., Dept. S, Burlington, Wis.

VEST POCKET SIZE!

**WORLD'S
LOWEST
PRICED
ADDING
MACHINE**



Fits vest pocket or purse. Guaranteed Accurate. Operated as easily, and as reliable, as machines costing many times as much. NOT A TOY OR GADGET. Substantially made of 28-gauge steel — guaranteed for life against defects in construction. Beautiful looking, modernized design. Finished in Black, Silver and Red. You positively can't buy a Calculator of equal quality for as little money. **ACCEPTED AS THE FINEST LOW PRICED CALCULATOR FOR OVER 30 YEARS!** Operates with a flick of your finger. Adds, subtracts, multiplies, divides—counts up to ten million. Pays for itself over and over in mistakes avoided, and time saved.

MAKES IDEAL GIFT
Baby Calculator makes an ideal gift for every Gift occasion. Birthday — Graduation — Christmas — Anniversaries. For men, women, children—teachers, business people, home or shop use. **COMES PACKED READY FOR GIFT WRAPPING.**

TEN DAY TRIAL
Money Back Guarantee
Because we know that our machine is the very best calculator to be obtained at this low price, we make this 10 Day Trial offer on a positive money back guarantee!! Don't buy ANY Calculator without this guarantee! Send only name and address, pay postman \$2.50 plus postage (if cash is sent, we pay postage—you save up to 40c. (If outside U. S., send \$3.00). Money back within 10 days if not delighted.

AGENTS WANTED

CALCULATOR MACHINE CO. (Mfrs.)
DEPT. 186, P. O. Box 248 GLENVIEW, ILL.

USE COUPON

CALCULATOR MACHINE CO., (Mfrs.)
P.O. Box 248, Dept. 186, Glenview, Ill.
Your Calculator is just what I've been looking for. Send one at once (C.O.D.) or (I am enclosing \$2.50).

Name.....
Address.....
City.....State.....

Free Trial

Each Baby Calculator enclosed in beautiful rich-looking Leatherette Case — at no extra cost.

ONLY
\$2.50
TOTAL COST
SEND NO MONEY

• DEEP — FAST — FREEZERS •

Reliable Manufacturer of 25 Years Experience Offers Factory Plans For 1/4 H.P. Complete Deep Fast Home Freezers For ONLY \$2.00 — Complete Kit Of All New Parts For Easy Assembly \$208. Or, Completely Assembled Deep

Factory Plans for 1/4 H.P. Deep Freeze Unit \$2

Fast Home Freezer Ready To Use

GENERAL ICE MACHINE CO., DEPT. PM, DECATUR, INDIANA

ONLY \$295. **RUSH YOUR ORDER**

"Tip Off Sheet" On Hard to Get MERCHANDISE

We tell you—WHERE TO GET THEM
Get Them NOW! for Immediate Delivery at WHOLESALE PRICES

only \$2.00

SAVES YOU TIME, WORRY AND TRAVELING EXPENSES

RADIOS, ELECTRIC IRONS, RADIO-PHONO COMBINATIONS, ELECTRIC TOASTERS, ELECTRIC HEATERS & FANS, ELECTRIC WATER HEATERS, WASHING MACHINES, LOW PRICED SWISS WATCHES, LOW PRICED JEWELRY, FREE CATALOGS, MANY OTHER SPECIALTY MERCHANDISE— ALL AVAILABLE NOW FOR IMMEDIATE DELIVERY. THIS LIST IS PRICELESS!

HERE is a TIP OFF SHEET AND SERVICE that is worth its weight in gold TODAY! Salesmen and Dealers all over the country know that it is difficult to secure immediate delivery of the type of merchandise that "really sells" . . . The SALEMENS' GUILD OF AMERICA was designed and planned for this predicament . . . so that you can secure the type of merchandise YOU WANT and NEED and we tell you exactly WHERE YOU CAN GET IT and RIGHT NOW! No fake or bull either . . . Our references; First National Bank of Montgomery.

• START THE NEW YEAR RIGHT! •

Many large firms spend thousands of dollars each year sending their purchasing agents all over the globe to secure merchandise that will sell . . . This you cannot afford to do, nor can the average merchant . . . But you can afford to JOIN the SALEMENS' GUILD OF AMERICA for only \$2.00 and receive our "TIP OFF SHEETS" that will tell you WHERE TO GET THE ITEMS YOU NEED! . . . Remit in cash, check or money order . . . MAIL TODAY . . . THIS OFFER WILL NOT BE REPEATED!

WE DO NOT SELL ANY MERCHANDISE . . . No Dues to Pay

Join NOW and Receive YOUR MEMBERSHIP CARD and "Tip Off Sheet"

SALEMENS' GUILD OF AMERICA, Dept. PM-SG
12 Adams Ave. MONTGOMERY 4, ALABAMA

LIVE WIRE DEALERS ARE REAPING BIG PROFITS FROM OUR PRICELESS "Tip Off Sheet"

GET THE TYPE OF MERCHANDISE YOU WANT THROUGH THIS EXCLUSIVE SERVICE

Only \$2.00 MAIL TODAY

Plane · Rabbet · Groove
Rout · Panel · Tenon
on Your Drill Press



This exclusive tool fits any drill press, simultaneously planes, panels, rabbets, rots, tenons, beads, grooves. No extra blades to buy. Over fifty thousand now in use by hobbyists, pattern and cabinet workers, etc. Satisfaction guaranteed or your money back. Complete **\$7.50**

ALL-METAL DRILL PRESS TABLE



Solid Alecoa aluminum heavily ribbed. Blanchard ground top and bottom. Equipped with Barron adjustable steel fence. Extra large working surface 13" x 18". Fits all standard drill presses. Instantly mounted or removed.

\$9.85

SPIRAL FLUTE ROUTER BITS

New 45° helix angle tool steel design for smoother, faster, accurate routing, grooving, carving, mortising. Extra long cutting flutes. Individual sizes 1/8" to 1/2". Prices on application. Complete set of six graduated sizes. **\$9.50**



ROTARY SURFACE SANDER



Fits chuck of any drill press. Provides satin smooth, even, accurate surfacing of woods, plastics and metals. No ridges, no striations. Original in design, a great labor saver. Complete with 20 sanding discs. Fully guaranteed. **\$5.95**

Liberal 10 Day Money Back Guarantee

Workshop Guide FREE



BARRON TOOL CO.

461 Architects Bldg., Detroit 1, Mich.

BARRON PRECISION WORK SHOP TOOLS

BLADE ADJUSTMENT: MAX. 9" — MIN. 2"

FRAME LENGTH 10"

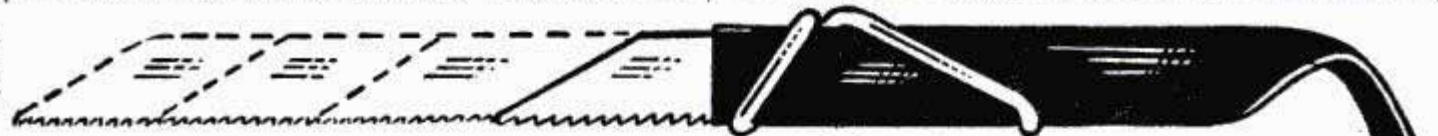

JIFFY-MATIC 3-PURPOSE SAW

OUTPERFORMS YOUR PRESENT KEYHOLE SAW • HACKSAW • MEAT SAW

1. Blade adjustable to any position.
2. Gets into close corners.
3. Uses Standard 10" Hacksaw Blades. (No special blade required.)
4. Saws Anything: Wood, Metal, Composition — even Meat Bones.

Built for a lifetime of hard use. \$1.00 Complete with Blade, Postpaid. Money Back Guarantee. ORDER TODAY! Sorry, no COD's.

A. A. DOWER, 1325 E. Carson St. PITTSBURGH 3, PENNA.

New "THERMO-SAW" (cuts with heat)

MAKE THINGS FOR THE HOME or FOR SALE

• ANY CHILD CAN USE IT •

No Noise—No Vibration—No Sawdust

Boys and Mechanics thrill over the many interesting things that can be made with this NEW ALL-STEEL THERMO-SAW. You can cut out any pattern or design in 1/2 the time. . . . Difficult patterns are made QUICK and EASY. . . . No turning of work. . . . Cuts in every direction! . . . Cuts plywood 1/8" or 1/4" . . . Cuts 14" x 36" board. Will cut 1/2" Plexiglas very well. . . . A special transformer produces high frequency current in a tough steel wire "blade" from ordinary Alternating (AC) Current. . . . IMMEDIATE DELIVERY!

Extra Blades ONLY 20c per dozen. ORDER TODAY

Machine Measures 11" x 4" x 3 1/2" High, Throat 7" Deep. PATTERN INCLUDED FREE.

AN IDEAL GIFT

NOTE: Operates on 110 volt Alternating Current; 50 to 60 cycle.

\$4.75 in Canada & Mexico. \$5.00 elsewhere. No C.O.D. Orders Please!

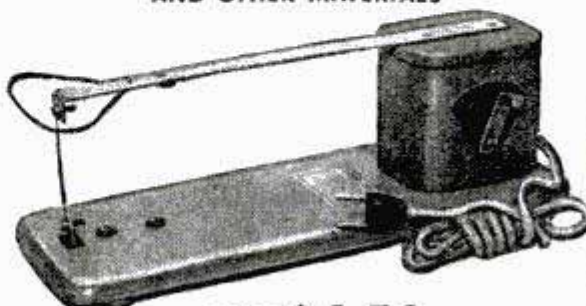

ONLY \$4.50 Postpaid

A FEW OF THE MANY INTERESTING THINGS YOU CAN MAKE



Boisselier Mfg. Co., Dept. P-1, Glen Ellyn, Ill.

Pat. No. 2,272,031 D-87-072

COMPLETE SAW outfit as illustrated with transformer and 12 spare blades. Ready to use.

FLUID PUMP

At last, a dependable, low priced coolant pump for machine tools. Fully guaranteed by old, reliable manufacturer.

Constructed of non-corrosive materials. Plastic screen quickly removed for cleaning. With this pump and small pan for fluid you obtain same results as with expensive equipment.

May be used for Evaporative Coolers, Fountains, Displays, etc.

DEPT. M **\$19.50** POSTPAID

JOBBER AND DEALER INQUIRIES INVITED

AMERICAN METAL PRODUCTS CO.
FORT WORTH 9, TEXAS



USE THE FINEST
WHEELS

MONEY CAN BUY!

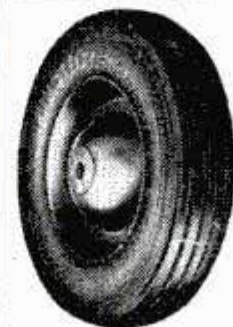

A BRAND NEW MODEL

Just off the production line, the Walton 8" x 1 1/4" Deluxe Wheel. Puncture-proof, heavy rubber tire . . . special type roller bearing. Fits 1 1/2" axle. ONLY \$5.50 set of 2 . . . \$10.80 set of 4.

Your wheeled project deserves the very best in wheels. And here it is . . . a heavy-duty, industrial type steel disc wheel . . . (weighs 5 1/2 lbs.) with a 1/2" precision type roller bearing . . . an air-cushion, puncture proof rubber tire 2 3/4" thick . . . 10" dia. The tire itself carries a load of 200 lbs.! Priced at only \$29.95 a set of 4, complete. Send money with order. No COD's.

WALTON WHEEL CO.

Dept. 77, Box 432 Milwaukee, Wis. Dealers, Jobbers, Salesmen Wanted.



BRONZE BABY SHOES!

Big profits! Preserving baby shoes in gold, silver, bronze, pearl and ivory finishes! Details free. Write R. O. MORGAN, Box 349, Long Beach 2, Calif.

HAND MICROPHONE



Top quality hand microphone with control button in handle. Highly sensitive. Has rubber covered cord and tel. plug. Fine for use on home recorders, public address systems, etc. Brand new—perfect. Shp. wgt. 2 lbs. Stock No. 170. Each... **\$1.95**

HAIR CLIPPER



Browne & Sharpe Size. Brand new. Clean cutting—easy working. Stays sharp thru long service. Bright finish. Shp. wgt. 1 lb. No. 333—Each... **\$3.75**

Shatterproof Goggles



All purpose type. Sponge rubber frame. Med shatterproof flexible lens. Adj. head band. With case. New. Wgt. 1 lb. No. 139—Each... **39c**

POPULAR RECORD ASSORTMENT



Fifty records of modern dance, race, blues and hillbilly selections. No two alike. Famous name bands and artists included. Used in juke boxes, but guar. perfect. Shipped exp. collect only—no exchanges or refunds. Wgt. 28 lbs. No. A303—50 records... **\$9.64**

PROF. TELEGRAPH KEY

Purchased from the gov't. Finest design and construction. Base measures 3 x 4 3/4 inches. Original value \$2.50. All parts of instrument brass. Adjustable. A-147. Each... **98c**



2 Man Mountain Tent

Regulation Army type two man mountain tent, complete with poles, guy ropes, etc. Of durable nylon with reinforced seams. Ideal for outdoorsmen, campers, etc. Shp. wgt. 10 lbs. A splendid value. Stock No. 202—Each... **\$9.95**

PUP TENTS



Regulation Army Pup Tents of durable, brown canvas. Used, but in good condition. Fine for campers, outdoorsmen, boy scouts, etc. Grand Xmas gift for children. Wgt. 8 lbs. A1—Tent only... **\$3.95**
A10—Tent, new... **\$7.95**
A101—Ropes, wooden poles and stakes for above. Per set **\$1.00**

LIFE PRESERVER BELTS

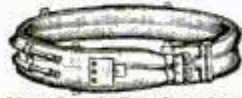

Right from the invasion beaches. Consists of two air chambers. May be inflated automatically with "sparklet" cartridges or manually by attached hose. Adjustable in waist size. One air chamber guaranteed air tight—other may need a tire patch. All belts are used and slightly soiled but a bargain at this low price. No. 1261—Each... **\$1.00**

SPARKLET CARTRIDGES

May be used with above belts. In boxes of 10. Stock No. 254. Per Box... **50c**

WARR

SURPLUS AND HUNDREDS OF OTHER BARGAINS

SIGNAL MIRROR



Used by downed airmen for rescue signalling. Brand new. Measures 4x5 in. with sighting guide. Shp. wgt. 1 lb. Stock No. 527—Each... **69c**

7 LB. EXPERIMENTER PARTS ASSORT. KIT



A "gold mine" for the radio serviceman. Hundreds of valuable radio parts, new radar and electronic parts and subassemblies, coils, resistors, trimming condensers—worth many times this low price. A130R—7 lbs... **\$1.79**

SATCHEL POUCH

Heavy canvas pouch. Ideal for totting lunches, shopping, books, etc. Has three 1 1/2 x 1 1/2 inch pockets. Brand new, guaranteed perfect. Has over-size flap with single strap fasteners. A113—Each... **\$1.69**

Plastic 8 oz. Flask

For hunters, scouts, fishermen. Waterproof and transparent. Use it for liquids. Use it for matches, flies, bait, etc. Has screw cap top for liquids, plus full open top. Size 5 1/2 x 4 1/4 x 1 3/4 ins. Has hundreds of other uses. Wgt. 1 lb. No. A347. Each... **29c**

OXYGEN TANKS

A shatterproof, welded seam oxygen tank. Fits gauge listed above. Measures 5 1/2 x 8 in. Internal volume 104 cu. in. Square inch pressure 1.4 cu. ft. Has 3/8 inch pipe thread vent. Shp. wgt. 2 lbs. No. 537. Each... **49c**
Same as above but 6x1 1/2 inches. Internal volume 280 cu. in. Takes pressure up to 3.8 cu. feet. Shp. wgt. 5 lbs. No. 538—Each... **\$2.00**

WOOL SLEEPING BAG

G.I. type 100% wool with 30 inch Talon zipper. Used but renovated for reissue. Shp. wgt. 3 lbs. No. 165. Each... **\$3.95**

JUNGLE HAMMOCK

For backyard, country home and camp use. Has waterproof roof with mosquito-proof nylon netting sides. Lets you sleep outdoors safely. Finest construction. Originally designed for U. S. Army use. Shp. wgt. 7 lbs. No. 134—Each... **\$9.95**

RAIN SUITS

New 2 piece rain suits. Of durable wear resisting water and wind repellent OD fabric. Bib style pants, zipper fly. Jacket has parka attached. Guaranteed 100% waterproof. Small, medium and large sizes. Shp. wgt. 3 lbs. No. R549. Ea... **\$4.95**

U.S. Govt. BOLO KNIFE



Extra heavy. For farm, home or jungle use. Blade of Gov't. formula cutlery steel. Walnut riveted handle. 3 1/2 inch hilt. 10 1/2 inch blade. You'll find hundreds of uses for a Bolo knife. Blade will take and hold a keen cutting edge. Wt. 2 lbs. A112—with Army Sheath... **\$4.95**

MESS KITS

Regulation two-piece Army Mess Kits with folding handle. Used, but perfect. Weight 2 lbs. No. A116—Ea... **69c**

CANTEENS

Reg. U. S. issue canteens. Plastic screw top chained to body. Slightly used but perfect. Wgt. 1 lb. 117—Metal... **69c**
118—Plastic—Ea... **69c**

CANTEEN CUPS

All metal. Folding handle. Wgt. 1 lb. No. A120—Each... **25c**

CANTEEN COVERS

Heavy canvas. Button fastener. New No. 530—Each... **69c**
Used No. 119—Each... **35c**

ARMY BANDOLERS

Of fine heavy khaki. Big roomy pockets with snap button fasteners. Fine for hunters, campers, boy scouts, etc., also for shop work in carrying small parts, etc. Material sign is worth this price. Shp. wgt. 1 lb. 11 Pocket Type No. 49c... **49c**
5 Pocket Type No. 29c... **29c**
120 Each... **49c**
110 Each... **29c**

Wool Blanket

Full size and 100% wool. Used but renovated for reissue. Use for camping, etc. Shp. wgt. 3 lbs. No. 233—Each... **\$4.89**

BRONSON FISHING REEL

New! Level winding, 100 yd. capacity. Quadriple multiplying. Bright nickel finish. New improved click. Shipping wgt. 8 ozs. No. F1133... **\$2.35**

WIRE PLIER

Genuine Bernard 6 1/2 inch wire cutting plier. Parallel opening jaws. Reg. \$3.00 value. Wgt. 1 lb. No. 168—Each... **\$1.29**

ORDER DIRECT FROM THIS AD

Values galore! Hundreds of hard-to-find items for home, shop and outdoors. Make remittances by money-order, bank draft or personal check. Send 25% deposit on C.O.D. orders. No C.O.D.'s on orders for less than \$5.00. Include sufficient postage on parcel-post orders—any overage will be promptly refunded. All quotations F.O.B. Chicago. Used items and materials are guaranteed serviceable and as described. Your money back if not more than satisfied.

Big Illustrated Catalog Free

STARK'S Dept. PM147
509 So. State St.
CHICAGO 5, ILL.

Wanted More Men- Big Income Assured Producers



If you are in your middle years, like dignified selling and want high earnings from the start, plus a sound, growing future—here is an unusual opportunity. Join a circle of fortunate, satisfied men. Many of them a year ago were nervous penny-pinchers trying to make ends meet. Today they plan a new home and car. Average, mature men are swelling their bank accounts, building security in this interesting occupation.

CERTIFIED EARNING FIGURES

C. H. Libby, \$29,628.78 (1 yr.) T. E. Hoffman, \$8,020.20 (1 yr.)
W. D. Michael 11,317.12 (1 yr.) J. H. Peacock, 6,228.46 (5 mos.)

Scores of others, while not making such money, are enjoying good, steady, year around earnings. There are openings now for men to sell our dependable, quality product in all parts of America. It saves up to 3/4 the cost of an expensive building-owners and maintenance men expect to pay. Post-war scarcities make orders as large as \$500 immediately possible. Cash commission paid on receipt of orders. We handle all collections and deliveries. Easy credit terms are available. **WRITE TODAY** for current earning figures and details. **Don't put it off!** Dept. M, Box 789, Fort Worth, Texas.

EARN MORE MONEY GRINDING LAWN MOWERS "THE UNIVERSAL WAY"

FULL OR SPARE TIME

Build a Business of Your Own in Your basement or garage and earn \$135 a month. Mr. Felber of Ind., writes, "My UNIVERSAL GRINDER is faster and more accurate than any other grinder. Its efficiency enabled me to sharpen 450 mowers in 4 1/2 months." More than paid for itself the first month. Every customer satisfied. Only on the UNIVERSAL can the inside face and edge of stationary blade as well as the edge of the reel blades, be ground to proper clearance **ALL IN ONE SET-UP** without removing any blade from the mower. Tool Grinding Rest included. "The Universal Way is the Modern Way" Write for Free Folder Rogers Mfg. Co., Dept. 17-M, Lindsey, O.



The Chief WORK BENCH

Built to Last a Lifetime!

With Bottom Shelf and 18" Sq. Drawer. 2"x6", Solid Plank, Grooved and Dovetailed Top and 1"x8" Back Rail, Shellacked to a Smooth, Satiny Finish.

MOHAWK LUMBER CO. Dept. 32
14525 W. Chicago Blvd. Detroit 27, Mich.

Enclosed Check Money Order for \$.....
Ship..... CHIEF WORK BENCHES at

Quantity.....
\$16.95 each, F.O.B. Detroit, Mich.
 Send C.O.D., \$5 Deposit Enclosed.

NAME.....

ADDRESS.....

CITY..... STATE.....

No Priority Necessary!

• 6 Ft. Long • 34" High • 26" Deep. Shipped Knock-down, with Bolts, Nuts and Screws and ABC Chart for Quick, Simple Assembly.

Prompt Delivery
MOHAWK LUMBER CO.

14525 W. Chicago Boulevard
DETROIT 32, MICHIGAN

Andy's HANDY Home Fix-It KIT

only \$2.25
POST PAID

6 Wood Wonder-Workers
Good for 1001 Jobs!

Now fix wood, metal, plastic, stone surfaces or articles with Andy's Handy Home Fix-It Kit of six great re-newers, restorers, re-builders and re-finishers. Just the thing for fixing furniture, chests, desks, floors, boats, anything of wood. Kit includes regular size package of Andersen's famous Crack Filler, Floor Re-finish-er, Brush Treet, Brush Re-Nu-er, new quick-action Zip-Off paint and varnish remover, and Tec-Stone Wood Replacer, the amazing plastic mix that contains wood, and will build up any worn or damaged wood surface to look and be like new. Every product a winner. Every home needs the Fix-It Kit for 1001 jobs of renewing, replacing, refinishing, restoring, re-building. Kit contains full size package of each product. Shipped postpaid in handy container for only \$2.25, check or money order. Satisfaction guaranteed. Illustrated folder FREE. Andersen Specialty Manufacturing Corp., Dept. A-1, 5618 S. Harper Ave., Chicago 37, Ill.



DEALERS WRITE for literature and dealer price list

ARMY SURPLUS BARGAINS



Jacket (illus.) — B-3 type pilots sheepskin lined brown leather, water repellent finish, zipper front, large collar and strap. Newly mfg. from surplus material. 36-40....\$15.95
New Air Corps A-5 Pants to Match.... 9.75
Write for free illustrated list "F" of jackets, pants, blankets, sweaters, etc. Orders sent postpaid except C.O.D.

Satisfaction or money back

CONSUMERS CLOTHING CO., INC.

Dept. 17, 2066 First Ave., New York 29, N. Y.

PLASTICS!

Fabricating plastics offers you a fascinating hobby or a profitable business. New Carmen-Bronson Plastics Handbook tells you how; gives construction plans. New Carmen-Bronson Catalog lists all needed materials—Plexiglas, Lucite, Bakelite, Lignolite, Tenite II, Lumarith in sheets, rods, tubes, special shapes—clear and glowing colors. Also plastics dyes, cements, accessories and supplies. 10c brings you both catalog and handbook. Send for them today.

CARMEN-BRONSON COMPANY
165 EAST 3RD STREET, DEPT. I-B, MOUNT VERNON, N. Y.

PROFIT-PRODUCING SPECIALTIES



• Build your business with proven money-makers—the outstanding line of specialties supplied for many years by Concession Supply Co.! Dept. C. These dependable products include Saratoga Kettle Popcorn... Candy Floss Machines... Waffle Irons or Rosecake Molds... Ice Cream Cone Bakers... and other profit producers. Write for more details.

CONCESSION SUPPLY CO., Dept. A

1858 Ottawa Drive Toledo 6, Ohio



\$16.95
F.O.B. DETROIT

Send Check or Money Order, or Will Ship C. O. D. (\$5 Deposit)

An Ideal and Practical Gift For Any Man!

Now A DYNAMIC HEAVY DUTY INDUSTRIAL WELDER

Available Now—Immediate Deliveries

Designed to Do High-Grade Welding Inexpensively

Maintenance men, farmers, mechanics, machine shops, foundries, auto, general repair and job welding shops using the DYNAMIC WELDER find it so indispensable and useful that they cannot afford to be without it. If inexperienced you can easily learn to do a variety of high-grade welding jobs by following the practical, simplified operating and welding instructions furnished.

WORKS ON IRON, STEEL, BRASS, BRONZE and OTHER METALS

Has eight metallic and carbon arc welding heat stages. Does work you would think only possible with a larger, more expensive machine.

READ WHAT USERS SAY...

Repair Shop Owner says, "It will do more than you say"

"I want to say I operate a repair garage and am more than satisfied with the welder. It will do more than you say." C. P., Butler, Ohio

It's the Greatest Portable Outfit

"Now I am equipped for all kinds of welding and I must say it's the greatest portable outfit for welding any man could ever wish to own. I wouldn't sell mine for the cost of plenty welders I have seen which were very high in cost but not in convenience. You may put me on file as a booster of your wonderful welding product." W. J. B., St. John, N. B., Canada

Better Than I Expected

"I have done quite a little welding with my welder and will say it is better than I expected. The price, convenience, and variety of work that can be done with the Dynamic are the attractive points." W. R. P., Portland, Ore.

EASY TO OPERATE!

DYNAMIC SUPERCHARGED WELDER

Once you see a DYNAMIC in operation you won't want to be without it. Its simplicity will amaze you. In a year the DYNAMIC only costs you about 6¢ a day. COMES COMPLETE, READY TO OPERATE, WITH HELMET, RODS, CABLES, ELECTRODE HOLDER AND OPERATING INSTRUCTIONS, ETC. NOTHING ELSE TO BUY. Write today for Free particulars. Act now and get details on our amazingly low-priced Dynamic Welder and 10-day trial offer.

DYNAMIC WELDER CO.

13 East 23rd Street FR, Chicago 16, Ill.

MAIL COUPON FOR FREE DETAILS

10-DAY TRIAL OFFER

DYNAMIC WELDER CO.

13 East 23rd Street FR, CHICAGO 16, ILL.

Send me free details of your 10-DAY trial offer.

Name.....

Address.....

City.....Zone.....State.....

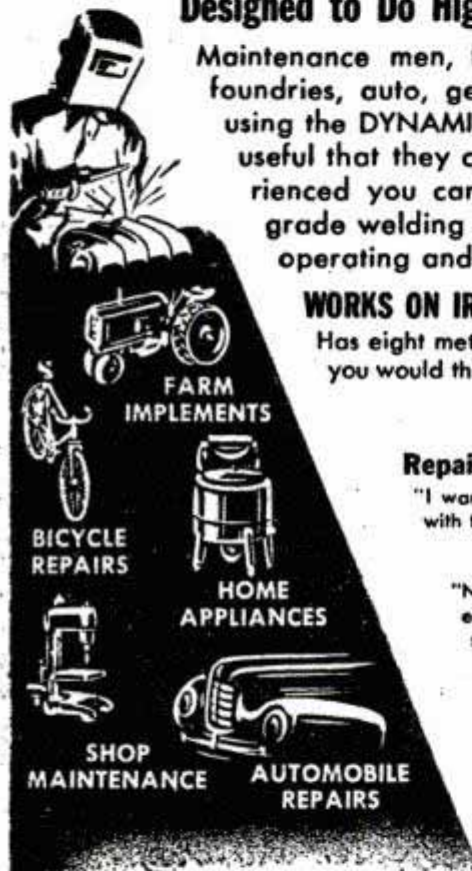

SOUTH BEND 9" PRECISION LATHES

*Quality-Built
for Quality Work*

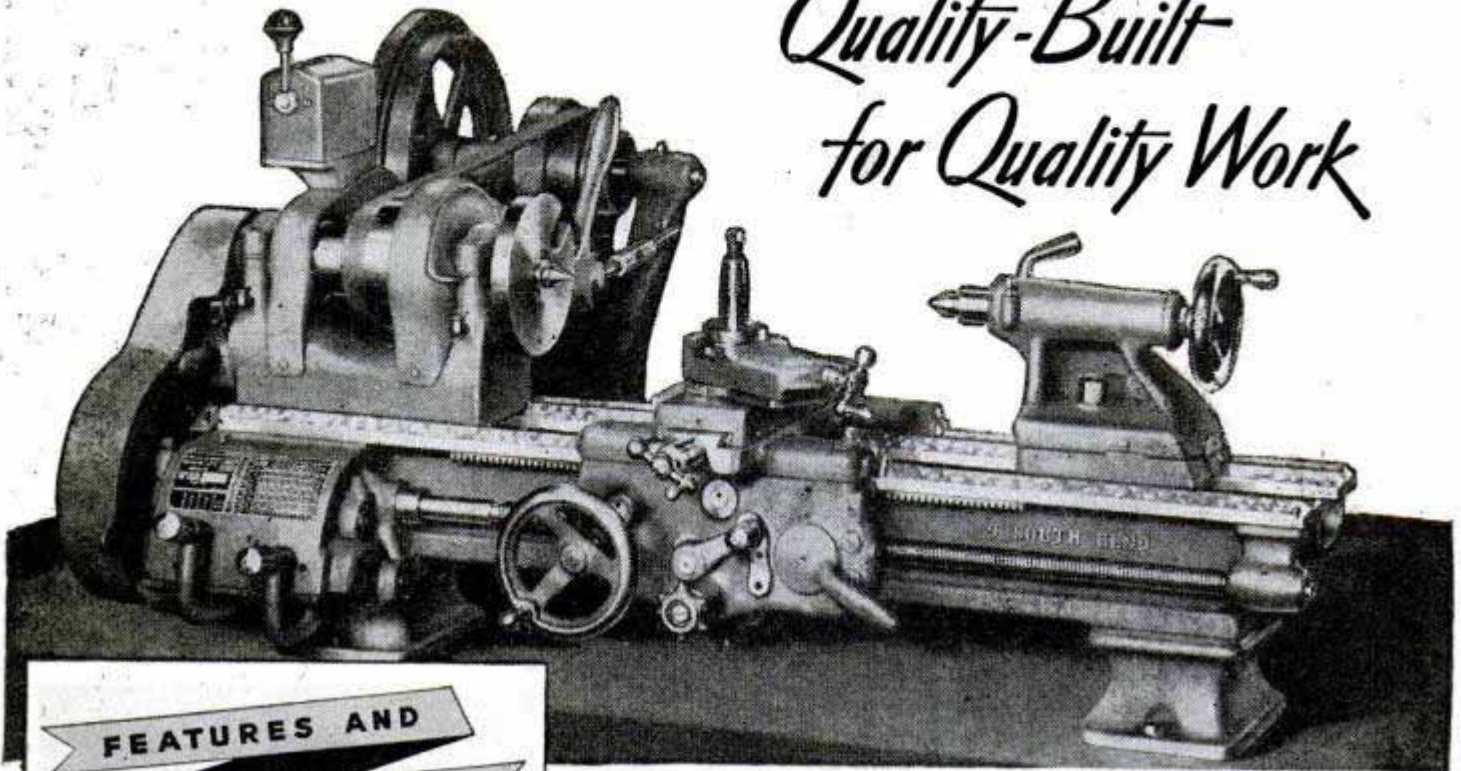

9" x 3' South Bend Model A Bench Lathe

FEATURES AND SPECIFICATIONS

SWINGS—9 1/4" over bed and saddle wings
5 1/2" over saddle cross slide

BED LENGTHS—3, 3 1/2, 4 and 4 1/2 feet

DISTANCE BETWEEN CENTERS—16 to 34 inches

SPINDLE SPEEDS—
depending on type of drive equipment

Six—41 to 658 r. p. m.
Twelve—41 to 1270 r. p. m.
Sixteen—46 to 1176 r. p. m.

POWER LONGITUDINAL FEEDS—
Model A Lathes—48, .0015" to .0853"
Model B Lathes—26, .0021" to .0155"
Model C Lathes—14, .0021" to .0156"

POWER CROSS FEEDS—
Model A Lathes—48, .0004" to .0252"
Model B Lathes—23, .001" to .0046"
Model C Lathes—manual operation

THREAD CUTTING RANGE—
Model A Lathe—48 pitches,
4 to 224 per inch
Models B and C Lathes—45 pitches,
4 to 160 per inch

MAXIMUM COLLET CAPACITY—1/2 inch

QUICK CHANGE GEAR BOX—Model A Lathes

PLAIN CHANGE GEARS—Models B and C Lathes

The quality that is built into South Bend 9-inch Precision Lathes enables them to produce quality work with efficiency under all conditions. Regardless of the type of machining—between-centers, collet, fixture, or chucking—close tolerances can be maintained and a maximum volume of fine work produced with a minimum of effort.

Write for Catalog 9-J which fully describes and illustrates all South Bend 9" Precision Lathes and attachments.

SPEED PRODUCTION WITH THESE ATTACHMENTS

COLLET ATTACHMENTS—Handwheel and Handlever types for toolroom and production work. Collet capacities from 1/16" to 1/2" by 64ths.

TAPER ATTACHMENT—For turning or boring tapers up to 3-1/2 inches per foot.

MILLING ATTACHMENT—Mounts on compound rest base for milling, boring, and keyway cutting operations.

ELECTRIC GRINDER—Powerful external grinding attachment for sharpening reamers and cutters, cylindrical grinding, etc.

HANDLEVER BED TURRET—For volume production of small duplicate parts. Hexagon turret head holds six tools.

DOUBLE TOOL CROSS SLIDE—Handlever or screw feed operation. Holds 3 cutter bits.

SQUARE TURRET—Mounts on cross slide. Holds 4 cutting tools for repetitive operations. Indexes accurately. Lever operated turret head lock.

ALSO—Collet rack, center rest, follower rest, carriage stops, thread cutting stop, face plates, centers, chucks, dogs, tools, etc.

LATHE BUILDERS SINCE 1906

SOUTH BEND LATHE WORKS



455 EAST MADISON STREET
SOUTH BEND 22, INDIANA

Printed by Popular Mechanics Company, Chicago, Ill., U. S. A.

NOW Being Delivered!

SHAW "DU-ALL" and "Peppy-Pal" TRACTORS

Buy Thru Dealer or Direct from Factory

DO ALL KINDS OF BELT JOBS

**WALKING and RIDING MODELS
1 to 9 H.P.**

**EASY TO OWN
EASY TO OPERATE**

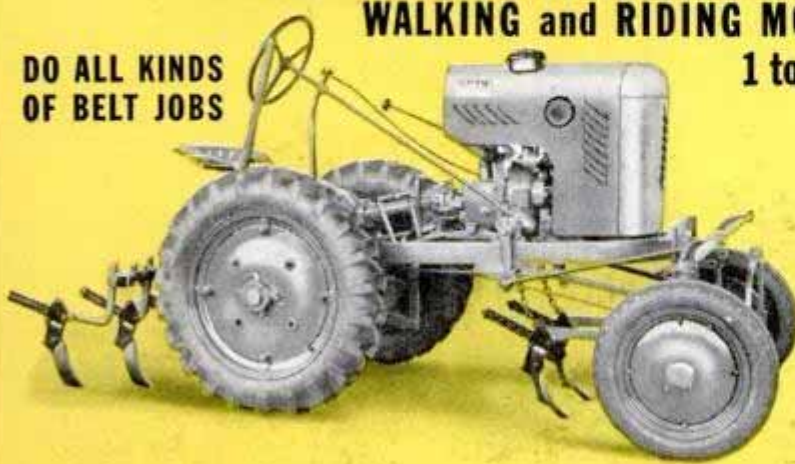

**Ideal for Small Farms,
Gardens, Estates,
Cemeteries,
Nurseries,
Poultry Farms,
Golf
Courses**

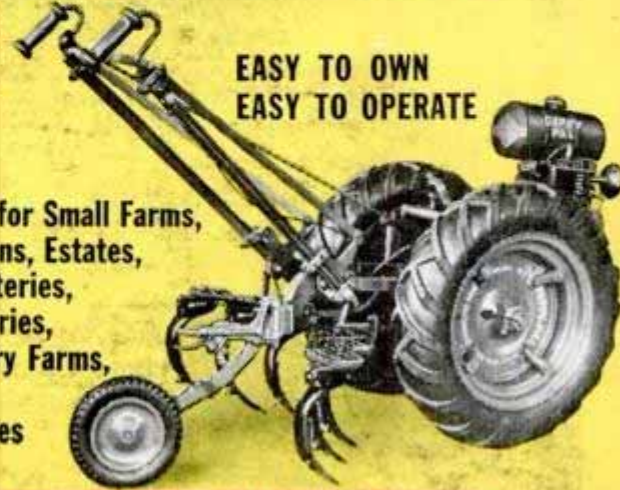

BACKED BY 44 YEARS OF MANUFACTURING KNOW-HOW

NOW is the Time to Order Your SHAW!

• Once again they're coming off our production line . . . famous SHAW "Peppy-Pal" and "Du-All" Tractors . . . the little machines that do big work-saving, time-saving, money-making jobs in the garden and on small farms! Deliveries are NOW being made! Orders are being filled in rotation as received. So get your order in early! Be among the first to get one of these tried-and-proved 1947 Model Tractors. The name SHAW is your guarantee of quality, dependability and workability . . . backed by 44 years of manufacturing know-how and a thorough knowledge of agricultural problems.

DO MANY JOBS AT LOW COST

For many years SHAW Tractors have proved dependable, versatile, low-cost helpers on scores of jobs . . . ideal workers on small farms, in gardens, truck farms, nurseries, orchards, cemeteries, golf courses, poultry farms and estates. They are used for plowing, cultivating, discing, seeding, harvesting, spraying, mowing; operate cutter bars and lawn mowers. For power on belt jobs . . . sawing wood, pumping water, grinding feed and running belt machinery. First cost is low and low operating cost will surprise and please you.

A SIZE TO FIT YOUR NEEDS—1 to 9 H.P. You'll find a SHAW "Peppy Pal" or "Du-All" Tractor just fitted to your needs . . . 1 to 9 H.P. And you'll find that a SHAW will do things a big tractor can't. Easy to operate by elderly persons, boys and girls. Easy to change from one piece of equipment to another. We can supply many attachments at low prices.

GET ALL THE FACTS . . . MAIL COUPON NOW! Get all the facts and you'll get a SHAW! Plan now to do your hard jobs the easy way. Have a SHAW Tractor to do a better job . . . easier and quicker. It will serve you well . . . it will give you years of satisfactory, trouble-free, willing service . . . at amazingly low cost. Fill out and mail coupon now for FREE Folder, prices, etc. Get all the SHAW Facts now!

SHAW MANUFACTURING CO.
4503C Front St. Galesburg, Kansas
668GC North 4th St. Columbus, Ohio



PLOWING



PLOWING



CULTIVATING



CULTIVATING



MOWING



MOWING



"PEPPY-PAL" SAWING WOOD

FREE FOLDER!

CLIP AND MAIL COUPON—

SHAW MANUFACTURING CO.

4503C Front St. Galesburg, Kansas
668GC North 4th St. Columbus, Ohio

Send me Free and Postpaid Descriptive Literature on SHAW "Du-All" and "Peppy Pal" Tractors

Name _____

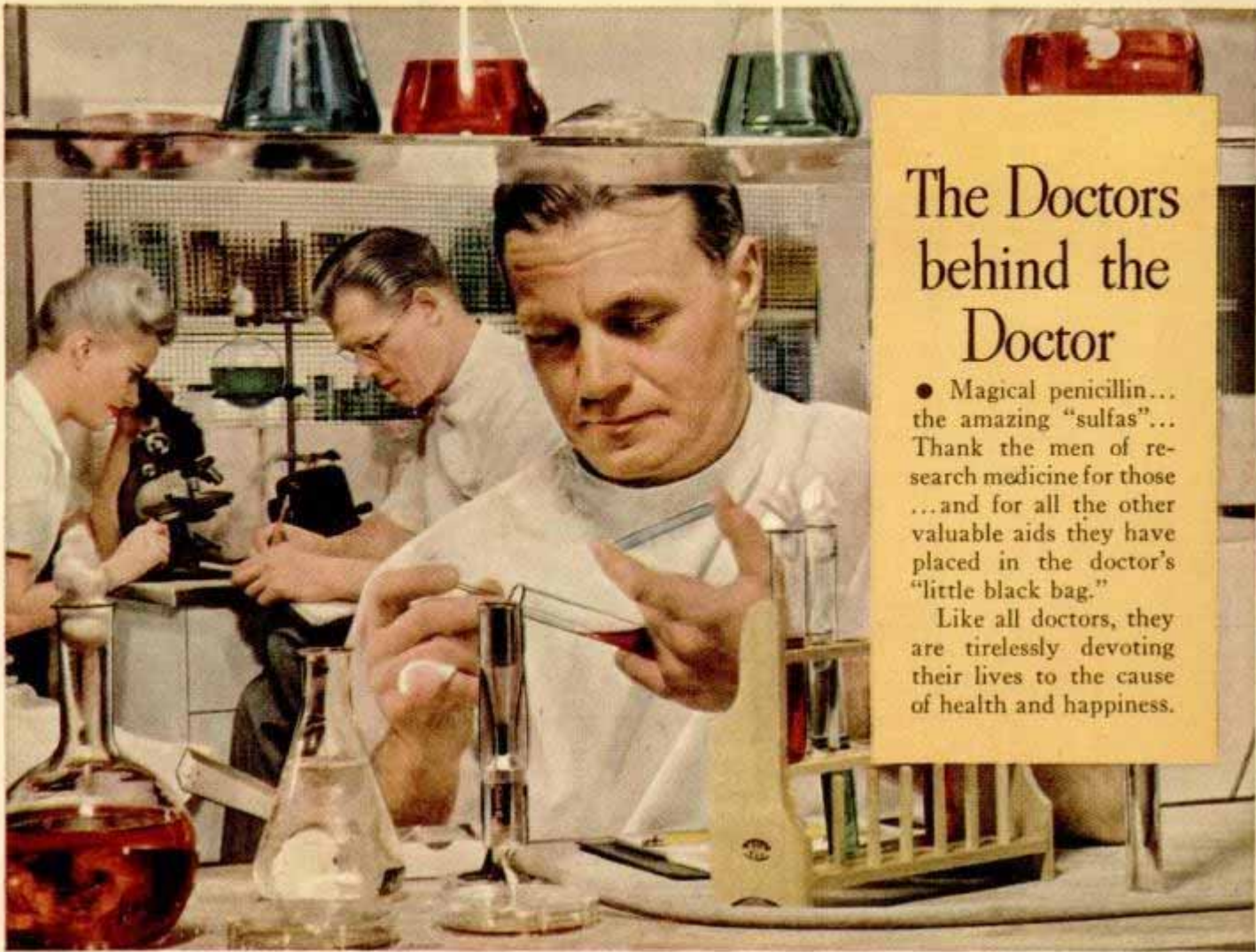

The Doctors behind the Doctor

● Magical penicillin... the amazing "sulfas"... Thank the men of research medicine for those ...and for all the other valuable aids they have placed in the doctor's "little black bag."

Like all doctors, they are tirelessly devoting their lives to the cause of health and happiness.

According to a recent Nationwide survey:

MORE DOCTORS SMOKE CAMELS THAN ANY OTHER CIGARETTE

● What cigarette do you smoke, Doctor? ... that was the question put to 113,597 doctors. Three independent research organizations did the asking ... covered doctors in every branch of medicine. *The brand named most was Camel!*

Like the rest of us, doctors smoke for pleasure. Their taste appreciates the flavor and mildness of Camel's choice tobaccos just as yours does.

YOUR "T-ZONE" WILL TELL YOU...



T for Taste...
T for Throat...
that's your proving ground for any cigarette. See if Camels don't suit your "T-Zone" to a "T."



CAMELS

R. J. Reynolds Tobacco Company
Winston-Salem, N. C.